

United States of America

United States Patent and Trademark Office



Reg. No. 4,203,953

Registered Sep. 11, 2012

Int. Cl.: 5

TRADEMARK

PRINCIPAL REGISTER

KERTELS, PETER (FED REP GERMANY INDIVIDUAL)
JEAN-MONNET-STRASSE 6
FOEHREN, FED REP GERMANY D54343

FOR: GELS FOR USE AS PERSONAL LUBRICANTS; PERSONAL LUBRICANT GELS CONTAINING SKIN CONDITIONERS AND SKIN MOISTURIZERS, IN CLASS 5 (U.S. CLS. 6, 18, 44, 46, 51 AND 52).

FIRST USE 11-0-1995; IN COMMERCE 11-0-1995.

OWNER OF U.S. REG. NOS. 3,697,337 AND 4,010,690.

THE MARK CONSISTS OF THE DESIGN OF A HUMAN BACK AND BUTTOCKS. THE BROKEN LINES IN THE DRAWING ARE NOT PART OF THE MARK, BUT SERVE TO SHOW THE POSITION OF THE MARK.

SER. NO. 76-472,341, FILED 12-4-2002.

LESLIE RICHARDS, EXAMINING ATTORNEY



David J. Kybas

Director of the United States Patent and Trademark Office

United States of America

United States Patent and Trademark Office

EROS SHEMALE ESCORTS

Reg. No. 4,203,954

Registered Sep. 11, 2012

Int. Cl.: 35

SERVICE MARK

PRINCIPAL REGISTER

GROUP KAITU, LLC (DELAWARE LIMITED LIABILITY COMPANY)
9702 GAYTON ROAD, #167
RICHMOND, VA 23233

FOR: PROMOTING THE GOODS AND SERVICES OF OTHERS BY PROVIDING A WEBSITE FEATURING ADVERTISEMENTS, BANNERS AND LINKS TO THE WEBSITES OF OTHERS IN THE FIELD OF ADULT-THEMED PRODUCTS, SERVICES AND ENTERTAINMENT; PROVIDING DISSEMINATION OF ADVERTISING FOR THE GOODS AND SERVICES OF OTHERS VIA A GLOBAL COMPUTER NETWORK; PROVIDING DIRECTORY INFORMATION SERVICES IN THE AREA OF ADULT-THEMED PRODUCTS, SERVICES AND ENTERTAINMENT VIA A GLOBAL COMPUTER NETWORK, PROVIDING AN ONLINE COMPUTER DATABASE IN THE AREA OF ADULT-THEMED PRODUCTS, SERVICES, AND ENTERTAINMENT VIA A GLOBAL COMPUTER NETWORK, IN CLASS 35 (U.S. CLS. 100, 101 AND 102).

FIRST USE 9-28-2007; IN COMMERCE 9-28-2007.

THE MARK CONSISTS OF STANDARD CHARACTERS WITHOUT CLAIM TO ANY PARTICULAR FONT, STYLE, SIZE, OR COLOR.

OWNER OF U.S. REG. NOS. 2,793,831, 3,134,894 AND OTHERS.

NO CLAIM IS MADE TO THE EXCLUSIVE RIGHT TO USE "SHEMALE ESCORTS", APART FROM THE MARK AS SHOWN.

SER. NO. 76-683,739, FILED 11-7-2007.

LEIGH LOWRY, EXAMINING ATTORNEY



David J. Kypos

Director of the United States Patent and Trademark Office

United States of America

United States Patent and Trademark Office

EROS SHEMALE ESCORTS

Reg. No. 4,203,955

GROUP KAITU, LLC (DELAWARE LIMITED LIABILITY COMPANY)
9702 GAYTON ROAD, #167
RICHMOND, VA 23233

Registered Sep. 11, 2012

Int. Cl.: 41

FOR: PROVIDING INFORMATION IN THE FIELD OF ADULT-THEMED ENTERTAINMENT VIA A GLOBAL COMPUTER NETWORK; PROVIDING ONLINE PUBLICATIONS, NAMELY, A MAGAZINE AND ARTICLES IN THE FIELD OF ADULT-THEMED ENTERTAINMENT VIA A GLOBAL COMPUTER NETWORK, IN CLASS 41 (U.S. CLS. 100, 101 AND 107).

SERVICE MARK

PRINCIPAL REGISTER

FIRST USE 9-28-2007; IN COMMERCE 9-28-2007.

THE MARK CONSISTS OF STANDARD CHARACTERS WITHOUT CLAIM TO ANY PARTICULAR FONT, STYLE, SIZE, OR COLOR.

OWNER OF U.S. REG. NOS. 2,793,831, 3,134,894 AND OTHERS.

NO CLAIM IS MADE TO THE EXCLUSIVE RIGHT TO USE "SHEMALE ESCORTS", APART FROM THE MARK AS SHOWN.

SER. NO. 76-683,740, FILED 11-7-2007.

LEIGH LOWRY, EXAMINING ATTORNEY



David J. Kyffers

Director of the United States Patent and Trademark Office

United States of America

United States Patent and Trademark Office

STELLAR

Reg. No. 4,203,956

HAMPTON FORGE, LTD. (NEW JERSEY CORPORATION)
442 STATE ROUTE 35 SOUTH
EATONTOWN, NJ 07724

Registered Sep. 11, 2012

Int. Cl.: 8

FOR: FLATWARE, NAMELY, FORKS, KNIVES, AND SPOONS; CUTLERY; AND FLATWARE AND SERVING UTENSILS SOLD AS A SET, IN CLASS 8 (U.S. CLS. 23, 28 AND 44).

TRADEMARK

FIRST USE 4-0-2000; IN COMMERCE 4-0-2000.

PRINCIPAL REGISTER

THE MARK CONSISTS OF STANDARD CHARACTERS WITHOUT CLAIM TO ANY PARTICULAR FONT, STYLE, SIZE, OR COLOR.

SER. NO. 76-685,130, FILED 12-20-2007.

JOHN HWANG, EXAMINING ATTORNEY



David J. Kybas

Director of the United States Patent and Trademark Office

United States of America

United States Patent and Trademark Office

VINEYARD SWEETS

Reg. No. 4,203,957

CRANBERRY SWEETS, INC. (OREGON CORPORATION)
1005 NEWMARK AVENUE
COOS BAY, OR 97420

Registered Sep. 11, 2012

Int. Cl.: 30

FOR: CONFECTIONARIES, NAMELY, CANDIES, IN CLASS 30 (U.S. CL. 46).

TRADEMARK

FIRST USE 6-15-2004; IN COMMERCE 6-15-2004.

PRINCIPAL REGISTER

THE MARK CONSISTS OF STANDARD CHARACTERS WITHOUT CLAIM TO ANY PARTICULAR FONT, STYLE, SIZE, OR COLOR.

OWNER OF U.S. REG. NOS. 2,526,336, 2,627,382 AND OTHERS.

NO CLAIM IS MADE TO THE EXCLUSIVE RIGHT TO USE "SWEETS", APART FROM THE MARK AS SHOWN.

SER. NO. 76-685,455, FILED 1-2-2008.

GINA FINK, EXAMINING ATTORNEY



David J. Kyffers

Director of the United States Patent and Trademark Office

United States of America

United States Patent and Trademark Office

FORENSIC MEDICAL MANAGEMENT SERVICES

Reg. No. 4,203,958

Registered Sep. 11, 2012

Int. Cls.: 35, 44 and 45

SERVICE MARK

PRINCIPAL REGISTER

FORENSIC MEDICAL MANAGEMENT SERVICES, PLC (TENNESSEE LIMITED LIABILITY COMPANY)
850 R. S. GASS BOULEVARD
NASHVILLE, TN 372162640

FOR: PROVIDING FORENSIC MEDICAL SERVICES, NAMELY, MEDICAL EXAMINER SERVICES IN THE NATURE OF BUSINESS MANAGEMENT OF FORENSIC MEDICAL CENTERS, SPECIFICALLY BUSINESS MANAGEMENT, PHYSICIAN STAFFING, AND STAFFING OF ANCILLARY PERSONNEL, IN CLASS 35 (U.S. CLS. 100, 101 AND 102).

FIRST USE 7-1-1997; IN COMMERCE 7-1-1997.

FOR: PROVIDING FORENSIC MEDICAL SERVICES, NAMELY, MEDICAL EXAMINER SERVICES IN THE FIELDS OF FORENSIC AUTOPSIES, FORENSIC INVESTIGATIONS, FORENSIC TESTING, FORENSIC RADIOLOGY, FORENSIC DENTAL, FORENSIC ANTHROPOLOGY, FOR THE PURPOSE OF DEATH INVESTIGATION, SPECIFICALLY INVESTIGATION OF THE NATURE AND CAUSE AND MANNER OF DEATH OR INJURY BY MEANS OF INVESTIGATION OF THE DEATH SCENE OR ACCIDENT SCENE, BY MEANS OF REVIEW OF ACCIDENT REPORTS AND POLICE REPORTS AND FIRE MARSHAL REPORTS, BY MEANS OF IDENTIFICATION OF THE REMAINS USING RADIOLOGIC, DENTAL AND ANTHROPOLOGIC FORENSICS, AND BY MEANS OF IDENTIFICATION AND RETENTION OF FORENSIC EVIDENCE; AND FOR THE PURPOSE OF PERFORMING FORENSIC AUTOPSIES IN THE FIELDS OF AUTOPSIES AND FORENSIC TESTING, SPECIFICALLY, MEDICOLEGAL AUTOPSIES, EXHUMATION AUTOPSIES, AUTOPSIES TO DETERMINE CAUSE OF DEATH, AUTOPSIES TO DETERMINE POSITIVE IDENTIFICATION OF DECEDENT, AND AUTOPSY FORENSIC TESTING PERFORMED IN THE FIELDS OF X-RAYS, TOXICOLOGY, HISTOLOGY, NEUROPATHOLOGY, IN CLASS 44 (U.S. CLS. 100 AND 101).

FIRST USE 7-1-1997; IN COMMERCE 7-1-1997.

FOR: PROVIDING FORENSIC MEDICAL SERVICES, NAMELY, FORENSIC TESTIMONY IN THE FIELDS OF EXPERT WITNESS SERVICES IN LEGAL MATTERS IN THE FIELD OF CRIMINAL AND CIVIL COURT CASES, SPECIFICALLY EXPERT FORENSIC MEDICAL OPINION SERVICES FEATURING EXPERT COURT TESTIMONY, WRITTEN REPORTS, INTERVIEWS, LEGAL DEPOSITIONS AND LEGAL PROCEEDINGS, AND IN THE FIELDS OF EXPERT FORENSIC MEDICAL OPINION PROVIDED TO MEDICAL, LEGAL AND LAW ENFORCEMENT PROFESSIONALS REGARDING NATURE OF DEATHS, SPECIFICALLY



David J. Kybas

Director of the United States Patent and Trademark Office

Reg. No. 4,203,958 EXPERT WITNESS SERVICES FEATURING AUTOPSY REPORTS PREPARED WITH EXPERT OPINION AS TO CAUSE AND MANNER OF DEATH, EXPERT WITNESS SERVICES FEATURING SECOND AUTOPSY REPORTS, INCLUDING REVIEW AND EVALUATION OF THE FINDINGS OF THE FIRST AUTOPSY AND THE RESULTS OF THE SECOND AUTOPSY WITH EXPERT OPINION, EXPERT WITNESS SERVICES FEATURING REVIEWS OF AUTOPSY REPORTS PREPARED BY OTHER PHYSICIANS AND EXPERT WITNESS SERVICES FEATURING EXPERT OPINIONS AS TO THE FINDINGS AND CONCLUSIONS MADE; FORENSIC MEDICAL SERVICES, NAMELY, EXPERT WITNESS SERVICES IN LEGAL MATTERS IN THE FIELD OF FORENSIC PATHOLOGY FEATURING EXHUMATION AUTOPSY REPORTS; FORENSIC MEDICAL SERVICES, NAMELY, EXPERT WITNESS SERVICES IN LEGAL MATTERS FOLLOWING THE COMPLETION OF A FORENSIC AUTOPSY IN THE FIELD OF FORENSIC PATHOLOGY, IN CLASS 45 (U.S. CLS. 100 AND 101).

FIRST USE 7-1-1997; IN COMMERCE 7-1-1997.

THE MARK CONSISTS OF STANDARD CHARACTERS WITHOUT CLAIM TO ANY PARTICULAR FONT, STYLE, SIZE, OR COLOR.

NO CLAIM IS MADE TO THE EXCLUSIVE RIGHT TO USE "MANAGEMENT SERVICES", APART FROM THE MARK AS SHOWN.

SEC. 2(F).

SER. NO. 76-704,890, FILED 10-14-2010.

JAMES STEIN, EXAMINING ATTORNEY

United States of America

United States Patent and Trademark Office



Reg. No. 4,203,959

Registered Sep. 11, 2012

**Int. Cls.: 1, 9, 11, 16, 17
and 20**

VALTERRA PRODUCTS, INC. (CALIFORNIA CORPORATION)
15230 SAN FERNANDO MISSION BLVD.
STE. 107
MISSION HILLS, CA 91345

FOR: WASTE WATER HOLDING TANK TREATMENT CHEMICALS FOR RECREATIONAL VEHICLES, IN CLASS 1 (U.S. CLS. 1, 5, 6, 10, 26 AND 46).

TRADEMARK

FIRST USE 12-31-2002; IN COMMERCE 12-31-2002.

PRINCIPAL REGISTER

FOR: WATER PRESSURE GAUGES, IN CLASS 9 (U.S. CLS. 21, 23, 26, 36 AND 38).

FIRST USE 12-31-2002; IN COMMERCE 12-31-2002.

FOR: PLUMBING FITTINGS FOR RECREATIONAL VEHICLES, NAMELY, WASTE VALVES, VALVE REPLACEMENT HANDLES, VALVE REPLACEMENT SEALS, VALVE EXTENSION RODS, CAPS AND HOSE ADAPTORS, TOILETS, DRAIN CONNECTORS, FITTING THAT CONNECTS TO WASTE SYSTEM VALVE TO FLUSH OUT THE WASTE SYSTEM WITH WATER, FITTING WITH A TUBE TO INSERT INTO WATER TANK FILL FITTING TO FILL THE TANK, AND REFRIGERATOR FANS, IN CLASS 11 (U.S. CLS. 13, 21, 23, 31 AND 34).

FIRST USE 12-31-2002; IN COMMERCE 12-31-2002.

FOR: BATHROOM TISSUE AND TOILET PAPER, IN CLASS 16 (U.S. CLS. 2, 5, 22, 23, 29, 37, 38 AND 50).

FIRST USE 12-31-2002; IN COMMERCE 12-31-2002.

FOR: NON-METAL FITTING THAT SLIPS OVER TO FIT ON THE END OF A HOSE TO ALLOW FOR A BETTER GRIP ON THE HOSE, NON-METAL HOSE FITTING USING HANDLE AND BALL VALVE COMBINATION TO SHUT OFF WATER FLOW, NON-METAL FITTINGS TO ADAPT END OF NOZZLE TO HOSE END, NON-METAL FITTINGS THAT CONNECT PIPES TO FILL TANKS, WATER PRESSURE REGULATORS, FLUID TRANSFER HOSES AND TUBING, HOLDING TANK DRAIN HOSES AND DRAIN HOSE ATTACHMENT FITTINGS, WATER HOOK-UP HOSES, FOR RECREATIONAL VEHICLES, IN CLASS 17 (U.S. CLS. 1, 5, 12, 13, 35 AND 50).



David J. Kyjars

Director of the United States Patent and Trademark Office

Reg. No. 4,203,959 FIRST USE 12-31-2002; IN COMMERCE 12-31-2002.

FOR: PLASTIC WHEEL CHOCK FOR RECREATIONAL VEHICLES, IN CLASS 20 (U.S. CLS. 2, 13, 22, 25, 32 AND 50).

FIRST USE 12-31-2002; IN COMMERCE 12-31-2002.

OWNER OF U.S. REG. NO. 1,974,911.

THE MARK CONSISTS OF THE WORDING "VALTERRA" IN STYLIZED FONT OVER A CURVE DESIGN.

SER. NO. 76-706,192, FILED 1-31-2011.

JULIE VEPPUMTHARA, EXAMINING ATTORNEY

United States of America

United States Patent and Trademark Office

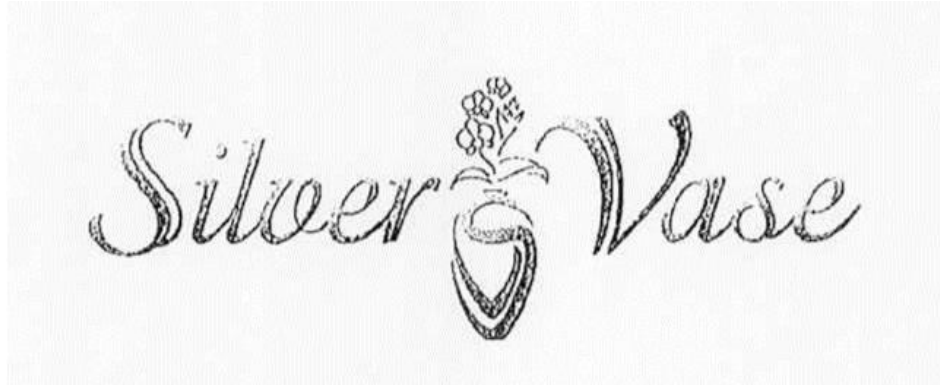

Reg. No. 4,203,960

SILVER VASE, INC. (FLORIDA CORPORATION)
26001 SW 217 AVENUE
MIAMI, FL 33031

Registered Sep. 11, 2012

Int. Cl.: 31

FOR: LIVE PLANTS AND FLOWERS, IN CLASS 31 (U.S. CLS. 1 AND 46).

TRADEMARK

FIRST USE 1-21-2011; IN COMMERCE 1-21-2011.

PRINCIPAL REGISTER

NO CLAIM IS MADE TO THE EXCLUSIVE RIGHT TO USE "SILVER VASE", APART FROM THE MARK AS SHOWN.

THE MARK CONSISTS OF THE WORDING "SILVER VASE" IN A STYLIZED FONT WITH THE REPRESENTATION OF A VASE AND COMPRISED OF THE LETTERS "SV" CENTERED BETWEEN THE WORDS, THE VASE HAVING LEAVES, A STEM, AND FOUR FLOWERS.

SER. NO. 76-707,479, FILED 5-3-2011.

ERIN FALK, EXAMINING ATTORNEY



David J. Kybas

Director of the United States Patent and Trademark Office

United States of America

United States Patent and Trademark Office

MONEY PUZZLE

Reg. No. 4,203,961

Registered Sep. 11, 2012

Int. Cl.: 41

SERVICE MARK

PRINCIPAL REGISTER

THE NEW HAMPSHIRE LOTTERY COMMISSION (NEW HAMPSHIRE STATE AGENCY)
14 INTEGRA DRIVE
CONCORD, NH 03301

FOR: LOTTERY GAME SERVICES, IN CLASS 41 (U.S. CLS. 100, 101 AND 107).

FIRST USE 12-31-2000; IN COMMERCE 12-31-2000.

THE MARK CONSISTS OF STANDARD CHARACTERS WITHOUT CLAIM TO ANY PARTICULAR FONT, STYLE, SIZE, OR COLOR.

NO CLAIM IS MADE TO THE EXCLUSIVE RIGHT TO USE "PUZZLE", APART FROM THE MARK AS SHOWN.

SER. NO. 76-708,256, FILED 7-7-2011.

CARYN GLASSER, EXAMINING ATTORNEY



David J. Kyffers

Director of the United States Patent and Trademark Office

United States of America

United States Patent and Trademark Office



Cheese Culture

Reg. No. 4,203,962

CHEESE CULTURE INC. (FLORIDA CORPORATION)

Registered Sep. 11, 2012

11040 NW 17 COURT
PEMBROKE PINES, FL 33026

Int. Cl.: 29

FOR: GIFT BASKETS PRIMARILY CONTAINING CHEESE BUT WHICH MAY CONTAIN OTHER EDIBLE PRODUCTS AND/OR BEVERAGES, IN CLASS 29 (U.S. CL. 46).

TRADEMARK

FIRST USE 5-1-2011; IN COMMERCE 5-1-2011.

PRINCIPAL REGISTER

NO CLAIM IS MADE TO THE EXCLUSIVE RIGHT TO USE "CHEESE", APART FROM THE MARK AS SHOWN.

THE MARK CONSISTS OF A DESIGN OF A GOAT PLAYING A VIOLIN OVER THE WORDING "CHEESE CULTURE".

SER. NO. 76-708,576, FILED 8-1-2011.

DOMINIC J. FERRAIUOLO, EXAMINING ATTORNEY



David J. Kyffers

Director of the United States Patent and Trademark Office

United States of America

United States Patent and Trademark Office

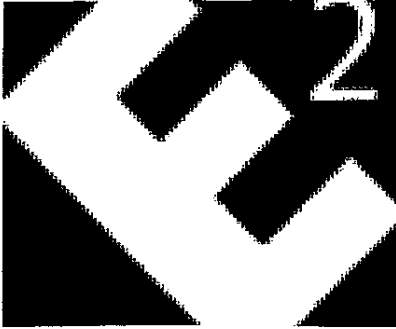

Reg. No. 4,203,963

Registered Sep. 11, 2012

Int. Cl.: 37

SERVICE MARK

PRINCIPAL REGISTER

EMPOWER ELECTRIC, LLC (TENNESSEE LIMITED LIABILITY COMPANY)
213 W MAPLEWOOD LANE SUITE 300
NASHVILLE, TN 37207

FOR: ELECTRICAL CONTRACTING AND ELECTRICAL CONTRACTOR SERVICES INCLUDING ELECTRICAL REPAIRS, MAINTENANCE, AND INSTALLATION OF ELECTRICAL WIRING, OUTLETS, LIGHT FIXTURES, AND ELECTRICAL PANELS, IN CLASS 37 (U.S. CLS. 100, 103 AND 106).

FIRST USE 12-8-2008; IN COMMERCE 12-8-2008.

THE MARK CONSISTS OF A SQUARE DESIGN WITH A CAPITAL LETTER "E" TILTED COUNTERCLOCKWISE APPROXIMATELY 45 DEGREES AND A SUPERSCRIPT NUMBER "2" IN THE UPPER RIGHT CORNER OF THE SQUARE.

SER. NO. 76-708,758, FILED 8-17-2011.

JAMES GRIFFIN, EXAMINING ATTORNEY



David J. Kyffers

Director of the United States Patent and Trademark Office

United States of America

United States Patent and Trademark Office

SILK

Reg. No. 4,203,964

Registered Sep. 11, 2012

Int. Cl.: 41

SERVICE MARK

PRINCIPAL REGISTER

CAMERON, TIMOTHY A. (UNITED STATES INDIVIDUAL)
434 RAVINES DRIVE
STONE MOUNTAIN, GA 30087 AND

GLENN, GARY W. (UNITED STATES INDIVIDUAL)
434 RAVINES DRIVE
STONE MOUNTAIN, GA 30087 AND

GATES, JIMMY E. (UNITED STATES INDIVIDUAL)
434 RAVINES DRIVE
STONE MOUNTAIN, GA 30087 AND

JENKINS, GARY E. (UNITED STATES INDIVIDUAL)
434 RAVINES DRIVE
STONE MOUNTAIN, GA 30087 AND

L. RASBORO, JOHNATHAN (UNITED STATES INDIVIDUAL)
434 RAVINES DRIVE
STONE MOUNTAIN, GA 30087

FOR: ENTERTAINMENT SERVICES IN THE NATURE OF LIVE AND RECORDED MUSICAL AND DRAMATIC PERFORMANCES BY A GROUP, IN CLASS 41 (U.S. CLS. 100, 101 AND 107).

FIRST USE 11-11-1992; IN COMMERCE 11-11-1992.

THE MARK CONSISTS OF STANDARD CHARACTERS WITHOUT CLAIM TO ANY PARTICULAR FONT, STYLE, SIZE, OR COLOR.

SER. NO. 76-708,921, FILED 8-29-2011.

SUZANNE BLANE, EXAMINING ATTORNEY



David J. Kybas

Director of the United States Patent and Trademark Office

United States of America

United States Patent and Trademark Office

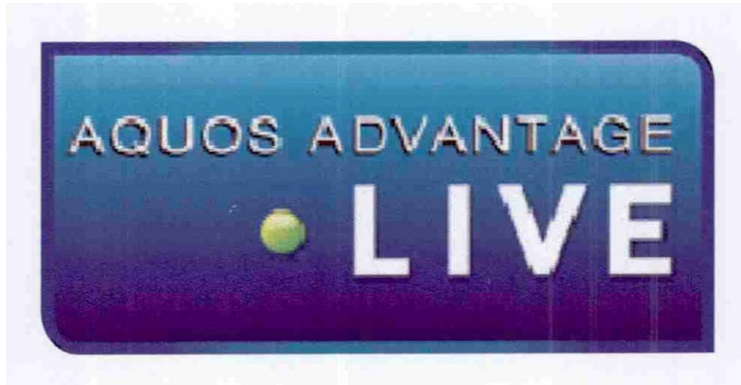

Reg. No. 4,203,965

Registered Sep. 11, 2012

Int. Cls.: 37 and 42

SERVICE MARK

PRINCIPAL REGISTER

SHARP KABUSHIKI KAISHA (JAPAN CORPORATION), TA SHARP CORPORATION
22-22, NAGAIKE-CHO, ABENO-KU
OSAKA, JAPAN 545-8522

FOR: REPAIR SERVICE FOR LCD TELEVISIONS FEATURING IN SITU REPAIR AND LOANER SERVICES, AND REMOTE SERVICES PROVIDED VIA THE INTERNET OR TELEPHONE, IN CLASS 37 (U.S. CLS. 100, 103 AND 106).

FIRST USE 10-0-2009; IN COMMERCE 10-0-2009.

FOR: CONSULTING IN THE FIELD OF TELECOMMUNICATIONS TECHNOLOGY RELATING TO LCD TELEVISIONS FEATURING TRAINED TECHNICAL ADVISERS IN THE AREA OF LCD TELEVISION TECHNOLOGY, PROVIDING ONLINE OR TELEPHONE INFORMATION AND SUPPORT SERVICES IN THE AREA OF LCD TELEVISION TECHNOLOGY, AND PROVIDING IN SITU OR REMOTE ASSISTANCE IN INITIAL PRODUCT SET-UP, SETTINGS MANAGEMENT, CONNECTIVITY ASSISTANCE (INCLUDING CABLE SET-UP), AUDIO-VIDEO SET-UP, SYSTEM CHECK-UPS, SYSTEMS REPAIR AND UPDATING, AND PERSONALIZED CALIBRATIONS FOR LCD TELEVISIONS, IN CLASS 42 (U.S. CLS. 100 AND 101).

FIRST USE 10-0-2009; IN COMMERCE 10-0-2009.

OWNER OF U.S. REG. NOS. 2,830,322, 3,612,818 AND OTHERS.

THE COLOR(S) BLUE, GREEN, GRAY AND WHITE IS/ARE CLAIMED AS A FEATURE OF THE MARK.

NO CLAIM IS MADE TO THE EXCLUSIVE RIGHT TO USE "LIVE", APART FROM THE MARK AS SHOWN.

THE MARK IS PRESENTED IN A STYLIZED FORMAT OF THE WORDING "AQUOS ADVANTAGE LIVE" IN ALL CAPS, WITH "AQUOS ADVANTAGE" IN A SMALLER FONT POSITIONED ABOUT "LIVE", WHICH IS PRESENTED IN A LARGER, BOLDER FONT POSITIONED FLUSH RIGHT BENEATH, WITH A SMALL CIRCLE TO THE LEFT OF "LIVE". COLOR CLAIM: APPLICANT CLAIMS THE COLORS BLUE, GREEN, GRAY AND WHITE, WITH THE LETTERS IN THE WORDING "AQUOS ADVANTAGE" FEATURED IN GRAY, WHEREAS THE WORD "LIVE" IS FEATURED IN A BOLD WHITE. THE CIRCLE IS FEAT-



David J. Kyros

Director of the United States Patent and Trademark Office

Reg. No. 4,203,965 TURED IN SHADES OF GREEN AND THE WORDING AND CIRCLE ARE POSITIONED ON
A GEOMETRIC BACKGROUND REFLECTING VARIOUS SHADES OF BLUE.

SER. NO. 76-709,015, FILED 9-8-2011.

JOHN SCHUYLER YARD, EXAMINING ATTORNEY

United States of America

United States Patent and Trademark Office

AERODECK

Reg. No. 4,203,966

AMERICAN HARLEQUIN CORPORATION (NEW JERSEY CORPORATION)
1531 GLEN AVENUE
MOORESTOWN, NJ 08057

Registered Sep. 11, 2012

Int. Cl.: 27

FOR: HARD SURFACE FLOOR COVERINGS USED ON STAGES, DANCE FLOORS AND SPORTS ARENAS, IN CLASS 27 (U.S. CLS. 19, 20, 37, 42 AND 50).

TRADEMARK

FIRST USE 7-11-2011; IN COMMERCE 7-11-2011.

PRINCIPAL REGISTER

THE MARK CONSISTS OF STANDARD CHARACTERS WITHOUT CLAIM TO ANY PARTICULAR FONT, STYLE, SIZE, OR COLOR.

SER. NO. 76-709,721, FILED 11-15-2011.

CARYN GLASSER, EXAMINING ATTORNEY



David J. Kyffers

Director of the United States Patent and Trademark Office

United States of America

United States Patent and Trademark Office

XANTASIL

Reg. No. 4,203,967

HERAEUS KULZER GMBH (FED REP GERMANY LIMITED LIABILITY COMPANY)
GRUENER WEG 11

Registered Sep. 11, 2012

D-63450 HANAU, FED REP GERMANY

Int. Cl.: 5

FOR: CHEMICAL PRODUCTS FOR DENTAL AND DENTAL TECHNOLOGY PURPOSES, NAMELY, DENTAL IMPRESSION MATERIAL, IN CLASS 5 (U.S. CLS. 6, 18, 44, 46, 51 AND 52).

TRADEMARK

THE MARK CONSISTS OF STANDARD CHARACTERS WITHOUT CLAIM TO ANY PARTICULAR FONT, STYLE, SIZE, OR COLOR.

PRINCIPAL REGISTER

PRIORITY CLAIMED UNDER SEC. 44(D) ON FED REP GERMANY APPLICATION NO. 302011056688, FILED 10-17-2011, REG. NO. 302011056688, DATED 12-7-2011, EXPIRES 10-31-2021.

SER. NO. 76-709,784, FILED 11-18-2011.

ANTHONY RINKER, EXAMINING ATTORNEY



David J. Kyffers

Director of the United States Patent and Trademark Office

United States of America

United States Patent and Trademark Office



Reg. No. 4,203,968

Registered Sep. 11, 2012

**Int. Cls.: 9, 16, 20, 25, 28
and 41**

BUCK COMMANDER, L.L.C. (LOUISIANA LIMITED LIABILITY COMPANY)
117 KINGS LANE
WEST MONROE, LA 71292

FOR: PRERECORDED AUDIO AND VIDEO CASSETTES, TAPES, COMPACT DISKS, LASER DISKS AND DVD'S FEATURING DEER HUNTING THEMES, IN CLASS 9 (U.S. CLS. 21, 23, 26, 36 AND 38).

TRADEMARK

FIRST USE 6-20-2008; IN COMMERCE 6-20-2008.

SERVICE MARK

FOR: DECALS AND POSTERS, IN CLASS 16 (U.S. CLS. 2, 5, 22, 23, 29, 37, 38 AND 50).

PRINCIPAL REGISTER

FIRST USE 2-11-2009; IN COMMERCE 2-11-2009.

FOR: LICENSE PLATES, NOT OF METAL; KEY RINGS, NOT OF METAL, IN CLASS 20 (U.S. CLS. 2, 13, 22, 25, 32 AND 50).

FIRST USE 4-6-2010; IN COMMERCE 4-6-2010.

FOR: APPAREL, NAMELY, SHIRTS, CAPS, IN CLASS 25 (U.S. CLS. 22 AND 39).

FIRST USE 9-12-2007; IN COMMERCE 9-12-2007.

FOR: HUNTING GAME CALLS FOR DEER, IN CLASS 28 (U.S. CLS. 22, 23, 38 AND 50).

FIRST USE 8-19-2009; IN COMMERCE 8-19-2009.

FOR: PRODUCTION OF TELEVISION SHOWS, IN CLASS 41 (U.S. CLS. 100, 101 AND 107).

FIRST USE 6-30-2010; IN COMMERCE 6-30-2010.

THE MARK CONSISTS OF THE DESIGN OF THE HEAD, ANTLERS, NECK AND SHOULDER PORTION OF A BUCK DEER POSED WITH ITS HEAD TURNED AND LOOKING BACK OVER ITS SHOULDER TOWARDS THE RIGHT OF THE DESIGN.

SER. NO. 76-709,872, FILED 12-1-2011.



David J. Kybas

Director of the United States Patent and Trademark Office

Reg. No. 4,203,968 SUZANNE BLANE, EXAMINING ATTORNEY

United States of America

United States Patent and Trademark Office



Reg. No. 4,203,969

RED BUG MOTORS, LLC (GEORGIA LIMITED LIABILITY COMPANY)
500 RIVERVIEW DRIVE
JEKYLL ISLAND, GA 31527

Registered Sep. 11, 2012

Int. Cl.: 39

FOR: RENTAL OF ELECTRIC LOW SPEED VEHICLES, IN CLASS 39 (U.S. CLS. 100 AND 105).

SERVICE MARK

FIRST USE 4-15-2006; IN COMMERCE 4-15-2006.

PRINCIPAL REGISTER

NO CLAIM IS MADE TO THE EXCLUSIVE RIGHT TO USE "MOTORS" AND "JEKYLL ISLAND", APART FROM THE MARK AS SHOWN.

THE COLOR(S) BLACK, RED AND WHITE IS/ARE CLAIMED AS A FEATURE OF THE MARK.

THE MARK CONSISTS OF THE WORDING "RED BUG MOTORS JEKYLL ISLAND" IN STYLIZED UPPERCASE LETTERING. THE WORDING "RED BUG MOTORS" APPEARS IN BLACK ARCHED ABOVE A DESIGN OF A RED CAR HAVING BLACK TIRES. THE WORDING "JEKYLL ISLAND" APPEARS IN WHITE INSIDE A RED CURVED BAND APPEARING UNDERNEATH THE RED CAR DESIGN.

SER. NO. 76-710,073, FILED 12-20-2011.

HAI-LY LAM, EXAMINING ATTORNEY



David J. Kyros

Director of the United States Patent and Trademark Office

United States of America

United States Patent and Trademark Office

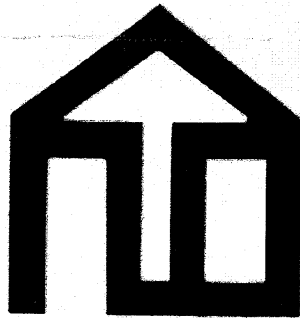

Reg. No. 4,203,970

COMPETITIVE SERVICES INTERNATIONAL INC. (MISSOURI CORPORATION)
1901 CHERRY STREET
KANSAS CITY, MO 64108

Registered Sep. 11, 2012

Int. Cl.: 35

FOR: RETAIL STORE SERVICES FEATURING DOOR AND WINDOW PARTS AND HARDWARE; ON-LINE RETAIL STORE SERVICES FEATURING DOOR AND WINDOW PARTS AND HARDWARE , IN CLASS 35 (U.S. CLS. 100, 101 AND 102).

SERVICE MARK

FIRST USE 8-0-2011; IN COMMERCE 8-0-2011.

PRINCIPAL REGISTER

THE MARK CONSISTS OF A STYLIZED DESIGN OF A HOUSE.

SER. NO. 76-710,203, FILED 1-6-2012.

JOHN DWYER, EXAMINING ATTORNEY



David J. Kyffers

Director of the United States Patent and Trademark Office

United States of America

United States Patent and Trademark Office

Sportsationals

Reg. No. 4,203,971

SPORTSATIONALS, LLC (PENNSYLVANIA LIMITED LIABILITY COMPANY)

Registered Sep. 11, 2012

P.O. BOX 1663
CHADDS FORD, PA 19317

Int. Cl.: 41

FOR: ENTERTAINMENT SERVICES, NAMELY, PROVIDING A WEBSITE FEATURING PRESENTATIONS IN THE FIELD OF EDUCATIONAL INFORMATION DIRECTED AT CHILDREN AND THEIR FAMILIES ABOUT LEARNING SKILLS, HEALTHFUL LIVING AND STAYING ACTIVE THROUGH INVOLVEMENT IN SPORTS, IN CLASS 41 (U.S. CLS. 100, 101 AND 107).

SERVICE MARK

PRINCIPAL REGISTER

FIRST USE 11-28-2011; IN COMMERCE 11-28-2011.

THE MARK CONSISTS OF STANDARD CHARACTERS WITHOUT CLAIM TO ANY PARTICULAR FONT, STYLE, SIZE, OR COLOR.

SER. NO. 76-710,255, FILED 1-12-2012.

KATINA MISTER, EXAMINING ATTORNEY



David J. Kyffers

Director of the United States Patent and Trademark Office

United States of America

United States Patent and Trademark Office

ANTONINO AJELLO & BROS. HOUSE OF CANDLES

Reg. No. 4,203,972

Registered Sep. 11, 2012

Int. Cl.: 4

TRADEMARK

PRINCIPAL REGISTER

SANTINA, VERGINIA DELLA (UNITED STATES INDIVIDUAL), DBA ANTONINO AJELLO
& BROS. HOUSE OF CANDLES
10315 WASHINGTON BLVD.
CULVER CITY, CA 90232

FOR: CANDLES, IN CLASS 4 (U.S. CLS. 1, 6 AND 15).

FIRST USE 11-0-1940; IN COMMERCE 11-0-1940.

THE MARK CONSISTS OF STANDARD CHARACTERS WITHOUT CLAIM TO ANY PARTICULAR FONT, STYLE, SIZE, OR COLOR.

THE NAME "ANTONINO AJELLO" DOES NOT IDENTIFY A LIVING INDIVIDUAL.

SER. NO. 76-710,307, FILED 1-19-2012.

AMEEN IMAM, EXAMINING ATTORNEY



David J. Kyffers

Director of the United States Patent and Trademark Office

United States of America

United States Patent and Trademark Office

LOYAL YEARS

Reg. No. 4,203,973

Registered Sep. 11, 2012

Int. Cl.: 36

SERVICE MARK

PRINCIPAL REGISTER

THE PRINCETON CORPORATION (INDIANA CORPORATION)
600 PRINCETON PARKWAY
KENTLAND, IN 47951

FOR: ADMINISTERING INSURANCE PROGRAMS FOR OTHERS, IN CLASS 36 (U.S. CLS. 100, 101 AND 102).

FIRST USE 10-3-2011; IN COMMERCE 10-3-2011.

THE MARK CONSISTS OF STANDARD CHARACTERS WITHOUT CLAIM TO ANY PARTICULAR FONT, STYLE, SIZE, OR COLOR.

OWNER OF U.S. REG. NOS. 3,052,542 AND 3,307,911.

SER. NO. 76-710,345, FILED 1-24-2012.

ELLEN PERKINS, EXAMINING ATTORNEY



David J. Kyffers

Director of the United States Patent and Trademark Office

United States of America

United States Patent and Trademark Office

ASSENMACHER SPECIALTY TOOLS

Reg. No. 4,203,974

Registered Sep. 11, 2012

Int. Cl.: 8

TRADEMARK

PRINCIPAL REGISTER

ASSENMACHER SPECIALTY TOOLS, INC. (COLORADO CORPORATION)
6440 ODELL PLACE
BOULDER, CO 80301

FOR: AUTOMOTIVE HAND TOOLS, NAMELY, WRENCHES AND WRENCH SETS, DRIVERS AND DRIVER SETS, SOCKETS AND SOCKET SETS, STUD REMOVERS AND INSERTION EXTRACTION TOOLS, FILES AND FILE SETS, FILLER ADAPTERS, TIMING TOOLS, CLUTCH CENTERING TOOLS, TIE ROD AND BALL JOINT PULLERS, RADIO REMOVAL TOOLS, ADJUSTMENT GAUGES, HINGE/HANDLE TOOLS, BITS, CAMSHAFT RULERS, CAMSHAFT ALIGNMENT TOOLS, KEYS, BELT INSTALL TOOLS, CHAIN ADJUSTERS, SUPPORT GUIDES, SPREADERS, LOCKING FIXTURES, LOCKING PINS, COIL PACK PULLERS, TENSIONER HOLDERS, SPROCKET HOLDERS, PULLEY HOLDERS, FILLERS AND FUNNELS, FLUID FILL CONTAINERS, SPROCKET TURNERS, LINE DISCONNECTORS, TANK ADAPTERS, WEDGE SETS, PLIERS, IGNITION LOCK REMOVAL TOOLS, CYLINDER HEAD SOCKETS, REAMERS, WIRE TERMINAL EXTRACTORS, CRANKSHAFT STOPS, CAM LOCK CLAMPS, AND VALVE SPRING DEPRESSORS, IN CLASS 8 (U.S. CLS. 23, 28 AND 44).

FIRST USE 7-0-1979; IN COMMERCE 7-0-1979.

THE MARK CONSISTS OF STANDARD CHARACTERS WITHOUT CLAIM TO ANY PARTICULAR FONT, STYLE, SIZE, OR COLOR.

NO CLAIM IS MADE TO THE EXCLUSIVE RIGHT TO USE "SPECIALTY TOOLS", APART FROM THE MARK AS SHOWN.

SEC. 2(F).

SER. NO. 76-710,365, FILED 1-25-2012.

MICHAEL KEATING, EXAMINING ATTORNEY



David J. Kybas

Director of the United States Patent and Trademark Office

United States of America

United States Patent and Trademark Office

MOBILITYCENTRAL

Reg. No. 4,203,975

VISAGE MOBILE, INC. (DELAWARE CORPORATION)
500 SANSOME ST., SUITE 300
SAN FRANCISCO, CA 94111

Registered Sep. 11, 2012

Int. Cl.: 35

FOR: SERVICES OF PROVIDING COST ANALYSIS SERVICES TO CUSTOMERS, NAMELY, AUTOMATED MONITORING OF MOBILE COMMUNICATIONS SPENDING IN ORDER TO MANAGE MOBILE COMMUNICATIONS AND REDUCE MOBILE COMMUNICATIONS COSTS, IN CLASS 35 (U.S. CLS. 100, 101 AND 102).

SERVICE MARK

PRINCIPAL REGISTER

FIRST USE 12-1-2007; IN COMMERCE 12-1-2007.

THE MARK CONSISTS OF STANDARD CHARACTERS WITHOUT CLAIM TO ANY PARTICULAR FONT, STYLE, SIZE, OR COLOR.

SER. NO. 76-710,540, FILED 2-6-2012.

PAUL MORENO, EXAMINING ATTORNEY



David J. Kybas

Director of the United States Patent and Trademark Office

United States of America

United States Patent and Trademark Office

~~LASERLINE~~

Reg. No. 4,203,976

LASERLINE NATIONAL LLC (OHIO LIMITED LIABILITY COMPANY)
P.O. BOX 47

Registered Sep. 11, 2012

VERSAILLES, OH 45380

Int. Cl.: 37

FOR: VEHICLE REPAIR AND MAINTENANCE, IN CLASS 37 (U.S. CLS. 100, 103 AND 106).

SERVICE MARK

FIRST USE 5-15-2001; IN COMMERCE 5-15-2001.

PRINCIPAL REGISTER

THE MARK CONSISTS OF THE WORD "LASERLINE" IN A STYLIZED BLUE FONT WITH A RED LINE SUPERIMPOSED OVER THE LOWER HALF OF THE WORD.

THE COLOR(S) RED AND BLUE IS/ARE CLAIMED AS A FEATURE OF THE MARK.

SER. NO. 76-710,604, FILED 2-13-2012.

MELISSA VALLILLO, EXAMINING ATTORNEY



David J. Kyffers

Director of the United States Patent and Trademark Office

United States of America

United States Patent and Trademark Office

ORANGE.COM

Reg. No. 4,203,977

Registered Sep. 11, 2012

**Int. Cls.: 16, 36, 37, 38,
39, 41 and 42**

TRADEMARK

SERVICE MARK

PRINCIPAL REGISTER

ORANGE BRAND SERVICES, LTD. (UNITED KINGDOM COMPANY)
ST. JAMES PARK, GREAT PARK ROAD
ALMONDSBURY PARK, BRADLEY STOKE
BRISTOL, UNITED KINGDOM

FOR: HOLOGRAMS , IN CLASS 16 (U.S. CLS. 2, 5, 22, 23, 29, 37, 38 AND 50).

FOR: FINANCING OF TELECOMMUNICATIONS APPARATUS, SYSTEMS AND INSTALLATIONS; CHARITABLE FUND RAISING SERVICES, NAMELY, ORGANIZING CHARITABLE COLLECTIONS AND FUND RAISING ACTIVITIES; FINANCIAL SPONSORSHIP IN THE AREA OF SPORTS, CULTURAL ACTIVITIES AND THE ARTS; PROVIDING EXTENDED WARRANTIES AND INSURANCE FOR TELECOMMUNICATIONS AND COMPUTING EQUIPMENT AND DEVICES, TELECOMMUNICATIONS AND COMPUTING NETWORKS AND SYSTEMS, BROADBAND AND OTHER INTERNET ACCESS SERVICES, IN CLASS 36 (U.S. CLS. 100, 101 AND 102).

FOR: INSTALLATION, MAINTENANCE AND REPAIR OF TELECOMMUNICATIONS APPARATUS AND SYSTEMS, TELEPHONES, MOBILE TELEPHONES AND TELEPHONE HANDSETS, PAGING APPARATUS, RADIO PAGING APPARATUS, RADIO TELEPHONE APPARATUS, COMPUTERS AND PERSONAL ORGANIZERS, COMPUTER HARDWARE, SATELLITE TRANSMITTERS AND RECEIVERS; INFORMATION AND CONSULTING SERVICES RELATING TO ALL THE AFOREMENTIONED; INFORMATION AND ADVISORY SERVICES RELATING TO HOUSEHOLD CONSTRUCTION, MAINTENANCE AND REPAIR ALL PROVIDED BY MEANS OF A TELECOMMUNICATIONS LINK; INFORMATION AND CONSULTING SERVICES RELATING TO VEHICLE MAINTENANCE AND REPAIR ALL PROVIDED BY MEANS OF A TELECOMMUNICATIONS LINK; INFORMATION AND CONSULTING SERVICES RELATING TO REPAIR OR INSTALLATION, PROVIDED ON-LINE FROM A COMPUTER DATABASE OR THE INTERNET, IN CLASS 37 (U.S. CLS. 100, 103 AND 106).

FOR: TELECOMMUNICATIONS AND COMMUNICATION SERVICES, NAMELY, TELEPHONE, FACSIMILE, USER TO USER TELEPRINTER EXCHANGE SERVICES; ELECTRONIC MESSAGE COLLECTION AND TRANSMISSION, RADIO-PAGING AND ELECTRONIC MAIL SERVICES; ELECTRONIC TRANSMISSION AND RECEPTION OF DATA AND OF INFORMATION; DELIVERY OF MESSAGES BY ELECTRONIC TRANSMISSION; ON-LINE INFORMATION SERVICES RELATING TO TELECOMMUNICATIONS; ELECTRONIC DATA INTERCHANGE SERVICES; TRANSFER OF DATA BY TELECOMMUNICATIONS; SATELLITE COMMUNICATION SERVICES; BROADCASTING OR TRANSMISSION OF RADIO OR TELEVISION PROGRAMS; VIDEOTEXT; TELETXT AND VIEWDATA SERVICES, NAMELY, VIEWING TEXT AND GRAPHICS VIA TELEVISION MONITORS TO DISPLAY INFORMATION WHICH IS ACCESSED THROUGH TELEPHONE LINES; VIDEO MESSAGING SERVICES; VIDEO CONFERENCING SERVICES; VIDEO TELEPHONE SERVICES; TELECOMMUNICATION OF ON-LINE INFORMATION, SOFTWARE AND ELECTRONIC DATABASES; PROVIDING USER ACCESS TO THE INTERNET; PROVIDING TELECOMMUNICATIONS CONNECTIONS TO THE INTERNET OR DATABASES;



David J. Kappas

Director of the United States Patent and Trademark Office

Reg. No. 4,203,977 PROVIDING ACCESS TO DIGITAL MUSIC WEBSITES ON THE INTERNET; PROVIDING ACCESS TO MP3 WEBSITES ON THE INTERNET; DELIVERY OF DIGITAL MUSIC BY TELECOMMUNICATIONS; TELECOMMUNICATION ACCESS SERVICES TO ON-LINE AND WIRELESS PROVIDERS; ELECTRONIC TRANSMISSION OF MESSAGES AND IMAGES VIA COMPUTER TERMINALS; COMPUTERIZED NETWORK CONFERENCING SERVICES; ELECTRONIC TRANSMISSION OF NEWS AND CURRENT AFFAIRS INFORMATION; LEASING AND RENTAL OF TELECOMMUNICATIONS EQUIPMENT; PROVISION OF ACCESS TO AN ELECTRONIC ON-LINE NETWORK FOR INFORMATION RETRIEVAL; PROVIDING ON-LINE CHAT ROOMS FOR TRANSMISSION OF MESSAGES AMONG COMPUTER USERS IN THE FIELDS OF TELECOMMUNICATIONS, BUSINESS, PRODUCT PROMOTION, FINANCIAL, REAL ESTATE, STOCKS AND SHARES, MAINTENANCE AND REPAIR OF PROPERTY, HOUSEHOLD ITEMS, VEHICLES, MAINTENANCE AND REPAIR OF TELECOMMUNICATIONS INSTALLATIONS, NETWORKS, TELEPHONES AND COMPUTER EQUIPMENT, TRAVEL, ENTERTAINMENT, SPORTS, CULTURAL EVENTS, COMPUTING, TRAVEL, AND RESTAURANTS, IN CLASS 38 (U.S. CLS. 100, 101 AND 104).

FOR: PICKUP AND STORAGE OF GOODS; DELIVERY OF GOODS BY ROAD, RAIL, SEA OR AIR; WRAPPING AND PACKAGING OF GOODS FOR TRANSPORTATION AND FOR DELIVERY; TRANSPORT AND TRAVEL ARRANGEMENTS; TRAVEL AND TRANSPORT INFORMATION AND CONSULTATION SERVICES RENDERED BY TELEPHONE, THE INTERNET, MAIL OR IN PERSON; ARRANGING TRAVEL AND PROVIDING INFORMATION IN CONNECTION THEREWITH, BY MEANS OF A COMPUTER DATABASE OR THE INTERNET; PROVISION OF VEHICLE RENTAL, RENTAL OF PARKING SPACES VIA THE INTERNET, TELEPHONE, FAX, MAIL; VEHICLE CHARTERING SERVICES; TRAVEL AGENCY SERVICES, NAMELY MAKING RESERVATIONS AND BOOKINGS FOR TRANSPORTATION AND ACCOMMODATION; CONSULTATION RENDERED IN CONJUNCTION WITH ALL OF THE AFORESAID SERVICES, IN CLASS 39 (U.S. CLS. 100 AND 105).

FOR: EDUCATION AND TRAINING SERVICES RELATING TO THE FIELD OF TELECOMMUNICATIONS IN THE FORM OF INTERACTIVE AND DISTANCE LEARNING SERVICES PROVIDED ON-LINE BY A TELECOMMUNICATION OR COMPUTER NETWORK OR BY TELEPHONE OR MAIL; ORGANIZING AND STAGING OF EDUCATIONAL AND TRAINING INITIATIVES AND EVENTS IN THE FIELD OF RELATING TO TELECOMMUNICATIONS, BUSINESS INFORMATION, PRODUCT INFORMATION, FINANCIAL INFORMATION, REAL ESTATE INFORMATION, STOCKS AND SHARES INFORMATION, MAINTENANCE AND REPAIR OF PROPERTY, HOUSEHOLD ITEMS AND VEHICLES, MAINTENANCE AND REPAIR OF TELECOMMUNICATIONS INSTALLATIONS AND NETWORKS, TELEPHONES AND COMPUTER EQUIPMENT, TRAVEL, ENTERTAINMENT, SPORTS, CULTURAL EVENTS, COMPUTING AND FOOD; EDUCATIONAL SERVICES RELATING TO BUSINESS OPERATIONS IN THE FORM OF INTERACTIVE AND DISTANCE LEARNING SERVICES PROVIDED ON-LINE BY A TELECOMMUNICATION OR COMPUTER NETWORK OR BY TELEPHONE OR MAIL; EDUCATIONAL AND TRAINING SERVICES IN THE FIELDS OF TELECOMMUNICATIONS, BUSINESS INFORMATION, PRODUCT INFORMATION, FINANCIAL INFORMATION, REAL ESTATE INFORMATION, STOCKS AND SHARES INFORMATION, MAINTENANCE AND REPAIR OF PROPERTY, HOUSEHOLD ITEMS AND VEHICLES, MAINTENANCE AND REPAIR OF TELECOMMUNICATIONS INSTALLATIONS AND NETWORKS, TELEPHONES AND COMPUTER EQUIPMENT, TRAVEL, ENTERTAINMENT, SPORTS, CULTURAL EVENTS, COMPUTING AND FOOD IN THE FORM OF INTERACTIVE AND DISTANCE LEARNING SERVICES PROVIDED ON-LINE BY A TELECOMMUNICATION OR COMPUTER NETWORK OR BY TELEPHONE OR MAIL; ORGANIZATION AND STAGING OF CULTURAL INITIATIVES, COMPETITIONS AND EVENTS IN THE FIELD OF RELATING TO TELECOMMUNICATIONS, BUSINESS INFORMATION, PRODUCT INFORMATION, FINANCIAL INFORMATION, REAL ESTATE INFORMATION, STOCKS AND SHARES INFORMATION, MAINTENANCE AND REPAIR OF PROPERTY, HOUSEHOLD ITEMS AND VEHICLES, MAINTENANCE AND REPAIR OF TELECOMMUNICATIONS INSTALLATIONS AND NETWORKS, TELEPHONES AND COMPUTER EQUIPMENT, TRAVEL, ENTERTAINMENT, SPORTS, CULTURAL EVENTS, COMPUTING AND FOOD

Reg. No. 4,203,977 ORGANIZING AND STAGING OF EDUCATIONAL AND ENTERTAINMENT EVENTS AND COMPETITIONS IN THE FIELDS OF SCIENCE, TECHNOLOGY, SPORTS, THE ARTS, BUSINESS, FINANCE, LITERATURE, VOCATIONAL EVENTS, TELECOMMUNICATIONS, COMPUTING AND THE INTERNET; INFORMATION RELATING TO EDUCATION, ENTERTAINMENT, SPORTING AND CULTURAL EVENTS BY MEANS OF THE INTERNET, MAIL, TELEPHONE, FAX, COMPUTER, PERSON TO PERSON; PROVIDING ON-LINE COMPUTER GAMES; RENTAL OF VIDEO AND AUDIO TAPES; RADIO AND TELEVISION ENTERTAINMENT SERVICES, NAMELY, RADIO AND TELEVISION PROGRAMS RELATING TO TELECOMMUNICATIONS, BUSINESS INFORMATION, PRODUCT INFORMATION, FINANCIAL INFORMATION, REAL ESTATE INFORMATION, STOCKS AND SHARES INFORMATION, MAINTENANCE AND REPAIR OF PROPERTY, HOUSEHOLD ITEMS AND VEHICLES, MAINTENANCE AND REPAIR OF TELECOMMUNICATIONS INSTALLATIONS AND NETWORKS, TELEPHONES AND COMPUTER EQUIPMENT, TRAVEL, ENTERTAINMENT, SPORTS, CULTURAL EVENTS, COMPUTING AND FOOD; PUBLICATION OF ELECTRONIC BOOKS AND JOURNALS ON-LINE; PUBLICATION OF TEXTS IN ELECTRONIC FORMAT OR OTHERWISE IN THE FIELD OF RELATING TO TELECOMMUNICATIONS, BUSINESS INFORMATION, PRODUCT INFORMATION, FINANCIAL INFORMATION, REAL ESTATE INFORMATION, STOCKS AND SHARES INFORMATION, MAINTENANCE AND REPAIR OF PROPERTY, HOUSEHOLD ITEMS AND VEHICLES, MAINTENANCE AND REPAIR OF TELECOMMUNICATIONS INSTALLATIONS AND NETWORKS, TELEPHONES AND COMPUTER EQUIPMENT, TRAVEL, ENTERTAINMENT, SPORTS, CULTURAL EVENTS, COMPUTING AND FOOD; ORGANIZING EDUCATIONAL AND ENTERTAINMENT EXHIBITS IN THE FIELDS OF TELECOMMUNICATIONS, BUSINESS INFORMATION, PRODUCT INFORMATION, FINANCIAL INFORMATION, REAL ESTATE INFORMATION, STOCKS AND SHARES INFORMATION, MAINTENANCE AND REPAIR OF PROPERTY, HOUSEHOLD ITEMS AND VEHICLES, MAINTENANCE AND REPAIR OF TELECOMMUNICATIONS INSTALLATIONS AND NETWORKS, TELEPHONES AND COMPUTER EQUIPMENT, TRAVEL, ENTERTAINMENT, SPORTS, CULTURAL EVENTS, COMPUTING AND FOOD; NEWS PROGRAMMING SERVICES FOR TRANSMISSION ACROSS THE INTERNET; ARRANGING AND CONDUCTING OF CONFERENCES, SEMINARS, SYMPOSIA, TUTORIALS AND WORKSHOPS IN THE FIELD OF RELATING TO TELECOMMUNICATIONS, BUSINESS INFORMATION, PRODUCT INFORMATION, FINANCIAL INFORMATION, REAL ESTATE INFORMATION, STOCKS AND SHARES INFORMATION, MAINTENANCE AND REPAIR OF PROPERTY, HOUSEHOLD ITEMS AND VEHICLES, MAINTENANCE AND REPAIR OF TELECOMMUNICATIONS INSTALLATIONS AND NETWORKS, TELEPHONES AND COMPUTER EQUIPMENT, TRAVEL, ENTERTAINMENT, SPORTS, CULTURAL EVENTS, COMPUTING AND FOOD; INTERACTIVE AND DISTANCE LEARNING COURSES AND SESSIONS PROVIDED ON-LINE VIA A TELECOMMUNICATIONS LINK, OR A COMPUTER NETWORK, OR BY TELEPHONE, OR BY MAIL IN THE FIELDS OF TELECOMMUNICATIONS, BUSINESS INFORMATION, PRODUCT INFORMATION, FINANCIAL INFORMATION, REAL ESTATE INFORMATION, STOCKS AND SHARES INFORMATION, MAINTENANCE AND REPAIR OF PROPERTY, HOUSEHOLD ITEMS AND VEHICLES, MAINTENANCE AND REPAIR OF TELECOMMUNICATIONS INSTALLATIONS AND NETWORKS, TELEPHONES AND COMPUTER EQUIPMENT, TRAVEL, ENTERTAINMENT, SPORTS, CULTURAL EVENTS, COMPUTING AND FOOD; CASINO SERVICES; TICKET RESERVATION AND BOOKING SERVICES FOR ENTERTAINMENT, SPORTING AND CULTURAL EVENTS; ELECTRONIC LIBRARY SERVICES FOR THE SUPPLY OF ELECTRONIC INFORMATION, INCLUDING ARCHIVE INFORMATION, IN THE FORM OF ELECTRONIC TEXTS, AUDIO AND/OR VIDEO INFORMATION AND DATA, GAMES AND AMUSEMENTS; ELECTRONIC GAMES SERVICES PROVIDED BY MEANS OF THE INTERNET; ARRANGING AND CONDUCTING EDUCATIONAL AND ENTERTAINMENT CONFERENCES, SEMINARS, SYMPOSIA, TUTORIALS AND WORKSHOPS IN THE FIELDS OF TELECOMMUNICATIONS, BUSINESS INFORMATION, PRODUCT INFORMATION, FINANCIAL INFORMATION, REAL ESTATE INFORMATION, STOCKS AND SHARES INFORMATION, MAINTENANCE AND REPAIR OF PROPERTY, HOUSEHOLD ITEMS AND VEHICLES, MAINTENANCE AND REPAIR OF TELECOMMUNICATIONS INSTALLATIONS AND NETWORKS, TELEPHONES AND COMPUTER EQUIPMENT, TRAVEL, ENTERTAINMENT, SPORTS, CULTURAL EVENTS, COMPUTING AND FOOD; ENTERTAINMENT

Reg. No. 4,203,977 SERVICES, NAMELY, PROVIDING ON-LINE, DOWNLOADABLE MUSIC VIA THE INTERNET; CONSULTATION RENDERED ON CONJUNCTION WITH ALL THE AFORESAID SERVICES; PROVIDING ON-LINE MAGAZINES, NEWSLETTERS, JOURNALS AND CATALOGUES IN THE FIELDS OF TELECOMMUNICATIONS, BUSINESS INFORMATION, PRODUCT INFORMATION, FINANCIAL INFORMATION, REAL ESTATE INFORMATION, STOCKS AND SHARES INFORMATION, MAINTENANCE AND REPAIR OF PROPERTY, HOUSEHOLD ITEMS AND VEHICLES, MAINTENANCE AND REPAIR OF TELECOMMUNICATIONS INSTALLATIONS AND NETWORKS, TELEPHONES AND COMPUTER EQUIPMENT, TRAVEL, ENTERTAINMENT, SPORTS, CULTURAL EVENTS, COMPUTING AND FOOD, IN CLASS 41 (U.S. CLS. 100, 101 AND 107).

FOR: CAFE, BAR, CAFETERIA, BISTRO, RESTAURANT AND COFFEE HOUSE SERVICES FEATURING MULTIPLE-USER ACCESS TO A GLOBAL COMPUTER INFORMATION NETWORK; PREPARATION OF FOOD AND DRINK; CATERING SERVICES; RESTAURANT SERVICES; CAFE AND CAFETERIA SERVICES; SNACK-BAR SERVICES; FAST-FOOD RESTAURANT SERVICES; PROVIDING FACILITIES FOR CONFERENCES AND EXHIBITIONS; COMPUTER SERVICES, NAMELY, MAINTENANCE, UPDATING AND DESIGN OF COMPUTER SOFTWARE AND PROGRAMS; COMPUTER PROGRAMMING SERVICES FOR OTHERS; INFORMATION SERVICES IN THE FIELD OF COMPUTERS AND COMPUTER NETWORK FACILITIES VIA, THE INTERNET, TELEPHONE, MAIL, FAX, COMPUTER, PERSON TO PERSON; ON-LINE COMPUTER PROGRAMMING FOR OTHERS; COMPUTER RENTAL; DESIGN, DRAWING AND COMMISSIONED WRITING, ALL FOR THE COMPILATION OF WEB PAGES ON THE INTERNET; COMPUTER SERVICES, NAMELY, CREATING AND MAINTAINING WEB SITES FOR OTHERS; HOSTING THE WEB SITES OF OTHERS ON A COMPUTER SERVER FOR A GLOBAL COMPUTER NETWORK; INSTALLATION AND MAINTENANCE OF COMPUTER SOFTWARE; COMPUTER PROGRAMMING SERVICES FOR OTHERS PERTAINING TO PROVIDING ACCESS TIME TO A COMPUTER DATABASE; COMPILATION, CREATION AND MAINTENANCE OF A REGISTER OF DOMAIN NAMES FOR IDENTIFICATION OF USERS ON A GLOBAL COMPUTER NETWORK; SECURITY AND FRAUD PREVENTION INFORMATION AND ADVISORY SERVICES; ARRANGING OF INSURANCE SECURITY REGISTRATION SERVICES FOR THE PROTECTION OF MOBILE TELEPHONES AND THEIR ACCESSORIES AGAINST LOSS, THEFT OR DAMAGE; HOROSCOPE FORECASTING; WEATHER FORECASTING; NEWS AND CURRENT AFFAIRS CLIPPINGS AND INFORMATION SERVICES; HOTEL RESERVATION SERVICES FOR OTHERS; PERSONAL INTRODUCTION AND DATING AGENCY SERVICES; ESCORT AGENCY SERVICES; HEALTHCARE AND MEDICAL INFORMATION AND CONSULTING SERVICES PROVIDED ON-LINE FROM A COMPUTER DATABASE, VIA THE INTERNET, BY TELEPHONE, IN PERSON OR BY MAIL; BEAUTY INFORMATION AND CONSULTING SERVICES VIA ON-LINE FROM A COMPUTER DATABASE, VIA THE INTERNET, BY MAIL, IN PERSON OR BY TELEPHONE; GARDEN DESIGN AND GARDENING INFORMATION AND CONSULTING SERVICES VIA ON-LINE FROM A COMPUTER DATABASE, VIA THE INTERNET, BY MAIL, IN PERSON OR BY TELEPHONE; PROVISION OF INFORMATION AND ADVICE ON ENVIRONMENTAL AWARENESS ISSUES VIA ON-LINE FROM A COMPUTER DATABASE, VIA THE INTERNET, BY MAIL, IN PERSON OR BY TELEPHONE; INTERIOR DESIGN SERVICES AND INFORMATION AND CONSULTING SERVICES RELATING THERETO VIA ON-LINE FROM A COMPUTER DATABASE, VIA THE INTERNET, BY MAIL, IN PERSON OR BY TELEPHONE; LANGUAGE TRANSLATION SERVICES; INFORMATION AND ADVICE RELATING TO FOOD, NUTRITION AND COOKERY VIA ON-LINE FROM A COMPUTER DATABASE, VIA THE INTERNET, BY MAIL, IN PERSON OR BY TELEPHONE; TELECOMMUNICATIONS CONSULTING SERVICES; FASHION INFORMATION PROVIDED BY TELECOMMUNICATIONS MEANS FROM A COMPUTER DATABASE OR VIA THE INTERNET; DATABASE DEVELOPMENT SERVICES; COMPUTER SERVICES, NAMELY, PROVIDING SEARCH ENGINES FOR OBTAINING DATA ON THE INTERNET; NEWS AGENCY SERVICES; SOCIAL CLUBS, NAMELY, ORGANIZATION AND RUNNING OF CLUBS FOR MEMBERS FOR EDUCATIONAL, SOCIAL, SPORTING AND ENTERTAINMENT AND CULTURAL ACTIVITIES; TRAVEL AGENCY SERVICES, NAMELY, ACCOMMODATION LOCATING, INFORMATION, AND BOOKING RESERVATION SERVICES, IN CLASS 42 (U.S. CLS. 100 AND 101).

Reg. No. 4,203,977 PRIORITY CLAIMED UNDER SEC. 44(D) ON ERPN CMNTY TM OFC APPLICATION NO. 1561877, FILED 3-16-2000, REG. NO. 1561877, DATED 3-13-2002, EXPIRES 3-16-2020.

OWNER OF U.S. REG. NO. 920,090.

SER. NO. 76-975,297, FILED 8-9-2000.

JAMES A. RAUEN, EXAMINING ATTORNEY

United States of America

United States Patent and Trademark Office

GOSSIP GIRL

Reg. No. 4,203,978

Registered Sep. 11, 2012

Int. Cl.: 25

TRADEMARK

PRINCIPAL REGISTER

WARNER BROS. ENTERTAINMENT INC. (DELAWARE CORPORATION)
4000 WARNER BOULEVARD
BURBANK, CA 91522

FOR: CLOTHING, NAMELY, SHIRTS, IN CLASS 25 (U.S. CLS. 22 AND 39).

FIRST USE 4-0-2008; IN COMMERCE 4-0-2008.

THE MARK CONSISTS OF STANDARD CHARACTERS WITHOUT CLAIM TO ANY PARTICULAR FONT, STYLE, SIZE, OR COLOR.

OWNER OF U.S. REG. NOS. 3,043,178, 4,092,743, AND 4,143,208.

NO CLAIM IS MADE TO THE EXCLUSIVE RIGHT TO USE "GIRL", APART FROM THE MARK AS SHOWN.

SER. NO. 77-123,303, FILED 3-6-2007.

JAY BESCH, EXAMINING ATTORNEY



David J. Kyffers

Director of the United States Patent and Trademark Office

United States of America

United States Patent and Trademark Office



Reg. No. 4,203,979

Registered Sep. 11, 2012

**Int. Cls.: 5, 29, 31, 35
and 40**

TRADEMARK

SERVICE MARK

PRINCIPAL REGISTER

VITERRA INC. (CANADA CORPORATION)
2625 VICTORIA AVENUE
REGINA, CANADA S4T7T9

FOR: NON-MEDICATED ADDITIVES FOR ANIMAL FEED FOR USE AS NUTRITIONAL PROTEIN SUPPLEMENTS, IN CLASS 5 (U.S. CLS. 6, 18, 44, 46, 51 AND 52).

FOR: PULSES, IN CLASS 29 (U.S. CL. 46).

FOR: LIVESTOCK SUPPLIES, NAMELY, ANIMAL FEED, GRAIN SCREENING PELLETS IN THE NATURE OF UNPROCESSED GRAIN, MILL ANIMAL FEEDS; AGRICULTURAL SEED AND UNPROCESSED GRAIN, NAMELY, REGISTERED, COMMERCIAL OILSEEDS AND UNPROCESSED CEREALS, IN CLASS 31 (U.S. CLS. 1 AND 46).

FOR: WHOLESALE DISTRIBUTORSHIPS AND RETAIL STORE SERVICES ALL FEATURING AGRICULTURAL PRODUCTS, NAMELY, GRAINS, OILSEEDS, LEGUMES AND FORAGES, AND SEEDS OF AGRICULTURAL PRODUCTS AND PRIMARY BY-PRODUCTS OF AGRICULTURAL PRODUCTS; WHOLESALE DISTRIBUTORSHIPS AND RETAIL STORE SERVICES ALL FEATURING ANIMAL FEEDS, NAMELY, COMPLETE FEEDS, CONCENTRATED VITAMIN PREMIX FEEDS, MINERAL PREMIX FEEDS, CONCENTRATED VITAMIN AND MINERAL PREMIX FEEDS, SUPPLEMENT FEEDS AND FEED CONCENTRATES; WHOLESALE DISTRIBUTORSHIPS AND RETAIL STORE SERVICES ALL FEATURING ANIMAL FEED NUTRIENTS AND ADDITIVES; WHOLESALE DISTRIBUTORSHIPS AND RETAIL STORE SERVICES ALL FEATURING ANIMAL FEED MEDICATIONS AND INJECTABLES TO TREAT AND PREVENT DISEASE IN ANIMALS; MERCHANDISING SERVICES, NAMELY, STRATEGIC DEVELOPMENT, ADVERTISEMENT AND MARKETING RELATING TO THE PRODUCTION, PURCHASE AND SALE OF THE FOLLOWING PRODUCTS OF OTHERS AGRICULTURAL PRODUCTS, NAMELY, GRAINS, OILSEEDS, LEGUMES AND FORAGES, AND SEEDS OF AGRICULTURAL PRODUCTS AND PRIMARY BY-PRODUCTS OF AGRICULTURAL PRODUCTS, IN CLASS 35 (U.S. CLS. 100, 101 AND 102).

FOR: CONTRACT MANUFACTURING IN THE FIELD OF AGRICULTURAL PRODUCTS, NAMELY, GRAINS, OILSEEDS, LEGUMES AND FORAGES, AND SEEDS OF AGRICULTURAL PRODUCTS AND PRIMARY BY-PRODUCTS OF AGRICULTURAL PRODUCTS, ANIMAL FEEDS, NAMELY, COMPLETE FEEDS, CONCENTRATED VITAMIN PREMIX FEEDS, MINERAL PREMIX FEEDS, CONCENTRATED VITAMIN AND MINERAL PREMIX FEEDS, SUPPLEMENT FEEDS AND FEED CONCENTRATES, ANIMAL FEED NUTRIENTS



David J. Kybas

Director of the United States Patent and Trademark Office

Reg. No. 4,203,979 AND ADDITIVES, ANIMAL FEED MEDICATIONS AND INJECTABLES TO TREAT AND PREVENT DISEASE IN ANIMALS, IN CLASS 40 (U.S. CLS. 100, 103 AND 106).

PRIORITY CLAIMED UNDER SEC. 44(D) ON CANADA APPLICATION NO. 1359166, FILED 8-9-2007, REG. NO. TMA810,578, DATED 10-28-2011, EXPIRES 10-28-2026.

OWNER OF U.S. REG. NOS. 999,467 AND 1,642,507.

THE WORDING "VITERRA" HAS NO MEANING IN A FOREIGN LANGUAGE.

SER. NO. 77-256,704, FILED 8-16-2007.

LINDA ESTRADA, EXAMINING ATTORNEY

United States of America

United States Patent and Trademark Office



Reg. No. 4,203,980

Registered Sep. 11, 2012

**Int. Cls.: 9, 16, 28, 35, 36,
38, 41, 42 and 43**

TRADEMARK

SERVICE MARK

PRINCIPAL REGISTER

KABUSHIKI KAISHA SONY COMPUTER ENTERTAINMENT (JAPAN CORPORATION),
DBA SONY COMPUTER ENTERTAINMENT INC.
2-6-21, MINAMI-AOYAMA, MINATO-KU
TOKYO, JAPAN 107-0062

FOR: MOUSE PADS FOR COMPUTERS; MOUSE FOR COMPUTERS; ELECTRONIC CIRCUITS, MAGNETIC DISCS AND MAGNETIC TAPES, ENCODED WITH COMPUTER PROGRAMS FOR ENCRYPTING OR DECRYPTING INFORMATION DATA; INFORMATION PROVING DEVICES, NAMELY, ENCRYPTING AND MICRO PROGRAMMING DEVICES FOR INFORMATION PROCESSING MACHINES, ENCRYPTING AND MICRO PROGRAMMING DEVICES FOR INFORMATION PROCESSING MACHINES, NAMELY, COMPUTER AND VIDEO GAME MACHINES FOR USE WITH TELEVISIONS; STRAPS FOR CELLULAR PHONES; INSTANT CAMERAS WITH FILMS; DOWNLOADABLE COMPUTER PROGRAMS FOR VIDEO GAME MACHINES WITH TELEVISION FOR COMMERCIAL USE; DOWNLOADABLE MUSIC VIA THE INTERNET; DOWNLOADABLE IMAGES, NAMELY, GRAPHICS, FILMS AND ELECTRONIC BOOKS, ALL RELATING TO COMPUTER GAMES AND VIDEO GAMES; DOWNLOADABLE MOVIES IN THE FIELD OF SCIENCE FICTION, DRAMA, AND COMEDY; DOWNLOADABLE ELECTRONIC PUBLICATIONS IN THE NATURE OF BOOKS AND MAGAZINES FEATURING COMPUTER GAMES AND VIDEO GAMES; DOWNLOADABLE VIDEO GAME SOFTWARE; READ-ONLY CARTRIDGE TYPE ELECTRONIC CIRCUITS RECORDED WITH ASSEMBLERS, COMPILERS AND COMPUTER PROGRAMS FOR SOFTWARE DEVELOPMENT AND COMPUTER PROGRAMMING; MAGNETIC DISCS, MAGNETIC TAPES, OPTICAL DISCS, CD-ROMS AND MAGNETIC CARDS ALL FEATURING RECORDED ASSEMBLERS, COMPILERS AND COMPUTER PROGRAMS FOR SOFTWARE DEVELOPMENT AND COMPUTER PROGRAMMING; ENCRYPTION DEVICES USED FOR SCRAMBLING IN TELECOMMUNICATION, NAMELY, COMPUTERS AND COMPUTER PERIPHERALS; ELECTRONIC CIRCUITS, MAGNETIC DISCS, OPTICAL DISCS, MAGNETIC OPTICAL DISCS, CD-ROMS, MAGNETIC TAPES AND DVD-ROMS ENCODED WITH VIDEO GAME PROGRAMS FOR PERSONAL USE; ELECTRONIC CIRCUITS, MAGNETIC DISCS, OPTICAL DISCS, MAGNETIC OPTICAL DISCS, CD-ROMS, MAGNETIC TAPES AND DVD-ROMS ENCODED WITH VIDEO GAME PROGRAMS FOR BUSINESS USE; CONTROLLERS, JOYSTICKS, MEMORY CARDS, VOLUME CONTROLLERS, MOUSE AND KEYBOARDS FOR VIDEO GAME MACHINES FOR USE WITH TELEVISIONS FOR PERSONAL USE; PRE-RECORDED MAGNETIC DISCS, OPTICAL DISCS, MAGNETIC OPTICAL DISCS, CD-ROMS, MAGNETIC TAPES AND DVD-ROMS ENCODED WITH MAGAZINES, BOOKS, NEWSPAPERS, MAPS, PICTURES, IMAGES AND LITERAL INFORMATION ALL FEATURING INFORMATION ABOUT VIDEO GAMES,



David J. Kybas

Director of the United States Patent and Trademark Office

Reg. No. 4,203,980 MUSIC AND VIDEO MOVIES; APPARATUS AND INSTRUMENTS FOR SCIENTIFIC RESEARCH IN LABORATORIES, NAMELY, AIR-GAS PRODUCING UNITS FOR USE IN LABORATORIES, CONSTANT TEMPERATURE INCUBATORS FOR USE IN LABORATORIES; MEASURING APPARATUS BY STANDARD MEASURING UNITS, NAMELY, PRESSURE GAUGES, LEVEL INDICATORS, ACOUSTIC METERS, TACHOMETERS, ACCELEROMETERS; MEASURING APPARATUS BY DERIVED MEASURING UNITS, NAMELY, PRESSURE GAUGES, LEVEL INDICATORS, ACOUSTIC METERS, TACHOMETERS, ACCELEROMETERS; PRECISION MEASURING MACHINES AND INSTRUMENT, NAMELY, ANGLE GAUGES, ANGLE DIVIDING MACHINES, SPHEROMETERS, INCLINOMETERS; MATERIAL TESTING MACHINES AND INSTRUMENTS, NAMELY, COMPRESSION TESTING UNITS FOR METALLIC MATERIALS, HARDNESS TESTING MACHINES FOR METALLIC MATERIALS, STRENGTH TESTING UNITS FOR METALLIC MATERIALS; ASTRONOMIC MEASURING MACHINES AND INSTRUMENTS, NAMELY, MERIDIAN TRANSITS, ASTRONOMICAL SPECTROGRAPHS, TELESCOPES; POWER DISTRIBUTION AND/OR CONTROL APPARATUS, NAMELY, ELECTRIC SWITCHES, ELECTRIC RELAYS, CIRCUITS BREAKERS, POWER CONTROLLERS, CURRENT RECTIFIERS, ELECTRIC CONNECTORS, ELECTRIC CIRCUIT CLOSERS; ELECTRIC CAPACITORS, ELECTRIC RESISTORS, LOCAL SWITCHES, POWER DISTRIBUTING BOXES, SWITCHBOARDS, FUSES FOR ELECTRIC CURRENT, LIGHTNING ARRESTERS, ELECTRIC TRANSFORMERS, INDUCTION VOLTAGE REGULATORS, ELECTRIC REACTORS; ROTARY CONVERTERS; PHASE MODIFIERS; DRY CELLS; WET CELLS; ELECTRIC ACCUMULATORS AND BATTERIES; PHOTOVOLTAIC CELLS; ELECTRIC MAGNETIC METERS AND AMPERAGE TESTERS; ELECTRIC WIRES; ELECTRIC CABLES. PHOTOGRAPHIC APPARATUS AND INSTRUMENTS, NAMELY, TILTING HEADS FOR CAMERAS, CAMERAS, RANGE FINDERS FOR CAMERAS, PHOTO-DEVELOPING, PRINTING, ENLARGING AND FINISHING UNITS, TRIPODS FOR CAMERAS, SHUTTERS FOR CAMERAS; CINEMATOGRAPHIC APPARATUS AND INSTRUMENTS; TELESCOPES; MICROSCOPES; EYEGLASSES AND SKI GOGGLES; PARTS AND ACCESSORIES FOR EYEGLASSES AND GOGGLES, NAMELY, CONTAINERS FOR CONTACT LENSES, SPECTACLE TEMPLES, PINCE-NEZ FRAMES, PINCE-NEZ CHAINS, PINCE-NEZ CORDS, SPECTACLE CASES, SPECTACLE WIPES, SPECTACLE GLASSES, SPECTACLE FRAMES; OPTICAL GLASSES; LIFE NETS; LIFE BELTS; LIFE JACKETS; LIFE-BUOYS; TELEPHONE APPARATUS, NAMELY, INTERCOMS, AUTOMATIC SWITCHING APPARATUS FOR TELECOMMUNICATION, MANUAL SWITCHING APPARATUS FOR TELECOMMUNICATION, TELEPHONE SETS; WIRE COMMUNICATION APPARATUS, NAMELY, TELETYPEWRITERS, AUTOMATIC TELEGRAPH UNITS, PHOTO TELEGRAPHY UNITS; FREQUENCY-CARRIER APPARATUS, NAMELY, AUDIO FREQUENCY TRANSMISSION GENERATORS, CABLE-TYPE FREQUENCY-CARRIER GENERATORS, POWER-LINE-TYPE FREQUENCY-CARRIER GENERATORS, OPEN-WIRE-TYPE FREQUENCY-CARRIER GENERATORS, CARRIER-FREQUENCY REPEATERS; BROADCASTING APPARATUS, NAMELY, TELEVISION RECEIVERS, TELEVISION TRANSMITTERS, RADIO RECEIVERS AND RADIO TRANSMITTERS, RADIO COMMUNICATION APPARATUS, NAMELY, AERONAUTICAL RADIO COMMUNICATION MACHINES AND APPARATUS, MARINE RADIO COMMUNICATION MACHINES AND APPARATUS AND SINGLE-CHANNEL RADIO COMMUNICATION MACHINES AND APPARATUS FOR FIXED STATIONS; RADIO APPLICATION APPARATUS, NAMELY, RADIO BEACON UNITS, RADIO DIRECTION FINDERS, RADARS, LORAN NAVIGATION UNITS; REMOTE CONTROL APPARATUS, NAMELY, REMOTE CONTROL TELEMETERING APPARATUS; AUDIO FREQUENCY APPARATUS, NAMELY, PUBLIC-ADDRESS SYSTEMS, JUKE BOXES, TAPE RECORDERS, ELECTRIC PHONOGRAPHS, RECORD PLAYERS, VIDEOTAPE RECORDERS; VIDEO FREQUENCY APPARATUS, NAMELY, VIDEO CAMERAS, VIDEODISC PLAYERS, VIDEOTAPE RECORDERS; PARTS AND ACCESSORIES FOR ELECTRIC COMMUNICATION APPARATUS AND INSTRUMENTS, NAMELY, ANTENNAS, HEADPHONES, MICROPHONES AND BLANK VIDEO TAPES; PHONOGRAPH RECORDS FEATURING MUSIC; METRONOMES; RECORDED COMPACT DISCS FEATURING MUSIC; COMPUTERS; ELECTRON MICROSCOPES; ELECTRONIC DESK CALCULATORS; WORD PROCESSORS; PHOTO-SENSITIVE TUBES FOR LABORATORY USE; VACUUM TUBES; RECTIFIER TUBES; CATHODE RAY TUBES; THERMISTORS; DIODES; TRANSISTORS; ELECTRON TUBES; SEMI-CONDUCTOR DEVICES. INTEGRATED CIRCUITS; LARGE SCALE INTEGRATED CIRCUITS; ELECTRIC

Reg. No. 4,203,980 FLAT IRONS FOR HOUSEHOLD USE; ELECTRIC HAIR-CURLERS FOR HOUSEHOLD USE; ELECTRIC BUZZERS FOR HOUSEHOLD USE; EXPOSED CINEMATOGRAPHIC FILMS; EXPOSED SLIDE FILMS; PHOTOGRAPHIC SLIDE TRANSPARENCIES; SLIDE FILM MOUNTS; PRERECORDED VIDEO DISCS AND TAPES FEATURING VIDEO GAMES, MOVIES, AND MUSIC; VENDING MACHINES; VIDEO GAME MACHINES FOR USE WITH TELEVISION FOR PERSONAL USE, IN CLASS 9 (U.S. CLS. 21, 23, 26, 36 AND 38).

FOR: ADDRESS PLATES FOR ADDRESSING MACHINES; ADDRESS STAMPS; ADDRESSING MACHINES; ADHESIVE BANDS FOR STATIONERY OR HOUSEHOLD PURPOSES; ADHESIVE TAPES FOR STATIONERY OR HOUSEHOLD PURPOSES; ADVERTISEMENT BOARDS OF PAPER OR CARDBOARD; ALBUMS FOR STICKERS, COINS, AND PHOTOGRAPHS; ALMANACS; ARCHITECTS' MODELS; PRINTED ARITHMETICAL TABLES; ATLASES; BALLS FOR BALL-POINT PENS; BIBS OF PAPER; BLACKBOARDS; BLOTTERS; BLUEPRINTS; BOOKBINDING CLOTH; BOOKBINDING CORDS; BOOKBINDING MATERIALS; BOOK BINDINGS; BOOKENDS; BOOKLETS ABOUT VIDEO GAME MACHINES AND VIDEO GAME SOFTWARE; BOOKMARKERS; BOOKS ABOUT VIDEO GAME MACHINES AND VIDEO GAME SOFTWARE; BOTTLE ENVELOPES OF CARDBOARD OR PAPER; BOTTLE WRAPPERS OF CARDBOARD OR PAPER; BOXES FOR PENS; BOXES OF CARDBOARD OR PAPER; PRINTED CALCULATING TABLES; CALENDARS; CANVAS FOR PAINTING; CARBON PAPER; CARDBOARD; CARDBOARD ARTICLES, NAMELY, CARDBOARD BOXES; CARDBOARD TUBES; CARDS, NAMELY, INDEX CARDS, GREETING CARDS; PRINTED CATALOGUES IN THE FIELD OF VIDEO GAMES USED WITH TELEVISION AND VIDEO GAME SOFTWARE; CHALK FOR LITHOGRAPHY; CHALK HOLDERS; CHAPLETS; CHARCOAL PENCILS; PRINTED CHARTS; CHROMOS, NAMELY, CHROMOLITHOGRAPHS; PAPER CLIPS FOR OFFICES; CLOTH FOR BOOKBINDING; COASTERS OF PAPER; COMIC BOOKS; COMPASSES FOR DRAWING; CORDS FOR BOOKBINDING; COVERS OF PAPER FOR FLOWER POTS; CREAM CONTAINERS OF PAPER; DECALCOMANIAS; DRAWING T-SQUARES; DRAWING BOARDS; DRAWING INSTRUMENTS; DRAWING PADS; DRAWING PENS; DRAWING PUSH PINS; DRAWING SQUARES; ROTARY DUPLICATORS; ELASTIC BANDS FOR OFFICES; ELECTROCARDIOGRAPH PAPER; ELECTROTYPES; ENGRAVING PLATES; ENGRAVINGS; ENVELOPE SEALING MACHINES, FOR OFFICES; ERASING PRODUCTS, NAMELY, ERASERS, INK ERASERS, AND CORRECTING FLUID FOR TYPE; ERASING SHIELDS; ETCHING NEEDLES; ETCHINGS; FABRICS FOR BOOKBINDING; FACE TOWELS OF PAPER; FILTER PAPER; FLOWER-POT COVERS OF PAPER; FOLDERS FOR PAPERS; FOUNTAIN PENS. FRENCH DRAWING CURVES; GEOGRAPHICAL MAPS; GLUE FOR STATIONERY OR HOUSEHOLD PURPOSES; PAINTING INSTRUMENTS, NAMELY, GRAINING COMBS; GRAPHIC PRINTS; GRAPHIC REPRESENTATIONS; GRAPHIC REPRODUCTIONS; GREETING CARDS; GUMMED CLOTH FOR STATIONERY PURPOSES; HAND-RESTS FOR PAINTERS; HANDKERCHIEFS OF PAPER; PRINTED HANDWRITING SPECIMENS FOR COPYING; HAT BOXES OF CARDBOARD; HECTOGRAPHS; PRINTED HISTOLOGICAL SECTIONS REPRODUCTIONS FOR TEACHING PURPOSES; HOUSE PAINTERS' PAINT ROLLERS; HYGIENIC PAPER; TELEPHONE INDEXES; INDIAN INKS; INDIA INKS; INK STICKS; INKING PADS; INKING RIBBONS; INKING RIBBONS FOR COMPUTER PRINTERS; INKING SHEETS FOR DOCUMENT REPRODUCING MACHINES; INKING SHEETS FOR DUPLICATORS; INKSTANDS; INKWELLS; ISINGLASS PASTE FOR STATIONERY OR HOUSEHOLD PURPOSES; JACKETS FOR PAPERS, NAMELY, PAPER FILE JACKETS; PAPER LABELS; LETTER TRAYS; LITHOGRAPHIC STONES; LITHOGRAPHIC WORKS OF ART; LITHOGRAPHS; LOOSE-LEAF BINDERS; LUMINOUS PAPER; MARKING CHALK; PAPER MATS FOR BEER GLASSES; MIMEOGRAPH MACHINES; MODELING CLAY; MODELING MATERIALS FOR USE BY CHILDREN; MODELING PASTE; MODELING WAX, NOT FOR DENTAL PURPOSES; MUSICAL GREETING CARDS; NAPKINS OF PAPER FOR REMOVING MAKE-UP; NEWSLETTERS ABOUT VIDEO GAME MACHINES USED WITH TELEVISIONS AND VIDEO GAME SOFTWARE; NEWSPAPERS; PEN NIBS; PEN NIBS OF GOLD; NOTE BOOKS; NUMBERING MACHINES; OFFICE PERFORATORS; OFFICE REQUISITES, EXCEPT FURNITURE, NAMELY, ENVELOPE SEALING MACHINES; OLEOGRAPHS; PACKING PAPER; PAINTBRUSHES; PAINTERS' EASELS; PALETTES FOR PAINTERS; PRINTED PAMPHLETS IN THE FIELD OF VIDEO GAMES USED WITH TELEVISION AND VIDEO

Reg. No. 4,203,980 GAME SOFTWARE; PAPER CLASPS; PAPER FOR RECORDING MACHINES; PAPER RIBBONS; PAPER TAPES AND CARDS FOR THE RECORDING OF COMPUTER PROGRAMS; PAPER-CLIPS; PAPERWEIGHTS; PAPER MACHE; PARCHMENT PAPER; PASSPORT HOLDERS; PASTES FOR STATIONERY OR HOUSEHOLD PURPOSES; PRINTED PATTERNS FOR DRESSMAKING; PRINTED PATTERNS FOR MAKING CLOTHES. PEN CASES; PEN CLIPS; CELLULOSE PEN WIPERS; PENCIL HOLDERS; PENCIL LEAD HOLDERS; PENCIL LEADS; PENCIL SHARPENERS; PENCIL SHARPENING MACHINES; PENCILS; PENHOLDERS; PERFORATED CARDS FOR JACQUARD LOOMS; PRINTED PERIODICALS IN THE FIELD OF VIDEO GAMES, MUSIC, MOVIES, AND PLAYS; PHOTO-ENGRAVINGS; PHOTOGRAPH STANDS; PHOTOGRAPHS; PICTURES; PLACARDS OF PAPER OR CARDBOARD; PLACE MATS OF PAPER; PRINTED PLANS; PLASTIC FILM FOR WRAPPING FOOD FOR HOUSEHOLD USE; PLASTICS FOR MODELING; PORTRAITS; POSTAGE STAMPS; PRINTED HIDING-CHARTS FOR IDENTIFYING HIDING POWER OF PAINT, IN CLASS 16 (U.S. CLS. 2, 5, 22, 23, 29, 37, 38 AND 50).

FOR: ARCHERY IMPLEMENTS, NAMELY, BOWSTRINGS, ARCHERY GLOVES, TARGETS FOR ARCHERY, ARROWS FOR ARCHERY, QUIVERS FOR ARCHERY, BOWS FOR JAPANESE ARCHERY, BOWS FOR ARCHERY; BACKGAMMON GAME SETS; BALLS FOR GAMES; BAR-BELLS; BASEBALL GLOVES; BATS FOR GAMES; BELLS FOR CHRISTMAS TREES; BILLIARD BALLS; BILLIARD CUE TIPS; BILLIARD CUES; BILLIARD MARKERS; BILLIARD TABLE CUSHIONS; BILLIARD TABLES; BLADDERS OF BALLS FOR GAMES; BOARD GAMES; BOB-SLEIGHS; BODY-BUILDING APPARATUS; BODY-TRAINING APPARATUS; BOWLING APPARATUS AND MACHINERY; BOXING GLOVES; BUILDING GAMES; CANDLE HOLDERS FOR CHRISTMAS TREES; CHALK FOR BILLIARD CUES; CHECKERBOARDS; CHESS GAMES; CHESSBOARDS; CHRISTMAS TREE STANDS; CHRISTMAS TREES OF SYNTHETIC MATERIAL; CLAY PIGEON TRAPS; CLIMBERS' HARNESSES; COIN-OPERATED BILLIARD TABLES; CONJURING APPARATUS, NAMELY, MAGIC TRICKS; BAGS SPECIALLY ADAPTED FOR SPORTS EQUIPMENT, NAMELY, CRICKET BAGS; CUPS FOR DICE; DARTS; DECOYS FOR HUNTING OR FISHING; DICE; DISCUSES FOR SPORTS; DOLLS; DOLLS' BEDS; DOLLS' CLOTHES; DOLLS' FEEDING BOTTLES; DOLL'S HOUSES; DOLLS' ROOMS; DOMINOES; DRAUGHT BOARDS; DUMB-BELLS; EDGES OF SKIS; FENCING GAUNTLETS; FENCING MASKS; FENCING WEAPONS; FISH HOOKS; FISHING TACKLE; FLIPPERS FOR SWIMMING; FLOATS FOR FISHING; FOILS FOR FENCING; GLOVES FOR GAMES, NAMELY, BASEBALL GLOVES; GOLF BAGS WITH OR WITHOUT WHEELS; GOLF CLUBS; GOLF GLOVES; GUT FOR FISHING; GUT FOR RACKETS; HAND-HELD GAME WITH LIQUID CRYSTAL DISPLAY; HAND HELD UNIT FOR PLAYING ELECTRONIC GAMES; HANG GLIDERS; HOCKEY STICKS; HORSESHOE GAMES; ICE SKATES; KITE REELS; KITES; LANDING NETS FOR ANGLERS; LINES FOR FISHING; LURES FOR HUNTING OR FISHING; MAHJONG; MARBLES FOR GAMES; MARIONETTES; NETS FOR SPORTS; NINEPINS; PARAGLIDERS; PARLOR GAMES; PLAY BALLOONS; PLAY BALLS; PLAYING CARDS; PLUSH TOYS; PUPPETS; QUILTS; RACKETS. REELS FOR FISHING; RING GAMES; ROCKING HORSES; RODS FOR FISHING; ROLLER SKATES; ROLLERS FOR STATIONARY EXERCISE BICYCLES; SAILBOARDS; SCALE MODEL VEHICLES; SCRAPERS FOR SKIS; SHUTTLECOCKS; SKATEBOARDS; SKATING BOOTS WITH SKATES ATTACHED, SKI BINDINGS; SKIS; SKITTLES; SOLE COVERINGS FOR SKIS; STATIONARY EXERCISE BICYCLES; STRINGS FOR RACKETS; SURF BOARDS; SURF SKIS; SWINGS; TABLES FOR INDOOR FOOTBALL; TABLES FOR TABLE TENNIS; TARGETS; TEDDY BEARS; TENNIS NETS; THEATRICAL MASKS; TOY MASKS; TOY PISTOLS; TOY VEHICLES; TOY ACTION FIGURES; TOYS FOR DOMESTIC PETS; TWIRLING BATONS; WATERSKIS; WAX FOR SKIS; CONFETTI, IN CLASS 28 (U.S. CLS. 22, 23, 38 AND 50).

FOR: BUSINESS ADMINISTRATION CONSULTANCY; AUTOMATED DATA PROCESSING; COMPUTER DATA PROCESSING; COMPUTERIZED BUSINESS INFORMATION PROCESSING SERVICES, NAMELY, COLLECTION, PREPARATION, COMPOSITION, PROCESSING, ACQUISITION AND PROVISION OF BUSINESS INFORMATION, DATA, STATISTICS AND INDICES; COMPUTERIZED DATA PROCESSING SERVICES; DATA PROCESSING SERVICES; DATA PROCESSING SERVICES FOR BUSINESSES; DATA PRO-

Reg. No. 4,203,980 CESSING FOR THE COLLECTION OF DATA FOR BUSINESS PURPOSES; ELECTRONIC DATA PROCESSING SERVICES; INFORMATION SERVICES RELATING TO DATA PROCESSING; ON-LINE DATA PROCESSING SERVICES, NAMELY, DATA PROCESSING SALES AND PROMOTIONAL DATA AND PREPARING BUSINESS REPORTS FEATURING SUCH SALES AND PROMOTIONAL DATA FOR EVALUATING CONSUMER RESPONSE TO PROMOTIONAL ACTIVITY IN THE CONSUMER GOODS INDUSTRY, AND PROVIDING AN ON-LINE COMPUTER DATABASE IN THE FIELD OF BUSINESS REPORTS FEATURING SALES AND PROMOTIONAL DATA FOR EVALUATING CONSUMER RESPONSE TO PROMOTIONAL ACTIVITY IN THE CONSUMER GOODS INDUSTRY; ADMINISTRATION OF THE BUSINESS AFFAIRS OF RETAIL STORES OF OTHERS; COMPUTERIZED POINT-OF-SALE DATA COLLECTION SERVICES FOR RETAILERS; MANAGEMENT OF A RETAIL ENTERPRISE FOR OTHERS; THE BRINGING TOGETHER, FOR THE BENEFIT OF OTHERS, OF A VARIETY OF GOODS, ENABLING CUSTOMERS TO CONVENIENTLY VIEW AND PURCHASE THOSE GOODS IN THE FIELD OF RETAIL ELECTRICAL GOODS; ONLINE RETAIL STORE SERVICES FEATURING GENERAL CONSUMER MERCHANDISE AND A WIDE VARIETY OF CONSUMER GOODS OF OTHERS; RETAIL STORE SERVICES FEATURING DOMESTIC VIDEO GAME MACHINES; ACCOUNTING SERVICES; ADVERTISING SERVICES; ADVERTISING AGENCIES; ADVERTISING BY MAIL ORDER, NAMELY, DIRECT MAIL ADVERTISING; AUCTIONEERING; ACCOUNT AUDITING; ADVERTISING BY BILL-POSTING; BOOK-KEEPING; BUSINESS APPRAISALS; BUSINESS INFORMATION SERVICES; BUSINESS INQUIRIES; BUSINESS INVESTIGATIONS; BUSINESS MANAGEMENT AND ORGANIZATION CONSULTANCY; BUSINESS MANAGEMENT ASSISTANCE; BUSINESS MANAGEMENT CONSULTANCY; BUSINESS MANAGEMENT OF HOTELS FOR OTHERS. BUSINESS MANAGEMENT FOR PERFORMING ARTISTS; BUSINESS ORGANIZATION CONSULTANCY; BUSINESS RESEARCH; COMMERCIAL INFORMATION AGENCIES; COMMERCIAL AND INDUSTRIAL MANAGEMENT ASSISTANCE; COMPILATION OF INFORMATION INTO COMPUTER DATABASES; COMPUTERIZED ON-LINE ORDERING SERVICES IN THE FIELD OF VIDEO GAME MACHINES FOR USE WITH TELEVISION RECEIVER ONLY AND SOFTWARE THEREOF; COST PRICE ANALYSIS; DEMONSTRATION OF GOODS FOR OTHERS FOR ADVERTISING PURPOSE; DIRECT MAIL ADVERTISING; DISSEMINATION OF ADVERTISING MATTER; DISTRIBUTION OF SAMPLES; DOCUMENT REPRODUCTION; ECONOMIC FORECASTING; EFFICIENCY EXPERTS; EMPLOYMENT AGENCIES; EVALUATION OF STANDING TIMBER; EVALUATION OF WOOL; IMPORT-EXPORT AGENCIES; LOCATION OF FREIGHT CARS BY COMPUTER; MARKETING RESEARCH; MARKETING STUDIES; MODELING FOR ADVERTISING OR SALES PROMOTION; OFFICE MACHINES AND EQUIPMENT RENTAL; PUBLIC OPINION POLLING; ORGANIZATION OF EXHIBITIONS FOR COMMERCIAL OR ADVERTISING PURPOSES; ARRANGING AND CONDUCTING TRADE FAIRS FOR COMMERCIAL OR ADVERTISING PURPOSES; PREPARING AND PLACING OUTDOOR ADVERTISING FOR OTHERS; PAYROLL PREPARATION; PERSONNEL MANAGEMENT CONSULTANCY; PERSONNEL RECRUITMENT; PHOTOCOPYING; PROVIDING INFORMATION SERVICES ABOUT NEW PRODUCTS, NAMELY, MAGAZINES, VIDEO GAMES AND VIDEOS; PUBLIC RELATIONS; PUBLICATION OF PUBLICITY TEXTS; PUBLICITY CONSULTATION; PUBLICITY AGENTS; WRITING OF PUBLICITY COLUMNS; RENTAL OF PUBLICITY MATERIALS; RADIO ADVERTISING, NAMELY, PRODUCTION AND DISTRIBUTION OF RADIO COMMERCIALS; PRODUCTION AND DISTRIBUTION OF RADIO COMMERCIALS; RELOCATION SERVICES FOR BUSINESSES; RENTAL OF ADVERTISING SPACE; RENTAL OF PHOTOCOPYING MACHINES; RETAIL STORE SERVICES AND ON-LINE RETAIL STORE SERVICES FEATURING VIDEO GAME MACHINES AND VIDEO GAME SOFTWARE; SECRETARIAL SERVICES; SHOP WINDOW DRESSING; SHORTHAND SERVICES; PROVIDING STATISTICAL INFORMATION; SYSTEMIZATION OF INFORMATION INTO COMPUTER DATABASES; TAX PREPARATION; TELEVISION ADVERTISING AGENCIES; PRODUCTION OF TELEVISION COMMERCIALS; STENOGRAPHIC TRANSCRIPTION; TYPING; UPDATING OF ADVERTISING MATERIAL. PROVIDING BUSINESS INFORMATION IN THE NATURE OF VALUATION OF STANDING TIMBER; WORD PROCESSING; CLEARANCE AGENCY SERVICES, NAMELY, MONEY ACCOUNTING SERVICES VIA COMPUTER NETWORKS, IN CLASS 35 (U.S. CLS. 100, 101 AND 102).

Reg. No. 4,203,980 FOR: ACCIDENT INSURANCE UNDERWRITING; ACCOMMODATION BUREAU, NAMELY, LEASING OF APARTMENTS; ACTUARIAL SERVICES; FINANCIAL ANALYSIS; ANTIQUE APPRAISAL; APARTMENT HOUSE MANAGEMENT; ART APPRAISAL; BAIL-BONDING; BANKING; CAPITAL INVESTMENT; CHARITABLE FUND RAISING; CHECK VERIFICATION; CLEARANCE AGENCY SERVICES, NAMELY, MONEY EXCHANGE AND MONEY COLLECTION VIA COMPUTER NETWORKS; CREDIT BUREAU; CREDIT CARD SERVICES; CUSTOMS BROKERAGE; DEBIT CARD SERVICES; DEBT COLLECTION AGENCIES; DEPOSITS OF VALUABLES, NAMELY, SAFE DEPOSIT BOX SERVICES; ELECTRONIC FUNDS TRANSFER; ELECTRONIC TOLL COLLECTION SERVICES; ELECTRONIC COMMERCE PAYMENT SERVICES, NAMELY, ESTABLISHING FUNDED ACCOUNTS USED TO PURCHASE GOODS AND SERVICES ON THE INTERNET; EXCHANGING MONEY; FACTORING; FIDUCIARY REPRESENTATIVES; FINANCIAL CONSULTANCY; FINANCIAL EVALUATION OF INSURANCE BANKING AND REAL ESTATE; FINANCIAL INFORMATION; FINANCIAL MANAGEMENT; FINANCIAL SPONSORSHIP, NAMELY, THE FUNDING OF SPORT EVENTS, CULTURAL EXHIBITIONS AND EVENTS, FESTIVALS, ART EXHIBITIONS, ART FOUNDATIONS, HEALTH RESEARCH, AND HUMANITARIAN ACTIONS FOR ADVERTISING AND COMMERCIAL PURPOSES; FINANCING SERVICES; FIRE INSURANCE UNDERWRITING; FISCAL ASSESSMENTS; FUND INVESTMENTS; MONEY ORDER PAYMENT GUARANTEE SERVICES; HEALTH INSURANCE UNDERWRITING; HIRE-PURCHASE FINANCING; HOME BANKING; HOUSING AGENTS; INSURANCE OF CHARGE FOR GOODS AND SERVICES THROUGH THE INTERNET; INSTALLMENT LOANS; INSURANCE BROKERAGE; INSURANCE CONSULTANCY; PROVIDING INSURANCE INFORMATION; INSURANCE UNDERWRITING FOR ALL TYPE INSURANCE; ISSUANCE OF CREDIT CARDS; ISSUE OF TOKENS OF VALUE; ISSUING OF TRAVELERS' CHECKS; LEASE-PURCHASE FINANCING; LEASING OF FARMS; LEASING OF REAL ESTATE; LENDING AGAINST SECURITY; LIFE INSURANCE UNDERWRITING; LOAN FINANCING; MARINE INSURANCE UNDERWRITING; MORTGAGE BANKING; MUTUAL FUNDS; NUMISMATIC APPRAISAL; ORGANIZATION OF COLLECTIONS, NAMELY, COLLECTION AGENCIES; PAWN BROKERAGE; REAL ESTATE AGENCIES; REAL ESTATE APPRAISAL; REAL ESTATE BROKERS; REAL ESTATE MANAGEMENT; RENT COLLECTION; RENTAL OF OFFICES; RENTING OF APARTMENTS. RENTING OF FLATS; RETIREMENT PAYMENT SERVICES; SAFE DEPOSIT SERVICES; SAVINGS BANKS; SECURITIES BROKERAGE; STAMP APPRAISAL; STOCK EXCHANGE QUOTATIONS; STOCKS AND BONDS BROKERAGE; SURETY SERVICES; TRUSTEESHIP, IN CLASS 36 (U.S. CLS. 100, 101 AND 102).

FOR: BROADCASTING SERVICES AND PROVISION OF TELECOMMUNICATION ACCESS TO FILMS AND VIDEO PROGRAMS PROVIDED VIA A VIDEO-ON-DEMAND SERVICE; CABLE TELEVISION BROADCASTING; CELLULAR TELEPHONE COMMUNICATION; COMMUNICATIONS BY COMPUTER TERMINALS; COMMUNICATIONS BY TELEGRAMS; COMMUNICATIONS BY TELEPHONE; COMPUTER AIDED TRANSMISSION OF MESSAGES AND IMAGES; ELECTRONIC MAIL; ELECTRONIC BULLETIN BOARD SERVICES; FACSIMILE TRANSMISSION; PROVIDING INFORMATION ABOUT TELECOMMUNICATION; MESSAGE SENDING BY ELECTRONIC MAIL; NEWS AGENCIES, NAMELY, THE TRANSMISSION OF NEWS ITEMS TO NEWS REPORTING ORGANIZATIONS; PROVIDING TELECOMMUNICATIONS CONNECTIONS TO A GLOBAL COMPUTER NETWORK; PROVIDING USER ACCESS TO A GLOBAL COMPUTER NETWORK; RADIO BROADCASTING; RENTAL OF FACSIMILE APPARATUS; RENTAL OF MESSAGE SENDING APPARATUS, NAMELY, TELETEXT MACHINES; RENTAL OF MODEMS; RENTAL OF TELECOMMUNICATION EQUIPMENT; RENTAL OF TELEPHONES; SATELLITE TRANSMISSION SERVICES; SENDING OF TELEGRAMS; TELECOMMUNICATION ROUTING AND JUNCTION SERVICES; TELECONFERENCING SERVICES; TELEGRAPH SERVICES; TELEPHONE SERVICES; TELEVISION BROADCASTING; TELEVISION BROADCASTING SERVICES PROVIDED ON-LINE FROM A COMPUTER NETWORK; SERVICES OF A COMMUNICATIONS SYSTEM CONSISTING OF TELETYPEWRITERS CONNECTED TO A TELEPHONIC NETWORK TO SEND AND RECEIVE SIGNALS; TRANSMISSION OF TELEGRAMS; VIDEO ON DEMAND TRANSMISSION SERVICES; WIRE SERVICE; PROVIDING ON-LINE ELECTRONIC BULLETIN BOARDS FOR TRANSMISSION OF MESSAGES AMONG COMPUTER

Reg. No. 4,203,980 USERS CONCERNING VIDEO GAMES; PROVIDING ACCESS TO ELECTRONIC BULLETIN BOARDS VIA TELECOMMUNICATIONS NETWORKS; ELECTRONIC MAIL SERVICES, IN CLASS 38 (U.S. CLS. 100, 101 AND 104).

FOR: AMUSEMENT PARKS; AMUSEMENTS, NAMELY, PROVIDING FACILITIES FOR A HAUNTED HOUSE ATTRACTION; ANIMAL TRAINING; ARRANGING AND CONDUCTING OF COLLOQUIUMS IN THE FIELD OF COMPUTER AND VIDEO GAMES; ARRANGING AND CONDUCTING OF EDUCATIONAL CONFERENCES IN THE FIELD OF COMPUTER AND VIDEO GAMES; ARRANGING AND CONDUCTING OF CONGRESSES IN THE FIELD OF COMPUTER AND VIDEO GAMES; ARRANGING AND CONDUCTING OF SEMINARS IN THE FIELD OF COMPUTER AND VIDEO GAMES; ARRANGING AND CONDUCTING OF SYMPOSIUMS IN THE FIELD OF COMPUTER AND VIDEO GAMES; ARRANGING OF BEAUTY CONTESTS; BOARDING SCHOOLS; BOOKING OF SEATS FOR SHOWS; BOOK-MOBILE SERVICES; CIRCUSES; EDUCATION IN THE FIELD OF COMPUTER, MUSIC, AND VIDEO GAMES RENDERED THROUGH CORRESPONDENCE COURSES; DISCOTHEQUE SERVICES, NAMELY, OPERATING DISCOTHEQUES; DUBBING; PROVIDING INFORMATION ABOUT EDUCATION; EDUCATIONAL EXAMINATION SERVICES; EDUCATIONAL SERVICES, NAMELY, CONDUCTING ON-LINE EXHIBITIONS AND DISPLAYS AND INTERACTIVE EXHIBITS IN THE FIELD OF VIDEO GAME; ENTERTAINMENT SERVICES, NAMELY, PROVIDING ON-LINE COMPUTER GAMES; PROVIDING INFORMATION ABOUT ENTERTAINMENT; FILM PRODUCTION; GYMNASIIC INSTRUCTION; HEALTH CLUB SERVICES, NAMELY, PROVIDING EQUIPMENT AND INSTRUCTION IN THE FIELD OF PHYSICAL FITNESS; PROVIDING FITNESS AND EXERCISE FACILITIES, GOLF COURSES, TENNIS COURTS, HORSEBACK RIDING FACILITIES, COURSES OF INSTRUCTION AT THE KINDERGARTEN LEVEL, CINEMA THEATRE FACILITIES, DISCOTHEQUES, MUSEUMS; LENDING LIBRARIES; MOBILE LIBRARY SERVICES; MODELING FOR ARTISTS; MOVIE STUDIOS; MUSIC-HALLS; NURSERY SCHOOLS; OPERATING LOTTERIES; ORCHESTRA SERVICES; ORGANIZATION OF BALLS; ORGANIZATION OF EXHIBITIONS FOR CULTURAL OR EDUCATIONAL PURPOSES; ORGANIZATION OF SPORTS COMPETITIONS; PHYSICAL EDUCATION; PRODUCTION OF RADIO AND TELEVISION PROGRAMS; PRODUCTION OF TELEVISION SHOWS; PROVIDING AMUSEMENT ARCADE SERVICES; PROVIDING SPORTS FACILITIES; PUBLICATION OF BOOKS. PUBLICATION OF ELECTRONIC BOOKS AND JOURNALS ON-LINE FROM A COMPUTER NETWORK; RADIO ENTERTAINMENT, NAMELY, PRODUCTION OF RADIO PROGRAMS; RECORDING STUDIO SERVICES; PROVIDING INFORMATION ON RECREATIONAL ACTIVITIES, NAMELY, FESTIVALS, FAIRS, CONCERTS, WATER PARKS, THEME PARKS, AND LOCATIONS FOR BOATING, FISHING, CANOEING, SNORKELING, SWIMMING, WATER SKIING, SNOW SKIING, SNOWBOARDING, ICE SKATING, SNOW-SHOEING, AND SLEDDING; RENTAL OF AUDIO EQUIPMENT; RENTAL OF CAMCORDERS; RENTAL OF CINE-FILMS; RENTAL OF LIGHTING APPARATUS FOR THEATRICAL SETS OR TELEVISION STUDIOS; RENTAL OF MOTION PICTURES; RENTAL OF MOVIE PROJECTORS AND ACCESSORIES; RENTAL OF RADIO AND TELEVISION SETS; RENTAL OF SHOW SCENERY; RENTAL OF SKIN DIVING EQUIPMENT; RENTAL OF SOUND RECORDINGS; RENTAL OF STADIUM FACILITIES; RENTAL OF STAGE SCENERY; RENTAL OF TENNIS COURTS; RENTAL OF VIDEO CAMERAS; RENTAL OF VIDEO CASSETTE RECORDERS; RENTAL OF VIDEOTAPES; SCRIPTWRITING SERVICES; SPORT CAMP SERVICES; TEACHING IN THE FIELD OF MUSIC, VIDEO GAMES; ENTERTAINMENT, NAMELY, TELEVISION PROGRAMS IN THE FIELD OF NEWS, VARIETY SHOWS, MUSIC AND MOVIE; ENTERTAINMENT IN THE NATURE OF THEATRE PRODUCTIONS; TIMING OF SPORTS EVENTS; TUITION SERVICES, NAMELY, PROVIDING INSTRUCTIONAL CLASSES IN THE FIELD OF INFORMATION TECHNOLOGY; EDUCATION SERVICES, NAMELY, PROVIDING CLASSES, SEMINARS, WORKSHOPS IN THE FIELD OF TUITION VIDEO TAPE EDITING; VIDEO TAPE FILM PRODUCTION; ZOOLOGICAL GARDENS; PROVIDING INFORMATION ONLINE ABOUT COMPUTER GAMES AND COMPUTER GAME PROGRAMS; PUBLICATION SERVICES, NAMELY, MAKING MANUALS FOR VIDEO GAME PROGRAMS FOR VIDEO GAME MACHINES WITH TELEVISIONS FOR PERSONAL USE; RENTAL AND LEASING OF MAGNETIC TAPES ENCODED WITH SYSTEM

Reg. No. 4,203,980 PROGRAMS FOR VIDEO GAME MACHINES WITH TELEVISIONS FOR COMPUTER SYSTEM SECURITY, IN CLASS 41 (U.S. CLS. 100, 101 AND 107).

FOR: ENCRYPTION OF INFORMATION AVAILABLE ON A COMPUTER; PLANNING, DEVELOPING AND MAINTAINING COMPUTER SYSTEM PROGRAMS FOR OTHERS FOR DATA SECURITY AVAILABLE ON A COMPUTER; ENCRYPTION OF COMPUTER DATA IN RELATION TO ELECTRONICALLY TRANSMITTED INFORMATION ON A GLOBAL COMMUNICATION NETWORK; PROVIDING ELECTRONIC VERIFICATION OF ONLINE ORDERS OF DIGITAL CONTENT AND GENERATING ELECTRONIC PERMISSION CODES WHICH THEN ALLOW USERS TO ACCESS SAID DIGITAL CONTENT ONLINE; CONDUCTING COMPUTER SEARCHES OF DATABASES ABOUT NEWS ARTICLES FOR OTHERS; COMPUTER AIDED GRAPHIC DESIGN; DESIGNING AND DEVELOPING COMPUTER GRAPHICS PROGRAMS FOR OTHERS; ESTABLISHING AND MANAGING INTERNET WEB SITES FOR OTHERS; ESTABLISHING AND MAINTAINING INTERNET WEBSITES FOR OTHERS; PREPARATION OF TECHNICAL CALCULATIONS BY COMPUTER FOR OTHERS IN THE FIELD OF COMPUTER PROGRAMMING; COMPUTER SERVICES, NAMELY, MAINTAINING AND MANAGING ELECTRONIC MAIL SERVERS FOR OTHERS; CONVERSION OF DATA OR DOCUMENTS FROM PHYSICAL TO ELECTRONIC MEDIA; DATA CONVERSION OF COMPUTER PROGRAMS AND DATA, NOT PHYSICAL CONVERSION; PROFESSIONAL CONSULTANCY REGARDING THE SELECTION OF COMPUTER SYSTEMS; PROFESSIONAL CONSULTANCY REGARDING DESIGNING COMPUTER SYSTEMS; DEVELOPING COMPUTER SYSTEMS FOR OTHERS; DEVELOPING SOFTWARE FOR VIDEO GAME MACHINES; PROVIDING ELECTRONIC VERIFICATION OF ON-LINE USERS OF ELECTRONIC MAIL AND WEB PAGE AND GENERATING ELECTRONIC PERMISSION CODES WHICH THEN ALLOW USERS TO ACCESS SAID DIGITAL CONTENT; DESIGNING PROGRAMS FOR OTHERS FOR VIDEO GAME MACHINES WITH TELEVISION FOR PERSONAL USE; PROVIDING INFORMATION ABOUT COMPUTER PROGRAMS AND COMPUTERS; WRITING TECHNICAL MANUALS FOR OTHERS FOR USE WITH COMPUTER PROGRAMS AND COMPUTERS, COMPUTER PROFESSIONAL CONSULTANCY REGARDING CREATION, PROCESSING, AND PROVIDING DATA THROUGH USE OF A COMPUTER; DESIGNING AND MAINTAINING INFORMATION PROCESSING SYSTEMS BY A COMPUTER; COMPUTER SOFTWARE DEVELOPMENT AND CUSTOMIZATION; DESIGNING COMPUTER NETWORKS FOR OTHERS; PROFESSIONAL CONSULTANCY REGARDING DESIGNING AND STUDYING COMPUTER NETWORKS; RENTAL AND LEASING OF MAGNETIC TAPES ENCODED WITH COMPUTER PROGRAMS FOR MAINTAINING COMPUTER SYSTEM SECURITY; LEASING OF SERVERS FOR WEB PAGES; RENTAL AND LEASING OF COMPUTERS AND COMPUTER PROGRAMS; HOURLY RENTAL AND LEASING OF COMPUTERS VIA ON-LINE NETWORK; COMPUTER SERVICES, NAMELY, DESIGNING, IMPLEMENTING, TESTING, AND ANALYZING SECURITY, AUTHORIZATION, AUTHENTICATION, AND ENCRYPTION SYSTEMS TO PROVIDE SECURE ACCESS TO COMPUTER SOFTWARE, COMPUTER HARDWARE, AND COMPUTER NETWORKS, IN CLASS 42 (U.S. CLS. 100 AND 101).

FOR: PROVIDING TEMPORARY ACCOMMODATION; ACCOMMODATION BUREAU, NAMELY, BROKERING RESERVATIONS FOR HOTELS AND BOARDING HOUSES; PROVIDING TEA, COFFEE, COCOA, CARBONATED DRINKS OR FRUIT JUICE BEVERAGES, IN A SETTING WHICH INCLUDES PERMITTING CUSTOMERS TO PLAY GAMES ON INSTALLED VIDEO GAME MACHINES WHILE CONSUMING THEIR BEVERAGES; PROVIDING FOOD AND BEVERAGES IN A SETTING WHICH INCLUDES PERMITTING CUSTOMERS TO USE EQUIPMENT WHICH ENABLES ACCESS TO THE INTERNET; PROVIDING UDON AND SOBA, JAPANESE NOODLES; PROVIDING COOKED EELS; PROVIDING SUSHI; PROVIDING TEMPURA; PROVIDING PORK CUTLETS; PROVIDING ITALIAN CUISINE; PROVIDING SPANISH CUISINE; PROVIDING FRENCH CUISINE; PROVIDING RUSSIAN CUISINE; PROVIDING INDIAN CUISINE; PROVIDING KWANGTUNG STYLE CHINESE CUISINE; PROVIDING SICHUAN STYLE CHINESE CUISINE; PROVIDING SHANGHAI STYLE CHINESE CUISINE; PROVIDING BEIJING STYLE CHINESE CUISINE; PROVIDING ALCOHOLIC BEVERAGES; PROVIDING CAFE SERVICES FEATURING TEA, COFFEE, COCOA, CARBONATED DRINKS AND FRUIT JUICE BEVERAGES; PROVIDING

Reg. No. 4,203,980 OF FOODS AND BEVERAGES; BOARDING FOR ANIMALS; PRESCHOOLER AND INFANT CARE AT DAYCARE CENTERS; CARING OF ELDERLY, NAMELY, RETIREMENT HOMES COMMUNITY PROVIDING CONTINUING CARE SERVICES IN THE NATURE OF ELDER CARE; RENTAL OF MEETING ROOMS; PROVIDING FACILITIES FOR EXHIBITIONS; RENTAL OF FUTON AND QUILTS; RENTAL OF COOKING EQUIPMENT FOR INDUSTRIAL PURPOSES; RENTAL OF NON-ELECTRIC COOKING HEATERS; RENTAL OF KITCHEN WORKTOPS; RENTAL OF SINKS; RENTAL OF CURTAINS; RENTAL OF FURNITURE; RENTAL OF WALL HANGINGS; RENTAL OF FLOOR COVERINGS, IN CLASS 43 (U.S. CLS. 100 AND 101).

OWNER OF ERPN CMNTY TM OFC REG. NO. 006220248, DATED 11-20-2008, EXPIRES 8-22-2017.

THE MARK CONSISTS OF A SOLID CIRCLE WITH A STYLIZED SQUARE, TRIANGLE, "O" AND "X" SUPERIMPOSED ON THE CIRCLE.

SER. NO. 77-262,989, FILED 8-23-2007.

ALYSSA STEEL, EXAMINING ATTORNEY

United States of America

United States Patent and Trademark Office

COCKPIT1

Reg. No. 4,203,981

Registered Sep. 11, 2012

Int. Cls.: 9, 10 and 16

TRADEMARK

PRINCIPAL REGISTER

KARL STORZ GMBH & CO. KG (FED REP GERMANY LIMITED PARTNERSHIP)
MITTELSTRASSE 8
TUTTLINGEN, FED REP GERMANY D-78532

FOR: ILLUMINATION AND LIGHTING INSTALLATIONS FOR USE IN PERFORMING SCIENTIFIC AND INDUSTRIAL ENDOSCOPIC PROCEDURES, NAMELY, LIGHTS AS PARTS OF OR AS SPECIAL ACCESSORIES SPECIALLY ADAPTED FOR ENDOSCOPES FOR NON-MEDICAL USE; CAMERAS, IN PARTICULAR CCD CAMERAS, FOR INDUSTRIAL ENDOSCOPY; MICROSCOPES; ADAPTERS AND CABLES FOR CONNECTING CAMERAS TO SURGICAL DEVICES AND INSTRUMENTS; PICTURE PRESENTATION AND RECORDING DEVICES, IN PARTICULAR FOR TECHNICAL ENDOSCOPY, NAMELY, COMPUTER HARDWARE, SOFTWARE AND PERIPHERALS FOR RECORDING, REPRODUCING AND PROCESSING THE RESULTS OF NON-MEDICAL ENDOSCOPIC PROCEDURES; TRAINING AND TEACHING APPARATUS IN THE NATURE OF COMPUTER SOFTWARE IN THE FIELD OF ENDOSCOPY AND ENDOSCOPIC APPARATUS FOR USE IN TRAINING, TEACHING AND INSTRUCTING TECHNICIANS ON INSTALLATION AND USE OF ENDOSCOPIC APPARATUS; TEST EQUIPMENT AND DEVICES, NAMELY, TEST AND CHECK DEVICES FOR EXAMINING, TESTING AND CHECKING THE AFOREMENTIONED NON-MEDICAL INSTRUMENTS AND APPARATUS FOR PROPER FUNCTION; CARRYING CASES SPECIALLY ADAPTED FOR HOLDING THE EQUIPMENT LISTED ABOVE; SOFTWARE, NAMELY, FOR CONTROLLING SURGICAL INSTRUMENTS AND APPARATUS; REMOTE CONTROLS FOR MEDICAL APPARATUS AND INSTRUMENTS, IN CLASS 9 (U.S. CLS. 21, 23, 26, 36 AND 38).



FOR: MEDICAL INSTRUMENTS AND APPARATUS, NAMELY, SURGICAL INSTRUMENTS AND APPARATUS; CAMERAS, IN PARTICULAR CCD CAMERAS, FOR MEDICAL ENDOSCOPY; PICTURE PRESENTATION AND RECORDING DEVICES, IN PARTICULAR FOR USE IN MEDICAL ENDOSCOPY, NAMELY, COMPUTER HARDWARE, SOFTWARE AND PERIPHERALS FOR RECORDING, REPRODUCING AND PROCESSING THE RESULTS OF MEDICAL ENDOSCOPIC PROCEDURES; CARRYING CASES SPECIALLY ADAPTED FOR HOLDING THE EQUIPMENT LISTED ABOVE, IN CLASS 10 (U.S. CLS. 26, 39 AND 44).

FOR: PRINTED MATERIAL, NAMELY, BROCHURES AND INFORMATIONAL FLYERS, LETTERS, AND SHEETS IN THE FIELDS OF MEDICAL TECHNOLOGY, IN CLASS 16 (U.S. CLS. 2, 5, 22, 23, 29, 37, 38 AND 50).

David J. Kyjars

Director of the United States Patent and Trademark Office

Reg. No. 4,203,981 THE MARK CONSISTS OF STANDARD CHARACTERS WITHOUT CLAIM TO ANY PARTICULAR FONT, STYLE, SIZE, OR COLOR.

PRIORITY CLAIMED UNDER SEC. 44(D) ON FED REP GERMANY APPLICATION NO. 30739919.2, FILED 6-20-2007, REG. NO. 30739919, DATED 12-6-2007, EXPIRES 6-20-2017.

OWNER OF U.S. REG. NOS. 2,813,349, 3,143,037 AND OTHERS.

SER. NO. 77-356,990, FILED 12-20-2007.

SUE LAWRENCE, EXAMINING ATTORNEY

United States of America

United States Patent and Trademark Office

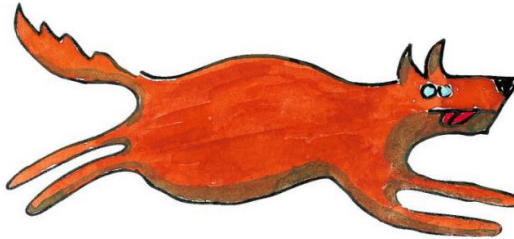

UNLEASHED PRODUCTIONS

Reg. No. 4,203,982

Registered Sep. 11, 2012

Int. Cl.: 40

SERVICE MARK

PRINCIPAL REGISTER

SLEEPING DOG, LTD. (MINNESOTA CORPORATION)
SUITE 113
1121 JACKSON STREET NE
MINNEAPOLIS, MN 55413

FOR: PHOTOGRAPHIC RETOUCHING, IMAGE RETOUCHING AND COLOR MANIPULATION OF IMAGES; ELECTRONIC IMAGING, SCANNING, DIGITIZING, ALTERATION AND/OR RETOUCHING OF PHOTOGRAPHIC AND DIGITAL IMAGES AND GRAPHIC ARTWORK, IN CLASS 40 (U.S. CLS. 100, 103 AND 106).

FIRST USE 1-4-2006; IN COMMERCE 1-18-2006.

NO CLAIM IS MADE TO THE EXCLUSIVE RIGHT TO USE "PRODUCTIONS", APART FROM THE MARK AS SHOWN.

THE COLOR(S) REDDISH BROWN, TAN, RED, BLACK AND WHITE IS/ARE CLAIMED AS A FEATURE OF THE MARK.

THE MARK CONSISTS OF THE WORD "UNLEASHED" IN REDDISH BROWN FOLLOWED BY THE WORD "PRODUCTIONS" IN TAN CENTERED UNDER A DRAWING OF A RUNNING PROFILE OF A REDDISH BROWN DOG WITH WHITE EYES, RED TONGUE AND BLACK NOSE. THE BODY OF THE DOG IS OUTLINED IN BLACK.

SER. NO. 77-360,809, FILED 12-28-2007.

PAULA MAHONEY, EXAMINING ATTORNEY



David J. Kybas

Director of the United States Patent and Trademark Office

United States of America

United States Patent and Trademark Office

fabspots

Reg. No. 4,203,983

Registered Sep. 11, 2012

Int. Cl.: 35

SERVICE MARK

PRINCIPAL REGISTER

BINNIE WIKANE (UNITED STATES INDIVIDUAL)
820 WEST G STREET
APT. 234
SAN DIEGO, CA 92101

FOR: ADVERTISING SERVICES, NAMELY, PROMOTING AND MARKETING THE GOODS AND SERVICES OF OTHERS IN THE FIELD OF UPSCALE CHOICES SUCH AS CULTURAL EVENTS, RESTAURANTS, SHOPPING, AND TRAVEL VIA PRINT AND ELECTRONIC MEDIA, IN CLASS 35 (U.S. CLS. 100, 101 AND 102).

FIRST USE 5-22-2009; IN COMMERCE 5-22-2009.

THE MARK CONSISTS OF STANDARD CHARACTERS WITHOUT CLAIM TO ANY PARTICULAR FONT, STYLE, SIZE, OR COLOR.

SER. NO. 77-414,683, FILED 3-6-2008.

MARK PILARO, EXAMINING ATTORNEY



David J. Kyffers

Director of the United States Patent and Trademark Office

United States of America

United States Patent and Trademark Office

FRANCOPIA

Reg. No. 4,203,984

Registered Sep. 11, 2012

Int. Cls.: 5 and 39

TRADEMARK

SERVICE MARK

PRINCIPAL REGISTER

SANOFI (FRANCE SOCIETE ANONYME)
54 RUE LA BOÉTIE
PARIS, FRANCE 75008

FOR: PHARMACEUTICAL PREPARATIONS FOR THE PREVENTION AND TREATMENT OF CANCER, CARDIOVASCULAR DISEASES, DISORDERS AND CONDITIONS, OBESITY, DIABETES, METABOLIC DISEASES, DISORDERS AND CONDITIONS, CENTRAL NERVOUS SYSTEM DISEASES, DISORDERS AND CONDITIONS, RESPIRATORY DISEASES, DISORDERS AND CONDITIONS, THROMBOSIS, ALZHEIMER'S DISEASE, PARKINSON'S DISEASE, GASTROINTESTINAL DISEASES, DISORDERS AND CONDITIONS, UROLOGICAL DISEASES, DISORDERS AND CONDITIONS, GYNECOLOGICAL DISEASES, DISORDERS AND CONDITIONS, HORMONE-RELATED DISEASES, DISORDERS AND CONDITIONS, RHEUMATOLOGICAL DISEASES, DISORDERS AND CONDITIONS; PHARMACEUTICAL PRODUCTS, NAMELY, PREPARATIONS FOR THE PREVENTION AND TREATMENT OF DISEASES IN THE FIELD OF INTERNAL MEDICINE; VACCINES; AND PLANT EXTRACTS FOR PHARMACEUTICAL USE; CHEMICAL PREPARATIONS FOR PHARMACEUTICAL USE, NAMELY, FOR THE TREATMENT OF CANCER, CARDIOVASCULAR DISEASES, DISORDERS AND CONDITIONS, OBESITY, DIABETES, METABOLIC DISEASES, DISORDERS AND CONDITIONS, CENTRAL NERVOUS SYSTEM DISEASES, DISORDERS AND CONDITIONS, RESPIRATORY DISEASES, DISORDERS AND CONDITIONS, THROMBOSIS, ALZHEIMER'S DISEASE, PARKINSON'S DISEASE, GASTROINTESTINAL DISEASES, DISORDERS AND CONDITIONS, UROLOGICAL DISEASES, DISORDERS AND CONDITIONS, GYNECOLOGICAL DISEASES, DISORDERS AND CONDITIONS, HORMONE-RELATED DISEASES, DISORDERS AND CONDITIONS, RHEUMATOLOGICAL DISEASES, DISORDERS AND CONDITIONS, AND FOR USE IN INTERNAL MEDICINE AND FOR VACCINES, IN CLASS 5 (U.S. CLS. 6, 18, 44, 46, 51 AND 52).

FOR: STORAGE AND DELIVERY OF PHARMACEUTICAL PRODUCTS, CHEMICAL PRODUCTS FOR PHARMACEUTICAL USE, AND PLANT EXTRACTS FOR PHARMACEUTICAL USE, IN CLASS 39 (U.S. CLS. 100 AND 105).

THE MARK CONSISTS OF STANDARD CHARACTERS WITHOUT CLAIM TO ANY PARTICULAR FONT, STYLE, SIZE, OR COLOR.

PRIORITY CLAIMED UNDER SEC. 44(D) ON FRANCE APPLICATION NO. 083563994, FILED 3-20-2008, REG. NO. 083563994, DATED 3-20-2008, EXPIRES 3-20-2018.



David J. Kyffers

Director of the United States Patent and Trademark Office

Reg. No. 4,203,984 SER. NO. 77-450,561, FILED 4-17-2008.

PATRICIA EVANKO, EXAMINING ATTORNEY

United States of America

United States Patent and Trademark Office

FLORIDA JACK

Reg. No. 4,203,985

Registered Sep. 11, 2012

Int. Cls.: 25, 29, 30 and 32

FLORIDA JACK INC (FLORIDA CORPORATION)
9956 SW 155 CT
MIAMI, FL 33196

FOR: CLOTHING, NAMELY, CAPS USED FOR PROMOTIONAL PURPOSES, IN CLASS 25 (U.S. CLS. 22 AND 39).

FIRST USE 1-20-2007; IN COMMERCE 1-20-2007.

TRADEMARK

PRINCIPAL REGISTER

FOR: BANANA CHIPS, PLANTAIN CHIPS, FISH AND CHIPS, FRUIT CHIPS, POTATO CHIPS, YUCCA CHIPS AND CANNED FRUITS, IN CLASS 29 (U.S. CL. 46).

FIRST USE 6-30-2007; IN COMMERCE 6-30-2007.

FOR: HONEY, HOT SAUCE, SAUCES, IN CLASS 30 (U.S. CL. 46).

FIRST USE 11-4-2004; IN COMMERCE 11-4-2004.

FOR: COCONUT WATER, IN CLASS 32 (U.S. CLS. 45, 46 AND 48).

FIRST USE 6-30-2007; IN COMMERCE 6-30-2007.

THE MARK CONSISTS OF STANDARD CHARACTERS WITHOUT CLAIM TO ANY PARTICULAR FONT, STYLE, SIZE, OR COLOR.

OWNER OF U.S. REG. NO. 2,921,535.

NO CLAIM IS MADE TO THE EXCLUSIVE RIGHT TO USE FLORIDA, APART FROM THE MARK AS SHOWN.

SER. NO. 77-469,632, FILED 5-8-2008.

ANDREA BUTLER, EXAMINING ATTORNEY



David J. Kyros

Director of the United States Patent and Trademark Office

United States of America

United States Patent and Trademark Office

PRIVATE EQUITY INTERNATIONAL

Reg. No. 4,203,986

Registered Sep. 11, 2012

Int. Cls.: 9, 16, 36 and 41

TRADEMARK

SERVICE MARK

PRINCIPAL REGISTER

PEI MEDIA LIMITED (ENGLAND LIMITED LIABILITY COMPANY)
SYCAMORE HOUSE, SYCAMORE STREET
LONDON, UNITED KINGDOM EC1Y0SG

FOR: (BASED ON 44(E)) ELECTRONIC PUBLICATIONS IN THE NATURE OF BOOKS, MAGAZINES, NEWSLETTERS, DIRECTORIES, PAMPHLETS, E-ZINES AND REPORTS IN THE FIELDS OF MARKET STUDIES, MARKET RESEARCH, ASSET SALE AND PURCHASE, FINANCIAL SERVICES, INVESTMENTS, STOCKS AND SHARES; CD-ROMS FEATURING DATA IN THE FIELDS OF MARKET STUDIES, MARKET RESEARCH, ASSET SALE AND PURCHASE, FINANCIAL SERVICES, INVESTMENTS, STOCKS AND SHARES; CDS, CDROMS, CDIS, DVDS, AND MACHINE READABLE PRE-RECORDED DIGITAL MEDIA FEATURING MAGAZINES AND REPORTS RELATING TO MARKET STUDIES, MARKET RESEARCH, ASSET SALE AND PURCHASE, FINANCIAL SERVICES, INVESTMENTS, STOCKS AND SHARES; INSTRUCTION MANUALS FOR THE FOREGOING RECORDED ON CD-ROM AND DOWNLOADABLE COMPUTER SOFTWARE FEATURING INSTRUCTION MANUALS FOR EACH OF THE FOREGOING, IN CLASS 9 (U.S. CLS. 21, 23, 26, 36 AND 38).

FOR: (BASED ON 44(E)) PRINTED MATTER AND PUBLICATIONS, NAMELY, BOOKS, MAGAZINES, NEWSLETTERS, DIRECTORIES, PAMPHLETS, GUIDES AND REPORTS IN THE FIELDS OF MARKET STUDIES, MARKET RESEARCH, ASSET SALE AND PURCHASE, FINANCIAL SERVICES, INVESTMENTS, STOCKS AND SHARES; PRINTED INSTRUCTIONAL AND TEACHING MATERIALS IN THE FIELDS OF MARKET STUDIES, MARKET RESEARCH, ASSET SALE AND PURCHASE, FINANCIAL SERVICES, INVESTMENTS, STOCKS AND SHARES; DRAWINGS; ILLUSTRATIONS IN THE NATURE OF ART PRINTS AND POSTERS, IN CLASS 16 (U.S. CLS. 2, 5, 22, 23, 29, 37, 38 AND 50).

FOR: (BASED ON USE IN COMMERCE) ELECTRONIC DATA BANKS, NAMELY, PROVIDING ONLINE FINANCIAL INFORMATION ABOUT INVESTMENTS, STOCKS AND SHARES; PROVIDING INTERACTIVE DATABASES FEATURING FINANCIAL INFORMATION ABOUT INVESTMENTS, STOCKS AND SHARES, IN CLASS 36 (U.S. CLS. 100, 101 AND 102).

FIRST USE 12-31-2001; IN COMMERCE 12-31-2001.

FOR: (BASED ON USE IN COMMERCE) ELECTRONIC NON-DOWNLOADABLE PUBLICATIONS IN THE NATURE OF BOOKS, MAGAZINES, NEWSLETTERS, DIRECTORIES,



David J. Kyjars

Director of the United States Patent and Trademark Office

Reg. No. 4,203,986 PAMPHLETS, E-ZINES AND REPORTS IN THE FIELDS OF MARKET STUDIES, MARKET RESEARCH, ASSET SALE AND PURCHASE, FINANCIAL SERVICES, INVESTMENTS, STOCKS AND SHARES, IN CLASS 41 (U.S. CLS. 100, 101 AND 107).

FIRST USE 12-31-2001; IN COMMERCE 12-31-2001.

THE MARK CONSISTS OF STANDARD CHARACTERS WITHOUT CLAIM TO ANY PARTICULAR FONT, STYLE, SIZE, OR COLOR.

PRIORITY CLAIMED UNDER SEC. 44(D) ON ERPN CMNTY TM OFC APPLICATION NO. CTM6508154, FILED 12-12-2007, REG. NO. 006508154, DATED 7-10-2009, EXPIRES 12-12-2017.

NO CLAIM IS MADE TO THE EXCLUSIVE RIGHT TO USE "PRIVATE EQUITY", APART FROM THE MARK AS SHOWN.

SEC. 2(F).

SER. NO. 77-491,762, FILED 6-5-2008.

BRENDAN MCCAULEY, EXAMINING ATTORNEY

United States of America

United States Patent and Trademark Office

BAREFOOT CONTESSA

Reg. No. 4,203,987

Registered Sep. 11, 2012

Int. Cls.: 29 and 30

TRADEMARK

PRINCIPAL REGISTER

INA GARTEN, LLC (NEW YORK LIMITED LIABILITY COMPANY)
46 NEWTOWN LANE
EAST HAMPTON, NY 11937

FOR: JAMS; CURDS; FRUIT PRESERVES, IN CLASS 29 (U.S. CL. 46).

FIRST USE 3-0-2006; IN COMMERCE 3-0-2006.

FOR: MIXES FOR BAKERY GOODS; CAKE MIXES; COOKIE MIXES; FROSTING MIXES;
ICING MIXES; PANCAKE MIXES; WAFFLE MIXES; MUFFIN MIXES; MARSHMALLOW
MIXES; COFFEE; CHOCOLATE; HOT CHOCOLATE; FLAVORING SYRUPS; TOPPING
SYRUPS, IN CLASS 30 (U.S. CL. 46).

FIRST USE 3-0-2006; IN COMMERCE 3-0-2006.

THE MARK CONSISTS OF STANDARD CHARACTERS WITHOUT CLAIM TO ANY PAR-
TICULAR FONT, STYLE, SIZE, OR COLOR.

OWNER OF U.S. REG. NOS. 2,892,226 AND 3,216,738.

SER. NO. 77-550,245, FILED 8-19-2008.

KEVIN DINALLO, EXAMINING ATTORNEY



David J. Kybas

Director of the United States Patent and Trademark Office

United States of America

United States Patent and Trademark Office



Reg. No. 4,203,988

Registered Sep. 11, 2012

Int. Cls.: 16, 35, 41 and 42

TRADEMARK

SERVICE MARK

PRINCIPAL REGISTER

OLIVER SCHROTT KOMMUNIKATION GMBH (FED REP GERMANY LIMITED LIABILITY COMPANY)
AN DEN DOMINIKANERN 11-27
50668 KÖLN, FED REP GERMANY

FOR: GOODS OF PAPER AND CARDBOARD, NAMELY, SIGNBOARDS, NAME BADGES, BANNERS, BOOKMARKS, PRINTED POINT OF SALE INFORMATION DISPLAYS IN THE NATURE OF POSTERS AND SIGNBOARDS, EVENT DECORATIONS IN THE NATURE OF PAPER RIBBONS AND DECORATIVE PAPER CENTERPIECES, AND FOLDERS; PRINTED GOODS, NAMELY, PROMOTIONAL FLYERS FEATURING INFORMATION ABOUT THE GOODS AND SERVICES OF OTHERS, PRESS KITS FEATURING INFORMATION ABOUT THE GOODS AND SERVICES OF OTHERS CONSISTING OF BROCHURES, FLYERS, AND PRESS RELEASES, BROCHURES FEATURING INFORMATION ABOUT THE GOODS AND SERVICES OF OTHERS, INVITATIONS, POSTERS FEATURING INFORMATION ABOUT THE GOODS AND SERVICES OF OTHERS, ADVERTISING MATERIAL FEATURING INFORMATION ABOUT THE GOODS AND SERVICES OF OTHERS, NAMELY, NEWSLETTERS, BROCHURES, CATALOGUES, FLYERS AND FACT SHEETS, AGENDAS, EVENT PROGRAMS; POSTERS, CALENDARS, CATALOGS FEATURING MERCHANDISE OF OTHERS, PHOTOGRAPHS; NONE OF THE FOREGOING IN THE FIELDS OF REAL ESTATE SALES, REAL ESTATE BROKERAGE, REAL ESTATE APPRAISAL, MORTGAGE BROKERING, MORTGAGE LENDING, NURSING, EMPLOYEE BENEFITS ISSUES OR RELATING IN ANY WAY TO EMPLOYEE BENEFITS, IN CLASS 16 (U.S. CLS. 2, 5, 22, 23, 29, 37, 38 AND 50).



David J. Kyjars

FOR: ADVERTISING, SALES PROMOTION AND PRODUCT MERCHANDISING, PUBLIC RELATIONS, MARKETING, CONSULTING SERVICES IN THE FIELDS OF MARKETING AND COMMUNICATIONS RELATING TO THE AUTOMOTIVE INDUSTRY, TO THE TRANSPORTATION AND LOGISTICS INDUSTRIES, TO TECHNOLOGY AND INDUSTRIAL GOODS, TO ENVIRONMENTAL GOODS AND SERVICES, TO CONSUMER PRODUCTS AND ELECTRONICS, AND TO LUXURY AND LIFESTYLE PRODUCTS; BUSINESS CONSULTING SERVICES IN THE FIELD OF COMMUNICATIONS; EVENT SERVICES FOR OTHERS, NAMELY, ORGANIZATION OF EVENTS, EXHIBITIONS, FAIRS AND SHOWS FOR COMMERCIAL, PROMOTIONAL AND ADVERTISING PURPOSES; DISSEMINATION OF ADVERTISING FOR OTHERS VIA THE INTERNET; ORGANIZATION OF EXHIBITIONS FOR COMMERCIAL AND ADVERTISING PURPOSES; BUSINESS MANAGEMENT CONSULTING; ORGANIZATION OF BUSINESS CONVENTIONS; NONE OF THE FOREGOING IN ANY MANNER RELATING TO EMPLOYEE BENEFITS ISSUES AND ALSO EXCLUDING

Reg. No. 4,203,988 THE FIELD OF DIRECT MARKETING FOR OTHERS IN THE FIELD OF CRUDE OIL AND NATURAL GAS, IN CLASS 35 (U.S. CLS. 100, 101 AND 102).

FOR: PRODUCTION OF TELEVISION AND RADIO SHOWS, FILM PRODUCTION; VIDEO PRODUCTION; ORGANIZATION AND REALIZATION OF EDUCATIONAL SEMINARS AND CONVENTIONS IN THE FIELD OF PUBLIC RELATIONS, INFORMATION MANAGEMENT AND MARKETING; ARRANGING AND CONDUCTING SPECIAL EVENTS AND EXHIBITIONS FOR EDUCATIONAL PURPOSES, NAMELY, ARRANGING AND CONDUCTING EXHIBITS IN THE FIELDS OF PUBLIC RELATIONS, MARKETING, AND THE PRESENTATION AND DISPLAY OF PRODUCTS AND GOODS FOR OTHERS; EVENT SERVICES FOR OTHERS, NAMELY, BOOKING OF VENUES, ARTISTS, AND ENTERTAINERS, ALL FOR COMMERCIAL, PROMOTIONAL AND ADVERTISING PURPOSES, IN CLASS 41 (U.S. CLS. 100, 101 AND 107).

FOR: ADVISING OTHERS CONCERNING THE DESIGN OF HOMEPAGES AND INTERNET SITES; DESIGN AND CREATION OF INTERNET SITES FOR THIRD PARTIES, IN CLASS 42 (U.S. CLS. 100 AND 101).

PRIORITY CLAIMED UNDER SEC. 44(D) ON ERPN CMNTY TM OFC APPLICATION NO. 007112551, FILED 7-30-2008, REG. NO. 007112551, DATED 5-25-2009, EXPIRES 7-30-2018.

THE COLOR(S) LIGHT BLUE, DARK BLUE, WHITE AND BLACK IS/ARE CLAIMED AS A FEATURE OF THE MARK.

NO CLAIM IS MADE TO THE EXCLUSIVE RIGHT TO USE "BRAND RELEVANCE", APART FROM THE MARK AS SHOWN.

THE MARK CONSISTS OF THE WHITE LETTER "B" ON A DARK BLUE BACKGROUND, THE WHITE LETTER "R" ON A LIGHT BLUE BACKGROUND AND THE WORDS "BRAND RELEVANCE" IN BLACK.

SER. NO. 77-551,747, FILED 8-20-2008.

KRISTINA MORRIS, EXAMINING ATTORNEY

United States of America

United States Patent and Trademark Office

LUXOTIK

Reg. No. 4,203,989

ARELLANO REYES, JOSÉ LUIS (MEXICO INDIVIDUAL)
AV. ALFONSO REYES #400A, COL. NEXXUS XXI
ESCOBEDO, NUEVO LEÓN, MEXICO 66055

Registered Sep. 11, 2012

Int. Cl.: 12

FOR: TIRES; VEHICLE WHEEL RIMS AND STRUCTURAL PARTS THEREFOR, IN CLASS 12 (U.S. CLS. 19, 21, 23, 31, 35 AND 44).

TRADEMARK

PRIORITY CLAIMED UNDER SEC. 44(D) ON MEXICO APPLICATION NO. 953591, FILED 8-8-2008, REG. NO. 1060186, DATED 8-9-2008, EXPIRES 8-8-2018.

PRINCIPAL REGISTER

THE COLOR(S) LIGHT PURPLE, DARK PURPLE, AND WHITE IS/ARE CLAIMED AS A FEATURE OF THE MARK.

THE MARK CONSISTS OF THE WORD "LUXOTIK", IN STYLIZED LIGHT PURPLE LETTERS, WITH DARK PURPLE SHADOWING AND WHITE HIGHLIGHTING.

SER. NO. 77-596,493, FILED 10-20-2008.

JIM RINGLE, EXAMINING ATTORNEY



David J. Kybas

Director of the United States Patent and Trademark Office

United States of America
United States Patent and Trademark Office

HOCKOOL

Reg. No. 4,203,990

Registered Sep. 11, 2012

Int. Cl.: 18

TRADEMARK

PRINCIPAL REGISTER

JAMES AND CATHY HOLDINGS CORP. (CANADA CORPORATION)
1660 NORTH SERVICE ROAD E. SUITE 110
OAKVILLE, ONTARIO, CANADA L6H7G3

FOR: ALL-PURPOSE SPORT BAGS AND ALL-PURPOSE ATHLETIC BAGS, IN CLASS 18
(U.S. CLS. 1, 2, 3, 22 AND 41).

THE MARK CONSISTS OF STANDARD CHARACTERS WITHOUT CLAIM TO ANY PAR-
TICULAR FONT, STYLE, SIZE, OR COLOR.

PRIORITY CLAIMED UNDER SEC. 44(D) ON CANADA APPLICATION NO. 1401580, FILED
6-19-2008, REG. NO. TMA795,692, DATED 4-15-2011, EXPIRES 4-15-2026.

SER. NO. 77-636,719, FILED 12-19-2008.

ESTHER BELENKER, EXAMINING ATTORNEY



David J. Kybas

Director of the United States Patent and Trademark Office

United States of America

United States Patent and Trademark Office



PUMPWELL
SOLUTIONS

Reg. No. 4,203,991

Registered Sep. 11, 2012

Int. Cls.: 9 and 42

TRADEMARK

SERVICE MARK

PRINCIPAL REGISTER

PUMPWELL SOLUTIONS LTD. (CANADA CORPORATION)
4720-14TH STREET N.E.
CALGARY, AB T2E 6L7, CANADA

FOR: OIL WELL CONTROLLERS, NAMELY, AN ELECTRICAL CONTROLLER WITH CURRENT MICROPROCESSOR TECHNOLOGY INCLUDING ALGORITHMS TO PROVIDE PROTECTION TO PRODUCING OIL WELL COMPONENTS, AUTOMATION COMPONENTS SUCH AS VARIABLE FREQUENCY DRIVE OR SOFT-STARTER TO ENHANCE WELL PERFORMANCE BY CONTROLLING WELL OPERATION THROUGH CONTROL OF THE WELL'S ELECTRICAL MOTOR AND DATA LOGGING ALGORITHMS TO RECORD AND RELAY INFORMATION FROM VARIOUS SENSORS ATTACHED TO OIL PRODUCING WELL, IN CLASS 9 (U.S. CLS. 21, 23, 26, 36 AND 38).

FOR: OIL WELL MONITORING SERVICES, NAMELY, REMOTE MONITORING OF WELL PERFORMANCE AND CONDITION OF THE WELL IN REAL TIME WITH USE OF WIRELESS INTERNET TECHNOLOGY AND CURRENT MICROPROCESSOR TECHNOLOGY TO ENSURE EFFICIENT AND UNINTERRUPTED WELL OPERATION; OIL WELL OPTIMIZATION SERVICES, NAMELY, THE DESIGN OF WELL COMPONENTS THROUGH THE USE OF ALGORITHMS, AND CONTROLLING THE OPERATION OF WELLS THROUGH THE USE OF ALGORITHMS, BOTH FOR THE PURPOSE OF ENSURING MAXIMIZATION OF WELL PRODUCTIVITY AND MINIMIZATION OF LOADING AND WELL COMPONENT BREAK-DOWNS, IN CLASS 42 (U.S. CLS. 100 AND 101).

PRIORITY CLAIMED UNDER SEC. 44(D) ON CANADA APPLICATION NO. 1412105, FILED 9-24-2008, REG. NO. TMA758113, DATED 1-27-2010, EXPIRES 1-27-2025.

NO CLAIM IS MADE TO THE EXCLUSIVE RIGHT TO USE "SOLUTIONS", APART FROM THE MARK AS SHOWN.

THE MARK CONSISTS OF THE DESIGN OF AN ARROW WITH A SQUARE UNDERNEATH. THE SQUARE IS INCOMPLETE. IT CONTAINS A SERIES OF SMALL SQUARES IN THE LOWER RIGHT CORNER. THE WORD "PUMPWELL" APPEARS UNDERNEATH THE DESIGN ELEMENT IN STYLIZED LETTERS WITH "WELL" IN BOLDFACE TYPE. THE WORDING "SOLUTIONS" APPEARS IN STYLIZED LETTERS UNDERNEATH THE TERM "PUMPWELL" WITH A HORIZONTAL LINE ABOVE IT.



David J. Kybas

Director of the United States Patent and Trademark Office

SER. NO. 77-637,073, FILED 12-19-2008.

Reg. No. 4,203,991 GINA FINK, EXAMINING ATTORNEY

United States of America

United States Patent and Trademark Office

CRED-EX

Reg. No. 4,203,992

EMERGING PAYMENTS TECHNOLOGIES, INC. (DELAWARE CORPORATION)
1 HARMON PLAZA
SECAUCUS, NJ 07096

Registered Sep. 11, 2012

Int. Cl.: 36

FOR: CONSUMER CREDIT SERVICES, NAMELY, PROVIDING REVOLVING CREDIT ACCOUNT SERVICES AND BILL PAYMENT SERVICES TO OTHERS VIA THE INTERNET AND WIRELESS DEVICES, IN CLASS 36 (U.S. CLS. 100, 101 AND 102).

SERVICE MARK

FIRST USE 7-1-2008; IN COMMERCE 7-1-2008.

PRINCIPAL REGISTER

THE MARK CONSISTS OF STANDARD CHARACTERS WITHOUT CLAIM TO ANY PARTICULAR FONT, STYLE, SIZE, OR COLOR.

SER. NO. 77-640,695, FILED 12-29-2008.

MATTHEW MCDOWELL, EXAMINING ATTORNEY



David J. Kyros

Director of the United States Patent and Trademark Office

United States of America

United States Patent and Trademark Office

M.O.G. Medically Oriented Gym

Reg. No. 4,203,993

THE MOG, INC. (NEW YORK CORPORATION)
1801 GRAND ISLAND BOULEVARD
GRAND ISLAND, NY 14072

Registered Sep. 11, 2012

Int. Cls.: 35 and 41

FOR: BUSINESS CONSULTING SERVICES FOR PHYSICAL THERAPY FACILITIES, MEDICAL FACILITIES AND EXERCISE AND FITNESS FACILITIES IN THE FIELD OF BUSINESS OPERATIONS OF SUCH FACILITIES, IN CLASS 35 (U.S. CLS. 100, 101 AND 102).

SERVICE MARK

PRINCIPAL REGISTER

FIRST USE 12-15-2007; IN COMMERCE 12-15-2007.

FOR: CONSULTING FOR PHYSICAL THERAPY FACILITIES, MEDICAL FACILITIES AND EXERCISE AND FITNESS FACILITIES IN THE FIELD OF PROVIDING EDUCATIONAL PROGRAMS AND INSTRUCTION DESIGNED FOR MEDICALLY COMPROMISED INDIVIDUALS IN EXERCISE, FITNESS, NUTRITION, HEALTH AND WELLNESS; PROVIDING PROGRAMS IN THE NATURE OF CLASSES, WORKSHOPS AND INSTRUCTION SPECIALLY DESIGNED FOR MEDICALLY COMPROMISED ADULTS AND CHILDREN IN THE FIELDS OF EXERCISE, FITNESS, NUTRITION, HEALTH AND WELLNESS, IN CLASS 41 (U.S. CLS. 100, 101 AND 107).

FIRST USE 12-15-2007; IN COMMERCE 12-15-2007.

THE MARK CONSISTS OF STANDARD CHARACTERS WITHOUT CLAIM TO ANY PARTICULAR FONT, STYLE, SIZE, OR COLOR.

NO CLAIM IS MADE TO THE EXCLUSIVE RIGHT TO USE "MEDICALLY ORIENTED GYM", APART FROM THE MARK AS SHOWN.

SER. NO. 77-665,048, FILED 2-6-2009.

LESLIE RICHARDS, EXAMINING ATTORNEY



David J. Kypos

Director of the United States Patent and Trademark Office

United States of America

United States Patent and Trademark Office

SISLIVE

Reg. No. 4,203,994

Registered Sep. 11, 2012

**Int. Cls.: 9, 36, 37, 38, 41
and 42**

TRADEMARK

SERVICE MARK

PRINCIPAL REGISTER

SATELLITE INFORMATION SERVICES LIMITED (UNITED KINGDOM PRIVATE LIMITED COMPANY)
SATELLITE HOUSE, 17 CORSHAM STREET
LONDON N1 6DR, UNITED KINGDOM

FOR: APPARATUS FOR RECORDING, TRANSMISSION, REPRODUCTION, RECEIVING AND PLAY-OUT OF SOUND AND IMAGES FOR THE TRANSMISSION BY SATELLITE, TERRESTRIAL RADIO, TERRESTRIAL VIDEO CIRCUITS AND TERRESTRIAL DATA CIRCUITS AND BROADCASTING OF INFORMATION, DATA, GRAPHICS, SOUND, MUSIC, VIDEOS, ANIMATION AND TEXT; PRE-RECORDED VIDEO CASSETTES, TAPES AND CARTRIDGES, COMPACT DISCS, DVDS IN THE FIELD OF CURRENT EVENTS AND RECREATIONAL ACTIVITIES, CULTURAL, ENTERTAINMENT AND SPORTING EVENTS; VIDEO CONFERENCING APPARATUS, NAMELY, SATELLITE DISHES, SATELLITE TRANSMITTER AND RECEIVERS, SATELLITE TELEPHONES AND CAMERAS; SATELLITE APPARATUS, NAMELY, SATELLITES; SATELLITE DISHES, SATELLITE TRANSMITTER AND RECEIVERS, SATELLITE TELEPHONES; PORTABLE AND TRANSPORTABLE APPARATUS FOR RECEIVING AND SENDING SATELLITE TRANSMISSIONS; SATELLITE BROADCASTING INSTRUMENTS, NAMELY, SATELLITE DISHES AND SATELLITE TRANSMITTERS AND RECEIVERS; SATELLITE EARTH STATIONS; SATELLITE RECEIVERS; SATELLITE TELEVISION RECEIVING APPARATUS, NAMELY, ANTENNAS FOR SATELLITES; SATELLITE COMMUNICATIONS EQUIPMENT, NAMELY, ANTENNAS, TRANSMITTERS AND RECEIVERS; SATELLITE TRANSCEIVERS; SATELLITE TELEVISION TRANSMISSION UPLINK ENCRYPTION AND ENCODING APPARATUS; TRANSMITTING APPARATUS FOR SATELLITE BROADCAST; RECEIVING ANTENNAS FOR SATELLITE BROADCAST; SATELLITE NAVIGATIONAL INSTRUMENTS; INTERCOMMUNICATION SATELLITES; ELECTRONIC TELEVISION SATELLITE APPARATUS, NAMELY, TELEVISION AERIALS, TELEVISION RECEIVERS AND TELEVISION TRANSMITTERS; AUDIOVISUAL APPARATUS FOR USE IN SATELLITE, NAMELY, AUDIOVISUAL RECEIVERS; BROADCASTING SATELLITE EARTH STATIONS; SATELLITE TELEVISION SIGNAL ENCRYPTION APPARATUS; CAMERAS; TELEVISION CAMERAS; ELECTRICAL AND ELECTRONIC APPARATUS, FOR MANAGEMENT AND PERFORMANCE ANALYSIS OF TELECOMMUNICATIONS, TERRESTRIAL AND SATELLITE BROADCASTING, SIGNALING AND DATA COMMUNICATIONS NETWORKS THAT CONTROLS, MANAGES AND MONITORS AUTOMATED SATELLITES; APPARATUS FOR USE IN BROADCASTING, TRANSMISSION, RECEIVING, PROCESSING, REPRODUCING, ENCODING AND DECODING OF DIGITAL SIGNALS; SIGNAL GENERATORS FOR TRANSMISSION, DISTRIBUTION AND BROADCASTING OF INFORMATION, DATA, GRAPHICS, SOUND, MUSIC, VIDEOS,



David J. Kybas

Director of the United States Patent and Trademark Office

Reg. No. 4,203,994 ANIMATION AND TEXT; ELECTRONIC CIRCUITS FOR PROCESSING, CODING AND DECODING ELECTRONIC RADIO FREQUENCY AND OPTICAL SIGNALS; ENCODING AND DECODING APPARATUS AND INSTRUMENTS; RECEIVERS AND TRANSMITTERS FOR TRANSMISSION, DISTRIBUTION AND BROADCASTING OF INFORMATION, DATA, GRAPHICS, SOUND, MUSIC, VIDEOS, ANIMATION AND TEXT; COMPUTER SOFTWARE FOR THE MONITORING OF AUTOMATED SATELLITE UPLINKING APPARATUS, SATELLITE TRANSMISSION, SATELLITE BROADCASTING SERVICES AND SATELLITE BROADCASTING TECHNOLOGY; COMPUTER SOFTWARE FOR TELECOMMUNICATIONS, DATA COMMUNICATIONS, SATELLITE BROADCASTING, NAMELY, FOR THE TRANSMISSION, RECEIVING, DISPLAY, ENCRYPTION AND DECRYPTION OF DIGITAL SIGNALS; COMPUTER SOFTWARE FOR RECEIVING, EXCHANGE AND DISPLAY OF MESSAGES, IMAGES OR DATA, NAMELY, CONTROLLING AND MANAGING ACCESS SERVER APPLICATIONS; COMPUTER SOFTWARE FOR CREATING AND SAFEGUARDING A COMMUNICATIONS NETWORK, FOR NETWORK SECURITY AND FOR MESSAGING AND ELECTRONIC MAIL SERVICES; COMPUTER SOFTWARE FOR PROVIDING ACCESS TO LOCAL AND GLOBAL COMPUTER NETWORKS AND COMPUTER SOFTWARE ENABLING PARTIES TO VIEW, DISPLAY, TRANSMIT AND DOWNLOAD INFORMATION FROM LOCAL AND GLOBAL COMPUTER NETWORKS; COMPUTER E-COMMERCE SOFTWARE TO ALLOW USERS TO PERFORM BUSINESS TRANSACTIONS VIA LOCAL AND GLOBAL COMPUTER NETWORKS; COMPUTER SOFTWARE FOR USE IN THE CREATION AND DEVELOPMENT OF WEBSITES, INCLUDING THOSE HAVING INTERACTIVE CONTENT; ELECTRONIC DOWNLOADABLE PUBLICATIONS, NAMELY, MANUALS IN THE FIELD OF SATELLITES, SATELLITE APPARATUS, SATELLITE TRANSMISSION, SATELLITE BROADCASTING SERVICES AND SATELLITE BROADCASTING TECHNOLOGY; TELEVISION AERIALS; TELEVISIONS; TELEVISION RECEIVERS; VIEWING SCREENS, NAMELY, PROJECTION SCREENS; CLOSED CIRCUIT TELEVISIONS; SECURITY CAMERAS, IN CLASS 9 (U.S. CLS. 21, 23, 26, 36 AND 38).

FOR: FINANCIAL SPONSORSHIP OF SPORTING EVENTS, IN CLASS 36 (U.S. CLS. 100, 101 AND 102).

FOR: INSTALLATION, MAINTENANCE AND REPAIR OF APPARATUS FOR RECORDING, TRANSMISSION AND REPRODUCTION OF SOUND OR IMAGES FOR THE TRANSMISSION, DISTRIBUTION AND BROADCASTING OF INFORMATION, DATA, GRAPHICS, SOUND, MUSIC, VIDEOS, ANIMATION AND TEXT, VIA SATELLITE SYSTEMS OR COMPUTER NETWORKS; INSTALLATION, MAINTENANCE AND REPAIR OF DATA PROCESSING EQUIPMENT, COMPUTER HARDWARE, TELECOMMUNICATION APPARATUS, DIGITAL SIGNAGE; INSTALLATION, REPAIR AND MAINTENANCE OF ELECTRONIC APPARATUS AND INSTRUMENTS FOR SATELLITE BROADCASTING; INFORMATION, CONSULTANCY AND ADVISORY SERVICES RELATING TO THE INSTALLATION, MAINTENANCE AND REPAIR OF APPARATUS FOR RECORDING, TRANSMISSION AND REPRODUCTION OF SOUND OR IMAGES, DATA PROCESSING EQUIPMENT, COMPUTER HARDWARE, TELECOMMUNICATION APPARATUS, AND DIGITAL SIGNAGE, IN CLASS 37 (U.S. CLS. 100, 103 AND 106).

FOR: TELECOMMUNICATION SERVICES, NAMELY, LOCAL AND LONG DISTANCE TRANSMISSION OF VOICE, DATA, AND GRAPHICS BY MEANS OF TELEPHONE, TELEGRAPHIC, CABLE, AND SATELLITE TRANSMISSIONS; TRANSMISSION OF INFORMATION, COMPUTER PROGRAMS, COMPUTER SOFTWARE AND OTHER DATA VIA TELECOMMUNICATION MEANS; PROVIDING SATELLITE TRANSMISSION OF COMPUTER PROGRAMS AND COMPUTER SOFTWARE, SATELLITE BROADCASTING OF GRAPHICS, INFORMATION, DATA, SOUND, MUSIC, VIDEOS, ANIMATION AND TEXT, AUDIO, VIDEO AND DATA COMMUNICATIONS SERVICES; SATELLITE BROADCASTING SERVICES; SATELLITE COMMUNICATIONS SERVICES; SATELLITE TRANSMISSION; TELECOMMUNICATIONS SERVICES, NAMELY, THE TRANSMISSION OF DATA, SOUND AND IMAGES VIA SATELLITE EARTH STATIONS WHETHER FIXED OR TRANSPORTABLE; RENTAL OF SATELLITE BROADCASTING SETS; TRANSMISSION OF DATA BY COMMUNICATIONS SATELLITE; TRANSMISSION OF INFORMATION, COMPUTER

Reg. No. 4,203,994 PROGRAMS, COMPUTER SOFTWARE AND OTHER DATA BY COMMUNICATIONS SATELLITE; RADIO AND TELEVISION TRANSMISSION, BROADCAST AND RECEPTION OF AUDIO, VIDEO, STILL AND MOVING IMAGES AND DATA WHETHER IN COMPRESSED OR UNCOMPRESSED FORM AND WHETHER IN REAL OR DELAYED TIME VIA TELECOMMUNICATION MEANS; ELECTRONIC MAIL SERVICES; COMMUNICATION SERVICES FOR VIDEO CONFERENCING PURPOSES, NAMELY, ELECTRONIC TRANSMISSION OF DATA AND DOCUMENTS AMONG REMOTE SITES USING SATELLITES; SATELLITE VIDEO CONFERENCING SERVICES; VIDEO CONFERENCING SERVICES; PROVIDING VOICE OVER INTERNET PROTOCOL (VOIP) PEER-TO-PEER COMMUNICATIONS; ELECTRONIC TRANSMISSION OF DATA AND DOCUMENTS OVER COMPUTER TERMINALS AND INSTANT MESSAGING SERVICES; PROVIDING A HIGH SPEED ACCESS TO LOCAL AND WIDE AREA NETWORKS AND A GLOBAL COMPUTER INFORMATION NETWORK; TELETXT SERVICES; NEWS AGENCY SERVICES, NAMELY, THE TRANSMISSION OF NEWS ITEMS TO NEWS REPORTING ORGANIZATIONS; TRANSMISSION OF NEWS; LEASING SATELLITE TIME FOR THE BROADCAST OF SATELLITE RADIO AND TELEVISION; PROVIDING ACCESS TO A COMPUTER DATABASE; PROVIDING ACCESS TO AND LEASING OF ACCESS TO SATELLITE CAPACITY; BROADCASTING ON RADIO, TV AND ON THE INTERNET OF AUDIO, VIDEO, STILL AND MOVING IMAGES AND DATA WHETHER IN COMPRESSED OR UNCOMPRESSED FORM AND WHETHER DOWNLOADABLE OR NON-DOWNLOADABLE; TRANSMISSION OF AUDIO, VIDEO, STILL AND MOVING IMAGES AND DATA WHETHER IN COMPRESSED OR UNCOMPRESSED FORM AND WHETHER DOWNLOADABLE OR NON-DOWNLOADABLE BY SATELLITE; TELECOMMUNICATION SERVICES, NAMELY, THE TRANSMISSION OF DATA, SOUND AND IMAGES VIA SATELLITE EARTH STATIONS WHETHER FIXED OR TRANSPORTABLE; DISSEMINATION OF TELEVISION PROGRAMS RELAYED BY SATELLITES, NAMELY, TELEVISION BROADCASTING; PROVIDING ON-LINE COMMUNICATIONS LINKS WHICH TRANSFER THE WEBSITE USER TO OTHER LOCAL AND GLOBAL WEB PAGES, NAMELY, ONLINE SYSTEMS FOR BOOKING SATELLITE CAPACITY AND FOR THE AUTOMATED REMOTE-CONTROL OF SATELLITE TRANSMISSION EQUIPMENT; WEB-BASED ONLINE SYSTEMS FOR BOOKING SATELLITE CAPACITY AND FOR THE AUTOMATED REMOTE-CONTROL OF SATELLITE TRANSMISSION EQUIPMENT, IN CLASS 38 (U.S. CLS. 100, 101 AND 104).

FOR: TELEVISION AND RADIO ENTERTAINMENT SERVICES, NAMELY, EDITING AND PLAY-OUT OF SOUNDS AND IMAGES; INFORMATION RELATING TO SPORTING EVENTS PROVIDED BY SATELLITE TRANSMISSION, THE INTERNET OR BY OTHER ELECTRONIC MEANS; PRODUCTION OF TELEVISION PROGRAMS, RADIO PROGRAMS AND FILMS IN STUDIOS OR BY MEANS OF OUTSIDE BROADCASTING FACILITIES; PROVIDING INFORMATION AND ADVISORY SERVICES RELATING TO GAMBLING, BETTING AND WAGERING; ON-LINE AND TELEPHONE GAMBLING, BETTING AND WAGERING; ENTERTAINMENT SPORTING SERVICES IN THE NATURE OF GAMBLING, BETTING AND WAGERING PROVIDED BY TELEPHONE, SATELLITE, THE INTERNET OR ON-LINE FROM A COMPUTER NETWORK DATABASE; RENTAL OF GAMBLING, BETTING, WAGERING AND GAMING MACHINES; INFORMATION, CONSULTANCY AND ADVISORY SERVICES RELATING TO GAMBLING, BETTING, WAGERING AND GAMING SERVICES, IN CLASS 41 (U.S. CLS. 100, 101 AND 107).

FOR: DESIGN AND DEVELOPMENT OF COMPUTER HARDWARE AND SOFTWARE IN THE FIELD OF TELECOMMUNICATIONS AND SATELLITE COMMUNICATION; COMPUTER PROGRAMMING, COMPUTER SYSTEMS ANALYSIS, REPAIR, MAINTENANCE, UPDATING OF COMPUTER SOFTWARE AND COMPUTER PROGRAMS, ALL FOR THE TRANSMISSION, DISTRIBUTION AND BROADCASTING OF INFORMATION, DATA, GRAPHICS, SOUND, MUSIC, VIDEOS, ANIMATION AND TEXT, VIA SATELLITE SYSTEMS OR LANDLINE COMPUTER NETWORKS; INFORMATION CONSULTANCY AND ADVISORY SERVICES, NAMELY, TROUBLESHOOTING IN THE NATURE OF DIAGNOSING PROBLEMS WITH COMPUTER SOFTWARE; COMPUTER SOFTWARE CONSULTING AND ADVISORY SERVICES IN CONNECTION WITH INFORMATION, DATA, GRAPHICS, SOUND, MUSIC, VIDEOS, ANIMATION AND TEXT, ALL FOR THE TRANSMISSION,

Reg. No. 4,203,994 DISTRIBUTION AND BROADCASTING OF INFORMATION, DATA, GRAPHICS, SOUND, MUSIC, VIDEOS, ANIMATION AND TEXT, VIA SATELLITE SYSTEMS OR LANDLINE COMPUTER NETWORKS; RENTAL OF SOFTWARE USED IN CONNECTION WITH GAMBLING, BETTING, WAGERING OR GAMING SERVICES, IN CLASS 42 (U.S. CLS. 100 AND 101).

THE MARK CONSISTS OF STANDARD CHARACTERS WITHOUT CLAIM TO ANY PARTICULAR FONT, STYLE, SIZE, OR COLOR.

PRIORITY CLAIMED UNDER SEC. 44(D) ON ERPN CMNTY TM OFC APPLICATION NO. 7168421, FILED 8-19-2008, REG. NO. 007168421, DATED 2-25-2011, EXPIRES 8-19-2018.

OWNER OF U.S. REG. NOS. 3,625,125 AND 3,918,592.

SER. NO. 77-673,869, FILED 2-19-2009.

KIM SAITO, EXAMINING ATTORNEY

United States of America

United States Patent and Trademark Office



Reg. No. 4,203,995

Registered Sep. 11, 2012

**Int. Cls.: 9, 36, 37, 38, 41
and 42**

TRADEMARK

SERVICE MARK

PRINCIPAL REGISTER

SATELLITE INFORMATION SERVICES LIMITED (UNITED KINGDOM PRIVATE LIMITED COMPANY)
SATELLITE HOUSE, 17 CORSHAM STREET
LONDON, UNITED KINGDOM N1 6DR

FOR: APPARATUS FOR RECORDING, TRANSMISSION, REPRODUCTION, RECEIVING AND PLAY-OUT OF SOUND AND IMAGES FOR THE TRANSMISSION BY SATELLITE, TERRESTRIAL RADIO, TERRESTRIAL VIDEO CIRCUITS AND TERRESTRIAL DATA CIRCUITS AND BROADCASTING OF INFORMATION, DATA, GRAPHICS, SOUND, MUSIC, VIDEOS, ANIMATION AND TEXT; PRE-RECORDED VIDEO CASSETTES, TAPES AND CARTRIDGES, COMPACT DISCS, DVDS IN THE FIELD OF CURRENT EVENTS AND RECREATIONAL ACTIVITIES, CULTURAL, ENTERTAINMENT AND SPORTING EVENTS; VIDEO CONFERENCING APPARATUS, NAMELY, SATELLITE DISHES, SATELLITE TRANSMITTER AND RECEIVERS, SATELLITE TELEPHONES AND CAMERAS; SATELLITE APPARATUS, NAMELY, SATELLITES; SATELLITE DISHES, SATELLITE TRANSMITTER AND RECEIVERS, SATELLITE TELEPHONES; PORTABLE AND TRANSPORTABLE APPARATUS FOR RECEIVING AND SENDING SATELLITE TRANSMISSIONS; SATELLITE BROADCASTING INSTRUMENTS, NAMELY, SATELLITE DISHES AND SATELLITE TRANSMITTERS AND RECEIVERS; SATELLITE EARTH STATIONS; SATELLITE RECEIVERS; SATELLITE TELEVISION RECEIVING APPARATUS, NAMELY, ANTENNAS FOR SATELLITES; SATELLITE COMMUNICATIONS EQUIPMENT, NAMELY, ANTENNAS, TRANSMITTERS AND RECEIVERS; SATELLITE TRANSCEIVERS; SATELLITE TELEVISION TRANSMISSION UPLINK ENCRYPTION AND ENCODING APPARATUS; TRANSMITTING APPARATUS FOR SATELLITE BROADCAST; RECEIVING ANTENNAS FOR SATELLITE BROADCAST; SATELLITE NAVIGATIONAL INSTRUMENTS; INTERCOMMUNICATION SATELLITES; ELECTRONIC TELEVISION SATELLITE APPARATUS, NAMELY, TELEVISION AERIALS, TELEVISION RECEIVERS AND TELEVISION TRANSMITTERS; AUDIOVISUAL APPARATUS FOR USE IN SATELLITE, NAMELY, AUDIOVISUAL RECEIVERS; BROADCASTING SATELLITE EARTH STATIONS; SATELLITE TELEVISION SIGNAL ENCRYPTION APPARATUS; CAMERAS; TELEVISION CAMERAS; ELECTRICAL AND ELECTRONIC APPARATUS, FOR MANAGEMENT AND PERFORMANCE ANALYSIS OF TELECOMMUNICATIONS, TERRESTRIAL AND SATELLITE BROADCASTING, SIGNALING AND DATA COMMUNICATIONS NETWORKS THAT CONTROLS, MANAGES AND MONITORS AUTOMATED SATELLITES; APPARATUS FOR USE IN BROADCASTING, TRANSMISSION, RECEIVING, PROCESSING, REPRODUCING, ENCODING AND DECODING OF DIGITAL SIGNALS; SIGNAL GENERATORS FOR TRANSMISSION, DISTRIBUTION AND BROADCASTING OF INFORMATION, DATA, GRAPHICS, SOUND, MUSIC, VIDEOS,



David J. Kybas

Director of the United States Patent and Trademark Office

Reg. No. 4,203,995 ANIMATION AND TEXT; ELECTRONIC CIRCUITS FOR PROCESSING, CODING AND DECODING ELECTRONIC RADIO FREQUENCY AND OPTICAL SIGNALS; ENCODING AND DECODING APPARATUS AND INSTRUMENTS; RECEIVERS AND TRANSMITTERS FOR TRANSMISSION, DISTRIBUTION AND BROADCASTING OF INFORMATION, DATA, GRAPHICS, SOUND, MUSIC, VIDEOS, ANIMATION AND TEXT; COMPUTER SOFTWARE FOR THE MONITORING OF AUTOMATED SATELLITE UPLINKING APPARATUS, SATELLITE TRANSMISSION, SATELLITE BROADCASTING SERVICES AND SATELLITE BROADCASTING TECHNOLOGY; COMPUTER SOFTWARE FOR TELECOMMUNICATIONS, DATA COMMUNICATIONS, SATELLITE BROADCASTING, NAMELY, FOR THE TRANSMISSION, RECEIVING, DISPLAY, ENCRYPTION AND DECRYPTION OF DIGITAL SIGNALS; COMPUTER SOFTWARE FOR RECEIVING, EXCHANGE AND DISPLAY OF MESSAGES, IMAGES OR DATA, NAMELY, CONTROLLING AND MANAGING ACCESS SERVER APPLICATIONS; COMPUTER SOFTWARE FOR CREATING AND SAFEGUARDING A COMMUNICATIONS NETWORK, FOR NETWORK SECURITY AND FOR MESSAGING AND ELECTRONIC MAIL SERVICES; COMPUTER SOFTWARE FOR PROVIDING ACCESS TO LOCAL AND GLOBAL COMPUTER NETWORKS AND COMPUTER SOFTWARE ENABLING PARTIES TO VIEW, DISPLAY, TRANSMIT AND DOWNLOAD INFORMATION FROM LOCAL AND GLOBAL COMPUTER NETWORKS; COMPUTER E-COMMERCE SOFTWARE TO ALLOW USERS TO PERFORM BUSINESS TRANSACTIONS VIA LOCAL AND GLOBAL COMPUTER NETWORKS; COMPUTER SOFTWARE FOR USE IN THE CREATION AND DEVELOPMENT OF WEBSITES, INCLUDING THOSE HAVING INTERACTIVE CONTENT; ELECTRONIC DOWNLOADABLE PUBLICATIONS, NAMELY, MANUALS IN THE FIELD OF SATELLITES, SATELLITE APPARATUS, SATELLITE TRANSMISSION, SATELLITE BROADCASTING SERVICES AND SATELLITE BROADCASTING TECHNOLOGY; TELEVISION AERIALS; TELEVISIONS; TELEVISION RECEIVERS; VIEWING SCREENS, NAMELY, PROJECTION SCREENS; CLOSED CIRCUIT TELEVISIONS; SECURITY CAMERAS, IN CLASS 9 (U.S. CLS. 21, 23, 26, 36 AND 38).

FOR: FINANCIAL SPONSORSHIP OF SPORTING EVENTS, IN CLASS 36 (U.S. CLS. 100, 101 AND 102).

FOR: INSTALLATION, MAINTENANCE AND REPAIR OF APPARATUS FOR RECORDING, TRANSMISSION AND REPRODUCTION OF SOUND OR IMAGES FOR THE TRANSMISSION, DISTRIBUTION AND BROADCASTING OF INFORMATION, DATA, GRAPHICS, SOUND, MUSIC, VIDEOS, ANIMATION AND TEXT, VIA SATELLITE SYSTEMS OR COMPUTER NETWORKS; INSTALLATION, MAINTENANCE AND REPAIR OF DATA PROCESSING EQUIPMENT, COMPUTER HARDWARE, TELECOMMUNICATION APPARATUS, DIGITAL SIGNAGE; INSTALLATION, REPAIR AND MAINTENANCE OF ELECTRONIC APPARATUS AND INSTRUMENTS FOR SATELLITE BROADCASTING; INFORMATION, CONSULTANCY AND ADVISORY SERVICES RELATING TO THE INSTALLATION, MAINTENANCE AND REPAIR OF APPARATUS FOR RECORDING, TRANSMISSION AND REPRODUCTION OF SOUND OR IMAGES, DATA PROCESSING EQUIPMENT, COMPUTER HARDWARE, TELECOMMUNICATION APPARATUS, AND DIGITAL SIGNAGE, IN CLASS 37 (U.S. CLS. 100, 103 AND 106).

FOR: TELECOMMUNICATION SERVICES, NAMELY, LOCAL AND LONG DISTANCE TRANSMISSION OF VOICE, DATA, AND GRAPHICS BY MEANS OF TELEPHONE, TELEGRAPHIC, CABLE, AND SATELLITE TRANSMISSIONS; TRANSMISSION OF INFORMATION, COMPUTER PROGRAMS, COMPUTER SOFTWARE AND OTHER DATA VIA TELECOMMUNICATION MEANS; PROVIDING SATELLITE TRANSMISSION OF COMPUTER PROGRAMS AND COMPUTER SOFTWARE, SATELLITE BROADCASTING OF GRAPHICS, INFORMATION, DATA, SOUND, MUSIC, VIDEOS, ANIMATION AND TEXT, AUDIO, VIDEO AND DATA COMMUNICATIONS SERVICES; SATELLITE BROADCASTING SERVICES; SATELLITE COMMUNICATIONS SERVICES; SATELLITE TRANSMISSION; TELECOMMUNICATIONS SERVICES, NAMELY, THE TRANSMISSION OF DATA, SOUND AND IMAGES VIA SATELLITE EARTH STATIONS WHETHER FIXED OR TRANSPORTABLE; RENTAL OF SATELLITE BROADCASTING SETS; TRANSMISSION OF DATA BY COMMUNICATIONS SATELLITE; TRANSMISSION OF INFORMATION, COMPUTER

Reg. No. 4,203,995 PROGRAMS, COMPUTER SOFTWARE AND OTHER DATA BY COMMUNICATIONS SATELLITE; RADIO AND TELEVISION TRANSMISSION, BROADCAST AND RECEPTION OF AUDIO, VIDEO, STILL AND MOVING IMAGES AND DATA WHETHER IN COMPRESSED OR UNCOMPRESSED FORM AND WHETHER IN REAL OR DELAYED TIME VIA TELECOMMUNICATION MEANS; ELECTRONIC MAIL SERVICES; COMMUNICATION SERVICES FOR VIDEO CONFERENCING PURPOSES, NAMELY, ELECTRONIC TRANSMISSION OF DATA AND DOCUMENTS AMONG REMOTE SITES USING SATELLITES; SATELLITE VIDEO CONFERENCING SERVICES; VIDEO CONFERENCING SERVICES; PROVIDING VOICE OVER INTERNET PROTOCOL (VOIP) PEER-TO-PEER COMMUNICATIONS; ELECTRONIC TRANSMISSION OF DATA AND DOCUMENTS OVER COMPUTER TERMINALS AND INSTANT MESSAGING SERVICES; PROVIDING A HIGH SPEED ACCESS TO LOCAL AND WIDE AREA NETWORKS AND A GLOBAL COMPUTER INFORMATION NETWORK; TELETXT SERVICES; NEWS AGENCY SERVICES, NAMELY, THE TRANSMISSION OF NEWS ITEMS TO NEWS REPORTING ORGANIZATIONS; TRANSMISSION OF NEWS; LEASING SATELLITE TIME FOR THE BROADCAST OF SATELLITE RADIO AND TELEVISION; PROVIDING ACCESS TO A COMPUTER DATABASE; PROVIDING ACCESS TO AND LEASING OF ACCESS TO SATELLITE CAPACITY; BROADCASTING ON RADIO, TV AND ON THE INTERNET OF AUDIO, VIDEO, STILL AND MOVING IMAGES AND DATA WHETHER IN COMPRESSED OR UNCOMPRESSED FORM AND WHETHER DOWNLOADABLE OR NON-DOWNLOADABLE; TRANSMISSION OF AUDIO, VIDEO, STILL AND MOVING IMAGES AND DATA WHETHER IN COMPRESSED OR UNCOMPRESSED FORM AND WHETHER DOWNLOADABLE OR NON-DOWNLOADABLE BY SATELLITE; TELECOMMUNICATION SERVICES, NAMELY, THE TRANSMISSION OF DATA, SOUND AND IMAGES VIA SATELLITE EARTH STATIONS WHETHER FIXED OR TRANSPORTABLE; DISSEMINATION OF TELEVISION PROGRAMS RELAYED BY SATELLITES, NAMELY, TELEVISION BROADCASTING; PROVIDING ON-LINE COMMUNICATIONS LINKS WHICH TRANSFER THE WEBSITE USER TO OTHER LOCAL AND GLOBAL WEB PAGES, NAMELY, ONLINE SYSTEMS FOR BOOKING SATELLITE CAPACITY AND FOR THE AUTOMATED REMOTE-CONTROL OF SATELLITE TRANSMISSION EQUIPMENT; WEB-BASED ONLINE SYSTEMS FOR BOOKING SATELLITE CAPACITY AND FOR THE AUTOMATED REMOTE-CONTROL OF SATELLITE TRANSMISSION EQUIPMENT, IN CLASS 38 (U.S. CLS. 100, 101 AND 104).

FOR: TELEVISION AND RADIO ENTERTAINMENT SERVICES, NAMELY, EDITING AND PLAY-OUT OF SOUNDS AND IMAGES; INFORMATION RELATING TO SPORTING EVENTS PROVIDED BY SATELLITE TRANSMISSION, THE INTERNET OR BY OTHER ELECTRONIC MEANS; PRODUCTION OF TELEVISION PROGRAMS, RADIO PROGRAMS AND FILMS IN STUDIOS OR BY MEANS OF OUTSIDE BROADCASTING FACILITIES; PROVIDING INFORMATION AND ADVISORY SERVICES RELATING TO GAMBLING, BETTING AND WAGERING; ON-LINE AND TELEPHONE GAMBLING, BETTING AND WAGERING; ENTERTAINMENT SPORTING SERVICES IN THE NATURE OF GAMBLING, BETTING AND WAGERING PROVIDED BY TELEPHONE, SATELLITE, THE INTERNET OR ON-LINE FROM A COMPUTER NETWORK DATABASE; RENTAL OF GAMBLING, BETTING, WAGERING AND GAMING MACHINES; INFORMATION, CONSULTANCY AND ADVISORY SERVICES RELATING TO GAMBLING, BETTING, WAGERING AND GAMING SERVICES, IN CLASS 41 (U.S. CLS. 100, 101 AND 107).

FOR: DESIGN AND DEVELOPMENT OF COMPUTER HARDWARE AND SOFTWARE IN THE FIELD OF TELECOMMUNICATIONS, DATA PROCESSING AND SATELLITE COMMUNICATION; COMPUTER PROGRAMMING, COMPUTER SYSTEMS ANALYSIS, REPAIR, MAINTENANCE, UPDATING OF COMPUTER SOFTWARE AND COMPUTER PROGRAMS, INFORMATION CONSULTANCY AND ADVISORY SERVICES, NAMELY, COMPUTER AND SOFTWARE TECHNICAL SUPPORT, TECHNICAL SUPPORT IN THE FIELD OF DATA PROCESSING EQUIPMENT, COMPUTER HARDWARE, APPARATUS FOR RECORDING, TRANSMISSION OR REPRODUCTION OF SOUND OR IMAGES, ALL FOR THE TRANSMISSION, DISTRIBUTION AND BROADCASTING OF INFORMATION, DATA, GRAPHICS, SOUND, MUSIC, VIDEOS, ANIMATION AND TEXT, VIA SATELLITE SYSTEMS OR LANDLINE COMPUTER NETWORKS; COMPUTER SOFTWARE CONSULTING AND AD-

Reg. No. 4,203,995 VISORY SERVICES IN CONNECTION WITH INFORMATION, DATA, GRAPHICS, SOUND, MUSIC, VIDEOS, ANIMATION AND TEXT, INFORMATION, CONSULTANCY AND ADVISORY SERVICES, NAMELY, TECHNICAL ADVISORY AND CONSULTING SERVICES IN THE TECHNOLOGY FIELD OF COMPUTER HARDWARE SYSTEMS; RENTAL OF SOFTWARE USED IN CONNECTION WITH GAMBLING, BETTING, WAGERING OR GAMING SERVICES, IN CLASS 42 (U.S. CLS. 100 AND 101).

PRIORITY CLAIMED UNDER SEC. 44(D) ON ERPN CMNTY TM OFC APPLICATION NO. 7168495, FILED 8-19-2008, REG. NO. 007168495, DATED 9-6-2011, EXPIRES 8-19-2018.

OWNER OF U.S. REG. NOS. 3,625,125 AND 3,918,592.

NO CLAIM IS MADE TO THE EXCLUSIVE RIGHT TO USE "LIVE" FOR INTERNATIONAL CLASS(ES) 9, 38, 41, AND 42, APART FROM THE MARK AS SHOWN.

THE MARK CONSISTS OF THE LETTERS "SISLIVE" IN A STYLIZED FONT ON A SHADED BACKGROUND. THE LETTERS "SIS" APPEAR IN A LARGER SIZE, AND THE LETTERS "LIVE" APPEAR IN A SUPERScript LETTERING TO THE RIGHT OF "SIS". THERE IS A DESIGN OF CIRCLES APPEARING ABOVE THE LETTER "I".

SER. NO. 77-673,936, FILED 2-19-2009.

KIM SAITO, EXAMINING ATTORNEY

United States of America

United States Patent and Trademark Office



Reg. No. 4,203,996

Registered Sep. 11, 2012

Int. Cls.: 9 and 42

TRADEMARK

SERVICE MARK

PRINCIPAL REGISTER

BACKBONE ENTERTAINMENT (CALIFORNIA CORPORATION)
SUITE 100
17600 GILLETTE STREET
IRVINE, CA 92614

FOR: COMPUTER GAME CARTRIDGES AND DISCS; COMPUTER GAME SOFTWARE; DOWNLOADABLE DESIGNING GAME VIA THE INTERNET AND WIRELESS DEVICES; ELECTRONIC GAME SOFTWARE FOR HANDHELD ELECTRONIC DEVICES; ELECTRONIC GAME SOFTWARE FOR WIRELESS DEVICES; VIDEO GAME CARTRIDGES AND DISCS, IN CLASS 9 (U.S. CLS. 21, 23, 26, 36 AND 38).

FIRST USE 9-30-2008; IN COMMERCE 9-30-2008.

FOR: DESIGNING AND DEVELOPING COMPUTER GAME SOFTWARE AND VIDEO GAME SOFTWARE FOR USE WITH COMPUTERS, VIDEO GAME PROGRAM SYSTEMS AND COMPUTER NETWORKS, IN CLASS 42 (U.S. CLS. 100 AND 101).

FIRST USE 3-27-2008; IN COMMERCE 3-27-2008.

THE MARK CONSISTS OF A SERIES OF HORIZONTAL LINES PRESENTED IN AN HOURGLASS SHAPE THAT REPRESENTS THE DOUBLE HELIX GEOMETRIC SHAPE OFTEN ASSOCIATED WITH DNA.

SER. NO. 77-680,836, FILED 2-28-2009.

LINDA LAVACHE, EXAMINING ATTORNEY



David J. Kybas

Director of the United States Patent and Trademark Office

United States of America

United States Patent and Trademark Office

SINATRA

Reg. No. 4,203,997

Registered Sep. 11, 2012

**Int. Cls.: 9, 14, 16, 28, 35,
41, 42 and 43**

TRADEMARK

SERVICE MARK

PRINCIPAL REGISTER

FRANK SINATRA ENTERPRISES, LLC (DELAWARE LIMITED LIABILITY COMPANY)
3400 WEST OLIVE AVENUE
BURBANK, CA 91505

FOR: (BASED ON USE IN COMMERCE) (BASED ON 44(D) PRIORITY APPLICATION) MUSICAL SOUND RECORDINGS; DOWNLOADABLE MUSICAL SOUND RECORDINGS; PRE-RECORDED ELECTRONIC AND DIGITAL MEDIA FEATURING AUDIO RECORDINGS OF MUSIC, MUSICAL ENTERTAINMENT AND PERFORMING ARTISTS; DOWNLOADABLE RING TONES VIA THE INTERNET AND WIRELESS DEVICES; MUSICAL VIDEO RECORDINGS; PRE-RECORDED ELECTRONIC AND DIGITAL MEDIA FEATURING VIDEO AND AUDIOVISUAL RECORDINGS OF MUSIC, MUSICAL ENTERTAINMENT, AND PERFORMING ARTISTS, IN CLASS 9 (U.S. CLS. 21, 23, 26, 36 AND 38).

FIRST USE 0-0-1943; IN COMMERCE 0-0-1943.

FOR: (BASED ON USE IN COMMERCE) WATCHES, IN CLASS 14 (U.S. CLS. 2, 27, 28 AND 50).

FIRST USE 7-0-2004; IN COMMERCE 7-0-2004.

FOR: (BASED ON USE IN COMMERCE) (BASED ON 44(D) PRIORITY APPLICATION) PHOTOGRAPHS; ART PRINTS; LITHOGRAPHIC WORKS OF ART; PRINTED ART REPRODUCTIONS; COFFEE TABLE BOOKS FEATURING ENTERTAINMENT AND LIFESTYLE; SONG BOOKS; PLASTIC CUSHIONING MATERIAL THAT CONTAINS ENCAPSULATED AIR CELLS FOR WRAPPING OR PACKAGING; PAPER MAIL POUCHES; CALENDARS, IN CLASS 16 (U.S. CLS. 2, 5, 22, 23, 29, 37, 38 AND 50).

FIRST USE 9-0-1999; IN COMMERCE 9-0-1999.

FOR: (BASED ON USE IN COMMERCE) (BASED ON 44(D) PRIORITY APPLICATION) DECORATIONS FOR CHRISTMAS TREES; CHRISTMAS TREE ORNAMENTS, IN CLASS 28 (U.S. CLS. 22, 23, 38 AND 50).

FIRST USE 10-0-1999; IN COMMERCE 10-0-1999.

FOR: (BASED ON USE IN COMMERCE) (BASED ON 44(D) PRIORITY APPLICATION) ON-LINE RETAIL STORE SERVICES FEATURING MUSICAL SOUND RECORDINGS, VIDEO



David J. Kyros

Director of the United States Patent and Trademark Office

Reg. No. 4,203,997 RECORDINGS, DOWNLOADABLE PRE-RECORDED MUSIC, PRE-RECORDED ELECTRONIC AND DIGITAL MEDIA FEATURING AUDIO, VIDEO AND AUDIOVISUAL RECORDINGS OF MUSIC, MUSICAL ENTERTAINMENT, PERFORMING ARTISTS, MUSICAL MOTION PICTURES AND DRAMATIC MOTION PICTURES, BOOKS, CLOTHING, BAGS, SPORTING GOODS, AND GIFTS, IN CLASS 35 (U.S. CLS. 100, 101 AND 102).

FIRST USE 10-0-2006; IN COMMERCE 10-0-2006.

FOR: (BASED ON USE IN COMMERCE) (BASED ON 44(D) PRIORITY APPLICATION) PROVISION OF ENTERTAINMENT INFORMATION RELATING TO ENTERTAINMENT AND CULTURAL EVENTS AND ACTIVITIES, VIA THE INTERNET OR OTHER COMMUNICATIONS NETWORKS; PROVIDING ONLINE ENTERTAINMENT INFORMATION IN THE FIELD OF MUSIC, ENTERTAINMENT, AND MUSICAL ARTISTS VIA THE INTERNET; FAN CLUBS; PROVIDING A WEB SITE FEATURING NON-DOWNLOADABLE MUSICAL SOUND RECORDINGS, MUSICAL VIDEOS, RELATED FILM CLIPS, PHOTOGRAPHS AND OTHER ENTERTAINMENT MULTIMEDIA MATERIALS FEATURING MUSIC, MUSICAL ENTERTAINMENT AND PERFORMING ARTISTS, AND NEWS AND INFORMATION ABOUT MUSIC, MUSICAL ENTERTAINMENT, FILM, AND PERFORMING ARTISTS; PROVIDING NEWSLETTERS AND ALERTS, NAMELY, ENTERTAINMENT NEWS AND INFORMATION IN THE FIELD OF MUSIC, ENTERTAINMENT, MUSICAL ARTISTS, AND FILM VIA E-MAIL; GAMING SERVICES IN THE NATURE OF CASINO GAMING AND ONLINE GAMING SERVICES; ENTERTAINMENT SERVICES, NAMELY, PROVIDING ONGOING RADIO PROGRAMS IN THE FIELD OF MUSIC; ARRANGING AND CONDUCTING ENTERTAINMENT EVENTS, NAMELY, MUSICAL EVENTS AND PARTIES; ARRANGING ENTERTAINMENT EVENTS, NAMELY, DANCE EVENTS AND THEATRICAL EVENTS; ORGANIZATION OF GOLF TOURNAMENTS, IN CLASS 41 (U.S. CLS. 100, 101 AND 107).

FIRST USE 7-0-2008; IN COMMERCE 7-0-2008.

FOR: (BASED ON USE IN COMMERCE) (BASED ON 44(D) PRIORITY APPLICATION) HOSTING AN ON-LINE COMMUNITY WEBSITE FOR REGISTERED USERS TO PARTICIPATE IN DISCUSSIONS, GET FEEDBACK FROM THEIR PEERS, FORM VIRTUAL COMMUNITIES, AND ENGAGE IN SOCIAL NETWORKING, IN CLASS 42 (U.S. CLS. 100 AND 101).

FIRST USE 7-0-2008; IN COMMERCE 7-0-2008.

FOR: (BASED ON USE IN COMMERCE) (BASED ON 44(D) PRIORITY APPLICATION) RESTAURANT SERVICES; BAR SERVICES, IN CLASS 43 (U.S. CLS. 100 AND 101).

FIRST USE 12-0-2008; IN COMMERCE 12-0-2008.

THE MARK CONSISTS OF STANDARD CHARACTERS WITHOUT CLAIM TO ANY PARTICULAR FONT, STYLE, SIZE, OR COLOR.

PRIORITY CLAIMED UNDER SEC. 44(D) ON ERPN CMNTY TM OFC APPLICATION NO. 7245046, FILED 9-19-2008.

OWNER OF U.S. REG. NOS. 3,201,113, 3,243,889 AND OTHERS.

SER. NO. 77-693,949, FILED 3-18-2009.

DARRYL SPRUILL, EXAMINING ATTORNEY

United States of America

United States Patent and Trademark Office

THE GIFT OF YOUTH

Reg. No. 4,203,998

Registered Sep. 11, 2012

Int. Cl.: 3

TRADEMARK

PRINCIPAL REGISTER

WESTERN HOLDINGS, LLC (WYOMING LIMITED LIABILITY COMPANY)
1821 LOGAN AVENUE
CHEYENNE, WY 82001

FOR: COSMETICS, IN CLASS 3 (U.S. CLS. 1, 4, 6, 50, 51 AND 52).

FIRST USE 5-13-2007; IN COMMERCE 5-13-2007.

THE MARK CONSISTS OF STANDARD CHARACTERS WITHOUT CLAIM TO ANY PARTICULAR FONT, STYLE, SIZE, OR COLOR.

SER. NO. 77-703,101, FILED 3-31-2009.

VIVIAN MICZNIK FIRST, EXAMINING ATTORNEY



David J. Kybas

Director of the United States Patent and Trademark Office

United States of America

United States Patent and Trademark Office



Reg. No. 4,203,999

Registered Sep. 11, 2012

Int. Cl.: 9

TRADEMARK

PRINCIPAL REGISTER

LG ELECTRONICS INC. (REPUBLIC OF KOREA CORPORATION)
20, YOIDO-DONG, YONGDUNGPO-GU
SEOUL, REPUBLIC OF KOREA

FOR: TELEVISION RECEIVERS, IN CLASS 9 (U.S. CLS. 21, 23, 26, 36 AND 38).

PRIORITY CLAIMED UNDER SEC. 44(D) ON REPUBLIC OF KOREA APPLICATION NO.
40-2009-0011, FILED 3-11-2009.

OWNER OF ERPN CMNTY TM OFC REG. NO. 008539868, DATED 3-8-2010, EXPIRES 9-10-
2019.

NO CLAIM IS MADE TO THE EXCLUSIVE RIGHT TO USE "FULL HD 1080P", APART
FROM THE MARK AS SHOWN.

SER. NO. 77-705,548, FILED 4-2-2009.

JANICE L. MCMORROW, EXAMINING ATTORNEY



David J. Kybas

Director of the United States Patent and Trademark Office

United States of America

United States Patent and Trademark Office



Reg. No. 4,204,000

Registered Sep. 11, 2012

**Int. Cls.: 9, 36, 37, 38, 41
and 42**

SATELLITE INFORMATION SERVICES LIMITED (UNITED KINGDOM PRIVATE LIMITED COMPANY)
SATELLITE HOUSE
17 CORSHAM STREET
LONDON N1 6DR, UNITED KINGDOM

TRADEMARK

SERVICE MARK

PRINCIPAL REGISTER

FOR: APPARATUS FOR RECORDING, TRANSMISSION, REPRODUCTION, RECEIVING AND PLAY-OUT OF SOUND AND IMAGES FOR THE TRANSMISSION BY SATELLITE, TERRESTRIAL RADIO, TERRESTRIAL VIDEO CIRCUITS AND TERRESTRIAL DATA CIRCUITS AND BROADCASTING OF INFORMATION, DATA, GRAPHICS, SOUND, MUSIC, VIDEOS, ANIMATION AND TEXT; PRE-RECORDED VIDEO CASSETTES, TAPES AND CARTRIDGES, COMPACT DISCS, DVDS IN THE FIELD OF CURRENT EVENTS AND RECREATIONAL ACTIVITIES, CULTURAL, ENTERTAINMENT AND SPORTING EVENTS; VIDEO CONFERENCING APPARATUS, NAMELY, SATELLITE DISHES, SATELLITE TRANSMITTER AND RECEIVERS, SATELLITE TELEPHONES AND CAMERAS; SATELLITE APPARATUS, NAMELY, SATELLITES; SATELLITE DISHES, SATELLITE TRANSMITTER AND RECEIVERS, SATELLITE TELEPHONES; PORTABLE AND TRANSPORTABLE APPARATUS FOR RECEIVING AND SENDING SATELLITE TRANSMISSIONS; SATELLITE BROADCASTING INSTRUMENTS, NAMELY, SATELLITE DISHES AND SATELLITE TRANSMITTERS AND RECEIVERS; SATELLITE EARTH STATIONS; SATELLITE RECEIVERS; SATELLITE TELEVISION RECEIVING APPARATUS, NAMELY, ANTENNAS FOR SATELLITES; SATELLITE COMMUNICATIONS EQUIPMENT, NAMELY, ANTENNAS, TRANSMITTERS AND RECEIVERS; SATELLITE TRANSCEIVERS; SATELLITE TELEVISION TRANSMISSION UPLINK ENCRYPTION AND ENCODING APPARATUS; TRANSMITTING APPARATUS FOR SATELLITE BROADCAST; RECEIVING ANTENNAS FOR SATELLITE BROADCAST; SATELLITE NAVIGATIONAL INSTRUMENTS; INTERCOMMUNICATION SATELLITES; ELECTRONIC TELEVISION SATELLITE APPARATUS, NAMELY, TELEVISION AERIALS, TELEVISION RECEIVERS AND TELEVISION TRANSMITTERS; AUDIOVISUAL APPARATUS FOR USE IN SATELLITE, NAMELY, AUDIOVISUAL RECEIVERS; BROADCASTING SATELLITE EARTH STATIONS; SATELLITE TELEVISION SIGNAL ENCRYPTION APPARATUS; CAMERAS; TELEVISION CAMERAS; ELECTRICAL AND ELECTRONIC APPARATUS, FOR MANAGEMENT AND PERFORMANCE ANALYSIS OF TELECOMMUNICATIONS, TERRESTRIAL AND SATELLITE BROADCASTING, SIGNALING AND DATA COMMUNICATIONS NETWORKS THAT CONTROLS, MANAGES AND MONITORS AUTOMATED SATELLITES; APPARATUS FOR USE IN BROADCASTING, TRANSMISSION, RECEIVING, PROCESSING, REPRODUCING, ENCODING AND DECODING OF DIGITAL SIGNALS; SIGNAL GENERATORS FOR TRANSMISSION, DISTRIBUTION



David J. Kybas

Director of the United States Patent and Trademark Office

Reg. No. 4,204,000 AND BROADCASTING OF INFORMATION, DATA, GRAPHICS, SOUND, MUSIC, VIDEOS, ANIMATION AND TEXT; ELECTRONIC CIRCUITS FOR PROCESSING, CODING AND DECODING ELECTRONIC RADIO FREQUENCY AND OPTICAL SIGNALS; ENCODING AND DECODING APPARATUS AND INSTRUMENTS; RECEIVERS AND TRANSMITTERS FOR TRANSMISSION, DISTRIBUTION AND BROADCASTING OF INFORMATION, DATA, GRAPHICS, SOUND, MUSIC, VIDEOS, ANIMATION AND TEXT; COMPUTER SOFTWARE FOR THE MONITORING OF AUTOMATED SATELLITE UPLINKING APPARATUS, SATELLITE TRANSMISSION, SATELLITE BROADCASTING SERVICES AND SATELLITE BROADCASTING TECHNOLOGY; COMPUTER SOFTWARE FOR TELECOMMUNICATIONS, DATA COMMUNICATIONS, SATELLITE BROADCASTING, NAMELY, FOR THE TRANSMISSION, RECEIVING, DISPLAY, ENCRYPTION AND DECRYPTION OF DIGITAL SIGNALS; COMPUTER SOFTWARE FOR RECEIVING, EXCHANGE AND DISPLAY OF MESSAGES, IMAGES OR DATA, NAMELY, CONTROLLING AND MANAGING ACCESS SERVER APPLICATIONS; COMPUTER SOFTWARE FOR CREATING AND SAFEGUARDING A COMMUNICATIONS NETWORK, FOR NETWORK SECURITY AND FOR MESSAGING AND ELECTRONIC MAIL SERVICES; COMPUTER SOFTWARE FOR PROVIDING ACCESS TO LOCAL AND GLOBAL COMPUTER NETWORKS AND COMPUTER SOFTWARE ENABLING PARTIES TO VIEW, DISPLAY, TRANSMIT AND DOWNLOAD INFORMATION FROM LOCAL AND GLOBAL COMPUTER NETWORKS; COMPUTER E-COMMERCE SOFTWARE TO ALLOW USERS TO PERFORM BUSINESS TRANSACTIONS VIA LOCAL AND GLOBAL COMPUTER NETWORKS; COMPUTER SOFTWARE FOR USE IN THE CREATION AND DEVELOPMENT OF WEBSITES, INCLUDING THOSE HAVING INTERACTIVE CONTENT; ELECTRONIC DOWNLOADABLE PUBLICATIONS, NAMELY, MANUALS IN THE FIELD OF SATELLITES, SATELLITE APPARATUS, SATELLITE TRANSMISSION, SATELLITE BROADCASTING SERVICES AND SATELLITE BROADCASTING TECHNOLOGY; TELEVISION AERIALS; TELEVISIONS; TELEVISION RECEIVERS; VIEWING SCREENS, NAMELY, PROJECTION SCREENS; CLOSED CIRCUIT TELEVISIONS; SECURITY CAMERAS, IN CLASS 9 (U.S. CLS. 21, 23, 26, 36 AND 38).

FOR: FINANCIAL SPONSORSHIP OF SPORTING EVENTS, IN CLASS 36 (U.S. CLS. 100, 101 AND 102).

FOR: INSTALLATION, MAINTENANCE AND REPAIR OF APPARATUS FOR RECORDING, TRANSMISSION AND REPRODUCTION OF SOUND OR IMAGES FOR THE TRANSMISSION, DISTRIBUTION AND BROADCASTING OF INFORMATION, DATA, GRAPHICS, SOUND, MUSIC, VIDEOS, ANIMATION AND TEXT, VIA SATELLITE SYSTEMS OR COMPUTER NETWORKS; INSTALLATION, MAINTENANCE AND REPAIR OF DATA PROCESSING EQUIPMENT, COMPUTER HARDWARE, TELECOMMUNICATION APPARATUS, DIGITAL SIGNAGE; INSTALLATION, REPAIR AND MAINTENANCE OF ELECTRONIC APPARATUS AND INSTRUMENTS FOR SATELLITE BROADCASTING; INFORMATION, CONSULTANCY AND ADVISORY SERVICES RELATING TO THE INSTALLATION, MAINTENANCE AND REPAIR OF APPARATUS FOR RECORDING, TRANSMISSION AND REPRODUCTION OF SOUND OR IMAGES, DATA PROCESSING EQUIPMENT, COMPUTER HARDWARE, TELECOMMUNICATION APPARATUS, AND DIGITAL SIGNAGE, IN CLASS 37 (U.S. CLS. 100, 103 AND 106).

FOR: TELECOMMUNICATION SERVICES, NAMELY, LOCAL AND LONG DISTANCE TRANSMISSION OF VOICE, DATA, AND GRAPHICS BY MEANS OF TELEPHONE, TELEGRAPHIC, CABLE, AND SATELLITE TRANSMISSIONS; TRANSMISSION OF INFORMATION, COMPUTER PROGRAMS, COMPUTER SOFTWARE AND OTHER DATA VIA TELECOMMUNICATION MEANS; PROVIDING SATELLITE TRANSMISSION OF COMPUTER PROGRAMS AND COMPUTER SOFTWARE, SATELLITE BROADCASTING OF GRAPHICS, INFORMATION, DATA, SOUND, MUSIC, VIDEOS, ANIMATION AND TEXT, AUDIO, VIDEO AND DATA COMMUNICATIONS SERVICES; SATELLITE BROADCASTING SERVICES; SATELLITE COMMUNICATIONS SERVICES; SATELLITE TRANSMISSION; TELECOMMUNICATIONS SERVICES, NAMELY, THE TRANSMISSION OF DATA, SOUND AND IMAGES VIA SATELLITE EARTH STATIONS WHETHER FIXED OR TRANSPORTABLE; RENTAL OF SATELLITE BROADCASTING SETS; TRANSMISSION OF DATA BY

Reg. No. 4,204,000 COMMUNICATIONS SATELLITE; TRANSMISSION OF INFORMATION, COMPUTER PROGRAMS, COMPUTER SOFTWARE AND OTHER DATA BY COMMUNICATIONS SATELLITE; RADIO AND TELEVISION TRANSMISSION, BROADCAST AND RECEPTION OF AUDIO, VIDEO, STILL AND MOVING IMAGES AND DATA WHETHER IN COMPRESSED OR UNCOMPRESSED FORM AND WHETHER IN REAL OR DELAYED TIME VIA TELECOMMUNICATION MEANS; ELECTRONIC MAIL SERVICES; COMMUNICATION SERVICES FOR VIDEO CONFERENCING PURPOSES, NAMELY, ELECTRONIC TRANSMISSION OF DATA AND DOCUMENTS AMONG REMOTE SITES USING SATELLITES; SATELLITE VIDEO CONFERENCING SERVICES; VIDEO CONFERENCING SERVICES; PROVIDING VOICE OVER INTERNET PROTOCOL (VOIP) PEER-TO-PEER COMMUNICATIONS; ELECTRONIC TRANSMISSION OF DATA AND DOCUMENTS OVER COMPUTER TERMINALS AND INSTANT MESSAGING SERVICES; PROVIDING A HIGH SPEED ACCESS TO LOCAL AND WIDE AREA NETWORKS AND A GLOBAL COMPUTER INFORMATION NETWORK; TELETEXT SERVICES; NEWS AGENCY SERVICES, NAMELY, THE TRANSMISSION OF NEWS ITEMS TO NEWS REPORTING ORGANIZATIONS; TRANSMISSION OF NEWS; LEASING SATELLITE TIME FOR THE BROADCAST OF SATELLITE RADIO AND TELEVISION; PROVIDING ACCESS TO A COMPUTER DATABASE; PROVIDING ACCESS TO AND LEASING OF ACCESS TO SATELLITE CAPACITY; BROADCASTING ON RADIO, TV AND ON THE INTERNET OF AUDIO, VIDEO, STILL AND MOVING IMAGES AND DATA WHETHER IN COMPRESSED OR UNCOMPRESSED FORM AND WHETHER DOWNLOADABLE OR NON-DOWNLOADABLE; TRANSMISSION OF AUDIO, VIDEO, STILL AND MOVING IMAGES AND DATA WHETHER IN COMPRESSED OR UNCOMPRESSED FORM AND WHETHER DOWNLOADABLE OR NON-DOWNLOADABLE BY SATELLITE; TELECOMMUNICATION SERVICES, NAMELY, THE TRANSMISSION OF DATA, SOUND AND IMAGES VIA SATELLITE EARTH STATIONS WHETHER FIXED OR TRANSPORTABLE; DISSEMINATION OF TELEVISION PROGRAMS RELAYED BY SATELLITES, NAMELY, TELEVISION BROADCASTING; PROVIDING ON-LINE COMMUNICATIONS LINKS WHICH TRANSFER THE WEBSITE USER TO OTHER LOCAL AND GLOBAL WEB PAGES, NAMELY, ONLINE SYSTEMS FOR BOOKING SATELLITE CAPACITY AND FOR THE AUTOMATED REMOTE-CONTROL OF SATELLITE TRANSMISSION EQUIPMENT; WEB-BASED ONLINE SYSTEMS FOR BOOKING SATELLITE CAPACITY AND FOR THE AUTOMATED REMOTE-CONTROL OF SATELLITE TRANSMISSION EQUIPMENT, IN CLASS 38 (U.S. CLS. 100, 101 AND 104).

FOR: TELEVISION AND RADIO ENTERTAINMENT SERVICES, NAMELY, EDITING AND PLAY-OUT OF SOUNDS AND IMAGES; INFORMATION RELATING TO SPORTING EVENTS PROVIDED BY SATELLITE TRANSMISSION, THE INTERNET OR BY OTHER ELECTRONIC MEANS; PRODUCTION OF TELEVISION PROGRAMS, RADIO PROGRAMS AND FILMS IN STUDIOS OR BY MEANS OF OUTSIDE BROADCASTING FACILITIES; PROVIDING INFORMATION AND ADVISORY SERVICES RELATING TO GAMBLING, BETTING AND WAGERING; ON-LINE AND TELEPHONE GAMBLING, BETTING AND WAGERING; ENTERTAINMENT SPORTING SERVICES IN THE NATURE OF GAMBLING, BETTING AND WAGERING PROVIDED BY TELEPHONE, SATELLITE, THE INTERNET OR ON-LINE FROM A COMPUTER NETWORK DATABASE; RENTAL OF GAMBLING, BETTING, WAGERING AND GAMING MACHINES; INFORMATION, CONSULTANCY AND ADVISORY SERVICES RELATING TO GAMBLING, BETTING, WAGERING AND GAMING SERVICES, IN CLASS 41 (U.S. CLS. 100, 101 AND 107).

FOR: DESIGN AND DEVELOPMENT OF COMPUTER HARDWARE AND SOFTWARE IN THE FIELD OF TELECOMMUNICATIONS AND SATELLITE COMMUNICATION; COMPUTER PROGRAMMING, COMPUTER SYSTEMS ANALYSIS, REPAIR, MAINTENANCE, UPDATING OF COMPUTER SOFTWARE AND COMPUTER PROGRAMS, ALL FOR THE TRANSMISSION, DISTRIBUTION AND BROADCASTING OF INFORMATION, DATA, GRAPHICS, SOUND, MUSIC, VIDEOS, ANIMATION AND TEXT, VIA SATELLITE SYSTEMS OR LANDLINE COMPUTER NETWORKS; INFORMATION CONSULTANCY AND ADVISORY SERVICES, NAMELY, TROUBLESHOOTING IN THE NATURE OF DIAGNOSING PROBLEMS WITH COMPUTER SOFTWARE; COMPUTER SOFTWARE CONSULTING AND ADVISORY SERVICES IN CONNECTION WITH INFORMATION, DATA, GRAPHICS,

Reg. No. 4,204,000 SOUND, MUSIC, VIDEOS, ANIMATION AND TEXT, ALL FOR THE TRANSMISSION, DISTRIBUTION AND BROADCASTING OF INFORMATION, DATA, GRAPHICS, SOUND, MUSIC, VIDEOS, ANIMATION AND TEXT, VIA SATELLITE SYSTEMS OR LANDLINE COMPUTER NETWORKS; RENTAL OF SOFTWARE USED IN CONNECTION WITH GAMBLING, BETTING, WAGERING OR GAMING SERVICES, IN CLASS 42 (U.S. CLS. 100 AND 101).

PRIORITY CLAIMED UNDER SEC. 44(D) ON ERPN CMNTY TM OFC APPLICATION NO. 007338511, FILED 10-23-2008, REG. NO. 007338511, DATED 8-12-2011, EXPIRES 10-23-2018.

OWNER OF U.S. REG. NOS. 3,625,125 AND 3,918,592.

THE GRAY TONES ARE INTENDED TO INDICATE SHADING ONLY.

THE MARK CONSISTS OF THE LETTERS "SIS" IN A STYLIZED FONT ON A SHADED BACKGROUND. THERE IS A DESIGN OF CIRCLES APPEARING ABOVE THE LETTER "I".

SER. NO. 77-720,555, FILED 4-23-2009.

KIM SAITO, EXAMINING ATTORNEY

United States of America

United States Patent and Trademark Office

FUSIONCAST

Reg. No. 4,204,001

Registered Sep. 11, 2012

Int. Cls.: 6 and 20

TRADEMARK

PRINCIPAL REGISTER

FUSIONCAST INC. (CANADA CORPORATION)
2520 BRISTOL CIRCLE
OAKVILLE, ONTARIO, CANADA L6H 5S1

FOR: COMPOSITE CASTINGS MADE PREDOMINANTLY OF METAL AND CONTAINING LESSER AMOUNTS OF NON-METAL MATERIALS FOR USE IN THE MANUFACTURE OF SIGNS, PLAQUES, AND GRAVE MARKERS; NON-LUMINOUS AND NON-MECHANICAL SIGNS, AND WALL PLAQUES AND RECOGNITION PLAQUES ALL OF WHICH ARE CAST PREDOMINANTLY FROM NON-PRECIOUS METALS AND LESSER AMOUNTS OF NON-METAL MATERIALS; AND GRAVE MARKERS CAST PREDOMINANTLY FROM NON-PRECIOUS METAL AND LESSER AMOUNTS OF NON-METAL MATERIALS, IN CLASS 6 (U.S. CLS. 2, 12, 13, 14, 23, 25 AND 50).

FOR: COMPOSITE CASTINGS MADE PREDOMINANTLY OF NON-METAL RESINOUS MATERIALS AND CONTAINING LESSER AMOUNTS OF METAL FOR USE IN THE MANUFACTURE OF SIGNS, PLAQUES AND GRAVE MARKERS; NON-LUMINOUS AND NON-MECHANICAL SIGNS CAST PREDOMINANTLY FROM NON-METAL RESINOUS MATERIALS AND LESSER AMOUNTS OF METAL; PLAQUES AND GRAVE MARKERS CAST PREDOMINANTLY FROM NON-METAL RESINOUS MATERIALS WITH LESSER AMOUNTS OF METAL, NAMELY, WALL PLAQUES, RECOGNITION PLAQUES AND GRAVE MARKERS, IN CLASS 20 (U.S. CLS. 2, 13, 22, 25, 32 AND 50).

THE MARK CONSISTS OF STANDARD CHARACTERS WITHOUT CLAIM TO ANY PARTICULAR FONT, STYLE, SIZE, OR COLOR.

PRIORITY CLAIMED UNDER SEC. 44(D) ON CANADA APPLICATION NO. 1423135, FILED 12-29-2008, REG. NO. TMA797042, DATED 5-10-2011, EXPIRES 5-10-2026.

SER. NO. 77-761,556, FILED 6-17-2009.

GRETCHEN ULRICH, EXAMINING ATTORNEY



David J. Kypos

Director of the United States Patent and Trademark Office

United States of America

United States Patent and Trademark Office

DINOSA WUS

Reg. No. 4,204,002

Registered Sep. 11, 2012

**Int. Cls.: 9, 16, 25, 28, 30
and 41**

TRADEMARK

SERVICE MARK

PRINCIPAL REGISTER

CUSTARD SQUARE LIMITED (NEW ZEALAND CORPORATION)
2 WAGENER PLACE, ST LUKES
AUCKLAND, NEW ZEALAND 1346

FOR: APPARATUS FOR RECORDING, TRANSMISSION OR REPRODUCTION OF SOUND OR IMAGES; AUDIO AND VISUAL RECORDINGS FEATURING AUDIO, MUSIC, TEXT, STILL IMAGES, ANIMATION AND VIDEO; INTERACTIVE AUDIO AND VISUAL RECORDINGS FEATURING AUDIO, MUSIC, TEXT, STILL IMAGES, ANIMATION AND VIDEO AUDIO CASSETTE PLAYERS; AUDIO CASSETTE RECORDERS; AUDIO CASSETTES FEATURING SOUND AND MUSIC; AUDIO DISCS FEATURING SOUND AND MUSIC; AUDIO SPEAKERS; AUTOMATIC VENDING MACHINES AND MECHANISMS FOR COIN-OPERATED APPARATUS; BINOCULARS; CALCULATING MACHINES; CALCULATORS; CAMCORDERS; CAMERAS; PRERECORDED CD-ROMS FEATURING SOUND, MUSIC, TEXT, STILL IMAGES, VIDEO AND ANIMATION; COMPACT DISC PLAYERS; COMPACT DISC RECORDERS; COMPACT DISCS FEATURING AUDIO, MUSIC, TEXT, STILL IMAGES, ANIMATION AND VIDEO; INTERACTIVE COMPACT DISCS FEATURING AUDIO, MUSIC, TEXT, STILL IMAGES, ANIMATION AND VIDEO; COMPUTER DISK DRIVES; COMPUTER GAME CARTRIDGES; COMPUTER GAME DISCS; COMPUTERS; COMPUTER GAME PROGRAMS; COMPUTER HARDWARE; COMPUTER KEYBOARDS; COMPUTER MONITORS; COMPUTER MOUSE; COMPUTER SOFTWARE FOR TRANSMITTING TEXT, IMAGES AND SOUND IN RELATION TO LEARNING ACTIVITIES, GAMES AND ENTERTAINMENT; DATA PROCESSING EQUIPMENT; DECORATIVE MAGNETS; DIGITAL AUDIO TAPE RECORDERS; DIGITAL CAMERAS; DIGITAL VERSATILE DISCS FEATURING AUDIO, MUSIC, TEXT, STILL IMAGES, ANIMATION AND VIDEO; INTERACTIVE DIGITAL VERSATILE DISCS FEATURING AUDIO, MUSIC, TEXT, STILL IMAGES, ANIMATION AND VIDEO; DIGITAL VIDEO DISCS FEATURING AUDIO, MUSIC, TEXT, STILL IMAGES, ANIMATION AND VIDEO; INTERACTIVE DIGITAL VIDEO DISCS FEATURING AUDIO, MUSIC, TEXT, STILL IMAGES, ANIMATION AND VIDEO DIGITAL VIDEO RECORDERS; DVD PLAYERS; DVD RECORDERS; ELECTRONIC PERSONAL ORGANIZERS; EYEGLASSES AND CASES THEREFOR; HEADPHONES; KARAOKE MACHINES; LASER VIDEO DISCS FEATURING AUDIO, MUSIC, TEXT, STILL IMAGES, ANIMATION AND VIDEO; INTERACTIVE LASER VIDEO DISCS FEATURING AUDIO, MUSIC, TEXT, STILL IMAGES, ANIMATION AND VIDEO; LOUDSPEAKERS; PRE-RECORDED MAGNETIC DATA CARRIERS FEATURING AUDIO, MUSIC, TEXT, STILL IMAGES, ANIMATION AND VIDEO; INTERACTIVE PRE-RECORDED MAGNETIC DATA CARRIERS FEATURING AUDIO, MUSIC, TEXT, STILL IMAGES, ANIMATION AND VIDEO; MICROPHONES; MINIDISC PLAYERS; MINIDISKS FEATURING SOUND, MUSIC, TEXT, STILL IMAGES, ANIMATION



David J. Kyffers

Director of the United States Patent and Trademark Office

Reg. No. 4,204,002 AND VIDEO; MOBILE PHONE CASES, STEREO HEADSETS, EXTERNAL SPEAKERS, DOWNLOADABLE RING TONES VIA MOBILE PHONES, MOBILE PHONE ACCESSORIES, NAMELY, COVERS AND FACEPLATES, SOFTWARE FOR DOWNLOADING AND TRANSMITTING SOUND, MUSIC, TEXT, ANIMATION, VIDEO AND IMAGES; DOWNLOADABLE MUSIC VIA MOBILE PHONES; DOWNLOADABLE ELECTRONIC GAME PROGRAMS VIA MOBILE PHONES, HAND-HELD UNITS FOR PLAYING ELECTRONIC GAMES FOR USE WITH EXTERNAL DISPLAY SCREENS OR MONITORS, ELECTRONIC GAME PROGRAMS FEATURING AVATARS, ELECTRONIC GAMES FEATURING VIRTUAL WORLDS, HAND-HELD ELECTRONIC GAMES ADAPTED FOR USE WITH TELEVISION RECEIVERS ONLY, DOWNLOADABLE ELECTRONIC GAME PROGRAMS VIA THE INTERNET, MOBILE TELEPHONES; MOTION PICTURE FILMS ABOUT CULTURAL ARTIFACTS; MOUSE PADS; MP3 PLAYERS; MP3 RECORDERS; PAGERS; PERSONAL DIGITAL ASSISTANTS; PERSONAL STEREO; PHONOGRAPH RECORDS FEATURING MUSIC; PORTABLE TELECOMMUNICATION INSTANT MESSAGING DEVICES; PRINTERS; RADIOS; RECORDING DISCS, NAMELY, PRE-RECORDED COMPACT DISCS FEATURING AUDIO, MUSIC, TEXT, STILL IMAGES, ANIMATION AND VIDEO; INTERACTIVE RECORDING DISCS, NAMELY, PRE-RECORDED COMPACT DISCS FEATURING AUDIO, MUSIC, TEXT, STILL IMAGES, ANIMATION AND VIDEO; SUNGLASSES AND CASES THEREFOR; TELEPHONES; TELEVISIONS; VIDEO CAMERAS; VIDEO CASSETTES FEATURING AUDIO, MUSIC, TEXT, STILL IMAGES, ANIMATION AND VIDEO; INTERACTIVE VIDEO CASSETTES FEATURING AUDIO, MUSIC, TEXT, STILL IMAGES, ANIMATION AND VIDEO; VIDEO DISCS FEATURING AUDIO, MUSIC, TEXT, STILL IMAGES, ANIMATION AND VIDEO; INTERACTIVE VIDEO DISCS FEATURING AUDIO, MUSIC, TEXT, STILL IMAGES, ANIMATION AND VIDEO; VIDEO GAME CARTRIDGES AND DISCS; VIDEO TAPES FEATURING AUDIO, MUSIC, TEXT, STILL IMAGES, ANIMATION AND VIDEO; INTERACTIVE VIDEO TAPES FEATURING AUDIO, MUSIC, TEXT, STILL IMAGES, ANIMATION AND VIDEO; VIDEO PHONES; WALKIE-TALKIES; WRIST AND ARM SUPPORT PADS FOR USE WITH COMPUTERS; VIDEO GAME SOFTWARE, IN CLASS 9 (U.S. CLS. 21, 23, 26, 36 AND 38).

FOR: ADDRESS BOOKS; ADHESIVES FOR STATIONERY OR HOUSEHOLD PURPOSES; ALMANACS; APPLIQUES IN THE FORM OF DECALS; APPOINTMENT BOOKS; ART PRINTS; ARTS AND CRAFT PAINT KITS; AUTOGRAPH BOOKS; BABY BOOKS; BALL-POINT PENS; BASEBALL CARDS; BINDERS; BOOKBINDING MATERIAL; BOOKENDS; BOOKMARKS; FICTIONAL BOOKS FOR CHILDREN; CALENDARS; CARTOON STRIPS; CARTOON PRINTS; CHALK; CHILDREN'S ACTIVITY BOOKS; CHRISTMAS CARDS; COIN ALBUMS; COLOUR PENCILS; COLOURING BOOKS; COMIC BOOKS; COMIC STRIPS; COUPON BOOKS; DECORATIVE PAPER CENTREPIECES; DIARIES; DISPOSABLE DIAPERS FOR BABIES; DRAWING RULERS; ENVELOPES; ERASERS; FELT PENS; FLASH CARDS; PAPER GIFT CARDS; GIFT WRAPPING PAPER; GLOBES; GREETING CARDS; GUEST BOOKS; LETTER OPENERS OF PRECIOUS METAL; MAGAZINES IN THE FIELDS OF SCIENCE, HEALTH, CARTOONS, BUSINESS, ENTERTAINMENT, ONLINE GAMING, AND CHILDREN'S AND PARENTING MAGAZINES; MAPS; MEMO PADS; MODELING CLAY; NEWSPAPERS; NEWSLETTERS IN THE FIELDS OF SCIENCE, HEALTH, CARTOONS, BUSINESS, ENTERTAINMENT, ONLINE, GAMING, AND CHILDREN'S AND PARENTING NEWSLETTERS; UNGRADUATED RULERS; NOTE PAPER; NOTEBOOK PAPER; NOTEBOOKS; PAINT BRUSHES; PAINTINGS; PAPER CAKE DECORATIONS; PAPER COASTERS; PAPER FLAGS; PAPER GIFT WRAP BOWS; PAPER MATS; PAPER NAPKINS; PAPER PARTY BAGS; PAPER PARTY DECORATIONS; PAPER PENNANTS; PAPER PLACE MATS; PAPER TABLE CLOTHS; PAPER WEIGHTS; PAPER, CARDBOARD; PEN AND PENCIL BOXES; PEN AND PENCIL CASES; PEN OR PENCIL HOLDERS; PENCIL SHARPENERS; PENCILS; PENS; PRINTED PERIODICALS IN THE FIELDS OF SCIENCE, HEALTH, CARTOONS, BUSINESS, ENTERTAINMENT, ONLINE, GAMING, AND CHILDREN'S AND PARENTING PERIODICALS; PHOTO-ENGRAVINGS; PHOTOGRAPH ALBUMS; PHOTOGRAPHS; PICTORIAL PRINTS; PICTURE BOOKS; PORTRAITS; POSTCARDS; POSTERS; PRINTED AWARDS; PRINTED CERTIFICATES; PRINTED INVITATIONS; PRINTED MATTER AND PUBLICATIONS, NAMELY, BOOKS AND HANDOUTS IN THE FIELDS OF SCIENCE, HEALTH, CARTOONS, BUSINESS, ENTERTAINMENT, ONLINE, GAMING, AND

Reg. No. 4,204,002 CHILDREN'S AND PARENTING PUBLICATIONS, NAMELY, BOOKS AND HANDOUTS IN THE FIELD OF PARENTING; PRINTED MENU; PRINTERS' TYPE; PRINTING BLOCKS; RECIPE BOOKS; RUBBER STAMPS; SCHOOL SUPPLIES, NAMELY, NOTEBOOKS, WRITING PADS, WIREBOUND NOTEBOOKS, ENVELOPES, FOUNTAIN PENS, BALLPOINT PENS, ROLLERBALL PENS, PENCILS, POROUS POINT PENS, ADHESIVE TAPES AND DISPENSERS; SCORE CARDS; STAMP ALBUMS; STAPLERS; STATIONERY; STICKERS; TRADING CARDS; TYPEWRITERS; WRITING IMPLEMENTS; WRITING PAPER; BIBS OF PAPER; PAPER PARTY FAVORS, IN CLASS 16 (U.S. CLS. 2, 5, 22, 23, 29, 37, 38 AND 50).

FOR: CLOTHING, FOOTWEAR AND HEADGEAR, NAMELY, ATHLETIC SHOES; BANDANAS; BASEBALL CAPS; BATHING SUITS; BEACH COVER-UPS; BEACHWEAR; BELTS; CLOTH BIBS; EAR MUFFS; BIKINIS; BLAZERS; BOW TIES; BRAS; CHAPS; BOOTS; CAPS; COATS; COSTUMES FOR USE IN CHILDREN'S DRESS UP PLAY; DRESSES; GLOVES; GOLF SHIRTS; HALLOWEEN AND MASQUERADE COSTUMES; HATS; HEAD BANDS; HOSIERY; INFANT WEAR; JACKETS; JEANS; JERSEYS; KERCHIEFS; LEG WARMERS; LEOTARDS; MITTENS; NECKTIES; NECKWEAR; NIGHT GOWNS; NIGHT SHIRTS; PANTS; PANTY HOSE; POLO SHIRTS; PONCHOS; PAJAMAS; RAINWEAR; ROBES; SANDALS; SLACKS; SCARVES; SHIRTS; SHOES; SHORTS; SKIRTS; INFANT SLEEPERS; SLEEPWEAR; SLIPPERS; SOCKS; STOCKINGS; SWEAT PANTS; SWEAT SHIRTS; SWEATERS; SWIM-SUITS; TANK TOPS; TIGHTS; T-SHIRTS; UNDERWEAR; VESTS; WRIST BANDS, IN CLASS 25 (U.S. CLS. 22 AND 39).

FOR: ACTION FIGURES AND ACCESSORIES THEREFOR; ACTION SKILL GAMES; BAD-MINTON SETS; BALLOONS; BASEBALLS; BASKETBALLS; BATH TOYS; BATTERY-OPERATED ACTION TOYS; BEACH BALLS; BEAN BAG DOLLS; BEAN BAG TOYS; BOARD GAMES; BOWLING BALLS; TOY BOWS AND ARROWS; BUBBLE MAKING WANDS AND SOLUTION SETS; TOY BUILDING BLOCKS; CARD GAMES; CHESS SETS; CHILDREN'S MULTIPLE ACTIVITY TOYS; CHILDREN'S PLAY COSMETICS; CHRISTMAS TREE ORNAMENTS AND DECORATIONS; CRIB MOBILES; CRIB TOYS; COLLECTABLE TOY FIGURES; DISC-TYPE TOSS TOYS; DOLL ACCESSORIES; DOLL PLAYSETS; DOLLS AND DOLL CLOTHING; ELECTRIC ACTION TOYS; EQUIPMENT SOLD AS A UNIT FOR PLAYING CARD GAMES; FACE MASKS; FISHING TACKLES; GAMES, TOYS AND PLAYTHINGS, NAMELY, AVATAR GAMES, ROLE PLAYING GAMES, CHILDREN'S TOYS, NAMELY, ARTICLES OF CLOTHING FOR TOYS, ATTACHABLE, WEARABLE, MAGNETIC TOY FIGURINES, BENDABLE TOYS, CASES FOR TOY STRUCTURES, CASES FOR TOY VEHICLES, CHILDREN'S WIRE CONSTRUCTION AND ART ACTIVITY TOYS, CHILDREN'S TOY BICYCLES OTHER THAN FOR TRANSPORT, CONSTRUCTION TOYS, DRAWING TOYS, EDUCATIONAL TOYS FOR TEACHING MATH PRINCIPLES TO CHILDREN, NAMELY, MANIPULATIVE BLOCKS FOR DISPLAYING PATTERNS AND GROUPINGS, EDUCATIONAL TOYS IN THE NATURE OF AN ILLUSTRATED WALL MAP, ELECTRONIC ACTION TOYS, ELECTRONIC LEARNING TOYS, ELECTRONIC TOY BUILDING BLOCKS THAT LIGHT UP AS A NIGHT LIGHT, ELECTRONIC TOY VEHICLES, ELECTRONICALLY OPERATED TOY MOTOR VEHICLES, FANTASY CHARACTER TOYS, HAND-POWERED NON-MECHANICAL FLYING TOYS, LEVER ACTION TOYS, MECHANICAL TOYS, MODEL TOY VEHICLES, MOLDED TOY FIGURES, NON-ELECTRONIC TOY VEHICLES, PLASTIC CHARACTER TOYS, PLAYING PIECES IN THE NATURE OF MINIATURE ACTION FIGURES AND TOY MODEL VEHICLES FOR USE WITH TABLE TOP HOBBY BATTLE GAMES IN THE NATURE OF BATTLE, WAR AND SKIRMISH GAMES, AND FANTASY GAMES, PLUSH TOYS, POP UP TOYS, POSITIONABLE TOY FIGURES, PRINTED POSITIONABLE TOYS FOR USE IN CHILDREN'S BOARD GAMES, PRINTING TOYS, PULL TOYS, PUSH TOYS, RACKS AND STANDS SPECIFICALLY DESIGNED TO HOLD TOY SCOOTERS, RACKS AND STANDS SPECIFICALLY DESIGNED TO HOLD TOY VEHICLES, RADIO CONTROLLED TOY VEHICLES, RIDE-ON TOYS, RUBBER CHARACTER TOYS, SANDBOX TOYS, SKETCHING TOYS, SOFT SCULPTURE TOYS, STACKING TOYS, TALKING TOYS, TOY AND NOVELTY FACE MASKS, TOY ANIMALS, TOY BALLOONS, TOY BANKS, TOY BOXES, TOY BUILDING BLOCKS CAPABLE OF INTERCONNECTION, TOY CANDY DISPENSERS, TOY CAP PISTOLS, TOY CARS, TOY CLOCKS AND WATCHES, TOY CONSTRUCTION SETS, TOY FIGURES, TOY FILM CARTRIDGES AND VIEWERS,

Reg. No. 4,204,002 TOY FIREWORKS, TOY FURNITURE, TOY HARMONICAS, TOY HOUSES, TOY MASKS, TOY MODELING DOUGH, TOY MUSIC BOXES, TOY PRISM GLASSES, TOY PUTTY, TOY ROBOTS, TOY SCOOTERS, TOY SNOW GLOBES, TOY STAMPS, TOY TELESCOPES, TOY TOOLS, TOY WEAPONS, BATTERY-POWERED COMPUTER GAMES WITH LCD SCREENS WHICH FEATURE ANIMATION AND SOUND EFFECTS, CHILDREN'S DRESS-UP ACCESSORIES, TWO AND THREE DIMENSIONAL POSITIONABLE TOY FIGURES SOLD AS A UNIT WITH OTHER TOYS, AND WATER TOYS; GOLF BALL MARKERS; GOLF BALLS; GOLF GLOVES; HAND HELD UNITS FOR PLAYING ELECTRONIC GAMES OTHER THAN THOSE ADAPTED FOR USE WITH AN EXTERNAL DISPLAY SCREEN OR MONITOR; HOCKEY PUCKS; INFLATABLE TOYS; JIGSAW PUZZLES; JUMP ROPES; KITES; MAGIC TRICKS; MANIPULATIVE GAMES; MARBLES; MECHANICAL TOYS; MOBILES FOR CHILDREN; MUSIC BOX TOYS; MUSICAL TOYS; PAPER PARTY HATS; PARLOUR GAMES; PARTY GAMES; PARTY FAVORS IN THE NATURE OF SMALL TOYS; PLAYING CARDS; PLUSH TOYS; PUPPETS; ROLE PLAYING GAMES; ROLLER SKATES; RUBBER BALLS; SKATEBOARDS; SOCCER BALLS; SPINNING TOPS; SQUEEZE TOYS; STUFFED TOYS; TABLE TENNIS TABLES; TARGET GAMES; TEDDY BEARS; TENNIS BALLS; TOY SCOOTERS; TOY BANKS; TOY BUCKET AND SHOVEL SETS; TOY CARS; MODELED PLASTIC TOY FIGURINES; TOY GUNS; TOY HOLSTERS; TOY MOBILES; TOY MODEL HOBBYCRAFT KITS; TOY ROCKETS; TOY TRUCKS; TOY VEHICLES; TOY WATCHES; ELECTRONIC GAMES FOR TEACHING CHILDREN; WIND-UP TOYS; YO-YOS, IN CLASS 28 (U.S. CLS. 22, 23, 38 AND 50).

FOR: ARTIFICIAL COFFEE; BAGELS; BAKERY DESSERTS; FROZEN DAIRY DESSERTS, NAMELY, ICE CREAM DESSERTS; BAKERY GOODS; BISCUITS; BREAKFAST CEREALS; BREAD; CAKE MIXES; CAKES; CANDY; CHEWING AND BUBBLE GUM; READY TO EAT, CEREAL DERIVED SNACK BARS; CHOCOLATE AND WHITE CHOCOLATE; CHOCOLATE-BASED BEVERAGES WITH MILK; COCOA MIXES; PREPARED COCOA, COCOA-BASED BEVERAGES; COFFEE; CONES FOR ICE CREAM; COOKIES; CONFECTIONERY MADE OF SUGAR; CORN CHIPS; CORN-BASED SNACK FOODS; CRACKERS; DELI SANDWICHES; EDIBLE CAKE DECORATIONS; FLOUR; FROZEN CONFECTIONS, NAMELY, ICE CREAM, SORBETS AND YOGURT; FROZEN MEALS CONSISTING PRIMARILY OF PASTA OR RICE; FROZEN YOGURT; GINGERBREAD; HONEY; ICE MILK; EDIBLE ICES; KETCHUP; LIQUORICE; LOLLIPOPS; MARSHMALLOWS; MAYONNAISE; MUESLI BARS; MUFFINS; MUSTARD; NOODLES; OATMEAL; PANCAKE MIXES; PANCAKE SYRUP; PANCAKES; PASTA, PREPARED PASTA, PACKAGED MEAL MIXES OR KITS CONSISTING PRIMARILY OF PASTA, PASTA AND NOODLES, PASTA SALAD AND PASTA FOR SOUPS; PASTRIES; PEANUT BRITTLE; PIES AND PIZZAS; POPCORN; PRETZELS; DESSERTS PUDDINGS; READY-TO-SERVE MEALS AND SEMI-COOKED MEALS, NAMELY, FROZEN, PREPARED OR PACKAGED MEALS CONSISTING PRIMARILY OF PASTA, RICE, NOODLES, MEAT, VEGETABLES, AND/OR FRUIT; RICE; ROLLS; SAGO; SALAD DRESSINGS; SALT; SANDWICHES; SAUCES; SHERBETS; SPAGHETTI; SPICES; SUGAR; TABLE SYRUP; TAPIOCA; TARTS AND WAFFLES; TEA; TORTILLAS; TREACLE; YEAST, IN CLASS 30 (U.S. CL. 46).

FOR: AMUSEMENT PARK AND THEME PARK SERVICES; EDUCATION SERVICES, NAMELY, EDUCATIONAL WORKSHOPS, SEMINARS, CLASSES FOR PRIMARY AND SECONDARY SCHOOLS IN THE FIELD OF EARTH SCIENCE AND PREHISTORIC SUBJECT MATTER; THEME PARKS SERVICES, PROVIDING ENTERTAINMENT INFORMATION; ENTERTAINMENT IN THE NATURE OF LIVE STAGE PERFORMANCES IN THE NATURE OF PLAYS AND MUSICALS; ENTERTAINMENT IN THE NATURE OF LIVE PERFORMANCES IN THE NATURE OF PLAYS AND MUSICALS; ENTERTAINMENT IN THE NATURE OF TELEVISION NEWS SHOWS; ENTERTAINMENT IN THE NATURE OF PROGRAMS, SEGMENTS, MOVIES, SHORT FILM, GAMES, ANIMATION AND CARTOONS FEATURING COMEDY, STORYTELLING, VARIETY AND COMMENTARY BROADCAST OVER TELEVISION, RADIO, INTERNET, SATELLITE AND TELECOMMUNICATION NETWORKS; PRODUCTION OF ENTERTAINMENT SHOWS, NAMELY, ICE SHOWS, ONE-MAN SHOWS, MUSICALS AND VARIETY SHOWS FOR DISTRIBUTION VIA TELEVISION, CABLE, SATELLITE, AUDIO AND VIDEO MEDIA, CARTRIDGES, LASER DISCS, COMPUTER

Reg. No. 4,204,002 DISCS AND ELECTRONIC MEANS; PRODUCTION, DISTRIBUTION AND RENTAL OF MOTION PICTURE FILMS; PRODUCTION AND RENTAL OF SOUND AND VIDEO RECORDINGS; PRODUCTION OF TELEVISION AND RADIO PROGRAMS; ORGANIZING SPORTING AND CULTURAL EVENTS; THEATRE PRODUCTIONS; PROVIDING INFORMATION VIA COMMUNICATION AND COMPUTER NETWORKS IN RELATION TO THE AFORESAID SERVICES; ENTERTAINMENT SERVICES, NAMELY, PROVIDING ONLINE ELECTRONIC GAMES; PROVIDING ONLINE ELECTRONIC GAMES, NAMELY, ELECTRONIC MASSIVELY MULTI PLAYER ONLINE GAMES AND ELECTRONIC ROLE-PLAYING ONLINE GAMES, IN CLASS 41 (U.S. CLS. 100, 101 AND 107).

THE MARK CONSISTS OF STANDARD CHARACTERS WITHOUT CLAIM TO ANY PARTICULAR FONT, STYLE, SIZE, OR COLOR.

PRIORITY CLAIMED UNDER SEC. 44(D) ON NEW ZEALAND APPLICATION NO. 801444, FILED 1-16-2009, REG. NO. 801444, DATED 1-16-2009, EXPIRES 1-16-2019.

SER. NO. 77-782,535, FILED 7-16-2009.

MICHELE SWAIN, EXAMINING ATTORNEY

United States of America

United States Patent and Trademark Office

CHIVAS

Reg. No. 4,204,003

Registered Sep. 11, 2012

Int. Cl.: 3

TRADEMARK

PRINCIPAL REGISTER

CHIVAS SKIN CARE LLC (CALIFORNIA LIMITED LIABILITY COMPANY)
2220 BARSDALE AVENUE
FILLMORE, CA 93015

FOR: BATH SALTS; COSMETIC SOAPS; ESSENTIAL OILS; FACE AND BODY LOTIONS;
LIP BALM; NON-MEDICATED SKIN CARE PREPARATIONS; SKIN CREAMS , IN CLASS
3 (U.S. CLS. 1, 4, 6, 50, 51 AND 52).

FIRST USE 4-29-2005; IN COMMERCE 8-26-2006.

THE MARK CONSISTS OF STANDARD CHARACTERS WITHOUT CLAIM TO ANY PAR-
TICULAR FONT, STYLE, SIZE, OR COLOR.

THE ENGLISH TRANSLATION OF "CHIVAS" IS "GOAT".

SER. NO. 77-791,595, FILED 7-28-2009.

KIMBERLY FRYE, EXAMINING ATTORNEY



David J. Kyffers

Director of the United States Patent and Trademark Office

United States of America

United States Patent and Trademark Office



Reg. No. 4,204,004

Registered Sep. 11, 2012

Int. Cl.: 3

TRADEMARK

PRINCIPAL REGISTER

CHIVAS SKIN CARE LLC (CALIFORNIA LIMITED LIABILITY COMPANY)
2220 BARSDALE AVENUE
FILLMORE, CA 93015

FOR: BATH SALTS; COSMETIC SOAPS; ESSENTIAL OILS; FACE AND BODY LOTIONS;
LIP BALM; NON-MEDICATED SKIN CARE PREPARATIONS; SKIN CREAMS , IN CLASS
3 (U.S. CLS. 1, 4, 6, 50, 51 AND 52).

FIRST USE 4-29-2005; IN COMMERCE 8-26-2006.

THE MARK CONSISTS OF CONCENTRIC CIRCLES, WITH THE WORD "CHIVAS" BETWEEN
TWO LEAF DESIGNS IN THE OUTER CIRCLE AND A PICTURE OF A GOAT WEARING
A COLLAR AND BELL IN THE INNER CIRCLE.

THE ENGLISH TRANSLATION OF "CHIVAS" IS "GOAT".

SER. NO. 77-793,516, FILED 7-30-2009.

KIMBERLY FRYE, EXAMINING ATTORNEY



David J. Kyffers

Director of the United States Patent and Trademark Office

United States of America

United States Patent and Trademark Office

Image booster

Reg. No. 4,204,005

LG ELECTRONICS INC. (REPUBLIC OF KOREA CORPORATION)
20, YOIDO-DONG, YONGDUNGPO-GU
SEOUL, REPUBLIC OF KOREA

Registered Sep. 11, 2012

Int. Cl.: 9

FOR: COMPUTER MONITORS, IN CLASS 9 (U.S. CLS. 21, 23, 26, 36 AND 38).

TRADEMARK

THE MARK CONSISTS OF STANDARD CHARACTERS WITHOUT CLAIM TO ANY PARTICULAR FONT, STYLE, SIZE, OR COLOR.

PRINCIPAL REGISTER

OWNER OF ERPN CMNTY TM OFC REG. NO. 008595647, DATED 3-29-2010, EXPIRES 10-6-2019.

NO CLAIM IS MADE TO THE EXCLUSIVE RIGHT TO USE "IMAGE", APART FROM THE MARK AS SHOWN.

SER. NO. 77-839,106, FILED 10-1-2009.

TAMARA FRAZIER, EXAMINING ATTORNEY



David J. Kyffers

Director of the United States Patent and Trademark Office

United States of America

United States Patent and Trademark Office

PLASTIC LOGIC

Reg. No. 4,204,006

Registered Sep. 11, 2012

**Int. Cls.: 1, 7, 9, 16, 40,
42 and 45**

TRADEMARK

SERVICE MARK

PRINCIPAL REGISTER

PLASTIC LOGIC LIMITED (UNITED KINGDOM LIMITED LIABILITY COMPANY)
296 CAMBRIDGE SCIENCE PARK, MILTON ROAD
CAMBRIDGE, UNITED KINGDOM CB40WD

FOR: CHEMICALS USED IN INDUSTRY AND SCIENCE; UNPROCESSED PLASTICS IN THE FORM OF POWDER, LIQUID OR PASTE; MATERIALS HAVING ELECTRICALLY-CONDUCTIVE, SEMI-CONDUCTIVE OR INSULATING PROPERTIES, NAMELY, POLYMERS FOR ELECTRONIC MATERIALS, IN CLASS 1 (U.S. CLS. 1, 5, 6, 10, 26 AND 46).

FOR: MACHINES FOR THE CONSTRUCTION AND FABRICATION OF ELECTRICAL AND ELECTRONIC CIRCUITRY; MACHINES FOR THE DEPOSITION ONTO A SURFACE OF PLASTICS AND/OR NON-PLASTICS IN THE FORM OF POWDERS, LIQUIDS OR PASTES; MACHINES FOR THE PRINTING ONTO SURFACES OF MATERIALS FOR THE PREPARATION OF ELECTRONIC CIRCUITRY COMPONENTS, INCLUDING TRANSISTORS AND OTHER SEMI-CONDUCTOR DEVICES, USING THE TECHNIQUES OF SOLUTION DEPOSITION, SURFACE ENERGY PATTERNING, SURFACE MODIFICATION, INK-JET PRINTING, BUBBLE-JET PRINTING, LITHOGRAPHIC PRINTING, SOFT LITHOGRAPHY, PAD PRINTING OR MICRO-EMBOSSING, OR CONFORMAL PRINTING ON NON-PLANAR SURFACES; MACHINES FOR THE THERMAL OR OPTICAL ANNEALING OF SOLUTION-DEPOSITED ELECTRICAL AND ELECTRONIC CIRCUITRY, IN CLASS 7 (U.S. CLS. 13, 19, 21, 23, 31, 34 AND 35).

FOR: ELECTRICAL AND ELECTRONIC APPARATUS AND INSTRUMENTS, NAMELY, SEMICONDUCTOR DEVICES; TRANSISTORS AND ELECTRONIC ACTIVE AND PASSIVE CIRCUITS, ALL BEING CONSTRUCTED FROM POLYMERS, ORGANIC MOLECULES AND SOLUTION-PROCESSED INORGANIC MATERIALS HAVING ELECTRICALLY-CONDUCTIVE, SEMI-CONDUCTIVE OR INSULATING PROPERTIES, AND BEING PREPARED BY SOLUTION DEPOSITION, SURFACE ENERGY PATTERNING, SURFACE MODIFICATION AND/OR PRINTING METHODS; ACTIVE MATRIX LCD DISPLAYS, TRANSPARENT LCD DISPLAYS, ELECTRONIC PAPER, NAMELY, THIN, FLEXIBLE DISPLAYS ON WHICH ELECTRONIC INK IN THE FORM OF TINY CAPSULES WITH PARTICLES CHANGE COLOR WHEN A CURRENT IS APPLIED FOR DISPLAYING TEXT AND IMAGES, ELECTRONIC LED SIGNS, ELECTRONIC TAGS FOR GOODS, ELECTRONIC LABELS CARRYING MAGNETICALLY, OPTICALLY, OR ELECTRONICALLY RECORDED OR ENCODED INFORMATION; BLANK SMART CARDS, VOLATILE AND NON-VOLATILE ELECTRONIC MEMORIES, ELECTRONIC SENSORS, ANTENNAE AND BATTERIES; COMPUTER-READABLE INFORMATION STORAGE DEVICES, NAMELY, BLANK SEMICONDUCTOR



David J. Kyffers

Director of the United States Patent and Trademark Office

Reg. No. 4,204,006 COMPUTER MEMORY CHIPS AND BLANK MAGNETIC AND OPTICAL COMPUTER TAPES AND DISKS FOR INSTRUCTIONAL, TRAINING AND TEACHING PURPOSES, AND ALL RELATING TO THE DESIGN AND/OR USE OF MATERIALS AND MACHINERY FOR THE PREPARATION OF ELECTRONIC CIRCUITRY COMPONENTS BY SOLUTION DEPOSITION, SURFACE ENERGY PATTERNING, SURFACE MODIFICATION AND/OR PRINTING OF MATERIALS, INCLUDING INK-JET PRINTING, BUBBLE-JET PRINTING, LITHOGRAPHIC PRINTING, SOFT LITHOGRAPHY, PAD PRINTING AND MICRO-EMBOSSING, AND CONFORMAL PRINTING ON NON-PLANAR SURFACES, USING POLYMERS, ORGANIC MOLECULES, OR SOLUTION-PROCESSED INORGANIC MATERIALS, HAVING ELECTRICALLY CONDUCTIVE, SEMI-CONDUCTIVE OR INSULATING PROPERTIES, IN CLASS 9 (U.S. CLS. 21, 23, 26, 36 AND 38).

FOR: NEWSPAPERS, MANUALS, AND PRINTED INSTRUCTIONAL, TRAINING AND TEACHING MATERIALS, ALL RELATING TO THE DESIGN AND/OR USE OF MATERIALS AND MACHINERY FOR THE PREPARATION OF ELECTRONIC CIRCUITRY COMPONENTS BY SOLUTION DEPOSITION, SURFACE ENERGY PATTERNING, SURFACE MODIFICATION AND/OR PRINTING OF MATERIALS INCLUDING INK-JET PRINTING, BUBBLE-JET PRINTING, LITHOGRAPHIC PRINTING, SOFT LITHOGRAPHY, PAD PRINTING AND MICRO-EMBOSSING, AND CONFORMAL PRINTING ON NON-PLANAR SURFACES, USING POLYMERS, ORGANIC MOLECULES, OR SOLUTION-PROCESSED INORGANIC MATERIALS, HAVING ELECTRICALLY CONDUCTIVE, SEMI-CONDUCTIVE OR INSULATING PROPERTIES, IN CLASS 16 (U.S. CLS. 2, 5, 22, 23, 29, 37, 38 AND 50).

FOR: CUSTOM MANUFACTURE OF ELECTRONIC COMPONENTS; CUSTOM FABRICATION OF SEMICONDUCTOR COMPONENTS AND DEVICES, AND OF CIRCUITS USING SEMICONDUCTOR DEVICES FOR OTHERS, IN CLASS 40 (U.S. CLS. 100, 103 AND 106).

FOR: TECHNICAL CONSULTATION IN THE FIELD OF MATERIALS AND MACHINERY FOR THE PREPARATION OF ELECTRONIC CIRCUITRY COMPONENTS BY SOLUTION DEPOSITION, SURFACE ENERGY PATTERNING, SURFACE MODIFICATION AND/OR PRINTING OF MATERIALS INCLUDING INK-JET PRINTING, BUBBLE-JET PRINTING, LITHOGRAPHIC PRINTING, SOFT LITHOGRAPHY, PAD PRINTING AND MICRO-EMBOSSING, AND CONFORMAL PRINTING ON NON-PLANAR SURFACES, USING POLYMERS, ORGANIC MOLECULES, OR SOLUTION-PROCESSED INORGANIC MATERIALS, HAVING ELECTRICALLY CONDUCTIVE, SEMI-CONDUCTIVE OR INSULATING PROPERTIES, TECHNICAL SUPPORT, NAMELY, TROUBLESHOOTING OF MATERIALS AND MACHINERY FOR THE PREPARATION OF ELECTRONIC CIRCUITRY COMPONENTS BY SOLUTION DEPOSITION, SURFACE ENERGY PATTERNING, SURFACE MODIFICATION AND/OR PRINTING OF MATERIALS INCLUDING INK-JET PRINTING, BUBBLE-JET PRINTING, LITHOGRAPHIC PRINTING, SOFT LITHOGRAPHY, PAD PRINTING AND MICRO-EMBOSSING, AND CONFORMAL PRINTING ON NON-PLANAR SURFACES, USING POLYMERS, ORGANIC MOLECULES, OR SOLUTION-PROCESSED INORGANIC MATERIALS, HAVING ELECTRICALLY CONDUCTIVE, SEMI-CONDUCTIVE OR INSULATING PROPERTIES; DESIGN OF MATERIALS AND MACHINERY FOR THE PREPARATION OF ELECTRONIC CIRCUITRY COMPONENTS BY SOLUTION DEPOSITION, SURFACE ENERGY PATTERNING, SURFACE MODIFICATION AND/OR PRINTING OF MATERIALS INCLUDING INK-JET PRINTING, BUBBLE-JET PRINTING, LITHOGRAPHIC PRINTING, SOFT LITHOGRAPHY, PAD PRINTING AND MICRO-EMBOSSING, AND CONFORMAL PRINTING ON NON-PLANAR SURFACES, USING POLYMERS, ORGANIC MOLECULES, OR SOLUTION-PROCESSED INORGANIC MATERIALS, HAVING ELECTRICALLY CONDUCTIVE, SEMI-CONDUCTIVE OR INSULATING PROPERTIES, IN CLASS 42 (U.S. CLS. 100 AND 101).

FOR: LICENSING OF MATERIALS AND MACHINERY FOR THE PREPARATION OF ELECTRONIC CIRCUITRY COMPONENTS BY SOLUTION DEPOSITION, SURFACE ENERGY PATTERNING, SURFACE MODIFICATION AND/OR PRINTING OF MATERIALS INCLUDING INK-JET PRINTING, BUBBLE-JET PRINTING, LITHOGRAPHIC PRINTING, SOFT LITHOGRAPHY, PAD PRINTING AND MICRO-EMBOSSING, AND CONFORMAL PRINTING ON NON-PLANAR SURFACES, USING POLYMERS, ORGANIC MOLECULES, OR SOLUTION-

Reg. No. 4,204,006 PROCESSED INORGANIC MATERIALS, HAVING ELECTRICALLY CONDUCTIVE, SEMI-CONDUCTIVE OR INSULATING PROPERTIES, IN CLASS 45 (U.S. CLS. 100 AND 101).

THE MARK CONSISTS OF STANDARD CHARACTERS WITHOUT CLAIM TO ANY PARTICULAR FONT, STYLE, SIZE, OR COLOR.

OWNER OF UNITED KINGDOM REG. NO. 003919867, DATED 9-25-2005, EXPIRES 6-23-2014.

NO CLAIM IS MADE TO THE EXCLUSIVE RIGHT TO USE "PLASTIC", APART FROM THE MARK AS SHOWN.

SER. NO. 77-848,728, FILED 10-14-2009.

MICHELE SWAIN, EXAMINING ATTORNEY

United States of America

United States Patent and Trademark Office

DK

Reg. No. 4,204,007

Registered Sep. 11, 2012

Int. Cls.: 9 and 45

TRADEMARK

SERVICE MARK

PRINCIPAL REGISTER

GABRIELLE STUDIO, INC. (NEW YORK CORPORATION)
550 SEVENTH AVENUE
NEW YORK, NY 10018

FOR: DOWNLOADABLE SOFTWARE APPLICATION FOR WIRELESS MOBILE DEVICES FOR THE DISTRIBUTION OF MULTIMEDIA CONTENT CONTAINING TEXT, GRAPHICS, IMAGES, AUDIO AND VIDEO IN THE FIELD OF FASHION, NAMELY, FASHION ADVICE, FASHION COLLECTIONS, FASHION SHOW FOOTAGE, PERSONAL SHOPPING TIPS, DESIGNER INTERVIEWS AND PERSONAL JOURNAL ENTRIES OF A FASHION DESIGNER, IN CLASS 9 (U.S. CLS. 21, 23, 26, 36 AND 38).

FIRST USE 8-6-2009; IN COMMERCE 8-6-2009.

FOR: PERSONAL SHOPPING SERVICES FOR OTHERS, IN CLASS 45 (U.S. CLS. 100 AND 101).

FIRST USE 8-6-2009; IN COMMERCE 8-6-2009.

OWNER OF U.S. REG. NOS. 1,802,526, 2,750,929 AND OTHERS.

THE MARK CONSISTS OF "DK" IN STYLIZED LETTERING.

SER. NO. 77-863,504, FILED 11-3-2009.

COLLEEN DOMBROW, EXAMINING ATTORNEY



David J. Kybas

Director of the United States Patent and Trademark Office

United States of America

United States Patent and Trademark Office

I AM IN

Reg. No. 4,204,008

Registered Sep. 11, 2012

Int. Cls.: 29 and 30

TRADEMARK

PRINCIPAL REGISTER

ALIMENTS IN FOODS INC. (CANADA CORPORATION)
SUITE 2202
1010 SHERBROOKE STREET WEST
MONTREAL, QUEBEC H3A 2R7

FOR: FROZEN MEALS CONSISTING PRIMARILY OF MEAT, FISH, POULTRY OR VEGETABLES; CANDIED FRUIT SNACKS; DEHYDRATED FRUIT SNACKS; FRUIT-BASED SNACK FOOD; MEAT-BASED SNACK FOODS; NUT AND SEED-BASED SNACK BARS; POTATO-BASED SNACK FOODS; SNACK DIPS EXCLUDING SALSA AND OTHER SAUCES USED AS DIPS; SNACK MIX CONSISTING OF DEHYDRATED FRUIT AND PROCESSED NUTS; TOFU-BASED SNACKS; VEGETABLE-BASED SNACK FOODS; DIPS EXCLUDING SALSA AND OTHER SAUCES USED AS DIPS; PRE-PACKAGED DINNERS CONSISTING OF PRIMARILY OF MEAT, SEAFOOD OR POULTRY SERVED WITH PASTA; CHEESE SPREADS; DAIRY-BASED SPREADS; FRUIT-BASED SPREADS; MEAT-BASED SPREADS; VEGETABLE-BASED SPREADS; FROZEN, PREPARED OR PACKAGED SIDE DISH CONSISTING PRIMARILY OF MASHED POTATOES OR PUREED VEGETABLES; FROZEN, PREPARED OR PACKAGED SIDE DISH CONSISTING PRIMARILY OF POTATOES MIXED WITH VEGETABLES; SHELLED NUTS; ROASTED NUTS; PROCESSED NUTS; NUT-BASED SNACK FOODS, IN CLASS 29 (U.S. CL. 46).

FOR: STUFFING MIXES CONTAINING BREAD, STUFFING MIXES CONTAINING RICE, STUFFING MIXES CONTAINING POTATOES; FROZEN MEALS CONSISTING PRIMARILY OF PASTA OR RICE; SALSA; SAUCES; CEREAL-BASED SNACK FOODS; MULTIGRAIN-BASED SNACK FOODS; RICE-BASED SNACK FOODS; FROZEN CONFECTIONERY; RICE; FROZEN, PREPARED OR PACKAGED MEALS CONSISTING PRIMARILY OF RICE; PITA BREAD AND PITA CHIPS; FRUIT PIES; PIES, IN CLASS 30 (U.S. CL. 46).

THE MARK CONSISTS OF STANDARD CHARACTERS WITHOUT CLAIM TO ANY PARTICULAR FONT, STYLE, SIZE, OR COLOR.

PRIORITY CLAIMED UNDER SEC. 44(D) ON CANADA APPLICATION NO. 1,458,476, FILED 11-9-2009, REG. NO. TMA816221, DATED 1-26-2012, EXPIRES 1-26-2027.

SER. NO. 77-870,911, FILED 11-12-2009.

LESLEY LAMOTHE, EXAMINING ATTORNEY



David J. Kyffers

Director of the United States Patent and Trademark Office

United States of America

United States Patent and Trademark Office

DIVINE ORGANICS

Reg. No. 4,204,009

KAPLAN, DAVID (UNITED STATES INDIVIDUAL)
16-A PAMARON WAY
NOVATO, CA 94949

Registered Sep. 11, 2012

Int. Cl.: 30

FOR: ORGANIC FOODS, NAMELY, VANILLA; CACAO; CANDY; BREAKFAST CEREAL;
CRACKERS; COOKIES; ICE CREAM; VANILLA BEANS, IN CLASS 30 (U.S. CL. 46).

TRADEMARK

FIRST USE 9-14-2007; IN COMMERCE 10-31-2007.

PRINCIPAL REGISTER

THE MARK CONSISTS OF STANDARD CHARACTERS WITHOUT CLAIM TO ANY PARTICULAR FONT, STYLE, SIZE, OR COLOR.

NO CLAIM IS MADE TO THE EXCLUSIVE RIGHT TO USE "ORGANICS", APART FROM THE MARK AS SHOWN.

SER. NO. 77-877,133, FILED 11-20-2009.

GIANCARLO CASTRO, EXAMINING ATTORNEY



David J. Kyffers

Director of the United States Patent and Trademark Office

United States of America

United States Patent and Trademark Office

ENDOMAGNETICS

Reg. No. 4,204,010

Registered Sep. 11, 2012

Int. Cls.: 9, 10, 42 and 44

TRADEMARK

SERVICE MARK

PRINCIPAL REGISTER

ENDOMAGNETICS LIMITED (UNITED KINGDOM COMPANY)
MILTON ROAD
23 CAMBRIDGE SCIENCE PARK
CAMBRIDGE, UNITED KINGDOM CB40EY

FOR: NON-DESTRUCTIVE TESTING APPARATUS AND INSTRUMENTS, NAMELY, NON-INVASIVE MAGNETOMETERS FOR TESTING THE INTEGRITY OF SOLID MATERIALS AND LIQUIDS, NONE OF THE AFORESAID GOODS USING ULTRASOUND, IN CLASS 9 (U.S. CLS. 21, 23, 26, 36 AND 38).

FOR: MEDICAL DIAGNOSTIC APPARATUS, DEVICES AND INSTRUMENTS, NAMELY, NON-INVASIVE MAGNETOMETERS FOR USE IN THE DIAGNOSIS AND STAGING OF CANCERS, NONE OF THE AFORESAID GOODS USING ULTRASOUND, IN CLASS 10 (U.S. CLS. 26, 39 AND 44).

FOR: PRODUCT RESEARCH, DESIGN AND DEVELOPMENT OF MEDICAL APPARATUS, NAMELY, NON-INVASIVE MAGNETOMETERS FOR USE IN THE DIAGNOSIS AND STAGING OF CANCERS, NONE OF THE AFORESAID GOODS USING ULTRASOUND; PRODUCT RESEARCH, DESIGN AND DEVELOPMENT OF SCIENTIFIC TESTING APPARATUS, NAMELY, NON-INVASIVE MAGNETOMETERS FOR TESTING THE INTEGRITY OF SOLID MATERIALS AND LIQUIDS, NONE OF THE AFORESAID GOODS USING ULTRASOUND, IN CLASS 42 (U.S. CLS. 100 AND 101).

FOR: MEDICAL INFORMATION SERVICES FOR THE DIAGNOSIS AND STAGING OF CANCERS USING NON-INVASIVE MAGNETOMETERS, NONE OF THE AFORESAID PRODUCTS USING ULTRASOUND, IN CLASS 44 (U.S. CLS. 100 AND 101).

THE MARK CONSISTS OF STANDARD CHARACTERS WITHOUT CLAIM TO ANY PARTICULAR FONT, STYLE, SIZE, OR COLOR.

PRIORITY CLAIMED UNDER SEC. 44(D) ON ERPN CMNTY TM OFC APPLICATION NO. 008729899, FILED 12-2-2009, REG. NO. 008729899, DATED 11-6-2010, EXPIRES 11-6-2020.

SER. NO. 77-885,529, FILED 12-3-2009.

ANDREA BUTLER, EXAMINING ATTORNEY



David J. Kyros

Director of the United States Patent and Trademark Office

United States of America

United States Patent and Trademark Office



Reg. No. 4,204,011

WHITE, EDMOND (UNITED STATES INDIVIDUAL), FORMERLY SILKEWAY, INC
9024 B TANYA DR.

Registered Sep. 11, 2012

LITTLE ROCK, AR 72204 AND

Int. Cl.: 3

FELLS, KENNETH (UNITED STATES INDIVIDUAL), FORMERLY SILKEWAY, INC.
9024 B TANYA DR.

LITTLE ROCK, AR 72204

TRADEMARK

PRINCIPAL REGISTER

FOR: HAIR CARE PRODUCTS, NAMELY, SHAMPOOS, CONDITIONERS, HAIR OIL, HAIR SPRAY, HAIR CURL SPRAY, HAIR SPRITZS, HAIR GELS, HAIR RELAXERS, PRESSING OILS, POMADES, MOUSE, HOT OIL TREATMENTS, SETTING LOTION, HAIR MOISTURIZER, HAIR HOLDING SPRAY, DEEP CONDITIONER, IN CLASS 3 (U.S. CLS. 1, 4, 6, 50, 51 AND 52).

FIRST USE 5-5-1996; IN COMMERCE 5-5-1996.

THE MARK CONSISTS OF THE STYLIZED WORD "SILK" WITH THE STYLIZED WORD "WAY" BELOW AND TO THE RIGHT; A STYLIZED SMALL LETTER "E" IS CENTERED OVER THE WORDS "SILK" AND "WAY".

SER. NO. 77-892,799, FILED 12-14-2009.

MARY CRAWFORD, EXAMINING ATTORNEY



David J. Kyffers

Director of the United States Patent and Trademark Office

United States of America

United States Patent and Trademark Office

PWiz

Reg. No. 4,204,012

LG ELECTRONICS INC. (REPUBLIC OF KOREA CORPORATION)
20, YEOUIDO-DONG, YEONGDEUNGPO-GU
SEOUL, REPUBLIC OF KOREA 150-721

Registered Sep. 11, 2012

Int. Cl.: 9

FOR: TELEVISION RECEIVERS; ENCODED ELECTRONIC CHIP CARDS FOR TV IMAGE IMPROVEMENT, IN CLASS 9 (U.S. CLS. 21, 23, 26, 36 AND 38).

TRADEMARK

THE MARK CONSISTS OF STANDARD CHARACTERS WITHOUT CLAIM TO ANY PARTICULAR FONT, STYLE, SIZE, OR COLOR.

PRINCIPAL REGISTER

PRIORITY CLAIMED UNDER SEC. 44(D) ON REPUBLIC OF KOREA APPLICATION NO. 40-2009-0060, FILED 12-8-2009, REG. NO. 0872168, DATED 7-11-2011, EXPIRES 7-11-2021.

SER. NO. 77-907,860, FILED 1-8-2010.

JESSICA FATHY, EXAMINING ATTORNEY



David J. Kybas

Director of the United States Patent and Trademark Office

United States of America

United States Patent and Trademark Office

DR. GUM

Reg. No. 4,204,013

Registered Sep. 11, 2012

Int. Cls.: 3, 7 and 37

TRADEMARK

SERVICE MARK

PRINCIPAL REGISTER

DR. GUM INC. (CANADA CORPORATION)
SUITE 104
800, FORD BOULEVARD
CHATEAUGUAY, QUEBEC, CANADA J6J4Z2

FOR: CLEANING PREPARATIONS FOR INDUSTRIAL AND HOUSEHOLD APPLICATIONS TO REMOVE GUM, GRAFFITI, PAINTS, GREASE, GLUE, DIRT, BLOOD, GARBAGE SLUDGE, FOOD AND INDOOR STAINS, BIRD DROPPINGS AND TAPE RESIDUE FROM ANY SURFACE, IN CLASS 3 (U.S. CLS. 1, 4, 6, 50, 51 AND 52).

FOR: STEAM MACHINE FOR CLEANING AND SANITIZING SIDEWALKS, LAMP POSTS, STREET FURNITURE, CARPETS, UPHOLSTERY AND ARCHITECTURAL SURFACES; STEAM MACHINE FOR REMOVING GUM, GRAFFITI, PAINTS, GREASE, GLUE, DIRT, BLOOD, GARBAGE SLUDGE, FOOD AND INDOOR STAINS, BIRD DROPPINGS AND TAPE RESIDUE FROM ANY SURFACE, IN CLASS 7 (U.S. CLS. 13, 19, 21, 23, 31, 34 AND 35).

FOR: ALL-SURFACE CLEANING SERVICES, NAMELY, CLEANING AND SANITIZING SIDEWALKS, LAMP POSTS, STREET FURNITURE, CARPETS, UPHOLSTERY AND ARCHITECTURAL SURFACES; ALL-SURFACE CLEANING SERVICES, NAMELY, REMOVING GUM, GRAFFITI, PAINTS, GREASE, GLUE, DIRT, BLOOD, GARBAGE SLUDGE, FOOD AND INDOOR STAINS, BIRD DROPPINGS AND TAPE RESIDUE FROM ANY SURFACE, IN CLASS 37 (U.S. CLS. 100, 103 AND 106).

THE MARK CONSISTS OF STANDARD CHARACTERS WITHOUT CLAIM TO ANY PARTICULAR FONT, STYLE, SIZE, OR COLOR.

OWNER OF CANADA REG. NO. TMA800290, DATED 6-20-2011, EXPIRES 6-20-2026.

OWNER OF U.S. REG. NO. 4,018,611.

SER. NO. 77-908,817, FILED 1-11-2010.

ANNE E. GUSTASON, EXAMINING ATTORNEY



David J. Kypos

Director of the United States Patent and Trademark Office

United States of America

United States Patent and Trademark Office

Accessory Power Powerup

Reg. No. 4,204,014

Registered Sep. 11, 2012

Int. Cl.: 9

TRADEMARK

PRINCIPAL REGISTER

BRIGHT IDEAS, INC (CALIFORNIA CORPORATION)
30242 BELMONT COURT
AGOURA HILLS, CA 91301

FOR: BATTERY CHARGER, IN CLASS 9 (U.S. CLS. 21, 23, 26, 36 AND 38).

FIRST USE 1-1-2005; IN COMMERCE 1-1-2005.

THE MARK CONSISTS OF STANDARD CHARACTERS WITHOUT CLAIM TO ANY PARTICULAR FONT, STYLE, SIZE, OR COLOR.

OWNER OF U.S. REG. NOS. 3,594,464 AND 3,678,698.

NO CLAIM IS MADE TO THE EXCLUSIVE RIGHT TO USE "ACCESSORY POWER", APART FROM THE MARK AS SHOWN.

SER. NO. 77-909,032, FILED 1-11-2010.

MARIA-VICTORIA SUAREZ, EXAMINING ATTORNEY



David J. Kyffers

Director of the United States Patent and Trademark Office

United States of America

United States Patent and Trademark Office

TOP TIER

Reg. No. 4,204,015

GENERAL MOTORS LLC (DELAWARE LIMITED LIABILITY COMPANY)
300 RENAISSANCE CENTER
DETROIT, MI 482653000

Registered Sep. 11, 2012

Int. Cl.: 4

FOR: GASOLINE, IN CLASS 4 (U.S. CLS. 1, 6 AND 15).

TRADEMARK

FIRST USE 9-1-2004; IN COMMERCE 9-1-2004.

PRINCIPAL REGISTER

THE MARK CONSISTS OF STANDARD CHARACTERS WITHOUT CLAIM TO ANY PARTICULAR FONT, STYLE, SIZE, OR COLOR.

SEC. 2(F).

SER. NO. 77-915,532, FILED 1-20-2010.

HANNO RITTNER, EXAMINING ATTORNEY



David J. Kyffers

Director of the United States Patent and Trademark Office

United States of America

United States Patent and Trademark Office

EHESS

Reg. No. 4,204,016

Registered Sep. 11, 2012

Int. Cls.: 7 and 9

KAYABA INDUSTRY CO., LTD. (JAPAN CORPORATION), AKA KAYABA KOGYO
KABUSHIKI KAISHA
WORLD TRADE CENTER BLDG., 4-1
HAMAMATSU-CHO 2-CHOME
MINATO-KU, TOKYO, JAPAN

TRADEMARK

PRINCIPAL REGISTER

FOR: PRESSURE CONTROL VALVES BEING PARTS OF MACHINES; FLOW CONTROL VALVES, NAMELY, FLOW CONTROL AND FLOW DIVIDING VALVES, ALL BEING PARTS OF MACHINES; SWITCHING VALVES BEING PARTS OF MACHINES; REGENERATIVE HYDRAULIC STARTER MOTORS FOR DRIVING HYDRAULIC PUMPS; ELECTRIC HYDRAULIC PUMPS; RADIATORS FOR ELECTRIC MOTORS AND INVERTER MOTORS FOR CONSTRUCTION MACHINES AND APPARATUS; COOLING WATER PUMPS FOR USE IN ELECTRIC MOTORS AND INVERTERS; ELECTRIC MOTORS FOR MACHINES; ELECTRICITY GENERATORS NOT FOR LAND VEHICLES; REDUCTION GEARS FOR MACHINES; MINING MACHINES, NAMELY, MINE BORERS, EARTH DRILLING MACHINES, AND ELECTRIC MINE DRAINAGE PUMPS, AND STRUCTURAL PARTS THEREOF; CONSTRUCTION AND EARTH MOVING MACHINES, NAMELY, POWER SHOVELS, BULLDOZERS, POWER-OPERATED DIGGERS, AND EXCAVATORS, AND STRUCTURAL PARTS THEREOF; LOADING AND UNLOADING MACHINES AND STRUCTURAL PARTS THEREOF; MACHINE ELEMENTS, NAMELY, GASOLINE ENGINES NOT FOR LAND VEHICLES, DIESEL ENGINES NOT FOR LAND VEHICLES, KEROSENE ENGINES NOT FOR LAND VEHICLES; PNEUMATIC OR HYDRAULIC MACHINES AND INSTRUMENTS, NAMELY, ELECTRIC PUMPS; MACHINE ELEMENTS, NAMELY, SHAFT COUPLINGS FOR MACHINES, AXLES FOR MACHINES, ENGINE BEARINGS, AND VALVES BEING PARTS OF MACHINES; MACHINE ELEMENTS IN THE NATURE OF PRESSURE CONTROL VALVES BEING PARTS OF MACHINES FOR THE GENERATION, STORAGE AND UTILIZATION OF REGENERATIVE ENERGY, IN CLASS 7 (U.S. CLS. 13, 19, 21, 23, 31, 34 AND 35).



David J. Kybas

Director of the United States Patent and Trademark Office

FOR: BATTERY SYSTEMS CONSISTING PRIMARILY OF BATTERY PACKS; BATTERY CHARGERS; BATTERY MANAGEMENT INTERFACES CONTROLLED BY COMPUTERS; BATTERY CHARGERS; BATTERIES; INVERTERS; INTERFACES FOR COMPUTERS, ELECTRONIC DISPLAY INTERFACES FOR POWER CONTROLLERS; ELECTRONIC MACHINES, APPARATUS AND THEIR PARTS, NAMELY, REGENERATIVE ELECTRONIC CIRCUITS; POWER DISTRIBUTION OR CONTROL MACHINES AND APPARATUS, NAMELY, ELECTRICAL CONTROLLERS FOR HYBRID SYSTEMS; PERSONAL COMPUTERS; POWER DISTRIBUTION BOXES; ELECTRONIC MACHINES, APPARATUS AND THEIR PARTS, NAMELY, POWER-ASSISTED HYDRAULIC PRINTED CIRCUITS; TELE-

Reg. No. 4,204,016 COMMUNICATION DEVICES AND APPARATUS, NAMELY, ELECTRIC INSTALLATIONS FOR THE REMOTE CONTROL OF INDUSTRIAL OPERATIONS; ELECTRONIC MACHINES AND APPARATUS, NAMELY, COMPUTERS AND COMPUTER PERIPHERAL DEVICES, AND STRUCTURAL PARTS THEREOF; PNEUMATIC OR HYDRAULIC MACHINES AND INSTRUMENTS, NAMELY, ELECTRIC ACCUMULATORS, IN CLASS 9 (U.S. CLS. 21, 23, 26, 36 AND 38).

THE MARK CONSISTS OF STANDARD CHARACTERS WITHOUT CLAIM TO ANY PARTICULAR FONT, STYLE, SIZE, OR COLOR.

PRIORITY CLAIMED UNDER SEC. 44(D) ON JAPAN APPLICATION NO. 2009-057946, FILED 7-30-2009, REG. NO. 5325129, DATED 5-21-2010, EXPIRES 5-21-2020.

SER. NO. 77-923,987, FILED 1-29-2010.

DAWN HAN, EXAMINING ATTORNEY

United States of America

United States Patent and Trademark Office

LIVEINTENT

Reg. No. 4,204,017

Registered Sep. 11, 2012

**Int. Cls.: 35, 38, 41, 42
and 45**

SERVICE MARK

PRINCIPAL REGISTER

LIVE INTENT, INC. (DELAWARE CORPORATION)
PH-N OFFICE
89 READE STREET
NEW YORK, NY 10013

FOR: ADVERTISING, MARKETING AND PROMOTION SERVICES BY THE TRANSMISSION OF ADVERTISING MATERIAL AND THE DISSEMINATION OF ADVERTISING MESSAGES ON COMPUTER NETWORKS AND WIRELESS COMMUNICATIONS NETWORKS; ON-LINE BUSINESS NETWORKING SERVICES; AFFILIATE MARKETING SERVICES, NAMELY, PROMOTING THE GOODS AND SERVICES OF OTHERS BY PLACING PROMOTIONAL ADVERTISEMENTS VIA THE INTERNET AND WIRED AND WIRELESS COMMUNICATION DEVICES; ONLINE ADVERTISING AND MARKETING SERVICES, NAMELY, PROVIDING PAY FOR PERFORMANCE AND PAY-PER-CLICK ADVERTISING; ONLINE AUCTION SERVICES, NAMELY, AN ONLINE AUCTION EXCHANGE FOR BUYING AND SELLING DIGITAL ADVERTISING , IN CLASS 35 (U.S. CLS. 100, 101 AND 102).

FIRST USE 11-23-2009; IN COMMERCE 11-23-2009.

FOR: TELECOMMUNICATION SERVICES, NAMELY, PROVIDING ONLINE FACILITIES FOR REAL-TIME INTERACTION BETWEEN AND AMONG USERS OF COMPUTERS, MOBILE AND HANDHELD COMPUTERS, AND WIRED AND WIRELESS COMMUNICATION DEVICES IN THE FIELD OF GENERAL INTEREST, IN CLASS 38 (U.S. CLS. 100, 101 AND 104).

FIRST USE 11-29-2009; IN COMMERCE 11-29-2009.

FOR: ENTERTAINMENT SERVICES, NAMELY, PROVIDING ONLINE BLOGS FEATURING AUDIO CLIPS, VIDEO CLIPS, MULTI-MEDIA MATERIAL AND USER-DEFINED CONTENT IN THE FIELD OF SOCIAL NETWORKING, IN CLASS 41 (U.S. CLS. 100, 101 AND 107).

FIRST USE 11-23-2009; IN COMMERCE 11-23-2009.

FOR: APPLICATION SERVICE PROVIDER FEATURING SOFTWARE TO ENABLE UPLOADING, POSTING, SHOWING, DISPLAYING, TAGGING, BLOGGING, SHARING OR PROVIDING ELECTRONIC MEDIA OVER THE INTERNET OR OTHER COMMUNICATIONS NETWORKS; COMPUTER SERVICES, NAMELY, CREATING AN ONLINE COMMUNITY FOR REGISTERED USERS TO ENGAGE IN SOCIAL NETWORKING; COMPUTER SERVICES,



David J. Kyjars

Director of the United States Patent and Trademark Office

Reg. No. 4,204,017 NAMELY, PROVIDING TEMPORARY USE OF ONLINE NON-DOWNLOADABLE SOFTWARE TO MANAGE AN ONLINE AFFILIATE MARKETING NETWORK; PROVIDING TEMPORARY USE OF ONLINE NON-DOWNLOADABLE SOFTWARE TO MANAGE AN ADVERTISING EXCHANGE, IN CLASS 42 (U.S. CLS. 100 AND 101).

FIRST USE 11-23-2009; IN COMMERCE 11-23-2009.

FOR: ONLINE SOCIAL NETWORKING SERVICES, IN CLASS 45 (U.S. CLS. 100 AND 101).

FIRST USE 11-23-2009; IN COMMERCE 11-23-2009.

THE MARK CONSISTS OF STANDARD CHARACTERS WITHOUT CLAIM TO ANY PARTICULAR FONT, STYLE, SIZE, OR COLOR.

SER. NO. 77-929,498, FILED 2-5-2010.

LINDA E. BLOHM, EXAMINING ATTORNEY

United States of America

United States Patent and Trademark Office

PARAMOUNT FMS

Reg. No. 4,204,018

DANCKER, SELLEW & DOUGLAS, INC. (NEW YORK CORPORATION)
291 EVANS WAY

Registered Sep. 11, 2012

SOMERVILLE, NJ 08876

Int. Cl.: 42

FOR: PLANNING AND LAYOUT DESIGN FOR THE INTERIOR SPACE OF OFFICES, IN CLASS 42 (U.S. CLS. 100 AND 101).

SERVICE MARK

FIRST USE 1-20-2009; IN COMMERCE 3-1-2009.

PRINCIPAL REGISTER

THE MARK CONSISTS OF STANDARD CHARACTERS WITHOUT CLAIM TO ANY PARTICULAR FONT, STYLE, SIZE, OR COLOR.

SER. NO. 77-931,114, FILED 2-9-2010.

ESTHER A. BORSUK, EXAMINING ATTORNEY



David J. Kyffers

Director of the United States Patent and Trademark Office

United States of America

United States Patent and Trademark Office

PARAMOUNT FACILITY MANAGEMENT SOLUTIONS

Reg. No. 4,204,019

DANCKER, SELLEW & DOUGLAS, INC. (NEW YORK CORPORATION)
291 EVANS WAY

Registered Sep. 11, 2012

SOMERVILLE, NJ 08876

Int. Cl.: 42

FOR: PLANNING AND LAYOUT DESIGN FOR THE INTERIOR SPACE OF OFFICES, IN CLASS 42 (U.S. CLS. 100 AND 101).

SERVICE MARK

FIRST USE 1-20-2009; IN COMMERCE 3-1-2009.

PRINCIPAL REGISTER

THE MARK CONSISTS OF STANDARD CHARACTERS WITHOUT CLAIM TO ANY PARTICULAR FONT, STYLE, SIZE, OR COLOR.

NO CLAIM IS MADE TO THE EXCLUSIVE RIGHT TO USE "FACILITY MANAGEMENT SOLUTIONS", APART FROM THE MARK AS SHOWN.

SER. NO. 77-931,127, FILED 2-9-2010.

ESTHER A. BORSUK, EXAMINING ATTORNEY



David J. Kybas

Director of the United States Patent and Trademark Office

United States of America
United States Patent and Trademark Office

HARDCORE

Reg. No. 4,204,020

CALIFORNIA INNOVATIONS INC. (CANADA CORPORATION)
36 DUFFLAW ROAD

Registered Sep. 11, 2012

TORONTO, ONTARIO, CANADA M6A2W1

Int. Cl.: 21

FOR: INSULATED BAGS FOR FOOD AND BEVERAGES, NAMELY, SOFT-SIDED COOLERS WITH PLASTIC INTERIOR LINERS FOR DOMESTIC USE, IN CLASS 21 (U.S. CLS. 2, 13, 23, 29, 30, 33, 40 AND 50).

TRADEMARK

FIRST USE 12-31-2007; IN COMMERCE 12-31-2007.

PRINCIPAL REGISTER

THE MARK CONSISTS OF STANDARD CHARACTERS WITHOUT CLAIM TO ANY PARTICULAR FONT, STYLE, SIZE, OR COLOR.

PRIORITY CLAIMED UNDER SEC. 44(D) ON CANADA APPLICATION NO. 1468301, FILED 2-3-2010, REG. NO. 818606, DATED 2-28-2012, EXPIRES 2-28-2027.

SER. NO. 77-946,209, FILED 2-26-2010.

ALYSSA STEEL, EXAMINING ATTORNEY



David J. Kybas

Director of the United States Patent and Trademark Office

United States of America

United States Patent and Trademark Office

SEALFLEX

Reg. No. 4,204,021

LAYFIELD POLY FILMS LTD. (CANADA CORPORATION)

Registered Sep. 11, 2012

11120 SILVERSMITH PLACE
RICHMOND, BC, CANADA V7A5E4

Int. Cl.: 17

FOR: PLASTIC FILM FOR COMMERCIAL, MEDICAL, AND INDUSTRIAL PACKAGING USE, NAMELY, SEALABLE, NON-SHRINK PLASTIC FILM IN THE FORM OF A WEB AND SOLD AS AN INTEGRAL COMPONENT OF MULTI-LAYER PACKAGING TO FORM A LAMINATION SEAL AROUND OTHER NON-FOOD GOODS, IN CLASS 17 (U.S. CLS. 1, 5, 12, 13, 35 AND 50).

TRADEMARK

PRINCIPAL REGISTER

THE MARK CONSISTS OF STANDARD CHARACTERS WITHOUT CLAIM TO ANY PARTICULAR FONT, STYLE, SIZE, OR COLOR.

PRIORITY CLAIMED UNDER SEC. 44(D) ON CANADA APPLICATION NO. 1450249, FILED 9-1-2009, REG. NO. TMA821,031, DATED 3-29-2012, EXPIRES 3-29-2027.

SER. NO. 77-946,219, FILED 2-26-2010.

ALYSSA STEEL, EXAMINING ATTORNEY



David J. Kyros

Director of the United States Patent and Trademark Office

United States of America

United States Patent and Trademark Office

ETHOS PARTNERS

Reg. No. 4,204,022

Registered Sep. 11, 2012

Int. Cls.: 35 and 36

SERVICE MARK

PRINCIPAL REGISTER

NAVIGANT CONSULTING, INC. (DELAWARE CORPORATION)
30 S. WACKER DR.
SUITE 3550
CHICAGO, IL 60606

FOR: MEDICAL AND HEALTHCARE PROVIDER REVENUE CYCLE MANAGEMENT SERVICES, NAMELY, ADMINISTRATION, BILLING, AND RECONCILIATION OF ACCOUNTS ON BEHALF OF OTHERS; MEDICAL BILLING OUTSOURCING SERVICES AND MEDICAL BILLING SUPPORT SERVICES; MEDICAL AND HEALTHCARE PROVIDER SUPPORT SERVICES IN THE NATURE OF BILLING CODING SERVICES, IN CLASS 35 (U.S. CLS. 100, 101 AND 102).

FIRST USE 7-12-2005; IN COMMERCE 7-12-2005.

FOR: DEBT COLLECTION MANAGEMENT FOR MEDICAL AND HEALTHCARE PROVIDERS, NAMELY, PROVIDING FINANCIAL OVERSIGHT, SUPERVISION AND COORDINATION WITH RESPECT TO MONIES OWED MEDICAL AND HEALTHCARE PROVIDERS; INSURANCE CLAIM ADMINISTRATION AND ADJUSTMENT; DEVELOPMENT OF AMBULATORY SURGICAL CENTERS, NAMELY, CONDUCTING FINANCIAL FEASIBILITY STUDIES, IN CLASS 36 (U.S. CLS. 100, 101 AND 102).

FIRST USE 7-12-2005; IN COMMERCE 7-12-2005.

THE MARK CONSISTS OF STANDARD CHARACTERS WITHOUT CLAIM TO ANY PARTICULAR FONT, STYLE, SIZE, OR COLOR.

NO CLAIM IS MADE TO THE EXCLUSIVE RIGHT TO USE "PARTNERS", APART FROM THE MARK AS SHOWN.

SER. NO. 77-946,849, FILED 2-28-2010.

MARCIE MILONE, EXAMINING ATTORNEY



David J. Kyffers

Director of the United States Patent and Trademark Office

United States of America

United States Patent and Trademark Office

SUREPROTEIN

Reg. No. 4,204,023

FONTERRA TM LIMITED (NEW ZEALAND COMPANY)
9 PRINCES STREET

Registered Sep. 11, 2012

AUCKLAND, NEW ZEALAND

Int. Cl.: 29

FOR: MILK PROTEINS FOR FOOD AND BEVERAGES; MILK PROTEIN POWDERS FOR HUMAN CONSUMPTION FOR USE AS A FOOD ADDITIVE; MILK PROTEINS FOR HUMAN CONSUMPTION; WHEY; WHEY PROTEIN FOR USE AS A FOOD ADDITIVE; WHEY PROTEIN ISOLATE FOR USE AS A FOOD ADDITIVE; MILK PROTEIN CASEINATE FOR USE AS A FOOD ADDITIVE; MILK PROTEIN CONCENTRATES; ALL SOLD AT WHOLESALE ONLY TO FOOD AND BEVERAGE MANUFACTURERS, IN CLASS 29 (U.S. CL. 46).

TRADEMARK

PRINCIPAL REGISTER

THE MARK CONSISTS OF STANDARD CHARACTERS WITHOUT CLAIM TO ANY PARTICULAR FONT, STYLE, SIZE, OR COLOR.

PRIORITY CLAIMED UNDER SEC. 44(D) ON NEW ZEALAND APPLICATION NO. 816990, FILED 12-9-2009, REG. NO. 816990, DATED 12-9-2009, EXPIRES 12-9-2019.

SER. NO. 77-959,354, FILED 3-15-2010.

CHRISTINE COOPER, EXAMINING ATTORNEY



David J. Kybas

Director of the United States Patent and Trademark Office

United States of America

United States Patent and Trademark Office

GELART FLORAL

Reg. No. 4,204,024

LOURDES REYES ROSAS (MEXICO INDIVIDUAL)
WISCONSIN 93-204
D.F., MEXICO 03810

Registered Sep. 11, 2012

Int. Cl.: 41

FOR: EDUCATIONAL SERVICES, NAMELY, CONDUCTING WORKSHOPS ON THE CREATION OF DECORATIVE GELATIN FOOD PRODUCTS, AND DISTRIBUTION OF TRAINING MATERIALS IN CONNECTION THEREWITH, IN CLASS 41 (U.S. CLS. 100, 101 AND 107).

SERVICE MARK

FIRST USE 11-29-1997; IN COMMERCE 6-13-2003.

PRINCIPAL REGISTER

THE MARK CONSISTS OF STANDARD CHARACTERS WITHOUT CLAIM TO ANY PARTICULAR FONT, STYLE, SIZE, OR COLOR.

NO CLAIM IS MADE TO THE EXCLUSIVE RIGHT TO USE "FLORAL", APART FROM THE MARK AS SHOWN.

SER. NO. 77-969,284, FILED 3-26-2010.

KATHERINE STOIDES, EXAMINING ATTORNEY



David J. Kyffers

Director of the United States Patent and Trademark Office

United States of America

United States Patent and Trademark Office

NETGLOBERS

Reg. No. 4,204,025

Registered Sep. 11, 2012

Int. Cl.: 36

SERVICE MARK

PRINCIPAL REGISTER

EUROP ASSISTANCE HOLDING (FRANCE CORPORATION)
7 BOULEVARD HAUSSMANN
PARIS, FRANCE 75009

FOR: INSURANCE, NAMELY, INSURANCE UNDERWRITING SERVICES, NAMELY, HEALTH INSURANCE UNDERWRITING, ACCIDENT INSURANCE UNDERWRITING, CAR INSURANCE UNDERWRITING, TRAVEL INSURANCE UNDERWRITING, REINSURANCE UNDERWRITING, INSURANCE BROKERAGE SERVICES; ALL OPERATIONS OF AID, ASSISTANCE, INFORMATION OR ADVICE WHICH MAY BE USED AND PROVIDED BY AN ORGANIZATION WHOSE PRINCIPAL PURPOSE IS TO AID, ASSIST AND ADVISE ITS SUBSCRIBERS DURING THEIR TRAVEL IN FRANCE OR ABROAD AND, GENERALLY, TO COME TO THEIR AID ON THE OCCASION OF ANY UNFORESEEN EVENT, INCIDENT, OR ILLNESS ARISING DURING THEIR TRAVEL, NAMELY, INFORMATION ON INSURANCE ASSUMPTION OF COSTS BY SOCIAL SECURITY, FINANCIAL SERVICES, NAMELY, ADVANCING OF FUNDS IN CASE OF LOSS OR THEFT, ADVANCING OF FUNDS FOR MEDICAL, FUNERAL, HOSPITALIZATION, ACCOMMODATION, LAWYER, BAIL, TRANSPORT, SEARCH, EMERGENCY, RESCUE AND ANY OTHER COSTS CAUSED BY AN INCIDENT, ILLNESS OR ANY OTHER UNFORESEEN EVENT, IN CLASS 36 (U.S. CLS. 100, 101 AND 102).

THE MARK CONSISTS OF STANDARD CHARACTERS WITHOUT CLAIM TO ANY PARTICULAR FONT, STYLE, SIZE, OR COLOR.

OWNER OF FRANCE REG. NO. 093646393, DATED 4-24-2009, EXPIRES 4-24-2019.

SER. NO. 77-983,030, FILED 8-25-2009.

FLORENTINA BLANDU, EXAMINING ATTORNEY



David J. Kyffers

Director of the United States Patent and Trademark Office

United States of America

United States Patent and Trademark Office

KINETEKS

Reg. No. 4,204,026

Registered Sep. 11, 2012

Int. Cl.: 9

TRADEMARK

PRINCIPAL REGISTER

KINETEKS CORPORATION (CANADA CORPORATION)
211 - 1847 WEST BROADWAY
VANCOUVER, BRITISH COLUMBIA, CANADA V6J 1Y6

FOR: ELECTRONIC MEASURING APPARATUSES AND INSTRUMENTS, NAMELY, MULTIFUNCTIONAL SENSORS, WIRELESS COMMUNICATION SYSTEMS COMPRISING WIRELESS TRANSMITTERS, WIRELESS RECEIVERS AND COMPUTER SOFTWARE FOR USE THEREWITH AND COMPUTERS FOR IN SITU USE TO MEASURE PRESSURE, TORQUE, POSITION AND TIME AND ANALYZE SUCH DATA; ELECTRONIC NAVIGATION SYSTEM AND APPARATUS, NAMELY, SATELLITE NAVIGATIONAL SYSTEM, NAMELY, A GLOBAL POSITIONING SYSTEM FOR PERSONAL POSITION MEASUREMENT AND LOGGING; COMPUTER SOFTWARE FOR REAL TIME ANALYSIS OF SENSORY DATA TO PROVIDE WEIGHT TRANSFER ANALYSIS, SPEED AND ACCELERATION CALCULATIONS, CALORIC BURN CALCULATIONS, WORKOUT PROFILING, TRAJECTORY CALCULATIONS, RECOMMENDATIONS FOR MOVEMENT AND GAIT ALTERATIONS FOR OPTIMAL PERFORMANCE INJURY AND/OR RISK ASSESSMENTS, ORTHOTICS ASSESSMENT AND 3-D MODELING; IN SITU SENSORS TO PROVIDE MOVEMENT AND GAIT ANALYSIS COMPRISING FORCE PRESSURE SHOE INLAY SENSORS, VIDEO CAMERAS, SATELLITE NAVIGATIONAL SYSTEM, NAMELY, A GLOBAL POSITIONING SYSTEM, WIRELESS COMMUNICATION SYSTEMS COMPRISING WIRELESS TRANSMITTERS, WIRELESS RECEIVERS AND COMPUTER SOFTWARE FOR USE THEREWITH AND ACCELEROMETERS; ELECTRONIC MOVEMENT AND GAIT PERFORMANCE TESTING MACHINES IN THE NATURE OF FORCE AND/OR PRESSURE INLAY MONITORS, VIDEO CAMERAS, WIRELESS COMMUNICATION SYSTEMS COMPRISING WIRELESS TRANSMITTERS, WIRELESS RECEIVERS AND COMPUTER SOFTWARE FOR USE THEREWITH, SATELLITE NAVIGATIONAL SYSTEM, NAMELY, A GLOBAL POSITIONING SYSTEM, ACCELEROMETERS AND OPERATIONAL SOFTWARE SOLD AS A UNIT THEREOF, IN CLASS 9 (U.S. CLS. 21, 23, 26, 36 AND 38).



THE MARK CONSISTS OF STANDARD CHARACTERS WITHOUT CLAIM TO ANY PARTICULAR FONT, STYLE, SIZE, OR COLOR.

PRIORITY CLAIMED UNDER SEC. 44(D) ON CANADA APPLICATION NO. 1230523, FILED 9-16-2004, REG. NO. 820875, DATED 3-28-2012, EXPIRES 3-28-2027.

SER. NO. 78-524,787, FILED 11-30-2004.

David J. Kybas

Director of the United States Patent and Trademark Office

Reg. No. 4,204,026 KAREN SEVERSON, EXAMINING ATTORNEY

United States of America

United States Patent and Trademark Office

PokerTime

Reg. No. 4,204,027

ENTERTAINMENT NETWORKS LIMITED (BELIZE CORPORATION)

Registered Sep. 11, 2012

LA CORVEE HOUSE, LA CORVEE
ALDERNEY, CHANNEL ISLANDS GY9 3TQ

Int. Cls.: 9, 28 and 41

FOR: COMPUTER SOFTWARE FOR PLAYING CASINO-TYPE GAMES THAT MAY BE DOWNLOADED FROM A GLOBAL COMPUTER NETWORK; ELECTRONIC BOARD GAME SOFTWARE; DOWNLOADABLE ELECTRONIC PUBLICATIONS IN THE NATURE OF MAGAZINES, NEWSLETTERS, INFORMATION SHEETS AND INSTRUCTION MANUALS FEATURING INFORMATION CONCERNING BETTING, GAMBLING, GAMING, CASINO GAMING AND GAMES OF CHANCE PROVIDED ONLINE FROM DATABASES OR THE INTERNET; DOWNLOADABLE ELECTRONIC PUBLICATIONS IN THE NATURE OF MAGAZINES, NEWSLETTERS, INFORMATION SHEETS AND INSTRUCTION MANUALS FEATURING INFORMATION CONCERNING BETTING, GAMBLING, GAMING, CASINO GAMING AND GAMES OF CHANCE PROVIDED BY ELECTRONIC MAIL; GAMING MACHINES FOR USE IN GAMING ESTABLISHMENTS; SLOT MACHINES, IN CLASS 9 (U.S. CLS. 21, 23, 26, 36 AND 38).

TRADEMARK

SERVICE MARK

PRINCIPAL REGISTER

FOR: CASINO GAMBLING AND BETTING GAME EQUIPMENT, NAMELY, PLAYING CARDS, CHIPS, POKER CHIPS, GAMING TABLES, POKER TABLES, IN CLASS 28 (U.S. CLS. 22, 23, 38 AND 50).

FOR: PROVISION OF CASINO SERVICES; BETTING SERVICES; GAMBLING SERVICES; GAMING SERVICES, NAMELY, PROVIDING LOTTERIES, SWEEPSTAKES, GAMES OF CHANCE, CARD GAMES, NUMBER GAMES AND CONTESTS BY MEANS OF COMPUTER NETWORKS, INTRANETS AND THE INTERNET; INFORMATION SERVICES RELATING TO BETTING, GAMBLING AND GAMING SERVICES; OPERATION OF ONLINE BETTING SERVICES VIA THE INTERNET; OPERATION OF ONLINE GAMBLING SERVICES VIA THE INTERNET; OPERATION OF ONLINE GAMING SERVICES VIA THE INTERNET, NAMELY, PROVIDING ONLINE POKER GAMES AND ONLINE INTERACTIVE COMPUTER GAMES; PROVIDING AN ONLINE COMPUTER DATABASE FEATURING INFORMATION ON BETTING, GAMBLING, GAMING, POKER AND CASINOS, IN CLASS 41 (U.S. CLS. 100, 101 AND 107).



David J. Kyffers

THE MARK CONSISTS OF STANDARD CHARACTERS WITHOUT CLAIM TO ANY PARTICULAR FONT, STYLE, SIZE, OR COLOR.

Reg. No. 4,204,027 PRIORITY CLAIMED UNDER SEC. 44(D) ON ERPN CMNTY TM OFC APPLICATION NO. 4599999, FILED 8-22-2005.

OWNER OF BELIZE REG. NO. 7780.11, DATED 12-12-2011, EXPIRES 5-12-2021.

SER. NO. 78-709,994, FILED 9-9-2005.

KRISTINA MORRIS, EXAMINING ATTORNEY

United States of America

United States Patent and Trademark Office

NOMAD

Reg. No. 4,204,028

Registered Sep. 11, 2012

Int. Cls.: 16, 35 and 36

TRADEMARK

SERVICE MARK

PRINCIPAL REGISTER

LONDON STOCK EXCHANGE PLC (UNITED KINGDOM CORPORATION)
10 PATERNOSTER SQUARE
LONDON, UNITED KINGDOM EC4M 7LS

FOR: PHOTOGRAPHS IN THE FIELD OF FINANCIAL SERVICES; STATIONERY IN THE FIELD OF FINANCIAL SERVICES; PRINTED INSTRUCTIONAL AND TEACHING MATERIAL IN THE FIELD OF FINANCIAL SERVICES; PRINTED NEWSLETTERS AND NEWS BULLETINS IN THE FIELD OF FINANCIAL SERVICES; PRINTED PERIODICALS, BOOKS AND BOOKLETS IN THE FIELD OF FINANCIAL SERVICES; DIARIES AND ADDRESS BOOKS IN THE FIELD OF FINANCIAL SERVICES, IN CLASS 16 (U.S. CLS. 2, 5, 22, 23, 29, 37, 38 AND 50).

FOR: BUSINESS MANAGEMENT; BUSINESS ADMINISTRATION; PROVIDING OFFICE FUNCTIONS; BUSINESS INFORMATION SERVICES AND APPRAISALS; COMPUTER-ASSISTED BUSINESS INFORMATION AND RESEARCH SERVICES; STATISTICAL INFORMATION SERVICES; PROMOTIONAL, PUBLICITY, MARKETING AND ADVERTISING SERVICES; PUBLICATION OF PUBLICITY AND PROMOTIONAL TEXTS; RECORDING AND REGISTERING THE TRANSFER OF STOCKS, SHARES AND SECURITIES; BOOK-KEEPING AND ACCOUNTING; MAINTAINING RECORDS OF OWNERSHIP OF STOCKS, SHARES AND SECURITIES; MAINTAINING RECORDS OF SETTLEMENTS FOR TRANSFERS OF STOCKS, SHARES AND SECURITIES; BUSINESS INFORMATION SERVICES FOR BUSINESS APPRAISALS, AND STATISTICAL INFORMATION; COMPILATION AND PROVISION OF BUSINESS INFORMATION; BUSINESS RESEARCH; PROVISION OF BUSINESS STATISTICAL INFORMATION; BUSINESS SERVICES FOR OTHERS, NAMELY, PROVIDING BUSINESS ADVICE CONCERNING REGULATION OF COMPANIES LISTED ON OR APPLYING FOR ADMISSION TO A STOCK EXCHANGE OR STOCK EXCHANGES; BUSINESS SERVICES FOR OTHERS, NAMELY, PROVIDING BUSINESS MANAGEMENT ADVICE IN THE FIELD OF CORPORATE FINANCE; BUSINESS SERVICES FOR OTHERS, NAMELY, PROVIDING BUSINESS MANAGEMENT ADVICE IN THE FIELD OF CORPORATE TRANSACTIONS; BUSINESS SERVICES FOR OTHERS, NAMELY, PROVIDING BUSINESS ADVICE TO ENABLE MEMBERSHIP OF A STOCK EXCHANGE OR STOCK EXCHANGES; BUSINESS SERVICES FOR OTHERS, NAMELY, PROVIDING BUSINESS ADVICE TO ENABLE ADMISSION TO A STOCK EXCHANGE OR STOCK EXCHANGES; BUSINESS SERVICES FOR OTHERS, NAMELY, PROVIDING BUSINESS MANAGEMENT ADVICE IN THE FIELD OF PUBLIC LISTED COMPANIES AND THEIR ROLE IN THE FIELD OF FINANCIAL SERVICES; BUSINESS SERVICES FOR OTHERS, NAMELY, PROVIDING BUSINESS MANAGEMENT ADVICE TO ENABLE COMPLIANCE WITH STOCK EXCHANGE RULES



David J. Kyjars

Director of the United States Patent and Trademark Office

Reg. No. 4,204,028 AND CRITERIA; BUSINESS SERVICES FOR OTHERS, NAMELY, PROVIDING BUSINESS MANAGEMENT ADVICE TO ENABLE FLOATING OR TRADING ON A STOCK EXCHANGE OR STOCK EXCHANGES; BUSINESS SERVICES FOR OTHERS, NAMELY, PROVIDING BUSINESS MANAGEMENT ADVICE CONCERNING LIAISING WITH A REGULATOR OF A STOCK EXCHANGE OR STOCK EXCHANGES; BUSINESS SERVICES FOR OTHERS, NAMELY, PROVIDING BUSINESS MANAGEMENT ADVICE TO ENABLE COMPANIES TO ISSUE SHARES OR OTHER FINANCIAL INSTRUMENTS OR CONDUCT FINANCIAL TRANSACTIONS; PROVIDING BUSINESS MANAGEMENT AND BUSINESS REGULATORY ADVICE TO OTHERS IN INTERPRETATION OF REGULATOR RULES AND DISCIPLINARY PROCEDURES IN CONNECTION WITH STOCK EXCHANGES; PROVIDING BUSINESS MANAGEMENT AND BUSINESS REGULATORY ADVICE TO OTHERS TO ENABLE COMPLIANCE BY THOSE THIRD PARTIES WITH THE RULES OR REGULATIONS APPLICABLE TO LISTING ON OR ADMISSION TO A STOCK EXCHANGE OR STOCK EXCHANGES; PROVIDING BUSINESS MANAGEMENT AND BUSINESS REGULATORY ADVICE TO OTHERS IN REVIEWING THEIR BUSINESS STANDARDS AND PRACTICES FOR COMPLIANCE WITH STOCK MARKET LAWS, RULES AND REGULATIONS; PROVIDING BUSINESS MANAGEMENT AND BUSINESS REGULATORY ADVICE TO OTHERS IN REVIEWING THEIR STANDARDS AND PRACTICES TO ENSURE COMPLIANCE WITH BUSINESS LAWS AND REGULATIONS; PROVIDING COMPUTERISED INFORMATION SERVICES FOR OTHERS IN THE FIELD OF BUSINESS APPRAISALS, IN CLASS 35 (U.S. CLS. 100, 101 AND 102).

FOR: FINANCIAL CONSULTANCY; FINANCIAL MANAGEMENT; FINANCIAL ADMINISTRATION, NAMELY, FINANCIAL ADMINISTRATION OF SHARES AND OTHER FINANCIAL SECURITIES IN FINANCIAL MARKETS, STOCK EXCHANGE ADMINISTRATION OF SHARES AND OTHER FINANCIAL SECURITIES IN FINANCIAL MARKETS, AND ADMISSION AND TRADING OF SHARES AND OTHER FINANCIAL SECURITIES IN FINANCIAL MARKETS; FINANCIAL RESEARCH; FINANCIAL ADVICE; MONETARY CONSULTATION, MONETARY RESEARCH, MONETARY ADVICE; REAL ESTATE CONSULTATION, REAL ESTATE RESEARCH, NAMELY, FINANCIAL RESEARCH IN THE FIELD OF REAL ESTATE; REAL ESTATE ADVICE; FINANCIAL INFORMATION, MANAGEMENT AND ANALYSIS SERVICES; PROVISION OF FINANCIAL INFORMATION; PROVISION OF SHARE PRICE INFORMATION; STOCK EXCHANGE QUOTATION AND LISTING SERVICES; SHARE PRICE INFORMATION SERVICES; PROVISION OF A FINANCIAL MARKET FOR THE TRADING OF SECURITIES, SHARES AND OPTIONS AND OTHER DERIVATIVE PRODUCTS; SERVICES FOR THE COMPLETION OF THE EXCHANGE OF MONIES AND THE UNDERLYING ASSET REQUIRED FOR SETTLEMENT IN THE FIELD OF FINANCIAL SERVICES; SERVICES FOR MATCHING TRADE BIDS AND OFFERS IN THE FIELD OF STOCK EXCHANGES; PREPARATION AND QUOTATION OF STOCK EXCHANGE PRICES AND INDICES; AUTOMATED TRADING OF FINANCIAL INSTRUMENTS, SHARES, OPTIONS, FUTURES AND SWAPS, WHETHER OVER-THE-COUNTER OR EXCHANGE-TRADED; ELECTRONIC TRADING SERVICES FOR OTHERS IN FINANCIAL INSTRUMENTS, SHARES, OPTIONS, FUTURES AND SWAPS, WHETHER OVER-THE-COUNTER OR EXCHANGE-TRADED; FINANCIAL SERVICES FOR THE TRADING OF FINANCIAL INSTRUMENTS, SHARES, OPTIONS, FUTURES AND SWAPS, WHETHER OVER-THE-COUNTER OR EXCHANGE-TRADED; STOCKS AND BONDS BROKERAGE; THE PROVISION AND DISSEMINATION OF FINANCIAL INFORMATION AND INDICES TO OTHERS TO FACILITATE THOSE PARTIES TRADING OF FINANCIAL INSTRUMENTS, SHARES OPTIONS, FUTURES AND SWAPS, WHETHER OVER-THE-COUNTER OR EXCHANGE-TRADED; INFORMATION AND RESEARCH SERVICES RELATED TO OR CONNECTED WITH TRADING OF FINANCIAL INSTRUMENTS, SHARES OPTIONS, FUTURES AND SWAPS, WHETHER OVER-THE-COUNTER OR EXCHANGE-TRADED, COMPANY VALUATIONS, EARNINGS, FINANCIAL RESULTS AND STOCK PRICES RELEVANT TO THE RAISING OF CAPITAL AND TRADING ON A STOCK EXCHANGE; STOCK EXCHANGE PRICE QUOTATIONS; FINANCIAL INFORMATION SERVICES TO PROVIDE STOCK EXCHANGE QUOTATIONS AND STATISTICS IN RELATION TO SUCH QUOTATIONS; FINANCIAL SERVICES FOR OTHERS, NAMELY, FINANCIAL CONSULTATION CONCERNING THE REGULATION OF COMPANIES LISTED ON OR APPLYING FOR ADMISSION TO A STOCK EXCHANGE OR STOCK

Reg. No. 4,204,028 EXCHANGES; FINANCIAL CONSULTATION IN THE FIELD OF CORPORATE FINANCE; FINANCIAL SERVICES FOR OTHERS, NAMELY, FINANCIAL CONSULTATION TO ENABLE CORPORATE TRANSACTIONS; FINANCIAL SERVICES FOR OTHERS, NAMELY, FINANCIAL CONSULTATION TO ENABLE MEMBERSHIP OF A STOCK EXCHANGE OR STOCK EXCHANGES; FINANCIAL SERVICES FOR OTHERS, NAMELY, FINANCIAL CONSULTATION TO ENABLE ADMISSION TO A STOCK EXCHANGE OR STOCK EXCHANGES; FINANCIAL SERVICES FOR OTHERS, NAMELY, FINANCIAL CONSULTATION IN THE FIELD OF PUBLIC LISTED COMPANIES AND THEIR ROLE IN THE FIELD OF FINANCIAL SERVICES; FINANCIAL SERVICES FOR OTHERS, NAMELY, FINANCIAL CONSULTATION TO ENABLE COMPLIANCE WITH STOCK EXCHANGE RULES AND CRITERIA; FINANCIAL SERVICES FOR OTHERS, NAMELY, FINANCIAL CONSULTATION TO ENABLE FLOATING OR TRADING ON A STOCK EXCHANGE OR STOCK EXCHANGES; FINANCIAL SERVICES FOR OTHERS, NAMELY, FINANCIAL CONSULTATION CONCERNING LIAISING WITH A REGULATOR OF A STOCK EXCHANGE OR STOCK EXCHANGES; FINANCIAL SERVICES FOR OTHERS, NAMELY, FINANCIAL CONSULTATION TO ENABLE THEM TO ISSUE SHARES OR OTHER FINANCIAL INSTRUMENTS OR CONDUCT FINANCIAL TRANSACTIONS; INFORMATION SERVICES IN THE FIELD OF FINANCIAL CONSULTANCY, FINANCIAL MANAGEMENT, FINANCIAL ADMINISTRATION, FINANCIAL RESEARCH AND FINANCIAL ADVICE; FINANCIAL ADVISORY AND CONSULTANCY SERVICES IN RELATION TO THE FOREGOING; FINANCIAL EXCHANGE, NAMELY, COMPLETION OF THE EXCHANGE OF MONIES AND THE UNDERLYING ASSET REQUIRED FOR THE SETTLEMENT OF THE TRANSFER OF STOCKS, SHARES AND SECURITIES; PROVIDING COMPUTERISED FINANCIAL INFORMATION SERVICES FOR OTHERS FOR THE TRADING OF FINANCIAL INSTRUMENTS, SHARES OPTIONS, FUTURES AND SWAPS, WHETHER OVER-THE-COUNTER OR EXCHANGE-TRADED, IN CLASS 36 (U.S. CLS. 100, 101 AND 102).

THE MARK CONSISTS OF STANDARD CHARACTERS WITHOUT CLAIM TO ANY PARTICULAR FONT, STYLE, SIZE, OR COLOR.

PRIORITY CLAIMED UNDER SEC. 44(D) ON ERPN CMNTY TM OFC APPLICATION NO. 005015433, FILED 3-29-2006, REG. NO. 005015433, DATED 11-22-2009, EXPIRES 3-29-2016.

SER. NO. 78-849,831, FILED 3-30-2006.

LINDA LAVACHE, EXAMINING ATTORNEY

United States of America

United States Patent and Trademark Office



Reg. No. 4,204,029

Registered Sep. 11, 2012

**Int. Cls.: 35, 36, 37, 38
and 42**

SERVICE MARK

PRINCIPAL REGISTER

GETRONICS N.V. (NETHERLANDS LIMITED LIABILITY COMPANY)
STAALMEESTERSLAAN 410
AMSTERDAM, NETHERLANDS NL1057 PH

FOR: ADVERTISING SERVICES; BUSINESS MANAGEMENT; BUSINESS ADMINISTRATION; PROVIDING OFFICE FUNCTIONS; PROFESSIONAL BUSINESS CONSULTANCY; BUSINESS MANAGEMENT, BUSINESS ECONOMICS AND BUSINESS ADMINISTRATION CONSULTANCY; BUSINESS SERVICES IN THE FIELD OF AUTOMATIC DATA PROCESSING, NAMELY, CONSULTANCY REGARDING THE SYSTEMATIC ORDERING OF INFORMATION IN COMPUTER DATABASES AND COMPILATION OF INFORMATION IN COMPUTER DATABASES; BUSINESS MEDIATION WITH REGARD TO THE PURCHASE AND SALE OF COMPUTERS, COMPUTER PERIPHERALS, TELECOMMUNICATIONS AND DATA COMMUNICATIONS DEVICES, COMPUTER SOFTWARE AND OFFICE MACHINES FOR THIRD PARTIES; SALES PROMOTION, FOR OTHERS, WITH REGARD TO COMPUTERS, COMPUTER PERIPHERALS, TELECOMMUNICATIONS AND DATA COMMUNICATIONS DEVICES, COMPUTER SOFTWARE AND OFFICE MACHINES; DEMONSTRATION OF COMPUTERS, COMPUTER PERIPHERALS, TELECOMMUNICATIONS AND DATA COMMUNICATIONS DEVICES, COMPUTER SOFTWARE AND OFFICE MACHINES FOR COMMERCIAL AND ADVERTISING PURPOSES; BRINGING TOGETHER, FOR OTHERS, OF COMPUTERS, COMPUTER PERIPHERALS, TELECOMMUNICATIONS AND DATA COMMUNICATIONS DEVICES, COMPUTER SOFTWARE AND OFFICE MACHINES EXCEPT THE TRANSPORT THEREOF, TO ALLOW CONSUMERS TO VIEW AND PURCHASE THE AFORESAID GOODS EASILY; PROCESSING OF SALARY DATA, CALCULATING SALARIES, PROCESSING DATA IN THE FIELD OF PERSONNEL MANAGEMENT; RETAIL STORE SERVICES IN RESPECT OF TELECOMMUNICATIONS APPARATUS, SOFTWARE AND COMPUTER APPARATUS, PHOTOGRAPHIC APPARATUS AND INSTRUMENTS, IN CLASS 35 (U.S. CLS. 100, 101 AND 102).

FOR: PROFESSIONAL FINANCIAL CONSULTANCY; ELECTRONIC FUNDS TRANSFER, IN CLASS 36 (U.S. CLS. 100, 101 AND 102).

FOR: INSTALLATION, REPAIR AND MAINTENANCE OF COMPUTER HARDWARE; TECHNICAL CONSULTANCY REGARDING THE INSTALLATION, REPAIR AND MAINTENANCE OF COMPUTER HARDWARE; BUILDING CONSTRUCTION; MAINTENANCE AND REPAIR OF COMPUTERS, COMPUTER PERIPHERALS, INTERNET COMPUTER DEVICES, TELECOMMUNICATIONS AND DATA COMMUNICATIONS DEVICES AND OFFICE MACHINES; INSTALLATION OF COMPUTERS; INSTALLATION OF CABLES AND



David J. Kyjars

Director of the United States Patent and Trademark Office

Reg. No. 4,204,029 NETWORKS IN OFFICES; INSTALLATION OF AIR-CONDITIONING INSTALLATIONS; INSTALLATION OF TRANSMISSION APPARATUS FOR COMMUNICATIONS AND MOBILE COMMUNICATIONS; CONSULTANCY REGARDING THE INSTALLATION AND MAINTENANCE OF COMPUTER HARDWARE, AS PART OF A LOCAL OR WIDE-AREA NETWORK OR A GLOBAL COMPUTER NETWORK OR INDEPENDENT OF SUCH NETWORKS, IN CLASS 37 (U.S. CLS. 100, 103 AND 106).

FOR: TELECOMMUNICATION SERVICES, NAMELY, PROVIDING TELEPHONE COMMUNICATIONS SERVICES; PROVIDING ACCESS TO THE INTERNET; ELECTRONIC DATA TRANSMISSION; TECHNICAL ADVICE WITH REGARD TO TELECOMMUNICATIONS SERVICES, EQUIPMENT, AND PERIPHERAL EQUIPMENT; TELECOMMUNICATIONS SERVICES, NAMELY, TELEPHONE SERVICES; DATA COMMUNICATIONS BY ELECTRONIC MAIL; OPTICAL FIBRE NETWORK COMMUNICATIONS SERVICES; CALL SERVICES MAKING USE OF RADIO, TELEPHONE OR OTHER ELECTRONIC MEANS OF COMMUNICATION, NAMELY, ELECTRONIC COMMUNICATIONS NETWORKS; WIRELESS BROADBAND COMMUNICATIONS SERVICES; COMMUNICATION SERVICES WITH REMOTE SCREENS, NAMELY, VIDEO CONFERENCING; INSTANT MESSAGE-SENDING SERVICES; COMMUNICATIONS SERVICES USING REMOTE COMPUTERS; ARTIFICIAL SATELLITE COMMUNICATIONS SERVICES; PROVIDING INFORMATION IN THE FIELD OF TELECOMMUNICATIONS; ELECTRONIC MAIL; TELEPHONE SERVICES; TELEPHONE COMMUNICATIONS SERVICES; COMPUTER-AIDED TRANSMISSION OF MESSAGES AND IMAGES; COMPUTER COMMUNICATIONS SERVICES, NAMELY, ELECTRONIC TRANSMISSION OF DATA AND DOCUMENTS AMONG USERS OF COMPUTERS; MOBILE TELEPHONE COMMUNICATIONS SERVICES; CABLE TELEVISION BROADCASTING, IN CLASS 38 (U.S. CLS. 100, 101 AND 104).

FOR: CONSULTANCY REGARDING COMPUTERS, COMPUTER PERIPHERALS AND COMPUTER SOFTWARE; COMPUTER SOFTWARE MAINTENANCE; COMPUTER SOFTWARE DEVELOPMENT AND ADJUSTMENT, NAMELY, UPDATING; COMPUTER DATA SOFTWARE ADJUSTMENT, NAMELY, UPDATING; COMPUTER PROGRAMMING; RENTAL OF ACCESS TIME TO GLOBAL COMPUTER DATABASES; RENTAL OF COMPUTERS AND COMPUTER PERIPHERALS; CONSULTANCY REGARDING THE DESIGN, INSTALLATION, INTEGRATION MANAGEMENT AND MAINTENANCE OF SOFTWARE AND LOCAL AND WIDE-AREA COMPUTER NETWORKS AND GLOBAL COMPUTER NETWORKS; CONSULTANCY REGARDING COMPUTER HARDWARE DESIGN; CONSULTANCY REGARDING INTEGRATION MANAGEMENT IN RESPECT OF COMPUTER HARDWARE; CONSULTANCY REGARDING THE DESIGN AND MAINTENANCE OF WEBSITES AND PORTALS; DESIGN OF WEBSITES AND PORTALS; TECHNICAL CONSULTING AND ASSISTANCE WITH COMPUTER-BASED INFORMATION SYSTEMS AND COMPONENTS; COMPUTER CONSULTANCY REGARDING THE SELECTION OF COMPUTER HARDWARE, COMPUTER SOFTWARE AND LOCAL AND WIDE-AREA NETWORKS AND GLOBAL NETWORKS; TECHNICAL CONSULTANCY AND ASSISTANCE WITH COMPUTER BASED INFORMATION SYSTEMS AND COMPONENTS, NAMELY, COMPUTER HARDWARE NOT INCLUDING THE INSTALLATION, REPAIR AND MAINTENANCE OF HARDWARE, SOFTWARE AND COMPUTERISATION CONCEPTS; LEASING OF COMPUTERS, COMPUTER PERIPHERALS, DATA COMMUNICATIONS APPARATUS, COMPUTER SOFTWARE AND OFFICE MACHINES, IN CLASS 42 (U.S. CLS. 100 AND 101).

THE MARK CONSISTS OF A BLACK RECTANGLE FEATURING HORIZONTAL LINES IN THE COLORS GREEN, RED, ORANGE, BLUE AND WHITE. THE LINES IN THE CENTER OF THE DRAWING FORM A CIRCLE AND ARE SHADED IN RED, GREEN, ORANGE, BLUE AND WHITE, FROM TOP TO BOTTOM. THE WORDING "GETRONICS" APPEARS OVER THE LINES, WITH THE LETTERS "GETR" AND "NICS" APPEARING IN WHITE AND THE "O" IS THE CIRCLE FORMED BY THE COLORED HORIZONTAL LINES. .

PRIORITY DATE OF 10-23-2008 IS CLAIMED.

Reg. No. 4,204,029 OWNER OF INTERNATIONAL REGISTRATION 1008811 DATED 11-13-2008, EXPIRES 11-13-2018.

THE COLOR(S) BLACK, WHITE, GREEN, BLUE, ORANGE, RED IS/ARE CLAIMED AS A FEATURE OF THE MARK.

SER. NO. 79-071,329, FILED 11-13-2008.

MARILYN IZZI, EXAMINING ATTORNEY

United States of America

United States Patent and Trademark Office

MAPEI ULTRALITE

Reg. No. 4,204,030

Registered Sep. 11, 2012

Int. Cls.: 1 and 19

TRADEMARK

PRINCIPAL REGISTER

MAPEI S.P.A. (ITALY SOCIETE PAR ACTIONS)
VIA CAFIERO, 22
I-20158 MILANO
ITALY

FOR: CHEMICAL PRODUCTS FOR USE IN INDUSTRY; UNPROCESSED ARTIFICIAL AND SYNTHETIC RESINS; DISPERSIONS OF PLASTICS, NAMELY, PLASTICIZERS AND PLASTISOLS FOR USE AS ADDITIVES IN CEMENT AND CONCRETE; ADHESIVES FOR INDUSTRIAL USE; ROOFING ADHESIVES; CONSTRUCTION INDUSTRY ADHESIVES, ADHESIVES FOR GENERAL INDUSTRIAL USE, ADHESIVES FOR USE IN APPLYING WALL COVERINGS, ADHESIVES FOR USE IN THE MANUFACTURE OF FURNITURE; SCALE PREVENTIVE AGENTS, NAMELY, CHEMICAL PRODUCTS FOR PREVENTING SCALE; CHEMICAL PRODUCTS FOR IMPROVING THE CHARACTERISTICS OF MORTARS AND CEMENT BLOCKS, NAMELY, DUAL COMPONENT CHEMICAL ADDITIVES FOR USE AS A BINDING AGENT IN CEMENT MORTARS, IN CLASS 1 (U.S. CLS. 1, 5, 6, 10, 26 AND 46).

FOR: CEMENT MIXES; CEMENT, NAMELY, PORTLAND CEMENT, MAGNESIA CEMENT, NON-AGRICULTURAL LIME FOR USE IN CONSTRUCTION; CEMENT GLUE, NAMELY, FILLING CEMENT; SLAG-LIME CEMENT; MORTAR; CONCRETE; CONCRETE ROAD PAVEMENT BOARDS, CRASH BARRIERS OF CONCRETE FOR ROADS; CONCRETE PANELS; LATEX FOR MIXING WITH CEMENT AND SAND AND FOR USE IN THE BUILDING INDUSTRY, IN CLASS 19 (U.S. CLS. 1, 12, 33 AND 50).

THE MARK CONSISTS OF STANDARD CHARACTERS WITHOUT CLAIM TO ANY PARTICULAR FONT, STYLE, SIZE, OR COLOR.

OWNER OF INTERNATIONAL REGISTRATION 1018203 DATED 7-2-2009, EXPIRES 7-2-2019.

OWNER OF U.S. REG. NOS. 2,252,757, 3,623,147 AND OTHERS.

NO CLAIM IS MADE TO THE EXCLUSIVE RIGHT TO USE "ULTRALITE", APART FROM THE MARK AS SHOWN.

SER. NO. 79-074,712, FILED 7-2-2009.



David J. Kyffers

Director of the United States Patent and Trademark Office

Reg. No. 4,204,030 JESSICA FATHY, EXAMINING ATTORNEY

United States of America

United States Patent and Trademark Office

WORLD FAMILY OF RADIO MARIA

Reg. No. 4,204,031

WORLD FAMILY OF RADIO MARIA (ITALY ASSOCIATION)

Registered Sep. 11, 2012

CORSO VITTORIO EMANUELE II, 229
I-00186 ROMA, ITALY

Int. Cls.: 9, 16, 38 and 41

FOR: RECORDING DISCS, NAMELY, BLANK MAGNETIC DISCS, BLANK OPTICAL DISCS; RECORDING DISCS, NAMELY, PRE-RECORDED DVDS, CDS, CD-ROMS, AND VIDEOCASSETTES ALL FEATURING RELIGIOUS CONTENTS; RADIO APPARATUS, NAMELY, RADIOS, IN CLASS 9 (U.S. CLS. 21, 23, 26, 36 AND 38).

TRADEMARK

SERVICE MARK

FOR: PAPER, CARDBOARD AND GOODS MADE FROM THESE MATERIALS, NOT INCLUDED IN OTHER CLASSES, NAMELY, PAPER AND CARDBOARD BOXES, ADHESIVE LABELS, ADHESIVE NOTE PADS; POSTCARDS, BOOKMARKS, NOTEBOOKS, DIARIES, CALENDARS, AND HOLY PICTURES; PRINTED MATTER, NAMELY, NEWSPAPERS, PHOTOGRAPHS, MAGAZINES, BOOKS, PRINTED PERIODICALS, NEWSLETTERS, AND BROCHURES ALL IN THE FIELD OF RELIGION, IN CLASS 16 (U.S. CLS. 2, 5, 22, 23, 29, 37, 38 AND 50).

PRINCIPAL REGISTER

FOR: TELECOMMUNICATIONS, NAMELY, BROADBAND RADIO COMMUNICATIONS SERVICES, AUDIO TELECONFERENCING, CABLE RADIO BROADCASTING, CALL FORWARDING SERVICES, CHAT ROOM SERVICES FOR SOCIAL NETWORKING; RADIO BROADCASTING STATIONS, IN CLASS 38 (U.S. CLS. 100, 101 AND 104).

FOR: EDUCATION SERVICES, NAMELY, PROVIDING CLASSES, SEMINARS, AND WORKSHOPS IN THE FIELD OF RELIGION; ORGANIZING COMMUNITY SPORTING AND CULTURAL EVENTS, IN CLASS 41 (U.S. CLS. 100, 101 AND 107).



THE MARK CONSISTS OF STANDARD CHARACTERS WITHOUT CLAIM TO ANY PARTICULAR FONT, STYLE, SIZE, OR COLOR.

OWNER OF INTERNATIONAL REGISTRATION 1042654 DATED 5-24-2010, EXPIRES 5-24-2020.

NO CLAIM IS MADE TO THE EXCLUSIVE RIGHT TO USE "WORLD" AND "RADIO", APART FROM THE MARK AS SHOWN.

SER. NO. 79-083,964, FILED 5-24-2010.

David J. Kyffers

Director of the United States Patent and Trademark Office

Reg. No. 4,204,031 HAI-LY LAM, EXAMINING ATTORNEY

United States of America
United States Patent and Trademark Office

GROFIT

Reg. No. 4,204,032

Registered Sep. 11, 2012

Int. Cl.: 1

TRADEMARK

PRINCIPAL REGISTER

ROCKWOOL B.V. (NETHERLANDS PRIVATE LIMITED COMPANY)
INDUSTRIEWEG 15
NL-6045 JG ROERMOND
NETHERLANDS

FOR: CHEMICALS USED IN AGRICULTURE, HORTICULTURE AND FORESTRY EXCEPT FOR FUNGICIDES, HERBICIDES, INSECTICIDES AND PARASITICIDES; FERTILIZERS; CUBES, PLATES AND UNMOLDED MASS MAINLY EXISTING OF MINERAL FIBERS, WITH OR WITHOUT EARTH AND/OR FERTILIZER OR SEEDS OR CLAY, ACTING AS A NUTRIENT OR ROOT MEDIUM, FOR THE CULTIVATION OF AGRICULTURE, HORTICULTURE OR FORESTRY PRODUCTS, OR ACTING AS A WATER DISTRIBUTING LAYER FOR CULTIVATING AGRICULTURE, NAMELY, ARTIFICIAL PLANT-CULTIVATION SOIL, GROWING MEDIA FOR PLANTS, AND PLANT GROWTH REGULATING PREPARATIONS, IN CLASS 1 (U.S. CLS. 1, 5, 6, 10, 26 AND 46).

THE MARK CONSISTS OF STANDARD CHARACTERS WITHOUT CLAIM TO ANY PARTICULAR FONT, STYLE, SIZE, OR COLOR.

PRIORITY DATE OF 1-25-2010 IS CLAIMED.

OWNER OF INTERNATIONAL REGISTRATION 1048732 DATED 6-9-2010, EXPIRES 6-9-2020.

SER. NO. 79-086,479, FILED 6-9-2010.

MAYUR VAGHANI, EXAMINING ATTORNEY



David J. Kyffers

Director of the United States Patent and Trademark Office

United States of America

United States Patent and Trademark Office



Reg. No. 4,204,033

Registered Sep. 11, 2012

**Int. Cls.: 3, 14, 16, 20, 24,
25, 28, 29, 30, 32, 41 and
43**

TRADEMARK

SERVICE MARK

PRINCIPAL REGISTER

ATLANTYCA SPA (ITALY JOINT STOCK COMPANY)
VIA GIACOMO LEOPARDI, 8
I-20123 MILANO
ITALY

FOR: BLEACHING PREPARATIONS AND OTHER SUBSTANCES FOR LAUNDRY USE, NAMELY, LAUNDRY DETERGENTS, LAUNDRY SOAP, LAUNDRY BLEACH, ESSENTIAL OILS AS PERFUME FOR LAUNDRY PURPOSES, LAUNDRY STARCH; CLEANING, POLISHING, SCOURING AND ABRASIVE PREPARATIONS; SOAPS; PERFUMERY; ESSENTIAL OILS; COSMETICS, HAIR LOTIONS, DENTIFRICES; FRAGRANCED BODY CARE PREPARATIONS, NAMELY, BODY SCRUBS, SHOWER GELS, BODY BALM, BODY POLISH; SHAMPOOS; NON MEDICATED BALMS FOR USE ON HAIR, SKIN AND LIPS; SKIN AND BODY CREAMS, IN CLASS 3 (U.S. CLS. 1, 4, 6, 50, 51 AND 52).

FOR: PRECIOUS METALS AND THEIR ALLOYS AND GOODS IN PRECIOUS METALS OR COATED THEREWITH, NOT INCLUDED IN OTHER CLASSES, NAMELY, BRACELETS, BANGLES, BODY PIERCING RINGS, BUCKLES, CHARMS, CHOKERS, CUFF LINKS, DECORATIVE BOXES MADE OF PRECIOUS METAL, EAR CLIPS, EAR STUDS, EARRINGS, FANCY KEY RINGS, KEY CHAINS, KEY HOLDERS, FIGURINES, CHAINS, PENDANTS, RINGS, ANKLETS, ARM CUFFS, NECKLACES, LOCKETS, TIE BARS, TIE CLIPS; JEWELRY, PRECIOUS STONES; HOROLOGICAL AND CHRONOMETRIC INSTRUMENTS, IN CLASS 14 (U.S. CLS. 2, 27, 28 AND 50).



FOR: PAPER, CARDBOARD AND GOODS MADE FROM THESE MATERIALS, NOT INCLUDED IN OTHER CLASSES, NAMELY, ADDRESS BOOKS, PAPER LABELS, PAPER AND CARDBOARD; PRINTED MATTER, NAMELY, PRINTED AWARDS, PRINTED INVITATIONS, GREETING CARDS, SCRAPBOOKS; BAGS, ENVELOPES AND/OR POUCHES OF PAPER AND/OR PLASTICS FOR PACKAGING, BOOKMARKERS, DISPOSABLE BABIES' DIAPERS OF PAPER AND CELLULOSE, TOWELS OF PAPER, NAPKINS OF PAPER, MODELLING CLAY; PRINTED MATTER, NAMELY, TEACHING MATERIALS IN THE FIELD OF MATHEMATICS, GEOGRAPHY, HISTORY, ORGANIC AND INORGANIC SCIENCE, COMPUTING, LANGUAGE; BOOKBINDING MATERIAL; PHOTOGRAPHS; STATIONERY; ADHESIVES FOR STATIONERY OR HOUSEHOLD PURPOSES; ARTISTS' MATERIALS, NAMELY, BRUSHES, PASTELS; PAINT BRUSHES, DRAWING BOARDS, DRAWING INSTRUMENTS, NAMELY, PADS, PENS AND PINS; TYPEWRITERS AND OFFICE REQUISITES, NAMELY, STAPLERS, RUBBER BANDS, PENCILS, PENS, RUBBER ERASERS; PRINTED INSTRUCTIONAL AND TEACHING MATERIAL IN THE FIELD OF PUBLICATION

David J. Kappas

Director of the United States Patent and Trademark Office

Reg. No. 4,204,033 OF TEXTS, BOOKS, MAGAZINES AND OTHER PRINTED MATTER IN THE FORM OF NEWSPAPERS, PHOTOGRAPHS, MAGAZINES, BOOKS, PRINTED PERIODICALS, SONG BOOKS, ALMANACS, BOOKLETS, NEWSLETTERS, AND BROCHURES IN THE FIELD OF MATHEMATICS, GEOGRAPHY, HISTORY, ORGANIC AND INORGANIC SCIENCE, COMPUTING, LANGUAGE; PLASTIC MATERIALS FOR PACKAGING, NAMELY, AN ALL-IN-ONE PORTABLE CARDBOARD BOX THAT DISPENSES BOTH CUPS MADE OF PAPER, PLASTIC OR OTHER MATERIAL AND LIQUIDS, NAMELY, FOR DOMESTIC USE; PRINTERS' TYPE; PRINTING BLOCKS; PHOTOGRAPHIC ALBUMS, PHOTOGRAPHIC PRINTS, POSTAGE STAMPS, IN CLASS 16 (U.S. CLS. 2, 5, 22, 23, 29, 37, 38 AND 50).

FOR: FURNITURE, MIRRORS, PICTURE FRAMES; GOODS OF WOOD, CORK, REED, CANE, WICKER, HORN, BONE, IVORY, WHALEBONE, SHELL, AMBER, MOTHER-OF-PEARL, MEERSCHAUM AND SUBSTITUTES FOR ALL THESE MATERIALS, OR OF PLASTICS, NAMELY, PLASTIC SLEEPING BAGS FOR CAMPING, BINS NOT OF METAL, CHAIRS, CHESTS FOR TOYS, BOTTLE CLOSURES NOT OF METAL, PLASTIC CUSHIONS, PLASTIC PET CUSHIONS, DECORATIONS OF PLASTIC FOR FOODSTUFFS, FIGURINES AND/OR STATUETTES OF WOOD, WAX, PLASTER OR PLASTIC, COAT HANGERS, MATS FOR INFANT PLAYPENS, INFANT WALKERS, INFLATABLE PUBLICITY OBJECTS, PLASTIC PILLOWS, SCHOOL FURNITURE NOT OF METAL, NAMELY, CHAIRS, DESKS, WRITING DESKS, IN CLASS 20 (U.S. CLS. 2, 13, 22, 25, 32 AND 50).

FOR: TEXTILES AND TEXTILE GOODS, NOT INCLUDED IN OTHER CLASSES, NAMELY, PLACE MATS, HANDKERCHIEFS, ADHESIVE FABRIC FOR APPLICATION BY HEAT, BATH LINEN, EXCEPT CLOTHING, COVERS FOR CUSHIONS, HOUSEHOLD LINEN, LABELS OF CLOTH, MATTRESS COVERS, SHOWER CURTAINS OF TEXTILE OR PLASTIC, TABLE RUNNERS, BED BLANKETS AND TEXTILE TABLE COVERS, IN CLASS 24 (U.S. CLS. 42 AND 50).

FOR: CLOTHING, NAMELY, PANTS, SHIRTS, BELT, BOTTOMS, BABIES' DIAPERS OF TEXTILE, TEXTILE BABIES' NAPPIES, BABIES' PANTS, BANDANAS, BATH ROBES, BATHING SUITS, BATHING TRUNKS, BEACHWEAR, CAMISOLES, CLOTHING FOR GYMNASTICS, NAMELY, LEOTARDS, GYMNASTIC SHOES, ATHLETIC TIGHTS, ATHLETIC UNIFORMS, PADDED SHORTS, PADDED PANTS, PADDED SHIRTS, GYM BOOTS; MASQUERADE COSTUMES, GLOVES, JUMPERS, LEGGINGS, PANTS, PAPER CLOTHING IN THE NATURE OF SHIRTS, SKIRTS, PANTS, BELTS, TIES, BOTTOMS, TROUSERS, JACKETS, PULLOVERS, PYJAMAS, SANDALS, SCARVES, SLIPS, SOCKS, SWEATERS, TROUSERS, UNDERWEAR, WATERPROOF CLOTHING IN THE NATURE OF SHIRTS, SKIRTS, PANTS, BELTS, TIES, BOTTOMS, TROUSERS, JACKETS; FOOTWEAR, NAMELY, BATH SANDALS, BATH SLIPPERS, BEACH SHOES, BOOTS, FOOTBALL BOOTS, FOOTBALL SHOES, GYMNASTIC SHOES, INNER SOLES; HEADGEAR, NAMELY, HATS, CAPS, BATHING CAPS, BERETS, IN CLASS 25 (U.S. CLS. 22 AND 39).

FOR: GAMES AND PLAYTHINGS, NAMELY, DICE GAMES, CRIB TOYS, AIR PISTOLS, AMUSEMENT GAME MACHINES, AUTOMATIC AND COIN-OPERATED, ARTIFICIAL FISHING BAIT, BALLOONS, BALLS FOR GAMES, BASEBALL GLOVES, BATS FOR GAME, BATTING GLOVES, BILLIARD BALLS, BILLIARD CUE TIPS, BILLIARD CUES, BILLIARD MARKERS, BILLIARD TABLE CUSHIONS, BILLIARD TABLES, COIN-OPERATED BILLIARD TABLES, BINGO CARDS, FISHING TACKLE, BUILDING BLOCKS, BOARD GAMES, BOB-SLEIGHS, BODY BOARDS, SKATING BOOTS WITH SKATES ATTACHED, BOWLING APPARATUS AND MACHINERY, BOXING GLOVES, BUILDING GAMES, BUTTERFLY NETS, PLAYING CARDS, CHECKERBOARDS, CHECKERS, CHESS GAMES, CHESSBOARDS, GOLF CLUBS, COIN-OPERATED BILLIARD TABLES, CRICKET BAGS, CUPS FOR DICE, DARTS, DICE, DOLLS, DOLLS' BEDS, DOLLS' CLOTHES, DOLLS' FEEDING BOTTLES, DOLLS' HOUSES, DOLLS' ROOMS, DOMINOES, DRAUGHTBOARDS, DRAUGHTS, DUMBBELLS, ELECTRONIC TARGETS FOR GAMES AND SPORTS, FLIPPERS FOR SWIMMING, FLYING DISCS, TABLES FOR INDOOR FOOTBALL GAMES, MARBLES FOR GAMES, GOLF BAGS WITH OR WITHOUT WHEELS, ICE SKATES, IN-LINE ROLLER SKATES, JIGSAW PUZZLES, PRACTICAL JOKES IN THE NATURE OF FAKE TEETH, FAKE FLOWERS

Reg. No. 4,204,033 SQUIRTING WATER, FAKE FINGERS, FAKE HANDS, FAKE FEET, FAKE PISTOLS SQUIRTING WATER, FAKE CIGARS, KALEIDOSCOPIES, MAH-JONG, MARIONETTES, SCALE MODEL VEHICLES, PIÑATAS, TOY SWIMMING POOLS, PUPPETS, RACKETS, RADIO-CONTROLLED TOY VEHICLES, RING GAMES, ROLLER SKATES, TOY SCOOTERS, SKATEBOARD, ICE SKATES, SNOW GLOBES, TOY SOAP BUBBLES, TABLES FOR TABLE TENNIS, TEDDY BEARS, THEATRICAL MASKS, TOY MASKS, TOY VEHICLES, TOYS FOR DOMESTIC PETS; GYMNAS TIC AND SPORTING ARTICLES NOT INCLUDED IN OTHER CLASSES, NAMELY, BALANCE BEAMS, TENNIS BALLS; DECORATIONS FOR CHRISTMAS TREES, IN CLASS 28 (U.S. CLS. 22, 23, 38 AND 50).

FOR: MEAT, FISH, POULTRY AND GAME, MEAT EXTRACTS, TINNED MEAT, PRESERVED, FROZEN, DRIED AND COOKED FRUITS AND VEGETABLES, JELLIES, JAMS, COMPOTES, EGGS, EDIBLE OILS AND FATS; LIQUID MILK, LIQUID MILK PRODUCTS, NAMELY, HALF AND HALF, VANILLA MILK, YOGURT, FLAVOURED MILK, LIQUID MILK AND YOGURT BASED PRODUCTS BUT NOT INCLUDING ANY OTHER DAIRY PRODUCTS, NAMELY, YOGURT-BASED BEVERAGES AND DRINKS, MILK BEVERAGES, NAMELY, BEVERAGES HAVING A MILK BASE, IN CLASS 29 (U.S. CL. 46).

FOR: COFFEE, TEA, COCOA, SUGAR, RICE, TAPIOCA, SAGO, ARTIFICIAL COFFEE; FLOUR AND PREPARATIONS MADE FROM CEREALS, NAMELY, CEREAL-BASED SNACK FOODS, BISCUITS MADE WITH CEREALS, BREAD, PASTRY AND CONFECTIONERY, NAMELY, FROZEN CONFECTIONERY, CRYSTAL SUGAR PIECES, ICES; HONEY, TREACLE; YEAST, BAKING-POWDER; SALT, MUSTARD; VINEGAR, SAUCES; SPICES; ICE; ALMOND CONFECTIONERY, ALMOND PASTE, ANISEED FOR USE AS A FLAVORING IN FOOD AND DRINKS, AROMATIC PREPARATIONS FOR FOOD IN THE NATURE OF SPICES, ARTIFICIAL COFFEE, BEER VINEGAR, COCOA-BASED BEVERAGES, COFFEE-BASED BEVERAGES, TEA-BASED BEVERAGES, GINGER BREAD, BREAD ROLLS, CAKE PASTE FLAVOURED WITH CHOCOLATE, ALMOND, VANILLA, BUTTER, CITRUS, PISTACHIO, NUT, YOGURT, CAKE POWDER FLAVORED WITH CHOCOLATE, ALMOND, VANILLA, BUTTER, CITRUS, PISTACHIO, NUT, YOGURT, CAKES, EDIBLE DECORATIONS FOR CAKES, CANDY FOR FOOD, CANDY CARAMELS, CEREAL PREPARATIONS, NAMELY, GRAIN-BASED ITEMS IN THE NATURE OF TACO SHELLS, BREAD, BISCUITS, TOASTED BREAD SLICES, BREADSTICKS, CEREAL-BASED SNACK FOOD, CHEWING GUM NOT FOR MEDICAL PURPOSES, CHOCOLATE, COFFEE, COFFEE BEVERAGES WITH MILK, COFFEE-BASED BEVERAGES, CORN FLAKES, CORN MEAL, CRACKERS, ICE CREAM, EDIBLE ICES, FARINACEOUS FOOD PASTES FOR HUMAN CONSUMPTION, ROLLED OATS AND WHEAT; FROZEN YOGURT, HONEY, ICED TEA, KETCHUP, MACARONI, PASTRY MACAROONS, MARZIPAN, MAYONNAISE, MUESLI, NOODLES, PANCAKES, PASTA, PETIT-BEURRE BISCUITS, PIES, PIZZAS, POWDERS FOR ICE CREAM, RAVIOLI, RICE, RICE CAKES, RICE-BASED SNACK FOOD, SANDWICHES, SPAGHETTI, SUGAR, CEREAL OR GRAIN BASED TACO SHELLS, TAPIOCA, TARTS, TEA, ICED TEA, TORTILLAS , IN CLASS 30 (U.S. CL. 46).

FOR: BEER, NON-ALCOHOLIC BEVERAGES IN THE NATURE OF CARBONATED AND NON-CARBONATED BEVERAGES, NAMELY, FRUIT JUICES, NON CARBONATED SOFT DRINKS, NON-ALCOHOLIC HONEY-BASED BEVERAGES, NON-ALCOHOLIC CIDER, NON-ALCOHOLIC COCKTAILS, NON-ALCOHOLIC FRUIT EXTRACTS, NON-ALCOHOLIC FRUIT JUICE BEVERAGES, FRUIT JUICES, GINGER ALE, LEMONADES, MINERAL WATER, NON-ALCOHOLIC BEVERAGES, NAMELY, LOW CALORIE SOFT DRINKS, SODA WATER, SYRUPS FOR BEVERAGES, SYRUPS FOR LEMONADE, PREPARATIONS FOR MAKING AERATED WATER, MILK OF ALMONDS, NON-ALCOHOLIC APERITIFS, IN CLASS 32 (U.S. CLS. 45, 46 AND 48).

FOR: SERVICES FOR EDUCATION AND ENTERTAINMENT, NAMELY, PROVIDING CLASSES IN THE FIELD OF SCIENCE, LIVE MUSIC CONCERTS; ORGANIZATION OF EDUCATIONAL, TRAINING AND REFRESHER COURSES IN THE FIELD OF SCIENCE, MATH, COLLOQUIUMS, SEMINARS, EXHIBITIONS, SHOWS, EVENTS, COMPETITIONS, ALL IN THE FIELD OF SCIENCE, MATH, CULTURAL AND SPORTING ACTIVITIES ALL

Reg. No. 4,204,033 FOR ENTERTAINMENT AND/OR EDUCATIONAL PURPOSES, ON-LINE PUBLICATION OF BOOKS AND TEXTS, FILM PRODUCTION, THEATRE PRODUCTIONS, PRODUCTION AND SHOWING OF TELEVISION AND RADIO EVENTS AND SHOWS, IN CLASS 41 (U.S. CLS. 100, 101 AND 107).

FOR: PROVIDING OF FOOD AND DRINK; TEMPORARY ACCOMMODATION, IN CLASS 43 (U.S. CLS. 100 AND 101).

NO CLAIM IS MADE TO THE EXCLUSIVE RIGHT TO USE "TEA" IN CLASSES 30, 32 AND 43, APART FROM THE MARK AS SHOWN.

PRIORITY DATE OF 3-25-2010 IS CLAIMED.

OWNER OF INTERNATIONAL REGISTRATION 1053294 DATED 7-26-2010, EXPIRES 7-26-2020.

THE MARK CONSISTS OF A STYLIZED HEART CONTAINING THE WORDING "TEA SISTERS" WITH A SMALL HEART OVER THE "T" IN "SISTERS", FIVE STYLIZED MICE WITH HAIR AND CLOTHING, AND A BACKGROUND DESIGN OF STYLIZED BRANCHES OR FANCIFUL CURVED LINES.

SER. NO. 79-088,139, FILED 7-26-2010.

TOBY BULLOFF, EXAMINING ATTORNEY

United States of America

United States Patent and Trademark Office



Reg. No. 4,204,034

Registered Sep. 11, 2012

Int. Cl.: 12

TRADEMARK

PRINCIPAL REGISTER

JIAXING XINGTENG CASTER CO.,LTD. (CHINA CORPORATION)
XINGQIAO ROAD, QIXING TOWN
NANHU DISTRICT, JIAXING; 314002 ZHEJIANG
CHINA

FOR: MINE CART WHEELS; LUGGAGE HAND TRUCKS; HAND CARTS; WHEELCHAIRS;
WHEELBARROWS; CARTS; CASTORS FOR HAND CARTS; SHOPPING CARTS; FOLDING
LUGGAGE WHEEL BARROW; GOODS HANDLING CARTS, IN CLASS 12 (U.S. CLS. 19,
21, 23, 31, 35 AND 44).

THE MARK CONSISTS OF THE LETTER "X" INSIDE OF A LUGGAGE OR CART WHEEL
DESIGN APPEARING ABOVE THE WORD "TENG".

OWNER OF INTERNATIONAL REGISTRATION 1060152 DATED 11-23-2010, EXPIRES 11-
23-2020.

SER. NO. 79-090,625, FILED 11-23-2010.

ALEXANDER L. POWERS, EXAMINING ATTORNEY



David J. Kyffers

Director of the United States Patent and Trademark Office

United States of America

United States Patent and Trademark Office

STÖHR

BY SÜDWOLLE

Reg. No. 4,204,035

Registered Sep. 11, 2012

Int. Cls.: 23, 24, 25 and 28

SÜDWOLLE GMBH & CO. KG (FED REP GERMANY GMBH & CO. KG)
WIESENECKSTRASSE 26
90571 SCHWAIG
FED REP GERMANY

FOR: GOODS MADE IN SUBSTANTIAL PART OF WOOL, NAMELY, YARNS AND THREADS, FOR TEXTILE USE, IN CLASS 23 (U.S. CL. 43).

TRADEMARK

PRINCIPAL REGISTER

FOR: TEXTILES AND TEXTILE GOODS MADE IN SUBSTANTIAL PART OF WOOL, NAMELY, BATH LINEN, COTTON-BLEND FABRICS, BED BLANKETS, BED LINEN, BED SHEETS, BED COMFORTERS, COVERS FOR CUSHIONS, BILLIARDS CLOTHS, CHENILLE FABRICS, CREPON DAMASK, DRUGGET, FELT, LINEN CLOTHS, FLANNEL, FABRICS FOR TEXTILE USE, TOWELS OF TEXTILE, HOUSEHOLD LINEN, UPHOLSTERY AND UNFITTED SEAT COVERS OF TEXTILES, LINEN LINING FABRIC FOR SHOES, AND TABLE LINEN; PLASTIC TABLE COVERS, IN CLASS 24 (U.S. CLS. 42 AND 50).

FOR: T-SHIRTS AND WET SUIT GLOVES; CLOTHING MADE IN SUBSTANTIAL PART OF WOOL, NAMELY, PULLOVERS, SPORTS JACKETS, RAINCOATS, SPORTS UNDERWEAR, JACKETS, CLIMBING TROUSERS, TRAINING SUITS, SKI CLOTHES, NAMELY, SCARVES, HEADWEAR, NAMELY, BOBBLE CAPS, SKI CAPS, WOOLEN HATS, WOOLEN CAPS, SKI PANTS, SKI JACKETS, SKI SUITS AND SOCKS, GLOVES, SAILING CLOTHES, NAMELY, TROUSERS, JACKETS, SOCKS AND SAILING SUITS, NAMELY, PANTS, SHIRTS, ONE-PIECE SUITS, CYCLING CLOTHING, NAMELY, PANTS, JACKETS, CYCLING SUITS, NAMELY, SHORTS, SHIRTS, AND SOCKS, JOGGING CLOTHES, NAMELY, PANTS, JACKETS, JOGGING SUITS AND SOCKS, HEADGEAR, NAMELY, HATS, CAPS, HEAD-BANDS, AND FOOTWEAR, HORSEBACK RIDING GLOVES, IN CLASS 25 (U.S. CLS. 22 AND 39).

FOR: GAMES AND PLAYTHINGS, NAMELY, KITES; GYMNAS TIC AND SPORTING ARTICLES, NAMELY, ELBOW GUARDS FOR ATHLETIC USE, GOLF BAGS, GYMNAS TIC APPARATUS, GLOVES FOR GAMES, NAMELY, BOXING GLOVES, FENCING GLOVES, BASEBALL GLOVES, FOOTBALL GLOVES, SOCCER GLOVES, KEEPER GLOVES, WORKOUT GLOVES, GOLF GLOVES, FITNESS GLOVES, RUNNING GLOVES, CLIMBING GLOVES, BOWLING GLOVES, HOCKEY GLOVES, SKATING GLOVES, RUGBY GLOVES, SURFING GLOVES, SKY DIVING GLOVES, TENNIS GLOVES, KNEE GUARDS FOR ATHLETIC USE, NETS FOR SPORTS AND PARAGLIDERS, IN CLASS 28 (U.S. CLS. 22, 23, 38 AND 50).



David J. Kyjars

Director of the United States Patent and Trademark Office

Reg. No. 4,204,035 THE MARK CONSISTS OF THE STYLIZED WORDING "STOHR BY SUDWOLLE" IN BLACK WITHIN A WHITE RECTANGLE.

PRIORITY DATE OF 8-4-2010 IS CLAIMED.

OWNER OF INTERNATIONAL REGISTRATION 1064356 DATED 12-15-2010, EXPIRES 12-15-2020.

THE COLOR(S) BLACK AND WHITE IS/ARE CLAIMED AS A FEATURE OF THE MARK.

THE ENGLISH TRANSLATION OF "SUDWOLLE" IN THE MARK IS ROUGHLY SOUTHERN WOOL WHERE "SUDWOLLE" IS A COMBINATION OF TWO GERMAN WORDS "SUD" (SOUTH) AND "WOLLE" (WOOL).

SER. NO. 79-092,312, FILED 12-15-2010.

TRACY FLETCHER, EXAMINING ATTORNEY

United States of America

United States Patent and Trademark Office

INTHEA

Reg. No. 4,204,036

INTHEA S.R.L. (ITALY LIMITED CORPORATION)

Registered Sep. 11, 2012

CORSO RE UMBERTO I, 1
I-10121 TORINO, ITALY

Int. Cls.: 1, 36 and 42

TRADEMARK

SERVICE MARK

PRINCIPAL REGISTER

FOR: DRY ICE COMPRISED OF CARBON DIOXIDE; FATTY ACIDS FOR USE IN THE MANUFACTURE OF FOOD AND BEVERAGES, COSMETICS, PHARMACEUTICALS, CHEMICALS AND LEATHER; ACIDS FOR USE IN INDUSTRY, NAMELY, ACETIC ACID, ACID ANHYDRIDES, ACID GELLING AGENTS, ACID PROOF CHEMICAL COMPOSITIONS, ACIDS FOR USE IN ETCHING, ADIPIC ACID, AGRICULTURAL ACIDS, AMINO ACIDS FOR INDUSTRIAL PURPOSES, ANTRANILIC ACID, ARSENIUS ACID, BENZENE-BASED ACIDS, BENZOIC ACID, BORIC ACID, CARBONIC ACIDS, CARBONIC ACID GAS, CHLORINATED ACIDS, CHLOROSULPHONIC ACID, CHOLIC ACID, CHROMIC ACID, CITRIC ACID, CITRIC ACID FOR INDUSTRIAL PURPOSES, CORROSIVE ACIDS, CROTONIC ACID, ESTERS OF FATTY ACIDS, ETCHING MORDANTS ACIDS, FLUORIC ACID, FLUOROSILICIC ACID, FORMIC ACID, GALLOTANNIC ACID, GALLIC ACID, GLUCONIC ACID, HALIDES AND HALOGEN ACID SALTS, HUMIC ACID, HYDROCHLORIC ACID, HYDROCHLORIC ACID (HYDROGEN CHLORIDE), HYDROFLUORIC ACID, HYDROHALIC ACIDS, IODIC ACID, LACTIC ACID, METHACRYLIC ACID, MINERAL ACIDS, MONOCHLOROACETIC ACID, MONOCHLOROACETIC ACID, NUCLEIC ACIDS, OLEIC ACID, OXALIC ACID, PALMITIC ACID, PERCHLORIC ACID, PERSULPHURIC ACID, PHOSPHORIC ACID, PHTHALIC ACID, PICRIC ACID, POLYUNSATURATED FATTY ACIDS, PYROGALLIC ACID, PYROLIGNEOUS ACID, SALICYLIC ACID, SALTS ORGANIC ACIDS, SEBACIC ACID, STEARIC ACID, SUCCINIC ACID, SUCROSE ESTERS OF ACIDS, SULFINIC ACID, SULPHONIC ACIDS, SULPHURIC ACID, SULPHUROUS ACID, SULPHUROUS ACID GAS (SULPHUR DIOXIDE), TANNIC ACID; TARTARIC ACID, TUNGSTIC ACID, VALERIC ACID; ALKALIES; MANGANESE DIOXIDE; GRAPHITE FOR INDUSTRIAL PURPOSES; SALTS, NAMELY, ALKALINE SALTS, ALUMINIUM SALTS, AMMONIACAL SALTS, AMMONIUM SALTS, CALCIUM SALTS, CHROME SALTS, CHROMIC SALTS, RAW SALTS USED IN THE MANUFACTURE OF COLORED METAL, GLUCONIC SALTS, GOLD SALTS, HALIDES AND HALOGEN ACID SALTS, IRON SALTS, MAGNESIUM SALTS, MERCURY SALTS, METAL SALTS, RARE EARTH SALTS, RAW SALT, ROCK SALT; SALTS FOR INDUSTRIAL PURPOSES, SALTS FROM RARE EARTH METALS, SALTS OF ALKALINE METALS, SALTS OF METALS, SALTS OF PRECIOUS METALS FOR INDUSTRIAL PURPOSES, SALTS ORGANIC ACIDS, SODIUM SALTS CHEMICAL PREPARATIONS, SORREL SALT FOR INDUSTRIAL PURPOSES; ACETATES; ACETYLENE; ETHERS, NAMELY, BENZYL ETHER, CHLOROMETHYL ETHER, DIISOPROPYL ETHER, ETHER ALCOHOLS, ETHYL ETHER, GLYCOL ETHER, METHYL ETHER, SULPHURIC ETHER; PHENOL FOR



David J. Kyjars

Director of the United States Patent and Trademark Office

Reg. No. 4,204,036 INDUSTRIAL PURPOSES; CHEMICALS FOR USE IN INDUSTRY AND SCIENCE, NAMELY, ALKALOIDS; KETONES; ALDEHYDES; ESTERS, NAMELY, ACETATE ESTERS, ACETIC ACID ESTERS, FATTY ACID ESTERS, FOOD ESTERS, GLYCERINE ESTERS, METHYL ESTERS; PROTEIN IN RAW MATERIAL FORM USED IN THE MANUFACTURE OF FOOD AND BEVERAGES, TEXTILES, PAPER PRODUCTS, COSMETICS, PHARMACEUTICALS, CHEMICALS, RUBBER AND PLASTICS PRODUCTS, LEATHER; STARCH FOR INDUSTRIAL PURPOSES FOR USE IN THE MANUFACTURE OF FOOD AND BEVERAGES, TEXTILES, PAPER PRODUCTS, COSMETICS, PHARMACEUTICALS, CHEMICALS, RUBBER AND PLASTICS PRODUCTS; ENZYMES FOR INDUSTRIAL PURPOSES IN THE FIELD OF FOOD AND BEVERAGES, TEXTILES, PAPER PRODUCTS, COSMETICS, PHARMACEUTICALS, CHEMICALS, LEATHER, RUBBER AND PLASTICS PRODUCTS; CHEMICALS FOR USE IN INDUSTRY AND SCIENCE, NAMELY, SURFACE-ACTIVE CHEMICAL AGENTS; DIOXIDE OF HYDROGEN; DISTILLED WATER; ALCOHOL FOR INDUSTRIAL PURPOSES; CHEMICALS FOR USE IN INDUSTRY AND SCIENCE, NAMELY, ISOTOPES FOR INDUSTRIAL PURPOSES; INDUSTRIAL CHEMICALS; AGRICULTURAL CHEMICALS, EXCEPT FUNGICIDES, WEEDKILLERS, HERBICIDES, INSECTICIDES AND PARASITICIDES; CHEMICAL REAGENTS OTHER THAN FOR MEDICAL OR VETERINARY PURPOSES; CHEMICAL PREPARATIONS FOR USE IN PHOTOGRAPHY; PLASTICS, UNPROCESSED; FERTILIZERS, NAMELY, CHEMICAL ADDITIVES FOR FERTILISERS, AMMONIUM CHLORIDE FERTILIZER, AMMONIUM NITRATE FERTILIZER, AMMONIUM SULPHATE FERTILIZER, CALCINED POTASSIUM FERTILIZER, CALCIUM SILICATE FERTILIZER, CALCIUM SUPERPHOSPHATE FERTILIZER, CHEMICAL FERTILIZERS, CHEMICALLY CONVERTED COMPOUND FERTILIZERS, CHLORINE-FREE FERTILIZERS, COMPLEX FERTILIZER, FERTILIZERS CONTAINING NITROGEN AND MAGNESIUM, FERTILIZERS FOR AGRICULTURAL USE, FERTILIZERS FOR DOMESTIC USE, INORGANIC FERTILIZERS, LIQUID FERTILISERS, MANGANESE FERTILIZER, MARINE FERTILIZER, MINERAL FERTILIZERS, MIXED FERTILIZER, NATURAL FERTILIZERS, NITROGENOUS FERTILISERS, SODIUM NITRATE FERTILIZER; FIRE EXTINGUISHING COMPOSITIONS; QUENCHER, NAMELY, QUENCHING FLUIDS FOR USE IN METALWORKING; SOLDERING FLUXES; CHEMICAL SUBSTANCES FOR PRESERVING FOODSTUFFS; FILTERING PREPARATIONS FOR THE BEVERAGES INDUSTRY, IN CLASS 1 (U.S. CLS. 1, 5, 6, 10, 26 AND 46).

FOR: INSURANCE UNDERWRITING, NAMELY, ACCIDENT INSURANCE UNDERWRITING SERVICES, FIRE INSURANCE UNDERWRITING, HEALTH INSURANCE UNDERWRITING, INSURANCE UNDERWRITING SERVICES FOR ALL TYPES OF INSURANCE, LIFE INSURANCE UNDERWRITING, MARINE INSURANCE UNDERWRITING, MEDICAL INSURANCE UNDERWRITING, TRANSIT INSURANCE UNDERWRITING, INSURANCE ADMINISTRATION FOR BUSINESSES, ADVISORY SERVICES RELATING TO INSURANCE, ARRANGING INVESTMENTS, IN PARTICULAR CAPITAL INVESTMENTS, FINANCING SERVICES; EVALUATION RELATING TO INSURANCE, NAMELY, FINANCIAL EVALUATION FOR INSURANCE PURPOSES; CONSULTANCY RELATING TO INSURANCE, UNDERWRITING OF INSURANCE FOR ALL TYPES OF INSURANCE, NAMELY, BUSINESS AND COMPANY INSURANCE; FINANCING SERVICES; JEWELLERY APPRAISAL; REAL ESTATE AGENCIES; ACCOMMODATION BUREAUX FOR APARTMENTS, NAMELY, RENTAL OF APARTMENTS AND OFFICES, ARRANGING OF LEASES AND RENTAL AGREEMENTS FOR REAL ESTATE, REAL ESTATE AGENCY SERVICES FOR SALE AND RENTAL OF BUILDINGS, REAL ESTATE AGENCY SERVICES FOR SALE AND RENTAL OF BUSINESSES, REAL ESTATE MANAGEMENT SERVICES, REAL ESTATE INSURANCE SERVICES, NAMELY, REAL ESTATE INSURANCE UNDERWRITING SERVICES, REAL ESTATE TITLE INSURANCE UNDERWRITING SERVICES; BROKERAGE, NAMELY, BROKERAGE SERVICES IN THE FIELD OF ART, STOCKS, FINANCIAL INVESTMENT BROKERAGE, NAMELY, BROKERAGE SERVICES FOR ARRANGING FINANCING BY OTHER FINANCIAL INSTITUTION AND BROKERAGE SERVICES FOR CAPITAL INVESTMENTS, BROKERAGE SERVICES RELATING TO FINANCIAL INSTRUMENTS, NAMELY, REAL ESTATE NOTE BROKERAGE, BROKERAGE IN THE FIELD OF OPTIONS, SECURITIES; FINANCIAL GUARANTEES; CHARITABLE FUND RAISING; FACTORING AGENCIES; PAWN, NAMELY, PAWN BROKERAGE, IN CLASS 36 (U.S. CLS. 100, 101 AND 102).

Reg. No. 4,204,036 FOR: RESEARCH AND DEVELOPMENT FOR OTHERS IN THE BIOCHEMICAL INDUSTRY, PRODUCT RESEARCH AND DEVELOPMENT IN THE PHARMACEUTICAL AND BIOTECHNOLOGY FIELDS AND IN THE FIELD OF COMPUTER HARDWARE AND SOFTWARE, RESEARCH AND DEVELOPMENT OF NEW PRODUCTS, RESEARCH AND DEVELOPMENT SERVICES, RESEARCH, DEVELOPMENT, DESIGN AND UPGRADING OF COMPUTER SOFTWARE; QUALITY CONTROL FOR OTHERS; CALIBRATION; CHEMICAL RESEARCH; BIOLOGICAL RESEARCH; WEATHER FORECASTING; MATERIAL TESTING; PHYSICS RESEARCH; MECHANICAL RESEARCH; INDUSTRIAL DESIGN; ARCHITECTURE, NAMELY, ARCHITECTURE CONSULTANCY SERVICES, PROFESSIONAL CONSULTANCY RELATING TO ARCHITECTURE, ENGINEERING SERVICES RELATING TO ARCHITECTURE, PREPARATION OF REPORTS RELATING TO ARCHITECTURE IN THE FIELD OF SCIENTIFIC RESEARCH, ENGINEERING RESEARCH, TECHNICAL RESEARCH, GREEN PRODUCTS; SCIENTIFIC RESEARCH RELATING TO ARCHITECTURE; DRESS DESIGNING; COMPUTER SOFTWARE DESIGN; CREATING AND MAINTAINING WEB SITES FOR OTHERS; HOSTING COMPUTER WEB SITES; PROVIDING SEARCH ENGINES FOR THE INTERNET; AUTHENTICATING WORKS OF ART, IN CLASS 42 (U.S. CLS. 100 AND 101).

THE MARK CONSISTS OF STANDARD CHARACTERS WITHOUT CLAIM TO ANY PARTICULAR FONT, STYLE, SIZE, OR COLOR.

PRIORITY DATE OF 12-1-2010 IS CLAIMED.

OWNER OF INTERNATIONAL REGISTRATION 1065286 DATED 12-6-2010, EXPIRES 12-6-2020.

THE WORDING "INTHEA" HAS NO MEANING IN A FOREIGN LANGUAGE.

SER. NO. 79-092,626, FILED 12-6-2010.

ALLISON SCHRODY, EXAMINING ATTORNEY

United States of America

United States Patent and Trademark Office



Reg. No. 4,204,037

Registered Sep. 11, 2012

Int. Cls.: 28 and 41

TRADEMARK

SERVICE MARK

PRINCIPAL REGISTER

VERTICAL LEISURE LTD (UNITED KINGDOM LIMITED COMPANY REGISTERED IN THE UNITED KINGDOM)
45-47 HIGH STREET
POTTERS BAR, HERTFORDSHIRE EN6 5AW, UNITED KINGDOM

FOR: SPORTING AND GYMNAS TIC EQUIPMENT, NAMELY, VERTICAL AND HORIZONTAL POLES FOR USE IN GYMNAS TIC; EXERCISE EQUIPMENT NOT FOR MEDICAL USE, NAMELY, MANUALLY OPERATED WEIGHT AND RESISTANCE EXERCISERS FOR PHYSICAL FITNESS DEVELOPMENT AND ATTACHMENTS TO SUCH EQUIPMENT TO INCREASE MUSCLE RESISTANCE, SUSPENDED WEIGHTS ATTACHED TO RESISTANCE CABLES FOR TWISTING, LIFTING AND STEPPING EXERCISES, ALL OF THE ABOVE BEING ATTACHED TO VERTICAL OR HORIZONTAL POLES BY MEANS OF METAL SUPPORTS AND BRACKETS, AND REPLACEMENT PARTS AND FITTINGS THEREFOR, IN CLASS 28 (U.S. CLS. 22, 23, 38 AND 50).

FOR: EDUCATIONAL SERVICES, NAMELY, PROVIDING CLASSES, INSTRUCTION AND SEMINARS IN THE FIELD OF GYMNAS TIC AND EXERCISE; PROVIDING GYMNAS TIC AND PHYSICAL FITNESS TRAINING, BOXING TRAINING AND DANCE TRAINING; ENTERTAINMENT SERVICES, NAMELY, CONDUCTING AND PRODUCING GYMNAS TIC, PHYSICAL FITNESS, BOXING AND DANCE EXHIBITIONS AND PERFORMANCES; CONDUCTING SPORTING EVENTS AND COMPETITIONS, NAMELY, GYMNAS TIC AND PHYSICAL FITNESS COMPETITIONS, AND ORGANIZING AND CONDUCTING DANCE AND BOXING COMPETITIONS; HEALTH CLUB SERVICES, NAMELY, PROVIDING INSTRUCTION AND EQUIPMENT IN THE FIELD OF PHYSICAL EXERCISE AND TRAINING; AND PROVIDING EXERCISE FACILITIES AND GYMNAS IUMS, IN CLASS 41 (U.S. CLS. 100, 101 AND 107).



OWNER OF U.S. REG. NO. 3,787,618.

PRIORITY DATE OF 3-24-2010 IS CLAIMED.

OWNER OF INTERNATIONAL REGISTRATION 1065976 DATED 9-23-2010, EXPIRES 9-23-2020.

THE COLOR(S) MAUVE AND WHITE IS/ARE CLAIMED AS A FEATURE OF THE MARK.

David J. Kybas

Director of the United States Patent and Trademark Office

Reg. No. 4,204,037 NO CLAIM IS MADE TO THE EXCLUSIVE RIGHT TO USE "EXPERT", APART FROM THE MARK AS SHOWN.

THE MARK CONSISTS OF WORD "XPERT" IN MAUVE WORD "X-POLE" IN WHITE SUPERIMPOSED OVER DOTTED MAUVE "X".

SER. NO. 79-092,893, FILED 9-23-2010.

SEAN CROWLEY, EXAMINING ATTORNEY

United States of America

United States Patent and Trademark Office

südwollgroup

Reg. No. 4,204,038

Registered Sep. 11, 2012

**Int. Cls.: 23, 24, 25 and
28**

SÜDWOLLE GMBH & CO. KG (FED REP GERMANY GMBH & CO. KG)
WIESENECKSTRASSE 26
90571 SCHWAIG
FED REP GERMANY

FOR: GOODS MADE IN SUBSTANTIAL PART OF WOOL, NAMELY, YARNS AND THREADS, FOR TEXTILE USE, IN CLASS 23 (U.S. CL. 43).

TRADEMARK

PRINCIPAL REGISTER

FOR: TEXTILES AND TEXTILE GOODS MADE IN SUBSTANTIAL PART OF WOOL, NAMELY, BATH LINEN, COTTON-BLEND FABRICS, BED BLANKETS, BED LINEN, BED SHEETS, BED COMFORTERS, COVERS FOR CUSHIONS, BILLIARDS CLOTHS, CHENILLE FABRICS, CREPON DAMASK, DRUGGET, FELT, LINEN CLOTHS, FLANNEL, FABRICS FOR TEXTILE USE, TOWELS OF TEXTILE, HOUSEHOLD LINEN, UPHOLSTERY AND UNFITTED SEAT COVERS OF TEXTILES, LINEN LINING FABRIC FOR SHOES, AND TABLE LINEN; PLASTIC TABLE COVERS, IN CLASS 24 (U.S. CLS. 42 AND 50).

FOR: T-SHIRTS AND WET SUIT GLOVES; CLOTHING MADE IN SUBSTANTIAL PART OF WOOL, NAMELY, PULLOVERS, SPORTS JACKETS, RAINCOATS, SPORTS UNDERWEAR, JACKETS, CLIMBING TROUSERS, TRAINING SUITS, SKI CLOTHES, NAMELY, SCARVES, HEADWEAR, NAMELY, BOBBLE CAPS, SKI CAPS, WOOLEN CAPS, SKI PANTS, SKI JACKETS, SKI SUITS AND SOCKS, GLOVES, SAILING CLOTHES, NAMELY, TROUSERS, JACKETS, SOCKS AND SAILING SUITS, NAMELY, PANTS, SHIRTS, ONE-PIECE SUITS, CYCLING CLOTHING, NAMELY, PANTS, JACKETS, CYCLING SUITS, NAMELY, SHORTS, SHIRTS, AND SOCKS, JOGGING CLOTHES, NAMELY, PANTS, JACKETS, JOGGING SUITS AND SOCKS, HEADGEAR, NAMELY, HATS, CAPS, HEAD-BANDS, AND FOOTWEAR; HORSEBACK RIDING GLOVES, IN CLASS 25 (U.S. CLS. 22 AND 39).

FOR: GAMES AND PLAYTHINGS, NAMELY, KITES; GYMNAS TIC AND SPORTING ARTICLES, NAMELY, ELBOW GUARDS FOR ATHLETIC USE, GOLF BAGS, GYMNAS TIC APPARATUS, GLOVES FOR GAMES, NAMELY, BOXING GLOVES, FENCING GLOVES, BASEBALL GLOVES, FOOTBALL GLOVES, SOCCER GLOVES, KEEPER GLOVES, WORKOUT GLOVES, GOLF GLOVES, FITNESS GLOVES, RUNNING GLOVES, CLIMBING GLOVES, BOWLING GLOVES, HOCKEY GLOVES, SKATING GLOVES, RUGBY GLOVES, SURFING GLOVES, SKY DIVING GLOVES, TENNIS GLOVES, KNEE GUARDS FOR ATHLETIC USE, NETS FOR SPORTS AND PARAGLIDERS, IN CLASS 28 (U.S. CLS. 22, 23, 38 AND 50).



David J. Kyffers

Director of the United States Patent and Trademark Office

Reg. No. 4,204,038 THE MARK CONSISTS OF THE STYLIZED WORDING "SUDWOLLEGROUP" IN BLACK WITHIN A WHITE RECTANGLE.

PRIORITY DATE OF 8-4-2010 IS CLAIMED.

OWNER OF INTERNATIONAL REGISTRATION 1067516 DATED 12-15-2010, EXPIRES 12-15-2020.

THE COLOR(S) BLACK AND WHITE IS/ARE CLAIMED AS A FEATURE OF THE MARK.

THE ENGLISH TRANSLATION OF "SUDWOLLE" IN THE MARK IS ROUGHLY "SOUTHERN WOOL" WHERE "SUDWOLLE" IS A COMBINATION OF TWO GERMAN WORDS "SUD" (SOUTH) AND "WOLLE" (WOOL).

SER. NO. 79-093,721, FILED 12-15-2010.

TRACY FLETCHER, EXAMINING ATTORNEY

United States of America

United States Patent and Trademark Office



Reg. No. 4,204,039

Registered Sep. 11, 2012

Int. Cl.: 36

SERVICE MARK

PRINCIPAL REGISTER

RAIFFEISEN ZENTRALBANK ÖSTERREICH AKTIENGESELLSCHAFT (AUSTRIA PUBLIC LIMITED COMPANY)
AM STADTPARK 9
A-1030 WIEN
AUSTRIA

FOR: TRADE FINANCING FOR IMPORTS AND EXPORTS, IN CLASS 36 (U.S. CLS. 100, 101 AND 102).

THE MARK CONSISTS OF THE LITERAL ELEMENT "RBI" IN BLACK WITH THE DESIGN OF A SQUARE OUTLINED IN BLACK TO THE LEFT; INSIDE THE SQUARE IS A STYLIZED GABLE CROSS IN THE FORM OF TWO HORSE-HEADS IN BLACK; THE BACKGROUND OF THE SQUARE IS IN YELLOW.

PRIORITY DATE OF 9-3-2010 IS CLAIMED.

OWNER OF INTERNATIONAL REGISTRATION 1068215 DATED 12-3-2010, EXPIRES 12-3-2020.

THE COLOR(S) BLACK AND YELLOW IS/ARE CLAIMED AS A FEATURE OF THE MARK.

SER. NO. 79-093,993, FILED 12-3-2010.

CHRISIE B. KING, EXAMINING ATTORNEY



David J. Kybas

Director of the United States Patent and Trademark Office

United States of America

United States Patent and Trademark Office



Reg. No. 4,204,040

KIM, JONG MIN (REPUBLIC OF KOREA INDIVIDUAL)
158-5, GUSEO-2 DONG

Registered Sep. 11, 2012

GEUMJEONG-GU, BUSAN, REPUBLIC OF KOREA

Int. Cls.: 9, 25 and 41

FOR: PRE-RECORDED ELECTRONIC MEDIA FEATURING IMAGES; PRE-RECORDED DVDS AND VIDEOS FEATURING FILM OF IMAGES; DOWNLOADABLE ELECTRONIC MEDIA, NAMELY, NEWSLETTERS IN THE FIELD OF ENTERTAINMENT, DRAMA, DOCUMENTARY FILM, EDUCATION, ANIMATION AND GAME SHOWS; DOWNLOADABLE FILMS AND TELEVISION SHOWS FEATURING DRAMA, ENTERTAINMENT AND EDUCATION INFORMATION, ANIMATION AND GAME SHOWS; DOWNLOADABLE ELECTRONIC DATA FILES FEATURING IMAGES; EXPOSED CINEMATOGRAPHIC FILMS, IN CLASS 9 (U.S. CLS. 21, 23, 26, 36 AND 38).

TRADEMARK

SERVICE MARK

PRINCIPAL REGISTER

FOR: FOOTWEAR; HEADWEAR; SPORTSWEAR FOR EXCLUSIVE USE FOR SPORTS, NAMELY, SPORTS SHIRTS, SPORTS PANTS, CARDIGANS, AND CAPS; OVERCOATS EXCLUDING OVERCOATS FOR USE IN SPORTS AND KOREAN CLOTHES; BEACH CLOTHES, NAMELY, SWIM SUITS, BEACH GOWNS, AND BATHING CAPS; FUR COATS; LEATHER TROUSERS; GOLF TROUSERS; FISHING TROUSERS; CLIMBING TROUSERS; SHORTS; TROUSERS FOR SWEATING; BRIEFS; LADIES' PANTS; SNOWBOARD PANTS; SKATEBOARD PANTS; SKI PANTS; BREECHES; TROUSERS; BABIES' PANTS; BLUE JEANS; SWEATERS; DRESS SHIRTS; TEE-SHIRTS; CHILDREN'S CLOTHING, NAMELY, TROUSERS, SHIRTS, JACKETS, INFANTS CLOTHING, OVERCOATS, AND CAPS; JACKETS; PARKAS; VESTS; SHIRTS; COATS; RUNNING CLOTHES, NAMELY, SPORTS SHIRTS, SPORTS PANTS, AND CAPS; PANTS; BLOUSES; JUMPERS; OUTER CLOTHING, NAMELY, OVERCOATS; UNDERWEAR; UNDERGARMENTS; CLIMBING CLOTHES, NAMELY, SHIRTS FOR CLIMBING, TROUSERS FOR CLIMBING, AND CAPS FOR CLIMBING; MEN'S SUITS; SUITS; SKIRTS; TRAINING WEAR, NAMELY, SHIRTS, PANTS, AND CAPS FOR EXERCISE, IN CLASS 25 (U.S. CLS. 22 AND 39).



David J. Kyjars

Director of the United States Patent and Trademark Office

FOR: PRODUCTION OF DOCUMENTARIES; PRODUCTION OF IMAGE FILES; PRODUCTION OF LIVE PERFORMANCES; PRODUCTION OF LIVE SHOWS; PRODUCTION OF MUSIC VIDEOS; RENTAL OF CAMCORDERS; PRODUCTION OF VIDEOTAPE MOVIES; ENTERTAINMENT INFORMATION; CINEMA PRESENTATIONS, NAMELY, CINEMA THEATERS; PRODUCTION AND DISTRIBUTION OF MOVIES, FILM AND TELEVISION SHOWS FEATURING DRAMA, DOCUMENTARIES, AND COMEDY; PREPARATION OF SPECIAL EFFECTS FOR FILMS; TELEVISION SHOW PRODUCTION; TELEVISION ENTERTAINMENT, NAMELY, ENTERTAINMENT IN THE NATURE OF ON-GOING TELEVISION PROGRAMS

Reg. No. 4,204,040 IN THE FIELD OF NEWS, COMEDY, VARIETY, MOVIE, DRAMA, AND DOCUMENTARY;
PRODUCTION OF TELEVISION PROGRAMS, IN CLASS 41 (U.S. CLS. 100, 101 AND 107).

THE MARK CONSISTS OF STRIPES, A CHARACTER AND WORDING "CHALLENGE KING"; THE STRIPES ARE BLUE; THE CHARACTER'S HAIR IS RED WITH GRADIENT ORANGE; THE CHARACTER'S EYEBROWS ARE ORANGE; THE CHARACTER'S FACE IS BEIGE AND THE EYES AND MOUTH ARE BLACK; THE CHARACTER'S ARM IS GREEN, THE CHARACTER'S HAND IS WHITE WITH GRAY SHADING AND A GRAY BORDER; THE WORDING "CHALLENGE KING" IS BLACK.

OWNER OF INTERNATIONAL REGISTRATION 1068664 DATED 1-11-2011, EXPIRES 1-11-2021.

THE COLOR(S) BLUE, RED, ORANGE, BEIGE, BLACK, GREEN, GREY AND WHITE IS/ARE CLAIMED AS A FEATURE OF THE MARK.

SER. NO. 79-094,152, FILED 1-11-2011.

MICHELE SWAIN, EXAMINING ATTORNEY

United States of America
United States Patent and Trademark Office

Cankobi

Reg. No. 4,204,041

Registered Sep. 11, 2012

Int. Cls.: 9, 38 and 41

TRADEMARK

SERVICE MARK

PRINCIPAL REGISTER

MICHAEL CANDREIA (SWITZERLAND INDIVIDUAL)
WEIHERSTRASSE 10
CH-8307 EFFRETIKON
SWITZERLAND

FOR: APPARATUS FOR RECORDING, TRANSMISSION OR REPRODUCTION OF SOUND OR IMAGES; MAGNETIC DATA CARRIERS, NAMELY, BLANK MAGNETIC DATA CARRIERS, PRE-RECORDED MAGNETIC DATA CARRIERS FEATURING MUSIC, RECORDING DISKS, NAMELY, BLANK RECORD DISKS AND PRE-RECORDED DIGITAL VIDEO DISCS FEATURING RECORDED MUSIC; AUTOMATIC VENDING MACHINES AND MECHANISMS FOR COIN-OPERATED APPARATUS; CASH REGISTERS, CALCULATING MACHINES, DATA PROCESSING EQUIPMENT AND COMPUTERS; FIRE EXTINGUISHERS, IN CLASS 9 (U.S. CLS. 21, 23, 26, 36 AND 38).

FOR: TELECOMMUNICATIONS, NAMELY, TELECOMMUNICATIONS BY E-MAIL; TELEPHONE TELECOMMUNICATIONS SERVICES PROVIDED VIA PREPAID TELEPHONE CALLING CARDS, IN CLASS 38 (U.S. CLS. 100, 101 AND 104).

FOR: EDUCATIONAL SERVICES, NAMELY, CONDUCTING CLASSES, SEMINARS, CONFERENCES, WORKSHOPS, IN THE FIELD OF MUSIC, PROVIDING OF TRAINING SERVICES IN THE FIELD OF MUSIC; ENTERTAINMENT IN THE NATURE OF VISUAL AND AUDIO PERFORMANCES, AND MUSICAL, VARIETY, NEWS AND COMEDY SHOWS; ORGANIZING COMMUNITY SPORTING AND CULTURAL EVENTS, IN CLASS 41 (U.S. CLS. 100, 101 AND 107).

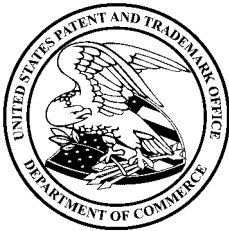

THE MARK CONSISTS OF STANDARD CHARACTERS WITHOUT CLAIM TO ANY PARTICULAR FONT, STYLE, SIZE, OR COLOR.

OWNER OF INTERNATIONAL REGISTRATION 1068924 DATED 1-4-2011, EXPIRES 1-4-2021.

THE WORDING "CANKOBI" HAS NO MEANING IN A FOREIGN LANGUAGE.

SER. NO. 79-094,277, FILED 1-4-2011.

BARBARA RUTLAND, EXAMINING ATTORNEY

David J. Kyffers

Director of the United States Patent and Trademark Office

United States of America

United States Patent and Trademark Office



Reg. No. 4,204,042

Registered Sep. 11, 2012

Int. Cl.: 10

TRADEMARK

PRINCIPAL REGISTER

CUBE S.R.L. (ITALY LIMITED LIABILITY COMPANY)
VIA DORSALE, 9/A
MASSA (MASSA CARRARA), ITALY

FOR: SURGICAL AND MEDICAL APPARATUS AND INSTRUMENTS, NAMELY, SURGICAL AND INTERVENTIONAL MEDICAL ELASTIC DEVICES, BEING ELASTIC RINGS FOR MITRAL ANNULOPLASTY AND ELASTIC BANDS FOR THE TREATMENT OF VENTRICULAR DYSFUNCTION; SURGICAL IMPLANTS COMPRISING ARTIFICIAL MATERIAL AND ASSOCIATED SURGICAL INSTRUMENTS SETS; HEART VALVES, NAMELY, CARDIAC VALVES FOR SURGICAL PROSTHESES; PROSTHESES FOR TREATMENT, REPLACEMENT AND REPAIR OF CARDIAC DISEASES; CARDIAC SURGERY DEVICES, NAMELY, AN ANNULOPLASTY SYSTEM COMPRISED OF A BAND FOR MEDICAL PURPOSES, RING, SIZER SET, AND ANNULOPLASTY HANDLE, IN CLASS 10 (U.S. CLS. 26, 39 AND 44).

THE MARK CONSISTS OF A STYLIZED REPRESENTATION OF A HEART, WITH TOUCHING ADJACENT SQUARES CONNECTING THE HEART TO THE WORDING "CUBE", WRITTEN IN PARTICULAR LOWER-CASE LETTERS, WHICH IS BIGGER THAN THE WORDING "A NEW SPRING IN YOUR LIFE", WRITTEN IN LOWER-CASE LETTERS BELOW THE WORDING "CUBE".

PRIORITY DATE OF 11-29-2010 IS CLAIMED.

OWNER OF INTERNATIONAL REGISTRATION 1068945 DATED 12-29-2010, EXPIRES 12-29-2020.

SER. NO. 79-094,290, FILED 12-29-2010.

RUDY R. SINGLETON, EXAMINING ATTORNEY



David J. Kybas

Director of the United States Patent and Trademark Office

United States of America

United States Patent and Trademark Office



Reg. No. 4,204,043

SILICON FIRE AG (SWITZERLAND SOCIÉTÉ ANONYME)
NAUMATTHALDE 11
CH-6045 MEGGEN, SWITZERLAND

Registered Sep. 11, 2012

Int. Cls.: 4, 7, 12, 16, 25, 28, 35, 38, 40, 41, 42 and 43

FOR: INDUSTRIAL OILS AND GREASES; LUBRICANTS, NAMELY, LUBRICANTS FOR METALWORKING AND DRILLING LUBRICANTS; FUELS, NAMELY, MOTOR SPIRIT AND FUELS FOR LIGHTING AND HEATING, IN CLASS 4 (U.S. CLS. 1, 6 AND 15).

FOR: ENGINES FOR BOATS AND YACHTS, IN CLASS 7 (U.S. CLS. 13, 19, 21, 23, 31, 34 AND 35).

TRADEMARK

SERVICE MARK

FOR: MOTORIZED VEHICLES, NAMELY, MOTORCYCLES, SCOOTERS, ALL TERRAIN VEHICLES, CARS, TRACTORS; SNOWMOBILES; MOTORIZED GOLF CARTS; MOTORIZED VEHICLES, NAMELY, GO CARTS, MOTOR BUSES, MOTOR COACHES; HELICOPTERS, AIRCRAFT, MOTORIZED BOATS AND YACHTS; PERSONAL WATERCRAFTS, NAMELY, SMALL POWER BOATS, MOTORIZED WATERBIKES, MOTORIZED HYDROJET BOATS, SPEED BOATS WITH INBOARD AND OUTBOARD MOTORS, IN CLASS 12 (U.S. CLS. 19, 21, 23, 31, 35 AND 44).

PRINCIPAL REGISTER

FOR: PAPER, CARDBOARD AND STATIONERY; PRINTED CARDBOARD; PRINTED MATTER, NAMELY, BOOKS, FLYERS, MAGAZINES, BROCHURES, AND LEAFLETS IN THE FIELD OF RACING, MOTOR RALLYING, REGENERATIVE FUELS, BOATING, AND YACHTING; PRINTED MATTER FOR ADVERTISING SIGNBOARDS, NAMELY, CARDBOARD SIGNS; CALENDARS; PHOTOGRAPHS; PRINTED COLLECTING CARDS MADE PRIMARILY OF PAPER; PRINTED STICKERS AND ALBUMS FOR STICKERS; PRINTED PAPER PLACARDS; TRADING CARDS; ADDRESS BOOKS; AGENDAS OF PAPER; WRITING PAPER AND PAPER NOTEPADS; PRINTING, PAINTING AND DRAWING SETS COMPRISED OF PENS, PENCILS, PAINT BRUSHES, DRAWING PAPER; PRINTED CATALOGS IN THE FIELD OF RACING, MOTOR RALLYING, REGENERATIVE FUELS, BOATING, AND YACHTING; ITINERARIES MADE PRIMARILY OF PAPER, PRINTED MAPS, PLANS AND CHARTS MADE PRIMARILY OF PAPER; PRINTED POSTERS; PICTURES; RUBBER STAMPS; BOOK COVERS AND BINDINGS; STATIONERY-TYPE PORTFOLIOS; NEWSPAPERS; PRINTED PUBLICATIONS, NAMELY, MAGAZINES, PERIODICALS, MANUALS, DIRECTORIES IN THE FIELD OF RACING, MOTOR RALLYING, REGENERATIVE FUELS, BOATING, AND YACHTING; BUSINESS PAPERS, NAMELY, BUSINESS CARDS, LETTER-HEAD MADE OF PAPER; AUTOGRAPH BOOKS AND AGENDAS MADE OF PAPER; SCRIBBLING BOOKS, NAMELY, WRITING AND DRAWING PADS; FILE FOLDERS; TIME



David J. Kappas

Director of the United States Patent and Trademark Office

Reg. No. 4,204,043 USE DIARIES; PRINTED COMPUTER DOCUMENTATION MADE OF PAPER; STENCILS; IRON ON AND GLUE ON TRANSFERS; GIFT WRAPPING PAPER; WRAPPING PAPER; PORTRAITS, IN CLASS 16 (U.S. CLS. 2, 5, 22, 23, 29, 37, 38 AND 50).

FOR: CLOTHING, NAMELY, BATHING SUITS; RAINWEAR; CLOTHING FOR SPORTS, NAMELY, TROUSERS, T-SHIRTS, TRACK SUITS; LEISURE WEAR, NAMELY, TROUSERS, T-SHIRTS, SHIRTS, BLOUSES; NIGHTWEAR; SKIWEAR; UNDERWEAR; COMBINATIONS; PELERINES; SUITS; BATH ROBES; POLO SHIRTS; CAPS AND HEADGEAR, NAMELY, VISORS; CAPPEAKS; BASEBALL CAPS; NECKTIES; SCARVES AND COLLARS; GLOVES; BELTS; BRACES FOR CLOTHING; BOOTS, SKI BOOTS, SPATS; FOOTWEAR, SOCKS; HEAD AND WRIST SWEATBANDS; BOOTS FOR SPORTS, IN CLASS 25 (U.S. CLS. 22 AND 39).

FOR: GAMES AND PLAYTHINGS, NAMELY, CARD GAMES, BOARD GAMES; GYMNAS TIC AND SPORTING ARTICLES, NAMELY, TRAMPOLINES, EXERCISE MACHINES; ARCADE GAMES, TOYS, NAMELY, DOLLS, TEDDY BEARS; AND PLAYING CARDS, IN CLASS 28 (U.S. CLS. 22, 23, 38 AND 50).

FOR: PROMOTION AND ADVERTISING; THE BRINGING TOGETHER, FOR THE BENEFIT OF OTHERS, OF A VARIETY OF GOODS IN THE FIELD OF SPORTING EQUIPMENT OR REQUISITES, CLOTHING, GAMES, TOYS, SOUVENIRS, PRINTED MATTER, BOOKS AND SOFTWARE, ENABLING CUSTOMERS TO VIEW AND PURCHASE THEM CONVENIENTLY, VIA COMPUTERS, INTERACTIVE COMMUNICATION MEDIA, AND ELECTRONIC MEDIA SUCH AS THE INTERNET AND OTHER DATA COMMUNICATIONS SERVERS; PROVIDING A DATABASE FEATURING BUSINESS INFORMATION FOR COMPUTERIZED STORING AND RETRIEVAL OF BUSINESS INFORMATION; PROVIDING A DATABASE FEATURING BUSINESS INFORMATION ABOUT RACING, MOTOR RALLYING, REGENERATIVE FUEL, BOATING, AND YACHTING, FOR COMPUTERIZED STORING AND RETRIEVAL OF BUSINESS INFORMATION; EXHIBITION SERVICES FOR PROMOTIONAL PURPOSES; COMPILATION AND DISSEMINATION OF ADVERTISING MATTER; PRODUCTION OF PROMOTIONAL MATERIAL; PROVIDING SUBSCRIPTIONS TO PRINTED MATTER, NAMELY, NEWSPAPERS, MAGAZINES FOR OTHERS BY ELECTRONIC MEANS AND VIA INTERACTIVE COMMUNICATION MEDIA, IN CLASS 35 (U.S. CLS. 100, 101 AND 102).

FOR: RADIO AND TELEVISION BROADCASTING, INCLUDING BY MEANS OF A PAY TV SYSTEM; SATELLITE AND CABLE BROADCASTING; RADIO AND TELEVISION BROADCASTING VIA DIGITAL NETWORKS, PARTICULARLY THE INTERNET AND ASSOCIATED INTERACTIVE TELECOMMUNICATIONS SERVICES; TELECOMMUNICATIONS SERVICES, NAMELY, CELLULAR TELEPHONE SERVICES; ELECTRONIC TRANSMISSION OF DATA, IMAGES AND SOUNDS VIA COMPUTER TERMINALS AND COMPUTER NETWORKS; PROVIDING ACCESS TO REAL-TIME CHAT FORUMS IN THE FIELD OF SPORTS, IN CLASS 38 (U.S. CLS. 100, 101 AND 104).

FOR: PRINTING, IN CLASS 40 (U.S. CLS. 100, 103 AND 106).

FOR: ARRANGING, ORGANIZING AND STAGING OF SPORTS EVENTS, TOURNAMENTS AND COMPETITIONS; PRODUCTION OF SPORTS EVENTS, TOURNAMENTS AND COMPETITIONS FOR RADIO, FILM AND TELEVISION; PROVISION OF SPORTS INFORMATION USING REAL-TIME CHAT FORUMS AND COMPUTER BULLETIN BOARDS; PROVISION OF RECREATION FACILITIES FOR SPORTS EVENTS, TOURNAMENTS AND COMPETITIONS; PHOTOGRAPHY SERVICES, IN CLASS 41 (U.S. CLS. 100, 101 AND 107).

FOR: PROVIDING ACCESS TO INTERACTIVE DATABASES IN THE FIELD OF SPORTS; PROVIDING ACCESS TO ELECTRONIC BULLETIN BOARDS IN THE FIELD OF SPORTS, IN CLASS 42 (U.S. CLS. 100 AND 101).

Reg. No. 4,204,043 FOR: HOTEL, RESTAURANT AND CATERING SERVICES, IN CLASS 43 (U.S. CLS. 100 AND 101).

NO CLAIM IS MADE TO THE EXCLUSIVE RIGHT TO USE "CLEAN", APART FROM THE MARK AS SHOWN.

PRIORITY DATE OF 8-19-2010 IS CLAIMED.

OWNER OF INTERNATIONAL REGISTRATION 1069984 DATED 2-7-2011, EXPIRES 2-7-2021.

THE MARK CONSISTS OF THE WORDING "FORMULA CLEAN" WITH THE DESIGN OF A FLAME.

SER. NO. 79-094,683, FILED 2-7-2011.

KRISTIN DAHLING, EXAMINING ATTORNEY

United States of America

United States Patent and Trademark Office

RAVN copenhagen

Reg. No. 4,204,044

Registered Sep. 11, 2012

Int. Cl.: 25

TRADEMARK

PRINCIPAL REGISTER

DESIGN WORKS/RETAIL WORKS, C/O SUSANNE RAVN/OLFERT RAHBK (DENMARK PARTNERSHIP)
MARGRETHEVEJ 28
DK-2900 HELLERUP, DENMARK

FOR: CLOTHING, NAMELY, SCARVES, GLOVES, JERSEYS, TOPS, PANTS, CARDIGANS, DRESSES, JACKETS; OUTERWEAR, NAMELY, COATS, OVERCOATS AND RAINCOATS; KNITWEAR, NAMELY, SWEATERS, KNIT SHORTS, KNIT JACKETS, KNIT CARDIGANS; LEGGINGS, SKIRTS, SHIRTS, T-SHIRTS, VESTS, BELTS; FOOTWEAR; HEADGEAR, NAMELY, HATS, CAPS, IN CLASS 25 (U.S. CLS. 22 AND 39).

THE MARK CONSISTS OF STANDARD CHARACTERS WITHOUT CLAIM TO ANY PARTICULAR FONT, STYLE, SIZE, OR COLOR.

PRIORITY DATE OF 8-9-2010 IS CLAIMED.

OWNER OF INTERNATIONAL REGISTRATION 1070704 DATED 2-9-2011, EXPIRES 2-9-2021.

NO CLAIM IS MADE TO THE EXCLUSIVE RIGHT TO USE "COPENHAGEN" , APART FROM THE MARK AS SHOWN.

SER. NO. 79-094,959, FILED 2-9-2011.

MATTHEW EINSTEIN, EXAMINING ATTORNEY



David J. Kyffers

Director of the United States Patent and Trademark Office

United States of America

United States Patent and Trademark Office



Reg. No. 4,204,045

Registered Sep. 11, 2012

**Int. Cls.: 25, 29, 30, 31,
32 and 42**

TRADEMARK

SERVICE MARK

PRINCIPAL REGISTER

INTERNATIONAL FEDERATION OF ORGANIC AGRICULTURE MOVEMENTS (FED REP GERMANY REGISTERED ASSOCIATION)

CHARLES-DE-GAULLE ST. 5

53113 BONN

FED REP GERMANY

FOR: CLOTHING, NAMELY, PANTS, SHORTS, SHIRTS, TOPS, SKIRTS, DRESSES, GOWNS, COATS, JACKETS, JUMPERS, OVERALLS, COVERALLS, VESTS, PULLOVERS, SWEATERS, PAJAMAS, ROBES, APRONS, UNDERWEAR, GLOVES, MITTENS, SOCKS, STOCKINGS, LEGGINGS, SCARVES, BELTS, NECKTIES, DIAPERS; FOOTWEAR; HEADGEAR, NAMELY, HATS, CAPS, VISORS, ALL OF THE PRECEDING COMPRISED IN WHOLE OR IN PART OF ORGANIC MATERIALS, IN CLASS 25 (U.S. CLS. 22 AND 39).

FOR: MEAT, FISH, POULTRY AND GAME; MEAT EXTRACTS; PRESERVED, FROZEN, DRIED AND COOKED FRUITS AND VEGETABLES; JELLIES, JAMS, COMPOTES; EGGS, MILK AND MILK PRODUCTS, EXCLUDING ICE CREAM, ICE MILK AND FROZEN YOGURT; EDIBLE OILS AND FATS, ALL OF THE PRECEDING BEING ORGANIC OR MADE FROM ORGANIC INGREDIENTS, IN CLASS 29 (U.S. CL. 46).

FOR: COFFEE, TEA, COCOA, SUGAR, RICE, TAPIOCA, SAGO, ARTIFICIAL COFFEE; FLOUR AND PREPARATIONS MADE FROM CEREALS, NAMELY, GRANOLA-BASED SNACK BARS, MUFFINS; BREAD, PASTRY AND CONFECTIONERY, NAMELY, CONFECTIONERY MADE OF SUGAR; ICES; HONEY, TREACLE; YEAST, BAKING-POWDER; SALT, MUSTARD; VINEGAR, SAUCES; SPICES; ICE, ALL OF THE PRECEDING BEING ORGANIC OR MADE FROM ORGANIC INGREDIENTS, IN CLASS 30 (U.S. CL. 46).

FOR: AGRICULTURAL, HORTICULTURAL AND FORESTRY PRODUCTS AND GRAINS NOT INCLUDED IN OTHER CLASSES, NAMELY, LIVE TREES, UNPROCESSED GRAIN, LIVE HATCHING EGGS; LIVE ANIMALS; FRESH FRUITS AND VEGETABLES; SEEDS, NAMELY, GRASS SEEDS, FRUIT SEEDS, VEGETABLE SEEDS; NATURAL PLANTS AND FLOWERS; FOODSTUFFS FOR ANIMALS; MALT, NAMELY, MALT FOR BREWING AND DISTILLING, ALL OF THE PRECEDING BEING ORGANIC OR MADE FROM ORGANIC INGREDIENTS, IN CLASS 31 (U.S. CLS. 1 AND 46).

FOR: BEERS; MINERAL AND AERATED WATERS AND OTHER NON-ALCOHOLIC DRINKS, NAMELY, SOFT DRINKS; FRUIT DRINKS AND FRUIT JUICES; SYRUPS AND OTHER



David J. Kyjars

Director of the United States Patent and Trademark Office

Reg. No. 4,204,045 PREPARATIONS FOR MAKING BEVERAGES, ALL OF THE PRECEDING BEING ORGANIC OR MADE FROM ORGANIC INGREDIENTS, IN CLASS 32 (U.S. CLS. 45, 46 AND 48).

FOR: SCIENTIFIC AND TECHNOLOGICAL SERVICES, NAMELY, ACCREDITATION SERVICES, NAMELY, EVALUATING ORGANIZATIONS TO DETERMINE WHETHER THE ORGANIZATIONS CONFORM TO AN ESTABLISHED STANDARD; INDUSTRIAL ANALYSIS AND RESEARCH SERVICES, NAMELY, INDUSTRIAL RESEARCH IN THE FIELDS OF FOOD, AGRICULTURE, AND PROCESSED GOODS; SCIENTIFIC RESEARCH, IN CLASS 42 (U.S. CLS. 100 AND 101).

OWNER OF U.S. REG. NOS. 2,518,278 AND 2,520,871.

OWNER OF INTERNATIONAL REGISTRATION 1071190 DATED 2-15-2011, EXPIRES 2-15-2021.

THE COLOR(S) GREEN AND RED IS/ARE CLAIMED AS A FEATURE OF THE MARK.

NO CLAIM IS MADE TO THE EXCLUSIVE RIGHT TO USE "ORGANIC", APART FROM THE MARK AS SHOWN.

THE MARK CONSISTS OF THE STYLIZED WORDING "ORGANIC" IN THE COLOR GREEN WITH A GLOBE DEPICTED IN THE COLOR RED INSIDE THE LETTER "O" OF "ORGANIC." A LINE BELOW APPEARS THE STYLIZED WORDING "IFOAM" IN THE COLOR RED. THE COLOR WHITE APPEARING IN THE MARK REPRESENTS BACKGROUND AND IS NOT CLAIMED AS A FEATURE OF THE MARK.

SER. NO. 79-095,133, FILED 2-15-2011.

ALLISON SCHRODY, EXAMINING ATTORNEY

United States of America

United States Patent and Trademark Office



Reg. No. 4,204,046

Registered Sep. 11, 2012

Int. Cls.: 7 and 40

TRADEMARK

SERVICE MARK

PRINCIPAL REGISTER

TURBOCOATING S.P.A. (ITALY JOINT STOCK COMPANY)
VIA MISTRALI, 7 LOC. RUBBIANO
I-43040 SOLIGNANO
(PARMA), ITALY

FOR: MATERIAL PROCESSING INSTALLATIONS, NAMELY, MACHINE FOR SPECIAL PROCESSES IN THE NATURE OF SPRAYING AND APPLYING SURFACE TREATMENTS AND COATINGS ON COMPONENT PARTS AND MANUFACTURING PROTECTIVE COATINGS FOR COMPONENTS USED IN INDUSTRIAL GAS TURBINES AND AERO ENGINES, IN CLASS 7 (U.S. CLS. 13, 19, 21, 23, 31, 34 AND 35).

FOR: TREATMENT OF MATERIALS, NAMELY, HEAT TREATMENT AND COATING OF COMPONENTS USED IN INDUSTRIAL GAS TURBINES AND AERO ENGINES; METAL TREATMENT; TREATMENT OF METAL; ALL THE FOREGOING EXCLUDING METAL REFINING SERVICES, IN CLASS 40 (U.S. CLS. 100, 103 AND 106).

NO CLAIM IS MADE TO THE EXCLUSIVE RIGHT TO USE "GROUP", APART FROM THE MARK AS SHOWN.

PRIORITY DATE OF 5-5-2010 IS CLAIMED.

OWNER OF INTERNATIONAL REGISTRATION 1072727 DATED 11-5-2010, EXPIRES 11-5-2020.

THE MARK CONSISTS OF THE REPRESENTATION OF THE WORDING "UNITEDCOATINGS GROUP" ABOVE A BAND AND PRECEDED BY A SQUARE IMAGE COMPOSED OF TWO TRIANGLES PLACED OPPOSITE EACH OTHER AND A SERIES OF SQUARES IN DECREASING ORDER OF SIZE AND ARRANGED DIAGONALLY BETWEEN THE TWO TRIANGLES.

SER. NO. 79-095,657, FILED 11-5-2010.

SARA BENJAMIN, EXAMINING ATTORNEY



David J. Kyffers

Director of the United States Patent and Trademark Office

United States of America

United States Patent and Trademark Office



Reg. No. 4,204,047

Registered Sep. 11, 2012

**Int. Cls.: 6, 7, 8, 9, 11, 17,
19, 20 and 22**

TRADEMARK

PRINCIPAL REGISTER

SCHÜCO INTERNATIONAL KG (FED REP GERMANY LIMITED COMMERCIAL PARTNERSHIP)
KAROLINENSTRASSE 1-3
33609 BIELEFELD, FED REP GERMANY

FOR: BUILDING MATERIALS MADE OF METAL, NAMELY, PROFILES, TUBES, PLATES, SHEETS AND FOILS FOR WINDOWS, DOORS, GATES, STAIRS, BALCONIES, FACADES, SKYLIGHTS, SOLAR COLLECTORS AND FRAMES; METAL BUILDING MATERIALS, NAMELY, WINDOWS, DOORS, GATES, STAIRS, PARTITION WALLS, FACADES, BALCONIES, CONSERVATORIES, ROOFS, FRAMES, NAMELY, DOOR FRAMES, WINDOW FRAMES, COLLECTOR FRAMES AND PREFABRICATED COMPONENTS FOR COLLECTOR FRAMES AND PREFABRICATED STRUCTURAL PART THEREFOR, BLADES FOR SHADING INSTALLATIONS, SHUTTERS MADE OF METAL, BALUSTRADES FOR STAIRS AND BALCONIES, WINDOWSILLS, RAIN LEADING SHEETS AND PROFILES, LETTER BOXES, FENCES, SCAFFOLDS; IRONMONGERY, SMALL ITEMS OF METAL HARDWARE, NAMELY, NUTS AND SCREWS, MECHANICAL LOCKING AND OPENING DEVICES FOR WINDOWS, DOORS AND GATES, NAMELY, METAL LOCKS; TRANSPORTABLE BUILDINGS MADE OF METAL, AS MOVABLE PAVILIONS AND EXHIBITION STANDS, ALL THE AFOREMENTIONED GOODS MADE OF METAL ALSO IN COMBINATION WITH GLASS, WOOD OR PLASTIC, IN CLASS 6 (U.S. CLS. 2, 12, 13, 14, 23, 25 AND 50).

FOR: METAL AND PLASTICS WORKING MACHINES; MECHANICAL TOOLS EXCEPT FOR ELECTRIC INSTALLATION PURPOSES, NAMELY, POWER TOOLS AND DRILLS; MACHINE FRAMES FOR TREATMENT OF ANY MATERIAL, DRIVING GEARS FOR WINDOWS AND DOORS, IN CLASS 7 (U.S. CLS. 13, 19, 21, 23, 31, 34 AND 35).

FOR: HAND OPERATED TOOLS EXCEPT FOR ELECTRIC INSTALLATION PURPOSES, NAMELY, DRILLS, SAWS, SCREWDRIVERS, HAND PUNCHING TOOLS, NAMELY, PUNCHING DIES, SCISSORS, FOIL ROLL COATERS, KNIVES, AUGERS; AND PLANNING BLADES FOR SHADING SYSTEMS, IN CLASS 8 (U.S. CLS. 23, 28 AND 44).

FOR: MEASURING, CONTROLLING AND REGULATING APPARATUS FOR BUILDINGS, WINDOWS, DOORS, SHADING INSTALLATIONS, SOLAR HEATING INSTALLATIONS, PHOTOVOLTAIC INSTALLATIONS, SOLAR COLLECTORS, AS WELL AS PARTS THEREOF, FOR MEASURING, CONTROLLING AND REGULATING TEMPERATURE, MOISTURE, LIGHT, AIR CONDITIONING AND WIND; COMPUTERS, IN CLASS 9 (U.S. CLS. 21, 23, 26, 36 AND 38).



David J. Kybas

Director of the United States Patent and Trademark Office

Reg. No. 4,204,047 FOR: APPARATUS FOR LIGHTING, HEATING, REFRIGERATING, VENTILATING, SOLAR COLLECTORS FOR HEATING PURPOSES, IN CLASS 11 (U.S. CLS. 13, 21, 23, 31 AND 34).

FOR: PACKING AND INSULATING MATERIAL, PACKAGING AND PACKING MATERIAL, NAMELY, SEALS MADE OF PLASTIC, SEALING COMPOUNDS; PLASTIC IN EXTRUDED FORM FOR USE IN MANUFACTURE; NON-METAL SEALS OF PLASTIC; WEATHER STRIPPING IN THE NATURE OF SEALING BRUSHES FOR WINDOWS AND DOORS FOR GENERAL MANUFACTURING USE; POLYURETHANE FILM FOR FORMING SEALS, IN CLASS 17 (U.S. CLS. 1, 5, 12, 13, 35 AND 50).

FOR: NON-METALLIC BUILDING MATERIALS, NAMELY, PROFILES, TUBES, PLATES, SHEETS AND FOILS FOR WINDOWS, DOORS, GATES, BALCONIES, CONSERVATORIES, ROOFS, SOLAR COLLECTORS AND FRAMES; WINDOWS, DOORS, GATES, STAIRS, PARTITION WALLS, BALCONIES, CONSERVATORIES, ROOFS, FRAMES, FACINGS AND PREFABRICATED STRUCTURAL PARTS THEREFOR; BLADES FOR SHADING INSTALLATIONS, SHUTTERS NON-METALLIC, BALUSTRADES FOR STAIRS AND BALCONIES, WINDOWSILLS, RAIN LEADING PROFILES, FENCES, SCAFFOLDS, TRANSPORTABLE BUILDINGS NON-METALLIC, AS MOVABLE PAVILIONS AND EXHIBITION STANDS, ALL THE AFOREMENTIONED GOODS NOT OF METAL OR ONLY IN COMBINATION WITH METALS, IN CLASS 19 (U.S. CLS. 1, 12, 33 AND 50).

FOR: FURNITURE, SHELVES, GLASS CABINETS, FITTED CUPBOARDS; FITTINGS FOR FURNITURE, NAMELY, LATCHES, HINGES, LOCKS, HANDLES, CORNER GUIDES, CORNER JOINTS, TURN-TILT BALANCE ARMS AND LOCKING AND OPENING SYSTEMS FOR FURNITURE MADE OF OR MAINLY MADE OF PLASTIC AND IN COMBINATION WITH METAL; FRAMES, NAMELY, FRAMES FOR FURNITURE, CUPBOARDS, LOCKERS, AND WALK-IN CLOSETS; FURNITURE FITTINGS, NOT OF METAL, IN CLASS 20 (U.S. CLS. 2, 13, 22, 25, 32 AND 50).

FOR: SUN-BLINDS AND SUNSHADES IN THE NATURE OF AWNINGS, BLINDS, AND LOUVERS MADE OF PLASTICS, TEXTILE MATERIAL OR METAL OR IN COMBINATIONS WITH THESE MATERIALS, IN CLASS 22 (U.S. CLS. 1, 2, 7, 19, 22, 42 AND 50).

THE MARK CONSISTS OF THREE QUADRILATERALS OF DIFFERENT SHAPES FORMING A STYLIZED REPRESENTATION OF A CROWN.

PRIORITY DATE OF 8-4-2010 IS CLAIMED.

OWNER OF INTERNATIONAL REGISTRATION 1073489 DATED 2-4-2011, EXPIRES 2-4-2021.

SER. NO. 79-095,970, FILED 2-4-2011.

FLORENTINA BLANDU, EXAMINING ATTORNEY

United States of America

United States Patent and Trademark Office

MPT

Reg. No. 4,204,048

Registered Sep. 11, 2012

Int. Cls.: 7, 37 and 42

TRADEMARK

SERVICE MARK

PRINCIPAL REGISTER

ITREC B.V. (NETHERLANDS BESLOTEN VENNOOTSCHAP)
ADMIRAAL TROMPSTRAAT 2
NL-3115 HH SCHIEDAM
NETHERLANDS

FOR: DRILLING EQUIPMENT, NAMELY, INDUSTRIAL DRILLING RIGS; POWER DRILLS FOR THE OIL AND GAS EXPLORATION AND PRODUCTION INDUSTRY; DERRICKS; CRANES; GROUND DRILLING MACHINES; INSTALLATIONS, NAMELY, MACHINERY AND EQUIPMENT FOR LAYING DRAIN PIPES, IN CLASS 7 (U.S. CLS. 13, 19, 21, 23, 31, 34 AND 35).

FOR: INSTALLATION, MAINTENANCE AND REPAIR OF ITEMS USED IN THE OIL AND GAS EXPLORATION AND PRODUCTION INDUSTRY, NAMELY, DRILLING MACHINES, DERRICKS AND THEIR PARTS, CRANES, AND PIPE LAYING MACHINES, WELL DRILLING MACHINES, IN CLASS 37 (U.S. CLS. 100, 103 AND 106).

FOR: DESIGN, DEVELOPMENT IN THE OIL AND GAS EXPLORATION AND PRODUCTION INDUSTRY; TECHNICAL CONSULTING SERVICES, NAMELY, ENGINEERING FOR THE OIL AND GAS EXPLORATION AND PRODUCTION INDUSTRIES IN CONNECTION WITH LOCATION, RECOVERY, PROCESSING, STORAGE AND DISTRIBUTION OF OIL AND NATURAL GASES RENDERED BY AN ENGINEER IN REGARD TO THE CONSTRUCTION OF DERRICKS, WELLS AND OTHER PRODUCTS, NAMELY, DRILLING MACHINES, PIPE LAYING MACHINES AND CRANES, IN CLASS 42 (U.S. CLS. 100 AND 101).

THE MARK CONSISTS OF STANDARD CHARACTERS WITHOUT CLAIM TO ANY PARTICULAR FONT, STYLE, SIZE, OR COLOR.

PRIORITY DATE OF 5-31-2010 IS CLAIMED.

OWNER OF INTERNATIONAL REGISTRATION 1075539 DATED 11-30-2010, EXPIRES 11-30-2020.

SER. NO. 79-096,820, FILED 11-30-2010.

STEVEN JACKSON, EXAMINING ATTORNEY



David J. Kypos

Director of the United States Patent and Trademark Office

United States of America

United States Patent and Trademark Office



Reg. No. 4,204,049

ÏD GROUP (FRANCE SOCIÉTÉ ANONYME)
162 BOULEVARD DE FOURMIÉS
F-59100 ROUBAIX, FRANCE

Registered Sep. 11, 2012

**Int. Cls.: 8, 9, 12, 14, 15,
16, 18, 19, 20, 21, 24, 25,
26, 28, 35 and 41**

FOR: HAND OPERATED HAND TOOLS AND IMPLEMENTS, NAMELY, CLAMPS, HAMMERS, CHISELS; NON-ELECTRIC CUTLERY, NAMELY, TABLE FORKS; SPOONS; SCISSORS; HAND-OPERATED GARDENING TOOLS, NAMELY, GARDENING TROWELS, WEEDING FORKS, SPADES, HOES; MECHANICAL TOOLS FOR CHOPPING AND CUTTING FOODSTUFFS, NAMELY, HAND OPERATED CHOPPERS; NON ELECTRIC CAN OPENERS; NUTCRACKERS; RAZORS, RAZOR BLADES; NAIL NIPPERS AND FILES, NAIL CLIPPERS; MANICURE AND PEDICURE SETS; ELECTRIC AND NON-ELECTRIC HAIR CLIPPERS FOR PERSONAL USE, NON-ELECTRIC CURLING IRONS, NAMELY, CURLING TONGS; HAIR-REMOVING TWEEZERS, IN CLASS 8 (U.S. CLS. 23, 28 AND 44).

TRADEMARK

SERVICE MARK

PRINCIPAL REGISTER

FOR: SCIENTIFIC, OTHER THAN MEDICAL, NAUTICAL, SURVEYING, PHOTOGRAPHIC, CINEMATOGRAPHIC, OPTICAL, WEIGHING, MEASURING, SIGNALING, CHECKING AND LIFE-SAVING APPARATUS AND INSTRUMENTS, NAMELY, CAMERAS; TEACHING APPARATUS AND INSTRUMENTS, NAMELY, MEDICAL TEACHING MANNEQUINS; APPARATUS AND INSTRUMENTS FOR CONDUCTING, SWITCHING, TRANSFORMING, ACCUMULATING, REGULATING OR CONTROLLING ELECTRICITY, NAMELY, ELECTRICITY CONDUITS, ELECTRICITY LIMITERS, ADAPTERS; MATERIAL FOR ELECTRICITY MAINS, NAMELY, ELECTRICITY WIRES AND CABLES; ELECTRIC SWITCHES, SOCKETS, PLUGS AND OTHER CONTACTS, NAMELY, SAFETY CONTACT PLUGS, ELECTRICAL CONNECTORS, ELECTRICAL CONNECTIONS; FUSES, ELECTRIC SOCKET; BATTERIES, ELECTRIC; BATTERIES FOR LIGHTING; APPARATUS FOR RECORDING, TRANSMISSION OR REPRODUCTION OF SOUND OR IMAGES; AMPLIFIERS; HEADPHONES; LOUDSPEAKERS; MAGNETIC RECORDING MEDIA, NAMELY, BLANK MAGNETIC DATA CARRIERS; BLANK MAGNETIC DISKS; BLANK MAGNETIC COMPUTER TAPES; SOUND RECORDING, MAGNETIC AND OPTICAL DISKS, AUDIO AND VIDEO COMPACT DISKS, NAMELY, BLANK MAGNETIC AND OPTICAL DISKS FOR SOUND RECORDING, BLANK MAGNETIC AND OPTICAL DISKS, BLANK AUDIO AND VIDEO COMPACT DISKS; PRERECORDED MAGNETIC AND OPTICAL DISKS FEATURING MUSIC; DIGITAL, VERSATILE, OPTICAL DISK PLAYERS; DVD PLAYERS; CAMCORDERS; VIDEOTAPES, NAMELY, BLANK VIDEOTAPES, PRERECORDED VIDEOTAPES FEATURING MOVIES; FACSIMILE MACHINES; TELEPHONES APPARATUS; ADAPTERS DESIGNED FOR TELEPHONES, BATTERY CHARGERS FOR USE WITH TELEPHONES; BAGS, COVERS AND CASES SPECIALLY ADAPTED FOR MOBILE TELEPHONES AND TELEPHONE



David J. Kappas

Director of the United States Patent and Trademark Office

Reg. No. 4,204,049 EQUIPMENT; ANSWERING MACHINES; HANDS FREE KITS FOR PHONES; TELEVISION APPARATUS, NAMELY, TELEVISIONS, TELEVISION CAMERAS, TELEVISION TRANSMITTERS; ANTENNAS; PHOTOGRAPHIC SLIDES, PROJECTION APPARATUS AND SCREENS, NAMELY, SLIDE AND PHOTOGRAPHIC PROJECTION APPARATUS, TRANSPARENCY PROJECTION APPARATUS, COMPUTER SCREENS, FLAT PANEL DISPLAY SCREENS, PROJECTION SCREENS; PHOTOGRAPH FLASH-BULBS; EXPOSED CAMERA, CINEMATOGRAPHIC, PHOTOGRAPHIC, SLIDE, X-RAY FILMS. CASES ESPECIALLY MADE FOR PHOTOGRAPHIC APPARATUS AND INSTRUMENTS; AUTOMATED TELLER MACHINES; CALCULATING MACHINES; DATA PROCESSING APPARATUS, NAMELY, DATA PROCESSORS, MEMORIES FOR DATA PROCESSING EQUIPMENT, INTERFACE CARDS FOR DATA PROCESSING EQUIPMENT IN THE FORM OF PRINTED CIRCUITS; COMPUTERS; COMPUTER PERIPHERAL DEVICES; DATA PROCESSING EQUIPMENT, NAMELY, FLASH CARD, OPTICAL, SMART CARD READERS; FLOPPY DISKS, NAMELY, BLANK FLOPPY COMPUTER DISKS; MODEMS; ELECTRONIC AGENDAS; VIDEO GAME CARTRIDGES; BINOCULARS; OPTICS, NAMELY, SPECTACLES; SPECTACLE CASES; INTEGRATED CIRCUIT CARDS, NAMELY, BLANK INTEGRATED CIRCUIT CARDS; MAGNETICALLY ENCODED DEBIT, CREDIT, KEY, IDENTITY CARDS; CREDIT AND PAYMENT CARDS, NAMELY, MAGNETICALLY ENCODED CREDIT CARDS, MAGNETICALLY ENCODED DEBIT CARDS, ELECTRONIC AND MAGNETIC ID CARDS FOR USE IN CONNECTION WITH PAYMENT FOR SERVICES; MAGNETIC CODED PAYMENT GIFT CARDS; MAGNETICALLY ENCODED IDENTITY CARDS; TELEPHONE CARDS, NAMELY, MAGNETICALLY ENCODED PRE-PAID TELEPHONE CALLING CARDS; DIRECTIONAL COMPASSES; SWIMMING LIFE BELTS AND LIFE JACKETS; DIVING MASKS, NAMELY, FACE MASKS FOR DIVING, SCUBA DIVING MASKS, SKIN DIVING MASKS; WET SUITS, IN THE NATURE OF SURVIVAL SUITS; BABY, CALCULATING, WEIGHING SCALES; PROTECTIVE HELMETS; PROTECTION DEVICES FOR PERSONAL USE AGAINST ACCIDENTS, NAMELY, ARTICLES OF PROTECTIVE CLOTHING FOR PROTECTION AGAINST ACCIDENT OR INJURY FOR USE IN MOTORCYCLING, SKATEBOARDING, SURFING, EYE COVERS FOR PROTECTIVE PURPOSES, PROTECTIVE EAR COVERINGS, PROTECTIVE EYEWEAR; NETS FOR PROTECTION AGAINST ACCIDENTS; CLOTHING FOR PROTECTION AGAINST ACCIDENTS, IRRADIATION AND FIRE; BAROMETERS; FIRE EXTINGUISHERS; EGG TIMERS; LOCKS, ELECTRIC; ELECTRIC DOOR BELLS; BURGLAR, FIRE, ELECTRONIC DOOR ALARMS; ANTI-THEFT ALARMS, NAMELY, BURGLAR ALARMS; MAGNETS; DECORATIVE MAGNETS, IN CLASS 9 (U.S. CLS. 21, 23, 26, 36 AND 38).

FOR: VEHICLES, NAMELY, LAND VEHICLES, BOATS, MOTORCYCLES; APPARATUS FOR LOCOMOTION BY LAND, AIR OR WATER, NAMELY, LAND VEHICLES, BOATS, AIRPLANES, MOTORCYCLES; BICYCLES; GOODS HANDLING CARTS; SUN BLINDS ADAPTED FOR AUTOMOBILES; HEAD RESTRAINTS AND SAFETY BELTS FOR VEHICLE SEATS; CHILDREN'S SAFETY SEATS FOR VEHICLES; KICKSTANDS; BICYCLE, LICENSE PLATE FRAMES; NETS, NAMELY, NET CARGO CARRIERS FOR VEHICLES, NET CARGO STORAGE BINS ESPECIALLY ADAPTED TO FIT IN CARS, TRUCKS AND SUVs; BICYCLE, VEHICLE, MOTORCYCLE BRAKES; HANDLEBARS; BICYCLE SADDLES; BICYCLE PUMPS; PUSH CHAIRS; FITTED VEHICLE COVERS; SEAT COVERS FOR VEHICLES; LUGGAGE CARRIERS FOR VEHICLES; BICYCLE RACKS FOR VEHICLES; SKI CARRIERS FOR VEHICLES; PUSH CHAIRS; PUSH CHAIR HOODS; ANTI-THEFT DEVICES FOR VEHICLES; SHOPPING TROLLEYS, IN CLASS 12 (U.S. CLS. 19, 21, 23, 31, 35 AND 44).

FOR: PRECIOUS METALS AND THEIR ALLOYS OTHER THAN FOR DENTAL USE; JEWELRY; PRECIOUS STONES; JEWELRY CASES OF PRECIOUS METAL; JEWELRY CASES; HOROLOGICAL AND CHRONOMETRIC INSTRUMENTS; WATCHES AND WATCH BANDS; CUFF LINKS; TIE PINS; ORNAMENTAL PINS; JEWELRY, NAMELY, LAPEL BADGES OF PRECIOUS METAL; TRINKETS AND FOBS, NAMELY, KEY RINGS OF PRECIOUS METAL; SUNDIALS; BOXES OF PRECIOUS METAL; COLLECTIBLE, COMMEMORATIVE, NON-MONETARY COINS; FIGURINES AND STATUETTES OF PRECIOUS METAL; WORKS OF ART OF PRECIOUS METAL AND PRECIOUS STONES; LAPEL PINS, IN CLASS 14 (U.S. CLS. 2, 27, 28 AND 50).

Reg. No. 4,204,049 FOR: MUSICAL INSTRUMENTS AND COMPONENT PARTS OF MUSICAL INSTRUMENTS, NAMELY, FOOT PEDALS FOR USE IN CONNECTION WITH MUSICAL INSTRUMENTS, STANDS FOR MUSICAL INSTRUMENTS, MUSICAL INSTRUMENT STRINGS; MUSICAL BOXES; BRIDGES FOR MUSICAL INSTRUMENTS, NAMELY, GUITAR BRIDGES; TUNING FORKS; CASES FOR MUSICAL INSTRUMENTS, IN CLASS 15 (U.S. CLS. 2, 21 AND 36).

FOR: PAPER; UNPROCESSED AND SEMI-PROCESSED CARDBOARD; CARDBOARD FOR STATIONERY USE; CARDBOARD ARTICLES, NAMELY, CARDBOARD BOXES, CARDBOARD CARTONS, CARDBOARD CONTAINERS; PAPER AND PLASTIC PACKAGING BAGS, POUCHES AND SHEETS; PAPER SHEETS, NAMELY, STATIONERY; PRINTED MATTER, NAMELY, PRINTED AWARDS, PRINTED CALENDARS, PRINTED CHARTS; PRINTING TYPE; BOOKBINDING MATERIALS; PHOTOGRAPHS; PRINTING BLOCKS; STATIONERY; GLUES FOR STATIONERY OR HOUSEHOLD PURPOSES; ARTISTS' MATERIALS, NAMELY, ARTISTS' BRUSHES, ARTISTS' PASTELS, ARTISTS' PENCILS, ARTISTS' PENS; PAINTBRUSHES; ARTICLES FOR USE IN SCHOOL, NAMELY, PAINT BOXES; MODELING PASTE; TYPEWRITERS AND OFFICE REQUISITES EXCEPT FURNITURE, NAMELY, FRANKING MACHINES, PAPER EMBOSSERS, PUNCHES; PRINTED INSTRUCTIONAL, EDUCATIONAL AND TEACHING MATERIALS IN THE FIELD OF MUSIC, PROTECTION AND RIGHTS OF CHILDREN, CHILDREN PSYCHOLOGY, CHILD-CARE, AND ENVIRONMENTAL PROTECTION; WRITING AND DRAWING MATERIALS, NAMELY, DRAWING BRUSHES, DRAWING INSTRUMENTS, WRITING INSTRUMENTS; SCHOOL SUPPLIES, NAMELY, SCHOOL WRITING BOOKS, PENS, PENCILS; STAPLES FOR OFFICES; THUMB TACKS; PENCIL SHARPENERS; CORRECTING FLUIDS FOR TYPE; PAPER KNIVES; PENCILS; WRITING CHALK; PENCIL LEAD HOLDERS; RUBBER ERASERS; ENVELOPES; CARD, DOCUMENT, LETTER FILES; COIN, EVENTS, PHOTOGRAPHIC ALBUMS; BOOKS AND PERIODICALS IN THE FIELD OF MUSIC; COMIC BOOKS; ALMANACS; PAMPHLETS IN THE FIELD OF MUSIC AND ADVERTISING; WRITING AND DRAWING BOOKS, NAMELY, SCHOOL WRITING BOOKS, DRAWING PADS, DRAWING TABLETS; CATALOGUES IN THE FIELD OF MUSIC; CALENDARS; LITHOGRAPHS; ENGRAVINGS; PAINTINGS; POSTERS; GEOGRAPHICAL MAPS; NEWS-PAPERS; INKING RIBBONS FEATURING A SPOOL; MAILERS, NAMELY, MAILING LABELS, CARDBOARD MAILING TUBES, PAPER MAIL POUCHES; POSTAGE STAMPS; OFFICE REQUISITES, NAMELY, ADHESIVE TAPE DISPENSERS; TISSUES OF PAPER FOR REMOVING MAKE-UP; BABIES' DIAPERS OF PAPER AND CELLULOSE; PICTURES; DECALCOMANIAS; GARBAGE BAGS OF PAPER AND OF PLASTICS; BAGS FOR MICROWAVE COOKING; SIGNBOARDS OF PAPER AND CARDBOARD; TOILET PAPER; BIBS OF PAPER. TABLE LINEN OF PAPER; TOWELS OF PAPER, HANDKERCHIEFS OF PAPER; GREETING CARDS; POSTCARDS; PATTERNS FOR DRESSMAKING; TERRESTRIAL GLOBES; NON-MAGNETICALLY ENCODED LOYALTY CARDS; NON-MAGNETICALLY ENCODED IDENTITY CARDS, IN CLASS 16 (U.S. CLS. 2, 5, 22, 23, 29, 37, 38 AND 50).

FOR: LEATHER AND IMITATIONS OF LEATHER; ANIMAL SKINS; TRUNKS; SUITCASES; SMALL CASES, NAMELY, ATTACHÉ CASES, CALLING CARD CASES, BUSINESS CARD CASES; UMBRELLAS; PARASOLS; WALKING STICKS; WHIPS; HARNESSES AND SADDLERY; HANDBAGS; BEACH BAGS; BAGS, NAMELY, ATHLETIC BAGS, ALL-PURPOSE CARRYING BAGS; TRAVELING SETS CONSISTING OF TRAVELING BAGS, GARMENT BAGS FOR TRAVEL, GROOMING ORGANIZERS FOR TRAVEL; TRUNKS; VANITY CASES, NOT FITTED; COSMETIC SETS CONSISTING OF COSMETIC BAGS SOLD EMPTY, COSMETIC CASES SOLD EMPTY; SHOPPING NETS AND BAGS, NAMELY, MESH SHOPPING BAGS, STRING BAGS FOR SHOPPING, CANVAS SHOPPING BAGS, LEATHER SHOPPING BAGS; BACKPACKS; SPORTS BAGS; WHEELED SHOPPING BAGS; GARMENT BAGS FOR TRAVEL; SCHOOL BAGS; WALLETS; NOTECASES, NAMELY, NAME, BUSINESS, CALLING CARD CASES; BRIEFCASES; LEATHER KEY CASES; PURSES; TOOL BAGS OF LEATHER SOLD EMPTY; HAT BOXES OF LEATHER; SATCHEL BAGS, NAMELY, SATCHELS, SCHOOL SATCHEL; SLINGS FOR CARRYING INFANT CHILDREN; COLLARS AND CLOTHING FOR ANIMALS, IN CLASS 18 (U.S. CLS. 1, 2, 3, 22 AND 41).

Reg. No. 4,204,049 FOR: BUILDING MATERIALS, NOT OF METAL, NAMELY, BUILDING GLASS, SEMI-WORKED WOODS, BUILDING STONE; CEMENT, NAMELY, CEMENT AGGREGATES, CEMENT MIXES, FILLING CEMENT; CONCRETE; COATINGS, NAMELY, ASPHALT ROOF COATINGS, BITUMINOUS ROOF COATINGS, PROTECTIVE SEALING COATINGS SOLD AS AN INTEGRAL COMPONENT OF GRANITE AND STONE; PLASTER; ARTIFICIAL, BUILDING, FOOTING STONE; MARBLE; BUILDING TIMBER; WOOD VENEER; WOOD PANNELLING; PLYWOOD; PARQUET FLOOR BOARDS; FIRED, UNFIRED, COMMEMORATIVE, GLASS BRICKS; WINDOW GLASS FOR BUILDING; NONSTRUCTURAL BUILDING MATERIALS, NAMELY, BRICK VENEER, CEMENT PANELS; BUILDING MATERIALS, NAMELY, MANUFACTURED BRICK VENEER FOR USE ON INTERIOR AND EXTERIOR WALLS, FLOORS AND SURFACES, PATIOS, POOL SIDES AND DRIVEWAYS; BUILDING STONE; BUILDING TIMBER; CEMENTITIOUS MATERIAL FOR BUILDING PURPOSES; CONCRETE BUILDING MATERIALS, NAMELY, BLOCKS, BRICKS, POSTS, SLABS, PANELS; NONSTRUCTURAL SURFACE BUILDING MATERIALS IN THE NATURE OF GRANITE USED IN DECORATIVE SURFACE APPLICATIONS FOR COUNTERTOPS AND VANITY TOPS; TILE FLOORINGS, NOT OF METAL, NAMELY, FLOOR TILES OF WOOD, RUBBER FLOOR TILES, NON-METAL FLOOR TILES; CHIMNEYS, NOT OF METAL; STAIRCASES, NOT OF METAL; WINDOWS AND DOORS, NOT OF METAL; BLINDS OUTDOOR, NOT OF METAL AND NOT OF TEXTILE; NON-METAL SWIMMING POOLS; NON-METALLIC SWIMMING POOLS; CABANAS NOT OF METAL; WATER PIPES, NOT OF METAL; NON-METALLIC TRANSPORTABLE BUILDINGS; NON-TRANSPORTABLE NON-METALLIC BUILDINGS, NAMELY, PREFABRICATED NON-METAL BUILDINGS; AQUARIA STRUCTURES, NAMELY, AQUARIUM GRAVEL, AQUARIUM SAND, DECORATIVE AQUARIUM STONES; MONUMENTS, NOT OF METAL; ADVERTISEMENT COLUMNS, NOT OF METAL; DUCKBOARDS, NOT OF METAL, IN CLASS 19 (U.S. CLS. 1, 12, 33 AND 50).

FOR: FURNITURE; DISPLAY STANDS; LOOKING GLASSES, NAMELY, MIRRORS; FRAMES EXCEPT CONSTRUCTION FRAMES, NAMELY, BED FRAMES, PICTURE FRAMES, FURNITURE FRAMES, MIRROR FRAMES; WORKS OF ART MADE OF WOOD, WAX, PLASTER, CORK, REED, CANE, WICKER, HORN, BONE, IVORY, WHALEBONE, SHELL, AMBER, MOTHER-OF-PEARL, MEERSCHAUM AND SUBSTITUTES FOR ALL THESE MATERIALS OR PLASTIC; NON-METALLIC BASKETS AND TRAYS, NAMELY, NON-METALLIC BASKETS FOR TRANSPORTING GOODS FOR COMMERCIAL PURPOSES, NON-METALLIC BAKER'S BREAD BASKETS, COMPUTER KEYBOARD TRAYS, PACKAGING MATERIALS IN THE NATURE OF RIGID PLASTIC TRAYS; PACKAGING CONTAINERS OF PLASTIC; DECORATIVE, LETTER BOXES OF WOOD AND PLASTIC; HOUSES FOR HOUSEHOLD PETS, NAMELY, PET CRATES, PLAYHOUSES FOR PETS; BEDS FOR HOUSEHOLD PETS; DISPLAY BOARDS; WORK BENCHES; EMBROIDERY FRAMES; REGISTRATION PLATES, NOT OF METAL, NON-METAL IDENTITY PLATES, NON-METAL NAME PLATES, NON-METAL NOVELTY LICENSE PLATES; SIGNBOARDS OF WOOD AND PLASTICS; NON-METALLIC AND NON-ELECTRICAL METAL WORK, NAMELY, NON-METAL HOSE HANGERS, NON-METAL CASTORS, NON-METAL BOLTS; NON-METALLIC HINGES AND PEGS; PLAYPENS FOR BABIES; CRADLES; INFANT WALKERS; BEDDING MATERIAL EXCLUDING LINEN, NAMELY, BED FRAMES, BED HEADBOARDS, BED PILLOWS, BED MATTRESSES; BEDS; SLEEPING BAGS FOR CAMPING; CUSHIONS; PILLOWS; BOLSTERS; BEDSPRINGS; MATTRESSES; CLOTHES HANGERS; COVERS, NAMELY, FITTED FABRIC FURNITURE COVERS, PLASTIC TISSUE BOX COVERS, FITTED COVERS FOR HIGH CHAIRS; CURTAIN RINGS, RODS AND HOOKS; DOOR HANDLES, NOT OF METAL; TOWEL DISPENSERS, FIXED, NOT OF METAL; COSTUME DISPLAY STANDS; UMBRELLA STANDS; LADDERS OF WOOD AND PLASTICS; DECORATIONS OF PLASTIC FOR FOODSTUFFS; SLATTED INDOOR BLINDS; MANNEQUINS; FANS FOR PERSONAL USE, NON-ELECTRIC, IN CLASS 20 (U.S. CLS. 2, 13, 22, 25, 32 AND 50).

FOR: NON-ELECTRIC UTENSILS FOR HOUSEHOLD OR KITCHEN USE, NAMELY, SPATULAS, STRAINERS, TURNERS, SIEVES; CONTAINERS FOR HOUSEHOLD OR KITCHEN USE; COMBS; BATH, CLEANING, SCOURING SPONGES; BRUSHES, EXCEPT PAINT BRUSHES, NAMELY, BATH BRUSHES, CLEANING BRUSHES FOR HOUSEHOLD USE, COSMETIC BRUSHES; BROOMS; BOWLS; ARTICLES FOR CLEANING PURPOSES,

Reg. No. 4,204,049 NAMELY, CLEANING CLOTHS, CLEANING SPONGES, CLEANING RAGS; STEEL WOOL; GLOVES FOR HOUSEHOLD PURPOSES; CLEANING CLOTHS; CHAMOIS LEATHER FOR CLEANING; GLASS, UNWORKED OR SEMIWORKED, EXCEPT BUILDING GLASS; UTENSILS FOR KITCHEN AND TABLEWARE USE OF GLASS, PORCELAIN AND EARTHENWARE, NAMELY, BEVERAGE GLASSWARE, GLASS DISHES, FRUIT BOWLS OF GLASS; COOKING POT SETS; THERMALLY INSULATED CONTAINERS FOR FOOD AND BEVERAGES; DRINKING FLASKS FOR TRAVELERS; NON-ELECTRIC PORTABLE COOLERS; TABLEWARE, OTHER THAN KNIVES, FORKS AND SPOONS, NAMELY, PLATES, BOWLS, DRINKING GLASSES; VASES; NON-ELECTRIC CANDELABRA; CANDLE EXTINGUISHERS; PICNIC BASKETS FITTED WITH DISHES; CORKSCREWS; BOTTLE OPENERS; BOXES OF METAL FOR DISPENSING PAPER TOWELS; TOWEL RAILS AND RINGS; SOAP AND TOILET PAPER DISPENSERS; TOILET PAPER HOLDERS; CHAMBER POTS; DRYING RACKS FOR WASHING, NAMELY, CLOTHES DRYING RACKS, DISH DRYING RACKS; CLOTHES PEGS; DUST BINS; IRONING BOARDS AND IRONING BOARD COVERS; ISOTHERMIC BAGS, NAMELY, THERMAL INSULATED BAGS FOR FOOD OR BEVERAGES; INSECT TRAPS; FLOWER POTS; COVERS, NOT OF PAPER, FOR FLOWER POTS; LITTER TRAYS FOR PETS; CAGES FOR HOUSEHOLD PETS; INDOOR AQUARIA; COMBS FOR ANIMALS; WATERING DEVICES, NAMELY, WATER TROUGHS, WATERING CANS, WATERING POTS; GARDENING GLOVES; TOOTHBRUSHES; FLOSS FOR DENTAL PURPOSES; SOAP BOXES; COSMETIC UTENSILS, NAMELY, MICRODERMABRASION SPONGES FOR COSMETIC USE, NON-WOVEN FABRIC COSMETIC WIPES, TOILET SETS CONSISTING OF TOILET BRUSHES, TOILET BRUSH HOLDERS, TOILET SPONGES; PERFUME VAPORIZERS AND ATOMIZERS, SOLD EMPTY; PORTABLE BABY BATHTUBS; SHOE HORNS; PIGGY BANKS, NOT OF METAL; WORKS OF ART OF PORCELAIN, TERRA-COTTA AND GLASS, IN CLASS 21 (U.S. CLS. 2, 13, 23, 29, 30, 33, 40 AND 50).

FOR: FABRIC, NAMELY, FABRIC FOR THE MANUFACTURE OF CLOTHING, FABRIC FOR TEXTILE USE, COTTON FABRIC; ADHESIVE FABRIC FOR APPLICATION BY HEAT; UPHOLSTERY FABRICS; BED AND HOUSEHOLD LINEN; TABLE LINEN, NOT OF PAPER; BED, BATH SHEETS; PILLOWCASES; BED COVERS; BATH LINEN, EXCEPT CLOTHING; TEXTILE FACE CLOTHS AND TOWELS; BILLIARD CLOTH; WALL HANGINGS OF TEXTILE; CURTAINS OF TEXTILE AND PLASTIC; TABLECLOTHS, NOT OF PAPER; OILCLOTH FOR USE AS TABLECLOTHS; SLEEPING BAGS IN THE NATURE OF SHEETING; NAPKINS, OF CLOTH, FOR REMOVING MAKE-UP; MOSQUITO NETS; LABELS OF CLOTH; CANVAS FOR EMBROIDERY; LOOSE COVERS FOR FURNITURE, NAMELY, UNFITTED FURNITURE COVERS NOT OF PAPER; BLINDS OF TEXTILE, NAMELY, FABRIC WINDOW CURTAINS AND DRAPERIES; HANDKERCHIEFS OF TEXTILE, IN CLASS 24 (U.S. CLS. 42 AND 50).

FOR: CLOTHING, NAMELY, SHIRTS, PANTS, JACKETS; KNITWEAR, NAMELY, KNIT BOTTOMS, KNIT DRESSES, KNIT JACKETS; UNDERWEAR; PAJAMAS; DRESSING GOWNS; SWEATERS; SKIRTS; FROCKS; TROUSERS; JACKETS; COATS; WATERPROOF CLOTHING, NAMELY, WATERPROOF JACKETS AND PANTS; SHIRTS; NECKTIES; SCARVES; SASHES FOR WEAR; BELTS; CLOTHING GLOVES; BRACES FOR CLOTHING; HEADGEAR FOR WEAR, NAMELY, HATS, CAPS, BERETS, VISORS; HATS; CAPS; FOOTWEAR; SOCKS; STOCKINGS; TIGHTS; FOOTWEAR EXCLUDING ORTHOPEDIC FOOTWEAR; SLIPPERS, BOOTS; BEACH SHOES, SKI BOOTS; BOOTS FOR SPORTS; BATHING TRUNKS AND COSTUMES; CLOTHING FOR SPORTS EXCLUDING DIVING CLOTHING, NAMELY, SPORTS JERSEYS, SPORTS VESTS, SKI WEAR; LAYETTES; BABIES' PANTS, IN CLASS 25 (U.S. CLS. 22 AND 39).

FOR: HABERDASHERY, EXCEPT THREAD, NAMELY, BEADS OTHER THAN FOR MAKING JEWELRY; LACE TRIMMINGS; LACE AND EMBROIDERY; RIBBONS AND BRAID; BUTTONS; HOOKS AND EYES; MARKING, SEWING, SAFETY PINS AND NEEDLES; SNAP FASTENERS; ARTIFICIAL FLOWERS AND FRUITS; HOOKS AND FASTENERS IN THE NATURE OF SNAP FASTENERS, SNAP CLIPS FOR CLOTHING; CLOTHING BUCKLES; ORNAMENTAL NOVELTY BADGES; HAT ORNAMENTS NOT OF PRECIOUS METAL; HAIR ORNAMENTS; HAIR BANDS AND HAIR NETS; HAIR PINS AND GRIPS; BARRETTES; WIGS; ZIP FASTENERS; SHOE LACES; BUCKLES FOR FOOTWEAR; FASTENINGS FOR

Reg. No. 4,204,049 SUSPENDERS; BELT CLASPS; ELASTIC RIBBONS; LACEWORK, NAMELY, FRILLS FOR ATTACHMENT TO CLOTHING; HABERDASHERY, NAMELY, HEAT ADHESIVE PATCHES FOR DECORATION AND REPAIR OF TEXTILE ARTICLES; SPANGLES FOR CLOTHING; SEWING BOXES, IN CLASS 26 (U.S. CLS. 37, 39, 40, 42 AND 50).

FOR: GAMES, NAMELY, BOARD GAMES, CARD GAMES, HAND HELD UNITS FOR PLAYING ELECTRONIC GAMES OTHER THAN THOSE ADAPTED FOR USE WITH AN EXTERNAL DISPLAY SCREEN OR MONITOR; TOYS, NAMELY, ACTION FIGURES, ELECTRONIC LEARNING TOYS; GYMNAS TIC AND SPORTING ARTICLES EXCEPT FOR SWIMMING ARTICLES, CLOTHING, FOOTWEAR AND MATS, NAMELY, GYMNAS TIC APPARATUS, HORIZONTAL BARS, BASKETBALLS, BASEBALL BATS; RACKETS; PARTS OF SPORTS SUITS, NAMELY, PROTECTIVE PADDING FOR PLAYING FOOTBALL, SOCCER, HOCKEY; SHIN GUARDS, NAMELY, SHIN PADS FOR ATHLETIC USE; KNEE GUARDS, NAMELY, KNEE PADS FOR ATHLETIC USE; NETS FOR SPORTS; ARCHERY IMPLEMENTS; CLAY PIGEON TRAPS; TARGETS, DARTS; FENCING WEAPONS; DISCUSSES FOR SPORTS; SKIS; SURF BOARDS; SKATING BOOTS WITH SKATES ATTACHED; ICE SKATES; ROLLER SKATES; SKATEBOARDS; KITES; ORNAMENTS FOR CHRISTMAS TREES EXCEPT ILLUMINATION ARTICLES AND CONFECTIONERY; NOVELTIES FOR PARTIES AND DANCES, NAMELY, PAPER AND PLASTIC PARTY HATS, PARTY GAMES, PARTY FAVORS IN THE NATURE OF CRACKERS AND NOISEMAKERS; TOY MASKS; SWINGS; BOWLING BALLS, BOWLING PINS, BOWLING BAGS; PLAY BALLS AND BALLOONS; ROCKING HORSES; SPORTS AND PLAY ARTICLES, NAMELY, PLAY, INFLATABLE SWIMMING POOLS; MARBLES AND COUNTERS FOR GAMES; PLUSH TOYS; DOLLS AND DOLLS' HOUSES; PUPPETS; DOLLS' CLOTHES; TOY FIGURINES, NAMELY, MODELED PLASTIC TOY FIGURINES, ATTACHABLE, WEARABLE, MAGNETIC TOY FIGURINES; PARLOR GAMES; BUILDING GAMES; TOY SPINNING TOPS; TOY MOBILES; TOY VEHICLES AND SCOOTERS; KITES; GAMES AND GAME APPLIANCES OTHER THAN THOSE DESIGNED TO BE USED ONLY WITH TELEVISION RECEIVER, AN EXTERNAL DISPLAY SCREEN OR MONITOR, NAMELY, ELECTRONIC GAMES OTHER THAN THOSE ADAPTED FOR USE WITH TELEVISION RECEIVERS ONLY, FLOOR-STANDING UNITS FOR PLAYING ELECTRONIC GAMES OTHER THAN IN CONJUNCTION WITH A TELEVISION OR COMPUTER, HAND HELD UNITS FOR PLAYING ELECTRONIC GAMES OTHER THAN THOSE ADAPTED FOR USE WITH AN EXTERNAL DISPLAY SCREEN OR MONITOR, IN CLASS 28 (U.S. CLS. 22, 23, 38 AND 50).

FOR: ADVERTISING; PUBLICATION OF PUBLICITY TEXTS; DIRECT MAIL ADVERTISING; BILL POSTING, NAMELY, BILL STICKING, BILL PRESENTMENT SERVICES; COMMERCIAL AND INDUSTRIAL MANAGEMENT ASSISTANCE; BUSINESS MANAGEMENT; BUSINESS MANAGEMENT ASSISTANCE; EFFICIENCY EXPERTS; BUSINESS CONSULTING, INFORMATION AND INQUIRIES; ORGANIZATION AND MANAGEMENT OF SHOPPING MALLS, NAMELY, BUSINESS ORGANIZATION CONSULTING FOR SHOPPING MALLS; PROFESSIONAL BUSINESS CONSULTANTS; SECRETARIAL SERVICES; BOOKKEEPING; RENTAL OF OFFICE MACHINERY AND EQUIPMENT; RENTAL OF VENDING MACHINES; ARRANGING NEWSPAPER SUBSCRIPTIONS FOR OTHERS; ELECTRONIC NEWSPAPER SUBSCRIPTION SERVICES; TELEPHONE SUBSCRIPTION SERVICES; ARRANGING SUBSCRIPTIONS TO TELECOMMUNICATIONS SERVICES FOR OTHERS TO A WIRELESS TELEPHONY SERVICE AND TO A RADIO-PAGING SERVICE; ARRANGING SUBSCRIPTION SERVICES FOR SUBSCRIBING TO TELECOMMUNICATION SERVICES; ARRANGING SUBSCRIPTION SERVICES FOR SUBSCRIBING TO A GLOBAL TELECOMMUNICATION NETWORK IN THE NATURE OF THE INTERNET AND PRIVATE ACCESS NETWORKS IN THE NATURE OF INTRANETS; ARRANGING SUBSCRIPTION SERVICES TO A DATABASE AND MULTIMEDIA SERVER CENTER FOR OTHERS; ARRANGING SUBSCRIPTIONS FOR OTHERS TO TELEMATIC SERVICES AND DATA TRANSMISSION SERVICES USING TELEMATIC MEANS; ARRANGING SUBSCRIPTIONS FOR OTHERS TO A CENTRAL SERVICE PROVIDING ACCESS TO A COMPUTER NETWORK OR DATA COMMUNICATION NETWORK; ARRANGING SUBSCRIPTIONS FOR OTHERS TO COMPUTER DATABASES; GOODS IMPORT-EXPORT AGENCIES; COMMERCIAL INFORMATION AGENCIES; COST PRICE ANALYSIS; MARKET STUDY; MARKET RE-

Reg. No. 4,204,049 SEARCH; OPINION POLLING, NAMELY, PUBLIC OPINION POLLING, MARKET OPINION POLLING STUDIES; PRICE COMPARISON SERVICES; COMPILATION OF STATISTICS; PUBLIC RELATIONS; PRESENTATION OF GOODS ON ANY COMMUNICATION MEDIA FOR RETAIL PURPOSES, NAMELY, SALES PROMOTION; COMMERCIAL INFORMATION AND ADVICE FOR CONSUMERS; ADMINISTRATIVE PROCESSING OF PURCHASE ORDERS; ORGANIZATION OF EXHIBITIONS AND TRADE FAIRS FOR COMMERCIAL OR ADVERTISING PURPOSES; COMPUTERIZED FILE MANAGEMENT; COMPILATION AND SYSTEMIZATION OF DATA INTO COMPUTER DATABASES; DOCUMENT REPRODUCTION. BRINGING TOGETHER, FOR THE BENEFIT OF OTHERS, OF A VARIETY OF GOODS, EXCLUDING TRANSPORT, TO ENABLE CUSTOMERS TO EXAMINE AND CONVENIENTLY VIEW AND PURCHASE THOSE GOODS, NAMELY, RETAIL STORE SERVICES, WHOLESALE STORE SERVICES, ONLINE AND WHOLESALE ORDERING SERVICES, RETAIL STORES, DISTRIBUTORSHIPS SERVICES, MAIL ORDER SERVICES, INTERNET RETAIL STORE SERVICES, AND COMPUTERIZED ONLINE ORDERING SERVICES FEATURING BLEACHING PREPARATIONS AND OTHER SUBSTANCES FOR LAUNDRY USE, CLEANING, POLISHING, SCOURING AND ABRASIVE PREPARATIONS AND PRODUCTS, STAIN REMOVERS, FABRIC SOFTENERS, LAUNDRY BLUEING, SOAP, PERFUMES, TOILET WATER, PERFUMERY IN THE NATURE OF DEODORANTS FOR PERSONAL USE, COSMETICS, PREPARATIONS FOR HAIR CARE, HAIR DYES, SHAMPOOS, DENTIFRICES, MOUTH WASHES NOT FOR MEDICAL PURPOSES, DEPILATORIES, MAKE-UP AND MAKE-UP REMOVING PREPARATIONS, SHAVING PREPARATIONS, TOILETRIES, NAIL VARNISH AND PREPARATIONS FOR REMOVING NAIL VARNISH, COSMETIC PREPARATIONS FOR BATHS AND FOR SKIN TANNING, TOILETRY SWABS, COTTON WOOL FOR COSMETIC PURPOSES, TISSUES IMPREGNATED WITH COSMETIC LOTIONS, COSMETIC PREPARATIONS FOR SKIN TANNING IN THE NATURE OF SUNSCREENS, SHAMPOOS FOR PETS, INCENSE, SCENTED WOOD, FRAGRANCES IN THE NATURE OF POTPOURRIS, LIGHTING IN THE NATURE OF CANDLES AND WICKS, TAPERS, PERFUMED CANDLES, GREASE FOR LEATHER, FOODSTUFFS AND LACTEAL FLOUR FOR BABIES, ANTISEPTIC COTTON NOT IMPREGNATED WITH PREPARATIONS FOR TREATING ACNE OR SIMILAR SKIN CONDITIONS, COTTON WOOL NOT IMPREGNATED WITH PREPARATIONS FOR TREATING ACNE OR SIMILAR SKIN CONDITIONS, SANITARY PADS, NAPKINS AND PANTIES, BREAST-NURSING PADS, STERILIZING PREPARATIONS, METAL CONSTRUCTION MATERIALS, LADDERS OF METAL, NON-ELECTRIC CABLES AND WIRES OF COMMON METAL, NONELECTRICAL LOCKSMITHING ARTICLES, HARDWARE OF METAL, CHAINS OF METAL, RINGS OF METAL, HINGES OF METAL, KEYS, PADLOCKS, METAL BOXES, CRATES, BINS, BASKETS AND CONTAINERS, CLOTHES HOOKS OF METAL, WORKS OF ART OF COMMON METAL, HAND-HELD TOOLS NOT MANUALLY DRIVEN, ELECTRO-MECHANICAL APPARATUS FOR THE PREPARATION OF FOODSTUFFS AND BEVERAGES, ELECTRIC MACHINES AND FOOD PROCESSORS, SEWING AND KNITTING MACHINES, HAND-OPERATED HAND TOOLS AND IMPLEMENTS, NON-ELECTRIC CUTLERY, TABLE FORKS, SPOONS OTHER THAN FOR FISHING AND FOR MEDICINES, SCISSORS, HAND-OPERATED HAND TOOLS AND IMPLEMENTS FOR GARDENING, MECHANICAL TOOLS FOR CHOPPING AND CUTTING FOODSTUFFS, NON-ELECTRICAL CAN OPENERS, NUTCRACKERS, RAZORS, RAZOR BLADES, NAIL NIPPERS AND FILES, NAIL CLIPPERS, MANICURE AND PEDICURE SETS, ELECTRIC AND NON-ELECTRIC HAIR CLIPPERS FOR PERSONAL USE, ELECTRIC OR NON-ELECTRIC DEPILATION APPLIANCES, HAIR-REMOVING TWEEZERS, SCIENTIFIC OTHER THAN MEDICAL, NAUTICAL, SURVEYING, PHOTOGRAPHIC, CINEMATOGRAPHIC, OPTICAL, WEIGHING, MEASURING, SIGNALING, SUPERVISION CHECKING AND LIFE-SAVING APPARATUS AND INSTRUMENTS, APPARATUS AND INSTRUMENTS FOR CONDUCTING, SWITCHING, TRANSFORMING, ACCUMULATING, REGULATING OR CONTROLLING ELECTRICITY, MATERIAL FOR ELECTRICITY MAINS IN THE NATURE OF WIRES, CABLES, ELECTRIC SWITCHES, PLUGS, SOCKETS AND OTHER CONTACTS, FUSES, SOCKET COVERS, ELECTRIC BATTERIES, BATTERIES FOR LIGHTING, ELECTRIC FLAT IRONS, APPARATUS FOR RECORDING, TRANSMISSION OR REPRODUCTION OF SOUND OR IMAGES, MAGNETIC RECORDING MEDIA, SOUND RECORDING, MAGNETIC AND OPTICAL DISKS, AUDIO AND VIDEO COMPACT DISKS, VIDEO TAPES, FACSIMILE MACHINES, TELEPHONE APPARATUS, ADAPTORS DESIGNED FOR TELEPHONES,

Reg. No. 4,204,049 BATTERY CHARGERS FOR TELEPHONES, BAGS, COVERS AND CASES FOR MOBILE TELEPHONES AND TELEPHONE EQUIPMENT, TELEPHONE ANSWERING MACHINES, ANTENNAS, PROJECTION APPARATUS AND SCREENS, PHOTOGRAPHY FLASH-BULBS, EXPOSED FILMS, CASES ESPECIALLY MADE FOR PHOTOGRAPHIC APPARATUS AND INSTRUMENTS, DICTATION MACHINES, CASH REGISTERS, CALCULATING MACHINES, DATA PROCESSING APPARATUS, COMPUTERS, COMPUTER PERIPHERAL DEVICES, COMPUTER SOFTWARE, FLOPPY DISKS, MODEMS, ELECTRONIC AGENDAS. APPARATUS FOR GAMES ADAPTED FOR USE ONLY WITH TELEVISION RECEIVERS, INDEPENDENT DISPLAY SCREENS OR MONITORS, VIDEO GAME CARTRIDGES, BINOCULARS, OPTICS IN THE NATURE OF SPECTACLES, SPECTACLE CASES, INTEGRATED CIRCUIT CARDS IN THE NATURE OF SMART CARDS, MAGNETIC CARDS, TELEPHONE CARDS, DIRECTIONAL COMPASSES, SWIMMING BELTS AND JACKETS, DIVING MASKS AND WET SUITS, WEIGHING SCALES, PROTECTIVE HELMETS, PROTECTION DEVICES FOR PERSONAL USE AGAINST ACCIDENTS, NETS FOR PROTECTION AGAINST ACCIDENTS, CLOTHING FOR PROTECTION AGAINST ACCIDENTS, IRRADIATION AND FIRE, BAROMETERS, FIRE EXTINGUISHERS, EGG-TIMERS, ELECTRIC LOCKS, ELECTRIC DOOR BELLS, ALARMS, ORNAMENTAL MAGNETS, FEEDING BOTTLES, FEEDING BOTTLE TEATS, SPOONS FOR ADMINISTERING MEDICINE, DROPPERS FOR MEDICAL PURPOSES, PACIFIERS FOR BABIES, BREAST-FEEDING TEATS MADE OF LATEX OR SILICONE. TEETHING RINGS, NURSING APPLIANCES, BREAST PUMPS, THERMOMETERS FOR MEDICAL PURPOSES, MATERNITY BELTS, UMBILICAL BELTS, NASAL ASPIRATOR DEVICES, APPARATUS FOR LIGHTING, HEATING, STEAM GENERATING, COOKING, REFRIGERATING, DRYING, VENTILATING, DISINFECTING, WATER SUPPLY, APPARATUS FOR AIR DEODORIZING AND PURIFICATION, ELECTRIC FANS FOR PERSONAL USE, WATER PURIFYING APPARATUS, STERILIZERS, ELECTRIC HEATERS FOR FEEDING BOTTLES, ICE CHESTS, HAIR DRYERS, ELECTRIC LAUNDRY DRYERS, LIGHT BULBS AND ELECTRIC LAMPS, VEHICLES, APPARATUS FOR LOCOMOTION BY LAND, AIR AND WATER, BICYCLES, GOODS HANDLING CARTS, VEHICLES IN THE NATURE OF TRAILERS, SUN-BLINDS ADAPTED FOR AUTOMOBILES, WINDSHIELD WIPERS, INNER TUBES AND SPIKES FOR WHEEL TIRES, WHEEL TIRES, HEAD RESTRAINTS AND SAFETY BELTS FOR VEHICLE SEATS, CHILDREN'S SAFETY SEATS FOR VEHICLES, BICYCLE PUMPS, BABY CARRIAGES, SCOOTERS, VEHICLE COVERS, SEAT COVERS FOR VEHICLES, LUGGAGE CARRIERS, BICYCLE RACKS, SKICARRIERS FOR VEHICLES, STROLLERS, ANTI-THEFT DEVICES FOR VEHICLES, SHOPPING TROLLEYS, FIREWORKS, FIRECRACKERS, JEWELRY PRODUCTS, JEWEL CASES OF PRECIOUS METAL, PRESENTATION CASES, HOROLOGICAL AND CHRONOMETRIC INSTRUMENTS, WATCHES AND WATCH BANDS, CUFF LINKS, TIE PINS, KEY RINGS IN THE NATURE OF TRINKETS AND FOBS, BOXES OF PRECIOUS METAL, STATUETTES OF PRECIOUS METAL, WORKS OF ART OF PRECIOUS METAL AND OF PRECIOUS STONES, MUSICAL INSTRUMENTS AND COMPONENT PARTS OF MUSICAL INSTRUMENTS, MUSICAL BOXES, BRIDGES FOR MUSICAL INSTRUMENTS, TUNING FORKS, CASES FOR MUSICAL INSTRUMENTS, PAPER, UNPROCESSED AND SEMI-PROCESSED CARDBOARD, CARDBOARD FOR STATIONERY USE, CARDBOARD ARTICLES, PAPER AND PLASTIC PACKAGING BAGS, POUCHES AND SHEETS, STATIONERY PAPER SHEETS, PRINTED MATTER, BOOKBINDING ARTICLES, PHOTOGRAPHS, STATIONERY, ADHESIVE GLUES FOR STATIONERY OR HOUSEHOLD PURPOSES, ARTISTS' MATERIALS, PAINTBRUSHES, PAINT BOXES FOR USE IN SCHOOL. TYPEWRITERS AND OFFICE REQUISITES EXCEPT FURNITURE, INSTRUCTIONAL AND TEACHING MATERIAL EXCEPT APPARATUS, SCHOOL SUPPLIES, ENVELOPES, FILES, SCRAPBOOKS, BOOKS, PERIODICALS, ALMANACS, PAMPHLETS, WRITING OR DRAWING BOOKS, CALENDARS, LITHOGRAPHS, ENGRAVINGS, PAINTINGS, POSTERS, GEOGRAPHICAL MAPS, NEWSPAPERS, MAILERS, PAPER TISSUES FOR REMOVING MAKE-UP, BABIES' NAPKIN-PANTS IN THE NATURE OF DIAPER-PANTS OF PAPER AND CELLULOSE, DECALCOMANIAS, GARBAGE BAGS OF PAPER OR OF PLASTICS, BAGS FOR MICROWAVE COOKING, SIGNBOARDS OF PAPER AND CARDBOARD, TOILET PAPER, TABLE LINEN OF PAPER, HAND TOWELS, HANDKERCHIEFS OF PAPER, GREETING CARDS, POSTCARDS, SEWING PATTERNS, TERRESTRIAL GLOBES, SEALING AND INSULATING GASKETS, ELASTIC AND PLASTIC THREADS AND YARNS NOT FOR TEXTILE USE, LEATHER AND IMITATIONS OF

Reg. No. 4,204,049 LEATHER, ANIMAL SKINS, PELTS AND HIDES, TRUNKS, SUITCASES AND SMALL CASES, SUN UMBRELLAS, UMBRELLAS, PARASOLS AND WALKING STICKS, WHIPS, HARNESSSES AND SADDLERY, HANDBAGS, BEACH BAGS, BAGS, TRAVELING SETS AND TRUNKS, VANITY CASES NOT FITTED, COSMETIC SETS, SHOPPING NETS AND BAGS, BACKPACKS, SPORTS BAGS EXCEPT THOSE ADAPTED TO THE PRODUCT THAT THEY ARE INTENDED TO CONTAIN, WHEELED BAGS, GARMENT BAGS FOR TRAVEL, SCHOOL BAGS, WALLETS, CARD CASES IN THE NATURE OF WALLETS, ATTACHÉ CASES, LEATHER KEY CASES, PURSES, EMPTY TOOL SET BAGS, HAT BOXES OF LEATHER, SACHEL BAGS AND SLINGS FOR CARRYING CHILDREN, COLLARS AND CLOTHING FOR ANIMALS, NON-METAL CONSTRUCTION MATERIALS, CEMENT, COATINGS, PLASTER, BUILDING TIMBER, VENEER, BRICKS, SURFACING FOR BUILDING, NON-METAL FLOOR TILES, NON-METAL CHIMNEYS, NON-METAL WINDOWS AND DOORS, NON-METAL AND NON-TEXTILE OUTDOOR BLINDS, SWIMMING POOLS, NON-METALLIC TRANSPORTABLE CONSTRUCTIONS, AQUARIA STRUCTURES, FURNITURE, DISPLAY STANDS, LOOKING GLASSES IN THE NATURE OF MIRRORS, FRAMES EXCEPT CONSTRUCTION FRAMES, WORKS OF ART MADE OF WOOD, WAX, PLASTER, CORK, REED, CANE, WICKER, HORN, BONE, IVORY, WHALEBONE, SHELL, AMBER, MOTHER-OF-PEARL, MEERSCHAUM, SUBSTITUTES FOR ALL THESE MATERIALS AND PLASTIC, NON-METALLIC BASKETS AND TRAYS, PACKAGING CONTAINERS OF PLASTIC, BOXES OF WOOD AND PLASTIC, HOUSES AND BEDS FOR HOUSEHOLD PETS, DISPLAY BOARDS, VISE BENCHES, EMBROIDERY FRAMES, SIGNBOARDS OF WOOD AND PLASTICS, NON-METALLIC AND NON-ELECTRICAL METAL WORK, NON-METALLIC HINGES AND PEGS, PLAYPENS FOR BABIES, BASSINETS, INFANT WALKERS, NON-METAL DUCKBOARDS, BEDDING MATERIAL EXCLUDING LINEN, SLEEPING BAGS FOR CAMPING, CUSHIONS, PILLOWS, BOLSTERS, BED BASES, MATTRESSES, CLOTHES HANGERS AND COVERS, CURTAIN RINGS, RODS AND HOOKS, NON-METAL DOOR HANDLES, FIXED NON-METAL TOWEL DISPENSERS, BOTTLE RACKS, BOTTLE STOPPERS, NON-METAL BROOM HANDLES, UMBRELLA STANDS, LADDERS OF WOOD AND PLASTICS, DECORATIONS OF PLASTIC FOR FOODSTUFFS, STRAWS FOR DRINKING, SLATTED INDOOR BLINDS, MANNEQUINS, FANS FOR PERSONAL USE, NON-ELECTRIC UTENSILS AND CONTAINERS FOR HOUSEHOLD OR KITCHEN USE, COMBS AND SPONGES, BRUSHES EXCEPT PAINTBRUSHES, BROOMS, BASINS, MATERIAL FOR BRUSH-MAKING, ARTICLES FOR CLEANING PURPOSES, STEEL WOOL, GLOVES FOR HOUSEHOLD PURPOSES, CLEANING CLOTHS, CHAMOIS LEATHER FOR CLEANING, UTENSILS FOR KITCHEN AND TABLEWARE USE OF GLASS, PORCELAIN AND EARTHENWARE, COOKING POT SETS, DRINKING FLASKS FOR TRAVELLERS, NON-ELECTRIC PORTABLE COOLERS, TABLEWARE OTHER THAN KNIVES, FORKS AND SPOONS, VASES, CANDLE HOLDERS, FITTED PICNIC BASKETS INCLUDING DISHES, BOTTLE OPENERS, SOAP AND TOILET PAPER DISPENSERS, TOILET PAPER ROLL HOLDERS, CHAMBER POTS, DRYING RACKS FOR WASHING, CLOTHESPINS, TRASH CANS, IRONING BOARDS AND IRONING BOARD COVERS, ISOTHERMIC BAGS, INSECT TRAPS, FLOWER POTS, FLOWER-POT COVERS NOT OF PAPER, SPRINKLING DEVICES, GARDENING GLOVES, TOOTHBRUSHES, SOAP BOXES, COSMETIC UTENSILS, TOILET SETS, PERFUME VAPORIZERS AND ATOMIZERS, PORTABLE BATHS FOR BABIES, PIGGY BANKS, NOT OF METAL, WORKS OF ART, OF PORCELAIN, TERRA-COTTA OR GLASS, ROPES NEITHER MADE OF RUBBER, NOR INTENDED AS STRINGS FOR RACKETS OR MUSICAL INSTRUMENTS, STRING, TENTS, TARPULINS NEITHER AS SAFETY TARPULINS, NOR AS PUSHCHAIR COVERS, BAGS AND POUCHES FOR PACKAGING MADE OF TEXTILES, PADDING AND STUFFING MATERIALS EXCEPT OF RUBBER AND PLASTICS, HAMMOCKS, NONMETAL THREAD FOR WRAPPING AND BINDING, YARNS AND THREADS FOR TEXTILE USE, SPUN WOOL, ELASTIC AND PLASTIC THREADS AND YARNS FOR TEXTILE USE, FABRICS, BED AND HOUSEHOLD LINEN, TABLE LINEN NOT OF PAPER, BATH LINEN EXCEPT CLOTHING, WALL HANGINGS OF TEXTILE, SHEETING IN THE NATURE OF SLEEPING BAGS, TEXTILE TISSUES FOR REMOVING MAKE-UP, MOSQUITO NETS, HOUSEHOLD LINEN, LABELS OF CLOTH, BLINDS OF TEXTILE, HANDKERCHIEFS OF TEXTILE, CLOTHING, BELTS, CLOTHING GLOVES, SUSPENDERS, HATS, FOOTWEAR, SOCKS, STOCKINGS, TIGHTS, FOOTWEAR EXCLUDING ORTHOPEDIC FOOTWEAR, SLIPPERS, BOOTS, INNER SOLES,

Reg. No. 4,204,049 BEACH SHOES, SKI BOOTS, SPORTS FOOTWEAR, BONNETS, BATHING SUITS AND TRUNKS, CLOTHING FOR SPORTS EXCLUDING DIVING CLOTHING, SLEEPING MASKS, HABERDASHERY EXCEPT THREAD, LACE TRIMMINGS, LACE AND EMBROIDERY, RIBBONS AND BRAID, BUTTONS, HOOKS AND EYES, PINS AND NEEDLES, ARTIFICIAL FLOWERS AND FRUITS, ORNAMENTAL NOVELTY BADGES, HAT ORNAMENTS NOT OF PRECIOUS METAL, HAIR ORNAMENTS, HAIR BANDS AND HAIR NETS, HAIR PINS AND GRIPS, BARRETTES, WIGS, ZIP FASTENERS, SHOE LACES, HABERDASHERY IN THE NATURE OF HEAT ADHESIVE PATCHES FOR DECORATION OR REPAIR OF TEXTILE ARTICLES, SEWING BOXES, CARPETS, RUGS, MATS AND MATTING, LINOLEUM AND OTHER MATERIALS FOR COVERING FLOORS EXCLUDING FLOOR TILING AND PAINT, NON-TEXTILE WALL HANGINGS, BATH MATS, GYMNAS TIC MATS, NON-SLIP MATS, GAMES, TOYS, PRACTICAL JOKES IN THE NATURE OF NOVELTIES, ORNAMENTS FOR CHRISTMAS TREES EXCEPT ILLUMINATION ARTICLES AND CONFECTIONERY, PARTY FAVORS, TOY MASKS, KITES; PLAYING CARDS, GYMNAS TIC AND SPORTING ARTICLES EXCEPT FOR SWIMMING ARTICLES, CLOTHING, FOOTWEAR AND MATS, RODS FOR FISHING, EXERCISERS AND BODYBUILDING APPARATUS, TOYS FOR DOMESTIC PETS, COIN-OPERATED AMUSEMENT MACHINES, GAMES AND GAMES APPARATUS OTHER THAN THOSE DESIGNED TO BE USED ONLY WITH TELEVISION RECEIVERS, SEPARATE DISPLAY SCREENS OR MONITORS, MEAT, FISH, POULTRY AND GAME, PRESERVED, FROZEN, DRIED AND COOKED FRUITS AND VEGETABLES, FRUIT PULP AND SALADS, VEGETABLE SALADS, CANNED MEAT, FISH, VEGETABLES AND FRUIT, JAMS, MARMALADES, STEWED FRUIT, JELLIES FOR FOOD, SOUPS, EGGS, MILK, BUTTER, CREAM, YOGHURTS, CHEESE AND OTHER DAIRY PRODUCTS, EDIBLE OILS AND FATS, COFFEE, TEA, COCOA, CHOCOLATE, CHOCOLATE GOODS, BEVERAGES MADE WITH COFFEE, TEA, COCOA, CHOCOLATE, NON-MEDICINAL INFUSIONS, SUGAR, RICE, PASTA, SEMOLINA, FLOURS AND CEREAL PREPARATIONS, BREAD, PASTRY, CONFECTIONERY, EDIBLE ICES, HONEY, SALT, MUSTARD, VINEGAR, CONDIMENTS IN THE NATURE OF SAUCES, SANDWICHES, PIZZAS, AGRICULTURAL, HORTICULTURAL AND FORESTRY PRODUCTS NEITHER PREPARED NOR TRANSFORMED, SOWING SEEDS, FRESH FRUITS AND VEGETABLES, TREES, SHRUBS, NATURAL PLANTS AND FLOWERS, CHRISTMAS TREES, MINERAL AND AERATED WATERS AND OTHER NON-ALCOHOLIC DRINKS, IN CLASS 35 (U.S. CLS. 100, 101 AND 102).

FOR: PRACTICAL TRAINING, NAMELY, EDUCATIONAL DEMONSTRATIONS; ENTERTAINMENT SERVICES, NAMELY, LIVE PERFORMANCES BY MUSICAL BANDS, PREPARATION OF SPECIAL EFFECTS, CONDUCTING CONTESTS; AMUSEMENT PARKS; SPORTING ACTIVITIES, NAMELY, ORGANIZATION OF SPORTS COMPETITIONS, SPORT CAMP SERVICES, SPORTS INSTRUCTION SERVICES; PROVIDING SPORTS FACILITIES; ORGANIZATION OF SPORTS COMPETITIONS; ENTERTAINMENT AND EDUCATION SERVICES, NAMELY, COUNTRY, FAN CLUB SERVICES; CULTURAL ACTIVITIES, NAMELY, ORGANIZATION OF EXHIBITIONS FOR CULTURAL PURPOSES, ORGANIZING CULTURAL EVENTS; PUBLICATION OF BOOKS AND REVIEWS; PUBLICATION OF TEXTS OTHER THAN ADVERTISING TEXTS; LENDING LIBRARIES; ELECTRONIC DESKTOP PUBLISHING; PUBLICATION OF ELECTRONIC BOOKS AND INTERACTIVE ONLINE WEB JOURNALS FEATURING GAME SERVICES PROVIDED ON-LINE FROM A COMPUTER NETWORK, NAMELY, PROVIDING ONLINE COMPUTER GAMES, PROVIDING ONLINE VIDEO GAMES, PROVIDING ONLINE ELECTRONIC GAMES; MUSIC COMPOSITION FOR OTHERS; TELEVISION SHOW AND FILM PRODUCTION; RENTAL OF MOTION PICTURE FILMS, VIDEO RECORDERS, TELEVISION SETS, VIDEO TAPES, PHONOGRAPH RECORDINGS, SOUND RECORDINGS, AUDIO EQUIPMENT, VIDEO CAMERAS, VIDEO RECORDERS, RADIO AND TELEVISION SETS, CINEMATOGRAPHIC PROJECTION APPARATUS, CINEMATOGRAPHIC APPARATUS AND ACCESSORIES AND THEATER AND SHOW SETS; RENTAL OF SPORTS EQUIPMENT EXCEPT VEHICLES AND UNDERWATER DIVING EQUIPMENT; ORGANIZATION OF COMPETITIONS IN THE FIELD OF EDUCATION AND ENTERTAINMENT, NAMELY, ATHLETIC COMPETITIONS, CULINARY COMPETITIONS; ORGANIZATION OF EXHIBITIONS FOR CULTURAL OR EDUCATIONAL PURPOSES; BOOKING OF SEATS FOR SHOWS; ARRANGING AND CONDUCTING OF SPECIAL EVENTS FOR SOCIAL ENTERTAINMENT PURPOSES; ORGANIZING COMMUNITY

Reg. No. 4,204,049 SPORTING AND CULTURAL EVENTS; TICKET AGENCY SERVICES FOR ENTERTAINMENT EVENTS; OPERATING LOTTERIES; PRODUCTION OF RADIO AND TELEVISION PROGRAMS; DIGITAL IMAGING SERVICES; PHOTOGRAPHY; PHOTOGRAPHIC REPORTING; NEWS REPORTERS SERVICES; VIDEOTAPING; VIDEO TAPE EDITING; MICROFILMING FOR OTHERS; TRANSLATION; CONFERENCING SERVICES, NAMELY, ARRANGING AND CONDUCTING EDUCATIONAL CONFERENCES; ENTERTAINMENT SERVICES, NAMELY, PROVIDING DIGITAL NON-DOWNLOADABLE PRERECORDED MUSIC FROM THE INTERNET; ENTERTAINMENT SERVICES, NAMELY, PROVIDING DIGITAL NON-DOWNLOADABLE PRERECORDED MUSIC IN MP3 FORMAT FROM WEBSITES ON THE INTERNET, IN CLASS 41 (U.S. CLS. 100, 101 AND 107).

THE MARK CONSISTS OF THE WORD "OXYBUL" IN GREY WITH A STYLIZED CUBE IN THE CENTER OF THE LETTER "O" COMPRISED OF THREE SQUARES WHICH DO NOT TOUCH. THE LEFT SQUARE IS GREEN, THE TOP SQUARE IS YELLOW AND THE RIGHT SQUARE IS RED.

PRIORITY DATE OF 12-6-2010 IS CLAIMED.

OWNER OF INTERNATIONAL REGISTRATION 1076264 DATED 1-5-2011, EXPIRES 1-5-2021.

THE COLOR(S) GREY, YELLOW, GREEN AND RED IS/ARE CLAIMED AS A FEATURE OF THE MARK.

SER. NO. 79-097,060, FILED 1-5-2011.

LOURDES AYALA, EXAMINING ATTORNEY

United States of America

United States Patent and Trademark Office

FILL

Reg. No. 4,204,050

FILL GESELLSCHAFT M.B.H. (AUSTRIA PRIVATE LIMITED COMPANY)
FILLSTRASSE 1

Registered Sep. 11, 2012

A-4942 GURTEN, AUSTRIA

Int. Cls.: 7, 9, 37, 40 and 42

FOR: MACHINES FOR FOUNDING, NAMELY, ROBOTER SYSTEMS, PORTAL MANIPULATORS, TURNTABLES; MACHINES FOR COOLING, TRANSPORTATION AND CORE REMOVAL OF CASTINGS; MACHINES FOR PROCESSING OF CASTINGS; CIRCULAR SAWS; CONVEYORS; FOUNDRY MACHINES; METAL WORKING MACHINES, NAMELY, BENDING MACHINES, BORING MACHINES, CUTTING MACHINES, DRILLING AND DEBURRING MACHINES, GRINDING MACHINES, MILLING MACHINES, SHAPING MACHINES, SHEARING MACHINES, SLOTTING MACHINES; MACHINE TOOLS FOR DRILLING, TURNING, BORING, DEBURRING, GRINDING, SHAPING, MILLING, SAWING, CUTTING, PENDING, AND SAWS; MACHINES FOR WOODWORKING, NAMELY, BANDSAWS, PRESSES, MACHINES FOR REPAIRING DEFECTS IN WOOD, CONVEYORS, TRANSPORTATION; MACHINES FOR PLASTICS WORKING, NAMELY, FOAMING MACHINES, FORMING MACHINES, PREFORMING MACHINES, PRESSES; MACHINES FOR PRODUCING SKIES AND SNOWBOARDS, IN CLASS 7 (U.S. CLS. 13, 19, 21, 23, 31, 34 AND 35).

TRADEMARK

SERVICE MARK

PRINCIPAL REGISTER

FOR: SCIENTIFIC, NAUTICAL, SURVEYING, PHOTOGRAPHIC, CINEMATOGRAPHIC, OPTICAL, WEIGHING, MEASURING, SIGNALING, CHECKING (SUPERVISION), LIFE-SAVING AND TEACHING APPARATUS AND INSTRUMENTS IN THE NATURE OF ULTRASONIC DEVICES FOR ULTRASONIC INSPECTION AND TESTING OF LIGHT-WEIGHT STRUCTURES, NAMELY, STRUCTURES THE SHAPE OF WHICH IS DETERMINED THROUGH AN OPTIMIZATION PROCESS TO EFFICIENTLY CARRY THE LOADS FROM A CRITICAL LOADING CASE, AS WELL AS THEIR COMPOSITE COMPONENTS, DISTANCE MEASURING APPARATUS; ELECTRONIC ULTRASONIC TEST EQUIPMENT, NAMELY, ULTRASONIC FLAW DETECTORS, THICKNESS TESTERS AND HARDNESS TESTERS, FOR NON-MEDICAL USE; APPARATUS AND INSTRUMENTS FOR CONDUCTING, SWITCHING, TRANSFORMING, ACCUMULATING, REGULATING OR CONTROLLING ELECTRICITY IN THE NATURE OF CONDUCTORS, SWITCHES, TRANSFORMERS, ACCUMULATORS, VOLTAGE REGULATORS AND CONTROLLERS; APPARATUS FOR RECORDING, TRANSMISSION OR REPRODUCTION OF SOUND OR IMAGES; DATA PROCESSING EQUIPMENT, NAMELY, DATA PROCESSORS; COMPUTERS, IN CLASS 9 (U.S. CLS. 21, 23, 26, 36 AND 38).



David J. Kappas

Director of the United States Patent and Trademark Office

Reg. No. 4,204,050 FOR: BUILDING CONSTRUCTION; REPAIR OF MACHINES FOR FOUNDING, NAMELY, ROBOTER SYSTEMS, PORTAL MANIPULATORS, TURNTABLES; REPAIR OF MACHINES FOR COOLING, TRANSPORTATION, CORE REMOVAL OF CASTINGS, MACHINES FOR PROCESSING OF CASTINGS, CIRCULAR SAWS, CONVEYORS AND FOUNDRY MACHINES; REPAIR OF METAL WORKING MACHINES, NAMELY, BENDING MACHINES, BORING MACHINES, CUTTING MACHINES, DRILLING AND DEBURRING MACHINES, GRINDING MACHINES, MILLING MACHINES, SHAPING MACHINES, SHEARING MACHINES, SLOTTING MACHINES; REPAIR OF MACHINE TOOLS FOR DRILLING, TURNING, BORING, DEBURRING, GRINDING, SHAPING, MILLING, SAWING, CUTTING, PENDING, AND SAWS; REPAIR OF MACHINES FOR WOODWORKING, NAMELY, BANDSAWS, PRESSES, MACHINES FOR REPAIRING DEFECTS IN WOOD, CONVEYORS, TRANSPORTATION; REPAIR OF MACHINES FOR PLASTICS, NAMELY, FOAMING MACHINES, FORMING MACHINES, PREFORMING MACHINES, PRESSES; REPAIR OF MACHINES FOR PRODUCING SKIES AND SNOWBOARDS; INSTALLATION SERVICES AND MAINTENANCE FOR MACHINES FOR FOUNDING, NAMELY, ROBOTER SYSTEMS, PORTAL MANIPULATORS, TURNTABLES; REPAIR OF MACHINES FOR COOLING, TRANSPORTATION, CORE REMOVAL OF CASTINGS, MACHINES FOR PROCESSING OF CASTINGS, CIRCULAR SAWS, CONVEYORS AND FOUNDRY MACHINES; REPAIR OF METAL WORKING MACHINES, NAMELY, BENDING MACHINES, BORING MACHINES, CUTTING MACHINES, DRILLING AND DEBURRING MACHINES, GRINDING MACHINES, MILLING MACHINES, SHAPING MACHINES, SHEARING MACHINES, SLOTTING MACHINES; REPAIR OF MACHINE TOOLS FOR DRILLING, TURNING, BORING, DEBURRING, GRINDING, SHAPING, MILLING, SAWING, CUTTING, PENDING, AND SAWS; INSTALLATION SERVICES AND MAINTENANCE OF MACHINES FOR WOODWORKING, NAMELY, BANDSAWS, PRESSES, MACHINES FOR REPAIRING DEFECTS IN WOOD, CONVEYORS, TRANSPORTATION; INSTALLATION SERVICES AND MAINTENANCE OF MACHINES FOR PLASTICS, NAMELY, FOAMING MACHINES, FORMING MACHINES, PREFORMING MACHINES, PRESSES; INSTALLATION SERVICES AND MAINTENANCE OF MACHINES FOR PRODUCING SKIES AND SNOWBOARDS, IN CLASS 37 (U.S. CLS. 100, 103 AND 106).

FOR: TREATMENT OF MATERIALS, NAMELY, TREATMENT OF METAL; WOODWORKING; CUSTOM ASSEMBLING OF MATERIALS FOR OTHERS, NAMELY, ASSEMBLY OF PRODUCTS FOR OTHERS; METAL CASTING , IN CLASS 40 (U.S. CLS. 100, 103 AND 106).

FOR: SCIENTIFIC AND TECHNOLOGICAL SERVICES, NAMELY, SCIENTIFIC RESEARCH, ANALYSIS, AND TESTING, IN THE FIELDS OF MACHINES FOR FOUNDING, NAMELY, ROBOTER SYSTEMS, PORTAL MANIPULATORS, TURNTABLES, REPAIR OF MACHINES FOR COOLING, TRANSPORTATION, CORE REMOVAL OF CASTINGS, MACHINES FOR PROCESSING OF CASTINGS, CIRCULAR SAWS, CONVEYORS, FOUNDRY MACHINES, REPAIR OF METAL WORKING MACHINES, NAMELY, BENDING MACHINES, BORING MACHINES, CUTTING MACHINES, DRILLING AND DEBURRING MACHINES, GRINDING MACHINES, MILLING MACHINES, SHAPING MACHINES, SHEARING MACHINES, SLOTTING MACHINES, REPAIR OF MACHINE TOOLS FOR DRILLING, TURNING, BORING, DEBURRING, GRINDING, SHAPING, MILLING, SAWING, CUTTING, PENDING, AND SAWS; SCIENTIFIC RESEARCH AND DESIGN RELATING THERETO IN THE FIELDS OF COMPUTER NETWORKING HARDWARE, COMPUTER DATA CENTER ARCHITECTURE, COMPUTER MODELING SERVICES, NAMELY, COMPUTER SIMULATION FROM COMPUTER PROGRAMS FOR OTHERS; INDUSTRIAL ANALYSIS AND RESEARCH SERVICES IN THE FIELD OF ENGINEERING; DESIGN AND DEVELOPMENT OF COMPUTER HARDWARE AND SOFTWARE; ENGINEERING; CONSTRUCTION DRAFTING; TECHNICAL PROJECT STUDIES IN THE NATURE OF TECHNICAL RESEARCH IN THE FIELD OF ENGINEERING, IN CLASS 42 (U.S. CLS. 100 AND 101).

THE MARK CONSISTS OF STANDARD CHARACTERS WITHOUT CLAIM TO ANY PARTICULAR FONT, STYLE, SIZE, OR COLOR.

PRIORITY DATE OF 10-11-2010 IS CLAIMED.

Reg. No. 4,204,050 OWNER OF INTERNATIONAL REGISTRATION 1076745 DATED 3-22-2011, EXPIRES 3-22-2021.

SER. NO. 79-097,228, FILED 3-22-2011.

ANN E. SAPPENFIELD, EXAMINING ATTORNEY

United States of America

United States Patent and Trademark Office



Reg. No. 4,204,051

Registered Sep. 11, 2012

Int. Cls.: 6 and 16

TRADEMARK

PRINCIPAL REGISTER

METSÄ TISSUE OYJ (FINLAND PUBLIC LIMITED LIABILITY COMPANY)
REVONTULENTIE 8 C
FI-02100 ESPOO
FINLAND

FOR: ALUMINUM FOIL AND GOODS MADE THEREOF INCLUDED IN THIS CLASS, NAMELY, BAKING CUPS AND PACKAGES FOR FOODSTUFFS IN THE NATURE OF ALUMINUM FOIL SANDWICH POUCHES, IN CLASS 6 (U.S. CLS. 2, 12, 13, 14, 23, 25 AND 50).

FOR: PAPER AND GOODS MADE THEREOF INCLUDED IN THIS CLASS, NAMELY, COOKING PAPER AND BAKING PAPER, BAKING CUPS, PAPER PACKAGING AND CONTAINERS FOR FOODS, ALL THE AFORESAID GOODS ONLY FOR BAKING AND COOKING PURPOSES; PLASTIC MATERIALS FOR PACKAGING, NAMELY, PLASTIC FILMS FOR PACKAGING FOR HOUSEHOLD USE, PLASTIC BAGS FOR PACKAGING, PLASTIC WRAPS FOR PACKAGING AND INTEGRATED FASTENERS THEREFOR, IN CLASS 16 (U.S. CLS. 2, 5, 22, 23, 29, 37, 38 AND 50).

THE MARK CONSISTS OF A RED CIRCLE CONTAINING THE WORDS "SAGA ONE-UP" IN WHITE ALONG WITH A DEPICTION OF A WHITE POP-UP BOX FOR FOOD CONTACT PAPER.

PRIORITY DATE OF 7-8-2010 IS CLAIMED.

OWNER OF INTERNATIONAL REGISTRATION 1076912 DATED 12-28-2010, EXPIRES 12-28-2020.

THE COLOR(S) RED AND WHITE IS/ARE CLAIMED AS A FEATURE OF THE MARK.

SER. NO. 79-097,317, FILED 12-28-2010.

SANI KHOURI, EXAMINING ATTORNEY



David J. Kyffers

Director of the United States Patent and Trademark Office

United States of America

United States Patent and Trademark Office

DAMPÀ

Reg. No. 4,204,052

GIOVANNETTI SIMONA (ITALY INDIVIDUAL)
VIA ARNALDO DA BRESCIA, 2/4
I-57031 CAPOLIVERI (LI), ITALY

Registered Sep. 11, 2012

Int. Cls.: 14 and 25

FOR: IMITATION JEWELLERY, IN CLASS 14 (U.S. CLS. 2, 27, 28 AND 50).

TRADEMARK

FOR: CLOTHING, NAMELY, SHIRTS, PANTS, COATS, DRESSES; FOOTWEAR; HEADGEAR, NAMELY, HATS, VISORS, IN CLASS 25 (U.S. CLS. 22 AND 39).

PRINCIPAL REGISTER

THE WORDING "DAMPÀ" HAS NO MEANING IN A FOREIGN LANGUAGE.

OWNER OF INTERNATIONAL REGISTRATION 1077113 DATED 4-8-2011, EXPIRES 4-8-2021.

SER. NO. 79-097,376, FILED 4-8-2011.

MARILYN IZZI, EXAMINING ATTORNEY



David J. Kybas

Director of the United States Patent and Trademark Office

United States of America

United States Patent and Trademark Office



Reg. No. 4,204,053

Registered Sep. 11, 2012

Int. Cls.: 6, 40 and 42

PETER SCHÖTTLER GMBH (FED REP GERMANY COMPANY ORGANIZED UNDER GERMAN LAW)
SÜDSTR. 5
58135 HAGEN
FED REP GERMANY

TRADEMARK

SERVICE MARK

PRINCIPAL REGISTER

FOR: METAL CASTINGS AND METAL FORGINGS; WORKED AND UNWORKED CASTINGS AND FORGINGS, IN PARTICULAR FORGED PIECES OF UNALLOYED, ALLOYED, RUST AND/OR ACID RESISTANT METAL MATERIALS, WORKED AND UNWORKED CASTINGS AND FORGINGS MADE OF STEELS; METAL FORGINGS MADE BY DROP FORGING; CHAIN TENSIONERS MADE OF METAL, ROPE TENSIONERS MADE OF METAL AND BELT TENSIONERS MADE OF METAL; METAL GUIDANCE FOR GUIDING CHAINS, ROPES AND BELTS, NAMELY, METAL GUIDE BARS FOR RAILING, METAL GUIDE RAILS, METAL GUIDE RODS FOR RAILING, DUCTS OF METAL FOR GUIDING CHAINS, ROPES AND BELTS FOR USE IN LIFTING, LASHING, AND RIGGING AS WELL AS CONVEYORS; METAL SHORTENERS FOR ADJUSTING THE LENGTH OF A CHAIN, ROPE AND BELT, NAMELY, SHORTENING CLAWS, SHORTENING HOOKS, SHORTENING CLUTCHES AND SHORTENING COUPLERS; METAL CONNECTORS AND CONNECTING LINKS FOR USE IN LIFTING, LASHING AND RIGGING AS WELL AS CONVEYORS; METAL CHAIN CONNECTORS FOR USE IN LIFTING, LASHING AND RIGGING AS WELL AS CONVEYORS; METAL CHAIN JOINTS AND CHAIN LINKS FOR LIFTING, LASHING AND RIGGING; METAL LIFTING CHAINS AND ROPES, THIN METAL BANDS, BELTS OF METAL FOR HANDLING LOADS, METAL SLINGS FOR LOADING, WIRE ROPE SLINGS, CARGO SLINGS OF METAL; LIFTING GEAR COMPRISING METAL ROPES, METAL CHAINS, METAL BANDS, METAL SLINGS AS WELL AS METAL BEAMS, MECHANICAL FASTENING ELEMENTS OF METAL, METAL BARS, METAL CHAINS, WIRE NETS, METAL BEAMS, METAL HOOKS, METAL CATCH HOOKS, METAL SINGLE HOOKS, METAL DOUBLE HOOKS, METAL FORK HEAD HOOKS, METAL EYE HOOKS, METAL SLIDING HOOKS, METAL WIDE-MOUTH HOOKS, METAL EYEBOLTS, LONG METAL EYES FOR WELDING, SWIVEL EYEBOLTS OF METAL, LONG SWIVEL EYES FOR WELDING OF METAL, SWIVELS, METAL CLAMPS, NAMELY, GRABS AND CLAWS, METAL CLAMPS, NAMELY, CLAWS, SHACKLES AND SPREADER BARS OF METAL; METAL SECURING ELEMENTS FOR LIFTING, LASHING AND FASTENING MEANS, NAMELY, HOOK CATCHES, COFFER PINS, PINS, RINGS, BOLTS, SCREWS, IN CLASS 6 (U.S. CLS. 2, 12, 13, 14, 23, 25 AND 50).



David J. Kypos

Director of the United States Patent and Trademark Office

Reg. No. 4,204,053 FOR: TREATMENT OF MATERIALS, IN PARTICULAR METALWORKING AND FORGING, IN PARTICULAR TREATMENT OF METAL IN THE NATURE OF ABRADING, DEBURRING, BLASTING, SANDBLASTING, DYEING, LACQUERING, COATING, ELECTROPLATING, PUNCHING, FORGING, DROP FORGING, ANNEALING AND TEMPERING, HARDENING, PLATING, POLISHING, GRINDING, WELDING, ROLLING; CUSTOM ASSEMBLING AND FINISHING OF MATERIALS, IN PARTICULAR METALS, FOR OTHERS, NAMELY, METAL FINISHING SERVICES; CUSTOM MANUFACTURE OF TOOLS FOR OTHERS, IN CLASS 40 (U.S. CLS. 100, 103 AND 106).

FOR: TECHNICAL PROJECT RESEARCH AND TECHNICAL PRODUCT PLANNING, ENGINEERING IN THE FIELD OF METALWORKING AND FORGING; MATERIAL TESTING; DEVELOPMENT OF NEW PRODUCTS, FOR OTHERS, IN CLASS 42 (U.S. CLS. 100 AND 101).

THE MARK CONSISTS OF A DESIGN OF A HOOK WITHIN A RECTANGLE WITH CURVED EDGES.

PRIORITY DATE OF 3-25-2010 IS CLAIMED.

OWNER OF INTERNATIONAL REGISTRATION 1078106 DATED 9-20-2010, EXPIRES 9-20-2020.

SER. NO. 79-097,703, FILED 9-20-2010.

CHRISTINA SOBRAL, EXAMINING ATTORNEY

United States of America

United States Patent and Trademark Office

Lyrique

Reg. No. 4,204,054

Registered Sep. 11, 2012

Int. Cls.: 18 and 25

TRADEMARK

PRINCIPAL REGISTER

CHENG SHU YING (CHINA INDIVIDUAL)
10 LANGJIAYUANCUN CHAOYANGQU
100022 BEIJING
CHINA

FOR: BACKPACKS; BANDS OF LEATHER; ANIMAL SKINS; IMITATION LEATHER; PURSES; HANDBAGS; TRAVELING BAGS; UMBRELLAS; WALKING STICKS; GUT FOR MAKING SAUSAGE CASINGS, IN CLASS 18 (U.S. CLS. 1, 2, 3, 22 AND 41).

FOR: CLOTHING, NAMELY, T-SHIRTS, SHIRTS, DRESSES, TROUSERS, JACKETS; LAY-ETTES; BELTS; WATERPROOF CLOTHING, NAMELY, JACKETS AND PANTS; FOOTWEAR; SOCKS; GLOVES; NECKTIES; HEADGEAR FOR WEAR, NAMELY, HATS AND CAPS; SASHES FOR WEAR AND SCARVES, IN CLASS 25 (U.S. CLS. 22 AND 39).

THE ENGLISH TRANSLATION OF "LYRIQUE" IN THE MARK IS "OPERA".

OWNER OF INTERNATIONAL REGISTRATION 1079028 DATED 5-4-2011, EXPIRES 5-4-2021.

SER. NO. 79-097,996, FILED 5-4-2011.

DAVID HOFFMAN, EXAMINING ATTORNEY



David J. Kyros

Director of the United States Patent and Trademark Office

United States of America

United States Patent and Trademark Office

medi panthera CF I

Reg. No. 4,204,055

Registered Sep. 11, 2012

Int. Cl.: 10

TRADEMARK

PRINCIPAL REGISTER

MEDI GMBH & CO. KG (FED REP GERMANY LIMITED PARTNERSHIP WITH A LIMITED LIABILITY COMPANY AS GENERAL PARTNER)
MEDICUSSTRABE 1
95448 BAYREUTH, FED REP GERMANY

FOR: CUSHIONED ARTIFICIAL FEET FOR PROSTHESES MADE OF CARBON; CERVICAL, TRUNK, SHOULDER, ARM, HAND, LEG, KNEE, FOOT AND ANKLE JOINT ORTHESES; ARTIFICIAL LEG, KNEE AND FOOT PROSTHESES; PARTS OF PROSTHESES, NAMELY, ARTIFICIAL KNEE CAPS, LINERS FOR PROSTHESES, COVERS FOR PROSTHESES, ADAPTERS FOR PROSTHESES AND ARTIFICIAL LIMBS; PROSTHESES ACCESSORIES OF SILICON, NAMELY, ARTIFICIAL KNEE CAPS, LINERS FOR PROSTHESES, COVERS FOR PROSTHESES, AND ADAPTERS FOR PROSTHESES: ARTIFICIAL JOINTS; ARTIFICIAL KNEE CAPS, LINERS FOR PROSTHESES, ARTIFICIAL FEET FOR PROSTHESES, COVERS FOR PROSTHESES, AND ADAPTERS FOR PROSTHESES, IMPLANTS CONSISTING OF ARTIFICIAL MATERIAL, IN CLASS 10 (U.S. CLS. 26, 39 AND 44).

THE MARK CONSISTS OF STANDARD CHARACTERS WITHOUT CLAIM TO ANY PARTICULAR FONT, STYLE, SIZE, OR COLOR.

PRIORITY DATE OF 12-30-2010 IS CLAIMED.

OWNER OF INTERNATIONAL REGISTRATION 1079044 DATED 3-24-2011, EXPIRES 3-24-2021.

SER. NO. 79-098,003, FILED 3-24-2011.

ANNE FARRELL, EXAMINING ATTORNEY



David J. Kyjars

Director of the United States Patent and Trademark Office

United States of America

United States Patent and Trademark Office

DODUCO

Reg. No. 4,204,056

Registered Sep. 11, 2012

**Int. Cls.: 1, 2, 3, 6, 9, 14,
40 and 42**

TRADEMARK

SERVICE MARK

PRINCIPAL REGISTER

DODUCO GMBH (FED REP GERMANY LIMITED LIABILITY COMPANY)
IM ALTGEFÄLL 12
75181 PFORZHEIM
FED REP GERMANY

FOR: CHEMICAL PREPARATIONS FOR USE IN INDUSTRY; CHEMICAL PREPARATIONS FOR SCIENTIFIC PURPOSES; PHOTOGRAPHIC CHEMICALS; UNPROCESSED ARTIFICIAL RESINS, UNPROCESSED PLASTICS; FERTILIZING PREPARATIONS; FIRE EXTINGUISHING COMPOSITIONS; CHEMICAL PREPARATIONS FOR HARDENING, TEMPERING, BRAZING AND SOLDERING OF METALS; CHEMICAL PREPARATIONS FOR PRESERVING FOODSTUFFS; ADHESIVES FOR INDUSTRIAL PURPOSES; GALVANIZING BATHS FOR ELECTROLYTIC TREATMENT AND COATING OF SURFACES AND CHEMICAL PREPARATIONS FOR SUCH BATHS; CHEMICAL BATHS FOR ELECTROLESS PLATING OF SURFACES AND CHEMICAL PREPARATIONS FOR SUCH BATHS; CERAMIC SUBSTRATES COATED WITH COMMON METALS AND THEIR ALLOYS FOR ELECTRIC OR ELECTRONIC COMPONENTS; CERAMIC SUBSTRATES COATED WITH PRECIOUS METALS AND THEIR ALLOYS FOR ELECTRIC OR ELECTRONIC COMPONENTS; CHEMICALS FOR THE SURFACE PRE-TREATMENT OF METALS BEFORE ELECTROPLATING AND BEFORE ELECTROLESS PLATING; CHEMICALS FOR GALVANOPLASTICS; GALVANIZING BATHS; SALTS FROM PRECIOUS METALS; RESINATES ON THE BASIS OF PRECIOUS METALS; OILS, CORROSION INHIBITORS AND CLEANING AGENTS FOR ELECTRIC CONTACT PIECES; ION EXCHANGER RESINS FOR PRECIOUS METAL RECOVERY; CHEMICAL CATALYSTS OF PRECIOUS OR NON-PRECIOUS METALS; EMBEDDING COMPOUNDS FOR MANUFACTURING MOLDS FOR USE IN CENTRIFUGAL CASTING; CHEMICALS FOR BRAZING AND SOLDERING; ELECTRICALLY CONDUCTING ADHESIVES FOR INDUSTRIAL PURPOSES, IN CLASS 1 (U.S. CLS. 1, 5, 6, 10, 26 AND 46).



David J. Kyjars

Director of the United States Patent and Trademark Office

FOR: PAINTS, VARNISHES, LACQUERS; PRE-TREATMENT COATINGS FOR INORGANIC METAL SURFACES TO IMPROVE ADHESION AND CORROSION RESISTANCE AGAINST RUST; COLORANTS; MORDANT DYES; RAW NATURAL RESINS; METALS IN FOIL AND POWDER FORM FOR PAINTERS, DECORATORS, PRINTERS AND ARTISTS; PAINTS, LACQUERS AND PRINTERS' PASTES CONTAINING METALLIC PIGMENTS FOR USE IN INDUSTRY AND METALLIC POWDER PIGMENTS FOR PREPARING SUCH PAINTS, LACQUERS AND PRINTERS' PASTES; COATING COMPOSITIONS IN THE NATURE OF PAINTS, LACQUERS AND PASTES CONTAINING THERMOSETTING RESINS AND METALLIC PIGMENTS FOR INDUSTRIAL APPLICATIONS; BRONZING POWDERS, IN CLASS 2 (U.S. CLS. 6, 11 AND 16).

Reg. No. 4,204,056 FOR: CLEANING AGENTS FOR ELECTRIC CONTACTS, IN CLASS 3 (U.S. CLS. 1, 4, 6, 50, 51 AND 52).

FOR: COMMON METALS AND THEIR ALLOYS; TRANSPORTABLE BUILDINGS OF METAL; MATERIALS OF METAL FOR RAILWAY TRACKS; NON-ELECTRIC CABLES AND WIRES OF COMMON METAL; SMALL ITEMS OF METAL HARDWARE, NAMELY, NUTS, SCREWS, SPRINGS, DISCS, PINS, RIVETS, PLATES; PIPES AND TUBES OF METAL; METAL SAFES; RAW MATERIALS, NAMELY, POWDERS, FLAKES AND GRANULES OF COMMON METALS AND THEIR ALLOYS, AND COMPOSITE MATERIALS, NAMELY, POWDERS, FLAKES AND GRANULES COMPOSED OF COMMON METALS AND METAL OXIDES OR OF COMMON METALS AND METALLOIDS OR OF COMMON METALS AND GRAPHITE; METAL WIRES, BANDS, STAMPED BANDS, TAPES, STRIPS, BARS, PLATES, STAMPINGS AND PROFILES MADE OF COMMON METALS AND THEIR ALLOYS OR COATED WITH COMMON METALS AND THEIR ALLOYS, OR OF COMPOSITE MATERIALS CONTAINING COMMON METALS OR THEIR ALLOYS AND GRAPHITE OR METAL OXIDES OR METALLOIDS FOR USE IN INDUSTRY; RAW MATERIALS, COMPOSITE MATERIALS, WROUGHT MATERIALS, NAMELY, POWDERS, FLAKES AND GRANULES OF THE AFORESAID MATERIALS, AND SEMI-FINISHED PRODUCTS, NAMELY, METAL WIRES, BANDS, STAMPED BANDS, TAPES, STRIPS, BARS, PLATES, STAMPINGS AND PROFILES MADE OF COMMON METALS AND THEIR ALLOYS OR COATED WITH COMMON METALS AND THEIR ALLOYS, OR OF COMPOSITE MATERIALS CONTAINING COMMON METALS OR THEIR ALLOYS AND GRAPHITE OR METAL OXIDES OR METALLOIDS FOR ELECTRIC CONTACTS, ELECTRIC AND ELECTRONIC APPLICATIONS AND FUSES; SOLDERING ALLOYS AND BRAZING ALLOYS CONSISTING OF COMMON METALS; COMMON METALS AND THEIR ALLOYS IN THE FORM OF FOILS, POWDERS, BIMETALS, LAMINATED METALS, SINTERED MATERIALS, MATERIALS CONTAINING GRAPHITE, MATERIALS CONTAINING METAL OXIDES AND MATERIALS CONTAINING METALLOIDS, IN CLASS 6 (U.S. CLS. 2, 12, 13, 14, 23, 25 AND 50).

FOR: APPARATUS AND INSTRUMENTS FOR CONDUCTING, SWITCHING, TRANSFORMING, ACCUMULATING, REGULATING OR CONTROLLING ELECTRICITY, NAMELY, ELECTRIC LEADS, ELECTRIC LEAD-FRAMES, ELECTRIC SENSORS, ELECTRIC ACTUATORS, ELECTRIC CURRENT AND VOLTAGE LIMITERS, DEVICES FOR PREVENTING OR EXTINGUISHING AN ELECTRICAL DISCHARGE; APPARATUS FOR RECORDING, TRANSMISSION OR REPRODUCTION OF DATA, SOUND OR IMAGES; BLANK OPTICAL DATA CARRIERS; BLANK MAGNETIC DATA CARRIERS; AUTOMATIC VENDING MACHINES AND MECHANISMS FOR COIN-OPERATED APPARATUS; CASH REGISTERS, CALCULATING MACHINES, DATA PROCESSING EQUIPMENT AND COMPUTERS; FIRE-EXTINGUISHING APPARATUS; ELECTRIC CONTACTS AND PARTS THEREFOR, NAMELY, ELECTRIC CONTACT RIVETS, ELECTRIC CONTACT TIPS, ELECTRIC CONTACT PINS, ELECTRIC BURN-OFF PIECES, FOR USE IN ELECTRIC SWITCHES, ELECTRIC CONTACT TULIPS, ELECTRIC CONTACT TUBES, ELECTRIC CONTACT RINGS, ELECTRIC CONTACT DISCS, ELECTRIC CONTACT SPRINGS, WELD BUTTONS; ELECTRIC SHAPED PARTS, NAMELY, METALLIC PREFORMED PARTS MOUNTED WITH CONTACT PIECES FOR MAKING ELECTRIC CONTACT; ELECTRIC CONTACT PARTS, NAMELY, SNAP DISCS FOR ELECTRIC SWITCHES, CONTACT RIVETS, CONTACT SPRINGS, SELECTIVELY ELECTROPLATED CONTACTS AS INDIVIDUAL PARTS OR AS CONTINUOUS STRIPS OR STAMPED STRIPS FOR ELECTRIC CONNECTORS, FOR LEAD-FRAMES, FOR SWITCHES, ALSO FOR VACUUM SWITCHES AND FOR HIGH-VOLTAGES SWITCHES; ELECTRIC CONTACT PARTS COATED WITH PLASTIC OR CERAMIC OR MOUNTED THEREIN, ALSO IN THE FORM OF ELECTRIC OR ELECTRONIC CIRCUIT MODULES; ELECTRIC SWITCHES; ELECTROMECHANIC SWITCHES; ELECTRIC SWITCHGEARS; HOUSINGS FOR ELECTRIC AND ELECTRONIC SWITCH MODULES, FOR ELECTRIC AND ELECTRONIC CIRCUITS AND FOR COMPONENTS OF ELECTRIC AND ELECTRONIC CIRCUITS. HYBRID FRAMES, NAMELY, COMPOSITE HOUSINGS, INCLUDING MOLDED PLASTIC HOUSINGS AND MOLDED CERAMIC HOUSINGS, HAVING ELECTRIC LEADS AND/OR ELECTRIC CONTACTS AND/OR COMPONENTS OF ELECTRIC OR ELECTRONIC CIRCUITS INTEGRATED IN THE MOLDED PLASTIC OR IN THE MOLDED CERAMIC,

Reg. No. 4,204,056 FOR USE IN INDUSTRY; ELECTRIC CIRCUIT MODULES; ELECTRONIC CIRCUIT MODULES; MODULES CONTAINING ELECTROMECHANIC COMPONENTS; ELECTRODES, IN CLASS 9 (U.S. CLS. 21, 23, 26, 36 AND 38).

FOR: PRECIOUS METALS AND THEIR ALLOYS; JEWELLERY AND PRECIOUS STONES; HOROLOGICAL AND CHRONOMETRIC INSTRUMENTS; RAW MATERIALS, NAMELY, POWDERS, FLAKES AND GRANULES OF PRECIOUS METALS AND THEIR ALLOYS, AND COMPOSITE MATERIALS, NAMELY, POWDERS, FLAKES AND GRANULES COMPOSED OF PRECIOUS METALS AND METAL OXIDES OR OF PRECIOUS METALS AND METALLOIDS OR OF PRECIOUS METALS AND GRAPHITE; METAL WIRES, BANDS, STAMPED BANDS, TAPES, STRIPS, BARS, PLATES, STAMPINGS AND PROFILES MADE OF PRECIOUS METALS AND THEIR ALLOYS OR COATED WITH PRECIOUS METALS AND THEIR ALLOYS, OR OF COMPOSITE MATERIALS CONTAINING PRECIOUS METALS OR THEIR ALLOYS AND GRAPHITE OR METAL OXIDES OR METALLOIDS FOR USE IN INDUSTRY AND IN MAKING JEWELLERY; RAW MATERIALS, COMPOSITE MATERIALS, WROUGHT MATERIALS NAMELY, POWDERS, FLAKES AND GRANULES OF THE AFORESAID MATERIALS, AND SEMI-FINISHED PRODUCTS, NAMELY, METAL WIRES, BANDS, STAMPED BANDS, TAPES, STRIPS, BARS, PLATES, STAMPINGS AND PROFILES MADE OF PRECIOUS METALS AND THEIR ALLOYS OR COATED WITH PRECIOUS METALS AND THEIR ALLOYS, OR OF COMPOSITE MATERIALS CONTAINING PRECIOUS METALS OR THEIR ALLOYS AND GRAPHITE OR METAL OXIDES OR METALLOIDS FOR ELECTRIC CONTACTS, ELECTRIC AND ELECTRONIC APPLICATIONS AND FUSES; SOLDERING ALLOYS AND BRAZING ALLOYS CONTAINING PRECIOUS METALS; PRECIOUS METALS AND THEIR ALLOYS IN THE FORM OF FOILS, POWDERS, BIMETALS, LAMINATED METALS, SINTERED MATERIALS, MATERIALS CONTAINING GRAPHITE, MATERIALS CONTAINING METAL OXIDES AND MATERIALS CONTAINING METALLOIDS, IN CLASS 14 (U.S. CLS. 2, 27, 28 AND 50).

FOR: TREATMENT OF MATERIALS, NAMELY, COATING OR PLATING THE MATERIALS WITH METALS; REFINING AND RECYCLING OF PRECIOUS METALS; COATING SERVICES, NAMELY, ELECTROLYTIC COATING, ELECTROLESS COATING, COATING BY PHYSICAL VAPOUR DEPOSITION PROCESSES, CHEMICAL VAPOUR DEPOSITION PROCESSES, SPUTTERING AND BY OTHER METHODS FOR DEPOSITION OF METALS FROM GASEOUS PHASES, COATING BY ROLLING, COATING BY SPRAYING, METAL TREATING AND CASTING, HARDENING OF METAL AND METAL PRODUCTS FOR USE IN ELECTROTECHNOLOGY, ELECTRONICS, AUTOMOTIVE ENGINEERING, AEROSPACE ENGINEERING, HIGH-FREQUENCY ENGINEERING, CHEMICAL ENGINEERING, MEDICAL ENGINEERING, MECHANICS, LASER OPTICS; COATING OF CIRCUIT BOARDS; COATING OF BANDS AND PRE-CUT BANDS; COATING OF STAMPED PARTS; COATING OF WIRES; COATING OF WIRES, BANDS, STAMPED BANDS, TAPES, STRIPS, PLATES, STAMPINGS, PROFILES, MACHINED PARTS AND MOLDED PARTS BY USE OF PHYSICAL VAPOUR DEPOSITION PROCESSES, CHEMICAL VAPOUR DEPOSITION PROCESSES, SPUTTERING AND BY OTHER METHODS FOR DEPOSITION OF METALS FROM GASEOUS PHASES; CHEMICAL AND ELECTROLYTICAL COATING OF CARRIERS FOR ELECTRIC AND ELECTRONIC COMPONENTS, IN PARTICULAR OF CERAMIC CARRIERS, WITH COMMON METALS AND PRECIOUS METALS; MANUFACTURING TOOLS FOR STAMPING AND PLASTIC MOLDING TO THE ORDER AND SPECIFICATION OF OTHERS; TECHNICAL CONSULTING AND TECHNICAL SUPPORT SERVICES, NAMELY, PROVIDING TECHNICAL ADVICE RELATED TO MANUFACTURING IN THE FIELDS OF MATERIALS, SURFACE ENGINEERING, JOINING TECHNOLOGY, POWDER METALLURGY, PROTECTIVE COATINGS, DECORATIVE COATINGS AND OPERATIONAL COATINGS, ELECTRICAL CONTACTS AND ELECTRICAL SWITCHES, SURFACE ANALYSIS, TESTING OF SWITCHES, ENDURANCE TESTS, LIFETIME TESTS, IN CLASS 40 (U.S. CLS. 100, 103 AND 106).

FOR: RESEARCH SERVICES AND ANALYTICAL STUDIES IN THE FIELD OF MATERIALS, SURFACE ENGINEERING, JOINING TECHNOLOGY, POWDER METALLURGY, PROTECTIVE COATINGS, DECORATIVE COATINGS AND OPERATIONAL COATINGS, ELECTRICAL CONTACTS AND ELECTRICAL SWITCHES; TECHNOLOGICAL SERVICES, NAMELY,

Reg. No. 4,204,056 DESIGNING TOOLS FOR STAMPING AND PLASTIC MOLDING; DESIGN AND DEVELOPMENT OF COMPUTER HARDWARE AND SOFTWARE; CREATION OF DATA PROCESSING PROGRAMS AND COMPUTER SOFTWARE; CREATION OF PROGRAMS FOR PROCESS CONTROL; TECHNICAL CONSULTING IN THE FIELD OF PHYSICS, MATERIAL SCIENCE, SURFACE ENGINEERING, JOINING TECHNOLOGY, POWDER METALLURGY, ELECTRICAL ENGINEERING, SURFACE ANALYSIS, TESTING OF SWITCHES; CHEMISTRY SERVICES, NAMELY, DEVELOPING BATH COMPOSITIONS FOR ELECTROLYTICAL AND ELECTROLESS COATING PROCESSES; ENGINEERING; TESTING OF SWITCHGEARS; MATERIAL TESTING AND EVALUATION, NAMELY, METALLOGRAPHIC ANALYSIS, CHEMICAL ANALYSIS, GAS ANALYSIS, SURFACE ANALYSIS, ELECTRON MICROSCOPY AND ANALYSIS BY USE OF X-RAYS; RESEARCH AND DEVELOPMENT IN THE FIELD OF MATERIALS, SURFACE TECHNOLOGY, ANALYTICS, JOINING TECHNOLOGY, POWDER METALLURGY, WEAR-RESISTANT COATINGS, DECORATIVE COATINGS AND FUNCTIONAL COATINGS , IN CLASS 42 (U.S. CLS. 100 AND 101).

THE MARK CONSISTS OF THE STYLIZED WORDING "DODUCO" IN BLUE WITH A RED SQUARE AT THE BEGINNING OF THE WORD.

PRIORITY DATE OF 8-25-2010 IS CLAIMED.

OWNER OF INTERNATIONAL REGISTRATION 1079298 DATED 2-24-2011, EXPIRES 2-24-2021.

THE COLOR(S) BLUE AND RED IS/ARE CLAIMED AS A FEATURE OF THE MARK.

SER. NO. 79-098,117, FILED 2-24-2011.

PAUL MORENO, EXAMINING ATTORNEY

United States of America

United States Patent and Trademark Office



DRUMMONDS

Reg. No. 4,204,057

Registered Sep. 11, 2012

Int. Cl.: 11

FRUMMONDS ARCHITECTURAL ANTIQUES LIMITED (GREAT BRITAIN LIMITED LIABILITY COMPANY)

PIRBRIGHT ROAD
UNIT 2C HENLEY BUSINESS PARK
NORMANDY, UNITED KINGDOM GU32DX

TRADEMARK

FOR: BATHS AND BATH TUBS, BASINS BEING PARTS OF SANITARY INSTALLATIONS AND SINKS, TOILETS AND WATER CLOSETS, TAPS AND SHOWERS, IN CLASS 11 (U.S. CLS. 13, 21, 23, 31 AND 34).

PRINCIPAL REGISTER

THE NAME(S), PORTRAIT(S), AND/OR SIGNATURE(S) SHOWN IN THE MARK DOES NOT IDENTIFY A PARTICULAR LIVING INDIVIDUAL.

OWNER OF INTERNATIONAL REGISTRATION 1079965 DATED 5-13-2011, EXPIRES 5-13-2021.

THE MARK CONSISTS OF A CIRCLE WITH THE LETTER'S "DD" INTERSECTING AND BACKWARDS. THE WORDING "DRUMMONDS" APPEARS BELOW THE DESIGN.

SER. NO. 79-098,388, FILED 5-13-2011.

DAVID HOFFMAN, EXAMINING ATTORNEY



David J. Kyffers

Director of the United States Patent and Trademark Office

United States of America

United States Patent and Trademark Office

i P P Q

Reg. No. 4,204,058

Registered Sep. 11, 2012

**Int. Cls.: 9, 16, 35, 41
and 45**

TRADEMARK

SERVICE MARK

PRINCIPAL REGISTER

IOPENER LIMITED (UNITED KINGDOM LIMITED COMPANY (LTD.))
THE OLD BAKEHOUSE, 2 SOUTH PARADE,
SUMMERTOWN; OXFORD, OXFORDSHIRE OX2 7LJ
UNITED KINGDOM

FOR: DOWNLOADABLE QUESTIONNAIRES, PSYCHOMETRIC TESTS AND WRITTEN REPORTS FEATURING PERSONAL ATTITUDES, APTITUDES AND CHARACTER TRAITS, AS WELL AS ORGANIZATIONAL MANAGEMENT INFORMATION, PROVIDED ON-LINE FROM DATABASES OR THE INTERNET; COMPUTER SOFTWARE FOR THE ASSESSMENT OF PERSONAL DATA, NAMELY, PERSONAL ATTITUDES, APTITUDES AND CHARACTER TRAITS; ELECTRONIC DATABASES IN THE FIELD OF BUSINESS AND PERSONNEL ASSESSMENT AND MANAGEMENT CONTAINING INFORMATION REGARDING PERSONAL ATTITUDES, APTITUDES AND CHARACTER TRAITS RECORDED ON COMPUTER MEDIA; DOWNLOADABLE ELECTRONIC PUBLICATIONS IN THE NATURE OF QUESTIONNAIRES, PSYCHOMETRIC TESTS, PRINTED REPORTS IN THE FIELD OF BUSINESS AND PERSONNEL ASSESSMENT AND MANAGEMENT, AS WELL AS PERSONNEL DEVELOPMENT; DOWNLOADABLE MANUALS AND INSTRUCTION MATERIALS FEATURING EDUCATIONAL, INSTRUCTIONAL, COACHING, TRAINING AND TEACHING MATERIAL IN THE FIELD OF BUSINESS AND PERSONNEL ASSESSMENT AND MANAGEMENT, AS WELL AS PERSONNEL DEVELOPMENT PROVIDED BY ELECTRONIC MEANS AND OTHER ON-LINE COMMUNICATIONS, IN CLASS 9 (U.S. CLS. 21, 23, 26, 36 AND 38).



David J. Kyjars

Director of the United States Patent and Trademark Office

FOR: PRINTED MATTER, NAMELY, BOOKS, PAMPHLETS, JOURNALS, NEWSLETTERS AND BOOKLETS IN THE FIELD OF BUSINESS AND PERSONNEL MANAGEMENT, PERSONNEL ASSESSMENT, ORGANISATIONAL CHANGE MANAGEMENT, EXECUTIVE COACHING, TEAM AND PERSONNEL DEVELOPMENT; PRINTED QUESTIONNAIRES FOR PERSONAL ASSESSMENT; PRINTED PSYCHOMETRIC TESTS FOR SELF-ASSESSMENT AND EMPLOYEE ASSESSMENT; PRINTED REPORTS IN THE FIELD OF BUSINESS AND PERSONNEL MANAGEMENT, PERSONNEL ASSESSMENT, ORGANISATIONAL CHANGE MANAGEMENT, EXECUTIVE COACHING, TEAM AND PERSONNEL DEVELOPMENT; PRINTED TRAINING GUIDES IN THE FIELD OF BUSINESS AND PERSONNEL MANAGEMENT, PERSONNEL ASSESSMENT, ORGANISATIONAL CHANGE MANAGEMENT, EXECUTIVE COACHING, TEAM AND PERSONNEL DEVELOPMENT; MANUALS IN THE FIELD OF BUSINESS AND PERSONNEL MANAGEMENT, PERSONNEL ASSESSMENT, ORGANISATIONAL CHANGE MANAGEMENT, EXECUTIVE COACHING, TEAM AND PERSONNEL DEVELOPMENT; PRINTED INSTRUCTION MATERIALS IN THE FIELD OF BUSINESS AND PERSONNEL MANAGEMENT, PERSONNEL ASSESSMENT, ORGAN-

Reg. No. 4,204,058 ISATIONAL CHANGE MANAGEMENT, EXECUTIVE COACHING, TEAM AND PERSONNEL DEVELOPMENT, IN CLASS 16 (U.S. CLS. 2, 5, 22, 23, 29, 37, 38 AND 50).

FOR: BUSINESS MANAGEMENT CONSULTANCY AND BUSINESS APPRAISAL SERVICES; BUSINESS MANAGEMENT, BUSINESS APPRAISAL AND BUSINESS CONSULTANCY SERVICES IN RELATION TO ORGANIZATIONAL CHANGE MANAGEMENT AND DEVELOPMENT, PERSONNEL MANAGEMENT AND PERFORMANCE MANAGEMENT; ARRANGING, ORGANIZING AND CONDUCTING PSYCHOMETRIC TESTS, SURVEYS, QUESTIONNAIRES AND POLLS FOR BUSINESS PURPOSES, TO DETERMINE EMPLOYEE SKILLS, OPINIONS, ATTITUDES, APTITUDES AND CHARACTER, AS WELL AS ORGANIZATIONAL CULTURE; BUSINESS INFORMATION SERVICES, NAMELY, COMPILATION, ANALYSIS AND PROVISION OF BUSINESS DATA AND STATISTICAL INFORMATION; COMPILATION, ANALYSIS AND PROVISION OF PSYCHOMETRIC DATA AND STATISTICAL INFORMATION FOR BUSINESS PURPOSES TO DETERMINE EMPLOYEE SKILLS, OPINIONS, ATTITUDES, APTITUDES AND CHARACTER, AS WELL AS ORGANIZATIONAL CULTURE; PREPARATION OF BUSINESS AND BUSINESS MANAGEMENT REPORTS; BUSINESS INFORMATION, BUSINESS ADVISORY AND BUSINESS CONSULTANCY SERVICES; PROVIDING AN ON-LINE COMPUTER DATABASE IN THE FIELD OF BUSINESS INFORMATION; ON-LINE BUSINESS MANAGEMENT CONSULTANCY AND BUSINESS APPRAISAL SERVICES; ON-LINE ARRANGING, ORGANIZING AND CONDUCTING PSYCHOMETRIC TESTS, SURVEYS, QUESTIONNAIRES AND POLLS FOR BUSINESS PURPOSES, TO DETERMINE EMPLOYEE SKILLS, OPINIONS, ATTITUDES, APTITUDES AND CHARACTER, AS WELL AS ORGANIZATIONAL CULTURE; ON-LINE BUSINESS INFORMATION SERVICES, NAMELY, COMPILATION, ANALYSIS AND PROVISION OF BUSINESS DATA AND STATISTICAL INFORMATION; ON-LINE COMPILATION, ANALYSIS AND PROVISION OF PSYCHOMETRIC DATA AND STATISTICAL INFORMATION FOR BUSINESS PURPOSES TO DETERMINE EMPLOYEE SKILLS, OPINIONS, ATTITUDES, APTITUDES AND CHARACTER, AS WELL AS ORGANIZATIONAL CULTURE; ONLINE PREPARATION OF BUSINESS AND BUSINESS MANAGEMENT REPORTS; ON-LINE BUSINESS INFORMATION, BUSINESS ADVISORY AND BUSINESS CONSULTANCY SERVICES, IN CLASS 35 (U.S. CLS. 100, 101 AND 102).

FOR: EDUCATIONAL, INSTRUCTIONAL, COACHING, TRAINING AND TEACHING SERVICES, NAMELY, PROVIDING CLASSES, SEMINARS AND WORKSHOPS IN THE FIELD OF BUSINESS AND PERSONNEL MANAGEMENT, PERSONNEL ASSESSMENT, ORGANIZATIONAL CHANGE MANAGEMENT, EXECUTIVE COACHING, TEAM AND PERSONNEL DEVELOPMENT; BUSINESS TRAINING SERVICES, NAMELY, PERSONNEL AND EXECUTIVE COACHING, LEADERSHIP AND TEAM DEVELOPMENT SERVICES, INCLUDING THE AFORESAID IN RELATION TO ORGANIZATIONAL CHANGE MANAGEMENT AND DEVELOPMENT, BUSINESS MANAGEMENT, PRESENTATION SKILLS, INTERCULTURAL MANAGEMENT, LEADERSHIP, NEGOTIATING, STRESS MANAGEMENT, TEAM DEVELOPMENT AND WRITING SKILLS; TRAINING IN RELATION TO THE DESIGN AND USE OF PSYCHOMETRIC TESTS, SURVEYS, QUESTIONNAIRES AND POLLS; EDUCATIONAL SERVICES, NAMELY, ORGANIZING AND CONDUCTING CLASSES, WORKSHOPS, TRAINING COURSES, SEMINARS, SYMPOSIUMS, EDUCATIONAL CONFERENCES AND EDUCATIONAL EXHIBITIONS IN THE FIELD OF BUSINESS AND PERSONNEL MANAGEMENT, PERSONNEL ASSESSMENT, ORGANIZATIONAL CHANGE MANAGEMENT, EXECUTIVE COACHING, TEAM AND PERSONNEL DEVELOPMENT; PUBLISHING AND ELECTRONIC PUBLISHING SERVICES, NAMELY, PUBLICATION OF BOOKS, MAGAZINES, PAMPHLETS, JOURNALS, NEWSLETTERS, BOOKLETS, QUESTIONNAIRES, PSYCHOMETRIC TESTS, PRINTED REPORTS AND ELECTRONIC PUBLICATIONS; PROVISION OF ONLINE QUESTIONNAIRES, PSYCHOMETRIC TESTS AND REPORTS IN THE NATURE OF NON-DOWNLOADABLE ELECTRONIC PUBLICATIONS IN THE FIELD OF PERSONNEL MANAGEMENT, PERSONNEL ASSESSMENT, TEAM AND PERSONNEL DEVELOPMENT; PROVIDING ONLINE NON-DOWNLOADABLE ELECTRONIC PUBLICATIONS IN THE NATURE OF ARTICLES, INFORMATION SHEETS, EDUCATIONAL AND TRAINING MATERIAL IN THE FIELD OF BUSINESS AND PERSONNEL MANAGEMENT, PERSONNEL ASSESSMENT, ORGANIZATIONAL CHANGE MANAGEMENT, EXECUTIVE COACHING,

Reg. No. 4,204,058 TEAM AND PERSONNEL DEVELOPMENT; PRODUCTION, DISTRIBUTION, SYNDICATION, AND RENTAL OF TELEVISION PROGRAMS, RADIO PROGRAMS, FILMS, VIDEOS, AND SOUND/VIDEO RECORDINGS; PROVIDING ONLINE NON-DOWNLOADABLE MANUALS AND INSTRUCTION MATERIALS IN THE FIELD OF BUSINESS AND PERSONNEL MANAGEMENT, PERSONNEL ASSESSMENT, ORGANIZATIONAL CHANGE MANAGEMENT, EXECUTIVE COACHING, TEAM AND PERSONNEL DEVELOPMENT PROVIDED BY ELECTRONIC MEANS AND OTHER ON-LINE COMMUNICATIONS; INFORMATION, ADVISORY AND CONSULTANCY SERVICES, NAMELY, PROVIDING PROFESSIONAL, GROUP, AND EXECUTIVE COACHING IN THE FIELDS OF BUSINESS, LEADERSHIP DEVELOPMENT, AND PERSONNEL DEVELOPMENT; INFORMATION, ADVISORY AND CONSULTANCY SERVICES PROVIDED ON-LINE, NAMELY, PROVIDING PROFESSIONAL, GROUP, AND EXECUTIVE COACHING IN THE FIELDS OF BUSINESS, LEADERSHIP DEVELOPMENT, AND PERSONNEL DEVELOPMENT; ORGANIZING AND CONDUCTING CLASSES, WORKSHOPS, TRAINING COURSES, SEMINARS, SYMPOSIUMS, EDUCATIONAL CONFERENCES AND EDUCATIONAL EXHIBITIONS IN THE FIELD OF BUSINESS AND PERSONNEL MANAGEMENT, PERSONNEL ASSESSMENT, ORGANIZATIONAL CHANGE MANAGEMENT, EXECUTIVE COACHING, TEAM AND PERSONNEL DEVELOPMENT, ALL PROVIDED ONLINE, IN CLASS 41 (U.S. CLS. 100, 101 AND 107).

FOR: LICENSING OF BUSINESS MANAGEMENT AND CONSULTANCY SERVICES IN THE FIELD OF ORGANIZATIONAL CHANGE MANAGEMENT AND DEVELOPMENT, PERSONNEL MANAGEMENT AND PERFORMANCE MANAGEMENT; LICENSING OF EDUCATIONAL INSTRUCTIONAL, COACHING, TRAINING AND TEACHING SERVICES IN THE FIELD OF ORGANIZATIONAL CHANGE MANAGEMENT AND DEVELOPMENT, PERSONNEL MANAGEMENT AND PERFORMANCE MANAGEMENT; LICENSING OF DOWNLOADABLE MATERIAL, PRINTED MATTER, ELECTRONIC DATABASES AND COMPUTER SOFTWARE, ALL USED IN THE FIELD OF ORGANIZATIONAL CHANGE MANAGEMENT AND DEVELOPMENT, PERSONNEL MANAGEMENT AND PERFORMANCE MANAGEMENT, TO BUSINESSES, PERSONNEL CONSULTANTS AND EXECUTIVE COACHES, IN CLASS 45 (U.S. CLS. 100 AND 101).

THE MARK CONSISTS OF STANDARD CHARACTERS WITHOUT CLAIM TO ANY PARTICULAR FONT, STYLE, SIZE, OR COLOR.

PRIORITY DATE OF 12-21-2010 IS CLAIMED.

OWNER OF INTERNATIONAL REGISTRATION 1080252 DATED 2-15-2011, EXPIRES 2-15-2021.

SER. NO. 79-098,518, FILED 2-15-2011.

DAVID HOFFMAN, EXAMINING ATTORNEY

United States of America

United States Patent and Trademark Office



Reg. No. 4,204,059

Registered Sep. 11, 2012

Int. Cl.: 41

ILC INTERNATIONAL LEGAL CONSULTANTS (SINGAPORE) PTE. LTD. (SINGAPORE A PRIVATE LIMITED COMPANY)
70A CLUB STREET
SINGAPORE 069443
SINGAPORE

SERVICE MARK

FOR: ENTERTAINMENT SERVICES, NAMELY, LIVE PERFORMANCES BY A MUSICAL GROUP, IN CLASS 41 (U.S. CLS. 100, 101 AND 107).

PRINCIPAL REGISTER

THE MARK CONSISTS OF THE STYLIZED WORD "BLUSH" IN MAGENTA LETTERS AND A CIRCULAR DESIGN WITH OVERLAPPING DIAGONAL LINES COMPRISING OF BANDS OF COLOR IN MAGENTA, RED, ORANGE, YELLOW AND WHITE, ALL ON A BLACK BACKGROUND.

PRIORITY DATE OF 12-16-2010 IS CLAIMED.

OWNER OF INTERNATIONAL REGISTRATION 1081151 DATED 4-8-2011, EXPIRES 4-8-2021.

THE COLOR(S) BLACK, MAGENTA, RED, ORANGE, YELLOW AND WHITE IS/ARE CLAIMED AS A FEATURE OF THE MARK.

SER. NO. 79-098,824, FILED 4-8-2011.

PATRICIA EVANKO, EXAMINING ATTORNEY



David J. Kybas

Director of the United States Patent and Trademark Office

United States of America

United States Patent and Trademark Office

ACAL

Reg. No. 4,204,060

Registered Sep. 11, 2012

Int. Cls.: 35, 39 and 42

SERVICE MARK

PRINCIPAL REGISTER

ACAL PLC (UNITED KINGDOM PUBLIC LIMITED COMPANY)
2 CHANCELLOR COURT, OCCAM ROAD
SURREY RESEARCH PARK; GUILFORD, SURREY GU2 7AH
UNITED KINGDOM

FOR: THE BRINGING TOGETHER, FOR THE BENEFIT OF OTHERS OF A VARIETY OF GOODS ENABLING CUSTOMERS TO CONVENIENTLY VIEW AND PURCHASE THOSE GOODS, NAMELY, ELECTRIC, ELECTRONIC, COMMUNICATION, ELECTROMECHANICAL, IMAGING, MAGNETIC AND OPTICAL APPARATUS, EQUIPMENT AND INSTRUMENTS, SENSORS, LASERS, SCANNERS, SEMICONDUCTORS, MICROSYSTEMS AND PHOTONICS BY WHOLESALE OR IN A RETAIL STORE OR FROM A CATALOGUE BY MAIL ORDER OR BY MEANS OF TELECOMMUNICATIONS OR FROM AN INTERNET WEBSITE; BUSINESS MANAGEMENT SERVICES; BUSINESS ADMINISTRATION SERVICES; OFFICE FUNCTIONS; MARKETING SERVICES; ADVERTISING SERVICES; ADVISORY SERVICES RELATING TO MARKETING; ADVISORY SERVICES FOR BUSINESS MANAGEMENT; THE PROVISION OF INFORMATION AND/OR ADVICE RELATING TO RETAIL SERVICES, IN CLASS 35 (U.S. CLS. 100, 101 AND 102).

FOR: TRANSPORTATION, PACKAGING, STORAGE AND DISTRIBUTION OF ELECTRIC, ELECTRONIC, COMMUNICATION, ELECTROMECHANICAL, IMAGING, MAGNETIC AND OPTICAL APPARATUS, EQUIPMENT AND INSTRUMENTS, SENSORS, LASER, SCANNERS, SEMICONDUCTORS, MICROSYSTEMS AND PHOTONICS, IN CLASS 39 (U.S. CLS. 100 AND 105).



David J. Kyjars

Director of the United States Patent and Trademark Office

FOR: SCIENTIFIC AND TECHNOLOGICAL SERVICES, NAMELY, RESEARCH AND DESIGN IN THE FIELD OF COMPUTER NETWORKING HARDWARE; INDUSTRIAL RESEARCH IN THE FIELD OF COMMUNICATIONS NETWORKS, MEDICAL, ELECTRIC, ELECTRONIC, ELECTRO MECHANICAL, IMAGING, MAGNETIC AND OPTICAL APPARATUS, EQUIPMENT AND INSTRUMENTS; COMPUTER PROGRAMMING; COMPUTER SOFTWARE DESIGN AND DEVELOPMENT; DESIGN AND DEVELOPMENT OF COMPUTER HARDWARE; ENGINEERING SERVICES AND RESEARCH RELATING TO MECHANICAL ENGINEERING; RESEARCH AND DEVELOPMENT RELATING TO MEDICAL, ELECTRIC, ELECTRONIC, COMMUNICATION, ELECTROMECHANICAL, IMAGING, MAGNETIC AND OPTICAL APPARATUS, EQUIPMENT AND INSTRUMENTS; RESEARCH AND DEVELOPMENT RELATING TO MICROSYSTEMS AND PHOTONICS; RESEARCH AND DEVELOPMENT AND CONSULTATION RELATED THERETO IN THE FIELD OF MEDICAL, ELECTRIC, ELECTRONIC, COMMUNICATION, ELECTROMECHANICAL, IMAGING, MAGNETIC

Reg. No. 4,204,060 AND OPTICAL APPARATUS, EQUIPMENT AND INSTRUMENTS, MICROSYSTEMS AND PHOTONICS; MEDICAL AND SCIENTIFIC RESEARCH INFORMATION IN THE FIELD OF MEDICAL, ELECTRIC, ELECTRONIC, COMMUNICATION, ELECTROMECHANICAL, IMAGING, MAGNETIC AND OPTICAL APPARATUS, EQUIPMENT AND INSTRUMENTS, MICROSYSTEMS AND PHOTONICS; TECHNOLOGICAL CONSULTATION IN THE TECHNOLOGY FIELD OF COMPUTER HARDWARE SYSTEMS; TECHNICAL SUPPORT SERVICES, NAMELY, TROUBLESHOOTING OF COMPUTER SOFTWARE PROBLEMS; TECHNICAL ADVICE RELATING TO OPERATION OF COMPUTERS AND PRODUCT DEVELOPMENT CONSULTATION, IN CLASS 42 (U.S. CLS. 100 AND 101).

THE MARK CONSISTS OF STANDARD CHARACTERS WITHOUT CLAIM TO ANY PARTICULAR FONT, STYLE, SIZE, OR COLOR.

PRIORITY DATE OF 11-19-2010 IS CLAIMED.

OWNER OF INTERNATIONAL REGISTRATION 1081393 DATED 5-12-2011, EXPIRES 5-12-2021.

SER. NO. 79-098,904, FILED 5-12-2011.

ZACHARY BELLO, EXAMINING ATTORNEY

United States of America

United States Patent and Trademark Office

DAOSIN

Reg. No. 4,204,061

Registered Sep. 11, 2012

Int. Cls.: 5 and 29

SCIOTEC DIAGNOSTIC TECHNOLOGIES GMBH (AUSTRIA LIMITED LIABILITY COMPANY)
ZIEGELFELDSTRASSE 3
A-3430 TULIN
AUSTRIA

TRADEMARK

PRINCIPAL REGISTER

FOR: PHARMACEUTICAL PREPARATIONS FOR THE TREATMENT OF HISTAMINE INTOLERANCE; CHEMICO-PHARMACEUTICAL PREPARATIONS FOR THE TREATMENT OF HISTAMINE INTOLERANCE; SANITARY PREPARATIONS FOR MEDICAL PURPOSES; BIOLOGICAL PREPARATIONS FOR MEDICAL PURPOSES, NAMELY, FOR THE TREATMENT OF HISTAMINE INTOLERANCE; CHEMICAL PREPARATIONS FOR MEDICAL PURPOSES, NAMELY, FOR THE TREATMENT OF HISTAMINE INTOLERANCE; ENZYMES AND ENZYME PREPARATIONS FOR MEDICAL PURPOSES; DIETETIC FOODS ADAPTED FOR MEDICAL PURPOSES; DIAGNOSTIC PREPARATIONS FOR MEDICAL PURPOSES; CHEMICAL REAGENTS FOR MEDICAL PURPOSES; NUTRITIONAL ADDITIVES FOR MEDICAL PURPOSES FOR USE IN FOODS AND DIETARY SUPPLEMENTS FOR HUMAN CONSUMPTION; NUTRITIONAL ADDITIVES TO FOODSTUFFS FOR ANIMALS FOR MEDICAL PURPOSES, IN CLASS 5 (U.S. CLS. 6, 18, 44, 46, 51 AND 52).

FOR: FOOD ADDITIVES, NAMELY, NATURAL FOOD EXTRACTS DERIVED FROM PIG, NOT FOR MEDICINAL PURPOSES AND FOR HUMAN CONSUMPTION; PROTEIN FOR USE AS A FOOD ADDITIVE; PROTEIN PELLETS FOR HUMAN CONSUMPTION FOR USE AS A FOOD ADDITIVE; PROTEINS BEING FOODSTUFFS FOR HUMAN CONSUMPTION, IN CLASS 29 (U.S. CL. 46).



THE MARK CONSISTS OF STANDARD CHARACTERS WITHOUT CLAIM TO ANY PARTICULAR FONT, STYLE, SIZE, OR COLOR.

OWNER OF INTERNATIONAL REGISTRATION 1065130 DATED 11-12-2010, EXPIRES 11-12-2020.

THE WORDING "DAOSIN" HAS NO MEANING IN A FOREIGN LANGUAGE.

SER. NO. 79-098,939, FILED 5-13-2011.

ELIZABETH HUGHITT, EXAMINING ATTORNEY

David J. Kyffers

Director of the United States Patent and Trademark Office

United States of America

United States Patent and Trademark Office



Reg. No. 4,204,062

Registered Sep. 11, 2012

Int. Cl.: 40

SERVICE MARK

PRINCIPAL REGISTER

ESSILOR INTERNATIONAL (COMPAGNIE GENERALE D'OPTIQUE) (FRANCE SOCIÉTÉ ANONYME)
147 RUE DE PARIS
F-94220 CHARENTON LE PONT, FRANCE

FOR: MACHINING, SIZING, CUTTING, GRINDING, EDGING, BEVELLING, FEATHER EDGING, EDGING WITH A GROOVE, CHAMFERING, DRILLING, FINISHING, SMOOTHING, POLISHING, FINE REWORKING AND STRIPPING OF SPECTACLE LENSES AND OPHTHALMIC LENSES; TREATMENT AND COATING OF SPECTACLE LENSES AND OPHTHALMIC LENSES; APPLICATION OF TEMPORARY ADHERENT TOP LAYERS AND COATINGS TO SPECTACLE LENSES AND OPHTHALMIC LENSES, IN CLASS 40 (U.S. CLS. 100, 103 AND 106).

NO CLAIM IS MADE TO THE EXCLUSIVE RIGHT TO USE "BLOCKING" , APART FROM THE MARK AS SHOWN.

PRIORITY DATE OF 11-9-2010 IS CLAIMED.

OWNER OF INTERNATIONAL REGISTRATION 1081858 DATED 5-6-2011, EXPIRES 5-6-2021.

THE COLOR(S) GREEN, BLUE AND OFF-WHITE IS/ARE CLAIMED AS A FEATURE OF THE MARK.

THE WORDS "GREEN" AND "TECHNO" ARE IN GREEN; THE WORD "BLOCKING" IS IN OFF-WHITE AND APPEARS INSIDE A FRAME WITH A BLUE BACKGROUND.

SER. NO. 79-099,071, FILED 5-6-2011.

ERNEST SHOSHO, EXAMINING ATTORNEY



David J. Kybas

Director of the United States Patent and Trademark Office

United States of America

United States Patent and Trademark Office

TINSELTOWN

Reg. No. 4,204,063

Registered Sep. 11, 2012

Int. Cl.: 43

SERVICE MARK

PRINCIPAL REGISTER

SUHAIL HASAN (UNITED KINGDOM INDIVIDUAL)
UNIT D/E, 17 QUEENSWAY
ENFIELD, MIDDLESEX EN3 4SA
UNITED KINGDOM

FOR: SERVICES FOR PROVIDING FOOD AND DRINK; RESTAURANT, BAR AND CATERING SERVICES; CAFÉS; SNACK-BARS; TAKEAWAY RESTAURANT SERVICES; RESTAURANT, CAFÉS AND SNACK-BARS FEATURING HOME DELIVERY, IN CLASS 43 (U.S. CLS. 100 AND 101).

THE MARK CONSISTS OF STANDARD CHARACTERS WITHOUT CLAIM TO ANY PARTICULAR FONT, STYLE, SIZE, OR COLOR.

OWNER OF INTERNATIONAL REGISTRATION 1082308 DATED 6-10-2011, EXPIRES 6-10-2021.

SER. NO. 79-099,266, FILED 6-10-2011.

RON FAIRBANKS, EXAMINING ATTORNEY



David J. Kyffers

Director of the United States Patent and Trademark Office

United States of America

United States Patent and Trademark Office

alpurel

Reg. No. 4,204,064

Registered Sep. 11, 2012

Int. Cl.: 32

TRADEMARK

PRINCIPAL REGISTER

KURT BRAUNHOFER (AUSTRIA INDIVIDUAL)
GRABEN 27
A-1010 WIEN
AUSTRIA

FOR: MINERAL AND AERATED WATERS; NON-ALCOHOLIC COCKTAILS; NON-ALCOHOLIC BEVERAGES, NAMELY, CARBONATED BEVERAGES; FRUIT DRINKS AND FRUIT JUICES; SYRUPS FOR BEVERAGES; PREPARATIONS FOR MAKING BEVERAGES, NAMELY, FRUIT DRINKS; CONCENTRATES, SYRUPS OR POWDERS FOR MAKING SOFT DRINKS OR TEA-FLAVORED BEVERAGES, IN CLASS 32 (U.S. CLS. 45, 46 AND 48).

THE MARK CONSISTS OF STANDARD CHARACTERS WITHOUT CLAIM TO ANY PARTICULAR FONT, STYLE, SIZE, OR COLOR.

PRIORITY DATE OF 12-27-2010 IS CLAIMED.

OWNER OF INTERNATIONAL REGISTRATION 1082379 DATED 6-21-2011, EXPIRES 6-21-2021.

THE WORDING "ALPUREL" HAS NO MEANING IN A FOREIGN LANGUAGE.

SER. NO. 79-099,291, FILED 6-21-2011.

SKYE YOUNG, EXAMINING ATTORNEY



David J. Kyffers

Director of the United States Patent and Trademark Office

United States of America

United States Patent and Trademark Office

VIVID

Reg. No. 4,204,065

Registered Sep. 11, 2012

Int. Cl.: 16

TRADEMARK

PRINCIPAL REGISTER

STORA ENSO OYJ (FINLAND PUBLIC LIMITED LIABILITY COMPANY)
KANAVARANTA 1
FI-00160 HELSINKI
FINLAND

FOR: PAPER, NAMELY, UNPRINTED BOOK PAPER, IN CLASS 16 (U.S. CLS. 2, 5, 22, 23, 29, 37, 38 AND 50).

THE MARK CONSISTS OF STANDARD CHARACTERS WITHOUT CLAIM TO ANY PARTICULAR FONT, STYLE, SIZE, OR COLOR.

PRIORITY DATE OF 1-20-2011 IS CLAIMED.

OWNER OF INTERNATIONAL REGISTRATION 1084756 DATED 7-11-2011, EXPIRES 7-11-2021.

SER. NO. 79-100,244, FILED 7-11-2011.

DAVID HOFFMAN, EXAMINING ATTORNEY



David J. Kyffers

Director of the United States Patent and Trademark Office

United States of America

United States Patent and Trademark Office



Reg. No. 4,204,066

Registered Sep. 11, 2012

Int. Cls.: 9 and 10

TRADEMARK

PRINCIPAL REGISTER

AEROCRINE AB (SWEDEN CORPORATION)
SUNDBYBERG SVÄGEN 9
SE-171 73 SOLNA
SWEDEN

FOR: COMPUTER EQUIPMENT FOR DIAGNOSIS AND MONITORING OF AIRWAY INFLAMMATION AND RESPIRATORY STATUS, NAMELY, COMPUTER SOFTWARE FOR DIAGNOSIS AND MONITORING OF AIRWAY INFLAMMATION AND RESPIRATORY STATUS; RECORDED COMPUTER PROGRAMS, NAMELY, COMPUTER SOFTWARE FOR USE IN THE CALIBRATION, CALCULATION AND CORRECTION OF DATA VALUES FOR USE IN MONITORING OF AIRWAY INFLAMMATION AND RESPIRATORY STATUS; AND COMPUTER HARDWARE, IN CLASS 9 (U.S. CLS. 21, 23, 26, 36 AND 38).

FOR: MEDICAL APPARATUS FOR SAMPLING OF GASES IN HUMAN ORGANS AND FOR CONTROL OF PULMONARY FUNCTIONALITY; FLOW REGULATORS FOR EXHALATION CONTROL; CONTAINERS FOR STORAGE OF EXHALATION TESTS; RESPIRATORY FILTERS AND NOZZLES FOR USE IN SAMPLING OF EXHALATION; CONTAINERS FOR SAMPLING AND STORAGE OF GAS TESTS, IN CLASS 10 (U.S. CLS. 26, 39 AND 44).

OWNER OF U.S. REG. NOS. 2,595,291, 3,303,027 AND OTHERS.

PRIORITY DATE OF 12-16-2010 IS CLAIMED.

OWNER OF INTERNATIONAL REGISTRATION 1084868 DATED 6-13-2011, EXPIRES 6-13-2021.

SER. NO. 79-100,293, FILED 6-13-2011.

SKYE YOUNG, EXAMINING ATTORNEY



David J. Kybas

Director of the United States Patent and Trademark Office

United States of America

United States Patent and Trademark Office



THUROS

Reg. No. 4,204,067

PETER SCHNEIDER (FED REP GERMANY INDIVIDUAL)
FRIEDENSSTRASSE 8

Registered Sep. 11, 2012

GEORGENTHAL, FED REP GERMANY 99887

Int. Cls.: 8, 11, 20 and 21

FOR: HAND GRILL TOOLS, NAMELY, GRILL SCRAPERS, GRILL TONGS, GRILL FORKS AND GRILL SPATULAS, IN CLASS 8 (U.S. CLS. 23, 28 AND 44).

TRADEMARK

FOR: PARTS AND ACCESSORIES FOR GRILLS, NAMELY, GRIDIRONS AND WARMING GRIDIRONS, GRILL HOODS AND GRILL COVERS, DRIP PANS, STAINLESS STEEL SHELVES, GRILL SPITS WITH MOTOR, ROTATABLE TUBE FOR GRILLING, MOUNTABLE WIND DEFLECTORS, AND HEATERS AND FIREPLACE INSERTS, ELECTRIC GRILL ELEMENT, GRILL STAND AND GRILL CARTS; SMOKING CABINETS, NOT FOR MEDICAL PURPOSES, IN CLASS 11 (U.S. CLS. 13, 21, 23, 31 AND 34).

PRINCIPAL REGISTER

FOR: FURNITURE, IN CLASS 20 (U.S. CLS. 2, 13, 22, 25, 32 AND 50).

FOR: HOUSEHOLD AND KITCHEN GOODS, NAMELY, GRIDIRONS FOR GRILLING, ROASTING SPITS, MEAT SKEWERS, FISH ROASTING PANS, GRILL PANS, GRILL POTS, BARBECUE CUPS, GLOVES FOR HOUSEHOLD PURPOSES, NAMELY, GRILL GLOVES, AND BARBECUE CLEANING BRUSHES, GRILL SCRAPERS, INCENSE BURNERS, IN CLASS 21 (U.S. CLS. 2, 13, 23, 29, 30, 33, 40 AND 50).

OWNER OF U.S. REG. NO. 3,968,836.

PRIORITY DATE OF 5-6-2010 IS CLAIMED.

OWNER OF INTERNATIONAL REGISTRATION 1085234 DATED 11-4-2010, EXPIRES 11-4-2020.

THE COLOR(S) BLACK, RED AND WHITE IS/ARE CLAIMED AS A FEATURE OF THE MARK.

THE MARK CONSISTS OF THE WORDING "THUROS" IN THE COLOR BLACK WITH STYLIZED FLAME IN THE COLORS RED AND WHITE ABOVE THE "U".

THE WORD(S) "THUROS" HAS NO MEANING IN A FOREIGN LANGUAGE.



David J. Kyffers

Director of the United States Patent and Trademark Office

Reg. No. 4,204,067 SER. NO. 79-100,462, FILED 11-4-2010.

LESLIE RICHARDS, EXAMINING ATTORNEY

United States of America

United States Patent and Trademark Office

c o n i c o n i

Reg. No. 4,204,068

Registered Sep. 11, 2012

Int. Cl.: 28

TRADEMARK

PRINCIPAL REGISTER

MEDIA LABORATORY CO., LTD. (JAPAN CORPORATION)
3-9-14-203, ADACHI
ADACHI-KU
TOKYO 120-0015, JAPAN

FOR: GO GAMES; JAPANESE PLAYING CARDS (UTAGARUTA); JAPANESE CHESS (SHOGI GAMES); DICE; JAPANESE DICE GAMES (SUGOROKU); PLAYING CARDS; JAPANESE PLAYING CARDS (HANAFUDA); MAH-JONG; CARDS FOR GAMES, IN CLASS 28 (U.S. CLS. 22, 23, 38 AND 50).

THE WORD(S) "CONI CONI" HAS NO MEANING IN A FOREIGN LANGUAGE.

PRIORITY DATE OF 5-26-2011 IS CLAIMED.

OWNER OF INTERNATIONAL REGISTRATION 1085521 DATED 6-29-2011, EXPIRES 6-29-2021.

SER. NO. 79-100,560, FILED 6-29-2011.

GINA FINK, EXAMINING ATTORNEY



David J. Kyffers

Director of the United States Patent and Trademark Office

United States of America

United States Patent and Trademark Office

pressmaster

Quality To Hand

Reg. No. 4,204,069

Registered Sep. 11, 2012

Int. Cls.: 7 and 8

TRADEMARK

PRINCIPAL REGISTER

PRESSMASTER AB (SWEDEN CORPORATION)
PO BOX 3
SE-796 21 ÄLVDALLEN
SWEDEN

FOR: HAND-HELD TOOLS, NAMELY, HAND-HELD POWERED AND BATTERY ACTUATED HYDRAULIC CRIMP TOOL, IN CLASS 7 (U.S. CLS. 13, 19, 21, 23, 31, 34 AND 35).

FOR: HAND TOOLS, NAMELY, CRIMP WRENCHES AND CRIMP WRENCH SETS; HAND TOOLS, NAMELY, WIRE CRIMPERS; HAND STRIPPING TOOLS FOR PREPARING ELECTRONIC AND ELECTRICAL WIRES AND CABLES, IN CLASS 8 (U.S. CLS. 23, 28 AND 44).

OWNER OF U.S. REG. NO. 990,779.

OWNER OF INTERNATIONAL REGISTRATION 1085721 DATED 7-4-2011, EXPIRES 7-4-2021.

THE COLOR(S) BLUE IS/ARE CLAIMED AS A FEATURE OF THE MARK.

THE MARK CONSISTS OF THE WORDING "PRESSMASTER" IN BLUE FOLLOWED UNDERNEATH BY THE WORDING "QUALITY TO HAND" IN BLUE.

SER. NO. 79-100,670, FILED 7-4-2011.

HAI-LY LAM, EXAMINING ATTORNEY



David J. Kyros

Director of the United States Patent and Trademark Office

United States of America

United States Patent and Trademark Office

İSKO FUTURE FACE

Reg. No. 4,204,070

Registered Sep. 11, 2012

**Int. Cls.: 24, 25, 35 and
40**

SANKO TEKSTİL İŞLETMELERİ SANAYİ VE TİCARET ANONİM ŞİRKETİ (TURKEY JOINT STOCK COMPANY)

SANI KONUKOĞLU BULVARI ÜZERİ

PK: 83 SEHİTKAMİL; GAZİANTEP

TURKEY

TRADEMARK

SERVICE MARK

PRINCIPAL REGISTER

FOR: WOVEN TEXTILE FABRICS FOR USE IN THE MANUFACTURE OF CLOTHING, TOWELS, TABLE LINEN, BED LINEN, HOUSEHOLD LINEN; NON-WOVEN TEXTILE FABRICS FOR USE IN THE MANUFACTURE OF CLOTHING, TOWELS, TABLE LINEN, BED LINEN, HOUSEHOLD LINEN; FIBERGLASS FABRICS FOR TEXTILE USE; FABRIC IMPERVIOUS TO GASES FOR AERONAUTICAL BALLOONS; WATERPROOF FABRICS, NAMELY, WATERPROOF FABRIC FOR MANUFACTURING CLOTHING, FURNITURE AND AUTOMOBILE UPHOLSTERY, AND LUGGAGE; GUMMED WATERPROOF CLOTH; FABRIC OF IMITATION ANIMAL SKINS; TEXTILE LININGS, NAMELY, LINEN LINING FABRIC FOR SHOES, UNFINISHED TEXTILE FOR THE MANUFACTURE OF LININGS FOR GARMENTS, TEXTILE USED AS LINING FOR CLOTHING; BUCKRAM; FILTERING MATERIALS OF TEXTILE, NAMELY, CHEMICAL FIBER FABRICS, SYNTHETIC FIBER FABRICS AND INORGANIC FIBER MIXED FABRICS, ALL OF THE FOREGOING FOR USE IN FILTERING LIQUIDS AND POWDERS; QUILTS OF TEXTILE, LAP BLANKETS; WASHING MITTS, BATH LINEN, HAND TOWELS, FACE TOWELS OF TEXTILE, BATHING TOWELS; HANDKERCHIEFS OF TEXTILE, BANNERS OF TEXTILE, NAMELY, CLOTH BANNERS; FLAGS NOT OF PAPER, NAMELY, CLOTH FLAGS, FABRIC FLAGS; TRAVELING RUGS, NAMELY, LAP RUGS; CURTAINS OF TEXTILE, SHOWER CURTAINS OF TEXTILE, SHOWER CURTAINS OF PLASTICS; OILCLOTH FOR USE AS TABLE CLOTHS; BED COVERS, NAMELY, BED BLANKETS, BED SHEETS, BEDSPREADS, BED LINEN, PILLOW CASES, QUILT COVERS; UPHOLSTERY FABRICS; TABLE NAPKINS OF TEXTILE, IN CLASS 24 (U.S. CLS. 42 AND 50).



David J. Kyros

Director of the United States Patent and Trademark Office

FOR: CLOTHING, NAMELY, TROUSERS, JACKETS, OVERCOATS, COATS, SKIRTS, SUITS, JERSEYS, WAISTCOATS, SHIRTS, T-SHIRTS, SWEATSHIRTS, DRESSES, BERMUDA SHORTS, SHORTS, PAJAMAS, PULLOVERS, JEANS, TRACKSUITS, RAINWEAR, BEACHWEAR, BATHING SUITS, SWIMMING SUITS; ARTICLES OF CLOTHING MADE FROM COTTON DENIM, NAMELY, DENIM JACKETS AND DENIM JEANS, ARTICLES OF CLOTHING MADE FROM KNITTED FABRICS, NAMELY, KNIT SHIRTS AND KNIT JACKETS, CLOTHING FOR SPORTSWEAR, NAMELY, SHIRTS, SHORTS AND TRACK SUITS, CLOTHING FOR BABIES, NAMELY, SHIRTS AND PANTS; UNDERCLOTHING, NAMELY, BOXER SHORTS, BRASSIERES, BRIEFS, PANTS, SOCKS, FOOTWEAR, NAMELY,

Reg. No. 4,204,070 SHOES EXCLUDING ORTHOPEDIC SHOES, SANDALS, WATERPROOF BOOTS, WALKING BOOTS, BOOTIES, SPORTING SHOES, SLIPPERS; SHOE PARTS, NAMELY, HEELPIECES, NAMELY, HEEL PIECES FOR SHOES, INSOLES FOR FOOTWEAR, FOOTWEAR UPPERS, NAMELY, UPPERS OF WOVEN RATTAN FOR JAPANESE STYLE SANDALS, HEADGEAR, NAMELY, CAPS, SKULL CAPS, SPORTS CAPS, HATS, BERETS; GLOVES, STOCKINGS, BELTS, CAMISOLES, SARONGS, SCARVES, NECK SCARVES, SHAWLS, COLLARS, MUFFLERS, NECKTIES, TIES, SUSPENDER BELTS, IN CLASS 25 (U.S. CLS. 22 AND 39).

FOR: ADVERTISING AGENCIES, MARKETING CONSULTING AND PUBLICITY BUREAU SERVICES; ADVERTISEMENT AND PUBLICITY SERVICES BY TELEVISION, RADIO, MAIL; DISSEMINATION OF ADVERTISING MATTER, WRITING OF PUBLICITY TEXTS, ORGANIZING EXHIBITIONS AND FAIRS FOR COMMERCIAL AND ADVERTISING PURPOSES, ADVERTISING SERVICES, ADVERTISING AGENCIES, NAMELY, PROMOTING THE GOODS AND SERVICES OF OTHERS; PRODUCTION AND DISTRIBUTION OF RADIO AND TELEVISION COMMERCIALS; ORGANIZATION OF EXHIBITIONS FOR PROMOTING THE SALE OF CLOTHING AND TEXTILES, MODELING FOR ADVERTISING OR SALES PROMOTION, CONDUCTING MARKETING STUDIES; PUBLICITY AND SALES PROMOTION SERVICES; WINDOW DRESSING AND DISPLAY ARRANGEMENT SERVICES; PUBLIC OPINION POLLING; PUBLIC RELATIONS; PROVIDING OFFICE FUNCTIONS; BUSINESS MANAGEMENT OF PERFORMING ARTISTS; SECRETARIAL SERVICES, DOCUMENT REPRODUCTION, PHOTOCOPYING, TYPING SERVICES, WORD PROCESSING, COMPILATION OF INFORMATION INTO COMPUTER DATABASES, SYSTEMIZATION OF INFORMATION INTO COMPUTER DATABASES, TELEPHONE ANSWERING SERVICES, ARRANGING NEWSPAPER SUBSCRIPTIONS FOR OTHERS, RENTAL OF TYPEWRITERS AND COPYING MACHINES, RENTAL OF VENDING MACHINES; BUSINESS ADMINISTRATION CONSULTANCY; COMMERCIAL AND INDUSTRIAL MANAGEMENT ASSISTANCE, BUSINESS MANAGEMENT AND ORGANIZATION CONSULTANCY, BUSINESS MANAGEMENT OF HOTELS FOR OTHERS; BUSINESS INVESTIGATIONS; PROVIDING STATISTICAL INFORMATION FOR BUSINESS AND COMMERCIAL PURPOSES, PERSONNEL MANAGEMENT CONSULTANCY, PERSONNEL RECRUITMENT, ACCOUNTING SERVICES, FINANCIAL STATEMENT PREPARATION AND ANALYSIS FOR BUSINESSES; BUSINESS AUDITING; COST/PRICE ANALYSIS; ECONOMIC FORECASTING AND ANALYSIS; PAYROLL PREPARATION, TAX PREPARATION; IMPORT AND EXPORT AGENCIES; BUSINESS INVESTIGATIONS, EVALUATIONS, EXPERT APPRAISALS, AUCTIONEERING; BRINGING TOGETHER, FOR THE BENEFIT OF OTHERS, OF WOVEN AND NON-WOVEN TEXTILE FABRICS FOR USE IN THE MANUFACTURE OF CLOTHING, TOWELS, TABLE LINEN, BED LINEN, HOUSEHOLD LINEN, CLOTHING, FOOTWEAR, HEADGEAR, ENABLING CUSTOMERS TO VIEW AND PURCHASE THOSE GOODS, IN CLASS 35 (U.S. CLS. 100, 101 AND 102).

FOR: METAL TREATMENT SERVICES, NAMELY, GALVANIZING, METAL PLATING, METAL CASTING, CUSTOM MANUFACTURE OF BOILERS, METAL TEMPERING, PROVIDING MATERIAL TREATMENT INFORMATION, NICKEL PLATING, CADMIUM PLATING, CHROMIUM PLATING, TIN PLATING, LEAD WORKING; PRECIOUS METAL TREATMENT SERVICES, NAMELY, GOLD PLATING, SILVER PLATING, SILVERSMITHING; PROCESSING OF CINEMATOGRAPHIC FILMS, PHOTOGRAPHIC PROCESSING, PHOTOGRAPHIC FILM DEVELOPING, PHOTOGRAPHIC PRINTING, PHOTOGRAVURE, PHOTOCOMPOSING SERVICES; PROCESSING OF RAW MATERIALS FOR USE IN THE MANUFACTURE OF FOOD; MILLWORKING, FLOUR MILLING, FOOD CANNING; SLAUGHTERING OF ANIMALS; FUR AND LEATHER TREATMENT, NAMELY, FUR DYEING, LEATHER STAINING, TANNING OF LEATHER, MOTHPROOFING, FUR CONDITIONING, LEATHER CONDITIONING, FUR GLOSSING, LEATHER GLOSSING; SADDLERY WORKING; TREATMENT OF FABRIC, NAMELY, YARN WARPING USING LOOMS FOR WEAVING, MOTHPROOFING OF FABRIC, EDGING OF FABRIC, CUTTING OF FABRIC, BLEACHING OF FABRIC, DYEING OF FABRIC, PERMANENT PRESS TREATMENT OF FABRIC, FIREPROOFING OF FABRIC, WATERPROOFING OF FABRIC, PRE-SHRINKING OF FABRIC, CREASE RESISTANT TREATMENT OF FABRIC, WOOL TREATMENT AND FINISHING; TAILORING OR DRESSMAKING, SEWING SERVICES, CUTTING OF CLOTH,

Reg. No. 4,204,070 CLOTHING ALTERATION, EMBROIDERY SERVICES; WOODWORKING, TIMBER FELLING AND PROCESSING, TIMBER LOGGING, ENGRAVING; FRAMING OF WORKS OF ART; ENVIRONMENTAL REMEDIATION SERVICES, NAMELY, WASTE AND WATER TREATMENT SERVICES, AIR DEODORIZING, RECYCLING OF WASTE MATERIALS, SORTING OF WASTE AND RECYCLABLE MATERIAL, FUEL TREATMENT SERVICES, FUEL REFINING, WATER TREATMENT AND PURIFICATION; TREATMENT OF GLASS MATERIALS, OPTICAL GLASS GRINDING, GLASS BLOWING, GLASS TINTING, GLASS PLATING, NAMELY, SOLDERING TOGETHER TWO OR MORE LAYERS OF GLASS, GRINDING AND POLISHING GLASS FOR EYEGLASSES; CUSTOM ASSEMBLING OF PRODUCTS FOR OTHERS; DENTAL TECHNICIAN SERVICES; POTTERY FIRING; PRODUCTION OF ENERGY, RENTAL OF ELECTRIC POWER GENERATORS; PAPER TREATMENT, PAPER FINISHING; PRINTING OF BOOKS, OFFSET PRINTING, LITHOGRAPHIC PRINTING, SILK SCREEN PRINTING, PRINTING OF PATTERNS ON TEXTILES, BOOKBINDING; MATERIAL TREATMENT OF PLASTICS, NAMELY, LAMINATING OF PLASTIC SHEETS, INJECTION MOLDING OF PLASTICS FOR OTHERS, IN CLASS 40 (U.S. CLS. 100, 103 AND 106).

THE MARK CONSISTS OF STANDARD CHARACTERS WITHOUT CLAIM TO ANY PARTICULAR FONT, STYLE, SIZE, OR COLOR.

PRIORITY DATE OF 12-24-2010 IS CLAIMED.

OWNER OF INTERNATIONAL REGISTRATION 1085726 DATED 12-28-2010, EXPIRES 12-28-2020.

OWNER OF U.S. REG. NO. 3,885,599.

NO CLAIM IS MADE TO THE EXCLUSIVE RIGHT TO USE "FUTURE FACE", APART FROM THE MARK AS SHOWN.

THE WORDING "ISKO" HAS NO MEANING IN A FOREIGN LANGUAGE.

SER. NO. 79-100,675, FILED 12-28-2010.

NANCY CLARKE, EXAMINING ATTORNEY

United States of America

United States Patent and Trademark Office

SOULNESS

Reg. No. 4,204,071

PETER ZU SAYN-WITTGENSTEIN (FED REP GERMANY INDIVIDUAL)
VIALE B. PAPIO 1

Registered Sep. 11, 2012

CH-6612 ASCONA, SWITZERLAND

**Int. Cls.: 3, 10, 16, 25, 32,
41, 42, 43 and 44**

FOR: BLEACHING PREPARATIONS AND OTHER SUBSTANCES FOR LAUNDRY USE, NAMELY, LAUNDRY SOAP, LAUNDRY PRE-SOAK AND LAUNDRY STARCH; CLEANING, POLISHING, DEGREASING AND ABRASIVE PREPARATIONS; SOAP; PERFUMERY, ESSENTIAL OILS, COSMETICS, HAIR LOTIONS, DENTIFRICES, IN CLASS 3 (U.S. CLS. 1, 4, 6, 50, 51 AND 52).

TRADEMARK

SERVICE MARK

FOR: SURGICAL, MEDICAL AND VETERINARY APPARATUS AND INSTRUMENTS FOR USE IN GENERAL SURGERY; DENTAL INSTRUMENTS, NAMELY, PICKS, BURRS, MIRRORS AND ORAL IRRIGATORS; DENTAL APPARATUS, NAMELY, INTRA-ORAL LIGHT SYSTEMS; ARTIFICIAL LIMBS, EYES AND TEETH; ORTHOPAEDIC ARTICLES, NAMELY, BELTS, BRACES, JOINT, SUPPORTS; SUTURE MATERIALS, IN CLASS 10 (U.S. CLS. 26, 39 AND 44).

PRINCIPAL REGISTER

FOR: PAPER, CARDBOARD AND GOODS MADE FROM THESE MATERIALS PROVIDED THAT THEY ARE NOT INCLUDED IN OTHER CLASSES, NAMELY, PAPER BAGS, BOXES OF CARDBOARD, CARDBOARD PACKAGING; PRINTED MATTER, NAMELY, NEWSPAPERS, PHOTOGRAPHS, MAGAZINES, BOOKS, PRINTED PERIODICALS, PUBLICATIONS, NEWSLETTERS AND BROCHURES ALL IN THE FIELDS OF SCIENCE, HEALTH, TRAVEL AND LEISURE, LIFESTYLE, DESIGN AND DECORATION, ARCHITECTURE, CONSCIOUSNESS, WELL-BEING, FITNESS AND WELLNESS AS WELL AS FICTION BOOKS AND NOVELS; BOOKBINDING MATERIAL; PHOTOGRAPHS; STATIONERY; ADHESIVES GLUES FOR STATIONERY OR HOUSEHOLD PURPOSES; ARTISTS MATERIALS, NAMELY, BRUSHES, PENCILS, CANVAS PANELS; PAINTBRUSHES; TYPEWRITERS AND OFFICE REQUISITES, NAMELY, STAPLERS, HOLE PUNCHES; INSTRUCTIONAL AND TEACHING MATERIALS, NAMELY, STUDY GUIDES; PLASTIC MATERIALS FOR PACKAGING, PROVIDED THAT THEY ARE NOT INCLUDED IN OTHER CLASSES, NAMELY, PLASTIC BAGS, PLASTIC BUBBLE PACKS; PRINTING TYPE; PRINTING BLOCKS, IN CLASS 16 (U.S. CLS. 2, 5, 22, 23, 29, 37, 38 AND 50).



David J. Kybas

Director of the United States Patent and Trademark Office

FOR: CLOTHING, NAMELY, BEACH COVER-UPS, BEACHWEAR, BELTS, BERMUDA SHORTS, BIKINIS, BLAZERS, BLOOMERS, BLOUSES, BLOUSONS, BODY SUITS, BOTTOMS, BOW TIES, CATSUITS, CHAPS, CORSETS, EVENING GOWNS, GLOVES, GYM SHORTS, GYM SUITS, JACKETS, JEANS, JOGGING SUITS, LEATHER COATS, LEATHER

Reg. No. 4,204,071 JACKETS, LEGGINGS, LINGERIE, LOUNGEWEAR, MANTLES, MINISKIRTS, OVERALLS, PAJAMAS, PANTIES, PANTS, PANTSUITS, PANTYHOSE, PLAY SUITS, POLO SHIRTS, PONCHOS, PULLOVERS, ROBES, SHIRTS, SHORTS, SKI WEAR, SLEEPWEAR, SLIPPERS, SNOW SUITS, SOCKS, SPORT COATS, SPORT SHIRTS, STOCKINGS, SUITS, SWEAT PANTS, SWEAT SHIRTS, SWEAT SHORTS, SWEATERS, SWIM WEAR, SWIMSUITS, TAILLEURS, TANK TOPS, TENNIS WEAR, TIGHTS, TUXEDOS, UNDERWEAR, UNIFORMS, VESTED SUITS, VESTS, WET SUITS AND WIND RESISTANT JACKETS; FOOTWEAR, NAMELY, ATHLETIC FOOTWEAR, ATHLETIC SHOES, BOOTS, FOOTWEAR, HEELS, SANDALS, SHOES AND SNEAKERS; HEADGEAR, NAMELY, HATS, CAPS AND VISORS, IN CLASS 25 (U.S. CLS. 22 AND 39).

FOR: BEER, MINERAL AND AERATED WATERS AND OTHER NON-ALCOHOLIC DRINKS, NAMELY, COCONUT WATER, COCONUT-BASED BEVERAGES, COLAS, DRINKING WATER, ENERGY DRINKS, FLAVOURED MINERAL WATER, FLAVOURED WATER FRUIT FLAVOURED SOFT DRINKS, LAGER, LEMONADE, NON-ALCOHOLIC BEER, NON-ALCOHOLIC COCKTAIL MIXES, NON-ALCOHOLIC WINES, PUNCH, SELTZER WATER, SODA WATER, SOFT DRINKS, SPORTS DRINKS, SPRING WATER, TABLE WATER, TOMATO JUICE, VEGETABLE JUICE; FRUIT DRINKS AND FRUIT JUICES; SYRUPS FOR MAKING BEVERAGES; CONCENTRATES AND POWDERS FOR MAKING SOFT DRINKS AND FRUIT DRINKS, IN CLASS 32 (U.S. CLS. 45, 46 AND 48).

FOR: TEACHING, NAMELY, EDUCATION COURSES AND CONFERENCES AND PROVIDING CLASSES, SEMINARS AND WORKSHOPS IN THE FIELDS OF SCIENCE, HEALTH, SPORTS, DANCING, CONSCIOUSNESS, WELL-BEING, FITNESS, WELLNESS, LIFESTYLE, SELF- AND PERSONAL AWARENESS; GYMNASIUMS; PROVIDING TRAINING IN THE FIELDS OF COMPUTER AND MULTIMEDIA EDUCATION; ENTERTAINMENT, NAMELY, CONCERTS, CABARETS, CASINOS, CINEMA STUDIOS, CINEMA THEATRES, DISC JOCKEYS FOR PARTIES AND EVENTS, DISCOTHEQUES, DISTRIBUTION FOR TELEVISION PROGRAMS FOR OTHERS, DANCE PERFORMANCES, LASER SHOWS, WINE TASTINGS, MOTION PICTURE FILM PRODUCTION, NIGHT CLUBS, PARTY PLANNING, ONLINE ELECTRONIC PUBLISHING OF BOOKS AND PERIODICALS, PUBLICATION OF BOOKS, TELEVISION SHOW PRODUCTION AND VIDEOTAPE PRODUCTION; SPORTING AND CULTURAL ACTIVITIES, NAMELY, ORGANIZING COMMUNITY AND CULTURAL EVENTS; COUNTRY CLUBS PROVIDING INTERACTIVE WEBSITE FEATURING SOCIAL COMMUNITY ACTIVITIES AND INFORMATION IN THE FIELDS OF SCIENCE, HEALTH, SPORTS, WELL-BEING-FITNESS, WELLNESS, CONSCIOUSNESS TRAVEL AND LEISURE, LIFESTYLE AND ENTERTAINMENT, IN CLASS 41 (U.S. CLS. 100, 101 AND 107).

FOR: SCIENTIFIC AND TECHNOLOGICAL SERVICES, NAMELY, SCIENTIFIC RESEARCH, DEVELOPMENT AND CONSULTATION IN THE FIELDS OF, MEDICINE, PHYSICS AND CHEMISTRY, BIOPHYSICS AND BIOCHEMISTRY, SEXOLOGY, SPORTS, HEALTH, WELLNESS, CONSCIOUSNESS, PSYCHOLOGY; AND RESEARCH AND DESIGN RELATING THERETO; INDUSTRIAL ANALYSIS AND RESEARCH SERVICES IN THE FIELDS OF PHARMACEUTICAL, BIOMEDICAL, COSMETICS, AND CHEMICAL MANUFACTURING; DESIGN AND DEVELOPMENT OF COMPUTERS AND SOFTWARE; PRODUCT RESEARCH AND DEVELOPMENT; SURVEYING AND ENGINEERING; INTERIOR DECORATING; ARCHITECTURAL DESIGN, IN CLASS 42 (U.S. CLS. 100 AND 101).

FOR: SERVICES FOR PROVIDING FOOD AND DRINK, NAMELY, BAR SERVICES, COCKTAIL LOUNGE BUFFETS, CONTRACT FOOD SERVICES, DELICATESSEN SERVICES, RESTAURANT SERVICES, RESTAURANTS FEATURING HOME DELIVERY, SALAD BARS, TAKE-OUT RESTAURANT SERVICES, WINE BARS; ARRANGING TEMPORARY HOUSING ACCOMMODATIONS; MAKING HOTEL RESERVATIONS FOR OTHERS; PROVIDING TEMPORARY HOUSING ACCOMMODATIONS; TEMPORARY PUBLIC HOUSING SERVICES; RESIDENTIAL HOTEL SERVICES; RESORT HOTEL SERVICES; RESORT LODGING SERVICES; TEMPORARY RETIREMENT HOMES; TOURIST HOMES; PROVIDING TEMPORARY ACCOMMODATIONS AND MEALS TO CLIENTS OF A HEALTH OR BEAUTY

Reg. No. 4,204,071 SPA; TRAVEL AGENCY SERVICES, NAMELY, MAKING RESERVATIONS AND BOOKING FOR TEMPORARY LODGING, IN CLASS 43 (U.S. CLS. 100 AND 101).

FOR: MEDICAL SERVICES; HEALTH CARE; ADDICTION TREATMENT SERVICES; ALTERNATIVE MEDICINE SERVICES; AROMATHERAPY SERVICES; BODYWORK THERAPY; CHIROPRACTICS, COSMETIC AND PLASTIC SURGERY; COSMETICIAN SERVICES; DIETITIAN SERVICES; EMERGENCY MEDICAL SERVICES; VETERINARY SERVICES; HEALTH SPA SERVICES, NAMELY, WELLNESS PROGRAMS AND COSMETIC BODY CARE SERVICES; MASSAGE; MEDICAL CLINICS; MENTAL HEALTH SERVICES; NURSING CARE; NUTRITION COUNSELLING; OPERATION OF SAUNA FACILITIES; PERFORMING DIAGNOSIS OF DISEASE; PHYSICAL THERAPY; PROVIDING BATH HOUSES; PROVIDING HOT TUB FACILITIES; PROVIDING PUBLIC BATH FACILITIES; PROVIDING MENTAL AND PHYSICAL REHABILITATION FACILITIES; PSYCHOLOGICAL CONSULTATION AND COUNSELLING; SANITARIUMS; WEIGHT REDUCTION DIET PLANNING AND SUPERVISION; HOME HEALTH CARE SERVICES; HYPNOSES SERVICES; TELEMEDICINE SERVICES; PROVIDING A WEBSITE FEATURING CONTENT REGARDING HEALTHY LIVING, NUTRITION, FITNESS AND LIFESTYLE WELLNESS; HYGIENIC AND BEAUTY CARE FOR HUMAN BEINGS OR ANIMALS; BEAUTY SALONS; SKIN CARE SALONS; TANNING SALONS; PROVIDING INFORMATION ABOUT BEAUTY; WELLNESS AND HEALTH-RELATED CONSULTING SERVICES; AGRICULTURE SERVICES, NAMELY, AGRICULTURAL ADVISE; LANDSCAPE GARDENING; LANDSCAPE GARDENING DESIGN FOR OTHERS; GREENHOUSE SERVICES; HORTICULTURAL SERVICES; AND FORESTRY SERVICES IN THE NATURE OF MANAGING HARVESTING FORESTS, IN CLASS 44 (U.S. CLS. 100 AND 101).

THE MARK CONSISTS OF STANDARD CHARACTERS WITHOUT CLAIM TO ANY PARTICULAR FONT, STYLE, SIZE, OR COLOR.

PRIORITY DATE OF 3-30-2011 IS CLAIMED.

OWNER OF INTERNATIONAL REGISTRATION 1085819 DATED 6-10-2011, EXPIRES 6-10-2021.

SER. NO. 79-100,715, FILED 6-10-2011.

RON FAIRBANKS, EXAMINING ATTORNEY

United States of America
United States Patent and Trademark Office

ANCO

Reg. No. 4,204,072

Registered Sep. 11, 2012

Int. Cl.: 31

TRADEMARK

PRINCIPAL REGISTER

ANCO ORCHIDEEËN B.V. (NETHERLANDS B.V.)
MIDDENZWET 28
NL-2291 HM WATERINGEN
NETHERLANDS

FOR: LIVING PLANTS AND PARTS OF LIVING PLANTS; SOWING SEEDS; CUT FLOWERS,
IN CLASS 31 (U.S. CLS. 1 AND 46).

THE MARK CONSISTS OF STANDARD CHARACTERS WITHOUT CLAIM TO ANY PAR-
TICULAR FONT, STYLE, SIZE, OR COLOR.

OWNER OF INTERNATIONAL REGISTRATION 1086081 DATED 5-13-2011, EXPIRES 5-13-
2021.

SER. NO. 79-100,795, FILED 5-13-2011.

MIDGE BUTLER, EXAMINING ATTORNEY



David J. Kyffers

Director of the United States Patent and Trademark Office

United States of America
United States Patent and Trademark Office

PERLITA

Reg. No. 4,204,073

SH AVENIR (FRANCE SOCIÉTÉ PAR ACTIONS SIMPLIFIÉE)
39, AVENUE DE MONT DE MARSAN
F-33850 LEOGNAN, FRANCE

Registered Sep. 11, 2012

Int. Cl.: 33

FOR: AOC WINES, NAMELY, WINES WITH PROTECTED APPELLATION OF ORIGIN, IN CLASS 33 (U.S. CLS. 47 AND 49).

TRADEMARK

THE MARK CONSISTS OF STANDARD CHARACTERS WITHOUT CLAIM TO ANY PARTICULAR FONT, STYLE, SIZE, OR COLOR.

PRINCIPAL REGISTER

PRIORITY DATE OF 3-22-2011 IS CLAIMED.

OWNER OF INTERNATIONAL REGISTRATION 1086447 DATED 6-30-2011, EXPIRES 6-30-2021.

SER. NO. 79-100,936, FILED 6-30-2011.

KRISTIN CARLSON, EXAMINING ATTORNEY



David J. Kyffers

Director of the United States Patent and Trademark Office

United States of America

United States Patent and Trademark Office

YENISTA

Reg. No. 4,204,074

YENISTA OPTICS S.A. (FRANCE SA)

Registered Sep. 11, 2012

4, RUE DE BROGLIE
F-22300 LANNION, FRANCE

Int. Cls.: 9, 38 and 42

FOR: SCIENTIFIC, OPTICAL, WEIGHING, MEASURING, SIGNALING, CHECKING, TEACHING APPARATUS AND INSTRUMENTS, FIBER OPTIC TEST APPARATUS NAMELY, TUNABLE LASERS, TUNABLE FILTERS, DFB LASERS, DBR LASERS, EXTERNAL CAVITY LASERS, SLED / SUPERLUMINESCENT, LIGHT EMITTING DIODES, VARIABLE OPTICAL ATTENUATORS, VARIABLE OPTICAL BACKREFLECTORS, SHUTTERS, SWITCHES, PMD ANALYZERS, PDM ANALYZERS, CHROMATIC DISPERSION ANALYZERS, OPTICAL POWER METERS, OPTICAL, BACKREFLECTION METERS, OPTICAL SPECTRUM ANALYZERS, OPTICAL CHANNEL MONITORS, OPTICAL TIME DOMAIN, REFLECTOMETERS, OPTICAL COMPONENT TESTERS; APPARATUS AND INSTRUMENTS FOR THE SUPPLY, DISTRIBUTION, TRANSFORMATION, ACCUMULATION, REGULATION OR CONTROL OF ELECTRICITY, NAMELY, ELECTRICAL POWER SUPPLIES; APPARATUS FOR RECORDING, TRANSMISSION OR REPRODUCTION OF SOUND OR IMAGES; OPTICAL APPARATUS AND INSTRUMENTS, NAMELY, INTERFEROMETERS, LENSED FIBERS, FILTERS, MULTIPLEXERS, DEMULTIPLEXERS, OPTICAL FIBERS LIGHT CONDUCTING FILAMENTS, FIBER OPTIC CABLES, OPTICAL CABLES, OPTICAL FILTERS, OPTICAL LASERS NOT FOR MEDICAL USE, OPTICAL COUPLERS, OPTICAL SWITCHES, OPTICAL SHUTTERS, IN CLASS 9 (U.S. CLS. 21, 23, 26, 36 AND 38).

TRADEMARK

SERVICE MARK

PRINCIPAL REGISTER



FOR: TELECOMMUNICATIONS, NAMELY, TRANSMISSION OF PODCASTS; COMMUNICATIONS BY FIBER OPTIC NETWORKS, TELECOMMUNICATIONS ROUTING AND JUNCTION SERVICES, COMPUTER AIDED TRANSMISSION OF INFORMATION, MESSAGES AND IMAGES; ELECTRONIC BULLETIN BOARD SERVICES; TELECOMMUNICATIONS SERVICES, NAMELY, CALL HUNTING, IN CLASS 38 (U.S. CLS. 100, 101 AND 104).

FOR: SCIENTIFIC AND INDUSTRIAL RESEARCH AND DEVELOPMENT IN THE FIELD OF OPTICAL APPARATUS AND INSTRUMENTS; TECHNICAL PROJECT STUDIES IN THE FIELD OF OPTICAL APPARATUS AND INSTRUMENTS, IN CLASS 42 (U.S. CLS. 100 AND 101).

David J. Kyffers

THE MARK CONSISTS OF STANDARD CHARACTERS WITHOUT CLAIM TO ANY PARTICULAR FONT, STYLE, SIZE, OR COLOR.

Reg. No. 4,204,074 OWNER OF INTERNATIONAL REGISTRATION 1086773 DATED 6-23-2011, EXPIRES 6-23-2021.

THE WORDING "YENISTA" HAS NO MEANING IN A FOREIGN LANGUAGE.

SER. NO. 79-101,052, FILED 6-23-2011.

ALLISON HOLTZ, EXAMINING ATTORNEY

United States of America

United States Patent and Trademark Office



Reg. No. 4,204,075

Registered Sep. 11, 2012

**Int. Cls.: 16, 18, 25, 35
and 41**

TRADEMARK

SERVICE MARK

PRINCIPAL REGISTER

SURFING AUSTRALIA INC (AUSTRALIA INCORPORATED ASSOCIATION)
SUITE 215 SHOWCASE ON THE BEACH
72-80 MARINE PARADE; COOLANGATTA QLD 4225
AUSTRALIA

FOR: PRINTED EDUCATIONAL MATERIALS FOR USE IN TEACHING IN THE FIELD OF SURFING; EDUCATIONAL MATERIALS IN PRINTED FORM IN THE FIELD OF SURFING; EDUCATIONAL MATERIALS IN WRITTEN FORM IN THE FIELD OF SURFING; TRAINING BOOKLETS IN THE FIELD OF SURFBOARD RIDING; TRAINING GUIDES IN THE FORM OF PRINTED MATTER IN THE FIELD OF SURFING; TRAINING MANUALS IN THE FORM OF PRINTED MATTER IN THE FIELD OF SURFING; BROCHURES IN THE FIELD OF SURF TRAINING; INDIVIDUALLY DESIGNED PRINTED BROCHURES IN THE FIELD OF SURF TRAINING; PRESENTATION BROCHURES IN THE FIELD OF SURF TRAINING; PRINTED PUBLICATIONS FOR ADVERTISING PUBLICATIONS, NAMELY, ADVERTISING POSTERS; ADVERTISING PUBLICATIONS, NAMELY, ADVERTISING PAMPHLETS; PRINTED MATTER FOR ADVERTISING PURPOSES, NAMELY, ADVERTISING PAMPHLETS; PRINTED PUBLICATIONS FOR ADVERTISING BUSINESSES, NAMELY, ADVERTISING PAMPHLETS; TEACHING MATERIALS FOR EDUCATION IN THE FIELD OF SURFING; TEACHING MATERIALS FOR INFORMATION IN THE FIELD OF SURFING; TEACHING MATERIALS FOR INSTRUCTION IN THE FIELD OF SURFING; PHOTOGRAPHS, IN CLASS 16 (U.S. CLS. 2, 5, 22, 23, 29, 37, 38 AND 50).

FOR: BACKPACKS; ATHLETICS BAGS; BAGS FOR CLOTHES, NAMELY, LUGGAGE; BEACH BAGS; ALL PURPOSE CARRYING BAGS OTHER THAN DISPOSABLE CARRIER BAGS; CASUAL BAGS, NAMELY, BUM BAGS; GYM BAGS; LUGGAGE BAGS; OVERNIGHT BAGS; SCHOOL BAGS; SHOULDER BAGS; SHOULDER BAGS FOR USE BY CHILDREN; SPORT BAGS, OTHER THAN ADAPTED (SHAPED) TO CONTAIN SPECIFIC SPORTS APPARATUS; TRAVEL BAGS, IN CLASS 18 (U.S. CLS. 1, 2, 3, 22 AND 41).

FOR: APPAREL, CLOTHING, NAMELY, SHORTS, TANK TOPS, T-SHIRTS, PANTS, SPORTS CAPS; ATHLETIC CLOTHING, NAMELY, ATHLETIC UNIFORMS, ATHLETIC FOOTWEAR; BEACH CLOTHING, NAMELY, T-SHIRTS, BOARDSHORTS, TANK TOPS, BIKINIS, SPORTS CAPS; BOYS' CLOTHING, NAMELY, T-SHIRTS, BOARDSHORTS, TANK TOPS, BIKINIS, SPORTS CAPS; CASUAL CLOTHING, NAMELY, T-SHIRTS, BOARDSHORTS, TANK TOPS, BIKINIS, SPORTS CAPS; CHILDREN'S CLOTHING, NAMELY, T-SHIRTS, BOARDSHORTS, TANK TOPS, BIKINIS, SPORTS CAPS; CLOTHING, NAMELY, T-SHIRTS, BOARDSHORTS, TANK TOPS, BIKINIS, SPORTS CAPS; CLOTHING FOR BABIES, NAMELY, ONE PIECE



David J. Kybas

Director of the United States Patent and Trademark Office

Reg. No. 4,204,075 GARMENT FOR TODDLERS; CLOTHING FOR SURFING, NAMELY, WETSUITS, BOARD-SHORTS, RASHVESTS; GIRLS' CLOTHING, NAMELY, T-SHIRTS, BOARDSHORTS, TANK TOPS, BIKINIS, SPORTS CAPS; INFANTS' CLOTHING, NAMELY, T-SHIRTS, BOARD-SHORTS, TANK TOPS, BIKINIS, SUN HATS; JACKETS; LADIES' CLOTHING, NAMELY, T-SHIRTS, BOARDSHORTS, TANK TOPS, BIKINIS, SPORTS CAPS; MEN'S CLOTHING, NAMELY, T-SHIRTS, BOARDSHORTS, TANK TOPS, BIKINIS, SPORTS CAPS; THONGS; WRISTBANDS; SPORTSWEAR, NAMELY, WETSUITS FOR SURFING; FOOTWEAR; HEADGEAR, NAMELY, HEADBANDS, HOODS, SPORTS CAPS, IN CLASS 25 (U.S. CLS. 22 AND 39).

FOR: ADVERTISING; ADVERTISING SERVICES PROVIDED BY TELEVISION; ADVERTISING SERVICES PROVIDED OVER THE INTERNET; DISTRIBUTION OF ADVERTISING MATERIAL; PRODUCTION OF VIDEO RECORDINGS FOR ADVERTISING PURPOSES; PRODUCTION OF VISUAL ADVERTISING MATTER; TELEVISION ADVERTISING; BUSINESS ADMINISTRATION; BUSINESS ADMINISTRATION ADVISORY SERVICES; BUSINESS ADMINISTRATION CONSULTANCY; PROVISION OF INFORMATION IN RELATION TO BUSINESS ADMINISTRATION; BUSINESS MARKETING SERVICES, NAMELY, ADMINISTRATION RELATING TO MARKETING; PROMOTIONAL SPONSORSHIP OF SURFING EVENTS, SURF TRAINING, IN CLASS 35 (U.S. CLS. 100, 101 AND 102).

FOR: DISSEMINATION OF EDUCATIONAL MATERIAL OF OTHERS IN THE FIELD OF SURFING; PUBLICATION OF EDUCATIONAL MATERIALS; ADVISORY SERVICES RELATING TO TRAINING, NAMELY, BUSINESS TRAINING CONSULTANCY SERVICES; ARRANGING AND CONDUCTING OF TRAINING WORKSHOPS, EDUCATION IN THE FIELD OF SURFING; CONDUCTING TRAINING WORKSHOPS, EDUCATION IN THE FIELD OF SURFING; ORGANISATION OF TRAINING COURSES, EDUCATION IN THE FIELD OF TRAINING; PROVISION OF TRAINING EDUCATION IN THE FIELD OF SURFING; DISTRIBUTION OF VIDEOS IN THE FIELD OF SURFING; PRODUCTION OF VIDEOS IN THE FIELD OF SURFING; ARRANGING OF SPORTS COMPETITIONS; INSTRUCTION IN SPORTS; OFFICIATING AT SPORTS CONTESTS; ORGANISATION OF SPORTS COMPETITIONS; PROVIDING SPORTS TRAINING FACILITIES; SPORTS COACHING; SPORTS TRAINING; EVENT MANAGEMENT SERVICES, NAMELY, ORGANISATION OF SURF TRAINING, SOCIAL ENTERTAINMENT, SPORTING OR CULTURAL EVENTS, IN CLASS 41 (U.S. CLS. 100, 101 AND 107).

NO CLAIM IS MADE TO THE EXCLUSIVE RIGHT TO USE "SURF GROMS", APART FROM THE MARK AS SHOWN.

PRIORITY DATE OF 5-17-2011 IS CLAIMED.

OWNER OF INTERNATIONAL REGISTRATION 1086875 DATED 5-27-2011, EXPIRES 5-27-2021.

THE COLOR(S) BLUE AND WHITE IS/ARE CLAIMED AS A FEATURE OF THE MARK.

THE MARK CONSISTS OF THE FOLLOWING: THE LITERAL PORTION "SURF GROMS" OUTLINED IN BLUE WITH WHITE FILL, WHERE THE "O" IN "GROMS" IS STYLIZED TO ENCOMPASS A WAVE DESIGN WITH STARS WHERE THE TWO WAVES ARE WHITE, THE FIVE STARS ARE WHITE, THE WATER IS REPRESENTED IN BLUE WITH A WHITE OUTLINING AND A LIGHTER BLUE OUTLINE NEAR THE BOTTOM OF THE "O"; EMANATING FROM THE "O" IS A LARGER WAVE DESIGN THAT CURLS ABOVE THE WORDING "SURF" AND HAS A BLUE STREAK, A WHITE STREAK, LIGHT BLUE STREAK, ANOTHER WHITE STREAK AND FINALLY ANOTHER BLUE STREAK.

SER. NO. 79-101,091, FILED 5-27-2011.

BENJAMIN OKEKE, EXAMINING ATTORNEY

United States of America
United States Patent and Trademark Office

accurapuls

Reg. No. 4,204,076

Registered Sep. 11, 2012

Int. Cls.: 7, 9 and 40

TRADEMARK

SERVICE MARK

PRINCIPAL REGISTER

LÖCKER,CHRISTIAN
HEIENKAMP 9
59510 LIPPETAL - HERZFELD
FED REP GERMANY

FOR: NUMERICALLY CONTROLLED MACHINES AND MACHINE TOOLS FOR MACHINING PARTS; MACHINES AND MACHINE TOOLS FOR TREATING SURFACES AND FOR STABILIZING SURFACES, NAMELY, KNOCKING MACHINES FOR THE TREATMENT OF CERAMICS AND METALS, IN CLASS 7 (U.S. CLS. 13, 19, 21, 23, 31, 34 AND 35).

FOR: SOFTWARE FOR CONTROLLING MACHINES AND MACHINE TOOLS, NAMELY, KNOCKING MACHINES FOR THE TREATMENT OF CERAMICS AND METALS; ENGINEERING DESIGN SOFTWARE FOR THE CALCULATION AND PICTORIAL REPRESENTATION OF SURFACES, MATERIAL STRENGTHS AND VOLUMES, IN CLASS 9 (U.S. CLS. 21, 23, 26, 36 AND 38).

FOR: TREATMENT OF MATERIALS, NAMELY, BY KNOCKING AND STRAIN HARDENING; MACHINE SHOP SERVICES, NAMELY, MACHINING OF PARTS FOR OTHERS; METAL TREATING BY MEANS OF STRAIN HARDENING; PROCESSING OF PLASTICS BY MEANS OF STRAIN HARDENING, IN CLASS 40 (U.S. CLS. 100, 103 AND 106).

THE MARK CONSISTS OF STANDARD CHARACTERS WITHOUT CLAIM TO ANY PARTICULAR FONT, STYLE, SIZE, OR COLOR.

PRIORITY DATE OF 3-1-2011 IS CLAIMED.

OWNER OF INTERNATIONAL REGISTRATION 1086916 DATED 7-12-2011, EXPIRES 7-12-2021.

SER. NO. 79-101,106, FILED 7-12-2011.

WILLIAM BRECKENFELD, EXAMINING ATTORNEY



David J. Kybas

Director of the United States Patent and Trademark Office

United States of America

United States Patent and Trademark Office

DOUTZEN KROES

Reg. No. 4,204,077

AHAU GELE ZON HOLDING B.V. (NETHERLANDS COMPANY WITH LIMITED LIABILITY)
ELECTRONICAWEG 23

Registered Sep. 11, 2012

NL-9503 GA STADSKANAAL, NETHERLANDS

Int. Cls.: 3, 9, 16, 25 and 35

FOR: COSMETIC SKIN AND HAIR TREATMENT PRODUCTS, NAMELY, MAKE-UP; HAIR LOTIONS; HAIR SHAMPOO; SKIN SOAP; CONDITIONERS FOR HAIR TREATMENT, SKIN LOTION; BODY LOTION, BODY CREAMS; DEODORANTS FOR PERSONAL USE; BATH FOAM AND SHOWER GEL, PARFUMS AND EAU-DE-COLOGNE; ESSENTIAL OILS; TOOTHPASTE AND TOOTH CLEANING PREPARATIONS, IN CLASS 3 (U.S. CLS. 1, 4, 6, 50, 51 AND 52).

TRADEMARK

SERVICE MARK

PRINCIPAL REGISTER

FOR: ELECTRONIC PUBLICATIONS, NAMELY, DOWNLOADABLE ELECTRONIC PUBLICATIONS IN THE NATURE OF MAGAZINES AND JOURNALS IN THE FIELD OF FASHION, ACTING, THEATER AND MUSIC; SUNGLASSES AND SPECTACLES, FASHION SPECTACLES, PROTECTIVE SPECTACLES, PROTECTION MASKS, AND SPECTACLES FOR SPORTS, SPECTACLE FRAMES AND FRAMES FOR PROTECTION MASKS; CASES, NAMELY, SPECTACLE CASES AND CASES FOR PROTECTION MASKS; CORDS FOR SUNGLASSES; MOUSE MATS; OPTICAL APPARATUS AND INSTRUMENTS, NAMELY, OPTICAL LENSES; COMPUTERS; HARDWARE AND SOFTWARE FOR SCHEDULING FASHION SHOWS, PROGRAMMING AUTOMATIC LIGHTING EFFECTS AND COMPOSING MUSIC FOR USE IN THE FIELDS OF FASHION, ACTING, THEATER AND MUSIC, AUDIO OR VIDEO RECORDINGS IN THE FIELDS OF FASHION, THEATER AND MUSIC; MAGNETS, WIRELESS MOBILE PHONES AND REPLACEMENT PARTS THEREFOR; MOBILE PHONE FACE PLATES, RING TONES BEING DOWNLOADABLE RING TONES, SOUND RECORDING MEDIUMS, NAMELY, MP3 PLAYERS; DOWNLOADABLE GRAPHICS AND VIDEO IMAGES FOR WIRELESS MOBILE COMMUNICATION DEVICES; TELEPHONE SETS; PRERECORDED VIDEOTAPES, COMPACT DISCS AND CD-ROMS ALL FEATURING INTERVIEWS, MODELING INSTRUCTION AND FASHION SHOWS WITH THE DUTCH MODEL AND ACTRESS DOUTZEN KROES; DVD DISKS FEATURING INTERVIEWS, MODELING INSTRUCTION AND FASHION SHOWS WITH THE DUTCH MODEL AND ACTRESS DOUTZEN KROES; VIDEO GAME PROGRAMS RECORDED ON CARTRIDGES, DISCS, CD-ROMS, CASSETTES, TAPES, AND MINI DISCS; COMPUTER GAME SOFTWARE RECORDED ON DISCS, CD ROMS, AND MINI DISCS, IN CLASS 9 (U.S. CLS. 21, 23, 26, 36 AND 38).



David J. Kyffers

Director of the United States Patent and Trademark Office

FOR: PRINTED MATTER IN THE NATURE OF JOURNALS, PERIODICALS, MAGAZINES AND BROCHURES ALL IN THE FIELD OF FASHION, ACTING, THEATER AND MUSIC; NEWSPAPERS, BOOKBINDING MATERIAL, PHOTOGRAPHS; STATIONERY, ADHESIVES

Reg. No. 4,204,077 FOR STATIONERY OR HOUSEHOLD PURPOSES; STICKER POSTERS IN THE NATURE OF SELFADHESIVE POSTERS; OFFICE AND SCHOOL SUPPLIES, NAMELY, NOTE BOOKS AND WRITING PADS, LOOSE LEAF NOTEBOOK COVERS, WRITING INSTRUMENTS, NAMELY, PENS, PENCILS, BALL-POINT PENS, PEN CASES AND PENCIL CASES, FINE LINERS IN THE NATURE OF FINE TIP PENS, ROLLER-BALL PENS, FELT TIP MARKERS, CALENDARS, SELF-ADHESIVE NOTE PADS, POSTERS, GREETING CARDS AND COLORING BOOKS, ARTISTS' MATERIALS, NAMELY, PAINT BRUSHES, ARTISTS PASTELS AND ARTISTS PENCILS; PAPER, CARDBOARD AND PRODUCTS MADE THEREOF NOT INCLUDED IN OTHER CLASSES, NAMELY, CARDBOARD HANG TAGS, CARDBOARD PACKAGING, ENVELOPES AND PAPER BAGS; TYPEWRITERS AND OFFICE REQUISITES, NAMELY, PAPER TRIMMERS, RUBBER BANDS AND STAPLERS; PLASTIC MATERIALS FOR PACKAGING, NAMELY, PLASTIC BAGS FOR PACKAGING, IN CLASS 16 (U.S. CLS. 2, 5, 22, 23, 29, 37, 38 AND 50).

FOR: CLOTHING, NAMELY, BATH WEAR IN THE NATURE OF BIKINIS, BATHING SUITS, PAREOS, BATHROBES, SLIPPERS AND DRESSES THAT MAY BE USED AS TOWELS AND SPORTSWEAR IN THE NATURE OF SPORTS PANTS, SPORTS SHIRTS, SPORTS BRAS, SHORTS, SWEATPANTS AND SWEATSHIRTS; LINGERIE AND BELTS; SHOES AND HEADGEAR, NAMELY, HEAD BANDS, HATS, CAPS AND VISORS, IN CLASS 25 (U.S. CLS. 22 AND 39).

FOR: ADVERTISING; BUSINESS INTERMEDIARY SERVICE IN THE FIELD OF SELLING PRODUCTS AND RENDERING SERVICES; BUSINESS MANAGEMENT; BUSINESS ADMINISTRATION; PERSONNEL INTERMEDIARY SERVICES, NAMELY, TEMPORARY PLACEMENT OF MODELS OR ACTRESSES AND FILLING THE TEMPORARY AND PERMANENT STAFFING NEEDS OF BUSINESSES; SERVICES IN THE FIELD OF PUBLICITY, NAMELY, PRODUCT AND SERVICE DEMONSTRATIONS IN SHOP WINDOWS AND STORES BY LIVE MODELS; PRODUCT MERCHANDISING AND BUSINESS ADVICE FOR OTHERS IN THE FIELD OF PUBLICITY AND MERCHANDISING PROVIDED BY MODELS; RETAIL STORE AND ONLINE RETAIL STORE SERVICES IN THE FIELD OF COSMETICS, SKIN AND HAIR TREATMENT PRODUCTS INCLUDING MAKE-UP, HAIR LOTIONS, HAIR SHAMPOO, SKIN SOAP, CONDITIONERS FOR HAIR TREATMENT, SKIN LOTION, BODY LOTION, BODY CREAMS, DEODORANTS FOR PERSONAL USE, BATH FOAM AND SHOWER GEL, PERFUMES AND EAU DE COLOGNE, ESSENTIAL OILS, TOOTHPASTE AND TOOTH CLEANSING PRODUCTS, PHARMACEUTICAL AND VETERINARY PREPARATIONS, SANITARY PREPARATIONS FOR MEDICAL PURPOSES, DIETETIC SUBSTANCES ADAPTED FOR MEDICAL USE, FOOD FOR BABIES, PLASTERS, BANDAGE MATERIAL, MATERIAL FOR STOPPING TEETH, DENTAL WAX, DISINFECTANTS, PREPARATIONS FOR DESTROYING VERMIN, FUNGICIDES, HERBICIDES, ELECTRONIC PUBLICATIONS, SUNGLASSES AND SPECTACLES, FASHIONABLE SPECTACLES, PROTECTIVE SPECTACLES, MASKS AND SPECTACLES FOR SPORTS, SPECTACLE FRAMES AND MASKS, CASES, SPECTACLE CASES AND FACE MASKS, CORDS FOR SUNGLASSES, MOUSE MATS, OPTICAL APPARATUS AND INSTRUMENTS, ELECTRICAL APPARATUS, COMPUTERS, HARDWARE AND SOFTWARE, MUSICAL SOUND OR VIDEO RECORDINGS IN THE FIELD OF FASHION, THEATER AND MUSIC, MAGNETS, WIRELESS MOBILE PHONES AND PARTS THEREOF, MOBILE PHONE FACE PLATES, RING TONES BEING DOWNLOADABLE RING TONES, SOUND RECORDING MEDIUMS, MP3S, GRAPHICS AND VIDEO IMAGES FOR WIRELESS MOBILE COMMUNICATION DEVICES, TELEPHONE SETS, VIDEOTAPES, COMPACT DISCS, CD-ROMS, DVD DISKS, VIDEO GAME PROGRAMS RECORDED ON CARTRIDGES, DISCS, CD-ROMS, CASSETTES, TAPES, AND MINI DISCS, COMPUTER GAME SOFTWARE RECORDED ON DISCS, CD ROMS AND MINI DISCS, PRECIOUS METALS AND THEIR ALLOYS AND GOODS IN PRECIOUS METALS OR COATED THEREWITH, JEWELRY AND BIJOUTERIE INCLUDING CHAINS, EARRINGS, RINGS, BRACELETS, ORNAMENTAL PINS, BROOCHES, PRECIOUS STONES, CLOCKS, HOROLOGICAL INSTRUMENTS INCLUDING WATCHES, KEY RINGS AND KEY CORDS, JOURNALS, PERIODICALS, MAGAZINES, BROCHURES, NEWSPAPERS, PRINTED MATTER, BOOKBINDING MATERIAL, PHOTOGRAPHS, STATIONERY, ADHESIVES FOR STATIONERY OR HOUSEHOLD PURPOSES, STICKERS, POSTERS, OFFICE AND SCHOOL

Reg. No. 4,204,077 SUPPLIES, NAMELY, NOTE BOOKS AND WRITING PADS, LOOSE COVERS, WRITING INSTRUMENTS, INCLUDING PENS, PENCILS, BALL-POINT PENS, PEN CASES AND PENCIL CASES, FINE LINERS IN THE NATURE OF FINE TIP PENS, ROLLER-BALL PENS, FELT TIP MARKERS, CALENDARS, SELF-ADHESIVE NOTE PADS, POSTERS, GREETING CARDS AND COLORING BOOKS, ARTISTS' MATERIALS, PAINTBRUSHES, PAPER, CARDBOARD AND PRODUCTS MADE THEREOF, TYPEWRITERS AND OFFICE REQUISITES, INSTRUCTIONAL AND TEACHING MATERIAL, PLASTIC MATERIALS FOR PACKAGING, LEATHER AND IMITATIONS OF LEATHER AND GOODS MADE OF THESE MATERIALS, TRUNKS AND TRAVELING BAGS, UMBRELLAS, PARASOLS AND WALKING STICKS, WHIPS, HARNESS AND SADDLERY, FURNITURE, MIRRORS, PICTURE FRAMES MADE OF WOOD, CORK, REED, CANE, WICKER, HORN, BONE, IVORY, WHALEBONE, SHELL, AMBER, MOTHER-OF-PEARL, MEERSCHAUM AND SUBSTITUTES FOR ALL THESE MATERIALS, GOODS MADE OF PLASTICS, CLOTHING, INCLUDING BATH WEAR AND SPORTSWEAR, LINGERIE AND BELTS, SHOES AND HEADGEAR, GAMES AND PLAYTHINGS, GYMNASTIC AND SPORTING ARTICLES, DECORATIONS FOR CHRISTMAS TREES, PLAYING CARDS, MEAT, FISH, POULTRY AND WILD, MEAT EXTRACTS, PRESERVED, FROZEN, DRIED AND COOKED FRUITS AND VEGETABLES, JELLIES, JAMS, COMPOTES, EGGS, MILK PRODUCTS, EDIBLE OILS AND FATS, COFFEE, TEA, COCOA, SUGAR, RICE, TAPIOCA, SAGO, ARTIFICIAL COFFEE, FLOUR AND PREPARATIONS MADE FROM CEREALS, BREAD, PASTRY AND CONFECTIONERY, ICE CREAM, HONEY, TREACLE, YEAST, LEAVEN, SALT, MUSTARD, VINEGAR, SAUCES, SPICES, ICE, AGRICULTURAL, HORTICULTURAL AND FORESTRY PRODUCTS AND GRAINS, LIVE ANIMALS, FRESH FRUITS AND VEGETABLES, SEEDS, NATURAL PLANTS AND FLOWERS, FOODSTUFFS FOR ANIMALS, MALT, BEERS, MINERAL AND AERATED WATERS AND OTHER NON-ALCOHOLIC DRINKS, FRUIT DRINKS AND FRUIT JUICES, SYRUPS AND OTHER PREPARATIONS FOR MAKING BEVERAGES, ALCOHOLIC BEVERAGES, WINES; MANAGEMENT OF PROFESSIONAL MODELS; MEDIATION OF TRADE BUSINESS FOR THIRD PARTIES IN THE FIELD OF COSMETICS, SKIN AND HAIR TREATMENT PRODUCTS INCLUDING MAKE-UP, HAIR LOTIONS, HAIR SHAMPOO, SKIN SOAP, CONDITIONERS FOR HAIR TREATMENT, SKIN LOTION, BODY LOTION, BODY CREAMS, DEODORANTS FOR PERSONAL USE, BATH FOAM AND SHOWER GEL, PERFUMES AND EAU DE COLOGNE, ESSENTIAL OILS, TOOTHPASTE AND TOOTH CLEANSING PRODUCTS, PHARMACEUTICAL AND VETERINARY PREPARATIONS, SANITARY PREPARATIONS FOR MEDICAL PURPOSES, DIETETIC SUBSTANCES ADAPTED FOR MEDICAL USE, FOOD FOR BABIES, PLASTERS, BANDAGE MATERIAL, MATERIAL FOR STOPPING TEETH, DENTAL WAX, DISINFECTANTS, PREPARATIONS FOR DESTROYING VERMIN, FUNGICIDES, HERBICIDES, ELECTRONIC PUBLICATIONS, SUNGLASSES AND SPECTACLES, FASHIONABLE SPECTACLES, PROTECTIVE SPECTACLES, MASKS AND SPECTACLES FOR SPORTS, SPECTACLES FRAMES AND MASKS, CASES, SPECTACLE CASES AND FACE MASKS, CORDS FOR SUNGLASSES, MOUSE MATS, OPTICAL APPARATUS AND INSTRUMENTS, ELECTRICAL APPARATUS, COMPUTERS, HARDWARE AND SOFTWARE, MUSICAL SOUND OR VIDEO RECORDINGS IN THE FIELD OF FASHION, THEATER AND MUSIC, MAGNETS, WIRELESS MOBILE PHONES AND ACCESSORIES, MOBILE PHONE FACE PLATES, RING TONES BEING DOWNLOADABLE RING TONES, SOUND RECORDING MEDIUMS, MP3S, GRAPHICS AND VIDEO IMAGES FOR WIRELESS MOBILE COMMUNICATION DEVICES, TELEPHONE SETS, VIDEOS, COMPACT DISCS, CD-ROMS, DVD DISKS, VIDEO GAME PROGRAMS RECORDED ON CARTRIDGE, DISCS, CD-ROMS, CASSETTES, TAPES AND MINI DISCS, COMPUTER GAME SOFTWARE RECORDED ON DISCS, CD ROMS AND MINI DISCS, PRECIOUS METALS AND THEIR ALLOYS AND GOODS IN PRECIOUS METAL OR COATED THEREWITH, JEWELRY AND BIJOUTERIE INCLUDING CHAINS, EARRINGS, RINGS, BRACELETS, ORNAMENTAL PINS, BROOCHES, PRECIOUS STONES, CLOCKS, HOROLOGICAL INSTRUMENTS INCLUDING WATCHES, KEY RINGS AND KEY CORDS, JOURNALS, PERIODICALS, MAGAZINES, BROCHURES, NEWSPAPERS, PRINTED MATTER, BOOK-BINDING MATERIAL, PHOTOGRAPHS, STATIONERY, ADHESIVES FOR STATIONERY OR HOUSEHOLD PURPOSES, STICKERS, POSTERS, OFFICE AND SCHOOL SUPPLIES, NAMELY, NOTE BOOKS AND WRITING PADS, LOOSE COVERS, WRITING INSTRUMENTS, INCLUDING PENS, PENCILS, BALL-POINT PENS, PEN CASES AND PENCIL CASES, FINE

Reg. No. 4,204,077 LINERS IN THE NATURE OF FINE TIP PENS, ROLLER-BALL PENS, FELT TIP MARKERS, CALENDARS, SELF-ADHESIVE NOTE PADS, POSTERS, GREETING CARDS AND COLORING BOOKS, ARTISTS' MATERIALS, PAINTBRUSHES, PAPER, CARDBOARD AND PRODUCTS MADE THEREOF, TYPEWRITERS AND OFFICE REQUISITES, INSTRUCTIONAL AND TEACHING MATERIAL, PLASTIC MATERIALS FOR PACKAGING, LEATHER AND IMITATIONS OF LEATHER AND GOODS MADE OF THESE MATERIALS, TRUNKS AND TRAVELING BAGS, UMBRELLAS, PARASOLS AND WALKING STICKS, WHIPS, HARNESS AND SADDLERY, FURNITURE, MIRRORS, PICTURE FRAMES MADE OF WOOD, CORK, REED, CANE, WICKER, HORN, BONE, IVORY, WHALEBONE, SHELL, AMBER, MOTHER-OF-PEARL, MEERSCHAUM AND SUBSTITUTES FOR ALL THESE MATERIALS, OR GOODS MADE OF PLASTIC, CLOTHING, INCLUDING BATH WEAR AND SPORTSWEAR, LINGERIE AND BELTS, SHOES AND HEADGEAR, GAMES AND PLAYTHINGS, GYMNAS- TIC AND SPORTING ARTICLES, DECORATIONS FOR CHRISTMAS TREES, PLAYING CARDS, MEAT, FISH, POULTRY AND WILD, MEAT EXTRACTS, PRESERVED, FROZEN, DRIED AND COOKED FRUITS AND VEGETABLES, JELLIES, JAMS, COMPOTES, EGGS, MILK AND MILK PRODUCTS, EDIBLE OILS AND FATS, COFFEE, TEA, COCOA, SUGAR, RICE, TAPIOCA, SAGO, ARTIFICIAL COFFEE, FLOUR AND PREPARATIONS MADE FROM CEREALS, BREAD, PASTRY AND CONFECTIONERY, ICES, HONEY, TREACLE, YEAST, LEAVEN, SALT, MUSTARD, VINEGAR, SAUCES, SPICES, ICE, AGRICULTURAL, HORTI- CULTURAL AND FORESTRY PRODUCTS AND GRAINS, LIVE ANIMALS, FRESH FRUITS AND VEGETABLES, SEEDS, NATURAL PLANTS AND FLOWERS, FOODSTUFFS FOR ANIMALS, MALT, BEERS, MINERAL AND AERATED WATERS AND OTHER NON-ALCO- HOLIC DRINKS, FRUIT DRINKS AND FRUIT JUICES, SYRUPS AND OTHER PREPARA- TIONS FOR MAKING BEVERAGES, ALCOHOLIC BEVERAGES, WINES , IN CLASS 35 (U.S. CLS. 100, 101 AND 102).

THE MARK CONSISTS OF STANDARD CHARACTERS WITHOUT CLAIM TO ANY PAR- TICULAR FONT, STYLE, SIZE, OR COLOR.

PRIORITY DATE OF 10-29-2009 IS CLAIMED.

OWNER OF INTERNATIONAL REGISTRATION 1086963 DATED 4-28-2010, EXPIRES 4-28- 2020.

THE NAME(S), PORTRAIT(S), AND/OR SIGNATURE(S) SHOWN IN THE MARK IDENTIFIES "DOUTZEN KROES", WHOSE CONSENT(S) TO REGISTER IS MADE OF RECORD.

SER. NO. 79-101,123, FILED 4-28-2010.

ELLEN PERKINS, EXAMINING ATTORNEY

United States of America

United States Patent and Trademark Office

QUVA

Reg. No. 4,204,078

Registered Sep. 11, 2012

Int. Cl.: 5

TRADEMARK

PRINCIPAL REGISTER

BUILDING APS (DENMARK CORPORATION)
DYREHAVEVEJ 45
DK-2930 KLAMPENBORG, DENMARK

FOR: SANITARY PREPARATIONS FOR MEDICAL USE; DIETETIC SUBSTANCES, NAMELY, FOODS AND BEVERAGES ADAPTED FOR MEDICAL USE, FOOD FOR BABIES; PLASTERS FOR MEDICAL PURPOSES, MATERIALS FOR DRESSINGS, NAMELY, BANDAGES AND GAUZES FOR DRESSINGS; MATERIAL FOR STOPPING TEETH, DENTAL WAX; ALL-PURPOSE DISINFECTANTS, IN CLASS 5 (U.S. CLS. 6, 18, 44, 46, 51 AND 52).

THE MARK CONSISTS OF STANDARD CHARACTERS WITHOUT CLAIM TO ANY PARTICULAR FONT, STYLE, SIZE, OR COLOR.

OWNER OF INTERNATIONAL REGISTRATION 1087056 DATED 7-7-2011, EXPIRES 7-7-2021.

SER. NO. 79-101,152, FILED 7-7-2011.

CARYN GLASSER, EXAMINING ATTORNEY



David J. Kyros

Director of the United States Patent and Trademark Office

United States of America

United States Patent and Trademark Office

UGARTE

Reg. No. 4,204,079

Registered Sep. 11, 2012

Int. Cl.: 33

TRADEMARK

PRINCIPAL REGISTER

HEREDAD UGARTE, S.A. (SPAIN SOCIEDAD ANÓNIMA)
CTRA NACIONAL 232 VITORIA-LOGROÑO, KM 69
E-01307 PAGANOS (ALAVA)
SPAIN

FOR: ALCOHOLIC BEVERAGES, NAMELY, WINES, IN CLASS 33 (U.S. CLS. 47 AND 49).

THE MARK CONSISTS OF STANDARD CHARACTERS WITHOUT CLAIM TO ANY PARTICULAR FONT, STYLE, SIZE, OR COLOR.

OWNER OF INTERNATIONAL REGISTRATION 1087076 DATED 6-29-2011, EXPIRES 6-29-2021.

OWNER OF U.S. REG. NO. 3,601,344.

SEC. 2(F).

SER. NO. 79-101,184, FILED 6-29-2011.

SARA BENJAMIN, EXAMINING ATTORNEY



David J. Kyffers

Director of the United States Patent and Trademark Office

United States of America

United States Patent and Trademark Office

PHYSIPOD

Reg. No. 4,204,080

Registered Sep. 11, 2012

Int. Cl.: 10

TRADEMARK

PRINCIPAL REGISTER

ALLIED HEALTH MEDICAL SUPPLIES PTY LTD (AUSTRALIA CORPORATION)
266 MAIN ROAD EAST
ST ALBANS VIC 3021
AUSTRALIA

FOR: ORTHOTIC APPARATUS AND DEVICES, NAMELY, ORTHOTICS FOR FEET; ORTHOTIC INSOLES; ELECTROTHERAPY DEVICES FOR PROVIDING TRANSCUTANEOUS ELECTRICAL NERVE STIMULATION AND ELECTRICAL MUSCLE STIMULATION; APPARATUS AND DEVICES FOR THE TREATMENT AND CARE OF FEET, TOES AND SKIN, NAMELY, ORTHOPEDIC INSOLES, ORTHOPEDIC FOOT CUSHIONS, ORTHOPEDIC HEEL CUPS, ORTHOPEDIC HEEL GUARDS, ORTHOPEDIC HEEL WEDGES, ORTHOPEDIC HEEL CUSHIONS, ORTHOPEDIC FORE-FOOT CUSHIONS, ORTHOPEDIC TOE SEPARATORS, ORTHOPEDIC FOOT SUPPORTS, ORTHOPEDIC TOE REGULATORS, ORTHOPEDIC TOE PROPS, ORTHOPEDIC TOE RELIEF PADS, ORTHOPEDIC THONG PROTECTORS; COMPRESSION HOSIERY, GRADUATED COMPRESSION HOSIERY, THERAPEUTIC HOSIERY, MEDICAL SUPPORT HOSIERY, AND HOSIERY TO ENHANCE BLOOD CIRCULATION, NAMELY, MEDICAL COMPRESSION STOCKINGS AND TIGHTS AND CALF HIGH HOSE; ORTHOPEDIC SUPPORT BANDAGES; ELASTIC BANDAGES FOR MEDICAL, THERAPEUTIC AND REHABILITATIVE PURPOSES; EXERCISE EQUIPMENT, DEVICES AND APPARATUS FOR MEDICAL, THERAPEUTIC AND REHABILITATIVE PURPOSES; EXERCISE EQUIPMENT, DEVICES AND APPARATUS FOR PHYSIOTHERAPY PURPOSES, IN CLASS 10 (U.S. CLS. 26, 39 AND 44).

THE MARK CONSISTS OF STANDARD CHARACTERS WITHOUT CLAIM TO ANY PARTICULAR FONT, STYLE, SIZE, OR COLOR.

OWNER OF INTERNATIONAL REGISTRATION 1087311 DATED 7-4-2011, EXPIRES 7-4-2021.

SER. NO. 79-101,273, FILED 7-4-2011.

HAI-LY LAM, EXAMINING ATTORNEY



David J. Kyros

Director of the United States Patent and Trademark Office

United States of America

United States Patent and Trademark Office



Reg. No. 4,204,081

Registered Sep. 11, 2012

Int. Cl.: 9

SHIN, HYUNG KYUN (REPUBLIC OF KOREA INDIVIDUAL)
103-1203, JINRO APT,
1506 GAGYEONG-DONG,; HEUNGDEOK-GU, CHEONGJU-SI; CHUNGCHEONGBUK-DO
361-735
REPUBLIC OF KOREA

TRADEMARK

PRINCIPAL REGISTER

FOR: LOAD CELLS, NAMELY, TRANSDUCERS FOR CONVERTING FORCE OR WEIGHT INTO ELECTRICAL SIGNALS; MATERIAL TESTING INSTRUMENTS AND MACHINES, NAMELY, APPARATUSES TO TEST THE STRENGTH OF MATERIALS SUCH AS CEMENT, GLASS, PLASTIC, AND METAL; COMPRESSION TESTING APPARATUS; SCALES; REVOLUTION SPEED INDICATORS; ACCELEROMETERS; STRAIN GAUGES; POWER TRANSFORMERS FOR AMPLIFICATION; POWER AMPLIFIERS; AMPLIFIERS; AMPLIFYING TUBES; INDICATORS, NAMELY, APPARATUSES FOR DIGITALLY INDICATING OUTPUT VALUES OR ELECTRICAL SIGNALS RECEIVED FROM LOAD CELLS OR OTHER EQUIPMENT THAT MEASURES FORCE OR WEIGHT; RECORDED COMPUTER PROGRAMS, NAMELY, SOFTWARE FOR OPERATING MEASUREMENT MACHINES SUCH AS LOAD CELLS OR MATERIALS TESTING INSTRUMENTS THAT TEST THE STRENGTH OF MATERIALS; TORQUE METER, IN CLASS 9 (U.S. CLS. 21, 23, 26, 36 AND 38).

THE MARK CONSISTS OF A SMALL RED SQUARE IS ON THE OUTER LEFT TOPSIDE OF A BLUE OVAL INCLINED TO THE RIGHT, LETTERS OF "DA" SLIGHTLY INCLINED TOWARD THE RIGHT INSIDE THE OVAL ARE IN WHITE, AND RIGHT BEHIND THE OVAL, LETTERS OF "CELL" IN THE SAME FONT AS "DA" ARE IN GREY.



PRIORITY DATE OF 6-20-2011 IS CLAIMED.

OWNER OF INTERNATIONAL REGISTRATION 1087600 DATED 7-1-2011, EXPIRES 7-1-2021.

THE COLOR(S) RED, BLUE, WHITE AND GREY IS/ARE CLAIMED AS A FEATURE OF THE MARK.

SER. NO. 79-101,386, FILED 7-1-2011.

REBECCA POVARCHUK, EXAMINING ATTORNEY

David J. Kyffers

Director of the United States Patent and Trademark Office

United States of America

United States Patent and Trademark Office



Reg. No. 4,204,082

Registered Sep. 11, 2012

Int. Cls.: 14 and 35

TRADEMARK

SERVICE MARK

PRINCIPAL REGISTER

MANUFACTURE ROGER DUBUIS SA (SWITZERLAND SOCIÉTÉ ANONYME (SA))
RUE ANDRÉ-DE-GARRINI 2
CH-1217 MEYRIN
SWITZERLAND

FOR: CUFF LINKS, TIE CLIPS, RINGS, BRACELETS, EARRINGS, NECKLACES, BROOCHES, KEY RINGS OF PRECIOUS METALS, WATCHES, CHRONOMETERS, CLOCKS, WATCH BANDS, BOXES OF PRECIOUS METAL FOR WATCHES AND JEWELRY, ALARM CLOCKS, IN CLASS 14 (U.S. CLS. 2, 27, 28 AND 50).

FOR: ADVERTISING; BUSINESS MANAGEMENT; BUSINESS ADMINISTRATION; DISSEMINATION OF ADVERTISING MATTER; PROCUREMENT SERVICES FOR OTHERS, NAMELY, PURCHASING GOODS AND SERVICES FOR OTHER BUSINESSES IN THE FIELD OF JEWELRY AND WATCHES; PRESENTATION OF GOODS ON COMMUNICATION MEDIA, FOR RETAIL PURPOSES; COMMERCIAL INFORMATION AND ADVICE FOR CONSUMERS; DEMONSTRATION OF GOODS; DIRECT MAIL ADVERTISING; AUCTIONEERING; ORGANIZATION OF EXHIBITIONS FOR COMMERCIAL OR ADVERTISING PURPOSES; ORGANIZATION OF TRADE FAIRS FOR COMMERCIAL OR ADVERTISING PURPOSES; SALES PROMOTION FOR OTHERS; PUBLICATION OF PUBLICITY TEXTS; ON-LINE ADVERTISING ON A COMPUTER NETWORK; PUBLIC RELATIONS; NEWS CLIPPING SERVICES; GATHERING, FOR THE BENEFIT OF OTHERS, OF GOODS IN THE FIELD OF JEWELRY AND WATCHES, ENABLING THE CONSUMER TO VIEW AND PURCHASE THESE GOODS CONVENIENTLY IN A STORE; GATHERING, FOR THE BENEFIT OF OTHERS, OF GOODS IN THE FIELD OF JEWELRY AND WATCHES, ENABLING THE CONSUMER TO VIEW AND PURCHASE THESE GOODS CONVENIENTLY FROM A GENERAL CATALOG OF GOODS BY E-MAIL OR BY ANY OTHER TELECOMMUNICATION MEANS; GATHERING, FOR THE BENEFIT OF OTHERS, OF GOODS IN THE FIELD OF JEWELRY AND WATCHES, ENABLING THE CONSUMER TO VIEW AND PURCHASE THESE GOODS CONVENIENTLY FROM AN INTERNET SITE, IN CLASS 35 (U.S. CLS. 100, 101 AND 102).



THE MARK CONSISTS OF A HIGHLY STYLIZED ABSTRACT DESIGN OF THE LETTERS "RD".

David J. Kybas

PRIORITY DATE OF 1-14-2011 IS CLAIMED.

Reg. No. 4,204,082 OWNER OF INTERNATIONAL REGISTRATION 1087648 DATED 6-30-2011, EXPIRES 6-30-2021.

SER. NO. 79-101,404, FILED 6-30-2011.

KRISTIN CARLSON, EXAMINING ATTORNEY

United States of America

United States Patent and Trademark Office

HYPERSVISION

Reg. No. 4,204,083

EXPRIMM (FRANCE SOCIÉTÉ PAR ACTIONS SIMPLIFIÉE)

Registered Sep. 11, 2012

3 ROND-POINT DES SAULES
F-78280 GUYANCOURT, FRANCE

Int. Cl.: 42

FOR: TECHNICAL APPRAISALS AND DIAGNOSTICS PERFORMED BY TECHNICAL AND ENGINEERING SPECIALISTS IN ORDER TO DETERMINE, OPTIMIZE AND MONITOR OVER TIME THE ENERGY PERFORMANCE OF BUILDINGS; ENERGY CONSUMPTION FORECASTING SERVICES, NAMELY, EVALUATIONS, ESTIMATES AND RESEARCH IN THE FIELD OF THE ENERGY PERFORMANCE OF BUILDINGS PROVIDED BY ENGINEERS; ENGINEERING SERVICES IN CONNECTION WITH THE ENERGY PERFORMANCE OF BUILDINGS; TECHNICAL PROJECT STUDIES, NAMELY, TECHNICAL STUDIES IN THE FIELD OF ANALYZING AND ACCESSING THE ENERGY PERFORMANCE OF BUILDINGS; TECHNICAL INSPECTION SERVICES ENABLING CERTIFICATION AND EVALUATION IN CONNECTION WITH THE ENERGY PERFORMANCE OF BUILDINGS, IN CLASS 42 (U.S. CLS. 100 AND 101).

SERVICE MARK

PRINCIPAL REGISTER

OWNER OF INTERNATIONAL REGISTRATION 1088125 DATED 7-11-2011, EXPIRES 7-11-2021.

SER. NO. 79-101,599, FILED 7-11-2011.

DAVID HOFFMAN, EXAMINING ATTORNEY



David J. Kyffers

Director of the United States Patent and Trademark Office

United States of America
United States Patent and Trademark Office

HENGE

Reg. No. 4,204,084

Registered Sep. 11, 2012

Int. Cl.: 20

TRADEMARK

PRINCIPAL REGISTER

HENGE - S.R.L. (ITALY LIMITED LIABILITY JOINT STOCK COMPANY)
VIA A. PERSIO, 38
MATERA (MT)
ITALY

FOR: FURNITURE, NAMELY, SIDEBOARDS, COUCHES, BEDS, MATTRESSES, DESKS, CHAIRS, TABLES, BEDSIDE TABLES, CUPBOARDS, MIRRORS, PICTURE FRAMES, PILLOWS, ARMCHAIRS, SOFAS, CHAISE LOUNGES, FLOWER-POT PEDESTALS, SHELVES, CHEST FOR DRAWERS, GLASS SHOWCASES, STOOLS AND BOOKCASES, IN CLASS 20 (U.S. CLS. 2, 13, 22, 25, 32 AND 50).

THE MARK CONSISTS OF STANDARD CHARACTERS WITHOUT CLAIM TO ANY PARTICULAR FONT, STYLE, SIZE, OR COLOR.

OWNER OF INTERNATIONAL REGISTRATION 1088270 DATED 6-24-2011, EXPIRES 6-24-2021.

SER. NO. 79-101,656, FILED 6-24-2011.

RONALD AIKENS, EXAMINING ATTORNEY



David J. Kyffers

Director of the United States Patent and Trademark Office

United States of America
United States Patent and Trademark Office

THEMIS

Reg. No. 4,204,085

Registered Sep. 11, 2012

Int. Cl.: 9

TRADEMARK

PRINCIPAL REGISTER

COLLECTE LOCALISATION SATELLITES (FRANCE SOCIÉTÉ ANONYME)
8-10 RUE HERMÈS -
PARC TECHNOLOGIQUE DU CANAL
F-31520 RAMONVILLE SAINT AGNE, FRANCE

FOR: COMPUTER SOFTWARE FOR RECEIVING AND PROCESSING DATA IN CONNECTION WITH OBSERVING LAND, SEAS AND OCEANS; COMPUTER SOFTWARE FOR RECEIVING AND PROCESSING DATA IN CONNECTION WITH FISHING, OCEANOGRAPHY, MONITORING SEAS AND OCEANS, MARITIME SAFETY, MARITIME SEARCH AND RESCUE, IN CLASS 9 (U.S. CLS. 21, 23, 26, 36 AND 38).

THE MARK CONSISTS OF STANDARD CHARACTERS WITHOUT CLAIM TO ANY PARTICULAR FONT, STYLE, SIZE, OR COLOR.

PRIORITY DATE OF 1-10-2011 IS CLAIMED.

OWNER OF INTERNATIONAL REGISTRATION 1088479 DATED 7-8-2011, EXPIRES 7-8-2021.

SER. NO. 79-101,728, FILED 7-8-2011.

JACLYN KIDWELL WALKER, EXAMINING ATTORNEY



David J. Kyffers

Director of the United States Patent and Trademark Office

United States of America

United States Patent and Trademark Office

QUENTRY

Reg. No. 4,204,086

Registered Sep. 11, 2012

Int. Cls.: 9, 35, 38 and 42

TRADEMARK

SERVICE MARK

PRINCIPAL REGISTER

BRAINLAB AG (FED REP GERMANY AKTIENGESELLSCHAFT)
KAPELLENSTR. 12
85622 FELDKIRCHEN
FED REP GERMANY

FOR: APPARATUS FOR RECORDING, TRANSMISSION OR REPRODUCTION OF SOUND OR IMAGES; DATA-PROCESSING EQUIPMENT AND COMPUTERS; COMPUTER SOFTWARE, NAMELY, COMPUTER SOFTWARE FOR USE IN VIEWING, EDITING, STORING, SHARING, ANALYZING AND UPDATING MEDICAL DIAGNOSTIC IMAGES AND PATIENT MEDICAL INFORMATION FOR USE BY MEDICAL PRACTITIONERS; COMPUTER HARDWARE; COMPUTER FIRMWARE, NAMELY, COMPUTER SOFTWARE FOR USE IN VIEWING, EDITING, STORING, SHARING, ANALYZING AND UPDATING MEDICAL DIAGNOSTIC IMAGES AND PATIENT MEDICAL INFORMATION FOR USE BY MEDICAL PRACTITIONERS; ELECTRONIC AND ELECTROMECHANICAL PERIPHERAL APPARATUS ALL FOR USE WITH COMPUTERS, NAMELY, COMPUTER PERIPHERAL APPARATUS; COMPUTER NETWORK EQUIPMENT, NAMELY, COMPUTER NETWORK SERVER, IN CLASS 9 (U.S. CLS. 21, 23, 26, 36 AND 38).

FOR: COMPILING, STORING, ANALYZING AND RETRIEVING DATA AND INFORMATION, NAMELY, ELECTRONIC DATA COLLECTION AND DATA SUBMISSION SERVICES FOR BUSINESS PURPOSES IN THE FIELDS OF MEDICINE AND HEALTHCARE; ADMINISTERING, INDEXING AND ELECTRONICALLY DISTRIBUTING INFORMATION MATERIALS, NAMELY, ELECTRONIC DATA COLLECTION AND DATA SUBMISSION SERVICES FOR BUSINESS PURPOSES IN THE FIELDS OF MEDICINE AND HEALTHCARE; CREATING INDICES FOR INFORMATION, WEBSITES AND OTHER INFORMATION SOURCES, NAMELY, COMPILING OF INFORMATION INTO COMPUTER DATABASES AND COMPILATION AND SYSTEMATIZATION OF INFORMATION IN DATABANKS; COMPILATION AND SYSTEMIZATION OF INFORMATION INTO COMPUTER DATABASES; ORGANIZING COMMERCIAL TRANSACTIONS VIA ELECTRONIC COMMUNICATIONS NETWORKS, NAMELY, PROVIDING A SECURED ACCESS DATABASE VIA THE INTERNET THROUGH WHICH DOCUMENTS AND IMAGES CAN BE VIEWED, COPIED, AND PRINTED FOR PURPOSES OF CONDUCTING COMMERCIAL MEDICAL TRANSACTIONS, IN CLASS 35 (U.S. CLS. 100, 101 AND 102).



David J. Kyjars

Director of the United States Patent and Trademark Office

FOR: TELECOMMUNICATION AND COMMUNICATION SERVICES, NAMELY, ELECTRONIC TRANSMISSION OF DATA AND DOCUMENTS VIA COMPUTER TERMINALS; PROVIDING ACCESS TO ELECTRONIC COMMUNICATIONS NETWORKS AND THE IN-

Reg. No. 4,204,086 TERNET AND EXTRANETS, NAMELY, PROVIDING ACCESS TO ELECTRONIC COMMUNICATIONS NETWORKS; ELECTRONICALLY TRANSMITTING MAIL AND MESSAGES; INTERNET SERVICE PROVIDER (ISP) SERVICES; PROVIDING INFORMATION RELATING TO TELECOMMUNICATION AND COMMUNICATIONS SERVICES, INCLUDING TELECOMMUNICATION AND COMMUNICATIONS SERVICES PROVIDED ONLINE FROM A COMPUTER NETWORK OR VIA THE INTERNET OR EXTRANETS, NAMELY, INFORMATION ABOUT TELECOMMUNICATION; TRANSMITTING AND DISSEMINATING INFORMATION AND DATA VIA COMPUTER NETWORKS AND THE INTERNET, NAMELY, ELECTRONIC EXCHANGE OF DATA STORED IN DATABASES ACCESSIBLE VIA TELECOMMUNICATION NETWORKS; SERVICES FOR ACCESSING WEBSITES, NAMELY, PROVIDING ACCESS TO ELECTRONIC COMMUNICATIONS NETWORKS; PROVIDING ACCESS TO PROPRIETARY COLLECTIONS OF INFORMATION, NAMELY, PROVIDING ACCESS TO DATABASES CONSISTING OF PROPRIETARY COLLECTIONS OF MEDICAL INFORMATION; CONSULTANCY SERVICES ALL RELATING TO TELECOMMUNICATIONS AND COMMUNICATIONS SERVICES, NAMELY, TELECOMMUNICATIONS CONSULTATION; CONSULTANCY SERVICES ALL RELATING TO ORGANIZING COMMERCIAL TRANSACTIONS VIA ELECTRONIC COMMUNICATION NETWORKS, NAMELY, TELECOMMUNICATIONS CONSULTATION WITH RESPECT TO ELECTRONIC DATA INTERCHANGE SERVICES IN THE FIELD OF HEALTHCARE TRANSACTIONS SUCH AS CLAIMS, ELIGIBILITY, CLAIM STATUS, ELECTRONIC REMITTANCE ADVICE, PRIOR AUTHORIZATIONS, ATTACHMENTS AND REFERRALS THAT ALLOW DIRECT TRANSACTION AND PAYMENT COMMUNICATIONS BETWEEN HEALTHCARE PROVIDERS AND PAYERS; CONSULTANCY SERVICES ALL RELATING TO ELECTRONICALLY TRANSMITTING MAIL AND MESSAGES, NAMELY, TELECOMMUNICATIONS CONSULTATION WITH RESPECT TO ELECTRONICALLY TRANSMITTED MAIL AND MESSAGES; CONSULTANCY SERVICES ALL RELATING TO INTERNET SERVICE PROVIDER (ISP) SERVICES INCLUDING SUCH SERVICES PROVIDED ONLINE FROM A COMPUTER NETWORK OR FROM THE INTERNET OR EXTRANETS, NAMELY, TELECOMMUNICATIONS CONSULTATION WITH RESPECT TO PROVIDING MULTIPLE-USER ACCESS TO A GLOBAL COMPUTER INFORMATION NETWORK; PROVIDING ACCESS TO COMPUTER DATABASES; PROVIDING ACCESS, LEASING ACCESS TIME, AND PROVIDING SEARCH, RETRIEVAL, INDEXING, LINKING AND DATA ORGANIZATION CAPABILITIES FOR THE INTERNET, ELECTRONIC COMMUNICATIONS NETWORKS AND ELECTRONIC DATABASES, NAMELY, PROVIDING ACCESS TO TELECOMMUNICATION NETWORKS, AND PROVIDING ACCESS TO THE INTERNET, IN CLASS 38 (U.S. CLS. 100, 101 AND 104).

FOR: COMPUTER SERVICES IN THE NATURE OF CONSULTANCY, DESIGN, TESTING, RESEARCH, ANALYSIS, TECHNICAL SUPPORT AND OTHER TECHNICAL AND ADVISORY SERVICES ALL RELATING TO COMPUTING, NAMELY, DESIGN OF COMPUTER HARDWARE AND SOFTWARE FOR OTHERS; COMPUTER PROGRAMMING FOR OTHERS; RESEARCHING, DEVELOPING, DESIGNING AND UPDATING OF COMPUTER SOFTWARE FOR OTHERS; INFORMATION, CONSULTANCY AND ADVISORY SERVICES ALL RELATING TO THE AFORESAID, INCLUDING SUCH SERVICES PROVIDED ONLINE FROM A COMPUTER NETWORK OR VIA THE INTERNET OR EXTRANETS, NAMELY, CONSULTING SERVICES IN THE FIELD OF CLOUD COMPUTING, TECHNICAL CONSULTING SERVICES IN THE FIELDS OF DATACENTER ARCHITECTURE, PUBLIC AND PRIVATE CLOUD COMPUTING SOLUTIONS, AND EVALUATION AND IMPLEMENTATION OF INTERNET TECHNOLOGY AND SERVICES; PROVIDING SOFTWARE INTERFACES VIA NETWORKS TO PROVIDE PERSONALIZED ACCESS TO GLOBAL COMPUTER INFORMATION NETWORKS FOR TRANSMITTING AND DISSEMINATING OF INFORMATION IN THE FORM OF TEXT, ELECTRONIC DOCUMENTS, DATABASES, GRAPHICS AND AUDIOVISUAL INFORMATION, NAMELY, PROVIDING TEMPORARY USE OF NON-DOWNLOADABLE SOFTWARE FOR USE IN VIEWING, EDITING, STORING, SHARING, ANALYZING AND UPDATING MEDICAL DIAGNOSTIC IMAGES AND PATIENT MEDICAL INFORMATION FOR USE BY MEDICAL PRACTITIONERS, IN CLASS 42 (U.S. CLS. 100 AND 101).

THE MARK CONSISTS OF STANDARD CHARACTERS WITHOUT CLAIM TO ANY PARTICULAR FONT, STYLE, SIZE, OR COLOR.

Reg. No. 4,204,086 PRIORITY DATE OF 10-19-2010 IS CLAIMED.

OWNER OF INTERNATIONAL REGISTRATION 1088540 DATED 4-18-2011, EXPIRES 4-18-2021.

SER. NO. 79-101,748, FILED 4-18-2011.

MICHAEL TANNER, EXAMINING ATTORNEY

United States of America
United States Patent and Trademark Office

DOROTEA

Reg. No. 4,204,087

AB GENSE (SWEDEN LIMITED COMPANY)
SKOGSTORPSVÄGEN 40
SE-631 80 ESKILSTUNA, SWEDEN

Registered Sep. 11, 2012

Int. Cl.: 8

FOR: CUTLERY, IN CLASS 8 (U.S. CLS. 23, 28 AND 44).

TRADEMARK

THE MARK CONSISTS OF STANDARD CHARACTERS WITHOUT CLAIM TO ANY PARTICULAR FONT, STYLE, SIZE, OR COLOR.

PRINCIPAL REGISTER

PRIORITY DATE OF 2-16-2011 IS CLAIMED.

OWNER OF INTERNATIONAL REGISTRATION 1088613 DATED 8-16-2011, EXPIRES 8-16-2021.

SER. NO. 79-101,772, FILED 8-16-2011.

ANNE FARRELL, EXAMINING ATTORNEY



David J. Kyffers

Director of the United States Patent and Trademark Office

United States of America

United States Patent and Trademark Office



Reg. No. 4,204,088

Registered Sep. 11, 2012

Int. Cl.: 32

TRADEMARK

PRINCIPAL REGISTER

SANPURO VERTRIEB GMBH (FED REP GERMANY LIMITED LIABILITY COMPANY)
MAINSTR. 45
41469 NEUSS
FED REP GERMANY

FOR: DRINKING WATER, MINERAL WATER, SPRING WATER, STILL WATER, OXYGENATED WATER IN THE NATURE OF DRINKING WATER, TABLE WATER, IN CLASS 32 (U.S. CLS. 45, 46 AND 48).

THE MARK CONSISTS OF THE WORDING "SANPURO" IN STYLIZED FONT WITH TWO PARALLEL VERTICAL LINES PLACED TO THE LOWER RIGHT OF THE LETTER "O".

PRIORITY DATE OF 1-14-2011 IS CLAIMED.

OWNER OF INTERNATIONAL REGISTRATION 1088637 DATED 7-6-2011, EXPIRES 7-6-2021.

THE WORDING "SANPURO" HAS NO MEANING IN A FOREIGN LANGUAGE.

SER. NO. 79-101,796, FILED 7-6-2011.

STEVEN PEREZ, EXAMINING ATTORNEY



David J. Kybas

Director of the United States Patent and Trademark Office

United States of America

United States Patent and Trademark Office

CIED

Reg. No. 4,204,089

Registered Sep. 11, 2012

Int. Cl.: 9

C.E.I.A. - COSTRUZIONI ELETTRONICHE INDUSTRIALI AUTOMATISMI S.P.A. (ITALY
JOINT STOCK COMPANY)
STRADA PROVINCIALE PESCAIOLA, 54/G-56
FRAZ. VICIOMAGGIO; I-52040 CIVITELLA INVAL DI CHIANA (AR)
ITALY

TRADEMARK

FOR: ELECTROMAGNETIC DETECTORS FOR INDUSTRIAL AND SECURITY INSPECTION,
IN CLASS 9 (U.S. CLS. 21, 23, 26, 36 AND 38).

PRINCIPAL REGISTER

THE MARK CONSISTS OF STANDARD CHARACTERS WITHOUT CLAIM TO ANY PAR-
TICULAR FONT, STYLE, SIZE, OR COLOR.

PRIORITY DATE OF 1-28-2011 IS CLAIMED.

OWNER OF INTERNATIONAL REGISTRATION 1088865 DATED 7-5-2011, EXPIRES 7-5-
2021.

SER. NO. 79-101,869, FILED 7-5-2011.

NATALIE POLZER, EXAMINING ATTORNEY



David J. Kyffers

Director of the United States Patent and Trademark Office

United States of America

United States Patent and Trademark Office

SiestUP

Reg. No. 4,204,090

Registered Sep. 11, 2012

Int. Cl.: 12

TRADEMARK

PRINCIPAL REGISTER

SIESTA SYSTEMS, S.A (SPAIN SOCIEDAD ANÓNIMA)
TRAVESIA DE LA ERMITA, 2
E-31486 ELCANO-NAVARRA
SPAIN

FOR: HEAD-RESTS FOR VEHICLE SEATS, IN CLASS 12 (U.S. CLS. 19, 21, 23, 31, 35 AND 44).

THE MARK CONSISTS OF THE FOLLOWING: THE COLOR GRAY IS FOUND IN THE WORDING "SIEST" AND THE COLOR BLUE IS FOUND IN THE WORDING "UP".

PRIORITY DATE OF 3-14-2011 IS CLAIMED.

OWNER OF INTERNATIONAL REGISTRATION 1089229 DATED 7-11-2011, EXPIRES 7-11-2021.

THE COLOR(S) GRAY AND BLUE IS/ARE CLAIMED AS A FEATURE OF THE MARK.

SER. NO. 79-102,016, FILED 7-11-2011.

ANNE E. GUSTASON, EXAMINING ATTORNEY



David J. Kyfos

Director of the United States Patent and Trademark Office

United States of America

United States Patent and Trademark Office

HOTTER COMFORT CONCEPT

Reg. No. 4,204,091

Registered Sep. 11, 2012

Int. Cls.: 25 and 35

TRADEMARK

SERVICE MARK

PRINCIPAL REGISTER

BEACONSFIELD FOOTWEAR LIMITED (UNITED KINGDOM LIMITED LIABILITY COMPANY)
2 PEEL ROAD, WEST PIMBO
SKELMERSDALE; LANCASHIRE WN8 9PT, UNITED KINGDOM

FOR: ARTICLES OF OUTERCLOTHING, NAMELY, COATS, GLOVES, JACKETS, JUMPERS, SCARVES AND SOCKS; FOOTWEAR; BOOTS, SHOES, SLIPPERS AND SANDALS, IN CLASS 25 (U.S. CLS. 22 AND 39).

FOR: THE BRINGING TOGETHER OF, FOR THE BENEFIT OF OTHERS, A VARIETY OF FASHION ACCESSORIES, CLOTHING, FOOTWEAR AND HEADGEAR, ENABLING CUSTOMERS TO CONVENIENTLY VIEW AND PURCHASE THOSE GOODS IN A CLOTHING STORE, IN A MAIL ORDER CATALOGUE, OR VIA AN INTERNET WEBSITE; BUSINESS INFORMATION, ADVISORY AND CONSULTANCY SERVICES RELATING TO THE AFORESAID SERVICES, IN CLASS 35 (U.S. CLS. 100, 101 AND 102).

THE MARK CONSISTS OF STANDARD CHARACTERS WITHOUT CLAIM TO ANY PARTICULAR FONT, STYLE, SIZE, OR COLOR.

OWNER OF INTERNATIONAL REGISTRATION 1089690 DATED 7-8-2011, EXPIRES 7-8-2021.

OWNER OF U.S. REG. NOS. 2,503,117 AND 2,665,999.

NO CLAIM IS MADE TO THE EXCLUSIVE RIGHT TO USE "COMFORT", APART FROM THE MARK AS SHOWN.

SER. NO. 79-102,142, FILED 7-8-2011.

HAI-LY LAM, EXAMINING ATTORNEY



David J. Kybas

Director of the United States Patent and Trademark Office

United States of America

United States Patent and Trademark Office



Reg. No. 4,204,092

Registered Sep. 11, 2012

Int. Cl.: 3

TRADEMARK

PRINCIPAL REGISTER

CASTER (FRANCE SOCIÉTÉ PAR ACTIONS SIMPLIFIÉE)
99 RUE DU FAUBOURG SAINT HONORÉ
F-75008 PARIS
FRANCE

FOR: PERFUMERY PRODUCTS IN THE NATURE OF PERFUMERY, COLOGNE AND AFTER-SHAVE LOTIONS; COSMETIC PREPARATIONS NOT FOR MEDICAL USE FOR SKIN CARE, MAINTENANCE AND IMPROVEMENT, FOR SHAVING AND AFTER SHAVING; COSMETIC SUN TANNING PREPARATIONS, NAMELY, SUNSCREEN PREPARATIONS FOR USE ON HAIR; NON-MEDICAL PREPARATIONS FOR THE CARE OF SKIN AND HAIR, MAINTENANCE AND BEAUTIFICATION OF THE HAIR, NAMELY, HAIR CARE PREPARATIONS, HAIR LOTIONS, SHAMPOOS, HAIR CREAMS, HAIR GELS, HAIR MASKS, HAIR MOUSSES, NON-MEDICATED BALMS FOR HAIR CARE AND STYLING, HAIR SPRAYS, HAIR DYES AND BLEACHING PREPARATIONS FOR THE HAIR, HAIR WAVING AND STYLING PREPARATIONS, IN CLASS 3 (U.S. CLS. 1, 4, 6, 50, 51 AND 52).

OWNER OF U.S. REG. NOS. 3,213,624, 3,272,524 AND OTHERS.

PRIORITY DATE OF 12-3-2010 IS CLAIMED.

OWNER OF INTERNATIONAL REGISTRATION 1089770 DATED 5-3-2011, EXPIRES 5-3-2021.

THE COLOR(S) BLUE AND WHITE IS/ARE CLAIMED AS A FEATURE OF THE MARK.

NO CLAIM IS MADE TO THE EXCLUSIVE RIGHT TO USE "PARIS", APART FROM THE MARK AS SHOWN.

THE MARK CONSISTS OF A STYLIZED REPRESENTATION OF TWO BLUE LEAVES WITH THE WHITE WORDING "PHYTO PARIS".

SER. NO. 79-102,173, FILED 5-3-2011.

JULIE VEPPUMTHARA, EXAMINING ATTORNEY



David J. Kyros

Director of the United States Patent and Trademark Office

United States of America

United States Patent and Trademark Office



omeline

Reg. No. 4,204,093

BIORGANIC PHARMA, S.L. (SPAIN SOCIEDAD LIMITADA)
CARRER JAUME PIQUET, 22
E-08017 BARCELONA
SPAIN

Registered Sep. 11, 2012

Int. Cl.: 3

FOR: SOAPS, PERFUMERY, ESSENTIAL OILS, COSMETICS, HAIR LOTIONS; PERFUMERY, SHAMPOOS, EAUX DE COLOGNE, DEODORANTS FOR PERSONAL USE; DENTIFRICES, IN CLASS 3 (U.S. CLS. 1, 4, 6, 50, 51 AND 52).

TRADEMARK

PRINCIPAL REGISTER

THE MARK CONSISTS OF THE WORDING "OMELINE" IN GREEN AND A RED STYLIZED FLOWER.

OWNER OF INTERNATIONAL REGISTRATION 1089774 DATED 7-1-2011, EXPIRES 7-1-2021.

THE COLOR(S) RED, GREEN IS/ARE CLAIMED AS A FEATURE OF THE MARK.

THE WORDING "OMELINE" HAS NO MEANING IN A FOREIGN LANGUAGE.

SER. NO. 79-102,176, FILED 7-1-2011.

REBECCA POVARCHUK, EXAMINING ATTORNEY



David J. Kybas

Director of the United States Patent and Trademark Office

United States of America

United States Patent and Trademark Office

SYMAX

Reg. No. 4,204,094

Registered Sep. 11, 2012

Int. Cl.: 7

TRADEMARK

PRINCIPAL REGISTER

SYMAX LIFT (CHINA) CO., LTD. (CHINA CORPORATION)
48 MIDDLE TUANJIE RD.
XISHAN ECONOMIC DEVELOPMENT ZONE, PROVINCE
WUXI CITY, JIANGSU, CHINA

FOR: LIFTS, OTHER THAN SKI LIFTS, NAMELY, MECHANICAL AND HYDRAULIC LIFTS; ELEVATORS; HOISTS; MOVING STAIRCASES; ESCALATORS; ROLLER BRIDGES; CONVEYOR MACHINES; HOISTING MACHINE; ELEVATOR DESIGNED FOR LIFTING LAND VEHICLES FOR USE IN GARAGES; ELEVATOR BELTS, IN CLASS 7 (U.S. CLS. 13, 19, 21, 23, 31, 34 AND 35).

THIS MARK IS ORIGINAL BY THE OWNER AND HAS NO MEANING.

OWNER OF INTERNATIONAL REGISTRATION 1089794 DATED 8-15-2011, EXPIRES 8-15-2021.

SER. NO. 79-102,186, FILED 8-15-2011.

RUSS HERMAN, EXAMINING ATTORNEY



David J. Kyfos

Director of the United States Patent and Trademark Office

United States of America

United States Patent and Trademark Office

The logo for 'eOPhy' features the word in a sans-serif font. The 'e' is brown. The 'O' is a stylized circle with a blue top half, a white center, and a green bottom half. The 'Phy' is brown.

Reg. No. 4,204,095

Registered Sep. 11, 2012

Int. Cl.: 5

TRADEMARK

PRINCIPAL REGISTER

BIORGANIC PHARMA, S.L. (SPAIN SOCIEDAD LIMITADA)
CARRER JAUME PIQUET, N° 22
E-08017 BARCELONA
SPAIN

FOR: PHARMACEUTICAL PREPARATIONS FOR USE IN DERMATOLOGY; MEDICINAL TEAS; MEDICINAL HERBS; MEDICINAL HERBAL TEAS; LAXATIVES; MINERAL FOOD SUPPLEMENTS; DIETETIC FOOD AND SUGAR ADAPTED FOR MEDICAL USE; DIETETIC FOODS ADAPTED FOR MEDICAL PURPOSES; DIETETIC BEVERAGES ADAPTED FOR MEDICAL PURPOSES, IN CLASS 5 (U.S. CLS. 6, 18, 44, 46, 51 AND 52).

THE MARK CONSISTS OF THE FOLLOWING: THE WORDING "EOPHY" WHERE ALL OF THE LETTERS EXCEPT FOR "O" ARE BROWN AND "O" IS BLUE ON THE TOP, WHITE IN THE CENTER AND FILLED WITH GREEN AT THE BOTTOM.

OWNER OF INTERNATIONAL REGISTRATION 1089824 DATED 7-1-2011, EXPIRES 7-1-2021.

THE COLOR(S) BROWN, BLUE, GREEN AND WHITE IS/ARE CLAIMED AS A FEATURE OF THE MARK.

SER. NO. 79-102,223, FILED 7-1-2011.

REBECCA POVARCHUK, EXAMINING ATTORNEY

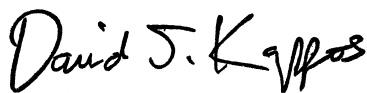
A handwritten signature in black ink that reads 'David J. Kyffers'.

Director of the United States Patent and Trademark Office

United States of America
United States Patent and Trademark Office

Sanpuro

Reg. No. 4,204,096

Registered Sep. 11, 2012

Int. Cl.: 32

TRADEMARK

PRINCIPAL REGISTER

SANPURO VERTRIEB GMBH (FED REP GERMANY LIMITED LIABILITY COMPANY)
MAINSTR. 45
41469 NEUSS
FED REP GERMANY

FOR: DRINKING WATER, MINERAL WATER, SPRING WATER, STILL WATER, OXYGENATED WATER IN THE NATURE OF DRINKING WATER, TABLE WATER, IN CLASS 32 (U.S. CLS. 45, 46 AND 48).

THE MARK CONSISTS OF STANDARD CHARACTERS WITHOUT CLAIM TO ANY PARTICULAR FONT, STYLE, SIZE, OR COLOR.

PRIORITY DATE OF 1-13-2011 IS CLAIMED.

OWNER OF INTERNATIONAL REGISTRATION 1089863 DATED 7-6-2011, EXPIRES 7-6-2021.

THE WORDING "SANPURO" HAS NO MEANING IN A FOREIGN LANGUAGE.

SER. NO. 79-102,235, FILED 7-6-2011.

STEVEN PEREZ, EXAMINING ATTORNEY



David J. Kyffers

Director of the United States Patent and Trademark Office

United States of America

United States Patent and Trademark Office

FESTO

Reg. No. 4,204,097

Registered Sep. 11, 2012

**Int. Cls.: 4, 6, 7, 8, 9, 11,
12, 16, 17, 19, 20, 28, 35,
41 and 42**

FESTO AG & CO. KG (FED REP GERMANY LIMITED PARTNERSHIP)
RUITER STRABE 82
73734 ESSLINGEN
FED REP GERMANY

FOR: INDUSTRIAL OILS AND GREASES; INDUSTRIAL LUBRICANTS; DUST ABSORBING, WETTING AND BINDING COMPOSITIONS; FUELS; CANDLES AND WICKS FOR LIGHTING, IN CLASS 4 (U.S. CLS. 1, 6 AND 15).

TRADEMARK

SERVICE MARK

PRINCIPAL REGISTER

FOR: COMMON METALS AND THEIR ALLOYS; METAL BUILDING MATERIALS; TRANSPORTABLE BUILDINGS OF METAL; MATERIALS OF METAL FOR RAILWAY TRACKS; NON-ELECTRIC CABLES AND WIRES OF COMMON METAL; IRONMONGERY, NAMELY, SMALL ITEMS OF METAL HARDWARE, NAMELY, SCREWS AND BOLTS; PIPES AND TUBES OF METAL; METAL SAFES; CONNECTING PIECES AND LINKS OF METAL OR MAINLY OF METAL FOR PIPE AND TUBES, NAMELY, PLUG-IN CONNECTORS, CONNECTORS, COUPLINGS, NIPPLES, ANGLE PIECES, T-PIECES, PUSH-IN FITTINGS, PLUG-IN CARTRIDGES, BARBED FITTINGS, QUICK CONNECTORS, HOSE FITTINGS, COUPLING PLUGS, DISTRIBUTORS, ROTARY DISTRIBUTORS, ADAPTERS, THREADED FITTINGS, DOUBLE NIPPLES, SLEEVES AND REDUCTIONS; TUBES AND PIPELINES OF METAL OR MAINLY OF METAL; FASTENING ELEMENTS OF METAL OR MAINLY OF METAL, FOR TUBES AND PIPELINES, NAMELY, PIPE CLIPS AND HOSE CLAMPS; VALVES OF METAL, OTHER THAN PARTS OF MACHINES; PORTABLE CONTAINERS OF METAL; METAL SHELTER BUILDINGS AND PARTS THEREFOR; REPLACEMENT PARTS FOR ALL THE AFORESAID GOODS, IN CLASS 6 (U.S. CLS. 2, 12, 13, 14, 23, 25 AND 50).



David J. Kyros

Director of the United States Patent and Trademark Office

FOR: MACHINES, NAMELY, FOR METAL, WOOD OR PLASTIC PROCESSING, EXCEPT RINSING AND WASHING MACHINES; WOODWORKING MACHINES; MACHINES FOR USE IN THE CHEMICAL INDUSTRY, PHARMACEUTICAL INDUSTRY, AGRICULTURE, MINING; TEXTILE MACHINES; MACHINES FOR THE DRINKS INDUSTRY; CONSTRUCTION MACHINES; PACKAGING MACHINES; MACHINE TOOLS; COMPRESSED-AIR MACHINES; MATERIALS HANDLING MACHINES; ROBOTIC MACHINES; SORTING MACHINES FOR INDUSTRY; CRANKCASES FOR MACHINES, MOTORS AND ENGINES; CYLINDERS FOR MACHINES; TABLES FOR MACHINES; MOTORS AND ENGINES, EXCEPT FOR LAND VEHICLES; MACHINE COUPLING AND TRANSMISSION COMPONENTS, EXCEPT FOR LAND VEHICLES; AGRICULTURAL IMPLEMENTS OTHER THAN HAND-OPERATED; INCUBATORS FOR EGGS; PNEUMATIC TOOLS, NAMELY, GRINDERS,

Reg. No. 4,204,097 SANDERS, POLISHERS, ROUTERS, JIGSAWS, CIRCULAR SAWS, CHAINSAWS, DRILLING MACHINES, PLANERS, SCREWDRIVERS AND MILLING MACHINES; ELECTRIC POWER TOOLS AND BATTERY-OPERATED ELECTRIC POWER TOOLS, NAMELY, GRINDERS, SANDERS, POLISHERS, ROUTERS, JIGSAWS, CIRCULAR SAWS, CHAINSAWS, DRILLING MACHINES, PLANERS, SCREWDRIVERS AND MILLING MACHINES; HYDRAULIC, PNEUMATIC AND ELECTRONIC CONTROLS FOR MACHINES, MOTORS AND ENGINES; PNEUMATIC, HYDRAULIC AND ELECTRIC DRIVE ELEMENTS AND EQUIPMENT, NAMELY, LINEAR ACTUATORS, ROTARY ACTUATORS, SWIVEL ACTUATORS, FLUID-ACTIVATED ACTUATORS, PNEUMATIC CYLINDERS, HYDRAULIC CYLINDERS, ELECTRIC LINEAR ACTUATORS AND LINEAR MOTORS, FEED APPARATUS, PISTONS, MOBILE ROBOTS, RODLESS CYLINDERS, LINEAR DRIVES, ROTARY DRIVES, SEMI-ROTARY DRIVES, SWIVEL MODULES, SWIVEL-LINEAR DRIVE UNITS, TANDEM CYLINDERS, HIGH-FORCE CYLINDERS, MULTI-POSITION CYLINDERS, STOPPER CYLINDERS, CLAMPING CYLINDERS, BELLOWS DRIVES, DIAPHRAGM DRIVES, BELLOWS CYLINDERS, ROTARY INDEXING TABLES, SERVO DRIVES, CYLINDER-VALVE COMBINATIONS, SHOCK ABSORBERS, HYDRAULIC CUSHIONING CYLINDERS, LINEAR GUIDES, GUIDE UNITS FOR PNEUMATIC CYLINDERS, CLAMPING UNITS, FREEWHEEL UNITS, DRIVES WITH DISPLACEMENT ENCODER, ELECTROMECHANICAL DRIVES, LINEAR SLIDES, ELECTRICAL CYLINDERS, SPINDLE AXES, TOOTHED BELT AXES, ELECTRIC SLIDES, CANTILEVER AXES, ELECTRIC HANDLING MODULES, ROTARY/LIFTING MODULES, ELECTRIC DIRECT DRIVES AND SHORT-STROKE CYLINDERS; PNEUMATIC, HYDRAULIC, ELECTRIC AND ELECTRONIC CONTROL AND REGULATING ELEMENTS AND APPARATUS, NAMELY, VALVES, VALVE TERMINALS, TAPS, STOPCOCKS, OIL BRAKE CYLINDERS, PRESSURE SWITCHES, PRESSURE REGULATORS, PROPORTIONAL DIRECTIONAL CONTROL VALVES, SERVO-PNEUMATIC POSITIONING SYSTEMS, PROPORTIONAL VALVES, PROCESS VALVES, PNEUMATIC CONTROLLERS, ELECTRO-PNEUMATIC CONTROLLERS, PNEUMATIC-MECHANICAL SEQUENCERS AND MEMORY MODULES, ELECTRO-PNEUMATIC CONTROL UNITS AND ELECTRO-PNEUMATIC TRANSDUCERS; VALVE PARTS FOR MACHINES; CONNECTOR PLATES AND DISTRIBUTOR PLATES FOR VALVES; MECHANICAL HANDLING APPARATUS; VACUUM-BASED HANDLING APPARATUS; ELECTRIC DRIVE MOTORS, AND SERVODRIVES; COMPRESSORS; COMPRESSED-AIR ACCUMULATORS; COMPRESSED-AIR MAINTENANCE APPARATUS FOR TREATING COMPRESSED AIR; SHOCK ABSORBERS BEING PARTS OF MACHINES; SILENCERS FOR COMPRESSED AIR; AIR FILTERS; BEARINGS FOR MACHINES; MACHINES AND MECHANICALLY-OPERATED APPARATUS, FOR WORK PIECE MACHINING, THE TREATMENT OF MATERIALS, HANDLING TECHNOLOGY, PRODUCTION TECHNOLOGY AND ASSEMBLY TECHNOLOGY, NAMELY, SAWS, MILLING MACHINES, ROUTERS, GRINDERS, PLANERS, DRILLING MACHINES, SCREWDRIVERS, GRIPPERS, MANIPULATORS, VACUUM-BASED HANDLING APPARATUS, SUCTION CUPS FOR VACUUM-BASED HANDLING APPARATUS, AGITATORS, CLAMPING DEVICES, STAPLING APPARATUS, GRIPPERS, PARALLEL GRIPPERS, THREE-POINT GRIPPERS, ANGLED GRIPPERS, RADIAL GRIPPERS, HANDLING SYSTEMS, PICK AND PLACE SYSTEMS AND HANDLING MODULES; TOOLS AS PARTS OF MACHINES, NAMELY, IN THE FORM OF SAW BLADES, MILLING CUTTERS OR GRINDING PLATES; VACUUM CLEANING DEVICES AND INSTALLATIONS; ELECTRIC CLEANING MACHINES AND EQUIPMENT, NOT PORTABLE; FITTINGS FOR PNEUMATIC USE; REPLACEMENT PARTS FOR ALL THE AFORESAID GOODS, IN CLASS 7 (U.S. CLS. 13, 19, 21, 23, 31, 34 AND 35).

FOR: HAND TOOLS AND IMPLEMENTS, NAMELY, HAND SAWS, FILES, FINGERNAIL POLISHERS, HAND GRINDERS, MANUAL CLAMPS, HAMMERS AND SCREWDRIVERS; CUTLERY; SIDE ARMS NOT INCLUDING FIREARMS, NAMELY, HUNTING KNIVES AND SWORDS; RAZORS; REPLACEMENT PARTS FOR ALL THE AFORESAID GOODS, IN CLASS 8 (U.S. CLS. 23, 28 AND 44).

FOR: SCIENTIFIC, NAUTICAL, SURVEYING, PHOTOGRAPHIC, CINEMATOGRAPHIC, OPTICAL, WEIGHING, MEASURING, SIGNALING APPARATUS AND INSTRUMENTS, NAMELY, FOR CONDUCTING, SWITCHING, TRANSFORMING, ACCUMULATING, REG-

Reg. No. 4,204,097 ULATING AND CONTROLLING ELECTRICITY; APPARATUS AND INSTRUMENTS FOR COMMUNICATIONS ENGINEERING, NAMELY, FOR COMMUNICATIONS, HIGH FREQUENCY AND CONTROL ENGINEERING; APPARATUS AND INSTRUMENTS FOR SCIENTIFIC RESEARCH IN LABORATORIES; MAGNETIC DATA CARRIERS, RECORDING DISCS; AUTOMATIC VENDING MACHINES AND MECHANISMS FOR COIN-OPERATED APPARATUS; CASH REGISTERS, CALCULATING MACHINES, DATA PROCESSING EQUIPMENT AND COMPUTERS; FIRE EXTINGUISHING APPARATUS, NOT PORTABLE; ELECTRIC AND ELECTRONIC CONTROL AND REGULATING APPARATUS, NAMELY, ELECTRONIC CONTROL UNITS FOR VALVES AND DRIVES, AXIS CONTROLLERS, END-POSITION CONTROLLERS, DISPLACEMENT ENCODERS AND MOTOR CONTROLLERS; ELECTRIC, ELECTRONIC, PNEUMATIC AND OPTICAL MEASURING AND MONITORING ELEMENTS AND APPARATUS, NAMELY, SENSORS, DISPLACEMENT ENCODERS, FORK LIGHT BARRIERS, IMAGE PROCESSING SYSTEMS, OPTICAL POSITION AND ORIENTATION DETECTORS, OPTICAL WORKPIECE TYPE DETECTORS, OPTICAL QUALITY INSPECTION SYSTEMS AND POSITION DETECTING DEVICES; SENSORS, NAMELY, POSITION SENSORS, SPEED SENSORS, DISTANCE SENSORS, PRESSURE SENSORS, VACUUM SENSORS, FLOW SENSORS, COLOR SENSORS, TEMPERATURE SENSORS, INDUCTIVE SENSORS, PROXIMITY SENSORS, AIR GAP SENSORS AND FLOW SENSORS; ACCUMULATORS AND BATTERIES; ACCUMULATOR AND BATTERY CHARGES; ELECTRIC CABLES AND WIRES; CONNECTING COMPONENTS FOR ELECTRIC CABLES AND LINES; ELECTRIC SWITCHES; RELAYS; SWITCH CABINETS; METEOROLOGICAL BALLOONS; COMPUTERS; DATA READERS; DEVICES FOR DISPLAYING DATA, FOR EXAMPLE MONITORS; SCANNERS; PRINTERS; PLOTTERS; DEVICES FOR INPUTTING DATA AND COMMANDS, NAMELY, TOUCH SCREEN DISPLAYS AND KEYBOARDS; APPARATUS FOR GENERATING, RECORDING, STORAGE, TRANSMISSION, PROCESSING AND/OR REPRODUCTION OF IMAGES AND/OR SOUND OR OTHER DATA AND SIGNALS; DATA-PROCESSING APPARATUS; COMPUTER PROGRAMS AND SOFTWARE, NAMELY, FOR DESIGNING FLUID CIRCUITS, FOR DESIGNING LABORATORIES, AND FOR THE PURPOSES OF LEARNING, TRAINING, CONTROLLING, VISUALIZATION, INFORMATION, DESIGNING, DRAWING AND SIMULATING, EACH IN THE FIELDS OF PNEUMATICS, ELECTRO-PNEUMATICS, HYDRAULICS, ELECTRO-HYDRAULICS, ELECTRICAL ENGINEERING, ELECTRONICS, ELECTRICAL SAFETY MEASURES AND AUTOMATION TECHNOLOGY; MACHINE-READABLE DATA CARRIERS EQUIPPED WITH PROGRAMS; INSTRUCTIONAL AND TEACHING MATERIAL AND APPARATUS, NAMELY, INTERFACES, MAGNETIC SYMBOL SETS, DRAWING TEMPLATES, PNEUMATIC TIMERS, VALVES, SINGLE ACTING CYLINDERS, DOUBLE ACTING CYLINDERS, DIFFERENTIAL CYLINDERS, CYLINDER LOAD SIMULATORS, WEIGHTS FOR CYLINDERS, COVERS FOR CYLINDERS, MEASURING STROKES FOR CYLINDERS, DISPLACEMENT ENCODERS FOR CYLINDERS, PROXIMITY SWITCHES, PRESSURE REGULATORS, PRESSURE GAUGES, MANIFOLDS, PLASTIC TUBING, COMPRESSORS, MOUNTING PLATES, PNEUMATIC PRESET COUNTERS, STEPPER MODULES, ELECTRICAL SIGNAL INPUTS, RELAYS, LIMIT SWITCHES, SENSORS, POWER SUPPLY UNITS, ELECTRONIC CONTROLLERS, VALVE TERMINALS, ELECTRIC AND PNEUMATIC DRIVES, VACUUM GAUGES, SUCTION GRIPPERS, AIR PRESSURE RESERVOIRS, VACUUM GENERATORS, ELECTRIC GRIPPERS, COMPARATORS, POSITION ENCODERS, SHOCK ABSORBERS, OSCILLOSCOPES, DIGITAL MULTIMETERS, CABLE CONNECTORS, HYDRAULIC MOTORS, HYDRAULIC POWER UNITS AND POWER PACKS, HOSE LINES, QUICK RELEASE COUPLINGS FOR TUBING AND HOSE LINES, PNEUMATIC AND HYDRAULIC DISTRIBUTORS, MOUNTING KITS, PRESSURE SWITCHES, DIAPHRAGM ACCUMULATORS, ELECTRICAL EMERGENCY STOP PUSHBUTTONS, INPUT-OUTPUT DATA CABLES, PROPORTIONAL AMPLIFIERS, PRESSURE FILTERS, ELECTRICAL INDICATOR UNITS AND DISTRIBUTORS, PID CONTROLLERS, STATUS CONTROLLERS, PATCH PANELS, SAFETY JUMPER PLUGS, POWER CABLES, MICROCONTROLLERS, INPUT-OUTPUT MODULES, SEQUENCERS, CONTACTOR BOARDS, MOTOR TECHNOLOGY CONTACTOR SETS, OPERATOR AND SIGNALING UNITS, NET BOARDS, SERVO BRAKE AND DRIVE SYSTEMS, ELECTRO MOTORS, FREQUENCY CONVERTERS, SERVO DRIVES, STEPPER MOTORS, PROGRAMMABLE LOGIC CONTROLLERS, HOLDER SYSTEMS AND RACK SYSTEMS FOR MODULE MOUNTING, ELECTRONIC SIMULATION MODULES, TOUCH PANELS, OPERATOR

Reg. No. 4,204,097 PANELS, ELECTRONIC CONTROL MODULES, ELECTRONIC SLAVE MODULES, SWITCH MODULES, INTERNET LINK MODULES, ETHERNET INTERFACES, SENSORS FOR OBJECT DETECTION, ACTUATOR/SENSOR INTERFACES FOR FIELDBUS TECHNOLOGY, DIGITAL CONNECTION UNITS, CALIPERS, ACCUMULATOR FILLING DEVICES, SPARE FILTER CARTRIDGES FOR PRESSURE FILTERS, MEASURING LEAD HOLDERS, PHASE SEQUENCE INDICATORS, VOLTAGE AND CONTINUITY TESTERS, CURRENT CLAMPS, POWER SUPPLY ANALYZERS, DIGITAL AND ANALOGUE SIMULATION BOXES, DIGITAL AND ANALOGUE CONNECTION UNITS, ADDRESSING DEVICES, MOUNTING RAILS, INDICATOR LIGHTS, PID INDUSTRIAL CLOSED-LOOP CONTROLLERS, ELECTRICAL SLIDES, LIGHT CURTAINS, DC WATTMETERS, WLAN ACCESS POINTS, MODULAR PRODUCTION SYSTEMS, TRANSFER SYSTEMS, STACKING MAGAZINE STATIONS, MODULAR PRODUCTION STATIONS, TESTING STATIONS, TURNING STATIONS, MEASURING STATIONS, DRILLING STATIONS, SORTING STATIONS, DISPENSING STATIONS, CAMERA INSPECTION STATIONS, DISTRIBUTING STATIONS, BUFFER STATIONS, ROBOT STATIONS, PICK AND PLACE STATIONS, PROCESSING STATIONS, HANDLING STATIONS, ASSEMBLY STATIONS, FILTERING STATIONS, MIXING STATIONS, REACTOR STATIONS, BOTTLING STATIONS, FILTRATION STATIONS, HOLDER MODULES, PUNCHING STATIONS, WORKPIECE SEPARATING STATIONS, STORING STATIONS, ORDER COMPILATION STATIONS, AUTOMATIC WAREHOUSE STATIONS, INCOMING GOODS/OUTGOING GOODS STATIONS, PALLET TRANSPORT SYSTEMS, WORKPIECE CHANGER MODULES, STACKING MAGAZINE MODULES, MEASURING MODULES, WORKPIECE SEPARATOR MODULES, CONVEYOR MODULES, RECOGNITION MODULES, LIFTING MODULES, TESTING MODULES, SORTING GATE MODULES, STOPPER MODULES, DRILL HOLE MONITORING MODULES, TRANSFER MODULES, RFID MODULES, DRILLING MODULES, ROTARY INDEXING TABLE MODULES, CLAMPING MODULES, EJECTING MODULES, MEASURING MODULES, PNEUMATIC SLIDE MODULES, ENGRAVING MODULES, PRESS MODULES, STORAGE MODULES, PAD PRINTING MODULES, DRYING MODULES, PICK AND PLACE MODULES, TRANSFER LINES, CONVEYORS, EMERGENCY STOP MODULES, WORKPIECE SETS, MILLING MACHINES, TURNING MACHINES, BOTTLE SETS, COOLING UNITS WITH HEAT EXCHANGER, PNEUMATICS TRAININGS PACKAGES; ELECTRO-PNEUMATICS TRAININGS PACKAGES; VACUUM TECHNOLOGY TRAININGS PACKAGES; HYDRAULICS TRAININGS PACKAGES; ELECTRICAL ENGINEERING TRAININGS PACKAGES; ELECTRONICS TRAININGS PACKAGES; AUTOMATION TECHNOLOGY TRAININGS PACKAGES; PROGRAMMABLE LOGIC CONTROLLER, TRAININGS PACKAGES; PROCESS INDUSTRY TRAININGS PACKAGES; MECHATRONICS LEARNING SYSTEMS AND TRAINING FACTORY PACKAGES; EDUCATIONAL COMPUTERS; ELECTRONIC EDUCATIONAL APPARATUS, NAMELY, COMPUTERS; REPLACEMENT PARTS FOR ALL THE AFORESAID GOODS; LABORATORY FURNITURE, IN CLASS 9 (U.S. CLS. 21, 23, 26, 36 AND 38).

FOR: APPARATUS FOR LIGHTING, HEATING, STEAM GENERATING, COOKING, REFRIGERATING, DRYING, VENTILATING, WATER SUPPLY AND SANITARY PURPOSES, NAMELY, LIGHT FIXTURES, STEAM GENERATORS, ELECTRIC SPACE HEATERS, AIR DRYERS; AERATION AND VENTILATION INSTALLATIONS FOR BUILDINGS; HUMIDIFIERS, AIR PURIFIERS AND WATER IONIZERS; AIR-CONDITIONING APPARATUS; BREAD MAKING MACHINES; REPLACEMENT PARTS FOR ALL THE AFORESAID GOODS, IN CLASS 11 (U.S. CLS. 13, 21, 23, 31 AND 34).

FOR: APPARATUS FOR LOCOMOTION BY LAND, VEHICLES AND LOCOMOTIVE APPARATUS, THE AFORESAID GOODS OTHER THAN POWERED BY COMBUSTION ENGINES OR ELECTRIC MOTORS, NAMELY, AUTOMOBILES; APPARATUS FOR LOCOMOTION BY AIR OR WATER, INCLUDING REMOTE-CONTROLLED APPARATUS, NAMELY, AUTOMOBILES; AIR CUSHION VEHICLES; AERONAUTICAL APPARATUS, MACHINES AND APPLIANCES, NAMELY, AEROSTATS AND AERODYNAMIC WINGS FOR AIRPLANES; AIR VEHICLES, NAMELY, AIRPLANES AND AIRCRAFT; WATER VEHICLES, NAMELY, HYDROFOIL BOATS SUPPORTED BY SINGULAR OR MULTI HULLS AND STRUCTURAL PARTS THEREFOR; VEHICULAR BALLOONS, HOT AIR BALLOONS, GAS BALLOONS, COMBINATION HOT AIR AND GAS BALLOONS, PARACHUTES, AIR SHIPS;

Reg. No. 4,204,097 REPLACEMENT PARTS FOR ALL THE AFORESAID GOODS, IN CLASS 12 (U.S. CLS. 19, 21, 23, 31, 35 AND 44).

FOR: FOILS, BAGS AND POUCHES OF PLASTIC FOR PACKAGING; ROTARY DUPLICATORS; PRINTED MATTER, NAMELY, BOOKS, BROCHURES, JOURNALS, MAGAZINES AND PERIODICALS, NAMELY, ON THE SUBJECTS OF PNEUMATICS, HYDRAULICS, SENSORS, ELECTRONICS, ELECTRICAL ENGINEERING, PROGRAMMABLE LOGICAL CONTROLLERS, ELECTRICAL CLOSED-LOOPED CONTROL TECHNOLOGY, MECHATRONICS, HANDLING TECHNOLOGY, PROCESS AUTOMATION, METAL TECHNOLOGY, CNC TECHNOLOGY, AUTOMATION TECHNOLOGY, METAL WORKING TECHNOLOGY, PROCUREMENT AND LOGISTICS, PRODUCT DEVELOPMENT, LEAN PRODUCTION AND COMPETENCE MANAGEMENT; BOOKBINDING MATERIAL; PHOTOGRAPHS; STATIONERY; ADHESIVES FOR STATIONERY OR HOUSEHOLD PURPOSES; PAINT BRUSHES; TYPEWRITERS; INSTRUCTIONAL AND TEACHING MATERIAL, NAMELY, PRINTED INSTRUCTIONAL AND TEACHING MATERIAL IN THE FIELDS OF PNEUMATICS, HYDRAULICS, SENSORS, ELECTRONICS, ELECTRICAL ENGINEERING, PROGRAMMABLE LOGICAL CONTROLLERS, ELECTRICAL CLOSED-LOOPED CONTROL TECHNOLOGY, MECHATRONICS, HANDLING TECHNOLOGY, PROCESS AUTOMATION, METAL TECHNOLOGY, CNC TECHNOLOGY, AUTOMATION TECHNOLOGY AND METAL WORKING TECHNOLOGY; PRINTERS' TYPE; PRINTING BLOCKS; WRITING IMPLEMENTS, NAMELY, BALL-POINT PENS, IN CLASS 16 (U.S. CLS. 2, 5, 22, 23, 29, 37, 38 AND 50).

FOR: GASKETS MADE OF RUBBER, GUTTA-PERCHA, GUM, ASBESTOS OR MICA, NAMELY, PIPE GASKETS; GOODS OF PLASTIC, SEMI-WORKED, NAMELY, IN THE FORM OF FILMS, SHEETS AND RODS; PADDING AND STUFFING MATERIALS OF RUBBER AND PLASTICS; PACKING, STOPPING AND INSULATING MATERIALS; FLEXIBLE TUBES, NOT OF METAL OR MAINLY NOT OF METAL; CONNECTING PIECES AND LINKS, NOT OF METAL OR MAINLY NOT OF METAL, FOR PIPES AND TUBES, NAMELY, PLUG-IN CONNECTORS, CONNECTORS, COUPLINGS, NIPPLES, ANGLE PIECES, T-PIECES, PUSH-IN FITTINGS, PLUG-IN CARTRIDGES, BARBED FITTINGS, QUICK CONNECTORS, HOSE FITTINGS, COUPLING PLUGS, DISTRIBUTORS, ROTARY DISTRIBUTORS, ADAPTERS, THREADED FITTINGS, DOUBLE NIPPLES, SLEEVES AND REDUCTIONS; FLEXIBLE TUBES, NOT OF METAL; FASTENING DEVICES NOT OF METAL FOR TUBES AND PIPEWORK, NAMELY, HOOKS FOR PIPES AND HOSE CLIPS; REPLACEMENT PARTS FOR ALL THE AFORESAID GOODS, IN CLASS 17 (U.S. CLS. 1, 5, 12, 13, 35 AND 50).

FOR: NON-METALLIC BUILDING MATERIALS, NAMELY, PIPES; NON-METALLIC RIGID PIPES FOR BUILDING; ASPHALT, PITCH AND BITUMEN; NON-METALLIC TRANSPORTABLE BUILDINGS; MONUMENTS, NOT OF METAL; BUILDING GLASS, NAMELY, IN THE FORM OF TILES AND ROOFING PANELS; BUILDINGS AND STRUCTURES OF ALL KINDS OTHER THAN THOSE OF METAL, NAMELY, FAIR STANDS; REPLACEMENT PARTS FOR ALL THE AFORESAID GOODS, IN CLASS 19 (U.S. CLS. 1, 12, 33 AND 50).

FOR: FURNITURE, EXCEPT KITCHEN FURNITURE, FITTED KITCHENS AND BATHROOM FURNITURE; MIRRORS, PICTURE FRAMES; NON-METAL VALVES OTHER THAN PARTS OF MACHINES, NAMELY, FOR COMPRESSED AIR PIPES AND FOR WATER PIPES; CURTAIN RODS; WORKING TABLES; WORKBENCHES; PLASTIC STORAGE CONTAINERS; STORAGE RACKS; REPLACEMENT PARTS FOR ALL THE AFORESAID GOODS, IN CLASS 20 (U.S. CLS. 2, 13, 22, 25, 32 AND 50).

FOR: GAME CARDS; BUILDING GAMES; TOY REMOTE-CONTROLLED VEHICLES, AIRCRAFT AND SHIPS; SCALE-MODEL VEHICLES, AIRCRAFT AND SHIPS; DECORATIONS FOR CHRISTMAS TREES; SPORT BALLS; BATS FOR GAMES; TRAMPOLINES; FISHING TACKLE; PARAGLIDERS AND KITES, IN CLASS 28 (U.S. CLS. 22, 23, 38 AND 50).

FOR: ADVERTISING SERVICES; CONSULTATION BUSINESS MANAGEMENT SERVICES; BUSINESS MANAGEMENT AND ORGANIZATION CONSULTANCY SERVICES; PERSON-

Reg. No. 4,204,097 NEL MANAGEMENT CONSULTANCY; MARKET RESEARCH; RETAIL AND WHOLESALE STORES FEATURING PNEUMATIC, ELECTRONIC, ELECTROTECHNICAL, CONTROL, REGULATING AND AUTOMATION SYSTEMS AND INSTRUCTIONAL AND EDUCATIONAL MATERIALS THEREFOR; BUSINESS ADMINISTRATION; OFFICE FUNCTIONS; ARRANGING AND CONDUCTING OF TRADE FAIRS AND TRADE EXHIBITIONS IN THE FIELDS OF EDUCATION, IN CLASS 35 (U.S. CLS. 100, 101 AND 102).

FOR: VOCATIONAL GUIDANCE; PUBLICATION OF PRINTED MATTER; PUBLISHING OF ELECTRONIC PUBLICATIONS, BOOKS AND MAGAZINES; EDUCATIONAL SERVICES, NAMELY, ARRANGING AND CONDUCTING OF SEMINARS AND TRAINING COURSES AND KNOWLEDGE TESTING ON THE SUBJECTS OF PNEUMATICS, HYDRAULICS, SENSORS, ELECTRONICS, ELECTRICAL ENGINEERING, PROGRAMMABLE LOGICAL CONTROLLERS, ELECTRICAL CLOSED-LOOPED CONTROL TECHNOLOGY, MECHATRONICS, HANDLING TECHNOLOGY, PROCESS AUTOMATION, METAL TECHNOLOGY, CNC TECHNOLOGY, AUTOMATION TECHNOLOGY, METAL WORKING TECHNOLOGY, PROCESS OPTIMIZATION, LEAN MANUFACTURING, FLOW-EFFICIENT PRODUCTION PROCESSES, PULL PRODUCTION, EQUIPMENT EFFICIENCY, SETUP OPTIMIZATION, VALUE-STREAM ANALYSIS, TARGET ENGINEERING, CUSTOMER CENTRICITY, PROBLEM-SOLUTION PROCESSES, MODERATING TEAMS, EFFICIENT COMMUNICATION, INTERCULTURAL COMPETENCE AND MANAGEMENT SKILLS, IN CLASS 41 (U.S. CLS. 100, 101 AND 107).

FOR: SCIENTIFIC AND TECHNOLOGICAL SERVICES AND RESEARCH AND DESIGN IN THE FIELDS OF PNEUMATICS, HYDRAULICS, SENSORS, ELECTRONICS, ELECTRICAL ENGINEERING, PROGRAMMABLE LOGICAL CONTROLLERS, ELECTRICAL CLOSED-LOOPED CONTROL TECHNOLOGY, MECHATRONICS, HANDLING TECHNOLOGY, PROCESS AUTOMATION, METAL TECHNOLOGY, CNC TECHNOLOGY, AUTOMATION TECHNOLOGY AND METAL WORKING TECHNOLOGY; INDUSTRIAL DESIGN; MATERIALS TESTING; INDUSTRIAL ANALYSIS AND RESEARCH SERVICES; DESIGN AND DEVELOPMENT OF COMPUTER HARDWARE AND SOFTWARE; COMPUTER PROGRAMMING; TECHNICAL CONSULTANCY AND ENGINEERING IN THE FIELDS OF PNEUMATICS, HYDRAULICS, SENSORS, ELECTRONICS, ELECTRICAL ENGINEERING, PROGRAMMABLE LOGICAL CONTROLLERS, ELECTRICAL CLOSED-LOOPED CONTROL TECHNOLOGY, MECHATRONICS, HANDLING TECHNOLOGY, PROCESS AUTOMATION, METAL TECHNOLOGY, CNC TECHNOLOGY, AUTOMATION TECHNOLOGY, METAL WORKING TECHNOLOGY, PROCUREMENT AND LOGISTICS, PRODUCT DEVELOPMENT, LEAN PRODUCTION AND COMPETENCE MANAGEMENT, IN CLASS 42 (U.S. CLS. 100 AND 101).

THE MARK CONSISTS OF STANDARD CHARACTERS WITHOUT CLAIM TO ANY PARTICULAR FONT, STYLE, SIZE, OR COLOR.

OWNER OF INTERNATIONAL REGISTRATION 1089902 DATED 12-10-2010, EXPIRES 12-10-2020.

OWNER OF U.S. REG. NO. 1,502,778.

THE WORDING "FESTO" HAS NO MEANING IN A FOREIGN LANGUAGE.

SER. NO. 79-102,246, FILED 12-10-2010.

EDWARD NELSON, EXAMINING ATTORNEY

United States of America

United States Patent and Trademark Office



Reg. No. 4,204,098

Registered Sep. 11, 2012

Int. Cls.: 7 and 37

TRADEMARK

SERVICE MARK

PRINCIPAL REGISTER

WONIK IPS CO., LTD (REPUBLIC OF KOREA LIMITED COMPANY)
332-1, CHEONGHO-RI,
JINWI-MYEON, PYEONGTAEK-SI, GYEONGGI-DO 451-862
REPUBLIC OF KOREA

FOR: SEMICONDUCTOR MANUFACTURING EQUIPMENT, NAMELY, THIN FILM DEPOSITION APPARATUS, SPUTTERING APPARATUS, ETCHING APPARATUS, EVAPORATION DEPOSITION APPARATUS, PLASMA CHEMICAL VAPOR DEPOSITION APPARATUS, COUPLED PLASMA CHEMICAL VAPOR DEPOSITION APPARATUS, ATOMIC LAYER DEPOSITION APPARATUS, ION BEAM DEPOSITION APPARATUS, ION BEAM ETCHING APPARATUS, ANNEALING APPARATUS, RAPID THERMAL PROCESSING APPARATUS, LOW TEMPERATURE ANNEALING APPARATUS, COUPLED SPUTTERING APPARATUS, MULTIPLE SPUTTERING APPARATUS, LASER SUBLIMATION DEPOSITION APPARATUS, ORGANIC MOLECULAR CHEMICAL VAPOR DEPOSITION APPARATUS, ION BEAM GENERATION APPARATUS, ION BEAM SPUTTER DEPOSITION APPARATUS, ION BEAM ETCHING APPARATUS, ION BEAM ASSISTED DEPOSITION APPARATUS, ELECTRON BEAM ASSISTED DEPOSITION APPARATUS, ELECTRON BEAM CRYSTALLIZATION APPARATUS, ELECTRON BEAM ANNEALING APPARATUS, OXIDATION MECHANICAL APPARATUS, ION IMPLANTATION APPARATUS, CHEMICAL VAPOR PRECIPITATION MECHANICAL APPARATUS, SPUTTERING MECHANICAL APPARATUS, AND PROBE; LIQUID CRYSTAL DISPLAY MANUFACTURING EQUIPMENT, NAMELY, FILM DEPOSITION APPARATUS, SPUTTERING APPARATUS, COUPLED SPUTTERING APPARATUS, ETCHING APPARATUS, EVAPORATION DEPOSITION APPARATUS, PLASMA CHEMICAL VAPOR DEPOSITION APPARATUS, ION BEAM DEPOSITION APPARATUS, ION BEAM ETCHING APPARATUS AND ANNEALING APPARATUS, SPUTTERING MECHANICAL APPARATUS, AND PROBE; ORGANIC ELECTROLUMINESCENCE DISPLAY MANUFACTURING EQUIPMENT, NAMELY, THIN FILM DEPOSITION APPARATUS, SPUTTERING APPARATUS, COUPLED SPUTTERING APPARATUS, ETCHING APPARATUS, EVAPORATION DEPOSITION APPARATUS, PLASMA CHEMICAL VAPOR DEPOSITION APPARATUS, ION BEAM DEPOSITION APPARATUS, ION BEAM ETCHING APPARATUS AND ANNEALING APPARATUS; PLASMA DISPLAY PANEL MANUFACTURING EQUIPMENT, NAMELY, THIN FILM DEPOSITION APPARATUS, SPUTTERING APPARATUS, COUPLED SPUTTERING APPARATUS, ETCHING APPARATUS, EVAPORATION DEPOSITION APPARATUS, ION BEAM DEPOSITION APPARATUS, ION BEAM ETCHING APPARATUS, AND ANNEALING APPARATUS; SOLAR CELL MANUFACTURING EQUIPMENT, NAMELY, THIN FILM DEPOSITION APPARATUS, SPUTTERING APPARATUS, COUPLED SPUTTERING APPARATUS, ETCHING APPARATUS, EVAPORATION DEPOSITION APPARATUS, PLASMA



David J. Kyjars

Director of the United States Patent and Trademark Office

Reg. No. 4,204,098 CHEMICAL VAPOR DEPOSITION APPARATUS, RAPID THERMAL PROCESSING APPARATUS, ION BEAM DEPOSITION APPARATUS, ION BEAM ETCHING APPARATUS AND ANNEALING APPARATUS; LIGHT EMITTING DIODE (LED) MANUFACTURING EQUIPMENT, NAMELY, THIN FILM DEPOSITION APPARATUS, CHEMICAL VAPOR DEPOSITION APPARATUS, SPUTTERING APPARATUS, COUPLED SPUTTERING APPARATUS, ETCHING APPARATUS, EVAPORATION DEPOSITION APPARATUS, PLASMA CHEMICAL VAPOR DEPOSITION APPARATUS, ION BEAM DEPOSITION APPARATUS, ION BEAM ETCHING APPARATUS, ELECTRON BEAM ANNEALING APPARATUS; MICROELECTROMECHANICAL SYSTEMS (MEMS) MANUFACTURING EQUIPMENT, NAMELY, THIN FILM DEPOSITION APPARATUS, SPUTTERING APPARATUS, EVAPORATION DEPOSITION APPARATUS AND CHEMICAL VAPOR DEPOSITION APPARATUS; ACTIVE MATRIX ORGANIC LIGHT EMITTING DIODE (AMOLED) DISPLAY MANUFACTURING EQUIPMENT, NAMELY, THIN FILM DEPOSITION APPARATUS, SPUTTERING APPARATUS, COUPLED SPUTTERING APPARATUS, ETCHING APPARATUS, EVAPORATION DEPOSITION APPARATUS, PLASMA CHEMICAL VAPOR DEPOSITION APPARATUS, ION BEAM DEPOSITION APPARATUS AND ION BEAM ANNEALING APPARATUS, IN CLASS 7 (U.S. CLS. 13, 19, 21, 23, 31, 34 AND 35).

FOR: INSTALLATION, REPAIR AND MAINTENANCE OF SEMICONDUCTOR PROCESSING MACHINES, SEMICONDUCTOR WAFER PROCESSING APPARATUS, ATOMIC LAYER DEPOSITION APPARATUS, LOW PRESSURE CHEMICAL VAPOR DEPOSITION APPARATUS, DIFFUSION FURNACES, PLASMA CHEMICAL VAPOR DEPOSITION APPARATUS, METAL ORGANIC CHEMICAL VAPOR DEPOSITION APPARATUS, FAST-HEATING PROCESSING APPARATUS, HIGH TEMPERATURE CHEMICAL VAPOR DEPOSITION APPARATUS, VAPOR EPITAXY APPARATUS, LIQUID EPITAXY APPARATUS, NORMAL PRESSURE CHEMICAL VAPOR DEPOSITION APPARATUS, MID PRESSURE CHEMICAL VAPOR DEPOSITION APPARATUS, ETCHERS, SPUTTERING APPARATUS, PHOTOLITHOGRAPHY APPARATUS, DEVELOPERS, ASHING APPARATUS, CLEANING APPARATUS AND POLISHING APPARATUS, ALL FOR THE MANUFACTURE OF SEMICONDUCTORS; INSTALLATION, REPAIR AND MAINTENANCE OF DEPOSITION APPARATUS ETCHERS, SPUTTERING APPARATUS, PHOTOLITHOGRAPHY APPARATUS, DEVELOPERS, ASHING APPARATUS, CLEANING APPARATUS AND POLISHING APPARATUS, ALL FOR THE MANUFACTURE OF LIQUID CRYSTAL DISPLAY PANELS; INSTALLATION, REPAIR AND MAINTENANCE OF DEPOSITION APPARATUS, ETCHERS FOR MANUFACTURING SOLAR CELLS, SPUTTERING APPARATUS, PHOTOLITHOGRAPHY APPARATUS, DEVELOPERS FOR MANUFACTURING SOLAR CELLS, ASHING APPARATUS, CLEANING APPARATUS AND POLISHING APPARATUS, ALL FOR THE MANUFACTURE OF SOLAR CELLS; MAINTENANCE OF DEPOSITION APPARATUS, ETCHERS, SPUTTERING APPARATUS, PHOTOLITHOGRAPHY APPARATUS, DEVELOPERS, ASHING APPARATUS, CLEANING APPARATUS, AND POLISHING APPARATUS, ALL FOR THE MANUFACTURE OF LED AND AMOLED DISPLAYS, IN CLASS 37 (U.S. CLS. 100, 103 AND 106).

THE MARK CONSISTS OF THE WORDING "WONIK IPS" AND A CIRCULAR BLUE, GRAY AND WHITE DESIGN FEATURE TO THE LEFT OF THE WORDING. THE WORDING "WONIK" IS IN BLUE, WITH A CIRCULAR GRAY AND WHITE DESIGN WITHIN THE LETTER "O", AND THE WORDING "IPS" IS IN RED.

PRIORITY DATE OF 3-2-2011 IS CLAIMED.

OWNER OF INTERNATIONAL REGISTRATION 1089910 DATED 3-16-2011, EXPIRES 3-16-2021.

THE COLOR(S) BLUE, RED, GRAY AND WHITE IS/ARE CLAIMED AS A FEATURE OF THE MARK.

THE WORDING "WONIK" HAS NO MEANING IN A FOREIGN LANGUAGE.

SER. NO. 79-102,249, FILED 3-16-2011.

Reg. No. 4,204,098 STEVEN R. FINE, EXAMINING ATTORNEY

United States of America

United States Patent and Trademark Office

PSAGING

Reg. No. 4,204,099

Registered Sep. 11, 2012

Int. Cls.: 3, 5 and 35

TRADEMARK

SERVICE MARK

PRINCIPAL REGISTER

BIORGANIC PHARMA, S.L. (SPAIN SOCIEDAD LIMITADA)
JAUME PIQUET, 22
E-08017 BARCELONA
SPAIN

FOR: SKIN ABRASIVE PREPARATIONS; SOAPS FOR PERSONAL USE; PERFUMERY, ESSENTIAL OILS, COSMETICS, HAIR LOTIONS; DENTIFRICES, IN CLASS 3 (U.S. CLS. 1, 4, 6, 50, 51 AND 52).

FOR: PHARMACEUTICAL PREPARATIONS FOR USE IN DERMATOLOGY; DIETETIC FOOD AND SUGAR ADAPTED FOR MEDICAL USE, IN CLASS 5 (U.S. CLS. 6, 18, 44, 46, 51 AND 52).

FOR: ADVERTISING SERVICES; BUSINESS MANAGEMENT; BUSINESS ADMINISTRATION; PROVIDING OFFICE FUNCTIONS; ORGANIZATION OF EXHIBITIONS FOR COMMERCIAL OR ADVERTISING PURPOSES, WHOLESALE AND RETAIL STORE SERVICES FEATURING COSMETICS, LAUNDRY PRODUCTS AND PERSONAL CARE PRODUCTS; ONLINE WHOLESALE AND RETAIL STORE SERVICES FEATURING COSMETICS, LAUNDRY PRODUCTS AND PERSONAL CARE PRODUCTS, IN CLASS 35 (U.S. CLS. 100, 101 AND 102).

THE MARK CONSISTS OF STANDARD CHARACTERS WITHOUT CLAIM TO ANY PARTICULAR FONT, STYLE, SIZE, OR COLOR.

OWNER OF INTERNATIONAL REGISTRATION 1089970 DATED 7-5-2011, EXPIRES 7-5-2021.

SER. NO. 79-102,269, FILED 7-5-2011.

REBECCA POVARCHUK, EXAMINING ATTORNEY



David J. Kyffers

Director of the United States Patent and Trademark Office

United States of America

United States Patent and Trademark Office



Reg. No. 4,204,100

Registered Sep. 11, 2012

Int. Cl.: 17

TRADEMARK

PRINCIPAL REGISTER

AKSA KARBON ELYAF SANAYI ANONIM SIRKETI (TURKEY JOINT STOCK COMPANY)
MIRALAY SEFIK BEY
SOK AKHAN NO: 15 34437TR-34437 GÜMÜSSUYU BEYOGLU
ISTANBUL, TURKEY

FOR: CARBON FIBERS, OTHER THAN TEXTILE USE, IN CLASS 17 (U.S. CLS. 1, 5, 12, 13, 35 AND 50).

OWNER OF U.S. REG. NO. 3,692,704.

OWNER OF INTERNATIONAL REGISTRATION 1090118 DATED 7-22-2011, EXPIRES 7-22-2021.

THE COLOR(S) DARK GREEN, LIGHT GREEN AND BLACK IS/ARE CLAIMED AS A FEATURE OF THE MARK.

THE MARK CONSISTS OF THE DESIGN OF TWO INCOMPLETE CONCENTRIC CIRCLES, WITH THE OUTER LARGER CIRCLE APPEARING IN DARK GREEN AND THE SMALLER INNER CIRCLE APPEARING IN LIGHT GREEN AND THE WORDS "AKSACA" APPEARING IN BLACK AND EMANATING FROM THE BROKEN AREA OF THE CIRCLES.

THE WORDING "AKSACA" HAS NO MEANING IN A FOREIGN LANGUAGE.

SER. NO. 79-102,336, FILED 7-22-2011.

JENNIFER WILLISTON, EXAMINING ATTORNEY



David J. Kyjars

Director of the United States Patent and Trademark Office

United States of America

United States Patent and Trademark Office

Fischer MiniMax

Reg. No. 4,204,101

Registered Sep. 11, 2012

Int. Cl.: 9

TRADEMARK

PRINCIPAL REGISTER

FISCHER CONNECTORS HOLDING S.A. (SWITZERLAND SOCIÉTÉ ANONYME (SA))
CHEMIN DU GLAPIN 20
CH-1162 SAINT-PREX
SWITZERLAND

FOR: CONNECTORS AND COMPONENT PARTS, PARTICULARLY CONNECTORS FOR ELECTRIC AND ELECTRONIC INSTRUMENTS AND APPARATUS, NAMELY, ELECTRICAL CONNECTORS, ELECTRIC CABLES, ELECTRIC CONTACTS, PROTECTORS FOR ELECTRIC CONTACTS, NAMELY, COVERS FOR ELECTRIC CONTACTS, OPTICAL FIBERS, SHEATHS FOR ELECTRIC CABLES; ELECTRIC FLUIDIC CONNECTORS, IN CLASS 9 (U.S. CLS. 21, 23, 26, 36 AND 38).

THE MARK CONSISTS OF STANDARD CHARACTERS WITHOUT CLAIM TO ANY PARTICULAR FONT, STYLE, SIZE, OR COLOR.

PRIORITY DATE OF 7-21-2011 IS CLAIMED.

OWNER OF INTERNATIONAL REGISTRATION 1090183 DATED 8-3-2011, EXPIRES 8-3-2021.

OWNER OF U.S. REG. NOS. 1,732,667, 2,749,222 AND OTHERS.

SER. NO. 79-102,357, FILED 8-3-2011.

MARY CRAWFORD, EXAMINING ATTORNEY



David J. Kybas

Director of the United States Patent and Trademark Office

United States of America

United States Patent and Trademark Office

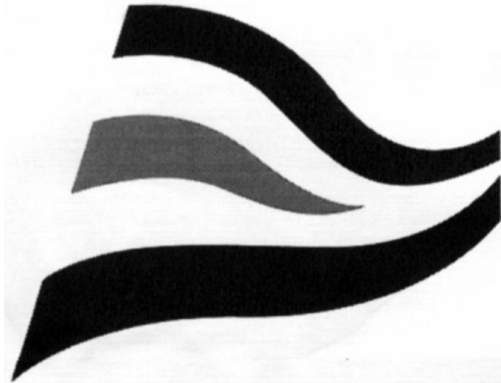

Reg. No. 4,204,102

Registered Sep. 11, 2012

Int. Cl.: 35

SERVICE MARK

PRINCIPAL REGISTER

XI'AN FAR EAST IMPORT & EXPORT CO., LTD. (CHINA CORPORATION)
34, HANCHENG SOUTH ROAD,
XIJIAO., XI'AN; 710077 SHAANXI
CHINA

FOR: IMPORT-EXPORT AGENCIES; SALES PROMOTION FOR OTHERS; ADVERTISING; BUSINESS INFORMATION; PROFESSIONAL BUSINESS CONSULTANCY; PROFESSIONAL BUSINESS CONSULTANCY; SYSTEMIZATION OF INFORMATION INTO COMPUTER DATABASES; COMPUTERIZED FILE MANAGEMENT; ADMINISTRATIVE PROCESSING OF PURCHASE ORDERS; PROCUREMENT SERVICES FOR OTHERS, NAMELY, PURCHASING OFFICE FURNITURE FOR OTHERS, IN CLASS 35 (U.S. CLS. 100, 101 AND 102).

THE MARK CONSISTS OF THREE WAVY BANDS RESEMBLING A TRIANGULAR FLAG.

OWNER OF INTERNATIONAL REGISTRATION 1090434 DATED 8-26-2011, EXPIRES 8-26-2021.

SER. NO. 79-102,436, FILED 8-26-2011.

MELISSA VALLILLO, EXAMINING ATTORNEY



David J. Kyffers

Director of the United States Patent and Trademark Office

United States of America

United States Patent and Trademark Office

MM - MTA

Reg. No. 4,204,103

MICRO MEGA INTERNATIONAL MANUFACTURES (FRANCE SOCIÉTÉ ANONYME)
5 RUE DU TUNNEL

Registered Sep. 11, 2012

F-25000 BESANCON, FRANCE

Int. Cl.: 5

FOR: ROOT CANAL FILLING PRODUCTS FOR DENTAL PURPOSES, PARTICULARLY
ROOT CANAL FILLING CEMENT, IN CLASS 5 (U.S. CLS. 6, 18, 44, 46, 51 AND 52).

TRADEMARK

NO CLAIM IS MADE TO THE EXCLUSIVE RIGHT TO USE "MTA", APART FROM THE
MARK AS SHOWN.

PRINCIPAL REGISTER

PRIORITY DATE OF 5-26-2011 IS CLAIMED.

OWNER OF INTERNATIONAL REGISTRATION 1090512 DATED 7-19-2011, EXPIRES 7-19-
2021.

SER. NO. 79-102,459, FILED 7-19-2011.

DAVID HOFFMAN, EXAMINING ATTORNEY



David J. Kyffers

Director of the United States Patent and Trademark Office

United States of America

United States Patent and Trademark Office

CAVIAROLI

Reg. No. 4,204,104

Registered Sep. 11, 2012

Int. Cls.: 29 and 35

TRADEMARK

SERVICE MARK

PRINCIPAL REGISTER

RAMON RAMON REAL (SPAIN INDIVIDUAL)
PLAZA SANTA EULALIA, 5
E-08292 ESPARRAGUERA
SPAIN

FOR: EDIBLE OILS AND FATS, NAMELY, OLIVE OIL, IN CLASS 29 (U.S. CL. 46).

FOR: RETAIL STORE SERVICES AND WHOLESALE STORE SERVICES VIA THE INTERNET
FEATURING OLIVE OIL, IN CLASS 35 (U.S. CLS. 100, 101 AND 102).

THE WORDING "CAVIAROLI" HAS NO MEANING IN A FOREIGN LANGUAGE.

PRIORITY DATE OF 3-1-2011 IS CLAIMED.

OWNER OF INTERNATIONAL REGISTRATION 1090760 DATED 8-31-2011, EXPIRES 8-31-2021.

SER. NO. 79-102,539, FILED 8-31-2011.

JAMES STEIN, EXAMINING ATTORNEY



David J. Kyffers

Director of the United States Patent and Trademark Office

United States of America

United States Patent and Trademark Office

SOLARCHECK

Reg. No. 4,204,105

Registered Sep. 11, 2012

Int. Cls.: 9, 37 and 42

TRADEMARK

SERVICE MARK

PRINCIPAL REGISTER

PHOENIX CONTACT GMBH & CO. KG (FED REP GERMANY LIMITED PARTNERSHIP
WITH A LIMITED LIABILITY COMPANY AS GENERAL PARTNER)
FLACHSMARKTSTR. 8
32825 BLOMBERG, FED REP GERMANY

FOR: PROTECTION SYSTEMS FOR STRINGS OF PHOTOVOLTAIC INSTALLATIONS, NAMELY, VOLTAGE SURGE PROTECTORS; SURGE PROTECTION SYSTEMS, NAMELY, VOLTAGE SURGE SUPPRESSORS, VOLTAGE SURGE PROTECTORS, TRANSIENT VOLTAGE SURGE SUPPRESSORS WITH POWER CONDITIONING TECHNOLOGY; ELECTRICAL AND ELECTRONIC DEVICES FOR SURGE PROTECTION, NAMELY, VOLTAGE SURGE SUPPRESSORS, VOLTAGE SURGE PROTECTORS, TRANSIENT VOLTAGE SURGE SUPPRESSORS WITH POWER CONDITIONING TECHNOLOGY; SYSTEMS AND DEVICES FOR MONITORING PHOTOVOLTAIC INSTALLATIONS, NAMELY, ALARM MONITORING SYSTEMS, ELECTRONIC DEVICES FOR MONITORING AND OPTIMIZING PHOTOVOLTAIC STRINGS AND ARRAYS, COMPUTER HARDWARE AND COMPUTER SOFTWARE FOR MONITORING AND CONTROLLING PHOTOVOLTAIC INSTALLATIONS; SYSTEMS AND DEVICES FOR MEASURING AND TRANSMITTING DATA AND INFORMATION, NAMELY, VOLTAGE MEASURING APPARATUS, CURRENT MEASURING APPARATUS, LIGHT MEASURING APPARATUS, COMPUTER CHIPSETS FOR USE IN TRANSMITTING DATA AND INFORMATION TO AND FROM A CENTRAL PROCESSING UNIT, COMPUTER HARDWARE AND COMPUTER SOFTWARE FOR MEASURING AND TRANSMITTING DATA AND INFORMATION; SYSTEMS AND DEVICES FOR MEASURING AND TRANSMITTING ELECTRICAL VOLTAGES AND TEMPERATURE, NAMELY, VOLTAGE REGULATORS, VOLTAGE MONITOR MODULES, VOLTAGE MEASURING APPARATUS, COMPUTER HARDWARE AND COMPUTER SOFTWARE FOR MEASURING AND TRANSMITTING ELECTRICAL VOLTAGES, TEMPERATURE REGULATORS, TEMPERATURE MONITOR MODULES, TEMPERATURE MEASURING APPARATUS, COMPUTER HARDWARE AND COMPUTER SOFTWARE FOR MEASURING AND TRANSMITTING TEMPERATURE; SYSTEMS AND DEVICES FOR DETECTING AND TRANSMITTING STATES OF SURGE PROTECTION SYSTEMS, NAMELY, TELECOMMUNICATION TRANSMITTERS, DIGITAL TRANSMITTERS, APPARATUS FOR MONITORING SURGE PROTECTION SYSTEMS, COMPUTER HARDWARE AND COMPUTER SOFTWARE FOR DETECTING AND TRANSMITTING STATES OF SURGE PROTECTION SYSTEMS; PHOTOVOLTAIC STRINGS FOR PHOTOVOLTAIC MODULES; PHOTOVOLTAIC STRINGS OF PHOTOVOLTAIC MODULES; JUNCTION BOXES; ELECTRONIC CONTROL SYSTEMS FOR MACHINES; ELECTRONIC MODULES FOR DETECTING DATA AND INFORMATION; ELECTRONIC MODULES FOR COLLECTING DATA AND INFORMATION; ELECTRONIC



David J. Kyjars

Director of the United States Patent and Trademark Office

Reg. No. 4,204,105 MODULES FOR MEASURING ELECTRICAL CURRENTS; CONCENTRATOR MODULES FOR PHOTOVOLTAIC INSTALLATIONS; ELECTRIC JUNCTION AND CONNECTING ELEMENTS MADE OF METAL AND PLASTICS FOR ELECTRICAL AND ELECTRONIC APPLICATIONS FOR INDUSTRIAL USE, PARTICULARLY TERMINAL CLAMPS AND CONNECTING TERMINALS; ELECTRONIC DATA TRANSMISSION DEVICES AND SOFTWARE FOR ELECTRONIC DATA TRANSMISSION; INDUSTRIAL PLUG-IN CONNECTORS; PLUG AND SOCKET DEVICES, NAMELY, ELECTRICAL PLUGS AND SOCKETS; ELECTRICAL CABLE AND LINE CONNECTORS; ADAPTERS FOR CONNECTING DIFFERENT PLUG-IN CONNECTORS; ELECTRICAL INSERT CONNECTORS; ELECTRICAL CONNECTOR MOUNTING PLATES; ELECTRICAL CABLE AND FLAT CABLE ADAPTER; ELECTRICAL EXTENSION, SOCKET AND COUPLING HOUSINGS FOR PLUG-IN CONNECTORS; MODULAR PLUG-IN CONNECTORS; ELECTRICAL TERMINAL CLAMPS AND CONNECTORS; ELECTRICAL, ELECTRONIC, OPTICAL WEIGHING, MEASURING, SIGNAL, CONTROL DEVICES AND INSTRUMENTS, PARTICULARLY FOR THE CONDUCTION, TRANSFORMATION, STORAGE, ADJUSTMENT AND CONTROL OF ELECTRICAL CURRENTS, NAMELY, ELECTRICAL CONDUCTORS, ELECTRONIC MONITORS AND MONITOR MODULES FOR MONITORING ELECTRIC CURRENT, ELECTRICAL CONTROLLERS; ELECTRICAL AND ELECTRONIC INSTALLATIONS, NAMELY, ELECTRIC INSTALLATIONS FOR THE REMOTE CONTROL OF INDUSTRIAL OPERATIONS, ELECTRICAL INSTALLATIONS FOR POWER TRANSMISSION, ELECTRICAL INSTALLATIONS FOR POWER DISTRIBUTION; COMPONENT PARTS AND DEVICES, NAMELY, AUTOMATION TERMINALS, PARTICULARLY BUS TERMINALS, INPUT TERMINALS, OUTPUT TERMINALS, INPUT MODULES, OUTPUT MODULES, POWER TERMINALS AND SAFETY TERMINALS, PARTICULARLY THOSE ADAPTED FOR SNAPPING ONTO A TOP-HAT RAIL, IN AS FAR AS THEY ARE INCLUDED IN THIS CLASS; DATA PROCESSING EQUIPMENT AND COMPUTERS; SOFTWARE FOR TRANSMITTING DATA; SIGNAL TRANSMISSION SYSTEMS AND COMPONENTS FOR SIGNAL TRANSMISSION SYSTEMS, PARTICULARLY SAFETY-RELATED CONTROLLERS AND DEVICES, NAMELY, CABLES, CONNECTORS AND PLUGS FOR ELECTRICAL OR OPTICAL SIGNAL TRANSMISSION; ELECTRICAL PLUG-IN CONNECTORS FOR PHOTOVOLTAIC APPLICATIONS; ELECTRICAL TERMINAL HOUSINGS FOR PHOTOVOLTAIC APPLICATIONS; DEVICES AND EQUIPMENT FOR DISTRIBUTING ELECTRICAL ENERGY, NAMELY, ELECTRICAL DISTRIBUTION BOXES, ELECTRICAL POWER DISTRIBUTION UNITS, ELECTRIC DISTRIBUTION CONSOLES; ELECTRICAL DISTRIBUTION CABINETS; ELECTRICAL DISTRIBUTION BOXES; ELECTRICAL TERMINAL PARTS, NAMELY, ELECTRICAL TERMINAL BLOCKS, COMPUTER TERMINALS; CONNECTION PARTS, NAMELY, ELECTRIC CONNECTIONS, CONNECTION CABLES, CONNECTION PLUGS, CONNECTION SOCKETS; METAL GROUNDING CABLE CLAMPS FOR USE ONLY AS PARTS AND FITTINGS FOR ELECTRIC CABLES, AND NOT FOR NON-ELECTRIC CABLE OR MACHINERY OR MACHINERY PART; ELECTRIC CONTACTS; ELECTRICAL CABLE DUCTS; ELECTRICAL CONDUCTORS; ELECTRICAL SOCKETS; ELECTRIC INDICATOR DEVICES, NAMELY, ELECTRONIC INDICATOR BOARDS, ELECTRONIC INDICATOR PANELS, TEMPERATURE INDICATORS, VOLTAGE INDICATORS, CURRENT INDICATORS; DATA PROCESSING EQUIPMENT AND COMPUTERS FOR REMOTE CONTROL AND DIAGNOSIS OF INDUSTRIAL PROCESSES; ELECTRICAL INSTALLATIONS FOR REMOTE CONTROL AND DIAGNOSIS OF INDUSTRIAL PROCESSES; ELECTRICAL HOUSINGS FOR ELECTRICAL AND ELECTRONIC INSTALLATIONS; DEVICES FOR DATA TRANSMISSION, NAMELY, TRANSMITTERS OF ELECTRONIC SIGNALS, SOUND TRANSMITTING APPARATUS, WIRELESS TRANSMITTERS AND RECEIVERS; ELECTRICAL CURRENT TRANSDUCERS; ELECTRICAL MONITORING DEVICES; NAMELY, ALARM MONITORING SYSTEMS, ELECTRONIC DEVICES FOR MONITORING AND OPTIMIZING PHOTOVOLTAIC STRINGS AND ARRAYS, COMPUTER HARDWARE AND COMPUTER SOFTWARE FOR MONITORING AND CONTROLLING PHOTOVOLTAIC INSTALLATIONS; LIGHTNING AND SURGE PROTECTION ELEMENTS, NAMELY, LIGHTNING ARRESTERS, LIGHTNING CONDUCTORS, VOLTAGE SURGE PROTECTORS; TERMINAL AND CONNECTING ELEMENTS MADE OF METAL AND PLASTICS FOR ELECTRICAL AND ELECTRONIC APPLICATIONS, PARTICULARLY TERMINAL CLAMPS, CONNECTING TERMINALS AND CONNECTOR BLOCKS; ELECTRICAL TERMINAL STRIPS; ELECTRICAL TERMINAL STRIPS FOR MEASURING ELEC-

Reg. No. 4,204,105 TRICAL CURRENTS; ELECTRICAL TERMINAL STRIPS FOR TRANSMITTING PROTOCOLS, MESSAGES, INFORMATION AND DATA; ELECTRICALLY CONDUCTING CABLES; ELECTRICAL COMMUNICATION CABLES; ELECTRICAL CABLES FOR TRANSMITTING PROTOCOLS, MESSAGES, INFORMATION AND DATA; PROGRAMMABLE LOGIC CONTROLLER (PLC); ELECTRICAL NETWORKS, NAMELY, COMPUTER NETWORK SERVERS, COMPUTER NETWORKING HARDWARE, NETWORK ROUTERS; COMPUTER NETWORKS, NAMELY, COMPUTER NETWORK SERVERS, COMPUTER NETWORKING HARDWARE, NETWORK ROUTERS; SYSTEMS FOR DATA TRANSMISSION, NAMELY, APPARATUS, COMPUTER HARDWARE AND COMPUTER SOFTWARE FOR DATA TRANSMISSION, APPARATUS FOR POWER DISTRIBUTION, APPARATUS FOR POWER TRANSMISSION; BIDIRECTIONAL SYSTEMS FOR DATA TRANSMISSION, NAMELY, APPARATUS, COMPUTER HARDWARE AND COMPUTER SOFTWARE FOR BIDIRECTIONAL DATA TRANSMISSION, IN CLASS 9 (U.S. CLS. 21, 23, 26, 36 AND 38).

FOR: INSTALLATION AND REPARATION SERVICES OF PHOTOVOLTAIC INSTALLATIONS, IN CLASS 37 (U.S. CLS. 100, 103 AND 106).

FOR: SERVICES FOR PROGRAMMING OF DIAGNOSIS SOFTWARE FOR PHOTOVOLTAIC INSTALLATIONS, AS FAR AS THEY ARE INCLUDED IN THIS CLASS; PLANNING AND DESIGNING OF LIGHTNING AND SURGE PROTECTION ELEMENTS; DEVELOPMENT SERVICES IN TERMS OF NOVEL PRODUCTS IN THE FIELD OF ELECTRICAL ENGINEERING AND ELECTRONICS FOR THIRD PARTIES; ENGINEERING CONSULTANCY IN RELATION TO THE IMPLEMENTATION AND MEASUREMENTS FOR ELECTRONIC DEVICES; ENGINEERING CONSULTATION IN RELATION TO ELIMINATING FAULTS FROM A PROGRAM, IN CLASS 42 (U.S. CLS. 100 AND 101).

THE MARK CONSISTS OF STANDARD CHARACTERS WITHOUT CLAIM TO ANY PARTICULAR FONT, STYLE, SIZE, OR COLOR.

PRIORITY DATE OF 9-29-2010 IS CLAIMED.

OWNER OF INTERNATIONAL REGISTRATION 1090854 DATED 3-24-2011, EXPIRES 3-24-2021.

SER. NO. 79-102,611, FILED 3-24-2011.

KRISTIN CARLSON, EXAMINING ATTORNEY

United States of America

United States Patent and Trademark Office

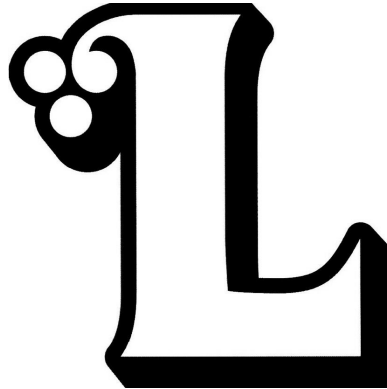

Reg. No. 4,204,106

Registered Sep. 11, 2012

**Int. Cls.: 16, 32, 33, 35,
38, 39, 41 and 43**

TRADEMARK

SERVICE MARK

PRINCIPAL REGISTER

OBSHCHESTVO S OGRANICHENNOI OTVETSTVENNOSTYU "LUDING" (RUSSIAN FED. LIMITED LIABILITY COMPANY)
RYABINOVAYA STREET, 55, BUILDING 3
RU-121471 MOSCOW
RUSSIAN FED.

FOR: PAPER, CARDBOARD AND GOODS MADE FROM THESE MATERIALS, NOT INCLUDED IN OTHER CLASSES, NAMELY, COPY PAPER, COLLAPSIBLE BOXES OF PAPER; PRINTED MATTER, NAMELY, PAPER SIGNS, BOOKS, MANUALS, CURRICULUM, NEWSLETTERS, INFORMATIONAL CARDS AND BROCHURES IN THE FIELD OF ALCOHOLIC BEVERAGES AND ALCOHOLIC BEVERAGE INDUSTRY; BOOKBINDING MATERIAL; PRINTED PHOTOGRAPHS; STATIONERY; ADHESIVES FOR STATIONERY OR HOUSEHOLD PURPOSES; ARTISTS' MATERIALS, NAMELY, CANVAS STRETCHER BARS FOR ARTISTS ; PAINT BRUSHES; ELECTRICAL AND ELECTRONIC TYPEWRITERS OFFICE REQUISITES, NAMELY, ENVELOPE SEALING MACHINES, PAPER EMBOSSERS, ELECTRIC PAPER HOLE PUNCHES, CORRECTING TAPES, ADHESIVE TAPE DISPENSERS; PAPER INSTRUCTIONAL AND TEACHING MATERIALS IN THE FIELD OF ALCOHOLIC BEVERAGES AND ALCOHOLIC BEVERAGE INDUSTRY ; PLASTIC MATERIALS FOR PACKAGING, NAMELY BAGS, BUBBLE PACKS; PRINTERS' TYPE; PRINTING BLOCKS, IN CLASS 16 (U.S. CLS. 2, 5, 22, 23, 29, 37, 38 AND 50).

FOR: BEERS; MINERAL AND AERATED WATERS; NON-ALCOHOLIC DRINKS, NAMELY, ENERGY SHOTS, DRINKS FLAVORED WITH TEA AND COFFEE; FRUIT DRINKS AND FRUIT JUICES; SYRUPS AND OTHER PREPARATIONS FOR MAKING NON-ALCOHOLIC BEVERAGES, IN CLASS 32 (U.S. CLS. 45, 46 AND 48).

FOR: ALCOHOLIC BEVERAGES EXCEPT BEER, IN CLASS 33 (U.S. CLS. 47 AND 49).

FOR: ADVERTISING AND MARKETING SERVICES, NAMELY, PROMOTING THE GOODS AND SERVICES OF OTHERS; BUSINESS OPERATION, BUSINESS ADMINISTRATION AND OFFICE FUNCTIONS, IN CLASS 35 (U.S. CLS. 100, 101 AND 102).

FOR: TELECOMMUNICATION SERVICES, NAMELY, TRANSMISSION OF VOICE, DATA, GRAPHICS, IMAGES, AUDIO AND VIDEO BY MEANS OF TELECOMMUNICATIONS NETWORKS, WIRELESS COMMUNICATION NETWORKS, AND THE INTERNET, IN CLASS 38 (U.S. CLS. 100, 101 AND 104).



David J. Kypos

Director of the United States Patent and Trademark Office

Reg. No. 4,204,106 FOR: TRANSPORT, PACKAGING AND STORAGE OF GOODS; COORDINATING TRAVEL ARRANGEMENTS FOR INDIVIDUALS AND GROUPS, IN CLASS 39 (U.S. CLS. 100 AND 105).

FOR: EDUCATION SERVICES, NAMELY, PROVIDING CLASSES, SEMINARS, WORKSHOPS IN THE FIELD OF ALCOHOLIC BEVERAGES AND ALCOHOLIC BEVERAGE INDUSTRY ; ENTERTAINMENT IN THE NATURE OF MUSICAL GROUP, TELEVISION COMEDY SERIES, ETHNIC FESTIVAL, AUTOMOBILE RACES, AIR SHOWS; SERVICES IN CONNECTION WITH THE ARRANGING AND CONDUCTING OF SPORTING AND CULTURAL ACTIVITIES, NAMELY, PROVISION OF INFORMATION RELATING TO SPORTING, CULTURAL AND LIVE THEATRICAL PRODUCTIONS, AND TICKET RESERVATION AND BOOKING SERVICES FOR ENTERTAINMENT, SPORTING AND CULTURAL EVENTS, IN CLASS 41 (U.S. CLS. 100, 101 AND 107).

FOR: SERVICES FOR PROVIDING FOOD AND DRINK, NAMELY, SERVING FOOD AND DRINKS, PROVIDING OF FOOD AND DRINKS FOR GUESTS, CATERING OF FOOD AND DRINKS; PROVIDING TEMPORARY HOUSING ACCOMMODATION, IN CLASS 43 (U.S. CLS. 100 AND 101).

THE MARK CONSISTS OF THE LETTER "L" IN STYLIZED FONT, WITH TWO CIRCLES ATTACHED TO THE CURLED TOP OF THE LETTER "L".

OWNER OF INTERNATIONAL REGISTRATION 1091370 DATED 7-19-2011, EXPIRES 7-19-2021.

SER. NO. 79-102,788, FILED 7-19-2011.

HENRY S. ZAK, EXAMINING ATTORNEY

United States of America

United States Patent and Trademark Office



Reg. No. 4,204,107

Registered Sep. 11, 2012

Int. Cls.: 9 and 12

TRADEMARK

PRINCIPAL REGISTER

GIMOTA AG (SWITZERLAND AKTIENGESELLSCHAFT)
CHRUMMACHERSTRASSE 3
CH-8954 GEROLDSWIL, SWITZERLAND

FOR: POWER OUTLETS, NAMELY, ELECTRICAL OUTLET, MULTI-OUTLET SOCKET BLOCKS; POWER CONNECTORS FOR HIGH VOLTAGE AND MODULAR CONNECTORS; PLUGS, NAMELY, ELECTRIC PLUGS, ELECTRICAL PLUGS, SAFETY CONTACT PLUGS; APPARATUS AND INSTRUMENTS FOR TRANSMITTING DATA, NAMELY, ELECTRONIC AND ELECTRICAL CONNECTORS FOR DATA BUS SYSTEMS, TRANSCEIVERS, COMPUTERS, COMPUTER CHIPSET FOR USE IN TRANSMITTING DATA TO AND FROM A CENTRAL PROCESSING UNIT, AND APPARATUS FOR RECORDING, TRANSMISSION, PROCESSING AND REPRODUCTION OF DATA; APPARATUS AND INSTRUMENTS FOR CONVEYING, DISTRIBUTING, TRANSFORMING, STORING, REGULATING OR CONTROLLING ELECTRIC CURRENT; APPARATUS AND INSTRUMENTS FOR CONVEYING, DISTRIBUTING, TRANSFORMING, STORING, REGULATING OR CONTROLLING DATA, NAMELY, BLANK MAGNETIC DATA CARRIERS, BLANK OPTICAL DATA CARRIERS, CALCULATING MACHINES AND DATA PROCESSING EQUIPMENT, COMPUTERS, ELECTRONIC DATA LOGGERS, INTERFACE CARDS FOR DATA PROCESSING EQUIPMENT IN THE FORM OF PRINTED CIRCUITS, TRANSCEIVERS, ELECTRIC CAPACITORS, ELECTRIC RESISTORS, ELECTRICAL TRANSFORMERS, CHANGE-OVER SWITCHES, FUSES, PICKUPS, TELECOMMUNICATION CABLES; VOLTAGE REGULATORS FOR VEHICLES; MEASURING, SIGNALING AND CONTROL APPARATUS AND INSTRUMENTS, NAMELY, COORDINATE MEASURING MACHINES, DISTANCE MEASURING APPARATUS, GRAVITY MEASURING INSTRUMENTS, INSTRUMENTS FOR DETECTING AND MEASURING TWO-DIMENSIONAL DISTRIBUTION OF FORCE AND PRESSURE, INSTRUMENTS FOR MEASURING LENGTH, LASER MEASURING SYSTEMS, LEVEL MEASURING MACHINES, BEVELS, RAIN GAUGES, ANGLE FINDERS, MEASURING CUPS, MEASURING RULES, DIGITIZERS, MECHANICAL AND ELECTRONIC MEASURING MACHINES FOR IDENTIFYING AND ANALYZING STRUCTURAL DAMAGE TO VEHICLES, DIGITAL SIGNAL PROCESSORS, SIGNAL BELLS, SIGNAL SPLITTERS FOR ELECTRONIC APPARATUS, SIGNALING BUOYS, AUTOMATIC COMBUSTION CONTROL MACHINES AND INSTRUMENTS, BRAKE CONTROLLERS, ELECTRICAL CONTROLLING DEVICES, ELECTRONIC CONTROL SYSTEMS FOR MACHINES, IN CLASS 9 (U.S. CLS. 21, 23, 26, 36 AND 38).



David J. Kyffers

Director of the United States Patent and Trademark Office

FOR: VEHICLE COMPONENT PARTS, NAMELY, STRUCTURAL PARTS FOR AUTOMOBILES, STRUCTURAL PARTS FOR RAIL VEHICLES AND TRAINS, SHOCK ABSORBERS,

Reg. No. 4,204,107 AND SENSORS FOR LAND VEHICLES IN THE NATURE OF ELECTRIC POWER STEERING TORQUE SENSORS, SOLD AS A COMPONENT OF THE POWER STEERING SYSTEM, IN CLASS 12 (U.S. CLS. 19, 21, 23, 31, 35 AND 44).

THE MARK CONSISTS OF THE STYLIZED WORDING "GIMOTA" IN THE COLOR BLACK, AND THE DESIGN OF AN ARC-SHAPED BAND IN A GRADIENT OF COLORS, STARTING WITH DARK BLUE ON THE LEFT, THEN GOING RIGHT LIGHT BLUE, GREEN, YELLOW, AND ENDING WITH ORANGE ON THE RIGHT.

OWNER OF INTERNATIONAL REGISTRATION 0807178 DATED 5-12-2003, EXPIRES 5-12-2013.

THE COLOR(S) DARK BLUE, LIGHT BLUE, GREEN, YELLOW, ORANGE, AND BLACK IS/ARE CLAIMED AS A FEATURE OF THE MARK.

THE WORDING "GIMOTA" HAS NO MEANING IN A FOREIGN LANGUAGE.

SER. NO. 79-102,850, FILED 3-1-2011.

JAY BESCH, EXAMINING ATTORNEY

United States of America

United States Patent and Trademark Office



Reg. No. 4,204,108

Registered Sep. 11, 2012

Int. Cl.: 30

TRADEMARK

PRINCIPAL REGISTER

ÇELIKLER GIDA SANAYI VE TICARET LIMITED SIRKETI (TURKEY LIMITED LIABILITY COMPANY)

2. ORGANIZE SANAYI BÖLGESİ

CELAL DOĞAN BULVARI NO: 3; BASPINAR GAZIANTEP
TURKEY

FOR: COFFEE, COCOA, COFFEE BASED BEVERAGES; COCOA-BASED BEVERAGES; CHOCOLATE FOOD BEVERAGES NOT BEING DAIRY-BASED OR VEGETABLE BASED; MACARONI, MEAT PIES, VERMICELLI, PASTRIES, PETIT FOURS, TARTS, CAKES; BAKERY DESSERT MADE OF FLOUR; HONEY, PROPOLIS FOR FOOD PURPOSES; FLAVOURINGS FOR FOODS; YEAST, BAKING-POWDER; FLAVOURING ADDITIVES FOR NON-NUTRITIONAL PURPOSES, FLOUR, PROCESSED SEMOLINA, FOOD STARCH; SUGAR, POWDERED SUGAR; TEA, ICED TEA; CONFECTIONERY, NAMELY, PASTILLES, FONDANTS, FRUIT JELLY CANDY; CHOCOLATES, BISCUITS, CRACKERS, WAFFLES, CHEWING GUM, ICE CREAM, EDIBLE ICES; SALT; BREAKFAST CEREALS, IN CLASS 30 (U.S. CL. 46).

THE MARK CONSISTS OF THE WORDING "TURKANA" IN STYLIZED FONT IN THE COLOR DARK KHAKI CENTERED ABOVE THE WORDING "VALLEY" WHICH APPEARS IN A SMALLER STYLIZED FONT ALSO IN THE COLOR DARK KHAKI. THE WORDING IS CENTERED IN AN ABSTRACT DESIGN APPEARING IN THE COLOR WHITE WITH BLACK BORDERS.

OWNER OF INTERNATIONAL REGISTRATION 1091589 DATED 4-25-2011, EXPIRES 4-25-2021.

THE COLOR(S) DARK KHAKI, WHITE AND BLACK IS/ARE CLAIMED AS A FEATURE OF THE MARK.

SER. NO. 79-102,893, FILED 4-25-2011.

DAVID I, EXAMINING ATTORNEY



David J. Kyros

Director of the United States Patent and Trademark Office

United States of America

United States Patent and Trademark Office

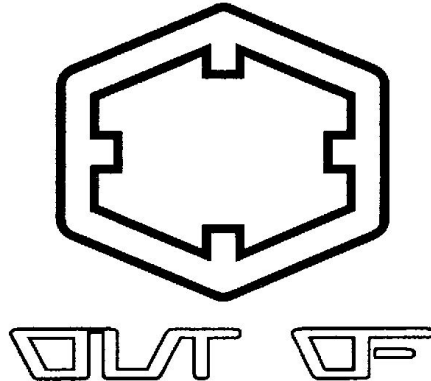

Reg. No. 4,204,109

Registered Sep. 11, 2012

Int. Cls.: 25 and 28

TRADEMARK

PRINCIPAL REGISTER

OUT OF DI RIGHI FEDERICO (ITALY SOLE PROPRIETORSHIP)
VIA DABBENI, 110
I-25133 BRESCIA
ITALY

FOR: CLOTHING, NAMELY, PANTS, T-SHIRTS, SHORTS, SWEATSHIRTS, HOODED SWEATSHIRTS, SWEATERS, FOOTWEAR, BELTS, HATS AND CAPS AND OUTERWEAR JACKETS FOR SKI AND SNOWBOARD USE, IN CLASS 25 (U.S. CLS. 22 AND 39).

FOR: PARLOR GAMES; GYMNAS TIC AND SPORTING ARTICLES NOT INCLUDED IN OTHER CLASSES, NAMELY, BINDINGS FOR ALPINE SKIS, COVERS FOR SKI BINDINGS, HARNESS ES SPECIALLY ADAPTED FOR CARRYING SNOWBOARDS, SKIS AND SKATEBOARDS, PORTABLE SKI CARRIERS, SCRAPERS FOR SKIS, SKI BAGS, SKI BINDINGS, SKI BINDINGS AND PARTS THEREFORE, SKI POLES, SKI ROPES, SKIS; DECORATIONS FOR CHRISTMAS TREES, IN CLASS 28 (U.S. CLS. 22, 23, 38 AND 50).

THE MARK CONSISTS OF A DOUBLE LINE HEXAGONAL SHAPE ABOVE THE WORDING "OUT OF" IN STYLIZED CHARACTERS.

OWNER OF INTERNATIONAL REGISTRATION 1091745 DATED 7-21-2011, EXPIRES 7-21-2021.

SER. NO. 79-102,943, FILED 7-21-2011.

JESSICA A. POWERS, EXAMINING ATTORNEY



David J. Kybas

Director of the United States Patent and Trademark Office

United States of America

United States Patent and Trademark Office

LUXSIC

LEGACY of USA

Reg. No. 4,204,110

Registered Sep. 11, 2012

Int. Cls.: 24 and 25

TRADEMARK

PRINCIPAL REGISTER

SEA ISLAND CLUB CO., LTD (JAPAN CORPORATION)
1-5-7, NIHONBASHI HORIDOME-CHO
CHUO-KU
TOKYO 103-0012, JAPAN

FOR: WOVEN FABRICS; KNITTED FABRICS; PERSONAL BELONGING OF WOVEN TEXTILE, NAMELY, TOWELS, JAPANESE COTTON TOWELS, HANDKERCHIEFS, JAPANESE CEREMONIAL WRAPPING CLOTH; MOSQUITO NETS; BED SHEETS; FUTON QUILTS; LINEN FUTON QUILTS CASES; FUTON TICKS, NAMELY, UNSTUFFED FUTON COVERS NOT OF PAPER; PILLOWCASES; BED BLANKETS; LAP BLANKETS; TRAVELLING BLANKETS; SERVIETTES OF TEXTILE; DISH TOWELS OF TEXTILE FOR DRYING; UNFITTED FABRIC CHAIR COVERS, NAMELY, SEAT COVERS OF TEXTILE; WALL HANGINGS OF TEXTILE; CURTAINS; FABRIC TABLE RUNNERS; DRAPERIES, NAMELY, THICK DROP CURTAINS, IN CLASS 24 (U.S. CLS. 42 AND 50).

FOR: CLOTHING, NAMELY, SUITS, JACKETS, PANTS, DRESSES, SKIRTS, COATS, SWEATERS, CARDIGANS, DENIMS, KNIT JACKETS, KNIT BOTTOMS, KNIT DRESSES, SHIRTS, T-SHIRTS, KNIT SHIRTS, KNIT TOPS, SHORTS, BLOUSES, UNDERWEAR, CAMISOLES, NIGHTWEAR, SOCKS, FOOTWEAR, KNITTED GLOVES, SCARVES, SHAWLS; CHILDREN'S CLOTHING, NAMELY, JUMPERS, OVERALLS, SLEEPERS, PAJAMAS, ROMPERS, ONE-PIECE GARMENTS; GARTERS; SOCK SUSPENDERS; TROUSER STRAPS; WAIST BANDS; BELTS FOR CLOTHING; CLOTHING FOR SPORTS, NAMELY, SPORT SHIRTS, SPORT BRAS, SPORTS PANTS, SPORTS JERSEYS, SPORTS OVER UNIFORMS, IN CLASS 25 (U.S. CLS. 22 AND 39).



NO CLAIM IS MADE TO THE EXCLUSIVE RIGHT TO USE "USA", APART FROM THE MARK AS SHOWN.

OWNER OF INTERNATIONAL REGISTRATION 1091874 DATED 6-7-2011, EXPIRES 6-7-2021.

SER. NO. 79-102,994, FILED 6-7-2011.

NAAKWAMA ANKRAH, EXAMINING ATTORNEY

David J. Kyffers

Director of the United States Patent and Trademark Office

United States of America

United States Patent and Trademark Office

Charmenne

Reg. No. 4,204,111

Registered Sep. 11, 2012

Int. Cl.: 3

TRADEMARK

PRINCIPAL REGISTER

JM WORLD CO., LTD. (REPUBLIC OF KOREA CORPORATION)
363-18, GWACHEON-DONG
GWACHEON-SI; GYEONGGI-DO
REPUBLIC OF KOREA

FOR: NAIL ENAMEL REMOVERS; EYEBROW PENCILS; EYEBROW COSMETICS; LAVENDER WATER; LOOSE FACE POWDER; ROUGE; LIQUID ROUGE; SACHETS FOR PERFUMING LINEN; LIP LINER; LIPSTICKS; MASSAGE GELS OTHER THAN FOR MEDICAL PURPOSES; MASSAGE OILS; MASCARA; NAIL VARNISH; NAIL ENAMEL; VARNISH-REMOVING PREPARATIONS; HAIR OILS; MAKE-UP FOUNDATIONS; MAKE-UP PREPARATIONS; GELS FOR SHAVING; SHAVING PREPARATIONS; HAIR DRYING PREPARATIONS; HAIR PRESERVATION TREATMENTS IN THE NATURE OF HAIR SPRAY; HAIR COLORANTS; HAIR MASCARA; WAVING PREPARATIONS FOR THE HAIR; HAIR-WASHING POWDERS; HAIR POMADES; HAIR BLEACHING PREPARATIONS; HAIR CREAMS; COLOR-REMOVING PREPARATIONS FOR HAIR; BATH SALTS; COSMETIC PREPARATIONS FOR BATHS; ADDITIVES FOR COSMETIC BATHS, NAMELY, BATH FOAM AND BATH BEADS; BEAUTY CREAMS; BODY LOTIONS; BODY MILKS; BADIAN ESSENCE; BODY OILS; BODY CREAMS; SACHETS FOR PERFUMING; VANISHING CREAMS FOR COSMETIC PURPOSES; BATH LOTIONS; BATH BEADS; BATH OILS; BATH FOAMS; WHITE MAKE-UP POWDER; BAY RUMS FOR COSMETIC PURPOSES; BABY OILS; BABY POWDERS; BLUSHERS; BLUSH PENCILS; PERFUMED POWDER FOR COSMETIC USE; BATH SALTS NOT FOR MEDICAL PURPOSES; DANDRUFF LOTIONS NOT FOR MEDICAL PURPOSES; DANDRUFF CREAMS NOT FOR MEDICAL PURPOSES; SUN-TANNING PREPARATIONS NOT FOR MEDICAL PURPOSES; SKIN CREAMS NOT FOR MEDICAL PURPOSES; COSMETIC OILS, NAMELY, SAFROL; ANTISEPTIC ALUM STONES; SHOWER AND BATH GELS; SHOWER CREAMS; SHOWER FOAMS AND BATH FOAMS; COSMETIC PREPARATIONS AGAINST SUNBURN; SUN-BLOCK LOTIONS; SUNSCREEN LOTIONS FOR COSMETIC USE; SUNSCREEN CREAMS FOR COSMETIC USE; SUNTAN LOTIONS FOR COSMETIC USE; COSMETIC SUN-TANNING PREPARATIONS; SUN-TANNING CREAMS; SHAVING LOTIONS; SHAVING CREAMS; SHAVING FOAMS; COSMETIC PREPARATIONS FOR EYELASHES; LOTIONS FOR STRENGTHENING THE NAILS; NAIL POLISHING POWDER; NAIL CARE PREPARATIONS; SKIN LOTIONS; COSMETIC CREAMS FOR SKIN CARE; COSMETIC PREPARATIONS FOR SKIN CARE; SKIN CREAMS; SKIN CLEANSERS; EYELINERS; EYELINER PENCILS; EYE LOTIONS; EYE MAKE-UP REMOVERS; EYE SHADOWS; EYE CREAMS; EYE PENCILS; COSMETICS FOR ANIMALS; AFTER SUN CREAMS FOR COSMETIC USE; AFTER-SHAVE LOTIONS; AFTER-SHAVE EMULSIONS; AFTER-SHAVE CREAMS; LIQUID PERFUMES; ETHEREAL ESSENCES; EAU



David J. Kyjars

Director of the United States Patent and Trademark Office

Reg. No. 4,204,111 DE COLOGNE; EAU DE PARFUM; EAU DE TOILETTE; COSMETIC OILS FOR THE EPI-
DERMIS; HAIR CONDITIONER FOR BABY; ANTIPERSPIRANTS FOR PERSONAL USE;
DEODORANTS FOR PERSONAL USE; FRAGRANCES FOR PERSONAL USE BEING PER-
FUME; ESSENTIAL OILS FOR PERSONAL USE; TOILET WATERS; COSMETIC PREPARA-
TIONS FOR DRY SKIN DURING PREGNANCY; LIP GLOSS; NON-MEDICATED LIP CON-
DITIONERS; NON-MEDICATED PROTECTIVE PREPARATIONS FOR LIPS; COSMETIC
SUN-PROTECTING PREPARATIONS; COSMETIC PREPARATIONS FOR SLIMMING PUR-
POSES; COLD CREAMS FOR COSMETIC USE; COLD WAVING SOLUTIONS; SOLID
POWDER FOR COMPACTS BEING COSMETICS; MUSTACHE WAX; CLEANSING MILK;
DEPILATORY WAX; DEPILATORY PREPARATIONS; TALCUM POWDER; LOTIONS FOR
BEARDS; BEARD DYES; PERMANENT WAVE PREPARATIONS; NEUTRALIZERS FOR
PERMANENT WAVING; FOUNDATIONS; CREAMY FOUNDATION; PERMANENT WAVING
LOTIONS; PERFUMED TALCUM POWDER; PERFUMED PASTE; PERFUMED CREAMS;
FACIAL LOTION; FACIAL CLEANSING MILKS; FACIAL CREAMS; FACE MILK AND
LOTIONS; FACE AND BODY LOTIONS; FACE AND BODY MILKS FOR COSMETIC USE;
COSMETICS FOR FACE AND BODY; COSMETIC LOTIONS FOR FACE AND BODY CARE;
FACE AND BODY CREAMS; MAKE-UP BASES IN THE FORM OF PASTES; POMADES
FOR COSMETIC USE; PRESSED FACE POWDER; PRE-SHAVE CREAMS; SKIN WHITENING
CREAMS; HAND LOTIONS; PERFUMED POWDERS; PERFUMES; HAIR GELS; HAIR
GLAZE; HAIR NOURISHERS; COSMETIC HAIR DRESSING PREPARATIONS; HAIR LAC-
QUERS; HAIR LOTIONS; HAIR MOISTURIZERS; HAIR MOUSSE; HAIR BALSAM; HAIR
STYLING GELS; HAIR STYLING SPRAY; HAIR SPRAY; HAIR CONDITIONER; HAIR
CONDITIONING OILS; HAIR CARE LOTIONS; BATH OILS FOR HAIR CARE; HAIR CARE
CREAMS; HAIR TONIC; HELIOTROPIN FOR PERFUMERY; GELS FOR COSMETIC PUR-
POSES, NAMELY, EYE GELS; HYDROGEN PEROXIDE FOR COSMETIC PURPOSES;
GREASES FOR COSMETIC PURPOSES; NOURISHING CREAMS FOR COSMETIC PURPOSES;
LOTIONS FOR COSMETIC PURPOSES; COSMETIC ROUGES; FACE MASK PACK FOR
COSMETIC PURPOSES; NAIL ENAMELS FOR COSMETIC PURPOSES; BATH POWDERS
FOR COSMETIC PURPOSES; PETROLEUM JELLY FOR COSMETIC PURPOSES; ANTIPER-
SPIRANTS FOR COSMETIC PURPOSES; BATH OILS FOR COSMETIC PURPOSES; SUN
MILK LOTIONS FOR COSMETIC PURPOSES; SUNTAN OILS FOR COSMETIC PURPOSES;
SUN-TANNING PREPARATIONS FOR COSMETIC PURPOSES; ASTRINGENTS FOR COS-
METIC PURPOSES; SKIN LOTIONS FOR COSMETIC PURPOSES; COSMETIC SKIN
FRESHENER; ALMOND MILK FOR COSMETIC PURPOSES; LIQUID FOUNDATION FOR
COSMETIC PURPOSES; FACE POWDER FOR COSMETIC PURPOSES; PENCILS FOR
COSMETIC PURPOSES; DYES FOR COSMETIC PURPOSES, NAMELY, HAIR DYES; OILS
FOR COSMETIC PURPOSES; BATH SALTS FOR COSMETIC PURPOSES; COLORANTS
FOR COSMETIC PURPOSES, NAMELY, HAIR COLORANTS; CLEANSING CREAMS FOR
COSMETIC PURPOSES; CLEANSING MILK FOR COSMETIC PURPOSES; CREAMS FOR
COSMETIC PURPOSES; TALCUM POWDER FOR COSMETIC PURPOSES; MAKE-UP
POWDER FOR COSMETIC PURPOSES; FACE CREAMS FOR COSMETIC PURPOSES; PO-
MADES FOR COSMETIC PURPOSES; BLEACHING PREPARATIONS FOR COSMETIC
PURPOSES; HAND CREAMS FOR COSMETIC PURPOSES; PERFUMED OILS FOR COSMET-
IC PURPOSES; MAKE-UP REMOVING LOTIONS; MAKE-UP REMOVING MILKS; MAKE-
UP REMOVING PREPARATIONS; COSMETICS; COSMETIC KITS COMPRISED OF LIPSTICK,
MASCARA AND LIP GLOSS; SOAP FOR PERSONAL USE IN THE FORM OF CAKE;
SHAVING MOUSSE; SHAVING SOAP; BATH SOAPS; LIQUID SOAPS; BEAUTY SOAPS;
BODY CREAM SOAPS; SOAPS FOR BODY CARE; SOAP FOR FOOT PERSPIRATION; AN-
TIPERSPIRANT SOAP; DEODORANT SOAP; SHAMPOOS; HAND CLEANING PREPARA-
TIONS; ALMOND SOAP; SHAMPOOS FOR PETS; LIQUID BATH SOAPS; SHAMPOOS FOR
BABIES; SOAPS FOR PERSONAL USE; LIQUID SOAPS USED IN FOOT BATH; SOAPS IN
THE FORM OF PAPER; CREAM SOAPS; FACIAL WASHES; HAND CLEANERS BEING
HAND CLEANING PREPARATIONS; PERFUMED SOAP; COSMETIC HAIR RINSES; COS-
METIC SOAPS; ESSENTIAL OILS IN THE NATURE OF GAULTHERIA OIL; AROMATICS
BEING ESSENTIAL OILS FOR HOUSEHOLD PURPOSES; FRAGRANCE FOR HOUSEHOLD
PURPOSES; EXTRACTS OF FLOWERS BEING PERFUMES; BASES FOR FLOWER PER-
FUMES; LAVENDER OIL; ESSENTIAL OILS OF LEMON; ELECAMPANE BEING PER-
FUMERY; MINT ESSENCE BEING ESSENTIAL OIL; VANILLA PERFUMERY; PEPPERMINT

Reg. No. 4,204,111 OIL PERFUMERY; SCENTED WOOD; BERGAMOT OIL; COMPLEX PERFUMERY; ESSENTIAL OILS OF CEDARWOOD; JOSS STICKS; ESSENTIAL OILS OF CITRON; ALMOND OIL FOR COSMETIC PURPOSES; AMBER PERFUME; ETHEREAL OILS; AMBERGRIS; IONONE PERFUMERY; AROMATICS FOR AUTOMOBILES; JASMINE OIL FOR COSMETIC PURPOSES; ROSE OIL FOR COSMETIC PURPOSES; GERANIOL FOR PERFUMERY; COMPOUND PERFUMERY; NATURAL PERFUMERY; CLOVE OIL FOR COSMETIC PURPOSES; TERPENES BEING ESSENTIAL OILS; POTPOURRIS BEING FRAGRANCES; SYNTHETIC MUSK; SYNTHETIC PERFUMERY; INCENSE; PERFUMERY; OILS FOR PERFUMES AND SCENTS; PERFUMERY BEING ESSENTIAL OIL; MINT FOR PERFUMERY; MUSK FOR PERFUMERY; NATURAL MUSK FOR PERFUMERY; PERFUMED OILS FOR THE MANUFACTURE OF COSMETIC PREPARATIONS; FUMIGATION PREPARATIONS BEING PERFUMES, IN CLASS 3 (U.S. CLS. 1, 4, 6, 50, 51 AND 52).

THE WORDING "CHAMENNE" HAS NO MEANING IN A FOREIGN LANGUAGE.

OWNER OF INTERNATIONAL REGISTRATION 1091995 DATED 5-27-2011, EXPIRES 5-27-2021.

SER. NO. 79-103,030, FILED 5-27-2011.

KRISTINA MORRIS, EXAMINING ATTORNEY

United States of America

United States Patent and Trademark Office

The logo for "AEROBOT" features the word in a bold, sans-serif font. The two 'O's are replaced by stylized fan designs with multiple blades. From the top of each fan, a trail of small black dots extends upwards and to the right, suggesting motion or air being blown.

Reg. No. 4,204,112

Registered Sep. 11, 2012

Int. Cls.: 7 and 11

TRADEMARK

PRINCIPAL REGISTER

POOLRITE RESEARCH PTY LTD (AUSTRALIA COMPANY)
415 CREEK ROAD
MOUNT GRAVATT QLD 4122
AUSTRALIA

FOR: SWIMMING POOL AND SPA CLEANING AND MAINTENANCE MACHINES AND EQUIPMENT, NAMELY, VACUUM CLEANERS, AUTOMATIC SWIMMING POOL CLEANERS AND PARTS THEREOF; SWEEPING MACHINES AND POWER-OPERATED SWEEPING APPARATUS FOR USE IN POOLS AND SPAS; POWER-OPERATED SKIMMERS FOR CLEANING POOLS AND SPAS; PUMPS, NAMELY, PUMPS FOR RECYCLING WATER IN SWIMMING POOLS AND SPAS, IN CLASS 7 (U.S. CLS. 13, 19, 21, 23, 31, 34 AND 35).

FOR: WATER PURIFYING AND FILTRATION APPARATUS FOR SWIMMING POOLS AND SPAS, NAMELY, WATER FILTERS, IN CLASS 11 (U.S. CLS. 13, 21, 23, 31 AND 34).

THE MARK CONSISTS OF THE WORD "AEROBOT" IN STYLIZED LETTERING WITH BOTH OF THE LETTER "O'S BEING FORMED BY STYLIZED FAN DESIGNS FROM WHICH BUBBLES ARE BEING EMITTED.

PRIORITY DATE OF 5-9-2011 IS CLAIMED.

OWNER OF INTERNATIONAL REGISTRATION 1092065 DATED 6-21-2011, EXPIRES 6-21-2021.

SER. NO. 79-103,058, FILED 6-21-2011.

JENNIFER MARTIN, EXAMINING ATTORNEY



David J. Kybas

Director of the United States Patent and Trademark Office

United States of America
United States Patent and Trademark Office

SolarGrip

Reg. No. 4,204,113

Registered Sep. 11, 2012

Int. Cl.: 6

TRADEMARK

PRINCIPAL REGISTER

SFS INTEC HOLDING AG (SWITZERLAND AKTIENGESELLSCHAFT)
NEFENSTRASSE 30
CH-9435 HEERBRUGG, SWITZERLAND

FOR: FASTENERS OF METAL, NAMELY, BOLTS, NAILS, RIVETS, SCREWS; ASSEMBLY ELEMENTS, NAMELY, METAL RIVETS, METAL BOLTS AND METAL SCREWS AND STRUCTURAL COMPONENTS THEREOF; BLIND METAL RIVETS; THREADED BLIND METAL RIVETS; BLIND METAL RIVETS WITH FLANGED SECTIONS; PROGRESSIVE BLIND METAL RIVETS AND BLIND METAL NUTS, IN CLASS 6 (U.S. CLS. 2, 12, 13, 14, 23, 25 AND 50).

THE MARK CONSISTS OF STANDARD CHARACTERS WITHOUT CLAIM TO ANY PARTICULAR FONT, STYLE, SIZE, OR COLOR.

PRIORITY DATE OF 4-27-2011 IS CLAIMED.

OWNER OF INTERNATIONAL REGISTRATION 1092150 DATED 9-6-2011, EXPIRES 9-6-2021.

SER. NO. 79-103,082, FILED 9-6-2011.

KATHERINE E. HALMEN, EXAMINING ATTORNEY



David J. Kybas

Director of the United States Patent and Trademark Office

United States of America

United States Patent and Trademark Office



Reg. No. 4,204,114

Registered Sep. 11, 2012

Int. Cls.: 10 and 25

TRADEMARK

PRINCIPAL REGISTER

SIGVARIS AG (SWITZERLAND AG)
GRÖBLISTRASSE 8
CH-9014 ST. GALLEN, SWITZERLAND

FOR: MEDICAL STOCKINGS, NAMELY, MEDICAL COMPRESSION STOCKINGS AND COMPRESSION SOCKS AS WELL AS MEDICAL SUPPORT STOCKINGS AND SUPPORT TIGHTS/PANTYHOSE, IN CLASS 10 (U.S. CLS. 26, 39 AND 44).

FOR: HOSIERY, NAMELY, SUPPORT STOCKINGS AND SUPPORT TIGHTS/PANTYHOSE FOR NON-MEDICAL PURPOSES, IN CLASS 25 (U.S. CLS. 22 AND 39).

OWNER OF U.S. REG. NO. 3,892,678.

PRIORITY DATE OF 3-7-2011 IS CLAIMED.

OWNER OF INTERNATIONAL REGISTRATION 1092186 DATED 8-19-2011, EXPIRES 8-19-2021.

NO CLAIM IS MADE TO THE EXCLUSIVE RIGHT TO USE "STOCKINGS", APART FROM THE MARK AS SHOWN.

THE MARK CONSISTS OF THE WORDS "CONTROLLED EFFICACY STOCKINGS" WITH A DOT BETWEEN "STOCKINGS" AND "CONTROLLED" WITHIN THE BORDER OF A CIRCLE. IN THE MIDDLE OF THE CIRCLE ARE THE LETTERS "CES" AND A GRAPHIC DESIGN DEPICTING LINES AND SWIRLS.

SER. NO. 79-103,098, FILED 8-19-2011.

CARYN GLASSER, EXAMINING ATTORNEY



David J. Kybas

Director of the United States Patent and Trademark Office

United States of America

United States Patent and Trademark Office

DREAM CRUISE

Reg. No. 4,204,115

Registered Sep. 11, 2012

**Int. Cls.: 9, 25, 28, 35, 38
and 41**

WOOGA GMBH (FED REP GERMANY GMBH (GESELLSCHAFT MIT BESCHRÄNKTER
HAFTUNG))
SAARBRÜCKER STR. 38
10405 BERLIN
FED REP GERMANY

TRADEMARK

FOR: COMPUTERS, RECORDED AND DOWNLOADABLE COMPUTER PROGRAMS AND SOFTWARE FOR VIDEO, ONLINE AND BROWSER GAMES AND FOR COMPUTER GAME PROGRAMS ON MOBILE PHONES, IN CLASS 9 (U.S. CLS. 21, 23, 26, 36 AND 38).

SERVICE MARK

FOR: CLOTHING, NAMELY, HEADWEAR, CAPS AND T-SHIRTS; OUTERWEAR, NAMELY, JACKETS, IN CLASS 25 (U.S. CLS. 22 AND 39).

PRINCIPAL REGISTER

FOR: ELECTRONIC GAMES OTHER THAN THOSE ADAPTED FOR USE WITH TELEVISION RECEIVERS; BOARD GAMES; HAND-HELD UNITS FOR PLAYING ELECTRONIC GAMES OTHER THAN THOSE ADAPTED FOR USE WITH AN EXTERNAL DISPLAY SCREEN OR MONITOR; LCD GAME MACHINES, IN CLASS 28 (U.S. CLS. 22, 23, 38 AND 50).

FOR: ADVERTISING SERVICES, ONLINE ADVERTISING FOR OTHERS ON A COMPUTER NETWORK, DISSEMINATION OF ADVERTISEMENTS FOR OTHERS, DISTRIBUTION OF ADVERTISING MATERIAL IN THE NATURE OF FLYERS, LEAFLETS, PRINTED MATTER, SAMPLES, IN CLASS 35 (U.S. CLS. 100, 101 AND 102).



FOR: PROVIDING ACCESS TO AN INTERNET PAGE AND PROVIDING ELECTRONIC TRANSMISSION OF INFORMATION IN THE FORM OF TEXT, IMAGES, SPEECH AND SOUNDS VIA AN INTERNET PAGE; RENTAL OF ACCESS TIME TO AN INTERNET PAGE; PROVIDING ACCESS TO A SOFTWARE IN DATA NETWORKS FEATURING SOFTWARE FOR INTERNET ACCESS; BROADCASTING OF MOVIE, TELEVISION, RADIO, VIDEO TEXT, TELETXT PROGRAMS OR BROADCASTS IN PARTICULAR ADVERTISING SPOTS; PROVIDING ACCESS TO DATABASES; PROVIDING ACCESS TO DATABASES OR THE INTERNET, IN CLASS 38 (U.S. CLS. 100, 101 AND 104).

David J. Kybas

Director of the United States Patent and Trademark Office

FOR: ORGANISING OF GAMES IN THE INTERNET; ENTERTAINMENT, NAMELY, PROVIDING ONLINE COMPUTER, VIDEO AND BROWSER GAMES, ONLINE COMPUTER GAME PROGRAMS FOR MOBILE PHONES AND PROVIDING ENTERTAINMENT INFORMATION ON THE INTERNET; PROVIDING GAME SERVICES OFFERED ONLINE, IN CLASS 41 (U.S. CLS. 100, 101 AND 107).

Reg. No. 4,204,115 THE MARK CONSISTS OF STANDARD CHARACTERS WITHOUT CLAIM TO ANY PARTICULAR FONT, STYLE, SIZE, OR COLOR.

PRIORITY DATE OF 1-6-2011 IS CLAIMED.

OWNER OF INTERNATIONAL REGISTRATION 1092218 DATED 7-5-2011, EXPIRES 7-5-2021.

SER. NO. 79-103,110, FILED 7-5-2011.

DEIRDRE ROBERTSON, EXAMINING ATTORNEY

United States of America

United States Patent and Trademark Office

ZAZEN BEAR

Reg. No. 4,204,116

Registered Sep. 11, 2012

Int. Cls.: 3, 10, 12 and 43

TRADEMARK

SERVICE MARK

PRINCIPAL REGISTER

CLEAN WRAP CO., LTD. (REPUBLIC OF KOREA CORPORATION)
NAESAM-RI 1111-2, JUCHON-MYEON, GIMHAE-S
GYEONGSANGNAM-DO
REPUBLIC OF KOREA

FOR: COSMETICS; BABY OIL; PERFUMES; SHAMPOOS; BATH SOAP; DENTIFRICES;
NATURAL PERFUMERY; BEAUTY MASKS, IN CLASS 3 (U.S. CLS. 1, 4, 6, 50, 51 AND 52).

FOR: BABIES' BOTTLES; NURSING APPLIANCES; BREAST PUMPS; PACIFIERS FOR
BABIES; MEDICAL APPARATUS AND INSTRUMENTS, IN CLASS 10 (U.S. CLS. 26, 39
AND 44).

FOR: BABY CARRIAGES; SAFETY SEATS FOR CHILDREN, FOR AUTOMOBILES;
WHEELCHAIRS; CHILDREN'S BICYCLES FOR TRANSPORT, IN CLASS 12 (U.S. CLS. 19,
21, 23, 31, 35 AND 44).

FOR: RESTAURANTS; CAFES; FAST-FOOD RESTAURANTS; HOLIDAY CAMP SERVICES
(LODGING); DAY-NURSERIES, IN CLASS 43 (U.S. CLS. 100 AND 101).

THE WORD "ZAZEN" IDENTIFIES A FORM OF ZEN YOGA MEDITATION.

PRIORITY DATE OF 3-31-2011 IS CLAIMED.

OWNER OF INTERNATIONAL REGISTRATION 1092224 DATED 7-19-2011, EXPIRES 7-19-
2021.

SER. NO. 79-103,113, FILED 7-19-2011.

HENRY S. ZAK, EXAMINING ATTORNEY



David J. Kypos

Director of the United States Patent and Trademark Office

United States of America

United States Patent and Trademark Office

Siderozyme

Reg. No. 4,204,117

Registered Sep. 11, 2012

Int. Cl.: 5

TRADEMARK

PRINCIPAL REGISTER

LOHMANN ANIMAL HEALTH GMBH (FED REP GERMANY GMBH & CO. KG)
HEINZ-LOHMANN-STRASSE 4
27472 CUXHAVEN
FED REP GERMANY

FOR: PHARMACEUTICAL AND VETERINARY PREPARATIONS, NAMELY, FOR ANTI-BACTERIAL MEDICATION; PREPARATIONS FOR DESTROYING VERMIN; FUNGICIDES; HERBICIDES; ALGICIDES; AMINO ACIDS FOR VETERINARY PURPOSES; ANTIBIOTICS; MEDICINES FOR VETERINARY PURPOSES, NAMELY, MEDICINES FOR TREATMENT OF INFECTIONS; BACTERIAL PREPARATIONS FOR VETERINARY PURPOSES; CHEMICAL PREPARATIONS FOR VETERINARY PURPOSES; ENZYMES FOR VETERINARY PURPOSES; ENZYME PREPARATIONS FOR VETERINARY PURPOSES; GREASES FOR VETERINARY PURPOSES; ANTIPARASITIC COLLARS FOR ANIMALS; ANTIPARASITIC PREPARATIONS; VITAMIN PREPARATIONS; VACCINES; FOODSTUFF ADDITIVES FOR MEDICAL AND VETERINARY PURPOSES; ADDITIVES TO FODDER FOR MEDICAL AND VETERINARY PURPOSES; AIR PURIFYING PREPARATIONS; SOIL-STERILIZING PREPARATIONS, IN CLASS 5 (U.S. CLS. 6, 18, 44, 46, 51 AND 52).

THE MARK CONSISTS OF STANDARD CHARACTERS WITHOUT CLAIM TO ANY PARTICULAR FONT, STYLE, SIZE, OR COLOR.

PRIORITY DATE OF 6-29-2011 IS CLAIMED.

OWNER OF INTERNATIONAL REGISTRATION 1092331 DATED 7-5-2011, EXPIRES 7-5-2021.

SER. NO. 79-103,145, FILED 7-5-2011.

KIMBERLY FRYE, EXAMINING ATTORNEY



David J. Kypos

Director of the United States Patent and Trademark Office

United States of America

United States Patent and Trademark Office



Reg. No. 4,204,118

Registered Sep. 11, 2012

**Int. Cls.: 9, 16, 28, 29, 30,
32, 34, 41 and 43**

TRADEMARK

SERVICE MARK

PRINCIPAL REGISTER

YANUA INTERNATIONAL PTE. LTD. (SINGAPORE PRIVATE LIMITED COMPANY)
138 ROBINSON ROAD
#17-00 THE CORPORATE OFFICE; SINGAPORE 068906
SINGAPORE

FOR: MOTION PICTURE FILMS FEATURING CHILDREN'S ENTERTAINMENT; MUSICAL RECORDINGS; AUDIO RECORDINGS IN THE FIELDS OF MUSIC, SELF-IMPROVEMENT, MATHEMATICS INSTRUCTION; VIDEO RECORDINGS IN THE FIELDS OF MUSIC, SELF-IMPROVEMENT, MATHEMATICS INSTRUCTION; PRERECORDED AUDIO TAPES AND DISCS IN THE FIELDS OF MUSIC, SELF-IMPROVEMENT, MATHEMATICS INSTRUCTION; PRERECORDED VIDEO TAPES AND DISCS IN THE FIELDS OF MUSIC, SELF-IMPROVEMENT, MATHEMATICS INSTRUCTION; MAGNETIC, OPTICAL AND DIGITAL RECORDING MEDIA PRERECORDED WITH EDUCATIONAL AND ENTERTAINING PROGRAMS IN THE FIELDS OF MUSIC, SELF-IMPROVEMENT, MATHEMATICS INSTRUCTION; ELECTRONIC APPARATUS FOR TESTING AUTOMOBILE ENGINE OIL, IN THE NATURE OF MOTION DETECTORS; APPARATUS FOR RECEIVING AND TRANSMITTING SOUND, IMAGES, AND AUDIO AND VIDEO PROGRAMS, NAMELY, SATELLITE TRANSMITTERS AND RECEIVERS, WIRELESS TRANSMITTERS AND RECEIVERS; AUDIO AND VIDEO RECORDING AND REPRODUCING APPARATUS; AUDIO AND VIDEO MACHINES FOR SINGING WITH PRERECORDED BACKGROUND MUSIC, NAMELY, KARAOKE PLAYERS; MICROPHONES; HEADPHONES; SPEAKERS, NAMELY, AUDIO SPEAKERS, LOUD SPEAKERS, BASS SPEAKERS; CABLES, NAMELY, AUDIO CABLES, COAXIAL CABLES AND CONNECTORS, NAMELY, ELECTRIC CONNECTORS, PLUG CONNECTORS; CALCULATORS; DATA PROCESSING EQUIPMENT, NAMELY, DATA PROCESSORS; COMPUTERS; COMPUTER HARDWARE AND SOFTWARE FOR USE IN DATABASE MANAGEMENT, USE AS A SPREADSHEET, WORD PROCESSING; COMPUTER KEYBOARDS, COMPUTER MOUSE AND MOUSE PADS; WEB CAMS; COMPUTER PERIPHERAL DEVICES AND USB DEVICES, NAMELY, USB (UNIVERSAL SERIAL BUS) HARDWARE, BLANK USB FLASH DRIVES; DATA CARRIERS, NAMELY, BLANK MAGNETIC DATA CARRIERS, BLANK OPTICAL DATA CARRIERS, PRERECORDED MAGNETIC DATA CARRIERS FEATURING MUSIC; RECORDING DISCS, NAMELY, PRERECORDED VIDEO DISCS FEATURING MUSIC, BLANK COMPACT DISCS; BLANK FLASH DRIVES; ELECTRONIC PERSONAL ORGANIZERS; PERSONAL DIGITAL ASSISTANTS; WIRELESS APPARATUS, NAMELY, WIRELESS TELEPHONY APPARATUS, WIRELESS TRANSCEIVER RADIO; TELEPHONES; VIDEOPHONES; CORDLESS TELEPHONES; CELLULAR TELEPHONES; CELLULAR TELEPHONE ACCESSORIES, NAMELY, BELT CLIPS, WIRELESS CELLULAR PHONE HEADSETS; CELLULAR TELEPHONE CASES; RADIOS; WALKIE-TALKIES;

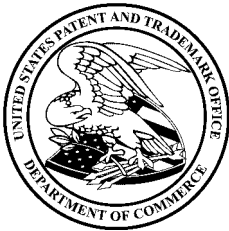

David J. Kybas

Director of the United States Patent and Trademark Office

Reg. No. 4,204,118 ELECTRONIC GAMES PROGRAMS; VIDEO GAME MACHINES FOR USE WITH TELEVISIONS OR MONITORS; PORTABLE GAMING SYSTEMS COMPRISED OF AND GAMING MACHINES ALL FOR USE WITH TELEVISIONS OR MONITORS; STANDALONE PORTABLE VIDEO GAMES, NAMELY, HAND-HELD ELECTRONIC GAME UNITS ADAPTED FOR USE WITH TELEVISIONS OR MONITORS; VIDEO GAME DISCS, SOFTWARE, CARTRIDGES; VIDEO AND COMPUTER GAME PROGRAMS; VIDEO AND COMPUTER GAME CARTRIDGES; VIDEO AND COMPUTER GAME DEVICES, NAMELY, HAND HELD JOY STICK UNITS FOR PLAYING VIDEO AND COMPUTER GAMES; PRERECORDED VIDEO GAME DISCS; PRERECORDED OPTICAL AND MAGNETIC DATA CARRIERS FEATURING, MUSIC, SELF-IMPROVEMENT, MATHEMATICS INSTRUCTION; INTERACTIVE VIDEO GAME PROGRAMS; MOTION-CONTROLLED VIDEO GAME PROGRAMS; MOTION-CONTROLLED VIDEO GAME MACHINES FOR USE WITH TELEVISIONS OR MONITORS; MOTION-SENSITIVE GAME CONTROLLERS FOR VIDEO GAMES; INTERACTIVE MULTIMEDIA COMPUTER GAME PROGRAMS; VIDEO AND COMPUTER INTERACTIVE GAME PROGRAMS COMBINING ANIMATED IMAGES OR LIVE-ACTION IMAGES WITH DATA AND SYNCHRONIZED SOUND FOR ENTERTAINMENT AND EDUCATIONAL USE; PLAYING APPARATUS FOR USE WITH TELEVISIONS OR MONITORS, NAMELY, VIRTUAL REALITY HEADSETS AND HELMETS FOR USE IN PLAYING VIDEO GAMES; DVD AND CD ROMS WITH RECORDED GAME SOFTWARE; VIDEO GAME CARDS, NAMELY, VIDEO GAME CARTRIDGES; VIDEO AND COMPUTER GAME DATA STORAGE APPARATUS, NAMELY, VIDEO AND COMPUTER GAME DISCS; DOWNLOADABLE GAMING PROGRAMS FOR VIDEO AND COMPUTER GAMES, NAMELY, DOWNLOADABLE ELECTRONIC GAME PROGRAMS; DOWNLOADABLE GAMING PROGRAMS FOR PORTABLE LCD ELECTRONIC GAMES, NAMELY, DOWNLOADABLE ELECTRONIC GAME PROGRAMS; VIDEO GAME JOYSTICKS; HANDHELD JOYSTICK UNITS FOR PLAYING VIDEO AND COMPUTER GAMES; CONTROLLERS AND ACCESSORIES, NAMELY, GUITAR SKINS FOR ELECTRONIC GUITAR GAME CONTROLLERS FOR PLAYING VIDEO AND COMPUTER GAMES; ELECTRONIC GAME PROGRAMS; GAME SOFTWARE; VIDEO GAME SYSTEMS COMPRISED OF AUDIO AND VISUAL HEADSETS FOR USE IN PLAYING VIDEO GAMES AND VIDEO GAME MACHINES ALL FOR USE WITH EXTERNAL DISPLAY SCREEN OR MONITOR; VIDEO AND COMPUTER GAME CONTROLLERS; VIDEO AND COMPUTER GAME ACCESSORIES, NAMELY, GAMING HEADSETS FOR USE IN PLAYING VIDEO AND COMPUTER GAMES; ACCESSORIES FOR VIDEO AND COMPUTER GAME CONTROLLERS, NAMELY, GUITAR SKINS FOR ELECTRONIC GUITAR GAME CONTROLLERS; OPTICAL APPARATUS AND INSTRUMENTS, NAMELY, OPTICAL MIRRORS, OPTICAL LENSES; MAGNIFYING DEVICES, NAMELY, MAGNIFYING GLASSES, MAGNIFYING LENSES AND VIDEO DEVICES, NAMELY, VIDEO DISK PLAYERS, VIDEO PROCESSORS; BINOCULARS; THREE DIMENSIONAL VIEWERS, NAMELY, THREE DIMENSIONAL GLASSES; BATTERIES; BATTERY CHARGERS; TRANSFORMERS; PHOTOGRAPHIC AND CINEMATOGRAPHIC APPARATUS AND INSTRUMENTS, NAMELY, VIDEO CAMERAS; TEACHING APPARATUS AND INSTRUMENTS, NAMELY, MEDICAL TEACHING MANNEQUINS, COMPUTERS; AUTOMATIC VENDING MACHINES AND MECHANISMS FOR COIN-OPERATED APPARATUS; EYEGLASSES; SUNGLASSES; EYEGLASS CASES; DECORATIVE MAGNETS; PARTS AND FITTINGS FOR ALL THE AFORESAID GOODS, IN CLASS 9 (U.S. CLS. 21, 23, 26, 36 AND 38).

FOR: WRITING ARTICLES, INSTRUMENTS AND MATERIALS, NAMELY, PENCILS, PENS, NOTEBOOKS; DRAWING ARTICLES, INSTRUMENTS AND MATERIALS, NAMELY, COLOR PENCILS, DRAWING BOARDS; ARTS AND CRAFT PAINT KITS AND ACCESSORIES, NAMELY, ART PAPER, CRAFT PAPER; COLORING PENCILS; CRAYONS; STAMPS, NAMELY, INK STAMPS, RUBBER STAMPS AND INKS, NAMELY, STAMP INKS, WRITING INK; PRINTED MATTER, NAMELY, GREETING CARDS, PRINTED PERIODICALS IN THE FIELD OF DANCE; BOOKS AND BOOKLETS IN THE FIELDS OF HISTORY, FASHION; PICTURE BOOKS; COMIC BOOKS; COMIC STRIPS; CARTOON STRIPS; MAGAZINES IN THE FIELDS OF GARDENING, FASHION; PRINTED PERIODICALS IN THE FIELDS OF GARDENING, FASHION; MOVIE NOVELS; PRINTED GUIDES FOR VIDEO GAMES; PAINTINGS; PORTRAITS; PHOTOGRAPHS; PICTURES; POSTERS; ART PRINTS; POSTCARDS; STICKERS; DECALS; IRON-ON AND PLASTIC PRINTED TRANSFERS; CHRISTMAS

Reg. No. 4,204,118 CARDS; GREETING CARDS; INVITATION CARDS; STATIONERY; LETTERHEAD PAPER; ENVELOPES; NAME CARDS, NAMELY, BUSINESS CARDS, PAPER NAME BADGES; NOTEBOOKS; NOTE PAPER; MEMO PADS; CALENDARS; DIARIES; ADDRESS BOOKS; GUEST BOOKS; PENS AND PENCILS; INK REFILLS FOR PENS AND PENCIL LEAD REFILLS FOR PENCILS; PENCIL SHARPENERS; PEN AND PENCIL CASES AND BOXES; RULERS, NAMELY, UNGRADUATED RULERS, DRAFTING RULERS; ERASERS; SCHOOL WRITING BOOKS AND SLATE BOARDS, LAP BOARDS FOR WRITING; WIRE-BOUND BOOKS FOR DRAWING AND DRAWING BOARDS; COLORING BOOKS AND PAPER BOARDS FOR COLORING; PICTURE BOOKS AND ILLUSTRATION BOARDS; CHILDREN'S ACTIVITY BOOKS; TRADING CARDS; FLASH CARDS; ADHESIVES FOR STATIONERY OR HOUSEHOLD PURPOSES; BOOKBINDING MATERIALS; STAPLERS; BINDERS; BOOK COVERS; BOOKMARKS; PHOTOGRAPH ALBUMS; STAMP ALBUMS; COIN ALBUMS; PAPER AND PAPER ARTICLES, NAMELY, GRAPH PAPER, PAPER LABELS; CARDBOARD AND CARDBOARD ARTICLES, NAMELY, CARDBOARD BOXES, CARDBOARD SIGNBOARDS; ARTISTS' MATERIALS, NAMELY, ARTISTS' PASTELS, CANVAS FOR PAINTING; PAINT BRUSHES; MODELING PLASTICS, NAMELY, MOLDS FOR MODELING CLAYS; MODELING COMPOUNDS AND MATERIALS, NAMELY, MODELING CLAY, MODELING PASTE; PRINTED INSTRUCTIONAL, TEACHING AND EDUCATIONAL MATERIALS IN THE FIELDS OF MATH, SCIENCE; OFFICE REQUISITES EXCEPT FURNITURE, NAMELY, STAPLERS, PUNCHES; BOOKENDS; PAPERWEIGHTS; PRINTERS' TYPE; PRINTING BLOCKS; DISPOSABLE DIAPERS FOR BABIES; PAPER NAPKINS; PLASTIC MATERIALS FOR PACKAGING PURPOSES, NAMELY, PLASTIC BUBBLE PACKS FOR PACKAGING, PLASTIC BAGS FOR PACKAGING; GIFT CARDS; GIFT WRAPPING PAPER; DECORATIVE PAPER, NAMELY, ART PAPER; PAPER BAGS AND CARDBOARD BOXES; PRINTED ADVERTISING AND PROMOTIONAL MATERIALS, NAMELY, PRINTED ADVERTISING PAMPHLETS, PRINTED ADVERTISING SIGNS OF PAPER OR CARDBOARD, IN CLASS 16 (U.S. CLS. 2, 5, 22, 23, 29, 37, 38 AND 50).

FOR: TOYS, GAMES AND PLAYTHINGS, NAMELY, CONSTRUCTION TOYS, BOARD GAMES, PUPPET THEATRES; TOY ACTION FIGURES; DOLLS AND DOLL PLAY SETS; DOLL CLOTHING, DOLL ACCESSORIES; TOY ANIMALS; PLUSH TOYS; STUFFED TOYS; TOY VEHICLES; SPINNING TOYS, NAMELY, SPINNING TOPS; TOY WHEELS, NAMELY, FINGERBOARD WHEELS, SKATEBOARD WHEELS; INTERACTIVE TOYS AND GAMES, NAMELY, INTERACTIVE ACTION FIGURE TOYS, INTERACTIVE PINBALL GAMES; CHILDREN'S MULTIPLE ACTIVITY TOYS AND PLAY SETS; OUTDOOR ACTIVITY TOYS, NAMELY, BASEBALL BATS, SOCCER BALLS; FLYING TOYS, NAMELY, FLYING SAUCERS, TOY AIRPLANES; KITES; WATER TOYS AND POOL TOYS, NAMELY, BEACH BALLS, SWIM FLOATS FOR RECREATIONAL USE; WATER SQUIRTING TOYS; TOY BUCKET AND SHOVEL SETS; BEACH BALLS; INFLATABLE TOYS; BUBBLE MAKING WAND AND SOLUTION SETS; CONSTRUCTION TOYS; TOY BUILDING BLOCKS; MUSICAL TOYS; ELECTRONIC LEARNING TOYS; TOY SCALE MODELS OR REPLICAS, NAMELY, SCALE MODEL AIRCRAFT, SCALE MODEL VEHICLES; COLLECTIBLE TOY FIGURES; PUPPETS; TOY MOULDS, NAMELY, MOLDED TOY FIGURES AND MOULDING COMPOUNDS AND MATERIALS, NAMELY, TOY PUTTY; JIGSAW PUZZLES; PLAYING CARDS; CARD GAMES; BOARD GAMES; BALL GAMES, NAMELY, PADDLE BALL GAMES, HAND BALLS; TOY SPORTING ARTICLES, NAMELY, BALL PITCHING SCREENS, TENNIS RACKETS; ATHLETIC, GYMNASTIC AND SPORTING ARTICLES, NAMELY, MOUTH GUARDS, SPRINGBOARDS; SPORT BALLS; GOLF BALLS; GOLF BALL MARKERS; JUMP ROPES; SKATEBOARDS; KNEE GUARDS AND WRIST GUARDS FOR ATHLETIC USE; ORNAMENTS AND DECORATIONS FOR CHRISTMAS TREES; CHRISTMAS STOCKINGS; BALLOONS; PARTY GAMES; CHARACTER PLAYING TOYS, NAMELY, FACE MASKS; PAPER PARTY HATS AND COSTUME MASKS; PARTY FAVORS IN THE NATURE OF SMALL TOYS; FESTIVAL TOYS, NAMELY, PIÑATAS; TOY PLAY SETS FOR DOLLS; ELECTRONIC TOYS, NAMELY, ELECTRONIC ACTION TOYS, ELECTRONIC LEARNING TOYS; ELECTRIC TOYS, NAMELY, ELECTRIC ACTION TOYS, ELECTRIC TOY TRAIN TRANSFORMERS; MECHANICAL TOYS; WIND-UP TOYS; SQUEEZE TOYS; ACTION SKILL GAMES; TARGET GAMES; SHOOTING GAME TOYS, NAMELY, TOY GUNS, PAINTBALL GUNS; DRIVING GAME TOYS, NAMELY, TOY CARS; TOYS WITH LIGHT

Reg. No. 4,204,118 VISUAL EFFECTS AND AUDIO SOUND EFFECTS, NAMELY, ELECTRONIC ACTION TOYS, TALKING ELECTRONIC PRESS-DOWN TOY; PARLOR GAMES; ELECTRONIC GAMES NOT FOR USE WITH TELEVISIONS OR MONITORS; VIDEO GAMES NOT FOR USE WITH TELEVISIONS OR MONITORS, NAMELY, STANDALONE VIDEO GAME MACHINES; HANDHELD UNIT FOR PLAYING ELECTRONIC GAMES OTHER THAN THOSE ADAPTED FOR USE WITH AN EXTERNAL DISPLAY SCREEN OR MONITOR; HANDHELD UNIT FOR PLAYING VIDEO GAMES OTHER THAN THOSE ADAPTED FOR USE WITH AN EXTERNAL DISPLAY SCREEN OR MONITOR; HANDHELD LCD GAME MACHINES; BATTERY-POWERED VIDEO GAME WITH LCD SCREEN WHICH FEATURES ANIMATION AND SOUND EFFECTS; PARTS AND FITTINGS FOR ALL THE AFORESAID GOODS, IN CLASS 28 (U.S. CLS. 22, 23, 38 AND 50).

FOR: MEAT, FISH, POULTRY AND GAME; MEAT EXTRACTS; PRESERVED, FROZEN, DRIED AND COOKED FRUITS AND VEGETABLES; JELLIES, JAMS, COMPOTES; EGGS, MILK AND MILK PRODUCTS EXCLUDING ICE CREAM, ICE MILK AND FROZEN YOGURT; EDIBLE OILS AND FATS; CHEESE; DAIRY BASED FOOD PRODUCTS, NAMELY, DAIRY-BASED DIPS, DAIRY-BASED FOOD BEVERAGES; NON-DAIRY CREAMERS, IN CLASS 29 (U.S. CL. 46).

FOR: COFFEE, TEA, COCOA, SUGAR, RICE, TAPIOCA, SAGO, ARTIFICIAL COFFEE; FLOUR AND PREPARATIONS MADE FROM CEREALS, NAMELY, BREAKFAST CEREALS, CEREAL BASED SNACK FOOD; BISCUITS, CAKES, COOKIES, WAFERS, PUDDINGS; ICE CREAM; CHOCOLATE, CHOCOLATE PRODUCTS, NAMELY, CHOCOLATE CHIPS, CHOCOLATE MOUSSE; CHOCOLATE-BASED PREPARATIONS, NAMELY, CHOCOLATE FONDUE, CHOCOLATE-BASED FILLINGS FOR CAKES AND PIES AND BEVERAGES WITH A CHOCOLATE BASE; BREAD, PASTRY AND CONFECTIONERY, NAMELY, FONDANTS, PASTILLES; EDIBLE ICES; HONEY, TREACLE; YEAST, BAKING-POWDER; SALT, MUSTARD; VINEGAR; SAUCES; SPICES; ICE; PASTA; NOODLES; PIZZAS; SANDWICHES; TEA-BASED BEVERAGES, IN CLASS 30 (U.S. CL. 46).

FOR: BEERS, MINERAL AND AERATED WATERS AND OTHER NON-ALCOHOLIC DRINKS, NAMELY, LEMONADES, COLAS; FRUIT DRINKS AND FRUIT JUICES; SYRUPS AND OTHER PREPARATIONS FOR MAKING BEVERAGES, NAMELY, FRUIT DRINKS, LEMONADES; SOYA-BASED BEVERAGES NOT BEING MILK SUBSTITUTES; MALT-BASED BEVERAGES, NAMELY, MALT BEER; NON-ALCOHOLIC BEVERAGES WITH TEA FLAVOR, SOFT DRINKS FLAVORED WITH TEA; READY TO DRINK BEVERAGES, NAMELY, SODA POPS, FRUIT BEVERAGES; ISOTONIC BEVERAGES, IN CLASS 32 (U.S. CLS. 45, 46 AND 48).

FOR: TOBACCO, RAW OR MANUFACTURED; TOBACCO PRODUCTS, NAMELY, CIGARS, CIGARETTES, CIGARILLOS, TOBACCO FOR ROLL YOUR OWN CIGARETTES, PIPE TOBACCO, CHEWING TOBACCO, SNUFF TOBACCO, KRETEK CIGARETTES, SNUF; TOBACCO SUBSTITUTES NOT FOR MEDICAL PURPOSES; SMOKERS' ARTICLES, NAMELY, CIGARETTE PAPER AND TUBES, POCKET APPARATUS FOR ROLLING CIGARETTES, CIGARETTE FILTERS, TOBACCO TINS, CIGARETTE CASES, SMOKING PIPES, TOBACCO PIPE FILTERS, ASHTRAYS, TOBACCO SMOKE FILTERS, LIGHTERS FOR SMOKERS; MATCHES, IN CLASS 34 (U.S. CLS. 2, 8, 9 AND 17).

FOR: ENTERTAINMENT AND RECREATIONAL SERVICES, NAMELY, DANCE CLUB SERVICES, LIVE MUSIC CONCERTS; PROVISION OF ENTERTAINMENT FACILITIES, NAMELY, PROVISION OF CINEMA FACILITIES, PROVIDING SPORTS FACILITIES; CLUB SERVICES FOR ENTERTAINMENT, RECREATION, HEALTH, SPORT AND EDUCATION PURPOSES, NAMELY, COUNTRY CLUBS, GOLF CLUB SERVICES; PROVIDING KARAOKE FACILITIES; DISCOTHEQUE SERVICES; NIGHT CLUBS; PROVISION OF RECREATIONAL AND SPORTS FACILITIES; HEALTH CLUB SERVICES, NAMELY, PROVIDING INSTRUCTION AND EQUIPMENT IN THE FIELD OF PHYSICAL EXERCISE; RECREATION AND LEISURE CLUB SERVICES, NAMELY, COUNTRY CLUBS; GOLF COURSES AND DRIVING RANGES; PROVIDING TENNIS COURT FACILITIES; PROVIDING SWIMMING POOL FA-

Reg. No. 4,204,118 CILITIES; PROVISION OF FITNESS AND EXERCISE FACILITIES; PHYSICAL FITNESS AND EXERCISE INSTRUCTIONS; PROVISION OF GYMNASIUM AND HEALTH CLUB FACILITIES, NAMELY, PROVIDING INSTRUCTION AND EQUIPMENT IN THE FIELD OF PHYSICAL EXERCISE; BODY TRAINING AND SPORTS INSTRUCTIONS; PHYSICAL EDUCATION SERVICES; ENTERTAINMENT, SPORTING AND CULTURAL ACTIVITIES, NAMELY, TRIATHLONS, RECREATIONAL CAMPS; ARRANGING AND ORGANIZATION OF MEETINGS, CONFERENCES, EXHIBITIONS, SOCIAL EVENTS, SHOWS AND DISPLAYS ALL FOR SPORTING AND CULTURAL PURPOSES; ART GALLERY SERVICES, NAMELY, ART EXHIBITION SERVICES; PUBLICATION OF BOOKS, BOOKLETS, PICTURE BOOKS, COMIC BOOKS, COMIC STRIPS, CARTOON STRIPS, MAGAZINES, PERIODICALS, MOVIE NOVELS AND VIDEO GAME GUIDES; ON LINE AND ELECTRONIC PUBLISHING SERVICES OF BOOKS, MAGAZINES; EDUCATION, NAMELY, PROVIDING CLASSES, SEMINARS, WORKSHOPS IN THE FIELDS OF MUSIC, MATH; PROVIDING OF TRAINING IN THE FIELDS OF MUSIC, COMPUTERS; PROVISION OF EDUCATION AND LEARNING FACILITIES, NAMELY, LIBRARIES, BOARDING SCHOOLS; EDUCATION AND TRAINING CENTERS, NAMELY, DANCE SCHOOLS, BEAUTY SCHOOLS; ARRANGING AND CONDUCTING EDUCATIONAL COURSES, LECTURES, SEMINARS, TRAINING PROGRAMS AND WORKSHOPS IN THE FIELDS OF MUSIC, COMPUTERS; TRAINING OF PERSONNEL IN THE FIELDS OF COMPUTER EDUCATION; MOTION PICTURE ENTERTAINMENT, NAMELY, MOTION PICTURE THEATERS, MOTION PICTURE FILM PRODUCTION; TELEVISION ENTERTAINMENT, NAMELY, TELEVISION NEWS SHOWS, ON-GOING TELEVISION PROGRAMS IN THE FIELD OF SPORTS; LIVE ENTERTAINMENT SERVICES, NAMELY, LIVE MUSICAL PERFORMANCES, PRESENTATION OF LIVE COMEDY SHOWS; PRODUCTION, PRESENTATION, DISTRIBUTION AND RENTAL OF MOTION PICTURE FILMS; PRODUCTION AND RENTAL OF MUSICAL RECORDINGS, AUDIO RECORDINGS AND VIDEO RECORDINGS; PRODUCTION, PRESENTATION, DISTRIBUTION AND RENTAL OF TELEVISION PROGRAMS AND RADIO PROGRAMS; PRODUCTION, PRESENTATION, DISTRIBUTION AND RENTAL OF EDUCATIONAL AND ENTERTAINING TELEVISION, RADIO PROGRAMS; PRODUCTION OF INTERACTIVE EDUCATIONAL AND ENTERTAINING TELEVISION, RADIO PROGRAMS; PROVISION OF CONTINUING EDUCATIONAL AND ENTERTAINING PROGRAMS FEATURING NEWS, COMEDY, COMMENTARY DELIVERED VIA GLOBAL COMMUNICATION NETWORKS, COMPUTER NETWORKS AND THE INTERNET; PRODUCTION AND PROVISION OF ANIMATED TELEVISION SERIES; PROVISION OF ELECTRONIC GAMES PLAYABLE VIA GLOBAL COMMUNICATION NETWORKS, COMPUTER NETWORKS AND THE INTERNET, NAMELY, PROVIDING ONLINE ELECTRONIC GAMES; PROVISION OF DOWNLOADABLE COMPUTER GAMES VIA GLOBAL COMMUNICATION NETWORKS, COMPUTER NETWORKS AND THE INTERNET, NAMELY, PROVIDING ON-LINE COMPUTER GAMES; CINEMA THEATERS; AMUSEMENT PARKS; THEME PARKS; GAME ARCADES, NAMELY, AMUSEMENT ARCADES, VIDEO ARCADE SERVICES; CASINOS AND CASINO GAMING SERVICES; LIVE STAGE SHOWS, NAMELY, LIVE MUSIC CONCERTS, LIVE COMEDY SHOWS; LIVE MUSICAL CONCERTS; PRODUCTION AND PRESENTATION OF LIVE SHOW PERFORMANCES BY SINGERS, MUSICIANS, COMEDIANS; THEATRE PRODUCTIONS; ONLINE EDUCATION SERVICES, NAMELY, PROVIDING ONLINE CLASSES, ONLINE SEMINARS, ONLINE WORKSHOPS IN THE FIELDS OF MUSIC, MATH; ONLINE ENTERTAINMENT SERVICES, NAMELY, PROVIDING ON-LINE INTERACTIVE CHILDREN'S STORIES, PROVIDING ONLINE VIDEO GAMES; ONLINE GAME SERVICES, NAMELY, PROVIDING ON-LINE CARD GAMES, PROVIDING AN ON-LINE BOARD GAME, PROVIDING ON-LINE COMPUTER GAMES, IN CLASS 41 (U.S. CLS. 100, 101 AND 107).

FOR: HOSPITALITY SERVICES, NAMELY, SERVING FOOD AND DRINKS, BED AND BREAKFAST INN SERVICES; PROVISION OF TEMPORARY ACCOMMODATIONS AND LODGINGS; HOTEL, MOTEL, MOTOR INN, RESORT LODGING AND GUESTHOUSE SERVICES; ARRANGING TEMPORARY HOUSING ACCOMMODATIONS AT HOLIDAY VILLAS, COTTAGES, LODGES AND RETREATS; PROVISION OF FACILITIES FOR MEETINGS, CONFERENCES AND EXHIBITIONS; PROVISION OF FACILITIES FOR SOCIAL FUNCTIONS AND EVENTS; PROVISION OF HOTEL FACILITIES, NAMELY, BALL ROOMS, FUNCTION ROOMS AND MEETING ROOMS; HOTEL CONCIERGE SERVICES; RESTAUR-

Reg. No. 4,204,118 ANT, HOT POT RESTAURANT, BARBECUE RESTAURANT, SASHIMI AND SUSHI BAR, TEA HOUSE, COFFEE SHOP, CAKE SHOP, NAMELY, CAFES FEATURING CAKES, CATERING IN THE FIELD OF CAKES; CAFE, CAFETERIA, FAST FOOD RESTAURANTS, SELF-SERVICE RESTAURANT, CANTEEN, SNACK BAR AND FOOD COUNTER SERVICES, NAMELY, MOBILE CAFE SERVICES FOR PROVIDING FOOD; COCKTAIL AND BAR LOUNGE SERVICES; PROVISION OF FOOD AND DRINK FOR DINE IN, TAKE HOME AND DELIVERY; PROVISION OF FOOD AND DRINK FOR CONSUMPTION ON AND OFF HOTEL PREMISES; CATERING AND BANQUETING SERVICES; PROVISION OF BANQUET AND SOCIAL FUNCTION FACILITIES; THE OPERATION OF HOTELS AND RESORTS, NAMELY, HOTELS AND RESORT HOTELS SERVICES; RESTAURANTS AND BARS; RESERVATION SERVICES FOR TEMPORARY ACCOMMODATIONS, HOTEL SERVICES AND HOTEL FACILITIES, IN CLASS 43 (U.S. CLS. 100 AND 101).

THE MARK CONSISTS OF A CIRCULAR DESIGN MADE FROM INTERCONNECTED ELEMENTS OF THE LETTER "Y".

PRIORITY DATE OF 2-13-2011 IS CLAIMED.

OWNER OF INTERNATIONAL REGISTRATION 1092338 DATED 2-24-2011, EXPIRES 2-24-2021.

SER. NO. 79-103,147, FILED 2-24-2011.

JORDAN BAKER, EXAMINING ATTORNEY

United States of America

United States Patent and Trademark Office

MYCOCHLEAR

Reg. No. 4,204,119

Registered Sep. 11, 2012

Int. Cls.: 42, 44 and 45

SERVICE MARK

PRINCIPAL REGISTER

COCHLEAR LIMITED (AUSTRALIA PUBLIC COMPANY, LIMITED BY SHARES)
1 UNIVERSITY AVENUE MACQUARIE UNIV.
NSW 2109, AUSTRALIA

FOR: DESIGN AND DEVELOPMENT OF COMPUTER HARDWARE AND SOFTWARE;
PROVIDING A WEBSITE FEATURING ONLINE NON-DOWNLOADABLE SOFTWARE FOR
MANAGEMENT OF PATIENT MEDICAL AND DEVICE INFORMATION; COMPUTER
SERVICES, NAMELY, CREATING AN ON-LINE COMMUNITY FOR REGISTERED USERS
TO PARTICIPATE IN DISCUSSIONS, FORM VIRTUAL COMMUNITIES, AND ENGAGE IN
SOCIAL NETWORKING, IN CLASS 42 (U.S. CLS. 100 AND 101).

FOR: MEDICAL SERVICES; PROVIDING MEDICAL AND MEDICAL DEVICE INFORMATION
INCLUDING IN THE FIELD OF PROSTHETIC HEARING DEVICES VIA THE INTERNET,
IN CLASS 44 (U.S. CLS. 100 AND 101).

FOR: ONLINE SOCIAL NETWORKING SERVICES, IN CLASS 45 (U.S. CLS. 100 AND 101).

THE MARK CONSISTS OF STANDARD CHARACTERS WITHOUT CLAIM TO ANY PAR-
TICULAR FONT, STYLE, SIZE, OR COLOR.

PRIORITY DATE OF 6-9-2011 IS CLAIMED.

OWNER OF INTERNATIONAL REGISTRATION 1092373 DATED 6-30-2011, EXPIRES 6-30-
2021.

SER. NO. 79-103,159, FILED 6-30-2011.

KRISTIN CARLSON, EXAMINING ATTORNEY



David J. Kybas

Director of the United States Patent and Trademark Office

United States of America

United States Patent and Trademark Office



ZIP & FRIENDS
C O M P A N Y

Reg. No. 4,204,120

Registered Sep. 11, 2012

Int. Cl.: 18

TRADEMARK

PRINCIPAL REGISTER

ZIPITBAG GMBH & CO.KG (FED REP GERMANY GMBH & CO.KG)
SENEFELDER STR. 1/F1
63110 RODGAU
FED REP GERMANY

FOR: CARRY-ALL BAGS, BACKPACKS, PURSES AND WALLETS, LEATHER GOODS, NAMELY, SADDLERY, SUITCASES, TRUNKS AND TRAVELLING BAGS, CARRY-ALL BAGS WITH IMPRINTS, IN CLASS 18 (U.S. CLS. 1, 2, 3, 22 AND 41).

NO CLAIM IS MADE TO THE EXCLUSIVE RIGHT TO USE "COMPANY", APART FROM THE MARK AS SHOWN.

PRIORITY DATE OF 6-1-2011 IS CLAIMED.

OWNER OF INTERNATIONAL REGISTRATION 1092390 DATED 7-8-2011, EXPIRES 7-8-2021.

THE MARK CONSISTS OF THE STYLIZED LETTERS "ZF" ABOVE THE WORDING "ZIP&FRIENDS" WHICH IS ABOVE THE WORD "COMPANY".

SER. NO. 79-103,165, FILED 7-8-2011.

JESSICA A. POWERS, EXAMINING ATTORNEY



David J. Kyffers

Director of the United States Patent and Trademark Office

United States of America

United States Patent and Trademark Office

BERSHKA

Reg. No. 4,204,121

Registered Sep. 11, 2012

**Int. Cls.: 9, 14, 16, 25, 26,
28 and 35**

TRADEMARK

SERVICE MARK

PRINCIPAL REGISTER

INDUSTRIA DE DISEÑO TEXTIL, S.A. (INDITEX, S.A.) (SPAIN CORPORATION)
AVDA. DE LA DIPUTACIÓN
"EDIFICIO INDITEX"
E-15142 ARTEIXO (A CORUÑA), SPAIN

FOR: SCIENTIFIC, NAUTICAL, SURVEYING, PHOTOGRAPHIC, CINEMATOGRAPHIC, OPTICAL, WEIGHING, MEASURING, SIGNALLING, MONITORING, SUPERVISION, EMERGENCY, LIFE-SAVING AND TEACHING APPARATUS AND INSTRUMENTS, NAMELY, MEDICAL TEACHING MANNEQUINS, PHOTOGRAPHIC SLIDES, AND OPTICAL FIBERS; APPARATUS AND INSTRUMENTS FOR CONDUCTING, SWITCHING, TRANSFORMING, ACCUMULATING, REGULATING OR CONTROLLING ELECTRICITY, NAMELY, ELECTRICAL SWITCHES, ELECTRIC CONDUCTORS, ELECTRIC TRANSFORMERS; APPARATUS FOR RECORDING, TRANSMITTING, AND REPRODUCING SOUND OR IMAGES; MAGNETIC DATA MEDIA, NAMELY, BLANK MAGNETIC DATA CARRIERS, PRERECORDED MAGNETIC DATA CARRIERS FEATURING MUSIC, FILMS AND PHOTOGRAPHS; SOUND RECORDING DISKS, NAMELY, BLANK RECORDABLE OPTICAL DISCS; AUTOMATIC VENDING MACHINES AND MECHANISMS FOR COIN-OPERATED APPARATUS; CASH REGISTERS; CALCULATING MACHINES; DATA PROCESSING AND COMPUTER EQUIPMENT, NAMELY, DATA PROCESSORS AND COMPUTERS; COMPUTER PERIPHERAL DEVICES; FIRE EXTINGUISHERS; ANTI-DAZZLE SPECTACLES; EYEGLASSES; PINCE-NEZ; OPTICAL LENSES; PINCE-NEZ CHAINS; CONTACT LENSES; PINCE-NEZ CORDS; DRESSMAKERS' MEASURES, NAMELY, MEASURING TAPES; SPECTACLES; SPECTACLE LENSES; SPECTACLES CASES; SPECTACLE FRAMES AND LENSES; EYEGLASSES; SUNGLASSES; CASES FOR EYEGLASSES AND FOR CONTACT LENSES; SHOES FOR PROTECTION AGAINST ACCIDENTS, IRRADIATION AND FIRE; BULLETPROOF JACKETS; LIFE JACKETS; FIRE PROTECTION SUITS AND CLOTHING; GLOVES FOR DIVERS; GLOVES FOR PROTECTION AGAINST ACCIDENTS; SURVIVAL SUITS, NAMELY, INSULATED OVERALL WETSUITS; MAGNETIC CARDS, NAMELY, MAGNETIC IDENTIFYING CARDS AND MAGNETIC CODED GIFT CARDS; MAGNETIC IDENTITY CARDS; CLOTHING FOR PROTECTION AGAINST ACCIDENTS AND IRRADIATION; PROTECTIVE SUITS FOR AVIATORS; ELECTRONIC AGENDAS; ELECTRIC APPLIANCES FOR REMOVING MAKE-UP; TELEPHONE SETS; WEIGHING SCALES; COMPASSES; ACCOUNTING MACHINES, NAMELY, AUTOMATED BILLING MACHINES FOR PROCESSING ACCOUNTING INFORMATION; PROTECTIVE HELMETS; SPYGLASSES; CHRONOGRAPHS FOR USE AS SPECIALIZED TIME RECORDING APPARATUSES; MEASURING SPOONS; PEDOMETERS; AUDIO-VIDEO COMPACT DISCS FEATURING MUSIC, FILMS AND PHOTOGRAPHS; READ-ONLY MEMORY COMPACT DISCS FEATUR-



David J. Kyffers

Director of the United States Patent and Trademark Office

Reg. No. 4,204,121 ING MUSIC, FILMS AND PHOTOGRAPHS; MIRRORS, NAMELY, INSPECTIONS MIRRORS AND REFLECTIVE MIRRORS TO PREVENT ACCIDENTS; SWIM FLOATS FOR SAFETY PURPOSES FOR BATHING AND SWIMMING; BINOCULARS; PRINTERS FOR USE WITH COMPUTERS; TEMPERATURE INDICATORS; COMPUTER GAME PROGRAMS; CASSETTE PLAYERS; BAR CODE READERS; OPTICAL SIGNAL AND MAGICAL LANTERNS; OPTICAL LAMPS, NAMELY, FLASH LAMPS; MAGNIFYING GLASSES; DICTATING MACHINES; TEST WEIGHTS; ELECTRIC, GALVANIC AND SOLAR BATTERIES; ELECTRIC IRONS; COMPUTER SOFTWARE FOR CREATING DATABASES AND FOR ORDERING, CONFIGURING AND PREPARING PRICE QUOTES FOR ELECTRICAL DISTRIBUTION PRODUCTS; RECORDED COMPUTER OPERATING PROGRAMS; COMPUTER MICE; ELECTRONIC POCKET TRANSLATORS; TRANSISTORS; THERMOMETERS NOT FOR MEDICAL USE; APPARATUS FOR GAMES ADAPTED FOR USE WITH TELEVISION RECEIVERS ONLY; INTERCOMS; BLANK VIDEO CASSETTES; VIDEO DISKS AND VIDEO TAPES WITH RECORDED ANIMATED CARTOONS; TEACHING APPARATUS, NAMELY, MEDICAL TEACHING MANNEQUINS; BABY CRY DETECTORS, NAMELY, BABY MONITORS; WALKIE-TALKIES; DOWNLOADABLE ELECTRONIC PUBLICATIONS IN THE NATURE OF MAGAZINES IN THE FIELDS OF TEXTILES, RETAIL SERVICES, FASHION AND BUSINESS ADMINISTRATION; SANDGLASSES; ACOUSTIC SOUND ALARMS; THEFT ALARMS; FIRE ALARMS; MOUSEPADS; LOUDSPEAKERS; APPARATUS FOR SOUND AMPLIFICATION, NAMELY, SOUND AMPLIFIERS; ANTENNAE; ANTI-DAZZLE SHADES, NAMELY, ANTI-DAZZLE SUNGLASSES; HEADSETS FOR TELEPHONES; HEADSETS FOR MUSIC, NAMELY, EARPHONES; TELEPHONE ANSWERING MACHINES; FALSE COIN DETECTORS, NAMELY, COIN ACCEPTORS FOR SEPARATING GOOD COINS FROM COUNTERFEITS; MONEY COUNTING AND SORTING MACHINES; ELECTRONIC TAGS FOR GOODS; SPORTS GLASSES; MAGNETS; LIGHT-EMITTING ELECTRONIC POINTERS; EAR PLUGS NOT FOR MEDICAL PURPOSES; MOBILE TELEPHONES, IN CLASS 9 (U.S. CLS. 21, 23, 26, 36 AND 38).

FOR: PRECIOUS METALS AND THEIR ALLOYS; GOODS IN PRECIOUS METALS OR COATED THEREWITH NOT INCLUDED IN OTHER CLASSES, NAMELY, CUFF LINKS OF PRECIOUS METAL AND FIGURES OF PRECIOUS METAL; JEWELRY; PRECIOUS STONES; HOROLOGICAL AND CHRONOMETRIC INSTRUMENTS; ORNAMENTAL PINS; TIE PINS; NEEDLE CASES OF PRECIOUS METAL; CASES FOR NEEDLES OF PRECIOUS METALS; NAPKIN RINGS OF PRECIOUS METAL; WORKS OF ART OF PRECIOUS METAL; FANCY KEY RINGS OF PRECIOUS METAL; MEDALS; COLLECTIBLE COINS; SILVER AND GOLD-PLATED ITEMS EXCEPT KNIVES, FORKS AND SPOONS, NAMELY, JEWELRY; BADGES OF PRECIOUS METAL; ORNAMENTS OF PRECIOUS METALS FOR FOOTWEAR AND HATS; ASHTRAYS OF PRECIOUS METAL FOR SMOKERS; CUFF LINKS; WATCH CHAINS; CLOCK CASES; CRUETS OF PRECIOUS METAL; VASES OF PRECIOUS METAL; TEA AND COFFEE SERVICES IN PRECIOUS METALS; THREADS OF PRECIOUS METAL; JEWEL CASES IN PRECIOUS METALS; CIGARETTE CASES OF PRECIOUS METAL; POWDER COMPACTS OF PRECIOUS METAL, IN CLASS 14 (U.S. CLS. 2, 27, 28 AND 50).

FOR: PAPER, CARDBOARD AND GOODS MADE OF THESE MATERIALS, NAMELY, BOXES OF PAPER, CARDBOARD TUBES, PAPER MACHE FIGURINES, CARDBOARD BOXES, AND HANG TAGS; PRINTED MATTER, NAMELY, PRINTED CALENDARS AND PRINTED FORMS; BOOKBINDING MATERIAL; PHOTOGRAPHS; STATIONERY; ADHESIVES FOR STATIONERY OR HOUSEHOLD PURPOSES; ARTISTS' SUPPLIES, NAMELY, ARTISTS' BRUSHES, ARTISTS' PENS, EASELS, ARTISTS' PENCILS, ARTISTS' PASTELS AND MODELING CLAY; PAINTBRUSHES; TYPEWRITERS; OFFICE REQUISITES, NAMELY, PUNCHES, STAPLERS AND PAPER EMBOSSERS; INSTRUCTIONAL AND TEACHING MATERIAL, NAMELY, PRINTED TEACHING MATERIALS IN THE FIELD OF TEXTILES, RETAIL SERVICES, FASHION AND BUSINESS ADMINISTRATION; PLASTIC MATERIALS FOR PACKAGING, NAMELY, PLASTIC BAGS FOR PACKAGING; PRINTERS' TYPE; PRINTING BLOCKS; ENGRAVED WORKS OF ART, NAMELY, LITHOGRAPHIC WORKS OF ART; CARDBOARD OR PAPER BOXES; PRINTED PATTERNS FOR MAKING CLOTHES AND SEWING; PAPER TISSUES FOR REMOVING MAKE-UP; STENCIL CASES; NON-TEXTILE LABELS, NAMELY, SHIPPING LABELS, ADHESIVE LABELS, PAPER LABELS

Reg. No. 4,204,121 AND MAILING LABELS; TABLE LINEN OF PAPER; TABLE NAPKINS OF PAPER; DISPOSABLE BABIES' DIAPERS OF PAPER AND CELLULOSE; DISPOSABLE NAPPIES OF PAPER OR CELLULOSE; PAPER HANDKERCHIEFS; PEN HOLDERS; CHECK BOOK HOLDERS; STATIONERY CASES; INKING SHEETS FOR DOCUMENT REPRODUCING MACHINES FOR REPRODUCING IMAGES IN THE PRINTING INDUSTRY; BAGS, ENVELOPES AND POUCHES OF PAPER OR PLASTICS FOR MERCHANDISE PACKAGING; TAILORS' CHALK; FACE TOWELS OF PAPER; HAT BOXES OF PAPER; TRACING PAPER; BOOKBINDING CLOTH; CANVASES FOR PAINTING; HAND TOWELS OF PAPER; PHOTOGRAPH, STAMP AND STICKER ALBUMS; ALMANACS; HAND LABELING APPLIANCES, NAMELY, HANDHELD LABELING DEVICES; LOOSELEAF BINDERS; WRITING ARTICLES AND INSTRUMENTS, NAMELY, PENS AND PENCILS; IRON-ON TRANSFERS AND PLASTIC TRANSFERS; CALENDARS; POSTERS; PAPER FILE JACKETS FOR PAPERS; PASSPORT HOLDERS; CATALOGUES IN THE FIELD OF CLOTHING, FOOTWEAR, JEWELRY, ACCESSORIES, PERFUMES AND COSMETICS; CHROMOS, NAMELY, PICTURE CARDS; DRAWING SETS COMPRISED OF DRAWING PADS, DRAWING CURVES, AND DRAWING BRUSHES; DAILY NEWSPAPERS; NEWSPAPERS; MAGAZINES FEATURING TEXTILES, RETAIL SERVICES, FASHION AND BUSINESS ADMINISTRATION; SEALING WAX; BOOKS IN THE FIELD OF TEXTILES, RETAIL SERVICES, FASHION AND BUSINESS ADMINISTRATION; LITHOGRAPHS; WRAPPING PAPER; TOILET PAPER; PAPERWEIGHTS; MATS FOR BEER GLASSES, NAMELY, COASTERS OF PAPER; BOOKMARKERS; BOOKENDS; INKWELLS; PAPER BIBS; DRAWING ARTICLES, NAMELY, DRAWING BOARDS AND DRAWING CURVES; DESIGNS, NAMELY, EMBROIDERY DESIGN PATTERNS; SCHOOL SUPPLIES, NAMELY, SCHOOL WRITING BOOKS; WRITING SLATES; COMIC BOOKS; EMBROIDERY DESIGN PATTERNS; PAPER AND PLASTIC PACKING BAGS; GEOGRAPHICAL MAPS; TERRESTRIAL GLOBES; FINGER MOISTENERS; PRINTED PLANS; STENCILS; PAPER OR CARDBOARD PLACARDS; PRINTED CHARTS; PUBLICATIONS, NAMELY, BOOKS, HANDOUTS, WORKBOOKS, MAGAZINES, BROCHURES, BOOKLETS IN THE FIELDS OF TEXTILES, RETAIL SERVICES, FASHION AND BUSINESS ADMINISTRATION, IN CLASS 16 (U.S. CLS. 2, 5, 22, 23, 29, 37, 38 AND 50).

FOR: MEN'S, WOMEN'S AND CHILDREN'S READY-TO-WEAR CLOTHING, NAMELY, JACKETS, SHIRTS, PANTS, SKIRTS, TROUSERS, JEANS, DRESSES, LEGGINGS, T-SHIRTS, BLOUSES, JERSEYS, SHORTS, TOPS, COATS, PARKAS, UNDERSHIRTS, OVERCOATS, WAISTCOATS, SWEATERS, PULLOVERS, VESTS, SUITS, BLAZERS; FOOTWEAR; HEADGEAR, NAMELY, HATS, CAPS, HEADWEAR, BERETS; CLOTHING FOR MOTORISTS AND CYCLISTS, NAMELY, CYCLING SHOES, CYCLING SHORTS, MOTORIST BOOTS, MOTORIST JACKETS AND MOTORIST PANTS; BIBS NOT OF PAPER; HEADBANDS; BATHROBES; SWIMMING COSTUMES; BATHING CAPS AND SANDALS; BOAS; LINGERIE; BABIES' PANTS; SCARVES; HOODS; SHAWLS; BELTS; MONEY BELTS; WATER SKIING WETSUITS; TIES; CORSETS; FUR STOLE; FOULARDS; CAPS; GLOVES FOR WEAR; UNDERWEAR; MANTILLAS; STOCKINGS; SOCKS; BANDANAS; TEXTILE NAPPIES; FURS, NAMELY, FUR CLOAKS, FUR HATS, FUR STOLE, FUR MUFFS AND FUR COATS; PYJAMAS; SOLES; HEELS; VEILS; BRACES; PAPER CLOTHING, NAMELY, PAPER APRONS, AND PAPER SHOES USED WHEN GOING THROUGH METAL DETECTORS TO KEEP FEET AND SOCKS CLEAN; GYMNASTIC AND SPORTS OUTFITS, NAMELY, GYMNASTIC SHOES, LEOTARDS AND TIGHTS; LAYETTES; COLLARS; SINGLET; MITTENS; EAR MUFFS; INNER SOLES; SHOULDER PADS FOR CLOTHING; BOW TIES; PAREUS; DRESSING GOWNS; POCKETS SQUARES FOR CLOTHING; SOCK SUSPENDERS; GARTER BELTS; PETTICOATS; TIGHTS; APRONS; HEADDRESSES IN THE NATURE OF HEADWEAR; CARNIVAL MASQUERADE COSTUMES; UNIFORMS; CAP PEAKS; CLOGS; CAPS; COMBINATION UNDERWEAR; GARTERS, IN CLASS 25 (U.S. CLS. 22 AND 39).

FOR: LACE AND EMBROIDERY, RIBBONS AND BRAID; BUTTONS, HOOKS AND EYES; HAIR PINS, MARKING PINS, SAFETY PINS AND HAT PINS; NEEDLES; ARTIFICIAL FLOWERS; TINSELS IN THE NATURE OF TRIMMINGS FOR CLOTHING, NAMELY, LACE TRIMMING; PIN CUSHIONS; HAT AND SHOE ORNAMENTS NOT OF PRECIOUS METAL; HAIR ORNAMENTS; HABERDASHERY ARTICLES, NAMELY, BEADS OTHER THAN FOR MAKING JEWELRY; HAIR BANDS; ARM BANDS; REINS FOR GUIDING CHILDREN;

Reg. No. 4,204,121 BROOCHES AS CLOTHING ACCESSORIES; SEWING KIT BOXES COMPRISED OF NEEDLES, THIMBLES, SCISSORS AND THREAD SOLD AS A UNIT; BELT CLASPS; SHOE LACES; ARTIFICIAL GARLANDS AND CROWNS OF ARTIFICIAL FLOWERS; TEA COSIES; ORNAMENTAL NOVELTY BADGES; SEWING THIMBLES; NEEDLE CASES, NOT OF PRECIOUS METAL; BOXES FOR NEEDLES, NOT OF PRECIOUS METAL; CLOTHING BUCKLES; SHOE BUCKLES; HAIRPINS; ORNAMENTAL NOVELTY BADGES, NOT OF PRECIOUS METAL; CLOTHING SEQUINS; BODKINS; HAIRCLIPS; LACE TRIMMINGS; FEATHERS FOR ORNAMENTATION; ARTS AND CRAFTS FINDINGS, NAMELY, POMPONS; ZIP FASTENERS; COMPETITORS' NUMBERS NOT OF TEXTILE; WHALEBONES FOR CORSETS; FALSE HAIR; WIGS; ARTIFICIAL FRUIT, IN CLASS 26 (U.S. CLS. 37, 39, 40, 42 AND 50).

FOR: GAMES AND TOYS, NAMELY, ACTION SKILL GAMES, BACKGAMMON GAMES AND BOARD GAMES; GYMNASTIC AND SPORTING ARTICLES NOT INCLUDED IN OTHER CLASSES, NAMELY, GYMNASTIC APPARATUS, GYMNASTIC TRAINING STOOLS, AND HORIZONTAL BARS; DECORATIONS FOR CHRISTMAS TREES; FISHING TACKLE; FISHING RODS; CARNIVAL AND THEATRE MASKS; DOLLS' HOUSES; CLIMBERS' HARNESES; PARTY FAVORS IN THE NATURE OF SMALL TOYS; SWIMMING, SOCCER AND FOOTBALL GLOVES; BASEBALL, BOXING, FENCING AND GOLF GLOVES; MARIONETTES; AUTOMATIC GAMES APPARATUS FOR ELECTRONIC GAMES NOT ADAPTED FOR USE WITH TELEVISION RECEIVERS; MACHINES FOR PHYSICAL EXERCISES; CHRISTMAS TREES OF SYNTHETIC MATERIAL; BLADDERS BEING STRUCTURAL PARTS OF BALLS FOR GAMES; SHIN, ELBOW AND KNEE PADS FOR USE IN SKATING, SOCCER AND FOOTBALL; KITES; BABY RATTLES; KALEIDOSCOPIES; ROCKING HORSES; TOY CONSTRUCTION SETS; PREPAID AUTOMATIC ARCADE GAMES MACHINES; CARD GAMES; PLUSH TOYS; DOLLS; DOLLS' CLOTHES; DOLLS' FEEDING BOTTLES; CHESS GAMES; DRAUGHTBOARDS; TOYS FOR DOMESTIC PETS; PLAY BALLOONS; BILLIARD TABLES, CUE STICKS, BILLIARD BALLS AND CUES; BOWLS, NAMELY, BOWLING APPARATUS AND MACHINERY; SWINGS; TOBOGGANS; FLYING DISCS; DICE; DARTS; SKIS; TABLES FOR TABLE FOOTBALL; TABLES FOR TABLE TENNIS; SCALE MODELS OF VEHICLES; SKATEBOARDS; TOY SCOOTERS; ROLLER AND ICE SKATES; PINATAS; PAINTBALL GUNS; PUZZLES; SQUASH, TENNIS, BADMINTON AND TABLE TENNIS RACKETS; PARLOUR GAMES; TOY VEHICLES; SPRING BOARDS; GOLF CLUBS; SOAP BUBBLES, NAMELY, BUBBLE MAKING WAND AND SOLUTION SETS; TOY MOBILES, IN CLASS 28 (U.S. CLS. 22, 23, 38 AND 50).

FOR: ADVERTISING SERVICES; COMMERCIAL BUSINESS MANAGEMENT; BUSINESS ADMINISTRATION AND OFFICE WORK; SERVICES OF ASSISTANCE IN THE BUSINESS MANAGEMENT OR COMMERCIAL FUNCTIONS OF AN INDUSTRIAL OR COMMERCIAL COMPANY; ORGANIZATION OF EXHIBITIONS WITH COMMERCIAL OR ADVERTISING PURPOSES; PROMOTION SERVICES PROVIDED BY A COMMERCIAL COMPANY BY MEANS OF A CUSTOMER LOYALTY CARD; MODELING SERVICES FOR ADVERTISING OR SALES PROMOTION; PUBLISHING OF ADVERTISING TEXTS; SHOP WINDOW DRESSING SERVICES; SERVICES OF ASSISTANCE FOR THE OPERATION OF COMMERCIAL COMPANIES AS FRANCHISES, NAMELY, FRANCHISING, NAMELY, OFFERING BUSINESS MANAGEMENT ASSISTANCE IN THE ESTABLISHMENT AND/OR OPERATION OF RETAIL CLOTHING, FOOTWEAR, HEADWEAR, ACCESSORIES, PERFUMES, JEWELRY, DECORATION AND FURNITURE STORES; DEMONSTRATION OF GOODS; ORGANIZATION OF TRADE FAIRS FOR COMMERCIAL OR ADVERTISING PURPOSES; SALES PROMOTION SERVICES FOR OTHERS; PUBLIC AUCTION SERVICES; SERVICES OF SALES PROMOTION AND BUSINESS MANAGEMENT OF COMMERCIAL CENTERS; SERVICES OF ASSISTANCE IN THE COMMERCIAL FUNCTIONS OF BUSINESS, NAMELY, ELECTRONIC PROCESSING OF ORDERS FOR OTHERS AND ORDER FULFILLMENT SERVICES VIA GLOBAL COMMUNICATION NETWORKS; ONLINE WHOLESALE AND RETAIL STORE SERVICES FEATURING CLOTHING, CLOTHING ACCESSORIES, FOOTWEAR, EYEGLASSES, SUNGLASSES AND THEIR ACCESSORIES, APPARATUS FOR RECORDING, TRANSMITTING, AND REPRODUCING SOUND OR IMAGES, WATCHES AND CLOCKS, LEATHER AND ARTIFICIAL LEATHER GOODS, LUGGAGE AND BAGS, JEW-

Reg. No. 4,204,121 ELRY, PERSONAL CARE PRODUCTS, PERFUMERY AND COSMETICS; MAIL ORDER SERVICES FEATURING CLOTHING, CLOTHING ACCESSORIES, FOOTWEAR, EYEGLASSES, SUNGLASSES AND THEIR ACCESSORIES, APPARATUS FOR RECORDING, TRANSMITTING, AND REPRODUCING SOUND OR IMAGES, WATCHES AND CLOCKS, LEATHER AND ARTIFICIAL LEATHER GOODS, LUGGAGE AND BAGS, JEWELRY, PERSONAL CARE PRODUCTS, PERFUMERY AND COSMETICS; ELECTRONIC CATALOG SERVICES FEATURING CLOTHING, CLOTHING ACCESSORIES, FOOTWEAR, EYEGLASSES, SUNGLASSES AND THEIR ACCESSORIES, APPARATUS FOR RECORDING, TRANSMITTING, AND REPRODUCING SOUND OR IMAGES, WATCHES AND CLOCKS, LEATHER AND ARTIFICIAL LEATHER GOODS, LUGGAGE AND BAGS, JEWELRY, PERSONAL CARE PRODUCTS, PERFUMERY AND COSMETICS; TELEPHONE ORDERING SERVICES IN THE FIELD OF CLOTHING, CLOTHING ACCESSORIES, FOOTWEAR, EYEGLASSES, SUNGLASSES AND THEIR ACCESSORIES, APPARATUS FOR RECORDING, TRANSMITTING, AND REPRODUCING SOUND OR IMAGES, WATCHES AND CLOCKS, LEATHER AND ARTIFICIAL LEATHER GOODS, LUGGAGE AND BAGS, JEWELRY, PERSONAL CARE PRODUCTS, PERFUMERY AND COSMETICS; PROVIDING HOME SHOPPING SERVICES IN THE FIELD CLOTHING, CLOTHING ACCESSORIES, FOOTWEAR, EYEGLASSES, SUNGLASSES AND THEIR ACCESSORIES, APPARATUS FOR RECORDING, TRANSMITTING, AND REPRODUCING SOUND OR IMAGES, WATCHES AND CLOCKS, LEATHER AND ARTIFICIAL LEATHER GOODS, LUGGAGE AND BAGS, JEWELRY, PERSONAL CARE PRODUCTS, PERFUMERY AND COSMETICS BY MEANS OF TELEVISION AND OTHER ELECTRONIC MEANS; IMPORT-EXPORT AGENCIES; ONLINE ADVERTISING ON A COMPUTER NETWORK; PROCUREMENT SERVICES FOR OTHERS, NAMELY, PURCHASING CLOTHING, CLOTHING ACCESSORIES, FOOTWEAR, EYEGLASSES, SUNGLASSES AND THEIR ACCESSORIES, APPARATUS FOR RECORDING, TRANSMITTING, AND REPRODUCING SOUND OR IMAGES, WATCHES AND CLOCKS, LEATHER AND ARTIFICIAL LEATHER GOODS, LUGGAGE AND BAGS, JEWELRY, PERSONAL CARE PRODUCTS, PERFUMERY AND COSMETICS FOR OTHER BUSINESS; NEWSPAPER SUBSCRIPTION SERVICES FOR OTHERS; DISTRIBUTION OF SAMPLES; COMPILATION AND SYSTEMIZATION OF INFORMATION INTO COMPUTER DATABASES; MANAGEMENT OF COMPUTER FILES; PUBLIC RELATIONS; WHOLESALE AND RETAIL STORE SERVICES FEATURING CLOTHING, CLOTHING ACCESSORIES, FOOTWEAR, EYEGLASSES, SUNGLASSES AND THEIR ACCESSORIES, APPARATUS FOR RECORDING, TRANSMITTING, AND REPRODUCING SOUND OR IMAGES, WATCHES AND CLOCKS, LEATHER AND ARTIFICIAL LEATHER GOODS, LUGGAGE AND BAGS, JEWELRY, PERSONAL CARE PRODUCTS, PERFUMERY AND COSMETICS, IN CLASS 35 (U.S. CLS. 100, 101 AND 102).

OWNER OF U.S. REG. NOS. 2,539,882, 4,019,521 AND OTHERS.

OWNER OF INTERNATIONAL REGISTRATION 0928432 DATED 1-2-2007, EXPIRES 1-2-2017.

THE WORD(S) "BERSHKA" HAS NO MEANING IN A FOREIGN LANGUAGE.

SER. NO. 79-103,182, FILED 9-7-2010.

KATHERINE E. HALMEN, EXAMINING ATTORNEY

United States of America
United States Patent and Trademark Office

LATIS

Reg. No. 4,204,122

Registered Sep. 11, 2012

Int. Cl.: 6

TRADEMARK

PRINCIPAL REGISTER

SHIN NIPPON SEITETSU KABUSHIKI KAISHA (JAPAN CORPORATION), DBA NIPPON
STEEL CORPORATION
NO. 6-1, MARUNOUCHI 2-CHOME
CHIYODA-KU; TOKYO, JAPAN 1008071

FOR: EMBOSSED STEEL SHEETS; GALVANIZED STEEL SHEETS; COLORED STEEL
SHEETS; STEEL SHEETS WITH DESIGN; STEEL SHEETS; STEEL STRIPS; METAL BOARDS
FOR BUILDING; LININGS OF METAL FOR BUILDING PURPOSES; METAL MATERIALS
USED FOR BUILDING, NAMELY, SHEETS AND PLATES OF METAL FOR USE IN
BUILDING CONSTRUCTION, IN CLASS 6 (U.S. CLS. 2, 12, 13, 14, 23, 25 AND 50).

THE WORDING "LATIS" HAS NO MEANING IN A FOREIGN LANGUAGE.

PRIORITY DATE OF 8-18-2011 IS CLAIMED.

OWNER OF INTERNATIONAL REGISTRATION 1092468 DATED 8-29-2011, EXPIRES 8-29-
2021.

SER. NO. 79-103,223, FILED 8-29-2011.

SUZANNE BLANE, EXAMINING ATTORNEY



David J. Kyfos

Director of the United States Patent and Trademark Office

United States of America

United States Patent and Trademark Office

SHOWROOM MARCONA 3

Reg. No. 4,204,123

Registered Sep. 11, 2012

Int. Cl.: 35

SERVICE MARK

PRINCIPAL REGISTER

TORDINI SOCIETA' A RESPONSABILITA LIMITATA - UNIPERSONALE (ITALY LIMITED LIABILITY COMPANY)
VIA PARINI, 36
I-62012 CIVITANOVA MARCHE (MC), ITALY

FOR: THE BRINGING TOGETHER, FOR THE BENEFIT OF OTHERS, OF A VARIETY OF GOODS, NAMELY, HOROLOGICAL INSTRUMENTS, GLASSES, GLASS FRAMES, SUNGLASSES, GLASS CASES, GLASS CHAINS, GLASS STRINGS - ENABLING CUSTOMERS TO CONVENIENTLY VIEW AND PURCHASE THOSE GOODS; ON-LINE RETAIL STORE SERVICES FEATURING HOROLOGICAL INSTRUMENTS, GLASSES, GLASS FRAMES, SUNGLASSES, GLASS CASES, GLASS CHAINS, GLASS STRINGS; ADVERTISING AND ADVERTISEMENT SERVICES; BUSINESS MANAGEMENT ASSISTANCE; BUSINESS ADMINISTRATION; PROVIDING OFFICE FUNCTIONS, IN CLASS 35 (U.S. CLS. 100, 101 AND 102).

THE MARK CONSISTS OF STANDARD CHARACTERS WITHOUT CLAIM TO ANY PARTICULAR FONT, STYLE, SIZE, OR COLOR.

PRIORITY DATE OF 6-8-2011 IS CLAIMED.

OWNER OF INTERNATIONAL REGISTRATION 1092490 DATED 6-27-2011, EXPIRES 6-27-2021.

NO CLAIM IS MADE TO THE EXCLUSIVE RIGHT TO USE "SHOWROOM.", APART FROM THE MARK AS SHOWN.

SER. NO. 79-103,229, FILED 6-27-2011.

PRISCILLA MILTON, EXAMINING ATTORNEY



David J. Kybas

Director of the United States Patent and Trademark Office

United States of America

United States Patent and Trademark Office

Ko-ga-me

Reg. No. 4,204,124

Registered Sep. 11, 2012

Int. Cls.: 7 and 9

TRADEMARK

PRINCIPAL REGISTER

MITUTOYO CORPORATION (JAPAN CORPORATION)
20-1, SAKADO 1-CHOME
TAKATSU-KU.; KAWASAKI; KANAGAWA 213-8533
JAPAN

FOR: SPARK EROSION MACHINES, AND THEIR PARTS OR ACCESSORIES; METAL WORKING MACHINES AND TOOLS, AND THEIR PARTS OR ACCESSORIES; MACHINES AND APPARATUS FOR LUMBERING, WOOD-WORKING, OR VENEERING OR PLYWOOD MAKING; MACHINES FOR PLASTICS WORKING; SEMICONDUCTOR MANUFACTURING MACHINES, AND THEIR PARTS OR ACCESSORIES; STONE WORKING MACHINES AND APPARATUS, IN CLASS 7 (U.S. CLS. 13, 19, 21, 23, 31, 34 AND 35).

FOR: MICROSCOPES AND PARTS THEREOF; COORDINATE MEASURING MACHINES; STRAIGHTNESS TESTING MACHINES AND INSTRUMENTS; DEVICES FOR DETECTING SEISMIC MOTION; VIBRATION METERS; SURFACE ROUGHNESS TESTING MACHINES AND INSTRUMENTS; FLATNESS TESTING MACHINES AND INSTRUMENTS; DISTANCE MEASURING APPARATUS; COMPUTERS; CENTRAL PROCESSING UNITS (CPU); MAGNETIC ENCODED CARD READERS; SCANNERS; DATA PROCESSORS; ELECTRONIC MAGNETIC-CODED IDENTIFYING CARDS; ELECTRONIC MAGNETIC ID CARDS FOR USE IN CONNECTION WITH PAYMENT FOR SERVICES; COMPUTER OPERATIONAL SOFTWARE FOR MONITORING AND CONTROLLING FACTORY MANUFACTURING PROCESSES; COMPUTER OPERATIONAL SOFTWARE FOR 3D MEASURING MACHINES AND INSTRUMENTS, IN CLASS 9 (U.S. CLS. 21, 23, 26, 36 AND 38).



THE MARK CONSISTS OF STANDARD CHARACTERS WITHOUT CLAIM TO ANY PARTICULAR FONT, STYLE, SIZE, OR COLOR.

PRIORITY DATE OF 9-30-2010 IS CLAIMED.

OWNER OF INTERNATIONAL REGISTRATION 1092743 DATED 3-29-2011, EXPIRES 3-29-2021.

THE ENGLISH TRANSLATION OF "KO-GA-ME" IN THE MARK IS "CHILD TURTLE".

SER. NO. 79-103,316, FILED 3-29-2011.

JANICE KIM, EXAMINING ATTORNEY

David J. Kyffers

Director of the United States Patent and Trademark Office

United States of America

United States Patent and Trademark Office

OWEC Quattropod

Reg. No. 4,204,125

Registered Sep. 11, 2012

Int. Cls.: 6 and 7

TRADEMARK

PRINCIPAL REGISTER

OWEC TOWER AS (NORWAY AKSJESELSKAP)
STORETVEITVEIEN 96
N-5072 BERGEN
NORWAY

FOR: PIPES AND TUBES OF METAL; FOUNDATION STRUCTURES AND PARTS THEREFOR, OF METAL, NAMELY, METAL SHEETING, ALUMINUM SIDING, AND METAL FOUNDATION BOARDS; FOUNDATION STRUCTURES AND PARTS THEREFOR, OF METAL, FOR TURBINES AND WIND TURBINES, NAMELY, METAL SHEETING, ALUMINUM SIDING, AND METAL FOUNDATION BOARDS, IN CLASS 6 (U.S. CLS. 2, 12, 13, 14, 23, 25 AND 50).

FOR: TURBINES, OTHER THAN FOR LAND VEHICLES; WIND TURBINES; PARTS AND FITTINGS FOR THE AFOREMENTIONED GOODS, IN CLASS 7 (U.S. CLS. 13, 19, 21, 23, 31, 34 AND 35).

THE MARK CONSISTS OF STANDARD CHARACTERS WITHOUT CLAIM TO ANY PARTICULAR FONT, STYLE, SIZE, OR COLOR.

PRIORITY DATE OF 1-28-2011 IS CLAIMED.

OWNER OF INTERNATIONAL REGISTRATION 1092900 DATED 7-28-2011, EXPIRES 7-28-2021.

SER. NO. 79-103,363, FILED 7-28-2011.

JACLYN KIDWELL WALKER, EXAMINING ATTORNEY



David J. Kyffers

Director of the United States Patent and Trademark Office

United States of America

United States Patent and Trademark Office

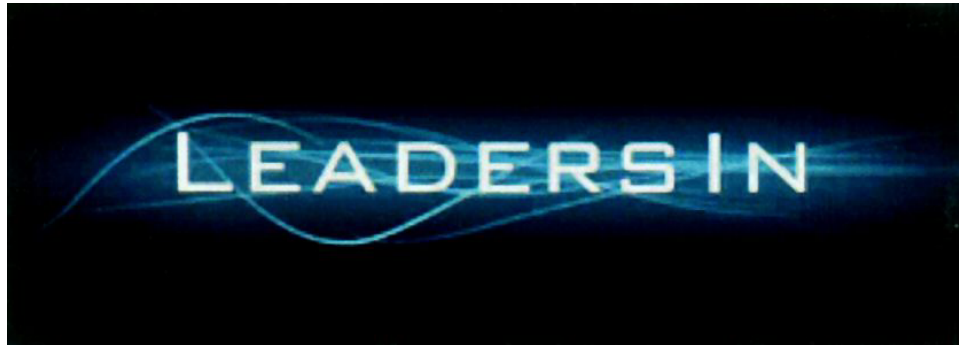

Reg. No. 4,204,126

Registered Sep. 11, 2012

Int. Cls.: 35, 38 and 41

SERVICE MARK

PRINCIPAL REGISTER

BVO (UNITED KINGDOM PRIVATE LIMITED COMPANY)
REGUS
50 BROADWAY
LONDON, UNITED KINGDOM SW1H 0RG

FOR: ADVERTISING AND COMMERCIAL INFORMATION SERVICES ALL PROVIDED VIA THE INTERNET; RENTAL OF ADVERTISING SPACE; BUSINESS INFORMATION SERVICES PROVIDED ONLINE FROM A GLOBAL COMPUTER NETWORK; PROVIDING A SEARCHABLE ONLINE ADVERTISING GUIDE FEATURING THE GOODS AND SERVICES OF PUBLIC SPEAKERS AND PROVIDERS OF EDUCATIONAL AND INFORMATIONAL CONTENT; ARRANGING BUSINESS INTRODUCTIONS, NAMELY, BUSINESS NETWORKING SERVICES; FACILITATING NETWORKING AND SOCIALIZING OPPORTUNITIES FOR BUSINESS PURPOSES BETWEEN PUBLIC SPEAKERS AND PROVIDERS OF EDUCATIONAL AND INFORMATIONAL CONTENT TO POTENTIAL CLIENTS; ARRANGING AND CONDUCTING OFFLINE AND ONLINE NETWORKING EVENTS FOR BUSINESS PURPOSES, IN CLASS 35 (U.S. CLS. 100, 101 AND 102).

FOR: INTERNET BROADCASTING SERVICES; TELEVISION AND RADIO BROADCASTING SERVICES; TELECOMMUNICATION SERVICES, NAMELY, TRANSMISSION AND PEER-TO-PEER SHARING OF VOICE, DATA, GRAPHICS, IMAGES, AUDIO AND VIDEO BY MEANS OF TELECOMMUNICATIONS NETWORKS, WIRELESS COMMUNICATION NETWORKS, AND THE INTERNET; PROVISION OF ACCESS TO A PORTAL ENABLING USERS TO SHARE VIDEOS, AUDIO CONTENT AND MULTIMEDIA CONTENT; PROVISION OF ONLINE FORUMS ON WHICH USERS CAN POST, SEARCH, WATCH, RATE, ASSESS, CRITIQUE AND COMMENT ON VIDEOS, AUDIO CONTENT AND MULTIMEDIA CONTENT; VIDEOPHONE CONFERENCING SERVICES; AUDIO CONFERENCING SERVICES; VIDEO-CONFERENCING SERVICES; PROVIDING ACCESS TO A VIDEO SHARING PORTAL FOR ENTERTAINMENT AND EDUCATION PURPOSES, IN CLASS 38 (U.S. CLS. 100, 101 AND 104).

FOR: TRAINING SERVICES, NAMELY, INTERACTIVE ON-LINE TRAINING SERVICES IN THE FIELDS OF BUSINESS PRODUCTIVITY, LEADERSHIP, INNOVATION, MARKETING AND ENTREPRENEURSHIP; TRAINING SERVICES, NAMELY, BUSINESS TRAINING; PROVISION INFORMATION ABOUT EDUCATION OVER A GLOBAL COMPUTER NETWORK OR THE INTERNET; PROVISION OF INFORMATION RELATING TO EDUCATIONAL AND TRAINING CONFERENCES AND SEMINARS; ARRANGING AND CONDUCTING EDUCATIONAL CONFERENCES; EDUCATIONAL SERVICES, NAMELY, CONDUCTING



David J. Kappas

Director of the United States Patent and Trademark Office

Reg. No. 4,204,126 COURSES, SEMINARS, WORKSHOPS, CLASSES AND WEBINARS IN THE FIELD OF IN THE FIELDS OF BUSINESS PRODUCTIVITY, LEADERSHIP, INNOVATION, MARKETING AND ENTREPRENEURSHIP; ARRANGING AND CONDUCTING EDUCATIONAL CONFERENCES OVER A GLOBAL COMPUTER NETWORK OR THE INTERNET; EDUCATIONAL SERVICES, NAMELY, CONDUCTING COURSES, SEMINARS, WORKSHOPS AND CLASSES PROVIDED OVER A GLOBAL COMPUTER NETWORK OR THE INTERNET IN THE FIELD OF IN THE FIELDS OF BUSINESS PRODUCTIVITY, LEADERSHIP, INNOVATION, MARKETING AND ENTREPRENEURSHIP, IN CLASS 41 (U.S. CLS. 100, 101 AND 107).

THE MARK CONSISTS OF WORDING "LEADERSIN" IN WHITE AGAINST A BLACK BACKGROUND WITH STRAIGHT AND WAVY HORIZONTAL LINES IN TURQUOISE BEHIND THE WORDING "LEADERSIN".

PRIORITY DATE OF 1-21-2011 IS CLAIMED.

OWNER OF INTERNATIONAL REGISTRATION 1092966 DATED 6-20-2011, EXPIRES 6-20-2021.

THE COLOR(S) WHITE, BLACK AND TURQUOISE IS/ARE CLAIMED AS A FEATURE OF THE MARK.

THE TEXT OF "LEADERSIN" IS IN WHITE AND THE BACKGROUND TO THE TEXT IS BLACK AND TURQUOISE.

SER. NO. 79-103,398, FILED 6-20-2011.

JANICE KIM, EXAMINING ATTORNEY

United States of America

United States Patent and Trademark Office



Reg. No. 4,204,127

Registered Sep. 11, 2012

Int. Cls.: 10 and 16

TRADEMARK

PRINCIPAL REGISTER

KARL STORZ GMBH & CO. KG (FED REP GERMANY GMBH & CO. KG)
MITTELSTRASSE 8
78532 TUTTLINGEN
FED REP GERMANY

FOR: MEDICAL APPARATUS AND INSTRUMENTS, NAMELY, SURGICAL INSTRUMENTS AND APPARATUS CONSISTING OF AN ILLUMINATED MODULAR RETRACTOR FOR MINIMALLY INVASIVE SPINAL SURGERY, IN CLASS 10 (U.S. CLS. 26, 39 AND 44).

FOR: PRINTED MATERIAL, NAMELY, CATALOGUES, MAGAZINES, JOURNALS, BROCHURES AND INFORMATIONAL FLYERS, LETTERS AND SHEETS IN THE FIELD OF MEDICAL TECHNOLOGY RELATED TO AN ILLUMINATED MODULAR RETRACTOR FOR MINIMALLY INVASIVE SPINAL SURGERY; PRINTED TEACHING AND INSTRUCTIONAL MANUALS IN THE FIELD OF MEDICAL TECHNOLOGY RELATED TO AN ILLUMINATED MODULAR RETRACTOR FOR MINIMALLY INVASIVE SPINAL SURGERY; BINDERS; PHOTOGRAPHS, IN CLASS 16 (U.S. CLS. 2, 5, 22, 23, 29, 37, 38 AND 50).

THE MARK CONSISTS OF A RECTANGLE CONTAINING THE SHAPE OF AN OCTOPUS AND WORD "TENTACLES".

PRIORITY DATE OF 3-12-2011 IS CLAIMED.

OWNER OF INTERNATIONAL REGISTRATION 1092979 DATED 8-17-2011, EXPIRES 8-17-2021.

SER. NO. 79-103,404, FILED 8-17-2011.

JOHN DWYER, EXAMINING ATTORNEY



David J. Kybas

Director of the United States Patent and Trademark Office

United States of America
United States Patent and Trademark Office

RoT Tac

Reg. No. 4,204,128

Registered Sep. 11, 2012

Int. Cl.: 7

TRADEMARK

PRINCIPAL REGISTER

OERLIKON TEXTILE GMBH & CO. KG (FED REP GERMANY LIMITED PARTNERSHIP)
LEVERKUSER STRAÙE 65
42897 REMSCHEID
FED REP GERMANY

FOR: MELT-SPINNING MACHINES FOR THE PRODUCTION OF YARNS, FIBRES OR FIL-AMENTS MADE OF THERMOPLASTIC AND COMPONENTS FOR THESE MACHINES IN-CLUDED IN THIS CLASS; SPINNING TEXTURING MACHINES FOR THE PRODUCTION OF CRIMPED YARNS, CRIMPED FIBRES OR CRIMPED FILAMENTS MADE OF THERMO-PLASTIC AND COMPONENTS FOR THESE MACHINES INCLUDED IN THIS CLASS; TEXTILE MACHINE COMPONENTS AND APPARATUSES FOR TREATMENT OF SYNTHET-IC FILAMENTS, FIBRES, YARNS OR THREADS NAMELY TEXTILE MACHINE COMPON-ENTS AND APPARATUSES FOR ENTANGLEMENT OR INTERMINGLING OF SYNTHETIC MULTIFILAMENT YARNS; ALL OF THE FOREGOING EXCLUDING ROTARY ACTUATORS , IN CLASS 7 (U.S. CLS. 13, 19, 21, 23, 31, 34 AND 35).

THE MARK CONSISTS OF STANDARD CHARACTERS WITHOUT CLAIM TO ANY PAR-TICULAR FONT, STYLE, SIZE, OR COLOR.

PRIORITY DATE OF 4-14-2011 IS CLAIMED.

OWNER OF INTERNATIONAL REGISTRATION 1092980 DATED 7-30-2011, EXPIRES 7-30-2021.

SER. NO. 79-103,405, FILED 7-30-2011.

ANN E. SAPPENFIELD, EXAMINING ATTORNEY



David J. Kyffers

Director of the United States Patent and Trademark Office

United States of America

United States Patent and Trademark Office

VIOT

Reg. No. 4,204,129

Registered Sep. 11, 2012

Int. Cls.: 9 and 10

TRADEMARK

PRINCIPAL REGISTER

INTERACOUSTICS A/S (DENMARK AKTIESELSKAB)
DREJERVÆNGET 8
DK-5610 ASSENS
DENMARK

FOR: SOFTWARE FOR MEASURING APPARATUS AND INSTRUMENTS, NAMELY, SOFTWARE TO TRANSMIT OTOSCOPE IMAGES TO COMPUTER SCREENS; EARPHONES, VIDEO PROJECTORS, VIDEO GLASSES, IN CLASS 9 (U.S. CLS. 21, 23, 26, 36 AND 38).

FOR: MEASURING APPARATUS AND INSTRUMENTS, NAMELY, AUDIOLOGICAL MEASURING EQUIPMENT AND BALANCE MEASURING EQUIPMENT, AUDIOLOGICAL, NEUROLOGIC AND VESTIBULAR MEASURING INSTRUMENTS, MIDDLE EAR ANALYZERS, AUDIOMETERS, HEARING AID ANALYZERS AND PATIENT COUNSELING TOOLS AND INSTRUMENTATIONS FOR ADAPTATION AND INDIVIDUALIZATION OF HEARING AIDS; VIDEO OTOSCOPE; PARTS OF AND FITTINGS FOR MEDICAL AND CLINICAL PURPOSES FOR ALL THE AFORESAID GOODS, IN CLASS 10 (U.S. CLS. 26, 39 AND 44).

THE MARK CONSISTS OF STANDARD CHARACTERS WITHOUT CLAIM TO ANY PARTICULAR FONT, STYLE, SIZE, OR COLOR.

PRIORITY DATE OF 1-7-2011 IS CLAIMED.

OWNER OF INTERNATIONAL REGISTRATION 1093033 DATED 6-1-2011, EXPIRES 6-1-2021.

SER. NO. 79-103,422, FILED 6-1-2011.

AMY C. KEAN, EXAMINING ATTORNEY



David J. Kappas

Director of the United States Patent and Trademark Office

United States of America

United States Patent and Trademark Office

SAIBENE

Reg. No. 4,204,130

Registered Sep. 11, 2012

Int. Cls.: 24, 25 and 40

TRADEMARK

SERVICE MARK

PRINCIPAL REGISTER

SAIBENE ALFONSO (ITALY INDIVIDUAL)
PIAZZA G. AMENDOLA, 33
I-22100 COMO
ITALY AND

SAIBENE CARLOTTA (ITALY INDIVIDUAL)
VIA STOPPA, 3
SAN FERMO DELLA BATTAGLIA (CO)
ITALY

FOR: TEXTILE AND TEXTILE GOODS, NAMELY, CURTAINS, BED AND TABLE LINENS, WALL HANGINGS, AND TEXTILE FABRICS FOR HOME AND COMMERCIAL INTERIORS; BED COVERS AND PLASTIC TABLE COVERS, IN CLASS 24 (U.S. CLS. 42 AND 50).

FOR: CLOTHING, NAMELY, COATS, MANTLES, RAINCOATS, DRESSES, SUITS, SKIRTS, JACKETS, TROUSERS, WAISTCOATS, SHIRTS, T-SHIRTS, BLOUSES, JERSEYS, SWEATERS, BLAZERS, CARDIGANS, STOCKINGS, SOCKS, UNDERWEAR, CORSETS, NIGHTGOWNS, PAJAMAS, BATHROBES, BATHING SUITS, SUNSUITS, JEANS, SPORT JACKETS, WIND-RESISTANT JACKETS, ANORAKS, SWEATSUITS, TIES, NECKTIES, SCARVES, SHAWLS, FOULARDS, CAPS, HATS, GLOVES, SASHES, AND BELTS; FOOTWEAR, NAMELY, BOOTS, SHOES, AND SLIPPERS; HEADWEAR, IN CLASS 25 (U.S. CLS. 22 AND 39).

FOR: CUSTOM ASSEMBLY OF THREAD, YARN AND TEXTILES FOR OTHERS, IN CLASS 40 (U.S. CLS. 100, 103 AND 106).

THE MARK CONSISTS OF STANDARD CHARACTERS WITHOUT CLAIM TO ANY PARTICULAR FONT, STYLE, SIZE, OR COLOR.

PRIORITY DATE OF 5-30-2011 IS CLAIMED.

OWNER OF INTERNATIONAL REGISTRATION 1093081 DATED 6-8-2011, EXPIRES 6-8-2021.

SER. NO. 79-103,448, FILED 6-8-2011.

CHRISIE B. KING, EXAMINING ATTORNEY



David J. Kyros

Director of the United States Patent and Trademark Office

United States of America
United States Patent and Trademark Office

VALESTA

Reg. No. 4,204,131

Registered Sep. 11, 2012

Int. Cl.: 35

SERVICE MARK

PRINCIPAL REGISTER

ON ASSIGNMENT, INC., DELAWARE CORPORATION (DELAWARE CORPORATION)
26745 MALIBU HILLS ROAD
CALABASAS, CA
UNITED STATES 91301

FOR: PERSONNEL PLACEMENT SERVICES, NAMELY, PROVIDING AND SELECTING PERSONNEL; EMPLOYMENT AND CONSULTANCY AGENCIES FOR MATTERS RELATING TO PERSONNEL AND PERSONNEL MATTERS, NAMELY, PERSONNEL PLACEMENT AND PERSONNEL RELOCATION; BUSINESS MIDDLEMAN SERVICES BETWEEN THOSE LOOKING FOR AND THOSE PROVIDING SERVICES, NAMELY, FACILITATING TRANSACTIONS BETWEEN BUYERS AND SELLERS BY PROVIDING BUYERS WITH INFORMATION ABOUT SELLERS, GOODS AND SERVICES AND PROVIDING SELLERS WITH INFORMATION ABOUT POTENTIAL BUYERS; COMMERCIAL LOBBYING SERVICES, NAMELY, LOBBYING FOR BUSINESS PURPOSES; ORGANIZATION OF EXHIBITIONS AND TRADE SHOWS FOR COMMERCIAL OR ADVERTISING PURPOSES; PUBLIC RELATIONS; COMPUTER FILE MANAGEMENT; INFORMATION AND CONSULTING IN THE FIELDS OF PERSONNEL PLACEMENT AND RELOCATION SERVICES, EMPLOYMENT SERVICES, AND COMMERCIAL LOBBYING SERVICES, IN CLASS 35 (U.S. CLS. 100, 101 AND 102).

THE MARK CONSISTS OF STANDARD CHARACTERS WITHOUT CLAIM TO ANY PARTICULAR FONT, STYLE, SIZE, OR COLOR.

OWNER OF INTERNATIONAL REGISTRATION 0999900 DATED 7-15-2008, EXPIRES 7-15-2018.

THE WORDING "VALESTA" HAS NO MEANING IN A FOREIGN LANGUAGE.

SER. NO. 79-103,477, FILED 12-22-2010.

DAVID MURRAY, EXAMINING ATTORNEY



David J. Kyffers

Director of the United States Patent and Trademark Office

United States of America

United States Patent and Trademark Office

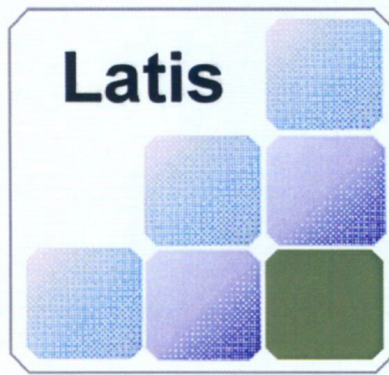

Reg. No. 4,204,132

Registered Sep. 11, 2012

Int. Cl.: 6

SHIN NIPPON SEITETSU KABUSHIKI KAISHA (JAPAN CORPORATION), DBA NIPPON STEEL CORPORATION
NO. 6-1, MARUNOUCHI 2-CHOME
CHIYODA-KU; TOKYO 100-8071
JAPAN

TRADEMARK

PRINCIPAL REGISTER

FOR: EMBOSSED STEEL SHEETS; GALVANIZED STEEL SHEETS; COLORED STEEL SHEETS; STEEL SHEETS WITH DESIGN; STEEL SHEETS; STEEL STRIPS; METAL BOARDS FOR BUILDING; LININGS OF METAL FOR BUILDING PURPOSES; METAL MATERIALS USED FOR BUILDING, NAMELY, SHEETS AND PLATES OF METAL FOR USE IN BUILDING CONSTRUCTION, IN CLASS 6 (U.S. CLS. 2, 12, 13, 14, 23, 25 AND 50).

THE MARK CONSISTS OF THE FOLLOWING: A LARGE WHITE SQUARE BORDERED BY A THIN GREY LINE WITHIN WHICH IS THE WORDING "LATIS" IN THE COLOR BLACK APPEARING IN THE UPPER LEFT SECTION OF THE LARGE WHITE SQUARE; IN THE BOTTOM RIGHT CORNER OF THE SQUARE APPEARS A SMALLER GREEN SQUARE; TO THE LEFT OF THE GREEN SQUARE ARE TWO PURPLE SQUARES OF THE SAME SIZE AS THE GREEN AND APPEARING IN A DIAGONAL LINE; TO THE LEFT OF THE TWO PURPLE SQUARES ARE THREE BLUE SQUARES FORMING A DIAGONAL LINE.

PRIORITY DATE OF 8-18-2011 IS CLAIMED.

OWNER OF INTERNATIONAL REGISTRATION 1093170 DATED 8-29-2011, EXPIRES 8-29-2021.

THE COLOR(S) BLUE, PURPLE, GREEN, WHITE, BLACK AND GREY IS/ARE CLAIMED AS A FEATURE OF THE MARK.

SER. NO. 79-103,509, FILED 8-29-2011.

SUZANNE BLANE, EXAMINING ATTORNEY



David J. Kyros

Director of the United States Patent and Trademark Office

Reg. No. 4,204,133 IN EXHIBITION CENTERS, NAMELY, PROVIDING SEMINARS, WORKSHOPS, LECTURES AND TUTORIALS IN THE FIELD OF GRANITES, STONES, MARBLE, MACHINERY AND ARCHITECTURAL DESIGN, ON SHOW GROUNDS AND IN UNIVERSITY CENTERS FOR CULTURAL, EDUCATIONAL, SPORTING AND ENTERTAINMENT PURPOSES; PROFESSIONAL TRAINING SERVICES FOR ARCHITECTS AND DESIGNERS; ALL THE AFORE SAID SERVICES ON BEHALF OF THIRD PARTIES, IN CLASS 41 (U.S. CLS. 100, 101 AND 107).

FOR: PROVIDING FACILITIES FOR EXHIBITIONS; PROVIDING CONFERENCE ROOMS; ALL THE AFORE SAID SERVICES ON BEHALF OF THIRD PARTIES, IN CLASS 43 (U.S. CLS. 100 AND 101).

THE MARK CONSISTS OF A SIGN DEPICTING THE WORDING "MARMOMACC" IN FANCY CHARACTERS, UNDER WHICH THERE IS A SERIES OF STYLIZED BOXES PLACED HORIZONTALLY ONE NEXT TO THE OTHER, UNDER WHICH THERE ARE THE WORDINGS "MEETS DESIGN" IN FANCY CHARACTERS.

PRIORITY DATE OF 9-16-2010 IS CLAIMED.

OWNER OF INTERNATIONAL REGISTRATION 1093181 DATED 1-26-2011, EXPIRES 1-26-2021.

THE WORDING "MARMOMACC" HAS NO MEANING IN A FOREIGN LANGUAGE.

SER. NO. 79-103,518, FILED 1-26-2011.

AMY ALFIERI, EXAMINING ATTORNEY

United States of America

United States Patent and Trademark Office

WONIK IPS

Reg. No. 4,204,134

Registered Sep. 11, 2012

Int. Cls.: 7 and 37

TRADEMARK

SERVICE MARK

PRINCIPAL REGISTER

WONIK IPS CO., LTD (REPUBLIC OF KOREA LIMITED COMPANY)
332-1, CHEONGHO-RI,
JINWI-MYEON, PYEONGTAEK-SI, GYEONGGI-DO 451-862
REPUBLIC OF KOREA

FOR: SEMICONDUCTOR MANUFACTURING EQUIPMENT, NAMELY, THIN FILM DEPOSITION APPARATUS, SPUTTERING APPARATUS, ETCHING APPARATUS, EVAPORATION DEPOSITION APPARATUS, PLASMA CHEMICAL VAPOR DEPOSITION APPARATUS, COUPLED PLASMA CHEMICAL VAPOR DEPOSITION APPARATUS, ATOMIC LAYER DEPOSITION APPARATUS, ION BEAM DEPOSITION APPARATUS, ION BEAM ETCHING APPARATUS, ANNEALING APPARATUS, RAPID THERMAL PROCESSING APPARATUS, LOW TEMPERATURE ANNEALING APPARATUS, COUPLED SPUTTERING APPARATUS, MULTIPLE SPUTTERING APPARATUS, LASER SUBLIMATION DEPOSITION APPARATUS, ORGANIC MOLECULAR CHEMICAL VAPOR DEPOSITION APPARATUS, ION BEAM GENERATION APPARATUS, ION BEAM SPUTTER DEPOSITION APPARATUS, ION BEAM ETCHING APPARATUS, ION BEAM ASSISTED DEPOSITION APPARATUS, ELECTRON BEAM ASSISTED DEPOSITION APPARATUS, ELECTRON BEAM CRYSTALLIZATION APPARATUS, ELECTRON BEAM ANNEALING APPARATUS, OXIDATION MECHANICAL APPARATUS, ION IMPLANTATION APPARATUS, CHEMICAL VAPOR PRECIPITATION MECHANICAL APPARATUS, SPUTTERING MECHANICAL APPARATUS, AND PROBE; LIQUID CRYSTAL DISPLAY MANUFACTURING EQUIPMENT, NAMELY, FILM DEPOSITION APPARATUS, SPUTTERING APPARATUS, COUPLED SPUTTERING APPARATUS, ETCHING APPARATUS, EVAPORATION DEPOSITION APPARATUS, PLASMA CHEMICAL VAPOR DEPOSITION APPARATUS, ION BEAM DEPOSITION APPARATUS, ION BEAM ETCHING APPARATUS AND ANNEALING APPARATUS, SPUTTERING MECHANICAL APPARATUS, AND PROBE; ORGANIC ELECTROLUMINESCENCE DISPLAY MANUFACTURING EQUIPMENT, NAMELY, THIN FILM DEPOSITION APPARATUS, SPUTTERING APPARATUS, COUPLED SPUTTERING APPARATUS, ETCHING APPARATUS, EVAPORATION DEPOSITION APPARATUS, PLASMA CHEMICAL VAPOR DEPOSITION APPARATUS, ION BEAM DEPOSITION APPARATUS, ION BEAM ETCHING APPARATUS AND ANNEALING APPARATUS; PLASMA DISPLAY PANEL MANUFACTURING EQUIPMENT, NAMELY, THIN FILM DEPOSITION APPARATUS, SPUTTERING APPARATUS, COUPLED SPUTTERING APPARATUS, ETCHING APPARATUS, EVAPORATION DEPOSITION APPARATUS, ION BEAM DEPOSITION APPARATUS, ION BEAM ETCHING APPARATUS, AND ANNEALING APPARATUS; SOLAR CELL MANUFACTURING EQUIPMENT, NAMELY, THIN FILM DEPOSITION APPARATUS, SPUTTERING APPARATUS, COUPLED SPUTTERING APPARATUS, ETCHING APPARATUS, EVAPORATION DEPOSITION APPARATUS, PLASMA



David J. Kyjars

Director of the United States Patent and Trademark Office

Reg. No. 4,204,134 CHEMICAL VAPOR DEPOSITION APPARATUS, RAPID THERMAL PROCESSING APPARATUS, ION BEAM DEPOSITION APPARATUS, ION BEAM ETCHING APPARATUS AND ANNEALING APPARATUS; LIGHT EMITTING DIODE (LED) MANUFACTURING EQUIPMENT, NAMELY, THIN FILM DEPOSITION APPARATUS, CHEMICAL VAPOR DEPOSITION APPARATUS, SPUTTERING APPARATUS, COUPLED SPUTTERING APPARATUS, ETCHING APPARATUS, EVAPORATION DEPOSITION APPARATUS, PLASMA CHEMICAL VAPOR DEPOSITION APPARATUS, ION BEAM DEPOSITION APPARATUS, ION BEAM ETCHING APPARATUS, ELECTRON BEAM ANNEALING APPARATUS; MICROELECTROMECHANICAL SYSTEMS (MEMS) MANUFACTURING EQUIPMENT, NAMELY, THIN FILM DEPOSITION APPARATUS, SPUTTERING APPARATUS, EVAPORATION DEPOSITION APPARATUS AND CHEMICAL VAPOR DEPOSITION APPARATUS; ACTIVE MATRIX LIGHT EMITTING DIODE (AMOLED) DISPLAY MANUFACTURING EQUIPMENT, NAMELY, THIN FILM DEPOSITION APPARATUS, SPUTTERING APPARATUS, COUPLED SPUTTERING APPARATUS, ETCHING APPARATUS, EVAPORATION DEPOSITION APPARATUS, PLASMA CHEMICAL VAPOR DEPOSITION APPARATUS, ION BEAM DEPOSITION APPARATUS AND ION BEAM ANNEALING APPARATUS, IN CLASS 7 (U.S. CLS. 13, 19, 21, 23, 31, 34 AND 35).

FOR: INSTALLATION, REPAIR AND MAINTENANCE OF SEMICONDUCTOR PROCESSING MACHINES, SEMICONDUCTOR WAFER PROCESSING APPARATUS, ATOMIC LAYER DEPOSITION APPARATUS, LOW PRESSURE CHEMICAL VAPOR DEPOSITION APPARATUS, DIFFUSION FURNACES, PLASMA CHEMICAL VAPOR DEPOSITION APPARATUS, METAL ORGANIC CHEMICAL VAPOR DEPOSITION APPARATUS, FAST-HEATING PROCESSING APPARATUS, HIGH TEMPERATURE CHEMICAL VAPOR DEPOSITION APPARATUS, VAPOR EPITAXY APPARATUS, LIQUID EPITAXY APPARATUS, NORMAL PRESSURE CHEMICAL VAPOR DEPOSITION APPARATUS, MID PRESSURE CHEMICAL VAPOR DEPOSITION APPARATUS, ETCHERS, SPUTTERING APPARATUS, PHOTOLITHOGRAPHY APPARATUS, DEVELOPERS, ASHING APPARATUS, CLEANING APPARATUS AND POLISHING APPARATUS, ALL FOR THE MANUFACTURE OF SEMICONDUCTORS; INSTALLATION, REPAIR AND MAINTENANCE OF DEPOSITION APPARATUS ETCHERS, SPUTTERING APPARATUS, PHOTOLITHOGRAPHY APPARATUS, DEVELOPERS, ASHING APPARATUS, CLEANING APPARATUS AND POLISHING APPARATUS, ALL FOR THE MANUFACTURE OF LIQUID CRYSTAL DISPLAY PANELS; INSTALLATION, REPAIR AND MAINTENANCE OF DEPOSITION APPARATUS, ETCHERS FOR MANUFACTURING SOLAR CELLS, SPUTTERING APPARATUS, PHOTOLITHOGRAPHY APPARATUS, DEVELOPERS FOR MANUFACTURING SOLAR CELLS, ASHING APPARATUS, CLEANING APPARATUS AND POLISHING APPARATUS, ALL FOR THE MANUFACTURE OF SOLAR CELLS; MAINTENANCE OF DEPOSITION APPARATUS, ETCHERS, SPUTTERING APPARATUS, PHOTOLITHOGRAPHY APPARATUS, DEVELOPERS, ASHING APPARATUS, CLEANING APPARATUS, AND POLISHING APPARATUS, ALL FOR THE MANUFACTURE OF LED AND AMOLED DISPLAYS, IN CLASS 37 (U.S. CLS. 100, 103 AND 106).

THE MARK CONSISTS OF THE STYLIZED WORDING "WONIK" IN BLUE, THE STYLIZED LETTERS "IPS" IN RED, AND A GRAY CIRCULAR DESIGN INSIDE THE CHARACTER "O".

PRIORITY DATE OF 3-10-2011 IS CLAIMED.

OWNER OF INTERNATIONAL REGISTRATION 1093207 DATED 3-16-2011, EXPIRES 3-16-2021.

THE COLOR(S) BLUE, RED AND GRAY IS/ARE CLAIMED AS A FEATURE OF THE MARK.

THE WORDING "WONIK" HAS NO MEANING IN A FOREIGN LANGUAGE.

SER. NO. 79-103,531, FILED 3-16-2011.

ROBIN MITTLER, EXAMINING ATTORNEY

United States of America

United States Patent and Trademark Office



幽幽清泉

Reg. No. 4,204,135

Registered Sep. 11, 2012

Int. Cls.: 5 and 30

TRADEMARK

PRINCIPAL REGISTER

GUANGXI GOLDEN THROAT CO., LTD. (CHINA LIMITED COMPANY)
NO. 28, YUEJIN ROAD
545001 LIUZHOU CITY, GUANGXI
CHINA

FOR: MEDICINES FOR HUMAN PURPOSES, NAMELY, THROAT LOZENGES, MEDICATED LOZENGES, ANALGESICS, ANTI-INFECTIVES, ANTI-FLAMMATORIES, ANTIBIOTICS, ANTIVIRALS, ANTIDEPRESSANTS, ANTIFLATULANTS, ANTIPARASITICS AND ANTI-SEPTICS; MEDICATED CANDY; SANITARY STERILIZING PREPARATIONS; GASES FOR MEDICAL PURPOSES; MEDICINAL TEA; MEDICATED LIQUOR FOR USE IN ACTIVATING BLOOD CIRCULATION AND ELIMINATE BLOOD STASIS, TO RELIEVE MUSCULAR CONTRACTURE, TO REMOVE SWELLING AND PAIN, TO TREAT TRAUMATIC INJURIES, AND TO ELIMINATE FATIGUE BEFORE AND AFTER EXERCISE; SYRUPS FOR MEDICAL PURPOSES, NAMELY, COUGH SYRUPS; CONTACT LENS CLEANING PREPARATIONS; CANDY FOR MEDICAL PURPOSES; CHEWING GUM FOR MEDICAL PURPOSES; DIETETIC SUBSTANCES ADAPTED FOR MEDICAL USE, NAMELY, DIETETIC FOODS ADAPTED FOR MEDICAL PURPOSES, DIETARY SUPPLEMENTAL DRINKS, DIETARY SUPPLEMENTS, DIETARY AND NUTRITIONAL SUPPLEMENTS AND LIQUID NUTRITIONAL SUPPLEMENTS; DIETETIC BEVERAGES ADAPTED FOR MEDICAL PURPOSES; FOOD FOR BABIES; AIR PURIFYING PREPARATIONS; MEDICINES FOR VETERINARY PURPOSES, NAMELY, VETERINARY VACCINES FOR BOVINES AND HORSES; PESTICIDES; SANITARY TOWELS; ADHESIVE BANDS FOR MEDICAL PURPOSES; MEDICINAL HEALTH KITS CONSISTING PRIMARILY OF MEDICAL HERBS; TEETH FILLING MATERIALS, NAMELY, FILLINGS FOR TEETH, IN CLASS 5 (U.S. CLS. 6, 18, 44, 46, 51 AND 52).



David J. Kypos

Director of the United States Patent and Trademark Office

FOR: COFFEE; COFFEE-BASED BEVERAGES; TEA; TEA-BASED BEVERAGES; SUGAR; CANDY; HONEY; DIETETIC SUBSTANCES IN LIQUID FORM NOT FOR MEDICAL PURPOSES, NAMELY, HERBAL FOOD BEVERAGES; CHEWING GUM, NOT FOR MEDICAL PURPOSES; PASTRIES; INSTANT RICE IN THE NATURE OF DRIED COOKED-RICE; EIGHT INGREDIENT PORRIDGE, NAMELY, RICE BASED PORRIDGE CONTAINING DRIED LONGAN PULP, LOTUS NUT, PEANUT, RED BEAN, GREEN BEAN, RED JUJUBE, GLUTINOUS RICE AND DRIED LILY BULB; CEREAL PREPARATIONS, NAMELY, PROCESSED CEREALS AND BREAKFAST CEREALS; OAT FLAKES; NOODLES; INSTANT NOODLES; GOODS MADE FROM SESAME SEEDS, NAMELY, SESAME PASTE; CRISPY RICE, NAMELY, RICE-BASED SNACK FOODS; FOOD STARCH; ICE CREAM; SALT; VINEGAR; SOY SAUCES; SEASONINGS; YEAST; FLAVORINGS FOR FOODS, EXCLUDING ETHERIC

Reg. No. 4,204,135 ESSENCES AND ESSENTIAL OILS; MEAT TENDERIZERS FOR HOUSEHOLD PURPOSES,
IN CLASS 30 (U.S. CL. 46).

OWNER OF U.S. REG. NO. 3,956,809.

PRIORITY DATE OF 5-4-2011 IS CLAIMED.

OWNER OF INTERNATIONAL REGISTRATION 1093210 DATED 6-1-2011, EXPIRES 6-1-2021.

THE TRANSLITERATION OF THE NON-LATIN CHARACTERS IN THE MARK IS: YOU
YOU QING QUAN.

THE MARK CONSISTS OF A WATERFALL RUNNING THROUGH DARK ROCKS, ALL
APPEARING IN A SQUARE. ASIAN CHARACTERS APPEAR BENEATH THE SQUARE.

THE ENGLISH TRANSLATION OF THE FOREIGN WORD(S) IN THE MARK IS: "QUIET
CLEAR SPRING".

SER. NO. 79-103,534, FILED 6-1-2011.

KAREN SEVERSON, EXAMINING ATTORNEY

United States of America

United States Patent and Trademark Office

brosway

Reg. No. 4,204,136

Registered Sep. 11, 2012

Int. Cls.: 9, 16 and 25

TRADEMARK

PRINCIPAL REGISTER

4B COMPANY S.R.L. (ITALY LIMITED LIABILITY COMPANY)
VIA GUIDO ROSSA, 1
I-63833 MONTEGIORGIO (FERMO)
ITALY

FOR: SCIENTIFIC, NAUTICAL APPARATUS AND INSTRUMENTS, NAMELY, ANEMOMETERS; SURVEYING APPARATUS AND INSTRUMENTS, NAMELY, DISTANCE MEASURING APPARATUS; PHOTOGRAPHIC, CINEMATOGRAPHIC APPARATUS AND INSTRUMENTS, NAMELY, VIDEO CAMERAS, STILL CAMERAS; INSTRUMENTS OPTICAL, NAMELY, EYE GLASSES, SUNGLASSES, OPTICAL GLASSES; WEIGHING INSTRUMENTS, NAMELY, BALANCES; MEASURING INSTRUMENTS, NAMELY, RULES, COMPASSES; SIGNALING, CHECKING, SUPERVISION, LIFE-SAVING AND TEACHING APPARATUS AND INSTRUMENTS, NAMELY, LIFE JACKETS, LIFE RAFTS, MEDICAL TEACHING MANNEQUINS, DIGITAL SIGNAL PROCESSORS; APPARATUS AND INSTRUMENTS FOR CONDUCTING, SWITCHING, TRANSFORMING, ACCUMULATING, REGULATING OR CONTROLLING ELECTRICITY, NAMELY, ELECTRICAL CONDUCTORS, ELECTRIC SWITCHES, ELECTRIC TRANSFORMERS, ELECTRIC ACCUMULATORS, VOLTAGE REGULATORS FOR ELECTRIC POWER; COMPUTERS, COMPUTER HARDWARE AND COMPUTER GAME SOFTWARE; APPARATUS FOR RECORDING, TRANSMISSION OR REPRODUCTION OF SOUND OR IMAGES, NAMELY, HI-FI AUDIO SPEAKERS, AMPLIFIERS, HI-FI SOUND EQUALIZERS, AUDIO, VIDEO AND COMPUTER ELECTRICAL CONNECTORS; MAGNETIC DATA CARRIERS, NAMELY, HARD DISK PLAYERS AND RECORDERS, FLOPPY DISCS FOR COMPUTERS FOR USE IN DATABASE MANAGEMENT, FOR USE AS A SPREADSHEET, AND FLOPPY DISK DRIVES; PRE-RECORDED VIDEO DISCS FEATURING MUSIC; AUTOMATIC VENDING MACHINES AND MECHANISMS FOR COIN-OPERATED APPARATUS; CASH REGISTERS, CALCULATING MACHINES, DATA PROCESSING EQUIPMENT AND COMPUTERS; FIRE-EXTINGUISHING APPARATUS, IN CLASS 9 (U.S. CLS. 21, 23, 26, 36 AND 38).



David J. Kyros

Director of the United States Patent and Trademark Office

FOR: PAPER, CARDBOARD AND GOODS MADE FROM THESE MATERIALS, NOT INCLUDED IN OTHER CLASSES, NAMELY, WRITING PAPER AND PRINTING PAPER; PRINTED MATTER, NAMELY, PRINTED GUIDES FOR CARD GAMES; BOOK BINDING MATERIAL; PHOTOGRAPHS; STATIONERY; ADHESIVES FOR STATIONERY OR HOUSEHOLD PURPOSES; ARTISTS' MATERIALS, NAMELY, ARTISTS' BRUSHES; PAINT BRUSHES; TYPEWRITERS AND OFFICE REQUISITES EXCEPT FURNITURE, NAMELY, CORRECTING FLUID FOR TYPE; INSTRUCTIONAL AND TEACHING MATERIAL EXCEPT APPARATUS, NAMELY, PRINTED INSTRUCTIONAL AND TEACHING MATERIALS IN

Reg. No. 4,204,136 THE FIELD OF MUSIC; PLASTIC MATERIALS FOR PACKAGING NOT INCLUDED IN OTHER CLASSES, NAMELY, PLASTIC BAGS FOR PACKAGING; PRINTERS' TYPE; PRINTING BLOCKS, IN CLASS 16 (U.S. CLS. 2, 5, 22, 23, 29, 37, 38 AND 50).

FOR: CLOTHING, NAMELY, COATS, JACKETS, SKIRTS, TROUSERS, SHORTS, JERSEYS, SHIRTS; FOOTWEAR, NAMELY, BOOTS, SLIPPERS, MULES; HEADGEAR, NAMELY, CAPS AND HATS, IN CLASS 25 (U.S. CLS. 22 AND 39).

THE MARK CONSISTS OF STANDARD CHARACTERS WITHOUT CLAIM TO ANY PARTICULAR FONT, STYLE, SIZE, OR COLOR.

PRIORITY DATE OF 4-28-2011 IS CLAIMED.

OWNER OF INTERNATIONAL REGISTRATION 1093273 DATED 7-13-2011, EXPIRES 7-13-2021.

OWNER OF U.S. REG. NO. 3,307,569.

SER. NO. 79-103,555, FILED 7-13-2011.

COLLEEN DOMBROW, EXAMINING ATTORNEY

United States of America

United States Patent and Trademark Office

GREENHOPPER

Reg. No. 4,204,137

Registered Sep. 11, 2012

Int. Cls.: 9, 41 and 42

TRADEMARK

SERVICE MARK

PRINCIPAL REGISTER

ATLASSIAN PTY LTD (ACN 102 443 916) (AUSTRALIA COMPANY)
LEVEL 1
173-185 SUSSEX STREET; SYDNEY NSW 2000
AUSTRALIA

FOR: DOWNLOADABLE COMPUTER SOFTWARE FOR MANAGING BACKLOG, PLANNING SPRINTS AND TRACKING TEAMS IN THE FIELDS OF PROJECT MANAGEMENT AND DEVELOPMENT; COMPUTER SOFTWARE FOR MANAGING BACKLOG, PLANNING SPRINTS AND TRACKING TEAMS IN THE FIELDS OF PROJECT MANAGEMENT AND DEVELOPMENT RECORDED ON COMPUTER MEDIA; COMPUTER PROGRAMS AND RECORDED SOFTWARE FOR MANAGING BACKLOG, PLANNING SPRINTS AND TRACKING TEAMS IN THE FIELDS OF PROJECT MANAGEMENT AND DEVELOPMENT; DOWNLOADABLE ELECTRONIC PUBLICATIONS, NAMELY, NEWSLETTERS, BROCHURES, TECHNICAL DATA SHEETS, PAMPHLETS AND REPORTS IN THE FIELDS OF PROJECT MANAGEMENT AND DEVELOPMENT; ELECTRONIC PUBLICATIONS, NAMELY, NEWSLETTERS, BROCHURES, TECHNICAL DATA SHEETS, PAMPHLETS AND REPORTS IN THE FIELDS OF PROJECT MANAGEMENT AND DEVELOPMENT RECORDED ON COMPUTER MEDIA; DOWNLOADABLE ELECTRONIC NEWSLETTERS IN THE FIELDS OF PROJECT MANAGEMENT AND DEVELOPMENT; DOWNLOADABLE EDUCATIONAL SOFTWARE FEATURING INSTRUCTION IN PROJECT MANAGEMENT AND DEVELOPMENT, IN CLASS 9 (U.S. CLS. 21, 23, 26, 36 AND 38).

FOR: EDUCATION AND TRAINING, NAMELY, PROVISION OF SEMINARS AND TRAINING TOOLS FOR USING COMPUTER SOFTWARE AND COMPUTER PROGRAMS; PROVIDING EDUCATIONAL SERVICES, NAMELY, SEMINARS AND TUTORIALS IN THE FIELDS OF PROJECT MANAGEMENT AND DEVELOPMENT BY ELECTRONIC MEANS VIA A GLOBAL COMPUTER NETWORK AND DISTRIBUTION OF INSTRUCTIONAL MATERIALS THEREWITH, IN CLASS 41 (U.S. CLS. 100, 101 AND 107).

FOR: COMPUTER SERVICES, NAMELY, HOSTING AND MAINTAINING AN ON-LINE WEB SITE TO ENABLE OTHERS TO MANAGE USER STORIES, REQUIREMENTS AND DEVELOPMENT TASKS; CONSULTING SERVICES IN THE FIELD OF DESIGN AND DEVELOPMENT OF COMPUTER SOFTWARE; SERVICES OF AN APPLICATION SERVICE PROVIDER, NAMELY, HOSTING COMPUTER SOFTWARE APPLICATIONS OF OTHERS; COMPUTER SOFTWARE DESIGN; INSTALLATION, MODIFICATION AND MAINTENANCE OF COMPUTER SOFTWARE; COMPUTER SYSTEM DESIGN AND ANALYSIS; DATE HOSTING SERVICES, NAMELY, APPLICATION SERVICE PROVIDER IN THE FIELD OF



David J. Kyffers

Director of the United States Patent and Trademark Office

Reg. No. 4,204,137 KNOWLEDGE MANAGEMENT TO HOST COMPUTER APPLICATION SOFTWARE FOR CREATING SEARCHABLE DATABASES OF INFORMATION AND DATA AND INTERACTIVE HOSTING SERVICES WHICH ALLOW THE USER TO PUBLISH AND SHARE THEIR OWN CONTENT AND IMAGES ONLINE; DATA CONVERSION OF COMPUTER PROGRAMS AND DATA, NOT PHYSICAL CONVERSION; CONSULTANCY SERVICES IN THE FIELD OF COMPUTERS AND SOFTWARE; PROVIDING INFORMATION AND CONSULTANCY SERVICES IN THE FIELDS OF DESIGN AND DEVELOPMENT OF COMPUTER SOFTWARE, COMPUTER SOFTWARE SYSTEM DESIGN AND ANALYSIS AND DATA HOSTING SERVICES, INCLUDING BY ELECTRONIC MEANS VIA A GLOBAL COMPUTER NETWORK, IN CLASS 42 (U.S. CLS. 100 AND 101).

THE MARK CONSISTS OF STANDARD CHARACTERS WITHOUT CLAIM TO ANY PARTICULAR FONT, STYLE, SIZE, OR COLOR.

PRIORITY DATE OF 5-31-2011 IS CLAIMED.

OWNER OF INTERNATIONAL REGISTRATION 1093422 DATED 8-16-2011, EXPIRES 8-16-2021.

SER. NO. 79-103,610, FILED 8-16-2011.

ANNE FARRELL, EXAMINING ATTORNEY

United States of America

United States Patent and Trademark Office

AEROINV.COM

Reg. No. 4,204,138

Registered Sep. 11, 2012

Int. Cl.: 35

SERVICE MARK

PRINCIPAL REGISTER

AERO INVENTORY (UK) LIMITED (UNITED KINGDOM LIMITED COMPANY)
30 LANCASTER ROAD
NEW BARNET; HERTFORDSHIRE EN4 8AP
UNITED KINGDOM

FOR: THE BRINGING TOGETHER, FOR THE BENEFIT OF OTHERS, OF A VARIETY OF GOODS, ENABLING CUSTOMERS TO CONVENIENTLY VIEW AND PURCHASE, NAMELY, GOODS CONNECTED TO THE REPAIR AND MAINTENANCE OF AIRCRAFT, AIRCRAFT PARTS, AIRCRAFT COMPONENTS, AIRCRAFT FITTINGS, ENGINES, WHEELS, BRAKES, LIGHTING, AND PARTS AND FITTINGS FOR THE AFORESAID; RETAIL AND WHOLESALE STORE SERVICES FEATURING AIRCRAFT PARTS, FITTINGS AND COMPONENTS; THE PROVISION OF BUSINESS INFORMATIONAL, ADVISORY, CONSULTANCY, AND OFFICE SUPPORT STAFF SERVICES TO CUSTOMERS BEFORE, DURING AND AFTER THEIR PURCHASE OF THE AFOREMENTIONED FEATURED AIRCRAFT PARTS, FITTINGS AND COMPONENTS; PROVISION OF ALL AFOREMENTIONED SERVICES BY ELECTRONIC MEANS, INCLUDING VIA THE INTERNET, IN CLASS 35 (U.S. CLS. 100, 101 AND 102).

THE MARK CONSISTS OF STANDARD CHARACTERS WITHOUT CLAIM TO ANY PARTICULAR FONT, STYLE, SIZE, OR COLOR.

PRIORITY DATE OF 5-26-2011 IS CLAIMED.

OWNER OF INTERNATIONAL REGISTRATION 1093472 DATED 9-12-2011, EXPIRES 9-12-2021.

SER. NO. 79-103,632, FILED 9-12-2011.

WILLIAM ROSSMAN, EXAMINING ATTORNEY



David J. Kypos

Director of the United States Patent and Trademark Office

United States of America

United States Patent and Trademark Office

turkana

Reg. No. 4,204,139

Registered Sep. 11, 2012

Int. Cl.: 30

ÇELIKLER GIDA SANAYI VE TICARET LIMITED SIRKETI (TURKEY LIMITED LIABILITY COMPANY)

2.ORGANIZE SANAYI BÖLGESİ

CELAL DOGAN BULVARI NO:3; BASPINAR GAZIANTEP

TURKEY

TRADEMARK

PRINCIPAL REGISTER

FOR: COFFEE, COCOA, COFFEE BASED BEVERAGES; COCOA-BASED BEVERAGES; CHOCOLATE FOOD BEVERAGES NOT BEING DAIRY-BASED OR VEGETABLE BASED; MACARONI, MEAT PIES, VERMICELLI, PASTRIES, PETIT FOURS, TARTS, CAKES; BAKERY DESSERT MADE OF FLOUR; HONEY, PROPOLIS FOR FOOD PURPOSES; FLAVOURINGS FOR FOODS; YEAST, BAKING-POWDER; FLAVOURING ADDITIVES FOR NON-NUTRITIONAL PURPOSES, FLOUR, PROCESSED SEMOLINA, FOOD STARCH; SUGAR, POWDERED SUGAR; TEA, ICED TEA; CONFECTIONERY, NAMELY, PASTILLES, FONDANTS, FRUIT JELLY CANDY; CHOCOLATES, BISCUITS, CRACKERS, WAFFLES, CHEWING GUM, ICE CREAM, EDIBLE ICES; SALT; BREAKFAST CEREALS , IN CLASS 30 (U.S. CL. 46).

THE WORDING "TURKANA" HAS NO MEANING IN A FOREIGN LANGUAGE.

OWNER OF INTERNATIONAL REGISTRATION 1093534 DATED 4-25-2011, EXPIRES 4-25-2021.

SER. NO. 79-103,655, FILED 4-25-2011.

DAVID I, EXAMINING ATTORNEY



David J. Kyffers

Director of the United States Patent and Trademark Office

United States of America

United States Patent and Trademark Office



Reg. No. 4,204,140

Registered Sep. 11, 2012

Int. Cl.: 3

TRADEMARK

PRINCIPAL REGISTER

EXAMONE ENTERPRISES LTD (RUSSIAN FED. LIMITED LIABILITY COMPANY)
ARCH. MAKARIOU III
155 PROTEAS HOUSE., 5TH. FLOOR P.C.; CY-3021 LIMASSOL
CYPRUS

FOR: PERFUMERY; COSMETIC CREAMS; SKIN WHITENING CREAMS; HAIR LOTIONS; LOTIONS FOR COSMETIC PURPOSES; BEAUTY MASKS; OILS FOR COSMETIC PURPOSES; ESSENTIAL OILS; CLEANSING MILK FOR TOILET PURPOSES; SOAP; COSMETIC KITS; LIPSTICKS; POMADES FOR COSMETIC PURPOSES; COSMETIC PREPARATIONS FOR BATHS; COSMETIC PREPARATIONS FOR SLIMMING PURPOSES; MAKE-UP REMOVING PREPARATIONS; TISSUES IMPREGNATED WITH COSMETIC LOTIONS; COSMETIC PREPARATIONS FOR SKIN CARE; COSMETICS; SHAMPOOS, IN CLASS 3 (U.S. CLS. 1, 4, 6, 50, 51 AND 52).

OWNER OF U.S. REG. NO. 3,359,965.

PRIORITY DATE OF 12-29-2010 IS CLAIMED.

OWNER OF INTERNATIONAL REGISTRATION 1093720 DATED 6-23-2011, EXPIRES 6-23-2021.

NO CLAIM IS MADE TO THE EXCLUSIVE RIGHT TO USE "ECO-FRIENDLY" AND THE UNIVERSAL RECYCLING SYMBOL, APART FROM THE MARK AS SHOWN.

THE MARK CONSISTS OF THE FIGURE OF A STICK FIGURE GIRL WITH HEAD AS A SMILEY FACE, AND TORSO COMPRISING THE UNIVERSAL RECYCLING SYMBOL. THE WORDING "DIZAO-ECO-FRIENDLY" ENCIRCLES THE TOP HALF OF THE SMILEY-FACE'S HEAD.

THE WORDING "DIZAO" HAS NO MEANING IN A FOREIGN LANGUAGE.

SER. NO. 79-103,721, FILED 6-23-2011.

RON FAIRBANKS, EXAMINING ATTORNEY



David J. Kyffers

Director of the United States Patent and Trademark Office

United States of America

United States Patent and Trademark Office

INTERIA AWARDS

Reg. No. 4,204,141

Registered Sep. 11, 2012

Int. Cls.: 41 and 42

SERVICE MARK

PRINCIPAL REGISTER

THE INDEPENDENT NONCOMMERCIAL ORGANIZATION "COUNCIL OF EXPERTS IN INTERIOR DESIGN AND ARCHITECTURAL ENVIRONMENT" (RUSSIAN FED. INDEPENDENT NONCOMMERCIAL ORGANIZATION)
KORP. 3, D. 1, ELEKTROLITNIY PR-D
RU-115230 MOSCOW
RUSSIAN FED.

FOR: VIDEOTAPING; PUBLICATION OF BOOKS; PROVIDING INFORMATION ABOUT EDUCATION; PROVIDING INFORMATION IN THE FIELD OF RECREATION; ENTERTAINMENT INFORMATION; MOVIE STUDIOS; VIDEOTAPE EDITING; PRODUCTION OF RADIO AND TELEVISION PROGRAMS; PROVIDING NON-DOWNLOADABLE, ON-LINE ELECTRONIC PUBLICATIONS IN THE NATURE OF MAGAZINES AND BOOKS IN THE FIELD OF ARCHITECTURE, ENGINEERING AND INTERIOR DESIGN; ORGANIZATION OF EXHIBITIONS FOR CULTURAL OR EDUCATIONAL PURPOSES; PROVIDING RECREATION FACILITIES; ARRANGING AND CONDUCTING OF COLLOQUIUMS IN THE FIELD OF ARCHITECTURE, ENGINEERING AND INTERIOR DESIGN; ARRANGING AND CONDUCTING OF CONGRESSES IN THE FIELD OF ARCHITECTURE, ENGINEERING AND INTERIOR DESIGN; ARRANGING AND CONDUCTING OF CONFERENCES IN THE FIELD OF ARCHITECTURE, ENGINEERING AND INTERIOR DESIGN; ARRANGING AND CONDUCTING OF WORKSHOP TRAININGS IN THE FIELD OF ARCHITECTURE, ENGINEERING AND INTERIOR DESIGN; ARRANGING AND CONDUCTING OF SEMINARS IN THE FIELD OF ARCHITECTURE, ENGINEERING AND INTERIOR DESIGN; ARRANGING AND CONDUCTING OF SYMPOSIUMS IN THE FIELD OF INTERIOR DESIGN; ARRANGING AND CONDUCTING OF CONCERTS AND PUBLIC ENTERTAINMENT EVENTS IN THE FIELD OF ARCHITECTURE, ENGINEERING AND INTERIOR DESIGN; EDUCATIONAL AND ENTERTAINMENT SERVICES, NAMELY, ORGANIZATION OF COMPETITIONS FOCUSED ON REVEALING THE MOST TALENTED AND ORIGINAL ARCHITECTURAL AND DESIGN DECISIONS, ORGANIZATION OF DISCUSSIONS CONCERNING TOPICAL ISSUES OF ARCHITECTURE AND DESIGN; OPERATING LOTTERIES; PROVIDING VOCATIONAL GUIDANCE, EDUCATION OR TRAINING ADVICE; TELEVISION ENTERTAINMENT, NAMELY, PROVIDING ON-GOING TELEVISION PROGRAMS IN THE FIELD OF ARCHITECTURE, ENGINEERING AND INTERIOR DESIGN; VIDEOTAPE FILM PRODUCTION; FILM PRODUCTION; ANIMATED FILM PRODUCTION; ELECTRONIC DESKTOP PUBLISHING; PUBLICATION OF ELECTRONIC BOOKS AND JOURNALS ON-LINE; PUBLICATION OF TEXTS, OTHER THAN PUBLICITY TEXTS; SUBTITLING; RADIO ENTERTAINMENT, NAMELY, PROVIDING ON-GOING RADIO PROGRAMS IN THE FIELD OF ARCHITECTURE, ENGINEERING AND INTERIOR DESIGN; ENTERTAINMENT SERVICES, NAMELY,



David J. Kyjars

Director of the United States Patent and Trademark Office

Reg. No. 4,204,141 CONDUCTING CONTESTS IN THE FIELD OF INTERIOR DESIGN; EDUCATIONAL SERVICES IN THE FIELD OF ARCHITECTURE, ENGINEERING AND INTERIOR DESIGN; TRANSLATION; PHOTOGRAPHY; PHOTOGRAPHIC REPORTING; ENTERTAINMENT, NAMELY, PRODUCTION OF SHOWS, IN CLASS 41 (U.S. CLS. 100, 101 AND 107).

FOR: ARCHITECTURE, NAMELY, ARCHITECTURAL DESIGN AND INTERIOR DESIGN; AUTHENTICATING WORKS OF ART; GRAPHIC ARTS DESIGNING; ARCHITECTURAL CONSULTATION; DRESS DESIGNING; DESIGN OF INTERIOR DECOR; INDUSTRIAL DESIGN; INDUSTRIAL DESIGN STYLING SERVICES; PACKAGING DESIGN SERVICES, IN CLASS 42 (U.S. CLS. 100 AND 101).

THE MARK CONSISTS OF STANDARD CHARACTERS WITHOUT CLAIM TO ANY PARTICULAR FONT, STYLE, SIZE, OR COLOR.

PRIORITY DATE OF 6-30-2011 IS CLAIMED.

OWNER OF INTERNATIONAL REGISTRATION 1093864 DATED 8-31-2011, EXPIRES 8-31-2021.

NO CLAIM IS MADE TO THE EXCLUSIVE RIGHT TO USE "AWARDS", APART FROM THE MARK AS SHOWN.

THE WORDING "INTERIA" HAS NO MEANING IN A FOREIGN LANGUAGE.

SER. NO. 79-103,779, FILED 8-31-2011.

RICHARD WHITE, EXAMINING ATTORNEY

United States of America

United States Patent and Trademark Office



Reg. No. 4,204,142

Registered Sep. 11, 2012

Int. Cl.: 35

SERVICE MARK

PRINCIPAL REGISTER

WEDDING DANCE DIRECTORY INTERNATIONAL PTY LTD (AUSTRALIA PROPRIETARY LIMITED COMPANY)
P.O. BOX 3167
ST MARYS SOUTH, AUSTRALIA NSW 2760

FOR: ADVERTISING SERVICES PROVIDED OVER THE INTERNET, IN CLASS 35 (U.S. CLS. 100, 101 AND 102).

NO CLAIM IS MADE TO THE EXCLUSIVE RIGHT TO USE "WEDDING DANCE DIRECTORY", APART FROM THE MARK AS SHOWN.

PRIORITY DATE OF 5-8-2011 IS CLAIMED.

OWNER OF INTERNATIONAL REGISTRATION 1093876 DATED 8-30-2011, EXPIRES 8-30-2021.

THE COLOR(S) GOLD OR GOLDISH YELLOW, BLACK, AND WHITE IS/ARE CLAIMED AS A FEATURE OF THE MARK.

THE MARK CONSISTS OF THE WORDING "WEDDING" IN GOLD OR GOLDISH YELLOW, THE WORDING "DANCE DIRECTORY" IN BLACK, AND A DESIGN OF A GLOBE IN GOLD OR GOLDISH YELLOW WITH THE REPRESENTATION OF THE CONTINENTS IN WHITE, AND A GOLD OR GOLDISH YELLOW SCROLL-LIKE LINE.

SER. NO. 79-103,781, FILED 8-30-2011.

SUSAN RICHARDS, EXAMINING ATTORNEY



David J. Kybas

Director of the United States Patent and Trademark Office

United States of America

United States Patent and Trademark Office

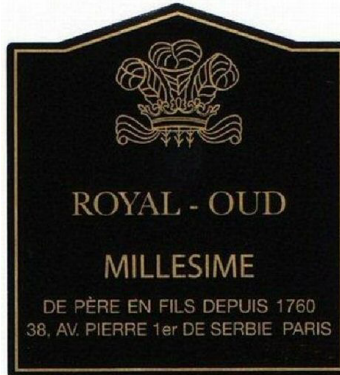

Reg. No. 4,204,143

Registered Sep. 11, 2012

Int. Cl.: 3

TRADEMARK

PRINCIPAL REGISTER

EROL SARL (LUXEMBOURG SOCIÉTÉ DE DROIT LUXEMBOURGEOIS)
9, RUE DU LABORATOIRE
L-1911 LUXEMBOURG
LUXEMBOURG

FOR: SOAP, PERFUMES, ESSENTIAL OILS, COSMETICS, HAIR LOTIONS, IN CLASS 3
(U.S. CLS. 1, 4, 6, 50, 51 AND 52).

NO CLAIM IS MADE TO THE EXCLUSIVE RIGHT TO USE "DEPUIS 1760" AND "38, AV.
PIERRE 1ER DE SERBIE PARIS", APART FROM THE MARK AS SHOWN.

OWNER OF INTERNATIONAL REGISTRATION 1094050 DATED 9-15-2011, EXPIRES 9-15-
2021.

THE COLOR(S) BLACK, GOLD IS/ARE CLAIMED AS A FEATURE OF THE MARK.

THE MARK CONSISTS OF A GOLD CROWN ABOVE THE WORDING "ROYAL-OD",
WHICH IS ABOVE THE WORD "MILLESIME". BELOW THIS WORDING IS THE WORDING
"DE PÈRE EN FILS DEPUIS 1760 38, AV. PIERRE 1ER DE SERBIE PARIS" PRESENTED ON
TWO LINES. ALL OF THE WORDING IS IN GOLD. THE CROWN AND THE WORDING
APPEAR ON A BLACK BACKGROUND WITH A GOLD OUTLINE.

THE ENGLISH TRANSLATION OF "MILLESIME; DE PÈRE EN FILS; DEPUIS"; AND "AV.
PIERRE 1ER DE SERBIE PARIS" IS AVENUE PETER I OF SERBIA IN THE MARK IS
"VINTAGE" OR "DATE"; "OF THE FATHER AND SONS"; "SINCE"; AND "AVENUE PETER
I OF SERBIA."

SER. NO. 79-103,862, FILED 9-15-2011.

SHANNON TWOHIG, EXAMINING ATTORNEY



David J. Kybas

Director of the United States Patent and Trademark Office

United States of America

United States Patent and Trademark Office

"KOSSWELL PROFESSIONAL"

Reg. No. 4,204,144

Registered Sep. 11, 2012

Int. Cl.: 3

TRADEMARK

PRINCIPAL REGISTER

KOSSWELL COSMETIC, S.L. (SPAIN SOCIEDAD LIMITADA)
C/ COMARE PILAR MARTI, 1-10
E-46900 TORRENTE
SPAIN

FOR: SOAP, NAMELY, BATH SOAP, BEAUTY SOAP, COSMETIC SOAP, DEODORANT SOAP, SOAPS FOR PERSONAL USE AND COSMETIC SOAP; PERFUMERY, ESSENTIAL OILS, COSMETICS, HAIR LOTIONS; DENTIFRICES, IN CLASS 3 (U.S. CLS. 1, 4, 6, 50, 51 AND 52).

THE MARK CONSISTS OF STANDARD CHARACTERS WITHOUT CLAIM TO ANY PARTICULAR FONT, STYLE, SIZE, OR COLOR.

OWNER OF INTERNATIONAL REGISTRATION 1094107 DATED 6-10-2011, EXPIRES 6-10-2021.

NO CLAIM IS MADE TO THE EXCLUSIVE RIGHT TO USE "PROFESSIONAL", APART FROM THE MARK AS SHOWN.

SER. NO. 79-103,874, FILED 6-10-2011.

PRISCILLA MILTON, EXAMINING ATTORNEY



David J. Kyffers

Director of the United States Patent and Trademark Office

United States of America

United States Patent and Trademark Office

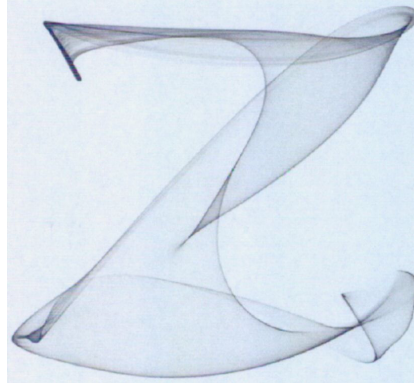

Reg. No. 4,204,145

Registered Sep. 11, 2012

Int. Cls.: 23, 24 and 25

SANKO TEKSTIL ISLETMELERI SANAYIVE TICARET ANONIM SIRKETI (TURKEY JOINT STOCK COMPANY)
SANI KONUKOGLU BULVARI ÜZERI
PK: 83 SEHITKAMIL
GAZIANTEP, TURKEY

TRADEMARK

PRINCIPAL REGISTER

FOR: YARNS AND THREADS FOR TEXTILE USE, SEWING THREADS, EMBROIDERY THREADS, KNITTING THREADS, COTTON THREADS AND ELASTIC THREADS FOR TEXTILE USE, IN CLASS 23 (U.S. CL. 43).

FOR: WOVEN TEXTILE FABRICS FOR USE IN THE MANUFACTURE OF CLOTHING, TOWELS, TABLE LINEN, BED LINEN, HOUSEHOLD LINEN; NON-WOVEN TEXTILE FABRICS FOR USE IN THE MANUFACTURE OF CLOTHING, TOWELS, TABLE LINEN, BED LINEN, HOUSEHOLD LINEN; HAND TOWELS, FACE TOWELS OF TEXTILE, BATH TOWELS, IN CLASS 24 (U.S. CLS. 42 AND 50).

FOR: CLOTHING, NAMELY, SHIRTS, T-SHIRTS, TROUSERS; UNDERCLOTHING, NAMELY, BOXER SHORTS, BRASSIERES, BRIEFS, PANTS; BATHROBES, IN CLASS 25 (U.S. CLS. 22 AND 39).

THE MARK CONSISTS OF A PIECE OF GREY TULLE FORMING A STYLIZED LETTER "Z" ON A WHITE BACKGROUND.

PRIORITY DATE OF 7-5-2011 IS CLAIMED.

OWNER OF INTERNATIONAL REGISTRATION 1094287 DATED 7-8-2011, EXPIRES 7-8-2021.

THE COLOR(S) WHITE AND GREY IS/ARE CLAIMED AS A FEATURE OF THE MARK.

SER. NO. 79-103,942, FILED 7-8-2011.

ROBERT STRUCK, EXAMINING ATTORNEY



David J. Kyffers

Director of the United States Patent and Trademark Office

United States of America

United States Patent and Trademark Office

SMART^{RH}

Reg. No. 4,204,146

Registered Sep. 11, 2012

Int. Cls.: 9, 35 and 41

TRADEMARK

SERVICE MARK

PRINCIPAL REGISTER

CEGEDIM (FRANCE SOCIÉTÉ ANONYME)
127-137 RUE D'AGUESSEAU
F-92100 BOULOGNE-BILLANCOURT
FRANCE

FOR: HUMAN RESOURCE MANAGEMENT AND PAYROLL PAYMENTS SOFTWARE, IN CLASS 9 (U.S. CLS. 21, 23, 26, 36 AND 38).

FOR: BUSINESS MANAGEMENT ASSISTANCE AND BUSINESS MANAGEMENT IN THE FIELDS OF HUMAN RESOURCES AND PAYROLL PAYMENTS; HUMAN RESOURCE MANAGEMENT, IN CLASS 35 (U.S. CLS. 100, 101 AND 102).

FOR: TRAINING SERVICES IN THE FIELDS OF HUMAN RESOURCES AND PAYROLL PAYMENTS, IN CLASS 41 (U.S. CLS. 100, 101 AND 107).

NO CLAIM IS MADE TO THE EXCLUSIVE RIGHT TO USE "SMART" FOR GOODS IN CLASS 9 ONLY, APART FROM THE MARK AS SHOWN.

PRIORITY DATE OF 4-8-2011 IS CLAIMED.

OWNER OF INTERNATIONAL REGISTRATION 1094504 DATED 9-15-2011, EXPIRES 9-15-2021.

THE MARK CONSISTS OF THE WORD "SMART" IN STYLIZED LETTERS FOLLOWED BY THE LETTERS "RH" IN A RAISED SUPERSCRIPIT.

SER. NO. 79-104,022, FILED 9-15-2011.

JOHN WILKE, EXAMINING ATTORNEY



David J. Kybas

Director of the United States Patent and Trademark Office

United States of America

United States Patent and Trademark Office

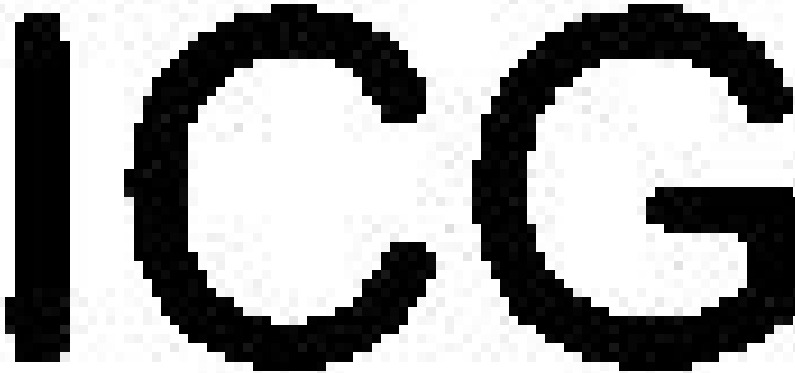

Reg. No. 4,204,147

HORST KEPPNER (FED REP GERMANY INDIVIDUAL)
SPITZENBAUM 3

Registered Sep. 11, 2012

REICHENSCHWAND, FED REP GERMANY 91244

**Int. Cls.: 9, 10, 12, 16, 25,
28 and 41**

FOR: RECORDED DATA MEDIA, NAMELY, DVDS CONTAINING TRAINING INSTRUCTIONS IN THE FIELD OF SPORTS TRAINING; PRE-RECORDED CDS CONTAINING MUSIC; ERGOMETERS FOR STATIONARY BICYCLES, NOT FOR MEDICAL PURPOSES; APPARATUS FOR RECORDING, TRANSMISSION AND REPRODUCTION OF SOUND, IMAGES AND DATA, NAMELY, VIDEO CASSETTE RECORDERS AND PLAYERS, CD AND DVD RECORDERS AND PLAYERS; REVOLUTION COUNTERS FOR BICYCLE WHEELS, TACHOMETERS; COMPUTER HARDWARE FOR USE WITH BICYCLES; SPORTS EQUIPMENT IN THE NATURE OF PORTABLE ELECTRONIC DEVICES SHOWING TRAINING DATA, NAMELY, TIME, HEART RATE, OUTPUT AND SPEED INCORPORATING CLOCKS, IN CLASS 9 (U.S. CLS. 21, 23, 26, 36 AND 38).

TRADEMARK

SERVICE MARK

PRINCIPAL REGISTER

FOR: HEART RATE MONITORS, MEDICAL APPARATUS SHOWING TRAINING DATA, NAMELY, HEART RATE, BODILY OUTPUT, AND SPEED, IN CLASS 10 (U.S. CLS. 26, 39 AND 44).

FOR: BICYCLES FOR SPORTS; PARTS OF BICYCLES FOR SPORTS, NAMELY, SADDLES AND PEDALS, IN CLASS 12 (U.S. CLS. 19, 21, 23, 31, 35 AND 44).

FOR: PRINTED MATTER, NAMELY, MANUALS, INSTRUCTIONAL AND TEACHING MATERIAL IN THE FIELD OF BICYCLE TRAINING, IN CLASS 16 (U.S. CLS. 2, 5, 22, 23, 29, 37, 38 AND 50).

FOR: CLOTHING, NAMELY, JOGGING SUITS, EXERCISE TOPS AND BOTTOMS, BRAS, BUSTIERS, COATS, JACKETS, PANTS, SHORTS, SHIRTS, DRESSES, SKIRTS, VESTS, SWEATERS, BLOUSES, BODY SUITS, SWEAT SUITS, HOSIERY, SOCKS AND STOCKINGS, UNDERWEAR, LINGERIE, SLIPS, UNDERCLOTHES, BELTS, SCARVES AND SHAWLS, KERCHIEFS, TIES AND BOW TIES, FASHION AND DRESS GLOVES; FOOTWEAR; HEADGEAR, NAMELY, HATS AND CAPS, SWEATBANDS, HEAD SCARVES, IN CLASS 25 (U.S. CLS. 22 AND 39).



David J. Keppner

Director of the United States Patent and Trademark Office

FOR: STATIONARY EXERCISE BICYCLES FOR SPORTS AS AN APPARATUS FOR FITNESS TRAINING, STATIONARY BICYCLES FOR FITNESS TRAINING, APPARATUS FOR FITNESS TRAINING AND APPARATUS FOR SPORTS, NAMELY, DUMB-BELLS, EXERCISE BALLS,

Reg. No. 4,204,147 EXERCISING CABLE PULLEYS, EXERCISERS IN THE NATURE OF CHEST EXPANDERS, CORE ABDOMINAL BOARDS, AEROBIC STEPS, STATIONARY TRAINING CYCLES; PARTS OF THE AFOREMENTIONED GOODS, NAMELY, HANDLEBARS, SADDLES AND PEDALS, IN CLASS 28 (U.S. CLS. 22, 23, 38 AND 50).

FOR: PROVIDING OF TRAINING AND ADVANCED TRAINING IN THE FIELD OF SPORTS WITH STATIONARY BICYCLES; ENTERTAINMENT SERVICES, NAMELY, PROVIDING MOTIVATIONAL AND EDUCATIONAL SPEAKERS IN THE FIELD OF SPORTS WITH STATIONARY BICYCLES AND PROVIDING LIVE CONTESTS, GAMES, PERFORMANCES AND SHOWS IN THE FIELD OF SPORTS WITH STATIONARY BICYCLES; PROVIDING SPORTING AND CULTURAL ACTIVITIES AND EVENTS, NAMELY, ORGANIZING, SANCTIONING, CONDUCTING, REGULATING AND GOVERNING SPORT PROGRAMS AND ACTIVITIES IN THE FIELD OF SPORTS WITH STATIONARY BICYCLES; PROVIDING OF THE SERVICES OF A GYM, IN CLASS 41 (U.S. CLS. 100, 101 AND 107).

THE MARK CONSISTS OF STANDARD CHARACTERS WITHOUT CLAIM TO ANY PARTICULAR FONT, STYLE, SIZE, OR COLOR.

OWNER OF INTERNATIONAL REGISTRATION 1094518 DATED 7-25-2011, EXPIRES 7-25-2021.

SER. NO. 79-104,031, FILED 7-25-2011.

TRACY CROSS, EXAMINING ATTORNEY

United States of America

United States Patent and Trademark Office



Reg. No. 4,204,148

Registered Sep. 11, 2012

**Int. Cls.: 6, 7, 9, 35, 41
and 42**

TRADEMARK

SERVICE MARK

PRINCIPAL REGISTER

SANKEI ENGINEERING CO.,LTD. (JAPAN CORPORATION)
14-2, SHINYOKOHAMA 2-CHOME
KOUHOKU-KU., YOKOHAMA-SHI; KANAGAWA 222-0033
JAPAN

FOR: IRON AND STEEL; UNWROUGHT OR SEMI-WROUGHT IRON; UNWROUGHT OR SEMI-WROUGHT STEEL; NONFERROUS METALS AND THEIR ALLOYS; UNWROUGHT OR SEMI-WROUGHT BRASS, UNWROUGHT OR SEMI-WROUGHT COPPER; METAL ORES; MATERIALS OF METAL FOR BUILDING AND CONSTRUCTION, NAMELY, SOFFITS; PULLEYS, SPRINGS AND VALVES OF METAL, NOT INCLUDING MACHINE ELEMENTS; METAL CLASPS FOR DOOR SECURITY HARDWARE; BINDING SCREWS OF METAL FOR CABLES; METAL HARDWARE, NAMELY, PLUGS, RIVETS, CASTER, AND SLEEVES; BINDINGS OF METAL FOR CABLES AND PIPES; CLIPS OF METAL FOR CABLES AND PIPES; NUTS OF METAL; HARDWARE, NAMELY, METAL PINS; RINGS OF METAL FOR GASKETS; SCREWS OF METAL; WASHERS OF METAL; BOXES OF COMMON METAL; ALLOYS OF COMMON METAL; COMMON METALS, UNWROUGHT OR SEMI-WROUGHT; INGOTS OF COMMON METAL; METAL PIPES AND TUBES, IN CLASS 6 (U.S. CLS. 2, 12, 13, 14, 23, 25 AND 50).

FOR: METALWORKING MACHINES AND TOOLS; DRILL CHUCKS BEING PARTS OF MACHINES; GRINDING MACHINES; HAND-HELD TOOLS, OTHER THAN HAND-OPERATED, NAMELY, BATTERY ACTUATED HYDRAULIC CRIMP TOOLS; HEMMING MACHINES; LATHES BEING MACHINE TOOLS; METALWORKING MACHINES; MILLING MACHINES; CHEMICAL PROCESSING MACHINES AND APPARATUS; MACHINE ELEMENTS NOT FOR LAND VEHICLES, NAMELY, SHAFT COUPLINGS AS PARTS OF MACHINES, SHAFT COUPLINGS FOR MACHINES, AXLES OR SPINDLES, BEARINGS, CONNECTORS, SHOCK ABSORBERS, SPRINGS, PNEUMATIC SHOCK ABSORBERS, AIR SPRINGS, SPRING SHOCK ABSORBERS, SPRING-ASSISTED HYDRAULIC SHOCK ABSORBERS, SPIRAL SPRINGS, LAMINATED LEAF-SPRINGS; SEMICONDUCTOR MANUFACTURING MACHINES, AND SEMICONDUCTOR MANUFACTURING MACHINES SOLD AS A UNIT; PRINTED CIRCUIT BOARDS PROCESSING MACHINES AND MACHINE TOOLS; PRINTED CIRCUIT BOARDS MANUFACTURING MACHINES SOLD AS A UNIT; PRINTED ELECTRONIC CIRCUIT BOARDS PROCESSING MACHINES AND MACHINE TOOLS, IN CLASS 7 (U.S. CLS. 13, 19, 21, 23, 31, 34 AND 35).



David J. Kyjars

Director of the United States Patent and Trademark Office

FOR: CINEMATOGRAPHIC INSTRUMENTS AND APPARATUS; APPARATUS AND INSTRUMENTS FOR TESTING PRINTED CIRCUIT BOARDS AND THEIR PARTS; PROBES FOR

Reg. No. 4,204,148 TESTING INTEGRATED CIRCUITS, AND ULTRASOUND PROBES, NOT FOR MEDICAL USE; MEASURING PROBES FOR USE OF NEAR-INFRARED SPECTROANALYSIS APPARATUS; SURVEYING INSTRUMENTS; ELECTRIC OR MAGNETIC METERS AND TESTERS, NAMELY, PHASE INDICATORS, OSCILLOGRAPHS AND OSCILLOSCOPES, CIRCUIT TESTERS, ANTENNA PARAMETER MEASURING APPARATUS, DETECTORS FOR ELECTRIC OR MAGNETIC METERS AND TESTERS, GROUND DETECTORS, NAMELY, ELECTRIC LEAKAGE DETECTORS, MAGNETOMETERS, FREQUENCY METERS, VACUUM TUBE CHARACTERISTIC TESTERS, WATT HOUR METERS, RESISTANCE MEASURING INSTRUMENTS, AMMETERS, WATTMETERS, OSCILLATORS AND CAPACITY MEASURES FOR ELECTRIC OR MAGNETIC METERS AND TESTERS; AMMETERS; ELECTRIC LOSS INDICATORS; FREQUENCY METERS; GALVANOMETERS; OHMMETERS; VOLTMETERS; WAVEMETERS, IN CLASS 9 (U.S. CLS. 21, 23, 26, 36 AND 38).

FOR: ADVERTISING; PROMOTING THE GOODS AND SERVICES OF OTHERS THROUGH THE ISSUANCE OF TRADING STAMPS; BUSINESS MANAGEMENT ANALYSIS OR BUSINESS CONSULTANCY; MARKETING RESEARCH; PROVIDING INFORMATION ON SALES OF GOODS AND PRESENTATION OF GOODS ON COMMUNICATION MEDIA, FOR RETAIL PURPOSES; BUSINESS APPRAISALS; BUSINESS MANAGEMENT OF PERFORMING ARTISTS; PROFESSIONAL BUSINESS CONSULTANCY; BUSINESS INFORMATION; BUSINESS INVESTIGATIONS; BUSINESS MANAGEMENT AND ORGANIZATION CONSULTANCY; RELOCATION SERVICES FOR BUSINESSES; COST PRICE ANALYSIS; ECONOMIC FORECASTING; EFFICIENCY EXPERTS; COMMERCIAL AND INDUSTRIAL MANAGEMENT ASSISTANCE; PERSONNEL MANAGEMENT CONSULTANCY; PSYCHOLOGICAL TESTING FOR THE SELECTION OF PERSONNEL; PREPARATION OF FINANCIAL STATEMENTS OF ACCOUNTS; AUDITING; TAX PREPARATION; EMPLOYMENT AGENCIES; PERSONNEL RECRUITMENT; IMPORT-EXPORT AGENCIES, IN CLASS 35 (U.S. CLS. 100, 101 AND 102).

FOR: EDUCATIONAL AND INSTRUCTION SERVICES, NAMELY, WORKSHOPS, CLASSES, TUTORING RELATING TO MEASURING AND TESTING MACHINES AND INSTRUMENTS; EDUCATION OR TRAINING ADVICE IN THE NATURE OF VOCATIONAL GUIDANCE; EDUCATION INFORMATION; ARRANGING, CONDUCTING AND ORGANIZATION OF SEMINARS; ARRANGING AND CONDUCTING OF COLLOQUIUMS; ARRANGING AND CONDUCTING OF EDUCATIONAL CONFERENCES; ARRANGING AND CONDUCTING OF EDUCATIONAL CONGRESSES; ARRANGING AND CONDUCTING OF EDUCATIONAL SYMPOSIUMS; ARRANGING AND CONDUCTING OF TRAINING WORKSHOPS IN THE FIELDS OF MEASURING AND TESTING MACHINES AND INSTRUMENTS; PROVIDING ELECTRONIC PUBLICATIONS IN THE NATURE OF BOOKS, MAGAZINES, BROCHURES IN THE FIELD OF MEASURING AND TESTING MACHINES AND INSTRUMENTS; SERVICES OF REFERENCE LIBRARIES FOR LITERATURE AND DOCUMENTARY RECORDS; ORGANIZATION OF ENTERTAINMENT EVENTS FOR MEASURING AND TESTING MACHINES AND INSTRUMENTS; PROVIDING AMUSEMENT FACILITIES; PROVIDING FACILITIES FOR MOVIES, SHOWS, PLAYS, MUSIC OR EDUCATIONAL TRAINING; RENTAL OF RECORDS OR SOUND-RECORDED MAGNETIC TAPES; ORGANIZATION OF COMPETITIONS FOR EDUCATION OR ENTERTAINMENT PURPOSES IN THE FIELD OF MEASURING AND TESTING MACHINES AND INSTRUMENTS; ORGANIZATION OF EXHIBITIONS FOR CULTURAL OR EDUCATIONAL PURPOSES, IN CLASS 41 (U.S. CLS. 100, 101 AND 107).

FOR: DESIGNING OF MACHINES, APPARATUS, INSTRUMENTS, INCLUDING THEIR PARTS OR SYSTEMS COMPOSED OF SUCH MACHINES, APPARATUS AND INSTRUMENTS, ALL IN THE FIELDS OF MEASURING AND TESTING MACHINES AND INSTRUMENTS; DESIGNING, NAMELY, GRAPHIC DESIGNING; COMPUTER PROGRAMMING; TECHNICAL ADVICE RELATING TO COMPUTERS; TESTING OR RESEARCH ON MACHINES, APPARATUS AND INSTRUMENTS; CALIBRATION (MEASURING); MECHANICAL RESEARCH; RENTAL OF COMPUTERS; DESIGNING COMPUTER PROGRAMS TO THE SPECIFICATIONS OF OTHERS; RENTAL OF LABORATORY APPARATUS AND INSTRUMENTS, IN CLASS 42 (U.S. CLS. 100 AND 101).

Reg. No. 4,204,148 NO CLAIM IS MADE TO THE EXCLUSIVE RIGHT TO USE "PROFESSIONALS", APART FROM THE MARK AS SHOWN.

PRIORITY DATE OF 11-8-2010 IS CLAIMED.

OWNER OF INTERNATIONAL REGISTRATION 1094560 DATED 5-6-2011, EXPIRES 5-6-2021.

SER. NO. 79-104,054, FILED 5-6-2011.

KEVIN DINALLO, EXAMINING ATTORNEY

United States of America

United States Patent and Trademark Office

IVAR

Reg. No. 4,204,149

Registered Sep. 11, 2012

Int. Cls.: 6, 11, 17 and 19

TRADEMARK

PRINCIPAL REGISTER

I.V.A.R. S.P.A. (ITALY JOINT STOCK COMPANY)
VIA IV NOVEMBRE, 181
I-25080 PREVALLE (BRESCIA)
BRESCIA, ITALY

FOR: METAL ACCESSORIES FOR PLUMBING PLANTS, NAMELY, METAL HOSES FOR PLUMBING USE AND METAL PIPE FITTINGS; METAL CONNECTING TUBES; METAL CONDUITS FOR CENTRAL HEATING; METAL MANIFOLDS FOR PIPELINES; METAL ELBOW TUBES; METAL FITTINGS FOR TUBES; VALVES FOR METAL WATER CONDUITS; METAL DRAINAGE TUBE VALVES; METAL VALVES NOT PARTS OF MACHINES; METAL SPHERE VALVES; METAL CUT-OUT VALVES; METAL CHECK VALVES; UNWORKED OR SEMI-FINISHED BRASS, IN CLASS 6 (U.S. CLS. 2, 12, 13, 14, 23, 25 AND 50).

FOR: APPARATUS AND PLANTS FOR WATER DISTRIBUTION AND RELATIVE COMPONENTS AND ACCESSORIES, NAMELY, MANUALLY-OPERATED PLUMBING VALVES; PLUMBING FITTINGS, NAMELY, BIBBS, MANIFOLDS, COCKS, TRAPS, DRAINS, VALVES, COUPLERS AND BAFFLES; PLUMBING PLANTS AND RELATIVE COMPONENTS AND ACCESSORIES, NAMELY, PLUMBING FITTINGS, NAMELY, VALVES; WATER INJECTION, MIXING AND DISTRIBUTION SYSTEMS FOR HEATING APPARATUS, COMPRISING TUBES, PIPES AND PRE-ASSEMBLED MANIFOLDS THROUGH WHICH COLD OR LOW TEMPERATURE WATER CIRCULATES; HEATING SYSTEMS COMPOSED PRIMARILY OF TUBES, PIPES AND MANIFOLDS THROUGH WHICH WARM OR HIGH TEMPERATURE WATER CIRCULATES; REGULATING AND SAFETY ACCESSORIES FOR HYDRAULIC PLANTS, NAMELY, THERMOSTATIC VALVES; PRESSURE REGULATORS FOR SANITARY INSTALLATIONS; HEATING PLANTS, NAMELY, HEATING INSTALLATIONS; CENTRAL HEATING RADIATORS; HOT WATER HEATING PLANTS; SOLAR MANIFOLDS FOR HEATING; PLUMBING FITTINGS, NAMELY, THERMOSTAT VALVES BEING PARTS OF HEATING PLANTS; PLUMBING FITTINGS, NAMELY, THERMOSTATIC HEADS; REGULATING ACCESSORIES, NAMELY, PRESSURE REGULATORS FOR WATER INSTALLATIONS, IN CLASS 11 (U.S. CLS. 13, 21, 23, 31 AND 34).

FOR: NON-METAL FLEXIBLE CONDUIT FITTINGS; NON-METAL FITTINGS FOR NON-METAL FLEXIBLE TUBES; NON-METAL FITTINGS FOR FLEXIBLE TUBES; NON-METAL CONNECTORS FOR NON-METAL FLEXIBLE TUBES; NON-METAL CONNECTORS FOR FLEXIBLE TUBES AND GASKETS, IN CLASS 17 (U.S. CLS. 1, 5, 12, 13, 35 AND 50).



David J. Kyros

Director of the United States Patent and Trademark Office

Reg. No. 4,204,149 FOR: NON-METAL WATER CONDUITS; NON-METAL WATER PIPE FITTING TUBES FOR JOINING AND TERMINATING PIPES, IN CLASS 19 (U.S. CLS. 1, 12, 33 AND 50).

THE MARK CONSISTS OF STANDARD CHARACTERS WITHOUT CLAIM TO ANY PARTICULAR FONT, STYLE, SIZE, OR COLOR.

PRIORITY DATE OF 5-17-2011 IS CLAIMED.

OWNER OF INTERNATIONAL REGISTRATION 1094569 DATED 6-15-2011, EXPIRES 6-15-2021.

OWNER OF U.S. REG. NO. 3,071,277.

SER. NO. 79-104,056, FILED 6-15-2011.

KEVIN DINALLO, EXAMINING ATTORNEY

United States of America

United States Patent and Trademark Office

LFK

Reg. No. 4,204,150

Registered Sep. 11, 2012

Int. Cl.: 7

TRADEMARK

PRINCIPAL REGISTER

WUXI HAIFENG HAILIN PRECISION BEARING CO., LTD (CHINA CORPORATION)
A2, 88 QIAN YAO ROAD
QINXIN PRIVATE INDUSTRY PARK,; BINHU DISTRICT,; WUXI; JIANGSU
CHINA

FOR: BEARINGS BEING PARTS OF MACHINES; BEARINGS FOR TRANSMISSION SHAFTS
BEING PARTS OF MACHINES; BALL-BEARINGS FOR MACHINES, NAMELY, BALL-
BEARINGS FOR CUTTING MACHINES, BALL-BEARINGS FOR ROLLING MACHINES,
BALL-BEARINGS FOR INDUSTRIAL MACHINES PRESSES, BALL-BEARINGS FOR INJEC-
TION MOLDING MACHINES, IN CLASS 7 (U.S. CLS. 13, 19, 21, 23, 31, 34 AND 35).

THE MARK CONSISTS OF THE WORDING "LFK".

OWNER OF INTERNATIONAL REGISTRATION 1094644 DATED 10-10-2011, EXPIRES 10-
10-2021.

SER. NO. 79-104,084, FILED 10-10-2011.

NICHOLAS COLEMAN, EXAMINING ATTORNEY



David J. Kyffers

Director of the United States Patent and Trademark Office

United States of America

United States Patent and Trademark Office



Reg. No. 4,204,151

Registered Sep. 11, 2012

Int. Cl.: 29

TRADEMARK

PRINCIPAL REGISTER

CONSERVAS EMILIA, S.L. (SPAIN SOCIEDAD LIMITADA)
AVDA. LONS, S/N,
SANTOÑA; E-39740 SANTANDER-CANTABRIA
SPAIN

FOR: FISH PRESERVES AND SEMI-PRESERVES AND SALTED FISH, IN CLASS 29 (U.S. CL. 46).

NO CLAIM IS MADE TO THE EXCLUSIVE RIGHT TO USE "CONSERVAS", APART FROM THE MARK AS SHOWN.

OWNER OF INTERNATIONAL REGISTRATION 1019961 DATED 10-29-2009, EXPIRES 10-29-2019.

THE MARK CONSISTS OF THE WORDS "CONSERVAS EMILIA" ON AN OVAL BACKGROUND BENEATH A STAR AND WITHIN AN ORNATE INCOMPLETE OVAL BORDER.

THE ENGLISH TRANSLATION OF "CONSERVAS" IN THE MARK IS "PRESERVES".

SER. NO. 79-104,097, FILED 9-27-2011.

JOHN WILKE, EXAMINING ATTORNEY



David J. Kybas

Director of the United States Patent and Trademark Office

United States of America
United States Patent and Trademark Office

LUCCIEN

Reg. No. 4,204,152

Registered Sep. 11, 2012

Int. Cl.: 3

TRADEMARK

PRINCIPAL REGISTER

R & G PARKER GROUP PTY LTD (AUSTRALIA A PROPRIETARY LIMITED COMPANY)
302A QUEENS PARADE
NORTH FITZROY VIC 3068
AUSTRALIA

FOR: COSMETICS; COSMETICS FOR PERSONAL USE; COSMETICS FOR PROTECTING THE SKIN FROM SUNBURN; COSMETICS IN THE FORM OF CREAMS, LOTIONS AND OILS; COSMETIC PREPARATIONS; ESSENTIAL OILS FOR USE IN COSMETICS; PREPARATIONS FOR REMOVING COSMETICS; DECOLORANTS IN THE NATURE OF BLEACHING PREPARATIONS FOR COSMETIC PURPOSES, NAMELY, HAIR COLOR REMOVERS; ASTRINGENTS FOR COSMETIC PURPOSES; COSMETICS TO REMOVE PIGMENTATION MARKS, NAMELY, NON-MEDICATED PIGMENT LIGHTENING GELS, IN CLASS 3 (U.S. CLS. 1, 4, 6, 50, 51 AND 52).

THE MARK CONSISTS OF THE WORD "LUCCIEN" IN STYLIZED TEXT.

OWNER OF INTERNATIONAL REGISTRATION 1094764 DATED 8-17-2011, EXPIRES 8-17-2021.

SER. NO. 79-104,150, FILED 8-17-2011.

SHANNON TWOHIG, EXAMINING ATTORNEY



David J. Kyffers

Director of the United States Patent and Trademark Office

United States of America

United States Patent and Trademark Office

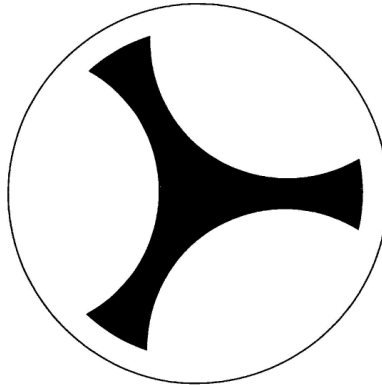

Reg. No. 4,204,153

Registered Sep. 11, 2012

Int. Cls.: 7, 16 and 37

TRADEMARK

SERVICE MARK

PRINCIPAL REGISTER

MANN+HUMMEL GMBH (FED REP GERMANY GMBH (LIMITED LIABILITY COMPANY))
HINDENBURGSTRASSE 45
71638 LUDWIGSBURG
FED REP GERMANY

FOR: MACHINE TOOLS FOR PROCESSING OF COMPONENTS AND TOOLS; ELECTRIC DISCHARGE MACHINES FOR PROCESSING OF CONDUCTIVE MATERIALS; FILTERS FOR MACHINE TOOLS FOR PROCESSING OF COMPONENTS AND TOOLS AND FOR FILTERING DIELECTRIC FLUIDS, USED BY ELECTRIC DISCHARGE MACHINES FOR PROCESSING OF CONDUCTIVE MATERIALS; FILTER ELEMENTS FOR MACHINE TOOLS FOR PROCESSING OF COMPONENTS AND TOOLS AND FOR FILTERING DIELECTRIC FLUIDS, USED BY ELECTRIC DISCHARGE MACHINES FOR PROCESSING OF CONDUCTIVE MATERIALS; FILTERS AND FILTER ELEMENTS FOR MACHINE TOOLS FOR PROCESSING OF COMPONENTS AND TOOLS; FILTERS AND FILTER ELEMENTS FOR FILTERING DIELECTRIC FLUIDS, USED BY ELECTRIC DISCHARGE MACHINES FOR PROCESSING OF CONDUCTIVE MATERIALS; LIQUID FILTERS FOR MACHINE TOOLS FOR PROCESSING OF COMPONENTS AND TOOLS; LIQUID FILTERS FOR FILTERING DIELECTRIC FLUIDS, USED BY ELECTRIC DISCHARGE MACHINES FOR PROCESSING OF CONDUCTIVE MATERIALS; FILTER ELEMENTS FOR LIQUID FILTERS FOR MACHINE TOOLS FOR PROCESSING OF COMPONENTS AND TOOLS AND FOR FILTERING DIELECTRIC FLUIDS, USED BY ELECTRIC DISCHARGE MACHINES FOR PROCESSING OF CONDUCTIVE MATERIALS; AND PARTS THEREFOR OF THE AFORESAID GOODS, IN CLASS 7 (U.S. CLS. 13, 19, 21, 23, 31, 34 AND 35).



FOR: PRINTED MATTER, NAMELY, PAMPHLETS, PERIODICALS, BROCHURES, PROSPECTUSES, CATALOGUES, PRINTED ADVERTISING, NAMELY, LEAFLETS, POSTERS AND PRODUCT ADVERTS IN PROFESSIONAL JOURNALS, OPERATION MANUALS, INSTALLATION GUIDES, USER INSTRUCTIONS, PRESS KITS FEATURING PRESS RELEASES, ALL FEATURING MACHINE TOOLS FOR PROCESSING OF COMPONENTS AND TOOLS AND FILTERS FOR FILTERING DIELECTRIC FLUIDS, USED BY ELECTRIC DISCHARGE MACHINES FOR PROCESSING OF CONDUCTIVE MATERIALS, IN CLASS 16 (U.S. CLS. 2, 5, 22, 23, 29, 37, 38 AND 50).

David J. Kyjars

Director of the United States Patent and Trademark Office

FOR: REPAIR OF MACHINE TOOLS AND OF FILTERS FOR MACHINE TOOLS AND THEIR SPARE PARTS; REPAIR OF ELECTRIC DISCHARGE MACHINES AND OF FILTERS FOR ELECTRIC DISCHARGE MACHINES AND THEIR SPARE PARTS; REPAIR OF LIQUID FILTERS FOR MACHINE TOOLS AND THEIR SPARE PARTS; REPAIR OF LIQUID FILTERS

Reg. No. 4,204,153 FOR ELECTRIC DISCHARGE MACHINES AND THEIR SPARE PARTS, IN CLASS 37 (U.S. CLS. 100, 103 AND 106).

THE MARK CONSISTS OF TRIANGULAR SHAPES WITHIN A CIRCLE CARRIER.

PRIORITY DATE OF 2-18-2011 IS CLAIMED.

OWNER OF INTERNATIONAL REGISTRATION 1094867 DATED 8-12-2011, EXPIRES 8-12-2021.

SER. NO. 79-104,189, FILED 8-12-2011.

JOSETTE BEVERLY, EXAMINING ATTORNEY

United States of America

United States Patent and Trademark Office

SUPECT

Reg. No. 4,204,154

Registered Sep. 11, 2012

Int. Cl.: 5

TRADEMARK

PRINCIPAL REGISTER

IL YANG PHARMACEUTICAL CO., LTD (REPUBLIC OF KOREA CORPORATION)
182-4, HAGAL-DONG
GIHEUNG-GU, YONGIN-SI; GYEONGGI-DO
REPUBLIC OF KOREA

FOR: ANTI-VIRUS PHARMACEUTICAL PREPARATIONS, NAMELY, ANTIVIRALS; DIAGNOSTIC PREPARATIONS FOR MEDICAL PURPOSES; ANTI-INFLAMMATORY PREPARATIONS; FEBRIFUGES; ALLERGY MEDICATIONS; PHARMACEUTICAL PRODUCTS FOR TREATING RESPIRATORY DISEASES; PHARMACEUTICAL PREPARATIONS FOR TREATING DIGESTIVE DISEASES; HORMONES FOR MEDICAL PURPOSES; MEDICINES FOR NUTRIENTS; INSECTICIDES; DIARRHEA MEDICINES; PHARMACEUTICAL PREPARATIONS FOR EPIDERMIS; MEDICINES FOR ATOPIC DERMATITIS; PHARMACEUTICAL PREPARATIONS FOR SKIN CARE; PHARMACEUTICAL PREPARATIONS FOR SKIN REGENERATION; ANTI-AGING PREPARATIONS FOR SKIN FOR MEDICAL PURPOSES; AMINO ACIDS FOR MEDICAL PURPOSES; VITAMIN PREPARATIONS; CARDIOVASCULAR PHARMACEUTICALS; MEDICINES FOR CEREBROVASCULAR DISEASES; MEDICINES FOR MENOPAUSAL DISORDERS; MEDICINES FOR LEUKEMIA; ANTI-CANCER PREPARATIONS; PHARMACEUTICAL PREPARATIONS ACTING ON THE CENTRAL NERVOUS SYSTEM, IN CLASS 5 (U.S. CLS. 6, 18, 44, 46, 51 AND 52).

THE WORD(S) "SUPECT" HAS NO MEANING IN A FOREIGN LANGUAGE.

OWNER OF INTERNATIONAL REGISTRATION 1095326 DATED 7-29-2011, EXPIRES 7-29-2021.

SER. NO. 79-104,375, FILED 7-29-2011.

JAMES STEIN, EXAMINING ATTORNEY



David J. Kypos

Director of the United States Patent and Trademark Office

United States of America
United States Patent and Trademark Office

EIWAL

Reg. No. 4,204,155

Registered Sep. 11, 2012

Int. Cls.: 9 and 12

TRADEMARK

PRINCIPAL REGISTER

PATWAL GMBH (SWITZERLAND GESELLSCHAFT MIT BESCHRÄNKTER HAFTUNG
(GMBH))
TEUFENER STRASSE 3
SPEICHER, SWITZERLAND CH9042

FOR: MAGNIFYING GLASSES FOR READING, MAGNIFYING GLASSES, IN CLASS 9 (U.S.
CLS. 21, 23, 26, 36 AND 38).

FOR: SHOPPING CARTS, IN CLASS 12 (U.S. CLS. 19, 21, 23, 31, 35 AND 44).

THE MARK CONSISTS OF STANDARD CHARACTERS WITHOUT CLAIM TO ANY PAR-
TICULAR FONT, STYLE, SIZE, OR COLOR.

OWNER OF INTERNATIONAL REGISTRATION 1095732 DATED 9-27-2011, EXPIRES 9-27-
2021.

SER. NO. 79-104,546, FILED 9-27-2011.

FRANK LATTUCA, EXAMINING ATTORNEY



David J. Kybas

Director of the United States Patent and Trademark Office

United States of America

United States Patent and Trademark Office

SMART HEART

Reg. No. 4,204,156

Registered Sep. 11, 2012

Int. Cls.: 9, 10, 38 and 44

TRADEMARK

SERVICE MARK

PRINCIPAL REGISTER

SHL TELEMEDICINE INTERNATIONAL LTD. (ISRAEL A PRIVATE LIMITED LIABILITY COMPANY)
90 YIGAL ALON ST.
TEL AVIV, ISRAEL 67891

FOR: COMPUTER APPLICATION SOFTWARE FOR MOBILE DEVICES, NAMELY, SOFTWARE FOR COMMUNICATION AND TRANSMISSION OF DATA DIRECTLY FROM A MOBILE DEVICE TO A MEDICAL CENTER PROVIDING EMERGENCY RESPONSE, IN CLASS 9 (U.S. CLS. 21, 23, 26, 36 AND 38).

FOR: MEDICAL EQUIPMENT, NAMELY, AN ELECTROCARDIOGRAPHIC (ECG) RECORDER WHICH RECORDS THE ELECTRIC ACTIVITY OF THE HEART AND TRANSMITS THE DATA TO AN END-USER'S MOBILE DEVICE, IN CLASS 10 (U.S. CLS. 26, 39 AND 44).

FOR: ELECTRONIC TRANSMISSION OF MEDICAL DATA, IN CLASS 38 (U.S. CLS. 100, 101 AND 104).

FOR: PROVISION OF MEDICAL SERVICES, NAMELY, PROVISION OF HEALTH CARE AND MEDICAL SERVICES BY HEALTH CARE PROFESSIONALS VIA THE INTERNET OR TELECOMMUNICATION NETWORKS, IN CLASS 44 (U.S. CLS. 100 AND 101).

THE MARK CONSISTS OF STANDARD CHARACTERS WITHOUT CLAIM TO ANY PARTICULAR FONT, STYLE, SIZE, OR COLOR.

PRIORITY DATE OF 1-2-2011 IS CLAIMED.

OWNER OF INTERNATIONAL REGISTRATION 1096059 DATED 6-21-2011, EXPIRES 6-21-2021.

NO CLAIM IS MADE TO THE EXCLUSIVE RIGHT TO USE "HEART", APART FROM THE MARK AS SHOWN.

SER. NO. 79-104,652, FILED 6-21-2011.

JIM RINGLE, EXAMINING ATTORNEY



David J. Kyffers

Director of the United States Patent and Trademark Office

United States of America
United States Patent and Trademark Office

AVÈZE

Reg. No. 4,204,157

AVEZE SAS (FRANCE SOCIÉTÉ PAR ACTIONS SIMPLIFIÉE (SAS))
RUE DES FRÈRES MONTGOLFIER
NUTTS-SAINT-GEORGES, FRANCE F21700

Registered Sep. 11, 2012

Int. Cl.: 33

FOR: APERITIFS, ALCOHOLS, NAMELY, LIQUEURS AND SPIRITS, EXCLUDING WINES,
IN CLASS 33 (U.S. CLS. 47 AND 49).

TRADEMARK

THE MARK CONSISTS OF THE STYLIZED WORDING "AVÈZE".

PRINCIPAL REGISTER

OWNER OF INTERNATIONAL REGISTRATION 0271690 DATED 7-12-1963, EXPIRES 7-12-2013.

THE WORDING "AVÈZE" HAS NO MEANING IN A FOREIGN LANGUAGE.

SER. NO. 79-104,672, FILED 6-24-2011.

COURTNEY ALVAREZ, EXAMINING ATTORNEY



David J. Kyros

Director of the United States Patent and Trademark Office

United States of America
United States Patent and Trademark Office

Liquiderma

Reg. No. 4,204,158

Registered Sep. 11, 2012

Int. Cls.: 3 and 5

TRADEMARK

PRINCIPAL REGISTER

PINO PHARMAZEUTISCHE PRÄPARATE GMBH (FED REP GERMANY GMBH & CO. KG)
PAUL-DESSAU-STRASSE 5
22761 HAMBURG
FED REP GERMANY

FOR: COSMETIC PREPARATIONS, IN CLASS 3 (U.S. CLS. 1, 4, 6, 50, 51 AND 52).

FOR: VEGETABLE OILS AND PLANT EXTRACTS FOR MEDICAL AND SANITARY PURPOSES, IN CLASS 5 (U.S. CLS. 6, 18, 44, 46, 51 AND 52).

THE MARK CONSISTS OF THE WORDING "LIQUIDERMA" IN STYLIZED FONT.

OWNER OF INTERNATIONAL REGISTRATION 0377981 DATED 3-30-1971, EXPIRES 3-30-2021.

SER. NO. 79-104,676, FILED 6-29-2011.

HEATHER BIDDULPH, EXAMINING ATTORNEY



David J. Kybas

Director of the United States Patent and Trademark Office

United States of America

United States Patent and Trademark Office

MARIAGE PARFAIT

Reg. No. 4,204,159

Registered Sep. 11, 2012

Int. Cl.: 32

TRADEMARK

PRINCIPAL REGISTER

"BROUWERIJ FRANK BOON",; NAAMLOZE VENNOOTSCHAP (BELGIUM NAAMLOZE
VENNOOTSCHAP (NV))
FONTEINSTRAT 65
B-1502 LEMBEEK, BELGIUM

FOR: BEER, ALE AND PORTER; MINERAL AND AERATED WATERS; SYRUPS AND
OTHER PREPARATIONS FOR MAKING BEVERAGES, NAMELY, BEERS, ALE AND
PORTER , IN CLASS 32 (U.S. CLS. 45, 46 AND 48).

THE ENGLISH TRANSLATION OF "MARIAGE PARFAIT" IN THE MARK IS "PERFECT
MARRIAGE" OR "PERFECT BLEND".

OWNER OF INTERNATIONAL REGISTRATION 0461719 DATED 6-11-1981, EXPIRES 6-11-
2021.

SER. NO. 79-104,682, FILED 6-12-2011.

HEATHER BIDDULPH, EXAMINING ATTORNEY



David J. Kybas

Director of the United States Patent and Trademark Office

United States of America

United States Patent and Trademark Office

GT 3000

Reg. No. 4,204,160

Registered Sep. 11, 2012

Int. Cl.: 9

TRADEMARK

PRINCIPAL REGISTER

ANSALDO SISTEMI INDUSTRIALI S.P.A. (ITALY JOINT STOCK COMPANY)
VIALE SARCA, 336
I-20126 MILANO MI
ITALY

FOR: ELECTRIC AND ELECTRONIC CHECKING APPARATUS FOR PUMPING SYSTEMS, VENTILATION SYSTEMS, LIFTING APPARATUS, PAPER AND STEEL PRODUCTIONS LINES AND SHIPYARDS; ELECTRIC AND ELECTRONIC APPARATUS FOR SWITCHING, TRANSFORMING, REGULATING ELECTRICITY; ELECTRIC AND ELECTRONIC CONVERTERS; TRANSFORMERS, IN CLASS 9 (U.S. CLS. 21, 23, 26, 36 AND 38).

THE TRADEMARK CONSISTS IN THE WORD "GT 3000".

OWNER OF INTERNATIONAL REGISTRATION 0860791 DATED 7-18-2005, EXPIRES 7-18-2015.

SER. NO. 79-104,745, FILED 11-22-2010.

LAURA KOVALSKY, EXAMINING ATTORNEY



David J. Kyffers

Director of the United States Patent and Trademark Office

United States of America

United States Patent and Trademark Office



Reg. No. 4,204,161

Registered Sep. 11, 2012

Int. Cls.: 6, 7 and 9

TRADEMARK

PRINCIPAL REGISTER

ATIKER METAL İTHALAT İHRACAT; VE İMALAT; SANAYİ TİCARET ANONİM ŞİRKETİ
(TURKEY JOINT STOCK COMPANY)

1. ORGANİZE SANAYİ BÖLGESİ
ATABEY SOKAK 5/A; KONYA
TURKEY

FOR: CONTAINERS OF METAL FOR COMPRESSED GAS OR LIQUID AIR, EMPTY METAL CONTAINERS FOR LIQUEFIED PETROLEUM GAS (LPG), METAL CONTAINERS FOR GAS, IN CLASS 6 (U.S. CLS. 2, 12, 13, 14, 23, 25 AND 50).

FOR: FUEL ECONOMIZERS FOR ENGINES, LIQUEFIED PETROLEUM GAS (LPG) FUEL CONVERSION APPARATUS FOR INTERNAL COMBUSTION ENGINES, IN CLASS 7 (U.S. CLS. 13, 19, 21, 23, 31, 34 AND 35).

FOR: ELECTRONIC DEVICES USED IN MACHINES AND DEVICES, NAMELY, SEMI-CONDUCTORS, ELECTRONIC CIRCUITS, INTEGRATED CIRCUITS, CHIPS, PHOTOCELLS, DIODES, TRANSISTORS, CIRCUIT BOARDS, CRYSTAL OSCILLATORS, CAPACITORS, INTERFACE CIRCUITS FOR VIDEO CAMERAS AND FOR DATA PROCESSING EQUIPMENT IN THE FORM OF PRINTED CIRCUITS, ELECTRONIC LCD DISPLAY UNITS, ELECTRONIC HYBRID CIRCUITS, ELECTRONIC HEAT SENSORS, ELECTRONIC CONVERTERS, MAGNETIC HEAD CLEANER APPARATUS, ELECTRONIC INDICATORS FOR VEHICLES; SPEED INDICATORS, OIL LEVEL INDICATORS, FUEL LEVEL INDICATORS AND TEMPERATURE INDICATORS, TACHOMETERS, TAXIMETERS, IN CLASS 9 (U.S. CLS. 21, 23, 26, 36 AND 38).

THE MARK CONSISTS OF THE WORDING "GASNORD" IN WHITE INSIDE A GREEN RECTANGLE WHICH HAS FOUR RED TRIANGLES ON THE OUTSIDE OF EACH SIDE OF THE RECTANGLE, THE ENTIRE MARK IS ON A WHITE BACKGROUND.

PRIORITY DATE OF 7-26-2011 IS CLAIMED.

OWNER OF INTERNATIONAL REGISTRATION 1096409 DATED 8-22-2011, EXPIRES 8-22-2021.

THE COLOR(S) GREEN, RED AND WHITE IS/ARE CLAIMED AS A FEATURE OF THE MARK.



David J. Kappas

Director of the United States Patent and Trademark Office

Reg. No. 4,204,161 SER. NO. 79-104,901, FILED 8-22-2011.

AISHA CLARKE, EXAMINING ATTORNEY

United States of America

United States Patent and Trademark Office



Reg. No. 4,204,162

Registered Sep. 11, 2012

Int. Cl.: 39

SERVICE MARK

PRINCIPAL REGISTER

APM TERMINALS B.V. (NETHERLANDS BESLOTEN VENNOOTSCHAP (B.V.))
ANNA VAN SAKSENLAAN 71
NL-2593 HW THE HAGUE
NETHERLANDS

FOR: TRANSPORT AND STORAGE OF GOODS; PACKAGING OF GOODS FOR TRANSPORT; DELIVERY OF GOODS; STEVEDORING IN THE NATURE OF CARGO LOADING AND UNLOADING OF SHIPS; FREIGHT FORWARDING; STORAGE, CARGO AND RECYCLING CONTAINER RENTAL; WAREHOUSE RENTAL AND STORE ROOM RENTAL IN THE NATURE OF WAREHOUSE SPACE RENTAL; INFORMATION REGARDING TRANSPORTATION AND STORAGE OF GOODS; LOGISTICS SERVICES, NAMELY, STORAGE, TRANSPORTATION AND DELIVERY OF GOODS FOR OTHERS BY AIR, RAIL, SHIP OR TRUCK; AFOREMENTIONED SERVICES ALSO IN THE CONTEXT OF THE MANAGEMENT OF CONTAINER TERMINALS, NAMELY, TRANSPORT OF GOODS, STORAGE OF GOODS, PACKAGING OF GOODS TO THE ORDER AND SPECIFICATION OF OTHERS, DELIVERY OF GOODS, STORAGE CONTAINER RENTAL, WAREHOUSE RENTAL, IN CLASS 39 (U.S. CLS. 100 AND 105).

THE MARK CONSISTS OF THE WORDING "LIFTING GLOBAL TRADE" IN ORANGE WITH THREE DIAGONAL LINES APPEARING IN ORANGE ABOVE THE "L" IN "LIFTING".

PRIORITY DATE OF 5-30-2011 IS CLAIMED.

OWNER OF INTERNATIONAL REGISTRATION 1096516 DATED 9-2-2011, EXPIRES 9-2-2021.

THE COLOR(S) ORANGE IS/ARE CLAIMED AS A FEATURE OF THE MARK.

SER. NO. 79-104,947, FILED 9-2-2011.

KATHRYN COWARD, EXAMINING ATTORNEY



David J. Kypos

Director of the United States Patent and Trademark Office

United States of America
United States Patent and Trademark Office

satinbase

Reg. No. 4,204,163

Registered Sep. 11, 2012

Int. Cl.: 1

TRADEMARK

PRINCIPAL REGISTER

OTC GMBH (FED REP GERMANY GESELLSCHAFT MIT BESCHRÄNKTER HAFTUNG
(GMBH))
BRAMMENRING 11
46047 OBERHAUSEN, FED REP GERMANY

FOR: EMULSIFIERS FOR USE IN THE MANUFACTURE OF BODY AND BEAUTY CARE PRODUCTS; CHEMICAL PREPARATIONS FOR USE AS RAW MATERIALS IN THE COSMETICS INDUSTRY; CHEMICAL PREPARATIONS FOR USE IN THE MANUFACTURE OF MEANS FOR BODY AND BEAUTY CARE, IN CLASS 1 (U.S. CLS. 1, 5, 6, 10, 26 AND 46).

THE MARK CONSISTS OF STANDARD CHARACTERS WITHOUT CLAIM TO ANY PARTICULAR FONT, STYLE, SIZE, OR COLOR.

PRIORITY DATE OF 9-30-2011 IS CLAIMED.

OWNER OF INTERNATIONAL REGISTRATION 1096633 DATED 9-30-2011, EXPIRES 9-30-2021.

SER. NO. 79-104,977, FILED 9-30-2011.

KHANH LE, EXAMINING ATTORNEY



David J. Kyfos

Director of the United States Patent and Trademark Office

United States of America

United States Patent and Trademark Office

ME-MOVER

Reg. No. 4,204,164

Registered Sep. 11, 2012

Int. Cl.: 12

TRADEMARK

PRINCIPAL REGISTER

ME-MOVER APS (DENMARK LIMITED LIABILITY COMPANY)
KROGSBÆKVEJ 13 A
DK-2610 RØDOVRE, DENMARK

FOR: LAND VEHICLES, NAMELY, BICYCLES AND BICYCLE TRAILERS; APPARATUS FOR LOCOMOTION BY LAND, AIR OR WATER, NAMELY BICYCLES, IN CLASS 12 (U.S. CLS. 19, 21, 23, 31, 35 AND 44).

THE MARK CONSISTS OF STANDARD CHARACTERS WITHOUT CLAIM TO ANY PARTICULAR FONT, STYLE, SIZE, OR COLOR.

OWNER OF INTERNATIONAL REGISTRATION 1096684 DATED 10-17-2011, EXPIRES 10-17-2021.

SER. NO. 79-104,999, FILED 10-17-2011.

RAUL CORDOVA, EXAMINING ATTORNEY



David J. Kyffers

Director of the United States Patent and Trademark Office

United States of America

United States Patent and Trademark Office

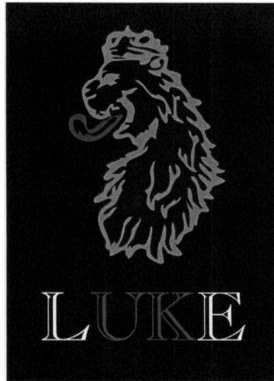

Reg. No. 4,204,165

Registered Sep. 11, 2012

Int. Cls.: 14, 18 and 25

LUKE ROPER LTD (UNITED KINGDOM A LIMITED COMPANY INCORPORATED WITHIN THE UNITED KINGDOM)
FURZE GROUNDS FARM
MARSH GIBBON ROAD,; MARSH GIBBON; BICESTER, OXON OX27 0AQ
UNITED KINGDOM

TRADEMARK

PRINCIPAL REGISTER

FOR: JEWELLERY AND KEY RINGS IN PRECIOUS METALS OR COATED THEREWITH; PRECIOUS STONES; HOROLOGICAL AND CHRONOMETRIC INSTRUMENTS, NAMELY, CLOCKS AND WATCHES, IN CLASS 14 (U.S. CLS. 2, 27, 28 AND 50).

FOR: WALLETS; POCKET WALLETS; HOLDALLS FOR CLOTHING, SUITS AND SHOES; VANITY CASES SOLD EMPTY; BAGS, NAMELY, LUGGAGE, HANDBAGS, SHOULDER BAGS, ATTACHÉ CASES, BRIEFCASES, IN CLASS 18 (U.S. CLS. 1, 2, 3, 22 AND 41).

FOR: CLOTHING, NAMELY, SHIRTS, DENIM SHIRTS, T-SHIRTS, BLOUSES, SWEAT SHIRTS, KNITWEAR, NAMELY, SWEATERS, JUMPERS AND CARDIGANS, JACKETS, DENIM JACKETS, LEATHER JACKETS, COATS, SHORTS, PANTS, TROUSERS, CLOTHING BELTS, SUITS FOR MEN, SUITS FOR WOMEN, JEANS, DRESSES, SKIRTS, SCARVES, GLOVES, MITTENS, SOCKS; FOOTWEAR, NAMELY, SHOES, SNEAKERS AND SANDALS; HEADGEAR, NAMELY, HATS AND CAPS; BELTS MADE OF LEATHER; BELTS MADE OF IMITATION LEATHER, IN CLASS 25 (U.S. CLS. 22 AND 39).

THE NAME "LUKE" IDENTIFIES A LIVING INDIVIDUAL WHOSE CONSENT IS OF RECORD.

PRIORITY DATE OF 5-6-2011 IS CLAIMED.

OWNER OF INTERNATIONAL REGISTRATION 1096855 DATED 7-29-2011, EXPIRES 7-29-2021.

THE MARK CONSISTS OF THE DESIGN OF A LION WEARING A CROWN WITH HIS TONGUE OUT ABOVE THE WORDING "LUKE". THE LETTERS "L" AND "E" APPEAR MORE DISTINCT THAN THE LETTERS "U" AND "K".

SER. NO. 79-105,092, FILED 7-29-2011.

JESSICA FATHY, EXAMINING ATTORNEY



David J. Kybas

Director of the United States Patent and Trademark Office

United States of America

United States Patent and Trademark Office



Reg. No. 4,204,166

Registered Sep. 11, 2012

Int. Cls.: 5, 29, 30 and 32

EMMIAG (SWITZERLAND SOCIÉTÉ ANONYME (SA) / JOINT STOCK COMPANY LEGALLY ORGANIZED UNDER THE LAWS OF SWITZERLAND)
HABSBURGERSTRASSE 12
POSTFACH; CH-6002 LUZERN
SWITZERLAND

TRADEMARK

FOR: DIETETIC FOODS ADAPTED FOR MEDICAL USE; FOOD FOR BABIES , IN CLASS 5 (U.S. CLS. 6, 18, 44, 46, 51 AND 52).

PRINCIPAL REGISTER

FOR: MILK AND MILK PRODUCTS EXCLUDING ICE CREAM, ICE MILK AND FROZEN YOGURT, IN CLASS 29 (U.S. CL. 46).

FOR: COFFEE, COCOA, EDIBLE ICES, IN CLASS 30 (U.S. CL. 46).

FOR: MINERAL AND AERATED WATERS AND OTHER NON-ALCOHOLIC DRINKS, NAMELY, NON-ALCOHOLIC BEVERAGES CONTAINING FRUIT JUICES AND SOFT DRINKS; FRUIT DRINKS AND FRUIT JUICES; SYRUPS FOR MAKING BEVERAGES, IN CLASS 32 (U.S. CLS. 45, 46 AND 48).

OWNER OF U.S. REG. NOS. 2,344,670, 3,421,077 AND OTHERS.

PRIORITY DATE OF 3-18-2011 IS CLAIMED.

OWNER OF INTERNATIONAL REGISTRATION 1097078 DATED 8-12-2011, EXPIRES 8-12-2021.

THE COLOR(S) BLUE, RED AND WHITE IS/ARE CLAIMED AS A FEATURE OF THE MARK.

THE MARK CONSISTS OF A WHITE CROWN AND THE TERM "EMMI" IN WHITE UNDERLINED WITH A WHITE CURVED LINE INSIDE AN OVAL SHAPE THAT IS BLUE AND RED, WITH A RED BANNER APPEARING TO THE LEFT AND RIGHT OF THE OVAL SHAPE. THE REMAINDER OF THE WHITE IN THE MARK IS FOR BACKGROUND PURPOSES ONLY AND IS NOT CLAIMED AS A FEATURE OF THE MARK.



David J. Kypos

SER. NO. 79-105,175, FILED 8-12-2011.

AMY ALFIERI, EXAMINING ATTORNEY

United States of America

United States Patent and Trademark Office



Reg. No. 4,204,167

Registered Sep. 11, 2012

Int. Cls.: 7 and 11

DUNKERMOTOREN GMBH (FED REP GERMANY GESELLSCHAFT MIT BESCHRÄNKTER HAFTUNG)
ALLMENDSTRASSE 11
79848 BONNDORF/SCHWARZWALD
FED REP GERMANY

TRADEMARK

PRINCIPAL REGISTER

FOR: LOW-POWER DIRECT CURRENT, ALTERNATING CURRENT OR THREE-PHASE CURRENT ELECTRIC MOTORS AND GENERATORS, ESPECIALLY DIRECT AND ALTERNATING CURRENT MOTORS, PERMANENT MAGNET MOTORS, ASYNCHRONOUS MOTORS, SYNCHRONOUS MOTORS, CAPACITOR MOTORS, SHADED-POLE MOTORS, HYSTERESIS MOTORS, SERVO-MOTORS, TACHOMETRIC MOTORS, AND PARTS OF THE AFORESAID MOTORS AND ENGINES, ALL NOT FOR LAND VEHICLES; SPEED ADJUSTMENT APPARATUS, NAMELY, VARIABLE SPEED DRIVES FOR MOTORS AND ENGINES NOT FOR LAND VEHICLES; VARIABLE SPEED MECHANISMS, ESPECIALLY GOVERNORS AND GEARINGS, IN CLASS 7 (U.S. CLS. 13, 19, 21, 23, 31, 34 AND 35).

FOR: SMALL APPARATUS FITTED WITH MOTORS NOT FOR LAND VEHICLES, NAMELY, VENTILATORS FOR AIR-CONDITIONING AND AIR COOLING, VENTILATORS FOR COMMERCIAL AND INDUSTRIAL USE, AND HAIR-DRYING APPARATUS, IN CLASS 11 (U.S. CLS. 13, 21, 23, 31 AND 34).

THE MARK CONSISTS OF A LOWER CASE LETTER "D" PARTIALLY INSIDE OF A CIRCLE.

OWNER OF INTERNATIONAL REGISTRATION 0322662 DATED 10-10-1966, EXPIRES 10-10-2016.

SER. NO. 79-105,327, FILED 8-24-2011.

APRIL ROACH, EXAMINING ATTORNEY



David J. Kybas

Director of the United States Patent and Trademark Office

United States of America

United States Patent and Trademark Office

COUGAR

Reg. No. 4,204,168

Registered Sep. 11, 2012

Int. Cl.: 14

TRADEMARK

PRINCIPAL REGISTER

CARTIER INTERNATIONAL AG (SWITZERLAND JOINT STOCK COMPANY)
HINTERBERGSTRASSE 22, POSTFACH 61
CH-6312 STEINHAUSEN
SWITZERLAND

FOR: PRECIOUS METALS AND THEIR ALLOYS AND GOODS MADE OF OR COATED WITH THESE MATERIALS NOT INCLUDED IN OTHER CLASSES, NAMELY, JEWELRY, KEY RINGS, WATCHES, CHRONOMETERS; BIJOUTERIE, PRECIOUS STONES; TIMEPIECES AND CHRONOMETRIC INSTRUMENTS, IN CLASS 14 (U.S. CLS. 2, 27, 28 AND 50).

THE MARK CONSISTS OF STANDARD CHARACTERS WITHOUT CLAIM TO ANY PARTICULAR FONT, STYLE, SIZE, OR COLOR.

OWNER OF INTERNATIONAL REGISTRATION 0540630 DATED 6-22-1989, EXPIRES 6-22-2019.

OWNER OF U.S. REG. NO. 1,619,761.

SER. NO. 79-105,344, FILED 4-29-2011.

KAREN SEVERSON, EXAMINING ATTORNEY



David J. Kybas

Director of the United States Patent and Trademark Office

United States of America

United States Patent and Trademark Office

BERGABEST

Reg. No. 4,204,169

Registered Sep. 11, 2012

Int. Cls.: 1 and 4

TRADEMARK

PRINCIPAL REGISTER

BERG + SCHMIDT GMBH & CO. KG (FED REP GERMANY LIMITED PARTNERSHIP)
AN DER ALSTER 81
20099 HAMBURG
FED REP GERMANY

FOR: CHEMICALS USED IN INDUSTRY; CHEMICALS USED IN THE COSMETIC INDUSTRY; CHEMICALS USED IN THE FOOD INDUSTRY; FATTY ACID ESTERS FOR USE AS SOLUBILIZERS; FATTY ACID ESTERS FOR PRODUCING SOLUBILIZERS; CHEMICAL RELEASE AGENT PREPARATIONS USED IN THE BAKERY AND CONFECTIONERY INDUSTRIES; CHEMICAL SUPPORT SUBSTANCES FOR LIPOPHILIC SUBSTANCES USED IN THE FOOD INDUSTRY; CHEMICAL-BASED SURFACE TREATMENT AGENTS FOR STICKY PRODUCTS USED IN THE FOOD INDUSTRY; CHEMICAL-BASED HYDROPHOBIZING AGENTS USED IN THE FOOD INDUSTRY; CHEMICAL-BASED VISCOSITY REGULATORS USED IN THE FOOD INDUSTRY, IN CLASS 1 (U.S. CLS. 1, 5, 6, 10, 26 AND 46).

FOR: LUBRICANTS, NAMELY, LUBRICATING GREASES, LUBRICATING OILS AND ALL PURPOSE LUBRICANTS; LUBRICANTS FOR THE FOOD INDUSTRY, IN CLASS 4 (U.S. CLS. 1, 6 AND 15).

THE MARK CONSISTS OF STANDARD CHARACTERS WITHOUT CLAIM TO ANY PARTICULAR FONT, STYLE, SIZE, OR COLOR.

OWNER OF INTERNATIONAL REGISTRATION 0793355 DATED 8-27-2002, EXPIRES 8-27-2012.

SER. NO. 79-105,412, FILED 6-27-2011.

JANICE KIM, EXAMINING ATTORNEY



David J. Kyffers

Director of the United States Patent and Trademark Office

United States of America

United States Patent and Trademark Office



Reg. No. 4,204,170

Registered Sep. 11, 2012

Int. Cls.: 16, 35 and 41

HUBERT BURDA; MEDIA HOLDING KOMMANDITGESELLSCHAFT (FED REP GERMANY LIMITED LIABILITY COMPANY)
HAUPTSTR. 130
77652 OFFENBURG
FED REP GERMANY

TRADEMARK

SERVICE MARK

PRINCIPAL REGISTER

FOR: PRINTED MATTER, NAMELY, PERIODICALS AND BOOKS IN THE FIELD OF ONLINE BUSINESS, ELECTRONICS, SOCIAL MEDIA, COMPUTER AND ONLINE TECHNOLOGY; PRINTED INSTRUCTIONAL AND TEACHING MATERIAL IN THE FIELD OF ONLINE BUSINESS, ELECTRONICS, SOCIAL MEDIA, COMPUTER AND ONLINE TECHNOLOGY, IN CLASS 16 (U.S. CLS. 2, 5, 22, 23, 29, 37, 38 AND 50).

FOR: ADVERTISING IN PRINT AND ON THE INTERNET, NAMELY, PROMOTING THE GOODS AND SERVICES, BRAND IDENTITY AND COMMERCIAL INFORMATION AND NEWS FOR THIRD PARTIES THROUGH PRINT AND ONLINE MEDIA; PUBLIC RELATIONS; ADVERTISING EVENTS, NAMELY, ARRANGING AND CONDUCTING SPECIAL EVENTS FOR COMMERCIAL, PROMOTIONAL OR ADVERTISING PURPOSES; DEMONSTRATION OF GOODS FOR THIRD PARTIES, NAMELY, DEMONSTRATION OF COMPUTERS, PRINTERS FOR USE WITH COMPUTERS, LOUDSPEAKERS, SCANNERS, TELEPHONES, MOBILE TELEPHONES, HANDHELD POCKET COMPUTERS, PDAS, TELEVISION SETS, RADIOS, ALARM CLOCKS, STEREO APPARATUS, DOWNLOADABLE COMPUTER SOFTWARE, CDS, DVDS AND RECORDING MEDIA, IN CLASS 35 (U.S. CLS. 100, 101 AND 102).

FOR: PUBLICATION OF PERIODICALS, BOOKS, PRINTED INSTRUCTIONAL AND TEACHING MATERIAL IN THE FIELD OF ONLINE BUSINESS, ELECTRONICS, SOCIAL MEDIA, COMPUTER AND ONLINE TECHNOLOGY; ENTERTAINMENT, IN THE NATURE OF VISUAL AND AUDIO PERFORMANCES; ORGANIZING TRAINING COURSES, NAMELY, ARRANGING PROFESSIONAL WORKSHOP AND TRAINING COURSES; ORGANIZING CULTURAL EVENTS, IN CLASS 41 (U.S. CLS. 100, 101 AND 107).

THE MARK CONSISTS OF THE TERM "DLD" WITH A STAR BEHIND TO THE UPPER RIGHT PORTION OF THE SECOND "D", ALL IN RED.



David J. Kyjars

OWNER OF INTERNATIONAL REGISTRATION 0933841 DATED 6-18-2007, EXPIRES 6-18-2017.

Reg. No. 4,204,170 THE COLOR(S) RED IS/ARE CLAIMED AS A FEATURE OF THE MARK.

SER. NO. 79-105,429, FILED 6-29-2011.

JANICE KIM, EXAMINING ATTORNEY

United States of America
United States Patent and Trademark Office

ONLEAD

Reg. No. 4,204,171

Registered Sep. 11, 2012

Int. Cl.: 20

TRADEMARK

PRINCIPAL REGISTER

GUANGZHOU; ONLEAD FURNITURE CO., LTD. (CHINA CORPORATION)
NO. 100, 7TH HELONG ROAD
REHE TOWN, BAIYUN DISTRICT;; GUANGZHOU CITY; GUANGDONG PROVINCE
CHINA

FOR: OFFICE FURNITURE; BINS OF WOOD; BINS OF PLASTIC; DISPLAY BOARDS;
FURNITURE FITTINGS, NOT OF METAL; MIRRORS; BAMBOO POLES; NON-METAL
HAND-OPERATED GARDEN HOSE REELS; DECORATIVE MOBILES; CUSHIONS; INDOOR
WINDOW BLINDS, IN CLASS 20 (U.S. CLS. 2, 13, 22, 25, 32 AND 50).

THE MARK CONSISTS OF THE STYLIZED WORDS "ONLEAD".

OWNER OF INTERNATIONAL REGISTRATION 1097716 DATED 10-31-2011, EXPIRES 10-31-2021.

SER. NO. 79-105,548, FILED 10-31-2011.

CURTIS FRENCH, EXAMINING ATTORNEY



David J. Kyffers

Director of the United States Patent and Trademark Office

United States of America

United States Patent and Trademark Office

GURUNAVI

Reg. No. 4,204,172

Registered Sep. 11, 2012

**Int. Cls.: 16, 35, 42, 43
and 45**

TRADEMARK

SERVICE MARK

PRINCIPAL REGISTER

GOURMET NAVIGATOR INCORPORATED (JAPAN CORPORATION)
2-2, YURAKUCHOU 1-CHOME
CHIYODA-KU; TOKYO 100-0006
JAPAN

FOR: HYGIENIC HAND TOWELS OF PAPER; FACE OR HAND TOWELS OF PAPER; TABLE NAPKINS OF PAPER; HAND TOWELS OF PAPER; HANDKERCHIEFS OF PAPER; TABLECLOTHS OF PAPER; PAPER AND CARDBOARD; STATIONERY AND STUDY MATERIALS, NAMELY, STUDY GUIDES; PRINTED MATTER, NAMELY, BOOKS, MANUALS, CURRICULUM, NEWSLETTERS, INFORMATIONAL CARDS AND BROCHURES IN THE FIELD OF RESTAURANTS AND FOODS; PRINTED TICKETS, IN CLASS 16 (U.S. CLS. 2, 5, 22, 23, 29, 37, 38 AND 50).

FOR: ADVERTISING AND PUBLICITY SERVICES; INTERNET ADVERTISING SERVICES; ASSISTANCE, ADVISORY SERVICES AND CONSULTANCY WITH REGARD TO BUSINESS PLANNING, BUSINESS ANALYSIS, BUSINESS MANAGEMENT, AND BUSINESS ORGANIZATION; MARKETING RESEARCH SERVICES; PROVIDING INFORMATION CONCERNING COMMERCIAL SALES; BUSINESS BROKERAGE OF CONTRACTS OF PRODUCT SALES; BUSINESS MANAGEMENT OF HOTELS FOR OTHERS; PUBLICITY MATERIAL RENTAL; EMPLOYMENT AGENCIES; PROVIDING BUSINESS MANAGEMENT ASSISTANCE IN THE OPERATION OF COMPUTERS, TYPEWRITERS, AND OTHER SIMILAR OFFICE MACHINES FOR OTHERS; IMPORT AND EXPORT AGENCIES; PROVIDING EMPLOYMENT INFORMATION, IN CLASS 35 (U.S. CLS. 100, 101 AND 102).

FOR: PROVIDING COMPUTER PROGRAMMING SERVICES FOR ENABLING THE USE OF ON-LINE BOOKMARKS; COMPUTER SOFTWARE DESIGN, COMPUTER PROGRAMMING, OR MAINTENANCE OF COMPUTER SOFTWARE; COMPUTER SERVICES, NAMELY, PROVIDING TEMPORARY USE OF ONLINE, NON-DOWNLOADABLE COMPUTER PROGRAMS FOR INDEXING OF INFORMATION, SITES AND OTHER RESOURCES; CREATING OR MAINTAINING WEB SITES FOR OTHERS; RENTAL OF COMPUTERS; COMPUTER PROGRAMMING AND MAINTENANCE OF COMPUTER PROGRAMS; RENTAL OF WEB SERVERS; COMPUTER PROGRAMMING SERVICES FOR CREATING WEBLOGS; COMPUTER PROGRAMMING SERVICES FOR BROWSING OF WEBLOGS; PROVIDING METEOROLOGICAL INFORMATION; SERVICES FOR DESIGNING COMPUTER SOFTWARE; COMPUTER SERVICES, NAMELY, DESIGNING AND IMPLEMENTING NETWORK WEB PAGES FOR OTHERS; GRAPHIC ARTS DESIGNING; DESIGN OF WEBSITE; TECHNICAL ADVICE RELATING TO OPERATION AND PERFORMANCE OF COMPUTERS; TESTING,



David J. Kyffers

Director of the United States Patent and Trademark Office

Reg. No. 4,204,172 INSPECTION OR RESEARCH OF PHARMACEUTICALS, COSMETICS OR FOODSTUFF; TESTING, INSPECTION OR RESEARCH ON AGRICULTURE, LIVESTOCK BREEDING OR FISHERIES, IN CLASS 42 (U.S. CLS. 100 AND 101).

FOR: PROVIDING INFORMATION ON PROVIDING TEMPORARY ACCOMMODATION; PROVIDING INFORMATION ON ACCOMMODATION BUREAUX, NAMELY, BROKERING RESERVATIONS FOR TEMPORARY ACCOMMODATIONS; PROVIDING INFORMATION ON PROVIDING FOODS AND BEVERAGES, NAMELY, RESTAURANT SERVICES; PROVIDING INFORMATION ON PROVIDING TEMPORARY ACCOMMODATION FOR ANIMALS; PROVIDING INFORMATION ON DAY-NURSERIES, NAMELY, CRECHE SERVICES; PROVIDING RETIREMENT HOMES; PROVIDING INFORMATION ON RENTALS OF INDUSTRIAL COOKING EQUIPMENT, INDUSTRIAL DISH-DRYING MACHINES, OR INDUSTRIAL DISH-WASHING MACHINES; PROVIDING INFORMATION RELATING TO RESTAURANT SERVICES, INCLUDING LOCATION OF RESTAURANTS, IN CLASS 43 (U.S. CLS. 100 AND 101).

FOR: INFORMATION RELATED TO CLOTHING RENTAL; PROVIDING INFORMATION ON NEWSPAPER ARTICLES, NAMELY, PROVIDING INFORMATION FROM NEWSPAPER ARTICLES IN THE FIELD OF MARRIAGE COUNSELING; MARRIAGE PARTNER INTRODUCTION OR DATING SERVICES; CONSULTANCY CONCERNING MARRIAGE PARTNER INTRODUCTION OR DATING SERVICES; ORGANIZATION OF WEDDING CEREMONY, NAMELY, PROVIDING FACILITIES FOR WEDDING CEREMONIES; FORTUNE-TELLING; PERSONAL LEGAL AFFAIRS CONSULTANCY; PROVIDING INFORMATION ABOUT FORTUNE-TELLING AND PERSONAL LEGAL AFFAIRS CONSULTANCY; PROVIDING INFORMATION RELATED TO CLOTHING RENTAL, IN CLASS 45 (U.S. CLS. 100 AND 101).

OWNER OF U.S. REG. NOS. 3,623,575 AND 3,824,208.

PRIORITY DATE OF 4-25-2011 IS CLAIMED.

OWNER OF INTERNATIONAL REGISTRATION 1097911 DATED 5-24-2011, EXPIRES 5-24-2021.

THE MARK CONSISTS OF THE WORDING "GURUNAVI" IN STYLIZED FONT.

THE WORDING "GURUNAVI" HAS NO MEANING IN A FOREIGN LANGUAGE.

SER. NO. 79-105,612, FILED 5-24-2011.

APRIL HESIK, EXAMINING ATTORNEY

United States of America

United States Patent and Trademark Office

FLAXPREG

Reg. No. 4,204,173

Registered Sep. 11, 2012

Int. Cls.: 12, 17 and 22

TRADEMARK

PRINCIPAL REGISTER

FAURECIA AUTOMOTIVE INDUSTRIE (FRANCE SOCIÉTÉ PAR ACTIONS SIMPLIFIÉE)
2 RUE HENNAPE
F-92000 NANTERRE
FRANCE

FOR: LAND VEHICLES AND AUTOMOBILES AND STRUCTURAL PARTS THEREFOR, NAMELY, FLOORS FOR VEHICLE TRUNKS, PASSENGER COMPARTMENTS FOR VEHICLES, SEPARATION BOARDS FITTED TO VEHICLES, VEHICLE TRUNKS, DOORS FOR VEHICLES, CAR WINDOW SHADES, AUTOMOTIVE WINDSHIELD SHADE SCREEN, FITTED VEHICLE COVERS AND VEHICLE SEAT COVERS, ALL OF THE AFORESAID GOODS MADE IN WHOLE OR IN SIGNIFICANT PART OF FLAX, IN CLASS 12 (U.S. CLS. 19, 21, 23, 31, 35 AND 44).

FOR: MATS AND PANELS OF FIBERS COMPRISING MAINLY CANVAS FOR USE IN THE PRODUCTION OF FLOORING OF TRUNKS AND PASSENGER COMPARTMENTS AND IN THE PRODUCTION OF SEPARATION BOARDS FITTED TO VEHICLES, TRUNKS AND PASSENGER COMPARTMENTS FOR VEHICLES; SEMI-PROCESSED CELLULOSE ACETATE, CANVAS HOSE PIPES, ARTIFICIAL AND SYNTHETIC RESINS, EPOXY AND POLYESTER IN ROLLS OR SHEETS FOR FURTHER MANUFACTURE, AND ALL OF THE AFORESAID GOODS MADE IN WHOLE OR COMBINED IN SIGNIFICANT PART WITH FLAX, IN CLASS 17 (U.S. CLS. 1, 5, 12, 13, 35 AND 50).

FOR: PANELS MADE OF FIBERS COMPRISING MAINLY CANVAS, TEXTILE FIBERS, RAW OR TREATED WOOL, WOOD WOOL, UPHOLSTERY WOOL, STUFFING MATERIALS NOT OF RUBBER, PAPER OR PLASTICS, WADDING FOR FILTERING, WADDING NOT OF RUBBER, PAPER OR PLASTIC FOR PADDING OR STUFFING UPHOLSTERY, FIBER OF RAMIE, HEMP, BAMBOO FIBER, RAW SILK, AND ALL OF THE AFORESAID GOODS MADE IN WHOLE OR COMBINED IN SIGNIFICANT PART WITH FLAX, IN CLASS 22 (U.S. CLS. 1, 2, 7, 19, 22, 42 AND 50).



THE MARK CONSISTS OF STANDARD CHARACTERS WITHOUT CLAIM TO ANY PARTICULAR FONT, STYLE, SIZE, OR COLOR.

PRIORITY DATE OF 4-7-2011 IS CLAIMED.

OWNER OF INTERNATIONAL REGISTRATION 1098026 DATED 9-30-2011, EXPIRES 9-30-2021.

David J. Kybas

Director of the United States Patent and Trademark Office

Reg. No. 4,204,173 SER. NO. 79-105,649, FILED 9-30-2011.

JULIE WATSON, EXAMINING ATTORNEY

United States of America

United States Patent and Trademark Office

BluePower

Reg. No. 4,204,174

Registered Sep. 11, 2012

Int. Cls.: 18 and 28

TRADEMARK

PRINCIPAL REGISTER

YE JINXU (CHINA INDIVIDUAL)
NO. 25 MATANG, SHANGCUO VILLAGE
WUXIAN TOWN, TONG'AN DISTRICT, XIAMEN
FUJIAN, CHINA

FOR: HANDBAGS; TRAVELLING BAGS; LEATHERWARE TRAVELLING SETS COMPRISED OF LUGGAGE, DUFFEL BAGS, SUITCASES, AND TRUNKS; HAVERSACKS; UMBRELLAS; WALKING STICKS; SADDLERY; PURSES; SCHOOL SACHELS; BACKPACKS, IN CLASS 18 (U.S. CLS. 1, 2, 3, 22 AND 41).

FOR: GOLF CLUBS; GOLF CLUB HEADS; GOLF CLUB GRIPS; TOYS, NAMELY, PLUSH TOYS, ACTION FIGURE TOYS, TOY VEHICLES, DOLLS; FISHING TACKLE; GOLF GLOVES; BALLS FOR GAMES; GOLF BAGS, WITH OR WITHOUT WHEELS; BODY-BUILDING APPARATUS; PHYSICAL EXERCISE APPARATUS IN THE NATURE OF EXERCISE MACHINE; RACKETS, IN CLASS 28 (U.S. CLS. 22, 23, 38 AND 50).

THE MARK CONSISTS OF STANDARD CHARACTERS WITHOUT CLAIM TO ANY PARTICULAR FONT, STYLE, SIZE, OR COLOR.

OWNER OF INTERNATIONAL REGISTRATION 1098486 DATED 11-2-2011, EXPIRES 11-2-2021.

SER. NO. 79-105,791, FILED 11-2-2011.

JEAN IM, EXAMINING ATTORNEY



David J. Kypos

Director of the United States Patent and Trademark Office

United States of America
United States Patent and Trademark Office

GUAM

Reg. No. 4,204,175

Registered Sep. 11, 2012

Int. Cl.: 3

TRADEMARK

PRINCIPAL REGISTER

LACOTE S.R.L. (ITALY LIMITED LIABILITY COMPANY)
VIA SAN GEMINIANO, 2/A
I-41030 SAN PROSPERO (MO)
ITALY

FOR: BODY AND BEAUTY CARE CREAMS AND COSMETICS, IN CLASS 3 (U.S. CLS. 1, 4, 6, 50, 51 AND 52).

THE MARK CONSISTS OF STANDARD CHARACTERS WITHOUT CLAIM TO ANY PARTICULAR FONT, STYLE, SIZE, OR COLOR.

OWNER OF INTERNATIONAL REGISTRATION 0713557 DATED 5-3-1999, EXPIRES 5-3-2019.

SER. NO. 79-105,821, FILED 6-7-2011.

SUE LAWRENCE, EXAMINING ATTORNEY



David J. Kyffers

Director of the United States Patent and Trademark Office

United States of America
United States Patent and Trademark Office

SILVINI

Reg. No. 4,204,176

Registered Sep. 11, 2012

Int. Cl.: 25

TRADEMARK

PRINCIPAL REGISTER

SILVINI S.R.O. (CZECH REPUBLIC LIMITED LIABILITY COMPANY)
U LOUZE 380
CZ-250 66 ZDIBY
CZECH REPUBLIC

FOR: SPORTS CLOTHING, NAMELY, TROUSERS, T-SHIRTS, JERSEYS, ANORAKS, CAPS, SCARVES, GLOVES, FOOTWEAR, OVERALLS, SWEATSHIRTS, TRAINING SUITS, SHORTS, WAISTCOATS, LEGGINGS, GAITERS, WATERPROOF JACKETS AND PANTS, VESTS, JACKETS, BRACES, SOCKS, HEADBANDS, SWEATBANDS, SHAWLS, SCARVES, HEADGEAR, NAMELY, CAPS, BALACLAVAS; CLOTHING FOR CYCLING AND CYCLISTS, NAMELY, TROUSERS, T-SHIRTS, JERSEYS, ANORAKS, SCARVES, GLOVES, FOOTWEAR, OVERALLS, SWEATSHIRTS, TRAINING SUITS, SHORTS, WAISTCOATS, LEGGINGS, GAITERS, WATERPROOF JACKETS AND PANTS, VESTS, JACKETS, BRACES, SOCKS, HEADBANDS, SWEATBANDS, SHAWLS, SCARVES, HEADGEAR, NAMELY, CAPS, BALACLAVAS, IN CLASS 25 (U.S. CLS. 22 AND 39).

THE MARK CONSISTS OF STANDARD CHARACTERS WITHOUT CLAIM TO ANY PARTICULAR FONT, STYLE, SIZE, OR COLOR.

OWNER OF INTERNATIONAL REGISTRATION 0962296 DATED 3-18-2008, EXPIRES 3-18-2018.

SER. NO. 79-105,857, FILED 7-14-2011.

ROBERT STRUCK, EXAMINING ATTORNEY



David J. Kyfos

Director of the United States Patent and Trademark Office

United States of America

United States Patent and Trademark Office

CHRISTIAAN VAN DER KLAAUW

Reg. No. 4,204,177

Registered Sep. 11, 2012

Int. Cl.: 14

CHRISTIAAN VAN DER KLAAUW HORLOGE ATELIER B.V. (NETHERLANDS BESLOTEN
VENNOOTSCHAP (B.V.))
BUSINESSPARK FRIESLAND-W 47
NL-8466 SL NIJEHASKE
NETHERLANDS

TRADEMARK

PRINCIPAL REGISTER

FOR: PRECIOUS METALS AND THEIR ALLOYS; GOODS IN PRECIOUS METALS OR
COATED THEREWITH, NAMELY, WATCHES AND HOROLOGICAL INSTRUMENTS;
JEWELRY; TRINKETS, NAMELY, WATCHES AND HOROLOGICAL INSTRUMENTS;
PRECIOUS STONES; HOROLOGICAL AND CHRONOMETRIC INSTRUMENTS, IN CLASS
14 (U.S. CLS. 2, 27, 28 AND 50).

THE MARK CONSISTS OF STANDARD CHARACTERS WITHOUT CLAIM TO ANY PAR-
TICULAR FONT, STYLE, SIZE, OR COLOR.

OWNER OF INTERNATIONAL REGISTRATION 1028824 DATED 1-22-2010, EXPIRES 1-22-
2020.

THE NAME(S), PORTRAIT(S), AND/OR SIGNATURE(S) SHOWN IN THE MARK IDENTIFIES
"CHRISTIAAN VAN DER KLAAUW", WHOSE CONSENT(S) TO REGISTER IS MADE OF
RECORD.

SER. NO. 79-105,883, FILED 5-10-2011.

CAROLINE WOOD, EXAMINING ATTORNEY



David J. Kyffers

Director of the United States Patent and Trademark Office

United States of America

United States Patent and Trademark Office



Reg. No. 4,204,178

Registered Sep. 11, 2012

Int. Cl.: 14

TRADEMARK

PRINCIPAL REGISTER

CHRISTIAAN VAN DER KLAUW HORLOGE ATELIER B.V. (NETHERLANDS BESLOTEN
VENNOOTSCHAP (B.V.))
BUSINESSPARK FRIESLAND-W 47
NL-8466 SL NIJEHASKE
NETHERLANDS

FOR: PRECIOUS METALS AND THEIR ALLOYS; GOODS IN PRECIOUS METALS OR
COATED THEREWITH, NAMELY, WATCHES AND HOROLOGICAL INSTRUMENTS;
JEWELRY; TRINKETS, NAMELY, WATCHES AND HOROLOGICAL INSTRUMENTS;
PRECIOUS STONES; HOROLOGICAL AND CHRONOMETRIC INSTRUMENTS, IN CLASS
14 (U.S. CLS. 2, 27, 28 AND 50).

OWNER OF INTERNATIONAL REGISTRATION 1030910 DATED 1-22-2010, EXPIRES 1-22-
2020.

SER. NO. 79-105,886, FILED 5-10-2011.

CAROLINE WOOD, EXAMINING ATTORNEY



David J. Kyffers

Director of the United States Patent and Trademark Office

United States of America

United States Patent and Trademark Office

dot

Reg. No. 4,204,179

Registered Sep. 11, 2012

**Int. Cls.: 1, 8, 19, 20 and
37**

WERBETECHNIK ART OF DISPLAY GMBH & CO. KG (FED REP GERMANY G.M.B.H.)
RUDOLF-DIESEL-WEG 22
23879 MÖLLN
FED REP GERMANY

FOR: ADHESIVES FOR FLOOR AND WALL BOARDS AND TILES, NOT OF METAL; ADHESIVES FOR FLOOR AND WALL BOARDS AND TILES, OF METAL; ADHESIVES FOR MIRRORED TILES; ADHESIVES FOR WOOD, CORK AND PLASTIC FLOOR AND WALL BOARDS, IN CLASS 1 (U.S. CLS. 1, 5, 6, 10, 26 AND 46).

TRADEMARK

SERVICE MARK

PRINCIPAL REGISTER

FOR: HAND TOOLS AND IMPLEMENTS, IN PARTICULAR FOR LAYING TILES AND BOARDS, NAMELY, TROWELS, MASONS' TROWELS, MASONS' EDGES, MASONS' GROOVERS, TILE CUTTERS, FILES, SAW, SQUARES, NIPPERS, IN CLASS 8 (U.S. CLS. 23, 28 AND 44).

FOR: TILES FOR FLOORING, NOT OF METAL; BOARDS AND TILES, NOT OF METAL, NAMELY, GLASS, CERAMIC, PLASTIC, EARTHENWARE; MORTAR, IN PARTICULAR TILE MORTAR; BOARDS OF WOOD; CORK BOARDS; MULTILAYER PLASTIC PANELS FOR USE IN BUILDING, IN CLASS 19 (U.S. CLS. 1, 12, 33 AND 50).

FOR: MIRROR TILES, IN CLASS 20 (U.S. CLS. 2, 13, 22, 25, 32 AND 50).

FOR: TILE LAYING, IN CLASS 37 (U.S. CLS. 100, 103 AND 106).

THE MARK CONSISTS OF STANDARD CHARACTERS WITHOUT CLAIM TO ANY PARTICULAR FONT, STYLE, SIZE, OR COLOR.

OWNER OF INTERNATIONAL REGISTRATION 1098597 DATED 8-3-2011, EXPIRES 8-3-2021.

SER. NO. 79-105,955, FILED 8-3-2011.

ALAIN LAPTER, EXAMINING ATTORNEY



David J. Kypos

Director of the United States Patent and Trademark Office

United States of America

United States Patent and Trademark Office



Reg. No. 4,204,180

Registered Sep. 11, 2012

Int. Cl.: 11

TRADEMARK

PRINCIPAL REGISTER

CISAPLAST S.P.A. (ITALY JOINT STOCK COMPANY)
VIA POLISKI, 3
I-46029 SUZZARA (MN)
ITALY

FOR: REFRIGERATORS; LIGHTING FIXTURES; COMPONENTS FOR INDUSTRIAL REFRIGERATORS MADE FROM METAL, PLASTIC AND/OR GLASS, NAMELY, SHELVING, DRAWERS, BINS AND TRAYS; METAL CONDENSERS FOR INDUSTRIAL REFRIGERATORS; MODULAR INSULATED PANELS AND DOORS FOR WALK-IN REFRIGERATED ENCLOSURES, ENVIRONMENTAL COOLING ROOMS AND FREEZERS, IN CLASS 11 (U.S. CLS. 13, 21, 23, 31 AND 34).

THE MARK CONSISTS OF THE WORDING "CISAPLAST"; ON THE LEFT SIDE OF THE MARK, THERE IS A SYMBOL COMPOSED BY A LETTER "W" PLACED ABOVE AND SLIGHTLY SUPERPOSED ON THE LETTER "M"; THE CHARACTERS OF THE WRITING "CISAPLAST" ARE IN SQUARED BLOCK ITALICS.

OWNER OF INTERNATIONAL REGISTRATION 1098853 DATED 8-2-2011, EXPIRES 8-2-2021.

SER. NO. 79-106,026, FILED 8-2-2011.

LINDA M. KING, EXAMINING ATTORNEY



David J. Kyffers

Director of the United States Patent and Trademark Office

United States of America
United States Patent and Trademark Office

COLEXIO

Reg. No. 4,204,181

Registered Sep. 11, 2012

Int. Cls.: 9, 39 and 42

TRADEMARK

SERVICE MARK

PRINCIPAL REGISTER

COLEXIO GMBH (FED REP GERMANY LIMITED LIABILITY COMPANY)
SCHLOSSKOPPELWEG 8
24226 HEIKENDORF
FED REP GERMANY

FOR: COMPUTER SOFTWARE FOR COORDINATING THE USE OF VEHICLES AND FOR PLANNING THE EFFICIENT USE OF MEANS OF PUBLIC AND PRIVATE TRANSPORTATION, IN CLASS 9 (U.S. CLS. 21, 23, 26, 36 AND 38).

FOR: PASSENGER TRANSPORT, IN CLASS 39 (U.S. CLS. 100 AND 105).

FOR: COMPUTER SOFTWARE PROGRAMMING, IN CLASS 42 (U.S. CLS. 100 AND 101).

THE MARK CONSISTS OF STANDARD CHARACTERS WITHOUT CLAIM TO ANY PARTICULAR FONT, STYLE, SIZE, OR COLOR.

OWNER OF INTERNATIONAL REGISTRATION 1098998 DATED 9-17-2011, EXPIRES 9-17-2021.

THE ENGLISH TRANSLATION OF "COLEXIO" IN THE MARK IS "SCHOOL".

SER. NO. 79-106,073, FILED 9-17-2011.

HEATHER BIDDULPH, EXAMINING ATTORNEY



David J. Kybas

Director of the United States Patent and Trademark Office

United States of America

United States Patent and Trademark Office



Reg. No. 4,204,182

Registered Sep. 11, 2012

Int. Cls.: 1 and 5

TRADEMARK

PRINCIPAL REGISTER

LONZA AG (LONZA LTD.) (SWITZERLAND CORPORATION)
LONZASTRASSE
3930 VISP; GESCHÄFTSLEITUNG; MÜNCHENSTEINERSTRASSE 38; CH-4002 BASEL
SWITZERLAND

FOR: INDUSTRIAL CHEMICALS, IN CLASS 1 (U.S. CLS. 1, 5, 6, 10, 26 AND 46).

FOR: PESTICIDES, IN CLASS 5 (U.S. CLS. 6, 18, 44, 46, 51 AND 52).

THE MARK CONSISTS OF A PURPLE OVAL CONTAINING THE WORD "LORE" IN WHITE,
AND A CIRCULAR PURPLE AND WHITE REPRESENTATION OF A DOG'S HEAD.

PRIORITY DATE OF 6-17-2011 IS CLAIMED.

OWNER OF INTERNATIONAL REGISTRATION 1099066 DATED 11-14-2011, EXPIRES 11-
14-2021.

THE COLOR(S) PURPLE AND WHITE IS/ARE CLAIMED AS A FEATURE OF THE MARK.

SER. NO. 79-106,089, FILED 11-14-2011.

BRIAN NEVILLE, EXAMINING ATTORNEY



David J. Kybas

Director of the United States Patent and Trademark Office

United States of America

United States Patent and Trademark Office

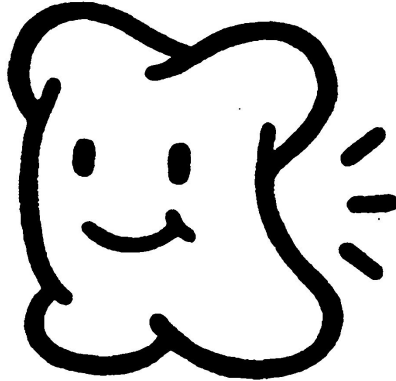

Reg. No. 4,204,183

Registered Sep. 11, 2012

Int. Cls.: 10, 42 and 44

TRADEMARK

SERVICE MARK

PRINCIPAL REGISTER

CATALYMEDIC INC. (JAPAN CORPORATION)
212 VENTURE PLAZA FUNABASHI
17-25, KITAHONCHO 1-CHOME,; FUNABASHI-SHI; CHIBA 273-0864
JAPAN

FOR: ARTIFICIAL BONES FOR IMPLANTATION; ARTIFICIAL BONE FILLING MATERIALS, NAMELY, BONE VOID FILLERS CONSISTING OF ARTIFICIAL MATERIALS, IN CLASS 10 (U.S. CLS. 26, 39 AND 44).

FOR: TESTING, INSPECTION OR RESEARCH OF PHARMACEUTICALS, COSMETICS OR FOODSTUFF, IN CLASS 42 (U.S. CLS. 100 AND 101).

FOR: PROVIDING MEDICAL INFORMATION, IN CLASS 44 (U.S. CLS. 100 AND 101).

THE MARK CONSISTS OF A CARTOON DESIGN OF A BONE.

PRIORITY DATE OF 10-11-2011 IS CLAIMED.

OWNER OF INTERNATIONAL REGISTRATION 1099187 DATED 11-9-2011, EXPIRES 11-9-2021.

SER. NO. 79-106,127, FILED 11-9-2011.

ROBERT STRUCK, EXAMINING ATTORNEY



David J. Kybas

Director of the United States Patent and Trademark Office

United States of America

United States Patent and Trademark Office

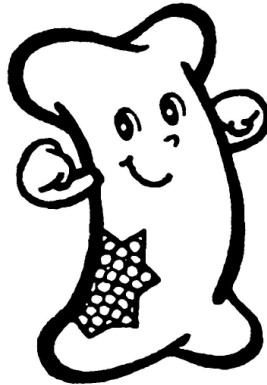

Reg. No. 4,204,184

Registered Sep. 11, 2012

Int. Cls.: 10, 42 and 44

TRADEMARK

SERVICE MARK

PRINCIPAL REGISTER

CATALYMEDIC INC. (JAPAN CORPORATION)
212 VENTURE PLAZA FUNABASHI
17-25, KITAHONCHO 1-CHOME,; FUNABASHI-SHI; CHIBA 273-0864
JAPAN

FOR: ARTIFICIAL BONES FOR IMPLANTATION; ARTIFICIAL BONE FILLING MATERIALS, NAMELY, BONE VOID FILLERS CONSISTING OF ARTIFICIAL MATERIALS, IN CLASS 10 (U.S. CLS. 26, 39 AND 44).

FOR: TESTING, INSPECTION OR RESEARCH OF PHARMACEUTICALS, COSMETICS OR FOODSTUFF, IN CLASS 42 (U.S. CLS. 100 AND 101).

FOR: PROVIDING MEDICAL INFORMATION, IN CLASS 44 (U.S. CLS. 100 AND 101).

THE MARK CONSISTS OF A CARTOON DESIGN OF A BONE WITH A STAR-SHAPED PATCH.

PRIORITY DATE OF 10-11-2011 IS CLAIMED.

OWNER OF INTERNATIONAL REGISTRATION 1099188 DATED 11-9-2011, EXPIRES 11-9-2021.

SER. NO. 79-106,128, FILED 11-9-2011.

ROBERT STRUCK, EXAMINING ATTORNEY



David J. Kybas

Director of the United States Patent and Trademark Office

United States of America

United States Patent and Trademark Office



GOODONNA

Reg. No. 4,204,185

Registered Sep. 11, 2012

Int. Cls.: 18 and 25

TRADEMARK

PRINCIPAL REGISTER

GUANGZHOU FINE HORSE LEATHER; CO., LTD. (CHINA CORPORATION)
FENGGANG, HECHENG VILLAGE
SHILING TOWN.; HUADU DISTRICT.; GUANGZHOU CITY; GUANGDONG PROVINCE
CHINA

FOR: REUSABLE SHOPPING BAGS; HANDBAGS; RUCKSACKS; WALLETS; LEATHER PURSES; ATTACHÉ CASES; VALISES; SCHOOL BAGS; LEATHER LEADS; SUITCASES OF IMITATION LEATHER, IN CLASS 18 (U.S. CLS. 1, 2, 3, 22 AND 41).

FOR: CLOTHING, NAMELY, TOPS, BOTTOMS, PANTS, SHIRTS, DRESSES, SHORTS, T-SHIRTS; CLOTHING FOR CHILDREN, NAMELY, TOPS, BOTTOMS, PANTS, SHIRTS, DRESSES, SHORTS, T-SHIRTS; FOOTWEAR; HEADWEAR; SOCKS AND STOCKINGS; GLOVES; NECKTIES; SCARVES AND SASHES FOR WEAR; BELTS; SWIMWEAR, IN CLASS 25 (U.S. CLS. 22 AND 39).

THE MARK CONSISTS OF THE WORDING "GOODONNA" BELOW A DESIGN ELEMENT CONSISTING OF A POLYGON DISPLAYING TWO CANDLES THAT SHARE A SINGLE DIAMOND-SHAPED FLAME.

OWNER OF INTERNATIONAL REGISTRATION 1099602 DATED 11-16-2011, EXPIRES 11-16-2021.

SER. NO. 79-106,271, FILED 11-16-2011.

KAREN SEVERSON, EXAMINING ATTORNEY



David J. Kyros

Director of the United States Patent and Trademark Office

United States of America

United States Patent and Trademark Office

9

Reg. No. 4,204,186

Registered Sep. 11, 2012

Int. Cl.: 3

TRADEMARK

PRINCIPAL REGISTER

AGNÈS ANDRÉE MARGUERITE MARIE TROUBLÉ (FRANCE INDIVIDUAL)
194 RUE DE RIVOLI
F-75001 PARIS
FRANCE

FOR: FOOT SMOOTHING STONES; COSMETIC SUNSCREEN PREPARATIONS; COSMETIC PREPARATIONS FOR BATHS; JOSS STICKS; HAIR LOTIONS; FALSE EYELASHES; COSMETICS; MAKE-UP REMOVING PRODUCTS; DEODORANTS FOR PERSONAL USE; SOAP; SHOWER GELS; ESSENTIAL OILS; HAIR SPRAYS; DENTIFRICES; HAIR LOTIONS; MAKE-UP PRODUCTS; COSMETIC SETS; NAIL POLISH; NAIL CARE PRODUCTS; SACHETS FOR PERFUMING LINEN; PERFUMERY; EAU DE PARFUM; TOILET WATER; EAU DE COLOGNE; SHAVING PRODUCTS; SHAMPOOS; PRODUCTS FOR REMOVING VARNISH; SHAVING BRUSHES; PERFUMED TOWELETTES; FACE CLEANSER; DEODORANT FOR BODY CARE; COSMETIC PREPARATIONS FOR SLIMMING PURPOSES; LIP BALM; HAIR STYLING PRODUCT, IN CLASS 3 (U.S. CLS. 1, 4, 6, 50, 51 AND 52).

PRIORITY DATE OF 10-17-2011 IS CLAIMED.

OWNER OF INTERNATIONAL REGISTRATION 1099632 DATED 11-7-2011, EXPIRES 11-7-2021.

SER. NO. 79-106,280, FILED 11-7-2011.

KELLY TRUSILO, EXAMINING ATTORNEY



David J. Kybas

Director of the United States Patent and Trademark Office

United States of America
United States Patent and Trademark Office

Quadrumat

Reg. No. 4,204,187

BRABENDER GMBH & CO. KG (FED REP GERMANY LIMITED PARTNERSHIP)
KULTUV STRAÙE 51-55

Registered Sep. 11, 2012

47055 DUISBURG, FED REP GERMANY

Int. Cl.: 7

FOR: MILLS, NAMELY, GRINDING MACHINES FOR CRUSHING GRAIN SEEDS, PARTICULARLY WHEAT AND RYE; MILLS, NAMELY, GRINDING MACHINES FOR MILLING PLANT AND GRAIN SEEDS, IN CLASS 7 (U.S. CLS. 13, 19, 21, 23, 31, 34 AND 35).

TRADEMARK

THE MARK CONSISTS OF THE TERM "QUADRUMAT" IN STYLIZED FONT.

PRINCIPAL REGISTER

OWNER OF INTERNATIONAL REGISTRATION 0247853 DATED 9-27-1961, EXPIRES 9-27-2021.

THE WORDING "QUADRUMAT" HAS NO MEANING IN A FOREIGN LANGUAGE.

SER. NO. 79-106,291, FILED 10-6-2011.

STEVEN PEREZ, EXAMINING ATTORNEY



David J. Kyffers

Director of the United States Patent and Trademark Office

United States of America

United States Patent and Trademark Office

LIGHT MY FIRE

Reg. No. 4,204,188

Registered Sep. 11, 2012

Int. Cl.: 8

TRADEMARK

PRINCIPAL REGISTER

LIGHT MY FIRE SWEDEN AB (SWEDEN JOINT STOCK COMPANY)
VÄSTKUSTVÄGEN 7
SE-211 24 MALMÖ
SWEDEN

FOR: HAND TOOLS FOR CUTTING AND FOR STARTING FIRES, NAMELY, UTILITY KNIVES, KNIFE SHEATHS, AND FIRE IGNITERS ALL SOLD TOGETHER AS A UNIT, IN CLASS 8 (U.S. CLS. 23, 28 AND 44).

THE MARK CONSISTS OF STANDARD CHARACTERS WITHOUT CLAIM TO ANY PARTICULAR FONT, STYLE, SIZE, OR COLOR.

OWNER OF INTERNATIONAL REGISTRATION 0929928 DATED 1-15-2007, EXPIRES 1-15-2017.

OWNER OF U.S. REG. NO. 2,876,989.

SER. NO. 79-106,336, FILED 5-17-2011.

WILLIAM ROSSMAN, EXAMINING ATTORNEY



David J. Kyffers

Director of the United States Patent and Trademark Office

United States of America

United States Patent and Trademark Office

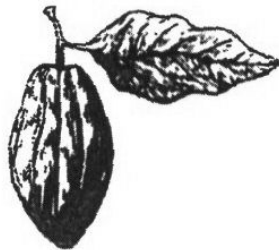

KOKO BLACK

Reg. No. 4,204,189

Registered Sep. 11, 2012

Int. Cls.: 30, 35 and 43

HILLS 100 COMPANY PTY LTD (AUSTRALIA AUSTRALIAN PROPRIETARY LIMITED COMPANY)
4 HOWITT DRIVE
LOWER TEMPLESTOWE VIC 3107
AUSTRALIA

TRADEMARK

SERVICE MARK

PRINCIPAL REGISTER

FOR: CHOCOLATE; CHOCOLATE PRODUCTS, NAMELY, INDIVIDUAL HANDMADE CHOCOLATES, CHOCOLATE BARS, CHOCOLATE CANDIES, CHOCOLATE CARMELS, CHOCOLATE DESSERTS; CHOCOLATE-BASED BEVERAGES; COCOA; TEA; COFFEE; ARTIFICIAL COFFEE; COFFEE-BASED BEVERAGES; BISCUITS; ICE CREAM; PASTRY AND CONFECTIONERY MADE OF SUGAR; CARMELS; HARD CANDY, IN CLASS 30 (U.S. CL. 46).

FOR: WHOLESALE STORE, RETAIL STORE AND DISTRIBUTORSHIP SERVICES FEATURING CHOCOLATE, CHOCOLATE PRODUCTS, COCOA, TEA, COFFEE, ARTIFICIAL COFFEE, COFFEE-BASED BEVERAGES, BISCUITS, ICE CREAM, PASTRY AND CONFECTIONERY, IN CLASS 35 (U.S. CLS. 100, 101 AND 102).

FOR: PROVIDING FOOD AND DRINK; RESTAURANT SERVICES; CAFE SERVICES; COFFEE BAR SERVICES; CATERING SERVICES; FOOD PREPARATION; TAKE-OUT RESTAURANT SERVICES; ALL THE AFOREMENTIONED SERVICES PROVIDED AT VENUES THAT PRIMARILY SELL CHOCOLATE PRODUCTS, IN CLASS 43 (U.S. CLS. 100 AND 101).



NO CLAIM IS MADE TO THE EXCLUSIVE RIGHT TO USE "BLACK" , APART FROM THE MARK AS SHOWN.

PRIORITY DATE OF 8-17-2011 IS CLAIMED.

OWNER OF INTERNATIONAL REGISTRATION 1099699 DATED 8-18-2011, EXPIRES 8-18-2021.

THE MARK CONSISTS OF THE DISTINCTIVE DESIGN OF A CACAO POD (FRUIT) AND LEAF PROTRUDING FROM THE STEM, ABOVE THE WORDING "KOKO BLACK".

SER. NO. 79-106,400, FILED 8-18-2011.

David J. Kyros

Director of the United States Patent and Trademark Office

Reg. No. 4,204,189 DAVID HOFFMAN, EXAMINING ATTORNEY

United States of America

United States Patent and Trademark Office



Reg. No. 4,204,190

Registered Sep. 11, 2012

Int. Cls.: 9 and 41

TRADEMARK

SERVICE MARK

PRINCIPAL REGISTER

HANSOFT AB (SWEDEN LIMITED LIABILITY COMPANY)
DRAGARBRUNNSGATAN 39
SE-753 20 UPPSALA
SWEDEN

FOR: COMPUTER SOFTWARE FOR PROJECT AND QUALITY MANAGEMENT, IN CLASS 9 (U.S. CLS. 21, 23, 26, 36 AND 38).

FOR: EDUCATION AND TRAINING SERVICES, NAMELY, TRAINING SERVICES IN THE FIELD OF PROJECT AND QUALITY MANAGEMENT SOFTWARE, IN CLASS 41 (U.S. CLS. 100, 101 AND 107).

THE MARK CONSISTS OF THE WORD "HANSOFT" IN BLACK LETTERING WITH AN OVAL DESIGN TO THE LEFT OF THE WORD; THE LEFT HALF OF THE OVAL IS BLACK AND THE RIGHT HALF IS LIGHT BLUE; IN THE CENTER OF THE OVAL IS A STYLIZED PORTION OF THE LETTER "H" IN BLACK.

OWNER OF INTERNATIONAL REGISTRATION 1099843 DATED 10-5-2011, EXPIRES 10-5-2021.

THE COLOR(S) BLACK AND LIGHT BLUE IS/ARE CLAIMED AS A FEATURE OF THE MARK.

SER. NO. 79-106,457, FILED 10-5-2011.

MATTHEW MCDOWELL, EXAMINING ATTORNEY



David J. Kybas

Director of the United States Patent and Trademark Office

United States of America

United States Patent and Trademark Office

L.E.M.

Reg. No. 4,204,191

Registered Sep. 11, 2012

Int. Cls.: 7, 11 and 40

TRADEMARK

SERVICE MARK

PRINCIPAL REGISTER

FIVES STEIN (FRANCE SOCIÉTÉ ANONYME)
Z.A.I. DU BOIS DE L'EPINE
3 RUE JULES GUESDE; F-91130 RIS ORANGIS
FRANCE

FOR: INDUSTRIAL PLANTS, NAMELY, MACHINES FOR THE CONTINUOUS PROCESSING OF GLASS, IN CLASS 7 (U.S. CLS. 13, 19, 21, 23, 31, 34 AND 35).

FOR: MELTING AND REFINING FURNACES FOR GLASS; THERMAL PLANTS FOR TREATING GLASS, IN CLASS 11 (U.S. CLS. 13, 21, 23, 31 AND 34).

FOR: INDUSTRIAL, MECHANICAL AND THERMAL TREATMENT OF GLASS, NAMELY, PROCESSING AND FINISHING OF GLASS; HEAT TREATMENT AND COATING OF GLASS; GLASS POLISHING; GLASS BLOWING, IN CLASS 40 (U.S. CLS. 100, 103 AND 106).

THE MARK CONSISTS OF STANDARD CHARACTERS WITHOUT CLAIM TO ANY PARTICULAR FONT, STYLE, SIZE, OR COLOR.

OWNER OF INTERNATIONAL REGISTRATION 1099924 DATED 11-8-2011, EXPIRES 11-8-2021.

SER. NO. 79-106,482, FILED 11-8-2011.

BERNICE MIDDLETON, EXAMINING ATTORNEY



David J. Kybas

Director of the United States Patent and Trademark Office

United States of America

United States Patent and Trademark Office

ACTISEVEN

Reg. No. 4,204,192

Registered Sep. 11, 2012

Int. Cls.: 5 and 42

TRADEMARK

SERVICE MARK

PRINCIPAL REGISTER

LABORATOIRE FRANCAIS DU; FRACTIONNEMENT; ET DES BIOTECHNOLOGIES
(FRANCE SOCIÉTÉ ANONYME)
3 AVENUE DES TROPIQUES
F-91940 LES ULIS, FRANCE

FOR: PHARMACEUTICAL PREPARATIONS FOR TREATING COAGULATION DISORDERS,
IN CLASS 5 (U.S. CLS. 6, 18, 44, 46, 51 AND 52).

FOR: SCIENTIFIC AND INDUSTRIAL RESEARCH RELATING TO HEMOSTASIS; CON-
DUCTING CLINICAL TRIALS FOR OTHERS RELATING TO HEMOSTASIS, IN CLASS 42
(U.S. CLS. 100 AND 101).

THE MARK CONSISTS OF STANDARD CHARACTERS WITHOUT CLAIM TO ANY PAR-
TICULAR FONT, STYLE, SIZE, OR COLOR.

PRIORITY DATE OF 6-24-2011 IS CLAIMED.

OWNER OF INTERNATIONAL REGISTRATION 1099975 DATED 10-28-2011, EXPIRES 10-
28-2021.

SER. NO. 79-106,488, FILED 10-28-2011.

AISHA SALEM, EXAMINING ATTORNEY



David J. Kybas

Director of the United States Patent and Trademark Office

United States of America

United States Patent and Trademark Office



Reg. No. 4,204,193

Registered Sep. 11, 2012

Int. Cl.: 9

TRADEMARK

PRINCIPAL REGISTER

NINGBO ULICA; SOLAR SCIENCE & TECHNOLOGY CO., LTD. (CHINA CORPORATION)
NO. 1 SHANSHAN ROAD
WANGCHUN INDUSTRIAL ZONE,; NINGBO; ZHEJIANG
CHINA

FOR: MONOCRYSTALLINE SILICON WAFERS; POLYCRYSTALLINE SILICON SOLAR
CELLS; BATTERIES FOR LIGHTING; BATTERY CHARGERS; EPITAXIAL WAFERS OF
SILICON; CURRENT RECTIFIERS; ELECTRICITY INVERTERS, IN CLASS 9 (U.S. CLS. 21,
23, 26, 36 AND 38).

OWNER OF U.S. REG. NO. 4,097,706.

PRIORITY DATE OF 6-16-2011 IS CLAIMED.

OWNER OF INTERNATIONAL REGISTRATION 1100175 DATED 11-2-2011, EXPIRES 11-
2-2021.

NO CLAIM IS MADE TO THE EXCLUSIVE RIGHT TO USE "SOLAR", APART FROM THE
MARK AS SHOWN.

THE MARK CONSISTS OF THE WORDING "ULICA SOLAR" AND A SUN DESIGN ABOVE
THE WORDING "LEADING IN TECHNOLOGY" ON A BROKEN HORIZONTAL LINE.

SER. NO. 79-106,564, FILED 11-2-2011.

LEIGH LOWRY, EXAMINING ATTORNEY



David J. Kyffers

Director of the United States Patent and Trademark Office

United States of America

United States Patent and Trademark Office

Easy  Jet Jr.

Reg. No. 4,204,194

MIRAIE CORPORATION (JAPAN CORPORATION)

250-167, YADA-CHO

Registered Sep. 11, 2012

MATSUE-CITY, SHIMANE-PREFECTURE 690-0021, JAPAN

Int. Cl.: 7

FOR: ORGANIC WASTE PROCESSING EQUIPMENT, NAMELY, COMPOSTING MACHINES IN THE NATURE OF MACHINES THAT AGITATE ORGANIC MATTER TO SUPPLY AIR IN ORDER TO FACILITATE DECOMPOSITION, IN CLASS 7 (U.S. CLS. 13, 19, 21, 23, 31, 34 AND 35).

TRADEMARK

PRINCIPAL REGISTER

THE COLOR LIGHT BLUE APPEARS IN THE STYLIZED WORDING "EASY JET JR." AND IN THE CIRCLES THAT FORM THE INVERTED TRIANGLE. THE COLOR WHITE APPEARS BETWEEN THE CIRCLES AND IN THE BACKGROUND OF THE MARK.

PRIORITY DATE OF 10-19-2011 IS CLAIMED.

OWNER OF INTERNATIONAL REGISTRATION 1100177 DATED 10-31-2011, EXPIRES 10-31-2021.

THE COLOR(S) LIGHT BLUE AND WHITE IS/ARE CLAIMED AS A FEATURE OF THE MARK.

SER. NO. 79-106,566, FILED 10-31-2011.

EVELYN BRADLEY, EXAMINING ATTORNEY



David J. Kybas

Director of the United States Patent and Trademark Office

United States of America

United States Patent and Trademark Office

ALTIFLEX

Reg. No. 4,204,195

Registered Sep. 11, 2012

Int. Cls.: 6, 19, 20 and 37

TRADEMARK

SERVICE MARK

PRINCIPAL REGISTER

ALTIFLEX APS (DENMARK LIMITED COMPANY)
NORDHOLMEN 10
DK-2650 HVIDOVRE
DENMARK

FOR: FLEXIBLE AND TELESCOPIC FRAMES OF METAL FOR TEMPORARILY COVERING WINDOW OR DOOR OPENINGS WITH A PLATE OF METAL; METAL WINDOWS, METAL DOORS, PARTITION WALLS OF METAL, METAL SCREWS, METAL BOLTS, METAL NUTS, METAL PROFILES, METAL SLEEVES FOR PIPE DUCTS AND VENTILATION, IN CLASS 6 (U.S. CLS. 2, 12, 13, 14, 23, 25 AND 50).

FOR: FLEXIBLE AND TELESCOPIC FRAMES FOR TEMPORARILY COVERING WINDOW OR DOOR OPENINGS WITH A PLATE OF WOOD, GLASS OR PLASTIC; NON-METAL WINDOWS, NON-METAL DOORS, NON-METAL PARTITION WALLS, RUBBER STRIPS FOR INSULATION AND SEALING, IN CLASS 19 (U.S. CLS. 1, 12, 33 AND 50).

FOR: SCREWS, BOLTS, NUTS, NOT OF METAL, IN CLASS 20 (U.S. CLS. 2, 13, 22, 25, 32 AND 50).

FOR: BUILDING CONSTRUCTION, REPAIR IN CONNECTION WITH BUILDING CONSTRUCTIONS, AND INSTALLATION SERVICES IN CONNECTION WITH BUILDING CONSTRUCTION, NAMELY, TEMPORARY SEALING OF BUILDINGS DURING CONSTRUCTION USING FLEXIBLE WINDOW AND DOOR MODULES, WHICH ARE MADE OF ALUMINUM AND SEMI-TRANSPARENT BREAKPROOF PLASTIC, IN CLASS 37 (U.S. CLS. 100, 103 AND 106).

THE MARK CONSISTS OF STANDARD CHARACTERS WITHOUT CLAIM TO ANY PARTICULAR FONT, STYLE, SIZE, OR COLOR.

OWNER OF INTERNATIONAL REGISTRATION 1100293 DATED 10-25-2011, EXPIRES 10-25-2021.

SER. NO. 79-106,605, FILED 10-25-2011.

SAMUEL E. SHARPER JR., EXAMINING ATTORNEY



David J. Kypos

Director of the United States Patent and Trademark Office

United States of America

United States Patent and Trademark Office

mytranslate

Reg. No. 4,204,196

Registered Sep. 11, 2012

**Int. Cls.: 35, 38, 41 and
42**

SERVICE MARK

PRINCIPAL REGISTER

MYTRANSLATE AG (SWITZERLAND AKTIENGESELLSCHAFT)
WEISSBADSTRASSE 14
CH-9050 APPENZEL
SWITZERLAND

FOR: ADVERTISING; BUSINESS MANAGEMENT; BUSINESS ADMINISTRATION; OFFICE FUNCTIONS; ELECTRONIC COMMERCE SERVICES, NAMELY, ADVERTISING IN THE FORM OF DATA, TEXTS, IMAGES OR SOUNDS, ALONE OR IN COMBINATIONS, PROVIDED VIA COMPUTER NETWORKS, FOR THE SALE OF GOODS AND SERVICES OF ALL TYPES; COMPILATION AND SYSTEMIZATION OF DATA INTO COMPUTER DATABASES, IN CLASS 35 (U.S. CLS. 100, 101 AND 102).

FOR: TELECOMMUNICATIONS SERVICES, NAMELY, THE PROVISION OF ACCESS TO INTERNET PLATFORMS THAT SUPPLY OFFERS OF LANGUAGE TRANSLATION SERVICES VIA ELECTRONICALLY AND INTERACTIVELY ACCESSIBLE DATABASES, WITH THE POSSIBILITY OF ORDERING DIRECTLY, IN CLASS 38 (U.S. CLS. 100, 101 AND 104).

FOR: SERVICES IN THE FIELD OF ENTERTAINMENT, EDUCATION AND TRAINING, NAMELY, PROVIDING COURSES OF INSTRUCTION, GAMES, PUZZLES, COMPETITIONS, AND TRIVIA IN THE FIELD OF LANGUAGE TRANSLATION AND LINGUISTICS, PROVIDED ON-LINE FROM A COMPUTER, THE INTERNET OR OTHER ELECTRONIC NETWORKS; SPORTING AND CULTURAL ACTIVITIES, NAMELY, ORGANIZATION AND HOSTING OF CULTURAL SHOWS AND COMPETITIONS RELATING TO LANGUAGE TRANSLATION AND LINGUISTICS; ARRANGING AND CONDUCTING OF WORKSHOPS IN THE FIELD OF LANGUAGE TRANSLATION; EDUCATIONAL SERVICES, NAMELY, ARRANGING AND CONDUCTING OF SEMINARS, COLLOQUIUMS, CONFERENCES OR CONGRESSES IN THE FIELD OF LANGUAGE TRANSLATION; TRANSLATION; FOREIGN-LANGUAGE DUBBING, IN CLASS 41 (U.S. CLS. 100, 101 AND 107).

FOR: SCIENTIFIC AND TECHNOLOGICAL SERVICES AND RESEARCH AND DESIGN RELATING THERETO, NAMELY, THE DEVELOPMENT OF COMPUTER-AIDED LANGUAGE TRANSLATION TOOLS; INDUSTRIAL ANALYSIS AND RESEARCH SERVICES IN THE FIELD OF LANGUAGE TRANSLATION; DESIGN AND DEVELOPMENT OF COMPUTERS AND SOFTWARE, IN CLASS 42 (U.S. CLS. 100 AND 101).

THE MARK CONSISTS OF STANDARD CHARACTERS WITHOUT CLAIM TO ANY PARTICULAR FONT, STYLE, SIZE, OR COLOR.



David J. Kybas

Director of the United States Patent and Trademark Office

Reg. No. 4,204,196 PRIORITY DATE OF 10-14-2011 IS CLAIMED.

OWNER OF INTERNATIONAL REGISTRATION 1100337 DATED 11-11-2011, EXPIRES 11-11-2021.

SER. NO. 79-106,623, FILED 11-11-2011.

SHANNON TWOHIG, EXAMINING ATTORNEY

United States of America

United States Patent and Trademark Office



nanobionic

Reg. No. 4,204,197

Registered Sep. 11, 2012

Int. Cls.: 10 and 25

TRADEMARK

PRINCIPAL REGISTER

PSIPSIKAS GEORGE (GREECE INDIVIDUAL)
52B KAPODISTRIOU STR.
GR-151 23 MAROUSSI
GREECE

FOR: ORTHOPEDIC APPARATUS, NAMELY, MEDICAL ORTHOPEDIC SPLINTS, IN CLASS 10 (U.S. CLS. 26, 39 AND 44).

FOR: CLOTHING, NAMELY, DRESSES, PANTS, SHIRTS, SHORTS, SOCKS, PANTIES, STOCKINGS, BRAS, TIGHTS AND UNDERSHIRTS; FOOTWEAR AND HEADWEAR, IN CLASS 25 (U.S. CLS. 22 AND 39).

THE MARK CONSISTS OF TWO RINGS IN WHITE, BLACK, AND GRAY AND BENEATH THEM THE WORD "NANOBIONIC" IN BLACK AND GRAY WITH A GRAY REFLECTION BELOW; ALL ON A WHITE BACKGROUND.

PRIORITY DATE OF 4-15-2011 IS CLAIMED.

OWNER OF INTERNATIONAL REGISTRATION 1100383 DATED 7-8-2011, EXPIRES 7-8-2021.

THE COLOR(S) WHITE, BLACK, AND GRAY IS/ARE CLAIMED AS A FEATURE OF THE MARK.

SER. NO. 79-106,638, FILED 7-8-2011.

MAYUR VAGHANI, EXAMINING ATTORNEY



David J. Kyffers

Director of the United States Patent and Trademark Office

United States of America

United States Patent and Trademark Office

Wilmax England

Reg. No. 4,204,198

Registered Sep. 11, 2012

Int. Cls.: 8 and 21

TRADEMARK

PRINCIPAL REGISTER

WILMAX LIMITED (UNITED KINGDOM LIMITED LIABILITY COMPANY)
1 UNDINE ROAD
LONDON E14 9UW
UNITED KINGDOM

FOR: HAND TOOLS AND IMPLEMENTS, NAMELY, HAND-OPERATED KITCHEN APPLIANCES FOR DICING, MINCING, SLICING AND CHOPPING FOOD; ABRADING INSTRUMENTS, NAMELY, ABRADING TOOLS; HAND TOOLS, NAMELY, ADZES; AGRICULTURAL IMPLEMENTS, HAND-OPERATED, NAMELY, BROADFORKS, CIDER PRESSES, CHICKEN PLUCKERS; SIDE ARMS, NOT INCLUDING FIREARMS, NAMELY, HUNTING KNIVES, SWORDS; INSECTICIDE ATOMIZERS, NAMELY, HAND-OPERATED SPRAYERS FOR INSECTICIDE; HAND TOOLS, NAMELY, AUGERS; HAND TOOLS, NAMELY, AWLS; AXES; CUTTING BARS, NAMELY, METAL CUTTING SAWS, SAWS FOR CUTTING BRANCHES; BAYONETS; BEARD CLIPPERS; FIREPLACE BELLOWS; TOOL BELTS; BILL-HOOKS, NAMELY, GRASS HOOKS, HAND HOOKS; BITS, NAMELY, BITS FOR HAND DRILLS; BLADE SHARPENING INSTRUMENTS, NAMELY, KNIFE SHARPENERS, SHARPENING RODS, SHARPENING STONES; BLADES FOR KITCHEN KNIVES; BLUDGEONS; BORDER SHEARS; BOW SAWS; HAND TOOLS, NAMELY, BREAST DRILLS; BUDDING KNIVES; BUSHHAMMERS; HAND-OPERATED SKINNING APPLIANCES AND INSTRUMENTS, NAMELY, HAND-OPERATED SCRAPERS, HAND-OPERATED KNIVES, HAND-OPERATED PLIERS TO AID IN SKINNING AN ANIMAL FOR BUTCHERS' ANIMALS; CAN OPENERS, NON-ELECTRIC; HAND TOOLS, NAMELY, CARPENTERS' AUGERS; RAZOR CASES; CATTLE MARKING TOOLS, NAMELY, BRANDING IRONS; HAND-OPERATED CATTLE SHEARERS; CAULKING IRONS, NAMELY, CAULKING GUNS; CENTRE PUNCHES; CHEESE SLICERS, NON-ELECTRIC; CHISELS; HAND-OPERATED CHOPPERS; CLAMPS FOR CARPENTERS OR COOPERS; CLEAVERS; HAND-OPERATED CRIMPING IRONS; CROW BARS; EYELASH CURLERS; CURLING TONGS, NAMELY, BUTTER CURLERS, NON-ELECTRIC CURLING IRONS; CUTICLE NIPPERS; CUTLERY, OTHER THAN SURGICAL CUTLERY; HAND-TOOLS, NAMELY, CUTTER BARS; CUTTERS, NAMELY, GLASS CUTTERS, WIRE CUTTERS; PIZZA CUTTERS, NON ELECTRIC; HAND-OPERATED CUTTING TOOLS; DAGGERS; HAND TOOL IMPLEMENTS FOR DECANTING LIQUIDS; DEPILATION APPLIANCES, ELECTRIC AND NON-ELECTRIC; GLAZIERS' DIAMONDS BEING PARTS OF HAND TOOLS; PUNCHING DIES; DIGGERS, NAMELY, HAND-OPERATED POST HOLE DIGGERS AND WEED DIGGERS; DITCHERS, NAMELY, DITCHER DIGGING FORKS; DRAWING KNIVES; MANUAL DRILL HOLDERS; DRILLS, NAMELY, MANUAL DRILLS; EAR-PIERCING APPARATUS; HAND TOOLS, NAMELY, EARTH RAMMERS; EDGE TOOLS, NAMELY, HAND-OPERATED LAWN EDGERS; EGG



David J. Kyjars

Director of the United States Patent and Trademark Office

Reg. No. 4,204,198 SLICERS, NON-ELECTRIC; EMBOSSERS, NAMELY, HAND-OPERATED PRESS MACHINES FOR EMBOSSING; EMERY GRINDING WHEELS, NAMELY, HAND TOOLS IN THE NATURE OF MANUALLY-OPERATED GRINDING WHEELS; ENGRAVING NEEDLES; HAND TOOLS, NAMELY, EXPANDERS; EXTENSION PIECES FOR BRACES FOR SCREWTAPS, NAMELY, EXTENSIONS FOR HAND TOOLS; NAIL EXTRACTORS, NAMELY, CARPENTERS' PINCERS; FARRIERS' KNIVES; FILES; FINGERNAIL POLISHERS, ELECTRIC OR NON-ELECTRIC; FIRE IRONS; FIREPLACE BELLOWS; HARPOONS FOR COMMERCIAL FISHING; FLAT IRONS, NON-ELECTRIC; FLESHING KNIVES; FORKS; HAND TOOLS, NAMELY, FOUNDRY LADLES; FRAMES FOR HANDSAWS; HAND TOOLS, NAMELY, FRUIT PICKERS; HAND TOOLS, NAMELY, FULLERS; GARDEN TOOLS, HAND-OPERATED, NAMELY, CULTIVATORS, TROWELS, WEEDING FORKS, SPADES, HOES; GIMLETS; GLAZING IRONS, NAMELY, FIRE IRONS, HAND TOOLS IN THE NATURE OF PRIMING IRONS; HAND TOOLS, NAMELY, ELECTRIC GOFFERING IRONS; HAND TOOLS, NAMELY, GOUGES; HAND TOOLS, NAMELY, GRAFTING TOOLS; HAND TOOLS, NAMELY, MANUALLY-OPERATED GRINDSTONES; GUNS, NAMELY, CAULKING GUNS; GUNS, HAND-OPERATED, FOR THE EXTRUSION OF MASTICS, NAMELY, MANUALLY OPERATED GREASE GUNS; HAINAULT SCYTHES; HAIR CLIPPERS FOR ANIMALS; HAIR CLIPPERS FOR PERSONAL USE, ELECTRIC AND NON-ELECTRIC; HAND-OPERATED HAIR CURLERS, NON-ELECTRIC; HAIR-REMOVING TWEEZERS; HAMMER SHARPENERS, NAMELY, SHARPENING RODS, SHARPENING STEELS; HAMMERS; HAND TOOLS, NAMELY, HAND DRILLS; HAND TOOLS, NAMELY, HAND-OPERATED PUMPS; HAND TOOLS, HAND-OPERATED, NAMELY, PICKS, REAMERS; HATCHETS; HOES; HOLING AXES; HOLLOWING BITS FOR HAND DRILLS; HOOP CUTTERS, NAMELY, HAND TOOLS IN THE NATURE OF PIPE CUTTERS, WIRE CUTTERS; HUNTING KNIVES; ICE PICKS; INSECTICIDE VAPORIZERS, NAMELY, HAND-OPERATED VAPORIZER SPRAYERS FOR INSECTICIDES; FLAT IRONS, NON-ELECTRIC; LIFTING JACKS, HAND-OPERATED; JIG-SAWS, HAND-OPERATED; KNIVES; HAND-TO-HAND COMBAT WEAPONS, NAMELY, KNUCKLE DUSTERS; LADLES, NAMELY, LADLES FOR WINE; LASTS FOR SHOE-MAKING; LEATHER STROPS; HAND TOOLS, NAMELY, LEVERS; LIVESTOCK MARKING TOOLS, NAMELY, BRANDING IRONS; MACHETES; MALLETs; MANICURE SETS; MANICURE SETS, ELECTRIC; MASONS' HAMMERS; MATTOCKS; MEAT CHOPPERS, NAMELY, KITCHEN MEAT MALLETs; HAND TOOLS, NAMELY, METAL BAND STRETCHERS; HAND TOOLS, NAMELY, MILLING CUTTERS; MINCING KNIVES; HAND TOOLS, NAMELY, MITRE BOXES; MOLDING IRONS, NAMELY, HAND TOOLS IN THE NATURE OF CRIMPING IRONS; MORTARS FOR POUNDING; MORTISE AXES; MORTISE CHISELS; NAIL BUFFERS, ELECTRIC OR NON-ELECTRIC; NAIL CLIPPERS, ELECTRIC OR NON-ELECTRIC; NAIL DRAWERS, NAMELY, HAND TOOLS IN THE NATURE OF NAIL SETS; NAIL FILES; NAIL FILES, ELECTRIC; NAIL NIPPERS; HAND TOOLS, NAMELY, NAIL PUNCHES; HAND TOOLS, NAMELY, NEEDLE FILES; NIPPERS; HAND TOOLS, NAMELY, NUMBERING PUNCHES; NUTCRACKERS; OYSTER OPENERS; PALETTE KNIVES; PARING IRONS; PARING KNIVES; PEDICURE SETS; PENKNIVES; PERFORATING TOOLS, NAMELY, SCISSORS; PESTLES FOR POUNDING; PICKAXES; PICKHAMMERS; HAND TOOLS, NAMELY, PICKS; EAR PIERCING APPARATUS; HAND TOOLS, NAMELY, PIN PUNCHES; HAND TOOLS, NAMELY, PINCERS; HAND TOOLS, NAMELY, PLANES IN THE NATURE OF PLANE IRONS; PLANES; PLIERS; POLICE BATONS; HAND TOOLS, NAMELY, PRIMING IRONS; PRUNING KNIVES; PRUNING SCISSORS; PRUNING SHEARS; PUNCH PLIERS; PUNCH RINGS, NAMELY, HAND-TO-HAND COMBAT WEAPONS IN THE NATURE OF KNUCKLE DUSTERS; HAND TOOLS, NAMELY, PUNCHES; RABBETING PLANES; RAKES, SAND TRAP RAKES; HAND TOOLS, NAMELY, RAMMERS; HAND TOOLS, NAMELY, RASPS; HAND TOOLS, NAMELY, RATCHET WRENCHES; RAZOR BLADES; RAZOR STROPS; RAZORS, ELECTRIC OR NON-ELECTRIC; REAMER SOCKETS SOLD AS AN INTEGRAL COMPONENT OF REAMERS; REAMERS; HAND TOOLS, NAMELY, RIVETERS; RIVETING HAMMERS; HAND SAW BLADES; HAND SAW HOLDERS; SAWS, NAMELY, PIT SAWS, METAL CUTTING SAWS; SCALING KNIVES; SCISSORS; HAND TOOLS, NAMELY, SCRAPERS; SCRAPING TOOLS, NAMELY, HAND TOOLS IN THE NATURE OF PAINT SCRAPERS; SCREW STOCKS, NAMELY, HAND TOOLS IN THE NATURE OF SCREW EXTRACTORS; EXTENSION PIECES FOR BRACES FOR HAND TOOLS IN THE NATURE OF SCREW TAPS; SCREWDRIVERS; HAND TOOLS, NAMELY, SCREW-THREAD CUTTERS;

Reg. No. 4,204,198 SCYTHE RINGS; SCYTHE STONES; SCYTHES; SECATEURS; SHARPENING INSTRUMENTS, NAMELY, SHARPENING RODS, SHARPENING STEELS; SHARPENING STONES; SHARPENING WHEELS; SHEAR BLADES; PAPER SHEARS; SHEARS; SHOVELS; SICKLES; SILVERWARE, NAMELY, FORKS, KNIVES AND SPOONS THAT ARE SILVER-PLATED; SLEDGEHAMMERS; SPADES; SPANNERS; HAND TOOLS, NAMELY, SPATULAS; SPOONS; HAND TOOLS, NAMELY, SQUARES; HAND TOOLS, NAMELY, STAMPING-OUT TOOLS; HAND TOOLS, NAMELY, STAMPS; STONE HAMMERS, NAMELY, BUSHHAMMERS; HAND TOOLS, NAMELY, STRETCHERS FOR WIRE AND METAL BANDS; STROPPING INSTRUMENTS, NAMELY, LEATHER STROPS, RAZOR STROPS; CATTLE STUNNING APPARATUS, NAMELY, HAND-OPERATED CATTLE PRODS; SUGAR TONGS; SWORDS; SYRINGES FOR SPRAYING INSECTICIDES, NAMELY, HAND-OPERATED SPRAYERS FOR INSECTICIDE; TABLE CUTLERY; TABLE FORKS; TABLEWARE, NAMELY, KNIVES, FORKS, AND SPOONS; TAP WRENCHES; HAND TOOLS, NAMELY, TAPS; APPARATUS FOR TATTOOING, NAMELY, TATTOO MACHINES; CAN OPENERS, NON-ELECTRIC; HAND TOOLS, NAMELY, TONGS; HAND TOOLS, NAMELY, TREE PRUNERS; TROWELS; GARDENING TROWELS; TUBE CUTTERS, NAMELY, HAND OPERATED PIPE CUTTERS; TWEEZERS; HAND OPERATED VEGETABLE CHOPPERS; VEGETABLE KNIVES; HAND OPERATED VEGETABLE SHREDDERS; VEGETABLE SLICERS; VICES; WEEDING FORKS; WHETSTONE HOLDERS; WHETSTONES; CANDLE WICK TRIMMERS; HAND TOOLS, NAMELY, WIRE STRETCHERS; WRENCHES, IN CLASS 8 (U.S. CLS. 23, 28 AND 44).

FOR: HOUSEHOLD OR KITCHEN UTENSILS AND CONTAINERS, NAMELY, GRATERS, SPATULAS, GRILLS, SIEVES, SKIMMERS, POT SCRAPERS, CONTAINERS FOR HOUSEHOLD OR KITCHEN USE NOT OF PRECIOUS METAL, POURING AND STRAINING SPOUTS, KITCHEN TONGS, STRAINERS, WIRE BASKETS, TURNERS; COMBS AND SPONGES, NAMELY, BATH SPONGES, CLEANING SPONGES; BRUSHES EXCEPT PAINT BRUSHES, NAMELY, CLOTHES BRUSHES, BRUSHES FOR FOOTWEAR, FILE BRUSHES, DISHWASHING BRUSHES, CAKE BRUSHES, MUSHROOM BRUSHES, SCRAPING BRUSHES, SCRUBBING BRUSHES, FLOOR BRUSHES, BRUSHES FOR PETS; SHAVING BRUSHES; BRUSH-MAKING MATERIALS, NAMELY, FILAMENTS FOR MAKING BRUSHES; ARTICLES FOR CLEANING PURPOSES, NAMELY, CLEANING RAGS, CLEANING SPONGES, CLEANING CLOTHS, CLEANING COMBS, CLEANING COTTON, CLEANING PADS, METAL WOOL FOR CLEANING; STEELWOOL; UNWORKED OR SEMI-WORKED GLASS EXCEPT GLASS USED IN BUILDING; GLASSWARE, NAMELY, GLASS STORAGE JARS, DRINKING GLASSES, FOOD PRESERVING JARS OF GLASS, GLASS BOWLS, GLASS DISHES, GLASS VASES, GLASS MUGS, GLASS PANS; PORCELAIN, NAMELY, PORCELAIN EGGS, PORCELAIN MUGS, PORCELAIN FLOWER POTS, PORCELAIN DISHES, PORCELAIN WORKS OF ART, PORCELAIN CAKE DECORATIONS; EARTHENWARE, NAMELY, EARTHENWARE MUGS, EARTHENWARE FIGURES, EARTHENWARE DISHES, EARTHENWARE BOWLS; ABRASIVE PADS FOR KITCHEN PURPOSES; ABRASIVE SPONGES FOR SCRUBBING THE SKIN; AEROSOL DISPENSERS, NOT FOR MEDICAL PURPOSES; INDOOR AQUARIA, AQUARIUM HOODS; AUTOCLAVES, NON-ELECTRIC; BABY BATHTUBS, PORTABLE; BOWLS; BASINS; BASKETS FOR DOMESTIC USE, NOT OF METAL; BASTING SPOONS, FOR KITCHEN USE; CARPET BEATERS, NOT BEING MACHINES; EGG BEATERS, NON-ELECTRIC; BEER MUGS; HEAT INSULATED CONTAINERS FOR BEVERAGES FOR DOMESTIC USE; DUST BINS; BIRD BATHS; BIRDCAGES; FOOD BLENDERS, NON-ELECTRIC, FOR HOUSEHOLD PURPOSES; BOOTJACKS; BOOT TREES; BOTTLE GOURDS; BOTTLE OPENERS; BOTTLES, SOLD EMPTY; REFRIGERATING BOTTLES, SOLD EMPTY; GLASS BOWLS; BOXES OF GLASS; BOXES FOR SWEETMEATS; BOXES OF METAL, FOR DISPENSING PAPER TOWELS; SOAP BOXES; BREAD BASKETS, DOMESTIC; BREAD BINS; BREAD BOARDS; ANIMAL BRISTLES; BROOMS; ELECTRIC TOOTH BRUSHES, EXCEPT PARTS OF MACHINES; BRUSHES FOR CLEANING TANKS AND CONTAINERS, NAMELY, TOILET BOWL BRUSHES, SCRUBBING BRUSHES, FOR HOUSEHOLD USE; BUCKETS; BUCKSKIN CLOTHES FOR CLEANING; PERFUME BURNERS; BUSTS OF CHINA, TERRA-COTTA OR GLASS; BUTTER DISHES; BUTTER-DISH COVERS; BUTTONHOOKS; TRAYS, NAMELY, SERVING TRAYS, TRAYS FOR DOMESTIC PURPOSES; CAGES FOR HOUSEHOLD PETS; CAKE MOLDS; CANDLESTICKS; CANDLE EXTINGUISHERS; CANDLE RINGS; CARBOYS, SOLD EMPTY FOR HOUSEHOLD

Reg. No. 4,204,198 PURPOSES; CARPET BEATERS; CARPET SWEEPERS; COMB CASES; CAULDRONS; CERAMICS FOR HOUSEHOLD PURPOSES, NAMELY, CERAMIC PULLS, CERAMIC FIGURINES, CERAMIC SCULPTURES, CERAMIC VASES, CERAMIC VESSELS, CERAMIC BOWLS, CERAMIC PLATES AND CERAMIC POTS; CHAMBER POTS; CHAMOIS LEATHER FOR CLEANING; CHEESE-DISH COVERS; CHINA ORNAMENTS; CHOPSTICKS; CINDER SIFTERS FOR HOUSEHOLD USE; CLEANING TOW, NAMELY, CLEANING PADS IN THE SHAPE OF ROPES; CLOSURES FOR POT LIDS, NAMELY, TENSION CLOSING DEVICES FOR POT LIDS; CLOTH FOR WASHING FLOORS; CLOTHES RACKS, FOR DRYING; CLOTHES PEGS; CLOTHES PINS; CLOTHING STRETCHERS; CLOTHS FOR CLEANING; COAL SCUTTLES; COASTERS, NOT OF PAPER AND OTHER THAN TABLE LINEN; COCKTAIL STIRRERS; COFFEE FILTERS NOT BEING PART OF NON-ELECTRIC COFFEE MAKERS; COFFEE GRINDERS, HAND-OPERATED; COFFEE PERCOLATORS, NON-ELECTRIC; COFFEE SERVICES; COFFEEPOTS, NON-ELECTRIC; PORTABLE COLDBOXES, NON-ELECTRIC; COMBS; CONFECTIONERS' DECORATING BAGS; CONTAINERS FOR HOUSEHOLD OR KITCHEN USE; COOKERY MOLDS; COOKIE CUTTERS; COOKIE JARS; COOKING POT SETS; COOKING POTS; COOKING SKEWERS, OF METAL; COOLERS, NAMELY, BUTTER COOLERS, CAVIAR COOLERS, COOLERS FOR WINE, PORTABLE COOLERS; FOOD COOLING DEVICES CONTAINING HEAT EXCHANGE FLUIDS IN THE FORM OF RECEPTACLES, FOR HOUSEHOLD PURPOSES; CORKSCREWS; COSMETIC UTENSILS, NAMELY, COSMETIC BRUSHES, DROPPERS SOLD EMPTY FOR COSMETIC PURPOSES, ELECTRICAL APPLICATORS FOR APPLYING COSMETICS TO THE SKIN; COVERS FOR DISHES; COVERS, NOT OF PAPER, FOR FLOWER POTS; CROCKERY, NAMELY, POTS, DISHES, DRINKING CUPS AND SAUCERS, BOWLS, SERVING BOWLS, TRAYS; CRUET STANDS FOR OIL AND VINEGAR; CRUMB TRAYS; CRYSTAL BEVERAGE GLASSWARE; CUPS; CUPS OF PAPER OR PLASTIC; CURRY COMBS; CUTTING BOARDS FOR THE KITCHEN; DECANTERS; DEEP FRYERS, NON-ELECTRIC; DEMIJOHNS; DISHES; DISHES FOR SOAP; SOAP DISPENSERS; METAL BOXES FOR DISPENSING PAPER TOWELS; DISPOSABLE TABLE PLATES; DOMESTIC GRINDERS, NON-ELECTRIC; DRINKING FLASKS FOR TRAVELERS; DRINKING GLASSES; DRINKING TROUGHS; DRINKING VESSELS; DISH DRYING RACKS FOR WASHING; DUSTBINS; FURNITURE BRUSHES; DUSTING APPARATUS, NON-ELECTRIC, NAMELY, DUSTERS, DUSTING BRUSHES, DUST GLOVES; DUSTING CLOTHS; EGG CUPS; ENAMELLED GLASS; EPERGNES; EYEBROW BRUSHES; BUCKETS MADE OF WOVEN FABRICS; FEATHER-DUSTERS; HEATERS FOR FEEDING BOTTLES, NON-ELECTRIC; FEEDING TROUGHS; FEEDING TROUGHS FOR ANIMALS; FIBERGLASS OTHER THAN FOR INSULATION OR TEXTILE USE; FIBERGLASS THREAD, NOT FOR TEXTILE USE; FIGURINES OF PORCELAIN, TERRA-COTTA OR GLASS; FLASKS; FLOSS FOR DENTAL PURPOSES; FLOWER POTS; FLOWER-POT COVERS, NOT OF PAPER; FLY CATCHERS; FLY SWATTERS; FRUIT CUPS SOLD EMPTY FOR HOLDING FRUIT; FRUIT PRESSES, NON-ELECTRIC, FOR HOUSEHOLD PURPOSES; FRYING PANS; FUNNELS; FUSED SILICA AS A SEMI-FINISHED PRODUCT, OTHER THAN FOR BUILDING, NAMELY, INGOTS, TUBES, RODS, DISCS, PLATES AND RINGS ALL FOR GENERAL INDUSTRIAL AND FURTHER MANUFACTURING USE; GARBAGE CANS; GARDENING GLOVES; GARLIC PRESSES; GLASS BULBS IN THE NATURE OF CONTAINERS FOR HOUSEHOLD USE; GLASS FLASKS; GLASS FOR VEHICLE WINDOWS; GLASS INCORPORATING FINE ELECTRICAL CONDUCTORS; OPAL GLASS; GLASS STOPPERS; GLASS, UNWORKED OR SEMI-WORKED, EXCEPT BUILDING GLASS; GLASS WOOL OTHER THAN FOR INSULATION; PAINTED BEVERAGE GLASSWARE; GLOVE STRETCHERS; GLOVES FOR HOUSEHOLD PURPOSES; POLISHING GLOVES; GLUE-POTS; GOBLETS; BOTTLE GOURDS; GRATERS, NAMELY, GRATERS FOR HOUSEHOLD PURPOSES; GRIDDLES; GRILLS; HEAT-INSULATED VESSELS; HOLDERS FOR FLOWERS AND PLANTS; TOILET PAPER HOLDERS; DRINKING HORNS; HORSE BRUSHES; HOT POTS, NOT ELECTRICALLY HEATED; ICE BUCKETS; ICE CUBE MOLDS; ICE PAILS; INDOOR TERRARIUMS; INSECT TRAPS; INSULATING FLASKS; IRONING BOARD COVERS, SHAPED; IRONING BOARDS; ISOTHERMIC BAGS, NAMELY, THERMAL INSULATED BAGS FOR FOOD OR BEVERAGES; JUGS; KETTLES, NON-ELECTRIC; KITCHEN CONTAINERS; KITCHEN FOOD MIXERS, NON-ELECTRIC; KNIFE RESTS FOR THE TABLE; KNOBS OF PORCELAIN; LAMP-GLASS BRUSHES; LAZY SUSANS; POLISHING LEATHER; LIQUEUR SETS, NAMELY, BEVERAGE GLASSWARE, FLASKS; LITTER BOXES

Reg. No. 4,204,198 FOR PETS; LUNCH BOXES; LYE WASHTUBS; MAJOLICA, NAMELY, EARTHENWARE MUGS, EARTHENWARE FIGURES, EARTHENWARE PLATES, EARTHENWARE POTS, EARTHENWARE DISHES, EARTHENWARE DRINKING CUPS; APPLIANCES FOR REMOVING MAKE-UP, NON-ELECTRIC, NAMELY, FACIAL CLEANSING SPONGES; MANGERS FOR ANIMALS; MANGERS FOR LIVESTOCK; MENU CARD HOLDERS; MESS-TINS; SALT MILLS FOR DOMESTIC PURPOSES, HAND-OPERATED; PEPPER MILLS FOR DOMESTIC PURPOSES, HAND-OPERATED; MIXING MACHINES, NON-ELECTRIC, FOR HOUSEHOLD PURPOSES, NAMELY, NON-ELECTRIC FOOD MIXERS; MIXING SPOONS; MOLDS, NAMELY, COOKERY MOLDS, PUDDING MOLDS, PASTRY MOLDS; MOPS; MOSAICS OF GLASS, NOT FOR BUILDING; MOUSE TRAPS; MUGS; NAIL BRUSHES; NAPKIN HOLDERS; NAPKIN RINGS; NEST EGGS, ARTIFICIAL; NOZZLES FOR LAWN SPRINKLER HOSE; PLASTIC NOZZLES FOR WATERING CANS; OIL CRUETS; PADS FOR CLEANING; PAILS; PEPPER MILLS, HAND-OPERATED; PEPPER POTS; PERFUME BURNERS; PERFUME SPRAYERS; PERFUME VAPORIZERS SOLD EMPTY; FITTED PICNIC BASKETS, INCLUDING DISHES; PIE SERVERS; PIG BRISTLES; PIGGY BANKS, NOT OF METAL; COOKING PINS OF METAL, NAMELY, ROLLING PINS; PITCHERS; PLATE GLASS, NAMELY, GROUND PLATE GLASS, PLATE GLASS FOR CARDS, POLISHED PLATE GLASS; PAPER PLATES; PLATES TO PREVENT MILK BOILING OVER; PLUNGERS FOR CLEARING BLOCKED DRAINS; POLISHING APPARATUS AND MACHINES, FOR HOUSEHOLD PURPOSES, NON-ELECTRIC, NAMELY, POLISHING CLOTHS, POLISHING LEATHER, SHOE POLISHING MILS; POLISHING MATERIALS FOR MAKING SHINY, EXCEPT PREPARATIONS, NAMELY, POLISHING CLOTHS; POT LIDS; POTS; POTTERY, NAMELY, FLOWER VASES, VASES; POULTRY RINGS; POWDER COMPACTS; POWDER PUFFS; POWDERED GLASS FOR DECORATION; RAILS AND RINGS FOR TOWELS; RAT TRAPS; REFRIGERATING BOTTLES, NAMELY, BOTTLES SOLD EMPTY, VACUUM BOTTLES; REFUSE BINS; ROLLING PINS, DOMESTIC; ROSES FOR WATERING CANS, NAMELY, A POURING SPOUT FOR HOUSEHOLD PURPOSES THAT CONTAINS HOLES FOR ALLOWING WATER TO BE SPRAYED ONTO FLOWERS AND POTS; SALT CELLARS, SALT SHAKERS; SAUCEPAN SCOURERS OF METAL; EARTHENWARE SAUCEPANS, SAUCERS; SCOOPS; SCOURING PADS; SERVICES, NAMELY, DISHES; SHAKERS, NAMELY, COCKTAIL SHAKERS, SALT SHAKERS; SHIRT STRETCHERS; SHOE BRUSHES; SHOE HORNS; SHOE STRETCHERS; SIEVES FOR HOUSEHOLD UTENSILS; SIFTERS, NAMELY, CINDER SIFTER FOR HOUSEHOLD PURPOSES, FLOUR SIFTERS, COOKING SIFTERS; UPRIGHT SIGNBOARDS OF PORCELAIN OR GLASS; SIPHONS FOR CARBONATED WATER, NAMELY, GAS PRESSURIZED BEVERAGE SIPHON CONTAINERS, NAMELY, CREAM WHIPPERS, CREAM PITCHERS AND SODA WATER HOLDERS AND GAS CARTRIDGES SOLD EMPTY; SKINS OF CHAMOIS FOR CLEANING; SOAP HOLDERS; SPICE SETS, NAMELY, SPICE RACKS, SPICE CONTAINER SETS FOR HOUSEHOLD USE SOLD EMPTY; SPONGE HOLDERS; SPONGES FOR HOUSEHOLD PURPOSES; KITCHEN UTENSILS IN THE NATURE OF POURING AND STRAINING SPOUTS; SPRINKLERS, NAMELY, GRASS SPRINKLER, LAWN SPRINKLER; SPRINKLERS FOR WATERING FLOWERS AND PLANTS; STANDS FOR SHAVING BRUSHES; STATUES OF PORCELAIN, TERRA-COTTA OR GLASS; STEEL WOOL FOR CLEANING; STEW-PANS; STRAINERS, NAMELY, COOKING STRAINERS, WINE STRAINERS; STRAINERS FOR HOUSEHOLD PURPOSES; STRETCHERS FOR CLOTHING; SUGAR BOWLS; SYRINGES FOR WATERING FLOWERS AND PLANTS; TABLE PLATES; TABLEWARE, OTHER THAN KNIVES, FORKS AND SPOONS, NAMELY, TEA SERVICES, COFFEE SERVICES; TANKARDS; TART SCOOPS; TEA BALLS; TEA CADDIES; TEA INFUSERS; TEA SERVICES; TEA STRAINERS; TEAPOTS; THERMALLY INSULATED CONTAINERS FOR FOOD FOR DOMESTIC PURPOSES; TIE PRESSES; TOILET BRUSHES; TOILET CASES, NAMELY, TOILET BRUSH HOLDERS, TOILET ROLL HOLDERS; TOILET SPONGES; TOOTHBRUSHES; TOOTHBRUSHES, ELECTRIC; TOOTHPICK HOLDERS; TOOTHPICKS; TRASH CANS; TRAYS FOR DOMESTIC PURPOSES; TRAYS FOR DOMESTIC PURPOSES, OF PAPER; TRIVETS; TROUGHS FOR LIVESTOCK; NON-ELECTRIC TROUSER PRESSES; TROUSER STRETCHERS; VACUUM BOTTLES; FITTED VANITY CASES; VASES; VEGETABLE DISHES FOR HOLDING VEGETABLES SOLD EMPTY; DRINKING VESSELS OF METAL FOR MAKING ICES AND ICED DRINKS; WAFFLE IRONS, NON-ELECTRIC; WASHING BOARDS; WASHTUBS; WATER APPARATUS FOR CLEANING TEETH AND GUMS FOR HOME USE; WATERING CANS; WATERING DEVICES,

Reg. No. 4,204,198 NAMELY, WATERING CANS; WAX-POLISHING APPLIANCES, NON-ELECTRIC, FOR SHOES, NAMELY, SHOW POLISH APPLICATORS NOT CONTAINING SHOE POLISH; WINE TASTERS; WORKS OF ART, OF PORCELAIN, TERRA-COTTA OR GLASS, IN CLASS 21 (U.S. CLS. 2, 13, 23, 29, 30, 33, 40 AND 50).

THE MARK CONSISTS OF STANDARD CHARACTERS WITHOUT CLAIM TO ANY PARTICULAR FONT, STYLE, SIZE, OR COLOR.

OWNER OF INTERNATIONAL REGISTRATION 1100405 DATED 8-20-2011, EXPIRES 8-20-2021.

NO CLAIM IS MADE TO THE EXCLUSIVE RIGHT TO USE "ENGLAND", APART FROM THE MARK AS SHOWN.

SER. NO. 79-106,653, FILED 8-20-2011.

MAYUR VAGHANI, EXAMINING ATTORNEY

United States of America

United States Patent and Trademark Office

Companisto

Reg. No. 4,204,199

Registered Sep. 11, 2012

Int. Cls.: 35 and 36

SERVICE MARK

PRINCIPAL REGISTER

COMPANISTO GMBH (FED REP GERMANY GMBH)
HAUPTSTR. 12
10827 BERLIN
FED REP GERMANY

FOR: BUSINESS MANAGEMENT AND ORGANIZATION CONSULTANCY SERVICES; AUCTIONEERING; BUSINESS CONSULTANCY; ARRANGEMENT AND CONCLUSION OF TRADING TRANSACTIONS FOR THIRD PARTIES; ADVERTISING; BUSINESS ACQUISITION AND MERGER CONSULTATION, IN CLASS 35 (U.S. CLS. 100, 101 AND 102).

FOR: ELECTRONIC CASH TRANSACTIONS; FINANCING SERVICES; FINANCIAL SERVICES, NAMELY, BUSINESS FUNDRAISING PROVIDED OVER A COMPUTER NETWORK SUCH AS THE INTERNET; CAPITAL INVESTMENTS SERVICES; MUTUAL FUND INVESTMENT; CORPORATE FINANCING SERVICES; BROKERAGE OF SHARES OR STOCKS AND OTHER SECURITIES; CAPITAL INVESTMENT BROKERAGE; INVESTMENT BROKERAGE; ARRANGING INVESTMENTS, IN PARTICULAR CAPITAL INVESTMENTS, NAMELY, INVESTMENTS IN STARTUP COMPANIES; FINANCING SERVICES; BROKERAGE OF SECURITIES AND INVESTMENTS; ADVISORY SERVICES RELATING TO CORPORATE FINANCE; VENTURE CAPITAL FINANCING; VENTURE CAPITAL MANAGEMENT SERVICES; VENTURE CAPITAL INVESTMENT SERVICES; INVESTMENT TRUSTEESHIP REPRESENTATIVES; INVESTMENT ADVISORY SERVICES; CAPITAL INVESTMENT CONSULTATION SERVICES; FINANCIAL AND INVESTMENT CONSULTANCY SERVICES; INVESTMENT CONSULTATION, IN CLASS 36 (U.S. CLS. 100, 101 AND 102).



THE MARK CONSISTS OF STANDARD CHARACTERS WITHOUT CLAIM TO ANY PARTICULAR FONT, STYLE, SIZE, OR COLOR.

OWNER OF INTERNATIONAL REGISTRATION 1100560 DATED 10-19-2011, EXPIRES 10-19-2021.

THE WORDING "COMPANISTO" HAS NO MEANING IN A FOREIGN LANGUAGE.

SER. NO. 79-106,716, FILED 10-19-2011.

EVELYN BRADLEY, EXAMINING ATTORNEY

David J. Kyffers

Director of the United States Patent and Trademark Office

United States of America

United States Patent and Trademark Office



Reg. No. 4,204,200

Registered Sep. 11, 2012

Int. Cl.: 8

TRADEMARK

PRINCIPAL REGISTER

ZHEJIANG VOLCANO MACHINERY CO., LTD. (CHINA CORPORATION)
NO. 500 XIANHUA NORTH STREET
JINHUA; 321000 ZHEJIANG
CHINA

FOR: GUNS, NAMELY, CAULKING GUNS, MANUALLY-OPERATED GREASE GUNS; GUNS, HAND-OPERATED, FOR THE EXTRUSION OF MASTICS; HAND TOOLS, NAMELY, RIVETERS; HAND TOOLS FOR DECANTING LIQUIDS, NOT FOR HOUSEHOLD USE; HAND-OPERATED CUTTING TOOLS; TOOL BELTS; HAND TOOLS, NAMELY, SPATULAS; SCREWDRIVERS; HAND-OPERATED SCRAPING TOOLS, IN CLASS 8 (U.S. CLS. 23, 28 AND 44).

THE MARK CONSISTS OF THE WORDING "FOAMMATE" WITH THE LETTER "F" IN THE SHAPE OF A GUN WITH BUBBLES EXTENDING FROM THE END OF THE GUN.

OWNER OF INTERNATIONAL REGISTRATION 1100604 DATED 11-24-2011, EXPIRES 11-24-2021.

SER. NO. 79-106,737, FILED 11-24-2011.

DAVID HOFFMAN, EXAMINING ATTORNEY



David J. Kyffers

Director of the United States Patent and Trademark Office

United States of America

United States Patent and Trademark Office

Charge eMosphere

Reg. No. 4,204,201

Registered Sep. 11, 2012

Int. Cls.: 9 and 42

TRADEMARK

SERVICE MARK

PRINCIPAL REGISTER

SIEMENS AKTIENGESELLSCHAFT (FED REP GERMANY JOINT STOCK COMPANY)
WITTELSBACHERPLATZ 2
80333 MÜNCHEN
FED REP GERMANY

FOR: ELECTRICAL SIGNALING, MEASURING, METERING, REGISTERING, MONITORING, CONTROLLING, REGULATING AND SWITCHING APPARATUS, NAMELY, ELECTRIC METERS, ELECTRIC SWITCHES, ELECTRIC CONTROLLERS; ELECTRICAL DEVICES FOR INPUT, PROCESSING, TRANSMISSION, STORAGE AND OUTPUT OF DATA, NAMELY, COMPUTER HARDWARE, HARD DISC DRIVES; DATA-PROCESSING PROGRAMS, NAMELY, COMPUTER SOFTWARE FOR MANAGING, PROCESSING AND ANALYZING DATA RELATING TO ELECTRICAL VEHICLE CHARGING STATIONS AND NETWORKS AND FOR MONITORING AND CONTROLLING THE OPERATION OF ELECTRICAL CHARGING STATIONS AND NETWORKS, COMPUTER SOFTWARE FOR MANAGING CUSTOMER PAYMENTS AND ACCOUNTS AND FOR PROVIDING STATUS INFORMATION REGARDING AND ACCESS TO ELECTRICAL POWER SUPPLY NETWORKS FOR ELECTRIC VEHICLES, IN CLASS 9 (U.S. CLS. 21, 23, 26, 36 AND 38).

FOR: DEVELOPMENT, GENERATION AND RENTING OF DATA PROCESSING PROGRAMS, IN CLASS 42 (U.S. CLS. 100 AND 101).

THE MARK CONSISTS OF STANDARD CHARACTERS WITHOUT CLAIM TO ANY PARTICULAR FONT, STYLE, SIZE, OR COLOR.

PRIORITY DATE OF 8-9-2011 IS CLAIMED.

OWNER OF INTERNATIONAL REGISTRATION 1100766 DATED 11-14-2011, EXPIRES 11-14-2021.

NO CLAIM IS MADE TO THE EXCLUSIVE RIGHT TO USE "CHARGE", APART FROM THE MARK AS SHOWN.

SER. NO. 79-106,806, FILED 11-14-2011.

ERNEST SHOSHO, EXAMINING ATTORNEY



David J. Kyfos

Director of the United States Patent and Trademark Office

United States of America

United States Patent and Trademark Office



Reg. No. 4,204,202

Registered Sep. 11, 2012

Int. Cl.: 23

TRADEMARK

PRINCIPAL REGISTER

FILIVIVI S.R.L. (ITALY JOINT STOCK COMPANY WITH LIMITED LIABILITY)
VIA TURATI, 16/18
I-20121 MILANO (MI)
ITALY

FOR: YARNS AND THREADS, FOR TEXTILE USE EXCEPT THREADS FOR TECHNICAL TEXTILES, IN CLASS 23 (U.S. CL. 43).

THE MARK CONSISTS OF THE STYLIZED WORD "FOLCO" IN CAPITAL BLOCK LETTERS, WHERE THE FIRST LETTER "O" IS REPRESENTED BY A BALL OF YARN.

OWNER OF INTERNATIONAL REGISTRATION 1100967 DATED 9-21-2011, EXPIRES 9-21-2021.

SER. NO. 79-106,922, FILED 9-21-2011.

STEVEN JACKSON, EXAMINING ATTORNEY



David J. Kyffers

Director of the United States Patent and Trademark Office

United States of America

United States Patent and Trademark Office

NUFF  (NUFF LUV)

Reg. No. 4,204,203

Registered Sep. 11, 2012

Int. Cl.: 25

TRADEMARK

PRINCIPAL REGISTER

WAJID HUSSAIN (UNITED KINGDOM INDIVIDUAL)
8 ABBOTSFORD ROAD, SPARKBROOK
BIRMINGHAM B11 1NU
UNITED KINGDOM

FOR: CLOTHING, NAMELY, JACKETS, SHIRTS; HEADGEAR, NAMELY, CAPS, HATS, IN CLASS 25 (U.S. CLS. 22 AND 39).

THE MARK CONSISTS OF A HEART SHAPED LOGO WHICH REPRESENTS THE WORD LOVE AND THE WORD "NUFF" PLACED ON THE LEFT HAND SIDE OF THE LOGO; AT THE BOTTOM OF THE LOGO ARE THE WORDS "NUFF LUV" IN BRACKETS.

OWNER OF INTERNATIONAL REGISTRATION 1101171 DATED 7-26-2011, EXPIRES 7-26-2021.

SER. NO. 79-106,995, FILED 7-26-2011.

SUZANNE BLANE, EXAMINING ATTORNEY



David J. Kyffers

Director of the United States Patent and Trademark Office

United States of America

United States Patent and Trademark Office



Reg. No. 4,204,204

Registered Sep. 11, 2012

Int. Cls.: 29 and 30

TUKAS GIDA; SANAYI VE TICARET ANONIM SIRKETI (TURKEY JOINT STOCK COMPANY)
ÇAYBASI MAH. IZMIR CAD. NO:51
TORBALI IZMIR
TURKEY

TRADEMARK

PRINCIPAL REGISTER

FOR: MEAT, FISH; POULTRY AND GAME MEAT, AND PROCESSED MEAT, NAMELY, KIDNEYS, TURKEY, LAMB, LUNCHEON MEATS AND VEAL; DRIED LEGUMES; READY MADE SOUPS AND BOUILLON; PROCESSED OLIVES, PRESERVED OLIVES AND OLIVE PASTE; MILK AND MILK PRODUCTS, NAMELY, BUTTER, EVAPORATED MILK, AND MILK CURD; EDIBLE VEGETABLE OILS; DRIED, CANNED, FROZEN, COOKED, SMOKED, AND BRINED FRUITS AND VEGETABLES; DRIED FRUITS; HAZELNUT SPREAD AND PISTACHIO PASTES; SESAME SEED PASTE; EGGS; POWDERED EGGS; NON-MEDICAL FOODS USED FOR SUPPLEMENTARY PURPOSES, NAMELY, PROCESSED BEE POLLENS AS A FOODSTUFF; PROTEINS, NAMELY, TEXTURED VEGETABLE PROTEIN FOR USE AS A MEAT EXTENDER, PROTEIN MILK, FORMED TEXTURED VEGETABLE PROTEIN FOR USE AS A MEAT SUBSTITUTE, AND TOFU; NON-CARBOHYDRATE SUPPLEMENTS OTHER THAN FOR MEDICAL USE, NAMELY, NON-ALCOHOLIC FRUIT EXTRACTS FOR USE AS INGREDIENTS OF NUTRITIONAL SUPPLEMENTS AND VITAMINS, POTATO CHIPS, IN CLASS 29 (U.S. CL. 46).



David J. Kappas

Director of the United States Patent and Trademark Office

FOR: COFFEE; COCOA; COFFEE SUBSTITUTES; COFFEE BASED BEVERAGES; COCOA BASED BEVERAGES; CHOCOLATE BASED BEVERAGES; PASTRY AND BAKERY PRODUCTS; BAKERY DESSERTS; HONEY; ROYAL JELLY FOR FOOD; PROPOLIS FOR FOOD PURPOSES; YEASTS; BAKING POWDER; CONDIMENTS FOR FOODSTUFF, NAMELY, PEPPER SAUCE, CHUTNEY, AND PICKLED GINGER, KETCHUP, AND MUSTARD; NATURAL SUBSTANCES FOR IMPROVING SHAPE AND COLOR OF BREAD AND RETARDING ITS PERIOD OF GETTING STALE, NAMELY, BREAD BASES, AND BAKING SODA; FLOUR; PROCESSED SEMOLINA; CORN STARCH; CRYSTALISED SUGAR; CUBED SUGAR; POWDERED SUGAR; TEA; ICED TEA; CONFECTIONERY, NAMELY, FONDANTS, AND PASTILLES; BISCUITS; CRACKERS; WAFFLES; CHEWING GUMS; ICE CREAMS; FROZEN CREAMS, NAMELY, ICE CREAM, PASTRY CREAM, AND FROZEN DESSERTS CONSISTING OF CREAM; SALT; PROCESSED CEREALS AND PRODUCTS MADE FROM CEREALS, NAMELY, HIGH PROTEIN CEREAL BARS, CEREAL BASED ENERGY BARS, AND CEREAL BASED SNACK FOOD, IN CLASS 30 (U.S. CL. 46).

OWNER OF U.S. REG. NO. 3,329,785.

Reg. No. 4,204,204 OWNER OF INTERNATIONAL REGISTRATION 1101414 DATED 7-18-2011, EXPIRES 7-18-2021.

THE COLOR(S) BLACK, WHITE AND GREEN IS/ARE CLAIMED AS A FEATURE OF THE MARK.

THE MARK CONSISTS OF THE WORDING "TUKAS" IN WHITE, WITH TWO GREEN LEAVES EMANATING FROM THE TOP RIGHT OF THE LETTER "K", WITH THE WORDING "DOGAYA ÖZEN GÖSTERDİK" APPEARING IN WHITE UNDERNEATH; ALL OF THE WORDING AND LEAVES APPEAR ON A BLACK BACKGROUND.

THE ENGLISH TRANSLATION OF "DOGAYA ÖZEN GÖSTERDİK" IN THE MARK IS "WE HAVE TAKEN CARE OF NATURE". THE WORDING "TUKAS" HAS NO MEANING IN A FOREIGN LANGUAGE.

SER. NO. 79-107,082, FILED 7-18-2011.

SHAILA SETTLES, EXAMINING ATTORNEY

United States of America

United States Patent and Trademark Office



Reg. No. 4,204,205

Registered Sep. 11, 2012

Int. Cls.: 32, 33 and 43

TRADEMARK

SERVICE MARK

PRINCIPAL REGISTER

CUSTOMDRINKS, S.L. (SPAIN LIMITED LIABILITY COMPANY)
POL. IND. OS ACIBROS, PARCELA C-1
E-27500 CHANTADA (LUGO)
SPAIN

FOR: BEERS; CONCENTRATES, SYRUP OR POWDERS USED IN THE PREPARATION OF SOFT DRINKS; FRUIT DRINKS; FRUIT JUICES; MALT SYRUP FOR BEVERAGES; MINERAL WATER; NON-ALCOHOLIC BEVERAGES CONTAINING FRUIT JUICES; NON-ALCOHOLIC COCKTAIL MIXES; NON-ALCOHOLIC FRUIT EXTRACTS USED IN THE PREPARATION OF BEVERAGES; NON-ALCOHOLIC MALT BEVERAGE; SPARKLING WATER; SYRUP FOR BEVERAGES; SYRUP FOR MAKING FRUIT DRINKS, SOFT DRINKS, IN CLASS 32 (U.S. CLS. 45, 46 AND 48).

FOR: ALCOHOLIC BEVERAGES EXCEPT BEERS, IN CLASS 33 (U.S. CLS. 47 AND 49).

FOR: SERVICES FOR PROVIDING FOOD AND DRINK; TEMPORARY ACCOMMODATION , IN CLASS 43 (U.S. CLS. 100 AND 101).

THE NAME(S), PORTRAIT(S), AND/OR SIGNATURE(S) SHOWN IN THE MARK DOES NOT IDENTIFY A PARTICULAR LIVING INDIVIDUAL.

OWNER OF INTERNATIONAL REGISTRATION 1101446 DATED 10-28-2011, EXPIRES 10-28-2021.

THE COLOR(S) BLACK, WHITE AND RED IS/ARE CLAIMED AS A FEATURE OF THE MARK.

THE MARK CONSISTS OF THE WORDING "LA TITA RIVERA" IN STYLIZED WHITE FONT WITH BLACK OUTLINING. THE WORDING APPEARS BENEATH A BLACK AND WHITE PICTURE OF A WOMAN WEARING A RED APRON AND HOLDING TWO RED CANS WITH BLACK AND WHITE TOPS AND BOTTOMS. THE WOMAN APPEARS IN A BLACK CIRCLE WITH A WHITE CENTER.

THE ENGLISH TRANSLATION OF "LA TITA RIVERA" IN THE MARK IS "THE LITTLE AUNT RIVERA".

SER. NO. 79-107,094, FILED 10-28-2011.



David J. Kypos

Director of the United States Patent and Trademark Office

Reg. No. 4,204,205 LIEF MARTIN, EXAMINING ATTORNEY

United States of America

United States Patent and Trademark Office

accure 

Reg. No. 4,204,206

ACCURE AB (SWEDEN JOINT STOCK COMPANY)
KUNGSTORGET 2

Registered Sep. 11, 2012

GÖTEBORG, SWEDEN SE411 17

Int. Cls.: 9, 35 and 42

FOR: COMPUTER SOFTWARE AND PROGRAMS FOR ELECTRONIC ARCHIVING, DOCUMENT SOLUTIONS AND SYSTEM INTEGRATION; DATA PROCESSING EQUIPMENT AND COMPUTERS, IN CLASS 9 (U.S. CLS. 21, 23, 26, 36 AND 38).

TRADEMARK

FOR: ASSISTANCE AND CONSULTATION REGARDING BUSINESS MANAGEMENT, BUSINESS ADMINISTRATION AND BUSINESS ORGANIZATION, IN CLASS 35 (U.S. CLS. 100, 101 AND 102).

SERVICE MARK

PRINCIPAL REGISTER

FOR: CONSULTATION REGARDING IT; DESIGN AND DEVELOPMENT OF COMPUTER HARDWARE AND COMPUTER SOFTWARE, IN CLASS 42 (U.S. CLS. 100 AND 101).

THE MARK CONSISTS OF THE WORD "ACCURE" IN BLACK WITH A DESIGN TO THE RIGHT CONSISTING OF A LINE OF SIX DIAGONAL LINES AT THE TOP AND MIRRORED DIAGONAL LINES AT THE BOTTOM; THE FIRST SIX LINES - THREE TOP AND THREE BOTTOM - ARE ORANGE, THE NEXT TWO - TWO TOP AND TWO BOTTOM - WHICH MAKE AN "X" DESIGN ARE BLACK AND THE LAST ONE - ONE TOP AND ONE BOTTOM - IS ORANGE. THE COLOR WHITE REPRESENTS BACKGROUND AND IS NOT A PART OF THE MARK.



PRIORITY DATE OF 5-16-2011 IS CLAIMED.

OWNER OF INTERNATIONAL REGISTRATION 1101787 DATED 11-15-2011, EXPIRES 11-15-2021.

THE COLOR(S) ORANGE AND BLACK IS/ARE CLAIMED AS A FEATURE OF THE MARK.

SER. NO. 79-107,228, FILED 11-15-2011.

MAYUR VAGHANI, EXAMINING ATTORNEY

David J. Kyffers

Director of the United States Patent and Trademark Office

United States of America

United States Patent and Trademark Office

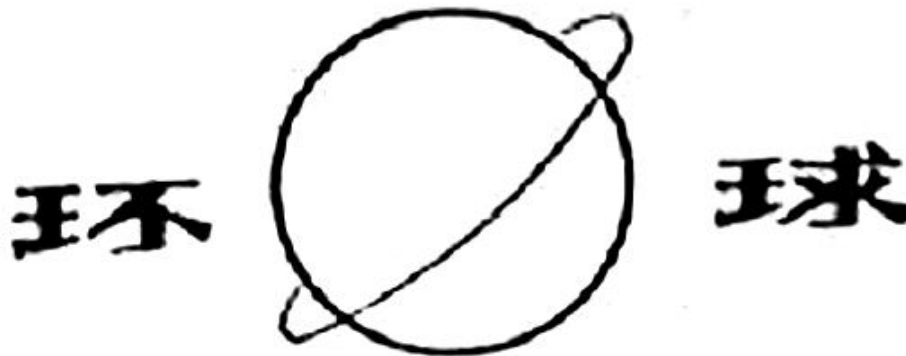

Reg. No. 4,204,207

Registered Sep. 11, 2012

Int. Cl.: 7

TRADEMARK

PRINCIPAL REGISTER

SUZHOU GLOBAL GROUP CO.,LTD. (CHINA CORPORATION)
188, SHIZHONGLU
XUKOUZHEN.; WUZHONGQU; 215000 SUZHOU, JIANGSU
CHINA

FOR: DRIVE CHAINS AND DRIVING CHAINS OTHER THAN FOR LAND VEHICLES,
NAMELY, FOR USE WITH SLEEVE BEARING, IN CLASS 7 (U.S. CLS. 13, 19, 21, 23, 31, 34
AND 35).

THE MARK CONSISTS OF AN OUTLINE OF A GLOBE WITH AN ORBIT RING. ON EITHER
SIDE OF THE GLOBE, ASIAN CHARACTERS APPEAR.

OWNER OF INTERNATIONAL REGISTRATION 1101869 DATED 12-6-2011, EXPIRES 12-
6-2021.

THE NON-LATIN CHARACTERS IN THE MARK TRANSLITERATE TO HUAN QIU AND
THIS HAS NO MEANING IN A FOREIGN LANGUAGE.

SER. NO. 79-107,252, FILED 12-6-2011.

MARILYN IZZI, EXAMINING ATTORNEY



David J. Kypos

Director of the United States Patent and Trademark Office

United States of America

United States Patent and Trademark Office

SelfSealMatic

Reg. No. 4,204,208

Registered Sep. 11, 2012

Int. Cl.: 9

TRADEMARK

PRINCIPAL REGISTER

HAWO GERÄTEBAU GMBH & CO MASCHINENBAU KG (FED REP GERMANY GMBH & CO. KG)
OBERE AU 2
74847 OBRIGHEIM, FED REP GERMANY

FOR: SENSORS FOR THE CONTROL OF CONTACT PRESSURE AND PASSING SPEED OF ADHESIVE BONDS AND CONTROL SOFTWARE INTEGRATED IN ELECTRIC SEALING MACHINES FOR SEALING STERILE GOODS PACKAGING, IN CLASS 9 (U.S. CLS. 21, 23, 26, 36 AND 38).

THE MARK CONSISTS OF STANDARD CHARACTERS WITHOUT CLAIM TO ANY PARTICULAR FONT, STYLE, SIZE, OR COLOR.

OWNER OF INTERNATIONAL REGISTRATION 1101933 DATED 5-30-2011, EXPIRES 5-30-2021.

SER. NO. 79-107,278, FILED 5-30-2011.

ERNEST SHOSHO, EXAMINING ATTORNEY



David J. Kyffers

Director of the United States Patent and Trademark Office

United States of America
United States Patent and Trademark Office

FATTIES

Reg. No. 4,204,209

Registered Sep. 11, 2012

Int. Cl.: 26

TRADEMARK

PRINCIPAL REGISTER

HARDCORE HOLDING B.V. (NETHERLANDS BESLOTEN VENNOOTSCHAP)
SPECTRUMLAAN 51
NL-2665 NM BLEISWIJK
NETHERLANDS

FOR: LACE AND EMBROIDERY, RIBBONS AND BRAID; BUTTONS, HOOKS AND EYES,
AND NEEDLES; ARTIFICIAL FLOWERS; SHOE LACES, IN CLASS 26 (U.S. CLS. 37, 39, 40,
42 AND 50).

THE MARK CONSISTS OF STANDARD CHARACTERS WITHOUT CLAIM TO ANY PAR-
TICULAR FONT, STYLE, SIZE, OR COLOR.

PRIORITY DATE OF 7-12-2011 IS CLAIMED.

OWNER OF INTERNATIONAL REGISTRATION 1102127 DATED 10-21-2011, EXPIRES 10-
21-2021.

SER. NO. 79-107,346, FILED 10-21-2011.

ALEX KEAM, EXAMINING ATTORNEY



David J. Kyfos

Director of the United States Patent and Trademark Office

United States of America

United States Patent and Trademark Office



Reg. No. 4,204,210

Registered Sep. 11, 2012

Int. Cl.: 4

TRADEMARK

PRINCIPAL REGISTER

HROVAL ROBERT (SLOVENIA INDIVIDUAL)
POD GOZDOM C.V/1
SI-1290 GROSUPLJE
SLOVENIA

FOR: CANDLES AND WICKS FOR CANDLES FOR LIGHTING; CANDLES; GRAVEYARD CANDLES; TAPERS; PERFUMED CANDLES; CHRISTMAS TREE CANDLES; WICKS FOR CANDLES; WAX, IN CLASS 4 (U.S. CLS. 1, 6 AND 15).

THE MARK CONSISTS OF THE WORDING "EASYCANDLE" IN STYLIZED TEXT TO THE RIGHT OF A FANCIFUL FLAME DESIGN.

PRIORITY DATE OF 5-12-2011 IS CLAIMED.

OWNER OF INTERNATIONAL REGISTRATION 1102148 DATED 11-11-2011, EXPIRES 11-11-2021.

SER. NO. 79-107,356, FILED 11-11-2011.

SHANNON TWOHIG, EXAMINING ATTORNEY



David J. Kyffers

Director of the United States Patent and Trademark Office

United States of America
United States Patent and Trademark Office

DeHao

Reg. No. 4,204,211

WENZHOU SHI PULAI SI XIE YE; YOU XIAN GONG SI (CHINA CORPORATION)
GONG YE QU XIE CHENG
OU HAI CHA SHAN ZHEN, WEN ZHOU
ZHEJIANG 325000, CHINA

Registered Sep. 11, 2012

Int. Cl.: 25

FOR: SHOES; GYMNAS TIC SHOES; CLOTHING, NAMELY, PANTS, SHIRTS, JACKETS,
SOCKS, DRESSES; LAYETTES; HATS; HOSIERY; GLOVES; NECKTIES; LEATHER BELTS;
BATHING SUITS, IN CLASS 25 (U.S. CLS. 22 AND 39).

TRADEMARK

PRINCIPAL REGISTER

THE WORDING "DEHAO" HAS NO MEANING IN A FOREIGN LANGUAGE.

OWNER OF INTERNATIONAL REGISTRATION 1102159 DATED 12-7-2011, EXPIRES 12-7-2021.

SER. NO. 79-107,358, FILED 12-7-2011.

JOHN SCHUYLER YARD, EXAMINING ATTORNEY



David J. Kyros

Director of the United States Patent and Trademark Office

United States of America

United States Patent and Trademark Office



Reg. No. 4,204,212

Registered Sep. 11, 2012

Int. Cl.: 25

POCHETTINI FASHION S.R.L. (ITALY JOINT STOCK COMPANY WITH LIMITED LIABILITY)
VIA XXV APRILE, 28
NOGARA (VR)
ITALY

TRADEMARK

PRINCIPAL REGISTER

FOR: CLOTHING, NAMELY, NECKTIES, BELTS, SWEATERS, CARDIGANS, PULLOVERS, WAISTCOATS, JACKETS, OVERCOATS, SHIRTS, GOLF SHIRTS, COATS, BERMUDA SHORTS, PANTS, JEANS, RAINCOATS, SASHES, BLOUSES, SUITS, DRESSES, SKIRTS, SHAWLS, SCARVES, GLOVES, FUR COATS, FUR JACKETS, FUR STOLE; LEATHER CLOTHING, NAMELY, JACKETS, COATS, PANTS, BELTS, WAISTCOATS, SKIRTS; IMITATION LEATHER CLOTHING, NAMELY, JACKETS, COATS, PANTS, BELTS, WAISTCOATS, SKIRTS; HEADGEAR, NAMELY, HATS, CAPS, VISORS, IN CLASS 25 (U.S. CLS. 22 AND 39).

THE MARK CONSISTS OF THE LETTERS "FP" IN STYLIZED FONT WITH AN INCOMPLETE DOTTED CIRCLE DESIGN.

OWNER OF INTERNATIONAL REGISTRATION 1102237 DATED 11-4-2011, EXPIRES 11-4-2021.

SER. NO. 79-107,392, FILED 11-4-2011.

NATALIE POLZER, EXAMINING ATTORNEY



David J. Kybas

Director of the United States Patent and Trademark Office

United States of America

United States Patent and Trademark Office

Baby Steps

Reg. No. 4,204,213

Registered Sep. 11, 2012

Int. Cl.: 28

TRADEMARK

PRINCIPAL REGISTER

TAF PLASTIC PRODUCTS LTD (ISRAEL CORPORATION)
SOUTH INDUSTRIAL ZONE
B.O.X. 8790; NETANYA
ISRAEL

FOR: TOYS AND PLAYTHINGS, NAMELY, CRIB TOYS, INFANT TOYS, BABY MULTIPLE ACTIVITY TOYS, MUSICAL TOYS, BATHTUB TOYS, PLAY MATS CONTAINING INFANT TOYS, PLUSH TOYS, STUFFED TOYS, SQUEEZABLE SQUEAKING TOYS, PLASTIC CHARACTER TOYS, STACKING TOYS, RIDE-ON TOYS, SOFT-SCULPTURE TOYS, IN CLASS 28 (U.S. CLS. 22, 23, 38 AND 50).

THE MARK CONSISTS OF STANDARD CHARACTERS WITHOUT CLAIM TO ANY PARTICULAR FONT, STYLE, SIZE, OR COLOR.

PRIORITY DATE OF 8-8-2011 IS CLAIMED.

OWNER OF INTERNATIONAL REGISTRATION 1102291 DATED 11-20-2011, EXPIRES 11-20-2021.

SER. NO. 79-107,410, FILED 11-20-2011.

STEVEN R. FINE, EXAMINING ATTORNEY



David J. Kyffers

Director of the United States Patent and Trademark Office

United States of America

United States Patent and Trademark Office



SAVICO GROUP

Reg. No. 4,204,214

Registered Sep. 11, 2012

Int. Cls.: 35, 36 and 39

CONG TY CO PHAN DICH VU TONG HOP SAI GON (VIETNAM JOINT STOCK COMPANY),
DBA SAVICO
68 NAM KY KHOI NGHIA
NGUYEN THAI BINH WARD, DISTRICT 1
HO CHI MINH CITY, VIETNAM

SERVICE MARK

PRINCIPAL REGISTER

FOR: COMMERCIAL SUPERMARKETS IN THE FIELDS OF GOODS, NAMELY FOODS AND FOODSTUFF, HANDICRAFTS, CRAFT INDUSTRY PRODUCTS, GARMENTS, FOOTWEAR, PAPER, LEATHER, PLASTIC AND PRODUCTS MADE OF PAPER, LEATHER, PLASTIC, INTERIOR DECORATION PRODUCTS, METALLIC PRODUCTS, ELECTRIC-MECHANICAL PRODUCTS AND SPARE PARTS THEREOF, ELECTRIC AND ELECTRONIC EQUIPMENTS AND THEIR SPARE PARTS, HOUSEHOLD COMMODITIES, CAMERAS, SPARE PARTS AND ACCESSORIES THEREOF, MUSIC INSTRUMENTS, WATCHES AND CLOCKS, EYE GLASSES AND SPARE PARTS THEREOF, TOYS FOR CHILDREN, PUBLICATIONS, OFFICE STATIONERY, OFFICE MACHINES AND EQUIPMENTS, COSMETICS, SPORT TOOLS, JEWELRY, WINE, BEER, SOFT DRINKS, TELEPHONES, FAX MACHINES, TELEPHONE CARDS, TELEPHONE EXCHANGERS AND OTHER POSTAL AND TELECOMMUNICATION EQUIPMENTS; RETAIL STORE SERVICES FEATURING AGRICULTURAL, FORESTAL, SEA AND AQUATIC PRODUCTS, FOODS AND FOODSTUFF, FINE ARTS AND HANDICRAFTS, CRAFT INDUSTRY PRODUCTS, GARMENTS, FOOTWEAR, PAPER, LEATHER, PLASTIC AND PRODUCTS MADE OF PAPER, LEATHER, PLASTIC, INDUSTRIAL PRODUCTS, MACHINES AND EQUIPMENTS AND SPARE PARTS, MATERIALS, CHEMICAL SUBSTANCES, RAW AND AUXILIARY MATERIALS SERVING FIELDS OF INDUSTRIAL PRODUCTIONS, MEDICAL TOOLS AND EQUIPMENTS, CONSTRUCTION MATERIALS, INTERIOR DECORATION PRODUCTS, MOTORCYCLES, CARS AND SPARE PARTS AND ACCESSORIES IN ALL KINDS THEREOF, ELECTRIC-FREEZING EQUIPMENTS, METALLIC PRODUCTS, ELECTRIC-MECHANICAL PRODUCTS AND SPARE PARTS THEREOF, ELECTRIC AND ELECTRONIC EQUIPMENTS AND THEIR SPARE PARTS, HOUSEHOLD COMMODITIES, COMPUTERS AND SPARE PARTS THEREOF, PERIPHERAL DEVICES, CAMERAS, SPARE PARTS AND ACCESSORIES THEREOF, PRODUCTS SERVING PHOTOGRAPH INDUSTRY, MUSIC INSTRUMENTS, WATCHES AND CLOCKS, EYE GLASSES AND SPARE PARTS THEREOF, TOYS FOR CHILDREN, PUBLICATIONS, OFFICE STATIONERY, OFFICE MACHINES AND EQUIPMENTS, COSMETICS, SPORT TOOLS, JEWELRY, GOLD, SILVER, PRECIOUS STONES, WINE, BEER, SOFT DRINKS, TELEPHONES, FAX MACHINES, TELEPHONE CARDS, TELEPHONE EXCHANGERS AND OTHER POSTAL AND TELECOMMUNICATION EQUIPMENTS; ADVERTISING SERVICES; RETAIL SERVICES BY DIRECT SOLICITATION BY SALES AGENTS IN THE FIELDS OF AGRICULTUR-



David J. Kybas

Director of the United States Patent and Trademark Office

Reg. No. 4,204,214 AL, FORESTAL, SEA AND AQUATIC PRODUCTS, FOODS AND FOODSTUFF, FINE ARTS AND HANDICRAFTS, CRAFT INDUSTRY PRODUCTS, GARMENTS, FOOTWEAR, PAPER, LEATHER, PLASTIC AND PRODUCTS MADE OF PAPER, LEATHER, PLASTIC, INDUSTRIAL PRODUCTS, MACHINES AND EQUIPMENTS AND SPARE PARTS, MATERIALS, CHEMICAL SUBSTANCES, RAW AND AUXILIARY MATERIALS SERVING FIELDS OF INDUSTRIAL PRODUCTIONS, MEDICAL TOOLS AND EQUIPMENTS, CONSTRUCTION MATERIALS, INTERIOR DECORATION PRODUCTS, MOTORCYCLES, CARS AND SPARE PARTS AND ACCESSORIES IN ALL KINDS THEREOF, ELECTRIC-FREEZING EQUIPMENTS, METALLIC PRODUCTS, ELECTRIC-MECHANICAL PRODUCTS AND SPARE PARTS THEREOF, ELECTRIC AND ELECTRONIC EQUIPMENTS AND THEIR SPARE PARTS, HOUSEHOLD COMMODITIES, COMPUTERS AND SPARE PARTS THEREOF, PERIPHERAL DEVICES, CAMERAS, SPARE PARTS AND ACCESSORIES THEREOF, PRODUCTS SERVING PHOTOGRAPH INDUSTRY, MUSIC INSTRUMENTS, WATCHES AND CLOCKS, EYE GLASSES AND SPARE PARTS THEREOF, TOYS FOR CHILDREN, PUBLICATIONS, OFFICE STATIONERIES, OFFICE MACHINES AND EQUIPMENTS, COSMETICS, SPORT TOOLS, JEWELRY, GOLD, SILVER, PRECIOUS STONES, WINE, BEER, SOFT DRINKS, TELEPHONES, FAX MACHINES, TELEPHONE CARDS, TELEPHONE EXCHANGERS AND OTHER POSTAL AND TELECOMMUNICATION EQUIPMENTS; BUSINESS PROJECT MANAGEMENT; ESTIMATING CONTRACTING WORK, NAMELY, SERVICE OF MAKING GENERAL BUDGET ESTIMATES AND BUDGET ESTIMATES FOR CONSTRUCTION PROJECTS; BIDDING CONSULTANCY, NAMELY, ONLINE AUCTION BIDDING AND/OR BIDDING QUOTATION; BIDDING SERVICE FOR OTHERS, NAMELY, ONLINE AUCTION BIDDING AND/OR BIDDING QUOTATION; AGENCY SERVICES OF EXPORT AND IMPORT OF GOODS, IN CLASS 35 (U.S. CLS. 100, 101 AND 102).

FOR: RENTAL OF REAL ESTATE, NAMELY, VACATION HOMES; REAL ESTATE BROKERAGES; REAL ESTATE AGENCIES; RENTAL OF HOUSES, OFFICES, APARTMENTS, AND BUILDINGS FOR WORKSHOPS AND TRADE CENTRES; CAPITAL INVESTMENTS IN FIELDS OF TRADING, REAL ESTATE AND FINANCE; REAL ESTATE CONSULTANCY; MORTGAGE SERVICES OF PROPERTIES FOR REFINANCING AND/OR LENDING, IN CLASS 36 (U.S. CLS. 100, 101 AND 102).

FOR: ARRANGING OF DOMESTIC AND INTERNATIONAL TOURS; TRANSPORT OF PASSENGERS BY TAXI; SERVICES OF TRANSPORT OF GOODS AND/OR BY MAN-POWERED VEHICLES; STORAGE OF GOODS; RENTAL OF WAREHOUSES, PARKING PLACE RENTAL; CAR RENTAL, IN CLASS 39 (U.S. CLS. 100 AND 105).

NO CLAIM IS MADE TO THE EXCLUSIVE RIGHT TO USE "GROUP", APART FROM THE MARK AS SHOWN.

OWNER OF INTERNATIONAL REGISTRATION 1102366 DATED 7-27-2011, EXPIRES 7-27-2021.

THE COLOR(S) RED AND WHITE IS/ARE CLAIMED AS A FEATURE OF THE MARK.

THE MARK CONSISTS OF THE LETTERS "S", "I", AND THE WORDS "SAVICO GROUP", ALL IN RED; A WHITE CIRCLE DESIGN IN THE MIDDLE OF THE STYLIZED "S" LETTER WITH THE "I" LETTER INSIDE; AND A LOZENGE SHAPE DESIGN IN WHITE WITH A RED BORDER.

THE WORDING "SAVICO" HAS NO MEANING IN A FOREIGN LANGUAGE.

SER. NO. 79-107,464, FILED 7-27-2011.

TINA MAI, EXAMINING ATTORNEY

United States of America

United States Patent and Trademark Office



Reg. No. 4,204,215

Registered Sep. 11, 2012

Int. Cl.: 28

TRADEMARK

PRINCIPAL REGISTER

TOSY ROBOTICS JOINT STOCK COMPANY (VIETNAM JOINT STOCK COMPANY)
NO. 7, 538 LANE
LANG ROAD,; DONG DA DISTRICT; HANOI CITY
VIETNAM AND

HO VINII HOANG (VIETNAM INDIVIDUAL)
MO LAO
HA DONG DISTRICT; HANOI CITY
VIETNAM

FOR: FLYING DISCS; PARLOR GAMES; QUILTS; SPINNING TOPS; TOYS, NAMELY, SPINNING TOPS WITH LIGHTS, ELECTRONIC SPINNING TOPS, ELECTRIC ACTION TOYS, ELECTRIC EDUCATIONAL TOY USED TO DEMONSTRATE ALTERNATIVE ENERGY SOURCES, ELECTRIC TOY TRAIN TRANSFORMERS, ELECTRONIC ACTION TOYS, ELECTRONIC LEARNING TOYS, ELECTRONIC TOY VEHICLES, ELECTRONICALLY OPERATED TOY MOTOR VEHICLES, ELECTRONIC TOY BUILDING BLOCKS THAT LIGHT UP AS A NIGHT LIGHT; APPARATUS FOR ELECTRONIC GAMES OTHER THAN THOSE ADAPTED FOR USE WITH AN EXTERNAL DISPLAY SCREEN OR MONITOR, IN CLASS 28 (U.S. CLS. 22, 23, 38 AND 50).

THE MARK CONSISTS OF TWO STYLIZED ALIEN FACES.

PRIORITY DATE OF 8-24-2011 IS CLAIMED.

OWNER OF INTERNATIONAL REGISTRATION 1102609 DATED 10-24-2011, EXPIRES 10-24-2021.

SER. NO. 79-107,552, FILED 10-24-2011.

GINA FINK, EXAMINING ATTORNEY



David J. Kyjars

Director of the United States Patent and Trademark Office

United States of America
United States Patent and Trademark Office

HGPOWER

Reg. No. 4,204,216

Registered Sep. 11, 2012

Int. Cl.: 9

TRADEMARK

PRINCIPAL REGISTER

CHANGZHOU WUJIN HONGGUANG; RADIO CO., LTD (CHINA CORPORATION)
PUAN BANSHANG
LIJIA TOWN WUJIN.; CHANGZHOU; JIANGSU
CHINA

FOR: COMPUTER PERIPHERAL DEVICES; ELECTRIC CONVERTERS; ELECTRONIC CONTROLLERS USED TO REDUCE POWER CONSUMPTION; COMMUTATORS; VOLTAGE STABILIZING POWER SUPPLY; DISTRIBUTION BOXES FOR ELECTRICITY; MATERIALS FOR ELECTRICITY MAINS, NAMELY, WIRES AND CABLES; LOW VOLTAGE DC POWER SUPPLIES, IN CLASS 9 (U.S. CLS. 21, 23, 26, 36 AND 38).

THE MARK CONSISTS OF THE TERM "HGPOWER" APPEARING IN A STYLIZED FONT.

OWNER OF INTERNATIONAL REGISTRATION 1102668 DATED 12-9-2011, EXPIRES 12-9-2021.

THE WORDING "HGPOWER" HAS NO MEANING IN A FOREIGN LANGUAGE.

SER. NO. 79-107,578, FILED 12-9-2011.

SAIMA MAKHDOOM, EXAMINING ATTORNEY



David J. Kyffers

Director of the United States Patent and Trademark Office

United States of America

United States Patent and Trademark Office

Timetop

Reg. No. 4,204,217

Registered Sep. 11, 2012

Int. Cl.: 9

GUANGZHOU TIMETOP; ELECTRONICS TECHNOLOGY CO.,LTD (CHINA COMPANY WITH LIMITED LIABILITY)

NO.2 INDUSTRIAL DISTRICT OF SHAKENG,
SHAWAN TOWN PANYU; GUANGZHOU
CHINA

TRADEMARK

PRINCIPAL REGISTER

FOR: CAMERAS; CINEMATOGRAPHIC CAMERAS; AUDIOVISUAL TEACHING APPARATUS, NAMELY, AUDIO-VISUAL RECEIVERS, MULTIMEDIA PROJECTORS, FLAT PANEL DISPLAY SCREENS; EYEGLASSES; GALVANIC BATTERIES; VIDEO DISKS AND VIDEO TAPES WITH RECORDED ANIMATED CARTOONS; COMPUTER MEMORIES; TELECONTROLLER FOR HOUSE-USE ONLY, NAMELY, REMOTE CONTROLS FOR RADIOS, TELEVISIONS, STEREOS, IN CLASS 9 (U.S. CLS. 21, 23, 26, 36 AND 38).

THE MARK CONSISTS OF THE TERM "TIMETOP" WITH A CONTRASTING CURVED-EDGE SQUARE BEHIND THE FIRST "T", AN OVAL-SHAPED DOT OVER THE "I" AND A SHADED CENTER IN THE LETTER "O".

OWNER OF INTERNATIONAL REGISTRATION 1102697 DATED 12-13-2011, EXPIRES 12-13-2021.

SER. NO. 79-107,590, FILED 12-13-2011.

HEATHER THOMPSON, EXAMINING ATTORNEY



David J. Kyffers

Director of the United States Patent and Trademark Office

United States of America
United States Patent and Trademark Office

QUATRABOT

Reg. No. 4,204,218

Registered Sep. 11, 2012

Int. Cl.: 7

TRADEMARK

PRINCIPAL REGISTER

POOLRITE RESEARCH PTY LTD (AUSTRALIA PROPRIETARY LIMITED COMPANY)
415 CREEK ROAD
MOUNT GRAVATT, AUSTRALIA QLD 4122

FOR: SWIMMING POOL AND SPA CLEANING AND MAINTENANCE MACHINES AND EQUIPMENT, NAMELY, VACUUM CLEANERS, WATER PURIFYING AND FILTRATION APPARATUS FOR SWIMMING POOLS AND SPAS; SWEEPING MACHINES AND SWEEPERS FOR USE IN SWIMMING POOLS AND SPAS; SKIMMERS FOR CLEANING POOLS AND SPAS; PUMPS, NAMELY, HYDRAULIC PUMPS AND ELECTRIC PUMPS; GENERATORS, NAMELY, ELECTRIC GENERATORS; PARTS FOR THE AFOREMENTIONED GOODS, IN CLASS 7 (U.S. CLS. 13, 19, 21, 23, 31, 34 AND 35).

THE MARK CONSISTS OF STANDARD CHARACTERS WITHOUT CLAIM TO ANY PARTICULAR FONT, STYLE, SIZE, OR COLOR.

OWNER OF INTERNATIONAL REGISTRATION 1102817 DATED 10-31-2011, EXPIRES 10-31-2021.

THE WORD(S) "QUATRABOT" HAS NO MEANING IN A FOREIGN LANGUAGE.

SER. NO. 79-107,628, FILED 10-31-2011.

EVELYN BRADLEY, EXAMINING ATTORNEY



David J. Kybas

Director of the United States Patent and Trademark Office

United States of America

United States Patent and Trademark Office

FALKE

Reg. No. 4,204,219

Registered Sep. 11, 2012

Int. Cl.: 35

FALKE KGAA (FED REP GERMANY LIMITED COMMERCIAL PARTNERSHIP, LIMITED ON SHARES)
OSTSTRASSE 5
57392 SCHMALLEMBERG
FED REP GERMANY

SERVICE MARK

PRINCIPAL REGISTER

FOR: WHOLESALE AND RETAIL STORE SERVICES FEATURING SOAPS FOR COSMETIC PURPOSES, SOAPS FOR TEXTILES, PERFUMERIES, ETHEREAL OILS, PRODUCTS FOR PERSONAL HYGIENE AND BEAUTY, PRODUCTS TO CLEAN, CARE FOR AND BEAUTIFY THE SKIN, SCALP AND HAIR, TOILET ARTICLES, DEODORANTS FOR PERSONAL USE, PRE-SHAVE AND AFTER-SHAVE PRODUCTS, EYEGASSES AND EYEGASS FRAMES, JEWELLERY AND WATCHES, LEATHER AND IMITATIONS OF LEATHER, NAMELY, SUITCASES, BAGS, SMALL LEATHER ARTICLES INCLUDED, ESPECIALLY PURSES, WALLETS, KEY CASES UMBRELLAS AND SUNSHADES, SHOES, CLOTHING AND HEADGEAR, BELTS, SPORTS ARTICLES, GAMES AND TOYS, IN CLASS 35 (U.S. CLS. 100, 101 AND 102).

THE MARK CONSISTS OF STANDARD CHARACTERS WITHOUT CLAIM TO ANY PARTICULAR FONT, STYLE, SIZE, OR COLOR.

PRIORITY DATE OF 3-30-2011 IS CLAIMED.

OWNER OF INTERNATIONAL REGISTRATION 1103054 DATED 9-6-2011, EXPIRES 9-6-2021.

OWNER OF U.S. REG. NOS. 1,201,185, 3,602,663 AND OTHERS.

THE ENGLISH TRANSLATION OF "FALKE" IS "FALCON".

SER. NO. 79-107,717, FILED 9-6-2011.

DAVID HOFFMAN, EXAMINING ATTORNEY



David J. Kyfos

Director of the United States Patent and Trademark Office

United States of America

United States Patent and Trademark Office



Reg. No. 4,204,220

Registered Sep. 11, 2012

Int. Cl.: 12

TRADEMARK

PRINCIPAL REGISTER

DRETTMANN YACHTS GMBH (FED REP GERMANY CORPORATION)
ARBERGER HAFENDAMM 22
28309 BREMEN
FED REP GERMANY

FOR: VEHICLES, NAMELY, BOATS; APPARATUS FOR LOCOMOTION BY WATER,
NAMELY, BOATS, IN CLASS 12 (U.S. CLS. 19, 21, 23, 31, 35 AND 44).

THE MARK CONSISTS OF THE STYLIZED LETTERS "DY", THE LEFT PORTION OF THE
DESIGN IS IN VARYING SHADES OF THE COLORS BEIGE AND WHITE, AND THE RIGHT
SIDE OF THE DESIGN IN THE COLORS BLACK, GREY, AND WHITE.

OWNER OF INTERNATIONAL REGISTRATION 1103058 DATED 7-25-2011, EXPIRES 7-25-
2021.

THE COLOR(S) BLACK, BEIGE, WHITE, GREY IS/ARE CLAIMED AS A FEATURE OF THE
MARK.

SER. NO. 79-107,719, FILED 7-25-2011.

DAVID HOFFMAN, EXAMINING ATTORNEY



David J. Kyffers

Director of the United States Patent and Trademark Office

United States of America

United States Patent and Trademark Office



Reg. No. 4,204,221

Registered Sep. 11, 2012

Int. Cl.: 12

TRADEMARK

PRINCIPAL REGISTER

DRETTMANN YACHTS GMBH (FED REP GERMANY CORPORATION)
ARBERGER HAFENDAMM 22
28309 BREMEN
FED REP GERMANY

FOR: VEHICLES, NAMELY, BOATS; APPARATUS FOR LOCOMOTION BY WATER, NAMELY, BOATS, IN CLASS 12 (U.S. CLS. 19, 21, 23, 31, 35 AND 44).

NO CLAIM IS MADE TO THE EXCLUSIVE RIGHT TO USE "YACHTS", APART FROM THE MARK AS SHOWN.

OWNER OF INTERNATIONAL REGISTRATION 1103060 DATED 7-25-2011, EXPIRES 7-25-2021.

THE COLOR(S) BLACK, BEIGE, WHITE, GREY IS/ARE CLAIMED AS A FEATURE OF THE MARK.

THE MARK CONSISTS OF THE STYLIZED LETTERS "DY" ABOVE THE WORDING "DRETTMAN YACHTS" IN BLACK. THE LEFT PORTION OF THE DESIGN IS IN VARYING SHADES OF THE COLORS BEIGE AND WHITE, AND THE RIGHT SIDE OF THE DESIGN IN THE COLORS BLACK, GREY, AND WHITE.

SER. NO. 79-107,721, FILED 7-25-2011.

DAVID HOFFMAN, EXAMINING ATTORNEY



David J. Kyffers

Director of the United States Patent and Trademark Office

United States of America
United States Patent and Trademark Office

COEUR^{DE}LION

Reg. No. 4,204,222

Registered Sep. 11, 2012

Int. Cl.: 14

TRADEMARK

PRINCIPAL REGISTER

COEUR DE LION SCHMUCKDESIGN GMBH (FED REP GERMANY LIMITED LIABILITY COMPANY (GMBH))
KREFELDER STR. 32
70376 STUTTGART
FED REP GERMANY

FOR: JEWELLERY, IN PARTICULAR, NECKLACES, EAR JEWELRY, BRACELETS, RINGS, BROOCHES; WATCHES, IN CLASS 14 (U.S. CLS. 2, 27, 28 AND 50).

OWNER OF U.S. REG. NO. 2,282,745.

OWNER OF INTERNATIONAL REGISTRATION 1103094 DATED 10-28-2011, EXPIRES 10-28-2021.

THE MARK CONSISTS OF THE STYLIZED WORDING "COEUR DE LION" WITH THE "O" AND "E" IN "COEUR" BEING INTERSECTED AND THE TERM "DE" APPEARING IN SMALLER FONT.

THE ENGLISH TRANSLATION OF "COEUR DE LION" IN THE MARK IS "LION HEART".

SER. NO. 79-107,735, FILED 10-28-2011.

CHRISTINE MARTIN, EXAMINING ATTORNEY



David J. Kybas

Director of the United States Patent and Trademark Office

United States of America

United States Patent and Trademark Office

Angeli e Demoni

Reg. No. 4,204,223

Registered Sep. 11, 2012

Int. Cl.: 25

TRADEMARK

PRINCIPAL REGISTER

IVAX DEVELOPMENT CORPORATION LTD (CYPRUS LIMITED LIABILITY COMPANY)
1 ELLIS STREET, STROVOLOS
CY-2057 NICOSIA
CYPRUS

FOR: CLOTHING, NAMELY, DRESSES, SKIRTS, SHIRT, PANTS, TROUSERS, SHORTS, JACKETS, SOCKS, UNDERWEAR; FOOTWEAR; HEADWEAR, IN CLASS 25 (U.S. CLS. 22 AND 39).

THE MARK CONSISTS OF THE WORDING "ANGELIE DEMONI" IN BLACK SURROUNDED BY VINES OF SCROLLWORK IN GREY AND ALL SET ON A WHITE BACKGROUND.

PRIORITY DATE OF 11-25-2011 IS CLAIMED.

OWNER OF INTERNATIONAL REGISTRATION 1103133 DATED 12-8-2011, EXPIRES 12-8-2021.

THE COLOR(S) BLACK, GREY AND WHITE IS/ARE CLAIMED AS A FEATURE OF THE MARK.

THE ENGLISH TRANSLATION OF "ANGELIE DEMONI" IN THE MARK IS "ANGELS AND DEMONS".

SER. NO. 79-107,753, FILED 12-8-2011.

CHARLOTTE CORWIN, EXAMINING ATTORNEY



David J. Kybas

Director of the United States Patent and Trademark Office

United States of America

United States Patent and Trademark Office



Reg. No. 4,204,224

Registered Sep. 11, 2012

Int. Cls.: 32 and 33

TRADEMARK

PRINCIPAL REGISTER

LE CONTESSE S.R.L. (ITALY SOCIETA' A RESPONSABILITA' LIMITATA)
VIA CADORNA, 39
I-31028 VAZZOLA (TV)
ITALY

FOR: BEERS; MINERAL AND AERATED WATERS AND OTHER NON-ALCOHOLIC DRINKS, NAMELY, FRUIT DRINKS AND FRUIT JUICES; SYRUPS FOR MAKING BEVERAGES AND OTHER PREPARATIONS FOR MAKING BEVERAGES, NAMELY, FRUIT DRINKS, IN CLASS 32 (U.S. CLS. 45, 46 AND 48).

FOR: ALCOHOLIC BEVERAGES EXCEPT BEERS, IN CLASS 33 (U.S. CLS. 47 AND 49).

THE MARK CONSISTS OF THE STYLIZED WORDING "LE CONTESSE". BEHIND THE WORDING IS A STYLIZED DESIGN OF A BUILDING AND A DOTTED LINE. ABOVE THE WORDING IS A STYLIZED CROWN AND A DOTTED LINE.

OWNER OF INTERNATIONAL REGISTRATION 1103150 DATED 12-14-2011, EXPIRES 12-14-2021.

THE ENGLISH TRANSLATION OF "LE CONTESSE" IN THE MARK IS "COUNTESSSES".

SER. NO. 79-107,758, FILED 12-14-2011.

COLLEEN DOMBROW, EXAMINING ATTORNEY



David J. Kybas

Director of the United States Patent and Trademark Office

United States of America
United States Patent and Trademark Office

Kartun

Reg. No. 4,204,225

Registered Sep. 11, 2012

Int. Cl.: 3

TRADEMARK

PRINCIPAL REGISTER

GUANGZHOU FRANDY DAILY; CHEMICAL CO., LTD. (CHINA CORPORATION)
NO.8, XINKE SANSHE INDUSTRIAL ZONE
JUNHE STREET.; BAIYUN DISTRICT.; GUANGZHOU; GUANGDONG PROVINCE
CHINA

FOR: PERFUMES; SHAMPOOS; FACIAL WASHING MILK; BATH LOTION; DENTIFRICES;
COSMETICS; HAIR SPRAY; CAKES OF SOAP; HAIR CONDITIONER; ANTIMICROBIAL
HAND LOTIONS, IN CLASS 3 (U.S. CLS. 1, 4, 6, 50, 51 AND 52).

THE WORDING "KARTUN" HAS NO MEANING IN A FOREIGN LANGUAGE.

PRIORITY DATE OF 6-21-2011 IS CLAIMED.

OWNER OF INTERNATIONAL REGISTRATION 1103535 DATED 12-6-2011, EXPIRES 12-6-2021.

SER. NO. 79-107,881, FILED 12-6-2011.

DAVID ELTON, EXAMINING ATTORNEY



David J. Kyffers

Director of the United States Patent and Trademark Office

United States of America

United States Patent and Trademark Office

BRAND
EXPO

Reg. No. 4,204,226

Registered Sep. 11, 2012

Int. Cl.: 35

NORWOOD PROMOTIONAL PRODUCTS EUROPE S.L. (SPAIN LIMITED LIABILITY COMPANY)
POLIGONO IND. ENTRE VIAS, COMPLEJO BIC
E-43006 TARRAGONA
SPAIN

SERVICE MARK

PRINCIPAL REGISTER

FOR: ADVERTISING; BUSINESS MANAGEMENT; BUSINESS ADMINISTRATION; OFFICE FUNCTIONS; RETAIL STORES SERVICES, ONLINE RETAIL STORES SERVICES AND DISTRIBUTORSHIP SERVICES IN THE FIELD OF PRINTED PUBLICITY MATERIAL AND PROMOTIONAL PRODUCTS, NAMELY, SOAPS, PERFUMERY, ESSENTIAL OILS, COSMETICS, HAIR LOTIONS, DENTIFRICES, PHARMACEUTICAL PREPARATIONS SANITARY PREPARATIONS FOR MEDICAL PURPOSES, PLASTERS, MATERIALS FOR DRESSINGS, DENTAL WAX, DISINFECTANTS, IRONMONGERY, SMALL ITEMS OF METAL HARDWARE, HAND TOOLS AND HAND OPERATED IMPLEMENTS, CUTLERY, RAZORS, APPARATUS FOR RECORDING, TRANSMISSION OR REPRODUCTION OF SOUND OR IMAGES, MAGNETIC DATA CARRIERS, RECORDING DISCS, CALCULATING MACHINES, DATA PROCESSING EQUIPMENT AND COMPUTERS, MEDICAL AND DENTAL APPARATUS AND INSTRUMENTS, APPARATUS FOR LIGHTING, HEATING, STEAM GENERATING, COOKING, REFRIGERATING, DRYING, VENTILATING, WATER SUPPLY AND SANITARY PURPOSES, FIREWORKS, JEWELLERY, PRECIOUS STONES, HOROLOGICAL AND CHRONOMETRIC INSTRUMENTS, MUSICAL INSTRUMENTS, PRINTED PAPER, PLASTIC, WOOD, CARDBOARD PRODUCTS, PHOTOGRAPHS, STATIONERY, ADHESIVES FOR STATIONERY OR HOUSEHOLD PURPOSES, ARTISTS' MATERIALS, TYPEWRITERS AND OFFICE REQUISITES, LEATHER AND IMITATIONS OF LEATHER, AND CLOTHING, LUGGAGE, HAND BAGS, SHOPPING BAGS, BRIEFCASES, WALLETS, BACKPACKS MADE OF THESE MATERIALS, TRUNKS AND TRAVELLING BAGS, BAGS, UMBRELLAS, FURNITURE, MIRRORS, PICTURE FRAMES, ORNAMENTS OF WOOD, CORK, REED, CANE, WICKER, HORN, BONE, IVORY, WHALEBONE, SHELL, AMBER, MOTHER-OF-PEARL, MEERSCHAUM AND SUBSTITUTES FOR ALL THESE MATERIALS, OR OF PLASTICS, HOUSEHOLD OR KITCHEN UTENSILS AND CONTAINERS, INCLUDING PORTABLE BEVERAGE COOLERS, COMBS AND SPONGES, BRUSHES EXCEPT PAINT BRUSHES, ARTICLES FOR CLEANING PURPOSES, GLASSWARE, PORCELAIN AND EARTHENWARE, TEXTILES AND TEXTILE GOODS, BED AND TABLE COVERS, CLOTHING, FOOTWEAR, HEADGEAR, GAMES AND PLAYTHINGS, GYMNASTIC AND SPORTING ARTICLES, DECORATIONS FOR CHRISTMAS TREES, SMOKERS' ARTICLES AND MATCHES, IN CLASS 35 (U.S. CLS. 100, 101 AND 102).



David J. Kybas

Director of the United States Patent and Trademark Office

Reg. No. 4,204,226 NO CLAIM IS MADE TO THE EXCLUSIVE RIGHT TO USE "BRAND EXPO", APART FROM THE MARK AS SHOWN.

PRIORITY DATE OF 6-14-2011 IS CLAIMED.

OWNER OF INTERNATIONAL REGISTRATION 1103787 DATED 9-12-2011, EXPIRES 9-12-2021.

THE COLOR(S) BLACK AND GREY IS/ARE CLAIMED AS A FEATURE OF THE MARK.

THE MARK CONSISTS OF THE STYLIZED WORDING "BRAND EXPO" WITH "BRAND" IN GREY AND "EXPO" IN BLACK WITH A CURVED SQUARE IN GREY TO THE LEFT OF THE WORDING.

SER. NO. 79-107,963, FILED 9-12-2011.

DOUGLAS LEE, EXAMINING ATTORNEY

United States of America

United States Patent and Trademark Office



Reg. No. 4,204,227

BH SALON S.R.L. (ITALY LIMITED LIABILITY COMPANY)
VIA IRNO S.N.

Registered Sep. 11, 2012

PONTECAGNANO (SA), ITALY I84089

**Int. Cls.: 3, 6, 14, 16, 18,
20, 35, 41 and 44**

FOR: SOAPS FOR PERSONAL USE; PERFUMERY, ESSENTIAL OILS, COSMETICS, HAIR LOTIONS; DENTIFRICES, IN CLASS 3 (U.S. CLS. 1, 4, 6, 50, 51 AND 52).

TRADEMARK

FOR: COMMON METALS AND THEIR ALLOYS; TRANSPORTABLE BUILDINGS OF METAL; NON-ELECTRIC CABLES AND WIRES OF COMMON METAL, IN CLASS 6 (U.S. CLS. 2, 12, 13, 14, 23, 25 AND 50).

SERVICE MARK

FOR: PRECIOUS METALS AND THEIR ALLOYS; GOODS IN PRECIOUS METALS OR COATED, NAMELY, BOXES, JEWEL CASES, KEY HOLDERS; JEWELLERY, PRECIOUS STONES; HOROLOGICAL AND CHRONOMETRIC INSTRUMENTS, IN CLASS 14 (U.S. CLS. 2, 27, 28 AND 50).

PRINCIPAL REGISTER

FOR: PAPER, PAPER TOWELS, TISSUE PAPER, BATHROOM TISSUE PAPER, FACIAL TISSUE PAPER, TOILET PAPER; WRITING PAPER AND PADS, WRITING TABLETS AND WRITING INSTRUMENTS; CARDBOARD; STATIONERY, STATIONERY BOXES, STATIONERY FOLDERS; PENS; PENCILS; PAINT BRUSHES; BOOKS, MAGAZINES, BROCHURES IN THE FIELD OF BEAUTY, COSMETOLOGY EDUCATION, FASHION, HAIRDRESSING, HAIRSTYLING, MAKEUP ARTISTRY; CALENDARS; PHOTOGRAPHS; DIARIES, RUBBER STAMPS; STICKERS; TEMPORARY TATTOOS, IN CLASS 16 (U.S. CLS. 2, 5, 22, 23, 29, 37, 38 AND 50).



FOR: LEATHER AND IMITATIONS OF LEATHER AND GOODS MADE OF THESE MATERIALS, NAMELY, BAGS, HANDBAGS, SHOULDER BAGS; PURSES, WALLETS, LUGGAGE, POUCHES; ATTACHÉ CASES, RUCKSACKS, BACKPACKS; SHOPPING BAGS; SCHOOL BAGS; SLING BAGS FOR CARRYING INFANTS; BAGS FOR SPORT; BEACH BAGS; MUSIC CASES; TOOL BAGS SOLD EMPTY; CASES; SHOULDER BELTS; COLLARS FOR ANIMAL AND PETS; CLOTHING FOR PETS; CREDIT CARD CASES; DOCUMENT CASES; KEY CASES; EMPTY COSMETIC CASES; EMPTY TOILETRY CASES, TRUNKS; TRAVELLING BAGS, TRAVELLING SETS; VALISES; VANITY CASES SOLD EMPTY; SUITCASES; BRIEFCASES; ANIMAL SKINS; HIDES; BEACH PARASOLS; PARASOLS; UMBRELLAS, UMBRELLA COVERS, UMBRELLA HANDLES; FRAMES FOR UMBRELLA OR PARASOLS; HARNESS AND SADDLERY, IN CLASS 18 (U.S. CLS. 1, 2, 3, 22 AND 41).

David J. Kybas

Director of the United States Patent and Trademark Office

Reg. No. 4,204,227 FOR: FURNITURE, MIRRORS, PICTURE FRAMES, IN CLASS 20 (U.S. CLS. 2, 13, 22, 25, 32 AND 50).

FOR: ADVERTISING, MARKETING, MARKET RESEARCH AND MARKET STUDIES, BUSINESS MANAGEMENT, RELATING TO THE SALE OF GOODS BELONGING TO CLASSES 3, 6, 14, 16, 18, 20 MADE IN ANY WAY, IN CLASS 35 (U.S. CLS. 100, 101 AND 102).

FOR: PROVISION OF EDUCATIONAL COURSES ABOUT HAIRDRESSING, MAKE-UP AND BEAUTY; PUBLICATION OF BOOKS, MAGAZINES, JOURNALS ABOUT HAIRDRESSING AND MAKE-UP; EDUCATION, NAMELY, PROVIDING CLASSES, WORKSHOPS, SEMINARS ABOUT HAIRDRESSING, MAKE-UP AND BEAUTY; PROVIDING TRAINING IN THE FIELD OF HAIRDRESSING, MAKE-UP AND BEAUTY; ORGANIZATION OF EDUCATION AND ENTERTAINMENT COMPETITIONS; ORGANIZATION OF EXHIBITIONS FOR EDUCATION PURPOSES, IN CLASS 41 (U.S. CLS. 100, 101 AND 107).

FOR: HEALTH CARE, HAIR SALON SERVICES, BEAUTY SALON SERVICES; PROVISION OF HAIRDRESSING SALON SERVICES; PROVISION OF INFORMATION AND ADVISORY SERVICES IN THE BEAUTY AND HAIR FIELD, IN CLASS 44 (U.S. CLS. 100 AND 101).

THE MARK CONSIST OF MADE UP BY A CIRCLE; INSIDE, ARE PLACED THREE FANCY CHARACTER LETTERS "M" "U" "P" OVERLAPPED BETWEEN THEM; BELOW, THERE IS THE WORD "MASHUP" WHERE THE LETTERS "U" AND "P" ARE WRITTEN IN FANCY CURSIVE CHARACTER.

PRIORITY DATE OF 9-29-2011 IS CLAIMED.

OWNER OF INTERNATIONAL REGISTRATION 1103800 DATED 10-28-2011, EXPIRES 10-28-2021.

SER. NO. 79-107,968, FILED 10-28-2011.

CHRIS WELLS, EXAMINING ATTORNEY

United States of America

United States Patent and Trademark Office

ELETILE

Reg. No. 4,204,228

Registered Sep. 11, 2012

Int. Cls.: 19 and 27

TRADEMARK

PRINCIPAL REGISTER

TOWER IPCO COMPANY LIMITED (IRELAND LIMITED LIABILITY COMPANY)
28-32 UPPER PEMBROKE STREET
DUBLIN 2
IRELAND

FOR: FLOOR BOARDS OF NON-METALLIC MATERIALS; NON-METALLIC FLOOR BOARDS; PARQUET FLOOR BOARDS; FLOOR TILES, NOT OF METAL; NON-METALLIC FLOORING TILES, IN CLASS 19 (U.S. CLS. 1, 12, 33 AND 50).

FOR: VINYL FLOOR COVERINGS; VINYL FLOOR COVERINGS FOR FORMING A FLOOR, IN CLASS 27 (U.S. CLS. 19, 20, 37, 42 AND 50).

THE MARK CONSISTS OF STANDARD CHARACTERS WITHOUT CLAIM TO ANY PARTICULAR FONT, STYLE, SIZE, OR COLOR.

PRIORITY DATE OF 6-2-2011 IS CLAIMED.

OWNER OF INTERNATIONAL REGISTRATION 1104333 DATED 10-17-2011, EXPIRES 10-17-2021.

SER. NO. 79-108,180, FILED 10-17-2011.

TAMARA FRAZIER, EXAMINING ATTORNEY



David J. Kybas

Director of the United States Patent and Trademark Office

United States of America
United States Patent and Trademark Office

PLANA

Reg. No. 4,204,229

Registered Sep. 11, 2012

Int. Cl.: 9

TRADEMARK

PRINCIPAL REGISTER

VIMAR S.P.A. (ITALY JOINT STOCK COMPANY)
VIALE VICENZA, 14
I-36063 MAROSTICA (VICENZA)
ITALY

FOR: ELECTRICAL COVER OUTLET PLATES; CONTROL DEVICES TO BE USED IN THE ELECTRIC FIELD, NAMELY, SWITCHES, REVERSING SWITCHES, PUSH BUTTONS AND REMOTE CONTROL SWITCHES; ELECTRIC SWITCH PLATES AND OUTLETS, NAMELY, BLANK COVERS AND CORD OUTLETS; ELECTRIC SOCKET-OUTLETS AND TELEPHONE SOCKET CONNECTORS; SIGNAL ELECTRICAL SOCKET-OUTLETS; TV-ELECTRICAL SOCKET OUTLETS; COAXIAL ELECTRICAL CONNECTORS; ELECTRICAL OPTICAL AND ACOUSTIC SIGNALING EQUIPMENT, NAMELY, EMERGENCY WARNING LIGHTS, ELECTROMECHANICAL, ELECTRONIC AND ELECTRIC CALL, DOOR, WARNING, AND SIGNAL, BELLS, BUZZERS AND CHIMES; ELECTRONIC PROTECTION AND DETECTION EQUIPMENT, NAMELY, CIRCUIT BREAKERS, GAS AND CARBON MONOXIDE DETECTORS, SMOKE DETECTORS, PRESENCE DETECTORS FOR BURGLAR AND ALARM SYSTEMS; ELECTRONIC DIMMERS FOR RESISTIVE AND INDUCTIVE LOADS; ELECTRONIC TIME-DELAY SWITCHES; ELECTRONIC PROGRAMMABLE SWITCHES; ELECTRIC RESISTORS; ELECTRONIC THERMOSTATS; REGULATION ELECTRIC SWITCHES; STEREOPHONIC SOUND SYSTEM EQUIPMENT, NAMELY, SOUND AMPLIFIERS AND SOUND TRANSMITTING APPARATUS; INFRARED CONTROL EQUIPMENT, NAMELY, REMOTE CONTROLS FOR CONTROLLING ENTRY; INFRARED RECEIVERS AND REGULATORS FOR LIGHTS, CURRENT, VOLTAGE, TEMPERATURE; PROGRAMMABLE MAGNETIC CHIPCARDS; ANTI-BURGLAR EQUIPMENT, NAMELY, ALARMS, CENTRAL CONTROL UNITS, SIRENS, POWER SUPPLIES, DETECTORS, TRANSFORMERS, RECEIVERS, TRANSMITTERS OF ELECTRICAL SIGNALS AND PARTS THEREOF, IN CLASS 9 (U.S. CLS. 21, 23, 26, 36 AND 38).



THE MARK CONSISTS OF STANDARD CHARACTERS WITHOUT CLAIM TO ANY PARTICULAR FONT, STYLE, SIZE, OR COLOR.

OWNER OF INTERNATIONAL REGISTRATION 0725163 DATED 8-23-1999, EXPIRES 8-23-2019.

David J. Kyjars

THE ENGLISH TRANSLATION OF "PLANA" IN THE MARK IS "PLANE" OR "FLAT SURFACE".

Reg. No. 4,204,229 SER. NO. 79-108,260, FILED 10-26-2011.

LOURDES AYALA, EXAMINING ATTORNEY

United States of America

United States Patent and Trademark Office



Reg. No. 4,204,230

Registered Sep. 11, 2012

Int. Cls.: 3, 18 and 25

TRADEMARK

PRINCIPAL REGISTER

BOI TRADING COMPANY LTD. (UNITED KINGDOM LIMITED COMPANY)
UNITS 1-7 THE EUROCENTRE,
116-118 BURY NEW ROAD; MANCHESTER, LANCASHIRE M8 8EB
UNITED KINGDOM

FOR: NON-MEDICATED TOILETRIES; AFTERSHAVE; PERFUME; COSMETICS; ESSENTIAL OILS; SOAPS; SHAMPOOS; DENTIFRICES; HAIR LOTIONS, IN CLASS 3 (U.S. CLS. 1, 4, 6, 50, 51 AND 52).

FOR: LEATHER AND IMITATIONS OF LEATHER; ANIMAL SKINS, HIDES; HANDBAGS; TRUNKS AND TRAVELLING BAGS; UMBRELLAS, PARASOLS AND WALKING STICKS, IN CLASS 18 (U.S. CLS. 1, 2, 3, 22 AND 41).

FOR: CLOTHING, NAMELY, T-SHIRTS, TOPS, SHIRTS, JUMPERS, SWEATSHIRTS, JACKETS, TROUSERS, JEANS, PANTS, SWEAT PANTS, TEXTILE BELTS AND UNDERWEAR; FOOTWEAR, NAMELY, SHOES; AND HEADGEAR, NAMELY, CAPS AND HATS, IN CLASS 25 (U.S. CLS. 22 AND 39).

OWNER OF U.S. REG. NO. 3,935,347.

PRIORITY DATE OF 7-26-2011 IS CLAIMED.

OWNER OF INTERNATIONAL REGISTRATION 1104561 DATED 8-2-2011, EXPIRES 8-2-2021.

THE MARK CONSISTS OF A THREE PRONGED ARROW AND AN ENCIRCLED CROWN DESIGN, FOLLOWED BY THE WORD "CROSSHATCH" IN STYLIZED FORMAT, ABOVE THE WORDS "FORWARD THINKING".

SER. NO. 79-108,287, FILED 8-2-2011.

KELLY TRUSILO, EXAMINING ATTORNEY

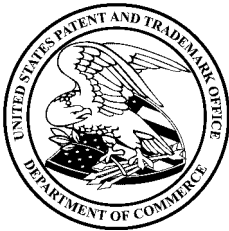

David J. Kyros

Director of the United States Patent and Trademark Office

United States of America

United States Patent and Trademark Office



Reg. No. 4,204,231

Registered Sep. 11, 2012

Int. Cl.: 25

TRADEMARK

PRINCIPAL REGISTER

ROCKFORD MILLS B.V. (NETHERLANDS BESLOTEN VENNOOTSCHAP)
PRINSENEILAND 36 E
NL-1013 LR AMSTERDAM
NETHERLANDS

FOR: CLOTHING, NAMELY, JEANS, PANTS, SHORTS, TROUSERS, T-SHIRTS, SWEATERS, TOPS, VESTS, JACKETS, DRESSES, SKIRTS, HOODED SWEATSHIRTS, BLOUSES AND FOOTWEAR, IN CLASS 25 (U.S. CLS. 22 AND 39).

THE MARK CONSISTS OF THE WORDING "RM" IN STYLIZED FONT.

PRIORITY DATE OF 7-20-2011 IS CLAIMED.

OWNER OF INTERNATIONAL REGISTRATION 1104788 DATED 8-5-2011, EXPIRES 8-5-2021.

SER. NO. 79-108,363, FILED 8-5-2011.

ROBERT STRUCK, EXAMINING ATTORNEY



David J. Kyffers

Director of the United States Patent and Trademark Office

United States of America

United States Patent and Trademark Office

ARCHIMODE

Reg. No. 4,204,232

Registered Sep. 11, 2012

Int. Cls.: 9 and 11

TRADEMARK

PRINCIPAL REGISTER

SRA INSTRUMENTS (FRANCE SOCIÉTÉ ANONYME (À DIRECTOIRE))
50 RUE DES SOURCES
MARCY L'ETOILE, FRANCE F69280

FOR: LABORATORY CHROMATOGRAPHS; CHROMATOGRAPHY APPARATUS FOR LABORATORY USE; AUTOMATIC SAMPLING SYSTEMS, CONSISTING OF PUMPS, FILTERS, VALVES, HEATERS, VAPORIZERS, PRESSURE REDUCERS, FLOW METERS AND SAFETY VALVES FOR CHROMATOGRAPHY APPARATUS INTENDED FOR LABORATORY USE OR ON-LINE ANALYZERS AS WELL AS RELATED SOFTWARE AND INTERFACING HARDWARE FOR CONTROLLING AND MONITORING; PHYSICO-CHEMICAL ANALYSIS APPARATUS INTENDED FOR INDUSTRIAL OR RESEARCH PURPOSES, NOT INTENDED FOR MEDICAL PURPOSES; GAS TESTING INSTRUMENTS; ON-LINE ANALYSIS APPARATUS, NAMELY, CHROMATOGRAPHS, MASS SPECTROMETERS, COMPUTERS AND ASSOCIATED SOFTWARE; SOFTWARE FOR CHROMATOGRAPHY APPARATUS, CHROMATOGRAPHS AND PHYSICO-CHEMICAL ANALYSIS APPARATUS, IN CLASS 9 (U.S. CLS. 21, 23, 26, 36 AND 38).

FOR: INDUSTRIAL CHROMATOGRAPHS; CHROMATOGRAPHY APPARATUS FOR INDUSTRIAL PURPOSES, IN CLASS 11 (U.S. CLS. 13, 21, 23, 31 AND 34).

THE MARK CONSISTS OF STANDARD CHARACTERS WITHOUT CLAIM TO ANY PARTICULAR FONT, STYLE, SIZE, OR COLOR.

PRIORITY DATE OF 4-6-2011 IS CLAIMED.

OWNER OF INTERNATIONAL REGISTRATION 1105089 DATED 8-19-2011, EXPIRES 8-19-2021.

SER. NO. 79-108,489, FILED 8-19-2011.

ALAIN LAPTER, EXAMINING ATTORNEY



David J. Kypos

Director of the United States Patent and Trademark Office

United States of America

United States Patent and Trademark Office

IMMUNIO

Reg. No. 4,204,233

Registered Sep. 11, 2012

Int. Cl.: 5

TRADEMARK

PRINCIPAL REGISTER

PROBIONOV (FRANCE SOCIÉTÉ ANONYME)
RUE DES FRÈRES LUMIÈRE
F-15130 ARPAJON SUR CERE
FRANCE

FOR: DIETARY SUPPLEMENTS IN THE NATURE OF NUTRITIONAL ADDITIVES FOR MEDICAL USE; MEDICAL NUTRITIONAL SUPPLEMENTS TAKEN BY MOUTH; FOODSTUFFS, DIETETIC SUGAR FOR MEDICAL USE; NUTRITIONALLY FORTIFIED BEVERAGES; FOODSTUFFS FOR MEDICAL USE, NAMELY, DIETETIC SUGAR; VITAMIN PREPARATIONS; MINERAL FOOD-SUPPLEMENTS; PHARMACEUTICAL AND SANITARY PREPARATIONS FOR MEDICAL USE FOR FIGHTING AGAINST VIRAL AND BACTERIAL INFECTIONS AND/OR IMPROVING THE EFFECTS OF VACCINATIONS; PHARMACEUTICAL AND SANITARY PREPARATIONS FOR MEDICAL USE FOR FIGHTING AGAINST RESPIRATORY AND GASTRO-INTESTINAL INFECTIONS; PHARMACEUTICAL AND SANITARY PREPARATIONS FOR MEDICAL USE FOR STIMULATING THE IMMUNE DEFENSE; MEDICINES AND MEDICAL PREPARATIONS, NAMELY, FREEZE-DRIED BACTERIA USED FOR PRODUCING BIOLOGICAL PREPARATIONS FOR USE IN TREATMENTS IN HUMANS FOR VIRAL, GASTRO-INTESTINAL AND BACTERIAL INFECTIONS AND/OR FOR IMPROVING THE EFFECTS OF VACCINATION; ANTI-FUNGAL AND/OR ANTIBIOTIC PREPARATIONS; DISINFECTANTS FOR USE IN THE SANITARY FOLLOW-UP OF PATIENTS SUFFERING FROM INFECTIONS; APPETITE SUPPRESSANTS, MINERAL ENHANCED WATERS FOR MEDICAL PURPOSES; MEDICAL PREPARATIONS FOR SLIMMING PURPOSES; REDUCING TEA FOR MEDICAL PURPOSES; MILK FERMENTS FOR PHARMACEUTICAL PURPOSES; DIETARY SUPPLEMENTS IN THE NATURE OF NON-NUTRITIVE EDIBLE PLANT FIBERS; DIETARY SUPPLEMENTS IN THE FORM OF GELATIN FOR MEDICAL PURPOSES; ROYAL JELLY FOR MEDICAL PURPOSES; HOMEOPATHIC SUPPLEMENTS; MEDICATED MOUTHWASHES; MEDICINAL INFUSIONS FOR TREATING INTESTINAL DISORDERS, VAGINAL DISORDERS; MEDICINAL PLANT EXTRACTS; VACCINES; LACTOSE FOR MEDICAL PURPOSES; EXTRACTS OF HOPS FOR PHARMACEUTICAL USE; ALBUMEN FOR MEDICAL USE; STARCH FOR DIETETIC OR PHARMACEUTICAL USE; DIETETIC SUGAR, MALT, LECITHIN, YEAST FOR MEDICAL USE PURPOSES; BABY FOOD; PHARMACEUTICAL PREPARATIONS FOR THE TREATMENT OF INTESTINAL DISORDERS, VAGINAL DISORDERS, THE AFOREMENTIONED IN THE FORM OF WAFERS, PASTILS, SACHETS, HARD GELATIN CAPSULES, AND SYRUPS; MEDICINES FOR THE TREATMENT OF INTESTINAL DISORDERS, VAGINAL DISORDERS, THE AFOREMENTIONED NOT WATER SOLUBLE AND ADMINISTERED IN



David J. Kyjars

Director of the United States Patent and Trademark Office

Reg. No. 4,204,233 SUSPENSION FORM TO BE SHAKEN FOR BLENDING BEFORE ABSORPTION, IN CLASS 5 (U.S. CLS. 6, 18, 44, 46, 51 AND 52).

THE MARK CONSISTS OF STANDARD CHARACTERS WITHOUT CLAIM TO ANY PARTICULAR FONT, STYLE, SIZE, OR COLOR.

PRIORITY DATE OF 5-5-2011 IS CLAIMED.

OWNER OF INTERNATIONAL REGISTRATION 1105096 DATED 9-15-2011, EXPIRES 9-15-2021.

THE WORDING "IMMUNIO" HAS NO MEANING IN A FOREIGN LANGUAGE.

SER. NO. 79-108,495, FILED 9-15-2011.

ELI HELLMAN, EXAMINING ATTORNEY

United States of America

United States Patent and Trademark Office

MultLink
by Multi-Contact & Shoals

Reg. No. 4,204,234

Registered Sep. 11, 2012

Int. Cl.: 9

MULTI-HOLDING AG (SWITZERLAND AKTIENGESELLSCHAFT (AG) / SOCIÉTÉ ANONYME (SA) / JOINT STOCK COMPANY)
STOCKBRUNNENRAIN 8
CH-4123 ALLSCHWIL
SWITZERLAND

TRADEMARK

PRINCIPAL REGISTER

FOR: ELECTRICAL CONNECTORS; ELECTRIC CONTACTS; ELECTROMECHANICAL AND ELECTRONIC COMPONENTS, NAMELY, SOCKETS FOR ELECTRICAL CONNECTORS; LABORATORY LEADS TO BE USED FOR MAKING ELECTRICAL CONNECTIONS, CONNECTING CABLES, DISCONNECTORS AND DISTRIBUTORS, CROSS-BAR CONNECTORS, CONNECTION WASHERS, SLIDE ISOLATORS, SHORT CIRCUIT BRIDGES, AND MULTICOMPONENT ELECTRICAL PLUG AND SOCKET UNITS, ELECTRICAL CONNECTION BOXES; CABLE CONNECTORS AND ELECTRICAL JUNCTION BOXES FOR PHOTOVOLTAIC SOLAR PANELS, IN CLASS 9 (U.S. CLS. 21, 23, 26, 36 AND 38).

THE MARK CONSISTS OF THE WORDING "MULTILINK BY MULTI-CONTACT & SHOALS" WITH A STYLIZED SUN DESIGN ABOVE THE SECOND "L" IN "MULTILINK" AND THE WORD "SUN" DEPICTED VERTICALLY WITHIN THE UPPER STEM OF THE SECOND "L" IN "MULTILINK".

PRIORITY DATE OF 5-27-2011 IS CLAIMED.

OWNER OF INTERNATIONAL REGISTRATION 1105107 DATED 11-21-2011, EXPIRES 11-21-2021.

SER. NO. 79-108,501, FILED 11-21-2011.

TINA L. SNAPP, EXAMINING ATTORNEY



David J. Kybas

Director of the United States Patent and Trademark Office

United States of America

United States Patent and Trademark Office

WHERE ELSE . . .

Reg. No. 4,204,235

Registered Sep. 11, 2012

Int. Cls.: 14, 18 and 25

TRADEMARK

PRINCIPAL REGISTER

VANESSA DESTAING (FRANCE INDIVIDUAL)
39 AVENUE GEORGES MANDEL
F-75116 PARIS
FRANCE

FOR: JEWELRY; JEWELRY PRODUCTS, NAMELY, HAIR JEWELRY IN THE NATURE OF JEWELRY FOR USE IN THE HAIR, NECKLACES, RINGS, BROACHES, ORNAMENTAL PINS; PRECIOUS METALS AND THEIR ALLOYS JEWELRY CASES; BOXES OF PRECIOUS METAL; WATCH BANDS; KEY RINGS TRINKETS AND FOBS OF PRECIOUS METAL; CASES OR PRESENTATION CASES FOR TIMEPIECES; MEDALS, IN CLASS 14 (U.S. CLS. 2, 27, 28 AND 50).

FOR: LEATHER AND IMITATIONS OF LEATHER; ANIMAL SKINS; TRUNKS AND SUIT-CASES; UMBRELLAS, PARASOLS AND WALKING STICKS; WHIPS, HARNESSSES AND SADDLERY; WALLETS; PURSES; HANDBAGS, BACKPACKS, WHEELED BAGS; BAGS FOR CAMPERS IN THE NATURE OF BACKPACKS, TRAVELING BAGS, BEACH BAGS, SCHOOL BAGS; UNFITTED VANITY CASES; ANIMAL COLLARS; COVERS FOR ANIMALS; SHOPPING NETS IN THE NATURE OF BAGS MADE OF A MESH NET FOR USE IN SHOPPING AND SHOPPING BAGS; BAGS IN THE NATURE OF LEATHER ENVELOPES AND LEATHER POUCHES FOR PACKAGING, IN CLASS 18 (U.S. CLS. 1, 2, 3, 22 AND 41).

FOR: CLOTHING, FOOTWEAR, AND HEADGEAR, NAMELY, SHIRTS, LEATHER OR IMITATION LEATHER CLOTHING, BELTS, FURS, GLOVES, SCARVES, NECKTIES; HOSIERY, SOCKS, SLIPPERS, BEACH, SKI OR SPORTS FOOTWEAR; BABIES' DIAPERS OF TEXTILE, AND UNDERWEAR, IN CLASS 25 (U.S. CLS. 22 AND 39).

THE MARK CONSISTS OF THE WORDING "WHERE ELSE" FOLLOWED BY AN ELLIPSIS.

OWNER OF INTERNATIONAL REGISTRATION 1105125 DATED 12-2-2011, EXPIRES 12-2-2021.

SER. NO. 79-108,509, FILED 12-2-2011.

JENNIFER WILLISTON, EXAMINING ATTORNEY



David J. Kyffers

Director of the United States Patent and Trademark Office

United States of America

United States Patent and Trademark Office

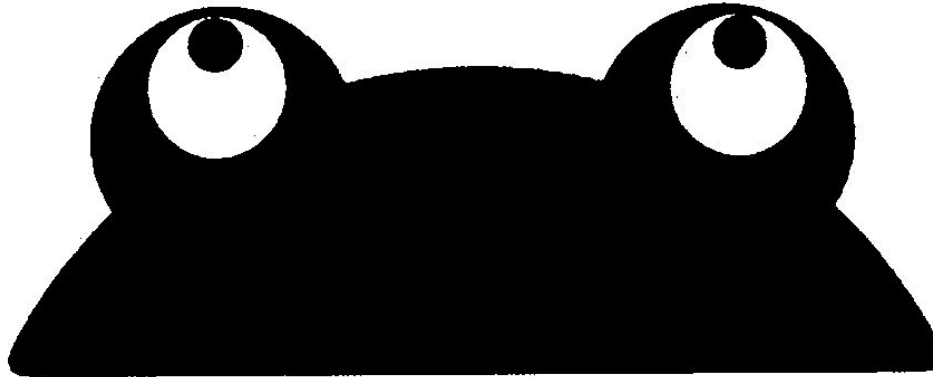

Reg. No. 4,204,236

Registered Sep. 11, 2012

Int. Cl.: 9

TRADEMARK

PRINCIPAL REGISTER

SHENZHEN AONI; ELECTRONIC INDUSTRY CO., (CHINA CORPORATION)
4TH, 7TH AND 8TH FLOOR, NO.5 BUILDING,
HONGHUI INDUSTRIAL PARK.; 2ND LIUXIAN RO
CHINA

FOR: COMPUTER PERIPHERAL DEVICES; QUANTITY INDICATORS, NAMELY, AIR QUALITY MEASUREMENT APPARATUS IN THE NATURE OF PARTICLE COUNTERS, INSTRUMENTS FOR MEASURING MILK QUALITY PARAMETERS, ELECTROOPTICAL INSTRUMENTS FOR USE IN INSPECTION AND MEASUREMENT OF INDUSTRIAL COMPONENTS; PHOTOTELEGRAPHY APPARATUS; AUTOMATIC GAUGE, NAMELY, FUEL GAUGES, TIRE PRESSURE GAUGES; MEASURES, NAMELY, TAPE MEASURES, INSTRUMENTS FOR MEASURING LENGTH, LASER MEASURING SYSTEMS, MEASURING GLASSWARE; ELECTRONIC NOTICE BOARDS; TRANSMITTERS OF ELECTRONIC SIGNALS; CABINETS FOR LOUDSPEAKERS; RADIOS; MICROPHONES; VIDEO RECORDERS; HORNS FOR LOUDSPEAKERS; AMUSEMENT APPARATUS ADAPTED FOR USE WITH TELEVISION RECEIVERS ONLY; PERSONAL STEREOS; HEADPHONES; CAMCORDERS; CAMERAS FOR PHOTOGRAPHY; SOUND RECORDING CARRIERS, NAMELY, BLACK MAGNETIC DATA CARRIERS FOR SOUND RECORDINGS, BLANK AUDIO TAPES, BLANK CD-ROMS FOR SOUND OR VIDEO RECORDING; AUDIOVISUAL TEACHING APPARATUS, NAMELY, AUDIOVISUAL RECEIVERS, VISUAL RECORDINGS AND AUDIOVISUAL RECORDINGS FEATURING MUSIC AND ANIMATION, VIDEO AND SOUND PROJECTORS; STEREOSCOPES; STEREOSCOPIC APPARATUS, NAMELY, 3D DIGITAL PHOTOGRAPH VIEWERS, LIQUID CRYSTAL SHUTTER GLASSES, POLARIZED GLASSES, AUTOSTEREO-SCOPIC VIDEO MONITORS; MATERIAL FOR ELECTRICITY MAINS, NAMELY, ELECTRIC WIRES, POWER WIRES, ELECTRIC CABLES, BATTERY CABLES, ELECTRICAL CABLES; SOCKETS, PLUGS AND OTHER CONTACTS, NAMELY, ELECTRICAL SOCKETS, ELECTRICAL PLUGS, ELECTRIC CONNECTIONS AND CONNECTORS; TURNSTILES, AUTOMATIC; ELECTROPLATING APPARATUS, NAMELY, ELECTROLYSIS APPARATUS FOR ELECTROPLATING; SPRINKLER SYSTEMS FOR FIRE PROTECTION; SOLDERING IRONS, ELECTRIC; X-RAYS PRODUCING APPARATUS AND INSTALLATIONS, NOT FOR MEDICAL PURPOSES; PROTECTION DEVICES FOR PERSONAL USE AGAINST ACCIDENTS, NAMELY, FACE-PROTECTION SHIELDS, NETS FOR PROTECTION AGAINST ACCIDENTS, HEARING PROTECTION HEADSETS NOT FOR MEDICAL USE; THEFT PREVENTION INSTALLATIONS, ELECTRIC, NAMELY, BURGLAR ALARMS, THEFT ALARMS; PINCE-NEZ CORDS; CHARGERS FOR ELECTRIC BATTERIES; GALVANIC CELLS, NAMELY, GALVANIC BATTERIES; ANIMATED CARTOONS, NAMELY, VIDEOTAPES AND VIDEO DISKS RECORDED WITH ANIMATION, VISUAL RECORDINGS AND AUDIOVISUAL RECORDING



David J. Kybas

Director of the United States Patent and Trademark Office

Reg. No. 4,204,236 FEATURING MUSIC AND ANIMATION; DECORATIVE MAGNETS; PORTABLE TELEPHONES; WALKIE-TALKIES; ANTENNAS; ANTI-INTERFERENCE DEVICES, NAMELY, CONDUCTIVE SILICONE PACKING FOR ELECTRO-MAGNETIC INTERFERENCE, ELECTRICAL SHIELDING SPACERS FOR CABLES AND CABLE ASSEMBLIES; INTERCOMMUNICATION APPARATUS, NAMELY, APPARATUS FOR TRANSMISSION OF COMMUNICATION, COMMUNICATION HUBS, COMMUNICATIONS COMPUTERS, IN CLASS 9 (U.S. CLS. 21, 23, 26, 36 AND 38).

THE MARK CONSISTS OF A STYLIZED DESIGN OF THE TOP OF A FROG HEAD WITH TWO-EYES CAST UPWARDS.

PRIORITY DATE OF 8-8-2011 IS CLAIMED.

OWNER OF INTERNATIONAL REGISTRATION 1105206 DATED 11-7-2011, EXPIRES 11-7-2021.

SER. NO. 79-108,560, FILED 11-7-2011.

MARK SHINER, EXAMINING ATTORNEY

United States of America

United States Patent and Trademark Office

SOL-F

Reg. No. 4,204,237

SFS INTEC HOLDING AG (SWITZERLAND AKTIENGESELLSCHAFT)
NEFENSTRASSE 30

Registered Sep. 11, 2012

CH-9435 HEERBRUGG, SWITZERLAND

Int. Cls.: 6, 19, 20 and 37

FOR: METAL HARDWARE, NAMELY, SCREWS, RIVETS, BOLTS; ARTICLES OF SMALL IRONWARE, NAMELY, BOLTS, NAILS, RIVETS, SCREWS; METAL CONSTRUCTION MATERIALS FOR SOLAR PANELS, NAMELY, BRACES, SUPPORTS, AND CLADDING; METAL ROOF COVERING MATERIALS, NAMELY, FLASHING, PANELS, AND TILES INCORPORATING METAL FRAMES FOR SOLAR PANELS; RETAINING SYSTEMS COMPRISED OF METAL CABLE WIRES AND METAL CANTILEVERED BRACKETS FOR SOLAR PANELS; GROUND SUPPORTS OF METAL FOR SOLAR PANELS; STEEL RODS FOR USE WITH SOLAR PANELS, IN CLASS 6 (U.S. CLS. 2, 12, 13, 14, 23, 25 AND 50).

TRADEMARK

SERVICE MARK

PRINCIPAL REGISTER

FOR: NON-METAL ROOF CLADDING AND ROOFING ELEMENTS WITH INTEGRATED PHOTOVOLTAIC ELEMENTS, NAMELY, NON-METAL ROOFING PANELS, TILES, AND ROOF COVERINGS; STRUCTURAL COMPONENT PARTS OF THE AFOREMENTIONED GOODS; ROOFING, NOT OF METAL, INCORPORATING SOLAR CELLS, IN CLASS 19 (U.S. CLS. 1, 12, 33 AND 50).

FOR: NON-METAL FASTENERS, NAMELY, SCREWS, RIVETS, AND BOLTS, IN CLASS 20 (U.S. CLS. 2, 13, 22, 25, 32 AND 50).

FOR: INSTALLATION OF SOLAR ENERGY INSTALLATIONS, IN CLASS 37 (U.S. CLS. 100, 103 AND 106).

THE MARK CONSISTS OF STANDARD CHARACTERS WITHOUT CLAIM TO ANY PARTICULAR FONT, STYLE, SIZE, OR COLOR.

PRIORITY DATE OF 7-7-2011 IS CLAIMED.

OWNER OF INTERNATIONAL REGISTRATION 1105549 DATED 12-20-2011, EXPIRES 12-20-2021.

SER. NO. 79-108,696, FILED 12-20-2011.

ADA HAN, EXAMINING ATTORNEY



David J. Kyffers

Director of the United States Patent and Trademark Office

United States of America

United States Patent and Trademark Office

NATURE'S PHARMACY

Reg. No. 4,204,238

Registered Sep. 11, 2012

Int. Cl.: 3

TRADEMARK

PRINCIPAL REGISTER

DADO-COSMED; HERSTELLUNG UND VERTRIEB KOSMETISCHER; ERZEUGNISSE
ALLER ART GMBH (FED REP GERMANY LIMITED LIABILITY CORPORATION)
LINDENSTR. 15
CALW, FED REP GERMANY 75365

FOR: COSMETICS AND PERSONAL CARE PREPARATIONS, NAMELY, SHOWER GEL,
NON-MEDICATED LIP CARE PREPARATIONS AND SUN SCREEN PREPARATIONS; NON-
MEDICATED SKIN CARE PREPARATIONS; SOAPS FOR PERSONAL USE; HAIR CARE
PREPARATIONS, NAMELY, HAIR SHAMPOO, IN CLASS 3 (U.S. CLS. 1, 4, 6, 50, 51 AND
52).

THE MARK CONSISTS OF STANDARD CHARACTERS WITHOUT CLAIM TO ANY PAR-
TICULAR FONT, STYLE, SIZE, OR COLOR.

PRIORITY DATE OF 5-25-2011 IS CLAIMED.

OWNER OF INTERNATIONAL REGISTRATION 1105669 DATED 11-21-2011, EXPIRES 11-
21-2021.

NO CLAIM IS MADE TO THE EXCLUSIVE RIGHT TO USE "PHARMACY" , APART FROM
THE MARK AS SHOWN.

SER. NO. 79-108,747, FILED 11-21-2011.

TINA L. SNAPP, EXAMINING ATTORNEY



David J. Kyffers

Director of the United States Patent and Trademark Office

United States of America

United States Patent and Trademark Office

LINGOONA

Reg. No. 4,204,239

Registered Sep. 11, 2012

Int. Cls.: 9, 38, 41 and 42

LINGOONA GMBH (FED REP GERMANY DEUTSCHE GESELLSCHAFT MIT
BESCHRÄNKTER HAFTUNG (GMBH))
HILDASTR. 38
68273 PLANKSTADT
FED REP GERMANY

TRADEMARK

SERVICE MARK

PRINCIPAL REGISTER

FOR: DOWNLOADABLE SOUND RECORDINGS, IMAGES, AND VIDEO RECORDINGS IN THE FIELD OF TRANSLATION AND LINGUISTIC ADAPTATION OF COMPUTER AND VIDEO GAMES AND SOFTWARE TO REGIONAL CUSTOMS AND CONVENTIONS, BEING DOWNLOADABLE TO COMPUTERS AND MOBILE COMMUNICATIONS APPARATUS; DOWNLOADABLE MUSICAL SOUND RECORDINGS, BEING DOWNLOADABLE TO COMPUTERS AND MOBILE COMMUNICATIONS APPARATUS; DOWNLOADABLE COMPUTER GAME PROGRAMS, BEING DOWNLOADABLE TO COMPUTERS AND MOBILE COMMUNICATIONS APPARATUS; COMPUTER SOFTWARE FOR TRANSLATION AND LINGUISTIC ADAPTATION OF COMPUTER AND VIDEO GAMES AND SOFTWARE TO REGIONAL CUSTOMS AND CONVENTIONS; TRANSLATIONS AND LOCALIZATION SOFTWARE FOR TRANSLATION AND LINGUISTIC ADAPTATION OF COMPUTER AND VIDEO GAMES AND SOFTWARE TO REGIONAL CUSTOMS AND CONVENTIONS, INTERACTIVE SOFTWARE, NAMELY, COMPUTER GAME SOFTWARE AND SOFTWARE FOR TRANSLATION AND LINGUISTIC ADAPTATION OF COMPUTER AND VIDEO GAMES AND SOFTWARE TO REGIONAL CUSTOMS AND CONVENTIONS; DOWNLOADABLE IMAGE FILES IN THE FIELD OF TRANSLATION AND LINGUISTIC ADAPTATION OF COMPUTER AND VIDEO GAMES AND SOFTWARE TO REGIONAL CUSTOMS AND CONVENTIONS; GAMES PROGRAMS FOR COMPUTERS, NAMELY, COMPUTER GAME PROGRAMS, IN CLASS 9 (U.S. CLS. 21, 23, 26, 36 AND 38).



David J. Kyjars

Director of the United States Patent and Trademark Office

FOR: PROVIDING A VIDEO SHARING PORTAL, NAMELY, ELECTRONIC TRANSMISSION OF DIGITAL VIDEO FILES AMONG INTERNET USERS; TRANSMITTING NEWS, DATA AND CONTENT VIA THE INTERNET AND OTHER COMPUTER AND COMMUNICATION NETWORKS; TRANSMITTING ELECTRONIC MEDIA, MULTIMEDIA CONTENT, VIDEOS, MOVIES, IMAGES, TEXT, PHOTOS, GAMES, USER-GENERATED CONTENT, AUDIO CONTENT AND INFORMATION VIA THE INTERNET AND OTHER COMPUTER AND COMMUNICATION NETWORKS; PROVIDING ACCESS TO INFORMATION ON THE INTERNET, NAMELY, PROVISION OF ACCESS TO ELECTRONIC SITES; PROVIDING ACCESS TO DATA FILES VIA THE INTERNET, NAMELY, PROVIDING ACCESS TO ELECTRONICALLY STORED DATA FILES RELATING TO TRANSLATION AND LOCALIZATION SOFTWARE, VIDEOS, GAMES, VOICE MESSAGES, MUSIC AND PUBLICATIONS;

Reg. No. 4,204,239 PROVIDING ACCESS TO DATABASES IN COMPUTER NETWORKS, IN CLASS 38 (U.S. CLS. 100, 101 AND 104).

FOR: PROVIDING INFORMATION ONLINE RELATING TO COMPUTER GAMES AND COMPUTER ENHANCEMENTS FOR GAMES; PROVIDING INFORMATION ONLINE IN THE FIELD OF TRANSLATION AND LOCALIZATION SERVICES RELATED TO COMPUTER AND VIDEO GAMES AND SOFTWARE, NAMELY, PROVIDING INFORMATION RELATING TO TRANSLATION AND LINGUISTIC ADAPTATION OF COMPUTER AND VIDEO GAMES AND SOFTWARE TO REGIONAL CUSTOMS AND CONVENTIONS; TRANSLATION AND LOCALIZATION SERVICES, NAMELY, TRANSLATION AND LINGUISTIC ADAPTATION OF COMPUTER AND VIDEO GAMES AND SOFTWARE TO REGIONAL CUSTOMS AND CONVENTIONS; TRANSLATION SERVICES, IN CLASS 41 (U.S. CLS. 100, 101 AND 107).

FOR: DESIGN AND DEVELOPMENT OF COMPUTER HARDWARE, SOFTWARE AND DATABASES, IN PARTICULAR, DESIGN, DEVELOPMENT, AND UPDATING OF COMPUTER SOFTWARE; PROVIDING ONLINE, NONDOWNLOADABLE TRANSLATION AND LOCALIZATION SOFTWARE ON DATA NETWORKS FOR TRANSLATION AND LINGUISTIC ADAPTATION OF COMPUTER AND VIDEO GAMES AND SOFTWARE TO REGIONAL CUSTOMS AND CONVENTIONS; DESIGN OF TRANSLATION AND LOCALIZATION COMPUTER PROGRAMS, IN CLASS 42 (U.S. CLS. 100 AND 101).

THE MARK CONSISTS OF STANDARD CHARACTERS WITHOUT CLAIM TO ANY PARTICULAR FONT, STYLE, SIZE, OR COLOR.

PRIORITY DATE OF 12-22-2010 IS CLAIMED.

OWNER OF INTERNATIONAL REGISTRATION 1105853 DATED 6-22-2011, EXPIRES 6-22-2021.

SER. NO. 79-108,826, FILED 6-22-2011.

LINDA LAVACHE, EXAMINING ATTORNEY

United States of America

United States Patent and Trademark Office

LUNA D'OR

Reg. No. 4,204,240

Registered Sep. 11, 2012

Int. Cl.: 33

TRADEMARK

PRINCIPAL REGISTER

LE CONTESSE S.R.L. (ITALY LIMITED LIABILITY COMPANY)
VIA CADORNA, 39
I-31028 VAZZOLA (TV)
ITALY

FOR: ALCOHOLIC BEVERAGES EXCEPT BEERS, IN CLASS 33 (U.S. CLS. 47 AND 49).

THE MARK CONSISTS OF STANDARD CHARACTERS WITHOUT CLAIM TO ANY PARTICULAR FONT, STYLE, SIZE, OR COLOR.

OWNER OF INTERNATIONAL REGISTRATION 1106242 DATED 1-25-2012, EXPIRES 1-25-2022.

THE ENGLISH TRANSLATION OF "LUNA D'OR" IN THE MARK IS "GOLDEN MOON".

SER. NO. 79-108,945, FILED 1-25-2012.

COLLEEN DOMBROW, EXAMINING ATTORNEY



David J. Kybas

Director of the United States Patent and Trademark Office

United States of America

United States Patent and Trademark Office

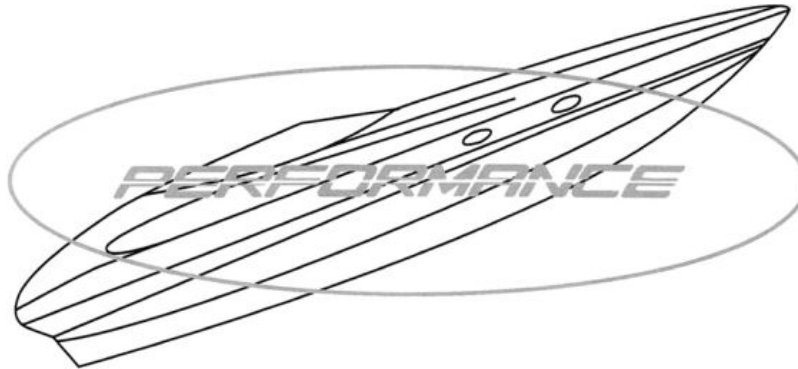

Reg. No. 4,204,241

Registered Sep. 11, 2012

Int. Cls.: 12 and 25

TRADEMARK

PRINCIPAL REGISTER

PERFORMANCE MARINE GMBH (FED REP GERMANY GMBH)
HERTZSTR. 4
85757 KARLSFELD
FED REP GERMANY

FOR: SPORT MOTORBOATS AND REPLACEMENT PARTS THEREFOR, IN CLASS 12 (U.S. CLS. 19, 21, 23, 31, 35 AND 44).

FOR: CLOTHING AND HEADGEAR, NAMELY, BATHING SUITS, SWIM SUITS, JACKETS, VESTS, T-SHIRTS, POLO SHIRTS, JERSEYS, TROUSERS, HATS AND CAPS, IN CLASS 25 (U.S. CLS. 22 AND 39).

NO CLAIM IS MADE TO THE EXCLUSIVE RIGHT TO USE "PERFORMANCE", APART FROM THE MARK AS SHOWN.

OWNER OF INTERNATIONAL REGISTRATION 1106450 DATED 12-20-2011, EXPIRES 12-20-2021.

THE MARK CONSISTS OF THE WORDING "PERFORMANCE" APPEARING INSIDE OF AN OVAL, WITH THE STYLIZED DESIGN OF A MOTORBOAT APPEARING BEHIND THE LITERAL ELEMENT AND THE OVAL.

SER. NO. 79-109,009, FILED 12-20-2011.

SEAN CROWLEY, EXAMINING ATTORNEY



David J. Kybas

Director of the United States Patent and Trademark Office

United States of America

United States Patent and Trademark Office

⌘
EBEL

Reg. No. 4,204,242

Registered Sep. 11, 2012

Int. Cl.: 9

TRADEMARK

PRINCIPAL REGISTER

EBEL WATCHES SA (SWITZERLAND SOCIÉTÉ ANONYME)
NIDAUGASSE 35
CH-2502 BIENNE
SWITZERLAND

FOR: SPECTACLES AND SUNGLASSES, IN CLASS 9 (U.S. CLS. 21, 23, 26, 36 AND 38).

OWNER OF U.S. REG. NO. 1,655,257.

OWNER OF INTERNATIONAL REGISTRATION 0517146 DATED 10-7-1987, EXPIRES 10-7-2017.

SER. NO. 79-109,052, FILED 11-15-2011.

ZACHARY BELLO, EXAMINING ATTORNEY



David J. Kybas

Director of the United States Patent and Trademark Office

United States of America

United States Patent and Trademark Office



Reg. No. 4,204,243

Registered Sep. 11, 2012

Int. Cl.: 12

TRADEMARK

PRINCIPAL REGISTER

DISC BRAKES AUSTRALIA PTY LIMITED (AUSTRALIA PROPRIETARY COMPANY)
UNIT 33 SLOUGH BUSINESS PARK
HOLKER STREET
SILVERWATER NSW 2128, AUSTRALIA

FOR: DISC BRAKES FOR LAND VEHICLES; BRAKE PARTS FOR VEHICLES, NAMELY, DISC BRAKE ROTORS AND DISC BRAKES; DISC BRAKE ROTORS FOR VEHICLES; DISC BRAKE PADS FOR VEHICLES, IN CLASS 12 (U.S. CLS. 19, 21, 23, 31, 35 AND 44).

THE MARK CONSISTS OF WORDING "T3" IN STYLIZED FONT, SHOWN IN WHITE, WITH THE "3" OUTLINED IN RED, AND WITH THE RED OUTLINE AROUND THE MIDDLE AND LOWER PARTS OF THE "3" EXTENDING LEFTWARD TOWARD THE "T", WITH THE ENTIRE "T3" SURROUNDED BY A BLACK OUTLINE, AND WITH A CURVED, VERTICAL RED LINE TO THE RIGHT OF THE "T3", BROKEN IN THE MIDDLE, WITH A SMALLER, RED CURVED LINE BISECTING THE VERTICAL RED LINE.

PRIORITY DATE OF 4-1-2011 IS CLAIMED.

OWNER OF INTERNATIONAL REGISTRATION 1106884 DATED 9-30-2011, EXPIRES 9-30-2021.

THE COLOR(S) RED, WHITE AND BLACK IS/ARE CLAIMED AS A FEATURE OF THE MARK.

SER. NO. 79-109,183, FILED 9-30-2011.

ESTHER BELENKER, EXAMINING ATTORNEY



David J. Kyffers

Director of the United States Patent and Trademark Office

United States of America

United States Patent and Trademark Office

LEI

Reg. No. 4,204,244

Registered Sep. 11, 2012

Int. Cl.: 20

TRADEMARK

PRINCIPAL REGISTER

LT OFFICE LINE AB (SWEDEN AKTIEBOLAG)
KONSUL JOHNSONS VÄG 1
SE-149 45 NYNÄSHAMN
SWEDEN

FOR: FURNITURE; CHAIRS, OFFICE CHAIRS, IN CLASS 20 (U.S. CLS. 2, 13, 22, 25, 32 AND 50).

THE MARK CONSISTS OF STANDARD CHARACTERS WITHOUT CLAIM TO ANY PARTICULAR FONT, STYLE, SIZE, OR COLOR.

OWNER OF INTERNATIONAL REGISTRATION 1107110 DATED 2-1-2012, EXPIRES 2-1-2022.

SER. NO. 79-109,260, FILED 2-1-2012.

ROBIN MITTLER, EXAMINING ATTORNEY



David J. Kyffers

Director of the United States Patent and Trademark Office

United States of America

United States Patent and Trademark Office

HPML

Reg. No. 4,204,245

Registered Sep. 11, 2012

Int. Cls.: 9 and 11

TRADEMARK

PRINCIPAL REGISTER

OSRAM AG (FED REP GERMANY CORPORATION), AKA OSRAM AKTIENGESELLSCHAFT
HELLABRUNNER STR. 1
DEPT OSR GC IP TM, 2011W-IR-1107251
MÜNCHEN, FED REP GERMANY 81543

FOR: LIGHT CONTROL SYSTEMS, NAMELY, TRANSISTOR CIRCUITS FOR REGULATING CURRENT APPLIED TO DRIVE LIGHT-EMITTING DIODES; LIGHT-EMITTING DIODES; ORGANIC LIGHT-EMITTING DIODES; LIGHT-EMITTING DIODE MODULES, NAMELY, MODULES FOR EMITTING LIGHT, CONSTRUCTED FROM LIGHT-EMITTING DIODES; AND COMPONENT PARTS OF ALL THE AFORESAID GOODS, IN CLASS 9 (U.S. CLS. 21, 23, 26, 36 AND 38).

FOR: APPARATUS FOR LIGHTING, NAMELY, ELECTRIC LAMPS AND LUMINAIRES; LUMINAIRES, USING LIGHT-EMITTING DIODES AS A LIGHT SOURCE, FOR STREET OR ROADWAY LIGHTING; LIGHTING APPARATUS AND SYSTEMS CONSTRUCTED FROM LIGHT-EMITTING DIODES (LEDS); LED LAMPS AND LED LUMINAIRES; AND COMPONENT PARTS OF ALL THE AFORESAID GOODS, IN CLASS 11 (U.S. CLS. 13, 21, 23, 31 AND 34).

THE MARK CONSISTS OF STANDARD CHARACTERS WITHOUT CLAIM TO ANY PARTICULAR FONT, STYLE, SIZE, OR COLOR.

PRIORITY DATE OF 6-10-2011 IS CLAIMED.

OWNER OF INTERNATIONAL REGISTRATION 1107251 DATED 10-24-2011, EXPIRES 10-24-2021.

THE WORDING "HPML" HAS NO MEANING IN A FOREIGN LANGUAGE.

SER. NO. 79-109,308, FILED 10-24-2011.

KEVIN CORWIN, EXAMINING ATTORNEY



David J. Kypos

Director of the United States Patent and Trademark Office

United States of America
United States Patent and Trademark Office

Copy.Me

Reg. No. 4,204,246

Registered Sep. 11, 2012

Int. Cl.: 9

TRADEMARK

PRINCIPAL REGISTER

ETORO GROUP LTD. (BR.VIRGIN ISLANDS CORPORATION)
P.O.BOX 3221
DRAKE CHAMBERS, ROAD TOWN; TORTOLA 3321
BR.VIRGIN ISLANDS

FOR: COMPUTER SOFTWARE COMPONENT FOR ACCESSING ONLINE INTERACTIVE FINANCIAL SERVICES AND OTHER RELATED ONLINE SERVICES, DOWNLOADABLE AS AN INTEGRAL COMPONENT OF COMPUTER SOFTWARE, IN CLASS 9 (U.S. CLS. 21, 23, 26, 36 AND 38).

THE MARK CONSISTS OF STANDARD CHARACTERS WITHOUT CLAIM TO ANY PARTICULAR FONT, STYLE, SIZE, OR COLOR.

PRIORITY DATE OF 9-15-2011 IS CLAIMED.

OWNER OF INTERNATIONAL REGISTRATION 1107362 DATED 9-15-2011, EXPIRES 9-15-2021.

SER. NO. 79-109,348, FILED 9-15-2011.

CHARLOTTE CORWIN, EXAMINING ATTORNEY



David J. Kyffers

Director of the United States Patent and Trademark Office

United States of America

United States Patent and Trademark Office



M.P.T.

Reg. No. 4,204,247

Registered Sep. 11, 2012

Int. Cls.: 7, 8, 11, 20 and 21

JIANGMEN CITY RIYING STAINLESS; STEEL MATERIALS MANUFACTORY LIMITED
(CHINA LIMITED LIABILITY COMPANY)
DONGHOU INDUSTRIAL ZONE,
XINHUI DISTRICT.; JIANGMEN; GUANGDONG
CHINA

TRADEMARK

PRINCIPAL REGISTER

FOR: TEA PROCESSING MACHINERY, NAMELY, CUTTING MACHINES, HARVEST DRYING MACHINES; PAPERMAKING MACHINES; LOCAL SPECIALTIES AND SUNDRY GOODS PROCESSING MACHINES, NAMELY, PACKAGING MACHINES, FILLING MACHINES; AERATED BEVERAGES MAKING MACHINES; BICYCLE ASSEMBLING MACHINES; WASHING MACHINES, NAMELY, CLOTHES WASHING MACHINES, DISH WASHING MACHINES, FLOOR WASHING MACHINES; PHARMACY PROCESSING MACHINES, NAMELY, MACHINES USED FOR PROCESS FILTRATION IN THE PHARMACEUTICAL INDUSTRY; ELEVATORS BEING LIFTS; GLASS CUTTING MACHINE; ROLLING MILLS, IN CLASS 7 (U.S. CLS. 13, 19, 21, 23, 31, 34 AND 35).

FOR: KNIFE STEELS, NAMELY, KNIFE SHARPENERS; OYSTER OPENERS; APPLIANCES AND INSTRUMENTS FOR SLAUGHTERING BUTCHERS' ANIMALS, NAMELY, BUTCHER KNIVES, SLEDGEHAMMERS; ELECTRIC AND NON-ELECTRIC RAZORS; HARPOONS FOR COMMERCIAL FISHING; HAND TOOLS AND INSTRUMENTS FOR WATCH MAKING, NAMELY, HAND TOOLS IN THE NATURE OF PRECISION SCREWDRIVERS, PLIERS, HAMMERS; THREE-JAW BEARING PULLER HAND TOOLS; DRILL TOOLS, NAMELY, MANUAL DRILLS; SIDE ARMS, OTHER THAN FIREARMS, NAMELY, SWORDS, HUNTING KNIVES; TABLE CUTLERY, NAMELY, KNIVES, FORKS AND SPOONS, IN CLASS 8 (U.S. CLS. 23, 28 AND 44).

FOR: THEATRICAL AND FILM LIGHTING APPARATUS, NAMELY, STAGE LAMPS AND LANTERNS FOR LIGHTING; LIGHTS FOR VEHICLES; BAKERS' OVENS; REFRIGERATORS; HAIR DRYERS; ELECTRIC HEATING APPARATUS, NAMELY, ELECTRIC SPACE HEATERS, ELECTRIC RADIANT HEATERS FOR HOUSEHOLD PURPOSES; HOT WATER HEATING INSTALLATIONS, NAMELY, HOT WATER HEATERS; BATH INSTALLATIONS, NAMELY, SINKS INTEGRATED INTO COUNTERS OR COUNTERTOPS, TOILETS, SHOWER ENCLOSURES; WATER PURIFYING APPARATUS AND MACHINES; RADIATORS, ELECTRIC, IN CLASS 11 (U.S. CLS. 13, 21, 23, 31 AND 34).

FOR: TABLES, NAMELY, PLOT TABLES; TABLES OF METAL; KNIFE HANDLES NOT OF METAL; DISPLAY BOARDS; MOBILE BOARDING STAIRS, NOT OF METAL, FOR PAS-



David J. Kybas

Director of the United States Patent and Trademark Office

Reg. No. 4,204,247 SENGERS; REELS, NOT OF METAL, NON-MECHANICAL, FOR FLEXIBLE HOSES, NAMELY, HAND-OPERATED NON-METAL GARDEN HOSE REELS; NON-METAL VALVES FOR CONTAINERS, NAMELY, NON-METAL BALL VALVES; INFLATABLE PUBLICITY OBJECTS; PILLOWS, NAMELY, MAGNETIC PILLOWS, IN CLASS 20 (U.S. CLS. 2, 13, 22, 25, 32 AND 50).

FOR: KITCHEN UTENSILS, NAMELY, KITCHEN TONGS, SPLATTER SCREENS, POURING AND STRAINING SPOUTS; CRYSTAL HANDICRAFT, NAMELY, DECORATIVE CRYSTAL PRISMS, DESKTOP STATUARY MADE OF CRYSTAL, ORNAMENTS OF CRYSTAL; GLASSWARE OF CRYSTAL, NAMELY, BEVERAGE GLASSWARE; BRUSHES, NAMELY, BATH BRUSHES, CLOTHES BRUSHES, CLEANING BRUSHES FOR HOUSEHOLD USE; TOOTHBRUSHES, ELECTRIC; COSMETIC UTENSILS, NAMELY, COSMETIC BRUSHES, DROPPERS SOLD EMPTY FOR COSMETIC PURPOSES, COSMETIC SPATULAS FOR USE WITH DEPILATORY PREPARATIONS; INDOOR AQUARIA; VIVARIUMS BEING INDOOR TERRARIUMS; DRINKING TROUGHS; COSMETIC BRUSHES, NAMELY, CHEEK BRUSHES, IN CLASS 21 (U.S. CLS. 2, 13, 23, 29, 30, 33, 40 AND 50).

THE MARK CONSISTS OF THE STYLIZED BLOCK WORDING "M.P.T." APPEARING TO THE RIGHT OF A DESIGN COMPRISED OF A CENTRAL SPHERE DESIGN LARGELY ENCIRCLED BY THREE ROUGHLY TRIANGULAR SHAPES, WITH EACH HAVING TWO SLIGHTLY CURVED SIDES.

OWNER OF INTERNATIONAL REGISTRATION 1107645 DATED 12-8-2011, EXPIRES 12-8-2021.

SER. NO. 79-109,474, FILED 12-8-2011.

KEVIN CORWIN, EXAMINING ATTORNEY

United States of America

United States Patent and Trademark Office



Reg. No. 4,204,248

Registered Sep. 11, 2012

Int. Cl.: 9

TRADEMARK

PRINCIPAL REGISTER

HENGDIAN GROUP DMEGC CO., LTD. (CHINA CORPORATION)
HENGDIAN INDUSTRIAL ZONE
DONGYANG; 322100 ZHEJIANG
CHINA

FOR: POLYSILICON WAFER; MONOSILICON WAFER; SILICON EPITAXIAL WAFER; SOLAR CELLS; SOLAR PANELS FOR PRODUCTION OF ELECTRICITY; BATTERIES; WALKIE-TALKIES; INTEGRATED CIRCUITS; MEDIUM-HIGH VOLTAGE ETCHED FOIL AND FORMED FOIL FOR ALUMINUM ELECTROLYTIC CAPACITOR; MAGNETIC MATERIALS AND DEVICES, NAMELY, MAGNETIC COILS, MAGNETIC HEADS, MAGNETIC CORES, IN CLASS 9 (U.S. CLS. 21, 23, 26, 36 AND 38).

OWNER OF U.S. REG. NO. 2,824,385.

PRIORITY DATE OF 5-20-2011 IS CLAIMED.

OWNER OF INTERNATIONAL REGISTRATION 1107659 DATED 7-18-2011, EXPIRES 7-18-2021.

THE MARK CONSISTS OF THE LETTERING "DMEGC" BELOW A ROUNDED TRIANGLE PENETRATED BY A ROUND-NOSED FORM FROM WHICH LINES EXTEND REPRESENTING SPEED.

SER. NO. 79-109,483, FILED 7-18-2011.

HANNO RITTNER, EXAMINING ATTORNEY



David J. Kyffers

Director of the United States Patent and Trademark Office

United States of America
United States Patent and Trademark Office

DARRLING

Reg. No. 4,204,249

Registered Sep. 11, 2012

Int. Cl.: 30

TRADEMARK

PRINCIPAL REGISTER

NEWBY TEAS (U.K.) LIMITED (UNITED KINGDOM LIMITED COMPANY)
105 ST. JOHN STREET
LONDON EC1M 4AS
UNITED KINGDOM

FOR: TEA, TEA PRODUCTS IN THE NATURE OF TEA BAGS, TEA BASED BEVERAGES;
ICED TEA; TEA FOR INFUSIONS; AND INFUSIONS, NOT MEDICINAL, NAMELY, HERBAL
INFUSIONS, AND INFUSIONS FOR TEA, IN CLASS 30 (U.S. CL. 46).

THE MARK CONSISTS OF STANDARD CHARACTERS WITHOUT CLAIM TO ANY PAR-
TICULAR FONT, STYLE, SIZE, OR COLOR.

PRIORITY DATE OF 7-11-2011 IS CLAIMED.

OWNER OF INTERNATIONAL REGISTRATION 1107747 DATED 12-20-2011, EXPIRES 12-
20-2021.

THE WORDING "DARRLING" HAS NO MEANING IN A FOREIGN LANGUAGE.

SER. NO. 79-109,524, FILED 12-20-2011.

SEAN CROWLEY, EXAMINING ATTORNEY



David J. Kybas

Director of the United States Patent and Trademark Office

United States of America

United States Patent and Trademark Office

d:facto

Reg. No. 4,204,250

Registered Sep. 11, 2012

Int. Cl.: 9

TRADEMARK

PRINCIPAL REGISTER

DPA MICROPHONES A/S (DENMARK LIMITED COMPANY)
GYDEVANG 42-44
DK-3450 ALLERØD
DENMARK

FOR: MICROPHONES, MICROPHONE GRIDS AND NOSE CONES, MICROPHONE WIND SCREENS, MICROPHONE HOLDERS, MICROPHONE STANDS, MICROPHONE CABLES, MICROPHONE CONNECTORS AND ADAPTERS, MICROPHONE BOOMS, MICROPHONE AMPLIFIERS, MICROPHONE POWER SUPPLIES AND MICROPHONE CALIBRATORS, IN CLASS 9 (U.S. CLS. 21, 23, 26, 36 AND 38).

THE MARK CONSISTS OF THE WORDING "D FACTO" WITH A COLON BETWEEN "D" AND "FACTO".

PRIORITY DATE OF 9-28-2011 IS CLAIMED.

OWNER OF INTERNATIONAL REGISTRATION 1107902 DATED 12-14-2011, EXPIRES 12-14-2021.

SER. NO. 79-109,583, FILED 12-14-2011.

EUGENIA MARTIN, EXAMINING ATTORNEY



David J. Kyffers

Director of the United States Patent and Trademark Office

United States of America
United States Patent and Trademark Office

d:imension

Reg. No. 4,204,251

Registered Sep. 11, 2012

Int. Cl.: 9

TRADEMARK

PRINCIPAL REGISTER

DPA MICROPHONES A/S (DENMARK LIMITED COMPANY)
GYDEVANG 42-44
DK-3450 ALLERØD
DENMARK

FOR: MICROPHONES, MICROPHONE GRIDS AND NOSE CONES, MICROPHONE WIND SCREENS, MICROPHONE HOLDERS, MICROPHONE STANDS, MICROPHONE CABLES, MICROPHONE CONNECTORS AND ADAPTERS, MICROPHONE BOOMS, MICROPHONE AMPLIFIERS, MICROPHONE POWER SUPPLIES AND MICROPHONE CALIBRATORS, IN CLASS 9 (U.S. CLS. 21, 23, 26, 36 AND 38).

THE MARK CONSISTS OF THE WORDING "D MENSION" WITH A COLON BETWEEN "D" AND "MENSION".

PRIORITY DATE OF 9-28-2011 IS CLAIMED.

OWNER OF INTERNATIONAL REGISTRATION 1107903 DATED 12-14-2011, EXPIRES 12-14-2021.

SER. NO. 79-109,584, FILED 12-14-2011.

EUGENIA MARTIN, EXAMINING ATTORNEY



David J. Kyjars

Director of the United States Patent and Trademark Office

United States of America

United States Patent and Trademark Office

d:vote

Reg. No. 4,204,252

Registered Sep. 11, 2012

Int. Cl.: 9

TRADEMARK

PRINCIPAL REGISTER

DPA MICROPHONES A/S (DENMARK LIMITED COMPANY)
GYDEVANG 42-44
DK-3450 ALLERØD
DENMARK

FOR: MICROPHONES, MICROPHONE GRIDS AND NOSE CONES, MICROPHONE WIND-SCREENS, MICROPHONE HOLDERS, MICROPHONE STANDS, MICROPHONE CABLES, MICROPHONE CONNECTORS AND ADAPTERS, MICROPHONE BOOMS, MICROPHONE AMPLIFIERS, MICROPHONE POWER SUPPLIES AND MICROPHONE CALIBRATORS, IN CLASS 9 (U.S. CLS. 21, 23, 26, 36 AND 38).

THE MARK CONSISTS OF THE WORDING "D VOTE" WITH A COLON BETWEEN "D" AND "VOTE".

PRIORITY DATE OF 9-28-2011 IS CLAIMED.

OWNER OF INTERNATIONAL REGISTRATION 1107904 DATED 12-14-2011, EXPIRES 12-14-2021.

SER. NO. 79-109,585, FILED 12-14-2011.

EUGENIA MARTIN, EXAMINING ATTORNEY



David J. Kyffers

Director of the United States Patent and Trademark Office

United States of America
United States Patent and Trademark Office

d:screet

Reg. No. 4,204,253

Registered Sep. 11, 2012

Int. Cl.: 9

TRADEMARK

PRINCIPAL REGISTER

DPA MICROPHONES A/S (DENMARK LIMITED COMPANY)
GYDEVANG 42-44
DK-3450 ALLERØD
DENMARK

FOR: MICROPHONES, MICROPHONE GRIDS AND NOSE CONES, MICROPHONE WIND-SCREENS, MICROPHONE HOLDERS, MICROPHONE STANDS, MICROPHONE CABLES, MICROPHONE CONNECTORS AND ADAPTERS, MICROPHONE BOOMS, MICROPHONE AMPLIFIERS, MICROPHONE POWER SUPPLIES AND MICROPHONE CALIBRATORS, IN CLASS 9 (U.S. CLS. 21, 23, 26, 36 AND 38).

THE MARK CONSISTS OF THE WORDING "D SCREET" WITH A COLON BETWEEN "D" AND "SCREET".

PRIORITY DATE OF 9-28-2011 IS CLAIMED.

OWNER OF INTERNATIONAL REGISTRATION 1107905 DATED 12-14-2011, EXPIRES 12-14-2021.

SER. NO. 79-109,586, FILED 12-14-2011.

EUGENIA MARTIN, EXAMINING ATTORNEY



David J. Kyffers

Director of the United States Patent and Trademark Office

United States of America

United States Patent and Trademark Office

d: fine

Reg. No. 4,204,254

Registered Sep. 11, 2012

Int. Cl.: 9

TRADEMARK

PRINCIPAL REGISTER

DPA MICROPHONES A/S (DENMARK LIMITED COMPANY)
GYDEVANG 42-44
DK-3450 ALLERØD
DENMARK

FOR: MICROPHONES, MICROPHONE GRIDS AND NOSE CONES, MICROPHONE WIND-SCREENS, MICROPHONE HOLDERS, MICROPHONE STANDS, MICROPHONE CABLES, MICROPHONE CONNECTORS AND ADAPTERS, MICROPHONE BOOMS, MICROPHONE AMPLIFIERS, MICROPHONE POWER SUPPLIES AND MICROPHONE CALIBRATORS, IN CLASS 9 (U.S. CLS. 21, 23, 26, 36 AND 38).

THE MARK CONSISTS OF THE WORDING "D FINE" WITH A COLON BETWEEN "D" AND "FINE".

PRIORITY DATE OF 9-28-2011 IS CLAIMED.

OWNER OF INTERNATIONAL REGISTRATION 1107906 DATED 12-14-2011, EXPIRES 12-14-2021.

SER. NO. 79-109,587, FILED 12-14-2011.

EUGENIA MARTIN, EXAMINING ATTORNEY



David J. Kyffers

Director of the United States Patent and Trademark Office

United States of America
United States Patent and Trademark Office

EXPERIOR

Reg. No. 4,204,255

XYLEM WATER SOLUTIONS AB (SWEDEN AKTIEBOLAG)
SE-361 80 EMMABODA
SWEDEN

Registered Sep. 11, 2012

Int. Cl.: 7

FOR: ELECTRONICALLY MONITORED AND CONTROLLED SUBMERSIBLE PUMPING SYSTEMS COMPRISED OF A ELECTRIC MOTOR DRIVEN PUMP, ELECTRIC MOTOR, ELECTRIC MOTOR SPEED CONTROLLER AND ELECTRONIC PUMP CONDITION MONITOR, IN CLASS 7 (U.S. CLS. 13, 19, 21, 23, 31, 34 AND 35).

TRADEMARK

PRINCIPAL REGISTER

THE MARK CONSISTS OF STANDARD CHARACTERS WITHOUT CLAIM TO ANY PARTICULAR FONT, STYLE, SIZE, OR COLOR.

PRIORITY DATE OF 9-8-2011 IS CLAIMED.

OWNER OF INTERNATIONAL REGISTRATION 1108151 DATED 1-19-2012, EXPIRES 1-19-2022.

SER. NO. 79-109,691, FILED 1-19-2012.

ARETHA SOMERVILLE, EXAMINING ATTORNEY



David J. Kyffers

Director of the United States Patent and Trademark Office

United States of America

United States Patent and Trademark Office



Reg. No. 4,204,256

Registered Sep. 11, 2012

Int. Cl.: 41

STUDIO PILATES INTERNATIONAL PTY LTD; AS TRUSTEE FOR; THE STUDIO PILATES
IP TRUST (AUSTRALIA COMPANY)
246 HAWTHORNE ROAD
HAWTHORNE QLD 4171
AUSTRALIA

SERVICE MARK

FOR: PROVIDING FITNESS AND EXERCISE FACILITIES; HEALTH CLUB SERVICES,
NAMELY, PROVIDING EXERCISE INSTRUCTION, EDUCATION AND EQUIPMENT IN
THE FIELD OF PHYSICAL EXERCISE, IN CLASS 41 (U.S. CLS. 100, 101 AND 107).

PRINCIPAL REGISTER

NO CLAIM IS MADE TO THE EXCLUSIVE RIGHT TO USE "STUDIO PILATES INTERNA-
TIONAL", APART FROM THE MARK AS SHOWN.

OWNER OF INTERNATIONAL REGISTRATION 1108272 DATED 12-16-2011, EXPIRES 12-
16-2021.

THE MARK CONSISTS OF THE STYLIZED WORDING "STUDIO PILATES INTERNATION-
AL" TO THE RIGHT OF A PARTIALLY SHADED CIRCLE CONTAINING THE LETTERS
"SP".

SER. NO. 79-109,741, FILED 12-16-2011.

HEATHER THOMPSON, EXAMINING ATTORNEY



David J. Kyffers

Director of the United States Patent and Trademark Office

United States of America

United States Patent and Trademark Office

b-used

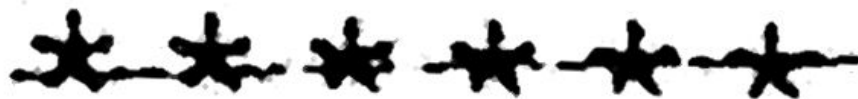

Reg. No. 4,204,257

Registered Sep. 11, 2012

Int. Cls.: 14, 18 and 25

TRADEMARK

PRINCIPAL REGISTER

SALVATORE SANTORO (ITALY INDIVIDUAL)
VIA CAMALDOLILLI, 59
I-80100 NAPOLI
ITALY

FOR: BANGLE BRACELETS, JEWELRY CASES OF PRECIOUS METAL, IN CLASS 14 (U.S. CLS. 2, 27, 28 AND 50).

FOR: LEATHER BAGS, SUITCASES AND WALLETS, IN CLASS 18 (U.S. CLS. 1, 2, 3, 22 AND 41).

FOR: BOMBER JACKETS, LEATHER JACKETS, FUR COATS AND JACKETS, IN CLASS 25 (U.S. CLS. 22 AND 39).

THE MARK CONSISTS OF SIX ASTERISKS TRAVERSED BY A THIN LINE AT A SLIGHT INCLINATION WITH THE NAME "B-USED" ABOVE, FORMED FROM THE LETTER "B" IN LOWER-CASE AND THE WORD "USED" IN LOWER-CASE.

OWNER OF INTERNATIONAL REGISTRATION 1108722 DATED 12-15-2011, EXPIRES 12-15-2021.

SER. NO. 79-109,904, FILED 12-15-2011.

BERNICE MIDDLETON, EXAMINING ATTORNEY



David J. Kyros

Director of the United States Patent and Trademark Office

United States of America

United States Patent and Trademark Office



Reg. No. 4,204,258

Registered Sep. 11, 2012

Int. Cls.: 3, 5, 16, 30 and 32

OBSHESTVO S OGRANICHENNOY OTVETSTVENNOST'YU; "KORPORATSIYA
"SIBIRSKOE ZDOROVIE" (RUSSIAN FED. LIMITED LIABILITY COMPANY)
UL. LENINA, 48
RU-630004 NOVOSIBIRSK
RUSSIAN FED.

TRADEMARK

PRINCIPAL REGISTER

FOR: AFTER-SHAVE LOTIONS; ANTIPERSPIRANTS; AROMATICS ESSENTIAL OILS; BATH SALTS, NOT FOR MEDICAL PURPOSES; BEAUTY MASKS; BREATH FRESHENING SPRAYS; CLEANSING MILK FOR TOILET PURPOSES; COSMETICS; COSMETIC CREAMS; COSMETIC HAIR DYES; COSMETIC MAKE UP KITS COMPRISED OF LIPSTICK, LIP GLOSS, MASCARA; COSMETIC PENCILS; COSMETIC PREPARATIONS FOR BATHS; COSMETIC PREPARATIONS FOR EYELASHES; COTTON STICKS FOR COSMETIC PURPOSES; PREPARATIONS FOR SLIMMING PURPOSES; COSMETIC PREPARATIONS FOR SKIN CARE; COTTON WOOL FOR COSMETIC PURPOSES; DENTAL BLEACHING GELS; DENTIFRICES; DEPILATORY PREPARATIONS; DEODORANTS FOR PERSONAL USE; EAU DE COLOGNE; EYEBROW COSMETICS; HAIR DYES; HAIR LOTIONS; HAIR SPRAY; HAIR WAVING PREPARATIONS; LOTIONS FOR COSMETIC PURPOSES; MAKE-UP POWDER; MAKE-UP REMOVING PREPARATIONS; MASCARA; MOUTH WASHES, NOT FOR MEDICAL PURPOSES; NAIL CARE PREPARATIONS; NAIL POLISH; OILS FOR COSMETIC PURPOSES; PERFUMERY; PERFUMES; POMADES FOR COSMETIC PURPOSES; POTPOURRI; AROMATIC POTPOURRI, SHAMPOOS; SHAVING PREPARATIONS; SOAP; TISSUES IMPREGNATED WITH COSMETIC LOTIONS; NON-MEDICAL TOILETRIES; TOILET WATER, IN CLASS 3 (U.S. CLS. 1, 4, 6, 50, 51 AND 52).



David J. Kyros

Director of the United States Patent and Trademark Office

FOR: ADJUVANTS FOR MEDICAL PURPOSES; ALBUMINOUS FOODSTUFFS FOR MEDICAL PURPOSES; ALBUMINOUS PREPARATIONS FOR MEDICAL PURPOSES; BALMS FOR MEDICAL PURPOSES; BARK FOR PHARMACEUTICAL PURPOSES; BATH PREPARATIONS, MEDICATED; BATH SALTS FOR MEDICAL PURPOSES; BIOLOGICAL PREPARATIONS FOR MEDICAL PURPOSES, NAMELY, BIOACTIVE FOOD ADDITIVES; CANDY, MEDICATED; DENTAL LACQUER; DENTAL MASTICS; DIETETIC BEVERAGES ADAPTED FOR MEDICAL PURPOSES; DIETETIC FOODS ADAPTED FOR MEDICAL PURPOSES; DIETETIC SUBSTANCES ADAPTED FOR MEDICAL USE, NAMELY, BIOACTIVE FOOD ADDITIVES; DIGESTIVES FOR PHARMACEUTICAL PURPOSES; NON-NUTRITIVE EDIBLE DIETARY PLANT FIBERS TO AID NUTRITION; ENZYMES FOR MEDICAL PURPOSES; FOOD FOR BABIES; HERBS TEAS FOR MEDICINAL PURPOSES; LINIMENTS; ANTIBACTERIAL LOTIONS FOR PHARMACEUTICAL PURPOSES; MEDICINAL DRINKS; MEDICINAL HAIR GROWTH PREPARATIONS; MEDICINAL HERBS; HERBAL MUD PACKS FOR

Reg. No. 4,204,258 MEDICINAL PURPOSES; MEDICINAL OILS; MEDICINAL ROOTS; MINERAL FOOD-SUPPLEMENTS; MINERAL ENHANCED WATER FOR MEDICAL PURPOSES; MOUTH-WASHES FOR MEDICAL PURPOSES; NUTRITIONAL ADDITIVES FOR MEDICAL PURPOSES USED IN FOODS AND DIETARY SUBSTANCES; SEA WATER FOR MEDICINAL BATHING; SANITARY TOWELS; VITAMIN PREPARATIONS, IN CLASS 5 (U.S. CLS. 6, 18, 44, 46, 51 AND 52).

FOR: PHOTO ALBUMS; ALMANACS; BAGS, NAMELY, ENVELOPES AND POUCHES OF PAPER OR PLASTICS, FOR PACKAGING; BOOKLETS AND BOOKS IN THE FIELD OF HEALTH CARE; CALENDARS; CATALOGUES IN THE FIELD OF HEALTH CARE; STATIONERY ENVELOPES; FORMS, PRINTED; GRAPHIC PRINTS; GREETING CARDS; PAPER; PRINTED PERIODICALS IN THE FIELD OF HEALTH CARE; POSTCARDS; POSTERS; PRINTED BUSINESS PROSPECTUSES; LABELS, NOT OF TEXTILE; NEWSLETTERS IN THE FIELD OF HEALTH CARE; NEWSPAPERS IN THE FIELD OF HEALTH CARE; BLANK NOTE BOOKS; SIGNBOARDS OF PAPER OR CARDBOARD; STATIONERY; STATIONERY STICKERS; PRINTED TEACHING MATERIALS IN THE FIELD OF HEALTH CARE; DESK SETS FOR WRITING; WRITING INSTRUMENTS, IN CLASS 16 (U.S. CLS. 2, 5, 22, 23, 29, 37, 38 AND 50).

FOR: BAKING POWDER; BREAD; BREAD ROLLS; BUNS; CEREAL-BASED SNACK FOOD; CEREAL PREPARATIONS, NAMELY, ENERGY BARS; CHEWING GUM, NOT FOR MEDICAL PURPOSES; CEREAL PRODUCTS, NAMELY, CONFECTIONERY CHIPS FOR BAKING; CHOCOLATE; CHOCOLATE-BASED BEVERAGES; CHOCOLATE BASED BEVERAGES WITH MILK; COCOA; COCOA-BASED BEVERAGES; COCOA BEVERAGES WITH MILK; COCOA BASED INGREDIENTS IN CONFECTIONERY PRODUCTS; COFFEE; COFFEE-BASED BEVERAGES; COFFEE BEVERAGES WITH MILK; CONDIMENTS, NAMELY, PEPPER SAUCE; CONFECTIONERY MADE OF SUGAR; COOKING SALT; CRACKERS; EDIBLE ICES; FARINACEOUS FOOD PASTES FOR HUMAN CONSUMPTION; FLOUR FOR FOOD; FLOUR-MILLING PRODUCTS, NAMELY, FLOUR BASED CHIPS; FRUIT JELLY CANDY; GARDEN HERBS, PRESERVED; GINGERBREAD; GRUEL, WITH A MILK BASE, NAMELY, PORRIDGE FOR FOOD; HONEY; ICE CREAM; MACARONI; MALT FOR HUMAN CONSUMPTION, NAMELY, FOOD PURPOSES; MUESLI; OAT-BASED FOOD, NAMELY, OAT FLAKES; PANCAKES; PASTRIES; PIZZAS; POPCORN; PROPOLIS FOR HUMAN CONSUMPTION; PUDDINGS; RAVIOLI; RICE-BASED SNACK FOOD; RUSKS; SANDWICHES; SEASONINGS; SPICES; STARCH FOR USE IN MANUFACTURING FOOD; SUGAR; SUSHI; SWEETMEATS; TARTS; TEA; TEA-BASED BEVERAGES; THICKENING AGENTS FOR COOKING FOODSTUFFS; VINEGAR; YEAST, IN CLASS 30 (U.S. CL. 46).

FOR: APERITIFS, NON-ALCOHOLIC; BEER; COCKTAILS, NON-ALCOHOLIC; ESSENCES FOR MAKING BEVERAGES; FRUIT JUICES; FRUIT NECTARS, NON-ALCOHOLIC; ISOTONIC BEVERAGES; KVASS NON-ALCOHOLIC BEVERAGES WITH TEA FLAVOR; NON-ALCOHOLIC FRUIT EXTRACTS USED IN THE PREPARATION OF BEVERAGES; SYRUPS FOR BEVERAGES; VEGETABLE JUICES; WATERS BEVERAGES, IN CLASS 32 (U.S. CLS. 45, 46 AND 48).

OWNER OF U.S. REG. NO. 4,107,393.

OWNER OF INTERNATIONAL REGISTRATION 1109137 DATED 11-11-2011, EXPIRES 11-11-2021.

THE COLOR(S) BLUE, GREEN, LIGHT BLUE AND DARK YELLOW IS/ARE CLAIMED AS A FEATURE OF THE MARK.

THE MARK CONSISTS OF AN APPLE TREE DESIGN WITHIN A SQUARE WITH ROUNDED CORNERS IN DARK BLUE, THE TREE AND APPLES APPEAR IN DARK YELLOW OUTLINED IN BLUE, BELOW THE TREE LINE IS GREEN AND THE LIGHT BLUE SKY SHOWS THROUGH THE BRANCHES.

Reg. No. 4,204,258 SER. NO. 79-110,018, FILED 11-11-2011.

JASON TURNER, EXAMINING ATTORNEY

United States of America
United States Patent and Trademark Office

LUMISTAR

Reg. No. 4,204,259

Registered Sep. 11, 2012

Int. Cl.: 2

TRADEMARK

PRINCIPAL REGISTER

NEMOTO & CO., LTD. (JAPAN CORPORATION)

MARUSAN BLDG.

15-1, KAMIOGI 1-CHOME,; SUGINAMI-KU; TOKYO 167-0043

JAPAN

FOR: PIGMENTS; INORGANIC PIGMENTS, IN CLASS 2 (U.S. CLS. 6, 11 AND 16).

OWNER OF INTERNATIONAL REGISTRATION 1086411 DATED 7-22-2011, EXPIRES 7-22-2021.

SER. NO. 79-110,125, FILED 2-9-2012.

ELI HELLMAN, EXAMINING ATTORNEY



David J. Kyffers

Director of the United States Patent and Trademark Office

United States of America

United States Patent and Trademark Office



Reg. No. 4,204,260

Registered Sep. 11, 2012

Int. Cl.: 28

TRADEMARK

PRINCIPAL REGISTER

PROFESSIONAL GOLF EUROPE LTD (UNITED KINGDOM PRIVATE COMPANY LIMITED BY SHARES)
19 WILLOW RISE,
SUTTON ST. NICHOLAS., HEREFORD HR1 3DH
UNITED KINGDOM

FOR: APPARATUS FOR USE IN THE GAME OF GOLF, NAMELY, BALL MARKERS AND DIVOT TOOLS; GOLF GLOVES; CADDIE BAGS FOR GOLF CLUBS; GOLF BALL MARKERS; GOLF BALLS; GOLF CLUBS; GOLF PUTTERS; GOLF DRIVING PRACTICE MATS; GOLF TEES; GOLF TEE BAGS, IN CLASS 28 (U.S. CLS. 22, 23, 38 AND 50).

THE MARK CONSISTS OF THE STYLIZED WORD "UNITED".

OWNER OF INTERNATIONAL REGISTRATION 1109762 DATED 11-29-2011, EXPIRES 11-29-2021.

SER. NO. 79-110,162, FILED 11-29-2011.

TASHIA BUNCH, EXAMINING ATTORNEY



David J. Kyffers

Director of the United States Patent and Trademark Office

United States of America

United States Patent and Trademark Office

CASPEROME

Reg. No. 4,204,261

Registered Sep. 11, 2012

Int. Cls.: 1, 3, 5 and 29

TRADEMARK

PRINCIPAL REGISTER

INDENA SPA (ITALY CORPORATION)
VIALE ORTLES, 12
I-20139 MILANO
ITALY

FOR: CHEMICALS MADE FROM BOTANICAL EXTRACTS FOR USE IN THE PREPARATION OF PHARMACEUTICAL AND COSMETIC PRODUCTS, NUTRACEUTICALS AND FOOD-STUFFS, WITH THE EXCEPTION OF PRODUCTS INTENDED FOR USE IN THE FLAVOR INDUSTRY, IN CLASS 1 (U.S. CLS. 1, 5, 6, 10, 26 AND 46).

FOR: BOTANICAL EXTRACTS, ESSENTIAL OILS EXCLUDED, FOR THE PREPARATION OF COSMETICS, NAMELY, FACE CREAMS, GELS, OINTMENTS, PRE-SUN BATH PRODUCTS, AFTER-SUN BATH PRODUCTS AND LIPSTICKS, IN CLASS 3 (U.S. CLS. 1, 4, 6, 50, 51 AND 52).

FOR: MEDICINAL PLANTS EXTRACTS FOR PHARMACEUTICAL USE, NAMELY, FOR THE TREATMENT OF INFLAMMATION, FOR THE TREATMENT OF IMMUNE SYSTEM DISEASES, RESPIRATORY SYSTEM DISEASES, CENTRAL NERVOUS SYSTEM DISEASES AND FOR THE TREATMENT OF SKIN DISEASES; MEDICINAL PLANT EXTRACTS FOR USE AS NUTRITIONAL SUPPLEMENTS, IN CLASS 5 (U.S. CLS. 6, 18, 44, 46, 51 AND 52).

FOR: PLANT EXTRACTS, NAMELY, EXTRACTS FROM BOSWELLIA SERRATA, FOR USE AS FOOD, IN CLASS 29 (U.S. CL. 46).

THE MARK CONSISTS OF STANDARD CHARACTERS WITHOUT CLAIM TO ANY PARTICULAR FONT, STYLE, SIZE, OR COLOR.

PRIORITY DATE OF 11-8-2011 IS CLAIMED.

OWNER OF INTERNATIONAL REGISTRATION 1110144 DATED 12-29-2011, EXPIRES 12-29-2021.

SER. NO. 79-110,442, FILED 12-29-2011.

JORDAN BAKER, EXAMINING ATTORNEY



David J. Kyffers

Director of the United States Patent and Trademark Office

United States of America
United States Patent and Trademark Office

gapDRIVE

Reg. No. 4,204,262

Registered Sep. 11, 2012

Int. Cl.: 9

TRADEMARK

PRINCIPAL REGISTER

STMICROELECTRONICS NV (NETHERLANDS NAAMLOZE VENNOOTSCHAP)
WTC SCHIPHOL AIRPORT
SCHIPHOL BOULEVARD 265.; SCHIPHOL AIRPORT.; NL-1118 BH AMSTERDAM
NETHERLANDS

FOR: SEMI-CONDUCTORS; INTEGRATED CIRCUITS; MICROPROCESSORS; MICRO
CONTROLLERS; EMBEDDED MICROPROCESSORS; INTEGRATED CIRCUIT CARDS;
INTEGRATED CIRCUIT CHIPS; PRINTED ELECTRONIC CIRCUITS FOR INTEGRATED
CIRCUIT APPARATUS AND CARDS, IN CLASS 9 (U.S. CLS. 21, 23, 26, 36 AND 38).

THE MARK CONSISTS OF STANDARD CHARACTERS WITHOUT CLAIM TO ANY PAR-
TICULAR FONT, STYLE, SIZE, OR COLOR.

PRIORITY DATE OF 7-7-2011 IS CLAIMED.

OWNER OF INTERNATIONAL REGISTRATION 1110303 DATED 12-30-2011, EXPIRES 12-
30-2021.

SER. NO. 79-110,500, FILED 12-30-2011.

KATHERINE E. HALMEN, EXAMINING ATTORNEY



David J. Kyjars

Director of the United States Patent and Trademark Office

United States of America

United States Patent and Trademark Office

YUKIZNA

Reg. No. 4,204,263

Registered Sep. 11, 2012

Int. Cls.: 18 and 25

TRADEMARK

PRINCIPAL REGISTER

BUILMATEL CO., LTD. (JAPAN CORPORATION)
7-5, NIHONBASHIKAYABACHO 1-CHOME
CHUO-KU; TOKYO 103-0025
JAPAN

FOR: TANNED LEATHER; FOLDING BRIEFCASES; SHOULDER BAGS; GLADSTONE BAGS; BRIEFCASES; SUITCASES; CARRY-ON BAGS; TRAVELLING TRUNKS; HANDBAGS; BOSTON BAGS; TOTE BAGS; RUCKSACKS; PURSES; KEY CASES; POCKET WALLETS; BUSINESS CARD CASES, IN CLASS 18 (U.S. CLS. 1, 2, 3, 22 AND 41).

FOR: JACKETS CLOTHING; SKIRTS AND DRESSES; OVERCOATS; TOPCOATS; CAPS HEADWEAR; HATS; BELTS CLOTHING; LEATHER SHOES; SANDAL SHOES; BEACH SHOES; LADIES' BOOTS, IN CLASS 25 (U.S. CLS. 22 AND 39).

THE MARK CONSISTS OF STANDARD CHARACTERS WITHOUT CLAIM TO ANY PARTICULAR FONT, STYLE, SIZE, OR COLOR.

PRIORITY DATE OF 7-21-2011 IS CLAIMED.

OWNER OF INTERNATIONAL REGISTRATION 1110536 DATED 1-19-2012, EXPIRES 1-19-2022.

SER. NO. 79-110,616, FILED 1-19-2012.

PATRICIA EVANKO, EXAMINING ATTORNEY



David J. Kyffers

Director of the United States Patent and Trademark Office

United States of America

United States Patent and Trademark Office

THE SPLATTERS

Reg. No. 4,204,264

Registered Sep. 11, 2012

Int. Cls.: 9 and 41

TRADEMARK

SERVICE MARK

PRINCIPAL REGISTER

SPIKY SNAIL LTD. (ISRAEL LIMITED LIABILITY COMPANY)
5 REMEZ ST.
52325 RAMAT GAN
ISRAEL

FOR: COMPUTER GAME SOFTWARE; VIDEO GAME PROGRAMS; DOWNLOADABLE COMPUTER GAME PROGRAMS; INTERACTIVE COMPUTER GAME PROGRAMS; DOWNLOADABLE GAME SOFTWARE FOR WIRELESS DEVICES; DOWNLOADABLE GAME SOFTWARE FOR CELLULAR TELEPHONES, IN CLASS 9 (U.S. CLS. 21, 23, 26, 36 AND 38).

FOR: ENTERTAINMENT SERVICES, NAMELY, PROVIDING ON-LINE COMPUTER GAMES, ON-LINE GAME SERVICES, PROVISION OF ON-LINE INFORMATION IN THE FIELD OF COMPUTER GAMES; GAME SERVICES PROVIDED ON-LINE FROM A COMPUTER NETWORK OR MOBILE PHONE NETWORK, IN CLASS 41 (U.S. CLS. 100, 101 AND 107).

THE MARK CONSISTS OF STANDARD CHARACTERS WITHOUT CLAIM TO ANY PARTICULAR FONT, STYLE, SIZE, OR COLOR.

PRIORITY DATE OF 8-10-2011 IS CLAIMED.

OWNER OF INTERNATIONAL REGISTRATION 1112045 DATED 2-7-2012, EXPIRES 2-7-2022.

SER. NO. 79-111,327, FILED 2-7-2012.

JASON BLAIR, EXAMINING ATTORNEY



David J. Kybas

Director of the United States Patent and Trademark Office

United States of America

United States Patent and Trademark Office

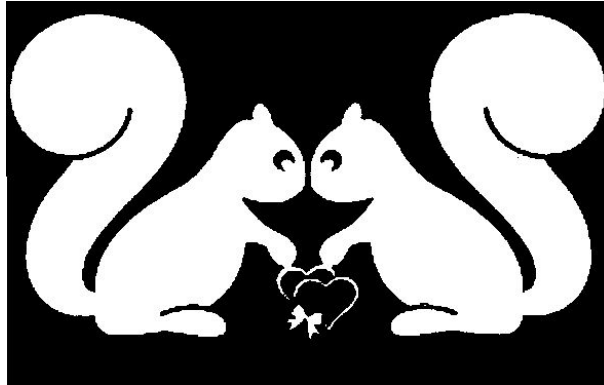

Reg. No. 4,204,265

Registered Sep. 11, 2012

Int. Cl.: 25

TRADEMARK

PRINCIPAL REGISTER

FIVE SEASONS REAL ESTATE S.R.L. (ITALY LIMITED LIABILITY COMPANY)
VIA BENZONI, 11
I-26013 CREMA (CR)
ITALY

FOR: CLOTHING, NAMELY, T-SHIRTS, SHIRTS, JUMPERS, TROUSERS, SKIRTS, BATHING SUITS, JEANS, JACKETS, UNDERCLOTHES, HATS AND CAPS, FOOTWEAR, IN CLASS 25 (U.S. CLS. 22 AND 39).

THE TRADEMARK CONSISTS OF THE DESIGN OF TWO WHITE SQUIRRELS IN PROFILE VIEW AND STANDING IN FRONT OF EACH OTHER WHOSE FORELEG REST ON TWO PARTIALLY SUPERIMPOSED HEARTS WITH A WHITE BOW IN THEIR LOWER LEFT SIDE, THE COLOR WHITE IS NOT PART OF THE MARK, THE COLOR BLACK REPRESENTS BACKGROUND AREAS AND IS NOT PART OF THE MARK.

PRIORITY DATE OF 1-20-2012 IS CLAIMED.

OWNER OF INTERNATIONAL REGISTRATION 1112894 DATED 2-9-2012, EXPIRES 2-9-2022.

SER. NO. 79-111,684, FILED 2-9-2012.

ROBERT STRUCK, EXAMINING ATTORNEY



David J. Kybas

Director of the United States Patent and Trademark Office

United States of America

United States Patent and Trademark Office

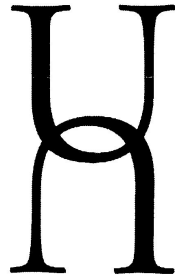

UNIQUENESS

Reg. No. 4,204,266

Registered Sep. 11, 2012

Int. Cls.: 18 and 25

TRADEMARK

PRINCIPAL REGISTER

CRIS CONF. S.P.A. (ITALY JOINT STOCK COMPANY)
STRADA COMUNALE DI FORNIO, 132
I-43036 FIDENZA (PARMA)
ITALY

FOR: HANDBAGS; SHOULDER BAGS; CLUTCH BAGS, IN CLASS 18 (U.S. CLS. 1, 2, 3, 22 AND 41).

FOR: DRESSING GOWNS; PULLOVERS; GLOVES BEING CLOTHING; CARDIGANS; JERSEYS BEING CLOTHING; FOULARDS BEING CLOTHING; SCARVES; MUFFS BEING CLOTHING; SWEATERS; TWIN SETS; TROUSERS; LEGGINGS; SKIRTS; JACKETS BEING CLOTHING; JERKINS; SHIRTS; DRESS SHIRTS; POLO SHIRTS; UNDERSHIRTS; VESTS; WAISTCOATS; JUMPERS; BLOUSES; JEANS; BERMUDA SHORTS; T-SHIRTS; SHAWLS; SUITS; DRESSES; CLOAKS; OVERCOATS; ANORAKS; COATS; BELTS BEING CLOTHING; SHOES; BOOTS; SANDALS; SNEAKERS; HATS; CAPS, IN CLASS 25 (U.S. CLS. 22 AND 39).

THE MARK CONSISTS OF A SIGN DEPICTING THE WORDING UNIQUENESS IN FANCY CHARACTERS UNDERLINED CENTRALLY BY A STYLIZED HORIZONTAL BAND, ABOVE ALL OF WHICH ARE TWO U LETTERS PLACED VERTICALLY, REVERSED ONE WITH THE OTHER TO INTERSECT IN THE CURVED PARTS.

PRIORITY DATE OF 6-30-2011 IS CLAIMED.

OWNER OF INTERNATIONAL REGISTRATION 1114184 DATED 11-8-2011, EXPIRES 11-8-2021.

SER. NO. 79-112,231, FILED 11-8-2011.

SETH A. RAPPAPORT, EXAMINING ATTORNEY



David J. Kybas

Director of the United States Patent and Trademark Office

United States of America

United States Patent and Trademark Office

ONLY FOR YOUR EYES

Reg. No. 4,204,267

Registered Sep. 11, 2012

Int. Cl.: 25

TRADEMARK

PRINCIPAL REGISTER

FIVE SEASONS REAL ESTATE S.R.L. (ITALY LIMITED LIABILITY COMPANY)
VIA BENZONI, 11
I-26013 CREMA (CR)
ITALY

FOR: CLOTHING, NAMELY, T-SHIRTS, SHIRTS, JUMPERS, TROUSERS, SKIRTS, BATHING SUITS, JEANS, JACKETS, UNDERCLOTHES, HATS AND CAPS, FOOTWEAR, IN CLASS 25 (U.S. CLS. 22 AND 39).

THE MARK CONSISTS OF STANDARD CHARACTERS WITHOUT CLAIM TO ANY PARTICULAR FONT, STYLE, SIZE, OR COLOR.

PRIORITY DATE OF 11-18-2011 IS CLAIMED.

OWNER OF INTERNATIONAL REGISTRATION 1114203 DATED 12-7-2011, EXPIRES 12-7-2021.

SER. NO. 79-112,239, FILED 12-7-2011.

ROBERT STRUCK, EXAMINING ATTORNEY



David J. Kybas

Director of the United States Patent and Trademark Office

United States of America

United States Patent and Trademark Office

UVRICH

Reg. No. 4,204,268

Registered Sep. 11, 2012

Int. Cls.: 9 and 11

TRADEMARK

PRINCIPAL REGISTER

SEOUL SEMICONDUCTOR CO., LTD (REPUBLIC OF KOREA CORPORATION)
148-29 GASAN-DONG, KEUMCHUN-GU
KEUMCHUN-GU, SEOUL
REPUBLIC OF KOREA

FOR: DIODES; LIGHT EMITTING DIODES; TOP LIGHT EMITTING DIODES; POWER LIGHT EMITTING DIODES; CHIP LIGHT EMITTING DIODES; BIG TOP LIGHT EMITTING DIODES; HIGH FLUX LIGHT EMITTING DIODES; SIDE VIEW LIGHT EMITTING DIODES; ELECTROLUMINESCENCE DIODES; LASER DIODES; TRAFFIC SIGNAL DEVICES LUMINOUS OR MECHANICAL; TRAFFIC SIGNALING PANELS LUMINOUS OR MECHANICAL; ROAD SIGNS LUMINOUS OR MECHANICAL; SAFETY SIGNALING PANELS LUMINOUS OR MECHANICAL; SAFETY DISPLAY PANELS LUMINOUS OR MECHANICAL; SIGNALING PANELS LUMINOUS OR MECHANICAL; LUMINOUS SIGNS; LUMINOUS BEACONS; VEHICLE BREAKDOWN WARNING TRIANGLES LUMINOUS; INCUBATORS FOR BACTERIA CULTURE; CONSTANT-TEMPERATURE INCUBATORS FOR BACTERIA CULTURES; LIGHT EMITTING DIODE DISPLAYS, IN CLASS 9 (U.S. CLS. 21, 23, 26, 36 AND 38).

FOR: LIGHTS FOR SHIPS; LAMPS FOR DIRECTIONAL SIGNALS OF SHIPS; LIGHT BULBS FOR DIRECTIONAL SIGNALS FOR SHIPS; HEADLIGHTS FOR SHIPS; LIGHTS FOR AIRCRAFTS; LAMPS FOR DIRECTIONAL SIGNALS OF AIRCRAFTS; LIGHT BULBS FOR DIRECTIONAL SIGNALS OF AIRCRAFTS; HEADLIGHTS FOR AIRCRAFTS; LIGHTS FOR RAILWAY VEHICLES; LAMPS FOR DIRECTIONAL SIGNALS OF RAILWAY VEHICLES; HEADLIGHTS FOR RAILWAY VEHICLES; CYCLE LIGHTS; AUTOMOBILE LIGHTS; LAMPS FOR DIRECTIONAL SIGNALS OF AUTOMOBILES; LIGHT BULBS FOR DIRECTIONAL SIGNALS OF AUTOMOBILES; HEADLIGHTS FOR AUTOMOBILES; BICYCLE LIGHTS; AIR PURIFYING APPARATUS AND MACHINES; AIR DEODORIZING APPARATUS, NAMELY, ELECTRIC ROOM DEODORIZING UNITS; WATER STERILIZERS; STREET LAMPS; GERMICIDAL LAMPS FOR PURIFYING AIR; ULTRAVIOLET RAY LAMPS FOR NON-MEDICAL PURPOSES; GERMICIDAL LAMPS NOT FOR MEDICAL PURPOSES; SPOTLIGHTS; DECORATIVE ELECTRIC LIGHTS, NAMELY, FAIRY LIGHTS; ELECTRIC TORCHES FOR LIGHTING; FAIRY LIGHTS FOR FESTIVE DECORATION; ELECTRIC LIGHTS FOR CHRISTMAS TREES; STANDARD LAMPS; ARTIFICIAL SOLAR LAMPS; FLUORESCENT LAMPS; WATER PURIFIERS FOR HOUSEHOLD PURPOSES; HUMIDIFIERS; ELECTRIC REFRIGERATORS; ELECTRIC KETTLES; LIGHT EMITTING DIODE LAMPS; DISH DISINFECTANT APPARATUS FOR HOUSEHOLD PURPOSES; FLASHLIGHTS; LIGHT EMITTING DIODES LIGHTING FIXTURES; LIGHT EMITTING DIODES LIGHTING FIXTURES FOR USE IN DISPLAY, COMMERCIAL, INDUSTRIAL, RESIDENTIAL, AND ARCHI-



David J. Kypos

Director of the United States Patent and Trademark Office

Reg. No. 4,204,268 TECTURAL ACCENT LIGHTING APPLICATIONS; CRANK-POWERED PORTABLE LAMPS; LIGHT EMITTING DIODES LAMPS WHOSE LIGHT CAN BE TURNED IN ALL DIRECTIONS; LAMPS; OVERHEAD LAMPS; PROJECTOR LAMPS; SAFETY LAMPS FOR UNDERGROUND USE; SOLDERING LAMPS; SUN LAMPS NOT FOR MEDICAL PURPOSE; TANNING LAMPS; VEHICLE DYNAMO LAMPS; OUTDOOR LAMPS; FLASHLIGHTS WITH LIGHT EMITTING DIODES FOR USE IN PHOTOGRAPHY, IN CLASS 11 (U.S. CLS. 13, 21, 23, 31 AND 34).

THE MARK CONSISTS OF STANDARD CHARACTERS WITHOUT CLAIM TO ANY PARTICULAR FONT, STYLE, SIZE, OR COLOR.

PRIORITY DATE OF 9-30-2011 IS CLAIMED.

OWNER OF INTERNATIONAL REGISTRATION 1114583 DATED 12-16-2011, EXPIRES 12-16-2021.

SER. NO. 79-112,364, FILED 12-16-2011.

DOMINICK J. SALEMI, EXAMINING ATTORNEY

United States of America

United States Patent and Trademark Office



KOMPRESSOR

Reg. No. 4,204,269

LG ELECTRONICS INC. (REPUBLIC OF KOREA CORPORATION)
20, YEOUIDO-DONG, YEONGDEUNGPO-GU
SEOUL, REPUBLIC OF KOREA 150-721

Registered Sep. 11, 2012

Int. Cl.: 7

FOR: ELECTRIC VACUUM CLEANERS, IN CLASS 7 (U.S. CLS. 13, 19, 21, 23, 31, 34 AND 35).

TRADEMARK

OWNER OF REPUBLIC OF KOREA REG. NO. 0860228, DATED 4-8-2011, EXPIRES 4-8-2021.

PRINCIPAL REGISTER

OWNER OF U.S. REG. NO. 3,631,943.

NO CLAIM IS MADE TO THE EXCLUSIVE RIGHT TO USE "KOMPRESSOR", APART FROM THE MARK AS SHOWN.

THE MARK CONSISTS OF THE WORDING "KOMPRESSOR" IN A STYLIZED FONT UNDERNEATH A SQUARE WITH ROUNDED EDGES AND A SPIRAL DESIGN. WITHIN THE SQUARE IS A LETTER "K" IN A STYLIZED FONT, TO THE RIGHT OF WHICH IS A HEXAGON WITH SIX SURROUNDING HEXAGONS.

THE ENGLISH TRANSLATION OF "KOMPRESSOR" IN THE MARK IS "COMPRESSOR".

SER. NO. 85-001,654, FILED 3-30-2010.

JAMES MACFARLANE, EXAMINING ATTORNEY



David J. Kyros

Director of the United States Patent and Trademark Office

United States of America

United States Patent and Trademark Office

GLOBAL EXCELLENCE IN MICROSURGERY

Reg. No. 4,204,270

Registered Sep. 11, 2012

Int. Cl.: 10

TRADEMARK

PRINCIPAL REGISTER

SYNOVIS LIFE TECHNOLOGIES, INC. (MINNESOTA CORPORATION)
SUITE 180
2575 UNIVERSITY AVENUE WEST
ST. PAUL, MN 551141024

FOR: MICROVASCULAR ANASTOMOTIC COUPLERS FOR PERFORMING ANASTOMOSIS AND MONITORING PARAMETERS DURING AND AFTER SURGERY; ABSORBABLE WOVEN POLYGLYCOLIC ACID MESH TUBE FOR USE IN JOINING SEVERED NERVES TO ALLOW REGENERATION AND REJOINING OF NERVES; SURGICAL MICROCLIPS; SURGICAL HEADLAMP, IN CLASS 10 (U.S. CLS. 26, 39 AND 44).

FIRST USE 3-31-2010; IN COMMERCE 3-31-2010.

THE MARK CONSISTS OF STANDARD CHARACTERS WITHOUT CLAIM TO ANY PARTICULAR FONT, STYLE, SIZE, OR COLOR.

NO CLAIM IS MADE TO THE EXCLUSIVE RIGHT TO USE "MICROSURGERY", APART FROM THE MARK AS SHOWN.

SER. NO. 85-010,169, FILED 4-9-2010.

ROBERT C. CLARK JR., EXAMINING ATTORNEY



David J. Kyffers

Director of the United States Patent and Trademark Office

United States of America
United States Patent and Trademark Office

TISANAX

Reg. No. 4,204,271

VLADIMIR BADMAEV (UNITED STATES INDIVIDUAL)
1440-6 FOREST HILL RD.

Registered Sep. 11, 2012

STATEN ISLAND, NY 10314

Int. Cl.: 5

FOR: DIETARY AND NUTRITIONAL SUPPLEMENTS, IN CLASS 5 (U.S. CLS. 6, 18, 44, 46, 51 AND 52).

TRADEMARK

FIRST USE 6-15-1986; IN COMMERCE 6-15-1986.

PRINCIPAL REGISTER

THE MARK CONSISTS OF STANDARD CHARACTERS WITHOUT CLAIM TO ANY PARTICULAR FONT, STYLE, SIZE, OR COLOR.

SER. NO. 85-011,113, FILED 4-10-2010.

RAMONA ORTIGA, EXAMINING ATTORNEY



David J. Kyffers

Director of the United States Patent and Trademark Office

United States of America

United States Patent and Trademark Office

PALLIARE24

Reg. No. 4,204,272

Registered Sep. 11, 2012

Int. Cls.: 5 and 10

TRADEMARK

PRINCIPAL REGISTER

JANISYS LIMITED (IRELAND LIMITED COMPANY)
GALWAY BUSINESS PARK
DANGAN, GALWAY, IRELAND

FOR: MEDICAL AND VETERINARY DELIVERY APPARATUS, EQUIPMENT, INSTRUMENTS, DEVICES AND SYSTEMS, NAMELY, DRUG DELIVERY AGENTS IN THE FORM OF TABLETS, POWDERS, CAPSULES, PILLS, CAPLETS, LIQUID DROPS AND SACHETS THAT PROVIDE CONTROLLED RELEASE OF ACTIVE INGREDIENTS FOR A WIDE VARIETY OF MEDICAMENTS, PHARMACEUTICALS, VACCINES AND DRUGS FOR DELIVERY THEREOF INTRADERMALLY, TRANSDERMALLY, SUBCUTANEOUSLY OR OTHERWISE THROUGH THE SKIN; TRANSDERMAL PATCHES FOR USE IN THE TREATMENT OF VIRAL, METABOLIC, ENDOCRINE, MUSCULOSKELETAL, CARDIOVASCULAR, CARDIOPULMONARY, GENITOURINARY, SEXUAL DYSFUNCTION, ONCOLOGICAL, HEPATOLOGICAL, OPHTHALMIC, RESPIRATORY, NEUROLOGICAL, GASTROINTESTINAL, HORMONAL AND DERMATOLOGICAL DISEASES AND DISORDERS, IMMUNE SYSTEM RELATED DISEASES AND DISORDERS, CANCER, AUTOIMMUNE DISEASES AND DISORDERS, DIABETES, KIDNEY DISEASES AND DISORDERS, OCULAR DISEASES AND DISORDERS, BACTERIA-BASED DISEASES AND DISORDERS, INFLUENZA, PSYCHIATRIC DISEASES AND DISORDERS, VOICE DISORDERS, DIGESTIVE DISORDERS, VULVOVAGINAL DISORDERS, CONGENITAL DISORDERS, DEPRESSION, EATING DISORDERS, ANOREXIA, OBESITY, INFECTIOUS DISEASES AND BONE DISEASES CONTAINING MEDICAMENTS, PHARMACEUTICALS, VACCINES AND DRUGS FOR DELIVERY THEREOF INTRADERMALLY, TRANSDERMALLY, SUBCUTANEOUSLY OR OTHERWISE THROUGH THE SKIN; MICRO-NEEDLE DEVICES, NAMELY, ACTIVE TRANSDERMAL MICRO-NEEDLE DRUG DELIVERY PATCHES FOR USE IN THE TREATMENT OF VIRAL, METABOLIC, ENDOCRINE, MUSCULOSKELETAL, CARDIOVASCULAR, CARDIOPULMONARY, GENITOURINARY, SEXUAL DYSFUNCTION, ONCOLOGICAL, HEPATOLOGICAL, OPHTHALMIC, RESPIRATORY, NEUROLOGICAL, GASTROINTESTINAL, HORMONAL AND DERMATOLOGICAL DISEASES AND DISORDERS, IMMUNE SYSTEM RELATED DISEASES AND DISORDERS, CANCER, AUTOIMMUNE DISEASES AND DISORDERS, DIABETES, KIDNEY DISEASES AND DISORDERS, OCULAR DISEASES AND DISORDERS, BACTERIA-BASED DISEASES AND DISORDERS, INFLUENZA, PSYCHIATRIC DISEASES AND DISORDERS, VOICE DISORDERS, DIGESTIVE DISORDERS, VULVOVAGINAL DISORDERS, CONGENITAL DISORDERS, DEPRESSION, EATING DISORDERS, ANOREXIA, OBESITY, INFECTIOUS DISEASES AND BONE DISEASES CONTAINING MEDICAMENTS, PHARMACEUTICALS, VACCINES AND DRUGS INTRADERMALLY, TRANSDERMALLY, SUBCUTANEOUSLY



David J. Kypos

Director of the United States Patent and Trademark Office

Reg. No. 4,204,272 OR OTHERWISE THROUGH THE SKIN; CARTRIDGES SOLD PRE-FILLED WITH MEDICAMENTS, PHARMACEUTICALS, VACCINES AND DRUGS FOR THE TREATMENT OF VIRAL, METABOLIC, ENDOCRINE, MUSCULOSKELETAL, CARDIOVASCULAR, CARDIOPULMONARY, GENITOURINARY, SEXUAL DYSFUNCTION, ONCOLOGICAL, HEPATOLOGICAL, OPHTHALMIC, RESPIRATORY, NEUROLOGICAL, GASTROINTESTINAL, HORMONAL AND DERMATOLOGICAL DISEASES AND DISORDERS, IMMUNE SYSTEM RELATED DISEASES AND DISORDERS, CANCER, AUTOIMMUNE DISEASES AND DISORDERS, DIABETES, KIDNEY DISEASES AND DISORDERS, OCULAR DISEASES AND DISORDERS, BACTERIA-BASED DISEASES AND DISORDERS, INFLUENZA, PSYCHIATRIC DISEASES AND DISORDERS, VOICE DISORDERS, DIGESTIVE DISORDERS, VULVOVAGINAL DISORDERS, CONGENITAL DISORDERS, DEPRESSION, EATING DISORDERS, ANOREXIA, OBESITY, INFECTIOUS DISEASES AND BONE DISEASES USED IN MEDICAL AND VETERINARY DELIVERY APPARATUS, EQUIPMENT, INSTRUMENTS, DEVICES AND SYSTEMS; AND CARTRIDGES SOLD PRE-FILLED WITH MEDICAMENTS, PHARMACEUTICALS, VACCINES AND DRUGS FOR THE TREATMENT OF VIRAL, METABOLIC, ENDOCRINE, MUSCULOSKELETAL, CARDIOVASCULAR, CARDIOPULMONARY, GENITOURINARY, SEXUAL DYSFUNCTION, ONCOLOGICAL, HEPATOLOGICAL, OPHTHALMIC, RESPIRATORY, NEUROLOGICAL, GASTROINTESTINAL, HORMONAL AND DERMATOLOGICAL DISEASES AND DISORDERS, IMMUNE SYSTEM RELATED DISEASES AND DISORDERS, CANCER, AUTOIMMUNE DISEASES AND DISORDERS, DIABETES, KIDNEY DISEASES AND DISORDERS, OCULAR DISEASES AND DISORDERS, BACTERIA-BASED DISEASES AND DISORDERS, INFLUENZA, PSYCHIATRIC DISEASES AND DISORDERS, VOICE DISORDERS, DIGESTIVE DISORDERS, VULVOVAGINAL DISORDERS, CONGENITAL DISORDERS, DEPRESSION, EATING DISORDERS, ANOREXIA, OBESITY, INFECTIOUS DISEASES AND BONE DISEASES USED IN MICRO-NEEDLE DEVICES, IN CLASS 5 (U.S. CLS. 6, 18, 44, 46, 51 AND 52).

FOR: TRANSDERMAL DRUG DELIVERY PATCHES SOLD WITHOUT MEDICATION; MEDICAL AND VETERINARY DELIVERY APPARATUS, EQUIPMENT, INSTRUMENTS, DEVICES AND SYSTEMS, NAMELY, DRUG DELIVERY PATCHES SOLD WITHOUT MEDICATION, ELECTRONIC-KINETIC TRANSDERMAL DRUG DELIVERY CONTROL UNIT FOR THE TREATMENT OF DISEASES FOR DELIVERING MEDICAMENTS, PHARMACEUTICALS, VACCINES AND OTHER SUBSTANCES INTRADERMALLY, TRANSDERMALLY, SUBCUTANEOUSLY OR OTHERWISE THROUGH THE SKIN; MEDICAL AND VETERINARY APPARATUS, EQUIPMENT, INSTRUMENTS, DEVICES AND SYSTEMS, NAMELY, MICRO-NEEDLES FOR MEDICAL USE; MEDICAL NEEDLES AND INTRODUCERS, DRAINAGE TUBES FOR MEDICAL PURPOSES AND WOUND SUCTION APPARATUS FOR WITHDRAWING BODILY SUBSTANCES INTRADERMALLY, TRANSDERMALLY, SUBCUTANEOUSLY OR OTHERWISE THROUGH THE SKIN; DRUG DELIVERY PATCHES SOLD WITHOUT MEDICATION FOR DELIVERING MEDICAMENTS, PHARMACEUTICALS, VACCINES AND OTHER SUBSTANCES INTRADERMALLY, TRANSDERMALLY, SUBCUTANEOUSLY OR OTHERWISE THROUGH THE SKIN; MICRO-NEEDLE DEVICES, NAMELY, ACTIVE TRANSDERMAL MICRO-NEEDLE DRUG DELIVERY PATCHES SOLD WITHOUT MEDICATION FOR THE TREATMENT OF DISEASES FOR DELIVERING MEDICAMENTS, PHARMACEUTICALS, VACCINES AND OTHER SUBSTANCES INTRADERMALLY, TRANSDERMALLY, SUBCUTANEOUSLY OR OTHERWISE THROUGH THE SKIN; MICRO-NEEDLE DEVICES, NAMELY, ACTIVE TRANSDERMAL MICRO-NEEDLE DRUG DELIVERY PATCHES SOLD WITHOUT MEDICATION FOR THE TREATMENT OF DISEASES FOR WITHDRAWING BODILY SUBSTANCES INTRADERMALLY, TRANSDERMALLY, SUBCUTANEOUSLY OR OTHERWISE THROUGH THE SKIN; MICRO-NEEDLES FOR DELIVERING MEDICAMENTS, PHARMACEUTICALS, VACCINES AND OTHER SUBSTANCES INTRADERMALLY, TRANSDERMALLY, SUBCUTANEOUSLY OR OTHERWISE THROUGH THE SKIN; MICRO-NEEDLES FOR MEDICAL USE FOR WITHDRAWING BODILY SUBSTANCES INTRADERMALLY, TRANSDERMALLY, SUBCUTANEOUSLY OR OTHERWISE THROUGH THE SKIN; MICRO-NEEDLE ELEMENTS, NAMELY, NEEDLE-FREE INJECTION SYSTEMS, NEEDLE-BASED INJECTION SYSTEMS AND INJECTION INSTRUMENTS WITH NEEDLES FOR USE IN SUCH MICRO-NEEDLE DEVICES; CARTRIDGES SOLD EMPTY SPECIALLY DESIGNED FOR HOLDING MEDICAMENTS, PHARMACEUTICALS, VACCINES

Reg. No. 4,204,272 AND DRUGS FOR USE IN MEDICAL AND VETERINARY DELIVERY APPARATUS, EQUIPMENT, INSTRUMENTS, DEVICES AND SYSTEMS; CARTRIDGES SOLD EMPTY SPECIALLY DESIGNED FOR HOLDING MEDICAMENTS, PHARMACEUTICALS, VACCINES AND DRUGS USED IN MICRO-NEEDLE DEVICES; NEEDLES FOR MEDICAL AND VETERINARY PURPOSES; DIAGNOSTIC APPARATUS, EQUIPMENT, INSTRUMENTS, DEVICES AND SYSTEMS, NAMELY, BLOOD PRESSURE MONITORS, HEMATOLOGY ANALYZERS FOR MEDICAL DIAGNOSTIC USES, HAEMOSTATS AND DIALYSIS MACHINES FOR MEDICAL AND VETERINARY PURPOSES, IN CLASS 10 (U.S. CLS. 26, 39 AND 44).

THE MARK CONSISTS OF STANDARD CHARACTERS WITHOUT CLAIM TO ANY PARTICULAR FONT, STYLE, SIZE, OR COLOR.

PRIORITY CLAIMED UNDER SEC. 44(D) ON ERPN CMNTY TM OFC APPLICATION NO. 008731416, FILED 12-3-2009, REG. NO. 008731416, DATED 6-11-2010, EXPIRES 12-3-2019.

THE WORDING "PALLIARE" HAS NO MEANING IN A FOREIGN LANGUAGE.

SER. NO. 85-014,806, FILED 4-15-2010.

CHARISMA HAMPTON, EXAMINING ATTORNEY

United States of America

United States Patent and Trademark Office

AUXX

Reg. No. 4,204,273

Registered Sep. 11, 2012

Int. Cls.: 5 and 10

TRADEMARK

PRINCIPAL REGISTER

JANISYS LIMITED (IRELAND LIMITED COMPANY)
GALWAY BUSINESS PARK
DANGAN, GALWAY, IRELAND

FOR: MEDICAL AND VETERINARY DELIVERY APPARATUS, EQUIPMENT, INSTRUMENTS, DEVICES AND SYSTEMS, NAMELY, DRUG DELIVERY AGENTS IN THE FORM OF TABLETS, POWDERS, CAPSULES, PILLS, CAPLETS, LIQUID DROPS AND SACHETS THAT PROVIDE CONTROLLED RELEASE OF ACTIVE INGREDIENTS FOR A WIDE VARIETY OF MEDICAMENTS, PHARMACEUTICALS, VACCINES AND DRUGS FOR DELIVERY THEREOF INTRADERMALLY, TRANSDERMALLY, SUBCUTANEOUSLY OR OTHERWISE THROUGH THE SKIN; TRANSDERMAL PATCHES FOR USE IN THE TREATMENT OF VIRAL, METABOLIC, ENDOCRINE, MUSCULOSKELETAL, CARDIOVASCULAR, CARDIOPULMONARY, GENITOURINARY, SEXUAL DYSFUNCTION, ONCOLOGICAL, HEPATOLOGICAL, OPHTHALMIC, RESPIRATORY, NEUROLOGICAL, GASTROINTESTINAL, HORMONAL AND DERMATOLOGICAL DISEASES AND DISORDERS, IMMUNE SYSTEM RELATED DISEASES AND DISORDERS, CANCER, AUTOIMMUNE DISEASES AND DISORDERS, DIABETES, KIDNEY DISEASES AND DISORDERS, OCULAR DISEASES AND DISORDERS, BACTERIA-BASED DISEASES AND DISORDERS, INFLUENZA, PSYCHIATRIC DISEASES AND DISORDERS, VOICE DISORDERS, DIGESTIVE DISORDERS, VULVOVAGINAL DISORDERS, CONGENITAL DISORDERS, DEPRESSION, EATING DISORDERS, ANOREXIA, OBESITY, INFECTIOUS DISEASES AND BONE DISEASES CONTAINING MEDICAMENTS, PHARMACEUTICALS, VACCINES AND DRUGS FOR DELIVERY THEREOF INTRADERMALLY, TRANSDERMALLY, SUBCUTANEOUSLY OR OTHERWISE THROUGH THE SKIN; MICRO-NEEDLE DEVICES, NAMELY, ACTIVE TRANSDERMAL MICRO-NEEDLE DRUG DELIVERY PATCHES FOR USE IN THE TREATMENT OF VIRAL, METABOLIC, ENDOCRINE, MUSCULOSKELETAL, CARDIOVASCULAR, CARDIOPULMONARY, GENITOURINARY, SEXUAL DYSFUNCTION, ONCOLOGICAL, HEPATOLOGICAL, OPHTHALMIC, RESPIRATORY, NEUROLOGICAL, GASTROINTESTINAL, HORMONAL AND DERMATOLOGICAL DISEASES AND DISORDERS, IMMUNE SYSTEM RELATED DISEASES AND DISORDERS, CANCER, AUTOIMMUNE DISEASES AND DISORDERS, DIABETES, KIDNEY DISEASES AND DISORDERS, OCULAR DISEASES AND DISORDERS, BACTERIA-BASED DISEASES AND DISORDERS, INFLUENZA, PSYCHIATRIC DISEASES AND DISORDERS, VOICE DISORDERS, DIGESTIVE DISORDERS, VULVOVAGINAL DISORDERS, CONGENITAL DISORDERS, DEPRESSION, EATING DISORDERS, ANOREXIA, OBESITY, INFECTIOUS DISEASES AND BONE DISEASES CONTAINING MEDICAMENTS, PHARMACEUTICALS, VACCINES AND DRUGS INTRADERMALLY, TRANSDERMALLY, SUBCUTANEOUSLY



David J. Kyros

Director of the United States Patent and Trademark Office

Reg. No. 4,204,273 OR OTHERWISE THROUGH THE SKIN; CARTRIDGES SOLD PRE-FILLED WITH MEDICAMENTS, PHARMACEUTICALS, VACCINES AND DRUGS FOR THE TREATMENT OF VIRAL, METABOLIC, ENDOCRINE, MUSCULOSKELETAL, CARDIOVASCULAR, CARDIOPULMONARY, GENITOURINARY, SEXUAL DYSFUNCTION, ONCOLOGICAL, HEPATOLOGICAL, OPHTHALMIC, RESPIRATORY, NEUROLOGICAL, GASTROINTESTINAL, HORMONAL AND DERMATOLOGICAL DISEASES AND DISORDERS, IMMUNE SYSTEM RELATED DISEASES AND DISORDERS, CANCER, AUTOIMMUNE DISEASES AND DISORDERS, DIABETES, KIDNEY DISEASES AND DISORDERS, OCULAR DISEASES AND DISORDERS, BACTERIA-BASED DISEASES AND DISORDERS, INFLUENZA, PSYCHIATRIC DISEASES AND DISORDERS, VOICE DISORDERS, DIGESTIVE DISORDERS, VULVOVAGINAL DISORDERS, CONGENITAL DISORDERS, DEPRESSION, EATING DISORDERS, ANOREXIA, OBESITY, INFECTIOUS DISEASES AND BONE DISEASES USED IN MEDICAL AND VETERINARY DELIVERY APPARATUS, EQUIPMENT, INSTRUMENTS, DEVICES AND SYSTEMS; AND CARTRIDGES SOLD PRE-FILLED WITH MEDICAMENTS, PHARMACEUTICALS, VACCINES AND DRUGS FOR THE TREATMENT OF VIRAL, METABOLIC, ENDOCRINE, MUSCULOSKELETAL, CARDIOVASCULAR, CARDIOPULMONARY, GENITOURINARY, SEXUAL DYSFUNCTION, ONCOLOGICAL, HEPATOLOGICAL, OPHTHALMIC, RESPIRATORY, NEUROLOGICAL, GASTROINTESTINAL, HORMONAL AND DERMATOLOGICAL DISEASES AND DISORDERS, IMMUNE SYSTEM RELATED DISEASES AND DISORDERS, CANCER, AUTOIMMUNE DISEASES AND DISORDERS, DIABETES, KIDNEY DISEASES AND DISORDERS, OCULAR DISEASES AND DISORDERS, BACTERIA-BASED DISEASES AND DISORDERS, INFLUENZA, PSYCHIATRIC DISEASES AND DISORDERS, VOICE DISORDERS, DIGESTIVE DISORDERS, VULVOVAGINAL DISORDERS, CONGENITAL DISORDERS, DEPRESSION, EATING DISORDERS, ANOREXIA, OBESITY, INFECTIOUS DISEASES AND BONE DISEASES USED IN MICRO-NEEDLE DEVICES, IN CLASS 5 (U.S. CLS. 6, 18, 44, 46, 51 AND 52).

FOR: TRANSDERMAL DRUG DELIVERY PATCHES SOLD WITHOUT MEDICATION; MEDICAL AND VETERINARY DELIVERY APPARATUS, EQUIPMENT, INSTRUMENTS, DEVICES AND SYSTEMS, NAMELY, DRUG DELIVERY PATCHES SOLD WITHOUT MEDICATION, ELECTRONIC-KINETIC TRANSDERMAL DRUG DELIVERY CONTROL UNIT FOR THE TREATMENT OF DISEASES FOR DELIVERING MEDICAMENTS, PHARMACEUTICALS, VACCINES AND OTHER SUBSTANCES INTRADERMALLY, TRANSDERMALLY, SUBCUTANEOUSLY OR OTHERWISE THROUGH THE SKIN; MEDICAL AND VETERINARY APPARATUS, EQUIPMENT, INSTRUMENTS, DEVICES AND SYSTEMS, NAMELY, MICRO-NEEDLES FOR MEDICAL USE; MEDICAL NEEDLES AND INTRODUCERS, DRAINAGE TUBES FOR MEDICAL PURPOSES AND WOUND SUCTION APPARATUS FOR WITHDRAWING BODILY SUBSTANCES INTRADERMALLY, TRANSDERMALLY, SUBCUTANEOUSLY OR OTHERWISE THROUGH THE SKIN; DRUG DELIVERY PATCHES SOLD WITHOUT MEDICATION FOR DELIVERING MEDICAMENTS, PHARMACEUTICALS, VACCINES AND OTHER SUBSTANCES INTRADERMALLY, TRANSDERMALLY, SUBCUTANEOUSLY OR OTHERWISE THROUGH THE SKIN; MICRO-NEEDLE DEVICES, NAMELY, ACTIVE TRANSDERMAL MICRO-NEEDLE DRUG DELIVERY PATCHES SOLD WITHOUT MEDICATION FOR THE TREATMENT OF DISEASES FOR DELIVERING MEDICAMENTS, PHARMACEUTICALS, VACCINES AND OTHER SUBSTANCES INTRADERMALLY, TRANSDERMALLY, SUBCUTANEOUSLY OR OTHERWISE THROUGH THE SKIN; MICRO-NEEDLE DEVICES, NAMELY, ACTIVE TRANSDERMAL MICRO-NEEDLE DRUG DELIVERY PATCHES SOLD WITHOUT MEDICATION FOR THE TREATMENT OF DISEASES FOR WITHDRAWING BODILY SUBSTANCES INTRADERMALLY, TRANSDERMALLY, SUBCUTANEOUSLY OR OTHERWISE THROUGH THE SKIN; MICRO-NEEDLES FOR DELIVERING MEDICAMENTS, PHARMACEUTICALS, VACCINES AND OTHER SUBSTANCES INTRADERMALLY, TRANSDERMALLY, SUBCUTANEOUSLY OR OTHERWISE THROUGH THE SKIN; MICRO-NEEDLES FOR MEDICAL USE FOR WITHDRAWING BODILY SUBSTANCES INTRADERMALLY, TRANSDERMALLY, SUBCUTANEOUSLY OR OTHERWISE THROUGH THE SKIN; MICRO-NEEDLE ELEMENTS, NAMELY, NEEDLE-FREE INJECTION SYSTEMS, NEEDLE-BASED INJECTION SYSTEMS AND INJECTION INSTRUMENTS WITH NEEDLES FOR USE IN SUCH MICRO-NEEDLE DEVICES; CARTRIDGES SOLD EMPTY SPECIALLY DESIGNED FOR HOLDING MEDICAMENTS, PHARMACEUTICALS, VACCINES

Reg. No. 4,204,273 AND DRUGS FOR USE IN MEDICAL AND VETERINARY DELIVERY APPARATUS, EQUIPMENT, INSTRUMENTS, DEVICES AND SYSTEMS; CARTRIDGES SOLD EMPTY SPECIALLY DESIGNED FOR HOLDING MEDICAMENTS, PHARMACEUTICALS, VACCINES AND DRUGS USED IN MICRO-NEEDLE DEVICES; NEEDLES FOR MEDICAL AND VETERINARY PURPOSES; DIAGNOSTIC APPARATUS, EQUIPMENT, INSTRUMENTS, DEVICES AND SYSTEMS, NAMELY, BLOOD PRESSURE MONITORS, HEMATOLOGY ANALYZERS FOR MEDICAL DIAGNOSTIC USES, HAEMOSTATS AND DIALYSIS MACHINES FOR MEDICAL AND VETERINARY PURPOSES, IN CLASS 10 (U.S. CLS. 26, 39 AND 44).

THE MARK CONSISTS OF STANDARD CHARACTERS WITHOUT CLAIM TO ANY PARTICULAR FONT, STYLE, SIZE, OR COLOR.

PRIORITY CLAIMED UNDER SEC. 44(D) ON ERPN CMNTY TM OFC APPLICATION NO. 008731465, FILED 12-3-2009, REG. NO. 008731465, DATED 6-2-2010, EXPIRES 12-3-2019.

THE WORDING "AUXX" HAS NO MEANING IN A FOREIGN LANGUAGE.

SER. NO. 85-014,822, FILED 4-15-2010.

CHARISMA HAMPTON, EXAMINING ATTORNEY

United States of America

United States Patent and Trademark Office



Reg. No. 4,204,274

PRIMAL SPIRIT, INC. (WEST VIRGINIA CORPORATION), DBA PRIMAL SPIRIT FOODS
RR 1, BOX 314
MOUNDSVILLE, WV 26041

Registered Sep. 11, 2012

Int. Cl.: 29

FOR: SOY, WHEAT, GLUTEN, AND OTHER VEGETABLE-BASED MEAT SUBSTITUTE
SNACK FOODS, IN CLASS 29 (U.S. CL. 46).

TRADEMARK

FIRST USE 3-6-2009; IN COMMERCE 3-6-2009.

PRINCIPAL REGISTER

OWNER OF U.S. REG. NOS. 3,070,583 AND 3,070,585.

THE MARK CONSISTS OF THE WORD "PRIMAL" IN STYLIZED FONT UNDER A DESIGN
OF A STYLIZED HEART.

SER. NO. 85-035,467, FILED 5-11-2010.

MARILYN IZZI, EXAMINING ATTORNEY



David J. Kybas

Director of the United States Patent and Trademark Office

United States of America

United States Patent and Trademark Office



Reg. No. 4,204,275

Registered Sep. 11, 2012

Int. Cl.: 41

SERVICE MARK

PRINCIPAL REGISTER

IMPOSSIBLE2POSSIBLE, INC. (COLORADO CORPORATION)
9706 MAPLE STREET
BELLFLOWER, CA 90706

FOR: EDUCATIONAL AND ENTERTAINMENT SERVICES, NAMELY, PROVIDING EXPERIENTIAL LEARNING ACTIVITIES, NAMELY, CLASSES, SEMINARS AND WORKSHOPS FOR YOUTH IN THE FIELD OF GLOBAL SOCIAL AND ENVIRONMENTAL ACTION; EDUCATIONAL SERVICES, NAMELY, CONDUCTING CLASSES, SEMINARS, CONFERENCES, WORKSHOPS, RETREATS, CAMPS AND FIELD TRIPS IN THE FIELD OF GLOBAL SOCIAL AND ENVIRONMENTAL ACTION; EDUCATIONAL SERVICES, NAMELY, PROVIDING LIVE AND ON-LINE CLASSES, SEMINARS AND WORKSHOPS IN THE FIELD OF GLOBAL SOCIAL AND ENVIRONMENTAL ACTION; ORGANIZING ON-LINE EXHIBITIONS AND CONFERENCES IN THE FIELDS OF EDUCATION, CULTURE, SPORTS AND ENTERTAINMENT FOR NON-BUSINESS AND NON-COMMERCIAL PURPOSES; EDUCATIONAL SERVICES, NAMELY, CONDUCTING ON-LINE CLASSES AND WORKSHOPS IN THE FIELD OF CUSTOMIZED LEADERSHIP TRAINING AND RESEARCH AND WRITING EDUCATIONAL MATERIALS; PRODUCTION OF FILMS AND TELEVISION PROGRAMS; PROVIDING CURRENT EVENT NEWS AND INFORMATION VIA A GLOBAL COMPUTER NETWORK, NAMELY, CURRENT EVENT NEWS RELATING TO GLOBAL AND SOCIAL AND ENVIRONMENTAL ACTION UNDERTAKEN BY OTHERS; PROVIDING A WEBSITE FEATURING INFORMATION ON EXERCISE AND FITNESS; PROVIDING COURSES AND INFORMATION IN THE FIELD OF GLOBAL WATER RESOURCES AND WATER MANAGEMENT, IN CLASS 41 (U.S. CLS. 100, 101 AND 107).

FIRST USE 6-17-2008; IN COMMERCE 6-17-2008.

THE MARK CONSISTS OF THE STYLIZED WORDING "I2P" BELOW WHICH IS LOCATED THE STYLIZED WORDING "IMPOSSIBLE2POSSIBLE". ALL OF THE STYLIZED WORDING ARE CONTAINED WITHIN AN OUTLINED RECTANGLE WITH ROUNDED CORNERS.

SER. NO. 85-036,989, FILED 5-12-2010.

NAPOLEON SHARMA, EXAMINING ATTORNEY



David J. Kyjars

Director of the United States Patent and Trademark Office

United States of America

United States Patent and Trademark Office

Lemon / Lime Saver

Reg. No. 4,204,276

Registered Sep. 11, 2012

Int. Cl.: 21

TRADEMARK

PRINCIPAL REGISTER

HUTZLER MANUFACTURING CO., INC. (NEW YORK CORPORATION)
4 GRACE WAY
CANAAN, CT 06018

FOR: CONTAINERS FOR HOUSEHOLD OR KITCHEN USE; CONTAINERS FOR HOUSEHOLD USE; HOUSEHOLD CONTAINERS FOR FOODS; PLASTIC STORAGE CONTAINERS FOR HOUSEHOLD OR DOMESTIC USE; PLASTIC STORAGE CONTAINERS FOR HOUSEHOLD USE; PORTABLE PLASTIC CONTAINERS FOR STORING HOUSEHOLD AND KITCHEN GOODS; SERVINGWARE FOR SERVING FOOD, IN CLASS 21 (U.S. CLS. 2, 13, 23, 29, 30, 33, 40 AND 50).

FIRST USE 3-1-2005; IN COMMERCE 3-1-2005.

THE MARK CONSISTS OF STANDARD CHARACTERS WITHOUT CLAIM TO ANY PARTICULAR FONT, STYLE, SIZE, OR COLOR.

NO CLAIM IS MADE TO THE EXCLUSIVE RIGHT TO USE "LEMON / LIME", APART FROM THE MARK AS SHOWN.

SER. NO. 85-041,309, FILED 5-18-2010.

SARA BENJAMIN, EXAMINING ATTORNEY



David J. Kyffers

Director of the United States Patent and Trademark Office

United States of America
United States Patent and Trademark Office

IWATER

Reg. No. 4,204,277

CADMAN POWER EQUIPMENT LTD. (CANADA LIMITED COMPANY (LTD.))
38 MAIN ST., BOX 100

Registered Sep. 11, 2012

COURTLAND, ONTARIO, CANADA N0J1E0

Int. Cl.: 9

FOR: ELECTRONIC IRRIGATION RATE CONTROLLERS FOR USE WITH IRRIGATION DEVICES, IN CLASS 9 (U.S. CLS. 21, 23, 26, 36 AND 38).

TRADEMARK

FIRST USE 5-0-2010; IN COMMERCE 5-0-2010.

PRINCIPAL REGISTER

THE MARK CONSISTS OF STANDARD CHARACTERS WITHOUT CLAIM TO ANY PARTICULAR FONT, STYLE, SIZE, OR COLOR.

PRIORITY CLAIMED UNDER SEC. 44(D) ON CANADA APPLICATION NO. 1,483,912, FILED 5-27-2010.

SER. NO. 85-057,216, FILED 6-8-2010.

MARCIE MILONE, EXAMINING ATTORNEY



David J. Kybas

Director of the United States Patent and Trademark Office

United States of America

United States Patent and Trademark Office



Reg. No. 4,204,278

Registered Sep. 11, 2012

Int. Cl.: 25

TRADEMARK

PRINCIPAL REGISTER

COTTON ON CLOTHING PTY LTD (AUSTRALIA CORPORATION)
14 SHEPHERD COURT
NORTH GEELONG, AUSTRALIA VIC3215

FOR: CLOTHING, NAMELY, TOPS, KNIT SHIRTS, POLO SHIRTS, SHIRTS, JUMPERS, T-SHIRTS, SWEAT SHIRTS, BLOUSES, BLAZERS, SWEATERS, JACKETS, VESTS, COATS, PONCHOS, DRESSES, SKIRTS, TROUSERS, PANTS, OVERALLS, JEANS AND DENIM TROUSERS, SHORTS, CAMISOLES, LINGERIE, SLEEPWEAR, UNDERWEAR, SWIM WEAR, GLOVES, TIES, SCARVES, HEADSCARVES, SHAWLS, LEATHER BELTS, FABRIC BELTS, SOCKS, HOSIERY; HEADGEAR, NAMELY, HATS, CAPS, IN CLASS 25 (U.S. CLS. 22 AND 39).

OWNER OF AUSTRALIA REG. NO. 1123260, DATED 4-4-2008, EXPIRES 7-17-2016.

THE MARK CONSISTS OF A LION RAMPANT DESIGN.

SER. NO. 85-058,844, FILED 6-9-2010.

CHARISMA HAMPTON, EXAMINING ATTORNEY



David J. Kyffers

Director of the United States Patent and Trademark Office

United States of America

United States Patent and Trademark Office

PERFORMANCE-PCS.COM

Reg. No. 4,204,279

Registered Sep. 11, 2012

Int. Cl.: 35

SERVICE MARK

PRINCIPAL REGISTER

PERFORMANCE PC'S, INC. (FLORIDA CORPORATION)
SUITE 5
1701 ROBERT J. CONLAN BLVD. NE
PALM BAY, FL 32905

FOR: ONLINE RETAIL STORE SERVICES FEATURING COMPUTERS AND COMPUTERS ACCESSORIES, NAMELY, CPU WATER BLOCKS, CASES, EXTERNAL HARD DRIVES, POWER SUPPLIES, FANS, CPU HEATSINKS, MEMORY CHIPS, MOTHERBOARDS, PROCESSORS, LAPTOP AND VIDEO CARD COOLERS, BAYS AND DOCKS, CABLES AND CABLE SLEEVING, CATHODES AND LED LIGHTS, KEYBOARDS, MICE, DISPLAYS, GAMEPADS, MEDIA PLAYERS, PORTABLE CARD READERS, AND USB ADAPTERS, IN CLASS 35 (U.S. CLS. 100, 101 AND 102).

FIRST USE 2-18-2000; IN COMMERCE 2-18-2000.

THE MARK CONSISTS OF STANDARD CHARACTERS WITHOUT CLAIM TO ANY PARTICULAR FONT, STYLE, SIZE, OR COLOR.

SER. NO. 85-060,717, FILED 6-11-2010.

LEIGH CAROLINE CASE, EXAMINING ATTORNEY



David J. Kybas

Director of the United States Patent and Trademark Office

United States of America

United States Patent and Trademark Office

UNIVERSITY OF NORTH TEXAS

Reg. No. 4,204,280

UNIVERSITY OF NORTH TEXAS (TEXAS STATE UNIVERSITY)
1501 CHESTNUT STREET
DENTON, TX 76203

Registered Sep. 11, 2012

**Int. Cls.: 16, 18, 21, 25,
28 and 41**

FOR: PAPER GOODS AND PRINTED MATERIALS, NAMELY, GREETING CARDS, NOTE CARDS, NOTEPADS, POST CARDS, STICKERS, PAPER LABELS, STATIONERY, BUSINESS CARDS, GRADUATION ANNOUNCEMENT CARDS; RUBBER STAMPS; PHOTO ALBUMS, SCRAPBOOKS AND ACCESSORIES, NAMELY, DECORATIVE PAPER; DECALS; AND MONEY CLIPS, IN CLASS 16 (U.S. CLS. 2, 5, 22, 23, 29, 37, 38 AND 50).

TRADEMARK

SERVICE MARK

FIRST USE 4-0-2005; IN COMMERCE 4-0-2005.

PRINCIPAL REGISTER

FOR: BACKPACKS, FANNY PACKS, AND ATHLETIC BAGS, IN CLASS 18 (U.S. CLS. 1, 2, 3, 22 AND 41).

FIRST USE 4-0-2005; IN COMMERCE 4-0-2005.

FOR: HOUSEWARES AND GLASS, NAMELY, CUPS, MUGS, STEINS, BEVERAGE GLASSWARE; BARWARE, NAMELY, FLASKS, TRIVETS, ALCOHOL AND WINE DECANTERS; WINE BOTTLE CHILLERS, NAMELY, ICE BUCKETS; CHINA, NAMELY, PLATES, CUPS, BOWLS AND SERVING DISHES; CRYSTAL, NAMELY, HIGH BALL GLASSES, SHOT GLASSES, BEVERAGE AND WINE GLASSES; COASTERS, NAMELY, COASTERS NOT OF PAPER AND OTHER THAN TABLE LINEN; COOLERS, NAMELY, PORTABLE BEVERAGE COOLERS, COOLERS FOR WINE, ICE COOLERS; TRAYS, NAMELY, BUTLER'S TRAYS, SERVING PLATTERS, CRUMB TRAYS AND SERVING TRAYS; BARWARE ACCESSORIES, NAMELY, WINE BOTTLE OPENERS, DRINK SHAKERS AND STIRRERS; AND CONCESSION CUPS MADE OF PAPER AND PLASTIC, AND SPORT BOTTLES SOLD EMPTY, IN CLASS 21 (U.S. CLS. 2, 13, 23, 29, 30, 33, 40 AND 50).

FIRST USE 4-0-2005; IN COMMERCE 4-0-2005.

FOR: CLOTHING, NAMELY, MEN'S UNISEX T-SHIRTS; MEN'S AND UNISEX OUTERWEAR, NAMELY, RAINCOATS, OVERCOATS, JACKETS, SWEATERS, PULLOVERS, HEADWEAR; MEN'S AND UNISEX COMBO PACKAGES, NAMELY, SHIRTS AND PANTS; JERSEYS; UNIFORMS; INFANT AND TODDLER APPAREL, NAMELY, PAJAMAS, JACKETS, SHIRTS, SHORTS, PANTS, HATS, JUMPERS, ROMPERS, LAYETTES AND ONE-PIECE GARMENTS; YOUTH APPAREL, NAMELY, PAJAMAS, JACKETS, SHIRTS, SHORTS, PANTS, HATS AND



David J. Kyffers

Director of the United States Patent and Trademark Office

Reg. No. 4,204,280 JUMPERS; MEN'S FASHION APPAREL, NAMELY, COATS, JACKETS, SHIRTS, PANTS AND HATS; WOMEN'S APPAREL, NAMELY, PAJAMAS, COATS, JACKETS, SHIRTS, SHORTS, PANTS, SKIRTS AND HATS; MEN'S AND UNISEX FLEECE PULLOVERS, TOPS AND VESTS; MEN'S AND UNISEX LOUNGEWEAR AND SLEEPWEAR; MEN'S AND UNISEX PERFORMANCE APPAREL, NAMELY, SHORTS, SHIRTS, HATS, T-SHIRTS, SWEAT SHIRTS AND SWEAT PANTS; CLOTHING ACCESSORIES, NAMELY, SCARVES, SOCKS AND TIES; STRUCTURED CLOSED BACK HEADWEAR; STRUCTURED STRETCH FIT HEADWEAR; UNSTRUCTURED CLOSED BACK HEADWEAR; ADJUSTABLE WOOL BLEND HEADWEAR; AND ADJUSTABLE NON WOOL HEADWEAR, IN CLASS 25 (U.S. CLS. 22 AND 39).

FIRST USE 4-0-2005; IN COMMERCE 4-0-2005.

FOR: TOYS AND SPORTING GOODS, NAMELY, BASEBALL AND SOFTBALL ACCESSORIES, NAMELY, BASEBALLS, SOFTBALLS, BATTING TEES, GLOVES, MITTS, BATS AND BATTING GLOVES; BASKETBALL ACCESSORIES, NAMELY, BASKETBALLS AND BACKBOARDS; BOWLING ACCESSORIES, NAMELY, BOWLING BAGS, BALLS AND GLOVES; FISHING ACCESSORIES, NAMELY, TACKLE BOXES, ROD AND REELS AND ROD CASES; FOOTBALL ACCESSORIES, NAMELY, GLOVES, KNEE PADS, LEG PADS, SHOULDER PADS AND FOOTBALLS; GOLF ACCESSORIES, NAMELY, GOLF BALL TEES AND MARKERS, GLOVES AND DIVOT REPAIR TOOLS, GOLF BAGS, GOLF CLUBS, GOLF BALLS; BILLIARD ACCESSORIES, NAMELY, BALLS, RACKS AND CUES; COLLECTIBLE BALLS, NAMELY, FOOTBALLS, BASKETBALLS, BASEBALLS AND SOCCER BALLS; COMPETITION AND LEATHER SPORTS BALLS, NAMELY, RUBBER BALLS, FOAM BALLS; PUMPS FOR INFLATING SPORTS EQUIPMENT, NAMELY, FOOTBALLS, SOCCER BALLS, PLUSH SPORTS AND TOY BALLS, VINYL SPORTS AND TOY BALLS; DOLLS; PLUSH MASCOT TOYS; ACTION FIGURES; FLYING DISCS; GAMES, NAMELY, BOARD GAMES, PLAYING CARDS, PUZZLES, PARLOR AND MEMORY GAMES; STAND ALONE AND ARCADE-TYPE VIDEO GAME MACHINES; HAND-HELD MOBILE VIDEO GAMES WITH LIQUID CRYSTAL DISPLAYS; BALLOONS; TOY FOOTBALL HELMETS, IN CLASS 28 (U.S. CLS. 22, 23, 38 AND 50).

FIRST USE 4-0-2005; IN COMMERCE 4-0-2005.

FOR: EDUCATIONAL SERVICES, NAMELY, PROVIDING COLLEGE AND GRADUATE LEVEL COURSES OF INSTRUCTION AND SEMINARS, AND EDUCATIONAL OPPORTUNITIES TO PARTICIPATE IN RESEARCH PROGRAMS; AND ENTERTAINMENT SERVICES, NAMELY, PROVIDING COLLEGE SPORT GAMES AND EVENTS, MUSICAL CONCERTS AND ENTERTAINMENT AND PERFORMANCES OF DRAMATIC WORKS, IN CLASS 41 (U.S. CLS. 100, 101 AND 107).

FIRST USE 4-0-2005; IN COMMERCE 4-0-2005.

THE MARK CONSISTS OF STANDARD CHARACTERS WITHOUT CLAIM TO ANY PARTICULAR FONT, STYLE, SIZE, OR COLOR.

OWNER OF U.S. REG. NO. 3,780,422.

SEC. 2(F).

SER. NO. 85-061,577, FILED 6-13-2010.

THOMAS MANOR, EXAMINING ATTORNEY

United States of America

United States Patent and Trademark Office

POLITICAL INTELLIGENCE

Reg. No. 4,204,281

Registered Sep. 11, 2012

Int. Cls.: 35 and 41

SERVICE MARK

PRINCIPAL REGISTER

REYNOLDS POULSON CONSULTING, LLC (WASHINGTON LIMITED LIABILITY COMPANY)
4216 SW FINDLAY STREET, SUITE 7
SEATTLE, WA 98136

FOR: BUSINESS MANAGEMENT CONSULTING, IN CLASS 35 (U.S. CLS. 100, 101 AND 102).

FIRST USE 9-18-2008; IN COMMERCE 9-18-2008.

FOR: EDUCATION SERVICES, NAMELY, PROVIDING LIVE AND ON-LINE CLASSES, SEMINARS, WORKSHOPS AND COACHING IN THE FIELD OF BUSINESS MARKETING AND SALES, MANAGEMENT, AND LEADERSHIP DEVELOPMENT, IN CLASS 41 (U.S. CLS. 100, 101 AND 107).

FIRST USE 9-18-2008; IN COMMERCE 1-15-2010.

THE MARK CONSISTS OF STANDARD CHARACTERS WITHOUT CLAIM TO ANY PARTICULAR FONT, STYLE, SIZE, OR COLOR.

NO CLAIM IS MADE TO THE EXCLUSIVE RIGHT TO USE "POLITICAL", APART FROM THE MARK AS SHOWN.

SER. NO. 85-069,894, FILED 6-23-2010.

MAUREEN DALL, EXAMINING ATTORNEY



David J. Kybas

Director of the United States Patent and Trademark Office

United States of America
United States Patent and Trademark Office

**HAWKEN
& BARLOW**

Reg. No. 4,204,282

THE ALDO GROUP INC./LE GROUPE ALDO INC. (CANADA CORPORATION)
2300, ÉMILE BÉLANGER

Registered Sep. 11, 2012

SAINT-LAURENT, QUÉBEC, CANADA H4R3J4

Int. Cl.: 25

FOR: FOOTWEAR, NAMELY, SHOES, BOOTS, ATHLETIC SHOES, SANDALS AND SLIP-
PERS, IN CLASS 25 (U.S. CLS. 22 AND 39).

TRADEMARK

PRIORITY CLAIMED UNDER SEC. 44(D) ON CANADA APPLICATION NO. 1482568, FILED
5-26-2010, REG. NO. TMA802969, DATED 7-26-2011, EXPIRES 7-26-2026.

PRINCIPAL REGISTER

THE MARK CONSISTS OF A STYLIZED VERSION OF THE WORDING "HAWKEN &
BARLOW".

SER. NO. 85-072,991, FILED 6-28-2010.

BRENDAN REGAN, EXAMINING ATTORNEY



David J. Kybas

Director of the United States Patent and Trademark Office

United States of America

United States Patent and Trademark Office

Attractivo

Reg. No. 4,204,283

ATTRACTIVO LTD (ISRAEL CORPORATION)
CHITA STREET 2
SHOHAM, ISRAEL 60850

Registered Sep. 11, 2012

Int. Cl.: 45

FOR: ON-LINE SOCIAL NETWORKING SERVICES, IN CLASS 45 (U.S. CLS. 100 AND 101).

SERVICE MARK

THE MARK CONSISTS OF STANDARD CHARACTERS WITHOUT CLAIM TO ANY PARTICULAR FONT, STYLE, SIZE, OR COLOR.

PRINCIPAL REGISTER

OWNER OF ISRAEL REG. NO. 234639, DATED 5-2-2012, EXPIRES 1-3-2021.

THE ENGLISH TRANSLATION OF THE WORD "ATTRACTIVO" IN THE MARK IS "ATTRACTION".

SER. NO. 85-077,789, FILED 7-4-2010.

ANNE E. GUSTASON, EXAMINING ATTORNEY



David J. Kyffers

Director of the United States Patent and Trademark Office

United States of America

United States Patent and Trademark Office

THE ADVENTURES OF A SINGLISTA

Reg. No. 4,204,284

Registered Sep. 11, 2012

Int. Cl.: 41

SERVICE MARK

PRINCIPAL REGISTER

BONNER, LISA (UNITED STATES INDIVIDUAL)
100 WALL STREET, 20TH FLOOR
C/O BONNER LAW PC
NEW YORK, NY 10001

FOR: PROVIDING AN ON-LINE MONTHLY COLUMN AND NON-DOWNLOADABLE ELECTRONIC PUBLICATIONS IN THE NATURE OF MAGAZINES, NEWSLETTERS, ARTICLES IN THE FIELDS OF TRAVEL, URBAN EVENTS, DATING AND RELATIONSHIP ADVICE, IN CLASS 41 (U.S. CLS. 100, 101 AND 107).

FIRST USE 7-6-2010; IN COMMERCE 7-6-2010.

THE MARK CONSISTS OF STANDARD CHARACTERS WITHOUT CLAIM TO ANY PARTICULAR FONT, STYLE, SIZE, OR COLOR.

SER. NO. 85-079,764, FILED 7-7-2010.

JAMES LOVELACE, EXAMINING ATTORNEY



David J. Kyffers

Director of the United States Patent and Trademark Office

United States of America

United States Patent and Trademark Office

Harvey Prince

EAU TEASE

Reg. No. 4,204,285

KUMAR RAMANI (UNITED STATES INDIVIDUAL)
PO BOX 805

Registered Sep. 11, 2012

PRINCETON JUNCTION, NJ 08550

Int. Cl.: 3

FOR: EAU DE TOILETTE, IN CLASS 3 (U.S. CLS. 1, 4, 6, 50, 51 AND 52).

TRADEMARK

FIRST USE 7-20-2010; IN COMMERCE 7-20-2010.

PRINCIPAL REGISTER

THE MARK CONSISTS OF STANDARD CHARACTERS WITHOUT CLAIM TO ANY PARTICULAR FONT, STYLE, SIZE, OR COLOR.

NO CLAIM IS MADE TO THE EXCLUSIVE RIGHT TO USE "EAU", APART FROM THE MARK AS SHOWN.

THE NAME(S), PORTRAIT(S), AND/OR SIGNATURE(S) SHOWN IN THE MARK DOES NOT IDENTIFY A PARTICULAR LIVING INDIVIDUAL.

THE ENGLISH TRANSLATION OF "EAU" IN THE MARK IS WATER.

SER. NO. 85-089,021, FILED 7-20-2010.

SUNG IN, EXAMINING ATTORNEY



David J. Kyfos

Director of the United States Patent and Trademark Office

United States of America

United States Patent and Trademark Office

THE ENERGY STORE

Reg. No. 4,204,286

Registered Sep. 11, 2012

Int. Cls.: 37 and 42

SERVICE MARK

PRINCIPAL REGISTER

THE ENERGY STORE INC. (CANADA CORPORATION), DBA THE ENERGY STORE
SUITE 201
17 GRAYSTONE GARDENS
ETOBICOKE, ONTARIO, CANADA M8Z3C2

FOR: CONSULTING SERVICES IN THE FIELD OF INSTALLATION OF RENEWABLE ENERGY SYSTEMS; INSTALLATION, AND SERVICING OF RENEWABLE ENERGY SYSTEMS FOR PRIVATE HOMES, AND FOR COMMERCIAL, EDUCATIONAL AND RELIGIOUS INSTITUTIONAL BUILDINGS, IN CLASS 37 (U.S. CLS. 100, 103 AND 106).

FOR: CONSULTING SERVICES IN THE FIELD OF ENVIRONMENTAL SITE ASSESSMENT, TECHNICAL PLANNING AND EVALUATION GOODS OF OTHERS FOR THE PURPOSE OF CERTIFICATION, ALL IN THE FIELD OF RENEWABLE ENERGY SYSTEMS, IN CLASS 42 (U.S. CLS. 100 AND 101).

THE MARK CONSISTS OF STANDARD CHARACTERS WITHOUT CLAIM TO ANY PARTICULAR FONT, STYLE, SIZE, OR COLOR.

PRIORITY CLAIMED UNDER SEC. 44(D) ON CANADA APPLICATION NO. 1,483,218, FILED 6-1-2010, REG. NO. TMA822,992, DATED 4-26-2012, EXPIRES 4-26-2027.

NO CLAIM IS MADE TO THE EXCLUSIVE RIGHT TO USE "ENERGY", APART FROM THE MARK AS SHOWN.

SER. NO. 85-090,605, FILED 7-22-2010.

BRIAN CALLAGHAN, EXAMINING ATTORNEY



David J. Kybas

Director of the United States Patent and Trademark Office

United States of America

United States Patent and Trademark Office

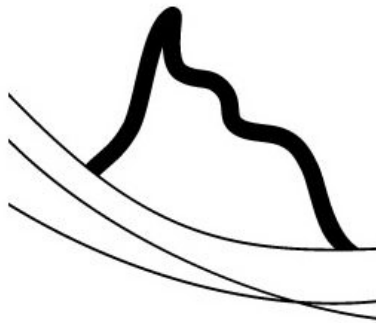

Reg. No. 4,204,287

Registered Sep. 11, 2012

Int. Cls.: 18, 21 and 35

TRADEMARK

SERVICE MARK

PRINCIPAL REGISTER

CASEY SORENSEN (CANADA INDIVIDUAL)
35 LINDMAN CLOSE
SYLVAN LAKE, ALBERTA, CANADA T4S2M5

FOR: SPORTS BAGS, BEACH BAGS, ALL-PURPOSE CARRYING BAGS FOR CARRYING PORTABLE BEVERAGE COOLERS, IN CLASS 18 (U.S. CLS. 1, 2, 3, 22 AND 41).

FOR: REFRIGERANT PACKS TO KEEP FOOD AND DRINK COLD; RE-USABLE, RE-FREEZABLE ICE PACKS, COLD PACKS AND ICE GEL PACKS TO KEEP FOODS AND DRINK COLD; NON-TOXIC, REUSABLE COLD PACKS CONTAINING ICE SUBSTITUTES USED TO KEEP FOOD AND DRINK COLD IN COOLERS; PORTABLE BEVERAGE COOLERS; BAGS SPECIALLY ADAPTED FOR CARRYING PORTABLE BEVERAGE COOLERS; THERMALLY INSULATING CONTAINERS FOR FOOD AND/OR BEVERAGES, IN CLASS 21 (U.S. CLS. 2, 13, 23, 29, 30, 33, 40 AND 50).

FOR: RETAIL STORE SERVICES AND ON-LINE RETAIL STORE SERVICES FEATURING REFRIGERANT PACKS, RE-USABLE, RE-FREEZABLE ICE PACKS, COLD PACKS AND ICE GEL PACKS, NON-TOXIC, REUSABLE ICE SUBSTITUTES USED IN COOLERS, PORTABLE BEVERAGE COOLERS, SPORTS BAGS, BEACH BAGS, BAGS FOR CARRYING PORTABLE BEVERAGE COOLERS AND THERMALLY INSULATING CONTAINERS FOR FOOD AND/OR BEVERAGES, IN CLASS 35 (U.S. CLS. 100, 101 AND 102).

PRIORITY CLAIMED UNDER SEC. 44(D) ON CANADA APPLICATION NO. 1487243, FILED 7-2-2010, REG. NO. TMA817494, DATED 2-13-2012, EXPIRES 2-13-2027.

THE MARK CONSISTS OF AN ICEBERG DESIGN.

SER. NO. 85-092,396, FILED 7-26-2010.

ANDREW LEASER, EXAMINING ATTORNEY



David J. Kybas

Director of the United States Patent and Trademark Office

United States of America

United States Patent and Trademark Office

PRESTO DOTS

Reg. No. 4,204,288

Registered Sep. 11, 2012

Int. Cl.: 16

TRADEMARK

PRINCIPAL REGISTER

CRAYOLA PROPERTIES, INC. (DELAWARE CORPORATION)
1100 CHURCH LANE
EASTON, PA 18042

FOR: MODELING COMPOUNDS, IN CLASS 16 (U.S. CLS. 2, 5, 22, 23, 29, 37, 38 AND 50).

FIRST USE 12-31-2009; IN COMMERCE 12-31-2009.

THE MARK CONSISTS OF STANDARD CHARACTERS WITHOUT CLAIM TO ANY PARTICULAR FONT, STYLE, SIZE, OR COLOR.

NO CLAIM IS MADE TO THE EXCLUSIVE RIGHT TO USE "DOTS", APART FROM THE MARK AS SHOWN.

SER. NO. 85-095,546, FILED 7-29-2010.

MARTHA FROMM, EXAMINING ATTORNEY



David J. Kyffers

Director of the United States Patent and Trademark Office

United States of America

United States Patent and Trademark Office

INFRAGRILL

Reg. No. 4,204,289

LG ELECTRONICS INC. (REPUBLIC OF KOREA CORPORATION)
20 YEUIDO-DONG YEONGDEUNGPO-GU
SEOUL, REPUBLIC OF KOREA 150-721

Registered Sep. 11, 2012

Int. Cl.: 11

FOR: ELECTRIC COOKWARE, NAMELY, INFRARED BROILERS; GAS COOKTOP; ELECTRIC RANGES FOR HOUSEHOLD PURPOSES; GAS RANGE; MICROWAVE OVENS; GAS GRILLS, IN CLASS 11 (U.S. CLS. 13, 21, 23, 31 AND 34).

TRADEMARK

THE MARK CONSISTS OF STANDARD CHARACTERS WITHOUT CLAIM TO ANY PARTICULAR FONT, STYLE, SIZE, OR COLOR.

PRINCIPAL REGISTER

PRIORITY CLAIMED UNDER SEC. 44(D) ON REPUBLIC OF KOREA APPLICATION NO. 40-2010-0033, FILED 6-28-2010, REG. NO. 0908716, DATED 3-7-2012, EXPIRES 6-28-2020.

SER. NO. 85-101,970, FILED 8-6-2010.

IRA J. GOODSaid, EXAMINING ATTORNEY



David J. Kybas

Director of the United States Patent and Trademark Office

United States of America

United States Patent and Trademark Office



Reg. No. 4,204,290

SPIN GEEKS, LLC (UTAH LIMITED LIABILITY COMPANY)
266 PRICKLEY PEAR DRIVE
WASHINGTON, UT 84780

Registered Sep. 11, 2012

Int. Cl.: 41

FOR: ENTERTAINMENT SERVICES IN THE NATURE OF ORGANIZING BICYCLE RACING AND EXHIBITIONS, IN CLASS 41 (U.S. CLS. 100, 101 AND 107).

SERVICE MARK

FIRST USE 1-1-2009; IN COMMERCE 1-1-2009.

PRINCIPAL REGISTER

THE MARK CONSISTS OF THE WORDS "SPINGEEKS" IN BLOCK ITALICIZED DESIGN, OUTLINED WITH ABOVE THE "NGE" OF "SPINGEEKS" APPEARS A STYLIZED IMAGE OF A BICYCLIST RIDING A BICYCLE. THE RIDER OF THE BICYCLE APPEARS TO BE WEARING A CAPE, BLOWING BEHIND HIM AS IF IN A BREEZE. THE WHEELS OF THE BICYCLE CONTAIN TWO DOTS THAT MAKE THE IMAGE, WHEN TAKEN AS A WHOLE, TO LOOK LIKE EYEBALLS WITHIN A PAIR OF SPECTACLES. THERE IS A SMALL AREA OF WHITE BENEATH THE BICYCLIST'S TORSO. THE UPPER PORTION OF THE LETTER "G" APPEARS TO BE THE MOUTH OF THE IMAGE.

SER. NO. 85-102,385, FILED 8-6-2010.

LINDA MICKLEBURGH, EXAMINING ATTORNEY



David J. Kyffers

Director of the United States Patent and Trademark Office

United States of America

United States Patent and Trademark Office

BAILEY

Reg. No. 4,204,291

Registered Sep. 11, 2012

Int. Cl.: 6

TRADEMARK

PRINCIPAL REGISTER

BAILEY METAL PRODUCTS LIMITED (CANADA CORPORATION)
1 CALDARI ROAD
CONCORD, ONTARIO, CANADA L4K3Z9

FOR: METAL BUILDING COMPONENTS, NAMELY, STEEL CHANNELS; METAL LATHS; METAL STUDS, JOISTS, RAFTERS; METAL WALL, FLOOR AND ROOF COMPONENTS, NAMELY, TRACKS, RESILIENT CHANNELS, FURRING CHANNELS, FURRING BARS, CARRYING CHANNELS, Z-BARS, STEEL PROFILES, NAMELY, ANGLES; METAL BUILDING FLASHINGS; METAL CLIPS FOR ATTACHING METAL STUDS, JOISTS AND RAFTERS TO EACH OTHER; METAL DRYWALL AND PLASTER CONSTRUCTION PRODUCTS, NAMELY, DRYWALL CORNER BEAD COVERS, ALL-METAL DRYWALL CORNER BEADS AND PAPER-FACED METAL DRYWALL CORNER BEADS; METAL DRYWALL TRIMS, NAMELY, PAPER-FACED TRIMS AND METAL L-TRIMS, J-TRIMS, Z-TRIMS, ANGLE TRIMS, FRAMING TRIMS AND REVEAL TRIMS FOR PROTECTING AND FINISHING DRYWALL EDGES AND DRYWALL JOINTS; METAL CEILING GRID SYSTEMS COMPRISED OF MAIN T RUNNERS AND CROSS TEES ADAPTED TO BE CONNECTED INTO A GRID TO SUPPORT CEILING TILES; METAL CEILING TRIMS, NAMELY, WALL ANGLES, COLUMN RINGS, REVEAL COLUMN RINGS, CORNER CAPS, HOLD DOWN CLIPS, PAIRED TEE CLIPS AND FIELD CUT TEE ATTACHMENT CLIPS; PROFILED METAL DECKS FOR USE IN CONSTRUCTING CONCRETE FLOORS AND ROOFS, IN CLASS 6 (U.S. CLS. 2, 12, 13, 14, 23, 25 AND 50).

FIRST USE 0-0-1950; IN COMMERCE 0-0-1988.

THE MARK CONSISTS OF STANDARD CHARACTERS WITHOUT CLAIM TO ANY PARTICULAR FONT, STYLE, SIZE, OR COLOR.

SER. NO. 85-103,187, FILED 8-9-2010.

THEODORE MCBRIDE, EXAMINING ATTORNEY



David J. Kypos

Director of the United States Patent and Trademark Office

United States of America

United States Patent and Trademark Office

BAILEY
METAL PRODUCTS LIMITED

Reg. No. 4,204,292

Registered Sep. 11, 2012

Int. Cl.: 6

TRADEMARK

PRINCIPAL REGISTER

BAILEY METAL PRODUCTS LIMITED (CANADA CORPORATION)
1 CALDARI ROAD
CONCORD, ONTARIO, CANADA L4K3Z9

FOR: METAL BUILDING COMPONENTS, NAMELY, METAL STUDS, JOISTS, RAFTERS; METAL WALL, FLOOR AND ROOF COMPONENTS, NAMELY, TRACKS, RESILIENT CHANNELS, FURRING CHANNELS, FURRING BARS, CARRYING CHANNELS, Z-BARS, STEEL PROFILES, NAMELY, ANGLES, AND CHANNELS; METAL BUILDING FLASHINGS; METAL CLIPS FOR ATTACHING METAL STUDS, JOISTS AND RAFTERS TO EACH OTHER; METAL DRYWALL AND PLASTER CONSTRUCTION PRODUCTS, NAMELY, DRYWALL CORNER BEAD COVERS, ALL-METAL DRYWALL CORNER BEADS AND PAPER-FACED METAL DRYWALL CORNER BEADS; METAL DRYWALL TRIMS, NAMELY, PAPER-FACED TRIMS AND METAL L-TRIMS, J-TRIMS, Z-TRIMS, ANGLE TRIMS, FRAMING TRIMS AND REVEAL TRIMS FOR PROTECTING AND FINISHING DRYWALL EDGES AND DRYWALL JOINTS; METAL LATHES; METAL CEILING GRID SYSTEMS COMPRISED OF MAIN T RUNNERS AND CROSS TEES ADAPTED TO BE CONNECTED INTO A GRID TO SUPPORT CEILING TILES; METAL CEILING TRIMS, NAMELY, WALL ANGLES, COLUMN RINGS, REVEAL COLUMN RINGS, CORNER CAPS, HOLD DOWN CLIPS, PAIRED TEE CLIPS AND FIELD CUT TEE ATTACHMENT CLIPS; PROFILED METAL DECKS FOR USE IN CONSTRUCTING CONCRETE FLOORS AND ROOFS, IN CLASS 6 (U.S. CLS. 2, 12, 13, 14, 23, 25 AND 50).

FIRST USE 0-0-2000; IN COMMERCE 0-0-2005.

NO CLAIM IS MADE TO THE EXCLUSIVE RIGHT TO USE "METAL PRODUCTS LIMITED", APART FROM THE MARK AS SHOWN.

THE MARK CONSISTS OF "BAILEY METAL PRODUCTS LIMITED" WITH A HORIZONTAL LINE.

SER. NO. 85-103,205, FILED 8-9-2010.

THEODORE MCBRIDE, EXAMINING ATTORNEY



David J. Kyffers

Director of the United States Patent and Trademark Office

United States of America

United States Patent and Trademark Office



Reg. No. 4,204,293

Registered Sep. 11, 2012

Int. Cls.: 3, 9 and 28

TRADEMARK

PRINCIPAL REGISTER

CANTERBURY LIMITED (UNITED KINGDOM COMPANY)
HOLLINSBROOK WAY
PILSWORTH BURY
LANCASHIRE, UNITED KINGDOM BL98RR

FOR: SOAPS; PERFUMERY, ESSENTIAL OILS, COSMETICS, HAIR LOTIONS; DENTIFRICES; PREPARATIONS FOR BODY CARE; COSMETIC TOILET PREPARATIONS; SHAMPOO; PREPARATIONS FOR SKIN CARE; PREPARATIONS FOR HAIR CARE; DEODORANTS FOR PERSONAL USE; BEAUTY PREPARATIONS, IN CLASS 3 (U.S. CLS. 1, 4, 6, 50, 51 AND 52).

FOR: OPTICAL APPARATUS AND INSTRUMENTS; SPECTACLES; SUNGLASSES; FASHION SPECTACLES; SPECTACLES, GOGGLES; LENSES; LENSES FOR SPECTACLES, GOGGLES AND MASKS; SPECTACLE FRAMES; CASES FOR SPECTACLES, SUNGLASSES, GOGGLES AND MASKS; CHAINS FOR SPECTACLES, SUNGLASSES, GOGGLES AND MASKS, IN CLASS 9 (U.S. CLS. 21, 23, 26, 36 AND 38).

FOR: SPORTING ARTICLES AND EQUIPMENT, NAMELY, CONTACT SHIELDS, TACKLE BAGS, TACKLE TUBES, SCRUM MACHINES, RUGBY POSTS, POST PADS, CORNER POSTS, CORNER FLAGS, TOUCHLINE BARRIERS, EVASION BELTS, TACKLE SUITS, KICKING RINGS, KICKING TEES, SCRUM SHIELDS, RUCKING SHIELDS, TACKLE SHIELDS, RUGBY NETS, SPORTS BALLS, RUGBY BALLS, AGILITY LADDERS, TRAINING HURDLES, TRAINING POLES, SPEED RESISTORS, HEAD GUARDS, SHOULDER PADS, BICEP PADS, FOREARM GUARDS, MOUTH GUARDS, SPEED CHUTES, SCRUM SLEDGES, RUGBY HARNESES, LIFTING BLOCKS; MASKS FOR SPORTING ACTIVITIES, IN CLASS 28 (U.S. CLS. 22, 23, 38 AND 50).

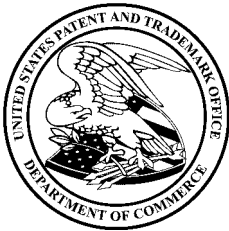

PRIORITY CLAIMED UNDER SEC. 44(D) ON ERPN CMNTY TM OFC APPLICATION NO. 009304452, FILED 8-10-2010, REG. NO. 009304452, DATED 1-24-2011, EXPIRES 8-10-2020.

OWNER OF U.S. REG. NO. 1,689,124.

THE MARK CONSISTS OF THREE OVERLAPPING CIRCLES EACH CARRYING A SILHOUETTE OF A BIRD HEAD AND BEAK, ALL OVER THE STYLIZED WORD "CANTERBURY".

SER. NO. 85-110,928, FILED 8-19-2010.

David J. Kybas

Director of the United States Patent and Trademark Office

Reg. No. 4,204,293 GINA HAYES, EXAMINING ATTORNEY

United States of America

United States Patent and Trademark Office

mobile air

Reg. No. 4,204,294

Registered Sep. 11, 2012

Int. Cl.: 9

TRADEMARK

PRINCIPAL REGISTER

ACCTON WIRELESS BROADBAND CORPORATION (TAIWAN CORPORATION)
NO. 1 CREATION ROAD 3
HSINCHU SCIENCE PARK, TAIWAN

FOR: MOBILE NETWORK ROUTER, MOBILE PHONE, MOBILE VIDEO PHONE, COMPUTER STORAGE DEVICES, NAMELY, HIGH-SPEED STORAGE SUBSYSTEMS FOR STORAGE AND BACKUP OF ELECTRONIC DATA EITHER LOCALLY OR VIA A TELECOMMUNICATIONS NETWORK, BROADBAND POWER LINE COMMUNICATION SYSTEMS FOR TRANSFERRING BROADBAND DATA OVER ELECTRICAL POWER LINES, COMPRISED OF COMPUTER HARDWARE, SOFTWARE AND MODEMS, CONNECTOR NETWORK ADAPTER, BATTERY, POWER ADAPTER, BATTERY CHARGER, IN-VEHICLE BATTERY CHARGER, EAR-SET COMPRISED OF EAR PHONES AND EAR BUDS, MICROPHONE, LOUDSPEAKER, MOBILE PHONE POUCH, IN-VEHICLE HANDSET CRADLE, PRINTED CIRCUIT BOARD ASSEMBLY (PCBA), CD/DVD FEATURING DATA-FILE, SOUND, MUSIC, PICTURE, MOTION PICTURES, MULTIMEDIA, IN CLASS 9 (U.S. CLS. 21, 23, 26, 36 AND 38).

PRIORITY CLAIMED UNDER SEC. 44(D) ON TAIWAN APPLICATION NO. 099038575, FILED 8-6-2010.

OWNER OF CHINA REG. NO. 01498930, DATED 1-16-2012, EXPIRES 1-15-2022.

NO CLAIM IS MADE TO THE EXCLUSIVE RIGHT TO USE "MOBILE", APART FROM THE MARK AS SHOWN.

THE MARK CONSISTS OF WORDS "MOBILE AIR" IN STYLIZED LETTERS.

SER. NO. 85-113,938, FILED 8-23-2010.

ARETHA SOMERVILLE, EXAMINING ATTORNEY



David J. Kyros

Director of the United States Patent and Trademark Office

United States of America

United States Patent and Trademark Office

SECURITY

Reg. No. 4,204,295

Registered Sep. 11, 2012

Int. Cl.: 41

SERVICE MARK

PRINCIPAL REGISTER

BNP MEDIA II, LLC (MICHIGAN LIMITED LIABILITY COMPANY)
2401 W. BIG BEAVER RD.
SUITE 700
TROY, MI 48084

FOR: PROVIDING ONLINE PUBLICATIONS IN THE NATURE OF ARTICLES, MAGAZINES, WHITE PAPERS, COLUMNS, AND NEWSLETTERS IN THE FIELD OF SAFETY AND SECURITY PRODUCTS AND SERVICES THAT ARE OF INTEREST TO THOSE IN THE SAFETY AND SECURITY PRODUCTS AND SERVICES INDUSTRY; PROVIDING ONLINE JOURNALS, NAMELY, BLOGS, FEATURING TOPICS OF INTEREST TO THOSE IN THE SAFETY AND SECURITY PRODUCTS AND SERVICES INDUSTRY, IN CLASS 41 (U.S. CLS. 100, 101 AND 107).

FIRST USE 1-25-1999; IN COMMERCE 1-25-1999.

THE MARK CONSISTS OF STANDARD CHARACTERS WITHOUT CLAIM TO ANY PARTICULAR FONT, STYLE, SIZE, OR COLOR.

OWNER OF U.S. REG. NOS. 1,602,233, 1,610,901, AND 2,099,200.

SEC. 2(F).

SER. NO. 85-115,760, FILED 8-25-2010.

MICHELLE DUBOIS, EXAMINING ATTORNEY



David J. Kyjars

Director of the United States Patent and Trademark Office

United States of America

United States Patent and Trademark Office

ScanItAll

Reg. No. 4,204,296

Registered Sep. 11, 2012

Int. Cl.: 9

STOPLIFT, INC. (DELAWARE CORPORATION), DBA STOPLIFT CHECKOUT VISION
SYSTEMS
SUITE 401
185 ALEWIFE BROOK PARKWAY
CAMBRIDGE, MA 02138

TRADEMARK

FOR: SOFTWARE TO DETECT RETAIL FRAUD; SYSTEMS COMPRISING COMPUTERS,
CAMERAS AND SOFTWARE TO DETECT RETAIL FRAUD, IN CLASS 9 (U.S. CLS. 21, 23,
26, 36 AND 38).

PRINCIPAL REGISTER

FIRST USE 7-29-2009; IN COMMERCE 7-29-2009.

THE MARK CONSISTS OF STANDARD CHARACTERS WITHOUT CLAIM TO ANY PAR-
TICULAR FONT, STYLE, SIZE, OR COLOR.

SER. NO. 85-115,824, FILED 8-25-2010.

LIEF MARTIN, EXAMINING ATTORNEY



David J. Kyffers

Director of the United States Patent and Trademark Office

United States of America

United States Patent and Trademark Office

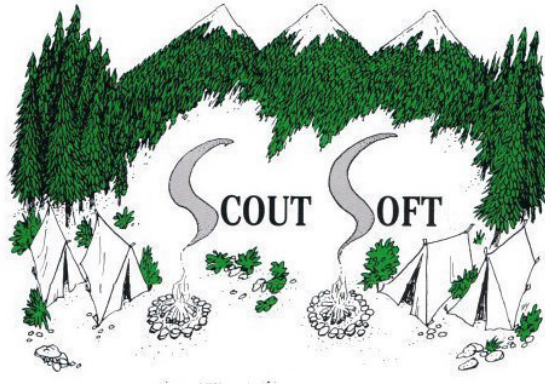

Reg. No. 4,204,297

Registered Sep. 11, 2012

Int. Cl.: 9

TRADEMARK

PRINCIPAL REGISTER

BOY SCOUTS OF AMERICA (UNITED STATES UNITED STATES FEDERALLY CHARTERED CORPORATION)
1325 WEST WALNUT HILL LANE
P.O. BOX 152079
IRVING, TX 750152079

FOR: COMPUTER SOFTWARE FOR USE IN MAINTAINING RECORDS OF SCOUT TROOPS AND RELIGIOUS ORGANIZATIONS AWARDS, IN CLASS 9 (U.S. CLS. 21, 23, 26, 36 AND 38).

FIRST USE 11-30-1988; IN COMMERCE 5-10-1989.

NO CLAIM IS MADE TO THE EXCLUSIVE RIGHT TO USE "SCOUT", APART FROM THE MARK AS SHOWN.

THE COLOR(S) GRAY, GREEN, WHITE AND BLACK IS/ARE CLAIMED AS A FEATURE OF THE MARK.

THE STIPPLING IS A FEATURE OF THE MARK AND DOES NOT INDICATE COLOR. THE STIPPLING IS FOR SHADING PURPOSES ONLY.

THE MARK CONSISTS OF A NATURE SCENE CONSISTING OF THREE GREEN, BLACK AND WHITE SNOW CAPPED MOUNTAINS, TREES ON EACH SIDE OF THE MARKS IN BLACK AND GREEN, GREEN AND BLACK BUSHES SCATTERED THROUGHOUT THE MARK AND SURROUNDING FOUR BLACK AND WHITE TENTS, TWO CAMPFIRES IN BLACK AND WHITE WITH BLACK AND WHITE ROCKS SURROUNDING THE FIRE AND BLACK ROCKS SCATTERED THROUGHOUT THE MARK. THE WORDING "SCOUT SOFT" APPEARS IN THE MIDDLE OF THE MARK, WITH THE LETTER "S" IN EACH WORD PRESENTED AS GRAY SMOKE RISING FROM THE CAMPFIRES AND OUTLINED IN BLACK. THE REMAINING LETTERS "COUT" AND "OFT" ARE IN BLACK LETTERS. THE WHITE BACKGROUND IS PART OF THE MARK.

SER. NO. 85-115,970, FILED 8-25-2010.

RENEE SERVANCE, EXAMINING ATTORNEY



David J. Kybas

Director of the United States Patent and Trademark Office

United States of America

United States Patent and Trademark Office

NORTH CAROLINA 100

Reg. No. 4,204,298

GRANT THORNTON LLP (ILLINOIS LIMITED LIABILITY PARTNERSHIP)
175 W. JACKSON STREET, SUITE 2000
CHICAGO, IL 60604

Registered Sep. 11, 2012

Int. Cls.: 16 and 41

FOR: PAMPHLETS AND BROCHURES RANKING PRIVATELY HELD BUSINESSES, IN CLASS 16 (U.S. CLS. 2, 5, 22, 23, 29, 37, 38 AND 50).

TRADEMARK

FIRST USE 6-0-1984; IN COMMERCE 6-0-1984.

SERVICE MARK

FOR: ENTERTAINMENT AND EDUCATIONAL SERVICES, NAMELY, PROVIDING A WEBSITE THAT DISPLAYS RANKINGS OF THE TOP 100 PRIVATELY HELD COMPANIES IN THE STATE OF NORTH CAROLINA, IN CLASS 41 (U.S. CLS. 100, 101 AND 107).

PRINCIPAL REGISTER

FIRST USE 6-0-1984; IN COMMERCE 6-0-1984.

THE MARK CONSISTS OF STANDARD CHARACTERS WITHOUT CLAIM TO ANY PARTICULAR FONT, STYLE, SIZE, OR COLOR.

OWNER OF U.S. REG. NO. 1,558,623.

SEC. 2(F).

SER. NO. 85-124,591, FILED 9-8-2010.

LESLEY LAMOTHE, EXAMINING ATTORNEY



David J. Kybas

Director of the United States Patent and Trademark Office

United States of America

United States Patent and Trademark Office

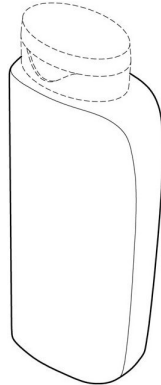

Reg. No. 4,204,299

Registered Sep. 11, 2012

Int. Cl.: 3

TRADEMARK

PRINCIPAL REGISTER

JOHNSON & JOHNSON (NEW JERSEY CORPORATION)
ONE JOHNSON & JOHNSON PLAZA
NEW BRUNSWICK, NJ 089337001

FOR: BODY WASH, IN CLASS 3 (U.S. CLS. 1, 4, 6, 50, 51 AND 52).

FIRST USE 12-15-2010; IN COMMERCE 12-15-2010.

THE MARK CONSISTS OF A THREE-DIMENSIONAL CONFIGURATION OF THE PACKAGING FOR THE GOODS. THE CONFIGURATION IS COMPRISED OF THE DESIGN OF A BOTTLE HAVING A BODY THAT IS ROUNDED ON ONE SIDE AND FLAT WITH CURVED EDGES ON THE OTHER SIDE. THE MATTER SHOWN IN BROKEN LINES IS NOT A PART OF THE MARK AND IS MERELY INCLUDED TO SHOW THE POSITION OF THE MARK.

SEC. 2(F).

SER. NO. 85-125,486, FILED 9-8-2010.

ELLEN BURNS, EXAMINING ATTORNEY



David J. Kyffers

Director of the United States Patent and Trademark Office

United States of America

United States Patent and Trademark Office

4DPLEX

Reg. No. 4,204,300

Registered Sep. 11, 2012

Int. Cls.: 7 and 11

TRADEMARK

PRINCIPAL REGISTER

CJ 4DPLEX CO., LTD. (REPUBLIC OF KOREA CORPORATION)
164-1 JEUNGSAN-DONG, EUNPYEONG-GU
SEOUL, REPUBLIC OF KOREA

FOR: EQUIPMENT FOR MOVIE AUDIENCE EFFECTS IN CINEMAS WITH SPECIAL EFFECTS SUCH AS WIND, MOTION, VIBRATION, BUBBLE, NAMELY, WIND-GENERATING MACHINES, VIBRATING AND MOTION-PRODUCING MACHINES, MECHANICAL BUBBLE MAKING MACHINES ALL FOR CREATING SPECIAL CINEMATIC EFFECTS; COMPRESSED AIR PUMPS; BLOWING MACHINES FOR THE COMPRESSION, EXHAUSTION AND TRANSPORT OF GASES; ELECTRIC MOTORS FOR MACHINES, OTHER THAN FOR VEHICLES; AUTOMATIC HANDLING MACHINES FOR USE IN CREATING SPECIAL CINEMATIC EFFECTS; INDUSTRIAL ROBOTS, IN CLASS 7 (U.S. CLS. 13, 19, 21, 23, 31, 34 AND 35).

FOR: SMOKE AND MIST GENERATING MACHINES AND FLASHING STROBE LIGHT APPARATUS FOR CREATING SPECIAL CINEMATIC EFFECTS; ELECTRIC SCENT DISPENSERS FOR USE IN CREATING SPECIAL CINEMATIC EFFECTS, IN CLASS 11 (U.S. CLS. 13, 21, 23, 31 AND 34).

THE MARK CONSISTS OF STANDARD CHARACTERS WITHOUT CLAIM TO ANY PARTICULAR FONT, STYLE, SIZE, OR COLOR.

PRIORITY CLAIMED UNDER SEC. 44(D) ON REPUBLIC OF KOREA APPLICATION NO. 40201047704, FILED 9-10-2010, REG. NO. 0914933, DATED 4-10-2012, EXPIRES 4-10-2022.

SER. NO. 85-128,107, FILED 9-13-2010.

RON FAIRBANKS, EXAMINING ATTORNEY



David J. Kypos

Director of the United States Patent and Trademark Office

United States of America

United States Patent and Trademark Office

4DPLEX

Reg. No. 4,204,301

Registered Sep. 11, 2012

Int. Cl.: 9

TRADEMARK

PRINCIPAL REGISTER

CJ 4DPLEX CO., LTD. (REPUBLIC OF KOREA CORPORATION)
164-1 JEUNGSAN-DONG, EUNPYEONG-GU
SEOUL, REPUBLIC OF KOREA

FOR: DVDS FEATURING PRERECORDED ENTERTAINMENT IN THE NATURE OF MOTION PICTURES, TELEVISION SERIES EPISODES AND MADE FOR TELEVISION MOTION PICTURES; BLANK RECORDABLE DVDS; AMUSEMENT APPARATUS ADAPTED FOR USE WITH COMPUTER MONITORS; COMPUTER SOFTWARE FOR USE IN PRODUCING SPECIAL CINEMATIC EFFECTS; COMPUTER GRAPHICS SOFTWARE; EYEGLASSES; AMUSEMENT APPARATUS ADAPTED FOR USE WITH TELEVISION RECEIVERS ONLY; COMPUTER GRAPHICS SOFTWARE, EYEGLASSES AND AMUSEMENT APPARATUS ADAPTED FOR USE WITH TELEVISION RECEIVERS ONLY FEATURING MOVIES AUDIENCE EFFECTS IN CINEMAS WITH SPECIAL EFFECTS SUCH AS WIND, SCENT, WATER SPRAY, MOTION, VIBRATION, SMOKE, BUBBLE, LASER OR FLASH; OPTICAL GLASSES; PICTURE PROJECTORS; EDITING APPLIANCES FOR CINEMATOGRAPHIC FILMS; PROJECTION SCREENS FOR MOVIE FILMS; MOVIE EDITING PROJECTORS; CINEMATOGRAPHIC CAMERAS; CINEMATOGRAPHIC PROJECTORS; SOUND RECORDING APPARATUS AND INSTRUMENTS BEING CINEMATOGRAPHIC APPARATUS; CINEMATOGRAPHIC MACHINES AND APPARATUS; PHOTOGRAPHY EQUIPMENT, NAMELY, REFLECTORS; PROJECTION SCREENS; DIGITAL CAMERAS; THEATRE GLASSES; GLASSES FOR VIEWING 3D DIGITAL PHOTOGRAPHS; BLINKERS BEING SIGNALING LIGHTS; VOLTAGE STABILIZING POWER SUPPLY; MP3 PLAYERS; DVD PLAYERS; CD PLAYERS; SOUND REPRODUCTION APPARATUS; SOUND RECORDING APPARATUS; CD-ROMS FEATURING PRERECORDED ENTERTAINMENT IN THE NATURE OF MOTION PICTURES, TELEVISION SERIES EPISODES AND MADE FOR TELEVISION MOTION PICTURES; BLANK RECORDABLE CD-ROMS; SOFTWARE TO CONTROL AND IMPROVE AUDIO EQUIPMENT SOUND QUALITY; COMPUTER PROGRAMS FOR EDITING IMAGES, SOUND AND VIDEO; SOFTWARE FOR PROCESSING IMAGES, GRAPHICS AND TEXT; DATA PROCESSING APPARATUS; DOWNLOADABLE COMPUTER PROGRAMS FOR USE IN PRODUCING SPECIAL CINEMATIC EFFECTS; PRE-RECORDED ELECTRONIC MEDIA FEATURING MUSIC; DOWNLOADABLE ELECTRONIC MUSIC; DOWNLOADABLE ELECTRONIC PUBLICATIONS IN THE NATURE OF ELECTRONIC JOURNALS, MAGAZINES, AND NEWSPAPERS, ALL IN THE FIELD OF CINEMATIC SPECIAL EFFECTS, IN CLASS 9 (U.S. CLS. 21, 23, 26, 36 AND 38).



David J. Kyjars

Director of the United States Patent and Trademark Office

THE MARK CONSISTS OF STANDARD CHARACTERS WITHOUT CLAIM TO ANY PARTICULAR FONT, STYLE, SIZE, OR COLOR.

Reg. No. 4,204,301 PRIORITY CLAIMED UNDER SEC. 44(D) ON REPUBLIC OF KOREA APPLICATION NO. 40-2010-4770, FILED 9-10-2010, REG. NO. 0914934, DATED 4-10-2012, EXPIRES 4-10-2022.

SER. NO. 85-128,123, FILED 9-13-2010.

RON FAIRBANKS, EXAMINING ATTORNEY

United States of America

United States Patent and Trademark Office

Inflight Fitness

Reg. No. 4,204,302

Registered Sep. 11, 2012

Int. Cl.: 28

TRADEMARK

PRINCIPAL REGISTER

IN-FLIGHT PRODUCTS, INC. (CALIFORNIA CORPORATION), AKA INFLIGHT FITNESS
8321 STANDUSTRIAL STREET
STANTON, CA 90680

FOR: EXERCISE MACHINES, IN CLASS 28 (U.S. CLS. 22, 23, 38 AND 50).

FIRST USE 4-1-2001; IN COMMERCE 4-1-2001.

THE MARK CONSISTS OF STANDARD CHARACTERS WITHOUT CLAIM TO ANY PARTICULAR FONT, STYLE, SIZE, OR COLOR.

NO CLAIM IS MADE TO THE EXCLUSIVE RIGHT TO USE "FITNESS", APART FROM THE MARK AS SHOWN.

SER. NO. 85-128,484, FILED 9-13-2010.

SARA BENJAMIN, EXAMINING ATTORNEY



David J. Kyros

Director of the United States Patent and Trademark Office

United States of America

United States Patent and Trademark Office

4DPLEX

Reg. No. 4,204,303

Registered Sep. 11, 2012

Int. Cl.: 28

TRADEMARK

PRINCIPAL REGISTER

CJ 4DPLEX CO., LTD. (REPUBLIC OF KOREA CORPORATION)
164-1 JEUNGSAN-DONG, EUNPYEONG-GU
SEOUL, REPUBLIC OF KOREA

FOR: AMUSEMENT PARK RIDES; GAME APPARATUS AND EQUIPMENT, NAMELY, AMUSEMENT APPARATUS INCORPORATING A TELEVISION MONITOR, AMUSEMENT APPARATUS INCORPORATING A VIDEO MONITOR, AMUSEMENT APPARATUS INCORPORATING A TELEVISION SCREEN; AMUSEMENT PARK RIDES INCORPORATING APPARATUS AND EQUIPMENT FOR MOVIES AUDIENCE EFFECTS IN CINEMAS WITH SPECIAL EFFECTS SUCH AS WIND, SCENT, WATER SPRAY, MOTION, VIBRATION, SMOKE, BUBBLE, LASER OR FLASH; TOY DOLLS; APPARATUS FOR ELECTRONIC GAMES OTHER THAN THOSE ADAPTED FOR USE WITH TELEVISION RECEIVERS, IN CLASS 28 (U.S. CLS. 22, 23, 38 AND 50).

THE MARK CONSISTS OF STANDARD CHARACTERS WITHOUT CLAIM TO ANY PARTICULAR FONT, STYLE, SIZE, OR COLOR.

PRIORITY CLAIMED UNDER SEC. 44(D) ON REPUBLIC OF KOREA APPLICATION NO. 40-2010-4770, FILED 9-10-2010, REG. NO. 0914935, DATED 4-10-2012, EXPIRES 4-10-2022.

SER. NO. 85-130,017, FILED 9-15-2010.

RON FAIRBANKS, EXAMINING ATTORNEY



David J. Kypos

Director of the United States Patent and Trademark Office

United States of America

United States Patent and Trademark Office

IT Made Easy

Reg. No. 4,204,304

Registered Sep. 11, 2012

Int. Cls.: 9 and 42

TRADEMARK

SERVICE MARK

PRINCIPAL REGISTER

ESOZO LLC (NEW JERSEY LIMITED LIABILITY COMPANY)
9 MAIN STREET
FLEMINGTON, NJ 08822

FOR: COMPUTER HARDWARE AND PERIPHERALS; COMPUTER HARDWARE AND SOFTWARE FOR SETTING UP AND CONFIGURING LOCAL AREA NETWORKS; COMPUTER HARDWARE AND SOFTWARE USED FOR THE CONTROL OF VOICE CONTROLLED INFORMATION AND COMMUNICATION DEVICES; COMPUTER HARDWARE FOR COMMUNICATING AUDIO, VIDEO AND DATA BETWEEN COMPUTERS VIA A GLOBAL COMPUTER NETWORK, WIDE-AREA COMPUTER NETWORKS, AND PEER-TO-PEER COMPUTER NETWORKS; COMPUTER HARDWARE FOR UPLOAD, STORAGE, RETRIEVAL, DOWNLOAD, TRANSMISSION AND DELIVERY OF DIGITAL CONTENT; COMPUTER NETWORKING HARDWARE; COMPUTER PROGRAMS FOR CONNECTING REMOTELY TO COMPUTERS OR COMPUTER NETWORKS; COMPUTER SERVERS, IN CLASS 9 (U.S. CLS. 21, 23, 26, 36 AND 38).

FIRST USE 9-22-2010; IN COMMERCE 9-22-2010.

FOR: COMPUTER SERVICES, NAMELY, COMPUTER SYSTEM ADMINISTRATION FOR OTHERS, IN CLASS 42 (U.S. CLS. 100 AND 101).

FIRST USE 9-22-2010; IN COMMERCE 9-22-2010.

THE MARK CONSISTS OF STANDARD CHARACTERS WITHOUT CLAIM TO ANY PARTICULAR FONT, STYLE, SIZE, OR COLOR.

NO CLAIM IS MADE TO THE EXCLUSIVE RIGHT TO USE "IT", APART FROM THE MARK AS SHOWN.

SER. NO. 85-135,232, FILED 9-22-2010.

DEZMONA MIZELLE, EXAMINING ATTORNEY



David J. Kyros

Director of the United States Patent and Trademark Office

United States of America

United States Patent and Trademark Office

HAPPY START BY NUTELLA

Reg. No. 4,204,305

SOREMARTEC S.A. (BELGIUM CORPORATION)

Registered Sep. 11, 2012

RUE JOSEPH NETZER, 5
ARLON, BELGIUM 6700

Int. Cls.: 30, 35 and 41

FOR: COCOA SPREADS, SPREAD CONTAINING CHOCOLATE AND NUTS, PASTRY AND CANDY EXCLUDING BREAKFAST CEREALS, IN CLASS 30 (U.S. CL. 46).

TRADEMARK

FOR: ADVERTISING; BUSINESS MANAGEMENT, IN CLASS 35 (U.S. CLS. 100, 101 AND 102).

SERVICE MARK

PRINCIPAL REGISTER

FOR: EDUCATION AND ENTERTAINMENT SERVICES PROVIDED VIA THE INTERNET, NAMELY PROVISION OF AN INTERACTIVE ENTERTAINMENT WEBSITE, PROVISION OF INFORMATION IN THE FIELD OF FOOD TASTING, PROVISION OF ON-LINE NON-DOWNLOADABLE VIDEO GAMES VIA A WEB SITE; ORGANIZING COMMUNITY SPORTING AND CULTURAL EVENTS, CONTESTS AND GAMES, IN CLASS 41 (U.S. CLS. 100, 101 AND 107).

THE MARK CONSISTS OF STANDARD CHARACTERS WITHOUT CLAIM TO ANY PARTICULAR FONT, STYLE, SIZE, OR COLOR.

OWNER OF BENELUX REG. NO. 885709, DATED 8-9-2010, EXPIRES 8-5-2020.

SER. NO. 85-143,094, FILED 10-1-2010.

FRANK LATTUCA, EXAMINING ATTORNEY



David J. Kyffers

Director of the United States Patent and Trademark Office

United States of America

United States Patent and Trademark Office

Alpha-Omega Collection

Reg. No. 4,204,306

Registered Sep. 11, 2012

Int. Cl.: 16

TRADEMARK

PRINCIPAL REGISTER

KATHLEEN D. COWLEY (UNITED STATES INDIVIDUAL)
7924 CHAPEL CREEK DRIVE
DENVER, NC 28037

FOR: PORTABLE HOME AND OFFICE FILING AND ORGANIZATION SYSTEMS COMPRISED OF A FILE CARRIER IN THE NATURE OF A FILE BOX OR TOTE BAG SPECIALLY ADAPTED FOR USE AS A FILE CARRIER AND ONE OR MORE OF THE FOLLOWING, NAMELY, HANGING FOLDERS, TICKLER FILES, BIENNIAL CALENDARS, MONTHLY CALENDARS, DAILY CALENDARS AND NOTE CARDS SOLD TOGETHER AS A SINGLE UNIT, IN CLASS 16 (U.S. CLS. 2, 5, 22, 23, 29, 37, 38 AND 50).

FIRST USE 4-29-2009; IN COMMERCE 10-1-2009.

THE MARK CONSISTS OF STANDARD CHARACTERS WITHOUT CLAIM TO ANY PARTICULAR FONT, STYLE, SIZE, OR COLOR.

NO CLAIM IS MADE TO THE EXCLUSIVE RIGHT TO USE "COLLECTION", APART FROM THE MARK AS SHOWN.

SER. NO. 85-146,230, FILED 10-6-2010.

PRISCILLA MILTON, EXAMINING ATTORNEY



David J. Kybas

Director of the United States Patent and Trademark Office

United States of America

United States Patent and Trademark Office

MOON

Reg. No. 4,204,307

Registered Sep. 11, 2012

Int. Cl.: 25

TRADEMARK

PRINCIPAL REGISTER

MIMRAN GROUP INC. (CANADA CORPORATION)
171 EAST LIBERTY STREET, SUITE 360
TORONTO, ONTARIO, CANADA M6K3P6

FOR: MEN'S CLOTHING, NAMELY, TAILORED AND SOFT CONSTRUCTION SUITS, SPORTS JACKETS, COORDINATED AND SEPARATE SLACKS, WALKING SHORTS, COATS, DRESS AND SPORT SHIRTS, SWEATERS, POLO SHIRTS AND T-SHIRTS, IN CLASS 25 (U.S. CLS. 22 AND 39).

THE MARK CONSISTS OF STANDARD CHARACTERS WITHOUT CLAIM TO ANY PARTICULAR FONT, STYLE, SIZE, OR COLOR.

PRIORITY CLAIMED UNDER SEC. 44(D) ON CANADA APPLICATION NO. 1484400, FILED 6-9-2010, REG. NO. TMA819102, DATED 3-5-2012, EXPIRES 3-5-2027.

OWNER OF U.S. REG. NO. 3,927,628.

SER. NO. 85-151,385, FILED 10-13-2010.

JASON BLAIR, EXAMINING ATTORNEY



David J. Kyros

Director of the United States Patent and Trademark Office

United States of America

United States Patent and Trademark Office

ECO ANIMAL HEALTH

Reg. No. 4,204,308

Registered Sep. 11, 2012

Int. Cl.: 5

TRADEMARK

PRINCIPAL REGISTER

ECO ANIMAL HEALTH LIMITED (UNITED KINGDOM CORPORATION)
THE GRANGE
100 THE HIGH STREET
LONDON, UNITED KINGDOM N146BN

FOR: VETERINARY PREPARATIONS, NAMELY, POWDERS, SOLUTIONS, PASTES AND PRE-MIXES FOR THE TREATMENT OF PNEUMONIA IN LIVESTOCK AND COMPANION ANIMALS; VETERINARY PREPARATIONS, NAMELY, POWDERS, SOLUTIONS, PASTES AND PRE-MIXES FOR THE TREATMENT OF ENTERIC DISEASES IN LIVESTOCK AND COMPANION ANIMALS; ANTIBIOTICS FOR THE TREATMENT OF LIVESTOCK AND COMPANION ANIMALS; VETERINARY PREPARATIONS, NAMELY, POWDERS, SOLUTIONS, PASTES AND PRE-MIXES FOR THE CONTROL OF PARASITES IN LIVESTOCK AND COMPANION ANIMALS; VETERINARY PREPARATIONS, NAMELY, POWDERS, SOLUTIONS, PASTES AND PRE-MIXES FOR THE TREATMENT OF E-COLI IN LIVESTOCK AND COMPANION ANIMALS; VETERINARY PREPARATIONS, NAMELY, POWDERS, SOLUTIONS, PASTES AND PRE-MIXES FOR THE TREATMENT OF RESPIRATORY INFECTIONS IN LIVESTOCK AND COMPANION ANIMALS; VETERINARY PREPARATIONS, NAMELY, POWDERS, SOLUTIONS, PASTES AND PRE-MIXES FOR THE TREATMENT OF GALL SICKNESS, HEART WATER, FOOT ROT IN LIVESTOCK AND COMPANION ANIMALS; FUNGICIDES, GERMICIDES, BACTERICIDES, VIRUCIDES, INSECTICIDES; FOOD SUPPLEMENTS FOR ANIMALS, NAMELY, SUPPLEMENTS FOR THE TREATMENT OF RESPIRATORY AND ENTERIC DISEASE IN LIVESTOCK AND COMPANION ANIMALS; FOOD SUPPLEMENTS FOR ANIMALS, NAMELY, SUPPLEMENTS FOR THE TREATMENT OF PARASITES IN LIVESTOCK AND COMPANION ANIMALS; FOOD SUPPLEMENTS FOR ANIMALS, NAMELY, SUPPLEMENTS TO ENHANCE THE GROWTH OF LIVESTOCK AND COMPANION ANIMALS, IN CLASS 5 (U.S. CLS. 6, 18, 44, 46, 51 AND 52).



THE MARK CONSISTS OF STANDARD CHARACTERS WITHOUT CLAIM TO ANY PARTICULAR FONT, STYLE, SIZE, OR COLOR.

OWNER OF ERPN CMNTY TM OFC REG. NO. 009803511, DATED 2-6-2012, EXPIRES 3-11-2021.

David J. Kypos

NO CLAIM IS MADE TO THE EXCLUSIVE RIGHT TO USE "ANIMAL HEALTH", APART FROM THE MARK AS SHOWN.

SER. NO. 85-151,498, FILED 10-13-2010.

Reg. No. 4,204,308 ANDREA HACK, EXAMINING ATTORNEY

United States of America

United States Patent and Trademark Office

Water Into Wine LLC

Reg. No. 4,204,309

Registered Sep. 11, 2012

Int. Cl.: 45

SERVICE MARK

PRINCIPAL REGISTER

BUTLER HESKETT PRODUCTIONS LLC (COLORADO LIMITED LIABILITY COMPANY),
DBA WATER INTO WINE, LLC
C/O LERMAN & ASSOC. LLC
815 E. 17TH AVE.
DENVER, CO 80218

FOR: PROVIDING INFORMATION RELATING TO DIVERSE HUMAN CULTURES, BELIEFS,
AND LIFESTYLES , IN CLASS 45 (U.S. CLS. 100 AND 101).

FIRST USE 10-9-2010; IN COMMERCE 10-9-2010.

THE MARK CONSISTS OF STANDARD CHARACTERS WITHOUT CLAIM TO ANY PAR-
TICULAR FONT, STYLE, SIZE, OR COLOR.

NO CLAIM IS MADE TO THE EXCLUSIVE RIGHT TO USE "LLC", APART FROM THE
MARK AS SHOWN.

SER. NO. 85-154,515, FILED 10-17-2010.

ELISSA GARBER KON, EXAMINING ATTORNEY



David J. Kybas

Director of the United States Patent and Trademark Office

United States of America

United States Patent and Trademark Office

FUEL THE CARE

Reg. No. 4,204,310

Registered Sep. 11, 2012

Int. Cl.: 36

SERVICE MARK

PRINCIPAL REGISTER

IRVING OIL OPERATIONS G.P. (CANADA PARTNERSHIP)
10 SYDNEY STREET, SAINT JOHN
NEW BRUNSWICK, CANADA E2L4K1

FOR: CHARITABLE FUNDRAISING SERVICES TO PROVIDE FINANCIAL SUPPORT TO FAMILIES WHO TRAVEL BETWEEN HOME AND HOSPITAL WHEN THEIR CHILDREN REQUIRE MEDICAL TREATMENT, IN CLASS 36 (U.S. CLS. 100, 101 AND 102).

FIRST USE 11-0-2002; IN COMMERCE 11-0-2003.

THE MARK CONSISTS OF STANDARD CHARACTERS WITHOUT CLAIM TO ANY PARTICULAR FONT, STYLE, SIZE, OR COLOR.

PRIORITY CLAIMED UNDER SEC. 44(D) ON CANADA APPLICATION NO. 1497949, FILED 9-30-2010, REG. NO. TMA809,209, DATED 10-17-2011, EXPIRES 10-17-2026.

SER. NO. 85-155,226, FILED 10-18-2010.

TAMARA FRAZIER, EXAMINING ATTORNEY



David J. Kybas

Director of the United States Patent and Trademark Office

United States of America

United States Patent and Trademark Office

Silent Design

Reg. No. 4,204,311

Registered Sep. 11, 2012

Int. Cls.: 9 and 10

TRADEMARK

PRINCIPAL REGISTER

SYSMEX CORPORATION (JAPAN CORPORATION)
1-5-1, WAKINOHAMA-KAIGANDORI, CHUO-KU
KOBE, HYOGO, JAPAN

FOR: PARTICLE ANALYZERS; PARTICLE IMAGE ANALYZERS; PARTICLE COUNTERS; PARTICLE SIZE DISTRIBUTION ANALYZERS; CELL COUNTERS; BLOOD CELL COUNTERS; BACTERIA ANALYZERS; INFRARED SPECTROSCOPIC ANALYZERS; TEST TUBES AND HOLDERS THEREFOR FOR LABORATORY USE; PIPETTES; COMPUTERS; COMPUTER PERIPHERAL DEVICES; COMPUTER MONITORS; PRINTERS FOR USE WITH COMPUTER; COMPUTER KEYBOARDS; COMPUTER MEMORIES; COMPUTER SOFTWARE FOR GATHERING, PROCESSING, STORING AND SUPPLYING DATA IN THE FIELD OF MEDICAL, CLINICAL, OR LABORATORY ANALYSIS AND DIAGNOSIS, AND FOR MANAGING SUCH DATA; COMPUTER TERMINALS; COMPUTER SERVERS; PRE-RECORDED MAGNETIC DATA MEDIA, PRE-RECORDED MAGNETIC COMPUTER TAPES, PRE-RECORDED VIDEO DISCS AND VIDEO TAPES, PRE-RECORDED OPTICAL DATA MEDIA, PRE-RECORDED OPTICAL DISCS, PRE-RECORDED COMPACT DISCS, AND PRE-RECORDED DATA COMPACT DISCS FEATURING INFORMATION ON MEDICAL, CLINICAL, SCIENTIFIC, DIAGNOSTIC OR RESEARCH ANALYSIS TECHNIQUES; DOWNLOADABLE IMAGE FILES FEATURING INFORMATION ON MEDICAL, CLINICAL, SCIENTIFIC, DIAGNOSTIC OR RESEARCH ANALYSIS TECHNIQUES; DOWNLOADABLE ELECTRONIC PUBLICATIONS, NAMELY, BOOK AND MAGAZINE FEATURING INFORMATION ON MEDICAL, CLINICAL, SCIENTIFIC, DIAGNOSTIC OR RESEARCH ANALYSIS TECHNIQUES; INTEGRATED CIRCUITS; MICROSCOPE SLIDES; LABORATORY BEAKERS; PLASTIC CUPS FOR LABORATORY USE; TEST TUBES FOR MICROBIOLOGICAL LABORATORY PURPOSES; TEST TUBES FOR IMMUNOLOGICAL RESEARCH LABORATORY PURPOSES; CONTAINERS FOR SAMPLES FOR IN VITRO DIAGNOSIS FOR LABORATORY USE; LABORATORY CONTAINERS IN THE NATURE OF CUPS FOR SAMPLES FOR PARTICLE ANALYSIS; LABORATORY SAMPLING BOTTLES; DISPOSABLE LABORATORY BEAKERS; DISPOSABLE CUPS FOR URINALYSIS FOR LABORATORY USE; LABORATORY BEAKER STANDS; LABORATORY TEST TUBE STANDS; REPLACEMENT PARTS FOR THE AFOREMENTIONED GOODS, IN CLASS 9 (U.S. CLS. 21, 23, 26, 36 AND 38).



David J. Kyffers

Director of the United States Patent and Trademark Office

FOR: DIAGNOSTIC OR MEASURING APPARATUS AND INSTRUMENTS FOR MEDICAL PURPOSES, NAMELY HEMATOLOGICAL ANALYZERS, BLOOD CELL ANALYZERS, RETICULOCYTE ANALYZERS, ERYTHROCYTE ANALYZERS, BLOOD COAGULATION ANALYZERS, PLATELET AGGREGATION ANALYZERS, BLOOD PRETREATMENT

Reg. No. 4,204,311 TESTERS, NON-INVASIVE BLOOD ANALYZERS FOR TESTING HEMOGLOBIN, NON-INVASIVE BLOOD VESSEL MONITOR IN THE NATURE OF INFRARED SPECTROSCOPIC ANALYZING, CELL COUNTER, BLOOD CELL COUNTERS, PLATELET COUNTERS, PARTICLE COUNTERS FOR MEDICAL PURPOSES, URINE ANALYZERS, URINE CELL ANALYZERS, URINE PARTICLE ANALYZERS, URINE PRETREATMENT TESTERS, IMMUNOCHEMICAL ANALYZERS, IMMUNOLOGICAL TESTERS, IMMUNOASSAY ANALYZERS, CLINICAL CHEMISTRY ANALYZERS, OCCULT BLOOD ANALYZERS, BACTERIA ANALYZERS, GENETIC TESTERS FOR MEDICAL DIAGNOSTIC PURPOSES, GENE AMPLIFICATION ANALYZER FOR MEDICAL DIAGNOSTIC PURPOSES, CANCER METASTASIS ANALYZER, CELL CYCLE ANALYZER FOR MEDICAL DIAGNOSTIC PURPOSES, CANCER RECURRENCE PREDICTION TESTING DEVICE FOR MEDICAL PURPOSES, ANTICANCER DRUG SENSITIVITY PREDICTION TESTING DEVICE FOR MEDICAL PURPOSES, SMEAR TEST SAMPLE MAKERS, SLIDES FOR MEDICAL PURPOSES, SAMPLE TRANSFER TRACK, SAMPLE CONTAINER TRANSFER TRACK, SAMPLE RACK TRANSFER TRACK, DILUTERS FOR MEDICAL DIAGNOSTIC PURPOSES, BLOOD COLLECTING CUVETTE, BLOOD SAMPLING TUBES, PIPETTES FOR MEDICAL PURPOSES, BLOOD AND URINE ASPIRATORS FOR MEDICAL PURPOSES, SPHYGMOMANOMETERS, CONTAINERS IN THE NATURE OF JARS OR CUPS FOR SAMPLES FOR IN VITRO MEDICAL DIAGNOSIS, DIAGNOSTIC SAMPLING BOTTLES FOR MEDICAL DIAGNOSTIC USE, DISPOSABLE BEAKERS FOR MEDICAL DIAGNOSTIC USE, DISPOSABLE CUPS FOR URINALYSIS FOR MEDICAL DIAGNOSTIC USE, BLOOD COLLECTING TUBES FOR TESTING BLOOD FOR MEDICAL DIAGNOSTIC USE, REPLACEMENT PARTS FOR THE AFOREMENTIONED GOODS, IN CLASS 10 (U.S. CLS. 26, 39 AND 44).

THE MARK CONSISTS OF STANDARD CHARACTERS WITHOUT CLAIM TO ANY PARTICULAR FONT, STYLE, SIZE, OR COLOR.

PRIORITY CLAIMED UNDER SEC. 44(D) ON JAPAN APPLICATION NO. T2010-080640, FILED 10-15-2010, REG. NO. 5453285, DATED 11-25-2011, EXPIRES 11-25-2021.

NO CLAIM IS MADE TO THE EXCLUSIVE RIGHT TO USE "DESIGN", APART FROM THE MARK AS SHOWN.

SER. NO. 85-156,360, FILED 10-19-2010.

KAREN K. BUSH, EXAMINING ATTORNEY

United States of America

United States Patent and Trademark Office

SUPPORT THE CURE

Reg. No. 4,204,312

WEST COAST NOVELTY CORPORATION (CALIFORNIA CORPORATION)
2401 MONARCH STREET
ALAMEDA, CA 94501

Registered Sep. 11, 2012

Int. Cl.: 25

FOR: CLOTHING, NAMELY, T-SHIRTS, LONG SLEEVE SHIRTS, BASEBALL CAPS, KNIT HATS, SOCKS, SWEATSHIRTS, SWEAT PANTS, PAJAMA PANTS, PAJAMA SHIRTS, AND NIGHT SHIRTS, IN CLASS 25 (U.S. CLS. 22 AND 39).

TRADEMARK

FIRST USE 5-31-2005; IN COMMERCE 5-31-2005.

PRINCIPAL REGISTER

THE MARK CONSISTS OF STANDARD CHARACTERS WITHOUT CLAIM TO ANY PARTICULAR FONT, STYLE, SIZE, OR COLOR.

SER. NO. 85-156,368, FILED 10-19-2010.

SOPHIA S. KIM, EXAMINING ATTORNEY



David J. Kyffers

Director of the United States Patent and Trademark Office

United States of America

United States Patent and Trademark Office



Reg. No. 4,204,313

Registered Sep. 11, 2012

Int. Cl.: 25

TRADEMARK

PRINCIPAL REGISTER

WEST COAST NOVELTY CORPORATION (CALIFORNIA CORPORATION)
2401 MONARCH STREET
ALAMEDA, CA 94501

FOR: CLOTHING, NAMELY, T-SHIRTS, LONG SLEEVE SHIRTS, BASEBALL CAPS, KNIT HATS, SOCKS, SWEATSHIRTS, SWEAT PANTS, PAJAMA PANTS, PAJAMA SHIRTS, AND NIGHT SHIRTS, IN CLASS 25 (U.S. CLS. 22 AND 39).

FIRST USE 5-31-2005; IN COMMERCE 5-31-2005.

THE MARK CONSISTS OF A PINK RIBBON DESIGN POSITIONED ON THE LEFT SIDE WITH STYLIZED PINK LETTERING "SUPPORT" POSITIONED TO THE RIGHT OF THE RIBBON AND STYLIZED PINK LETTERING "THE CURE" BELOW THE WORD "SUPPORT".

THE COLOR(S) PINK IS/ARE CLAIMED AS A FEATURE OF THE MARK.

SER. NO. 85-158,104, FILED 10-21-2010.

SOPHIA S. KIM, EXAMINING ATTORNEY



David J. Kybas

Director of the United States Patent and Trademark Office

United States of America

United States Patent and Trademark Office

SUMMITVOICE

Reg. No. 4,204,314

Registered Sep. 11, 2012

Int. Cl.: 9

TRADEMARK

PRINCIPAL REGISTER

KRAMER ELECTRONICS LTD. (ISRAEL LIMITED COMPANY (LTD.))
P.O. BOX 34499
3 AM VEOLAMO STREET
JERUSALEM, ISRAEL 95463

FOR: DEVICES AND FITTINGS THEREFOR, NAMELY, AMPLIFIERS, AUDIO PROCESSORS, MICROPHONES AND LOUDSPEAKERS FOR PRODUCING AND SELECTIVELY TRANSMITTING AUDIO IN ENCLOSED SPACES; COMPUTER HARDWARE AND SOFTWARE FOR AUDIO PRODUCTION AND SELECTED TRANSMISSION IN ENCLOSED SPACES, NAMELY, BOARD AND CONFERENCE ROOMS, LECTURE ROOMS AND LOUNGES, IN CLASS 9 (U.S. CLS. 21, 23, 26, 36 AND 38).

THE MARK CONSISTS OF STANDARD CHARACTERS WITHOUT CLAIM TO ANY PARTICULAR FONT, STYLE, SIZE, OR COLOR.

OWNER OF ISRAEL REG. NO. 232891, DATED 2-2-2012, EXPIRES 9-19-2020.

SER. NO. 85-161,291, FILED 10-26-2010.

RONALD AIKENS, EXAMINING ATTORNEY



David J. Kyffers

Director of the United States Patent and Trademark Office

United States of America

United States Patent and Trademark Office

DBT

Reg. No. 4,204,315

LINEHAN, MARSHA M. (UNITED STATES INDIVIDUAL)
3935 UNIVERSITY WAY NE
SEATTLE, WA 98105

Registered Sep. 11, 2012

Int. Cls.: 41, 42 and 44

FOR: EDUCATIONAL SERVICES, NAMELY, CONDUCTING CLASSES, SEMINARS, WORKSHOPS AND CONFERENCES IN THE FIELD OF CLINICAL PSYCHOLOGY AND DISTRIBUTION OF TRAINING AND COURSE MATERIALS IN CONNECTION THEREWITH, IN CLASS 41 (U.S. CLS. 100, 101 AND 107).

SERVICE MARK

PRINCIPAL REGISTER

FIRST USE 3-31-1993; IN COMMERCE 3-31-1993.

FOR: RESEARCH AND DEVELOPMENT OF TREATMENTS IN THE FIELD OF CLINICAL PSYCHOLOGY; PROVIDING SCIENTIFIC INFORMATION IN THE FIELD OF CLINICAL TRIALS, IN CLASS 42 (U.S. CLS. 100 AND 101).

FIRST USE 3-31-1993; IN COMMERCE 3-31-1993.

FOR: PSYCHOTHERAPY SERVICES, IN CLASS 44 (U.S. CLS. 100 AND 101).

FIRST USE 3-31-1993; IN COMMERCE 3-31-1993.

THE MARK CONSISTS OF STANDARD CHARACTERS WITHOUT CLAIM TO ANY PARTICULAR FONT, STYLE, SIZE, OR COLOR.

SER. NO. 85-161,464, FILED 10-26-2010.

VIVIAN MICZNIK FIRST, EXAMINING ATTORNEY



David J. Kyffers

Director of the United States Patent and Trademark Office

United States of America

United States Patent and Trademark Office

RIDE ME

Reg. No. 4,204,316

K-2 CORPORATION (INDIANA CORPORATION)
4201 6TH AVENUE SOUTH
SEATTLE, WA 98108

Registered Sep. 11, 2012

Int. Cl.: 25

FOR: HEADWEAR; JACKETS; PANTS; SHIRTS; SHORTS; UNDERWEAR, IN CLASS 25
(U.S. CLS. 22 AND 39).

TRADEMARK

FIRST USE 3-1-2010; IN COMMERCE 3-1-2010.

PRINCIPAL REGISTER

THE MARK CONSISTS OF STANDARD CHARACTERS WITHOUT CLAIM TO ANY PARTICULAR FONT, STYLE, SIZE, OR COLOR.

SER. NO. 85-165,864, FILED 11-1-2010.

FLORENTINA BLANDU, EXAMINING ATTORNEY



David J. Kybas

Director of the United States Patent and Trademark Office

United States of America

United States Patent and Trademark Office

I'M ON IT! Clothing

Reg. No. 4,204,317

PINK SLIP RECORDS LLC (TEXAS LIMITED LIABILITY COMPANY)

Registered Sep. 11, 2012

P. O. BOX 219171
HOUSTON, TX 772189171

Int. Cl.: 25

FOR: SHIRTS; SHIRTS AND SHORT-SLEEVED SHIRTS; SHORT-SLEEVED OR LONG-SLEEVED T-SHIRTS; SHORT-SLEEVED SHIRTS; T-SHIRTS; TEE SHIRTS, IN CLASS 25 (U.S. CLS. 22 AND 39).

TRADEMARK

FIRST USE 11-23-2008; IN COMMERCE 4-5-2009.

PRINCIPAL REGISTER

THE MARK CONSISTS OF STANDARD CHARACTERS WITHOUT CLAIM TO ANY PARTICULAR FONT, STYLE, SIZE, OR COLOR.

NO CLAIM IS MADE TO THE EXCLUSIVE RIGHT TO USE "CLOTHING", APART FROM THE MARK AS SHOWN.

SER. NO. 85-166,324, FILED 11-1-2010.

EUGENIA MARTIN, EXAMINING ATTORNEY



David J. Kybas

Director of the United States Patent and Trademark Office

United States of America

United States Patent and Trademark Office

GRACE HOSPICE

Reg. No. 4,204,318

Registered Sep. 11, 2012

Int. Cl.: 44

SERVICE MARK

PRINCIPAL REGISTER

U.S. MEDICAL MANAGEMENT, LLC (DELAWARE LIMITED LIABILITY COMPANY)
27000 HILLS TECH CT.
SUITE 200
FARMINGTON HILLS, MI 48331

FOR: HOSPICES, IN CLASS 44 (U.S. CLS. 100 AND 101).

FIRST USE 5-9-2005; IN COMMERCE 5-9-2005.

THE MARK CONSISTS OF STANDARD CHARACTERS WITHOUT CLAIM TO ANY PARTICULAR FONT, STYLE, SIZE, OR COLOR.

NO CLAIM IS MADE TO THE EXCLUSIVE RIGHT TO USE "HOSPICE", APART FROM THE MARK AS SHOWN.

SER. NO. 85-167,092, FILED 11-2-2010.

CHARLOTTE CORWIN, EXAMINING ATTORNEY



David J. Kybas

Director of the United States Patent and Trademark Office

United States of America

United States Patent and Trademark Office

BUSATIS TECHNOLOGY

Reg. No. 4,204,319

Registered Sep. 11, 2012

Int. Cls.: 6, 7, 8 and 40

TRADEMARK

SERVICE MARK

PRINCIPAL REGISTER

GEBRUEDER BUSATIS GESELLSCHAFT M.B.H. (AUSTRIA LIMITED PARTNERSHIP)
BUSATISSTRASSE
PURGSTALL, AUSTRIA A-3251

FOR: COMMON METALS AND THEIR ALLOYS; HARD METAL ALLOYS FOR PLATING OF METAL PARTS, IN CLASS 6 (U.S. CLS. 2, 12, 13, 14, 23, 25 AND 50).

FOR: MACHINES AND STRUCTURAL PARTS THEREOF WITH SURFACES PLATED WITH HARD METALS, NAMELY, ELECTRIC MACHINE KNIVES, BLADES, SLIDES NAMELY POWERED RAMPS FOR TRANSPORT INSTALLATIONS, COULTERS AND PLOWS FOR AGRICULTURAL MACHINES, GROUND SURFACE FINISHING AND COMPACTING MACHINES NAMELY UNDERCARRIAGE ROLLERS FOR CONSTRUCTION MACHINES; HAND- OPERATED MECHANICAL LAWN MOWERS WITH SURFACES PLATED WITH HARD METALS , IN CLASS 7 (U.S. CLS. 13, 19, 21, 23, 31, 34 AND 35).

FOR: HAND-OPERATED HAND TOOLS WITH SURFACES PLATED WITH HARD METALS, NAMELY, HAND-OPERATED SAWS, WIRE CUTTERS, GLASS CUTTERS, BOLT CUTTERS, WEED CUTTERS, TILE CUTTERS, BAR CUTTERS, MILLING CUTTERS, BOX CUTTERS, SAFETY CUTTERS AND PIPE CUTTERS; BLADES, NAMELY, HAND SAW BLADES, CROSSCUT SAW BLADES, RIP SAW HAND SAW BLADES, HACK SAW BLADES, SPAN WEB HAND SAW BLADES, TENON BACK SAW HAND SAW BLADES, TREE PRUNING HAND SAW BLADES, VINEYARD PRUNING HAND SAW BLADES, BUTCHER'S HAND SAW BLADES, BOW HAND SAW BLADES, PLANING BLADES, KNIVES, IN CLASS 8 (U.S. CLS. 23, 28 AND 44).

FOR: TREATMENT OF MATERIALS, NAMELY, METAL TREATING, METAL COATING , METAL TREATING AND CASTING, HARDENING OF METAL AND METAL PRODUCTS, ANNEALING, METAL PLATING OF METAL PARTS, IN CLASS 40 (U.S. CLS. 100, 103 AND 106).

THE MARK CONSISTS OF STANDARD CHARACTERS WITHOUT CLAIM TO ANY PARTICULAR FONT, STYLE, SIZE, OR COLOR.

OWNER OF AUSTRIA REG. NO. 257669, DATED 6-30-2010, EXPIRES 6-30-2020.

OWNER OF U.S. REG. NO. 2,007,527.



David J. Kyjars

Director of the United States Patent and Trademark Office

Reg. No. 4,204,319 NO CLAIM IS MADE TO THE EXCLUSIVE RIGHT TO USE "TECHNOLOGY", APART FROM THE MARK AS SHOWN.

SER. NO. 85-170,016, FILED 11-5-2010.

KATHERINE E. HALMEN, EXAMINING ATTORNEY

United States of America

United States Patent and Trademark Office

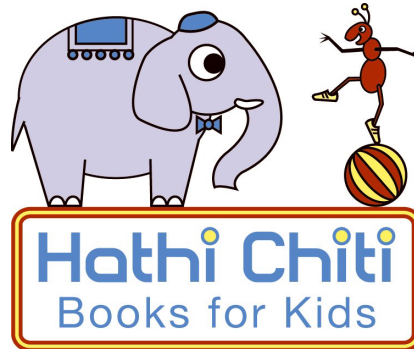

Reg. No. 4,204,320

Registered Sep. 11, 2012

Int. Cl.: 16

TRADEMARK

PRINCIPAL REGISTER

RESHMA SAPRE (UNITED STATES INDIVIDUAL)
203 RIVINGTON STREET, #2L
NEW YORK, NY 10002

FOR: PUBLICATIONS, NAMELY, FICTION CHILDREN'S BOOKS; SERIES OF CHILDREN'S BOOKS; EDUCATIONAL BOOKS IN THE FIELD OF READING; CHILDREN'S ACTIVITY BOOKS, IN CLASS 16 (U.S. CLS. 2, 5, 22, 23, 29, 37, 38 AND 50).

FIRST USE 1-1-2005; IN COMMERCE 1-1-2005.

NO CLAIM IS MADE TO THE EXCLUSIVE RIGHT TO USE "BOOKS FOR KIDS", APART FROM THE MARK AS SHOWN.

THE COLOR(S) RED, WHITE, BLUE, YELLOW, DARK BLUE AND BLACK IS/ARE CLAIMED AS A FEATURE OF THE MARK.

THE NAME(S), PORTRAIT(S), AND/OR SIGNATURE(S) SHOWN IN THE MARK DOES NOT IDENTIFY A PARTICULAR LIVING INDIVIDUAL.

THE MARK CONSISTS OF THE DESIGN OF A BLUE ELEPHANT WITH A DARK BLUE HAT, DARK BLUE BOW TIE, DARK BLUE BLANKET, WHITE TUSK, WHITE AND BLACK EYES AND WHITE TOENAILS, WITH ALL OF THE FOREGOING FEATURES OUTLINED IN BLACK. TO THE RIGHT OF THE ELEPHANT IS A RED ANT WITH YELLOW TENNIS SHOES, YELLOW ANTENNAE, BLACK ARMS, AND WHITE AND BLACK EYES, STANDING ON A RED AND YELLOW STRIPED BALL, WITH ALL OF THE FEATURES OF THE ANT AND BALL OUTLINED IN BLACK. BELOW THESE DESIGN ELEMENTS IS THE WORDING "HATHI CHITI BOOKS FOR KIDS" IN BLUE, EXCEPT FOR THE DOTS OVER EACH LETTER "I" IN "HATHI CHITI", WHICH ARE YELLOW OUTLINED IN BLUE. ALL OF THE WORDING APPEARS INSIDE A WHITE RECTANGLE THAT IS OUTLINED IN THREE CONCENTRIC RECTANGULAR BANDS COMPRISED OF A RED BAND, YELLOW BAND AND ANOTHER RED BAND.

THE ENGLISH TRANSLATION OF "HATHI CHITI" IN THE MARK IS "ELEPHANT ANT".

SER. NO. 85-174,693, FILED 11-11-2010.

BERNICE MIDDLETON, EXAMINING ATTORNEY



David J. Kyffers

Director of the United States Patent and Trademark Office

United States of America

United States Patent and Trademark Office

More Is More

Reg. No. 4,204,321

Registered Sep. 11, 2012

Int. Cl.: 14

TRADEMARK

PRINCIPAL REGISTER

WILKINSON, HUTTON (UNITED STATES INDIVIDUAL)
1354 DAWN RIDGE DRIVE
BEVERLY HILLS, CA 90210

FOR: JEWELRY, IN CLASS 14 (U.S. CLS. 2, 27, 28 AND 50).

FIRST USE 5-31-1997; IN COMMERCE 5-31-1997.

THE MARK CONSISTS OF STANDARD CHARACTERS WITHOUT CLAIM TO ANY PARTICULAR FONT, STYLE, SIZE, OR COLOR.

SER. NO. 85-175,126, FILED 11-11-2010.

COLLEEN DOMBROW, EXAMINING ATTORNEY



David J. Kyffers

Director of the United States Patent and Trademark Office

United States of America

United States Patent and Trademark Office

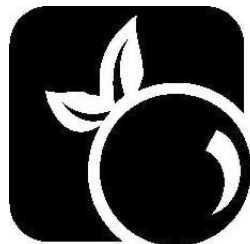

MailStore

Reg. No. 4,204,322

Registered Sep. 11, 2012

Int. Cl.: 9

TRADEMARK

PRINCIPAL REGISTER

MAILSTORE SOFTWARE GMBH (FED REP GERMANY LIMITED LIABILITY COMPANY)
CLOERATHER STR. 1-3
VIERSEN, FED REP GERMANY 41748

FOR: SOFTWARE FOR EMAIL ARCHIVING, IN CLASS 9 (U.S. CLS. 21, 23, 26, 36 AND 38).

FIRST USE 5-23-2008; IN COMMERCE 5-23-2008.

OWNER OF U.S. REG. NOS. 3,443,247 AND 3,443,248.

NO CLAIM IS MADE TO THE EXCLUSIVE RIGHT TO USE "MAIL STORE", APART FROM THE MARK AS SHOWN.

THE MARK CONSISTS OF A SQUARE HAVING ROUNDED CORNERS AND A REPRESENTATION OF AN ORANGE IN THE LOWER RIGHT CORNER TOGETHER WITH THE MARK "MAILSTORE".

SER. NO. 85-177,657, FILED 11-16-2010.

AMY ALFIERI, EXAMINING ATTORNEY



David J. Kyffers

Director of the United States Patent and Trademark Office

United States of America

United States Patent and Trademark Office

SUREFIRE ULTRA

Reg. No. 4,204,323

Registered Sep. 11, 2012

Int. Cl.: 5

TRADEMARK

PRINCIPAL REGISTER

TGR BIOSCIENCES PTY LTD (AUSTRALIA PROPRIETARY LIMITED COMPANY (P/L OR PTY. LTD.))
31 DALGLEISH STREET
THEBARTON, AUSTRALIA 5031

FOR: DIAGNOSTIC PREPARATIONS AND REAGENTS FOR MEDICAL USE; DIAGNOSTIC TESTING KITS CONSISTING OF DIAGNOSTIC PREPARATIONS AND REAGENTS FOR USE IN MEASURING PROTEINS IN PATIENT SAMPLES AND FOR MEASURING PROTEIN LEVELS IN HUMAN BODY FLUIDS, IN CLASS 5 (U.S. CLS. 6, 18, 44, 46, 51 AND 52).

THE MARK CONSISTS OF STANDARD CHARACTERS WITHOUT CLAIM TO ANY PARTICULAR FONT, STYLE, SIZE, OR COLOR.

OWNER OF AUSTRALIA REG. NO. 1367588, DATED 1-31-2011, EXPIRES 6-17-2020.

OWNER OF U.S. REG. NO. 3,228,037.

SER. NO. 85-178,718, FILED 11-17-2010.

JEFFREY LOOK, EXAMINING ATTORNEY



David J. Kyros

Director of the United States Patent and Trademark Office

United States of America

United States Patent and Trademark Office

My Life Check

Reg. No. 4,204,324

Registered Sep. 11, 2012

Int. Cls.: 16 and 41

TRADEMARK

SERVICE MARK

PRINCIPAL REGISTER

AMERICAN HEART ASSOCIATION (NEW YORK CORPORATION)
LEGAL DEPARTMENT
7272 GREENVILLE AVENUE
DALLAS, TX 75231

FOR: BROCHURES ABOUT CARDIOVASCULAR HEALTH; INFORMATIONAL FLYERS
FEATURING CARDIOVASCULAR HEALTH; POSTERS, IN CLASS 16 (U.S. CLS. 2, 5, 22,
23, 29, 37, 38 AND 50).

FIRST USE 2-26-2010; IN COMMERCE 2-26-2010.

FOR: PROVIDING A WEB SITE THAT FEATURES INFORMAL INSTRUCTION ON CARDI-
OVASCULAR HEALTH, IN CLASS 41 (U.S. CLS. 100, 101 AND 107).

FIRST USE 1-31-2010; IN COMMERCE 1-31-2010.

THE MARK CONSISTS OF STANDARD CHARACTERS WITHOUT CLAIM TO ANY PAR-
TICULAR FONT, STYLE, SIZE, OR COLOR.

SER. NO. 85-179,969, FILED 11-18-2010.

JESSICA FATHY, EXAMINING ATTORNEY



David J. Kyjars

Director of the United States Patent and Trademark Office

United States of America

United States Patent and Trademark Office

HOOKED ON

Reg. No. 4,204,325

Registered Sep. 11, 2012

Int. Cls.: 9 and 16

TRADEMARK

PRINCIPAL REGISTER

SANDVIKS HOP, INC. (CONNECTICUT CORPORATION)
103 MILL PLAIN ROAD
DANBURY, CT 06811

FOR: PRE-RECORDED CDS, VIDEO TAPES, LASER DISKS AND DVDS FEATURING READING, WRITING, SPELLING, LANGUAGE ARTS, FOREIGN LANGUAGES, MATH, SCIENCE, TECHNOLOGY, SOCIAL SCIENCES, ARTS, HUMANITIES, RELIGION, MUSIC INSTRUCTION, TYPING, CHILD DEVELOPMENT, HOME SCHOOLING, HEALTH, FITNESS, AND NUTRITION, ALL OF THE ABOVE EXCLUDING MUSICAL ENTERTAINMENT, IN CLASS 9 (U.S. CLS. 21, 23, 26, 36 AND 38).

FIRST USE 7-27-2001; IN COMMERCE 7-27-2001.

FOR: PACKAGED KITS COMPRISING PRINTED INSTRUCTIONAL, EDUCATIONAL, AND TEACHING MATERIALS FOR EDUCATIONAL ACTIVITIES IN THE FIELD OF READING, WRITING, SPELLING, LANGUAGE ARTS, FOREIGN LANGUAGES, MATH, SCIENCE, TECHNOLOGY, SOCIAL SCIENCES, ARTS, HUMANITIES, RELIGION, MUSIC, TYPING, CHILD DEVELOPMENT, HOME SCHOOLING, HEALTH, FITNESS, AND NUTRITION; PRINTED INSTRUCTIONAL, EDUCATIONAL, AND TEACHING MATERIALS IN THE FIELD OF READING, WRITING, SPELLING, LANGUAGE ARTS, FOREIGN LANGUAGES, MATH, SCIENCE, TECHNOLOGY, SOCIAL SCIENCES, ARTS, HUMANITIES, RELIGION, MUSIC INSTRUCTION, TYPING, CHILD DEVELOPMENT, HOME SCHOOLING, HEALTH, FITNESS, AND NUTRITION, ALL OF THE ABOVE EXCLUDING MUSIC ENTERTAINMENT, IN CLASS 16 (U.S. CLS. 2, 5, 22, 23, 29, 37, 38 AND 50).

FIRST USE 2-0-1987; IN COMMERCE 2-0-1987.

THE MARK CONSISTS OF STANDARD CHARACTERS WITHOUT CLAIM TO ANY PARTICULAR FONT, STYLE, SIZE, OR COLOR.

OWNER OF U.S. REG. NOS. 1,876,555, 2,591,385 AND OTHERS.

SER. NO. 85-181,106, FILED 11-19-2010.

JAY FLOWERS, EXAMINING ATTORNEY



David J. Kyffers

Director of the United States Patent and Trademark Office

United States of America

United States Patent and Trademark Office

FILLY

Reg. No. 4,204,326

Registered Sep. 11, 2012

Int. Cls.: 14 and 25

TRADEMARK

PRINCIPAL REGISTER

HOME FOCUS DEVELOPMENT LIMITED (BR.VIRGIN ISLANDS CORPORATION)
TRUSTNET CHAMBERS LIMITED, PO BOX 3444
ROAD TOWN
TORTOLA, BR.VIRGIN ISLANDS

FOR: PRECIOUS METALS AND THEIR ALLOYS; GOODS MADE OF PRECIOUS METALS OR COATED THEREWITH, NAMELY, BUSTS OF PRECIOUS METALS, DECORATIVE BOXES MADE OF PRECIOUS METAL, DESKTOP STATUARY MADE OF PRECIOUS METAL, FIGURINES OF PRECIOUS METAL, JEWEL CASES OF PRECIOUS METAL, JEWELLERY CASES OF PRECIOUS METAL, KEY CHAINS OF PRECIOUS METAL, KEY HOLDERS OF PRECIOUS METALS, KEY RINGS OF PRECIOUS METALS, MODEL FIGURES MADE OF PRECIOUS METAL; JEWELLERY; PRECIOUS STONES; HOROLOGICAL AND CHRONOMETRIC INSTRUMENTS, IN CLASS 14 (U.S. CLS. 2, 27, 28 AND 50).

FOR: CLOTHING AND FOOTWEAR, NAMELY, FOOTWEAR OF ALL KINDS; JACKETS, COATS, SHIRTS, BLOUSES, T-SHIRTS, SOCKS, SHORTS, SCARVES; SPORTSWEAR, NAMELY, SHORTS, UNDERWEAR, NIGHTWEAR, GLOVES, BATHROBES, APRONS, PANTS, HOSIERY, WINTERWEAR, NAMELY, LONG UNDERWEAR, RAINWEAR, VESTS, SWIMWEAR, BEACH PONCHOS; HEADWEAR OF ALL KINDS; CAPS, IN CLASS 25 (U.S. CLS. 22 AND 39).

THE MARK CONSISTS OF STANDARD CHARACTERS WITHOUT CLAIM TO ANY PARTICULAR FONT, STYLE, SIZE, OR COLOR.

OWNER OF ERPN CMNTY TM OFC REG. NO. 004863999, DATED 1-17-2007, EXPIRES 1-27-2016.

SER. NO. 85-181,472, FILED 11-19-2010.

JESSICA FATHY, EXAMINING ATTORNEY



David J. Kypos

Director of the United States Patent and Trademark Office

United States of America

United States Patent and Trademark Office

WEBOP

Reg. No. 4,204,327

MARKUS M. HEISS (FED REP GERMANY INDIVIDUAL)
RONDORFERSTR. 54
KOLN, FED REP GERMANY 50968

Registered Sep. 11, 2012

Int. Cls.: 35, 38 and 44

FOR: BUSINESS MANAGEMENT, BUSINESS CONSULTANCY, BUSINESS ADMINISTRATION, ALL OF THE FOREGOING RELATING TO AND IN THE NATURE OF PROVIDING SERVICES IN THE MEDICAL SECTOR, IN CLASS 35 (U.S. CLS. 100, 101 AND 102).

SERVICE MARK

FOR: TELECOMMUNICATIONS PROVIDED TO THE MEDICAL SECTOR, NAMELY, ELECTRONIC TRANSMISSION OF MEDICAL DATA, IN CLASS 38 (U.S. CLS. 100, 101 AND 104).

PRINCIPAL REGISTER

FOR: MEDICAL SERVICES; MEDICAL ANALYSIS SERVICES FOR THE DIAGNOSIS AND TREATMENT OF INDIVIDUALS; MEDICAL AND CLINICAL EXAMINATIONS OF INDIVIDUALS FOR MEDICAL DIAGNOSTIC PURPOSES, IN CLASS 44 (U.S. CLS. 100 AND 101).

THE MARK CONSISTS OF STANDARD CHARACTERS WITHOUT CLAIM TO ANY PARTICULAR FONT, STYLE, SIZE, OR COLOR.

PRIORITY CLAIMED UNDER SEC. 44(D) ON ERPN CMNTY TM OFC APPLICATION NO. 009162454, FILED 5-21-2010, REG. NO. 009162454, DATED 7-13-2010, EXPIRES 5-21-2020.

SER. NO. 85-182,110, FILED 11-22-2010.

BARBARA GAYNOR, EXAMINING ATTORNEY



David J. Kyjars

Director of the United States Patent and Trademark Office

United States of America

United States Patent and Trademark Office

Sunday Nite Slow Jams

Reg. No. 4,204,328

Registered Sep. 11, 2012

Int. Cl.: 25

TRADEMARK

PRINCIPAL REGISTER

FUSION RADIO NETWORKS (ARIZONA LIMITED LIABILITY COMPANY)
PO BOX 36731
FUSION RADIO NETWORKS
TUCSON, AZ 85740

FOR: T-SHIRTS, IN CLASS 25 (U.S. CLS. 22 AND 39).

FIRST USE 1-0-2002; IN COMMERCE 1-0-2002.

THE MARK CONSISTS OF STANDARD CHARACTERS WITHOUT CLAIM TO ANY PARTICULAR FONT, STYLE, SIZE, OR COLOR.

SER. NO. 85-182,926, FILED 11-22-2010.

CHARLES L. JENKINS, EXAMINING ATTORNEY



David J. Kyffers

Director of the United States Patent and Trademark Office

United States of America

United States Patent and Trademark Office

ORENDAIN

Reg. No. 4,204,329

Registered Sep. 11, 2012

Int. Cl.: 33

TEQUILA ORENDAIN DE JALISCO, S.A. DE C.V. (MEXICO CORPORATION)
PROLONGACION AV. VALLARTA NO. 6230
COL. JOCOTAN, ZAPOPAN
CP 45017 JALISCO, MEXICO

FOR: LIQUOR; SPIRITS, IN CLASS 33 (U.S. CLS. 47 AND 49).

TRADEMARK

THE MARK CONSISTS OF STANDARD CHARACTERS WITHOUT CLAIM TO ANY PARTICULAR FONT, STYLE, SIZE, OR COLOR.

PRINCIPAL REGISTER

OWNER OF MEXICO REG. NO. 370399, DATED 2-3-1989, RENEWED AS REG. NO. 32487/2003, DATED 11-5-2003, EXPIRES 2-3-2014.

OWNER OF U.S. REG. NO. 2,063,773.

SER. NO. 85-184,708, FILED 11-24-2010.

JENNIFER MARTIN, EXAMINING ATTORNEY



David J. Kyffers

Director of the United States Patent and Trademark Office

United States of America

United States Patent and Trademark Office

BLACK CROWN DIAMOND

Reg. No. 4,204,330

Registered Sep. 11, 2012

Int. Cl.: 14

TRADEMARK

PRINCIPAL REGISTER

PANDORA JEWELRY, LLC (MARYLAND LIMITED LIABILITY COMPANY)
8671 ROBERT FULTON DRIVE, SUITE A
COLUMBIA, MD 21046

FOR: WATCHES CONTAINING DIAMONDS, IN CLASS 14 (U.S. CLS. 2, 27, 28 AND 50).

FIRST USE 9-0-2010; IN COMMERCE 9-0-2010.

THE MARK CONSISTS OF STANDARD CHARACTERS WITHOUT CLAIM TO ANY PARTICULAR FONT, STYLE, SIZE, OR COLOR.

NO CLAIM IS MADE TO THE EXCLUSIVE RIGHT TO USE "DIAMOND", APART FROM THE MARK AS SHOWN.

SER. NO. 85-186,214, FILED 11-29-2010.

JOHN DALIER, EXAMINING ATTORNEY



David J. Kyffers

Director of the United States Patent and Trademark Office

United States of America

United States Patent and Trademark Office

SAVING SECOND BASE . . . ONE BREAST AT A TIME

Reg. No. 4,204,331

Registered Sep. 11, 2012

Int. Cl.: 44

SERVICE MARK

PRINCIPAL REGISTER

SOUTH DENVER OB/GYN (COLORADO CORPORATION)
SUITE 280
7780 S BROADWAY
LITTLETON, CO 80122

FOR: MEDICAL SERVICES, NAMELY, BREAST CANCER PREVENTION AND AWARENESS,
NAMELY, BREAST EXAMS, IN CLASS 44 (U.S. CLS. 100 AND 101).

FIRST USE 7-1-2010; IN COMMERCE 9-1-2010.

THE MARK CONSISTS OF STANDARD CHARACTERS WITHOUT CLAIM TO ANY PAR-
TICULAR FONT, STYLE, SIZE, OR COLOR.

SER. NO. 85-186,842, FILED 11-30-2010.

MATTHEW EINSTEIN, EXAMINING ATTORNEY



David J. Kyjars

Director of the United States Patent and Trademark Office

United States of America

United States Patent and Trademark Office

Organic Essence

Reg. No. 4,204,332

Registered Sep. 11, 2012

Int. Cl.: 3

TRADEMARK

PRINCIPAL REGISTER

WEST, ELLERY (UNITED STATES INDIVIDUAL)
629 BERTSCH AVENUE
CRESCENT CITY, CA 95531

FOR: ORGANIC BODY CARE PRODUCTS, NAMELY, ORGANIC NON-MEDICATED LIP BALM, ORGANIC NON-MEDICATED SKIN CARE CREAM, IN CLASS 3 (U.S. CLS. 1, 4, 6, 50, 51 AND 52).

FIRST USE 9-10-2004; IN COMMERCE 9-10-2004.

THE MARK CONSISTS OF STANDARD CHARACTERS WITHOUT CLAIM TO ANY PARTICULAR FONT, STYLE, SIZE, OR COLOR.

OWNER OF U.S. REG. NO. 3,042,992.

NO CLAIM IS MADE TO THE EXCLUSIVE RIGHT TO USE "ORGANIC", APART FROM THE MARK AS SHOWN.

SEC. 2(F).

SER. NO. 85-187,186, FILED 11-30-2010.

JENNIFER MARTIN, EXAMINING ATTORNEY



David J. Kyffers

Director of the United States Patent and Trademark Office

United States of America

United States Patent and Trademark Office



Reg. No. 4,204,333

Registered Sep. 11, 2012

Int. Cls.: 29, 30, 31 and 35

TRADEMARK

SERVICE MARK

PRINCIPAL REGISTER

JOHN WOODS (LISGLYN) LIMITED (UNITED KINGDOM LIMITED CORPORATION)
190 MONAGHAN ROAD
ARMAGH, UNITED KINGDOM BT604EZ

FOR: PRESERVED, DRIED, FROZEN, CHILLED, CANNED AND COOKED FRUITS AND VEGETABLES, NAMELY, PRESERVED, DRIED AND COOKED FRUIT, NUTS AND SEEDS; JELLIES, JAMS, COMPOTES; PRESERVES AND PICKLES; MILK AND MILK PRODUCTS, EXCLUDING ICE CREAM, ICE MILK AND FROZEN YOGURT; DAIRY PRODUCTS, EXCLUDING ICE CREAM, ICE MILK AND FROZEN YOGURT; CHEESE; YOGURT; BUTTER, MARGARINE AND BUTTER SUBSTITUTES; PREPARED SNACKS, NAMELY, CANDIED FRUIT SNACKS, DRIED FRUIT SNACKS, DRIED BERRY SNACKS, POWDERED BERRY SNACKS, PREPARED SEED SNACKS, PREPARED NUT SNACKS, DRIED GOJI BERRIES, DRIED STRAWBERRIES, DRIED BLUEBERRIES, DRIED CRANBERRIES, SHELLLED HEMP SEEDS, PREPARED FLAXSEED, PREPARED SUNFLOWER SEEDS, PREPARED PUMPKIN SEEDS, PREPARED SESAME SEEDS, PREPARED POPPY SEEDS, PREPARED CHIA SEEDS, PREPARED WALNUTS, PREPARED BRAZIL NUTS, PREPARED ALMONDS, GROUND FLAXSEED, NUT BASED SNACK MIXES CONSISTING OF MIXTURES OF GROUND FLAXSEED AND GOJI BERRIES, NUT BASED SNACKS MIXES CONSISTING OF GROUND FLAXSEED, PROCESSED SUNFLOWER SEEDS, PROCESSED PUMPKIN SEEDS, SESAME SEEDS AND GOJI BERRIES, NUT BASED SNACK MIXES CONSISTING OF MIXTURES OF GROUND FLAXSEED, PREPARED ALMONDS, PREPARED BRAZIL NUTS, PREPARED WALNUTS AND CO-ENZYME Q10, NUT BASED SNACK MIXTURES CONSISTING OF GROUND FLAXSEED, COCOA POWDER, DRIED STRAWBERRIES AND DRIED BLUEBERRIES; EDIBLE NUTS AND SEEDS; PROCESSED EDIBLE NUTS AND SEEDS; DIPS; DESSERTS AND PUDDINGS, NAMELY, FRUIT BASED FILLING FOR PIES AND TARTS; FRUIT PUREES FOR FILLING FOR PASTRY, IN CLASS 29 (U.S. CL. 46).



David J. Kyros

Director of the United States Patent and Trademark Office

FOR: COCOA; COCOA POWDER; FLOUR AND PREPARATIONS MADE FROM CEREALS, NAMELY, BREAD, PASTRY AND CONFECTIONERY, FOOD STARCH, CORN STARCH, RICE STARCH FLOUR, WHEAT STARCH FLOUR, STARCH POWDER, STARCH SYRUP; BREAD, PASTRY AND CONFECTIONERY, NAMELY, BREAD, FIVE SEED BREAD, FLAXSEED BREAD, WHEATEN BREAD, FARM HOUSE BREAD, BREAD ROLLS, FINGER ROLLS, BAPS, NAMELY, BREAD ROLLS, PANCAKES, POTATO BREAD, POTATO SCONES, SODA FARLS, NAMELY, SODA BREAD, FRUIT BREAD, FRUIT LOAF, FRUIT BRACK, NAMELY, FRUIT BREAD, FRUIT LOGS, ICED FRUIT LOGS, TARTS, APPLE TARTS, RHUBARB TARTS, TURNOVERS, APPLE TURNOVERS, SPONGES, NAMELY, SPONGE CAKES, ICED SPONGE CAKE FINGERS, CAKES, SNOWBALLS, NAMELY, SPONGE CAKES,

Reg. No. 4,204,333 CUP CAKES, MUFFINS, BISCUITS, OATMEAL BISCUITS, COOKIES, OATMEAL COOKIES; PROCESSED CEREAL; BREAD, BISCUITS, CAKES AND FARINACEOUS FOOD PRODUCTS FOR HUMAN CONSUMPTION; DESSERTS AND PUDDINGS; CEREAL ENERGY BARS; CEREAL BARS, IN CLASS 30 (U.S. CL. 46).

FOR: EDIBLE FRESH FRUITS AND VEGETABLES, IN CLASS 31 (U.S. CLS. 1 AND 46).

FOR: RETAIL STORE SERVICES, MAIL ORDER RETAIL STORE SERVICES AND ON-LINE RETAIL STORE SERVICES FEATURING PRESERVED, DRIED, FROZEN, CHILLED, CANNED AND COOKED FRUITS AND VEGETABLES, PRESERVED, DRIED AND COOKED FRUIT, NUTS AND SEEDS, JELLIES, JAMS, COMPOTES; PRESERVES AND PICKLES, MILK AND MILK PRODUCTS, DAIRY PRODUCTS, CHEESE; YOGURT; BUTTER, MARGARINE AND BUTTER SUBSTITUTES, PREPARED SNACKS, CANDIED FRUIT SNACKS, DRIED FRUIT SNACKS, DRIED BERRY SNACKS, POWDERED BERRY SNACKS, PREPARED SEED SNACKS, PREPARED NUT SNACKS, DRIED GOJI BERRIES, DRIED STRAWBERRIES, DRIED BLUEBERRIES, DRIED CRANBERRIES, SHELLED HEMP, PREPARED FLAXSEED, PREPARED SUNFLOWER SEEDS, PREPARED PUMPKIN SEEDS, PREPARED SESAME SEEDS, PREPARED POPPY SEEDS, PREPARED CHIA SEEDS, PREPARED WALNUTS, PREPARED BRAZIL NUTS, PREPARED ALMONDS, GROUND FLAXSEED, NUT BASED SNACK MIXES CONSISTING OF MIXTURES OF GROUND FLAXSEED AND GOJI BERRIES, NUT BASED SNACK MIXES CONSISTING OF MIXTURES OF GROUND FLAXSEED, SUNFLOWER SEEDS, PROCESSED PUMPKIN SEEDS, SESAME SEEDS AND GOJI BERRIES, NUT BASED SNACK MIXES CONSISTING OF MIXTURES OF GROUND FLAXSEED, PREPARED ALMONDS, PREPARED BRAZIL NUTS, PREPARED WALNUTS AND CO-ENZYME Q10, MIXTURES OF GROUND FLAXSEED, COCOA POWDER, DRIED STRAWBERRIES AND DRIED BLUEBERRIES, SHELLED HEMP, EDIBLE NUTS AND SEEDS, PROCESSED EDIBLE NUTS AND SEEDS, DIPS, DESSERTS AND PUDDINGS, FRUIT BASED FILLING FOR PIES AND TARTS, FRUIT PUREES FOR FILLING FOR PASTRY, COCOA, COCOA POWDER, FLOUR AND PREPARATIONS MADE FROM CEREALS, BREAD, PASTRY AND CONFECTIONERY, FOOD STARCH, CORN STARCH, RICE STARCH FLOUR, WHEAT STARCH FLOUR, STARCH POWDER, STARCH SYRUP, BREAD, PASTRY AND CONFECTIONERY, NAMELY, BREAD, FIVE SEED BREAD, FLAXSEED BREAD, WHEATEN BREAD, FARMHOUSE BREAD, BREAD ROLLS, FINGER ROLLS, BAPS, NAMELY, BREAD ROLLS, PANCAKES, POTATO BREAD, POTATO SCONES, SODA FARLS, FRUIT BREAD, FRUIT LOAF, FRUIT BRACK, NAMELY, FRUIT BREAD, FRUIT LOGS, ICED FRUIT LOGS, TARTS, APPLE TARTS, RHUBARB TARTS, TURNOVERS, APPLE TURNOVERS, SPONGES, NAMELY, SPONGE CAKES, ICED SPONGE CAKE FINGERS, CAKES, SNOWBALLS, NAMELY, SPONGE CAKES, CUP CAKES, MUFFINS, BISCUITS, OATMEAL BISCUITS, COOKIES, OATMEAL COOKIES, PROCESSED CEREAL, BREAD, BISCUITS, CAKES AND FARINACEOUS FOOD PRODUCTS FOR HUMAN CONSUMPTION, DESSERTS AND PUDDINGS, CEREAL ENERGY BARS, CEREAL BARS, NUTRITIONAL SUPPLEMENTS, PROBIOTIC SUPPLEMENTS AND HEALTHFOOD SUPPLEMENTS, IN CLASS 35 (U.S. CLS. 100, 101 AND 102).

PRIORITY CLAIMED UNDER SEC. 44(D) ON ERPN CMNTY TM OFC APPLICATION NO. 009561481, FILED 11-30-2010, REG. NO. 009561481, DATED 5-10-2011, EXPIRES 11-20-2020.

THE COLOR(S) RED, ORANGE AND WHITE IS/ARE CLAIMED AS A FEATURE OF THE MARK.

THE MARK CONSISTS OF THE LITERAL ELEMENT "LINWOODS" APPEARS IN WHITE WITH THE TWO LETTER "O"'S INTERLOCKING AND APPEARING IN AN ORANGE HIGHLIGHTED AREA, THE LITERAL ELEMENT APPEARS WITHIN A SEMI-OVAL SHAPE THAT IS PRIMARILY RED.

SER. NO. 85-187,698, FILED 11-30-2010.

SAIMA MAKHDOOM, EXAMINING ATTORNEY

United States of America

United States Patent and Trademark Office

FOR THE PERFECT SURVEY EVERY DAY

Reg. No. 4,204,334

Registered Sep. 11, 2012

Int. Cl.: 9

TRADEMARK

PRINCIPAL REGISTER

PROFESSIONAL MEDICAL SURGICAL SUPPLY, INC. (ILLINOIS CORPORATION)
1917 GARNET COURT
NEW LENOX, IL 60451

FOR: PROVIDING NECESSARY TOOLS, TRAINING AND TRACKING RESOURCES ONLINE IN THE FIELD OF LONG TERM CARE FACILITY MANAGEMENT TO ASSIST IN PREPARATION FOR THE QUALITY INDICATOR SURVEY, NAMELY, DOWNLOADABLE ONLINE SURVEY FORMS CATEGORIZED BY F-TAG, TASK AND CATEGORY, EDUCATIONAL MATERIALS, NAMELY, DOWNLOADABLE ONLINE IN-SERVICE GUIDE, ONLINE COURSES AND DOWNLOADABLE ONLINE MANUALS TO ASSIST IN THE TRAINING OF STAFF, AND DOWNLOADABLE ONLINE FORMS TO TRACK THE PROCESS OF STAFF MEMBERS, IN CLASS 9 (U.S. CLS. 21, 23, 26, 36 AND 38).

FIRST USE 6-11-2010; IN COMMERCE 6-11-2010.

THE MARK CONSISTS OF STANDARD CHARACTERS WITHOUT CLAIM TO ANY PARTICULAR FONT, STYLE, SIZE, OR COLOR.

SER. NO. 85-191,381, FILED 12-6-2010.

EUGENIA MARTIN, EXAMINING ATTORNEY



David J. Kyffers

Director of the United States Patent and Trademark Office

United States of America

United States Patent and Trademark Office



Reg. No. 4,204,335

Registered Sep. 11, 2012

Int. Cl.: 30

TRADEMARK

PRINCIPAL REGISTER

THE MEDITERRANEAN SNACK FOOD COMPANY, LLC (NEW JERSEY LIMITED LIABILITY COMPANY)
708 MAIN STREET
BOONTON, NJ 07005

FOR: CORN-BASED SNACK FOODS; CRACKERS; GRAIN-BASED CHIPS; MULTIGRAIN-BASED SNACK FOODS; POPPED POPCORN; PROCESSED GRAINS; PUFFED CORN SNACKS; PUFFED RICE; RICE-BASED SNACK FOODS; WHEAT-BASED SNACK FOODS, IN CLASS 30 (U.S. CL. 46).

FIRST USE 6-1-2007; IN COMMERCE 6-1-2007.

NO CLAIM IS MADE TO THE EXCLUSIVE RIGHT TO USE "SNACKS", APART FROM THE MARK AS SHOWN.

THE COLOR(S) YELLOW, DARK BROWN, LIGHT BROWN, BLACK, GREEN, LIGHT GREEN, CREAM, WHITE, LIGHT BLUE, AND LIGHT TAN IS/ARE CLAIMED AS A FEATURE OF THE MARK.

THE MARK CONSISTS OF A PASTORAL SCENE CONTAINING YELLOW SUNFLOWERS WITH A DARK BROWN CENTER IN THE FOREGROUND AND BLACK SHADOWING; ROWS OF GREEN CROPS WITH LIGHT BROWN DIRT AND BLACK SHADOWING; A CREAM BUILDING CLUSTER WITH DARK BROWN ROOFS WITH BLACK WINDOWS AND SHADOWS ON A LIGHT GREEN HILLSIDE WITH GREEN TREES AND ROWS OF GREEN BUSHES AND BLACK SHADOWING; LIGHT BROWN MOUNTAINS AND BLACK SHADOWING AND A LIGHT BLUE SKY WITH WHITE CLOUDS AT THE TOP ALL ENCOMPASSED IN A TWO TONE FRAME, THE TOP PORTION OF THE FRAME IN LIGHT BROWN AND THE BOTTOM PORTION IN DARK BROWN, WITH THE LITERAL ELEMENT "MEDITERRANEAN SNACKS" IN LIGHT TAN BELOW THE SCENE WITHIN THE DARK BROWN PORTION OF THE FRAME AND THE WHOLE OUTER EDGE OF THE FRAME IN LIGHT TAN WITH LIGHT BROWN BEADS.

SEC. 2(F) AS TO "MEDITERRANEAN SNACKS".

SER. NO. 85-192,478, FILED 12-7-2010.

NICHOLAS COLEMAN, EXAMINING ATTORNEY



David J. Kyros

Director of the United States Patent and Trademark Office

United States of America

United States Patent and Trademark Office

Gary Cooper

Reg. No. 4,204,336

Registered Sep. 11, 2012

Int. Cl.: 41

SERVICE MARK

PRINCIPAL REGISTER

MARIA COOPER, JANIS (UNITED STATES INDIVIDUAL)
C/O M. ERLINGER, 630 BROOKS STREET
LAGUNA BEACH, CA 92651

FOR: ENTERTAINMENT SERVICES, NAMELY, PROVIDING A WEB SITE FEATURING PHOTOGRAPHIC, VIDEO AND PROSE PRESENTATIONS FEATURING FILM-CLIPS, INFORMATION, PHOTOGRAPHS, BIOGRAPHIES, AND FILM CREDITS CONCERNING OR RELATED TO GARY COOPER AND HIS RECORDED ARTISTIC, DRAMATIC AND VISUAL ARTS PERFORMANCES AS AN ACTOR AND LIFE AS AN AMERICAN ENTERTAINER, IN CLASS 41 (U.S. CLS. 100, 101 AND 107).

FIRST USE 9-15-2011; IN COMMERCE 9-15-2011.

THE MARK CONSISTS OF STANDARD CHARACTERS WITHOUT CLAIM TO ANY PARTICULAR FONT, STYLE, SIZE, OR COLOR.

THE NAME(S), PORTRAIT(S), AND/OR SIGNATURE(S) SHOWN IN THE MARK DOES NOT IDENTIFY A PARTICULAR LIVING INDIVIDUAL.

SER. NO. 85-192,728, FILED 12-7-2010.

KELLY BOULTON, EXAMINING ATTORNEY



David J. Kyffers

Director of the United States Patent and Trademark Office

United States of America

United States Patent and Trademark Office

AP AUTOMATION

Reg. No. 4,204,337

Registered Sep. 11, 2012

Int. Cls.: 7 and 9

TRADEMARK

PRINCIPAL REGISTER

ARC PRODUCTS, INC. (DELAWARE CORPORATION)
22801 ST. CLAIR AVENUE
CLEVELAND, OH 44117

FOR: ELECTRIC WELDING MACHINES AND PARTS AND FITTINGS THEREOF; MACHINE PARTS FOR LINEAR MOVEMENT TECHNOLOGY APPARATUSES, NAMELY, EXTRUDED ALUMINUM U-CHANNELS USED TO CREATE THE BASE STRUCTURE FOR LINEAR GUIDES, LINEAR SLIDES AND CROSS SLIDES; MACHINES PARTS, NAMELY, PIPE ROLLERS AND ROTATORS USED TO HOLD ROTATING PIPE OR LARGE PRESSURE VESSELS WHILE WELDING; DRIVE UNITS USED TO ROTATE OR TURN PIPES AND LARGE PRESSURE VESSELS ON THE ROLLERS AND ROTATORS FOR WELDING EQUIPMENT AND MACHINERY; WELDING WIRE FEEDERS AND ELECTRIC WELDING GUIDES USED FOR POSITIONING THE TORCH OVER THE JOINT TO BE WELDED; WELDING HEADS; PARTS AND FITTINGS FOR ALL OF THE WELDING EQUIPMENT; REPLACEMENT PARTS FOR ALL OF THE WELDING EQUIPMENT, IN CLASS 7 (U.S. CLS. 13, 19, 21, 23, 31, 34 AND 35).

FIRST USE 5-23-2002; IN COMMERCE 5-23-2002.

FOR: ELECTRIC WELDING APPARATUS, NAMELY, ELECTRIC ARC WELDERS; ELECTRICAL CONTROLLERS FOR ELECTRICAL ARC WELDERS; ELECTRICAL CONTROLLERS FOR SEAM TRACKING SYSTEMS USED TO ACCURATELY TRACK THE SEAM BEING WELDED; ELECTRICAL CONTROLLERS FOR WELDING WIRE FEEDERS USED WITH ELECTRIC ARC WELDERS; MICRO-PROCESSOR, ELECTRONIC, ELECTRICAL AND COMPUTER-GENERATED CONTROLLERS FOR CONTROLLING, AUTOMATING AND MANAGING WELDING EQUIPMENT IN THE NATURE OF GAS TUNGSTEN ARC WELDERS, SUBMERGED ARC WELDERS AND GAS METAL ARC WELDERS; ELECTRICAL CONTROLLERS FOR PLASMA ARC WELDING PROCESSES, CYCLES AND PROGRAMS, NAMELY, AMP, VOLT, WIRE SPEED, AND TRAVEL SPEED PROGRAMS; HAND-HELD ELECTRONIC UNITS AND CABLES FOR CONTROLLING, AUTOMATING AND MANAGING WELDING EQUIPMENT IN THE NATURE OF GAS TUNGSTEN ARC WELDERS, SUBMERGED ARC WELDERS, AND GAS METAL ARC WELDERS AND FOR PLASMA ARC WELDING PROCESSES; HAND HELD ELECTRONIC UNITS AND CABLES FOR PLASMA ARC WELDING PROCESSES, CYCLES AND PROGRAMS, NAMELY, AMP, VOLT, WIRE SPEED, AND TRAVEL SPEED PROGRAMS; PROGRAMMABLE MICRO-PROCESSOR, ELECTRONIC, ELECTRICAL AND COMPUTER-GENERATED CONTROLLERS AND HAND-HELD ELECTRONIC UNITS AND CABLES FOR CONTROLLING, AUTOMATING AND



David J. Kyffers

Director of the United States Patent and Trademark Office

Reg. No. 4,204,337 MANAGING WELDING EQUIPMENT IN THE NATURE OF GAS TUNGSTEN ARC WELDERS, SUBMERGED ARC WELDERS AND GAS METAL ARC WELDERS; PROGRAMMABLE MICROPROCESSOR, ELECTRONIC, ELECTRICAL AND COMPUTER-GENERATED CONTROLLERS AND HAND-HELD ELECTRONIC UNITS AND CABLES FOR PLASMA ARC WELDING PROCESSES, CYCLES AND PROGRAMS, NAMELY, AMP, VOLT, WIRE SPEED, AND TRAVEL SPEED PROGRAMS FOR THE PURPOSE OF SEAM TRACKING, ARC VOLTAGE CONTROL, MAGNETIC ARC CONTROL, AND FEEDING WELDING WIRE; ELECTRIC SENSORS AND RELATED MOUNTING BRACKETS; TIP PARTS, NAMELY, A COMPUTER STYLUS FOR ELECTRIC SENSORS; MAGNETIC PROBES USED TO STABILIZE OR OSCILLATE A WELDING ARC; ELECTRICAL POWER DISTRIBUTION UNITS FOR PIPES AND LARGE PRESSURE VESSELS; ELECTRIC FOOT CONTROL SWITCHES USED TO ADJUST THE WELDING MACHINE; PARTS AND FITTINGS FOR ALL THE FOREGOING, IN CLASS 9 (U.S. CLS. 21, 23, 26, 36 AND 38).

FIRST USE 1-28-2002; IN COMMERCE 1-28-2002.

THE MARK CONSISTS OF STANDARD CHARACTERS WITHOUT CLAIM TO ANY PARTICULAR FONT, STYLE, SIZE, OR COLOR.

NO CLAIM IS MADE TO THE EXCLUSIVE RIGHT TO USE "AUTOMATION", APART FROM THE MARK AS SHOWN.

SER. NO. 85-193,667, FILED 12-8-2010.

WENDY GOODMAN, EXAMINING ATTORNEY

United States of America

United States Patent and Trademark Office

CHAIRMAN'S RESERVE

Reg. No. 4,204,338

ST. LUCIA DISTILLERS LTD. (ST.LUCIA CORPORATION)

Registered Sep. 11, 2012

ROSEAU
CASTRIES, ST.LUCIA

Int. Cl.: 33

FOR: RUM, IN CLASS 33 (U.S. CLS. 47 AND 49).

TRADEMARK

FIRST USE 10-1-2009; IN COMMERCE 10-1-2009.

PRINCIPAL REGISTER

THE MARK CONSISTS OF STANDARD CHARACTERS WITHOUT CLAIM TO ANY PARTICULAR FONT, STYLE, SIZE, OR COLOR.

NO CLAIM IS MADE TO THE EXCLUSIVE RIGHT TO USE "RESERVE", APART FROM THE MARK AS SHOWN.

SER. NO. 85-196,381, FILED 12-13-2010.

MAUREEN DALL, EXAMINING ATTORNEY



David J. Kyffers

Director of the United States Patent and Trademark Office

United States of America

United States Patent and Trademark Office



Reg. No. 4,204,339

Registered Sep. 11, 2012

Int. Cls.: 9 and 35

TRADEMARK

SERVICE MARK

PRINCIPAL REGISTER

PRODIGY MUSIC GROUP LTD. (CANADA LIMITED COMPANY (LTD.))
3300 EXETER ROAD
VICTORIA, CANADA

FOR: PRE-RECORDED AUDIO TAPES, DISCS AND CASSETTES, VIDEO TAPES, DIGITAL AUDIO AND AUDIO VIDEO TAPES, CDS, DVDS, AND PHONOGRAPH RECORDS FEATURING MUSIC; MUSIC VIDEO RECORDINGS; DOWNLOADABLE RING TONES, MUSIC, MP3 FILES FEATURING MUSIC, GRAPHICS, GAME SOFTWARE, IMAGE FILES FEATURING MUSICIANS AND MUSIC VIDEOS FEATURING MUSICIANS FOR WIRELESS COMMUNICATION DEVICES; DOWNLOADABLE MUSIC, MP3 FILES FEATURING MUSIC, GRAPHICS, COMPUTER GAME SOFTWARE, IMAGE FILES IN THE FIELD OF MUSIC AND VIDEOS FEATURING MUSIC VIA A GLOBAL COMPUTER NETWORK, IN CLASS 9 (U.S. CLS. 21, 23, 26, 36 AND 38).

FIRST USE 11-19-2010; IN COMMERCE 12-12-2010.

FOR: DISTRIBUTORSHIP OF MUSICAL RECORDINGS; DISTRIBUTORSHIP OF MUSICAL AND NON-MUSICAL SOUND RECORDINGS AND VIDEO RECORDINGS; ADVERTISING AND PROMOTION SERVICES AND RELATED CONSULTING SERVICES; ADVERTISING AND PUBLICITY SERVICES; ASSOCIATION SERVICES, NAMELY, PROMOTING THE INTERESTS OF MUSICIANS, SINGERS, SONGWRITERS, MUSICAL PERFORMERS AND ARTISTS; COMPUTERIZED ONLINE ORDERING FEATURING GENERAL MERCHANDISE AND GENERAL CONSUMER GOODS; COMPUTERIZED ONLINE ORDERING SERVICES IN THE FIELD OF MUSICAL RECORDINGS, DVDS; COMPUTERIZED ONLINE RETAIL STORE SERVICES IN THE FIELD OF MUSICAL RECORDINGS, DVDS; ONLINE RETAIL STORE SERVICES FEATURING DOWNLOADABLE PRE-RECORDED MUSIC AND AUDIO-VISUAL CONTENT AND GENERAL MERCHANDISE; PREPARING AUDIO-VISUAL DISPLAYS IN THE FIELD OF MUSIC ADVERTISING; ARRANGING AND CONDUCTING FAIRS AND EXHIBITIONS FOR BUSINESS AND ADVERTISING PURPOSES; PROMOTING THE CONCERTS OF OTHERS; PROMOTING THE GOODS AND SERVICES OF OTHERS BY ARRANGING FOR SPONSORS TO AFFILIATE THEIR GOODS AND SERVICES WITH CONCERTS, MUSICAL AND SPORTS EVENTS; PROMOTING THE GOODS OF OTHERS BY PREPARING AND PLACING ADVERTISEMENTS IN AN ELECTRONIC MAGAZINE ACCESSED THROUGH A GLOBAL COMPUTER NETWORK; PROVIDING INFORMATION ABOUT THE GOODS AND SERVICES OF OTHERS VIA A GLOBAL COMPUTER NETWORK; RETAIL STORE SERVICES AVAILABLE THROUGH COMPUTER COMMUNICATIONS FEATURING CD'S, DVD'S, AND LICENSED CLOTHING MERCHANDISE; MANAGEMENT



David J. Kyjars

Director of the United States Patent and Trademark Office

Reg. No. 4,204,339 SERVICES FOR PROFESSIONAL PERFORMING AND RECORDING ARTISTS; TALENT AGENCY SERVICES; ADVERTISING, INCLUDING PROMOTION OF PRODUCTS AND SERVICES OF THIRD PARTIES THROUGH SPONSORING ARRANGEMENTS AND LICENSE AGREEMENTS RELATING TO MUSIC EVENTS; PROMOTING MUSIC COMPETITIONS AND EVENTS FOR OTHERS; PROMOTING GOODS AND SERVICES OF OTHERS BY ARRANGING FOR SPONSORS TO AFFILIATE THEIR GOODS AND SERVICES WITH MUSIC COMPETITIONS; PROMOTING THE INTERESTS OF PEOPLE INVOLVED AND CONCERNED WITH MUSIC; PROVIDING ONLINE REGISTRATION SERVICES FOR MUSIC COMPETITIONS , IN CLASS 35 (U.S. CLS. 100, 101 AND 102).

FIRST USE 11-19-2010; IN COMMERCE 12-12-2010.

NO CLAIM IS MADE TO THE EXCLUSIVE RIGHT TO USE "MUSIC GROUP", APART FROM THE MARK AS SHOWN.

THE COLOR(S) BLACK, WHITE, RED, AND GREY IS/ARE CLAIMED AS A FEATURE OF THE MARK.

THE MARK CONSISTS OF THE WORDS "PRODIGY MUSIC GROUP" WITH THE LETTER "I" OF "PRODIGY" BEING FORMED FROM A MICROPHONE DESIGN. ALL WORDING OF THE MARK IS BLACK EXCEPT FOR THE MICROPHONE LETTER I WHICH IS WHITE ON TOP WITH RED DOTS AND A GRAY SHADOW ON THE UPPER RIGHT AND LOWER LEFT. THE BOTTOM PORTION OF THE MICROPHONE IS BLACK.

SER. NO. 85-196,714, FILED 12-13-2010.

BRENDAN MCCAULEY, EXAMINING ATTORNEY

United States of America

United States Patent and Trademark Office

BIOTECH

Reg. No. 4,204,340

Registered Sep. 11, 2012

Int. Cls.: 3 and 5

TRADEMARK

PRINCIPAL REGISTER

BIOTECH INTERNATIONAL CORPORATION (CONNECTICUT CORPORATION)
107 OAKWOOD DRIVE
GLASTONBURY, CT 06033

FOR: BEAUTY CREAMS; BEAUTY LOTIONS; BEAUTY SERUMS; BODY CREAMS; BODY LOTIONS; CREAMS FOR CELLULITE REDUCTION; EYE CREAM; EYE LOTIONS; FACE AND BODY BEAUTY CREAMS; FACE AND BODY CREAMS; FACE AND BODY LOTIONS; FACE CREAMS; HAND CREAMS; HAND LOTIONS; LOTIONS FOR CELLULITE REDUCTION; SKIN CARE PRODUCTS, NAMELY, NON-MEDICATED SKIN SERUM; SKIN CREAMS; SKIN LOTIONS; TONING LOTION, FOR THE FACE, BODY AND HANDS, IN CLASS 3 (U.S. CLS. 1, 4, 6, 50, 51 AND 52).

FIRST USE 4-30-2002; IN COMMERCE 4-30-2002.

FOR: DIETARY AND NUTRITIONAL SUPPLEMENTS, IN CLASS 5 (U.S. CLS. 6, 18, 44, 46, 51 AND 52).

FIRST USE 9-30-1994; IN COMMERCE 9-30-1994.

THE MARK CONSISTS OF STANDARD CHARACTERS WITHOUT CLAIM TO ANY PARTICULAR FONT, STYLE, SIZE, OR COLOR.

OWNER OF U.S. REG. NO. 2,411,711.

SEC. 2(F).

SER. NO. 85-196,784, FILED 12-13-2010.

TRACY FLETCHER, EXAMINING ATTORNEY



David J. Kybas

Director of the United States Patent and Trademark Office

United States of America

United States Patent and Trademark Office

The PINK
FUND

Reg. No. 4,204,341

THE PINK FUND (MICHIGAN NON-PROFIT ORGANIZATION)
22122 METAMORA
BEVERLY HILLS, MI 48025

Registered Sep. 11, 2012

Int. Cl.: 36

FOR: CHARITABLE FUNDRAISING SERVICES, NAMELY, PROVIDING FINANCIAL ASSISTANCE IN THE NATURE OF PAYMENT OF BILLS AND EXPENSES OF OTHERS FOR THOSE UNDERGOING MEDICAL TREATMENT AND THEIR FAMILIES, IN CLASS 36 (U.S. CLS. 100, 101 AND 102).

SERVICE MARK

PRINCIPAL REGISTER

FIRST USE 10-1-2006; IN COMMERCE 10-1-2006.

NO CLAIM IS MADE TO THE EXCLUSIVE RIGHT TO USE "FUND", APART FROM THE MARK AS SHOWN.

THE COLOR(S) PINK IS/ARE CLAIMED AS A FEATURE OF THE MARK.

THE MARK CONSISTS OF THE WORD "PINK" ARRANGED HORIZONTALLY OVER THE WORD "FUND", THE WORD "THE" ARRANGED VERTICALLY IN FRONT OF THE WORD "PINK", AND A HEART LOGO ARRANGED ADJACENT THE END OF THE WORD "PINK". THE ENTIRE MARK APPEARS IN THE COLOR PINK.

SER. NO. 85-197,328, FILED 12-14-2010.

JULIE WATSON, EXAMINING ATTORNEY



David J. Kybas

Director of the United States Patent and Trademark Office

United States of America

United States Patent and Trademark Office

Brochure Key

Reg. No. 4,204,342

Registered Sep. 11, 2012

Int. Cl.: 9

TRADEMARK

PRINCIPAL REGISTER

MICROLAN INTEGRATION, INC. (TEXAS CORPORATION), DBA KTI PROMOTION
10415A WESTPARK DRIVE
HOUSTON, TX 77042

FOR: COMBINATION OF A USB (UNIVERSAL SERIAL BUS) HARDWARE ENCASED IN A HARDCOVER PAPER PAMPHLET, WITH THE HARDWARE USED TO LAUNCH PRE-PROGRAMMED WEB ADDRESS WHEN CONNECTED TO A COMPUTER AND THE PAPER PAMPHLET CONTAINING ADVERTISEMENTS AND INSTRUCTIONS ASSOCIATED USING THE HARDWARE, IN CLASS 9 (U.S. CLS. 21, 23, 26, 36 AND 38).

FIRST USE 11-1-2010; IN COMMERCE 12-1-2010.

THE MARK CONSISTS OF STANDARD CHARACTERS WITHOUT CLAIM TO ANY PARTICULAR FONT, STYLE, SIZE, OR COLOR.

NO CLAIM IS MADE TO THE EXCLUSIVE RIGHT TO USE "KEY", APART FROM THE MARK AS SHOWN.

SER. NO. 85-198,450, FILED 12-15-2010.

RAMONA ORTIGA, EXAMINING ATTORNEY



David J. Kyffers

Director of the United States Patent and Trademark Office

United States of America

United States Patent and Trademark Office

Whistling Duck Vineyards

Reg. No. 4,204,343

Registered Sep. 11, 2012

Int. Cl.: 44

SERVICE MARK

PRINCIPAL REGISTER

WHISTLING DUCK VINEYARDS (TEXAS LIMITED LIABILITY COMPANY)
3753 FOSSILWOOD WAY
ROUND ROCK, TX 78681

FOR: VINEYARD AND WINERY SERVICES, NAMELY, THE CULTIVATION OF GRAPES FOR OTHERS. PROVIDE INFORMATION IN THE FIELD OF VINEYARD HORTICULTURE, IN CLASS 44 (U.S. CLS. 100 AND 101).

FIRST USE 3-1-2010; IN COMMERCE 3-1-2010.

THE MARK CONSISTS OF STANDARD CHARACTERS WITHOUT CLAIM TO ANY PARTICULAR FONT, STYLE, SIZE, OR COLOR.

NO CLAIM IS MADE TO THE EXCLUSIVE RIGHT TO USE "VINEYARDS", APART FROM THE MARK AS SHOWN.

SER. NO. 85-199,057, FILED S.R. 12-15-2010 AM. P.R. 4-2-2012.

ANN E. SAPPENFIELD, EXAMINING ATTORNEY



David J. Kybas

Director of the United States Patent and Trademark Office

United States of America

United States Patent and Trademark Office

ISAAC PUBLISHING

Reg. No. 4,204,344

BARNABAS FUND, INC. (VIRGINIA CORPORATION), DBA BARNABAS AID
6731 CURRAN STREET
MCLEAN, VA 22106

Registered Sep. 11, 2012

Int. Cl.: 42

FOR: GRAPHIC DESIGN SERVICES; PROVIDING GRAPHIC AND MULTIMEDIA DESIGN SERVICES FOR THE PURPOSE OF PROMOTING THE GOODS AND SERVICES OF OTHERS; DESIGN AND CREATING WEB SITES FOR OTHERS; WEB SITE DESIGN, IN CLASS 42 (U.S. CLS. 100 AND 101).

SERVICE MARK

PRINCIPAL REGISTER

FIRST USE 1-12-2007; IN COMMERCE 1-12-2007.

THE MARK CONSISTS OF STANDARD CHARACTERS WITHOUT CLAIM TO ANY PARTICULAR FONT, STYLE, SIZE, OR COLOR.

NO CLAIM IS MADE TO THE EXCLUSIVE RIGHT TO USE "PUBLISHING", APART FROM THE MARK AS SHOWN.

SER. NO. 85-199,059, FILED 12-15-2010.

ROBIN CHOSID, EXAMINING ATTORNEY



David J. Kyffers

Director of the United States Patent and Trademark Office

United States of America

United States Patent and Trademark Office

Termite Prufe

Reg. No. 4,204,345

COPPER BRITE, INC. (CALIFORNIA CORPORATION)
P.O. BOX 50610
SANTA BARBARA, CA 93150

Registered Sep. 11, 2012

Int. Cl.: 5

FOR: INSECTICIDAL AND FUNGICIDAL PREPARATION FOR DESTROYING TERMITES FOR DOMESTIC USE, IN CLASS 5 (U.S. CLS. 6, 18, 44, 46, 51 AND 52).

TRADEMARK

FIRST USE 5-12-1998; IN COMMERCE 5-12-1998.

PRINCIPAL REGISTER

THE MARK CONSISTS OF STANDARD CHARACTERS WITHOUT CLAIM TO ANY PARTICULAR FONT, STYLE, SIZE, OR COLOR.

OWNER OF U.S. REG. NO. 2,349,893.

NO CLAIM IS MADE TO THE EXCLUSIVE RIGHT TO USE "TERMITE", APART FROM THE MARK AS SHOWN.

SEC. 2(F).

SER. NO. 85-199,743, FILED 12-16-2010.

CHARLES L. JENKINS, EXAMINING ATTORNEY



David J. Kyffers

Director of the United States Patent and Trademark Office

United States of America

United States Patent and Trademark Office



Reg. No. 4,204,346

Registered Sep. 11, 2012

Int. Cls.: 41, 43, 44 and 45

SERVICE MARK

PRINCIPAL REGISTER

ELDER CARE ALLIANCE (CALIFORNIA CORPORATION)
2361 EAST 29TH STREET
OAKLAND, CA 94606

FOR: SUPPORT SERVICES FOR SENIOR ADULTS AND THE ELDERLY, NAMELY, ORGANIZING PERSONAL FITNESS CLASSES AND CULTURAL, SOCIAL, AND ARTS EVENTS AND OUTINGS; EDUCATIONAL SERVICES IN THE NATURE OF PROVIDING COGNITIVE FITNESS PROGRAMS; HOSTING EDUCATIONAL SEMINARS AND WORKSHOPS FOR SENIOR ADULTS AND THE ELDERLY IN THE FIELD OF PHYSICAL HEALTH, MENTAL HEALTH, WELLNESS, FINANCIAL PLANNING, AND DEMENTIA, IN CLASS 41 (U.S. CLS. 100, 101 AND 107).

FIRST USE 11-30-1997; IN COMMERCE 11-30-1997.

FOR: PROVIDING ASSISTED LIVING FACILITIES; PROVIDING INDEPENDENT LIVING FACILITIES; SUPPORT SERVICES FOR SENIOR ADULTS AND THE ELDERLY, NAMELY, PROVIDING ASSISTANCE TO SENIOR ADULTS AND THE ELDERLY SEEKING TO DETERMINE ASSISTED LIVING FACILITIES APPROPRIATE FOR THEIR NEEDS; PROVIDING RESPITE CARE IN THE NATURE OF PROVIDING TEMPORARY ACCOMMODATION AND PROVIDING ELDER CARE FOR SENIOR ADULTS AND THE ELDERLY; PROVIDING MEALS FOR SENIOR ADULTS AND THE ELDERLY, IN CLASS 43 (U.S. CLS. 100 AND 101).

FIRST USE 11-30-1997; IN COMMERCE 11-30-1997.

FOR: SKILLED NURSING; ALZHEIMER'S AND DEMENTIA HEALTH CARE; PROVIDING NON-MEDICAL ASSISTED LIVING SERVICES FOR PERSONAL PURPOSES IN THE NATURE OF PROVIDING A BEAUTY SALON FOR ON-SITE RESIDENTS; SUPPORTIVE PROGRAMMING FOR DEMENTIA CARE, NAMELY, PROVIDING NON-MEDICAL ASSISTED LIVING SERVICES FOR PERSONAL PURPOSES IN THE NATURE OF PROVIDING A BEAUTY SALON FOR ON-SITE RESIDENTS, IN CLASS 44 (U.S. CLS. 100 AND 101).

FIRST USE 11-30-1997; IN COMMERCE 11-30-1997.

FOR: SUPPORT SERVICES FOR SENIOR ADULTS AND THE ELDERLY, NAMELY, GERIATRIC CARE MANAGEMENT SERVICES IN THE NATURE OF THE COORDINATION OF NECESSARY SERVICES AND PERSONAL CARE FOR OLDER INDIVIDUALS AND ORGAN-



David J. Kyjars

Director of the United States Patent and Trademark Office

Reg. No. 4,204,346 IZING AND CONDUCTING SUPPORT GROUPS AND SOCIAL DISCUSSION GROUPS IN THE FIELD OF AGING, MENTAL HEALTH, AND DEMENTIA; PERSONAL CARE AND HOSPITALITY SERVICES, NAMELY, ASSISTANCE WITH ACTIVITIES OF DAILY LIVING, SUCH AS BATHING, GROOMING AND PERSONAL MOBILITY FOR SENIOR ADULTS, THE ELDERLY AND THOSE SUFFERING FROM DEMENTIA; PROVIDING NON-MEDICAL ASSISTED LIVING SERVICES FOR PERSONAL PURPOSES IN THE NATURE OF SCHEDULING APPOINTMENTS, MAIL SORTING, MAIL HANDLING, AND MAIL RECEIVING; SUPPORTIVE PROGRAMMING FOR DEMENTIA CARE, NAMELY, PROVIDING NON-MEDICAL ASSISTED LIVING SERVICES FOR PERSONAL PURPOSES IN THE NATURE OF SCHEDULING APPOINTMENTS, MAIL SORTING, MAIL HANDLING, AND MAIL RECEIVING; SECURITY SERVICES, NAMELY, PROVIDING DELAYED EGRESS IN THE NATURE OF PASSWORD-PROTECTED ACCESS TO THE BUILDING ENVIRONMENT FOR THOSE SUFFERING FROM DEMENTIA, IN CLASS 45 (U.S. CLS. 100 AND 101).

FIRST USE 11-30-1997; IN COMMERCE 11-30-1997.

OWNER OF U.S. REG. NO. 2,613,315.

NO CLAIM IS MADE TO THE EXCLUSIVE RIGHT TO USE "ELDER CARE" AND "SENIOR HOUSING AND SERVICES", APART FROM THE MARK AS SHOWN.

THE MARK CONSISTS OF TWO CONCENTRIC HEARTS TO THE LEFT OF THE WORDING "ELDER CARE" WITH THE WORDING "ALLIANCE" CENTERED BELOW THE LETTERS "ERCARE" AND THE WORDING "SENIOR HOUSING AND SERVICES" CENTERED BELOW THE LETTERS "LLIANCE" IN THE WORD "ALLIANCE".

SEC. 2(F) AS TO "ELDER CARE ALLIANCE".

SER. NO. 85-201,757, FILED 12-20-2010.

TINA BROWN, EXAMINING ATTORNEY

United States of America

United States Patent and Trademark Office



Reg. No. 4,204,347

Registered Sep. 11, 2012

Int. Cl.: 30

TRADEMARK

PRINCIPAL REGISTER

GARNER, CRAIG A. (TENNESSEE CORPORATION), DBA BFC INC.
WWW.BBQFIGHTCLUB.COM/INDEX.HTM
782 RHONDA LN.
NASHVILLE, TN 37205

FOR: BARBEQUE SAUCE, IN CLASS 30 (U.S. CL. 46).

FIRST USE 7-17-1986; IN COMMERCE 7-17-1986.

NO CLAIM IS MADE TO THE EXCLUSIVE RIGHT TO USE "BBQ", "WHITE SAUCE", "AS SERVED AT HOG HEAVEN IN NASHVILLE, TENNESSEE" AND "MUSIC CITY ORIGINAL", APART FROM THE MARK AS SHOWN.

THE MARK CONSISTS OF A CHICKEN, STANDING IN FRONT OF A CLOUD OF SMOKE, WEARING A KARATE UNIFORM, ABOVE THE WORDS "KICKIN' CHICKEN" "WHITE SAUCE" "AS SERVED AT HOG HEAVEN IN NASHVILLE TENNESSEE" AND "A MUSIC CITY ORIGINAL", AND BENEATH THE WORDS "OFTEN IMITATED!" "BBQ FIGHT CLUB", AND "NEVER DUPLICATED!", WITH A FORK TO THE LEFT OF THE CHICKEN AND A SPATULA TO THE RIGHT OF THE CHICKEN.

SER. NO. 85-202,163, FILED 12-20-2010.

ARETHA SOMERVILLE, EXAMINING ATTORNEY



David J. Kyros

Director of the United States Patent and Trademark Office

United States of America

United States Patent and Trademark Office



Reg. No. 4,204,348

Registered Sep. 11, 2012

Int. Cl.: 41

SERVICE MARK

PRINCIPAL REGISTER

ROSEMARY DANIELL (UNITED STATES INDIVIDUAL), DBA ZONA ROSA, LLC
1205 SKIDAWAY ROAD
SAVANNAH, GA 31404

FOR: PERSONAL COACHING SERVICES IN THE FIELD OF WRITING, IN CLASS 41 (U.S. CLS. 100, 101 AND 107).

FIRST USE 0-0-1983; IN COMMERCE 0-0-1983.

THE MARK CONSISTS OF A DARK PINK LIP PRINT ON A PALE PINK BACKGROUND WITH BLACK CURSIVE LETTERS SPELLING OUT "ZONA ROSA".

THE COLOR(S) PINK, BLACK, AND DARK PINK IS/ARE CLAIMED AS A FEATURE OF THE MARK.

THE ENGLISH TRANSLATION OF THE SPANISH WORDS "ZONA ROSA" IS "PINK ZONE".

SER. NO. 85-203,041, FILED 12-21-2010.

ANN E. SAPPENFIELD, EXAMINING ATTORNEY



David J. Kybas

Director of the United States Patent and Trademark Office

United States of America

United States Patent and Trademark Office

AROMA

Reg. No. 4,204,349

Registered Sep. 11, 2012

Int. Cls.: 9 and 41

TRADEMARK

SERVICE MARK

PRINCIPAL REGISTER

BUSINESS PROPERTIES OF MEXICO, S. DE R.L. DE C.V. (MEXICO CORPORATION)
MANUEL BARRAGÁN 1700, COL LAS MISIONES
NICOLAS DE LOS GZA, NL, MEXICO 66428

FOR: PRE-RECORDED CDS, VIDEO TAPES, LASER DISKS AND DVDS FEATURING MUSIC
, IN CLASS 9 (U.S. CLS. 21, 23, 26, 36 AND 38).

FIRST USE 12-10-2010; IN COMMERCE 12-10-2010.

FOR: ENTERTAINMENT IN THE NATURE OF LIVE PERFORMANCES BY A VOCAL AND
INSTRUMENTAL MUSICAL GROUP, IN CLASS 41 (U.S. CLS. 100, 101 AND 107).

FIRST USE 12-10-2010; IN COMMERCE 12-10-2010.

THE MARK CONSISTS OF STANDARD CHARACTERS WITHOUT CLAIM TO ANY PAR-
TICULAR FONT, STYLE, SIZE, OR COLOR.

SER. NO. 85-203,684, FILED 12-22-2010.

CARYN GLASSER, EXAMINING ATTORNEY



David J. Kyffers

Director of the United States Patent and Trademark Office

United States of America
United States Patent and Trademark Office

FIANDACA

Reg. No. 4,204,350

FIANDACA, ALFRED (UNITED STATES INDIVIDUAL)
350 WEST 50TH STREET
NEW YORK, NY 10019

Registered Sep. 11, 2012

Int. Cls.: 25 and 42

FOR: WEARING APPAREL, NAMELY, BLOUSES, COATS, DRESSES, GOWNS, JACKETS, LOUNGEWEAR, PANTS, SKIRTS AND SUITS; ACCESSORIES, NAMELY, BELTS, GLOVES, SCARVES AND SHAWLS, IN CLASS 25 (U.S. CLS. 22 AND 39).

TRADEMARK

FIRST USE 5-1-1979; IN COMMERCE 5-1-1979.

SERVICE MARK

FOR: DESIGN FOR OTHERS OF WEARING APPAREL AND ACCESSORIES, IN CLASS 42 (U.S. CLS. 100 AND 101).

PRINCIPAL REGISTER

FIRST USE 5-1-1979; IN COMMERCE 5-1-1979.

THE MARK CONSISTS OF STANDARD CHARACTERS WITHOUT CLAIM TO ANY PARTICULAR FONT, STYLE, SIZE, OR COLOR.

SEC. 2(F).

SER. NO. 85-207,319, FILED 12-29-2010.

H. M. FISHER, EXAMINING ATTORNEY



David J. Kypos

Director of the United States Patent and Trademark Office

United States of America

United States Patent and Trademark Office

FREIGHT MANAGER

Reg. No. 4,204,351

UNISHIPPERS GLOBAL LOGISTICS, LLC (DELAWARE LIMITED LIABILITY COMPANY)
746 EAST WINCHESTER STREET, SUITE 200
SALT LAKE CITY, UT 84107

Registered Sep. 11, 2012

Int. Cl.: 39

FOR: PARCEL SHIPPING SERVICES; SHIPPING AND DELIVERY SERVICES, NAMELY, PICKUP, TRANSPORTATION, AND DELIVERY OF PACKAGES AND LETTERS BY VARIOUS MODES OF TRANSPORTATION, IN CLASS 39 (U.S. CLS. 100 AND 105).

SERVICE MARK

FIRST USE 11-30-2010; IN COMMERCE 11-30-2010.

PRINCIPAL REGISTER

NO CLAIM IS MADE TO THE EXCLUSIVE RIGHT TO USE "FREIGHT MANAGER", APART FROM THE MARK AS SHOWN.

THE MARK CONSISTS OF THE WORDS "FREIGHT MANAGER" IN STYLIZED LETTERING WITH THE WORD "FREIGHT" POSITIONED AS A TRAILER ON THE BACK OF A TRUCK.

SER. NO. 85-207,661, FILED 12-29-2010.

TINA L. SNAPP, EXAMINING ATTORNEY



David J. Kybas

Director of the United States Patent and Trademark Office

United States of America

United States Patent and Trademark Office

POLYmatte

Reg. No. 4,204,352

DEETZ, DAYTON J. (UNITED STATES INDIVIDUAL)
73 WASHINGTON STREET
MENDON, MA 01756

Registered Sep. 11, 2012

Int. Cl.: 16

FOR: ART PAPER; ART PRINTS; ART PRINTS ON CANVAS; CHALK BOARDS FOR SCHOOL AND HOME USE; CHILDREN'S WALL STICKERS AND MURALS; DIGITAL PRINTING PAPER; DRAWING BOARDS; DRY ERASE WRITING BOARDS AND WRITING SURFACES; DYE-SUBLIMATION PRINT PAPER; GRAPHIC PRINTS AND REPRESENTATIONS; LASER PRINT PAPER; LASER PRINTING PAPER; MAGNETIC BOARDS; MAGNETIC PAPER; PAPER; PAPER FOR USE IN MAKING SIGNS; PAPER FOR USE IN THE GRAPHIC ARTS INDUSTRY; PAPER FOR USE IN THE MANUFACTURE OF WALLPAPER; PHOTOGRAPHIC PRINTS; PICTORIAL PRINTS; PLASTIC SHEETS FOR WRITING, PRINTING, AND MARKING; POLYESTER FILM FOR USE AS A PAPER SUBSTITUTE FOR DRY TONER XEROGRAPHIC IMAGING, NAMELY, LASER PRINTING, COLOR COPIER PRINTING, DRY TONER PRINTING, SCREEN PRINTING, AND OFFSET PRINTING; PRINT SUBSTRATE, NAMELY, TRANSPARENT, OPAQUE, AND TRANSLUCENT FILMS FOR USE WITH INK JET COPIERS AND LASER PRINTERS; PRINTED EDUCATIONAL MATERIAL, NAMELY, TEACHING TILES; PRINTED GRAPHS; PRINTED PAPER SIGNS; PRINTING PAPER; PRINTING PAPERS, IN CLASS 16 (U.S. CLS. 2, 5, 22, 23, 29, 37, 38 AND 50).

TRADEMARK

PRINCIPAL REGISTER

FIRST USE 3-1-2007; IN COMMERCE 3-1-2007.

THE MARK CONSISTS OF A STYLIZED WORD, "POLYMATTE".

SER. NO. 85-208,546, FILED 12-31-2010.

ANTHONY RINKER, EXAMINING ATTORNEY



David J. Kyjars

Director of the United States Patent and Trademark Office

United States of America

United States Patent and Trademark Office

GLO Brilliant

Reg. No. 4,204,353

GLO SCIENCE LLC (DELAWARE LIMITED LIABILITY COMPANY)
923 FIFTH AVENUE
NEW YORK, NY 10021

Registered Sep. 11, 2012

Int. Cls.: 3, 5 and 10

FOR: DENTAL BLEACHING GELS; TEETH WHITENING KITS; TEETH BLEACHING PREPARATIONS; TEETH CLEANING PREPARATIONS; TEETH WHITENING GELS; TEETH WHITENING PREPARATIONS, IN CLASS 3 (U.S. CLS. 1, 4, 6, 50, 51 AND 52).

TRADEMARK

FIRST USE 5-25-2010; IN COMMERCE 5-25-2010.

PRINCIPAL REGISTER

FOR: PRE-FILLED CONTAINERS FOR APPLYING TEETH BLEACHING PREPARATIONS AND BLEACHING GELS, IN CLASS 5 (U.S. CLS. 6, 18, 44, 46, 51 AND 52).

FIRST USE 5-25-2010; IN COMMERCE 5-25-2010.

FOR: TEETH WHITENING DEVICES, NAMELY, MOUTHGUARDS, IN CLASS 10 (U.S. CLS. 26, 39 AND 44).

FIRST USE 5-25-2010; IN COMMERCE 5-25-2010.

THE MARK CONSISTS OF STANDARD CHARACTERS WITHOUT CLAIM TO ANY PARTICULAR FONT, STYLE, SIZE, OR COLOR.

OWNER OF U.S. REG. NO. 3,873,849.

SER. NO. 85-211,707, FILED 1-6-2011.

GISELLE AGOSTO, EXAMINING ATTORNEY



David J. Kyjars

Director of the United States Patent and Trademark Office

United States of America

United States Patent and Trademark Office

SNAPS

Reg. No. 4,204,354

AMERICAN LICORICE CO. (DELAWARE CORPORATION)
2796 NW CLEARWATER DRIVE
BEND, OR 97701

Registered Sep. 11, 2012

Int. Cl.: 30

FOR: CANDY-COATED HOLLOW LICORICE PIECES, NOT PEPPERMINT CANDY, IN CLASS 30 (U.S. CL. 46).

TRADEMARK

FIRST USE 12-0-1935; IN COMMERCE 12-0-1935.

PRINCIPAL REGISTER

THE MARK CONSISTS OF STANDARD CHARACTERS WITHOUT CLAIM TO ANY PARTICULAR FONT, STYLE, SIZE, OR COLOR.

OWNER OF U.S. REG. NO. 2,827,194.

SER. NO. 85-213,227, FILED 1-7-2011.

KIM MONINGHOFF, EXAMINING ATTORNEY



David J. Kybas

Director of the United States Patent and Trademark Office

United States of America

United States Patent and Trademark Office



The Fence Connection

Reg. No. 4,204,355

Registered Sep. 11, 2012

Int. Cl.: 20

TRADEMARK

PRINCIPAL REGISTER

1347805 ALBERTA LTD. (CANADA CORPORATION)
BOX 628
HYTHE, ALBERTA, CANADA T0H2C0

FOR: PLASTIC FENCE FASTENERS, NAMELY, RESILIENT CLIPS FOR ATTACHING TEMPORARY PLASTIC FENCES TO POSTS, IN CLASS 20 (U.S. CLS. 2, 13, 22, 25, 32 AND 50).

PRIORITY CLAIMED UNDER SEC. 44(D) ON CANADA APPLICATION NO. 1504931, FILED 11-22-2010, REG. NO. TMA813925, DATED 12-13-2011, EXPIRES 12-13-2026.

NO CLAIM IS MADE TO THE EXCLUSIVE RIGHT TO USE "SAFETY FENCE" AND "FENCE", APART FROM THE MARK AS SHOWN.

THE MARK CONSISTS OF A STYLIZED CIRCLE PARTIALLY COVERED BY AN ENLARGED "T"; THE WORD "SAFE" SITS TO THE LEFT OF THE ENLARGED "T" AND THE WORD "FENCE" COVERS A PORTION OF THE ENLARGED "T"; THE WORD "MATE" IS POSITIONED ON THE RIGHT SIDE OF THE ENLARGED "T" BELOW THE WORD "FENCE"; THE PHRASE "THE FENCE CONNECTION" IS POSITIONED CENTRALLY BELOW THE OTHER PORTION OF THE MARK.

SER. NO. 85-213,953, FILED 1-10-2011.

DARRYL SPRUILL, EXAMINING ATTORNEY



David J. Kyffers

Director of the United States Patent and Trademark Office

United States of America

United States Patent and Trademark Office

CERTIFIED SOUS CHEF

Reg. No. 4,204,356

AMERICAN CULINARY FEDERATION (NEW YORK CORPORATION)
180 CENTER PLACE WAY ST.
AUGUSTINE, FL 32095

Registered Sep. 11, 2012

CERTIFICATION MARK

FOR: COOKING SERVICES, IN CLASS B (U.S. CL. B).

PRINCIPAL REGISTER

FIRST USE 0-0-1995; IN COMMERCE 0-0-1995.

THE MARK CONSISTS OF STANDARD CHARACTERS WITHOUT CLAIM TO ANY PARTICULAR FONT, STYLE, SIZE, OR COLOR.

OWNER OF U.S. REG. NOS. 3,575,642, 3,575,666 AND OTHERS.

NO CLAIM IS MADE TO THE EXCLUSIVE RIGHT TO USE "CERTIFIED", APART FROM THE MARK AS SHOWN.

THE CERTIFICATION MARK, AS USED BY AUTHORIZED PERSONS, CERTIFIES THAT THE PERSON USING THE MARK IS A PROFESSIONAL CHEF WHO HAS DEMONSTRATED ADVANCED KNOWLEDGE AND SKILLS PERTAINING TO PROFESSIONAL COOKING, NUTRITION, FOOD SAFETY, SANITATION, AND KITCHEN MANAGEMENT AS DETERMINED BY A TEST OF CULINARY SKILL AND KNOWLEDGE AUTHORIZED BY THE CERTIFIER. THE PROFESSIONAL SKILL AND KNOWLEDGE CAN BE DOCUMENTED BY BEING SUCCESSFULLY EMPLOYED FOR A MINIMUM OF FIVE YEARS AS AN ENTRY LEVEL CULINARIAN AND BY PASSING THE CERTIFICATION KNOWLEDGE AND SKILL PROFICIENCY TESTS ESTABLISHED BY THE CERTIFIER.



SEC. 2(F).

SER. NO. 85-214,732, FILED 1-11-2011.

DARRYL SPRUILL, EXAMINING ATTORNEY

David J. Kybas

Director of the United States Patent and Trademark Office

United States of America

United States Patent and Trademark Office

IT'S NOT STICKY!

Reg. No. 4,204,357

Registered Sep. 11, 2012

Int. Cl.: 1

TRADEMARK

PRINCIPAL REGISTER

PARK METALLURGICAL CORPORATION (DELAWARE CORPORATION)
8074 MILITARY AVENUE
DETROIT, MI 48204

FOR: WATER-BASED QUENCHANT FOR STEEL AND ALUMINUM, IN CLASS 1 (U.S. CLS. 1, 5, 6, 10, 26 AND 46).

FIRST USE 0-0-2003; IN COMMERCE 0-0-2003.

THE MARK CONSISTS OF STANDARD CHARACTERS WITHOUT CLAIM TO ANY PARTICULAR FONT, STYLE, SIZE, OR COLOR.

SEC. 2(F).

SER. NO. 85-216,185, FILED 1-12-2011.

DAVID TAYLOR, EXAMINING ATTORNEY



David J. Kyffers

Director of the United States Patent and Trademark Office

United States of America

United States Patent and Trademark Office

ANITA KO

Reg. No. 4,204,358

KO, ANITA (UNITED STATES INDIVIDUAL)

Registered Sep. 11, 2012

8033 SUNSET BLVD #865
LOS ANGELES, CA 90046

Int. Cl.: 14

FOR: JEWELLERY AND PRECIOUS STONES; JEWELRY; JEWELRY AND IMITATION JEWELRY; PRECIOUS AND SEMI-PRECIOUS STONES; PRECIOUS METALS AND THEIR ALLOYS; PRECIOUS STONES, IN CLASS 14 (U.S. CLS. 2, 27, 28 AND 50).

TRADEMARK

FIRST USE 1-1-2006; IN COMMERCE 1-1-2006.

PRINCIPAL REGISTER

THE MARK CONSISTS OF STANDARD CHARACTERS WITHOUT CLAIM TO ANY PARTICULAR FONT, STYLE, SIZE, OR COLOR.

THE NAME(S), PORTRAIT(S), AND/OR SIGNATURE(S) SHOWN IN THE MARK IDENTIFIES "ANITA KO", WHOSE CONSENT(S) TO REGISTER IS MADE OF RECORD.

SER. NO. 85-216,331, FILED 1-12-2011.

ANTHONY RINKER, EXAMINING ATTORNEY



David J. Kyffers

Director of the United States Patent and Trademark Office

United States of America

United States Patent and Trademark Office

NET ENERGY MARKET

Reg. No. 4,204,359

Registered Sep. 11, 2012

Int. Cls.: 35 and 40

SERVICE MARK

PRINCIPAL REGISTER

BLUEBONNET ELECTRIC COOPERATIVE, INC. (TEXAS CORPORATION)
P.O. BOX 729
BASTROP, TX 78602

FOR: ENERGY USAGE MANAGEMENT; PROVIDING ENERGY USAGE MANAGEMENT SERVICES, NAMELY, REDUCING ENERGY CONSUMPTION BY REMOTELY INTERACTING WITH AND CONTROLLING SMART APPLIANCES AND SMART PLUGS; ENERGY USAGE MANAGEMENT SERVICES, NAMELY, ENERGY DEMAND MANAGEMENT SERVICES; ENERGY USAGE MANAGEMENT INFORMATION SERVICES; HOME ENERGY ASSESSMENT SERVICES FOR THE PURPOSE OF DETERMINING ENERGY EFFICIENCY OR USAGE MANAGEMENT; PROVIDING INFORMATION IN THE FIELD OF ENERGY EFFICIENCY; PROVIDING INFORMATION ON THE ENVIRONMENTAL IMPACT OF CONSUMERS' ONGOING ENERGY USAGE; PROVIDING INFORMATION TO CONSUMERS ABOUT THE EFFICIENT USE OF RENEWABLE ENERGY, ELECTRICITY, AND OTHER UTILITY SERVICES, IN CLASS 35 (U.S. CLS. 100, 101 AND 102).

FIRST USE 5-27-2010; IN COMMERCE 5-27-2010.

FOR: PROVIDING INFORMATION TO CONSUMERS ABOUT RENEWABLE ENERGY GENERATION, IN CLASS 40 (U.S. CLS. 100, 103 AND 106).

FIRST USE 5-27-2010; IN COMMERCE 5-27-2010.

THE MARK CONSISTS OF STANDARD CHARACTERS WITHOUT CLAIM TO ANY PARTICULAR FONT, STYLE, SIZE, OR COLOR.

NO CLAIM IS MADE TO THE EXCLUSIVE RIGHT TO USE "NET ENERGY", APART FROM THE MARK AS SHOWN.

SER. NO. 85-218,050, FILED 1-14-2011.

JASON LOTT, EXAMINING ATTORNEY



David J. Kyffers

Director of the United States Patent and Trademark Office

United States of America

United States Patent and Trademark Office

RICARD



Reg. No. 4,204,360

Registered Sep. 11, 2012

Int. Cl.: 33

TRADEMARK

PRINCIPAL REGISTER

PERNOD RICARD (FRANCE SOCIÉTÉ ANONYME (SA))
12, PLACE DES ETATS-UNIS
PARIS, FRANCE 75016

FOR: ALCOHOLIC BEVERAGES EXCEPT BEERS, IN CLASS 33 (U.S. CLS. 47 AND 49).

PRIORITY CLAIMED UNDER SEC. 44(D) ON FRANCE APPLICATION NO. 103759054,
FILED 8-5-2010, REG. NO. 103759054, DATED 12-24-2010, EXPIRES 8-5-2020.

THE COLOR(S) SILVER, DARK BLUE, RED, AND WHITE IS/ARE CLAIMED AS A FEATURE
OF THE MARK.

OWNER OF U.S. REG. NOS. 2,741,426, 3,261,227 AND OTHERS.

THE MARK CONSISTS OF THREE ELEMENTS, NAMELY, AN UPPER DARK BLUE CARTOUCHE WITH THE WORD "RICARD" IN WHITE LETTERS; A BOTTOM WHITE RECTANGLE; AND IN THE MIDDLE, A SHAPE THAT HAS FOUR BEVELED CORNERS AND IS WIDER AT THE TOP THAN THE BOTTOM. THIS MIDDLE ELEMENT CONTAINS A SILVER, WHITE, AND DARK BLUE FOLIAGE DESIGN WITH A RED CIRCLE AT THE CENTER AND A SILVER RIBBON MOTIF WITH DARK BLUE EDGES THAT UNFURLS TO THE RIGHT AND LEFT OF THE RED CIRCLE AND EXTENDS BEYOND THE EDGES OF THE SHAPE, APPEARING TO CURL AROUND BEHIND IT. THE REMAINDER OF THE MIDDLE ELEMENT IS COMPRISED OF FINE SILVER LINES RADIATING OUT FROM THE FOLIAGE DESIGN ON A WHITE GROUND. ALL THREE ELEMENTS OF THE MARK ARE OUTLINED IN SILVER, DARK BLUE AND WHITE. THE MARK IS CHARACTERIZED BY THE RELATIVE PLACEMENT AND SEPARATION BETWEEN THESE THREE ELEMENTS WHICH TOGETHER CREATE A TAPERING EFFECT, WITH THE TOP CARTOUCHE THE WIDEST, THE MIDDLE ELEMENT WIDER AT THE TOP THAN THE BOTTOM, AND THE BOTTOM RECTANGLE THE NARROWEST.

THE WORDING "RICARD" HAS NO MEANING IN A FOREIGN LANGUAGE.

SER. NO. 85-218,401, FILED 1-14-2011.

MARTHA SANTOMARTINO, EXAMINING ATTORNEY



David J. Kyros

Director of the United States Patent and Trademark Office

United States of America

United States Patent and Trademark Office

SYNC ROLL

Reg. No. 4,204,361

SEKAI ELECTRONICS, INC. (CALIFORNIA CORPORATION)
14600 INDUSTRY CIRCLE
LA MIRADA, CA 90638

Registered Sep. 11, 2012

Int. Cl.: 9

FOR: VIDEO RECORDER PLAYBACK COMPUTER SOFTWARE, IN CLASS 9 (U.S. CLS. 21, 23, 26, 36 AND 38).

TRADEMARK

FIRST USE 10-25-2010; IN COMMERCE 10-25-2010.

PRINCIPAL REGISTER

THE MARK CONSISTS OF STANDARD CHARACTERS WITHOUT CLAIM TO ANY PARTICULAR FONT, STYLE, SIZE, OR COLOR.

NO CLAIM IS MADE TO THE EXCLUSIVE RIGHT TO USE "SYNC", APART FROM THE MARK AS SHOWN.

SER. NO. 85-220,025, FILED 1-18-2011.

RONALD AIKENS, EXAMINING ATTORNEY



David J. Kyffers

Director of the United States Patent and Trademark Office

United States of America
United States Patent and Trademark Office

BARZEL

Reg. No. 4,204,362

THE BEDA GROUP, LLC (NEW YORK LIMITED LIABILITY COMPANY)
ONE 43RD STREET, SUITE L9
BROOKLYN, NY 11232

Registered Sep. 11, 2012

Int. Cls.: 7 and 8

FOR: SNOW THROWER, LAWN MOWER, POWER-OPERATED GRASS TRIMMER, POWER-OPERATED HEDGE TRIMMER, IN CLASS 7 (U.S. CLS. 13, 19, 21, 23, 31, 34 AND 35).

TRADEMARK

FIRST USE 11-30-2010; IN COMMERCE 11-30-2010.

PRINCIPAL REGISTER

FOR: HAND-OPERATED ICE CHOPPER, IN CLASS 8 (U.S. CLS. 23, 28 AND 44).

FIRST USE 11-1-2010; IN COMMERCE 11-1-2010.

THE MARK CONSISTS OF STANDARD CHARACTERS WITHOUT CLAIM TO ANY PARTICULAR FONT, STYLE, SIZE, OR COLOR.

THE ENGLISH TRANSLATION OF "BARZEL" IN THE MARK IS "IRON".

SER. NO. 85-222,167, FILED 1-20-2011.

ANNE E. GUSTASON, EXAMINING ATTORNEY



David J. Kybas

Director of the United States Patent and Trademark Office

United States of America

United States Patent and Trademark Office



Reg. No. 4,204,363

Registered Sep. 11, 2012

Int. Cls.: 6 and 40

TRADEMARK

SERVICE MARK

PRINCIPAL REGISTER

IPSCO TUBULARS INC. (DELAWARE CORPORATION)
SUITE 700
2650 WARRENVILLE ROAD
DOWNERS GROVE, IL 60515

FOR: METAL PIPES; METAL OIL AND GAS DRILL PIPES FOR USE IN WELL BORING; METAL OIL AND GAS WELL CASINGS; METAL OIL AND GAS WELL TUBING; METAL OIL AND GAS WELL PIPES; CUSTOMIZED MANUFACTURED METAL PIPES MADE TO CUSTOMER SPECIFICATIONS FEATURING PATENTED THREADS UTILIZED FOR FASTENING PIPE SECTIONS; METAL HOLLOW STRUCTURAL SECTIONS FOR CONSTRUCTION, STRUCTURAL AND HIGH-STRENGTH APPLICATIONS; METAL STRUCTURAL TUBING; AND METAL PIPE CONNECTIONS, IN CLASS 6 (U.S. CLS. 2, 12, 13, 14, 23, 25 AND 50).

FIRST USE 11-0-2009; IN COMMERCE 11-0-2009.

FOR: CUSTOM MANUFACTURING OF PIPE AND PIPE CONNECTIONS; CUSTOM PIPE THREADING SERVICES, IN CLASS 40 (U.S. CLS. 100, 103 AND 106).

FIRST USE 11-0-2009; IN COMMERCE 11-0-2009.

OWNER OF U.S. REG. NO. 2,478,141.

THE MARK CONSISTS OF THE LETTERS "TMK" APPEARING IN THE LOWER LEFT SIDE OF A SHADED SQUARE AND TO THE LEFT OF AN ARC DESIGN WITH THE TERM "IPSCO" APPEARING UNDERNEATH THE SQUARE IN A BACKGROUND WITH AN IN THE OUTLINE OF THE RECTANGLE.

SER. NO. 85-222,181, FILED 1-20-2011.

ANNE E. GUSTASON, EXAMINING ATTORNEY



David J. Kybas

Director of the United States Patent and Trademark Office

United States of America

United States Patent and Trademark Office



Reg. No. 4,204,364

Registered Sep. 11, 2012

Int. Cl.: 11

TRADEMARK

PRINCIPAL REGISTER

BARED DI BELLUSSI DR. ANTONI PAOLO (ITALY SOLE PROPRIETORSHIP)
VIA EMILIA, 25
CONEGLIANO (TV), ITALY I-31015

FOR: INDUSTRIAL AND COMMERCIAL FILTERING UNITS FOR FLUIDS, NAMELY,
WATER, WINE, JUICE AND MILK, IN CLASS 11 (U.S. CLS. 13, 21, 23, 31 AND 34).

OWNER OF ITALY REG. NO. 965267, DATED 5-12-2005, RENEWED AS REG. NO. 1474052,
DATED 12-7-2011, EXPIRES 12-7-2021.

THE COLOR(S) WHITE, BLACK, BRIGHT RED, DARK RED AND GREY IS/ARE CLAIMED
AS A FEATURE OF THE MARK.

THE MARK CONSISTS OF THE WORD "BARED" IN LOWER CASE AND WHITE COLOR
WITH A BLACK OUTLINE, BENEATH THE WORD IS A MOTIF CONSISTING OF A THREE
DIMENSIONAL ARROW IN BRIGHT AND DARK RED SPLIT IN TWO PARTS, A HORI-
ZONTAL PART DIRECTED FROM LEFT TO RIGHT AND THE OTHER PART DIRECTED
DOWNWARDLY, AND A RECTANGULAR BACKGROUND FOR THE WHOLE IN A WHITE
AND GREY CHESS BOARD FORMAT.

SER. NO. 85-222,207, FILED 1-20-2011.

JORDAN BAKER, EXAMINING ATTORNEY



David J. Kyros

Director of the United States Patent and Trademark Office

United States of America

United States Patent and Trademark Office

Cover-Clad

Reg. No. 4,204,365

U.S. FLOORING COMPANY, INC. (MISSOURI CORPORATION)
1550 KATHERINE AVENUE
JOPLIN, MO 64801

Registered Sep. 11, 2012

Int. Cl.: 2

FOR: EPOXY COATING FOR USE ON CONCRETE INDUSTRIAL FLOORS, IN CLASS 2
(U.S. CLS. 6, 11 AND 16).

TRADEMARK

FIRST USE 1-22-2008; IN COMMERCE 1-22-2008.

PRINCIPAL REGISTER

THE MARK CONSISTS OF STANDARD CHARACTERS WITHOUT CLAIM TO ANY PARTICULAR FONT, STYLE, SIZE, OR COLOR.

SER. NO. 85-222,257, FILED 1-20-2011.

CHRISTOPHER BUONGIORNO, EXAMINING ATTORNEY



David J. Kybas

Director of the United States Patent and Trademark Office

United States of America

United States Patent and Trademark Office

CORVEL

Reg. No. 4,204,366

Registered Sep. 11, 2012

Int. Cls.: 9, 35, 36 and 42

TRADEMARK

SERVICE MARK

PRINCIPAL REGISTER

CORVEL CORPORATION (DELAWARE CORPORATION)
2010 MAIN STREET, SUITE 600
IRVINE, CA 92614

FOR: DOWNLOADABLE SOFTWARE FOR USE ON MOBILE DEVICES THAT ENABLES EMPLOYEES OF CLIENTS TO REMOTELY ACCESS INFORMATION ABOUT AND SCHEDULE APPOINTMENTS FOR HEALTH CARE SERVICES, WORKER'S COMPENSATION SERVICES, MEDICAL DIAGNOSTIC AND TREATMENT SERVICES, AND DISABILITY MANAGEMENT SERVICES; DOWNLOADABLE SOFTWARE FOR USE ON MOBILE DEVICES THAT ENABLES EMPLOYERS TO TRACK AND OBTAIN REPORTS ON EMPLOYEE INSURANCE CLAIMS AND WORKER'S COMPENSATION CLAIMS; DOWNLOADABLE SOFTWARE USED FOR REPORTING PHYSICAL INJURIES, REQUESTING HEALTH CARE SERVICES THROUGH AN ONLINE REQUEST FORM, AND SCHEDULING MEDICAL, DIAGNOSTIC AND THERAPY APPOINTMENTS, FOR MEDICAL AND LEGAL BILL REVIEW THROUGH AN ONLINE REQUEST FORM, ADJUDICATION OF MEDICAL AND WORKER'S COMPENSATION CLAIMS VIA AN ONLINE DATABASE PLATFORM AND AUDITING OF MEDICAL AND WORKER'S COMPENSATION CLAIMS VIA AN ONLINE DATABASE PLATFORM, FOR MEDICAL CLAIMS INFORMATION MANAGEMENT, AND FOR MANAGING MEDICAL CARE AND TREATMENT BY ENABLING CLIENTS TO REPORT INCIDENTS OR INJURIES AND TO OBTAIN AND SCHEDULE MEDICAL CARE AND TREATMENT VIA AN ONLINE DATA PLATFORM; DOWNLOADABLE SOFTWARE USED FOR ACCESSING A DATABASE FEATURING INFORMATION ON HEALTH CARE PROVIDER CREDENTIALS, PARTICIPATING HEALTH CARE PROVIDERS, HEALTH CARE NETWORK INFORMATION, AND PHARMACIES OFFERING DISCOUNT PRESCRIPTIONS, IN CLASS 9 (U.S. CLS. 21, 23, 26, 36 AND 38).

FIRST USE 9-20-2010; IN COMMERCE 9-20-2010.

FOR: HEALTH CARE COST REVIEW, NAMELY, MEDICAL PROVIDER REIMBURSEMENT REVIEW SERVICES; PROVIDING MEDICAL REFERRALS, PATIENT FILE MANAGEMENT, AND MEDICAL COST VERIFICATION SERVICES; PROVIDING REFERRALS FOR DISABILITY SERVICES; REVIEW OF UTILIZATION OF DISABILITY SERVICES; SCHEDULING OF APPOINTMENTS FOR MEDICAL CARE, EXAMS, TREATMENTS AND THERAPY SERVICES; COORDINATING ORDERS AND DELIVERY OF AND BILLING FOR RENTAL MEDICAL EQUIPMENT FROM PREFERRED DISTRIBUTORS THROUGH WEB-BASED SCHEDULING AND CALL CENTERS FOR CLIENTS; PATIENT CARE MANAGEMENT SERVICES, NAMELY, MEDICAL COST MANAGEMENT, MEDICAL REFERRALS, HEALTH



David J. Kybas

Director of the United States Patent and Trademark Office

Reg. No. 4,204,366 CARE UTILIZATION AND REVIEW, EMPLOYMENT COUNSELING, AND TRACKING AND MONITORING COMPLIANCE WITH ACCIDENT, HEALTH AND WORKERS' COMPENSATION MANAGED CARE INSURANCE REQUIREMENTS TO MEET THE NEEDS OF EMPLOYERS; PROMOTING THE GOODS OF OTHERS BY PROVIDING ONLINE ACCESS TO A NETWORK OF PHARMACIES OFFERING DISCOUNTED PHARMACEUTICALS; HEALTHCARE ADMINISTRATION SERVICES, NAMELY, PROVIDING ONLINE BUSINESS DIRECTORY LISTINGS OF REGIONAL HEALTH CARE NETWORKS AND OPERATING FOR OTHERS OF REGIONAL HEALTH CARE NETWORKS OF HEALTH CARE PROVIDERS, PHYSICIANS, MEDICAL IMAGING SERVICES, PHYSICAL THERAPISTS, CHIROPRACTORS, MEDICAL CLINICS AND HOSPITALS, ELECTRONIC PROCESSING OF PATIENT HEALTH CARE INFORMATION, MEDICAL AND THERAPY FEE NEGOTIATION SERVICES FOR OTHERS; PROVIDING AN ONLINE WEB SITE THAT ENABLES EMPLOYEES OF CLIENTS TO SCHEDULE APPOINTMENTS FOR HEALTH CARE SERVICES, WORKER'S COMPENSATION SERVICES, MEDICAL DIAGNOSTIC AND TREATMENT SERVICES; PROVIDING AN ONLINE WEB SITE THAT ENABLES EMPLOYERS TO TRACK AND OBTAIN REPORTS ON EMPLOYEE INSURANCE CLAIMS AND WORKER'S COMPENSATION CLAIMS FOR RECORD-KEEPING AND COST ANALYSIS PURPOSES; PROVIDING AN ONLINE WEB SITE THROUGH WHICH OTHERS CAN REPORT PHYSICAL INJURIES IN ORDER TO OBTAIN HEALTH CARE SERVICES; PROVIDING AN ONLINE WEB SITE FOR SCHEDULING MEDICAL, DIAGNOSTIC AND THERAPY APPOINTMENTS, FOR MEDICAL AND LEGAL BILL RECONCILIATION FOR OTHERS, FOR INSURANCE CLAIMS AUDITING, AND FOR MEDICAL CLAIMS INFORMATION MANAGEMENT AND COST MANAGEMENT FOR THE HEALTH CARE BENEFIT PLANS OF OTHERS; PROVIDING AN ONLINE WEB SITE FOR MEDICAL REFERRALS AND FOR PROVIDING A DATABASE FEATURING CONSUMER INFORMATION ON PARTICIPATING HEALTH CARE PROVIDERS, HEALTH CARE NETWORKS AND PHARMACIES OFFERING DISCOUNT PRESCRIPTIONS; TRACKING AND MONITORING USE OF MEDICAL EQUIPMENT AND SUPPLIES FOR BUSINESS PURPOSES; MEDICAL COST MANAGEMENT AND CONTAINMENT SERVICES; PROVIDING ANALYSIS OF MEDICAL COSTS AND MEDICAL TREATMENT SERVICES; PROVIDING AN ONLINE WEB SITE FOR MEDICAL BILL PAYMENT AND COMPLIANCE WITH STATE MEDICAL FEE SCHEDULES; COST MANAGEMENT AND COST ANALYSIS SERVICES, NAMELY, PRODUCING REPORTS OF AND ANALYZING WORKERS' COMPENSATION CLAIMS AND INSURANCE CLAIMS FOR MEDICAL CARE AND TREATMENT FOR BUSINESS PURPOSES; ADMINISTERING HEALTH CARE PROVIDER REIMBURSEMENTS, IN CLASS 35 (U.S. CLS. 100, 101 AND 102).

FIRST USE 5-27-1991; IN COMMERCE 7-27-1991.

FOR: MEDICAL CLAIMS ADJUSTMENT IN THE FIELD OF INSURANCE; MEDICAL INSURANCE CASE AND UTILIZATION REVIEW SERVICES FOR HEALTHCARE PURCHASERS AND PAYORS; COMPUTING PRENEGOTIATED PREFERRED PROVIDER INSURANCE RATES IN THE FIELD OF HEALTH CARE; WORKERS' COMPENSATION CLAIM SUBMISSION AND FIRST NOTICE OF LOSS PROCESSING SERVICES; PROCESSING INFORMATION PROVIDED BY EMPLOYERS FOR WORKER'S COMPENSATION CLAIMS; PROVIDING AN ONLINE WEB SITE FOR HEALTH, AUTO AND LIABILITY INSURANCE AND WORKERS' COMPENSATION CLAIMS ADMINISTRATION AND FIRST NOTICE OF LOSS PROCESSING SERVICES; PROCESSING OF WORKERS' COMPENSATION CLAIMS AND INSURANCE CLAIMS FOR MEDICAL CARE AND TREATMENT; ELECTRONIC PROCESSING OF INSURANCE CLAIMS AND PAYMENT DATA, IN CLASS 36 (U.S. CLS. 100, 101 AND 102).

FIRST USE 6-1-1992; IN COMMERCE 6-1-1992.

FOR: PROVIDING ON-LINE NON-DOWNLOADABLE SOFTWARE FOR THE AUTOMATED PREPARATION AND COMPLETION OF INSURANCE CLAIMS, IN CLASS 42 (U.S. CLS. 100 AND 101).

FIRST USE 4-0-2000; IN COMMERCE 4-0-2000.

Reg. No. 4,204,366 THE MARK CONSISTS OF STANDARD CHARACTERS WITHOUT CLAIM TO ANY PARTICULAR FONT, STYLE, SIZE, OR COLOR.

OWNER OF U.S. REG. NOS. 1,796,491, 2,720,818, AND 2,868,502.

SER. NO. 85-222,724, FILED 1-20-2011.

BARNEY CHARLON, EXAMINING ATTORNEY

United States of America

United States Patent and Trademark Office

FITRIGHT

Reg. No. 4,204,367

Registered Sep. 11, 2012

Int. Cl.: 11

TRADEMARK

PRINCIPAL REGISTER

STYLE CREST ENTERPRISES, INC. (OHIO CORPORATION)
2450 ENTERPRISE STREET
FREMONT, OH 43420

FOR: HEATING, VENTING AND AIR CONDITIONER (HVAC) EQUIPMENT AND ACCESSORIES, NAMELY, FITTINGS IN THE NATURE OF BRASS FITTINGS THAT CONNECT THE LINE SET HOSE FROM THE CONDENSER TO THE COILS AND COUPLINGS FOR USE WITH GAS, ELECTRIC AND OIL FURNACES, WITH HEAT PUMPS, WITH CONDENSERS BEING PARTS OF HVAC EQUIPMENT, AND WITH LINE SETS BEING PARTS OF HVAC EQUIPMENT AND COILS BEING PARTS OF HVAC EQUIPMENT, IN CLASS 11 (U.S. CLS. 13, 21, 23, 31 AND 34).

FIRST USE 6-0-2010; IN COMMERCE 6-0-2010.

THE MARK CONSISTS OF STANDARD CHARACTERS WITHOUT CLAIM TO ANY PARTICULAR FONT, STYLE, SIZE, OR COLOR.

SER. NO. 85-223,627, FILED 1-21-2011.

KRISTINA MORRIS, EXAMINING ATTORNEY



David J. Kyffers

Director of the United States Patent and Trademark Office

United States of America

United States Patent and Trademark Office

SEECRYPT

Reg. No. 4,204,368

Registered Sep. 11, 2012

Int. Cls.: 9, 38 and 42

TRADEMARK

SERVICE MARK

PRINCIPAL REGISTER

SEECRYPT GROUP INC (CAYMAN ISLANDS CORPORATION)
C/O MAPLES CORPORATE SERVICES
P.O. BOX 309, UGLAND HOUSE
GRAND CAYMAN, CAYMAN ISLANDS KY1-1104

FOR: COMPUTER SOFTWARE TO ENABLE VIDEO AND VOICE TELEPHONY AND COMMUNICATIONS; COMPUTER SOFTWARE FOR THE TRANSMISSION OF DATA, EMAIL, TEXT MESSAGING, AUDIO, VIDEO AND IMAGES; COMPUTER SOFTWARE FOR INSTANT MESSAGING; COMPUTER SOFTWARE FOR MAKING CONFERENCE CALLS VIA MOBILE TELEPHONE, FIXED TELEPHONE, INTERNET AND COMPUTER NETWORKS; DOWNLOADABLE COMPUTER SOFTWARE TO ENABLE VIDEO AND VOICE TELEPHONY AND COMMUNICATIONS; DOWNLOADABLE COMPUTER SOFTWARE FOR INSTANT MESSAGING; DOWNLOADABLE COMPUTER SOFTWARE FOR MAKING CONFERENCE CALLS VIA MOBILE TELEPHONE, FIXED TELEPHONE, INTERNET AND COMPUTER NETWORKS, IN CLASS 9 (U.S. CLS. 21, 23, 26, 36 AND 38).

FOR: SECURED TELECOMMUNICATION SERVICES, NAMELY, PROVIDING SECURED ACCESS TO TELECOMMUNICATION NETWORKS; MOBILE AND FIXED TELECOMMUNICATION SERVICES, NAMELY, PROVIDING CELLULAR AND FIXED TELEPHONE NETWORKS; VIDEO TELECOMMUNICATION TRANSMISSION SERVICES; INTERNET AND COMPUTER COMMUNICATION SERVICES, NAMELY, PROVIDING COMMUNICATION NETWORKS BY MEANS OF WIRELESS NETWORK; PROVIDING VOICE OVER INTERNET PROTOCOL (VOIP) COMMUNICATION SERVICES; MOBILE AND FIXED TELECOMMUNICATIONS NETWORK SERVICES; INTERNET ACCESS SERVICES; DATA COMMUNICATION SERVICES BY ELECTRONIC MAIL; ELECTRONIC DATA TRANSMISSION SERVICES; TRANSMISSION OF EMAIL, TEXT MESSAGING, AUDIO, VIDEO AND IMAGES BY TELEPHONE AND THE INTERNET; INSTANT MESSAGING SERVICES; MOBILE AND FIXED TELEPHONE CONFERENCING SERVICES; VIDEO CONFERENCING SERVICES; CONFERENCING SERVICES PROVIDED VIA A COMPUTER NETWORK; WEB CONFERENCING SERVICES; HOSTING, JOINING, MANAGING, SCHEDULING AND STREAMING VOICE, VIDEO AND AUDIO-VISUAL CONTENT BETWEEN USERS VIA A COMMUNICATIONS NETWORK; INFORMATION AND ADVISORY SERVICES RELATING TO ALL THE AFORESAID SERVICES; DOWNLOADABLE COMPUTER SOFTWARE FOR THE TRANSMISSION OF DATA, EMAIL, TEXT MESSAGING, AUDIO, VIDEO AND IMAGES, IN CLASS 38 (U.S. CLS. 100, 101 AND 104).



David J. Kyjars

Director of the United States Patent and Trademark Office

Reg. No. 4,204,368 FOR: DESIGN AND DEVELOPMENT OF COMPUTER HARDWARE AND SOFTWARE; PROVIDING COMPUTER NON-DOWNLOADABLE SOFTWARE TO ENABLE VIDEO AND VOICE TELEPHONY AND COMMUNICATIONS; PROVIDING ONLINE NON-DOWNLOADABLE COMPUTER SOFTWARE TO ENABLE VIDEO AND VOICE TELEPHONY AND COMMUNICATIONS; PROVIDING NON-DOWNLOADABLE COMPUTER SOFTWARE TO ENABLE SECURED VIDEO AND VOICE TELEPHONY AND COMMUNICATIONS; PROVIDING ONLINE NON-DOWNLOADABLE COMPUTER SOFTWARE TO ENABLE SECURED VIDEO AND VOICE TELEPHONY AND COMMUNICATIONS; PROVIDING NON-DOWNLOADABLE COMPUTER SOFTWARE FOR THE TRANSMISSION OF DATA, EMAIL, TEXT MESSAGING, AUDIO, VIDEO AND IMAGES; PROVIDING ONLINE NON-DOWNLOADABLE COMPUTER SOFTWARE FOR THE TRANSMISSION OF DATA, EMAIL, TEXT MESSAGING, AUDIO, VIDEO AND IMAGES; PROVIDING NON-DOWNLOADABLE COMPUTER SOFTWARE FOR INSTANT MESSAGING; PROVIDING ONLINE AND DOWNLOADABLE COMPUTER SOFTWARE FOR INSTANT MESSAGING; PROVIDING NON-DOWNLOADABLE COMPUTER SOFTWARE FOR MAKING CONFERENCE CALLS VIA MOBILE TELEPHONE, FIXED TELEPHONE, INTERNET AND COMPUTER NETWORKS; PROVIDING NON-DOWNLOADABLE COMPUTER SOFTWARE FOR MAKING CONFERENCE CALLS VIA MOBILE TELEPHONE, FIXED TELEPHONE, INTERNET AND COMPUTER NETWORKS; DATA HOSTING SERVICES, NAMELY, HOSTING DIGITAL DATA RELATING TO MOBILE AND TELECOMMUNICATIONS, IN CLASS 42 (U.S. CLS. 100 AND 101).

THE MARK CONSISTS OF STANDARD CHARACTERS WITHOUT CLAIM TO ANY PARTICULAR FONT, STYLE, SIZE, OR COLOR.

OWNER OF ERPN CMNTY TM OFC REG. NO. 009677436, DATED 7-22-2011, EXPIRES 1-31-2021.

SER. NO. 85-224,125, FILED 1-24-2011.

MARILYN IZZI, EXAMINING ATTORNEY

United States of America

United States Patent and Trademark Office

ONLY MY KIND

Reg. No. 4,204,369

YADIRA-CAMPOS, MARLENE (UNITED STATES INDIVIDUAL)
608 CIVIC CENTER STREET
RICHMOND, CA 94804

Registered Sep. 11, 2012

Int. Cl.: 25

FOR: WEARABLE GARMENTS AND CLOTHING, NAMELY, SHIRTS, JACKETS AND HATS,
IN CLASS 25 (U.S. CLS. 22 AND 39).

TRADEMARK

FIRST USE 10-2-2008; IN COMMERCE 10-2-2008.

PRINCIPAL REGISTER

THE MARK CONSISTS OF STANDARD CHARACTERS WITHOUT CLAIM TO ANY PAR-
TICULAR FONT, STYLE, SIZE, OR COLOR.

SER. NO. 85-224,338, FILED 1-24-2011.

JOHN DWYER, EXAMINING ATTORNEY



David J. Kyffers

Director of the United States Patent and Trademark Office

United States of America

United States Patent and Trademark Office

NATIONAL BEEF

Reg. No. 4,204,370

Registered Sep. 11, 2012

Int. Cl.: 18

TRADEMARK

PRINCIPAL REGISTER

NATIONAL BEEF PACKING COMPANY, LLC (DELAWARE LIMITED LIABILITY COMPANY)

SUITE 500
12200 N. AMBASSADOR DRIVE
KANSAS CITY, MO 64163

FOR: CATTLE HIDES SOLD TO OTHERS FOR FURTHER PROCESSING, IN CLASS 18 (U.S. CLS. 1, 2, 3, 22 AND 41).

FIRST USE 5-3-2010; IN COMMERCE 5-3-2010.

THE MARK CONSISTS OF STANDARD CHARACTERS WITHOUT CLAIM TO ANY PARTICULAR FONT, STYLE, SIZE, OR COLOR.

NO CLAIM IS MADE TO THE EXCLUSIVE RIGHT TO USE "BEEF", APART FROM THE MARK AS SHOWN.

SER. NO. 85-224,384, FILED 1-24-2011.

BRENDAN MCCAULEY, EXAMINING ATTORNEY



David J. Kyffers

Director of the United States Patent and Trademark Office

United States of America

United States Patent and Trademark Office

PLUMA VIRES

Reg. No. 4,204,371

TYR TACTICAL, LLC (ARIZONA LIMITED LIABILITY COMPANY)

Registered Sep. 11, 2012

16661 N. 84TH AVENUE #110
PEORIA, AZ 85382

Int. Cl.: 18

FOR: BALLISTIC RESISTANT FABRIC SOLD AS AN INTEGRAL COMPONENT OF MILITARY DUFFLE BAGS, TOTE BAGS, SHOULDER BAGS, BACKPACKS AND TEXTILE POUCHES, IN CLASS 18 (U.S. CLS. 1, 2, 3, 22 AND 41).

TRADEMARK

FIRST USE 1-15-2011; IN COMMERCE 1-15-2011.

PRINCIPAL REGISTER

THE MARK CONSISTS OF STANDARD CHARACTERS WITHOUT CLAIM TO ANY PARTICULAR FONT, STYLE, SIZE, OR COLOR.

THE ENGLISH TRANSLATION OF "PLUMA VIRES" IN THE MARK IS "FEATHER FORCE".

SER. NO. 85-224,428, FILED 1-24-2011.

IRA J. GOODSaid, EXAMINING ATTORNEY



David J. Kyffers

Director of the United States Patent and Trademark Office

United States of America

United States Patent and Trademark Office

SOBER PRINCESS

Reg. No. 4,204,372

ROSE, MARY PAIGE (UNITED STATES INDIVIDUAL)
5047 WINDLAND DRIVE
SPRINGFIELD, TN 37172

Registered Sep. 11, 2012

Int. Cl.: 25

FOR: CLOTHING, NAMELY, HOODED SWEATSHIRTS, SHIRTS, SWEATSHIRTS, T-SHIRTS, VESTS, FLEECE VESTS, IN CLASS 25 (U.S. CLS. 22 AND 39).

TRADEMARK

FIRST USE 9-17-2006; IN COMMERCE 9-17-2006.

PRINCIPAL REGISTER

THE MARK CONSISTS OF STANDARD CHARACTERS WITHOUT CLAIM TO ANY PARTICULAR FONT, STYLE, SIZE, OR COLOR.

SEC. 2(F).

SER. NO. 85-225,991, FILED 1-25-2011.

DAVID C. REIHNER, EXAMINING ATTORNEY



David J. Kyffers

Director of the United States Patent and Trademark Office

United States of America

United States Patent and Trademark Office

DEGLAS

Reg. No. 4,204,373

Registered Sep. 11, 2012

Int. Cl.: 17

TRADEMARK

PRINCIPAL REGISTER

ISOVOLTA AG (AUSTRIA CORPORATION)
IZ NÖ-SÜD
WIENER NEUDORF, AUSTRIA A-2355

FOR: ELECTRICAL INSULATING GLASS CLOTHS COATED WITH MODIFIED POLYESTER RESINS FOR PHASE INSULATION IN THE PRODUCTION OF LOW AND MEDIUM VOLTAGE MOTORS AND INTERLAYER INSULATION IN TRANSFORMERS AND OTHER ELECTRICAL MACHINES; ELECTRICAL GRADE GLASS CLOTHS IMPREGNATED WITH POLYURETHANE VARNISH FOR INSULATION OF ELECTRICAL MACHINES SUBJECTED TO A HIGH THERMAL STRESS AND CONTINUOUS ALTERNATING DEFORMATIONS CAUSED BY APPLIED FORCES AND PARTICULARLY SUITABLE FOR END-WINDINGS AND OTHER CURVED PARTS IN ELECTRICAL MACHINES, IN CLASS 17 (U.S. CLS. 1, 5, 12, 13, 35 AND 50).

FIRST USE 5-6-2003; IN COMMERCE 7-19-2006.

THE MARK CONSISTS OF STANDARD CHARACTERS WITHOUT CLAIM TO ANY PARTICULAR FONT, STYLE, SIZE, OR COLOR.

THE WORDING "DEGLAS" HAS NO MEANING IN A FOREIGN LANGUAGE.

SER. NO. 85-226,432, FILED 1-26-2011.

DAVID YONTEF, EXAMINING ATTORNEY



David J. Kyffers

Director of the United States Patent and Trademark Office

United States of America

United States Patent and Trademark Office

SPRINGBOARD

Reg. No. 4,204,374

Registered Sep. 11, 2012

Int. Cls.: 35 and 42

SERVICE MARK

PRINCIPAL REGISTER

VISION CRITICAL COMMUNICATIONS INC. (CANADA CORPORATION)
SUITE 700
858 BEATTY STREET
VANCOUVER, BC, CANADA V6B1C1

FOR: DATA PROCESSING FOR OTHERS IN THE REALMS OF MARKET RESEARCH, AND INDUSTRIAL, COMMERCIAL, ECONOMIC, POLITICAL, SOCIOLOGICAL AND ECONOMIC RESEARCH; PROCESSING ONLINE DATA FOR OTHERS IN THE FIELDS OF ONLINE SURVEYS, POLLS, AND OPINION PANELS FOR MARKET RESEARCH PURPOSES AND FOR INDUSTRIAL, COMMERCIAL, ECONOMIC, POLITICAL, SOCIOLOGICAL AND ECONOMIC RESEARCH PURPOSES; PROVIDING MARKET RESEARCH, NAMELY, CONDUCTING SURVEYS, POLLING AND OPINION SURVEYS FOR OTHERS IN THE FIELD OF INDUSTRIAL, COMMERCIAL, ECONOMIC, POLITICAL, SOCIOLOGICAL AND ECONOMIC RESEARCH; MARKET RESEARCH, NAMELY, CONDUCTING AND MANAGING THE CONDUCT OF SURVEYS, POLLING, AND OPINION-GATHERING ON BEHALF OF OTHERS AND MANAGING RESPONSES FROM SURVEYS; ALL OF THE AFOREMENTIONED NOT INCLUDING SERVICES IN THE AREA OF CORPORATE AND BUSINESS AWARENESS OF PEOPLE WITH DISABILITIES, DISABILITY ETIQUETTE, WORKPLACE DIVERSITY, WORKPLACE INITIATIVES, PUBLIC RELATIONS, ADVERTISING, AND MARKETING OF THE GOODS AND SERVICES OF OTHERS TO PEOPLE WITH DISABILITIES AND THEIR FAMILIES, IN CLASS 35 (U.S. CLS. 100, 101 AND 102).

FIRST USE 8-0-2009; IN COMMERCE 8-0-2009.



FOR: HOSTED COMPUTING SERVICES, NAMELY, HOSTING DIGITAL CONTENT ON THE GLOBAL COMPUTER NETWORK AND HOSTING COMPUTER SOFTWARE APPLICATIONS OF OTHERS IN THE REALMS OF MARKET RESEARCH, AND INDUSTRIAL, COMMERCIAL, ECONOMIC, POLITICAL, SOCIOLOGICAL AND ECONOMIC RESEARCH, IN CLASS 42 (U.S. CLS. 100 AND 101).

FIRST USE 8-0-2009; IN COMMERCE 8-0-2009.

THE MARK CONSISTS OF STANDARD CHARACTERS WITHOUT CLAIM TO ANY PARTICULAR FONT, STYLE, SIZE, OR COLOR.

SER. NO. 85-226,669, FILED 1-26-2011.

David J. Kyffers

Director of the United States Patent and Trademark Office

Reg. No. 4,204,374 KAREN SEVERSON, EXAMINING ATTORNEY

United States of America

United States Patent and Trademark Office

SlimSweet

Reg. No. 4,204,375

Registered Sep. 11, 2012

Int. Cl.: 30

TRADEMARK

PRINCIPAL REGISTER

CHRISTY, MARTHA (UNITED STATES INDIVIDUAL)
1895 S LOS FELIZ DRIVE
TEMPE, AZ 85281 AND

CHRISTY, JOSEPH (UNITED STATES INDIVIDUAL)
1895 S LOS FELIZ DRIVE
TEMPE, AZ 85281

FOR: NATURAL SWEETENER, IN CLASS 30 (U.S. CL. 46).

FIRST USE 4-24-2000; IN COMMERCE 4-24-2000.

THE MARK CONSISTS OF STANDARD CHARACTERS WITHOUT CLAIM TO ANY PARTICULAR FONT, STYLE, SIZE, OR COLOR.

SER. NO. 85-228,136, FILED 1-27-2011.

KRISTIN DAHLING, EXAMINING ATTORNEY



David J. Kybas

Director of the United States Patent and Trademark Office

United States of America

United States Patent and Trademark Office

KITARA

Reg. No. 4,204,376

Registered Sep. 11, 2012

Int. Cls.: 9 and 15

TRADEMARK

PRINCIPAL REGISTER

MISA DIGITAL INSTRUMENTS (HK) LIMITED (HONG KONG CORPORATION)
21/F, 9 CHONG YIP STREET, KWUN TONG
KOWLOON, HONG KONG

FOR: DIGITAL AUDIO AND VIDEO PLAYERS; APPARATUS FOR USE IN RELATION TO SOUND AMPLIFIERS, NAMELY, ELECTRONIC EFFECT PEDALS FOR USE WITH SOUND AMPLIFIERS; APPARATUS FOR REPRODUCING SOUND OR IMAGES; AND STRUCTURAL PARTS AND FITTINGS FOR ALL THE AFORESAID GOODS, IN CLASS 9 (U.S. CLS. 21, 23, 26, 36 AND 38).

FOR: MUSICAL INSTRUMENTS AND STRUCTURAL PARTS AND FITTINGS THEREOF, IN CLASS 15 (U.S. CLS. 2, 21 AND 36).

PRIORITY CLAIMED UNDER SEC. 44(D) ON HONG KONG APPLICATION NO. 301789156, FILED 12-15-2010, REG. NO. 301789156AA, DATED 12-15-2010, EXPIRES 12-15-2020.

THE MARK CONSISTS OF THE LETTERS "KIT" FOLLOWED BY AN INVERTED "V" FOLLOWED BY AN "R" FOLLOWED BY AN INVERTED "V".

SER. NO. 85-228,465, FILED 1-28-2011.

JAMES LOVELACE, EXAMINING ATTORNEY



David J. Kybas

Director of the United States Patent and Trademark Office

United States of America

United States Patent and Trademark Office

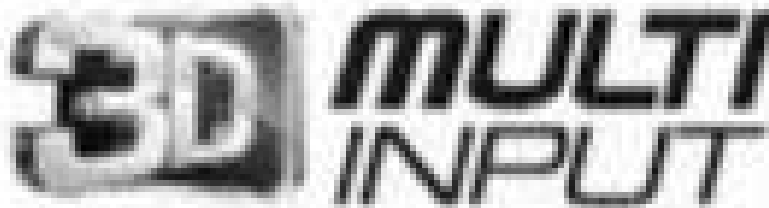

Reg. No. 4,204,377

LG ELECTRONICS INC. (REPUBLIC OF KOREA CORPORATION)
20 YEOUIDO-DONG YOUNGDEUNGPO-GU
SEOUL 150-721, REPUBLIC OF KOREA

Registered Sep. 11, 2012

Int. Cl.: 9

FOR: TELEVISION RECEIVERS, IN CLASS 9 (U.S. CLS. 21, 23, 26, 36 AND 38).

TRADEMARK

PRIORITY CLAIMED UNDER SEC. 44(D) ON REPUBLIC OF KOREA APPLICATION NO. 402011000257, FILED 1-17-2011, REG. NO. 0913153, DATED 3-30-2012, EXPIRES 3-30-2022.

PRINCIPAL REGISTER

NO CLAIM IS MADE TO THE EXCLUSIVE RIGHT TO USE "3D MULTI INPUT", APART FROM THE MARK AS SHOWN.

THE MARK CONSISTS OF THE DESIGNATION "3D" THAT HAS THE APPEARANCE OF COMING OUT OF A FLAT SCREEN TELEVISION. TO THE RIGHT OF THE "3D" LOGO AND DESIGN ARE WRITTEN THE WORDS "MULTI INPUT". THE TERM "MULTI" IS POSITIONED ABOVE THE WORD "INPUT". BOTH WORDS ARE SHOWN IN STYLIZED FONT.

SER. NO. 85-229,095, FILED 1-28-2011.

RUSS HERMAN, EXAMINING ATTORNEY



David J. Kyros

Director of the United States Patent and Trademark Office

United States of America

United States Patent and Trademark Office



Reg. No. 4,204,378

Registered Sep. 11, 2012

Int. Cl.: 35

SERVICE MARK

PRINCIPAL REGISTER

EXCLUSIVE FABRICS & FURNISHINGS, LLC (CALIFORNIA LIMITED LIABILITY COMPANY)
20 HAPPY VALLEY ROAD
PLEASANTON, CA 94566

FOR: ONLINE RETAIL STORE SERVICES FEATURING INTERIOR WINDOW COVERINGS, HARDWARE, AND ACCESSORIES, IN CLASS 35 (U.S. CLS. 100, 101 AND 102).

FIRST USE 5-0-2009; IN COMMERCE 5-0-2009.

NO CLAIM IS MADE TO THE EXCLUSIVE RIGHT TO USE "HALF PRICE DRAPES", APART FROM THE MARK AS SHOWN.

THE MARK CONSISTS OF STYLIZED VINES ABOVE THE STYLIZED LETTERS "HPD" AND THE WORDS "HALF" AND "PRICE", AND "DRAPES" BELOW THE LETTERS, ALL APPEARING ON A SHADED RECTANGULAR BACKGROUND.

SER. NO. 85-229,167, FILED 1-28-2011.

KATHERINE CONNOLLY, EXAMINING ATTORNEY



David J. Kyjars

Director of the United States Patent and Trademark Office

United States of America

United States Patent and Trademark Office

Exclusive Fabrics



Reg. No. 4,204,379

Registered Sep. 11, 2012

Int. Cl.: 24

TRADEMARK

PRINCIPAL REGISTER

EXCLUSIVE FABRICS & FURNISHINGS, LLC (CALIFORNIA LIMITED LIABILITY COMPANY)
20 HAPPY VALLEY ROAD
PLEASANTON, CA 94566

FOR: TEXTILE GOODS, NAMELY INTERIOR FABRIC WINDOW COVERINGS IN THE NATURE OF DRAPES AND CURTAINS, IN CLASS 24 (U.S. CLS. 42 AND 50).

FIRST USE 7-0-2007; IN COMMERCE 7-0-2007.

NO CLAIM IS MADE TO THE EXCLUSIVE RIGHT TO USE "EXCLUSIVE FABRICS" AND "FURNISHINGS", APART FROM THE MARK AS SHOWN.

THE MARK CONSISTS OF THE WORDS "EXCLUSIVE" AND "FABRICS" AND "FURNISHINGS" WITH A STYLIZED AMPERSAND APPEARING BELOW THE TERM "FABRICS" AND ABOVE THE TERM "FURNISHINGS". THE AMPERSAND HAS A SHADED CIRCLE BEHIND IT, A STYLIZED UPSIDE DOWN LETTER "F" ON ITS LEFT SIDE AND A STYLIZED RIGHT SIDE UP LETTER "F" ON ITS RIGHT SIDE.

SER. NO. 85-229,320, FILED 1-28-2011.

KATHERINE CONNOLLY, EXAMINING ATTORNEY



David J. Kyjars

Director of the United States Patent and Trademark Office

United States of America

United States Patent and Trademark Office



Reg. No. 4,204,380

Registered Sep. 11, 2012

Int. Cl.: 35

SERVICE MARK

PRINCIPAL REGISTER

EXCLUSIVE FABRICS & FURNISHINGS, LLC (CALIFORNIA LIMITED LIABILITY COMPANY)
20 HAPPY VALLEY ROAD
PLEASANTON, CA 94566

FOR: ONLINE WHOLESALE AND RETAIL STORE SERVICES FEATURING FABRICS, INTERIOR WINDOW COVERINGS, AND RELATED ACCESSORIES, IN CLASS 35 (U.S. CLS. 100, 101 AND 102).

FIRST USE 7-0-2007; IN COMMERCE 7-0-2007.

NO CLAIM IS MADE TO THE EXCLUSIVE RIGHT TO USE "EXCLUSIVE FABRICS" AND "FURNISHINGS", APART FROM THE MARK AS SHOWN.

THE MARK CONSISTS OF THE WORDS "EXCLUSIVE" AND "FABRICS" AND "FURNISHINGS" WITH A STYLIZED AMPERSAND APPEARING BELOW THE TERM "FABRICS" AND ABOVE THE TERM "FURNISHINGS". THE AMPERSAND HAS A SHADED CIRCLE BEHIND IT, A STYLIZED UPSIDE DOWN LETTER "F" ON ITS LEFT SIDE AND A STYLIZED RIGHT SIDE UP LETTER "F" ON ITS RIGHT SIDE, ALL APPEARING ON A SHADED RECTANGULAR BACKGROUND.

SER. NO. 85-229,329, FILED 1-28-2011.

KATHERINE CONNOLLY, EXAMINING ATTORNEY



David J. Kybas

Director of the United States Patent and Trademark Office

United States of America

United States Patent and Trademark Office

THE RIVALRY RUN

Reg. No. 4,204,381

Registered Sep. 11, 2012

Int. Cl.: 36

SERVICE MARK

PRINCIPAL REGISTER

THOMAS, WADE (UNITED STATES INDIVIDUAL)
SUITE 105
509 DELAWARE
KANSAS CITY, MO 64105

FOR: CHARITABLE FUNDRAISING SERVICES, NAMELY, ORGANIZING AND CONDUCTING FUNDRAISING EVENTS, IN CLASS 36 (U.S. CLS. 100, 101 AND 102).

FIRST USE 4-3-2009; IN COMMERCE 4-22-2010.

THE MARK CONSISTS OF STANDARD CHARACTERS WITHOUT CLAIM TO ANY PARTICULAR FONT, STYLE, SIZE, OR COLOR.

NO CLAIM IS MADE TO THE EXCLUSIVE RIGHT TO USE "RUN", APART FROM THE MARK AS SHOWN.

SER. NO. 85-230,848, FILED 2-1-2011.

PAULA MAHONEY, EXAMINING ATTORNEY



David J. Kyjars

Director of the United States Patent and Trademark Office

United States of America

United States Patent and Trademark Office

PAY MY TAXES

Reg. No. 4,204,382

PAY MY TAXES, LLC (CONNECTICUT LIMITED LIABILITY COMPANY)
2252 MAIN STREET
GLASTONBURY, CT 06033

Registered Sep. 11, 2012

Int. Cl.: 36

FOR: PROVIDING TAX ESCROW AND TAX PAYMENT PROCESSING SERVICES, IN CLASS 36 (U.S. CLS. 100, 101 AND 102).

SERVICE MARK

FIRST USE 10-5-2009; IN COMMERCE 12-1-2009.

PRINCIPAL REGISTER

THE MARK CONSISTS OF STANDARD CHARACTERS WITHOUT CLAIM TO ANY PARTICULAR FONT, STYLE, SIZE, OR COLOR.

SER. NO. 85-232,957, FILED 2-3-2011.

MICHAEL SOUDERS, EXAMINING ATTORNEY



David J. Kyffers

Director of the United States Patent and Trademark Office

United States of America

United States Patent and Trademark Office



Do Yourself a Flava!!!

Reg. No. 4,204,383

Registered Sep. 11, 2012

Int. Cl.: 43

SERVICE MARK

PRINCIPAL REGISTER

RANDY PEACHES (UNITED STATES INDIVIDUAL), DBA DO YOURSELF A FLAVA
12709 GLADYS RETREAT CIR.
BOWIE, MD 20720

FOR: RESTAURANT, BAR AND CATERING SERVICES, IN CLASS 43 (U.S. CLS. 100 AND 101).

FIRST USE 3-13-2010; IN COMMERCE 4-9-2010.

THE MARK CONSISTS OF A PEACH CHEF WALKING WHILE HOLDING AN ELEGANT SERVING TRAY; THE BODY OF THE CHEF IS A PEACH IN ORANGE; THE NECKER-CHIEF/SCARF IS A GREEN LEAF; ALL ELEMENTS IN THE CHEF DESIGN ARE OUTLINED IN BLACK; THE COLOR WHITE APPEARS IN THE DOME AND HANDLE OF THE SERVING TRAY AND THE CHEF HAT; THE BACKGROUND OF THE MARK IS TRANSPARENT; THE CHEF DESIGN APPEARS ABOVE THE WORDING "DO YOURSELF A FLAVA!!!" WHICH APPEARS IN GRAY; AND A SWOOPING ORANGE LINE APPEARS BELOW THE WORDING "DO YOURSELF A FLAVA!!!".

THE COLOR(S) GREEN, ORANGE, BLACK, WHITE AND GRAY IS/ARE CLAIMED AS A FEATURE OF THE MARK.

SER. NO. 85-233,849, FILED 2-3-2011.

BILL DAWE, EXAMINING ATTORNEY



David J. Kyfos

Director of the United States Patent and Trademark Office

United States of America

United States Patent and Trademark Office

WoodSpoon

Reg. No. 4,204,384

WOODSPOON, INC. (CALIFORNIA CORPORATION)
107 W. 9TH STREET
LOS ANGELES, CA 90015

Registered Sep. 11, 2012

Int. Cl.: 43

FOR: RESTAURANT SERVICES FEATURING BRAZILIAN CUISINE, EXCLUDING BARBEQUE SAUCE AND FOODS PREPARED WITH BARBEQUE SAUCE; RESTAURANT SERVICES, INCLUDING SIT-DOWN SERVICE OF FOOD AND TAKE-OUT RESTAURANT SERVICES FEATURING BRAZILIAN CUISINE, EXCLUDING BARBEQUE SAUCE AND FOODS PREPARED WITH BARBEQUE SAUCE, IN CLASS 43 (U.S. CLS. 100 AND 101).

SERVICE MARK

PRINCIPAL REGISTER

FIRST USE 11-26-2006; IN COMMERCE 11-26-2006.

THE MARK CONSISTS OF STANDARD CHARACTERS WITHOUT CLAIM TO ANY PARTICULAR FONT, STYLE, SIZE, OR COLOR.

SER. NO. 85-234,370, FILED 2-4-2011.

ANDREA K. NADELMAN, EXAMINING ATTORNEY



David J. Kybas

Director of the United States Patent and Trademark Office

United States of America

United States Patent and Trademark Office

HITWEEK

Reg. No. 4,204,385

Registered Sep. 11, 2012

Int. Cl.: 41

SERVICE MARK

PRINCIPAL REGISTER

FRANCESCO DEL MARO (ITALY INDIVIDUAL)
MUSIC EXPERIENCE ROMA S.R.L.
VIA MANFREDI AZZARITA, 211
ROME, ITALY 00189

FOR: ENTERTAINMENT SERVICES IN THE NATURE OF DEVELOPMENT, CREATION, PRODUCTION AND POST-PRODUCTION SERVICES OF MULTIMEDIA ENTERTAINMENT CONTENT; ENTERTAINMENT SERVICES IN THE NATURE OF PRESENTING LIVE MUSICAL PERFORMANCES, IN CLASS 41 (U.S. CLS. 100, 101 AND 107).

FIRST USE 1-1-2009; IN COMMERCE 4-1-2009.

THE MARK CONSISTS OF STANDARD CHARACTERS WITHOUT CLAIM TO ANY PARTICULAR FONT, STYLE, SIZE, OR COLOR.

SER. NO. 85-235,310, FILED 2-7-2011.

STEVEN PEREZ, EXAMINING ATTORNEY



David J. Kyffers

Director of the United States Patent and Trademark Office

United States of America

United States Patent and Trademark Office

STERLING FACTORS

Reg. No. 4,204,386

STERLING NATIONAL BANK (UNITED STATES NATIONAL BANKING ASSOCIATION)
650 FIFTH AVENUE
NEW YORK, NY 10019

Registered Sep. 11, 2012

Int. Cl.: 36

FOR: ACCOUNTS RECEIVABLE FINANCING; PROVIDING LETTERS OF CREDIT FOR THE FINANCING OF THE IMPORT AND EXPORT OF GOODS; CUSTOMER CREDIT PROTECTION SERVICES, NAMELY, MONITORING PAYMENTS AND PURSUING COLLECTIONS OF OUTSTANDING DEBTS, IN CLASS 36 (U.S. CLS. 100, 101 AND 102).

SERVICE MARK

PRINCIPAL REGISTER

FIRST USE 12-31-1960; IN COMMERCE 12-31-1960.

THE MARK CONSISTS OF STANDARD CHARACTERS WITHOUT CLAIM TO ANY PARTICULAR FONT, STYLE, SIZE, OR COLOR.

OWNER OF U.S. REG. NOS. 3,717,824, 3,800,217, AND 3,873,890.

SEC. 2(F) AS TO "FACTORS".

SER. NO. 85-235,690, FILED 2-7-2011.

ZACHARY BELLO, EXAMINING ATTORNEY



David J. Kyffers

Director of the United States Patent and Trademark Office

United States of America

United States Patent and Trademark Office

GEIER FUNDS

Reg. No. 4,204,387

Registered Sep. 11, 2012

Int. Cls.: 9, 16 and 36

TRADEMARK

SERVICE MARK

PRINCIPAL REGISTER

GEIER ASSET MANAGEMENT, INC. (MARYLAND CORPORATION)
SUITE 200
2205 WARWICK WAY
MARRIOTTSVILLE, MD 21104

FOR: ELECTRONIC DOWNLOADABLE PUBLICATIONS, NAMELY, NEWSLETTERS, MAGAZINES, ARTICLES, REPORTS, GUIDES, CHARTS AND GRAPHS, WORKSHEETS, FORMS, INSTRUCTIONAL MATERIALS, EDUCATIONAL MATERIALS, BULLETINS, PAMPHLETS, BOOKLETS, VIDEO RECORDINGS IN THE INVESTMENT, INVESTMENT BROKERAGE, ASSET MANAGEMENT AND FINANCIAL FIELD; DOWNLOADABLE VIDEO RECORDINGS FEATURING PRESENTATIONS IN THE INVESTMENT, INVESTMENT BROKERAGE, ASSET MANAGEMENT AND FINANCIAL FIELD, IN CLASS 9 (U.S. CLS. 21, 23, 26, 36 AND 38).

FIRST USE 4-0-2011; IN COMMERCE 4-0-2011.

FOR: PUBLICATIONS, NAMELY, NEWSLETTERS, MAGAZINES, ARTICLES, REPORTS, GUIDES, CHARTS AND GRAPHS, WORKSHEETS, FORMS, INSTRUCTIONAL MATERIALS, EDUCATIONAL MATERIALS, BULLETINS, PAMPHLETS, BOOKLETS IN THE INVESTMENT, INVESTMENT BROKERAGE, ASSET MANAGEMENT AND FINANCIAL FIELD, IN CLASS 16 (U.S. CLS. 2, 5, 22, 23, 29, 37, 38 AND 50).

FIRST USE 4-0-2011; IN COMMERCE 4-0-2011.

FOR: MUTUAL FUND INVESTMENT; INVESTMENT BROKERAGE; INVESTMENT MANAGEMENT; FINANCIAL ASSET MANAGEMENT; INVESTMENT ADVICE; INVESTMENT CONSULTATION; FINANCIAL RESEARCH; FINANCIAL ANALYSIS IN THE FIELD OF TAXATION; BANKING; FINANCIAL PLANNING FOR RETIREMENT; FINANCIAL ADMINISTRATION OF RETIREMENT PLANS; FINANCIAL PLANNING FOR EDUCATIONAL EXPENSES; FINANCIAL PLANNING SERVICES, NAMELY, DEVELOPING AND MANAGING CHARITABLE GIVING PROGRAMS ON BEHALF OF WEALTHY INDIVIDUALS OR FAMILIES, IN CLASS 36 (U.S. CLS. 100, 101 AND 102).

FIRST USE 4-0-2011; IN COMMERCE 4-0-2011.

THE MARK CONSISTS OF STANDARD CHARACTERS WITHOUT CLAIM TO ANY PARTICULAR FONT, STYLE, SIZE, OR COLOR.



David J. Kyjars

Director of the United States Patent and Trademark Office

Reg. No. 4,204,387 NO CLAIM IS MADE TO THE EXCLUSIVE RIGHT TO USE "FUNDS", APART FROM THE MARK AS SHOWN.

SEC. 2(F).

SER. NO. 85-239,814, FILED 2-11-2011.

ROBERT C. CLARK JR., EXAMINING ATTORNEY

United States of America

United States Patent and Trademark Office

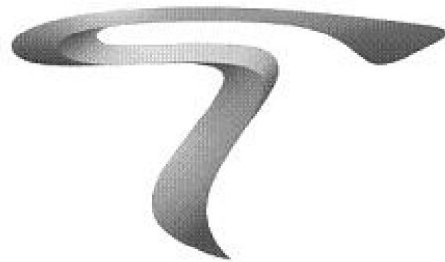

Reg. No. 4,204,388

Registered Sep. 11, 2012

Int. Cl.: 33

TRADEMARK

PRINCIPAL REGISTER

TAILS LIMITED (UNITED KINGDOM COMPANY)
61-63 LOWER ESSEX STREET
BIRMINGHAM, UNITED KINGDOM B56SN

FOR: ALCOHOLIC BEVERAGES EXCEPT BEER; PREPARED ALCOHOLIC COCKTAILS; PREPARED ALCOHOLIC COCKTAILS BASED ON SPIRITS; PREPARED ALCOHOLIC COCKTAILS BASED ON WINES; PREPARED ALCOHOLIC COCKTAILS CONTAINING GIN; PREPARED ALCOHOLIC COCKTAILS CONTAINING WINE; PREPARED ALCOHOLIC COCKTAILS HAVING A SPIRIT BASE; PREPARED ALCOHOLIC COCKTAILS PREDOMINANTLY OF MILK AND HAVING AN ALCOHOL CONTENT OF MORE THAN 1.2% ; PREPARED ALCOHOLIC COCKTAILS WITH A WINE BASE, IN CLASS 33 (U.S. CLS. 47 AND 49).

OWNER OF ERPN CMNTY TM OFC REG. NO. 008541278, DATED 3-8-2010, EXPIRES 9-10-2019.

THE MARK CONSISTS OF A RIBBON DESIGN.

SER. NO. 85-240,386, FILED 2-11-2011.

DANNEAN HETZEL, EXAMINING ATTORNEY



David J. Kyffers

Director of the United States Patent and Trademark Office

United States of America

United States Patent and Trademark Office

Wait A Green Minute

Reg. No. 4,204,389

Registered Sep. 11, 2012

Int. Cl.: 16

TRADEMARK

PRINCIPAL REGISTER

GREEN STEPS TO LIFE (CALIFORNIA CORPORATION), DBA BMB CONSTRUCTION
PROPERTIES
945 MARINA VILLAGE PARKWAY
ALAMEDA, CA 94501

FOR: EDUCATIONAL PUBLICATIONS, NAMELY, TRAINING MANUALS IN THE FIELD
OF SUSTAINABILITY, IN CLASS 16 (U.S. CLS. 2, 5, 22, 23, 29, 37, 38 AND 50).

FIRST USE 4-1-2010; IN COMMERCE 2-14-2011.

THE MARK CONSISTS OF STANDARD CHARACTERS WITHOUT CLAIM TO ANY PAR-
TICULAR FONT, STYLE, SIZE, OR COLOR.

SER. NO. 85-242,103, FILED 2-14-2011.

CORY BOONE, EXAMINING ATTORNEY



David J. Kybas

Director of the United States Patent and Trademark Office

United States of America

United States Patent and Trademark Office

BOYS TOWN INTEGRATED CONTINUUM OF CARE

Reg. No. 4,204,390

FATHER FLANAGAN'S BOYS' HOME (NEBRASKA CORPORATION)
14100 CRAWFORD STREET
BOYS TOWN, NE 68010

Registered Sep. 11, 2012

Int. Cl.: 43

FOR: JUVENILE CUSTODIAL CARE SERVICES, NAMELY, PROVIDING EMERGENCY SHELTER SERVICES IN THE NATURE OF TEMPORARY HOUSING; PROVIDING TEMPORARY HOMES AND EMERGENCY SHELTERS FOR CHILDREN, IN CLASS 43 (U.S. CLS. 100 AND 101).

SERVICE MARK

PRINCIPAL REGISTER

FIRST USE 5-1-2010; IN COMMERCE 5-1-2010.

THE MARK CONSISTS OF STANDARD CHARACTERS WITHOUT CLAIM TO ANY PARTICULAR FONT, STYLE, SIZE, OR COLOR.

OWNER OF U.S. REG. NOS. 1,334,772, 3,627,959 AND OTHERS.

NO CLAIM IS MADE TO THE EXCLUSIVE RIGHT TO USE "INTEGRATED CONTINUUM OF CARE", APART FROM THE MARK AS SHOWN.

SER. NO. 85-242,878, FILED 2-15-2011.

ALEXANDER L. POWERS, EXAMINING ATTORNEY



David J. Kyffers

Director of the United States Patent and Trademark Office

United States of America

United States Patent and Trademark Office



Reg. No. 4,204,391

Registered Sep. 11, 2012

Int. Cl.: 35

SERVICE MARK

PRINCIPAL REGISTER

VGM GROUP, INC. (IOWA CORPORATION)
1111 WEST SAN MARNAN DRIVE
WATERLOO, IA 50701

FOR: MEMBERSHIP CLUB SERVICES, NAMELY, PROVIDING DISCOUNTS ON GOODS AND SERVICES OF OTHERS TO MEMBERS WHO ARE PART OF A NETWORK OF INDEPENDENTLY OWNED AND OPERATED, CERTIFIED PROFESSIONALS AND CONTRACTORS WHO PROVIDE HOME MODIFICATIONS AND RELATED PRODUCTS AND SERVICES TO ENHANCE ACCESSIBILITY AND INDEPENDENT LIVING FOR THE ELDERLY AND DISABLED, IN CLASS 35 (U.S. CLS. 100, 101 AND 102).

FIRST USE 3-31-2009; IN COMMERCE 3-31-2009.

NO CLAIM IS MADE TO THE EXCLUSIVE RIGHT TO USE "ACCESSIBLE HOME IMPROVEMENT OF AMERICA", APART FROM THE MARK AS SHOWN.

THE MARK CONSISTS OF THE WORDS "ACCESSIBLE HOME", POSITIONED HORIZONTALLY IN BOLD-STYLED LETTERING. DIRECTLY BENEATH "ACCESSIBLE HOME" ARE THE WORDS "IMPROVEMENT OF AMERICA" IN SMALLER SIZED, BOLD-STYLED LETTERING. TO THE LEFT OF THE WORDS IS AN OUTLINE OF A HOUSE, WHICH CONSISTS OF TWO VERTICAL LINES TOPPED BY A ROOF. INSIDE THE HOUSE IS A STYLIZED SILHOUETTE OF A PERSON IN A WHEELCHAIR, FACING RIGHT. ALONG THE BOTTOM OF THE MARK, BEGINNING TO THE LEFT OF THE HOUSE AND EXTENDING BELOW THE HOUSE AND THE WORDS "IMPROVEMENT OF AMERICA", IS A SOLID LINE, VARYING IN THICKNESS, REPRESENTING THE GROUND.



SER. NO. 85-245,099, FILED 2-17-2011.

TINA MAI, EXAMINING ATTORNEY

David J. Kyjars

Director of the United States Patent and Trademark Office

United States of America

United States Patent and Trademark Office



Reg. No. 4,204,392

K. HOV IP, II, INC. (CALIFORNIA CORPORATION)
110 WEST FRONT STREET
RED BANK, NJ 07701

Registered Sep. 11, 2012

Int. Cls.: 35 and 42

FOR: PROVIDING INFORMATION, ADVICE AND CONSULTANCY IN THE FIELD OF ENERGY EFFICIENCY, WATER CONSERVATION, AND AIR QUALITY; PROVIDING INFORMATION REGARDING ENERGY EFFICIENCY, CONSERVATION BENEFITS, AIR QUALITY, AND ENERGY SAVING RESOURCES OF RESIDENTIAL PROPERTIES; REAL ESTATE MARKETING SERVICES, NAMELY, PROVIDING AN INTERACTIVE WEBSITE WHICH PROMOTES RESIDENTIAL PROPERTIES THROUGH PROVISION OF MAPS, LOCATIONS, AND ENERGY SAVING RESOURCES OF RESIDENTIAL PROPERTIES; ADVERTISING SERVICES, NAMELY, PROMOTING THE BRANDS, GOODS AND SERVICES OF OTHERS, IN CLASS 35 (U.S. CLS. 100, 101 AND 102).

SERVICE MARK

FIRST USE 1-6-2011; IN COMMERCE 1-6-2011.

PRINCIPAL REGISTER

FOR: PROVIDING A WEBSITE THAT GIVES USERS THE ABILITY TO SUBMIT QUESTIONS IN THE FIELD OF ENERGY EFFICIENCY, WATER CONSERVATION, AIR QUALITY, AND ENERGY SAVING RESOURCES, IN CLASS 42 (U.S. CLS. 100 AND 101).

FIRST USE 1-6-2011; IN COMMERCE 1-6-2011.



NO CLAIM IS MADE TO THE EXCLUSIVE RIGHT TO USE "NATURE TECHNOLOGY EFFICIENCY", APART FROM THE MARK AS SHOWN.

THE MARK CONSISTS OF THE WORDS "NATURE TECHNOLOGY EFFICIENCY" BELOW A CURVED ARROW POINTING RIGHT AND ABOVE A CURVED ARROW POINTING LEFT.

SER. NO. 85-245,892, FILED 2-18-2011.

KIMBERLY PERRY, EXAMINING ATTORNEY

David J. Kybas

Director of the United States Patent and Trademark Office

United States of America

United States Patent and Trademark Office



Reg. No. 4,204,393

Registered Sep. 11, 2012

Int. Cl.: 44

SERVICE MARK

PRINCIPAL REGISTER

POSITIVE MARKETING CONCEPTS, LLC (WASHINGTON LIMITED LIABILITY COMPANY)
3101 NORTHEAST 143RD STREET
VANCOUVER, WA 98686

FOR: HEALTH ASSESSMENT SERVICES, NAMELY, PROVIDING METABOLIC ASSESSMENT PROFILES (MAP) TO CLIENTS OBTAINED BY USING A PORTABLE METABOLIC MEASUREMENT SYSTEM IN THE NATURE OF A UNIQUE, HEART-RATE BASED OVERVIEW OF THEIR OWN METABOLISM IN ORDER TO ASSIST IN REACHING WEIGHT LOSS, SPORTS PERFORMANCE, HEALTH, FITNESS, AND WELLNESS-RELATED GOALS; CONDUCTING MEDICAL PHYSICAL EVALUATIONS, IN CLASS 44 (U.S. CLS. 100 AND 101).

FIRST USE 1-15-2010; IN COMMERCE 4-1-2010.

NO CLAIM IS MADE TO THE EXCLUSIVE RIGHT TO USE "HEALTH", APART FROM THE MARK AS SHOWN.

THE COLOR(S) BLUE, GREEN AND WHITE IS/ARE CLAIMED AS A FEATURE OF THE MARK.

THE MARK CONSISTS OF A BOX IN GREEN COLOR AND INSIDE THE BOX THERE IS AN IMAGE DEPICTING LETTER "V" AND BELOW WHICH THERE IS LETTER "H" BOTH CURVED IN WHITE COLOR. AT THE BOTTOM OF THE IMAGE THERE ARE WORDS "VITELA" WRITTEN IN BLUE COLOR AND THE WORD "HEALTH" IN GREEN COLOR AS SHOWN IN THE MARK.

THE ENGLISH TRANSLATION OF "VITELA" IN THE MARK IS "CALF".

SER. NO. 85-247,850, FILED 2-22-2011.

MICHELE SWAIN, EXAMINING ATTORNEY



David J. Kyros

Director of the United States Patent and Trademark Office

United States of America

United States Patent and Trademark Office

TWIZTED STRAWBERRY BLAST

Reg. No. 4,204,394

Registered Sep. 11, 2012

Int. Cl.: 30

TRADEMARK

PRINCIPAL REGISTER

HERSHEY CHOCOLATE & CONFECTIONERY CORPORATION (DELAWARE CORPORATION)
4860 ROBB STREET, SUITE 204
WHEAT RIDGE, CO 80033

FOR: CANDY, IN CLASS 30 (U.S. CL. 46).

FIRST USE 2-28-2007; IN COMMERCE 2-28-2007.

THE MARK CONSISTS OF STANDARD CHARACTERS WITHOUT CLAIM TO ANY PARTICULAR FONT, STYLE, SIZE, OR COLOR.

OWNER OF U.S. REG. NOS. 2,986,697, 4,120,463 AND OTHERS.

NO CLAIM IS MADE TO THE EXCLUSIVE RIGHT TO USE "STRAWBERRY", APART FROM THE MARK AS SHOWN.

SEC. 2(F) AS TO "TWIZTED".

SER. NO. 85-250,379, FILED 2-24-2011.

TINA L. SNAPP, EXAMINING ATTORNEY



David J. Kybas

Director of the United States Patent and Trademark Office

United States of America

United States Patent and Trademark Office



Reg. No. 4,204,395

Registered Sep. 11, 2012

Int. Cl.: 41

SERVICE MARK

PRINCIPAL REGISTER

WINGSPAN PICTURES, LLC (CALIFORNIA LIMITED LIABILITY COMPANY)
1400 N. PASS AVE
BURBANK, CA 91505

FOR: ANIMATION PRODUCTION SERVICES; ENTERTAINMENT AND EDUCATION SERVICES IN THE NATURE OF A SERIES OF SHORT SHOWS FEATURING ONLINE EDUCATIONAL CONTENT DISTRIBUTED TO MOBILE HANDSETS, WHICH MAY INCLUDE VIDEO, TEXT, PHOTOS, ILLUSTRATIONS OR HYPERTEXT; ENTERTAINMENT MEDIA PRODUCTION SERVICES FOR MOTION PICTURES, TELEVISION AND INTERNET; ENTERTAINMENT SERVICES, NAMELY, MULTIMEDIA PRODUCTION SERVICES; FILM AND VIDEO PRODUCTION; FILM AND VIDEO PRODUCTION CONSULTING SERVICES; FILM EDITING; FILM STUDIOS; MEDIA PRODUCTION SERVICES, NAMELY, VIDEO AND FILM PRODUCTION; MULTIMEDIA ENTERTAINMENT SERVICES IN THE NATURE OF DEVELOPMENT, PRODUCTION AND POST-PRODUCTION SERVICES IN THE FIELDS OF VIDEO AND FILMS; PRODUCTION OF HUMOROUS VIDEOS FOR THE INTERNET, IN CLASS 41 (U.S. CLS. 100, 101 AND 107).

FIRST USE 11-14-2008; IN COMMERCE 11-14-2008.

NO CLAIM IS MADE TO THE EXCLUSIVE RIGHT TO USE "PICTURES", APART FROM THE MARK AS SHOWN.

THE MARK CONSISTS OF THE WORDING "WINGSPAN PICTURES" PRESENTED IN STYLIZED FONT. BETWEEN THESE TWO WORDS IS A DESIGN ELEMENT COMPRISED A SINGLE LINE CIRCLE WITH A STYLIZED "W" SUPERIMPOSED THEREON. EACH SIDE ELEMENT OF THE "W" IS COMPRISED OF A STYLIZED DEPICTION OF A WING.

SER. NO. 85-251,142, FILED 2-24-2011.

GRETCHEN ULRICH, EXAMINING ATTORNEY



David J. Kyffers

Director of the United States Patent and Trademark Office

United States of America

United States Patent and Trademark Office

METHODOLOGIE

Reg. No. 4,204,396

Registered Sep. 11, 2012

Int. Cl.: 35

SERVICE MARK

PRINCIPAL REGISTER

METHODOLOGIE, INC. (WASHINGTON CORPORATION)
720 3RD AVE SUITE 800
SEATTLE, WA 98104

FOR: CONSULTING SERVICES IN THE FIELDS OF BRAND AND COMMUNICATIONS STRATEGY AND GRAPHIC DESIGN, NAMELY, CREATING, DEVELOPING AND IMPLEMENTING BRANDS AND CORPORATE IDENTITY SYSTEMS, PRINTED AND ELECTRONIC COMMUNICATIONS, SIGNAGE, ADVERTISING, INTERACTIVE WEB SITES, KIOSKS, PRODUCT DEMONSTRATION AND TRAINING MODULES, MOBILE APPLICATIONS, AND, FOR CONSULTING SERVICES, GRAPHICS AND INTERACTIVE COMMUNICATIONS IN THE FIELDS OF CORPORATE SOCIAL RESPONSIBILITY, MARKETING AND INVESTOR COMMUNICATIONS, IN CLASS 35 (U.S. CLS. 100, 101 AND 102).

FIRST USE 10-1-1999; IN COMMERCE 10-1-1999.

THE MARK CONSISTS OF STANDARD CHARACTERS WITHOUT CLAIM TO ANY PARTICULAR FONT, STYLE, SIZE, OR COLOR.

SER. NO. 85-251,603, FILED 2-25-2011.

FRED CARL, EXAMINING ATTORNEY



David J. Kypos

Director of the United States Patent and Trademark Office

United States of America

United States Patent and Trademark Office

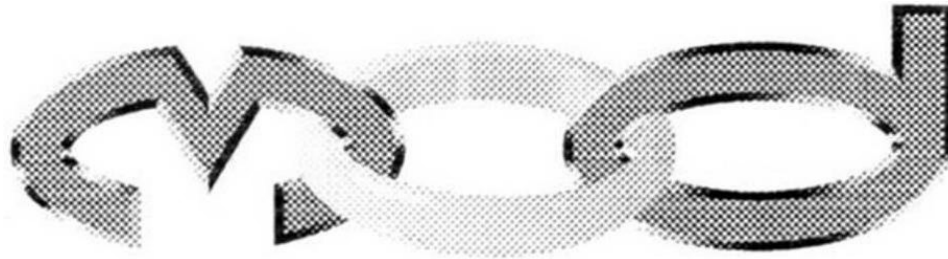

Reg. No. 4,204,397

Registered Sep. 11, 2012

Int. Cls.: 14 and 35

TRADEMARK

SERVICE MARK

PRINCIPAL REGISTER

MOD JEWELRY, INC. (CALIFORNIA CORPORATION)
3176 PULLMAN STREET, SUITE 104
COSTA MESA, CA 92626

FOR: JEWELRY, IN CLASS 14 (U.S. CLS. 2, 27, 28 AND 50).

FIRST USE 12-0-2004; IN COMMERCE 12-0-2004.

FOR: ON-LINE RETAIL STORE SERVICES FEATURING JEWELRY, IN CLASS 35 (U.S. CLS. 100, 101 AND 102).

FIRST USE 1-0-2007; IN COMMERCE 1-0-2007.

OWNER OF U.S. REG. NO. 2,525,569.

THE MARK CONSISTS OF THE LETTERING "MOD" WITH THE LETTER "O" SHOWN AS A RING LINKING THE LETTERS "M" AND "D" TOGETHER.

SER. NO. 85-254,988, FILED 3-1-2011.

KATHERINE STOIDES, EXAMINING ATTORNEY



David J. Kyffers

Director of the United States Patent and Trademark Office

United States of America

United States Patent and Trademark Office



THE JIRAFFE GROUP^{LLC}

Reg. No. 4,204,398

Registered Sep. 11, 2012

Int. Cl.: 42

SERVICE MARK

PRINCIPAL REGISTER

THE JIRAFFE GROUP (VIRGINIA LIMITED LIABILITY COMPANY)
8516 WAGON WHEEL ROAD
ALEXANDRIA, VA 22309

FOR: IT CONSULTING SERVICES, CONSULTING SERVICES FOR BUSINESS-PROCESS AND WORKFLOW AUTOMATION, COMPUTER CONSULTING SERVICES IN THE FIELD OF INFORMATION TECHNOLOGY MANAGEMENT, CONSULTING SERVICES IN THE FIELD OF CLOUD COMPUTING, COMPUTER PROGRAMMING SERVICES, IN CLASS 42 (U.S. CLS. 100 AND 101).

FIRST USE 7-1-2001; IN COMMERCE 7-1-2001.

NO CLAIM IS MADE TO THE EXCLUSIVE RIGHT TO USE "GROUP LLC", APART FROM THE MARK AS SHOWN.

THE MARK CONSISTS OF THE WORDING "THE JIRAFFE GROUP LLC" BELOW A TREE, A GIRAFFE STANDING BEHIND THE TREE, AND A HORIZONTAL LINE UNDER THE TREE AND THE GIRAFFE.

SER. NO. 85-256,540, FILED 3-3-2011.

TINA MAI, EXAMINING ATTORNEY



David J. Kybas

Director of the United States Patent and Trademark Office

United States of America

United States Patent and Trademark Office

HILMAN ROLLERS

Reg. No. 4,204,399

HILMAN, INC. (NEW JERSEY CORPORATION)
12 TIMBER LANE
MARLBORO, NJ 07746

Registered Sep. 11, 2012

Int. Cl.: 12

FOR: NON-MOTORIZED LOAD-CARRYING DEVICES, NAMELY, ROLLER MECHANISMS IN THE NATURE OF DOLLIES AND WHEELED PLATFORMS WITH NON-MOTORIZED WHEELS FOR MOVING MACHINERY AND OTHER HEAVY OBJECTS; DOLLIES FOR MOVING LOADS, IN CLASS 12 (U.S. CLS. 19, 21, 23, 31, 35 AND 44).

TRADEMARK

PRINCIPAL REGISTER

FIRST USE 0-0-1980; IN COMMERCE 0-0-1980.

THE MARK CONSISTS OF STANDARD CHARACTERS WITHOUT CLAIM TO ANY PARTICULAR FONT, STYLE, SIZE, OR COLOR.

NO CLAIM IS MADE TO THE EXCLUSIVE RIGHT TO USE "ROLLERS", APART FROM THE MARK AS SHOWN.

SEC. 2(F).

SER. NO. 85-256,661, FILED 3-3-2011.

ROBIN MITTLER, EXAMINING ATTORNEY



David J. Kypos

Director of the United States Patent and Trademark Office

United States of America

United States Patent and Trademark Office

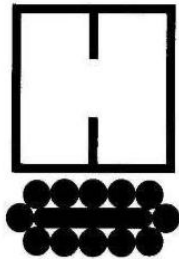

HILMAN ROLLERS

Reg. No. 4,204,400

Registered Sep. 11, 2012

Int. Cls.: 7 and 12

TRADEMARK

PRINCIPAL REGISTER

HILMAN, INC. (NEW JERSEY CORPORATION)
12 TIMBER LANE
MARLBORO, NJ 07746

FOR: POWER-OPERATED MOVING AND LIFTING EQUIPMENT, NAMELY, CENTRAL CONTROLLER MACHINES IN THE NATURE OF MACHINES WITH WHEELS TO CONTROL LOAD-BEARING PLATFORMS, AND HEAVY LOAD-CARRYING MODULAR MOTORIZED CRAWLING DEVICES IN THE NATURE OF MACHINE OPERATED LOAD-BEARING PLATFORMS; HYDRAULIC JACKS, IN CLASS 7 (U.S. CLS. 13, 19, 21, 23, 31, 34 AND 35).

FIRST USE 4-0-2008; IN COMMERCE 4-0-2008.

FOR: NON-MOTORIZED LOAD CARRYING DEVICES, NAMELY, ROLLER MECHANISMS IN THE NATURE OF DOLLIES AND WHEELED PLATFORMS WITH NON-MOTORIZED WHEELS FOR MOVING MACHINERY AND OTHER HEAVY OBJECTS; DOLLIES FOR MOVING LOADS, IN CLASS 12 (U.S. CLS. 19, 21, 23, 31, 35 AND 44).

FIRST USE 0-0-1980; IN COMMERCE 0-0-1980.

NO CLAIM IS MADE TO THE EXCLUSIVE RIGHT TO USE "ROLLERS", APART FROM THE MARK AS SHOWN.

THE MARK CONSISTS OF A STYLIZED LETTER "H" ABOVE A DESIGN CONSISTING OF TWELVE CIRCLES SURROUNDING A HORIZONTAL BAR SHAPE, AND THE WORDS "HILMAN ROLLERS" ON THE RIGHT SIDE OF THE STYLIZED LETTER "H" AND THE CIRCLES AND BAR DESIGN.

SER. NO. 85-256,676, FILED 3-3-2011.

ROBIN MITTLER, EXAMINING ATTORNEY



David J. Kybas

Director of the United States Patent and Trademark Office

United States of America

United States Patent and Trademark Office

MAXXIS

Reg. No. 4,204,401

Registered Sep. 11, 2012

**Int. Cls.: 35, 37, 38 and
42**

SERVICE MARK

PRINCIPAL REGISTER

SMOOTHSTONE IP COMMUNICATIONS CORPORATION (DELAWARE CORPORATION)
200 SMOOTHSTONE CENTER
401 S. FOURTH STREET
LOUISVILLE, KY 40202

FOR: BUSINESS CONSULTING SERVICES IN THE FIELDS OF TELECOMMUNICATIONS, UNIFIED IP COMMUNICATIONS, VOICE OVER INTERNET-PROTOCOL (VOIP), WIDE AREA NETWORKING (WAN), AND NETWORK MANAGEMENT, IN CLASS 35 (U.S. CLS. 100, 101 AND 102).

FIRST USE 2-25-2011; IN COMMERCE 2-25-2011.

FOR: INSTALLATION, MAINTENANCE AND REPAIR OF TELECOMMUNICATIONS AND DATA NETWORKING HARDWARE FOR PROVIDING UNIFIED IP COMMUNICATIONS SERVICES ACROSS MULTIPLE NETWORK INFRASTRUCTURES AND COMMUNICATION PROTOCOLS, IN CLASS 37 (U.S. CLS. 100, 103 AND 106).

FIRST USE 2-25-2011; IN COMMERCE 2-25-2011.

FOR: UNIFIED IP COMMUNICATIONS SERVICES THAT FACILITATE COMMUNICATIONS ACROSS VARIOUS NETWORKS, MEDIA AND DEVICES, NAMELY, COMMUNICATION VIA COMPUTER TERMINALS, BY DIGITAL TRANSMISSION, OR BY SATELLITE; VOICE OVER INTERNET-PROTOCOL (VOIP) SERVICES; VIDEO, AUDIO AND DATA CONFERENCING SERVICES, IN CLASS 38 (U.S. CLS. 100, 101 AND 104).

FIRST USE 2-25-2011; IN COMMERCE 2-25-2011.

FOR: SOFTWARE AS A SERVICE (SAAS) PROVIDER FEATURING SOFTWARE FOR ENABLING UNIFIED COMMUNICATIONS ACROSS VARIOUS NETWORKS, MEDIA AND DEVICES, NAMELY, SOFTWARE FOR QUEUING, HANDLING, LOGGING, RECORDING, MONITORING, TRACKING, SUPERVISION, MANAGEMENT AND ROUTING OF TELEPHONE CALLS, VIDEO, E-MAILS, AND WEB BASED MESSAGES, AND SOFTWARE FOR MONITORING AND MANAGEMENT OF COMPUTER AND NETWORK SYSTEMS FOR SECURITY AND APPLICATION OPTIMIZATION PURPOSES; INSTALLATION, MAINTENANCE AND REPAIR OF APPLICATION SOFTWARE FOR PROVIDING UNIFIED IP COMMUNICATIONS SERVICES ACROSS MULTIPLE NETWORK INFRASTRUCTURES AND COMMUNICATION PROTOCOLS; INTEGRATION OF TELECOMMUNICATIONS AND



David J. Kyffers

Director of the United States Patent and Trademark Office

Reg. No. 4,204,401 DATA NETWORKING EQUIPMENT AND APPLICATION SOFTWARE FOR PROVIDING UNIFIED IP COMMUNICATIONS SERVICES ACROSS MULTIPLE NETWORK INFRASTRUCTURES AND COMMUNICATION PROTOCOLS; COMPUTER SERVICES, NAMELY, WAN DESIGN; APPLICATION OPTIMIZATION SERVICES, NAMELY, UPDATING OF COMPUTER NETWORK CONFIGURATIONS; DEVELOPMENT OF SECURITY SYSTEMS AND CONTINGENCY PLANNING FOR COMPUTER NETWORKS; PROVIDING TEMPORARY USE OF NON-DOWNLOADABLE COMPUTER SOFTWARE FOR ENABLING UNIFIED IP COMMUNICATIONS ACROSS VARIOUS NETWORKS, MEDIA AND DEVICES; COMPUTER SECURITY CONSULTANCY, IN CLASS 42 (U.S. CLS. 100 AND 101).

FIRST USE 2-25-2011; IN COMMERCE 2-25-2011.

THE MARK CONSISTS OF STANDARD CHARACTERS WITHOUT CLAIM TO ANY PARTICULAR FONT, STYLE, SIZE, OR COLOR.

SER. NO. 85-257,496, FILED 3-3-2011.

VIVIAN MICZNIK FIRST, EXAMINING ATTORNEY

United States of America

United States Patent and Trademark Office

BETTER WORLD MATERIALS

Reg. No. 4,204,402

Registered Sep. 11, 2012

Int. Cl.: 40

SERVICE MARK

PRINCIPAL REGISTER

BETTER WORLD MATERIALS INTERNATIONAL, INC. (WYOMING CORPORATION)
222 162ND STREET SOUTH SUITE 1
SPANAWAY, WA 98387

FOR: RECYCLING, IN CLASS 40 (U.S. CLS. 100, 103 AND 106).

FIRST USE 6-16-2008; IN COMMERCE 6-16-2008.

THE MARK CONSISTS OF STANDARD CHARACTERS WITHOUT CLAIM TO ANY PARTICULAR FONT, STYLE, SIZE, OR COLOR.

NO CLAIM IS MADE TO THE EXCLUSIVE RIGHT TO USE "MATERIALS", APART FROM THE MARK AS SHOWN.

SER. NO. 85-258,205, FILED 3-4-2011.

KATHERINE M. DUBRAY, EXAMINING ATTORNEY



David J. Kyffers

Director of the United States Patent and Trademark Office

United States of America

United States Patent and Trademark Office

planning with **PRIDE**

Reg. No. 4,204,403

METROPOLITAN LIFE INSURANCE COMPANY (NEW YORK CORPORATION)
1095 AVENUE OF THE AMERICAS
NEW YORK, NY 10036

Registered Sep. 11, 2012

Int. Cl.: 36

FOR: INSURANCE AND FINANCIAL ADVISORY AND CONSULTANCY SERVICES FOR THE LESBIAN, GAY, BISEXUAL AND TRANSGENDER (LGBT) COMMUNITY , IN CLASS 36 (U.S. CLS. 100, 101 AND 102).

SERVICE MARK

FIRST USE 2-21-2011; IN COMMERCE 2-21-2011.

PRINCIPAL REGISTER

THE MARK CONSISTS OF THE STYLIZED WORDING "PLANNING WITH PRIDE." THE COLOR OLIVE GREEN APPEARS IN THE WORDING "PLANNING WITH." THE COLOR RED APPEARS IN THE LEFT PORTION OF THE "P" IN "PRIDE" AND FADES TO ORANGE ON THE RIGHT SIDE OF THE "P." THE COLOR ORANGE APPEARS IN THE LEFT SIDE OF THE "R" IN "PRIDE" AND FADES TO YELLOW ON THE RIGHT SIDE OF THE "R." THE COLOR YELLOW APPEARS IN THE LEFT SIDE OF THE "I" IN "PRIDE" AND FADES TO GREEN ON THE RIGHT SIDE OF THE "I." THE COLOR GREEN APPEARS ON THE LEFT SIDE OF THE "D" IN "PRIDE" AND FADES TO BLUE ON THE RIGHT SIDE OF THE "D." THE COLOR BLUE APPEARS IN THE LEFT SIDE OF THE "E" IN "PRIDE" AND FADES TO PURPLE ON THE RIGHT SIDE OF THE "E." THE WHITE IN THE DRAWING REPRESENTS BACKGROUND AREAS ONLY AND IS NOT PART OF THE MARK.

THE COLOR(S) OLIVE GREEN, RED, ORANGE, YELLOW, GREEN, BLUE AND PURPLE IS/ARE CLAIMED AS A FEATURE OF THE MARK.

SER. NO. 85-259,823, FILED S.R. 3-7-2011 AM. P.R. 6-23-2011.

MAUREEN DALL, EXAMINING ATTORNEY



David J. Kyros

Director of the United States Patent and Trademark Office

United States of America

United States Patent and Trademark Office

LIGHTBOX

Reg. No. 4,204,404

Registered Sep. 11, 2012

Int. Cl.: 38

SERVICE MARK

PRINCIPAL REGISTER

T2 LABS, INC. (DELAWARE CORPORATION)
2711 CENTERVILLE ROAD, SUITE 400
WILMINGTON, DE 19808

FOR: COMMUNICATIONS BY MEANS OF TELEPHONE, CABLE, BROADBAND, FIBER-OPTIC AND WIRELESS NETWORKS; TELECOMMUNICATION SERVICES, NAMELY, TRANSMISSION OF VOICE, DATA, GRAPHICS AND VIDEO BY MEANS OF TELEPHONE, CABLE, BROADBAND, FIBER-OPTIC AND WIRELESS NETWORKS; ELECTRONIC MAIL SERVICES; ELECTRONIC TRANSMISSION OF DATA, MESSAGE, IMAGES, AND DOCUMENTS; PROVIDING ONLINE CHAT ROOMS; ELECTRONIC TRANSMISSION OF VOICE, DATA AND IMAGES BY TELEVISION AND VIDEO BROADCASTING; WEBCASTING SERVICES; PROVIDING ONLINE FORUMS AND CHAT ROOMS FOR THE TRANSMISSION OF MESSAGES, COMMENTS AND MULTIMEDIA CONTENT AMONG USERS INCLUDING IMAGES, PHOTOS AND VIDEOS, IN CLASS 38 (U.S. CLS. 100, 101 AND 104).

THE MARK CONSISTS OF STANDARD CHARACTERS WITHOUT CLAIM TO ANY PARTICULAR FONT, STYLE, SIZE, OR COLOR.

PRIORITY CLAIMED UNDER SEC. 44(D) ON UNITED KINGDOM APPLICATION NO. 009728536, FILED 2-10-2011, REG. NO. 009728536, DATED 9-29-2011, EXPIRES 2-10-2021.

OWNER OF U.S. REG. NO. 2,870,252.

SER. NO. 85-260,337, FILED 3-7-2011.

CAROLINE WOOD, EXAMINING ATTORNEY



David J. Kyros

Director of the United States Patent and Trademark Office

United States of America

United States Patent and Trademark Office

शान्तिनिकेतन

Reg. No. 4,204,405

Registered Sep. 11, 2012

Int. Cl.: 43

SERVICE MARK

PRINCIPAL REGISTER

SHANTINIKETAN INC (FLORIDA CORPORATION)
999 DAVID WALKER DRIVE
TAVARES, FL 32778

FOR: RETIREMENT HOMES, IN CLASS 43 (U.S. CLS. 100 AND 101).

FIRST USE 1-1-2008; IN COMMERCE 1-1-2008.

THE NAME(S), PORTRAIT(S), AND/OR SIGNATURE(S) SHOWN IN THE MARK DOES NOT IDENTIFY A PARTICULAR LIVING INDIVIDUAL.

THE COLOR(S) GOLD IS/ARE CLAIMED AS A FEATURE OF THE MARK.

THE MARK CONSISTS OF THE WORDING "SHANTINIKETAN" REPRESENTED IN STYLIZED FONT AND IN THE COLOR GOLD.

THE ENGLISH TRANSLATION OF "SHANTINIKETAN" IN THE MARK IS "PEACE HOUSE".

SEC. 2(F).

SER. NO. 85-262,546, FILED 3-9-2011.

WARREN L. OLANDRIA, EXAMINING ATTORNEY



David J. Kyros

Director of the United States Patent and Trademark Office

United States of America

United States Patent and Trademark Office

ASI

Reg. No. 4,204,406

ASPHALT SYSTEMS, INC. (UTAH CORPORATION)
P.O. BOX 25511
SALT LAKE CITY, UT 84125

Registered Sep. 11, 2012

Int. Cls.: 19 and 35

FOR: ASPHALT-BASED SEALANTS FOR USE ON PAVEMENTS, IN CLASS 19 (U.S. CLS. 1, 12, 33 AND 50).

TRADEMARK

FIRST USE 4-11-1975; IN COMMERCE 4-11-1975.

SERVICE MARK

FOR: ON-LINE RETAIL STORE SERVICES FEATURING ASPHALT SEALANTS, HAND TOOLS AND SEAL-COATING SUPPLIES, IN CLASS 35 (U.S. CLS. 100, 101 AND 102).

PRINCIPAL REGISTER

FIRST USE 4-11-1975; IN COMMERCE 4-11-1975.

THE MARK CONSISTS OF STANDARD CHARACTERS WITHOUT CLAIM TO ANY PARTICULAR FONT, STYLE, SIZE, OR COLOR.

SER. NO. 85-263,192, FILED 3-10-2011.

DAWN HAN, EXAMINING ATTORNEY



David J. Kyffers

Director of the United States Patent and Trademark Office

United States of America

United States Patent and Trademark Office

GOLD STANDARD

Reg. No. 4,204,407

WEST CENTRAL COOPERATIVE (IOWA CORPORATION)
406 1ST STREET

Registered Sep. 11, 2012

RALSTON, IA 51459

Int. Cl.: 31

FOR: DAIRY FEED INGREDIENTS, NAMELY, SOYBEAN MEAL; DAIRY FEED INGREDIENTS, NAMELY, SOYBEAN MEAL SOLD AS AN INTEGRAL INGREDIENT OF ANIMAL FEED, IN CLASS 31 (U.S. CLS. 1 AND 46).

TRADEMARK

FIRST USE 0-0-1996; IN COMMERCE 0-0-1996.

PRINCIPAL REGISTER

THE MARK CONSISTS OF STANDARD CHARACTERS WITHOUT CLAIM TO ANY PARTICULAR FONT, STYLE, SIZE, OR COLOR.

SER. NO. 85-263,658, FILED 3-10-2011.

SHANNON TWOHIG, EXAMINING ATTORNEY



David J. Kybas

Director of the United States Patent and Trademark Office

United States of America

United States Patent and Trademark Office



Hearing Care
R E S O U R C E S

Reg. No. 4,204,408

Registered Sep. 11, 2012

Int. Cls.: 10, 35 and 44

TRADEMARK

SERVICE MARK

PRINCIPAL REGISTER

HEARING CARE RESOURCES, LLC (NEW YORK LIMITED LIABILITY COMPANY)
P.O. BOX 1224
GLOVERSVILLE, NY 12078

FOR: HEARING AIDS, HEARING INSTRUMENTS, HEARING ASSIST DEVICES, NAMELY, ELECTRICALLY OPERATED HEARING AIDS, WIRELESS SYSTEMS TO CONNECT TELEPHONES AND OTHER SOUND SOURCES TO HEARING AID(S), TELEPHONE AMPLIFIERS, TELEVISION AMPLIFIERS, DATA STREAMING DEVICES TO WIRELESSLY TRANSMIT DATA TO HEARING AIDS OR SOUND REPRODUCTION DEVICES, WIRELESS TRANSMITTERS THAT CREATE AMPLIFIED SOUND NEAR THE EAR(S); HEARING ACCESSORIES, NAMELY, WIRELESS TRANSMITTERS AND RECEIVERS FOR USE WITH HEARING AIDS; HEARING AID BATTERIES, BRUSHES FOR CLEANING HEARING AIDS AND HEARING DEVICES, WAX REMOVAL TOOLS, DRYING DEVICES TO REMOVE MOISTURE FROM HEARING AIDS, DESICCANTS TO REMOVE MOISTURE FROM HEARING AIDS, RETENTION CLIPS AND DEVICES TO KEEP HEARING AIDS ATTACHED TO THE BODY AND IN PROPER POSITION FOR OPERATION, MOISTURE COVERS FOR HEARING AIDS, SWEAT PROTECTION COVERS FOR HEARING AIDS, CUSTOM COVERS TO PROTECT HEARING AIDS; EAR MOLDS, CUSTOM EAR MOLDS FOR HOUSING HEARING AID COMPONENTS; HEARING PROTECTION DEVICES, NAMELY, CERUMEN PROTECTION SYSTEMS, WAX GUARDS, HEARING PROTECTING EAR MUFFS; TINNITUS TREATMENT DEVICES, NAMELY, TINNITUS MASKING DEVICES; TINNITUS MASKING DEVICES INTEGRATED INTO HEARING AIDS, SOUND GENERATORS (EAR LEVEL), SOUND GENERATORS (FOR A ROOM); DEVICES INTENDED TO ASSIST THE HEARING IMPAIRED, NAMELY, WIRELESS TRANSMITTERS AND RECEIVERS FOR USE WITH HEARING AIDS, IN CLASS 10 (U.S. CLS. 26, 39 AND 44).



FIRST USE 9-23-2009; IN COMMERCE 10-1-2010.

FOR: RETAIL STORE SERVICES FEATURING HEARING AIDS, HEARING INSTRUMENTS, HEARING ASSIST DEVICES, NAMELY, ELECTRICALLY OPERATED HEARING AIDS, WIRELESS SYSTEMS TO CONNECT TELEPHONES AND OTHER SOUND SOURCES TO HEARING AID(S), TELEPHONE AMPLIFIERS, TELEVISION AMPLIFIERS, DATA STREAMING DEVICES TO WIRELESSLY TRANSMIT DATA TO HEARING AIDS OR SOUND REPRODUCTION DEVICES, WIRELESS TRANSMITTERS THAT CREATE AMPLIFIED SOUND NEAR THE EAR(S), HEARING ACCESSORIES, NAMELY, WIRELESS TRANSMITTERS AND RECEIVERS FOR USE WITH HEARING AIDS, HEARING AID BATTERIES, BRUSHES FOR CLEANING HEARING AIDS AND HEARING DEVICES, WAX REMOVAL

David J. Kyjars

Director of the United States Patent and Trademark Office

Reg. No. 4,204,408 TOOLS, DRYING DEVICES TO REMOVE MOISTURE FROM HEARING AIDS, DESICCANTS TO REMOVE MOISTURE FROM HEARING AIDS, RETENTION CLIPS AND DEVICES TO KEEP HEARING AIDS ATTACHED TO THE BODY AND IN PROPER POSITION FOR OPERATION, MOISTURE COVERS FOR HEARING AIDS, SWEAT PROTECTION COVERS FOR HEARING AIDS, CUSTOM COVERS TO PROTECT HEARING AIDS, EAR MOLDS, CUSTOM EAR MOLDS FOR HOUSING HEARING AID COMPONENTS, HEARING PROTECTION DEVICES, NAMELY, CERUMEN PROTECTION SYSTEMS, WAX GUARDS, HEARING PROTECTING EAR MUFFS, TINNITUS TREATMENT DEVICES, NAMELY, TINNITUS MASKING DEVICES, TINNITUS MASKING DEVICES INTEGRATED INTO HEARING AIDS, SOUND GENERATORS (EAR LEVEL), SOUND GENERATORS (FOR A ROOM), DEVICES INTENDED TO ASSIST THE HEARING IMPAIRED, NAMELY, WIRELESS TRANSMITTERS AND RECEIVERS FOR USE WITH HEARING AIDS; DEALERSHIPS IN THE FIELD OF HEARING AIDS; THE BRINGING TOGETHER, FOR THE BENEFIT OF OTHERS, HEARING AIDS AND HEARING AID-RELATED INSTRUMENTS, ENABLING CUSTOMERS TO CONVENIENTLY VIEW AND PURCHASE THOSE GOODS; RETAIL STORE SERVICES FEATURING BATTERY PLANS FOR HEARING AIDS, NAMELY, PLANS FOR PROVIDING REPLACEMENT BATTERIES TO CUSTOMERS AT REGULAR INTERVALS; DEMONSTRATION OF HEARING AIDS AND HEARING ASSIST DEVICES, IN CLASS 35 (U.S. CLS. 100, 101 AND 102).

FIRST USE 9-23-2009; IN COMMERCE 3-3-2011.

FOR: HEARING TESTING FOR AUDIOLOGICAL DIAGNOSTIC PURPOSES; CONSULTING SERVICES IN THE FIELD OF AUDIOLOGICAL DIAGNOSTIC HEARING TESTING; AUDIOLOGICAL SERVICES, NAMELY, CERUMEN REMOVAL SERVICES, MIDDLE EAR EVALUATIONS INCLUDING TYMPANOMETRY TESTING, ACOUSTIC REFLEX TESTING, DIAGNOSTIC HEARING EVALUATIONS AND TINNITUS TREATMENT, AUDITORY EVOKE POTENTIAL TESTING, BALANCE TESTING, OTOACOUSTIC EMISSION TESTING; HEARING AID SERVICES; AUDIOLOGICAL SERVICES, NAMELY, PROVIDING AUDIOLOGIST SERVICES, PROVIDING AUDIOMETRIC MEASUREMENT(S); FITTING OF HEARING AIDS, IN CLASS 44 (U.S. CLS. 100 AND 101).

FIRST USE 9-23-2009; IN COMMERCE 3-3-2011.

NO CLAIM IS MADE TO THE EXCLUSIVE RIGHT TO USE "HEARING CARE RESOURCES" , APART FROM THE MARK AS SHOWN.

THE MARK CONSISTS OF THE LITERAL ELEMENT "HEARING CARE RESOURCES" AND A DESIGN ELEMENT CONSISTING OF A PROFILE OF A PERSON'S FACE WITH WAVE LINES ADJACENT THE EAR. A LINE SEPARATES THE WORDING "HEARING CARE" AND THE WORD "RESOURCES".

SER. NO. 85-266,365, FILED 3-14-2011.

PAUL MORENO, EXAMINING ATTORNEY

United States of America

United States Patent and Trademark Office



Reg. No. 4,204,409

AMERICAN MEDICAL SERVICES (MICHIGAN CORPORATION)
1827 NORTHFIELD DR
ROCHESTER HILLS, MI 48309

Registered Sep. 11, 2012

Int. Cl.: 35

FOR: ON-LINE RETAIL STORE SERVICES FEATURING ORTHOPEDIC AND FOOT CARE PRODUCTS, IN CLASS 35 (U.S. CLS. 100, 101 AND 102).

SERVICE MARK

FIRST USE 10-18-2010; IN COMMERCE 11-15-2010.

PRINCIPAL REGISTER

NO CLAIM IS MADE TO THE EXCLUSIVE RIGHT TO USE "STORES.COM", APART FROM THE MARK AS SHOWN.

THE COLOR(S) BLUE, GRAY, GREEN AND WHITE IS/ARE CLAIMED AS A FEATURE OF THE MARK.

THE MARK CONSISTS OF THE LITERAL ELEMENTS "ALEVA STORES.COM ...CLICK, SHOP, SAVE" ARRANGED IN A VERTICAL CONFIGURATION, WHEREIN THE WORD "ALEVA" IN BLUE COLOR IS UNDERLINED IN A GRAY COLOR WITH AN IMAGE OF A LEAF IN GREEN COLOR PLACED ABOVE THE LETTER "E" IN "ALEVA" AND HAVING A WHITE STEM AND WHITE LINES AT THE EDGES TO REPRESENT CONTOUR, AND THE WORDING "STORES.COM" IS SHOWN IN GREEN COLOR BELOW THE GRAY UNDERLINE, AND THE WORDING "...CLICK, SHOP, SAVE" IS SHOWN IN GRAY COLOR BELOW THE WORDING "STORES.COM". THE REMAINING WHITE REPRESENTS TRANSPARENT BACKGROUND AND IS NOT CLAIMED AS A FEATURE OF THE MARK.



SER. NO. 85-266,867, FILED 3-15-2011.

JENNIFER DIXON, EXAMINING ATTORNEY

David J. Kyffers

Director of the United States Patent and Trademark Office

United States of America

United States Patent and Trademark Office

ALEVA HEALTH

Reg. No. 4,204,410

AMERICAN MEDICAL SERVICES (MICHIGAN CORPORATION)
1827 NORTHFIELD DR
ROCHESTER HILLS, MI 48309

Registered Sep. 11, 2012

Int. Cl.: 35

FOR: WHOLESALE DISTRIBUTORSHIP SERVICES FEATURING ORTHOPEDIC AND FOOT CARE PRODUCTS, IN CLASS 35 (U.S. CLS. 100, 101 AND 102).

SERVICE MARK

FIRST USE 1-31-2008; IN COMMERCE 3-15-2008.

PRINCIPAL REGISTER

THE MARK CONSISTS OF STANDARD CHARACTERS WITHOUT CLAIM TO ANY PARTICULAR FONT, STYLE, SIZE, OR COLOR.

NO CLAIM IS MADE TO THE EXCLUSIVE RIGHT TO USE "HEALTH", APART FROM THE MARK AS SHOWN.

SER. NO. 85-266,880, FILED 3-15-2011.

JENNIFER DIXON, EXAMINING ATTORNEY



David J. Kyffers

Director of the United States Patent and Trademark Office

United States of America

United States Patent and Trademark Office



Reg. No. 4,204,411

AMERICAN MEDICAL SERVICES (MICHIGAN CORPORATION)
1827 NORTHFIELD DR
ROCHESTER HILLS, MI 48309

Registered Sep. 11, 2012

Int. Cl.: 35

FOR: WHOLESALE DISTRIBUTORSHIP SERVICES FEATURING ORTHOPEDIC AND FOOT CARE PRODUCTS, IN CLASS 35 (U.S. CLS. 100, 101 AND 102).

SERVICE MARK

FIRST USE 1-31-2008; IN COMMERCE 3-15-2008.

PRINCIPAL REGISTER

NO CLAIM IS MADE TO THE EXCLUSIVE RIGHT TO USE "HEALTH", APART FROM THE MARK AS SHOWN.

THE COLOR(S) BLACK, RED AND GREEN IS/ARE CLAIMED AS A FEATURE OF THE MARK.

THE MARK CONSISTS OF THE LITERAL ELEMENTS "ALEVA HEALTH" WHEREIN THE FIRST LETTER "A" OF THE WORD "ALEVA" DEPICTS AN ELECTROCARDIOGRAM WAVE SIGNAL REPRESENTING A HEART BEAT IN BLACK COLOR AND EXTENDING ACROSS UNDERNEATH THE WORD "ALEVA", WITH AN ARROW IN GREEN COLOR POINTING TO THE RIGHT ON THE RIGHT SIDE OF THE LETTER "A" AT THE BEGINNING AND END OF "ALEVA", AND THE WORD "HEALTH" IS BELOW THE WORD "ALEVA" IN RED COLOR AS SHOWN IN THE MARK.



SER. NO. 85-266,882, FILED 3-15-2011.

JENNIFER DIXON, EXAMINING ATTORNEY

David J. Kybas

Director of the United States Patent and Trademark Office

United States of America

United States Patent and Trademark Office

PANACEA WRAP

Reg. No. 4,204,412

WESTERN PLASTICS INC. (CANADA CORPORATION)

Registered Sep. 11, 2012

5850 KEATON CRESCENT
MISSISSAUGA, ONTARIO, CANADA L5R3K2

Int. Cl.: 17

FOR: PLASTIC MULTI-LAYER REINFORCED FLEXIBLE WRAPPING MATERIAL IN THE NATURE OF PACKAGING FILM SOLD IN BULK TO INDUSTRIAL AND COMMERCIAL MANUFACTURERS , IN CLASS 17 (U.S. CLS. 1, 5, 12, 13, 35 AND 50).

TRADEMARK

FIRST USE 7-31-2006; IN COMMERCE 8-31-2006.

PRINCIPAL REGISTER

THE MARK CONSISTS OF STANDARD CHARACTERS WITHOUT CLAIM TO ANY PARTICULAR FONT, STYLE, SIZE, OR COLOR.

PRIORITY CLAIMED UNDER SEC. 44(D) ON CANADA APPLICATION NO. 1495950, FILED 9-15-2010, REG. NO. TMA823,430, DATED 5-4-2012, EXPIRES 5-4-2027.

NO CLAIM IS MADE TO THE EXCLUSIVE RIGHT TO USE "WRAP", APART FROM THE MARK AS SHOWN.

SER. NO. 85-267,064, FILED 3-15-2011.

ALICIA COLLINS, EXAMINING ATTORNEY



David J. Kyros

Director of the United States Patent and Trademark Office

United States of America

United States Patent and Trademark Office



Reg. No. 4,204,413

Registered Sep. 11, 2012

Int. Cl.: 42

JULINGTON CREEK PLANTATION PROPERTY OWNERS' ASSOCIATION, INC. (FLORIDA CORPORATION)

SUITE 206
1637 RACE TRACK RD
ST JOHNS, FL 32259

SERVICE MARK

FOR: ARCHITECTURAL CONSULTANCY, NAMELY, ARCHITECTURAL REVIEW AND APPROVAL SERVICES, IN CLASS 42 (U.S. CLS. 100 AND 101).

PRINCIPAL REGISTER

FIRST USE 1-1-2000; IN COMMERCE 1-1-2000.

NO CLAIM IS MADE TO THE EXCLUSIVE RIGHT TO USE "JULINGTON CREEK", APART FROM THE MARK AS SHOWN.

THE MARK CONSISTS OF STYLIZED LETTERS "JC" IN A BOX BROKEN BY WAVY LINES WITH THE WORDS "JULINGTON CREEK PLANTATION" BELOW, AND A HORIZONTAL LINE APPEARING BELOW THE WORDING "JULINGTON CREEK", AND ABOVE "PLANTATION".

SER. NO. 85-267,147, FILED 3-15-2011.

ALAIN LAPTER, EXAMINING ATTORNEY



David J. Kyffers

Director of the United States Patent and Trademark Office

United States of America

United States Patent and Trademark Office

Vanguard Flagship Community

Reg. No. 4,204,414

Registered Sep. 11, 2012

**Int. Cls.: 9, 35, 36, 41
and 42**

TRADEMARK

SERVICE MARK

PRINCIPAL REGISTER

THE VANGUARD GROUP, INC. (PENNSYLVANIA CORPORATION)
V26
100 VANGUARD BLVD
MALVERN, PA 19355

FOR: DOWNLOADABLE ELECTRONIC PUBLICATIONS IN THE NATURE OF NEWSLETTERS, REPORTS, GUIDES, CHARTS, WORKSHEETS, FORMS, INSTRUCTIONAL MATERIALS, EDUCATIONAL MATERIALS, PRESENTATIONS, BULLETINS, PAMPHLETS, AND BOOKLETS IN THE FIELDS OF FINANCE, SAVING, INVESTING, INVESTMENTS, INVESTMENT BROKERAGE, AND ASSET MANAGEMENT; COMPUTER SOFTWARE FOR USE IN OBTAINING ACCESS TO, AND ENHANCING THE USER'S EXPERIENCE OF, AN INTERNET WEB SITE WHICH PROVIDES NEWS AND INFORMATION AND A PLATFORM FOR INTERACTIVE DISCUSSIONS, PARTICIPATING IN POLLS AND SURVEYS, AND SOCIAL-NETWORKING, IN CLASS 9 (U.S. CLS. 21, 23, 26, 36 AND 38).

FIRST USE 2-15-2011; IN COMMERCE 2-15-2011.

FOR: PROVIDING AN INTERACTIVE WEBSITE FOR CLIENT FEEDBACK AND COLLABORATION WHERE CLIENTS CAN ANALYZE AN IDEA OR PROTOTYPE SUCH AS AN ADVERTISEMENT, BROCHURE, PAMPHLET IN ORDER FOR CLIENTS TO PROVIDE FEEDBACK FOR FUTURE MATERIALS DIRECTED TO CLIENTS, IN CLASS 35 (U.S. CLS. 100, 101 AND 102).

FIRST USE 2-15-2011; IN COMMERCE 2-15-2011.

FOR: FINANCIAL SERVICES, NAMELY, INVESTMENT MANAGEMENT SERVICES, FINANCIAL PLANNING SERVICES, MUTUAL FUND INVESTMENT SERVICES, SECURITIES BROKERAGE SERVICES AND FINANCIAL INFORMATION PROVIDED BY ELECTRONIC MEANS; PROVIDING INFORMATION IN THE FINANCIAL AND INVESTMENT FIELDS; PROVIDING AN INTERACTIVE WEBSITE IN THE FIELDS OF INVESTING, FINANCE, SAVING, FINANCIAL PLANNING, FINANCIAL NEWS, FINANCIAL INFORMATION, ANALYSIS IN THE FIELDS OF INVESTING, FINANCE, AND FINANCIAL PLANNING, FINANCIAL PORTFOLIO MANAGEMENT, FINANCIAL DECISION MAKING, INVESTMENT RESEARCH, MONITORING INVESTMENT VALUE AND PERFORMANCE OF INVESTMENTS, ANALYZING INVESTMENT PERFORMANCE, EVALUATING ASSET ALLOCATION, RISK TOLERANCE, FINANCIAL ALTERNATIVE PLANS AND INVESTMENT TIME FRAMES; RESEARCH IN THE FIELDS OF FINANCE, SAVING, INVESTING, INVESTMENTS,



David J. Kyjars

Director of the United States Patent and Trademark Office

Reg. No. 4,204,414 INVESTMENT BROKERAGE, AND ASSET MANAGEMENT, IN CLASS 36 (U.S. CLS. 100, 101 AND 102).

FIRST USE 2-15-2011; IN COMMERCE 2-15-2011.

FOR: EDUCATIONAL SERVICES, NAMELY, PROVIDING ONLINE PUBLICATIONS IN THE NATURE OF NEWSLETTERS, REPORTS, GUIDES, CHARTS, WORKSHEETS, FORMS, INSTRUCTIONAL MATERIALS, EDUCATIONAL MATERIALS, PRESENTATIONS, BULLETINS, PAMPHLETS, AND BOOKLETS IN THE FIELDS OF FINANCE, SAVING, INVESTING, INVESTMENTS, INVESTMENT BROKERAGE, AND ASSET MANAGEMENT; PROVIDING INFORMATION IN THE FIELD OF FINANCIAL EDUCATION TO CLIENTS BY MEANS OF AN INTERACTIVE INTERNET WEB SITE, IN CLASS 41 (U.S. CLS. 100, 101 AND 107).

FIRST USE 2-15-2011; IN COMMERCE 2-15-2011.

FOR: COMPUTER SERVICES, NAMELY, CREATING AN ONLINE COMMUNITY FOR REGISTERED USERS TO PARTICIPATE IN DISCUSSIONS, GET FEEDBACK FROM THEIR PEERS, AND FORM VIRTUAL COMMUNITIES; PROVIDING USE OF ON-LINE NON-DOWNLOADABLE SOFTWARE IN THE FIELDS OF CLIENT COLLABORATION, NAMELY, THE SHARING AND COMMUNICATION OF IDEAS, INSIGHT, AND FEEDBACK BETWEEN CLIENTS AND FINANCIAL EXPERTS, AND SOCIAL NETWORKING; PROVIDING AN ONLINE COMMUNITY FOR USERS TO ENGAGE IN CLIENT COLLABORATION, NAMELY, THE SHARING AND COMMUNICATION OF IDEAS, INSIGHT, AND FEEDBACK BETWEEN COMPANIES AND THEIR CUSTOMERS, AND TO ENGAGE IN SOCIAL NETWORKING RELATED TO THE ONLINE CUSTOMER COLLABORATION COMMUNITY, IN CLASS 42 (U.S. CLS. 100 AND 101).

FIRST USE 2-15-2011; IN COMMERCE 2-15-2011.

THE MARK CONSISTS OF STANDARD CHARACTERS WITHOUT CLAIM TO ANY PARTICULAR FONT, STYLE, SIZE, OR COLOR.

OWNER OF U.S. REG. NOS. 1,617,920, 1,784,435 AND OTHERS.

NO CLAIM IS MADE TO THE EXCLUSIVE RIGHT TO USE "COMMUNITY", APART FROM THE MARK AS SHOWN.

SER. NO. 85-268,450, FILED 3-16-2011.

ALLISON HOLTZ, EXAMINING ATTORNEY

United States of America

United States Patent and Trademark Office

≡ STUDIO ≡
MOVIE GRILL ≡
EAT · DRINK · MOVIES

Reg. No. 4,204,415

Registered Sep. 11, 2012

Int. Cls.: 41 and 43

SERVICE MARK

PRINCIPAL REGISTER

MOVIE GRILL CONCEPTS TRADEMARK HOLDINGS, LLC (TEXAS LIMITED LIABILITY COMPANY)
11300 N. CENTRAL EXPRESSWAY, SUITE 200
DALLAS, TX 75243

FOR: MOVIE THEATERS; PROVIDING FACILITIES FOR MOVIES, PRERECORDED VIDEOS, MOVIE PREMIERS AND OTHER AUDIO-VISUAL PRESENTATIONS FOR ENTERTAINMENT PURPOSES; PROVIDING FACILITIES FOR LIVE ENTERTAINMENT IN THE NATURE OF THEATER SHOWS, PLAYS, MUSICAL PERFORMANCES AND SHOW PERFORMANCES; DINNER THEATER SERVICES, IN CLASS 41 (U.S. CLS. 100, 101 AND 107).

FIRST USE 3-0-2009; IN COMMERCE 3-0-2009.

FOR: BAR AND RESTAURANT SERVICES; PROVISION OF FACILITIES FOR CONFERENCES AND MEETINGS, IN CLASS 43 (U.S. CLS. 100 AND 101).

FIRST USE 3-0-2009; IN COMMERCE 3-0-2009.

OWNER OF U.S. REG. NO. 2,963,249.

NO CLAIM IS MADE TO THE EXCLUSIVE RIGHT TO USE "MOVIE GRILL" AND "EAT DRINK MOVIES", APART FROM THE MARK AS SHOWN.

THE MARK CONSISTS OF THE WORD "STUDIO" ABOVE THE WORDS "MOVIE GRILL" ABOVE THE WORDS "EAT", "DRINK" AND "MOVIES", EACH OF WHICH ARE SEPARATED BY A DOT, AS WELL AS THREE PARALLEL LINES ON EITHER SIDE OF "STUDIO" AND "MOVIE GRILL".

SER. NO. 85-268,869, FILED 3-16-2011.

CHRIS WELLS, EXAMINING ATTORNEY



David J. Kyffers

Director of the United States Patent and Trademark Office

United States of America
United States Patent and Trademark Office

SMACK

Reg. No. 4,204,416

PAUL CONYETTE (CANADA INDIVIDUAL)
374 RIVER AVENUE, SUITE 101
WINNIPEG, MANITOBA, CANADA R3L0E4

Registered Sep. 11, 2012

Int. Cl.: 5

FOR: MOSQUITO REPELLANT, IN CLASS 5 (U.S. CLS. 6, 18, 44, 46, 51 AND 52).

TRADEMARK

THE MARK CONSISTS OF STANDARD CHARACTERS WITHOUT CLAIM TO ANY PARTICULAR FONT, STYLE, SIZE, OR COLOR.

PRINCIPAL REGISTER

PRIORITY CLAIMED UNDER SEC. 44(D) ON CANADA APPLICATION NO. 1519588, FILED 3-17-2011, REG. NO. TMA822,612, DATED 4-20-2012, EXPIRES 4-20-2027.

SER. NO. 85-269,865, FILED 3-17-2011.

NELSON SNYDER, EXAMINING ATTORNEY



David J. Kybas

Director of the United States Patent and Trademark Office

United States of America

United States Patent and Trademark Office



Reg. No. 4,204,417

Registered Sep. 11, 2012

Int. Cl.: 42

SERVICE MARK

PRINCIPAL REGISTER

QUICK-CHECK, INC. (FLORIDA CORPORATION)
9270 UNIVERSITY PARKWAY
PENSACOLA, FL 32514

FOR: COMPUTER CONSULTATION; TECHNOLOGICAL CONSULTATION IN THE TECHNOLOGY FIELD OF COMPUTER SOFTWARE FOR AUTOMATED CLEARING HOUSE PAYMENT PROCESSING; CUSTOMIZED SOFTWARE DEVELOPMENT SERVICES IN THE FIELD OF PROCESSING FINANCIAL TRANSACTIONS, IN CLASS 42 (U.S. CLS. 100 AND 101).

FIRST USE 4-21-2005; IN COMMERCE 4-21-2005.

THE MARK CONSISTS OF A CARTOON DOLLAR SIGN WITH EYES, ARMS, LEGS DEPICTED IN A RUNNING MOTION. THE COLORS TAN AND GREEN APPEAR ON THE BODY, GLOVES, AND SHOES OF THE CARTOON CHARACTER DOLLAR. THE COLOR BLUE-GREEN APPEARS ON THE SHADING OF THE CARTOON CHARACTER DOLLAR. THE COLOR BLACK APPEARS ON THE OUTLINE AND THE EYES ON THE CARTOON CHARACTER DOLLAR. THE COLOR WHITE APPEARS ON THE EYES.

THE COLOR(S) TAN, GREEN, BLUE-GREEN, WHITE, AND BLACK IS/ARE CLAIMED AS A FEATURE OF THE MARK.

SER. NO. 85-271,442, FILED 3-19-2011.

CIMMERIAN COLEMAN, EXAMINING ATTORNEY



David J. Kyros

Director of the United States Patent and Trademark Office

United States of America

United States Patent and Trademark Office



Reg. No. 4,204,418

Registered Sep. 11, 2012

Int. Cl.: 28

TRADEMARK

PRINCIPAL REGISTER

DIAMOND TECH INTERNATIONAL (FLORIDA CORPORATION)
STE. C
5600 AIRPORT BLVD
TAMPA, FL 33634

FOR: HOBBY CRAFT KITS COMPRISING STAINED GLASS FOR MAKING COASTER AND TRIVETS, IN CLASS 28 (U.S. CLS. 22, 23, 38 AND 50).

FIRST USE 9-28-1998; IN COMMERCE 9-28-1998.

NO CLAIM IS MADE TO THE EXCLUSIVE RIGHT TO USE "MOSAICS", APART FROM THE MARK AS SHOWN.

THE COLOR(S) BLACK, ORANGE, RED, GREEN, PURPLE AND YELLOW IS/ARE CLAIMED AS A FEATURE OF THE MARK.

THE MARK CONSISTS OF THE STYLIZED WORDS "JENNIFER'S" IN BLACK AND "MOSAICS" IN ORANGE AND YELLOW AND OUTLINED IN BLACK NEXT TO A TRIANGULAR GLASS MOSAIC IN ORANGE, GREEN, PURPLE AND RED.

SEC. 2(F).

SER. NO. 85-271,620, FILED 3-20-2011.

HOWARD B. LEVINE, EXAMINING ATTORNEY



David J. Kybas

Director of the United States Patent and Trademark Office

United States of America

United States Patent and Trademark Office

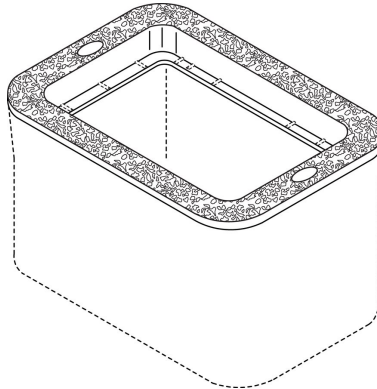

Reg. No. 4,204,419

Registered Sep. 11, 2012

Int. Cl.: 20

TRADEMARK

PRINCIPAL REGISTER

OLDCASTLE PRECAST, INC. (WASHINGTON CORPORATION)
1002 15TH STREET S.W., SUITE 110
AUBURN, WA 98001

FOR: CONSTRUCTION MATERIALS, NAMELY, PLASTIC CAP RINGS BEING AN INTEGRAL COMPONENT OF PRECAST CONCRETE UTILITY BOXES FOR IN GROUND USE, IN CLASS 20 (U.S. CLS. 2, 13, 22, 25, 32 AND 50).

FIRST USE 0-0-1978; IN COMMERCE 0-0-1978.

THE MARK CONSISTS OF A THREE DIMENSIONAL CONFIGURATION OF A RECTANGULAR PLASTIC CONCRETE UTILITY BOX CAP RING WITH ROUNDED CORNERS. THE TOP OF THE CAP CONTAINS NUMEROUS SMALL, RAISED IRREGULAR SHAPES OVER THE ENTIRETY OF ITS SURFACE. A SMALL OVAL IS CENTERED ON EACH SHORT SIDE OF THE RECTANGLE. THE DOTTED OUTLINE OF THE BOX SERVES TO SHOW POSITIONING OF THE MARK AND IS NOT PART OF THE MARK.

SEC. 2(F).

SER. NO. 85-272,629, FILED 3-21-2011.

GRETCHEN ULRICH, EXAMINING ATTORNEY



David J. Kyffers

Director of the United States Patent and Trademark Office

United States of America

United States Patent and Trademark Office

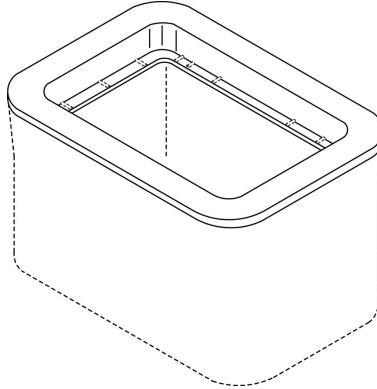

Reg. No. 4,204,420

Registered Sep. 11, 2012

Int. Cl.: 20

TRADEMARK

PRINCIPAL REGISTER

OLDCASTLE PRECAST, INC. (WASHINGTON CORPORATION)
1002 15TH STREET S.W., SUITE 110
AUBURN, WA 98001

FOR: CONSTRUCTION MATERIALS, NAMELY, PLASTIC CAP RINGS BEING AN INTEGRAL COMPONENT OF PRECAST CONCRETE UTILITY BOXES FOR IN GROUND USE , IN CLASS 20 (U.S. CLS. 2, 13, 22, 25, 32 AND 50).

FIRST USE 0-0-1978; IN COMMERCE 0-0-1978.

THE MARK CONSISTS OF A THREE DIMENSIONAL CONFIGURATION OF A RECTANGULAR PLASTIC CONCRETE UTILITY BOX CAP RING WITH ROUNDED CORNERS. THE DOTTED OUTLINE OF THE BOX SERVES TO SHOW POSITIONING OF THE MARK AND IS NOT PART OF THE MARK.

SEC. 2(F).

SER. NO. 85-272,635, FILED 3-21-2011.

GRETCHEN ULRICH, EXAMINING ATTORNEY



David J. Kyffers

Director of the United States Patent and Trademark Office

United States of America

United States Patent and Trademark Office



Reg. No. 4,204,421

CARROLL STREAM MOTOR COMPANY (MICHIGAN LIMITED LIABILITY COMPANY)
425 W. DAVISON LK. RD.
OXFORD, MI 48371

Registered Sep. 11, 2012

Int. Cl.: 7

FOR: SMALL GAS AND DIESEL ENGINES NOT FOR LAND VEHICLES; GAS AND DIESEL OPERATED POWER GENERATORS; GAS AND DIESEL OPERATED WATER PUMPS FOR USE IN MOTORS AND ENGINES; AIR COMPRESSORS, IN CLASS 7 (U.S. CLS. 13, 19, 21, 23, 31, 34 AND 35).

TRADEMARK

PRINCIPAL REGISTER

FIRST USE 7-1-2005; IN COMMERCE 7-1-2005.

NO CLAIM IS MADE TO THE EXCLUSIVE RIGHT TO USE "MOTOR COMPANY", APART FROM THE MARK AS SHOWN.

THE NAME(S), PORTRAIT(S), AND/OR SIGNATURE(S) SHOWN IN THE MARK DOES NOT IDENTIFY A PARTICULAR LIVING INDIVIDUAL.

THE MARK CONSISTS OF AN ELLIPTICAL LOGO, "CS" IN THE CENTER, "MOTOR" AT LEFT CENTER, "COMPANY" AT RIGHT CENTER, "CARROLL" AT THE TOP, AND "STREAM" AT THE BOTTOM.

SER. NO. 85-272,823, FILED 3-21-2011.

MARC LEIPZIG, EXAMINING ATTORNEY



David J. Kyfos

Director of the United States Patent and Trademark Office

United States of America

United States Patent and Trademark Office

ECOFLASH

Reg. No. 4,204,422

Registered Sep. 11, 2012

Int. Cls.: 7 and 11

TRADEMARK

PRINCIPAL REGISTER

BORGWARNER BERU SYSTEMS GMBH (FED REP GERMANY LIMITED LIABILITY COMPANY)
MÖRIKESTRASSE 155
71636 LUDWIGSBURG, FED REP GERMANY

FOR: ELECTRONIC IGNITIONS FOR VEHICLES; SPARK PLUGS; SPARK PLUG IGNITION WIRES; IGNITION COILS FOR INTERNAL COMBUSTION ENGINES, IN CLASS 7 (U.S. CLS. 13, 19, 21, 23, 31, 34 AND 35).

FOR: SPARK IGNITERS FOR OIL AND GAS BURNERS, IN CLASS 11 (U.S. CLS. 13, 21, 23, 31 AND 34).

THE MARK CONSISTS OF STANDARD CHARACTERS WITHOUT CLAIM TO ANY PARTICULAR FONT, STYLE, SIZE, OR COLOR.

PRIORITY CLAIMED UNDER SEC. 44(D) ON FED REP GERMANY APPLICATION NO. 302010038897, FILED 9-22-2010, REG. NO. 302010038897, DATED 2-10-2011, EXPIRES 2-10-2021.

SER. NO. 85-273,065, FILED 3-22-2011.

GILBERT SWIFT, EXAMINING ATTORNEY



David J. Kyfos

Director of the United States Patent and Trademark Office

United States of America

United States Patent and Trademark Office



Reg. No. 4,204,423

ALL OF THE ABOVE LLC (HAWAII LIMITED LIABILITY COMPANY)
1050 ALA MOANA BLVD. SUITE 1310
HONOLULU, HI 96814

Registered Sep. 11, 2012

Int. Cl.: 25

FOR: CLOTHING, NAMELY, TOPS, BOTTOMS, FOOTWEAR, HEADWEAR, T-SHIRTS,
DENIMS, IN CLASS 25 (U.S. CLS. 22 AND 39).

TRADEMARK

FIRST USE 2-15-2007; IN COMMERCE 2-15-2007.

PRINCIPAL REGISTER

THE MARK CONSISTS OF THE LITERAL ELEMENTS "HI" IN SMALLER FONT AS SHOWN
IN THE MARK.

SER. NO. 85-275,064, FILED 3-23-2011.

FONG HSU, EXAMINING ATTORNEY



David J. Kybas

Director of the United States Patent and Trademark Office

United States of America

United States Patent and Trademark Office



Reg. No. 4,204,424

Registered Sep. 11, 2012

Int. Cl.: 9

TRADEMARK

PRINCIPAL REGISTER

QUOMATION INSURANCE SERVICES, INC. (UTAH CORPORATION)
7400 SOUTH UNION PARK AVENUE
SUITE 101
MIDVALE, UT 84047

FOR: COMPUTER SOFTWARE FOR COMPARATIVE RATING OF AUTOMOBILES, HOMES AND COMMERCIAL INSURANCE QUOTES THAT MAY BE DOWNLOADED FROM A GLOBAL COMPUTER NETWORK, IN CLASS 9 (U.S. CLS. 21, 23, 26, 36 AND 38).

FIRST USE 11-10-2010; IN COMMERCE 11-10-2010.

THE MARK CONSISTS OF A GREEN GEOMETRIC DESIGN ELEMENT DIRECTLY LEFT OF THE WORD "QUOLYTICS" IN BLACK.

THE COLOR(S) GREEN, BLACK IS/ARE CLAIMED AS A FEATURE OF THE MARK.

SER. NO. 85-275,094, FILED 3-23-2011.

MARK SPARACINO, EXAMINING ATTORNEY



David J. Kyffers

Director of the United States Patent and Trademark Office

United States of America

United States Patent and Trademark Office

PROFLORA

Reg. No. 4,204,425

NATURAL PACK, INC. (CALIFORNIA CORPORATION)
PO BOX 30352
SANTA BARBARA, CA 93130

Registered Sep. 11, 2012

Int. Cls.: 1, 21 and 31

FOR: POTTING SOIL; SOIL AMENDMENTS; SOIL MIXTURES COMPRISED OF ONE OR MORE OF THE FOLLOWING FLOWER, VEGETABLE, HERB AND GRASS SEEDS, MANURE, COMPOST, COCONUT PITH, PEAT MOSS, AND SLOW RELEASE, POWDER AND GRANULAR FERTILIZER; HYDROPONIC GROWING MEDIA FOR PLANTS; FERTILIZERS; PLANT GROWTH NUTRIENTS, IN CLASS 1 (U.S. CLS. 1, 5, 6, 10, 26 AND 46).

TRADEMARK

PRINCIPAL REGISTER

FIRST USE 12-27-2009; IN COMMERCE 12-27-2009.

FOR: FLORIST AND GARDEN SUPPLIES, NAMELY, DECORATIVE POTS, PLANT BASKETS, AND PLANT BASKET LINERS, IN CLASS 21 (U.S. CLS. 2, 13, 23, 29, 30, 33, 40 AND 50).

FIRST USE 12-27-2009; IN COMMERCE 12-27-2009.

FOR: MULCH; COCONUT HUSK, COIR AND BARK FOR USE AS MULCH; PEAT MOSS; LIVING LICHEN; MOSSES, NAMELY, NATURAL DECORATIVE MOSSES SOLD DRIED, DYED AND PRESERVED FOR USE WITH FLORAL ARRANGEMENTS, ARTS, CRAFTS, AND HOBBY, IN CLASS 31 (U.S. CLS. 1 AND 46).

FIRST USE 12-27-2009; IN COMMERCE 12-27-2009.

THE MARK CONSISTS OF STANDARD CHARACTERS WITHOUT CLAIM TO ANY PARTICULAR FONT, STYLE, SIZE, OR COLOR.

SER. NO. 85-275,100, FILED 3-23-2011.

CHRIS WELLS, EXAMINING ATTORNEY



David J. Kyffers

Director of the United States Patent and Trademark Office

United States of America

United States Patent and Trademark Office



Reg. No. 4,204,426

Registered Sep. 11, 2012

Int. Cls.: 25 and 35

TRADEMARK

SERVICE MARK

PRINCIPAL REGISTER

STRICTLY HODAKA, LLC (VERMONT LIMITED LIABILITY COMPANY)
723 STANNARD ROAD
SANDGATE, VT 05250

FOR: SHIRTS; HATS, IN CLASS 25 (U.S. CLS. 22 AND 39).

FIRST USE 0-0-1990; IN COMMERCE 0-0-1990.

FOR: RETAIL STORE SERVICES AND ON-LINE RETAIL STORE SERVICES FEATURING VINTAGE MOTORCYCLES, MOTORCYCLE PARTS, AND MOTORCYCLE ACCESSORIES; WEBSITE FEATURING CONSUMER INFORMATION IN THE FIELD OF VINTAGE MOTORCYCLES, MOTORCYCLE PARTS, AND MOTORCYCLE ACCESSORIES, IN CLASS 35 (U.S. CLS. 100, 101 AND 102).

FIRST USE 0-0-1986; IN COMMERCE 7-0-1990.

OWNER OF U.S. REG. NOS. 3,566,479 AND 3,614,388.

NO CLAIM IS MADE TO THE EXCLUSIVE RIGHT TO USE "MOTORCYCLES", APART FROM THE MARK AS SHOWN.

THE MARK CONSISTS OF TWO CONCENTRIC CIRCLES WITH A TRIANGLE DESIGN INSIDE THE INNER CIRCLE. THE WORDS "HODAKA" AND "MOTORCYCLES" ARE WRITTEN BETWEEN THE CIRCLES, AND THE LETTER "H" IS WRITTEN WITHIN THE INNER TRIANGLE DESIGN.

THE WORD(S) "HODAKA" HAS NO MEANING IN A FOREIGN LANGUAGE.

SER. NO. 85-275,257, FILED 3-24-2011.

JAMES STEIN, EXAMINING ATTORNEY



David J. Kybas

Director of the United States Patent and Trademark Office

United States of America

United States Patent and Trademark Office

PRO ATM

Reg. No. 4,204,427

PRO ATM, LLC (PENNSYLVANIA LIMITED LIABILITY COMPANY)
969 REESE ROAD
SLIPPERY ROCK, PA 16057

Registered Sep. 11, 2012

Int. Cls.: 35, 36 and 37

FOR: RETAIL STORE SERVICES AND WHOLESALE DISTRIBUTORSHIP SERVICES FEATURING AUTOMATED TELLER MACHINES AND CASH DISPENSERS AND PROVIDING AUTOMATED TELLER MACHINE AND CASH DISPENSER SUPPLIES TO OTHERS, IN CLASS 35 (U.S. CLS. 100, 101 AND 102).

SERVICE MARK

PRINCIPAL REGISTER

FIRST USE 0-0-2009; IN COMMERCE 0-0-2009.

FOR: AUTOMATED TELLER MACHINE AND CASH DISPENSER SERVICES IN THE NATURE OF AUTOMATED TELLER MACHINE MANAGEMENT, AUTOMATED TELLER MACHINE ACCOUNT MANAGEMENT, AUTOMATED TELLER MACHINE CASH MANAGEMENT, AUTOMATED TELLER MACHINE PROCESSING AND AUTOMATED TELLER MACHINE FEE COLLECTION AND PAYMENT SERVICES; RENTAL OF AUTOMATED TELLER MACHINES AND CASH DISPENSERS, IN CLASS 36 (U.S. CLS. 100, 101 AND 102).

FIRST USE 0-0-2009; IN COMMERCE 0-0-2009.

FOR: AUTOMATED TELLER MACHINE AND CASH DISPENSER MAINTENANCE SERVICES, IN CLASS 37 (U.S. CLS. 100, 103 AND 106).

FIRST USE 0-0-2009; IN COMMERCE 0-0-2009.

THE MARK CONSISTS OF STANDARD CHARACTERS WITHOUT CLAIM TO ANY PARTICULAR FONT, STYLE, SIZE, OR COLOR.

NO CLAIM IS MADE TO THE EXCLUSIVE RIGHT TO USE "ATM", APART FROM THE MARK AS SHOWN.

SER. NO. 85-279,450, FILED 3-29-2011.

SAIMA MAKHDOOM, EXAMINING ATTORNEY



David J. Kyffers

Director of the United States Patent and Trademark Office

United States of America

United States Patent and Trademark Office

ECOSTIR

Reg. No. 4,204,428

ECOTENSIL, INC. (CALIFORNIA CORPORATION)
74 MEADOWOOD DRIVE
LARKSPUR, CA 94939

Registered Sep. 11, 2012

Int. Cl.: 21

FOR: BEVERAGE STIRRERS, IN CLASS 21 (U.S. CLS. 2, 13, 23, 29, 30, 33, 40 AND 50).

TRADEMARK

FIRST USE 2-21-2011; IN COMMERCE 2-21-2011.

PRINCIPAL REGISTER

THE MARK CONSISTS OF STANDARD CHARACTERS WITHOUT CLAIM TO ANY PARTICULAR FONT, STYLE, SIZE, OR COLOR.

SER. NO. 85-280,335, FILED 3-29-2011.

ALAIN LAPTER, EXAMINING ATTORNEY



David J. Kybas

Director of the United States Patent and Trademark Office

United States of America

United States Patent and Trademark Office

GEORGES
DUBOEUF



Reg. No. 4,204,429

Registered Sep. 11, 2012

Int. Cl.: 33

TRADEMARK

PRINCIPAL REGISTER

LES VINS GEORGES DUBOEUF (FRANCE SOCIÉTÉ ANONYME (SA))
ROMANECHÉ-THORINS
LA CHAPELLE DE GUINCHAY, FRANCE 71570

FOR: WINES, IN CLASS 33 (U.S. CLS. 47 AND 49).

PRIORITY CLAIMED UNDER SEC. 44(D) ON FRANCE APPLICATION NO. 113808318,
FILED 2-22-2011, REG. NO. 113808318, DATED 2-22-2011, EXPIRES 2-21-2021.

THE COLOR(S) BLACK, BLUE, WHITE, YELLOW, RED AND GREEN IS/ARE CLAIMED
AS A FEATURE OF THE MARK.

OWNER OF U.S. REG. NOS. 3,180,291, 3,311,993 AND OTHERS.

THE NAME "GEORGES DUBOEUF" IDENTIFIES A LIVING INDIVIDUAL WHOSE CONSENT
IS OF RECORD.

THE MARK CONSISTS OF THE WORD "GEORGES" ABOVE THE WORD "DUBOEUF"
WITH A HORIZONTAL LINE BETWEEN THEM, IN WHITE, BOUNDED BY A BLACK BOX.
BELOW THE BOX IS A DESIGN ELEMENT OF THREE FLOWERS, FROM LEFT TO RIGHT
THE FLOWERS ARE BLUE, WHITE WITH A YELLOW CENTER THEN RED. GREEN
LEAVES SURROUND THE FLOWERS.

SER. NO. 85-281,084, FILED 3-30-2011.

MARTHA SANTOMARTINO, EXAMINING ATTORNEY



David J. Kybas

Director of the United States Patent and Trademark Office

United States of America

United States Patent and Trademark Office



Reg. No. 4,204,430

PINCKNEY II M.D., JAMES S. (UNITED STATES INDIVIDUAL)
2201 WOLF STREET, APT. 5201
DALLAS, TX 75201

Registered Sep. 11, 2012

Int. Cl.: 44

FOR: MEDICAL SERVICES, IN CLASS 44 (U.S. CLS. 100 AND 101).

SERVICE MARK

FIRST USE 6-0-2010; IN COMMERCE 6-0-2010.

PRINCIPAL REGISTER

NO CLAIM IS MADE TO THE EXCLUSIVE RIGHT TO USE "PHYSICIAN SENIOR SERVICES" AND THE CADUCEUS SYMBOL, APART FROM THE MARK AS SHOWN.

THE MARK CONSISTS OF THE TERM "PHYSICIAN" IN STYLIZED LETTERING HAVING AN "I" THAT IS FORMED USING A DRAWING OF A CADUCEUS STAFF. DIRECTLY BE- NEATH THE TERM "PHYSICIAN" IS THE PHRASE "SENIOR SERVICES" IN SMALLER, STYLIZED LETTERING ALL CONTAINED WITHIN A RECTANGLE RUNNING HORIZONT- AL AT THE BOTTOM OF THE MARK. THE TOP PORTION OF THE MARK CONSISTS OF A DRAWING OF A HOUSE'S ROOFTOP WITH A CHIMNEY PROTRUDING UP FROM THE RIGHT SLOPE OF THE ROOFTOP.

SER. NO. 85-281,505, FILED 3-30-2011.

CHRISTINE COOPER, EXAMINING ATTORNEY



David J. Kybas

Director of the United States Patent and Trademark Office

United States of America

United States Patent and Trademark Office

FIGHT GAME

Reg. No. 4,204,431

FIGHT GAME LLC (CALIFORNIA LIMITED LIABILITY COMPANY)
P.O. BOX 252052

Registered Sep. 11, 2012

LOS ANGELES, CA 90025

Int. Cl.: 16

FOR: MAGAZINES RELATING TO PHYSICAL FITNESS, IN CLASS 16 (U.S. CLS. 2, 5, 22, 23, 29, 37, 38 AND 50).

TRADEMARK

FIRST USE 3-25-2011; IN COMMERCE 3-25-2011.

PRINCIPAL REGISTER

NO CLAIM IS MADE TO THE EXCLUSIVE RIGHT TO USE "FIGHT", APART FROM THE MARK AS SHOWN.

THE MARK CONSISTS OF THE STYLIZED WORDS "FIGHT GAME".

SER. NO. 85-281,534, FILED 3-30-2011.

SKYE YOUNG, EXAMINING ATTORNEY



David J. Kyffers

Director of the United States Patent and Trademark Office

United States of America

United States Patent and Trademark Office



Reg. No. 4,204,432

Registered Sep. 11, 2012

Int. Cl.: 9

TRADEMARK

PRINCIPAL REGISTER

PARROT (FRANCE SOCIÉTÉ ANONYME (SA))
174 QUAI DE JEMMAPES
PARIS, FRANCE 75010

FOR: ELECTRONIC GAME SOFTWARE FOR CELLULAR TELEPHONES; ELECTRONIC GAME SOFTWARE FOR WIRELESS DEVICES; HAND-HELD UNITS FOR PLAYING ELECTRONIC GAMES FOR USE WITH EXTERNAL DISPLAY SCREEN OR MONITOR; COMPUTER GAME SOFTWARE AND DOWNLOADABLE ELECTRONIC GAMES VIA THE INTERNET AND WIRELESS DEVICES, IN CLASS 9 (U.S. CLS. 21, 23, 26, 36 AND 38).

FIRST USE 6-30-2010; IN COMMERCE 6-30-2010.

PRIORITY CLAIMED UNDER SEC. 44(D) ON ERPN CMNTY TM OFC APPLICATION NO. 009893934, FILED 3-31-2011.

THE MARK CONSISTS OF SKELETON OF A HEAD IN THE MIDDLE OF A RING OF FOUR CIRCLES.

SER. NO. 85-282,697, FILED 3-31-2011.

GISELLE AGOSTO, EXAMINING ATTORNEY



David J. Kybas

Director of the United States Patent and Trademark Office

United States of America

United States Patent and Trademark Office

BeaBu

Reg. No. 4,204,433

PRECIADO, NANCY (UNITED STATES INDIVIDUAL)
1800 GROVE POINT RD APT 911
SAVANNAH, GA 31419

Registered Sep. 11, 2012

**Int. Cls.: 14, 16, 18, 21,
25 and 28**

FOR: CLOCKS, IN CLASS 14 (U.S. CLS. 2, 27, 28 AND 50).

FIRST USE 3-19-2011; IN COMMERCE 3-19-2011.

TRADEMARK

FOR: BUMPER STICKERS, IN CLASS 16 (U.S. CLS. 2, 5, 22, 23, 29, 37, 38 AND 50).

PRINCIPAL REGISTER

FIRST USE 3-19-2011; IN COMMERCE 3-19-2011.

FOR: DOG APPAREL; MESSENGER BAGS; TOTE BAGS, IN CLASS 18 (U.S. CLS. 1, 2, 3, 22 AND 41).

FIRST USE 3-19-2011; IN COMMERCE 3-19-2011.

FOR: ALUMINUM WATER BOTTLES SOLD EMPTY; COFFEE CUPS, TEA CUPS AND MUGS, IN CLASS 21 (U.S. CLS. 2, 13, 23, 29, 30, 33, 40 AND 50).

FIRST USE 3-19-2011; IN COMMERCE 3-19-2011.

FOR: APRONS; BABY BIBS NOT OF PAPER; BABY BODYSUITS; CAPS; HOODED SWEATSHIRTS; T-SHIRTS, IN CLASS 25 (U.S. CLS. 22 AND 39).

FIRST USE 3-19-2011; IN COMMERCE 3-19-2011.

FOR: STUFFED AND PLUSH TOYS, IN CLASS 28 (U.S. CLS. 22, 23, 38 AND 50).

FIRST USE 3-19-2011; IN COMMERCE 3-19-2011.

THE MARK CONSISTS OF STANDARD CHARACTERS WITHOUT CLAIM TO ANY PARTICULAR FONT, STYLE, SIZE, OR COLOR.

SER. NO. 85-284,529, FILED 4-2-2011.

TAMARA FRAZIER, EXAMINING ATTORNEY



David J. Kyffers

Director of the United States Patent and Trademark Office

United States of America

United States Patent and Trademark Office

Stellaris

Reg. No. 4,204,434

BIOSEARCH TECHNOLOGIES, INC. (CALIFORNIA CORPORATION)
81 DIGITAL DRIVE
NOVATO, CA 949495728

Registered Sep. 11, 2012

Int. Cl.: 1

FOR: BIOCHEMICAL REAGENTS, COMMONLY KNOWN AS PROBES, FOR SCIENTIFIC OR RESEARCH USE THAT ENABLE THE DETECTION OF RNA IN CELL AND TISSUE SAMPLES BY FLUORESCENCE IN SITU HYBRIDIZATION (FISH), IN CLASS 1 (U.S. CLS. 1, 5, 6, 10, 26 AND 46).

TRADEMARK

PRINCIPAL REGISTER

FIRST USE 10-10-2011; IN COMMERCE 10-10-2011.

THE MARK CONSISTS OF STANDARD CHARACTERS WITHOUT CLAIM TO ANY PARTICULAR FONT, STYLE, SIZE, OR COLOR.

SER. NO. 85-287,616, FILED 4-6-2011.

ALYSSA STEEL, EXAMINING ATTORNEY



David J. Kyffers

Director of the United States Patent and Trademark Office

United States of America

United States Patent and Trademark Office

BGSTAR LEGATO

Reg. No. 4,204,435

SANOFI (FRANCE SOCIETE ANONYME)
54 RUE LA BOÉTIE
PARIS, FRANCE 75008

Registered Sep. 11, 2012

Int. Cls.: 5, 9 and 10

FOR: BLOOD GLUCOSE MONITORING KITS COMPRISING STRIPS FOR MEASURING BLOOD GLUCOSE CONCENTRATIONS, LANCETS AND CONTROL SOLUTION, ALL OF THE FOREGOING SOLD TO PATIENTS, IN CLASS 5 (U.S. CLS. 6, 18, 44, 46, 51 AND 52).

TRADEMARK

FOR: SOFTWARE INTENDED FOR DIABETIC PATIENTS FOR RECORDING BLOOD TEST RESULTS FROM A BLOOD GLUCOSE MONITOR, SOLD TO PATIENTS, IN CLASS 9 (U.S. CLS. 21, 23, 26, 36 AND 38).

PRINCIPAL REGISTER

FOR: BLOOD GLUCOSE MONITORS, AND BLOOD GLUCOSE MONITORS SOLD AS A UNIT WITH BLOOD GLUCOSE MONITORING KITS COMPRISING STRIPS FOR MEASURING BLOOD GLUCOSE CONCENTRATIONS, LANCETS AND CONTROL SOLUTION, ALL OF THE FOREGOING SOLD TO PATIENTS, IN CLASS 10 (U.S. CLS. 26, 39 AND 44).

THE MARK CONSISTS OF STANDARD CHARACTERS WITHOUT CLAIM TO ANY PARTICULAR FONT, STYLE, SIZE, OR COLOR.

OWNER OF FRANCE REG. NO. 11/3821184, DATED 4-6-2011, EXPIRES 4-6-2021.

OWNER OF U.S. REG. NO. 3,787,454.

SER. NO. 85-290,000, FILED 4-8-2011.

FRED CARL, EXAMINING ATTORNEY



David J. Kypos

Director of the United States Patent and Trademark Office

United States of America

United States Patent and Trademark Office

CAMERA CREATURES

Reg. No. 4,204,436

Registered Sep. 11, 2012

Int. Cl.: 28

TRADEMARK

PRINCIPAL REGISTER

CAMERA CREATURES LIMITED LIABILITY COMPANY (NEW JERSEY LIMITED LIABILITY COMPANY)
23 JOHN DRIVE
ANNANDALE, NJ 08801

FOR: STUFFED TOY ANIMALS FOR ATTACHMENT TO CAMERA LENSES TO PROVIDE A COLORFUL AND FUN ATTENTION POINT FOR THE SUBJECT OF A PHOTO OR VIDEO , IN CLASS 28 (U.S. CLS. 22, 23, 38 AND 50).

FIRST USE 1-1-2001; IN COMMERCE 1-1-2001.

THE MARK CONSISTS OF STANDARD CHARACTERS WITHOUT CLAIM TO ANY PARTICULAR FONT, STYLE, SIZE, OR COLOR.

NO CLAIM IS MADE TO THE EXCLUSIVE RIGHT TO USE "CAMERA", APART FROM THE MARK AS SHOWN.

SER. NO. 85-291,287, FILED 4-11-2011.

TIMOTHY FINNEGAN, EXAMINING ATTORNEY



David J. Kyffers

Director of the United States Patent and Trademark Office

United States of America

United States Patent and Trademark Office

VILLA ROUGE

Reg. No. 4,204,437

Registered Sep. 11, 2012

Int. Cl.: 25

TRADEMARK

PRINCIPAL REGISTER

CHIANG CHIH CHUNG (HONG KONG INDIVIDUAL)
ROOMS 1621-22M 16/F, STAR HOUSE
NO. 3 SALISBURY ROAD, TSIM SHA TSUI
KOWLOON, HONG KONG

FOR: WOMEN'S FOOTWEAR, NAMELY, DRESS SHOES, PUMPS, SLIPPERS, SANDALS, AND BOOTS; MEN'S FOOTWEAR, NAMELY, DRESS SHOES, LOAFERS, SLIPPERS, SANDALS AND BOOTS, IN CLASS 25 (U.S. CLS. 22 AND 39).

THE MARK CONSISTS OF STANDARD CHARACTERS WITHOUT CLAIM TO ANY PARTICULAR FONT, STYLE, SIZE, OR COLOR.

PRIORITY CLAIMED UNDER SEC. 44(D) ON HONG KONG APPLICATION NO. 301855918, FILED 3-11-2011, REG. NO. 301855918, DATED 3-11-2011, EXPIRES 3-11-2021.

THE ENGLISH TRANSLATION OF "VILLA ROUGE" IN THE MARK IS "RED VILLA".

SER. NO. 85-292,444, FILED 4-12-2011.

NELSON SNYDER, EXAMINING ATTORNEY



David J. Kyffers

Director of the United States Patent and Trademark Office

United States of America

United States Patent and Trademark Office



Reg. No. 4,204,438

Registered Sep. 11, 2012

Int. Cl.: 9

TRADEMARK

PRINCIPAL REGISTER

ALEXIS POWER SYSTEMS, INC. (NEVADA CORPORATION)
#202
1105 TERMINAL WAY
RENO, NV 89502

FOR: LITHIUM ION BATTERIES; NICKEL METAL HYDRIDE BATTERIES; BATTERY MONITORING SYSTEMS COMPRISED OF ELECTRIC CIRCUITRY AND COMPUTING HARDWARE THAT MONITORS THE CONDITION OF BATTERIES, CALCULATES THE BATTERY LIFE-CYCLE AND REPORTS BATTERY HEALTH, IN CLASS 9 (U.S. CLS. 21, 23, 26, 36 AND 38).

FIRST USE 2-7-2011; IN COMMERCE 2-7-2011.

NO CLAIM IS MADE TO THE EXCLUSIVE RIGHT TO USE "POWER SYSTEMS", APART FROM THE MARK AS SHOWN.

THE MARK CONSISTS OF THE STYLIZED TEXT "ALEXIS" IN A BOX WITH A LIGHTING BOLT COMING OUT OF THE BOTTOM OF THE "X" AND THE STYLIZED TEXT "POWER SYSTEMS" IN THE LOWER BOARDER OF THE BOX.

SER. NO. 85-293,324, FILED 4-12-2011.

NAAKWAMA ANKRAH, EXAMINING ATTORNEY



David J. Kyros

Director of the United States Patent and Trademark Office

United States of America

United States Patent and Trademark Office

3 Star

Reg. No. 4,204,439

YOUNG, JEROME M (UNITED STATES INDIVIDUAL)
3333 BROADWAY APT D6J
NEW YORK, NY 10031

Registered Sep. 11, 2012

Int. Cl.: 41

FOR: ENTERTAINMENT SERVICES IN THE NATURE OF LIVE MUSICAL PERFORMANCES,
IN CLASS 41 (U.S. CLS. 100, 101 AND 107).

SERVICE MARK

FIRST USE 9-30-2005; IN COMMERCE 10-31-2005.

PRINCIPAL REGISTER

THE MARK CONSISTS OF STANDARD CHARACTERS WITHOUT CLAIM TO ANY PARTICULAR FONT, STYLE, SIZE, OR COLOR.

SER. NO. 85-294,534, FILED 4-13-2011.

SEAN CROWLEY, EXAMINING ATTORNEY



David J. Kyffers

Director of the United States Patent and Trademark Office

United States of America

United States Patent and Trademark Office

AREA510

Reg. No. 4,204,440

SAUNDERS, MICHAEL J. (UNITED STATES INDIVIDUAL)
PO BOX 22601
OAKLAND, CA 94609

Registered Sep. 11, 2012

Int. Cl.: 25

FOR: GLOVES; HATS; HOODED PULLOVERS; HOODED SWEAT SHIRTS; JACKETS; SHORT-SLEEVED OR LONG-SLEEVED T-SHIRTS; SHORTS; SWEATSHIRTS; T-SHIRTS; TANK TOPS, ALL OF THE AFOREMENTIONED FOR RESIDENTS AND TOURISTS OF ALAMEDA COUNTY, CALIFORNIA, IN CLASS 25 (U.S. CLS. 22 AND 39).

TRADEMARK

PRINCIPAL REGISTER

FIRST USE 9-1-2010; IN COMMERCE 9-1-2010.

THE MARK CONSISTS OF STANDARD CHARACTERS WITHOUT CLAIM TO ANY PARTICULAR FONT, STYLE, SIZE, OR COLOR.

SER. NO. 85-301,073, FILED 4-21-2011.

JOHN HWANG, EXAMINING ATTORNEY



David J. Kybas

Director of the United States Patent and Trademark Office

United States of America

United States Patent and Trademark Office

OPTIMUS HEALTHCARE PARTNERS

Reg. No. 4,204,441

Registered Sep. 11, 2012

Int. Cl.: 35

SERVICE MARK

PRINCIPAL REGISTER

OPTIMUS HEALTHCARE PARTNERS (NEW JERSEY LIMITED LIABILITY COMPANY)
95 SUMMIT AVE
SUMMIT, NJ 07901

FOR: BUSINESS SERVICES, NAMELY, FORMULATION OF BEST PRACTICES FOR HEALTH CARE PROVIDERS IN DELIVERING IMPROVED QUALITY, LOWER COSTS, AND BETTER EXPERIENCE TO PATIENT POPULATIONS, IN CLASS 35 (U.S. CLS. 100, 101 AND 102).

FIRST USE 4-20-2011; IN COMMERCE 4-20-2011.

THE MARK CONSISTS OF STANDARD CHARACTERS WITHOUT CLAIM TO ANY PARTICULAR FONT, STYLE, SIZE, OR COLOR.

NO CLAIM IS MADE TO THE EXCLUSIVE RIGHT TO USE "HEALTHCARE PARTNERS", APART FROM THE MARK AS SHOWN.

SER. NO. 85-302,908, FILED 4-23-2011.

ANGELA M. MICHELI, EXAMINING ATTORNEY



David J. Kybas

Director of the United States Patent and Trademark Office

United States of America

United States Patent and Trademark Office



Reg. No. 4,204,442

AMERICAN SOFTWARE TESTING QUALIFICATIONS BOARD, INC. (FLORIDA CORPORATION)

Registered Sep. 11, 2012

13153 N. DALE MABRY HWY., SUITE 105
TAMPA, FL 33618

Int. Cl.: 42

FOR: TESTING, ANALYSIS, AND EVALUATION OF THE SKILLS OF OTHERS FOR THE PURPOSE OF CERTIFICATION IN THE FIELD OF SOFTWARE, IN CLASS 42 (U.S. CLS. 100 AND 101).

SERVICE MARK

PRINCIPAL REGISTER

FIRST USE 12-1-2005; IN COMMERCE 12-1-2005.

NO CLAIM IS MADE TO THE EXCLUSIVE RIGHT TO USE "SOFTWARE TESTING QUALIFICATIONS BOARD, INC.", APART FROM THE MARK AS SHOWN.

THE MARK CONSISTS OF THE LETTERS "ASTQB" WITH A CURVED LINE CROSSING FROM THE "A" THROUGH THE "Q", WITH THE WORDS "AMERICAN SOFTWARE TESTING QUALIFICATIONS BOARD, INC." BELOW THE LETTERS "ASTQB".

SEC. 2(F) AS TO "AMERICAN SOFTWARE TESTING QUALIFICATIONS BOARD, INC.".

SER. NO. 85-303,219, FILED 4-25-2011.

LESLEY LAMOTHE, EXAMINING ATTORNEY



David J. Kyffers

Director of the United States Patent and Trademark Office

United States of America

United States Patent and Trademark Office

LION CAPITAL

Reg. No. 4,204,443

Registered Sep. 11, 2012

Int. Cls.: 16, 35 and 36

TRADEMARK

SERVICE MARK

PRINCIPAL REGISTER

LION CAPITAL LLP (UNITED KINGDOM LIMITED LIABILITY PARTNERSHIP)
21 GROSVENOR PLACE
LONDON SW1X 7HF, UNITED KINGDOM

FOR: PRINTED MATTER, NAMELY, MAGAZINES, BOOKS, NEWSLETTERS AND PAMPHLETS RELATING TO FINANCE, INVESTMENT OR ASSET MANAGEMENT; BROCHURES IN RELATION TO FINANCE, INVESTMENT OR ASSET MANAGEMENT; INVESTMENT BRIEFING PACKS, IN CLASS 16 (U.S. CLS. 2, 5, 22, 23, 29, 37, 38 AND 50).

FOR: ADVICE RELATING TO BUSINESS MANAGEMENT; BUSINESS ADVICE AND INFORMATION; GATHERING AND PROVIDING BUSINESS INFORMATION RELATING TO COMPANY ACTIVITIES; BUSINESS ACQUISITIONS CONSULTANCY AND ADVISORY SERVICES; BUSINESS MANAGEMENT AND ADMINISTRATION RELATING TO THE FIELD OF INVESTMENT AND FINANCIAL AFFAIRS; BUSINESS CONSULTANCY; ADVISORY, CONSULTANCY AND INFORMATION SERVICES RELATING TO ALL THE AFORESAID SERVICES, IN CLASS 35 (U.S. CLS. 100, 101 AND 102).

FOR: FINANCIAL AFFAIRS AND MONETARY AFFAIRS, NAMELY, FINANCIAL AND MONETARY INFORMATION, MANAGEMENT AND ANALYSIS SERVICES; FINANCIAL SERVICES, NAMELY, FINANCIAL AND INVESTMENT PLANNING AND RESEARCH, FINANCIAL CONSULTATION AND ASSISTING OTHERS WITH THE COMPLETION OF FINANCIAL TRANSACTIONS FOR STOCKS, BONDS, SECURITIES AND EQUITIES; CORPORATE FINANCE SERVICES, NAMELY, CONSULTATION IN THE FIELD OF ASSET ACQUISITIONS AND SALES AND CAPITAL STRUCTURE; PRIVATE EQUITY FUND INVESTMENT SERVICES; INVESTMENT CONSULTANCY AND ADVISORY SERVICES; CAPITAL, FUNDS AND TRUST INVESTMENT SERVICES; INVESTMENT MANAGEMENT SERVICES; OPERATION AND MANAGEMENT OF HEDGE FUNDS AND OTHER COLLECTIVE INVESTMENT VEHICLES; FINANCIAL AND INVESTMENT PLANNING AND RESEARCH; FUND RAISING, NAMELY, BUSINESS FUND-RAISING FOR OTHERS AND FUND-RAISING FOR OTHERS FOR THE PURPOSE OF PURCHASING COMPANIES; RAISING OF FINANCE AND FINANCING, NAMELY, RAISING DEBT AND EQUITY CAPITAL FOR OTHERS AND RAISING MONEY FOR THE HEDGE FUND OF OTHERS; ADVISORY, CONSULTANCY AND INFORMATION SERVICES RELATING TO ALL THE AFORESAID SERVICES, IN CLASS 36 (U.S. CLS. 100, 101 AND 102).



David J. Kybas

Director of the United States Patent and Trademark Office

PRIORITY CLAIMED UNDER SEC. 44(D) ON ERPN CMNTY TM OFC APPLICATION NO. 009813131, FILED 3-15-2011, REG. NO. 009813131, DATED 8-25-2011, EXPIRES 3-15-2021.

Reg. No. 4,204,443 NO CLAIM IS MADE TO THE EXCLUSIVE RIGHT TO USE "CAPITAL", APART FROM THE MARK AS SHOWN.

THE MARK CONSISTS OF THE WORDS "LION" AND "CAPITAL", WITH THE WORD "LION" APPEARING ABOVE THE WORD "CAPITAL" AND BOTH HAVING A RIGHT JUSTIFICATION.

SER. NO. 85-303,840, FILED 4-25-2011.

STEVEN R. FINE, EXAMINING ATTORNEY

United States of America

United States Patent and Trademark Office

STOVETOP PRODUCTIONS

Reg. No. 4,204,444

SE ENTERTAINMENT (IOWA UNINCORPORATED ASSOCIATION)
4920 320TH ST.
SHELDON, IA 51201

Registered Sep. 11, 2012

Int. Cl.: 41

FOR: ENTERTAINMENT SERVICES, NAMELY, LIVE MUSICAL PERFORMANCES; DISC
JOCKEY SERVICES, IN CLASS 41 (U.S. CLS. 100, 101 AND 107).

SERVICE MARK

FIRST USE 1-1-2011; IN COMMERCE 1-1-2011.

PRINCIPAL REGISTER

THE MARK CONSISTS OF STANDARD CHARACTERS WITHOUT CLAIM TO ANY PAR-
TICULAR FONT, STYLE, SIZE, OR COLOR.

NO CLAIM IS MADE TO THE EXCLUSIVE RIGHT TO USE "PRODUCTIONS", APART
FROM THE MARK AS SHOWN.

SER. NO. 85-303,890, FILED 4-25-2011.

KATHLEEN M. VANSTON, EXAMINING ATTORNEY



David J. Kyffers

Director of the United States Patent and Trademark Office

United States of America

United States Patent and Trademark Office

SPINEOTIC

Reg. No. 4,204,445

Registered Sep. 11, 2012

Int. Cl.: 20

TRADEMARK

PRINCIPAL REGISTER

INSTITUT PROSCHLAF E.U. (AUSTRIA CORPORATION)
SCHALLMOOSER HAUPTSTRASSE 51
SALZBURG, AUSTRIA A-5020

FOR: FURNITURE, NAMELY, BEDS; MATTRESSES; BED SLATS NOT MADE OF METAL;
PILLOWS, IN CLASS 20 (U.S. CLS. 2, 13, 22, 25, 32 AND 50).

THE MARK CONSISTS OF STANDARD CHARACTERS WITHOUT CLAIM TO ANY PAR-
TICULAR FONT, STYLE, SIZE, OR COLOR.

OWNER OF AUSTRIA REG. NO. 261602, DATED 3-29-2011, EXPIRES 3-29-2021.

SER. NO. 85-304,136, FILED 4-25-2011.

SALLY SHIH, EXAMINING ATTORNEY



David J. Kyffers

Director of the United States Patent and Trademark Office

United States of America

United States Patent and Trademark Office

CAROLINAS HEALTHCARE SYSTEM

Reg. No. 4,204,446

Registered Sep. 11, 2012

Int. Cls.: 16 and 35

THE CHARLOTTE-MECKLENBURG HOSPITAL AUTHORITY (NORTH CAROLINA HOSPITAL AUTHORITY ORGANIZED PURSUANT TO THE STATUTORY AUTHORITY OF THE MUNICIPAL HOSPITAL ACT OF THE STATE OF NORTH CAROLINA)
1000 BLYTHE BLVD.; P.O. BOX 32861
CHARLOTTE, NC 282322861

TRADEMARK

FOR: PRINTED INSTRUCTIONAL, EDUCATIONAL, AND TEACHING MATERIALS IN THE FIELD OF HEALTH, WELLNESS, FITNESS, EXERCISE, SCIENTIFIC AND MEDICAL RESEARCH, HEALTHCARE CAREERS, AND HEALTH SURVEYS, QUESTIONNAIRES AND REPORTS, IN CLASS 16 (U.S. CLS. 2, 5, 22, 23, 29, 37, 38 AND 50).

SERVICE MARK

PRINCIPAL REGISTER

FIRST USE 12-31-1996; IN COMMERCE 12-31-1996.

FOR: RETAIL PHARMACY SERVICES, IN CLASS 35 (U.S. CLS. 100, 101 AND 102).

FIRST USE 12-31-2003; IN COMMERCE 12-31-2003.

THE MARK CONSISTS OF STANDARD CHARACTERS WITHOUT CLAIM TO ANY PARTICULAR FONT, STYLE, SIZE, OR COLOR.

NO CLAIM IS MADE TO THE EXCLUSIVE RIGHT TO USE "HEALTHCARE SYSTEM", APART FROM THE MARK AS SHOWN.

SEC. 2(F).

SER. NO. 85-304,509, FILED 4-26-2011.

LINDA LAVACHE, EXAMINING ATTORNEY



David J. Kyjars

Director of the United States Patent and Trademark Office

United States of America

United States Patent and Trademark Office



Reg. No. 4,204,447

Registered Sep. 11, 2012

Int. Cl.: 36

SERVICE MARK

PRINCIPAL REGISTER

PREP FOR PREP (NEW YORK NON-PROFIT CORPORATION)
328 WEST 71ST STREET
NEW YORK, NY 10023

FOR: CHARITABLE FUNDRAISING SERVICES, NAMELY, RAISING FUNDS TO SUPPORT THE LEADERSHIP DEVELOPMENT OF TALENTED MINORITY STUDENTS, IN CLASS 36 (U.S. CLS. 100, 101 AND 102).

FIRST USE 2-28-1984; IN COMMERCE 2-28-1984.

NO CLAIM IS MADE TO THE EXCLUSIVE RIGHT TO USE "FOUNDED 1978", APART FROM THE MARK AS SHOWN.

THE MARK CONSISTS OF A SEAL CONTAINING THE WORDS "PREP FOR PREP", "FOUNDED 1978" AND TWO SMALL SOLID BLACK DOTS; A DIAMOND WITHIN A DIAMOND; A PARTIAL SUN WITH SUNRAYS AND CLOUDS; A CHARIOT, A CHARIOTEER, AND THREE HORSES OVERLAYING THE SUNRAYS; AND THE WORDS "EXCELLENCE", "INTEGRITY", "COMMITMENT" AND "COURAGE".

SER. NO. 85-305,095, FILED 4-26-2011.

DAVID C. REIHNER, EXAMINING ATTORNEY



David J. Kyffers

Director of the United States Patent and Trademark Office

United States of America

United States Patent and Trademark Office

YUKON TRAIL

Reg. No. 4,204,448

Registered Sep. 11, 2012

Int. Cl.: 12

TRADEMARK

PRINCIPAL REGISTER

YUKON TRAIL INC. (CALIFORNIA CORPORATION)
4142 PACIFIC PRIVADO
ONTARIO, CA 91761

FOR: PARTS AND ACCESSORIES FOR CARS AND TRUCKS, NAMELY, TONNEAU COVERS, PICKUP TRUCK CAPS, RACKS, NAMELY, AUTOMOBILE ROOF RACKS, RAILS, NAMELY, GUIDE RAILS FOR TRUCK BEDS, FITTED TRUCK BED LINERS, TRUCK VAULTS, NAMELY, LOCK BOXES SPECIALLY ADAPTED FOR USE IN VEHICLES, TAILGATE ACCESSORIES, NAMELY, RETRACTABLE TAILGATE BENCHES AND CAB AND CARGO ORGANIZERS, NAMELY, TRUCK BED STORAGE ORGANIZERS, IN CLASS 12 (U.S. CLS. 19, 21, 23, 31, 35 AND 44).

FIRST USE 3-1-2010; IN COMMERCE 3-1-2010.

THE MARK CONSISTS OF STANDARD CHARACTERS WITHOUT CLAIM TO ANY PARTICULAR FONT, STYLE, SIZE, OR COLOR.

SER. NO. 85-305,390, FILED 4-26-2011.

WANDA KAY PRICE, EXAMINING ATTORNEY



David J. Kyros

Director of the United States Patent and Trademark Office

United States of America

United States Patent and Trademark Office

KooKee Monsters

Reg. No. 4,204,449

KOOKEE MONSTERS, INC. (CALIFORNIA CORPORATION)
130 LEWELLING BLVD
SAN LORENZO, CA 94580

Registered Sep. 11, 2012

Int. Cl.: 41

FOR: ENTERTAINMENT SERVICES, NAMELY, PROVIDING ONLINE VIDEO GAMES, IN CLASS 41 (U.S. CLS. 100, 101 AND 107).

SERVICE MARK

FIRST USE 1-7-2011; IN COMMERCE 4-1-2011.

PRINCIPAL REGISTER

THE MARK CONSISTS OF STANDARD CHARACTERS WITHOUT CLAIM TO ANY PARTICULAR FONT, STYLE, SIZE, OR COLOR.

SER. NO. 85-305,418, FILED 4-26-2011.

BILL DAWE, EXAMINING ATTORNEY



David J. Kybas

Director of the United States Patent and Trademark Office

United States of America

United States Patent and Trademark Office

SPYPEDIA

Reg. No. 4,204,450

Registered Sep. 11, 2012

Int. Cl.: 41

SERVICE MARK

PRINCIPAL REGISTER

DAVID G. MAJOR ASSOCIATES, INC. (VIRGINIA CORPORATION)
5650 GENERAL WASHINGTON DR.
ALEXANDRIA, VA 22312

FOR: EDUCATIONAL AND TRAINING SERVICES, NAMELY, CONDUCTING EDUCATIONAL RESEARCH, PUBLISHING RESEARCH RESULTS IN THE FORM OF ELECTRONIC PUBLICATIONS, AND PROVIDING ON-LINE EDUCATIONAL RESEARCH SERVICES IN THE FIELD OF COUNTERINTELLIGENCE, IN CLASS 41 (U.S. CLS. 100, 101 AND 107).

FIRST USE 5-25-2011; IN COMMERCE 5-25-2011.

THE MARK CONSISTS OF STANDARD CHARACTERS WITHOUT CLAIM TO ANY PARTICULAR FONT, STYLE, SIZE, OR COLOR.

SER. NO. 85-305,802, FILED 4-27-2011.

TIMOTHY FINNEGAN, EXAMINING ATTORNEY



David J. Kybas

Director of the United States Patent and Trademark Office

United States of America

United States Patent and Trademark Office

CLASSIC RESIDENCE

Reg. No. 4,204,451

Registered Sep. 11, 2012

Int. Cl.: 43

SERVICE MARK

PRINCIPAL REGISTER

CLASSIC RESIDENCE MANAGEMENT LIMITED PARTNERSHIP (ILLINOIS LIMITED PARTNERSHIP)
71 SOUTH WACKER DRIVE
CHICAGO, IL 60606

FOR: PROVIDING ASSISTED LIVING FACILITIES, IN CLASS 43 (U.S. CLS. 100 AND 101).

FIRST USE 6-8-2010; IN COMMERCE 6-8-2010.

THE MARK CONSISTS OF STANDARD CHARACTERS WITHOUT CLAIM TO ANY PARTICULAR FONT, STYLE, SIZE, OR COLOR.

SER. NO. 85-308,709, FILED 4-29-2011.

WARREN L. OLANDRIA, EXAMINING ATTORNEY



David J. Kyffers

Director of the United States Patent and Trademark Office

United States of America

United States Patent and Trademark Office



Reg. No. 4,204,452

TEXAS CHEER, INC. (TEXAS CORPORATION), DBA CHEER TEXAS
9200 S. SONCY DR.
AMARILLO, TX 79119

Registered Sep. 11, 2012

Int. Cl.: 41

FOR: INSTRUCTION IN THE FIELD OF CHEERLEADING, TUMBLING AND TRAMPOLINE,
IN CLASS 41 (U.S. CLS. 100, 101 AND 107).

SERVICE MARK

FIRST USE 8-0-2000; IN COMMERCE 8-0-2000.

PRINCIPAL REGISTER

NO CLAIM IS MADE TO THE EXCLUSIVE RIGHT TO USE "CHEER", APART FROM THE
MARK AS SHOWN.

THE MARK CONSISTS OF THE WORD "CHEER" IN STYLIZED BLOCK LETTERS WITH
A 5-POINTED STAR SITUATED BENEATH AND PARTIALLY COVERING THE FIRST "E"
IN THE WORD "CHEER" AND STYLIZED BLOCK LETTERS "TE" AND "AS" SITUATED
TO THE LEFT AND RIGHT OF THE STAR, RESPECTIVELY.

SEC. 2(F) AS TO "CHEER TEXAS".

SER. NO. 85-309,756, FILED 5-2-2011.

ALICIA COLLINS, EXAMINING ATTORNEY



David J. Kybas

Director of the United States Patent and Trademark Office

United States of America

United States Patent and Trademark Office

France Media

Reg. No. 4,204,453

FRANCE PUBLICATIONS, INC. (GEORGIA CORPORATION)
3500 PIEDMONT ROAD, SUITE 415
ATLANTA, GA 30305

Registered Sep. 11, 2012

Int. Cls.: 35 and 41

FOR: ADVERTISING AND COMMERCIAL INFORMATION SERVICES, VIA THE INTERNET,
IN CLASS 35 (U.S. CLS. 100, 101 AND 102).

SERVICE MARK

FIRST USE 4-1-2011; IN COMMERCE 4-1-2011.

PRINCIPAL REGISTER

FOR: BUSINESS TRAINING, IN CLASS 41 (U.S. CLS. 100, 101 AND 107).

FIRST USE 4-1-2011; IN COMMERCE 4-1-2011.

THE MARK CONSISTS OF STANDARD CHARACTERS WITHOUT CLAIM TO ANY PARTICULAR FONT, STYLE, SIZE, OR COLOR.

OWNER OF U.S. REG. NOS. 3,886,484 AND 3,894,052.

NO CLAIM IS MADE TO THE EXCLUSIVE RIGHT TO USE "MEDIA", APART FROM THE MARK AS SHOWN.

SER. NO. 85-311,033, FILED 5-3-2011.

KYLE PEETE, EXAMINING ATTORNEY



David J. Kybas

Director of the United States Patent and Trademark Office

United States of America

United States Patent and Trademark Office



Reg. No. 4,204,454

Registered Sep. 11, 2012

Int. Cl.: 44

SERVICE MARK

PRINCIPAL REGISTER

AJ CONSULTING, LLC (MICHIGAN LIMITED LIABILITY COMPANY)
7607 WEST VERNOR HWY
DETROIT, MI 49209

FOR: COUNSELING SERVICES IN THE FIELDS OF HEALTH, HERBALISM, AND LIFESTYLE WELLNESS; PROVIDING A WEBSITE FEATURING INFORMATION ABOUT HERBALISM, HEALTH AND WELLNESS; PROVIDING MEDICAL AND HEALTH INFORMATION; PROVIDING ON-LINE INFORMATION, NEWS AND COMMENTARY IN THE FIELD OF HERBALISM, HEALTH AND WELLNESS, IN CLASS 44 (U.S. CLS. 100 AND 101).

FIRST USE 6-1-2010; IN COMMERCE 6-1-2010.

NO CLAIM IS MADE TO THE EXCLUSIVE RIGHT TO USE "LEARNING", APART FROM THE MARK AS SHOWN.

THE MARK CONSISTS OF A DOCTOR HOLDING A CIGAR AND WEARING GLOVES, EYEGLASSES AND A HEAD MIRROR WITH AN IMAGE OF A MARIJUANA LEAF; A DOCTOR IS SITTING ON A ROUND EMBLEM, WHICH CONSISTS OF TWO CIRCLES SHARING THE SAME CENTER WITH THE LETTERS "H", "G", "E", "R" AND THE WORD "LEARNING" BETWEEN TWO DOTS AND A SHIELD WITH AN IMAGE OF A MARIJUANA LEAF, A CROSS, A STACK OF BOOKS AND A SCALE.

SER. NO. 85-312,758, FILED 5-4-2011.

ROBERT STRUCK, EXAMINING ATTORNEY



David J. Kyffers

Director of the United States Patent and Trademark Office

United States of America
United States Patent and Trademark Office

EASI-SPAN

Reg. No. 4,204,455

EASI-SET INDUSTRIES (VIRGINIA CORPORATION)
5119 CATLETT ROAD
MIDLAND, VA 22728

Registered Sep. 11, 2012

Int. Cl.: 19

FOR: EXPANDABLE AND TRANSPORTABLE PRECAST CONCRETE BUILDINGS, IN CLASS 19 (U.S. CLS. 1, 12, 33 AND 50).

TRADEMARK

FIRST USE 8-5-1995; IN COMMERCE 8-5-1995.

PRINCIPAL REGISTER

THE MARK CONSISTS OF STANDARD CHARACTERS WITHOUT CLAIM TO ANY PARTICULAR FONT, STYLE, SIZE, OR COLOR.

OWNER OF U.S. REG. NOS. 2,581,512, 2,657,514 AND OTHERS.

SER. NO. 85-313,292, FILED 5-5-2011.

SHAILA SETTLES, EXAMINING ATTORNEY



David J. Kyffers

Director of the United States Patent and Trademark Office

United States of America

United States Patent and Trademark Office

TesPro

Reg. No. 4,204,456

Registered Sep. 11, 2012

Int. Cl.: 9

TRADEMARK

PRINCIPAL REGISTER

TESPRO ELECTRONICS CO., LTD. (CHINA CORPORATION)
NANSHAN INDUSTRIAL ZONE
407 YONGFA BUILDING, JIDA, ZHUHAI
GUANDONG PROVINCE, CHINA 519015

FOR: OPTICAL COMMUNICATION DEVICES, NAMELY, OPTICAL PROBES IN THE NATURE OF OPTICAL SENSORS FOR DATA EXCHANGE BETWEEN ELECTRIC ENERGY METERS OR GAS METERS, AND OTHER METERING EQUIPMENT, OPTICAL TRANSMITTERS AND OPTICAL RECEIVERS; INTERCOMMUNICATION APPARATUS, NAMELY, MODEM, SOUND AMPLIFIERS, AND ELECTRICAL OUTLET SOCKETS; ELECTRIC CONNECTORS AND COUPLERS; INSTRUMENT TRANSFORMERS; ELECTRIC SIGNS, IN CLASS 9 (U.S. CLS. 21, 23, 26, 36 AND 38).

OWNER OF CHINA REG. NO. 6098549, DATED 2-14-2010, EXPIRES 2-13-2020.

THE MARK CONSISTS OF THE WORD "TESPRO" IN STYLIZED FORM.

SER. NO. 85-313,518, FILED 5-5-2011.

BRENDAN MCCAULEY, EXAMINING ATTORNEY



David J. Kyffers

Director of the United States Patent and Trademark Office

United States of America

United States Patent and Trademark Office

KARLSSON'S GOLD

Reg. No. 4,204,457

SPIRITS OF GOLD AB (SWEDEN CORPORATION)
REGERINGSGATAN 25
5 TR. STOCKHOLM, SWEDEN

Registered Sep. 11, 2012

Int. Cl.: 33

FOR: ALCOHOLIC BEVERAGES, EXCEPT BEERS; VODKA, IN CLASS 33 (U.S. CLS. 47 AND 49).

TRADEMARK

FIRST USE 6-1-2007; IN COMMERCE 6-1-2007.

PRINCIPAL REGISTER

OWNER OF U.S. REG. NO. 3,699,231.

THE MARK CONSISTS OF THE WORDING "KARLSSON'S GOLD" IN STYLIZED FORM, INCORPORATING THE STYLIZED REPRESENTATION OF A POTATO AS THE LETTER "O" IN "KARLSSON'S".

SER. NO. 85-314,517, FILED 5-6-2011.

DAVID H. STINE, EXAMINING ATTORNEY



David J. Kyfos

Director of the United States Patent and Trademark Office

United States of America
United States Patent and Trademark Office

PROSERV

Reg. No. 4,204,458

COUNTRY WIDE PROSERV (NEVADA CORPORATION)
2017 HUMBLE HOLLOW PLACE
NORTH LAS VEGAS, NV 89084

Registered Sep. 11, 2012

Int. Cl.: 37

FOR: INSTALLATION, REPAIR AND MAINTENANCE OF RESIDENTIAL HEATING SYSTEMS, AIR CONDITIONING SYSTEMS, PLUMBING SYSTEMS, ELECTRICAL SYSTEMS, HOUSEHOLD APPLIANCES, IN CLASS 37 (U.S. CLS. 100, 103 AND 106).

SERVICE MARK

FIRST USE 3-1-2009; IN COMMERCE 2-28-2010.

PRINCIPAL REGISTER

THE MARK CONSISTS OF STANDARD CHARACTERS WITHOUT CLAIM TO ANY PARTICULAR FONT, STYLE, SIZE, OR COLOR.

SER. NO. 85-317,314, FILED 5-10-2011.

JOSETTE BEVERLY, EXAMINING ATTORNEY



David J. Kyros

Director of the United States Patent and Trademark Office

United States of America

United States Patent and Trademark Office

Medical College
Admission Test

MCAT



AAMC

Reg. No. 4,204,459

Registered Sep. 11, 2012

Int. Cl.: 9

TRADEMARK

PRINCIPAL REGISTER

ASSOCIATION OF AMERICAN MEDICAL COLLEGES (ILLINOIS CORPORATION)
2450 N STREET, NW
WASHINGTON, DC 20036

FOR: DOWNLOADABLE ELECTRONIC PUBLICATIONS, NAMELY, PRACTICE STANDARDIZED TESTS AND GUIDEBOOKS FOR TAKING AND PREPARING FOR STANDARDIZED TESTS, IN CLASS 9 (U.S. CLS. 21, 23, 26, 36 AND 38).

FIRST USE 3-0-2011; IN COMMERCE 3-0-2011.

OWNER OF U.S. REG. NOS. 1,946,740, 3,249,566 AND OTHERS.

NO CLAIM IS MADE TO THE EXCLUSIVE RIGHT TO USE "TEST", APART FROM THE MARK AS SHOWN.

THE MARK CONSISTS OF THE TERM "MEDICAL COLLEGE ADMISSION TEST" ABOVE THE LETTERS "MCAT" TO THE RIGHT OF WHICH IS A VERTICAL LINE, A STYLIZED STAFF INTERTWINED BY A SNAKE, AND THE LETTERS "AAMC".

SEC. 2(F) AS TO "MEDICAL COLLEGE ADMISSION TEST".

SER. NO. 85-320,596, FILED 5-13-2011.

ROBIN MITTLER, EXAMINING ATTORNEY



David J. Kyffers

Director of the United States Patent and Trademark Office

United States of America

United States Patent and Trademark Office

HAUK CUSTOM POOLS

Reg. No. 4,204,460

Registered Sep. 11, 2012

Int. Cls.: 37 and 42

SERVICE MARK

PRINCIPAL REGISTER

HAUK CUSTOM POOLS (TEXAS LIMITED LIABILITY COMPANY)
1060 N. PRESTON ROAD
CELINA, TX 75009

FOR: CONSTRUCTION, REMODELING AND MAINTENANCE OF SWIMMING POOLS;
CONSTRUCTION OF OUTDOOR LIVING AREAS, IN CLASS 37 (U.S. CLS. 100, 103 AND
106).

FIRST USE 5-10-2001; IN COMMERCE 5-10-2001.

FOR: DESIGN OF SWIMMING POOLS; DESIGN OF OUTDOOR LIVING AREAS, IN CLASS
42 (U.S. CLS. 100 AND 101).

FIRST USE 5-10-2001; IN COMMERCE 5-10-2001.

THE MARK CONSISTS OF STANDARD CHARACTERS WITHOUT CLAIM TO ANY PAR-
TICULAR FONT, STYLE, SIZE, OR COLOR.

NO CLAIM IS MADE TO THE EXCLUSIVE RIGHT TO USE "CUSTOM POOLS", APART
FROM THE MARK AS SHOWN.

SEC. 2(F).

SER. NO. 85-320,991, FILED 5-13-2011.

ZHALEH DELANEY, EXAMINING ATTORNEY



David J. Kybas

Director of the United States Patent and Trademark Office

United States of America

United States Patent and Trademark Office

Cooking Matters

Reg. No. 4,204,461

Registered Sep. 11, 2012

Int. Cl.: 35

SERVICE MARK

PRINCIPAL REGISTER

COOKING MATTERS, LLC (NEW HAMPSHIRE LIMITED LIABILITY COMPANY)
8 WINN ROAD
NASHUA, NH 03062

FOR: RETAIL STORE SERVICES FEATURING GOURMET FOODS, SPECIALTY FOODS, IN-STORE PREPARED FOODS AND KITCHENWARE ITEMS, IN CLASS 35 (U.S. CLS. 100, 101 AND 102).

FIRST USE 11-14-2002; IN COMMERCE 4-21-2003.

THE MARK CONSISTS OF STANDARD CHARACTERS WITHOUT CLAIM TO ANY PARTICULAR FONT, STYLE, SIZE, OR COLOR.

NO CLAIM IS MADE TO THE EXCLUSIVE RIGHT TO USE "COOKING", APART FROM THE MARK AS SHOWN.

SER. NO. 85-321,748, FILED 5-16-2011.

MATTHEW EINSTEIN, EXAMINING ATTORNEY



David J. Kybas

Director of the United States Patent and Trademark Office

United States of America

United States Patent and Trademark Office

avado

Reg. No. 4,204,462

Registered Sep. 11, 2012

Int. Cl.: 35

SERVICE MARK

PRINCIPAL REGISTER

AVADO, INC. (DELAWARE CORPORATION)
3181 156TH AVE SE, SUITE 200
BELLEVUE, WA, WA 98007

FOR: ELECTRONIC DATA COLLECTION AND DATA SUBMISSION SERVICES FOR BUSINESS PURPOSES IN THE FIELDS OF MEDICINE AND HEALTHCARE, IN CLASS 35 (U.S. CLS. 100, 101 AND 102).

FIRST USE 4-30-2011; IN COMMERCE 4-30-2011.

THE MARK CONSISTS OF STANDARD CHARACTERS WITHOUT CLAIM TO ANY PARTICULAR FONT, STYLE, SIZE, OR COLOR.

SER. NO. 85-322,945, FILED 5-17-2011.

SANI KHOURI, EXAMINING ATTORNEY



David J. Kybas

Director of the United States Patent and Trademark Office

United States of America

United States Patent and Trademark Office

BRAIN BUILDER

Reg. No. 4,204,463

VITONOMY, LLC (ARIZONA LIMITED LIABILITY COMPANY)
4950 S. 48TH STREET
PHOENIX, AZ 85040

Registered Sep. 11, 2012

Int. Cl.: 5

FOR: DIETARY AND NUTRITIONAL SUPPLEMENTS, IN CLASS 5 (U.S. CLS. 6, 18, 44, 46, 51 AND 52).

TRADEMARK

FIRST USE 8-13-2011; IN COMMERCE 8-13-2011.

PRINCIPAL REGISTER

THE MARK CONSISTS OF STANDARD CHARACTERS WITHOUT CLAIM TO ANY PARTICULAR FONT, STYLE, SIZE, OR COLOR.

NO CLAIM IS MADE TO THE EXCLUSIVE RIGHT TO USE "BRAIN", APART FROM THE MARK AS SHOWN.

SER. NO. 85-324,198, FILED 5-18-2011.

TRACY CROSS, EXAMINING ATTORNEY



David J. Kyffers

Director of the United States Patent and Trademark Office

United States of America

United States Patent and Trademark Office

POWERTECH

Reg. No. 4,204,464

Registered Sep. 11, 2012

Int. Cl.: 9

TRADEMARK

PRINCIPAL REGISTER

POWERTECH ELECTRONICS INC. (TAIWAN CORPORATION)
7F., NO.6 WANHE ST., WENSHAN DIST.,
TAIPEI CITY 116, TAIWAN

FOR: AUTOMATED GATE OPERATORS, IN CLASS 9 (U.S. CLS. 21, 23, 26, 36 AND 38).

FIRST USE 9-20-2006; IN COMMERCE 5-15-2007.

THE MARK CONSISTS OF "POWERTECH" IN STYLIZED UPPER CASE LETTERS FOLLOWING A STYLIZED LETTER "P".

SER. NO. 85-325,094, FILED 5-19-2011.

DAVID TAYLOR, EXAMINING ATTORNEY



David J. Kybas

Director of the United States Patent and Trademark Office

United States of America

United States Patent and Trademark Office



Reg. No. 4,204,465

Registered Sep. 11, 2012

Int. Cl.: 30

TRADEMARK

PRINCIPAL REGISTER

TOSTADITOS SUSANITA S.A. (COLOMBIA CORPORATION)
CALLE 85 B NO. 48-32, ITAGUI
ANTIOQUIA, COLOMBIA

FOR: COFFEE, TEA, COCOA, SUGAR, RICE, TAPIOCA, SAGO, ARTIFICIAL COFFEE; FLOUR AND PREPARATIONS MADE FROM CEREALS, NAMELY, BREAKFAST CEREALS, CEREAL-BASED SNACK FOODS, PROCESSED CEREAL-BASED FOOD TO BE USED AS A BREAKFAST FOOD, SNACK FOOD OR INGREDIENT FOR MAKING OTHER FOODS, READY TO EAT, CEREAL DERIVED FOOD BARS, READY-TO-EAT CEREALS; BREAD; PASTRY; CONFECTIONERY, NAMELY, PASTILLES, CONFECTIONERY MADE OF SUGAR, CRYSTAL SUGAR PIECES, CHOCOLATE, FONDANTS; EDIBLE ICES; HONEY, TREACLE; YEAST, BAKING-POWDER; SALT, MUSTARD; VINEGAR, SAUCES; SPICES; ICE, IN CLASS 30 (U.S. CL. 46).

FIRST USE 3-31-2010; IN COMMERCE 3-31-2010.

OWNER OF U.S. REG. NO. 2,705,925.

THE COLOR(S) ORANGE, RED, BLACK, AND WHITE IS/ARE CLAIMED AS A FEATURE OF THE MARK.

THE MARK CONSISTS OF A STYLIZED FEMALE DOLL WITH RED HAIR, ORANGE SKIN AND HAIR RIBBONS, WHITE AND BLACK EYES, AND WEARING A WHITE TOP WITH BLACK OUTLINING THROUGHOUT THE DESIGN; THE DOLL APPEARS INSIDE A WHITE CIRCLE WITH A RED BANNER BENEATH WITH BLACK OUTLINING IN WHICH THE TERM "SUSANITA" IN ORANGE APPEARS. SURROUNDING THE WHITE CIRCLE ARE A SERIES OF ORANGE HALF-CIRCLES WITH RED OUTLINING. THE BACKGROUND OF THE ENTIRE MARK IS TRANSLUCENT.

THE ENGLISH TRANSLATION OF "SUSANITA" IN THE MARK IS "LITTLE SUSAN".

SER. NO. 85-326,173, FILED 5-20-2011.

JIM RINGLE, EXAMINING ATTORNEY



David J. Kyffers

Director of the United States Patent and Trademark Office

United States of America

United States Patent and Trademark Office



Innovation through Nature

Reg. No. 4,204,466

Registered Sep. 11, 2012

Int. Cl.: 19

TRADEMARK

PRINCIPAL REGISTER

UMEHIKO (M) SDN BHD (MALAYSIA LIMITED LIABILITY COMPANY)
LOT 1546, 2ND FLOOR, 2ND MILE ROCK ROAD
P.O. BOX 546
KUCHING, MALAYSIA 93710 AND

KHO, KAK HEE (MALAYSIA INDIVIDUAL), AKA ANDY KHO KAK HEE
3, KELLY GARDEN, LINTANG PARK SELATAN
KUCHING, MALAYSIA 93200 AND

KHO, JASMINE POH SHEUN (MALAYSIA INDIVIDUAL), AKA JASMINE KHO
3, KELLY GARDEN, LINTANG PARK SELATAN
KUCHING, MALAYSIA

FOR: BUILDING MATERIALS, NAMELY, CONCRETE-BASED SLABS MADE USING RECYCLED GLASS; BUILDING MATERIALS, NAMELY, MANUFACTURED BRICK VENEER FOR USE ON INTERIOR AND EXTERIOR WALLS, FLOORS AND SURFACES, PATIOS, POOLSIDES AND DRIVEWAYS; CEMENTITIOUS MATERIAL FOR BUILDING PURPOSES; CONCRETE BUILDING MATERIALS, NAMELY, STAINART, ECO-FRIENDLY CONCRETE SPECIALTIES SEALERS AND POLYMER KORA TOP; CONSTRUCTION MATERIAL, NAMELY, FIBERGLASS BOARD; CONSTRUCTION MATERIALS, NAMELY, CONCRETE SLABS DESIGNED TO INCREASE ENERGY EFFICIENCY AND ENERGY CONSERVATION; GLASS MOSAICS FOR USE IN BUILDING CONSTRUCTION; GYPSUM; MARBLE; NON-METAL FORMING SYSTEMS FOR CONCRETE AND OTHER CURABLE CONSTRUCTION MATERIALS COMPRISED OF NON-METAL MODULAR CASTING FORMS; PAVEMENT INCORPORATING SILICON SOLAR CELL MATERIAL FOR ELECTRICAL ENERGY GENERATION; ROCK MATERIALS USED IN THE MANUFACTURE OF FLOORING, ROOFING, COUNTERTOPS, WALLS, CLADDING AND FIREPLACES; SEALER COATINGS SOLD AS AN INTEGRAL COMPONENT OF NON-METAL TILES, NATURAL STONE, AND MOLDED RESINS FOR CONSTRUCTION PURPOSES; STONE FOR BUILDING AND CONSTRUCTION; SYNTHETIC FLOORING MATERIALS OR WALL-CLADDINGS; TRAVERTINE FOR BUILDING AND CONSTRUCTION PURPOSES; WATERPROOF FABRIC USED IN BUILDING CONSTRUCTION FOR PROTECTION AGAINST FLOODS, IN CLASS 19 (U.S. CLS. 1, 12, 33 AND 50).



David J. Kybas

FIRST USE 3-28-2003; IN COMMERCE 3-28-2005.

Reg. No. 4,204,466 THE MARK CONSISTS OF THE STYLIZED WORDING "AHE" IN MAROON COLOR WITH SLOGAN "INNOVATION THROUGH NATURE" IN BLACK, AND A GRASS SYMBOL IN GREEN.

THE COLOR(S) MAROON, BLACK, AND GREEN IS/ARE CLAIMED AS A FEATURE OF THE MARK.

SER. NO. 85-326,962, FILED 5-23-2011.

JOHN E. MICHOS, EXAMINING ATTORNEY

United States of America

United States Patent and Trademark Office

Point2 Running Company

Reg. No. 4,204,467

POINT 2 RUNNING, LLC (VIRGINIA LIMITED LIABILITY COMPANY)
114 SELDON RD.

Registered Sep. 11, 2012

NEWPORT NEWS, VA 23606

Int. Cl.: 35

FOR: RETAIL STORE SERVICES FEATURING FOOTWEAR, TOPS, BOTTOMS, JACKETS, SWEATERS, GLOVES, SHORTS, SHIRTS, TANK-TOPS, SOCKS, SWEAT BANDS, UNDERWEAR, BRAS, PANTS, HEADGEAR IN THE NATURE OF HATS, CAPS, VISORS, HEADBANDS, AND BANDANNAS, SWIMWEAR, WATER BOTTLES, ENERGY DRINKS, ENERGY BARS, ENERGY GELS, WATCHES, SUNGLASSES, AND SPORTING GOODS, IN CLASS 35 (U.S. CLS. 100, 101 AND 102).

SERVICE MARK

PRINCIPAL REGISTER

FIRST USE 5-16-2011; IN COMMERCE 5-16-2011.

THE MARK CONSISTS OF STANDARD CHARACTERS WITHOUT CLAIM TO ANY PARTICULAR FONT, STYLE, SIZE, OR COLOR.

NO CLAIM IS MADE TO THE EXCLUSIVE RIGHT TO USE "RUNNING COMPANY", APART FROM THE MARK AS SHOWN.

SER. NO. 85-327,210, FILED 5-23-2011.

SUNG IN, EXAMINING ATTORNEY



David J. Kyfos

Director of the United States Patent and Trademark Office

United States of America

United States Patent and Trademark Office

ECO SPARK

Reg. No. 4,204,468

Registered Sep. 11, 2012

Int. Cl.: 11

TRADEMARK

PRINCIPAL REGISTER

MAGEN ECO-ENERGY (A.C.S.) LTD. (ISRAEL LIMITED PARTNERSHIP)
D.N. HANEDEV
KIBBUTZ MAGEN, ISRAEL 85465

FOR: HEAT EXCHANGERS AND SOLAR ENERGY HEAT EXCHANGERS NOT BEING PARTS OF MACHINES; SOLAR AND ELECTRIC APPARATUS FOR WATER HEATING, NAMELY, POOL WATER HEATING AND HOT WATER SPACE HEATING APPARATUS; APPARATUS AND INSTRUMENTS FOR WATER SUPPLY, NAMELY, METER VALVES; STRUCTURAL PARTS FOR THE AFOREMENTIONED GOODS, IN CLASS 11 (U.S. CLS. 13, 21, 23, 31 AND 34).

THE MARK CONSISTS OF STANDARD CHARACTERS WITHOUT CLAIM TO ANY PARTICULAR FONT, STYLE, SIZE, OR COLOR.

OWNER OF ISRAEL REG. NO. 22875, DATED 9-16-2010, EXPIRES 9-16-2020.

SER. NO. 85-327,328, FILED 5-23-2011.

HENRY S. ZAK, EXAMINING ATTORNEY



David J. Kyffers

Director of the United States Patent and Trademark Office

United States of America

United States Patent and Trademark Office

4DX

Reg. No. 4,204,469

Registered Sep. 11, 2012

Int. Cl.: 28

TRADEMARK

PRINCIPAL REGISTER

CJ 4DPLEX CO., LTD. (REPUBLIC OF KOREA CORPORATION)
164-1 JEUNGSAN-DONG, EUNPYEONG-GU
SEOUL, REPUBLIC OF KOREA

FOR: AMUSEMENT PARK RIDES; GAME APPARATUS AND EQUIPMENT, NAMELY, AMUSEMENT APPARATUS INCORPORATING A TELEVISION MONITOR, AMUSEMENT APPARATUS INCORPORATING A VIDEO MONITOR, AMUSEMENT APPARATUS INCORPORATING A TELEVISION SCREEN; AMUSEMENT PARK RIDES INCORPORATING APPARATUS AND EQUIPMENT FOR MOVIES AUDIENCE EFFECTS IN CINEMAS WITH SPECIAL EFFECTS SUCH AS WIND, SCENT, WATER SPRAY, MOTION, VIBRATION, SMOKE, BUBBLE, LASER OR FLASH; TOY DOLLS; APPARATUS FOR ELECTRONIC GAMES OTHER THAN THOSE ADAPTED FOR USE WITH TELEVISION RECEIVERS, IN CLASS 28 (U.S. CLS. 22, 23, 38 AND 50).

THE MARK CONSISTS OF STANDARD CHARACTERS WITHOUT CLAIM TO ANY PARTICULAR FONT, STYLE, SIZE, OR COLOR.

PRIORITY CLAIMED UNDER SEC. 44(D) ON REPUBLIC OF KOREA APPLICATION NO. 40-2010-6159, FILED 11-30-2010, REG. NO. 0902120, DATED 2-3-2012, EXPIRES 2-3-2022.

SER. NO. 85-327,383, FILED 5-23-2011.

PATRICIA EVANKO, EXAMINING ATTORNEY



David J. Kyjars

Director of the United States Patent and Trademark Office

United States of America

United States Patent and Trademark Office

4DX

Reg. No. 4,204,470

Registered Sep. 11, 2012

Int. Cl.: 38

SERVICE MARK

PRINCIPAL REGISTER

CJ 4DPLEX CO., LTD. (REPUBLIC OF KOREA CORPORATION)
164-1 JEUNGSAN-DONG, EUNPYEONG-GU
SEOUL, REPUBLIC OF KOREA

FOR: BROADCASTING MOVIES; BROADCASTING MOVIES FEATURING MOVIES AUDIENCE EFFECTS SUCH AS WIND, SCENT, WATER SPRAY, MOTION, VIBRATION, SMOKE, BUBBLE, LASER OR FLASH; CABLE TELEVISION BROADCASTING; RADIO BROADCASTING; TELEVISION BROADCASTING; PROVIDING TELECOMMUNICATIONS CONNECTIONS TO A GLOBAL COMPUTER NETWORK; TELEPHONE SERVICES; COMPUTER-AIDED TRANSMISSION OF MESSAGES AND IMAGES; WIRELESS BROADBAND COMMUNICATION SERVICES, IN CLASS 38 (U.S. CLS. 100, 101 AND 104).

THE MARK CONSISTS OF STANDARD CHARACTERS WITHOUT CLAIM TO ANY PARTICULAR FONT, STYLE, SIZE, OR COLOR.

PRIORITY CLAIMED UNDER SEC. 44(D) ON REPUBLIC OF KOREA APPLICATION NO. 41-2010-3068, FILED 11-30-2010, REG. NO. 0226357, DATED 2-13-2012, EXPIRES 2-13-2022.

SER. NO. 85-327,423, FILED 5-23-2011.

PATRICIA EVANKO, EXAMINING ATTORNEY



David J. Kyjars

Director of the United States Patent and Trademark Office

United States of America

United States Patent and Trademark Office

4DX

Reg. No. 4,204,471

CJ 4DPLEX CO., LTD. (REPUBLIC OF KOREA CORPORATION)
164-1 JEUNGSAN-DONG, EUNPYEONG-GU
SEOUL, REPUBLIC OF KOREA

Registered Sep. 11, 2012

Int. Cl.: 41

FOR: CINEMA THEATERS; CINEMA THEATERS PROVIDING MOVIE AUDIENCE EFFECTS SUCH AS WIND, SCENT, WATER SPRAY, MOTION, VIBRATION, SMOKE, BUBBLE, LASER OR FLASH; PRODUCTION OF RADIO AND TELEVISION PROGRAMS; PRESENTATION OF LIVE SHOW PERFORMANCES; PRESENTATION OF MUSICAL PERFORMANCE; IMPRESARIO SERVICES, NAMELY, ORGANIZATION OF LIVE SHOW PERFORMANCES IN THE FIELD OF MOVIES; ANIMATION PRODUCTION SERVICES; ENTERTAINMENT IN THE NATURE OF LIVE STAGE PERFORMANCES IN THE NATURE OF PLAYS AND CONCERTS; DISTRIBUTION OF MOTION PICTURE FILMS; ENTERTAINMENT SERVICES, NAMELY, PLANNING AND CONDUCTING A SERIES OF FILM FESTIVALS; FILM PRODUCTION; MOVIE STUDIOS; RENTAL OF CINE-FILMS; PUBLICATION OF PERIODICALS; NIGHT CLUBS; VIDEOTAPING; NEWS REPORTERS SERVICES; PROVIDING AMUSEMENT FACILITIES; ARRANGING FOR TICKET RESERVATIONS FOR MOVIES; ARRANGING FOR TICKET RESERVATIONS FOR SHOWS AND OTHER ENTERTAINMENT EVENTS; PROVISION OF ENTERTAINMENT INFORMATION AND DATA CONCERNING MOVIES, IN CLASS 41 (U.S. CLS. 100, 101 AND 107).

SERVICE MARK

PRINCIPAL REGISTER

THE MARK CONSISTS OF STANDARD CHARACTERS WITHOUT CLAIM TO ANY PARTICULAR FONT, STYLE, SIZE, OR COLOR.



PRIORITY CLAIMED UNDER SEC. 44(D) ON REPUBLIC OF KOREA APPLICATION NO. 41-2010-3068, FILED 11-30-2010, REG. NO. 0229083, DATED 3-26-2012, EXPIRES 3-26-2022.

SER. NO. 85-327,457, FILED 5-23-2011.

PATRICIA EVANKO, EXAMINING ATTORNEY

David J. Kyjars

Director of the United States Patent and Trademark Office

United States of America

United States Patent and Trademark Office

4DX

Reg. No. 4,204,472

Registered Sep. 11, 2012

Int. Cl.: 36

SERVICE MARK

PRINCIPAL REGISTER

CJ 4DPLEX CO., LTD. (REPUBLIC OF KOREA CORPORATION)
164-1 JEUNGSAN-DONG, EUNPYEONG-GU
SEOUL, REPUBLIC OF KOREA

FOR: BUILDING LEASING; RENTAL OF OFFICE SPACE; LEASING OF SHOPPING MALL SPACE; RENTAL OF THEATRES; RENTAL OF THEATRES FEATURING MOVIES AUDIENCE EFFECTS SUCH AS WIND, SCENT, WATER SPRAY, MOTION, VIBRATION, SMOKE, BUBBLE, LASER OR FLASH; INSURANCE INFORMATION; INSURANCE SERVICES, NAMELY, UNDERWRITING LIFE INSURANCE, UNDERWRITING HEALTH INSURANCE, UNDERWRITING ACCIDENT INSURANCE, UNDERWRITING FIRE INSURANCE; BANKING; ART APPRAISAL; LEASING OF REAL ESTATE; CUSTOMS BROKERAGE; GUARANTEE ASSURANCE UNDERWRITING; CHARITABLE FUNDRAISING SERVICES; FACTORING AGENCY SERVICES; LENDING AGAINST SECURITY, IN CLASS 36 (U.S. CLS. 100, 101 AND 102).

THE MARK CONSISTS OF STANDARD CHARACTERS WITHOUT CLAIM TO ANY PARTICULAR FONT, STYLE, SIZE, OR COLOR.

PRIORITY CLAIMED UNDER SEC. 44(D) ON REPUBLIC OF KOREA APPLICATION NO. 41-2010-3068, FILED 11-30-2010, REG. NO. 0226356, DATED 2-13-2012, EXPIRES 2-13-2022.

SER. NO. 85-328,258, FILED 5-24-2011.

PATRICIA EVANKO, EXAMINING ATTORNEY



David J. Kyjars

Director of the United States Patent and Trademark Office

United States of America

United States Patent and Trademark Office

4DX

Reg. No. 4,204,473

Registered Sep. 11, 2012

Int. Cl.: 37

SERVICE MARK

PRINCIPAL REGISTER

CJ 4DPLEX CO., LTD. (REPUBLIC OF KOREA CORPORATION)
164-1 JEUNGSAN-DONG, EUNPYEONG-GU
SEOUL, REPUBLIC OF KOREA

FOR: CONSTRUCTION OF BUILDINGS; REPAIR OF BUILDINGS; BUILDING OF THEATRES; INSTALLATION OF THEATRE PLANTS; BUILDING OF THEATRES FEATURING MOVIES AUDIENCE EFFECTS SUCH AS WIND, SCENT, WATER SPRAY, MOTION, VIBRATION, SMOKE, BUBBLE, LASER OR FLASH; INSTALLATION OF THEATRE PLANTS FOR MOVIES AUDIENCE EFFECTS SUCH AS WIND, SCENT, WATER SPRAY, MOTION, VIBRATION, SMOKE, BUBBLE, LASER OR FLASH; BUILDING CONSTRUCTION SUPERVISION; DRILLING OF WELLS; CLEANING OF BUILDING EXTERIOR SURFACES; HEATING EQUIPMENT INSTALLATION AND REPAIR; INSTALLATION, MAINTENANCE AND REPAIR OF MACHINERY FOR MOVIES AUDIENCE EFFECTS IN CINEMA; FILM PROJECTOR REPAIR; SAFE MAINTENANCE AND REPAIR; FURNITURE RESTORATION; REPAIR OF MUSICAL INSTRUMENTS, IN CLASS 37 (U.S. CLS. 100, 103 AND 106).

THE MARK CONSISTS OF STANDARD CHARACTERS WITHOUT CLAIM TO ANY PARTICULAR FONT, STYLE, SIZE, OR COLOR.

PRIORITY CLAIMED UNDER SEC. 44(D) ON REPUBLIC OF KOREA APPLICATION NO. 41-2010-3068, FILED 11-30-2010, REG. NO. 0229082, DATED 3-26-2012, EXPIRES 3-26-2022.

SER. NO. 85-328,262, FILED 5-24-2011.

PATRICIA EVANKO, EXAMINING ATTORNEY



David J. Kyjars

Director of the United States Patent and Trademark Office

United States of America

United States Patent and Trademark Office



Reg. No. 4,204,474

Registered Sep. 11, 2012

Int. Cl.: 35

SERVICE MARK

PRINCIPAL REGISTER

BOBO MARKET, INC. (NEW YORK CORPORATION)
2007 71ST STREET
BROOKLYN, NY 11204

FOR: EXPORT AND IMPORT AGENCIES, IN CLASS 35 (U.S. CLS. 100, 101 AND 102).

FIRST USE 2-2-2007; IN COMMERCE 2-2-2007.

THE MARK CONSISTS OF THE WORD "BOBO", WHICH FIRST APPEARS IN ALL CAPITAL LETTERS, IN "ADOBE GARAMOND PRO BOLD" FONT, IN TECHNORATI BLUE COLOR, FOLLOWED BY A RED PAINT SPLASH. AFTER THE RED SPLASH, AND CONNECTED TO THE RED SPLASH, IS A BALL. THE BALL IS SIMILAR IN APPEARANCE TO A SOCCER BALL. THE BALL CONSISTS OF 4 EQUAL SIZED RED SEMI-CIRCLES APPEARING AROUND THE OUTSIDE OF THE BALL, AND A CURVED GOLD DIAMOND IN THE CENTER OF THE BALL. HOWEVER, THE OUTER EDGE OF EACH SEMI-CIRCLE WHICH WOULD NORMALLY BE STRAIGHT, IS CONVEX RATHER THAN STRAIGHT. THE FOUR SEMI-CIRCLES MAKE THE ROUND OUTER OUTLINE OF THE BALL. THE INSIDE OF THE BALL IS A GOLD DIAMOND WITH OUTER EDGES OF THE DIAMOND CURVING SLIGHTLY INWARD (CONCAVE RATHER THAN STRAIGHT). A THIN WHITE OUTLINE IN THE SHAPE OF THE CONCAVE DIAMOND, APPEARS AROUND THE GOLD CONCAVE DIAMOND, OUTLINING THE GOLD DIAMOND, HOWEVER, EACH POINT OF THE WHITE OUTLINE, RATHER THAN STOPPING AT THE END POINTS OF THE DIAMOND, RUNS TO THE OUTER EDGE OF THE BALL, THUS SEPARATING EACH RED SEMI-CIRCLE IN THE BALL.

THE COLOR(S) BLUE, RED, GOLD AND WHITE IS/ARE CLAIMED AS A FEATURE OF THE MARK.

THE ENGLISH TRANSLATION OF "BOBO" IN THE MARK IS "PRECIOUS PRECIOUS".

SER. NO. 85-329,854, FILED 5-25-2011.

CIMMERIAN COLEMAN, EXAMINING ATTORNEY



David J. Kyffers

Director of the United States Patent and Trademark Office

United States of America

United States Patent and Trademark Office

ION GEOPHYSICAL

Reg. No. 4,204,475

Registered Sep. 11, 2012

Int. Cl.: 42

SERVICE MARK

PRINCIPAL REGISTER

ION GEOPHYSICAL CORPORATION (DELAWARE CORPORATION)
SUITE 400
2100 CITYWEST BOULEVARD
HOUSTON, TX 770422839

FOR: GEOPHYSICAL ENGINEERING AND CONSULTING SERVICES; DESIGN AND PLANNING OF SEISMIC SURVEYS; AND SCIENTIFIC STUDY AND RESEARCH IN THE FIELDS OF OIL AND GAS EXPLORATION AND PRODUCTION OF OIL AND GAS, IN CLASS 42 (U.S. CLS. 100 AND 101).

FIRST USE 9-21-2007; IN COMMERCE 5-25-2011.

THE MARK CONSISTS OF STANDARD CHARACTERS WITHOUT CLAIM TO ANY PARTICULAR FONT, STYLE, SIZE, OR COLOR.

NO CLAIM IS MADE TO THE EXCLUSIVE RIGHT TO USE "GEOPHYSICAL", APART FROM THE MARK AS SHOWN.

SER. NO. 85-330,979, FILED 5-26-2011.

DAVID C. REIHNER, EXAMINING ATTORNEY



David J. Kyfos

Director of the United States Patent and Trademark Office

United States of America

United States Patent and Trademark Office

MSS media

Reg. No. 4,204,476

Registered Sep. 11, 2012

Int. Cl.: 35

SERVICE MARK

PRINCIPAL REGISTER

MSS MEDIA (FLORIDA CORPORATION), AKA UNIVERSITY ADVERTISING
SUITE 1220
1200 BRICKELL AVENUE
MIAMI, FL 33131

FOR: OUT-OF-HOME ADVERTISING SERVICES, NAMELY, RENTAL OF ADVERTISING SPACE, AND PREPARING AND PLACING ADVERTISEMENTS FOR OTHERS; PROVIDING ADVERTISING SPACE ON BILLBOARDS AND IN KIOSKS; PROVIDING ADVERTISING SPACE ON FREE-STANDING VISUAL ADVERTISING SYSTEMS FEATURING THE GOODS AND SERVICES OF OTHERS; PROVIDING ADVERTISING, MARKETING AND PROMOTIONAL SERVICES, NAMELY, DEVELOPMENT OF ADVERTISING CAMPAIGNS PROVIDED THROUGH CABLE TELEVISION BROADCAST, WEB CASTS, RADIO BROADCASTS, NEWSPAPERS, MAGAZINES, ONLINE BANNERS, OUTDOOR BILLBOARDS, WILD POSTINGS, BUS AND SUBWAY ADS, IN CLASS 35 (U.S. CLS. 100, 101 AND 102).

FIRST USE 1-1-2006; IN COMMERCE 1-1-2006.

THE MARK CONSISTS OF STANDARD CHARACTERS WITHOUT CLAIM TO ANY PARTICULAR FONT, STYLE, SIZE, OR COLOR.

NO CLAIM IS MADE TO THE EXCLUSIVE RIGHT TO USE "MEDIA", APART FROM THE MARK AS SHOWN.

SER. NO. 85-331,578, FILED 5-26-2011.

B. PARADEWELAI, EXAMINING ATTORNEY



David J. Kyffers

Director of the United States Patent and Trademark Office

United States of America

United States Patent and Trademark Office

ESMART TAX

Reg. No. 4,204,477

LTS SOFTWARE, INC. (VIRGINIA CORPORATION)
1716 CORPORATE LANDING PARKWAY
VIRGINIA BEACH, VA 23454

Registered Sep. 11, 2012

Int. Cl.: 42

FOR: NON-DOWNLOADABLE COMPUTER FIRMWARE AND SOFTWARE USED TO PREPARE AND ELECTRONICALLY FILE INDIVIDUAL INCOME TAX RETURNS, 1040S, TAX SCHEDULES AND OTHER RELATED TAX FORMS WITH THE IRS OR OTHER GOVERNMENT AGENCIES, IN CLASS 42 (U.S. CLS. 100 AND 101).

SERVICE MARK

PRINCIPAL REGISTER

FIRST USE 6-0-1998; IN COMMERCE 10-0-1998.

THE MARK CONSISTS OF STANDARD CHARACTERS WITHOUT CLAIM TO ANY PARTICULAR FONT, STYLE, SIZE, OR COLOR.

OWNER OF U.S. REG. NO. 2,526,313.

NO CLAIM IS MADE TO THE EXCLUSIVE RIGHT TO USE "TAX", APART FROM THE MARK AS SHOWN.

SEC. 2(F).

SER. NO. 85-332,083, FILED 5-27-2011.

RAUL CORDOVA, EXAMINING ATTORNEY



David J. Kyjars

Director of the United States Patent and Trademark Office

United States of America

United States Patent and Trademark Office

ATSS

Reg. No. 4,204,478

Registered Sep. 11, 2012

Int. Cl.: 13

TRADEMARK

PRINCIPAL REGISTER

ADVANCED TACTICAL SIGHTING SYSTEMS (WASHINGTON LIMITED LIABILITY COMPANY)
130 SE KODIAK RIDGE ROAD
SHELTON, WA 98584

FOR: FIREARM ATTACHMENTS, NAMELY, MOUNTS FOR ATTACHING LIGHTS AND GUN SIGHTS TO CREW-SERVED FIREARMS, IN CLASS 13 (U.S. CLS. 2 AND 9).

FIRST USE 12-1-2008; IN COMMERCE 12-1-2008.

THE MARK CONSISTS OF STANDARD CHARACTERS WITHOUT CLAIM TO ANY PARTICULAR FONT, STYLE, SIZE, OR COLOR.

SER. NO. 85-333,594, FILED 5-31-2011.

WENDY GOODMAN, EXAMINING ATTORNEY



David J. Kyffers

Director of the United States Patent and Trademark Office

United States of America

United States Patent and Trademark Office

MERCHANT SYSTEMS.COM

Reg. No. 4,204,479

U.S. MERCHANT SYSTEMS LLC (CALIFORNIA LIMITED LIABILITY COMPANY)
48073 FREMONT BLVD.

Registered Sep. 11, 2012

FREMONT, CA 945386541

Int. Cl.: 36

FOR: MERCHANT SERVICES, NAMELY, PAYMENT TRANSACTION PROCESSING SERVICES, IN CLASS 36 (U.S. CLS. 100, 101 AND 102).

SERVICE MARK

FIRST USE 7-23-1999; IN COMMERCE 7-23-1999.

PRINCIPAL REGISTER

THE MARK CONSISTS OF STANDARD CHARACTERS WITHOUT CLAIM TO ANY PARTICULAR FONT, STYLE, SIZE, OR COLOR.

SEC. 2(F).

SER. NO. 85-334,349, FILED 5-31-2011.

H. M. FISHER, EXAMINING ATTORNEY



David J. Kybas

Director of the United States Patent and Trademark Office

United States of America

United States Patent and Trademark Office

DELTA DIRECT

Reg. No. 4,204,480

DELTA SCREEN & FILTRATION, LLC (TEXAS LIMITED LIABILITY COMPANY)
13223 FM 529

Registered Sep. 11, 2012

HOUSTON, TX 77041

Int. Cl.: 6

FOR: METAL WELL SCREENS FOR SAND CONTROL IN OIL AND GAS WELLS, IN CLASS 6 (U.S. CLS. 2, 12, 13, 14, 23, 25 AND 50).

TRADEMARK

FIRST USE 10-28-2010; IN COMMERCE 10-28-2010.

PRINCIPAL REGISTER

THE MARK CONSISTS OF STANDARD CHARACTERS WITHOUT CLAIM TO ANY PARTICULAR FONT, STYLE, SIZE, OR COLOR.

SER. NO. 85-335,215, FILED 6-1-2011.

SUZANNE BLANE, EXAMINING ATTORNEY



David J. Kybas

Director of the United States Patent and Trademark Office

United States of America

United States Patent and Trademark Office



Reg. No. 4,204,481

Registered Sep. 11, 2012

Int. Cls.: 42 and 44

SERVICE MARK

PRINCIPAL REGISTER

AEDAS LTD. (HONG KONG CORPORATION)
31/F ONE ISLAND EAST, 18 WESTLANDS ROAD
QUARRY BAY, HONG KONG

FOR: TECHNICAL DESIGN SERVICES FOR OTHERS IN THE FIELD OF ARCHITECTURE; INTERIOR DESIGN SERVICES; LANDSCAPE ARCHITECTURAL DESIGN SERVICES; CONCEPT DESIGN DEVELOPMENT, NAMELY, THE DEVELOPMENT OF CONCEPT DESIGNS IN THE FIELDS OF ARCHITECTURE AND INTERIOR DESIGN; INTERIOR DESIGN SERVICES, NAMELY, SPACE PLANNING; ARCHITECTURAL CONSULTANCY AND ADVISORY SERVICES; ARCHITECTURAL SERVICES; ARCHITECTURAL PLANNING SERVICES; ARCHITECTURAL DESIGN SERVICES; PREPARATION OF ARCHITECTURAL PLANS AND REPORTS IN CONNECTION WITH ARCHITECTURAL CONSULTATION; CIVIL ENGINEERING ADVISORY AND CONSULTANCY SERVICES; STRUCTURAL ENGINEERING ADVISORY AND CONSULTANCY SERVICES; CIVIL ENGINEERING SERVICES; CIVIL ENGINEERING DESIGN SERVICES; CIVIL ENGINEERING DRAWING SERVICES; CIVIL ENGINEERING PLANNING SERVICES; TECHNICAL CONSULTATION IN THE FIELD OF CIVIL ENGINEERING; STRUCTURAL ENGINEERING SERVICES; SURVEYING; CONSULTANCY AND ADVISORY SERVICES RELATING TO BUILDING DESIGN FOR OTHERS; ELECTRICAL ENGINEERING SERVICES; SCIENTIFIC AND TECHNOLOGICAL SERVICES, NAMELY, SCIENTIFIC RESEARCH IN THE FIELDS OF ARCHITECTURE, INTERIOR DESIGN AND ENGINEERING; INDUSTRIAL RESEARCH IN THE FIELDS OF ARCHITECTURE, INTERIOR DESIGN AND ENGINEERING; DESIGN AND DEVELOPMENT OF COMPUTER HARDWARE AND SOFTWARE, IN CLASS 42 (U.S. CLS. 100 AND 101).

FOR: LANDSCAPE DESIGN SERVICES, IN CLASS 44 (U.S. CLS. 100 AND 101).

OWNER OF HONG KONG REG. NO. 301930365, DATED 5-27-2011, EXPIRES 5-26-2021.

THE MARK CONSISTS OF A CHEVRON DESIGN ON THE LEFT AND THE WORDS "VIEWVANTAGE" ON THE RIGHT.

SER. NO. 85-336,317, FILED 6-2-2011.

LINDA M. KING, EXAMINING ATTORNEY



David J. Kypos

Director of the United States Patent and Trademark Office

United States of America

United States Patent and Trademark Office

LOOP 21

Reg. No. 4,204,482

Registered Sep. 11, 2012

Int. Cl.: 41

SERVICE MARK

PRINCIPAL REGISTER

WILLIAMS, DARRELL (UNITED STATES INDIVIDUAL), DBA THELOOP21.COM
C/O A. F. DAVIS LAW
468 N. CAMDEN DRIVE, SUITE 200
BEVERLY HILLS, CA 90210

FOR: PROVIDING AN INTERNET WEBSITE FEATURING NEWS AND INFORMATION IN THE FIELD OF AFRICAN-AMERICAN FOCUSED EDUCATION, SPORTS, AND ENTERTAINMENT, IN CLASS 41 (U.S. CLS. 100, 101 AND 107).

FIRST USE 8-1-2008; IN COMMERCE 8-1-2008.

THE MARK CONSISTS OF STANDARD CHARACTERS WITHOUT CLAIM TO ANY PARTICULAR FONT, STYLE, SIZE, OR COLOR.

SER. NO. 85-336,956, FILED 6-2-2011.

ANNE E. GUSTASON, EXAMINING ATTORNEY



David J. Kybas

Director of the United States Patent and Trademark Office

United States of America

United States Patent and Trademark Office

SNAPTAG

Reg. No. 4,204,483

Registered Sep. 11, 2012

Int. Cls.: 16 and 35

TRADEMARK

SERVICE MARK

PRINCIPAL REGISTER

SPYDER LYNK, LLC (COLORADO LIMITED LIABILITY COMPANY)
SUITE 2E
1620 MARKET STREET
DENVER, CO 80202

FOR: GRAPHIC EMBLEMS, NAMELY, PRINTED AND PAPER EMBLEMS THAT MAY BE APPLIED TO A FLAT SURFACE FOR MOBILE MARKETING PURPOSE TO IDENTIFY THE SOURCE FOR INFORMATION ABOUT A PARTICULAR GOOD OR SERVICE, IN CLASS 16 (U.S. CLS. 2, 5, 22, 23, 29, 37, 38 AND 50).

FIRST USE 6-1-2008; IN COMMERCE 8-5-2008.

FOR: MARKETING, PROMOTION AND ADVERTISING SERVICES; PROVIDING INFORMATION ABOUT THE GOODS OR SERVICES OF OTHERS VIA THE INTERNET OR OTHER COMPUTER OR COMMUNICATIONS NETWORKS BASED ON IMAGE RECOGNITION TECHNOLOGY; PROVIDING CONSUMER PRODUCT INFORMATION VIA THE INTERNET AND OTHER COMMUNICATIONS NETWORKS FOR ADVERTISING AND SALES PROMOTION PURPOSES, IN CLASS 35 (U.S. CLS. 100, 101 AND 102).

FIRST USE 6-1-2008; IN COMMERCE 8-5-2008.

THE MARK CONSISTS OF STANDARD CHARACTERS WITHOUT CLAIM TO ANY PARTICULAR FONT, STYLE, SIZE, OR COLOR.

SER. NO. 85-338,547, FILED 6-6-2011.

ESTHER BELENKER, EXAMINING ATTORNEY



David J. Kyjars

Director of the United States Patent and Trademark Office

United States of America

United States Patent and Trademark Office

FILM SCHOOLED

Reg. No. 4,204,484

FILM SCHOOLED, LLC (OHIO LIMITED LIABILITY COMPANY)
33 E MILLS AVE
CINCINNATI, OH 45215

Registered Sep. 11, 2012

Int. Cl.: 41

FOR: ENTERTAINMENT SERVICES, NAMELY, ARRANGING AND CONDUCTING OF COMPETITIONS FOR MOVIE MAKING, NAMELY, WRITING, PRODUCING, SCORING, DIRECTING, EDITING, SPECIAL EFFECTS, GRAPHICS, AND FILMING, IN CLASS 41 (U.S. CLS. 100, 101 AND 107).

SERVICE MARK

PRINCIPAL REGISTER

FIRST USE 2-11-2011; IN COMMERCE 2-11-2011.

THE MARK CONSISTS OF STANDARD CHARACTERS WITHOUT CLAIM TO ANY PARTICULAR FONT, STYLE, SIZE, OR COLOR.

NO CLAIM IS MADE TO THE EXCLUSIVE RIGHT TO USE "FILM", APART FROM THE MARK AS SHOWN.

SER. NO. 85-338,603, FILED 6-6-2011.

SEAN CROWLEY, EXAMINING ATTORNEY



David J. Kyffers

Director of the United States Patent and Trademark Office

United States of America

United States Patent and Trademark Office

ONE FOR ONE

Reg. No. 4,204,485

Registered Sep. 11, 2012

Int. Cl.: 25

TRADEMARK

PRINCIPAL REGISTER

MYCOSKIE, LLC (CALIFORNIA LIMITED LIABILITY COMPANY)
STAGE C
3025 OLYMPIC BOULEVARD
SANTA MONICA, CA 90404

FOR: CLOTHING, NAMELY, HATS, SWEATSHIRTS, HOODED SWEATSHIRTS, T-SHIRTS
AND SHOES, IN CLASS 25 (U.S. CLS. 22 AND 39).

FIRST USE 5-1-2008; IN COMMERCE 5-1-2008.

THE MARK CONSISTS OF STANDARD CHARACTERS WITHOUT CLAIM TO ANY PAR-
TICULAR FONT, STYLE, SIZE, OR COLOR.

SER. NO. 85-339,106, FILED 6-6-2011.

MEGHAN REINHART, EXAMINING ATTORNEY



David J. Kyffers

Director of the United States Patent and Trademark Office

United States of America

United States Patent and Trademark Office



Reg. No. 4,204,486

PETEDGE, INC. (MASSACHUSETTS CORPORATION)
PO BOX 1000
BEVERLY, MA 019150700

Registered Sep. 11, 2012

Int. Cls.: 6, 20, 21 and 27

FOR: METAL KEY CHAINS, IN CLASS 6 (U.S. CLS. 2, 12, 13, 14, 23, 25 AND 50).

TRADEMARK

FIRST USE 3-0-2005; IN COMMERCE 3-0-2005.

PRINCIPAL REGISTER

FOR: WIND CHIMES, METAL PICTURE FRAMES, PET FURNITURE, PET CRATES, PET STAIRS AND RAMPS, IN CLASS 20 (U.S. CLS. 2, 13, 22, 25, 32 AND 50).

FIRST USE 3-0-2005; IN COMMERCE 3-0-2005.

FOR: PET FEEDING AND DRINKING BOWLS, IN CLASS 21 (U.S. CLS. 2, 13, 23, 29, 30, 33, 40 AND 50).

FIRST USE 3-0-2005; IN COMMERCE 3-0-2005.

FOR: DOOR MATS AND RUGS, IN CLASS 27 (U.S. CLS. 19, 20, 37, 42 AND 50).

FIRST USE 3-0-2005; IN COMMERCE 3-0-2005.

NO CLAIM IS MADE TO THE EXCLUSIVE RIGHT TO USE "PET" AND "GIFTS FOR PETS & PET PEOPLE", APART FROM THE MARK AS SHOWN.



THE MARK CONSISTS OF A FANCIFUL DRAWING OF A DOG WITH A BERET ON ITS HEAD, A COLLAR AROUND ITS NECK, WITH A DRAWING OF A BOX WITH RIBBON AND BOW HELD BY THE RIBBON IN THE DOG'S TEETH WITH CURVED LINES AROUND THE TAIL INDICATING 'WAGGING' WITH THE WORDS "PET STUDIO GIFTS FOR PETS & PET PEOPLE!" BELOW THE DOG.

SER. NO. 85-339,771, FILED 6-7-2011.

SUE LAWRENCE, EXAMINING ATTORNEY

David J. Kyffers

Director of the United States Patent and Trademark Office

United States of America

United States Patent and Trademark Office



Reg. No. 4,204,487

Registered Sep. 11, 2012

Int. Cls.: 35, 39 and 40

SERVICE MARK

PRINCIPAL REGISTER

HYDRO-QUEBEC (CANADA CORPORATION)
4TH FLOOR
75 RENÉ-LÉVESQUE BOULEVARD WEST
MONTREAL, QUEBEC, CANADA H2Z1A4

FOR: RETAIL ENERGY PROVIDER SERVICES, NAMELY, PROVIDING A SERVICE THAT ALLOWS CUSTOMERS TO PURCHASE ENERGY, NAMELY, ELECTRICITY AND RENEWABLE ENERGY, IN CLASS 35 (U.S. CLS. 100, 101 AND 102).

FOR: UTILITY SERVICES, NAMELY, TRANSMISSION AND DISTRIBUTION OF ELECTRICITY AND ENERGY, IN CLASS 39 (U.S. CLS. 100 AND 105).

FOR: GENERATION OF ELECTRICITY; GENERATION OF ENERGY, IN CLASS 40 (U.S. CLS. 100, 103 AND 106).

PRIORITY CLAIMED UNDER SEC. 44(D) ON CANADA APPLICATION NO. 1512704, FILED 1-26-2011, REG. NO. 821408, DATED 4-3-2012, EXPIRES 4-3-2027.

OWNER OF U.S. REG. NOS. 1,651,729 AND 1,975,711.

THE MARK CONSISTS OF A CIRCLE WITH LIGHTNING OF ELECTRICITY FORMING A "Q".

SER. NO. 85-341,097, FILED 6-8-2011.

JASON TURNER, EXAMINING ATTORNEY



David J. Kybas

Director of the United States Patent and Trademark Office

United States of America

United States Patent and Trademark Office

NETAPP

Reg. No. 4,204,488

Registered Sep. 11, 2012

Int. Cls.: 36 and 42

SERVICE MARK

PRINCIPAL REGISTER

NETAPP, INC. (DELAWARE CORPORATION)
495 EAST JAVA DRIVE
SUNNYVALE, CA 94089

FOR: FINANCING SERVICES, IN CLASS 36 (U.S. CLS. 100, 101 AND 102).

FIRST USE 3-0-2008; IN COMMERCE 3-0-2008.

FOR: SOFTWARE AS A SERVICE (SAAS) SERVICES FEATURING SOFTWARE FOR MANAGEMENT, STORAGE, TROUBLESHOOTING, OPTIMIZATION, AND ANALYSIS OF NETWORK DATA, IN CLASS 42 (U.S. CLS. 100 AND 101).

FIRST USE 3-0-2008; IN COMMERCE 3-0-2008.

THE MARK CONSISTS OF STANDARD CHARACTERS WITHOUT CLAIM TO ANY PARTICULAR FONT, STYLE, SIZE, OR COLOR.

OWNER OF U.S. REG. NOS. 2,088,731, 2,844,772, AND 3,771,053.

SEC. 2(F).

SER. NO. 85-342,535, FILED 6-9-2011.

JAY BESCH, EXAMINING ATTORNEY



David J. Kybas

Director of the United States Patent and Trademark Office

United States of America

United States Patent and Trademark Office

PHANTOMCLOUD

Reg. No. 4,204,489

DYNAFLOW, INC. (MARYLAND CORPORATION)
10621-J IRON BRIDGE ROAD
JESSUP, MD 20794

Registered Sep. 11, 2012

Int. Cl.: 42

FOR: SOFTWARE AS A SERVICE (SAAS) SERVICES FEATURING SOFTWARE FOR COMPUTATIONAL FLUID DYNAMICS OF THE INTERACTION OF BUBBLE CLOUDS AND NEARBY STRUCTURES, IN CLASS 42 (U.S. CLS. 100 AND 101).

SERVICE MARK

FIRST USE 7-29-2005; IN COMMERCE 11-9-2007.

PRINCIPAL REGISTER

THE MARK CONSISTS OF THE WORDS "PHANTOMCLOUD" STYLIZED. THE "P" IN "PHANTOM" IS CAPITALIZED WITH THE REST "HANTOM" IS STYLIZED IN SMALL CAPS. THE "C" IN "CLOUD" IS CAPITALIZED WITH THE REST "LOUD" IS STYLIZED IN SMALL CAPS. THERE IS NO SPACE BETWEEN THE TWO WORDS "PHANTOM" AND "CLOUD".

SER. NO. 85-343,344, FILED 6-10-2011.

ANN E. SAPPENFIELD, EXAMINING ATTORNEY



David J. Kybas

Director of the United States Patent and Trademark Office

United States of America

United States Patent and Trademark Office



Reg. No. 4,204,490

JJCK LLC (TEXAS LIMITED LIABILITY COMPANY)
6170 RESEARCH ROAD
FRISCO, TX 75034

Registered Sep. 11, 2012

Int. Cls.: 35 and 41

FOR: ADMINISTRATION OF PROGRAM FOR LAW ENFORCEMENT AGENCIES TO TRACK, LOCATE, AND MONITOR INDIVIDUALS THROUGH CELLULAR TELEPHONE INFRASTRUCTURE AND NETWORK, IN CLASS 35 (U.S. CLS. 100, 101 AND 102).

SERVICE MARK

FIRST USE 5-1-2011; IN COMMERCE 5-1-2011.

PRINCIPAL REGISTER

FOR: TRAINING SERVICES IN THE FIELD OF USING ELECTRONIC DEVICES, NAMELY, TRANSCEIVERS WORN BY INDIVIDUALS WITH PHYSICAL AND/OR COGNITIVE DISABILITIES OR IMPAIRMENTS IN THE NATURE OF ALZHEIMER'S DISEASE, AUTISM, AND DOWN SYNDROME TO TRACK, LOCATE AND MONITOR SUCH INDIVIDUALS THROUGH CELLULAR TELEPHONE INFRASTRUCTURE AND NETWORK, IN CLASS 41 (U.S. CLS. 100, 101 AND 107).

FIRST USE 5-1-2011; IN COMMERCE 5-1-2011.

THE MARK CONSISTS OF A DESIGN OF A SHIELD AND BANNER WITH A RAISED ARM AND HAND WEARING AN ELECTRONIC DEVICE WITH THE WORDING "OPERATION IMPACT" APPEARING ON THE SHIELD AND BANNER.

SER. NO. 85-343,387, FILED 6-10-2011.

DARRYL SPRUILL, EXAMINING ATTORNEY



David J. Kybas

Director of the United States Patent and Trademark Office

United States of America

United States Patent and Trademark Office

OPERATION EMPACT

Reg. No. 4,204,491

JJCK LLC (TEXAS LIMITED LIABILITY COMPANY)
6170 RESEARCH ROAD
FRISCO, TX 75034

Registered Sep. 11, 2012

Int. Cls.: 35 and 41

FOR: ADMINISTRATION OF PROGRAM FOR LAW ENFORCEMENT AGENCIES TO TRACK, LOCATE, AND MONITOR INDIVIDUALS THROUGH CELLULAR TELEPHONE INFRASTRUCTURE AND NETWORK, IN CLASS 35 (U.S. CLS. 100, 101 AND 102).

SERVICE MARK

FIRST USE 5-1-2011; IN COMMERCE 5-1-2011.

PRINCIPAL REGISTER

FOR: TRAINING SERVICES IN THE FIELD OF USING ELECTRONIC DEVICES, NAMELY, TRANSCEIVERS WORN BY INDIVIDUALS WITH PHYSICAL AND/OR COGNITIVE DISABILITIES OR IMPAIRMENTS IN THE NATURE OF ALZHEIMER'S DISEASE, AUTISM, AND DOWN SYNDROME TO TRACK, LOCATE AND MONITOR SUCH INDIVIDUALS THROUGH CELLULAR TELEPHONE INFRASTRUCTURE AND NETWORK, IN CLASS 41 (U.S. CLS. 100, 101 AND 107).

FIRST USE 5-1-2011; IN COMMERCE 5-1-2011.

THE MARK CONSISTS OF STANDARD CHARACTERS WITHOUT CLAIM TO ANY PARTICULAR FONT, STYLE, SIZE, OR COLOR.

SER. NO. 85-343,394, FILED 6-10-2011.

DARRYL SPRUILL, EXAMINING ATTORNEY



David J. Kybas

Director of the United States Patent and Trademark Office

United States of America

United States Patent and Trademark Office

More Customers. Less Work.

Reg. No. 4,204,492

Registered Sep. 11, 2012

Int. Cls.: 9 and 42

TRADEMARK

SERVICE MARK

PRINCIPAL REGISTER

NIMBLE, INC. (DELAWARE CORPORATION)
P.O. BOX 3313
SANTA MONICA, CA 90408

FOR: COMPUTER SOFTWARE FOR USE IN CUSTOMER RELATIONSHIP MANAGEMENT (CRM), IN CLASS 9 (U.S. CLS. 21, 23, 26, 36 AND 38).

FIRST USE 1-0-2010; IN COMMERCE 1-0-2010.

FOR: COMPUTER SOFTWARE DEVELOPMENT IN THE FIELD OF CUSTOMER RELATIONSHIP MANAGEMENT; PROVIDING ON-LINE NON-DOWNLOADABLE SOFTWARE FOR USE IN CUSTOMER RELATIONSHIP MANAGEMENT, IN CLASS 42 (U.S. CLS. 100 AND 101).

FIRST USE 1-0-2010; IN COMMERCE 1-0-2010.

THE MARK CONSISTS OF STANDARD CHARACTERS WITHOUT CLAIM TO ANY PARTICULAR FONT, STYLE, SIZE, OR COLOR.

SER. NO. 85-343,849, FILED 6-11-2011.

ALLISON HOLTZ, EXAMINING ATTORNEY



David J. Kybas

Director of the United States Patent and Trademark Office

United States of America

United States Patent and Trademark Office

ADIPAD

Reg. No. 4,204,493

Registered Sep. 11, 2012

Int. Cl.: 9

TRADEMARK

PRINCIPAL REGISTER

ADI SOFTWARE, LLC (DELAWARE LIMITED LIABILITY COMPANY)
C/O MESSERLI & KRAMER P.A.
100 SOUTH 5TH STREET, SUITE 1400
MINNEAPOLIS, MN 55421

FOR: TIME CLOCKS; TIME RECORDING APPARATUS, IN CLASS 9 (U.S. CLS. 21, 23, 26, 36 AND 38).

FIRST USE 6-1-2011; IN COMMERCE 6-1-2011.

THE MARK CONSISTS OF STANDARD CHARACTERS WITHOUT CLAIM TO ANY PARTICULAR FONT, STYLE, SIZE, OR COLOR.

OWNER OF U.S. REG. NOS. 2,663,934 AND 3,959,761.

SER. NO. 85-344,277, FILED 6-13-2011.

MARTHA SANTOMARTINO, EXAMINING ATTORNEY



David J. Kybas

Director of the United States Patent and Trademark Office

United States of America

United States Patent and Trademark Office

ADITOUCH

Reg. No. 4,204,494

Registered Sep. 11, 2012

Int. Cl.: 9

TRADEMARK

PRINCIPAL REGISTER

ADI SOFTWARE, LLC (DELAWARE LIMITED LIABILITY COMPANY)
C/O MESSERLI & KRAMER P.A.
100 SOUTH 5TH STREET, SUITE 1400
MINNEAPOLIS, MN 55421

FOR: TIME CLOCKS; TIME RECORDING APPARATUS, IN CLASS 9 (U.S. CLS. 21, 23, 26, 36 AND 38).

FIRST USE 6-1-2011; IN COMMERCE 6-1-2011.

THE MARK CONSISTS OF STANDARD CHARACTERS WITHOUT CLAIM TO ANY PARTICULAR FONT, STYLE, SIZE, OR COLOR.

OWNER OF U.S. REG. NOS. 2,663,934 AND 3,959,761.

SER. NO. 85-344,325, FILED 6-13-2011.

MARTHA SANTOMARTINO, EXAMINING ATTORNEY



David J. Kyffers

Director of the United States Patent and Trademark Office

United States of America

United States Patent and Trademark Office



Reg. No. 4,204,495

Registered Sep. 11, 2012

Int. Cl.: 17

TRADEMARK

PRINCIPAL REGISTER

MALLETTE, JOHN W SR (UNITED STATES INDIVIDUAL)
STE A100
311 FLANNAN RD
PENSACOLA, FL 325073160

FOR: ACOUSTIC AND THERMAL INSULATION FOR USE IN THE AUTOMOTIVE, HVAC, APPLIANCE AND COMMERCIAL INTERIOR INDUSTRIES; ACOUSTICAL INSULATION BARRIER PANELS; HEAT AND ACOUSTICAL COMPOSITE INSULATING SHIELD FOR AUTOMOBILES AND MACHINERY; INSULATING FABRICS; INSULATING MATERIALS; INSULATION FOR AIRCRAFT, IN CLASS 17 (U.S. CLS. 1, 5, 12, 13, 35 AND 50).

FIRST USE 6-1-2004; IN COMMERCE 6-1-2004.

THE MARK CONSISTS OF THE WORDING "SOLAR ARMOR" WITH THREE CURVED LINES ABOVE THE "SOLA" PORTION OF "SOLAR" AND THREE CURVED LINES BELOW THE TERM "ARMOR".

SER. NO. 85-344,686, FILED S.R. 6-13-2011 AM. P.R. 4-23-2012.

PAULA MAHONEY, EXAMINING ATTORNEY



David J. Kyffers

Director of the United States Patent and Trademark Office

United States of America

United States Patent and Trademark Office



Reg. No. 4,204,496

Registered Sep. 11, 2012

Int. Cl.: 41

SERVICE MARK

PRINCIPAL REGISTER

ACADEMY OF TELEVISION ARTS & SCIENCES FOUNDATION (CALIFORNIA NON-PROFIT CORPORATION)
5220 LANKERSHIM BOULEVARD
NORTH HOLLYWOOD, CA 916013109

FOR: ENTERTAINMENT SERVICES, NAMELY, PLANNING, ORGANIZING, ARRANGING, MANAGING AND CONDUCTING COMPETITIONS IN THE FIELD OF TELEVISION, FILM, VIDEO FILM, AND DIGITAL FILM PRODUCTION; PROVIDING RECOGNITION BY THE WAY OF A SERIES OF AWARDS TO DEMONSTRATE EXCELLENCE IN THE FIELD OF TELEVISION, FILM, VIDEO FILM, AND DIGITAL FILM PRODUCTION, IN CLASS 41 (U.S. CLS. 100, 101 AND 107).

FIRST USE 4-9-2011, THE MARK WAS FIRST USED ANYWHERE IN A DIFFERENT FORM OTHER THAN THAT SOUGHT TO BE REGISTERED AT LEAST AS EARLY AS 03/19/2006; IN COMMERCE 4-9-2011, THE MARK WAS FIRST USED IN COMMERCE IN A DIFFERENT FORM OTHER THAN THAT SOUGHT TO BE REGISTERED AT LEAST AS EARLY AS 03/19/2006.

OWNER OF U.S. REG. NOS. 1,649,437, 2,755,461, AND 3,156,041.

NO CLAIM IS MADE TO THE EXCLUSIVE RIGHT TO USE "TELEVISION AWARDS", APART FROM THE MARK AS SHOWN.

THE MARK CONSISTS OF THE STYLIZED WORDING "COLLEGE TELEVISION AWARDS" OVER A GLOBE, AND A STYLIZED FIGURE OF A HUMAN HOLDING A GLOBE NEXT TO THE WORDING.

SEC. 2(F) AS TO "COLLEGE TELEVISION AWARDS".

SER. NO. 85-345,036, FILED 6-13-2011.

PAULA MAHONEY, EXAMINING ATTORNEY



David J. Kyros

Director of the United States Patent and Trademark Office

United States of America

United States Patent and Trademark Office



Reg. No. 4,204,497

Registered Sep. 11, 2012

Int. Cl.: 37

SERVICE MARK

PRINCIPAL REGISTER

MCLELLAN, DWIGHT (CANADA INDIVIDUAL)
11504 W. PICCADILLY RD.
AVONDALE, AZ 85392

FOR: OIL AND GAS DRILLING, IN CLASS 37 (U.S. CLS. 100, 103 AND 106).

FIRST USE 3-4-2007; IN COMMERCE 6-25-2008.

NO CLAIM IS MADE TO THE EXCLUSIVE RIGHT TO USE "WELL PATH" , APART FROM THE MARK AS SHOWN.

THE STIPPLING IS FOR SHADING PURPOSES ONLY.

THE MARK CONSISTS OF THE STYLIZED WORDING "WELLPATH SOLUTIONS". THE DESIGN OF AN OIL WELL GOES THROUGH THE "W" IN "WELLPATH" AND THE DESIGN OF A PIPE GOES FROM THE BOTTOM OF THE WELL DESIGN THROUGH THE WORD "SOLUTIONS". THE BACKGROUND CONSISTS OF A VIEW FROM THE CENTER OF THE EARTH LOOKING UP WITH VARIOUS GEOLOGICAL STRATA. AN OIL RIG IS AT THE TOP CENTER OF THE MARK WITH TWO OIL PIPES LINES RUNNING DOWN FROM THE OIL RIG.

SER. NO. 85-345,042, FILED 6-13-2011.

KIM SAITO, EXAMINING ATTORNEY



David J. Kybas

Director of the United States Patent and Trademark Office

United States of America

United States Patent and Trademark Office



Reg. No. 4,204,498

Registered Sep. 11, 2012

Int. Cls.: 9, 16, 41 and 45

TRADEMARK

SERVICE MARK

PRINCIPAL REGISTER

WORD OF GOD CHURCH & MINISTRIES (SOUTH CAROLINA NON-PROFIT ORGANIZATION), AKA WORD OF GOD
7355 GARNERS FERRY ROAD
COLUMBIA, SC 29209

FOR: DIGITAL MEDIA, NAMELY, CDS, DVDS, DOWNLOADABLE AUDIO AND VIDEO RECORDINGS FEATURING INFORMATIONAL, INSTRUCTIONAL, AND EDUCATIONAL CONTENT FOR RELIGIOUS, EDUCATIONAL, EVANGELISTIC AND MINISTERIAL TRAINING, EXHORTATION AND INSTRUCTION, IN CLASS 9 (U.S. CLS. 21, 23, 26, 36 AND 38).

FIRST USE 9-10-2001; IN COMMERCE 9-10-2001.

FOR: PRINTED INSTRUCTIONAL, EDUCATIONAL, AND TEACHING MATERIALS IN THE FIELD OF RELIGIOUS, MINISTERIAL, EVANGELISTIC AND EDUCATIONAL TRAINING AND INSTRUCTION; INFORMATIONAL LETTERS CONCERNING CHURCH EVENTS, NEWS AND CHURCH LIFE; INFORMATIONAL SHEETS ABOUT CHURCH DOCTRINE, VALUES, CHARACTERISTICS AND CHURCH LIFE, IN CLASS 16 (U.S. CLS. 2, 5, 22, 23, 29, 37, 38 AND 50).

FIRST USE 9-10-2001; IN COMMERCE 9-10-2001.

FOR: DEVELOPMENT AND DISSEMINATION OF EDUCATIONAL MATERIALS OF OTHERS IN THE FIELD OF CHRISTIANITY, THEOLOGY, CHRISTIAN DOCTRINE, BIBLE STUDY, EVANGELISM, RELIGIOUS MISSIONS, SOCIAL JUSTICE, RACIAL HARMONY, WORSHIP MUSIC, CHRISTIAN DISCIPLESHIP AND CHRISTIAN LIVING; EDUCATION SERVICES, NAMELY, PROVIDING RELIGIOUS INSTRUCTION, CLASSES, SEMINARS, WORKSHOPS, AND GROUP COACHING AND DISTRIBUTING COURSE MATERIALS IN CONNECTION THERE, ALL IN THE FIELD OF CHRISTIANITY, THEOLOGY, CHRISTIAN DOCTRINE, BIBLE STUDY, EVANGELISM, RELIGIOUS MISSIONS, SOCIAL JUSTICE, RACIAL HARMONY, WORSHIP MUSIC, CHRISTIAN DISCIPLESHIP AND CHRISTIAN LIVING; MUSIC COMPOSITION AND TRANSCRIPTION FOR OTHERS; MUSIC PRODUCTION SERVICES; PRESENTATION OF MUSICAL PERFORMANCE; PRODUCTION OF SOUND AND MUSIC VIDEO RECORDINGS; PROVIDING FACILITIES FOR MOVIES, SHOWS, PLAYS, MUSIC OR EDUCATIONAL TRAINING; RELIGIOUS INSTRUCTION SERVICES, IN CLASS 41 (U.S. CLS. 100, 101 AND 107).



David J. Kyjars

Director of the United States Patent and Trademark Office

Reg. No. 4,204,498 FIRST USE 4-15-2007; IN COMMERCE 4-15-2007.

FOR: COUNSELING SERVICES IN THE FIELD OF CHRISTIAN CONDUCT IN PERSONAL RELATIONSHIPS; EVANGELISTIC AND MINISTERIAL SERVICES; GRIEF COUNSELING; MARRIAGE COUNSELING; RELIGIOUS AND SPIRITUAL SERVICES, NAMELY, CONDUCTING RELIGIOUS WORSHIP, MARRIAGE CEREMONIES, BAPTISMAL CEREMONIES, BABY DEDICATIONS, BEREAVEMENT CEREMONIES, AND RELIGIOUS COUNSELING, IN CLASS 45 (U.S. CLS. 100 AND 101).

FIRST USE 9-10-2001; IN COMMERCE 9-10-2001.

NO CLAIM IS MADE TO THE EXCLUSIVE RIGHT TO USE "WORD OF GOD CHURCH & MINISTRIES", APART FROM THE MARK AS SHOWN.

THE MARK CONSISTS OF THE STYLIZED WORDING "WORD OF GOD CHURCH & MINISTRIES" AND THE DESIGN OF A SWORD INTERLOCKED THROUGH THE MIDDLE OF THE THREE "O" LETTERS IN "WORD OF GOD" AND UNDER THE "&" AMPERSAND. THERE IS A DESIGN OF A CONTINENT AND MERIDIAN AND PARALLEL LINES INSIDE THE LETTER "O" OF THE WORDING "OF".

SER. NO. 85-345,417, FILED 6-14-2011.

DAWN HAN, EXAMINING ATTORNEY

United States of America

United States Patent and Trademark Office

TOOL MANAGER

Reg. No. 4,204,499

Registered Sep. 11, 2012

Int. Cl.: 9

TRADEMARK

PRINCIPAL REGISTER

ALLSOFT TECHNOLOGIES, INC. (FLORIDA CORPORATION)
SUITE 700
601 BAYSHORE BOULEVARD
TAMPA, FL 33606

FOR: COMPUTER DATABASE MANAGEMENT SOFTWARE FOR USE IN DATABASE MANAGEMENT OF INVENTORY CONTROL AND CUSTOMER ACCOUNT INFORMATION, IN CLASS 9 (U.S. CLS. 21, 23, 26, 36 AND 38).

FIRST USE 4-1-1992; IN COMMERCE 4-1-1992.

THE MARK CONSISTS OF STANDARD CHARACTERS WITHOUT CLAIM TO ANY PARTICULAR FONT, STYLE, SIZE, OR COLOR.

NO CLAIM IS MADE TO THE EXCLUSIVE RIGHT TO USE "MANAGER", APART FROM THE MARK AS SHOWN.

SEC. 2(F).

SER. NO. 85-345,535, FILED 6-14-2011.

AMY KERTGATE, EXAMINING ATTORNEY



David J. Kyffers

Director of the United States Patent and Trademark Office

United States of America

United States Patent and Trademark Office



Reg. No. 4,204,500

Registered Sep. 11, 2012

Int. Cl.: 36

SERVICE MARK

PRINCIPAL REGISTER

KRISTIN L. MARINELLI (DELAWARE LIMITED LIABILITY COMPANY), DBA INSOURCE
HELP
727 B NORTH MARKET STREET
WILMINGTON, DE 19801

FOR: ADVISORY SERVICES IN THE FIELD OF EMPLOYEE BENEFITS FOR GROUP HEALTHCARE AND BUSINESS INSURANCE OFFERED TO EMPLOYEES IN ADDITION TO STANDARD BENEFITS SUCH AS MEDICAL, DENTAL, LIFE INSURANCE INCLUDING SHORT TERM DISABILITY, LONG TERM DISABILITY, CANCER INSURANCE, ACCIDENTAL DEATH AND DISMEMBERMENT; BROKERAGE IN THE FIELD OF INSURANCE, OSHA SAFETY COMPLIANCE, WORKERS COMPENSATION COST REDUCTION SERVICES, INSURANCE AUDIT DISPUTE SERVICES; CONSULTING AND INFORMATION CONCERNING INSURANCE; CONSULTING SERVICES IN THE FIELD OF STATE AND FEDERAL EMPLOYEE BENEFIT PLANS CONCERNING INSURANCE AND FINANCE; DESIGN AND DEVELOPMENT OF INSURANCE POLICIES FOR OTHERS; ELECTRONIC PROCESSING OF INSURANCE CLAIMS AND PAYMENT DATA; FINANCIAL CONSULTANCY AND INSURANCE CONSULTANCY; FINANCIAL EVALUATION FOR INSURANCE PURPOSES; FINANCIAL SERVICES, NAMELY, ISSUANCE AND MANAGEMENT OF CERTIFICATES BACKED BY LOAN PORTFOLIOS WHICH ARE SUBSEQUENTLY MANAGED TO INSURE THE INTEGRITY OF THE CERTIFICATES; INSURANCE ADMINISTRATION; INSURANCE ADMINISTRATION IN THE FIELD OF COMMERCIAL PROPERTY AND CASUALTY AND PERSONAL LINES AND BENEFITS; INSURANCE ADMINISTRATION SERVICES, NAMELY, ASSISTING OTHERS WITH COLLECTING INSURANCE PREMIUMS; INSURANCE AGENCIES; INSURANCE AGENCIES IN THE FIELD OF COMMERCIAL PROPERTY AND CASUALTY AND PERSONAL LINES AND BENEFITS; INSURANCE AGENCY AND BROKERAGE; INSURANCE AND FINANCIAL INFORMATION AND CONSULTANCY SERVICES; INSURANCE BROKERAGE; INSURANCE BROKERAGE IN THE FIELD OF COMMERCIAL PROPERTY AND CASUALTY AND PERSONAL LINES AND BENEFITS; INSURANCE BROKERAGE SERVICES; INSURANCE CONSULTANCY; INSURANCE CONSULTANCY SERVICES, NAMELY, PROVIDING ADVICE IN THE FIELD OF PROPERTY AND CASUALTY INSURANCE; INSURANCE CONSULTING IN THE FIELD OF COMMERCIAL PROPERTY AND CASUALTY AND PERSONAL LINES AND BENEFITS; INSURANCE INFORMATION; INSURANCE INFORMATION AND CONSULTANCY; INSURANCE PREMIUM RATE COMPUTING; INSURANCE SERVICES IN THE NATURE OF LOSS CONTROL MANAGEMENT FOR OTHERS; INSURANCE SERVICES, NAMELY, INSURANCE ELIGIBILITY REVIEW AND VERIFICATION AND CONSULTATION IN THE COMMERCIAL PROPERTY AND CASUALTY AND PERSONAL LINES AND BENEFITS AND CAPTIVE



David J. Kyjars

Director of the United States Patent and Trademark Office

Reg. No. 4,204,500 INSURANCE PROGRAMS INDUSTRY; INSURANCE SERVICES, NAMELY, UNDERWRITING COMMERCIAL PROPERTY AND CASUALTY AND PERSONAL LINES INSURANCE; INSURANCE SERVICES, NAMELY, WRITING PROPERTY AND CASUALTY INSURANCE; INSURANCE SERVICES, NAMELY, PROVIDING PREMIUM RATE QUOTES VIA ON-LINE, TELEPHONE AND MAIL MEANS; INSURANCE UNDERWRITING CONSULTATION; INSURANCE UNDERWRITING IN THE FIELD OF COMMERCIAL PROPERTY AND CASUALTY AND PERSONAL LINES; INSURANCE UNDERWRITING SERVICES FOR ALL TYPES OF INSURANCE; LIFE INSURANCE BROKERAGE; MARINE INSURANCE UNDERWRITING; MEDICAL INSURANCE UNDERWRITING; PROCESSING, ADMINISTERING AND MANAGING EMPLOYEE BENEFIT PLANS CONCERNING INSURANCE AND FINANCE; PROVIDING A WEBSITE FEATURING EDUCATIONAL INFORMATION IN THE FIELD OF BUSINESS INSURANCE; PROVIDING DETAILED INFORMATION REGARDING AVAILABLE INSURANCE PRODUCTS FOR COMMERCIAL PROPERTY AND CASUALTY, PROFESSIONAL AND PERSONAL LINES; PROVIDING INFORMATION IN INSURANCE MATTERS; PROVIDING INFORMATION REGARDING POLICY RATES FOR ALL TYPES OF INSURANCE AND ELECTRONIC PROCESSING OF INSURANCE CLAIMS AND PAYMENT DATA OVER A WEB BASED COMPUTER NETWORK; PROVIDING INFORMATION REGARDING WORKERS' COMPENSATION INSURANCE POLICY RATES; PROVIDING VEHICLE INSURANCE RATE QUOTES, IN CLASS 36 (U.S. CLS. 100, 101 AND 102).

FIRST USE 2-11-2011; IN COMMERCE 6-13-2011.

NO CLAIM IS MADE TO THE EXCLUSIVE RIGHT TO USE "INSOURCE", APART FROM THE MARK AS SHOWN.

THE COLOR(S) BLUE AND GREEN AND WHITE IS/ARE CLAIMED AS A FEATURE OF THE MARK.

THE MARK CONSISTS OF TWO CONNECTED CIRCLES, ONE GREEN AND THE OTHER BLUE AND GREEN, WITH A LIGHT GREEN AND WHITE BACKGROUND THAT IS FOLLOWED TO THE RIGHT BY THE WORDS "INSOURCE HELP". THE WORD "INSOURCE" IS IN THE COLOR BLUE AND THE WORD "HELP" IS IN THE COLOR GREEN.

SER. NO. 85-346,194, FILED 6-14-2011.

HOWARD FRIEDMAN, EXAMINING ATTORNEY

United States of America

United States Patent and Trademark Office



Reg. No. 4,204,501

Registered Sep. 11, 2012

Int. Cl.: 9

TRADEMARK

PRINCIPAL REGISTER

GXL TECHNOLOGIES LIMITED (UNITED KINGDOM LIMITED LIABILITY COMPANY)
2 LANGDON COURT, CITY ROAD
LONDON, ENGLAND, UNITED KINGDOM

FOR: COMPUTERS; ELECTRICAL TRANSDUCER; ELECTRONIC CHIPS FOR THE MANUFACTURER OF INTEGRATED CIRCUITS; INTEGRATED CIRCUIT CARDS AND COMPONENTS; INTEGRATED CIRCUIT MODULE; INTEGRATED CIRCUIT MODULES; MICROWAVE ANTENNAE; MICROWAVE TRANSMISSION APPARATUS FOR DELIVERING RADIO PROGRAMS AND MESSAGES; OSCILLATORS; PORTABLE TELEPHONES; SEMICONDUCTOR DEVICES; TRANSMITTERS OF ELECTRONIC SIGNALS, IN CLASS 9 (U.S. CLS. 21, 23, 26, 36 AND 38).

FIRST USE 12-5-2006; IN COMMERCE 8-9-2010.

NO CLAIM IS MADE TO THE EXCLUSIVE RIGHT TO USE "TECHNOLOGIES", APART FROM THE MARK AS SHOWN.

THE MARK CONSISTS OF THE LETTERS "GXL" WITH A STAR IN THE "G" AND "TECHNOLOGIES".

SER. NO. 85-346,404, FILED 6-15-2011.

JULIE VEPPUMTHARA, EXAMINING ATTORNEY



David J. Kyffers

Director of the United States Patent and Trademark Office

United States of America

United States Patent and Trademark Office

Querida

Reg. No. 4,204,502

Registered Sep. 11, 2012

Int. Cl.: 3

TRADEMARK

PRINCIPAL REGISTER

LAURENCE C RAINES (UNITED STATES INDIVIDUAL)
441 VASSAR AVE
BERKELEY, CA 94708

FOR: COLOGNES, PERFUMES AND COSMETICS; COSMETICS IN GENERAL, INCLUDING PERFUMES; DISINFECTING PERFUMED SOAPS; EAU DE PERFUME; ESSENTIAL OILS AS PERFUME FOR LAUNDRY PURPOSES; LIQUID PERFUMES; OILS FOR PERFUMES AND SCENTS; PERFUME; PERFUME OILS; PERFUME OILS FOR THE MANUFACTURE OF COSMETIC PREPARATIONS; PERFUMED CREAMS; PERFUMED EXTRACTS FOR TISSUES AND PERFUMES; PERFUMED PASTE; PERFUMED POWDER; PERFUMED POWDERS; PERFUMED SOAP; PERFUMED SOAPS; PERFUMED TALCUM POWDER; PERFUMES; PERFUMES AND COLOGNES; PERFUMES AND TOILET WATERS; PERFUMES IN SOLID FORM; PERFUMES, AFTERSHAVES AND COLOGNES; PERFUMES, EAU DE COLOGNES AND AFTERSHAVES; PERFUMES, EAUX DE COLOGNE AND AFTERSHAVES; PERFUMING SACHETS; SACHETS FOR PERFUMING LINEN, IN CLASS 3 (U.S. CLS. 1, 4, 6, 50, 51 AND 52).

FIRST USE 12-7-2010; IN COMMERCE 6-1-2011.

THE MARK CONSISTS OF STANDARD CHARACTERS WITHOUT CLAIM TO ANY PARTICULAR FONT, STYLE, SIZE, OR COLOR.

OWNER OF U.S. REG. NO. 3,887,785.

THE ENGLISH TRANSLATION OF "QUERIDA" IN THE MARK IS BELOVED, DEAR, AND SWEETHEART.

SER. NO. 85-347,295, FILED 6-15-2011.

DARRYL SPRUILL, EXAMINING ATTORNEY



David J. Kypos

Director of the United States Patent and Trademark Office

United States of America

United States Patent and Trademark Office



Reg. No. 4,204,503

Registered Sep. 11, 2012

Int. Cl.: 41

SERVICE MARK

PRINCIPAL REGISTER

FIRST BAPTIST CHURCH MILLINGTON (TENNESSEE CORPORATION)
5010 WEST UNION RD
MILLINGTON, TN 38053

FOR: A CHRISTIAN BASED SUMMER CAMP FOR STUDENTS IN THE 6 - 12 GRADE COMBINING MISSION OPPORTUNITIES, RECREATION AND WORSHIP, IN CLASS 41 (U.S. CLS. 100, 101 AND 107).

FIRST USE 6-15-2011; IN COMMERCE 6-15-2011.

THE MARK CONSISTS OF STYLIZED WORDING "MERGE" IN BOLD SILVER PRINT OUTLINED IN BLACK WITH A BLACK ROAD WITH YELLOW AND WHITE LINES AND A GRAY CURB LEADING TO THE WORD "MERGE" AND THE BLACK WORDS "WHERE CAMP AND MISSIONS MEET" ABOVE THE WORD "MERGE" WITH GRAY TIRE TRACKS, YELLOW ROAD LINES, AND GRAY PICTURES OF STUDENTS DOING SPORTS AND MISSIONS IN GRAY BEHIND THE WORD "MERGE", ALL ON A SILVER RECTANGULAR BACKGROUND.

THE COLOR(S) SILVER, BLACK, YELLOW, WHITE AND GRAY IS/ARE CLAIMED AS A FEATURE OF THE MARK.

SER. NO. 85-347,775, FILED 6-16-2011.

NICHOLAS COLEMAN, EXAMINING ATTORNEY



David J. Kybas

Director of the United States Patent and Trademark Office

United States of America

United States Patent and Trademark Office



Reg. No. 4,204,504

Registered Sep. 11, 2012

Int. Cl.: 24

TRADEMARK

PRINCIPAL REGISTER

TISKIEWIC, HANA (CZECH REPUBLIC INDIVIDUAL)
6719 6TH STREET WEST
BRADENTON, FL 34207

FOR: CHILDREN'S BLANKETS; PILLOW CASES; PILLOW COVERS; THROWS DESIGNED TO ALSO BE WRAPPED AROUND A PERSON; TOWELS THAT MAY BE WORN AS A DRESS OR SIMILAR GARMENT; TRAVELLING BLANKETS, IN CLASS 24 (U.S. CLS. 42 AND 50).

FIRST USE 1-20-2010; IN COMMERCE 3-10-2010.

NO CLAIM IS MADE TO THE EXCLUSIVE RIGHT TO USE "TOWEL", APART FROM THE MARK AS SHOWN.

THE COLOR(S) WHITE, BLUE, AND AQUA IS/ARE CLAIMED AS A FEATURE OF THE MARK.

THE MARK CONSISTS OF A RECTANGLE HAVING VARIOUS SHADES OF BLUE AND AQUA, WITH DARKER SHADES OF COLOR IN THE LOWER HALF OF THE RECTANGLE AND THE WORDS "DOODLE TOWEL" IN WHITE LETTERING ALSO IN THE LOWER HALF.

SER. NO. 85-348,404, FILED 6-16-2011.

KRISTINA MORRIS, EXAMINING ATTORNEY



David J. Kybas

Director of the United States Patent and Trademark Office

United States of America

United States Patent and Trademark Office



Reg. No. 4,204,505

Registered Sep. 11, 2012

Int. Cl.: 30

TRADEMARK

PRINCIPAL REGISTER

HANGZHOU WELLONG FOOD CO., LTD. (CHINA LIMITED LIABILITY COMPANY)
JINGYI VILLAGE
GUALI TOWN, XIAOSHAN DISTRICT
HANGZHOU, ZHEJIANG, CHINA

FOR: BISCUITS; CEREAL BASED SNACK FOOD; COFFEE AND TEA; EDIBLE FLOUR;
MACARONI; NOODLES; POWDERED STARCH SYRUP; RICE FLOUR; RICE PUDDING;
SPAGHETTI; SUGAR; WHEAT FLOUR, IN CLASS 30 (U.S. CL. 46).

FIRST USE 6-17-2009; IN COMMERCE 6-17-2009.

NO CLAIM IS MADE TO THE EXCLUSIVE RIGHT TO USE THE NON-LATIN CHARACTERS
THAT TRANSLITERATE TO "MAI", APART FROM THE MARK AS SHOWN.

THE NON-LATIN CHARACTERS IN THE MARK TRANSLITERATE TO MAI XIANG CUN
AND THIS MEANS WHEAT FRAGRANT VILLAGE IN ENGLISH.

THE MARK CONSISTS OF STYLIZED CHINESE CHARACTERS WHICH ARE IN AN IRREG-
ULAR RECTANGLE.

THE ENGLISH TRANSLATION OF "MAI XIANG CUN" IN THE MARK IS "WHEAT FRA-
GRANT VILLAGE".

SER. NO. 85-348,658, FILED 6-17-2011.

LYDIA BELZER, EXAMINING ATTORNEY



David J. Kyjars

Director of the United States Patent and Trademark Office

United States of America

United States Patent and Trademark Office



Reg. No. 4,204,506

Registered Sep. 11, 2012

Int. Cl.: 30

TRADEMARK

PRINCIPAL REGISTER

HANGZHOU WELLONG FOOD CO., LTD. (CHINA LIMITED LIABILITY COMPANY)
JINGYI VILLAGE
GUALI TOWN, XIAOSHAN DISTRICT
HANGZHOU, ZHEJIANG, CHINA

FOR: BISCUITS; CEREAL BASED SNACK FOOD; COFFEE AND TEA; EDIBLE FLOUR;
MACARONI; NOODLES; POWDERED STARCH SYRUP; RICE FLOUR; RICE PUDDING;
SPAGHETTI; SUGAR; WHEAT FLOUR, IN CLASS 30 (U.S. CL. 46).

FIRST USE 6-10-2009; IN COMMERCE 6-10-2009.

NO CLAIM IS MADE TO THE EXCLUSIVE RIGHT TO USE "WHEAT" OR THE NON-LATIN CHARACTERS THAT TRANSLITERATE TO "MAI", APART FROM THE MARK AS SHOWN.

THE NON-LATIN CHARACTERS IN THE MARK TRANSLITERATE TO MAI TIAN CUN AND THIS MEANS WHEAT FIELD VILLAGE IN ENGLISH.

THE MARK CONSISTS OF TWO ENGLISH WORDS "WHEAT VILLAGE" IN THE LEFT WHICH IS SURROUNDED INCOMPLETELY BY DISCONTINUOUS LINES AND THREE CHINESE CHARACTERS IN THE RIGHT WHICH IS SURROUNDED INCOMPLETELY BY TWO WAVED LINES.

THE ENGLISH TRANSLATION OF "MAI TIAN CUN" IN THE MARK IS "WHEAT FIELD VILLAGE".

SER. NO. 85-348,667, FILED 6-17-2011.

LYDIA BELZER, EXAMINING ATTORNEY



David J. Kybas

Director of the United States Patent and Trademark Office

United States of America

United States Patent and Trademark Office

PEACE WARE

Reg. No. 4,204,507

PEACE REHABILITATION CENTER (NEPAL CORPORATION)
232 CLIFTON AVENUE, SUITE 5
MINNEAPOLIS, MN 55403

Registered Sep. 11, 2012

Int. Cl.: 14

FOR: JEWELRY, IN CLASS 14 (U.S. CLS. 2, 27, 28 AND 50).

TRADEMARK

FIRST USE 12-14-2010; IN COMMERCE 12-14-2010.

PRINCIPAL REGISTER

THE MARK CONSISTS OF STANDARD CHARACTERS WITHOUT CLAIM TO ANY PARTICULAR FONT, STYLE, SIZE, OR COLOR.

NO CLAIM IS MADE TO THE EXCLUSIVE RIGHT TO USE "WARE", APART FROM THE MARK AS SHOWN.

SER. NO. 85-349,128, FILED 6-17-2011.

NELSON SNYDER, EXAMINING ATTORNEY



David J. Kyffers

Director of the United States Patent and Trademark Office

United States of America

United States Patent and Trademark Office

MANAGED MOMS.COM

Reg. No. 4,204,508

Registered Sep. 11, 2012

Int. Cl.: 45

SERVICE MARK

PRINCIPAL REGISTER

MANIC MANAGED MOM, LLC (ARIZONA LIMITED LIABILITY COMPANY)
1334 E. CHANDLER BLVD
PMB A-31, SUITE 5
PHOENIX, AZ 85048

FOR: PROVIDING A WEBSITE FEATURING INFORMATION IN THE FIELD OF IDEAS FOR MANAGING DAILY LIFE, NAMELY, PERSONAL SCHEDULING AND ORGANIZATION OF DAILY TASKS, OBLIGATIONS AND DUTIES, IN CLASS 45 (U.S. CLS. 100 AND 101).

FIRST USE 3-1-2011; IN COMMERCE 3-1-2011.

THE MARK CONSISTS OF STANDARD CHARACTERS WITHOUT CLAIM TO ANY PARTICULAR FONT, STYLE, SIZE, OR COLOR.

NO CLAIM IS MADE TO THE EXCLUSIVE RIGHT TO USE "MANAGED", APART FROM THE MARK AS SHOWN.

SER. NO. 85-349,591, FILED 6-17-2011.

BRENDAN REGAN, EXAMINING ATTORNEY



David J. Kyffers

Director of the United States Patent and Trademark Office

United States of America

United States Patent and Trademark Office

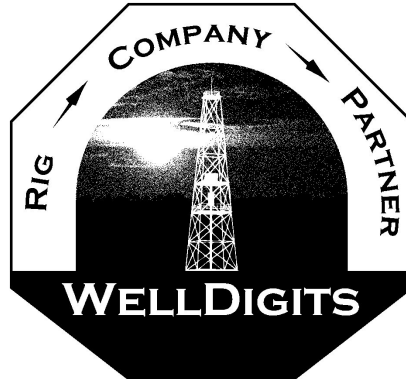

Reg. No. 4,204,509

Registered Sep. 11, 2012

Int. Cl.: 9

TRADEMARK

PRINCIPAL REGISTER

DIGITAL WELL FILE (TEXAS CORPORATION)
2042 CROSSING NEXUS
KATY, TX 77450

FOR: DATABASE MANAGEMENT SOFTWARE FOR THE OIL INDUSTRY USING SECURE WEB BASED TECHNOLOGY TO UPLOAD DATA FILES FROM CONTRACTORS DURING THE DRILLING PROCESS INTO A DATABASE, WHERE THE OIL COMPANY CAN VIEW, EDIT, DOWNLOAD AND SHARE SELECTED FILES WITH PARTNER COMPANIES, IN CLASS 9 (U.S. CLS. 21, 23, 26, 36 AND 38).

FIRST USE 6-1-2011; IN COMMERCE 6-1-2011.

NO CLAIM IS MADE TO THE EXCLUSIVE RIGHT TO USE "RIG" AND "COMPANY" AND "PARTNER", APART FROM THE MARK AS SHOWN.

THE MARK CONSISTS OF THE STYLIZED WORDS "WELLDIGITS RIG COMPANY PARTNER" ALL WITHIN AN HEXAGON. THE WORDS "RIG", "COMPANY" AND "PARTNER" ARE SEPARATED BY ARROWS. AN IMAGE OF A WELL RIG IS IN THE CENTER OF THE HEXAGON.

SER. NO. 85-350,894, FILED 6-20-2011.

LAKEISHA LEWIS, EXAMINING ATTORNEY



David J. Kyffers

Director of the United States Patent and Trademark Office

United States of America

United States Patent and Trademark Office

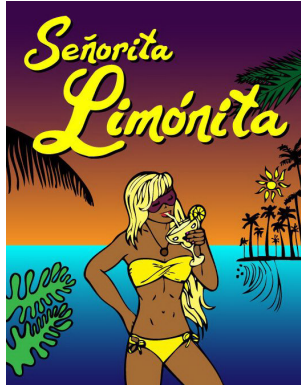

Reg. No. 4,204,510

Registered Sep. 11, 2012

Int. Cl.: 33

TRADEMARK

PRINCIPAL REGISTER

ICREBIT MARKETING, INC. (ARIZONA CORPORATION)
POST OFFICE BOX 27484
SCOTTSDALE, AZ 85255

FOR: MARGARITA MIX, IN CLASS 33 (U.S. CLS. 47 AND 49).

FIRST USE 5-24-2011; IN COMMERCE 6-20-2011.

THE NAME "SEÑORITA LIMÓNITA" DOES NOT IDENTIFY A LIVING INDIVIDUAL.

THE COLOR(S) YELLOW, TAN, PURPLE, ORANGE, BLACK, GREEN, AND BLUE IS/ARE CLAIMED AS A FEATURE OF THE MARK.

THE MARK CONSISTS OF THE STYLIZED WORDING "SEÑORITA LIMÓNITA" IN THE COLOR YELLOW. BELOW THE WORDING IS THE DESIGN OF A TAN WOMAN WEARING A YELLOW BIKINI. THE WOMAN HAS YELLOW HAIR AND IS WEARING PURPLE SUNGLASSES. IN HER HAND SHE IS HOLDING A YELLOW DRINK. THE BACKGROUND CONSISTS OF A PURPLE AND ORANGE SKY, BLUE WATER, A YELLOW SUN OUTLINED IN BLACK, THE BLACK SILHOUETTES OF SEVERAL PALM TREES, GREEN PALM FRONDS AND PLANT LEAVES, AND THE BLACK SILHOUETTE OF A PALM FROND.

SER. NO. 85-351,068, FILED S.R. 6-20-2011 AM. P.R. 4-19-2012.

BARBARA GAYNOR, EXAMINING ATTORNEY



David J. Kyffers

Director of the United States Patent and Trademark Office

United States of America

United States Patent and Trademark Office

B I G M O U T H

Reg. No. 4,204,511

Registered Sep. 11, 2012

Int. Cl.: 35

SERVICE MARK

PRINCIPAL REGISTER

BIGMOUTH LLC (CALIFORNIA LIMITED LIABILITY COMPANY)
FL 6
244 KEARNY STREET
SAN FRANCISCO, CA 94108

FOR: ADVERTISING AND BRANDING CONSULTANCY, NAMELY, CONDUCTING BUSINESS RESEARCH AND BUSINESS STRATEGY DEVELOPMENT TO DEFINE AND GROW BRANDS OF OTHERS , IN CLASS 35 (U.S. CLS. 100, 101 AND 102).

FIRST USE 10-1-1994; IN COMMERCE 5-1-1999.

THE MARK CONSISTS OF STANDARD CHARACTERS WITHOUT CLAIM TO ANY PARTICULAR FONT, STYLE, SIZE, OR COLOR.

SER. NO. 85-351,210, FILED 6-21-2011.

LEIGH LOWRY, EXAMINING ATTORNEY



David J. Kybas

Director of the United States Patent and Trademark Office

United States of America

United States Patent and Trademark Office

MDG

Reg. No. 4,204,512

Registered Sep. 11, 2012

Int. Cl.: 35

SERVICE MARK

PRINCIPAL REGISTER

MDG, INC. (MASSACHUSETTS CORPORATION)
13 WATER STREET
HOLLISTON, MA 01746

FOR: BRANDING SERVICES, NAMELY, CONSULTING, DEVELOPMENT, MANAGEMENT AND MARKETING OF CONSUMER BRANDS FOR BUSINESSES, OTHER THAN IN THE FIELD OF MEDICINE OR PROVIDED TO MEDICAL SERVICE PROVIDERS OR MEDICAL PRODUCT MANUFACTURERS, IN CLASS 35 (U.S. CLS. 100, 101 AND 102).

FIRST USE 6-23-2004; IN COMMERCE 12-31-2004.

THE MARK CONSISTS OF STANDARD CHARACTERS WITHOUT CLAIM TO ANY PARTICULAR FONT, STYLE, SIZE, OR COLOR.

SER. NO. 85-351,290, FILED 6-21-2011.

RON FAIRBANKS, EXAMINING ATTORNEY



David J. Kyffers

Director of the United States Patent and Trademark Office

United States of America

United States Patent and Trademark Office



Reg. No. 4,204,513

NATIONWIDE SECURITY SOLUTIONS (OREGON CORPORATION)
7200 NE 41ST STREET, SUITE 101
VANCOUVER, WA 98662

Registered Sep. 11, 2012

Int. Cl.: 37

FOR: INSTALLATION AND MAINTENANCE OF BURGLAR AND/OR FIRE ALARMS; INSTALLATION OF SECURITY SYSTEM, IN CLASS 37 (U.S. CLS. 100, 103 AND 106).

SERVICE MARK

FIRST USE 5-0-2006; IN COMMERCE 5-0-2006.

PRINCIPAL REGISTER

NO CLAIM IS MADE TO THE EXCLUSIVE RIGHT TO USE "SECURITY SOLUTIONS", APART FROM THE MARK AS SHOWN.

THE COLOR(S) BLACK AND BLUE IS/ARE CLAIMED AS A FEATURE OF THE MARK.

THE MARK CONSISTS OF THE WORDS "NATIONWIDE SECURITY SOLUTIONS" IN A STYLIZED FONT. THE "N" IN "NATIONWIDE" IS IN THE LARGEST FONT AND IS STYLIZED WITH POINTED ARROWS IN A NORTHERLY DIRECTION. "NATIONWIDE" IS IN A BLACK FONT AND "SECURITY SOLUTIONS" IS A BLACK FONT UNDERNEATH THE WORD "NATIONWIDE". IN THE BACKGROUND BEHIND THE LARGE STYLIZED "N" IS A CIRCULAR MAP WITH THE COLOR BLUE. WHITE IS PRESENTED IN THE BACKGROUND OF THE MARK AND IS NOT CLAIMED AS PART OF THE TRADEMARK.

SEC. 2(F) AS TO "NATIONWIDE SECURITY SOLUTIONS".

SER. NO. 85-351,667, FILED 6-21-2011.

ANGELA DUONG, EXAMINING ATTORNEY



David J. Kyffers

Director of the United States Patent and Trademark Office

United States of America

United States Patent and Trademark Office

DACTEK

Reg. No. 4,204,514

Registered Sep. 11, 2012

Int. Cl.: 16

TRADEMARK

PRINCIPAL REGISTER

DACTEK INTERNATIONAL CORPORATION (CALIFORNIA CORPORATION)
17150 NEW HOPE STREET, SUITE 301
FOUNTAIN VALLEY, CA 92708

FOR: INKLESS FINGER PRINTING INK; INKLESS PAD RECHARGING SOLUTION FOR FINGERPRINT PAD; FINGERPRINTING INK; FINGERPRINTING INK PADS; FINGERPRINT CARDS; INKLESS AND INK-BASED FINGER PRINTING KITS FOR OBTAINING FINGERPRINTS, FOOTPRINTS, PALM PRINTS, AND PET PAW PRINTS, COMPRISING OF CARD-HOLDER FOR HOLDING FINGERPRINT CARD, FINGERPRINT CARD, FINGERPRINT PAD, PAD SOLUTION FOR FINGERPRINT PAD AND CLEANSING TOWELETTES, IN CLASS 16 (U.S. CLS. 2, 5, 22, 23, 29, 37, 38 AND 50).

FIRST USE 3-1-1977; IN COMMERCE 3-1-1977.

THE MARK CONSISTS OF STANDARD CHARACTERS WITHOUT CLAIM TO ANY PARTICULAR FONT, STYLE, SIZE, OR COLOR.

OWNER OF U.S. REG. NO. 2,969,310.

SER. NO. 85-351,752, FILED 6-21-2011.

BRENDAN MCCAULEY, EXAMINING ATTORNEY



David J. Kyffers

Director of the United States Patent and Trademark Office

United States of America

United States Patent and Trademark Office

ARROWEYE

Reg. No. 4,204,515

Registered Sep. 11, 2012

**Int. Cls.: 35, 36, 39, 40
and 42**

SERVICE MARK

PRINCIPAL REGISTER

ARROWEYE SOLUTIONS, INC. (DELAWARE CORPORATION)
SUITE 200 549 WEST RANDOLPH STREET
CHICAGO, IL 60661

FOR: MARKETING FOR OTHERS OF GREETING CARDS, CARRIERS AND FINANCIAL TRANSACTION CARDS, NAMELY, CUSTOMIZED PLASTIC GIFT, INCENTIVE AND PAYMENT CARDS, PREPAID AND STORED VALUE CARD, CREDIT AND DEBIT CARDS, AND REWARD CARD; ON-LINE ART GALLERIES, IN CLASS 35 (U.S. CLS. 100, 101 AND 102).

FIRST USE 6-0-2007; IN COMMERCE 6-0-2007.

FOR: ADMINISTERING WEB BASED FINANCIAL TRANSACTIONS CARD PROGRAMS, NAMELY, PROVIDING SECURE COMMERCIAL TRANSACTIONS AND PAYMENT OPTIONS, IN CLASS 36 (U.S. CLS. 100, 101 AND 102).

FIRST USE 6-0-2007; IN COMMERCE 6-0-2007.

FOR: PROVIDING WEBSITES FOR THE ELECTRONIC STORAGE OF CARD DESIGNS AND IMAGES FOR OTHERS, IN CLASS 39 (U.S. CLS. 100 AND 105).

FIRST USE 6-0-2007; IN COMMERCE 6-0-2007.

FOR: PERSONALIZED GIFTING SOLUTIONS FOR OTHERS, NAMELY, CREATION AND ON-DEMAND PRINTING OF CUSTOMIZED MATERIALS, INCLUDING GREETING CARDS, VALUE ADDED CARDS, ADVERTISEMENTS AND CATALOGS; PRODUCTION AND MANUFACTURING SERVICES FOR OTHERS OF GREETING CARDS, CARRIERS AND FINANCIAL TRANSACTION CARDS, NAMELY, CUSTOMIZED PLASTIC GIFT, INCENTIVE AND PAYMENT CARDS, PREPAID AND STORED VALUE CARD, CREDIT AND DEBIT CARDS, AND REWARD CARDS, IN CLASS 40 (U.S. CLS. 100, 103 AND 106).

FIRST USE 6-0-2007; IN COMMERCE 6-0-2007.

FOR: TEMPORARY USE OF ON-LINE, NON-DOWNLOADABLE COMPUTER SOFTWARE FOR USE IN CREATING, PERSONALIZING AND MANAGING GREETING CARDS, GIFT CARDS, AND FINANCIAL TRANSACTIONS CARDS, CARD DESIGNS, CARD PROGRAMS, AND CUSTOM CARD TEMPLATES; ADMINISTERING WEB BASED DESIGN SERVICES



David J. Kyjars

Director of the United States Patent and Trademark Office

Reg. No. 4,204,515 FOR OTHERS, NAMELY, SERVICES FOR THE CREATION OF GREETING CARD AND GIFT CARDS; PROVIDING A WEBSITE THAT GIVES USERS THE ABILITY TO REVIEW VARIOUS PRINT, PHOTOGRAPHIC, GRAPHIC IMAGE, AND AUDIO AND VIDEO CONTENT AND UTILIZE A CUSTOM TEMPLATES IN THE CREATION OF GREETING CARDS AND GIFT CARDS, IN CLASS 42 (U.S. CLS. 100 AND 101).

FIRST USE 6-0-2007; IN COMMERCE 6-0-2007.

THE MARK CONSISTS OF STANDARD CHARACTERS WITHOUT CLAIM TO ANY PARTICULAR FONT, STYLE, SIZE, OR COLOR.

SER. NO. 85-351,785, FILED 6-21-2011.

RONALD AIKENS, EXAMINING ATTORNEY

United States of America

United States Patent and Trademark Office

ALLPACK FULFILLMENT

Reg. No. 4,204,516

Registered Sep. 11, 2012

Int. Cl.: 35

SERVICE MARK

PRINCIPAL REGISTER

ALLPACK ASSEMBLY, INC. (NORTH CAROLINA CORPORATION), DBA ALLPACK
FULFILLMENT
1604 EAST LAWSON STREET
DURHAM, NC 27703

FOR: PROVIDING ORDER FULFILLMENT; PROVIDING ORDER MANAGEMENT, NAMELY,
ELECTRONIC PROCESSING OF ORDERS FOR OTHERS; INVENTORY MANAGEMENT ,
IN CLASS 35 (U.S. CLS. 100, 101 AND 102).

FIRST USE 9-15-2008; IN COMMERCE 9-15-2008.

THE MARK CONSISTS OF STANDARD CHARACTERS WITHOUT CLAIM TO ANY PAR-
TICULAR FONT, STYLE, SIZE, OR COLOR.

NO CLAIM IS MADE TO THE EXCLUSIVE RIGHT TO USE "FULFILLMENT", APART FROM
THE MARK AS SHOWN.

SER. NO. 85-352,020, FILED 6-21-2011.

JENNIFER WILLISTON, EXAMINING ATTORNEY



David J. Kyffers

Director of the United States Patent and Trademark Office

United States of America

United States Patent and Trademark Office



Reg. No. 4,204,517

ALLPACK ASSEMBLY, INC. (NORTH CAROLINA CORPORATION), DBA ALLPACK
1604 EAST LAWSON STREET
DURHAM, NC 27703

Registered Sep. 11, 2012

Int. Cl.: 35

FOR: PROVIDING ORDER FULFILLMENT; PROVIDING ORDER MANAGEMENT, NAMELY, ELECTRONIC PROCESSING OF ORDERS FOR OTHERS; INVENTORY MANAGEMENT , IN CLASS 35 (U.S. CLS. 100, 101 AND 102).

SERVICE MARK

FIRST USE 3-2-2005; IN COMMERCE 3-2-2005.

PRINCIPAL REGISTER

THE MARK CONSISTS OF THE WRITTEN UNDERLINED TEXT "ALLPACK" PLUS THE DESIGN OF A PACKAGE/BOX CONTAINING THE IMAGE OF AN ALPACA.

SER. NO. 85-352,071, FILED 6-21-2011.

JENNIFER WILLISTON, EXAMINING ATTORNEY



David J. Kybas

Director of the United States Patent and Trademark Office

United States of America

United States Patent and Trademark Office



Reg. No. 4,204,518

Registered Sep. 11, 2012

Int. Cl.: 41

SERVICE MARK

PRINCIPAL REGISTER

JAX PHOTOGRAPHY (MARYLAND LIMITED LIABILITY COMPANY)
4019 17TH STREET
CHESAPEAKE BEACH, MD 20732

FOR: WEDDING PHOTOGRAPHY SERVICES, IN CLASS 41 (U.S. CLS. 100, 101 AND 107).

FIRST USE 0-0-2000; IN COMMERCE 0-0-2000.

NO CLAIM IS MADE TO THE EXCLUSIVE RIGHT TO USE "PHOTOGRAPHY", APART FROM THE MARK AS SHOWN.

THE MARK CONSISTS OF THE WORDING "JAX PHOTOGRAPHY", USING SCRIPT LETTERS FOR THE WORD "JAX", AND UPPERCASE LETTERS WITH A STROKE ABOVE AND BELOW FOR THE WORD "PHOTOGRAPHY".

SER. NO. 85-352,603, FILED 6-22-2011.

SARA BENJAMIN, EXAMINING ATTORNEY



David J. Kybas

Director of the United States Patent and Trademark Office

United States of America

United States Patent and Trademark Office

Pimp My Kicks

Reg. No. 4,204,519

C.O.O.L. LLC (OHIO LIMITED LIABILITY COMPANY), DBA PIMP MY KICKS
5474 OMEGA AVENUE

Registered Sep. 11, 2012

BEDFORD HEIGHTS, OH 44146

Int. Cl.: 42

FOR: CUSTOM DESIGN OF SNEAKER AND SHIRTS BASED ON PERSONAL SELECTIONS
MADE BY THE CUSTOMER, IN CLASS 42 (U.S. CLS. 100 AND 101).

SERVICE MARK

FIRST USE 6-1-2004; IN COMMERCE 6-1-2004.

PRINCIPAL REGISTER

THE MARK CONSISTS OF STANDARD CHARACTERS WITHOUT CLAIM TO ANY PAR-
TICULAR FONT, STYLE, SIZE, OR COLOR.

NO CLAIM IS MADE TO THE EXCLUSIVE RIGHT TO USE "KICKS", APART FROM THE
MARK AS SHOWN.

SER. NO. 85-352,808, FILED 6-22-2011.

SEAN CROWLEY, EXAMINING ATTORNEY



David J. Kyffers

Director of the United States Patent and Trademark Office

United States of America

United States Patent and Trademark Office



Reg. No. 4,204,520

KLAYMAN, JAMES S. (UNITED STATES INDIVIDUAL)

Registered Sep. 11, 2012

P.O. BOX 172
HEWLETT, NY 11557

Int. Cl.: 43

FOR: FOOD PREPARATION SERVICES IN RESTAURANTS, TRUCKS, KIOSKS, CARTS, WAGONS, BOATS, AIRPLANES, TRAILERS, BICYCLES, AND MOTORCYCLES, NAMELY, PREPARING CHEESE FOODS AND FOOD PRODUCTS, IN CLASS 43 (U.S. CLS. 100 AND 101).

SERVICE MARK

PRINCIPAL REGISTER

FIRST USE 11-4-2010; IN COMMERCE 11-4-2010.

NO CLAIM IS MADE TO THE EXCLUSIVE RIGHT TO USE "CHEESE", APART FROM THE MARK AS SHOWN.

THE STIPLING IS FOR SHADING PURPOSES ONLY.

THE MARK CONSISTS OF A GORILLA HOLDING A BUILDING AND A GRILLED CHEESE SANDWICH. ON THE TOP THERE IS THE STYLIZED TEXT "GORILLA CHEESE".

SER. NO. 85-353,300, FILED 6-22-2011.

SEAN CROWLEY, EXAMINING ATTORNEY



David J. Kybas

Director of the United States Patent and Trademark Office

United States of America

United States Patent and Trademark Office



Reg. No. 4,204,521

Registered Sep. 11, 2012

Int. Cl.: 43

SERVICE MARK

PRINCIPAL REGISTER

PURE CONCEPTS, LTD. (TEXAS LIMITED PARTNERSHIP)
6320 FM 1960 RD. E
HUMBLE, TX 77346

FOR: RESTAURANT AND CAFE SERVICES; CATERING SERVICES; RESTAURANT SERVICES FEATURING SANDWICHES; RESTAURANT SERVICES FEATURING NATURAL, ORGANIC FOODS; SERVING OF FOOD AND DRINKS, IN CLASS 43 (U.S. CLS. 100 AND 101).

FIRST USE 9-7-2010; IN COMMERCE 9-7-2010.

NO CLAIM IS MADE TO THE EXCLUSIVE RIGHT TO USE "HEALTHY EATERY", APART FROM THE MARK AS SHOWN.

THE COLOR(S) GREEN, BROWN AND WHITE IS/ARE CLAIMED AS A FEATURE OF THE MARK.

THE MARK CONSISTS OF A DESIGN FEATURING LEAVES AND A FORK IN GREEN OUTLINED IN WHITE, AND BELOW IS THE WORDING "PURE" IN BROWN AND "HEALTHY EATERY" IN GREEN.

SER. NO. 85-353,369, FILED 6-22-2011.

AMY KELLY, EXAMINING ATTORNEY



David J. Kybas

Director of the United States Patent and Trademark Office

United States of America

United States Patent and Trademark Office



Reg. No. 4,204,522

KIK POOL ADDITIVES INC. (CALIFORNIA CORPORATION)
5160 AIRPORT DRIVE
ONTARIO, CA 91761

Registered Sep. 11, 2012

Int. Cl.: 1

FOR: WATER TREATMENT CHEMICALS FOR USE IN SWIMMING POOLS AND SPAS, IN CLASS 1 (U.S. CLS. 1, 5, 6, 10, 26 AND 46).

TRADEMARK

FIRST USE 6-19-1998; IN COMMERCE 6-19-1998.

PRINCIPAL REGISTER

NO CLAIM IS MADE TO THE EXCLUSIVE RIGHT TO USE "SHOCK", APART FROM THE MARK AS SHOWN.

THE MARK CONSISTS OF THE OUTLINED WORDING "SHOCK QUICK" SURROUNDED BY AN OVAL DESIGN WITH ZIG-ZAG EDGES.

SER. NO. 85-353,573, FILED 6-22-2011.

MARGARET POWER, EXAMINING ATTORNEY



David J. Kybas

Director of the United States Patent and Trademark Office

United States of America

United States Patent and Trademark Office

TeaHealthy

Reg. No. 4,204,523

Registered Sep. 11, 2012

Int. Cl.: 30

TRADEMARK

PRINCIPAL REGISTER

HART INDUSTRIES, INC. (WASHINGTON CORPORATION)
10611 CANYON RD. E., UNIT 236
PUYALLUP, WA 98373

FOR: ARTIFICIAL COFFEE AND TEA; BEVERAGES MADE OF TEA; BEVERAGES WITH A TEA BASE; BLACK TEA; CHAI TEA; COFFEE AND TEA; DISPOSABLE CUPS WITH A TEA-FILLED POUCH ULTRASONICALLY WELDED TO ONE SIDE OF THE BOTTOM OF THE CUP, WHICH ALLOWS THE NATURAL FIBER POUCH TO FLOAT NEAR THE BOTTOM; FLAVOURINGS OF TEA; FRUIT TEAS; GINSENG TEA; GREEN TEA; HERB TEA; HERBAL TEA; ICED TEA; INSTANT TEA; JAPANESE GREEN TEA; LIME TEA; MIXES IN THE NATURE OF CONCENTRATES, SYRUPS OR POWDERS USED IN THE PREPARATION OF TEA BASED BEVERAGES; OOLONG TEA; SAGE TEA; SYRUPS FOR MAKING TEA; TEA; TEA BAGS; TEA EXTRACTS; TEA FOR INFUSIONS; TEA OF PARCHED POWDER OF BARLEY WITH HUSK (MUGI-CHA); TEA OF SALTY KELP POWDER (KOMBU-CHA); TEA PODS; TEA SUBSTITUTES; TEA-BASED BEVERAGES; TEA-BASED BEVERAGES WITH FRUIT FLAVORING; THEINE-FREE TEA SWEETENED WITH SWEETENERS, IN CLASS 30 (U.S. CL. 46).

FIRST USE 4-1-2011; IN COMMERCE 4-1-2011.

THE MARK CONSISTS OF STANDARD CHARACTERS WITHOUT CLAIM TO ANY PARTICULAR FONT, STYLE, SIZE, OR COLOR.

SER. NO. 85-354,243, FILED 6-23-2011.

JEFF DEFORD, EXAMINING ATTORNEY



David J. Kyros

Director of the United States Patent and Trademark Office

United States of America

United States Patent and Trademark Office

10-CODE

Reg. No. 4,204,524

Registered Sep. 11, 2012

Int. Cl.: 38

SERVICE MARK

PRINCIPAL REGISTER

TEXTPOWER, INC. (CALIFORNIA CORPORATION)
27134-A PASEO ESPADA, SUITE 324
SAN JUAN CAPISTRANO, CA 92675

FOR: TELECOMMUNICATION SERVICE TO ALLOW CUSTOMERS TO RESERVE A 10-DIGIT PHONE NUMBER ADDRESS ASSOCIATED WITH A TEXT MESSAGE SERVICE , IN CLASS 38 (U.S. CLS. 100, 101 AND 104).

FIRST USE 6-13-2011; IN COMMERCE 6-13-2011.

THE MARK CONSISTS OF STANDARD CHARACTERS WITHOUT CLAIM TO ANY PARTICULAR FONT, STYLE, SIZE, OR COLOR.

SER. NO. 85-354,517, FILED 6-23-2011.

EDWARD NELSON, EXAMINING ATTORNEY



David J. Kyffers

Director of the United States Patent and Trademark Office

United States of America

United States Patent and Trademark Office

TCARD

Reg. No. 4,204,525

TEXTPOWER, INC. (CALIFORNIA CORPORATION)
27134-A PASEO ESPADA, SUITE 324
SAN JUAN CAPISTRANO, CA 92675

Registered Sep. 11, 2012

Int. Cl.: 38

FOR: TELECOMMUNICATIONS SERVICES TO ALLOW INDIVIDUALS TO USE CELLULAR TELEPHONES TO ACCESS A BUSINESS CARD THAT IS DEFINED BY THE BUSINESS CARD HOLDER VIA THE SENDING OF A TEXT MESSAGE, IN CLASS 38 (U.S. CLS. 100, 101 AND 104).

SERVICE MARK

PRINCIPAL REGISTER

FIRST USE 6-13-2011; IN COMMERCE 6-13-2011.

THE MARK CONSISTS OF STANDARD CHARACTERS WITHOUT CLAIM TO ANY PARTICULAR FONT, STYLE, SIZE, OR COLOR.

SER. NO. 85-354,559, FILED 6-23-2011.

EDWARD NELSON, EXAMINING ATTORNEY



David J. Kyffers

Director of the United States Patent and Trademark Office

United States of America

United States Patent and Trademark Office

TEMP-TATIONS

Reg. No. 4,204,526

Registered Sep. 11, 2012

**Int. Cls.: 8, 9, 14, 18, 20,
21 and 24**

TRADEMARK

PRINCIPAL REGISTER

TEMP-TATIONS, LLC (DELAWARE LIMITED LIABILITY COMPANY)
SUITE 102
180 GORDON DRIVE
EXTON, PA 19341

FOR: FLATWARE; UTENSIL SETS SOLD AS A UNIT CONSISTING OF FORKS, KNIVES, SPOONS, KITCHEN TONGS, SPATULAS, SERVING SPOONS, SERVING FORKS, SERVING LADLES, AND SERVING TONGS, IN CLASS 8 (U.S. CLS. 23, 28 AND 44).

FIRST USE 11-5-2009; IN COMMERCE 11-5-2009.

FOR: MEASURING SPOON SETS AND MEASURING CUP SETS, IN CLASS 9 (U.S. CLS. 21, 23, 26, 36 AND 38).

FIRST USE 5-4-2010; IN COMMERCE 5-4-2010.

FOR: WALL CLOCK, IN CLASS 14 (U.S. CLS. 2, 27, 28 AND 50).

FIRST USE 5-20-2010; IN COMMERCE 5-20-2010.

FOR: INSULATED TOTE BAGS, IN CLASS 18 (U.S. CLS. 1, 2, 3, 22 AND 41).

FIRST USE 5-27-2009; IN COMMERCE 5-27-2009.

FOR: HOSTESS TABLE, IN CLASS 20 (U.S. CLS. 2, 13, 22, 25, 32 AND 50).

FIRST USE 11-18-2010; IN COMMERCE 11-18-2010.

FOR: TRAVEL MUGS; SERVING TRAY; UTENSIL SETS SOLD AS A UNIT CONSISTING OF KITCHEN TONGS, SPATULAS, SERVING SPOONS, SERVING FORKS, SERVING LADLES, SERVING TONGS, FORKS, KNIVES AND SPOONS; SALAD BOWL W/SERVING TONGS; COOKIE JAR; PORTABLE BEVERAGE DISPENSER; BREAD BOX; CREAM AND SUGAR SET; SALT AND PEPPER SHAKER SET, SPICE HOLDER, NAMELY, SPICE RACK AND CONTAINERS FOR HOLDING SPICES; PAPER TOWEL HOLDER, IN CLASS 21 (U.S. CLS. 2, 13, 23, 29, 30, 33, 40 AND 50).

FIRST USE 5-27-2009; IN COMMERCE 5-27-2009.



David J. Kybas

Director of the United States Patent and Trademark Office

Reg. No. 4,204,526 FOR: KITCHEN TOWELS; PLACEMATS NOT MADE OF PAPER; CLOTH NAPKINS;
TABLECLOTH NOT MADE OF PAPER; OVEN MITTS, IN CLASS 24 (U.S. CLS. 42 AND 50).

FIRST USE 8-14-2009; IN COMMERCE 8-14-2009.

THE MARK CONSISTS OF STANDARD CHARACTERS WITHOUT CLAIM TO ANY PARTICULAR FONT, STYLE, SIZE, OR COLOR.

OWNER OF U.S. REG. NOS. 3,145,875 AND 3,529,117.

SER. NO. 85-354,560, FILED 6-23-2011.

MATTHEW EINSTEIN, EXAMINING ATTORNEY

United States of America

United States Patent and Trademark Office

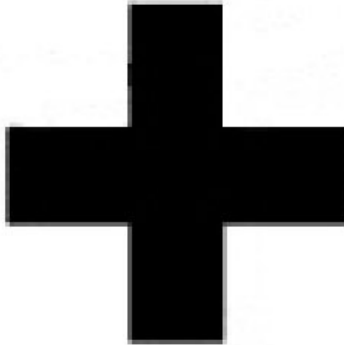

Reg. No. 4,204,527

Registered Sep. 11, 2012

Int. Cl.: 25

TRADEMARK

PRINCIPAL REGISTER

IMOGENE AND WILLIE, LLC (TENNESSEE LIMITED LIABILITY COMPANY)
2601 12TH AVENUE SOUTH
NASHVILLE, TN 37204

FOR: CLOTHING, NAMELY, JEANS, SHIRTS, CAPS, BLOUSES, COATS AND NOT INCLUDING FOOTWEAR, IN CLASS 25 (U.S. CLS. 22 AND 39).

FIRST USE 1-23-2009; IN COMMERCE 1-23-2009.

THE MARK CONSISTS OF A PLUS SIGN ("+") IN A BOLD FONT.

SER. NO. 85-354,594, FILED 6-23-2011.

KAREN K. BUSH, EXAMINING ATTORNEY



David J. Kyffers

Director of the United States Patent and Trademark Office

United States of America

United States Patent and Trademark Office

IMOGENE + WILLIE

Reg. No. 4,204,528

IMOGENE AND WILLIE, LLC (TENNESSEE LIMITED LIABILITY COMPANY)
2601 12TH AVENUE SOUTH
NASHVILLE, TN 37204

Registered Sep. 11, 2012

Int. Cl.: 25

FOR: CLOTHING, NAMELY, JEANS, SHIRTS, CAPS, BLOUSES, COATS, IN CLASS 25 (U.S. CLS. 22 AND 39).

TRADEMARK

FIRST USE 1-23-2009; IN COMMERCE 1-23-2009.

PRINCIPAL REGISTER

THE MARK CONSISTS OF STANDARD CHARACTERS WITHOUT CLAIM TO ANY PARTICULAR FONT, STYLE, SIZE, OR COLOR.

SER. NO. 85-354,596, FILED 6-23-2011.

KAREN K. BUSH, EXAMINING ATTORNEY



David J. Kybas

Director of the United States Patent and Trademark Office

United States of America

United States Patent and Trademark Office

PAINTER

Reg. No. 4,204,529

Registered Sep. 11, 2012

Int. Cl.: 9

TRADEMARK

PRINCIPAL REGISTER

COREL CORPORATION (CANADA CORPORATION)
1600 CARLING AVENUE
OTTAWA, ONTARIO K1Z8R7, CANADA

FOR: COMPUTER GRAPHICS SOFTWARE, COMPUTER SOFTWARE FOR DIGITAL IMAGE PROCESSING AND DIGITAL ART; COMPUTER SOFTWARE FOR DIGITAL IMAGE PROCESSING THAT MAY BE DOWNLOADED; SOFTWARE FOR DISSEMINATING, RECEIVING, CREATING, PUBLISHING AND EDITING DIGITAL IMAGES AND MULTIMEDIA CONTENTS, USER MANUALS IN ELECTRONIC AND/OR PHYSICAL FORM SOLD AS A UNIT THEREWITH, IN CLASS 9 (U.S. CLS. 21, 23, 26, 36 AND 38).

FIRST USE 0-0-1991; IN COMMERCE 0-0-1991.

THE MARK CONSISTS OF STANDARD CHARACTERS WITHOUT CLAIM TO ANY PARTICULAR FONT, STYLE, SIZE, OR COLOR.

SEC. 2(F).

SER. NO. 85-355,544, FILED 6-24-2011.

JOHN E. MICHOS, EXAMINING ATTORNEY



David J. Kyffers

Director of the United States Patent and Trademark Office

United States of America

United States Patent and Trademark Office

"CENTS" ABLE MOMMA

Reg. No. 4,204,530

CENTSABLE MOMMA LLC (MICHIGAN LIMITED LIABILITY COMPANY)

Registered Sep. 11, 2012

PO BOX 511431
LIVONIA, MI 48151

Int. Cl.: 35

FOR: PROMOTING THE GOODS AND SERVICES OF OTHERS BY PROVIDING A WEBSITE FEATURING COUPONS, REBATES, VOUCHERS AND SPECIAL OFFERS FOR THE GOODS AND SERVICES OF OTHERS, IN CLASS 35 (U.S. CLS. 100, 101 AND 102).

SERVICE MARK

FIRST USE 9-0-2008; IN COMMERCE 9-0-2008.

PRINCIPAL REGISTER

THE MARK CONSISTS OF STANDARD CHARACTERS WITHOUT CLAIM TO ANY PARTICULAR FONT, STYLE, SIZE, OR COLOR.

SER. NO. 85-356,021, FILED 6-24-2011.

SUSAN STIGLITZ, EXAMINING ATTORNEY



David J. Kybas

Director of the United States Patent and Trademark Office

United States of America

United States Patent and Trademark Office

WOUNDED WARRIOR PROJECT

Reg. No. 4,204,531

Registered Sep. 11, 2012

Int. Cl.: 36

SERVICE MARK

PRINCIPAL REGISTER

WOUNDED WARRIOR PROJECT, INC. (VIRGINIA NON-STOCK CORPORATION)
SUITE 300
4899 BELFORT ROAD
JACKSONVILLE, FL 32256

FOR: CHARITABLE FUNDRAISING SERVICES, IN CLASS 36 (U.S. CLS. 100, 101 AND 102).

FIRST USE 7-0-2003; IN COMMERCE 7-0-2003.

THE MARK CONSISTS OF STANDARD CHARACTERS WITHOUT CLAIM TO ANY PARTICULAR FONT, STYLE, SIZE, OR COLOR.

OWNER OF U.S. REG. NOS. 3,001,447 AND 3,841,207.

NO CLAIM IS MADE TO THE EXCLUSIVE RIGHT TO USE "PROJECT", APART FROM THE MARK AS SHOWN.

SEC. 2(F).

SER. NO. 85-356,470, FILED 6-26-2011.

LINDSEY RUBIN, EXAMINING ATTORNEY



David J. Kybas

Director of the United States Patent and Trademark Office

United States of America

United States Patent and Trademark Office

TRANQUILITY SPA

Reg. No. 4,204,532

Registered Sep. 11, 2012

Int. Cl.: 44

SERVICE MARK

PRINCIPAL REGISTER

TRANQUILITY SPA (NEW YORK CORPORATION)
917 CENTRAL PARK AVENUE
SCARSDALE, NY 10583

FOR: HEALTH SPA SERVICES FOR HEALTH AND WELLNESS OF THE BODY AND SPIRIT, NAMELY, PROVIDING MASSAGE, FACIAL AND BODY TREATMENT SERVICES, COSMETIC BODY CARE SERVICES; HEALTH SPA SERVICES FOR HEALTH AND WELLNESS OF THE MIND, BODY AND SPIRIT OFFERED IN OR FROM A REMOTE, MOBILE OR TEMPORARY ON-SITE LOCATION; HEALTH SPA SERVICES, NAMELY, BODY WRAPS, MUD TREATMENTS, SEAWEED TREATMENTS, HYDROTHERAPY BATHS, AND BODY SCRUBS; HEALTH SPA SERVICES, NAMELY, COSMETIC BODY CARE SERVICES, IN CLASS 44 (U.S. CLS. 100 AND 101).

FIRST USE 7-28-2010; IN COMMERCE 7-28-2010.

THE MARK CONSISTS OF STANDARD CHARACTERS WITHOUT CLAIM TO ANY PARTICULAR FONT, STYLE, SIZE, OR COLOR.

NO CLAIM IS MADE TO THE EXCLUSIVE RIGHT TO USE "SPA", APART FROM THE MARK AS SHOWN.

SER. NO. 85-356,535, FILED 6-27-2011.

JOHN E. MICHOS, EXAMINING ATTORNEY



David J. Kyffers

Director of the United States Patent and Trademark Office

United States of America

United States Patent and Trademark Office

DEEBLER

Reg. No. 4,204,533

Registered Sep. 11, 2012

Int. Cls.: 9, 35, 39 and 42

TRADEMARK

SERVICE MARK

PRINCIPAL REGISTER

DEEBLER INC. (CANADA CORPORATION)
318 6TH AVENUE N.E.
CALGARY, ALBERTA, CANADA T2E0L9

FOR: COMPUTER SOFTWARE FOR USE IN FINDING PRODUCTS IN THE CLOSEST PROXIMITY TO THE USER AND COMPARING PRICES FOR SUCH PRODUCTS; COMPUTER SOFTWARE FOR USE IN FINDING THE LOWEST PRICES FOR SPECIFIC PRODUCTS AND ALERTING THE USER OF SAME; COMPUTER SOFTWARE FOR USE IN NAVIGATING SHOPPING WEBSITES, OBTAINING INFORMATION ABOUT RETAILERS AND THE GOODS AND SERVICES OF OTHERS, PROMOTING THE SALE OF GOODS AND SERVICES OF OTHERS AND IDENTIFYING THE LOCATION OF AND DIRECTION TO SUCH RETAILERS; COMPUTER SOFTWARE FOR USE IN MANAGING CONSUMER PURCHASE INFORMATION; COMPUTER SOFTWARE FOR USE IN GENERATING CUSTOMIZED WEB PAGES; COMPUTER SOFTWARE FOR USE IN STORING DATA RELATING TO CONSUMER PURCHASING PATTERNS AND PERSONAL, SOCIAL AND RECREATIONAL INTERESTS OF OTHERS; COMPUTER SOFTWARE FOR USE IN ADVERTISING, PROMOTING, AND MARKETING THE GOODS AND SERVICES OF OTHERS, IN CLASS 9 (U.S. CLS. 21, 23, 26, 36 AND 38).

FOR: PROVIDING INFORMATION ABOUT THE GOODS AND SERVICES OF OTHERS VIA A GLOBAL COMPUTER NETWORK; PROMOTING THE SALE OF GOODS AND SERVICES, NAMELY, ADVERTISING THE WARES AND SERVICES OF OTHERS OVER THE INTERNET; PROVIDING CONSUMER INFORMATION ABOUT RETAILERS VIA A GLOBAL COMPUTER NETWORK; PROVISION OF INFORMATION AND ADVICE TO CONSUMERS REGARDING THE SELECTION OF PRODUCTS AND ITEMS TO BE PURCHASED OVER A GLOBAL COMPUTER NETWORK; ONLINE RETAIL STORE SERVICES FEATURING COMPUTER SOFTWARE, IN CLASS 35 (U.S. CLS. 100, 101 AND 102).

FOR: ELECTRONIC STORAGE OF DATA RELATING TO CONSUMER PURCHASING PATTERNS AND PERSONAL, SOCIAL AND RECREATIONAL INTERESTS FOR USE BY OTHERS IN CONNECTION WITH ADVERTISING, PROMOTING, AND MARKETING THE GOODS AND SERVICES OF OTHERS OVER A GLOBAL COMPUTER NETWORK, IN CLASS 39 (U.S. CLS. 100 AND 105).

FOR: PROVIDING ONLINE USE OF NON-DOWNLOADABLE SOFTWARE FOR USE IN PROVIDING INFORMATION ABOUT THE GOODS AND SERVICES AND LOCATION OF OTHERS; PROVIDING ONLINE USE OF NON-DOWNLOADABLE SOFTWARE FOR USE



David J. Kyjars

Director of the United States Patent and Trademark Office

Reg. No. 4,204,533 IN PROMOTING THE SALE OF GOODS AND SERVICES OF OTHERS; PROVIDING ONLINE USE OF NON-DOWNLOADABLE SOFTWARE FOR USE IN PROVIDING INFORMATION ABOUT RETAILERS AND THE LOCATION OF SUCH RETAILERS; PROVIDING ONLINE USE OF NONDOWNLOADABLE SOFTWARE FOR USE IN MANAGING CONSUMER PURCHASING INFORMATION; PROVIDING A SEARCH ENGINE FOR GENERATING CUSTOMIZED WEB PAGES IN RESPONSE TO THE USER REQUESTED INFORMATION ABOUT THE GOODS AND SERVICES OF OTHERS; PROVIDING ONLINE USE OF NON-DOWNLOADABLE SOFTWARE FOR USE IN PROVIDING INFORMATION ABOUT THE GOODS AND SERVICES OF OTHERS; PROVIDING ONLINE USE OF NON-DOWNLOADABLE SOFTWARE FOR USE IN PROMOTING THE SALE OF GOODS AND SERVICES OF OTHERS; PROVIDING ONLINE USE OF NON-DOWNLOADABLE SOFTWARE FOR USE IN PROVIDING INFORMATION ABOUT RETAILERS; PROVIDING ONLINE USE OF NON-DOWNLOADABLE SOFTWARE FOR USE IN MANAGING CONSUMER PURCHASING INFORMATION, IN CLASS 42 (U.S. CLS. 100 AND 101).

THE MARK CONSISTS OF STANDARD CHARACTERS WITHOUT CLAIM TO ANY PARTICULAR FONT, STYLE, SIZE, OR COLOR.

PRIORITY CLAIMED UNDER SEC. 44(D) ON CANADA APPLICATION NO. 1514003, FILED 2-4-2011.

OWNER OF CANADA REG. NO. TMA820,136, DATED 3-19-2012, EXPIRES 3-19-2027.

THE WORDING "DEEBLER" HAS NO MEANING IN A FOREIGN LANGUAGE.

SER. NO. 85-356,589, FILED 6-27-2011.

KAPIL BHANOT, EXAMINING ATTORNEY

United States of America

United States Patent and Trademark Office

FIFTY BILLION HIGH POTENTIALS

Reg. No. 4,204,534

MORPHOSYS AG (FED REP GERMANY CORPORATION)
LENA-CHRIST-STRASSE 48

Registered Sep. 11, 2012

MARTINSRIED-PLANEGER, FED REP GERMANY 82152

Int. Cls.: 1, 5 and 42

FOR: CHEMICAL, BIOCHEMICAL, BIOLOGICAL AND BIOTECHNOLOGICAL PREPARATIONS, NAMELY, ANTIBODIES AND FRAGMENTS OF ANTIBODIES FOR USE IN THE DEVELOPMENT OR MANUFACTURE OF IMMUNOLOGICAL REAGENTS USED IN INDUSTRY AND SCIENCE; BIOLOGICAL PREPARATIONS, NAMELY, ANTIBODIES AND FRAGMENTS OF ANTIBODIES FOR LABORATORIES, DIAGNOSTICS AND ANALYTICS FOR SCIENTIFIC OR RESEARCH USE, IN CLASS 1 (U.S. CLS. 1, 5, 6, 10, 26 AND 46).

TRADEMARK

SERVICE MARK

PRINCIPAL REGISTER

FOR: BIOLOGICAL SUBSTANCES, NAMELY, ANTIBODIES AND FRAGMENTS OF ANTIBODIES FOR HUMAN MEDICAL DIAGNOSTICS AND ANALYSIS; PHARMACEUTICAL PREPARATIONS, NAMELY, ANTIBODIES AND FRAGMENTS OF ANTIBODIES FOR THE TREATMENT OF METABOLIC DISORDERS, INFECTIOUS DISEASES, CANCER, INFLAMMATORY DISEASES, ALZHEIMER, SEPSIS, AND RESTENOSIS; SANITARY PREPARATIONS FOR MEDICAL USE, IN CLASS 5 (U.S. CLS. 6, 18, 44, 46, 51 AND 52).

FOR: SCIENTIFIC, BIOLOGICAL, PHARMACEUTICAL AND MEDICAL RESEARCH SERVICES; LABORATORY RESEARCH IN THE FIELD OF ANALYTICAL CHEMISTRY, BIOCHEMISTRY, MEDICINAL CHEMISTRY, DRUG DEVELOPMENT, BIOTECHNOLOGY, MICROBIOLOGY AND MOLECULAR BIOLOGY; CHEMICAL, BIOCHEMICAL AND BIOTECHNOLOGICAL ANALYSIS, IN CLASS 42 (U.S. CLS. 100 AND 101).



THE MARK CONSISTS OF STANDARD CHARACTERS WITHOUT CLAIM TO ANY PARTICULAR FONT, STYLE, SIZE, OR COLOR.

PRIORITY CLAIMED UNDER SEC. 44(D) ON ERPN CMNTY TM OFC APPLICATION NO. 010074839, FILED 6-24-2011, REG. NO. 010074839, DATED 1-25-2012, EXPIRES 6-24-2021.

SER. NO. 85-356,612, FILED 6-27-2011.

BENJAMIN OKEKE, EXAMINING ATTORNEY

David J. Kyffers

Director of the United States Patent and Trademark Office

United States of America

United States Patent and Trademark Office

SATIN GLIDE

Reg. No. 4,204,535

DW-NATIONAL STANDARD-NILES, LLC (DELAWARE LIMITED LIABILITY COMPANY)
1631 LAKE STREET
NILES, MI 49120

Registered Sep. 11, 2012

Int. Cl.: 6

FOR: WELDING WIRE, IN CLASS 6 (U.S. CLS. 2, 12, 13, 14, 23, 25 AND 50).

TRADEMARK

FIRST USE 9-25-1984; IN COMMERCE 9-25-1984.

PRINCIPAL REGISTER

THE MARK CONSISTS OF STANDARD CHARACTERS WITHOUT CLAIM TO ANY PARTICULAR FONT, STYLE, SIZE, OR COLOR.

SER. NO. 85-356,725, FILED 6-27-2011.

KEVON CHISOLM, EXAMINING ATTORNEY



David J. Kyffers

Director of the United States Patent and Trademark Office

United States of America

United States Patent and Trademark Office

FRESH FASHIONS AND MORE

Reg. No. 4,204,536

WAY TO BE DESIGNS, LLC (CALIFORNIA LIMITED LIABILITY COMPANY)
30987 SAN CLEMENTE STREET
HAYWARD, CA 94544

Registered Sep. 11, 2012

Int. Cl.: 35

FOR: CATALOG ORDERING SERVICE FEATURING APPAREL, GIFT ITEMS, CORPORATE
BRANDED AND LOGO MERCHANDIZE, IN CLASS 35 (U.S. CLS. 100, 101 AND 102).

SERVICE MARK

FIRST USE 1-1-2000; IN COMMERCE 1-1-2000.

PRINCIPAL REGISTER

THE MARK CONSISTS OF STANDARD CHARACTERS WITHOUT CLAIM TO ANY PAR-
TICULAR FONT, STYLE, SIZE, OR COLOR.

NO CLAIM IS MADE TO THE EXCLUSIVE RIGHT TO USE "FASHIONS", APART FROM
THE MARK AS SHOWN.

SER. NO. 85-356,841, FILED 6-27-2011.

LINDA M. KING, EXAMINING ATTORNEY



David J. Kyffers

Director of the United States Patent and Trademark Office

United States of America

United States Patent and Trademark Office

TUBB 2000

Reg. No. 4,204,537

Registered Sep. 11, 2012

Int. Cl.: 13

TRADEMARK

PRINCIPAL REGISTER

SUPERIOR SHOOTING SYSTEM, INC. (TEXAS CORPORATION)
800 N. SECOND STREET
CANADIAN, TX 79014

FOR: RIFLES, IN CLASS 13 (U.S. CLS. 2 AND 9).

FIRST USE 1-1-1999; IN COMMERCE 1-1-1999.

THE MARK CONSISTS OF STANDARD CHARACTERS WITHOUT CLAIM TO ANY PARTICULAR FONT, STYLE, SIZE, OR COLOR.

NO CLAIM IS MADE TO THE EXCLUSIVE RIGHT TO USE "2000", APART FROM THE MARK AS SHOWN.

SER. NO. 85-357,338, FILED 6-27-2011.

SETH A. RAPPAPORT, EXAMINING ATTORNEY



David J. Kyffers

Director of the United States Patent and Trademark Office

United States of America

United States Patent and Trademark Office

I.SOUND

Reg. No. 4,204,538

Registered Sep. 11, 2012

Int. Cl.: 9

TRADEMARK

PRINCIPAL REGISTER

DREAMGEAR, LLC (CALIFORNIA LIMITED LIABILITY COMPANY)
20001 S. WESTERN AVENUE
TORRANCE, CA 90501

FOR: ELECTRONICS EQUIPMENT, NAMELY, RADIOS INCORPORATING CLOCKS CONTAINING A COMPUTER DOCKING STATION FOR USE WITH MP3 AND MP4 DIGITAL PLAYERS, MOBILE TELEPHONES, AND TABLET COMPUTERS; ELECTRONICS ACCESSORIES FOR USE WITH PORTABLE OR HANDHELD DIGITAL ELECTRONIC DEVICES FOR ORGANIZING, TRANSMITTING, MANIPULATING, AND REVIEWING TEXT, DATA, AUDIO, IMAGE, AND VIDEO FILES, NAMELY, DOCKING STATIONS, STANDS SPECIALLY DESIGNED FOR HOLDING A DIGITAL ELECTRONIC DEVICE, MOBILE TELEPHONES AND ACCESSORIES IN THE NATURE OF HEADSETS, BATTERIES, BATTERY CHARGERS, BATTERY PACKS, ELECTRICAL WIRES, ELECTRICAL CABLES AND ELECTRICAL ADAPTORS; COMPUTER, VIDEO GAME AND ELECTRONICS EQUIPMENT, NAMELY, KEYBOARDS; COMPUTER AND VIDEO GAME CONTROLLERS, NAMELY, STEERING WHEEL UNITS FOR PLAYING COMPUTER AND VIDEO GAMES; ELECTRICAL CABLES TO CONNECT VIDEO GAME SYSTEMS, MOBILE TELEPHONES AND OTHER HANDHELD DIGITAL DEVICES TO TELEVISIONS, DVD PLAYERS, VCR PLAYERS, COMPUTERS AND MULTIPLE VIDEO GAME SYSTEMS; AUTOMOBILE AND AC ELECTRICAL POWER ADAPTORS FOR HANDHELD DIGITAL ELECTRONIC DEVICES; COMPUTER MICE; COMPUTER MOUSE PADS AND WRIST PADS IN THE NATURE OF WRIST RESTS AND SUPPORTS FOR USE WITH COMPUTERS; HEADPHONES; EAR PHONES FOR VIDEO GAME SYSTEMS, TELEVISIONS, VCRS, DVD PLAYERS, MOBILE TELEPHONES, HANDHELD DIGITAL ELECTRONIC DEVICES, MP3 PLAYERS AND RADIOS; MICROPHONES; WIRELESS MICROPHONES; MICROPHONE RECEIVERS; ELECTRICAL CONNECTION BOXES FOR CONNECTING MULTIPLE MICROPHONES; SHIELDED COMPUTER AND MOBILE TELEPHONE SPEAKERS; HEADSETS FOR COMPUTERS, TELEVISIONS, DVD PLAYERS, CD PLAYERS, MP3 PLAYERS, MOBILE TELEPHONES, HANDHELD DIGITAL ELECTRONIC DEVICES AND RADIOS, MP4 DIGITAL PLAYERS, COMBINATION STEREO AUDIO RECEIVER AND TAPE RECORDER, RECORD PLAYERS, TAPE RECORDERS, CD PLAYERS, DVD PLAYERS, MINI DISC RECORDERS, AND MINI DISC; AUDIO SPEAKERS; WIRELESS SPEAKERS; PORTABLE AUDIO SPEAKERS; SPEAKER BASE STATIONS, NAMELY, A MP3 PLAYER DOCKING STATION CONTAINING AUDIO SPEAKERS; LOUDSPEAKERS; LOUDSPEAKER SYSTEMS, NAMELY, WOOFER, TWEETER, OR MID-RANGE SPEAKER CONES CONTAINED IN A CABINET; REMOTE CONTROL UNITS FOR CONTROLLING STEREOS, TELEVISIONS, VIDEO CASSETTE PLAYERS, DVD PLAYERS, AND MP3 PLAYERS; WOOFERS; KEYBOARDS NOT SOLD AS AN INTEGRATED PART



David J. Kybas

Director of the United States Patent and Trademark Office

Reg. No. 4,204,538 OF PERSONAL COMPUTERS; ADAPTERS TO CONNECT KEYBOARDS TO COMPUTER SYSTEMS; ELECTRIC WIRE, NAMELY, SPEAKER WIRE; ELECTRICAL SWITCHES USED TO CONTROL THE AUDIO SOUND LEVEL; COMPUTER CABLES, COMPUTER MONITOR CABLES, MODEM CABLES, AND VIDEO GAME SYSTEM ELECTRICAL CABLES; AUDIO CABLES, AND OPTICAL CABLES FOR VIDEO CAMERAS AND STEREO SYSTEMS; TELEPHONES, TELEPHONE ACCESSORIES AND EQUIPMENT, NAMELY, WIRELESS TELEPHONES; BATTERIES; BATTERY CHARGERS; TELEPHONE CARRYING CASES; HANDS-FREE DEVICES, NAMELY, EARPHONES FOR ALLOWING HANDS FREE OPERATION OF CELLULAR TELEPHONES; CARRYING CLIPS FOR WIRELESS TELEPHONES SOLD AS A UNIT IN COMBINATION WITH WIRELESS TELEPHONES; COMMUNICATIONS DEVICES IN THE NATURE OF WIRELESS APPLICATION PROTOCOL (WAP) RECEIVERS AND TRANSMITTERS; TELECOMMUNICATIONS TRANSMISSION EQUIPMENT, COMPONENTS, SWITCHING, AND NETWORK SYSTEMS COMPRISED OF RADIO TRANSMITTERS AND RECEIVERS; ANTENNAS; TELECOMMUNICATIONS SWITCHES; SIGNAL TRANSFER POINT DIGITAL MEDIA AND COMPUTER SERVERS; SIGNAL CONTROL POINT DIGITAL MEDIA AND COMPUTER SERVERS; SERVICE RESOURCE PLATFORM DIGITAL MEDIA AND COMPUTER SERVERS; CALL ROUTING DIGITAL MEDIA AND COMPUTER SERVERS AND OPERATING SOFTWARE FOR THE FOREGOING; COMPUTERS AND COMPUTER SOFTWARE FOR THE ACTIVATION AND OPERATION OF WIRELESS TELECOMMUNICATIONS SERVICES; MACHINE READABLE MAGNETICALLY ENCODED CALLING CARDS, CALLER IDENTIFICATION CARDS, DEBIT AND CREDIT CARDS; PAGERS; CALLER IDENTIFICATION BOXES; PROTECTIVE CASES FOR PORTABLE ELECTRONIC DEVICES, NAMELY, PERSONAL DIGITAL ASSISTANTS AND MOBILE TELEPHONES, IN CLASS 9 (U.S. CLS. 21, 23, 26, 36 AND 38).

FIRST USE 8-2-2004; IN COMMERCE 10-7-2004.

THE MARK CONSISTS OF STANDARD CHARACTERS WITHOUT CLAIM TO ANY PARTICULAR FONT, STYLE, SIZE, OR COLOR.

OWNER OF U.S. REG. NOS. 3,105,624, 3,185,384, AND 3,423,348.

SER. NO. 85-357,453, FILED 6-27-2011.

ANDREA HACK, EXAMINING ATTORNEY

United States of America

United States Patent and Trademark Office

Flex⁺

Reg. No. 4,204,539

Registered Sep. 11, 2012

Int. Cl.: 10

TRADEMARK

PRINCIPAL REGISTER

SPINEVISION (FRANCE SOCIÉTÉ ANONYME (SA))
ANTONY PARC II,
10 PLACE DU GÉNÉRAL DE GAULLE
ANTONY CEDEX, FRANCE 92184

FOR: SPINAL IMPLANTS COMPOSED OF ARTIFICIAL MATERIAL, IN CLASS 10 (U.S. CLS. 26, 39 AND 44).

PRIORITY CLAIMED UNDER SEC. 44(D) ON ERPN CMNTY TM OFC APPLICATION NO. 009797507, FILED 3-9-2011, REG. NO. 009797507, DATED 7-20-2011, EXPIRES 3-9-2021.

THE COLOR(S) BLUE AND GREY IS/ARE CLAIMED AS A FEATURE OF THE MARK.

OWNER OF U.S. REG. NO. 3,519,053.

THE MARK CONSISTS OF THE STYLIZED WORDING "FLEX" IN THE COLOR BLUE AND WITH A STYLIZED PLUS SIGN FOLLOWING THE WORDING IN THE COLOR GREY.

SER. NO. 85-357,840, FILED 6-28-2011.

JAY BESCH, EXAMINING ATTORNEY



David J. Kyros

Director of the United States Patent and Trademark Office

United States of America

United States Patent and Trademark Office



Reg. No. 4,204,540

Registered Sep. 11, 2012

Int. Cl.: 3

TRADEMARK

PRINCIPAL REGISTER

FINANZ ST. HONORE, B.V. (NETHERLANDS LIMITED LIABILITY COMPANY)
PRINS BERNHARDPLEIN 200
1097 JB AMSTERDAM, NETHERLANDS

FOR: AFTER-SHAVE; AFTER-SHAVE LIQUID; AFTERSHAVE COLOGNE; COLOGNE; EAU DE COLOGNES; FRAGRANCES; FRAGRANCES AND PERFUMERY; FRAGRANCES FOR PERSONAL USE, IN CLASS 3 (U.S. CLS. 1, 4, 6, 50, 51 AND 52).

FIRST USE 11-18-1988; IN COMMERCE 11-18-1988.

OWNER OF U.S. REG. NO. 1,582,172.

THE MARK CONSISTS OF A THREE-DIMENSIONAL CONFIGURATION OF FRAGRANCE BOTTLE WITH ONE CURVED SIDE AND ONE POINTED SIDE WITH A GEOMETRICALLY SHAPED CAP. THE BROKEN LINES DEPICTING THE SPRAY NOZZLE, PUMP AND PIPE INDICATE PLACEMENT OF THE MARK ON THE GOODS AND ARE NOT PART OF THE MARK.

SER. NO. 85-358,376, FILED 6-28-2011.

JANET LEE, EXAMINING ATTORNEY



David J. Kybas

Director of the United States Patent and Trademark Office

United States of America

United States Patent and Trademark Office



Reg. No. 4,204,541

Registered Sep. 11, 2012

Int. Cl.: 30

TRADEMARK

PRINCIPAL REGISTER

NISSIN FOODS HOLDINGS CO., LTD. (JAPAN CORPORATION)
1-1, NISHINAKAJIMA 4-CHOME, YODOGAWA-KU
OSAKA, JAPAN

FOR: NOODLES, INSTANT NOODLES, IN CLASS 30 (U.S. CL. 46).

FIRST USE 8-0-1976; IN COMMERCE 8-0-1976.

OWNER OF U.S. REG. NO. 2,087,260.

THE NON-LATIN CHARACTERS IN THE MARK TRANSLITERATE TO "NISSIN-NO-DONBEI" AND THIS MEANS "NISSIN'S DONBEI" IN ENGLISH.

THE MARK CONSISTS OF A SEMI-CIRCLE WITH JAPANESE CHARACTERS.

SER. NO. 85-358,385, FILED 6-28-2011.

RON FAIRBANKS, EXAMINING ATTORNEY



David J. Kyffers

Director of the United States Patent and Trademark Office

United States of America

United States Patent and Trademark Office

NOBLE EXPERIMENT

Reg. No. 4,204,542

Registered Sep. 11, 2012

Int. Cls.: 25, 40 and 42

NOBLE EXPERIMENT (FLORIDA LIMITED LIABILITY COMPANY), DBA NOBLE
EXPERIMENT
171 NW 23RD ST, MIAMI FL 33127
171 NW 23RD ST
MIAMI, FL 33127

TRADEMARK

SERVICE MARK

PRINCIPAL REGISTER

FOR: MEN'S AND WOMEN'S CLOTHING APPAREL, NAMELY, SHIRTS, SHIRT ACCESSORIES IN THE NATURE OF POCKET SQUARES, T-SHIRTS, TANK TOPS, DRESS SHIRTS, COLLARED SHIRTS, RUGBY SHIRTS, KNIT SHIRTS, BLOUSES, SWEATERS, SWEATSHIRTS, SHORTS, JEANS, PANTS, TROUSERS, SLACKS, SWEATPANTS, SUITS, COATS, JACKETS, BLAZERS, VESTS, WAISTCOATS, FROCKS, DRESSES, SKIRTS, HATS, CAPS, FOOTWEAR, BELTS, SUSPENDERS, GLOVES, SOCKS, STOCKINGS, SCARVES, NECKTIES, BOW TIES, ASCOT, KERCHIEFS, UNDERGARMENTS, SLEEPWEAR, SWIMWEAR, IN CLASS 25 (U.S. CLS. 22 AND 39).

FIRST USE 2-1-2011; IN COMMERCE 2-1-2011.

FOR: TAILORING; CUSTOM MANUFACTURE OF WEARABLE APPAREL, IN CLASS 40 (U.S. CLS. 100, 103 AND 106).

FIRST USE 2-1-2011; IN COMMERCE 2-1-2011.

FOR: CUSTOM DESIGN OF WEARABLE APPAREL, IN CLASS 42 (U.S. CLS. 100 AND 101).

FIRST USE 2-1-2011; IN COMMERCE 2-1-2011.

THE MARK CONSISTS OF STANDARD CHARACTERS WITHOUT CLAIM TO ANY PARTICULAR FONT, STYLE, SIZE, OR COLOR.

SER. NO. 85-358,449, FILED 6-28-2011.

NICHOLAS COLEMAN, EXAMINING ATTORNEY



David J. Kybas

Director of the United States Patent and Trademark Office

United States of America

United States Patent and Trademark Office



Reg. No. 4,204,543

Registered Sep. 11, 2012

Int. Cl.: 1

TRADEMARK

PRINCIPAL REGISTER

SILK WATER SOLUTIONS INC. (CANADA CORPORATION)
101-12080 NORDEL WAY
SURREY, BC, CANADA V3W6Y7

FOR: WATER TREATMENT CHEMICALS FOR USE IN SWIMMING POOLS AND SPAS, IN CLASS 1 (U.S. CLS. 1, 5, 6, 10, 26 AND 46).

FIRST USE 12-0-2007; IN COMMERCE 12-0-2007.

THE MARK CONSISTS OF A CONTOURED BULB-SHAPED THREE-DIMENSIONAL BOTTLE TAPERED TOWARDS THE CAP. THE BODY AND CAP OF THE BOTTLE IS ORANGE.

THE COLOR(S) ORANGE IS/ARE CLAIMED AS A FEATURE OF THE MARK.

SEC. 2(F).

SER. NO. 85-358,755, FILED 6-28-2011.

LINDA E. BLOHM, EXAMINING ATTORNEY



David J. Kyffers

Director of the United States Patent and Trademark Office

United States of America

United States Patent and Trademark Office



Reg. No. 4,204,544

RICH, PRESTON D. (UNITED STATES INDIVIDUAL)
5346 PERRING PARKWAY
BALTIMORE, MD 21239

Registered Sep. 11, 2012

Int. Cl.: 41

FOR: ENTERTAINMENT SERVICES IN THE NATURE OF RECORDING, PRODUCTION AND POST-PRODUCTION SERVICES IN THE FIELD OF MUSIC, IN CLASS 41 (U.S. CLS. 100, 101 AND 107).

SERVICE MARK

FIRST USE 3-1-2001; IN COMMERCE 3-1-2001.

PRINCIPAL REGISTER

NO CLAIM IS MADE TO THE EXCLUSIVE RIGHT TO USE "RECORDS", APART FROM THE MARK AS SHOWN.

SER. NO. 85-359,649, FILED 6-29-2011.

HANNO RITTNER, EXAMINING ATTORNEY



David J. Kyffers

Director of the United States Patent and Trademark Office

United States of America

United States Patent and Trademark Office



Reg. No. 4,204,545

Registered Sep. 11, 2012

Int. Cl.: 35

SERVICE MARK

PRINCIPAL REGISTER

NOVANTAS, LLC (DELAWARE LIMITED LIABILITY COMPANY)
485 LEXINGTON AVENUE
NEW YORK, NY 11789

FOR: BUSINESS ADVISORY, CONSULTING AND INFORMATION SERVICES IN THE FIELD OF STRATEGY, MARKETING, SALES, OPERATION, AND NETWORK DESIGN TAILORED TO THE FINANCIAL SERVICES INDUSTRY SPECIALIZING IN THE USE OF ANALYTIC AND STATISTICAL MODELS FOR THE UNDERSTANDING AND PRIORITIZATION OF MARKET OPPORTUNITIES, IN CLASS 35 (U.S. CLS. 100, 101 AND 102).

FIRST USE 1-1-2010; IN COMMERCE 1-1-2010.

OWNER OF U.S. REG. NOS. 3,605,284 AND 3,726,420.

THE COLOR(S) GOLD, DARK BLUE AND LIGHT BLUE IS/ARE CLAIMED AS A FEATURE OF THE MARK.

THE MARK CONSISTS OF A GOLD "RAMS HORN" FOLLOWED BY THE WORD "STRATA" IN DARK BLUE BOLD CAPITAL LETTERS AND THE WORD "SCAPE" IN NON-BOLD LIGHT BLUE CAPITAL LETTERS.

SER. NO. 85-359,753, FILED 6-29-2011.

KATHERINE E. HALMEN, EXAMINING ATTORNEY



David J. Kyjars

Director of the United States Patent and Trademark Office

United States of America

United States Patent and Trademark Office



Reg. No. 4,204,546

Registered Sep. 11, 2012

Int. Cls.: 39 and 45

SERVICE MARK

PRINCIPAL REGISTER

ANNE TAYLOR COMMUNICATIONS, LLC (WASHINGTON LIMITED LIABILITY COMPANY)
C/O LEYDIG 2 PRUDENTIAL PLAZA, STE. 4900
CHICAGO, IL 60601

FOR: TRAVEL INFORMATION SERVICES; ARRANGING TRAVEL TOURS AND TRAVEL EVENTS IN THE NATURE OF ARRANGING TRAVEL EXCURSION, ARRANGING WEEK-END TRAVEL GETAWAYS AND RETREAT TRAVEL ARRANGEMENT; ONLINE TRIP AND TRAVEL RESERVATION SERVICES, NAMELY, ARRANGING RESERVATIONS FOR TRAVEL AND TOUR TICKET RESERVATION SERVICES FOR TRAVEL EXCURSIONS, GETAWAYS AND RETREATS; PROVIDING A WEBSITE FEATURING TRAVEL INFORMATION AND COMMENTARY; TRAVEL CLUB SERVICES; PROVIDING AN ONLINE WEBSITE FEATURING INFORMATION ON FAMILY TRAVEL, LUXURY TRAVEL, TRAVEL TIPS AND COMMENTARY; CITY TRAVEL GUIDE SERVICES, IN CLASS 39 (U.S. CLS. 100 AND 105).

FIRST USE 9-14-2010; IN COMMERCE 9-14-2010.

FOR: PROVIDING A WEB SITE FEATURING INFORMATION ON FASHION AND LIFESTYLE FOR FAMILIES, MEN, WOMEN AND CHILDREN AND INFORMATION ON ISSUES RELATING TO MOTHERHOOD, NAMELY, INFORMATION IN THE FIELD OF PARENTING AND PARENTAL WORK AND LIFE BALANCE, IN CLASS 45 (U.S. CLS. 100 AND 101).

FIRST USE 2-14-2009; IN COMMERCE 2-14-2009.

NO CLAIM IS MADE TO THE EXCLUSIVE RIGHT TO USE "TRAVEL", APART FROM THE MARK AS SHOWN.

THE MARK CONSISTS OF CONSISTS OF FLOWING AND SWIRLING LINES WITH THE WORDS "HIP TRAVEL MAMA" AND PICTURES OF A SUITCASE, CAR, BOAT, CAMERA AND AIRPLANE.

SER. NO. 85-359,856, FILED 6-29-2011.

ANDREA K. NADELMAN, EXAMINING ATTORNEY



David J. Kyros

Director of the United States Patent and Trademark Office

United States of America

United States Patent and Trademark Office

THE ZERO POLLUTION SOLUTION

Reg. No. 4,204,547

FAROOQ, ANWAR M (UNITED STATES INDIVIDUAL)
4133 HOWARD ST
MONTCLAIR, CA 91763

Registered Sep. 11, 2012

Int. Cl.: 42

FOR: PROVIDING INFORMATION IN THE FIELD OF GREEN AND ENVIRONMENTALLY-FRIENDLY VEHICLE TRANSPORTATION AND TRAFFIC PLANNING SOLUTIONS AND INNOVATIONS, IN CLASS 42 (U.S. CLS. 100 AND 101).

SERVICE MARK

FIRST USE 0-0-2009; IN COMMERCE 0-0-2009.

PRINCIPAL REGISTER

THE MARK CONSISTS OF STANDARD CHARACTERS WITHOUT CLAIM TO ANY PARTICULAR FONT, STYLE, SIZE, OR COLOR.

NO CLAIM IS MADE TO THE EXCLUSIVE RIGHT TO USE "POLLUTION SOLUTION", APART FROM THE MARK AS SHOWN.

SER. NO. 85-360,050, FILED 6-29-2011.

WILLIAM VERHOSEK, EXAMINING ATTORNEY



David J. Kybas

Director of the United States Patent and Trademark Office

United States of America

United States Patent and Trademark Office

BUBBLE BEAD

Reg. No. 4,204,548

Registered Sep. 11, 2012

Int. Cl.: 11

TRADEMARK

PRINCIPAL REGISTER

AQUACULTURE SYSTEMS TECHNOLOGIES, LLC (LOUISIANA LIMITED LIABILITY COMPANY)
108 INDUSTRIAL AVE.
NEW ORLEANS, LA 70121

FOR: WATER TREATMENT EQUIPMENT, NAMELY, WATER FILTRATION UNITS AND BUBBLE-WASHED BEAD FILTERS; WATER FILTERS, IN CLASS 11 (U.S. CLS. 13, 21, 23, 31 AND 34).

FIRST USE 10-15-1995; IN COMMERCE 10-15-1995.

THE MARK CONSISTS OF STANDARD CHARACTERS WITHOUT CLAIM TO ANY PARTICULAR FONT, STYLE, SIZE, OR COLOR.

NO CLAIM IS MADE TO THE EXCLUSIVE RIGHT TO USE "BEAD", APART FROM THE MARK AS SHOWN.

SER. NO. 85-360,128, FILED 6-30-2011.

KIMBERLY PERRY, EXAMINING ATTORNEY



David J. Kyffers

Director of the United States Patent and Trademark Office

United States of America

United States Patent and Trademark Office

UBFit

Reg. No. 4,204,549

Registered Sep. 11, 2012

Int. Cl.: 41

SERVICE MARK

PRINCIPAL REGISTER

GC2 LLC (DELAWARE LIMITED LIABILITY COMPANY)
7 WEST MILL STREET
MEDFIELD, MA 02052

FOR: INTERACTIVE ON-LINE WEB JOURNALS IN THE FIELD OF FITNESS, IN CLASS 41
(U.S. CLS. 100, 101 AND 107).

FIRST USE 2-11-2010; IN COMMERCE 2-11-2010.

THE MARK CONSISTS OF STANDARD CHARACTERS WITHOUT CLAIM TO ANY PARTICULAR FONT, STYLE, SIZE, OR COLOR.

SER. NO. 85-360,451, FILED 6-30-2011.

STEVEN JACKSON, EXAMINING ATTORNEY



David J. Kybas

Director of the United States Patent and Trademark Office

United States of America

United States Patent and Trademark Office

FAR ABOVE: THE CAMPAIGN FOR KANSAS

Reg. No. 4,204,550

Registered Sep. 11, 2012

Int. Cl.: 36

SERVICE MARK

PRINCIPAL REGISTER

UNIVERSITY OF KANSAS (KANSAS STATE UNIVERSITY)
1450 JAYHAWK BLVD.
245 STRONG HALL
LAWRENCE, KS 66045

FOR: CHARITABLE FUNDRAISING SERVICES, NAMELY, RAISING FUNDS FOR UNIVERSITY EDUCATION COSTS, NAMELY, SCHOLARSHIPS, PAY FOR FACULTY, EDUCATIONAL PROGRAMS, CAPITAL, AND ENDOWMENT, IN CLASS 36 (U.S. CLS. 100, 101 AND 102).

FIRST USE 11-16-2011; IN COMMERCE 11-16-2011.

THE MARK CONSISTS OF STANDARD CHARACTERS WITHOUT CLAIM TO ANY PARTICULAR FONT, STYLE, SIZE, OR COLOR.

OWNER OF U.S. REG. NO. 2,073,857.

SER. NO. 85-361,041, FILED 6-30-2011.

KIM MONINGHOFF, EXAMINING ATTORNEY



David J. Kyffers

Director of the United States Patent and Trademark Office

United States of America

United States Patent and Trademark Office

FAR ABOVE THE CAMPAIGN FOR KANSAS

Reg. No. 4,204,551

Registered Sep. 11, 2012

Int. Cl.: 36

SERVICE MARK

PRINCIPAL REGISTER

UNIVERSITY OF KANSAS (KANSAS STATE UNIVERSITY)
1450 JAYHAWK BLVD.
245 STRONG HALL
LAWRENCE, KS 66045

FOR: CHARITABLE FUNDRAISING SERVICES, NAMELY, RAISING FUNDS FOR UNIVERSITY EDUCATION COSTS, NAMELY, SCHOLARSHIPS, PAY FOR FACULTY, EDUCATIONAL PROGRAMS, CAPITAL, AND ENDOWMENT, IN CLASS 36 (U.S. CLS. 100, 101 AND 102).

FIRST USE 11-16-2011; IN COMMERCE 11-16-2011.

THE MARK CONSISTS OF STANDARD CHARACTERS WITHOUT CLAIM TO ANY PARTICULAR FONT, STYLE, SIZE, OR COLOR.

OWNER OF U.S. REG. NO. 2,073,857.

SER. NO. 85-361,047, FILED 6-30-2011.

KIM MONINGHOFF, EXAMINING ATTORNEY



David J. Kyffers

Director of the United States Patent and Trademark Office

United States of America

United States Patent and Trademark Office



Reg. No. 4,204,552

Registered Sep. 11, 2012

Int. Cls.: 12 and 35

TRADEMARK

SERVICE MARK

PRINCIPAL REGISTER

FOX FACTORY, INC. (CALIFORNIA CORPORATION)
130 HANGAR WAY
WATSONVILLE, CA 95076

FOR: SUSPENSION SYSTEMS FOR VEHICLES, NAMELY, BICYCLES AND LAND MOTOR VEHICLES; VEHICLE PARTS, NAMELY, SHOCK ABSORBERS, IN CLASS 12 (U.S. CLS. 19, 21, 23, 31, 35 AND 44).

FIRST USE 1-31-1983; IN COMMERCE 1-31-1983.

FOR: ADVERTISING, MARKETING AND PROMOTIONAL SERVICES FOR DEALERS AND DISTRIBUTORS OF VEHICLE SUSPENSION SYSTEMS INCLUDING SHOCK ABSORBERS FOR VEHICLES, IN CLASS 35 (U.S. CLS. 100, 101 AND 102).

FIRST USE 1-31-1983; IN COMMERCE 1-31-1983.

OWNER OF U.S. REG. NOS. 2,321,069, 3,669,224 AND OTHERS.

NO CLAIM IS MADE TO THE EXCLUSIVE RIGHT TO USE "RACING SHOCKS", APART FROM THE MARK AS SHOWN.

THE MARK CONSISTS OF THE STYLIZED WORD "FOX" FEATURING A STYLIZED BUSHY FOX TAIL THROUGH THE LETTER "O" OVER THE WORDING "RACING SHOX".

SER. NO. 85-361,080, FILED 6-30-2011.

DOMINIC J. FERRAIUOLO, EXAMINING ATTORNEY



David J. Kyffers

Director of the United States Patent and Trademark Office

United States of America

United States Patent and Trademark Office

The Civil Wars

Reg. No. 4,204,553

Registered Sep. 11, 2012

Int. Cl.: 9

TRADEMARK

PRINCIPAL REGISTER

THE CIVIL WARS, LLC (TENNESSEE LIMITED LIABILITY COMPANY), DBA THE CIVIL WARS
1906 ACKLEN AVENUE
NASHVILLE, TX 37212

FOR: DIGITAL MEDIA, NAMELY, PRE-RECORDED VIDEO CASSETTES, DIGITAL VIDEO DISCS, DIGITAL VIDEO DISCS, DIGITAL VERSATILE DISCS, DOWNLOADABLE AUDIO AND VIDEO RECORDINGS, DVDS, AND HIGH-DEFINITION DISCS FEATURING MUSICAL PERFORMANCES; PRE-RECORDED CDS FEATURING MUSICAL PERFORMANCES; PRE-RECORDED CDS, VIDEO TAPES, LASER DISCS AND DVDS FEATURING MUSICAL PERFORMANCES; SOUND RECORDINGS FEATURING MUSICAL PERFORMANCES, IN CLASS 9 (U.S. CLS. 21, 23, 26, 36 AND 38).

FIRST USE 11-15-2009; IN COMMERCE 11-15-2009.

THE MARK CONSISTS OF STANDARD CHARACTERS WITHOUT CLAIM TO ANY PARTICULAR FONT, STYLE, SIZE, OR COLOR.

SER. NO. 85-361,090, FILED 6-30-2011.

DOMINIC J. FERRAIUOLO, EXAMINING ATTORNEY



David J. Kyros

Director of the United States Patent and Trademark Office

United States of America

United States Patent and Trademark Office

ASSIST

Reg. No. 4,204,554

Registered Sep. 11, 2012

Int. Cls.: 9 and 42

TRADEMARK

SERVICE MARK

PRINCIPAL REGISTER

ADVANCE EDUCATION, INC. (GEORGIA CORPORATION), DBA ADVANCED
9115 WESTSIDE PARKWAY
LEGAL DEPARTMENT
ALPHARETTA, GA 30009

FOR: COMPUTER SOFTWARE PLATFORMS FOR KNOWLEDGE MANAGEMENT OF DATA AND DIAGNOSTIC TOOLS FOR USE IN SCHOOL IMPROVEMENT, ACCREDITATION AND COMPLIANCE PROCESSES TO DRIVE QUALITY EDUCATION AND STUDENT PERFORMANCE, IN CLASS 9 (U.S. CLS. 21, 23, 26, 36 AND 38).

FIRST USE 7-1-2009; IN COMMERCE 5-21-2010.

FOR: APPLICATION SERVICE PROVIDER (ASP) FEATURING SOFTWARE FOR USE BY EDUCATIONAL INSTITUTIONS TO MERGE PROCESS, CONTENT, DATA AND TECHNOLOGY INTO A WEB-BASED PLATFORM THAT SUPPORTS END TO END MANAGEMENT OF SCHOOL IMPROVEMENT, ACCREDITATION PROCESSES AND COMPLIANCE MONITORING; COMPUTER SERVICES, NAMELY, ACTING AS AN APPLICATION SERVICE PROVIDER IN THE FIELD OF KNOWLEDGE MANAGEMENT TO HOST COMPUTER APPLICATION SOFTWARE FOR THE PURPOSE OF SCHOOL IMPROVEMENT, ACCREDITATION SERVICES AND COMPLIANCE MONITORING; CONSULTING ON ROOT CAUSE ANALYSIS IN THE FIELD OF SCHOOL IMPROVEMENT; SOFTWARE AS A SERVICE (SAAS) SERVICES FEATURING SOFTWARE IN THE FIELD OF SCHOOL IMPROVEMENT, ACCREDITATION PROCESSES AND COMPLIANCE MONITORING, IN CLASS 42 (U.S. CLS. 100 AND 101).

FIRST USE 7-1-2009; IN COMMERCE 5-21-2010.

THE MARK CONSISTS OF STANDARD CHARACTERS WITHOUT CLAIM TO ANY PARTICULAR FONT, STYLE, SIZE, OR COLOR.

SER. NO. 85-361,941, FILED 7-1-2011.

RAUL CORDOVA, EXAMINING ATTORNEY



David J. Kyffers

Director of the United States Patent and Trademark Office

United States of America

United States Patent and Trademark Office

WEST COAST ENGINEERING

Reg. No. 4,204,555

Registered Sep. 11, 2012

Int. Cls.: 6, 17 and 20

TRADEMARK

PRINCIPAL REGISTER

VALMONT INDUSTRIES, INC. (DELAWARE CORPORATION)
ONE VALMONT PLAZA
OMAHA, NE 681545215

FOR: METAL POLES; METAL BOLLARDS; METAL CASTINGS; METAL LAMP POSTS; METAL SIGN BRIDGES; METAL OUTDOOR LIGHTING STRUCTURES; POLE ACCESSORIES MADE OF METAL, NAMELY, ANCHOR BOLTS, NUT COVERS AND POLE TOP CAPS; METAL POLE BASE COVERS; METAL POLE BASES; METAL LADDERS; METAL HAND HOLE COVERS; MONOPOLES WITH PINWHEEL ANTENNA MOUNTING BRACKETS, IN CLASS 6 (U.S. CLS. 2, 12, 13, 14, 23, 25 AND 50).

FIRST USE 0-0-1992; IN COMMERCE 0-0-1996.

FOR: POLE ACCESSORIES MADE OF PLASTIC, NAMELY, ANCHOR BOLT NUT COVERS AND POLE TOP CAPS; PLASTIC POLE BASE COVERS, IN CLASS 17 (U.S. CLS. 1, 5, 12, 13, 35 AND 50).

FIRST USE 0-0-1992; IN COMMERCE 0-0-1996.

FOR: COMPOSITE POLES MADE PRIMARILY OF RESIN, IN CLASS 20 (U.S. CLS. 2, 13, 22, 25, 32 AND 50).

FIRST USE 0-0-1992; IN COMMERCE 0-0-1996.

THE MARK CONSISTS OF STANDARD CHARACTERS WITHOUT CLAIM TO ANY PARTICULAR FONT, STYLE, SIZE, OR COLOR.

NO CLAIM IS MADE TO THE EXCLUSIVE RIGHT TO USE "ENGINEERING", APART FROM THE MARK AS SHOWN.

SEC. 2(F).

SER. NO. 85-361,958, FILED 7-1-2011.

JANICE L. MCMORROW, EXAMINING ATTORNEY

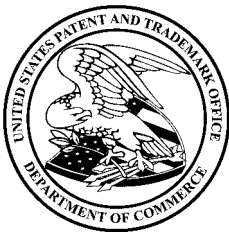

David J. Kyros

Director of the United States Patent and Trademark Office

United States of America

United States Patent and Trademark Office

VALMONT WEST COAST ENGINEERING

Reg. No. 4,204,556

Registered Sep. 11, 2012

Int. Cls.: 6, 17 and 20

TRADEMARK

PRINCIPAL REGISTER

VALMONT INDUSTRIES, INC. (DELAWARE CORPORATION)
ONE VALMONT PLAZA
OMAHA, NE 681545215

FOR: METAL POLES; METAL BOLLARDS; METAL CASTINGS; METAL LAMP POSTS; METAL SIGN BRIDGES; METAL OUTDOOR LIGHTING STRUCTURES; POLE ACCESSORIES MADE OF METAL, NAMELY, ANCHOR BOLTS, NUT COVERS AND POLE TOP CAPS; METAL POLE BASES; METAL LADDERS; METAL HAND HOLE COVERS; MONOPOLES WITH PINWHEEL ANTENNA MOUNTING BRACKETS, IN CLASS 6 (U.S. CLS. 2, 12, 13, 14, 23, 25 AND 50).

FIRST USE 2-0-2008; IN COMMERCE 2-0-2008.

FOR: POLE ACCESSORIES MADE OF PLASTIC, NAMELY, ANCHOR BOLT NUT COVERS AND POLE TOP CAPS; PLASTIC POLE BASE COVERS, IN CLASS 17 (U.S. CLS. 1, 5, 12, 13, 35 AND 50).

FIRST USE 2-0-2008; IN COMMERCE 2-0-2008.

FOR: COMPOSITE POLES MADE PRIMARILY OF RESIN, IN CLASS 20 (U.S. CLS. 2, 13, 22, 25, 32 AND 50).

FIRST USE 2-0-2008; IN COMMERCE 2-0-2008.

THE MARK CONSISTS OF STANDARD CHARACTERS WITHOUT CLAIM TO ANY PARTICULAR FONT, STYLE, SIZE, OR COLOR.

OWNER OF U.S. REG. NOS. 846,915 AND 1,151,459.

NO CLAIM IS MADE TO THE EXCLUSIVE RIGHT TO USE "ENGINEERING", APART FROM THE MARK AS SHOWN.

SEC. 2(F) AS TO "WEST COAST ENGINEERING".

SER. NO. 85-361,964, FILED 7-1-2011.

JANICE L. MCMORROW, EXAMINING ATTORNEY



David J. Kyros

Director of the United States Patent and Trademark Office

United States of America

United States Patent and Trademark Office

DataRx

Reg. No. 4,204,557

Registered Sep. 11, 2012

Int. Cls.: 35, 36 and 38

SERVICE MARK

PRINCIPAL REGISTER

DATA RX MANAGEMENT, INCORPORATED (TEXAS CORPORATION)
5920 ODELL STREET
CUMMING, GA 30040

FOR: BUSINESS MANAGEMENT CONSULTATION, NAMELY, ASSISTING PHARMACIES IN NEGOTIATING PRICING AND REIMBURSEMENT LEVELS, DISPENSING FEES AND OTHER CONTRACTUAL TERMS WITH PHARMACY BENEFIT MANAGERS; ASSISTING PHARMACIES IN NEGOTIATING PRICING WITH PHARMACEUTICAL WHOLESALERS; PROVIDING CLAIM RECONCILIATION SERVICES IN THE NATURE OF PROVIDING INSURANCE/PAYOR CLAIMS AUDITING INFORMATION TO PHARMACIES PERTAINING TO PAYMENTS FROM INSURANCE CARRIERS AND OTHER PAYORS VIA A WORLDWIDE COMMUNICATIONS NETWORK; ADMINISTRATION OF PRESCRIPTION DISCOUNT DRUG PROGRAMS; PROMOTING THE GOODS AND SERVICES OF OTHERS BY PROVIDING HYPERTEXT LINKS TO THE WEB SITES OF OTHERS; INSURANCE PLAN RECONCILIATION FOR OTHERS; PROVIDING AN ONLINE DATABASE FEATURING CUSTOMER ORDER STATUS INFORMATION, IN CLASS 35 (U.S. CLS. 100, 101 AND 102).

FIRST USE 7-1-2005; IN COMMERCE 7-1-2005.

FOR: PROVIDING PHARMACY BENEFIT MANAGEMENT SERVICES TO EMPLOYER GROUPS; PROVIDING FINANCIAL CONSULTING SERVICES TO PHARMACIES AND OTHERS; PROVIDING PRESCRIPTION CLAIMS AGGREGATION SERVICES TO PHARMACIES; PROVIDING INFORMATION IN THE FIELD OF INSURANCE PLAN INFORMATION ALL VIA A GLOBAL COMPUTER NETWORK; INSURANCE CONSULTATION SERVICES, NAMELY, PRE-SCREENING PHARMACY CLAIMS FOR COMPLIANCE WITH INSURANCE PLAN REQUIREMENTS; INSURANCE MANAGEMENT SERVICES, NAMELY, INSURANCE PLAN FACTORING FOR OTHERS, IN CLASS 36 (U.S. CLS. 100, 101 AND 102).

FIRST USE 7-1-2008; IN COMMERCE 7-1-2008.

FOR: TELECOMMUNICATION SERVICES, NAMELY, DATA SWITCHING SERVICES FOR USE IN TRANSMITTING MEDICAL PRESCRIPTIONS BETWEEN PHARMACIES AND INSURANCE PROVIDERS AND PROVIDING MULTIPLE USER ACCESS TO THE INTERNET FOR PHARMACIES AND INSURANCE PROVIDERS FOR USE IN AUTHORIZING AND FILLING PRESCRIPTIONS AND PRESCRIPTION REFILLS; PROVIDING ACCESS TO DATABASES, IN CLASS 38 (U.S. CLS. 100, 101 AND 104).



David J. Kyjars

Director of the United States Patent and Trademark Office

Reg. No. 4,204,557 FIRST USE 7-1-1998; IN COMMERCE 7-1-1998.

THE MARK CONSISTS OF STANDARD CHARACTERS WITHOUT CLAIM TO ANY PARTICULAR FONT, STYLE, SIZE, OR COLOR.

SER. NO. 85-362,681, FILED 7-4-2011.

JAMES GRIFFIN, EXAMINING ATTORNEY

United States of America

United States Patent and Trademark Office

RxSense

Reg. No. 4,204,558

Registered Sep. 11, 2012

Int. Cls.: 35 and 36

SERVICE MARK

PRINCIPAL REGISTER

DATA RX MANAGEMENT, INCORPORATED (TEXAS CORPORATION)
5920 ODELL STREET
CUMMING, GA 30040

FOR: BUSINESS MANAGEMENT CONSULTATION, NAMELY, ASSISTING PHARMACIES IN NEGOTIATING PRICING AND REIMBURSEMENT LEVELS, DISPENSING FEES AND OTHER CONTRACTUAL TERMS WITH PHARMACY BENEFIT MANAGERS; ASSISTING PHARMACIES IN NEGOTIATING PRICING WITH PHARMACEUTICAL WHOLESALERS; PROVIDING CLAIM RECONCILIATION SERVICES IN THE NATURE OF PROVIDING INSURANCE/PAYOR CLAIMS AUDITING INFORMATION TO PHARMACIES PERTAINING TO PAYMENTS FROM INSURANCE CARRIERS AND OTHER PAYORS VIA A WORLDWIDE COMMUNICATIONS NETWORK; INSURANCE PLAN RECONCILIATION FOR OTHERS, IN CLASS 35 (U.S. CLS. 100, 101 AND 102).

FIRST USE 12-31-2004; IN COMMERCE 12-31-2004.

FOR: PROVIDING PHARMACY BENEFIT MANAGEMENT SERVICES TO EMPLOYER GROUPS; PROVIDING FINANCIAL CONSULTING SERVICES TO PHARMACIES AND OTHERS; PROVIDING PRESCRIPTION CLAIMS AGGREGATION SERVICES TO PHARMACIES; PROVIDING INFORMATION IN THE FIELD OF INSURANCE PLAN INFORMATION ALL VIA A GLOBAL COMPUTER NETWORK; INSURANCE CONSULTATION SERVICES, NAMELY, PRE-SCREENING PHARMACY CLAIMS FOR COMPLIANCE WITH INSURANCE PLAN REQUIREMENTS; INSURANCE MANAGEMENT SERVICES, NAMELY, INSURANCE PLAN FACTORING FOR OTHERS, IN CLASS 36 (U.S. CLS. 100, 101 AND 102).

FIRST USE 12-31-2004; IN COMMERCE 12-31-2004.

THE MARK CONSISTS OF STANDARD CHARACTERS WITHOUT CLAIM TO ANY PARTICULAR FONT, STYLE, SIZE, OR COLOR.

SER. NO. 85-362,726, FILED 7-5-2011.

JAMES GRIFFIN, EXAMINING ATTORNEY



David J. Kyffers

Director of the United States Patent and Trademark Office

United States of America

United States Patent and Trademark Office

YANFENG

Reg. No. 4,204,559

Registered Sep. 11, 2012

Int. Cl.: 12

TRADEMARK

PRINCIPAL REGISTER

YANFENG VISTEON AUTOMOTIVE TRIM SYSTEMS CO., LTD. (CHINA LIMITED LIABILITY COMPANY)
1001, QUINZHOU ROAD NORTH
SHANGHAI, CHINA 200233

FOR: VEHICLE PARTS, COMPONENTS AND ACCESSORIES, NAMELY, STRUCTURAL VEHICLE INTERIOR PARTS FOR LAND VEHICLES, NAMELY, COCKPITS CONSISTING OF INSTRUMENT PANELS, SWITCH MODULES, STEERING COLUMNS, VEHICLE AIRBAGS, SENSORS, HEATING, VENTILATION AND AIR CONDITIONING SYSTEMS, NAVIGATION MODULES, AUDIO SYSTEMS AND WIRE HARNESSSES ASSEMBLED AS A MODULE; INSTRUMENT PANELS, CONSOLES AND PILLARS; DOOR PANELS FOR VEHICLES; VEHICLE SEATS; AUTOMOTIVE VEHICLE PARTS, NAMELY, HEADLINERS AND STEERING WHEELS; VEHICLE SAFETY AIRBAGS, NAMELY, DRIVER AIRBAGS, PASSENGER AIRBAGS, SIDE AIRBAGS AND CURTAIN AIRBAGS; SEAT BELTS, STEPLESS LOAD-LIMITER SEAT BELTS, MULTI-STOP LOAD LIMITER SEAT BELTS AND PRE-TENSIONER SEAT BELTS ALL FOR USE IN VEHICLES; STRUCTURAL PARTS FOR VEHICLES, NAMELY, BUMPERS, FENDERS, RADIATOR GRILLS; BODY TRIM FOR AUTOMOBILES, NAMELY, ROCK PANELS, ANTI-SCRAPING PANELS, AND WHEEL TRIM; REAR CLOSURES, NAMELY, REAR PARCEL SHELVES; FRONT-END MODULES, NAMELY, ENGINE BRACKETS, COOLING WATER TANKS AND AIR CONDITIONING EVAPORATORS ASSEMBLED AS A MODULE, IN CLASS 12 (U.S. CLS. 19, 21, 23, 31, 35 AND 44).

FIRST USE 5-14-2011; IN COMMERCE 5-14-2011.

THE MARK CONSISTS OF STANDARD CHARACTERS WITHOUT CLAIM TO ANY PARTICULAR FONT, STYLE, SIZE, OR COLOR.

SER. NO. 85-362,753, FILED 7-5-2011.

DAVID MURRAY, EXAMINING ATTORNEY



David J. Kypos

Director of the United States Patent and Trademark Office

United States of America

United States Patent and Trademark Office

WRITE GURU

Reg. No. 4,204,560

THE WRITE GURU, LTD. (WASHINGTON CORPORATION)
4338 32NE AVE W
SEATTLE, WA 98127

Registered Sep. 11, 2012

Int. Cls.: 41 and 42

FOR: CUSTOM WRITING SERVICES FOR OTHERS; CUSTOM WRITING SERVICES FOR OTHERS, NAMELY, WRITING AN INDEX FOR PRINTED PUBLICATIONS AND ONLINE PUBLICATIONS; WRITING OF ARTICLES FOR PERIODICALS OTHER THAN FOR ADVERTISING OR PUBLICITY FOR OTHERS; WRITING OF TEXTS FOR OTHERS, IN CLASS 41 (U.S. CLS. 100, 101 AND 107).

SERVICE MARK

PRINCIPAL REGISTER

FIRST USE 12-23-1994; IN COMMERCE 1-31-1995.

FOR: WEBSITE DESIGN AND DEVELOPMENT FOR OTHERS; TECHNICAL WRITING FOR OTHERS, IN CLASS 42 (U.S. CLS. 100 AND 101).

FIRST USE 12-23-1994; IN COMMERCE 1-31-1995.

THE MARK CONSISTS OF STANDARD CHARACTERS WITHOUT CLAIM TO ANY PARTICULAR FONT, STYLE, SIZE, OR COLOR.

SEC. 2(F).

SER. NO. 85-362,794, FILED 7-5-2011.

KIM MONINGHOFF, EXAMINING ATTORNEY



David J. Kybas

Director of the United States Patent and Trademark Office

United States of America

United States Patent and Trademark Office

Immersion Listening

Reg. No. 4,204,561 SPEECH IMPROVEMENT RESOURCES, LLC (GEORGIA LIMITED LIABILITY COMPANY)
9915 BARSTON CT.
Registered Sep. 11, 2012 JOHNS CREEK, GA 30022

Int. Cl.: 41 FOR: PROFESSIONAL COACHING SERVICES IN THE FIELD OF BUSINESS COMMUNICATIONS, IN CLASS 41 (U.S. CLS. 100, 101 AND 107).

SERVICE MARK FIRST USE 4-0-2008; IN COMMERCE 4-0-2008.

PRINCIPAL REGISTER THE MARK CONSISTS OF STANDARD CHARACTERS WITHOUT CLAIM TO ANY PARTICULAR FONT, STYLE, SIZE, OR COLOR.

SER. NO. 85-363,060, FILED 7-5-2011.

REGINA DRUMMOND, EXAMINING ATTORNEY



David J. Kyjars

Director of the United States Patent and Trademark Office

United States of America

United States Patent and Trademark Office

LA FEE MARABOUTEE

Reg. No. 4,204,562

Registered Sep. 11, 2012

Int. Cl.: 25

TRADEMARK

PRINCIPAL REGISTER

LA FEE (FRANCE SOCIETE PAR ACTIONS SIMPLIFIEE UNIPERSONNELLE)
2 PASSAGE GERBAY
ROANNE, FRANCE 42300

FOR: (BASED ON 44(E) CLOTHING, NAMELY, UNDERGARMENTS, SHIRTS, JACKETS, PIRATE PANTS, OVERALLS, LEOTARDS, SUSPENDERS, BRIEFS, BELTS, LEG WARMERS, SOCKS, STOCKINGS, SASHES, HEADBANDS, PARTS AND FITTINGS FOR SHOES AND SLIPPERS; CLOTHING AND SPORTSWEAR, NAMELY, JACKETS, PARKAS, VESTS, WIND JACKETS, ANORAKS, SWEATSHIRTS, POLO SHIRTS, TEE SHIRTS TRACK SUITS, SHORTS, TROUSERS OVER TROUSERS, SHIRTS, SHORTS, SWIMSUITS; (BASED ON USE IN COMMERCE) FOOTWEAR; HEADGEAR, NAMELY, HEADWEAR; CLOTHING, NAMELY, DRESSES, TROUSERS, SHORTS, PANTS, TEE SHIRTS, SKIRTS, TANK TOPS, TUNICS, TOPS; CLOTHING AND SPORTSWEAR, NAMELY, JACKETS, DUFFLE COATS, SWEATERS, PULLOVERS, SCARVES AND GLOVES , IN CLASS 25 (U.S. CLS. 22 AND 39).

FIRST USE 4-23-2002; IN COMMERCE 9-0-2010.

THE MARK CONSISTS OF STANDARD CHARACTERS WITHOUT CLAIM TO ANY PARTICULAR FONT, STYLE, SIZE, OR COLOR.

OWNER OF ERPN CMNTY TM OFC REG. NO. 002690683, DATED 9-23-2003, EXPIRES 4-23-2022.

THE ENGLISH TRANSLATION OF "LA FEE MARABOUTEE" IN THE MARK IS "THE FAIRY MARABOUTEE".

SER. NO. 85-363,387, FILED 7-5-2011.

WILLIAM P. SHANAHAN, EXAMINING ATTORNEY



David J. Kybas

Director of the United States Patent and Trademark Office

United States of America

United States Patent and Trademark Office

NoshPlanet

Reg. No. 4,204,563

Registered Sep. 11, 2012

Int. Cl.: 35

SERVICE MARK

PRINCIPAL REGISTER

NOSHPLANET PTY LTD (AUSTRALIA PROPRIETARY LIMITED COMPANY)
C/- P. ROWAN & ASSOCS, 24 MOORABOOL ST.
GEELONG, VIC 3220, AUSTRALIA

FOR: PROVIDING A SEARCHABLE ONLINE ADVERTISING INFORMATIONAL REFERRAL DINING GUIDE FEATURING THE FOOD PRODUCTS AND DINING SERVICES OF OTHER VENDORS VIA THE INTERNET FOR USERS OF COMPUTERS AND MOBILE DEVICES, IN CLASS 35 (U.S. CLS. 100, 101 AND 102).

THE MARK CONSISTS OF STANDARD CHARACTERS WITHOUT CLAIM TO ANY PARTICULAR FONT, STYLE, SIZE, OR COLOR.

PRIORITY CLAIMED UNDER SEC. 44(D) ON AUSTRALIA APPLICATION NO. 15004469, FILED 7-6-2011, REG. NO. 1435236, DATED 5-17-2012, EXPIRES 7-6-2021.

SER. NO. 85-363,727, FILED 7-6-2011.

SIMON TENG, EXAMINING ATTORNEY



David J. Kybas

Director of the United States Patent and Trademark Office

United States of America

United States Patent and Trademark Office

Old Wives

Reg. No. 4,204,564

GLEASON, JASON (UNITED STATES INDIVIDUAL)
88 GROVE AVE.
VERONA, NJ 07044

Registered Sep. 11, 2012

Int. Cl.: 9

FOR: AUDIO AND VIDEO RECORDINGS FEATURING MUSIC AND ARTISTIC PERFORMANCES, IN CLASS 9 (U.S. CLS. 21, 23, 26, 36 AND 38).

TRADEMARK

FIRST USE 8-9-2007; IN COMMERCE 1-1-2008.

PRINCIPAL REGISTER

THE MARK CONSISTS OF STANDARD CHARACTERS WITHOUT CLAIM TO ANY PARTICULAR FONT, STYLE, SIZE, OR COLOR.

SER. NO. 85-364,299, FILED 7-6-2011.

FONG HSU, EXAMINING ATTORNEY



David J. Kybas

Director of the United States Patent and Trademark Office

United States of America

United States Patent and Trademark Office

STUDIO 18

Reg. No. 4,204,565

IDEA FACTORY ASSOCIATES LLC (NEW YORK LIMITED LIABILITY COMPANY)
552 SEVENTH AVE STE 202
NEW YORK, NY 10018

Registered Sep. 11, 2012

Int. Cl.: 25

FOR: BERMUDA SHORTS; CAPRIS; JEANS; PANTS; SHIRTS; SHORTS; SKIRTS; SWEATERS;
T-SHIRTS; TANK TOPS, IN CLASS 25 (U.S. CLS. 22 AND 39).

TRADEMARK

FIRST USE 9-0-2010; IN COMMERCE 9-0-2010.

PRINCIPAL REGISTER

THE MARK CONSISTS OF STANDARD CHARACTERS WITHOUT CLAIM TO ANY PARTICULAR FONT, STYLE, SIZE, OR COLOR.

OWNER OF U.S. REG. NO. 1,145,472.

NO CLAIM IS MADE TO THE EXCLUSIVE RIGHT TO USE "STUDIO", APART FROM THE MARK AS SHOWN.

SER. NO. 85-364,668, FILED 7-6-2011.

MARLENE BELL, EXAMINING ATTORNEY



David J. Kyffers

Director of the United States Patent and Trademark Office

United States of America

United States Patent and Trademark Office



Fillies Race for *Hope*

CANTERBURY PARK

Reg. No. 4,204,566

Registered Sep. 11, 2012

Int. Cls.: 25 and 36

TRADEMARK

SERVICE MARK

PRINCIPAL REGISTER

CANTERBURY PARK HOLDING CORPORATION (MINNESOTA CORPORATION)
1100 CANTERBURY RD
SHAKOPEE, MN 55379

FOR: CLOTHING, NAMELY, T-SHIRTS AND HATS, IN CLASS 25 (U.S. CLS. 22 AND 39).

FIRST USE 9-30-2010; IN COMMERCE 9-30-2010.

FOR: CHARITABLE FUNDRAISING SERVICES, NAMELY, RAISING FUNDS FOR FINANCIAL SUPPORT OF INDIVIDUALS AND THEIR FAMILIES THAT SUFFER FROM CANCER BY MEANS OF HORSE RACING EVENTS, IN CLASS 36 (U.S. CLS. 100, 101 AND 102).

FIRST USE 9-30-2010; IN COMMERCE 9-30-2010.

OWNER OF U.S. REG. NO. 2,093,394.

THE COLOR(S) WHITE, TAN, LIGHT PINK AND DARK PINK IS/ARE CLAIMED AS A FEATURE OF THE MARK.

NO CLAIM IS MADE TO THE EXCLUSIVE RIGHT TO USE "FILLIES RACE", APART FROM THE MARK AS SHOWN.

THE MARK CONSISTS OF A LIGHT AND DARK PINK RIBBON IN THE SHAPE OF A HORSE'S HEAD AND NECK APPEARING ABOVE THE WORDS "FILLIES RACE FOR" IN TAN AND THE WORD "HOPE" IN DARK PINK BELOW THE RIBBON; "CANTERBURY PARK" IN WHITE INSIDE A TAN BOX.

SER. NO. 85-364,943, FILED 7-7-2011.

ANTHONY RINKER, EXAMINING ATTORNEY



David J. Kyffers

Director of the United States Patent and Trademark Office

United States of America

United States Patent and Trademark Office

Virtus Module

Reg. No. 4,204,567

Registered Sep. 11, 2012

Int. Cl.: 9

TRADEMARK

PRINCIPAL REGISTER

ZHEJIANG YUHUI SOLAR ENERGY SOURCE CO., LTD. (CHINA CORPORATION)
YAOZHUANG INDUSTRIAL PARK
JIASHAN COUNTY, ZHEJIANG PROVINCE
JIAXING CITY, CHINA

FOR: MONOCRYSTALLINE SILICON WAFERS; POLYCRYSTALLINE SILICON WAFERS;
PHOTOVOLTAIC CELLS; ELECTRIC CONTROL PANELS; ELECTRIC ACCUMULATORS
FOR VEHICLES; ACCUMULATOR BOXES; SOLAR BATTERIES; GALVANIC BATTERIES;
PLATES FOR BATTERIES; ACCUMULATOR JARS; PHOTOVOLTAIC SOLAR MODULES
FOR PRODUCTION OF ELECTRICITY, IN CLASS 9 (U.S. CLS. 21, 23, 26, 36 AND 38).

FIRST USE 4-29-2011; IN COMMERCE 4-29-2011.

THE MARK CONSISTS OF STANDARD CHARACTERS WITHOUT CLAIM TO ANY PARTICULAR FONT, STYLE, SIZE, OR COLOR.

NO CLAIM IS MADE TO THE EXCLUSIVE RIGHT TO USE "MODULE", APART FROM THE MARK AS SHOWN.

SER. NO. 85-365,398, FILED 7-7-2011.

EMILY CHUO, EXAMINING ATTORNEY



David J. Kybas

Director of the United States Patent and Trademark Office

United States of America

United States Patent and Trademark Office

BOLT-RITE

Reg. No. 4,204,568

NORTHWEST PLASTICS, INC. (CALIFORNIA CORPORATION)
PO BOX 993636
REDDING, CA 96099

Registered Sep. 11, 2012

Int. Cl.: 8

FOR: HAND OPERATED FOUNDATION BOLT PLACEMENT TOOLS, IN CLASS 8 (U.S. CLS. 23, 28 AND 44).

TRADEMARK

FIRST USE 1-1-2004; IN COMMERCE 1-1-2004.

PRINCIPAL REGISTER

THE MARK CONSISTS OF STANDARD CHARACTERS WITHOUT CLAIM TO ANY PARTICULAR FONT, STYLE, SIZE, OR COLOR.

SER. NO. 85-365,587, FILED 7-7-2011.

STEVEN JACKSON, EXAMINING ATTORNEY



David J. Kyffers

Director of the United States Patent and Trademark Office

United States of America
United States Patent and Trademark Office

TEXTKEY

Reg. No. 4,204,569

Registered Sep. 11, 2012

Int. Cl.: 38

SERVICE MARK

PRINCIPAL REGISTER

TEXTPOWER, INC. (CALIFORNIA CORPORATION)
27134-A PASEO ESPADA, SUITE 324
SAN JUAN CAPISTRANO, CA 92675

FOR: TELECOMMUNICATIONS SERVICES TO ALLOW INDIVIDUALS TO USE CELLULAR TELEPHONES TO ACCESS TEXT MESSAGES DESIGNATED FOR AN ALTERNATIVE TO SHORT CODES WHERE THE CUSTOMER'S CELLULAR SERVICE PROVIDER MAY NOT UTILIZE THE USE OF SHORT CODES FOR TEXTING, IN CLASS 38 (U.S. CLS. 100, 101 AND 104).

FIRST USE 11-16-2010; IN COMMERCE 11-16-2010.

THE MARK CONSISTS OF STANDARD CHARACTERS WITHOUT CLAIM TO ANY PARTICULAR FONT, STYLE, SIZE, OR COLOR.

SER. NO. 85-365,875, FILED 7-7-2011.

EDWARD NELSON, EXAMINING ATTORNEY



David J. Kyffers

Director of the United States Patent and Trademark Office

United States of America
United States Patent and Trademark Office

RITA ORA

Reg. No. 4,204,570

RITA ORA (UNITED KINGDOM INDIVIDUAL)
1411 BROADWAY, 39TH FLOOR
NEW YORK, NY 10018

Registered Sep. 11, 2012

Int. Cl.: 9

FOR: AUDIO AND VIDEO RECORDINGS FEATURING MUSIC; DOWNLOADABLE RING-
TONES, IN CLASS 9 (U.S. CLS. 21, 23, 26, 36 AND 38).

TRADEMARK

FIRST USE 4-12-2010; IN COMMERCE 4-12-2010.

PRINCIPAL REGISTER

THE MARK CONSISTS OF STANDARD CHARACTERS WITHOUT CLAIM TO ANY PAR-
TICULAR FONT, STYLE, SIZE, OR COLOR.

THE NAME(S), PORTRAIT(S), AND/OR SIGNATURE(S) SHOWN IN THE MARK IDENTIFIES
"RITA ORA", WHOSE CONSENT(S) TO REGISTER IS MADE OF RECORD.

SER. NO. 85-365,884, FILED 7-7-2011.

KAREN K. BUSH, EXAMINING ATTORNEY



David J. Kyffers

Director of the United States Patent and Trademark Office

United States of America

United States Patent and Trademark Office

DJ EVENT PLANNER

Reg. No. 4,204,571

DJ EVENT PLANNER, INC. (MINNESOTA CORPORATION)
504 N 4TH ST
MARSHALL, MN 56258

Registered Sep. 11, 2012

Int. Cl.: 42

FOR: NON-DOWNLOADABLE COMPUTER SOFTWARE FOR USE IN EVENT PLANNING AND EVENT MANAGEMENT, IN CLASS 42 (U.S. CLS. 100 AND 101).

SERVICE MARK

FIRST USE 11-1-2000; IN COMMERCE 2-1-2001.

PRINCIPAL REGISTER

THE MARK CONSISTS OF STANDARD CHARACTERS WITHOUT CLAIM TO ANY PARTICULAR FONT, STYLE, SIZE, OR COLOR.

SEC. 2(F).

SER. NO. 85-366,135, FILED 7-8-2011.

JULIE GUTTADAURO, EXAMINING ATTORNEY



David J. Kybas

Director of the United States Patent and Trademark Office

United States of America

United States Patent and Trademark Office



Reg. No. 4,204,572

Registered Sep. 11, 2012

Int. Cl.: 30

TRADEMARK

PRINCIPAL REGISTER

CENTERS, JAMES A. (UNITED STATES INDIVIDUAL)
13654 KNOLLBROOK LN
CHARLESTON, IL 61920

FOR: HOT DOG SANDWICHES, IN CLASS 30 (U.S. CL. 46).

FIRST USE 7-5-2011; IN COMMERCE 7-5-2011.

NO CLAIM IS MADE TO THE EXCLUSIVE RIGHT TO USE "WIENER", APART FROM THE MARK AS SHOWN.

THE MARK CONSISTS OF A CIRCLE WITH THE WORDS "BE HAPPY" CURVED TO FIT INSIDE THE TOP OF THE CIRCLE AND THE WORDS "EAT A WIENER" CURVED TO FIT INSIDE THE BOTTOM OF THE CIRCLE. A CARICATURE OF THE HEAD OF A SMALL BOY APPEARS IN THE CENTER OF THE CIRCLE.

SER. NO. 85-366,556, FILED 7-8-2011.

LESLEY LAMOTHE, EXAMINING ATTORNEY



David J. Kyffers

Director of the United States Patent and Trademark Office

United States of America

United States Patent and Trademark Office



Reg. No. 4,204,573

NBCUNIVERSAL MEDIA, LLC (DELAWARE LIMITED LIABILITY COMPANY)
30 ROCKEFELLER PLAZA
NEW YORK, NY 10112

Registered Sep. 11, 2012

Int. Cl.: 41

FOR: ENTERTAINMENT SERVICES, NAMELY, PROVIDING ON-GOING PROGRAMMING IN THE FIELDS OF SPORTS, SPORTS NEWS AND ENTERTAINMENT VIA TELEVISION, CABLE TELEVISION, RADIO SYSTEMS AND WIRELESS COMMUNICATION NETWORKS; PROVIDING INFORMATION IN THE FIELD OF SPORTS, SPORTS NEWS AND ENTERTAINMENT VIA A GLOBAL COMPUTER NETWORK AND WIRELESS COMMUNICATION NETWORKS; ENTERTAINMENT SERVICES, NAMELY, PROVIDING NON-DOWNLOADABLE AUDIO, VISUAL AND AUDIO-VISUAL CONTENT FEATURING SPORTS, SPORTS NEWS AND ENTERTAINMENT VIA A GLOBAL COMPUTER NETWORK AND WIRELESS COMMUNICATION NETWORKS, IN CLASS 41 (U.S. CLS. 100, 101 AND 107).

SERVICE MARK

PRINCIPAL REGISTER

FIRST USE 6-30-2008; IN COMMERCE 6-30-2008.

OWNER OF U.S. REG. NOS. 1,144,545, 1,637,487 AND OTHERS.

NO CLAIM IS MADE TO THE EXCLUSIVE RIGHT TO USE "SPORTS", APART FROM THE MARK AS SHOWN.

THE MARK CONSISTS OF THE WORDS "UNIVERSAL SPORTS" WITH THE NBC PEACOCK DESIGN USED AS THE DOT OF THE LETTER "I" SET AGAINST A PARTIAL CIRCLE BACKGROUND.

SER. NO. 85-367,130, FILED 7-8-2011.

THOMAS MANOR, EXAMINING ATTORNEY



David J. Kyjars

Director of the United States Patent and Trademark Office

United States of America

United States Patent and Trademark Office

DESIGN WORKS

Reg. No. 4,204,574

Registered Sep. 11, 2012

Int. Cls.: 35 and 40

SERVICE MARK

PRINCIPAL REGISTER

DESIGN WORKS (DELAWARE CORPORATION)
218 RIVER HILLS DRIVE
NASHVILLE, TN 37210

FOR: RETAIL AND WHOLESALE DISTRIBUTORSHIP SERVICES FEATURING COUNTER-TOPS, IN CLASS 35 (U.S. CLS. 100, 101 AND 102).

FIRST USE 8-1-2009; IN COMMERCE 8-1-2009.

FOR: CUSTOM FABRICATION OF COUNTERTOPS TO WHOLESALE AND RETAIL CUSTOMERS, IN CLASS 40 (U.S. CLS. 100, 103 AND 106).

FIRST USE 8-1-2009; IN COMMERCE 8-1-2009.

THE MARK CONSISTS OF STANDARD CHARACTERS WITHOUT CLAIM TO ANY PARTICULAR FONT, STYLE, SIZE, OR COLOR.

NO CLAIM IS MADE TO THE EXCLUSIVE RIGHT TO USE "DESIGN", APART FROM THE MARK AS SHOWN.

SER. NO. 85-367,249, FILED 7-9-2011.

AHSEN KHAN, EXAMINING ATTORNEY



David J. Kybas

Director of the United States Patent and Trademark Office

United States of America

United States Patent and Trademark Office

Soletron

Reg. No. 4,204,575

Registered Sep. 11, 2012

Int. Cl.: 41

SERVICE MARK

PRINCIPAL REGISTER

SOLETRON LLC (DELAWARE LIMITED LIABILITY COMPANY)
8969 HIDDEN PINE STREET
PARKLAND, FL 33067

FOR: PROVIDING A WEBSITE FEATURING ON-LINE JOURNALS, NAMELY, BLOGS IN THE FIELDS OF SNEAKERS AND OTHER SPORTS AND URBAN APPAREL AND ACCESSORIES, LIFESTYLE ACTIVITIES, MUSIC, MOVIES, AND FASHION MODELS; PROVIDING A WEBSITE FEATURING NON-DOWNLOADABLE ELECTRONIC PUBLICATIONS IN THE NATURE OF WRITTEN ARTICLES IN THE FIELDS OF SNEAKERS AND OTHER SPORTS AND URBAN APPAREL AND ACCESSORIES, LIFESTYLE ACTIVITIES, MUSIC, MOVIES AND FASHION MODELS; PROVIDING A WEBSITE FEATURING NON-DOWNLOADABLE VIDEOS AND VIDEO INTERVIEWS IN THE FIELD OF ENTERTAINMENT, NAMELY, MUSIC, MOVIES, AND FASHION MODELING FOR ENTERTAINMENT PURPOSES, IN CLASS 41 (U.S. CLS. 100, 101 AND 107).

FIRST USE 3-16-2011; IN COMMERCE 3-16-2011.

THE MARK CONSISTS OF STANDARD CHARACTERS WITHOUT CLAIM TO ANY PARTICULAR FONT, STYLE, SIZE, OR COLOR.

SER. NO. 85-367,402, FILED 7-10-2011.

SEAN CROWLEY, EXAMINING ATTORNEY



David J. Kyffers

Director of the United States Patent and Trademark Office

United States of America

United States Patent and Trademark Office

THE OKLAHOMA ORIGINAL
**BRICKTOWN
BREWERY**
SINCE 1992

Reg. No. 4,204,576

BT CONCEPTS LLC (OKLAHOMA LIMITED LIABILITY COMPANY)
1101 W. WATERLOO ROAD
EDMOND, OK 73025

Registered Sep. 11, 2012

Int. Cl.: 43

FOR: BAR AND RESTAURANT SERVICES, IN CLASS 43 (U.S. CLS. 100 AND 101).

SERVICE MARK

FIRST USE 6-6-2011; IN COMMERCE 6-6-2011.

PRINCIPAL REGISTER

OWNER OF U.S. REG. NO. 4,028,083.

NO CLAIM IS MADE TO THE EXCLUSIVE RIGHT TO USE "THE OKLAHOMA ORIGINAL", "BREWERY", AND "SINCE 1992", APART FROM THE MARK AS SHOWN.

THE MARK CONSISTS OF THE WORDS "THE OKLAHOMA ORIGINAL" ACROSS ON THE FIRST LINE IN ALL CAPITAL LETTERS, THE WORD "BRICKTOWN" ON THE SECOND LINE IN ALL CAPITAL LETTERS, THE WORD "BREWERY" ON A THIRD LINE IN ALL CAPITAL LETTERS, AND THE WORDS "SINCE 1992" IN ALL CAPITAL LETTERS ON THE FOURTH LINE WITH TWO LEAF DESIGNS ON EACH SIDE OF THE WORDS "SINCE 1992".

SEC. 2(F) AS TO "BRICKTOWN".

SER. NO. 85-367,673, FILED 7-11-2011.

DEBORAH LOBO, EXAMINING ATTORNEY



David J. Kyffers

Director of the United States Patent and Trademark Office

United States of America

United States Patent and Trademark Office

Peloton Coffee Roasters

Reg. No. 4,204,577

DEWANE, TERENCE M. (UNITED STATES INDIVIDUAL)
2056 VINEYARD RD.
NOVATO, CA 94947

Registered Sep. 11, 2012

Int. Cl.: 30

FOR: COFFEE, IN CLASS 30 (U.S. CL. 46).

TRADEMARK

FIRST USE 1-1-2011; IN COMMERCE 1-1-2011.

PRINCIPAL REGISTER

THE MARK CONSISTS OF STANDARD CHARACTERS WITHOUT CLAIM TO ANY PARTICULAR FONT, STYLE, SIZE, OR COLOR.

NO CLAIM IS MADE TO THE EXCLUSIVE RIGHT TO USE "COFFEE ROASTERS", APART FROM THE MARK AS SHOWN.

SER. NO. 85-367,796, FILED 7-11-2011.

SHAUNIA CARLYLE, EXAMINING ATTORNEY



David J. Kyffers

Director of the United States Patent and Trademark Office

United States of America

United States Patent and Trademark Office

PATIENT SATISFACTION REAL TIME

Reg. No. 4,204,578

STERLING READINESS ROUNDS L.L.C. (KANSAS LIMITED LIABILITY COMPANY)
112 E. 10TH STREET
EUDORA, KS 66025

Registered Sep. 11, 2012

Int. Cl.: 42

FOR: NON-DOWNLOADABLE COMPUTER SOFTWARE FOR USE BY HOSPITALS TO IMPROVE PATIENT SAFETY AND QUALITY BY GATHERING QUALITY AND EXPERIENCE OBSERVATIONS, TRIGGERING SERVICE RECOVERY, AGGREGATING RESULTS, PROVIDING REMINDERS AND CHECKLISTS, AND PROVIDING IMPROVEMENT DASHBOARDS TO ENABLE A FOCUSED APPROACH TO IMPROVING PATIENT SAFETY, IN CLASS 42 (U.S. CLS. 100 AND 101).

SERVICE MARK

PRINCIPAL REGISTER

FIRST USE 4-1-2011; IN COMMERCE 4-1-2011.

THE MARK CONSISTS OF STANDARD CHARACTERS WITHOUT CLAIM TO ANY PARTICULAR FONT, STYLE, SIZE, OR COLOR.

NO CLAIM IS MADE TO THE EXCLUSIVE RIGHT TO USE "REAL TIME", APART FROM THE MARK AS SHOWN.

SER. NO. 85-368,015, FILED 7-11-2011.

TEJBIR SINGH, EXAMINING ATTORNEY



David J. Kybas

Director of the United States Patent and Trademark Office

United States of America

United States Patent and Trademark Office



Reg. No. 4,204,579

Registered Sep. 11, 2012

Int. Cl.: 2

TRADEMARK

PRINCIPAL REGISTER

WAZANA BROTHERS INTERNATIONAL, INC. (CALIFORNIA CORPORATION), DBA
MICRO SOLUTIONS ENTERPRISES
8201 WOODLEY AVE.
VAN NUYS, CA 91406

FOR: FILLED INK CARTRIDGES; PHOTOCOPIER TONER IN CARTRIDGES; PRINTING
TONER; TONER; TONER CARTRIDGES; TONER FOR COPIERS; TONERS , IN CLASS 2
(U.S. CLS. 6, 11 AND 16).

FIRST USE 7-1-2011; IN COMMERCE 7-1-2011.

NO CLAIM IS MADE TO THE EXCLUSIVE RIGHT TO USE "MPS ENGINEERED", APART
FROM THE MARK AS SHOWN.

THE COLOR(S) BLUE, WHITE, GREEN, LIGHT GREEN AND BLACK IS/ARE CLAIMED
AS A FEATURE OF THE MARK.

THE MARK CONSISTS OF THE CAPITAL LETTERS "MPS" UNDERLINED AND WITH
THREE DOTS CENTERED ABOVE THEM IN WHITE AND CONTAINED WITHIN A SOLID
BLUE BOX WITH THE CAPITAL LETTERS "ENGINEERED" IN BLACK TO THE RIGHT
OF SUCH LETTERS, AND A DESIGN OF THREE INCREASINGLY LARGER RECTANGULAR
WAVE-TYPE ELEMENTS APPEARING ABOVE THE LETTERS "MPS" IN GREEN, LIGHT
GREEN, AND OUTLINED IN LIGHT GREEN ON A WHITE BACKGROUND.

SER. NO. 85-368,321, FILED 7-11-2011.

STEPHANIE ALI, EXAMINING ATTORNEY



David J. Kybas

Director of the United States Patent and Trademark Office

United States of America

United States Patent and Trademark Office



mlm compliance
virtual training

Reg. No. 4,204,580

MLM COMPLIANCE VT, LLC (NEVADA LIMITED LIABILITY COMPANY)

Registered Sep. 11, 2012

P. O. BOX 1772
IDAHO FALLS, ID 83403

Int. Cl.: 41

FOR: INTERACTIVE ON-LINE TRAINING SERVICES IN THE FIELD OF DIRECT SELLING AND MULTILEVEL MARKETING LEGAL AND REGULATORY COMPLIANCE, IN CLASS 41 (U.S. CLS. 100, 101 AND 107).

SERVICE MARK

FIRST USE 6-24-2011; IN COMMERCE 6-24-2011.

PRINCIPAL REGISTER

NO CLAIM IS MADE TO THE EXCLUSIVE RIGHT TO USE "MLM COMPLIANCE VIRTUAL TRAINING", APART FROM THE MARK AS SHOWN.

THE MARK CONSISTS OF THE STYLIZED WORDING "MLM COMPLIANCE VIRTUAL TRAINING" WITH A GRAPHIC SPIRAL COMPRISED OF FOUR ARMS CONSISTING OF TRIANGLES OF DECREASING SIZE IN CONTRASTING SHADES.

SER. NO. 85-368,480, FILED 7-11-2011.

STEVEN PEREZ, EXAMINING ATTORNEY



David J. Kyros

Director of the United States Patent and Trademark Office

United States of America

United States Patent and Trademark Office



Reg. No. 4,204,581

Registered Sep. 11, 2012

Int. Cl.: 3

TRADEMARK

PRINCIPAL REGISTER

DONNATELLA HANDBAGS & PERFUMES INC. (FLORIDA CORPORATION)
2273 NW 20 STREET
MIAMI, FL 33142

FOR: COLOGNES, PERFUMES AND COSMETICS, IN CLASS 3 (U.S. CLS. 1, 4, 6, 50, 51 AND 52).

FIRST USE 1-1-2000; IN COMMERCE 1-1-2000.

THE MARK CONSISTS OF THE WORD "DONNATELLA" IN BLUE SCRIPT SUPERIMPOSED OVER A RECTANGLE BORDERED IN AN ORANGE AND BLUE LINE, WITH LARGE WHITE LETTER "D" OVER A BLUE, ORANGE AND WHITE BACKGROUND.

THE COLOR(S) ORANGE, BLUE AND WHITE IS/ARE CLAIMED AS A FEATURE OF THE MARK.

SER. NO. 85-368,841, FILED 7-12-2011.

SUSAN LESLIE DUBOIS, EXAMINING ATTORNEY



David J. Kyffers

Director of the United States Patent and Trademark Office

United States of America

United States Patent and Trademark Office

Speedticket

Reg. No. 4,204,582

Registered Sep. 11, 2012

Int. Cl.: 9

TRADEMARK

PRINCIPAL REGISTER

CLUB SPEED, INC. (CALIFORNIA CORPORATION)
81
3943 IRVINE BLVD
IRVINE, CA 92602

FOR: COMPUTER SOFTWARE FOR TICKET VALIDATION, PATRON ACCESS CONTROL, EVENT BOOKING, AND RACING TIMING FOR USE IN MOTORSPORTS AND SPORTING VENUE MANAGEMENT, IN CLASS 9 (U.S. CLS. 21, 23, 26, 36 AND 38).

FIRST USE 1-1-2011; IN COMMERCE 6-1-2011.

THE MARK CONSISTS OF STANDARD CHARACTERS WITHOUT CLAIM TO ANY PARTICULAR FONT, STYLE, SIZE, OR COLOR.

SER. NO. 85-368,948, FILED 7-12-2011.

REBECCA SMITH, EXAMINING ATTORNEY



David J. Kyffers

Director of the United States Patent and Trademark Office

United States of America

United States Patent and Trademark Office

TRU-LITE

Reg. No. 4,204,583

VAUGHN C. JEWELL (UNITED STATES INDIVIDUAL)
704 BLACKLAWN ROAD
CONYERS, GA 30016

Registered Sep. 11, 2012

Int. Cl.: 12

FOR: AUTOMOTIVE PARTS, NAMELY, FLYWHEELS, LIGHT WEIGHT FLYWHEELS, AND ALUMINUM FLYWHEELS, IN CLASS 12 (U.S. CLS. 19, 21, 23, 31, 35 AND 44).

TRADEMARK

FIRST USE 7-2-2006; IN COMMERCE 7-2-2006.

PRINCIPAL REGISTER

THE MARK CONSISTS OF STANDARD CHARACTERS WITHOUT CLAIM TO ANY PARTICULAR FONT, STYLE, SIZE, OR COLOR.

SER. NO. 85-369,421, FILED 7-12-2011.

ALLISON SCHRODY, EXAMINING ATTORNEY



David J. Kybas

Director of the United States Patent and Trademark Office

United States of America

United States Patent and Trademark Office



Reg. No. 4,204,584

Registered Sep. 11, 2012

Int. Cl.: 12

TRADEMARK

PRINCIPAL REGISTER

FOX FACTORY, INC. (CALIFORNIA CORPORATION)
130 HANGAR WAY
WATSONVILLE, CA 95076

FOR: SUSPENSION SYSTEMS FOR VEHICLES, NAMELY, BICYCLES AND MOTOR VEHICLES; VEHICLE PARTS, NAMELY, SHOCK ABSORBERS, IN CLASS 12 (U.S. CLS. 19, 21, 23, 31, 35 AND 44).

FIRST USE 11-15-2010; IN COMMERCE 11-15-2010.

NO CLAIM IS MADE TO THE EXCLUSIVE RIGHT TO USE "RACING SHOCKS" OR "SERIES", APART FROM THE MARK AS SHOWN.

THE MARK CONSISTS OF A STYLIZED BROKEN CIRCLE WITH THE WORD "FOX" IN THE CENTER AND A WHITE-TIPPED FOX TAIL EXTENDED THROUGH THE CENTER OF THE LETTER "O" IN THE WORD "FOX" AND TO THE RIGHT, "EVOLUTION" (WORD) WITH A PARTIAL STYLIZED UNDERLINE OF ALTERNATING BLACK AND WHITE SQUARES AND "SERIES" (WORD) BELOW, AND TO THE FAR RIGHT, "FOX RACING SHOX" (WORDS) STACKED ON TOP OF EACH OTHER IN STRIPES ORIGINATING FROM THE BROKEN CIRCLE, THE MIDDLE STRIPE BROKEN BY "EVOLUTION", THE UNDERLINING, AND "SERIES".

SER. NO. 85-369,682, FILED 7-12-2011.

DOMINIC J. FERRAIUOLO, EXAMINING ATTORNEY



David J. Kyffers

Director of the United States Patent and Trademark Office

United States of America

United States Patent and Trademark Office

ScienceWorks

Reg. No. 4,204,585

Registered Sep. 11, 2012

Int. Cl.: 35

SERVICE MARK

PRINCIPAL REGISTER

SCIENCEWORKS INTERNATIONAL, LLC (D.C. LIMITED LIABILITY COMPANY)
SUITE 675 EAST
101 CONSTITUTION AVENUE NW
WASHINGTON, DC 20001

FOR: BUSINESS CONSULTATION IN THE FIELD OF SCIENTIFIC AND ENGINEERING RESEARCH AND EDUCATION, IN CLASS 35 (U.S. CLS. 100, 101 AND 102).

FIRST USE 5-15-2011; IN COMMERCE 11-4-2011.

THE MARK CONSISTS OF THE WORD "SCIENCEWORKS" IN THE COLOR RED WITH THE "I" BEING A HALF FILLED TEST TUBE WITH FOUR SOLID RED CIRCLE BUBBLES AS DOTS ABOVE THE "I"; THE "W" IN "WORKS" IS CAPITALIZED; THE WORD "SCIENCEWORKS" IS UNDERLINED WITH A RED LINE.

THE COLOR(S) RED IS/ARE CLAIMED AS A FEATURE OF THE MARK.

SER. NO. 85-370,210, FILED 7-13-2011.

RICHARD WHITE, EXAMINING ATTORNEY



David J. Kyffers

Director of the United States Patent and Trademark Office

United States of America

United States Patent and Trademark Office



Reg. No. 4,204,586

Registered Sep. 11, 2012

Int. Cl.: 35

SERVICE MARK

PRINCIPAL REGISTER

ZT WEALTH, INC. (TEXAS CORPORATION)
11233 SHARDOW CREEK PARKWAY
PEARLAND, TX 77584

FOR: HEALTHCARE MANAGEMENT SERVICE ORGANIZATION (MSO) SERVICES, NAMELY, PROVIDING PRACTICE ORGANIZATION, MANAGEMENT AND ADMINISTRATIVE SUPPORT SERVICES TO INDIVIDUAL PHYSICIANS OR SMALL GROUP PRACTICES; HOSPITAL MANAGEMENT; HOSPITAL ADMINISTRATION SERVICES, IN CLASS 35 (U.S. CLS. 100, 101 AND 102).

FIRST USE 6-30-2010; IN COMMERCE 6-30-2010.

NO CLAIM IS MADE TO THE EXCLUSIVE RIGHT TO USE "HEALTHCARE MANAGEMENT SERVICES", APART FROM THE MARK AS SHOWN.

THE COLOR(S) GOLD, YELLOW AND DARK PURPLE IS/ARE CLAIMED AS A FEATURE OF THE MARK.

THE MARK CONSISTS OF A CHEVRON WITH A RIGHT YELLOW SIDE AND A LEFT GOLD SIDE, "ALTUS" IN DARK PURPLE AND "HEALTHCARE MANAGEMENT SERVICES" IN GOLD. THE "A" IN "ALTUS" IS STYLIZED. THE CHEVRON IS LOCATED ABOVE "ALTUS" AND "ALTUS" IS LOCATED ABOVE "HEALTHCARE MANAGEMENT SERVICES".

SER. NO. 85-370,275, FILED 7-13-2011.

ALEX KEAM, EXAMINING ATTORNEY



David J. Kybas

Director of the United States Patent and Trademark Office

United States of America

United States Patent and Trademark Office

YesPix

Reg. No. 4,204,587

Registered Sep. 11, 2012

Int. Cl.: 42

SERVICE MARK

PRINCIPAL REGISTER

YESPIX, LLC (DELAWARE LIMITED LIABILITY COMPANY)
ONE COMMERCE CENTER 1201 ORANGE ST. #600
WILMINGTON, DE 19899

FOR: PROVIDING A WEB SITE THAT GIVE COMPUTER USERS AND MOBILE PHONE USERS THE ABILITY TO UPLOAD, EXCHANGE AND SHARE PHOTOS, VIDEOS AND VIDEO LOGS; PROVIDING ON-LINE, NON-DOWNLOADABLE SOFTWARE APPLICATIONS FOR MOBILE PHONES, PORTABLE MEDIA PLAYERS, AND HANDHELD COMPUTERS THAT PROVIDE USERS THE ABILITY TO UPLOAD, EXCHANGE AND SHARE PHOTOS, VIDEOS AND VIDEO LOGS, IN CLASS 42 (U.S. CLS. 100 AND 101).

FIRST USE 9-9-2010; IN COMMERCE 2-1-2011.

THE MARK CONSISTS OF STANDARD CHARACTERS WITHOUT CLAIM TO ANY PARTICULAR FONT, STYLE, SIZE, OR COLOR.

SER. NO. 85-370,347, FILED 7-13-2011.

MARK SHINER, EXAMINING ATTORNEY



David J. Kybas

Director of the United States Patent and Trademark Office

United States of America

United States Patent and Trademark Office



Reg. No. 4,204,588

CEJKA SEARCH, INC. (DELAWARE CORPORATION)
CITYPLACE DRIVE; SUITE 300
CREVE COEUR, MO 63141

Registered Sep. 11, 2012

Int. Cls.: 35 and 44

FOR: PROVIDING AN ON-LINE COMPUTER DATABASE IN THE FIELD OF BUSINESS CONTACTS CONCERNING PHYSICIANS, RESIDENT PHYSICIANS, AND PHYSICIAN GRADUATES, IN CLASS 35 (U.S. CLS. 100, 101 AND 102).

SERVICE MARK

FIRST USE 2-1-2011; IN COMMERCE 2-1-2011.

PRINCIPAL REGISTER

FOR: PROVIDING A WEBSITE FEATURING INFORMATION IN THE FIELD OF MEDICAL RECORDS, IN CLASS 44 (U.S. CLS. 100 AND 101).

FIRST USE 2-1-2011; IN COMMERCE 2-1-2011.

NO CLAIM IS MADE TO THE EXCLUSIVE RIGHT TO USE "PHYSICIANS", APART FROM THE MARK AS SHOWN.

THE MARK CONSISTS OF THE TERM "CONTACT" IN UPPERCASE LETTERS ABOVE THE TERM "PHYSICIANS" IN UPPERCASE LETTERS, ALL TO THE RIGHT OF A STYLIZED LETTER "X", WITH SEVERAL CIRCLES OUTLINING THE "X".

SER. NO. 85-370,532, FILED 7-13-2011.

TEJBIR SINGH, EXAMINING ATTORNEY



David J. Kybas

Director of the United States Patent and Trademark Office

United States of America

United States Patent and Trademark Office

KREWE OF LYRA

Reg. No. 4,204,589

KREWE OF LYRA, INC. (LOUISIANA CORPORATION)
1217 FLORIDA STREET
MANDEVILLE, LA 70448

Registered Sep. 11, 2012

Int. Cl.: 41

FOR: ENTERTAINMENT SERVICES, NAMELY, ORGANIZING AND CONDUCTING CAR-
NIVAL PARADES AND BALLS, IN CLASS 41 (U.S. CLS. 100, 101 AND 107).

SERVICE MARK

FIRST USE 2-5-2011; IN COMMERCE 2-5-2011.

PRINCIPAL REGISTER

THE MARK CONSISTS OF STANDARD CHARACTERS WITHOUT CLAIM TO ANY PAR-
TICULAR FONT, STYLE, SIZE, OR COLOR.

SER. NO. 85-371,013, FILED 7-14-2011.

AMY C. KEAN, EXAMINING ATTORNEY



David J. Kappas

Director of the United States Patent and Trademark Office

United States of America

United States Patent and Trademark Office

Suzanna Dai

Reg. No. 4,204,590

Registered Sep. 11, 2012

Int. Cl.: 14

SUZANNA DAI, INC (NEW YORK CORPORATION)
4A
133 SEAMAN AVENUE
NEW YORK, NY 10034

FOR: JEWELRY, IN CLASS 14 (U.S. CLS. 2, 27, 28 AND 50).

TRADEMARK

FIRST USE 8-0-2008; IN COMMERCE 8-0-2008.

PRINCIPAL REGISTER

THE NAME(S), PORTRAIT(S), AND/OR SIGNATURE(S) SHOWN IN THE MARK IDENTIFIES "SUZANNA DAI" GALLEHUGH, WHOSE CONSENT(S) TO REGISTER IS MADE OF RECORD.

THE MARK CONSISTS OF TWO SWIRLED, CURLY-CUED PATTERNS THAT FRAME. IN THE MIDDLE THERE IS THE STYLIZED TEXT "SUZANNA DAI".

SER. NO. 85-371,203, FILED 7-14-2011.

MARK SPARACINO, EXAMINING ATTORNEY



David J. Kyffers

Director of the United States Patent and Trademark Office

United States of America

United States Patent and Trademark Office

fog

Reg. No. 4,204,591

BEARY, WESLEY RAPHAEL (UNITED STATES INDIVIDUAL)
314 FAIRCHILD ST
IOWA CITY, IA 52245

Registered Sep. 11, 2012

Int. Cl.: 9

FOR: COMPUTER SOFTWARE FOR INTERACTING WITH CLOUD SERVICES, NAMELY, PROVIDING DATA ACCESS AND PORTABILITY FOR DEPLOYING, MANAGING AND DEVELOPING APPLICATIONS ON AND ACROSS MULTIPLE CLOUD COMPUTING INFRASTRUCTURE SERVICES, IN CLASS 9 (U.S. CLS. 21, 23, 26, 36 AND 38).

TRADEMARK

PRINCIPAL REGISTER

FIRST USE 5-18-2009; IN COMMERCE 5-18-2009.

THE MARK CONSISTS OF STANDARD CHARACTERS WITHOUT CLAIM TO ANY PARTICULAR FONT, STYLE, SIZE, OR COLOR.

SER. NO. 85-371,216, FILED 7-14-2011.

THOMAS MANOR, EXAMINING ATTORNEY



David J. Kyffers

Director of the United States Patent and Trademark Office

United States of America

United States Patent and Trademark Office

RSBA

Reg. No. 4,204,592

Registered Sep. 11, 2012

Int. Cl.: 42

SERVICE MARK

PRINCIPAL REGISTER

EARTH CONSULTING GROUP, INC. (GEORGIA CORPORATION)
1880 WEST OAK PARKWAY BLDG. 100, ST. 106
MARIETTA, GA 30062

FOR: ENVIRONMENTAL EVALUATION SERVICES, NAMELY, EVALUATING THE EFFICIENCY OF GROUNDWATER REMEDIATION SYSTEMS THAT REMOVE CONTAMINANT MASS FROM GROUNDWATER, IN CLASS 42 (U.S. CLS. 100 AND 101).

FIRST USE 7-11-2011; IN COMMERCE 7-11-2011.

THE MARK CONSISTS OF STANDARD CHARACTERS WITHOUT CLAIM TO ANY PARTICULAR FONT, STYLE, SIZE, OR COLOR.

SER. NO. 85-371,253, FILED 7-14-2011.

DAVID H. STINE, EXAMINING ATTORNEY



David J. Kyffers

Director of the United States Patent and Trademark Office

United States of America

United States Patent and Trademark Office

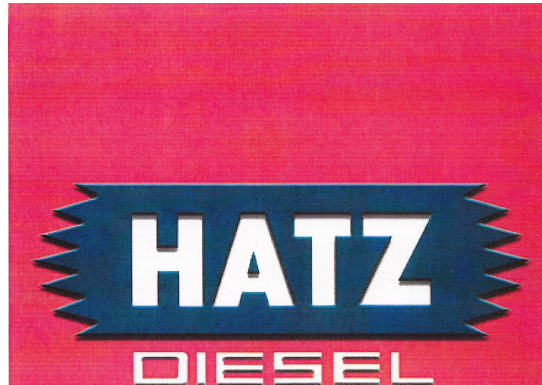

Reg. No. 4,204,593

Registered Sep. 11, 2012

Int. Cl.: 7

TRADEMARK

PRINCIPAL REGISTER

MOTORENFABRIK HATZ GMBH & CO. KG (FED REP GERMANY CORPORATION)
ERNST - HATZ - STRASSE 16
RUHSTORF/ROTT, FED REP GERMANY D-94099

FOR: INTERNAL COMBUSTION ENGINES FOR MACHINE OPERATION AND REPLACEMENT PARTS THEREFOR, IN CLASS 7 (U.S. CLS. 13, 19, 21, 23, 31, 34 AND 35).

FIRST USE 2-28-1960; IN COMMERCE 10-17-1977.

OWNER OF U.S. REG. NOS. 1,136,595 AND 1,781,088.

THE COLOR(S) RED, WHITE AND BLUE IS/ARE CLAIMED AS A FEATURE OF THE MARK.

NO CLAIM IS MADE TO THE EXCLUSIVE RIGHT TO USE "DIESEL", APART FROM THE MARK AS SHOWN.

THE MARK CONSISTS OF A RED COLORED RECTANGLE IN WHICH IS LOCATED A FURTHER BLUE COLORED RECTANGLE HAVING JAGGED LEFT AND RIGHT EDGES AND IN WHICH THE WORD "HATZ" IN WHITE LETTERS IS LOCATED WHILE A FURTHER WORD "DIESEL" IN WHITE LETTERS IS LOCATED BELOW THE BLUE RECTANGLE AND INSIDE THE RED RECTANGLE.

SER. NO. 85-371,623, FILED 7-14-2011.

LEIGH CAROLINE CASE, EXAMINING ATTORNEY



David J. Kybas

Director of the United States Patent and Trademark Office

United States of America

United States Patent and Trademark Office

TBRC Roofing Company

Reg. No. 4,204,594

TBRC INC. (TEXAS CORPORATION), AKA TBRC ROOFING COMPANY
17304 PRESTON ROAD, SUITE 800
DALLAS, TX 75252

Registered Sep. 11, 2012

Int. Cl.: 37

FOR: ROOFING CONSULTATION; ROOFING CONTRACTING; ROOFING INSTALLATION;
ROOFING REPAIR; ROOFING SERVICES, IN CLASS 37 (U.S. CLS. 100, 103 AND 106).

SERVICE MARK

FIRST USE 5-1-2004; IN COMMERCE 5-1-2004.

PRINCIPAL REGISTER

THE MARK CONSISTS OF STANDARD CHARACTERS WITHOUT CLAIM TO ANY PARTICULAR FONT, STYLE, SIZE, OR COLOR.

NO CLAIM IS MADE TO THE EXCLUSIVE RIGHT TO USE "ROOFING COMPANY", APART FROM THE MARK AS SHOWN.

SER. NO. 85-371,638, FILED 7-14-2011.

REBECCA SMITH, EXAMINING ATTORNEY



David J. Kybas

Director of the United States Patent and Trademark Office

United States of America

United States Patent and Trademark Office



Reg. No. 4,204,595

HERRERA, BRYANT (UNITED STATES INDIVIDUAL)
627 ELLEN LYNN RD
REDWOOD VALLEY, CA 95470 AND

Registered Sep. 11, 2012

Int. Cl.: 25

RONCO, AUSTIN (UNITED STATES INDIVIDUAL)
627 ELLEN LYNN ROAD
REDWOOD VALLEY, CA 95470

TRADEMARK

PRINCIPAL REGISTER

FOR: GOLF SHIRTS; HOODED SWEAT SHIRTS; HOODED SWEATSHIRTS; T-SHIRTS , IN CLASS 25 (U.S. CLS. 22 AND 39).

FIRST USE 6-1-2011; IN COMMERCE 6-1-2011.

NO CLAIM IS MADE TO THE EXCLUSIVE RIGHT TO USE "DISC GOLF", APART FROM THE MARK AS SHOWN.

THE MARK CONSISTS OF "DGFL" IN UNIQUE SCRIPT WITH STARS IN THE "D" AND THE "F" ABOVE THE WORDS "DISC GOLF FOR LIFE".

SER. NO. 85-371,754, FILED 7-14-2011.

NATALIE POLZER, EXAMINING ATTORNEY



David J. Kybas

Director of the United States Patent and Trademark Office

United States of America

United States Patent and Trademark Office

YONGNUO

Reg. No. 4,204,596

Registered Sep. 11, 2012

Int. Cl.: 9

SHENZHEN YONGNUO PHOTOGRAPHIC EQUIPMENT CO., LTD. (CHINA LIMITED LIABILITY COMPANY)
1F, 4TH BUILDING, SAIGE TECH. &IND. AREA
HUAQIANG NORTH ROAD, FUTIAN DISTRICT
SHENZHEN, CHINA

TRADEMARK

PRINCIPAL REGISTER

FOR: BAGS FOR CAMERAS AND PHOTOGRAPHIC EQUIPMENT; CAMERAS; CASES FOR PHOTOGRAPHIC APPARATUS; DRYING RACKS FOR PHOTOGRAPHY; FLASHLIGHTS FOR USE IN PHOTOGRAPHY; PHOTOGRAPHIC FILTERS; SHUTTER RELEASES; SHUTTERS; SPEED INDICATORS; STANDS FOR PHOTOGRAPHIC APPARATUS, IN CLASS 9 (U.S. CLS. 21, 23, 26, 36 AND 38).

FIRST USE 3-19-2009; IN COMMERCE 3-19-2009.

OWNER OF U.S. REG. NO. 3,882,063.

THE MARK CONSISTS OF STYLIZED WORD "YONGNUO".

THE ENGLISH TRANSLATION OF "YONGNUO" IN THE MARK IS ETERNAL PROMISE.

SER. NO. 85-372,068, FILED 7-15-2011.

HOWARD SMIGA, EXAMINING ATTORNEY



David J. Kybas

Director of the United States Patent and Trademark Office

United States of America

United States Patent and Trademark Office



Reg. No. 4,204,597

LIFE CREDIT UNION (TENNESSEE CORPORATION)
2010 CHURCH ST., STE. 204
NASHVILLE, TN 37203

Registered Sep. 11, 2012

**Int. Cls.: 9, 16, 18, 21, 25,
35, 36 and 38**

FOR: DOWNLOADABLE ELECTRONIC NEWSLETTERS DELIVERED BY E-MAIL IN THE FIELD OF CREDIT UNION SERVICES, IN CLASS 9 (U.S. CLS. 21, 23, 26, 36 AND 38).

FIRST USE 4-16-2010; IN COMMERCE 4-16-2010.

TRADEMARK

FOR: NEWSLETTERS IN THE FIELD OF CREDIT UNION SERVICES, IN CLASS 16 (U.S. CLS. 2, 5, 22, 23, 29, 37, 38 AND 50).

SERVICE MARK

PRINCIPAL REGISTER

FIRST USE 4-16-2010; IN COMMERCE 4-16-2010.

FOR: TOTE BAGS; UMBRELLAS, IN CLASS 18 (U.S. CLS. 1, 2, 3, 22 AND 41).

FIRST USE 4-16-2010; IN COMMERCE 4-16-2010.

FOR: CUPS AND MUGS, IN CLASS 21 (U.S. CLS. 2, 13, 23, 29, 30, 33, 40 AND 50).

FIRST USE 4-16-2010; IN COMMERCE 4-16-2010.

FOR: JACKETS; LONG-SLEEVED SHIRTS; POLO SHIRTS; WEARABLE GARMENTS AND CLOTHING, NAMELY, SHIRTS, IN CLASS 25 (U.S. CLS. 22 AND 39).

FIRST USE 4-16-2010; IN COMMERCE 4-16-2010.

FOR: DIRECT MARKETING, IN CLASS 35 (U.S. CLS. 100, 101 AND 102).

FIRST USE 4-16-2010; IN COMMERCE 4-16-2010.

FOR: CREDIT UNION SERVICES; CREDIT UNIONS, IN CLASS 36 (U.S. CLS. 100, 101 AND 102).

FIRST USE 4-16-2010; IN COMMERCE 4-16-2010.



David J. Kybas

Director of the United States Patent and Trademark Office

Reg. No. 4,204,597 FOR: DATA COMMUNICATION BY ELECTRONIC MAIL; ELECTRONIC MAIL, IN CLASS 38 (U.S. CLS. 100, 101 AND 104).

FIRST USE 4-16-2010; IN COMMERCE 4-16-2010.

NO CLAIM IS MADE TO THE EXCLUSIVE RIGHT TO USE "CREDIT UNION", APART FROM THE MARK AS SHOWN.

THE MARK CONSISTS OF A LEAF DESIGN WHICH CONSISTS OF FOUR LEAVES THAT COME TOGETHER INTO A BURST OF LIGHT IN THE CENTER FORMING A CROSS FORMATION SHINING FROM THE CENTER OF THE FOUR LEAVES. THE WORD "LIFE" APPEARS TO THE RIGHT OF THE LEAF DESIGN AND THE WORDS "CREDIT UNION" APPEAR BELOW THE WORD "LIFE". THE WORDS "CREDIT UNION" HAVE LINE ABOVE AND BELOW THEM.

SER. NO. 85-372,401, FILED 7-15-2011.

PATRICIA EVANKO, EXAMINING ATTORNEY

United States of America

United States Patent and Trademark Office

SENSITEL

Reg. No. 4,204,598

Registered Sep. 11, 2012

Int. Cls.: 9 and 12

TRADEMARK

PRINCIPAL REGISTER

SENSITEL INC. (CALIFORNIA CORPORATION)
975 CORPORATE WAY
FREMONT, CA 94539

FOR: COMPUTER APPLICATION SOFTWARE FOR MOBILE PHONES, HANDHELD COMPUTERS, DESKTOP COMPUTERS, SERVERS, NAMELY, SOFTWARE FOR ASSET TRACKING, CONDITION MONITORING AND PREDICTION, SUPPLY CHAIN MANAGEMENT, INVENTORY TRACKING, SECURITY, FRAUD AND THEFT DETECTION AND PREVENTION, IN CLASS 9 (U.S. CLS. 21, 23, 26, 36 AND 38).

FIRST USE 3-28-2005; IN COMMERCE 6-20-2005.

FOR: VEHICLE TRACKING DEVICES COMPRISED OF CELLULAR RADIO MODULES, COMPUTER SOFTWARE AND COMPUTER HARDWARE, SENSORS, TRANSMITTERS, CELLULAR RECEIVERS AND GLOBAL POSITIONING SATELLITE RECEIVERS, ALL FOR USE IN CONNECTION WITH CONDITION MONITORING OF PRODUCTS IN VEHICLES, VEHICLE TRACKING, VEHICLE MONITORING AND ANTI-THEFT ALARMS, IN CLASS 12 (U.S. CLS. 19, 21, 23, 31, 35 AND 44).

FIRST USE 3-28-2005; IN COMMERCE 6-20-2005.

THE MARK CONSISTS OF STANDARD CHARACTERS WITHOUT CLAIM TO ANY PARTICULAR FONT, STYLE, SIZE, OR COLOR.

SER. NO. 85-372,989, FILED 7-15-2011.

LINDA MICKLEBURGH, EXAMINING ATTORNEY



David J. Kyjars

Director of the United States Patent and Trademark Office

United States of America

United States Patent and Trademark Office

RETRO
Channel

Reg. No. 4,204,599

Registered Sep. 11, 2012

Int. Cls.: 9 and 15

TRADEMARK

PRINCIPAL REGISTER

KELTNER, ROBERT LANCE (UNITED STATES INDIVIDUAL)
9300 S IH 35
AUSTIN, TX 78748

FOR: GUITAR AMPLIFIER ACCESSORY, NAMELY, A FITTED FACE PLATE TO AFFIX TO AN AMPLIFIER FOR USE WITH ELECTRIC GUITARS; GUITAR AMPLIFIERS; GUITAR EFFECTS, MUSICAL INSTRUMENT AMPLIFIERS; POWER AMPLIFIERS; PRE-AMPLIFIERS SIGNAL PROCESSORS AND GUITAR PEDALS; ALL FOR USE IN CONNECTIONS WITH ELECTRIC GUITARS IN A PERFORMANCE ENVIRONMENT AND NOT FOR USE IN STUDIO SIGNAL PROCESSING OR THE PROCESSING OF PRE-RECORDED MUSIC OR MUSIC STUDIO PRODUCTION, IN CLASS 9 (U.S. CLS. 21, 23, 26, 36 AND 38).

FIRST USE 1-1-2009; IN COMMERCE 1-1-2009.

FOR: GUITAR PEDALS, IN CLASS 15 (U.S. CLS. 2, 21 AND 36).

FIRST USE 1-1-2009; IN COMMERCE 1-1-2009.

THE MARK CONSISTS OF THE WORDING "RETRO CHANNEL" AND A DESIGN OF A LIGHTNING BOLT.

SER. NO. 85-373,413, FILED 7-18-2011.

DEIRDRE ROBERTSON, EXAMINING ATTORNEY



David J. Kybas

Director of the United States Patent and Trademark Office

United States of America

United States Patent and Trademark Office

VERTIFI SOFTWARE

Reg. No. 4,204,600

Registered Sep. 11, 2012

Int. Cl.: 9

TRADEMARK

PRINCIPAL REGISTER

VERTIFI SOFTWARE, LLC (DELAWARE LIMITED LIABILITY COMPANY)
35 CORPORATE DRIVE, SUITE 300
BURLINGTON, MA 01803

FOR: DOWNLOADABLE COMPUTER SOFTWARE IN THE NATURE OF A MOBILE APPLICATION TO ENABLE CUSTOMERS OF FINANCIAL INSTITUTIONS TO ACCESS BANK ACCOUNT INFORMATION, CONDUCT BANKING TRANSACTIONS AND MAKE DEPOSITS REMOTELY; COMPUTER SOFTWARE FOR FINANCIAL INSTITUTIONS TO PROCESS CHECKS AND OTHER FINANCIAL INSTRUMENTS; COMPUTER SOFTWARE FOR FINANCIAL INSTITUTIONS TO PROCESS CHECKS AND LOANS; COMPUTER SOFTWARE FOR FINANCIAL INSTITUTIONS TO DOWNLOAD IMAGES OF CHECKS AND BANK STATEMENTS, IN CLASS 9 (U.S. CLS. 21, 23, 26, 36 AND 38).

FIRST USE 12-1-2009; IN COMMERCE 12-1-2009.

THE MARK CONSISTS OF STANDARD CHARACTERS WITHOUT CLAIM TO ANY PARTICULAR FONT, STYLE, SIZE, OR COLOR.

NO CLAIM IS MADE TO THE EXCLUSIVE RIGHT TO USE "SOFTWARE", APART FROM THE MARK AS SHOWN.

SER. NO. 85-373,489, FILED 7-18-2011.

DEIRDRE ROBERTSON, EXAMINING ATTORNEY



David J. Kybas

Director of the United States Patent and Trademark Office

United States of America

United States Patent and Trademark Office

All West Container

Reg. No. 4,204,601

Registered Sep. 11, 2012

Int. Cl.: 16

TRADEMARK

PRINCIPAL REGISTER

KANDRIS, THOMAS P (UNITED STATES INDIVIDUAL), DBA PACKAGEONE INC
CORPORATE ACCOUNTING
4225 PELL DRIVE
SACRAMENTO, CA 95838

FOR: CARDBOARD; CARDBOARD BOXES; CARDBOARD CARRIERS FOR FOOD AND BEVERAGES; CARDBOARD CARTONS; CARDBOARD CONTAINERS; CARDBOARD PACKAGING; CARDBOARD PACKAGING BOXES IN COLLAPSIBLE FORM; CARDBOARD PACKAGING BOXES IN MADE-UP FORM; CARDBOARD SIGNBOARDS; COLLAPSIBLE CARDBOARD BOXES; CONTAINERS FOR STORAGE OR TRANSPORT MADE OF PAPER OR CARDBOARD; CORRUGATED BOARD; CORRUGATED BOARD AND PAPER CONTAINERS; CORRUGATED BOXES; CORRUGATED CARDBOARD; CORRUGATED CARDBOARD BOXES; CORRUGATED CONTAINERS; CORRUGATED PAPER; CORRUGATED PAPER PANELS LAMINATED WITH BLEACHED WHITE PAPER PRIMARILY FOR APPLICATION OF PRINTED MEDIA FOR FURTHER USE IN SIGNAGE APPLICATIONS; CORRUGATED PAPER PANELS LAMINATED WITH KRAFT LINERBOARD PRIMARILY FOR LAMINATION WITH DECORATIVE OVERLAYS FOR FURTHER USE IN THE CONSTRUCTION OF WALL PARTITIONS, ROOM DIVIDERS, DESKTOPS AND TABLETOPS; CORRUGATED RECORD STORAGE BOXES; FILE BOXES FOR STORAGE OF BUSINESS AND PERSONAL RECORD; FILE BOXES FOR STORAGE OF MAGAZINES; GIFT BOXES MADE OF CARDBOARD; PACKAGING CONTAINERS COMPRISED OF PAPERBOARD FOR FOOD AND BEVERAGES; PACKAGING MATERIALS MADE OF RECYCLED PAPER; PACKING CARDBOARD; PACKING CARDBOARD CONTAINERS; PAPER AND CARDBOARD, IN CLASS 16 (U.S. CLS. 2, 5, 22, 23, 29, 37, 38 AND 50).



FIRST USE 6-1-1958; IN COMMERCE 6-1-2011.

THE MARK CONSISTS OF STANDARD CHARACTERS WITHOUT CLAIM TO ANY PARTICULAR FONT, STYLE, SIZE, OR COLOR.

NO CLAIM IS MADE TO THE EXCLUSIVE RIGHT TO USE "CONTAINER", APART FROM THE MARK AS SHOWN.

SER. NO. 85-373,610, FILED 7-18-2011.

STEVEN PEREZ, EXAMINING ATTORNEY

David J. Kyffers

Director of the United States Patent and Trademark Office

United States of America

United States Patent and Trademark Office



Reg. No. 4,204,602

FIRST PACTRUST BANCORP, INC. (MARYLAND CORPORATION)
610 BAY BOULEVARD
CHULA VISTA, CA 91910

Registered Sep. 11, 2012

Int. Cl.: 36

FOR: BANK HOLDING COMPANY SERVICES, NAMELY, BANKING SERVICES, IN CLASS 36 (U.S. CLS. 100, 101 AND 102).

SERVICE MARK

FIRST USE 4-27-2011; IN COMMERCE 4-27-2011.

PRINCIPAL REGISTER

NO CLAIM IS MADE TO THE EXCLUSIVE RIGHT TO USE "FIRST" AND "BANCORP, INC.", APART FROM THE MARK AS SHOWN.

THE MARK CONSISTS OF A CIRCLE WITH A BORDER OF FOUR CURVED LINES WITH EACH LINE CURVING INTO THE CIRCLE WITH FLAT EDGES. THE CURVED LINES DO NOT TOUCH. THE LINES ARE SHADED. THE CIRCLE IS ON THE LEFT-HAND SIDE OF THE WORDS "FIRST" AND "PACTRUST" WITH "FIRST" APPEARING ABOVE "PACTRUST" IN SMALLER FONT EVEN WITH THE "PA." THE WORDS "BANCORP, INC." APPEAR BELOW "PACTRUST" IN SMALLER FONT STARTING WITH THE STRAIGHT LINE IN THE "A" THROUGH "T".

SER. NO. 85-373,637, FILED 7-18-2011.

H. M. FISHER, EXAMINING ATTORNEY



David J. Kyffers

Director of the United States Patent and Trademark Office

United States of America

United States Patent and Trademark Office

TERRA LAW

Reg. No. 4,204,603

Registered Sep. 11, 2012

Int. Cl.: 45

SERVICE MARK

PRINCIPAL REGISTER

TERRA LAW LLP (CALIFORNIA LIMITED PARTNERSHIP)
177 PARK AVENUE, THIRD FLOOR
SAN JOSE, CA 95113

FOR: LEGAL SERVICES, IN CLASS 45 (U.S. CLS. 100 AND 101).

FIRST USE 3-16-1999; IN COMMERCE 4-30-2000.

THE MARK CONSISTS OF STANDARD CHARACTERS WITHOUT CLAIM TO ANY PARTICULAR FONT, STYLE, SIZE, OR COLOR.

NO CLAIM IS MADE TO THE EXCLUSIVE RIGHT TO USE "LAW", APART FROM THE MARK AS SHOWN.

SER. NO. 85-373,845, FILED 7-18-2011.

JAMES STEIN, EXAMINING ATTORNEY



David J. Kyffers

Director of the United States Patent and Trademark Office

United States of America

United States Patent and Trademark Office

SootSucker

Reg. No. 4,204,604

Registered Sep. 11, 2012

Int. Cl.: 11

TRADEMARK

PRINCIPAL REGISTER

FSX EQUIPMENT INC. (WASHINGTON CORPORATION), AKA FSX INC., FSX
RECONDITIONING INC.
P.O. BOX 1617
GRANITE FALLS, WA 98252

FOR: AIR PURIFIERS; AIR FILTERS FOR USE IN INDUSTRIAL INSTALLATIONS; AIR
CLEANING UNITS, NAMELY, AIR CLEANERS FOR EXTRACTING DIESEL PARTICULATE
FROM FILTERS USED ON DIESEL EQUIPMENT, IN CLASS 11 (U.S. CLS. 13, 21, 23, 31 AND
34).

FIRST USE 6-5-2008; IN COMMERCE 6-5-2008.

THE MARK CONSISTS OF STANDARD CHARACTERS WITHOUT CLAIM TO ANY PAR-
TICULAR FONT, STYLE, SIZE, OR COLOR.

OWNER OF U.S. REG. NOS. 2,450,125 AND 3,575,627.

SER. NO. 85-373,936, FILED 7-18-2011.

TEJBIR SINGH, EXAMINING ATTORNEY



David J. Kyffers

Director of the United States Patent and Trademark Office

United States of America

United States Patent and Trademark Office

Trap Tester

Reg. No. 4,204,605

Registered Sep. 11, 2012

Int. Cl.: 11

TRADEMARK

PRINCIPAL REGISTER

FSX EQUIPMENT INC. (WASHINGTON CORPORATION), AKA FSX INC., FSX
RECONDITIONING INC.
P.O. BOX 1617
GRANITE FALLS, WA 98252

FOR: AIR CLEANING UNITS, NAMELY, AIR CLEANERS FOR EXTRACTING DIESEL
PARTICULATE FROM FILTERS USED ON DIESEL EQUIPMENT, IN CLASS 11 (U.S. CLS.
13, 21, 23, 31 AND 34).

FIRST USE 6-5-2008; IN COMMERCE 6-5-2008.

THE MARK CONSISTS OF STANDARD CHARACTERS WITHOUT CLAIM TO ANY PAR-
TICULAR FONT, STYLE, SIZE, OR COLOR.

OWNER OF U.S. REG. NOS. 2,450,125 AND 3,575,627.

SER. NO. 85-373,950, FILED 7-18-2011.

TEJBIR SINGH, EXAMINING ATTORNEY



David J. Kyffers

Director of the United States Patent and Trademark Office

United States of America

United States Patent and Trademark Office

TrapBurner

Reg. No. 4,204,606

Registered Sep. 11, 2012

Int. Cl.: 11

TRADEMARK

PRINCIPAL REGISTER

FSX EQUIPMENT INC. (WASHINGTON CORPORATION), AKA FSX INC., FSX
RECONDITIONING INC.
P.O. BOX 1617
GRANITE FALLS, WA 98252

FOR: AIR CLEANING UNITS, NAMELY, AIR CLEANERS FOR EXTRACTING DIESEL
PARTICULATE FROM FILTERS USED ON DIESEL EQUIPMENT, IN CLASS 11 (U.S. CLS.
13, 21, 23, 31 AND 34).

FIRST USE 6-5-2008; IN COMMERCE 6-5-2008.

THE MARK CONSISTS OF STANDARD CHARACTERS WITHOUT CLAIM TO ANY PAR-
TICULAR FONT, STYLE, SIZE, OR COLOR.

OWNER OF U.S. REG. NOS. 2,450,125 AND 3,575,627.

SER. NO. 85-373,972, FILED 7-18-2011.

TEJBIR SINGH, EXAMINING ATTORNEY



David J. Kyffers

Director of the United States Patent and Trademark Office

United States of America

United States Patent and Trademark Office

STEVEN SCOTT

Reg. No. 4,204,607

STEVEN SCOTT MANAGEMENT, INC. (MINNESOTA CORPORATION)
5402 PARKDALE DRIVE, SUITE 200
ST. LOUIS PARK, MN 55416

Registered Sep. 11, 2012

Int. Cl.: 36

FOR: REAL ESTATE SERVICES, NAMELY, RENTAL PROPERTY MANAGEMENT;
APARTMENT RENTAL AGENCY, IN CLASS 36 (U.S. CLS. 100, 101 AND 102).

SERVICE MARK

FIRST USE 4-27-1992; IN COMMERCE 4-27-1992.

PRINCIPAL REGISTER

THE MARK CONSISTS OF STANDARD CHARACTERS WITHOUT CLAIM TO ANY PARTICULAR FONT, STYLE, SIZE, OR COLOR.

THE NAME(S), PORTRAIT(S), AND/OR SIGNATURE(S) SHOWN IN THE MARK DOES NOT IDENTIFY A PARTICULAR LIVING INDIVIDUAL.

SER. NO. 85-374,645, FILED 7-19-2011.

FRED CARL, EXAMINING ATTORNEY



David J. Kyffers

Director of the United States Patent and Trademark Office

United States of America

United States Patent and Trademark Office



Reg. No. 4,204,608

Registered Sep. 11, 2012

Int. Cl.: 39

SERVICE MARK

PRINCIPAL REGISTER

DALLAS VALET SERVICE INC. (TEXAS CORPORATION)
500 N. CENTRAL EXPRESSWAY
DALLAS, TX 75080 AND

DEMACHKIE, DANNY (UNITED STATES INDIVIDUAL)
500 N. CENTRAL EXPRESSWAY
RICHARDSON, TX 75080

FOR: VALET PARKING, IN CLASS 39 (U.S. CLS. 100 AND 105).

FIRST USE 6-1-1993; IN COMMERCE 6-1-1993.

NO CLAIM IS MADE TO THE EXCLUSIVE RIGHT TO USE "DALLAS VALET", APART FROM THE MARK AS SHOWN.

THE COLOR(S) BLACK, RED AND WHITE IS/ARE CLAIMED AS A FEATURE OF THE MARK.

THE MARK CONSISTS OF THE WORDS "DALLAS VALET" WITH "DALLAS" VERTICAL IN BLACK AND "VALET" IN RED, DIVIDED BY A BLACK TRIANGLE THAT CONNECTS WITH A BLACK LINE UNDER BOTH WORDS AND A WHITE RECTANGLE INSIDE THE BLACK LINE.

SER. NO. 85-375,606, FILED 7-19-2011.

FRANK LATTUCA, EXAMINING ATTORNEY



David J. Kyffers

Director of the United States Patent and Trademark Office

United States of America

United States Patent and Trademark Office

FIND THE BEST

Reg. No. 4,204,609

FINDTHEBEST.COM, INC. (DELAWARE CORPORATION)
15 W. FIGUEROA ST.
SANTA BARBARA, CA 93101

Registered Sep. 11, 2012

Int. Cls.: 35 and 42

FOR: COMMERCIAL EVALUATION AND RATING OF CONSUMER GOODS FOR OTHERS PRIOR TO PURCHASE; EXPERT EVALUATIONS AND REPORTS RELATING TO BUSINESS MATTERS; PROVIDING A WEB SITE FEATURING PRODUCT RATINGS OF THE CONSUMER GOODS AND SERVICES OF OTHERS IN THE FIELD OF ALL GOODS AND SERVICES AVAILABLE, NAMELY, IN THE FIELDS OF BUSINESS, CAREER DEVELOPMENT, CHILD CARE, FASHION, FINANCE, EDUCATION, ELECTRONICS, ENTERTAINMENT, GARDENING, HEALTH, HOME CARE, HOME IMPROVEMENT, FAMILY, LANDSCAPING, MOTOR VEHICLES, PETS, REAL ESTATE, SOFTWARE, SPORTS, RECREATION, TECHNOLOGY, TRAVEL AND LIFESTYLE; PROVIDING AN ON-LINE COMMERCIAL INFORMATION DIRECTORY ON THE INTERNET; PROVIDING AN ON-LINE COMPUTER DATABASE IN THE FIELD OF LOCATING PRODUCTS, DESCRIBING PRODUCTS, RATING PRODUCTS, PRICING PRODUCTS AND COMPARING PRICES OF PRODUCTS; SHOPPING FACILITATION SERVICES, NAMELY, PROVIDING AN ONLINE COMPARISON-SHOPPING SEARCH ENGINE FOR OBTAINING PURCHASING INFORMATION, IN CLASS 35 (U.S. CLS. 100, 101 AND 102).

SERVICE MARK

PRINCIPAL REGISTER

FIRST USE 8-7-2009; IN COMMERCE 8-7-2009.



FOR: COMPUTER SERVICES, NAMELY, PROVIDING SEARCH ENGINES FOR OBTAINING DATA ON A GLOBAL COMPUTER NETWORK; COMPUTER SERVICES, NAMELY, PROVIDING SEARCH ENGINES FOR OBTAINING COMPARISONS OF PRODUCTS, GOODS, SERVICES, ITEMS, AND TOPICS ON A GLOBAL COMPUTER NETWORK; PROVIDING SPECIFIC INFORMATION AS REQUESTED BY CUSTOMERS VIA THE INTERNET; PROVISION OF SEARCH ENGINES FOR THE INTERNET; SEARCHING AND RETRIEVING INFORMATION, SITES, AND OTHER RESOURCES AVAILABLE ON COMPUTER NETWORKS FOR OTHERS, IN CLASS 42 (U.S. CLS. 100 AND 101).

FIRST USE 8-7-2009; IN COMMERCE 8-7-2009.

David J. Kyffers

THE MARK CONSISTS OF STANDARD CHARACTERS WITHOUT CLAIM TO ANY PARTICULAR FONT, STYLE, SIZE, OR COLOR.

Director of the United States Patent and Trademark Office

SER. NO. 85-376,207, FILED 7-20-2011.

Reg. No. 4,204,609 SETH A. RAPPAPORT, EXAMINING ATTORNEY

United States of America

United States Patent and Trademark Office

SWAGE-SERT

Reg. No. 4,204,610

ACME INDUSTRIAL COMPANY (ILLINOIS CORPORATION)
441 MAPLE AVENUE
CARPENTERSVILLE, IL 60110

Registered Sep. 11, 2012

Int. Cl.: 6

FOR: METAL THREADED FASTENERS, NAMELY, INSERTS IN THE NATURE OF THREADED INSERTS AND THIN WALL THREADED INSERTS, IN CLASS 6 (U.S. CLS. 2, 12, 13, 14, 23, 25 AND 50).

TRADEMARK

FIRST USE 11-30-2010; IN COMMERCE 11-30-2010.

PRINCIPAL REGISTER

THE MARK CONSISTS OF STANDARD CHARACTERS WITHOUT CLAIM TO ANY PARTICULAR FONT, STYLE, SIZE, OR COLOR.

SER. NO. 85-376,231, FILED 7-20-2011.

BRIAN CALLAGHAN, EXAMINING ATTORNEY



David J. Kyffers

Director of the United States Patent and Trademark Office

United States of America

United States Patent and Trademark Office

reliant

an NRG company

Reg. No. 4,204,611

Registered Sep. 11, 2012

Int. Cls.: 35, 36 and 42

RELIANT ENERGY RETAIL HOLDINGS, LLC (DELAWARE LIMITED LIABILITY COMPANY)
NRG TOWER AT HOUSTON PAVILIONS
1201 FANNIN
HOUSTON, TX 77002

SERVICE MARK

PRINCIPAL REGISTER

FOR: ENERGY MANAGEMENT SERVICES, NAMELY, PROVIDING A SERVICE THAT ALLOWS CUSTOMERS TO PURCHASE ENERGY; BILLING SERVICES; PROVIDING INFORMATION RESOURCES THAT ASSIST IN REDUCING ENERGY USAGE; PROVIDING INFORMATION REGARDING ENERGY EFFICIENCY AND ENERGY USAGE; COMMERCIAL AND INDUSTRIAL MANAGEMENT ASSISTANCE, NAMELY, CONTROLLING AND MANAGING OF ENERGY USAGE FOR COMMERCIAL, INDUSTRIAL, AND INSTITUTIONAL CUSTOMERS; PROVIDING ON-LINE INFORMATION IN THE FIELD OF ENERGY EFFICIENCY; PROVIDING BUSINESS INFORMATION REGARDING THE ENERGY INDUSTRY AND ENERGY COMMODITIES; PROMOTING PUBLIC AWARENESS OF THE NEED FOR ENVIRONMENTALLY FRIENDLY ENERGY; PROMOTING PUBLIC AWARENESS OF ALTERNATIVE ENERGY GENERATION ALTERNATIVES, IN CLASS 35 (U.S. CLS. 100, 101 AND 102).

FIRST USE 9-12-2011; IN COMMERCE 9-12-2011.



FOR: ENERGY BROKERAGE SERVICES, NAMELY, ELECTRICITY AND NATURAL GAS; ELECTRICITY BROKERAGE, NAMELY, THE BROKERAGE OF ELECTRIC POWER, BOTH GENERATED INTERNALLY AND PURCHASED FROM ELECTRIC UTILITIES AND FROM OTHER ELECTRIC POWER PRODUCERS, SUPPLIERS AND SOURCES, FOR TRANSFER TO OTHERS; PROVIDING VARIOUS PAYMENT PLANS FOR THE PURCHASE OF ELECTRICITY, NAMELY, ELECTRICITY RATE PLANS; OFFERING SERVICE SUPPORT FOR ELECTRICITY CUSTOMERS, NAMELY, BILL PAYMENT SERVICES, NAMELY, BILL PAYMENT SERVICES; PROVIDING FINANCIAL INFORMATION REGARDING THE ENERGY INDUSTRY AND ENERGY COMMODITIES, IN CLASS 36 (U.S. CLS. 100, 101 AND 102).

FIRST USE 9-12-2011; IN COMMERCE 9-12-2011.

David J. Kybas

FOR: PROVIDING TECHNOLOGY INFORMATION REGARDING THE ENERGY INDUSTRY AND ENERGY COMMODITIES, IN CLASS 42 (U.S. CLS. 100 AND 101).

Reg. No. 4,204,611 FIRST USE 9-12-2011; IN COMMERCE 9-12-2011.

OWNER OF U.S. REG. NOS. 2,666,766, 4,029,969 AND OTHERS.

NO CLAIM IS MADE TO THE EXCLUSIVE RIGHT TO USE "COMPANY", APART FROM THE MARK AS SHOWN.

THE MARK CONSISTS OF THE WORD "RELIANT" WITH A DESIGN OF CROSSES LOCATED IN THE UPPER RIGHT CORNER ABOVE THE LETTER "T" AND THE WORDS "AN NRG COMPANY" DIRECTLY BELOW.

SER. NO. 85-376,261, FILED 7-20-2011.

SUE LAWRENCE, EXAMINING ATTORNEY

United States of America

United States Patent and Trademark Office



Reg. No. 4,204,612

OLIVIA GARDEN INTERNATIONAL INC. (DELAWARE CORPORATION)
3745 SHADOWBROOK CT
WALNUT CREEK, CA 94598

Registered Sep. 11, 2012

Int. Cls.: 8, 21, 25 and 26

FOR: BARBER SCISSORS, BEAUTY SALON SCISSORS, NON-ELECTRICAL RAZORS AND NON-ELECTRICAL HAIR SHAVERS, NON-ELECTRICAL HAIR CLIPPERS, SCISSORS FOR PET GROOMING, FINGER NAIL CLIPPERS, TOE NAIL CLIPPERS, FOOT CARE IMPLEMENTS, NAMELY, FOOT FILES; NAIL FILES; NAIL SCISSORS; TWEEZERS, IN CLASS 8 (U.S. CLS. 23, 28 AND 44).

TRADEMARK

PRINCIPAL REGISTER

FIRST USE 6-13-2011; IN COMMERCE 6-13-2011.

FOR: HAIR BRUSHES, IN CLASS 21 (U.S. CLS. 2, 13, 23, 29, 30, 33, 40 AND 50).

FIRST USE 6-13-2011; IN COMMERCE 6-13-2011.

FOR: BARBER OR BEAUTY SALON OR SPA APPAREL, NAMELY, CAPES, APRONS, ROBES, GOWNS, SMOCKS, VESTS, OR CAPS, IN CLASS 25 (U.S. CLS. 22 AND 39).

FIRST USE 6-13-2011; IN COMMERCE 6-13-2011.

FOR: NON-ELECTRIC HAIR CURLERS, IN CLASS 26 (U.S. CLS. 37, 39, 40, 42 AND 50).

FIRST USE 6-13-2011; IN COMMERCE 6-13-2011.

OWNER OF U.S. REG. NO. 2,597,698.

THE MARK CONSISTS OF THE LETTER "O" AND THE LETTER "G" INTERTWINED.

SER. NO. 85-376,847, FILED 7-21-2011.

WENDY JUN, EXAMINING ATTORNEY



David J. Kyffers

Director of the United States Patent and Trademark Office

United States of America

United States Patent and Trademark Office

Love Your
Boobies

The logo for "Love Your Boobies" features the words "Love Your" in black, with the "O"s in "Love" and "Your" replaced by red and pink hearts. Below "Love Your" is the word "Boobies" in black, with the "O"s replaced by red and pink hearts. To the right of "Boobies" is a large red heart with a pink ribbon forming its right side. To the right of the large heart is a smaller pink heart with a pink ribbon forming its right side. The ribbons have a smiley face on their heads.

Reg. No. 4,204,613

YABLON, ERIC (UNITED STATES INDIVIDUAL)
8160 VINE WOOD DR.

Registered Sep. 11, 2012

NORTH RICHLAND HILLS, TX 76182

Int. Cl.: 25

FOR: CLOTHING, NAMELY, T-SHIRTS, TANK TOPS, SLEEP SHIRTS, BASEBALL CAPS, SHORTS, AND HATS, IN CLASS 25 (U.S. CLS. 22 AND 39).

TRADEMARK

FIRST USE 6-9-2010; IN COMMERCE 6-9-2010.

PRINCIPAL REGISTER

THE MARK CONSISTS OF THE STYLIZED WORDS "LOVE YOUR" ABOVE THE WORD "BOOBIES" IN BLACK EXCEPT THE LETTER "O"S IN THE WORDS "LOVE" AND "BOOBIES" ARE DEPICTED BY HEARTS SHADED IN RED AND PINK AND THE LETTER "I" IS DEPICTED BY A HUMAN FIGURE FORMED BY A CANCER RIBBON HAVING A HEAD IN THE SHAPE OF A PINK HEART WITH A SMILEY FACE; TO THE RIGHT OF THE WORDING IS THE IMAGE OF TWO HEARTS SHADED IN RED AND PINK ON TOP OF ONE ANOTHER TOUCHING AT THEIR APEX AND ANOTHER HUMAN FIGURE FORMED BY A CANCER RIBBON HAVING A HEAD IN THE SHAPE OF A PINK HEART WITH A SMILEY FACE.

THE COLOR(S) BLACK, PINK AND RED IS/ARE CLAIMED AS A FEATURE OF THE MARK.

SER. NO. 85-376,850, FILED 7-21-2011.

JULIE GUTTADAURO, EXAMINING ATTORNEY



David J. Kyffers

Director of the United States Patent and Trademark Office

United States of America

United States Patent and Trademark Office



Schaub

Reg. No. 4,204,614

Registered Sep. 11, 2012

Int. Cls.: 6 and 20

TRADEMARK

PRINCIPAL REGISTER

R. E. SCHAUB ENTERPRISES, INC. (MICHIGAN CORPORATION)
SUITE 4
4740 TALON COURT SE
GRAND RAPIDS, MI 49512

FOR: CABINET, FURNITURE AND APPLIANCE HARDWARE OF METAL, NAMELY, KNOBS, PULLS, HANDLES, BACKPLATES AND HINGES, IN CLASS 6 (U.S. CLS. 2, 12, 13, 14, 23, 25 AND 50).

FIRST USE 1-0-2002; IN COMMERCE 1-0-2002.

FOR: NON-METAL CABINET AND FURNITURE HARDWARE, NAMELY, KNOBS, PULLS AND HANDLES; PRODUCT DISPLAY MERCHANDISERS, TOWERS AND BOARDS, IN CLASS 20 (U.S. CLS. 2, 13, 22, 25, 32 AND 50).

FIRST USE 1-0-2002; IN COMMERCE 1-0-2002.

THE NAME(S), PORTRAIT(S), AND/OR SIGNATURE(S) SHOWN IN THE MARK IDENTIFIES ROBERT E. "SCHAUB", WHOSE CONSENT(S) TO REGISTER IS MADE OF RECORD.

THE MARK CONSISTS OF A DESIGN COMPRISED OF INTERLOCKING OPPOSING ARCS CONTAINED WITH A RECTANGLE UNDER WHICH THE WORD "SCHAUB" IN STYLIZED FONT IS CENTERED.

SER. NO. 85-376,915, FILED 7-21-2011.

ZACHARY BELLO, EXAMINING ATTORNEY



David J. Kyffers

Director of the United States Patent and Trademark Office

United States of America

United States Patent and Trademark Office

Variloc

Reg. No. 4,204,615

Registered Sep. 11, 2012

Int. Cl.: 6

TRADEMARK

PRINCIPAL REGISTER

GAY, DWIGHT S. (UNITED STATES INDIVIDUAL), DBA VARILOC PRODUCTS, LLC
3432 PINEMEADOW COURT
DAVISON, MI 48423

FOR: RELEASABLE METAL LATCH FOR LATCHING ROTATING PARTS IN A SELECTED ONE OF A PLURALITY OF ANGULARY ADJUSTED POSITIONS, IN CLASS 6 (U.S. CLS. 2, 12, 13, 14, 23, 25 AND 50).

FIRST USE 7-15-1995; IN COMMERCE 7-15-1995.

THE MARK CONSISTS OF STANDARD CHARACTERS WITHOUT CLAIM TO ANY PARTICULAR FONT, STYLE, SIZE, OR COLOR.

SER. NO. 85-376,929, FILED 7-21-2011.

KIMBERLY FRYE, EXAMINING ATTORNEY



David J. Kyffers

Director of the United States Patent and Trademark Office

United States of America

United States Patent and Trademark Office



BOLD
THINKERS
DRIVING
REAL-WORLD
IMPACT

Reg. No. 4,204,616

Registered Sep. 11, 2012

Int. Cls.: 35, 41 and 42

SERVICE MARK

PRINCIPAL REGISTER

ABT ASSOCIATES INC. (MASSACHUSETTS CORPORATION)
55 WHEELER STREET
CAMBRIDGE, MA 02138

FOR: BUSINESS CONSULTING AND BUSINESS RESEARCH CONSULTING IN THE FIELDS OF SOCIAL, ECONOMIC, ENVIRONMENTAL AND HEALTH POLICY AND INTERNATIONAL DEVELOPMENT; PUBLIC POLICY CONSULTANCY SERVICES IN THE FIELDS OF ECONOMIC, ENVIRONMENTAL AND HEALTH POLICY AND INTERNATIONAL DEVELOPMENT, IN CLASS 35 (U.S. CLS. 100, 101 AND 102).

FIRST USE 5-18-2011; IN COMMERCE 6-13-2011.

FOR: EDUCATION SERVICES, NAMELY, PROVIDING SEMINARS, WORKSHOPS, CONFERENCES IN THE FIELDS OF HEALTH, SOCIAL AND ENVIRONMENTAL POLICY, INTERNATIONAL DEVELOPMENT, AND SCIENTIFIC RESEARCH, IN CLASS 41 (U.S. CLS. 100, 101 AND 107).

FIRST USE 5-18-2011; IN COMMERCE 6-13-2011.

FOR: SCIENTIFIC RESEARCH, TECHNICAL CONSULTING IN RELATION TO SCIENTIFIC RESEARCH, AND SCIENTIFIC RESEARCH CONSULTING IN THE IN THE FIELDS OF SOCIAL, ECONOMIC, HEALTH POLICY, AND INTERNATIONAL DEVELOPMENT, IN CLASS 42 (U.S. CLS. 100 AND 101).

FIRST USE 5-18-2011; IN COMMERCE 6-13-2011.

OWNER OF U.S. REG. NOS. 3,597,457 AND 3,605,158.

THE COLOR(S) RED AND GRAY IS/ARE CLAIMED AS A FEATURE OF THE MARK.

NO CLAIM IS MADE TO THE EXCLUSIVE RIGHT TO USE "ASSOCIATES", APART FROM THE MARK AS SHOWN.

THE MARK CONSISTS OF THE WORDS "ABT ASSOCIATES" IN RED ENCAPSULATED BY A CIRCULAR SPIRAL COMPRISED OF FOUR BOXES, ONE OF WHICH IS IN RED AND THE REMAINING THREE ARE IN GRAY, THE WORDING "BOLD THINKERS DRIVING REAL-WORLD IMPACT" ARE TO THE RIGHT OF THE BOXES IN GRAY. THE COLOR



David J. Kyjars

Director of the United States Patent and Trademark Office

Reg. No. 4,204,616 WHITE IS NOT PART OF THE MARK AND REPRESENTS BACKGROUND OR TRANSPARENT AREAS.

SER. NO. 85-377,281, FILED 7-21-2011.

DEIRDRE ROBERTSON, EXAMINING ATTORNEY

United States of America

United States Patent and Trademark Office



Reg. No. 4,204,617

UNIVERSAL HEALTH CARE GROUP, INC. (DELAWARE CORPORATION)
100 CENTRAL AVE., STE. 200
ST. PETERSBURG, FL 33701

Registered Sep. 11, 2012

Int. Cl.: 41

FOR: PHYSICAL FITNESS CONSULTATION PROVIDED TO BENEFIT MEMBERS ENROLLED IN A REPLACEMENT BENEFIT HEALTH PLAN, IN CLASS 41 (U.S. CLS. 100, 101 AND 107).

SERVICE MARK

FIRST USE 8-0-2008; IN COMMERCE 8-0-2008.

PRINCIPAL REGISTER

THE MARK CONSISTS OF THE STYLIZED WORDING "VITA" ON TOP OF "LIFE" IN CAPITAL LETTERS WITH A STYLIZED HUMAN SILHOUETTE FIGURE FORMED BY GEOMETRIC SHAPES COMPRISING THE LETTER "I" FOR BOTH THE WORD "VITA" AND "LIFE".

SER. NO. 85-377,316, FILED 7-21-2011.

DORITT L. CARROLL, EXAMINING ATTORNEY



David J. Kyjars

Director of the United States Patent and Trademark Office

United States of America

United States Patent and Trademark Office

TRIPPI-WELLS

Reg. No. 4,204,618

Registered Sep. 11, 2012

Int. Cl.: 10

TRADEMARK

PRINCIPAL REGISTER

DEPUY, INC. (DELAWARE CORPORATION)
700 ORTHOPAEDIC DRIVE
WARSAW, IN 46581

FOR: SURGICAL INSTRUMENTS FOR ORTHOPAEDIC USE; MEDICAL APPARATUS FOR STABILIZATION OF THE CERVICAL SPINE IN STATIONARY AND/OR MOBILE TRACTION, IN CLASS 10 (U.S. CLS. 26, 39 AND 44).

FIRST USE 6-1-2011, THE MARK WAS FIRST USED ANYWHERE IN A DIFFERENT FORM OTHER THAN THAT SOUGHT TO BE REGISTERED AT LEAST AS EARLY AS 10/19/1981; IN COMMERCE 6-1-2011, THE MARK WAS FIRST USED IN COMMERCE IN A DIFFERENT FORM OTHER THAN THAT SOUGHT TO BE REGISTERED AT LEAST AS EARLY AS 10/19/1981.

THE MARK CONSISTS OF STANDARD CHARACTERS WITHOUT CLAIM TO ANY PARTICULAR FONT, STYLE, SIZE, OR COLOR.

OWNER OF U.S. REG. NO. 2,927,968.

SER. NO. 85-377,519, FILED 7-21-2011.

DAVID TAYLOR, EXAMINING ATTORNEY



David J. Kyfos

Director of the United States Patent and Trademark Office

United States of America

United States Patent and Trademark Office



Greeting Stones

Reg. No. 4,204,619

Registered Sep. 11, 2012

Int. Cl.: 19

TRADEMARK

PRINCIPAL REGISTER

CAST IN STONE LLC (DELAWARE LIMITED LIABILITY COMPANY)
8983 OKEECHOBEE BLVD. SUITE 202-422
WEST PALM BEACH, FL 33411

FOR: NATURAL STONES THAT ARE INSCRIBED WITH A NAME, QUOTATION AND/OR PHRASE, IN CLASS 19 (U.S. CLS. 1, 12, 33 AND 50).

FIRST USE 7-1-2011; IN COMMERCE 7-1-2011.

NO CLAIM IS MADE TO THE EXCLUSIVE RIGHT TO USE "GREETING STONES", APART FROM THE MARK AS SHOWN.

THE MARK CONSISTS OF THE STYLIZED TERMS "GREETING STONES". ABOVE THE TERMS IS A STYLIZED CAKE WITH TWO LIT CANDLES AND FROSTING POSITIONED ON A PLATE.

SER. NO. 85-377,589, FILED 7-21-2011.

CORY BOONE, EXAMINING ATTORNEY



David J. Kyffers

Director of the United States Patent and Trademark Office

United States of America

United States Patent and Trademark Office



Reg. No. 4,204,620

Registered Sep. 11, 2012

Int. Cl.: 12

TRADEMARK

PRINCIPAL REGISTER

DIA-COMPE, TAIWAN, CO., LTD. (TAIWAN CORPORATION)
NO.62, 35TH RD, TAICHUNG INDUSTRIAL PARK
TAICHUNG, TAIWAN

FOR: BICYCLES, BICYCLE FRAMES, BICYCLE HEAD TUBES, BICYCLE FRONT FORKS, BICYCLE PEDALS, BICYCLE WHEELS, QUICK RELEASE DEVICES FOR BICYCLE WHEELS, TIRES FOR BICYCLES, BICYCLE SPOKES, BICYCLE RIMS, BICYCLE BRAKE ASSEMBLIES, BICYCLE CRANKS, BICYCLE CHAINS, CHAINRINGS FOR BICYCLES, WHEEL HUBS FOR BICYCLES, BOTTOM BRACKETS FOR BICYCLES, SEAT POSTS FOR BICYCLES, SEAT TUBES FOR BICYCLES, BICYCLE SADDLES, SADDLE BAGS FOR BICYCLES, WATER BOTTLE CAGES FOR BICYCLES, HANDLEBARS FOR BICYCLES, BICYCLE HANDLEBAR STEM, HEADSET BEARINGS FOR BICYCLES, BEARINGS FOR BICYCLE BOTTOM BRACKETS, WHEEL BEARINGS FOR BICYCLES, BICYCLE GEARS, DERAILLEURS FOR BICYCLES, SPROCKETS FOR BICYCLES, AXLES FOR BICYCLES, FREEWHEELS FOR BICYCLES, BRAKE LEVERS FOR BICYCLES, IN CLASS 12 (U.S. CLS. 19, 21, 23, 31, 35 AND 44).

FIRST USE 0-0-2009; IN COMMERCE 4-0-2011.

NO CLAIM IS MADE TO THE EXCLUSIVE RIGHT TO USE "CICLO", APART FROM THE MARK AS SHOWN.

THE MARK CONSISTS OF THE WORDS "ENE CICLO" IN GENERIC FONT ON THE RIGHT, AND WORD "ENE" IN STYLIZED FORM DEPICTED AS AN OVAL DEVICE ON THE LEFT. IN THE STYLIZED "ENE", THE SECOND STYLIZED LETTER "E" IS SHOWN IN A MIRROR IMAGE OF THE FIRST STYLIZED LETTER "E".

THE ENGLISH TRANSLATION OF "CICLO" IN THE MARK IS "CYCLE".

SER. NO. 85-377,648, FILED 7-21-2011.

MICHELE SWAIN, EXAMINING ATTORNEY



David J. Kybas

Director of the United States Patent and Trademark Office

United States of America

United States Patent and Trademark Office

Find The Best

Reg. No. 4,204,621

Registered Sep. 11, 2012

Int. Cls.: 35 and 42

SERVICE MARK

PRINCIPAL REGISTER

FINDTHEBEST.COM, INC. (DELAWARE CORPORATION)
15 W. FIGUEROA ST.
SANTA BARBARA, CA 93101

FOR: COMMERCIAL EVALUATION AND RATING OF CONSUMER GOODS FOR OTHERS PRIOR TO PURCHASE; EXPERT EVALUATIONS AND REPORTS RELATING TO BUSINESS MATTERS; PROVIDING A WEB SITE FEATURING PRODUCT RATINGS OF THE CONSUMER GOODS AND SERVICES OF OTHERS IN THE FIELD OF ALL GOODS AND SERVICES AVAILABLE, NAMELY, IN THE FIELDS OF BUSINESS, CAREER DEVELOPMENT, CHILD CARE, FASHION, FINANCE, EDUCATION, ELECTRONICS, ENTERTAINMENT, GARDENING, HEALTH, HOME CARE, HOME IMPROVEMENT, FAMILY, LANDSCAPING, MOTOR VEHICLES, PETS, REAL ESTATE, SOFTWARE, SPORTS, RECREATION, TECHNOLOGY, TRAVEL AND LIFESTYLE; PROVIDING AN ON-LINE COMMERCIAL INFORMATION DIRECTORY ON THE INTERNET; PROVIDING AN ON-LINE COMPUTER DATABASE IN THE FIELD OF LOCATING PRODUCTS, DESCRIBING PRODUCTS, RATING PRODUCTS, PRICING PRODUCTS AND COMPARING PRICES OF PRODUCTS; SHOPPING FACILITATION SERVICES, NAMELY, PROVIDING AN ONLINE COMPARISON-SHOPPING SEARCH ENGINE FOR OBTAINING PURCHASING INFORMATION, IN CLASS 35 (U.S. CLS. 100, 101 AND 102).

FIRST USE 1-5-2010; IN COMMERCE 1-5-2010.



FOR: COMPUTER SERVICES, NAMELY, PROVIDING SEARCH ENGINES FOR OBTAINING DATA ON A GLOBAL COMPUTER NETWORK; COMPUTER SERVICES, NAMELY, PROVIDING SEARCH ENGINES FOR OBTAINING COMPARISONS OF PRODUCTS, GOODS, SERVICES, ITEMS, AND TOPICS ON A GLOBAL COMPUTER NETWORK; PROVIDING SPECIFIC INFORMATION AS REQUESTED BY CUSTOMERS VIA THE INTERNET; PROVISION OF SEARCH ENGINES FOR THE INTERNET; SEARCHING AND RETRIEVING INFORMATION, SITES, AND OTHER RESOURCES AVAILABLE ON COMPUTER NETWORKS FOR OTHERS, IN CLASS 42 (U.S. CLS. 100 AND 101).

FIRST USE 1-5-2010; IN COMMERCE 1-5-2010.

David J. Kyffers

THE MARK CONSIST OF THE WORDING "FIND THE BEST" WITH THE WORDING "FIND" IN BLUE, THE WORDING "THE" IN GREEN, AND THE WORDING "BEST" IN ORANGE.

Reg. No. 4,204,621 THE COLOR(S) BLUE, GREEN AND ORANGE IS/ARE CLAIMED AS A FEATURE OF THE MARK.

SER. NO. 85-377,684, FILED 7-21-2011.

SETH A. RAPPAPORT, EXAMINING ATTORNEY

United States of America

United States Patent and Trademark Office

21ST CENTURY LIFESKILLS

Reg. No. 4,204,622

Registered Sep. 11, 2012

Int. Cl.: 16

TRADEMARK

PRINCIPAL REGISTER

SADDLEBACK EDUCATIONAL, INC. (CALIFORNIA CORPORATION)
3120-A PULLMAN STREET
COSTA MESA, CA 926264564

FOR: SERIES OF FICTION BOOKS, WORKBOOKS, HANDBOOKS AND TEACHER'S GUIDES IN THE FIELD OF REMEDIAL EDUCATION FOR SECONDARY AND ADULT EDUCATION; PRINTED MATTER, NAMELY, BOOKS, WORKBOOKS, HANDBOOKS AND TEACHER'S GUIDES IN THE FIELD OF REMEDIAL EDUCATION FOR SECONDARY AND ADULT EDUCATION, IN CLASS 16 (U.S. CLS. 2, 5, 22, 23, 29, 37, 38 AND 50).

FIRST USE 0-0-2010; IN COMMERCE 0-0-2010.

THE MARK CONSISTS OF STANDARD CHARACTERS WITHOUT CLAIM TO ANY PARTICULAR FONT, STYLE, SIZE, OR COLOR.

NO CLAIM IS MADE TO THE EXCLUSIVE RIGHT TO USE "LIFE SKILLS", APART FROM THE MARK AS SHOWN.

SER. NO. 85-377,944, FILED 7-21-2011.

JULIE GUTTADAURO, EXAMINING ATTORNEY



David J. Kyros

Director of the United States Patent and Trademark Office

United States of America

United States Patent and Trademark Office

BIG PLAYER

Reg. No. 4,204,623

Registered Sep. 11, 2012

Int. Cl.: 42

SERVICE MARK

PRINCIPAL REGISTER

BIG PLAYER INC. (CALIFORNIA CORPORATION)
9595 WILSHIRE BOULEVARD, SUITE 900
BEVERLY HILLS, CA 90212

FOR: CREATION AND DEVELOPMENT OF AUGMENTED REALITY GOODS AND SERVICES, NAMELY, SOFTWARE DEVELOPMENT SERVICES FOR OTHERS; DESIGN AND DEVELOPMENT OF COMPUTER GAME SOFTWARE; COMPUTER PROGRAMMING SERVICES FOR THE CREATION OF AUGMENTED REALITY GOODS AND SERVICES, IN CLASS 42 (U.S. CLS. 100 AND 101).

FIRST USE 4-0-2011; IN COMMERCE 4-0-2011.

THE MARK CONSISTS OF STANDARD CHARACTERS WITHOUT CLAIM TO ANY PARTICULAR FONT, STYLE, SIZE, OR COLOR.

SER. NO. 85-378,428, FILED 7-22-2011.

ALLISON SCHRODY, EXAMINING ATTORNEY



David J. Kyffers

Director of the United States Patent and Trademark Office

United States of America

United States Patent and Trademark Office



Reg. No. 4,204,624

Registered Sep. 11, 2012

Int. Cls.: 7 and 12

TRADEMARK

PRINCIPAL REGISTER

PRIEFERT MFG. CO., INC. (TEXAS CORPORATION)
PO BOX 1540
MOUNT PLEASANT, TX 754561540

FOR: AGRICULTURAL EQUIPMENT TOWED BY OR ATTACHED TO TRACTORS OR ATVS, NAMELY, HARROWS, PLOWS, GROOMERS, TILLERS, GRADERS, SCRAPES, LANDSCAPE RAKES, SEED SPREADERS, SUB SOILERS, CULTIVATORS, MOWERS, SEED PACKERS, BOOM POLES, PALLET FORKS; AGRICULTURAL MACHINERY, NAMELY, PLOWS, HARROWS, GROOMERS, GRADERS, SCRAPES, LANDSCAPE RAKES TOWED BY TRACTORS, TILLERS TOWED BY TRACTORS, CULTIVATORS, MOWERS, SEED PACKERS, DIRT SCOOPERS, ROUND BALE MOVERS, BALE SPIKES, BALE FORKS; PLOWS; HARROWS; POWER-OPERATED LOG SPLITTERS; CHAIN SAWS, IN CLASS 7 (U.S. CLS. 13, 19, 21, 23, 31, 34 AND 35).

FIRST USE 5-0-2009; IN COMMERCE 5-0-2009.

FOR: TRAILER HITCHES; DOLLIES, IN CLASS 12 (U.S. CLS. 19, 21, 23, 31, 35 AND 44).

FIRST USE 5-0-2009; IN COMMERCE 5-0-2009.

THE MARK CONSISTS OF THE WORD "PRIEFERT" IN STYLIZED FONT WITH A DIAMOND SHAPE OVER THE LETTER "I" AND WHICH IS ABOVE A TRIANGLE DESIGN AND THE WORD "3-POINT" WITH THE NUMBER "3" INSIDE OF THE TRIANGLE.

SER. NO. 85-378,447, FILED 7-22-2011.

MICHAEL SOUDERS, EXAMINING ATTORNEY



David J. Kybas

Director of the United States Patent and Trademark Office

United States of America

United States Patent and Trademark Office

Priefert

Reg. No. 4,204,625

PRIEFERT MFG. CO., INC. (TEXAS CORPORATION)

Registered Sep. 11, 2012

PO BOX 1540
MOUNT PLEASANT, TX 754561540

Int. Cls.: 6, 7, 19, 20 and 21

FOR: METAL LIVESTOCK AND EQUINE HANDLING EQUIPMENT, NAMELY, METAL SQUEEZE CHUTES, CALF TABLES, LOADING CHUTES, CHUTES, STALLS, HEAD GATES, STOCKS, PANELS, PENS, ALLEYS, SWEEPS, BUCKING CHUTES, ROPING CHUTES; METAL LIVESTOCK HANDLING EQUIPMENT, NAMELY, FENCE AND CORRAL PANELS, GATES, TUBULAR FENCING, FENCE POSTS, PLATFORMS, STAIRS, STALLS AND SHELTERS; METAL LIVESTOCK CHUTES AND SWEEPS FOR MOVING AND SORTING CATTLE; METAL CALF TABLES; METAL LIVESTOCK PENS; METAL CORRALS; METAL ARENA KITS COMPRISING METAL SWEEPS, CHUTES, PANELS, PENS, ALLEYS, GATES, FENCES, PANELS, BUCKING CHUTES, ROPING CHUTES; METAL STOCK TURN AND TRAP KITS COMPRISING METAL PENS, ALLEYS AND SWEEPS; METAL CATTLE GUARDS; WIRE FENCES; METAL HORSE STOCKS, NAMELY, NARROW STALLS; ARCHITECTURAL METALWORK; METAL STORAGE SHEDS; HORSE BARN AND SHELTER KITS COMPRISING METAL WALLS, FRAMES, ROOFS, WINDOWS, DOORS, STALLS, STALL DIVIDERS, STALL PANELS, STALL FRONTS, AISLES, FEEDERS, TACK ROOMS, OFFICES, WASH BAYS, AWNINGS, PENS; HORSE ARENA KITS COMPRISING METAL WALL PANELS, PENS, POSTS, GATES AND CHUTES, IN CLASS 6 (U.S. CLS. 2, 12, 13, 14, 23, 25 AND 50).

TRADEMARK

PRINCIPAL REGISTER



FIRST USE 9-0-1999; IN COMMERCE 9-0-1999.

FOR: MECHANIZED HORSE WALKERS; MECHANIZED BULL AND HORSE WALKER, IN CLASS 7 (U.S. CLS. 13, 19, 21, 23, 31, 34 AND 35).

FIRST USE 7-0-2003; IN COMMERCE 10-0-2003.

FOR: HORSE STALL KICK WALLS; NON-METAL FENCE PANELS; NON-METAL GATES AND FENCES, IN CLASS 19 (U.S. CLS. 1, 12, 33 AND 50).

FIRST USE 9-0-1999; IN COMMERCE 9-0-1999.

David J. Kyffers

FOR: DOG KENNELS; METAL PET KENNELS, IN CLASS 20 (U.S. CLS. 2, 13, 22, 25, 32 AND 50).

Reg. No. 4,204,625 FIRST USE 9-0-1999; IN COMMERCE 9-0-1999.

FOR: NON-MECHANIZED ANIMAL FEEDERS; ANIMAL ACTIVATED ANIMAL FEEDERS;
ANIMAL ACTIVATED LIVESTOCK FEEDERS, IN CLASS 21 (U.S. CLS. 2, 13, 23, 29, 30, 33,
40 AND 50).

FIRST USE 1-0-1990; IN COMMERCE 1-0-1990.

THE MARK CONSISTS OF THE WORD "PRIEFERT" IN STYLIZED FONT WITH A DIAMOND
SHAPE OVER THE LETTER "I".

SER. NO. 85-378,459, FILED 7-22-2011.

MICHAEL SOUDERS, EXAMINING ATTORNEY

United States of America

United States Patent and Trademark Office

Startup Mixology

Reg. No. 4,204,626

Registered Sep. 11, 2012

Int. Cl.: 41

SERVICE MARK

PRINCIPAL REGISTER

TECH COCKTAIL, LLC (ILLINOIS LIMITED LIABILITY COMPANY)
UNIT 505
1000 N RANDOLPH ST
ARLINGTON, VA 22201

FOR: EDUCATIONAL SERVICES, NAMELY, IN CONDUCTING CONFERENCES IN THE FIELD OF NEW BUSINESS VENTURES AND BUSINESS DEVELOPMENT, IN CLASS 41 (U.S. CLS. 100, 101 AND 107).

FIRST USE 8-1-2010; IN COMMERCE 8-1-2010.

THE MARK CONSISTS OF STANDARD CHARACTERS WITHOUT CLAIM TO ANY PARTICULAR FONT, STYLE, SIZE, OR COLOR.

NO CLAIM IS MADE TO THE EXCLUSIVE RIGHT TO USE "STARTUP", APART FROM THE MARK AS SHOWN.

SER. NO. 85-379,827, FILED 7-25-2011.

JAMES A. RAUEN, EXAMINING ATTORNEY



David J. Kyffers

Director of the United States Patent and Trademark Office

United States of America

United States Patent and Trademark Office



vidi entertainment inc

Reg. No. 4,204,627

VIDI ENTERTAINMENT, INC. (MONTANA CORPORATION)
PO BOX 10818
BOZEMAN, MT 59719

Registered Sep. 11, 2012

Int. Cl.: 42

FOR: PROVIDING A WEB SITE FEATURING TEMPORARY USE OF NON-DOWNLOADABLE SOFTWARE ALLOWING WEB SITE USERS TO UPLOAD, POST AND DISPLAY ONLINE VIDEOS FOR SHARING WITH OTHERS FOR ENTERTAINMENT PURPOSES, IN CLASS 42 (U.S. CLS. 100 AND 101).

SERVICE MARK

PRINCIPAL REGISTER

FIRST USE 7-0-2010; IN COMMERCE 8-0-2010.

NO CLAIM IS MADE TO THE EXCLUSIVE RIGHT TO USE "ENTERTAINMENT INC", APART FROM THE MARK AS SHOWN.

THE COLOR(S) RED, GREEN, BLUE, AND GREY IS/ARE CLAIMED AS A FEATURE OF THE MARK.

THE MARK CONSISTS OF THE GREY STYLIZED WORDING "VIDI ENTERTAINMENT INC" AND STYLIZED LETTER "V" IN THREE DIMENSIONS EMBEDDED WITHIN A THREE DIMENSIONAL CUBE WITH GREY STIPPLING BENEATH THE CUBE. THE TOP OF THE CUBE IS RED WITH THE REMAINING SIDES IN GREY. THE LEFT SIDE OF THE LETTER "V" IS GREEN WITH THE RIGHT SIDE IN BLUE. THE COLOR WHITE REPRESENTS BACKGROUND, OUTLINING, SHADING AND/OR TRANSPARENT AREAS AND IS NOT PART OF THE MARK.

THE ENGLISH TRANSLATION OF "VIDI" IS "I SAW".

SER. NO. 85-380,438, FILED 7-25-2011.

BRIAN PINO, EXAMINING ATTORNEY



David J. Kybas

Director of the United States Patent and Trademark Office

United States of America

United States Patent and Trademark Office

ioiom

Reg. No. 4,204,628

Registered Sep. 11, 2012

Int. Cl.: 25

TRADEMARK

PRINCIPAL REGISTER

GOWORLD COMMERCE & TRADE COMPANY LIMITED (HONG KONG LIMITED LIABILITY COMPANY)
ROOM 01, 10/F, CARNIVAL COMMERCIAL BUILDING, NO.18 JAVA ROAD, NORTH POINT HONG KONG, HONG KONG

FOR: ATHLETIC FOOTWEAR; ATHLETIC UNIFORMS; BASEBALL CAPS; CYCLISTS' JERSEYS; GOWNS; PANTS; SHIRTS; SHOES; SUITS; WEDDING DRESSES; WEDDING GOWNS, IN CLASS 25 (U.S. CLS. 22 AND 39).

FIRST USE 7-2-2008; IN COMMERCE 4-28-2010.

THE MARK CONSISTS OF STANDARD CHARACTERS WITHOUT CLAIM TO ANY PARTICULAR FONT, STYLE, SIZE, OR COLOR.

THE WORDING "IOIOM" HAS NO MEANING IN A FOREIGN LANGUAGE.

SER. NO. 85-380,607, FILED 7-26-2011.

HANNO RITTNER, EXAMINING ATTORNEY



David J. Kyffers

Director of the United States Patent and Trademark Office

United States of America

United States Patent and Trademark Office

ioiom

Reg. No. 4,204,629

Registered Sep. 11, 2012

Int. Cl.: 35

GOWORLD COMMERCE & TRADE COMPANY LIMITED (HONG KONG LIMITED LIABILITY COMPANY)
ROOM 01,10/F, CARNIVAL COMMERCIAL BUILDING, NO.18 JAVA ROAD, NORTH POINT HONG KONG, HONG KONG

SERVICE MARK

PRINCIPAL REGISTER

FOR: AUCTIONEERING; BUSINESS INVESTIGATIONS; BUSINESS MANAGEMENT; BUSINESS ORGANIZATION AND OPERATION CONSULTANCY; CONDUCTING AND ADMINISTERING A PROGRAM FOR PARTICIPATING HEALTH AND FITNESS CLUBS FEATURING DISCOUNTS ON CLUB MEMBERSHIP FOR ACCESS TO THE CLUBS TO PROGRAM MEMBERS; CONDUCTING MARKETING STUDIES; DIRECT MAIL ADVERTISING SERVICES; DISSEMINATION OF ADVERTISING MATTER; DISTRIBUTION OF PROSPECTUSES AND SAMPLES; GOODS IMPORT-EXPORT AGENCIES; ONLINE ADVERTISEMENTS; ONLINE ADVERTISING AND PROMOTIONAL SERVICES; PRESENTATION OF GOODS ON COMMUNICATION MEDIA FOR RETAIL PURPOSES; PROMOTING THE GOODS AND SERVICES OF OTHERS BY MEANS OF OPERATING AN ON-LINE SHOPPING MALL WITH LINKS TO THE RETAIL WEB SITES OF OTHERS; PROVIDING LISTINGS OF BUSINESSES FOR SALE; SALES PROMOTION FOR OTHERS PROVIDED THROUGH THE DISTRIBUTION AND THE ADMINISTRATION OF PRIVILEGED USER CARDS; SALES PROMOTION SERVICES, IN CLASS 35 (U.S. CLS. 100, 101 AND 102).

FIRST USE 7-2-2008; IN COMMERCE 4-28-2010.

THE MARK CONSISTS OF STANDARD CHARACTERS WITHOUT CLAIM TO ANY PARTICULAR FONT, STYLE, SIZE, OR COLOR.

THE WORDING "IOIOM" HAS NO MEANING IN A FOREIGN LANGUAGE.

SER. NO. 85-380,611, FILED 7-26-2011.

HANNO RITTNER, EXAMINING ATTORNEY



David J. Kypos

Director of the United States Patent and Trademark Office

United States of America

United States Patent and Trademark Office

NEW JERSEY TURNPIKE

Reg. No. 4,204,630

Registered Sep. 11, 2012

Int. Cl.: 37

SERVICE MARK

PRINCIPAL REGISTER

NEW JERSEY TURNPIKE AUTHORITY (NEW JERSEY QUASI-STATE GOVERNMENT AGENCY)
P.O. BOX 5042
WOODBIDGE, NJ 07095

FOR: HIGHWAY MANAGEMENT AND MAINTENANCE SERVICES, NAMELY, MAINTENANCE AND REPAIR OF HIGHWAY GUIDE RAILS, HIGHWAY SIGNS, TOLL BOOTHS, PEDESTRIAN WALKWAYS AND OVERPASSES, ROADS, SERVICE AREAS, REST AREAS, COMMUTER PARKING LOTS, TOLL COLLECTION EQUIPMENT, AND TOLL COLLECTION FACILITIES, IN CLASS 37 (U.S. CLS. 100, 103 AND 106).

FIRST USE 0-0-1951; IN COMMERCE 0-0-1951.

THE MARK CONSISTS OF STANDARD CHARACTERS WITHOUT CLAIM TO ANY PARTICULAR FONT, STYLE, SIZE, OR COLOR.

OWNER OF U.S. REG. NO. 2,873,593.

NO CLAIM IS MADE TO THE EXCLUSIVE RIGHT TO USE "TURNPIKE", APART FROM THE MARK AS SHOWN.

SEC. 2(F).

SER. NO. 85-381,339, FILED 7-26-2011.

CHRISIE B. KING, EXAMINING ATTORNEY



David J. Kyffers

Director of the United States Patent and Trademark Office

United States of America

United States Patent and Trademark Office

King Kalibur

Reg. No. 4,204,631

PARR, JASON J (UNITED STATES INDIVIDUAL), DBA KING KALIBUR LLC
W.355 S.8875 GODFREY LANE
EAGLE, WI 53119

Registered Sep. 11, 2012

Int. Cl.: 29

FOR: MEAT, BEEF JERKY, JERKY, BEEF STICKS, MEAT STICKS AND SAUSAGES, IN CLASS 29 (U.S. CL. 46).

TRADEMARK

FIRST USE 5-1-1998; IN COMMERCE 5-1-1998.

PRINCIPAL REGISTER

THE MARK CONSISTS OF STANDARD CHARACTERS WITHOUT CLAIM TO ANY PARTICULAR FONT, STYLE, SIZE, OR COLOR.

SER. NO. 85-381,608, FILED 7-26-2011.

KELLY TRUSILO, EXAMINING ATTORNEY



David J. Kybas

Director of the United States Patent and Trademark Office

United States of America

United States Patent and Trademark Office

DAY KEG

Reg. No. 4,204,632

MILLERCOORS LLC (DELAWARE LIMITED LIABILITY COMPANY)
250 SOUTH WACKER DRIVE, SUITE 800
CHICAGO, IL 60606

Registered Sep. 11, 2012

Int. Cl.: 32

FOR: BEER, IN CLASS 32 (U.S. CLS. 45, 46 AND 48).

FIRST USE 10-25-2011; IN COMMERCE 10-25-2011.

TRADEMARK

THE MARK CONSISTS OF STANDARD CHARACTERS WITHOUT CLAIM TO ANY PARTICULAR FONT, STYLE, SIZE, OR COLOR.

PRINCIPAL REGISTER

NO CLAIM IS MADE TO THE EXCLUSIVE RIGHT TO USE "KEG", APART FROM THE MARK AS SHOWN.

SER. NO. 85-382,007, FILED 7-27-2011.

SUSAN RICHARDS, EXAMINING ATTORNEY



David J. Kyffers

Director of the United States Patent and Trademark Office

United States of America

United States Patent and Trademark Office

IAC

Reg. No. 4,204,633

Registered Sep. 11, 2012

Int. Cls.: 12, 27 and 40

TRADEMARK

SERVICE MARK

PRINCIPAL REGISTER

INTERNATIONAL AUTOMOTIVE COMPONENTS GROUP, S.A. (LUXEMBOURG CORPORATION)
73, CÔTE D'EICH
LUXEMBOURG, LUXEMBOURG 1450

FOR: INTERIOR TRIM FOR VEHICLES, NAMELY, DECORATIVE AND PROTECTIVE TRIM PIECES; INTERIOR PANELS FOR VEHICLES, NAMELY, DOOR PANELS, OVERHEAD PANELS, BODY PANELS, DASHBOARD PANELS, INSTRUMENT PANELS AND FLOORING PANELS; FITTED DASHBOARD COVERS FOR VEHICLES; FITTED LINERS FOR THE CARGO AREA OF VEHICLES; CARGO STORAGE BINS SPECIALLY ADAPTED FOR USE IN MOTOR VEHICLES; SEMI-FINISHED INJECTION MOLDED PRODUCTS OF PLASTIC FOR USE IN VEHICLES, NAMELY, FLUID RECOVERY BOTTLES, WASHER FLUID BOTTLES, HVAC DUCTS; PLASTIC PARTS FOR VEHICLES, NAMELY, AUTOMOTIVE DECORATIVE AND PROTECTIVE TRIM; UPHOLSTERY FOR VEHICLES, IN CLASS 12 (U.S. CLS. 19, 21, 23, 31, 35 AND 44).

FOR: RUBBER MATS, CARPETS, FLOOR MATS, FLOOR COVERINGS, BACKING LAYERS FOR FLOOR MATS, ALL OF THE FORGOING FOR VEHICLES, IN CLASS 27 (U.S. CLS. 19, 20, 37, 42 AND 50).

FOR: MANUFACTURE OF VEHICLE PARTS AND ACCESSORIES FOR OTHERS; PROTOTYPE FABRICATION OF NEW PRODUCTS AND AUTOMOTIVE PARTS AND ACCESSORIES FOR OTHERS; INJECTION MOLDING OF PLASTIC FOR OTHERS; TECHNICAL CONSULTANCY IN THE NATURE OF PROVIDING ADVICE ABOUT HOW TO MANUFACTURE MACHINED GOODS, IN CLASS 40 (U.S. CLS. 100, 103 AND 106).

THE MARK CONSISTS OF STANDARD CHARACTERS WITHOUT CLAIM TO ANY PARTICULAR FONT, STYLE, SIZE, OR COLOR.

PRIORITY CLAIMED UNDER SEC. 44(D) ON BENELUX APPLICATION NO. 1229765, FILED 7-25-2011, REG. NO. 908672, DATED 1-10-2012, EXPIRES 1-10-2022.

SER. NO. 85-382,338, FILED 7-27-2011.

JEFFREY LOOK, EXAMINING ATTORNEY



David J. Kyffers

Director of the United States Patent and Trademark Office

United States of America

United States Patent and Trademark Office

My Very Own Quiet Time

Reg. No. 4,204,634

WILLIAMS, CARLA (UNITED STATES INDIVIDUAL)

Registered Sep. 11, 2012

10524 238TH AV. CT. E
BUCKLEY, WA 98321

Int. Cl.: 16

FOR: EDUCATIONAL KITS SOLD AS A UNIT IN THE FIELD OF EARLY CHILDHOOD DEVELOPMENT CONSISTING PRIMARILY OF FLASH CARDS, BOOKS AND PRINTED INSTRUCTIONAL AND TEACHING MATERIALS ALL FEATURING INFORMATION ON, AS WELL AS TIPS AND TECHNIQUES ON HOW TO IMPROVE OR STRENGTHEN, INFANT COGNITIVE DEVELOPMENT, SPEECH DEVELOPMENT, FINE MOTOR SKILL DEVELOPMENT, COUNTING SKILLS, COLOR AND SHAPE RECOGNITION, AND SOCIAL SKILLS AND ALSO INCLUDING DVDS, IN CLASS 16 (U.S. CLS. 2, 5, 22, 23, 29, 37, 38 AND 50).

TRADEMARK

PRINCIPAL REGISTER

FIRST USE 4-1-2005; IN COMMERCE 4-1-2005.

THE MARK CONSISTS OF STANDARD CHARACTERS WITHOUT CLAIM TO ANY PARTICULAR FONT, STYLE, SIZE, OR COLOR.

SER. NO. 85-383,602, FILED 7-28-2011.

MICHAEL TANNER, EXAMINING ATTORNEY



David J. Kyffers

Director of the United States Patent and Trademark Office

United States of America

United States Patent and Trademark Office

SOLE OVER SUBSTANCE

Reg. No. 4,204,635

Registered Sep. 11, 2012

Int. Cl.: 25

TRADEMARK

PRINCIPAL REGISTER

VANS, INC. (DELAWARE CORPORATION)
LEGAL DPT
6550 KATELLA AVE
CYPRESS, CA 90630

FOR: FOOTWEAR; MEN'S, WOMEN'S AND CHILDREN'S CLOTHING, NAMELY, SHIRTS, T-SHIRTS, TANK TOPS, SWEATERS, SWEATSHIRTS, HOODED SWEAT SHIRTS, FLEECE TOPS, FLEECE PULLOVERS, FLEECE BOTTOMS, JACKETS, PANTS, TROUSERS, DENIMS, LEGGINGS, SHORTS, BOARDSHORTS, SKIRTS, DRESSES, SWIMWEAR, SOCKS; BEANIES; HATS; BELTS FOR CLOTHING; BOXER SHORTS AND BRIEFS; MUKLUKS; SLIPPERS; SCARVES; GLOVES; MITTENS; SLEEPWEAR, IN CLASS 25 (U.S. CLS. 22 AND 39).

FIRST USE 7-1-2011; IN COMMERCE 7-1-2011.

THE MARK CONSISTS OF STANDARD CHARACTERS WITHOUT CLAIM TO ANY PARTICULAR FONT, STYLE, SIZE, OR COLOR.

SER. NO. 85-383,690, FILED 7-28-2011.

LOURDES AYALA, EXAMINING ATTORNEY



David J. Kyjars

Director of the United States Patent and Trademark Office

United States of America

United States Patent and Trademark Office

Steelsmith

Reg. No. 4,204,636

STEELSMITH, INC. (PENNSYLVANIA CORPORATION)
519 SOUTHERN AVE
PITTSBURGH, PA 15211

Registered Sep. 11, 2012

Int. Cl.: 6

FOR: PRE-FABRICATED AND PRE-ENGINEERED STEEL BUILDINGS, IN CLASS 6 (U.S. CLS. 2, 12, 13, 14, 23, 25 AND 50).

TRADEMARK

FIRST USE 1-1-2007; IN COMMERCE 1-1-2007.

PRINCIPAL REGISTER

THE MARK CONSISTS OF STANDARD CHARACTERS WITHOUT CLAIM TO ANY PARTICULAR FONT, STYLE, SIZE, OR COLOR.

SER. NO. 85-383,863, FILED 7-28-2011.

DANIEL CAPSHAW, EXAMINING ATTORNEY



David J. Kybas

Director of the United States Patent and Trademark Office

United States of America

United States Patent and Trademark Office

GEN SPA

Reg. No. 4,204,637

Registered Sep. 11, 2012

Int. Cl.: 44

SERVICE MARK

PRINCIPAL REGISTER

GENEROSA DINGAL (UNITED STATES INDIVIDUAL)
750 EAST SAMPLE ROAD, BUILDING 3, BAY 4
POMPANO BEACH, FL 33064

FOR: EQUINE MASSAGE AND KINESTHESIOLOGY SERVICES; HEALTH SPA SERVICES FOR HEALTH AND WELLNESS OF THE BODY AND SPIRIT, NAMELY, PROVIDING MASSAGE, FACIAL AND BODY TREATMENT SERVICES, COSMETIC BODY CARE SERVICES; HEALTH SPA SERVICES, NAMELY, LASER TREATMENTS FOR ACNE, REJUVENATION, SCARS, TATTOO REMOVAL AND FOR FACIALS AND MASSAGE; INFORMATION RELATING TO MASSAGE; MASSAGE; MASSAGE AND THERAPEUTIC SHIATSU MASSAGE; MASSAGE THERAPY SERVICES; MESSAGES; SALON SERVICES, NAMELY, FACIALS, MANICURES AND MESSAGES THAT ARE PROVIDED IN A TRAILER OUTFITTED WITH CHAIR, TABLE AND SINK ACCESSORIES, IN CLASS 44 (U.S. CLS. 100 AND 101).

FIRST USE 5-25-2011; IN COMMERCE 5-26-2011.

THE MARK CONSISTS OF STANDARD CHARACTERS WITHOUT CLAIM TO ANY PARTICULAR FONT, STYLE, SIZE, OR COLOR.

NO CLAIM IS MADE TO THE EXCLUSIVE RIGHT TO USE "SPA", APART FROM THE MARK AS SHOWN.

SER. NO. 85-383,949, FILED 7-28-2011.

STEVEN R. FINE, EXAMINING ATTORNEY



David J. Kypos

Director of the United States Patent and Trademark Office

United States of America

United States Patent and Trademark Office

HELPFUL STEPS FOR PARENTS

Reg. No. 4,204,638

Registered Sep. 11, 2012

Int. Cl.: 36

SERVICE MARK

PRINCIPAL REGISTER

BMO HARRIS BANK NATIONAL ASSOCIATION (UNITED STATES NATIONAL BANKING ASSOCIATION)
111 WEST MONROE STREET
CHICAGO, IL 60603

FOR: BANKING, IN CLASS 36 (U.S. CLS. 100, 101 AND 102).

FIRST USE 10-31-2011; IN COMMERCE 10-31-2011.

THE MARK CONSISTS OF STANDARD CHARACTERS WITHOUT CLAIM TO ANY PARTICULAR FONT, STYLE, SIZE, OR COLOR.

OWNER OF U.S. REG. NO. 3,932,837.

NO CLAIM IS MADE TO THE EXCLUSIVE RIGHT TO USE "FOR PARENTS", APART FROM THE MARK AS SHOWN.

SER. NO. 85-383,962, FILED 7-28-2011.

TRACY FLETCHER, EXAMINING ATTORNEY



David J. Kyffers

Director of the United States Patent and Trademark Office

United States of America

United States Patent and Trademark Office

ECCHO

Reg. No. 4,204,639

Registered Sep. 11, 2012

Int. Cls.: 9, 16, 35 and 41

TRADEMARK

SERVICE MARK

PRINCIPAL REGISTER

ELECTRONIC CHECK CLEARING HOUSE ORGANIZATION (CALIFORNIA CORPORATION)
3710 RAWLINS STREET, SUITE 1075
DALLAS, TX 75219

FOR: DOWNLOADABLE ELECTRONIC PUBLICATIONS IN THE NATURE OF WHITE PAPERS, SLIDE PRESENTATIONS, PRESENTATION NOTES, DOCUMENT SUMMARIES, AND INFORMATIONAL COURSE MATERIALS, ALL ON THE TOPICS OF FREQUENTLY ASKED QUESTIONS ON THE CHECK PAYMENT INDUSTRY, DESCRIPTIONS AND EXPLANATIONS OF CHECK CLEARING FOR THE 21ST CENTURY ACT AND REGULATION CC, ECCHO RULES, ACTIVITIES AND DECISIONS OF OPERATIONS COMMITTEE, ENDORSEMENT CONSIDERATIONS FOR CHECKS, RETURN CHECK HIERARCHY DECISION STANDARDS, DETECTING AND AVOIDING DUPLICATE PAYMENTS, CHECK 21 ACT SUBSTITUTE CHECK HANDLING, CHECK 21 EXPEDITED RECREDIT REQUIREMENTS AND CONSIDERATIONS, MINIMUM CHECK 21 COMPLIANCE REQUIREMENTS, PROCESSING QUALITY STANDARDS, GREY SCALE AND BLACK AND WHITE IMAGES FOR SUBSTITUTE CHECK STANDARDS, TIFF TAG DISCUSSIONS, BANKING PRACTICES AGREEMENTS, AND INDUSTRY PERSPECTIVES ON CHECK IMAGE EXCHANGE, IN CLASS 9 (U.S. CLS. 21, 23, 26, 36 AND 38).

FIRST USE 9-24-1997; IN COMMERCE 9-24-1997.



David J. Kyjars

Director of the United States Patent and Trademark Office

FOR: PRINTED MATERIALS, NAMELY, WHITE PAPERS, HARD COPIES OF SLIDE PRESENTATIONS, PRESENTATION NOTES, INFORMATIONAL COURSE MATERIALS AND DOCUMENT SUMMARIES, ALL ON THE TOPICS OF FREQUENTLY ASKED QUESTIONS ON THE CHECK PAYMENT INDUSTRY, DESCRIPTIONS AND EXPLANATIONS OF CHECK CLEARING FOR THE 21ST CENTURY ACT AND REGULATION CC, ECCHO RULES, ACTIVITIES AND DECISIONS OF OPERATIONS COMMITTEE, ENDORSEMENT CONSIDERATIONS FOR CHECKS, RETURN CHECK HIERARCHY DECISION STANDARDS, DETECTING AND AVOIDING DUPLICATE PAYMENTS, CHECK 21 ACT SUBSTITUTE CHECK HANDLING, CHECK 21 EXPEDITED RECREDIT REQUIREMENTS AND CONSIDERATIONS, MINIMUM CHECK 21 COMPLIANCE REQUIREMENTS, PROCESSING QUALITY STANDARDS, GREY SCALE AND BLACK AND WHITE IMAGES FOR SUBSTITUTE CHECK STANDARDS, TIFF TAG DISCUSSIONS, BANKING PRACTICES AGREEMENTS, AND INDUSTRY PERSPECTIVES ON CHECK IMAGE EXCHANGE, IN CLASS 16 (U.S. CLS. 2, 5, 22, 23, 29, 37, 38 AND 50).

FIRST USE 3-3-1992; IN COMMERCE 3-3-1992.

Reg. No. 4,204,639 FOR: BUSINESS CONSULTATION SERVICES ABOUT DEVELOPMENT AND MAINTENANCE OF UNIFORM COMMERCIAL CODE CLEARINGHOUSE RULES TO ALLOCATE LIABILITIES AMONG MEMBER FINANCIAL INSTITUTIONS ENGAGED IN THE INTERBANK COLLECTION, RETURN AND ADJUSTMENT OF CHECK IMAGES; CONSENSUS BUILDING, NAMELY, PROMOTING AWARENESS OF BEST PRACTICES, STANDARDS AND RULES FOR CHECK IMAGES, AMONG ITS MEMBERS, FINANCIAL SERVICES ORGANIZATIONS AND OTHER CHECK PAYMENT INDUSTRY ORGANIZATIONS; PUBLIC ADVOCACY FOR STATUTORY AND REGULATORY CHANGES AT THE STATE AND NATIONAL LEVELS; PROMOTING INDUSTRY AWARENESS IN THE FINANCIAL SERVICES INDUSTRY ON THE ISSUE OF ENHANCED EFFICIENCIES AND REDUCED RISKS IN THE CHECK PAYMENT SYSTEM, IN CLASS 35 (U.S. CLS. 100, 101 AND 102).

FIRST USE 3-5-1990; IN COMMERCE 3-5-1990.

FOR: DEVELOPMENT OF INDUSTRY FILE AND FORMAT STANDARDS FOR THE EXCHANGE OF CHECK IMAGES AND CHECK PAYMENTS, IN CLASS 41 (U.S. CLS. 100, 101 AND 107).

FIRST USE 3-3-1992; IN COMMERCE 3-3-1992.

THE MARK CONSISTS OF STANDARD CHARACTERS WITHOUT CLAIM TO ANY PARTICULAR FONT, STYLE, SIZE, OR COLOR.

SER. NO. 85-384,210, FILED 7-29-2011.

HANNO RITTNER, EXAMINING ATTORNEY

United States of America

United States Patent and Trademark Office

ECCHO



Reg. No. 4,204,640

Registered Sep. 11, 2012

Int. Cls.: 9, 16, 35 and 41

TRADEMARK

SERVICE MARK

PRINCIPAL REGISTER

ELECTRONIC CHECK CLEARING HOUSE ORGANIZATION (CALIFORNIA CORPORATION)
3710 RAWLINS STREET, SUITE 1075
DALLAS, TX 75219

FOR: DOWNLOADABLE ELECTRONIC PUBLICATIONS IN THE NATURE OF WHITE PAPERS, SLIDE PRESENTATIONS, PRESENTATION NOTES, DOCUMENT SUMMARIES, AND INFORMATIONAL COURSE MATERIALS, ALL ON THE TOPICS OF FREQUENTLY ASKED QUESTIONS ON THE CHECK PAYMENT INDUSTRY, DESCRIPTIONS AND EXPLANATIONS OF CHECK CLEARING FOR THE 21ST CENTURY ACT AND REGULATION CC, ECCHO RULES, ACTIVITIES AND DECISIONS OF OPERATIONS COMMITTEE, ENDORSEMENT CONSIDERATIONS FOR CHECKS, RETURN CHECK HIERARCHY DECISION STANDARDS, DETECTING AND AVOIDING DUPLICATE PAYMENTS, CHECK 21 ACT SUBSTITUTE CHECK HANDLING, CHECK 21 EXPEDITED RECREDIT REQUIREMENTS AND CONSIDERATIONS, MINIMUM CHECK 21 COMPLIANCE REQUIREMENTS, PROCESSING QUALITY STANDARDS, GREY SCALE AND BLACK AND WHITE IMAGES FOR SUBSTITUTE CHECK STANDARDS, TIFF TAG DISCUSSIONS, BANKING PRACTICES AGREEMENTS, AND INDUSTRY PERSPECTIVES ON CHECK IMAGE EXCHANGE, IN CLASS 9 (U.S. CLS. 21, 23, 26, 36 AND 38).

FIRST USE 9-24-1997; IN COMMERCE 9-24-1997.



David J. Kyjars

Director of the United States Patent and Trademark Office

FOR: PRINTED MATERIALS, NAMELY, WHITE PAPERS, HARD COPIES OF SLIDE PRESENTATIONS, PRESENTATION NOTES, INFORMATIONAL COURSE MATERIALS AND DOCUMENT SUMMARIES, ALL ON THE TOPICS OF FREQUENTLY ASKED QUESTIONS ON THE CHECK PAYMENT INDUSTRY, DESCRIPTIONS AND EXPLANATIONS OF CHECK CLEARING FOR THE 21ST CENTURY ACT AND REGULATION CC, ECCHO RULES, ACTIVITIES AND DECISIONS OF OPERATIONS COMMITTEE, ENDORSEMENT CONSIDERATIONS FOR CHECKS, RETURN CHECK HIERARCHY DECISION STANDARDS, DETECTING AND AVOIDING DUPLICATE PAYMENTS, CHECK 21 ACT SUBSTITUTE CHECK HANDLING, CHECK 21 EXPEDITED RECREDIT REQUIREMENTS AND CONSIDERATIONS, MINIMUM CHECK 21 COMPLIANCE REQUIREMENTS, PROCESSING QUALITY STANDARDS, GREY SCALE AND BLACK AND WHITE IMAGES FOR SUBSTITUTE CHECK STANDARDS, TIFF TAG DISCUSSIONS, BANKING PRACTICES AGREEMENTS, AND INDUSTRY PERSPECTIVES ON CHECK IMAGE EXCHANGE, IN CLASS 16 (U.S. CLS. 2, 5, 22, 23, 29, 37, 38 AND 50).

FIRST USE 3-3-1992; IN COMMERCE 3-3-1992.

Reg. No. 4,204,640 FOR: BUSINESS CONSULTATION SERVICES ABOUT DEVELOPMENT AND MAINTENANCE OF UNIFORM COMMERCIAL CODE CLEARINGHOUSE RULES TO ALLOCATE LIABILITIES AMONG MEMBER FINANCIAL INSTITUTIONS ENGAGED IN THE INTERBANK COLLECTION, RETURN AND ADJUSTMENT OF CHECK IMAGES; CONSENSUS BUILDING, NAMELY, PROMOTING AWARENESS OF BEST PRACTICES, STANDARDS AND RULES FOR CHECK IMAGES, AMONG ITS MEMBERS, FINANCIAL SERVICES ORGANIZATIONS AND OTHER CHECK PAYMENT INDUSTRY ORGANIZATIONS; PUBLIC ADVOCACY FOR STATUTORY AND REGULATORY CHANGES AT THE STATE AND NATIONAL LEVELS; PROMOTING INDUSTRY AWARENESS IN THE FINANCIAL SERVICES INDUSTRY ON THE ISSUE OF ENHANCED EFFICIENCIES AND REDUCED RISKS IN THE CHECK PAYMENT SYSTEM, IN CLASS 35 (U.S. CLS. 100, 101 AND 102).

FIRST USE 2-14-1991; IN COMMERCE 2-14-1991.

FOR: DEVELOPMENT OF INDUSTRY FILE AND FORMAT STANDARDS FOR THE EXCHANGE OF CHECK IMAGES AND CHECK PAYMENTS, IN CLASS 41 (U.S. CLS. 100, 101 AND 107).

FIRST USE 3-3-1992; IN COMMERCE 3-3-1992.

THE MARK CONSISTS OF THE WORD "ECCHO" APPEARING ABOVE A HEART BEAT SYMBOL WHICH IS SUPERIMPOSED OVER A DIAMOND SHAPE.

SER. NO. 85-384,212, FILED 7-29-2011.

HANNO RITTNER, EXAMINING ATTORNEY

United States of America

United States Patent and Trademark Office

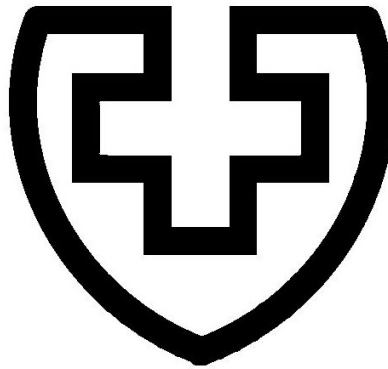

Reg. No. 4,204,641

Registered Sep. 11, 2012

Int. Cl.: 5

TRADEMARK

PRINCIPAL REGISTER

ST. TERESA MEDICAL, INC. (MINNESOTA CORPORATION)
1371 DONEGAL DRIVE
WOODBURY, MN 55125

FOR: BANDAGES FOR WOUNDS, NAMELY, HEMOSTATIC BANDAGES AND GAUZE, IN CLASS 5 (U.S. CLS. 6, 18, 44, 46, 51 AND 52).

FIRST USE 3-0-2011; IN COMMERCE 3-0-2011.

THE MARK CONSISTS OF A CROSS WITHIN A SHIELD.

SER. NO. 85-384,489, FILED 7-29-2011.

JAMES LOVELACE, EXAMINING ATTORNEY



David J. Kyffers

Director of the United States Patent and Trademark Office

United States of America

United States Patent and Trademark Office

THE ACCIDENTAL EXECUTIVE

Reg. No. 4,204,642

FITZGERALD, SHANNON (CANADA INDIVIDUAL)

Registered Sep. 11, 2012

276 W. 11TH ST. APT. 4R
NEW YORK, NY 10014

Int. Cl.: 41

SERVICE MARK

PRINCIPAL REGISTER

FOR: ARRANGING AND CONDUCTING NIGHTCLUB PARTIES; ARRANGING AND CONDUCTING OF CONCERTS; ARRANGING, ORGANIZING, CONDUCTING, AND HOSTING SOCIAL ENTERTAINMENT EVENTS; CONDUCTING WORKSHOPS AND SEMINARS IN PERSONAL AWARENESS; CONDUCTING WORKSHOPS AND SEMINARS IN SELF AWARENESS; CONDUCTING WORKSHOPS AND SEMINARS IN CLOTHING, CLOTHING DESIGN, FASHION AND MUSIC; CUSTOM WRITING SERVICES; EDUCATIONAL AND ENTERTAINMENT SERVICES, NAMELY, PROVIDING MOTIVATIONAL AND EDUCATIONAL SPEAKERS; EDUCATIONAL AND ENTERTAINMENT SERVICES, NAMELY, PROVIDING MOTIVATIONAL AND EDUCATIONAL SPEAKERS IN THE FIELD OF SELF-AND PERSONAL IMPROVEMENT; ENTERTAINMENT IN THE NATURE OF ON-GOING TELEVISION PROGRAMS IN THE FIELD OF CLOTHING, CLOTHING DESIGN, FASHION AND MUSIC; ENTERTAINMENT IN THE NATURE OF TELEVISION NEWS SHOWS; ENTERTAINMENT SERVICES, NAMELY, WINE AND FOOD TASTINGS; ENTERTAINMENT SERVICES, NAMELY, WINE TASTINGS; FILM AND VIDEO PRODUCTION; FILM PRODUCTION; MEDIA PRODUCTION SERVICES, NAMELY, VIDEO AND FILM PRODUCTION; MOTION PICTURE FILM PRODUCTION; MOVIE STUDIOS; MULTIMEDIA ENTERTAINMENT SERVICES IN THE NATURE OF DEVELOPMENT, PRODUCTION AND POST-PRODUCTION SERVICES IN THE FIELDS OF VIDEO AND FILMS; MULTIMEDIA ENTERTAINMENT SERVICES IN THE NATURE OF RECORDING, PRODUCTION AND POST-PRODUCTION SERVICES IN THE FIELDS OF MUSIC, VIDEO, AND FILMS; ON-LINE JOURNALS, NAMELY, BLOGS FEATURING CLOTHING, CLOTHING AND ARCHITECTURAL DESIGN, FASHION AND MUSIC; ORGANIZING CULTURAL AND ARTS EVENTS; PARTY PLANNING; PARTY PLANNING CONSULTATION; PHOTOGRAPHY; PHOTOGRAPHY SERVICES; POEM AND LYRIC WRITING; PRODUCTION OF FILMS; PRODUCTION OF TELEVISION PROGRAMS; PUBLISHING OF BOOKS, E-BOOKS, AUDIO BOOKS, MUSIC AND ILLUSTRATIONS; PUBLISHING OF WEB MAGAZINES; SCRIPT WRITING SERVICES; SONG WRITING SERVICES; WRITING OF ARTICLES FOR JOURNALS OTHER THAN FOR ADVERTISING OR PUBLICITY; WRITING OF ARTICLES FOR PERIODICALS OTHER THAN FOR ADVERTISING OR PUBLICITY; WRITING OF ARTICLES FOR PROFESSIONAL JOURNALS OTHER THAN FOR ADVERTISING OR PUBLICITY; WRITING OF TEXTS; WRITING OF TEXTS OTHER THAN PUBLICITY TEXTS, IN CLASS 41 (U.S. CLS. 100, 101 AND 107).



David J. Kybas

Director of the United States Patent and Trademark Office

Reg. No. 4,204,642 FIRST USE 6-25-2011; IN COMMERCE 6-25-2011.

THE MARK CONSISTS OF STANDARD CHARACTERS WITHOUT CLAIM TO ANY PARTICULAR FONT, STYLE, SIZE, OR COLOR.

NO CLAIM IS MADE TO THE EXCLUSIVE RIGHT TO USE "EXECUTIVE", APART FROM THE MARK AS SHOWN.

SER. NO. 85-384,838, FILED 7-29-2011.

MARC LEIPZIG, EXAMINING ATTORNEY

United States of America

United States Patent and Trademark Office

EASYFLASH

Reg. No. 4,204,643

Registered Sep. 11, 2012

Int. Cls.: 6 and 19

TRADEMARK

PRINCIPAL REGISTER

MONIER ROOFING COMPONENTS GMBH (FED REP GERMANY LIMITED LIABILITY COMPANY)
FRANKFURTER LANDSTRASSE 2-4
OBERURSEL, FED REP GERMANY 61440

FOR: METAL BUILDING MATERIALS FOR ROOFING, NAMELY, FLASHING FOR METAL AND NON-METAL ROOFING, IN CLASS 6 (U.S. CLS. 2, 12, 13, 14, 23, 25 AND 50).

FOR: NON-METALLIC BUILDING MATERIALS FOR ROOFING, NAMELY, FLASHING FOR METAL AND NON-METAL ROOFING, IN CLASS 19 (U.S. CLS. 1, 12, 33 AND 50).

THE MARK CONSISTS OF STANDARD CHARACTERS WITHOUT CLAIM TO ANY PARTICULAR FONT, STYLE, SIZE, OR COLOR.

OWNER OF ERPN CMNTY TM OFC REG. NO. 009578147, DATED 5-13-2011, EXPIRES 12-7-2020.

SER. NO. 85-384,868, FILED 7-29-2011.

JIM RINGLE, EXAMINING ATTORNEY



David J. Kybas

Director of the United States Patent and Trademark Office

United States of America

United States Patent and Trademark Office

PARTY<<<CHASER

.com

Reg. No. 4,204,644

TRINARY MEDIA GROUP L.L.C. (TEXAS LIMITED LIABILITY COMPANY)
2822 COMMERCE ST.
DALLAS, TX 75226

Registered Sep. 11, 2012

Int. Cl.: 35

FOR: PROMOTING THE NIGHT CLUBS OF OTHERS; ONLINE ADVERTISING AND MARKETING SERVICES, NAMELY, PROMOTING THE GOODS AND SERVICES OF OTHERS, IN CLASS 35 (U.S. CLS. 100, 101 AND 102).

SERVICE MARK

FIRST USE 3-22-2003; IN COMMERCE 3-22-2003.

PRINCIPAL REGISTER

NO CLAIM IS MADE TO THE EXCLUSIVE RIGHT TO USE "PARTY" OR ".COM", APART FROM THE MARK AS SHOWN.

THE MARK CONSISTS OF THE WORD "PARTY" FOLLOWED BY 3 ARROWS POINTING TO THE LEFT, FOLLOWED BY THE WORD "CHASER", THEN A HORIZONTAL LINE BENEATH, AND THE TEXT ".COM" AT THE RIGHT END OF THE LINE.

SER. NO. 85-385,908, FILED 8-1-2011.

DOUGLAS LEE, EXAMINING ATTORNEY



David J. Kyffers

Director of the United States Patent and Trademark Office

United States of America

United States Patent and Trademark Office



Reg. No. 4,204,645

Registered Sep. 11, 2012

Int. Cls.: 29, 30, 31 and 32

TRADEMARK

PRINCIPAL REGISTER

T FARM, LLC (WISCONSIN LIMITED LIABILITY COMPANY)
UNIT 408
8201 MAYO DRIVE
MADISON, WI 53719

FOR: CANNED TOMATOES; DICED TOMATOES; PEELED TOMATOES; TINNED TOMATOES; TOMATO EXTRACTS; TOMATO PASTE; TOMATO PRESERVES; TOMATO PUREE; DRIED TOMATOES; PRESERVED TOMATOES IN VINEGAR, IN CLASS 29 (U.S. CL. 46).

FIRST USE 1-28-2011; IN COMMERCE 1-28-2011.

FOR: TOMATO SAUCE; TOMATO-BASED SALSA; DRIED HERBS; HERBS PRESERVED IN VINEGAR, IN CLASS 30 (U.S. CL. 46).

FIRST USE 1-28-2011; IN COMMERCE 1-28-2011.

FOR: FRESH HERBS; RAW HERBS; FRESH GRAPE CHERRY TOMATOES; FRESH TOMATOES; RAW TOMATOES; UNPROCESSED TOMATOES, IN CLASS 31 (U.S. CLS. 1 AND 46).

FIRST USE 1-28-2011; IN COMMERCE 1-28-2011.

FOR: TOMATO JUICE, IN CLASS 32 (U.S. CLS. 45, 46 AND 48).

FIRST USE 1-28-2011; IN COMMERCE 1-28-2011.

NO CLAIM IS MADE TO THE EXCLUSIVE RIGHT TO USE "FARM", "LLC" OR "TOMATOES", APART FROM THE MARK AS SHOWN.

THE MARK CONSISTS OF A SYMBOL OF A TOMATO WITH A SPACE AND RING LABELED "T · FARM LLC", WITH "LLC" ABOVE THE "M", AND A BANNER ACROSS THE BOTTOM CONTAINING THE WORDS "TOMATOES WITH TASTE".

SER. NO. 85-386,050, FILED 8-1-2011.

MATTHEW PAPPAS, EXAMINING ATTORNEY



David J. Kyffers

Director of the United States Patent and Trademark Office

United States of America

United States Patent and Trademark Office

Blok 9

Reg. No. 4,204,646

Registered Sep. 11, 2012

Int. Cls.: 9 and 28

TRADEMARK

PRINCIPAL REGISTER

SIFTEO, INC. (DELAWARE CORPORATION)
SFTO T005
2475 3RD ST, SUITE 252
SAN FRANCISCO, CA 94107

FOR: MULTIPLE DISTRIBUTED TANGIBLE COMPUTER HARDWARE DEVICES THAT INTERFACE AND RESPOND TO A USER'S PHYSICAL MANIPULATION AND ACT IN CONCERT TO FORM A SINGLE INTERFACE, IN CLASS 9 (U.S. CLS. 21, 23, 26, 36 AND 38).

FIRST USE 9-0-2011; IN COMMERCE 9-0-2011.

FOR: ELECTRONIC TOY COMPRISING MULTIPLE DISTRIBUTED TANGIBLE COMPUTER INTERFACES THAT ARE RESPONSIVE TO A USER'S PHYSICAL MANIPULATION AND ACT IN CONCERT TO FORM A SINGLE INTERFACE; ELECTRONIC ACTION TOY, NAMELY, ELECTRONIC BLOCKS ACTING IN CONCERT TO FORM A COMPUTER INTERFACE; ELECTRONIC LEARNING TOY, NAMELY, ELECTRONIC BLOCKS ACTING IN CONCERT TO FORM A COMPUTER INTERFACE, IN CLASS 28 (U.S. CLS. 22, 23, 38 AND 50).

FIRST USE 9-0-2011; IN COMMERCE 9-0-2011.

THE MARK CONSISTS OF STANDARD CHARACTERS WITHOUT CLAIM TO ANY PARTICULAR FONT, STYLE, SIZE, OR COLOR.

SER. NO. 85-386,224, FILED 8-1-2011.

EDWARD NELSON, EXAMINING ATTORNEY



David J. Kyffers

Director of the United States Patent and Trademark Office

United States of America

United States Patent and Trademark Office

Booker the Penguin

Reg. No. 4,204,647

Registered Sep. 11, 2012

Int. Cls.: 9 and 28

TRADEMARK

PRINCIPAL REGISTER

SIFTEO, INC. (DELAWARE CORPORATION)
SFTO T006
2475 3RD ST, SUITE 252
SAN FRANCISCO, CA 94107

FOR: MULTIPLE DISTRIBUTED TANGIBLE COMPUTER HARDWARE DEVICES THAT INTERFACE AND RESPOND TO A USER'S PHYSICAL MANIPULATION THAT ACT IN CONCERT TO FORM A SINGLE INTERFACE, IN CLASS 9 (U.S. CLS. 21, 23, 26, 36 AND 38).

FIRST USE 9-0-2011; IN COMMERCE 9-0-2011.

FOR: ELECTRONIC GAME FEATURING A PENGUIN CHARACTER AND COMPRISING MULTIPLE DISTRIBUTED TANGIBLE COMPUTER INTERFACES THAT ARE RESPONSIVE TO USER PHYSICAL MANIPULATION AND ACT IN CONCERT TO FORM A SINGLE INTERFACE; ELECTRONIC LEARNING TOY, NAMELY, MULTIPLE DISTRIBUTED TANGIBLE COMPUTER INTERFACES IN THE FORM OF BLOCKS; ELECTRONIC ACTION TOY, NAMELY, MULTIPLE DISTRIBUTED TANGIBLE COMPUTER INTERFACES IN THE FORM OF BLOCKS, IN CLASS 28 (U.S. CLS. 22, 23, 38 AND 50).

FIRST USE 9-0-2011; IN COMMERCE 9-0-2011.

THE MARK CONSISTS OF STANDARD CHARACTERS WITHOUT CLAIM TO ANY PARTICULAR FONT, STYLE, SIZE, OR COLOR.

SER. NO. 85-386,275, FILED 8-1-2011.

EDWARD NELSON, EXAMINING ATTORNEY



David J. Kyffers

Director of the United States Patent and Trademark Office

United States of America

United States Patent and Trademark Office

Do the Sift

Reg. No. 4,204,648

SIFTEO, INC. (DELAWARE CORPORATION)
2475 3RD ST, SUITE 252
SAN FRANCISCO, CA 94107

Registered Sep. 11, 2012

Int. Cls.: 9 and 28

FOR: MULTIPLE DISTRIBUTED TANGIBLE COMPUTER HARDWARE DEVICES THAT INTERFACE AND RESPOND TO A USER'S PHYSICAL MANIPULATION AND ACT IN CONCERT TO FORM A SINGLE INTERFACE, IN CLASS 9 (U.S. CLS. 21, 23, 26, 36 AND 38).

TRADEMARK

PRINCIPAL REGISTER

FIRST USE 9-0-2011; IN COMMERCE 9-0-2011.

FOR: ELECTRONIC TOY COMPRISING MULTIPLE DISTRIBUTED TANGIBLE COMPUTER INTERFACES THAT ARE RESPONSIVE TO A USER'S PHYSICAL MANIPULATION AND ACT IN CONCERT TO FORM A SINGLE INTERFACE; ELECTRONIC ACTION TOY, NAMELY, MULTIPLE DISTRIBUTED COMPUTER INTERFACES IN THE FORM OF INDIVIDUAL CUBES; ELECTRONIC LEARNING TOY, NAMELY, MULTIPLE DISTRIBUTED COMPUTER INTERFACES IN THE FORM OF INDIVIDUAL CUBES , IN CLASS 28 (U.S. CLS. 22, 23, 38 AND 50).

FIRST USE 9-0-2011; IN COMMERCE 9-0-2011.

THE MARK CONSISTS OF STANDARD CHARACTERS WITHOUT CLAIM TO ANY PARTICULAR FONT, STYLE, SIZE, OR COLOR.

OWNER OF U.S. REG. NO. 4,016,490.

SER. NO. 85-386,369, FILED 8-1-2011.

EDWARD NELSON, EXAMINING ATTORNEY



David J. Kyffers

Director of the United States Patent and Trademark Office

United States of America
United States Patent and Trademark Office

Gopher Run

Reg. No. 4,204,649

Registered Sep. 11, 2012

Int. Cls.: 9 and 28

TRADEMARK

PRINCIPAL REGISTER

SIFTEO, INC. (DELAWARE CORPORATION)
SFTO T010
2475 3RD ST, SUITE 252
SAN FRANCISCO, CA 94107

FOR: MULTIPLE DISTRIBUTED TANGIBLE COMPUTER HARDWARE DEVICES THAT INTERFACE AND RESPOND TO A USER'S PHYSICAL MANIPULATION AND ACT IN CONCERT TO FORM A SINGLE INTERFACE, IN CLASS 9 (U.S. CLS. 21, 23, 26, 36 AND 38).

FIRST USE 9-0-2011; IN COMMERCE 9-0-2011.

FOR: ELECTRONIC TOY COMPRISING MULTIPLE DISTRIBUTED TANGIBLE COMPUTER INTERFACES THAT ARE RESPONSIVE TO A USER'S PHYSICAL MANIPULATION AND ACT IN CONCERT TO FORM A SINGLE INTERFACE; ELECTRONIC ACTION TOY, NAMELY, ELECTRONIC BLOCKS ACTING IN CONCERT TO FORM A COMPUTER INTERFACE; ELECTRONIC LEARNING TOY, NAMELY, ELECTRONIC BLOCKS ACTING IN CONCERT TO FORM A COMPUTER INTERFACE, IN CLASS 28 (U.S. CLS. 22, 23, 38 AND 50).

FIRST USE 9-0-2011; IN COMMERCE 9-0-2011.

THE MARK CONSISTS OF STANDARD CHARACTERS WITHOUT CLAIM TO ANY PARTICULAR FONT, STYLE, SIZE, OR COLOR.

NO CLAIM IS MADE TO THE EXCLUSIVE RIGHT TO USE "GOPHER", APART FROM THE MARK AS SHOWN.

SER. NO. 85-386,409, FILED 8-1-2011.

EDWARD NELSON, EXAMINING ATTORNEY



David J. Kyffers

Director of the United States Patent and Trademark Office

United States of America

United States Patent and Trademark Office

No Evil Monkeys

Reg. No. 4,204,650

Registered Sep. 11, 2012

Int. Cls.: 9 and 28

TRADEMARK

PRINCIPAL REGISTER

SIFTEO, INC. (DELAWARE CORPORATION)
SFTO T013
2475 3RD ST, SUITE 252
SAN FRANCISCO, CA 94107

FOR: MULTIPLE DISTRIBUTED TANGIBLE COMPUTER INTERFACES RESPONSIVE TO A USER'S PHYSICAL MANIPULATION THAT ACT IN CONCERT TO FORM A SINGLE INTERFACE, IN CLASS 9 (U.S. CLS. 21, 23, 26, 36 AND 38).

FIRST USE 9-0-2011; IN COMMERCE 9-0-2011.

FOR: ELECTRONIC GAME COMPRISING MULTIPLE DISTRIBUTED TANGIBLE COMPUTER INTERFACES RESPONSIVE TO USER PHYSICAL MANIPULATION OF ONE OR MORE OF SAID USER INTERFACES; ELECTRONIC TOY COMPRISING MULTIPLE DISTRIBUTED TANGIBLE COMPUTER INTERFACES THAT RESPONSIVE TO A USER'S PHYSICAL MANIPULATION ACT IN CONCERT TO FORM A SINGLE INTERFACE, IN CLASS 28 (U.S. CLS. 22, 23, 38 AND 50).

FIRST USE 9-0-2011; IN COMMERCE 9-0-2011.

THE MARK CONSISTS OF STANDARD CHARACTERS WITHOUT CLAIM TO ANY PARTICULAR FONT, STYLE, SIZE, OR COLOR.

SER. NO. 85-386,641, FILED 8-2-2011.

EDWARD NELSON, EXAMINING ATTORNEY



David J. Kyffers

Director of the United States Patent and Trademark Office

United States of America

United States Patent and Trademark Office

Oogor's Day

Reg. No. 4,204,651

SIFTEO, INC. (DELAWARE CORPORATION)
2475 3D STREET, SUITE 252
SAN FRANCISCO, CA 94107

Registered Sep. 11, 2012

Int. Cls.: 9 and 28

FOR: MULTIPLE DISTRIBUTED TANGIBLE COMPUTER HARDWARE DEVICES THAT INTERFACE AND RESPOND TO A USER'S PHYSICAL MANIPULATION AND ACT IN CONCERT TO FORM A SINGLE INTERFACE, IN CLASS 9 (U.S. CLS. 21, 23, 26, 36 AND 38).

TRADEMARK

PRINCIPAL REGISTER

FIRST USE 9-0-2011; IN COMMERCE 9-0-2011.

FOR: ELECTRONIC TOY COMPRISING MULTIPLE DISTRIBUTED TANGIBLE COMPUTER INTERFACES THAT ARE RESPONSIVE TO A USER'S PHYSICAL MANIPULATION AND ACT IN CONCERT TO FORM A SINGLE INTERFACE; ELECTRONIC ACTION TOY, NAMELY, AN ELECTRONIC BLOCKS ACTING IN CONCERT TO FORM A COMPUTER INTERFACE IN THE FORM OF A STORYTELLING AND ADVENTURE GAME, IN CLASS 28 (U.S. CLS. 22, 23, 38 AND 50).

FIRST USE 9-0-2011; IN COMMERCE 9-0-2011.

THE MARK CONSISTS OF STANDARD CHARACTERS WITHOUT CLAIM TO ANY PARTICULAR FONT, STYLE, SIZE, OR COLOR.

SER. NO. 85-386,645, FILED 8-2-2011.

EDWARD NELSON, EXAMINING ATTORNEY



David J. Kyfos

Director of the United States Patent and Trademark Office

United States of America

United States Patent and Trademark Office

CARBOWET

Reg. No. 4,204,652

AIR PRODUCTS AND CHEMICALS, INC. (DELAWARE CORPORATION)
7201 HAMILTON BLVD.
ALLENTOWN, PA 18195

Registered Sep. 11, 2012

Int. Cl.: 1

FOR: CHEMICAL COMPOSITIONS, NAMELY, SURFACE TENSION AND RHEOLOGY MODIFIERS FOR AQUEOUS INKS AND PAPER COATINGS FOR USE IN THE PRINTING INDUSTRY, IN CLASS 1 (U.S. CLS. 1, 5, 6, 10, 26 AND 46).

TRADEMARK

FIRST USE 11-24-1986; IN COMMERCE 11-24-1986.

PRINCIPAL REGISTER

THE MARK CONSISTS OF STANDARD CHARACTERS WITHOUT CLAIM TO ANY PARTICULAR FONT, STYLE, SIZE, OR COLOR.

SER. NO. 85-386,699, FILED 8-2-2011.

JOSETTE BEVERLY, EXAMINING ATTORNEY



David J. Kyros

Director of the United States Patent and Trademark Office

United States of America

United States Patent and Trademark Office

CUNA

Reg. No. 4,204,653

Registered Sep. 11, 2012

Int. Cl.: 9

TRADEMARK

PRINCIPAL REGISTER

CREDIT UNION NATIONAL ASSOCIATION, INC. (WISCONSIN CORPORATION)
5710 MINERAL POINT ROAD
MADISON, WI 53705

FOR: DOWNLOADABLE ELECTRONIC NEWSLETTERS IN THE FIELD OF CREDIT UNION BUSINESS, MARKETING AND EDUCATION, IN CLASS 9 (U.S. CLS. 21, 23, 26, 36 AND 38).

FIRST USE 5-15-1995; IN COMMERCE 2-0-1998.

THE MARK CONSISTS OF STANDARD CHARACTERS WITHOUT CLAIM TO ANY PARTICULAR FONT, STYLE, SIZE, OR COLOR.

OWNER OF U.S. REG. NO. 1,243,837.

SER. NO. 85-388,433, FILED 8-3-2011.

ANDREA BUTLER, EXAMINING ATTORNEY



David J. Kyffers

Director of the United States Patent and Trademark Office

United States of America

United States Patent and Trademark Office



Reg. No. 4,204,654

Registered Sep. 11, 2012

Int. Cl.: 41

SERVICE MARK

PRINCIPAL REGISTER

FLORIDA ACADEMY OF PERFORMING ARTS, INC. (FLORIDA NON-PROFIT CORPORATION)
16765 FISH HAWK BOULEVARD, #309
LITHIA, FL 33547

FOR: CONDUCTING WORKSHOPS AND SEMINARS IN THE FIELDS OF MUSIC, THEATRICS, AND DANCE; DIRECTION OR PRESENTATION OF LIVE MUSIC, THEATRICS, AND DANCE PERFORMANCES; EDUCATION SERVICES, NAMELY, PROVIDING LIVE AND ON-LINE CLASSES, CAMPS, LESSONS, SEMINARS, WORKSHOPS, INSTRUCTIONS, TUTORING AND MENTORING IN THE FIELDS OF MUSIC, THEATRICS, AND DANCE; EDUCATIONAL SERVICES, NAMELY, CONDUCTING LIVE AND ON-LINE CLASSES, CAMPS, LESSONS, SEMINARS, WORKSHOPS, INSTRUCTIONS, TUTORING AND MENTORING IN THE FIELDS OF MUSIC, THEATRICS, AND DANCE AND DISTRIBUTION OF PRINTED MATERIALS IN CONNECTION THEREWITH IN HARD COPY OR ELECTRONIC FORMAT ON THE SAME TOPICS; ENTERTAINMENT IN THE NATURE OF VISUAL AND AUDIO PERFORMANCES BY ACTORS, MUSICAL BANDS, ROCK GROUPS, ORCHESTRAS, AND DANCERS; ENTERTAINMENT SERVICES, NAMELY, LIVE PERFORMANCES IN THE FIELDS OF MUSIC, THEATRICS, AND DANCE; ENTERTAINMENT SERVICES, NAMELY, PROVIDING A WEB SITE FEATURING PHOTOGRAPHIC, AUDIO, VIDEO AND PROSE PRESENTATIONS FEATURING PERFORMANCES IN THE FIELDS OF MUSIC, THEATRICS, AND DANCE; ENTERTAINMENT, NAMELY, PRODUCTION OF LIVE PERFORMANCES IN THE FIELDS OF MUSIC, THEATRICS, AND DANCE; INSTRUCTION IN THE FIELDS OF MUSIC, THEATRICS AND DANCE; PLANNING ARRANGEMENT OF PERFORMANCES IN THE FIELDS OF MUSIC, THEATRICS, AND DANCE; PRESENTATION OF PERFORMANCES IN THE FIELDS OF MUSIC, THEATRICS, AND DANCE; PROVIDING A WEBSITE FEATURING INFORMATION IN THE FIELDS OF MUSIC, THEATRICS, DANCE AND ENTERTAINMENT; PROVIDING A WEBSITE FOR PERSONS TO REGISTER FOR CLASSES FOR THE PURPOSE OF ENTERTAINMENT; PROVIDING CLASSES, CAMPS, LESSONS, SEMINARS, WORKSHOPS, INSTRUCTIONS, TUTORING AND MENTORING IN THE FIELDS OF MUSIC, THEATRICS, AND DANCE; PROVIDING FACILITIES FOR PERFORMANCES IN THE FIELDS OF MUSIC, THEATRICS, AND DANCE; TEACHING IN THE FIELDS OF MUSIC, THEATRICS, AND DANCE; PROVIDING FACILITIES FOR LIVE PERFORMANCES IN THE FIELDS OF MUSIC, THEATRICS, AND DANCE, NAMELY, THEATRES, STAGES, CENTERS, AND VENUES, IN CLASS 41 (U.S. CLS. 100, 101 AND 107).



David J. Kyjars

Director of the United States Patent and Trademark Office

FIRST USE 9-1-2009; IN COMMERCE 2-1-2010.

Reg. No. 4,204,654 NO CLAIM IS MADE TO THE EXCLUSIVE RIGHT TO USE "FLORIDA ACADEMY OF PERFORMING ARTS", APART FROM THE MARK AS SHOWN.

THE MARK CONSISTS OF THE STYLIZED LETTERS "FAOPA", WITH THE "O" EMITTING RAYS IN THE MANNER OF A SUN. BELOW THESE LETTERS IS THE WORDING "THE FLORIDA ACADEMY OF PERFORMING ARTS" IN STYLIZED FORM.

SER. NO. 85-388,659, FILED 8-3-2011.

REBECCA EISINGER, EXAMINING ATTORNEY

United States of America

United States Patent and Trademark Office

Glebar

Reg. No. 4,204,655

Registered Sep. 11, 2012

Int. Cls.: 7, 40 and 42

TRADEMARK

SERVICE MARK

PRINCIPAL REGISTER

GLEBAR COMPANY, INC (NEW JERSEY CORPORATION)
527 COMMERCE STREET
FRANKLIN LAKES, NJ 07417

FOR: CENTRIFUGAL GRINDING MACHINES; COMPONENTS FOR MACHINES AND MACHINE TOOLS, GRINDING MACHINES, MATERIAL HANDLING MACHINES, FOOD PROCESSING MACHINES, CHEMISTRY PROCESSING MACHINES AND TEXTILE INDUSTRY MACHINES, NAMELY, SAND, CHEMICAL AND REVERSE OSMOSIS FILTERS; GRINDING AND POLISHING MACHINES; GRINDING MACHINES; GRINDING MACHINES FOR THE TREATMENT OF CERAMICS AND METAL; GRINDING MACHINES FOR MEDICAL DEVICE EQUIPMENT DESIGNED FOR MEDICAL DEVICE PRECISION GRINDING AND GAUGING, GLASS MATERIAL PRODUCTION GRINDING, METAL WORKING, CERAMIC MATERIAL FORMING AND FINISHING; COMPOSITE MATERIAL PRECISION FORMING AND FINISHING; RUBBER MATERIAL PRECISION FORMING AND FINISHING; WOOD PRECISION FORM GRINDING; PLASTIC MATERIALS PRECISION GRINDING AND FINISHING MACHINES; GRINDING MACHINES WITH SPIRAL BEVEL GEARS; GRINDING TOOLS FOR GRINDING MACHINES; INTERNAL GRINDING MACHINES; INVOLUTE GRINDING MACHINES; POLISHING MACHINES FOR USE IN GRINDING AND POLISHING METAL, WOOD, CERAMICS AND PLASTICS; POLISHING SYSTEM FOR USE IN SINGLE-HEAD MACHINES COMPRISING GRINDING AND POLISHING DISCS FOR STONE PROFILING AND EDGES; POWER-OPERATED GRINDING WHEELS; POWER-OPERATED GRINDING WHEELS FOR OPTICAL LENS GRINDING; WOOD GRINDING MACHINES, IN CLASS 7 (U.S. CLS. 13, 19, 21, 23, 31, 34 AND 35).

FIRST USE 4-1-1958; IN COMMERCE 4-1-1958.

FOR: APPLYING FINISHES TO METAL, CERAMIC, WOOD, RUBBER, COMPOSITE MATERIALS, GLASS AND MEDICAL DEVICES.; CUSTOM BUILDING OF TOOLS AND COMPONENTS FOR METAL, CERAMIC, WOOD, RUBBER, COMPOSITE MATERIALS, GLASS AND MEDICAL DEVICE MANUFACTURE AND WORKING; CUSTOM FABRICATION AND PRODUCTION OF METAL, CERAMIC, WOOD, RUBBER, COMPOSITE MATERIALS, GLASS AND MEDICAL DEVICES; CUSTOM MANUFACTURE OF TOOLS AND COMPONENTS FOR METAL, CERAMIC, WOOD, RUBBER, COMPOSITE MATERIALS, GLASS AND MEDICAL DEVICE MANUFACTURE AND WORKING; GRINDING; MANUFACTURE OF TOOLS AND COMPONENTS FOR METAL, CERAMIC, WOOD, RUBBER, COMPOSITE MATERIALS, GLASS AND MEDICAL DEVICE MANUFACTURE AND WORKING TO ORDER AND/OR SPECIFICATION OF OTHERS; MANUFACTURING SER-



David J. Kybas

Director of the United States Patent and Trademark Office

Reg. No. 4,204,655 VICES FOR OTHERS IN THE FIELD OF TOOLS AND COMPONENTS FOR METAL, CERAMIC, WOOD, RUBBER, COMPOSITE MATERIALS, GLASS AND MEDICAL DEVICE MANUFACTURE AND WORKING; METAL FABRICATION AND FINISHING SERVICES, IN CLASS 40 (U.S. CLS. 100, 103 AND 106).

FIRST USE 4-1-1958; IN COMMERCE 4-1-1958.

FOR: ENGINEERING SERVICES IN THE FIELD OF DEVELOPMENT OF TOOLS AND COMPONENTS FOR METAL, CERAMIC, WOOD, RUBBER, COMPOSITE MATERIALS, GLASS AND MEDICAL DEVICE MANUFACTURE AND WORKING; ENGINEERING SERVICES, NAMELY, ENGINEERING FOR THE DEVELOPMENT OF TOOLS AND COMPONENTS FOR METAL, CERAMIC, WOOD, RUBBER, COMPOSITE MATERIALS, GLASS AND MEDICAL DEVICE MANUFACTURE AND WORKING; PRODUCT DEVELOPMENT AND ENGINEERING SERVICES FOR OTHERS; TESTING, ANALYSIS AND EVALUATION OF METAL TOOLS, MACHINERY AND FABRICATION EQUIPMENT; TOOL DESIGN; TOOL MANAGEMENT SYSTEMS DESIGN SERVICES, IN CLASS 42 (U.S. CLS. 100 AND 101).

FIRST USE 4-1-1958; IN COMMERCE 4-1-1958.

THE MARK CONSISTS OF STANDARD CHARACTERS WITHOUT CLAIM TO ANY PARTICULAR FONT, STYLE, SIZE, OR COLOR.

SER. NO. 85-390,306, FILED 8-5-2011.

FONG HSU, EXAMINING ATTORNEY

United States of America

United States Patent and Trademark Office



PACIFIC
MARINE MAMMAL
CENTER

Reg. No. 4,204,656

Registered Sep. 11, 2012

Int. Cl.: 35

SERVICE MARK

PRINCIPAL REGISTER

FRIENDS OF THE SEA LION, INC. (CALIFORNIA CORPORATION), DBA PACIFIC MARINE MAMMAL CENTER
20612 LAGUNA CANYON ROAD
LAGUNA BEACH, CA 92651

FOR: RETAIL GIFT SHOPS AVAILABLE ON-SITE AND ONLINE, IN CLASS 35 (U.S. CLS. 100, 101 AND 102).

FIRST USE 1-1-2005; IN COMMERCE 1-1-2005.

NO CLAIM IS MADE TO THE EXCLUSIVE RIGHT TO USE "MARINE MAMMAL CENTER", APART FROM THE MARK AS SHOWN.

THE MARK CONSISTS OF TWO SEA LION SILHOUETTES ABOVE THE STYLIZED TEXT "PACIFIC MARINE MAMMAL CENTER".

SER. NO. 85-390,738, FILED 8-5-2011.

NORA BUCHANAN WILL, EXAMINING ATTORNEY



David J. Kybas

Director of the United States Patent and Trademark Office

United States of America

United States Patent and Trademark Office

Asha for Education

Reg. No. 4,204,657

ASHA FOR EDUCATION (CALIFORNIA CORPORATION)
819 EAGLE DR
EMMAUS, PA 18049

Registered Sep. 11, 2012

Int. Cl.: 36

FOR: CHARITABLE SERVICES, NAMELY, ORGANIZING FUNDRAISING SERVICES AND EVENTS TO RAISE FUNDS IN THE FIELD OF EDUCATION, IN CLASS 36 (U.S. CLS. 100, 101 AND 102).

SERVICE MARK

FIRST USE 7-8-1996; IN COMMERCE 5-9-1999.

PRINCIPAL REGISTER

THE MARK CONSISTS OF STANDARD CHARACTERS WITHOUT CLAIM TO ANY PARTICULAR FONT, STYLE, SIZE, OR COLOR.

NO CLAIM IS MADE TO THE EXCLUSIVE RIGHT TO USE "EDUCATION", APART FROM THE MARK AS SHOWN.

SER. NO. 85-391,433, FILED 8-6-2011.

MARIA-VICTORIA SUAREZ, EXAMINING ATTORNEY



David J. Kyjars

Director of the United States Patent and Trademark Office

United States of America

United States Patent and Trademark Office

SAN DIEGO UNION-TRIBUNE

Reg. No. 4,204,658

Registered Sep. 11, 2012

Int. Cl.: 41

SERVICE MARK

PRINCIPAL REGISTER

THE SAN DIEGO UNION-TRIBUNE, LLC (DELAWARE LIMITED LIABILITY COMPANY)
350 CAMINO DE LA REINA
SAN DIEGO, CA 921083090

FOR: ENTERTAINMENT SERVICES, NAMELY, PROVIDING A GENERAL INTEREST WEB SITE FEATURING BLOGS, NON-DOWNLOADABLE PUBLICATIONS IN THE NATURE OF NEWSPAPERS FEATURING NEWS AND INFORMATION IN THE FIELDS OF BUSINESS, HEALTH, DINING, BEAUTY, LIFESTYLES, POLITICS, ENTERTAINMENT, ART, SCIENCE, TECHNOLOGY, TRAVEL, SHOPPING, REAL ESTATE, ATTRACTIONS, EVENTS, AND COMMUNITIES, AND INFORMATION IN THE FIELD OF ENTERTAINMENT NEWS, ENTERTAINMENT ATTRACTIONS AND ENTERTAINMENT EVENTS; PROVIDING A WEB SITE FEATURING INFORMATION AND NEWS IN THE FIELD OF ART, IN CLASS 41 (U.S. CLS. 100, 101 AND 107).

FIRST USE 11-18-1995; IN COMMERCE 11-18-1995.

THE MARK CONSISTS OF STANDARD CHARACTERS WITHOUT CLAIM TO ANY PARTICULAR FONT, STYLE, SIZE, OR COLOR.

SEC. 2(F) AS TO "SAN DIEGO".

SER. NO. 85-392,177, FILED 8-8-2011.

JAY BESCH, EXAMINING ATTORNEY



David J. Kyros

Director of the United States Patent and Trademark Office

United States of America

United States Patent and Trademark Office

SPR

Reg. No. 4,204,659

DANA LIMITED (OHIO LIMITED LIABILITY COMPANY)
PO BOX 1000
MAUMEE, OH 435377000

Registered Sep. 11, 2012

Int. Cl.: 12

FOR: UNIVERSAL JOINTS FOR LAND VEHICLES AND STRUCTURAL PARTS THEREFOR,
NAMELY, JOURNAL CROSSES, IN CLASS 12 (U.S. CLS. 19, 21, 23, 31, 35 AND 44).

TRADEMARK

FIRST USE 1-1-1992; IN COMMERCE 1-1-1992.

PRINCIPAL REGISTER

THE MARK CONSISTS OF STANDARD CHARACTERS WITHOUT CLAIM TO ANY PAR-
TICULAR FONT, STYLE, SIZE, OR COLOR.

SER. NO. 85-392,283, FILED 8-8-2011.

DAVID YONTEF, EXAMINING ATTORNEY



David J. Kyfos

Director of the United States Patent and Trademark Office

United States of America
United States Patent and Trademark Office

U-T

Reg. No. 4,204,660

Registered Sep. 11, 2012

Int. Cl.: 16

TRADEMARK

PRINCIPAL REGISTER

THE SAN DIEGO UNION-TRIBUNE, LLC (DELAWARE LIMITED LIABILITY COMPANY)
350 CAMINO DE LA REINA
SAN DIEGO, CA 921083090

FOR: NEWSPAPERS, IN CLASS 16 (U.S. CLS. 2, 5, 22, 23, 29, 37, 38 AND 50).

FIRST USE 1-3-2012; IN COMMERCE 1-3-2012.

THE MARK CONSISTS OF A STYLIZED LETTER "U" AND A STYLIZED LETTER "T"
SEPARATED BY A STYLIZED HYPHEN.

SER. NO. 85-392,348, FILED 8-8-2011.

JAY BESCH, EXAMINING ATTORNEY



David J. Kyffers

Director of the United States Patent and Trademark Office

United States of America

United States Patent and Trademark Office

DISCOVERSD

Reg. No. 4,204,661

SAN DIEGO UNION-TRIBUNE, LLC (DELAWARE LIMITED LIABILITY COMPANY)
350 CAMINO DE LA REINA
SAN DIEGO, CA 921083090

Registered Sep. 11, 2012

Int. Cl.: 41

FOR: ENTERTAINMENT SERVICES, NAMELY, PROVIDING A GENERAL INTEREST WEB SITE FEATURING BLOGS, NON-DOWNLOADABLE PUBLICATIONS IN THE NATURE OF NEWSPAPERS FEATURING NEWS AND INFORMATION IN THE FIELDS OF BUSINESS, HEALTH, DINING, BEAUTY, LIFESTYLES, POLITICS, ENTERTAINMENT, ART, SCIENCE, TECHNOLOGY, TRAVEL, SHOPPING, REAL ESTATE, ATTRACTIONS, EVENTS, AND COMMUNITIES, AND INFORMATION IN THE FIELD OF ENTERTAINMENT NEWS, ENTERTAINMENT ATTRACTIONS AND ENTERTAINMENT EVENTS; PROVIDING A WEB SITE FEATURING INFORMATION AND NEWS IN THE FIELD OF ART, IN CLASS 41 (U.S. CLS. 100, 101 AND 107).

SERVICE MARK

PRINCIPAL REGISTER

FIRST USE 2-28-2006; IN COMMERCE 2-28-2006.

THE MARK CONSISTS OF STANDARD CHARACTERS WITHOUT CLAIM TO ANY PARTICULAR FONT, STYLE, SIZE, OR COLOR.

SER. NO. 85-392,397, FILED 8-8-2011.

JAY BESCH, EXAMINING ATTORNEY



David J. Kypos

Director of the United States Patent and Trademark Office

United States of America

United States Patent and Trademark Office

IFFOR

Reg. No. 4,204,662

Registered Sep. 11, 2012

Int. Cl.: 35

SERVICE MARK

PRINCIPAL REGISTER

INTERNATIONAL FOUNDATION FOR ONLINE RESPONSIBILITY (DELAWARE
NON-PROFIT CORPORATION)
919 18TH STREET NW, SUITE 925
WASHINGTON, DC 20006

FOR: PUBLIC ADVOCACY TO PROMOTE AWARENESS OF THE NEED FOR CORPORATE
ONLINE RESPONSIBILITY, BEST PRACTICES AND EDUCATION IN THE AREA OF CHILD
PROTECTION, USER EMPOWERMENT TOOLS, FREE EXPRESSION, PRIVACY, SECURITY
AND CONSUMER RIGHTS, IN CLASS 35 (U.S. CLS. 100, 101 AND 102).

FIRST USE 3-23-2004; IN COMMERCE 5-1-2011.

THE MARK CONSISTS OF STANDARD CHARACTERS WITHOUT CLAIM TO ANY PAR-
TICULAR FONT, STYLE, SIZE, OR COLOR.

SER. NO. 85-392,716, FILED 8-8-2011.

JASON TURNER, EXAMINING ATTORNEY



David J. Kybas

Director of the United States Patent and Trademark Office

United States of America

United States Patent and Trademark Office



Reg. No. 4,204,663

Registered Sep. 11, 2012

Int. Cl.: 35

SERVICE MARK

PRINCIPAL REGISTER

INTERNATIONAL FOUNDATION FOR ONLINE RESPONSIBILITY (DELAWARE
NON-PROFIT CORPORATION)
919 18TH STREET NW, SUITE 925
WASHINGTON, DC 20006

FOR: PUBLIC ADVOCACY TO PROMOTE AWARENESS OF THE NEED FOR CORPORATE
ONLINE RESPONSIBILITY, BEST PRACTICES AND EDUCATION IN THE AREA OF CHILD
PROTECTION, USER EMPOWERMENT TOOLS, FREE EXPRESSION, PRIVACY, SECURITY
AND CONSUMER RIGHTS, IN CLASS 35 (U.S. CLS. 100, 101 AND 102).

FIRST USE 3-23-2004; IN COMMERCE 5-1-2011.

THE MARK CONSISTS OF THE LETTERS "I" "F" "F" "O" "R" ALONG WITH A HALF
CRESCENT MOON SHAPE THAT SURROUNDS THE "I" AND TOUCHES UPON THE
BOTTOM PART OF THE FIRST "F" AND CONTINUES ON THE TOP OF ALL OF THE LET-
TERS AND ENDS AT THE BEGINNING OF THE "R". THE "I" HAS A SPECIALIZED CIRCUL-
LAR DOT AT THE TOP OF IT.

SER. NO. 85-392,724, FILED 8-8-2011.

JASON TURNER, EXAMINING ATTORNEY



David J. Kybas

Director of the United States Patent and Trademark Office

United States of America

United States Patent and Trademark Office

Pasquale Fisco

Reg. No. 4,204,664

Registered Sep. 11, 2012

Int. Cl.: 45

SERVICE MARK

PRINCIPAL REGISTER

FISCO, PASQUALE (UNITED STATES INDIVIDUAL)
APT. 5A
765 AMSTERDAM AVENUE
NEW YORK, NY 10025

FOR: SECURITY CONSULTANCY, IN CLASS 45 (U.S. CLS. 100 AND 101).

FIRST USE 5-13-1967; IN COMMERCE 5-13-1987.

THE MARK CONSISTS OF STANDARD CHARACTERS WITHOUT CLAIM TO ANY PARTICULAR FONT, STYLE, SIZE, OR COLOR.

THE NAME "PASQUALE FISCO" IDENTIFIES A LIVING INDIVIDUAL WHOSE CONSENT IS OF RECORD.

SER. NO. 85-392,740, FILED 8-8-2011.

COLLEEN DOMBROW, EXAMINING ATTORNEY



David J. Kybas

Director of the United States Patent and Trademark Office

United States of America

United States Patent and Trademark Office



Reg. No. 4,204,665

Registered Sep. 11, 2012

Int. Cl.: 35

SERVICE MARK

PRINCIPAL REGISTER

MOVING HOUND, LLC (TEXAS LIMITED LIABILITY COMPANY)
4401 BARNETT ROAD
WICHITA FALLS, TX 76310

FOR: PROVIDING A WEBSITE FEATURING INFORMATION ON MOVING AND RELOCATION OF HOMES AND OFFICES, NAMELY, PROVIDING BIDDING QUOTATIONS, PRICE COMPARISONS, AND INFORMATION RELATING TO THE BENEFITS AND ADVANTAGES OF RELOCATION SERVICE VENDORS, LABORERS, SUPPLIES, EQUIPMENT, STORAGE ALTERNATIVES, FOR-HIRE TRANSPORTATION AND TRUCK RENTAL ALTERNATIVES IN ORDER TO ALLOW A CUSTOMER TO PURCHASE DESIRED SELECTIONS TOGETHER; PROVIDING BUSINESS RELOCATION MANAGEMENT SERVICES, NAMELY, PLANNING, COORDINATING AND IMPLEMENTING A CUSTOMER'S RELOCATION OF HOMES AND OFFICES, IN CLASS 35 (U.S. CLS. 100, 101 AND 102).

FIRST USE 5-17-2011; IN COMMERCE 5-17-2011.

OWNER OF U.S. REG. NO. 4,031,970.

NO CLAIM IS MADE TO THE EXCLUSIVE RIGHT TO USE "MOVING", APART FROM THE MARK AS SHOWN.

THE MARK CONSISTS OF THE WORDS "MOVINGHOUND" WITH THE "MOVING" TERM POSITIONED TO THE LEFT OF A PROFILE IMAGE OF A DOG IN A RUNNING POSE. THE BACK LEGS OF THE DOG ARE EXTENDED OUTWARD AND APPEAR UNDER A LATTER PORTION OF "MOVING". THE TAIL OF THE DOG EXTENDS OUT FROM THE DOG AND ABOVE THE LATTER PORTION OF "MOVING". THE "HOUND" TERM IS POSITIONED WITHIN THE BODY OF THE DOG AND THE HEAD AND FRONT LEGS OF THE DOG EXTEND OUT AND TO THE RIGHT OF "HOUND".

SER. NO. 85-392,965, FILED 8-9-2011.

WILLIAM JACKSON, EXAMINING ATTORNEY



David J. Kybas

Director of the United States Patent and Trademark Office

United States of America

United States Patent and Trademark Office



Reg. No. 4,204,666

Registered Sep. 11, 2012

Int. Cls.: 35 and 36

REAL ESTATE CENTERS OF AMERICA LLC (SOUTH DAKOTA LIMITED LIABILITY COMPANY), FORMERLY REAL ESTATE CENTER, INC.
1230 NORTH AVENUE
SUITE 6
SPEARFISH, SD 57783

SERVICE MARK

PRINCIPAL REGISTER

FOR: ADVERTISING OF COMMERCIAL OR RESIDENTIAL REAL ESTATE; MATCHING CONSUMERS WITH REAL ESTATE PROFESSIONALS IN THE FIELD OF REAL ESTATE SERVICES VIA COMPUTER NETWORK; NEGOTIATION AND RENEGOTIATION FOR OTHERS OF LEASES AND SUBLEASES AND REAL ESTATE PURCHASE AGREEMENTS; PROVIDING AN INTERACTIVE REAL ESTATE WEBSITE WHICH PROMOTES HOUSING AND APARTMENT PROPERTIES THROUGH OFFERING PROSPECTIVE TENANTS VIDEO WALK THROUGHs, PROPERTY DESCRIPTIONS, TEXT, PRICE, LOCATION, MAPS AND OTHER INFORMATION THAT WOULD BE INFLUENTIAL TO A PROSPECTIVE TENANT IN MAKING A RENTAL DECISION; PROVIDING BUSINESS PLANNING AND MARKETING SOLUTIONS FOR REAL ESTATE PROFESSIONALS; PROVIDING REAL ESTATE LEADS FOR PROSPECTIVE PURCHASERS; PROVIDING REAL ESTATE VIDEO TOURS FOR MARKETING PURPOSES; REAL ESTATE ADVERTISING SERVICES; REAL ESTATE MARKETING ANALYSIS; REAL ESTATE MARKETING SERVICES IN THE FIELD OF RESIDENTIAL, COMMERCIAL, AND LAND; REAL ESTATE MARKETING SERVICES, NAMELY, ON-LINE SERVICES FEATURING TOURS OF RESIDENTIAL AND COMMERCIAL REAL ESTATE; REAL ESTATE SALES MANAGEMENT, IN CLASS 35 (U.S. CLS. 100, 101 AND 102).

FIRST USE 2-14-1992; IN COMMERCE 2-14-1992.



David J. Kyros

Director of the United States Patent and Trademark Office

FOR: COMMERCIAL AND RESIDENTIAL REAL ESTATE AGENCY SERVICES; EVALUATION OF REAL PROPERTY; FINANCIAL VALUATION OF PERSONAL PROPERTY AND REAL ESTATE; LAND ACQUISITION, NAMELY, REAL ESTATE BROKERAGE; PROVIDING A DATABASE OF INFORMATION ABOUT RESIDENTIAL REAL ESTATE LISTINGS IN DIFFERENT NEIGHBORHOODS AND COMMUNITIES; PROVIDING A DATABASE OF RESIDENTIAL REAL ESTATE LISTINGS WITHIN NEIGHBORHOODS AND COMMUNITIES SPECIFICALLY IDENTIFIED BY USERS; PROVIDING AN INTERNET WEBSITE PORTAL OFFERING INFORMATION IN THE FIELDS OF REAL ESTATE CONCERNING THE PURCHASE AND SALE OF NEW AND RESALE HOMES AND CONDOS; PROVIDING INFORMATION IN THE FIELD OF REAL ESTATE BY MEANS OF LINKING THE WEB SITE TO OTHER WEB SITES FEATURING REAL ESTATE INFORMATION; PROVIDING INFORMA-

Reg. No. 4,204,666 TION IN THE FIELD OF REAL ESTATE VIA THE INTERNET; PROVIDING REAL ESTATE LISTINGS AND REAL ESTATE INFORMATION VIA THE INTERNET; PROVIDING REAL ESTATE LISTINGS VIA THE INTERNET; REAL ESTATE ACQUISITION SERVICES; REAL ESTATE AGENCIES; REAL ESTATE APPRAISAL AND VALUATION; REAL ESTATE BROKERAGE; REAL ESTATE CONSULTANCY; REAL ESTATE CONSULTATION; REAL ESTATE ESCROW SERVICES; REAL ESTATE FINANCING SERVICES; REAL ESTATE INVESTMENT SERVICES IN THE NATURE OF PURCHASING AND SELLING OF REAL ESTATE FOR OTHERS; REAL ESTATE LISTING; REAL ESTATE MANAGEMENT SERVICES; REAL ESTATE MULTIPLE LISTING SERVICES; REAL ESTATE RENTAL SERVICES, NAMELY, RENTAL OF RESIDENTIAL HOUSING; REAL ESTATE SERVICES IN THE FORM OF PROVIDING PHYSICAL ACCESS TO AVAILABLE PROPERTIES VIA A REMOTE CALL-IN LOCKING DEVICE; REAL ESTATE SERVICES, NAMELY, RENTAL, BROKERAGE, LEASING AND MANAGEMENT OF COMMERCIAL PROPERTY, OFFICES AND OFFICE SPACE; REAL ESTATE VALUATION SERVICES; REAL ESTATE VALUATIONS; RESIDENTIAL REAL ESTATE AGENCY SERVICES; VALUATIONS IN REAL ESTATE MATTERS, IN CLASS 36 (U.S. CLS. 100, 101 AND 102).

FIRST USE 2-14-1992; IN COMMERCE 2-14-1992.

NO CLAIM IS MADE TO THE EXCLUSIVE RIGHT TO USE "THE REAL ESTATE CENTER", APART FROM THE MARK AS SHOWN.

THE COLOR(S) GREEN, YELLOW, WHITE, AND LIGHT GREEN IS/ARE CLAIMED AS A FEATURE OF THE MARK.

THE MARK CONSISTS OF A WHITE STRUCTURE THAT HAS PILLARS WITH A WHITE ROOF. WITHIN THE STRUCTURE IS A GREEN BACKGROUND WITH YELLOW LETTERING THAT READS "THE REAL ESTATE CENTER". EVERYTHING LISTED ABOVE IS SURROUNDED BY A LIGHT GREEN BOX WITH THE PEAK OF THE ROOF FROM THE STRUCTURE SLIGHTLY GOING ABOVE THE LIGHT GREEN BOX.

SER. NO. 85-393,117, FILED 8-9-2011.

ROBERT STRUCK, EXAMINING ATTORNEY

United States of America

United States Patent and Trademark Office

APPLIED HCT

Reg. No. 4,204,667

Registered Sep. 11, 2012

Int. Cl.: 7

TRADEMARK

PRINCIPAL REGISTER

APPLIED MATERIALS, INC. (DELAWARE CORPORATION)
M/S 1241
3050 BOWERS AVENUE
SANTA CLARA, CA 95054

FOR: MACHINES AND PARTS THEREFOR FOR WORKING METALS, METALLOIDS, SEMICONDUCTORS; MACHINES AND PARTS THEREFOR FOR SAWING, CUTTING, POLISHING, AND LAPPING; LOADING BRIDGES, CRANES, AND ELEVATORS; TRANSFER DEVICES IN THE NATURE OF BELT CONVEYORS, ROPE CONVEYORS, CHAIN CONVEYORS, PNEUMATIC CONVEYORS, CONVEYORS TUBES AND SLOPES; TRANSPORTERS IN THE NATURE OF PNEUMATIC, POWER-OPERATED RAIL, AND POWER-OPERATED ROPE TRANSPORTERS; HANDLING APPARATUS IN THE NATURE OF POWER-OPERATED GRIPPING MANIPULATORS; MACHINES FOR WASHING AND CLEANING OF SAWED PRODUCTS; MACHINES FOR SAWING HARD MATERIALS AND MATERIALS FOR THE SEMICONDUCTOR AND SOLAR INDUSTRIES; MACHINES FOR ORIENTING AND TRANSFERRING MONOCRYSTALS AND MONOCRYSTALLINE MATERIALS FOR SAWING MACHINES AND PARTS THEREFOR; AND MECHANICAL CONTROL FOR MACHINES, MACHINE ENGINES AND MACHINE MOTORS, IN CLASS 7 (U.S. CLS. 13, 19, 21, 23, 31, 34 AND 35).

FIRST USE 3-31-2011; IN COMMERCE 3-31-2011.

THE MARK CONSISTS OF STANDARD CHARACTERS WITHOUT CLAIM TO ANY PARTICULAR FONT, STYLE, SIZE, OR COLOR.

OWNER OF U.S. REG. NOS. 2,445,458, 4,002,845, AND 4,044,528.

SER. NO. 85-393,856, FILED 8-9-2011.

MICHAEL WIENER, EXAMINING ATTORNEY



David J. Kyjars

Director of the United States Patent and Trademark Office

United States of America

United States Patent and Trademark Office

TONG ZHEN

Reg. No. 4,204,668

Registered Sep. 11, 2012

Int. Cls.: 29 and 30

TRADEMARK

PRINCIPAL REGISTER

TUNG CHUN (IP) HOLDINGS LIMITED (HONG KONG CORPORATION)
C/O SUITE 1803, 18TH FLOOR, THE LANDMARK
11 PEDDER STREET, , GLOUCESTER TOWER
CENTRAL, HONG KONG

FOR: MEAT, FISH, POULTRY AND GAME; MEAT EXTRACTS; PRESERVED PRUNE; PROCESSED SALTED LEMON; PROCESSED SALTED BLACK BEANS; PRESERVED SWEET WHITE CUCUMBER; PICKLED ONION; PICKLED PLUMS; PICKLED PEACH; PICKLES; PRESERVED, PROCESSED, FROZEN, DRIED AND COOKED FRUITS AND VEGETABLES, INSTANT PREPARED VEGETABLES, PROCESSED NUTS; JELLIES, JAMS, COMPOTES; EGGS, MILK AND MILK PRODUCTS EXCLUDING ICE CREAM, ICE MILK AND FROZEN YOGURT; OLIVE OIL; SESAME OIL; EDIBLE OILS AND FATS; CANNED SEAFOOD; CANNED BEANS, FISH, FRUITS AND PORK; BEAN CURD; FERMENTED BEAN CURD; RED BEAN CURD; PRODUCTS MADE FROM BEAN CURD, NAMELY, BEAN AND JELLY, BEAN CURD IN SHEET AND STICK FORM, SOUPS; INSTANT SOUP; SOUP MIXES; FRUIT PUREE SAUCES, NAMELY, APPLESAUCE, CRANBERRY SAUCE; FRUIT-BASED PUREE SAUCES, NAMELY, APPLESAUCE, CRANBERRY SAUCE; SHRIMP SLICES; SHRIMP PASTE; CHICKEN POWDER FOR HUMAN CONSUMPTION FOR USE AS A FOOD ADDITIVE; SHRIMP CHIPS, IN CLASS 29 (U.S. CL. 46).

FOR: CHOW CHOW IN SYRUP; PICKLED GINGER; PRESERVED RED GINGER; PRESERVED SWEET MIXED GINGER; PRESERVED STEM GINGER; CRYSTALLIZED STEM GINGER; CHILI OIL FOR USE AS A SEASONING OR CONDIMENT; GARLIC SESAME OIL FOR USE AS A SEASONING OR CONDIMENT; COFFEE; TEA; COCOA; SUGAR; RICE; TAPIOCA; SAGO; ARTIFICIAL COFFEE; FLOUR; PREPARATIONS MADE FROM CEREALS, NAMELY, BREAKFAST CEREALS AND CEREAL BASED ENERGY BARS FOR USE AS A MEAL REPLACEMENT; BREAD; PASTRY AND CONFECTIONERY MADE OF SUGAR; ICE; ICES; HONEY; TREACLE; YEAST; BAKING-POWDER; ICE CREAM; FROZEN ICE CREAMS; DUMPLINGS; CORN FLOUR; CORN STARCH; POTATO STARCH; POTATO FLOUR AND STARCH FOR FOOD; TASTE AND FLAVOR ENHANCERS USED IN FOOD PRODUCTS, OTHER THAN ESSENTIAL OILS; PASTA; NOODLES; INSTANT NOODLES; COOKED RICE CONGEE AND PORRIDGE IN THE NATURE OF BREAKFAST CEREALS; FROZEN RICE CONGEE AND PORRIDGE IN THE NATURE OF BREAKFAST CEREALS; INSTANT RICE CONGEE AND PORRIDGE IN THE NATURE OF BREAKFAST CEREALS; SALT; MUSTARD; PREPARED WASABI; FIVE SPICE POWDER IN THE NATURE OF A SPICE; CURRY POWDER; CURRY SAUCE; CURRY PASTE; CHUTNEYS OR RELISH; BLACK VINEGAR; SWEETENED BLACK RICE VINEGAR; CHINESE VINEGAR; SPICE VINEGAR; WHITE



David J. Kyffers

Director of the United States Patent and Trademark Office

Reg. No. 4,204,668 VINEGAR; VINEGAR SAUCE; SOY SAUCE; DARK SOY SAUCE; THIN SOY SAUCE; THICK SOY SAUCE; SWEET SOY SAUCE; FISH SOY SAUCE; OYSTER SAUCE; MAYONNAISE; MEAT GRAVIES; MARINADE SAUCE; CHILI SAUCE; CHILI GARLIC SAUCE; SWEET SAUCE; PASTA SAUCE; SAUCES MIXES; KETCHUP; SALAD DRESSINGS; PEPPER; PEPPER SAUCE; PEPPER DRESSINGS, NAMELY, PEPPER SALAD DRESSINGS AND PEPPER MARINADE; SPICY BAKING SAUCE; SHRIMP SAUCE; STEAK SAUCE; WORCESTERSHIRE SAUCE; SAUCE FOR RICE; FISH SAUCE; TERIYAKI SAUCE, JAPANESE SAUCE; CHICKEN SAUCE; SESAME SAUCE; GROUND BEAN SAUCE; WHOLE BEAN SAUCE; FERMENTED SOY BEAN SAUCE; BEAN SAUCE; CHILI BEAN SAUCE; BLACK BEAN SAUCE; BLACK BEAN GARLIC SAUCE; SOY BEAN BARBECUE SAUCE; SPICY BEAN SAUCE; BARBECUE SAUCE; HOISIN SAUCE, SEAFOOD SAUCE; PLUM SAUCE; LEMON SAUCE; SWEET AND SOUR SAUCE; CHU HOU SAUCE, CHINESE SOY SAUCE; CHINESE BARBECUE SAUCE; SATAY SAUCES; PEKING DUCK SAUCE; CHOCOLATE SAUCE; SAUCES; SPICES; SEASONINGS; CONDIMENTS, NAMELY, CHUTNEYS, PICKLED GINGER, PREPARED HORSERADISH, SOYA BEAN PASTE; VINEGAR; FLAVORINGS FOR FOOD-STUFFS; LYE WATER, NON-MEDICATED ADDITIVES FOR FOODSTUFFS, NAMELY, FOOD ADDITIVES FOR NON-NUTRITIONAL PURPOSES FOR USE AS A FLAVORING; PRAWN CRACKER; CHOCOLATE WITH LIQUID FILLINGS, IN PARTICULAR OF WINES AND SPIRITS; CHOCOLATE COVERED NUTS; CHOCOLATE; DIM SUMS, NAMELY, DUMPLINGS AND NOODLES, IN CLASS 30 (U.S. CL. 46).

THE MARK CONSISTS OF STANDARD CHARACTERS WITHOUT CLAIM TO ANY PARTICULAR FONT, STYLE, SIZE, OR COLOR.

PRIORITY CLAIMED UNDER SEC. 44(D) ON HONG KONG APPLICATION NO. 301992718, FILED 8-3-2011.

OWNER OF HONG KONG REG. NO. 301992718, DATED 8-3-2011, EXPIRES 8-3-2021.

THE ENGLISH TRANSLATION OF THE INDIVIDUAL TERM "TONG" IN THE MARK IS SAME AND THE ENGLISH TRANSLATION OF THE INDIVIDUAL TERM "ZHEN" IN THE MARK IS TREASURE.

SER. NO. 85-393,969, FILED 8-10-2011.

BRENDAN MCCAULEY, EXAMINING ATTORNEY

United States of America

United States Patent and Trademark Office

American Microwave Corporation

Reg. No. 4,204,669

Registered Sep. 11, 2012

Int. Cl.: 9

TRADEMARK

PRINCIPAL REGISTER

AMERICAN MICROWAVE CORPORATION (MARYLAND CORPORATION)
SUITE 206
7310 GROVE ROAD
FREDERICK, MD 21704

FOR: ELECTRONIC SWITCHES; ATTENUATORS, IN CLASS 9 (U.S. CLS. 21, 23, 26, 36 AND 38).

FIRST USE 9-1-1978; IN COMMERCE 9-1-1978.

THE MARK CONSISTS OF STANDARD CHARACTERS WITHOUT CLAIM TO ANY PARTICULAR FONT, STYLE, SIZE, OR COLOR.

NO CLAIM IS MADE TO THE EXCLUSIVE RIGHT TO USE "MICROWAVE CORPORATION", APART FROM THE MARK AS SHOWN.

SEC. 2(F).

SER. NO. 85-395,305, FILED 8-11-2011.

APRIL ROACH, EXAMINING ATTORNEY



David J. Kyfos

Director of the United States Patent and Trademark Office

United States of America

United States Patent and Trademark Office

DOC BROC ROCKS

Reg. No. 4,204,670

HIKARI HOLDINGS, L.C. (UTAH LIMITED LIABILITY COMPANY)
16390 DIA DEL SOL
VALLEY CENTER, CA 92082

Registered Sep. 11, 2012

Int. Cl.: 5

FOR: DIETARY AND NUTRITIONAL SUPPLEMENTS; VITAMIN AND MINERAL SUPPLEMENTS, IN CLASS 5 (U.S. CLS. 6, 18, 44, 46, 51 AND 52).

TRADEMARK

FIRST USE 5-1-2006; IN COMMERCE 5-1-2006.

PRINCIPAL REGISTER

THE MARK CONSISTS OF STANDARD CHARACTERS WITHOUT CLAIM TO ANY PARTICULAR FONT, STYLE, SIZE, OR COLOR.

OWNER OF U.S. REG. NOS. 2,984,685, 3,138,676, AND 3,243,233.

SER. NO. 85-395,873, FILED 8-11-2011.

FLORENTINA BLANDU, EXAMINING ATTORNEY



David J. Kybas

Director of the United States Patent and Trademark Office

United States of America

United States Patent and Trademark Office



Reg. No. 4,204,671

SENIOR MARKET SALES, INC. (NEBRASKA CORPORATION)
8420 W. DODGE RD., 5TH FLOOR
OMAHA, NE 68114

Registered Sep. 11, 2012

Int. Cl.: 36

FOR: INSURANCE BROKERAGE AND FINANCIAL PLANNING SERVICES IN THE FIELDS OF LIFE, MEDICAL, LONG-TERM CARE, DENTAL, DISABILITY, ACCIDENT, HEALTH AND SAFETY, ANNUITY, AND SUPPLEMENTAL MEDICARE INSURANCE AND RETIREMENT PLANNING, IN CLASS 36 (U.S. CLS. 100, 101 AND 102).

SERVICE MARK

PRINCIPAL REGISTER

FIRST USE 5-7-2005; IN COMMERCE 5-7-2005.

THE MARK CONSISTS OF THE LETTERS "SMS" IN A STYLIZED FORMAT.

SER. NO. 85-396,614, FILED 8-12-2011.

DEZMONA MIZELLE, EXAMINING ATTORNEY



David J. Kyjars

Director of the United States Patent and Trademark Office

United States of America

United States Patent and Trademark Office

SCHWALLER

Reg. No. 4,204,672

SCHWALLER, INC. (WASHINGTON CORPORATION)
707 SE 128TH AVE.

Registered Sep. 11, 2012

VANCOUVER, WA 98683

Int. Cl.: 28

FOR: BAGS SPECIALLY ADAPTED FOR SPORTS EQUIPMENT; STORAGE RACKS FOR ATHLETIC EQUIPMENT, IN CLASS 28 (U.S. CLS. 22, 23, 38 AND 50).

TRADEMARK

FIRST USE 1-1-2006; IN COMMERCE 1-1-2006.

PRINCIPAL REGISTER

THE MARK CONSISTS OF STANDARD CHARACTERS WITHOUT CLAIM TO ANY PARTICULAR FONT, STYLE, SIZE, OR COLOR.

SEC. 2(F).

SER. NO. 85-396,990, FILED 8-12-2011.

LINDA E. BLOHM, EXAMINING ATTORNEY



David J. Kyffers

Director of the United States Patent and Trademark Office

United States of America

United States Patent and Trademark Office

VITA ShadeAssist

Reg. No. 4,204,673

Registered Sep. 11, 2012

Int. Cl.: 9

TRADEMARK

PRINCIPAL REGISTER

VITA ZAHNFABRIK H. RAUTER GMBH & CO. KG (FED REP GERMANY LIMITED PARTNERSHIP)
SPITALGASSE 3
BAD SACKINGEN, FED REP GERMANY D-79713

FOR: COMMUNICATION SOFTWARE FOR DENTAL PURPOSES, NAMELY, FOR DETAILED TOOTH COLOR PRESCRIPTION, CASE PLANNING AND PATIENT DATA STORAGE, IN CLASS 9 (U.S. CLS. 21, 23, 26, 36 AND 38).

THE MARK CONSISTS OF STANDARD CHARACTERS WITHOUT CLAIM TO ANY PARTICULAR FONT, STYLE, SIZE, OR COLOR.

OWNER OF FED REP GERMANY REG. NO. 302009034801, DATED 10-22-2009, EXPIRES 6-30-2019.

OWNER OF U.S. REG. NOS. 873,134, 2,909,972 AND OTHERS.

SER. NO. 85-397,194, FILED 8-12-2011.

CHRISTOPHER SIDOTI, EXAMINING ATTORNEY



David J. Kyffers

Director of the United States Patent and Trademark Office

United States of America

United States Patent and Trademark Office

IT'S BRIGHTER UP HERE

Reg. No. 4,204,674

Registered Sep. 11, 2012

Int. Cls.: 36 and 42

SERVICE MARK

PRINCIPAL REGISTER

NYSE GROUP, INC. (DELAWARE CORPORATION)
18TH FLOOR, ATTN: JANET PARKHURST
20 BROAD STREET
NEW YORK, NY 10005

FOR: PROVIDING FINANCIAL INFORMATION SERVICES IN THE FIELD OF MARKET TRADING, NAMELY, PROVIDING REAL TIME AND HISTORICAL MARKET TRADING DATA, SECURITIES QUOTATIONS, COMMODITY QUOTATIONS, AND FINANCIAL ANALYSIS; FINANCIAL INFORMATION SERVICES PROVIDED ON-LINE FROM A COMPUTER DATABASES OR A GLOBAL COMPUTER NETWORK IN THE FIELD OF SECURITIES MARKET INFORMATION, IN CLASS 36 (U.S. CLS. 100, 101 AND 102).

FIRST USE 5-31-2011; IN COMMERCE 5-31-2011.

FOR: COMPUTER SERVICES, NAMELY, CLOUD HOSTING PROVIDER SERVICES; PROVIDING VIRTUAL COMPUTER SYSTEMS AND VIRTUAL COMPUTER ENVIRONMENTS THROUGH CLOUD COMPUTING; COMPUTER SERVICES, NAMELY, DESIGNING, INSTALLING, UPGRADING, MAINTAINING OF COMPUTER SOFTWARE PLATFORMS; COMPUTER MONITORING SERVICE WHICH TRACKS APPLICATION SOFTWARE PERFORMANCE, PERFORMS PERIODIC MAINTENANCE AND PROVIDES REPORTS AND ALERTS CONCERNING SUCH PERFORMANCE; DEVELOPMENT OF SOFTWARE FOR SECURE NETWORK OPERATIONS; COMPUTER SERVICES, NAMELY, PROVIDING VIRTUAL AND NON-VIRTUAL PRIVATE APPLICATION SERVERS, FILE SERVERS, CO-LOCATION SERVERS AND DATABASE SERVERS OF VARIABLE CAPACITY TO THIRD PARTY COMPUTING AND DATA STORAGE FACILITIES, IN CLASS 42 (U.S. CLS. 100 AND 101).

FIRST USE 5-31-2011; IN COMMERCE 5-31-2011.

THE MARK CONSISTS OF STANDARD CHARACTERS WITHOUT CLAIM TO ANY PARTICULAR FONT, STYLE, SIZE, OR COLOR.

SER. NO. 85-397,678, FILED 8-15-2011.

CHRISIE B. KING, EXAMINING ATTORNEY



David J. Kybas

Director of the United States Patent and Trademark Office

United States of America

United States Patent and Trademark Office

PURA VIDA

Reg. No. 4,204,675

Registered Sep. 11, 2012

Int. Cls.: 31 and 35

TRADEMARK

SERVICE MARK

PRINCIPAL REGISTER

GEMS GROUP, INC. (FLORIDA CORPORATION)
7205 CORPORATE CENTER DRIVE
SUITE 400
MIAMI, FL 33126

FOR: LIVE FLOWERS, CUT FLOWERS, FLOWER BULBS; FLOWER SEEDS; LIVE PLANTS,
IN CLASS 31 (U.S. CLS. 1 AND 46).

FIRST USE 8-1-2006; IN COMMERCE 8-1-2006.

FOR: WHOLESALE DISTRIBUTORSHIPS, WHOLESALE AND RETAIL STORE SERVICES,
AND MAIL ORDER CATALOGUE SERVICES FEATURING FLOWERS AND LIVE PLANTS;
PROVIDING MARKETING AND SALES METHOD INFORMATION ON FLOWERS AND
LIVE PLANTS TO THOSE IN THE FLOWER INDUSTRY, NAMELY, RETAILERS,
WHOLESALE, AND GROWERS; BUSINESS SERVICES, NAMELY, FLORAL CLEARING
HOUSE; ADVERTISING, MARKETING, AND PROMOTION SERVICES IN THE FIELD OF
FLOWERS; ONLINE WHOLESALE AND RETAIL STORE SERVICES, AND MAIL ORDER
CATALOGUE SERVICES FEATURING FLOWERS AND LIVE PLANTS, IN CLASS 35 (U.S.
CLS. 100, 101 AND 102).

FIRST USE 8-1-2006; IN COMMERCE 8-1-2006.

THE MARK CONSISTS OF STANDARD CHARACTERS WITHOUT CLAIM TO ANY PAR-
TICULAR FONT, STYLE, SIZE, OR COLOR.

OWNER OF U.S. REG. NO. 3,404,289.

THE ENGLISH TRANSLATION OF "PURA VIDA" IN THE MARK IS PURE LIFE.

SER. NO. 85-397,702, FILED 8-15-2011.

CAROLINE WOOD, EXAMINING ATTORNEY



David J. Kyffers

Director of the United States Patent and Trademark Office

United States of America

United States Patent and Trademark Office

G&H

Reg. No. 4,204,676

Registered Sep. 11, 2012

Int. Cl.: 40

SERVICE MARK

PRINCIPAL REGISTER

G & H DIVERSIFIED MANUFACTURING, LP (TEXAS LIMITED PARTNERSHIP)
11660 BRITTMOORE PARK DRIVE
HOUSTON, TX 77041

FOR: TECHNICAL SERVICES IN THE FIELD OF FABRICATION, NAMELY, CUSTOM MANUFACTURING AND PROTOTYPE FABRICATION OF METAL PARTS FOR INDUSTRIAL AND HOUSEHOLD GOODS, REQUIRING MANUAL ROBOTIC WELDING, PRECISION MACHINING, CNC (COMPUTER NUMERICAL CONTROL) LASER CUTTING, TOOLING AND WIRE EDM (ELECTRICAL DISCHARGE MACHINING) AND/OR PRECISION SHEET METAL AND FABRICATION, IN CLASS 40 (U.S. CLS. 100, 103 AND 106).

FIRST USE 0-0-1958; IN COMMERCE 0-0-1958.

THE MARK CONSISTS OF STANDARD CHARACTERS WITHOUT CLAIM TO ANY PARTICULAR FONT, STYLE, SIZE, OR COLOR.

SER. NO. 85-397,831, FILED 8-15-2011.

RICHARD WHITE, EXAMINING ATTORNEY



David J. Kyffers

Director of the United States Patent and Trademark Office

United States of America

United States Patent and Trademark Office

Studio Arielle

Reg. No. 4,204,677

BRIANNA ARIELLE TOWNSEND (UNITED STATES INDIVIDUAL), DBA STUDIO ARIELLE
7706 14TH ST. N.W.

Registered Sep. 11, 2012

WASHINGTON, DC 20012

Int. Cl.: 41

FOR: PHOTOGRAPHY SERVICES, IN CLASS 41 (U.S. CLS. 100, 101 AND 107).

SERVICE MARK

FIRST USE 10-20-2010; IN COMMERCE 3-15-2011.

PRINCIPAL REGISTER

THE MARK CONSISTS OF STANDARD CHARACTERS WITHOUT CLAIM TO ANY PARTICULAR FONT, STYLE, SIZE, OR COLOR.

NO CLAIM IS MADE TO THE EXCLUSIVE RIGHT TO USE "STUDIO", APART FROM THE MARK AS SHOWN.

SER. NO. 85-398,501, FILED 8-15-2011.

LINDA M. KING, EXAMINING ATTORNEY



David J. Kyffers

Director of the United States Patent and Trademark Office

United States of America

United States Patent and Trademark Office

星天空数码
SKY DIGITAL

Reg. No. 4,204,678

Registered Sep. 11, 2012

Int. Cl.: 35

SERVICE MARK

PRINCIPAL REGISTER

SKY DIGITAL (SHENZHEN) CO., LTD. (CHINA LIMITED LIABILITY COMPANY)
ROOM 307, BLOCK B YUANZHENGCHUANGXIN
BUILDING, 19 LANGSHAN ROAD
SHENZHEN, CHINA

FOR: ADVERTISING AND PUBLICITY SERVICES; ASSISTANCE WITH BUSINESS MANAGEMENT AND PLANNING; COMMERCIAL ADMINISTRATION OF THE LICENSING OF THE GOODS AND SERVICES OF OTHERS; GOODS IMPORT-EXPORT AGENCIES; MANAGEMENT OF PERFORMING ARTISTS; PRESENTATION OF GOODS ON COMMUNICATION MEDIA FOR RETAIL PURPOSES; PURCHASING AND PROCUREMENT SERVICES, NAMELY, PROCURING OF CONTRACTS FOR OTHERS FOR THE PURCHASE OF GOODS AND LABOR CONTRACTING SERVICES; RELOCATION SERVICES FOR BUSINESS; SALES PROMOTION FOR OTHERS PROVIDED THROUGH THE DISTRIBUTION AND THE ADMINISTRATION OF PRIVILEGED USER CARDS; SPONSORSHIP SEARCH, IN CLASS 35 (U.S. CLS. 100, 101 AND 102).

FIRST USE 10-1-2010; IN COMMERCE 10-1-2010.

NO CLAIM IS MADE TO THE EXCLUSIVE RIGHT TO USE "DIGITAL", APART FROM THE MARK AS SHOWN.

THE NON-LATIN CHARACTERS IN THE MARK TRANSLITERATE TO XING TIAN KONG SHU MA AND THIS MEANS STAR, DAY, SPATIAL, NUMBER AND CODE IN ENGLISH.

THE MARK CONSISTS OF FIVE CHINESE CHARACTERS AND ENGLISH WORDING "SKY DIGITAL" BENEATH IN STYLIZED FONT.

THE ENGLISH TRANSLATION OF CHINESE CHARACTERS IN THE MARK IS "SKY DIGITAL".

SER. NO. 85-398,524, FILED 8-15-2011.

ELLEN B. AWRICH, EXAMINING ATTORNEY



David J. Kyros

Director of the United States Patent and Trademark Office

United States of America

United States Patent and Trademark Office

CHRIS BULLARD

Reg. No. 4,204,679

BULLARD, CHRIS (UNITED STATES INDIVIDUAL)
3717 LOGAN DR
DENTON, TX 76207

Registered Sep. 11, 2012

Int. Cl.: 41

FOR: ENTERTAINMENT RENDERED BY A MUSICAL ARTIST, NAMELY, ENTERTAINMENT IN THE NATURE OF VISUAL AND AUDIO PERFORMANCES BY A MUSICAL ACT; LIVE PERFORMANCES BY A MUSICAL ACT; MULTIMEDIA ENTERTAINMENT SERVICES IN THE NATURE OF RECORDING, PRODUCTION AND POST-PRODUCTION SERVICES IN THE FIELD OF MUSIC AND VIDEO; ENTERTAINMENT SERVICES BY A MUSICAL ARTIST, NAMELY, MUSIC COMPOSITION FOR OTHERS; ENTERTAINMENT SERVICES BY A MUSICAL ARTIST, NAMELY, PRODUCTION OF MUSICAL SOUND RECORDINGS; PROVIDING A WEBSITE FEATURING PHOTOGRAPHIC, VIDEO AND PROSE PRESENTATIONS FEATURING A SOLO MUSIC RECORDING ARTIST; PROVIDING A WEBSITE FEATURING NEWS AND ON-LINE REVIEWS OF A SOLO MUSIC RECORDING ARTIST, IN CLASS 41 (U.S. CLS. 100, 101 AND 107).

SERVICE MARK

PRINCIPAL REGISTER

FIRST USE 8-1-2011; IN COMMERCE 8-1-2011.

THE MARK CONSISTS OF STANDARD CHARACTERS WITHOUT CLAIM TO ANY PARTICULAR FONT, STYLE, SIZE, OR COLOR.

THE NAME(S), PORTRAIT(S), AND/OR SIGNATURE(S) SHOWN IN THE MARK IDENTIFIES "CHRIS BULLARD", WHOSE CONSENT(S) TO REGISTER IS MADE OF RECORD.

SER. NO. 85-398,618, FILED 8-16-2011.

KEVIN CORWIN, EXAMINING ATTORNEY



David J. Kybas

Director of the United States Patent and Trademark Office

United States of America

United States Patent and Trademark Office

VITA ENAMIC

Reg. No. 4,204,680

Registered Sep. 11, 2012

Int. Cl.: 5

TRADEMARK

PRINCIPAL REGISTER

VITA ZAHNFABRIK H. RAUTER GMBH & CO. KG (FED REP GERMANY LIMITED PARTNERSHIP)
SPITALGASSE 3
BAD SACKINGEN, FED REP GERMANY D-79713

FOR: DENTAL CERAMICS WITH PLASTIC FRACTIONS FOR PREPARING DENTAL PROSTHESES, IN CLASS 5 (U.S. CLS. 6, 18, 44, 46, 51 AND 52).

THE MARK CONSISTS OF STANDARD CHARACTERS WITHOUT CLAIM TO ANY PARTICULAR FONT, STYLE, SIZE, OR COLOR.

OWNER OF FED REP GERMANY REG. NO. 302010005552, DATED 4-1-2010, EXPIRES 1-30-2020.

OWNER OF U.S. REG. NOS. 873,134, 2,909,972 AND OTHERS.

SER. NO. 85-398,958, FILED 8-16-2011.

CHRISTOPHER SIDOTI, EXAMINING ATTORNEY



David J. Kybas

Director of the United States Patent and Trademark Office

United States of America

United States Patent and Trademark Office

PEPPY BANDS

Reg. No. 4,204,681

PEPPY BANDS (IOWA CORPORATION)
1144 CHURCH ST
JESUP, IA 50648

Registered Sep. 11, 2012

Int. Cl.: 14

FOR: HAIR JEWELRY IN THE NATURE OF JEWELRY FOR USE IN THE HAIR, IN CLASS 14 (U.S. CLS. 2, 27, 28 AND 50).

TRADEMARK

FIRST USE 7-1-2011; IN COMMERCE 7-16-2011.

PRINCIPAL REGISTER

THE MARK CONSISTS OF STANDARD CHARACTERS WITHOUT CLAIM TO ANY PARTICULAR FONT, STYLE, SIZE, OR COLOR.

NO CLAIM IS MADE TO THE EXCLUSIVE RIGHT TO USE "BANDS", APART FROM THE MARK AS SHOWN.

SER. NO. 85-399,717, FILED 8-16-2011.

JENNIFER VASQUEZ, EXAMINING ATTORNEY



David J. Kybas

Director of the United States Patent and Trademark Office

United States of America

United States Patent and Trademark Office

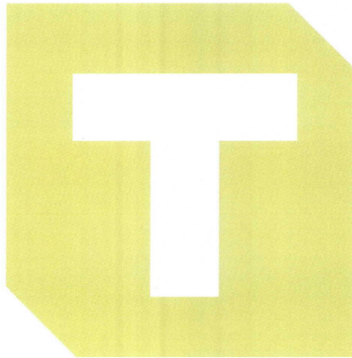

Reg. No. 4,204,682

HORN GMBH & CO. KG (FED REP GERMANY GMBH & CO. KG)
MUNKETOFT 42

Registered Sep. 11, 2012

FLENSBURG, FED REP GERMANY 24937

Int. Cls.: 6, 7, 8, 9 and 17

FOR: IRONMONGERY AND SMALL ITEMS OF METAL HARDWARE, NAMELY, PIPES, PIPEWORK AND CONNECTORS AND CONNECTING PARTS FOR PIPES ALL FORMED OF METAL; FLEXIBLE TUBES, HOSE ASSEMBLIES AND CONNECTIONS, AND CONNECTION PARTS FOR FLEXIBLE TUBES, ALL FORMED OF METAL; CONTAINERS OF METAL AND PRESSURIZED CONTAINERS OF METAL FOR VISCOUS, LIQUID AND GASEOUS MEDIA, SOLD EMPTY; AND METAL CLOSURES FOR CONTAINERS, IN CLASS 6 (U.S. CLS. 2, 12, 13, 14, 23, 25 AND 50).

TRADEMARK

PRINCIPAL REGISTER

FOR: MACHINES AND MECHANICAL EQUIPMENT AND INSTALLATIONS CONSTRUCTED THEREOF FOR CONVEYING, DELIVERING, PROPORTIONING, EXTRACTION, RECEIVING, COLLECTING AND STORAGE OF VISCOUS, LIQUID AND GASEOUS MEDIA, NAMELY, COMBUSTION FUEL OIL, GREASE LUBRICANTS, SEALING PREPARATIONS, FUEL VAPOR AND UREA SOLUTIONS, NAMELY, ELECTRIC PUMPS, PNEUMATIC PUMPS, CENTRIFUGAL PUMPS, VANE PUMPS, GEAR PUMPS, AND HYBRID PUMPS, NAMELY, CENTRIFUGAL AND POSITIVE DISPLACEMENT PUMPS, PUMPS AS PARTS OF MACHINES, ELECTRIC MOTORS AND ENGINES, ELECTRIC MIXERS, COMPRESSED AIR PUMPS, POWER-OPERATED DISPENSERS, TIRE INFLATORS, NAMELY, ELECTRICALLY OPERATED INFLATION MACHINES NOT FOR USE WITH VEHICLES, POWER-OPERATED WASTE OIL DRAINERS, AND TANKS AS PART OF MACHINES FOR STORAGE OF FUEL, OIL AND UREA SOLUTIONS, IN CLASS 7 (U.S. CLS. 13, 19, 21, 23, 31, 34 AND 35).



FOR: MANUALLY-OPERATED TOOLS, NAMELY, HAND-OPERATED DEVICES FOR CONVEYING, DELIVERING, PROPORTIONING, EXTRACTION, RECEIVING, COLLECTING AND STORAGE OF VISCOUS, LIQUID, AND GASEOUS MEDIA, NAMELY, COMBUSTION FUEL, OIL, GREASE, LUBRICANTS, SEALING PREPARATIONS, FUEL VAPOR AND UREA SOLUTIONS, NAMELY, HAND-OPERATED CARTRIDGE PUMPS, IN CLASS 8 (U.S. CLS. 23, 28 AND 44).

David J. Kybas

Director of the United States Patent and Trademark Office

FOR: ELECTRIC AND ELECTRONIC EQUIPMENT FOR RECORDING OF FILLING PROCESS PARAMETERS AND FLUID LEVELS; ELECTRIC AND ELECTRONIC DEVICES FOR USE IN CONTROL, REGULATING, PRE-SELECTION, STORAGE, PROPORTIONING, FILLING, COLLECTING, OPERATING AND DATA INPUT FOR VISCOUS, LIQUID AND GASEOUS MEDIA, NAMELY, COMBUSTION FUEL, OIL, GREASE, LUBRICANTS, SEALING PREPAR-

Reg. No. 4,204,682 ATIONS, FUEL VAPOR AND UREA SOLUTIONS, NAMELY, ELECTRONIC LIQUID LEVEL SENSORS, ELECTRONIC FLOW METERS, MECHANICAL ROLLER COUNTERS, FILLING STATIONS FOR COMBUSTION FUEL AND UREA SOLUTIONS, DISPENSING STATIONS FOR COMBUSTION FUEL, OIL AND UREA SOLUTIONS, AND ELECTRIC TIRE INFLATORS NOT FOR VEHICLES, IN CLASS 9 (U.S. CLS. 21, 23, 26, 36 AND 38).

FOR: FLEXIBLE PIPES, HOSE ASSEMBLIES AND CONNECTIONS AND CONNECTION PARTS FOR FLEXIBLE PARTS, NOT FORMED OF METAL; PIPES, PIPEWORK AND CONNECTIONS AND CONNECTING PARTS FOR PIPES, NOT FORMED OF METAL; NON-METAL COMPONENTS FOR CONVEYING, DELIVERING, PROPORTIONING, EXTRACTING, RECEIVING, COLLECTING AND STORAGE OF VISCOUS, LIQUID AND GASEOUS MEDIA, NAMELY, COMBUSTION FUEL, OIL, GREASE, LUBRICANTS, SEALING PREPARATIONS, FUEL VAPOR AND UREA SOLUTIONS, NAMELY, NON-METAL HOSE AND PIPE FITTINGS, IN CLASS 17 (U.S. CLS. 1, 5, 12, 13, 35 AND 50).

PRIORITY CLAIMED UNDER SEC. 44(D) ON ERPN CMNTY TM OFC APPLICATION NO. 009745282, FILED 2-17-2011, REG. NO. 009745282, DATED 10-7-2011, EXPIRES 2-17-2021.

THE COLOR(S) LIGHT GREEN AND WHITE IS/ARE CLAIMED AS A FEATURE OF THE MARK.

THE MARK CONSISTS OF A LIGHT GREEN SQUARE WITH THE UPPER RIGHT AND LOWER LEFT CORNERS REMOVED. A WHITE LETTER "T" APPEARS IN THE CENTER OF THE SQUARE.

SER. NO. 85-399,815, FILED 8-17-2011.

ALYSSA STEEL, EXAMINING ATTORNEY

United States of America

United States Patent and Trademark Office

ATOMIC MUSIC

Reg. No. 4,204,683

L & E ATOMIC, INC. (MARYLAND CORPORATION)

Registered Sep. 11, 2012

10111A BACON DRIVE
BELTSVILLE, MD 20705

Int. Cl.: 35

FOR: PROVIDING A BUY-BACK AND TRADE IN PROGRAM FOR USED MUSICAL INSTRUMENTS; SECOND HAND DEALERSHIPS FOR BUYING BACK AND TRADING IN MUSICAL INSTRUMENTS; RETAIL STORE SERVICES FEATURING MUSICAL INSTRUMENTS AND SOUND SYSTEMS, IN CLASS 35 (U.S. CLS. 100, 101 AND 102).

SERVICE MARK

PRINCIPAL REGISTER

FIRST USE 8-12-1994; IN COMMERCE 8-12-1994.

THE MARK CONSISTS OF STANDARD CHARACTERS WITHOUT CLAIM TO ANY PARTICULAR FONT, STYLE, SIZE, OR COLOR.

NO CLAIM IS MADE TO THE EXCLUSIVE RIGHT TO USE "MUSIC", APART FROM THE MARK AS SHOWN.

SER. NO. 85-399,928, FILED 8-17-2011.

APRIL ROACH, EXAMINING ATTORNEY



David J. Kyffers

Director of the United States Patent and Trademark Office

United States of America

United States Patent and Trademark Office



Reg. No. 4,204,684

Registered Sep. 11, 2012

Int. Cl.: 44

SERVICE MARK

PRINCIPAL REGISTER

SPECTRUM LABS, INC. (ARIZONA CORPORATION)
2143 E. 5TH STREET
TEMPE, AZ 85281

FOR: MEDICAL TESTING FOR DIAGNOSTIC OR TREATMENT PURPOSES FEATURING A DIAGNOSTIC ASSAY THAT IDENTIFIES NON PLANKTONIC STRAINS OF BACTERIA AND DETERMINES THE REGIMEN OF ANTIBIOTIC TO ELIMINATE THE BACTERIA, IN CLASS 44 (U.S. CLS. 100 AND 101).

FIRST USE 5-19-2011; IN COMMERCE 5-19-2011.

NO CLAIM IS MADE TO THE EXCLUSIVE RIGHT TO USE "TECHNOLOGY", APART FROM THE MARK AS SHOWN.

THE MARK CONSISTS OF THE STYLIZED LETTERS "BECSCREEN" WITH CIRCLES TO THE LEFT AND AN OVAL UNDERNEATH THE LETTERS "BECSCREEN" CONTAINING THE WORDS "UTILIZING INNOVOSCEPT TECHNOLOGY".

SER. NO. 85-400,164, FILED 8-17-2011.

ANN E. SAPPENFIELD, EXAMINING ATTORNEY



David J. Kyjars

Director of the United States Patent and Trademark Office

United States of America

United States Patent and Trademark Office

MEDITAPE CHECK

Reg. No. 4,204,685

Registered Sep. 11, 2012

Int. Cls.: 1 and 5

TRADEMARK

PRINCIPAL REGISTER

SYSMEX CORPORATION (JAPAN CORPORATION)
1-5-1, WAKINOHAMA-KAIGANDORI, CHUO-KU
KOBE, HYOGO, JAPAN

FOR: QUALITY CONTROL STANDARD CHEMICAL SOLUTIONS AND QUALITY CONTROL CHEMICAL REAGENTS FOR TESTING AND CALIBRATING MEDICAL APPARATUS AND REAGENTS, NAMELY, FREEZE DRIED SOLIDS, LIQUIDS AND POWDERS USED FOR MONITORING THE SYSTEM PERFORMANCE OF ANALYZERS TO ASSURE STABLE AND ACCURATE TEST RESULTS, IN CLASS 1 (U.S. CLS. 1, 5, 6, 10, 26 AND 46).

FOR: SANITARY PREPARATIONS FOR MEDICAL PURPOSES; DIAGNOSTIC REAGENTS AND DIAGNOSTIC PREPARATIONS FOR MEDICAL OR VETERINARY PURPOSES; REAGENTS FOR HEMATOLOGY ANALYSIS; REAGENTS FOR URINALYSIS; REAGENTS FOR URINARY SEDIMENT ANALYSIS; REAGENTS FOR URINE QUALITATIVE ANALYSIS; REAGENTS FOR BACTERIA ANALYSIS; REAGENTS FOR CLINICAL CHEMISTRY TESTING; AND REFERENCE CONTROL REAGENTS FOR MEDICAL USE, IN CLASS 5 (U.S. CLS. 6, 18, 44, 46, 51 AND 52).

THE MARK CONSISTS OF STANDARD CHARACTERS WITHOUT CLAIM TO ANY PARTICULAR FONT, STYLE, SIZE, OR COLOR.

OWNER OF JAPAN REG. NO. 5325848, DATED 5-28-2010, EXPIRES 5-28-2020.

NO CLAIM IS MADE TO THE EXCLUSIVE RIGHT TO USE "CHECK", APART FROM THE MARK AS SHOWN.

SER. NO. 85-400,588, FILED 8-17-2011.

JANET LEE, EXAMINING ATTORNEY



David J. Kypos

Director of the United States Patent and Trademark Office

United States of America

United States Patent and Trademark Office



Reg. No. 4,204,686

CABELA'S INCORPORATED (DELAWARE CORPORATION)
ONE CABELA DRIVE
SIDNEY, NE 69160

Registered Sep. 11, 2012

Int. Cl.: 41

FOR: ENTERTAINMENT SERVICES, NAMELY, ORGANIZING AND CONDUCTING FISHING TOURNAMENTS, IN CLASS 41 (U.S. CLS. 100, 101 AND 107).

SERVICE MARK

FIRST USE 12-15-2010; IN COMMERCE 12-15-2010.

PRINCIPAL REGISTER

OWNER OF U.S. REG. NOS. 1,151,981, 3,072,246 AND OTHERS.

NO CLAIM IS MADE TO THE EXCLUSIVE RIGHT TO USE "TEAM CHAMPIONSHIP", APART FROM THE MARK AS SHOWN.

THE MARK CONSISTS OF THE WORDS "CABELA'S" IN STYLIZED FONT ABOVE "NTC" IN STYLIZED BLOCK LETTERS ABOVE THE WORDS "NATIONAL TEAM CHAMPIONSHIP" WITH A FISH DESIGN ABOVE THE WORD "CABELA'S".

SEC. 2(F) AS TO "NATIONAL TEAM CHAMPIONSHIP".

SER. NO. 85-400,591, FILED 8-17-2011.

ROBERT STRUCK, EXAMINING ATTORNEY



David J. Kybas

Director of the United States Patent and Trademark Office

United States of America

United States Patent and Trademark Office

MY BIG FAT GREEK

Reg. No. 4,204,687

Registered Sep. 11, 2012

Int. Cl.: 43

SERVICE MARK

PRINCIPAL REGISTER

CHRIS TSAILAKIS (UNITED STATES INDIVIDUAL)
SUITE 5
2303 NORTH 44TH STREET
PHOENIX, AZ 85008

FOR: RESTAURANT SERVICES, IN CLASS 43 (U.S. CLS. 100 AND 101).

FIRST USE 12-31-2002; IN COMMERCE 12-31-2002.

THE MARK CONSISTS OF STANDARD CHARACTERS WITHOUT CLAIM TO ANY PARTICULAR FONT, STYLE, SIZE, OR COLOR.

OWNER OF U.S. REG. NO. 3,202,521.

NO CLAIM IS MADE TO THE EXCLUSIVE RIGHT TO USE "GREEK", APART FROM THE MARK AS SHOWN.

SER. NO. 85-400,656, FILED 8-17-2011.

DAVID H. STINE, EXAMINING ATTORNEY



David J. Kyros

Director of the United States Patent and Trademark Office

United States of America

United States Patent and Trademark Office

The logo for VOYLUX features a large, stylized red letter 'V' on the left, followed by the word 'OYLUX' in a bold, black, sans-serif font.

Reg. No. 4,204,688

Registered Sep. 11, 2012

Int. Cl.: 18

TRADEMARK

PRINCIPAL REGISTER

TWINKLE LEATHERWARE COMPANY LIMITED (TAIWAN CORPORATION)
FLAT/RM 6 2F, JOIN-IN HANGSING CENTRE
71-75 CONTAINER PORT RD.
KWAICHUN, N. T., HONG KONG

FOR: HANDBAGS, LEATHER BAGS AND FOLDERS, BRIEFCASES, TRAVELING CASES, UNFITTED VANITY CASES AND VANITY CASES SOLD EMPTY, PURSES, WALLETS, COSMETIC BAGS, NOT FITTED, AND BAGS FOR BEAUTY CASES SOLD EMPTY, LADIES HANDBAGS, BACKPACKS, ALL PURPOSE ATHLETIC BAGS, ALL PURPOSE SPORT BAGS OTHER THAN SHAPED TO CONTAIN SPECIFIC SPORTS APPARATUS, BEACH BAGS, CARRY ON BAGS, CLUTCH BAGS, DUFFEL BAGS, LEATHER SHOPPING BAGS, OVERNIGHT BAGS, SCHOOL BAGS, SHOULDER BAGS, TEXTILE SHOPPING BAGS, TOTE BAGS, TRAVEL BAGS, GARMENT BAGS FOR TRAVEL, SHOE BAGS FOR TRAVEL, ATTACHE CASES, BRIEFCASES, SUITCASES, LUGGAGE TRUNKS, LUGGAGE, KEY CASES, BRIEFCASE-TYPE PORTFOLIOS; ANIMAL SKINS; UMBRELLAS, WALKING STICKS; SADDLERY, IN CLASS 18 (U.S. CLS. 1, 2, 3, 22 AND 41).

OWNER OF TAIWAN REG. NO. 1419242, DATED 7-16-2010, EXPIRES 7-15-2020.

THE COLOR(S) RED AND BLACK IS/ARE CLAIMED AS A FEATURE OF THE MARK.

THE MARK CONSISTS OF THE WORDING "VOYLUX" IN STYLIZED LETTERING; THE LETTER "V" IN COLOR RED AND "OYLUX" IN COLOR BLACK.

SER. NO. 85-402,012, FILED 8-19-2011.

JOSETTE BEVERLY, EXAMINING ATTORNEY



David J. Kyffers

Director of the United States Patent and Trademark Office

United States of America

United States Patent and Trademark Office



Reg. No. 4,204,689

ORGANIC SALES & MARKETING, INC. (DELAWARE CORPORATION)
114 BROADWAY

Registered Sep. 11, 2012

RAYNHAM, MA 02767

Int. Cl.: 3

FOR: ALL-PURPOSE CLEANING PREPARATIONS, IN CLASS 3 (U.S. CLS. 1, 4, 6, 50, 51 AND 52).

TRADEMARK

FIRST USE 12-7-2010; IN COMMERCE 12-7-2010.

PRINCIPAL REGISTER

THE MARK CONSISTS OF THE WORDS "HEALTHIER HOMESTEAD" AND "URBAN TO SUBURBAN SUSTAINABILITY". THE WORD "HEALTHIER" APPEARS ABOVE THE WORD "HOMESTEAD", WHICH APPEARS ABOVE THE PHRASE "URBAN TO SUBURBAN SUSTAINABILITY". THE FIRST LETTER "H" IN THE WORD "HEALTHIER" IS CAPPED BY THE ROOFLINE OF A HOUSE AND THE FIRST LETTER "H" IN THE WORD "HOMESTEAD" IS CAPPED BY THE ROOFLINE OF A BARN. THE DOT OF THE "I" IN "HEALTHIER" HAS BEEN REPLACED BY A GREEN LEAF. THE WORDS "URBAN TO SUBURBAN SUSTAINABILITY" ARE FRAMED IN A RECTANGLE. THE WORD "HEALTHIER" APPEARS IN A LIGHT GREEN COLOR, WHILE THE WORD "HOMESTEAD" APPEARS IN A DARK GREEN COLOR. THE WORDS "URBAN TO SUBURBAN SUSTAINABILITY" APPEAR IN WHITE AND ARE CONTAINED IN A DARK GREEN RECTANGLE WITH A LIGHT GREEN BORDER.

THE COLOR(S) LIGHT GREEN, DARK GREEN, AND WHITE IS/ARE CLAIMED AS A FEATURE OF THE MARK.

SER. NO. 85-402,106, FILED 8-19-2011.

NAKIA HENRY, EXAMINING ATTORNEY



David J. Kybas

Director of the United States Patent and Trademark Office

United States of America

United States Patent and Trademark Office

LOVE BY DIEGO BINETTI

Reg. No. 4,204,690

DIEGO BINETTI INC (FLORIDA CORPORATION)

Registered Sep. 11, 2012

5709 WIND DRIFT LANE
BOCA RATON, FL 33433

Int. Cl.: 25

FOR: BLOUSES; CAMISOLES; COATS FOR MEN AND WOMEN; DRESSES; EVENING DRESSES; SKIRTS AND DRESSES; HATS; MEN AND WOMEN JACKETS, COATS, TROUSERS, VESTS; WOMEN'S UNDERWEAR; HOSIERY; MEN'S SUITS, WOMEN'S SUITS; CAPRI PANTS; DENIMS; PANTS; SHIRTS; SKIRTS; SOCKS AND STOCKINGS; DRESS SUITS; LADIES' UNDERWEAR; LINGERIE, IN CLASS 25 (U.S. CLS. 22 AND 39).

TRADEMARK

PRINCIPAL REGISTER

FIRST USE 8-15-2011; IN COMMERCE 8-15-2011.

THE MARK CONSISTS OF STANDARD CHARACTERS WITHOUT CLAIM TO ANY PARTICULAR FONT, STYLE, SIZE, OR COLOR.

THE NAME "DIEGO BINETTI" IDENTIFIES A LIVING INDIVIDUAL WHOSE CONSENT IS OF RECORD.

SER. NO. 85-402,165, FILED 8-19-2011.

JAMES LOVELACE, EXAMINING ATTORNEY



David J. Kyfos

Director of the United States Patent and Trademark Office

United States of America

United States Patent and Trademark Office

ALICE COLLINS

Reg. No. 4,204,691

Registered Sep. 11, 2012

Int. Cl.: 25

TRADEMARK

PRINCIPAL REGISTER

MATTHEW JUSTIN BARBER (UNITED KINGDOM INDIVIDUAL)
THE GRANGE
21 VICTORIA ROAD, LIVERSEEDGE
WEST YORKSHIRE, UNITED KINGDOM WF157DW AND

LOUISE CAROLINE COLLINS (UNITED KINGDOM INDIVIDUAL)
THE GRANGE
21 VICTORIA ROAD, LIVERSEEDGE
WEST YORKSHIRE, UNITED KINGDOM WF157DW

FOR: ARTICLES OF CLOTHING FOR WOMEN AND CHILDREN, NAMELY, FOOTWEAR, HEADWEAR, TOPS, PANTS, T-SHIRTS, POLO SHIRTS, SWEATSHIRTS, TROUSERS, JACKETS, SOCKS, SHIRTS AND SWEATERS, IN CLASS 25 (U.S. CLS. 22 AND 39).

THE MARK CONSISTS OF STANDARD CHARACTERS WITHOUT CLAIM TO ANY PARTICULAR FONT, STYLE, SIZE, OR COLOR.

OWNER OF UNITED KINGDOM REG. NO. 2000041, DATED 3-8-1996, EXPIRES 10-31-2014.

THE NAME(S), PORTRAIT(S), AND/OR SIGNATURE(S) SHOWN IN THE MARK IDENTIFIES "ALICE COLLINS", WHOSE CONSENT(S) TO REGISTER IS MADE OF RECORD.

SER. NO. 85-402,205, FILED 8-19-2011.

WENDY JUN, EXAMINING ATTORNEY



David J. Kyffers

Director of the United States Patent and Trademark Office

United States of America

United States Patent and Trademark Office

IT'S ABOUT TIME...

Reg. No. 4,204,692

Registered Sep. 11, 2012

Int. Cl.: 14

TRADEMARK

PRINCIPAL REGISTER

IT'S ABOUT TIME, A DIVISION OF CUSTOM QUEST (OHIO JOINT VENTURE)
SUITE A
6511 WEST CHESTER ROAD
WEST CHESTER, OH 45069

FOR: CHILDREN'S ALARM CLOCKS, IN CLASS 14 (U.S. CLS. 2, 27, 28 AND 50).

FIRST USE 0-0-2009; IN COMMERCE 0-0-2009.

THE MARK CONSISTS OF STANDARD CHARACTERS WITHOUT CLAIM TO ANY PARTICULAR FONT, STYLE, SIZE, OR COLOR.

SER. NO. 85-403,205, FILED 8-21-2011.

JASON TURNER, EXAMINING ATTORNEY



David J. Kyffers

Director of the United States Patent and Trademark Office

United States of America

United States Patent and Trademark Office

MASONITE COORDINATES

Reg. No. 4,204,693

Registered Sep. 11, 2012

Int. Cl.: 40

SERVICE MARK

PRINCIPAL REGISTER

MASONITE INTERNATIONAL CORPORATION (CANADA CORPORATION)
1820 MATHESON BOULEVARD, UNIT B4
MISSISSAUGA, CANADA L4W0B3

FOR: MANUFACTURE OF DOORS TO THE ORDER AND SPECIFICATION OF OTHERS,
IN CLASS 40 (U.S. CLS. 100, 103 AND 106).

FIRST USE 12-31-2009; IN COMMERCE 8-15-2011.

THE MARK CONSISTS OF STANDARD CHARACTERS WITHOUT CLAIM TO ANY PAR-
TICULAR FONT, STYLE, SIZE, OR COLOR.

OWNER OF U.S. REG. NOS. 3,114,552, 3,867,989 AND OTHERS.

NO CLAIM IS MADE TO THE EXCLUSIVE RIGHT TO USE "COORDINATES", APART
FROM THE MARK AS SHOWN.

SER. NO. 85-403,914, FILED 8-22-2011.

ELIZABETH KAJUBI, EXAMINING ATTORNEY



David J. Kybas

Director of the United States Patent and Trademark Office

United States of America

United States Patent and Trademark Office



Reg. No. 4,204,694

Registered Sep. 11, 2012

Int. Cls.: 16, 35 and 41

TRADEMARK

SERVICE MARK

PRINCIPAL REGISTER

NATIONAL ASSOCIATION OF TOURNAMENT DIRECTORS, LLC (NEW JERSEY LIMITED LIABILITY COMPANY)
200 RT. 31 NORTH, SUITE 202
FLEMINGTON, NJ 08822

FOR: PRINTED MATERIALS, NAMELY, MANUALS, PERIODICALS, NEWSLETTERS, AND INSTRUCTIONAL AND TEACHING MATERIALS IN THE FIELD OF DIRECTING AND ORGANIZING AMATEUR SPORTS TOURNAMENTS, IN CLASS 16 (U.S. CLS. 2, 5, 22, 23, 29, 37, 38 AND 50).

FIRST USE 8-22-2011; IN COMMERCE 8-22-2011.

FOR: ASSOCIATION SERVICES, NAMELY, PROMOTING THE INTERESTS OF AMATEUR SPORTS TOURNAMENT DIRECTORS; PROVISION OF CONSULTING AND ADVICE IN THE FIELD OF DIRECTING AND ORGANIZING AMATEUR SPORTS TOURNAMENTS, IN CLASS 35 (U.S. CLS. 100, 101 AND 102).

FIRST USE 8-22-2011; IN COMMERCE 8-22-2011.

FOR: CONDUCTING AND ARRANGING EDUCATIONAL SEMINARS AND CONFERENCES IN THE FIELD OF THE DIRECTING AND ORGANIZING OF AMATEUR SPORTS TOURNAMENTS, IN CLASS 41 (U.S. CLS. 100, 101 AND 107).

FIRST USE 8-22-2011; IN COMMERCE 8-22-2011.

NO CLAIM IS MADE TO THE EXCLUSIVE RIGHT TO USE "NATIONAL ASSOCIATION OF TOURNAMENT DIRECTORS", APART FROM THE MARK AS SHOWN.

THE COLOR(S) ORANGE AND BLUE IS/ARE CLAIMED AS A FEATURE OF THE MARK.

THE MARK CONSISTS OF A HALF OVAL STRETCHING FROM THE BOTTOM LEFT HAND CORNER TO THE UPPER RIGHT HAND CORNER. THE HALF OVAL IS THE COLOR BLUE. ABOVE THE HALF OVAL STRETCHING FROM THE BOTTOM LEFT HAND CORNER TO HALF WAY UP THE HALF OVAL IS THE GRAPHIC "V" SHAPE REACHING FROM THE BOTTOM LEFT HAND CORNER INTO THE TOP LEFT HAND CORNER WITH A CIRCLE AT THE POINT IN THE "V", BOTH OF WHICH ARE THE COLOR ORANGE. FROM THE MID POINT IN THE HALF OVAL TO THE UPPER RIGHT HAND CORNER IS A LINE,



David J. Kyffers

Director of the United States Patent and Trademark Office

Reg. No. 4,204,694 ENDING IN A STAR. TO THE RIGHT OF THE STAR ARE FOUR SMALL STARS. THIS LINE AND THE STARS ARE THE COLOR ORANGE. PARALLEL TO AND ABOVE THIS ORANGE LINE IS ANOTHER LINE WHICH IS THE COLOR BLUE. BELOW THE HALF OVAL LINE ARE THE CAPITAL LETTERS "NATD" IN THE COLOR BLUE, WITH THE CROSS IN THE LETTER "A" CONSISTING OF A BLUE LINE AND AN ORANGE LINE. BELOW THE LETTERS "NATD" ARE THE WORDS "NATIONAL ASSOCIATION OF TOURNAMENT DIRECTORS", WHICH WORDS ARE IN THE COLOR BLUE.

SER. NO. 85-403,965, FILED 8-22-2011.

HEATHER BIDDULPH, EXAMINING ATTORNEY

United States of America

United States Patent and Trademark Office



Reg. No. 4,204,695

Registered Sep. 11, 2012

Int. Cl.: 45

SERVICE MARK

PRINCIPAL REGISTER

NOBLE GRACE (TEXAS LIMITED LIABILITY COMPANY)
305-128
4101 W. GREEN OAKS
ARLINGTON, TX 76016

FOR: REGULATORY COMPLIANCE CONSULTING FOR THE ENERGY INDUSTRY, IN CLASS 45 (U.S. CLS. 100 AND 101).

FIRST USE 10-18-2010; IN COMMERCE 10-18-2010.

THE MARK CONSISTS OF THE STYLIZED TEXT "NOBLE GRACE" WITH A FLEUR DE LIS IS BEHIND THE WORDING "NOBLE GRACE" AND THE SYMBOL IS NOT REPLACING THE "O" IN NOBLE.

SER. NO. 85-404,670, FILED 8-23-2011.

STEPHANIE ALI, EXAMINING ATTORNEY



David J. Kybas

Director of the United States Patent and Trademark Office

United States of America

United States Patent and Trademark Office

PHIOTA

Reg. No. 4,204,696

Registered Sep. 11, 2012

Int. Cls.: 16 and 25

TRADEMARK

PRINCIPAL REGISTER

PHI IOTA ALPHA FRATERNITY, INC. (NEW YORK CORPORATION)
SUITE 412
9322 3RD AVE
BROOKLYN, NY 11209

FOR: MAGAZINES FEATURING NEWS AND INFORMATION ABOUT FRATERNITIES, IN CLASS 16 (U.S. CLS. 2, 5, 22, 23, 29, 37, 38 AND 50).

FIRST USE 8-1-1994; IN COMMERCE 8-1-1994.

FOR: SHIRTS; BASEBALL JERSEYS, IN CLASS 25 (U.S. CLS. 22 AND 39).

FIRST USE 8-1-1994; IN COMMERCE 8-1-1994.

THE MARK CONSISTS OF STANDARD CHARACTERS WITHOUT CLAIM TO ANY PARTICULAR FONT, STYLE, SIZE, OR COLOR.

OWNER OF U.S. REG. NO. 3,725,006.

SER. NO. 85-404,697, FILED 8-23-2011.

MICHELLE DUBOIS, EXAMINING ATTORNEY



David J. Kyros

Director of the United States Patent and Trademark Office

United States of America

United States Patent and Trademark Office

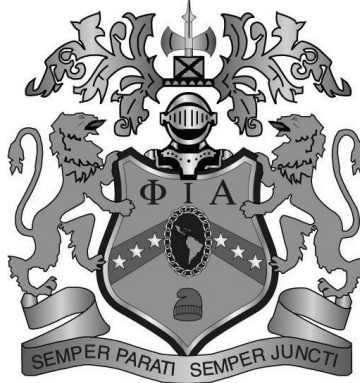

Reg. No. 4,204,697

Registered Sep. 11, 2012

Int. Cls.: 14, 21, 25 and 35

PHI IOTA ALPHA FRATERNITY, INC. (NEW YORK CORPORATION)
SUITE 412
9322 3RD AVE
NEW YORK, NY 11209

FOR: JEWELRY; NECKLACES; JEWELRY, NAMELY, DOG TAGS FOR WEAR BY HUMANS FOR DECORATIVE PURPOSES, IN CLASS 14 (U.S. CLS. 2, 27, 28 AND 50).

TRADEMARK

FIRST USE 1-1-1938; IN COMMERCE 1-1-1938.

SERVICE MARK

FOR: MUGS, IN CLASS 21 (U.S. CLS. 2, 13, 23, 29, 30, 33, 40 AND 50).

PRINCIPAL REGISTER

FIRST USE 1-1-1938; IN COMMERCE 1-1-1938.

FOR: JACKETS, IN CLASS 25 (U.S. CLS. 22 AND 39).

FIRST USE 1-1-1938; IN COMMERCE 1-1-1938.

FOR: ASSOCIATION SERVICES, NAMELY, ORGANIZING CHAPTERS OF A FRATERNITY AND PROMOTING THE INTERESTS OF THE MEMBERS THEREOF, IN CLASS 35 (U.S. CLS. 100, 101 AND 102).

FIRST USE 1-1-1938; IN COMMERCE 1-1-1938.

OWNER OF U.S. REG. NO. 3,725,006.



David J. Kyjars

Director of the United States Patent and Trademark Office

THE MARK CONSISTS OF AN IMAGE OF A TWELVE LEAVES, SIX ON THE LEFT, SIX ON THE RIGHT ATTACHED TO A SEVEN POINT BASE WHICH HAS A SMALL FASCE WITH A X SHAPED DESIGN ON TOP OF THE BASE. RESTING ON THIS FASCE IS A DOUBLE HEADED AX WITH A SPEAR HEAD PROTRUDING OUT OF THE AX HEAD. BELOW IS A KNIGHT'S ARMOR WITH THE FACE MASK SLIGHTLY OPENED. ATTACHED AT THE SHOULDER OF THE ARMOR IS A OLD SHIELD WITH THE SYMBOL OF PHI IOTA ALPHA WRITTEN IN GREEK SYMBOLS, JUST BELOW IS A PORTRAIT FRAME MADE OF TWENTY-ONE LINK CHAIN WITH A NON GEOGRAPHIC BOUNDARY MAP OF LATIN AMERICA. TWO BANDS POSITIONED ON AN ANGLE WITH THREE STARS ON EACH SIDE CONNECT THE CHAINED PORTRAIT AND THE EDGES OF THE SHIELD. BELOW THE CHAIN LINKED PORTRAIT IS A PHRYGIAN. THERE ARE TWO RAMPANT GRIFFINS

Reg. No. 4,204,697 ON EITHER SIDE HOLDING THE CREST AND FACING INWARD, TOWARDS THE CREST, THEY ARE SHOWING THEIR TONGUES. THE CREST AND THE GRIFFINS ARE ON TOP OF A BANNER WHICH HAS THE WORDS "SEMPER PARATI SEMPER JUNCTI" IN LATIN WRITTEN ACROSS IT.

THE ENGLISH TRANSLATION OF "SEMPER PARATI SEMPER JUNCTI" IN THE MARK IS ALWAYS PREPARED, ALWAYS TOGETHER.

SER. NO. 85-404,739, FILED 8-23-2011.

MICHELLE DUBOIS, EXAMINING ATTORNEY

United States of America

United States Patent and Trademark Office

Doctor Dread

Reg. No. 4,204,698

Registered Sep. 11, 2012

Int. Cl.: 30

TRADEMARK

PRINCIPAL REGISTER

GARY HIMELFARB (UNITED STATES INDIVIDUAL)
5120 BALTAN STREET
BETHESDA, MD 20816

FOR: SEASONING, RUBS AND SAUCES, IN CLASS 30 (U.S. CL. 46).

FIRST USE 1-1-2011; IN COMMERCE 1-1-2011.

THE MARK CONSISTS OF STANDARD CHARACTERS WITHOUT CLAIM TO ANY PARTICULAR FONT, STYLE, SIZE, OR COLOR.

THE NAME(S), PORTRAIT(S), AND/OR SIGNATURE(S) SHOWN IN THE MARK IDENTIFIES GARY HIMELFARB, WHOSE CONSENT(S) TO REGISTER IS MADE OF RECORD.

SER. NO. 85-405,132, FILED 8-23-2011.

ANNE MADDEN, EXAMINING ATTORNEY



David J. Kyffers

Director of the United States Patent and Trademark Office

United States of America

United States Patent and Trademark Office

nunu yummies

Reg. No. 4,204,699

BOBA TEA COMPANY, INC. (NEW MEXICO CORPORATION)
8216 MONTGOMERY BLVD NE
ALBUQUERQUE, NM 87109

Registered Sep. 11, 2012

Int. Cl.: 32

FOR: NON-ALCOHOLIC BEVERAGES WITH TEA FLAVOR; PREPARATIONS FOR MAKING BEVERAGES, NAMELY, TEA BASED BEVERAGES CONTAINING INGREDIENTS MADE WITH VARIOUS FRUIT FLAVORS AND TAPIOCA, IN CLASS 32 (U.S. CLS. 45, 46 AND 48).

TRADEMARK

PRINCIPAL REGISTER

FIRST USE 5-22-2011; IN COMMERCE 5-22-2011.

THE MARK CONSISTS OF STANDARD CHARACTERS WITHOUT CLAIM TO ANY PARTICULAR FONT, STYLE, SIZE, OR COLOR.

NO CLAIM IS MADE TO THE EXCLUSIVE RIGHT TO USE "NUNU", APART FROM THE MARK AS SHOWN.

SER. NO. 85-405,254, FILED 8-23-2011.

BARNEY CHARLON, EXAMINING ATTORNEY



David J. Kyffers

Director of the United States Patent and Trademark Office

United States of America

United States Patent and Trademark Office



Reg. No. 4,204,700

HALLBOURG, CRAIG (CANADA INDIVIDUAL)
7831 EAST PALM LANE
MESA, AZ 85207

Registered Sep. 11, 2012

Int. Cl.: 35

FOR: EXECUTIVE SEARCH AND PLACEMENT SERVICES, IN CLASS 35 (U.S. CLS. 100, 101 AND 102).

SERVICE MARK

FIRST USE 5-13-2011; IN COMMERCE 5-13-2011.

PRINCIPAL REGISTER

NO CLAIM IS MADE TO THE EXCLUSIVE RIGHT TO USE "MINING & TECHNICAL RECRUITING SERVICES", APART FROM THE MARK AS SHOWN.

THE MARK CONSISTS OF THE STYLIZED WORDING "ALTA MINING & TECHNICAL RECRUITING SERVICES" WITH A HORIZONTAL LINE SEPARATING THE WORD "ALTA" FROM THE REMAINING WORDING, AND A DESIGN TO THE LEFT OF THE WORDING COMPRISED OF A SHADED SQUARE FEATURING A DEPICTION OF TWO MOUNTAIN PEAKS, A SILHOUETTE OF A MINER'S HELMET WITH A LIGHT ON IT, TWO RAYS OF LIGHT, AND TWO CRESCENT-SHAPED CURVED BANDS.

THE ENGLISH TRANSLATION OF "ALTA" IN THE MARK IS "HIGH".

SER. NO. 85-405,809, FILED 8-24-2011.

CYNTHIA TRIPI, EXAMINING ATTORNEY



David J. Kyffers

Director of the United States Patent and Trademark Office

United States of America

United States Patent and Trademark Office



Reg. No. 4,204,701

TEKTRO TECHNOLOGY CORPORATION (TAIWAN CORPORATION)
138 MINJHU ST, SIOUSHUEI
CHANGHUA, TAIWAN

Registered Sep. 11, 2012

Int. Cl.: 12

FOR: BICYCLE BRAKES; BICYCLE PARTS, NAMELY, BRAKE LEVERS; HYDRAULIC DISC BRAKES; HYDRAULIC RIM BRAKES, IN CLASS 12 (U.S. CLS. 19, 21, 23, 31, 35 AND 44).

TRADEMARK

FIRST USE 1-1-2011; IN COMMERCE 1-1-2011.

PRINCIPAL REGISTER

OWNER OF U.S. REG. NOS. 2,739,515, 2,997,590, AND 3,031,686.

THE MARK CONSISTS OF STYLIZED WORDING "TEKTRO" ON AN UPPER PORTION AND STENCILED STYLIZED WORDING "DORADO" CONTAINED WITHIN A DARK BORDER ON A LOWER PORTION AND TO THE LEFT OF THE "TEKTRO".

SER. NO. 85-406,686, FILED 8-25-2011.

GEORGE LORENZO, EXAMINING ATTORNEY



David J. Kyffers

Director of the United States Patent and Trademark Office

United States of America

United States Patent and Trademark Office



Reg. No. 4,204,702

Registered Sep. 11, 2012

Int. Cl.: 20

TRADEMARK

PRINCIPAL REGISTER

HANGZHOU CHINASIA TEXTILE CO., LTD. (CHINA LIMITED COMPANY (LTD.))
NANSHAN INDUSTRY ZONE, CHONGXIAN TOWN
YUHANG SECTION, HANGZHOU CITY
ZHEJIANG PROVINCE, CHINA

FOR: BEDS; BENCHES; BOLSTERS; DOORS FOR FURNITURE; MATTRESSES; PILLOWS;
SOFAS; SPRING MATTRESSES; TABLES, IN CLASS 20 (U.S. CLS. 2, 13, 22, 25, 32 AND 50).

FIRST USE 4-5-2009; IN COMMERCE 7-8-2010.

NO CLAIM IS MADE TO THE EXCLUSIVE RIGHT TO USE THE NON-LATIN CHARACTERS
THAT TRANSLITERATE TO "PIN", APART FROM THE MARK AS SHOWN.

THE COLOR(S) BLACK AND RED IS/ARE CLAIMED AS A FEATURE OF THE MARK.

THE NON-LATIN CHARACTERS IN THE MARK TRANSLITERATE TO "YI"; "JU"; "SHANG";
"PIN" AND THIS MEANS "ONE"; "RESIDENCE"; "STILL"; "QUALITY" IN ENGLISH.

THE MARK CONSISTS OF AN INCOMPLETE RED POLYGON DESIGN ON THE LEFT,
FOUR CHINESE CHARACTERS IN BLACK WHICH TRANSLITERATE INTO "YI JU SHANG
PIN" ON THE RIGHT, AND THE WORDING "1GSHOP.COM" IN RED BELOW THE CHINESE
CHARACTERS.

THE WORDING "1GSHOP" HAS NO MEANING IN A FOREIGN LANGUAGE.

SER. NO. 85-406,706, FILED 8-25-2011.

WILLIAM BRECKENFELD, EXAMINING ATTORNEY



David J. Kypos

Director of the United States Patent and Trademark Office

United States of America

United States Patent and Trademark Office

HIPPO ROOFING

Reg. No. 4,204,703

HIPPO ROOFING, INC. (NEVADA CORPORATION)
1555 N. HARBOR CITY BLVD.
MELBOURNE, FL 32935

Registered Sep. 11, 2012

Int. Cl.: 37

FOR: ROOFING CONTRACTING; ROOFING INSTALLATION; ROOFING REPAIR; INSTALLATION OF BUILDING INSULATION, SOFFITS, SIDING, AND FASCIA, IN CLASS 37 (U.S. CLS. 100, 103 AND 106).

SERVICE MARK

FIRST USE 5-0-2008; IN COMMERCE 5-0-2008.

PRINCIPAL REGISTER

THE MARK CONSISTS OF STANDARD CHARACTERS WITHOUT CLAIM TO ANY PARTICULAR FONT, STYLE, SIZE, OR COLOR.

NO CLAIM IS MADE TO THE EXCLUSIVE RIGHT TO USE "ROOFING", APART FROM THE MARK AS SHOWN.

SER. NO. 85-406,855, FILED 8-25-2011.

NATALIE POLZER, EXAMINING ATTORNEY



David J. Kybas

Director of the United States Patent and Trademark Office

United States of America

United States Patent and Trademark Office

SOLARWALL

Reg. No. 4,204,704

CONSERVAL ENGINEERING INC. (CANADA CORPORATION)
200 WILDCAT ROAD

Registered Sep. 11, 2012

TORONTO, ONTARIO, CANADA M6P1V7

Int. Cls.: 6, 9, 37 and 42

FOR: METAL HEATING DUCTS; METAL STRUCTURES FOR MOUNTING SOLAR PANELS; SOLAR PANEL MOUNTS MADE OF METAL; SUBSTRATES PRIMARILY OF METAL FOR SUPPORTING SOLAR CELLS, PHOTOVOLTAIC CELLS AND SOLAR COLLECTORS, IN CLASS 6 (U.S. CLS. 2, 12, 13, 14, 23, 25 AND 50).

TRADEMARK

SERVICE MARK

FIRST USE 1-1-1988; IN COMMERCE 1-1-1988.

PRINCIPAL REGISTER

FOR: APPARATUS FOR CONVERTING ELECTRONIC RADIATION TO ELECTRICAL ENERGY, NAMELY, PHOTOVOLTAIC CLADDING PANELS; APPARATUS FOR CONVERTING ELECTRONIC RADIATION TO ELECTRICAL ENERGY, NAMELY, PHOTOVOLTAIC ROOFING MEMBERS; APPARATUS FOR CONVERTING ELECTRONIC RADIATION TO ELECTRICAL ENERGY, NAMELY, PHOTOVOLTAIC SOLAR HYBRID MODULES; APPARATUS FOR CONVERTING ELECTRONIC RADIATION TO ELECTRICAL ENERGY, NAMELY, PHOTOVOLTAIC SOLAR MODULES; APPARATUS FOR CONVERTING ELECTRONIC RADIATION TO ELECTRICAL ENERGY, NAMELY, PHOTOVOLTAIC THERMAL HYBRID MODULE; APPARATUS FOR CONVERTING ELECTRONIC RADIATION TO ELECTRICAL ENERGY, NAMELY, PHOTOVOLTAIC THERMAL MODULE; APPARATUS FOR CONVERTING ELECTRONIC RADIATION TO ELECTRICAL ENERGY, NAMELY, PVT (PHOTOVOLTAIC THERMAL) MODULE; PHOTOVOLTAIC CELLS ALSO INCLUDING A SOLAR THERMAL COLLECTOR SOLD AS A UNIT, IN CLASS 9 (U.S. CLS. 21, 23, 26, 36 AND 38).



FIRST USE 7-1-1995; IN COMMERCE 7-1-1995.

FOR: CONSULTING IN THE FIELD OF BUILDING CONSTRUCTION; TECHNICAL CONSULTATION IN THE FIELD OF BUILDING CONSTRUCTION, IN CLASS 37 (U.S. CLS. 100, 103 AND 106).

FIRST USE 1-1-1988; IN COMMERCE 1-1-1988.

David J. Kyffers

FOR: ENGINEERING SERVICES IN THE FIELD OF ENERGY EFFICIENCY; ENGINEERING SERVICES IN THE FIELD OF SOLAR ENERGY, IN CLASS 42 (U.S. CLS. 100 AND 101).

FIRST USE 1-1-1988; IN COMMERCE 1-1-1988.

Director of the United States Patent and Trademark Office

Reg. No. 4,204,704 THE MARK CONSISTS OF STANDARD CHARACTERS WITHOUT CLAIM TO ANY PARTICULAR FONT, STYLE, SIZE, OR COLOR.

OWNER OF U.S. REG. NOS. 1,294,112 AND 3,724,240.

SEC. 2(F).

SER. NO. 85-406,889, FILED 8-25-2011.

ANNE FARRELL, EXAMINING ATTORNEY

United States of America

United States Patent and Trademark Office

Shortest Distance to Revenue

Reg. No. 4,204,705

Registered Sep. 11, 2012

Int. Cls.: 35 and 36

SERVICE MARK

PRINCIPAL REGISTER

BIG FISH, LLC (CALIFORNIA LIMITED LIABILITY COMPANY)
#191
3755 AVOCADO BOULEVARD
LA MESA, CA 91941

FOR: ASSISTANCE, ADVISORY SERVICES AND CONSULTANCY WITH REGARD TO BUSINESS DEVELOPMENT AND CORPORATE STRATEGIC PLANNING, IN CLASS 35 (U.S. CLS. 100, 101 AND 102).

FIRST USE 3-15-2010; IN COMMERCE 3-15-2010.

FOR: ASSISTANCE, ADVISORY SERVICES AND CONSULTANCY SERVICES IN THE FIELD OF FINANCIAL FORECASTING IN THE NATURE OF BUDGET REVENUE AND REVENUE BUILDING, IN CLASS 36 (U.S. CLS. 100, 101 AND 102).

FIRST USE 3-15-2012; IN COMMERCE 3-15-2012.

THE MARK CONSISTS OF STANDARD CHARACTERS WITHOUT CLAIM TO ANY PARTICULAR FONT, STYLE, SIZE, OR COLOR.

SER. NO. 85-407,464, FILED 8-25-2011.

DANNEAN HETZEL, EXAMINING ATTORNEY



David J. Kypos

Director of the United States Patent and Trademark Office

United States of America

United States Patent and Trademark Office

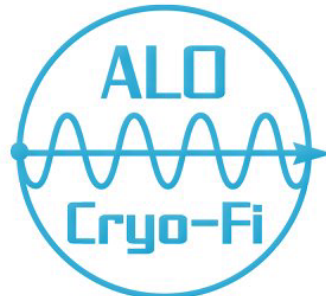

Deep Cryo Treatment

Reg. No. 4,204,706

ALOAUDIO LLC (OREGON LIMITED LIABILITY COMPANY)
1810 SE 10TH AVE UNIT B
PORTLAND, OR 97214

Registered Sep. 11, 2012

Int. Cl.: 9

FOR: HOME THEATER SYSTEMS COMPRISING CRYOGENICALLY TREATED CABLES, INTERCONNECTS AND WIRE, IN CLASS 9 (U.S. CLS. 21, 23, 26, 36 AND 38).

TRADEMARK

FIRST USE 8-1-2011; IN COMMERCE 8-1-2011.

PRINCIPAL REGISTER

OWNER OF U.S. REG. NOS. 3,780,834, 3,919,637, AND 3,919,902.

THE COLOR(S) GREEN IS/ARE CLAIMED AS A FEATURE OF THE MARK.

NO CLAIM IS MADE TO THE EXCLUSIVE RIGHT TO USE "CRYO TREATMENT", APART FROM THE MARK AS SHOWN.

THE MARK CONSISTS OF A 2PT LINE MAKES A CIRCLE ENCOMPASSING A HORIZONTAL RIGHT ORIENTED ARROW BISECTING THE CIRCLE AT THE MIDPOINT WITH THE ARROW HEAD PROTRUDING JUST PAST THE CIRCLE. A WAVE FORM LINE CROSSES THE ARROW LINE HORIZONTALLY. "ALO" IS WRITTEN ABOVE THE WAVE FORM LINE INSIDE THE CIRCLE. "CRYO-FI" IS WRITTEN BELOW THE WAVE FORM LINE INSIDE THE CIRCLE. "DEEP CRYO TREATMENT" IS WRITTEN OUTSIDE OF AND BELOW THE CIRCLE. ALL LINES AND LETTERING ARE GREEN COLOR. THE FONT IS SF THERAMIN GOTHIC.



SER. NO. 85-408,304, FILED 8-26-2011.

BRIAN NEVILLE, EXAMINING ATTORNEY

David J. Kybas

Director of the United States Patent and Trademark Office

United States of America

United States Patent and Trademark Office

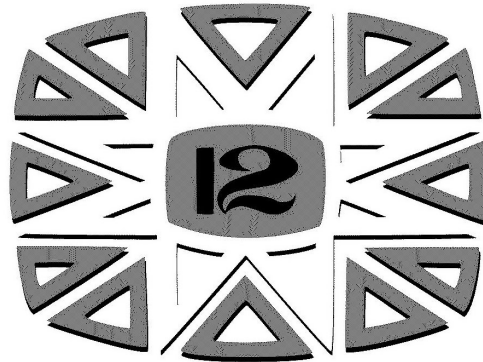

Reg. No. 4,204,707

Registered Sep. 11, 2012

Int. Cl.: 38

SERVICE MARK

PRINCIPAL REGISTER

VIRGIN ISLANDS PUBLIC TELEVISION SYSTEM (US VIRGIN ISLANDS U.S. VIRGIN ISLANDS PUBLIC AUTHORITY)
BOX 7879
CHARLOTTE AMALIE, US VIRGIN ISLANDS 00801

FOR: STREAMING OF AUDIOVISUAL MATERIAL ON THE INTERNET; TELECOMMUNICATION SERVICES, NAMELY, TRANSMISSION OF PODCASTS; TELEVISION BROADCASTING, IN CLASS 38 (U.S. CLS. 100, 101 AND 104).

FIRST USE 8-22-2003; IN COMMERCE 8-22-2003.

NO CLAIM IS MADE TO THE EXCLUSIVE RIGHT TO USE "12", APART FROM THE MARK AS SHOWN.

THE MARK CONSISTS OF A RECTANGLE ENCOMPASSING A NUMBER OF INTERSECTING TRIANGLES, WITH A RECTANGLE WITH CURVED SIDES IN THE CENTER ENCLOSING THE STYLIZED NUMBER "12".

SER. NO. 85-409,995, FILED 8-29-2011.

ANDREA HACK, EXAMINING ATTORNEY



David J. Kyjars

Director of the United States Patent and Trademark Office

United States of America

United States Patent and Trademark Office

SECOND LIFE

Reg. No. 4,204,708

G2 REVOLUTION, LLC (OHIO LIMITED LIABILITY COMPANY)
10725 WOLF DRIVE
HUNTLEY, IL 60142

Registered Sep. 11, 2012

Int. Cl.: 40

FOR: MATERIAL TREATMENT SERVICES IN CONNECTION WITH RECYCLING; RECYCLING, IN CLASS 40 (U.S. CLS. 100, 103 AND 106).

SERVICE MARK

FIRST USE 9-1-2010; IN COMMERCE 10-1-2010.

PRINCIPAL REGISTER

THE MARK CONSISTS OF STANDARD CHARACTERS WITHOUT CLAIM TO ANY PARTICULAR FONT, STYLE, SIZE, OR COLOR.

SER. NO. 85-410,310, FILED 8-30-2011.

RAMONA ORTIGA, EXAMINING ATTORNEY



David J. Kybas

Director of the United States Patent and Trademark Office

United States of America

United States Patent and Trademark Office

DEFENDING OUR PATIENTS EVERYWHERE

Reg. No. 4,204,709

Registered Sep. 11, 2012

Int. Cl.: 16

TRADEMARK

PRINCIPAL REGISTER

DOPE MAGAZINE, LLC (WASHINGTON LIMITED LIABILITY COMPANY)
#601
910 LENORA ST.
SEATTLE, WA 98121

FOR: MAGAZINES IN THE FIELD OF THE CANNABIS LIFESTYLE, IN CLASS 16 (U.S. CLS. 2, 5, 22, 23, 29, 37, 38 AND 50).

FIRST USE 8-19-2011; IN COMMERCE 8-29-2011.

THE MARK CONSISTS OF STANDARD CHARACTERS WITHOUT CLAIM TO ANY PARTICULAR FONT, STYLE, SIZE, OR COLOR.

SER. NO. 85-411,215, FILED 8-30-2011.

ROBERT STRUCK, EXAMINING ATTORNEY



David J. Kyffers

Director of the United States Patent and Trademark Office

United States of America

United States Patent and Trademark Office



Reg. No. 4,204,710

Registered Sep. 11, 2012

Int. Cl.: 20

TRADEMARK

PRINCIPAL REGISTER

ELITE FURNITURE CO., LIMITED (HONG KONG LIMITED LIABILITY COMPANY)
FLAT/RM 1404, 14/F KIMBERLEY HOUSE
35 KIMBERLEY RODE, TSIMSHATSUI
KOWLOON, HONG KONG, HONG KONG

FOR: DISPLAY BOARDS; FIREGUARDS; FIXED TOWEL DISPENSERS NOT OF METAL;
FURNITURE; FURNITURE PARTS; INDOOR WINDOW BLINDS; MIRROR FRAMES; NON-
METAL BINS; WOOD BINS; WOODEN CRAFT STICKS, IN CLASS 20 (U.S. CLS. 2, 13, 22,
25, 32 AND 50).

FIRST USE 2-25-2008; IN COMMERCE 12-16-2009.

THE MARK CONSISTS OF "SICARTT" AND A STYLIZED DESIGN OF A FLEUR-DE-LIS.

THE WORDING "SICARTT" HAS NO MEANING IN A FOREIGN LANGUAGE.

SER. NO. 85-411,370, FILED 8-31-2011.

PAUL E. FAHRENKOPF, EXAMINING ATTORNEY



David J. Kyffers

Director of the United States Patent and Trademark Office

United States of America

United States Patent and Trademark Office

KNUCKLE BUSTER

Reg. No. 4,204,711

ACA ENTERPRISES (OHIO LIMITED LIABILITY COMPANY)
870 N. WOODLAND AVENUE
CLYDE, OH 43410

Registered Sep. 11, 2012

Int. Cls.: 3, 21 and 24

FOR: IMPREGNATED CLEANING, DUSTING, AND POLISHING CLOTHS, IN CLASS 3 (U.S. CLS. 1, 4, 6, 50, 51 AND 52).

TRADEMARK

FIRST USE 1-1-2010; IN COMMERCE 1-1-2010.

PRINCIPAL REGISTER

FOR: HOOK AND LOOP-TYPE WET FLAT MOPS, HOOK AND LOOP-TYPE DUST MOPS, POCKET DUST MOPS WITH CANVAS BACK, WET MOPS, MICROFIBER FLAT MOPS, MICROFIBER STRING MOPS, MICROFIBER STRIP MOPS, MOP HANDLES, MOP BASES; BUCKETS; DUSTERS; MITTEN-SHAPED MICROFIBER CLEANING CLOTHS, COTTON RAGS, AND FABRIC AUTOMOTIVE WIPES NOT IMPREGNATED WITH CHEMICALS, IN CLASS 21 (U.S. CLS. 2, 13, 23, 29, 30, 33, 40 AND 50).

FIRST USE 1-1-2010; IN COMMERCE 1-10-2010.

FOR: MULTI-PURPOSE TOWELS, SHOP TOWELS, TERRY TOWELS, MICROFIBER TOWELS, AND MICROFIBER BAR TOWELS; BED SHEETS AND PILLOW CASES, IN CLASS 24 (U.S. CLS. 42 AND 50).

FIRST USE 1-1-2010; IN COMMERCE 1-1-2010.

THE MARK CONSISTS OF STANDARD CHARACTERS WITHOUT CLAIM TO ANY PARTICULAR FONT, STYLE, SIZE, OR COLOR.

SER. NO. 85-411,807, FILED 8-31-2011.

ROBIN CHOSID, EXAMINING ATTORNEY



David J. Kypos

Director of the United States Patent and Trademark Office

United States of America

United States Patent and Trademark Office

PROLASTIN C

Reg. No. 4,204,712

Registered Sep. 11, 2012

Int. Cl.: 5

TRADEMARK

PRINCIPAL REGISTER

GRIFOLS THERAPEUTICS, INC. (DELAWARE CORPORATION)
4101 RESEARCH COMMONS
79 TW ALEXANDER DRIVE
RESEARCH TRIANGLE PARK, NC 27709

FOR: PHARMACEUTICAL PREPARATION, NAMELY, AN ENZYME INHIBITOR FOR PULMONARY FUNCTION, IN CLASS 5 (U.S. CLS. 6, 18, 44, 46, 51 AND 52).

FIRST USE 1-13-2010; IN COMMERCE 1-13-2010.

THE MARK CONSISTS OF STANDARD CHARACTERS WITHOUT CLAIM TO ANY PARTICULAR FONT, STYLE, SIZE, OR COLOR.

OWNER OF U.S. REG. NOS. 1,473,862 AND 3,536,975.

SER. NO. 85-411,813, FILED 8-31-2011.

ALICE BENMAMAN, EXAMINING ATTORNEY



David J. Kyffers

Director of the United States Patent and Trademark Office

United States of America
United States Patent and Trademark Office

MIAMI BEACH

Reg. No. 4,204,713

CITY OF MIAMI BEACH (FLORIDA MUNICIPAL CORPORATION)
1700 CONVENTION CENTER DR.
MIAMI BEACH, FL 33139

Registered Sep. 11, 2012

Int. Cl.: 41

FOR: PROVIDING INFORMATION AND NEWS VIA A WEBSITE IN THE FIELD OF GOVERNMENT SERVICES, NAMELY, INFORMATION ABOUT ARTS, EDUCATION AND PARKS IN MIAMI BEACH, IN CLASS 41 (U.S. CLS. 100, 101 AND 107).

SERVICE MARK

FIRST USE 8-1-2005; IN COMMERCE 8-1-2005.

PRINCIPAL REGISTER

THE MARK CONSISTS OF THE STYLIZED WORDING, "MIAMI BEACH" IN WHICH "MIAMI" IS THINNER AND "BEACH" IS THICKER OR BOLDED.

SEC. 2(F).

SER. NO. 85-411,845, FILED 8-31-2011.

ROBIN CHOSID, EXAMINING ATTORNEY



David J. Kyffers

Director of the United States Patent and Trademark Office

United States of America

United States Patent and Trademark Office

TIPRNET

Reg. No. 4,204,714

Registered Sep. 11, 2012

Int. Cl.: 42

SERVICE MARK

PRINCIPAL REGISTER

CUMMINGS ENGINEERING CONSULTANTS, INCORPORATED (ARIZONA CORPORATION)
145 S. 79TH STREET, SUITE 26
CHANDLER, AZ 85226

FOR: COMPUTER HARDWARE AND SOFTWARE CONSULTING SERVICES; COMPUTER SERVICES, NAMELY, ACTING AS AN APPLICATION SERVICE PROVIDER IN THE FIELD OF INFORMATION MANAGEMENT TO HOST COMPUTER APPLICATION SOFTWARE FOR THE PURPOSE OF CRYPTOGRAPHIC SYSTEMS; COMPUTER SERVICES, NAMELY, REMOTE AND ON-SITE MANAGEMENT OF CRYPTOGRAPHIC SYSTEMS OF OTHERS; COMPUTER SOFTWARE DEVELOPMENT IN THE FIELD OF CRYPTOGRAPHIC SYSTEMS; COMPUTER SOFTWARE DEVELOPMENT, COMPUTER PROGRAMMING AND MAINTENANCE OF COMPUTER SOFTWARE FOR CRYPTOGRAPHIC SYSTEMS; CONSULTING SERVICES IN THE FIELD OF THE DESIGN OF CRYPTOGRAPHIC SYSTEMS; DESIGN AND DEVELOPMENT OF COMPUTER SOFTWARE FOR CRYPTOGRAPHIC SYSTEMS; DESIGN AND DEVELOPMENT OF SOFTWARE AND HARDWARE FOR CRYPTOGRAPHIC SYSTEMS; DESIGN FOR OTHERS IN THE FIELD OF CRYPTOGRAPHIC SYSTEMS; DESIGN, DEVELOPMENT, AND CONSULTING SERVICES RELATED THERETO IN THE FIELD OF CRYPTOGRAPHIC SYSTEMS; DESIGN, DEVELOPMENT, AND IMPLEMENTATION OF SOFTWARE FOR CRYPTOGRAPHIC SYSTEMS; INSTALLATION AND MAINTENANCE OF CRYPTOGRAPHIC SYSTEM SOFTWARE; INSTALLATION OF CRYPTOGRAPHIC SYSTEM SOFTWARE; INSTALLATION, MAINTENANCE AND REPAIR OF CRYPTOGRAPHIC SYSTEM SOFTWARE; MAINTENANCE OF COMPUTER SOFTWARE USED FOR CRYPTOGRAPHIC SYSTEMS; PLATFORM AS A SERVICE (PAAS) FEATURING COMPUTER SOFTWARE PLATFORMS FOR OPERATING AND MANAGING CRYPTOGRAPHIC SYSTEMS; PROVIDING ON-LINE NON-DOWNLOADABLE SOFTWARE FOR OPERATING AND MANAGING CRYPTOGRAPHIC SYSTEMS; PROVIDING TEMPORARY USE OF ON-LINE NON-DOWNLOADABLE SOFTWARE FOR OPERATING AND MANAGING CRYPTOGRAPHIC SYSTEMS; SOFTWARE AS A SERVICE (SAAS) SERVICES FEATURING SOFTWARE FOR OPERATING AND MANAGING CRYPTOGRAPHIC SYSTEMS; SOFTWARE DEVELOPMENT AND PRODUCT DEVELOPMENT CONSULTING IN THE FIELD OF CRYPTOGRAPHIC SYSTEMS; SOFTWARE DEVELOPMENT CONSULTING IN THE FIELD OF CRYPTOGRAPHIC SYSTEMS; SOFTWARE DEVELOPMENT IN THE FIELD OF CRYPTOGRAPHIC SYSTEMS; TECHNOLOGY SPECIFICATION, NAMELY, ANALYZING TECHNOLOGY REQUIREMENTS AND DEVELOPING RECOMMENDATIONS FOR THE COMPUTER SOFTWARE AND SYSTEMS AND OTHER TECHNOLOGY NEEDED TO MEET THOSE REQUIREMENTS, IN THE FIELD OF CRYPTOGRAPHIC SYSTEMS, IN CLASS 42 (U.S. CLS. 100 AND 101).



David J. Kybas

Director of the United States Patent and Trademark Office

Reg. No. 4,204,714 FIRST USE 11-1-2010; IN COMMERCE 11-1-2010.

THE MARK CONSISTS OF STANDARD CHARACTERS WITHOUT CLAIM TO ANY PARTICULAR FONT, STYLE, SIZE, OR COLOR.

SER. NO. 85-412,539, FILED 9-1-2011.

WARREN L. OLANDRIA, EXAMINING ATTORNEY

United States of America

United States Patent and Trademark Office



Reg. No. 4,204,715

Registered Sep. 11, 2012

Int. Cl.: 42

SERVICE MARK

PRINCIPAL REGISTER

CUMMINGS ENGINEERING CONSULTANTS, INCORPORATED (ARIZONA CORPORATION)
145 S. 79TH STREET, SUITE 26
CHANDLER, AZ 85226

FOR: COMPUTER HARDWARE AND SOFTWARE CONSULTING SERVICES; COMPUTER SERVICES, NAMELY, ACTING AS AN APPLICATION SERVICE PROVIDER IN THE FIELD OF INFORMATION MANAGEMENT TO HOST COMPUTER APPLICATION SOFTWARE FOR THE PURPOSE OF CRYPTOGRAPHIC SYSTEMS; COMPUTER SERVICES, NAMELY, REMOTE AND ON-SITE MANAGEMENT OF CRYPTOGRAPHIC SYSTEMS OF OTHERS; COMPUTER SOFTWARE DEVELOPMENT IN THE FIELD OF CRYPTOGRAPHIC SYSTEMS; COMPUTER SOFTWARE DEVELOPMENT, COMPUTER PROGRAMMING AND MAINTENANCE OF COMPUTER SOFTWARE FOR CRYPTOGRAPHIC SYSTEMS; CONSULTING SERVICES IN THE FIELD OF THE DESIGN OF CRYPTOGRAPHIC SYSTEMS; DESIGN AND DEVELOPMENT OF COMPUTER SOFTWARE FOR CRYPTOGRAPHIC SYSTEMS; DESIGN AND DEVELOPMENT OF SOFTWARE AND HARDWARE FOR CRYPTOGRAPHIC SYSTEMS; DESIGN FOR OTHERS IN THE FIELD OF CRYPTOGRAPHIC SYSTEMS; DESIGN, DEVELOPMENT, AND CONSULTING SERVICES RELATED THERETO IN THE FIELD OF CRYPTOGRAPHIC SYSTEMS; DESIGN, DEVELOPMENT, AND IMPLEMENTATION OF SOFTWARE FOR CRYPTOGRAPHIC SYSTEMS; INSTALLATION AND MAINTENANCE OF CRYPTOGRAPHIC SYSTEM SOFTWARE; INSTALLATION OF CRYPTOGRAPHIC SYSTEM SOFTWARE; INSTALLATION, MAINTENANCE AND REPAIR OF CRYPTOGRAPHIC SYSTEM SOFTWARE; MAINTENANCE OF COMPUTER SOFTWARE USED FOR CRYPTOGRAPHIC SYSTEMS; PLATFORM AS A SERVICE (PAAS) FEATURING COMPUTER SOFTWARE PLATFORMS FOR OPERATING AND MANAGING CRYPTOGRAPHIC SYSTEMS; PROVIDING ON-LINE NON-DOWNLOADABLE SOFTWARE FOR OPERATING AND MANAGING CRYPTOGRAPHIC SYSTEMS; PROVIDING TEMPORARY USE OF ON-LINE NON-DOWNLOADABLE SOFTWARE FOR OPERATING AND MANAGING CRYPTOGRAPHIC SYSTEMS; SOFTWARE AS A SERVICE (SAAS) SERVICES FEATURING SOFTWARE FOR OPERATING AND MANAGING CRYPTOGRAPHIC SYSTEMS; SOFTWARE DEVELOPMENT AND PRODUCT DEVELOPMENT CONSULTING IN THE FIELD OF CRYPTOGRAPHIC SYSTEMS; SOFTWARE DEVELOPMENT CONSULTING IN THE FIELD OF CRYPTOGRAPHIC SYSTEMS; SOFTWARE DEVELOPMENT IN THE FIELD OF CRYPTOGRAPHIC SYSTEMS; TECHNOLOGY SPECIFICATION, NAMELY, ANALYZING TECHNOLOGY REQUIREMENTS AND DEVELOPING RECOMMENDATIONS FOR THE COMPUTER SOFTWARE AND SYSTEMS AND OTHER TECHNOLOGY NEEDED TO MEET THOSE REQUIREMENTS, IN THE FIELD OF CRYPTOGRAPHIC SYSTEMS, IN CLASS 42 (U.S. CLS. 100 AND 101).



David J. Kybas

Director of the United States Patent and Trademark Office

Reg. No. 4,204,715 FIRST USE 9-1-2009; IN COMMERCE 9-29-2009.

NO CLAIM IS MADE TO THE EXCLUSIVE RIGHT TO USE "SECUREMOBILE", APART FROM THE MARK AS SHOWN.

THE MARK CONSISTS OF THE WORDING "SECUREMOBILE" WITH THREE (3) CONCENTRIC CURVES EMITTING FROM THE DOT ABOVE THE "I" IN THE WORD "MOBILE"; THE WORDING "SECUREMOBILE" APPEARS ON A RECTANGULAR BACKGROUND WITH A PAD LOCK ATTACHED TO THE UPPER RIGHT CORNER OF THE RECTANGLE.

SER. NO. 85-412,550, FILED 9-1-2011.

WARREN L. OLANDRIA, EXAMINING ATTORNEY

United States of America

United States Patent and Trademark Office

Paris Trunk

Reg. No. 4,204,716

ECO GREEN CRAFTS, INC. (NEW JERSEY CORPORATION)
271 ROUTE 46 WEST, SUITE F205
FAIRFIELD, NJ 07004

Registered Sep. 11, 2012

Int. Cl.: 16

FOR: STAMP INKS, IN CLASS 16 (U.S. CLS. 2, 5, 22, 23, 29, 37, 38 AND 50).

TRADEMARK

FIRST USE 1-1-2010; IN COMMERCE 1-1-2010.

PRINCIPAL REGISTER

SER. NO. 85-412,597, FILED 9-1-2011.

DEIRDRE ROBERTSON, EXAMINING ATTORNEY



David J. Kybas

Director of the United States Patent and Trademark Office

United States of America

United States Patent and Trademark Office

CATALYST

Reg. No. 4,204,717

Registered Sep. 11, 2012

Int. Cl.: 9

TRADEMARK

PRINCIPAL REGISTER

CATALYST INC. (OHIO NON-PROFIT CORPORATION)
120 WALL STREET, 5TH FLOOR
NEW YORK, NY 10005

FOR: DOWNLOADABLE AUDIO FILES, VIDEO FILES, DATA FILES, AND ELECTRONIC PUBLICATIONS IN THE NATURE OF BOOKS, NEWSLETTERS, ARTICLES, AND REPORTS, AND DVDS AND CDS ALL FEATURING EDUCATIONAL AND TRAINING INFORMATION DEVOTED TO PROMOTING THE INTERESTS OF WOMEN, NAMELY, ISSUES OF GENDER DIVERSITY AND DIVERSITY AND INCLUSION IN THE WORKPLACE, IN CLASS 9 (U.S. CLS. 21, 23, 26, 36 AND 38).

FIRST USE 9-30-1980; IN COMMERCE 9-30-1980.

THE MARK CONSISTS OF STANDARD CHARACTERS WITHOUT CLAIM TO ANY PARTICULAR FONT, STYLE, SIZE, OR COLOR.

OWNER OF U.S. REG. NO. 1,265,713.

SER. NO. 85-412,677, FILED 9-1-2011.

ROBERT STRUCK, EXAMINING ATTORNEY



David J. Kyffers

Director of the United States Patent and Trademark Office

United States of America

United States Patent and Trademark Office



Reg. No. 4,204,718

Registered Sep. 11, 2012

Int. Cl.: 35

NATIONAL BLACK LEADERSHIP COMMISSION ON AIDS, INC. (NEW YORK NON-PROFIT CORPORATION)
CORPORATION)
SUITE 2303
120 WALL STREET
NEW YORK, NY 10005

SERVICE MARK

FOR: PROVIDING A WEBSITE FEATURING INFORMATION TO PROMOTE PUBLIC AWARENESS OF HIV/AIDS, IN CLASS 35 (U.S. CLS. 100, 101 AND 102).

PRINCIPAL REGISTER

FIRST USE 0-0-2001; IN COMMERCE 0-0-2001.

THE MARK CONSISTS OF A RIBBON THAT IS DIVIDED IN HALF ALONG ITS LENGTH, WITH ONE HALF OF THE RIBBON BEING RED AND THE OTHER HALF IN THE GEOMETRIC PATTERN OF A TRADITIONAL AFRICAN KENTE CLOTH WITH GREEN, RED, WHITE, PURPLE AND BLACK RECTANGLES AND STRIPES AND YELLOW TRIANGLES AND GREEN TRIANGLES, AND A RECTANGULAR BACKGROUND OF FOUR STRIPES BEHIND THE RIBBON IN SHADES OF YELLOW AND BEIGE.

THE COLOR(S) YELLOW, RED, WHITE, PURPLE, BLACK, GREEN AND BEIGE IS/ARE CLAIMED AS A FEATURE OF THE MARK.

SER. NO. 85-412,844, FILED 9-1-2011.

SARA BENJAMIN, EXAMINING ATTORNEY



David J. Kybas

Director of the United States Patent and Trademark Office

United States of America

United States Patent and Trademark Office



Reg. No. 4,204,719

Registered Sep. 11, 2012

Int. Cl.: 35

NATIONAL BLACK LEADERSHIP COMMISSION ON AIDS, INC. (NEW YORK NON-PROFIT CORPORATION)

SUITE 2303
120 WALL STREET
NEW YORK, NY 10005

SERVICE MARK

FOR: PROMOTING PUBLIC AWARENESS OF HIV/AIDS, PARTICULARLY IN THE BLACK COMMUNITY, THROUGH EDUCATIONAL PROGRAMS, IN CLASS 35 (U.S. CLS. 100, 101 AND 102).

PRINCIPAL REGISTER

FIRST USE 12-0-1987; IN COMMERCE 12-0-1987.

THE MARK CONSISTS OF A RIBBON THAT IS DIVIDED IN HALF ALONG ITS LENGTH, WITH ONE HALF OF THE RIBBON BEING RED AND THE OTHER HALF IN THE GEOMETRIC PATTERN OF A TRADITIONAL AFRICAN KENTE CLOTH WITH GREEN, RED, WHITE, PURPLE AND BLACK RECTANGLES AND STRIPES AND YELLOW TRIANGLES AND GREEN TRIANGLES, AND A RECTANGULAR BACKGROUND OF FOUR STRIPES BEHIND THE RIBBON IN SHADES OF YELLOW AND BEIGE.

THE COLOR(S) YELLOW, RED, WHITE, PURPLE, BLACK, GREEN AND BEIGE IS/ARE CLAIMED AS A FEATURE OF THE MARK.

SER. NO. 85-412,849, FILED 9-1-2011.

SARA BENJAMIN, EXAMINING ATTORNEY



David J. Kyjars

Director of the United States Patent and Trademark Office

United States of America

United States Patent and Trademark Office

HAND BUILT DIGITAL

Reg. No. 4,204,720

Registered Sep. 11, 2012

Int. Cl.: 41

SERVICE MARK

PRINCIPAL REGISTER

REHABSTUDIO LIMITED (NORTHERN IRELAND LIMITED COMPANY (LTD.))
UNIT 12, 8 CROMAC AVE
ORMEAU BUSINESS PARK
BELFAST, NORTHERN IRELAND BT72JA

FOR: MULTIMEDIA ENTERTAINMENT SERVICES IN THE NATURE OF DEVELOPMENT, PRODUCTION AND POST-PRODUCTION SERVICES IN THE FIELDS OF VIDEO AND FILMS, IN CLASS 41 (U.S. CLS. 100, 101 AND 107).

FIRST USE 4-6-2005; IN COMMERCE 5-8-2008.

THE MARK CONSISTS OF STANDARD CHARACTERS WITHOUT CLAIM TO ANY PARTICULAR FONT, STYLE, SIZE, OR COLOR.

NO CLAIM IS MADE TO THE EXCLUSIVE RIGHT TO USE "DIGITAL", APART FROM THE MARK AS SHOWN.

SER. NO. 85-413,187, FILED 9-1-2011.

SKYE YOUNG, EXAMINING ATTORNEY



David J. Kyffers

Director of the United States Patent and Trademark Office

United States of America

United States Patent and Trademark Office

WHAT A GIRL EATS

Reg. No. 4,204,721

WOODMAN, CYNTHIA (UNITED STATES INDIVIDUAL)
2176 LAMBERT DRIVE
PASADENA, CA 91107

Registered Sep. 11, 2012

Int. Cls.: 43 and 44

FOR: EDUCATIONAL AND ENTERTAINMENT SERVICES, NAMELY, PROVIDING INFORMATION IN THE FIELDS OF FOOD PREPARATION, COOKING, AND RESTAURANTS VIA WIRED AND WIRELESS GLOBAL COMPUTER NETWORKS, IN CLASS 43 (U.S. CLS. 100 AND 101).

SERVICE MARK

PRINCIPAL REGISTER

FIRST USE 5-29-2011; IN COMMERCE 5-29-2011.

FOR: EDUCATIONAL AND ENTERTAINMENT SERVICES, NAMELY, PROVIDING INFORMATION IN THE FIELDS OF NUTRITION AND DIET VIA WIRED AND WIRELESS GLOBAL COMPUTER NETWORKS, IN CLASS 44 (U.S. CLS. 100 AND 101).

FIRST USE 5-29-2011; IN COMMERCE 5-29-2011.

THE MARK CONSISTS OF STANDARD CHARACTERS WITHOUT CLAIM TO ANY PARTICULAR FONT, STYLE, SIZE, OR COLOR.

SER. NO. 85-414,677, FILED 9-2-2011.

SUNG IN, EXAMINING ATTORNEY



David J. Kyfos

Director of the United States Patent and Trademark Office

United States of America

United States Patent and Trademark Office

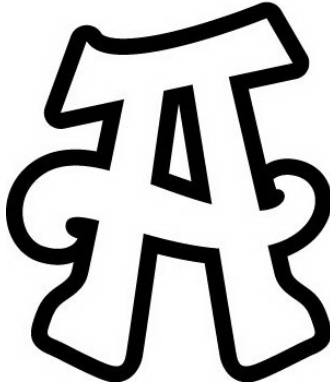

Reg. No. 4,204,722

Registered Sep. 11, 2012

Int. Cl.: 25

TRADEMARK

PRINCIPAL REGISTER

DEWINE SEEDS-SILVER DOLLAR BASEBALL, LLC (NORTH CAROLINA LIMITED LIABILITY COMPANY)
30 BUCHANAN PLACE
ASHEVILLE, NC 28001

FOR: CLOTHING, NAMELY, APRONS, ATHLETIC UNIFORMS, BANDANAS, SHORTS, CAPS, CLOTH BABY BIBS, COATS, GOLF SHIRTS, GYM SHORTS, GYM SUITS, HATS, JACKETS, JERSEYS, JOGGING SUITS, KNIT SHIRTS, POLO SHIRTS, PONCHOS, PULLOVERS, RAIN COATS, RAINWEAR, SWEATERS, SWEAT PANTS, SWEAT SHIRTS, SWEAT SUITS, SOCKS, SPORT SHIRTS, T- SHIRTS, TANK TOPS, TIES, VISORS, WIND RESISTANT JACKETS AND WRISTBANDS, IN CLASS 25 (U.S. CLS. 22 AND 39).

FIRST USE 11-9-2010; IN COMMERCE 11-9-2010.

THE MARK CONSISTS OF A STYLIZED LETTER "A".

SER. NO. 85-415,795, FILED 9-6-2011.

AMY KELLY, EXAMINING ATTORNEY



David J. Kyffers

Director of the United States Patent and Trademark Office

United States of America

United States Patent and Trademark Office



Reg. No. 4,204,723

Registered Sep. 11, 2012

Int. Cl.: 10

TRADEMARK

PRINCIPAL REGISTER

PRIME MEDICAL RESOURCES INC. (CALIFORNIA CORPORATION)
1317 NORTH SAN FERNANDO BLVD, UNIT 315
BURBANK, CA 91504

FOR: ELECTROMEDICAL REHABILITATIVE AND PAIN MANAGEMENT PRODUCTS FOR CLINICAL AND HOME USE, NAMELY, ELECTRICAL NERVE AND MUSCLE STIMULATORS, ULTRASONIC STIMULATORS, MAGNET THERAPY STIMULATORS AND LASER THERAPY STIMULATORS, IN CLASS 10 (U.S. CLS. 26, 39 AND 44).

FIRST USE 1-0-2009; IN COMMERCE 1-0-2009.

NO CLAIM IS MADE TO THE EXCLUSIVE RIGHT TO USE "ELECTRO CARE", APART FROM THE MARK AS SHOWN.

THE COLOR(S) RED, WHITE AND GRAY IS/ARE CLAIMED AS A FEATURE OF THE MARK.

THE MARK CONSISTS OF A GRAY HEART BEAT STATUS SYMBOL WITH WORDS "PRIME" AND "ELECTRO" IN RED SEPARATED BY THE HEART BEAT SYMBOL AND BELOW IS THE WORD "CARE" IN WHITE INSIDE A RED RECTANGLE.

SER. NO. 85-416,267, FILED 9-7-2011.

KELLY TRUSILO, EXAMINING ATTORNEY



David J. Kybas

Director of the United States Patent and Trademark Office

United States of America

United States Patent and Trademark Office

LAYER UP

Reg. No. 4,204,724

ACUSHNET COMPANY (DELAWARE CORPORATION)
333 BRIDGE STREET
FAIRHAVEN, MA 02719

Registered Sep. 11, 2012

Int. Cl.: 25

FOR: PERFORMANCE OUTERWEAR, NAMELY, PULLOVERS, PANTS, SHORTS, SWEATERS, GOLF SHIRTS, LONG-SLEEVE SHIRTS, JACKETS, VESTS AND WEATHER RESISTANT ATHLETIC PANTS, IN CLASS 25 (U.S. CLS. 22 AND 39).

TRADEMARK

FIRST USE 8-0-2010; IN COMMERCE 8-0-2010.

PRINCIPAL REGISTER

THE MARK CONSISTS OF STANDARD CHARACTERS WITHOUT CLAIM TO ANY PARTICULAR FONT, STYLE, SIZE, OR COLOR.

SER. NO. 85-416,828, FILED 9-7-2011.

VIVIAN MICZNIK FIRST, EXAMINING ATTORNEY



David J. Kybas

Director of the United States Patent and Trademark Office

United States of America

United States Patent and Trademark Office



Reg. No. 4,204,725

SYLVAN ENERGY, LLC (TEXAS LIMITED LIABILITY COMPANY)
1305 GRANDVIEW AVENUE
PITTSBURGH, PA 15211

Registered Sep. 11, 2012

Int. Cls.: 40 and 42

FOR: OIL AND GAS PRODUCTION, IN CLASS 40 (U.S. CLS. 100, 103 AND 106).

SERVICE MARK

FIRST USE 10-9-2007; IN COMMERCE 10-9-2007.

PRINCIPAL REGISTER

FOR: OIL AND GAS EXPLORATION , IN CLASS 42 (U.S. CLS. 100 AND 101).

FIRST USE 10-9-2007; IN COMMERCE 10-9-2007.

NO CLAIM IS MADE TO THE EXCLUSIVE RIGHT TO USE "ENERGY", APART FROM THE MARK AS SHOWN.

THE MARK CONSISTS OF THE WORDS "SYLVAN ENERGY" FOLLOWED BY A STYLIZED TREE HAVING A BOTTOM TRUNK PORTION RESEMBLING AN OIL DERRICK AND A TOP PORTION RESEMBLING LEAVES, THE LITERAL AND DESIGN ELEMENTS ARE POSITIONED ABOVE A HORIZONTAL LINE.

SER. NO. 85-416,839, FILED 9-7-2011.

ANTHONY RINKER, EXAMINING ATTORNEY



David J. Kybas

Director of the United States Patent and Trademark Office

United States of America

United States Patent and Trademark Office

SYLVAN ENERGY

Reg. No. 4,204,726

SYLVAN ENERGY, LLC (TEXAS LIMITED LIABILITY COMPANY)
1305 GRANDVIEW AVENUE
PITTSBURGH, PA 15211

Registered Sep. 11, 2012

Int. Cls.: 40 and 42

FOR: OIL AND GAS PRODUCTION, IN CLASS 40 (U.S. CLS. 100, 103 AND 106).

SERVICE MARK

FIRST USE 10-9-2007; IN COMMERCE 10-9-2007.

PRINCIPAL REGISTER

FOR: OIL AND GAS EXPLORATION , IN CLASS 42 (U.S. CLS. 100 AND 101).

FIRST USE 10-9-2007; IN COMMERCE 10-9-2007.

THE MARK CONSISTS OF STANDARD CHARACTERS WITHOUT CLAIM TO ANY PARTICULAR FONT, STYLE, SIZE, OR COLOR.

NO CLAIM IS MADE TO THE EXCLUSIVE RIGHT TO USE "ENERGY", APART FROM THE MARK AS SHOWN.

SER. NO. 85-416,882, FILED 9-7-2011.

ANTHONY RINKER, EXAMINING ATTORNEY



David J. Kybas

Director of the United States Patent and Trademark Office

United States of America

United States Patent and Trademark Office



Reg. No. 4,204,727

SHREINER TREE CARE SPECIALISTS, INC. (PENNSYLVANIA CORPORATION)
334 S. HENDERSON ROAD
KING OF PRUSSIA, PA 19406

Registered Sep. 11, 2012

Int. Cl.: 44

FOR: TREE CARE SERVICES, NAMELY, TREE SURGERY, ORNAMENTAL AND SAFETY PRUNING AND TRIMMING OF TREES AND SHRUBS, TREE FERTILIZATION AND TREE CARE MAINTENANCE FOR TREE PRESERVATION, DISEASE PREVENTION, DIAGNOSIS AND PROTECTIVE TREATMENT OF TREES AND SHRUBS, HAZARDOUS TREE EVALUATIONS TO DETERMINE WHETHER PRUNING IS REQUIRED, TREE REMOVALS AND STUMP GRINDING; LANDSCAPE PLANTINGS; PLANT HEALTH CARE SERVICES, NAMELY, INSPECTIONS AND MONITORING, TREE AND SHRUB FERTILIZATION, AND PEST CONTROL SERVICES FOR AGRICULTURAL PURPOSES, NAMELY, APPLYING INSECT AND DEER REPELLENT TREATMENTS, DISEASE MANAGEMENT AND INSECT AND DEER BROWSING CONTROL SERVICES; LANDSCAPE CARE OF GOLF FACILITIES, COMMERCIAL AND INSTITUTIONAL PROPERTIES, IN CLASS 44 (U.S. CLS. 100 AND 101).

SERVICE MARK

PRINCIPAL REGISTER

FIRST USE 8-1-2011; IN COMMERCE 8-1-2011.

NO CLAIM IS MADE TO THE EXCLUSIVE RIGHT TO USE "TREE CARE", APART FROM THE MARK AS SHOWN.

THE COLOR(S) GREEN AND YELLOW IS/ARE CLAIMED AS A FEATURE OF THE MARK.



THE MARK CONSISTS OF AN IMAGE OF A TREE WITHIN A SQUARE HAVING SEPARATE HALVES IN ALTERNATE COLORS. THE BACKGROUND OF THE LEFT SIDE OF THE SQUARE IS GREEN AND HALF OF THE TREE IS YELLOW. THE RIGHT SIDE OF THE SQUARE IS YELLOW AND BORDERED IN GREEN AND SHOWS THE RIGHT HALF OF THE TREE IN GREEN. NEXT TO THIS IMAGE ARE THE WORDS "SHREINER TREE CARE" IN GREEN. IN BETWEEN THE WORDS "SHREINER" AND "TREE CARE" ARE TWO HORIZONTAL LINES IN YELLOW AND GREEN.

SER. NO. 85-419,227, FILED 9-9-2011.

David J. Kypos

MICHELLE DUBOIS, EXAMINING ATTORNEY

United States of America

United States Patent and Trademark Office

Magicow

Reg. No. 4,204,728

EIEIO, INC. (TEXAS CORPORATION)
1615 RUTHERFORD LANE
AUSTIN, TX 78754

Registered Sep. 11, 2012

Int. Cls.: 11, 29 and 30

FOR: TEMPERATURE-CONTROLLED FOOD AND BEVERAGE DISPENSERS, AND COMPONENTS THEREOF, IN CLASS 11 (U.S. CLS. 13, 21, 23, 31 AND 34).

TRADEMARK

FIRST USE 3-28-2000; IN COMMERCE 1-1-2002.

PRINCIPAL REGISTER

FOR: COFFEE CREAMER, IN CLASS 29 (U.S. CL. 46).

FIRST USE 3-28-2000; IN COMMERCE 1-1-2002.

FOR: FLAVORINGS FOR BEVERAGES, IN CLASS 30 (U.S. CL. 46).

FIRST USE 3-28-2000; IN COMMERCE 1-1-2002.

THE MARK CONSISTS OF STANDARD CHARACTERS WITHOUT CLAIM TO ANY PARTICULAR FONT, STYLE, SIZE, OR COLOR.

OWNER OF U.S. REG. NO. 3,016,060.

SER. NO. 85-419,527, FILED 9-10-2011.

ROBIN CHOSID, EXAMINING ATTORNEY



David J. Kybas

Director of the United States Patent and Trademark Office

United States of America

United States Patent and Trademark Office

SAMBA SOLEIL

Reg. No. 4,204,729

SAMBA SOLEIL, INC. (NEW YORK CORPORATION)
356 SUCCABONE RD
BEDFORD CORNERS, NY 10549

Registered Sep. 11, 2012

Int. Cl.: 25

FOR: DRESSES, IN CLASS 25 (U.S. CLS. 22 AND 39).

TRADEMARK

FIRST USE 5-25-2010; IN COMMERCE 7-27-2010.

PRINCIPAL REGISTER

THE MARK CONSISTS OF STANDARD CHARACTERS WITHOUT CLAIM TO ANY PARTICULAR FONT, STYLE, SIZE, OR COLOR.

THE ENGLISH TRANSLATION OF THE WORD "SOLEIL" IN THE MARK IS "SUN".

SER. NO. 85-419,556, FILED S.R. 9-10-2011 AM. P.R. 5-3-2012.

CIMMERIAN COLEMAN, EXAMINING ATTORNEY



David J. Kyffers

Director of the United States Patent and Trademark Office

United States of America

United States Patent and Trademark Office

Tropicow

Reg. No. 4,204,730

Registered Sep. 11, 2012

Int. Cl.: 32

TRADEMARK

PRINCIPAL REGISTER

EIEIO, INC. (TEXAS CORPORATION)
1615 RUTHERFORD LANE
AUSTIN, TX 78754

FOR: SMOOTHIES, IN CLASS 32 (U.S. CLS. 45, 46 AND 48).

FIRST USE 2-22-2010; IN COMMERCE 3-15-2010.

THE MARK CONSISTS OF STANDARD CHARACTERS WITHOUT CLAIM TO ANY PARTICULAR FONT, STYLE, SIZE, OR COLOR.

SER. NO. 85-419,778, FILED 9-11-2011.

ROBIN CHOSID, EXAMINING ATTORNEY



David J. Kybas

Director of the United States Patent and Trademark Office

United States of America

United States Patent and Trademark Office



Reg. No. 4,204,731

EIEIO, INC. (TEXAS CORPORATION)
1615 RUTHERFORD LANE
AUSTIN, TX 78754

Registered Sep. 11, 2012

Int. Cl.: 32

FOR: SMOOTHIES, IN CLASS 32 (U.S. CLS. 45, 46 AND 48).

TRADEMARK

FIRST USE 2-22-2010; IN COMMERCE 3-15-2010.

PRINCIPAL REGISTER

NO CLAIM IS MADE TO THE EXCLUSIVE RIGHT TO USE "FRUIT SMOOTHIES", APART FROM THE MARK AS SHOWN.

THE MARK CONSISTS OF THE WORDS "TROPICOW FRUIT SMOOTHIES" ASIDE A COW IN A HULA SKIRT IN THE FOREGROUND WITH PALM TREES IN THE BACKGROUND.

SER. NO. 85-419,780, FILED 9-11-2011.

ROBIN CHOSID, EXAMINING ATTORNEY



David J. Kybas

Director of the United States Patent and Trademark Office

United States of America

United States Patent and Trademark Office



Reg. No. 4,204,732

EIEIO, INC. (TEXAS CORPORATION)
1615 RUTHERFORD LANE
AUSTIN, TX 78754

Registered Sep. 11, 2012

Int. Cl.: 29

FOR: WHIPPED TOPPING, IN CLASS 29 (U.S. CL. 46).

TRADEMARK

FIRST USE 12-20-2010; IN COMMERCE 1-1-2011.

PRINCIPAL REGISTER

NO CLAIM IS MADE TO THE EXCLUSIVE RIGHT TO USE "WHIP", APART FROM THE MARK AS SHOWN.

THE MARK CONSISTS OF THE WORD "WHIPTOPPER" WITH A WHIPPED TOPPING ANIMATED CHARACTER WEARING A TUXEDO AND HOLDING A WHISK AND HAT.

SER. NO. 85-419,786, FILED 9-11-2011.

ROBIN CHOSID, EXAMINING ATTORNEY



David J. Kybas

Director of the United States Patent and Trademark Office

United States of America

United States Patent and Trademark Office

LIFEPRINT

Reg. No. 4,204,733

Registered Sep. 11, 2012

**Int. Cls.: 36, 41, 43 and
44**

UNITEDHEALTH GROUP INCORPORATED (MINNESOTA CORPORATION)
MN008-T202
9900 BREN ROAD EAST
MINNETONKA, MN 55343

FOR: INSURANCE CLAIMS PROCESSING, IN CLASS 36 (U.S. CLS. 100, 101 AND 102).

FIRST USE 2-0-2011; IN COMMERCE 2-0-2011.

SERVICE MARK

PRINCIPAL REGISTER

FOR: EDUCATIONAL SERVICES, NAMELY, CONDUCTING PROGRAMS AND CLASSES IN THE FIELDS OF HEALTH, WELLNESS, NUTRITION, AND HEALTHY LIFESTYLE; PROVIDING A CENTER FOR EDUCATIONAL CLASSES IN THE FIELD OF HEALTH, WELLNESS, NUTRITION, AND HEALTHY LIFESTYLES, IN CLASS 41 (U.S. CLS. 100, 101 AND 107).

FIRST USE 2-0-2011; IN COMMERCE 2-0-2011.

FOR: PROVIDING COMMUNITY CENTERS FOR SOCIAL GATHERINGS, IN CLASS 43 (U.S. CLS. 100 AND 101).

FIRST USE 2-0-2011; IN COMMERCE 2-0-2011.

FOR: HEALTHCARE SERVICES, NAMELY, ESTABLISHING A NETWORK OF PHYSICIANS; MANAGED HEALTHCARE SERVICES; MEDICAL CLINICS; HEALTHCARE SERVICES; COUNSELING SERVICES IN THE FIELDS OF HEALTH, WELLNESS, NUTRITION AND HEALTHY LIFESTYLE; CONDUCTING PERSONAL HEALTH, WELLNESS, NUTRITION AND LIFESTYLE ASSESSMENTS, IN CLASS 44 (U.S. CLS. 100 AND 101).

FIRST USE 2-0-2011; IN COMMERCE 2-0-2011.

THE MARK CONSISTS OF STANDARD CHARACTERS WITHOUT CLAIM TO ANY PARTICULAR FONT, STYLE, SIZE, OR COLOR.

SER. NO. 85-420,352, FILED 9-12-2011.

ESTHER A. BORSUK, EXAMINING ATTORNEY



David J. Kyffers

Director of the United States Patent and Trademark Office

United States of America

United States Patent and Trademark Office

Akros Labs

Reg. No. 4,204,734

JAVIER MILIAN (UNITED STATES INDIVIDUAL)
8920 NW 166 TERRACE
MIAMI LAKES, FL 330186113

Registered Sep. 11, 2012

Int. Cl.: 9

FOR: KITS COMPRISING MICROCHIPS, MICRO-PROCESSORS, VOLTAGE REGULATORS, ELECTRIC RESISTORS, ELECTRIC WIRES, CAPACITATORS, AND CIRCUIT BOARDS FOR THE ASSEMBLY OF WIRED AND WIRELESS CONTROLLERS TO MONITOR AND CONTROL THE FUNCTIONING OF OTHER ELECTRONIC DEVICES, AND STRUCTURAL AND REPLACEMENT PARTS THEREOF, IN CLASS 9 (U.S. CLS. 21, 23, 26, 36 AND 38).

TRADEMARK

PRINCIPAL REGISTER

FIRST USE 6-15-2011; IN COMMERCE 6-15-2011.

THE MARK CONSISTS OF STANDARD CHARACTERS WITHOUT CLAIM TO ANY PARTICULAR FONT, STYLE, SIZE, OR COLOR.

NO CLAIM IS MADE TO THE EXCLUSIVE RIGHT TO USE "LABS", APART FROM THE MARK AS SHOWN.

SER. NO. 85-421,964, FILED 9-13-2011.

JANET LEE, EXAMINING ATTORNEY



David J. Kyffers

Director of the United States Patent and Trademark Office

United States of America

United States Patent and Trademark Office



Reg. No. 4,204,735

Registered Sep. 11, 2012

**Int. Cls.: 7, 9, 22, 35, 36,
37, 39, 41 and 42**

TRADEMARK

SERVICE MARK

PRINCIPAL REGISTER

HARCO CO. LTD. (CANADA CORPORATION)
5915 COOPERS AVENUE
MISSISSAUGA, ONTARIO, CANADA L4Z1R9

FOR: LAUNDRY AND DRY CLEANING MACHINE SYSTEMS, NAMELY, WASHERS, EXTRACTORS, DRY TUMBLERS, FLATWORK IRONERS, FOLDERS, CROSS FOLDERS, SPREADER FEEDERS, SMALL PIECE FOLDERS, TUNNEL WASHERS, DRY CLEANING UNITS, SHIRT FINISHING SYSTEMS, UTILITY PRESSES, BOILERS AND HEATERS; TEXTILE MACHINES, NAMELY, WASHERS, DRYERS AND IRONING MACHINES; LAUNDRY AND DRY CLEANING SYSTEMS, NAMELY, COMBINED CLOTHES WASHERS AND DRYERS AND ACCESSORIES AND PARTS THEREFORE, IN CLASS 7 (U.S. CLS. 13, 19, 21, 23, 31, 34 AND 35).

FOR: ENCODED SMART CARDS CONTAINING PROGRAMMING USED TO ACCESS LAUNDRY MACHINES AND DRY CLEANING SYSTEMS, IN CLASS 9 (U.S. CLS. 21, 23, 26, 36 AND 38).

FOR: LAUNDRY BAGS, IN CLASS 22 (U.S. CLS. 1, 2, 7, 19, 22, 42 AND 50).

FOR: WHOLESALE DISTRIBUTORSHIP SERVICES FEATURING LAUNDRY AND DRY CLEANING MACHINE SYSTEMS; BUSINESS CONSULTATION SERVICES IN THE LAUNDRY AND DRY CLEANING INDUSTRY, NAMELY, WORK FLOW PLANNING, LABOR, OPERATING AND COST ANALYSIS, EQUIPMENT SELECTION AND PROCUREMENT, INVENTORY MANAGEMENT AND CONTROL CONSULTATION, IN CLASS 35 (U.S. CLS. 100, 101 AND 102).

FOR: PROVISION OF WARRANTIES FOR LAUNDRY AND DRY CLEANING SYSTEMS FOR THIRD PARTIES, IN CLASS 36 (U.S. CLS. 100, 101 AND 102).

FOR: APPLIANCE INSTALLATION, REPAIR AND MAINTENANCE SERVICES, NAMELY, INSTALLATION, REPAIR, CONSULTATION AND MAINTENANCE SERVICES RELATED TO LAUNDRY AND DRY CLEANING SYSTEMS; APPLIANCE CONSULTATION SERVICES, NAMELY, CONSULTATION SERVICES IN THE FIELD OF LAUNDRY AND DRY CLEANING MACHINE INSTALLATION, MAINTENANCE AND REPAIR SYSTEMS; LAUNDRY AND DRY CLEANING MACHINERY MAINTENANCE CONSULTATION SERVICES; PROVISION OF LEASING SERVICES FOR LAUNDRY AND DRY CLEANING SYSTEMS, IN CLASS 37 (U.S. CLS. 100, 103 AND 106).



David J. Kybas

Director of the United States Patent and Trademark Office

Reg. No. 4,204,735 FOR: STORAGE CONSULTATION, NAMELY, WAREHOUSING CONSULTATION IN THE FIELD OF THE LAUNDRY AND DRY CLEANING INDUSTRY, IN CLASS 39 (U.S. CLS. 100 AND 105).

FOR: EDUCATION CONSULTATION IN THE FIELD OF OPERATOR TRAINING IN THE LAUNDRY AND DRY CLEANING INDUSTRY, IN CLASS 41 (U.S. CLS. 100, 101 AND 107).

FOR: DESIGN CONSULTING SERVICES, NAMELY, DESIGN ENGINEERING CONSULTATION IN THE FIELD OF LAUNDRY AND DRY CLEANING INDUSTRY MACHINERY, IN CLASS 42 (U.S. CLS. 100 AND 101).

PRIORITY CLAIMED UNDER SEC. 44(D) ON CANADA APPLICATION NO. 1521068, FILED 3-28-2011, REG. NO. TMA822160, DATED 4-16-2012, EXPIRES 4-16-2027.

NO CLAIM IS MADE TO THE EXCLUSIVE RIGHT TO USE "LAUNDRY SYSTEMS", APART FROM THE MARK AS SHOWN.

THE MARK CONSISTS OF THE STYLIZED LETTERING OF THE WORD "HARCO" FOLLOWED BY THE SWIRLING EDDY DESIGN THAT APPEARS AGAINST THE BACKGROUND OF TWO EQUAL SIZED PARALLELOGRAMS, THE LEFT ONE DARKER THAN THE RIGHT ONE. BELOW THE LETTER "A" IN "HARCO" APPEARS THE PHRASE "LEADERS IN LAUNDRY SYSTEMS".

SER. NO. 85-422,045, FILED 9-14-2011.

AMY C. KEAN, EXAMINING ATTORNEY

United States of America

United States Patent and Trademark Office



Reg. No. 4,204,736

Registered Sep. 11, 2012

Int. Cls.: 7, 9, 22, 35, 36, 37, 39, 41 and 42

TRADEMARK

SERVICE MARK

PRINCIPAL REGISTER

HARCO CO. LTD. (CANADA CORPORATION)
5915 COOPERS AVENUE
MISSISSAUGA, ONTARIO, CANADA L4Z1R9

FOR: LAUNDRY AND DRY CLEANING MACHINE SYSTEMS, NAMELY, WASHERS, EXTRACTORS, DRY TUMBLERS, FLATWORK IRONERS, FOLDERS, CROSS FOLDERS, SPREADER FEEDERS, SMALL PIECE FOLDERS, TUNNEL WASHERS, DRY CLEANING UNITS, SHIRT FINISHING SYSTEMS, UTILITY PRESSES, BOILERS AND HEATERS; TEXTILE MACHINES, NAMELY, WASHERS, DRYERS AND IRONING MACHINES; LAUNDRY AND DRY CLEANING SYSTEMS, NAMELY, COMBINED CLOTHES WASHERS AND DRYERS AND ACCESSORIES AND PARTS THEREFORE, IN CLASS 7 (U.S. CLS. 13, 19, 21, 23, 31, 34 AND 35).

FOR: ENCODED SMART CARDS CONTAINING PROGRAMMING USED TO ACCESS LAUNDRY MACHINES AND DRY CLEANING SYSTEMS, IN CLASS 9 (U.S. CLS. 21, 23, 26, 36 AND 38).

FOR: LAUNDRY BAGS, IN CLASS 22 (U.S. CLS. 1, 2, 7, 19, 22, 42 AND 50).

FOR: WHOLESALE DISTRIBUTORSHIP SERVICES FEATURING LAUNDRY AND DRY CLEANING MACHINE SYSTEMS; BUSINESS CONSULTATION SERVICES IN THE LAUNDRY AND DRY CLEANING INDUSTRY, NAMELY, WORK FLOW PLANNING, LABOR, OPERATING AND COST ANALYSIS, EQUIPMENT SELECTION AND PROCUREMENT, INVENTORY MANAGEMENT AND CONTROL CONSULTATION, IN CLASS 35 (U.S. CLS. 100, 101 AND 102).

FOR: PROVISION OF WARRANTIES FOR LAUNDRY AND DRY CLEANING SYSTEMS FOR THIRD PARTIES, IN CLASS 36 (U.S. CLS. 100, 101 AND 102).

FOR: APPLIANCE INSTALLATION, REPAIR AND MAINTENANCE SERVICES, NAMELY, INSTALLATION, REPAIR, CONSULTATION AND MAINTENANCE SERVICES RELATED TO LAUNDRY AND DRY CLEANING SYSTEMS; APPLIANCE CONSULTATION SERVICES, NAMELY CONSULTATION SERVICES IN THE FIELD OF LAUNDRY AND DRY CLEANING MACHINE INSTALLATION, MAINTENANCE AND REPAIR SYSTEMS; LAUNDRY AND DRY CLEANING MACHINERY MAINTENANCE CONSULTATION SERVICES; PROVISION OF LEASING SERVICES FOR LAUNDRY AND DRY CLEANING SYSTEMS, IN CLASS 37 (U.S. CLS. 100, 103 AND 106).



David J. Kybas

Director of the United States Patent and Trademark Office

Reg. No. 4,204,736 FOR: STORAGE CONSULTATION, NAMELY, WAREHOUSING CONSULTATION IN THE FIELD OF THE LAUNDRY AND DRY CLEANING INDUSTRY, IN CLASS 39 (U.S. CLS. 100 AND 105).

FOR: EDUCATION CONSULTATION IN THE FIELD OF OPERATOR TRAINING IN THE LAUNDRY AND DRY CLEANING INDUSTRY, IN CLASS 41 (U.S. CLS. 100, 101 AND 107).

FOR: DESIGN CONSULTING SERVICES, NAMELY, DESIGN ENGINEERING CONSULTATION IN THE FIELD OF LAUNDRY AND DRY CLEANING INDUSTRY MACHINERY, IN CLASS 42 (U.S. CLS. 100 AND 101).

PRIORITY CLAIMED UNDER SEC. 44(D) ON CANADA APPLICATION NO. 1521195, FILED 3-28-2011, REG. NO. TMA821980, DATED 4-11-2012, EXPIRES 4-11-2027.

THE MARK CONSISTS OF A SWIRLING EDDY DESIGN THAT APPEARS AGAINST THE BACKGROUND OF TWO EQUAL SIZED PARALLELOGRAMS, THE LEFT ONE DARKER THAN THE RIGHT ONE.

SER. NO. 85-422,049, FILED 9-14-2011.

AMY C. KEAN, EXAMINING ATTORNEY

United States of America

United States Patent and Trademark Office

FOREVER CRYSTALS

Reg. No. 4,204,737

Registered Sep. 11, 2012

Int. Cl.: 35

SERVICE MARK

PRINCIPAL REGISTER

FOREVER CRYSTALS (PUERTO RICO CORPORATION)
PMB 758
P.O. BOX 7891
GUAYNABO, PUERTO RICO 00970

FOR: DISTRIBUTORSHIP SERVICES IN THE FIELD OF FASHION JEWELRY MADE WITH CRYSTALS; RETAIL STORE AND ON-LINE RETAIL STORE SERVICES FEATURING FASHION JEWELRY MADE WITH CRYSTALS, IN CLASS 35 (U.S. CLS. 100, 101 AND 102).

FIRST USE 1-0-2008; IN COMMERCE 1-0-2008.

NO CLAIM IS MADE TO THE EXCLUSIVE RIGHT TO USE "CRYSTALS", APART FROM THE MARK AS SHOWN.

THE MARK CONSISTS OF THE WORDS "FOREVER CRYSTALS" IN A BLACK FONT. BETWEEN THE WORDS "FOREVER" AND "CRYSTALS" IS A STYLIZED IMAGE OF A DRAGONFLY PRESENTED IN BLACK.

SER. NO. 85-422,246, FILED 9-14-2011.

LEIGH LOWRY, EXAMINING ATTORNEY



David J. Kyffers

Director of the United States Patent and Trademark Office

United States of America

United States Patent and Trademark Office



Reg. No. 4,204,738

Registered Sep. 11, 2012

Int. Cl.: 40

SERVICE MARK

PRINCIPAL REGISTER

MAGGIE AUSTIN CAKE, LLC (VIRGINIA LIMITED LIABILITY COMPANY), DBA MAGGIE AUSTIN CAKE
104 HODGES LN.
TAKOMA PARK, MD 20912

FOR: CUSTOM CAKE DECORATING SERVICES, IN CLASS 40 (U.S. CLS. 100, 103 AND 106).

FIRST USE 6-1-2010; IN COMMERCE 7-1-2010.

THE MARK CONSISTS OF A BIRD AND TWO FLOWERS ON A BRANCH ABOVE THE LETTER "M".

SER. NO. 85-422,442, FILED 9-14-2011.

NORA BUCHANAN WILL, EXAMINING ATTORNEY



David J. Kybas

Director of the United States Patent and Trademark Office

United States of America

United States Patent and Trademark Office



Reg. No. 4,204,739

Registered Sep. 11, 2012

Int. Cls.: 35 and 42

SERVICE MARK

PRINCIPAL REGISTER

AES CORPORATION (MASSACHUSETTS CORPORATION)
285 NEWBURY STREET
PEABODY, MA 019601315

FOR: PROVIDING A WEB-BASED, ON-LINE PORTAL TO INDUSTRIES THAT PROVIDE CUSTOMERS ACCESS TO THEIR ALARM SYSTEM AND ALARM SYSTEM CONTROLS, TO THEIR VEHICLE TRACKING SYSTEM, TO THEIR HOME AUTOMATION SYSTEM, TO THEIR VIDEO MONITORING SYSTEM AND TO OTHER INDUSTRIES WHICH PROVIDE REMOTE CONTROL EQUIPMENT AND SERVICES FOR THE PURPOSE OF CUSTOMER ACCOUNT BUSINESS MANAGEMENT, IN CLASS 35 (U.S. CLS. 100, 101 AND 102).

FIRST USE 3-18-2011; IN COMMERCE 3-18-2011.

FOR: PROVIDING A WEB-BASED, ON-LINE PORTAL FOR INSTALLERS FEATURING TECHNOLOGY ENABLING THE INSTALLERS TO SERVICE AND MODIFY THE ALARMS IN ALARM SYSTEMS AND ALARM SYSTEM CONTROLS, VEHICLE TRACKING SYSTEMS, HOME AUTOMATION SYSTEMS AND VIDEO MONITORING SYSTEMS, IN CLASS 42 (U.S. CLS. 100 AND 101).

FIRST USE 3-18-2011; IN COMMERCE 3-18-2011.

NO CLAIM IS MADE TO THE EXCLUSIVE RIGHT TO USE "ONLINE", APART FROM THE MARK AS SHOWN.

THE MARK CONSISTS OF THE WORDS "SECURITY VISION ONLINE" WITH THE WORD "ONLINE" APPEARING BELOW "SECURITY VISION" AND A HORIZONTAL LINE APPEARING IN FRONT OF THE WORD "ONLINE". THE LETTER "I" IN "SECURITY" IS DOTTED WITH A CIRCLE WHICH IS SURROUNDED BY THREE ARCS, THE SMALLEST FACING LEFT, THE LARGER TWO FACING RIGHT.

SER. NO. 85-422,488, FILED 9-14-2011.

TRACY FLETCHER, EXAMINING ATTORNEY



David J. Kyros

Director of the United States Patent and Trademark Office

United States of America

United States Patent and Trademark Office

ModelSheet

Reg. No. 4,204,740

MODELSHEET SOFTWARE, LLC (MASSACHUSETTS LIMITED LIABILITY COMPANY)
146 GRAY STREET
ARLINGTON, MA 02476

Registered Sep. 11, 2012

Int. Cl.: 9

FOR: COMPUTER SOFTWARE FOR AUTHORIZING AND CUSTOMIZING SPREADSHEETS AND TABLE AND GRAPHICAL REPORTS FOR QUANTITATIVE ANALYSIS IN BUSINESS, ENGINEERING AND OTHER FIELDS WITH A GRAPHICAL USER INTERFACE, IN CLASS 9 (U.S. CLS. 21, 23, 26, 36 AND 38).

TRADEMARK

PRINCIPAL REGISTER

FIRST USE 8-31-2011; IN COMMERCE 8-31-2011.

OWNER OF U.S. REG. NO. 3,541,620.

THE COLOR(S) DARK BLUE, LIGHT BLUE, GREEN, GRAY IS/ARE CLAIMED AS A FEATURE OF THE MARK.

THE MARK CONSISTS OF THE TERM "MODEL" IN DARK BLUE SAN SERIF FONT FOLLOWED WITHOUT A SPACE BY THE TERM "SHEET" IN GRAY IN THE SAME FONT. TO THE RIGHT OF THIS WORD IS A GRAPHICAL ELEMENT CONSISTING OF THREE ROWS OF COLORED RECTANGLES, WITH THREE DARK BLUE RECTANGLES ON TOP ROW, THREE LIGHT BLUE RECTANGLES IN THE MIDDLE ROW, AND THREE GREEN RECTANGLES IN THE BOTTOM ROW.

SER. NO. 85-422,596, FILED 9-14-2011.

LESLEY LAMOTHE, EXAMINING ATTORNEY



David J. Kybas

Director of the United States Patent and Trademark Office

United States of America

United States Patent and Trademark Office



Reg. No. 4,204,741

Registered Sep. 11, 2012

Int. Cls.: 4, 6 and 37

TRADEMARK

SERVICE MARK

PRINCIPAL REGISTER

VIETNAM NATIONAL COAL, MINERAL INDUSTRIES HOLDING CORPORATION LIMITED
(VIETNAM CORPORATION)
226 LE DUAN STREET, TRUNG PHUNG WARD
DONG DA DIST., HANOI, VIETNAM

FOR: CHARCOAL AS FUEL; OILS AND GREASES FOR INDUSTRIAL PURPOSES; MINERAL FUEL, IN CLASS 4 (U.S. CLS. 1, 6 AND 15).

FOR: ALUMINUM ALLOYS; COPPER ORES; ZINC ORES; CHROMIUM; IRONS AND STEELS, IN CLASS 6 (U.S. CLS. 2, 12, 13, 14, 23, 25 AND 50).

FOR: CONSTRUCTION AND INSTALLATION SERVICES FOR INDUSTRIAL ELECTRICITY POWER PROJECTS, NAMELY, PLANT CONSTRUCTION, MAINTENANCE AND CONSTRUCTION PROJECT MANAGEMENT SERVICES FOR BUSINESSES IN THE ENERGY PRODUCTION AND TRANSMISSION SECTOR, INSTALLATION OF RENEWABLE ENERGY GENERATION EQUIPMENT, CONSTRUCTION OF NUCLEAR AND COAL-FIRED POWER PLANTS; MINING EXTRACTION; REPAIR OF MINING MACHINES AND APPARATUS, IN CLASS 37 (U.S. CLS. 100, 103 AND 106).

PRIORITY CLAIMED UNDER SEC. 44(D) ON VIETNAM APPLICATION NO. 4-2011-11952, FILED 6-16-2011, REG. NO. 183600, DATED 4-23-2012, EXPIRES 6-16-2021.

THE COLOR(S) WHITE, RED, BLUE, BROWN, YELLOW, AND BLACK IS/ARE CLAIMED AS A FEATURE OF THE MARK.

THE MARK CONSISTS OF THE STYLIZED TEXT "VINACOMIN", WITH THE LETTERS "V", "C", AND "M" IN RED, AND THE LETTERS, "I", "N", "A", "O", "I", AND "N", IN BLACK; A RED "V" IS LOCATED ABOVE THE TEXT, WITH A YELLOW STAR LOCATED IN THE SPACE IN THE "V", TWO BLUE CONCENTRIC CIRCLES WITH A BLUE LINE IN THE MIDDLE LOCATED BEHIND THE "V", TWO BROWN TRIANGLES LOCATED ON EACH SIDE OF THE "V", AND A WHITE CIRCLE AND WHITE LINE LOCATED INSIDE THE "V".

SER. NO. 85-422,985, FILED 9-14-2011.

NICHOLAS COLEMAN, EXAMINING ATTORNEY



David J. Kappas

Director of the United States Patent and Trademark Office

United States of America

United States Patent and Trademark Office



Reg. No. 4,204,742

Registered Sep. 11, 2012

Int. Cl.: 9

TRADEMARK

PRINCIPAL REGISTER

ICON ENERGY SYSTEM CO., LTD (CHINA LIMITED LIABILITY COMPANY)
BLD.A,4/F, JINMEIWEI INDUSTRIAL PARK
SHANGKENG COMMUNITY, GUANLAN TOWN, BAOANQU
SHENZHEN, CHINA

FOR: ACCUMULATOR JARS; BATTERIES, ELECTRIC, FOR VEHICLES; BATTERY BOXES;
CHARGERS FOR ELECTRIC BATTERIES; DRY CELLS; DRY CELLS AND BATTERIES;
ELECTRIC ACCUMULATORS; ELECTRIC ACCUMULATORS FOR VEHICLES; GRIDS FOR
BATTERIES; HIGH TENSION BATTERIES; SOLAR BATTERIES, IN CLASS 9 (U.S. CLS. 21,
23, 26, 36 AND 38).

FIRST USE 12-18-2009; IN COMMERCE 11-18-2010.

THE MARK CONSISTS OF THE WORD "ECUBE" IN BLUE WITH THE LETTER "E" IN RED
POSITIONED ATOP AND WITHIN THE LETTER "C".

THE COLOR(S) RED AND BLUE IS/ARE CLAIMED AS A FEATURE OF THE MARK.

SER. NO. 85-423,151, FILED 9-15-2011.

JOHN WILKE, EXAMINING ATTORNEY



David J. Kyffers

Director of the United States Patent and Trademark Office

United States of America

United States Patent and Trademark Office



Reg. No. 4,204,743

Registered Sep. 11, 2012

Int. Cl.: 9

TRADEMARK

PRINCIPAL REGISTER

ICON ENERGY SYSTEM CO.,LTD (CHINA LIMITED LIABILITY COMPANY)
BLD.A,4/F, JINMEIWEI INDUSTRIAL PARK
SHANGKENGCOMMUNITY, GUANLAN TOWN, BAOANQU
SHENZHEN, CHINA

FOR: ACCUMULATOR JARS; BATTERIES, ELECTRIC, FOR VEHICLES; BATTERY BOXES;
CHARGERS FOR ELECTRIC BATTERIES; DRY CELLS; DRY CELLS AND BATTERIES;
ELECTRIC ACCUMULATORS; ELECTRIC ACCUMULATORS FOR VEHICLES; GRIDS FOR
BATTERIES; HIGH TENSION BATTERIES; SOLAR BATTERIES, IN CLASS 9 (U.S. CLS. 21,
23, 26, 36 AND 38).

FIRST USE 12-18-2009; IN COMMERCE 11-18-2010.

THE MARK CONSISTS OF THE LETTERS "IES" IN PURPLE WITH THE DOT ON THE "I"
BEING RED, RINGED BY A PURPLE OVAL PASSING BETWEEN THE "I" AND "E" AND
BEHIND THE "S".

THE COLOR(S) PURPLE AND RED IS/ARE CLAIMED AS A FEATURE OF THE MARK.

SER. NO. 85-423,154, FILED 9-15-2011.

JOHN WILKE, EXAMINING ATTORNEY



David J. Kybas

Director of the United States Patent and Trademark Office

United States of America

United States Patent and Trademark Office

WHEELS OF DESTRUCTION: WORLD TOUR

Reg. No. 4,204,744

SPERASOFT, INC. (DELAWARE CORPORATION)
2421 REBECCA LYNN WAY
SANTA CLARA, CA 95050

Registered Sep. 11, 2012

Int. Cl.: 9

FOR: DOWNLOADABLE COMPUTER AND VIDEO GAME PROGRAMS; VIDEO AND
COMPUTER GAME PROGRAMS, IN CLASS 9 (U.S. CLS. 21, 23, 26, 36 AND 38).

TRADEMARK

FIRST USE 5-15-2010; IN COMMERCE 5-15-2010.

PRINCIPAL REGISTER

THE MARK CONSISTS OF STANDARD CHARACTERS WITHOUT CLAIM TO ANY PAR-
TICULAR FONT, STYLE, SIZE, OR COLOR.

SER. NO. 85-423,904, FILED 9-15-2011.

DARRYL SPRUILL, EXAMINING ATTORNEY



David J. Kyros

Director of the United States Patent and Trademark Office

United States of America

United States Patent and Trademark Office

Sanctuary Body Spa of St. Dominic's

Reg. No. 4,204,745

ST. DOMINIC JACKSON MEMORIAL HOSPITAL (MISSISSIPPI CORPORATION)
969 LAKELAND DRIVE
JACKSON, MS 39216

Registered Sep. 11, 2012

Int. Cl.: 44

FOR: HEALTH SPA SERVICES FOR HEALTH AND WELLNESS OF THE BODY AND SPIRIT, IN CLASS 44 (U.S. CLS. 100 AND 101).

SERVICE MARK

FIRST USE 7-25-2011; IN COMMERCE 9-14-2011.

PRINCIPAL REGISTER

THE MARK CONSISTS OF STANDARD CHARACTERS WITHOUT CLAIM TO ANY PARTICULAR FONT, STYLE, SIZE, OR COLOR.

NO CLAIM IS MADE TO THE EXCLUSIVE RIGHT TO USE "BODY SPA", APART FROM THE MARK AS SHOWN.

SER. NO. 85-424,044, FILED 9-15-2011.

FRED CARL, EXAMINING ATTORNEY



David J. Kyffers

Director of the United States Patent and Trademark Office

United States of America

United States Patent and Trademark Office



Reg. No. 4,204,746

Registered Sep. 11, 2012

Int. Cl.: 44

SERVICE MARK

PRINCIPAL REGISTER

ST. PETER'S HEALTH PARTNERS (NEW YORK NON-PROFIT CORPORATION)
315 S. MANNING BOULEVARD
ALBANY, NY 12208

FOR: HOSPITAL AND HEALTHCARE SERVICES, IN CLASS 44 (U.S. CLS. 100 AND 101).

FIRST USE 6-2-2011; IN COMMERCE 10-3-2011.

NO CLAIM IS MADE TO THE EXCLUSIVE RIGHT TO USE "HEALTH PARTNERS", APART FROM THE MARK AS SHOWN.

THE MARK CONSISTS OF THREE TEARDROP-TYPE SHAPES INTERSECTING EACH OTHER TO CREATE ONE SINGLE SHIELD WITH INTERTWINING ELEMENTS AND OPEN SPACES, WHICH IS TO THE LEFT OF THE WORDS "ST. PETER'S HEALTH PARTNERS" WITH THE WORD "PARTNERS" APPEARING UNDERNEATH THE WORDS "ST. PETER'S HEALTH".

SER. NO. 85-424,862, FILED 9-16-2011.

MARIA-VICTORIA SUAREZ, EXAMINING ATTORNEY



David J. Kybas

Director of the United States Patent and Trademark Office

United States of America

United States Patent and Trademark Office



Reg. No. 4,204,747

Registered Sep. 11, 2012

Int. Cl.: 36

SERVICE MARK

PRINCIPAL REGISTER

AMERICAN NATIONAL INSURANCE COMPANY (TEXAS CORPORATION)
ONE MOODY PLAZA
GALVESTON, TX 77550

FOR: UNDERWRITING MARINE PROPERTY AND CASUALTY INSURANCE, IN CLASS 36 (U.S. CLS. 100, 101 AND 102).

FIRST USE 6-0-2011; IN COMMERCE 6-0-2011.

OWNER OF U.S. REG. NOS. 1,243,114, 1,837,021 AND OTHERS.

THE MARK CONSISTS OF A RECTANGULAR BOX WITH "AMERICAN NATIONAL" DISPLAYED INSIDE; BELOW WORDING, INSIDE THE RECTANGULAR BOX IS THE FRONT OF A BOAT PROTRUDING OUT PAST THE RECTANGULAR BOX.

SEC. 2(F) AS TO "AMERICAN NATIONAL".

SER. NO. 85-425,612, FILED 9-19-2011.

STEVEN PEREZ, EXAMINING ATTORNEY



David J. Kyros

Director of the United States Patent and Trademark Office

United States of America

United States Patent and Trademark Office

Amazing Botanicals

Reg. No. 4,204,748

Registered Sep. 11, 2012

Int. Cl.: 3

TRADEMARK

PRINCIPAL REGISTER

AMAZING BOTANICALS (NEW YORK PARTNERSHIP)
APT. 2C
1273 PACIFIC STREET
BROOKLYN, NY 11216

FOR: SHAMPOOS; HAIR CONDITIONER; BODY BUTTER; POMADES; NON-MEDICATED HERBAL BODY CARE PRODUCTS, NAMELY, SALVES; HAIR OILS; BODY OILS; BATH SALTS; FOOT SCRUBS; NON-MEDICATED FOAMING BATH BUTTER, IN CLASS 3 (U.S. CLS. 1, 4, 6, 50, 51 AND 52).

FIRST USE 6-12-2010; IN COMMERCE 8-5-2010.

THE MARK CONSISTS OF STANDARD CHARACTERS WITHOUT CLAIM TO ANY PARTICULAR FONT, STYLE, SIZE, OR COLOR.

NO CLAIM IS MADE TO THE EXCLUSIVE RIGHT TO USE "BOTANICALS", APART FROM THE MARK AS SHOWN.

SER. NO. 85-425,718, FILED 9-19-2011.

ELI HELLMAN, EXAMINING ATTORNEY



David J. Kyfos

Director of the United States Patent and Trademark Office

United States of America

United States Patent and Trademark Office

FOLLOW THE WINGS

Reg. No. 4,204,749

Registered Sep. 11, 2012

Int. Cl.: 44

SERVICE MARK

PRINCIPAL REGISTER

SUNOVION PHARMACEUTICALS INC. (DELAWARE CORPORATION)
84 WATERFORD DRIVE
MARLBOROUGH, MA 01752

FOR: PROVIDING INFORMATION FOR CONSUMERS IN THE AREAS OF PHARMACEUTICAL SAFETY BY A WEBSITE; MEDICAL INFORMATION SERVICES, NAMELY, PROVIDING INFORMATION TO PATIENTS RELATING TO TREATMENT OF SLEEP DISORDERS; PHARMACEUTICAL ADVICE; ON-LINE INFORMATION SERVICES, NAMELY, A WEBSITE PROVIDING INFORMATION TO PATIENTS RELATING TO THE PREVENTION, DIAGNOSIS, AND TREATMENT OF SLEEP DISORDERS; PROVIDING MEDICAL INFORMATION RELATING TO ONGOING RESEARCH PROGRAMS AND STUDIES IN THE FIELD OF SLEEP DISORDERS; PROVIDING INFORMATION IN THE FIELD OF SLEEP DISORDERS VIA THE INTERNET, IN CLASS 44 (U.S. CLS. 100 AND 101).

FIRST USE 10-17-2011; IN COMMERCE 10-17-2011.

THE MARK CONSISTS OF STANDARD CHARACTERS WITHOUT CLAIM TO ANY PARTICULAR FONT, STYLE, SIZE, OR COLOR.

SER. NO. 85-427,512, FILED 9-20-2011.

MICHAEL LITZAU, EXAMINING ATTORNEY



David J. Kyffers

Director of the United States Patent and Trademark Office

United States of America

United States Patent and Trademark Office

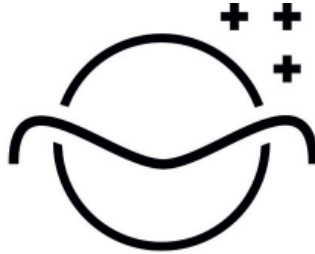

MISHAAL
AEROSPACE ENGINEERING CONSULTING

Reg. No. 4,204,750

Registered Sep. 11, 2012

Int. Cl.: 42

SERVICE MARK

PRINCIPAL REGISTER

MISHAAL AEROSPACE CORPORATION (FLORIDA CORPORATION)
SUITE 1550
701 BRICKELL AVENUE
MIAMI, FL 33131

FOR: TECHNICAL SERVICES, NAMELY, CONSULTING IN THE FIELD OF ENGINEERING FOR BUSINESSES IN THE AVIATION, AEROSPACE AND DEFENSE INDUSTRIES , IN CLASS 42 (U.S. CLS. 100 AND 101).

FIRST USE 7-10-2011; IN COMMERCE 9-19-2011.

NO CLAIM IS MADE TO THE EXCLUSIVE RIGHT TO USE "AEROSPACE ENGINEERING CONSULTING", APART FROM THE MARK AS SHOWN.

THE MARK CONSISTS OF THE WORD "MISHAAL" IN ALL CAPITAL LETTERS ABOVE THE WORDS "AEROSPACE ENGINEERING CONSULTING" IN SMALLER, ALL CAPITAL LETTERS, WITH THE WORDS UNDERNEATH A PLANET AND STARS IMAGE, WITH A CIRCLE SEPARATED IN HALF BY A HORIZONTAL WAVY LINE THAT REPRESENTS A PLANET, AND WITH THREE PLUS SIGNS ABOVE AND TO THE RIGHT OF THE CIRCLE REPRESENTING STARS.

SER. NO. 85-427,882, FILED 9-21-2011.

JAMES LOVELACE, EXAMINING ATTORNEY



David J. Kybas

Director of the United States Patent and Trademark Office

United States of America

United States Patent and Trademark Office

App47

Reg. No. 4,204,751

Registered Sep. 11, 2012

Int. Cl.: 9

TRADEMARK

PRINCIPAL REGISTER

APP47, INC. (DELAWARE CORPORATION)
11951 FREEDOM DR. 13TH FLOOR
RESTON, VA 20190

FOR: COMPUTER APPLICATION SOFTWARE FOR INTERNET-ENABLED DEVICES, MOBILE PHONES, PORTABLE MEDIA PLAYERS, COMPUTERS AND TELEVISIONS, NAMELY, SOFTWARE FOR USE IN MANAGEMENT OF APPLICATIONS OPERATING ON INTERNET-ENABLED, MOBILE DEVICES PORTABLE MEDIA PLAYERS, COMPUTERS AND TELEVISIONS IN THE FIELDS OF ANALYTICS, PERFORMANCE MANAGEMENT, REPORTING, CONFIGURATION MANAGEMENT, ASSET MANAGEMENT, DEPLOYMENT, PROVISIONING, COMPLIANCE, SECURITY MANAGEMENT AND APPLICATION STOREFRONTS, IN CLASS 9 (U.S. CLS. 21, 23, 26, 36 AND 38).

FIRST USE 6-29-2011; IN COMMERCE 2-15-2012.

THE MARK CONSISTS OF STANDARD CHARACTERS WITHOUT CLAIM TO ANY PARTICULAR FONT, STYLE, SIZE, OR COLOR.

SER. NO. 85-428,742, FILED 9-21-2011.

PAUL MORENO, EXAMINING ATTORNEY



David J. Kyffers

Director of the United States Patent and Trademark Office

United States of America

United States Patent and Trademark Office

BAZAARVOICE

Reg. No. 4,204,752

Registered Sep. 11, 2012

Int. Cls.: 35 and 42

SERVICE MARK

PRINCIPAL REGISTER

BAZAARVOICE, INC. (DELAWARE CORPORATION)
SUITE 300
3900 N. CAPITAL OF TEXAS HIGHWAY
AUSTIN, TX 78746

FOR: ADVERTISING, MARKETING AND PROMOTION SERVICES; BUSINESS DATA ANALYSIS; BUSINESS MARKETING SERVICES; BUSINESS MONITORING SERVICES, NAMELY, TRACKING WEB SITES OF OTHERS TO PROVIDE DETAILS ABOUT USER CLICK TRAFFIC OR VISITS TO THE WEB SITE; CONSUMER MARKETING RESEARCH AND CONSULTING RELATED THERETO; CONSULTING SERVICES IN THE FIELD OF INTERNET MARKETING; ADVERTISING, MARKETING AND PROMOTION SERVICES RELATED TO SOCIAL MEDIA; PROVIDING A WEBSITE FOR USERS WITH SPECIFIC INFORMED RECOMMENDATIONS OF SPECIFIC CONSUMER PRODUCTS AND SERVICES VALIDATED BY THE USERS' INPUTTED PREFERENCES AND SOCIAL NETWORK; CONSULTANCY REGARDING SOCIAL MEDIA MARKETING STRATEGY, IN CLASS 35 (U.S. CLS. 100, 101 AND 102).

FIRST USE 1-5-2006; IN COMMERCE 1-5-2006.

FOR: PROVIDING TEMPORARY USE OF ONLINE NON-DOWNLOADABLE SOFTWARE IN THE FIELD OF ENABLING THE SUBMISSION, DISPLAY, AGGREGATION, AND ANALYSIS OF USER GENERATED CONTENT; PROVIDING TEMPORARY USE OF ONLINE NON-DOWNLOADABLE SOFTWARE FOR CREATING, MAINTAINING, AND PROVIDING ACCESS TO A NETWORKED COMMUNITY OF CONSUMERS, FOR CONSUMER SUBMISSION OF INFORMATION, TEXT, AUDIO, VIDEO, AND MULTIMEDIA, FOR USERS TO VOTE IN RESPONSE TO QUESTIONS, AND FOR ACCESS TO INFORMATION OF OTHER CONSUMERS, CONCERNING PRODUCT AND SERVICE OFFERINGS OF THIRD PARTIES; PROVIDING TEMPORARY USE OF ONLINE NON-DOWNLOADABLE SOFTWARE FOR USE IN ADVERTISING, BUSINESS MARKETING, CONSUMER MARKETING RESEARCH, AND SOCIAL MEDIA MARKETING; PROVIDING TEMPORARY USE OF ONLINE NON-DOWNLOADABLE SOFTWARE TO ALLOW CONSUMERS AND BUSINESSES TO SHARE INFORMATION ABOUT AND COMMENT UPON THE PRODUCTS AND SERVICES AND TO ALLOW USERS TO CREATE AND USE ONLINE PROFILES FOR MARKETING PURPOSES; COMPUTER SERVICES, NAMELY, SEARCH ENGINE OPTIMIZATION; PROVIDING TEMPORARY USE OF ONLINE NON-DOWNLOADABLE SOFTWARE AND CONSULTING SERVICES IN THE FIELD OF SEARCH ENGINE OPTIMIZATION, IN CLASS 42 (U.S. CLS. 100 AND 101).



David J. Kyffers

Director of the United States Patent and Trademark Office

Reg. No. 4,204,752 FIRST USE 1-5-2006; IN COMMERCE 1-5-2006.

THE MARK CONSISTS OF STANDARD CHARACTERS WITHOUT CLAIM TO ANY PARTICULAR FONT, STYLE, SIZE, OR COLOR.

OWNER OF U.S. REG. NO. 3,296,895.

SER. NO. 85-428,811, FILED 9-21-2011.

TIMOTHY FINNEGAN, EXAMINING ATTORNEY

United States of America

United States Patent and Trademark Office



Reg. No. 4,204,753

ARIZONA CENTER FOR DISABILITY LAW (ARIZONA CORPORATION)
100 NORTH STONE AVENUE
TUCSON, AZ 85701

Registered Sep. 11, 2012

Int. Cl.: 45

FOR: LEGAL SERVICES, IN CLASS 45 (U.S. CLS. 100 AND 101).

SERVICE MARK

FIRST USE 4-1-2011; IN COMMERCE 4-1-2011.

PRINCIPAL REGISTER

NO CLAIM IS MADE TO THE EXCLUSIVE RIGHT TO USE "ARIZONA CENTER FOR DISABILITY LAW", APART FROM THE MARK AS SHOWN.

THE COLOR(S) BLACK, WHITE, RED, YELLOW, BROWN AND GREEN/TEAL IS/ARE CLAIMED AS A FEATURE OF THE MARK.

THE MARK CONSISTS OF THE LETTERS "ACDL" IN BLOCK BLACK TEXT. BELOW THE LETTERS IS A GREEN/TEAL BANNER CONTAINING THE WORDS "ARIZONA CENTER FOR DISABILITY LAW" IN WHITE. TO THE LEFT OF BOTH THE LETTERS AND BANNER IS A STYLIZED DESIGN IN RED, GREEN/TEAL, YELLOW, BLACK AND BROWN WITH A SHAPE RESEMBLING A SUN.

SER. NO. 85-429,557, FILED 9-22-2011.

ELI HELLMAN, EXAMINING ATTORNEY



David J. Kyros

Director of the United States Patent and Trademark Office

United States of America

United States Patent and Trademark Office

ROSWELL EAST

Reg. No. 4,204,754

PINNACLE APARTMENTS INVESTORS LLC (GEORGIA LIMITED LIABILITY COMPANY)
2970 CLAIRMONT ROAD NE
ATLANTA, GA 30329

Registered Sep. 11, 2012

Int. Cl.: 35

FOR: REAL ESTATE MARKETING SERVICES IN THE FIELD OF MIXED-USE DEVELOPMENT, IN CLASS 35 (U.S. CLS. 100, 101 AND 102).

SERVICE MARK

FIRST USE 1-1-2006; IN COMMERCE 1-1-2006.

PRINCIPAL REGISTER

THE MARK CONSISTS OF STANDARD CHARACTERS WITHOUT CLAIM TO ANY PARTICULAR FONT, STYLE, SIZE, OR COLOR.

SEC. 2(F).

SER. NO. 85-429,782, FILED 9-22-2011.

JULIE GUTTADAURO, EXAMINING ATTORNEY



David J. Kybas

Director of the United States Patent and Trademark Office

United States of America

United States Patent and Trademark Office

CENTER LINE

Reg. No. 4,204,755

ROCKLER COMPANIES, INC. (MINNESOTA CORPORATION)
4365 WILLOW DRIVE
MEDINA, MN 55340

Registered Sep. 11, 2012

Int. Cl.: 20

FOR: FURNITURE HARDWARE, NAMELY, DRAWER SLIDES, IN CLASS 20 (U.S. CLS. 2, 13, 22, 25, 32 AND 50).

TRADEMARK

FIRST USE 1-0-2009; IN COMMERCE 1-0-2009.

PRINCIPAL REGISTER

THE MARK CONSISTS OF STANDARD CHARACTERS WITHOUT CLAIM TO ANY PARTICULAR FONT, STYLE, SIZE, OR COLOR.

SER. NO. 85-429,877, FILED 9-22-2011.

KIM SAITO, EXAMINING ATTORNEY



David J. Kybas

Director of the United States Patent and Trademark Office

United States of America

United States Patent and Trademark Office

Writing Blocks Idea Dice

Reg. No. 4,204,756

MIKA BOBLITZ ZACHARY (UNITED STATES INDIVIDUAL), AKA MIA ZACHARY
8079 CRAINMONT DRIVE
GLEN BURNIE, MD 21061

Registered Sep. 11, 2012

Int. Cl.: 28

FOR: DICE; DICE GAMES, IN CLASS 28 (U.S. CLS. 22, 23, 38 AND 50).

TRADEMARK

FIRST USE 9-20-2010; IN COMMERCE 11-9-2011.

PRINCIPAL REGISTER

THE MARK CONSISTS OF STANDARD CHARACTERS WITHOUT CLAIM TO ANY PARTICULAR FONT, STYLE, SIZE, OR COLOR.

NO CLAIM IS MADE TO THE EXCLUSIVE RIGHT TO USE "IDEA DICE", APART FROM THE MARK AS SHOWN.

SER. NO. 85-430,006, FILED 9-22-2011.

JOHN GARTNER, EXAMINING ATTORNEY



David J. Kyffers

Director of the United States Patent and Trademark Office

United States of America

United States Patent and Trademark Office

AMPLIFY SOCIAL

Reg. No. 4,204,757

AMPLIFY SOCIAL, INC. (DELAWARE CORPORATION)

Registered Sep. 11, 2012

475 SANSOME ST # 730
SAN FRANCISCO, CA 94111

Int. Cls.: 35, 38 and 41

FOR: ADVERTISING AND PUBLICITY SERVICES, NAMELY, PROMOTING THE GOODS, SERVICES, CONTENT, BRAND IDENTITY AND COMMERCIAL INFORMATION AND NEWS OF THIRD PARTIES THROUGH DIGITAL AND ON-LINE MEDIUM; ADVERTISING AND MARKETING SERVICES PROVIDED BY MEANS OF INDIRECT METHODS OF MARKETING COMMUNICATIONS, NAMELY, THE DISSEMINATION OF SOCIAL MEDIA, SEARCHENGINE MARKETING, INQUIRY MARKETING, INTERNET MARKETING, MOBILE MARKETING, BLOGGING AND OTHER FORMS OF PASSIVE, SHARABLE OR VIRAL COMMUNICATIONS CHANNELS, IN CLASS 35 (U.S. CLS. 100, 101 AND 102).

SERVICE MARK

PRINCIPAL REGISTER

FIRST USE 5-1-2011; IN COMMERCE 5-1-2011.

FOR: ELECTRONIC TRANSMISSION OF THIRD PARTY CONTENT, NAMELY, THE DISTRIBUTION OF TEXT, GRAPHICS, VIDEO, AND AUDIO FOR PUBLICATION ON MULTIPLE WEBSITES AND OTHER DIGITAL AND ONLINE MEDIUM, IN CLASS 38 (U.S. CLS. 100, 101 AND 104).

FIRST USE 5-1-2011; IN COMMERCE 5-1-2011.

FOR: ONLINE SYNDICATION OF THIRD PARTY NEWS AND INFORMATIONAL CONTENT, NAMELY, TEXT, GRAPHICS, VIDEO AND AUDIO FEATURING ATHLETES, IN CLASS 41 (U.S. CLS. 100, 101 AND 107).

FIRST USE 5-1-2011; IN COMMERCE 5-1-2011.

THE MARK CONSISTS OF STANDARD CHARACTERS WITHOUT CLAIM TO ANY PARTICULAR FONT, STYLE, SIZE, OR COLOR.

NO CLAIM IS MADE TO THE EXCLUSIVE RIGHT TO USE "SOCIAL", APART FROM THE MARK AS SHOWN.

SER. NO. 85-430,164, FILED 9-23-2011.

JENNIFER VASQUEZ, EXAMINING ATTORNEY



David J. Kyffers

Director of the United States Patent and Trademark Office

United States of America

United States Patent and Trademark Office



Reg. No. 4,204,758

AMPLIFY SOCIAL, INC. (DELAWARE CORPORATION)

Registered Sep. 11, 2012

475 SANSOME ST # 730
SAN FRANCISCO, CA 94111

Int. Cls.: 35, 38 and 41

FOR: ADVERTISING AND PUBLICITY SERVICES, NAMELY, PROMOTING THE GOODS, SERVICES, CONTENT, BRAND IDENTITY AND COMMERCIAL INFORMATION AND NEWS OF THIRD PARTIES THROUGH DIGITAL AND ON-LINE MEDIUM; ADVERTISING AND MARKETING SERVICES PROVIDED BY MEANS OF INDIRECT METHODS OF MARKETING COMMUNICATIONS, NAMELY, THE DISSEMINATION OF SOCIAL MEDIA, SEARCHENGINE MARKETING, INQUIRY MARKETING, INTERNET MARKETING, MOBILE MARKETING, BLOGGING AND OTHER FORMS OF PASSIVE, SHARABLE OR VIRAL COMMUNICATIONS CHANNELS, IN CLASS 35 (U.S. CLS. 100, 101 AND 102).

SERVICE MARK

PRINCIPAL REGISTER

FIRST USE 9-5-2011; IN COMMERCE 9-25-2011.

FOR: ELECTRONIC TRANSMISSION OF THIRD PARTY CONTENT, NAMELY, THE DISTRIBUTION OF TEXT, GRAPHICS, VIDEO, AND AUDIO FOR PUBLICATION ON MULTIPLE WEBSITES AND OTHER DIGITAL AND ONLINE MEDIUM, IN CLASS 38 (U.S. CLS. 100, 101 AND 104).

FIRST USE 9-5-2011; IN COMMERCE 9-25-2011.

FOR: ONLINE SYNDICATION OF THIRD PARTY NEWS AND INFORMATIONAL CONTENT, NAMELY, TEXT, GRAPHICS, VIDEO AND AUDIO FEATURING ATHLETES, IN CLASS 41 (U.S. CLS. 100, 101 AND 107).

FIRST USE 9-5-2001; IN COMMERCE 9-25-2001.

THE MARK CONSISTS OF THE WORD "AMPLIFY" IN BLACK AND "SOCIAL" IN ORANGE TO THE RIGHT OF A GROUPING OF SEVERAL ORANGE CIRCLES.

THE COLOR(S) ORANGE AND BLACK IS/ARE CLAIMED AS A FEATURE OF THE MARK.

SER. NO. 85-430,171, FILED 9-23-2011.

JENNIFER VASQUEZ, EXAMINING ATTORNEY



David J. Kyjars

Director of the United States Patent and Trademark Office

United States of America

United States Patent and Trademark Office



Reg. No. 4,204,759

ZENITH MANAGEMENT CORPORATION (FLORIDA CORPORATION)
2025 NW 102 AVENUE SUITE 107
DORAL, FL 33172

Registered Sep. 11, 2012

Int. Cl.: 25

FOR: CLOTHING, NAMELY, SHIRTS, T-SHIRTS, SWEATSHIRTS, JACKETS, HATS, CAPS, PANTS, SHORTS AND SOCKS, IN CLASS 25 (U.S. CLS. 22 AND 39).

TRADEMARK

FIRST USE 5-15-2011; IN COMMERCE 5-15-2011.

PRINCIPAL REGISTER

THE MARK CONSISTS OF A BLACK AND WHITE SKULL WEARING A PIRATE HAT WITH A DAGGER BETWEEN ITS TEETH WITH SWORDS CROSSING BELOW THE SKULL AND RED BLOOD DRIPPING FROM THE DAGGER WITH THE WORD "SKETCHY".

THE COLOR(S) BLACK, WHITE AND RED IS/ARE CLAIMED AS A FEATURE OF THE MARK.

SER. NO. 85-430,210, FILED 9-23-2011.

CHRISTOPHER LAW, EXAMINING ATTORNEY



David J. Kybas

Director of the United States Patent and Trademark Office

United States of America

United States Patent and Trademark Office

Be Part of the Solution, Not Part of the Problem

Reg. No. 4,204,760

Registered Sep. 11, 2012

Int. Cl.: 42

SERVICE MARK

PRINCIPAL REGISTER

NACSO NON-PROFIT BUSINESS LEAGUE (TEXAS CORPORATION), AKA NATIONAL ASSOCIATION OF CREDIT SERVICES ORGANIZATIONS

1611 WILMETH RD
STE B
MCKINNEY, TX 75069

FOR: ACCREDITATION SERVICES, NAMELY, DEVELOPING AND ADMINISTERING STANDARDS AND PROCEDURES FOR CERTIFYING PROFESSIONALS IN THE FIELD OF CREDIT SERVICES ORGANIZATIONS, IN CLASS 42 (U.S. CLS. 100 AND 101).

FIRST USE 9-8-2011; IN COMMERCE 9-8-2011.

THE MARK CONSISTS OF STANDARD CHARACTERS WITHOUT CLAIM TO ANY PARTICULAR FONT, STYLE, SIZE, OR COLOR.

SER. NO. 85-430,226, FILED 9-23-2011.

MARK RADEMACHER, EXAMINING ATTORNEY



David J. Kyffers

Director of the United States Patent and Trademark Office

United States of America
United States Patent and Trademark Office

infotex

Reg. No. 4,204,761

INFOTEX INC. (INDIANA CORPORATION)
2366 WEST BOULEVARD
KOKOMO, IN 469042147

Registered Sep. 11, 2012

Int. Cl.: 42

FOR: COMPUTER SECURITY SERVICES, NAMELY, MANAGED SECURITY SERVICES
AND COMPUTER SECURITY CONSULTING, IN CLASS 42 (U.S. CLS. 100 AND 101).

SERVICE MARK

FIRST USE 8-18-2000; IN COMMERCE 8-18-2000.

PRINCIPAL REGISTER

THE MARK CONSISTS OF THE WORD "INFOTEX" WITH THE LETTERS "I" AND "T" IN
BLUE AND THE LETTERS "NFO" AND "EX" IN BLACK.

THE COLOR(S) BLUE AND BLACK IS/ARE CLAIMED AS A FEATURE OF THE MARK.

SER. NO. 85-430,560, FILED 9-23-2011.

LOURDES AYALA, EXAMINING ATTORNEY



David J. Kyffers

Director of the United States Patent and Trademark Office

United States of America

United States Patent and Trademark Office

Studio B

Reg. No. 4,204,762

Registered Sep. 11, 2012

Int. Cls.: 25 and 28

TRADEMARK

PRINCIPAL REGISTER

BETTINARDI, ROBERT J. (UNITED STATES INDIVIDUAL)
7800 GRAPHICS DRIVE
TINLEY PARK, IL 60477

FOR: ATHLETIC APPAREL, NAMELY, SHIRTS, PANTS, JACKETS, FOOTWEAR, HATS AND CAPS, ATHLETIC UNIFORMS; ATHLETIC FOOTWEAR; ATHLETIC SHOES; BUTTON DOWN SHIRTS; CARGO PANTS; COLLARED SHIRTS; DENIMS; GOLF CAPS; GOLF CLEATS; GOLF PANTS, SHIRTS AND SKIRTS; GOLF SHIRTS; GOLF SHOES; GOLF SHORTS; GOLF SPIKES; GOLF TROUSERS; GYM PANTS; HOODED SWEAT SHIRTS; JOGGING PANTS; KNIT SHIRTS; LONG-SLEEVED SHIRTS; LOUNGE PANTS; OPEN-NECKED SHIRTS; PANTS; PIQUE SHIRTS; POLO SHIRTS; SHIRTS; SPORTS PANTS; SPORTS SHIRTS; SPORTS SHIRTS WITH SHORT SLEEVES; SWEAT BANDS; SWEAT JACKETS; SWEAT PANTS; SWEAT SHIRTS; SWEAT SHORTS; T-SHIRTS, IN CLASS 25 (U.S. CLS. 22 AND 39).

FIRST USE 1-1-2006; IN COMMERCE 1-1-2006.

FOR: COVERS FOR GOLF CLUBS; DISCS FOR PLAYING DISC GOLF; DIVOT REPAIR TOOLS; DRIVING PRACTICE MATS; FITTED COVERS FOR NON-MOTORIZED GOLF CARTS; FITTED HEAD COVERS FOR GOLF CLUBS; GLOVES FOR GOLF; GOLF ACCESSORIES, NAMELY, CARRIERS AND DISPENSERS FOR GOLF BALLS; GOLF ACCESSORIES, NAMELY, HOLDERS SPECIALLY ADAPTED FOR HOLDING GOLF BALL MARKERS; GOLF ACCESSORY POUCHES; GOLF ACCESSORY, NAMELY, SUPPORT FOR HOLDING A GOLF CLUB; GOLF BAG COVERS; GOLF BAG PEGS; GOLF BAG TAGS; GOLF BAGS; GOLF BAGS WITH OR WITHOUT WHEELS; GOLF BALL MARKERS; GOLF BALL RETRIEVERS; GOLF BALL SLEEVES; GOLF BALLS; GOLF CLUB BAGS; GOLF CLUB COVERS; GOLF CLUB GRIPS; GOLF CLUB HEADS; GOLF CLUB HOLDERS FOR USE ON A DRIVING RANGE OR GOLF COURSE; GOLF CLUB INSERTS; GOLF CLUB SHAFTS; GOLF CLUB SWING AIDS, NAMELY, TARGET LASER AND LIGHTS; GOLF CLUB SWING AIDS, NAMELY, GOLF CLUB BALANCING SCALES AND SCALE PARTS THEREOF, TO ANALYZE, FIT AND/OR MAKE GOLF CLUBS; GOLF CLUBS; GOLF FLAGS; GOLF GLOVES; GOLF IRONS; GOLF PRACTICE NETS; GOLF PUTTER COVERS; GOLF PUTTERS; GOLF TEE MARKERS; GOLF TEES; GOLF TOWEL CLIPS FOR ATTACHMENT TO GOLF BAGS; GOLF TRAINING APPARATUS, NAMELY, DEVICES USED TO HELP GROOVE A REPETITIVE PUTTING STROKE; GOLF TRAINING APPARATUS, NAMELY, GOLF PRACTICE PLATFORMS; GOLF TRAINING EQUIPMENT, NAMELY, A GOLF TRAINING CAGE; GOLF TRAINING EQUIPMENT, NAMELY, A MOTORIZED GOLF CHIPPING PRACTICE AID;



David J. Kybas

Director of the United States Patent and Trademark Office

Reg. No. 4,204,762 HAND GRIPS FOR GOLF CLUBS; HEAD COVERS FOR GOLF CLUBS; IMPACT MARKERS IN THE NATURE OF PRESSURE SENSITIVE REUSABLE IMPACT LABELS FOR ATTACHMENT TO THE HEAD OF A GOLF CLUB TO INDICATE WHERE THE CLUB HITS THE BALL; MODULAR FOAM PREFABRICATED MINIATURE GOLF COURSES AND PUTTING SURFACES; PUTTING PRACTICE MATS; STANDS SPECIALLY ADAPTED FOR HOLDING GOLF CLUBS; TROLLEY BAGS FOR GOLF EQUIPMENT, IN CLASS 28 (U.S. CLS. 22, 23, 38 AND 50).

FIRST USE 1-1-2006; IN COMMERCE 1-1-2006.

THE MARK CONSISTS OF STANDARD CHARACTERS WITHOUT CLAIM TO ANY PARTICULAR FONT, STYLE, SIZE, OR COLOR.

SER. NO. 85-430,967, FILED 9-23-2011.

JAY FLOWERS, EXAMINING ATTORNEY

United States of America
United States Patent and Trademark Office

WASAN

Reg. No. 4,204,763

TKR PLANNERS, INC. (NEW YORK CORPORATION)
108 EAST 4TH STREET, WEST STORE
NEW YORK, NY 10003

Registered Sep. 11, 2012

Int. Cl.: 43

FOR: RESTAURANT SERVICES, IN CLASS 43 (U.S. CLS. 100 AND 101).

SERVICE MARK

FIRST USE 4-28-2010; IN COMMERCE 4-28-2010.

PRINCIPAL REGISTER

THE MARK CONSISTS OF STANDARD CHARACTERS WITHOUT CLAIM TO ANY PARTICULAR FONT, STYLE, SIZE, OR COLOR.

THE WORDING "WASAN" HAS NO MEANING IN A FOREIGN LANGUAGE.

SER. NO. 85-431,544, FILED 9-26-2011.

MICHAEL LITZAU, EXAMINING ATTORNEY



David J. Kyffers

Director of the United States Patent and Trademark Office

United States of America

United States Patent and Trademark Office



Reg. No. 4,204,764

Registered Sep. 11, 2012

Int. Cl.: 35

SERVICE MARK

PRINCIPAL REGISTER

NETWORK, INC. (DELAWARE CORPORATION)
2291 PORTOLA ROAD, SUITE A
VENTURA, CA 93003

FOR: ADVERTISING AND DIRECTORY SERVICES, NAMELY, PROMOTING THE SERVICES OF OTHERS BY PROVIDING A WEB PAGE FEATURING LINKS TO THE WEBSITES OF OTHERS; ADVERTISING AND MARKETING SERVICES PROVIDED BY MEANS OF INDIRECT METHODS OF MARKETING COMMUNICATIONS, NAMELY, SOCIAL MEDIA, SEARCH ENGINE MARKETING, INQUIRY MARKETING, INTERNET MARKETING, MOBILE MARKETING, BLOGGING AND OTHER FORMS OF PASSIVE, SHARABLE OR VIRAL COMMUNICATIONS CHANNELS, IN CLASS 35 (U.S. CLS. 100, 101 AND 102).

FIRST USE 6-1-2011, THE MARK WAS FIRST USED ANYWHERE IN A DIFFERENT FORM OTHER THAN THAT SOUGHT TO BE REGISTERED AT LEAST AS EARLY AS 07/01/2001.; IN COMMERCE 6-1-2011, THE MARK WAS FIRST USED IN COMMERCE IN A DIFFERENT FORM OTHER THAN THAT SOUGHT TO BE REGISTERED AT LEAST AS EARLY AS 07/27/2001..

THE MARK CONSISTS OF A RABBIT STANDING UPRIGHT, WEARING SUNGLASSES, WITH HIS ARMS CROSSED IN FRONT OF HIS CHEST. THE RABBIT'S EARS ARE PURPLE WITH THE INNER PORTION BEING LIGHT PURPLE. THE UPPER PORTION OF THE RABBIT'S HEAD IS PURPLE AND THE EYEBROWS ARE DARK PURPLE. BLACK AND GREY SUNGLASSES COVER THE RABBIT'S EYES. THE LOWER PORTION OF THE RABBIT'S HEAD IS WHITE AND GREY WITH PINK ON THE MUZZLE. THE RABBIT'S NOSE IS BLACK WITH GREY HIGHLIGHTS AND THE RABBIT'S WHISKERS ARE WHITE. THE MOUTH OPENING IS BLACK AND THE TWO TEETH ARE WHITE AND GREY. THE RABBIT'S TORSO AND ARMS ARE PURPLE, EXCEPT FOR THE CHEST, WHICH IS GREY AND WHITE. THE RABBIT'S HANDS ARE PINK, GREY AND WHITE. THE RABBIT'S LEGS ARE PURPLE WITH LIGHT PURPLE AND PINK HIGHLIGHTS, AND THE RABBIT'S FEET ARE GREY AND WHITE.

THE COLOR(S) BLACK, PURPLE, DARK PURPLE, LIGHT PURPLE, PINK, GREY AND WHITE IS/ARE CLAIMED AS A FEATURE OF THE MARK.

SER. NO. 85-431,898, FILED 9-26-2011.

NELSON SNYDER, EXAMINING ATTORNEY



David J. Kyffers

Director of the United States Patent and Trademark Office

United States of America

United States Patent and Trademark Office



Reg. No. 4,204,765

Registered Sep. 11, 2012

Int. Cls.: 30 and 43

TRADEMARK

SERVICE MARK

PRINCIPAL REGISTER

SPIN CONCEPTS, INC. (KANSAS CORPORATION)
12110 W. 129TH TERRACE
OVERLAND PARK, KS 66213

FOR: PREPARED FOODS FOR CONSUMPTION ON AND OFF THE PREMISES, NAMELY, PIZZA, PANINI, GELATO, DELI SANDWICHES, AND COFFEE AND TEA BEVERAGES , IN CLASS 30 (U.S. CL. 46).

FIRST USE 5-1-2005; IN COMMERCE 5-1-2005.

FOR: RESTAURANT AND RESTAURANT CARRY-OUT SERVICES, FEATURING PIZZA, PANINI, GELATO, DELI SANDWICHES, SOUPS AND SALADS, AND COFFEE AND TEA BEVERAGES; BAR SERVICES; CATERING SERVICES; WINE BAR SERVICES, IN CLASS 43 (U.S. CLS. 100 AND 101).

FIRST USE 5-1-2005; IN COMMERCE 5-1-2005.

OWNER OF U.S. REG. NOS. 3,163,808 AND 3,172,270.

THE MARK CONSISTS OF A REPRESENTATION OF A MAN BENT AT THE WAIST AND RIDING A BICYCLE WITH ONE ARM STRETCHED UP TOWARD A SPIRAL DESIGN, THE MAN'S MOUTH IS OPEN AND HE IS WEARING A BALL CAP WITH THE BILL POSITIONED UPWARD, THE TWO CIRCLES ON EITHER SIDE OF THE MAN REPRESENT THE BICYCLE.

SER. NO. 85-432,039, FILED 9-26-2011.

APRIL ROACH, EXAMINING ATTORNEY



David J. Kybas

Director of the United States Patent and Trademark Office

United States of America

United States Patent and Trademark Office

CryptoSleeve

Reg. No. 4,204,766

Registered Sep. 11, 2012

Int. Cl.: 42

SERVICE MARK

PRINCIPAL REGISTER

CUMMINGS ENGINEERING CONSULTANTS, INCORPORATED (ARIZONA CORPORATION)
145 S. 79TH STREET, SUITE 26
CHANDLER, AZ 85226

FOR: COMPUTER HARDWARE AND SOFTWARE CONSULTING SERVICES; COMPUTER SERVICES, NAMELY, ACTING AS AN APPLICATION SERVICE PROVIDER IN THE FIELD OF INFORMATION MANAGEMENT TO HOST COMPUTER APPLICATION SOFTWARE FOR THE PURPOSE OF CRYPTOGRAPHIC SYSTEMS; COMPUTER SERVICES, NAMELY, REMOTE AND ON-SITE MANAGEMENT OF CRYPTOGRAPHIC SYSTEMS OF OTHERS; COMPUTER SOFTWARE DEVELOPMENT IN THE FIELD OF CRYPTOGRAPHIC SYSTEMS; COMPUTER SOFTWARE DEVELOPMENT, COMPUTER PROGRAMMING AND MAINTENANCE OF COMPUTER SOFTWARE FOR CRYPTOGRAPHIC SYSTEMS; CONSULTING SERVICES IN THE FIELD OF THE DESIGN OF CRYPTOGRAPHIC SYSTEMS; DESIGN AND DEVELOPMENT OF COMPUTER SOFTWARE FOR CRYPTOGRAPHIC SYSTEMS; DESIGN AND DEVELOPMENT OF SOFTWARE AND HARDWARE FOR CRYPTOGRAPHIC SYSTEMS; DESIGN FOR OTHERS IN THE FIELD OF CRYPTOGRAPHIC SYSTEMS; DESIGN, DEVELOPMENT, AND CONSULTING SERVICES RELATED THERETO IN THE FIELD OF CRYPTOGRAPHIC SYSTEMS; DESIGN, DEVELOPMENT, AND IMPLEMENTATION OF SOFTWARE FOR CRYPTOGRAPHIC SYSTEMS; INSTALLATION AND MAINTENANCE OF CRYPTOGRAPHIC SYSTEM SOFTWARE; INSTALLATION OF CRYPTOGRAPHIC SYSTEM SOFTWARE; INSTALLATION, MAINTENANCE AND REPAIR OF CRYPTOGRAPHIC SYSTEM SOFTWARE; MAINTENANCE OF COMPUTER SOFTWARE USED FOR CRYPTOGRAPHIC SYSTEMS; PLATFORM AS A SERVICE (PAAS) FEATURING COMPUTER SOFTWARE PLATFORMS FOR OPERATING AND MANAGING CRYPTOGRAPHIC SYSTEMS; PROVIDING ON-LINE NON-DOWNLOADABLE SOFTWARE FOR OPERATING AND MANAGING CRYPTOGRAPHIC SYSTEMS; PROVIDING TEMPORARY USE OF ON-LINE NON-DOWNLOADABLE SOFTWARE FOR OPERATING AND MANAGING CRYPTOGRAPHIC SYSTEMS; SOFTWARE AS A SERVICE (SAAS) SERVICES FEATURING SOFTWARE FOR OPERATING AND MANAGING CRYPTOGRAPHIC SYSTEMS; SOFTWARE DEVELOPMENT AND PRODUCT DEVELOPMENT CONSULTING IN THE FIELD OF CRYPTOGRAPHIC SYSTEMS; SOFTWARE DEVELOPMENT CONSULTING IN THE FIELD OF CRYPTOGRAPHIC SYSTEMS; SOFTWARE DEVELOPMENT IN THE FIELD OF CRYPTOGRAPHIC SYSTEMS; TECHNOLOGY SPECIFICATION, NAMELY, ANALYZING TECHNOLOGY REQUIREMENTS AND DEVELOPING RECOMMENDATIONS FOR THE COMPUTER SOFTWARE AND SYSTEMS AND OTHER TECHNOLOGY NEEDED TO MEET THOSE REQUIREMENTS, IN THE FIELD OF CRYPTOGRAPHIC SYSTEMS, IN CLASS 42 (U.S. CLS. 100 AND 101).



David J. Kybas

Director of the United States Patent and Trademark Office

Reg. No. 4,204,766 FIRST USE 8-4-2011; IN COMMERCE 8-5-2011.

THE MARK CONSISTS OF STANDARD CHARACTERS WITHOUT CLAIM TO ANY PARTICULAR FONT, STYLE, SIZE, OR COLOR.

SER. NO. 85-432,495, FILED 9-27-2011.

WARREN L. OLANDRIA, EXAMINING ATTORNEY

United States of America

United States Patent and Trademark Office

GeospatialTrust

Reg. No. 4,204,767

Registered Sep. 11, 2012

Int. Cl.: 42

SERVICE MARK

PRINCIPAL REGISTER

CUMMINGS ENGINEERING CONSULTANTS, INCORPORATED (ARIZONA CORPORATION)
145 S. 79TH STREET, SUITE 26
CHANDLER, AZ 85226

FOR: COMPUTER HARDWARE AND SOFTWARE CONSULTING SERVICES; COMPUTER SERVICES, NAMELY, ACTING AS AN APPLICATION SERVICE PROVIDER IN THE FIELD OF INFORMATION MANAGEMENT TO HOST COMPUTER APPLICATION SOFTWARE FOR THE PURPOSE OF CRYPTOGRAPHIC SYSTEMS; COMPUTER SERVICES, NAMELY, REMOTE AND ON-SITE MANAGEMENT OF CRYPTOGRAPHIC SYSTEMS OF OTHERS; COMPUTER SOFTWARE DEVELOPMENT IN THE FIELD OF CRYPTOGRAPHIC SYSTEMS; COMPUTER SOFTWARE DEVELOPMENT, COMPUTER PROGRAMMING AND MAINTENANCE OF COMPUTER SOFTWARE FOR CRYPTOGRAPHIC SYSTEMS; CONSULTING SERVICES IN THE FIELD OF THE DESIGN OF CRYPTOGRAPHIC SYSTEMS; DESIGN AND DEVELOPMENT OF COMPUTER SOFTWARE FOR CRYPTOGRAPHIC SYSTEMS; DESIGN AND DEVELOPMENT OF SOFTWARE AND HARDWARE FOR CRYPTOGRAPHIC SYSTEMS; DESIGN FOR OTHERS IN THE FIELD OF CRYPTOGRAPHIC SYSTEMS; DESIGN, DEVELOPMENT, AND CONSULTING SERVICES RELATED THERETO IN THE FIELD OF CRYPTOGRAPHIC SYSTEMS; DESIGN, DEVELOPMENT, AND IMPLEMENTATION OF SOFTWARE FOR CRYPTOGRAPHIC SYSTEMS; INSTALLATION AND MAINTENANCE OF CRYPTOGRAPHIC SYSTEM SOFTWARE; INSTALLATION OF CRYPTOGRAPHIC SYSTEM SOFTWARE; INSTALLATION, MAINTENANCE AND REPAIR OF CRYPTOGRAPHIC SYSTEM SOFTWARE; MAINTENANCE OF COMPUTER SOFTWARE USED FOR CRYPTOGRAPHIC SYSTEMS; PLATFORM AS A SERVICE (PAAS) FEATURING COMPUTER SOFTWARE PLATFORMS FOR OPERATING AND MANAGING CRYPTOGRAPHIC SYSTEMS; PROVIDING ON-LINE NON-DOWNLOADABLE SOFTWARE FOR OPERATING AND MANAGING CRYPTOGRAPHIC SYSTEMS; PROVIDING TEMPORARY USE OF ON-LINE NON-DOWNLOADABLE SOFTWARE FOR OPERATING AND MANAGING CRYPTOGRAPHIC SYSTEMS; SOFTWARE AS A SERVICE (SAAS) SERVICES FEATURING SOFTWARE FOR OPERATING AND MANAGING CRYPTOGRAPHIC SYSTEMS; SOFTWARE DEVELOPMENT AND PRODUCT DEVELOPMENT CONSULTING IN THE FIELD OF CRYPTOGRAPHIC SYSTEMS; SOFTWARE DEVELOPMENT CONSULTING IN THE FIELD OF CRYPTOGRAPHIC SYSTEMS; SOFTWARE DEVELOPMENT IN THE FIELD OF CRYPTOGRAPHIC SYSTEMS; TECHNOLOGY SPECIFICATION, NAMELY, ANALYZING TECHNOLOGY REQUIREMENTS AND DEVELOPING RECOMMENDATIONS FOR THE COMPUTER SOFTWARE AND SYSTEMS AND OTHER TECHNOLOGY NEEDED TO MEET THOSE REQUIREMENTS, IN THE FIELD OF CRYPTOGRAPHIC SYSTEMS, IN CLASS 42 (U.S. CLS. 100 AND 101).



David J. Kybas

Director of the United States Patent and Trademark Office

Reg. No. 4,204,767 FIRST USE 8-1-2011; IN COMMERCE 8-1-2011.

THE MARK CONSISTS OF STANDARD CHARACTERS WITHOUT CLAIM TO ANY PARTICULAR FONT, STYLE, SIZE, OR COLOR.

SER. NO. 85-432,501, FILED 9-27-2011.

WARREN L. OLANDRIA, EXAMINING ATTORNEY

United States of America

United States Patent and Trademark Office



Reg. No. 4,204,768

UHS OF DELAWARE, INC. (DELAWARE CORPORATION)
367 SOUTH GULPH ROAD
KING OF PRUSSIA, PA 194060958

Registered Sep. 11, 2012

Int. Cl.: 44

FOR: HEALTHCARE; MEDICAL SERVICES, IN CLASS 44 (U.S. CLS. 100 AND 101).

SERVICE MARK

FIRST USE 9-22-2011; IN COMMERCE 9-22-2011.

PRINCIPAL REGISTER

OWNER OF U.S. REG. NOS. 2,649,125, 3,059,851 AND OTHERS.

NO CLAIM IS MADE TO THE EXCLUSIVE RIGHT TO USE "BREAST CARE CENTER AT" AND "HOSPITAL", APART FROM THE MARK AS SHOWN.

THE MARK CONSISTS OF THE WORDS "BREAST CARE CENTER AT SUMMERLIN HOSPITAL", WITH A FLOWER DESIGN ABOVE THE WORD "BREAST".

SEC. 2(F) AS TO "SUMMERLIN HOSPITAL".

SER. NO. 85-432,564, FILED 9-27-2011.

MATTHEW KLINE, EXAMINING ATTORNEY



David J. Kappas

Director of the United States Patent and Trademark Office

United States of America

United States Patent and Trademark Office

TRANSFER PACK

Reg. No. 4,204,769

Registered Sep. 11, 2012

Int. Cl.: 10

TRADEMARK

PRINCIPAL REGISTER

FENWAL, INC (DELAWARE CORPORATION)
THREE CORPORATE DRIVE
LAKE ZURICH, IL 60047

FOR: KITS AND PACKAGES OF FLEXIBLE CONTAINERS, FLEXIBLE TUBING AND HYPODERMIC AND COUPLING NEEDLES CONSTITUTING BLOOD OR BLOOD COMPONENT COLLECTING UNITS, BLOOD OR BLOOD COMPONENT STORING UNITS, BLOOD OR BLOOD COMPONENT PROCESSING UNITS, BLOOD OR BLOOD COMPONENT INFUSING UNITS, AND BLOOD OR BLOOD COMPONENT TRANSFER UNITS, IN CLASS 10 (U.S. CLS. 26, 39 AND 44).

FIRST USE 0-0-1981; IN COMMERCE 0-0-1981.

THE MARK CONSISTS OF STANDARD CHARACTERS WITHOUT CLAIM TO ANY PARTICULAR FONT, STYLE, SIZE, OR COLOR.

NO CLAIM IS MADE TO THE EXCLUSIVE RIGHT TO USE "PACK", APART FROM THE MARK AS SHOWN.

SER. NO. 85-432,576, FILED 9-27-2011.

JULIE VEPPUMTHARA, EXAMINING ATTORNEY



David J. Kybas

Director of the United States Patent and Trademark Office

United States of America

United States Patent and Trademark Office

We Are About You!

Reg. No. 4,204,770

Registered Sep. 11, 2012

Int. Cl.: 35

SERVICE MARK

PRINCIPAL REGISTER

MOTOR CONSULTANTS OF AMERICA, INC. (MICHIGAN CORPORATION), DBA MCA
INC.
3040 AIRPARK DRIVE S
FLINT, MI 48507

FOR: BUSINESS MANAGEMENT CONSULTING; BUSINESS CONSULTATION; BUSINESS
MANAGEMENT CONSULTING, STRATEGIC PLANNING AND BUSINESS ADVISORY
SERVICES PROVIDED TO THE CONSTRUCTION INDUSTRY, AUTOMOTIVE INDUSTRY,
MEDICAL PROFESSION, NON-PROFIT CORPORATIONS, ACADEMIC INSTITUTIONS,
INSURANCE INDUSTRY, BANKING INDUSTRY AND RETAIL BUSINESS ENTITIES, IN
CLASS 35 (U.S. CLS. 100, 101 AND 102).

FIRST USE 6-1-2002; IN COMMERCE 8-5-2011.

THE MARK CONSISTS OF STANDARD CHARACTERS WITHOUT CLAIM TO ANY PAR-
TICULAR FONT, STYLE, SIZE, OR COLOR.

SER. NO. 85-433,099, FILED 9-27-2011.

JANICE KIM, EXAMINING ATTORNEY



David J. Kyffers

Director of the United States Patent and Trademark Office

United States of America

United States Patent and Trademark Office



*Guardians
of Israel*

Reg. No. 4,204,771

Registered Sep. 11, 2012

Int. Cl.: 36

SERVICE MARK

PRINCIPAL REGISTER

INTERNATIONAL FELLOWSHIP OF CHRISTIANS & JEWS, INC. (ILLINOIS NON-PROFIT CORPORATION)
30 N. LASALLE, SUITE 2600
CHICAGO, IL 606023356

FOR: CHARITABLE FUNDRAISING SERVICES; PROVIDING GRANTS TO CHARITABLE AND HUMANITARIAN ORGANIZATIONS, COMMUNITY CENTERS, EDUCATIONAL INSTITUTIONS, RELIGIOUS ORGANIZATIONS, AND GOVERNMENTAL ENTITIES IN ISRAEL TO PROVIDE FOOD, CLOTHING, BASIC HOUSEHOLD APPLIANCES, SHELTER, SOCIAL WELFARE PROGRAMS, EDUCATION PROGRAMS, MEDICAL AND HEALTH CARE SERVICES, COUNSELING SERVICES, JOB TRAINING PROGRAMS, HEATING FUEL, BLANKETS, AND EMERGENCY ASSISTANCE TO FAMILIES, THE ELDERLY, CHILDREN, HOLOCAUST SURVIVORS, SOLDIERS, VICTIMS OF WAR AND TERROR, AND NEEDY PEOPLE IN ISRAEL; PROVIDING INFORMATION AND NEWS VIA A GLOBAL COMMUNICATIONS NETWORK ABOUT PROVISION OF GRANTS TO CHARITABLE AND HUMANITARIAN ORGANIZATIONS, COMMUNITY CENTERS, EDUCATIONAL INSTITUTIONS, RELIGIOUS ORGANIZATIONS, AND GOVERNMENTAL ENTITIES IN ISRAEL TO PROVIDE FOOD, CLOTHING, BASIC HOUSEHOLD APPLIANCES, SHELTER, SOCIAL WELFARE PROGRAMS, EDUCATION PROGRAMS, MEDICAL AND HEALTH CARE SERVICES, COUNSELING SERVICES, JOB TRAINING PROGRAMS, HEATING FUEL, BLANKETS, AND EMERGENCY ASSISTANCE TO FAMILIES, THE ELDERLY, CHILDREN, HOLOCAUST SURVIVORS, SOLDIERS, VICTIMS OF WAR AND TERROR, AND NEEDY PEOPLE IN ISRAEL, IN CLASS 36 (U.S. CLS. 100, 101 AND 102).

FIRST USE 12-1-2006; IN COMMERCE 12-1-2006.

NO CLAIM IS MADE TO THE EXCLUSIVE RIGHT TO USE "ISRAEL", APART FROM THE MARK AS SHOWN.

THE MARK CONSISTS OF A SILHOUETTE OF AN UPRIGHT LION AND THE WORDS "SHOMRAY YISRAEL" INSIDE OF A CREST OR SHIELD, NEXT TO THE WORDS "GUARDIANS OF ISRAEL".

THE ENGLISH TRANSLATION OF "SHOMRAY YISRAEL" IN THE MARK IS "GUARDIANS OF ISRAEL".



David J. Kappas

Director of the United States Patent and Trademark Office

SER. NO. 85-433,202, FILED 9-27-2011.

Reg. No. 4,204,771 DEZMONA MIZELLE, EXAMINING ATTORNEY

United States of America

United States Patent and Trademark Office

CLARION FINANCIAL

Reg. No. 4,204,772

Registered Sep. 11, 2012

Int. Cls.: 35, 36 and 44

SERVICE MARK

PRINCIPAL REGISTER

MILFORD HOLDING CO. (DELAWARE CORPORATION)
SUITE 1300
1105 NORTH MARKET STREET
WILMINGTON, DE 19801

FOR: LEASING OF OFFICE EQUIPMENT; AND LEASING OF OFFICE FURNITURE, IN CLASS 35 (U.S. CLS. 100, 101 AND 102).

FIRST USE 1-0-2003; IN COMMERCE 1-0-2003.

FOR: FINANCING SERVICES FOR DENTAL PRACTICES IN THE NATURE OF EQUIPMENT FINANCING SERVICES; VENTURE CAPITAL SERVICES IN THE NATURE OF PROVIDING FINANCING TO DENTAL PRACTICES; BUSINESS FINANCE PROCUREMENT SERVICES; BUSINESS LIQUIDATION SERVICES; DEBT CONSOLIDATION SERVICES; LEASE-PURCHASE FINANCING SERVICES; REFINANCING SERVICES AND PROVIDING WORKING CAPITAL LOANS, IN CLASS 36 (U.S. CLS. 100, 101 AND 102).

FIRST USE 1-0-2003; IN COMMERCE 1-0-2003.

FOR: LEASING SERVICES IN THE NATURE OF LEASING OF DENTAL EQUIPMENT, IN CLASS 44 (U.S. CLS. 100 AND 101).

FIRST USE 1-0-2003; IN COMMERCE 1-0-2003.

THE MARK CONSISTS OF STANDARD CHARACTERS WITHOUT CLAIM TO ANY PARTICULAR FONT, STYLE, SIZE, OR COLOR.

NO CLAIM IS MADE TO THE EXCLUSIVE RIGHT TO USE "FINANCIAL", APART FROM THE MARK AS SHOWN.

SER. NO. 85-433,406, FILED 9-27-2011.

ZACHARY BELLO, EXAMINING ATTORNEY



David J. Kyffers

Director of the United States Patent and Trademark Office

United States of America

United States Patent and Trademark Office

THE SOPRANOS

Reg. No. 4,204,773

HOME BOX OFFICE, INC. (DELAWARE CORPORATION)
1100 AVENUE OF THE AMERICAS
NEW YORK, NY 10036

Registered Sep. 11, 2012

Int. Cl.: 9

FOR: PROTECTIVE CASES FOR LAPTOP COMPUTERS, TABLET COMPUTERS, SMART PHONES AND OTHER PORTABLE ELECTRONIC DEVICES, NAMELY, MEDIA PLAYERS, MOBILE PHONES, GLOBAL POSITIONING SYSTEMS AND PERSONAL DIGITAL ASSISTANTS; PROTECTIVE COVERINGS FOR LAPTOP COMPUTERS, TABLET COMPUTERS, SMART PHONES AND OTHER PORTABLE ELECTRONIC DEVICES, NAMELY, MEDIA PLAYERS, MOBILE PHONES, GLOBAL POSITIONING SYSTEMS AND PERSONAL DIGITAL ASSISTANTS, IN CLASS 9 (U.S. CLS. 21, 23, 26, 36 AND 38).

TRADEMARK

PRINCIPAL REGISTER

FIRST USE 3-24-2011; IN COMMERCE 3-24-2011.

THE MARK CONSISTS OF STANDARD CHARACTERS WITHOUT CLAIM TO ANY PARTICULAR FONT, STYLE, SIZE, OR COLOR.

OWNER OF U.S. REG. NOS. 3,317,641, 3,537,044 AND OTHERS.

SER. NO. 85-433,817, FILED 9-28-2011.

KEVIN DINALLO, EXAMINING ATTORNEY



David J. Kyffers

Director of the United States Patent and Trademark Office

United States of America

United States Patent and Trademark Office

The logo for OSMART features the letters 'O', 'S', and 'M' in red, with a white horizontal line bisecting each of them. The letters 'A', 'R', and 'T' are in gray. The letters are bold and sans-serif.

Reg. No. 4,204,774

Registered Sep. 11, 2012

Int. Cl.: 35

SERVICE MARK

PRINCIPAL REGISTER

ONE STOP MAILING, LLC (ILLINOIS LIMITED LIABILITY COMPANY), DBA OSM
WORLDWIDE
651 SUPREME DRIVE
BENSENVILLE, IL 60106

FOR: BUSINESS SERVICES, NAMELY, FREIGHT INFORMATION MANAGEMENT SERVICES, SHIPMENT PROCESSING, PREPARING SHIPPING DOCUMENTS AND INVOICES, TRACKING DOCUMENTS, PACKAGES AND FREIGHT OVER COMPUTER NETWORKS, INTRANETS AND INTERNETS; COMPUTERIZED TRACKING AND TRACING OF PACKAGES IN TRANSIT; INFORMATION MANAGEMENT SERVICES, NAMELY, SHIPMENT PROCESSING, PREPARING SHIPPING DOCUMENTS AND INVOICES, TRACKING DOCUMENTS, PACKAGES AND FREIGHT OVER COMPUTER NETWORKS, INTRANETS AND INTERNETS, IN CLASS 35 (U.S. CLS. 100, 101 AND 102).

FIRST USE 6-1-2009; IN COMMERCE 6-1-2009.

THE MARK CONSISTS OF THE WORDING "OSMART" IN STYLIZED LETTERING. THE CAPITAL LETTERS "O" AND "M" APPEAR IN RED, "S" APPEARS IN WHITE, AND "OSM" IS BISECTED AT THE MIDPOINT WITH A HORIZONTAL WHITE LINE. THE LETTERS "ART" APPEAR IN GRAY.

THE COLOR(S) RED, WHITE AND GRAY IS/ARE CLAIMED AS A FEATURE OF THE MARK.

SER. NO. 85-433,935, FILED 9-28-2011.

ALICE BENMAMAN, EXAMINING ATTORNEY



David J. Kyjars

Director of the United States Patent and Trademark Office

United States of America

United States Patent and Trademark Office

GRACE CHEN

Reg. No. 4,204,775

Registered Sep. 11, 2012

Int. Cl.: 25

TRADEMARK

PRINCIPAL REGISTER

CHEN, GRACE YEHUAI (UNITED STATES INDIVIDUAL)
SUITE 15-11, #100 JIN BANG ROAD
SHANGHAI, CHINA 201335

FOR: ANKLE BOOTS; ANKLE SOCKS; ANKLETS; ANORAK; ANORAKS; APPAREL FOR DANCERS, NAMELY, TEE SHIRTS, SWEATSHIRTS, PANTS, LEGGINGS, SHORTS AND JACKETS; APRES-SKI SHOES; APRONS; ARTIFICIAL FLOWER HEADDRESSES; ASCOTS; A-SHIRTS; BABUSHKAS; BABY BIBS NOT OF PAPER; BABY BODYSUITS; BABY BOTTOMS; BABY BUNTING; BABY DOLL PYJAMAS; BABY LAYETTES FOR CLOTHING; BABY TOPS; BALACLAVAS; BALL GOWNS; BALLET SHOES; BALLET SLIPPERS; BALLOON PANTS; BALLROOM DANCING SHOES; BALLROOM DANCING UNIFORMS; BANDANAS; BANDEAU TOPS; BANDEAUX; BASEBALL CAPS; BATH SLIPPERS; BATHING CAPS; BATHING COSTUMES; BATHING COSTUMES FOR WOMEN; BATHING SUITS; BATHING SUITS FOR MEN; BATHING TRUNKS; BATHROBES; BEACH COVERUPS; BEACH COVER-UPS; BEACH FOOTWEAR; BEACH SHOES; BEACHWEAR; BEANIES; BED JACKETS; BELTS; BELTS FOR CLOTHING; BELTS MADE FROM IMITATION LEATHER; BELTS MADE OF LEATHER; BELTS MADE OUT OF CLOTH; BELTS OF TEXTILE; BELTS THAT ARE DESIGNED TO ACCOMMODATE PREGNANCY SIZE CHANGES; BERETS; BERMUDA SHORTS; BIKINIS; BLAZERS; BLOOMERS; BLOUSES; BLOUSONS; BOARD SHORTS; BOAS; BOAT SHOES; BODICES; BODY LINEN; BODY SHAPERS; BODY SHIRTS; BODY STOCKINGS; BODY SUITS; BOLEROS; BOLO TIES; BOMBER JACKETS; BONNETS; BOOTIES; BOOTS; BOTTOMS; BOW TIES; BRAS; BRASSIERES; BREECHES; BRIDESMAID DRESSES; BRIEFS; BRIEFS; BUCKET CAPS; BUSTIERS; BUSTLE HOLDER BANDS FOR OBI (OBIAGE); BUSTLES FOR OBI-KNOTS (OBIAGE-SHIN); BUTTON DOWN SHIRTS; BUTTON-FRONT ALOHA SHIRTS; CAFTANS; CAGOULES; CAMISETTES; CAMISOLES; CANVAS SHOES; CAP PEAKS; CAP VISORS; CAPELETS; CAPES; CAPRI PANTS; CAPRIS; CAPS; CAPS WITH VISORS; CARDIGANS; CARGO PANTS; CASSOCKS; CAT SUITS; CHEMISES; CHEMISSETTES; CHILDREN'S AND INFANTS' CLOTH BIBS; CHILDREN'S AND INFANT'S APPAREL, NAMELY, JUMPERS, OVERALL SLEEPWEAR, PAJAMAS, ROMPERS AND ONE-PIECE GARMENTS; CHILDREN'S AND INFANTS' APPAREL TREATED WITH FIRE AND HEAT RETARDANTS, NAMELY, JUMPERS, OVERALL SLEEPWEAR, PAJAMAS, ROMPERS AND ONE-PIECE GARMENTS; CHILDREN'S CLOTH EATING BIBS; CHILDREN'S HEADWEAR; CHOIR ROBES; CLOAKS; CLOGS; CLOTH BIBS; CLOTH BIBS FOR ADULT DINERS; CLOTH BIBS FOR USE BY SENIOR CITIZENS OR PHYSICALLY- OR MENTALLY-CHALLENGED PERSONS; CLOTH DIAPERS; CLOTHING EXTENSION USED TO EXTEND THE NORMAL SIZE RANGE OF CLOTHING ITEMS TO ACCOMMODATE PREGNANCY SIZE CHANGES; CLOTHING FOR BABIES,



David J. Kypos

Director of the United States Patent and Trademark Office

Reg. No. 4,204,775 TODDLERS AND CHILDREN, TREATED WITH FIRE AND HEAT RETARDANTS, NAMELY, PAJAMAS, JACKETS, SHIRTS, PANTS, JUMPERS; CLOTHING, NAMELY, BASE LAYERS; CLOTHING, NAMELY, COWLS AND SMOKE RING SCARVES; CLOTHING, NAMELY, FOLK COSTUMES; CLOTHING, NAMELY, HAND-WARMERS; CLOTHING, NAMELY, KHAKIS; CLOTHING, NAMELY, KNEE WARMERS; CLOTHING, NAMELY, WRAP-AROUNDS; COATS; COATS FOR MEN AND WOMEN; COATS MADE OF COTTON; COATS OF DENIM; COLLARED SHIRTS; COLLARS; COMBINATIONS; CORSELETS; CORSETS; COVERALLS; COVERUPS; CREW NECK SWEATERS; CREW NECKS; CROP PANTS; CROP TOPS; CROSS-COUNTRY GLOVES; CROSS-COUNTRY MITTENS; CUFFS; CULOTTES; CUMMERBUNDS; CUSTOM MADE TO MEASURE SUITS FOR MEN AND WOMEN; DANCE COSTUMES; DANCE SHOES; DANCE SLIPPERS; DENIM JACKETS; DENIMS; DETACHABLE NECKPIECES FOR KIMONOS (HANERI); DOWN JACKETS; DOWN SUITS; DRESS PANTS; DRESS SHIELDS; DRESS SHIRTS; DRESS SUITS; DRESSES; DRESSES MADE FROM SKINS; DRESSES THAT MAY ALSO BE USED AS TOWELS; DRESSING GOWNS; DRESSING GOWNS AND BATH ROBES; DRIVERS; DUNGAREES; DUST COATS; DUSTERS; EAR BANDS; EAR MUFFS; EAR WARMERS; EMBOSSED SOLES AND HEELS OF RUBBER OR OF PLASTIC MATERIALS; ESPADRILLES; EVENING DRESSES; EVENING GOWNS; EYESHADES; FABRIC BELTS; FINGERLESS GLOVES; FINISHED TEXTILE LININGS FOR GARMENTS; FITTED SHOE OR BOOT COVERING TO PROTECT THE SHOES OR BOOT FROM WATER OR OTHER DAMAGE; FITTED SWIMMING COSTUMES WITH BRA CUPS; FLEECE BOTTOMS; FLEECE PULLOVERS; FLEECE SHORTS; FLEECE TOPS; FLEECE VESTS; FOOTWEAR; FOOTWEAR; FOOTWEAR FOR MEN AND WOMEN; FOOTWEAR MADE OF WOOD; FOOTWEAR NOT FOR SPORTS; FOOTWEAR, NAMELY, PUMPS; FOOTWEAR, NAMELY, RUBBERS; FOOTWEAR, NAMELY, WORK BOOTS; FOULARDS; FOUNDATION GARMENTS; FOUNDATION GARMENTS WORN AROUND THE MIDSECTION OR THIGHS TO KEEP THE STOMACH IN AND CREATE A SLIMMING EFFECT; FROCKS; FUR CLOAKS; FUR COATS AND JACKETS; FUR HATS; FUR MUFFS; FUR STOLE; GABERDINES; GAITERS; GAITERS OF LEATHER; GALOSHES; GARTER BELTS; GARTERS; GAUCHOS; GIFT PACKAGES SOLD AS A UNIT CONSISTING PRIMARILY OF A SWEATSHIRT AND ALSO INCLUDING A PHOTO FRAME, A COFFEE MUG, AND A TOTE BAG; GILETS; GIRDLES; GLOVES; GLOVES FOR APPAREL; GLOVES INCLUDING THOSE MADE OF SKIN, HIDE OR FUR; GOWNS; GREATCOATS; GYM BOOTS; GYM PANTS; GYM SHORTS; GYM SUITS; GYMNASTIC SHOES; G-STRINGS; HALLOWEEN COSTUMES; HALTER TOPS; HAT BANDS; HATS; HATS FOR INFANTS, BABIES, TODDLERS AND CHILDREN; HEAD SCARVES; HEAD SWEATBANDS; HEAD WEAR; HEADBANDS; HEADBANDS AGAINST SWEATING; HEADBANDS FOR CLOTHING; HEAVY COATS; HEAVY JACKETS; HEEL INSERTS; HEEL PIECES FOR SHOES; HEELS; HIGH RAIN CLOGS (ASHIDA); HIKING BOOTS; HIP-GUARDS ESPECIALLY MADE FOR FISHING; HOCKEY SHOES; HOODED PULLOVERS; HOODED SWEAT SHIRTS; HOODED SWEATSHIRTS; HOODED SWEATSHIRTS; HOODS; HORSE-RIDING BOOTS; HOSIERY; HOUSECOATS; INFANT AND TODDLER ONE PIECE CLOTHING; INFANT CLOTH DIAPERS; INFANT DIAPER COVERS; INFANT SLEEPERS; INFANT WEAR; INFANT WEARABLE BLANKETS; INFANTS' SHOES AND BOOTS; INFANTS' TROUSERS; INFANTWEAR; JACKET LINERS; JACKETS AND SOCKS; JANDALS; JEANS; JEGGINGS, NAMELY, PANTS THAT ARE PARTIALLY JEANS AND PARTIALLY LEGGINGS; JERKINS; JERSEYS; JODHPURS; JOGGING OUTFITS; JOGGING PANTS; JOGGING SUITS; JUMP SUITS; JUMPER DRESSES; JUMPERS; JUMPSUITS; KAFTANS; KILTS; KIMONOS; KNEE HIGHS; KNEE-HIGH STOCKINGS; KNICKERS; KNIT BOTTOMS; KNIT DRESSES; KNIT FACE MASKS; KNIT JACKETS; KNIT SHIRTS; KNIT SKIRTS; KNIT TOPS; KNITTED CAPS; KNITTED GLOVES; KNITTED UNDERWEAR; KNOT CAPS; KNOTTED CAPS; LACE BOOTS; LADIES' BOOTS; LADIES' SUITS; LADIES' UNDERWEAR; LAYETTES; LEATHER BELTS; LEATHER BOOTS; LEATHER COATS; LEATHER HATS; LEATHER HEADWEAR; LEATHER JACKETS; LEATHER PANTS; LEATHER SHIRTS; LEATHER SHOES; LEATHER SKIRTS; LEATHER SLIPPERS; LEATHER VESTS; LEGGINGS; LEGGINS; LEG-WARMERS; LEISURE SHOES; LEISURE SUITS; LEOTARDS; LEOTARDS AND TIGHTS FOR WOMEN, MEN AND CHILDREN OF NYLON, COTTON OR OTHER TEXTILE FIBERS; LIGHT-REFLECTING COATS; LIGHT-REFLECTING JACKETS; LINGERIE; LINGERIE ACCESSORIES, NAMELY, REMOVABLE SILICONE BREAST ENHANCER PADS USED IN A BRA; LIVERIES;

Reg. No. 4,204,775 LOAFERS; LONG JACKETS; LONG JOHNS; LONG SLEEVE PULLOVERS; LONG SLEEVED VESTS; LONG UNDERWEAR; LONG-SLEEVED SHIRTS; LOUNGE PANTS; LOUNGEWEAR; LOW WOODEN CLOGS (HIYORI-GETA); LOW WOODEN CLOGS (KOMA-GETA); MAIL-LOTS; MANIPLES; MANTILLAS; MANTLES; OBIS; ONE PIECE GARMENT FOR INFANTS AND TODDLERS; ONE-PIECE GARMENTS FOR CHILDREN; ONE-PIECE PLAY SUITS; OPEN-NECKED SHIRTS; OUTDOOR GLOVES; OUTDOOR MITTENS; OUTER JACKETS; OVER COATS; OVER SHIRTS; OVERALLS; OVERALLS FOR USE IN SALONS AND BARBER SHOPS; OVERSHOES; OVER-TROUSERS; PADDED JACKETS; PADDING JACKETS; PAJAMA BOTTOMS; PAJAMAS; PAJAMAS TREATED WITH FIRE AND HEAT RETARDANTS; PANTALOONS; PANTIES; PANTIES, SHORTS AND BRIEFS; PANTS; PANTSUITS; PANTYHOSE; PARTS OF CLOTHING, NAMELY, GUSSETS FOR TIGHTS, GUSSETS FOR STOCKINGS, GUSSETS FOR BATHING SUITS, GUSSETS FOR UNDERWEAR, GUSSETS FOR LEOTARDS AND GUSSETS FOR FOOTLETS; PARTS OF CLOTHING, NAMELY, UNDERARM GUSSETS; PARTY HATS; PEACOATS; PEDICURE SANDALS; PEDICURE SLIPPERS; PETTICOATS; PETTI-PANTS; PIQUE SHIRTS; PLASTIC APRONS; PLASTIC BABY BIBS; PLAY SUITS; PLEATED SKIRTS FOR FORMAL KIMONOS (HAKAMA); POLO KNIT TOPS; POLO SHIRTS; PONCHOS; PRAM SUITS; PULLOVERS; PUMPS; PUTTEES AND GAITERS; PYJAMAS; QUILTED VESTS; RACE NUMBER BELTS THAT HOLD A PAPER NUMBER ON THE RACE PARTICIPANT'S FRONT OR BACK DURING COMPETITION; RAIN BOOTS; RAIN COATS; RAIN HATS; RAIN JACKETS; RAIN SLICKERS; RAIN SUITS; RAIN TROUSERS; RAIN WEAR; RAINPROOF JACKETS; RASH GUARDS; REDINGOTES; REMOVABLE COLLARS; REVERSIBLE JACKETS; RIDING BOOTS; RIDING COATS; RIDING GLOVES; RIDING SHOES; ROBES; ROMPERS; RUNNING SHOES; RUNNING SUITS; SABOTS; SAILOR SUITS; SALOPETTES; SANDALS; SANDALS AND BEACH SHOES; SANDAL-CLOGS; SAREES; SARIS; SARONGS; SASH BANDS FOR KIMONO (OBI); SASHES; SCARFS; SCARVES; SCHOOL UNIFORMS; SHAPEWEAR, NAMELY, GIRDLES, BRAS; SHAWLS; SHAWLS; STOLE; SHELL JACKETS; SHIRTS; SHIRT FRONTS; SHIRT INSERTS, NAMELY, DICKIES; SHIRT YOKES; SHIRTS; SHIRTS AND SHORT-SLEEVED SHIRTS; SHIRTS AND SLIPS; SHIRTS FOR INFANTS, BABIES, TODDLERS AND CHILDREN; SHIRTS FOR SUITS; SHOE STRAPS; SHOES; SHORT OVERCOAT FOR KIMONO (HAORI); SHORT PETTICOATS; SHORT SETS; SHORT TROUSERS; SHORTALLS; SHORTS; SHORT-SLEEVED OR ; LONG-SLEEVED T-SHIRTS; SHORT-SLEEVED SHIRTS; SHOULDER SCARVES; SHOULDER WRAPS; SHOULDER WRAPS FOR CLOTHING; SHRUGS; SILK SCARVES; SINGLET; SKATING OUTFITS; SKIRT SUITS; SKIRTS; SKORTS; SKULL CAPS; SKULLIES; SLACKS; SLEEP MASKS; SLEEP PANTS; SLEEP SHIRTS; SLEEPING GARMENTS; SLEEPWEAR; SLEEPWEAR TREATED WITH FIRE AND HEAT RETARDANTS; SLEEVED OR SLEEVELESS JACKETS; SLEEVELESS JERSEYS; SLEEVES WORN SEPARATE AND APART FROM BLOUSES, SHIRTS AND OTHER TOPS; SLIDING SHORTS; SLIPPOVERS; SLIPPER SOCKS; SLIPPER SOLES; SLIPPERS; SLIPS; SMALL HATS; SMOCKS; SMOKING JACKETS; SNAP CROTCH SHIRTS FOR INFANTS AND TODDLERS; SNEAKERS; SOCK SUSPENDERS; SOCKS AND STOCKINGS; SPATS; SPORT COATS; SPORT SHIRTS; SPORT STOCKINGS; SPORTS BRA; SPORTS BRAS; SPORTS CAPS AND HATS; SPORTS JACKETS; SPORTS JERSEYS; SPORTS JERSEYS AND BREECHES FOR SPORTS; SPORTS PANTS; SPORTS SHIRTS; SPORTS SHIRTS WITH SHORT SLEEVES; SPORTS VESTS; STILETTO HEELS, STOCKING SUSPENDERS, STOCKINGS, STOCKINGS, STRAPLESS BRAS, STRAPS FOR BRAS, STRETCH PANTS, STUDS FOR FOOTBALL BOOTS, STUFF JACKETS, SUEDE JACKETS; SUIT COATS; SUITS; SUITS OF LEATHER; SUN LEGGINGS; SUN PROTECTIVE CLOTHING, NAMELY, SHIRTS, PANTS; SUN SLEEVES; SUN VISORS; SUNDRESSES; SUNSUITS; SUSPENDER BELTS; SUSPENDER BELTS FOR MEN; SUSPENDER BELTS FOR WOMEN; SUSPENDERS; SUSPENDERS; SWADDLING CLOTHES; SWEAT BANDS; SWEAT JACKETS; SWEAT PANTS; SWEAT SHIRTS; SWEAT SHORTS; SWEAT SUITS; SWEATBANDS; SWEATERS; SWEATPANTS; SWEATSHIRTS; SWEATSHIRTS FOR BABIES, ADULTS, CHILDREN, WOMEN, MEN; SWEATSOCKS; SWEATSUITS; SWIM CAPS; SWIM SUITS; SWIM TRUNKS; SWIM WEAR; SWIM WEAR FOR GENTLEMEN AND LADIES; SWIMMING CAPS; SWIMMING CAPS; SWIMMING COSTUMES; SWIMMING TRUNKS; SWIMSUITS; SWIMWEAR; TANK TOPS; TANKINIS; TANK-TOPS; TAP PANTS; TAP SHOES; TEDDIES; TEE SHIRTS; TENNIS DRESSES; TENNIS SHOES; TENNIS WEAR; THERMAL SOCKS; THERMAL UNDERWEAR; THONGS; THONGS; TIES; TIGHTS; TIPS

Reg. No. 4,204,775 FOR FOOTWEAR; TOBOGGAN HATS, PANTS AND CAPS; TOGAS; TOP COATS; TOPS; TRACK AND FIELD SHOES; TRACK JACKETS; TRACK PANTS; TRACK SUITS; TRACK-SUITS; TRAINING SHOES; TRAINING SUITS; TRAVEL CLOTHING CONTAINED IN A PACKAGE COMPRISING REVERSIBLE JACKETS, PANTS, SKIRTS, TOPS AND A BELT OR SCARF; TREKKING BOOTS; TRENCH COATS; TROUSERS; TROUSERS FOR SWEATING; TROUSERS OF LEATHER; TRUNKS; TUBE TOPS; TUNICS; TURTLE NECK SHIRTS; TURTLENECK PULLOVERS; TURTLENECK SWEATERS; TURTLENECKS; TUXEDO BELTS; TUXEDOS; TWIN SETS; T-SHIRTS; T-SHIRTS FOR BABIES, ADULTS, CHILDREN, WOMEN, MEN; UNDER GARMENTS; UNDERARM CLOTHING SHIELDS; UNDERCLOTHES; UNDERGARMENT ACCESSORIES, NAMELY, REMOVABLE SILICONE BUTTOCK ENHANCER PADS; UNDERGARMENTS; UNDERGARMENTS, NAMELY, WASPIES; UNDERPANTS; UNDERSHIRTS; UNDERSHIRTS FOR KIMONOS (JUBAN); UNDERSHIRTS FOR KIMONOS (KOSHIMAKI); UNDERSHIRTS; UNDERWEAR; UNDERWEAR, NAMELY, BOY SHORTS; UNIFORMS; UNION SUITS; UNITARDS; VEILS; VEST EXTENDERS; VESTED SUITS; VESTS; VISCOUS GEL POLYMER SOLD AS A COMPONENT OF FINISHED CUSTOM CUSHIONED FOOTWEAR FOR NON-ORTHOPEDIC PURPOSES AND APPAREL; VISORS; V-NECK SWEATERS; WAIST BANDS; WAIST BELTS; WAIST CINCHERS; WAIST STRINGS FOR KIMONOS (KOSHIHIMO); WAISTBAND EXTENDER CONSISTING OF A BUTTON AND BUTTON HOLE MOUNTED ON A STRIP OF FABRIC THAT IS INSERTED INTO THE EXISTING WAISTBAND OF A GARMENT; WAISTBANDS; WAISTCOATS; WALKING SHORTS; WARM UP OUTFITS; WARM UP SUITS; WARM-UP SUITS; WATER PROOF BOOTS; WATER REPELLING BOOTS; WATER REPELLING FOOTWEAR; WATER REPELLING LEATHER BOOTS; WATER REPELLING LEATHER SHOES AND BOOTS; WATERPROOF FOOTWEAR; WATERPROOF JACKETS AND PANTS; WATERPROOF LEATHER BOOTS; WATERPROOF LEATHER SHOES; WATERPROOF LEATHER SHOES AND BOOTS; WEARABLE BLANKETS IN THE NATURE OF BLANKETS WITH SLEEVES; WEARABLE GARMENTS AND CLOTHING, NAMELY, SHIRTS; WEDDING DRESSES; WEDDING GOWNS; WELTS FOR BOOTS AND SHOES; WET SUIT GLOVES; WET SUITS; WET SUITS FOR WATER-SKIING AND SUB-AQUA; WETSUITS; WETSUITS FOR WATER-SKIING; WIND COATS; WIND PANTS; WIND RESISTANT JACKETS; WIND SHIRTS; WIND VESTS; WINDCHEATERS; WINDJAMMERS; WINDSHIRTS; WIND-JACKETS; WINTER BOOTS; WOMEN'S ATHLETIC TOPS WITH BUILT-IN BRAS; WOMEN'S CEREMONIAL DRESSES; WOMEN'S CLOTHING, NAMELY, SHIRTS, DRESSES, SKIRTS, BLOUSES; WOMEN'S FOLDABLE SLIPPERS; WOMEN'S HATS AND HOODS; WOMEN'S SHOES; WOMEN'S SHOES, NAMELY, FOLDABLE FLATS; WOMEN'S TOPS, NAMELY, CAMIS; WOMEN'S UNDERWEAR; WOODEN SHOES; WOOLLEN SOCKS', WOOLLEN TIGHTS, WOOLLY HATS, WORK SHOES AND BOOTS, WORKING OVERALLS, WOVEN BOTTOMS, WOVEN DRESSES, WOVEN OR KNITTED UNDERWEAR; WOVEN SKIRTS; WOVEN TOPS; WRAP BELTS FOR KIMONOS (DATEMAKI); WRAPS, WRIST BANDS, WRISTBANDS, WRISTBANDS CONTAINING A COOLING SUBSTANCE TO COOL THE WEARER; YOGA PANTS, YOGA SHIRTS, IN CLASS 25 (U.S. CLS. 22 AND 39).

FIRST USE 10-1-2009; IN COMMERCE 7-9-2011.

THE MARK CONSISTS OF STANDARD CHARACTERS WITHOUT CLAIM TO ANY PARTICULAR FONT, STYLE, SIZE, OR COLOR.

THE NAME(S), PORTRAIT(S), AND/OR SIGNATURE(S) SHOWN IN THE MARK IDENTIFIES APPLICANT, WHOSE CONSENT(S) TO REGISTER IS MADE OF RECORD.

SER. NO. 85-434,335, FILED 9-28-2011.

THOMAS MANOR, EXAMINING ATTORNEY

United States of America

United States Patent and Trademark Office

Optimal Diet

Reg. No. 4,204,776

Registered Sep. 11, 2012

Int. Cl.: 5

TRADEMARK

PRINCIPAL REGISTER

EAST WEST ESSENTIALS, INC. (CALIFORNIA CORPORATION)
SUITE 403
9025 WILSHIRE BLVD.
BEVERLY HILLS, CA 90211

FOR: DIETARY FOOD SUPPLEMENTS, IN CLASS 5 (U.S. CLS. 6, 18, 44, 46, 51 AND 52).

FIRST USE 11-1-2010; IN COMMERCE 11-1-2010.

THE MARK CONSISTS OF STANDARD CHARACTERS WITHOUT CLAIM TO ANY PARTICULAR FONT, STYLE, SIZE, OR COLOR.

OWNER OF U.S. REG. NO. 4,079,827.

NO CLAIM IS MADE TO THE EXCLUSIVE RIGHT TO USE "DIET", APART FROM THE MARK AS SHOWN.

SER. NO. 85-434,532, FILED 9-28-2011.

ALAIN LAPTER, EXAMINING ATTORNEY



David J. Kyffers

Director of the United States Patent and Trademark Office

United States of America

United States Patent and Trademark Office

Code Green

Reg. No. 4,204,777

Registered Sep. 11, 2012

Int. Cl.: 41

SERVICE MARK

PRINCIPAL REGISTER

JOHN E. JONES (UNITED STATES INDIVIDUAL)
5875 ROSENDALE DRIVE
EAST HELENA, MT 59635 AND

ORION THORNTON (UNITED STATES INDIVIDUAL)
5875 ROSENDALE DRIVE
EAST HELENA, MT 59635

FOR: EDUCATIONAL SERVICES, NAMELY, CONDUCTING SEMINARS, CLASSES, WORKSHOPS AND TRAINING TO FIRST RESPONDERS AND FIREFIGHTERS IN THE FIELD OF FIRES INVOLVING RENEWABLE ENERGY SYSTEMS AND DISTRIBUTION OF COURSE MATERIAL IN CONNECTION THEREWITH, IN CLASS 41 (U.S. CLS. 100, 101 AND 107).

FIRST USE 8-2-2011; IN COMMERCE 8-2-2011.

THE MARK CONSISTS OF STANDARD CHARACTERS WITHOUT CLAIM TO ANY PARTICULAR FONT, STYLE, SIZE, OR COLOR.

SER. NO. 85-434,766, FILED 9-28-2011.

REBECCA SMITH, EXAMINING ATTORNEY



David J. Kyffers

Director of the United States Patent and Trademark Office

United States of America

United States Patent and Trademark Office

Z-connector

Reg. No. 4,204,778

Registered Sep. 11, 2012

Int. Cl.: 22

TRADEMARK

PRINCIPAL REGISTER

Z-CONNECTOR, LLC (NEVADA LIMITED LIABILITY COMPANY)
3225 MCLEOD DR.,
SUITE 100
LAS VEGAS, NV 89121

FOR: APPARATUS IN THE NATURE OF LANYARDS FOR SECURING SMALL HANDHELD ELECTRONIC DEVICES TO THE PERSON, A PURSE, A CARRYING BAG OR CASE , IN CLASS 22 (U.S. CLS. 1, 2, 7, 19, 22, 42 AND 50).

FIRST USE 9-22-2011; IN COMMERCE 9-22-2011.

THE MARK CONSISTS OF STANDARD CHARACTERS WITHOUT CLAIM TO ANY PARTICULAR FONT, STYLE, SIZE, OR COLOR.

SER. NO. 85-434,842, FILED 9-28-2011.

ALEX KEAM, EXAMINING ATTORNEY



David J. Kyffers

Director of the United States Patent and Trademark Office

United States of America

United States Patent and Trademark Office

BUSINESS TRACK

Reg. No. 4,204,779

Registered Sep. 11, 2012

Int. Cl.: 35

SERVICE MARK

PRINCIPAL REGISTER

FIRST DATA CORPORATION (DELAWARE CORPORATION)
6200 SOUTH QUEBEC STREET
GREENWOOD VILLAGE, CO 80111

FOR: PROVIDING A WEB-BASED ONLINE PORTAL FEATURING COMMERCIAL SALES INFORMATION, SALES TRANSACTIONS AND ACCOUNTS RECEIVABLE INFORMATION AND BUSINESS ANALYTICAL REPORTS FOR RETAILERS, FINANCIAL INSTITUTIONS, PROCESSORS AND INDEPENDENT SALES ORGANIZATIONS, IN CLASS 35 (U.S. CLS. 100, 101 AND 102).

FIRST USE 7-31-2011; IN COMMERCE 7-31-2011.

THE MARK CONSISTS OF STANDARD CHARACTERS WITHOUT CLAIM TO ANY PARTICULAR FONT, STYLE, SIZE, OR COLOR.

NO CLAIM IS MADE TO THE EXCLUSIVE RIGHT TO USE "BUSINESS", APART FROM THE MARK AS SHOWN.

SER. NO. 85-434,974, FILED 9-29-2011.

MICHELE SWAIN, EXAMINING ATTORNEY



David J. Kyjars

Director of the United States Patent and Trademark Office

United States of America

United States Patent and Trademark Office

THE TOLL BROTHERS GREEN COMMITMENT

Reg. No. 4,204,780

Registered Sep. 11, 2012

Int. Cls.: 35 and 37

SERVICE MARK

PRINCIPAL REGISTER

TB PROPRIETARY CORPORATION (DELAWARE CORPORATION)
1105 NORTH MARKET STREET
SUITE 1414
WILMINGTON, DE 19801

FOR: REAL ESTATE SALES MANAGEMENT, IN CLASS 35 (U.S. CLS. 100, 101 AND 102).

FIRST USE 10-27-2010; IN COMMERCE 10-27-2010.

FOR: LAND DEVELOPMENT AND CONSTRUCTION SERVICES, NAMELY, PLANNING, LAYING OUT AND CUSTOM CONSTRUCTION OF RESIDENTIAL COMMUNITIES; CONSTRUCTION OF ENVIRONMENTALLY FRIENDLY RESIDENTIAL COMMUNITIES, IN CLASS 37 (U.S. CLS. 100, 103 AND 106).

FIRST USE 10-27-2010; IN COMMERCE 10-27-2010.

THE MARK CONSISTS OF STANDARD CHARACTERS WITHOUT CLAIM TO ANY PARTICULAR FONT, STYLE, SIZE, OR COLOR.

NO CLAIM IS MADE TO THE EXCLUSIVE RIGHT TO USE "BROTHERS" AND "GREEN", APART FROM THE MARK AS SHOWN.

SER. NO. 85-434,981, FILED 9-29-2011.

CARYN GLASSER, EXAMINING ATTORNEY



David J. Kybas

Director of the United States Patent and Trademark Office

United States of America

United States Patent and Trademark Office

CASCO BAY LINES

Reg. No. 4,204,781

Registered Sep. 11, 2012

Int. Cl.: 39

SERVICE MARK

PRINCIPAL REGISTER

CASCO BAY ISLAND TRANSIT DISTRICT (MAINE BODY POLITIC AND CORPORATE)
P.O. BOX 4656
56 COMMERCIAL STREET
PORTLAND, ME 041124656

FOR: CHARTERING OF BOATS; TRANSPORT BY FERRY AND BOAT, IN CLASS 39 (U.S. CLS. 100 AND 105).

FIRST USE 10-24-1987; IN COMMERCE 10-24-1987.

THE MARK CONSISTS OF STANDARD CHARACTERS WITHOUT CLAIM TO ANY PARTICULAR FONT, STYLE, SIZE, OR COLOR.

NO CLAIM IS MADE TO THE EXCLUSIVE RIGHT TO USE "LINES", APART FROM THE MARK AS SHOWN.

SEC. 2(F).

SER. NO. 85-435,031, FILED 9-29-2011.

ELLEN B. AWRICH, EXAMINING ATTORNEY



David J. Kyffers

Director of the United States Patent and Trademark Office

United States of America

United States Patent and Trademark Office

VINTAGE SOFTWARE

Reg. No. 4,204,782

Registered Sep. 11, 2012

Int. Cl.: 42

SERVICE MARK

PRINCIPAL REGISTER

VINTAGE SOFTWARE, LLC (MISSOURI LIMITED LIABILITY COMPANY)
100 S HIGH ST
JACKSON, MO 63755

FOR: COMPUTER PROGRAMMING SERVICES, NAMELY, CREATION OF MOBILE COMMUNICATION DEVICE APPLICATIONS; COMPUTER SOFTWARE DESIGN; COMPUTER SOFTWARE DEVELOPMENT; COMPUTER TECHNICAL SUPPORT SERVICES, NAMELY, 24/7 SERVICE DESK/HELP DESK SERVICES FOR IT INFRASTRUCTURE, OPERATING SYSTEMS, DATABASE SYSTEMS, AND WEB APPLICATIONS.; CONSULTANCY IN THE FIELD OF SOFTWARE DESIGN; CREATING, DESIGNING AND MAINTAINING WEB SITES; CUSTOMIZED SOFTWARE DEVELOPMENT SERVICES, IN CLASS 42 (U.S. CLS. 100 AND 101).

FIRST USE 2-28-2007; IN COMMERCE 2-28-2007.

THE MARK CONSISTS OF STANDARD CHARACTERS WITHOUT CLAIM TO ANY PARTICULAR FONT, STYLE, SIZE, OR COLOR.

NO CLAIM IS MADE TO THE EXCLUSIVE RIGHT TO USE "SOFTWARE", APART FROM THE MARK AS SHOWN.

SER. NO. 85-435,932, FILED 9-29-2011.

GISELLE AGOSTO, EXAMINING ATTORNEY



David J. Kybas

Director of the United States Patent and Trademark Office

United States of America

United States Patent and Trademark Office



Reg. No. 4,204,783

Registered Sep. 11, 2012

Int. Cl.: 9

TRADEMARK

PRINCIPAL REGISTER

INMOTION CCTV, INC. (CALIFORNIA CORPORATION)
5085 WALNUT GROVE AVE
SAN GABRIEL, CA 91776

FOR: BUILDING SECURITY SYSTEMS COMPRISING SOFTWARE AND HARDWARE FOR PROVIDING PICTURE, VIDEO, ALARM STATUS, BUILDING PLANS, AND OTHER INFORMATION TO A REMOTE STATION, IN CLASS 9 (U.S. CLS. 21, 23, 26, 36 AND 38).

FIRST USE 6-1-2011; IN COMMERCE 6-1-2011.

NO CLAIM IS MADE TO THE EXCLUSIVE RIGHT TO USE "SICHER", APART FROM THE MARK AS SHOWN.

THE MARK CONSISTS OF THE TERM "SICHER" WHERE THE LETTER "S" IS CONTAINED IN AN OVAL. OVAL HAS CONTRASTED SHADING IN THE UPPER LEFT CORNER THAT ILLUMINATES AND GIVES IT DIMENSION.

THE ENGLISH TRANSLATION OF "SICHER" IN THE MARK IS "CERTAIN", "SECURE", "SAFE".

SER. NO. 85-436,457, FILED 9-30-2011.

BILL DAWE, EXAMINING ATTORNEY



David J. Kyffers

Director of the United States Patent and Trademark Office

United States of America

United States Patent and Trademark Office

SpiraPave

Reg. No. 4,204,784

ELMICH PTE LTD. (SINGAPORE CORPORATION)
15 JOAN ROAD

Registered Sep. 11, 2012

SINGAPORE, SINGAPORE 298899

Int. Cl.: 19

FOR: NON-METALLIC LANDSCAPING MATERIALS, NAMELY, PLASTIC PEDESTAL PAVER AND BEARER SUPPORTS, IN CLASS 19 (U.S. CLS. 1, 12, 33 AND 50).

TRADEMARK

THE MARK CONSISTS OF STANDARD CHARACTERS WITHOUT CLAIM TO ANY PARTICULAR FONT, STYLE, SIZE, OR COLOR.

PRINCIPAL REGISTER

OWNER OF SINGAPORE REG. NO. T0910238B, DATED 9-14-2009, EXPIRES 9-14-2019.

SER. NO. 85-436,874, FILED 9-30-2011.

MEGHAN REINHART, EXAMINING ATTORNEY



David J. Kybas

Director of the United States Patent and Trademark Office

United States of America

United States Patent and Trademark Office

VERSIJACK

Reg. No. 4,204,785

ELMICH PTE LTD. (SINGAPORE CORPORATION)
15 JOAN ROAD

Registered Sep. 11, 2012

SINGAPORE, SINGAPORE 298899

Int. Cl.: 19

FOR: BUILDING MATERIALS OF PLASTIC MATERIAL FOR USE TO SUPPORT AND RAISE FLOORING MATERIALS INCLUDING STONE PAVERS, TILES AND TIMBER DECKING, NAMELY, PLASTIC PEDESTALS FOR ELEVATING PAVERS, IN CLASS 19 (U.S. CLS. 1, 12, 33 AND 50).

TRADEMARK

PRINCIPAL REGISTER

THE MARK CONSISTS OF STANDARD CHARACTERS WITHOUT CLAIM TO ANY PARTICULAR FONT, STYLE, SIZE, OR COLOR.

OWNER OF SINGAPORE REG. NO. T0520019C, DATED 10-14-2005, EXPIRES 10-14-2015.

SER. NO. 85-436,885, FILED 9-30-2011.

MEGHAN REINHART, EXAMINING ATTORNEY



David J. Kybas

Director of the United States Patent and Trademark Office

United States of America

United States Patent and Trademark Office

TURFPAVE

Reg. No. 4,204,786

ELMICH PTE LTD. (SINGAPORE CORPORATION)

Registered Sep. 11, 2012

15 JOAN ROAD
SINGAPORE, SINGAPORE 298899

Int. Cl.: 19

FOR: BUILDING MATERIALS, NAMELY, INTERLOCKING PLASTIC GRASS PAVER; NON-METALLIC RIGID PIPES FOR BUILDING; ASPHALT, PITCH AND BITUMEN; NON-METALLIC TRANSPORTABLE BUILDINGS; MONUMENTS, NOT OF METAL, IN CLASS 19 (U.S. CLS. 1, 12, 33 AND 50).

TRADEMARK

PRINCIPAL REGISTER

THE MARK CONSISTS OF STANDARD CHARACTERS WITHOUT CLAIM TO ANY PARTICULAR FONT, STYLE, SIZE, OR COLOR.

OWNER OF SINGAPORE REG. NO. T0302837G, DATED 3-3-2003, EXPIRES 3-3-2013.

SER. NO. 85-436,927, FILED 9-30-2011.

MEGHAN REINHART, EXAMINING ATTORNEY



David J. Kyjars

Director of the United States Patent and Trademark Office

United States of America

United States Patent and Trademark Office



Reg. No. 4,204,787

ALL FISHIN LLC (CALIFORNIA LIMITED LIABILITY COMPANY)
14847 VISTA DEL OCEANO
DEL MAR, CA 920144147

Registered Sep. 11, 2012

Int. Cl.: 28

FOR: FISHING LURES, IN CLASS 28 (U.S. CLS. 22, 23, 38 AND 50).

TRADEMARK

FIRST USE 12-1-1999; IN COMMERCE 11-1-2009.

PRINCIPAL REGISTER

NO CLAIM IS MADE TO THE EXCLUSIVE RIGHT TO USE "MEGABAIT", APART FROM THE MARK AS SHOWN.

THE MARK CONSISTS OF A STYLIZED FISH FEATURING THE WORDS "MEGABAIT" RUNNING ACROSS THE CENTER OF THE FISH.

SER. NO. 85-437,015, FILED 9-30-2011.

SIMON TENG, EXAMINING ATTORNEY



David J. Kybas

Director of the United States Patent and Trademark Office

United States of America

United States Patent and Trademark Office

HACKERSHIELD

Reg. No. 4,204,788

Registered Sep. 11, 2012

Int. Cls.: 42 and 45

SERVICE MARK

PRINCIPAL REGISTER

LOGICATION, LLC (DELAWARE LIMITED LIABILITY COMPANY)
SUITE 2600
130 WEST 42ND STREET
NEW YORK, NY 10036

FOR: ENGINEERING SERVICES COMPRISING TESTING AND ANALYSIS, AND CONSULTING SERVICES IN THE TECHNOLOGY FIELD OF SECURITY, ACCESS, AUTHORIZATION, AUTHENTICATION ENCRYPTION, AND IDENTIFICATION SYSTEMS FOR COMPUTERS, COMPUTER HARDWARE AND COMPUTER NETWORKS; DEVELOPMENT, INTEGRATION AND OPERATION OF COMPUTER SYSTEMS TO SUPPORT ISSUANCE AND MANAGEMENT OF DIGITAL CERTIFICATES; CREATION AND IMPLEMENTATION OF PROCEDURES AND PRACTICES FOR ISSUANCE AND MANAGEMENT OF DIGITAL CERTIFICATES; ENTERPRISE SOFTWARE INTEGRATION, NAMELY, INTEGRATION OF COMPUTER SOFTWARE INTO MULTIPLE SYSTEMS AND NETWORKS; COMPUTER SERVICES, NAMELY, PROVIDING A WEB SITE FEATURING NON-DOWNLOADABLE SOFTWARE THAT ENABLES USERS OF THE INTERNET TO DELIVER INFORMATION ABOUT THEMSELVES AND, IF APPLICABLE, THEIR BUSINESSES, PRODUCTS OR SERVICES, AND TO REGISTER THEIR UNIVERSAL RESOURCE LOCATORS (URLS), WITH ON-LINE CATALOGUES, DIRECTORIES, SEARCH ENGINES AND WEB SITES, VIA THE INTERNET AND OTHER COMPUTER NETWORKS; ON-LINE TECHNICAL SUPPORT SERVICES, NAMELY, TROUBLESHOOTING OF COMPUTER HARDWARE AND SOFTWARE PROBLEMS; COMPUTER CONSULTATION REGARDING COMPUTER NETWORKS AND INTERNAL COMPUTER NETWORKS, SECURITY SERVICES FOR COMPUTER NETWORKS AND INTERNAL COMPUTER NETWORKS, NAMELY, INSTALLATION, DESIGN AND CUSTOMIZATION OF INTERNET AND NETWORK FIREWALL SOFTWARE FOR OTHERS; COMPUTER CONSULTING SERVICES IN THE FIELD OF SECURITY INTEGRATION, NETWORK SECURITY, NETWORK ARCHITECTURE, ENCRYPTION TECHNOLOGY AND COMPUTER SECURITY; SECURITY VERIFICATION OF COMPUTER NETWORK FIREWALLS, SERVERS AND OTHER NETWORK DEVICES FROM UNAUTHORIZED ACCESS, NAMELY, ANALYZING GLOBAL COMPUTER INFORMATION NETWORK AND INTERNAL COMPUTER NETWORK VULNERABILITY; COMPUTER SOFTWARE CONSULTATION SERVICES FOR THE DEVELOPMENT OF SOFTWARE APPLICATIONS; DESIGNING AND PROGRAMMING COMPUTER CONTROLLED COMMUNICATIONS SYSTEMS; DATA AUTOMATION AND COLLECTION SERVICE USING PROPRIETARY SOFTWARE TO EVALUATE, ANALYZE, AND COLLECT SERVICE DATA; DATA CONVERSION OF COMPUTER PROGRAM DATA OR INFORMATION; APPLICATION SERVICE PROVIDER (ASP), NAMELY, HOSTING COMPUTER SOFTWARE APPLICATIONS FOR OTHERS; HOSTING OF WEB SITES; CON-



David J. Kyjars

Director of the United States Patent and Trademark Office

Reg. No. 4,204,788 SULTING IN THE FIELD OF COMPUTERS AND COMPUTER NETWORKS, NAMELY, COMPUTERS AND COMPUTER NETWORKS FEATURING TURN KEY E-COMMERCE SERVICES; PROVIDING TEMPORARY USE OF ONLINE NON-DOWNLOADABLE COMPUTER PROGRAMS FOR NETWORK SECURITY AUTHENTICATION FOR COMPUTER NETWORKS USING THE ELECTRONIC PRODUCT CODE (EPC); COMPUTER CONSULTATION IN THE FIELD OF COMPUTER SECURITY, IN CLASS 42 (U.S. CLS. 100 AND 101).

FIRST USE 1-1-2011; IN COMMERCE 1-1-2011.

FOR: PROVIDING USER AUTHENTICATION SERVICES IN E-COMMERCE TRANSACTIONS; COMPUTER SERVICES, NAMELY, PROVIDING ON-LINE LEGAL INFORMATION IN THE FIELD OF DOMAIN NAME DISPUTES; REGISTRATION OF DOMAIN NAMES FOR IDENTIFICATION OF USERS ON A GLOBAL COMPUTER NETWORK; ISSUANCE OF DIGITAL CERTIFICATES FOR AUTHENTICATION; MONITORING OF COMPUTER SYSTEMS FOR SECURITY PURPOSES; COMPUTER RELATED SERVICES, NAMELY, MANAGED COMPUTER NETWORK AND INTERNET SECURITY SERVICES, NAMELY, PUBLIC KEY INFRASTRUCTURE (PKI) VERIFICATION, AUTHENTICATION, DISTRIBUTION AND MANAGEMENT; DIGITAL CERTIFICATE ISSUANCE, VERIFICATION AND MANAGEMENT, IN CLASS 45 (U.S. CLS. 100 AND 101).

FIRST USE 1-1-2011; IN COMMERCE 1-1-2011.

THE MARK CONSISTS OF STANDARD CHARACTERS WITHOUT CLAIM TO ANY PARTICULAR FONT, STYLE, SIZE, OR COLOR.

SER. NO. 85-437,149, FILED 10-1-2011.

MICHAEL LITZAU, EXAMINING ATTORNEY

United States of America

United States Patent and Trademark Office

CARE. RIGHT. NOW.



Reg. No. 4,204,789

CENTENE CORPORATION (DELAWARE CORPORATION)
7700 FORSYTH BOULEVARD
ST. LOUIS, MO 63105

Registered Sep. 11, 2012

Int. Cl.: 44

FOR: NURSE INFORMATION SERVICES, NAMELY, NURSE TRIAGE AND NURSE CALL CENTERS PROVIDING INFORMATION REGARDING THE IDENTIFICATION OF SPECIFIC HEALTH RELATED CONCERNS AND GENERAL HEALTH ISSUES; MANAGED HEALTH CARE SERVICES, IN CLASS 44 (U.S. CLS. 100 AND 101).

SERVICE MARK

PRINCIPAL REGISTER

FIRST USE 7-25-2011; IN COMMERCE 7-25-2011.

THE MARK CONSISTS OF THE WORDING "CARE RIGHT NOW" AND DESIGN. EACH TERM IS SEPARATED BY A PERIOD AND BELOW THE WORDING IS A CROSS, CHECK MARK, AND A CLOCK, ALL SEPARATED BY A PLUS SIGN.

SER. NO. 85-437,622, FILED 10-3-2011.

MARLENE BELL, EXAMINING ATTORNEY



David J. Kyffers

Director of the United States Patent and Trademark Office

United States of America

United States Patent and Trademark Office

FIRST PACTRUST BANCORP, INC.

Reg. No. 4,204,790

FIRST PACTRUST BANCORP, INC. (MARYLAND CORPORATION)
610 BAY BLVD.

Registered Sep. 11, 2012

CHULA VISTA, CA 91910

Int. Cl.: 36

FOR: BANK HOLDING COMPANY SERVICES, NAMELY, BANKING SERVICES, IN CLASS
36 (U.S. CLS. 100, 101 AND 102).

SERVICE MARK

FIRST USE 4-27-2011; IN COMMERCE 4-27-2011.

PRINCIPAL REGISTER

THE MARK CONSISTS OF STANDARD CHARACTERS WITHOUT CLAIM TO ANY PAR-
TICULAR FONT, STYLE, SIZE, OR COLOR.

NO CLAIM IS MADE TO THE EXCLUSIVE RIGHT TO USE "FIRST" AND "BANCORP, INC.",
APART FROM THE MARK AS SHOWN.

SER. NO. 85-437,667, FILED 10-3-2011.

H. M. FISHER, EXAMINING ATTORNEY



David J. Kybas

Director of the United States Patent and Trademark Office

United States of America

United States Patent and Trademark Office

COMFORT BLOCK

Reg. No. 4,204,791

GENEST CONCRETE WORKS, INC (MAINE CORPORATION)

Registered Sep. 11, 2012

P.O. BOX 151
SANFORD, ME 04073

Int. Cl.: 19

FOR: CONCRETE BUILDING MATERIALS, NAMELY, CONCRETE PAVERS, INTERLOCKING CONCRETE PAVERS, SEGMENTED RETAINING WALLS, CONCRETE ROOF BALLASTS, CONCRETE WALL SEGMENTS, CONCRETE TILES, CONCRETE BLOCKS, IN CLASS 19 (U.S. CLS. 1, 12, 33 AND 50).

TRADEMARK

PRINCIPAL REGISTER

FIRST USE 9-26-2011; IN COMMERCE 9-26-2011.

THE MARK CONSISTS OF STANDARD CHARACTERS WITHOUT CLAIM TO ANY PARTICULAR FONT, STYLE, SIZE, OR COLOR.

NO CLAIM IS MADE TO THE EXCLUSIVE RIGHT TO USE "BLOCK", APART FROM THE MARK AS SHOWN.

SER. NO. 85-437,681, FILED 10-3-2011.

JEFFREY LOOK, EXAMINING ATTORNEY



David J. Kyfos

Director of the United States Patent and Trademark Office

United States of America

United States Patent and Trademark Office



Reg. No. 4,204,792

SAFETY GLASSES USA, INC. (MICHIGAN CORPORATION)
1501 KDF DRIVE
THREE RIVERS, MI 49093

Registered Sep. 11, 2012

Int. Cl.: 9

FOR: EYE COVERS FOR PROTECTIVE PURPOSES, IN CLASS 9 (U.S. CLS. 21, 23, 26, 36 AND 38).

TRADEMARK

FIRST USE 10-10-2000; IN COMMERCE 10-10-2000.

PRINCIPAL REGISTER

NO CLAIM IS MADE TO THE EXCLUSIVE RIGHT TO USE "SAFETY GLASSES USA.COM", APART FROM THE MARK AS SHOWN.

THE COLOR(S) RED, WHITE, BLUE AND BLACK IS/ARE CLAIMED AS A FEATURE OF THE MARK.

THE MARK CONSISTS OF A BLUE STAR WITH THE UPPER HALF OF THE STAR IN A LIGHTER BLUE THAN THE BOTTOM HALF AND PARTIAL BLACK AND WHITE OUTLINING ON THE STAR, FIVE RED STRIPES WHICH GRADUALLY FADE FROM RED ON THE LEFT TO WHITE ON THE RIGHT, THERE IS BLACK UNDERLINING ON EACH STRIPE, AND THE LETTERS ON THE WORDS "SAFETY GLASSES USA.COM" ARE BLUE, EXCEPT THE LETTERS "USA" WHICH ARE RED.

SER. NO. 85-438,022, FILED 10-3-2011.

BARBARA RUTLAND, EXAMINING ATTORNEY



David J. Kybas

Director of the United States Patent and Trademark Office

United States of America

United States Patent and Trademark Office

GXG Eyewear

Reg. No. 4,204,793

Registered Sep. 11, 2012

Int. Cl.: 9

TRADEMARK

PRINCIPAL REGISTER

NAGI K CORPORATION (CALIFORNIA CORPORATION)
#8
401 S LOS ANGELES ST.
LOS ANGELES, CA 90013

FOR: CASES FOR EYEGLASSES AND SUNGLASSES; SUNGLASSES, IN CLASS 9 (U.S. CLS. 21, 23, 26, 36 AND 38).

FIRST USE 9-0-2009; IN COMMERCE 7-19-2011.

THE MARK CONSISTS OF STANDARD CHARACTERS WITHOUT CLAIM TO ANY PARTICULAR FONT, STYLE, SIZE, OR COLOR.

OWNER OF U.S. REG. NO. 3,897,968.

NO CLAIM IS MADE TO THE EXCLUSIVE RIGHT TO USE "EYEWEAR", APART FROM THE MARK AS SHOWN.

THE WORDING "GXG" HAS NO MEANING IN A FOREIGN LANGUAGE.

SER. NO. 85-438,180, FILED 10-3-2011.

MYRIAH HABEEB, EXAMINING ATTORNEY



David J. Kyffers

Director of the United States Patent and Trademark Office

United States of America

United States Patent and Trademark Office

LIFEPRINT HEALTH CARE BUILT AROUND YOU

Reg. No. 4,204,794

Registered Sep. 11, 2012

**Int. Cls.: 36, 41, 43 and
44**

UNITEDHEALTH GROUP INCORPORATED (MINNESOTA CORPORATION)
9900 BREN ROAD EAST
MN008-T202
MINNETONKA, MN 55343

FOR: INSURANCE CLAIMS PROCESSING, IN CLASS 36 (U.S. CLS. 100, 101 AND 102).

FIRST USE 2-0-2011; IN COMMERCE 2-0-2011.

SERVICE MARK

PRINCIPAL REGISTER

FOR: EDUCATIONAL SERVICES, NAMELY, CONDUCTING PROGRAMS AND CLASSES IN THE FIELDS OF HEALTH, WELLNESS, NUTRITION, AND HEALTHY LIFESTYLE; PROVIDING A CENTER FOR EDUCATIONAL CLASSES IN THE FIELD OF HEALTH, WELLNESS, NUTRITION, AND HEALTHY LIFESTYLES, IN CLASS 41 (U.S. CLS. 100, 101 AND 107).

FIRST USE 2-0-2011; IN COMMERCE 2-0-2011.

FOR: PROVIDING COMMUNITY CENTERS FOR SOCIAL GATHERINGS, IN CLASS 43 (U.S. CLS. 100 AND 101).

FIRST USE 2-0-2011; IN COMMERCE 2-0-2011.

FOR: PROVIDING INFORMATION IN THE FIELD OF HEALTH CARE; HEALTHCARE SERVICES, NAMELY, ESTABLISHING A NETWORK OF PHYSICIANS; MANAGED HEALTHCARE SERVICES, IN CLASS 44 (U.S. CLS. 100 AND 101).

FIRST USE 2-0-2011; IN COMMERCE 2-0-2011.

THE MARK CONSISTS OF STANDARD CHARACTERS WITHOUT CLAIM TO ANY PARTICULAR FONT, STYLE, SIZE, OR COLOR.

SER. NO. 85-438,983, FILED 10-4-2011.

ESTHER A. BORSUK, EXAMINING ATTORNEY



David J. Kyffers

Director of the United States Patent and Trademark Office

United States of America

United States Patent and Trademark Office

ARENA
RELIVE THE ROCK

Reg. No. 4,204,795

Registered Sep. 11, 2012

Int. Cl.: 41

SERVICE MARK

PRINCIPAL REGISTER

BELOTTI, DUANE J. (UNITED STATES INDIVIDUAL)
8 VANDERHOOF ROAD
MONTVILLE, NJ 07045

FOR: ENTERTAINMENT SERVICES IN THE NATURE OF LIVE PERFORMANCES BY A MUSICAL BAND; ENTERTAINMENT SERVICES, NAMELY, PROVIDING A WEBSITE FEATURING NON-DOWNLOADABLE MUSICAL PERFORMANCES, MUSICAL VIDEOS, AND RELATED FILM CLIPS AND PHOTOGRAPHS IN THE FIELD OF MUSIC AND MUSICAL PERFORMANCES, IN CLASS 41 (U.S. CLS. 100, 101 AND 107).

FIRST USE 7-23-2010; IN COMMERCE 6-9-2011.

NO CLAIM IS MADE TO THE EXCLUSIVE RIGHT TO USE "ARENA", APART FROM THE MARK AS SHOWN.

THE MARK CONSISTS OF THE BOLD WORD "ARENA" IN AN ARC SHAPE AND PLACED ON TOP OF THE BOLD WORDS "RELIVE THE ROCK". THE GROUPING OF THESE WORDS TOGETHER CONNOTES A VISUAL REPRESENTATION OF AN ARENA STADIUM.

SER. NO. 85-438,990, FILED 10-4-2011.

LINDA LAVACHE, EXAMINING ATTORNEY



David J. Kyffers

Director of the United States Patent and Trademark Office

United States of America

United States Patent and Trademark Office

Little Bamboo

Reg. No. 4,204,796

THE LITTLE LINEN COMPANY (AUSTRALIA CORPORATION)
2/3 MANTON ROAD
OAKLEIGH SOUTH, AUSTRALIA

Registered Sep. 11, 2012

Int. Cl.: 24

FOR: BABY BATH LINEN MADE IN WHOLE OR SUBSTANTIALLY IN PART OF BAMBOO,
IN CLASS 24 (U.S. CLS. 42 AND 50).

TRADEMARK

THE MARK CONSISTS OF STANDARD CHARACTERS WITHOUT CLAIM TO ANY PAR-
TICULAR FONT, STYLE, SIZE, OR COLOR.

PRINCIPAL REGISTER

OWNER OF AUSTRALIA REG. NO. 1171764, DATED 4-19-2007, EXPIRES 4-19-2017.

NO CLAIM IS MADE TO THE EXCLUSIVE RIGHT TO USE "BAMBOO", APART FROM
THE MARK AS SHOWN.

SER. NO. 85-439,206, FILED 10-4-2011.

ANDREA BUTLER, EXAMINING ATTORNEY



David J. Kybas

Director of the United States Patent and Trademark Office

United States of America

United States Patent and Trademark Office



Reg. No. 4,204,797

Registered Sep. 11, 2012

Int. Cl.: 41

SERVICE MARK

PRINCIPAL REGISTER

ST. NORBERT COLLEGE, INC. (WISCONSIN CORPORATION)
100 GRANT STREET
DE PERE, WI 54115

FOR: EDUCATIONAL SERVICES, NAMELY, PROVIDING COURSES OF INSTRUCTION, CONDUCTING LECTURES, WORKSHOPS, SEMINARS AND CONFERENCES, ALL AT THE COLLEGE LEVEL, AND CONDUCTING EXTENSION COURSES AT THE COLLEGE OR HIGHER LEVEL AND COMMUNITY SERVICE WORKSHOPS AND LECTURE WORKSHOPS IN THE FIELDS OF HUMANITIES AND FINE ARTS, NATURAL SCIENCES, SOCIAL SCIENCES AND INTERNATIONAL STUDIES; ENTERTAINMENT IN THE NATURE OF HOCKEY, FOOTBALL, BASEBALL, BASKETBALL, SOCCER, VOLLEYBALL, SOFTBALL, TRACK, GOLF AND CROSS COUNTRY GAMES/MEETS, THEATER PRODUCTIONS, PUBLIC LECTURES IN THE FIELDS OF HUMANITIES AND FINE ARTS, NATURAL SCIENCES, SOCIAL SCIENCES AND INTERNATIONAL STUDIES, ART EXHIBITIONS, LIVE MUSIC CONCERTS, DANCE AND BALLET PERFORMANCES, AND MOTION PICTURE THEATER SERVICES, IN CLASS 41 (U.S. CLS. 100, 101 AND 107).

FIRST USE 9-1-2007; IN COMMERCE 9-1-2007.

OWNER OF U.S. REG. NOS. 2,997,410, 3,010,838, AND 3,010,839.

NO CLAIM IS MADE TO THE EXCLUSIVE RIGHT TO USE "COLLEGE" AND "1898", APART FROM THE MARK AS SHOWN.

THE MARK CONSISTS OF A SHIELD WITH HORIZONTAL BANDS AND AN EIGHT-ARMED CROSS OVERLAYING THE BANDS WITH A BRANCH AND LEAVES ON EACH SIDE OF THE SHIELD AND A BANNER ACROSS THE BOTTOM OF THE SHIELD CONTAINING "1898", ALL IN A CIRCLE, SURROUNDED BY ANOTHER CIRCULAR BAND CONTAINING "ST. NORBERT COLLEGE" AT THE TOP AND "DOCERE VERBO ET EXEMPLO" AT THE BOTTOM, ALL SURROUNDED BY A CIRCULAR BORDER CONTAINING SCALLOPED EDGES.

THE ENGLISH TRANSLATION OF "DOCERE VERBO ET EXEMPLO" IN THE MARK IS: "TO TEACH BY WORD AND EXAMPLE".

SER. NO. 85-440,163, FILED 10-5-2011.



David J. Kybas

Director of the United States Patent and Trademark Office

Reg. No. 4,204,797 DOMINICK J. SALEMI, EXAMINING ATTORNEY

United States of America

United States Patent and Trademark Office

THE EDGELESS BROWNIE

Reg. No. 4,204,798

SUGARDADDY'S SUMPTUOUS SWEETIES, LLC (OHIO LIMITED LIABILITY COMPANY)
1329 CAMERON AVENUE
COLUMBUS, OH 43035

Registered Sep. 11, 2012

Int. Cl.: 30

FOR: BAKERY GOODS, IN CLASS 30 (U.S. CL. 46).

TRADEMARK

FIRST USE 9-0-2005; IN COMMERCE 9-0-2005.

PRINCIPAL REGISTER

THE MARK CONSISTS OF STANDARD CHARACTERS WITHOUT CLAIM TO ANY PARTICULAR FONT, STYLE, SIZE, OR COLOR.

OWNER OF U.S. REG. NO. 3,022,181.

NO CLAIM IS MADE TO THE EXCLUSIVE RIGHT TO USE "BROWNIE", APART FROM THE MARK AS SHOWN.

SEC. 2(F).

SER. NO. 85-440,704, FILED 10-6-2011.

MICHELLE DUBOIS, EXAMINING ATTORNEY



David J. Kyffers

Director of the United States Patent and Trademark Office

United States of America

United States Patent and Trademark Office

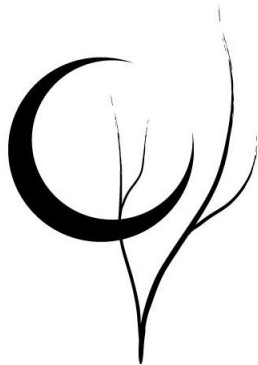

Reg. No. 4,204,799

Registered Sep. 11, 2012

Int. Cls.: 35 and 44

SERVICE MARK

PRINCIPAL REGISTER

THE URBAN MUSE, LLC (NEW JERSEY LIMITED LIABILITY COMPANY)
82 BROADWAY
DENVER, NJ 07834

FOR: RETAIL STORE SERVICES FEATURING CANDLES, HANDBAGS, BODY CARE PRODUCTS, PRE-RECORDED MUSIC CD'S, BOOKS, CLOTHING AND CLOTHING ACCESSORIES, IN CLASS 35 (U.S. CLS. 100, 101 AND 102).

FIRST USE 10-22-2004; IN COMMERCE 10-22-2004.

FOR: DAY SPA SERVICES, NAMELY, NAIL CARE, MANICURES, PEDICURES AND NAIL ENHANCEMENTS; HEALTH SPA SERVICES, NAMELY, COSMETIC BODY CARE SERVICES; MASSAGE THERAPY SERVICES; BODY WAXING SERVICES; SALON SERVICES, NAMELY, FACIALS, MANICURES AND MESSAGES THAT ARE PROVIDED IN A TRAILER OUTFITTED WITH CHAIR, TABLE AND SINK ACCESSORIES, IN CLASS 44 (U.S. CLS. 100 AND 101).

FIRST USE 10-22-2004; IN COMMERCE 12-24-2004.

THE MARK CONSISTS OF A CRESCENT MOON WITH A SIMPLE TREE PARTIALLY OVERLAPPING THE MOON.

SER. NO. 85-440,793, FILED 10-6-2011.

ANTHONY RINKER, EXAMINING ATTORNEY



David J. Kybas

Director of the United States Patent and Trademark Office

United States of America

United States Patent and Trademark Office

CHAT&

Reg. No. 4,204,800

Registered Sep. 11, 2012

Int. Cl.: 42

SERVICE MARK

PRINCIPAL REGISTER

CHATAND, INC. (NEVADA CORPORATION)
321 WEST 44TH STREET, SUITE 808
NEW YORK, NY 10036

FOR: PROVIDING TEMPORARY USE OF ONLINE, NON-DOWNLOADABLE COMPUTER SOFTWARE FOR WEB BROWSING AND INFORMATION SHARING IN THE FIELD OF SALES AND CONVERSION; PROVIDING TEMPORARY USE OF ONLINE, NON-DOWNLOADABLE COMPUTER SOFTWARE FOR WEB BROWSING AND INFORMATION SHARING IN THE FIELD OF COMMUNICATIONS; PROVIDING TEMPORARY USE OF ONLINE, NON-DOWNLOADABLE COMPUTER SOFTWARE FOR WEB BROWSING AND INFORMATION SHARING IN THE FIELD OF CO-BROWSING; PROVIDING ONLINE, NON-DOWNLOADABLE COMPUTER SOFTWARE FOR WEB BROWSING AND INFORMATION SHARING IN THE FIELD OF CUSTOMER SERVICE, IN CLASS 42 (U.S. CLS. 100 AND 101).

FIRST USE 6-0-2010; IN COMMERCE 1-0-2011.

THE MARK CONSISTS OF STANDARD CHARACTERS WITHOUT CLAIM TO ANY PARTICULAR FONT, STYLE, SIZE, OR COLOR.

SER. NO. 85-440,840, FILED 10-6-2011.

BILL DAWE, EXAMINING ATTORNEY



David J. Kyffers

Director of the United States Patent and Trademark Office

United States of America

United States Patent and Trademark Office



KANGOL

Reg. No. 4,204,801

Registered Sep. 11, 2012

Int. Cl.: 25

TRADEMARK

PRINCIPAL REGISTER

KANGOL LIMITED (UNITED KINGDOM COMPANY)
UNIT A, BROOK PARK EAST
SHIREBROOK, UNITED KINGDOM NG208RY

FOR: FOOTWEAR; CLOTHING, NAMELY, SHIRTS, SWEATSHIRTS, SWEATERS, PANTS, SHORTS, JACKETS, VESTS, COATS, HATS, GLOVES, UNDERWEAR, GAITERS, SCARVES, SOCKS, AND BELTS; WETSUITS; HEADGEAR, NAMELY, HATS AND CAPS; BALACLAVAS, IN CLASS 25 (U.S. CLS. 22 AND 39).

OWNER OF ERPN CMNTY TM OFC REG. NO. 009134107, DATED 12-6-2010, EXPIRES 5-26-2020.

OWNER OF U.S. REG. NOS. 535,357, 3,017,272 AND OTHERS.

THE MARK CONSISTS OF THE WORD "KANGOL" BELOW A KANGAROO DESIGN.

SER. NO. 85-440,932, FILED 10-6-2011.

MICHAEL KEATING, EXAMINING ATTORNEY



David J. Kyffers

Director of the United States Patent and Trademark Office

United States of America

United States Patent and Trademark Office

Laura Byrnes

Reg. No. 4,204,802

PIN UP GIRL INC. (ALASKA CORPORATION)
2537 DEVONSHIRE LN
ALTADENA, CA 91001

Registered Sep. 11, 2012

Int. Cl.: 25

FOR: WOMEN'S CLOTHING, NAMELY, DRESSES, TOPS, SKIRTS, AND JACKETS, IN CLASS 25 (U.S. CLS. 22 AND 39).

TRADEMARK

FIRST USE 1-31-2011; IN COMMERCE 3-1-2011.

PRINCIPAL REGISTER

THE MARK CONSISTS OF STANDARD CHARACTERS WITHOUT CLAIM TO ANY PARTICULAR FONT, STYLE, SIZE, OR COLOR.

THE NAME(S), PORTRAIT(S), AND/OR SIGNATURE(S) SHOWN IN THE MARK IDENTIFIES "LAURA BYRNES", WHOSE CONSENT(S) TO REGISTER IS MADE OF RECORD.

SER. NO. 85-441,122, FILED 10-6-2011.

WILLIAM BRECKENFELD, EXAMINING ATTORNEY



David J. Kybas

Director of the United States Patent and Trademark Office

United States of America

United States Patent and Trademark Office

COMFORT CUP

Reg. No. 4,204,803

Registered Sep. 11, 2012

Int. Cl.: 20

TRADEMARK

PRINCIPAL REGISTER

HUHTAMAKI, INC. (KANSAS CORPORATION)
9201 PACKAGING DRIVE
DESOTO, KS 66018

FOR: PLASTIC LIDS, IN CLASS 20 (U.S. CLS. 2, 13, 22, 25, 32 AND 50).

FIRST USE 4-2-2001; IN COMMERCE 4-2-2001.

THE MARK CONSISTS OF STANDARD CHARACTERS WITHOUT CLAIM TO ANY PARTICULAR FONT, STYLE, SIZE, OR COLOR.

OWNER OF U.S. REG. NOS. 3,350,378 AND 3,598,476.

NO CLAIM IS MADE TO THE EXCLUSIVE RIGHT TO USE "CUP", APART FROM THE MARK AS SHOWN.

SER. NO. 85-441,143, FILED 10-6-2011.

RAUL CORDOVA, EXAMINING ATTORNEY



David J. Kyffers

Director of the United States Patent and Trademark Office

United States of America

United States Patent and Trademark Office

fullcircle

Reg. No. 4,204,804

Registered Sep. 11, 2012

Int. Cls.: 9 and 45

TRADEMARK

SERVICE MARK

PRINCIPAL REGISTER

FULLCIRCLE GEOSOCIAL NETWORK, INC. (DELAWARE CORPORATION)
4720 MONTGOMERY AVENUE
SUITE 900
BETHESDA, MD 20814

FOR: COMPUTER APPLICATION SOFTWARE FOR MOBILE PHONES, NAMELY, SOFTWARE FOR SOCIAL INTRODUCTION, NETWORKING AND SOCIAL NETWORKING, IN CLASS 9 (U.S. CLS. 21, 23, 26, 36 AND 38).

FIRST USE 9-30-2011; IN COMMERCE 9-30-2011.

FOR: INTERNET BASED INTRODUCTION, NETWORKING AND SOCIAL NETWORKING SERVICES, IN CLASS 45 (U.S. CLS. 100 AND 101).

FIRST USE 9-30-2011; IN COMMERCE 9-30-2011.

THE MARK CONSISTS OF STANDARD CHARACTERS WITHOUT CLAIM TO ANY PARTICULAR FONT, STYLE, SIZE, OR COLOR.

SER. NO. 85-441,147, FILED 10-6-2011.

JAY FLOWERS, EXAMINING ATTORNEY



David J. Kyffers

Director of the United States Patent and Trademark Office

United States of America

United States Patent and Trademark Office

Social Brand U

Reg. No. 4,204,805

Registered Sep. 11, 2012

Int. Cl.: 35

SERVICE MARK

PRINCIPAL REGISTER

SOCIAL BRAND U, LLC (GEORGIA LIMITED LIABILITY COMPANY)
12195 HIGHWAY 92, SUITE 114-209
WOODSTOCK, GA 30188

FOR: BUSINESS CONSULTATION SERVICES, NAMELY, PROVIDING BUSINESS STRATEGIES FOR USE IN SOCIAL MEDIA; MARKETING CONSULTANCY IN THE FIELD OF HELPING CLIENTS CREATE AND EXTEND THEIR PRODUCT AND BRAND STRATEGIES BY BUILDING VIRALLY ENGAGING MARKETING SOLUTIONS, IN CLASS 35 (U.S. CLS. 100, 101 AND 102).

FIRST USE 12-1-2010; IN COMMERCE 12-1-2010.

THE MARK CONSISTS OF STANDARD CHARACTERS WITHOUT CLAIM TO ANY PARTICULAR FONT, STYLE, SIZE, OR COLOR.

NO CLAIM IS MADE TO THE EXCLUSIVE RIGHT TO USE "SOCIAL BRAND", APART FROM THE MARK AS SHOWN.

SER. NO. 85-441,654, FILED 10-7-2011.

TRACY WHITTAKER-BROWN, EXAMINING ATTORNEY



David J. Kyros

Director of the United States Patent and Trademark Office

United States of America

United States Patent and Trademark Office

WE PROTECT YOUR MOST
VALUABLE ASSET: PEACE OF
MIND

Reg. No. 4,204,806

PREPAYCPA, INC. (DELAWARE CORPORATION)
1521 CONCORD PIKE, SUITE 301
WILMINGTON, DE 19803

Registered Sep. 11, 2012

Int. Cl.: 36

FOR: FINANCIAL AFFAIRS AND MONETARY AFFAIRS, NAMELY, FINANCIAL INFORMATION, MANAGEMENT AND ANALYSIS SERVICES, IN CLASS 36 (U.S. CLS. 100, 101 AND 102).

SERVICE MARK

FIRST USE 10-1-2011; IN COMMERCE 10-1-2011.

PRINCIPAL REGISTER

THE MARK CONSISTS OF STANDARD CHARACTERS WITHOUT CLAIM TO ANY PARTICULAR FONT, STYLE, SIZE, OR COLOR.

SER. NO. 85-441,725, FILED 10-7-2011.

BRENDAN MCCAULEY, EXAMINING ATTORNEY



David J. Kyffers

Director of the United States Patent and Trademark Office

United States of America

United States Patent and Trademark Office

PROMODATA

Reg. No. 4,204,807

Registered Sep. 11, 2012

Int. Cl.: 35

SERVICE MARK

PRINCIPAL REGISTER

LEEMIS MARKETING CONSULTANTS, INC. (ILLINOIS CORPORATION), DBA
PROMODATA
1 S 270 SUMMIT AVENUE
OAKBROOK TERRACE, IL 60181

FOR: MARKETING RESEARCH SERVICES, IN CLASS 35 (U.S. CLS. 100, 101 AND 102).

FIRST USE 1-1-1988; IN COMMERCE 1-1-1988.

THE MARK CONSISTS OF STANDARD CHARACTERS WITHOUT CLAIM TO ANY PARTICULAR FONT, STYLE, SIZE, OR COLOR.

SER. NO. 85-442,834, FILED 10-8-2011.

ALAIN LAPTER, EXAMINING ATTORNEY



David J. Kybas

Director of the United States Patent and Trademark Office

United States of America

United States Patent and Trademark Office

PROMEDICA DEFIANCE REGIONAL HOSPITAL

Reg. No. 4,204,808

PROMEDICA HEALTH SYSTEM, INC. (OHIO CORPORATION)
1801 RICHARDS ROAD
TOLEDO, OH 43607

Registered Sep. 11, 2012

Int. Cl.: 44

FOR: HEALTH CARE SERVICES, IN CLASS 44 (U.S. CLS. 100 AND 101).

SERVICE MARK

FIRST USE 6-24-2011; IN COMMERCE 6-24-2011.

PRINCIPAL REGISTER

THE MARK CONSISTS OF STANDARD CHARACTERS WITHOUT CLAIM TO ANY PARTICULAR FONT, STYLE, SIZE, OR COLOR.

OWNER OF U.S. REG. NOS. 3,150,664, 3,966,382 AND OTHERS.

NO CLAIM IS MADE TO THE EXCLUSIVE RIGHT TO USE "DEFIANCE REGIONAL HOSPITAL", APART FROM THE MARK AS SHOWN.

SER. NO. 85-442,948, FILED 10-9-2011.

MARILYN IZZI, EXAMINING ATTORNEY



David J. Kyffers

Director of the United States Patent and Trademark Office

United States of America

United States Patent and Trademark Office

延锋

Reg. No. 4,204,809

Registered Sep. 11, 2012

Int. Cl.: 12

TRADEMARK

PRINCIPAL REGISTER

YANFENG VISTEON AUTOMOTIVE TRIM SYSTEMS CO., LTD. (CHINA LIMITED LIABILITY COMPANY)
1001, QUINZHOU ROAD NORTH
SHANGHAI, CHINA 200233

FOR: VEHICLE PARTS, COMPONENTS AND ACCESSORIES, NAMELY, STRUCTURAL VEHICLE INTERIOR PARTS FOR LAND VEHICLES, NAMELY, COCKPITS CONSISTING OF INSTRUMENT PANELS, SWITCH MODULES, STEERING COLUMNS, VEHICLE AIRBAGS, SENSORS, HEATING, VENTILATION AND AIR CONDITIONING SYSTEMS, NAVIGATION MODULES, AUDIO SYSTEMS AND WIRE HARNESSSES ASSEMBLED AS A MODULE; INSTRUMENT PANELS, CONSOLES AND PILLARS; DOOR PANELS FOR VEHICLES; VEHICLE SEATS; AUTOMOTIVE VEHICLE PARTS, NAMELY, HEADLINERS AND STEERING WHEELS; VEHICLE SAFETY AIRBAGS, NAMELY, DRIVER AIRBAGS, PASSENGER AIRBAGS, SIDE AIRBAGS AND CURTAIN AIRBAGS; SEAT BELTS, STEPLESS LOAD-LIMITER SEAT BELTS, MULTI-STOP LOAD LIMITER SEAT BELTS AND PRE-TENSIONER SEAT BELTS ALL FOR USE IN VEHICLES; STRUCTURAL PARTS FOR VEHICLES, NAMELY, BUMPERS, FENDERS, RADIATOR GRILLS; BODY TRIM FOR AUTOMOBILES, NAMELY, ROCK PANELS, ANTI-SCRAPING PANELS, AND WHEEL TRIM; REAR CLOSURES, NAMELY, REAR PARCEL SHELVES; FRONT-END MODULES, NAMELY, ENGINE BRACKETS, COOLING WATER TANKS AND AIR CONDITIONING EVAPORATORS ASSEMBLED AS A MODULE, IN CLASS 12 (U.S. CLS. 19, 21, 23, 31, 35 AND 44).

FIRST USE 10-8-2011; IN COMMERCE 10-8-2011.

THE MARK CONSISTS OF CHINESE CHARACTERS FOR "YANFENG".

THE NON-LATIN CHARACTERS IN THE MARK TRANSLITERATE TO "YANFENG" AND THIS HAS NO MEANING IN A FOREIGN LANGUAGE.

SER. NO. 85-443,041, FILED 10-10-2011.

AMY KELLY, EXAMINING ATTORNEY



David J. Kyros

Director of the United States Patent and Trademark Office

United States of America

United States Patent and Trademark Office



Reg. No. 4,204,810

Registered Sep. 11, 2012

Int. Cl.: 12

TRADEMARK

PRINCIPAL REGISTER

YANFENG VISTEON AUTOMOTIVE TRIM SYSTEMS CO., LTD. (CHINA LIMITED LIABILITY COMPANY)
1001, QUINZHOU ROAD NORTH
SHANGHAI, CHINA 200233

FOR: VEHICLE PARTS, COMPONENTS AND ACCESSORIES, NAMELY, STRUCTURAL VEHICLE INTERIOR PARTS FOR LAND VEHICLES, NAMELY, COCKPITS CONSISTING OF INSTRUMENT PANELS, SWITCH MODULES, STEERING COLUMNS, VEHICLE AIRBAGS, SENSORS, HEATING, VENTILATION AND AIR CONDITIONING SYSTEMS, NAVIGATION MODULES, AUDIO SYSTEMS AND WIRE HARNESSSES ASSEMBLED AS A MODULE; INSTRUMENT PANELS, CONSOLES AND PILLARS; DOOR PANELS FOR VEHICLES; VEHICLE SEATS; AUTOMOTIVE VEHICLE PARTS, NAMELY, HEADLINERS AND STEERING WHEELS; VEHICLE SAFETY AIRBAGS, NAMELY, DRIVER AIRBAGS, PASSENGER AIRBAGS, SIDE AIRBAGS AND CURTAIN AIRBAGS; SEAT BELTS, STEPLESS LOAD-LIMITER SEAT BELTS, MULTI-STOP LOAD LIMITER SEAT BELTS AND PRE-TENSIONER SEAT BELTS ALL FOR USE IN VEHICLES; STRUCTURAL PARTS FOR VEHICLES, NAMELY, BUMPERS, FENDERS, RADIATOR GRILLS; BODY TRIM FOR AUTOMOBILES, NAMELY, ROCK PANELS, ANTI-SCRAPING PANELS, AND WHEEL TRIM; REAR CLOSURES, NAMELY, REAR PARCEL SHELVES; FRONT-END MODULES, NAMELY, ENGINE BRACKETS, COOLING WATER TANKS AND AIR CONDITIONING EVAPORATORS ASSEMBLED AS A MODULE, IN CLASS 12 (U.S. CLS. 19, 21, 23, 31, 35 AND 44).

FIRST USE 10-8-2011; IN COMMERCE 10-8-2011.

THE MARK CONSISTS OF THE LETTERS "Y" AND "F" IN STYLIZED FONT, WITH THE LETTER "F" CRADLED WITHIN THE TOP OF THE LETTER "Y", ALL OF WHICH IS WITHIN A CIRCULAR BORDER.

SER. NO. 85-443,047, FILED 10-10-2011.

AMY KELLY, EXAMINING ATTORNEY



David J. Kypos

Director of the United States Patent and Trademark Office

United States of America

United States Patent and Trademark Office



Reg. No. 4,204,811

AMERICAN SILVER, LLC (UTAH LIMITED LIABILITY COMPANY)
80 WEST CANYON CREST ROAD
ALPINE, UT 84004

Registered Sep. 11, 2012

Int. Cl.: 5

FOR: LIQUID DIETARY AND NUTRITIONAL SUPPLEMENTS FOR ANIMALS; MINERAL SUPPLEMENTS FOR ANIMALS, IN CLASS 5 (U.S. CLS. 6, 18, 44, 46, 51 AND 52).

TRADEMARK

FIRST USE 3-31-2011; IN COMMERCE 3-31-2011.

PRINCIPAL REGISTER

THE MARK CONSISTS OF PAW PRINT.

SER. NO. 85-443,754, FILED 10-10-2011.

JASON BLAIR, EXAMINING ATTORNEY



David J. Kybas

Director of the United States Patent and Trademark Office

United States of America

United States Patent and Trademark Office

Effortless
Beauty brings you
SilkyFoot 

Reg. No. 4,204,812

CHEMCORP PTY LTD (AUSTRALIA CORPORATION)
7 BOX ROAD

Registered Sep. 11, 2012

TAREN POINT, AUSTRALIA NSW2229

Int. Cl.: 3

FOR: EXFOLIANTS FOR FEET, IN CLASS 3 (U.S. CLS. 1, 4, 6, 50, 51 AND 52).

TRADEMARK

FIRST USE 3-26-2007; IN COMMERCE 3-26-2007.

PRINCIPAL REGISTER

NO CLAIM IS MADE TO THE EXCLUSIVE RIGHT TO USE "BEAUTY" AND "SILKY FOOT",
APART FROM THE MARK AS SHOWN.

THE MARK CONSISTS OF "EFFORTLESS BEAUTY" WRITTEN AT THE TOP, FOLLOWED
BY "BRINGS YOU" WRITTEN IN A SMALLER FONT. FEATURES "SILKY FOOT" WRITTEN
IN LARGE FREE-HAND FONT FOLLOWED BY PICTURE OF FOOTPRINT.

SER. NO. 85-443,911, FILED 10-11-2011.

MEGHAN REINHART, EXAMINING ATTORNEY



David J. Kybas

Director of the United States Patent and Trademark Office

United States of America

United States Patent and Trademark Office



Reg. No. 4,204,813

Registered Sep. 11, 2012

Int. Cl.: 42

SERVICE MARK

PRINCIPAL REGISTER

AMERICAN ASSOCIATION OF PHYSICIAN SPECIALISTS, INC. (FLORIDA CORPORATION)
SUITE 400
5550 WEST EXECUTIVE DRIVE
TAMPA, FL 33609

FOR: ACCREDITATION SERVICES, NAMELY, DEVELOPING AND ADMINISTERING STANDARDS AND PROCEDURES FOR CERTIFYING PROFESSIONALS IN THE FIELD OF FAMILY MEDICINE OBSTETRICS, IN CLASS 42 (U.S. CLS. 100 AND 101).

FIRST USE 12-13-2010; IN COMMERCE 12-13-2010.

OWNER OF U.S. REG. NO. 3,991,368.

THE COLOR(S) BLUE, GOLD AND WHITE IS/ARE CLAIMED AS A FEATURE OF THE MARK.

NO CLAIM IS MADE TO THE EXCLUSIVE RIGHT TO USE "BOARD OF CERTIFICATION IN FAMILY MEDICINE OBSTETRICS ORGANIZED 2007" AND "THE PICTORIAL REPRESENTATION OF THE CADUCEUS SYMBOL", APART FROM THE MARK AS SHOWN.

THE MARK CONSISTS OF AN OVAL WITH A BLUE AND GOLD BORDER; INSIDE THE BORDER IS A WHITE BAND WITH THE BLUE WORDS "BOARD OF CERTIFICATION IN FAMILY MEDICINE OBSTETRICS" BEGINNING IN THE LOWER LEFT OF THE BAND AND RUNNING UPWARDS AND AROUND THE BORDER AND ENDING IN THE LOWER RIGHT; AT THE BOTTOM CENTER OF THE BORDER, IN SMALLER FONTS ARE THE BLUE WORDS "ORGANIZED 2007"; THE CENTER OF THE OVAL IS BLUE AND IN ITS CENTER IS A GOLD STAFF WITH A SNAKE WRAPPED AROUND IT, SIMILAR TO A CADUCEUS; IN THE CENTER, TO THE LEFT OF THE STAFF, IN WHITE OUTLINE FORM, ARE A MAN AND A WOMAN FACING INWARD AND ON THE RIGHT OF THE STAFF, ALSO IN WHITE OUTLINE FORM, IS A WOMAN FACING INWARD WITH AN UNBORN BABY IN HER STOMACH.

SER. NO. 85-444,030, FILED 10-11-2011.

AMY ALFIERI, EXAMINING ATTORNEY



David J. Kyjars

Director of the United States Patent and Trademark Office

United States of America

United States Patent and Trademark Office

TILDREN

Reg. No. 4,204,814

CEVA SANTE ANIMALE (FRANCE SOCIÉTÉ ANONYME (SA))
10 AVENUE DE LA BALLASTIÈRE
LIBOURNE, FRANCE F-33500

Registered Sep. 11, 2012

Int. Cl.: 5

FOR: VETERINARY PRODUCTS, NAMELY, VETERINARY PHARMACEUTICAL PREPARATIONS FOR USE IN THE TREATMENT OF LAMENESS IN HORSES, IN CLASS 5 (U.S. CLS. 6, 18, 44, 46, 51 AND 52).

TRADEMARK

THE MARK CONSISTS OF STANDARD CHARACTERS WITHOUT CLAIM TO ANY PARTICULAR FONT, STYLE, SIZE, OR COLOR.

PRINCIPAL REGISTER

OWNER OF FRANCE REG. NO. 002098010, DATED 5-8-2002, EXPIRES 5-9-2022.

SER. NO. 85-444,196, FILED 10-11-2011.

MARC LEIPZIG, EXAMINING ATTORNEY



David J. Kyffers

Director of the United States Patent and Trademark Office

United States of America

United States Patent and Trademark Office

THE COMPANY COACH

Reg. No. 4,204,815

Registered Sep. 11, 2012

Int. Cl.: 35

SERVICE MARK

PRINCIPAL REGISTER

THE COMPANY COACH LLC (TEXAS LIMITED LIABILITY COMPANY)
201 COUNTRYSIDE COURT
SOUTHLAKE, TX 76092

FOR: PROFESSIONAL BUSINESS CONSULTING FOR STRATEGIC PLANNING SERVICES AND SUCCESSION BY IDENTIFYING, GROWING AND TRANSFERRING COMPANY VALUE BY UTILIZING THE ELEMENTS OF CORPORATE ASSET PROTECTION, TAX PLANNING, AND EXIT STRATEGIES; PROFESSIONAL BUSINESS CONSULTING; BUSINESS SUCCESSION PLANNING; BUSINESS STRATEGIC PLANNING SERVICES, IN CLASS 35 (U.S. CLS. 100, 101 AND 102).

FIRST USE 9-26-2001; IN COMMERCE 9-26-2001.

THE MARK CONSISTS OF STANDARD CHARACTERS WITHOUT CLAIM TO ANY PARTICULAR FONT, STYLE, SIZE, OR COLOR.

OWNER OF U.S. REG. NO. 2,750,855.

NO CLAIM IS MADE TO THE EXCLUSIVE RIGHT TO USE "COMPANY", APART FROM THE MARK AS SHOWN.

SER. NO. 85-444,467, FILED 10-11-2011.

EDWARD NELSON, EXAMINING ATTORNEY



David J. Kyffers

Director of the United States Patent and Trademark Office

United States of America

United States Patent and Trademark Office

The Right Direction in Casualty Insurance



Reg. No. 4,204,816

Registered Sep. 11, 2012

Int. Cl.: 36

SERVICE MARK

PRINCIPAL REGISTER

MIDWEST BUILDERS' CASUALTY MUTUAL COMPANY (KANSAS CORPORATION)
SUITE 3010
1100 WALNUT STREET
KANSAS CITY, MO 64106

FOR: INSURANCE SERVICES, NAMELY, UNDERWRITING IN THE FIELD OF WORKERS' COMPENSATION INSURANCE; PROVIDING INSURANCE INFORMATION AND INSURANCE CONSULTATION IN THE FIELD OF WORKERS' COMPENSATION; FINANCIAL RISK MANAGEMENT IN THE FIELD OF WORKERS' COMPENSATION; INSURANCE SERVICES IN THE NATURE OF LOSS CONTROL MANAGEMENT FOR OTHERS, IN CLASS 36 (U.S. CLS. 100, 101 AND 102).

FIRST USE 1-22-2008; IN COMMERCE 1-22-2008.

NO CLAIM IS MADE TO THE EXCLUSIVE RIGHT TO USE "CASUALTY INSURANCE", APART FROM THE MARK AS SHOWN.

THE MARK CONSISTS OF THE WORDING "THE RIGHT DIRECTION IN CASUALTY INSURANCE" ABOVE THE LETTER "N" WHICH IS IN TURN ABOVE A STYLIZED DEPICTION OF A COMPASS COMPRISED OF AN EIGHT-POINTED STAR.

SER. NO. 85-444,508, FILED 10-11-2011.

JIM RINGLE, EXAMINING ATTORNEY



David J. Kybas

Director of the United States Patent and Trademark Office

United States of America

United States Patent and Trademark Office

MALIBU MAGAZINE

Reg. No. 4,204,817

Registered Sep. 11, 2012

Int. Cl.: 16

TRADEMARK

PRINCIPAL REGISTER

MALIBU MONTHLY, INC. (CALIFORNIA CORPORATION)
SUITE 201
22333 PACIFIC COAST HIGHWAY
MALIBU, CA 90265

FOR: PERIODICAL MAGAZINES IN THE FIELD OF LIFESTYLE, BOOKS AND RESTAURANT REVIEWS, FASHION, COMMUNITY EVENTS, CURRENT EVENTS, HOME DECOR, TRAVEL AND ENTERTAINMENT, IN CLASS 16 (U.S. CLS. 2, 5, 22, 23, 29, 37, 38 AND 50).

FIRST USE 2-10-2005; IN COMMERCE 3-30-2005.

THE MARK CONSISTS OF STANDARD CHARACTERS WITHOUT CLAIM TO ANY PARTICULAR FONT, STYLE, SIZE, OR COLOR.

OWNER OF U.S. REG. NO. 3,110,738.

NO CLAIM IS MADE TO THE EXCLUSIVE RIGHT TO USE "MAGAZINE", APART FROM THE MARK AS SHOWN.

SEC. 2(F).

SER. NO. 85-444,929, FILED 10-11-2011.

TINA MAI, EXAMINING ATTORNEY



David J. Kybas

Director of the United States Patent and Trademark Office

United States of America

United States Patent and Trademark Office

Life Changing Medicine

Reg. No. 4,204,818

Registered Sep. 11, 2012

**Int. Cls.: 35, 36, 41, 42
and 44**

SERVICE MARK

PRINCIPAL REGISTER

UPMC (PENNSYLVANIA CORPORATION)
U.S. STEEL TOWER, SUITE 6082
600 GRANT STREET
PITTSBURGH, PA 15219

FOR: BUSINESS MANAGEMENT AND CONSULTING SERVICES FOR THE HEALTHCARE INDUSTRY, NAMELY, PROVIDING INDUSTRY EXPERTISE AND SUPPLIER PARTNERSHIPS; HOSPITAL MANAGEMENT; NEW BUSINESS VENTURE DEVELOPMENT AND FORMATION CONSULTING SERVICES, IN CLASS 35 (U.S. CLS. 100, 101 AND 102).

FIRST USE 7-24-2011; IN COMMERCE 7-24-2011.

FOR: ADMINISTRATION AND UNDERWRITING OF HEALTH, MEDICAL, PHARMACEUTICAL AND PRESCRIPTION DRUG INSURANCE PLANS, IN CLASS 36 (U.S. CLS. 100, 101 AND 102).

FIRST USE 7-24-2011; IN COMMERCE 7-24-2011.

FOR: EDUCATIONAL SERVICES, NAMELY, PROVIDING CLASSES, SEMINARS AND WORKSHOPS FOR THE GENERAL PUBLIC IN THE FIELD OF HEALTH AND DISSEMINATION OF RELATED EDUCATIONAL MATERIALS, AND PROVIDING CLASSES AND SEMINARS FOR MEDICAL STUDENTS AND HEALTH CARE PROFESSIONALS' CONTINUING MEDICAL EDUCATION IN THE FIELD OF HEALTH CARE AND CURRENT MEDICAL ISSUES, IN CLASS 41 (U.S. CLS. 100, 101 AND 107).

FIRST USE 7-24-2011; IN COMMERCE 7-24-2011.

FOR: MEDICAL RESEARCH, IN CLASS 42 (U.S. CLS. 100 AND 101).

FIRST USE 7-24-2011; IN COMMERCE 7-24-2011.

FOR: HEALTHCARE; PHYSICIAN SERVICES; HOSPITALS; PROVIDING MEDICAL INFORMATION, IN CLASS 44 (U.S. CLS. 100 AND 101).

FIRST USE 7-24-2011; IN COMMERCE 7-24-2011.



David J. Kyjars

Director of the United States Patent and Trademark Office

Reg. No. 4,204,818 THE MARK CONSISTS OF STANDARD CHARACTERS WITHOUT CLAIM TO ANY PARTICULAR FONT, STYLE, SIZE, OR COLOR.

OWNER OF U.S. REG. NO. 4,032,796.

NO CLAIM IS MADE TO THE EXCLUSIVE RIGHT TO USE "MEDICINE", APART FROM THE MARK AS SHOWN.

SER. NO. 85-445,450, FILED 10-12-2011.

CIMMERIAN COLEMAN, EXAMINING ATTORNEY

United States of America

United States Patent and Trademark Office

Family Independence Initiative

Reg. No. 4,204,819

Registered Sep. 11, 2012

Int. Cl.: 35

SERVICE MARK

PRINCIPAL REGISTER

FII - NATIONAL (CALIFORNIA CORPORATION), DBA FAMILY INDEPENDENCE
INITIATIVE
SUITE 100
1203 PRESERVATION PARK WAY
OAKLAND, CA 94612

FOR: CHARITABLE SERVICES, NAMELY, ORGANIZING AND DEVELOPING PROJECTS
THAT AIM TO IMPROVE THE LIVES OF UNDERPRIVILEGED AND IMPOVERISHED
PEOPLE, IN CLASS 35 (U.S. CLS. 100, 101 AND 102).

FIRST USE 1-1-2001; IN COMMERCE 1-1-2001.

THE MARK CONSISTS OF STANDARD CHARACTERS WITHOUT CLAIM TO ANY PAR-
TICULAR FONT, STYLE, SIZE, OR COLOR.

SEC. 2(F).

SER. NO. 85-445,572, FILED 10-12-2011.

ALICE BENMAMAN, EXAMINING ATTORNEY



David J. Kyffers

Director of the United States Patent and Trademark Office

United States of America

United States Patent and Trademark Office

ULTRA MIRROR

Reg. No. 4,204,820

GUARDIAN INDUSTRIES CORP. (DELAWARE CORPORATION)
2300 HARMON
AUBURN HILLS, MI 48326

Registered Sep. 11, 2012

Int. Cl.: 20

FOR: MIRRORS, IN CLASS 20 (U.S. CLS. 2, 13, 22, 25, 32 AND 50).

TRADEMARK

FIRST USE 6-0-2004; IN COMMERCE 6-0-2004.

PRINCIPAL REGISTER

THE MARK CONSISTS OF STANDARD CHARACTERS WITHOUT CLAIM TO ANY PARTICULAR FONT, STYLE, SIZE, OR COLOR.

OWNER OF U.S. REG. NOS. 3,006,709 AND 3,016,095.

NO CLAIM IS MADE TO THE EXCLUSIVE RIGHT TO USE "MIRROR", APART FROM THE MARK AS SHOWN.

SER. NO. 85-445,670, FILED 10-12-2011.

RONALD MCMORROW, EXAMINING ATTORNEY



David J. Kybas

Director of the United States Patent and Trademark Office

United States of America

United States Patent and Trademark Office

TAXSEARCH

Reg. No. 4,204,821

Registered Sep. 11, 2012

Int. Cl.: 35

SERVICE MARK

PRINCIPAL REGISTER

TAXSEARCH INCORPORATED (OKLAHOMA CORPORATION)
7050 S. YALE, SUITE 310
TULSA, OK 74136

FOR: PERSONNEL PLACEMENT SERVICES, IN CLASS 35 (U.S. CLS. 100, 101 AND 102).

FIRST USE 1-2-1990; IN COMMERCE 1-2-1990.

THE MARK CONSISTS OF STANDARD CHARACTERS WITHOUT CLAIM TO ANY PARTICULAR FONT, STYLE, SIZE, OR COLOR.

OWNER OF U.S. REG. NO. 1,646,230.

SER. NO. 85-445,794, FILED 10-12-2011.

BILL DAWE, EXAMINING ATTORNEY



David J. Kyffers

Director of the United States Patent and Trademark Office

United States of America

United States Patent and Trademark Office

AN **ENGAGE** PRESENTATION

Reg. No. 4,204,822

Registered Sep. 11, 2012

Int. Cl.: 9

TRADEMARK

PRINCIPAL REGISTER

POPULATION REFERENCE BUREAU (D.C. NON-PROFIT ORGANIZATION)
SUITE 520
1875 CONNECTICUT AVE., NW
WASHINGTON, DC 20009

FOR: PRE-RECORDED VIDEO RECORDINGS FEATURING PRESENTATIONS IN THE FIELD OF HEALTH, FAMILY PLANNING, AND REPRODUCTIVE HEALTH FOR USE IN CLASSROOMS, MEETINGS, AND ON THE WEBSITE, IN CLASS 9 (U.S. CLS. 21, 23, 26, 36 AND 38).

FIRST USE 6-1-2011; IN COMMERCE 6-1-2011.

NO CLAIM IS MADE TO THE EXCLUSIVE RIGHT TO USE "PRESENTATION", APART FROM THE MARK AS SHOWN.

THE COLOR(S) BLACK AND BLUE IS/ARE CLAIMED AS A FEATURE OF THE MARK.

THE MARK CONSISTS OF THREE WORDS, "AN ENGAGE PRESENTATION", IN WHICH THE WORD "ENGAGE" IS IN BLUE AND THE WORDS "AN" AND "PRESENTATION" ARE IN BLACK.

SER. NO. 85-446,082, FILED 10-12-2011.

WILLIAM VERHOSEK, EXAMINING ATTORNEY



David J. Kyffers

Director of the United States Patent and Trademark Office

United States of America

United States Patent and Trademark Office

CHARLES PARSONS

Reg. No. 4,204,823

Registered Sep. 11, 2012

Int. Cls.: 24 and 35

CHARLES PARSONS (HOLDINGS) PTY LIMITED (AUSTRALIA PROPRIETARY LIMITED COMPANY (P/L OR PTY. LTD.))
LEVEL 4
59 GOULBURN STREET
SYDNEY, NSW 2000, AUSTRALIA

TRADEMARK

SERVICE MARK

PRINCIPAL REGISTER

FOR: TEXTILES AND TEXTILE GOODS, NAMELY, FABRICS FOR TEXTILE USE, COTTON FABRIC FOR USE AS A TEXTILE, CURTAINS OF TEXTILE, TAPESTRIES OF TEXTILE; HOUSEHOLD LINEN, BED LINEN, BED BLANKETS, BED BLANKETS MADE OF COTTON, BED BLANKETS MADE OF MAN-MADE FIBERS, BED BLANKETS MADE OF WOOL, QUILTED BED BLANKETS, TEXTILE FABRICS FOR MAKING INTO BLANKETS, BED QUILTS, CONTINENTAL QUILTS, QUILTS, BEDSPREADS, COVERLETS, BEDSHEETS, TEXTILE BED SHEETS, VALANCE BED SHEETS, VALANCED BED SHEETS, PILLOWCASES, BATH SHEETS, TOWELS, BATH TOWELS, FACE TOWELS OF TEXTILE, KITCHEN TOWELS, BEACH TOWELS, TOWELS, TOWELS OF TEXTILE, APPAREL FABRICS, FABRICS FOR TEXTILE USE FOR THE MANUFACTURE OF BEDROOM LINENS, BREATHABLE WATERPROOF FABRIC FOR MANUFACTURING CLOTHING, FURNITURE AND AUTOMOBILE UPHOLSTERY, AND LUGGAGE, BROAD WOVEN INDUSTRIAL FABRICS, CHEMICAL FIBER MIXED FABRICS, CHEMICAL FIBER LOOP KNIT FABRICS, CHENILLE FABRIC, COTTON FABRICS, CREPE FABRICS, CURTAIN FABRICS, EMBROIDERY FABRIC, FABRIC, NAMELY, FABRICS FOR TEXTILE USE, FABRICS FOR TEXTILE USE COATED WITH RUBBER OR PLASTICS, UNFITTED FABRIC FURNITURE COVERS, FABRIC FOR USE IN THE MANUFACTURE OF CLOTHING, FABRIC PLACE MATS, FABRICS BEING TEXTILE GOODS IN ROLL FORM, FABRICS FOR FURNITURE, FABRICS FOR TEXTILE USE FOR INTERIOR DECORATING, FABRICS FOR MAKING CURTAINS, FABRICS FOR TEXTILE USE, FURNISHING FABRICS, MIXED AND SYNTHETIC FABRICS, RAYON FABRIC, SILK FABRICS FOR FURNITURE, TEXTILE FABRICS FOR MAKING INTO CLOTHING, TEXTILE FABRICS FOR MAKING INTO LINENS, TEXTILE FABRICS FOR MAKING UP INTO HOUSEHOLD TEXTILE ARTICLES, TEXTILE FABRICS FOR USE IN THE MANUFACTURE OF BEDDING, TEXTILES IN THE NATURE OF FABRICS FOR TEXTILE USE, TEXTILE FABRICS FOR USE IN THE MANUFACTURE OF CURTAINS, TEXTILE FABRICS FOR USE IN THE MANUFACTURE OF FURNITURE, TEXTILE FABRICS FOR USE IN THE MANUFACTURE OF TOWELS, TEXTILE FABRICS IN THE PIECE, UPHOLSTERY FABRICS, WINDOW FURNISHING FABRICS, WOOLEN FABRICS, WOVEN FABRICS FOR FURNITURE, WOVEN FURNISHING FABRICS, WOVEN LINEN FABRICS, WOVEN SILK FABRICS, PLACE MATS (NOT OF PAPER), TEXTILE PLACE MATS, TEXTILE DINNER NAPKINS, TABLE NAPKINS OF TEXTILE, TEXTILE NAPKINS, TABLE LINEN,



David J. Kyffers

Director of the United States Patent and Trademark Office

Reg. No. 4,204,823 DRAPERIES, CURTAINS, COTTON FABRICS FOR USE AS A TEXTILE IN THE MANUFACTURE OF WINDOW BLINDS, COVERS FOR CUSHIONS, WOVEN FABRICS FOR CUSHIONS, CANVAS FOR TAPESTRY, CANVAS FOR TAPESTRY OR EMBROIDERY, TAPESTRY AND WALL HANGINGS OF TEXTILE, IN CLASS 24 (U.S. CLS. 42 AND 50).

FOR: RETAIL AND WHOLESALE STORE SERVICES FEATURING TEXTILES AND TEXTILE GOODS, FABRICS, CURTAINS AND DRAPES, AND ALSO INCLUDING CURTAINS MADE OF PLASTIC, BLINDS MADE OF TEXTILE MATERIAL, COVERS FOR CUSHIONS, BEDDING INCLUDING QUILTS, DUVETS, BLANKETS, SHEETS, PILLOWCASES, HOUSEHOLD LINEN, AND TOWELS, IN CLASS 35 (U.S. CLS. 100, 101 AND 102).

THE MARK CONSISTS OF STANDARD CHARACTERS WITHOUT CLAIM TO ANY PARTICULAR FONT, STYLE, SIZE, OR COLOR.

PRIORITY CLAIMED UNDER SEC. 44(D) ON NEW ZEALAND APPLICATION NO. 844267, FILED 6-21-2011, REG. NO. 844267, DATED 1-9-2012, EXPIRES 6-21-2021.

THE NAME(S), PORTRAIT(S), AND/OR SIGNATURE(S) SHOWN IN THE MARK DOES NOT IDENTIFY A PARTICULAR LIVING INDIVIDUAL.

SER. NO. 85-446,085, FILED 10-12-2011.

CHARLOTTE CORWIN, EXAMINING ATTORNEY

United States of America

United States Patent and Trademark Office

Hiplash

Reg. No. 4,204,824

Registered Sep. 11, 2012

Int. Cls.: 35 and 41

SERVICE MARK

PRINCIPAL REGISTER

CUNNINGHAM, KRISTEN (CALIFORNIA SOLE PROPRIETORSHIP), DBA HIPLASH
2155 VERDUGO BLVD. #615
MONTROSE, CA 91020

FOR: RETAIL SERVICES THROUGH DIRECT SOLICITATION BY SALESPERSONS DIRECTED TO END-USERS FEATURING DANCE CLOTHING AND ACCESSORIES, IN CLASS 35 (U.S. CLS. 100, 101 AND 102).

FIRST USE 8-3-1999; IN COMMERCE 8-3-1999.

FOR: CONDUCTING FITNESS CLASSES; DANCE INSTRUCTION; EDUCATION SERVICES, NAMELY, PROVIDING CLASSES AND INSTRUCTION IN THE FIELD OF DANCE; ENTERTAINMENT IN THE NATURE OF DANCE PERFORMANCES; ORGANIZATION OF DANCING EVENTS; PHYSICAL FITNESS INSTRUCTION; PHYSICAL FITNESS TRAINING OF INDIVIDUALS AND GROUPS, IN CLASS 41 (U.S. CLS. 100, 101 AND 107).

FIRST USE 8-3-1999; IN COMMERCE 8-3-1999.

THE MARK CONSISTS OF STANDARD CHARACTERS WITHOUT CLAIM TO ANY PARTICULAR FONT, STYLE, SIZE, OR COLOR.

SER. NO. 85-446,177, FILED 10-13-2011.

TASHIA BUNCH, EXAMINING ATTORNEY



David J. Kyffers

Director of the United States Patent and Trademark Office

United States of America

United States Patent and Trademark Office

DRIVING EXCELLENCE

Reg. No. 4,204,825

Registered Sep. 11, 2012

Int. Cls.: 35, 37 and 39

SERVICE MARK

PRINCIPAL REGISTER

MCCOY GROUP, INC. (WISCONSIN CORPORATION)
LEVEL 2
2099 SOUTHPARK COURT
DUBUQUE, IA 52003

FOR: BUSINESS MANAGEMENT SERVICES IN THE FIELD OF MANAGING DISTRIBUTION AND TRANSPORTATION OF BULK FREIGHT MATERIALS TRANSPORTED BY TRUCK; BUSINESS MANAGEMENT SERVICES IN THE FIELD OF ORGANIZING THE DELIVERY AND TRANSPORTING OF BULK FREIGHT MATERIALS TRANSPORTED BY TRUCK; AND TRUCK DEALERSHIP SERVICES, IN CLASS 35 (U.S. CLS. 100, 101 AND 102).

FIRST USE 7-31-2005; IN COMMERCE 7-31-2005.

FOR: SERVICING AND REPAIR OF TRUCKS, IN CLASS 37 (U.S. CLS. 100, 103 AND 106).

FIRST USE 7-31-2005; IN COMMERCE 7-31-2005.

FOR: TRUCKING SERVICES, NAMELY, HAULING OF BULK LIQUID AND BULK DRY MATERIALS; FREIGHT TRANSPORTATION OF BULK MATERIALS BY TRUCK, IN CLASS 39 (U.S. CLS. 100 AND 105).

FIRST USE 7-31-2005; IN COMMERCE 7-31-2005.

THE MARK CONSISTS OF STANDARD CHARACTERS WITHOUT CLAIM TO ANY PARTICULAR FONT, STYLE, SIZE, OR COLOR.

SER. NO. 85-446,528, FILED 10-13-2011.

PAUL MORENO, EXAMINING ATTORNEY



David J. Kybas

Director of the United States Patent and Trademark Office

United States of America

United States Patent and Trademark Office

COMPLEAT Express

Reg. No. 4,204,826

Registered Sep. 11, 2012

Int. Cl.: 42

SERVICE MARK

PRINCIPAL REGISTER

GDSX, LTD. (TEXAS LIMITED PARTNERSHIP)
700 CENTRAL EXPRESSWAY SOUTH, SUITE 230
ALLEN, TX 75013

FOR: PROVIDING A NON-DOWNLOADABLE PROPRIETARY SOFTWARE FOR AUTOMATING THE PROCESSING OF PASSENGER NAME RECORDS (PNRS) ON BEHALF OF TRAVEL AGENCIES, WHEREBY THE AGENCIES CAN SELECT FROM A MENU OF SCRIPTS TO RUN FROM A STANDARD LIST, IN CLASS 42 (U.S. CLS. 100 AND 101).

FIRST USE 3-31-2010; IN COMMERCE 3-31-2010.

THE MARK CONSISTS OF STANDARD CHARACTERS WITHOUT CLAIM TO ANY PARTICULAR FONT, STYLE, SIZE, OR COLOR.

SER. NO. 85-447,128, FILED 10-13-2011.

LAURIE MAYES, EXAMINING ATTORNEY



David J. Kyffers

Director of the United States Patent and Trademark Office

United States of America

United States Patent and Trademark Office

EASTERN ARCHITECTURAL SYSTEMS

Reg. No. 4,204,827

EASTERN METAL SUPPLY INC. (FLORIDA CORPORATION)
3600 23RD AVENUE, SOUTH
LAKE WORTH, FL 33461

Registered Sep. 11, 2012

Int. Cls.: 6 and 19

FOR: DOORS AND WINDOWS OF METAL, IN CLASS 6 (U.S. CLS. 2, 12, 13, 14, 23, 25 AND 50).

TRADEMARK

FIRST USE 5-19-2011; IN COMMERCE 5-19-2011.

PRINCIPAL REGISTER

FOR: NON-METAL WINDOWS AND DOORS, IN CLASS 19 (U.S. CLS. 1, 12, 33 AND 50).

FIRST USE 5-19-2011; IN COMMERCE 5-19-2011.

THE MARK CONSISTS OF STANDARD CHARACTERS WITHOUT CLAIM TO ANY PARTICULAR FONT, STYLE, SIZE, OR COLOR.

NO CLAIM IS MADE TO THE EXCLUSIVE RIGHT TO USE "ARCHITECTURAL SYSTEMS", APART FROM THE MARK AS SHOWN.

SER. NO. 85-447,518, FILED 10-14-2011.

CHRISTINA SOBRAL, EXAMINING ATTORNEY



David J. Kybas

Director of the United States Patent and Trademark Office

United States of America

United States Patent and Trademark Office

 glasses.com

Reg. No. 4,204,828

1-800 CONTACTS, INC. (DELAWARE CORPORATION)
66 EAST WADSWORTH PARK DRIVE
DRAPER, UT 84020

Registered Sep. 11, 2012

Int. Cl.: 35

FOR: ON-LINE RETAIL STORE SERVICES FEATURING SPECTACLES AND RELATED PRODUCTS, IN CLASS 35 (U.S. CLS. 100, 101 AND 102).

SERVICE MARK

FIRST USE 7-15-2011; IN COMMERCE 7-15-2011.

PRINCIPAL REGISTER

NO CLAIM IS MADE TO THE EXCLUSIVE RIGHT TO USE "GLASSES.COM", APART FROM THE MARK AS SHOWN.

THE COLOR(S) WHITE, NAVY BLUE, AND LIGHT BLUE IS/ARE CLAIMED AS A FEATURE OF THE MARK.

THE MARK CONSISTS OF A WHITE OUTLINE OF AN EYEGLASS LENS INSIDE A NAVY BLUE EYEGLASS-SHAPED SEMI-CIRCLE FOLLOWED BY THE WORD "GLASSES" IN NAVY BLUE AND THE WORDING ".COM" IN LIGHT BLUE.

SER. NO. 85-447,890, FILED 10-14-2011.

JERI J. FICKES, EXAMINING ATTORNEY



David J. Kyjars

Director of the United States Patent and Trademark Office

United States of America
United States Patent and Trademark Office

MISSOMA

Reg. No. 4,204,829

MISSOMA LIMITED (UNITED KINGDOM LIMITED COMPANY (LTD.))
KOVACS HOUSE, HATTON GARDEN
LONDON, UNITED KINGDOM EC1N8JD

Registered Sep. 11, 2012

Int. Cl.: 14

FOR: JEWELRY, IN CLASS 14 (U.S. CLS. 2, 27, 28 AND 50).

TRADEMARK

THE MARK CONSISTS OF STANDARD CHARACTERS WITHOUT CLAIM TO ANY PARTICULAR FONT, STYLE, SIZE, OR COLOR.

PRINCIPAL REGISTER

OWNER OF UNITED KINGDOM REG. NO. 2470794, DATED 6-13-2008, EXPIRES 10-29-2017.

SER. NO. 85-447,926, FILED 10-14-2011.

RAUL CORDOVA, EXAMINING ATTORNEY



David J. Kyffers

Director of the United States Patent and Trademark Office

United States of America

United States Patent and Trademark Office

VITAL PLANNING GROUP

Reg. No. 4,204,830

Registered Sep. 11, 2012

Int. Cl.: 36

SERVICE MARK

PRINCIPAL REGISTER

ALPASLAN, BURAK N. (UNITED STATES INDIVIDUAL)
90 WOODBRIDGE CENTER DRIVE, 7TH FLOOR
WOODBRIDGE, NJ 07095

FOR: ADMINISTRATION OF EMPLOYEE BENEFIT PLANS CONCERNING INSURANCE AND FINANCE; ADMINISTRATION OF EMPLOYEE PENSION PLANS; ADMINISTRATION OF EMPLOYEE WELFARE BENEFIT PLANS CONCERNING INSURANCE AND FINANCE; ADMINISTRATION OF PRE-PAID HEALTH CARE PLANS; ADMINISTRATION OF EMPLOYEE BENEFIT PLANS CONCERNING INSURANCE AND FINANCE; CONSULTING SERVICES IN THE FIELD OF RETIREMENT PLAN ADMINISTRATION AND FIDUCIARY COMPLIANCE; CONSULTING SERVICES IN THE FIELD OF STATE AND FEDERAL EMPLOYEE BENEFIT PLANS CONCERNING INSURANCE AND FINANCE; ESTATE PLANNING; ESTATE TRUST MANAGEMENT; ESTATE TRUST PLANNING; FINANCIAL ADMINISTRATION OF RETIREMENT PLANS; FINANCIAL ADMINISTRATION OF RETIREMENT PLANS; FINANCIAL CONSULTATION IN THE FIELD OF ENVIRONMENTAL MANAGEMENT, NAMELY, ADVISING BUSINESS AND INDIVIDUALS ON ISSUES OF PORTFOLIO PLANNING AND INVESTMENT PLANNING; FINANCIAL CONSULTING SERVICES IN THE FIELD OF PLANNED GIVING FOR NON-PROFIT AND CHARITABLE ORGANIZATIONS; FINANCIAL PLANNING; FINANCIAL PLANNING AND INVESTMENT ADVISORY SERVICES; FINANCIAL PLANNING CONSULTATION; FINANCIAL PLANNING FOR RETIREMENT; FINANCIAL PLANNING SERVICES, NAMELY, DEVELOPING AND MANAGING CHARITABLE GIVING PROGRAMS ON BEHALF OF WEALTHY INDIVIDUALS OR FAMILIES; FINANCIAL PLANNING, NAMELY, CREATING PERSONALIZED STRATEGIES ACHIEVING FINANCIAL INDEPENDENCE; FINANCIAL SERVICES, NAMELY, ADMINISTRATION OF TRANSACTIONS INVOLVING FUNDS DRAWN FROM SECURITIES, STOCKS, FUNDS, EQUITIES, BONDS, CASH, OR OTHER TYPES OF FINANCIAL INVESTMENTS IN RETIREMENT PLANS USING A CHECK OR NEGOTIABLE ORDER OF WITHDRAWAL OVER A GLOBAL DATA NETWORK; FINANCIAL SERVICES, NAMELY, ADMINISTRATION OF TRANSACTIONS INVOLVING FUNDS DRAWN FROM SECURITIES, STOCKS, FUNDS, EQUITIES, BONDS, CASH, OR OTHER TYPES OF FINANCIAL INVESTMENTS IN RETIREMENT PLANS USING A CREDIT OR DEBIT CARD OVER A GLOBAL DATA NETWORK; FINANCIAL TRUST PLANNING; ORGANIZING PRE-PAID HEALTH CARE PLANS; PROCESSING, ADMINISTERING AND MANAGING EMPLOYEE BENEFIT PLANS CONCERNING INSURANCE AND FINANCE; PROVIDING INFORMATION IN THE FIELD OF EMPLOYEE FINANCIAL BENEFIT PLANS; PROVIDING INFORMATION IN THE FIELD OF EMPLOYEE FINANCIAL BENEFIT PLANS AND ADMINISTRATION OF EMPLOYEE FINANCIAL BENEFIT PLANS FOR CLIENTS VIA THE INTERNET; PROVIDING ON-LINE INFORMATION



David J. Kybas

Director of the United States Patent and Trademark Office

Reg. No. 4,204,830 IN THE FIELD OF CHARITABLE MONETARY GIVING THROUGH FINANCIAL AND ESTATE PLANNING, IN CLASS 36 (U.S. CLS. 100, 101 AND 102).

FIRST USE 3-1-2008; IN COMMERCE 3-1-2008.

THE MARK CONSISTS OF STANDARD CHARACTERS WITHOUT CLAIM TO ANY PARTICULAR FONT, STYLE, SIZE, OR COLOR.

NO CLAIM IS MADE TO THE EXCLUSIVE RIGHT TO USE "PLANNING GROUP", APART FROM THE MARK AS SHOWN.

SER. NO. 85-448,503, FILED 10-17-2011.

LINDA ESTRADA, EXAMINING ATTORNEY

United States of America

United States Patent and Trademark Office

GEN 4

Reg. No. 4,204,831

Registered Sep. 11, 2012

Int. Cl.: 13

TRADEMARK

PRINCIPAL REGISTER

GLOCK, INC. (GEORGIA CORPORATION)
6000 HIGHLANDS PARKWAY
SMYRNA, GA 30082

FOR: FIREARMS, IN CLASS 13 (U.S. CLS. 2 AND 9).

FIRST USE 1-1-2010; IN COMMERCE 1-1-2010.

THE MARK CONSISTS OF STANDARD CHARACTERS WITHOUT CLAIM TO ANY PARTICULAR FONT, STYLE, SIZE, OR COLOR.

SER. NO. 85-448,648, FILED 10-17-2011.

DOMINIC FATHY, EXAMINING ATTORNEY



David J. Kybas

Director of the United States Patent and Trademark Office

United States of America

United States Patent and Trademark Office

WE

Reg. No. 4,204,832

HRABAL, ANTONIN (CZECH REPUBLIC INDIVIDUAL)
5516 BOULDER HWY SUITE 2F #113
LAS VEGAS, NV 89122 AND

Registered Sep. 11, 2012

Int. Cl.: 45

HIPPOCRATES UNIVERSITY (OREGON CORPORATION)
5516 BOULDER HWY SUITE 2F #113
LAS VEGAS, NV 89122

SERVICE MARK

PRINCIPAL REGISTER

FOR: RELIGIOUS AND SPIRITUAL SERVICES, NAMELY, PROVIDING GATHERINGS AND RETREATS TO DEVELOP AND ENHANCE THE SPIRITUAL LIVES OF INDIVIDUALS, IN CLASS 45 (U.S. CLS. 100 AND 101).

FIRST USE 5-1-2000; IN COMMERCE 5-1-2000.

THE MARK CONSISTS OF THE STYLIZED LETTERS "W" AND "E" DEPICTED IN A STRAIGHT ANGLE CONFIGURATION.

SER. NO. 85-449,372, FILED 10-17-2011.

BRIDGETT SMITH, EXAMINING ATTORNEY



David J. Kyffers

Director of the United States Patent and Trademark Office

United States of America

United States Patent and Trademark Office

Who Let the Dogs Out!

Reg. No. 4,204,833

Registered Sep. 11, 2012

Int. Cls.: 41 and 44

SERVICE MARK

PRINCIPAL REGISTER

WHO LET THE DOGS OUT, LLC (CALIFORNIA LIMITED LIABILITY COMPANY), DBA
WHO LET THE DOGS OUT
NO. 363
1819 POLK STREET
SAN FRANCISCO, CA 94109

FOR: DOG TRAINING; KENNEL SERVICES, NAMELY, DOG TRAINING SERVICES, IN
CLASS 41 (U.S. CLS. 100, 101 AND 107).

FIRST USE 1-1-2004; IN COMMERCE 1-1-2004.

FOR: DOG WALKING SERVICES; PET CARE SERVICES, NAMELY, DOG WALKING, DOG
BATHING AND NON-MEDICATED PET GROOMING, IN CLASS 44 (U.S. CLS. 100 AND
101).

FIRST USE 1-1-2004; IN COMMERCE 1-1-2004.

THE MARK CONSISTS OF STANDARD CHARACTERS WITHOUT CLAIM TO ANY PAR-
TICULAR FONT, STYLE, SIZE, OR COLOR.

SER. NO. 85-449,377, FILED 10-17-2011.

LESLIE RICHARDS, EXAMINING ATTORNEY



David J. Kybas

Director of the United States Patent and Trademark Office

United States of America

United States Patent and Trademark Office

DREAMZ

Reg. No. 4,204,834

Registered Sep. 11, 2012

Int. Cl.: 26

TRADEMARK

PRINCIPAL REGISTER

KNITPRO INTERNATIONAL (INDIA PARTNERSHIP), DBA KNITPRO INTERNATIONAL
PA 010-001, LIGHT ENGINEERING ZONE
MAHINDRA WORLD CITY SEZ
JAIPUR, INDIA

FOR: BUTTONS, HOOKS AND EYES, KNITTING PINS AND NEEDLES, IN CLASS 26 (U.S. CLS. 37, 39, 40, 42 AND 50).

FIRST USE 8-30-2011; IN COMMERCE 8-30-2011.

THE MARK CONSISTS OF STANDARD CHARACTERS WITHOUT CLAIM TO ANY PARTICULAR FONT, STYLE, SIZE, OR COLOR.

SER. NO. 85-449,432, FILED 10-18-2011.

WILLIAM JACKSON, EXAMINING ATTORNEY



David J. Kybas

Director of the United States Patent and Trademark Office

United States of America

United States Patent and Trademark Office

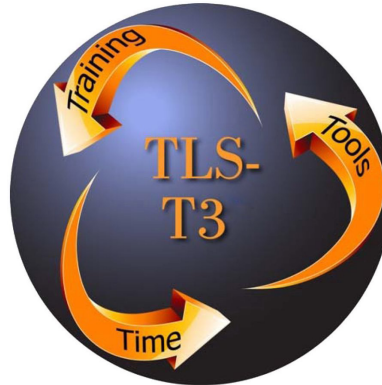

Reg. No. 4,204,835

KEVIN LANE TURNER (UNITED STATES INDIVIDUAL)
17300 DALLAS PARKWAY, SUITE 3100
DALLAS, TX 75248

Registered Sep. 11, 2012

Int. Cl.: 41

FOR: BUSINESS TRAINING; BUSINESS TRAINING CONSULTANCY SERVICES; BUSINESS TRAINING IN THE FIELD OF LEADERSHIP TRAINING AND HUMAN DEVELOPMENT; EDUCATIONAL SERVICES, NAMELY, CONDUCTING SEMINARS, WORKSHOPS, CONFERENCES IN THE FIELDS OF CHANGE MANAGEMENT, LEADERSHIP TRAINING, HUMAN DEVELOPMENT AND DISTRIBUTION OF TRAINING MATERIALS IN CONNECTION THEREWITH; EDUCATIONAL SERVICES, NAMELY, PROVIDING A LEARNING AND INNOVATION CENTER FEATURING FULLY CUSTOMIZED LEADERSHIP, MOTIVATIONAL, EDUCATIONAL, AND BRAINSTORMING TRAINING; INTERACTIVE ON-LINE TRAINING SERVICES IN THE FIELD OF CHANGE MANAGEMENT, LEADERSHIP TRAINING, HUMAN DEVELOPMENT; TEACHING AND TRAINING IN BUSINESS, INDUSTRY AND INFORMATION TECHNOLOGY; TEACHING, TRAINING, TUTORING AND COURSES OF INSTRUCTION AT THE UNDERGRADUATE, GRADUATE AND POST-GRADUATE LEVEL; TRAINING COURSES IN STRATEGIC PLANNING RELATING TO ADVERTISING, PROMOTION, MARKETING AND BUSINESS, IN CLASS 41 (U.S. CLS. 100, 101 AND 107).

SERVICE MARK

PRINCIPAL REGISTER

FIRST USE 10-8-2010; IN COMMERCE 10-8-2010.



THE MARK CONSISTS OF A DEEP BLUE GLOBE WITH A SUNBURST OFF-CENTER TOWARD THE UPPER-LEFT FROM THE GLOBE'S CENTER POINT WITH THE TEXT "TLS-T3" IN GOLD LETTERING TO THE LOWER RIGHT OF THE SUNBURST AND CENTERED IN THE MIDDLE OF THE GLOBE; ALONG THE OUTSIDE PERIMETER OF THE BLUE GLOBE AND SURROUNDING THE SUNBURST AND THE "TLS-T3" ARE THREE CURVED MOVING CLOCKWISE GOLD ARROWS WHOSE TAIL IS GOLD WITH THE HEAD OF EACH TRANSITIONING TO A PALE YELLOW. EACH ARROW CONTAINS A LABEL WITH BLACK TEXT CENTERED WITHIN THE ARROW. THE FIRST LETTER OF EACH LABEL BEGINS AT THE BOTTOM OF THE ARROW HEAD AND CONTINUES THROUGH BODY OF THE ARROW TOWARD THE TAIL. THE FIRST ARROW IN THE UPPER LEFT OF AND INSIDE THE BLUE GLOBE CONTAINS THE WORD "TRAINING". THE SECOND ARROW IN THE BOTTOM TO BOTTOM LEFT AND INSIDE OF THE BLUE GLOBE CONTAINS THE WORD "TIME". THE THIRD ARROW ALONG THE RIGHT INNER SIDE OF THE BLUE GLOBE CONTAINS THE WORD "TOOLS".

David J. Kybas

Director of the United States Patent and Trademark Office

Reg. No. 4,204,835 THE COLOR(S) GRADIENT LIGHT BLUE TO DARK BLUE, PURPLE, GRADIENT GOLD TO PALE YELLOW IS/ARE CLAIMED AS A FEATURE OF THE MARK.

SER. NO. 85-450,101, FILED 10-18-2011.

DORITT L. CARROLL, EXAMINING ATTORNEY

United States of America

United States Patent and Trademark Office

PACHANGACMS

Reg. No. 4,204,836

Z-SOFTNET (OREGON CORPORATION)

Registered Sep. 11, 2012

P.O. BOX 1685
PORTLAND, OR 97207

Int. Cl.: 9

FOR: COMPUTER SOFTWARE DEVELOPMENT TOOLS; COMPUTER SOFTWARE FOR APPLICATION AND DATABASE INTEGRATION; COMPUTER SOFTWARE FOR COMPUTER SYSTEM AND APPLICATION DEVELOPMENT, DEPLOYMENT AND MANAGEMENT; COMPUTER SOFTWARE FOR PROVIDING AN ON-LINE DATABASE IN THE FIELD OF TRANSACTION PROCESSING TO UPLOAD TRANSACTIONAL DATA, PROVIDE STATISTICAL ANALYSIS, AND PRODUCE NOTIFICATIONS AND REPORTS; COMPUTER SOFTWARE THAT PROVIDES WEB-BASED ACCESS TO APPLICATIONS AND SERVICES THROUGH A WEB OPERATING SYSTEM OR PORTAL INTERFACE; WEB SITE DEVELOPMENT SOFTWARE, IN CLASS 9 (U.S. CLS. 21, 23, 26, 36 AND 38).

TRADEMARK

PRINCIPAL REGISTER

FIRST USE 10-18-2011; IN COMMERCE 10-18-2011.

THE MARK CONSISTS OF STANDARD CHARACTERS WITHOUT CLAIM TO ANY PARTICULAR FONT, STYLE, SIZE, OR COLOR.

THE ENGLISH TRANSLATION OF "PACHANGA" IN THE MARK IS "LIVELY PARTY".

SER. NO. 85-450,320, FILED 10-18-2011.

SANJEEV VOHRA, EXAMINING ATTORNEY



David J. Kyros

Director of the United States Patent and Trademark Office

United States of America

United States Patent and Trademark Office

TRENDS TODAY

Reg. No. 4,204,837

AMERICAN ANIMAL HOSPITAL ASSOCIATION (ILLINOIS CORPORATION)
12575 W. BAYAUD AVENUE
LAKEWOOD, CO 80228

Registered Sep. 11, 2012

Int. Cl.: 44

FOR: PROVIDING ON-LINE INFORMATION, NEWS AND COMMENTARY FEATURING INFORMATION OF INTEREST TO COMPANION ANIMAL VETERINARY PRACTICES; PROVIDING ON-LINE INFORMATION, NEWS AND COMMENTARY IN THE FIELD OF VETERINARY MEDICINE AND PRACTICE, IN CLASS 44 (U.S. CLS. 100 AND 101).

SERVICE MARK

PRINCIPAL REGISTER

FIRST USE 2-27-2009; IN COMMERCE 2-27-2009.

THE MARK CONSISTS OF STANDARD CHARACTERS WITHOUT CLAIM TO ANY PARTICULAR FONT, STYLE, SIZE, OR COLOR.

OWNER OF U.S. REG. NO. 1,375,821.

NO CLAIM IS MADE TO THE EXCLUSIVE RIGHT TO USE "TRENDS", APART FROM THE MARK AS SHOWN.

SER. NO. 85-450,900, FILED 10-19-2011.

JEFF DEFORD, EXAMINING ATTORNEY



David J. Kybas

Director of the United States Patent and Trademark Office

United States of America

United States Patent and Trademark Office

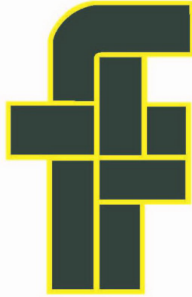

Reg. No. 4,204,838

Registered Sep. 11, 2012

Int. Cls.: 1 and 40

TRADEMARK

SERVICE MARK

PRINCIPAL REGISTER

FTS INTERNATIONAL SERVICES, LLC (TEXAS LIMITED LIABILITY COMPANY)
777 MAIN ST., STE. 3000
FORT WORTH, TX 76102

FOR: PROPPANT FOR USE IN OIL WELL AND GAS WELL HYDRAULIC FRACTURING OPERATIONS; CHEMICALS AND CHEMICAL ADDITIVES FOR DRILLING FLUID USED IN OIL AND GAS DRILLING AND ENHANCED RECOVERY OPERATIONS, IN CLASS 1 (U.S. CLS. 1, 5, 6, 10, 26 AND 46).

FIRST USE 6-15-2010; IN COMMERCE 6-15-2010.

FOR: OIL AND GAS WELL TREATMENT, IN CLASS 40 (U.S. CLS. 100, 103 AND 106).

FIRST USE 6-15-2010; IN COMMERCE 6-15-2010.

THE MARK CONSISTS OF A STYLIZED LETTER "F" THAT IS FORMED BY INTERLOCKING AND OUTLINED AND CURVED RECTANGULAR DESIGN ELEMENTS. THE OUTLINE OF THE DESIGN ELEMENTS IS IN YELLOW AND THE INSIDE OF THE OUTLINED PORTIONS IS IN GREEN.

THE COLOR(S) GREEN AND YELLOW IS/ARE CLAIMED AS A FEATURE OF THE MARK.

SER. NO. 85-451,092, FILED 10-19-2011.

NAPOLEON SHARMA, EXAMINING ATTORNEY



David J. Kyjars

Director of the United States Patent and Trademark Office

United States of America

United States Patent and Trademark Office

CONCERTO

Reg. No. 4,204,839

Registered Sep. 11, 2012

Int. Cl.: 31

TRADEMARK

PRINCIPAL REGISTER

GREENHOUSE GROWN FOODS INC. (CANADA CORPORATION)
3660 - 41B STREET
DELTA, BC, CANADA V4K3N2

FOR: FRESH VEGETABLES; FRESH TOMATOES, IN CLASS 31 (U.S. CLS. 1 AND 46).

FIRST USE 2-27-2006; IN COMMERCE 7-11-2007.

THE MARK CONSISTS OF STANDARD CHARACTERS WITHOUT CLAIM TO ANY PARTICULAR FONT, STYLE, SIZE, OR COLOR.

SER. NO. 85-451,337, FILED 10-19-2011.

SUSAN STIGLITZ, EXAMINING ATTORNEY



David J. Kyffers

Director of the United States Patent and Trademark Office

United States of America

United States Patent and Trademark Office

COMPLEAT Managed

Reg. No. 4,204,840

Registered Sep. 11, 2012

Int. Cl.: 42

SERVICE MARK

PRINCIPAL REGISTER

GDSX, LTD. (TEXAS LIMITED PARTNERSHIP)
700 CENTRAL EXPRESSWAY S., SUITE 230
ALLEN, TX 75013

FOR: PROVIDING A NON-DOWNLOADABLE PROPRIETARY SOFTWARE FOR AUTOMATING THE PROCESSING OF PASSENGER NAME RECORDS (PNRS) ON BEHALF OF TRAVEL AGENCIES, IN CLASS 42 (U.S. CLS. 100 AND 101).

FIRST USE 6-30-2010; IN COMMERCE 6-30-2010.

THE MARK CONSISTS OF STANDARD CHARACTERS WITHOUT CLAIM TO ANY PARTICULAR FONT, STYLE, SIZE, OR COLOR.

NO CLAIM IS MADE TO THE EXCLUSIVE RIGHT TO USE "MANAGED", APART FROM THE MARK AS SHOWN.

SER. NO. 85-451,381, FILED 10-19-2011.

Laurie Mayes, Examining Attorney



David J. Kyffers

Director of the United States Patent and Trademark Office

United States of America

United States Patent and Trademark Office

CrestHill SUITES

Reg. No. 4,204,841

CRESTHILLS SUITES COMPANY, LLC (NEW YORK LIMITED LIABILITY COMPANY)
225 GREENFIELD PKWY STE 102
LIVERPOOL, NY 13088

Registered Sep. 11, 2012

Int. Cl.: 43

FOR: HOTEL ACCOMMODATION SERVICES; HOTEL SERVICES, IN CLASS 43 (U.S. CLS. 100 AND 101).

SERVICE MARK

FIRST USE 3-17-2000; IN COMMERCE 3-17-2000.

PRINCIPAL REGISTER

NO CLAIM IS MADE TO THE EXCLUSIVE RIGHT TO USE "SUITES", APART FROM THE MARK AS SHOWN.

THE MARK CONSISTS OF THE LITERAL ELEMENT "CRESTHILL SUITES". THE APPLICANT IS NOT CLAIMING COLOR AS A FEATURE OF THE MARK. THE MARK CONSISTS OF RIGHT-ALIGNED WORDING WITH "CRESTHILL" UNDERLINED AND THE WORD "SUITES" BELOW.

SER. NO. 85-451,718, FILED 10-20-2011.

EMILY CARLSEN, EXAMINING ATTORNEY



David J. Kybas

Director of the United States Patent and Trademark Office

United States of America

United States Patent and Trademark Office

THE SPINE INSTITUTE OF SOUTHERN NEW JERSEY

Reg. No. 4,204,842

DR. O'SHEA, MD (UNITED STATES INDIVIDUAL)
538 LIPPINCOTT DRIVE
MARLTON, NJ 08053

Registered Sep. 11, 2012

Int. Cl.: 44

FOR: SPECIALIZED MEDICAL SERVICES, NAMELY, OPERATIVE AND NON-OPERATIVE ORTHOPEDIC AND NEUROSURGICAL SPINE CARE, IN CLASS 44 (U.S. CLS. 100 AND 101).

SERVICE MARK

FIRST USE 1-1-2000; IN COMMERCE 1-1-2000.

PRINCIPAL REGISTER

THE MARK CONSISTS OF STANDARD CHARACTERS WITHOUT CLAIM TO ANY PARTICULAR FONT, STYLE, SIZE, OR COLOR.

NO CLAIM IS MADE TO THE EXCLUSIVE RIGHT TO USE "SPINE INSTITUTE", APART FROM THE MARK AS SHOWN.

SEC. 2(F).

SER. NO. 85-451,961, FILED 10-20-2011.

DEZMONA MIZELLE, EXAMINING ATTORNEY



David J. Kyffers

Director of the United States Patent and Trademark Office

United States of America

United States Patent and Trademark Office

SUPPORT PLUS

Reg. No. 4,204,843

HAWKER BEECHCRAFT CORPORATION (KANSAS CORPORATION)
10511 EAST CENTRAL
WICHITA, KS 67206

Registered Sep. 11, 2012

Int. Cl.: 36

FOR: PROVIDING EXTENDED SERVICE AND MAINTENANCE CONTRACTS FOR AIRCRAFT, IN CLASS 36 (U.S. CLS. 100, 101 AND 102).

SERVICE MARK

FIRST USE 0-0-2002; IN COMMERCE 0-0-2002.

PRINCIPAL REGISTER

THE MARK CONSISTS OF STANDARD CHARACTERS WITHOUT CLAIM TO ANY PARTICULAR FONT, STYLE, SIZE, OR COLOR.

NO CLAIM IS MADE TO THE EXCLUSIVE RIGHT TO USE "SUPPORT", APART FROM THE MARK AS SHOWN.

SER. NO. 85-452,414, FILED 10-20-2011.

SANJEEV VOHRA, EXAMINING ATTORNEY



David J. Kybas

Director of the United States Patent and Trademark Office

United States of America

United States Patent and Trademark Office

A Blend For You To Be

Reg. No. 4,204,844

SOUTH BEACH CANDLE COMPANY, INC. (FLORIDA CORPORATION)
2260 W 80 STREET BAY #3
HIALEAH, FL 33016

Registered Sep. 11, 2012

Int. Cl.: 4

FOR: CANDLES; PERFUMED CANDLES; SCENTED CANDLES; SCENTED WAX FOR USE
IN CANDLE WARMERS, IN CLASS 4 (U.S. CLS. 1, 6 AND 15).

TRADEMARK

FIRST USE 9-1-2011; IN COMMERCE 9-1-2011.

PRINCIPAL REGISTER

THE MARK CONSISTS OF STANDARD CHARACTERS WITHOUT CLAIM TO ANY PAR-
TICULAR FONT, STYLE, SIZE, OR COLOR.

SER. NO. 85-452,675, FILED 10-20-2011.

HEATHER BIDDULPH, EXAMINING ATTORNEY



David J. Kybas

Director of the United States Patent and Trademark Office

United States of America

United States Patent and Trademark Office



Reg. No. 4,204,845

Registered Sep. 11, 2012

Int. Cl.: 38

SERVICE MARK

PRINCIPAL REGISTER

CUP O' DIRT L.L.C. (SOUTH DAKOTA LIMITED LIABILITY COMPANY)
320 SUMMER AVE.
BRANDON, SD 57005

FOR: RADIO BROADCASTING, IN CLASS 38 (U.S. CLS. 100, 101 AND 104).

FIRST USE 12-1-2010; IN COMMERCE 12-1-2010.

NO CLAIM IS MADE TO THE EXCLUSIVE RIGHT TO USE "RADIO", APART FROM THE MARK AS SHOWN.

THE MARK CONSISTS OF A SUN WITH 13 RAYS. THE SUN HAS A BIG SMILE, SLOTTED 80'S STYLE SUNGLASSES, AND A CURVED NOSE. TO THE RIGHT IS THE STYLIZED TEXT "SUNNY" ABOVE THE STYLIZED TEXT "RADIO". UNDER THE SUN AND THE PREVIOUS TEXT IS STYLIZED TEXT "WHERE IT'S ALWAYS IN THE 80'S!".

SER. NO. 85-453,244, FILED 10-21-2011.

EMILY CARLSEN, EXAMINING ATTORNEY



David J. Kyffers

Director of the United States Patent and Trademark Office

United States of America

United States Patent and Trademark Office



Reg. No. 4,204,846

Registered Sep. 11, 2012

Int. Cl.: 9

TRADEMARK

PRINCIPAL REGISTER

INCREMENTAL SYSTEMS CORPORATION (WASHINGTON CORPORATION), DBA INCSYS
3380 146TH PLACE SE, SUITE 440
BELLEVUE, WA 98007

FOR: ELECTRIC UTILITY GRID OPERATIONS AND MODELING SOFTWARE FOR TRAINING ELECTRIC SYSTEM OPERATORS, IN CLASS 9 (U.S. CLS. 21, 23, 26, 36 AND 38).

FIRST USE 8-1-2010; IN COMMERCE 9-1-2010.

THE MARK CONSISTS OF A MISCELLANEOUS DESIGN, NAMELY, A FANCIFUL CIRCULAR RING IN THE COLOR CYAN AND BOLDED; THREE WAVE-LIKE DESIGNS EXTENDING THROUGH AND BEYOND THE CIRCULAR RING IN THE COLOR CYAN ON TOP OF A WHITE SQUARE.

THE COLOR(S) CYAN AND WHITE IS/ARE CLAIMED AS A FEATURE OF THE MARK.

SER. NO. 85-453,622, FILED 10-21-2011.

TASHIA BUNCH, EXAMINING ATTORNEY



David J. Kyffers

Director of the United States Patent and Trademark Office

United States of America

United States Patent and Trademark Office

PURGRO

Reg. No. 4,204,847

Registered Sep. 11, 2012

Int. Cl.: 9

TRADEMARK

PRINCIPAL REGISTER

PURGRO ELECTRONICS, LLC (GEORGIA LIMITED LIABILITY COMPANY)
1434 CORNETT DRIVE
ELLIJAY, GA 30540

FOR: HYDROPONIC GARDENING ELECTRONIC CONTROL SYSTEM COMPRISED OF SENSORS, INJECTION PUMPS, AND RELAYS USED FOR REGULATING AND MONITORING LIGHTING, WATER LEVEL, ADDITIVE DOSING, AND OTHER ENVIRONMENTAL FACTORS FOR HYDROPONICALLY-GROWN PLANTS, IN CLASS 9 (U.S. CLS. 21, 23, 26, 36 AND 38).

FIRST USE 2-28-2010; IN COMMERCE 3-31-2010.

THE MARK CONSISTS OF STANDARD CHARACTERS WITHOUT CLAIM TO ANY PARTICULAR FONT, STYLE, SIZE, OR COLOR.

SER. NO. 85-454,082, FILED 10-24-2011.

ANDREA K. NADELMAN, EXAMINING ATTORNEY



David J. Kybas

Director of the United States Patent and Trademark Office

United States of America

United States Patent and Trademark Office



Reg. No. 4,204,848

Registered Sep. 11, 2012

Int. Cl.: 30

TRADEMARK

PRINCIPAL REGISTER

18 RABBITS, INC. (CALIFORNIA CORPORATION)
590 YORK STREET
SAN FRANCISCO, CA 94110

FOR: BAKERY PRODUCTS; BREAKFAST CEREALS; GRANOLA; GRANOLA SNACKS; GRANOLA-BASED SNACK BARS; CEREAL BASED SNACK FOOD; READY TO EAT, CEREAL DERIVED FOOD BARS; READY TO EAT, WHOLE GRAIN-BASED FOOD BARS CONTAINING NUTS, CHOCOLATE, DRIED FRUITS, AND SEEDS, IN CLASS 30 (U.S. CL. 46).

FIRST USE 1-0-2008; IN COMMERCE 1-0-2008.

OWNER OF U.S. REG. NO. 3,603,618.

THE MARK CONSISTS OF THE IMAGE OF A RABBIT SILHOUETTE STANDING ON TOP OF THE LETTER "R" WITH THE NUMBER "18" INSIDE OF THE "R" AND A LEAF DESIGN ON EITHER SIDE OF THE "R". THE RABBIT IMAGE IS ENCLOSED INSIDE OF AN OVAL AND THE OVAL IS ENCLOSED WITHIN A RECTANGLE.

SER. NO. 85-454,333, FILED 10-24-2011.

PAULA MAHONEY, EXAMINING ATTORNEY



David J. Kyffers

Director of the United States Patent and Trademark Office

United States of America

United States Patent and Trademark Office

Rail Logix

Reg. No. 4,204,849

Registered Sep. 11, 2012

Int. Cl.: 39

SERVICE MARK

PRINCIPAL REGISTER

RAIL LOGIX GP, LLC (TEXAS LIMITED LIABILITY COMPANY)
3330 S. SAM HOUSTON PKWY E.
HOUSTON, TX 77047

FOR: RAILCAR STORAGE; ON-DEMAND SWITCHING, NAMELY, MOVING OF RAILCARS TO A LOCATION DESIGNATED BY A CUSTOMER SUCH AS FROM STORAGE INTO THE STAGING AREA OF THE RAIL YARD, TO THE INTERCHANGE, TO A TRANSLOADING AREA, OR VICE VERSA; RAILCAR INTERCHANGE SERVICES, NAMELY, COORDINATING WITH MAIN RAIL LINE CARRIERS TO MOVE RAILCARS OUT OF THE RAIL YARD AND ONTO THE MAIN RAIL LINE FOR TRANSPORTATION OUT OF THE RAIL YARD, AND VICE VERSA; AND, TRANSLOADING SERVICES, NAMELY, FREIGHT LOADING SERVICES, IN CLASS 39 (U.S. CLS. 100 AND 105).

FIRST USE 9-1-2011; IN COMMERCE 9-1-2011.

THE MARK CONSISTS OF STANDARD CHARACTERS WITHOUT CLAIM TO ANY PARTICULAR FONT, STYLE, SIZE, OR COLOR.

NO CLAIM IS MADE TO THE EXCLUSIVE RIGHT TO USE "RAIL", APART FROM THE MARK AS SHOWN.

SER. NO. 85-454,426, FILED 10-24-2011.

JOHN DWYER, EXAMINING ATTORNEY



David J. Kypos

Director of the United States Patent and Trademark Office

United States of America

United States Patent and Trademark Office

Keeping Industry on Track

Reg. No. 4,204,850

Registered Sep. 11, 2012

Int. Cl.: 39

SERVICE MARK

PRINCIPAL REGISTER

RAIL LOGIX GP, LLC (TEXAS LIMITED LIABILITY COMPANY)
3330 S. SAM HOUSTON PKWY E.
HOUSTON, TX 77047

FOR: RAILCAR STORAGE; ON-DEMAND SWITCHING, NAMELY, MOVING OF RAILCARS TO A LOCATION DESIGNATED BY A CUSTOMER SUCH AS FROM STORAGE INTO THE STAGING AREA OF THE RAIL YARD, TO THE INTERCHANGE, TO A TRANSLOADING AREA, OR VICE VERSA; RAILCAR INTERCHANGE SERVICES, NAMELY, COORDINATING WITH MAIN RAIL LINE CARRIERS TO MOVE RAILCARS OUT OF THE RAIL YARD AND ONTO THE MAIN RAIL LINE FOR TRANSPORTATION OUT OF THE RAIL YARD, AND VICE VERSA; AND, TRANSLOADING SERVICES, NAMELY, FREIGHT LOADING SERVICES, IN CLASS 39 (U.S. CLS. 100 AND 105).

FIRST USE 9-1-2011; IN COMMERCE 9-1-2011.

THE MARK CONSISTS OF STANDARD CHARACTERS WITHOUT CLAIM TO ANY PARTICULAR FONT, STYLE, SIZE, OR COLOR.

SER. NO. 85-454,440, FILED 10-24-2011.

JOHN DWYER, EXAMINING ATTORNEY



David J. Kybas

Director of the United States Patent and Trademark Office

United States of America

United States Patent and Trademark Office

OPSYONS

Reg. No. 4,204,851

AVEDON B.V. (NETHERLANDS LIMITED LIABILITY COMPANY)
BORNEOKADE 205

Registered Sep. 11, 2012

AMSTERDAM, NETHERLANDS 1019XE

Int. Cl.: 3

FOR: COSMETICS AND SKIN CARE PRODUCTS, NAMELY, BASIC CREAMS, LIPSTICKS, LIP LINER, LIP BALM, MOISTURIZERS; SOAPS FOR THE SKIN; BATH GEL, BATH OILS, BATH SALTS, FIZZING BATH BALLS AND EFFERVESCENT BATH TABLETS; NON-MEDICINAL SKIN CARE PRODUCTS, NAMELY, LOTIONS, CREAMS, CLEANSERS, SCRUBS, MASKS AND VITALIZING BODY LOTION AND BODY OIL; HAIR CARE PRODUCTS AND HAIR SHAPING PRODUCTS, NAMELY, SHAMPOOS, HAIR CONDITIONERS; PERFUMES, EAU DE TOILETTE, ESSENTIAL OILS FOR PERSONAL USE, SCENTED OILS; PERFUMED SCENTED OILS FOR ROOMS, INCENSE STICKS, SCENTED OIL MIXTURES AND SACHETS; WIPES IMPREGNATED WITH LOTIONS; GIFT SETS AND SETS COMPRISING SKIN CARE PRODUCTS, NAMELY, BODY LOTIONS AND SKIN CREAMS; GIFT SETS AND SETS COMPRISING HAIR CARE PRODUCTS, NAMELY, SHAMPOOS AND CONDITIONERS, IN CLASS 3 (U.S. CLS. 1, 4, 6, 50, 51 AND 52).

TRADEMARK

PRINCIPAL REGISTER

THE MARK CONSISTS OF STANDARD CHARACTERS WITHOUT CLAIM TO ANY PARTICULAR FONT, STYLE, SIZE, OR COLOR.

OWNER OF BENELUX REG. NO. 901891, DATED 9-12-2011, EXPIRES 5-18-2021.

SER. NO. 85-454,500, FILED 10-24-2011.

DANIEL BRODY, EXAMINING ATTORNEY



David J. Kyffers

Director of the United States Patent and Trademark Office

United States of America

United States Patent and Trademark Office

Best Friends

Reg. No. 4,204,852

SOUTH BEACH CANDLE COMPANY, INC. (FLORIDA CORPORATION)
2260 W 80 STREET BAY #3
HIALEAH, FL 33016

Registered Sep. 11, 2012

Int. Cl.: 4

FOR: CANDLES; PERFUMED CANDLES; SCENTED CANDLES; SCENTED WAX FOR USE
IN CANDLE WARMERS, IN CLASS 4 (U.S. CLS. 1, 6 AND 15).

TRADEMARK

FIRST USE 9-1-2011; IN COMMERCE 9-1-2011.

PRINCIPAL REGISTER

THE MARK CONSISTS OF STANDARD CHARACTERS WITHOUT CLAIM TO ANY PAR-
TICULAR FONT, STYLE, SIZE, OR COLOR.

SER. NO. 85-455,028, FILED 10-24-2011.

HEATHER BIDDULPH, EXAMINING ATTORNEY



David J. Kyffers

Director of the United States Patent and Trademark Office

United States of America

United States Patent and Trademark Office

FAIR PARK FILM FORUM

Reg. No. 4,204,853

JANELE ELLIS (UNITED STATES INDIVIDUAL)
4094 LIVELY LN.

Registered Sep. 11, 2012

DALLAS, TX 752201825

Int. Cl.: 41

FOR: ENTERTAINMENT SERVICES, NAMELY, PLANNING AND CONDUCTING A SERIES OF FILM FESTIVALS TO PROMOTE DIALOG RELATED TO WOMEN TOPICS, IN CLASS 41 (U.S. CLS. 100, 101 AND 107).

SERVICE MARK

FIRST USE 10-11-2005; IN COMMERCE 10-11-2005.

PRINCIPAL REGISTER

THE MARK CONSISTS OF STANDARD CHARACTERS WITHOUT CLAIM TO ANY PARTICULAR FONT, STYLE, SIZE, OR COLOR.

NO CLAIM IS MADE TO THE EXCLUSIVE RIGHT TO USE "FILM FORUM", APART FROM THE MARK AS SHOWN.

SEC. 2(F).

SER. NO. 85-455,745, FILED 10-25-2011.

PRISCILLA MILTON, EXAMINING ATTORNEY



David J. Kybas

Director of the United States Patent and Trademark Office

United States of America

United States Patent and Trademark Office

PREMIUM MARINE PROTECTION

Reg. No. 4,204,854

LYNDON INSURANCE GROUP, INC. (MISSOURI CORPORATION)
14755 NORTH OUTER FORTY ROAD
ST. LOUIS, MO 63017

Registered Sep. 11, 2012

Int. Cl.: 36

FOR: INSURANCE UNDERWRITING SERVICES, NAMELY, EXTENDED SERVICE CONTRACTS SOLD THROUGH DEALERS TO VEHICLE AND WATERCRAFT PURCHASERS TO COVER EXPENSES INCURRED IN CONNECTION WITH MECHANICAL BREAKDOWN, IN CLASS 36 (U.S. CLS. 100, 101 AND 102).

SERVICE MARK

PRINCIPAL REGISTER

FIRST USE 1-0-1994; IN COMMERCE 1-0-1994.

THE MARK CONSISTS OF STANDARD CHARACTERS WITHOUT CLAIM TO ANY PARTICULAR FONT, STYLE, SIZE, OR COLOR.

OWNER OF U.S. REG. NOS. 3,170,273 AND 3,188,977.

NO CLAIM IS MADE TO THE EXCLUSIVE RIGHT TO USE "MARINE PROTECTION", APART FROM THE MARK AS SHOWN.

SEC. 2(F).

SER. NO. 85-455,772, FILED 10-25-2011.

WILLIAM JACKSON, EXAMINING ATTORNEY



David J. Kybas

Director of the United States Patent and Trademark Office

United States of America

United States Patent and Trademark Office



CETAS

Reg. No. 4,204,855

Registered Sep. 11, 2012

Int. Cl.: 42

SERVICE MARK

PRINCIPAL REGISTER

GDSX, LTD. (TEXAS LIMITED PARTNERSHIP)
700 CENTRAL EXPRESSWAY S., SUITE 230
ALLEN, TX 75013

FOR: PROVIDING PROPRIETARY ONLINE NON-DOWNLOADABLE SOFTWARE FOR AUTOMATING PRE-TRIP APPROVAL FOR OTHERS TO ENFORCE COMPLIANCE WITH THEIR CORPORATE TRAVEL POLICIES IN THE FIELD OF CORPORATE TRAVEL MANAGEMENT, IN CLASS 42 (U.S. CLS. 100 AND 101).

FIRST USE 7-31-2011; IN COMMERCE 7-31-2011.

THE MARK CONSISTS OF A SQUARE IMAGE CONSISTING OF AN ORANGE CHECK MARK ATOP A BLUE CHECK MARK, BOTH OF WHICH ARE ATOP A GREEN CHECK MARK, WITH THE REMAINDER OF THE SQUARE BEING GRAY. THE WORD "CETAS" APPEARS IN BLACK LETTERS TO THE RIGHT OF THE AFOREMENTIONED SQUARE IMAGE.

THE COLOR(S) ORANGE, BLUE, GREEN, GRAY AND BLACK IS/ARE CLAIMED AS A FEATURE OF THE MARK.

SER. NO. 85-455,969, FILED 10-25-2011.

LAURIE MAYES, EXAMINING ATTORNEY



David J. Kyros

Director of the United States Patent and Trademark Office

United States of America

United States Patent and Trademark Office

Clean Sensations

Reg. No. 4,204,856

SOUTH BEACH CANDLE COMPANY, INC (FLORIDA CORPORATION)
2260 W 80 STREET BAY #3
HIALEAH, FL 33016

Registered Sep. 11, 2012

Int. Cl.: 4

FOR: CANDLES; PERFUMED CANDLES; SCENTED CANDLES; SCENTED WAX FOR USE
IN CANDLE WARMERS, IN CLASS 4 (U.S. CLS. 1, 6 AND 15).

TRADEMARK

FIRST USE 8-1-2011; IN COMMERCE 8-1-2011.

PRINCIPAL REGISTER

THE MARK CONSISTS OF STANDARD CHARACTERS WITHOUT CLAIM TO ANY PAR-
TICULAR FONT, STYLE, SIZE, OR COLOR.

SER. NO. 85-456,262, FILED 10-26-2011.

HEATHER BIDDULPH, EXAMINING ATTORNEY



David J. Kybas

Director of the United States Patent and Trademark Office

United States of America

United States Patent and Trademark Office

CREATE WITH CONFIDENCE

Reg. No. 4,204,857

MARTINGALE & COMPANY (WASHINGTON CORPORATION)
19021 120TH AVENUE, N.E., SUITE 102
BOTHELL, WA 98011

Registered Sep. 11, 2012

Int. Cls.: 9, 16 and 35

FOR: DOWNLOADABLE BOOKS AND PATTERNS IN THE FIELDS OF CRAFTS, SEWING, QUILTING, KNITTING AND OTHER HOBBIES VIA INTERNET WEBSITE, IN CLASS 9 (U.S. CLS. 21, 23, 26, 36 AND 38).

TRADEMARK

FIRST USE 3-7-2012; IN COMMERCE 3-7-2012.

SERVICE MARK

PRINCIPAL REGISTER

FOR: BOOKS IN THE FIELDS OF CRAFTS, SEWING, QUILTING, KNITTING AND OTHER HOBBIES; CATALOGS IN THE FIELDS OF CRAFTS, SEWING, QUILTING, KNITTING AND OTHER HOBBIES; PATTERNS FOR SEWING, QUILTING, KNITTING AND OTHER HOBBIES, IN CLASS 16 (U.S. CLS. 2, 5, 22, 23, 29, 37, 38 AND 50).

FIRST USE 2-27-2012; IN COMMERCE 2-27-2012.

FOR: RETAIL STORE SERVICES IN THE FIELDS OF CRAFTS, SEWING, QUILTING, KNITTING AND OTHER HOBBIES, ACCESSIBLE ONLINE OR VIA MAIL ORDER AND TELEPHONE; PROVIDING A WEBSITE FEATURING INFORMATION FOR CONSUMERS IN THE FIELDS OF CRAFTS, SEWING, QUILTING, KNITTING AND OTHER HOBBIES, IN CLASS 35 (U.S. CLS. 100, 101 AND 102).

FIRST USE 3-7-2012; IN COMMERCE 3-7-2012.

THE MARK CONSISTS OF STANDARD CHARACTERS WITHOUT CLAIM TO ANY PARTICULAR FONT, STYLE, SIZE, OR COLOR.

SER. NO. 85-456,341, FILED 10-26-2011.

KATINA MISTER, EXAMINING ATTORNEY



David J. Kypos

Director of the United States Patent and Trademark Office

United States of America

United States Patent and Trademark Office

IGNITE YOUR PASSION FOR BARBEQUE!

Reg. No. 4,204,858

NEXSTAGE, INC. (INDIANA CORPORATION)
1675 ASPEN WAY
MARTINSVILLE, IN 46151

Registered Sep. 11, 2012

Int. Cls.: 30 and 43

FOR: SAUCES, IN CLASS 30 (U.S. CL. 46).

TRADEMARK

FIRST USE 10-1-2011; IN COMMERCE 10-1-2011.

SERVICE MARK

FOR: RESTAURANT AND CATERING SERVICES, IN CLASS 43 (U.S. CLS. 100 AND 101).

PRINCIPAL REGISTER

FIRST USE 4-1-2011; IN COMMERCE 4-1-2011.

THE MARK CONSISTS OF STANDARD CHARACTERS WITHOUT CLAIM TO ANY PARTICULAR FONT, STYLE, SIZE, OR COLOR.

SER. NO. 85-456,457, FILED 10-26-2011.

JEFF DEFORD, EXAMINING ATTORNEY



David J. Kyffers

Director of the United States Patent and Trademark Office

United States of America

United States Patent and Trademark Office



ALL-PRO
PEST SERVICES

Reg. No. 4,204,859

ALL PRO PEST SERVICES, INC. (GEORGIA CORPORATION)
1259 COBB INDUSTRIAL DRIVE
MARIETTA, GA 30066

Registered Sep. 11, 2012

Int. Cl.: 37

FOR: TERMITE AND PEST CONTROL, IN CLASS 37 (U.S. CLS. 100, 103 AND 106).

SERVICE MARK

FIRST USE 3-0-2011; IN COMMERCE 3-0-2011.

PRINCIPAL REGISTER

NO CLAIM IS MADE TO THE EXCLUSIVE RIGHT TO USE "PEST SERVICES", APART FROM THE MARK AS SHOWN.

THE MARK CONSISTS OF "ALL-PRO" ABOVE A SHADED RECTANGLE THAT INCLUDES THE WORDS "PEST SERVICES".

SER. NO. 85-456,551, FILED 10-26-2011.

NAAKWAMA ANKRAH, EXAMINING ATTORNEY



David J. Kyffers

Director of the United States Patent and Trademark Office

United States of America

United States Patent and Trademark Office

AMERI-KART

Reg. No. 4,204,860

AMERI-KART CORP. (KANSAS CORPORATION)

Registered Sep. 11, 2012

17196 STATE ROAD 120
BRISTOL, IN 46507

**Int. Cls.: 12, 20, 21 and
40**

FOR: STRUCTURAL PARTS OF MARINE VESSELS, NAMELY, FUEL TANKS; STRUCTURAL PARTS OF MARINE VESSELS, NAMELY, COOLERS AND STORAGE BOXES; STRUCTURAL PARTS OF MARINE VESSELS, NAMELY, LIVEWELLS AND BAITWELLS; STRUCTURAL PARTS OF MARINE VESSELS, NAMELY, SEAT SHELLS; WATER TANKS FOR MARINE VESSELS AND RECREATIONAL VEHICLES, NAMELY, MARINE VESSEL, TOWABLE TRAILER AND MOTOR HOME STRUCTURAL PARTS, NAMELY WATER STORAGE TANKS; HOLDING TANKS FOR MARINE VESSELS AND RECREATIONAL VEHICLES, NAMELY, WASTE HOLDING TANKS FOR HOLDING HUMAN WASTE OR WATER WASTE IN THE NATURE OF STRUCTURAL PARTS OF MARINE VESSELS AND RECREATIONAL VEHICLES; STRUCTURAL PARTS OF TOWABLE TRAILER AND MOTOR HOME, NAMELY, FENDERS; STRUCTURAL PARTS OF RECREATIONAL VEHICLES, NAMELY, SHOWER PANS; VACUUM FORMED PLASTIC STRUCTURAL PARTS FOR TOWABLE TRAILERS AND MOTOR HOMES, NAMELY, FAUCET BEZELS, PROPANE TANK COVERS, SINKS, AND TRIM PIECES; MOLDED PLASTIC STRUCTURAL PARTS FOR TOWABLE TRAILERS AND MOTOR HOMES, NAMELY, COMPARTMENT LINERS, CONVENIENCE CENTERS, RANGE HOLDERS, BATTERY BOXES, DRAWERS, SLIDES, AND WHEEL WELLS; MARINE VESSEL PARTS, NAMELY, AN EVAPORATIVE EMISSION CONTROL DEVICE CONSISTING PRIMARILY OF A DECK FITTING FOR FILLING FUEL AND A FUEL VENT; MARINE VESSEL PARTS, NAMELY, A FUEL OVERFILL PREVENTION SYSTEM CONSISTING PRIMARILY OF A DECK FITTING FOR FILLING FUEL AND A FUEL SENSOR; PLASTIC GOODS HANDLING CARTS, IN CLASS 12 (U.S. CLS. 19, 21, 23, 31, 35 AND 44).

TRADEMARK

SERVICE MARK

PRINCIPAL REGISTER



FIRST USE 5-31-1992; IN COMMERCE 5-31-1992.

FOR: PLASTIC STORAGE CONTAINERS FOR INDUSTRIAL USE; PLASTIC TANKS, NAMELY, HYDRAULIC AND FUEL TANKS, NAMELY, NON-METAL FLUID STORAGE TANKS; PLASTIC STORAGE TANKS FOR AGRICULTURAL USE; PLASTIC WATER TANKS FOR INDUSTRIAL AND AGRICULTURAL PURPOSES; NON-METAL AND NON-PAPER CONTAINERS FOR INDUSTRIAL, COMMERCIAL, OR AGRICULTURAL STORAGE USE; PLASTIC BINS AND PACKAGING CONTAINERS FOR HOUSEHOLD, INDUSTRIAL, OR COMMERCIAL USE; PLASTIC BINS AND PACKAGING CONTAINERS FOR HANDLING OF WASTE, SCRAP, AND RECYCLABLES, IN CLASS 20 (U.S. CLS. 2, 13, 22, 25, 32 AND 50).

David J. Kybas

Director of the United States Patent and Trademark Office

Reg. No. 4,204,860 FIRST USE 5-31-1992; IN COMMERCE 5-31-1992.

FOR: TRASH CANS, IN CLASS 21 (U.S. CLS. 2, 13, 23, 29, 30, 33, 40 AND 50).

FIRST USE 10-31-1989; IN COMMERCE 10-31-1989.

FOR: PARTS MOLDING; ROTATIONAL MOLDING OF PLASTIC FOR OTHERS; VACUUM FORMING OF PLASTIC FOR OTHERS, NAMELY, CUSTOM MOLDING OF PLASTICS; CUSTOM PLASTICS MOLDING SERVICES AND CUSTOM MANUFACTURE OF PLASTIC PARTS, COMPONENT ASSEMBLIES, AND FINISHED PLASTICS FOR A WIDE VARIETY OF INDUSTRIES; CUSTOM MANUFACTURE OF MOLDS FOR USE IN THE PLASTICS INDUSTRY; ASSEMBLY OF PLASTIC PRODUCTS FOR OTHERS; CONSULTING SERVICES PROVIDED WITH THE FOREGOING, IN CLASS 40 (U.S. CLS. 100, 103 AND 106).

FIRST USE 5-31-1992; IN COMMERCE 5-31-1992.

THE MARK CONSISTS OF STANDARD CHARACTERS WITHOUT CLAIM TO ANY PARTICULAR FONT, STYLE, SIZE, OR COLOR.

SER. NO. 85-456,582, FILED 10-26-2011.

ROBERT STRUCK, EXAMINING ATTORNEY

United States of America

United States Patent and Trademark Office

REDI POUR

Reg. No. 4,204,861

MIRANDA INDUSTRIES, INC. (OREGON CORPORATION)
17223 SE ROYER ROAD
DAMASCUS, OR 97089

Registered Sep. 11, 2012

Int. Cls.: 37 and 42

FOR: CONSTRUCTION SERVICES, NAMELY, CONSULTING CONCERNING CONCRETE STRUCTURES, IN CLASS 37 (U.S. CLS. 100, 103 AND 106).

SERVICE MARK

FIRST USE 10-21-2011; IN COMMERCE 10-21-2011.

PRINCIPAL REGISTER

FOR: DESIGNING CONCRETE STRUCTURES, AND BUILDING CONCRETE STRUCTURES, IN CLASS 42 (U.S. CLS. 100 AND 101).

FIRST USE 10-21-2011; IN COMMERCE 10-21-2011.

THE MARK CONSISTS OF STANDARD CHARACTERS WITHOUT CLAIM TO ANY PARTICULAR FONT, STYLE, SIZE, OR COLOR.

NO CLAIM IS MADE TO THE EXCLUSIVE RIGHT TO USE "POUR", APART FROM THE MARK AS SHOWN.

SER. NO. 85-457,141, FILED 10-26-2011.

MICHELE SWAIN, EXAMINING ATTORNEY



David J. Kybas

Director of the United States Patent and Trademark Office

United States of America

United States Patent and Trademark Office

STROHKOLADE

Reg. No. 4,204,862

Registered Sep. 11, 2012

Int. Cls.: 29, 30 and 33

STROHAUSTRIA GESELLSCHAFT MBH (AUSTRIA GESELLSCHAFT MIT BESCHRÄNKTER
HAFTUNG (GMBH))
STROHGASSE 6
KLAGENFURT
AM WÖRTHERSEE, AUSTRIA 9020

TRADEMARK

PRINCIPAL REGISTER

FOR: MILK AND MILK PRODUCTS EXCLUDING ICE CREAM, ICE MILK AND FROZEN
YOGURT; MILK PREDOMINATING BEVERAGES, NAMELY, MILK-SHAKES, WHEY;
WHIPPING CREAM; SOYA MILK, IN CLASS 29 (U.S. CL. 46).

FOR: COFFEE, TEA, COCOA, COFFEE BEVERAGES WITH MILK, COCOA BEVERAGES
WITH MILK, MILK CHOCOLATE, COCOA-BASED BEVERAGES, CHOCOLATE-BASED
BEVERAGES, COFFEE BASED BEVERAGES; FLAVORINGS, OTHER THAN ESSENTIAL
OILS, FOR BEVERAGES; COFFEE FLAVORINGS; COCOA-BASED INGREDIENT IN CON-
FECTIONERY PRODUCTS; CHOCOLATE; PASTRIES AND COOKIES, EDIBLE ICES, ICE
CREAM, IN CLASS 30 (U.S. CL. 46).

FOR: ALCOHOLIC BEVERAGES EXCEPT BEERS , IN CLASS 33 (U.S. CLS. 47 AND 49).

THE MARK CONSISTS OF STANDARD CHARACTERS WITHOUT CLAIM TO ANY PAR-
TICULAR FONT, STYLE, SIZE, OR COLOR.

OWNER OF ERPN CMNTY TM OFC REG. NO. 009820481, DATED 7-28-2011, EXPIRES 3-
18-2021.

SER. NO. 85-457,516, FILED 10-27-2011.

STEVEN JACKSON, EXAMINING ATTORNEY



David J. Kyffers

Director of the United States Patent and Trademark Office

United States of America

United States Patent and Trademark Office

Carolina Canines

Reg. No. 4,204,863

Registered Sep. 11, 2012

Int. Cl.: 44

CAROLINA CANINES FOR SERVICE INC. (NORTH CAROLINA CORPORATION), AKA
CAROLINA CANINES
1200 N. 23RD ST.
STE 101
WILMINGTON, NC 28405

SERVICE MARK

FOR: CHARITABLE SERVICES, NAMELY, PROVIDING TRAINED SERVICE DOGS FOR
DISABLED INDIVIDUALS, IN CLASS 44 (U.S. CLS. 100 AND 101).

PRINCIPAL REGISTER

FIRST USE 12-1-1996; IN COMMERCE 12-1-1996.

THE MARK CONSISTS OF STANDARD CHARACTERS WITHOUT CLAIM TO ANY PAR-
TICULAR FONT, STYLE, SIZE, OR COLOR.

NO CLAIM IS MADE TO THE EXCLUSIVE RIGHT TO USE "CANINES", APART FROM
THE MARK AS SHOWN.

SEC. 2(F).

SER. NO. 85-458,453, FILED 10-27-2011.

DEIRDRE ROBERTSON, EXAMINING ATTORNEY



David J. Kyffers

Director of the United States Patent and Trademark Office

United States of America

United States Patent and Trademark Office



Reg. No. 4,204,864

Registered Sep. 11, 2012

Int. Cl.: 41

SERVICE MARK

PRINCIPAL REGISTER

INTERNATIONAL IVY L.L.C. (NEW JERSEY LIMITED LIABILITY COMPANY)
232 SPRINGFIELD AVENUE
SUMMIT, NJ 07901 AND

WONG, PUI WAN LILY (UNITED STATES INDIVIDUAL)
232 SPRINGFIELD AVENUE
SUMMIT, NJ 07901

FOR: EDUCATION SERVICES, NAMELY, PROVIDING KINDERGARTEN THROUGH 12TH GRADE (K-12) CLASSROOM INSTRUCTION; EDUCATION SERVICES, NAMELY, PROVIDING LIVE AND ON-LINE INSTRUCTION, TUTORING, MENTORING, CLASSES, SEMINARS, WORKSHOPS AND ADVICE IN THE FIELD OF ENGLISH AS A SECOND OR FOREIGN LANGUAGE, TECHNOLOGY, SCIENCE, ARTS, SPORT, CREATIVITY, INNOVATION, BUSINESS, COLLEGE PREPARATION AND COGNITIVE TRAINING, IN CLASS 41 (U.S. CLS. 100, 101 AND 107).

FIRST USE 10-28-2011; IN COMMERCE 10-28-2011.

THE STIPPLING IS A FEATURE OF THE MARK AND DOES NOT INDICATE COLOR.

THE COLOR(S) GREEN AND WHITE IS/ARE CLAIMED AS A FEATURE OF THE MARK.

THE MARK CONSISTS OF TWO WHITE, FLUTED COLUMNS WITH A WHITE MARBLE BASE ABOVE AND BELOW THE TWO COLUMNS; A GREEN IVY VINE IS ENCIRCLING EACH COLUMN; A GREEN GLOBE IS BEHIND THE COLUMNS.

SER. NO. 85-459,211, FILED 10-28-2011.

ERIN FALK, EXAMINING ATTORNEY



David J. Kyjars

Director of the United States Patent and Trademark Office

United States of America

United States Patent and Trademark Office

THE SPORT SCREEN

Reg. No. 4,204,865

Registered Sep. 11, 2012

Int. Cl.: 19

TRADEMARK

PRINCIPAL REGISTER

THE SPORT SCREEN LTD. (CANADA CORPORATION)
UNIT 8
20 STECKLE PLACE
KITCHENER, ONTARIO, CANADA N2E2C3

FOR: BARRIERS COMPOSED PRIMARILY OF NON-METAL MATERIAL FOR PROTECTING GARAGE DOORS AGAINST DAMAGE CAUSED BY IMPACT OF OBJECTS, IN CLASS 19 (U.S. CLS. 1, 12, 33 AND 50).

FIRST USE 4-0-2010; IN COMMERCE 6-0-2011.

THE MARK CONSISTS OF STANDARD CHARACTERS WITHOUT CLAIM TO ANY PARTICULAR FONT, STYLE, SIZE, OR COLOR.

PRIORITY CLAIMED UNDER SEC. 44(D) ON CANADA APPLICATION NO. 1,525,725, FILED 4-29-2011.

NO CLAIM IS MADE TO THE EXCLUSIVE RIGHT TO USE "SCREEN", APART FROM THE MARK AS SHOWN.

SER. NO. 85-459,240, FILED 10-28-2011.

TEJBIR SINGH, EXAMINING ATTORNEY



David J. Kyffers

Director of the United States Patent and Trademark Office

United States of America

United States Patent and Trademark Office

DIVERSIFIED PROJECT MANAGEMENT

Reg. No. 4,204,866

Registered Sep. 11, 2012

Int. Cls.: 35, 37 and 39

SERVICE MARK

PRINCIPAL REGISTER

DIVERSIFIED PROJECT MANAGEMENT, INC. (NEW HAMPSHIRE CORPORATION)
SUITE 951
ONE GATEWAY CENTER
NEWTON, MA 02458

FOR: BUSINESS PROJECT MANAGEMENT, NAMELY, CONSULTING, PLANNING, AND SUPERVISING FACILITIES OPERATIONS MANAGEMENT FOR BUSINESSES AND ORGANIZATIONS; AND REPRESENTING BUSINESS OWNERS IN ARRANGING CONTRACTUAL SERVICES WITH THIRD PARTIES, IN CLASS 35 (U.S. CLS. 100, 101 AND 102).

FIRST USE 5-31-1994; IN COMMERCE 5-31-1994.

FOR: CONSTRUCTION MANAGEMENT, NAMELY, CONSULTING, PLANNING, AND SUPERVISING PRECONSTRUCTION, AND CONSTRUCTION FOR BUSINESSES AND ORGANIZATIONS, IN CLASS 37 (U.S. CLS. 100, 103 AND 106).

FIRST USE 5-31-1994; IN COMMERCE 5-31-1994.

FOR: CONSULTATION REGARDING COORDINATED MOVING AND RELOCATION SERVICES FOR BUSINESSES AND ORGANIZATIONS, IN CLASS 39 (U.S. CLS. 100 AND 105).

FIRST USE 5-31-1994; IN COMMERCE 5-31-1994.

THE MARK CONSISTS OF STANDARD CHARACTERS WITHOUT CLAIM TO ANY PARTICULAR FONT, STYLE, SIZE, OR COLOR.

NO CLAIM IS MADE TO THE EXCLUSIVE RIGHT TO USE "PROJECT MANAGEMENT", APART FROM THE MARK AS SHOWN.

SER. NO. 85-459,399, FILED 10-28-2011.

VERNA BETH RIRIE, EXAMINING ATTORNEY



David J. Kyffers

Director of the United States Patent and Trademark Office

United States of America

United States Patent and Trademark Office

SERVERHUB

Reg. No. 4,204,867

Registered Sep. 11, 2012

Int. Cl.: 42

SERVICE MARK

PRINCIPAL REGISTER

EONIX CORPORATION (NEVADA CORPORATION)
2360 CORPORATE CIRCLE SUITE 400
HENDERSON, NV 89074

FOR: COMPUTER CO-LOCATION SERVICES, NAMELY, PROVIDING FACILITIES FOR THE LOCATION OF COMPUTER SERVERS WITH THE EQUIPMENT OF OTHERS; COMPUTER SERVICES, NAMELY, INTERNET PROTOCOL ADDRESS MANAGEMENT; COMPUTER SERVICES, NAMELY, PROVIDING VIRTUAL AND NON VIRTUAL APPLICATION SERVERS, WEB SERVERS, FILE SERVERS, CO-LOCATION SERVERS, LOAD BALANCING SERVERS, REDUNDANCY SERVERS, MEDIA SERVERS AND DATABASE SERVERS OF VARIABLE CAPACITY TO THIRD PARTY COMPUTING AND DATA STORAGE FACILITIES; CREATING AND MAINTAINING INTERNET SITES FOR OTHERS; HOSTING INTERNET SITES FOR OTHERS; HOSTING WEBSITES ON THE INTERNET; MAINTENANCE OF SOFTWARE FOR INTERNET ACCESS; RENTAL OF WEB SERVERS; TECHNICAL CONSULTING SERVICES IN THE FIELDS OF DATACENTER ARCHITECTURE, PUBLIC AND PRIVATE CLOUD COMPUTING SOLUTIONS, AND EVALUATION AND IMPLEMENTATION OF INTERNET TECHNOLOGY AND SERVICES; TECHNOLOGY ADVICE PROVIDED TO INTERNET USERS BY MEANS OF A SUPPORT HOTLINE; WEB SITE HOSTING SERVICES, IN CLASS 42 (U.S. CLS. 100 AND 101).

FIRST USE 3-12-2002; IN COMMERCE 3-12-2002.

THE MARK CONSISTS OF STANDARD CHARACTERS WITHOUT CLAIM TO ANY PARTICULAR FONT, STYLE, SIZE, OR COLOR.

SEC. 2(F).

SER. NO. 85-459,572, FILED 10-28-2011.

REBECCA SMITH, EXAMINING ATTORNEY



David J. Kypos

Director of the United States Patent and Trademark Office

United States of America

United States Patent and Trademark Office

KYNESKA

Reg. No. 4,204,868

Registered Sep. 11, 2012

Int. Cls.: 9 and 41

TRADEMARK

SERVICE MARK

PRINCIPAL REGISTER

O'NEILL, AISLINN (UNITED KINGDOM INDIVIDUAL)
15 COLNE ROAD, BLUNTISHAM
HUNTINGDON, UNITED KINGDOM PE283LU

FOR: MUSICAL SOUND RECORDING AND MUSICAL VIDEO RECORDINGS IN ALL MEDIA; MOTION PICTURE FILMS ABOUT MUSICAL BANDS; PRERECORDED VIDEO DISCS, COMPACT DISCS, AUDIO CASSETTES, VIDEO CASSETTES, EXPOSED SLIDE FILMS AND PHOTOGRAPHIC SLIDE TRANSPARENCIES FEATURING PERFORMANCES BY A MUSICAL GROUP, THEATRICAL, ORCHESTRAL, VOCAL, CHORAL, CHOREOGRAPHIC, CINEMATIC PRESENTATIONS IN THE NATURE OF FILMS FEATURING MEMBERS OF A MUSICAL GROUP, AND MULTI-MEDIA PRESENTATIONS IN THE NATURE OF COMPUTER BASED FILMS FEATURING MEMBERS OF A MUSICAL GROUP; EYEGASSES, SPECTACLES, SPECTACLE FRAMES, SUNGLASSES; EYEGASSES CASES; MUSICAL SOUND AND VIDEO RECORDINGS; DIGITAL MUSIC DOWNLOADABLE FROM THE INTERNET; DIGITAL MUSIC DOWNLOADABLE PROVIDED FROM MP3 WEB SITES ON THE INTERNET; PRERECORDED VIDEO TAPES FEATURING MUSIC; DOWNLOADABLE RING TONES FOR MOBILE PHONES; CINEMATOGRAPHIC FILMS FEATURING MUSIC FOR ENTERTAINMENT EXHIBITIONS; PHONOGRAPH RECORDS FEATURING MUSIC; PRERECORDED AUDIO AND VIDEO TAPES, VIDEO AND AUDIO CASSETTES, COMPACT DISCS AND DVDS FEATURING MUSIC; MUSICAL SOUND AND VIDEO RECORDINGS; APPARATUS FOR RECORDING, TRANSMISSION OR REPRODUCTION OF SOUND; DOWNLOADABLE AUDIO AND VIDEO RECORDINGS FEATURING MUSIC; MOUSE PADS; DECORATIVE MAGNETS; PARTS AND FITTINGS FOR ALL THE AFORESAID GOODS, IN CLASS 9 (U.S. CLS. 21, 23, 26, 36 AND 38).



David J. Kyffers

Director of the United States Patent and Trademark Office

FOR: ENTERTAINMENT SERVICES, NAMELY, PROVIDING ADVICE AND INFORMATION FOR MUSIC, VIDEO AND FILM CONCEPT AND SCRIPT DEVELOPMENT; ENTERTAINMENT IN THE NATURE OF VISUAL AND AUDIO PERFORMANCES BY A MUSICAL BAND; LIVE PERFORMANCES BY A MUSICAL GROUP; LIVE ENTERTAINMENT SERVICES IN THE NATURE OF MUSICAL CONCERTS; ENTERTAINMENT SERVICES, NAMELY, THE PROVISION OF CONTINUING PROGRAMS FEATURING COMEDY DELIVERED BY TELEVISION; ENTERTAINMENT, NAMELY, LIVE PERFORMANCES BY A MUSICAL BAND; ENTERTAINMENT, NAMELY, LIVE MUSICAL CONCERTS; PRODUCTION OF SOUND RECORDING, FILM AND VIDEO PRODUCTION AND DISTRIBUTION OF MOTION PICTURE FILMS; PRODUCTION OF RADIO AND TELEVISION PROGRAMS; TELEVISION SHOW PRODUCTION; PRODUCTION OF MUSICAL VIDEOS; ARRANGING AND CONDUCTING CONCERTS; AUDIO RECORDING AND PRODUCTION SERVICES;

Reg. No. 4,204,868 FAN CLUBS; PROVIDING EDUCATION COURSES IN THE FIELD OF MUSIC OFFERED THROUGH ONLINE, NON-DOWNLOADABLE VIDEOS AND INSTRUCTOR ASSISTANCE, IN CLASS 41 (U.S. CLS. 100, 101 AND 107).

THE MARK CONSISTS OF STANDARD CHARACTERS WITHOUT CLAIM TO ANY PARTICULAR FONT, STYLE, SIZE, OR COLOR.

OWNER OF UNITED KINGDOM REG. NO. 2586846, DATED 10-21-2011, EXPIRES 7-6-2021.

THE WORDING "KYNESKA" HAS NO MEANING IN A FOREIGN LANGUAGE.

SER. NO. 85-460,014, FILED 10-31-2011.

CHRISIE B. KING, EXAMINING ATTORNEY

United States of America

United States Patent and Trademark Office

THE PATH TO THE PRESENT

Reg. No. 4,204,869

Registered Sep. 11, 2012

Int. Cl.: 43

SERVICE MARK

PRINCIPAL REGISTER

SPECTRUM RETIREMENT COMMUNITIES, LLC (COLORADO LIMITED LIABILITY COMPANY)
SUITE 200
200 SPRUCE STREET
DENVER, CO 80230

FOR: RETIREMENT HOMES, NAMELY, PROVIDING ASSISTED LIVING FACILITIES AND CONGREGATE LIVING FACILITIES FOR SENIORS, IN CLASS 43 (U.S. CLS. 100 AND 101).

FIRST USE 9-1-2011; IN COMMERCE 9-1-2011.

THE MARK CONSISTS OF STANDARD CHARACTERS WITHOUT CLAIM TO ANY PARTICULAR FONT, STYLE, SIZE, OR COLOR.

SER. NO. 85-460,112, FILED 10-31-2011.

MICHAEL WEBSTER, EXAMINING ATTORNEY



David J. Kyffers

Director of the United States Patent and Trademark Office

United States of America

United States Patent and Trademark Office

TUNDRA FILMS

Reg. No. 4,204,870

Registered Sep. 11, 2012

Int. Cl.: 41

SERVICE MARK

PRINCIPAL REGISTER

KNUTSON, GAYLE M. (UNITED STATES INDIVIDUAL), DBA TUNDRA FILMS, INC.
14430 RACINE AVE. N.
P.O. BOX 205
MARINE ON ST. CROIX, MN 55047

FOR: ENTERTAINMENT MEDIA PRODUCTION SERVICES FOR MOTION PICTURES,
TELEVISION AND INTERNET, IN CLASS 41 (U.S. CLS. 100, 101 AND 107).

FIRST USE 6-1-1998; IN COMMERCE 6-1-1998.

THE MARK CONSISTS OF STANDARD CHARACTERS WITHOUT CLAIM TO ANY PAR-
TICULAR FONT, STYLE, SIZE, OR COLOR.

NO CLAIM IS MADE TO THE EXCLUSIVE RIGHT TO USE "FILMS", APART FROM THE
MARK AS SHOWN.

SER. NO. 85-460,140, FILED 10-31-2011.

SUSAN LESLIE DUBOIS, EXAMINING ATTORNEY



David J. Kybas

Director of the United States Patent and Trademark Office

United States of America
United States Patent and Trademark Office

XOLEFIN

Reg. No. 4,204,871

M.H. STALLMAN COMPANY (RHODE ISLAND CORPORATION)
292 CHARLES STREET
PROVIDENCE, RI 02904

Registered Sep. 11, 2012

Int. Cl.: 17

FOR: POLYOLEFIN FOAM MATERIALS IN THE FORM OF ROLLS, SLABS, PLANKS AND EXTRUSIONS FOR SALE TO PRODUCT FABRICATORS FOR GENERAL INDUSTRIAL USE, IN CLASS 17 (U.S. CLS. 1, 5, 12, 13, 35 AND 50).

TRADEMARK

FIRST USE 3-24-2011; IN COMMERCE 3-24-2011.

PRINCIPAL REGISTER

THE MARK CONSISTS OF STANDARD CHARACTERS WITHOUT CLAIM TO ANY PARTICULAR FONT, STYLE, SIZE, OR COLOR.

SER. NO. 85-461,244, FILED 11-1-2011.

ALICIA COLLINS, EXAMINING ATTORNEY



David J. Kyffers

Director of the United States Patent and Trademark Office

United States of America
United States Patent and Trademark Office

Big Bison

Reg. No. 4,204,872

CROWN VALLEY WINERY, INC. (MISSOURI CORPORATION)
23589 STATE ROUTE WW
STE GENEVIEVE, MO 63670

Registered Sep. 11, 2012

Int. Cl.: 29

FOR: PACKAGED MEATS MADE IN WHOLE OR SIGNIFICANT PART OF BISON, IN CLASS 29 (U.S. CL. 46).

TRADEMARK

FIRST USE 8-1-2008; IN COMMERCE 8-1-2008.

PRINCIPAL REGISTER

THE MARK CONSISTS OF STANDARD CHARACTERS WITHOUT CLAIM TO ANY PARTICULAR FONT, STYLE, SIZE, OR COLOR.

NO CLAIM IS MADE TO THE EXCLUSIVE RIGHT TO USE "BISON", APART FROM THE MARK AS SHOWN.

SER. NO. 85-461,264, FILED 11-1-2011.

MYRIAH HABEEB, EXAMINING ATTORNEY



David J. Kyros

Director of the United States Patent and Trademark Office

United States of America

United States Patent and Trademark Office

Force M.D.'s

Reg. No. 4,204,873

Registered Sep. 11, 2012

Int. Cl.: 9

TRADEMARK

PRINCIPAL REGISTER

LUNDY, RODNEY (UNITED STATES INDIVIDUAL)
3423 PRIMEROSE TERRACE
TOBYHANNA, PA 18466 AND

LUNDY, STEVEN (UNITED STATES INDIVIDUAL)
3423 PRIMEROSE TERRACE
TOBYHANNA, PA 18466

FOR: AUDIO AND VIDEO RECORDINGS FEATURING MUSIC AND ARTISTIC PERFORMANCES; COMPACT DISCS FEATURING MUSIC; MUSICAL SOUND RECORDINGS, IN CLASS 9 (U.S. CLS. 21, 23, 26, 36 AND 38).

FIRST USE 1-1-1984; IN COMMERCE 1-1-1984.

THE MARK CONSISTS OF STANDARD CHARACTERS WITHOUT CLAIM TO ANY PARTICULAR FONT, STYLE, SIZE, OR COLOR.

SER. NO. 85-461,463, FILED 11-1-2011.

TRACY CROSS, EXAMINING ATTORNEY



David J. Kyffers

Director of the United States Patent and Trademark Office

United States of America

United States Patent and Trademark Office



Reg. No. 4,204,874

Registered Sep. 11, 2012

Int. Cl.: 28

TRADEMARK

PRINCIPAL REGISTER

SYNERGY SPORTZ LLC (MASSACHUSETTS LIMITED LIABILITY COMPANY), DBA
YUKON CHARLIES
24 JONATHAN BOURNE DRIVE
POCASSET, MA 02559

FOR: SNOWSHOES, TREKKING POLES, BAGS FOR CARRYING SNOWSHOES, IN CLASS
28 (U.S. CLS. 22, 23, 38 AND 50).

FIRST USE 1-0-2011; IN COMMERCE 9-0-2011.

OWNER OF U.S. REG. NO. 4,084,609.

NO CLAIM IS MADE TO THE EXCLUSIVE RIGHT TO USE "SNOWSHOES", APART FROM
THE MARK AS SHOWN.

SER. NO. 85-461,587, FILED 11-1-2011.

MARY CRAWFORD, EXAMINING ATTORNEY



David J. Kybas

Director of the United States Patent and Trademark Office

United States of America

United States Patent and Trademark Office

Wean-D



Reg. No. 4,204,875

GLYCOMYR, INC. (IOWA CORPORATION)
3359 STAGECOACH ROAD
AMES, IA 50010

Registered Sep. 11, 2012

Int. Cl.: 5

FOR: PHARMACEUTICAL PREPARATIONS, NAMELY, VITAMIN, MINERAL, ANTI-OXIDANT, AND DIETARY SUPPLEMENT PREPARATIONS FOR USE IN VETERINARY MEDICINE, ALL CONTAINING VITAMIN D, IN CLASS 5 (U.S. CLS. 6, 18, 44, 46, 51 AND 52).

TRADEMARK

FIRST USE 6-22-2011; IN COMMERCE 6-22-2011.

PRINCIPAL REGISTER

THE MARK CONSISTS OF THE PHRASE "WEAN-D", WITH THE IMAGE OF A PIGLET PROTRUDING FROM THE CENTER OF THE "D".

SER. NO. 85-462,092, FILED 11-2-2011.

JAMES STEIN, EXAMINING ATTORNEY



David J. Kyjars

Director of the United States Patent and Trademark Office

United States of America

United States Patent and Trademark Office

LUXE32

Reg. No. 4,204,876

Registered Sep. 11, 2012

Int. Cl.: 16

TRADEMARK

PRINCIPAL REGISTER

STUDIO 32, PLLC (MICHIGAN PARTNERSHIP), DBA LUXE 32
SUITE A
31396 NORTHWESTERN HWY
FARMINGTON HILLS, MI 48331

FOR: MAGAZINES IN THE FIELD OF LUXURIOUS AND WEALTHY LIFESTYLE, IN CLASS
16 (U.S. CLS. 2, 5, 22, 23, 29, 37, 38 AND 50).

FIRST USE 11-1-2011; IN COMMERCE 11-1-2011.

THE MARK CONSISTS OF STANDARD CHARACTERS WITHOUT CLAIM TO ANY PAR-
TICULAR FONT, STYLE, SIZE, OR COLOR.

SER. NO. 85-462,202, FILED 11-2-2011.

JOHN DALIER, EXAMINING ATTORNEY



David J. Kyffers

Director of the United States Patent and Trademark Office

United States of America

United States Patent and Trademark Office



Reg. No. 4,204,877

LOVE'S TRAVEL STOPS & COUNTRY STORES, INC. (OKLAHOMA CORPORATION)
10601 N. PENNSYLVANIA
OKLAHOMA CITY, OK 73120

Registered Sep. 11, 2012

Int. Cl.: 35

FOR: RETAIL CONVENIENCE STORE SERVICES, RETAIL GASOLINE STATION SERVICES, RETAIL DIESEL FUELING STATION SERVICES, RETAIL TRUCK AND TRAVEL STOP SERVICES FEATURING CONVENIENCE STORE ITEMS AND GASOLINE, IN CLASS 35 (U.S. CLS. 100, 101 AND 102).

SERVICE MARK

PRINCIPAL REGISTER

FIRST USE 3-30-2010; IN COMMERCE 3-30-2010.

OWNER OF U.S. REG. NOS. 1,269,485, 1,497,197 AND OTHERS.

THE COLOR(S) RED, YELLOW, ORANGE AND BLACK IS/ARE CLAIMED AS A FEATURE OF THE MARK.

THE MARK CONSISTS OF A WAVE STRIPE DESIGN WITH THE COLORS YELLOW, RED AND ORANGE FORMING THE STRIPES. THE WORD "LOVE'S" IN BLACK WITH A RED HEART AS THE APOSTROPHE IS POSITIONED ON THE YELLOW BACKGROUND. AN ECHOING HEARTS DESIGN IN RED, YELLOW AND ORANGE IS POSITIONED TO THE LEFT OF THE WORD "LOVE'S".

SER. NO. 85-462,498, FILED 11-2-2011.

SUZANNE BLANE, EXAMINING ATTORNEY



David J. Kyjars

Director of the United States Patent and Trademark Office

United States of America

United States Patent and Trademark Office

ENNOVATE

Reg. No. 4,204,878

Registered Sep. 11, 2012

Int. Cls.: 35, 36 and 37

EMPOWER ENNOVATION, LLC (GEORGIA LIMITED LIABILITY COMPANY), DBA
ENNOVATE
1835 SAVOY DRIVE
SUITE 102
ATLANTA, GA 30341

SERVICE MARK

PRINCIPAL REGISTER

FOR: CONSULTING SERVICES IN THE FIELDS OF ENERGY CONSUMPTION AND USAGE CONSERVATION TO IMPROVE ENERGY EFFICIENCY; CONDUCTING ENERGY AUDITS OF ENERGY AND WATER CONSERVATION PROJECTS FOR THE PURPOSE OF IMPROVING ENERGY EFFICIENCY; BUSINESS MANAGEMENT IN THE FIELDS OF ENERGY MANAGEMENT SYSTEMS, LIGHTING RETROFIT, BOILER AND HEATING, VENTILATION AND AIR CONDITIONING (HVAC) CONTROLS, WATER CONSERVATION, POWER MANAGEMENT AND RENEWABLE ENERGY EQUIPMENT, IN CLASS 35 (U.S. CLS. 100, 101 AND 102).

FIRST USE 9-15-2011; IN COMMERCE 9-15-2011.

FOR: PROVIDING VENTURE CAPITAL, DEVELOPMENT CAPITAL, PRIVATE EQUITY AND INVESTMENT FUNDING IN THE FIELDS OF ENERGY MANAGEMENT SYSTEMS, LIGHTING RETROFIT, BOILER AND HEATING, VENTILATION AND AIR CONDITIONING (HVAC) CONTROLS, WATER CONSERVATION, POWER MANAGEMENT AND RENEWABLE ENERGY EQUIPMENT, IN CLASS 36 (U.S. CLS. 100, 101 AND 102).

FIRST USE 9-15-2011; IN COMMERCE 9-15-2011.

FOR: INSTALLATION OF ENERGY MANAGEMENT SYSTEMS, LIGHTING RETROFIT, BOILER AND HEATING, VENTILATION AND AIR CONDITIONING (HVAC) CONTROLS, WATER CONSERVATION, POWER MANAGEMENT AND RENEWABLE ENERGY EQUIPMENT, IN CLASS 37 (U.S. CLS. 100, 103 AND 106).

FIRST USE 9-15-2011; IN COMMERCE 9-15-2011.

THE MARK CONSISTS OF STANDARD CHARACTERS WITHOUT CLAIM TO ANY PARTICULAR FONT, STYLE, SIZE, OR COLOR.

SER. NO. 85-462,622, FILED 11-2-2011.



David J. Kyffers

Director of the United States Patent and Trademark Office

Reg. No. 4,204,878 TINA L. SNAPP, EXAMINING ATTORNEY

United States of America

United States Patent and Trademark Office



Reg. No. 4,204,879

LOVE'S TRAVEL STOPS & COUNTRY STORES, INC. (OKLAHOMA CORPORATION)
10601 N. PENNSYLVANIA
OKLAHOMA CITY, OK 73120

Registered Sep. 11, 2012

Int. Cl.: 35

FOR: RETAIL CONVENIENCE STORE SERVICES, RETAIL GASOLINE STATION SERVICES, RETAIL DIESEL FUELING STATION SERVICES, RETAIL TRUCK AND TRAVEL STOP SERVICES FEATURING CONVENIENCE STORE ITEMS AND GASOLINE, IN CLASS 35 (U.S. CLS. 100, 101 AND 102).

SERVICE MARK

PRINCIPAL REGISTER

FIRST USE 3-30-2010; IN COMMERCE 3-30-2010.

OWNER OF U.S. REG. NOS. 1,269,485, 1,497,197 AND OTHERS.

THE MARK CONSISTS OF A SERIES OF HORIZONTAL WAVE STRIPES, WITH THE WORD "LOVE'S" HAVING A HEART AS THE APOSTROPHE APPEARING WITHIN THE BROADEST STRIPE, WHICH IS ALSO THE TOP STRIPE, AND A SMALL ECHOING HEARTS DESIGN POSITIONED TO THE LEFT OF THE WORD "LOVE'S".

SER. NO. 85-462,804, FILED 11-2-2011.

SUZANNE BLANE, EXAMINING ATTORNEY



David J. Kyffers

Director of the United States Patent and Trademark Office

United States of America

United States Patent and Trademark Office

ONE RESONANCE

Reg. No. 4,204,880

PRADO, PABLO (UNITED STATES INDIVIDUAL)
1950 UPAS ST APT 408
SAN DIEGO, CA 92104

Registered Sep. 11, 2012

Int. Cl.: 10

FOR: RADIOLOGICAL APPARATUS FOR DIAGNOSTIC AND MEDICAL, INDUSTRIAL AND AIRPORT SECURITY PURPOSES, NAMELY, MAGNETIC RESONANCE IMAGER, IN CLASS 10 (U.S. CLS. 26, 39 AND 44).

TRADEMARK

FIRST USE 9-5-2008; IN COMMERCE 9-5-2008.

PRINCIPAL REGISTER

THE MARK CONSISTS OF STANDARD CHARACTERS WITHOUT CLAIM TO ANY PARTICULAR FONT, STYLE, SIZE, OR COLOR.

NO CLAIM IS MADE TO THE EXCLUSIVE RIGHT TO USE "RESONANCE", APART FROM THE MARK AS SHOWN.

SER. NO. 85-462,998, FILED 11-2-2011.

ERNEST SHOSHO, EXAMINING ATTORNEY



David J. Kyffers

Director of the United States Patent and Trademark Office

United States of America

United States Patent and Trademark Office

JETBLACK

Reg. No. 4,204,881

AIR CONTROL INDUSTRIES, INC. (DELAWARE CORPORATION)
76 AUGUSTA ROCKLAND RD.
WINDSOR, ME 04363

Registered Sep. 11, 2012

Int. Cl.: 7

FOR: POWER-OPERATED PERSONAL BLOWERS, NAMELY, FIXED AND PORTABLE BLOWERS AND CLEANING STATIONS COMPOSED OF FAN, CONTROL BOX, HOSE, NOZZLE, AND INLET FILTER, POWER-OPERATED BLOWERS FOR CLEANING PERSONS AND OBJECTS, IN CLASS 7 (U.S. CLS. 13, 19, 21, 23, 31, 34 AND 35).

TRADEMARK

PRINCIPAL REGISTER

FIRST USE 6-3-2003; IN COMMERCE 6-3-2003.

THE MARK CONSISTS OF STANDARD CHARACTERS WITHOUT CLAIM TO ANY PARTICULAR FONT, STYLE, SIZE, OR COLOR.

SEC. 2(F).

SER. NO. 85-463,231, FILED 11-3-2011.

TIMOTHY FINNEGAN, EXAMINING ATTORNEY



David J. Kyffers

Director of the United States Patent and Trademark Office

United States of America

United States Patent and Trademark Office

Sterling Currency Group

Reg. No. 4,204,882

STERLING CURRENCY GROUP, LLC (GEORGIA LIMITED LIABILITY COMPANY)
3277 ROSWELL ROAD NE, SUITE 670
ATLANTA, GA 30305

Registered Sep. 11, 2012

Int. Cl.: 36

FOR: CURRENCY TRADING, NAMELY, TRADING OF FOREIGN CURRENCIES, IN CLASS 36 (U.S. CLS. 100, 101 AND 102).

SERVICE MARK

FIRST USE 10-1-2004; IN COMMERCE 10-1-2004.

PRINCIPAL REGISTER

THE MARK CONSISTS OF STANDARD CHARACTERS WITHOUT CLAIM TO ANY PARTICULAR FONT, STYLE, SIZE, OR COLOR.

NO CLAIM IS MADE TO THE EXCLUSIVE RIGHT TO USE "CURRENCY GROUP", APART FROM THE MARK AS SHOWN.

SER. NO. 85-463,338, FILED 11-3-2011.

GINA HAYES, EXAMINING ATTORNEY



David J. Kybas

Director of the United States Patent and Trademark Office

United States of America

United States Patent and Trademark Office

Lodo

Reg. No. 4,204,883

CONDE, SAUL (UNITED STATES INDIVIDUAL)
P.O. BOX 4773
DOWNEY, CA 90240

Registered Sep. 11, 2012

Int. Cl.: 25

FOR: ATHLETIC APPAREL, NAMELY, SHIRTS, PANTS, JACKETS, FOOTWEAR, HATS AND CAPS, ATHLETIC UNIFORMS, IN CLASS 25 (U.S. CLS. 22 AND 39).

TRADEMARK

FIRST USE 11-12-2008; IN COMMERCE 11-12-2008.

PRINCIPAL REGISTER

THE MARK CONSISTS OF STANDARD CHARACTERS WITHOUT CLAIM TO ANY PARTICULAR FONT, STYLE, SIZE, OR COLOR.

OWNER OF U.S. REG. NO. 3,607,584.

THE ENGLISH TRANSLATION OF "LODO" IN THE MARK IS "MUD".

SER. NO. 85-463,438, FILED 11-3-2011.

STEVEN PEREZ, EXAMINING ATTORNEY



David J. Kybas

Director of the United States Patent and Trademark Office

United States of America

United States Patent and Trademark Office

LEXIS ADVANCE

Reg. No. 4,204,884

Registered Sep. 11, 2012

**Int. Cls.: 9, 38, 41, 42
and 45**

TRADEMARK

SERVICE MARK

PRINCIPAL REGISTER

REED ELSEVIER PROPERTIES INC. (DELAWARE CORPORATION)
SUITE 501
1105 NORTH MARKET STREET
WILMINGTON, DE 19801

FOR: COMPUTER PROGRAM FOR INTEGRATING LEGAL RESEARCH APPLICATIONS; COMPUTER SOFTWARE APPLICATIONS, NAMELY, DOWNLOADABLE APPLICATIONS TO ACCESS LEGAL BUSINESS AND NEWS AND TO STORE, ANNOTATE AND SHARE DOCUMENTS ALL PROVIDED ONLINE AND BY MOBILE DEVICES, IN CLASS 9 (U.S. CLS. 21, 23, 26, 36 AND 38).

FIRST USE 10-4-2010; IN COMMERCE 10-4-2010.

FOR: PROVIDING MULTIPLE USER ACCESS TO A GLOBAL COMPUTER NETWORK, IN CLASS 38 (U.S. CLS. 100, 101 AND 104).

FIRST USE 10-4-2010; IN COMMERCE 10-4-2010.

FOR: PROVIDING NEWS AND INFORMATION IN THE FIELD OF LAW AND BUSINESS , IN CLASS 41 (U.S. CLS. 100, 101 AND 107).

FIRST USE 10-4-2010; IN COMMERCE 10-4-2010.

FOR: PROVIDING TEMPORARY USE OF ONLINE NONDOWNLOADABLE COMPUTER SOFTWARE FOR INTEGRATING LEGAL RESEARCH APPLICATIONS; COMPUTER SOFTWARE APPLICATIONS; AND, PROVIDING TEMPORARY USE OF COMPUTER SOFTWARE APPLICATIONS, NAMELY, LAW NEWS AND GENERAL BUSINESS INFORMATION TO STORE, ANNOTATE AND SHARE DOCUMENTS ALL PROVIDED ONLINE AND BY MOBILE DEVICES, IN CLASS 42 (U.S. CLS. 100 AND 101).

FIRST USE 10-4-2010; IN COMMERCE 10-4-2010.

FOR: PUBLIC RECORD INVESTIGATION SERVICES, IN CLASS 45 (U.S. CLS. 100 AND 101).

FIRST USE 10-4-2010; IN COMMERCE 10-4-2010.



David J. Kyffers

Director of the United States Patent and Trademark Office

Reg. No. 4,204,884 THE MARK CONSISTS OF STANDARD CHARACTERS WITHOUT CLAIM TO ANY PARTICULAR FONT, STYLE, SIZE, OR COLOR.

OWNER OF U.S. REG. NOS. 1,020,214, 1,128,529, AND 1,274,298.

SER. NO. 85-463,604, FILED 11-3-2011.

MATTHEW KLINE, EXAMINING ATTORNEY

United States of America

United States Patent and Trademark Office

MLIVE.COM

Reg. No. 4,204,885

Registered Sep. 11, 2012

Int. Cl.: 9

TRADEMARK

PRINCIPAL REGISTER

THE HERALD PUBLISHING COMPANY, LLC (MICHIGAN LIMITED LIABILITY COMPANY)
CLINTON SQUARE
SYRACUSE, NY 13201

FOR: DOWNLOADABLE SOFTWARE APPLICATIONS FOR USE IN CONNECTION WITH SMARTPHONES, PDA DEVICES, TABLET COMPUTERS AND OTHER PORTABLE AND HANDHELD DIGITAL ELECTRONIC DEVICES, NAMELY, SOFTWARE FOR ACCESSING, VIEWING, INTERACTING WITH AND DOWNLOADING CONTENT FROM NEWSPAPERS AND NEWS SERVICES, IN CLASS 9 (U.S. CLS. 21, 23, 26, 36 AND 38).

FIRST USE 9-20-2011; IN COMMERCE 9-20-2011.

THE MARK CONSISTS OF STANDARD CHARACTERS WITHOUT CLAIM TO ANY PARTICULAR FONT, STYLE, SIZE, OR COLOR.

SER. NO. 85-463,629, FILED 11-3-2011.

SANDRA BUJA, EXAMINING ATTORNEY



David J. Kybas

Director of the United States Patent and Trademark Office

United States of America

United States Patent and Trademark Office



Guardians of Israel

Reg. No. 4,204,886

Registered Sep. 11, 2012

Int. Cl.: 9

TRADEMARK

PRINCIPAL REGISTER

INTERNATIONAL FELLOWSHIP OF CHRISTIANS & JEWS, INC. (ILLINOIS NON-PROFIT CORPORATION)
30 N. LASALLE, SUITE 2600
CHICAGO, IL 606023356

FOR: PRE-RECORDED DVDS ABOUT ISSUES RELATED TO JEWISH FAITH AND TRADITIONS, JEWISH-CHRISTIAN RELATIONS, AND THE POLITICAL, ECONOMIC, SOCIAL, AND SPIRITUAL NEEDS OF ISRAEL, THE PEOPLE OF ISRAEL, AND JEWISH PEOPLE AROUND THE WORLD, IN CLASS 9 (U.S. CLS. 21, 23, 26, 36 AND 38).

FIRST USE 3-1-2008; IN COMMERCE 3-1-2008.

NO CLAIM IS MADE TO THE EXCLUSIVE RIGHT TO USE "ISRAEL", APART FROM THE MARK AS SHOWN.

THE MARK CONSISTS OF A SILHOUETTE OF AN UPRIGHT LION AND THE WORDS "SHOMRAY YISRAEL" INSIDE OF A CREST OR SHIELD, NEXT TO THE WORDS "GUARDIANS OF ISRAEL".

THE ENGLISH TRANSLATION OF "SHOMRAY YISRAEL" IN THE MARK IS "GUARDIANS OF ISRAEL".

SER. NO. 85-463,648, FILED 11-3-2011.

DEZMONA MIZELLE, EXAMINING ATTORNEY



David J. Kybas

Director of the United States Patent and Trademark Office

United States of America

United States Patent and Trademark Office



Reg. No. 4,204,887

Registered Sep. 11, 2012

Int. Cls.: 9, 37 and 42

TRADEMARK

SERVICE MARK

PRINCIPAL REGISTER

J.M. TEST SYSTEMS, INC. (LOUISIANA CORPORATION)
7323 TOM DRIVE
BATON ROUGE, LA 70806

FOR: ELECTRICAL EDDY CURRENT TEST EQUIPMENT, IN CLASS 9 (U.S. CLS. 21, 23, 26, 36 AND 38).

FIRST USE 6-1-2007; IN COMMERCE 6-1-2007.

FOR: RENTAL OF CONSTRUCTION EQUIPMENT, IN CLASS 37 (U.S. CLS. 100, 103 AND 106).

FIRST USE 6-1-2007; IN COMMERCE 6-1-2007.

FOR: CALIBRATION OF CONSTRUCTION TESTING EQUIPMENT, IN CLASS 42 (U.S. CLS. 100 AND 101).

FIRST USE 6-1-2007; IN COMMERCE 6-1-2007.

NO CLAIM IS MADE TO THE EXCLUSIVE RIGHT TO USE "TEST SYSTEMS", APART FROM THE MARK AS SHOWN.

THE COLOR(S) LIGHT YELLOW, DARK YELLOW, AND BLACK IS/ARE CLAIMED AS A FEATURE OF THE MARK.

THE COLOR BLACK APPEARS IN THE WORDING "JM TEST SYSTEMS"; THE COLORS LIGHT YELLOW AND DARK YELLOW APPEAR AS ALTERNATING LINES BEHIND THE TEXT.

SER. NO. 85-464,028, FILED 11-3-2011.

AISHA SALEM, EXAMINING ATTORNEY

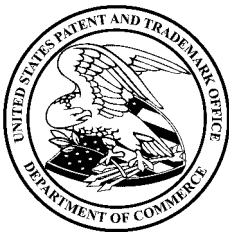

David J. Kybas

Director of the United States Patent and Trademark Office

United States of America

United States Patent and Trademark Office

ABEJA REINA

Reg. No. 4,204,888

DISTRIBUIDORA CUSCATLAN INC (MARYLAND CORPORATION)
6403 AMMENDALE RD.
BELTSVILLE, MD 20705

Registered Sep. 11, 2012

Int. Cl.: 31

FOR: UNPROCESSED BEANS, IN CLASS 31 (U.S. CLS. 1 AND 46).

TRADEMARK

FIRST USE 3-5-2003; IN COMMERCE 3-5-2003.

PRINCIPAL REGISTER

THE MARK CONSISTS OF STANDARD CHARACTERS WITHOUT CLAIM TO ANY PARTICULAR FONT, STYLE, SIZE, OR COLOR.

THE ENGLISH TRANSLATION OF "ABEJA REINA" IN THE MARK IS "QUEEN BEE".

SER. NO. 85-464,232, FILED 11-3-2011.

LESLEY LAMOTHE, EXAMINING ATTORNEY



David J. Kyffers

Director of the United States Patent and Trademark Office

United States of America

United States Patent and Trademark Office

Club
Risque

Reg. No. 4,204,889

Registered Sep. 11, 2012

Int. Cls.: 41 and 43

SERVICE MARK

PRINCIPAL REGISTER

CONCHETTA, INC. (PENNSYLVANIA CORPORATION), TA CLUB RISQUE ON THE
DELAWARE
1700 SOUTH COLUMBUS BLVD.
PHILADELPHIA, PA 19148

FOR: ARRANGING AND CONDUCTING NIGHTCLUB ENTERTAINMENT EVENTS, IN
CLASS 41 (U.S. CLS. 100, 101 AND 107).

FIRST USE 1-31-1997; IN COMMERCE 1-31-1997.

FOR: BAR SERVICES, IN CLASS 43 (U.S. CLS. 100 AND 101).

FIRST USE 1-31-1997; IN COMMERCE 1-31-1997.

NO CLAIM IS MADE TO THE EXCLUSIVE RIGHT TO USE "CLUB", APART FROM THE
MARK AS SHOWN.

THE MARK CONSISTS OF THE WORDING "CLUB" OVER A DESIGN OF HUMAN LIPS
THAT IS CONNECTED TO THE LETTER "R" IN THE WORDING "RISQUE".

SER. NO. 85-464,394, FILED 11-4-2011.

JANET LEE, EXAMINING ATTORNEY



David J. Kybas

Director of the United States Patent and Trademark Office

United States of America

United States Patent and Trademark Office

Club Risque

Reg. No. 4,204,890

Registered Sep. 11, 2012

Int. Cls.: 41 and 43

SERVICE MARK

PRINCIPAL REGISTER

CONCHETTA, INC. (PENNSYLVANIA CORPORATION), TA CLUB RISQUE ON THE
DELAWARE
1700 SOUTH COLUMBUS BLVD.
PHILADELPHIA, PA 19148

FOR: ARRANGING AND CONDUCTING NIGHTCLUB ENTERTAINMENT EVENTS, IN
CLASS 41 (U.S. CLS. 100, 101 AND 107).

FIRST USE 1-31-1997; IN COMMERCE 1-31-1997.

FOR: BAR SERVICES, IN CLASS 43 (U.S. CLS. 100 AND 101).

FIRST USE 1-31-1997; IN COMMERCE 1-31-1997.

THE MARK CONSISTS OF STANDARD CHARACTERS WITHOUT CLAIM TO ANY PAR-
TICULAR FONT, STYLE, SIZE, OR COLOR.

NO CLAIM IS MADE TO THE EXCLUSIVE RIGHT TO USE "CLUB", APART FROM THE
MARK AS SHOWN.

SER. NO. 85-464,518, FILED 11-4-2011.

JANET LEE, EXAMINING ATTORNEY



David J. Kybas

Director of the United States Patent and Trademark Office

United States of America

United States Patent and Trademark Office

Making Military Life Easier

Reg. No. 4,204,891

SAN DIEGO ARMED SERVICES YMCA (CALIFORNIA CORPORATION)
3293 SANTO RD
SAN DIEGO, CA 92124

Registered Sep. 11, 2012

Int. Cls.: 35 and 36

FOR: CHARITABLE SERVICES, NAMELY, ORGANIZING AND CONDUCTING VOLUNTEER PROGRAMS AND COMMUNITY SERVICE PROJECTS AIMED AT INCREASING SUPPORT AND MORALE OF FAMILIES OF DECEASED WAR VETERANS, WAR VETERANS, CURRENT MEMBERS AND FUTURE MEMBERS OF THE U.S. MILITARY; CHARITABLE SERVICES, NAMELY, ORGANIZING AND CONDUCTING VOLUNTEER PROGRAMS AND COMMUNITY SERVICE PROJECTS AIMED AT INCREASING SUPPORT AND MORALE OF MEMBERS OF THE U.S. MILITARY, IN CLASS 35 (U.S. CLS. 100, 101 AND 102).

SERVICE MARK

PRINCIPAL REGISTER

FIRST USE 9-15-2011; IN COMMERCE 9-15-2011.

FOR: ACCEPTING AND ADMINISTERING MONETARY CHARITABLE CONTRIBUTIONS TO ASSIST UNITED STATES SERVICE PERSONS SERVING IN COMBAT ZONES OR WOUNDED AND IN MILITARY HOSPITALS, IN CLASS 36 (U.S. CLS. 100, 101 AND 102).

FIRST USE 9-15-2011; IN COMMERCE 9-15-2011.

THE MARK CONSISTS OF STANDARD CHARACTERS WITHOUT CLAIM TO ANY PARTICULAR FONT, STYLE, SIZE, OR COLOR.

SER. NO. 85-464,765, FILED 11-4-2011.

KATHERINE CHANG, EXAMINING ATTORNEY



David J. Kypos

Director of the United States Patent and Trademark Office

United States of America

United States Patent and Trademark Office

metsuyan

Reg. No. 4,204,892

Registered Sep. 11, 2012

Int. Cl.: 43

SERVICE MARK

PRINCIPAL REGISTER

SUSHI METSUYAN INC (NEW YORK CORPORATION), AKA METSUYAN
719 EATERN PK ST
3
JAMAICA ESTATES, NY 11213

FOR: RESTAURANT SERVICES; CATERING SERVICES; CONTRACT FOOD SERVICES;
SUSHI RESTAURANTS, IN CLASS 43 (U.S. CLS. 100 AND 101).

FIRST USE 9-5-1995; IN COMMERCE 9-5-1995.

THE MARK CONSISTS OF STANDARD CHARACTERS WITHOUT CLAIM TO ANY PAR-
TICULAR FONT, STYLE, SIZE, OR COLOR.

OWNER OF U.S. REG. NOS. 2,899,701 AND 2,914,518.

THE ENGLISH TRANSLATION OF THE WORD "METSUYAN" IN THE MARK IS "FINE".

SER. NO. 85-465,501, FILED 11-6-2011.

JILL PRATER, EXAMINING ATTORNEY



David J. Kybas

Director of the United States Patent and Trademark Office

United States of America

United States Patent and Trademark Office

Doctor Painter

Reg. No. 4,204,893

Registered Sep. 11, 2012

Int. Cl.: 37

SERVICE MARK

PRINCIPAL REGISTER

MANIZANI, HOSSEIN F. (CALIFORNIA SOLE PROPRIETORSHIP), DBA DOCTOR PAINTER
SUITE 110-D
17171 ROSCOE BLVD.
NORTHRIDGE, CA 91325

FOR: CONSULTATION RELATING TO PAINTING OF BUILDINGS; DECORATIVE PAINTING SERVICES; DRYWALL AND PAINTING CONTRACTOR SERVICES; HOUSE PAINTING; PAINTING; PAINTING AND APPLYING COATINGS TO BUILDING INTERIORS AND BUILDING EXTERIORS; PAINTING AND VARNISHING; PAINTING CONTRACTOR SERVICES; PAINTING IN THE FIELD OF COMMERCIAL, INDUSTRIAL AND RESIDENTIAL PROPERTIES; SIGN PAINTING, IN CLASS 37 (U.S. CLS. 100, 103 AND 106).

FIRST USE 7-15-2011; IN COMMERCE 8-1-2011.

THE MARK CONSISTS OF STANDARD CHARACTERS WITHOUT CLAIM TO ANY PARTICULAR FONT, STYLE, SIZE, OR COLOR.

NO CLAIM IS MADE TO THE EXCLUSIVE RIGHT TO USE "PAINTER" , APART FROM THE MARK AS SHOWN.

SER. NO. 85-465,612, FILED 11-7-2011.

MARILYN IZZI, EXAMINING ATTORNEY



David J. Kyros

Director of the United States Patent and Trademark Office

United States of America

United States Patent and Trademark Office

MISSION FOR LIFE

Reg. No. 4,204,894

GORDON, DANIEL L. (UNITED STATES INDIVIDUAL)
19575 VICTOR PKWY SUITE 210
LIVONIA, MI 48152

Registered Sep. 11, 2012

Int. Cl.: 36

FOR: INSURANCE CONSULTING IN THE FIELD OF LIFE INSURANCE, IN CLASS 36 (U.S. CLS. 100, 101 AND 102).

SERVICE MARK

FIRST USE 3-18-2011; IN COMMERCE 9-12-2011.

PRINCIPAL REGISTER

THE MARK CONSISTS OF STANDARD CHARACTERS WITHOUT CLAIM TO ANY PARTICULAR FONT, STYLE, SIZE, OR COLOR.

SER. NO. 85-465,761, FILED 11-7-2011.

MARY ROSSMAN, EXAMINING ATTORNEY



David J. Kybas

Director of the United States Patent and Trademark Office

United States of America
United States Patent and Trademark Office

Passing
SCORE

Reg. No. 4,204,895

Registered Sep. 11, 2012

Int. Cl.: 9

TRADEMARK

PRINCIPAL REGISTER

PASSING SCORE LLC (CALIFORNIA LIMITED LIABILITY COMPANY)
APT 7
1840 TURK
SAN FRANCISCO, CA 94115

FOR: INTERACTIVE EDUCATIONAL SOFTWARE FEATURING INSTRUCTION IN MATH, FINANCE AND ENGLISH FOR USE ON TABLETS AND MOBILE PHONES, IN CLASS 9 (U.S. CLS. 21, 23, 26, 36 AND 38).

FIRST USE 8-1-2009; IN COMMERCE 10-13-2009.

THE MARK CONSISTS OF THE STYLIZED TEXT "PASSING SCORE" WITH A CHECK MARK OVER THE LOWER CASE LETTER "I" AND A RECTANGULAR BAR UNDER THE LETTERS "PA" AND PART OF THE FIRST LETTER "S" IN "PASSING".

SER. NO. 85-465,809, FILED 11-7-2011.

TRICIA SONNEBORN, EXAMINING ATTORNEY



David J. Kyffers

Director of the United States Patent and Trademark Office

United States of America

United States Patent and Trademark Office



Reg. No. 4,204,896

Registered Sep. 11, 2012

Int. Cl.: 7

TRADEMARK

PRINCIPAL REGISTER

BF GERMANY GMBH (FED REP GERMANY GESELLSCHAFT MIT BESCHRÄNKTER HAFTUNG (GMBH))
LEHENFELD 22
ASPERG, FED REP GERMANY 71679

FOR: DIESEL ENGINE PARTS, NAMELY, CYLINDER BLOCKS, CYLINDER LINERS, CYLINDER HEADS, GASKETS, SLIDE BEARINGS, CRANK SHAFTS, CRANK SHAFT BEARINGS, CRANKCASES, VIBRATION DAMPERS, PISTONS, PISTON PINS, PISTON RINGS, PISTON RING SEGMENTS, PISTON RING SETS, PISTON PIN CIRCLIPS, CONNECTING RODS, CONNECTING ROD BEARINGS, CAMSHAFTS, CAMSHAFT BEARINGS, ROCKER ARMS, PUSHING RODS, INLET VALVES, OUTLET VALVES, VALVE TAPPETS, VALVE STEM GUIDES, VALVE SEATS, VALVE SEAT RINGS, VALVE SPRINGS, INTAKE MANIFOLDS, EXHAUST MANIFOLDS, CARBURETORS, GEAR CASES, GEAR DRIVES, STARTER RING GEARS, PUMPS, CENTRIFUGAL PUMPS, ROTARY PUMPS, WATER PUMPS, FUEL PUMPS, OIL PUMPS, REPAIR KITS FOR PUMPS, OIL COOLERS, OIL PRESSURE RELIEF VALVES, CHARGE AIR COOLERS, FLYWHEELS, FANS, NUTS, BOLTS; COMPRESSORS AS PART OF DIESEL ENGINES AND THEIR PARTS, NAMELY, CYLINDER BLOCKS, CYLINDER HEADS, PISTONS, CRANK SHAFTS, DRIVE GEARS, CONNECTING RODS, IN CLASS 7 (U.S. CLS. 13, 19, 21, 23, 31, 34 AND 35).

OWNER OF ERPN CMNTY TM OFC REG. NO. 2357374, DATED 2-13-2003, EXPIRES 8-30-2021.

THE COLOR(S) BLUE, BLACK AND WHITE IS/ARE CLAIMED AS A FEATURE OF THE MARK.

OWNER OF U.S. REG. NO. 4,107,286.

NO CLAIM IS MADE TO THE EXCLUSIVE RIGHT TO USE "GERMANY", APART FROM THE MARK AS SHOWN.

THE MARK CONSISTS OF THE LETTERS "BF" IN BLUE WITH A BLACK BORDER, A BLUE OVAL AND "GERMANY" IN WHITE UPON A BLACK RECTANGLE.

SER. NO. 85-466,172, FILED 11-7-2011.

APRIL HESIK, EXAMINING ATTORNEY



David J. Kypos

Director of the United States Patent and Trademark Office

United States of America

United States Patent and Trademark Office



Reg. No. 4,204,897

Registered Sep. 11, 2012

Int. Cls.: 9 and 16

TRADEMARK

PRINCIPAL REGISTER

GREGG, STEPHEN (UNITED STATES INDIVIDUAL)
22641 LAKE FOREST DR.
SUITE B5 101
LAKE FOREST, CA 92630

FOR: COMPUTER APPLICATION SOFTWARE FOR PERSONAL COMPUTERS, HANDHELD DEVICES, AND CELL PHONES, NAMELY, SOFTWARE FOR TRACKING SALES AND SALES ACTIVITY INFORMATION, IN CLASS 9 (U.S. CLS. 21, 23, 26, 36 AND 38).

FIRST USE 6-14-2011; IN COMMERCE 6-14-2011.

FOR: BOOKLETS FOR RECORDING SALES AND SALES ACTIVITY INFORMATION, IN CLASS 16 (U.S. CLS. 2, 5, 22, 23, 29, 37, 38 AND 50).

FIRST USE 6-14-2011; IN COMMERCE 6-14-2011.

NO CLAIM IS MADE TO THE EXCLUSIVE RIGHT TO USE "WEEKLY" AND "REPORT", APART FROM THE MARK AS SHOWN.

THE COLOR(S) RED, WHITE AND GRAY IS/ARE CLAIMED AS A FEATURE OF THE MARK.

THE MARK CONSISTS OF A CIRCLE IN RED WITH TWO WHITE CHECK MARKS WITH WHITE DOTS IN THE ELBOW OF THE CHECK MARKS FOLLOWED BY THE WORD "WEEKLY" IN GRAY FOLLOWED BY THE WORD "SUCCESS" IN RED AND THE WORD "REPORT" IN GRAY UNDERNEATH THE WORD "SUCCESS" AND JUSTIFIED TO THE RIGHT OF THE WORD "SUCCESS."

SER. NO. 85-466,531, FILED 11-7-2011.

JENNY PARK, EXAMINING ATTORNEY



David J. Kybas

Director of the United States Patent and Trademark Office

United States of America

United States Patent and Trademark Office



Reg. No. 4,204,898

GREATER OMAHA PACKING CO., INC. (NEBRASKA CORPORATION)
3001 L. ST.
OMAHA, NE 68107

Registered Sep. 11, 2012

Int. Cl.: 29

FOR: MEAT, IN CLASS 29 (U.S. CL. 46).

FIRST USE 6-20-2011; IN COMMERCE 6-20-2011.

TRADEMARK

NO CLAIM IS MADE TO THE EXCLUSIVE RIGHT TO USE "NATURAL" AND "QUALITY ASSURANCE", APART FROM THE MARK AS SHOWN.

PRINCIPAL REGISTER

THE MARK CONSISTS OF A CIRCLE CONTAINING A CHECKMARK WITH THE TEXT "G.O. NATURAL" ABOVE AND THE TEXT "QUALITY ASSURANCE" BELOW.

SER. NO. 85-466,763, FILED 11-8-2011.

HAI-LY LAM, EXAMINING ATTORNEY



David J. Kybas

Director of the United States Patent and Trademark Office

United States of America

United States Patent and Trademark Office



Reg. No. 4,204,899

Registered Sep. 11, 2012

Int. Cl.: 29

TRADEMARK

PRINCIPAL REGISTER

GREATER OMAHA PACKING CO., INC. (NEBRASKA CORPORATION)
3001 L. ST.
OMAHA, NE 68107

FOR: MEAT, IN CLASS 29 (U.S. CL. 46).

FIRST USE 6-20-2011; IN COMMERCE 6-20-2011.

NO CLAIM IS MADE TO THE EXCLUSIVE RIGHT TO USE "HUMANE" AND "SUSTAINABLE", APART FROM THE MARK AS SHOWN.

THE MARK CONSISTS OF AN IMAGE OF A BARN WITH A WEATHER VANE FEATURING A CHICKEN AND A WINDOW ABOVE THE TEXT "HUMANE" ABOVE THE SYMBOL "+" ABOVE THE TEXT "SUSTAINABLE".

SER. NO. 85-466,784, FILED 11-8-2011.

HAI-LY LAM, EXAMINING ATTORNEY



David J. Kyffers

Director of the United States Patent and Trademark Office

United States of America

United States Patent and Trademark Office

RESOURCE FURNITURE

SPACE. REINVENTED.

Reg. No. 4,204,900

RESOURCE FURNITURE, LLC (NEW YORK LIMITED LIABILITY COMPANY)
969 THIRD AVENUE - 4TH FLOOR
NEW YORK, NY 10022

Registered Sep. 11, 2012

Int. Cl.: 35

FOR: WHOLESALE AND RETAIL STORES IN THE FIELD OF FURNITURE, IN CLASS 35
(U.S. CLS. 100, 101 AND 102).

SERVICE MARK

FIRST USE 5-0-2011; IN COMMERCE 5-0-2011.

PRINCIPAL REGISTER

NO CLAIM IS MADE TO THE EXCLUSIVE RIGHT TO USE "FURNITURE", APART FROM
THE MARK AS SHOWN.

THE MARK CONSISTS OF THE WORDS "RESOURCE FURNITURE" OVER NINE SOLID
SQUARES. A LINE APPEARS BELOW THE SQUARES, WITH THE WORDS "SPACE. REIN-
VENTED." UNDERNEATH.

SER. NO. 85-467,874, FILED 11-9-2011.

WILLIAM VERHOSEK, EXAMINING ATTORNEY



David J. Kybas

Director of the United States Patent and Trademark Office

United States of America

United States Patent and Trademark Office

Core Bible

Reg. No. 4,204,901

Registered Sep. 11, 2012

Int. Cl.: 16

TREASURE LEARNING SYSTEMS, LLC (COLORADO LIMITED LIABILITY COMPANY),
DBA DISCIPLELAND
#103
2121 MIDPOINT DRIVE
FORT COLLINS, CO 80525

TRADEMARK

PRINCIPAL REGISTER

FOR: EDUCATIONAL PUBLICATIONS, NAMELY, EDUCATIONAL LEARNING CARDS, FLASH CARDS, ACTIVITY CARDS, WORKBOOKS, TEXTBOOKS, ACTIVITY BOOKS, STORY BOOKS, PUZZLE BOOKS, PRINTED PUZZLES, TEACHER GUIDES, MANUALS, POSTERS AND EDUCATIONAL BOOKLETS IN THE FIELD OF RELIGION, IN CLASS 16 (U.S. CLS. 2, 5, 22, 23, 29, 37, 38 AND 50).

FIRST USE 11-4-2005; IN COMMERCE 11-4-2005.

THE MARK CONSISTS OF STANDARD CHARACTERS WITHOUT CLAIM TO ANY PARTICULAR FONT, STYLE, SIZE, OR COLOR.

SEC. 2(F).

SER. NO. 85-468,572, FILED 11-9-2011.

SUZANNE BLANE, EXAMINING ATTORNEY



David J. Kyffers

Director of the United States Patent and Trademark Office

United States of America

United States Patent and Trademark Office

My Awesome God

Reg. No. 4,204,902

Registered Sep. 11, 2012

Int. Cl.: 16

TREASURE LEARNING SYSTEMS, LLC (COLORADO LIMITED LIABILITY COMPANY),
DBA DISCIPLELAND
#103
2121 MIDPOINT DRIVE
FORT COLLINS, CO 80525

TRADEMARK

PRINCIPAL REGISTER

FOR: EDUCATIONAL PUBLICATIONS, NAMELY, EDUCATIONAL LEARNING CARDS, FLASH CARDS, ACTIVITY CARDS, WORKBOOKS, TEXTBOOKS, ACTIVITY BOOKS, STORY BOOKS, PUZZLE BOOKS, PRINTED PUZZLES, TEACHER GUIDES, MANUALS, POSTERS AND EDUCATIONAL BOOKLETS IN THE FIELD OF RELIGION, IN CLASS 16 (U.S. CLS. 2, 5, 22, 23, 29, 37, 38 AND 50).

FIRST USE 4-1-2011; IN COMMERCE 4-1-2011.

THE MARK CONSISTS OF STANDARD CHARACTERS WITHOUT CLAIM TO ANY PARTICULAR FONT, STYLE, SIZE, OR COLOR.

NO CLAIM IS MADE TO THE EXCLUSIVE RIGHT TO USE "GOD", APART FROM THE MARK AS SHOWN.

SER. NO. 85-468,835, FILED 11-9-2011.

SUZANNE BLANE, EXAMINING ATTORNEY



David J. Kyffers

Director of the United States Patent and Trademark Office

United States of America

United States Patent and Trademark Office

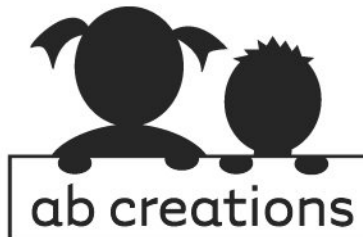

Reg. No. 4,204,903

ANNETTE BACK (UNITED STATES INDIVIDUAL)
303 WEST 66TH STREET, 17FW
NEW YORK, NY 10023

Registered Sep. 11, 2012

Int. Cl.: 42

FOR: VISUAL DESIGN SERVICES FOR OTHERS IN DIGITAL FORMAT IN THE FIELD OF ARTWORK, IN CLASS 42 (U.S. CLS. 100 AND 101).

SERVICE MARK

FIRST USE 9-22-2011; IN COMMERCE 9-22-2011.

PRINCIPAL REGISTER

NO CLAIM IS MADE TO THE EXCLUSIVE RIGHT TO USE "CREATIONS", APART FROM THE MARK AS SHOWN.

THE MARK CONSISTS OF DRAWING OF A BOY AND A GIRL HOLDING UP A SIGN IN WHICH IT SAYS "AB CREATIONS".

SER. NO. 85-468,974, FILED 11-9-2011.

LINDA ESTRADA, EXAMINING ATTORNEY



David J. Kyffers

Director of the United States Patent and Trademark Office

United States of America

United States Patent and Trademark Office



Reg. No. 4,204,904

Registered Sep. 11, 2012

Int. Cl.: 42

SERVICE MARK

PRINCIPAL REGISTER

ODIGIA, INC. (NORTH CAROLINA CORPORATION)
211 E. THIRD STREET, 2ND FLOOR
WINSTON SALEM, NC 27101

FOR: PROVIDING A WEB-BASED SYSTEM AND ONLINE PORTAL FEATURING ONLINE NON-DOWNLOADABLE SOFTWARE THAT ENABLES USERS TO ACCESS TRAINING, EDUCATION AND TESTING MATERIALS CREATED TO CUSTOMER SPECIFICATION FOR COURSES OF INSTRUCTION PROVIDED IN WORKFORCE TRAINING AND DEVELOPMENT, K-12 EDUCATION, COLLEGE LEVEL INSTRUCTION, AND PERSONAL DEVELOPMENT, IN CLASS 42 (U.S. CLS. 100 AND 101).

FIRST USE 3-25-2010; IN COMMERCE 3-25-2010.

OWNER OF U.S. REG. NO. 4,075,487.

NO CLAIM IS MADE TO THE EXCLUSIVE RIGHT TO USE "ODIGIA", APART FROM THE MARK AS SHOWN.

THE MARK CONSISTS OF AN IMAGE OF TWO LARGE LEAVES AND TWO SMALL LEAVES WITH THE WORD "ODIGIA" TO THE RIGHT OF THE IMAGE.

THE ENGLISH TRANSLATION OF "ODIGIA" IN THE MARK IS "INSTRUCTION."

SER. NO. 85-469,528, FILED 11-10-2011.

LINDA LAVACHE, EXAMINING ATTORNEY



David J. Kyffers

Director of the United States Patent and Trademark Office

United States of America

United States Patent and Trademark Office

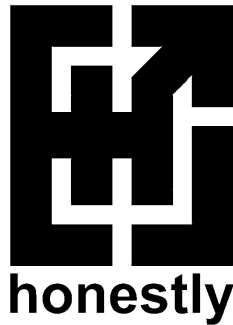

Reg. No. 4,204,905

Registered Sep. 11, 2012

Int. Cl.: 25

TRADEMARK

PRINCIPAL REGISTER

SKANNAL, DAVID I. (UNITED STATES INDIVIDUAL)
10339 LAKE SUMMIT DR.
MORENO VALLEY, CA 92557

FOR: HATS; JACKETS; T-SHIRTS; WRISTBANDS, IN CLASS 25 (U.S. CLS. 22 AND 39).

FIRST USE 7-1-2010; IN COMMERCE 9-15-2010.

THE MARK CONSISTS OF A RECTANGLE WITH A SLIT CUT OUT OF THE TOP, BOTTOM, AND RIGHT SIDES. IN THE CENTER OF THE RECTANGLE IS A STYLIZED LETTER "H" THAT IS CONNECTED TO THE INNER LEFT SIDE OF THE RECTANGLE BY A THICK BAR. THE UPPER RIGHT PORTION OF THE "H" IS CONNECTED TO THE INSIDE OF THE UPPER RIGHT CORNER OF THE RECTANGLE BY A THICK BAR, CREATING AN ARROW SHAPE. BELOW THE RECTANGLE IS THE STYLIZED TEXT "HONESTLY".

SER. NO. 85-469,887, FILED 11-10-2011.

DAVID ELTON, EXAMINING ATTORNEY



David J. Kybas

Director of the United States Patent and Trademark Office

United States of America

United States Patent and Trademark Office

CIRCLE IT

Reg. No. 4,204,906

EPSTEIN, JESSE C (VERMONT CORPORATION), DBA LOVEOPOLIS, INC.
464 SOUTH UNION STREET
BURLINGTON, VT 05401

Registered Sep. 11, 2012

Int. Cl.: 38

FOR: PROVIDING AN ON-LINE FORUM FOR SOCIAL NETWORKING, COMMUNICATIONS ON TOPICS OF GENERAL INTEREST, FOR TRANSMISSION OF MESSAGES AMONG COMPUTER USERS , IN CLASS 38 (U.S. CLS. 100, 101 AND 104).

SERVICE MARK

FIRST USE 2-1-2011; IN COMMERCE 2-1-2011.

PRINCIPAL REGISTER

THE MARK CONSISTS OF STANDARD CHARACTERS WITHOUT CLAIM TO ANY PARTICULAR FONT, STYLE, SIZE, OR COLOR.

SER. NO. 85-469,977, FILED 11-10-2011.

CURTIS FRENCH, EXAMINING ATTORNEY



David J. Kyffers

Director of the United States Patent and Trademark Office

United States of America

United States Patent and Trademark Office

RESTORES.M.A.R.T.

Reg. No. 4,204,907

Registered Sep. 11, 2012

Int. Cl.: 5

TRADEMARK

PRINCIPAL REGISTER

ARCH CHEMICALS, INC. (VIRGINIA CORPORATION)
P.O. BOX 5204
501 MERRITT 7
NORWALK, CT 068565204

FOR: AQUATIC HERBICIDES, IN CLASS 5 (U.S. CLS. 6, 18, 44, 46, 51 AND 52).

FIRST USE 7-25-2011; IN COMMERCE 7-25-2011.

THE MARK CONSISTS OF STANDARD CHARACTERS WITHOUT CLAIM TO ANY PARTICULAR FONT, STYLE, SIZE, OR COLOR.

OWNER OF U.S. REG. NO. 4,032,683.

SER. NO. 85-470,168, FILED 11-11-2011.

SARA BENJAMIN, EXAMINING ATTORNEY



David J. Kybas

Director of the United States Patent and Trademark Office

United States of America

United States Patent and Trademark Office

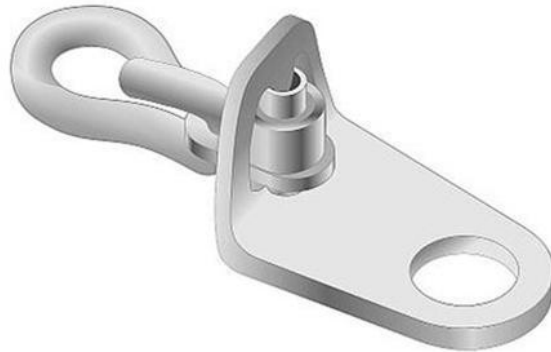

Reg. No. 4,204,908

Registered Sep. 11, 2012

Int. Cl.: 9

TRADEMARK

PRINCIPAL REGISTER

GLOBE TECHNOLOGIES CORPORATION (MICHIGAN CORPORATION)
1109 WEST CEDAR STREET
STANDISH, MI 48658

FOR: A HEAT FUSIBLE LINK FOR USE IN FIRE PROTECTION EQUIPMENT, IN CLASS 9
(U.S. CLS. 21, 23, 26, 36 AND 38).

FIRST USE 4-30-1977; IN COMMERCE 4-30-1977.

THE MARK CONSISTS OF THE CONFIGURATION OF A HEAT FUSIBLE LINK. THE
COLOR SILVER APPEARS AS TO THE ENTIRE LINK.

THE COLOR(S) SILVER IS/ARE CLAIMED AS A FEATURE OF THE MARK.

SEC. 2(F).

SER. NO. 85-470,397, FILED 11-11-2011.

DAWN HAN, EXAMINING ATTORNEY



David J. Kybas

Director of the United States Patent and Trademark Office

United States of America

United States Patent and Trademark Office

COMPLIANCE & ETHICS INSTITUTE

Reg. No. 4,204,909

Registered Sep. 11, 2012

Int. Cl.: 41

SERVICE MARK

PRINCIPAL REGISTER

THE HEALTH CARE COMPLIANCE ASSOCIATION (PENNSYLVANIA NON-PROFIT CORPORATION), DBA SOCIETY OF CORPORATE COMPLIANCE AND ETHICS
6500 BARRIE ROAD, SUITE 250
MINNEAPOLIS, MN 55435

FOR: EDUCATIONAL SERVICES, NAMELY, CONDUCTING CONFERENCES IN THE FIELD OF COMPLIANCE AND ETHICS, AND DISTRIBUTING COURSE MATERIALS IN CONNECTION THEREWITH, IN CLASS 41 (U.S. CLS. 100, 101 AND 107).

FIRST USE 8-0-2005; IN COMMERCE 8-0-2005.

THE MARK CONSISTS OF STANDARD CHARACTERS WITHOUT CLAIM TO ANY PARTICULAR FONT, STYLE, SIZE, OR COLOR.

NO CLAIM IS MADE TO THE EXCLUSIVE RIGHT TO USE "INSTITUTE", APART FROM THE MARK AS SHOWN.

SEC. 2(F).

SER. NO. 85-470,439, FILED 11-11-2011.

ZACHARY BELLO, EXAMINING ATTORNEY



David J. Kyffers

Director of the United States Patent and Trademark Office

United States of America

United States Patent and Trademark Office

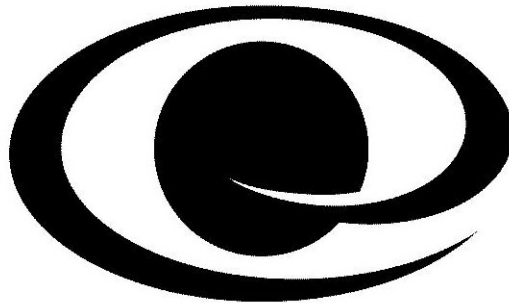

Reg. No. 4,204,910

Registered Sep. 11, 2012

Int. Cls.: 35, 36 and 37

EMPOWER ENNOVATION, LLC (GEORGIA LIMITED LIABILITY COMPANY), DBA
ENNOVATE
SUITE 102
1835 SAVOY DRIVE
ATLANTA, GA 30341

SERVICE MARK

PRINCIPAL REGISTER

FOR: CONSULTING SERVICES IN THE FIELDS OF ENERGY CONSUMPTION AND USAGE CONSERVATION TO IMPROVE ENERGY EFFICIENCY; CONDUCTING ENERGY AUDITS OF ENERGY AND WATER CONSERVATION PROJECTS FOR THE PURPOSE OF IMPROVING ENERGY EFFICIENCY; BUSINESS MANAGEMENT IN THE FIELDS OF ENERGY MANAGEMENT SYSTEMS, LIGHTING RETROFIT, BOILER AND HEATING, VENTILATION AND AIR CONDITIONING (HVAC) CONTROLS, WATER CONSERVATION, POWER MANAGEMENT AND RENEWABLE ENERGY EQUIPMENT, IN CLASS 35 (U.S. CLS. 100, 101 AND 102).

FIRST USE 9-15-2011; IN COMMERCE 9-15-2011.

FOR: PROVIDING VENTURE CAPITAL, DEVELOPMENT CAPITAL, PRIVATE EQUITY AND INVESTMENT FUNDING IN THE FIELDS OF ENERGY MANAGEMENT SYSTEMS, LIGHTING RETROFIT, BOILER AND HEATING, VENTILATION AND AIR CONDITIONING (HVAC) CONTROLS, WATER CONSERVATION, POWER MANAGEMENT AND RENEWABLE ENERGY EQUIPMENT, IN CLASS 36 (U.S. CLS. 100, 101 AND 102).

FIRST USE 9-15-2011; IN COMMERCE 9-15-2011.

FOR: INSTALLATION OF ENERGY MANAGEMENT SYSTEMS, LIGHTING RETROFIT, BOILER AND HEATING, VENTILATION AND AIR CONDITIONING (HVAC) CONTROLS, WATER CONSERVATION, POWER MANAGEMENT AND RENEWABLE ENERGY EQUIPMENT, IN CLASS 37 (U.S. CLS. 100, 103 AND 106).

FIRST USE 9-15-2011; IN COMMERCE 9-15-2011.

THE MARK CONSISTS OF A LOOSE INTERPRETATION OF A STYLIZED LOWER CASE "E" THAT CREATES A SWIRL AROUND AND INTERSECTS A SPHERE.

SER. NO. 85-470,641, FILED 11-11-2011.



David J. Kyffers

Director of the United States Patent and Trademark Office

Reg. No. 4,204,910 TINA L. SNAPP, EXAMINING ATTORNEY

United States of America

United States Patent and Trademark Office

Tenprature Test

Reg. No. 4,204,911

RELATIONSHIP AUDITS LTD. (ENGLAND PRIVATE LIMITED COMPANY)
29 HEDDON STREET

Registered Sep. 11, 2012

LONDON, ENGLAND W1B4BL

Int. Cl.: 35

FOR: BUSINESS ADMINISTRATION; BUSINESS APPRAISAL AND BUSINESS RESEARCH SERVICES RELATING TO THE MEASUREMENT OF BUSINESS RELATIONSHIPS; BUSINESS ADMINISTRATION, BUSINESS APPRAISAL AND BUSINESS RESEARCH SERVICES RELATING TO THE MEASUREMENT OF SUPPLIER, CUSTOMER, CLIENT AND INTRA-BUSINESS RELATIONSHIPS; PROVIDING BUSINESS INFORMATION IN THE FIELD OF THE MEASUREMENT OF SUPPLIER, CUSTOMER, CLIENT AND INTRA-BUSINESS RELATIONSHIPS VIA COMPUTER DATABASES; SYSTEMIZATION OF BUSINESS INFORMATION INTO COMPUTER DATABASES, NAMELY, COMPUTERIZED DATABASE MANAGEMENT; BUSINESS CONSULTING SERVICES UTILIZING BUSINESS RELATIONSHIP MODELING TO ANALYZE THE MARKET OPPORTUNITIES OF A GIVEN SOLUTION; PROVIDING STATISTICAL INFORMATION FOR BUSINESS PURPOSES, IN CLASS 35 (U.S. CLS. 100, 101 AND 102).

SERVICE MARK

PRINCIPAL REGISTER

FIRST USE 1-1-2006; IN COMMERCE 1-1-2006.

THE MARK CONSISTS OF STANDARD CHARACTERS WITHOUT CLAIM TO ANY PARTICULAR FONT, STYLE, SIZE, OR COLOR.

SER. NO. 85-472,149, FILED 11-14-2011.

DAVID I, EXAMINING ATTORNEY



David J. Kyfos

Director of the United States Patent and Trademark Office

United States of America

United States Patent and Trademark Office



Reg. No. 4,204,912

Registered Sep. 11, 2012

Int. Cl.: 35

SERVICE MARK

PRINCIPAL REGISTER

SLOANE TWO RODEO, LLC (DELAWARE LIMITED LIABILITY COMPANY)
SUITE 200
9480 DAYTON WAY
BEVERLY HILLS, CA 90210

FOR: BUSINESS OPERATIONS FOR SHOPPING MALLS; RETAIL SHOPPING MALL SERVICES, NAMELY, PROVIDING RETAIL STORE SERVICES IN THE FIELD OF LUXURY GOODS, IN CLASS 35 (U.S. CLS. 100, 101 AND 102).

FIRST USE 1-1-2003; IN COMMERCE 1-1-2003.

NO CLAIM IS MADE TO THE EXCLUSIVE RIGHT TO USE "VIA RODEO", APART FROM THE MARK AS SHOWN.

THE MARK CONSISTS OF THE WORDS "VIA RODEO" ENCLOSED BY AN OBLONG, STYLIZED BORDER IN THE FORM OF AN OLD FASHIONED STREET SIGN.

THE ENGLISH TRANSLATION OF "VIA" IN THE MARK IS DRIVE.

SER. NO. 85-472,355, FILED 11-14-2011.

SEAN CROWLEY, EXAMINING ATTORNEY



David J. Kybas

Director of the United States Patent and Trademark Office

United States of America

United States Patent and Trademark Office

SDMI

Reg. No. 4,204,913

Registered Sep. 11, 2012

Int. Cls.: 40 and 42

SERVICE MARK

PRINCIPAL REGISTER

SONS DESIGN & MANUFACTURING, INC. (TEXAS CORPORATION), AKA SDMI
LEGAL DEPARTMENT
PO BOX 2035
CITY OF INDUSTRY, CA 91746

FOR: CUSTOM CONSTRUCTION OF ELECTRONIC OR ELECTRICAL EQUIPMENT, PLASTICS, METAL AND STONE; CUSTOM FABRICATION AND PRODUCTION OF ELECTRONIC OR ELECTRICAL EQUIPMENT, PLASTICS, METAL AND STONE; CUSTOM FABRICATION OF COUNTER TOPS; CUSTOM MANUFACTURE OF ELECTRONIC OR ELECTRICAL EQUIPMENT, PLASTICS, METAL AND STONE; MANUFACTURE OF GENERAL PRODUCT LINES IN THE FIELD OF STEEL PIPE AND TUBING TO ORDER AND/OR SPECIFICATION OF OTHERS; CUSTOM MANUFACTURE OF TUNNELING EQUIPMENT; CUTTING OF PLASTICS, METAL AND STONE; MANUFACTURE OF GENERAL PRODUCT LINES IN THE FIELD OF ELECTRONIC OR ELECTRICAL EQUIPMENT, PLASTICS, METAL AND STONE TO THE ORDER AND SPECIFICATION OF OTHERS; MANUFACTURING SERVICES FOR OTHERS IN THE FIELD OF ELECTRONIC OR ELECTRICAL EQUIPMENT, PLASTICS, METAL, AND STONE; METAL CASTING; METAL FABRICATION AND FINISHING SERVICES; METAL LAMINATING; METAL PLATING; METAL PLATING AND LAMINATING; METAL RECLAMATION SERVICES; METAL REFINING SERVICES, NAMELY, ALL METALS IN THE NATURE OF STEEL, ALUMINUM, CHROMIUM, COBALT, COPPER, GOLD, IRON, LEAD, MAGNESIUM, MANGANESE, MERCURY, NICKEL, PLATINUM, SILVER, TIN, TITANIUM, TUNGSTEN AND ZINC; METAL STAMPING; METAL TEMPERING; METAL TREATING; METAL TREATMENT; METALIZING; OIL PRODUCTION SERVICES; TREATMENT OF MATERIALS BY LASER BEAM; AND TREATMENT OF METAL, IN CLASS 40 (U.S. CLS. 100, 103 AND 106).

FIRST USE 12-31-2002; IN COMMERCE 12-31-2002.

FOR: DESIGN AND DEVELOPMENT OF AUTOMATED HOME CONTROLLER SYSTEMS, NAMELY, TEMPERATURE, HUMIDITY, AND ELECTRICAL CONTROLLERS; DESIGN AND DEVELOPMENT OF AUTOMATED CONTROLLER SYSTEMS, NAMELY, TEMPERATURE, HUMIDITY AND ELECTRICAL CONTROLLERS; DESIGN AND TESTING FOR NEW PRODUCT DEVELOPMENT; DESIGN AND TESTING OF NEW PRODUCTS FOR OTHERS; DESIGN OF ENGINEERING PRODUCTS; DESIGN OF MECHANICAL AND MICROMECHANICAL COMPONENTS; DESIGN OF MECHANICAL, ELECTROMECHANICAL AND OPTOELECTRONIC APPARATUS AND INSTRUMENTS; DESIGN OF OPTICAL AND MICRO-OPTICAL COMPONENTS; DESIGN, DEVELOPMENT, AND CONSULTING SERVICES



David J. Kyffers

Director of the United States Patent and Trademark Office

Reg. No. 4,204,913 IN THE FIELD OF HOME AND WORKPLACE AUTOMATION HARDWARE AND SOFTWARE; DEVELOPMENT OF TECHNOLOGIES FOR THE FABRICATION OF CIRCUITS FOR WIRELESS COMMUNICATION, ELECTRONIC DATA PROCESSING, CONSUMER ELECTRONICS, AUTOMOTIVE ELECTRONICS; DRAFTING; DRAFTING OF PLANS AND ENGINEERING DRAWINGS FOR OTHERS; ENGINEERING; ENGINEERING AND SYSTEM ANALYSIS IN THE FIELD OF HOME SECURITY SYSTEMS; ENGINEERING SERVICES FOR BUILDING AND PROPERTY CONDITION ASSESSMENT, FACILITY MANAGEMENT, REPAIR, RESTORATION AND BUILDING INSTRUMENTATION. BUILDING MONITORING AND ENVIRONMENTAL CONSULTING; HOME INSPECTION SERVICES FOR PURPOSES OF HOME REPAIR AND RESTORATION; INDUSTRIAL DESIGN; INDUSTRIAL DESIGN SERVICES; MACHINE PART DESIGN SERVICES; MATERIAL TESTING; MATERIALS TESTING AND ANALYZING; MATERIALS TESTING AND EVALUATION; MECHANICAL ENGINEERING; MECHANICAL RESEARCH; MONITORING OF STREAM WATER QUALITY; NEW PRODUCT DESIGN SERVICES; OIL EXPLORATION; PRODUCT DESIGN AND DEVELOPMENT IN THE FIELD OF ELECTRONIC OR ELECTRICAL EQUIPMENT, METAL, STONE OR OTHER SOLID MATERIALS; PRODUCT DEVELOPMENT; PRODUCT DEVELOPMENT FOR OTHERS; PRODUCT DEVELOPMENT CONSULTATION; PRODUCT DEVELOPMENT AND ENGINEERING SERVICES FOR OTHERS; PRODUCT DEVELOPMENT IN THE FIELD OF ELECTRONIC OR ELECTRICAL EQUIPMENT, METAL, STONE OR OTHER SOLID MATERIALS; PRODUCT RESEARCH; PRODUCT RESEARCH AND DEVELOPMENT; RESEARCH AND DEVELOPMENT OF NEW PRODUCTS; RESEARCH, DEVELOPMENT, ENGINEERING AND TESTING SERVICES IN THE FIELDS OF CUTTING, WELDING AND MATERIAL JOINING; TESTING, ANALYSIS AND EVALUATION OF THE GOODS AND SERVICES OF OTHERS FOR THE PURPOSE OF CERTIFICATION; TESTING, ANALYSIS AND EVALUATION OF MATERIALS, NAMELY, METAL, PLASTIC AND NYLON; TESTING, ANALYSIS AND EVALUATION OF METAL TOOLS, MACHINERY AND FABRICATION EQUIPMENT; TOOL DESIGN, IN CLASS 42 (U.S. CLS. 100 AND 101).

FIRST USE 12-31-2002; IN COMMERCE 12-31-2002.

THE MARK CONSISTS OF STANDARD CHARACTERS WITHOUT CLAIM TO ANY PARTICULAR FONT, STYLE, SIZE, OR COLOR.

OWNER OF U.S. REG. NO. 4,055,310.

SER. NO. 85-472,491, FILED 11-15-2011.

CHRISTOPHER SIDOTI, EXAMINING ATTORNEY

United States of America

United States Patent and Trademark Office

Appreciative Strategies

Reg. No. 4,204,914

Registered Sep. 11, 2012

Int. Cl.: 41

SERVICE MARK

PRINCIPAL REGISTER

APPRECIATIVE STRATEGIES, LLC (PENNSYLVANIA LIMITED LIABILITY COMPANY)
P.O. BOX 164
MONTROUSEVILLE, PA 17754

FOR: ARRANGEMENT OF TRAINING COURSES IN TEACHING INSTITUTES; BUSINESS TRAINING; BUSINESS TRAINING CONSULTANCY SERVICES; BUSINESS TRAINING IN THE FIELD OF STRATEGIC PLANNING; DEVELOPING TRAINING SYSTEMS AND LEARNING METHODOLOGIES FOR OTHERS; EDUCATION SERVICES, NAMELY, PROVIDING CAREER RE-TRAINING CONFERENCES, WORKSHOPS, SEMINARS IN THE FIELDS OF SOFT SKILL EMPLOYEE DEVELOPMENT; EDUCATION SERVICES, NAMELY, PROVIDING ONLINE COGNITIVE ASSESSMENTS AND TRAINING PROGRAMS THAT HELP IDENTIFY COGNITIVE STRENGTHS AND WEAKNESSES OF AN INDIVIDUAL; EDUCATION SERVICES, NAMELY, TRAINING EDUCATORS TO TEACH THROUGH SERVICE LEARNING AND CIVIC ENGAGEMENT AND PROVIDING CURRICULA IN CONNECTION THEREWITH; EDUCATIONAL SERVICES, NAMELY, CONDUCTING CONFERENCES, WORKSHOPS, SEMINARS IN THE FIELDS OF ORGANIZATION DEVELOPMENT, INNOVATION, STRATEGIC PLANNING, SALES AND DISTRIBUTION OF TRAINING MATERIALS IN CONNECTION THEREWITH; EDUCATIONAL SERVICES, NAMELY, CONDUCTING CONFERENCES, WORKSHOPS, SEMINARS IN THE FIELD OF LEADERSHIP, COMMUNICATIONS, GROUP DYNAMICS, CUSTOMER SERVICE, CONFLICT, TRAIN-THE-TRAINER AND DISTRIBUTION OF TRAINING MATERIAL IN CONNECTION THEREWITH; EDUCATIONAL SERVICES, NAMELY, OFFERING OF ASSESSMENTS AND SURVEYS IN THE FIELD OF EDUCATOR TRAINING AND PERFORMANCE FOR THE PURPOSE OF IMPROVING TEACHING PROCEDURES; EDUCATIONAL SERVICES, NAMELY, PROVIDING A LEARNING AND INNOVATION CENTER FEATURING FULLY CUSTOMIZED LEADERSHIP, MOTIVATIONAL, EDUCATIONAL, AND BRAINSTORMING TRAINING; EDUCATIONAL SERVICES, NAMELY, TEACHER TRAINING IN THE FIELD OF SOFT SKILLS DEVELOPMENT, COMMUNICATION, LISTENING, RELATIONSHIP AND TEAM-BUILDING, CONFLICT, BULLYING PROVIDED ON A REAL-TIME BASIS DURING CLASSROOM INSTRUCTION; TRAINING COURSES IN STRATEGIC PLANNING RELATING TO ADVERTISING, PROMOTION, MARKETING AND BUSINESS; TRAINING SERVICES IN THE FIELD OF SOFT SKILLS EMPLOYEE DEVELOPMENT, IN CLASS 41 (U.S. CLS. 100, 101 AND 107).

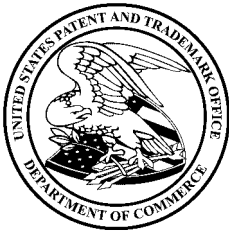

David J. Kyjars

FIRST USE 1-0-2007; IN COMMERCE 1-0-2007.

Reg. No. 4,204,914 THE MARK CONSISTS OF STANDARD CHARACTERS WITHOUT CLAIM TO ANY PARTICULAR FONT, STYLE, SIZE, OR COLOR.

SEC. 2(F).

SER. NO. 85-473,779, FILED 11-16-2011.

KIM MONINGHOFF, EXAMINING ATTORNEY

United States of America
United States Patent and Trademark Office

Forge
MOTORSPORT

Reg. No. 4,204,915

Registered Sep. 11, 2012

Int. Cl.: 12

TRADEMARK

PRINCIPAL REGISTER

FORGE MOTOR SPORT, INC. (FLORIDA CORPORATION)
UNIT C
6536 PINECASTLE BLVD.
ORLANDO, FL 32809

FOR: VEHICLE AND ENGINE PARTS, NAMELY, CHARGED AIR COMPONENTS, COOLANT SYSTEMS, TURBO CHARGED COMPONENTS, EXHAUSTS, BRAKES, BRAKE HOSES, COOLANT HOSES, RADIATORS, AIR COOLERS, ALLOY TANKS, ACTUATORS, VALVES, AND BOOST CONTROLLERS, ALL FOR USE IN AUTOMOBILES, MOTORCYCLES, WATERCRAFTS AND ALL STATIONARY ENGINES, IN CLASS 12 (U.S. CLS. 19, 21, 23, 31, 35 AND 44).

FIRST USE 12-31-1990; IN COMMERCE 12-31-1990.

NO CLAIM IS MADE TO THE EXCLUSIVE RIGHT TO USE "MOTORSPORT", APART FROM THE MARK AS SHOWN.

THE MARK CONSISTS OF THE WORDS "FORGE MOTORSPORT" IN STYLIZED FONT WITH THE WORD "MOTORSPORT" INSIDE AN ELONGATED OVAL UNDERNEATH THE WORD "FORGE".

SER. NO. 85-473,848, FILED 11-16-2011.

RAUL CORDOVA, EXAMINING ATTORNEY



David J. Kyffers

Director of the United States Patent and Trademark Office

United States of America

United States Patent and Trademark Office

KRISTIN MILES

Reg. No. 4,204,916

FREEWAY APPAREL, INC. (CALIFORNIA CORPORATION)

Registered Sep. 11, 2012

3100 S. SAN PEDRO ST.
LOS ANGELES, CA 90011

Int. Cl.: 25

FOR: ATHLETIC APPAREL, NAMELY, SHIRTS, PANTS, JACKETS, FOOTWEAR, HATS AND CAPS, ATHLETIC UNIFORMS; BATHING SUITS; BELTS FOR CLOTHING; BLAZERS; BLOUSES; BODY SUITS; BOMBER JACKETS; CAMISOLES; CARDIGANS; CLOAKS; CLOTHING, NAMELY, WRAP-AROUNDS; COATS; CREW NECK SWEATERS; CROP TOPS; DENIM JACKETS; DRESS SHIRTS; DRESS SUITS; DRESSES; EVENING DRESSES; GLOVES; HALTER TOPS; HATS; HEAVY COATS; HEAVY JACKETS; HOODED SWEAT SHIRTS; JEANS; JEGGINGS, NAMELY, PANTS THAT ARE PARTIALLY JEANS AND PARTIALLY LEGGINGS; JOGGING PANTS; JOGGING SUITS; JUMPSUITS; KNIT SHIRTS; LADIES' SUITS; LEGGINGS; LEISURE SUITS; LINGERIE; LONG JACKETS; LOUNGE PANTS; LOUNGEWEAR; MOCK TURTLE-NECK SWEATERS; NIGHT GOWNS; NIGHT SHIRTS; OUTER JACKETS; OVER COATS; OVERALLS; PAJAMAS; PANTS; POLO SHIRTS; SHIRTS AND SHORT-SLEEVED SHIRTS; SHIRTS FOR SUITS; SHORT-SLEEVED OR LONG-SLEEVED T-SHIRTS; SHORT-SLEEVED SHIRTS; SHOULDER WRAPS; SKIRTS AND DRESSES; SLACKS; SLEEPWEAR; SLEEVED OR SLEEVELESS JACKETS; SUITS; SWEAT JACKETS; SWEAT PANTS; SWEAT SHIRTS; SWEAT SHORTS; SWEAT SUITS; SWEATERS; SWIM WEAR; T-SHIRTS; TANK TOPS; TUBE TOPS; TURTLENECK SWEATERS; VESTS; WARM UP SUITS; WOMEN'S CLOTHING, NAMELY, SHIRTS, DRESSES, SKIRTS, BLOUSES, IN CLASS 25 (U.S. CLS. 22 AND 39).

TRADEMARK

PRINCIPAL REGISTER



FIRST USE 9-1-2011; IN COMMERCE 9-1-2011.

THE MARK CONSISTS OF STANDARD CHARACTERS WITHOUT CLAIM TO ANY PARTICULAR FONT, STYLE, SIZE, OR COLOR.

THE NAME(S), PORTRAIT(S), AND/OR SIGNATURE(S) SHOWN IN THE MARK DOES NOT IDENTIFY A PARTICULAR LIVING INDIVIDUAL.

SER. NO. 85-474,087, FILED 11-16-2011.

HOWARD SMIGA, EXAMINING ATTORNEY

David J. Kyffers

Director of the United States Patent and Trademark Office

United States of America

United States Patent and Trademark Office



Reg. No. 4,204,917

Registered Sep. 11, 2012

Int. Cl.: 28

TRADEMARK

PRINCIPAL REGISTER

CLB ASSETS LLC (MISSOURI LIMITED LIABILITY COMPANY), DBA C. L. BAILEY CO.
PO BOX 290
MARIONVILLE, MO 65705

FOR: BILLIARD BALLS; BILLIARD CHALK; BILLIARD CUE RACKS; BILLIARD CUES;
BILLIARD EQUIPMENT; BILLIARD GAME PLAYING EQUIPMENT; BILLIARD TABLES;
BILLIARD TALLY BALLS; BILLIARD TRIANGLES; CHALK FOR BILLIARD CUES; CUE
STICKS; FOOSBALL TABLES; GAME TABLES; GAMING TABLES, IN CLASS 28 (U.S. CLS.
22, 23, 38 AND 50).

FIRST USE 7-25-1998; IN COMMERCE 2-15-1999.

NO CLAIM IS MADE TO THE EXCLUSIVE RIGHT TO USE "CO" AND "MARIONVILLE,
MISSOURI", APART FROM THE MARK AS SHOWN.

THE COLOR(S) GREEN, BLACK AND WHITE IS/ARE CLAIMED AS A FEATURE OF THE
MARK.

THE MARK CONSISTS OF "THE C. L. BAILEY CO" IS DARK GREEN AND CENTERED
WITHIN A DECORATIVE FRAME OR CARRIER WHICH IS IN BLACK. BELOW IN A
SMALLER FONT IS "MARIONVILLE, MISSOURI" IN DARK GREEN AND CENTERED IN
A DECORATIVE BLACK BANNER CARRIER. THE AREAS BEHIND THE FONTS AND
DECORATIVE BORDERS ARE WHITE.

SER. NO. 85-474,176, FILED 11-16-2011.

MARY ROSSMAN, EXAMINING ATTORNEY



David J. Kyffers

Director of the United States Patent and Trademark Office

United States of America

United States Patent and Trademark Office



Reg. No. 4,204,918

Registered Sep. 11, 2012

Int. Cl.: 35

SERVICE MARK

PRINCIPAL REGISTER

DEALERS UNITED, LLC (FLORIDA LIMITED LIABILITY COMPANY)
1233 N. GULFSTREAM AVE, UNIT PH-1
SARASOTA, FL 34236

FOR: BUSINESS INFORMATION MANAGEMENT, NAMELY, ELECTRONIC REPORTING OF BUSINESS INFORMATION, NAMELY, BUSINESS INVESTIGATIONS, INFORMATION AND RESEARCH FOR AUTOMOBILE DEALERS IN THE NATURE OF EVALUATING VENDORS OF A PARTICULAR GOOD OR SERVICE AND VETTING THE VENDORS; COMMERCIAL EVALUATION AND RATING OF CONSUMER GOODS FOR OTHERS PRIOR TO PURCHASE TO DETERMINE IF A MINIMUM NUMBER OF AUTOMOBILE DEALERS DESIRE THE GOODS OR SERVICES PROVIDED BY THE VENDOR, IN CLASS 35 (U.S. CLS. 100, 101 AND 102).

FIRST USE 10-3-2011; IN COMMERCE 10-3-2011.

THE MARK CONSISTS OF STYLIZED SHIELD WITH A "D" INSIDE THE SHIELD.

SER. NO. 85-474,286, FILED 11-16-2011.

CHARISMA HAMPTON, EXAMINING ATTORNEY



David J. Kyjars

Director of the United States Patent and Trademark Office

United States of America

United States Patent and Trademark Office



Reg. No. 4,204,919

Registered Sep. 11, 2012

Int. Cl.: 29

TRADEMARK

PRINCIPAL REGISTER

STOVIT GROUP SP. Z.O.O. (POLAND SPÓLKA Z OGRANICZONA ODPOWIEDZIALNOSCIA
(SP. Z.O.O.))
UL. TRANSPORTOWA 4
BYDGOSZCZ, POLAND 85-790

FOR: COMPOTES; EDIBLE OILS AND FATS; FROZEN FRUITS; FROZEN VEGETABLES;
JELLIES AND JAMS; MARMALADES; PICKLES; PRESERVED, DRIED AND COOKED
FRUIT AND VEGETABLES; PRESERVED, DRIED AND COOKED OLIVES, IN CLASS 29
(U.S. CL. 46).

OWNER OF ERPN CMNTY TM OFC REG. NO. 9841974, DATED 7-21-2011, EXPIRES 3-25-
2021.

THE COLOR(S) BLUE, RED, GREEN, YELLOW, AND BROWN IS/ARE CLAIMED AS A
FEATURE OF THE MARK.

NO CLAIM IS MADE TO THE EXCLUSIVE RIGHT TO USE "PRESERVE" AND THE IMAGES
OF THE CHERRIES, APART FROM THE MARK AS SHOWN.

THE MARK CONSISTS OF THE STYLIZED WORD "STOVIT" WITHIN A BLUE RECTANGLE
WITH A HALF CIRCLE APPEARING IN YELLOW AND OUTLINED IN BLUE ABOVE IT
AND THE STYLIZED WORDS "GRANDMA'S PRESERVE" APPEARING IN RED WITHIN
AN IRREGULAR SHAPE OUTLINED IN YELLOW AND BROWN WITH TWO RED CHERRIES
TO ITS RIGHT BELOW THE WORD "STOVIT". THE WORDING DESIGNS APPEAR WITHIN
A RING OF RED CHERRIES WITH GREEN STEMS AND LEAVES AND OUTLINED WITH
BROWN ARC DESIGNS AND ENCIRCLED IN RED. THE COLOR WHITE APPEARING IN
THE BACKGROUND OF THE MARK REPRESENTS TRANSPARENT AREAS AND
THEREFORE IS NOT PART OF THE MARK.

SER. NO. 85-474,352, FILED 11-16-2011.

ARETHA SOMERVILLE, EXAMINING ATTORNEY



David J. Kyffers

Director of the United States Patent and Trademark Office

United States of America

United States Patent and Trademark Office

Pharmacy Friend

Reg. No. 4,204,920

PHARMACY FRIEND (RHODE ISLAND LIMITED LIABILITY COMPANY)
22 WEAVER AVE
NEWPORT, RI 02840

Registered Sep. 11, 2012

Int. Cl.: 44

FOR: MEDICAL AND PHARMACEUTICAL CONSULTATION, IN CLASS 44 (U.S. CLS. 100 AND 101).

SERVICE MARK

FIRST USE 10-25-2011; IN COMMERCE 11-1-2011.

PRINCIPAL REGISTER

THE MARK CONSISTS OF STANDARD CHARACTERS WITHOUT CLAIM TO ANY PARTICULAR FONT, STYLE, SIZE, OR COLOR.

NO CLAIM IS MADE TO THE EXCLUSIVE RIGHT TO USE "PHARMACY", APART FROM THE MARK AS SHOWN.

SER. NO. 85-474,675, FILED 11-16-2011.

SUZANNE BLANE, EXAMINING ATTORNEY



David J. Kyffers

Director of the United States Patent and Trademark Office

United States of America

United States Patent and Trademark Office



Reg. No. 4,204,921

SWAPS MONITOR PUBLICATIONS, INC. (NEW YORK CORPORATION)

Registered Sep. 11, 2012

29 BROADWAY, SUITE 1315
NEW YORK, NY 10006

Int. Cl.: 35

FOR: PROVIDING DATA CONCERNING HOLIDAYS, TRADING HOURS, TIME ZONES, EXPIRATION DATES AND TIMES FOR FUTURES AND OPTIONS, AND OTHER INFORMATION THAT MAY AFFECT THE TRADING SCHEDULE OF FINANCIAL MARKET TRANSACTIONS, IN CLASS 35 (U.S. CLS. 100, 101 AND 102).

SERVICE MARK

PRINCIPAL REGISTER

FIRST USE 9-0-2010, THE MARK WAS FIRST USED ANYWHERE IN A DIFFERENT FORM OTHER THAN THAT SOUGHT TO BE REGISTERED AT LEAST AS EARLY AS 00/00/1998.; IN COMMERCE 9-0-2010, THE MARK WAS FIRST USED IN COMMERCE IN A DIFFERENT FORM OTHER THAN THAT SOUGHT TO BE REGISTERED AT LEAST AS EARLY AS 00/00/1998..

NO CLAIM IS MADE TO THE EXCLUSIVE RIGHT TO USE "FINANCIAL CALENDAR", APART FROM THE MARK AS SHOWN.

THE MARK CONSISTS OF A DESIGN OF THE SUN AND MOON WITH THE SUN COMPOSED OF CURVED CONCENTRIC BANDS AND THE MOON COMPOSED OF CONCENTRIC CIRCLES AND THE WORDS "FINANCIAL CALENDAR".

SER. NO. 85-474,882, FILED 11-17-2011.

AMY HELLA, EXAMINING ATTORNEY



David J. Kybas

Director of the United States Patent and Trademark Office

United States of America

United States Patent and Trademark Office

Le Bac

Reg. No. 4,204,922

UNITED BAMBOO LLC (NEW YORK LIMITED LIABILITY COMPANY)
217 CENTRE STREET, 6TH FLOOR
NEW YORK, NY 10013

Registered Sep. 11, 2012

Int. Cl.: 18

FOR: LUGGAGE, IN CLASS 18 (U.S. CLS. 1, 2, 3, 22 AND 41).

TRADEMARK

FIRST USE 1-1-2010; IN COMMERCE 9-1-2010.

PRINCIPAL REGISTER

THE MARK CONSISTS OF STANDARD CHARACTERS WITHOUT CLAIM TO ANY PARTICULAR FONT, STYLE, SIZE, OR COLOR.

THE WORDING "BAC" HAS NO MEANING IN A FOREIGN LANGUAGE.

SER. NO. 85-475,168, FILED 11-17-2011.

JEAN IM, EXAMINING ATTORNEY



David J. Kyffers

Director of the United States Patent and Trademark Office

United States of America

United States Patent and Trademark Office

HEAL THE OCEAN

Reg. No. 4,204,923

Registered Sep. 11, 2012

Int. Cls.: 42 and 45

SERVICE MARK

PRINCIPAL REGISTER

HEAL THE OCEAN, INC. (CALIFORNIA CORPORATION)
C/O KOENIG & ASSOCIATES
920 GARDEN STREET, SUITE A
SANTA BARBARA, CA 93101

FOR: RESEARCH SERVICES IN THE FIELD OF WATER RECLAMATION, WASTEWATER TRACKING, WASTEWATER DISCHARGE, GROUNDWATER CONTAMINATION, TRACKING POLLUTION LEVELS IN COASTAL WATERS, DNA TESTING TO DETERMINE SOURCES OF POLLUTION, CHECKING FOR HUMAN WASTE IN CREEKS, STORM DRAINS, AND OCEANS, ENVIRONMENTAL CONSERVATION; PROVIDING ENVIRONMENTAL INFORMATION DEDICATED TO THE PRESERVATION, PROTECTION, AND ENHANCEMENT OF THE WORLD'S OCEANS AND BEACHES; PROVIDING ENVIRONMENTAL INFORMATION ON OCEAN WATER QUALITY VIA THE INTERNET; PROVIDING A WEBSITE FEATURING ENVIRONMENTAL INFORMATION ABOUT GROUNDWATER CONTAMINATION, THE DANGERS OF SWIMMING IN POLLUTED OCEAN WATER, UNLINED LANDFILLS WHICH CONTAMINATE THE ENVIRONMENT, AND FEASIBILITY STUDIES OF WASTEWATER TREATMENT PLANTS; RESEARCH IN THE FIELD OF ENVIRONMENTAL PROTECTION; OCEAN HABITAT PRESERVATION SERVICES, NAMELY, MONITORING, TESTING AND ANALYZING ECOLOGICAL SUCCESS IN THE FIELD OF ENVIRONMENTALLY SENSITIVE COASTAL WATERS; PROVIDING A WEBSITE FEATURING ENVIRONMENTAL INFORMATION, NAMELY, NON-DOWNLOADABLE PHOTOGRAPHIC, AUDIO, AND VIDEO PRESENTATIONS IN THE FIELD OF POLLUTION DETECTION, GROUNDWATER CONTAMINATION, AND ENVIRONMENTAL CONSERVATION; RESEARCH ON PREVENTION OF POLLUTION; PROVIDING A WEBSITE FEATURING ENVIRONMENTAL INFORMATION IN THE FIELD OF POLLUTION CONTROL, GROUNDWATER CONTAMINATION, AND ENVIRONMENTAL CONSERVATION, MARINE ECOSYSTEMS; TESTING OR RESEARCH ON PREVENTION OF WATER POLLUTION; ANALYSIS OF OCEAN WATER QUALITY; ENVIRONMENTAL ENFORCEMENT, NAMELY, ENGINEERING SERVICES IN THE FIELD OF ENVIRONMENTAL COMPLIANCE, IN CLASS 42 (U.S. CLS. 100 AND 101).

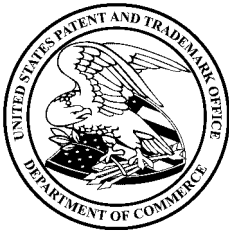

FIRST USE 8-25-1998; IN COMMERCE 8-25-1998.

David J. Kypas

Director of the United States Patent and Trademark Office

FOR: TRACKING AND MONITORING REGULATORY REQUIREMENTS IN THE FIELD OF POLLUTION LEVELS FOR REGULATORY COMPLIANCE PURPOSES IN COASTAL WATERS; PROVIDING NEWS REPORTING SERVICES FOR POLLUTION LEVEL MONITORING FOR REGULATORY COMPLIANCE PURPOSES IN COASTAL WATERS; PROVIDING WEBSITE FEATURING ENVIRONMENTAL INFORMATION ABOUT TRACKING AND

Reg. No. 4,204,923 MONITORING WASTEWATER FOR REGULATORY COMPLIANCE PURPOSES. PROVIDING A WEBSITE FEATURING ENVIRONMENTAL INFORMATIONAL, NON-DOWNLOADABLE PHOTOGRAPHIC, AUDIO, AND VIDEO PRESENTATIONS ABOUT TRACKING AND MONITORING WASTEWATER FOR REGULATORY COMPLIANCE PURPOSES, IN CLASS 45 (U.S. CLS. 100 AND 101).

FIRST USE 8-25-1998; IN COMMERCE 8-25-1998.

THE MARK CONSISTS OF STANDARD CHARACTERS WITHOUT CLAIM TO ANY PARTICULAR FONT, STYLE, SIZE, OR COLOR.

OWNER OF U.S. REG. NO. 2,566,735.

SER. NO. 85-475,632, FILED 11-17-2011.

LOURDES AYALA, EXAMINING ATTORNEY

United States of America

United States Patent and Trademark Office

CULINATE

Reg. No. 4,204,924

Registered Sep. 11, 2012

Int. Cl.: 9

TRADEMARK

PRINCIPAL REGISTER

CULINATE, INC. (OREGON CORPORATION)
SUITE 6 PMB 178
25 NW 23RD
PORTLAND, OR 97210

FOR: DOWNLOADABLE COMPUTER SOFTWARE PROVIDING DATABASES OF INFORMATION RELATED TO FOOD, DINING, COOKING, MENUS, RECIPES, GROCERIES, GROCERY SHOPPING INFORMATION AND OTHER AREAS OF CULINARY PURSUIT, NAMELY, ENTERTAINING, WINE AND BEVERAGES, AND THE CULINARY ARTS; AND FEATURING, TOOLS IN THE NATURE OF COMPUTER SOFTWARE DEVELOPMENT TOOLS FOR THE CREATION OF MOBILE INTERNET APPLICATIONS AND CLIENT INTERFACES AND OTHER RESOURCES IN THE NATURE OF COMPUTER SOFTWARE FOR CREATING SEARCHABLE DATABASE OF INFORMATION AND DATA ALL RELATED TO FOOD, DINING, COOKING, MENUS, RECIPES, GROCERIES, GROCERY SHOPPING INFORMATION AND OTHER AREAS OF CULINARY PURSUIT, NAMELY, ENTERTAINING, WINE AND BEVERAGES, AND THE CULINARY ARTS, IN CLASS 9 (U.S. CLS. 21, 23, 26, 36 AND 38).

FIRST USE 7-10-2009; IN COMMERCE 4-17-2010.

THE MARK CONSISTS OF STANDARD CHARACTERS WITHOUT CLAIM TO ANY PARTICULAR FONT, STYLE, SIZE, OR COLOR.

OWNER OF U.S. REG. NOS. 3,393,046 AND 3,393,047.

SER. NO. 85-475,813, FILED 11-17-2011.

ANDREA K. NADELMAN, EXAMINING ATTORNEY



David J. Kybas

Director of the United States Patent and Trademark Office

United States of America

United States Patent and Trademark Office



Reg. No. 4,204,925

MTHFR SOLUTIONS LLC (WASHINGTON LIMITED LIABILITY COMPANY)
9744 62ND AVENUE S.
SEATTLE, WA 98118

Registered Sep. 11, 2012

Int. Cl.: 5

FOR: DIETARY SUPPLEMENTS FOR PROMOTING AND OPTIMIZING THE BODY'S METHYLATION PROCESSES, IN CLASS 5 (U.S. CLS. 6, 18, 44, 46, 51 AND 52).

TRADEMARK

FIRST USE 3-17-2012; IN COMMERCE 3-17-2012.

PRINCIPAL REGISTER

NO CLAIM IS MADE TO THE EXCLUSIVE RIGHT TO USE "METHYL", APART FROM THE MARK AS SHOWN.

THE COLOR(S) BLUE AND GREEN IS/ARE CLAIMED AS A FEATURE OF THE MARK.

THE MARK CONSISTS OF THE TERMS "METHYL", IN BLUE, AND "LIFE", IN GREEN, SEPARATED BY A CLUSTER OF GREEN HEXAGONS, ALL POSITIONED ABOVE THE WORDING "RESTORING CELLULAR VITALITY", IN BLUE, AND A GENETIC HELIX DESIGN, IN BLUE AND GREEN, AND POSITIONED TO THE LEFT OF A HUMAN FIGURE WITH A GREEN HEAD AND BLUE BODY.

SER. NO. 85-475,860, FILED 11-17-2011.

NAPOLEON SHARMA, EXAMINING ATTORNEY



David J. Kyros

Director of the United States Patent and Trademark Office

United States of America

United States Patent and Trademark Office

Designs Around You

Reg. No. 4,204,926

Registered Sep. 11, 2012

Int. Cls.: 41 and 42

SERVICE MARK

PRINCIPAL REGISTER

DESIGNS AROUND YOU, INC. (WISCONSIN CORPORATION)
P.O. BOX 241195
MILWAUKEE, WI 53224

FOR: DESKTOP AND ELECTRONIC DESKTOP PUBLISHING FOR OTHERS; DESKTOP AND ELECTRONIC DESKTOP PUBLISHING FOR OTHERS FOR ADVERTISING PURPOSES; PROVIDING INDIVIDUAL INSTRUCTION AS TO THE DESIGN AND IMPLEMENTATION OF WEBSITE ADVERTISING AND WEB DESIGN, MULTIMEDIA DESIGN, COMMERCIAL ART DESIGN, GRAPHIC ART DESIGN, AND DESKTOP AND ELECTRONIC PUBLISHING FOR OTHERS, IN CLASS 41 (U.S. CLS. 100, 101 AND 107).

FIRST USE 1-1-1995; IN COMMERCE 1-1-1995.

FOR: PROVIDING WEBPAGE DESIGN SERVICES FOR ADVERTISING PURPOSES; PROVIDING MULTIMEDIA DESIGN SERVICES FOR THE PURPOSE OF PROMOTING THE GOODS AND SERVICES OF OTHERS; COMMERCIAL ART DESIGN FOR ADVERTISING PURPOSES; GRAPHIC ART DESIGN FOR ADVERTISING PURPOSES; COMPUTER SERVICES, NAMELY, CREATING AND MAINTAINING WEB SITES FOR OTHERS, DESIGNING AND IMPLEMENTING WEBSITES FOR OTHERS; PROVIDING MULTIMEDIA DESIGN SERVICES FOR THE PURPOSE OF PROMOTING THE GOODS AND SERVICES OF OTHERS; COMMERCIAL ART DESIGN; GRAPHIC ART DESIGN, IN CLASS 42 (U.S. CLS. 100 AND 101).

FIRST USE 1-1-1995; IN COMMERCE 1-1-1995.

THE MARK CONSISTS OF STANDARD CHARACTERS WITHOUT CLAIM TO ANY PARTICULAR FONT, STYLE, SIZE, OR COLOR.

OWNER OF U.S. REG. NO. 2,522,019.

SER. NO. 85-476,486, FILED 11-18-2011.

MARK SPARACINO, EXAMINING ATTORNEY



David J. Kyffers

Director of the United States Patent and Trademark Office

United States of America

United States Patent and Trademark Office

EDGE

Reg. No. 4,204,927

Registered Sep. 11, 2012

Int. Cl.: 35

SERVICE MARK

PRINCIPAL REGISTER

OKLAHOMA STATE REGENTS FOR HIGHER EDUCATION (OKLAHOMA STATE AGENCY)
655 RESEARCH PARKWAY, SUITE 200
OKLAHOMA CITY, OK 731018850

FOR: PROMOTING BUSINESS AND ECONOMIC DEVELOPMENT IN THE STATE OF OKLAHOMA, INCLUDING PROMOTING OKLAHOMA'S SCIENTIFIC AND TECHNOLOGICAL ADVANTAGES FOR BUSINESS, IN CLASS 35 (U.S. CLS. 100, 101 AND 102).

FIRST USE 11-0-2009; IN COMMERCE 11-0-2009.

OWNER OF U.S. REG. NOS. 2,951,647 AND 2,959,733.

THE MARK CONSISTS OF THE WORD "EDGE" IN STYLIZED LETTERS.

SER. NO. 85-476,542, FILED 11-18-2011.

KRISTINA MORRIS, EXAMINING ATTORNEY



David J. Kyffers

Director of the United States Patent and Trademark Office

United States of America

United States Patent and Trademark Office



Reg. No. 4,204,928

Registered Sep. 11, 2012

Int. Cl.: 37

SERVICE MARK

PRINCIPAL REGISTER

FIRE STOP TECHNOLOGIES, INC. (MISSOURI CORPORATION)
6280 KNOX INDUSTRIAL DRIVE
ST. LOUIS, MO 63139

FOR: INSTALLATION OF FIRE RETARDANT COMPOSITIONS IN COMMERCIAL, INDUSTRIAL AND RESIDENTIAL BUILDINGS TO INHIBIT THE SCOPE OF FIRE, IN CLASS 37 (U.S. CLS. 100, 103 AND 106).

FIRST USE 1-3-1994; IN COMMERCE 1-3-1994.

NO CLAIM IS MADE TO THE EXCLUSIVE RIGHT TO USE "FIRE STOP TECHNOLOGIES INC.", APART FROM THE MARK AS SHOWN.

THE COLOR(S) RED AND BLACK IS/ARE CLAIMED AS A FEATURE OF THE MARK.

THE MARK CONSISTS OF THE WORD "FIRE" ATOP THE WORD "STOP" IN MUCH LARGER TYPE, BOTH FADING FROM RED TO WHITE, BELOW "FIRE STOP" IS THE WORDING "TECHNOLOGIES INC." SHOWN IN THE COLOR RED ALL ON A BLACK BACKGROUND, SURROUNDED BY AN OCTAGONAL RED BORDER.

SER. NO. 85-476,739, FILED 11-18-2011.

LINDA E. BLOHM, EXAMINING ATTORNEY



David J. Kybas

Director of the United States Patent and Trademark Office

United States of America

United States Patent and Trademark Office

RAAB SALES

Reg. No. 4,204,929

RAAB SALES, INC. (MISSOURI CORPORATION)
14521 WEST 96TH TERRACE
LENEXA, KS 66215

Registered Sep. 11, 2012

Int. Cl.: 35

FOR: DISTRIBUTORSHIPS IN THE FIELD OF LABELING EQUIPMENT, CODING EQUIPMENT, MARKING EQUIPMENT AND SHIPPING ROOM SUPPLIES, IN CLASS 35 (U.S. CLS. 100, 101 AND 102).

SERVICE MARK

FIRST USE 0-0-1960; IN COMMERCE 0-0-1960.

PRINCIPAL REGISTER

THE MARK CONSISTS OF STANDARD CHARACTERS WITHOUT CLAIM TO ANY PARTICULAR FONT, STYLE, SIZE, OR COLOR.

OWNER OF U.S. REG. NO. 3,229,883.

NO CLAIM IS MADE TO THE EXCLUSIVE RIGHT TO USE "SALES", APART FROM THE MARK AS SHOWN.

SEC. 2(F).

SER. NO. 85-478,048, FILED 11-21-2011.

ERIN FALK, EXAMINING ATTORNEY



David J. Kyffers

Director of the United States Patent and Trademark Office

United States of America

United States Patent and Trademark Office



Reg. No. 4,204,930

Registered Sep. 11, 2012

Int. Cl.: 42

SERVICE MARK

PRINCIPAL REGISTER

MINDSHARE NETWORKS, INC. (IDAHO CORPORATION)
SUITE 200
645 E. STATE STREET
EAGLE, ID 83616

FOR: PLATFORM AS A SERVICE (PAAS) FEATURING COMPUTER SOFTWARE PLATFORMS FOR CONDUCTING CONFERENCES, SEMINARS, AND WORKSHOPS THROUGH PRESENTATIONS FOR BOTH PROFESSIONAL AND EDUCATIONAL CONTEXTS, IN CLASS 42 (U.S. CLS. 100 AND 101).

FIRST USE 8-15-2011; IN COMMERCE 9-15-2011.

THE MARK CONSISTS OF A STYLIZED WHITE CLOUD WITH A BLACK OUTLINE. INSIDE THE CLOUD ARE THREE PARTIALLY SHADED SQUARES IN GREEN. THE WORD "SLIDEKLOWD" IS TO THE RIGHT OF THE DESIGN WITH THE PORTION OF THE MARK "SLIDE" IN GREEN AND THE PORTION OF THE MARK "KLOWD" IN GRAY.

THE COLOR(S) BLACK, WHITE, GREEN, AND GRAY IS/ARE CLAIMED AS A FEATURE OF THE MARK.

SER. NO. 85-478,175, FILED 11-21-2011.

JEFFREY LOOK, EXAMINING ATTORNEY



David J. Kybas

Director of the United States Patent and Trademark Office

United States of America

United States Patent and Trademark Office

Reg. No. 4,204,931

HOWE, LLC (DELAWARE LIMITED LIABILITY COMPANY)
1633 WESTLAKE AVENUE N.
SEATTLE, WA 98109

Registered Sep. 11, 2012

Int. Cl.: 18

FOR: BACKPACKS, BOOK BAGS, SPORTS BAGS, BUM BAGS, WALLETS AND HANDBAGS;
LUGGAGE, IN CLASS 18 (U.S. CLS. 1, 2, 3, 22 AND 41).

TRADEMARK

FIRST USE 11-21-2011; IN COMMERCE 11-21-2011.

PRINCIPAL REGISTER

OWNER OF U.S. REG. NOS. 2,670,569, 3,061,845, AND 3,487,455.

THE MARK CONSISTS OF A STYLIZED WORD "HOWE".

SEC. 2(F).

SER. NO. 85-478,397, FILED 11-21-2011.

JEAN IM, EXAMINING ATTORNEY



Director of the United States Patent and Trademark Office

United States of America

United States Patent and Trademark Office

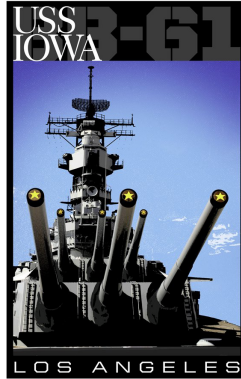

Reg. No. 4,204,932

Registered Sep. 11, 2012

Int. Cl.: 41

SERVICE MARK

PRINCIPAL REGISTER

PACIFIC BATTLESHIP CENTER (CALIFORNIA CORPORATION)
1077 N BRADFORD AVENUE
PLACENTIA, CA 92870

FOR: MUSEUMS, IN CLASS 41 (U.S. CLS. 100, 101 AND 107).

FIRST USE 10-1-2011; IN COMMERCE 10-1-2011.

NO CLAIM IS MADE TO THE EXCLUSIVE RIGHT TO USE "USS IOWA BB-61" AND "LOS ANGELES", APART FROM THE MARK AS SHOWN.

THE COLOR(S) BLACK, BLUE, WHITE, GOLD, TAN, GRAY AND LIGHT GRAY IS/ARE CLAIMED AS A FEATURE OF THE MARK.

THE MARK CONSISTS OF A BLACK RECTANGLE OUTLINED IN WHITE WITH "USS IOWA" IN WHITE, "BB-61" IN GRAY, THE BATTLESHIP IN GRAY AND LIGHT GRAY WITH BLACK SHADING, GOLD STARS ON A TAN BACKGROUND, A BLUE SKY WITH WHITE CLOUDS AND "LOS ANGELES" IN WHITE.

SER. NO. 85-478,436, FILED 11-21-2011.

MICHELE SWAIN, EXAMINING ATTORNEY



David J. Kyffers

Director of the United States Patent and Trademark Office

United States of America

United States Patent and Trademark Office



Innovate and Inspire Your Voice

Reg. No. 4,204,933

Registered Sep. 11, 2012

Int. Cls.: 35 and 39

SERVICE MARK

PRINCIPAL REGISTER

OLD CELL PHONE COMPANY, LLC (NEVADA LIMITED LIABILITY COMPANY)
4485 SW PORT WAY
PALM CITY, FL 34990

FOR: ORDER FULFILLMENT SERVICES; MANAGEMENT AND OPERATION OF A CALL CENTER FOR OTHERS, IN CLASS 35 (U.S. CLS. 100, 101 AND 102).

FIRST USE 11-16-2011; IN COMMERCE 11-16-2011.

FOR: WHOLESALE DISTRIBUTION OF CELLULAR PHONES; SERVICES CONNECTED WITH THE PACKAGING AND PARCELING OF GOODS FOR OTHERS BEFORE DISPATCH, IN CLASS 39 (U.S. CLS. 100 AND 105).

FIRST USE 11-16-2011; IN COMMERCE 11-16-2011.

THE MARK CONSISTS OF A GLOBE IN DIFFERENT SHADES OF BLUE WITH HORIZONTAL AND VERTICAL LINES, NORTH AND SOUTH AMERICA IN WHITE AND THE WORDS "IVOX SOLUTIONS" TO THE RIGHT OF THE GLOBE. THE "I" IN "IVOX" IS IN DARK BLUE AND THE "VOX" IS IN RED. THE WORD "SOLUTIONS" IS IN DARK BLUE UNDERNEATH THE "O" AND "X" IN "VOX." THE WORDS "INNOVATE AND INSPIRE YOUR VOICE" ARE UNDERNEATH BOTH THE GLOBE AND THE WORDS "IVOX SOLUTIONS" IN DARK BLUE.

THE COLOR(S) BLUE, WHITE AND RED IS/ARE CLAIMED AS A FEATURE OF THE MARK.

SER. NO. 85-478,732, FILED 11-22-2011.

LUCY ARANT, EXAMINING ATTORNEY



David J. Kyros

Director of the United States Patent and Trademark Office

United States of America

United States Patent and Trademark Office

1-877-NON-STOP

Reg. No. 4,204,934

RIVER BEND CENTER, LLC (CONNECTICUT LIMITED LIABILITY COMPANY)
ONE OMEGA DRIVE
STAMFORD, CT 06907

Registered Sep. 11, 2012

Int. Cl.: 42

FOR: COMPUTER SERVICES, NAMELY, PROVIDING DATA CENTER SERVICES IN THE NATURE OF PROVIDING FACILITIES FOR THE LOCATION OF COMPUTER SERVERS WITH THE EQUIPMENT OF OTHERS; COMPUTER SERVICES, NAMELY, DATA RECOVERY AND DISASTER RECOVERY PLANNING; BUSINESS CONTINUITY SERVICES FOR OTHERS, NAMELY, RENTAL OF SPACE IN A COMPUTER CO-LOCATION FACILITY FOR CONTAINERIZED DATA CENTERS OF OTHERS, AND LEASING OF COMPUTER FACILITIES, IN CLASS 42 (U.S. CLS. 100 AND 101).

SERVICE MARK

PRINCIPAL REGISTER

FIRST USE 0-0-2002; IN COMMERCE 11-17-2011.

THE MARK CONSISTS OF STANDARD CHARACTERS WITHOUT CLAIM TO ANY PARTICULAR FONT, STYLE, SIZE, OR COLOR.

SER. NO. 85-478,864, FILED 11-22-2011.

JAY BESCH, EXAMINING ATTORNEY



David J. Kyros

Director of the United States Patent and Trademark Office

United States of America

United States Patent and Trademark Office

COLUMBIA HELICOPTERS

Reg. No. 4,204,935

Registered Sep. 11, 2012

Int. Cls.: 37 and 39

SERVICE MARK

PRINCIPAL REGISTER

COLUMBIA HELICOPTERS, INC. (OREGON CORPORATION)
14452 ARNDT RD. NE
AURORA, OR 97002

FOR: HELICOPTER MAINTENANCE OR REPAIR; HELICOPTER REPAIR AND MAINTENANCE; FUELING SERVICES FOR HELICOPTERS; INFORMATION WITH RELATION TO HELICOPTER CONSTRUCTION, REPAIR AND MAINTENANCE; OUTER AND INNER CLEANING OF HELICOPTERS; REPAIR AND MAINTENANCE OF HELICOPTERS; TECHNICAL SUPPORT SERVICES, NAMELY, PROVIDING TECHNICAL ADVICE IN THE FIELD OF HELICOPTER ENGINE AND REPAIR, IN CLASS 37 (U.S. CLS. 100, 103 AND 106).

FIRST USE 1-1-1958; IN COMMERCE 1-1-1958.

FOR: HELICOPTER TRANSPORT; RENTAL OF HELICOPTER; CHARTERING OF HELICOPTERS, IN CLASS 39 (U.S. CLS. 100 AND 105).

FIRST USE 1-1-1958; IN COMMERCE 1-1-1958.

THE MARK CONSISTS OF STANDARD CHARACTERS WITHOUT CLAIM TO ANY PARTICULAR FONT, STYLE, SIZE, OR COLOR.

NO CLAIM IS MADE TO THE EXCLUSIVE RIGHT TO USE "HELICOPTERS", APART FROM THE MARK AS SHOWN.

SER. NO. 85-478,946, FILED 11-22-2011.

JENNIFER MARTIN, EXAMINING ATTORNEY



David J. Kybas

Director of the United States Patent and Trademark Office

United States of America

United States Patent and Trademark Office



Reg. No. 4,204,936

Registered Sep. 11, 2012

Int. Cl.: 41

SERVICE MARK

PRINCIPAL REGISTER

GLYDASCOPE INC. (CALIFORNIA CORPORATION)
10151-3 LARWIN AVE.
CHATSWORTH, CA 91311

FOR: ENTERTAINMENT SERVICES IN THE NATURE OF DEVELOPMENT, CREATION, PRODUCTION AND POST-PRODUCTION SERVICES OF MULTIMEDIA ENTERTAINMENT CONTENT, IN CLASS 41 (U.S. CLS. 100, 101 AND 107).

FIRST USE 9-10-2011; IN COMMERCE 9-10-2011.

THE STIPLING IS FOR SHADING PURPOSES ONLY.

THE MARK CONSISTS OF THE LETTER "G" IN LARGE TYPE FOLLOWED BY "LYDASCOPE" TO FORM THE WORD "GLYDASCOPE" WITH A STYLIZED DESIGN OF COMPASS POINTS COMPRISING THE CENTER OF THE LETTER "G". THE LETTERING "LYDASCOPE" IS LAID OVER A SLOPING FILM FRAME THAT REFLECTS THE IMAGE OF THE LETTERS.

SER. NO. 85-479,432, FILED 11-22-2011.

LAURA KOVALSKY, EXAMINING ATTORNEY



David J. Kyros

Director of the United States Patent and Trademark Office

United States of America

United States Patent and Trademark Office



東方海洋
ORIENTAL OCEAN

Reg. No. 4,204,937

Registered Sep. 11, 2012

Int. Cl.: 29

TRADEMARK

PRINCIPAL REGISTER

SHANDONG ORIENTAL OCEAN SCI-TECH CO.,LTD (CHINA CORPORATION)
NO.18, AUCMA AVENUE, LAISHAN ZONE
YANTAI, SHANDONG, CHINA

FOR: ALGAE FOOD BEVERAGES, NAMELY, SEAWEED DRINKS; BEVERAGES CONSISTING PRINCIPALLY OF MILK; BEVERAGES HAVING A MILK BASE; CANNED FISH; DRIED EDIBLE ALGAE; EDIBLE FATS; EGGS; FISH PRESERVES; FLAKES OF DRIED FISH MEAT (KEZURI-BUSHI); FOOD ADDITIVES, NAMELY, NATURAL FOOD EXTRACTS DERIVED FROM FISH, FISH OIL, FISH PROTEIN, ALGAE, SEAWEED, FISH OR SHARK CARTILAGE, OR SEASHELLS NOT FOR MEDICINAL PURPOSES AND FOR HUMAN CONSUMPTION; FRUIT-BASED SNACK FOOD; MARINATED FISH; MEAT; MILK BEVERAGES WITH HIGH MILK CONTENT; MILK-BASED BEVERAGES WITH HIGH MILK CONTENT; PREPARED FOOD KITS COMPOSED OF MEAT, POULTRY, FISH, SEAFOOD, AND/OR VEGETABLES AND ALSO INCLUDING SAUCES OR SEASONINGS, READY FOR COOKING AND ASSEMBLY AS A MEAL; PRESERVED FISH; PROCESSED ALGAE FOR HUMAN CONSUMPTION; PROCESSED FISH; PROCESSED FISH ROE; PROCESSED FISH SPAWN; PROCESSED SEAFOOD, NAMELY, FISH; PROCESSED, EDIBLE SEAWEED; TINNED FISH; VEGETABLES, NAMELY, PRESERVED, IN CLASS 29 (U.S. CL. 46).

FIRST USE 8-1-2005; IN COMMERCE 8-1-2005.

NO CLAIM IS MADE TO THE EXCLUSIVE RIGHT TO USE "ORIENTAL" AND THE NON-LATIN CHARACTERS THAT TRANSLITERATE TO "DONG FANG", APART FROM THE MARK AS SHOWN.

THE NON-LATIN CHARACTERS IN THE MARK TRANSLITERATE TO "DONG FANG HAI YANG" AND THIS MEANS "ORIENTAL OCEAN" IN ENGLISH.

THE MARK CONSISTS OF THE CHINESE CHARACTER DONG FANG HAI YANG WITH STYLIZED WORDING "ORIENTAL OCEAN" AND A SPECIAL DESIGN "H" AND OCEAN WAVE CRINKLE SURROUNDED BY A ROUND CIRCLE ON UPPER SIDE.

SER. NO. 85-479,565, FILED 11-22-2011.

JENNIFER WILLISTON, EXAMINING ATTORNEY



David J. Kyros

Director of the United States Patent and Trademark Office

United States of America

United States Patent and Trademark Office

The MamaSutra

Reg. No. 4,204,938

Registered Sep. 11, 2012

Int. Cl.: 41

SERVICE MARK

PRINCIPAL REGISTER

LANAE ST. JOHN (CALIFORNIA SOLE PROPRIETORSHIP), DBA THE MAMASUTRA
19 TAMALPAIS COMMONS LANE
MILL VALLEY, CA 94941

FOR: LIFE COACHING, INCLUDING ONE-ON-ONE COUNSELING AND GROUP COACHING, IN THE FIELD OF SEXUAL HEALTH AND SEXUALITY; ON-LINE JOURNALS, NAMELY, ONLINE BLOGS AND ARTICLES FEATURING TOPICS RELATED TO SEXUAL HEALTH AND SEXUALITY; EDUCATIONAL SERVICES IN THE FIELD OF SEXUAL HEALTH AND SEXUALITY, NAMELY, PROVIDING EDUCATIONAL SPEAKERS, SEMINARS, A CONTINUING EDUCATIONAL RADIO SHOW, EDUCATIONAL WEBINARS, WORKSHOPS, AND CLASSES, AND DISTRIBUTING COURSE MATERIALS, EDUCATIONAL MATERIALS, AND TRAINING MATERIALS IN CONNECTION THEREWITH, IN CLASS 41 (U.S. CLS. 100, 101 AND 107).

FIRST USE 8-1-2010; IN COMMERCE 8-1-2010.

THE MARK CONSISTS OF STANDARD CHARACTERS WITHOUT CLAIM TO ANY PARTICULAR FONT, STYLE, SIZE, OR COLOR.

SER. NO. 85-480,173, FILED 11-23-2011.

RAMONA ORTIGA, EXAMINING ATTORNEY



David J. Kyffers

Director of the United States Patent and Trademark Office

United States of America

United States Patent and Trademark Office

SAMMY ADAMS

Reg. No. 4,204,939

Registered Sep. 11, 2012

Int. Cl.: 41

SERVICE MARK

PRINCIPAL REGISTER

WISNER, SAMUEL ADAMS (UNITED STATES INDIVIDUAL)
SEDLMAYR & ASSOCIATES, P.C
200 PARK AVENUE SOUTH, SUITE 1408
NEW YORK, NY 10003

FOR: ENTERTAINMENT SERVICES BY A MUSICAL ARTIST IN THE NATURE OF LIVE MUSICAL PERFORMANCES, IN CLASS 41 (U.S. CLS. 100, 101 AND 107).

FIRST USE 10-7-2011, THE MARK WAS FIRST USED ANYWHERE IN A DIFFERENT FORM OTHER THAN THAT SOUGHT TO BE REGISTERED AT LEAST AS EARLY AS 09/00/2009; IN COMMERCE 10-7-2011, THE MARK WAS FIRST USED IN COMMERCE IN A DIFFERENT FORM OTHER THAN THAT SOUGHT TO BE REGISTERED AT LEAST AS EARLY AS 09/00/2009.

THE MARK CONSISTS OF STANDARD CHARACTERS WITHOUT CLAIM TO ANY PARTICULAR FONT, STYLE, SIZE, OR COLOR.

THE NAME(S), PORTRAIT(S), AND/OR SIGNATURE(S) SHOWN IN THE MARK IDENTIFIES SAMUEL ADAMS WISNER, WHOSE CONSENT(S) TO REGISTER IS MADE OF RECORD.

SER. NO. 85-480,232, FILED 11-23-2011.

ANTHONY RINKER, EXAMINING ATTORNEY



David J. Kybas

Director of the United States Patent and Trademark Office

United States of America
United States Patent and Trademark Office

AL DESKO

Reg. No. 4,204,940

Registered Sep. 11, 2012

Int. Cl.: 16

TRADEMARK

PRINCIPAL REGISTER

PIDGEON AIDEEN BLANAID (IRELAND INDIVIDUAL), DBA DO YOURSELF A FLAVOUR
APARTMENT 5 THE PAVILION
MARINE DRIVE
DUN LAOGAHAIRE DUBLIN, IRELAND 0000

FOR: COOKBOOKS, IN CLASS 16 (U.S. CLS. 2, 5, 22, 23, 29, 37, 38 AND 50).

THE MARK CONSISTS OF STANDARD CHARACTERS WITHOUT CLAIM TO ANY PARTICULAR FONT, STYLE, SIZE, OR COLOR.

OWNER OF AUSTRALIA REG. NO. 1341991, DATED 1-24-2010, EXPIRES 1-23-2020.

SER. NO. 85-481,206, FILED 11-28-2011.

DAVID MURRAY, EXAMINING ATTORNEY



David J. Kyffers

Director of the United States Patent and Trademark Office

United States of America

United States Patent and Trademark Office



Reg. No. 4,204,941

Registered Sep. 11, 2012

Int. Cl.: 36

SERVICE MARK

PRINCIPAL REGISTER

CARIBE REALTY (ALABAMA CORPORATION)
PO BOX 189
28103 PERDIDO BEACH BLVD.
ORANGE BEACH, AL 36561

FOR: REAL ESTATE SERVICES, NAMELY, VACATION HOME RENTAL MANAGEMENT SERVICES, IN CLASS 36 (U.S. CLS. 100, 101 AND 102).

FIRST USE 9-2-1996; IN COMMERCE 9-21-1996.

NO CLAIM IS MADE TO THE EXCLUSIVE RIGHT TO USE "CARIBE THE RESORT", APART FROM THE MARK AS SHOWN.

THE COLOR(S) BLUE, ORANGE, GREEN, AQUA, WHITE, BLACK, AND YELLOW IS/ARE CLAIMED AS A FEATURE OF THE MARK.

THE MARK CONSISTS OF THE STYLIZED WORDING "CARIBE THE RESORT" AND A STYLIZED FROG. THE BEGINNING TOP LEFT CORNER OF THE MARK IS A STYLIZED CAPITAL LETTER "C" IN THE COLOR BLUE WITH A GREEN TREE FROG ON TOP OF THE LETTER. THE GREEN FROG FEATURES ORANGE FEET AND EYES, WITH BLACK SLITS AND IS TRIMMED IN BLACK. THE FROG HAS A YELLOW MOUTH AND A BELLY THAT IS WHITE IN THE CENTER AND FADES TO YELLOW AROUND THE EDGES. THE FROG'S LEGS ARE GREEN WITH BLUE SHADING AT THE JOINTS, AND THE BACK LEGS HAVE YELLOW AND WHITE SHADING. THE REMAINDER OF THE STYLIZED WORD "CARIBE" IS IN THE SAME COLOR BLUE AS THE CAPITAL "C". UNDER THE WORD "CARIBE" AND POSITIONED TO THE RIGHT SIDE, IS THE STYLIZED CAPITAL WORDING "THE RESORT" IN AQUA BLUE.

THE ENGLISH TRANSLATION OF "CARIBE" IN THE MARK IS "CARIBBEAN".

SER. NO. 85-481,558, FILED S.R. 11-28-2011 AM. P.R. 3-26-2012.

MARCIE MILONE, EXAMINING ATTORNEY



David J. Kyros

Director of the United States Patent and Trademark Office

United States of America

United States Patent and Trademark Office

EDSI Solutions

Reg. No. 4,204,942

Registered Sep. 11, 2012

Int. Cl.: 35

SERVICE MARK

PRINCIPAL REGISTER

EDUCATIONAL DATA SYSTEMS INCORPORATED (MICHIGAN CORPORATION)
SUITE 200
15300 COMMERCE DRIVE NORTH
DEARBORN, MI 48120

FOR: CONSULTATION AND ANALYSIS REGARDING EMPLOYMENT AND JOB SKILLS, NAMELY, CONSULTATION IN THE FIELD OF HUMAN RESOURCES AND WORKFORCE DEVELOPMENT IN THE NATURE OF PERSONNEL MANAGEMENT, IN CLASS 35 (U.S. CLS. 100, 101 AND 102).

FIRST USE 1-31-2009; IN COMMERCE 1-31-2009.

THE MARK CONSISTS OF STANDARD CHARACTERS WITHOUT CLAIM TO ANY PARTICULAR FONT, STYLE, SIZE, OR COLOR.

NO CLAIM IS MADE TO THE EXCLUSIVE RIGHT TO USE "SOLUTIONS", APART FROM THE MARK AS SHOWN.

SER. NO. 85-481,749, FILED 11-28-2011.

LINDA ESTRADA, EXAMINING ATTORNEY



David J. Kyffers

Director of the United States Patent and Trademark Office

United States of America

United States Patent and Trademark Office

Axon

Reg. No. 4,204,943

WEST CENTRAL, INC. (MINNESOTA CORPORATION)
2700 TROTT AVE. SW
WILLMAR, MN 56201

Registered Sep. 11, 2012

Int. Cl.: 1

FOR: ADJUVANT FOR USE WITH AGRICULTURAL CHEMICALS; ADJUVANTS FOR USE WITH PESTICIDES; SURFACTANTS FOR USE IN CONNECTION WITH AGRICULTURAL PESTICIDES, IN CLASS 1 (U.S. CLS. 1, 5, 6, 10, 26 AND 46).

TRADEMARK

FIRST USE 5-26-2011; IN COMMERCE 5-31-2011.

PRINCIPAL REGISTER

THE MARK CONSISTS OF STANDARD CHARACTERS WITHOUT CLAIM TO ANY PARTICULAR FONT, STYLE, SIZE, OR COLOR.

SER. NO. 85-481,877, FILED 11-28-2011.

NICHOLAS ALTREE, EXAMINING ATTORNEY



David J. Kybas

Director of the United States Patent and Trademark Office

United States of America

United States Patent and Trademark Office

Plant A Tree For Life

Reg. No. 4,204,944

Registered Sep. 11, 2012

Int. Cl.: 31

TRADEMARK

PRINCIPAL REGISTER

WE ARE COMMUNITY FOUNDATION (CALIFORNIA CORPORATION)
1910 S. ARCHIBALD AVE
SUITE I
ONTARIO, CA 91761

FOR: LIVE PLANTS, IN CLASS 31 (U.S. CLS. 1 AND 46).

FIRST USE 3-7-2011; IN COMMERCE 4-1-2011.

THE MARK CONSISTS OF STANDARD CHARACTERS WITHOUT CLAIM TO ANY PARTICULAR FONT, STYLE, SIZE, OR COLOR.

NO CLAIM IS MADE TO THE EXCLUSIVE RIGHT TO USE "TREE", APART FROM THE MARK AS SHOWN.

SER. NO. 85-482,082, FILED 11-28-2011.

KATHERINE STOIDES, EXAMINING ATTORNEY



David J. Kybas

Director of the United States Patent and Trademark Office

United States of America

United States Patent and Trademark Office

GDCA

Reg. No. 4,204,945

Registered Sep. 11, 2012

Int. Cl.: 37

SERVICE MARK

PRINCIPAL REGISTER

GDCA, INC. (CALIFORNIA CORPORATION)
1799 PORTOLA AVENUE
LIVERMORE, CA 94550

FOR: REPAIR OF EMBEDDED ELECTRONIC PRODUCTS THAT MEET OEM SPECIFICATIONS, IN CLASS 37 (U.S. CLS. 100, 103 AND 106).

FIRST USE 6-30-2011; IN COMMERCE 6-30-2011.

THE MARK CONSISTS OF STANDARD CHARACTERS WITHOUT CLAIM TO ANY PARTICULAR FONT, STYLE, SIZE, OR COLOR.

SER. NO. 85-482,101, FILED 11-28-2011.

CHARLES L. JENKINS, EXAMINING ATTORNEY



David J. Kybas

Director of the United States Patent and Trademark Office

United States of America

United States Patent and Trademark Office

the
OWL  **360**

Reg. No. 4,204,946

THE OWL 360, LLC (CONNECTICUT LIMITED LIABILITY COMPANY)
112 SPRING STREET
GLASTONBURY, CT 06033

Registered Sep. 11, 2012

Int. Cl.: 9

FOR: SAFETY DEVICES FOR USE WITH BICYCLES IN THE NATURE OF AN ELECTRONIC CAMERA FEATURING A REAR VIEWING SCREEN, IN CLASS 9 (U.S. CLS. 21, 23, 26, 36 AND 38).

TRADEMARK

FIRST USE 9-1-2011; IN COMMERCE 9-14-2011.

PRINCIPAL REGISTER

NO CLAIM IS MADE TO THE EXCLUSIVE RIGHT TO USE "360", APART FROM THE MARK AS SHOWN.

THE MARK CONSISTS OF THE WORD "THE" WHICH IS SMALLER AND SUPERSCRIPED ABOVE THE SECOND WORD "OWL" WHICH IS FOLLOWED BY AN OUTLINE IMAGE OF AN OWL'S FACE AND UPPER BODY WHICH IS FOLLOWED BY THE NUMBER "360".

SER. NO. 85-482,110, FILED 11-28-2011.

NORA BUCHANAN WILL, EXAMINING ATTORNEY



David J. Kybas

Director of the United States Patent and Trademark Office

United States of America

United States Patent and Trademark Office

FALCONER'S FLIGHT 7C'S

Reg. No. 4,204,947

HOPUNION, L.L.C. (WASHINGTON LIMITED LIABILITY COMPANY)
203 DIVISION STREET
YAKIMA, WA 98902

Registered Sep. 11, 2012

Int. Cl.: 32

FOR: PROCESSED HOPS, NAMELY, PELLETIZED HOPS, IN CLASS 32 (U.S. CLS. 45, 46 AND 48).

TRADEMARK

FIRST USE 10-28-2011; IN COMMERCE 10-28-2011.

PRINCIPAL REGISTER

THE MARK CONSISTS OF STANDARD CHARACTERS WITHOUT CLAIM TO ANY PARTICULAR FONT, STYLE, SIZE, OR COLOR.

OWNER OF U.S. REG. NO. 4,039,720.

SER. NO. 85-482,771, FILED 11-29-2011.

SEAN CROWLEY, EXAMINING ATTORNEY



David J. Kyffers

Director of the United States Patent and Trademark Office

United States of America

United States Patent and Trademark Office



VERAMENDI
TRUE TEXAS HILL COUNTRY LIVING

Reg. No. 4,204,948

Registered Sep. 11, 2012

Int. Cls.: 35 and 37

SERVICE MARK

PRINCIPAL REGISTER

ASA PROPERTIES, LLC (TEXAS LIMITED LIABILITY COMPANY)
251 S. SEGUIN AVE
PO BOX 310699
NEW BRAUNFELS, TX 78131

FOR: REAL ESTATE MARKETING SERVICES IN THE FIELD OF MIXED USE DEVELOPMENT, RETAIL, PLANNED COMMUNITY, IN CLASS 35 (U.S. CLS. 100, 101 AND 102).

FIRST USE 5-1-2011; IN COMMERCE 5-1-2011.

FOR: CONSTRUCTION SERVICES, NAMELY, PLANNING, LAYING OUT AND CONSTRUCTION OF A PLANNED RESIDENTIAL COMMUNITY, IN CLASS 37 (U.S. CLS. 100, 103 AND 106).

FIRST USE 5-1-2011; IN COMMERCE 5-1-2011.

THE MARK CONSISTS OF A LARGE BROWN "V" THROUGH WHICH THREE WAVE-LIKE SHAPES ARE WOVEN TO REPRESENT THE ROLLING HILLS AND THE RIVER SURROUNDING THE COMMUNITY. THE "V" IS IN BROWN. THE TOP WAVE SHAPE IS DARK GREEN, THE MIDDLE AND LARGEST ONE IS LIGHT GREEN, AND THE BOTTOM ONE IS BLUE. UNDER THE "V", THE WORD "VERAMENDI" IN BROWN. BENEATH THE WORD "VERAMENDI", THE PHRASE "TRUE TEXAS HILL COUNTRY LIVING" APPEARS IN BLUE IN ALL CAPITAL LETTERS.

THE COLOR(S) BROWN, DARK GREEN, LIGHT GREEN, AND BLUE IS/ARE CLAIMED AS A FEATURE OF THE MARK.

SER. NO. 85-482,873, FILED 11-29-2011.

GRETTA YAO, EXAMINING ATTORNEY



David J. Kybas

Director of the United States Patent and Trademark Office

United States of America

United States Patent and Trademark Office



Reg. No. 4,204,949

Registered Sep. 11, 2012

Int. Cl.: 3

TRADEMARK

PRINCIPAL REGISTER

VO, THANH THUY DAO (UNITED STATES INDIVIDUAL)
SUITE 110-266
9360 W. FLAMINGO RD.
LAS VEGAS, NV 89147

FOR: LIP CREAM; LIP GLOSS; LIP POLISHER; NON-MEDICATED BALMS FOR USE ON LIPS AS A LIP VOLUME MAXIMIZER, IN CLASS 3 (U.S. CLS. 1, 4, 6, 50, 51 AND 52).

FIRST USE 11-1-2011; IN COMMERCE 11-1-2011.

NO CLAIM IS MADE TO THE EXCLUSIVE RIGHT TO USE "RX" AND "LIP PLUMPER", APART FROM THE MARK AS SHOWN.

THE MARK CONSISTS OF STYLIZED CURLING GRAPHICS ABOUT AND BELOW THE WORD: "SMILE SECRET RX" IN STYLIZED CURSIVE FONT WITH "SEXY LIP PLUMPER" BELOW IN STYLIZED STANDARD FONT.

SER. NO. 85-482,901, FILED 11-29-2011.

KELLY TRUSILO, EXAMINING ATTORNEY



David J. Kyjars

Director of the United States Patent and Trademark Office

United States of America

United States Patent and Trademark Office

FUTBOL MUNDIAL

Reg. No. 4,204,950

SENSACION MARKETING CREATIVES LLC (NEWYORK LIMITED LIABILITY COMPANY)
167 MADISON AVE. STE. 603
NEW YORK, NY 10016

Registered Sep. 11, 2012

Int. Cl.: 16

FOR: PUBLICATION, NAMELY, PERIODICAL MAGAZINE FEATURING ARTICLES RELATED TO THE SPORT OF SOCCER, IN CLASS 16 (U.S. CLS. 2, 5, 22, 23, 29, 37, 38 AND 50).

TRADEMARK

FIRST USE 1-1-2002; IN COMMERCE 5-1-2002.

PRINCIPAL REGISTER

THE MARK CONSISTS OF STANDARD CHARACTERS WITHOUT CLAIM TO ANY PARTICULAR FONT, STYLE, SIZE, OR COLOR.

NO CLAIM IS MADE TO THE EXCLUSIVE RIGHT TO USE "FUTBOL", APART FROM THE MARK AS SHOWN.

THE ENGLISH TRANSLATION OF "FUTBOL MUNDIAL" IN THE MARK IS "WORLD SOCCER".

SEC. 2(F).

SER. NO. 85-482,997, FILED 11-29-2011.

JAMES GRIFFIN, EXAMINING ATTORNEY



David J. Kyffers

Director of the United States Patent and Trademark Office

United States of America

United States Patent and Trademark Office



Pain Care Associates

Reg. No. 4,204,951

Registered Sep. 11, 2012

Int. Cl.: 44

SERVICE MARK

PRINCIPAL REGISTER

NEURO PAIN CONSULTANTS, P.C. (MICHIGAN PROFESSIONAL CORPORATION), DBA
PAIN CARE ASSOCIATES
799 DENISON COURT
BLOOMFIELD HILLS, MI 48302

FOR: HEALTH CARE, CONSISTING OF MULTI-DISCIPLINARY TEAM APPROACH TO
ACUTE AND CHRONIC PAIN MANAGEMENT, IN CLASS 44 (U.S. CLS. 100 AND 101).

FIRST USE 2-28-2006; IN COMMERCE 2-28-2006.

NO CLAIM IS MADE TO THE EXCLUSIVE RIGHT TO USE "PAIN CARE ASSOCIATES",
APART FROM THE MARK AS SHOWN.

THE MARK CONSISTS OF THE SILHOUETTE OF MAN HOLDING A BANNER WITH BOTH
HANDS AND THE WORDS "PAIN CARE ASSOCIATES".

SER. NO. 85-483,163, FILED 11-29-2011.

GINA HAYES, EXAMINING ATTORNEY



David J. Kybas

Director of the United States Patent and Trademark Office

United States of America

United States Patent and Trademark Office

**Neuro
Pain
Consultants**



Reg. No. 4,204,952

Registered Sep. 11, 2012

Int. Cl.: 44

SERVICE MARK

PRINCIPAL REGISTER

NEURO PAIN CONSULTANTS, P.C. (MICHIGAN PROFESSIONAL CORPORATION)
799 DENISON COURT
BLOOMFIELD HILLS, MI 48302

FOR: HEALTH CARE, CONSISTING OF MULTI-DISCIPLINARY APPROACH IN THE DIAGNOSIS AND TREATMENT OF ACUTE AND CHRONIC PAIN AND SURGERY OF THE BRAIN, SPINE AND PERIPHERAL NERVES, IN CLASS 44 (U.S. CLS. 100 AND 101).

FIRST USE 2-28-2006; IN COMMERCE 2-28-2006.

NO CLAIM IS MADE TO THE EXCLUSIVE RIGHT TO USE "NEURO PAIN CONSULTANTS", APART FROM THE MARK AS SHOWN.

THE MARK CONSISTS OF THE SILHOUETTE OF MAN HOLDING A BANNER WITH BOTH HANDS AND THE WORDS "NEURO PAIN CONSULTANTS".

SER. NO. 85-483,175, FILED 11-29-2011.

GINA HAYES, EXAMINING ATTORNEY



David J. Kyffers

Director of the United States Patent and Trademark Office

United States of America

United States Patent and Trademark Office



Center for Integrated Therapy

Reg. No. 4,204,953

Registered Sep. 11, 2012

Int. Cl.: 44

SERVICE MARK

PRINCIPAL REGISTER

NEURO PAIN CONSULTANTS, P.C. (MICHIGAN PROFESSIONAL CORPORATION), DBA
CENTER FOR INTEGRATED THERAPY
799 DENISON COURT
BLOOMFIELD HILLS, MI 48302

FOR: HEALTH CARE, CONSISTING OF BOTH TRADITIONAL AND NON-TRADITIONAL
PHYSICAL AND OTHER THERAPY SERVICES, IN CLASS 44 (U.S. CLS. 100 AND 101).

FIRST USE 2-28-2006; IN COMMERCE 2-28-2006.

NO CLAIM IS MADE TO THE EXCLUSIVE RIGHT TO USE "CENTER FOR INTEGRATED
THERAPY", APART FROM THE MARK AS SHOWN.

THE MARK CONSISTS OF THE SILHOUETTE OF MAN HOLDING A BANNER WITH BOTH
HANDS AND THE WORDS CENTER FOR INTEGRATED THERAPY.

SER. NO. 85-483,179, FILED 11-29-2011.

GINA HAYES, EXAMINING ATTORNEY



David J. Kyros

Director of the United States Patent and Trademark Office

United States of America

United States Patent and Trademark Office



Neurosurgical Consultants

Reg. No. 4,204,954

Registered Sep. 11, 2012

Int. Cl.: 44

SERVICE MARK

PRINCIPAL REGISTER

NEURO PAIN CONSULTANTS, P.C. (MICHIGAN PROFESSIONAL CORPORATION), DBA
NEUROSURGICAL CONSULTANTS
799 DENISON COURT
BLOOMFIELD HILLS, MI 48302

FOR: HEALTH CARE, CONSISTING OF SPECIALIZED SERVICES IN PAIN MANAGEMENT,
NEUROSURGICAL AND PHYSICAL THERAPY, IN CLASS 44 (U.S. CLS. 100 AND 101).

FIRST USE 2-28-2006; IN COMMERCE 2-28-2006.

NO CLAIM IS MADE TO THE EXCLUSIVE RIGHT TO USE "NEUROSURGICAL CONSULTANTS", APART FROM THE MARK AS SHOWN.

THE MARK CONSISTS OF THE SILHOUETTE OF MAN HOLDING A BANNER WITH BOTH HANDS AND THE WORDS "NEUROSURGICAL CONSULTANTS".

SER. NO. 85-483,186, FILED 11-29-2011.

GINA HAYES, EXAMINING ATTORNEY



David J. Kyjars

Director of the United States Patent and Trademark Office

United States of America

United States Patent and Trademark Office

CAL RANCH WINES

Reg. No. 4,204,955

Registered Sep. 11, 2012

Int. Cl.: 33

TRADEMARK

PRINCIPAL REGISTER

CAL RANCH, INC. (CALIFORNIA CORPORATION)
PO BOX 608
CLAYTON, CA 94517

FOR: WINES, IN CLASS 33 (U.S. CLS. 47 AND 49).

FIRST USE 7-1-2011; IN COMMERCE 10-15-2011.

THE MARK CONSISTS OF STANDARD CHARACTERS WITHOUT CLAIM TO ANY PARTICULAR FONT, STYLE, SIZE, OR COLOR.

NO CLAIM IS MADE TO THE EXCLUSIVE RIGHT TO USE "CAL" AND "WINES", APART FROM THE MARK AS SHOWN.

SER. NO. 85-483,216, FILED 11-30-2011.

KIMBERLY PARKS, EXAMINING ATTORNEY



David J. Kyffers

Director of the United States Patent and Trademark Office

United States of America

United States Patent and Trademark Office

MISS DISTRICT OF COLUMBIA TEEN USA

Reg. No. 4,204,956

MISS UNIVERSE L.P., LLLP (DELAWARE LIMITED PARTNERSHIP)
1370 AVENUE OF THE AMERICAS
NEW YORK, NY 10019

Registered Sep. 11, 2012

Int. Cl.: 41

FOR: ENTERTAINMENT SERVICES, NAMELY, BEAUTY PAGEANTS, IN CLASS 41 (U.S. CLS. 100, 101 AND 107).

SERVICE MARK

FIRST USE 8-0-1983; IN COMMERCE 8-0-1983.

PRINCIPAL REGISTER

THE MARK CONSISTS OF STANDARD CHARACTERS WITHOUT CLAIM TO ANY PARTICULAR FONT, STYLE, SIZE, OR COLOR.

NO CLAIM IS MADE TO THE EXCLUSIVE RIGHT TO USE "DISTRICT OF COLUMBIA TEEN", APART FROM THE MARK AS SHOWN.

SEC. 2(F) AS TO "USA".

SER. NO. 85-483,531, FILED 11-30-2011.

ZACHARY BELLO, EXAMINING ATTORNEY



David J. Kyffers

Director of the United States Patent and Trademark Office

United States of America

United States Patent and Trademark Office

HOME GALLERY

Reg. No. 4,204,957

Registered Sep. 11, 2012

Int. Cl.: 9

TRADEMARK

PRINCIPAL REGISTER

LIBERTY MUTUAL INSURANCE COMPANY (MASSACHUSETTS CORPORATION)
175 BERKELEY STREET
BOSTON, MA 02116

FOR: DOWNLOADABLE SOFTWARE IN THE NATURE OF A MOBILE APPLICATION FOR COLLECTING AND SAVING DATA FOR PURPOSES OF CREATING AN INVENTORY OF BELONGINGS , IN CLASS 9 (U.S. CLS. 21, 23, 26, 36 AND 38).

FIRST USE 12-23-2011; IN COMMERCE 12-23-2011.

THE MARK CONSISTS OF STANDARD CHARACTERS WITHOUT CLAIM TO ANY PARTICULAR FONT, STYLE, SIZE, OR COLOR.

NO CLAIM IS MADE TO THE EXCLUSIVE RIGHT TO USE "HOME", APART FROM THE MARK AS SHOWN.

SER. NO. 85-483,715, FILED 11-30-2011.

JORDAN BAKER, EXAMINING ATTORNEY



David J. Kybas

Director of the United States Patent and Trademark Office

United States of America

United States Patent and Trademark Office

TA-NON-KA

Reg. No. 4,204,958

Registered Sep. 11, 2012

Int. Cl.: 16

TRADEMARK

PRINCIPAL REGISTER

BPM INC. (MICHIGAN CORPORATION)
PO BOX 149
200 W. FRONT STREET
PESHTIGO, WI 54157

FOR: BOND PAPER; COPY PAPER, IN CLASS 16 (U.S. CLS. 2, 5, 22, 23, 29, 37, 38 AND 50).

FIRST USE 10-1-1931; IN COMMERCE 10-1-1931.

THE MARK CONSISTS OF STANDARD CHARACTERS WITHOUT CLAIM TO ANY PARTICULAR FONT, STYLE, SIZE, OR COLOR.

THE WORDING "TA-NON-KA" HAS NO MEANING IN A FOREIGN LANGUAGE.

SER. NO. 85-483,758, FILED 11-30-2011.

BERYL GARDNER, EXAMINING ATTORNEY



David J. Kybas

Director of the United States Patent and Trademark Office

United States of America

United States Patent and Trademark Office

DIAMOND MAXX

Reg. No. 4,204,959

Registered Sep. 11, 2012

Int. Cl.: 14

TRADEMARK

PRINCIPAL REGISTER

RADIUM ENTERPRISE, INC (TEXAS CORPORATION)
SUITE 272
7500 BELLAIRE BLVD.
LOS ANGELES, CA 90041

FOR: DIAMOND BRACELETS; DIAMOND JEWELRY; DIAMOND JEWELLERY AND WATCHES; DIAMOND JEWELRY WATCHES; DIAMOND POCKET WATCHES; DIAMOND STOP WATCHES; DIAMOND WATCHES; DIAMOND WATCHES AND JEWELRY; WOMEN'S DIAMOND JEWELRY; DIAMOND WRIST WATCHES, IN CLASS 14 (U.S. CLS. 2, 27, 28 AND 50).

FIRST USE 2-1-2010; IN COMMERCE 2-1-2010.

THE MARK CONSISTS OF STANDARD CHARACTERS WITHOUT CLAIM TO ANY PARTICULAR FONT, STYLE, SIZE, OR COLOR.

NO CLAIM IS MADE TO THE EXCLUSIVE RIGHT TO USE "DIAMOND", APART FROM THE MARK AS SHOWN.

SER. NO. 85-483,846, FILED 11-30-2011.

SHANNON TWOHIG, EXAMINING ATTORNEY



David J. Kyffers

Director of the United States Patent and Trademark Office

United States of America

United States Patent and Trademark Office



RECORDSAVE
GOVERNMENT RECORDS PRESERVATION

Reg. No. 4,204,960

Registered Sep. 11, 2012

Int. Cl.: 37

SERVICE MARK

PRINCIPAL REGISTER

HF GROUP, LLC (DELAWARE LIMITED LIABILITY COMPANY)
STE A
8834 MAYFIELD ROAD
CHESTERLAND, OH 44026

FOR: BOOK REPAIR AND RESTORATION, IN CLASS 37 (U.S. CLS. 100, 103 AND 106).

FIRST USE 11-30-2011; IN COMMERCE 11-30-2011.

NO CLAIM IS MADE TO THE EXCLUSIVE RIGHT TO USE "RECORDSAVE" AND "GOVERNMENT RECORDS PRESERVATION", APART FROM THE MARK AS SHOWN.

THE COLOR(S) RED, WHITE, LIGHT GRAY AND DARK GRAY IS/ARE CLAIMED AS A FEATURE OF THE MARK.

THE MARK CONSISTS OF A SHIELD WITH A SINGLE LINE IN LIGHT GRAY AND DARK GRAY COLORING FORMING THE SHIELD; IN THE UPPER LEFT CORNER OF THE SHIELD IS THE BLOCK LETTER "R" IN WHITE ON A RED BACKGROUND AND ON THE BOTTOM RIGHT OF THE SHIELD IS THE BLOCK LETTER "S" IN WHITE ON A RED BACKGROUND; THE UPPER RIGHT AND BOTTOM LEFT OF THE SHIELD ARE IN WHITE. TO THE RIGHT OF THE SHIELD IS THE WORD "RECORD" IN BLOCK RED LETTERS FOLLOWED WITHOUT A SPACE BY THE WORD "SAVE" IN DARK GRAY BLOCK LETTERS, BOTH APPEARING OVER THE WORDS "GOVERNMENT RECORDS PRESERVATION", ALL IN DARK GRAY LETTERS.

SER. NO. 85-483,851, FILED 11-30-2011.

SHAILA SETTLES, EXAMINING ATTORNEY



David J. Kyjars

Director of the United States Patent and Trademark Office

United States of America

United States Patent and Trademark Office

DOES YOUR BANK DO THAT?

Reg. No. 4,204,961

NAVYARMY COMMUNITY CREDIT UNION (TEXAS CREDIT UNION)

Registered Sep. 11, 2012

P.O. BOX 81349
CORPUS CHRISTI, TX 78468

Int. Cl.: 36

FOR: INSURANCE AND FINANCIAL SERVICES, NAMELY, CHECKING ACCOUNT SERVICES, ARRANGING AND PROVIDING AUTO LOANS, ARRANGING AND PROVIDING HOME EQUITY LOANS AND MORTGAGE LENDING; TERM SHARES, NAMELY, BANKING SERVICES FEATURING THE PROVISION OF CERTIFICATES OF DEPOSIT; SAVINGS ACCOUNT SERVICES; INTEREST RATES, NAMELY, PROVIDING INFORMATION IN THE FIELDS OF INTEREST RATE PRODUCTS VIA THE INTERNET AND INTRANET SYSTEMS; ATM BANKING SERVICES; ATM REIMBURSEMENT SERVICES, NAMELY, PROCESSING ELECTRONIC PAYMENTS MADE THROUGH AUTOMATED TELLER MACHINE CARDS, IN CLASS 36 (U.S. CLS. 100, 101 AND 102).

SERVICE MARK

PRINCIPAL REGISTER

FIRST USE 1-1-2010; IN COMMERCE 1-1-2010.

THE MARK CONSISTS OF STANDARD CHARACTERS WITHOUT CLAIM TO ANY PARTICULAR FONT, STYLE, SIZE, OR COLOR.

SER. NO. 85-483,863, FILED 11-30-2011.

MICHAEL TANNER, EXAMINING ATTORNEY



David J. Kybas

Director of the United States Patent and Trademark Office

United States of America

United States Patent and Trademark Office

cloud(n)

Reg. No. 4,204,962

VERIO INC. (DELAWARE CORPORATION)
8300 E. MAPLEWOOD AVENUE, SUITE 400
GREENWOOD VILLAGE, CO 80111

Registered Sep. 11, 2012

Int. Cl.: 42

FOR: COMPUTER SERVICES, NAMELY, CLOUD HOSTING PROVIDER SERVICES, IN CLASS 42 (U.S. CLS. 100 AND 101).

SERVICE MARK

FIRST USE 3-29-2012; IN COMMERCE 3-29-2012.

PRINCIPAL REGISTER

THE MARK CONSISTS OF STANDARD CHARACTERS WITHOUT CLAIM TO ANY PARTICULAR FONT, STYLE, SIZE, OR COLOR.

SER. NO. 85-484,249, FILED 11-30-2011.

NATALIE POLZER, EXAMINING ATTORNEY



David J. Kybas

Director of the United States Patent and Trademark Office

United States of America

United States Patent and Trademark Office

SALON AT THE DEL

Reg. No. 4,204,963

Registered Sep. 11, 2012

Int. Cl.: 44

SERVICE MARK

PRINCIPAL REGISTER

BSK DEL PARTNERS, LLC (DELAWARE LIMITED LIABILITY COMPANY)
C/O BLACKSTONE REAL ESTATE
345 PARK AVENUE
NEW YORK, NY 10154

FOR: BEAUTY SALON SERVICES; DAY SPA SERVICES, NAMELY, NAIL CARE, MANICURES, PEDICURES AND NAIL ENHANCEMENTS; HAIR SALON SERVICES, IN CLASS 44 (U.S. CLS. 100 AND 101).

FIRST USE 12-21-2011; IN COMMERCE 12-21-2011.

THE MARK CONSISTS OF STANDARD CHARACTERS WITHOUT CLAIM TO ANY PARTICULAR FONT, STYLE, SIZE, OR COLOR.

OWNER OF U.S. REG. NOS. 3,316,529, 3,499,002 AND OTHERS.

SER. NO. 85-484,374, FILED 11-30-2011.

SHAVELL MCPHERSON, EXAMINING ATTORNEY



David J. Kybas

Director of the United States Patent and Trademark Office

United States of America

United States Patent and Trademark Office

I want to give everything
away, but my wife won't
let me!

Reg. No. 4,204,964

DISCOUNT OPTICS, INC (FLORIDA CORPORATION)
1200 SOUTH ROGERS CIRCLE BLDG 13
BOCA RATON, FL 33487

Registered Sep. 11, 2012

Int. Cl.: 35

FOR: WHOLESALE DISTRIBUTORSHIPS FEATURING OPTICAL SUPPLIES, DENTAL SUPPLIES, AND MEDICAL SUPPLIES, NAMELY, PROVIDING PRODUCTS AND PROMOTIONAL SERVICES FOR OPTICAL OFFICES, MEDICAL OFFICES, RETAIL STORES, AND DENTAL OFFICES, IN CLASS 35 (U.S. CLS. 100, 101 AND 102).

SERVICE MARK

PRINCIPAL REGISTER

FIRST USE 0-0-1993; IN COMMERCE 0-0-1993.

THE MARK CONSISTS OF STANDARD CHARACTERS WITHOUT CLAIM TO ANY PARTICULAR FONT, STYLE, SIZE, OR COLOR.

SER. NO. 85-484,470, FILED 12-1-2011.

DORITT L. CARROLL, EXAMINING ATTORNEY



David J. Kybas

Director of the United States Patent and Trademark Office

United States of America

United States Patent and Trademark Office



Reg. No. 4,204,965

Registered Sep. 11, 2012

Int. Cl.: 9

TRADEMARK

PRINCIPAL REGISTER

IQUEST ANALYTICS, INC. (MASSACHUSETTS CORPORATION)
18 MAPLE AVENUE, SUITE #252
BARRINGTON, RI 02806

FOR: COMPUTER SOFTWARE FOR CREATING SEARCHABLE DATABASES OF INFORMATION AND DATA; COMPUTER SOFTWARE AND HARDWARE FOR SEMANTIC SEARCHING, RESEARCHING AND ANALYSIS OF DOCUMENTS, IN CLASS 9 (U.S. CLS. 21, 23, 26, 36 AND 38).

FIRST USE 1-1-2011; IN COMMERCE 1-1-2011.

OWNER OF U.S. REG. NOS. 3,051,677, 3,101,665, AND 3,210,228.

THE COLOR(S) LIGHT BLUE AND BLACK IS/ARE CLAIMED AS A FEATURE OF THE MARK.

THE MARK CONSISTS OF A STYLIZED LOWERCASE LETTER "I" INSIDE A CAPITAL LETTER "Q"; BELOW THIS IS THE STYLIZED WORDING "IQUEST". ALL THESE APPEAR IN BLACK COLOR EXCEPT THE TITLE OF THE LOWERCASE LETTER "I", WHICH APPEARS IN LIGHT BLUE COLOR.

SER. NO. 85-484,636, FILED 12-1-2011.

DAWN HAN, EXAMINING ATTORNEY



David J. Kyros

Director of the United States Patent and Trademark Office

United States of America

United States Patent and Trademark Office

STORYKEEP

Reg. No. 4,204,966

Registered Sep. 11, 2012

Int. Cl.: 41

SERVICE MARK

PRINCIPAL REGISTER

STORYKEEP (NEW YORK PARTNERSHIP)
540 PRESIDENT STREET, SUITE 1G
BROOKLYN, NY 11215

FOR: MULTIMEDIA PRODUCTION SERVICES FEATURING AUDIO, VIDEO, PHOTOGRAPHIC AND PROSE PRESENTATIONS IN THE NATURE OF PERSONALIZED STORIES OF INDIVIDUALS AND FAMILIES FOR THE PURPOSE OF PRESERVATION, IN CLASS 41 (U.S. CLS. 100, 101 AND 107).

FIRST USE 3-25-2011; IN COMMERCE 3-25-2011.

THE MARK CONSISTS OF STANDARD CHARACTERS WITHOUT CLAIM TO ANY PARTICULAR FONT, STYLE, SIZE, OR COLOR.

SER. NO. 85-485,171, FILED 12-1-2011.

KHANH LE, EXAMINING ATTORNEY



David J. Kyffers

Director of the United States Patent and Trademark Office

United States of America

United States Patent and Trademark Office



Reg. No. 4,204,967

Registered Sep. 11, 2012

Int. Cl.: 43

SERVICE MARK

PRINCIPAL REGISTER

LEGEND PETROLEUM LLC. (FLORIDA LIMITED LIABILITY COMPANY), TA TANDOOR
AND CURRY
SAME
1730 S MILITARY TRAIL
WEST PALM BEACH, FL 33415

FOR: RESTAURANT SERVICES, IN CLASS 43 (U.S. CLS. 100 AND 101).

FIRST USE 8-15-2011; IN COMMERCE 8-15-2011.

NO CLAIM IS MADE TO THE EXCLUSIVE RIGHT TO USE "TANDOOR & CURRY" AND
THE PICTORIAL REPRESENTATION OF A CURRY DISH, APART FROM THE MARK AS
SHOWN.

THE COLOR(S) BROWN, TAN, SILVER, GREEN, RED AND WHITE IS/ARE CLAIMED AS
A FEATURE OF THE MARK.

THE MARK CONSISTS OF A SIGN HANGING ON A SILVER ROD WITH TWO SILVER
CHAINS ATTACHED, THE OVAL IS OUTLINED IN THE COLOR RED WITH A BROWN
BACKGROUND IN THE CENTER APPEARS A PICTURE OF FOOD WITH RED SAUCE,
WHITE ONIONS AND GREEN CILANTRO, THE PAN APPEARS IN THE COLOR TAN AND
IS OUTLINED IN RED WITH TWO GREEN CILANTRO LEAVES BENEATH, THE WORDING.

SER. NO. 85-485,210, FILED 12-1-2011.

JAY FLOWERS, EXAMINING ATTORNEY



David J. Kyffers

Director of the United States Patent and Trademark Office

United States of America

United States Patent and Trademark Office

HUNT DRY

Reg. No. 4,204,968

WILDLIFE RESEARCH CENTER, INC. (MINNESOTA CORPORATION)
14485 AZURITE STREET NW
RAMSEY, MN 55303

Registered Sep. 11, 2012

Int. Cl.: 28

FOR: SCENT ELIMINATION PRODUCTS, NAMELY, SPRAYS FOR USE ASSOCIATED WITH HUNTING AND OUTDOOR RECREATION; HUNTERS' SCENT CAMOUFLAGE TO MASK AND COVER HUMAN ODOR, IN CLASS 28 (U.S. CLS. 22, 23, 38 AND 50).

TRADEMARK

FIRST USE 3-30-2012; IN COMMERCE 3-30-2012.

PRINCIPAL REGISTER

THE MARK CONSISTS OF STANDARD CHARACTERS WITHOUT CLAIM TO ANY PARTICULAR FONT, STYLE, SIZE, OR COLOR.

NO CLAIM IS MADE TO THE EXCLUSIVE RIGHT TO USE "HUNT", APART FROM THE MARK AS SHOWN.

SER. NO. 85-485,519, FILED 12-2-2011.

JAMES GRIFFIN, EXAMINING ATTORNEY



David J. Kyffers

Director of the United States Patent and Trademark Office

United States of America
United States Patent and Trademark Office

Conocopia

Reg. No. 4,204,969

ROC TON MANAGEMENT GROUP LLC (TEXAS LIMITED LIABILITY COMPANY)
6331 LLANO AVE
DALLAS, TX 75214

Registered Sep. 11, 2012

Int. Cl.: 11

FOR: RESTAURANT EQUIPMENT, NAMELY, BAKING FORM MACHINES, CONVECTION OVENS, HEATED DISPLAY CASES, IN CLASS 11 (U.S. CLS. 13, 21, 23, 31 AND 34).

TRADEMARK

FIRST USE 10-1-2011; IN COMMERCE 10-1-2011.

PRINCIPAL REGISTER

THE MARK CONSISTS OF STANDARD CHARACTERS WITHOUT CLAIM TO ANY PARTICULAR FONT, STYLE, SIZE, OR COLOR.

SER. NO. 85-485,533, FILED 12-2-2011.

TOBY BULLOFF, EXAMINING ATTORNEY



David J. Kybas

Director of the United States Patent and Trademark Office

United States of America

United States Patent and Trademark Office

PRO-ENROLL

Reg. No. 4,204,970

PAYLOGIX LLC (NEW YORK LIMITED LIABILITY COMPANY)
1025 OLD COUNTRY ROAD, SUITE 310
WESTBURY, NY 11590

Registered Sep. 11, 2012

Int. Cls.: 36 and 42

FOR: PROVIDING A WEBSITE FEATURING EDUCATIONAL INFORMATION REGARDING FINANCE, INSURANCE AND HEALTHCARE BENEFIT OPTIONS FOR EMPLOYEES AND A MEANS FOR EMPLOYEES TO EFFECT BENEFIT ELECTIONS, IN CLASS 36 (U.S. CLS. 100, 101 AND 102).

SERVICE MARK

PRINCIPAL REGISTER

FIRST USE 10-10-2011; IN COMMERCE 10-10-2011.

FOR: APPLICATION SERVICE PROVIDER (ASP) FEATURING SOFTWARE FOR EMPLOYEES TO ACCESS EMPLOYER SPONSORED HEALTH AND WELFARE BENEFIT OPTIONS, IN CLASS 42 (U.S. CLS. 100 AND 101).

FIRST USE 10-10-2011; IN COMMERCE 10-10-2011.

THE MARK CONSISTS OF STANDARD CHARACTERS WITHOUT CLAIM TO ANY PARTICULAR FONT, STYLE, SIZE, OR COLOR.

SER. NO. 85-485,553, FILED 12-2-2011.

MARLENE BELL, EXAMINING ATTORNEY



David J. Kybas

Director of the United States Patent and Trademark Office

United States of America

United States Patent and Trademark Office



Reg. No. 4,204,971

Registered Sep. 11, 2012

Int. Cl.: 42

SERVICE MARK

PRINCIPAL REGISTER

DOTQS, INC. (ILLINOIS CORPORATION)
742 N. LASALLE DRIVE SUITE 400
CHICAGO, IL 60654

FOR: QUALITY MANAGEMENT SERVICES, NAMELY, QUALITY EVALUATION AND ANALYSIS, QUALITY ASSURANCE, AND QUALITY CONTROL, IN THE FIELD OF BRIDGE CONSTRUCTION, BUILDING CONSTRUCTION, STRUCTURAL STEEL ERECTION, STRUCTURAL STEEL FABRICATION, TELECOMMUNICATIONS, PHARMACEUTICALS, AND QUALITY MANAGEMENT SYSTEMS; TESTING, ANALYSIS, AND EVALUATION OF THE KNOWLEDGE, SKILLS AND ABILITIES OF OTHERS FOR THE PURPOSE OF CERTIFICATION AND RE-CERTIFICATION IN THE FIELD OF BRIDGE CONSTRUCTION, BUILDING CONSTRUCTION, STRUCTURAL STEEL ERECTION, STRUCTURAL STEEL FABRICATION, TELECOMMUNICATIONS, PHARMACEUTICALS, AND QUALITY MANAGEMENT SYSTEMS, IN CLASS 42 (U.S. CLS. 100 AND 101).

FIRST USE 6-1-2011; IN COMMERCE 6-1-2011.

THE MARK CONSISTS OF AN IMAGE OF THE STYLIZED WORD "DOTQS" TO THE RIGHT OF A STYLIZED IMAGE OF A BRIDGE.

SER. NO. 85-485,572, FILED 12-2-2011.

MARLENE BELL, EXAMINING ATTORNEY



David J. Kyjars

Director of the United States Patent and Trademark Office

United States of America

United States Patent and Trademark Office

MGAC

Reg. No. 4,204,972

Registered Sep. 11, 2012

Int. Cls.: 35 and 37

SERVICE MARK

PRINCIPAL REGISTER

MARK G. ANDERSON CONSULTANTS, INC. (D.C. CORPORATION)
730 ELEVENTH STREET, NW
WASHINGTON, DC 20001

FOR: BUSINESS MANAGEMENT CONSULTING SERVICES IN THE FIELD OF BUILDING DESIGN AND CONSTRUCTION; PROVIDING CONSULTATION SERVICES IN PROCUREMENT, NAMELY, PROCURING CONTRACTS AND PURCHASING GOODS AND SERVICES FOR OTHERS IN THE FIELD OF BUILDING DESIGN AND CONSTRUCTION; BUSINESS SERVICES, NAMELY, FACILITIES MANAGEMENT OF TECHNICAL OPERATIONS; PROJECT MANAGEMENT FOR BUSINESS PURPOSES IN THE FIELD OF BUILDING DESIGN, IN CLASS 35 (U.S. CLS. 100, 101 AND 102).

FIRST USE 11-1-2011; IN COMMERCE 11-1-2011.

FOR: PROJECT MANAGEMENT IN THE FIELD OF CONSTRUCTION, IN CLASS 37 (U.S. CLS. 100, 103 AND 106).

FIRST USE 11-1-2011; IN COMMERCE 11-1-2011.

THE MARK CONSISTS OF STANDARD CHARACTERS WITHOUT CLAIM TO ANY PARTICULAR FONT, STYLE, SIZE, OR COLOR.

SER. NO. 85-486,155, FILED 12-2-2011.

AMY KELLY, EXAMINING ATTORNEY



David J. Kyffers

Director of the United States Patent and Trademark Office

United States of America

United States Patent and Trademark Office

Cook'n

Reg. No. 4,204,973

Registered Sep. 11, 2012

Int. Cl.: 9

TRADEMARK

PRINCIPAL REGISTER

DVO ENTERPRISES (UTAH CORPORATION)
620 WINDSOR CT
ALPINE, UT 84004

FOR: COMPUTER APPLICATION SOFTWARE FOR MOBILE PHONES, NAMELY, SOFTWARE FOR FINDING AND MANAGING RECIPES; COMPUTER APPLICATION SOFTWARE FOR COMPUTERS, NAMELY, SOFTWARE FOR FINDING AND MANAGING RECIPES, IN CLASS 9 (U.S. CLS. 21, 23, 26, 36 AND 38).

FIRST USE 5-1-1995; IN COMMERCE 5-1-1995.

THE MARK CONSISTS OF STANDARD CHARACTERS WITHOUT CLAIM TO ANY PARTICULAR FONT, STYLE, SIZE, OR COLOR.

SEC. 2(F).

SER. NO. 85-486,274, FILED 12-2-2011.

CURTIS FRENCH, EXAMINING ATTORNEY



David J. Kyffers

Director of the United States Patent and Trademark Office

United States of America

United States Patent and Trademark Office



Reg. No. 4,204,974

Registered Sep. 11, 2012

Int. Cl.: 43

SERVICE MARK

PRINCIPAL REGISTER

SANJAY PATEL (INDIA INDIVIDUAL), DBA BOLLYWOOD BITES
14033 BESSEMER ST. # 206
VAN NUYS, CA 91401

FOR: CONTRACT FOOD SERVICES; FAST-FOOD RESTAURANT SERVICES; FOOD PREPARATION SERVICES; PROVIDING OF FOOD AND DRINK VIA A MOBILE TRUCK; RESTAURANT SERVICES, INCLUDING SIT-DOWN SERVICE OF FOOD AND TAKE-OUT RESTAURANT SERVICES, IN CLASS 43 (U.S. CLS. 100 AND 101).

FIRST USE 12-15-2010; IN COMMERCE 1-6-2011.

NO CLAIM IS MADE TO THE EXCLUSIVE RIGHT TO USE "BITES", APART FROM THE MARK AS SHOWN.

THE COLOR(S) GOLDEN, BLACK, GRAY, SAFFRON, WHITE, GREEN, ORANGE, RED IS/ARE CLAIMED AS A FEATURE OF THE MARK.

THE MARK CONSISTS OF BLACK CIRCLE WITH GOLDEN BOUNDARY; INSIDE IS BIG GRAY STAR CONTAINING A GOLDEN PLATE WITH A GOLDEN FORK, GOLDEN KNIFE, AND GOLDEN SPOON; OUTSIDE THE CIRCLE ARE SMALL STARS OF SAFFRON, WHITE, AND GREEN COLORS; AND "BOLLYWOOD BITES" WRITTEN AT THE BOTTOM IN 2D STYLE IN ORANGE COLOR WITH RED SHADE.

SER. NO. 85-486,559, FILED 12-3-2011.

GINA HAYES, EXAMINING ATTORNEY



David J. Kybas

Director of the United States Patent and Trademark Office

United States of America

United States Patent and Trademark Office



Reg. No. 4,204,975

Registered Sep. 11, 2012

Int. Cl.: 3

TRADEMARK

PRINCIPAL REGISTER

HAYADI, INC. (VIRGINIA CORPORATION)
7728 HICKORY GLEN WAY
SPRINGFIELD, VA 22153

FOR: HAIR CARE PRODUCTS, NAMELY, SHAMPOO, CONDITIONER, RELAXER, FIXATIVE, MOISTURIZER, LOTION AND HAIR DRESSING, IN CLASS 3 (U.S. CLS. 1, 4, 6, 50, 51 AND 52).

FIRST USE 1-11-2011; IN COMMERCE 1-11-2011.

THE MARK CONSISTS OF AN OUTLINE OF A FACE WITH HAIR IN THE FORM OF TREE LEAVES.

SER. NO. 85-487,091, FILED 12-5-2011.

MELISSA VALLILLO, EXAMINING ATTORNEY



David J. Kyffers

Director of the United States Patent and Trademark Office

United States of America

United States Patent and Trademark Office

iSHRINK

Reg. No. 4,204,976

Registered Sep. 11, 2012

Int. Cl.: 7

TRADEMARK

PRINCIPAL REGISTER

MCLAREN STAINLESS LIMITED (NEW ZEALAND LIMITED LIABILITY COMPANY)
1019 MANCHESTER STREET
HASTINGS 4120, NEW ZEALAND

FOR: MACHINES AND MACHINE TOOLS, NAMELY, SHRINK WRAPPING MACHINES AND SHRINK WRAPPING MACHINE TOOLS, MACHINES AND MACHINE TOOLS FOR PACKAGING, WRAPPING AND SHRINK WRAPPING FOOD AND BEVERAGES; MACHINES AND MACHINE TOOLS FOR THE PROCESSING AND PREPARATION OF FOOD AND BEVERAGES, IN CLASS 7 (U.S. CLS. 13, 19, 21, 23, 31, 34 AND 35).

THE MARK CONSISTS OF STANDARD CHARACTERS WITHOUT CLAIM TO ANY PARTICULAR FONT, STYLE, SIZE, OR COLOR.

OWNER OF NEW ZEALAND REG. NO. 832875, DATED 5-9-2011, EXPIRES 11-5-2020.

SER. NO. 85-487,263, FILED 12-5-2011.

ANDREA K. NADELMAN, EXAMINING ATTORNEY



David J. Kyffers

Director of the United States Patent and Trademark Office

United States of America

United States Patent and Trademark Office

iDRY

Reg. No. 4,204,977

Registered Sep. 11, 2012

Int. Cl.: 7

TRADEMARK

PRINCIPAL REGISTER

MCLAREN STAINLESS LIMITED (NEW ZEALAND LIMITED LIABILITY COMPANY)
1019 MANCHESTER STREET
HASTINGS 4120, NEW ZEALAND

FOR: MACHINES AND MACHINE TOOLS FOR DRYING, PRESERVING, PACKAGING AND STORING OF FOOD AND BEVERAGES; MACHINES AND MACHINE TOOLS FOR THE PROCESSING AND PREPARATION OF FOODS AND BEVERAGES, IN CLASS 7 (U.S. CLS. 13, 19, 21, 23, 31, 34 AND 35).

THE MARK CONSISTS OF STANDARD CHARACTERS WITHOUT CLAIM TO ANY PARTICULAR FONT, STYLE, SIZE, OR COLOR.

OWNER OF NEW ZEALAND REG. NO. 832874, DATED 5-9-2011, EXPIRES 11-5-2020.

SER. NO. 85-487,305, FILED 12-5-2011.

ANDREA K. NADELMAN, EXAMINING ATTORNEY



David J. Kybas

Director of the United States Patent and Trademark Office

United States of America

United States Patent and Trademark Office

CAMARILLO HOSPICE

Reg. No. 4,204,978

Registered Sep. 11, 2012

Int. Cl.: 45

SERVICE MARK

PRINCIPAL REGISTER

CAMARILLO HOSPICE CORPORATION (CALIFORNIA CORPORATION)
400 ROSEWOOD AVENUE #102
CAMARILLO, CA 93010

FOR: CHARITABLE OUTREACH SERVICES, NAMELY, PROVIDING COUNSELING SERVICES IN THE FIELD OF GRIEF AND BEREAVEMENT SUPPORT; PROVIDING NON-MEDICAL IN-HOME PERSONAL SERVICES FOR INDIVIDUALS INCLUDING CHECKING HOME CONDITION, SUPPLIES AND INDIVIDUAL WELL-BEING, SCHEDULING APPOINTMENTS, RUNNING ERRANDS, MAKING SAFETY CHECKS, AND PROVIDING ON-LINE INFORMATION RELATED TO THESE PERSONAL SERVICES, IN CLASS 45 (U.S. CLS. 100 AND 101).

FIRST USE 4-8-1979; IN COMMERCE 4-30-1979.

THE MARK CONSISTS OF STANDARD CHARACTERS WITHOUT CLAIM TO ANY PARTICULAR FONT, STYLE, SIZE, OR COLOR.

NO CLAIM IS MADE TO THE EXCLUSIVE RIGHT TO USE "HOSPICE" , APART FROM THE MARK AS SHOWN.

SEC. 2(F).

SER. NO. 85-487,448, FILED 12-6-2011.

ZACHARY BELLO, EXAMINING ATTORNEY



David J. Kyffers

Director of the United States Patent and Trademark Office

United States of America

United States Patent and Trademark Office

O BY KIMBERLY OVITZ

Reg. No. 4,204,979

KIM OVITZ DESIGN INC. (NEW YORK CORPORATION)
401 BROADWAY, SUITE 1812
NEW YORK, NY 10013

Registered Sep. 11, 2012

Int. Cl.: 25

FOR: BELTS, SCARVES, PANTS, JEANS, FOOTWEAR, IN CLASS 25 (U.S. CLS. 22 AND 39).

TRADEMARK

FIRST USE 2-16-2012; IN COMMERCE 2-16-2012.

PRINCIPAL REGISTER

THE MARK CONSISTS OF STANDARD CHARACTERS WITHOUT CLAIM TO ANY PARTICULAR FONT, STYLE, SIZE, OR COLOR.

THE NAME(S), PORTRAIT(S), AND/OR SIGNATURE(S) SHOWN IN THE MARK IDENTIFIES "KIMBERLY OVITZ", WHOSE CONSENT(S) TO REGISTER IS MADE OF RECORD.

SER. NO. 85-488,540, FILED 12-6-2011.

ANNE MADDEN, EXAMINING ATTORNEY



David J. Kybas

Director of the United States Patent and Trademark Office

United States of America

United States Patent and Trademark Office

INSTANT GAVEL

Reg. No. 4,204,980

CONCIERGE AUCTIONS LLC (FLORIDA LIMITED LIABILITY COMPANY)
527 MADISON AVENUE, 18TH FLOOR
NEW YORK, NY 10022

Registered Sep. 11, 2012

Int. Cl.: 35

FOR: REAL ESTATE AUCTION SERVICES; ON-LINE AUCTION SERVICES; ON-LINE REAL ESTATE AUCTION SERVICES, IN CLASS 35 (U.S. CLS. 100, 101 AND 102).

SERVICE MARK

FIRST USE 6-30-2011; IN COMMERCE 6-30-2011.

PRINCIPAL REGISTER

THE MARK CONSISTS OF STANDARD CHARACTERS WITHOUT CLAIM TO ANY PARTICULAR FONT, STYLE, SIZE, OR COLOR.

SER. NO. 85-488,940, FILED 12-6-2011.

REGINA DRUMMOND, EXAMINING ATTORNEY



David J. Kybas

Director of the United States Patent and Trademark Office

United States of America

United States Patent and Trademark Office

N2IT

Reg. No. 4,204,981

N2IT CONTAINERS (TEXAS LIMITED LIABILITY COMPANY)
MURPHY STREET
HOUSTON, TX 77033

Registered Sep. 11, 2012

**Int. Cls.: 16, 20, 35 and
40**

FOR: CORRUGATED BOARD CONTAINERS, IN CLASS 16 (U.S. CLS. 2, 5, 22, 23, 29, 37, 38 AND 50).

FIRST USE 1-0-2000; IN COMMERCE 1-0-2000.

TRADEMARK

FOR: CONTAINERS, NOT OF METAL, FOR COMMERCIAL AND INDUSTRIAL USE, IN CLASS 20 (U.S. CLS. 2, 13, 22, 25, 32 AND 50).

SERVICE MARK

PRINCIPAL REGISTER

FIRST USE 1-0-2000; IN COMMERCE 1-0-2000.

FOR: DISTRIBUTORSHIP SERVICES IN THE FIELD OF CONTAINERS FOR COMMERCIAL AND INDUSTRIAL USE, IN CLASS 35 (U.S. CLS. 100, 101 AND 102).

FIRST USE 1-0-2000; IN COMMERCE 1-0-2000.

FOR: CUSTOM MANUFACTURE OF CONTAINERS, IN CLASS 40 (U.S. CLS. 100, 103 AND 106).

FIRST USE 1-0-2000; IN COMMERCE 1-0-2000.

THE MARK CONSISTS OF STANDARD CHARACTERS WITHOUT CLAIM TO ANY PARTICULAR FONT, STYLE, SIZE, OR COLOR.

SER. NO. 85-489,060, FILED 12-7-2011.

JULIE WATSON, EXAMINING ATTORNEY



David J. Kybas

Director of the United States Patent and Trademark Office

United States of America

United States Patent and Trademark Office



Reg. No. 4,204,982

FOREM PACKAGING, INC. (NEW JERSEY CORPORATION)
41 JOSEPH STREET
NEWARK, NJ 07105

Registered Sep. 11, 2012

Int. Cl.: 16

FOR: PLASTIC BAGS FOR OTHERS TO PACKAGE THEIR PRODUCTS, IN CLASS 16 (U.S. CLS. 2, 5, 22, 23, 29, 37, 38 AND 50).

TRADEMARK

FIRST USE 12-31-2002; IN COMMERCE 12-31-2002.

PRINCIPAL REGISTER

THE MARK CONSISTS OF THE WORD "RITE" IN CURSIVE SCRIPT ABOVE THE WORD "CHOICE" IN BLOCK LETTERS, ON A FIELD CONSISTING OF A RECTANGULAR BAND, ABOVE WHICH SITS A SUN, AND HAVING A CHECK MARK ACROSS THE DESIGN, UNDERNEATH THE WORDING.

SER. NO. 85-489,517, FILED 12-7-2011.

PRISCILLA MILTON, EXAMINING ATTORNEY



David J. Kyffers

Director of the United States Patent and Trademark Office

United States of America

United States Patent and Trademark Office



Reg. No. 4,204,983

Registered Sep. 11, 2012

CERTIFIED ONIONS, INC. (OREGON CORPORATION)
PO BOX 1606
NYSSA, OR 97913

CERTIFICATION MARK

FOR: ONIONS, IN CLASS A (U.S. CL. A).

PRINCIPAL REGISTER

FIRST USE 8-31-2009; IN COMMERCE 8-31-2009.

NO CLAIM IS MADE TO THE EXCLUSIVE RIGHT TO USE "CERTIFIED ONIONS, INC." AND "CHEMICAL RESIDUE TESTED", APART FROM THE MARK AS SHOWN.

THE COLOR(S) WHITE, RED AND GREEN IS/ARE CLAIMED AS A FEATURE OF THE MARK.

THE MARK CONSISTS OF A GREEN CIRCLE WITH THE WORDING "CERTIFIED ONIONS INC. CHEMICAL RESIDUE TESTED", APPEARING IN THE COLOR WHITE, THE CENTER OF THE CIRCLE CONTAINS A DESIGN WHICH RESEMBLES AN ONION IN THE COLOR WHITE, AND A LARGE RED CHECK MARK STARTS INSIDE THE CIRCLE AND EXTENDS BEYOND THE CIRCLE BORDER.

THE CERTIFICATION MARK, AS USED BY AUTHORIZED PERSONS, CERTIFIES ONIONS MARKETED FROM THE IDAHO OR OREGON GROWING AREA ARE TESTED BY THIRD PARTY FIELD AND FACILITIES TESTERS FOR PESTICIDE RESIDUE AND THE PRESENCE OF UNDESIRABLE PATHOGENS.

SER. NO. 85-489,599, FILED 12-7-2011.

JAY FLOWERS, EXAMINING ATTORNEY



David J. Kyjars

Director of the United States Patent and Trademark Office

United States of America

United States Patent and Trademark Office

MAHEE

Reg. No. 4,204,984

Registered Sep. 11, 2012

**Int. Cls.: 9, 35, 38, 41
and 42**

TRADEMARK

SERVICE MARK

PRINCIPAL REGISTER

CMC ONLINE S.R.O. (CZECH REPUBLIC LIMITED LIABILITY COMPANY)
MUSILKOVA 1303/22
PRAHA 5, CZECH REPUBLIC 15000

FOR: COMPUTER GAME PROGRAMMES DOWNLOADABLE VIA THE INTERNET; COMPUTER GAME SOFTWARE; COMPUTER GAME SOFTWARE FOR USE ON MOBILE AND CELLULAR PHONES; INTERACTIVE VIDEO GAME PROGRAMS; INTERNET SERVERS, IN CLASS 9 (U.S. CLS. 21, 23, 26, 36 AND 38).

FOR: ADVERTISEMENT FOR OTHERS ON THE INTERNET; ADVERTISING SERVICES; DIRECT MAIL ADVERTISING SERVICES; INTERNET ADVERTISING SERVICES; ONLINE ADVERTISEMENTS, IN CLASS 35 (U.S. CLS. 100, 101 AND 102).

FOR: DATA COMMUNICATION BY ELECTRONIC MAIL; PROVIDING INTERNET CHAT-ROOMS; TRANSMISSION AND DISTRIBUTION OF DATA OR AUDIO VISUAL IMAGES VIA A GLOBAL COMPUTER NETWORK OR THE INTERNET; VIDEO BROADCASTING SERVICES OVER THE INTERNET OR OTHER COMMUNICATIONS NETWORK, NAMELY, ELECTRONICALLY TRANSMITTING VIDEO CLIPS, IN CLASS 38 (U.S. CLS. 100, 101 AND 104).

FOR: ELECTRONIC GAMES SERVICES PROVIDED BY MEANS OF THE INTERNET; ENTERTAINMENT SERVICES, NAMELY, PROVIDING ON-LINE COMPUTER GAMES; PROVISION OF INFORMATION RELATING TO ELECTRONIC COMPUTER GAMES PROVIDED VIA THE INTERNET, IN CLASS 41 (U.S. CLS. 100, 101 AND 107).

FOR: COMPUTER PROGRAMMING OF COMPUTER GAMES; DESIGNING AND DEVELOPING COMPUTER GAME SOFTWARE AND VIDEO GAME SOFTWARE FOR USE WITH COMPUTERS, VIDEO GAME PROGRAM SYSTEMS AND COMPUTER NETWORKS; DESIGNING AND MODIFYING COMPUTER PROGRAMS AND VIDEO GAMES FOR OTHERS; WEB PUBLISHING, NAMELY, CREATING A WEBSITE AND UPLOADING IT ONTO AN INTERNET SERVER, IN CLASS 42 (U.S. CLS. 100 AND 101).

THE MARK CONSISTS OF STANDARD CHARACTERS WITHOUT CLAIM TO ANY PARTICULAR FONT, STYLE, SIZE, OR COLOR.

PRIORITY CLAIMED UNDER SEC. 44(D) ON ERPN CMNTY TM OFC APPLICATION NO. 010444586, FILED 11-24-2011, REG. NO. 010444586, DATED 4-12-2012, EXPIRES 11-24-2021.



David J. Kyjars

Director of the United States Patent and Trademark Office

Reg. No. 4,204,984 SER. NO. 85-490,283, FILED 12-8-2011.

CHRIS WELLS, EXAMINING ATTORNEY

United States of America

United States Patent and Trademark Office



Reg. No. 4,204,985

Registered Sep. 11, 2012

Int. Cls.: 25 and 41

TRADEMARK

SERVICE MARK

PRINCIPAL REGISTER

BOYD, MICHAEL (UNITED STATES INDIVIDUAL)
7821 SANCOLA AVENUE
SUN VALLEY, CA 91352

FOR: CLOTHING, NAMELY, T-SHIRTS, SWEATSHIRTS, TANK TOPS, WOVEN SHIRTS, SWEATERS, JACKETS, PANTS, SWEATPANTS, SHORTS, HATS, CAPS, COATS, SHOES, SOCKS, SKIRTS, DRESSES, BLOUSES, IN CLASS 25 (U.S. CLS. 22 AND 39).

FIRST USE 4-0-2002; IN COMMERCE 4-0-2002.

FOR: ENTERTAINMENT SERVICES IN THE NATURE OF BASEBALL TYPE GAMES, IN CLASS 41 (U.S. CLS. 100, 101 AND 107).

FIRST USE 4-0-2002; IN COMMERCE 4-0-2002.

NO CLAIM IS MADE TO THE EXCLUSIVE RIGHT TO USE "BASEBALL", APART FROM THE MARK AS SHOWN.

THE MARK CONSISTS OF A FIGURE OF A BASEBALL PLAYER HOLDING A BAT OVER HIS HEAD TO THE RIGHT IN A HITTING STANCE WITH LEGS SLIGHTLY MORE THAN SHOULDER WIDTH APART WEARING A BASEBALL UNIFORM AND A BASEBALL CAP STANDING IN THE CENTER OF A BASEBALL WITH BASEBALL STITCHES WITH CLOCK-LIKE NUMERALS IN BLACK ALONG THE OUTER CIRCUMFERENCE LIKE A STOP WATCH WITH THE NUMBERS "5, 10, 15, 20, 25, 30, 35, 40, 45, 50, 55 AND 60" DISPLAYED WITH FOUR DASHES IN BETWEEN EACH OF THE NUMBERS OUTLINED BY A BLACK CIRCLE WHICH IS OUTLINED BY A LARGER CIRCLE FILLED IN WITH LIGHT CONTAINING THE WORD "STANDSTILL" IN BLACK CURVED ACROSS THE TOP OF THE CIRCLE AND THE WORD "BASEBALL" IN BLACK CURVED ACROSS THE BOTTOM OF THE CIRCLE.

SER. NO. 85-490,305, FILED 12-8-2011.

ANNE MADDEN, EXAMINING ATTORNEY



David J. Kyffers

Director of the United States Patent and Trademark Office

United States of America

United States Patent and Trademark Office

ALLIE'S DREAM

Reg. No. 4,204,986

Registered Sep. 11, 2012

Int. Cl.: 41

SERVICE MARK

PRINCIPAL REGISTER

KRESSEN, LILI V. (UNITED STATES INDIVIDUAL)
26 MAPLE VALE DRIVE
WOODBIDGE, CT 06525

FOR: CHARITABLE SERVICES, NAMELY, PROVIDING EDUCATIONAL, SOCIAL, RECREATIONAL AND VOCATIONAL SUPPORTS IN THE NATURE OF CLASSROOM LEARNING, WORKSHOP SEMINARS, AND INDIVIDUAL AND GROUP TRAINING SESSIONS FOR PROVIDING AND TEACHING LIFE SKILLS FOR YOUNG ADULTS WITH DEVELOPMENTAL DISABILITIES TO PROMOTE INTEGRATION WITH THE COMMUNITY, IN CLASS 41 (U.S. CLS. 100, 101 AND 107).

FIRST USE 12-0-2009; IN COMMERCE 12-0-2009.

THE MARK CONSISTS OF STANDARD CHARACTERS WITHOUT CLAIM TO ANY PARTICULAR FONT, STYLE, SIZE, OR COLOR.

THE NAME(S), PORTRAIT(S), AND/OR SIGNATURE(S) SHOWN IN THE MARK IDENTIFIES ALLIE KRESSEN, WHOSE CONSENT(S) TO REGISTER IS MADE OF RECORD.

SER. NO. 85-491,270, FILED 12-9-2011.

DARRYL SPRUILL, EXAMINING ATTORNEY



David J. Kyffers

Director of the United States Patent and Trademark Office

United States of America

United States Patent and Trademark Office



Reg. No. 4,204,987

Registered Sep. 11, 2012

Int. Cl.: 44

SERVICE MARK

PRINCIPAL REGISTER

EMPATHY THERAPY, INC. (CALIFORNIA CORPORATION)
#326
5960 S LAND PARK DRIVE
SACRAMENTO, CA 95822

FOR: PSYCHIATRIC CONSULTATION; PSYCHIATRIC SERVICES, IN CLASS 44 (U.S. CLS. 100 AND 101).

FIRST USE 10-1-2011; IN COMMERCE 10-15-2011.

NO CLAIM IS MADE TO THE EXCLUSIVE RIGHT TO USE "THERAPY", APART FROM THE MARK AS SHOWN.

THE MARK CONSISTS OF THE STYLIZED TEXT "EMPATHY THERAPY" NEXT TO AN ABSTRACT DESIGN OF TWO PEOPLE FACING EACH OTHER AND INTERCONNECTING WITH EACH OTHER.

SER. NO. 85-492,379, FILED 12-11-2011.

RENEE MCCRAY, EXAMINING ATTORNEY



David J. Kyffers

Director of the United States Patent and Trademark Office

United States of America

United States Patent and Trademark Office

make ideas real

Reg. No. 4,204,988

FOGG LLC (COLORADO LIMITED LIABILITY COMPANY)
700 N COLORADO BLVD, SUITE 240
DENVER, CO 80206

Registered Sep. 11, 2012

Int. Cl.: 35

FOR: BUSINESS CONSULTATION SERVICES, IN CLASS 35 (U.S. CLS. 100, 101 AND 102).

SERVICE MARK

FIRST USE 12-11-2011; IN COMMERCE 12-11-2011.

PRINCIPAL REGISTER

THE MARK CONSISTS OF STANDARD CHARACTERS WITHOUT CLAIM TO ANY PARTICULAR FONT, STYLE, SIZE, OR COLOR.

SER. NO. 85-492,382, FILED 12-11-2011.

KAREN K. BUSH, EXAMINING ATTORNEY



David J. Kybas

Director of the United States Patent and Trademark Office

United States of America

United States Patent and Trademark Office

FENZER

Reg. No. 4,204,989

VETORA LLC (UTAH LIMITED LIABILITY COMPANY)
986 WEST 1875 SOUTH
LEHI, UT 84043

Registered Sep. 11, 2012

Int. Cl.: 9

FOR: PORTABLE ELECTRONICS ACCESSORIES, NAMELY, BATTERIES, BATTERY CHARGERS, AND POWER CABLES; PORTABLE ELECTRONICS ACCESSORIES, NAMELY, SCREEN PROTECTORS FOR CELL PHONES, COMPUTERS, LAPTOP COMPUTERS, NOTEBOOK COMPUTERS, TABLET COMPUTERS AND HANDHELD COMPUTERS IN THE NATURE OF ACRYLIC SHIELDS TO MOUNTED OVER THE DISPLAY SCREEN; PORTABLE ELECTRONICS ACCESSORIES, NAMELY, CASES FOR ELECTRONIC EQUIPMENT, NAMELY, CELL PHONES, COMPUTERS, LAPTOP COMPUTERS, NOTEBOOK COMPUTERS, TABLET COMPUTERS AND HANDHELD COMPUTERS, IN CLASS 9 (U.S. CLS. 21, 23, 26, 36 AND 38).

TRADEMARK

PRINCIPAL REGISTER

FIRST USE 6-8-2011; IN COMMERCE 8-12-2011.

THE MARK CONSISTS OF STANDARD CHARACTERS WITHOUT CLAIM TO ANY PARTICULAR FONT, STYLE, SIZE, OR COLOR.

SER. NO. 85-492,769, FILED 12-12-2011.

TRACY WHITTAKER-BROWN, EXAMINING ATTORNEY



David J. Kybas

Director of the United States Patent and Trademark Office

United States of America

United States Patent and Trademark Office

Shockstrip

Reg. No. 4,204,990

SHOCKSTRIP INC. (OHIO CORPORATION)

Registered Sep. 11, 2012

5850 DEER SPRING RUN
CANFIELD, OH 44406

Int. Cl.: 9

FOR: EXTERNAL PROTECTIVE HELMET PADDING STRIPS THAT ARE ATTACHED TO THE OUTSIDE OF HELMETS FOR IMPACT ABSORPTION, DEFLECTION AND TO ENHANCE THE PROTECTION LEVEL OF VIRTUALLY ALL HELMETS , IN CLASS 9 (U.S. CLS. 21, 23, 26, 36 AND 38).

TRADEMARK

PRINCIPAL REGISTER

FIRST USE 2-25-2010; IN COMMERCE 7-1-2011.

THE MARK CONSISTS OF STANDARD CHARACTERS WITHOUT CLAIM TO ANY PARTICULAR FONT, STYLE, SIZE, OR COLOR.

SER. NO. 85-492,842, FILED 12-12-2011.

MICHAEL TANNER, EXAMINING ATTORNEY



David J. Kyffers

Director of the United States Patent and Trademark Office

United States of America

United States Patent and Trademark Office



Reg. No. 4,204,991

NATIONAL PARKINSON FOUNDATION, INC. (FLORIDA NON-PROFIT CORPORATION)
1501 N.W. 9TH AVENUE
MIAMI, FL 33136

Registered Sep. 11, 2012

Int. Cl.: 16

FOR: PRINTED PAMPHLETS, BOOKLETS, NOTEPADS, NOTECARDS, NEWSLETTERS, BROCHURES AND INFORMATIONAL FLYERS IN THE FIELDS OF MEDICINE AND CAREGIVING, ALL FOR USE IN THE DIAGNOSIS AND TREATMENT OF PARKINSON'S DISEASE, IN CLASS 16 (U.S. CLS. 2, 5, 22, 23, 29, 37, 38 AND 50).

TRADEMARK

PRINCIPAL REGISTER

FIRST USE 11-0-2011; IN COMMERCE 11-0-2011.

NO CLAIM IS MADE TO THE EXCLUSIVE RIGHT TO USE "PARKINSON'S DISEASE" AND "PARKINSON FOUNDATION", APART FROM THE MARK AS SHOWN.

THE COLOR(S) BLUE, WHITE AND BLACK IS/ARE CLAIMED AS A FEATURE OF THE MARK.

THE MARK CONSISTS OF A STYLIZED LETTER "P" WITHIN A CIRCULAR DESIGN, WITH THE WORDING "AWARE IN CARE" AND "PARKINSON'S DISEASE" SET FORTH ABOVE AND BELOW THE "P", RESPECTIVELY. THE WORDING "NATIONAL PARKINSON FOUNDATION" IS TO THE RIGHT OF THE CIRCLE WITHIN STYLIZED LETTERING. THE WORD "NATIONAL" IS PLACED IN A VERTICAL POSITION NEXT TO THE WORDING "PARKINSON FOUNDATION". THE STYLIZED "P" AND THE WORDING "AWARE IN CARE" AND "PARKINSON'S DISEASE" ARE WHITE. THE WORD "PARKINSON" AND THE CIRCLE DESIGN ARE BLUE. THE WORDING "NATIONAL" AND "FOUNDATION" ARE BLACK.



SEC. 2(F) AS TO "NATIONAL PARKINSON FOUNDATION".

SER. NO. 85-492,867, FILED 12-12-2011.

ELLEN B. AWRICH, EXAMINING ATTORNEY

David J. Kyjars

Director of the United States Patent and Trademark Office

United States of America

United States Patent and Trademark Office



Reg. No. 4,204,992

SHOCKSTRIP INC. (OHIO CORPORATION)
5850 DEER SPRING RUN
CANFIELD, OH 44406

Registered Sep. 11, 2012

Int. Cl.: 9

FOR: EXTERNAL PROTECTIVE HELMET PADDING STRIPS THAT ARE ATTACHED TO THE OUTSIDE OF HELMETS FOR IMPACT ABSORPTION, DEFLECTION AND TO ENHANCE THE PROTECTION LEVEL OF VIRTUALLY ALL HELMETS, IN CLASS 9 (U.S. CLS. 21, 23, 26, 36 AND 38).

TRADEMARK

PRINCIPAL REGISTER

FIRST USE 2-25-2010; IN COMMERCE 7-1-2011.

THE MARK CONSISTS OF THE STYLIZED WORDING "SHOCKSTRIP" ABOVE WHICH APPEARS THE DEPICTION OF A LIGHTNING BOLT SURROUNDED BY AN EXPLOSION.

SER. NO. 85-492,911, FILED 12-12-2011.

MICHAEL TANNER, EXAMINING ATTORNEY



David J. Kybas

Director of the United States Patent and Trademark Office

United States of America

United States Patent and Trademark Office

SAVE YOUR BRAIN. STAY IN
THE GAME.

Reg. No. 4,204,993

SHOCKSTRIP INC. (OHIO CORPORATION)

Registered Sep. 11, 2012

5850 DEER SPRING RUN
CANFIELD, OH 44406

Int. Cl.: 9

FOR: EXTERNAL PROTECTIVE HELMET PADDING STRIPS THAT ARE ATTACHED TO THE OUTSIDE OF HELMETS FOR IMPACT ABSORPTION, DEFLECTION AND TO ENHANCE THE PROTECTION LEVEL OF VIRTUALLY ALL HELMETS , IN CLASS 9 (U.S. CLS. 21, 23, 26, 36 AND 38).

TRADEMARK

PRINCIPAL REGISTER

FIRST USE 2-25-2010; IN COMMERCE 7-1-2011.

THE MARK CONSISTS OF STANDARD CHARACTERS WITHOUT CLAIM TO ANY PARTICULAR FONT, STYLE, SIZE, OR COLOR.

SER. NO. 85-492,936, FILED 12-12-2011.

MICHAEL TANNER, EXAMINING ATTORNEY



David J. Kybas

Director of the United States Patent and Trademark Office

United States of America

United States Patent and Trademark Office

Farm + Cellar

Reg. No. 4,204,994

Registered Sep. 11, 2012

Int. Cl.: 35

SERVICE MARK

PRINCIPAL REGISTER

THIRD STREET WORKS, LLC (DELAWARE LIMITED LIABILITY COMPANY)
THE HEARST BUILDING
5 THIRD STREET, SUITE #505
SAN FRANCISCO, CA 94103

FOR: ADVERTISING AND MARKETING SERVICES, NAMELY, PROMOTING THE GOODS AND SERVICES OF OTHERS, IN CLASS 35 (U.S. CLS. 100, 101 AND 102).

FIRST USE 5-23-2011; IN COMMERCE 5-23-2011.

THE MARK CONSISTS OF STANDARD CHARACTERS WITHOUT CLAIM TO ANY PARTICULAR FONT, STYLE, SIZE, OR COLOR.

SER. NO. 85-493,313, FILED 12-12-2011.

CHRISTINA SOBRAL, EXAMINING ATTORNEY



David J. Kyros

Director of the United States Patent and Trademark Office

United States of America

United States Patent and Trademark Office

MARLY SKIN GUARD

Reg. No. 4,204,995

Registered Sep. 11, 2012

Int. Cl.: 3

TRADEMARK

PRINCIPAL REGISTER

MARLY PRODUCTS (FED REP GERMANY CORPORATION)
KOLOMANSTRASSE 5A
ISMANING, FED REP GERMANY 85737

FOR: COSMETIC PREPARATIONS FOR SKIN CARE, NAMELY, COSMETIC PREPARATIONS FOR THE PROTECTION OF SKIN FROM HARMFUL OR DAMAGING SUBSTANCES, IN CLASS 3 (U.S. CLS. 1, 4, 6, 50, 51 AND 52).

FIRST USE 6-1-1992; IN COMMERCE 6-1-1992.

THE MARK CONSISTS OF STANDARD CHARACTERS WITHOUT CLAIM TO ANY PARTICULAR FONT, STYLE, SIZE, OR COLOR.

OWNER OF U.S. REG. NO. 2,982,616.

NO CLAIM IS MADE TO THE EXCLUSIVE RIGHT TO USE "SKIN", APART FROM THE MARK AS SHOWN.

SER. NO. 85-493,752, FILED 12-13-2011.

KELLY TRUSILO, EXAMINING ATTORNEY



David J. Kybas

Director of the United States Patent and Trademark Office

United States of America

United States Patent and Trademark Office



Reg. No. 4,204,996

Registered Sep. 11, 2012

Int. Cls.: 29, 30 and 31

TRADEMARK

PRINCIPAL REGISTER

RHEE BROS., INC. (MARYLAND CORPORATION)
7461 COCA COLA DRIVE
HANOVER, MD 21076

FOR: ROASTED SHEETS OF LAVER; DRIED EDIBLE SEAWEED; PICKLED RADISHES; FISH SAUCE, NAMELY, SALTY SHRIMP SAUCE; PROCESSED FISH ROE; FISH CAKE; CRAB MEAT MADE FROM FISH PASTE; HOT PEPPER PASTE; SAUSAGES, IN CLASS 29 (U.S. CL. 46).

FIRST USE 11-9-1994; IN COMMERCE 11-9-1994.

FOR: PROCESSED GRAINS; MIXES FOR MAKING BATTERS FOR FRIED FOOD; NOODLES; RICE CAKE; COOKED BEEF DUMPLINGS; DUMPLING WRAPPERS; SOYBEAN PASTE, IN CLASS 30 (U.S. CL. 46).

FIRST USE 11-9-1994; IN COMMERCE 11-9-1994.

FOR: FRESH PEARS, IN CLASS 31 (U.S. CLS. 1 AND 46).

FIRST USE 11-13-2010; IN COMMERCE 11-13-2010.

THE MARK CONSISTS OF THE STYLIZED TERM "YISSINE", TWO LARGE CHINESE CHARACTERS AND TWO SMALL KOREAN CHARACTERS, ALL WITHIN A RECTANGLE; THE TERM "YISSINE" APPEARS AT THE BOTTOM IN A SHADED PORTION OF THE RECTANGLE.

THE NON-LATIN CHARACTERS IN THE MARK TRANSLITERATE TO "YISSINE" AND THIS HAS NO MEANING IN A FOREIGN LANGUAGE.

SER. NO. 85-493,870, FILED 12-13-2011.

HOWARD B. LEVINE, EXAMINING ATTORNEY



David J. Kypos

Director of the United States Patent and Trademark Office

United States of America

United States Patent and Trademark Office

International Colored Gemstone Association

Reg. No. 4,204,997

Registered Sep. 11, 2012

Int. Cl.: 35

SERVICE MARK

PRINCIPAL REGISTER

INTERNATIONAL COLORED GEMSTONE ASSOCIATION (SWITZERLAND
UNINCORPORATED ASSOCIATION)
36 W. 44TH STREET, SUITE 914
NEW YORK, NY 10036

FOR: PROVIDING A WEBSITE FEATURING INFORMATION RELATED TO BUSINESS ISSUES IN THE COLORED GEMSTONE INDUSTRY; PROVIDING A WEBSITE WHICH PROMOTES THE PUBLIC AWARENESS OF ISSUES CONCERNING THE COLORED GEMSTONE, MINING, GEMOLOGY, JEWELRY AND FASHION INDUSTRIES, IN CLASS 35 (U.S. CLS. 100, 101 AND 102).

FIRST USE 4-30-1984; IN COMMERCE 4-30-1984.

THE MARK CONSISTS OF STANDARD CHARACTERS WITHOUT CLAIM TO ANY PARTICULAR FONT, STYLE, SIZE, OR COLOR.

NO CLAIM IS MADE TO THE EXCLUSIVE RIGHT TO USE "COLORED GEMSTONE ASSOCIATION", APART FROM THE MARK AS SHOWN.

SEC. 2(F).

SER. NO. 85-493,966, FILED 12-13-2011.

JEFFREY LOOK, EXAMINING ATTORNEY



David J. Kyffers

Director of the United States Patent and Trademark Office

United States of America

United States Patent and Trademark Office



Reg. No. 4,204,998

Registered Sep. 11, 2012

Int. Cl.: 36

SERVICE MARK

PRINCIPAL REGISTER

REVERSE MORTGAGE SOLUTIONS, INC. (DELAWARE CORPORATION)
2727 SPRING CREEK DRIVE
SPRING, TX 77373

FOR: FINANCING AND LOAN SERVICES, NAMELY, ORIGINATION, ACQUISITION, SERVICING, SECURITIZATION AND BROKERAGE OF MORTGAGE LOANS; ORIGINATION OF REVERSE MORTGAGES AND REVERSE MORTGAGE ADMINISTRATION AND MANAGEMENT SERVICES, NAMELY, ORIGINATION, ACQUISITION, SERVICING, SECURITIZATION AND BROKERAGE OF REVERSE MORTGAGE LOANS; WHOLESALE LENDING SERVICES; REAL ESTATE AND HOME EQUITY LENDING SERVICES, NAMELY, HOME EQUITY LOANS, MORTGAGE LENDING AND MORTGAGE REFINANCING, IN CLASS 36 (U.S. CLS. 100, 101 AND 102).

FIRST USE 10-18-2011; IN COMMERCE 10-18-2011.

OWNER OF U.S. REG. NOS. 3,523,171, 3,550,915, AND 3,558,675.

THE MARK CONSISTS OF THE STYLIZED WORDING "RMPATH" WITH A PAIR OF ARROWS BEHIND THE WORDING POINTING IN OPPOSITE DIRECTIONS.

SER. NO. 85-494,041, FILED 12-13-2011.

MICHAEL TANNER, EXAMINING ATTORNEY



David J. Kybas

Director of the United States Patent and Trademark Office

United States of America

United States Patent and Trademark Office

RIO GRANDE

Mexican Restaurant



Reg. No. 4,204,999

RIO GRANDE MEXICAN RESTAURANTS, INC. (COLORADO CORPORATION)
143 W. MOUNTAIN AVENUE
FORT COLLINS, CO 80524

Registered Sep. 11, 2012

Int. Cl.: 43

FOR: BAR SERVICES; RESTAURANT SERVICES FEATURING MEXICAN FOOD, IN CLASS 43 (U.S. CLS. 100 AND 101).

SERVICE MARK

FIRST USE 6-5-2008; IN COMMERCE 6-5-2008.

PRINCIPAL REGISTER

OWNER OF U.S. REG. NO. 2,088,601.

THE COLOR(S) GREEN, GOLD, AND BLACK IS/ARE CLAIMED AS A FEATURE OF THE MARK.

NO CLAIM IS MADE TO THE EXCLUSIVE RIGHT TO USE "MEXICAN RESTAURANT", APART FROM THE MARK AS SHOWN.

THE MARK CONSISTS OF THE WORDS "RIO GRANDE" IN GREEN LETTERING OUTLINED IN BLACK ABOVE THE WORDS "MEXICAN RESTAURANT" IN BLACK LETTERING ABOVE A BLACK AND GOLD FIVE-POINT STAR BETWEEN TWO BLACK LINES.

SER. NO. 85-494,114, FILED 12-13-2011.

MICHAEL TANNER, EXAMINING ATTORNEY



David J. Kybas

Director of the United States Patent and Trademark Office

United States of America

United States Patent and Trademark Office



Reg. No. 4,205,000

FOREST LABORATORIES, INC. (DELAWARE CORPORATION)
909 THIRD AVENUE
NEW YORK, NY 10022

Registered Sep. 11, 2012

Int. Cls.: 42 and 44

FOR: INTERNET WEBSITE PROVIDING INFORMATION ON CLINICAL TRIALS FOR EXISTING AND PROSPECTIVE PHARMACEUTICAL PRODUCTS, IN CLASS 42 (U.S. CLS. 100 AND 101).

SERVICE MARK

FIRST USE 2-8-2005; IN COMMERCE 2-8-2005.

PRINCIPAL REGISTER

FOR: MEDICAL INFORMATION SERVICES, NAMELY, PROVIDING MEDICAL INFORMATION TO PATIENTS AND THE GENERAL PUBLIC REGARDING VARIOUS PROSPECTIVE AND AVAILABLE MEDICINES VIA A GLOBAL COMPUTER NETWORK, IN CLASS 44 (U.S. CLS. 100 AND 101).

FIRST USE 11-18-2004; IN COMMERCE 11-18-2004.

NO CLAIM IS MADE TO THE EXCLUSIVE RIGHT TO USE "LABORATORIES, INC.", APART FROM THE MARK AS SHOWN.

THE COLOR(S) GREEN IS/ARE CLAIMED AS A FEATURE OF THE MARK.

THE MARK CONSISTS OF A SLANTED "F", FOLLOWED BY A SLANTED " NBL" AND ANOTHER LINE SLANTED LEFT, FOLLOWED BY A SPHERE CONTAINING THREE CURVED HORIZONTAL AND THREE CURVED VERTICAL LINES, FOLLOWED BY THE WORDING "FOREST LABORATORIES, INC." ALL IN THE COLOR GREEN.

SER. NO. 85-494,191, FILED 12-13-2011.

MICHELE SWAIN, EXAMINING ATTORNEY



David J. Kyjars

Director of the United States Patent and Trademark Office

United States of America

United States Patent and Trademark Office

101 SNORKEL

Reg. No. 4,205,001

WHITE, JEFFREY (UNITED STATES INDIVIDUAL)
4372 NORTHPOINT CIR
SAINT LOUIS, MO 63129

Registered Sep. 11, 2012

Int. Cl.: 9

FOR: SCUBA SNORKELS; SNORKELS; FLOTATION VESTS, IN CLASS 9 (U.S. CLS. 21, 23, 26, 36 AND 38).

TRADEMARK

FIRST USE 8-9-2006; IN COMMERCE 8-9-2006.

PRINCIPAL REGISTER

THE MARK CONSISTS OF STANDARD CHARACTERS WITHOUT CLAIM TO ANY PARTICULAR FONT, STYLE, SIZE, OR COLOR.

SER. NO. 85-494,208, FILED 12-13-2011.

MICHELE SWAIN, EXAMINING ATTORNEY



David J. Kybas

Director of the United States Patent and Trademark Office

United States of America

United States Patent and Trademark Office



Reg. No. 4,205,002

Registered Sep. 11, 2012

Int. Cl.: 44

SERVICE MARK

PRINCIPAL REGISTER

WILBUR-ELLIS COMPANY (CALIFORNIA CORPORATION)
345 CALIFORNIA STREET
27TH FLOOR
SAN FRANCISCO, CA 94104

FOR: ADVISORY AND CONSULTATION SERVICES IN THE FIELDS OF AGRONOMY, AGRICULTURE, AND HORTICULTURE; PROVIDING AN ON-LINE COMPUTER DATABASE FOR MANAGING INFORMATION IN THE FIELD OF AGRONOMIC SERVICES, IN CLASS 44 (U.S. CLS. 100 AND 101).

FIRST USE 12-13-2010; IN COMMERCE 12-13-2010.

OWNER OF U.S. REG. NO. 3,935,143.

THE COLOR(S) BLACK AND GOLD IS/ARE CLAIMED AS A FEATURE OF THE MARK.

THE MARK CONSISTS OF THE STYLIZED WORDING "AGVERDICT KNOWLEDGE ACQUIRED, INTELLIGENCE APPLIED" AND DESIGN. THE WORDING "AGVERDICT" APPEARS ABOVE A BLACK HORIZONTAL LINE, WITH THE LETTERS "AG" IN GOLD AND THE LETTERS "VERDICT" IN BLACK WITH A BLACK LINE EXTENDING TO THE RIGHT FROM THE TOP OF THE "V". ABOVE THE WORD "AGVERDICT" APPEARS A DESIGN CONSISTING OF GOLD SQUARES ARRANGED IN A BINARY COMPUTER-LANGUAGE TYPE DISPLAY, IN AN AREA TWO SQUARES HIGH AND 27 SQUARES LONG, WITH THIRTEEN GOLD SQUARES IN THE UPPER LINE AND EIGHTEEN GOLD SQUARES IN THE LOWER LINE. UNDERNEATH THE WORD "AGVERDICT" AND THE HORIZONTAL LINE APPEARS THE WORDING "KNOWLEDGE ACQUIRED, INTELLIGENCE APPLIED" IN BLACK.

SER. NO. 85-494,282, FILED 12-13-2011.

JERI J. FICKES, EXAMINING ATTORNEY



David J. Kybas

Director of the United States Patent and Trademark Office

United States of America

United States Patent and Trademark Office

AURA

Reg. No. 4,205,003

Registered Sep. 11, 2012

Int. Cl.: 9

TRADEMARK

PRINCIPAL REGISTER

CARL ZEISS AG (FED REP GERMANY CORPORATION)
CARL-ZEISS-STRASSE 22
OBERKOCHEN, FED REP GERMANY 73447

FOR: SPECTROMETERS AND PARTS THEREOF, IN CLASS 9 (U.S. CLS. 21, 23, 26, 36 AND 38).

THE MARK CONSISTS OF STANDARD CHARACTERS WITHOUT CLAIM TO ANY PARTICULAR FONT, STYLE, SIZE, OR COLOR.

PRIORITY CLAIMED UNDER SEC. 44(D) ON FED REP GERMANY APPLICATION NO. 302011050175, FILED 9-10-2011, REG. NO. 302011050175, DATED 2-27-2012, EXPIRES 9-30-2021.

SER. NO. 85-494,446, FILED 12-13-2011.

JORDAN BAKER, EXAMINING ATTORNEY



David J. Kyffers

Director of the United States Patent and Trademark Office

United States of America

United States Patent and Trademark Office

TEXT N GO

Reg. No. 4,205,004

Registered Sep. 11, 2012

Int. Cl.: 38

SERVICE MARK

PRINCIPAL REGISTER

BRYTE LIGHT ENTERPRISES LLC (CALIFORNIA LIMITED LIABILITY COMPANY)
13697 CALAIS DRIVE
DEL MAR, CA 92014

FOR: WIRELESS ELECTRONIC TRANSMISSION OF CONTENT FOR PROCESSING ORDERS FOR GOOD AND SERVICES USING MOBILE COMMUNICATIONS DEVICES; PROVIDING E-MAIL SERVICES; TELECOMMUNICATION SERVICES, NAMELY, WIRELESS TRANSMISSION OF DATA TO ENABLE USERS TO SEND AND/OR RECEIVE MESSAGES THROUGH A WIRELESS DATA NETWORK; ONE-WAY AND TWO-WAY PAGING SERVICES; TELECOMMUNICATION SERVICES, NAMELY, ELECTRONIC AND DIGITAL TRANSMISSION AND RECEPTION OF VOICE COMMUNICATIONS BY MEANS OF WIRELESS COMMUNICATION NETWORKS, IN CLASS 38 (U.S. CLS. 100, 101 AND 104).

FIRST USE 10-1-2011; IN COMMERCE 10-1-2011.

THE MARK CONSISTS OF STANDARD CHARACTERS WITHOUT CLAIM TO ANY PARTICULAR FONT, STYLE, SIZE, OR COLOR.

NO CLAIM IS MADE TO THE EXCLUSIVE RIGHT TO USE "TEXT", APART FROM THE MARK AS SHOWN.

SER. NO. 85-494,542, FILED 12-13-2011.

CHRISTOPHER LAW, EXAMINING ATTORNEY



David J. Kyffers

Director of the United States Patent and Trademark Office

United States of America

United States Patent and Trademark Office



Reg. No. 4,205,005

Registered Sep. 11, 2012

Int. Cl.: 41

SERVICE MARK

PRINCIPAL REGISTER

WOEHLKE, LEANNE M (UNITED STATES INDIVIDUAL), DBA EPIC YOGA
782 OLD HICKORY BLVD STE 205
BRENTWOOD, TN 37027

FOR: YOGA INSTRUCTION, IN CLASS 41 (U.S. CLS. 100, 101 AND 107).

FIRST USE 4-20-2011; IN COMMERCE 4-20-2011.

NO CLAIM IS MADE TO THE EXCLUSIVE RIGHT TO USE "YOGA", APART FROM THE MARK AS SHOWN.

THE MARK CONSISTS OF THE WORDS "EPIC YOGA" IN CENTURY GOTHIC FONT WITH A DESIGN ELEMENT IN BETWEEN THE WORDS, CONSISTING OF A SUN IMAGE WITH THREE SWIRLS IN THE MIDDLE. THE SUN'S RAYS LOOK LIKE FLAMES AND ARE IN A GRADIENT PATTERN. AROUND THE DESIGN ELEMENT IS A SERIES OF DOTS.

SER. NO. 85-494,652, FILED 12-14-2011.

CHARISMA HAMPTON, EXAMINING ATTORNEY



David J. Kybas

Director of the United States Patent and Trademark Office

United States of America

United States Patent and Trademark Office

FOREST LABORATORIES CLINICAL TRIAL REGISTRY

Reg. No. 4,205,006

FOREST LABORATORIES, INC. (DELAWARE CORPORATION)
909 THIRD AVENUE
NEW YORK, NY 10022

Registered Sep. 11, 2012

Int. Cl.: 42

FOR: INTERNET WEBSITE PROVIDING INFORMATION ON CLINICAL TRIALS FOR EXISTING AND PROSPECTIVE PHARMACEUTICAL PRODUCTS, IN CLASS 42 (U.S. CLS. 100 AND 101).

SERVICE MARK

FIRST USE 2-8-2005; IN COMMERCE 2-8-2005.

PRINCIPAL REGISTER

THE MARK CONSISTS OF STANDARD CHARACTERS WITHOUT CLAIM TO ANY PARTICULAR FONT, STYLE, SIZE, OR COLOR.

NO CLAIM IS MADE TO THE EXCLUSIVE RIGHT TO USE "CLINICAL TRIAL REGISTRY", APART FROM THE MARK AS SHOWN.

SER. NO. 85-494,880, FILED 12-14-2011.

MICHELE SWAIN, EXAMINING ATTORNEY



David J. Kybas

Director of the United States Patent and Trademark Office

United States of America

United States Patent and Trademark Office

IMNOLVID

Reg. No. 4,205,007

CELGENE CORPORATION (DELAWARE CORPORATION)
86 MORRIS AVENUE
SUMMIT, NJ 07901

Registered Sep. 11, 2012

Int. Cl.: 5

FOR: PHARMACEUTICAL PREPARATIONS, NAMELY, CYTOKINE INHIBITORY DRUGS; PHARMACEUTICAL PREPARATIONS THAT MODULATE THE IMMUNE SYSTEM; PHARMACEUTICAL PREPARATIONS FOR THE TREATMENT OF CERTAIN CANCER AND BLOOD DISEASES, IN CLASS 5 (U.S. CLS. 6, 18, 44, 46, 51 AND 52).

TRADEMARK

PRINCIPAL REGISTER

THE MARK CONSISTS OF STANDARD CHARACTERS WITHOUT CLAIM TO ANY PARTICULAR FONT, STYLE, SIZE, OR COLOR.

PRIORITY CLAIMED UNDER SEC. 44(D) ON SWITZERLAND APPLICATION NO. 63910/2011, FILED 12-12-2011, REG. NO. 628507, DATED 12-12-2011, EXPIRES 12-12-2021.

OWNER OF U.S. REG. NOS. 3,988,920 AND 4,045,529.

SER. NO. 85-495,234, FILED 12-14-2011.

BARBARA GAYNOR, EXAMINING ATTORNEY



David J. Kyjars

Director of the United States Patent and Trademark Office

United States of America

United States Patent and Trademark Office

AVICII

Reg. No. 4,205,008

Registered Sep. 11, 2012

Int. Cls.: 9, 25 and 41

TRADEMARK

SERVICE MARK

PRINCIPAL REGISTER

AVICII MUSIC AB (SWEDEN AKTIEBOLAG (AB))
KAMMARKAGATAN 23
111 60 STOCKHOLM, SWEDEN

FOR: MUSICAL SOUND RECORDINGS AND AUDIOVISUAL RECORDINGS FEATURING MUSIC AND ENTERTAINMENT; SOUND RECORDINGS AND AUDIOVISUAL RECORDINGS, FEATURING MOTION PICTURE FILMS, TELEVISION PROGRAMS, TELEVISION FILMS, MUSIC VIDEOS, DOCUMENTARIES AND ANIMATION; SUNGLASSES; CASES FOR SUNGLASSES SOLD EMPTY; DECORATIVE MAGNETS; CELL PHONE CASES AND COVERS; ELECTRIC SIGNS; COMPUTER MOUSEPADS; LAPTOP CASES, STORAGE CASES FOR COMPACT DISCS, DVDS AND COMPUTER DISCS, IN CLASS 9 (U.S. CLS. 21, 23, 26, 36 AND 38).

FOR: CLOTHING, NAMELY, SHIRTS, TROUSERS, JEANS, TOPS, BOTTOMS, SHORTS, SKIRTS, DRESSES, JACKETS, COATS, RAINWEAR, NECKWEAR, SLEEPWEAR, LOUNGEWEAR, UNDERWEAR, SWIMWEAR, GLOVES, SOCKS, HOSIERY, BELTS, FOOTWEAR AND HEADWEAR, IN CLASS 25 (U.S. CLS. 22 AND 39).

FOR: ENTERTAINMENT SERVICES, NAMELY, LIVE MUSICAL AND VOCAL PERFORMANCES BY A DJ, SOLO RECORDING ARTIST OR MUSICAL GROUP; PROVIDING A WEB SITE FEATURING PRE-RECORDED MUSICAL AUDIO AND AUDIOVISUAL CLIPS, PHOTOGRAPHS, NEWS, REVIEWS AND OTHER MULTIMEDIA ARTICLES IN CONNECTION WITH A SOLO RECORDING ARTIST AND MUSICAL GROUP; FAN CLUB SERVICES; PRODUCTION OF TELEVISION PROGRAMS; ONLINE MAGAZINES IN THE FIELDS OF MUSIC AND ENTERTAINMENT; ENTERTAINMENT SERVICES IN THE NATURE OF ONGOING TELEVISION PROGRAMS IN THE FIELD OF MUSIC; TELEVISION PRODUCTION, THEATRICAL PRODUCTION AND MOTION PICTURE FILM PRODUCTION; MUSIC PRODUCTION AND PRODUCTION OF LYRICS TO MUSIC, IN CLASS 41 (U.S. CLS. 100, 101 AND 107).

THE MARK CONSISTS OF STANDARD CHARACTERS WITHOUT CLAIM TO ANY PARTICULAR FONT, STYLE, SIZE, OR COLOR.

OWNER OF ERPN CMNTY TM OFC REG. NO. 010477181, DATED 5-3-2012, EXPIRES 12-8-2021.



David J. Kyjars

Director of the United States Patent and Trademark Office

Reg. No. 4,205,008 THE NAME(S), PORTRAIT(S), AND/OR SIGNATURE(S) SHOWN IN THE MARK IDENTIFIES THE PROFESSIONAL NAME OF TIM BERGLING, WHOSE CONSENT(S) TO REGISTER IS MADE OF RECORD.

SER. NO. 85-495,248, FILED 12-14-2011.

RON FAIRBANKS, EXAMINING ATTORNEY

United States of America

United States Patent and Trademark Office

HCG Hot Body

Reg. No. 4,205,009

HCG HOT BODY LLC (ARIZONA LIMITED LIABILITY COMPANY)
60 CORTE BANCA
SEDONA, AZ 86351

Registered Sep. 11, 2012

Int. Cl.: 5

FOR: DIETARY SUPPLEMENTS, FOR WEIGHT LOSS, CONTAINING HUMAN CHORIONIC GONADOTROPIN (HCG), IN CLASS 5 (U.S. CLS. 6, 18, 44, 46, 51 AND 52).

TRADEMARK

FIRST USE 6-28-2011; IN COMMERCE 7-1-2011.

PRINCIPAL REGISTER

THE MARK CONSISTS OF STANDARD CHARACTERS WITHOUT CLAIM TO ANY PARTICULAR FONT, STYLE, SIZE, OR COLOR.

NO CLAIM IS MADE TO THE EXCLUSIVE RIGHT TO USE "HCG", APART FROM THE MARK AS SHOWN.

SER. NO. 85-495,253, FILED 12-14-2011.

RUDY R. SINGLETON, EXAMINING ATTORNEY



David J. Kyffers

Director of the United States Patent and Trademark Office

United States of America

United States Patent and Trademark Office

HEALTHSOUTH

Reg. No. 4,205,010

HEALTHSOUTH CORPORATION (DELAWARE CORPORATION)
3660 GRANDVIEW PARKWAY, SUITE 200
BIRMINGHAM, AL 35243

Registered Sep. 11, 2012

Int. Cls.: 41 and 44

FOR: EDUCATIONAL SERVICES, NAMELY, CONDUCTING CLASSES, SEMINARS, AND CONFERENCES IN THE FIELD OF HEALTH CARE, IN CLASS 41 (U.S. CLS. 100, 101 AND 107).

SERVICE MARK

FIRST USE 12-1-2005; IN COMMERCE 12-1-2005.

PRINCIPAL REGISTER

FOR: HEALTH CARE SERVICES, NAMELY, IN-PATIENT AND OUT-PATIENT PHYSICAL REHABILITATION SERVICES AND HOME HEALTH CARE, IN CLASS 44 (U.S. CLS. 100 AND 101).

FIRST USE 12-1-2005; IN COMMERCE 12-1-2005.

OWNER OF U.S. REG. NO. 2,144,242.

THE MARK CONSISTS OF "HEALTHSOUTH" IN A SLANTED POSITION AND BLOCK LETTERS.

SER. NO. 85-495,278, FILED 12-14-2011.

SANJEEV VOHRA, EXAMINING ATTORNEY



David J. Kybas

Director of the United States Patent and Trademark Office

United States of America

United States Patent and Trademark Office

IMNOLVYD

Reg. No. 4,205,011

CELGENE CORPORATION (DELAWARE CORPORATION)
86 MORRIS AVENUE
SUMMIT, NJ 07901

Registered Sep. 11, 2012

Int. Cl.: 5

FOR: PHARMACEUTICAL PREPARATIONS, NAMELY, CYTOKINE INHIBITORY DRUGS; PHARMACEUTICAL PREPARATIONS THAT MODULATE THE IMMUNE SYSTEM; PHARMACEUTICAL PREPARATIONS FOR THE TREATMENT OF CERTAIN CANCER AND BLOOD DISEASES, IN CLASS 5 (U.S. CLS. 6, 18, 44, 46, 51 AND 52).

TRADEMARK

PRINCIPAL REGISTER

THE MARK CONSISTS OF STANDARD CHARACTERS WITHOUT CLAIM TO ANY PARTICULAR FONT, STYLE, SIZE, OR COLOR.

PRIORITY CLAIMED UNDER SEC. 44(D) ON SWITZERLAND APPLICATION NO. 63909/2011, FILED 12-12-2011, REG. NO. 628506, DATED 12-12-2011, EXPIRES 12-12-2021.

OWNER OF U.S. REG. NOS. 3,988,920 AND 4,045,529.

SER. NO. 85-495,285, FILED 12-14-2011.

BARBARA GAYNOR, EXAMINING ATTORNEY



David J. Kybas

Director of the United States Patent and Trademark Office

United States of America

United States Patent and Trademark Office

MOST WANTED

Reg. No. 4,205,012

ORIGINAL JUAN SPECIALTY FOODS, INC. (KANSAS CORPORATION)
111 SOUTHWEST BLVD.
KANSAS CITY, KS 66103

Registered Sep. 11, 2012

Int. Cls.: 30 and 32

FOR: SAUCE; HOT SAUCE; HOT WING SAUCE; STEAK SAUCE; BARBEQUE SAUCE; AND MUSTARD, IN CLASS 30 (U.S. CL. 46).

TRADEMARK

FIRST USE 4-30-2010; IN COMMERCE 4-30-2010.

PRINCIPAL REGISTER

FOR: NON-ALCOHOLIC COCKTAIL MIXES, IN CLASS 32 (U.S. CLS. 45, 46 AND 48).

FIRST USE 12-9-2011; IN COMMERCE 12-9-2011.

THE MARK CONSISTS OF STANDARD CHARACTERS WITHOUT CLAIM TO ANY PARTICULAR FONT, STYLE, SIZE, OR COLOR.

SER. NO. 85-495,528, FILED 12-14-2011.

ADA HAN, EXAMINING ATTORNEY



David J. Kyffers

Director of the United States Patent and Trademark Office

United States of America

United States Patent and Trademark Office

ACCENTPRO

Reg. No. 4,205,013

Registered Sep. 11, 2012

Int. Cls.: 9 and 41

TRADEMARK

SERVICE MARK

PRINCIPAL REGISTER

SMITH, CAMILLA (CANADA INDIVIDUAL)
14956 22 AVENUE
SOUTH SURREY, CANADA V4A9J2

FOR: COMPUTER APPLICATION SOFTWARE FOR MOBILE PHONES AND HANDHELD COMPUTERS, NAMELY, EDUCATIONAL SOFTWARE FEATURING INSTRUCTION IN THE FIELD OF LANGUAGE, NAMELY, ACCULTURATED SPEECH, ACCENTS, PRONUNCIATION, AND VERBAL COMMUNICATION SKILLS, IN CLASS 9 (U.S. CLS. 21, 23, 26, 36 AND 38).

FIRST USE 11-0-2010; IN COMMERCE 11-0-2010.

FOR: EDUCATIONAL SERVICES, NAMELY, PROVIDING IN PERSON TRAINING AND PERSONAL COACHING IN THE FIELD OF LANGUAGE, NAMELY, ACCULTURATED SPEECH, ACCENTS, PRONUNCIATION, AND VERBAL PRESENTATION AND COMMUNICATION SKILLS; EDUCATIONAL SERVICES, NAMELY, PROVIDING COURSES VIA THE INTERNET AND TELEPHONE IN THE FIELD OF LANGUAGE, NAMELY, ACCULTURATED SPEECH, ACCENTS, PRONUNCIATION, AND VERBAL PRESENTATION AND COMMUNICATION SKILLS; EDUCATIONAL SERVICES, NAMELY, DEVELOPING CONTEXTUALIZED CURRICULA AND SYLLABI IN THE FIELD OF LANGUAGE, NAMELY, ACCULTURATED SPEECH, ACCENTS, PRONUNCIATION, AND VERBAL PRESENTATION AND COMMUNICATION SKILLS, IN CLASS 41 (U.S. CLS. 100, 101 AND 107).

FIRST USE 9-0-2007; IN COMMERCE 9-0-2007.

THE MARK CONSISTS OF STANDARD CHARACTERS WITHOUT CLAIM TO ANY PARTICULAR FONT, STYLE, SIZE, OR COLOR.

SER. NO. 85-495,770, FILED 12-15-2011.

JIM RINGLE, EXAMINING ATTORNEY



David J. Kypos

Director of the United States Patent and Trademark Office

United States of America

United States Patent and Trademark Office

10GEN

Reg. No. 4,205,014

10GEN, INC. (DELAWARE CORPORATION)
134 5TH AVENUE, 3RD FLOOR
NEW YORK, NY 10011

Registered Sep. 11, 2012

Int. Cls.: 41 and 42

FOR: EDUCATIONAL SERVICES, NAMELY, CONDUCTING CLASSES AND COURSES IN THE FIELDS OF DATABASE DEVELOPMENT, MAINTENANCE, AND MANAGEMENT AND DISTRIBUTION OF TRAINING MATERIALS IN CONNECTION THEREWITH, IN CLASS 41 (U.S. CLS. 100, 101 AND 107).

SERVICE MARK

PRINCIPAL REGISTER

FIRST USE 1-0-2010; IN COMMERCE 1-0-2010.

FOR: DATABASE DESIGN AND DEVELOPMENT; IT CONSULTING SERVICES; TECHNICAL SUPPORT SERVICES, NAMELY, TROUBLESHOOTING OF COMPUTER SOFTWARE PROBLEMS, IN CLASS 42 (U.S. CLS. 100 AND 101).

FIRST USE 1-0-2010; IN COMMERCE 1-0-2010.

THE MARK CONSISTS OF STANDARD CHARACTERS WITHOUT CLAIM TO ANY PARTICULAR FONT, STYLE, SIZE, OR COLOR.

SER. NO. 85-495,968, FILED 12-15-2011.

JERI J. FICKES, EXAMINING ATTORNEY



David J. Kybas

Director of the United States Patent and Trademark Office

United States of America
United States Patent and Trademark Office

● ● ● ●
10gen

Reg. No. 4,205,015

10GEN, INC. (DELAWARE CORPORATION)
134 5TH AVENUE, 3RD FLOOR
NEW YORK, NY 10011

Registered Sep. 11, 2012

Int. Cls.: 41 and 42

FOR: EDUCATIONAL SERVICES, NAMELY, CONDUCTING CLASSES AND COURSES IN THE FIELDS OF DATABASE DEVELOPMENT, MAINTENANCE, AND MANAGEMENT AND DISTRIBUTION OF TRAINING MATERIALS IN CONNECTION THEREWITH, IN CLASS 41 (U.S. CLS. 100, 101 AND 107).

SERVICE MARK

PRINCIPAL REGISTER

FIRST USE 1-0-2010; IN COMMERCE 1-0-2010.

FOR: DATABASE DESIGN AND DEVELOPMENT; IT CONSULTING SERVICES; TECHNICAL SUPPORT SERVICES, NAMELY, TROUBLESHOOTING OF COMPUTER SOFTWARE PROBLEMS, IN CLASS 42 (U.S. CLS. 100 AND 101).

FIRST USE 1-0-2010; IN COMMERCE 1-0-2010.

THE MARK CONSISTS OF THE WORDING "10GEN" BELOW FOUR CIRCLES.

SER. NO. 85-495,973, FILED 12-15-2011.

JERI J. FICKES, EXAMINING ATTORNEY



David J. Kybas

Director of the United States Patent and Trademark Office

United States of America

United States Patent and Trademark Office

Green Air Project

Reg. No. 4,205,016

THE GREEN AIR PROJECT, INC. (FLORIDA CORPORATION)
2269 LEE ROAD

Registered Sep. 11, 2012

WINTER PARK, FL 32789

Int. Cl.: 44

FOR: TREE PLANTING FOR CARBON OFFSETTING PURPOSES, IN CLASS 44 (U.S. CLS. 100 AND 101).

SERVICE MARK

FIRST USE 6-1-2011; IN COMMERCE 6-1-2011.

PRINCIPAL REGISTER

THE MARK CONSISTS OF STANDARD CHARACTERS WITHOUT CLAIM TO ANY PARTICULAR FONT, STYLE, SIZE, OR COLOR.

NO CLAIM IS MADE TO THE EXCLUSIVE RIGHT TO USE "PROJECT", APART FROM THE MARK AS SHOWN.

SER. NO. 85-496,527, FILED 12-15-2011.

AHSEN KHAN, EXAMINING ATTORNEY



David J. Kybas

Director of the United States Patent and Trademark Office

United States of America

United States Patent and Trademark Office

MIRA WHITE

Reg. No. 4,205,017

HAGER & WERKEN GMBH & CO. KG (FED REP GERMANY CORPORATION)
ACKERSTRASSE 1 D-47269
DUISBURG, FED REP GERMANY

Registered Sep. 11, 2012

Int. Cl.: 3

FOR: DENTAL WHITENING PEN CONTAINING TOOTH WHITENING LIQUID; DENTAL BLEACHING GEL IN A BRUSH-PEN APPLICATOR, IN CLASS 3 (U.S. CLS. 1, 4, 6, 50, 51 AND 52).

TRADEMARK

FIRST USE 12-2-2009; IN COMMERCE 12-2-2009.

PRINCIPAL REGISTER

THE MARK CONSISTS OF STANDARD CHARACTERS WITHOUT CLAIM TO ANY PARTICULAR FONT, STYLE, SIZE, OR COLOR.

SER. NO. 85-496,567, FILED 12-15-2011.

JOHN DWYER, EXAMINING ATTORNEY



David J. Kybas

Director of the United States Patent and Trademark Office

United States of America

United States Patent and Trademark Office

SocialLoop

Reg. No. 4,205,018

Registered Sep. 11, 2012

Int. Cl.: 35

SERVICE MARK

PRINCIPAL REGISTER

BLUEHORNET NETWORKS, INC. (CALIFORNIA CORPORATION)
2355 NORTHSIDE DR. SUITE B250
SAN DIEGO, CA 92108

FOR: ADVERTISING SERVICES IN THE NATURE OF PROVIDING INFORMATION ABOUT GOODS AND SERVICES OF OTHERS THROUGH SOFTWARE THAT PROVIDES A PLATFORM OF WIDGETS FOR SHARING E-MAILS AND SUBSCRIBING TO E-MAIL LISTS; DESIGNING FOR OTHERS OF ADVERTISING AND MARKETING MATERIALS DELIVERED VIA E-MAIL OR THE INTERNET; TRANSMISSION OF ADVERTISING AND MARKETING TRANSACTIONAL MESSAGES OF OTHERS VIA EMAIL OR THE INTERNET WITH SEGMENTATION BASED ON SHARING ACTIVITIES OF E-MAIL SUBSCRIBERS IN ON-LINE COMMUNITIES; COMPUTER SERVICES, NAMELY, ELECTRONICALLY MONITORING, REPORTING, AND ANALYZING E-MAIL SHARING ACTIVITIES OF SUBSCRIBERS IN ON-LINE COMMUNITIES IN CONNECTION WITH ADVERTISING, MARKETING, AND PROMOTIONAL CAMPAIGNS OR OTHERS, IN CLASS 35 (U.S. CLS. 100, 101 AND 102).

FIRST USE 7-15-2010; IN COMMERCE 11-16-2010.

THE MARK CONSISTS OF STANDARD CHARACTERS WITHOUT CLAIM TO ANY PARTICULAR FONT, STYLE, SIZE, OR COLOR.

SER. NO. 85-496,933, FILED 12-15-2011.

AISHA CLARKE, EXAMINING ATTORNEY



David J. Kyjars

Director of the United States Patent and Trademark Office

United States of America
United States Patent and Trademark Office

SICOMILL

Reg. No. 4,205,019

Registered Sep. 11, 2012

Int. Cl.: 1

TRADEMARK

PRINCIPAL REGISTER

VESTA SI LLC (UTAH LIMITED LIABILITY COMPANY)
SUITE B
9327 WHEATLANDS RD.
SANTEE, CA 92071

FOR: SILICON POWDER FOR ENGINEERING CERAMICS USE, IN CLASS 1 (U.S. CLS. 1, 5, 6, 10, 26 AND 46).

FIRST USE 4-29-1985; IN COMMERCE 4-29-1985.

THE MARK CONSISTS OF STANDARD CHARACTERS WITHOUT CLAIM TO ANY PARTICULAR FONT, STYLE, SIZE, OR COLOR.

SER. NO. 85-496,961, FILED 12-16-2011.

SOPHIA S. KIM, EXAMINING ATTORNEY



David J. Kybas

Director of the United States Patent and Trademark Office

United States of America

United States Patent and Trademark Office

BULL FROG

Reg. No. 4,205,020

HAGER WORLDWIDE, INC. (FLORIDA CORPORATION)
441 19TH STREET, SE
HICKORY, NC 29601

Registered Sep. 11, 2012

Int. Cls.: 10 and 37

FOR: DENTAL INSTRUMENTS, NAMELY, SALIVA EJECTORS IN THE NATURE OF MANUAL VALVES USED WITH A SUCTION VACUUM, AND ACCESSORIES THEREFORE, NAMELY, HAND PIECES AND EJECTOR TIPS, IN CLASS 10 (U.S. CLS. 26, 39 AND 44).

TRADEMARK

FIRST USE 12-31-1985; IN COMMERCE 12-31-1985.

SERVICE MARK

PRINCIPAL REGISTER

FOR: MOTOR REPAIR AND MAINTENANCE SERVICES FOR EQUIPMENT USED IN DENTAL OFFICES, NAMELY, VACUUM PUMPS AND CARTRIDGES, COMPRESSORS, VACUUMS, TURBINES, SEPARATORS, COLLECTORS, GAUGES, VALVES, SWITCHES AND REGULATORS, IN CLASS 37 (U.S. CLS. 100, 103 AND 106).

FIRST USE 12-31-1985; IN COMMERCE 12-31-1985.

THE MARK CONSISTS OF STANDARD CHARACTERS WITHOUT CLAIM TO ANY PARTICULAR FONT, STYLE, SIZE, OR COLOR.

SER. NO. 85-496,997, FILED 12-16-2011.

DAVID ELTON, EXAMINING ATTORNEY



David J. Kyffers

Director of the United States Patent and Trademark Office

United States of America

United States Patent and Trademark Office

ONE TOUCH

Reg. No. 4,205,021

Registered Sep. 11, 2012

Int. Cl.: 5

TRADEMARK

PRINCIPAL REGISTER

HAGER WORLDWIDE, INC. (FLORIDA CORPORATION)
441 19TH STREET, SE
HICKORY, NY 29601

FOR: ORAL TOPICAL ANESTHETIC GEL SOLD EXCLUSIVELY TO DENTISTS FOR USE
IN NUMBING PATIENTS' GUMS BEFORE PERFORMING ORAL PROCEDURES, IN CLASS
5 (U.S. CLS. 6, 18, 44, 46, 51 AND 52).

FIRST USE 12-16-1996; IN COMMERCE 12-16-1996.

THE MARK CONSISTS OF STANDARD CHARACTERS WITHOUT CLAIM TO ANY PAR-
TICULAR FONT, STYLE, SIZE, OR COLOR.

SER. NO. 85-497,014, FILED 12-16-2011.

DAVID ELTON, EXAMINING ATTORNEY



David J. Kyffers

Director of the United States Patent and Trademark Office

United States of America

United States Patent and Trademark Office

SUPER BIB CLIP

Reg. No. 4,205,022

HAGER WORLDWIDE, INC. (FLORIDA CORPORATION)
441 19TH STREET, SE
HICKORY, NC 29601

Registered Sep. 11, 2012

Int. Cl.: 10

FOR: DENTAL BIB CLIPS FOR SECURING DENTAL BIBS ON PATIENTS DURING DENTAL PROCEDURES, IN CLASS 10 (U.S. CLS. 26, 39 AND 44).

TRADEMARK

FIRST USE 4-7-1994; IN COMMERCE 4-7-1994.

PRINCIPAL REGISTER

THE MARK CONSISTS OF STANDARD CHARACTERS WITHOUT CLAIM TO ANY PARTICULAR FONT, STYLE, SIZE, OR COLOR.

NO CLAIM IS MADE TO THE EXCLUSIVE RIGHT TO USE "BIB CLIP", APART FROM THE MARK AS SHOWN.

SEC. 2(F).

SER. NO. 85-497,020, FILED 12-16-2011.

DAVID ELTON, EXAMINING ATTORNEY



David J. Kybas

Director of the United States Patent and Trademark Office

United States of America

United States Patent and Trademark Office

UNI-TIP

Reg. No. 4,205,023

HAGER WORLDWIDE, INC. (FLORIDA CORPORATION)
441 19TH STREET, SE
HICKORY, NC 29601

Registered Sep. 11, 2012

Int. Cl.: 10

FOR: SYRINGE TIPS FOR USE WITH DENTAL AIR AND WATER SYRINGES, IN CLASS 10 (U.S. CLS. 26, 39 AND 44).

TRADEMARK

FIRST USE 12-31-1985; IN COMMERCE 12-31-1985.

PRINCIPAL REGISTER

THE MARK CONSISTS OF STANDARD CHARACTERS WITHOUT CLAIM TO ANY PARTICULAR FONT, STYLE, SIZE, OR COLOR.

SER. NO. 85-497,033, FILED 12-16-2011.

DAVID ELTON, EXAMINING ATTORNEY



David J. Kyffers

Director of the United States Patent and Trademark Office

United States of America

United States Patent and Trademark Office

SimpliConnect

Reg. No. 4,205,024

TECMARK, INC. (MINNESOTA CORPORATION)
444 CEDAR STREET SUITE 1000
SAINT PAUL, MN 55101

Registered Sep. 11, 2012

Int. Cls.: 35 and 42

FOR: ADVERTISING AND MARKETING SERVICES, NAMELY, ADMINISTRATION OF CUSTOMER LOYALTY, INCENTIVE AWARD AND DATABASE MARKETING PROGRAMS, PROVIDING ACCOUNT STATEMENTS, PROMOTIONAL MATERIALS, MAIL AND ORDER FULFILLMENT SERVICES; PROCESSING, REPORTING AND ANALYSIS OF CUSTOMER LOYALTY DATA, IN CLASS 35 (U.S. CLS. 100, 101 AND 102).

SERVICE MARK

PRINCIPAL REGISTER

FIRST USE 2-1-2012; IN COMMERCE 2-1-2012.

FOR: SOFTWARE AS A SERVICES (SAAS) SERVICES FEATURING SOFTWARE FOR STORING, MANAGING, TRACKING, ANALYZING AND REPORTING DATA IN THE FIELDS OF MARKETING, PROMOTION, SALES, CUSTOMER INFORMATION, CUSTOMER RELATIONSHIP MANAGEMENT, SALES SUPPORT, AND EMPLOYEE EFFICIENCY, AND FOR USE IN ADMINISTERING AND MANAGING CUSTOMER LOYALTY, INCENTIVE AWARD, CUSTOMER REWARDS AND PROMOTIONAL MARKETING PROGRAMS; PROVIDING ON-LINE, NON-DOWNLOADABLE SOFTWARE FOR STORING, MANAGING, TRACKING, ANALYZING AND REPORTING DATA IN THE FIELDS OF MARKETING, PROMOTION, SALES, CUSTOMER INFORMATION, CUSTOMER RELATIONSHIP MANAGEMENT, SALES SUPPORT, AND EMPLOYEE EFFICIENCY, AND FOR USE IN ADMINISTERING AND MANAGING CUSTOMER LOYALTY, INCENTIVE AWARD, CUSTOMER REWARDS AND PROMOTIONAL MARKETING PROGRAMS, IN CLASS 42 (U.S. CLS. 100 AND 101).

FIRST USE 2-1-2012; IN COMMERCE 2-1-2012.

THE MARK CONSISTS OF STANDARD CHARACTERS WITHOUT CLAIM TO ANY PARTICULAR FONT, STYLE, SIZE, OR COLOR.

SER. NO. 85-497,367, FILED 12-16-2011.

ARETHA SOMERVILLE, EXAMINING ATTORNEY



David J. Kyffers

Director of the United States Patent and Trademark Office

United States of America

United States Patent and Trademark Office

Le Garage Sale

Reg. No. 4,205,025

LE GARAGE SALE, L.L.C. (TEXAS LIMITED LIABILITY COMPANY)
3529 FAWN CREEK PATH
AUSTIN, TX 78746

Registered Sep. 11, 2012

Int. Cl.: 35

FOR: THE BRINGING TOGETHER, FOR THE BENEFIT OF OTHERS, OF A VARIETY OF GOODS FROM LOCAL RETAIL CLOTHING BOUTIQUES, AND ENABLING CUSTOMERS TO CONVENIENTLY VIEW AND PURCHASE SUCH GOODS IN A CONVENTION ARENA SETTING, IN CLASS 35 (U.S. CLS. 100, 101 AND 102).

SERVICE MARK

PRINCIPAL REGISTER

FIRST USE 12-6-2010; IN COMMERCE 12-6-2010.

THE MARK CONSISTS OF STANDARD CHARACTERS WITHOUT CLAIM TO ANY PARTICULAR FONT, STYLE, SIZE, OR COLOR.

THE ENGLISH TRANSLATION OF "LE" IN THE MARK IS THE.

SER. NO. 85-497,582, FILED 12-16-2011.

DAVID ELTON, EXAMINING ATTORNEY



David J. Kyffers

Director of the United States Patent and Trademark Office

United States of America

United States Patent and Trademark Office

VC 2000

Reg. No. 4,205,026

ALEX JUN YANG (REPUBLIC OF KOREA INDIVIDUAL), DBA SOLAR MINERALS
621 S. VIRGIL AVE. #470
LOS ANGELES, CA 90005

Registered Sep. 11, 2012

Int. Cl.: 5

FOR: VITAMIN AND MINERAL SUPPLEMENTS, IN CLASS 5 (U.S. CLS. 6, 18, 44, 46, 51 AND 52).

TRADEMARK

FIRST USE 8-1-2006; IN COMMERCE 8-1-2006.

PRINCIPAL REGISTER

THE MARK CONSISTS OF STANDARD CHARACTERS WITHOUT CLAIM TO ANY PARTICULAR FONT, STYLE, SIZE, OR COLOR.

NO CLAIM IS MADE TO THE EXCLUSIVE RIGHT TO USE "2000", APART FROM THE MARK AS SHOWN.

SER. NO. 85-497,690, FILED 12-16-2011.

LESLIE RICHARDS, EXAMINING ATTORNEY



David J. Kyjars

Director of the United States Patent and Trademark Office

United States of America

United States Patent and Trademark Office

SELLA CARE

Reg. No. 4,205,027

YANG, ALEX JUN (REPUBLIC OF KOREA INDIVIDUAL), DBA SOLAR MINERALS
621 S. VIRGIL AVE. #470

Registered Sep. 11, 2012

LOS ANGELES, CA 90005

Int. Cl.: 5

FOR: VITAMIN AND MINERAL SUPPLEMENTS, IN CLASS 5 (U.S. CLS. 6, 18, 44, 46, 51 AND 52).

TRADEMARK

FIRST USE 8-1-2006; IN COMMERCE 8-1-2006.

PRINCIPAL REGISTER

THE MARK CONSISTS OF STANDARD CHARACTERS WITHOUT CLAIM TO ANY PARTICULAR FONT, STYLE, SIZE, OR COLOR.

SER. NO. 85-497,741, FILED 12-16-2011.

LESLIE RICHARDS, EXAMINING ATTORNEY



David J. Kybas

Director of the United States Patent and Trademark Office

United States of America

United States Patent and Trademark Office

ALBERTMING

Reg. No. 4,205,028

ALBERTMING INC. (DELAWARE CORPORATION)
1008 BANCROFT WAY
BERKELEY, CA 94710

Registered Sep. 11, 2012

Int. Cls.: 25 and 35

FOR: CLOTHING, NAMELY, SHIRTS, SUITS, PANTS, AND JACKETS, IN CLASS 25 (U.S. CLS. 22 AND 39).

TRADEMARK

FIRST USE 12-8-2011; IN COMMERCE 12-8-2011.

SERVICE MARK

FOR: RETAIL AND ONLINE STORES FEATURING CLOTHING, IN CLASS 35 (U.S. CLS. 100, 101 AND 102).

PRINCIPAL REGISTER

FIRST USE 12-8-2011; IN COMMERCE 12-8-2011.

THE MARK CONSISTS OF STANDARD CHARACTERS WITHOUT CLAIM TO ANY PARTICULAR FONT, STYLE, SIZE, OR COLOR.

THE NAME "ALBERTMING" DOES NOT IDENTIFY A LIVING INDIVIDUAL. THE MARK IS A COMBINATION OF THE TWO FOUNDERS' GIVEN NAMES. BOTH FOUNDERS HAVE SIGNED THE APPLICATION.

SER. NO. 85-497,969, FILED 12-16-2011.

EUGENIA MARTIN, EXAMINING ATTORNEY



David J. Kyros

Director of the United States Patent and Trademark Office

United States of America

United States Patent and Trademark Office

BERKELEY POINT

Reg. No. 4,205,029

Registered Sep. 11, 2012

Int. Cls.: 35 and 36

SERVICE MARK

PRINCIPAL REGISTER

RR HOLDINGS LLC (DELAWARE LIMITED LIABILITY COMPANY)
SUITE 1100
4550 MONTGOMERY AVENUE
BETHESDA, MD 20814

FOR: MARKET RESEARCH, IN CLASS 35 (U.S. CLS. 100, 101 AND 102).

FIRST USE 1-11-2012; IN COMMERCE 1-11-2012.

FOR: REAL ESTATE DEBT, EQUITY, AND MEZZANINE LOAN FINANCING AND LOAN SERVICING; FINANCIAL SERVICES RELATING TO COMMERCIAL AND MULTI-FAMILY MORTGAGE BANKING, LOAN SERVICING, AND MORTGAGE BROKERAGE SERVICES; ORIGINATING MULTIFAMILY, SENIORS HOUSING, HEALTH CARE FACILITIES, OR MANUFACTURED HOUSING COMMERCIAL LOANS UNDER U.S. GOVERNMENT, GOVERNMENT SPONSORED ENTERPRISE AND STATE AGENCY PROGRAMS; FINANCIAL ANALYSIS AND CONSULTATION RELATING TO COMMERCIAL AND MULTIFAMILY REAL ESTATE; FINANCIAL ADVISORY SERVICES REGARDING COMMERCIAL AND MULTIFAMILY REAL ESTATE; REAL ESTATE CAPITAL INVESTMENT CONSULTATION SERVICES; CONSULTATION AND MANAGEMENT OF INVESTMENT FUNDS RELATING TO REAL ESTATE, REAL ESTATE DEBT AND REAL ESTATE SECURITIES; COMMERCIAL AND MULTIFAMILY REAL ESTATE APPRAISAL, BROKERAGE, INVESTMENT, INVESTMENT SALES AND MANAGEMENT SERVICES; FINANCIAL RESEARCH IN THE AREA OF COMMERCIAL AND MULTIFAMILY REAL ESTATE; AND COMMERCIAL AND MULTIFAMILY REAL ESTATE INVESTMENT AND PROPERTY MANAGEMENT, IN CLASS 36 (U.S. CLS. 100, 101 AND 102).

FIRST USE 1-11-2012; IN COMMERCE 1-11-2012.

THE MARK CONSISTS OF STANDARD CHARACTERS WITHOUT CLAIM TO ANY PARTICULAR FONT, STYLE, SIZE, OR COLOR.

SER. NO. 85-498,096, FILED 12-17-2011.

BRIDGETT SMITH, EXAMINING ATTORNEY



David J. Kyffers

Director of the United States Patent and Trademark Office

United States of America

United States Patent and Trademark Office

LAMINATE TECHNOLOGIES

Reg. No. 4,205,030

LAMINATE TECHNOLOGIES, INC. (OHIO CORPORATION)
161 MAULE ROAD
TIFFIN, OH 44883

Registered Sep. 11, 2012

Int. Cl.: 40

FOR: MANUFACTURE OF LAMINATED WOOD PRODUCTS TO ORDER AND/OR SPECIFICATION OF OTHERS, IN CLASS 40 (U.S. CLS. 100, 103 AND 106).

SERVICE MARK

FIRST USE 0-0-1985; IN COMMERCE 0-0-1985.

PRINCIPAL REGISTER

THE MARK CONSISTS OF STANDARD CHARACTERS WITHOUT CLAIM TO ANY PARTICULAR FONT, STYLE, SIZE, OR COLOR.

NO CLAIM IS MADE TO THE EXCLUSIVE RIGHT TO USE "LAMINATE", APART FROM THE MARK AS SHOWN.

SEC. 2(F).

SER. NO. 85-498,126, FILED 12-17-2011.

ROBERT STRUCK, EXAMINING ATTORNEY



David J. Kybas

Director of the United States Patent and Trademark Office

United States of America

United States Patent and Trademark Office

SICONIDE

Reg. No. 4,205,031

Registered Sep. 11, 2012

Int. Cl.: 1

TRADEMARK

PRINCIPAL REGISTER

VESTA SI LLC (UTAH LIMITED LIABILITY COMPANY)
SUITE B
9327 WHEATLANDS RD.
SANTEE, CA 92071

FOR: SILICON NITRIDE POWDER FOR MANUFACTURING OF CONSTRUCTION CERAMICS COMPONENTS, IN PARTICULAR, BALL AND ROLL BEARINGS, ENGINE COMPONENTS, HIGH TEMPERATURE PROCESS COMPONENTS, AND COATINGS FOR HANDLING OF METAL MELTS; AND FOR USE IN SLIP-CASTING, INJECTION MOLDING, AND IN THE CERAMICS INDUSTRY, IN CLASS 1 (U.S. CLS. 1, 5, 6, 10, 26 AND 46).

FIRST USE 1-31-1983; IN COMMERCE 8-31-1983.

THE MARK CONSISTS OF STANDARD CHARACTERS WITHOUT CLAIM TO ANY PARTICULAR FONT, STYLE, SIZE, OR COLOR.

SER. NO. 85-498,203, FILED 12-17-2011.

SOPHIA S. KIM, EXAMINING ATTORNEY



David J. Kybas

Director of the United States Patent and Trademark Office

United States of America

United States Patent and Trademark Office

WOODBURY AUTOMOTIVE WAREHOUSE

Reg. No. 4,205,032

Registered Sep. 11, 2012

Int. Cl.: 35

SERVICE MARK

PRINCIPAL REGISTER

WOODBURY AUTOMOTIVE WAREHOUSE, LLC (NEW YORK LIMITED LIABILITY COMPANY)
605 ALBANY AVE.
AMITYVILLE, NY 11701

FOR: DISTRIBUTORSHIP SERVICES IN THE FIELD OF AUTOMOBILE REPLACEMENT PARTS, IN CLASS 35 (U.S. CLS. 100, 101 AND 102).

FIRST USE 1-1-1971; IN COMMERCE 1-1-1971.

THE MARK CONSISTS OF STANDARD CHARACTERS WITHOUT CLAIM TO ANY PARTICULAR FONT, STYLE, SIZE, OR COLOR.

NO CLAIM IS MADE TO THE EXCLUSIVE RIGHT TO USE "AUTOMOTIVE WAREHOUSE", APART FROM THE MARK AS SHOWN.

SEC. 2(F).

SER. NO. 85-498,332, FILED 12-19-2011.

MYRIAH HABEEB, EXAMINING ATTORNEY



David J. Kyffers

Director of the United States Patent and Trademark Office

United States of America

United States Patent and Trademark Office

PROSPECT VISION

Reg. No. 4,205,033

Registered Sep. 11, 2012

Int. Cl.: 35

SERVICE MARK

PRINCIPAL REGISTER

DIGITAL AUTOMOTIVE TECHNOLOGIES, INC. (NORTH CAROLINA CORPORATION)
SUITE 102
920 TATE BLVD. SE
HICKORY, NC 28601

FOR: BUSINESS MARKETING CONSULTING, NAMELY, DEVELOPING MARKETING PROGRAMS FOR VEHICLE DEALERS THAT INVOLVE ASSESSING A POTENTIAL CUSTOMER'S EQUITY IN AN EXISTING VEHICLE AND THEN CONTACTING THAT CUSTOMER WITH TARGETED MARKETING MESSAGES REGARDING THE PURCHASE OF A NEW VEHICLE, IN CLASS 35 (U.S. CLS. 100, 101 AND 102).

FIRST USE 2-12-2002; IN COMMERCE 6-1-2002.

THE MARK CONSISTS OF STANDARD CHARACTERS WITHOUT CLAIM TO ANY PARTICULAR FONT, STYLE, SIZE, OR COLOR.

NO CLAIM IS MADE TO THE EXCLUSIVE RIGHT TO USE "PROSPECT", APART FROM THE MARK AS SHOWN.

SER. NO. 85-498,382, FILED 12-19-2011.

DORITT L. CARROLL, EXAMINING ATTORNEY



David J. Kyffers

Director of the United States Patent and Trademark Office

United States of America

United States Patent and Trademark Office



commonground

Reg. No. 4,205,034

Registered Sep. 11, 2012

Int. Cls.: 35 and 38

SERVICE MARK

PRINCIPAL REGISTER

UNITED SOYBEAN BOARD (UNITED STATES NON-CORPORATE BOARD ORGANIZED UNDER THE LAWS OF THE UNITED STATES PURSUANT TO THE SOYBEAN PROMOTION, RESEARCH AND CONSUMER INFORMATION ACT (7 USC 6301-6311))
SUITE 150
16305 SWINGLEY RIDGE ROAD
CHESTERFIELD, MO 63017 AND

NATIONAL CORN GROWERS ASSOCIATION (IOWA CORPORATION)
632 CEPI DRIVE
CHESTERFIELD, MO 63005

FOR: ASSOCIATION SERVICES, NAMELY, PROMOTING GREATER PUBLIC AWARENESS OF MODERN AGRICULTURE, IN CLASS 35 (U.S. CLS. 100, 101 AND 102).

FIRST USE 2-28-2011; IN COMMERCE 2-28-2011.

FOR: PROVIDING AN ONLINE FORUM FOR TRANSMISSION OF MESSAGES AMONG COMPUTER USERS CONCERNING MODERN AGRICULTURE, IN CLASS 38 (U.S. CLS. 100, 101 AND 104).

FIRST USE 2-28-2011; IN COMMERCE 2-28-2011.

THE MARK CONSISTS OF A FANCIFUL LANDSCAPE SUGGESTING A FARM ON THE LEFT SIDE, A FIELD IN THE MIDDLE, AND A CITY ON THE RIGHT SIDE WITH A CLOUDED SKY ABOVE AND THE WORD "COMMONGROUND" BELOW.

SER. NO. 85-498,765, FILED 12-19-2011.

H. M. FISHER, EXAMINING ATTORNEY



David J. Kybas

Director of the United States Patent and Trademark Office

United States of America

United States Patent and Trademark Office

commonground

Reg. No. 4,205,035

Registered Sep. 11, 2012

Int. Cls.: 35 and 38

SERVICE MARK

PRINCIPAL REGISTER

UNITED SOYBEAN BOARD (UNITED STATES NON-CORPORATE BOARD ORGANIZED UNDER THE LAWS OF THE UNITED STATES PURSUANT TO THE SOYBEAN PROMOTION, RESEARCH AND CONSUMER INFORMATION ACT (7 USC 6301-6311))
SUITE 150
16305 SWINGLEY RIDGE ROAD
CHESTERFIELD, MO 63017 AND

NATIONAL CORN GROWERS ASSOCIATION (IOWA CORPORATION)
632 CEPI DRIVE
CHESTERFIELD, MO 63005

FOR: ASSOCIATION SERVICES, NAMELY, PROMOTING GREATER PUBLIC AWARENESS OF MODERN AGRICULTURE, IN CLASS 35 (U.S. CLS. 100, 101 AND 102).

FIRST USE 2-28-2011; IN COMMERCE 2-28-2011.

FOR: PROVIDING AN ONLINE FORUM FOR TRANSMISSION OF MESSAGES AMONG COMPUTER USERS CONCERNING MODERN AGRICULTURE, IN CLASS 38 (U.S. CLS. 100, 101 AND 104).

FIRST USE 2-28-2011; IN COMMERCE 2-28-2011.

THE MARK CONSISTS OF STANDARD CHARACTERS WITHOUT CLAIM TO ANY PARTICULAR FONT, STYLE, SIZE, OR COLOR.

SER. NO. 85-498,860, FILED 12-19-2011.

H. M. FISHER, EXAMINING ATTORNEY



David J. Kyffers

Director of the United States Patent and Trademark Office

United States of America

United States Patent and Trademark Office



Reg. No. 4,205,036

Registered Sep. 11, 2012

Int. Cl.: 29

TRADEMARK

PRINCIPAL REGISTER

JONMOR INVESTMENTS, INC. (DELAWARE CORPORATION)
BAYNARD BUILDING, SUITE 103
3411 SILVERSIDE ROAD
WILMINGTON, DE 19810

FOR: HAM; MEAT, IN CLASS 29 (U.S. CL. 46).

FIRST USE 10-31-2011; IN COMMERCE 10-31-2011.

OWNER OF U.S. REG. NOS. 1,054,792, 3,169,028 AND OTHERS.

THE COLOR(S) RED, BLACK, GOLD AND WHITE IS/ARE CLAIMED AS A FEATURE OF THE MARK.

NO CLAIM IS MADE TO THE EXCLUSIVE RIGHT TO USE "SINCE 1827" AND "SPECIAL RESERVE", APART FROM THE MARK AS SHOWN.

THE NAME(S), PORTRAIT(S), AND/OR SIGNATURE(S) SHOWN IN THE MARK DOES NOT IDENTIFY A PARTICULAR LIVING INDIVIDUAL.

THE MARK CONSISTS OF A CURVED RECTANGULAR SHAPED DESIGN WITH AN ALTERNATING BLACK, GOLD, BLACK, GOLD BORDER. A HORIZONTAL GOLD BAR WITH ALTERNATING BLACK AND GOLD BORDERS DIVIDES THE RECTANGLE INTO TWO HALVES. A RED BANNER WITH GOLD BORDER OVERLAYS THE GOLD BAR IN THE MIDDLE. THE TOP HALF OF THE RECTANGLE HAS A BLACK BACKGROUND WITH THE WORDS "SINCE 1827" IN GOLD STYLIZED LETTERING, "JOHN MORRELL" IN WHITE AND GOLD STYLIZED LETTERING AND "SPECIAL RESERVE" IN GOLD STYLIZED LETTERING. THE BOTTOM HALF OF THE REMARK IS RED WITH BLACK SHADING AROUND THE EDGES.

SER. NO. 85-499,781, FILED 12-20-2011.

CHRISTOPHER LAW, EXAMINING ATTORNEY



David J. Kybas

Director of the United States Patent and Trademark Office

United States of America

United States Patent and Trademark Office



berkeley point

Reg. No. 4,205,037

Registered Sep. 11, 2012

Int. Cls.: 35 and 36

SERVICE MARK

PRINCIPAL REGISTER

RR HOLDINGS LLC (DELAWARE LIMITED LIABILITY COMPANY)
SUITE 1100
4550 MONTGOMERY AVENUE
BETHESDA, MD 20814

FOR: MARKET RESEARCH, IN CLASS 35 (U.S. CLS. 100, 101 AND 102).

FIRST USE 1-11-2012; IN COMMERCE 1-11-2012.

FOR: REAL ESTATE DEBT, EQUITY, AND MEZZANINE LOAN FINANCING AND LOAN SERVICING; FINANCIAL SERVICES RELATING TO COMMERCIAL AND MULTI-FAMILY MORTGAGE BANKING, LOAN SERVICING, AND MORTGAGE BROKERAGE SERVICES; ORIGINATING MULTIFAMILY, SENIORS HOUSING, HEALTH CARE FACILITIES, OR MANUFACTURED HOUSING COMMERCIAL LOANS UNDER U.S. GOVERNMENT, GOVERNMENT SPONSORED ENTERPRISE AND STATE AGENCY PROGRAMS; FINANCIAL ANALYSIS AND CONSULTATION RELATING TO COMMERCIAL AND MULTIFAMILY REAL ESTATE; FINANCIAL ADVISORY SERVICES REGARDING COMMERCIAL AND MULTIFAMILY REAL ESTATE; REAL ESTATE CAPITAL INVESTMENT CONSULTATION SERVICES; CONSULTATION AND MANAGEMENT OF INVESTMENT FUNDS RELATING TO REAL ESTATE, REAL ESTATE DEBT AND REAL ESTATE SECURITIES; COMMERCIAL AND MULTIFAMILY REAL ESTATE APPRAISAL, BROKERAGE, INVESTMENT, INVESTMENT SALES AND MANAGEMENT SERVICES; FINANCIAL RESEARCH IN THE AREA OF COMMERCIAL AND MULTIFAMILY REAL ESTATE; AND COMMERCIAL AND MULTIFAMILY REAL ESTATE INVESTMENT AND PROPERTY MANAGEMENT, IN CLASS 36 (U.S. CLS. 100, 101 AND 102).

FIRST USE 1-11-2012; IN COMMERCE 1-11-2012.

THE MARK CONSISTS OF THREE CONSECUTIVE, OVERLAPPING FOUR-SIDED SHAPES WITH ARCS ENDING IN POINTS AT THE TOP OF EACH SHAPE ABOVE THE WORDS "BERKELEY POINT".

SER. NO. 85-500,393, FILED 12-20-2011.

BRIDGETT SMITH, EXAMINING ATTORNEY



David J. Kybas

Director of the United States Patent and Trademark Office

United States of America

United States Patent and Trademark Office

ATP/SMS

Reg. No. 4,205,038

Registered Sep. 11, 2012

RESNA (ILLINOIS CORPORATION)
1700 NORTH MOORE STREET, SUITE 1540
ARLINGTON, VA 222091903

CERTIFICATION MARK

PRINCIPAL REGISTER

FOR: ANALYSIS, RECOMMENDATION, FITTING, AND TRAINING FOR THE PERSONAL MOBILITY AND SEATING NEEDS OF PERSONS WITH DISABILITIES IN ORDER TO IMPROVE INDEPENDENCE, HEALTH, FUNCTION, AND INVOLVEMENT IN LIFE ACTIVITIES, IN CLASS B (U.S. CL. B).

FIRST USE 10-0-2010; IN COMMERCE 10-0-2010.

THE MARK CONSISTS OF STANDARD CHARACTERS WITHOUT CLAIM TO ANY PARTICULAR FONT, STYLE, SIZE, OR COLOR.

OWNER OF U.S. REG. NO. 3,059,937.

THE CERTIFICATION MARK, AS USED BY AUTHORIZED PERSONS, CERTIFIES THAT THE AUTHORIZED PRACTITIONER HAS COMPLETED RECOGNIZED ACCEPTED LEVELS OF ADVANCED KNOWLEDGE AND SKILL IN THE SPECIALTY ASSISTIVE TECHNOLOGY FIELD OF SEATING AND MOBILITY NEEDS WITH THE GOAL OF ENSURING CONSUMER SAFEGUARDS AND INCREASED CONSUMER SATISFACTION.

SER. NO. 85-500,693, FILED 12-21-2011.

NELSON SNYDER, EXAMINING ATTORNEY



David J. Kyffers

Director of the United States Patent and Trademark Office

United States of America

United States Patent and Trademark Office



Reg. No. 4,205,039

Registered Sep. 11, 2012

Int. Cl.: 41

SERVICE MARK

PRINCIPAL REGISTER

ROBERTS, GEORGE TRACY (UNITED STATES INDIVIDUAL)
505 CRIEVE ROAD
NASHVILLE, TN 37220

FOR: CHARITABLE SERVICES, NAMELY, PROVIDING TRAINING IN THE FIELD OF GROUP FACILITATION AND COMMUNICATIONS TO INDIVIDUALS AND ORGANIZATIONS FOR THE PURPOSE OF BUILDING COMMUNITY, REDUCING CONFLICT, ENHANCING COMMUNICATIONS AND PROVIDING PERSONAL AND LEADERSHIP DEVELOPMENT, IN CLASS 41 (U.S. CLS. 100, 101 AND 107).

FIRST USE 10-1-2008; IN COMMERCE 10-1-2008.

NO CLAIM IS MADE TO THE EXCLUSIVE RIGHT TO USE "CENTER", APART FROM THE MARK AS SHOWN.

THE COLOR(S) ORANGE, BROWN, GREEN, BLUE AND BLACK IS/ARE CLAIMED AS A FEATURE OF THE MARK.

THE MARK CONSISTS OF TEXT AND GEOMETRIC FEATURES -- FOUR (4) SEPARATE COLORED (ONE ORANGE, ONE BROWN, ONE BLUE, ONE GREEN) AND SHADED CIRCLES CONNECTED BY TWO (2) INTERSECTING BLACK LINES WITH THE WORDS "THE CIRCLE CENTER" IN BLACK OPTIMA REGULAR FONT ARCED OVER THE GEOMETRIC SHAPES AND A BLACK LINE ARCED UNDER THE GEOMETRIC SHAPES FORMING A GESTURAL OUTER CIRCLE AROUND THE GEOMETRIC SHAPES.

SER. NO. 85-500,951, FILED 12-21-2011.

MARIA-VICTORIA SUAREZ, EXAMINING ATTORNEY



David J. Kyjars

Director of the United States Patent and Trademark Office

United States of America

United States Patent and Trademark Office



Reg. No. 4,205,040

L&L WINGS, INC. (SOUTH CAROLINA CORPORATION)
666 BROADWAY 2ND FL
NEW YORK, NY 10012

Registered Sep. 11, 2012

Int. Cls.: 24, 25 and 35

FOR: BEACH TOWELS, IN CLASS 24 (U.S. CLS. 42 AND 50).

FIRST USE 2-9-2008; IN COMMERCE 2-9-2008.

TRADEMARK

SERVICE MARK

FOR: MEN'S, WOMEN'S AND CHILDREN'S CLOTHING, NAMELY, SWEAT PANTS, SWEATSHIRTS, TEE SHIRTS, TANK TOPS, SHIRTS, SHORTS, DRESSES, SKIRTS, PANTS, JACKETS, SWEATERS, SWIMSUITS, SWIMSUIT COVER-UPS, AND PAREOS; BEACH SHOES, NAMELY, SANDALS, THONGS AND SLIPPERS; SOCKS, NAMELY, AQUA SOCKS; HEAD WEAR, NAMELY, SWIM CAPS, HATS, CAPS, HEADBANDS, BANDANAS, AND KERCHIEFS; ACCESSORIES, NAMELY, WRISTBANDS, VESTS, SHAWLS, SCARVES AND BELTS, IN CLASS 25 (U.S. CLS. 22 AND 39).

PRINCIPAL REGISTER

FIRST USE 2-9-2008; IN COMMERCE 2-9-2008.

FOR: RETAIL STORE SERVICES FEATURING BODY BOARDS, SWIM BOARDS, SWIM FLOATS, BEACH UMBRELLAS, BEACH TOWELS, SCUBA DIVING EQUIPMENT, SWIM GOGGLES, BEACH MATS, COSTUME JEWELRY, SOUVENIRS, GIFT ITEMS, CANDY AND BOTTLED WATER, IN CLASS 35 (U.S. CLS. 100, 101 AND 102).

FIRST USE 2-9-2008; IN COMMERCE 2-9-2008.

OWNER OF U.S. REG. NO. 3,458,144.

THE MARK CONSISTS OF THE WORD "WINGS" IN A DOUBLE BAND OVAL WITH TWO HIBISCUS FLOWERS CUTTING INTO THE LOWER RIGHT CORNER OF THE OVAL.

SER. NO. 85-501,135, FILED 12-21-2011.

COLLEEN DOMBROW, EXAMINING ATTORNEY



David J. Kyffers

Director of the United States Patent and Trademark Office

United States of America

United States Patent and Trademark Office



Bazz Houston

Reg. No. 4,205,041

BAZZ HOUSTON (CALIFORNIA CORPORATION)
12700 WESTERN AVENUE
GARDEN GROVE, CA 92841

Registered Sep. 11, 2012

Int. Cl.: 40

FOR: CUSTOM MANUFACTURING OF COIL AND FLAT SPRINGS AND WIRE FORMS, METAL STAMPING, TOOLING AND ASSEMBLY, IN CLASS 40 (U.S. CLS. 100, 103 AND 106).

SERVICE MARK

FIRST USE 1-1-1965; IN COMMERCE 1-1-1965.

PRINCIPAL REGISTER

OWNER OF U.S. REG. NO. 1,669,763.

THE COLOR(S) BLACK AND RED IS/ARE CLAIMED AS A FEATURE OF THE MARK.

THE MARK CONSISTS OF THE FOLLOWING: THE LETTERS "BH" IN RED, ENCLOSED IN A BLACK SINGLE LINE SQUARE ABOVE THE WORDING "BAZZ HOUSTON" IN BLACK. THE MARK APPEARS ON A TRANSPARENT BACKGROUND.

SER. NO. 85-501,162, FILED 12-21-2011.

COLLEEN KEARNEY, EXAMINING ATTORNEY



David J. Kyffers

Director of the United States Patent and Trademark Office

United States of America

United States Patent and Trademark Office



Reg. No. 4,205,042

Registered Sep. 11, 2012

Int. Cl.: 45

SERVICE MARK

PRINCIPAL REGISTER

OODA GROUP, LLC (VIRGINIA LIMITED LIABILITY COMPANY)
22777 ZULLA CHASE PLACE
ASHBURN, VA 20148

FOR: SECURITY SERVICES, NAMELY, THREAT SIMULATION VULNERABILITY ANALYSIS AND MITIGATION AND EMERGENCY AND CRISIS RESPONSE; PROVIDING SECURITY ASSESSMENTS TO BUSINESSES IN SELECTION OF BUSINESS LOCATIONS, IN CLASS 45 (U.S. CLS. 100 AND 101).

FIRST USE 0-0-2009; IN COMMERCE 0-0-2009.

NO CLAIM IS MADE TO THE EXCLUSIVE RIGHT TO USE "OODA", APART FROM THE MARK AS SHOWN.

THE COLOR(S) BLUE AND BLACK IS/ARE CLAIMED AS A FEATURE OF THE MARK.

THE MARK CONSISTS OF THE STYLIZED WORD "OODA" IN BLUE WITH A BLACK OUTLINE. THE FIRST "O" IN "OODA" IS FORMED BY FOUR ARROWS IN BLUE WITH A BLACK OUTLINE. THE SECOND "O" IS FORMED BY THE ARTISTIC RENDERING OF THE EARTH IN BLUE WITH A BLACK OUTLINE; THE OCEAN AREA IN THE GLOBE IS TRANSPARENT. THE COLOR WHITE IN THE MARK REPRESENTS BACKGROUND, OUTLINING, SHADING AND/OR TRANSPARENT AREAS AND IS NOT PART OF THE MARK.

SER. NO. 85-501,335, FILED 12-21-2011.

HEATHER BIDDULPH, EXAMINING ATTORNEY



David J. Kyjars

Director of the United States Patent and Trademark Office

United States of America

United States Patent and Trademark Office

AUTOREPAIRMASTER

Reg. No. 4,205,043

ASA AUTOMOTIVE SYSTEMS, LLC (DELAWARE LIMITED LIABILITY COMPANY)
25 MANCHESTER STREET, SUITE 100
MERRIMACK, NH 03054

Registered Sep. 11, 2012

Int. Cl.: 9

FOR: COMPUTER SOFTWARE FOR USE IN BUSINESS OPERATIONS AND MANAGEMENT FUNCTIONS, NAMELY, ACCOUNTING, POINT-OF-SALE TRACKING AND INVENTORY CONTROL FOR USE IN THE FIELD OF AUTO REPAIR AND AUTO SERVICE, IN CLASS 9 (U.S. CLS. 21, 23, 26, 36 AND 38).

TRADEMARK

PRINCIPAL REGISTER

FIRST USE 11-0-1998; IN COMMERCE 11-0-1998.

THE MARK CONSISTS OF STANDARD CHARACTERS WITHOUT CLAIM TO ANY PARTICULAR FONT, STYLE, SIZE, OR COLOR.

SER. NO. 85-501,469, FILED 12-21-2011.

ROBERT C. CLARK JR., EXAMINING ATTORNEY



David J. Kyffers

Director of the United States Patent and Trademark Office

United States of America

United States Patent and Trademark Office



Reg. No. 4,205,044

LIFELINE SYSTEMS, INC. (WISCONSIN CORPORATION)
N2930 STATE ROAD 22
WAUTOMA, WI 54982

Registered Sep. 11, 2012

Int. Cl.: 9

FOR: GPS DATA LOGGER FOR RECORDING TRIPS AND CLASSIFYING THEM INTO DIFFERENT ACCOUNTS, IN CLASS 9 (U.S. CLS. 21, 23, 26, 36 AND 38).

TRADEMARK

FIRST USE 10-7-2011; IN COMMERCE 10-7-2011.

PRINCIPAL REGISTER

THE MARK CONSISTS OF "LIFETRAX" WRITTEN IN ONE WORD IN A STYLIZED FONT. "LIFE" IS WRITTEN IN GRAY AND "TRAX" IS WRITTEN IN BLUE. ICON IS A STAR OF LIFE BROKEN BY CIRCULAR RINGS AND A HEARTBEAT. THE ICON IS HALF BLUE AND HALF GRAY. THE UPPER THREE ARMS ARE BLUE AND THE LOWER THREE ARE GRAY.

THE COLOR(S) GRAY AND BLUE IS/ARE CLAIMED AS A FEATURE OF THE MARK.

SER. NO. 85-502,002, FILED 12-22-2011.

CHARLOTTE CORWIN, EXAMINING ATTORNEY



David J. Kybas

Director of the United States Patent and Trademark Office

United States of America

United States Patent and Trademark Office

GREASETROOPER

Reg. No. 4,205,045

Registered Sep. 11, 2012

Int. Cl.: 11

TRADEMARK

PRINCIPAL REGISTER

PARK ENVIRONMENTAL EQUIPMENT, LTD. (TEXAS LIMITED PARTNERSHIP)
7015 FAIRBANKS N HOUSTON RD
HOUSTON, TX 770404201

FOR: GREASE CONTAINMENT DEVICE COMPRISED OF A CONTAINMENT TANK, INTERNAL BAFFLE, INLET AND OUTLET PIPING, TO INTERCEPT AND REDUCE FATS, OILS AND GREASE IN WASTEWATER TO ACCEPTABLE EFFLUENT LEVELS BEFORE THEY ENTER A MUNICIPAL SANITARY SEWER SYSTEM, IN CLASS 11 (U.S. CLS. 13, 21, 23, 31 AND 34).

FIRST USE 10-12-2011; IN COMMERCE 11-9-2011.

THE MARK CONSISTS OF STANDARD CHARACTERS WITHOUT CLAIM TO ANY PARTICULAR FONT, STYLE, SIZE, OR COLOR.

OWNER OF U.S. REG. NOS. 2,628,121 AND 3,190,520.

SER. NO. 85-502,225, FILED 12-22-2011.

HAI-LY LAM, EXAMINING ATTORNEY



David J. Kyfos

Director of the United States Patent and Trademark Office

United States of America

United States Patent and Trademark Office

WHITSONS

Reg. No. 4,205,046

WHITSONS FOOD SERVICE CORP. (NEW YORK CORPORATION)
1800 MOTOR PARKWAY
ISLANDIA, NY 11749

Registered Sep. 11, 2012

Int. Cls.: 29 and 30

FOR: FROZEN AND FRESH PREPARED AND PACKAGED MEALS CONSISTING
PRIMARILY OF MEAT, FISH, POULTRY OR VEGETABLES, IN CLASS 29 (U.S. CL. 46).

TRADEMARK

FIRST USE 1-0-1979; IN COMMERCE 1-0-1979.

PRINCIPAL REGISTER

FOR: FROZEN AND FRESH PREPARED AND PACKAGED MEALS CONSISTING
PRIMARILY OF PASTA OR RICE, IN CLASS 30 (U.S. CL. 46).

FIRST USE 1-0-1979; IN COMMERCE 1-0-1979.

THE MARK CONSISTS OF STANDARD CHARACTERS WITHOUT CLAIM TO ANY PAR-
TICULAR FONT, STYLE, SIZE, OR COLOR.

OWNER OF U.S. REG. NO. 3,139,864.

SEC. 2(F).

SER. NO. 85-502,528, FILED 12-22-2011.

CHERYL CLAYTON, EXAMINING ATTORNEY



David J. Kyffers

Director of the United States Patent and Trademark Office

United States of America

United States Patent and Trademark Office

Mbaobao

Reg. No. 4,205,047

Registered Sep. 11, 2012

Int. Cls.: 18 and 35

JIAXING MBAOBAO NETWORK TECHNOLOGY CO., LTD. (CHINA LIMITED LIABILITY COMPANY)

ROOM 7L, NO. 1601 OFFICE BUILDING
CENTURY PLAZA, EAST ZHONG SHAN ROAD
JIAXING CITY, CHINA

TRADEMARK

SERVICE MARK

PRINCIPAL REGISTER

FOR: BACKPACKS; BRIEFCASES; CREDIT CARD HOLDERS; HANDBAGS; KEY CASES; NAME CARD CASES; PURSES; TRAVELLING BAGS; TRAVELLING TRUNKS; UMBRELLAS; WALLETS INCLUDING CARD HOLDERS, IN CLASS 18 (U.S. CLS. 1, 2, 3, 22 AND 41).

FIRST USE 8-27-2007; IN COMMERCE 8-27-2007.

FOR: ACCOUNTING SERVICES; ADVERTISING SERVICES; BUSINESS ORGANISATION AND MANAGEMENT CONSULTING SERVICES; COMMERCIAL BUSINESS MANAGEMENT; COMPILING OF INFORMATION INTO COMPUTER DATABASES; ON-LINE RETAIL STORE SERVICES FEATURING BAGS; ONLINE ADVERTISING VIA A COMPUTER COMMUNICATIONS NETWORK; ORGANISATION OF EXHIBITIONS AND EVENTS FOR COMMERCIAL OR ADVERTISING PURPOSES; PERSONNEL MANAGEMENT CONSULTATION; RELOCATION SERVICES FOR BUSINESS; RENTAL OF VENDING MACHINES; SALES PROMOTION SERVICES, IN CLASS 35 (U.S. CLS. 100, 101 AND 102).

FIRST USE 9-14-2007; IN COMMERCE 9-14-2007.

THE MARK CONSISTS OF STYLIZED WORD "MBAOBAO".

SER. NO. 85-502,770, FILED 12-22-2011.

FRANK LATTUCA, EXAMINING ATTORNEY



David J. Kyffers

Director of the United States Patent and Trademark Office

United States of America

United States Patent and Trademark Office



Reg. No. 4,205,048

IMAGINE SURF, LLC (CALIFORNIA LIMITED LIABILITY COMPANY)
924 B CALLE NEGOCIO
SAN CLEMENTE, CA 92673

Registered Sep. 11, 2012

Int. Cl.: 28

FOR: SURFBOARDS, PADDLEBOARDS, STAND UP PADDLEBOARDS, AND ACCESSORIES THEREFOR, NAMELY, FINS, LEASHES, PADDLES, PADDLE CLIPS, SEATS FOR PADDLEBOARDS, AND WHEEL ASSEMBLIES FOR PADDLEBOARDS, IN CLASS 28 (U.S. CLS. 22, 23, 38 AND 50).

TRADEMARK

PRINCIPAL REGISTER

FIRST USE 0-0-2008; IN COMMERCE 0-0-2008.

THE MARK CONSISTS OF A STYLIZED WAVE WITHIN A CIRCLE.

SER. NO. 85-502,821, FILED 12-23-2011.

YAT SYE, LEE, EXAMINING ATTORNEY



David J. Kybas

Director of the United States Patent and Trademark Office

United States of America

United States Patent and Trademark Office



Reg. No. 4,205,049

Registered Sep. 11, 2012

Int. Cl.: 41

SERVICE MARK

PRINCIPAL REGISTER

SLATER, ABRA (UNITED STATES INDIVIDUAL)
19330A OVERLOOK ROAD
LOS GATOS, CA 95030

FOR: ENTERTAINMENT IN THE NATURE OF COMPETITIONS IN THE FIELD OF GYMNASISTICS; ORGANIZING, ARRANGING, AND CONDUCTING GYMNASISTICS EVENTS, IN CLASS 41 (U.S. CLS. 100, 101 AND 107).

FIRST USE 2-28-2004; IN COMMERCE 3-0-2009.

NO CLAIM IS MADE TO THE EXCLUSIVE RIGHT TO USE "CHALLENGE", APART FROM THE MARK AS SHOWN.

THE STIPPLING IS FOR SHADING PURPOSES ONLY.

THE MARK CONSISTS OF A STYLIZED DESIGN WITH VARIOUS CURVED LINES SURROUNDED BY STARS AND STYLIZED FLAMES. AROUND THE LEFT SIDE OF THE FLAME DESIGN IS THE STYLIZED TEXT "SPIRIT OF THE FLAME". ALONG ONE CURVED LINE THROUGH THE CENTER OF THE DESIGN IS THE STYLIZED TEXT "CHALLENGE".

SER. NO. 85-502,887, FILED 12-23-2011.

MARILYN IZZI, EXAMINING ATTORNEY



David J. Kyros

Director of the United States Patent and Trademark Office

United States of America

United States Patent and Trademark Office



Reg. No. 4,205,050

GLOBAL CHRISTIAN NETWORK, INC. (GEORGIA CORPORATION)
4440 TUCK ROAD
LOGANVILLE, GA 30052

Registered Sep. 11, 2012

Int. Cl.: 38

FOR: CABLE TELEVISION BROADCASTING; TELEVISION BROADCASTING, IN CLASS 38 (U.S. CLS. 100, 101 AND 104).

SERVICE MARK

FIRST USE 9-1-2005; IN COMMERCE 9-1-2005.

PRINCIPAL REGISTER

NO CLAIM IS MADE TO THE EXCLUSIVE RIGHT TO USE "NETWORK", APART FROM THE MARK AS SHOWN.

THE MARK CONSISTS OF THE LETTERS "G","C","N" NEXT TO A GLOBE OVER THE WORDS "GLOBAL CHRISTIAN NETWORK".

SEC. 2(F) AS TO "GLOBAL CHRISTIAN NETWORK".

SER. NO. 85-502,933, FILED 12-23-2011.

ROSELLE HERRERA, EXAMINING ATTORNEY



David J. Kyros

Director of the United States Patent and Trademark Office

United States of America

United States Patent and Trademark Office

eDimensionCRM

Reg. No. 4,205,051

Registered Sep. 11, 2012

Int. Cl.: 35

SERVICE MARK

PRINCIPAL REGISTER

DATA RESEARCH NETWORK, INC. (CALIFORNIA CORPORATION)
SUITE 102
9290 WEST STOCKTON BLVD.
ELK GROVE, CA 95758

FOR: BUSINESS MANAGEMENT SERVICES; BUSINESS MANAGEMENT CONSULTATION SERVICES; CUSTOMER RELATIONSHIP MANAGEMENT SERVICES; MARKETING SERVICES; MARKETING RESEARCH SERVICES; BUSINESS MANAGEMENT SERVICES IN THE FIELD OF EMPLOYEE EFFICIENCY; PROVIDING A WEBSITE FEATURING INFORMATION IN THE FIELDS OF ADVERTISING AND MARKETING, IN CLASS 35 (U.S. CLS. 100, 101 AND 102).

FIRST USE 6-1-2010; IN COMMERCE 6-1-2010.

THE MARK CONSISTS OF STANDARD CHARACTERS WITHOUT CLAIM TO ANY PARTICULAR FONT, STYLE, SIZE, OR COLOR.

SER. NO. 85-503,202, FILED 12-23-2011.

HOWARD B. LEVINE, EXAMINING ATTORNEY



David J. Kyffers

Director of the United States Patent and Trademark Office

United States of America

United States Patent and Trademark Office

EDUCARE LEARNING NETWORK

Reg. No. 4,205,052

Registered Sep. 11, 2012

Int. Cls.: 35 and 41

SERVICE MARK

PRINCIPAL REGISTER

EDUCARE LEARNING NETWORK LLC (DELAWARE LIMITED LIABILITY COMPANY)
SUITE 2400
33 WEST MONROE STREET
CHICAGO, IL 60603

FOR: PUBLIC ADVOCACY VIA A VARIETY OF COMMUNICATIONS TOOLS AND STRATEGIES TO PROMOTE AWARENESS OF THE IMPORTANCE OF INVESTING IN QUALITY EARLY CARE AND LEARNING PROGRAMS FOR AT-RISK CHILDREN FROM BIRTH TO AGE FIVE; ASSOCIATION SERVICES, NAMELY, PROMOTING PUBLIC INTEREST AND AWARENESS IN THE IMPORTANCE OF INVESTING IN QUALITY EARLY CARE AND LEARNING PROGRAMS FOR AT-RISK CHILDREN FROM BIRTH TO AGE FIVE, IN CLASS 35 (U.S. CLS. 100, 101 AND 102).

FIRST USE 0-0-2003; IN COMMERCE 0-0-2003.

FOR: EDUCATIONAL SERVICES, NAMELY, DEVELOPING CURRICULUM FOR OTHERS IN THE FIELD OF EARLY CHILDHOOD EDUCATION AND DEVELOPMENT; EDUCATIONAL SERVICES, NAMELY, TEACHER TRAINING IN THE FIELDS OF EARLY CHILDHOOD EDUCATION AND DEVELOPMENT PROVIDED ON A REAL-TIME BASIS DURING CLASSROOM INSTRUCTION; EDUCATIONAL SERVICES, NAMELY, TEACHER TRAINING IN THE FIELDS OF EARLY CHILDHOOD EDUCATION AND DEVELOPMENT; RESEARCH IN THE FIELD OF EDUCATION; CONSULTING SERVICES IN THE FIELD OF TRAINING FOR EDUCATIONAL ADMINISTRATORS AND TEACHERS IN EARLY CHILDHOOD EDUCATION, IN CLASS 41 (U.S. CLS. 100, 101 AND 107).

FIRST USE 0-0-2003; IN COMMERCE 0-0-2003.

THE MARK CONSISTS OF STANDARD CHARACTERS WITHOUT CLAIM TO ANY PARTICULAR FONT, STYLE, SIZE, OR COLOR.

OWNER OF U.S. REG. NO. 2,868,355.

NO CLAIM IS MADE TO THE EXCLUSIVE RIGHT TO USE "LEARNING NETWORK", APART FROM THE MARK AS SHOWN.

SER. NO. 85-503,240, FILED 12-23-2011.



David J. Kyffers

Director of the United States Patent and Trademark Office

Reg. No. 4,205,052 DAWN HAN, EXAMINING ATTORNEY

United States of America

United States Patent and Trademark Office

URBAN OUTREACH

Reg. No. 4,205,053

COVERT, JAY (UNITED STATES INDIVIDUAL), DBA URBAN OUTREACH
9 PINOAK COURT
TROY, IL 62294

Registered Sep. 11, 2012

Int. Cl.: 45

FOR: RELIGIOUS SERVICES, NAMELY, PROVIDING MINISTERIAL AND EVANGELICAL SERVICES, IN CLASS 45 (U.S. CLS. 100 AND 101).

SERVICE MARK

FIRST USE 2-15-1995; IN COMMERCE 2-15-1995.

PRINCIPAL REGISTER

THE MARK CONSISTS OF STANDARD CHARACTERS WITHOUT CLAIM TO ANY PARTICULAR FONT, STYLE, SIZE, OR COLOR.

NO CLAIM IS MADE TO THE EXCLUSIVE RIGHT TO USE "OUTREACH", APART FROM THE MARK AS SHOWN.

SEC. 2(F).

SER. NO. 85-503,422, FILED 12-23-2011.

NAPOLEON SHARMA, EXAMINING ATTORNEY



David J. Kybas

Director of the United States Patent and Trademark Office

United States of America

United States Patent and Trademark Office

Sea M.D.

Reg. No. 4,205,054

Registered Sep. 11, 2012

Int. Cl.: 5

TRADEMARK

PRINCIPAL REGISTER

MINERAL RESOURCES INTERNATIONAL, INC. (UTAH CORPORATION), DBA IONIQUE
1990 WEST 3300 SOUTH
OGDEN, UT 84401

FOR: DIETARY AND NUTRITIONAL SUPPLEMENTS, IN CLASS 5 (U.S. CLS. 6, 18, 44, 46, 51 AND 52).

FIRST USE 12-23-2011, THE MARK WAS FIRST USED ANYWHERE IN A DIFFERENT FORM OTHER THAN THAT SOUGHT TO BE REGISTERED AT LEAST AS EARLY AS 07/01/2008.; IN COMMERCE 12-23-2011, THE MARK WAS FIRST USED IN COMMERCE IN A DIFFERENT FORM OTHER THAN THAT SOUGHT TO BE REGISTERED AT LEAST AS EARLY AS 07/01/2008..

THE MARK CONSISTS OF STANDARD CHARACTERS WITHOUT CLAIM TO ANY PARTICULAR FONT, STYLE, SIZE, OR COLOR.

NO CLAIM IS MADE TO THE EXCLUSIVE RIGHT TO USE "M.D.", APART FROM THE MARK AS SHOWN.

SER. NO. 85-503,426, FILED 12-23-2011.

MARY ROSSMAN, EXAMINING ATTORNEY



David J. Kyffers

Director of the United States Patent and Trademark Office

United States of America

United States Patent and Trademark Office

MICROSOFT

Reg. No. 4,205,055

Registered Sep. 11, 2012

Int. Cl.: 42

SERVICE MARK

PRINCIPAL REGISTER

MORPHLABS, INC. (DELAWARE CORPORATION)
3601 AVIATION BOULEVARD, SUITE 1000
MANHATTAN BEACH, CA 90266

FOR: PROVIDING TEMPORARY USE OF ON-LINE NON-DOWNLOADABLE COMPUTER PROGRAMS FOR CLOUD COMPUTING MANAGEMENT, IN CLASS 42 (U.S. CLS. 100 AND 101).

FIRST USE 6-27-2011; IN COMMERCE 6-27-2011.

THE MARK CONSISTS OF STANDARD CHARACTERS WITHOUT CLAIM TO ANY PARTICULAR FONT, STYLE, SIZE, OR COLOR.

SER. NO. 85-503,435, FILED 12-23-2011.

MATTHEW MCDOWELL, EXAMINING ATTORNEY



David J. Kyros

Director of the United States Patent and Trademark Office

United States of America

United States Patent and Trademark Office

NUVI

Reg. No. 4,205,056

Registered Sep. 11, 2012

Int. Cls.: 35 and 42

SERVICE MARK

PRINCIPAL REGISTER

REVEL8 LLC (UTAH LIMITED LIABILITY COMPANY)
SUITE 103
9571 SOUTH 700 EAST
SANDY, UT 84070

FOR: BUSINESS ANALYSIS, NAMELY, BUSINESS DATA ANALYSIS; CONSULTING SERVICES IN THE FIELD OF TRACKING AND ANALYZING SOCIAL MEDIA, WEB SITES AND APPLICATIONS AND DATABASES OF OTHERS TO PROVIDE VISUAL INTELLIGENCE, ENGAGEMENT AND INTERACTION, RESEARCH, STRATEGY, INSIGHT, OPTIMIZATION, MARKETING, SALES, OPERATION, AND PRODUCT DESIGN, PARTICULARLY SPECIALIZING IN THE USE OF ANALYTIC AND STATISTIC MODELS AND VISUALIZATIONS FOR THE UNDERSTANDING AND PREDICTING INTENT OF CONSUMERS, BUSINESSES, AND MARKET TRENDS AND ACTIONS IN THE FIELD OF SOCIAL MEDIA, CUSTOMER RELATIONSHIP, REPUTATION AND BRAND MANAGEMENT, POLITICAL DIALOGUE, FINANCIAL MANAGEMENT, NEWS MEDIA AND JOURNALISM; CONSULTING SERVICES IN THE FIELD OF INTERNET AND SOCIAL MEDIA MARKETING, IN CLASS 35 (U.S. CLS. 100, 101 AND 102).

FIRST USE 7-1-2011; IN COMMERCE 10-10-2011.

FOR: ONLINE, NON-DOWNLOADABLE SOFTWARE FOR TRACKING AND ANALYZING BUSINESS DATA, NAMELY, SOCIAL MEDIA, WEB SITES AND APPLICATIONS AND DATABASES OF OTHERS TO PROVIDE VISUAL INTELLIGENCE, ENGAGEMENT AND INTERACTION, RESEARCH, STRATEGY, MARKET TRENDS, CONSUMER INTENT PREDICTIONS, STATISTICAL MODELS, INSIGHT, OPTIMIZATION, MARKETING, SALES, OPERATION, AND PRODUCT DESIGN, FOR USE IN THE FIELDS OF SOCIAL MEDIA, CUSTOMER RELATIONSHIP, REPUTATION AND BRAND MANAGEMENT, POLITICAL DIALOGUE, FINANCIAL MANAGEMENT, NEWS MEDIA AND JOURNALISM, IN CLASS 42 (U.S. CLS. 100 AND 101).

FIRST USE 7-1-2011; IN COMMERCE 10-10-2011.

THE MARK CONSISTS OF STANDARD CHARACTERS WITHOUT CLAIM TO ANY PARTICULAR FONT, STYLE, SIZE, OR COLOR.

THE WORDING "NUVI" HAS NO MEANING IN A FOREIGN LANGUAGE.



David J. Kyjars

Director of the United States Patent and Trademark Office

Reg. No. 4,205,056 SER. NO. 85-503,622, FILED 12-24-2011.

WARREN L. OLANDRIA, EXAMINING ATTORNEY

United States of America

United States Patent and Trademark Office

It's better to give than
to guess

Reg. No. 4,205,057

MYPERFECTGIFT.COM, LLC (CALIFORNIA LIMITED LIABILITY COMPANY)
1436 SECOND ST
NAPA, CA 94558

Registered Sep. 11, 2012

Int. Cl.: 35

FOR: GIFT REGISTRY SERVICES, IN CLASS 35 (U.S. CLS. 100, 101 AND 102).

SERVICE MARK

FIRST USE 12-22-2011; IN COMMERCE 12-22-2011.

PRINCIPAL REGISTER

THE MARK CONSISTS OF STANDARD CHARACTERS WITHOUT CLAIM TO ANY PARTICULAR FONT, STYLE, SIZE, OR COLOR.

SER. NO. 85-503,627, FILED 12-25-2011.

FRANK LATTUCA, EXAMINING ATTORNEY



David J. Kyffers

Director of the United States Patent and Trademark Office

United States of America

United States Patent and Trademark Office



Sky Global Partners

Reg. No. 4,205,058

Registered Sep. 11, 2012

Int. Cl.: 37

SERVICE MARK

PRINCIPAL REGISTER

SKY GLOBAL PARTNERS, LLC (TEXAS LIMITED LIABILITY COMPANY), FORMERLY
BLUE SKY ENERGY, LLC
1302 WAUGH # 896
HOUSTON, TX 77019

FOR: REAL ESTATE DEVELOPMENT, NAMELY, DEVELOPING ENERGY PRODUCTION
FACILITIES, IN CLASS 37 (U.S. CLS. 100, 103 AND 106).

FIRST USE 12-12-2011; IN COMMERCE 12-12-2011.

NO CLAIM IS MADE TO THE EXCLUSIVE RIGHT TO USE "GLOBAL", APART FROM THE
MARK AS SHOWN.

THE COLOR(S) LIGHT BLUE, GREEN, DARK BLUE, GOLDEN, WHITE, BLACK IS/ARE
CLAIMED AS A FEATURE OF THE MARK.

THE MARK CONSISTS OF A CIRCULAR DESIGN WITH THE FOLLOWING COLORS
SEPARATED BY WHITE BORDERS AND A WHITE INTERIOR CIRCUMFERENCE LINE:
LIGHT BLUE (REPRESENTING SKY), GREEN (REPRESENTING EARTH), AND DARK
BLUE (REPRESENTING WATER) RUNNING THROUGH THE CIRCULAR DESIGN, WITH
A GOLDEN GLOW AROUND THE CIRCLE AND WITH THE WORDS "SKY GLOBAL
PARTNERS" IN BLACK ON THE RIGHT SIDE OF CIRCULAR DESIGN.

SER. NO. 85-504,227, FILED 12-27-2011.

KARANENDRA S. CHHINA, EXAMINING ATTORNEY



David J. Kybas

Director of the United States Patent and Trademark Office

United States of America

United States Patent and Trademark Office

Delicate Beauty

Reg. No. 4,205,059

Registered Sep. 11, 2012

Int. Cl.: 4

TRADEMARK

PRINCIPAL REGISTER

SOUTH BEACH CANDLE COMPANY, INC. (FLORIDA CORPORATION)
2260 W 80 STREET BAY #3
HIALEAH, FL 33016

FOR: AROMATHERAPY FRAGRANCE CANDLES; CANDLES; PERFUMED CANDLES;
SCENTED CANDLES; SCENTED WAX FOR USE IN CANDLE WARMERS, IN CLASS 4 (U.S.
CLS. 1, 6 AND 15).

FIRST USE 9-1-2011; IN COMMERCE 10-1-2011.

THE MARK CONSISTS OF STANDARD CHARACTERS WITHOUT CLAIM TO ANY PAR-
TICULAR FONT, STYLE, SIZE, OR COLOR.

SER. NO. 85-504,437, FILED 12-27-2011.

HEATHER BIDDULPH, EXAMINING ATTORNEY



David J. Kyffers

Director of the United States Patent and Trademark Office

United States of America

United States Patent and Trademark Office

A.K.T. American Freestyle Karate

Reg. No. 4,205,060

BROUGHTON, BARRY A (UNITED STATES INDIVIDUAL)
705 NORTH UNION STREET
OLEAN, NY 14760

Registered Sep. 11, 2012

Int. Cl.: 41

FOR: EDUCATION SERVICES, NAMELY, PROVIDING LIVE AND ON-LINE CLASSES, SEMINARS AND WORKSHOPS IN THE FIELD OF FITNESS, EXERCISE, KARATE AND MARTIAL ARTS, IN CLASS 41 (U.S. CLS. 100, 101 AND 107).

SERVICE MARK

FIRST USE 9-1-2007; IN COMMERCE 9-1-2008.

PRINCIPAL REGISTER

THE MARK CONSISTS OF STANDARD CHARACTERS WITHOUT CLAIM TO ANY PARTICULAR FONT, STYLE, SIZE, OR COLOR.

NO CLAIM IS MADE TO THE EXCLUSIVE RIGHT TO USE "AMERICAN FREESTYLE KARATE", APART FROM THE MARK AS SHOWN.

SER. NO. 85-504,911, FILED 12-28-2011.

SUZANNE BLANE, EXAMINING ATTORNEY



David J. Kyffers

Director of the United States Patent and Trademark Office

United States of America

United States Patent and Trademark Office

EZPRESS

Reg. No. 4,205,061

Registered Sep. 11, 2012

Int. Cl.: 21

TRADEMARK

PRINCIPAL REGISTER

BARBARA SCHECHTER (UNITED STATES INDIVIDUAL), DBA BARBARA'S HANDMADE COOKIES
22 KENSINGTON DRIVE
MANALPAN, NJ 07726

FOR: A HAND-OPERATED PRESS FOR USE IN THE KITCHEN, NAMELY, FOR PRESSING THE DOUGH OF COOKIES, PIES, DONUTS, AND OTHER BAKED GOODS AND FOR PRESSING HERBS, SPICES AND MEATS TO MAKE THEM FLAT AND EVEN, IN CLASS 21 (U.S. CLS. 2, 13, 23, 29, 30, 33, 40 AND 50).

FIRST USE 3-1-2012; IN COMMERCE 3-1-2012.

THE MARK CONSISTS OF STANDARD CHARACTERS WITHOUT CLAIM TO ANY PARTICULAR FONT, STYLE, SIZE, OR COLOR.

SER. NO. 85-505,253, FILED 12-28-2011.

NATALIE POLZER, EXAMINING ATTORNEY



David J. Kyffers

Director of the United States Patent and Trademark Office

United States of America

United States Patent and Trademark Office

EVERYBODY GETS A CHECK

Reg. No. 4,205,062

Registered Sep. 11, 2012

Int. Cl.: 36

SERVICE MARK

PRINCIPAL REGISTER

ITS FINANCIAL, LLC (OHIO LIMITED LIABILITY COMPANY)
SUITE 1400
ONE SOUTH MAIN STREET
DAYTON, OH 45402

FOR: TEMPORARY LOANS, IN CLASS 36 (U.S. CLS. 100, 101 AND 102).

FIRST USE 12-31-2009; IN COMMERCE 12-31-2009.

THE MARK CONSISTS OF STANDARD CHARACTERS WITHOUT CLAIM TO ANY PARTICULAR FONT, STYLE, SIZE, OR COLOR.

SER. NO. 85-505,694, FILED 12-29-2011.

CHRISTOPHER SIDOTI, EXAMINING ATTORNEY



David J. Kybas

Director of the United States Patent and Trademark Office

United States of America

United States Patent and Trademark Office

EVERYBODY GETS A CHECK

Reg. No. 4,205,063

Registered Sep. 11, 2012

Int. Cl.: 35

SERVICE MARK

PRINCIPAL REGISTER

ITS FINANCIAL, LLC (OHIO LIMITED LIABILITY COMPANY)
SUITE 1400
ONE SOUTH MAIN STREET
DAYTON, OH 45402

FOR: INCOME TAX CONSULTATION; INCOME TAX PREPARATION, IN CLASS 35 (U.S. CLS. 100, 101 AND 102).

FIRST USE 12-31-2009; IN COMMERCE 12-31-2009.

THE MARK CONSISTS OF STANDARD CHARACTERS WITHOUT CLAIM TO ANY PARTICULAR FONT, STYLE, SIZE, OR COLOR.

SER. NO. 85-505,774, FILED 12-29-2011.

CHRISTOPHER SIDOTI, EXAMINING ATTORNEY



David J. Kybas

Director of the United States Patent and Trademark Office

United States of America

United States Patent and Trademark Office

LATINO MIX

Reg. No. 4,205,064

Registered Sep. 11, 2012

Int. Cl.: 38

SERVICE MARK

PRINCIPAL REGISTER

UNIVISION RADIO, INC. (DELAWARE CORPORATION)
3102 OAK LAWN AVENUE, SUITE 215
DALLAS, TX 75219

FOR: RADIO BROADCASTING SERVICES, IN CLASS 38 (U.S. CLS. 100, 101 AND 104).

FIRST USE 8-0-1999; IN COMMERCE 8-4-1999.

THE MARK CONSISTS OF STANDARD CHARACTERS WITHOUT CLAIM TO ANY PARTICULAR FONT, STYLE, SIZE, OR COLOR.

OWNER OF U.S. REG. NO. 1,852,658.

SEC. 2(F).

SER. NO. 85-505,962, FILED 12-29-2011.

AMY C. KEAN, EXAMINING ATTORNEY



David J. Kappas

Director of the United States Patent and Trademark Office

United States of America

United States Patent and Trademark Office

LULU'S DESSERT

Reg. No. 4,205,065

MARIA DE LOURDES SOBRINO (UNITED STATES INDIVIDUAL)
25 LILAC
IRVINE, CA 92618

Registered Sep. 11, 2012

Int. Cl.: 30

FOR: FLAVORED, SWEETENED GELATIN DESSERTS, FLAN, PUDDING, TAPIOCA, IN CLASS 30 (U.S. CL. 46).

TRADEMARK

FIRST USE 7-1-1982; IN COMMERCE 7-1-1982.

PRINCIPAL REGISTER

THE MARK CONSISTS OF STANDARD CHARACTERS WITHOUT CLAIM TO ANY PARTICULAR FONT, STYLE, SIZE, OR COLOR.

OWNER OF U.S. REG. NO. 3,111,311.

NO CLAIM IS MADE TO THE EXCLUSIVE RIGHT TO USE "DESSERT", APART FROM THE MARK AS SHOWN.

SER. NO. 85-506,077, FILED 12-29-2011.

SUZANNE BLANE, EXAMINING ATTORNEY



David J. Kybas

Director of the United States Patent and Trademark Office

United States of America

United States Patent and Trademark Office

PULL FORCE center pull handles

Reg. No. 4,205,066

EMICK DANIEL W (UNITED STATES INDIVIDUAL)

Registered Sep. 11, 2012

P O BOX 3614
WILLIAMSPORT, PA 17701

Int. Cl.: 28

FOR: EXERCISE EQUIPMENT, NAMELY, CENTER PULL HANDLES FOR ATTACHMENT TO RESISTANCE CABLE EXERCISE MACHINES, IN CLASS 28 (U.S. CLS. 22, 23, 38 AND 50).

TRADEMARK

FIRST USE 6-1-2011; IN COMMERCE 6-1-2011.

PRINCIPAL REGISTER

THE MARK CONSISTS OF STANDARD CHARACTERS WITHOUT CLAIM TO ANY PARTICULAR FONT, STYLE, SIZE, OR COLOR.

NO CLAIM IS MADE TO THE EXCLUSIVE RIGHT TO USE "PULL" AND "CENTER PULL HANDLES", APART FROM THE MARK AS SHOWN.

SER. NO. 85-506,210, FILED 12-30-2011.

SARA BENJAMIN, EXAMINING ATTORNEY



David J. Kyjars

Director of the United States Patent and Trademark Office

United States of America

United States Patent and Trademark Office

π Shaper

Reg. No. 4,205,067

Registered Sep. 11, 2012

Int. Cl.: 9

TRADEMARK

PRINCIPAL REGISTER

ADLOPTICA OPTICAL SYSTEMS GMBH (FED REP GERMANY LIMITED LIABILITY COMPANY)
RUDOWER CHAUSSEE 29
12489 BERLIN, FED REP GERMANY

FOR: LASER BEAM DELIVERY SYSTEMS AND COMPONENTS, NAMELY, BEAM SHAPERS AND BEAM ATTENUATORS; OPTICAL APPARATUS AND INSTRUMENTS, NAMELY, SHAPERS AND ATTENUATORS FOR LASER BEAMS, IN CLASS 9 (U.S. CLS. 21, 23, 26, 36 AND 38).

FIRST USE 7-31-2006; IN COMMERCE 7-31-2006.

THE MARK CONSISTS OF PI SYMBOL NEXT TO THE WORD "SHAPER".

SER. NO. 85-506,298, FILED 12-30-2011.

PAUL E. FAHRENKOPF, EXAMINING ATTORNEY



David J. Kyffers

Director of the United States Patent and Trademark Office

United States of America

United States Patent and Trademark Office

SRVCalc

Reg. No. 4,205,068

FREDERICK T. ELDER & ASSOCIATES (WISCONSIN SOLE PROPRIETORSHIP)
PO BOX 44291
MADISON, WI 53744

Registered Sep. 11, 2012

Int. Cl.: 9

FOR: COMPUTER SOFTWARE FOR SOLVING SAFETY RELIEF VALVE RELIABILITY PROBLEMS USING STATISTICAL METHODS; OPERATING AND USER INSTRUCTIONS STORED IN DIGITAL FORM FOR COMPUTERS AND COMPUTER SOFTWARE, IN PARTICULAR ON FLOPPY DISKS OR CD-ROM, IN CLASS 9 (U.S. CLS. 21, 23, 26, 36 AND 38).

TRADEMARK

PRINCIPAL REGISTER

FIRST USE 12-20-2011; IN COMMERCE 12-20-2011.

THE MARK CONSISTS OF STANDARD CHARACTERS WITHOUT CLAIM TO ANY PARTICULAR FONT, STYLE, SIZE, OR COLOR.

SER. NO. 85-506,607, FILED 12-30-2011.

SHANNON TWOHIG, EXAMINING ATTORNEY



David J. Kyffers

Director of the United States Patent and Trademark Office

United States of America

United States Patent and Trademark Office

BUY HERE PAY HERE \$75 WEEKLY PAYMENTS EMPIRE AUTO SALES

Reg. No. 4,205,069

LACEY, DANIEL V. (UNITED STATES INDIVIDUAL)
56 KAREN PLACE
BUDD LAKE, NJ 07828

Registered Sep. 11, 2012

Int. Cl.: 35

FOR: AUTOMOBILE DEALERSHIPS, IN CLASS 35 (U.S. CLS. 100, 101 AND 102).

SERVICE MARK

FIRST USE 9-1-2011; IN COMMERCE 9-1-2011.

PRINCIPAL REGISTER

THE MARK CONSISTS OF STANDARD CHARACTERS WITHOUT CLAIM TO ANY PARTICULAR FONT, STYLE, SIZE, OR COLOR.

NO CLAIM IS MADE TO THE EXCLUSIVE RIGHT TO USE "BUY HERE PAY HERE \$75 WEEKLY PAYMENTS" AND "AUTO SALES", APART FROM THE MARK AS SHOWN.

SER. NO. 85-506,830, FILED 12-31-2011.

DAVID MURRAY, EXAMINING ATTORNEY



David J. Kyffers

Director of the United States Patent and Trademark Office

United States of America

United States Patent and Trademark Office

KING OF GREENS

Reg. No. 4,205,070

CRUSADOR ENTERPRISES, INC. (NORTH CAROLINA CORPORATION), AKA 7 LIGHTS
P.O. BOX 577

Registered Sep. 11, 2012

BLACK MOUNTAIN, NC 28711

Int. Cl.: 5

FOR: DIETARY AND NUTRITIONAL SUPPLEMENTS CONTAINING GREEN FOODS AND
SEA VEGETABLES, IN CLASS 5 (U.S. CLS. 6, 18, 44, 46, 51 AND 52).

TRADEMARK

FIRST USE 8-2-2010; IN COMMERCE 8-2-2010.

PRINCIPAL REGISTER

THE MARK CONSISTS OF STANDARD CHARACTERS WITHOUT CLAIM TO ANY PAR-
TICULAR FONT, STYLE, SIZE, OR COLOR.

NO CLAIM IS MADE TO THE EXCLUSIVE RIGHT TO USE "GREENS", APART FROM THE
MARK AS SHOWN.

SER. NO. 85-507,143, FILED 1-2-2012.

CHRIS WELLS, EXAMINING ATTORNEY



David J. Kyffers

Director of the United States Patent and Trademark Office

United States of America

United States Patent and Trademark Office

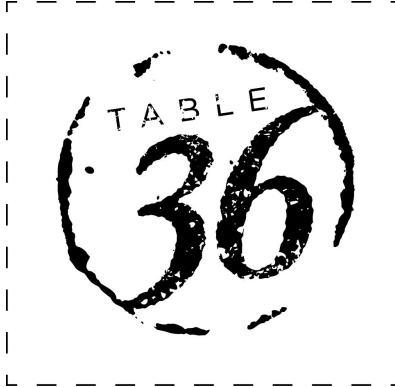

Reg. No. 4,205,071

Registered Sep. 11, 2012

Int. Cl.: 34

TRADEMARK

PRINCIPAL REGISTER

TABLE 36, LLC (MISSOURI LIMITED LIABILITY COMPANY)
20 WILLOW OAK LN.
ST. LOUIS, MO 63122

FOR: CIGAR BOXES; CIGAR TUBES; CIGARS, IN CLASS 34 (U.S. CLS. 2, 8, 9 AND 17).

FIRST USE 12-5-2011; IN COMMERCE 1-1-2012.

THE MARK CONSISTS OF THE WORDING "TABLE 36" CONTAINED WITHIN A BROKEN CIRCLE.

SER. NO. 85-507,424, FILED 1-3-2012.

FRED CARL, EXAMINING ATTORNEY



David J. Kyffers

Director of the United States Patent and Trademark Office

United States of America

United States Patent and Trademark Office

SuccessEtc

Reg. No. 4,205,072

SUCCESETC.COM LLC (IDAHO LIMITED LIABILITY COMPANY)
10280 W. USTICK RD.
BOISE, ID 83704

Registered Sep. 11, 2012

Int. Cl.: 35

FOR: ON-LINE RETAIL STORE SERVICES FEATURING BOOKS, E-BOOKS AND MANUALS IN THE FIELD OF MARKETING, INVESTING AND BUSINESS, AND PROVIDING AN INTERNET WEBSITE PORTAL IN THE FIELD OF MARKETING AND BUSINESS; PROMOTING THE GOODS AND SERVICES OF OTHERS BY PROVIDING A WEBSITE FEATURING DISCOUNT VOUCHERS, REBATES, PRICE-COMPARISON INFORMATION, PRODUCT AND SERVICE REVIEWS AND DISCOUNT INFORMATION, IN CLASS 35 (U.S. CLS. 100, 101 AND 102).

SERVICE MARK

PRINCIPAL REGISTER

FIRST USE 2-1-2011; IN COMMERCE 5-1-2011.

THE MARK CONSISTS OF STANDARD CHARACTERS WITHOUT CLAIM TO ANY PARTICULAR FONT, STYLE, SIZE, OR COLOR.

SER. NO. 85-507,589, FILED 1-3-2012.

RENEE MCCRAY, EXAMINING ATTORNEY



David J. Kybas

Director of the United States Patent and Trademark Office

United States of America

United States Patent and Trademark Office

agavoo

Reg. No. 4,205,073

KLEMESHEV, GENNADY (RUSSIAN FED. INDIVIDUAL)
AKADEMICHESKAYA, 22B-101
MOSCOW, RUSSIAN FED. 127299

Registered Sep. 11, 2012

Int. Cl.: 42

FOR: PROVIDING TEMPORARY USE OF ONLINE, NON-DOWNLOADABLE COMPUTER SOFTWARE THAT ALLOWS SUBSCRIBERS TO UTILIZE VOIP COMMUNICATION SERVICES IN THE NATURE OF VIDEO CHAT AND CONFERENCING, PHONE CALLS AND EXCHANGE OF ELECTRONIC DOCUMENTS, IN CLASS 42 (U.S. CLS. 100 AND 101).

SERVICE MARK

PRINCIPAL REGISTER

FIRST USE 7-26-2011; IN COMMERCE 7-26-2011.

THE MARK CONSISTS OF THE WORD "AGAVOO" IN STYLIZED FONT.

THE WORDING "AGAVOO" HAS NO MEANING IN A FOREIGN LANGUAGE.

SER. NO. 85-507,638, FILED 1-3-2012.

MARTHA FROMM, EXAMINING ATTORNEY



David J. Kybas

Director of the United States Patent and Trademark Office

United States of America

United States Patent and Trademark Office

CLEAR LAW INSTITUTE

Reg. No. 4,205,074

Registered Sep. 11, 2012

Int. Cl.: 41

SERVICE MARK

PRINCIPAL REGISTER

CLEAR LAW INSTITUTE LLC (VIRGINIA LIMITED LIABILITY COMPANY)
723 N IVY STREET
ARLINGTON, VA 22201

FOR: EDUCATION SERVICES, NAMELY, PROVIDING TRAINING, CLASSES, SEMINARS, WORKSHOPS, WEBINARS, AND ONLINE COURSES IN THE FIELD OF CONDUCTING INVESTIGATIONS AND DETECTING DECEPTION, LAW, COMPLIANCE WITH LAWS AND REGULATIONS, HUMAN RESOURCES, AND BUSINESS ETHICS, AND DISTRIBUTION OF PRINTED MATERIALS IN CONNECTION THEREWITH IN HARD COPY OR ELECTRONIC FORMAT ON THE SAME TOPICS, IN CLASS 41 (U.S. CLS. 100, 101 AND 107).

FIRST USE 10-4-2011; IN COMMERCE 10-4-2011.

THE MARK CONSISTS OF STANDARD CHARACTERS WITHOUT CLAIM TO ANY PARTICULAR FONT, STYLE, SIZE, OR COLOR.

NO CLAIM IS MADE TO THE EXCLUSIVE RIGHT TO USE "LAW INSTITUTE", APART FROM THE MARK AS SHOWN.

SER. NO. 85-508,068, FILED 1-3-2012.

JENNIFER RICHARDSON, EXAMINING ATTORNEY



David J. Kybas

Director of the United States Patent and Trademark Office

United States of America

United States Patent and Trademark Office

CLEAR LAW INSTITUTE

Reg. No. 4,205,075

Registered Sep. 11, 2012

Int. Cl.: 9

TRADEMARK

PRINCIPAL REGISTER

CLEAR LAW INSTITUTE LLC (VIRGINIA LIMITED LIABILITY COMPANY)
723 N IVY STREET
ARLINGTON, VA 22201

FOR: DOWNLOADABLE ELECTRONIC PUBLICATIONS IN THE NATURE OF MANUALS, BOOKS, HANDOUTS, AND PAMPHLETS IN THE FIELD OF CONDUCTING INVESTIGATIONS, DETECTING DECEPTION, LAW, COMPLIANCE WITH LAWS AND REGULATIONS, HUMAN RESOURCES, AND BUSINESS ETHICS, IN CLASS 9 (U.S. CLS. 21, 23, 26, 36 AND 38).

FIRST USE 10-4-2011; IN COMMERCE 10-4-2011.

THE MARK CONSISTS OF STANDARD CHARACTERS WITHOUT CLAIM TO ANY PARTICULAR FONT, STYLE, SIZE, OR COLOR.

NO CLAIM IS MADE TO THE EXCLUSIVE RIGHT TO USE "LAW INSTITUTE", APART FROM THE MARK AS SHOWN.

SER. NO. 85-508,071, FILED 1-3-2012.

JENNIFER RICHARDSON, EXAMINING ATTORNEY



David J. Kyros

Director of the United States Patent and Trademark Office

United States of America

United States Patent and Trademark Office

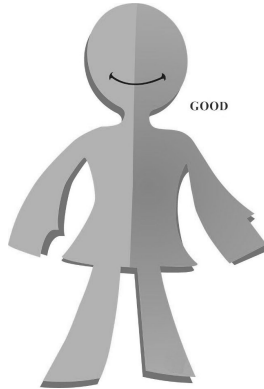

Reg. No. 4,205,076

Registered Sep. 11, 2012

Int. Cls.: 35 and 36

SERVICE MARK

PRINCIPAL REGISTER

GOODWILL COMMUNITY FOUNDATION, INC. (NORTH CAROLINA CORPORATION)
4808 CHIN PAGE ROAD
DURHAM, NC 27703

FOR: CHARITABLE SERVICES, NAMELY, COORDINATION OF NON-MONETARY CONTRIBUTIONS TO CHARITIES AND NON-PROFITS; CHARITABLE SERVICES, NAMELY, ORGANIZING AND DEVELOPING PROJECTS THAT AIM TO IMPROVE THE LIVES OF UNDERPRIVILEGED AND IMPOVERISHED PEOPLE; CHARITABLE SERVICES, NAMELY, PROVIDING OFFICE EQUIPMENT TO THOSE IN NEED; PROVIDING BUSINESS CONSULTING RELATING TO CHARITABLE FUNDRAISING TO NON-PROFIT ORGANIZATIONS, IN CLASS 35 (U.S. CLS. 100, 101 AND 102).

FIRST USE 6-24-2002; IN COMMERCE 6-24-2002.

FOR: CHARITABLE FUNDRAISING; CHARITABLE FUNDRAISING SERVICES BY MEANS OF COLLECTING AND REDEEMING RECYCLABLES FOR DONATION OF REDEMPTION PROCEEDS TO CHARITABLE ORGANIZATIONS; CHARITABLE FUNDRAISING SERVICES BY MEANS OF ORGANIZING AND CONDUCTING SPECIAL EVENTS; CHARITABLE FUNDRAISING SERVICES BY MEANS OF COLLECTING AND REDEEMING RECYCLABLES FOR DONATION OF REDEMPTION PROCEEDS TO NON-PROFIT CHARITABLE ORGANIZATIONS; CHARITABLE FUNDRAISING SERVICES BY MEANS OF PROVIDING GRANTS TO NON-PROFIT CHARITABLE ORGANIZATIONS; PROVIDING PHILANTHROPY AND FINANCIAL CONSULTING RELATING TO CHARITABLE FUNDRAISING TO NON-PROFIT ORGANIZATIONS; CHARITABLE FUNDRAISING TO SUPPORT EDUCATION, EMPLOYMENT AND LIFE ENRICHMENT OPPORTUNITIES FOR PERSONS WITH DISABILITIES OR OTHER DISADVANTAGING CIRCUMSTANCES, IN CLASS 36 (U.S. CLS. 100, 101 AND 102).

FIRST USE 6-24-2002; IN COMMERCE 6-24-2002.

THE MARK CONSISTS OF STYLIZED IMAGE OF A GIRL, BISECTED BY A VERTICAL LINE, WITH ONE SIDE OF THE FIGURE SHADED DARKER THAN THE OTHER, WITH THE WORD "GOOD" TO THE RIGHT OF THE FIGURE.

SER. NO. 85-508,202, FILED 1-4-2012.

LAURIE MAYES, EXAMINING ATTORNEY



David J. Kyros

Director of the United States Patent and Trademark Office

United States of America

United States Patent and Trademark Office

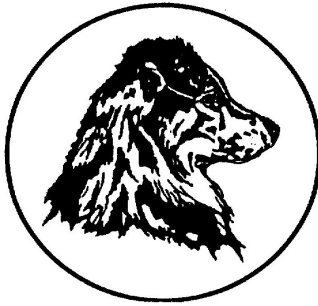

Reg. No. 4,205,077

Registered Sep. 11, 2012

Int. Cls.: 35 and 41

SERVICE MARK

PRINCIPAL REGISTER

AUSTRALIAN SHEPHERD CLUB OF AMERICA, INC. (WASHINGTON CORPORATION)
6091 EAST STATE HIGHWAY 21
BRYAN, TX 778039652

FOR: MAINTAINING A REGISTRY OF BREEDS IN THE FIELD OF DOGS, IN CLASS 35
(U.S. CLS. 100, 101 AND 102).

FIRST USE 10-10-1979; IN COMMERCE 10-10-1979.

FOR: DOG SHOWS, IN CLASS 41 (U.S. CLS. 100, 101 AND 107).

FIRST USE 10-10-1979; IN COMMERCE 10-10-1979.

THE MARK CONSISTS OF STYLIZED REPRESENTATION OF AN AUSTRALIAN SHEPHERD
DOG WITH A CIRCLE BORDER.

SEC. 2(F).

SER. NO. 85-508,351, FILED 1-4-2012.

KAPIL BHANOT, EXAMINING ATTORNEY



David J. Kybas

Director of the United States Patent and Trademark Office

United States of America

United States Patent and Trademark Office

Carat

PRECIOUS GOLD WATER

Reg. No. 4,205,078

EXKLUSIVE, LLC. (FLORIDA LIMITED LIABILITY COMPANY)
2701 SOUTH BAYSHORE DRIVE, SUITE 402
MIAMI, FL 33133

Registered Sep. 11, 2012

Int. Cl.: 32

FOR: BOTTLED DRINKING WATER CONTAINING GOLD FLAKES, IN CLASS 32 (U.S. CLS. 45, 46 AND 48).

TRADEMARK

FIRST USE 11-1-2011; IN COMMERCE 11-1-2011.

PRINCIPAL REGISTER

NO CLAIM IS MADE TO THE EXCLUSIVE RIGHT TO USE "GOLD WATER", APART FROM THE MARK AS SHOWN.

THE COLOR(S) BLACK AND GOLD IS/ARE CLAIMED AS A FEATURE OF THE MARK.

THE MARK CONSISTS OF THE WORD "CARAT" IN LARGE BLACK LETTERS WITH A GOLD DROPLET OUTLINED IN BLACK INSIDE THE LETTER "C". BELOW THAT IS THE WORDING "PRECIOUS GOLD WATER" IN GOLD LETTERING.

SER. NO. 85-508,405, FILED 1-4-2012.

TASHIA BUNCH, EXAMINING ATTORNEY



David J. Kyros

Director of the United States Patent and Trademark Office

United States of America

United States Patent and Trademark Office

NEVER



EST.

Reg. No. 4,205,079

IMPERIAL MOTION, LLC (WASHINGTON LIMITED LIABILITY COMPANY)
1112 CENTER STREET
TACOMA, WA 98409

Registered Sep. 11, 2012

Int. Cl.: 25

FOR: CLOTHING, NAMELY, PANTS, SHORTS, LEGGINGS, SHIRTS, TANK TOPS, SOCKS, BELTS, SWEATSHIRTS, T-SHIRTS AND HATS, IN CLASS 25 (U.S. CLS. 22 AND 39).

TRADEMARK

FIRST USE 8-31-2010; IN COMMERCE 8-31-2010.

PRINCIPAL REGISTER

THE MARK CONSISTS OF A CREST DESIGN WITH THE WORD "NEVER" ABOVE IT, AND THE WORD "EST." BELOW IT.

SER. NO. 85-508,480, FILED 1-4-2012.

AMEEN IMAM, EXAMINING ATTORNEY



David J. Kyffers

Director of the United States Patent and Trademark Office

United States of America

United States Patent and Trademark Office



DGTA

**DANGEROUS GOODS
TRAINERS ASSOCIATION**

Reg. No. 4,205,080

Registered Sep. 11, 2012

Int. Cls.: 16 and 41

TRADEMARK

SERVICE MARK

PRINCIPAL REGISTER

DANGEROUS GOODS TRAINERS ASSOCIATION, INC. (VIRGINIA CORPORATION), AKA
DGTA
558 JOAQUIN AVE.
SAN LEANDRO, CA 94577

FOR: PRINTED ANSWER SHEETS IN THE FIELD OF DANGEROUS GOODS TRANSPORTATION; PRINTED AWARD CERTIFICATES; PRINTED AWARDS; PRINTED EDUCATIONAL MATERIALS IN THE FIELD OF DANGEROUS GOODS TRANSPORTATION; PRINTED INSTRUCTIONAL, EDUCATIONAL, AND TEACHING MATERIALS IN THE FIELD OF DANGEROUS GOODS TRANSPORTATION; PRINTED MATERIALS, NAMELY, CURRICULA IN THE FIELD OF DANGEROUS GOODS TRANSPORTATION; PRINTED MATERIALS, NAMELY, WRITTEN ARTICLES IN THE FIELD OF DANGEROUS GOODS TRANSPORTATION; PRINTED NEWS RELEASES IN THE FIELD OF DANGEROUS GOODS TRANSPORTATION; PRINTED TEACHING MATERIALS IN THE FIELD OF DANGEROUS GOODS TRANSPORTATION; PRINTED TEACHING MATERIALS IN THE FIELD OF DANGEROUS GOODS TRANSPORTATION; PRINTED TRAINING MATERIALS IN THE FIELD OF DANGEROUS GOODS TRANSPORTATION, IN CLASS 16 (U.S. CLS. 2, 5, 22, 23, 29, 37, 38 AND 50).

FIRST USE 6-1-2009; IN COMMERCE 6-1-2009.



David J. Kyffers

Director of the United States Patent and Trademark Office

FOR: EDUCATIONAL EXAMINATION SERVICES; EDUCATIONAL SERVICES IN THE NATURE OF DANGEROUS GOODS TRANSPORTATION TRAINING SCHOOLS; EDUCATIONAL SERVICES, NAMELY, CONDUCTING CLASSES, SEMINARS, WORKSHOPS, FORUMS AND CONFERENCES IN THE FIELDS OF DANGEROUS GOODS TRANSPORTATION AND DISTRIBUTION OF TRAINING MATERIALS IN CONNECTION THEREWITH; EDUCATIONAL SERVICES, NAMELY, CONDUCTING CLASSES, SEMINARS, WORKSHOPS, FORUMS AND CONFERENCES IN THE FIELD OF DANGEROUS GOODS TRANSPORTATION; EDUCATIONAL SERVICES, NAMELY, CONDUCTING CLASSES, SEMINARS, WORKSHOPS, FORUMS AND CONFERENCES IN THE FIELD OF DANGEROUS GOODS TRANSPORTATION; PUBLICATION OF BROCHURES; PUBLICATION OF DOCUMENTS IN THE FIELD OF TRAINING, SCIENCE, PUBLIC LAW AND SOCIAL AFFAIRS; PUBLICATION OF JOURNALS; PUBLICATION OF LEAFLETS; PUBLICATION OF MATTERS AFFECTING DANGEROUS GOODS TRANSPORTATION PROFESSIONALS, EDUCATIONAL MATERIALS, ARTICLES AND LEAFLETS ON DANGEROUS GOODS TRANSPORTATION AND EXAMINATION MATERIALS FOR TRAINERS IN THE FIELD OF DANGEROUS GOODS TRANSPORTATION, IN CLASS 41 (U.S. CLS. 100, 101 AND 107).

Reg. No. 4,205,080 FIRST USE 6-1-2009; IN COMMERCE 6-1-2009.

NO CLAIM IS MADE TO THE EXCLUSIVE RIGHT TO USE "DANGEROUS GOODS TRAINERS ASSOCIATION", APART FROM THE MARK AS SHOWN.

THE COLOR(S) LIGHT GRAY, GRAY, WHITE, ORANGE, BLUE AND DARK BLUE IS/ARE CLAIMED AS A FEATURE OF THE MARK.

THE MARK CONSISTS OF A SHIELD WITH FOUR DIAMOND IN LIGHT GRAY AND GRAY OVER A BLUE AND DARK BLUE BACK GROUND ABOVE A DIAGONAL WHITE WAVY BAR AND ORANGE BACKGROUND AT THE BOTTOM OF THE SHIELD. THE SHIELD HAS A GRAY INNER BORDER AND BLUE AND DARK BLUE OUTER BORDER. THE LETTERS "D","G","T","A" IN BLUE WITH UNDERLINED IN GRAY IS ABOVE THE WORDING "DANGEROUS GOODS TRAINERS ASSOCIATION" IN ORANGE ALL TO THE RIGHT OF THE SHIELD DESIGN.

SER. NO. 85-508,704, FILED 1-4-2012.

SALLY SHIH, EXAMINING ATTORNEY

United States of America

United States Patent and Trademark Office

REAL

Reg. No. 4,205,081

Registered Sep. 11, 2012

Int. Cl.: 16

TRADEMARK

PRINCIPAL REGISTER

REVIEW AND HERALD PUBLISHING ASSOCIATION (D.C. CORPORATION)
55 W. OAK RIDGE DRIVE
HAGERSTOWN, MD 217407301

FOR: CHRISTIAN MAGAZINES FOR YOUTH FEATURING TRUE CHARACTER-BUILDING MISSION STORIES, PUZZLES, BIBLE STUDIES, FUN FACTS, AND CHRISTIAN ADVICE , IN CLASS 16 (U.S. CLS. 2, 5, 22, 23, 29, 37, 38 AND 50).

FIRST USE 12-3-2009; IN COMMERCE 12-3-2009.

THE MARK CONSISTS OF STANDARD CHARACTERS WITHOUT CLAIM TO ANY PARTICULAR FONT, STYLE, SIZE, OR COLOR.

SER. NO. 85-508,706, FILED 1-4-2012.

SALLY SHIH, EXAMINING ATTORNEY



David J. Kyffers

Director of the United States Patent and Trademark Office

United States of America

United States Patent and Trademark Office



Reg. No. 4,205,082

Registered Sep. 11, 2012

Int. Cl.: 12

TRADEMARK

PRINCIPAL REGISTER

POLYPORTABLES, INC. (GEORGIA CORPORATION), DBA BASS HUNTER BOATS
99 CRAFTON DR
DAHLONEGA, GA 30533

FOR: FISHING BOATS, IN CLASS 12 (U.S. CLS. 19, 21, 23, 31, 35 AND 44).

FIRST USE 0-0-1977; IN COMMERCE 0-0-1977.

NO CLAIM IS MADE TO THE EXCLUSIVE RIGHT TO USE "THE ORIGINAL", APART FROM THE MARK AS SHOWN.

THE MARK CONSISTS OF THE STYLIZED DESIGN OF A FISH IN WITH THE WORDING "BASS HUNTER" IN BOLD LETTERS SUPERIMPOSED ON THE FISH WITH THE WORDING "THE ORIGINAL" IN BOLD LETTERS APPEARING JUST BELOW THE WORDING "BASS HUNTER".

SER. NO. 85-508,709, FILED 1-4-2012.

SALLY SHIH, EXAMINING ATTORNEY



David J. Kybas

Director of the United States Patent and Trademark Office

United States of America

United States Patent and Trademark Office

FANDOR

Reg. No. 4,205,083

Registered Sep. 11, 2012

Int. Cl.: 41

SERVICE MARK

PRINCIPAL REGISTER

OUR FILM FESTIVAL, INC. (DELAWARE CORPORATION)
731 MARKET STREET, 6TH FLOOR
SAN FRANCISCO, CA 94103

FOR: ENTERTAINMENT SERVICES, NAMELY, THE PROVISION OF CONTINUING MOVIES, MOVIE CLIPS AND FILMS FEATURING COMEDY, DRAMA, ACTION, VARIETY, ADVENTURE, SPORTS, MUSICALS, CURRENT EVENTS AND ENTERTAINMENT NEWS, DOCUMENTARY AND ANIMATION, DELIVERED BY THE INTERNET, ELECTRONIC COMMUNICATIONS NETWORKS, COMPUTER NETWORKS AND WIRELESS COMMUNICATIONS NETWORKS; ENTERTAINMENT SERVICES, NAMELY, PROVIDING INFORMATION RELATING TO FILMS IN THE FIELDS OF COMEDY, DRAMA, ACTION, VARIETY, ADVENTURE, SPORTS, MUSICALS, CURRENT EVENTS AND ENTERTAINMENT NEWS, DOCUMENTARY AND ANIMATION, VIA THE INTERNET, ELECTRONIC COMMUNICATIONS NETWORKS, COMPUTER NETWORKS AND WIRELESS COMMUNICATIONS NETWORKS, IN CLASS 41 (U.S. CLS. 100, 101 AND 107).

FIRST USE 6-21-2010; IN COMMERCE 10-20-2010.

THE MARK CONSISTS OF STANDARD CHARACTERS WITHOUT CLAIM TO ANY PARTICULAR FONT, STYLE, SIZE, OR COLOR.

THE WORDING "FANDOR" HAS NO MEANING IN A FOREIGN LANGUAGE.

SER. NO. 85-508,912, FILED 1-4-2012.

JANICE KIM, EXAMINING ATTORNEY



David J. Kyros

Director of the United States Patent and Trademark Office

United States of America

United States Patent and Trademark Office

curiosity@work

Reg. No. 4,205,084

Registered Sep. 11, 2012

Int. Cls.: 9 and 42

TRADEMARK

SERVICE MARK

PRINCIPAL REGISTER

STARMER JR, CHARLES F (UNITED STATES INDIVIDUAL)
2781 GOLF LAKE DRIVE
PLANT CITY, FL 33566

FOR: COMPUTER PROGRAMS FOR USING THE INTERNET AND THE WORLD WIDE WEB; COMPUTER PROGRAMS FOR USING THE INTERNET AND THE WORLDWIDE WEB; COMPUTER SOFTWARE FOR THE COLLECTION, EDITING, ORGANIZING, MODIFYING, BOOK MARKING, TRANSMISSION, STORAGE AND SHARING OF DATA AND INFORMATION; COMPUTER SOFTWARE THAT PROVIDES WEB-BASED ACCESS TO APPLICATIONS AND SERVICES THROUGH A WEB OPERATING SYSTEM OR PORTAL INTERFACE, IN CLASS 9 (U.S. CLS. 21, 23, 26, 36 AND 38).

FIRST USE 5-1-2003; IN COMMERCE 12-1-2011.

FOR: COMPUTER SERVICES, NAMELY, CREATING AN ON-LINE COMMUNITY FOR REGISTERED USERS TO PARTICIPATE IN DISCUSSIONS, GET FEEDBACK FROM THEIR PEERS, FORM VIRTUAL COMMUNITIES, AND ENGAGE IN SOCIAL NETWORKING SERVICES IN THE FIELD OF LEARNING AND INSTRUCTION; COMPUTER SERVICES, NAMELY, CREATING AN ON-LINE COMMUNITY FOR REGISTERED USERS TO LEARN, ACQUIRE ACCREDITATION, SHARE INSIGHTS; COMPUTER SERVICES, NAMELY, HOSTING AN INTERACTIVE WEB SITE THAT ALLOWS ELEARNING, IN CLASS 42 (U.S. CLS. 100 AND 101).

FIRST USE 12-1-2011; IN COMMERCE 12-1-2011.

THE MARK CONSISTS OF STANDARD CHARACTERS WITHOUT CLAIM TO ANY PARTICULAR FONT, STYLE, SIZE, OR COLOR.

OWNER OF U.S. REG. NO. 3,056,118.

SER. NO. 85-508,916, FILED 1-4-2012.

JENNIFER VASQUEZ, EXAMINING ATTORNEY



David J. Kyffers

Director of the United States Patent and Trademark Office

United States of America

United States Patent and Trademark Office



Reg. No. 4,205,085

Registered Sep. 11, 2012

Int. Cls.: 12, 40 and 42

TRADEMARK

SERVICE MARK

PRINCIPAL REGISTER

SCALETTA MOLONEY ARMORING CORP. (ILLINOIS CORPORATION), DBA SCALETTA ARMORING
6755 S BELT CIRCLE DRIVE
BEDFORD PARK, IL 60638

FOR: ARMORED PASSENGER AND CARGO VEHICLES, IN CLASS 12 (U.S. CLS. 19, 21, 23, 31, 35 AND 44).

FIRST USE 10-15-2010; IN COMMERCE 3-15-2011.

FOR: CUSTOM MANUFACTURING OF ARMORED PASSENGER AND CARGO VEHICLES, IN CLASS 40 (U.S. CLS. 100, 103 AND 106).

FIRST USE 10-15-2010; IN COMMERCE 3-15-2011.

FOR: DESIGN AND ENGINEERING OF ARMORED PASSENGER AND CARGO VEHICLES, IN CLASS 42 (U.S. CLS. 100 AND 101).

FIRST USE 10-15-2010; IN COMMERCE 3-15-2011.

NO CLAIM IS MADE TO THE EXCLUSIVE RIGHT TO USE "ARMORING", APART FROM THE MARK AS SHOWN.

THE COLOR(S) BLACK, BLUE, WHITE IS/ARE CLAIMED AS A FEATURE OF THE MARK.

THE MARK CONSISTS OF THE FOLLOWING: THE WORD "SCALETTA" IN BLACK BLOCK LETTERS ABOVE THE WORD "ARMORING" IN ITALICIZED BLUE CAPITAL LETTERS, BOTH ABOVE THE WORDS "BUILT FOR LIFE" DEPICTED IN THE COLOR BLACK ALL TO THE LEFT A STYLIZED BLUE AND WHITE GLOBE DESIGN.

SER. NO. 85-509,059, FILED S.R. 1-5-2012 AM. P.R. 4-18-2012.

BRIDGETT SMITH, EXAMINING ATTORNEY



David J. Kyffers

Director of the United States Patent and Trademark Office

United States of America

United States Patent and Trademark Office

Derived Designs

Reg. No. 4,205,086

Registered Sep. 11, 2012

Int. Cl.: 42

SERVICE MARK

PRINCIPAL REGISTER

DERIVED DESIGNS LLC (WISCONSIN LIMITED LIABILITY COMPANY)
SUITE#: 177
N112W16298 MEQUON RD.
GERMANTOWN, WI 530223306

FOR: GRAPHIC DESIGN SERVICES; WEBSITE DESIGN, DEVELOPMENT, AND MAINTENANCE FOR OTHERS; COMPUTER SOFTWARE DESIGN FOR OTHERS, IN CLASS 42 (U.S. CLS. 100 AND 101).

FIRST USE 3-4-2011; IN COMMERCE 8-11-2011.

THE MARK CONSISTS OF STANDARD CHARACTERS WITHOUT CLAIM TO ANY PARTICULAR FONT, STYLE, SIZE, OR COLOR.

NO CLAIM IS MADE TO THE EXCLUSIVE RIGHT TO USE "DESIGNS", APART FROM THE MARK AS SHOWN.

SER. NO. 85-509,175, FILED 1-5-2012.

DANNEAN HETZEL, EXAMINING ATTORNEY



David J. Kyffers

Director of the United States Patent and Trademark Office

United States of America

United States Patent and Trademark Office

AMELIA'S GROCERY OUTLET

Reg. No. 4,205,087

GROCERY OUTLET INC. (CALIFORNIA CORPORATION)
2000 FIFTH STREET
BERKELEY, CA 94710

Registered Sep. 11, 2012

Int. Cl.: 35

FOR: RETAIL AND WHOLESALE GROCERY STORE SERVICES, IN CLASS 35 (U.S. CLS. 100, 101 AND 102).

SERVICE MARK

FIRST USE 8-31-1989; IN COMMERCE 8-31-1989.

PRINCIPAL REGISTER

THE MARK CONSISTS OF STANDARD CHARACTERS WITHOUT CLAIM TO ANY PARTICULAR FONT, STYLE, SIZE, OR COLOR.

NO CLAIM IS MADE TO THE EXCLUSIVE RIGHT TO USE "GROCERY OUTLET", APART FROM THE MARK AS SHOWN.

SER. NO. 85-509,375, FILED 1-5-2012.

JENNIFER VASQUEZ, EXAMINING ATTORNEY



David J. Kyffers

Director of the United States Patent and Trademark Office

United States of America

United States Patent and Trademark Office

SMITTEN

Reg. No. 4,205,088

LANDAU UNIFORMS, INCORPORATED (TENNESSEE CORPORATION)
P.O. BOX 516

Registered Sep. 11, 2012

OLIVE BRANCH, MS 386540516

Int. Cl.: 25

FOR: BLOUSES; COATS; DRESSES; INSOLES FOR FOOTWEAR; JACKETS; LAB COATS;
PANTS; SCRUBS NOT FOR MEDICAL PURPOSES; SHIRTS; SHOES; SKIRTS; SOCKS;
SWEATSHIRTS; T-SHIRTS; TOPS; TUNICS; UNIFORMS; VESTS, IN CLASS 25 (U.S. CLS.
22 AND 39).

TRADEMARK

PRINCIPAL REGISTER

FIRST USE 2-6-2012; IN COMMERCE 2-6-2012.

THE MARK CONSISTS OF STANDARD CHARACTERS WITHOUT CLAIM TO ANY PARTICULAR FONT, STYLE, SIZE, OR COLOR.

SER. NO. 85-509,641, FILED 1-5-2012.

HENRY S. ZAK, EXAMINING ATTORNEY



David J. Kyffers

Director of the United States Patent and Trademark Office

United States of America

United States Patent and Trademark Office



Reg. No. 4,205,089

Registered Sep. 11, 2012

Int. Cl.: 37

SERVICE MARK

PRINCIPAL REGISTER

GRIER ROOFING (SOUTH CAROLINA LIMITED LIABILITY COMPANY)
9329 ASHEVILLE HWY
INMAN, SC 29349

FOR: ROOFING SERVICES, IN CLASS 37 (U.S. CLS. 100, 103 AND 106).

FIRST USE 3-0-1995; IN COMMERCE 3-0-1995.

NO CLAIM IS MADE TO THE EXCLUSIVE RIGHT TO USE "ROOFING, LLC", APART FROM THE MARK AS SHOWN.

THE COLOR(S) RED AND BLUE IS/ARE CLAIMED AS A FEATURE OF THE MARK.

THE MARK CONSISTS OF THE STYLIZED LETTERS "GR", OF WHICH "G" IS IN RED COLOR OUTLINED IN BLUE AND "R" IS IN BLUE COLOR. BELOW THIS IS THE STYLIZED WORDING "GRIER ROOFING, LLC" IN BLUE COLOR OUTLINED IN RED.

SER. NO. 85-509,788, FILED 1-5-2012.

DAWN HAN, EXAMINING ATTORNEY



David J. Kyffers

Director of the United States Patent and Trademark Office

United States of America

United States Patent and Trademark Office

SuperPeek

Reg. No. 4,205,090

NU-GAMING VENTURES INC. (DELAWARE CORPORATION)
458 E. CROOKED HILL RD
PEARL RIVER, NY 10965

Registered Sep. 11, 2012

Int. Cl.: 28

FOR: CARD GAMES, IN CLASS 28 (U.S. CLS. 22, 23, 38 AND 50).

TRADEMARK

FIRST USE 2-14-2010; IN COMMERCE 2-14-2010.

PRINCIPAL REGISTER

THE MARK CONSISTS OF STANDARD CHARACTERS WITHOUT CLAIM TO ANY PARTICULAR FONT, STYLE, SIZE, OR COLOR.

SER. NO. 85-510,019, FILED 1-5-2012.

BRENDAN REGAN, EXAMINING ATTORNEY



David J. Kyffers

Director of the United States Patent and Trademark Office

United States of America

United States Patent and Trademark Office

PENTAKILL

Reg. No. 4,205,091

RIOT GAMES, INC. (DELAWARE CORPORATION)
2450 BROADWAY
SANTA MONICA, CA 90404

Registered Sep. 11, 2012

Int. Cls.: 9 and 41

FOR: COMPUTER AND VIDEO GAME SOFTWARE, IN CLASS 9 (U.S. CLS. 21, 23, 26, 36 AND 38).

TRADEMARK

FIRST USE 10-27-2009; IN COMMERCE 10-27-2009.

SERVICE MARK

FOR: ENTERTAINMENT SERVICES, NAMELY, PROVIDING ON-LINE COMPUTER GAMES, IN CLASS 41 (U.S. CLS. 100, 101 AND 107).

PRINCIPAL REGISTER

FIRST USE 10-27-2009; IN COMMERCE 10-27-2009.

THE MARK CONSISTS OF STANDARD CHARACTERS WITHOUT CLAIM TO ANY PARTICULAR FONT, STYLE, SIZE, OR COLOR.

SER. NO. 85-510,161, FILED 1-6-2012.

ALEX KEAM, EXAMINING ATTORNEY



David J. Kyffers

Director of the United States Patent and Trademark Office

United States of America

United States Patent and Trademark Office

MartiniRedd

Reg. No. 4,205,092

TERESA M. WHITE (UNITED STATES INDIVIDUAL)
2996 TUSCARORA TRAIL
MIDDLEBURG, FL 32068

Registered Sep. 11, 2012

Int. Cl.: 35

FOR: ADVERTISING, MARKETING AND PROMOTIONAL SERVICES RELATED TO ALL INDUSTRIES FOR THE PURPOSE OF FACILITATING NETWORKING AND SOCIALIZING OPPORTUNITIES FOR BUSINESS PURPOSES , IN CLASS 35 (U.S. CLS. 100, 101 AND 102).

SERVICE MARK

FIRST USE 9-19-2011; IN COMMERCE 9-19-2011.

PRINCIPAL REGISTER

NO CLAIM IS MADE TO THE EXCLUSIVE RIGHT TO USE "MARTINI", APART FROM THE MARK AS SHOWN.

THE MARK CONSISTS OF THE PHRASE "MARTINIREDD". THE "M" IN "MARTINIREDD" IS CAPITALIZED. THE SECOND "R" IN "MARTINIREDD" IS CAPITALIZED.

SER. NO. 85-510,382, FILED S.R. 1-6-2012 AM. P.R. 4-19-2012.

ELI HELLMAN, EXAMINING ATTORNEY



David J. Kyfos

Director of the United States Patent and Trademark Office

United States of America

United States Patent and Trademark Office

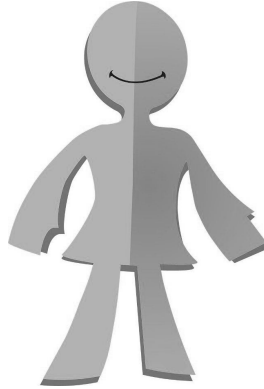

Reg. No. 4,205,093

Registered Sep. 11, 2012

Int. Cls.: 35 and 36

SERVICE MARK

PRINCIPAL REGISTER

GOODWILL COMMUNITY FOUNDATION, INC. (NORTH CAROLINA CORPORATION)
4808 CHIN PAGE ROAD
DURHAM, NC 27703

FOR: CHARITABLE SERVICES, NAMELY, COORDINATION OF NON-MONETARY CONTRIBUTIONS TO CHARITIES AND NON-PROFITS; CHARITABLE SERVICES, NAMELY, ORGANIZING AND DEVELOPING PROJECTS THAT AIM TO IMPROVE THE LIVES OF UNDERPRIVILEGED AND IMPOVERISHED PEOPLE; CHARITABLE SERVICES, NAMELY, PROVIDING OFFICE EQUIPMENT TO THOSE IN NEED; PROVIDING BUSINESS CONSULTING RELATING TO CHARITABLE FUNDRAISING TO NON-PROFIT ORGANIZATIONS, IN CLASS 35 (U.S. CLS. 100, 101 AND 102).

FIRST USE 6-24-2002; IN COMMERCE 6-24-2002.

FOR: CHARITABLE FUNDRAISING; CHARITABLE FUNDRAISING SERVICES BY MEANS OF COLLECTING AND REDEEMING RECYCLABLES FOR DONATION OF REDEMPTION PROCEEDS TO CHARITABLE ORGANIZATIONS; CHARITABLE FUNDRAISING SERVICES BY MEANS OF ORGANIZING AND CONDUCTING SPECIAL EVENTS; CHARITABLE FUNDRAISING SERVICES BY MEANS OF COLLECTING AND REDEEMING RECYCLABLES FOR DONATION OF REDEMPTION PROCEEDS TO NON-PROFIT CHARITABLE ORGANIZATIONS; CHARITABLE FUNDRAISING SERVICES BY MEANS OF PROVIDING GRANTS TO NON-PROFIT CHARITABLE ORGANIZATIONS; PROVIDING PHILANTHROPY AND FINANCIAL CONSULTING RELATING TO CHARITABLE FUNDRAISING TO NON-PROFIT ORGANIZATIONS; CHARITABLE FUNDRAISING TO SUPPORT EDUCATION, EMPLOYMENT AND LIFE ENRICHMENT OPPORTUNITIES FOR PERSONS WITH DISABILITIES OR OTHER DISADVANTAGING CIRCUMSTANCES, IN CLASS 36 (U.S. CLS. 100, 101 AND 102).

FIRST USE 6-24-2002; IN COMMERCE 6-24-2002.

THE MARK CONSISTS OF STYLIZED IMAGE OF A GIRL, BISECTED BY A VERTICAL LINE, WITH ONE SIDE OF THE FIGURE SHADED DARKER THAN THE OTHER.

SER. NO. 85-510,479, FILED 1-6-2012.

LAURIE MAYES, EXAMINING ATTORNEY



David J. Kyros

Director of the United States Patent and Trademark Office

United States of America

United States Patent and Trademark Office



Reg. No. 4,205,094

Registered Sep. 11, 2012

Int. Cls.: 7, 11, 20 and 42

TRADEMARK

SERVICE MARK

PRINCIPAL REGISTER

ROSINK GMBH + CO. KG MASCHINENFABRIK (FED REP GERMANY COMPANY)
BENTHEIMER STRASSE 207
NORDHORD, FED REP GERMANY 48529

FOR: TEXTILE MACHINES FOR PROCESSING YARN, FIBERS AND TEXTILE THREADS, NAMELY, YARN BUNDLING MACHINES, YARN REELING MACHINES, YARN SLIVERING AND COMBINING MACHINES, YARN WINDING MACHINES; GRINDING MACHINES FOR MACHINING SPINNING ROLLS; CLEANING MACHINES FOR CLEANING INDUSTRIAL MANUFACTURED PARTS; PAINT REMOVING MACHINES; STEEL ROLLERS FOR USE IN TEXTILE MACHINES AND PRINTING MACHINES, DYEING MACHINES, CALENDARS AND WASHING MACHINES, IN CLASS 7 (U.S. CLS. 13, 19, 21, 23, 31, 34 AND 35).

FOR: FINNED TUBES FOR THE PURPOSE OF HEAT TRANSFER SOLD AS AN INTEGRAL COMPONENT OF HEAT EXCHANGERS, NOT BEING PARTS OF MACHINES, IN CLASS 11 (U.S. CLS. 13, 21, 23, 31 AND 34).

FOR: FURNITURE, IN CLASS 20 (U.S. CLS. 2, 13, 22, 25, 32 AND 50).

FOR: CONSULTANCY IN THE FIELD OF INTERIOR AND ARCHITECTURAL DESIGN AND FURNISHING, IN CLASS 42 (U.S. CLS. 100 AND 101).

OWNER OF FED REP GERMANY REG. NO. 302010020390, DATED 10-26-2010, EXPIRES 5-31-2020.



THE MARK CONSISTS OF THE WORD "ROSINK" FEATURING A SQUARE BOX, HAVING A LIGHTER COLORED CIRCULAR DISK TOUCHING THE WALLS OF THE BOX AND A LIGHT COLORED COIL IN THE CIRCULAR DISK, OFF CENTERED TOWARD THE BOTTOM OF THE DISK.

SER. NO. 85-510,652, FILED 1-6-2012.

KEVIN DINALLO, EXAMINING ATTORNEY

David J. Kypos

Director of the United States Patent and Trademark Office

United States of America

United States Patent and Trademark Office

IMORE

Reg. No. 4,205,095

Registered Sep. 11, 2012

Int. Cls.: 35 and 42

SERVICE MARK

PRINCIPAL REGISTER

AXEL LTD. CO. (FLORIDA LIMITED LIABILITY COMPANY)
3151 E THOMAS ST.
IVENESS, FL 34453

FOR: MARKETING SERVICES, NAMELY, PROVIDING INFORMATIONAL WEB PAGES DESIGNED TO GENERATE SALES TRAFFIC VIA HYPERLINKS TO OTHER WEB SITES; ON-LINE RETAIL STORE SERVICES FEATURING DOWNLOADABLE RING TONES; ON-LINE RETAIL STORE SERVICES FEATURING CONSUMER ELECTRONICS AND TELECOMMUNICATION PRODUCTS AND ACCESSORIES; PROVIDING ON-LINE DIRECTORY INFORMATION SERVICES ALSO FEATURING HYPERLINKS TO OTHER WEB SITES, IN CLASS 35 (U.S. CLS. 100, 101 AND 102).

FIRST USE 1-5-2012; IN COMMERCE 1-5-2012.

FOR: COMPUTER SERVICES, NAMELY, CREATING AN ONLINE COMMUNITY FOR REGISTERED USERS TO ENGAGE IN SOCIAL NETWORKING, GIVE AND RECEIVE PEER-TO-PEER HELP AND FEEDBACK FOR SKILL AND KNOWLEDGE BUILDING, AND SHOWCASE THEIR TALENTS; COMPUTER SERVICES, NAMELY, REDIRECTING ELECTRONIC MAIL TO CHANGED PERSONAL ELECTRONIC ADDRESS, IN CLASS 42 (U.S. CLS. 100 AND 101).

FIRST USE 1-5-2012; IN COMMERCE 1-5-2012.

THE MARK CONSISTS OF STANDARD CHARACTERS WITHOUT CLAIM TO ANY PARTICULAR FONT, STYLE, SIZE, OR COLOR.

SER. NO. 85-510,653, FILED 1-6-2012.

EDWARD NELSON, EXAMINING ATTORNEY



David J. Kyffers

Director of the United States Patent and Trademark Office

United States of America

United States Patent and Trademark Office

SKINCALM

Reg. No. 4,205,096

SKINCALM, LLC (OREGON LIMITED LIABILITY COMPANY)
6107 SW MURRAY BLVD., SUITE 105
BEAVERTON, OR 97008

Registered Sep. 11, 2012

Int. Cl.: 5

FOR: NON-MEDICATED SKIN CARE PRODUCTS, NAMELY, SKIN CREAM, SKIN SALVE, HAND AND BODY SOAP, AND SCALP OIL, IN CLASS 5 (U.S. CLS. 6, 18, 44, 46, 51 AND 52).

TRADEMARK

FIRST USE 8-7-2010; IN COMMERCE 8-7-2010.

PRINCIPAL REGISTER

THE MARK CONSISTS OF STANDARD CHARACTERS WITHOUT CLAIM TO ANY PARTICULAR FONT, STYLE, SIZE, OR COLOR.

SER. NO. 85-510,863, FILED 1-6-2012.

DAWN HAN, EXAMINING ATTORNEY



David J. Kyffers

Director of the United States Patent and Trademark Office

United States of America

United States Patent and Trademark Office

DESIGN DETECTIVE

Reg. No. 4,205,097

JEANE DOLE (UNITED STATES INDIVIDUAL)
6364 S. HANOVER COURT
DENVER, CO 80111

Registered Sep. 11, 2012

Int. Cl.: 42

FOR: INTERIOR DESIGN SERVICES, IN CLASS 42 (U.S. CLS. 100 AND 101).

SERVICE MARK

FIRST USE 3-20-2011; IN COMMERCE 5-23-2011.

PRINCIPAL REGISTER

THE MARK CONSISTS OF STANDARD CHARACTERS WITHOUT CLAIM TO ANY PARTICULAR FONT, STYLE, SIZE, OR COLOR.

NO CLAIM IS MADE TO THE EXCLUSIVE RIGHT TO USE "DESIGN", APART FROM THE MARK AS SHOWN.

SER. NO. 85-510,968, FILED 1-6-2012.

SOPHIA S. KIM, EXAMINING ATTORNEY



David J. Kybas

Director of the United States Patent and Trademark Office

United States of America

United States Patent and Trademark Office

ACROSS CULTURES

Reg. No. 4,205,098

PETERSON, BROOKS R. (UNITED STATES INDIVIDUAL)
1602 JUNO AVENUE
SAINT PAUL, MN 55116

Registered Sep. 11, 2012

Int. Cl.: 41

FOR: EDUCATIONAL SERVICES, NAMELY, CONDUCTING WORKSHOPS IN THE FIELD OF MULTICULTURALISM FOR INDIVIDUALS AND GROUPS ENGAGED IN GLOBAL ACTIVITIES AND DISTRIBUTION OF TRAINING MATERIAL IN CONNECTION THEREWITH, IN CLASS 41 (U.S. CLS. 100, 101 AND 107).

SERVICE MARK

PRINCIPAL REGISTER

FIRST USE 5-15-1989; IN COMMERCE 5-15-1989.

THE MARK CONSISTS OF STANDARD CHARACTERS WITHOUT CLAIM TO ANY PARTICULAR FONT, STYLE, SIZE, OR COLOR.

SEC. 2(F).

SER. NO. 85-511,110, FILED 1-7-2012.

SUNG IN, EXAMINING ATTORNEY



David J. Kyffers

Director of the United States Patent and Trademark Office

United States of America

United States Patent and Trademark Office

Skate Buds Strap-on Heel Skates

Reg. No. 4,205,099

BATON ROUGE STOCK EXCHANGE (LOUISIANA CORPORATION)
4515 S. FAIRWAY DR.
SHREVEPORT, LA 71109

Registered Sep. 11, 2012

Int. Cl.: 28

FOR: ROLLER SKATES, IN CLASS 28 (U.S. CLS. 22, 23, 38 AND 50).

TRADEMARK

FIRST USE 8-10-2006; IN COMMERCE 9-1-2008.

PRINCIPAL REGISTER

THE MARK CONSISTS OF STANDARD CHARACTERS WITHOUT CLAIM TO ANY PARTICULAR FONT, STYLE, SIZE, OR COLOR.

NO CLAIM IS MADE TO THE EXCLUSIVE RIGHT TO USE "SKATE" AND "STRAP-ON HEEL SKATES", APART FROM THE MARK AS SHOWN.

SER. NO. 85-511,141, FILED 1-7-2012.

DAWN FELDMAN, EXAMINING ATTORNEY



David J. Kyffers

Director of the United States Patent and Trademark Office

United States of America

United States Patent and Trademark Office



Reg. No. 4,205,100

Registered Sep. 11, 2012

Int. Cl.: 16

TRADEMARK

PRINCIPAL REGISTER

MURPHY, HEATHER M (UNITED STATES INDIVIDUAL), AKA HEATHER CAHOON
304 CORBETT ROAD
MONTGOMERY, NY 12549

FOR: A SERIES OF BOOKS AND WRITTEN ARTICLES IN THE FIELD OF PAPER CRAFTS; BOOKS IN THE FIELD OF PAPER CRAFTS; CHILDREN'S ARTS AND CRAFTS PAPER KITS; PAPER BANNERS; PAPER CAKE DECORATIONS; PAPER DECORATIVE GARLANDS FOR PARTIES; PAPER PARTY DECORATIONS; PAPER PARTY FAVORS; PARTY ORNAMENTS OF PAPER; PUBLICATIONS, NAMELY, BOOKS IN THE FIELDS OF PAPER CRAFTS, IN CLASS 16 (U.S. CLS. 2, 5, 22, 23, 29, 37, 38 AND 50).

FIRST USE 5-18-2011; IN COMMERCE 10-5-2011.

THE MARK CONSISTS OF THE STYLIZED WORDING "YOU MAKE DO" INSIDE A ROUND OUTLINE AND THE DESIGN OF A PAIR OF SCISSORS ACROSS THE OUTLINE.

SER. NO. 85-511,212, FILED 1-7-2012.

DAWN HAN, EXAMINING ATTORNEY



David J. Kyffers

Director of the United States Patent and Trademark Office

United States of America

United States Patent and Trademark Office

CERTIFIED DIEHARD

Reg. No. 4,205,101

HARRIS, CHARLES R. (UNITED STATES INDIVIDUAL)
67 DUNCAN LANE
YOUNGSTOWN, OH 44506

Registered Sep. 11, 2012

Int. Cl.: 24

FOR: KITCHEN TOWELS, IN CLASS 24 (U.S. CLS. 42 AND 50).

TRADEMARK

FIRST USE 9-1-2011; IN COMMERCE 9-1-2011.

PRINCIPAL REGISTER

THE MARK CONSISTS OF STANDARD CHARACTERS WITHOUT CLAIM TO ANY PARTICULAR FONT, STYLE, SIZE, OR COLOR.

NO CLAIM IS MADE TO THE EXCLUSIVE RIGHT TO USE "CERTIFIED", APART FROM THE MARK AS SHOWN.

SER. NO. 85-511,217, FILED 1-7-2012.

DAWN HAN, EXAMINING ATTORNEY



David J. Kyffers

Director of the United States Patent and Trademark Office

United States of America

United States Patent and Trademark Office



Reg. No. 4,205,102

Registered Sep. 11, 2012

Int. Cl.: 25

TRADEMARK

PRINCIPAL REGISTER

AUDREY NASAR (UNITED STATES INDIVIDUAL)
301 EAST 21ST STREET #14L
NEW YORK, NY 10010 AND

GLORIA ERANI (UNITED STATES INDIVIDUAL)
401 2ND AVE #6E
NEW YORK, NY 10010

FOR: T-SHIRTS, IN CLASS 25 (U.S. CLS. 22 AND 39).

FIRST USE 1-1-2009; IN COMMERCE 1-1-2009.

THE MARK CONSISTS OF THE STYLIZED WORDING "URBAN CRICKET." TO THE LEFT OF THE DESIGN OF A GARBAGE TRUCK THAT RESEMBLES A CRICKET WITH A PAIR OF ANTENNAE.

SER. NO. 85-511,219, FILED 1-7-2012.

DAWN HAN, EXAMINING ATTORNEY



David J. Kyffers

Director of the United States Patent and Trademark Office

United States of America
United States Patent and Trademark Office

GRANZOW

Reg. No. 4,205,103

GRANZOW INC. (NORTH CAROLINA CORPORATION)
2300 CROWNPOINT EXECUTIVE DR
CHARLOTTE, NC 28227

Registered Sep. 11, 2012

Int. Cl.: 35

FOR: INDEPENDENT SALES REPRESENTATIVES IN THE FIELD OF FLUID CONTROLS,
IN CLASS 35 (U.S. CLS. 100, 101 AND 102).

SERVICE MARK

FIRST USE 4-1-1979; IN COMMERCE 4-1-1979.

PRINCIPAL REGISTER

THE MARK CONSISTS OF STANDARD CHARACTERS WITHOUT CLAIM TO ANY PAR-
TICULAR FONT, STYLE, SIZE, OR COLOR.

SEC. 2(F).

SER. NO. 85-511,580, FILED 1-9-2012.

RONALD MCMORROW, EXAMINING ATTORNEY



David J. Kybas

Director of the United States Patent and Trademark Office

United States of America

United States Patent and Trademark Office

BRANDED SAUCES

Reg. No. 4,205,104

Registered Sep. 11, 2012

Int. Cl.: 30

TRADEMARK

PRINCIPAL REGISTER

DANNY CASH UNLIMITED (COLORADO CORPORATION), AKA BRANDED SAUCES
3378 S BROADWAY ST
ENGLEWOOD, CO 80113

FOR: CONDIMENT, NAMELY, PEPPER SAUCE, IN CLASS 30 (U.S. CL. 46).

FIRST USE 1-1-2008; IN COMMERCE 1-1-2008.

THE MARK CONSISTS OF STANDARD CHARACTERS WITHOUT CLAIM TO ANY PARTICULAR FONT, STYLE, SIZE, OR COLOR.

NO CLAIM IS MADE TO THE EXCLUSIVE RIGHT TO USE "SAUCES", APART FROM THE MARK AS SHOWN.

SER. NO. 85-511,958, FILED 1-9-2012.

SUSAN LESLIE DUBOIS, EXAMINING ATTORNEY



David J. Kyffers

Director of the United States Patent and Trademark Office

United States of America

United States Patent and Trademark Office

TOP HAT

Reg. No. 4,205,105

INTERSTATE WORLDWIDE RELOCATION SERVICES (VIRGINIA CORPORATION)
5801 ROLLING ROAD
SPRINGFIELD, VA 22152

Registered Sep. 11, 2012

Int. Cl.: 39

FOR: MOVING, STORAGE, TRANSPORT AND SHIPPING OF GOODS, IN CLASS 39 (U.S. CLS. 100 AND 105).

SERVICE MARK

FIRST USE 6-25-1967; IN COMMERCE 6-25-1967.

PRINCIPAL REGISTER

THE MARK CONSISTS OF STANDARD CHARACTERS WITHOUT CLAIM TO ANY PARTICULAR FONT, STYLE, SIZE, OR COLOR.

SER. NO. 85-512,174, FILED 1-9-2012.

MICHAEL WEBSTER, EXAMINING ATTORNEY



David J. Kybas

Director of the United States Patent and Trademark Office

United States of America

United States Patent and Trademark Office

SLAPPY CAKES

Reg. No. 4,205,106

Registered Sep. 11, 2012

Int. Cl.: 43

SERVICE MARK

PRINCIPAL REGISTER

SCI RESTAURANT GROUP, INC. (OREGON CORPORATION)
#3
4246 S.E. BELMONT
PORTLAND, OR 97215

FOR: RESTAURANT SERVICES, NAMELY, A FULL SERVICE BREAKFAST RESTAURANT,
IN CLASS 43 (U.S. CLS. 100 AND 101).

FIRST USE 10-0-2008; IN COMMERCE 10-0-2008.

THE MARK CONSISTS OF STANDARD CHARACTERS WITHOUT CLAIM TO ANY PAR-
TICULAR FONT, STYLE, SIZE, OR COLOR.

SER. NO. 85-512,199, FILED 1-9-2012.

DAVID MURRAY, EXAMINING ATTORNEY



David J. Kyffers

Director of the United States Patent and Trademark Office

United States of America

United States Patent and Trademark Office

TEAMOPS

Reg. No. 4,205,107

Registered Sep. 11, 2012

Int. Cl.: 42

SERVICE MARK

PRINCIPAL REGISTER

CROTHALL SERVICES GROUP (DELAWARE CORPORATION)
SUITE 300
955 CHESTERBROOK BLVD.
WAYNE, PA 19087

FOR: PROVIDING ON-LINE, NON-DOWNLOADABLE SOFTWARE, NAMELY, SOFTWARE WHICH ALLOWS USERS TO INPUT AND OBTAIN INFORMATION RELATING TO EQUIPMENT INVENTORY, SCHEDULE MAINTENANCE WORK ORDERS, AND ACCESS CORRECTIVE AND PREVENTATIVE MAINTENANCE TRACKING DATA, ALL FOR USE IN CONNECTION WITH FACILITIES MANAGEMENT, IN CLASS 42 (U.S. CLS. 100 AND 101).

FIRST USE 9-1-2005; IN COMMERCE 11-16-2005.

THE MARK CONSISTS OF STANDARD CHARACTERS WITHOUT CLAIM TO ANY PARTICULAR FONT, STYLE, SIZE, OR COLOR.

SER. NO. 85-512,465, FILED 1-10-2012.

JIM RINGLE, EXAMINING ATTORNEY



David J. Kyffers

Director of the United States Patent and Trademark Office

United States of America

United States Patent and Trademark Office



Reg. No. 4,205,108

AMERISOURCEBERGEN DRUG CORPORATION (DELAWARE CORPORATION)
1300 MORRIS DRIVE
CHESTERBROOK, PA 19087

Registered Sep. 11, 2012

Int. Cls.: 16, 20, 35 and 44

FOR: PRINTED PUBLICATIONS, NAMELY, FLYERS AND BROCHURES FEATURING INFORMATION, NEWS AND COMMENTARY IN THE FIELD OF HEALTH AND WELLNESS RELATING TO HEALTHY DIETS AND ACTIVITIES FOR MALE AND FEMALE INFANTS, CHILDREN, TEENAGERS, ADULTS AND SENIORS AND TO ILLNESSES AND TREATMENTS AFFECTING THEM, IN CLASS 16 (U.S. CLS. 2, 5, 22, 23, 29, 37, 38 AND 50).

TRADEMARK

SERVICE MARK

FIRST USE 9-30-2011; IN COMMERCE 9-30-2011.

PRINCIPAL REGISTER

FOR: PLASTIC VIALS IN THE NATURE OF CONTAINERS FOR MEDICATIONS SOLD EMPTY FOR COMMERCIAL USE AND PLASTIC CAPS FOR USE THEREON, IN CLASS 20 (U.S. CLS. 2, 13, 22, 25, 32 AND 50).

FIRST USE 9-30-2011; IN COMMERCE 9-30-2011.

FOR: RETAIL DRUG STORE SERVICES, IN CLASS 35 (U.S. CLS. 100, 101 AND 102).

FIRST USE 9-30-2011; IN COMMERCE 9-30-2011.

FOR: PROVIDING ON-LINE INFORMATION, NEWS AND COMMENTARY IN THE FIELD OF HEALTH AND WELLNESS RELATING TO HEALTHY DIETS AND ACTIVITIES FOR MALE AND FEMALE INFANTS, CHILDREN, TEENAGERS, ADULTS AND SENIORS AND TO ILLNESSES AND TREATMENTS AFFECTING THEM, IN CLASS 44 (U.S. CLS. 100 AND 101).

FIRST USE 9-30-2011; IN COMMERCE 9-30-2011.

OWNER OF U.S. REG. NOS. 723,984, 3,512,962 AND OTHERS.

THE COLOR(S) RED AND BLUE IS/ARE CLAIMED AS A FEATURE OF THE MARK.

NO CLAIM IS MADE TO THE EXCLUSIVE RIGHT TO USE THE PRESCRIPTION SYMBOL "RX" AND "PHARMACY", APART FROM THE MARK AS SHOWN.



David J. Kyjars

Director of the United States Patent and Trademark Office

Reg. No. 4,205,108 THE MARK CONSISTS OF A BLUE MORTAR AND PESTLE AND PRESCRIPTION SYMBOL, AND THE WORDING "GOOD NEIGHBOR PHARMACY" IN RED. THE PRESCRIPTION SYMBOL AND THE OUTLINE OF THE MORTAR AND PESTLE ARE OF A LIGHT BLUE COLOR. THE MARK ALSO HAS A RECTANGULAR DARK BLUE BORDER EXTENDING AROUND THE WORDS AND OTHER DESIGN ELEMENTS. THE COLOR WHITE INSIDE THE RECTANGULAR BORDER IS TRANSPARENT AS BACKGROUND AND IS NOT CLAIMED AS A FEATURE OF THE MARK.

SER. NO. 85-512,758, FILED 1-10-2012.

KIMBERLY PERRY, EXAMINING ATTORNEY

United States of America

United States Patent and Trademark Office

Thrifty Propane

Reg. No. 4,205,109

THRIFTY PROPANE, INC. (OHIO CORPORATION)
3961 BURGUNDY BAY BLVD. W.
MEDINA, OH 44256

Registered Sep. 11, 2012

Int. Cl.: 39

FOR: FUEL DELIVERY SERVICES FEATURING PROPANE, IN CLASS 39 (U.S. CLS. 100 AND 105).

SERVICE MARK

FIRST USE 7-1-2003; IN COMMERCE 9-15-2005.

PRINCIPAL REGISTER

THE MARK CONSISTS OF STANDARD CHARACTERS WITHOUT CLAIM TO ANY PARTICULAR FONT, STYLE, SIZE, OR COLOR.

NO CLAIM IS MADE TO THE EXCLUSIVE RIGHT TO USE "PROPANE", APART FROM THE MARK AS SHOWN.

SER. NO. 85-512,856, FILED 1-10-2012.

CURTIS FRENCH, EXAMINING ATTORNEY



David J. Kyffers

Director of the United States Patent and Trademark Office

United States of America

United States Patent and Trademark Office

PROCESS IMPROVEMENTS TO ENHANCE PATIENT CARE

Reg. No. 4,205,110

Registered Sep. 11, 2012

Int. Cls.: 9, 16, 35 and 41

TRADEMARK

SERVICE MARK

PRINCIPAL REGISTER

ENGAGE HEALTHCARE COMMUNICATIONS, LLC (DELAWARE LIMITED LIABILITY COMPANY)
241 FORSGATE DRIVE, SUITE 205A
MONROE TOWNSHIP, NJ 08831

FOR: PROVIDING DOWNLOADABLE ELECTRONIC MAGAZINES, JOURNALS, NEWSLETTERS, FEATURE REPORTS, MONOGRAPHS AND ELECTRONIC SUPPLEMENTS TO THE FOREGOING IN THE FIELDS OF MEDICINE, HEALTHCARE, MEDICAL PRACTICE MANAGEMENT, PATIENT CARE COORDINATION, AND NURSING ADMINISTRATION, IN CLASS 9 (U.S. CLS. 21, 23, 26, 36 AND 38).

FIRST USE 8-1-2010; IN COMMERCE 4-1-2011.

FOR: PRINTED PUBLICATIONS, NAMELY, PEER REVIEWED MEDICAL MAGAZINES, JOURNALS, NEWSLETTERS, FEATURE REPORTS, MONOGRAPHS, AND PRINTED SUPPLEMENTS TO THE FOREGOING IN THE FIELDS OF MEDICINE, HEALTHCARE, MEDICAL PRACTICE MANAGEMENT, PATIENT CARE COORDINATION, AND NURSING ADMINISTRATION, IN CLASS 16 (U.S. CLS. 2, 5, 22, 23, 29, 37, 38 AND 50).

FIRST USE 8-1-2010; IN COMMERCE 4-1-2011.

FOR: ADVERTISING SERVICES, NAMELY, PROVIDING ADVERTISING SPACE IN MAGAZINES, JOURNALS, NEWSLETTERS, FEATURE REPORTS AND MAGAZINE SUPPLEMENTS TO NEWSPAPERS THAT CONCERN INFORMATION IN THE FIELDS OF HEMATOLOGY AND ONCOLOGY; ADVERTISING SERVICES, NAMELY, PROVIDING SPACE AT A WEB SITE FOR THE ADVERTISEMENT OF THE GOODS AND SERVICES OF OTHERS CONCERNING INFORMATION IN THE FIELDS OF HEMATOLOGY AND ONCOLOGY, IN CLASS 35 (U.S. CLS. 100, 101 AND 102).

FIRST USE 8-1-2010; IN COMMERCE 4-1-2011.

FOR: ONLINE EDUCATIONAL SERVICES, NAMELY, PROVIDING CONTINUING EDUCATION COURSES AND EXAMS IN THE FIELDS OF MEDICINE, HEALTHCARE, MEDICAL PRACTICE MANAGEMENT, PATIENT CARE COORDINATION, AND NURSING ADMINISTRATION VIA A GLOBAL COMPUTER INFORMATION NETWORK, IN CLASS 41 (U.S. CLS. 100, 101 AND 107).



David J. Kybas

Director of the United States Patent and Trademark Office

Reg. No. 4,205,110 FIRST USE 8-1-2010; IN COMMERCE 4-1-2011.

THE MARK CONSISTS OF STANDARD CHARACTERS WITHOUT CLAIM TO ANY PARTICULAR FONT, STYLE, SIZE, OR COLOR.

NO CLAIM IS MADE TO THE EXCLUSIVE RIGHT TO USE "PROCESS IMPROVEMENTS" OR "PATIENT CARE", APART FROM THE MARK AS SHOWN.

SER. NO. 85-514,310, FILED 1-11-2012.

DAWN HAN, EXAMINING ATTORNEY

United States of America

United States Patent and Trademark Office

Brown Beret National Organization - Los Brown Berets

Reg. No. 4,205,111

CALDERÓN, BYRON (UNITED STATES INDIVIDUAL)
1012 NOBLE ST.

Registered Sep. 11, 2012

EL PASO, TX 79902 AND

Int. Cl.: 35

BLÁNCO, JERÓNIMO (UNITED STATES INDIVIDUAL)
#63

SERVICE MARK

369 K ST.
CHULA VISTA, CA 91911 AND

PRINCIPAL REGISTER

CALLEROS, EDWARD (UNITED STATES INDIVIDUAL)
1124 E. 4TH AVE.
ESCONDIDO, CA 92025

FOR: ASSOCIATION SERVICES, NAMELY, PROMOTING PUBLIC AWARENESS OF CIVIL RIGHTS AND SOCIAL JUSTICE ISSUES; PUBLIC ADVOCACY TO PROMOTE AWARENESS OF THE IMPORTANCE OF CIVIL RIGHTS AND SOCIAL JUSTICE, IN CLASS 35 (U.S. CLS. 100, 101 AND 102).

FIRST USE 9-21-1968; IN COMMERCE 9-21-1968.

THE MARK CONSISTS OF STANDARD CHARACTERS WITHOUT CLAIM TO ANY PARTICULAR FONT, STYLE, SIZE, OR COLOR.

NO CLAIM IS MADE TO THE EXCLUSIVE RIGHT TO USE "NATIONAL ORGANIZATION", APART FROM THE MARK AS SHOWN.

SER. NO. 85-514,358, FILED 1-11-2012.

ODESSA BIBBINS, EXAMINING ATTORNEY



David J. Kyros

Director of the United States Patent and Trademark Office

United States of America

United States Patent and Trademark Office

Kwanti

Reg. No. 4,205,112

Registered Sep. 11, 2012

Int. Cl.: 42

SERVICE MARK

PRINCIPAL REGISTER

KWANTI INC. (CALIFORNIA CORPORATION)
120-242
650 CASTRO ST
MOUNTAIN VIEW, CA 94041

FOR: PROVIDING TEMPORARY USE OF A WEB-BASED SOFTWARE APPLICATION FOR USE IN MANAGEMENT OF FINANCIAL INVESTMENTS, IN CLASS 42 (U.S. CLS. 100 AND 101).

FIRST USE 11-1-2006; IN COMMERCE 7-16-2007.

THE MARK CONSISTS OF STANDARD CHARACTERS WITHOUT CLAIM TO ANY PARTICULAR FONT, STYLE, SIZE, OR COLOR.

THE ENGLISH TRANSLATION OF THE WORD "KWANTI" IN THE MARK IS "QUANTITATIVE".

SER. NO. 85-514,473, FILED 1-11-2012.

LESLEY LAMOTHE, EXAMINING ATTORNEY



David J. Kybas

Director of the United States Patent and Trademark Office

United States of America

United States Patent and Trademark Office



Reg. No. 4,205,113

GROOP, KRISTIN B. (UNITED STATES INDIVIDUAL)
4343 E. TURNBERRY CT.
GILBERT, AZ 85298

Registered Sep. 11, 2012

Int. Cl.: 41

FOR: CONTINUING EDUCATION SERVICES, NAMELY, PROVIDING LIVE AND ON-LINE CONTINUING PROFESSIONAL EDUCATION SEMINARS IN THE FIELD OF MEDICAL PROCEDURES, INCLUDING, LASER HAIR REMOVAL, ACNE REDUCTION, LASER TATTOO REMOVAL, SPIDER VEIN TREATMENTS, SKIN REJUVENATION, BOTULINUM TOXIN TREATMENTS, MICRODERMABRASION, INJECTABLE FILLER TREATMENTS, FACIALS, AND SKIN CARE; EDUCATIONAL SERVICES, NAMELY, PROVIDING CONTINUING PROFESSIONAL EDUCATION COURSES IN THE FIELD OF MEDICAL, COSMETIC AND AESTHETIC; PROVIDING CONTINUING MEDICAL EDUCATION COURSES; VOCATIONAL EDUCATION IN THE FIELD OF MEDICAL LASER SAFETY AND PROCEDURES, IN CLASS 41 (U.S. CLS. 100, 101 AND 107).

SERVICE MARK

PRINCIPAL REGISTER

FIRST USE 11-5-2011; IN COMMERCE 1-3-2012.

NO CLAIM IS MADE TO THE EXCLUSIVE RIGHT TO USE "ESTHETIC ADVISOR" OR "LASER ACADEMY", APART FROM THE MARK AS SHOWN.

THE COLOR(S) BLUE AND BLACK IS/ARE CLAIMED AS A FEATURE OF THE MARK.

THE MARK CONSISTS OF THREE TOUCHING BLUE TRIANGLES TO THE LEFT OF THE STYLIZED WORDINGS "ESTHETICADVISOR" AND "LASER ACADEMY", OF WHICH "ESTHETIC" AND "LASER ACADEMY" ARE IN BLACK COLOR AND "ADVISOR" IS IN BLUE COLOR.

SER. NO. 85-514,842, FILED 1-12-2012.

DAWN HAN, EXAMINING ATTORNEY



David J. Kyjars

Director of the United States Patent and Trademark Office

United States of America

United States Patent and Trademark Office

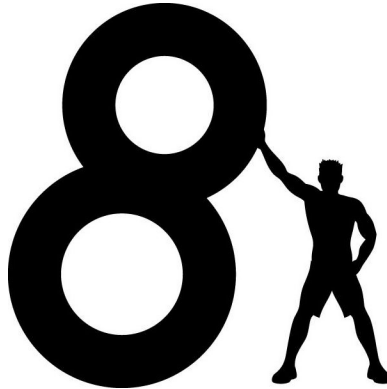

Reg. No. 4,205,114

Registered Sep. 11, 2012

Int. Cl.: 41

SERVICE MARK

PRINCIPAL REGISTER

DOMINGO, RAEMAR P (UNITED STATES INDIVIDUAL)
14525 CULVER DRIVE #A-331
IRVINE, CA 92604

FOR: PERSONAL FITNESS TRAINING SERVICES AND CONSULTANCY; PERSONAL FITNESS TRAINING SERVICES FEATURING AEROBIC AND ANAEROBIC ACTIVITIES COMBINED WITH RESISTANCE AND FLEXIBILITY TRAINING; PHYSICAL FITNESS STUDIO SERVICES, NAMELY, PROVIDING GROUP EXERCISE INSTRUCTION, EQUIPMENT, AND FACILITIES; PHYSICAL FITNESS TRAINING OF INDIVIDUALS AND GROUPS; PROVIDING A WEB SITE FEATURING INFORMATION ON EXERCISE AND FITNESS; PROVIDING A WEBSITE FEATURING INFORMATION ON EXERCISE AND FITNESS; PROVIDING AN ON-LINE COMPUTER DATABASE FEATURING INFORMATION REGARDING EXERCISE AND FITNESS; PROVIDING AN ON-LINE COMPUTER DATABASE FEATURING INFORMATION REGARDING EXERCISE AND FITNESS BEFORE AND AFTER PREGNANCY; PROVIDING ASSISTANCE, PERSONAL TRAINING AND PHYSICAL FITNESS CONSULTATION TO CORPORATE CLIENTS TO HELP THEIR EMPLOYEES MAKE PHYSICAL FITNESS, STRENGTH, CONDITIONING, AND EXERCISE ALTERATIONS IN THEIR DAILY LIVING; PROVIDING CLASSES, WORKSHOPS, SEMINARS AND CAMPS IN THE FIELDS OF FITNESS, EXERCISE, BOXING, KICK BOXING AND MIXED MARTIAL ARTS; PROVIDING PHYSICAL FITNESS AND EXERCISE SERVICE, NAMELY, INDOOR CYCLING AND YOGA INSTRUCTION, IN CLASS 41 (U.S. CLS. 100, 101 AND 107).

FIRST USE 12-16-2011; IN COMMERCE 12-16-2011.

THE MARK CONSISTS OF A STYLIZED NUMBER "8" NEXT TO THE SILHOUETTE OF A MAN WHOSE ARM IS SUPPORTING THE NUMBER "8" TO PREVENT IT FROM FALLING.

SER. NO. 85-514,920, FILED 1-12-2012.

ELIZABETH HUGHITT, EXAMINING ATTORNEY



David J. Kypos

Director of the United States Patent and Trademark Office

United States of America

United States Patent and Trademark Office

Suberi Brothers

Reg. No. 4,205,115

SUBERI BROTHERS LLC (NEW YORK LIMITED LIABILITY COMPANY)
902 BROADWAY, 14TH FLOOR
NEW YORK, NY 10010

Registered Sep. 11, 2012

Int. Cl.: 14

FOR: DIAMOND JEWELRY; DIAMONDS, IN CLASS 14 (U.S. CLS. 2, 27, 28 AND 50).

TRADEMARK

FIRST USE 4-1-2004; IN COMMERCE 4-1-2004.

PRINCIPAL REGISTER

THE MARK CONSISTS OF STANDARD CHARACTERS WITHOUT CLAIM TO ANY PARTICULAR FONT, STYLE, SIZE, OR COLOR.

THE WORDING "SUBERI" HAS NO MEANING IN A FOREIGN LANGUAGE.

SER. NO. 85-515,086, FILED 1-12-2012.

AMY KERTGATE, EXAMINING ATTORNEY



David J. Kyffers

Director of the United States Patent and Trademark Office

United States of America

United States Patent and Trademark Office



Reg. No. 4,205,116

Registered Sep. 11, 2012

Int. Cl.: 36

SERVICE MARK

PRINCIPAL REGISTER

DAILYACCESS CORPORATION (ALABAMA CORPORATION)
SUITE 1500
307 UNIVERSITY BLVD. NORTH
MOBILE, AL 36688

FOR: CONSULTING SERVICES IN THE FIELD OF EMPLOYEE HEALTH AND WELFARE BENEFIT PLANS CONCERNING INSURANCE AND FINANCE; ADMINISTRATION OF EMPLOYEE HEALTH AND WELFARE BENEFIT PLANS CONCERNING INSURANCE AND FINANCE, IN CLASS 36 (U.S. CLS. 100, 101 AND 102).

FIRST USE 6-8-2009; IN COMMERCE 6-8-2009.

NO CLAIM IS MADE TO THE EXCLUSIVE RIGHT TO USE "BENEFITS DESIGN", APART FROM THE MARK AS SHOWN.

THE COLOR(S) BLUE AND RED IS/ARE CLAIMED AS A FEATURE OF THE MARK.

THE MARK CONSISTS OF THE WORDS "RESOLUTION BENEFITS DESIGN" IN BLUE, WITH A BLUE DIAMOND BETWEEN THE WORDS "BENEFITS" AND "DESIGN". TO THE LEFT OF THE WORDING IS A BLUE FOUR SIDED DIAMOND AND TWO RED TRIANGLES THAT INTERSECT AT THE APEX OF THE TRIANGLES.

SER. NO. 85-515,463, FILED 1-12-2012.

HENRY S. ZAK, EXAMINING ATTORNEY



David J. Kybas

Director of the United States Patent and Trademark Office

United States of America

United States Patent and Trademark Office

BRILLIANT ROCKS OTM

Reg. No. 4,205,117

SHIFMAN, OURI (UNITED STATES INDIVIDUAL)
580 FIFTH AVE. SUITE #718
NEW YORK, NY 10036

Registered Sep. 11, 2012

Int. Cl.: 14

FOR: DIAMONDS, IN CLASS 14 (U.S. CLS. 2, 27, 28 AND 50).

TRADEMARK

FIRST USE 5-1-2010; IN COMMERCE 5-1-2010.

PRINCIPAL REGISTER

THE MARK CONSISTS OF STANDARD CHARACTERS WITHOUT CLAIM TO ANY PARTICULAR FONT, STYLE, SIZE, OR COLOR.

NO CLAIM IS MADE TO THE EXCLUSIVE RIGHT TO USE "BRILLIANT ROCKS", APART FROM THE MARK AS SHOWN.

SER. NO. 85-515,560, FILED 1-12-2012.

MARK SPARACINO, EXAMINING ATTORNEY



David J. Kyffers

Director of the United States Patent and Trademark Office

United States of America

United States Patent and Trademark Office

The Uptick Group

Reg. No. 4,205,118

Registered Sep. 11, 2012

Int. Cls.: 35 and 41

SERVICE MARK

PRINCIPAL REGISTER

THE UPTICK GROUP, LLC (FLORIDA LIMITED LIABILITY COMPANY)
2757 SOUTH PARK ROAD
PEMBROKE PARK, FL 33009

FOR: ACCOUNTING SERVICES; BUSINESS ADVISORY SERVICES, CONSULTANCY AND INFORMATION; BUSINESS ASSISTANCE, MANAGEMENT AND INFORMATION SERVICES; BUSINESS PROCESS OUTSOURCING SERVICES IN THE FIELD OF ACCOUNTING, SUPPLY CHAIN MANAGEMENT AND FULFILLMENT; GOODS IMPORT-EXPORT AGENCIES; SUPPLY CHAIN MANAGEMENT SERVICES, IN CLASS 35 (U.S. CLS. 100, 101 AND 102).

FIRST USE 1-5-2012; IN COMMERCE 1-5-2012.

FOR: ADVISORY AND CONSULTING SERVICES IN THE FIELD OF MANAGEMENT COACHING AND BUSINESS TRAINING FOCUSED ON BUSINESS STRATEGY, SALES, OPERATIONS AND DIRECT IMPORTING, IN CLASS 41 (U.S. CLS. 100, 101 AND 107).

FIRST USE 1-5-2012; IN COMMERCE 1-5-2012.

THE MARK CONSISTS OF STANDARD CHARACTERS WITHOUT CLAIM TO ANY PARTICULAR FONT, STYLE, SIZE, OR COLOR.

NO CLAIM IS MADE TO THE EXCLUSIVE RIGHT TO USE "GROUP", APART FROM THE MARK AS SHOWN.

SER. NO. 85-515,718, FILED 1-13-2012.

MARY ROSSMAN, EXAMINING ATTORNEY



David J. Kyffers

Director of the United States Patent and Trademark Office

United States of America

United States Patent and Trademark Office

TREE CLASSICS

Reg. No. 4,205,119

HEAVENLY HOLIDAYS, LLC (DELAWARE CORPORATION)
28 EAST 3RD AVENUE, SUITE 200
SAN MATEO, CA 94401

Registered Sep. 11, 2012

Int. Cl.: 28

FOR: ARTIFICIAL CHRISTMAS TREES, ARTIFICIAL CHRISTMAS WREATHS, AND ARTIFICIAL CHRISTMAS GARLANDS, IN CLASS 28 (U.S. CLS. 22, 23, 38 AND 50).

TRADEMARK

FIRST USE 1-2-1986; IN COMMERCE 1-2-1986.

PRINCIPAL REGISTER

THE MARK CONSISTS OF STANDARD CHARACTERS WITHOUT CLAIM TO ANY PARTICULAR FONT, STYLE, SIZE, OR COLOR.

OWNER OF U.S. REG. NO. 1,597,630.

NO CLAIM IS MADE TO THE EXCLUSIVE RIGHT TO USE "TREE", APART FROM THE MARK AS SHOWN.

SEC. 2(F).

SER. NO. 85-515,723, FILED 1-13-2012.

MARY ROSSMAN, EXAMINING ATTORNEY



David J. Kyffers

Director of the United States Patent and Trademark Office

United States of America

United States Patent and Trademark Office

EMP

Reg. No. 4,205,120

Registered Sep. 11, 2012

Int. Cl.: 41

SERVICE MARK

PRINCIPAL REGISTER

EXPERIENCE LEARNING COMMUNITY (WASHINGTON NON-PROFIT CORPORATION)
300 8TH AVENUE NORTH
SEATTLE, WA 98109

FOR: MUSEUM SERVICES, IN CLASS 41 (U.S. CLS. 100, 101 AND 107).

FIRST USE 6-23-2000; IN COMMERCE 6-23-2000.

THE MARK CONSISTS OF STANDARD CHARACTERS WITHOUT CLAIM TO ANY PARTICULAR FONT, STYLE, SIZE, OR COLOR.

OWNER OF U.S. REG. NOS. 2,522,869, 2,576,414 AND OTHERS.

SER. NO. 85-515,743, FILED 1-13-2012.

MAUREEN DALL, EXAMINING ATTORNEY



David J. Kyffers

Director of the United States Patent and Trademark Office

United States of America

United States Patent and Trademark Office

NeuralNet Case Development

Reg. No. 4,205,121

TRIAL ADVANTAGE LLC (CALIFORNIA LIMITED LIABILITY COMPANY)
38280 VIA MAJORCA
MURRIETA, CA 92562

Registered Sep. 11, 2012

Int. Cl.: 9

FOR: COMPUTER SOFTWARE FOR USE BY THE LEGAL INDUSTRY IN DEVELOPING A LAWSUIT AND ITS CONTENTS FOR NEGOTIATIONS, SETTLEMENTS, ARBITRATION AND JURY TRIAL , IN CLASS 9 (U.S. CLS. 21, 23, 26, 36 AND 38).

TRADEMARK

FIRST USE 8-1-2011; IN COMMERCE 8-1-2011.

PRINCIPAL REGISTER

THE MARK CONSISTS OF STANDARD CHARACTERS WITHOUT CLAIM TO ANY PARTICULAR FONT, STYLE, SIZE, OR COLOR.

NO CLAIM IS MADE TO THE EXCLUSIVE RIGHT TO USE "CASE DEVELOPMENT", APART FROM THE MARK AS SHOWN.

SER. NO. 85-515,939, FILED 1-13-2012.

JOHN DALIER, EXAMINING ATTORNEY



David J. Kyffers

Director of the United States Patent and Trademark Office

United States of America

United States Patent and Trademark Office

I'm not sayin' I'm just
sayin'

Reg. No. 4,205,122

VINCENT DIMARTINO (UNITED STATES INDIVIDUAL)
469 RT 17K, SUITE 3

Registered Sep. 11, 2012

ROCK TAVERN, NY 12575

Int. Cl.: 25

FOR: ATHLETIC APPAREL, NAMELY, SHIRTS, PANTS, JACKETS, FOOTWEAR, HATS
AND CAPS, ATHLETIC UNIFORMS, IN CLASS 25 (U.S. CLS. 22 AND 39).

TRADEMARK

FIRST USE 12-5-2011; IN COMMERCE 12-5-2011.

PRINCIPAL REGISTER

THE MARK CONSISTS OF STANDARD CHARACTERS WITHOUT CLAIM TO ANY PAR-
TICULAR FONT, STYLE, SIZE, OR COLOR.

SER. NO. 85-516,241, FILED 1-13-2012.

ANDREW LEASER, EXAMINING ATTORNEY



David J. Kybas

Director of the United States Patent and Trademark Office

United States of America

United States Patent and Trademark Office

THE NEW YORK NUMISMATIC CLUB

Reg. No. 4,205,123

Registered Sep. 11, 2012

Int. Cl.: 35

SERVICE MARK

PRINCIPAL REGISTER

NEW YORK NUMISMATIC CLUB (NEW YORK NON-PROFIT CORPORATION)
C/O ROBERT L. SACKS, ESQ., KANE KESSLER
1350 AVENUE OF THE AMERICAS
NEW YORK, NY 10019

FOR: ASSOCIATION SERVICES FOR PROMOTING THE INTERESTS OF COLLECTORS OF NUMISMATIC ITEMS AND FOR PROMOTING THE STUDY OF NUMISMATICS, NAMELY; COINS, MEDALS, PAPER CURRENCY, ORDERS, DECORATIONS, CERTIFICATES AND OTHER NUMISMATIC AND NUMISMATIC RELATED ITEMS, IN CLASS 35 (U.S. CLS. 100, 101 AND 102).

FIRST USE 12-11-1908; IN COMMERCE 12-11-1908.

THE MARK CONSISTS OF STANDARD CHARACTERS WITHOUT CLAIM TO ANY PARTICULAR FONT, STYLE, SIZE, OR COLOR.

NO CLAIM IS MADE TO THE EXCLUSIVE RIGHT TO USE "NUMISMATIC CLUB", APART FROM THE MARK AS SHOWN.

SEC. 2(F).

SER. NO. 85-516,286, FILED 1-13-2012.

JOHN E. MICHOS, EXAMINING ATTORNEY



David J. Kyjars

Director of the United States Patent and Trademark Office

United States of America

United States Patent and Trademark Office

TAMPA TROLLEYS

Reg. No. 4,205,124

Registered Sep. 11, 2012

Int. Cl.: 34

TRADEMARK

PRINCIPAL REGISTER

J.C. NEWMAN CIGAR COMPANY (FLORIDA CORPORATION)
2701-03 SIXTEENTH STREET
TAMPA, FL 33605

FOR: CIGARS, IN CLASS 34 (U.S. CLS. 2, 8, 9 AND 17).

FIRST USE 1-12-2012; IN COMMERCE 1-12-2012.

THE MARK CONSISTS OF STANDARD CHARACTERS WITHOUT CLAIM TO ANY PARTICULAR FONT, STYLE, SIZE, OR COLOR.

NO CLAIM IS MADE TO THE EXCLUSIVE RIGHT TO USE "TAMPA", APART FROM THE MARK AS SHOWN.

SER. NO. 85-516,430, FILED 1-13-2012.

BRENDAN REGAN, EXAMINING ATTORNEY



David J. Kyffers

Director of the United States Patent and Trademark Office

United States of America

United States Patent and Trademark Office

Stylish Blooms

Reg. No. 4,205,125

Registered Sep. 11, 2012

Int. Cl.: 35

SERVICE MARK

PRINCIPAL REGISTER

BONOFFSKI, MELISSA (CONNECTICUT SOLE PROPRIETORSHIP), DBA STYLISH BLOOMS
510 BREWSTER RD
BRISTOL, CT 06010

FOR: RETAIL FLORIST SHOPS, IN CLASS 35 (U.S. CLS. 100, 101 AND 102).

FIRST USE 8-1-2008; IN COMMERCE 8-1-2008.

THE MARK CONSISTS OF STANDARD CHARACTERS WITHOUT CLAIM TO ANY PARTICULAR FONT, STYLE, SIZE, OR COLOR.

NO CLAIM IS MADE TO THE EXCLUSIVE RIGHT TO USE "BLOOMS", APART FROM THE MARK AS SHOWN.

SER. NO. 85-516,778, FILED 1-14-2012.

ESTHER A. BORSUK, EXAMINING ATTORNEY



David J. Kybas

Director of the United States Patent and Trademark Office

United States of America

United States Patent and Trademark Office

DILATO POINT CAPITAL

Reg. No. 4,205,126

Registered Sep. 11, 2012

Int. Cl.: 36

SERVICE MARK

PRINCIPAL REGISTER

DILATO POINT CAPITAL LLC (CALIFORNIA LIMITED LIABILITY COMPANY)
47166
20929 VENTURA BLVD.
WOODLAND HILLS, CA 91364

FOR: ACCOUNTS RECEIVABLES FINANCING; BUSINESS FINANCE PROCUREMENT SERVICES; PROVIDING WORKING CAPITAL FINANCING TO SMALL BUSINESSES AND SMALL BUSINESS OWNERS, IN CLASS 36 (U.S. CLS. 100, 101 AND 102).

FIRST USE 7-8-2011; IN COMMERCE 7-8-2011.

THE MARK CONSISTS OF STANDARD CHARACTERS WITHOUT CLAIM TO ANY PARTICULAR FONT, STYLE, SIZE, OR COLOR.

NO CLAIM IS MADE TO THE EXCLUSIVE RIGHT TO USE "CAPITAL", APART FROM THE MARK AS SHOWN.

SER. NO. 85-516,919, FILED 1-15-2012.

TRICIA SONNEBORN, EXAMINING ATTORNEY



David J. Kyffers

Director of the United States Patent and Trademark Office

United States of America

United States Patent and Trademark Office

BULLION EXPRESS

Reg. No. 4,205,127

DGSE COMPANIES, INC. (NEVADA CORPORATION)

Registered Sep. 11, 2012

11311 REEDER ROAD
DALLAS, TX 75229

Int. Cl.: 36

FOR: PROVIDING MONETARY EXCHANGE SERVICES IN THE NATURE OF TRADING IN GOLD, SILVER, PLATINUM, AND PALLADIUM BULLION, IN CLASS 36 (U.S. CLS. 100, 101 AND 102).

SERVICE MARK

FIRST USE 6-0-2011; IN COMMERCE 6-0-2011.

PRINCIPAL REGISTER

THE MARK CONSISTS OF STANDARD CHARACTERS WITHOUT CLAIM TO ANY PARTICULAR FONT, STYLE, SIZE, OR COLOR.

NO CLAIM IS MADE TO THE EXCLUSIVE RIGHT TO USE "BULLION", APART FROM THE MARK AS SHOWN.

SER. NO. 85-517,035, FILED 1-16-2012.

JEFF DEFORD, EXAMINING ATTORNEY



David J. Kybas

Director of the United States Patent and Trademark Office

United States of America

United States Patent and Trademark Office

SEVILLE DIAMOND COLLECTION

Reg. No. 4,205,128

GOLD N DIAMONDS (GEORGIA CORPORATION)
250 SPRING STREET NW SUITE 6E320
ATLANTA, GA 30303

Registered Sep. 11, 2012

Int. Cl.: 14

FOR: DIAMOND JEWELRY, IN CLASS 14 (U.S. CLS. 2, 27, 28 AND 50).

TRADEMARK

FIRST USE 1-7-2012; IN COMMERCE 1-7-2012.

PRINCIPAL REGISTER

THE MARK CONSISTS OF STANDARD CHARACTERS WITHOUT CLAIM TO ANY PARTICULAR FONT, STYLE, SIZE, OR COLOR.

NO CLAIM IS MADE TO THE EXCLUSIVE RIGHT TO USE "DIAMOND COLLECTION", APART FROM THE MARK AS SHOWN.

SER. NO. 85-517,044, FILED 1-16-2012.

BRIAN CALLAGHAN, EXAMINING ATTORNEY



David J. Kyffers

Director of the United States Patent and Trademark Office

United States of America

United States Patent and Trademark Office

TOP PROMOTIONS

Reg. No. 4,205,129

Registered Sep. 11, 2012

Int. Cl.: 35

SERVICE MARK

PRINCIPAL REGISTER

TOP PROMOTIONS, INC. (WISCONSIN CORPORATION)
8831 S. GREENVIEW DRIVE
MIDDLETON, WI 53562

FOR: ADVERTISING, MARKETING, AND PROMOTING THE GOODS AND SERVICES OF OTHERS THROUGH THE DISTRIBUTION OF PROMOTIONAL MERCHANDISE; INVENTORY MANAGEMENT; ORDER FULFILLMENT SERVICES; WHOLESALE DISTRIBUTORSHIPS FEATURING GIFTS, APPAREL AND RELATED ACCESSORIES, IN CLASS 35 (U.S. CLS. 100, 101 AND 102).

FIRST USE 1-1-1983; IN COMMERCE 1-1-1983.

THE MARK CONSISTS OF STANDARD CHARACTERS WITHOUT CLAIM TO ANY PARTICULAR FONT, STYLE, SIZE, OR COLOR.

NO CLAIM IS MADE TO THE EXCLUSIVE RIGHT TO USE "PROMOTIONS", APART FROM THE MARK AS SHOWN.

SER. NO. 85-517,062, FILED 1-16-2012.

DEBORAH LOBO, EXAMINING ATTORNEY



David J. Kyffers

Director of the United States Patent and Trademark Office

United States of America

United States Patent and Trademark Office

CIRCLE-LETS

Reg. No. 4,205,130

Registered Sep. 11, 2012

Int. Cl.: 14

TRADEMARK

PRINCIPAL REGISTER

CIRCLE-LETS, INC. (ILLINOIS NON-PROFIT CORPORATION)
6908 STONE RUN DRIVE
NASHVILLE, TN 37211

FOR: COSTUME JEWELRY; JEWELRY, IN CLASS 14 (U.S. CLS. 2, 27, 28 AND 50).

FIRST USE 12-1-1963; IN COMMERCE 12-1-1963.

THE MARK CONSISTS OF STANDARD CHARACTERS WITHOUT CLAIM TO ANY PARTICULAR FONT, STYLE, SIZE, OR COLOR.

OWNER OF U.S. REG. NO. 4,087,295.

SER. NO. 85-517,438, FILED 1-16-2012.

PATRICIA EVANKO, EXAMINING ATTORNEY



David J. Kyffers

Director of the United States Patent and Trademark Office

United States of America

United States Patent and Trademark Office

TheHRConcierge
Creative HR solutions that ignite vision, collaboration and client satisfaction

Reg. No. 4,205,131

OSTENFELD, LORI A. (UNITED STATES INDIVIDUAL)
1 INDEPENDENCE COURT, UNIT 404
HOBOKEN, NJ 07030

Registered Sep. 11, 2012

Int. Cl.: 35

FOR: CONSULTING SERVICES IN THE FIELDS OF BUSINESS MANAGEMENT, HUMAN RESOURCES, AND BUSINESS ORGANIZATIONAL DESIGN, IN CLASS 35 (U.S. CLS. 100, 101 AND 102).

SERVICE MARK

FIRST USE 1-8-2012; IN COMMERCE 1-8-2012.

PRINCIPAL REGISTER

NO CLAIM IS MADE TO THE EXCLUSIVE RIGHT TO USE "HR CONCIERGE", APART FROM THE MARK AS SHOWN.

THE COLOR(S) DARK PURPLE, LAVENDER IS/ARE CLAIMED AS A FEATURE OF THE MARK.

THE MARK CONSISTS OF THE STYLIZED WORDING "THEHRCONCIERGE", WITH THE WORDING "THE" AND "CONCIERGE" APPEARING IN DARK PURPLE AND THE LETTERING "HR" APPEARING IN LAVENDER, ALL SET ABOVE THE STYLIZED WORDING "CREATIVE HR SOLUTIONS THAT IGNITE VISION, COLLABORATION AND CLIENT SATISFACTION" IN DARK PURPLE.

SER. NO. 85-517,442, FILED 1-16-2012.

MICHELE SWAIN, EXAMINING ATTORNEY



David J. Kybas

Director of the United States Patent and Trademark Office

United States of America

United States Patent and Trademark Office

IMEDTEACH

Reg. No. 4,205,132

Registered Sep. 11, 2012

Int. Cl.: 42

SERVICE MARK

PRINCIPAL REGISTER

IMEDMEDIA INC. (CANADA CORPORATION)
IMEDMEDIA
1804 WADE ROAD
RUSSELL, ON, CANADA K4R1E5

FOR: SOFTWARE AS A SERVICES FEATURING SOFTWARE FOR SCHOOLS, MEDICAL DIVISIONS, HOSPITALS, INSTITUTIONS, AND GOVERNMENT AGENCIES TO CREATE CUSTOMIZED TEACHING AND TESTING MODULES FOR STUDENTS, STAFF AND PROFESSIONALS, IN CLASS 42 (U.S. CLS. 100 AND 101).

FIRST USE 6-1-2009; IN COMMERCE 6-1-2009.

THE MARK CONSISTS OF STANDARD CHARACTERS WITHOUT CLAIM TO ANY PARTICULAR FONT, STYLE, SIZE, OR COLOR.

SER. NO. 85-517,462, FILED S.R. 1-16-2012 AM. P.R. 4-25-2012.

KAREN K. BUSH, EXAMINING ATTORNEY



David J. Kyffers

Director of the United States Patent and Trademark Office

United States of America

United States Patent and Trademark Office



Reg. No. 4,205,133

TECHNA CLIP, LLC (UTAH LIMITED LIABILITY COMPANY)
4642 WEST 10600 NORTH
HIGHLAND, UT 84003

Registered Sep. 11, 2012

Int. Cl.: 13

FOR: HAND GUN ACCESSORIES, NAMELY, BELT CLIPS FOR SECURING A GUN WITHOUT THE USE OF A HOLSTER, IN CLASS 13 (U.S. CLS. 2 AND 9).

TRADEMARK

FIRST USE 2-21-2011; IN COMMERCE 6-15-2011.

PRINCIPAL REGISTER

NO CLAIM IS MADE TO THE EXCLUSIVE RIGHT TO USE THE PICTORIAL REPRESENTATION OF THE GUN BELT CLIP AND "CLIP", APART FROM THE MARK AS SHOWN.

THE MARK CONSISTS OF THE WORD "TECHNA" IN CAPITAL LETTERS, WITH THE LETTER "T" BEING THE LARGEST AND THE LETTERS "ECHNA" BEING OF THE SAME HEIGHT. THE WORD "CLIP", WITH ALL LETTERS IN A LOWER CASE CURSIVE FONT, POSITIONED TO THE RIGHT AND BELOW THE WORD "TECHNA" AND SEPARATED THEREFROM BY A HANDGUN BELT CLIP. THE PHRASE "A" COMFORTABLE CONCEALABLE WAY TO CARRY A GUN IS POSITIONED DIRECTLY BELOW THE LETTERS "ECHNA".

SER. NO. 85-517,598, FILED 1-16-2012.

SUE LAWRENCE, EXAMINING ATTORNEY



David J. Kyffers

Director of the United States Patent and Trademark Office

United States of America

United States Patent and Trademark Office

Genealogy Sleuth

Reg. No. 4,205,134

Registered Sep. 11, 2012

Int. Cl.: 45

SERVICE MARK

PRINCIPAL REGISTER

ANCESTRY.COM OPERATIONS INC. (DELAWARE CORPORATION)
360 WEST 4800 NORTH
PROVO, UT 84604

FOR: PROVISION OF GENEALOGICAL INFORMATION, NAMELY, PROVISION OF EDUCATIONAL, RESEARCH AND HISTORICAL TABLES OF GENEALOGICAL INFORMATION; PROVIDING GENEALOGICAL INFORMATION, NAMELY, FAMILY HISTORY INFORMATION SERVICES, NAMELY, RETRIEVING, RECORDING AND REVIEWING ANCESTRAL DATA VIA THE GLOBAL COMPUTER NETWORK; CONSULTANCY, INFORMATION AND ADVISORY SERVICES RELATING TO THE AFORESAID; AND PROVIDING AN ON-LINE COMPUTER DATABASE IN THE FIELD OF GENEALOGY INFORMATION AND FAMILY HISTORY INFORMATION; PROVIDING A WEBSITE FEATURING LINKS TO THIRD PARTY WEBSITES FEATURING SEARCH ENGINES, DATABASES, SOFTWARE TOOLS, DIRECTORIES, WEB SITES, AND HISTORICAL RECORDS IN THE FIELD OF GENEALOGICAL AND FAMILY HISTORY INFORMATION, IN CLASS 45 (U.S. CLS. 100 AND 101).

FIRST USE 1-16-2000; IN COMMERCE 1-16-2000.

THE MARK CONSISTS OF STANDARD CHARACTERS WITHOUT CLAIM TO ANY PARTICULAR FONT, STYLE, SIZE, OR COLOR.

NO CLAIM IS MADE TO THE EXCLUSIVE RIGHT TO USE "GENEALOGY", APART FROM THE MARK AS SHOWN.

SER. NO. 85-517,865, FILED 1-17-2012.

LEIGH CAROLINE CASE, EXAMINING ATTORNEY



David J. Kypos

Director of the United States Patent and Trademark Office

United States of America

United States Patent and Trademark Office

Ancestry.ca

Reg. No. 4,205,135

Registered Sep. 11, 2012

Int. Cls.: 42 and 45

SERVICE MARK

PRINCIPAL REGISTER

ANCESTRY.COM OPERATIONS INC. (DELAWARE CORPORATION)
360 WEST 4800 NORTH
PROVO, UT 84604

FOR: APPLICATION SERVICE PROVIDER SERVICES FEATURING SOFTWARE FOR USE IN CREATING, DISPLAYING, SHARING AND STORING MULTIMEDIA PRESENTATIONS THAT INCLUDE PHOTOGRAPHS AND SOUND, ALL IN THE FIELD OF GENEALOGY AND FAMILY HISTORY; PROVIDING TEMPORARY USE OF NON-DOWNLOADABLE COMPUTER SOFTWARE FOR USE IN CREATING, DISPLAYING, SHARING AND STORING MULTIMEDIA PRESENTATIONS THAT INCLUDE PHOTOGRAPHS AND SOUND, ALL IN THE FIELD OF GENEALOGY AND FAMILY HISTORY; PROVIDING TEMPORARY USE OF NON-DOWNLOADABLE COMPUTER SOFTWARE THAT ENABLES FAMILY GROUPS TO CREATE AND MAINTAIN PERSONALIZED WEBSITES FOR THE PURPOSE OF SHARING INFORMATION REGARDING FAMILY MEMBERS; HOSTING OF DIGITAL CONTENT ON THE INTERNET, NAMELY, HOSTING ON-LINE JOURNALS AND BLOGS IN THE FIELD OF GENEALOGY AND FAMILY HISTORY; COMPUTER SERVICES, NAMELY, HOSTING AND MAINTAINING AN ONLINE WEBSITE FOR OTHERS TO ACCESS PHOTO ALBUMS AND CALENDARS; PROVIDING TEMPORARY USE OF NON-DOWNLOADABLE COMPUTER SOFTWARE FOR USE IN THE CREATION AND PUBLICATION OF ON-LINE JOURNALS AND BLOGS IN THE FIELD OF GENEALOGY AND FAMILY HISTORY, IN CLASS 42 (U.S. CLS. 100 AND 101).

FIRST USE 6-0-2006; IN COMMERCE 6-0-2006.



FOR: PROVISION OF GENEALOGICAL INFORMATION, NAMELY, PROVISION OF EDUCATIONAL, RESEARCH AND HISTORICAL TABLES OF GENEALOGICAL INFORMATION; PROVIDING GENEALOGICAL INFORMATION, NAMELY, FAMILY HISTORY INFORMATION SERVICES, NAMELY, RETRIEVING, RECORDING AND REVIEWING ANCESTRAL DATA VIA THE GLOBAL COMPUTER NETWORK; CONSULTANCY, INFORMATION AND ADVISORY SERVICES RELATING TO THE AFORESAID; AND PROVIDING AN ON-LINE COMPUTER DATABASE IN THE FIELD OF GENEALOGY INFORMATION AND FAMILY HISTORY INFORMATION; GENEALOGICAL SERVICES, NAMELY, GENEALOGY RESEARCH, PROVIDED IN PERSON AND VIA THE INTERNET, IN CLASS 45 (U.S. CLS. 100 AND 101).

FIRST USE 6-0-2006; IN COMMERCE 6-0-2006.

David J. Kyjars

Director of the United States Patent and Trademark Office

Reg. No. 4,205,135 THE MARK CONSISTS OF STANDARD CHARACTERS WITHOUT CLAIM TO ANY PARTICULAR FONT, STYLE, SIZE, OR COLOR.

OWNER OF U.S. REG. NOS. 3,566,509, 3,852,700 AND OTHERS.

SEC. 2(F).

SER. NO. 85-517,868, FILED 1-17-2012.

LEIGH CAROLINE CASE, EXAMINING ATTORNEY

United States of America

United States Patent and Trademark Office

Ancestry.co.uk

Reg. No. 4,205,136

Registered Sep. 11, 2012

Int. Cls.: 42 and 45

SERVICE MARK

PRINCIPAL REGISTER

ANCESTRY.COM OPERATIONS INC. (DELAWARE CORPORATION)
360 WEST 4800 NORTH
PROVO, UT 84604

FOR: APPLICATION SERVICE PROVIDER SERVICES FEATURING SOFTWARE FOR USE IN CREATING, DISPLAYING, SHARING AND STORING MULTIMEDIA PRESENTATIONS THAT INCLUDE PHOTOGRAPHS AND SOUND, ALL IN THE FIELD OF GENEALOGY AND FAMILY HISTORY; PROVIDING TEMPORARY USE OF NON-DOWNLOADABLE COMPUTER SOFTWARE FOR USE IN CREATING, DISPLAYING, SHARING AND STORING MULTIMEDIA PRESENTATIONS THAT INCLUDE PHOTOGRAPHS AND SOUND, ALL IN THE FIELD OF GENEALOGY AND FAMILY HISTORY; PROVIDING TEMPORARY USE OF NON-DOWNLOADABLE COMPUTER SOFTWARE THAT ENABLES FAMILY GROUPS TO CREATE AND MAINTAIN PERSONALIZED WEBSITES FOR THE PURPOSE OF SHARING INFORMATION REGARDING FAMILY MEMBERS; HOSTING OF DIGITAL CONTENT ON THE INTERNET, NAMELY, HOSTING ON-LINE JOURNALS AND BLOGS IN THE FIELD OF GENEALOGY AND FAMILY HISTORY; COMPUTER SERVICES, NAMELY, HOSTING AND MAINTAINING AN ONLINE WEBSITE FOR OTHERS TO ACCESS PHOTO ALBUMS AND CALENDARS; PROVIDING TEMPORARY USE OF NON-DOWNLOADABLE COMPUTER SOFTWARE FOR USE IN THE CREATION AND PUBLICATION OF ON-LINE JOURNALS AND BLOGS IN THE FIELD OF GENEALOGY AND FAMILY HISTORY, IN CLASS 42 (U.S. CLS. 100 AND 101).

FIRST USE 0-0-2002; IN COMMERCE 0-0-2002.



David J. Kyjars

FOR: PROVISION OF GENEALOGICAL INFORMATION, NAMELY, PROVISION OF EDUCATIONAL, RESEARCH AND HISTORICAL TABLES OF GENEALOGICAL INFORMATION; PROVIDING GENEALOGICAL INFORMATION, NAMELY, FAMILY HISTORY INFORMATION SERVICES, NAMELY, RETRIEVING, RECORDING AND REVIEWING ANCESTRAL DATA VIA THE GLOBAL COMPUTER NETWORK; CONSULTANCY, INFORMATION AND ADVISORY SERVICES RELATING TO THE AFORESAID; AND PROVIDING AN ON-LINE COMPUTER DATABASE IN THE FIELD OF GENEALOGY INFORMATION AND FAMILY HISTORY INFORMATION; GENEALOGICAL SERVICES, NAMELY, GENEALOGY RESEARCH, PROVIDED IN PERSON AND VIA THE INTERNET, IN CLASS 45 (U.S. CLS. 100 AND 101).

FIRST USE 0-0-2002; IN COMMERCE 0-0-2002.

Reg. No. 4,205,136 THE MARK CONSISTS OF STANDARD CHARACTERS WITHOUT CLAIM TO ANY PARTICULAR FONT, STYLE, SIZE, OR COLOR.

OWNER OF U.S. REG. NOS. 3,566,509, 3,852,700 AND OTHERS.

SEC. 2(F).

SER. NO. 85-517,869, FILED 1-17-2012.

LEIGH CAROLINE CASE, EXAMINING ATTORNEY

United States of America

United States Patent and Trademark Office

BOWDITCH & DEWEY

Reg. No. 4,205,137

Registered Sep. 11, 2012

Int. Cl.: 45

SERVICE MARK

PRINCIPAL REGISTER

BOWDITCH & DEWEY, LLP (MASSACHUSETTS LIMITED LIABILITY PARTNERSHIP)
P.O. BOX 15156
311 MAIN STREET
WORCESTER, MA 01615

FOR: LEGAL SERVICES, IN CLASS 45 (U.S. CLS. 100 AND 101).

FIRST USE 10-1-1977; IN COMMERCE 10-1-1977.

THE MARK CONSISTS OF STANDARD CHARACTERS WITHOUT CLAIM TO ANY PARTICULAR FONT, STYLE, SIZE, OR COLOR.

SER. NO. 85-517,939, FILED 1-17-2012.

MEGHAN REINHART, EXAMINING ATTORNEY



David J. Kybas

Director of the United States Patent and Trademark Office

United States of America

United States Patent and Trademark Office

Intelligent Re-Engineering

Reg. No. 4,205,138

Registered Sep. 11, 2012

Int. Cl.: 2

TRADEMARK

PRINCIPAL REGISTER

WAZANA BROTHERS INTERNATIONAL, INC. (CALIFORNIA CORPORATION), DBA
MICRO SOLUTIONS ENTERPRISES
8201 WOODLEY AVENUE
VAN NUYS, CA 91406

FOR: INK CARTRIDGES FOR PRINTERS; INK JET CARTRIDGES; PHOTOCOPIER TONER;
PHOTOCOPIER TONER IN CARTRIDGES; TONER CARTRIDGES, IN CLASS 2 (U.S. CLS.
6, 11 AND 16).

FIRST USE 10-1-2010; IN COMMERCE 10-1-2010.

THE MARK CONSISTS OF STANDARD CHARACTERS WITHOUT CLAIM TO ANY PAR-
TICULAR FONT, STYLE, SIZE, OR COLOR.

OWNER OF U.S. REG. NO. 4,055,517.

NO CLAIM IS MADE TO THE EXCLUSIVE RIGHT TO USE "RE-ENGINEERING", APART
FROM THE MARK AS SHOWN.

SER. NO. 85-518,035, FILED 1-17-2012.

AMY KELLY, EXAMINING ATTORNEY



David J. Kyfos

Director of the United States Patent and Trademark Office

United States of America

United States Patent and Trademark Office

SecondShells

Reg. No. 4,205,139

AURUM ENTERPRISES (FLORIDA CORPORATION)
1140 HOLLAND DRIVE STE 8
BOCA RATON, FL 33487

Registered Sep. 11, 2012

Int. Cl.: 9

FOR: CARRYING CASES FOR MOBILE COMPUTERS, IN CLASS 9 (U.S. CLS. 21, 23, 26, 36 AND 38).

TRADEMARK

FIRST USE 4-15-2011; IN COMMERCE 9-15-2011.

PRINCIPAL REGISTER

THE MARK CONSISTS OF STANDARD CHARACTERS WITHOUT CLAIM TO ANY PARTICULAR FONT, STYLE, SIZE, OR COLOR.

SER. NO. 85-518,180, FILED 1-17-2012.

SANDRA BUJA, EXAMINING ATTORNEY



David J. Kyffers

Director of the United States Patent and Trademark Office

United States of America

United States Patent and Trademark Office

Beautiful Experience By Dawn

Reg. No. 4,205,140

Registered Sep. 11, 2012

Int. Cl.: 41

SERVICE MARK

PRINCIPAL REGISTER

DS FOUNDATION, LLC (NEW YORK LIMITED LIABILITY COMPANY), DBA DAWN SELA
PHOTOGRAPHY
4 BELLEFORD LANE
BEACON, NY 12508

FOR: PHOTOGRAPHY SERVICES; PORTRAIT PHOTOGRAPHY, IN CLASS 41 (U.S. CLS.
100, 101 AND 107).

FIRST USE 1-17-2012; IN COMMERCE 1-17-2012.

THE MARK CONSISTS OF STANDARD CHARACTERS WITHOUT CLAIM TO ANY PAR-
TICULAR FONT, STYLE, SIZE, OR COLOR.

SER. NO. 85-518,283, FILED 1-17-2012.

ALEX KEAM, EXAMINING ATTORNEY



David J. Kyfos

Director of the United States Patent and Trademark Office

United States of America

United States Patent and Trademark Office

MyLawsuit.com

Reg. No. 4,205,141

Registered Sep. 11, 2012

Int. Cls.: 35 and 45

SERVICE MARK

PRINCIPAL REGISTER

MYLAWSUIT.COM, INC (CALIFORNIA CORPORATION)
2995 WOODSIDE ROAD, SUITE 400
WOODSIDE, CA 94062

FOR: BUSINESS SERVICES, NAMELY, PROVIDING AN ONLINE NETWORK FOR LEGAL SERVICES CONTRACTORS TO RECEIVE LEADS AND BIDDING OPPORTUNITIES BY MEANS OF AN ONLINE MARKETPLACE FOR THE PURPOSE OF DEVELOPING BUSINESS IN THE LEGAL SERVICES INDUSTRY; COMPUTERIZED ON-LINE RETAIL STORE SERVICES IN THE FIELD OF LEGAL OFFICE SUPPLIES, OFFICE EQUIPMENT, INCLUDING ENVELOPES, INDEX BOOKS, INDEX CARDS, INDEX DIVIDERS, LEGAL FORMS, PAPER FILING SUPPLIES, NAMELY, FILE JACKETS, FILING POCKETS, NON-LEATHER FILING WALLETS, FOLDERS, BINDERS AND MINUTE BOOKS, IN CLASS 35 (U.S. CLS. 100, 101 AND 102).

FIRST USE 10-10-2007; IN COMMERCE 12-3-2007.

FOR: PROVIDING AN ON-LINE INTERACTIVE DATABASE FEATURING LEGAL INFORMATION, IN CLASS 45 (U.S. CLS. 100 AND 101).

FIRST USE 10-10-2007; IN COMMERCE 12-3-2007.

THE MARK CONSISTS OF STANDARD CHARACTERS WITHOUT CLAIM TO ANY PARTICULAR FONT, STYLE, SIZE, OR COLOR.

SER. NO. 85-518,367, FILED 1-17-2012.

JEAN IM, EXAMINING ATTORNEY



David J. Kybas

Director of the United States Patent and Trademark Office

United States of America

United States Patent and Trademark Office

COMMOTION

Reg. No. 4,205,142

Registered Sep. 11, 2012

Int. Cl.: 42

SERVICE MARK

PRINCIPAL REGISTER

BE DIGITAL MEDIA SOLUTIONS, LLC (DELAWARE LIMITED LIABILITY COMPANY)
4100 N. 24TH STREET
QUINCY, IL 62305

FOR: APPLICATION SERVICE PROVIDER (ASP) FEATURING SOFTWARE FOR USE IN PROVIDING LIVE INTERACTIVE CHAT, LIVE LISTENER POLLING, LIVE PLAYLIST VOTING, ALBUM ART SYNCHRONIZATION, LIVE PLAYLISTS, INTERACTIVE MEDIA SERVICES, MOBILE MARKETING PLATFORMS AND CUSTOMIZED ELECTRONIC DISPLAYS IN THE FIELD OF RADIO PROGRAMME BROADCASTING; VENDOR-ON-PREMISE SERVICES, NAMELY, THE CUSTOMIZATION OF SOFTWARE APPLICATIONS FOR RADIO STATIONS THAT PROVIDE LIVE INTERACTIVE CHAT, LIVE LISTENER POLLING, LIVE PLAY LIST VOTING, ALBUM ART SYNCHRONIZATION, LIVE PLAYLISTS AND INTERACTIVE MEDIA SERVICES TO RADIO LISTENERS VIA MOBILE PHONES, TABLETS, COMPUTERS AND ELECTRONIC HANDHELD DEVICES, IN CLASS 42 (U.S. CLS. 100 AND 101).

FIRST USE 12-0-2011; IN COMMERCE 12-0-2011.

THE MARK CONSISTS OF STANDARD CHARACTERS WITHOUT CLAIM TO ANY PARTICULAR FONT, STYLE, SIZE, OR COLOR.

SER. NO. 85-518,374, FILED 1-17-2012.

JULIE VEPPUMTHARA, EXAMINING ATTORNEY



David J. Kyffers

Director of the United States Patent and Trademark Office

United States of America

United States Patent and Trademark Office

NUMB NUTS

Reg. No. 4,205,143

ALOHA HAWAIIAN STORES, INC. (HAWAII CORPORATION)

Registered Sep. 11, 2012

74-5077 LANA PLACE
KAILUA KONA, HI 96740

Int. Cl.: 30

FOR: CHOCOLATE COVERED NUTS, CANDIES, AND CRACKERS, ALL WITH HOT OR SPICY FLAVORINGS ADDED, IN CLASS 30 (U.S. CL. 46).

TRADEMARK

FIRST USE 1-17-2012; IN COMMERCE 1-17-2012.

PRINCIPAL REGISTER

THE MARK CONSISTS OF STANDARD CHARACTERS WITHOUT CLAIM TO ANY PARTICULAR FONT, STYLE, SIZE, OR COLOR.

SER. NO. 85-518,439, FILED 1-17-2012.

CHRISTINE MARTIN, EXAMINING ATTORNEY



David J. Kyffers

Director of the United States Patent and Trademark Office

United States of America

United States Patent and Trademark Office

WHIZZBURGER

Reg. No. 4,205,144

DIZZY WHIZZ, INC. (KENTUCKY CORPORATION)
217 W. ST. CATHERINE ST.
LOUISVILLE, KY 40203

Registered Sep. 11, 2012

Int. Cl.: 30

FOR: SANDWICHES, NAMELY, HAMBURGERS AND CHEESEBURGERS, IN CLASS 30
(U.S. CL. 46).

TRADEMARK

FIRST USE 12-31-1951; IN COMMERCE 12-31-1951.

PRINCIPAL REGISTER

THE MARK CONSISTS OF STANDARD CHARACTERS WITHOUT CLAIM TO ANY PARTICULAR FONT, STYLE, SIZE, OR COLOR.

SER. NO. 85-518,803, FILED 1-18-2012.

SETH A. RAPPAPORT, EXAMINING ATTORNEY



David J. Kyros

Director of the United States Patent and Trademark Office

United States of America

United States Patent and Trademark Office



Reg. No. 4,205,145

JFM STRINGED INSTRUMENTS (CALIFORNIA CORPORATION)
13655 JEREMY CT.

Registered Sep. 11, 2012

RANCHO CUCAMONGA, CA 91739

Int. Cl.: 15

FOR: STRINGED MUSICAL INSTRUMENTS, IN CLASS 15 (U.S. CLS. 2, 21 AND 36).

TRADEMARK

FIRST USE 6-1-2011; IN COMMERCE 6-1-2011.

PRINCIPAL REGISTER

THE MARK CONSISTS OF THE STYLIZED LETTERS "JFM".

SER. NO. 85-518,833, FILED 1-18-2012.

ROBERT C. CLARK JR., EXAMINING ATTORNEY



David J. Kyffers

Director of the United States Patent and Trademark Office

United States of America

United States Patent and Trademark Office



Reg. No. 4,205,146

Registered Sep. 11, 2012

Int. Cl.: 42

SUMMIT CONSULTING GROUP, INC. (MARYLAND CORPORATION), DBA SUMMIT
GLOBAL TESTING
138 MAIN STREET
2ND FLOOR
ANNAPOLIS, MD 21401

SERVICE MARK

PRINCIPAL REGISTER

FOR: DESIGN, DEVELOPMENT AND IMPLEMENTATION OF SOFTWARE, HARDWARE AND TECHNOLOGY SOLUTIONS, AND CONSULTING SERVICES RELATED THERETO, IN THE FIELD OF COMPUTER-BASED EDUCATIONAL AND STANDARDIZED TESTING, IN CLASS 42 (U.S. CLS. 100 AND 101).

FIRST USE 12-15-2011; IN COMMERCE 12-15-2011.

NO CLAIM IS MADE TO THE EXCLUSIVE RIGHT TO USE "GLOBAL TESTING", APART FROM THE MARK AS SHOWN.

THE COLOR(S) YELLOW AND GREEN IS/ARE CLAIMED AS A FEATURE OF THE MARK.

THE MARK CONSISTS OF THREE STYLIZED MOUNTAINS OF DIFFERING SIZES WITH A TRIANGULAR GREEN MOUNTAIN APPEARING MOST PROMINENT AND IS POSITIONED IN BETWEEN TWO SMALLER YELLOW STYLIZED MOUNTAINS ON EITHER SIDE, COUPLED WITH THE WORDS "SUMMIT GLOBAL TESTING" IN GREEN WHEREIN EACH "M" OF "SUMMIT" IS MISSING PART OF THE LETTER IN ORDER TO CONJURE MOUNTAIN PEAK IMAGES.

SER. NO. 85-518,835, FILED 1-18-2012.

THEODORE MCBRIDE, EXAMINING ATTORNEY



David J. Kybas

Director of the United States Patent and Trademark Office

United States of America
United States Patent and Trademark Office

BAKIBALL

Reg. No. 4,205,147

Registered Sep. 11, 2012

Int. Cl.: 28

TRADEMARK

PRINCIPAL REGISTER

CERPOK, MICHAEL L. (UNITED STATES INDIVIDUAL)
#1004
16800 E. EL LAGO BLVD
FOUNTAIN HILLS, AZ 85268

FOR: BALLS FOR SPORTS, IN CLASS 28 (U.S. CLS. 22, 23, 38 AND 50).

FIRST USE 3-3-2010; IN COMMERCE 3-3-2010.

THE MARK CONSISTS OF STANDARD CHARACTERS WITHOUT CLAIM TO ANY PARTICULAR FONT, STYLE, SIZE, OR COLOR.

THE WORDING "BAKI" HAS NO MEANING IN A FOREIGN LANGUAGE.

SER. NO. 85-519,081, FILED 1-18-2012.

MELISSA VALLILLO, EXAMINING ATTORNEY



David J. Kybas

Director of the United States Patent and Trademark Office

United States of America

United States Patent and Trademark Office

BAKIBOARD

Reg. No. 4,205,148

Registered Sep. 11, 2012

Int. Cl.: 28

TRADEMARK

PRINCIPAL REGISTER

CERPOK, MICHAEL L. (UNITED STATES INDIVIDUAL)
#1004
16800 E. EL LAGO BLVD.
FOUNTAIN HILLS, AZ 85268

FOR: BACKBOARD FOR SPORTS GAME, IN CLASS 28 (U.S. CLS. 22, 23, 38 AND 50).

FIRST USE 3-3-2010; IN COMMERCE 3-3-2010.

THE MARK CONSISTS OF STANDARD CHARACTERS WITHOUT CLAIM TO ANY PARTICULAR FONT, STYLE, SIZE, OR COLOR.

THE WORDING "BAKI" HAS NO MEANING IN A FOREIGN LANGUAGE.

SER. NO. 85-519,122, FILED 1-18-2012.

MELISSA VALLILLO, EXAMINING ATTORNEY



David J. Kyffers

Director of the United States Patent and Trademark Office

United States of America

United States Patent and Trademark Office

GALLERY SOLUTIONS

Reg. No. 4,205,149

PINNACLE FRAMES AND ACCENTS, INC. (DELAWARE CORPORATION)
12201 TECHNOLOGY BLVD, SUITE 100
AUSTIN, TX 78727

Registered Sep. 11, 2012

Int. Cl.: 20

FOR: WALL DECOR, NAMELY, SHADOW BOXES, DISPLAY CASES AND SHELVING, IN CLASS 20 (U.S. CLS. 2, 13, 22, 25, 32 AND 50).

TRADEMARK

FIRST USE 7-1-2005; IN COMMERCE 7-1-2005.

PRINCIPAL REGISTER

THE MARK CONSISTS OF STANDARD CHARACTERS WITHOUT CLAIM TO ANY PARTICULAR FONT, STYLE, SIZE, OR COLOR.

OWNER OF U.S. REG. NO. 3,459,400.

NO CLAIM IS MADE TO THE EXCLUSIVE RIGHT TO USE "GALLERY", APART FROM THE MARK AS SHOWN.

SER. NO. 85-519,148, FILED 1-18-2012.

ALEX KEAM, EXAMINING ATTORNEY



David J. Kybas

Director of the United States Patent and Trademark Office

United States of America

United States Patent and Trademark Office

Jack LaLanne

Reg. No. 4,205,150

Registered Sep. 11, 2012

Int. Cl.: 5

TRADEMARK

PRINCIPAL REGISTER

BEFIT ENTERPRISES (CALIFORNIA CORPORATION)
785 QUINTANA ROAD
MORRO BAY, CA 93442

FOR: VITAMINS, IN CLASS 5 (U.S. CLS. 6, 18, 44, 46, 51 AND 52).

FIRST USE 4-8-2011; IN COMMERCE 4-8-2011.

THE MARK CONSISTS OF STANDARD CHARACTERS WITHOUT CLAIM TO ANY PARTICULAR FONT, STYLE, SIZE, OR COLOR.

OWNER OF U.S. REG. NOS. 1,351,946, 3,034,163, AND 3,161,990.

THE NAME "JACK LALANNE" DOES NOT IDENTIFY A LIVING INDIVIDUAL.

SER. NO. 85-519,272, FILED 1-18-2012.

NICHOLAS COLEMAN, EXAMINING ATTORNEY



David J. Kybas

Director of the United States Patent and Trademark Office

United States of America

United States Patent and Trademark Office



Reg. No. 4,205,151

Registered Sep. 11, 2012

**COLLECTIVE
MEMBERSHIP**

PRINCIPAL REGISTER

WALDEN, WILFORD (UNITED STATES INDIVIDUAL)
1110 NEWPORT STREET
DENVER, CO 80220

FOR: INDICATING MEMBERSHIP IN A DOG CLUB, IN CLASS 200 (U.S. CL. 200).

FIRST USE 1-0-2009; IN COMMERCE 1-0-2009.

NO CLAIM IS MADE TO THE EXCLUSIVE RIGHT TO USE "VISLA CLUB OF COLORADO", APART FROM THE MARK AS SHOWN.

THE COLOR(S) RED, BLUE, GOLD AND WHITE IS/ARE CLAIMED AS A FEATURE OF THE MARK.

THE MARK CONSISTS OF THE STYLIZED LETTERS, A BLUE "V", NEXT TO A RED "C". INSIDE OF THE RED "C" IS A GOLD IMAGE OF GRASSY TERRAIN. THERE IS THE WHITE OUTLINE OF A DOG COVERING PART OF THE LETTERS. BELOW THE DOG IS THE BLUE WORD "VISLA" ABOVE THE BLUE WORDS "CLUB OF COLORADO". IN SIDE OF THE RED "C" IS A GOLD IMAGE OF GRASSY TERRAIN, WITH A WHITE BACKGROUND.

SER. NO. 85-519,286, FILED 1-18-2012.

HENRY S. ZAK, EXAMINING ATTORNEY



David J. Kyffers

Director of the United States Patent and Trademark Office

United States of America

United States Patent and Trademark Office

Naturally Born

Reg. No. 4,205,152

PHILLIPS, AMY K. (UNITED STATES INDIVIDUAL)
2141 STEWART AVENUE
WALNUT CREEK, CA 94596

Registered Sep. 11, 2012

Int. Cl.: 44

FOR: PROVIDING A WEBSITE FEATURING INFORMATION ABOUT HEALTH AND WELLNESS, NAMELY, METHODS OF NATURAL CHILDBIRTHING AND BREASTFEEDING; PROVIDING ONLINE REVIEWS OF NATURAL CHILDBIRTH AND BREASTFEEDING SUPPORT PROVIDERS, IN CLASS 44 (U.S. CLS. 100 AND 101).

SERVICE MARK

PRINCIPAL REGISTER

FIRST USE 12-1-2010; IN COMMERCE 12-1-2010.

THE MARK CONSISTS OF STANDARD CHARACTERS WITHOUT CLAIM TO ANY PARTICULAR FONT, STYLE, SIZE, OR COLOR.

SER. NO. 85-519,301, FILED 1-18-2012.

KIMBERLY FRYE, EXAMINING ATTORNEY



David J. Kyffers

Director of the United States Patent and Trademark Office

United States of America

United States Patent and Trademark Office

WEDDING STORY

Reg. No. 4,205,153

Registered Sep. 11, 2012

Int. Cl.: 41

SERVICE MARK

PRINCIPAL REGISTER

WEDDING STORY, LLC (VIRGINIA LIMITED LIABILITY COMPANY)
SUITE D3
7540 LITTLE RIVER TURNPIKE
ANNANDALE, VA 22003

FOR: WEDDING PLANNING AND COORDINATION SERVICES, IN CLASS 41 (U.S. CLS. 100, 101 AND 107).

FIRST USE 1-15-2005; IN COMMERCE 1-15-2005.

THE MARK CONSISTS OF STANDARD CHARACTERS WITHOUT CLAIM TO ANY PARTICULAR FONT, STYLE, SIZE, OR COLOR.

NO CLAIM IS MADE TO THE EXCLUSIVE RIGHT TO USE "WEDDING", APART FROM THE MARK AS SHOWN.

SER. NO. 85-519,349, FILED 1-18-2012.

JAMES GRIFFIN, EXAMINING ATTORNEY



David J. Kyffers

Director of the United States Patent and Trademark Office

United States of America

United States Patent and Trademark Office

Test
1
Chain Lubricant

Reg. No. 4,205,154

Registered Sep. 11, 2012

Int. Cl.: 4

TRADEMARK

PRINCIPAL REGISTER

MAURER, IRVING K. (CALIFORNIA CORPORATION), AKA I.K. MAURER SALES, INC.
1050 PIONEER WAY, SUITE C
EL CAJON, CA 92020

FOR: CHAIN LUBRICANT, IN CLASS 4 (U.S. CLS. 1, 6 AND 15).

FIRST USE 12-1-2010; IN COMMERCE 12-1-2010.

NO CLAIM IS MADE TO THE EXCLUSIVE RIGHT TO USE "CHAIN LUBRICANT", APART FROM THE MARK AS SHOWN.

THE COLOR(S) BLUE AND BLACK IS/ARE CLAIMED AS A FEATURE OF THE MARK.

THE MARK CONSISTS OF THE WORD "TEST" WITH A BLUE "T" AND BLACK "EST", WITH A NUMERIC "1" CENTERED UNDERNEATH ALSO IN BLACK. THE LETTERS IN THE WORD "TEST" IS WRITTEN IN TWO ASCENDING FROM THE "T" AND THEN ONE DESCENDING IN HEIGHT. THE TOP OF THE NUMERIC "1" IS NESTLED UNDER THE "E" AND THE "S" OF THE WORD "TEST". THE WORDS "CHAIN LUBRICANT" ARE WRITTEN IN BLACK BELOW IN SKEWED LETTERING SLANTING DESCENDING UNDERNEATH THE "TEST 1" LETTERING.

SER. NO. 85-519,381, FILED 1-18-2012.

BRIDGETT SMITH, EXAMINING ATTORNEY



David J. Kyffers

Director of the United States Patent and Trademark Office

United States of America

United States Patent and Trademark Office

HOWTHEMARKETWORKS.COM

Reg. No. 4,205,155

STOCK-TRAK, INC. (CANADA CORPORATION)
5115 TRANS ISLAND, SUITE 205
MONTREAL, QUEBEC, CANADA H3W2Z9

Registered Sep. 11, 2012

Int. Cl.: 42

FOR: PROVIDING ON-LINE NON-DOWNLOADABLE SOFTWARE FEATURING AN INVESTMENT PORTFOLIO SIMULATOR, IN CLASS 42 (U.S. CLS. 100 AND 101).

SERVICE MARK

FIRST USE 4-22-2004; IN COMMERCE 4-22-2004.

PRINCIPAL REGISTER

THE MARK CONSISTS OF STANDARD CHARACTERS WITHOUT CLAIM TO ANY PARTICULAR FONT, STYLE, SIZE, OR COLOR.

SER. NO. 85-519,386, FILED 1-18-2012.

BRIDGETT SMITH, EXAMINING ATTORNEY



David J. Kybas

Director of the United States Patent and Trademark Office

United States of America

United States Patent and Trademark Office

PNEU FAST

Reg. No. 4,205,156

Registered Sep. 11, 2012

Int. Cls.: 6 and 7

TRADEMARK

PRINCIPAL REGISTER

INDUSTRIAL PROPERTIES, LLC (ILLINOIS LIMITED LIABILITY COMPANY)
166 W. WASHINGTON SUITE 300
CHICAGO, IL 60602

FOR: NAILS SOLD IN BULK, COLLATED NAILS, METAL STAPLES FOR CONSTRUCTION OR INDUSTRIAL USE AND COLLATED METAL STAPLES FOR CONSTRUCTION OR INDUSTRIAL USE; METAL FASTENERS, NAMELY, NAILS, COLLATED NAILS, METAL STAPLES FOR CONSTRUCTION OR INDUSTRIAL USE AND COLLATED METAL STAPLES FOR CONSTRUCTION OR INDUSTRIAL USE, IN CLASS 6 (U.S. CLS. 2, 12, 13, 14, 23, 25 AND 50).

FIRST USE 0-0-1981; IN COMMERCE 0-0-1981.

FOR: HAND-OPERATED PNEUMATIC TOOLS, NAMELY, NAIL AND STAPLE GUNS AND REPLACEMENT PARTS THEREFORE, IN CLASS 7 (U.S. CLS. 13, 19, 21, 23, 31, 34 AND 35).

FIRST USE 0-0-1981; IN COMMERCE 0-0-1981.

THE MARK CONSISTS OF STANDARD CHARACTERS WITHOUT CLAIM TO ANY PARTICULAR FONT, STYLE, SIZE, OR COLOR.

SER. NO. 85-519,546, FILED 1-18-2012.

GENE MACIOL, EXAMINING ATTORNEY



David J. Kyffers

Director of the United States Patent and Trademark Office

United States of America

United States Patent and Trademark Office



Reg. No. 4,205,157

Registered Sep. 11, 2012

Int. Cl.: 39

SERVICE MARK

PRINCIPAL REGISTER

PARKING AUTHORITY OF THE CITY OF ELIZABETH, NJ (NEW JERSEY CORPORATION)
233 COMMERCE PLACE
ELIZABETH, NJ 07201

FOR: VEHICLE PARKING SERVICES RELATING TO THE AVAILABILITY OF ON-STREET AND OFF-STREET PARKING SPACES; PARKING LOT SERVICES; PARKING GARAGES SERVICES, IN CLASS 39 (U.S. CLS. 100 AND 105).

FIRST USE 1-1-2006; IN COMMERCE 1-1-2006.

THE MARK CONSISTS OF A YELLOW LETTER "E" ON A GREEN CIRCLE WITH 3 WHITE CARS PARKED ON THE HORIZONTAL SEGMENTS OF THE "E". THE CIRCLE APPEARS ON A BACKGROUND CONSISTING OF A BLACK HORIZONTAL BAND AT THE TOP, A WHITE HORIZONTAL BAND IN THE MIDDLE, AND A GREEN HORIZONTAL BAND AT THE BOTTOM.

THE COLOR(S) GREEN, YELLOW, WHITE, AND BLACK IS/ARE CLAIMED AS A FEATURE OF THE MARK.

SER. NO. 85-519,576, FILED 1-18-2012.

APRIL HESIK, EXAMINING ATTORNEY



David J. Kybas

Director of the United States Patent and Trademark Office

United States of America

United States Patent and Trademark Office

The 72 Pins

Reg. No. 4,205,158

LUNDBLAD, KENT (UNITED STATES INDIVIDUAL)

Registered Sep. 11, 2012

436 ORCHARD
SANTA ROSA, CA 95404

Int. Cl.: 41

FOR: PROVIDING INFORMATION, NEWS AND COMMENTARY IN THE FIELD OF VIDEO GAMES; ON-LINE JOURNALS, NAMELY, BLOGS FEATURING THE SUBJECT OF VIDEO GAMES, IN CLASS 41 (U.S. CLS. 100, 101 AND 107).

SERVICE MARK

FIRST USE 12-30-2010; IN COMMERCE 12-30-2010.

PRINCIPAL REGISTER

THE MARK CONSISTS OF STANDARD CHARACTERS WITHOUT CLAIM TO ANY PARTICULAR FONT, STYLE, SIZE, OR COLOR.

SER. NO. 85-519,585, FILED 1-18-2012.

NAAKWAMA ANKRAH, EXAMINING ATTORNEY



David J. Kyffers

Director of the United States Patent and Trademark Office

United States of America

United States Patent and Trademark Office

MONKS' TRIPEL

Reg. No. 4,205,159

ABBEY BEVERAGE COMPANY, LLC (NEW MEXICO LIMITED LIABILITY COMPANY)
P. O. BOX 32124
SANTE FE, NM 87594

Registered Sep. 11, 2012

Int. Cl.: 32

FOR: BEER AND ALE, IN CLASS 32 (U.S. CLS. 45, 46 AND 48).

TRADEMARK

FIRST USE 5-31-2011; IN COMMERCE 5-31-2011.

PRINCIPAL REGISTER

THE MARK CONSISTS OF STANDARD CHARACTERS WITHOUT CLAIM TO ANY PARTICULAR FONT, STYLE, SIZE, OR COLOR.

OWNER OF U.S. REG. NOS. 3,056,340, 4,034,565 AND OTHERS.

NO CLAIM IS MADE TO THE EXCLUSIVE RIGHT TO USE "TRIPLE", APART FROM THE MARK AS SHOWN.

SER. NO. 85-519,624, FILED 1-18-2012.

GENE MACIOL, EXAMINING ATTORNEY



David J. Kyffers

Director of the United States Patent and Trademark Office

United States of America

United States Patent and Trademark Office

Pneu FAST

Reg. No. 4,205,160

Registered Sep. 11, 2012

Int. Cls.: 6 and 7

TRADEMARK

PRINCIPAL REGISTER

INDUSTRIAL PROPERTIES, LLC (ILLINOIS LIMITED LIABILITY COMPANY)
166 W. WASHINGTON SUITE 300
CHICAGO, IL 60602

FOR: NAILS SOLD IN BULK, COLLATED NAILS, METAL STAPLES FOR CONSTRUCTION OR INDUSTRIAL USE AND COLLATED METAL STAPLES FOR CONSTRUCTION OR INDUSTRIAL USE; METAL FASTENERS, NAMELY, NAILS, COLLATED NAILS, METAL STAPLES FOR CONSTRUCTION OR INDUSTRIAL USE AND COLLATED METAL STAPLES FOR CONSTRUCTION OR INDUSTRIAL USE, IN CLASS 6 (U.S. CLS. 2, 12, 13, 14, 23, 25 AND 50).

FIRST USE 0-0-1981; IN COMMERCE 0-0-1981.

FOR: HAND-OPERATED PNEUMATIC TOOLS, NAMELY, NAIL AND STAPLE GUNS AND REPLACEMENT PARTS THEREFOR, IN CLASS 7 (U.S. CLS. 13, 19, 21, 23, 31, 34 AND 35).

FIRST USE 0-0-1981; IN COMMERCE 0-0-1981.

THE MARK CONSISTS OF STYLIZED CHARACTERS SPELLING "PNEU FAST" WITH A THREE-SIDED GEOMETRIC GRAPHIC BETWEEN THE WORDS "PNEU" AND "FAST".

SER. NO. 85-519,652, FILED 1-18-2012.

GENE MACIOL, EXAMINING ATTORNEY



David J. Kyffers

Director of the United States Patent and Trademark Office

United States of America

United States Patent and Trademark Office



Reg. No. 4,205,161

ACRO SPORTS INTERNATIONAL, INC. (TEXAS CORPORATION)
1317 E. HIGHWAY 80
MESQUITE, TX 75150

Registered Sep. 11, 2012

Int. Cl.: 41

FOR: GYMNASTIC INSTRUCTION; PROVIDING GYMNASTIC FACILITIES, IN CLASS 41
(U.S. CLS. 100, 101 AND 107).

SERVICE MARK

FIRST USE 5-1-1993; IN COMMERCE 5-1-1993.

PRINCIPAL REGISTER

NO CLAIM IS MADE TO THE EXCLUSIVE RIGHT TO USE "GYMNASTICS", APART FROM
THE MARK AS SHOWN.

THE COLOR(S) BLUE AND BLACK IS/ARE CLAIMED AS A FEATURE OF THE MARK.

THE MARK CONSISTS THREE BRILLIANT BLUE HORIZONTAL BARS ON EACH SIDE
OF THE BLACK CAPITAL LETTERS "ASI", WITH "GYMNASTICS" IN BLACK PRINT UN-
DERNEATH, AND THE COLOR WHITE REPRESENTS BACKGROUND AND/OR TRANS-
PARENT AREAS AND IS NOT PART OF THE MARK.

SER. NO. 85-519,655, FILED 1-18-2012.

GENE MACIOL, EXAMINING ATTORNEY



David J. Kyfos

Director of the United States Patent and Trademark Office

United States of America

United States Patent and Trademark Office

STYLESEAT

Reg. No. 4,205,162

STYLESEAT, INC. (DELAWARE CORPORATION)

Registered Sep. 11, 2012

1475 FOLSOM ST., STE. 400
SAN FRANCISCO, CA 94103

Int. Cl.: 42

FOR: PROVIDING TEMPORARY USE OF ON-LINE NON-DOWNLOADABLE SOFTWARE AND APPLICATIONS FOR LISTING SERVICES, SEARCHING FOR SERVICE PROVIDERS, LOCATING SERVICE PROVIDERS, SCHEDULING OR BOOKING APPOINTMENTS, MANAGING CALENDARS, MANAGING SCHEDULES, MANAGING CLIENT SERVICES, POSTING AND VIEWING INFORMATION AND PHOTOS, POSTING REVIEWS OF BUSINESSES OR INDIVIDUALS, SEARCHING FOR BUSINESSES OR INDIVIDUALS BASED ON LOCATION AND/OR SERVICES, CREATING WEB PAGES, CREATING PROFILES, AND CREATING, TRACKING OR MANAGING ADVERTISING OR PROMOTIONAL CAMPAIGNS; PLATFORM AS A SERVICE (PAAS) FEATURING COMPUTER SOFTWARE PLATFORMS FOR USE IN MANAGING BUSINESS OPERATIONS TO ALIGN WITH BUSINESS OBJECTIVES, IN CLASS 42 (U.S. CLS. 100 AND 101).

SERVICE MARK

PRINCIPAL REGISTER

FIRST USE 1-21-2010; IN COMMERCE 1-21-2010.

THE MARK CONSISTS OF STANDARD CHARACTERS WITHOUT CLAIM TO ANY PARTICULAR FONT, STYLE, SIZE, OR COLOR.

SER. NO. 85-519,667, FILED 1-18-2012.

GENE MACIOL, EXAMINING ATTORNEY



David J. Kyffers

Director of the United States Patent and Trademark Office

United States of America

United States Patent and Trademark Office

THE GROWING KEIKI

Reg. No. 4,205,163

LEE BROOKE ROY (UNITED STATES INDIVIDUAL)

Registered Sep. 11, 2012

66-051 KAMEHAMEHA HWY.
HALEIWA, HI 96712

Int. Cl.: 35

FOR: ON-LINE RETAIL STORE SERVICES FEATURING CHILDREN'S CLOTHING, BOOKS, AND GIFTS; RETAIL CLOTHING BOUTIQUES; RETAIL GIFT SHOPS; RETAIL STORE SERVICES FEATURING CHILDREN'S CLOTHING, BOOKS, AND GIFTS, IN CLASS 35 (U.S. CLS. 100, 101 AND 102).

SERVICE MARK

PRINCIPAL REGISTER

FIRST USE 4-1-1987; IN COMMERCE 4-1-1987.

THE MARK CONSISTS OF STANDARD CHARACTERS WITHOUT CLAIM TO ANY PARTICULAR FONT, STYLE, SIZE, OR COLOR.

NO CLAIM IS MADE TO THE EXCLUSIVE RIGHT TO USE "KEIKI", APART FROM THE MARK AS SHOWN.

THE ENGLISH TRANSLATION OF "KEIKI" IN THE MARK IS "BABY" OR "CHILD".

SER. NO. 85-519,669, FILED 1-18-2012.

GENE MACIOL, EXAMINING ATTORNEY



David J. Kybas

Director of the United States Patent and Trademark Office

United States of America

United States Patent and Trademark Office

SLAMMEDENUFF?

Reg. No. 4,205,164

BUENAVENTURA, CHARLAN (UNITED STATES INDIVIDUAL)
7456 OVERLOOK DR
SOUTHAVEN, MS 38671

Registered Sep. 11, 2012

Int. Cl.: 25

FOR: CLOTHING, NAMELY, T-SHIRTS, HOODED SWEAT SHIRTS, HATS, TANK TOPS, POLO SHIRTS, UNDERWEAR, PAJAMAS, IN CLASS 25 (U.S. CLS. 22 AND 39).

TRADEMARK

FIRST USE 7-10-2010; IN COMMERCE 7-13-2011.

PRINCIPAL REGISTER

THE MARK CONSISTS OF STANDARD CHARACTERS WITHOUT CLAIM TO ANY PARTICULAR FONT, STYLE, SIZE, OR COLOR.

SER. NO. 85-519,753, FILED 1-19-2012.

JENNIFER VASQUEZ, EXAMINING ATTORNEY



David J. Kyffers

Director of the United States Patent and Trademark Office

United States of America

United States Patent and Trademark Office

ASL360

Reg. No. 4,205,165

Registered Sep. 11, 2012

Int. Cl.: 16

TRADEMARK

PRINCIPAL REGISTER

ASLMATTERS, INC. (ILLINOIS CORPORATION)
1112 MATANUSKA TRAIL
MCHENRY, IL 60050

FOR: PRINTED INSTRUCTIONAL, EDUCATIONAL, AND TEACHING MATERIALS IN THE FIELD OF SIGN LANGUAGE LEARNING FOR HUMAN COMMUNICATION, IN CLASS 16 (U.S. CLS. 2, 5, 22, 23, 29, 37, 38 AND 50).

FIRST USE 12-19-2009; IN COMMERCE 1-14-2012.

THE MARK CONSISTS OF STANDARD CHARACTERS WITHOUT CLAIM TO ANY PARTICULAR FONT, STYLE, SIZE, OR COLOR.

SER. NO. 85-519,767, FILED 1-19-2012.

TASHIA BUNCH, EXAMINING ATTORNEY



David J. Kyffers

Director of the United States Patent and Trademark Office

United States of America

United States Patent and Trademark Office

EZ-CABLE ID

Reg. No. 4,205,166

HV DIAGNOSTICS, INC. (GEORGIA CORPORATION)
271 ROPE MILL PARKWAY
WOODSTOCK, GA 30188

Registered Sep. 11, 2012

Int. Cl.: 9

FOR: ELECTRICAL TEST AND MEASUREMENT DEVICE FOR USE IN IDENTIFYING CABLES, IN CLASS 9 (U.S. CLS. 21, 23, 26, 36 AND 38).

TRADEMARK

FIRST USE 0-0-2011; IN COMMERCE 0-0-2011.

PRINCIPAL REGISTER

THE MARK CONSISTS OF STANDARD CHARACTERS WITHOUT CLAIM TO ANY PARTICULAR FONT, STYLE, SIZE, OR COLOR.

NO CLAIM IS MADE TO THE EXCLUSIVE RIGHT TO USE "ID", APART FROM THE MARK AS SHOWN.

SER. NO. 85-519,820, FILED 1-19-2012.

CARYN GLASSER, EXAMINING ATTORNEY



David J. Kyffers

Director of the United States Patent and Trademark Office

United States of America
United States Patent and Trademark Office

BUBBY'S

Reg. No. 4,205,167

Registered Sep. 11, 2012

Int. Cl.: 43

SERVICE MARK

PRINCIPAL REGISTER

BUBBY'S IP HOLDINGS, INC. (NEW YORK CORPORATION)
120 HUDSON STREET
NEW YORK, NY 10013

FOR: RESTAURANT SERVICES, IN CLASS 43 (U.S. CLS. 100 AND 101).

FIRST USE 12-21-1990; IN COMMERCE 12-21-1990.

THE MARK CONSISTS OF STANDARD CHARACTERS WITHOUT CLAIM TO ANY PARTICULAR FONT, STYLE, SIZE, OR COLOR.

OWNER OF U.S. REG. NO. 1,802,422.

SER. NO. 85-519,928, FILED 1-19-2012.

DOUGLAS LEE, EXAMINING ATTORNEY



David J. Kyffers

Director of the United States Patent and Trademark Office

United States of America

United States Patent and Trademark Office

iSpy iWant

Reg. No. 4,205,168

Registered Sep. 11, 2012

Int. Cl.: 35

SERVICE MARK

PRINCIPAL REGISTER

BAUMGARTNER, TIMOTHY H. (UNITED STATES INDIVIDUAL)
6117 CHADSWORTH TER.
GLEN ALLEN, VA 23059

FOR: ON-LINE RETAIL STORE SERVICES FEATURING OUTDOOR EQUIPMENT, INSECTICIDES, PERSONAL ANTISEPTICS AND CONSUMER ELECTRONIC PRODUCTS, IN CLASS 35 (U.S. CLS. 100, 101 AND 102).

FIRST USE 1-1-2006; IN COMMERCE 7-1-2010.

THE MARK CONSISTS OF STANDARD CHARACTERS WITHOUT CLAIM TO ANY PARTICULAR FONT, STYLE, SIZE, OR COLOR.

SER. NO. 85-519,965, FILED 1-19-2012.

ROSELLE HERRERA, EXAMINING ATTORNEY



David J. Kybas

Director of the United States Patent and Trademark Office

United States of America

United States Patent and Trademark Office

COOK-A-STRATIONS

Reg. No. 4,205,169

Registered Sep. 11, 2012

Int. Cl.: 41

SERVICE MARK

PRINCIPAL REGISTER

FREAD, CHRISTOPHER (UNITED STATES INDIVIDUAL)
19815 SEDGFIELD TERRACE
BOCA RATON, FL 33498

FOR: PROVIDING EDUCATIONAL AND ENTERTAINING COOKING DEMONSTRATIONS AT TRADE SHOWS, GREEN MARKETS, WINE AND FOOD FESTIVALS AND PRIVATE EVENTS, IN CLASS 41 (U.S. CLS. 100, 101 AND 107).

FIRST USE 1-2-2012; IN COMMERCE 1-9-2012.

THE MARK CONSISTS OF STANDARD CHARACTERS WITHOUT CLAIM TO ANY PARTICULAR FONT, STYLE, SIZE, OR COLOR.

SER. NO. 85-520,000, FILED 1-19-2012.

THEODORE MCBRIDE, EXAMINING ATTORNEY



David J. Kyffers

Director of the United States Patent and Trademark Office

United States of America

United States Patent and Trademark Office

A&M Pet Sitting, The Boarding Alternative LLC

Reg. No. 4,205,170

HYMAN, STEPHANIE R. (UNITED STATES INDIVIDUAL)
1313 LAKEWOOD DR.
WILMINGTON, DE 19803

Registered Sep. 11, 2012

Int. Cl.: 45

FOR: PET SITTING, IN CLASS 45 (U.S. CLS. 100 AND 101).

SERVICE MARK

FIRST USE 11-14-2011; IN COMMERCE 11-14-2011.

PRINCIPAL REGISTER

THE MARK CONSISTS OF STANDARD CHARACTERS WITHOUT CLAIM TO ANY PARTICULAR FONT, STYLE, SIZE, OR COLOR.

NO CLAIM IS MADE TO THE EXCLUSIVE RIGHT TO USE "PET SITTING THE BOARDING ALTERNATIVE LLC", APART FROM THE MARK AS SHOWN.

SER. NO. 85-520,031, FILED 1-19-2012.

MEGHAN REINHART, EXAMINING ATTORNEY



David J. Kybas

Director of the United States Patent and Trademark Office

United States of America

United States Patent and Trademark Office



Reg. No. 4,205,171

Registered Sep. 11, 2012

Int. Cl.: 43

SERVICE MARK

PRINCIPAL REGISTER

WILSON MANAGEMENT, LLC, (SOUTH DAKOTA LIMITED LIABILITY COMPANY)
2601 S. MINNESOTA AVE. STE 105, PMB 385
SIOUX FALLS, SD 57105

FOR: BAR SERVICES; RESTAURANT SERVICES, IN CLASS 43 (U.S. CLS. 100 AND 101).

FIRST USE 0-0-2008; IN COMMERCE 0-0-2008.

OWNER OF U.S. REG. NOS. 3,169,593 AND 3,169,595.

NO CLAIM IS MADE TO THE EXCLUSIVE RIGHT TO USE "BRAZILIAN GRILL", APART FROM THE MARK AS SHOWN.

THE MARK CONSISTS OF THE WORDS "CARNIVAL BRAZILIAN GRILL" WITH A FLAME EMANATING FROM THE LETTER "N" IN "CARNIVAL".

SER. NO. 85-520,038, FILED 1-19-2012.

MEGHAN REINHART, EXAMINING ATTORNEY



David J. Kyffers

Director of the United States Patent and Trademark Office

United States of America

United States Patent and Trademark Office



Reg. No. 4,205,172

DENICAS (CALIFORNIA CORPORATION)
6058 DOUGHERTY RD.
DUBLIN, CA 94568

Registered Sep. 11, 2012

Int. Cl.: 43

FOR: RESTAURANT AND CAFE SERVICES, IN CLASS 43 (U.S. CLS. 100 AND 101).

SERVICE MARK

FIRST USE 12-27-2011; IN COMMERCE 12-27-2011.

PRINCIPAL REGISTER

NO CLAIM IS MADE TO THE EXCLUSIVE RIGHT TO USE "REAL FOOD KITCHEN" ,
APART FROM THE MARK AS SHOWN.

THE COLOR(S) LIGHT BLUE IS/ARE CLAIMED AS A FEATURE OF THE MARK.

THE MARK CONSISTS OF THE LIGHT BLUE STYLIZED WORDING "DENICA'S REAL
FOOD KITCHEN" AND A STYLIZED LIGHT BLUE FORK, ROLLING PIN, AND SPOON
VERTICALLY POSITIONED ON AN OVAL PLATE SHAPED BACKGROUND WITH IRREG-
ULAR BORDERS AND SHADING. THE COLOR WHITE REPRESENTS BACKGROUND,
OUTLINING, SHADING AND/OR TRANSPARENT AREAS AND IS NOT PART OF THE
MARK.

SER. NO. 85-520,339, FILED 1-19-2012.

BRIAN PINO, EXAMINING ATTORNEY



David J. Kyffers

Director of the United States Patent and Trademark Office

United States of America

United States Patent and Trademark Office

THE IMMORTAL ZIN

Reg. No. 4,205,173

Registered Sep. 11, 2012

Int. Cl.: 33

TRADEMARK

PRINCIPAL REGISTER

PEIRANO ESTATE VINEYARDS (CALIFORNIA SOLE PROPRIETORSHIP)
P.O. BOX 1992
LODI, CA 95241

FOR: WINES, IN CLASS 33 (U.S. CLS. 47 AND 49).

FIRST USE 12-30-2009; IN COMMERCE 12-30-2009.

THE MARK CONSISTS OF STANDARD CHARACTERS WITHOUT CLAIM TO ANY PARTICULAR FONT, STYLE, SIZE, OR COLOR.

NO CLAIM IS MADE TO THE EXCLUSIVE RIGHT TO USE "ZIN", APART FROM THE MARK AS SHOWN.

SER. NO. 85-520,353, FILED 1-19-2012.

NELSON SNYDER, EXAMINING ATTORNEY



David J. Kyffers

Director of the United States Patent and Trademark Office

United States of America

United States Patent and Trademark Office

SURROUND LEARNING

Reg. No. 4,205,174

MAGNIFICAT HIGH SCHOOL (OHIO CORPORATION)
20770 HILLIARD BOULEVARD
ROCKY RIVER, OH 441163397

Registered Sep. 11, 2012

Int. Cl.: 41

FOR: EDUCATIONAL SERVICES, NAMELY, PROVIDING A LEARNING AND INNOVATION CENTER FEATURING FULLY CUSTOMIZED EDUCATIONAL TRAINING THROUGH SPACE PLANNING AND ARRANGEMENT OF INFORMATION TECHNOLOGY, IN CLASS 41 (U.S. CLS. 100, 101 AND 107).

SERVICE MARK

PRINCIPAL REGISTER

FIRST USE 7-29-2010; IN COMMERCE 7-29-2010.

THE MARK CONSISTS OF STANDARD CHARACTERS WITHOUT CLAIM TO ANY PARTICULAR FONT, STYLE, SIZE, OR COLOR.

NO CLAIM IS MADE TO THE EXCLUSIVE RIGHT TO USE "LEARNING", APART FROM THE MARK AS SHOWN.

SER. NO. 85-520,438, FILED 1-19-2012.

DAVID YONTEF, EXAMINING ATTORNEY



David J. Kyffers

Director of the United States Patent and Trademark Office

United States of America

United States Patent and Trademark Office

Boston's Official ChampionSHIP

Reg. No. 4,205,175

BOSTON DUCK TOURS (MASSACHUSETTS LIMITED PARTNERSHIP)
FOUR COPLEY PLACE, SUITE 4155
BOSTON, MA 02116

Registered Sep. 11, 2012

Int. Cl.: 39

FOR: CONDUCTING SIGHTSEEING TOURS FOR OTHERS, IN CLASS 39 (U.S. CLS. 100 AND 105).

SERVICE MARK

FIRST USE 1-18-2012; IN COMMERCE 1-18-2012.

PRINCIPAL REGISTER

THE MARK CONSISTS OF STANDARD CHARACTERS WITHOUT CLAIM TO ANY PARTICULAR FONT, STYLE, SIZE, OR COLOR.

NO CLAIM IS MADE TO THE EXCLUSIVE RIGHT TO USE "BOSTON'S OFFICIAL", APART FROM THE MARK AS SHOWN.

SER. NO. 85-520,510, FILED 1-19-2012.

LOURDES AYALA, EXAMINING ATTORNEY



David J. Kybas

Director of the United States Patent and Trademark Office

United States of America

United States Patent and Trademark Office

THE GROOVE WORKOUT

Reg. No. 4,205,176

CORBETT, ROBERT (UNITED STATES INDIVIDUAL)
1417 MONTEREY BLVD
HERMOSA BEACH, CA 90254

Registered Sep. 11, 2012

Int. Cls.: 25 and 41

FOR: ATHLETIC APPAREL, NAMELY, SHIRTS, PANTS, JACKETS, FOOTWEAR, HATS AND CAPS, ATHLETIC UNIFORMS, IN CLASS 25 (U.S. CLS. 22 AND 39).

TRADEMARK

FIRST USE 7-8-2011; IN COMMERCE 7-8-2011.

SERVICE MARK

PRINCIPAL REGISTER

FOR: CONDUCTING FITNESS CLASSES; CONSULTING SERVICES IN THE FIELDS OF FITNESS AND EXERCISE; COUNSELING SERVICES IN THE FIELD OF PHYSICAL FITNESS; HEALTH CLUB SERVICES, NAMELY, PROVIDING INSTRUCTION AND EQUIPMENT IN THE FIELD OF PHYSICAL EXERCISE; PERSONAL FITNESS TRAINING SERVICES AND CONSULTANCY; PERSONAL FITNESS TRAINING SERVICES FEATURING AEROBIC AND ANAEROBIC ACTIVITIES COMBINED WITH RESISTANCE AND FLEXIBILITY TRAINING; PERSONAL TRAINING PROVIDED IN CONNECTION WITH WEIGHT LOSS AND EXERCISE PROGRAMS; PHYSICAL FITNESS CONDITIONING CLASSES; PHYSICAL FITNESS INSTRUCTION; PHYSICAL FITNESS TRAINING OF INDIVIDUALS AND GROUPS; PHYSICAL FITNESS TRAINING SERVICES; PROVIDING A WEBSITE FEATURING INFORMATION ON EXERCISE AND FITNESS; PROVIDING AN INTERACTIVE WEBSITE FEATURING INFORMATION AND LINKS RELATING TO FITNESS; PROVIDING ASSISTANCE, PERSONAL TRAINING AND PHYSICAL FITNESS CONSULTATION TO CORPORATE CLIENTS TO HELP THEIR EMPLOYEES MAKE PHYSICAL FITNESS, STRENGTH, CONDITIONING, AND EXERCISE ALTERATIONS IN THEIR DAILY LIVING; PROVIDING ASSISTANCE, PERSONAL TRAINING AND PHYSICAL FITNESS CONSULTATION TO INDIVIDUALS TO HELP THEM MAKE PHYSICAL FITNESS, STRENGTH, CONDITIONING, AND EXERCISE IMPROVEMENT IN THEIR DAILY LIVING; PROVIDING INFORMATION IN THE FIELD OF EXERCISE TRAINING; PROVIDING INFORMATION ON PHYSICAL EXERCISE, IN CLASS 41 (U.S. CLS. 100, 101 AND 107).



FIRST USE 7-8-2011; IN COMMERCE 7-8-2011.

THE MARK CONSISTS OF STANDARD CHARACTERS WITHOUT CLAIM TO ANY PARTICULAR FONT, STYLE, SIZE, OR COLOR.

NO CLAIM IS MADE TO THE EXCLUSIVE RIGHT TO USE "WORKOUT", APART FROM THE MARK AS SHOWN.

David J. Kyffers

Director of the United States Patent and Trademark Office

Reg. No. 4,205,176 SER. NO. 85-520,639, FILED 1-19-2012.

BILL DAWE, EXAMINING ATTORNEY

United States of America

United States Patent and Trademark Office

Reg. No. 4,205,177

Registered Sep. 11, 2012

Int. Cl.: 35

SERVICE MARK

PRINCIPAL REGISTER

THE SLEEP TRAIN, INC. (CALIFORNIA CORPORATION)
2205 PLAZA DRIVE
ROCKLIN, CA 95765

FOR: RETAIL FURNITURE STORES, IN CLASS 35 (U.S. CLS. 100, 101 AND 102).

FIRST USE 3-0-2008; IN COMMERCE 3-0-2008.

THE MARK CONSISTS OF A LOCOMOTIVE WITH A LIGHT AND WITH STEAM EMITTING FROM THE TOP OF THE ENGINE IN A CIRCLE BACKGROUND.

SER. NO. 85-520,793, FILED 1-19-2012.

AMY KELLY, EXAMINING ATTORNEY



David J. Kyffers

Director of the United States Patent and Trademark Office

United States of America

United States Patent and Trademark Office

SLEEP TRAIN
REGISTERED TRADEMARK

Reg. No. 4,205,178

Registered Sep. 11, 2012

Int. Cl.: 35

SERVICE MARK

PRINCIPAL REGISTER

THE SLEEP TRAIN, INC. (CALIFORNIA CORPORATION)
2205 PLAZA DRIVE
ROCKLIN, CA 95765

FOR: RETAIL FURNITURE STORES, IN CLASS 35 (U.S. CLS. 100, 101 AND 102).

FIRST USE 2-0-2007; IN COMMERCE 2-0-2007.

OWNER OF U.S. REG. NOS. 1,714,531 AND 1,715,817.

NO CLAIM IS MADE TO THE EXCLUSIVE RIGHT TO USE "OUTLET DEPOT STORE", APART FROM THE MARK AS SHOWN.

THE MARK CONSISTS OF THE WORDS "SLEEP TRAIN" ABOVE A RECTANGLE BOX DISPLAYING THE WORDING "OUTLET DEPOT STORE", WITH "DEPOT" IN STYLIZED FONT.

SER. NO. 85-520,796, FILED 1-19-2012.

AMY KELLY, EXAMINING ATTORNEY



David J. Kyffers

Director of the United States Patent and Trademark Office

United States of America

United States Patent and Trademark Office

SLEEP TRAIN
MATTRESS CENTERS

Reg. No. 4,205,179

Registered Sep. 11, 2012

Int. Cl.: 35

SERVICE MARK

PRINCIPAL REGISTER

THE SLEEP TRAIN, INC. (CALIFORNIA CORPORATION)
2205 PLAZA DRIVE
ROCKLIN, CA 95765

FOR: RETAIL FURNITURE STORES, IN CLASS 35 (U.S. CLS. 100, 101 AND 102).

FIRST USE 2-0-2008; IN COMMERCE 2-0-2008.

OWNER OF U.S. REG. NOS. 1,714,531, 1,715,817, AND 2,924,879.

NO CLAIM IS MADE TO THE EXCLUSIVE RIGHT TO USE "MATTRESS CENTERS", APART FROM THE MARK AS SHOWN.

THE MARK CONSISTS OF THE WORDS "SLEEP TRAIN" ABOVE THE WORDS "MATTRESS CENTERS", AND BETWEEN THE WORDS "SLEEP TRAIN" IS AN IMAGE OF THE FRONT OF A LOCOMOTIVE WITH STEAM EMITTING FROM THE TOP WITHIN A CIRCLE BACKGROUND.

SER. NO. 85-520,803, FILED 1-19-2012.

AMY KELLY, EXAMINING ATTORNEY



David J. Kyffers

Director of the United States Patent and Trademark Office

United States of America

United States Patent and Trademark Office

Arctic-Store

Reg. No. 4,205,180

ROMANOV, ALEXEY (RUSSIAN FED. INDIVIDUAL)

Registered Sep. 11, 2012

VAVILOVYH STR 15-1-116

SAINT-PETERSBURG, RUSSIAN FED. 195257

Int. Cl.: 25

FOR: FUR HATS; FUR MUFFS; FUR STOLES, IN CLASS 25 (U.S. CLS. 22 AND 39).

TRADEMARK

FIRST USE 1-1-2006; IN COMMERCE 1-1-2006.

PRINCIPAL REGISTER

THE MARK CONSISTS OF STANDARD CHARACTERS WITHOUT CLAIM TO ANY PARTICULAR FONT, STYLE, SIZE, OR COLOR.

SER. NO. 85-520,848, FILED 1-19-2012.

LAURA KOVALSKY, EXAMINING ATTORNEY



David J. Kyjars

Director of the United States Patent and Trademark Office

United States of America

United States Patent and Trademark Office

FRANKLIN RETAIL SOLUTIONS

Reg. No. 4,205,181

Registered Sep. 11, 2012

Int. Cl.: 35

SERVICE MARK

PRINCIPAL REGISTER

FRANKLIN RESOURCE GROUP, INC. (MASSACHUSETTS CORPORATION)
SUITE 380
4770 BASELINE ROAD
BOULDER, CO 80303

FOR: CONSULTING SERVICES, NAMELY, MARKETING AND SALES CONSULTING SERVICES TO RETAILERS OF SPORTING GOODS AND RECREATIONAL EQUIPMENT , IN CLASS 35 (U.S. CLS. 100, 101 AND 102).

FIRST USE 5-1-2010; IN COMMERCE 5-1-2010.

THE MARK CONSISTS OF STANDARD CHARACTERS WITHOUT CLAIM TO ANY PARTICULAR FONT, STYLE, SIZE, OR COLOR.

NO CLAIM IS MADE TO THE EXCLUSIVE RIGHT TO USE "RETAIL SOLUTIONS", APART FROM THE MARK AS SHOWN.

SER. NO. 85-520,853, FILED 1-19-2012.

LAURA KOVALSKY, EXAMINING ATTORNEY



David J. Kyffers

Director of the United States Patent and Trademark Office

United States of America

United States Patent and Trademark Office

Neptune Trading

Reg. No. 4,205,182

Registered Sep. 11, 2012

Int. Cl.: 8

TRADEMARK

PRINCIPAL REGISTER

NEPTUNE TRADING INC. (CALIFORNIA CORPORATION)
MICHAEL LU
4021 GREYSTONE DR.
ONTARIO, CA 91761

FOR: DAGGERS; DIVING KNIVES; FISHING KNIVES; FIXED BLADE KNIVES; FOLDING KNIVES; HOUSEHOLD KNIVES; HUNTING KNIVES; JACK KNIVES; JAPANESE CHOPPING KITCHEN KNIVES; JAPANESE SWORDS; KNIVES; KNIVES FOR HOBBY USE; LEATHER SHEATHS FOR KNIVES; PARING KNIVES; PEN KNIVES; POCKET KNIVES; POLICE BATONS; SABRES; SCALING KNIVES; SIDE ARMS, NOT INCLUDING FIREARMS, NAMELY, HUNTING KNIVES; SIDE ARMS, NOT INCLUDING FIREARMS, NAMELY, SWORDS; SPORT KNIVES; SWORD CANES; SWORDS; THROWING KNIVES; UTILITY KNIVES, IN CLASS 8 (U.S. CLS. 23, 28 AND 44).

FIRST USE 1-9-2002; IN COMMERCE 1-9-2002.

THE MARK CONSISTS OF STANDARD CHARACTERS WITHOUT CLAIM TO ANY PARTICULAR FONT, STYLE, SIZE, OR COLOR.

NO CLAIM IS MADE TO THE EXCLUSIVE RIGHT TO USE "TRADING", APART FROM THE MARK AS SHOWN.

SER. NO. 85-520,884, FILED 1-20-2012.

ADA HAN, EXAMINING ATTORNEY



David J. Kybas

Director of the United States Patent and Trademark Office

United States of America

United States Patent and Trademark Office



Reg. No. 4,205,183

Registered Sep. 11, 2012

Int. Cl.: 41

SERVICE MARK

PRINCIPAL REGISTER

BEW, LLC (PENNSYLVANIA LIMITED LIABILITY COMPANY)
17 S 17TH STREET
CAMP HILL, PA 17011

FOR: EDUCATION SERVICES, NAMELY, PROVIDING ON-LINE INSTRUCTION IN THE FIELD OF MATH, READING, WRITING, SCIENCE, AND SOCIAL STUDIES, IN CLASS 41 (U.S. CLS. 100, 101 AND 107).

FIRST USE 4-13-2011; IN COMMERCE 4-13-2011.

NO CLAIM IS MADE TO THE EXCLUSIVE RIGHT TO USE "MICRO SCHOOL", APART FROM THE MARK AS SHOWN.

THE COLOR(S) BROWN AND GREEN IS/ARE CLAIMED AS A FEATURE OF THE MARK.

THE MARK CONSISTS OF BROWN "BE" OVER GREEN "W" WITH THE A GREEN "MICRO" AND BROWN "SCHOOL" UNDERNEATH TWO PARALLEL LINES, ONE GREEN AND THE OTHER LINE BROWN.

SER. NO. 85-520,925, FILED 1-20-2012.

TEJBIR SINGH, EXAMINING ATTORNEY



David J. Kybas

Director of the United States Patent and Trademark Office

United States of America

United States Patent and Trademark Office



Reg. No. 4,205,184

EZCFO (NEW JERSEY LIMITED LIABILITY COMPANY)
52 ROME STREET
NEWARK, NJ 07105

Registered Sep. 11, 2012

Int. Cl.: 35

FOR: ACCOUNTING SERVICES; ADMINISTRATION OF BUSINESS PAYROLL FOR OTHERS; BOOKKEEPING; BUSINESS CONSULTING AND INFORMATION SERVICES, IN CLASS 35 (U.S. CLS. 100, 101 AND 102).

SERVICE MARK

FIRST USE 10-10-2009; IN COMMERCE 1-1-2010.

PRINCIPAL REGISTER

THE MARK CONSISTS OF THE WORDING "EZCFO" TO RIGHT OF A DESIGN THAT CONSISTS OF TWO CURVED CHECK MARKS AND THREE SHADED SQUARES.

SER. NO. 85-521,057, FILED 1-20-2012.

SETH A. RAPPAPORT, EXAMINING ATTORNEY



David J. Kybas

Director of the United States Patent and Trademark Office

United States of America

United States Patent and Trademark Office

DEATH OF KINGS

Reg. No. 4,205,185

Registered Sep. 11, 2012

Int. Cl.: 41

SERVICE MARK

PRINCIPAL REGISTER

CASEY, STEVEN (UNITED STATES INDIVIDUAL)
1372 BENNING PLACE APARTMENT 1
ATLANTA, GA 30307

FOR: ENTERTAINMENT RENDERED BY A MUSICAL BAND, NAMELY, ENTERTAINMENT IN THE NATURE OF VISUAL AND AUDIO PERFORMANCES BY A MUSICAL ACT ; LIVE PERFORMANCES BY A MUSICAL ACT; MULTIMEDIA ENTERTAINMENT SERVICES IN THE NATURE OF RECORDING, PRODUCTION AND POST-PRODUCTION SERVICES IN THE FIELD OF MUSIC AND VIDEO; ENTERTAINMENT SERVICES BY A MUSICAL ARTIST, NAMELY, MUSIC SONGWRITING, RECORDING, PRODUCTION AND PUBLISHING, MUSIC VIDEO PRODUCTION, MUSIC COMPOSITION AND PRODUCTION OF MUSICAL SOUND RECORDINGS; PROVIDING AN INTERNET WEBSITE PORTAL IN THE FIELD OF MUSIC, IN CLASS 41 (U.S. CLS. 100, 101 AND 107).

FIRST USE 1-1-2008; IN COMMERCE 1-1-2008.

THE MARK CONSISTS OF STANDARD CHARACTERS WITHOUT CLAIM TO ANY PARTICULAR FONT, STYLE, SIZE, OR COLOR.

SER. NO. 85-521,121, FILED 1-20-2012.

DAVID ELTON, EXAMINING ATTORNEY



David J. Kyffers

Director of the United States Patent and Trademark Office

United States of America

United States Patent and Trademark Office

clementine

Reg. No. 4,205,186

Registered Sep. 11, 2012

Int. Cl.: 12

TRADEMARK

PRINCIPAL REGISTER

CLEMENTINE BICYCLE WORKS, LLC (SOUTH CAROLINA LIMITED LIABILITY COMPANY)
220 N. CHURCH STREET, SUITE 4
SPARTANBURG, SC 29306

FOR: BICYCLES, IN CLASS 12 (U.S. CLS. 19, 21, 23, 31, 35 AND 44).

FIRST USE 11-30-2011; IN COMMERCE 11-30-2011.

SER. NO. 85-521,141, FILED 1-20-2012.

CHRISTINE MARTIN, EXAMINING ATTORNEY



David J. Kybas

Director of the United States Patent and Trademark Office

United States of America

United States Patent and Trademark Office



Reg. No. 4,205,187

Registered Sep. 11, 2012

Int. Cl.: 35

SERVICE MARK

PRINCIPAL REGISTER

NATIONAL ORGANIZATION FOR THE PROFESSIONAL ADVANCEMENT OF BLACK CHEMISTS AND CHEMICAL ENGINEERS, INC. (GEORGIA CORPORATION), AKA NOBCCHE
2426 GREENSIDE COURT
AUSTELL, GA 30106

FOR: ASSOCIATION SERVICES, NAMELY, PROMOTING THE INTERESTS OF AFRICAN-AMERICAN CHEMISTS, CHEMICAL ENGINEERS AND STUDENTS OF THOSE DISCIPLINES, IN CLASS 35 (U.S. CLS. 100, 101 AND 102).

FIRST USE 4-0-1972; IN COMMERCE 3-0-1974.

OWNER OF U.S. REG. NO. 3,168,025.

NO CLAIM IS MADE TO THE EXCLUSIVE RIGHT TO USE "RESEARCH", APART FROM THE MARK AS SHOWN.

THE MARK CONSISTS OF TWO CONCENTRIC CIRCLES, WITH THE OUTER CIRCLE CONSISTING OF THE WORDS IN ALL CAPS FONT "WISDOM", "RESEARCH" AND "KNOWLEDGE" FROM CLOCKWISE LEFT TO RIGHT; WITHIN THE INNER CIRCLE IS THE INFINITY SYMBOL FOR WHICH IN ITS CENTER IS AN IMAGE OF A SMALL TEST TUBE.

SER. NO. 85-521,190, FILED 1-20-2012.

TARAH HARDY, EXAMINING ATTORNEY



David J. Kyffers

Director of the United States Patent and Trademark Office

United States of America

United States Patent and Trademark Office



Reg. No. 4,205,188

Registered Sep. 11, 2012

Int. Cl.: 42

SERVICE MARK

PRINCIPAL REGISTER

CABA, STEVE (UNITED STATES INDIVIDUAL)
APT. 11A
45-55 PIKE STREET
NEW YORK, NY 10002

FOR: GRAPHIC DESIGN SERVICES, IN CLASS 42 (U.S. CLS. 100 AND 101).

FIRST USE 10-11-2011; IN COMMERCE 10-11-2011.

THE MARK CONSISTS OF A STYLIZED REPRESENTATION OF A PRAYING MANTIS.

SER. NO. 85-521,233, FILED 1-20-2012.

JEFFREY LOOK, EXAMINING ATTORNEY



David J. Kybas

Director of the United States Patent and Trademark Office

United States of America

United States Patent and Trademark Office

BODA

Reg. No. 4,205,189

Registered Sep. 11, 2012

Int. Cl.: 32

TRADEMARK

PRINCIPAL REGISTER

URSTUFF, LLC (ILLINOIS LIMITED LIABILITY COMPANY)
SUITE 103
4081 RYAN ROAD
GURNEE, IL 60031

FOR: FLAVOR ENHANCED WATER, NAMELY, ENERGY SUPPLEMENT DRINKS ENHANCED WITH ARONIA, GREEN TEA EXTRACT AND/OR VITAMINS, IN CLASS 32 (U.S. CLS. 45, 46 AND 48).

FIRST USE 7-28-2010; IN COMMERCE 7-28-2010.

THE MARK CONSISTS OF STANDARD CHARACTERS WITHOUT CLAIM TO ANY PARTICULAR FONT, STYLE, SIZE, OR COLOR.

THE ENGLISH TRANSLATION OF THE WORD "BODA" IN THE MARK IS "WEDDING".

SER. NO. 85-521,289, FILED 1-20-2012.

ROBIN MITTLER, EXAMINING ATTORNEY



David J. Kybas

Director of the United States Patent and Trademark Office

United States of America

United States Patent and Trademark Office



Reg. No. 4,205,190

Registered Sep. 11, 2012

Int. Cl.: 28

TRADEMARK

PRINCIPAL REGISTER

TRADEMARK GAMES, INC (OHIO CORPORATION)
WAREHOUSE 1
5401 BAUMHART ROAD
LORAIN, OH 44053

FOR: RIDE-ON TOYS; RIDE-ON TOYS AND ACCESSORIES THEREFOR; RIDEABLE TOY VEHICLES; RIDEABLE TOYS AND ACCESSORIES THEREFOR, IN CLASS 28 (U.S. CLS. 22, 23, 38 AND 50).

FIRST USE 1-11-2011; IN COMMERCE 4-13-2011.

NO CLAIM IS MADE TO THE EXCLUSIVE RIGHT TO USE "RIDER", APART FROM THE MARK AS SHOWN.

THE MARK CONSISTS OF A CARTOON TIRE WITH A HORIZONTAL FLAME BURSTING FROM IT AND THE STYLIZED WORDS "LIL' RIDER" IN FRONT OF THE FLAME.

SER. NO. 85-521,323, FILED 1-20-2012.

COLLEEN DOMBROW, EXAMINING ATTORNEY



David J. Kybas

Director of the United States Patent and Trademark Office

United States of America

United States Patent and Trademark Office



Reg. No. 4,205,191

Registered Sep. 11, 2012

Int. Cl.: 28

TRADEMARK

PRINCIPAL REGISTER

TRADEMARK GAMES, INC (OHIO CORPORATION)
WAREHOUSE 1
5401 BAUMHART ROAD
LORAIN, OH 44053

FOR: PLUSH TOYS; STUFFED AND PLUSH TOYS; STUFFED TOY ANIMALS; STUFFED TOYS; TOY ANIMALS, IN CLASS 28 (U.S. CLS. 22, 23, 38 AND 50).

FIRST USE 3-30-2011; IN COMMERCE 4-4-2011.

THE MARK CONSISTS OF A BEIGE AND BROWN HORIZONTAL CARTOON ARROW WITH THE RED STYLIZED WORDS "HAPPY TRAILS" SEEN HORIZONTALLY ACROSS THE ARROW WITH A RED STAR ABOVE THE LETTER "I" IN THE WORD "TRAILS".

THE COLOR(S) BEIGE, BROWN, AND RED IS/ARE CLAIMED AS A FEATURE OF THE MARK.

SER. NO. 85-521,336, FILED 1-20-2012.

COLLEEN DOMBROW, EXAMINING ATTORNEY



David J. Kyjars

Director of the United States Patent and Trademark Office

United States of America

United States Patent and Trademark Office

CARE2LEARN

Reg. No. 4,205,192

Registered Sep. 11, 2012

Int. Cl.: 41

SERVICE MARK

PRINCIPAL REGISTER

ONLINE HEALTHNOW, INC. (FLORIDA CORPORATION)
4890 W. KENNEDY BOULEVARD, SUITE 740
TAMPA, FL 33609

FOR: EDUCATIONAL SERVICES, NAMELY, CONDUCTING ONLINE EDUCATION CLASSES, PROVIDING ONLINE ASSESSMENT CHECKLISTS, TRACKING PROGRAMS AND RELATED ASSESSMENT SERVICES, AND PROVIDING ONLINE TRAINING TOOLS IN THE NATURE OF PROVIDING THE ABILITY TO ASSIGN, TRACK, AND MANAGE TRAINING AND TO FACILITATE LIVE TRAINING, ALL IN THE FIELD OF HEALTH CARE FOR HEALTHCARE PROFESSIONALS AND CORPORATIONS, IN CLASS 41 (U.S. CLS. 100, 101 AND 107).

FIRST USE 6-30-2000; IN COMMERCE 6-30-2000.

THE MARK CONSISTS OF STANDARD CHARACTERS WITHOUT CLAIM TO ANY PARTICULAR FONT, STYLE, SIZE, OR COLOR.

OWNER OF U.S. REG. NO. 2,990,811.

SER. NO. 85-521,352, FILED 1-20-2012.

TINA MAI, EXAMINING ATTORNEY



David J. Kyffers

Director of the United States Patent and Trademark Office

United States of America

United States Patent and Trademark Office

BAKIPIN

Reg. No. 4,205,193

Registered Sep. 11, 2012

Int. Cl.: 28

TRADEMARK

PRINCIPAL REGISTER

CERPOK, MICHAEL L. (UNITED STATES INDIVIDUAL)
#1004
16800 E. EL. LAGO BLVD.
FOUNTAIN HILLS, AZ 85268

FOR: GOAL PINS FOR SPORTS GAME, IN CLASS 28 (U.S. CLS. 22, 23, 38 AND 50).

FIRST USE 3-3-2010; IN COMMERCE 3-3-2010.

THE MARK CONSISTS OF STANDARD CHARACTERS WITHOUT CLAIM TO ANY PARTICULAR FONT, STYLE, SIZE, OR COLOR.

THE WORDING "BAKI" HAS NO MEANING IN A FOREIGN LANGUAGE.

SER. NO. 85-521,371, FILED 1-20-2012.

MELISSA VALLILLO, EXAMINING ATTORNEY



David J. Kybas

Director of the United States Patent and Trademark Office

United States of America

United States Patent and Trademark Office

BODA
B

Reg. No. 4,205,194

Registered Sep. 11, 2012

Int. Cl.: 32

TRADEMARK

PRINCIPAL REGISTER

URSTUFF, LLC (ILLINOIS LIMITED LIABILITY COMPANY)
SUITE 103
4081 RYAN ROAD
GURNEE, IL 60031

FOR: FLAVORED ENHANCED WATER, NAMELY, ENERGY SUPPLEMENT DRINKS ENHANCED WITH ARONIA GREEN TEA EXTRACT AND/OR VITAMINS, IN CLASS 32 (U.S. CLS. 45, 46 AND 48).

FIRST USE 7-28-2010; IN COMMERCE 7-28-2010.

THE MARK CONSISTS OF "BODA" AND ENLARGED LETTER "B".

THE ENGLISH TRANSLATION OF THE WORD "BODA" IN THE MARK IS "WEDDING".

SER. NO. 85-521,380, FILED 1-20-2012.

ROBIN MITTLER, EXAMINING ATTORNEY



David J. Kyffers

Director of the United States Patent and Trademark Office

United States of America

United States Patent and Trademark Office



Reg. No. 4,205,195

Registered Sep. 11, 2012

Int. Cl.: 42

SERVICE MARK

PRINCIPAL REGISTER

E-BUILDER, INC. (FLORIDA CORPORATION)
SUITE 201
1800 NW 69TH AVENUE
PLANTATION, FL 33313

FOR: PROVIDING TEMPORARY USE OF A WEB-BASED, DATABASE-DRIVEN SOFTWARE APPLICATION FOR USE IN COMPUTER PROJECT MANAGEMENT, CAPITAL PROJECT MANAGEMENT, AND BUSINESS PROCESS MANAGEMENT, INCLUDING COST MANAGEMENT, CAPITAL PROJECT PLANNING, SCHEDULING MANAGEMENT, DOCUMENT MANAGEMENT, BID MANAGEMENT, TO CREATE AUTOMATE AND MANAGE PROCUREMENT, SUPPLY CHAIN, WORKFLOW AND ANY OTHER BUSINESS PROCESSES, INCLUDING ON-SITE AND 24/7 TECHNICAL SUPPORT CONSULTATION SERVICES THEREFOR; SOFTWARE AS A SERVICE SERVICES FEATURING SOFTWARE FOR USE IN BUSINESS PROCESS MANAGEMENT, COMPUTER PROJECT MANAGEMENT, AND CAPITAL PROJECT MANAGEMENT, INCLUDING ON-SITE AND 24/7 TECHNICAL SUPPORT CONSULTATION SERVICES THEREFOR; COMPUTER SERVICES, NAMELY, CONSULTATION SERVICES IN THE FIELD OF SOFTWARE AS A SERVICE FOR USE IN CONSTRUCTION PROJECT MANAGEMENT, INCLUDING ON-SITE AND 24/7 TECHNICAL SUPPORT CONSULTATION SERVICES THEREFOR, IN CLASS 42 (U.S. CLS. 100 AND 101).

FIRST USE 7-1-2000; IN COMMERCE 7-1-2000.

THE MARK CONSISTS OF A STYLIZED "B" IN WHICH THE TOP AND BACK ARE IN BLACK WITH WHITE BANDS CORRESPONDING TO THE CIRCLES IN THE "B", AND THE FRONT FACE BEING IN GOLD.

THE COLOR(S) BLACK, WHITE, AND GOLD IS/ARE CLAIMED AS A FEATURE OF THE MARK.

SER. NO. 85-521,388, FILED 1-20-2012.

JUDITH HELFMAN, EXAMINING ATTORNEY



David J. Kyffers

Director of the United States Patent and Trademark Office

United States of America

United States Patent and Trademark Office

Prisma

Reg. No. 4,205,196

FRONTLINE TECHNOLOGIES, INC. (PENNSYLVANIA CORPORATION)
397 EAGLEVIEW BOULEVARD
EXTON, PA 19341

Registered Sep. 11, 2012

Int. Cl.: 42

FOR: SOFTWARE AS A SERVICE (SAAS) SERVICES FEATURING SOFTWARE FOR USE IN DATABASE MANAGEMENT FOR AUTOMATING TEACHER AND EMPLOYEE EVALUATIONS, IN CLASS 42 (U.S. CLS. 100 AND 101).

SERVICE MARK

FIRST USE 1-3-2012; IN COMMERCE 1-16-2012.

PRINCIPAL REGISTER

THE MARK CONSISTS OF THE STYLIZED WORD "PRISMA" ALONG WITH FOUR SMALL TRIANGLES INCLUDING A SHAPE OF A DIAMOND FORMING AN ARROW SERVING AS THE DOT IN THE LETTER "I".

THE ENGLISH TRANSLATION OF THE WORD "PRISMA" IN THE MARK IS "PRISM".

SER. NO. 85-521,393, FILED 1-20-2012.

JUDITH HELFMAN, EXAMINING ATTORNEY



David J. Kyros

Director of the United States Patent and Trademark Office

United States of America

United States Patent and Trademark Office

PolitiZoid

Reg. No. 4,205,197

ARVIN, ROBERT F. (UNITED STATES INDIVIDUAL)
20555 DEVONSHIRE STREET #250
CHATSWORTH, CA 91311

Registered Sep. 11, 2012

Int. Cl.: 41

FOR: ENTERTAINMENT SERVICES, NAMELY, PROVIDING A WEB SITE FEATURING ONLINE NON-DOWNLOADABLE AUDIO AND VIDEO RECORDINGS FEATURING POLITICAL SATIRE, IN CLASS 41 (U.S. CLS. 100, 101 AND 107).

SERVICE MARK

FIRST USE 9-25-2009; IN COMMERCE 9-25-2009.

PRINCIPAL REGISTER

THE MARK CONSISTS OF STANDARD CHARACTERS WITHOUT CLAIM TO ANY PARTICULAR FONT, STYLE, SIZE, OR COLOR.

SER. NO. 85-521,406, FILED 1-20-2012.

KRISTINA MORRIS, EXAMINING ATTORNEY



David J. Kybas

Director of the United States Patent and Trademark Office

United States of America

United States Patent and Trademark Office



Reg. No. 4,205,198

Registered Sep. 11, 2012

Int. Cl.: 41

SERVICE MARK

PRINCIPAL REGISTER

UNIVERSITY EMERGENCY MEDICINE FOUNDATION (RHODE ISLAND NON-PROFIT CORPORATION)
593 EDDY ST
PROVIDENCE, RI 02903

FOR: MEDICAL MULTIDISCIPLINE STAFF COMMUNICATION TRAINING VIA MEDICAL SIMULATION WITH VIDEO DEBRIEFING FOR THE APPLICATION OF CREW RESOURCE MANAGEMENT (CRM) AND PATIENT SERVICE PRINCIPLES, IN CLASS 41 (U.S. CLS. 100, 101 AND 107).

FIRST USE 3-15-2011; IN COMMERCE 3-15-2011.

THE MARK CONSISTS OF THE BLUE STYLIZED WORDING "BE" WITH A BLUE LINE EXTENDING FROM THE "E" FORMING AN EKG LINE THAT UNDERLINES THE WORDING "CLEAR", FORMS THE "A" IN "CLEAR", AND ENDS IN SOUND WAVES. THE LETTERS "C", "L", "E", AND "R" IN "CLEAR" ARE GOLD WITH A BLUE OUTLINE. THE ENTIRE MARK IS ON A WHITE BACKGROUND.

THE COLOR(S) BLUE, GOLD, AND WHITE IS/ARE CLAIMED AS A FEATURE OF THE MARK.

SER. NO. 85-521,435, FILED 1-20-2012.

KRISTINA MORRIS, EXAMINING ATTORNEY



David J. Kyjars

Director of the United States Patent and Trademark Office

United States of America

United States Patent and Trademark Office

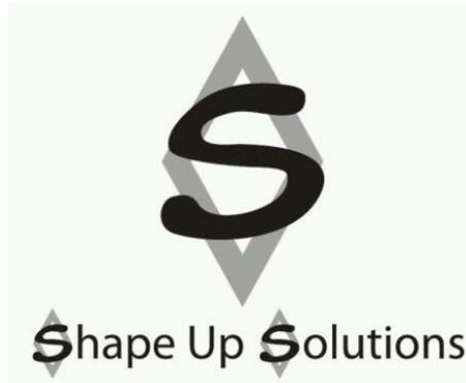

Reg. No. 4,205,199

Registered Sep. 11, 2012

Int. Cl.: 41

SERVICE MARK

PRINCIPAL REGISTER

JAMES, SHEILA (UNITED STATES INDIVIDUAL)
4530 PARK COMMONS DRIVE #120
MINNEAPOLIS, MN 55416

FOR: PROVIDING ASSISTANCE, PERSONAL TRAINING AND PHYSICAL FITNESS CONSULTATION TO INDIVIDUALS TO HELP THEM MAKE PHYSICAL FITNESS, STRENGTH, CONDITIONING, AND EXERCISE IMPROVEMENT IN THEIR DAILY LIVING, IN CLASS 41 (U.S. CLS. 100, 101 AND 107).

FIRST USE 1-1-2000; IN COMMERCE 1-1-2000.

NO CLAIM IS MADE TO THE EXCLUSIVE RIGHT TO USE "SOLUTIONS", APART FROM THE MARK AS SHOWN.

THE MARK CONSISTS OF A LARGE LETTER "S" INSIDE OF A DIAMOND ABOVE THE WORDS "SHAPE UP SOLUTIONS". THE "S" IN THE WORDS "SHAPE" AND "SOLUTION" ARE INSIDE OF DIAMONDS.

SER. NO. 85-521,557, FILED 1-20-2012.

Laurie Mayes, Examining Attorney



David J. Kyffers

Director of the United States Patent and Trademark Office

United States of America

United States Patent and Trademark Office



Reg. No. 4,205,200

Registered Sep. 11, 2012

Int. Cl.: 34

TRADEMARK

PRINCIPAL REGISTER

PITG WORLDWIDE (CALIFORNIA CORPORATION)
3164 N. MARKS SUITE 121
FRESNO, CA 93722

FOR: TOBACCO WATER PIPES, IN CLASS 34 (U.S. CLS. 2, 8, 9 AND 17).

FIRST USE 11-0-2011; IN COMMERCE 11-0-2011.

NO CLAIM IS MADE TO THE EXCLUSIVE RIGHT TO USE "FREEZABLE PIPES" , APART FROM THE MARK AS SHOWN.

THE COLOR(S) PURPLE, GREEN, YELLOW, BLUE, RED AND WHITE IS/ARE CLAIMED AS A FEATURE OF THE MARK.

THE MARK CONSISTS OF THE WORDS "IGLOW FREEZABLE PIPES". THE LETTERS IN "IGLOW" ARE PRESENTED IN MULTI COLORS AND ARE AS FOLLOWS THE "I" IS PURPLE, THE "G" IS GREEN, THE "L" IS YELLOW, THE "O" IS BLUE AND THE "W" IS RED. "FREEZABLE PIPES" IS IN A STYLIZED WHITE FONT. THE WORD "IGLOW" ALSO HAS WHITE SNOW ON THE LETTERS AS WELL AS BELOW THE LETTERS. THE COLOR BLACK SERVES AS BACKGROUND ONLY AND IS NOT PART OF THE MARK.

SER. NO. 85-521,564, FILED 1-20-2012.

SUSAN STIGLITZ, EXAMINING ATTORNEY



David J. Kyros

Director of the United States Patent and Trademark Office

United States of America

United States Patent and Trademark Office



Reg. No. 4,205,201

EXPERIMENTAL PATHOLOGY LABORATORIES, INC. (VIRGINIA CORPORATION)
P.O. BOX 169

Registered Sep. 11, 2012

STERLING, VA 20167

Int. Cl.: 42

FOR: PATHOLOGY STUDY SERVICES, IN CLASS 42 (U.S. CLS. 100 AND 101).

SERVICE MARK

FIRST USE 4-0-2004; IN COMMERCE 4-0-2004.

PRINCIPAL REGISTER

OWNER OF U.S. REG. NOS. 1,640,058 AND 3,099,032.

THE MARK CONSISTS OF THE LETTERS "EPL" AND A MICROSCOPE LOGO.

SER. NO. 85-521,693, FILED 1-20-2012.

SUE LAWRENCE, EXAMINING ATTORNEY



David J. Kyffers

Director of the United States Patent and Trademark Office

United States of America

United States Patent and Trademark Office



VOORHEES
TOWN CENTER

Reg. No. 4,205,202

Registered Sep. 11, 2012

Int. Cls.: 35 and 36

SERVICE MARK

PRINCIPAL REGISTER

ECHELON TITLE LLC (DELAWARE LIMITED LIABILITY COMPANY)
200 SOUTH BROAD STREET
PHILADELPHIA, PA 19102

FOR: BUSINESS MANAGEMENT SERVICES IN THE FIELD OF SHOPPING CENTERS, NAMELY, OPERATING SHOPPING CENTER SPACE FOR SELLERS AND CONSUMERS OF GOODS AND SERVICES, AND PROMOTING THE GOODS AND SERVICES OF LESSEES OF SHOPPING CENTERS THROUGH THE DISTRIBUTION OF PRINTED, AUDIO AND VISUAL PROMOTIONAL MATERIALS AND THROUGH A VARIETY OF MEANS AND BY RENDERING SALES PROMOTION ADVICE, IN CLASS 35 (U.S. CLS. 100, 101 AND 102).

FIRST USE 1-30-2007; IN COMMERCE 1-30-2007.

FOR: SHOPPING CENTER SERVICES, NAMELY, LEASING AND MANAGEMENT OF SHOPPING CENTER SPACE; REAL ESTATE SERVICES, NAMELY, LEASING AND MANAGEMENT OF OFFICE AND RESIDENTIAL SPACE, IN CLASS 36 (U.S. CLS. 100, 101 AND 102).

FIRST USE 1-30-2007; IN COMMERCE 1-30-2007.

NO CLAIM IS MADE TO THE EXCLUSIVE RIGHT TO USE "TOWN CENTER", APART FROM THE MARK AS SHOWN.

THE MARK CONSISTS OF AN IMAGE OF A STYLIZED "X" WITH THE STYLIZED WORDING "VOORHEES" ABOVE THE STYLIZED WORDING "TOWN CENTER" ALL SET TO THE RIGHT OF THE IMAGE OF THE "X".

SEC. 2(F) AS TO "VOORHEES TOWN CENTER".

SER. NO. 85-521,738, FILED 1-20-2012.

DANIEL CAPSHAW, EXAMINING ATTORNEY



David J. Kypos

Director of the United States Patent and Trademark Office

United States of America

United States Patent and Trademark Office

EPL

Reg. No. 4,205,203

Registered Sep. 11, 2012

Int. Cl.: 42

SERVICE MARK

PRINCIPAL REGISTER

EXPERIMENTAL PATHOLOGY LABORATORIES, INC. (VIRGINIA CORPORATION)
P.O. BOX 169
STERLING, VA 20167

FOR: PATHOLOGY STUDY SERVICES, IN CLASS 42 (U.S. CLS. 100 AND 101).

FIRST USE 7-0-1971; IN COMMERCE 7-0-1973.

THE MARK CONSISTS OF STANDARD CHARACTERS WITHOUT CLAIM TO ANY PARTICULAR FONT, STYLE, SIZE, OR COLOR.

OWNER OF U.S. REG. NO. 1,640,058.

SER. NO. 85-521,754, FILED 1-20-2012.

SUE LAWRENCE, EXAMINING ATTORNEY



David J. Kyffers

Director of the United States Patent and Trademark Office

United States of America

United States Patent and Trademark Office

Strongroom

Reg. No. 4,205,204

Registered Sep. 11, 2012

Int. Cl.: 42

SERVICE MARK

PRINCIPAL REGISTER

STRONGROOM SOLUTIONS, INC. (TEXAS CORPORATION)
SUITE #209
410 PIERCE STREET
HOUSTON, TX 77002

FOR: SOFTWARE AS A SERVICE (SAAS) SERVICES FEATURING SOFTWARE FOR USE
IN BILL PAYMENT APPLICATIONS, IN CLASS 42 (U.S. CLS. 100 AND 101).

FIRST USE 1-6-2004; IN COMMERCE 1-6-2004.

THE MARK CONSISTS OF STANDARD CHARACTERS WITHOUT CLAIM TO ANY PAR-
TICULAR FONT, STYLE, SIZE, OR COLOR.

SER. NO. 85-521,755, FILED 1-20-2012.

ROBERT C. CLARK JR., EXAMINING ATTORNEY



David J. Kybas

Director of the United States Patent and Trademark Office

United States of America

United States Patent and Trademark Office

CRUNCHA MA-ME

Reg. No. 4,205,205

Registered Sep. 11, 2012

Int. Cl.: 29

GREENWAVE FOODS, LLC (DELAWARE LIMITED LIABILITY COMPANY)
SUITE 803
2140 SHATTUCK AVE.
BERKELEY, CA 94704

FOR: DRIED VEGETABLES; PROCESSED EDAMAME, IN CLASS 29 (U.S. CL. 46).

TRADEMARK

FIRST USE 1-1-2011; IN COMMERCE 1-1-2011.

PRINCIPAL REGISTER

THE MARK CONSISTS OF STANDARD CHARACTERS WITHOUT CLAIM TO ANY PARTICULAR FONT, STYLE, SIZE, OR COLOR.

SER. NO. 85-521,788, FILED 1-20-2012.

KRISTINA MORRIS, EXAMINING ATTORNEY



David J. Kybas

Director of the United States Patent and Trademark Office

United States of America

United States Patent and Trademark Office



Reg. No. 4,205,206

Registered Sep. 11, 2012

Int. Cl.: 45

SERVICE MARK

PRINCIPAL REGISTER

REVEREND EUNICE COLDMAN MINISTRIES LLC (NEW YORK LIMITED LIABILITY COMPANY)
238-18 115TH TERRACE
ELMONT, NY 11003

FOR: MINISTERIAL SERVICES; SPIRITUAL COUNSELING SERVICES; SPIRITUAL SERVICES, NAMELY, PROVIDING GATHERINGS TO DEVELOP AND ENHANCE THE SPIRITUAL LIVES OF INDIVIDUALS AND CONDUCTING SPIRITUAL CEREMONIES IN THIS REGARD, IN CLASS 45 (U.S. CLS. 100 AND 101).

FIRST USE 1-4-2012; IN COMMERCE 1-4-2012.

THE MARK CONSISTS OF A CIRCLE WITH FOUR BARS CROSSING IT HORIZONTALLY. THERE IS A STYLIZED FIGURE IN THE CENTER OF THE CIRCLE THAT LOOKS SEATED WITH AN EMBLEM ON THE FRONT THAT LOOKS LIKE A FOOTBALL GOALPOST. THE FIGURE IS TOUCHING A PLANT. THERE IS A ZIG ZAG LINE IN THE LOWER PORTION OF THE CIRCLE.

SER. NO. 85-521,841, FILED 1-20-2012.

ZHALEH DELANEY, EXAMINING ATTORNEY



David J. Kyffers

Director of the United States Patent and Trademark Office

United States of America

United States Patent and Trademark Office



Reg. No. 4,205,207

Registered Sep. 11, 2012

Int. Cl.: 43

SERVICE MARK

PRINCIPAL REGISTER

RODOLFO VALENTIN PERALTA AREAS (MEXICO INDIVIDUAL)
COL. SAN JOSE INSURGENTES
MIGUEL NORENA 62
MEXICO, D.F., MEXICO 03900

FOR: BAR SERVICES; RESTAURANT SERVICES FEATURING ARGENTINE CUISINE, IN CLASS 43 (U.S. CLS. 100 AND 101).

FIRST USE 4-14-2011; IN COMMERCE 4-14-2011.

NO CLAIM IS MADE TO THE EXCLUSIVE RIGHT TO USE "FONDA ARGENTINA DESDE 1993", APART FROM THE MARK AS SHOWN.

THE MARK CONSISTS OF A DESIGN ELEMENT INCLUDING THE OUTLINED SKETCH OF THE HEADSHOT OF A MALE WITH LONG HAIR WEARING A HEAD BAND AND A SIDE SWEEP BANG THAT COVERS HIS LEFT EYEBROW. BELOW THE HEADSHOT IS THE LITERAL ELEMENT "FONDA ARGENTINA DESDE 1993". THE WORDING "FONDA" APPEARS IMMEDIATELY BELOW THE DESIGN ELEMENT IN ALL CAPITAL LETTERS. IMMEDIATELY BELOW THIS IS THE WORDING "ARGENTINA" IN ALL CAPITAL LETTERS WITH THE BEGINNING LETTER A AND ENDING LETTER A APPEARING IN RAISED CAPITAL LETTERS. IMMEDIATELY BELOW THIS IS THE WORDING "DESDE 1993" IN ALL CAPITAL LETTERS WHICH APPEARS WITH A SPACE BETWEEN EACH INDIVIDUAL LETTER INSIDE AN OUTLINED BORDER FRAMING SUCH WORDING.

THE ENGLISH TRANSLATION OF "FONDA ARGENTINA DESDE 1993" IN THE MARK IS "RESTAURANT ARGENTINA SINCE 1993".

SER. NO. 85-521,897, FILED 1-20-2012.

MATTHEW MCDOWELL, EXAMINING ATTORNEY



David J. Kyffers

Director of the United States Patent and Trademark Office

United States of America

United States Patent and Trademark Office



Reg. No. 4,205,208

Registered Sep. 11, 2012

Int. Cl.: 27

TRADEMARK

PRINCIPAL REGISTER

MORTIER, EMMANUELLE (FRANCE INDIVIDUAL)
CHEMIN DE GUILLENIA
ARCANGUES, FRANCE 64200

FOR: ARTIFICIAL TURF FOR LAYING ON THE SURFACES OF RECREATIONAL AREAS; CARPETS AND RUGS; CARPETS, RUGS, MATS AND MATTING, LINOLEUM FOR COVERING EXISTING FLOORS; DOOR MATS; GYMNASIUM EXERCISE MATS; GYMNASIUM MATS; SYNTHETIC GRASS; TEXTILE FLOOR MATS FOR USE IN THE HOME, IN CLASS 27 (U.S. CLS. 19, 20, 37, 42 AND 50).

FIRST USE 11-15-2011; IN COMMERCE 11-15-2011.

THE MARK CONSISTS OF A DESIGN CONSISTING OF THE SILHOUETTE OF A MAN WITH HIS ARMS RAISED FLANKED BY A BACKWARDS FACING LETTER "P" ON THE LEFT SIDE AND A LETTER "P" ON THE RIGHT SIDE OF THE MAN.

SER. NO. 85-521,947, FILED 1-21-2012.

TARAH HARDY, EXAMINING ATTORNEY



David J. Kybas

Director of the United States Patent and Trademark Office

United States of America

United States Patent and Trademark Office

E.O. 2 Go

Reg. No. 4,205,209

MOUNTAIN VIEW PACKAGING, LLC (UTAH LIMITED LIABILITY COMPANY)
752 SOUTH 1420 WEST
OREM, UT 84058

Registered Sep. 11, 2012

Int. Cl.: 3

FOR: AROMATIC ESSENTIAL OILS; AROMATIC PREPARATIONS, NAMELY, BODY SPRAY; ESSENTIAL OILS, IN CLASS 3 (U.S. CLS. 1, 4, 6, 50, 51 AND 52).

TRADEMARK

FIRST USE 1-20-2012; IN COMMERCE 1-20-2012.

PRINCIPAL REGISTER

THE MARK CONSISTS OF STANDARD CHARACTERS WITHOUT CLAIM TO ANY PARTICULAR FONT, STYLE, SIZE, OR COLOR.

NO CLAIM IS MADE TO THE EXCLUSIVE RIGHT TO USE "E.O.", APART FROM THE MARK AS SHOWN.

SER. NO. 85-521,988, FILED 1-21-2012.

JOHN WILKE, EXAMINING ATTORNEY



David J. Kybas

Director of the United States Patent and Trademark Office

United States of America

United States Patent and Trademark Office

PERFORMANCE ELECTRONICS

Reg. No. 4,205,210

PERFORMANCE ELECTRONICS, LTD. (OHIO LIMITED LIABILITY COMPANY)
6061 INDIAN TRAIL

Registered Sep. 11, 2012

WEST CHESTER, OH 45069

Int. Cl.: 9

FOR: ELECTRONIC CONTROL SYSTEMS FOR MACHINES, IN CLASS 9 (U.S. CLS. 21, 23, 26, 36 AND 38).

TRADEMARK

FIRST USE 6-23-1999; IN COMMERCE 6-23-1999.

PRINCIPAL REGISTER

THE MARK CONSISTS OF STANDARD CHARACTERS WITHOUT CLAIM TO ANY PARTICULAR FONT, STYLE, SIZE, OR COLOR.

NO CLAIM IS MADE TO THE EXCLUSIVE RIGHT TO USE "ELECTRONICS", APART FROM THE MARK AS SHOWN.

SER. NO. 85-522,017, FILED 1-21-2012.

AISHA SALEM, EXAMINING ATTORNEY



David J. Kyffers

Director of the United States Patent and Trademark Office

United States of America

United States Patent and Trademark Office

EYEPREDICT

Reg. No. 4,205,211

Registered Sep. 11, 2012

Int. Cl.: 42

SERVICE MARK

PRINCIPAL REGISTER

EYEPREDICT LLC (CALIFORNIA LIMITED LIABILITY COMPANY), AKA EYE-PREDICT
LLC
3400 BEN LOMOND PL #301
LOS ANGELES, CA 90027

FOR: APPLICATION SERVICE PROVIDER (ASP) FEATURING SOFTWARE FOR USE IN
ENHANCING VISUAL ATTENTION AND DISPLAY EFFECTIVENESS, ASSESSING ATTEN-
TION DEFICITS, AND IMPROVING PERFORMANCE IN ATTENTION-DEMANDING
ACTIVITIES, IN CLASS 42 (U.S. CLS. 100 AND 101).

FIRST USE 11-6-2006; IN COMMERCE 11-6-2006.

THE MARK CONSISTS OF STANDARD CHARACTERS WITHOUT CLAIM TO ANY PAR-
TICULAR FONT, STYLE, SIZE, OR COLOR.

OWNER OF U.S. REG. NO. 3,515,466.

SER. NO. 85-522,146, FILED 1-21-2012.

TINA BROWN, EXAMINING ATTORNEY



David J. Kyffers

Director of the United States Patent and Trademark Office

United States of America

United States Patent and Trademark Office

Think Green Limousine

Reg. No. 4,205,212

Registered Sep. 11, 2012

Int. Cl.: 39

SERVICE MARK

PRINCIPAL REGISTER

THINK GREEN LIMOUSINE (ILLINOIS LIMITED LIABILITY COMPANY), AKA THINK GREEN LIMO
PO BOX 2866
NAPERVILLE, IL 60567

FOR: LIMOUSINE SERVICES, IN CLASS 39 (U.S. CLS. 100 AND 105).

FIRST USE 3-5-2010; IN COMMERCE 4-19-2010.

THE MARK CONSISTS OF STANDARD CHARACTERS WITHOUT CLAIM TO ANY PARTICULAR FONT, STYLE, SIZE, OR COLOR.

NO CLAIM IS MADE TO THE EXCLUSIVE RIGHT TO USE "GREEN LIMOUSINE", APART FROM THE MARK AS SHOWN.

SER. NO. 85-522,251, FILED 1-22-2012.

WENDY JUN, EXAMINING ATTORNEY



David J. Kyffers

Director of the United States Patent and Trademark Office

United States of America

United States Patent and Trademark Office



**LUCKY
BUDDY**
petcare

Reg. No. 4,205,213

Registered Sep. 11, 2012

Int. Cl.: 45

SERVICE MARK

PRINCIPAL REGISTER

LUCKY BUDDY PETCARE (CALIFORNIA CORPORATION)
#305
5960 SOUTH LAND PARK DRIVE
SACRAMENTO, CA 95822

FOR: PET SITTING, IN CLASS 45 (U.S. CLS. 100 AND 101).

FIRST USE 1-20-2012; IN COMMERCE 1-20-2012.

NO CLAIM IS MADE TO THE EXCLUSIVE RIGHT TO USE "PETCARE" , APART FROM THE MARK AS SHOWN.

THE MARK CONSISTS OF A CLOVER SHAPE MADE UP OF CANINE NOSE SHAPES AND A STEM, THE STYLIZED WORDING "LUCKY BUDDY" WITH HORIZONTAL LINE ABOVE AND BELOW THE WORDING, AND THE STYLIZED WORDING "PETCARE".

SER. NO. 85-522,266, FILED 1-22-2012.

JEAN IM, EXAMINING ATTORNEY



David J. Kybas

Director of the United States Patent and Trademark Office

United States of America

United States Patent and Trademark Office

ECOPURE

Reg. No. 4,205,214

CN CREATIVE LTD (UNITED KINGDOM LIMITED LIABILITY COMPANY)
THE OLD TANNERY, EASTGATE, ACCRINGTON
LANCASHIRE, UNITED KINGDOM BB56PW

Registered Sep. 11, 2012

Int. Cl.: 1

FOR: LIQUID NICOTINE FOR USE IN ELECTRONIC CIGARETTES; GLYCERINE FOR USE IN ELECTRONIC CIGARETTES; CARTRIDGES SOLD FILLED WITH LIQUID NICOTINE FOR ELECTRONIC CIGARETTES; CARTRIDGES SOLD FILLED WITH GLYCERINE FOR ELECTRONIC CIGARETTES, IN CLASS 1 (U.S. CLS. 1, 5, 6, 10, 26 AND 46).

TRADEMARK

PRINCIPAL REGISTER

THE MARK CONSISTS OF STANDARD CHARACTERS WITHOUT CLAIM TO ANY PARTICULAR FONT, STYLE, SIZE, OR COLOR.

OWNER OF UNITED KINGDOM REG. NO. 2596770, DATED 1-6-2012, EXPIRES 10-5-2021.

SER. NO. 85-522,317, FILED 1-23-2012.

JAMES LOVELACE, EXAMINING ATTORNEY



David J. Kyros

Director of the United States Patent and Trademark Office

United States of America

United States Patent and Trademark Office

GREAT CARE. FAST.

Reg. No. 4,205,215

URGENT CARE MSO, LLC (DELAWARE LIMITED LIABILITY COMPANY)
1751 EARL CORE ROAD
MORGANTOWN, WV 26505

Registered Sep. 11, 2012

Int. Cl.: 44

FOR: MEDICAL CLINICS SPECIALIZING IN URGENT MEDICAL CARE AND TREATMENT,
IN CLASS 44 (U.S. CLS. 100 AND 101).

SERVICE MARK

FIRST USE 12-1-2004; IN COMMERCE 12-1-2004.

PRINCIPAL REGISTER

THE MARK CONSISTS OF STANDARD CHARACTERS WITHOUT CLAIM TO ANY PARTICULAR FONT, STYLE, SIZE, OR COLOR.

OWNER OF U.S. REG. NO. 3,195,312.

SEC. 2(F).

SER. NO. 85-522,321, FILED 1-23-2012.

JAMES LOVELACE, EXAMINING ATTORNEY



David J. Kybas

Director of the United States Patent and Trademark Office

United States of America

United States Patent and Trademark Office

THE KINFOLKS SOUL FOOD FESTIVAL

Reg. No. 4,205,216

Registered Sep. 11, 2012

Int. Cl.: 41

SERVICE MARK

PRINCIPAL REGISTER

KINFOLKS FOUNDATION, INC. (OKLAHOMA CORPORATION)
1337 WEST 20TH STREET
JACKSONVILLE, FL 32209

FOR: ORGANIZING COMMUNITY FESTIVALS FEATURING PRIMARILY MUSICAL ENTERTAINMENT AND COMEDY JAMS AND ALSO PROVIDING SOUL FOOD AND PLATFORMS OF INFORMATION FOR THE PUBLIC ON HEALTH AND WELLNESS, EDUCATION, HOUSING, FINANCING, BUSINESS AND WORKFORCE DEVELOPMENT, IN CLASS 41 (U.S. CLS. 100, 101 AND 107).

FIRST USE 6-0-2007; IN COMMERCE 6-0-2007.

THE MARK CONSISTS OF STANDARD CHARACTERS WITHOUT CLAIM TO ANY PARTICULAR FONT, STYLE, SIZE, OR COLOR.

NO CLAIM IS MADE TO THE EXCLUSIVE RIGHT TO USE "SOUL FOOD FESTIVAL", APART FROM THE MARK AS SHOWN.

SER. NO. 85-522,330, FILED 1-23-2012.

KEVIN DINALLO, EXAMINING ATTORNEY



David J. Kybas

Director of the United States Patent and Trademark Office

United States of America

United States Patent and Trademark Office



Reg. No. 4,205,217

Registered Sep. 11, 2012

Int. Cl.: 44

SERVICE MARK

PRINCIPAL REGISTER

SOBERMD, LLC (LOUISIANA LIMITED LIABILITY COMPANY)
2905 EVANGELINE STREET
MONROE, LA 71201

FOR: PROVIDING A WEBSITE FEATURING HEALTH AND WELLNESS INFORMATION IN THE FIELDS OF ALCOHOLISM, ADDICTION, AND EATING DISORDERS; PROVIDING A WEBSITE FEATURING INFORMATION, NEWS, AND COMMENTARY IN THE FIELD OF ALCOHOLISM, ADDICTION, AND EATING DISORDERS, IN CLASS 44 (U.S. CLS. 100 AND 101).

FIRST USE 1-11-2010; IN COMMERCE 1-11-2010.

THE MARK CONSISTS OF THE WORD "SOBERMD" IN THE COLOR BLACK; THREE QUARTER-MOON DESIGNS OF GRADUAL LESSER SIZE PLACED AT THE LEFT SIDE OF THE WORD "SOBERMD"; THE LARGEST QUARTER-MOON DESIGN IS PURPLE, THE MEDIUM QUARTER-MOON DESIGN IS BLUE, AND THE SMALLEST QUARTER-MOON DESIGN IS LIGHT BLUE. THE WHITE IN THE MARK REPRESENTS TRANSPARENCY OR BACKGROUND AND IS NOT CLAIMED AS A FEATURE OF THE MARK.

THE COLOR(S) PURPLE, BLUE, LIGHT BLUE, AND BLACK IS/ARE CLAIMED AS A FEATURE OF THE MARK.

SER. NO. 85-522,359, FILED 1-23-2012.

KIMBERLY FRYE, EXAMINING ATTORNEY



David J. Kyffers

Director of the United States Patent and Trademark Office

United States of America

United States Patent and Trademark Office

SELECT BIOSCIENCES

Reg. No. 4,205,218

Registered Sep. 11, 2012

Int. Cls.: 35 and 41

SERVICE MARK

PRINCIPAL REGISTER

SELECT BIOSCIENCES, LTD. (UNITED KINGDOM LIMITED COMPANY (LTD.))
WOODVIEW, BULL LANE
SUDBURY, UNITED KINGDOM CO100FD

FOR: PROVIDING BUSINESS ANALYSIS AND BUSINESS STRATEGIC PLANNING SERVICES IN THE SCIENTIFIC AND TECHNOLOGY INDUSTRY; BUSINESS CONSULTATION SERVICES IN THE FIELD OF COMPANY, BUSINESS SECTOR AND INDUSTRY DATA AND RESEARCH; PROVIDING BUSINESS INFORMATION IN THE FIELD OF LIFE SCIENCE AND DRUG RESEARCH INDUSTRY, IN CLASS 35 (U.S. CLS. 100, 101 AND 102).

FIRST USE 0-0-1994; IN COMMERCE 0-0-1994.

FOR: ARRANGING AND CONDUCTING CONFERENCES IN THE FIELDS OF SCIENCE, LIFE SCIENCE AND DRUG RESEARCH; PROVIDING EDUCATIONAL SERVICES, NAMELY, TRAINING COURSES IN THE FIELDS OF SCIENCE, LIFE SCIENCE AND DRUG RESEARCH , IN CLASS 41 (U.S. CLS. 100, 101 AND 107).

FIRST USE 0-0-1994; IN COMMERCE 0-0-1994.

THE MARK CONSISTS OF STANDARD CHARACTERS WITHOUT CLAIM TO ANY PARTICULAR FONT, STYLE, SIZE, OR COLOR.

NO CLAIM IS MADE TO THE EXCLUSIVE RIGHT TO USE "BIOSCIENCES", APART FROM THE MARK AS SHOWN.

SER. NO. 85-522,428, FILED 1-23-2012.

JANICE L. MCMORROW, EXAMINING ATTORNEY



David J. Kyros

Director of the United States Patent and Trademark Office

United States of America

United States Patent and Trademark Office

CONNECTING SHOPPERS AND BRANDS THROUGH INNOVATION

Reg. No. 4,205,219

HENSCHEL-STEINAU, INC. (NEW JERSEY CORPORATION)
50 COMMERCE AVENUE
ALLENDALE, NJ 07401

Registered Sep. 11, 2012

Int. Cl.: 20

FOR: POINT-OF-PURCHASE MERCHANDISE DISPLAYS, NAMELY, APPARATUS FOR THE DISPLAY AND SELECTIVE DISPENSING OF MERCHANDISE PACKAGES AT A POINT-OF-PURCHASE LOCATION, IN CLASS 20 (U.S. CLS. 2, 13, 22, 25, 32 AND 50).

TRADEMARK

FIRST USE 1-20-2012; IN COMMERCE 1-20-2012.

PRINCIPAL REGISTER

THE MARK CONSISTS OF STANDARD CHARACTERS WITHOUT CLAIM TO ANY PARTICULAR FONT, STYLE, SIZE, OR COLOR.

SER. NO. 85-522,458, FILED 1-23-2012.

LAURA KOVALSKY, EXAMINING ATTORNEY



David J. Kybas

Director of the United States Patent and Trademark Office

United States of America

United States Patent and Trademark Office

CLASSIC TIDINGS

Reg. No. 4,205,220

TARGET BRANDS, INC. (MINNESOTA CORPORATION)
1000 NICOLLET MALL, TPS 3165
MINNEAPOLIS, MN 55403

Registered Sep. 11, 2012

Int. Cl.: 27

FOR: RUGS, IN CLASS 27 (U.S. CLS. 19, 20, 37, 42 AND 50).

TRADEMARK

FIRST USE 11-0-2011; IN COMMERCE 11-0-2011.

PRINCIPAL REGISTER

THE MARK CONSISTS OF STANDARD CHARACTERS WITHOUT CLAIM TO ANY PARTICULAR FONT, STYLE, SIZE, OR COLOR.

OWNER OF U.S. REG. NOS. 4,009,130, 4,009,131, AND 4,009,132.

NO CLAIM IS MADE TO THE EXCLUSIVE RIGHT TO USE "CLASSIC", APART FROM THE MARK AS SHOWN.

SER. NO. 85-522,467, FILED 1-23-2012.

NICHOLAS ALTREE, EXAMINING ATTORNEY



David J. Kyffers

Director of the United States Patent and Trademark Office

United States of America

United States Patent and Trademark Office

CLASSIC TIDINGS

Reg. No. 4,205,221

TARGET BRANDS, INC. (MINNESOTA CORPORATION)
1000 NICOLLET MALL, TPS 3165
MINNEAPOLIS, MN 55403

Registered Sep. 11, 2012

Int. Cl.: 24

FOR: OVEN MITTS; TOWELS; BED BLANKETS AND THROWS, IN CLASS 24 (U.S. CLS. 42 AND 50).

TRADEMARK

FIRST USE 11-0-2011; IN COMMERCE 11-0-2011.

PRINCIPAL REGISTER

THE MARK CONSISTS OF STANDARD CHARACTERS WITHOUT CLAIM TO ANY PARTICULAR FONT, STYLE, SIZE, OR COLOR.

OWNER OF U.S. REG. NOS. 4,009,130, 4,009,131, AND 4,009,132.

NO CLAIM IS MADE TO THE EXCLUSIVE RIGHT TO USE "CLASSIC", APART FROM THE MARK AS SHOWN.

SER. NO. 85-522,470, FILED 1-23-2012.

NICHOLAS ALTREE, EXAMINING ATTORNEY



David J. Kyffers

Director of the United States Patent and Trademark Office

United States of America

United States Patent and Trademark Office

CLASSIC TIDINGS

Reg. No. 4,205,222

Registered Sep. 11, 2012

Int. Cl.: 21

TRADEMARK

PRINCIPAL REGISTER

TARGET BRANDS, INC. (MINNESOTA CORPORATION)
1000 NICOLLET MALL, TPS 3165
MINNEAPOLIS, MN 55403

FOR: VASES OF GLASS, CERAMIC OR METAL; SOAP DISPENSERS; BEVERAGE COASTERS NOT OF PAPER AND NOT BEING TABLE LINENS; PLASTIC STORAGE CONTAINERS FOR HOUSEHOLD USE; BASKETS OF WICKER, STRAW OR WOOD FOR HOUSEHOLD USE; PAPER PLATES AND PAPER CUPS, IN CLASS 21 (U.S. CLS. 2, 13, 23, 29, 30, 33, 40 AND 50).

FIRST USE 11-0-2008; IN COMMERCE 11-0-2008.

THE MARK CONSISTS OF STANDARD CHARACTERS WITHOUT CLAIM TO ANY PARTICULAR FONT, STYLE, SIZE, OR COLOR.

OWNER OF U.S. REG. NOS. 4,009,130, 4,009,131, AND 4,009,132.

NO CLAIM IS MADE TO THE EXCLUSIVE RIGHT TO USE "CLASSIC", APART FROM THE MARK AS SHOWN.

SER. NO. 85-522,473, FILED 1-23-2012.

NICHOLAS ALTREE, EXAMINING ATTORNEY



David J. Kybas

Director of the United States Patent and Trademark Office

United States of America

United States Patent and Trademark Office

FOX RUN KITCHENS

Reg. No. 4,205,223

Registered Sep. 11, 2012

Int. Cl.: 21

TRADEMARK

PRINCIPAL REGISTER

FOX RUN HOLDINGS, INC (DELAWARE CORPORATION)
1907 STOUT DRIVE
IVYLAND, PA 18974

FOR: COOKIE CUTTERS; PASTRY CUTTERS, NAMELY, PIE TOP CUTTERS AND COOKIE CUTTER STAMPS; BAKING ACCESSORIES AND COOKWARE, NAMELY, COOKERY DESSERT MOLDS FOR CAKES, PASTRY MOLDS, PUDDING MOLDS AND COOKIE MOLDS; METAL AND GLASS PANS FOR COOKING, NAMELY, CAKE PANS, PIE PANS, MUFFIN PANS, TART PANS, TART TINS AND LOAF PANS; NON-ELECTRIC HOUSEHOLD KITCHEN UTENSILS TO CREATE AND DECORATE DESSERTS SUCH AS CAKES AND CUPCAKES, NAMELY, COOKIE AND DOUGH SCOOPS, SPATULAS AND WHISKS AND CONFECTIONERS' DECORATING BAGS AND TIPS AND COUPLERS BEING STRUCTURAL PARTS THEREOF; MIXING BOWLS; COOKING RACKS, NAMELY, COOLING RACKS AND OVEN TO TABLE COOKING RACKS BOTH FOR BAKED GOODS; NON-ELECTRIC EGG BEATERS; PASTRY BRUSHES; FLOUR SIFTERS; POT AND PAN SCRAPERS, IN CLASS 21 (U.S. CLS. 2, 13, 23, 29, 30, 33, 40 AND 50).

FIRST USE 7-31-1999; IN COMMERCE 7-31-1999.

THE MARK CONSISTS OF STANDARD CHARACTERS WITHOUT CLAIM TO ANY PARTICULAR FONT, STYLE, SIZE, OR COLOR.

OWNER OF U.S. REG. NOS. 2,502,538, 3,525,715, AND 3,628,735.

NO CLAIM IS MADE TO THE EXCLUSIVE RIGHT TO USE "KITCHENS", APART FROM THE MARK AS SHOWN.

SER. NO. 85-522,544, FILED 1-23-2012.

DAVID YONTEF, EXAMINING ATTORNEY



David J. Kyffers

Director of the United States Patent and Trademark Office

United States of America

United States Patent and Trademark Office

GOODY'S WORLD FAMOUS POPCORN

Reg. No. 4,205,224

GOODWIN, DAVID (UNITED STATES INDIVIDUAL)
6102 GLENWOOD DRIVE
AMARILLO, TX 79119

Registered Sep. 11, 2012

Int. Cl.: 30

FOR: POPCORN, IN CLASS 30 (U.S. CL. 46).

TRADEMARK

FIRST USE 1-3-2012; IN COMMERCE 1-3-2012.

PRINCIPAL REGISTER

THE MARK CONSISTS OF STANDARD CHARACTERS WITHOUT CLAIM TO ANY PARTICULAR FONT, STYLE, SIZE, OR COLOR.

NO CLAIM IS MADE TO THE EXCLUSIVE RIGHT TO USE "WORLD FAMOUS POPCORN", APART FROM THE MARK AS SHOWN.

SER. NO. 85-522,561, FILED 1-23-2012.

ROBERT C. CLARK JR., EXAMINING ATTORNEY



David J. Kyffers

Director of the United States Patent and Trademark Office

United States of America

United States Patent and Trademark Office

HOLY SEXUALITY

Reg. No. 4,205,225

TRUESSENCE LLC (MINNESOTA LIMITED LIABILITY COMPANY)
671 HARMONY CR, P.O. BOX 583
WAYZATA, MN 55391

Registered Sep. 11, 2012

Int. Cl.: 41

FOR: WORKSHOPS AND SEMINARS IN THE FIELD OF SPIRITUALITY AND SEXUALITY,
IN CLASS 41 (U.S. CLS. 100, 101 AND 107).

SERVICE MARK

FIRST USE 3-27-2009; IN COMMERCE 3-27-2009.

PRINCIPAL REGISTER

THE MARK CONSISTS OF STANDARD CHARACTERS WITHOUT CLAIM TO ANY PAR-
TICULAR FONT, STYLE, SIZE, OR COLOR.

NO CLAIM IS MADE TO THE EXCLUSIVE RIGHT TO USE "SEXUALITY", APART FROM
THE MARK AS SHOWN.

SER. NO. 85-522,662, FILED 1-23-2012.

TINA L. SNAPP, EXAMINING ATTORNEY



David J. Kybas

Director of the United States Patent and Trademark Office

United States of America

United States Patent and Trademark Office

WHEEL DEALS

Reg. No. 4,205,226

Registered Sep. 11, 2012

Int. Cl.: 35

SERVICE MARK

PRINCIPAL REGISTER

CALIFON PRODUCTIONS, INC. (CALIFORNIA CORPORATION)
10202 W. WASHINGTON BOULEVARD
CULVER CITY, CA 90232

FOR: PROVIDING INCENTIVE AWARD PROGRAMS DESIGNED TO REWARD PARTICIPANTS IN A LOYALTY PROGRAM DESIGNED TO PROMOTE VIEWERSHIP OF TELEVISION PROGRAMS, IN CLASS 35 (U.S. CLS. 100, 101 AND 102).

FIRST USE 10-26-2011; IN COMMERCE 10-26-2011.

THE MARK CONSISTS OF STANDARD CHARACTERS WITHOUT CLAIM TO ANY PARTICULAR FONT, STYLE, SIZE, OR COLOR.

OWNER OF U.S. REG. NOS. 950,508 AND 1,491,571.

NO CLAIM IS MADE TO THE EXCLUSIVE RIGHT TO USE "DEALS", APART FROM THE MARK AS SHOWN.

SER. NO. 85-522,688, FILED 1-23-2012.

REBECCA GILBERT, EXAMINING ATTORNEY



David J. Kybas

Director of the United States Patent and Trademark Office

United States of America

United States Patent and Trademark Office



Reg. No. 4,205,227

Registered Sep. 11, 2012

Int. Cl.: 36

SERVICE MARK

PRINCIPAL REGISTER

U.S. RISK INSURANCE GROUP, INC. (DELAWARE CORPORATION)
SUITE 500
10210 NORTH CENTRAL EXPRESSWAY
DALLAS, TX 75231

FOR: INSURANCE BROKERAGE AND INSURANCE UNDERWRITING SERVICES IN THE FIELDS OF PROPERTY, CASUALTY, AND PROFESSIONAL LIABILITY INSURANCE, IN CLASS 36 (U.S. CLS. 100, 101 AND 102).

FIRST USE 1-1-2005; IN COMMERCE 1-1-2005.

NO CLAIM IS MADE TO THE EXCLUSIVE RIGHT TO USE "INSURANCE", APART FROM THE MARK AS SHOWN.

THE MARK CONSISTS OF A MOVIE CLAPPER BOARD DIRECTLY ABOVE THE WORD "TAKE" AND NUMERAL "1". BELOW "TAKE1" IS THE WORD "INSURANCE", WITH A HORIZONTAL LINE SEPARATING "TAKE1" AND "INSURANCE".

SER. NO. 85-522,738, FILED 1-23-2012.

MICHAEL KEATING, EXAMINING ATTORNEY



David J. Kyffers

Director of the United States Patent and Trademark Office

United States of America

United States Patent and Trademark Office

ALMOND DREAM

Reg. No. 4,205,228

WESTBRAE NATURAL, INC. (DELAWARE CORPORATION)
58 SOUTH SERVICE ROAD, SUITE 250
MELVILLE, NY 11747

Registered Sep. 11, 2012

Int. Cl.: 29

FOR: NON-DAIRY YOGURT, ALMOND BASED NON-DAIRY YOGURT, IN CLASS 29 (U.S. CL. 46).

TRADEMARK

FIRST USE 1-16-2012; IN COMMERCE 1-16-2012.

PRINCIPAL REGISTER

THE MARK CONSISTS OF STANDARD CHARACTERS WITHOUT CLAIM TO ANY PARTICULAR FONT, STYLE, SIZE, OR COLOR.

OWNER OF U.S. REG. NOS. 3,455,011 AND 3,945,208.

NO CLAIM IS MADE TO THE EXCLUSIVE RIGHT TO USE "ALMOND", APART FROM THE MARK AS SHOWN.

SER. NO. 85-522,944, FILED 1-23-2012.

GEOFFREY FOSDICK, EXAMINING ATTORNEY



David J. Kyfos

Director of the United States Patent and Trademark Office

United States of America

United States Patent and Trademark Office



Reg. No. 4,205,229

Registered Sep. 11, 2012

Int. Cl.: 25

TRADEMARK

PRINCIPAL REGISTER

JETTER II, DAVID (UNITED STATES INDIVIDUAL)
18 CATOONA LANE, APT. 2
STAMFORD, CT 06902

FOR: HATS; JACKETS; PANTS; SHORTS; SWEATSHIRTS; T-SHIRTS, IN CLASS 25 (U.S. CLS. 22 AND 39).

FIRST USE 12-20-2010; IN COMMERCE 11-19-2011.

OWNER OF U.S. REG. NO. 4,115,828.

THE MARK CONSISTS OF TWO HUMAN FISTS SMASHING TOGETHER SURROUNDED BY A BLACK IMPACT DESIGN WITH BIRDLIKE CLAWS ATTACHED BELOW THEM AND LARGE EAGLE-LIKE WINGS COMING OUT ON EITHER SIDE WITH THE WORDS "ARTISTIC FLOW IN BATTLE" UNDERNEATH.

SER. NO. 85-522,973, FILED 1-23-2012.

ELIZABETH HUGHITT, EXAMINING ATTORNEY



David J. Kyros

Director of the United States Patent and Trademark Office

United States of America

United States Patent and Trademark Office

AHC Advisors, Inc.

Reg. No. 4,205,230

Registered Sep. 11, 2012

Int. Cl.: 36

SERVICE MARK

PRINCIPAL REGISTER

AHC ADVISORS, INC. (ILLINOIS CORPORATION)
303 NORTH SECOND STREET
#24
SAINT CHARLES, IL 60175

FOR: CAPITAL INVESTMENT CONSULTING; FINANCIAL ADVICE; FINANCIAL PLANNING; FINANCIAL SERVICES, NAMELY, WEALTH MANAGEMENT SERVICES; INSURANCE ADMINISTRATION; INVESTMENT MANAGEMENT, IN CLASS 36 (U.S. CLS. 100, 101 AND 102).

FIRST USE 2-6-2008; IN COMMERCE 2-6-2008.

THE MARK CONSISTS OF STANDARD CHARACTERS WITHOUT CLAIM TO ANY PARTICULAR FONT, STYLE, SIZE, OR COLOR.

NO CLAIM IS MADE TO THE EXCLUSIVE RIGHT TO USE "ADVISORS, INC.", APART FROM THE MARK AS SHOWN.

SER. NO. 85-523,132, FILED 1-23-2012.

EDWARD NELSON, EXAMINING ATTORNEY



David J. Kybas

Director of the United States Patent and Trademark Office

United States of America

United States Patent and Trademark Office

E-Z LINE

Reg. No. 4,205,231

E-Z LINE PIPE SUPPORT COMPANY, LLC (TEXAS LIMITED LIABILITY COMPANY)
21340 HWY 6

Registered Sep. 11, 2012

MANVEL, TX 77578

Int. Cls.: 6 and 40

FOR: METAL PIPE SUPPORTS; METAL PIPE GUIDES; METAL PIPE CLAMPS; METAL PIPE SHOES; METAL SHIM BLOCKS AND ASSEMBLIES, IN CLASS 6 (U.S. CLS. 2, 12, 13, 14, 23, 25 AND 50).

TRADEMARK

FIRST USE 0-0-1952; IN COMMERCE 0-0-1952.

SERVICE MARK

FOR: CUSTOM STEEL FABRICATION TO THE ORDER AND SPECIFICATION OF OTHERS, IN CLASS 40 (U.S. CLS. 100, 103 AND 106).

PRINCIPAL REGISTER

FIRST USE 0-0-1989; IN COMMERCE 0-0-1989.

THE MARK CONSISTS OF STANDARD CHARACTERS WITHOUT CLAIM TO ANY PARTICULAR FONT, STYLE, SIZE, OR COLOR.

SER. NO. 85-523,172, FILED 1-23-2012.

JEFF DEFORD, EXAMINING ATTORNEY



David J. Kyfos

Director of the United States Patent and Trademark Office

United States of America

United States Patent and Trademark Office

Time Domain Reflective Analytics

Reg. No. 4,205,232

TDR ANALYTICS LLC (DELAWARE LIMITED LIABILITY COMPANY)
120 NORTH POINTE BOULEVARD
LANCASTER, PA 17601

Registered Sep. 11, 2012

Int. Cl.: 35

FOR: BUSINESS INTELLIGENCE ANALYTICS, IN CLASS 35 (U.S. CLS. 100, 101 AND 102).

SERVICE MARK

FIRST USE 12-1-2011; IN COMMERCE 12-1-2011.

PRINCIPAL REGISTER

THE MARK CONSISTS OF STANDARD CHARACTERS WITHOUT CLAIM TO ANY PARTICULAR FONT, STYLE, SIZE, OR COLOR.

NO CLAIM IS MADE TO THE EXCLUSIVE RIGHT TO USE "TIME DOMAIN" AND "ANALYTICS", APART FROM THE MARK AS SHOWN.

SER. NO. 85-523,198, FILED 1-23-2012.

JEFF DEFORD, EXAMINING ATTORNEY



David J. Kyffers

Director of the United States Patent and Trademark Office

United States of America
United States Patent and Trademark Office

KAPAXEN

Reg. No. 4,205,233

BOENN TECHNOLOGIES INC (NEW JERSEY CORPORATION)
126 STRYKER LANE, SUITE 2
HILLSBOROUGH, NJ 08844

Registered Sep. 11, 2012

Int. Cl.: 9

FOR: ACCESSORIES AND PARTS FOR CONSUMER ELECTRONICS, NAMELY, BATTERIES, BATTERY CHARGERS, POWER ADAPTERS, BATTERY CABLES, AND BATTERY CASES, IN CLASS 9 (U.S. CLS. 21, 23, 26, 36 AND 38).

TRADEMARK

FIRST USE 12-1-2011; IN COMMERCE 1-1-2012.

PRINCIPAL REGISTER

THE MARK CONSISTS OF STANDARD CHARACTERS WITHOUT CLAIM TO ANY PARTICULAR FONT, STYLE, SIZE, OR COLOR.

SER. NO. 85-523,326, FILED 1-23-2012.

SHARON MEIER, EXAMINING ATTORNEY



David J. Kyffers

Director of the United States Patent and Trademark Office

United States of America

United States Patent and Trademark Office

ModenaCam

Reg. No. 4,205,234

Registered Sep. 11, 2012

Int. Cl.: 9

TRADEMARK

PRINCIPAL REGISTER

GARESSIO S.R.L. (ROMANIA SOCIETÀ A RESPONSABILITÀ LIMITATA (SRL))
STR AUGUSTIN DOINAS NR 3 AP 2
CLUJ-NAPOCA, ROMANIA 400501

FOR: WEB SITE DEVELOPMENT SOFTWARE; COMPUTER SOFTWARE FOR INSTALLATION INTO A WEB SITE TO PROVIDE VIDEO CHAT CAPABILITIES FOR THAT WEB SITE, IN CLASS 9 (U.S. CLS. 21, 23, 26, 36 AND 38).

FIRST USE 1-19-2012; IN COMMERCE 1-19-2012.

THE MARK CONSISTS OF STANDARD CHARACTERS WITHOUT CLAIM TO ANY PARTICULAR FONT, STYLE, SIZE, OR COLOR.

SER. NO. 85-523,425, FILED 1-24-2012.

HANNO RITTNER, EXAMINING ATTORNEY



David J. Kyffers

Director of the United States Patent and Trademark Office

United States of America

United States Patent and Trademark Office

BLAUMAR

Reg. No. 4,205,235

Registered Sep. 11, 2012

Int. Cl.: 25

TRADEMARK

PRINCIPAL REGISTER

DOLORES FONT CORTES (SPAIN INDIVIDUAL)
PADRE LUÍS MARÍA LLOP, 8
12540 VILLARREAL
(CASTELLÓN), SPAIN

FOR: APPAREL FOR MEN, WOMEN, AND CHILDREN, NAMELY, SHIRTS, T-SHIRTS, TROUSERS, SHORTS, SKIRTS, PULLOVERS, SWEATERS, CARDIGANS, JACKETS, SWIMWEAR, COATS, ANORAKS, WRISTBANDS, SOCKS, UNDERWEAR, IN CLASS 25 (U.S. CLS. 22 AND 39).

THE MARK CONSISTS OF STANDARD CHARACTERS WITHOUT CLAIM TO ANY PARTICULAR FONT, STYLE, SIZE, OR COLOR.

OWNER OF SPAIN REG. NO. 2.661.819, DATED 2-10-2006, EXPIRES 7-13-2015.

THE WORDING "BLAUMAR" HAS NO MEANING IN A FOREIGN LANGUAGE.

SER. NO. 85-523,426, FILED 1-24-2012.

HANNO RITTNER, EXAMINING ATTORNEY



David J. Kyffers

Director of the United States Patent and Trademark Office

United States of America

United States Patent and Trademark Office

Cryptocat

Reg. No. 4,205,236

Registered Sep. 11, 2012

Int. Cl.: 9

TRADEMARK

PRINCIPAL REGISTER

KOBEISSI, NADIM (LEBANON INDIVIDUAL)
APARTMENT 4
4335 DE BREBEUF
MONTRÉAL, CANADA H2J3K6

FOR: COMMUNICATION SOFTWARE FOR PROVIDING ACCESS TO THE INTERNET; COMMUNICATIONS SOFTWARE FOR CONNECTING COMPUTER NETWORK USERS; COMPUTER APPLICATION SOFTWARE FOR MOBILE PHONES, NAMELY, SOFTWARE FOR ENCRYPTING COMMUNICATION OF SMART PHONE DEVICES; COMPUTER SOFTWARE FOR COMMUNICATING WITH USERS OF HAND-HELD COMPUTERS; COMPUTER SOFTWARE FOR ENCRYPTION, IN CLASS 9 (U.S. CLS. 21, 23, 26, 36 AND 38).

FIRST USE 5-19-2011; IN COMMERCE 5-19-2011.

THE MARK CONSISTS OF STANDARD CHARACTERS WITHOUT CLAIM TO ANY PARTICULAR FONT, STYLE, SIZE, OR COLOR.

SER. NO. 85-523,427, FILED S.R. 1-24-2012 AM. P.R. 5-3-2012.

HANNO RITTNER, EXAMINING ATTORNEY



David J. Kybas

Director of the United States Patent and Trademark Office

United States of America

United States Patent and Trademark Office

DAYMARK

Reg. No. 4,205,237

Registered Sep. 11, 2012

Int. Cl.: 42

SERVICE MARK

PRINCIPAL REGISTER

DAYMARK SOLUTIONS, INC. (MASSACHUSETTS CORPORATION)
23 THIRD AVENUE
BURLINGTON, MA 01803

FOR: COMPUTER CONSULTATION SERVICES; DESIGN AND IMPLEMENTATION OF COMPUTER HARDWARE AND SOFTWARE, INTEGRATION OF COMPUTER SYSTEMS AND NETWORKS, AND COMPUTER PROJECT MANAGEMENT SERVICES, ALL FOR DATA BACKUP AND RECOVERY, DIGITAL DATA STORAGE, DISASTER RECOVERY AND DATA STORAGE; COMPUTER SERVICES, NAMELY, CLOUD HOSTING PROVIDER SERVICES TO ENABLE DATA STORAGE; CONSULTING SERVICES IN THE FIELD OF CLOUD COMPUTING FOR THE PURPOSE OF DATA STORAGE, IN CLASS 42 (U.S. CLS. 100 AND 101).

FIRST USE 8-15-2001; IN COMMERCE 9-15-2001.

THE MARK CONSISTS OF STANDARD CHARACTERS WITHOUT CLAIM TO ANY PARTICULAR FONT, STYLE, SIZE, OR COLOR.

OWNER OF U.S. REG. NO. 3,161,550.

SER. NO. 85-523,449, FILED 1-24-2012.

IRA J. GOODSaid, EXAMINING ATTORNEY



David J. Kyros

Director of the United States Patent and Trademark Office

United States of America

United States Patent and Trademark Office



Reg. No. 4,205,238

Registered Sep. 11, 2012

Int. Cl.: 35

SERVICE MARK

PRINCIPAL REGISTER

FAUCETT SOCIAL DESIGN, LLC (MISSOURI LIMITED LIABILITY COMPANY)
3122 EAST CARDINAL COURT
SPRINGFIELD, MO 65804

FOR: BUSINESS MARKETING CONSULTING SERVICES; BUSINESS MARKETING SERVICES, IN CLASS 35 (U.S. CLS. 100, 101 AND 102).

FIRST USE 11-30-2011; IN COMMERCE 11-30-2011.

THE MARK CONSISTS OF AN EMPTY SPEECH BALLOON ADJACENT TO THE LOWER-CASE WORD "ENGAGE" NEXT TO THE NUMBER "5" AND THE LOWERCASE LETTER "W".

SER. NO. 85-523,490, FILED 1-24-2012.

BRIAN NEVILLE, EXAMINING ATTORNEY



David J. Kyros

Director of the United States Patent and Trademark Office

United States of America

United States Patent and Trademark Office

Sculptorium Studios

Reg. No. 4,205,239

BROWN, JEFFREY WADE (UNITED STATES INDIVIDUAL)
11400 FEBRUARY DRIVE
AUSTIN, TX 78753

Registered Sep. 11, 2012

Int. Cl.: 20

FOR: SCULPTURES OF PLASTER, WAX, OR WOOD, IN CLASS 20 (U.S. CLS. 2, 13, 22, 25, 32 AND 50).

TRADEMARK

FIRST USE 2-24-2000; IN COMMERCE 2-24-2000.

PRINCIPAL REGISTER

THE MARK CONSISTS OF STANDARD CHARACTERS WITHOUT CLAIM TO ANY PARTICULAR FONT, STYLE, SIZE, OR COLOR.

NO CLAIM IS MADE TO THE EXCLUSIVE RIGHT TO USE "STUDIOS", APART FROM THE MARK AS SHOWN.

SER. NO. 85-523,531, FILED 1-24-2012.

RENEE MCCRAY, EXAMINING ATTORNEY



David J. Kyffers

Director of the United States Patent and Trademark Office

United States of America

United States Patent and Trademark Office

TRANSITIONS HEALTHY SIGHT FOR LIFE

Reg. No. 4,205,240

TRANSITIONS OPTICAL, INC. (DELAWARE CORPORATION)
9251 BELCHER ROAD
PINELLAS PARK, FL 33782

Registered Sep. 11, 2012

Int. Cls.: 36 and 41

FOR: PROVIDING SCHOLARSHIPS AND GRANTS IN THE FIELD OF EYE CARE AND EYE HEALTH EDUCATION, IN CLASS 36 (U.S. CLS. 100, 101 AND 102).

SERVICE MARK

FIRST USE 1-31-2007; IN COMMERCE 1-31-2007.

PRINCIPAL REGISTER

FOR: EDUCATIONAL SERVICES, NAMELY, CONDUCTING CLASSES, SEMINARS, AND WORKSHOPS IN THE FIELD OF EYE CARE AND EYE HEALTH AND THE DISTRIBUTION OF COURSE MATERIAL FOR USE IN CONNECTION THEREWITH, IN CLASS 41 (U.S. CLS. 100, 101 AND 107).

FIRST USE 1-31-2007; IN COMMERCE 1-31-2007.

THE MARK CONSISTS OF STANDARD CHARACTERS WITHOUT CLAIM TO ANY PARTICULAR FONT, STYLE, SIZE, OR COLOR.

OWNER OF U.S. REG. NOS. 1,576,217, 3,336,227, AND 3,986,171.

NO CLAIM IS MADE TO THE EXCLUSIVE RIGHT TO USE "SIGHT", APART FROM THE MARK AS SHOWN.

SER. NO. 85-523,540, FILED 1-24-2012.

BRIDGETT SMITH, EXAMINING ATTORNEY



David J. Kybas

Director of the United States Patent and Trademark Office

United States of America

United States Patent and Trademark Office



Reg. No. 4,205,241

Registered Sep. 11, 2012

Int. Cl.: 25

TRADEMARK

PRINCIPAL REGISTER

BIONATURAL INTERNATIONAL CORP. (FLORIDA CORPORATION)
3321 NW 82ND AVE
DORAL, FL 33122

FOR: BODY SHAPERS; SHAPEWEAR, NAMELY, GIRDLES, HOSIERY, TIGHTS, SOCKS, BODY SHAPERS, BODYSUITS, CAMISOLES, BRAS, PANTIES, SLIPS, SHIRTS, PANTS, DRESSES, AND SKIRTS, IN CLASS 25 (U.S. CLS. 22 AND 39).

FIRST USE 10-1-2009; IN COMMERCE 4-10-2010.

NO CLAIM IS MADE TO THE EXCLUSIVE RIGHT TO USE "SLIM", APART FROM THE MARK AS SHOWN.

THE COLOR(S) RED, GRAY, BLACK, GOLD AND WHITE. IS/ARE CLAIMED AS A FEATURE OF THE MARK.

THE MARK CONSISTS OF THE WORDING FIR SLIM IN CURSIVE LETTERS IN RED COLOR WITH A BLACK SHADOW, ON A WHITE BACKGROUND WITH 7 GRAY LINES AND 1 GOLD LINE BEHIND THE TEXT.

SER. NO. 85-523,559, FILED 1-24-2012.

ERNEST SHOSHO, EXAMINING ATTORNEY



David J. Kybas

Director of the United States Patent and Trademark Office

United States of America

United States Patent and Trademark Office



Reg. No. 4,205,242

GIBBS & COX, INC. (NEW YORK CORPORATION), DBA G&C
485 7TH AVE ROOM 605
NEW YORK, NY 10018

Registered Sep. 11, 2012

Int. Cl.: 42

FOR: NAVAL ARCHITECTURAL DESIGN AND MARINE ENGINEERING SERVICES, IN CLASS 42 (U.S. CLS. 100 AND 101).

SERVICE MARK

FIRST USE 1-15-2012; IN COMMERCE 1-19-2012.

PRINCIPAL REGISTER

NO CLAIM IS MADE TO THE EXCLUSIVE RIGHT TO USE "MARITIME SOLUTIONS", APART FROM THE MARK AS SHOWN.

THE COLOR(S) BLUE, BLACK, AND GREY IS/ARE CLAIMED AS A FEATURE OF THE MARK.

THE MARK CONSISTS OF THE WORDING "GIBBS & COX" IN BLACK ABOVE THE WORDS "MARITIME SOLUTIONS" IN GREY. TO THE LEFT OF THE WORDING IS A STYLIZED IMAGE OF SHIP'S BOW CONSISTING OF CURVED LINES, BANDS OR BARS AND OTHER LINES, BANDS OR BARS IN BLUE. THE MARK APPEARS ON A TRANSPARENT BACKGROUND.

SER. NO. 85-523,597, FILED 1-24-2012.

CHRIS WELLS, EXAMINING ATTORNEY



David J. Kyffers

Director of the United States Patent and Trademark Office

United States of America

United States Patent and Trademark Office



Reg. No. 4,205,243

KANDOR DENTAL SPA & SALON LLC (FLORIDA LIMITED LIABILITY COMPANY)
8767 ATWATER LOOP
OVIEDO, FL 32765

Registered Sep. 11, 2012

Int. Cl.: 44

FOR: DENTIST SERVICES; HEALTH SPA SERVICES FOR HEALTH AND WELLNESS OF THE BODY AND SPIRIT, NAMELY, PROVIDING MASSAGE, FACIAL AND BODY TREATMENT SERVICES, COSMETIC BODY CARE SERVICES, IN CLASS 44 (U.S. CLS. 100 AND 101).

SERVICE MARK

PRINCIPAL REGISTER

FIRST USE 6-21-2011; IN COMMERCE 6-21-2011.

THE MARK CONSISTS OF THE WORDS "KANDOR" IN STYLIZED LETTERING, WITH LETTER "K" APPEARING AS A FANCIFUL REPRESENTATION OF A HUMAN BEING.

SER. NO. 85-523,623, FILED 1-24-2012.

JUDITH HELFMAN, EXAMINING ATTORNEY



David J. Kybas

Director of the United States Patent and Trademark Office

United States of America

United States Patent and Trademark Office

NetDocuments

Reg. No. 4,205,244

Registered Sep. 11, 2012

Int. Cls.: 9 and 42

TRADEMARK

SERVICE MARK

PRINCIPAL REGISTER

NETVOYAGE CORP. (UTAH CORPORATION)
625 S. STATE
OREM, UT 84058

FOR: COMPUTER SOFTWARE USED FOR ON-LINE STORAGE, ORGANIZATION, RETRIEVAL, MANAGEMENT VIA THE GLOBAL COMPUTER NETWORK OF A COLLECTION OF ONE OR MORE FILES FOR ESTABLISHING A DESIGNATED SET OF USERS HAVING ACCESS TO SUCH COLLECTION FOR CONTROL AND TRACKING OF CHANGES BY MEMBERS OF SAID SET OF USERS AND FOR AUTOMATICALLY NOTIFYING MEMBERS OF THE DESIGNATED SET OF USERS WHEN EACH MEMBER IS DESIGNATED AS A MEMBER OF SAID SET OF DESIGNATED USERS, WHEN FILES ARE ADDED TO OR REMOVED FROM THE COLLECTION, OR WHEN FILES WITHIN THE COLLECTION ARE MODIFIED, IN CLASS 9 (U.S. CLS. 21, 23, 26, 36 AND 38).

FIRST USE 2-26-1999; IN COMMERCE 2-26-1999.

FOR: CONSULTATION SERVICES IN THE NATURE OF ESTABLISHING COLLECTIONS OF FILES STORED, ORGANIZED AND MANAGED AND RETRIEVED ON-LINE VIA THE GLOBAL COMPUTER NETWORK FOR ESTABLISHING A DESIGNATED SET OF USERS HAVING ACCESS TO EACH SUCH COLLECTION FOR CONTROLLING AND TRACKING OF CHANGES BY MEMBERS OF SAID SET OF USERS TO FILES IN SAID COLLECTION AND FOR AUTOMATICALLY NOTIFYING EACH OF THE MEMBERS OF THE DESIGNATED SET OF USERS WHEN SAID MEMBER IS ADDED TO THE SET OF DESIGNATED AS A MEMBER OF SAID SET, WHEN FILES ARE ADDED TO OR REMOVED FROM THE COLLECTION, OR WHEN FILES WITHIN THE COLLECTION ARE MODIFIED, IN CLASS 42 (U.S. CLS. 100 AND 101).

FIRST USE 2-26-1999; IN COMMERCE 2-26-1999.

THE MARK CONSISTS OF STANDARD CHARACTERS WITHOUT CLAIM TO ANY PARTICULAR FONT, STYLE, SIZE, OR COLOR.

SEC. 2(F).

SER. NO. 85-523,651, FILED 1-24-2012.

JAY FLOWERS, EXAMINING ATTORNEY



David J. Kyros

Director of the United States Patent and Trademark Office

United States of America

United States Patent and Trademark Office

MEDMAP

Reg. No. 4,205,245

Registered Sep. 11, 2012

Int. Cls.: 35 and 42

SERVICE MARK

PRINCIPAL REGISTER

SCIESSENT LLC (DELAWARE LIMITED LIABILITY COMPANY)
60 AUDUBON ROAD
WAKEFIELD, MA 01880

FOR: ASSISTANCE, ADVISORY SERVICES AND CONSULTANCY WITH REGARD TO BUSINESS PLANNING, MARKET ASSESSMENT AND ANALYSIS, AND COMMERCIAL DEVELOPMENT, LAUNCH, AND EXPLOITATION OF MEDICAL DEVICES, MEDICAL EQUIPMENT, MEDICAL APPARATUS AND MEDICAL UTENSILS; ASSISTANCE, ADVISORY SERVICES AND CONSULTANCY PERTAINING TO REGULATORY APPROVAL AND REGULATORY SUBMISSION MANAGEMENT, NAMELY, PREPARATION, FILING AND PROCESSING OF APPLICATIONS FOR APPROVALS IN THE FIELD OF MEDICAL DEVICES, MEDICAL EQUIPMENT, MEDICAL APPARATUS AND MEDICAL UTENSILS, IN CLASS 35 (U.S. CLS. 100, 101 AND 102).

FIRST USE 5-4-2010; IN COMMERCE 5-4-2010.

FOR: DESIGN, ENGINEERING, RESEARCH, DEVELOPMENT AND TESTING SERVICES IN THE FIELD OF MEDICAL DEVICES, MEDICAL APPARATUS, MEDICAL EQUIPMENT, AND MEDICAL UTENSILS; DESIGN, ENGINEERING, RESEARCH, DEVELOPMENT AND TESTING SERVICES IN THE FIELD OF ANTIMICROBIAL, ANTIFUNGAL, ANTIBACTERIAL POLYMERS AND POLYMERIC MATERIALS, COATINGS, TREATMENTS AND MATERIALS CUSTOMIZATION FOR MEDICAL, SCIENTIFIC, AND TECHNOLOGICAL APPLICATIONS, IN CLASS 42 (U.S. CLS. 100 AND 101).

FIRST USE 5-4-2010; IN COMMERCE 5-4-2010.

THE MARK CONSISTS OF STANDARD CHARACTERS WITHOUT CLAIM TO ANY PARTICULAR FONT, STYLE, SIZE, OR COLOR.

SER. NO. 85-523,652, FILED 1-24-2012.

JAY FLOWERS, EXAMINING ATTORNEY



David J. Kypos

Director of the United States Patent and Trademark Office

United States of America

United States Patent and Trademark Office

DAILY CONNECT

Reg. No. 4,205,246

Registered Sep. 11, 2012

Int. Cl.: 41

SERVICE MARK

PRINCIPAL REGISTER

SOUTHERN CALIFORNIA PUBLIC RADIO (MINNESOTA NON-PROFIT CORPORATION)
474 S. RAYMOND AVENUE
PASADENA, CA 91105

FOR: PROVIDING ONLINE ELECTRONIC NEWSLETTERS DELIVERED BY EMAIL IN THE
FIELD OF NEWS, CURRENT EVENTS AND TOPICS OF GENERAL INTEREST , IN CLASS
41 (U.S. CLS. 100, 101 AND 107).

FIRST USE 4-18-2011; IN COMMERCE 4-18-2011.

THE MARK CONSISTS OF STANDARD CHARACTERS WITHOUT CLAIM TO ANY PAR-
TICULAR FONT, STYLE, SIZE, OR COLOR.

NO CLAIM IS MADE TO THE EXCLUSIVE RIGHT TO USE "DAILY", APART FROM THE
MARK AS SHOWN.

SER. NO. 85-523,659, FILED 1-24-2012.

JAY FLOWERS, EXAMINING ATTORNEY



David J. Kybas

Director of the United States Patent and Trademark Office

United States of America

United States Patent and Trademark Office

MR. G

Reg. No. 4,205,247

Registered Sep. 11, 2012

Int. Cl.: 31

TRADEMARK

PRINCIPAL REGISTER

RICH-PAK FARMS, LLC (CALIFORNIA LIMITED LIABILITY COMPANY)
P.O. BOX 60279
BAKERSFIELD, CA 93386

FOR: FRESH FRUITS, IN CLASS 31 (U.S. CLS. 1 AND 46).

FIRST USE 9-1-1998; IN COMMERCE 9-1-1998.

THE MARK CONSISTS OF STANDARD CHARACTERS WITHOUT CLAIM TO ANY PARTICULAR FONT, STYLE, SIZE, OR COLOR.

THE NAME "MR. G" DOES NOT IDENTIFY A LIVING INDIVIDUAL.

SER. NO. 85-523,661, FILED 1-24-2012.

JAY FLOWERS, EXAMINING ATTORNEY



David J. Kyffers

Director of the United States Patent and Trademark Office

United States of America

United States Patent and Trademark Office

THAT'S MASTERCARD. THAT'S
PRICELESS

Reg. No. 4,205,248

MASTERCARD INTERNATIONAL INCORPORATED (DELAWARE CORPORATION)
2000 PURCHASE STREET
PURCHASE, NY 105772405

Registered Sep. 11, 2012

Int. Cls.: 35 and 36

FOR: PROMOTING THE SALE OF THE GOODS AND SERVICES OF OTHERS BY MEANS OF ADVERTISEMENTS AND PROMOTIONS IN CONNECTION WITH THE USE OF CREDIT AND DEBIT CARDS, IN CLASS 35 (U.S. CLS. 100, 101 AND 102).

SERVICE MARK

FIRST USE 9-7-2011; IN COMMERCE 9-7-2011.

PRINCIPAL REGISTER

FOR: FINANCIAL SERVICES, NAMELY, BANKING SERVICES; PROVIDING CREDIT CARD AND DEBIT CARD SERVICES; PROVIDING ELECTRONIC FUNDS AND CURRENCY TRANSFER SERVICES, ELECTRONIC PAYMENTS SERVICES, CASH DISBURSEMENT SERVICES AND TRANSACTION AUTHORIZATION AND SETTLEMENT SERVICES; TRAVEL INSURANCE SERVICES; FINANCIAL SERVICES, NAMELY, BANKING AND PAYMENT CARD SERVICES PROVIDED BY MEANS OF A GLOBAL COMPUTER NETWORK OR THE INTERNET, IN CLASS 36 (U.S. CLS. 100, 101 AND 102).

FIRST USE 9-7-2011; IN COMMERCE 9-7-2011.

THE MARK CONSISTS OF STANDARD CHARACTERS WITHOUT CLAIM TO ANY PARTICULAR FONT, STYLE, SIZE, OR COLOR.

OWNER OF U.S. REG. NOS. 1,186,117, 2,370,508 AND OTHERS.

SER. NO. 85-523,672, FILED 1-24-2012.

SUNG IN, EXAMINING ATTORNEY



David J. Kypos

Director of the United States Patent and Trademark Office

United States of America

United States Patent and Trademark Office

SNOWMAN SHOWDOWN

Reg. No. 4,205,249

ASPHALT GREEN INC. (NEW YORK CORPORATION)
555 EAST 90TH STREET
NEW YORK, NY 10128

Registered Sep. 11, 2012

Int. Cl.: 41

FOR: ORGANIZING, ARRANGING, AND CONDUCTING SNOWMAN BUILDING TO ENCOURAGE PHYSICAL ACTIVITY FOR FAMILIES, IN CLASS 41 (U.S. CLS. 100, 101 AND 107).

SERVICE MARK

FIRST USE 12-16-2010; IN COMMERCE 12-16-2010.

PRINCIPAL REGISTER

THE MARK CONSISTS OF STANDARD CHARACTERS WITHOUT CLAIM TO ANY PARTICULAR FONT, STYLE, SIZE, OR COLOR.

NO CLAIM IS MADE TO THE EXCLUSIVE RIGHT TO USE "SNOWMAN", APART FROM THE MARK AS SHOWN.

SER. NO. 85-523,736, FILED 1-24-2012.

KAPIL BHANOT, EXAMINING ATTORNEY



David J. Kyffers

Director of the United States Patent and Trademark Office

United States of America

United States Patent and Trademark Office



Reg. No. 4,205,250

Registered Sep. 11, 2012

Int. Cl.: 10

TRADEMARK

PRINCIPAL REGISTER

LOMBARDOZZI RESEARCH & DEVELOPMENT, INC. (PENNSYLVANIA CORPORATION)
3604 STATE STREET
ERIE, PA 16508

FOR: APPARATUS FOR PHYSICAL TRAINING FOR MEDICAL USE; MANUALLY-OPERATED EXERCISE EQUIPMENT FOR PHYSICAL THERAPY PURPOSES, IN CLASS 10 (U.S. CLS. 26, 39 AND 44).

FIRST USE 7-15-2008; IN COMMERCE 9-30-2008.

NO CLAIM IS MADE TO THE EXCLUSIVE RIGHT TO USE "CHI ROPE", APART FROM THE MARK AS SHOWN.

THE MARK CONSISTS OF GEOMETRIC DESIGN WITH A HEAVY HANDLED ROPE INTERWOVEN THROUGH THE DESIGN AND THE WORD "CHI" ABOVE THE DESIGN AND THE WORD "ROPE" BELOW THE DESIGN.

THE ENGLISH TRANSLATION OF THE WORD "CHI" IN THE MARK IS "ENERGY" OR "LIFE FORCE".

SER. NO. 85-523,783, FILED 1-24-2012.

KAPIL BHANOT, EXAMINING ATTORNEY



David J. Kybas

Director of the United States Patent and Trademark Office

United States of America

United States Patent and Trademark Office



Reg. No. 4,205,251

Registered Sep. 11, 2012

Int. Cl.: 11

TRADEMARK

PRINCIPAL REGISTER

SOLAR WHOLESAL, LLC (NEW JERSEY LIMITED LIABILITY COMPANY)
BUILDING K, SUITE 100
280 N. MIDLAND AVENUE
SADDLE BROOK, NJ 07663

FOR: BATTERY OPERATED ELECTRIC CANDLES; ELECTRIC CANDLES; FLAMELESS CANDLES, IN CLASS 11 (U.S. CLS. 13, 21, 23, 31 AND 34).

FIRST USE 4-0-2011; IN COMMERCE 4-0-2011.

NO CLAIM IS MADE TO THE EXCLUSIVE RIGHT TO USE "HOME", APART FROM THE MARK AS SHOWN.

THE COLOR(S) GREEN, PINK, LIGHT PINK, GRAY, WHITE AND BLUE IS/ARE CLAIMED AS A FEATURE OF THE MARK.

THE MARK CONSISTS OF THE WORDING "LILY'S HOME" IN GREEN AND A GREEN INCOMPLETE CIRCLE WITH A PINK AND LIGHT PINK LILY AT THE BOTTOM OF THAT CIRCLE, AND WITH A GRAY TO LIGHT GRAY HOUSE WITH A WHITE DOOR OUTLINED IN GRAY, AND A GRAY WINDOW FEATURING BLUE AND WHITE ON THE INSIDE AND A GREEN ROOF OUTLINED IN GRAY INSIDE THAT CIRCLE, AND WITH SMOKE IN THE SHAPE OF GREEN LEAVES COMING OUT OF THAT HOUSE'S CHIMNEY.

SER. NO. 85-523,844, FILED 1-24-2012.

LOURDES AYALA, EXAMINING ATTORNEY



David J. Kypos

Director of the United States Patent and Trademark Office

United States of America

United States Patent and Trademark Office

AMAZING MIRACLE SPRAY

Reg. No. 4,205,252

GREAT SOLUTIONS, LLC (MICHIGAN LIMITED LIABILITY COMPANY)
22019 HANOVER CT.

Registered Sep. 11, 2012

WOODHAVEN, MI 48183

Int. Cl.: 5

FOR: HERBAL SPRAYS FOR THE RELIEF OF PAIN AND DISCOMFORT, IN CLASS 5 (U.S. CLS. 6, 18, 44, 46, 51 AND 52).

TRADEMARK

FIRST USE 1-20-2012; IN COMMERCE 1-20-2012.

PRINCIPAL REGISTER

THE MARK CONSISTS OF STANDARD CHARACTERS WITHOUT CLAIM TO ANY PARTICULAR FONT, STYLE, SIZE, OR COLOR.

NO CLAIM IS MADE TO THE EXCLUSIVE RIGHT TO USE "SPRAY", APART FROM THE MARK AS SHOWN.

SER. NO. 85-523,893, FILED 1-24-2012.

KIMBERLY PERRY, EXAMINING ATTORNEY



David J. Kyffers

Director of the United States Patent and Trademark Office

United States of America

United States Patent and Trademark Office



Reg. No. 4,205,253

NATIONAL COUNCIL OF YOUNG ISRAEL (NEW YORK CORPORATION)
111 JOHN STREET, SUITE 450
NEW YORK, NY 10038

Registered Sep. 11, 2012

CERTIFICATION MARK

FOR: KOSHER FOOD AND FOOD PRODUCTS, IN CLASS A (U.S. CL. A).

PRINCIPAL REGISTER

FIRST USE 5-1-1997; IN COMMERCE 5-1-1997.

NO CLAIM IS MADE TO THE EXCLUSIVE RIGHT TO USE "KOSHER DAIRY" , APART FROM THE MARK AS SHOWN.

THE MARK CONSISTS OF THE WORD "KOSHER" AND "DAIRY" SEPARATED BY A LINE AND WITH THE "D" WITH A STAR IN IT ABOVE THE WORD "DAIRY".

THE CERTIFICATION MARK, AS USED BY AUTHORIZED PERSONS, CERTIFIES ALL PRODUCTS UNDER THE STAR "D KOSHER DAIRY" MARK ARE CERTIFIED "KOSHER DAIRY".

SER. NO. 85-524,127, FILED 1-24-2012.

LINDSEY RUBIN, EXAMINING ATTORNEY



David J. Kybas

Director of the United States Patent and Trademark Office

United States of America

United States Patent and Trademark Office

Indulge Los Angeles

Reg. No. 4,205,254

BARCELONA ENTERPRISES (CALIFORNIA CORPORATION)

Registered Sep. 11, 2012

4230 STANSBURY AVENUE #101
SHERMAN OAKS, CA 91423

Int. Cl.: 41

FOR: ORGANIZING COMMUNITY FESTIVALS FEATURING PRIMARILY TASTINGS AND EXHIBITIONS FEATURING CHOCOLATE, PASTRY, WINE, SPIRITS AND BEER, IN CLASS 41 (U.S. CLS. 100, 101 AND 107).

SERVICE MARK

FIRST USE 1-14-2009; IN COMMERCE 6-19-2009.

PRINCIPAL REGISTER

THE MARK CONSISTS OF STANDARD CHARACTERS WITHOUT CLAIM TO ANY PARTICULAR FONT, STYLE, SIZE, OR COLOR.

NO CLAIM IS MADE TO THE EXCLUSIVE RIGHT TO USE "LOS ANGELES", APART FROM THE MARK AS SHOWN.

SER. NO. 85-524,145, FILED 1-24-2012.

TINA BROWN, EXAMINING ATTORNEY



David J. Kybas

Director of the United States Patent and Trademark Office

United States of America

United States Patent and Trademark Office

MindReflector

Reg. No. 4,205,255

MINDREFLECTOR TECHNOLOGIES, LLC (PENNSYLVANIA PARTNERSHIP)
4410 LINGLESTOWN ROAD
HARRISBURG, PA 17112

Registered Sep. 11, 2012

Int. Cl.: 9

FOR: COMPUTER APPLICATION SOFTWARE FOR BIOFEEDBACK, NAMELY, SOFTWARE FOR NEUROFEEDBACK APPLICATIONS, IN CLASS 9 (U.S. CLS. 21, 23, 26, 36 AND 38).

TRADEMARK

FIRST USE 6-1-2011; IN COMMERCE 1-1-2012.

PRINCIPAL REGISTER

THE MARK CONSISTS OF STANDARD CHARACTERS WITHOUT CLAIM TO ANY PARTICULAR FONT, STYLE, SIZE, OR COLOR.

SER. NO. 85-524,148, FILED 1-24-2012.

DOUGLAS LEE, EXAMINING ATTORNEY



David J. Kyffers

Director of the United States Patent and Trademark Office

United States of America

United States Patent and Trademark Office

Sharper CARDS

Marketing Made Easy.

Reg. No. 4,205,256

Registered Sep. 11, 2012

Int. Cl.: 16

TRADEMARK

PRINCIPAL REGISTER

CONSOLEA COMPANY (CANADA COMPANY)
2175 29STREET NE
UNIT 90
CALGARY, CANADA AB T1Y 7H

FOR: PRINTED MATTER, NAMELY, GREETING CARDS, THANK YOU CARDS, APPOINTMENT REMINDER CARDS, STICKERS AND BOOKMARKS, IN CLASS 16 (U.S. CLS. 2, 5, 22, 23, 29, 37, 38 AND 50).

FIRST USE 11-1-2011; IN COMMERCE 11-1-2011.

OWNER OF U.S. REG. NOS. 2,524,948 AND 2,542,840.

NO CLAIM IS MADE TO THE EXCLUSIVE RIGHT TO USE "CARDS", APART FROM THE MARK AS SHOWN.

THE MARK CONSISTS OF THE CAPITALIZED FIRST WORD "SHARPER" IN LARGE FONT, AND THE SECOND WORD "CARDS" APPEARING IN ALL CAPITAL LETTERS, BOTH ON THE FIRST LINE; THE UPPER AND LOWER CASE WORDS "MARKETING MADE EASY." WITH A PERIOD AT THE END OF THE SERIES ON THE SECOND LINE; WITH AN ENVELOPE STYLE DESIGN APPEARING DIRECTLY ABOVE THE WORD "CARDS".

SER. NO. 85-524,208, FILED 1-24-2012.

KRISTIN DAHLING, EXAMINING ATTORNEY



David J. Kybas

Director of the United States Patent and Trademark Office

United States of America

United States Patent and Trademark Office

Millionaire Marketing Formulas

Reg. No. 4,205,257

Registered Sep. 11, 2012

Int. Cls.: 9, 16 and 41

TRADEMARK

SERVICE MARK

PRINCIPAL REGISTER

THE BURCHARD GROUP LLC (OREGON LIMITED LIABILITY COMPANY)
PO BOX 5368
PORTLAND, OR 97228

FOR: AUDIO DISCS FEATURING MARKETING, BRAND POSITIONING, BUSINESS, LEADERSHIP, AND TECHNOLOGY INSTRUCTION; DOWNLOADABLE VIDEO RECORDINGS FEATURING MARKETING, BRAND POSITIONING, BUSINESS, LEADERSHIP, AND TECHNOLOGY INSTRUCTION; ELECTRONIC PUBLICATIONS, NAMELY, ARTICLES AND BOOKS FEATURING MARKETING, BRAND POSITIONING, BUSINESS, LEADERSHIP, AND TECHNOLOGY INSTRUCTION RECORDED ON COMPUTER MEDIA; VIDEO DISCS FEATURING MARKETING, BRAND POSITIONING, BUSINESS, LEADERSHIP, AND TECHNOLOGY INSTRUCTION, IN CLASS 9 (U.S. CLS. 21, 23, 26, 36 AND 38).

FIRST USE 8-1-2010; IN COMMERCE 8-1-2010.

FOR: A SERIES OF BOOKS, WRITTEN ARTICLES, HANDOUTS AND WORKSHEETS IN THE FIELD OF BUSINESS, NAMELY MARKETING, BRAND POSITIONING, BUSINESS, LEADERSHIP, HOW-TO ADVICE, AND TECHNOLOGY; BOOKS IN THE FIELD OF BUSINESS, NAMELY, MARKETING, BRAND POSITIONING, BUSINESS, LEADERSHIP, AND TECHNOLOGY, IN CLASS 16 (U.S. CLS. 2, 5, 22, 23, 29, 37, 38 AND 50).

FIRST USE 8-1-2010; IN COMMERCE 8-1-2010.

FOR: EDUCATIONAL SERVICES, NAMELY, CONDUCTING SEMINARS, LECTURES, AND WORKSHOPS IN THE FIELD OF MARKETING, BRAND POSITIONING, BUSINESS, LEADERSHIP, HOW-TO ADVICE, AND TECHNOLOGY AND DISTRIBUTION OF COURSE MATERIAL IN CONNECTION THEREWITH, IN CLASS 41 (U.S. CLS. 100, 101 AND 107).

FIRST USE 5-1-2010; IN COMMERCE 5-1-2010.

THE MARK CONSISTS OF STANDARD CHARACTERS WITHOUT CLAIM TO ANY PARTICULAR FONT, STYLE, SIZE, OR COLOR.

OWNER OF U.S. REG. NO. 4,079,963.

NO CLAIM IS MADE TO THE EXCLUSIVE RIGHT TO USE "MARKETING FORMULAS", APART FROM THE MARK AS SHOWN.



David J. Kyffers

Director of the United States Patent and Trademark Office

Reg. No. 4,205,257 SER. NO. 85-524,225, FILED 1-24-2012.

KATHERINE E. HALMEN, EXAMINING ATTORNEY

United States of America

United States Patent and Trademark Office

SPEEDYGEL

Reg. No. 4,205,258

AMAZING SHINE NAILS, INC. (CALIFORNIA CORPORATION)
13195 FLORES STREET
SANTA FE SPRINGS, CA 90670

Registered Sep. 11, 2012

Int. Cls.: 3 and 11

FOR: NAIL CARE PREPARATIONS; NAIL POLISH; NAIL POLISH KITS CONTAINING NAIL POLISH AND NAIL CLEANSERS, IN CLASS 3 (U.S. CLS. 1, 4, 6, 50, 51 AND 52).

TRADEMARK

FIRST USE 7-0-2011; IN COMMERCE 7-0-2011.

PRINCIPAL REGISTER

FOR: ULTRAVIOLET LAMPS NOT FOR MEDICAL PURPOSES, IN CLASS 11 (U.S. CLS. 13, 21, 23, 31 AND 34).

FIRST USE 7-0-2011; IN COMMERCE 7-0-2011.

THE MARK CONSISTS OF STANDARD CHARACTERS WITHOUT CLAIM TO ANY PARTICULAR FONT, STYLE, SIZE, OR COLOR.

OWNER OF U.S. REG. NOS. 3,823,830 AND 3,986,878.

SER. NO. 85-524,262, FILED 1-24-2012.

NATALIE POLZER, EXAMINING ATTORNEY



David J. Kybas

Director of the United States Patent and Trademark Office

United States of America
United States Patent and Trademark Office

Gamefetch

Reg. No. 4,205,259

GAMEFETCH, LLC (VIRGINIA LIMITED LIABILITY COMPANY)
18466 QUANTICO GATEWAY DR.
TRIANGLE, VA 22172

Registered Sep. 11, 2012

Int. Cl.: 41

FOR: PROVIDING ONLINE RENTALS OF VIDEO GAMES, DELIVERED TO RECIPIENTS VIA POSTAL MAIL, IN CLASS 41 (U.S. CLS. 100, 101 AND 107).

SERVICE MARK

FIRST USE 2-17-2011; IN COMMERCE 4-13-2011.

PRINCIPAL REGISTER

THE MARK CONSISTS OF STANDARD CHARACTERS WITHOUT CLAIM TO ANY PARTICULAR FONT, STYLE, SIZE, OR COLOR.

SER. NO. 85-524,273, FILED 1-24-2012.

MARILYN IZZI, EXAMINING ATTORNEY



David J. Kybas

Director of the United States Patent and Trademark Office

United States of America

United States Patent and Trademark Office



Reg. No. 4,205,260

Registered Sep. 11, 2012

Int. Cl.: 41

SERVICE MARK

PRINCIPAL REGISTER

CHEERS TO ART, LLC (OHIO LIMITED LIABILITY COMPANY)
7700 CAMARGO ROAD
CINCINNATI, OH 45243

FOR: ENTERTAINMENT SERVICES, IN THE NATURE OF ORGANIZING, ARRANGING, AND CONDUCTING ACRYLIC PAINTING CLASSES, IN CLASS 41 (U.S. CLS. 100, 101 AND 107).

FIRST USE 9-15-2010; IN COMMERCE 11-15-2010.

NO CLAIM IS MADE TO THE EXCLUSIVE RIGHT TO USE "PAINTING WINE GIFTS", APART FROM THE MARK AS SHOWN.

THE MARK CONSISTS OF THE STYLIZED TEXT "CHEERS" AT THE TOP, BELOW AND LEFT OF THAT IS AN ARTIST EASEL, WINE GLASS, AND SPLASH OF PAINT WITH THE STYLIZED TEXT "TO" ON IT, THE STYLIZED TEXT "ART!" TO THE RIGHT OF THE DESIGN, THE STYLIZED TEXT "ART AS ENTERTAINMENT" BELOW THAT, AND THE STYLIZED TEXT "PAINTING · WINE · GIFTS" BELOW THAT.

SER. NO. 85-524,275, FILED 1-24-2012.

MARILYN IZZI, EXAMINING ATTORNEY



David J. Kyros

Director of the United States Patent and Trademark Office

United States of America

United States Patent and Trademark Office

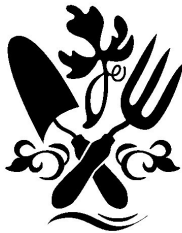

DEBORAH
WILSON
Garden Services, LLC

Reg. No. 4,205,261

Registered Sep. 11, 2012

Int. Cl.: 44

SERVICE MARK

PRINCIPAL REGISTER

DEBORAH WILSON GARDEN SERVICES LLC (MASSACHUSETTS LIMITED LIABILITY COMPANY)
37 FRIENDSHIP LANE
NANTUCKET, MA 02554

FOR: GARDEN DESIGN, INSTALLATION AND MAINTENANCE OF INTERIOR BOTANICAL DISPLAYS, STREETScape CONTAINER PLANTINGS AND ROOFTOP GARDENS FOR OTHERS; LANDSCAPE DESIGN; LANDSCAPE GARDENING, IN CLASS 44 (U.S. CLS. 100 AND 101).

FIRST USE 3-1-2011; IN COMMERCE 3-1-2011.

NO CLAIM IS MADE TO THE EXCLUSIVE RIGHT TO USE "GARDEN SERVICES LLC", APART FROM THE MARK AS SHOWN.

THE NAME "DEBORAH WILSON" IDENTIFIES A LIVING INDIVIDUAL WHOSE CONSENT IS OF RECORD.

THE MARK CONSISTS OF A GARDEN TROWEL AND GARDEN FORK CROSSED OVER EACH OTHER, SURROUNDED BY A STYLIZED DESIGN, AND THE TEXT "DEBORAH WILSON GARDEN SERVICES, LLC" STACKED BELOW THE DESIGN.

SER. NO. 85-524,277, FILED 1-24-2012.

GISELLE AGOSTO, EXAMINING ATTORNEY



David J. Kyjars

Director of the United States Patent and Trademark Office

United States of America
United States Patent and Trademark Office

ENFOQUE

Reg. No. 4,205,262

GONZALEZ, JUAN CARLOS (UNITED STATES INDIVIDUAL)
1014 S. WESTLAKE BLVD. #14-190
WESTLAKE VILLAGE, CA 91361

Registered Sep. 11, 2012

Int. Cl.: 45

FOR: LEGAL SERVICES, IN CLASS 45 (U.S. CLS. 100 AND 101).

SERVICE MARK

FIRST USE 1-15-2012; IN COMMERCE 1-15-2012.

PRINCIPAL REGISTER

THE MARK CONSISTS OF STANDARD CHARACTERS WITHOUT CLAIM TO ANY PARTICULAR FONT, STYLE, SIZE, OR COLOR.

THE ENGLISH TRANSLATION OF THE WORD "ENFOQUE" IN THE MARK IS "FOCUS".

SER. NO. 85-524,296, FILED 1-24-2012.

KATHERINE CONNOLLY, EXAMINING ATTORNEY



David J. Kybas

Director of the United States Patent and Trademark Office

United States of America

United States Patent and Trademark Office



Reg. No. 4,205,263

Registered Sep. 11, 2012

Int. Cl.: 37

SERVICE MARK

PRINCIPAL REGISTER

GREEN DRY PRESS LLC (NEW JERSEY LIMITED LIABILITY COMPANY), DBA LOTS OF CLEAN
137 1/2 WASHINGTON AVE. STE. 129
BELLEVILLE, NJ 07109

FOR: DRY CLEANING, IN CLASS 37 (U.S. CLS. 100, 103 AND 106).

FIRST USE 1-24-2012; IN COMMERCE 1-24-2012.

NO CLAIM IS MADE TO THE EXCLUSIVE RIGHT TO USE "CLEAN", APART FROM THE MARK AS SHOWN.

THE COLOR(S) DARK BLUE, LIGHT BLUE, GREEN AND WHITE IS/ARE CLAIMED AS A FEATURE OF THE MARK.

THE MARK CONSISTS OF A HANGER CREATING TWO CIRCLES, IN DARK BLUE, LIGHT BLUE AND GREEN, CONTAINING THE WORDS "LOTS OF CLEAN". "LOTS" APPEARS IN DARK BLUE, "CLEAN" IN A LIGHTER BLUE COLOR, AND "OF" IN WHITE, CONTAINED WITHIN A GREEN LEAF.

SER. NO. 85-524,429, FILED 1-24-2012.

GISELLE AGOSTO, EXAMINING ATTORNEY



David J. Kyffers

Director of the United States Patent and Trademark Office

United States of America

United States Patent and Trademark Office

The Stripper

Reg. No. 4,205,264

Registered Sep. 11, 2012

Int. Cl.: 3

TRADEMARK

PRINCIPAL REGISTER

DEBORAH LIPPMANN, LLC (DELAWARE LIMITED LIABILITY COMPANY)
#2B 200 9TH AVENUE
NEW YORK, NY 10011

FOR: NAIL POLISH REMOVER, IN CLASS 3 (U.S. CLS. 1, 4, 6, 50, 51 AND 52).

FIRST USE 10-1-1999; IN COMMERCE 10-1-1999.

THE MARK CONSISTS OF STANDARD CHARACTERS WITHOUT CLAIM TO ANY PARTICULAR FONT, STYLE, SIZE, OR COLOR.

SEC. 2(F).

SER. NO. 85-524,443, FILED 1-24-2012.

ANDREA HACK, EXAMINING ATTORNEY



David J. Kyffers

Director of the United States Patent and Trademark Office

United States of America

United States Patent and Trademark Office



Reg. No. 4,205,265

GAYLE, MICHAEL CHARLES (UNITED STATES INDIVIDUAL)
1103 CYPRESS CREEK RD SUITE 103
CEDAR PARK, TX 78613

Registered Sep. 11, 2012

Int. Cl.: 44

FOR: HOME HEALTH CARE SERVICES, NAMELY, PHYSICAL THERAPY, IN CLASS 44
(U.S. CLS. 100 AND 101).

SERVICE MARK

FIRST USE 5-10-2009; IN COMMERCE 8-20-2010.

PRINCIPAL REGISTER

NO CLAIM IS MADE TO THE EXCLUSIVE RIGHT TO USE "IPHYSICAL THERAPY", APART
FROM THE MARK AS SHOWN.

THE COLOR(S) BLUE, ORANGE, YELLOW, AND BLACK IS/ARE CLAIMED AS A FEATURE
OF THE MARK.

THE MARK CONSISTS OF A BLUE SWIRL SURROUNDING A SEPARATE YELLOW SWIRL.
THE WORDS "IPHYSICAL THERAPY" IN ORANGE WITH BLACK OUTLINING START
WITH THE LOWER CASE "I" LOCATED IN THE CENTER OF THE SWIRL AND THE
BOTTOM OF LETTER "P" IS INSIDE THE SWIRL. THE REMAINING LETTERS "HYSICAL
THERAPY" START FROM OUTSIDE OF THE SWIRL NEXT TO THE LETTER "P" AND
EXTEND FROM LEFT TO RIGHT.

SER. NO. 85-524,444, FILED 1-24-2012.

KAREN K. BUSH, EXAMINING ATTORNEY



David J. Kyros

Director of the United States Patent and Trademark Office

United States of America

United States Patent and Trademark Office

FARM TO CHEF

Reg. No. 4,205,266

Registered Sep. 11, 2012

Int. Cl.: 29

TRADEMARK

PRINCIPAL REGISTER

BASIS HOLDINGS LLC (NEW YORK LIMITED LIABILITY COMPANY)
341 WEST 11TH STREET, PHH
NEW YORK, NY 10014

FOR: BUTTER; EGGS; MILK, IN CLASS 29 (U.S. CL. 46).

FIRST USE 1-1-2006; IN COMMERCE 1-1-2006.

THE MARK CONSISTS OF STANDARD CHARACTERS WITHOUT CLAIM TO ANY PARTICULAR FONT, STYLE, SIZE, OR COLOR.

OWNER OF U.S. REG. NOS. 3,703,459 AND 3,872,107.

SER. NO. 85-524,477, FILED 1-25-2012.

DAVID COLLIER, EXAMINING ATTORNEY



David J. Kyffers

Director of the United States Patent and Trademark Office

United States of America

United States Patent and Trademark Office

ANIMALPAK.COM THE SHOP

Reg. No. 4,205,267

Registered Sep. 11, 2012

Int. Cl.: 35

SERVICE MARK

PRINCIPAL REGISTER

UNIVERSAL PROTEIN SUPPLEMENTS CORPORATION (NEW JERSEY CORPORATION),
DBA UNIVERSAL NUTRITION
3 TERMINAL ROAD
NEW BRUNSWICK, NJ 08901

FOR: ON-LINE RETAIL STORE SERVICES FEATURING HEALTH FOOD PRODUCTS,
CLOTHING, AND SPORTS GEAR, IN CLASS 35 (U.S. CLS. 100, 101 AND 102).

FIRST USE 3-6-2001; IN COMMERCE 3-6-2001.

THE MARK CONSISTS OF STANDARD CHARACTERS WITHOUT CLAIM TO ANY PAR-
TICULAR FONT, STYLE, SIZE, OR COLOR.

OWNER OF U.S. REG. NOS. 2,437,306, 3,439,799 AND OTHERS.

NO CLAIM IS MADE TO THE EXCLUSIVE RIGHT TO USE "THE SHOP", APART FROM
THE MARK AS SHOWN.

SER. NO. 85-524,528, FILED 1-25-2012.

DAVID COLLIER, EXAMINING ATTORNEY



David J. Kyfos

Director of the United States Patent and Trademark Office

United States of America

United States Patent and Trademark Office

ANIMALPAK.COM

Reg. No. 4,205,268

Registered Sep. 11, 2012

Int. Cl.: 35

SERVICE MARK

PRINCIPAL REGISTER

UNIVERSAL PROTEIN SUPPLEMENTS CORPORATION (NEW JERSEY CORPORATION),
DBA UNIVERSAL NUTRITION
3 TERMINAL ROAD
NEW BRUNSWICK, NJ 08901

FOR: ON-LINE RETAIL STORE SERVICES FEATURING HEALTH FOOD PRODUCTS,
CLOTHING, AND SPORTS GEAR, IN CLASS 35 (U.S. CLS. 100, 101 AND 102).

FIRST USE 3-6-2001; IN COMMERCE 3-6-2001.

THE MARK CONSISTS OF STANDARD CHARACTERS WITHOUT CLAIM TO ANY PAR-
TICULAR FONT, STYLE, SIZE, OR COLOR.

OWNER OF U.S. REG. NOS. 2,437,306, 3,439,799 AND OTHERS.

SER. NO. 85-524,530, FILED 1-25-2012.

DAVID COLLIER, EXAMINING ATTORNEY



David J. Kyffers

Director of the United States Patent and Trademark Office

United States of America

United States Patent and Trademark Office

OFFICIAL SABAKIBALL

Reg. No. 4,205,269

Registered Sep. 11, 2012

Int. Cls.: 28 and 41

TRADEMARK

SERVICE MARK

PRINCIPAL REGISTER

CERPOK, MICHAEL L. (UNITED STATES INDIVIDUAL)
#1004
16800 E. EL LAGO BLVD.
FOUNTAIN HILLS, AZ 85268

FOR: SPORTS EQUIPMENT, NAMELY, BALLS, BACKBOARDS, AND BALL GAME PINS,
IN CLASS 28 (U.S. CLS. 22, 23, 38 AND 50).

FIRST USE 3-3-2010; IN COMMERCE 3-3-2010.

FOR: ENTERTAINMENT SERVICES, NAMELY, ORGANIZING LEAGUES FOR PLAYING
BALL GAMES, IN CLASS 41 (U.S. CLS. 100, 101 AND 107).

FIRST USE 3-3-2010; IN COMMERCE 1-24-2012.

THE MARK CONSISTS OF STANDARD CHARACTERS WITHOUT CLAIM TO ANY PAR-
TICULAR FONT, STYLE, SIZE, OR COLOR.

NO CLAIM IS MADE TO THE EXCLUSIVE RIGHT TO USE "OFFICIAL", APART FROM
THE MARK AS SHOWN.

THE ENGLISH TRANSLATION OF "SABAKI" IS "TO MOVE".

SER. NO. 85-524,537, FILED 1-25-2012.

MELISSA VALLILLO, EXAMINING ATTORNEY



David J. Kyros

Director of the United States Patent and Trademark Office

United States of America

United States Patent and Trademark Office

APRENDI.COM

Reg. No. 4,205,270

AMERICAN AIRLINES, INC. (DELAWARE CORPORATION)
4333 AMON CARTER BLVD.
FORT WORTH, TX 76155

Registered Sep. 11, 2012

Int. Cl.: 39

FOR: PROVIDING A WEBSITE FOR OTHERS FEATURING INFORMATION ABOUT TRAVEL AND INTERNATIONAL DESTINATIONS, IN CLASS 39 (U.S. CLS. 100 AND 105).

SERVICE MARK

FIRST USE 9-21-2011; IN COMMERCE 9-21-2011.

PRINCIPAL REGISTER

THE MARK CONSISTS OF STANDARD CHARACTERS WITHOUT CLAIM TO ANY PARTICULAR FONT, STYLE, SIZE, OR COLOR.

THE ENGLISH TRANSLATION OF "APRENDI" IS "I LEARNED".

SER. NO. 85-524,559, FILED 1-25-2012.

DEBORAH LOBO, EXAMINING ATTORNEY



David J. Kybas

Director of the United States Patent and Trademark Office

United States of America

United States Patent and Trademark Office

UPTICK | THE UPTICK GROUP

Reg. No. 4,205,271

Registered Sep. 11, 2012

Int. Cls.: 35 and 41

SERVICE MARK

PRINCIPAL REGISTER

THE UPTICK GROUP, LLC (FLORIDA LIMITED LIABILITY COMPANY)
2757 SOUTH PARK ROAD
PEMBROKE PARK, FL 33009

FOR: ACCOUNTING SERVICES; BUSINESS ADVISORY SERVICES, CONSULTANCY AND INFORMATION; BUSINESS ASSISTANCE, MANAGEMENT AND INFORMATION SERVICES; BUSINESS PROCESS OUTSOURCING SERVICES IN THE FIELD OF ACCOUNTING, SUPPLY CHAIN MANAGEMENT AND FULFILLMENT; GOODS IMPORT-EXPORT AGENCIES; SUPPLY CHAIN MANAGEMENT SERVICES, IN CLASS 35 (U.S. CLS. 100, 101 AND 102).

FIRST USE 1-5-2012; IN COMMERCE 1-5-2012.

FOR: ADVISORY AND CONSULTING SERVICES IN THE FIELD OF MANAGEMENT COACHING AND BUSINESS TRAINING FOCUSED ON BUSINESS STRATEGY, SALES, OPERATIONS AND DIRECT IMPORTING, IN CLASS 41 (U.S. CLS. 100, 101 AND 107).

FIRST USE 1-5-2012; IN COMMERCE 1-5-2012.

NO CLAIM IS MADE TO THE EXCLUSIVE RIGHT TO USE "GROUP", APART FROM THE MARK AS SHOWN.

THE MARK CONSISTS OF "UPTICK" IN BOLD FACE SEPARATED BY VERTICAL LINE WITH "THE UPTICK GROUP" TO THE RIGHT OF THE VERTICAL LINE.

SER. NO. 85-524,571, FILED 1-25-2012.

MARY ROSSMAN, EXAMINING ATTORNEY



David J. Kybas

Director of the United States Patent and Trademark Office

United States of America

United States Patent and Trademark Office

Shep Hyken

Reg. No. 4,205,272

Registered Sep. 11, 2012

Int. Cl.: 41

SERVICE MARK

PRINCIPAL REGISTER

HYKEN, SHEP (UNITED STATES INDIVIDUAL)
SUITE 215
711 OLD BALLAS ROAD
ST. LOUIS, MO 63141

FOR: EDUCATIONAL AND ENTERTAINMENT SERVICES, NAMELY, PROVIDING MOTIVATIONAL SPEAKER SERVICES IN THE FIELD OF CUSTOMER SERVICE; BUSINESS TRAINING CONSULTANCY SERVICES; BUSINESS TRAINING IN THE FIELD OF CUSTOMER SERVICE AND OTHER BUSINESS RELATED TOPICS; ENTERTAINMENT IN THE NATURE OF LIVE PERFORMANCES BY A MOTIVATIONAL SPEAKER; ENTERTAINMENT IN THE NATURE OF LIVE STAGE PERFORMANCES IN THE NATURE OF SPEECHES FOR HIRE IN THE FIELD OF CUSTOMER SERVICE AND OTHER BUSINESS TOPICS BY AN INDIVIDUAL; EDUCATIONAL AND ENTERTAINMENT SERVICES, NAMELY, PROVIDING MOTIVATIONAL SPEAKER SERVICES IN THE FIELD OF CUSTOMER SERVICE AND OTHER BUSINESS TOPICS, IN CLASS 41 (U.S. CLS. 100, 101 AND 107).

FIRST USE 9-0-1983; IN COMMERCE 9-0-1983.

THE MARK CONSISTS OF STANDARD CHARACTERS WITHOUT CLAIM TO ANY PARTICULAR FONT, STYLE, SIZE, OR COLOR.

THE NAME "SHEP HYKEN" IDENTIFIES A LIVING INDIVIDUAL WHOSE CONSENT IS OF RECORD.

SER. NO. 85-524,676, FILED 1-25-2012.

SARA BENJAMIN, EXAMINING ATTORNEY



David J. Kybas

Director of the United States Patent and Trademark Office

United States of America

United States Patent and Trademark Office



Reg. No. 4,205,273

Registered Sep. 11, 2012

Int. Cl.: 30

TRADEMARK

PRINCIPAL REGISTER

GRUMA CORPORATION (NEVADA CORPORATION)
SUITE 200
1159 COTTONWOOD LANE
IRVING, TX 75038

FOR: TACO SHELLS, IN CLASS 30 (U.S. CL. 46).

FIRST USE 2-0-2011; IN COMMERCE 2-0-2011.

OWNER OF U.S. REG. NOS. 1,216,032, 3,897,072 AND OTHERS.

THE MARK CONSISTS OF THE WORD "MISSION" IN A RECTANGLE DESIGN. BELOW THE RECTANGLE CONTAINING THE WORD "MISSION" IS A BANNER DESIGN STARTING FROM UNDERNEATH THE LEFT HAND SIDE OF THE RECTANGLE AND ENDING JUST PAST THE RIGHT HAND END CORNER OF THE RECTANGLE. ABOVE THE RECTANGLE IS AN ARCH DESIGN CONTAINING A BELL IN AN OPENING WITH A FLOWER-LIKE DESIGN ON EITHER SIDE OF THE OPENING.

SER. NO. 85-524,716, FILED 1-25-2012.

MAUREEN DALL, EXAMINING ATTORNEY



David J. Kyffers

Director of the United States Patent and Trademark Office

United States of America

United States Patent and Trademark Office

UDEPLOY

Reg. No. 4,205,274

Registered Sep. 11, 2012

Int. Cl.: 9

URBAN CODE, INCORPORATED (OHIO CORPORATION), FORMERLY STARBELLY PRODUCTIONS, INCORPORATED
SUITE 600
2044 EUCLID AVENUE
CLEVELAND, OH 44115

TRADEMARK

FOR: COMPUTER SOFTWARE DEVELOPMENT TOOLS, IN CLASS 9 (U.S. CLS. 21, 23, 26, 36 AND 38).

PRINCIPAL REGISTER

FIRST USE 1-23-2012; IN COMMERCE 1-23-2012.

THE MARK CONSISTS OF STANDARD CHARACTERS WITHOUT CLAIM TO ANY PARTICULAR FONT, STYLE, SIZE, OR COLOR.

SER. NO. 85-524,730, FILED 1-25-2012.

MEGHAN REINHART, EXAMINING ATTORNEY



David J. Kybas

Director of the United States Patent and Trademark Office

United States of America

United States Patent and Trademark Office

MAGIC CHEF

Reg. No. 4,205,275

CNA INTERNATIONAL, INC. (ILLINOIS CORPORATION)
777 MARK ST.
WOOD DALE, IL 60191

Registered Sep. 11, 2012

Int. Cls.: 7 and 11

FOR: ELECTRIC MEAT GRINDERS AND ELECTRIC MEAT SLICERS, IN CLASS 7 (U.S. CLS. 13, 19, 21, 23, 31, 34 AND 35).

TRADEMARK

FIRST USE 12-27-2011; IN COMMERCE 12-27-2011.

PRINCIPAL REGISTER

FOR: ELECTRIC BUFFET SERVERS, ELECTRIC DEEP FRYERS AND ELECTRIC GRILLS, IN CLASS 11 (U.S. CLS. 13, 21, 23, 31 AND 34).

FIRST USE 12-22-2011; IN COMMERCE 12-22-2011.

THE MARK CONSISTS OF STANDARD CHARACTERS WITHOUT CLAIM TO ANY PARTICULAR FONT, STYLE, SIZE, OR COLOR.

OWNER OF U.S. REG. NOS. 1,055,942, 3,379,669 AND OTHERS.

SER. NO. 85-524,732, FILED 1-25-2012.

EMILY CARLSEN, EXAMINING ATTORNEY



David J. Kyffers

Director of the United States Patent and Trademark Office

United States of America

United States Patent and Trademark Office



Magic Chef

Reg. No. 4,205,276

CNA INTERNATIONAL, INC. (ILLINOIS CORPORATION)
777 MARK ST.
WOOD DALE, IL 60191

Registered Sep. 11, 2012

Int. Cls.: 7 and 11

FOR: ELECTRIC MEAT GRINDERS AND ELECTRIC MEAT SLICERS, IN CLASS 7 (U.S. CLS. 13, 19, 21, 23, 31, 34 AND 35).

TRADEMARK

FIRST USE 12-27-2011; IN COMMERCE 12-27-2011.

PRINCIPAL REGISTER

FOR: ELECTRIC BUFFET SERVERS, ELECTRIC DEEP FRYERS AND ELECTRIC GRILLS, IN CLASS 11 (U.S. CLS. 13, 21, 23, 31 AND 34).

FIRST USE 12-22-2011; IN COMMERCE 12-22-2011.

OWNER OF U.S. REG. NOS. 1,055,942, 3,379,669 AND OTHERS.

THE MARK CONSISTS OF A DESIGN OF A CHEF TO THE LEFT OF THE STYLIZED WORDS "MAGIC CHEF".

SER. NO. 85-524,738, FILED 1-25-2012.

EMILY CARLSEN, EXAMINING ATTORNEY



David J. Kybas

Director of the United States Patent and Trademark Office

United States of America

United States Patent and Trademark Office

SMOKEY POE'S BBQ SAUCE

Reg. No. 4,205,277

CHATEAU POE, LLC (OREGON LIMITED LIABILITY COMPANY)
7574 SW CRESMOOR DRIVE
BEAVERTON, OR 97008

Registered Sep. 11, 2012

Int. Cl.: 30

FOR: BARBEQUE SAUCE, IN CLASS 30 (U.S. CL. 46).

TRADEMARK

FIRST USE 1-1-2012; IN COMMERCE 1-1-2012.

PRINCIPAL REGISTER

THE MARK CONSISTS OF STANDARD CHARACTERS WITHOUT CLAIM TO ANY PARTICULAR FONT, STYLE, SIZE, OR COLOR.

NO CLAIM IS MADE TO THE EXCLUSIVE RIGHT TO USE "BBQ SAUCE", APART FROM THE MARK AS SHOWN.

SER. NO. 85-524,747, FILED 1-25-2012.

ELLEN B. AWRICH, EXAMINING ATTORNEY



David J. Kyffers

Director of the United States Patent and Trademark Office

United States of America

United States Patent and Trademark Office

EL MUNDO DE GOYA KID

Reg. No. 4,205,278

Registered Sep. 11, 2012

Int. Cls.: 41 and 44

SERVICE MARK

PRINCIPAL REGISTER

GOYA FOODS, INC. (DELAWARE CORPORATION)
100 SEAVIEW DRIVE
SECAUCUS, NJ 07096

FOR: ENTERTAINMENT SERVICES, NAMELY, PROVIDING A WEBSITE FEATURING GAMES AND PUZZLES; ENTERTAINMENT SERVICES, NAMELY, PROVIDING ON-LINE COMPUTER GAMES, IN CLASS 41 (U.S. CLS. 100, 101 AND 107).

FIRST USE 7-0-2010; IN COMMERCE 7-0-2010.

FOR: PROVIDING A WEB SITE THAT FEATURES INFORMATION ON CHILDREN'S NUTRITION, IN CLASS 44 (U.S. CLS. 100 AND 101).

FIRST USE 7-0-2010; IN COMMERCE 7-0-2010.

THE MARK CONSISTS OF STANDARD CHARACTERS WITHOUT CLAIM TO ANY PARTICULAR FONT, STYLE, SIZE, OR COLOR.

OWNER OF U.S. REG. NOS. 764,033, 966,178 AND OTHERS.

NO CLAIM IS MADE TO THE EXCLUSIVE RIGHT TO USE "KID", APART FROM THE MARK AS SHOWN.

THE ENGLISH TRANSLATION OF "EL MUNDO DE" IN THE MARK IS THE WORLD OF.

SER. NO. 85-524,749, FILED 1-25-2012.

KATHLEEN LORENZO, EXAMINING ATTORNEY



David J. Kybas

Director of the United States Patent and Trademark Office

United States of America
United States Patent and Trademark Office



Reg. No. 4,205,279

Registered Sep. 11, 2012

Int. Cl.: 43

SERVICE MARK

PRINCIPAL REGISTER

JUNIOR COLOMBIAN BURGER, INC. (FLORIDA CORPORATION)
SUITE 105
5389 SOUTH KIRKMAN ROAD
ORLANDO, FL 32819

FOR: FAST-FOOD RESTAURANT SERVICES; RESTAURANT SERVICES FEATURING COLOMBIAN STYLE BURGERS, CHEESEBURGERS, HOT DOGS, CORNCAKES, QUESADILLAS, SALCHIPAPAS, CHORIZOS, BEEF AND CHICKEN SKEWERS AND EMPANADAS, IN CLASS 43 (U.S. CLS. 100 AND 101).

FIRST USE 9-25-2010; IN COMMERCE 9-25-2010.

NO CLAIM IS MADE TO THE EXCLUSIVE RIGHT TO USE "COLOMBIAN BURGER", APART FROM THE MARK AS SHOWN.

THE COLOR(S) RED, BLACK, YELLOW, ORANGE, GREEN, BROWN AND WHITE IS/ARE CLAIMED AS A FEATURE OF THE MARK.

THE MARK CONSISTS OF THE WORD "JUNIOR" IN BOLD RED LETTERS, OUTLINED IN BLACK, WITH THE IMAGE OF A HAMBURGER REPRESENTING THE "O." THE WORD "JUNIOR" IS POSITIONED ABOVE A BLACK OVAL CONTAINING THE WORDS "COLOMBIAN BURGER" WHICH ARE CAPITALIZED AND WRITTEN IN A YELLOW, STYLIZED FONT. THE BURGER ITSELF CONSISTS OF AN ORANGE BOTTOM BUN AND, AS YOU PROGRESS UPWARD, A YELLOW SLICE OF CHEESE, RED TOMATO SLICES, A BROWN PATTY, GREEN LETTUCE AND AN ORANGE TOP BUN WITH A SET OF EYES IN WHITE WITH BLACK AND BROWN PUPIL AND IRIS, A WHITE SMILE AND TWO ARMS IN ORANGE. THE RIGHTMOST ARM IS POSITIONED AT THE HIP OF THE BURGER AND THE OTHER IS RAISED AND FORMED INTO A "THUMBS-UP" SIGN.

SER. NO. 85-524,753, FILED 1-25-2012.

B. PARADEWELAI, EXAMINING ATTORNEY



David J. Kyffers

Director of the United States Patent and Trademark Office

United States of America

United States Patent and Trademark Office



Reg. No. 4,205,280

Registered Sep. 11, 2012

Int. Cl.: 30

TRADEMARK

PRINCIPAL REGISTER

GRUMA CORPORATION (NEVADA CORPORATION)
SUITE 200
1159 COTTONWOOD LANE
IRVING, TX 75038

FOR: TACO SHELLS, IN CLASS 30 (U.S. CL. 46).

FIRST USE 2-0-2011; IN COMMERCE 2-0-2011.

OWNER OF U.S. REG. NOS. 1,216,032, 3,897,072 AND OTHERS.

THE MARK CONSISTS OF THE WORD "MISSION" IN A RECTANGLE DESIGN. BELOW THE RECTANGLE CONTAINING THE WORD "MISSION" IS A TWO-PART BANNER DESIGN STARTING FROM UNDERNEATH THE LEFT HAND SIDE OF THE RECTANGLE AND ENDING JUST PAST THE RIGHT HAND END CORNER OF THE RECTANGLE. ABOVE THE RECTANGLE IS AN ARCH DESIGN CONTAINING A BELL IN AN OPENING WITH A FLOWER-LIKE DESIGN ON EITHER SIDE OF THE OPENING.

SER. NO. 85-524,755, FILED 1-25-2012.

MAUREEN DALL, EXAMINING ATTORNEY



David J. Kyffers

Director of the United States Patent and Trademark Office

United States of America

United States Patent and Trademark Office

STERLING ENGAGEMENTS

Reg. No. 4,205,281

Registered Sep. 11, 2012

Int. Cls.: 35 and 41

SERVICE MARK

PRINCIPAL REGISTER

STERLING ENGAGEMENTS, INC. (CALIFORNIA CORPORATION)
30611 PORTSIDE PLACE
AGOURA HILLS, CA 91301

FOR: ARRANGING AND CONDUCTING SPECIAL EVENTS FOR BUSINESS PURPOSES; ARRANGING AND CONDUCTING SPECIAL EVENTS FOR COMMERCIAL, PROMOTIONAL OR ADVERTISING PURPOSES; EVENT PLANNING AND MANAGEMENT FOR MARKETING, BRANDING, PROMOTING OR ADVERTISING THE GOODS AND SERVICES OF OTHERS, IN CLASS 35 (U.S. CLS. 100, 101 AND 102).

FIRST USE 9-21-2005; IN COMMERCE 9-21-2005.

FOR: PARTY AND WEDDING PLANNING, COORDINATION AND CONSULTATION SERVICES; PROVIDING INFORMATION IN THE FIELD OF WEDDING PARTY PLANNING, IN CLASS 41 (U.S. CLS. 100, 101 AND 107).

FIRST USE 9-21-2005; IN COMMERCE 9-21-2005.

THE MARK CONSISTS OF STANDARD CHARACTERS WITHOUT CLAIM TO ANY PARTICULAR FONT, STYLE, SIZE, OR COLOR.

NO CLAIM IS MADE TO THE EXCLUSIVE RIGHT TO USE "ENGAGEMENTS", APART FROM THE MARK AS SHOWN.

SER. NO. 85-524,936, FILED 1-25-2012.

KIM MONINGHOFF, EXAMINING ATTORNEY



David J. Kybas

Director of the United States Patent and Trademark Office

United States of America

United States Patent and Trademark Office

Kegman

Reg. No. 4,205,282

Registered Sep. 11, 2012

Int. Cl.: 6

TRADEMARK

PRINCIPAL REGISTER

KEGMAN LLC (MASSACHUSETTS LIMITED LIABILITY COMPANY)
58 UNION STREET
ASHLAND, MA 01721

FOR: METAL TAPS FOR BEER KEGS, IN CLASS 6 (U.S. CLS. 2, 12, 13, 14, 23, 25 AND 50).

FIRST USE 1-15-1990; IN COMMERCE 1-15-1990.

THE MARK CONSISTS OF STANDARD CHARACTERS WITHOUT CLAIM TO ANY PARTICULAR FONT, STYLE, SIZE, OR COLOR.

SER. NO. 85-524,985, FILED 1-25-2012.

KATHLEEN M. VANSTON, EXAMINING ATTORNEY



David J. Kyffers

Director of the United States Patent and Trademark Office

United States of America

United States Patent and Trademark Office

BURGER UP

Reg. No. 4,205,283

PMK, LLC (TENNESSEE LIMITED LIABILITY COMPANY)
2509 12TH AVENUE SOUTH
NASHVILLE, TN 37204

Registered Sep. 11, 2012

Int. Cl.: 43

FOR: RESTAURANT SERVICES, IN CLASS 43 (U.S. CLS. 100 AND 101).

SERVICE MARK

FIRST USE 5-1-2010; IN COMMERCE 5-1-2010.

PRINCIPAL REGISTER

THE MARK CONSISTS OF STANDARD CHARACTERS WITHOUT CLAIM TO ANY PARTICULAR FONT, STYLE, SIZE, OR COLOR.

OWNER OF U.S. REG. NO. 4,128,018.

NO CLAIM IS MADE TO THE EXCLUSIVE RIGHT TO USE "BURGER", APART FROM THE MARK AS SHOWN.

SER. NO. 85-525,197, FILED 1-25-2012.

AMY ALFIERI, EXAMINING ATTORNEY



David J. Kybas

Director of the United States Patent and Trademark Office

United States of America

United States Patent and Trademark Office

The Restaurant Doctor

Reg. No. 4,205,284

Registered Sep. 11, 2012

Int. Cl.: 41

SERVICE MARK

PRINCIPAL REGISTER

MARVIN, WILLIAM R. (UNITED STATES INDIVIDUAL), DBA THE RESTAURANT DOCTOR
1111 - 115TH STREET COURT NW
GIG HARBOR, WA 98332

FOR: EDUCATIONAL SERVICES, NAMELY, CONDUCTING SEMINARS AND LECTURES
IN THE FIELD OF HOSPITALITY AND MANAGEMENT, IN CLASS 41 (U.S. CLS. 100, 101
AND 107).

FIRST USE 4-8-1991; IN COMMERCE 4-8-1991.

THE MARK CONSISTS OF STANDARD CHARACTERS WITHOUT CLAIM TO ANY PAR-
TICULAR FONT, STYLE, SIZE, OR COLOR.

NO CLAIM IS MADE TO THE EXCLUSIVE RIGHT TO USE "RESTAURANT", APART FROM
THE MARK AS SHOWN.

SER. NO. 85-525,277, FILED S.R. 1-25-2012 AM. P.R. 5-3-2012.

KAREN K. BUSH, EXAMINING ATTORNEY



David J. Kyffers

Director of the United States Patent and Trademark Office

United States of America

United States Patent and Trademark Office

QUADRA-HULL

Reg. No. 4,205,285

Registered Sep. 11, 2012

Int. Cl.: 11

TRADEMARK

PRINCIPAL REGISTER

CULLIGAN INTERNATIONAL COMPANY (DELAWARE CORPORATION)
9399 HIGGINS ROAD, SUITE 1100
ROSEMONT, IL 60018

FOR: WATER SOFTENER RESIN TANKS, IN CLASS 11 (U.S. CLS. 13, 21, 23, 31 AND 34).

FIRST USE 1-1-2003; IN COMMERCE 1-1-2003.

THE MARK CONSISTS OF STANDARD CHARACTERS WITHOUT CLAIM TO ANY PARTICULAR FONT, STYLE, SIZE, OR COLOR.

SER. NO. 85-525,280, FILED 1-25-2012.

KAREN K. BUSH, EXAMINING ATTORNEY



David J. Kybas

Director of the United States Patent and Trademark Office

United States of America

United States Patent and Trademark Office



Diversified Portfolio^{LLC}
Property Tax Lender

Reg. No. 4,205,286

Registered Sep. 11, 2012

Int. Cl.: 36

SERVICE MARK

PRINCIPAL REGISTER

DIVERSIFIED PORTFOLIO, LLC (TEXAS LIMITED LIABILITY COMPANY), DBA PROPERTY TAX LENDER
19901 SOUTHWEST FREEWAY SUITE 129
SUGAR LAND, TX 77479

FOR: FINANCING AND LOAN SERVICES, IN CLASS 36 (U.S. CLS. 100, 101 AND 102).

FIRST USE 12-10-2009; IN COMMERCE 12-10-2009.

NO CLAIM IS MADE TO THE EXCLUSIVE RIGHT TO USE "DIVERSIFIED PORTFOLIO LLC PROPERTY TAX LENDER", APART FROM THE MARK AS SHOWN.

THE COLOR(S) GREY, WHITE AND GREEN IS/ARE CLAIMED AS A FEATURE OF THE MARK.

THE MARK CONSISTS OF THE DESIGN OF A GREEN HOUSE OUTLINED IN WHITE INSIDE A SHADED GREEN AND WHITE ROUND EDGED SQUARE WITH GREEN ON THE BOTTOM TWO THIRDS OF THE SQUARE FADING INTO PROGRESSIVELY LIGHTER GREEN THEN WHITE AT THE TOP, INSIDE A BORDERING GREY AND WHITE ROUND EDGED SQUARE, ALL TO THE LEFT OF A STRAIGHT VERTICAL LINE WHICH IS TO THE LEFT OF THE WORDING, "DIVERSIFIED" IN GREEN, "PORTFOLIO" IN GREY, "LLC" IN GREEN AND "PROPERTY TAX LENDER" IN GREY.

SER. NO. 85-525,350, FILED 1-25-2012.

BARBARA A. GOLD, EXAMINING ATTORNEY



David J. Kyffers

Director of the United States Patent and Trademark Office

United States of America

United States Patent and Trademark Office

The Drawing Out Process

Reg. No. 4,205,287

Registered Sep. 11, 2012

Int. Cl.: 41

ELDREDGE, EMILY JANE (UNITED STATES INDIVIDUAL), DBA THE DRAWING OUT
PROCESS
APT 1406
4601 E SKYLINE DR
TUCSON, AZ 85718

SERVICE MARK

PRINCIPAL REGISTER

FOR: EDUCATIONAL AND PERSONAL COACHING SERVICES, NAMELY, CONDUCTING SEMINARS, CONFERENCES, RETREATS, WORKSHOPS, AND PRIVATE INSTRUCTION IN THE FIELD OF EMOTIONAL WELLNESS, IN CLASS 41 (U.S. CLS. 100, 101 AND 107).

FIRST USE 5-6-2011; IN COMMERCE 7-1-2011.

THE MARK CONSISTS OF STANDARD CHARACTERS WITHOUT CLAIM TO ANY PARTICULAR FONT, STYLE, SIZE, OR COLOR.

NO CLAIM IS MADE TO THE EXCLUSIVE RIGHT TO USE "PROCESS", APART FROM THE MARK AS SHOWN.

SER. NO. 85-525,375, FILED 1-25-2012.

DAVID MURRAY, EXAMINING ATTORNEY



David J. Kyfos

Director of the United States Patent and Trademark Office

United States of America

United States Patent and Trademark Office

GO GREEN ♥ GIVE CHARITY

Reg. No. 4,205,288

SHANNON CARRILLO (UNITED STATES INDIVIDUAL)
280 STANFORD STREET
LA HABRA, CA 90631

Registered Sep. 11, 2012

Int. Cl.: 36

FOR: CHARITABLE FUNDRAISING SERVICES BY MEANS OF DONATING CLOTH DIAPERS TO BABIES IN NEED IN THIRD WORLD COUNTRIES, IN CLASS 36 (U.S. CLS. 100, 101 AND 102).

SERVICE MARK

FIRST USE 12-14-2011; IN COMMERCE 12-14-2011.

PRINCIPAL REGISTER

NO CLAIM IS MADE TO THE EXCLUSIVE RIGHT TO USE "CHARITY", APART FROM THE MARK AS SHOWN.

THE MARK CONSISTS OF THE WORDS "GO GREEN" FOLLOWED BY A HEART, WHICH IS FOLLOWED BY THE WORDS "GIVE CHARITY".

SER. NO. 85-525,428, FILED 1-25-2012.

MICHAEL KEATING, EXAMINING ATTORNEY



David J. Kyros

Director of the United States Patent and Trademark Office

United States of America

United States Patent and Trademark Office

A Jazzy Day

Reg. No. 4,205,289

Registered Sep. 11, 2012

Int. Cl.: 9

TRADEMARK

PRINCIPAL REGISTER

THE MELODY BOOK, LLC (NEW YORK LIMITED LIABILITY COMPANY)
71W 109 STREET APT 1C
NEW YORK, NY 10025

FOR: COMPUTER APPLICATION SOFTWARE FOR MOBILE PHONES, NAMELY, SOFTWARE FOR CHILDREN'S MUSIC EDUCATION, IN CLASS 9 (U.S. CLS. 21, 23, 26, 36 AND 38).

FIRST USE 11-1-2011; IN COMMERCE 1-12-2012.

THE MARK CONSISTS OF STANDARD CHARACTERS WITHOUT CLAIM TO ANY PARTICULAR FONT, STYLE, SIZE, OR COLOR.

SER. NO. 85-525,509, FILED 1-25-2012.

JUDITH HELFMAN, EXAMINING ATTORNEY



David J. Kybas

Director of the United States Patent and Trademark Office

United States of America

United States Patent and Trademark Office



Reg. No. 4,205,290

Registered Sep. 11, 2012

Int. Cls.: 39 and 41

SERVICE MARK

PRINCIPAL REGISTER

EASTERN STATES VETERINARY ASSOCIATION, INC. (FLORIDA CORPORATION), DBA
NORTH AMERICAN VETERINARY CONFERENCE
5003 SW 41ST BOULEVARD
GAINESVILLE, FL 32608

FOR: ORGANIZATION OF EXCURSIONS, SIGHTSEEING TOURS, HOLIDAYS, TOURS
AND TRAVEL, IN CLASS 39 (U.S. CLS. 100 AND 105).

FIRST USE 10-28-2010; IN COMMERCE 10-28-2010.

FOR: CONTINUING EDUCATION SERVICES, NAMELY, PROVIDING LIVE AND ON-LINE
CONTINUING PROFESSIONAL EDUCATION SEMINARS IN THE FIELD OF VETERINARY
MEDICINE, IN CLASS 41 (U.S. CLS. 100, 101 AND 107).

FIRST USE 10-28-2010; IN COMMERCE 10-28-2010.

OWNER OF U.S. REG. NOS. 3,333,122, 3,550,575, AND 4,008,346.

THE COLOR(S) DARK BLUE, ORANGE, LIGHT BLUE, YELLOW AND WHITE IS/ARE
CLAIMED AS A FEATURE OF THE MARK.

NO CLAIM IS MADE TO THE EXCLUSIVE RIGHT TO USE "EXPEDITIONS", APART FROM
THE MARK AS SHOWN.

THE MARK CONSISTS OF THE WORDING "NAVC" AND "EXPEDITIONS" BETWEEN TWO
CONCENTRIC DARK BLUE CIRCLE OUTLINES WHICH FEATURE IN THE CENTER A
LETTER "V" IN BLUE WITH THE WORDING "NAVC" IN YELLOW, LIGHT BLUE WAVES
AND A YELLOW AND ORANGE SUN, ALL OVER A WHITE BACKGROUND.

SER. NO. 85-525,641, FILED 1-26-2012.

JULIE VEPPUMTHARA, EXAMINING ATTORNEY



David J. Kyffers

Director of the United States Patent and Trademark Office

United States of America

United States Patent and Trademark Office



Reg. No. 4,205,291

Registered Sep. 11, 2012

Int. Cl.: 33

TRADEMARK

PRINCIPAL REGISTER

TCHOLAKOV, MIROSLAV I. (UNITED STATES INDIVIDUAL), DBA MIRO CELLARS
412 S. FRANKLIN STREET
CLOVERDALE, CA 954253643

FOR: ALCOHOLIC BEVERAGES EXCEPT BEERS; WINES, IN CLASS 33 (U.S. CLS. 47 AND 49).

FIRST USE 2-4-2004; IN COMMERCE 2-4-2004.

THE MARK CONSISTS OF A MOUNTED HORSEMAN HOLDING A WINE GLASS AND A SPEAR, WHICH PIERCES A LION LYING BELOW THE HORSE.

SER. NO. 85-525,970, FILED 1-26-2012.

DAVID HOFFMAN, EXAMINING ATTORNEY



David J. Kyffers

Director of the United States Patent and Trademark Office

United States of America

United States Patent and Trademark Office

DYNOVALVE

Reg. No. 4,205,292

SAVICORP (NEVADA CORPORATION)
2530 SOUTH BIRCH STREET
SANTA ANA, CA 92707

Registered Sep. 11, 2012

Int. Cl.: 7

FOR: EMISSION REDUCTION UNITS FOR MOTORS AND ENGINES, NAMELY, PCV VALVES, IN CLASS 7 (U.S. CLS. 13, 19, 21, 23, 31, 34 AND 35).

TRADEMARK

FIRST USE 10-1-2006; IN COMMERCE 10-1-2006.

PRINCIPAL REGISTER

THE MARK CONSISTS OF STANDARD CHARACTERS WITHOUT CLAIM TO ANY PARTICULAR FONT, STYLE, SIZE, OR COLOR.

OWNER OF U.S. REG. NOS. 3,173,466, 3,204,740, AND 3,303,777.

SEC. 2(F).

SER. NO. 85-526,182, FILED 1-26-2012.

VERNA BETH RIRIE, EXAMINING ATTORNEY



David J. Kyffers

Director of the United States Patent and Trademark Office

United States of America

United States Patent and Trademark Office

Winston & Cashatt, Lawyers, A Professional Service Corporation

Reg. No. 4,205,293

Registered Sep. 11, 2012

Int. Cl.: 45

SERVICE MARK

PRINCIPAL REGISTER

WINSTON & CASHATT, LAWYERS, A PROFESSIONAL SERVICE CORPORATION
(WASHINGTON CORPORATION), AKA WINSTON & CASHATT; WINSTON & CASHATT,
LAWYERS
601 W. RIVERSIDE, SUITE 1900
SPOKANE, WA 99203

FOR: LEGAL SERVICES, IN CLASS 45 (U.S. CLS. 100 AND 101).

FIRST USE 9-20-1978; IN COMMERCE 9-20-1978.

THE MARK CONSISTS OF STANDARD CHARACTERS WITHOUT CLAIM TO ANY PARTICULAR FONT, STYLE, SIZE, OR COLOR.

NO CLAIM IS MADE TO THE EXCLUSIVE RIGHT TO USE "LAWYERS, A PROFESSIONAL SERVICE CORPORATION", APART FROM THE MARK AS SHOWN.

SER. NO. 85-526,357, FILED 1-26-2012.

KARANENDRA S. CHHINA, EXAMINING ATTORNEY



David J. Kybas

Director of the United States Patent and Trademark Office

United States of America

United States Patent and Trademark Office

SUBQUAL

Reg. No. 4,205,294

Registered Sep. 11, 2012

Int. Cl.: 35

SERVICE MARK

PRINCIPAL REGISTER

SUBQUAL, L.L.C. (ARIZONA LIMITED LIABILITY COMPANY)
SUITE 600
1501 W. FOUNTAINHEAD
TEMPE, AZ 85282

FOR: BUSINESS SERVICES, NAMELY, PROVIDING DATABASES FEATURING TRADE INFORMATION IN THE FIELD OF CONSTRUCTION AND SCREENING OF CONTRACTORS ON BEHALF OF OTHERS, IN CLASS 35 (U.S. CLS. 100, 101 AND 102).

FIRST USE 9-18-2007; IN COMMERCE 9-18-2007.

THE MARK CONSISTS OF STANDARD CHARACTERS WITHOUT CLAIM TO ANY PARTICULAR FONT, STYLE, SIZE, OR COLOR.

SER. NO. 85-526,472, FILED 1-26-2012.

GISELLE AGOSTO, EXAMINING ATTORNEY



David J. Kyffers

Director of the United States Patent and Trademark Office

United States of America

United States Patent and Trademark Office

Divine Blessings Academy

Reg. No. 4,205,295

YOUNG, LAVONDA (UNITED STATES INDIVIDUAL)
115 COUNTY ROAD 319B

Registered Sep. 11, 2012

ALVARADO, TX 76009

Int. Cl.: 41

FOR: EDUCATION SERVICES, NAMELY, PROVIDING ONLINE AND CORRESPONDENCE EDUCATIONAL COURSES AND DEGREE PROGRAMS IN THE FIELD OF HOLISTIC HEALING AND SPIRITUAL HEALING WITH DIRECT INSTRUCTOR ASSISTANCE, IN CLASS 41 (U.S. CLS. 100, 101 AND 107).

SERVICE MARK

PRINCIPAL REGISTER

FIRST USE 2-1-2010; IN COMMERCE 6-1-2010.

THE MARK CONSISTS OF STANDARD CHARACTERS WITHOUT CLAIM TO ANY PARTICULAR FONT, STYLE, SIZE, OR COLOR.

NO CLAIM IS MADE TO THE EXCLUSIVE RIGHT TO USE "ACADEMY", APART FROM THE MARK AS SHOWN.

SER. NO. 85-526,574, FILED 1-26-2012.

AISHA SALEM, EXAMINING ATTORNEY



David J. Kybas

Director of the United States Patent and Trademark Office

United States of America

United States Patent and Trademark Office

AEQUITAS CAPITAL

Reg. No. 4,205,296

AEQUITAS CAPITAL MANAGEMENT, INC. (OREGON CORPORATION)
5300 MEADOWS ROAD, SUITE 400
LAKE OSWEGO, OR 97035

Registered Sep. 11, 2012

Int. Cl.: 36

FOR: INVESTMENT MANAGEMENT SERVICES; INVESTMENT PRODUCT DEVELOPMENT SERVICES, NAMELY, CUSTOM DESIGN OF CAPITAL INVESTMENT VEHICLES AND CAPITAL INVESTMENT FUNDS FOR CUSTOMERS; INVESTMENT SERVICES, NAMELY, ASSET ACQUISITION, CONSULTATION, DEVELOPMENT AND MANAGEMENT SERVICES; MANAGEMENT OF CAPITAL INVESTMENT VEHICLES AND CAPITAL INVESTMENT FUNDS; FINANCIAL CONSULTING; COMMERCIAL LENDING SERVICES, OTHER THAN REAL ESTATE MORTGAGES, IN CLASS 36 (U.S. CLS. 100, 101 AND 102).

SERVICE MARK

PRINCIPAL REGISTER

FIRST USE 3-31-2005; IN COMMERCE 3-31-2005.

THE MARK CONSISTS OF STANDARD CHARACTERS WITHOUT CLAIM TO ANY PARTICULAR FONT, STYLE, SIZE, OR COLOR.

NO CLAIM IS MADE TO THE EXCLUSIVE RIGHT TO USE "CAPITAL", APART FROM THE MARK AS SHOWN.

SER. NO. 85-526,579, FILED 1-26-2012.

JULIE WATSON, EXAMINING ATTORNEY



David J. Kyffers

Director of the United States Patent and Trademark Office

United States of America

United States Patent and Trademark Office

All In 4 Jesus

Reg. No. 4,205,297

EVANS, TYRONE F. (UNITED STATES INDIVIDUAL)
57 LINWOOD ST.

Registered Sep. 11, 2012

MALDEN, MA 02148

Int. Cls.: 25 and 41

FOR: T-SHIRTS; HATS, SHORTS, UNDERWEAR, SOCKS, HEAD BANDS, EAR MUFFS, SWEAT PANTS, SNEAKERS, SLIPPERS, PULL OVERS, SWEAT SHIRTS AND SHOES , IN CLASS 25 (U.S. CLS. 22 AND 39).

TRADEMARK

FIRST USE 12-14-2011; IN COMMERCE 12-14-2011.

SERVICE MARK

FOR: ENTERTAINMENT SERVICES IN THE NATURE OF LIVE TALENT SHOWS, IN CLASS 41 (U.S. CLS. 100, 101 AND 107).

PRINCIPAL REGISTER

FIRST USE 12-14-2011; IN COMMERCE 12-14-2011.

THE MARK CONSISTS OF STANDARD CHARACTERS WITHOUT CLAIM TO ANY PARTICULAR FONT, STYLE, SIZE, OR COLOR.

SER. NO. 85-526,581, FILED 1-26-2012.

DAVID H. STINE, EXAMINING ATTORNEY



David J. Kypos

Director of the United States Patent and Trademark Office

United States of America

United States Patent and Trademark Office

aequitas
CAPITAL

Reg. No. 4,205,298

Registered Sep. 11, 2012

Int. Cl.: 36

SERVICE MARK

PRINCIPAL REGISTER

AEQUITAS CAPITAL MANAGEMENT, INC. (OREGON CORPORATION)
5300 MEADOWS ROAD
SUITE 400
LAKE OSWEGO, OR 97035

FOR: INVESTMENT MANAGEMENT SERVICES; INVESTMENT PRODUCT DEVELOPMENT SERVICES, NAMELY, CUSTOM DESIGN OF CAPITAL INVESTMENT VEHICLES AND CAPITAL INVESTMENT FUNDS FOR CUSTOMERS; INVESTMENT SERVICES, NAMELY, ASSET ACQUISITION, CONSULTATION, DEVELOPMENT AND MANAGEMENT SERVICES; MANAGEMENT OF CAPITAL INVESTMENT VEHICLES AND CAPITAL INVESTMENT FUNDS; FINANCIAL CONSULTING; COMMERCIAL LENDING SERVICES, OTHER THAN REAL ESTATE MORTGAGES, IN CLASS 36 (U.S. CLS. 100, 101 AND 102).

FIRST USE 3-5-2011; IN COMMERCE 3-5-2011.

NO CLAIM IS MADE TO THE EXCLUSIVE RIGHT TO USE "CAPITAL", APART FROM THE MARK AS SHOWN.

THE MARK CONSISTS OF THE STYLIZED WORDS "AEQUITAS CAPITAL".

SER. NO. 85-526,592, FILED 1-26-2012.

JULIE WATSON, EXAMINING ATTORNEY



David J. Kyffers

Director of the United States Patent and Trademark Office

United States of America

United States Patent and Trademark Office

blizzard in a bone

Reg. No. 4,205,299

SABIN, LORI (UNITED STATES INDIVIDUAL)
8401 WESTVIEW RD.
WILMINGTON, DE 19802

Registered Sep. 11, 2012

Int. Cl.: 31

FOR: PET TREATS, IN CLASS 31 (U.S. CLS. 1 AND 46).

TRADEMARK

FIRST USE 1-26-2012; IN COMMERCE 1-26-2012.

PRINCIPAL REGISTER

THE MARK CONSISTS OF STANDARD CHARACTERS WITHOUT CLAIM TO ANY PARTICULAR FONT, STYLE, SIZE, OR COLOR.

NO CLAIM IS MADE TO THE EXCLUSIVE RIGHT TO USE "BONE", APART FROM THE MARK AS SHOWN.

SER. NO. 85-526,640, FILED 1-26-2012.

ANDREW RHIM, EXAMINING ATTORNEY



David J. Kyffers

Director of the United States Patent and Trademark Office

United States of America

United States Patent and Trademark Office



Reg. No. 4,205,300

BRENNAN, JAMES C. (UNITED STATES INDIVIDUAL)
5 SPRING LANE APT. 236G
FARMINGTON, CT 06032

Registered Sep. 11, 2012

Int. Cl.: 44

FOR: PROVIDING ASSISTANCE, FITNESS EVALUATION AND CONSULTATION TO INDIVIDUALS TO HELP THEM MAKE HEALTH, WELLNESS AND NUTRITIONAL CHANGES IN THEIR DAILY LIVING TO IMPROVE HEALTH, IN CLASS 44 (U.S. CLS. 100 AND 101).

SERVICE MARK

FIRST USE 6-10-2007; IN COMMERCE 6-10-2007.

PRINCIPAL REGISTER

THE MARK CONSISTS OF THE STYLIZED WORDING "JEKL" IN GREEN AND OUTLINED IN WHITE, BLACK AND GRAY. THE WORDING OVERLAYS THE OUTLINE OF AN INCOMPLETE BLACK OVAL.

THE COLOR(S) GREEN, BLACK, WHITE AND GRAY IS/ARE CLAIMED AS A FEATURE OF THE MARK.

SER. NO. 85-526,642, FILED 1-26-2012.

KATHERINE CONNOLLY, EXAMINING ATTORNEY



David J. Kyffers

Director of the United States Patent and Trademark Office

United States of America

United States Patent and Trademark Office

THEN SHE SNAPPED

Reg. No. 4,205,301

TONETTI-SPELLMAN, JENNIFER (UNITED STATES INDIVIDUAL)
15 HEATH ROAD
VALHALLA, NY 10595

Registered Sep. 11, 2012

Int. Cl.: 41

FOR: PHOTOGRAPHY CONSULTING SERVICES, NAMELY, PROVIDING CLASSES AND INSTRUCTION IN THE FIELD OF PHOTOGRAPHY, IN CLASS 41 (U.S. CLS. 100, 101 AND 107).

SERVICE MARK

FIRST USE 9-19-2011; IN COMMERCE 9-19-2011.

PRINCIPAL REGISTER

THE MARK CONSISTS OF STANDARD CHARACTERS WITHOUT CLAIM TO ANY PARTICULAR FONT, STYLE, SIZE, OR COLOR.

SER. NO. 85-526,709, FILED 1-27-2012.

STEPHANIE ALI, EXAMINING ATTORNEY



David J. Kyffers

Director of the United States Patent and Trademark Office

United States of America

United States Patent and Trademark Office

MEDVANA

Reg. No. 4,205,302

Registered Sep. 11, 2012

Int. Cl.: 9

TRADEMARK

PRINCIPAL REGISTER

INFOALCHEMY LLC (DELAWARE LIMITED LIABILITY COMPANY)
6026 LOGANWOOD DRIVE
NORTH BETHESDA, MD 20852

FOR: COMPUTER SOFTWARE FOR COMMUNICATING WITH USERS OF DESK-TOP COMPUTERS, HAND-HELD COMPUTERS, SMART PHONES, AND REGULAR PHONES FOR DIRECTING USERS TO SPECIFIC MEDICAL RESOURCES, NAMELY, PRESCRIPTION DRUGS, PHARMACY SERVICES, HEALTHCARE PROVIDERS AND MEDICAL FACILITIES, CARE MANAGEMENT RESOURCES, DIFFERENTIAL DIAGNOSIS LISTS, DISEASE SPECIFIC INFORMATION, HEALTHCARE SOCIAL NETWORKS, INSURANCE INFORMATION, COST AND QUALITY INFORMATION AND WEB SEARCHES, IN CLASS 9 (U.S. CLS. 21, 23, 26, 36 AND 38).

FIRST USE 2-1-2012; IN COMMERCE 2-28-2012.

THE MARK CONSISTS OF STANDARD CHARACTERS WITHOUT CLAIM TO ANY PARTICULAR FONT, STYLE, SIZE, OR COLOR.

SER. NO. 85-526,871, FILED 1-27-2012.

MATTHEW PAPPAS, EXAMINING ATTORNEY



David J. Kyppas

Director of the United States Patent and Trademark Office

United States of America

United States Patent and Trademark Office

Q8

Reg. No. 4,205,303

AUDI AG (FED REP GERMANY CORPORATION)
85045

Registered Sep. 11, 2012

INGOLSTADT, FED REP GERMANY

Int. Cls.: 12, 18 and 28

FOR: AUTOMOBILES AND THEIR STRUCTURAL PARTS, IN CLASS 12 (U.S. CLS. 19, 21, 23, 31, 35 AND 44).

TRADEMARK

FOR: LEATHER AND IMITATION OF LEATHER AND GOODS MADE OF THESE MATERIALS, NAMELY, TRUNKS AND TRAVELING BAGS, PURSES, WALLETS, BAGS, KEY CHAINS, UMBRELLAS, IN CLASS 18 (U.S. CLS. 1, 2, 3, 22 AND 41).

PRINCIPAL REGISTER

FOR: GAMES AND PLAYTHINGS, NAMELY, MODEL CARS, PLUSH CARS, CHILDREN'S PEDAL CARS, PLAYING CARDS, IN CLASS 28 (U.S. CLS. 22, 23, 38 AND 50).

THE MARK CONSISTS OF STANDARD CHARACTERS WITHOUT CLAIM TO ANY PARTICULAR FONT, STYLE, SIZE, OR COLOR.

OWNER OF FED REP GERMANY REG. NO. 302011041044, DATED 9-15-2011, EXPIRES 7-31-2021.

SER. NO. 85-526,890, FILED 1-27-2012.

ANDREA K. NADELMAN, EXAMINING ATTORNEY



David J. Kybas

Director of the United States Patent and Trademark Office

United States of America

United States Patent and Trademark Office

TDR Analytics

Reg. No. 4,205,304

TDR ANALYTICS (DELAWARE LIMITED LIABILITY COMPANY)
742 LAUREL AVE
HIGHLAND PARK, IL 60035

Registered Sep. 11, 2012

Int. Cl.: 35

FOR: BUSINESS INTELLIGENCE ANALYTICS, IN CLASS 35 (U.S. CLS. 100, 101 AND 102).

SERVICE MARK

FIRST USE 11-1-2011; IN COMMERCE 11-1-2011.

PRINCIPAL REGISTER

THE MARK CONSISTS OF STANDARD CHARACTERS WITHOUT CLAIM TO ANY PARTICULAR FONT, STYLE, SIZE, OR COLOR.

NO CLAIM IS MADE TO THE EXCLUSIVE RIGHT TO USE "ANALYTICS", APART FROM THE MARK AS SHOWN.

SER. NO. 85-526,951, FILED 1-27-2012.

JEFF DEFORD, EXAMINING ATTORNEY



David J. Kybas

Director of the United States Patent and Trademark Office

United States of America

United States Patent and Trademark Office

H2KZ

Reg. No. 4,205,305

Registered Sep. 11, 2012

Int. Cl.: 41

SERVICE MARK

PRINCIPAL REGISTER

HHK ENTERTAINMENT LLC (CALIFORNIA LIMITED LIABILITY COMPANY)
RICHARD A. KURSHNER, PC
350 S. BEVERLY DRIVE, SUITE 170
BEVERLY HILLS, CA 90212

FOR: EDUCATION SERVICES, NAMELY, PROVIDING CLASSES AND INSTRUCTION IN THE FIELD OF DANCE, IN CLASS 41 (U.S. CLS. 100, 101 AND 107).

FIRST USE 9-1-2005; IN COMMERCE 9-1-2005.

THE MARK CONSISTS OF STANDARD CHARACTERS WITHOUT CLAIM TO ANY PARTICULAR FONT, STYLE, SIZE, OR COLOR.

SER. NO. 85-527,073, FILED 1-27-2012.

KIM MONINGHOFF, EXAMINING ATTORNEY



David J. Kybas

Director of the United States Patent and Trademark Office

United States of America

United States Patent and Trademark Office



Reg. No. 4,205,306

Registered Sep. 11, 2012

Int. Cl.: 28

TRADEMARK

PRINCIPAL REGISTER

FOX, MARY (UNITED STATES INDIVIDUAL)
5521 BELLE MEAD DRIVE
AIKEN, SC 29803

FOR: STUFFED TEDDY BEARS, IN CLASS 28 (U.S. CLS. 22, 23, 38 AND 50).

FIRST USE 12-8-1997; IN COMMERCE 12-8-1997.

NO CLAIM IS MADE TO THE EXCLUSIVE RIGHT TO USE "BEARS" , APART FROM THE MARK AS SHOWN.

THE STIPPLING IS FOR SHADING PURPOSES ONLY.

THE MARK CONSISTS OF TWO TEDDY BEARS. ONE IS STANDING ON TOP OF THE OTHER ONE AND HOLDING A SIGN THAT READS "HOLLY-KINS". BELOW THERE IS THE STYLIZED TEXT "BEARS".

SER. NO. 85-527,697, FILED 1-27-2012.

SAIMA MAKHDOOM, EXAMINING ATTORNEY



David J. Kyffers

Director of the United States Patent and Trademark Office

United States of America

United States Patent and Trademark Office



Reg. No. 4,205,307

SHUNG KEE FOOD CO. LTD. (NEW YORK CORPORATION)
85 LUDLOW STREET
NEW YORK, NY 10002

Registered Sep. 11, 2012

Int. Cl.: 29

FOR: PREPARED FOOD PRODUCTS, NAMELY, FISH BALLS AND FISH CAKES, IN CLASS 29 (U.S. CL. 46).

TRADEMARK

FIRST USE 1-5-1982; IN COMMERCE 1-5-1982.

PRINCIPAL REGISTER

THE MARK CONSISTS OF A SHADED OBLONG CONTAINING THE LETTER "K" AND AN OVAL ALL BISECTED BY A HORIZONTAL LINE, AND CONTAINED IN AN OBLONG.

SER. NO. 85-528,034, FILED 1-29-2012.

DAVID C. REIHNER, EXAMINING ATTORNEY



David J. Kyffers

Director of the United States Patent and Trademark Office

United States of America

United States Patent and Trademark Office

Harvest the Sun Enjoy a Greener Tomorrow

Reg. No. 4,205,308

GREEN LIGHT SOLAR COMPANY, LLC (PENNSYLVANIA LIMITED LIABILITY COMPANY)
796 SCHOOLHOUSE ROAD
ASPERS, PA 17304

Registered Sep. 11, 2012

Int. Cl.: 37

FOR: INSTALLATION OF SOLAR ENERGY SYSTEMS AND ALTERNATIVE ENERGY PRODUCTS FOR RESIDENTIAL AND COMMERCIAL USE, IN CLASS 37 (U.S. CLS. 100, 103 AND 106).

SERVICE MARK

FIRST USE 7-15-2011; IN COMMERCE 7-15-2011.

PRINCIPAL REGISTER

THE MARK CONSISTS OF STANDARD CHARACTERS WITHOUT CLAIM TO ANY PARTICULAR FONT, STYLE, SIZE, OR COLOR.

SER. NO. 85-528,318, FILED 1-30-2012.

JANICE KIM, EXAMINING ATTORNEY



David J. Kyffers

Director of the United States Patent and Trademark Office

United States of America

United States Patent and Trademark Office

LENDINGCRM

Reg. No. 4,205,309

Registered Sep. 11, 2012

Int. Cl.: 42

SERVICE MARK

PRINCIPAL REGISTER

NUBIFER INC. (NEVADA CORPORATION)
3138 #A CANON STREET
SAN DIEGO, CA 92107

FOR: APPLICATION SERVICE PROVIDER (ASP) FEATURING SOFTWARE FOR USE IN PROCESSING AND STORING DATA IN THE FIELD OF STUDENT LOANS; CLOUD COMPUTING FEATURING SOFTWARE FOR USE IN PROCESSING AND STORING DATA IN THE FIELD OF STUDENT LOANS; PROVIDING A WEBSITE FEATURING NON-DOWNLOADABLE SOFTWARE FOR PROCESSING AND STORING DATA IN THE FIELD OF STUDENT LOANS; SOFTWARE AS A SERVICE (SAAS) SERVICES FEATURING SOFTWARE FOR PROCESSING AND STORING DATA IN THE FIELD OF STUDENT LOANS, IN CLASS 42 (U.S. CLS. 100 AND 101).

FIRST USE 7-10-2009; IN COMMERCE 7-10-2009.

THE MARK CONSISTS OF THE WORDING "LENDINGCRM" IN A STYLIZED FONT WHERE "LENDING" IS WRITTEN IN THE COLOR GRAY AND "CRM" IS WRITTEN IN THE COLOR ORANGE.

THE COLOR(S) GRAY AND ORANGE IS/ARE CLAIMED AS A FEATURE OF THE MARK.

SER. NO. 85-528,337, FILED 1-30-2012.

JANICE KIM, EXAMINING ATTORNEY



David J. Kybas

Director of the United States Patent and Trademark Office

United States of America

United States Patent and Trademark Office

LIVE LOVE TEACH

Reg. No. 4,205,310

DEBORAH WILLIAMSON (UNITED STATES INDIVIDUAL)
136 LINCOLN CIRCLE
KOHLER, WI 53044 AND

Registered Sep. 11, 2012

Int. Cl.: 41

STACY DOCKINS (UNITED STATES INDIVIDUAL)
5640 MULBERRY LANE
MIDLOTHIAN, TX 76065 AND

SERVICE MARK

PRINCIPAL REGISTER

PHILLIP URSO (UNITED STATES INDIVIDUAL)
270 BELLEVUE AVENUE, #215
NEWPORT, RI 02840

FOR: PROVIDING CLASSES, WORKSHOPS, SEMINARS, CAMPS, AND TRAINING OF YOGA TEACHERS FOR CERTIFICATION, ALL IN THE FIELDS OF FITNESS, EXERCISE AND YOGA, IN CLASS 41 (U.S. CLS. 100, 101 AND 107).

FIRST USE 7-1-2010; IN COMMERCE 2-1-2011.

THE MARK CONSISTS OF STANDARD CHARACTERS WITHOUT CLAIM TO ANY PARTICULAR FONT, STYLE, SIZE, OR COLOR.

NO CLAIM IS MADE TO THE EXCLUSIVE RIGHT TO USE "TEACH", APART FROM THE MARK AS SHOWN.

SER. NO. 85-528,402, FILED 1-30-2012.

AMY ALFIERI, EXAMINING ATTORNEY



David J. Kybas

Director of the United States Patent and Trademark Office

United States of America

United States Patent and Trademark Office

The logo for ICEKON features the word "ICEKON" in a bold, sans-serif font. The letter "I" is replaced by a large, stylized icicle pointing downwards. The letter "K" is also stylized, with a vertical line through its center that extends above and below the main body of the letter.

Reg. No. 4,205,311

GENESIS PATTERN TECHNOLOGIES, LLC (NEVADA LIMITED LIABILITY COMPANY)
395 NC HWY 47

Registered Sep. 11, 2012

LEXINGTON, NC 27292

Int. Cl.: 25

FOR: CLOTHING, NAMELY, HEADWEAR, PANTS, SHIRTS, JACKETS, VESTS, FOOTWEAR,
IN CLASS 25 (U.S. CLS. 22 AND 39).

TRADEMARK

FIRST USE 1-10-2012; IN COMMERCE 1-10-2012.

PRINCIPAL REGISTER

THE MARK CONSISTS OF THE WORD "ICEKON" WITH A LARGE ICICLE IN PLACE OF
THE LETTER "I" AND A STYLIZED "K".

SER. NO. 85-528,528, FILED 1-30-2012.

KAREN K. BUSH, EXAMINING ATTORNEY



David J. Kyffers

Director of the United States Patent and Trademark Office

United States of America

United States Patent and Trademark Office

DOC SAVAGE

Reg. No. 4,205,312

ADVANCE MAGAZINE PUBLISHERS INC. (NEW YORK CORPORATION)
FOUR TIMES SQUARE
NEW YORK, NY 10036

Registered Sep. 11, 2012

Int. Cl.: 6

FOR: METAL RINGS AND CHAINS FOR KEYS, IN CLASS 6 (U.S. CLS. 2, 12, 13, 14, 23, 25 AND 50).

TRADEMARK

FIRST USE 6-15-2011; IN COMMERCE 6-15-2011.

PRINCIPAL REGISTER

THE MARK CONSISTS OF STANDARD CHARACTERS WITHOUT CLAIM TO ANY PARTICULAR FONT, STYLE, SIZE, OR COLOR.

OWNER OF U.S. REG. NOS. 1,033,845, 3,194,745, AND 4,049,309.

THE NAME "DOC SAVAGE" DOES NOT IDENTIFY A LIVING INDIVIDUAL.

SER. NO. 85-528,647, FILED 1-30-2012.

MICHELE SWAIN, EXAMINING ATTORNEY



David J. Kyffers

Director of the United States Patent and Trademark Office

United States of America

United States Patent and Trademark Office



Reg. No. 4,205,313

Registered Sep. 11, 2012

Int. Cl.: 9

TRADEMARK

PRINCIPAL REGISTER

ZY HOLDINGS LLC (DELAWARE LIMITED LIABILITY COMPANY)
3RD FLOOR
1450 BROADWAY
NEW YORK, NY 10018

FOR: EYEWEAR, NAMELY, SUNGLASSES AND CASES THEREFOR, IN CLASS 9 (U.S. CLS. 21, 23, 26, 36 AND 38).

FIRST USE 12-31-2011; IN COMMERCE 12-31-2011.

OWNER OF U.S. REG. NOS. 2,951,831, 2,976,072 AND OTHERS.

THE MARK CONSISTS OF A FANCIFUL INTERLOCKING "ZY" DESIGN.

SER. NO. 85-528,702, FILED 1-30-2012.

TARAH HARDY, EXAMINING ATTORNEY



David J. Kyffers

Director of the United States Patent and Trademark Office

United States of America

United States Patent and Trademark Office

Fly Boy Carnival

Reg. No. 4,205,314

Registered Sep. 11, 2012

Int. Cl.: 25

TRADEMARK

PRINCIPAL REGISTER

FLY BOY CARNIVAL, LLC (WISCONSIN LIMITED LIABILITY COMPANY), DBA FLY
BOY CARNIVAL
10075 W. LISBON
WAUWATOSA, WI 53222

FOR: SHIRTS, IN CLASS 25 (U.S. CLS. 22 AND 39).

FIRST USE 7-1-2007; IN COMMERCE 11-10-2007.

THE MARK CONSISTS OF STANDARD CHARACTERS WITHOUT CLAIM TO ANY PARTICULAR FONT, STYLE, SIZE, OR COLOR.

SER. NO. 85-528,711, FILED 1-30-2012.

RONALD AIKENS, EXAMINING ATTORNEY



David J. Kybas

Director of the United States Patent and Trademark Office

United States of America

United States Patent and Trademark Office

OUT LIVING IT

Reg. No. 4,205,315

Registered Sep. 11, 2012

Int. Cl.: 41

SERVICE MARK

PRINCIPAL REGISTER

FIRST DESCENTS (COLORADO NON-PROFIT CORPORATION)
767 SANTA FE DRIVE
DENVER, CO 80204

FOR: CHARITABLE SERVICES, NAMELY, PROVIDING MOTIVATIONAL EXTREME SPORTS CAMPS FOR YOUNG ADULTS WITH CANCER, IN CLASS 41 (U.S. CLS. 100, 101 AND 107).

FIRST USE 3-16-2012; IN COMMERCE 3-16-2012.

THE MARK CONSISTS OF STANDARD CHARACTERS WITHOUT CLAIM TO ANY PARTICULAR FONT, STYLE, SIZE, OR COLOR.

SER. NO. 85-528,723, FILED 1-30-2012.

FONG HSU, EXAMINING ATTORNEY



David J. Kyffers

Director of the United States Patent and Trademark Office

United States of America

United States Patent and Trademark Office

ZOO YORK

Reg. No. 4,205,316

Registered Sep. 11, 2012

Int. Cl.: 9

TRADEMARK

PRINCIPAL REGISTER

ZY HOLDINGS LLC (DELAWARE LIMITED LIABILITY COMPANY)
3RD FLOOR
1450 BROADWAY
NEW YORK, NY 10018

FOR: EYEWEAR, NAMELY, SUNGLASSES AND CASES THEREFOR, IN CLASS 9 (U.S. CLS. 21, 23, 26, 36 AND 38).

FIRST USE 12-31-2011; IN COMMERCE 12-31-2011.

THE MARK CONSISTS OF STANDARD CHARACTERS WITHOUT CLAIM TO ANY PARTICULAR FONT, STYLE, SIZE, OR COLOR.

OWNER OF U.S. REG. NOS. 1,927,011, 3,060,810 AND OTHERS.

SER. NO. 85-528,818, FILED 1-30-2012.

TARAH HARDY, EXAMINING ATTORNEY



David J. Kyffers

Director of the United States Patent and Trademark Office

United States of America

United States Patent and Trademark Office

INFOGRATE

Reg. No. 4,205,317

INFOGRATE, INC. (ILLINOIS CORPORATION)
35 ELM ROCK
BRONXVILLE, NY 10708

Registered Sep. 11, 2012

Int. Cl.: 42

FOR: DEVELOPING COMPUTER SOFTWARE; IT CONSULTING SERVICES, IN CLASS 42
(U.S. CLS. 100 AND 101).

SERVICE MARK

FIRST USE 8-20-1996; IN COMMERCE 8-20-1996.

PRINCIPAL REGISTER

THE MARK CONSISTS OF STANDARD CHARACTERS WITHOUT CLAIM TO ANY PARTICULAR FONT, STYLE, SIZE, OR COLOR.

SER. NO. 85-529,340, FILED 1-31-2012.

DAWN HAN, EXAMINING ATTORNEY



David J. Kybas

Director of the United States Patent and Trademark Office

United States of America

United States Patent and Trademark Office

PETS FOR PATRIOTS

Reg. No. 4,205,318

PETS FOR PATRIOTS, INC. (NEW YORK CORPORATION)
218 E. PARK AVENUE, SUITE 543
LONG BEACH, NY 11561

Registered Sep. 11, 2012

Int. Cl.: 45

FOR: ADOPTIONS SERVICES OF DOMESTIC COMPANION ANIMALS, IN CLASS 45 (U.S. CLS. 100 AND 101).

SERVICE MARK

FIRST USE 1-0-2010; IN COMMERCE 1-0-2010.

PRINCIPAL REGISTER

THE MARK CONSISTS OF STANDARD CHARACTERS WITHOUT CLAIM TO ANY PARTICULAR FONT, STYLE, SIZE, OR COLOR.

NO CLAIM IS MADE TO THE EXCLUSIVE RIGHT TO USE "PETS", APART FROM THE MARK AS SHOWN.

SER. NO. 85-529,341, FILED 1-31-2012.

DAWN HAN, EXAMINING ATTORNEY



David J. Kyffers

Director of the United States Patent and Trademark Office

United States of America

United States Patent and Trademark Office

MANUEL MANZANEQUE

Reg. No. 4,205,319

Registered Sep. 11, 2012

Int. Cl.: 33

TRADEMARK

PRINCIPAL REGISTER

MANUEL MANZANEQUE, S.L. (SPAIN SOCIEDAD DE RESPONSABILIDAD LIMITADA (SL))
ISABEL DE FARNESIO, 2 - LOCAL COMERCIAL
BOADILLA DEL MONTE, SPAIN 28668

FOR: WINES, IN CLASS 33 (U.S. CLS. 47 AND 49).

FIRST USE 1-1-1997; IN COMMERCE 1-1-1997.

THE MARK CONSISTS OF STANDARD CHARACTERS WITHOUT CLAIM TO ANY PARTICULAR FONT, STYLE, SIZE, OR COLOR.

THE NAME "MANUEL MANZANEQUE" IDENTIFIES A LIVING INDIVIDUAL WHOSE CONSENT IS OF RECORD.

SER. NO. 85-529,609, FILED 1-31-2012.

GEORGE LORENZO, EXAMINING ATTORNEY



David J. Kyffers

Director of the United States Patent and Trademark Office

United States of America

United States Patent and Trademark Office

IDEAL METABOLISM - IDEAL WEIGHT

Reg. No. 4,205,320

INTENDED HEALTH AND FITNESS (TEXAS LIMITED LIABILITY COMPANY)
3701 BEE CAVES ROAD, SUITE 102
AUSTIN, TX 78746

Registered Sep. 11, 2012

Int. Cl.: 41

FOR: PHYSICAL FITNESS TRAINING SERVICES, IN CLASS 41 (U.S. CLS. 100, 101 AND 107).

SERVICE MARK

FIRST USE 2-23-2011; IN COMMERCE 2-23-2011.

PRINCIPAL REGISTER

THE MARK CONSISTS OF STANDARD CHARACTERS WITHOUT CLAIM TO ANY PARTICULAR FONT, STYLE, SIZE, OR COLOR.

SER. NO. 85-529,699, FILED 1-31-2012.

DOMINICK J. SALEMI, EXAMINING ATTORNEY



David J. Kyffers

Director of the United States Patent and Trademark Office

United States of America

United States Patent and Trademark Office



Reg. No. 4,205,321

Registered Sep. 11, 2012

Int. Cl.: 43

SERVICE MARK

PRINCIPAL REGISTER

A NEW WAY TO MAKE DOUGH, LLC (TENNESSEE LIMITED LIABILITY COMPANY)
1613 HOLLY STREET
NASHVILLE, TN 37206

FOR: PIZZA PARLORS, IN CLASS 43 (U.S. CLS. 100 AND 101).

FIRST USE 8-13-2011; IN COMMERCE 8-13-2011.

NO CLAIM IS MADE TO THE EXCLUSIVE RIGHT TO USE "FIVE POINTS PIZZA", APART FROM THE MARK AS SHOWN.

THE MARK CONSISTS OF A TRIANGLE WITH THE POINT AT THE BOTTOM, INSIDE OF WHICH ARE THE FOLLOWING: A SMALL CURVED BAND PLACED ABOVE THE WORD "FIVE" IN CAPITAL LETTERS PLACED ABOVE THE WORD "POINTS" IN CAPITAL LETTERS PLACED ABOVE THE WORD "PIZZA" IN CAPITAL LETTERS WRITTEN INSIDE A LARGER BREAKOUT BOX THAT EXTENDS OUTSIDE THE TRIANGLE; THE BREAKOUT BOX SITS ABOVE A SMALL STAR PLACED JUST ABOVE THE POINT AT THE BOTTOM OF THE TRIANGLE.

SER. NO. 85-529,797, FILED 1-31-2012.

WILLIAM VERHOSEK, EXAMINING ATTORNEY



David J. Kybas

Director of the United States Patent and Trademark Office

United States of America

United States Patent and Trademark Office

Scoopy

Reg. No. 4,205,322

PINSCO, INC. (CALIFORNIA CORPORATION)
1901 CARNEGIE AVE., SUITE Q
SANTA ANA, CA 92705

Registered Sep. 11, 2012

Int. Cl.: 21

FOR: AN AID FOR DAILY LIVING, NAMELY, A SCOOP DISH TO ASSIST WITH FEEDING ONESELF, IN CLASS 21 (U.S. CLS. 2, 13, 23, 29, 30, 33, 40 AND 50).

TRADEMARK

FIRST USE 1-30-2012; IN COMMERCE 1-30-2012.

PRINCIPAL REGISTER

THE MARK CONSISTS OF STANDARD CHARACTERS WITHOUT CLAIM TO ANY PARTICULAR FONT, STYLE, SIZE, OR COLOR.

SER. NO. 85-530,087, FILED 1-31-2012.

LYNDSEY KUYKENDALL, EXAMINING ATTORNEY



David J. Kyffers

Director of the United States Patent and Trademark Office

United States of America

United States Patent and Trademark Office

Beaver Coffee Company

Reg. No. 4,205,323

COOPER, ALLEN (UNITED STATES INDIVIDUAL)
38 ROAN WASH LANE
POWELL, WY 82435

Registered Sep. 11, 2012

Int. Cl.: 30

FOR: COFFEE AND TEA, IN CLASS 30 (U.S. CL. 46).

TRADEMARK

FIRST USE 2-16-2012; IN COMMERCE 4-26-2012.

PRINCIPAL REGISTER

THE MARK CONSISTS OF STANDARD CHARACTERS WITHOUT CLAIM TO ANY PARTICULAR FONT, STYLE, SIZE, OR COLOR.

NO CLAIM IS MADE TO THE EXCLUSIVE RIGHT TO USE "COFFEE COMPANY", APART FROM THE MARK AS SHOWN.

SER. NO. 85-530,139, FILED 1-31-2012.

BRIDGETT SMITH, EXAMINING ATTORNEY



David J. Kybas

Director of the United States Patent and Trademark Office

United States of America

United States Patent and Trademark Office

WHERE THE GIRLS GO

Reg. No. 4,205,324

Registered Sep. 11, 2012

Int. Cl.: 41

SERVICE MARK

PRINCIPAL REGISTER

OROPEZA, CHRISTIAN ALEXANDER (UNITED STATES INDIVIDUAL)
APT 615
2420 16TH ST NW
WASHINGTON, DC 20009

FOR: PROVIDING A WEBSITE FEATURING BLOGS AND NON-DOWNLOADABLE PUBLICATIONS IN THE NATURE OF ARTICLES IN THE FIELD OF LESBIAN EVENTS; SPECIAL EVENT PLANNING FOR SOCIAL ENTERTAINMENT PURPOSES, IN CLASS 41 (U.S. CLS. 100, 101 AND 107).

FIRST USE 7-1-2007; IN COMMERCE 7-1-2007.

THE MARK CONSISTS OF STANDARD CHARACTERS WITHOUT CLAIM TO ANY PARTICULAR FONT, STYLE, SIZE, OR COLOR.

SER. NO. 85-530,440, FILED 1-31-2012.

LAURA KOVALSKY, EXAMINING ATTORNEY



David J. Kyffers

Director of the United States Patent and Trademark Office

United States of America

United States Patent and Trademark Office



Reg. No. 4,205,325

Registered Sep. 11, 2012

Int. Cl.: 20

TRADEMARK

PRINCIPAL REGISTER

NINGBO MH INDUSTRY CO., LTD. (CHINA LIMITED COMPANY (LTD.))
NO.18 NORTH NINGNAN ROAD, NINGBO
ZHEJIANG 315192, CHINA

FOR: CUSHIONS; DOG KENNELS; FIGURES MADE OF RATTAN; FURNITURE; FURNITURE FITTINGS, NOT OF METAL; LETTER BOXES NOT OF METAL OR MASONRY; NON-METAL DOOR FITTINGS; PICTURE FRAMES; WORKS OF ART OF WOOD, WAX, PLASTER OR PLASTIC, IN CLASS 20 (U.S. CLS. 2, 13, 22, 25, 32 AND 50).

FIRST USE 4-1-2011; IN COMMERCE 5-1-2011.

THE MARK CONSISTS OF THE STYLIZED WORD "HOMCOM" WITH THE ROOF-SHAPED DESIGN ABOVE THE CHARACTERS "OMCOM".

THE WORDING "HOMCOM" HAS NO MEANING IN A FOREIGN LANGUAGE.

SER. NO. 85-530,446, FILED 1-31-2012.

SANJEEV VOHRA, EXAMINING ATTORNEY



David J. Kyffers

Director of the United States Patent and Trademark Office

United States of America

United States Patent and Trademark Office

I.AM.YOU.

Reg. No. 4,205,326

Registered Sep. 11, 2012

Int. Cls.: 41 and 44

SERVICE MARK

PRINCIPAL REGISTER

IMPARATO, LAUREN (UNITED STATES INDIVIDUAL), DBA I.AM.YOU. STUDIO
6E
132 MULBERRY STREET
NEW YORK, NY 10013

FOR: YOGA INSTRUCTION, IN CLASS 41 (U.S. CLS. 100, 101 AND 107).

FIRST USE 4-0-2009; IN COMMERCE 4-0-2009.

FOR: COUNSELING SERVICES IN THE FIELDS OF HEALTH, NUTRITION AND LIFESTYLE WELLNESS; DIETARY AND NUTRITIONAL GUIDANCE; NUTRITION COUNSELING; NUTRITIONAL THERAPY SERVICES; PROVIDING A WEBSITE FEATURING INFORMATION ABOUT HEALTH, WELLNESS AND NUTRITION; PROVIDING HEALTHY LIFESTYLE AND NUTRITION SERVICES, NAMELY, PERSONAL ASSESSMENTS, PERSONALIZED ROUTINES, MAINTENANCE SCHEDULES, AND COUNSELING; PROVIDING INFORMATION ABOUT DIETARY SUPPLEMENTS AND NUTRITION, IN CLASS 44 (U.S. CLS. 100 AND 101).

FIRST USE 4-0-2009; IN COMMERCE 4-0-2009.

THE MARK CONSISTS OF STANDARD CHARACTERS WITHOUT CLAIM TO ANY PARTICULAR FONT, STYLE, SIZE, OR COLOR.

SER. NO. 85-530,455, FILED 1-31-2012.

JAY FLOWERS, EXAMINING ATTORNEY



David J. Kybas

Director of the United States Patent and Trademark Office

United States of America

United States Patent and Trademark Office

DETOX TO RETOX

Reg. No. 4,205,327

Registered Sep. 11, 2012

Int. Cls.: 41 and 44

SERVICE MARK

PRINCIPAL REGISTER

IMPARATO, LAUREN (UNITED STATES INDIVIDUAL), DBA I.AM.YOU. STUDIO
6E
132 MULBERRY STREET
NEW YORK, NY 10013

FOR: YOGA INSTRUCTION, IN CLASS 41 (U.S. CLS. 100, 101 AND 107).

FIRST USE 5-0-2009; IN COMMERCE 5-0-2009.

FOR: COUNSELING SERVICES IN THE FIELDS OF HEALTH, NUTRITION AND LIFESTYLE WELLNESS; NUTRITION COUNSELING; NUTRITIONAL THERAPY SERVICES; PROVIDING A WEBSITE FEATURING INFORMATION ABOUT HEALTH, WELLNESS AND NUTRITION; PROVIDING AN ON-LINE COMPUTER DATABASE FEATURING INFORMATION REGARDING HEALTH AND NUTRITION; PROVIDING ASSISTANCE, FITNESS EVALUATION AND CONSULTATION TO INDIVIDUALS TO HELP THEM MAKE HEALTH, WELLNESS AND NUTRITIONAL CHANGES IN THEIR DAILY LIVING TO IMPROVE HEALTH; PROVIDING HEALTHY LIFESTYLE AND NUTRITION SERVICES, NAMELY, PERSONAL ASSESSMENTS, PERSONALIZED ROUTINES, MAINTENANCE SCHEDULES, AND COUNSELING; PROVIDING INFORMATION ABOUT DIETARY SUPPLEMENTS AND NUTRITION, IN CLASS 44 (U.S. CLS. 100 AND 101).

FIRST USE 5-0-2009; IN COMMERCE 5-0-2009.

THE MARK CONSISTS OF STANDARD CHARACTERS WITHOUT CLAIM TO ANY PARTICULAR FONT, STYLE, SIZE, OR COLOR.

SER. NO. 85-530,465, FILED 1-31-2012.

JAY FLOWERS, EXAMINING ATTORNEY



David J. Kyffers

Director of the United States Patent and Trademark Office

United States of America

United States Patent and Trademark Office

Guesa

Reg. No. 4,205,328

GUESA USA LLC (MISSOURI LIMITED LIABILITY COMPANY)
31561 SUN VALLEY DR.
SEDALIA, MO 65301

Registered Sep. 11, 2012

Int. Cl.: 36

FOR: FINANCIAL AND INVESTMENT SERVICES, NAMELY, ASSET AND INVESTMENT ACQUISITION, CONSULTATION, ADVISORY AND DEVELOPMENT, IN CLASS 36 (U.S. CLS. 100, 101 AND 102).

SERVICE MARK

FIRST USE 12-22-2009; IN COMMERCE 12-22-2009.

PRINCIPAL REGISTER

THE MARK CONSISTS OF STANDARD CHARACTERS WITHOUT CLAIM TO ANY PARTICULAR FONT, STYLE, SIZE, OR COLOR.

THE WORDING GUESA HAS NO MEANING IN A FOREIGN LANGUAGE.

SER. NO. 85-530,492, FILED 2-1-2012.

KHANH LE, EXAMINING ATTORNEY



David J. Kyffers

Director of the United States Patent and Trademark Office

United States of America

United States Patent and Trademark Office

TAKE FANS

Reg. No. 4,205,329

TAKE FANS TECHNOLOGY (US) CO., LTD. (WASHINGTON CORPORATION)
9460 TELSTAR AVE., #5
EL MONTE, CA 91731

Registered Sep. 11, 2012

Int. Cl.: 9

FOR: ACOUSTIC COUPLERS; AMPLIFIERS; BATTERIES AND BATTERY CHARGERS;
CELL PHONES; CONNECTORS FOR ELECTRONIC CIRCUITS; DATA PROCESSORS; EAR
BUDS; EAR PHONES; HANDS FREE KITS FOR PHONES; MICROCHIP CARDS, IN CLASS
9 (U.S. CLS. 21, 23, 26, 36 AND 38).

TRADEMARK

PRINCIPAL REGISTER

FIRST USE 9-1-2010; IN COMMERCE 9-1-2010.

THE MARK CONSISTS OF THE WORDING "TAKE FANS", WITH A HAT IN THE UPPER
LEFT CORNER OF THE LETTER "F".

SER. NO. 85-530,511, FILED 2-1-2012.

LINDA M. KING, EXAMINING ATTORNEY



David J. Kyros

Director of the United States Patent and Trademark Office

United States of America

United States Patent and Trademark Office

KONA TOUCH

Reg. No. 4,205,330

Registered Sep. 11, 2012

Int. Cl.: 44

SERVICE MARK

PRINCIPAL REGISTER

MCMURRY, JEANNE D. (UNITED STATES INDIVIDUAL), DBA KONA DESTINATION
P.O. BOX 2914
KAILUA KONA, HI 96745

FOR: AROMATHERAPY SERVICES, IN CLASS 44 (U.S. CLS. 100 AND 101).

FIRST USE 1-30-2012; IN COMMERCE 1-31-2012.

THE MARK CONSISTS OF STANDARD CHARACTERS WITHOUT CLAIM TO ANY PARTICULAR FONT, STYLE, SIZE, OR COLOR.

NO CLAIM IS MADE TO THE EXCLUSIVE RIGHT TO USE "KONA", APART FROM THE MARK AS SHOWN.

SER. NO. 85-530,520, FILED 2-1-2012.

LUCY ARANT, EXAMINING ATTORNEY



David J. Kyffers

Director of the United States Patent and Trademark Office

United States of America

United States Patent and Trademark Office

AI-Dry

Reg. No. 4,205,331

TEX-RAY INDUSTRIAL CO., LTD. (TAIWAN LIMITED LIABILITY COMPANY)
10F, NO. 426, LINSSEN S ROAD
TAIPEI, TAIWAN

Registered Sep. 11, 2012

Int. Cl.: 23

FOR: CHEMICAL FIBER BASE MIXED THREAD AND YARN; CHEMICAL-FIBER THREADS AND YARNS FOR TEXTILE USE; CHENILLE YARN; ELASTIC THREAD; ELASTIC YARN; EMBROIDERY FLOSS; EMBROIDERY THREAD AND YARN; MIXED SPUN THREADS AND YARNS; PLASTIC THREAD FOR TEXTILE USE; REGENERATED FIBER THREAD AND YARN; RUBBER THREAD FOR TEXTILE USE; SEWING THREAD; SILK BASE MIXED THREAD AND YARN; SILK THREADS AND YARNS; SYNTHETIC FIBER THREAD AND YARN; SYNTHETIC THREAD; SYNTHETIC YARN; THREAD; TWISTED THREADS AND YARNS, IN CLASS 23 (U.S. CL. 43).

TRADEMARK

PRINCIPAL REGISTER

FIRST USE 12-9-2011; IN COMMERCE 12-9-2011.

THE MARK CONSISTS OF A STYLIZED WORDING "AI-DRY" WITH TOP PORTION OF THE LETTER "I" SHAPED AS A FLOWER BEING OPEN INTO BLOSSOMS AND STEM OF THE FLOWER SHAPED AS AN ARC SPACED FROM TOP AND TOP LEFT PORTIONS OF THE LETTER "A" AND CONNECTED TO THE TRANSVERSE PORTION OF THE LETTER "A".

SER. NO. 85-530,527, FILED 2-1-2012.

LEIGH CAROLINE CASE, EXAMINING ATTORNEY



David J. Kybas

Director of the United States Patent and Trademark Office

United States of America
United States Patent and Trademark Office

OPHIRAIN

Reg. No. 4,205,332

Registered Sep. 11, 2012

Int. Cl.: 18

TRADEMARK

PRINCIPAL REGISTER

ARANDEZ, JENNIFER JOYCE TAN (UNITED STATES INDIVIDUAL), FORMERLY TAN,
JENNIFER JOYCE FACTOR
5 MAREMMA LANE
LADERA RANCH, CA 92694

FOR: ATTACHE CASES MADE OF LEATHER; BRIEFCASES; LEATHER BAGS AND
WALLETS; LEATHER BAGS, SUITCASES AND WALLETS; LEATHER BRIEFCASES;
LEATHER CASES FOR KEYS; LEATHER CREDIT CARD CASES; LEATHER CREDIT CARD
HOLDER; LEATHER CREDIT CARD WALLETS; LEATHER HANDBAGS; LEATHER KEY
CASES; LEATHER KEY CHAINS; LEATHER POUCHES; LEATHER PURSES; LEATHER
SHOPPING BAGS; LEATHER SHOULDER BELTS; LEATHER STRAPS; THONGS; WALLETS
MADE OF LEATHER OR OTHER MATERIALS, IN CLASS 18 (U.S. CLS. 1, 2, 3, 22 AND 41).

FIRST USE 1-15-2012; IN COMMERCE 1-15-2012.

THE MARK CONSISTS OF STANDARD CHARACTERS WITHOUT CLAIM TO ANY PAR-
TICULAR FONT, STYLE, SIZE, OR COLOR.

SER. NO. 85-530,541, FILED 2-1-2012.

ANDREA K. NADELMAN, EXAMINING ATTORNEY



David J. Kyffers

Director of the United States Patent and Trademark Office

United States of America

United States Patent and Trademark Office

Conversations with the Board

Reg. No. 4,205,333

Registered Sep. 11, 2012

Int. Cl.: 41

SERVICE MARK

PRINCIPAL REGISTER

HOWARD & O'BRIEN ASSOCIATES, INC. (OHIO CORPORATION)
SUITE 100
29525 CHAGRIN BLVD.
CLEVELAND, OH 44122

FOR: CONDUCTING SPEAKING SERIES THAT HELPS PROMOTE FEMALE INCLUSION ON BOARDS OF DIRECTORS AND ADVISORY PANELS FOR PUBLICLY TRADED AND PRIVATE COMPANIES , IN CLASS 41 (U.S. CLS. 100, 101 AND 107).

FIRST USE 12-1-2004; IN COMMERCE 12-1-2004.

THE MARK CONSISTS OF STANDARD CHARACTERS WITHOUT CLAIM TO ANY PARTICULAR FONT, STYLE, SIZE, OR COLOR.

SER. NO. 85-530,553, FILED 2-1-2012.

SHAVELL MCPHERSON, EXAMINING ATTORNEY



David J. Kyffers

Director of the United States Patent and Trademark Office

United States of America

United States Patent and Trademark Office

MEDICAL RECOVERY SERVICES

Reg. No. 4,205,334

MEDICAL RECOVERY SERVICES, LLC. (IDAHO LIMITED LIABILITY COMPANY)
P.O. BOX 50731
IDAHO FALLS, ID 83405

Registered Sep. 11, 2012

Int. Cls.: 36 and 45

FOR: COLLECTION AGENCIES; COLLECTION OF DEBTS; DEBT RECOVERY AND COLLECTION AGENCIES, IN CLASS 36 (U.S. CLS. 100, 101 AND 102).

SERVICE MARK

FIRST USE 9-23-2003; IN COMMERCE 9-23-2003.

PRINCIPAL REGISTER

FOR: LEGAL SERVICES, IN CLASS 45 (U.S. CLS. 100 AND 101).

FIRST USE 9-23-2003; IN COMMERCE 9-23-2003.

THE MARK CONSISTS OF STANDARD CHARACTERS WITHOUT CLAIM TO ANY PARTICULAR FONT, STYLE, SIZE, OR COLOR.

OWNER OF U.S. REG. NO. 3,143,758.

NO CLAIM IS MADE TO THE EXCLUSIVE RIGHT TO USE "RECOVERY SERVICES", APART FROM THE MARK AS SHOWN.

SEC. 2(F).

SER. NO. 85-530,586, FILED 2-1-2012.

WILLIAM P. SHANAHAN, EXAMINING ATTORNEY



David J. Kyffers

Director of the United States Patent and Trademark Office

United States of America

United States Patent and Trademark Office



Reg. No. 4,205,335

AGILEX TECHNOLOGIES, INC. (FLORIDA CORPORATION), DBA AGILEX
5155 PARKSTONE DRIVE
CHANTILLY, VA 20151

Registered Sep. 11, 2012

Int. Cl.: 9

FOR: COMPUTER SOFTWARE FOR ANALYZING STRUCTURED AND UNSTRUCTURED DATA, IN CLASS 9 (U.S. CLS. 21, 23, 26, 36 AND 38).

TRADEMARK

FIRST USE 12-5-2011; IN COMMERCE 12-5-2011.

PRINCIPAL REGISTER

THE MARK CONSISTS OF THE WORDING "PHANERO" SPELLED OUT IN DARK TEAL PRECEDED BY A DOUBLE HELIX WITH NINETY DEGREE ANGLES AND ROUNDED ENDS WITH ONE HELIX IN DARK TEAL, THE OTHER HELIX IN LIGHT TEAL.

THE COLOR(S) DARK TEAL AND LIGHT TEAL IS/ARE CLAIMED AS A FEATURE OF THE MARK.

SER. NO. 85-530,603, FILED 2-1-2012.

MICHAEL WIENER, EXAMINING ATTORNEY



David J. Kybas

Director of the United States Patent and Trademark Office

United States of America

United States Patent and Trademark Office

Financial Sobriety, One Day at a Time

Reg. No. 4,205,336

Registered Sep. 11, 2012

Int. Cl.: 36

SERVICE MARK

PRINCIPAL REGISTER

SOKOLOWSKI, GREGORY (UNITED STATES INDIVIDUAL), DBA DEBTAHOLIC.COM
880 N LAKE SHORE DR APT 25D
CHICAGO, IL 60611

FOR: FINANCIAL COUNSELING SERVICES, NAMELY, HELPING OTHERS BUILD A BETTER WORKING RELATIONSHIP WITH THEIR MONEY; FINANCIAL INFORMATION PROVIDED BY ELECTRONIC MEANS; FINANCIAL SERVICES, NAMELY, CREDIT REPAIR AND RESTORATION; PROVIDING A WEB SITE FEATURING PERSONAL FINANCIAL INFORMATION AND FINANCIAL ADVICE; PROVIDING EMERGENCY FINANCIAL ASSISTANCE FOR INDIVIDUALS AND FAMILIES, IN CLASS 36 (U.S. CLS. 100, 101 AND 102).

FIRST USE 2-1-2012; IN COMMERCE 2-1-2012.

THE MARK CONSISTS OF STANDARD CHARACTERS WITHOUT CLAIM TO ANY PARTICULAR FONT, STYLE, SIZE, OR COLOR.

SER. NO. 85-530,621, FILED 2-1-2012.

LINDA MICKLEBURGH, EXAMINING ATTORNEY



David J. Kyffers

Director of the United States Patent and Trademark Office

United States of America

United States Patent and Trademark Office

Trust Earned. Prudence Employed.

Reg. No. 4,205,337

THE CAPE COD FIVE CENTS SAVINGS BANK (MASSACHUSETTS CHARTERED BANK)
10 WEST ROAD; P.O. BOX 10
ORLEANS, MA 02653

Registered Sep. 11, 2012

Int. Cl.: 36

FOR: FINANCIAL PLANNING AND INVESTMENT ADVISORY SERVICES, IN CLASS 36
(U.S. CLS. 100, 101 AND 102).

SERVICE MARK

FIRST USE 9-1-2004; IN COMMERCE 9-1-2004.

PRINCIPAL REGISTER

THE MARK CONSISTS OF STANDARD CHARACTERS WITHOUT CLAIM TO ANY PAR-
TICULAR FONT, STYLE, SIZE, OR COLOR.

SER. NO. 85-530,639, FILED 2-1-2012.

COLLEEN MULCRONE, EXAMINING ATTORNEY



David J. Kybas

Director of the United States Patent and Trademark Office

United States of America

United States Patent and Trademark Office

Defiantly Independent.
Exceptionally Strong.
Unquestionably Committed.

Reg. No. 4,205,338

THE CAPE COD FIVE CENTS SAVINGS BANK (MASSACHUSETTS CHARTERED BANK)
10 WEST ROAD; PO BOX 10
ORLEANS, MA 02653

Registered Sep. 11, 2012

Int. Cl.: 36

FOR: BANKING AND FINANCING SERVICES, IN CLASS 36 (U.S. CLS. 100, 101 AND 102).

SERVICE MARK

FIRST USE 9-1-2004; IN COMMERCE 9-1-2004.

PRINCIPAL REGISTER

THE MARK CONSISTS OF STANDARD CHARACTERS WITHOUT CLAIM TO ANY PARTICULAR FONT, STYLE, SIZE, OR COLOR.

SER. NO. 85-530,653, FILED 2-1-2012.

COLLEEN MULCRONE, EXAMINING ATTORNEY



David J. Kybas

Director of the United States Patent and Trademark Office

United States of America
United States Patent and Trademark Office

EASTON

Reg. No. 4,205,339

Registered Sep. 11, 2012

Int. Cls.: 36 and 37

SERVICE MARK

PRINCIPAL REGISTER

LIMITED BRANDS SERVICE COMPANY, LLC (DELAWARE LIMITED LIABILITY COMPANY)
3 LIMITED PARKWAY
COLUMBUS, OH 43230

FOR: REAL ESTATE SERVICES, NAMELY, RENTAL, BROKERAGE, LEASING AND MANAGEMENT OF COMMERCIAL PROPERTY, OFFICES AND OFFICE SPACE; LEASING OF SHOPPING MALL SPACE, IN CLASS 36 (U.S. CLS. 100, 101 AND 102).

FIRST USE 6-30-1999; IN COMMERCE 6-30-1999.

FOR: REAL ESTATE DEVELOPMENT AND CONSTRUCTION OF COMMERCIAL, RESIDENTIAL AND HOTEL PROPERTIES, IN CLASS 37 (U.S. CLS. 100, 103 AND 106).

FIRST USE 6-30-1999; IN COMMERCE 6-30-1999.

THE MARK CONSISTS OF STANDARD CHARACTERS WITHOUT CLAIM TO ANY PARTICULAR FONT, STYLE, SIZE, OR COLOR.

SER. NO. 85-530,662, FILED 2-1-2012.

HANNO RITTNER, EXAMINING ATTORNEY



David J. Kybas

Director of the United States Patent and Trademark Office

United States of America

United States Patent and Trademark Office

TheraBlessing

Reg. No. 4,205,340

SKYLYNCO LLC (OKLAHOMA LIMITED LIABILITY COMPANY)
20914 E RANCH LN

Registered Sep. 11, 2012

BLANCHARD, OK 73010

Int. Cl.: 10

FOR: THERAPEUTIC HOT AND COLD THERAPY PACKS, IN CLASS 10 (U.S. CLS. 26, 39 AND 44).

TRADEMARK

FIRST USE 1-8-2012; IN COMMERCE 1-8-2012.

PRINCIPAL REGISTER

THE MARK CONSISTS OF STANDARD CHARACTERS WITHOUT CLAIM TO ANY PARTICULAR FONT, STYLE, SIZE, OR COLOR.

SER. NO. 85-530,691, FILED 2-1-2012.

MIDGE BUTLER, EXAMINING ATTORNEY



David J. Kyffers

Director of the United States Patent and Trademark Office

United States of America

United States Patent and Trademark Office

RE : DESIGN

Reg. No. 4,205,341

ABLE TREE, INC. (OREGON CORPORATION)
5200 SW MEADOWS RD, SUITE 150
LAKE OSWEGO, OR 97035

Registered Sep. 11, 2012

Int. Cl.: 10

FOR: DENTAL PROSTHESES, IN CLASS 10 (U.S. CLS. 26, 39 AND 44).

TRADEMARK

FIRST USE 1-31-2012; IN COMMERCE 1-31-2012.

PRINCIPAL REGISTER

THE MARK CONSISTS OF STANDARD CHARACTERS WITHOUT CLAIM TO ANY PARTICULAR FONT, STYLE, SIZE, OR COLOR.

SER. NO. 85-530,694, FILED 2-1-2012.

PAM WILLIS, EXAMINING ATTORNEY



David J. Kyffers

Director of the United States Patent and Trademark Office

United States of America

United States Patent and Trademark Office

PAD

Reg. No. 4,205,342

Registered Sep. 11, 2012

Int. Cls.: 16 and 41

TRADEMARK

SERVICE MARK

PRINCIPAL REGISTER

SOC (FRANCE SOCIÉTÉ À RESPONSABILITÉ LIMITÉE (SARL))
102, RUE DU FAUBOURG SAINT HONORÉ
PARIS, FRANCE 75008

FOR: PRINTED MATTER, NAMELY, PAPER SIGNS, BOOKS, MANUALS, CURRICULUM, NEWSLETTERS, INFORMATIONAL CARDS AND BROCHURES IN THE FIELD OF CULTURAL MATTERS, IN CLASS 16 (U.S. CLS. 2, 5, 22, 23, 29, 37, 38 AND 50).

FIRST USE 11-7-2011; IN COMMERCE 11-7-2011.

FOR: ORGANIZATION OF CULTURAL SHOWS; ORGANIZATION OF EXHIBITIONS FOR CULTURAL OR EDUCATIONAL PURPOSES, IN CLASS 41 (U.S. CLS. 100, 101 AND 107).

FIRST USE 11-7-2011; IN COMMERCE 11-7-2011.

THE MARK CONSISTS OF STANDARD CHARACTERS WITHOUT CLAIM TO ANY PARTICULAR FONT, STYLE, SIZE, OR COLOR.

SER. NO. 85-530,705, FILED 2-1-2012.

LINDA MICKLEBURGH, EXAMINING ATTORNEY



David J. Kyjars

Director of the United States Patent and Trademark Office

United States of America

United States Patent and Trademark Office

NOTESTREAM

Reg. No. 4,205,343

FLORIDALEA HOLDINGS (LOUISIANA LIMITED LIABILITY COMPANY)
13521 RD. 520

Registered Sep. 11, 2012

SAUCIER, MS 39574

Int. Cl.: 42

FOR: SOFTWARE AS A SERVICE (SAAS) SERVICES FEATURING SOFTWARE FOR SHARING DOCUMENTS WITH PROFESSIONALS, IN CLASS 42 (U.S. CLS. 100 AND 101).

SERVICE MARK

FIRST USE 7-21-2011; IN COMMERCE 7-21-2011.

PRINCIPAL REGISTER

THE MARK CONSISTS OF STANDARD CHARACTERS WITHOUT CLAIM TO ANY PARTICULAR FONT, STYLE, SIZE, OR COLOR.

SER. NO. 85-530,707, FILED 2-1-2012.

INGA ERVIN, EXAMINING ATTORNEY



David J. Kyffers

Director of the United States Patent and Trademark Office

United States of America

United States Patent and Trademark Office



Reg. No. 4,205,344

MUSICIAN AUDITION, LLC (ARIZONA LIMITED LIABILITY COMPANY)
9304 E. VERDE GROVE VIEW
SCOTTSDALE, AZ 85255

Registered Sep. 11, 2012

Int. Cl.: 42

FOR: PROVIDING A WEBSITE THAT GIVES COMPUTER USERS THE ABILITY TO POST AND RETRIEVE CLASSIFIED LISTINGS, DATA, MESSAGES, IMAGES, MUSIC, VIDEO, AND INFORMATION RELATING TO MUSICIANS, MUSICAL COLLABORATIONS, AND MUSICAL EVENTS, IN CLASS 42 (U.S. CLS. 100 AND 101).

SERVICE MARK

PRINCIPAL REGISTER

FIRST USE 10-24-2011; IN COMMERCE 10-24-2011.

THE MARK CONSISTS OF TWO MUSIC NOTES CONNECTED TOGETHER TO FORM THE LETTER "M," THE MUSIC NOTE ON THE RIGHT BEING LARGER THAN THE MUSIC NOTE ON THE LEFT TO GIVE THE IMPRESSION OF PERSPECTIVE.

SER. NO. 85-530,711, FILED 2-1-2012.

CAROLINE WOOD, EXAMINING ATTORNEY



David J. Kybas

Director of the United States Patent and Trademark Office

United States of America

United States Patent and Trademark Office

PAD

Reg. No. 4,205,345

Registered Sep. 11, 2012

Int. Cls.: 16 and 41

TRADEMARK

SERVICE MARK

PRINCIPAL REGISTER

SOC (FRANCE SOCIÉTÉ À RESPONSABILITÉ LIMITÉE (SARL))
102, RUE DU FAUBOURG SAINT HONORÉ
PARIS, FRANCE 75008

FOR: PRINTED MATTER, NAMELY, NEWSPAPERS, PHOTOGRAPHS, MAGAZINES, BOOKS, PRINTED PERIODICALS, NEWSLETTERS, AND BROCHURES ALL IN THE FIELDS OF SECURITIES, OPTIONS AND OTHER FINANCIAL INSTRUMENTS, IN CLASS 16 (U.S. CLS. 2, 5, 22, 23, 29, 37, 38 AND 50).

FIRST USE 11-7-2011; IN COMMERCE 11-7-2011.

FOR: ORGANIZATION OF CULTURAL SHOWS; ORGANIZING EXHIBITIONS FOR CULTURAL PURPOSES, IN CLASS 41 (U.S. CLS. 100, 101 AND 107).

FIRST USE 11-7-2011; IN COMMERCE 11-7-2011.

THE MARK CONSISTS OF THE LITERAL ELEMENT "PAD" IN A SANS-SERIF FONT IN THE COLOR ORANGE.

THE COLOR(S) ORANGE IS/ARE CLAIMED AS A FEATURE OF THE MARK.

SER. NO. 85-530,723, FILED 2-1-2012.

LINDA MICKLEBURGH, EXAMINING ATTORNEY



David J. Kyros

Director of the United States Patent and Trademark Office

United States of America

United States Patent and Trademark Office

FIERCE FORCE

Reg. No. 4,205,346

Registered Sep. 11, 2012

Int. Cl.: 41

SERVICE MARK

PRINCIPAL REGISTER

NEXT LEVEL FITNESS, INC. (MINNESOTA CORPORATION)
6255 FALLBROOK ROAD
EDEN PRAIRIE, MN 55344

FOR: PROVIDING PHYSICAL FITNESS CLASSES, IN CLASS 41 (U.S. CLS. 100, 101 AND 107).

FIRST USE 12-1-2011; IN COMMERCE 12-1-2011.

THE MARK CONSISTS OF STANDARD CHARACTERS WITHOUT CLAIM TO ANY PARTICULAR FONT, STYLE, SIZE, OR COLOR.

OWNER OF U.S. REG. NOS. 3,221,909, 3,650,881 AND OTHERS.

SER. NO. 85-530,726, FILED 2-1-2012.

AMY ALFIERI, EXAMINING ATTORNEY



David J. Kybas

Director of the United States Patent and Trademark Office

United States of America

United States Patent and Trademark Office



Reg. No. 4,205,347

Registered Sep. 11, 2012

Int. Cls.: 16 and 41

TRADEMARK

SERVICE MARK

PRINCIPAL REGISTER

SOC (FRANCE SOCIÉTÉ À RESPONSABILITÉ LIMITÉE (SARL))
102, RUE DU FAUBOURG SAINT HONORÉ
PARIS, FRANCE 75008

FOR: PRINTED MATTER, NAMELY, PAPER SIGNS, BOOKS, MANUALS, CURRICULUM, NEWSLETTERS, INFORMATIONAL CARDS AND BROCHURES IN THE FIELD OF CULTURAL MATTERS, IN CLASS 16 (U.S. CLS. 2, 5, 22, 23, 29, 37, 38 AND 50).

FIRST USE 11-7-2011; IN COMMERCE 11-7-2011.

FOR: ORGANIZATION OF CULTURAL SHOWS; ORGANIZING EXHIBITIONS FOR CULTURAL PURPOSES, IN CLASS 41 (U.S. CLS. 100, 101 AND 107).

FIRST USE 11-7-2011; IN COMMERCE 11-7-2011.

THE MARK CONSISTS OF THE LITERAL ELEMENT "PAD" IN WHITE AND A SANS-SERIF FONT AGAINST AN ORANGE BACKGROUND.

THE COLOR(S) ORANGE AND WHITE IS/ARE CLAIMED AS A FEATURE OF THE MARK.

SER. NO. 85-530,727, FILED 2-1-2012.

LINDA MICKLEBURGH, EXAMINING ATTORNEY



David J. Kybas

Director of the United States Patent and Trademark Office

United States of America

United States Patent and Trademark Office



Reg. No. 4,205,348

FLORIDALEA HOLDINGS (LOUISIANA LIMITED LIABILITY COMPANY)
16521 RD. 520

Registered Sep. 11, 2012

SAUCIER, MS 39574

Int. Cl.: 42

FOR: SOFTWARE AS A SERVICE (SAAS) SERVICES FEATURING SOFTWARE FOR SHARING DOCUMENTS WITH PROFESSIONALS, IN CLASS 42 (U.S. CLS. 100 AND 101).

SERVICE MARK

FIRST USE 7-21-2011; IN COMMERCE 7-21-2011.

PRINCIPAL REGISTER

THE MARK CONSISTS OF THE STYLIZED TERMS "NOTESTREAMER" THE TERM "NOTE" IS IN BLUE, AND THE TERM "STREAMER" IS IN ORANGE. THE "S" IN "STREAMER" IS CAPITALIZED. NEXT TO THE TERMS IS A STYLIZED DESIGN OF A ROUNDED SQUARE THAT FADES FROM DARK BLUE AT THE BOTTOM TO BLUE AT THE TOP. WITHIN THE SQUARE IS A CURVED ARROW AND A LIGHT BLUE CLOUD. ABOVE THE TERMS IS AN EXTENDED LINE THAT FADES FROM PURPLE TO LIGHT BLUE AT THE END IS AN ARROW.

THE COLOR(S) DARK BLUE, BLUE, LIGHT BLUE, PURPLE AND ORANGE IS/ARE CLAIMED AS A FEATURE OF THE MARK.

SER. NO. 85-530,729, FILED 2-1-2012.

INGA ERVIN, EXAMINING ATTORNEY



David J. Kybas

Director of the United States Patent and Trademark Office

United States of America

United States Patent and Trademark Office

HATCHLATCH

Reg. No. 4,205,349

CURIO, LTD. (TEXAS LIMITED LIABILITY COMPANY)
7710 TRINITY BLVD.

Registered Sep. 11, 2012

FORT WORTH, TX 76118

Int. Cl.: 9

FOR: ELECTRO-MECHANICAL LOCK TO RESTRICT AND LOCK DOOR ON ELEVATOR CAB OPENINGS, IN CLASS 9 (U.S. CLS. 21, 23, 26, 36 AND 38).

TRADEMARK

FIRST USE 1-0-1997; IN COMMERCE 1-0-1997.

PRINCIPAL REGISTER

THE MARK CONSISTS OF STANDARD CHARACTERS WITHOUT CLAIM TO ANY PARTICULAR FONT, STYLE, SIZE, OR COLOR.

SER. NO. 85-530,749, FILED 2-1-2012.

CHRISTOPHER BUONGIORNO, EXAMINING ATTORNEY



David J. Kybas

Director of the United States Patent and Trademark Office

United States of America

United States Patent and Trademark Office

TO GIVE EVERY DAY IS LIVING

Reg. No. 4,205,350

STELUJAN ENTERPRISES, LLC (SOUTH CAROLINA LIMITED LIABILITY COMPANY)
P.O. BOX 7784

Registered Sep. 11, 2012

MYRTLE BEACH, SC 29572

Int. Cl.: 35

FOR: CHARITABLE SERVICES, NAMELY, ORGANIZING AND CONDUCTING VOLUNTEER PROGRAMS AND COMMUNITY SERVICE PROJECTS, IN CLASS 35 (U.S. CLS. 100, 101 AND 102).

SERVICE MARK

FIRST USE 10-31-2011; IN COMMERCE 10-31-2011.

PRINCIPAL REGISTER

THE MARK CONSISTS OF STANDARD CHARACTERS WITHOUT CLAIM TO ANY PARTICULAR FONT, STYLE, SIZE, OR COLOR.

SER. NO. 85-530,763, FILED 2-1-2012.

NICHOLAS ALTREE, EXAMINING ATTORNEY



David J. Kyffers

Director of the United States Patent and Trademark Office

United States of America
United States Patent and Trademark Office

TOOBZ

Reg. No. 4,205,351

CARSON OPTICAL (NEW YORK CORPORATION)
35 GILPIN AVENUE
HAUPPAUGE, NY 11788

Registered Sep. 11, 2012

Int. Cl.: 9

FOR: EYEGLOSS RETAINERS, IN CLASS 9 (U.S. CLS. 21, 23, 26, 36 AND 38).

TRADEMARK

FIRST USE 1-10-2012; IN COMMERCE 1-10-2012.

PRINCIPAL REGISTER

THE MARK CONSISTS OF THE STYLIZED WORDING "TOOBZ".

SER. NO. 85-530,776, FILED 2-1-2012.

EVELYN BRADLEY, EXAMINING ATTORNEY



David J. Kybas

Director of the United States Patent and Trademark Office

United States of America

United States Patent and Trademark Office

Giving Back in Style

Reg. No. 4,205,352

Registered Sep. 11, 2012

Int. Cl.: 35

SERVICE MARK

PRINCIPAL REGISTER

SILPADA DESIGNS LLC (DELAWARE LIMITED LIABILITY COMPANY)
ATTN: LORA WILLIAMS
11550 RENNER BLVD.
LENEXA, KS 66219

FOR: PRODUCT MERCHANDISING; RETAIL SERVICES BY DIRECT SOLICITATION BY SALES AGENTS, SHOP AT HOME PARTIES, TELEPHONE ORDERING SERVICES, MAIL ORDER CATALOG SERVICES, AND ON-LINE ORDERING SERVICES, ALL FEATURING JEWELRY, GIFT ITEMS, HANDBAGS, WATCHES, BELTS AND OTHER FASHION ACCESSORIES; DIRECT SALES ORGANIZATION AND PLANNING, NAMELY, OFFERING BUSINESS MANAGEMENT ASSISTANCE IN THE ESTABLISHMENT AND/OR OPERATION OF A RETAIL HOME PARTY BUSINESS; ADMINISTRATION OF AN INCENTIVE AWARDS PROGRAM TO PROMOTE THE SALE OF PRODUCTS OF OTHERS, IN CLASS 35 (U.S. CLS. 100, 101 AND 102).

FIRST USE 8-1-2011; IN COMMERCE 11-1-2011.

THE MARK CONSISTS OF STANDARD CHARACTERS WITHOUT CLAIM TO ANY PARTICULAR FONT, STYLE, SIZE, OR COLOR.

SER. NO. 85-530,787, FILED 2-1-2012.

MATTHEW EINSTEIN, EXAMINING ATTORNEY



David J. Kypos

Director of the United States Patent and Trademark Office

United States of America

United States Patent and Trademark Office

TORY BURCH

Reg. No. 4,205,353

RIVER LIGHT V, L.P. (DELAWARE LIMITED PARTNERSHIP)
11 WEST 19TH STREET, 7TH FLOOR
NEW YORK, NY 10011

Registered Sep. 11, 2012

Int. Cl.: 18

FOR: BACKPACKS; BEACH BAGS; BUSINESS CARD CASES; COIN PURSES; DOG COLLARS; DOG LEASHES; OVERNIGHT BAGS; PET CLOTHING; WALLETS; WRISTLET BAGS, IN CLASS 18 (U.S. CLS. 1, 2, 3, 22 AND 41).

TRADEMARK

FIRST USE 10-31-2008; IN COMMERCE 10-31-2008.

PRINCIPAL REGISTER

THE MARK CONSISTS OF STANDARD CHARACTERS WITHOUT CLAIM TO ANY PARTICULAR FONT, STYLE, SIZE, OR COLOR.

OWNER OF U.S. REG. NOS. 3,428,373, 3,428,816 AND OTHERS.

THE NAME(S), PORTRAIT(S), AND/OR SIGNATURE(S) SHOWN IN THE MARK IDENTIFIES "TORY BURCH", WHOSE CONSENT(S) TO REGISTER IS MADE OF RECORD.

SER. NO. 85-530,794, FILED 2-1-2012.

SUE LAWRENCE, EXAMINING ATTORNEY



David J. Kyros

Director of the United States Patent and Trademark Office

United States of America

United States Patent and Trademark Office

TORY BURCH

Reg. No. 4,205,354

RIVER LIGHT V, L.P. (DELAWARE LIMITED PARTNERSHIP)
11 WEST 19TH STREET, 7TH FLOOR
NEW YORK, NY 10011

Registered Sep. 11, 2012

Int. Cl.: 9

FOR: CELL PHONE CASES; LEATHER PROTECTIVE COVERS SPECIALLY ADAPTED FOR PERSONAL ELECTRONIC DEVICES; PROTECTIVE COVERS AND CASES FOR CELL PHONES, LAPTOPS AND PORTABLE MEDIA PLAYERS, IN CLASS 9 (U.S. CLS. 21, 23, 26, 36 AND 38).

TRADEMARK

PRINCIPAL REGISTER

FIRST USE 10-31-2009; IN COMMERCE 10-31-2009.

THE MARK CONSISTS OF STANDARD CHARACTERS WITHOUT CLAIM TO ANY PARTICULAR FONT, STYLE, SIZE, OR COLOR.

OWNER OF U.S. REG. NOS. 3,428,373, 3,428,816 AND OTHERS.

THE NAME(S), PORTRAIT(S), AND/OR SIGNATURE(S) SHOWN IN THE MARK IDENTIFIES "TORY BURCH", WHOSE CONSENT(S) TO REGISTER IS MADE OF RECORD.

SER. NO. 85-530,798, FILED 2-1-2012.

SUE LAWRENCE, EXAMINING ATTORNEY



David J. Kyros

Director of the United States Patent and Trademark Office

United States of America

United States Patent and Trademark Office

CMSA Today

Reg. No. 4,205,355

CASE MANAGEMENT SOCIETY OF AMERICA, INC. (D.C. NON-PROFIT CORPORATION)
6301 RANCH DR.

Registered Sep. 11, 2012

LITTLE ROCK, AR 72223

Int. Cls.: 9 and 16

FOR: DOWNLOADABLE ELECTRONIC PUBLICATIONS IN THE NATURE OF MAGAZINES
IN THE FIELD OF HEALTH CARE CASE MANAGEMENT , IN CLASS 9 (U.S. CLS. 21, 23,
26, 36 AND 38).

TRADEMARK

FIRST USE 5-19-2011; IN COMMERCE 5-19-2011.

PRINCIPAL REGISTER

FOR: MAGAZINES IN THE FIELD OF HEALTH CARE CASE MANAGEMENT, IN CLASS
16 (U.S. CLS. 2, 5, 22, 23, 29, 37, 38 AND 50).

FIRST USE 6-14-2011; IN COMMERCE 6-14-2011.

THE MARK CONSISTS OF STANDARD CHARACTERS WITHOUT CLAIM TO ANY PAR-
TICULAR FONT, STYLE, SIZE, OR COLOR.

OWNER OF U.S. REG. NOS. 2,087,728 AND 2,106,882.

SER. NO. 85-530,811, FILED 2-1-2012.

WILLIAM JACKSON, EXAMINING ATTORNEY



David J. Kyjars

Director of the United States Patent and Trademark Office

United States of America

United States Patent and Trademark Office

ADVANTAGE

Reg. No. 4,205,356

UL LLC (DELAWARE LIMITED LIABILITY COMPANY)
333 PFINGSTEN ROAD
NORTHBROOK, IL 600622096

Registered Sep. 11, 2012

Int. Cl.: 42

FOR: TESTING, ANALYSIS AND EVALUATION OF THE GOODS OF OTHERS FOR THE PURPOSE OF CERTIFICATION, IN CLASS 42 (U.S. CLS. 100 AND 101).

SERVICE MARK

FIRST USE 12-0-2011; IN COMMERCE 12-0-2011.

PRINCIPAL REGISTER

THE MARK CONSISTS OF STANDARD CHARACTERS WITHOUT CLAIM TO ANY PARTICULAR FONT, STYLE, SIZE, OR COLOR.

SER. NO. 85-530,831, FILED 2-1-2012.

JAMES LOVELACE, EXAMINING ATTORNEY



David J. Kyffers

Director of the United States Patent and Trademark Office

United States of America

United States Patent and Trademark Office

LegalSync

Reg. No. 4,205,357

LEGAL SYNC INC. (FLORIDA CORPORATION)
1000 BRICKELL AVENUE, SUITE 920
MIAMI, FL 33131

Registered Sep. 11, 2012

Int. Cls.: 35 and 45

FOR: BUSINESS ADVISORY SERVICES, CONSULTANCY AND INFORMATION; NEW BUSINESS VENTURE DEVELOPMENT AND FORMATION CONSULTING SERVICES, IN CLASS 35 (U.S. CLS. 100, 101 AND 102).

SERVICE MARK

FIRST USE 1-31-2012; IN COMMERCE 1-31-2012.

PRINCIPAL REGISTER

FOR: LEGAL DOCUMENT PREPARATION AND RESEARCH SERVICES FOR ATTORNEYS; LEGAL SERVICES, IN CLASS 45 (U.S. CLS. 100 AND 101).

FIRST USE 1-31-2012; IN COMMERCE 1-31-2012.

THE MARK CONSISTS OF STANDARD CHARACTERS WITHOUT CLAIM TO ANY PARTICULAR FONT, STYLE, SIZE, OR COLOR.

SER. NO. 85-530,833, FILED 2-1-2012.

KELLY BOULTON, EXAMINING ATTORNEY



David J. Kybas

Director of the United States Patent and Trademark Office

United States of America

United States Patent and Trademark Office

Variable Pop

Reg. No. 4,205,358

DANCES FOR A VARIABLE POPULATION, INC. (NEW YORK CORPORATION)
560 RIVERSIDE DRIVE APARTMENT 9K
NEW YORK, NY 10027

Registered Sep. 11, 2012

Int. Cl.: 41

FOR: DANCE CLASSES AND WORKSHOPS FOR PERSONS OF ALL AGES AND ABILITIES,
IN CLASS 41 (U.S. CLS. 100, 101 AND 107).

SERVICE MARK

FIRST USE 9-30-2009; IN COMMERCE 9-30-2009.

PRINCIPAL REGISTER

THE MARK CONSISTS OF STANDARD CHARACTERS WITHOUT CLAIM TO ANY PAR-
TICULAR FONT, STYLE, SIZE, OR COLOR.

SER. NO. 85-530,835, FILED 2-1-2012.

FRED CARL, EXAMINING ATTORNEY



David J. Kyffers

Director of the United States Patent and Trademark Office

United States of America

United States Patent and Trademark Office

BAR JAR

Reg. No. 4,205,359

Registered Sep. 11, 2012

Int. Cls.: 32 and 33

TRADEMARK

PRINCIPAL REGISTER

QSL INTELLECTUAL PROPERTIES CORP. (DELAWARE CORPORATION)
101 CHESTNUT STREET
SHARON, PA 16146

FOR: BEER AND SOFT DRINKS, IN CLASS 32 (U.S. CLS. 45, 46 AND 48).

FIRST USE 4-19-2011; IN COMMERCE 4-19-2011.

FOR: ALCOHOLIC BEVERAGES EXCEPT BEERS , IN CLASS 33 (U.S. CLS. 47 AND 49).

FIRST USE 4-19-2011; IN COMMERCE 4-19-2011.

THE MARK CONSISTS OF STANDARD CHARACTERS WITHOUT CLAIM TO ANY PARTICULAR FONT, STYLE, SIZE, OR COLOR.

SER. NO. 85-530,836, FILED 2-1-2012.

KELLY BOULTON, EXAMINING ATTORNEY



David J. Kybas

Director of the United States Patent and Trademark Office

United States of America

United States Patent and Trademark Office

IBEC

Reg. No. 4,205,360

Registered Sep. 11, 2012

Int. Cl.: 41

SERVICE MARK

PRINCIPAL REGISTER

IBEC LANGUAGE INSTITUTE, INC. (NEW YORK CORPORATION)
369 LEXINGTON AVENUE, SUITE 300
NEW YORK, NY 10017

FOR: LANGUAGE INSTRUCTION, IN CLASS 41 (U.S. CLS. 100, 101 AND 107).

FIRST USE 5-1-1994; IN COMMERCE 5-1-1994.

THE MARK CONSISTS OF STANDARD CHARACTERS WITHOUT CLAIM TO ANY PARTICULAR FONT, STYLE, SIZE, OR COLOR.

SER. NO. 85-530,844, FILED 2-1-2012.

MARY CRAWFORD, EXAMINING ATTORNEY



David J. Kyffers

Director of the United States Patent and Trademark Office

United States of America

United States Patent and Trademark Office

Articulated Brands

Reg. No. 4,205,361

ARTICULATED BRANDS (CALIFORNIA SOLE PROPRIETORSHIP)

Registered Sep. 11, 2012

11967 IOWA AVENUE #1
LOS ANGELES, CA 90025

Int. Cl.: 35

FOR: ADVERTISING AND MARKETING SERVICES, NAMELY, PROMOTING THE GOODS AND SERVICES OF OTHERS; ADVERTISING SERVICES, IN CLASS 35 (U.S. CLS. 100, 101 AND 102).

SERVICE MARK

FIRST USE 2-17-2008; IN COMMERCE 2-17-2008.

PRINCIPAL REGISTER

THE MARK CONSISTS OF STANDARD CHARACTERS WITHOUT CLAIM TO ANY PARTICULAR FONT, STYLE, SIZE, OR COLOR.

NO CLAIM IS MADE TO THE EXCLUSIVE RIGHT TO USE "BRANDS", APART FROM THE MARK AS SHOWN.

SER. NO. 85-530,852, FILED 2-1-2012.

REBECCA SMITH, EXAMINING ATTORNEY



David J. Kyffers

Director of the United States Patent and Trademark Office

United States of America

United States Patent and Trademark Office

Stretch the Fish

Reg. No. 4,205,362

Registered Sep. 11, 2012

Int. Cl.: 9

TRADEMARK

PRINCIPAL REGISTER

STRETCH THE FISH (WYOMING LIMITED LIABILITY COMPANY)
1621 CENTRAL AVENUE
CHEYENNE, WY 82001

FOR: TAPE MEASURES, IN CLASS 9 (U.S. CLS. 21, 23, 26, 36 AND 38).

FIRST USE 12-30-2011; IN COMMERCE 12-30-2011.

THE MARK CONSISTS OF STANDARD CHARACTERS WITHOUT CLAIM TO ANY PARTICULAR FONT, STYLE, SIZE, OR COLOR.

SER. NO. 85-530,855, FILED 2-1-2012.

ELLEN PERKINS, EXAMINING ATTORNEY



David J. Kyffers

Director of the United States Patent and Trademark Office

United States of America

United States Patent and Trademark Office

LEGION OF THE DAMNED

Reg. No. 4,205,363

DIETZ, WILLIAM C. (UNITED STATES INDIVIDUAL)
901 FIFTH AVENUE, SUITE 4100
SEATTLE, WA 98164

Registered Sep. 11, 2012

Int. Cls.: 9 and 16

FOR: VIDEO GAMES FOR MOBILE DEVICES, PERSONAL COMPUTERS, AND TABLETS,
IN CLASS 9 (U.S. CLS. 21, 23, 26, 36 AND 38).

TRADEMARK

FIRST USE 12-15-2011; IN COMMERCE 12-15-2011.

PRINCIPAL REGISTER

FOR: SERIES OF FICTION BOOKS, IN CLASS 16 (U.S. CLS. 2, 5, 22, 23, 29, 37, 38 AND 50).

FIRST USE 8-0-1993; IN COMMERCE 8-0-1993.

THE MARK CONSISTS OF STANDARD CHARACTERS WITHOUT CLAIM TO ANY PARTICULAR FONT, STYLE, SIZE, OR COLOR.

SER. NO. 85-530,876, FILED 2-1-2012.

NATALIE POLZER, EXAMINING ATTORNEY



David J. Kybas

Director of the United States Patent and Trademark Office

United States of America

United States Patent and Trademark Office

WHAT'S YOUR STUFF WORTH?

Reg. No. 4,205,364

ALLSTATE INSURANCE COMPANY (ILLINOIS CORPORATION)
ALLSTATE PLAZA
NORTHBROOK, IL 60062

Registered Sep. 11, 2012

Int. Cl.: 42

FOR: PROVIDING TEMPORARY USE OF ON-LINE NON-DOWNLOADABLE SOFTWARE APPLICATION FOR ESTIMATING THE VALUE OF PERSONAL PROPERTY AND ILLUSTRATING THE VALUE OF RENTER'S INSURANCE IN THE FIELD OF INSURANCE, IN CLASS 42 (U.S. CLS. 100 AND 101).

SERVICE MARK

PRINCIPAL REGISTER

FIRST USE 11-8-2011; IN COMMERCE 11-8-2011.

THE MARK CONSISTS OF STANDARD CHARACTERS WITHOUT CLAIM TO ANY PARTICULAR FONT, STYLE, SIZE, OR COLOR.

SER. NO. 85-530,887, FILED 2-1-2012.

ZACHARY BELLO, EXAMINING ATTORNEY



David J. Kyffers

Director of the United States Patent and Trademark Office

United States of America
United States Patent and Trademark Office

POWERJET

Reg. No. 4,205,365

Registered Sep. 11, 2012

Int. Cl.: 14

TRADEMARK

PRINCIPAL REGISTER

OKO INTERNATIONAL CO. (FLORIDA CORPORATION)
336 S. POWERLINE RD.
DEERFIELD BEACH, FL 33442

FOR: TIMEPIECES, IN CLASS 14 (U.S. CLS. 2, 27, 28 AND 50).

FIRST USE 9-29-2011; IN COMMERCE 9-29-2011.

THE MARK CONSISTS OF STANDARD CHARACTERS WITHOUT CLAIM TO ANY PARTICULAR FONT, STYLE, SIZE, OR COLOR.

SER. NO. 85-530,888, FILED 2-1-2012.

JORDAN BAKER, EXAMINING ATTORNEY



David J. Kyffers

Director of the United States Patent and Trademark Office

United States of America

United States Patent and Trademark Office

Safety Whips

Reg. No. 4,205,366

SAFETYWHIPS.COM LLC (ARIZONA LIMITED LIABILITY COMPANY)
2115 W. MOUNTAIN VIEW ROAD
PHOENIX, AZ 85021

Registered Sep. 11, 2012

Int. Cl.: 20

FOR: FLAGPOLES AND PLASTIC FLAGS AND ACCESSORIES FOR FLAGS AND FLAG-
POLES SOLD TOGETHER AS A UNIT, NAMELY, RODS, ROD SUPPORTS AND COUPLERS,
CONNECTORS, PINS, BRACKETS, CLAMPS, FASTENERS, NUTS AND BOLTS, AND POLE
SUPPORTS, IN CLASS 20 (U.S. CLS. 2, 13, 22, 25, 32 AND 50).

TRADEMARK

PRINCIPAL REGISTER

FIRST USE 5-1-2004; IN COMMERCE 5-1-2004.

THE MARK CONSISTS OF STANDARD CHARACTERS WITHOUT CLAIM TO ANY PAR-
TICULAR FONT, STYLE, SIZE, OR COLOR.

SER. NO. 85-530,898, FILED 2-1-2012.

JOHN DALIER, EXAMINING ATTORNEY



David J. Kyffers

Director of the United States Patent and Trademark Office

United States of America

United States Patent and Trademark Office

SUPER EASY OPEN

Reg. No. 4,205,367

LHS INTERNATIONAL LLC (CALIFORNIA LIMITED LIABILITY COMPANY)
25731 COMMERCENTRE DRIVE
LAKE FOREST, CA 92630

Registered Sep. 11, 2012

Int. Cl.: 21

FOR: ALL PURPOSE PORTABLE HOUSEHOLD CONTAINERS; CONTAINERS FOR HOUSEHOLD OR KITCHEN USE; HOUSEHOLD CONTAINERS FOR FOODS; PORTABLE PLASTIC CONTAINERS FOR STORING HOUSEHOLD AND KITCHEN GOODS, IN CLASS 21 (U.S. CLS. 2, 13, 23, 29, 30, 33, 40 AND 50).

TRADEMARK

PRINCIPAL REGISTER

FIRST USE 2-1-2005; IN COMMERCE 5-1-2005.

THE MARK CONSISTS OF STANDARD CHARACTERS WITHOUT CLAIM TO ANY PARTICULAR FONT, STYLE, SIZE, OR COLOR.

OWNER OF U.S. REG. NO. 3,137,336.

NO CLAIM IS MADE TO THE EXCLUSIVE RIGHT TO USE "EASY OPEN", APART FROM THE MARK AS SHOWN.

SEC. 2(F) AS TO "SUPER".

SER. NO. 85-530,906, FILED 2-1-2012.

JOHN DALIER, EXAMINING ATTORNEY



David J. Kyffers

Director of the United States Patent and Trademark Office

United States of America

United States Patent and Trademark Office

AQUATAILS

Reg. No. 4,205,368

Registered Sep. 11, 2012

Int. Cl.: 25

TRADEMARK

PRINCIPAL REGISTER

AQUATAILS (COLORADO LIMITED LIABILITY COMPANY)
4420 SOUTH BLISSFUL CIRCLE
COLORADO SPRINGS, CO 80917

FOR: BATHING COSTUMES; BIKINIS; COSTUMES FOR USE IN CHILDREN'S DRESS UP PLAY; HALLOWEEN COSTUMES; SWIM WEAR; SWIM WEAR FOR GENTLEMEN AND LADIES; SWIMMING COSTUMES; SWIMMING TRUNKS; SWIMSUITS, IN CLASS 25 (U.S. CLS. 22 AND 39).

FIRST USE 10-19-2009; IN COMMERCE 2-28-2010.

THE MARK CONSISTS OF STANDARD CHARACTERS WITHOUT CLAIM TO ANY PARTICULAR FONT, STYLE, SIZE, OR COLOR.

SER. NO. 85-530,911, FILED 2-1-2012.

KATINA MISTER, EXAMINING ATTORNEY



David J. Kyffers

Director of the United States Patent and Trademark Office

United States of America

United States Patent and Trademark Office

FACTS WITHOUT FICTION

Reg. No. 4,205,369

CRYSTAL RESEARCH ASSOCIATES, LLC (NEW JERSEY LIMITED LIABILITY COMPANY)
23 SCOTTSDALE COURT
CRANBURY, NJ 08512

Registered Sep. 11, 2012

Int. Cls.: 35 and 36

FOR: PUBLIC RELATIONS SERVICES; BUSINESS RESEARCH AND CONSULTING SERVICES RELATING TO BUSINESS MARKETING, IN CLASS 35 (U.S. CLS. 100, 101 AND 102).

SERVICE MARK

FIRST USE 4-2-2003; IN COMMERCE 4-2-2003.

PRINCIPAL REGISTER

FOR: INVESTOR SERVICES, NAMELY INDEPENDENT AND ACCURATE CORPORATE VALUATIONS, CAPITAL INVESTMENT CONSULTATION, AND COMMODITY INVESTMENT ADVICE; CONSULTING SERVICES, NAMELY FINANCIAL ANALYSIS AND PRESENTATION AND FINANCIAL INVESTMENT CONSULTATION, IN CLASS 36 (U.S. CLS. 100, 101 AND 102).

FIRST USE 4-2-2003; IN COMMERCE 4-2-2003.

THE MARK CONSISTS OF STANDARD CHARACTERS WITHOUT CLAIM TO ANY PARTICULAR FONT, STYLE, SIZE, OR COLOR.

OWNER OF U.S. REG. NOS. 2,904,801, 2,986,632, AND 3,010,491.

SER. NO. 85-530,934, FILED 2-1-2012.

FRANK LATTUCA, EXAMINING ATTORNEY



David J. Kybas

Director of the United States Patent and Trademark Office

United States of America

United States Patent and Trademark Office



Reg. No. 4,205,370

AQUATAILS (COLORADO LIMITED LIABILITY COMPANY)
4420 SOUTH BLISSFUL CIRCLE
COLORADO SPRINGS, CO 80917

Registered Sep. 11, 2012

Int. Cl.: 25

FOR: BATHING COSTUMES; BIKINIS; COSTUMES FOR USE IN CHILDREN'S DRESS UP PLAY; HALLOWEEN COSTUMES; SWIM WEAR; SWIM WEAR FOR GENTLEMEN AND LADIES; SWIMMING COSTUMES; SWIMMING TRUNKS; SWIMSUITS, IN CLASS 25 (U.S. CLS. 22 AND 39).

TRADEMARK

PRINCIPAL REGISTER

FIRST USE 2-23-2011; IN COMMERCE 2-23-2011.

THE MARK CONSISTS OF THE STYLIZED WORD AQUATAILS IN A SCRIPT FONT WITH THE SILHOUETTE OF A MERMAID, THE HANDS OF THE MERMAID PLACED UPON THE "Q" AND HER HAIR AND TAIL FLOWING TO THE RIGHT AND ABOVE THE LETTERS "UAT".

SER. NO. 85-530,954, FILED 2-1-2012.

KATINA MISTER, EXAMINING ATTORNEY



David J. Kyjars

Director of the United States Patent and Trademark Office

United States of America

United States Patent and Trademark Office

PRESWICK & MOORE

Reg. No. 4,205,371

Registered Sep. 11, 2012

Int. Cl.: 9

TRADEMARK

PRINCIPAL REGISTER

BOSCOV'S INVESTMENT COMPANY, INC. (DELAWARE CORPORATION)
2751 CENTERVILLE ROAD, SUITE 3217
WILMINGTON, DE 19808

FOR: EYEWEAR, IN CLASS 9 (U.S. CLS. 21, 23, 26, 36 AND 38).

FIRST USE 6-23-2011; IN COMMERCE 11-11-2011.

THE MARK CONSISTS OF STANDARD CHARACTERS WITHOUT CLAIM TO ANY PARTICULAR FONT, STYLE, SIZE, OR COLOR.

OWNER OF U.S. REG. NOS. 1,221,841 AND 1,290,249.

SER. NO. 85-530,955, FILED 2-1-2012.

MICHAEL WIENER, EXAMINING ATTORNEY



David J. Kyffers

Director of the United States Patent and Trademark Office

United States of America

United States Patent and Trademark Office

OPTIMIZEDB

Reg. No. 4,205,372

Registered Sep. 11, 2012

Int. Cl.: 35

SERVICE MARK

PRINCIPAL REGISTER

NTIRETY, INC. (DELAWARE CORPORATION)
SUITE 124
980 WASHINGTON STREET
DEDHAM, MA 02026

FOR: DATABASE ADMINISTRATION FOR OTHERS, NAMELY, DATABASE MANAGEMENT, IN CLASS 35 (U.S. CLS. 100, 101 AND 102).

FIRST USE 1-10-2012; IN COMMERCE 1-30-2012.

THE MARK CONSISTS OF STANDARD CHARACTERS WITHOUT CLAIM TO ANY PARTICULAR FONT, STYLE, SIZE, OR COLOR.

SER. NO. 85-530,956, FILED 2-1-2012.

HAI-LY LAM, EXAMINING ATTORNEY



David J. Kyffers

Director of the United States Patent and Trademark Office

United States of America

United States Patent and Trademark Office

FEED ADAM

Reg. No. 4,205,373

Registered Sep. 11, 2012

Int. Cl.: 35

SERVICE MARK

PRINCIPAL REGISTER

FEED ADAM LLC (IOWA LIMITED LIABILITY COMPANY)
516 DELAWARE AVENUE NW
ORANGE CITY, IA 51041

FOR: ON-LINE RETAIL STORE SERVICES FEATURING FOOD PRODUCTS; ON-LINE WHOLESALE STORE SERVICES FEATURING FOOD PRODUCTS; RETAIL STORE SERVICES FEATURING FOOD PRODUCTS; WHOLESALE FOOD DISTRIBUTORSHIP SERVICES; WHOLESALE STORE SERVICES FEATURING FOOD PRODUCTS, IN CLASS 35 (U.S. CLS. 100, 101 AND 102).

FIRST USE 7-0-2011; IN COMMERCE 7-0-2011.

THE MARK CONSISTS OF STANDARD CHARACTERS WITHOUT CLAIM TO ANY PARTICULAR FONT, STYLE, SIZE, OR COLOR.

SER. NO. 85-531,053, FILED 2-1-2012.

APRIL HESIK, EXAMINING ATTORNEY



David J. Kyffers

Director of the United States Patent and Trademark Office

United States of America

United States Patent and Trademark Office

SOCIAL GOODIES

Reg. No. 4,205,374

Registered Sep. 11, 2012

Int. Cl.: 35

SERVICE MARK

PRINCIPAL REGISTER

SOCIAL GOODIES, LLC (CALIFORNIA LIMITED LIABILITY COMPANY)
1507 OAKDALE STREET
PASADENA, CA 91106

FOR: ON-LINE RETAIL STORE SERVICES FEATURING NATIONAL RETAILER DISCOUNT AND PROMOTIONAL CODES WITH A PERCENTAGE OF THE PROCEEDS BEING CONTRIBUTED TO CHARITY, IN CLASS 35 (U.S. CLS. 100, 101 AND 102).

FIRST USE 5-23-2011; IN COMMERCE 5-23-2011.

THE MARK CONSISTS OF STANDARD CHARACTERS WITHOUT CLAIM TO ANY PARTICULAR FONT, STYLE, SIZE, OR COLOR.

SER. NO. 85-531,059, FILED 2-1-2012.

GEOFFREY FOSDICK, EXAMINING ATTORNEY



David J. Kyffers

Director of the United States Patent and Trademark Office

United States of America

United States Patent and Trademark Office



Reg. No. 4,205,375

SPATULA DAD, LLC (TEXAS LIMITED LIABILITY COMPANY)
2903 RICHARD LANE
AUSTIN, TX 78703

Registered Sep. 11, 2012

Int. Cl.: 25

FOR: T-SHIRTS, HATS AND APRONS, IN CLASS 25 (U.S. CLS. 22 AND 39).

TRADEMARK

FIRST USE 9-0-2011; IN COMMERCE 9-0-2011.

PRINCIPAL REGISTER

THE MARK CONSISTS OF THE WORDS "SPATULA DAD," WITH A SPATULA FORMED FROM THE LETTER "L" OF THE WORD "SPATULA".

SER. NO. 85-531,066, FILED 2-1-2012.

LESLIE RICHARDS, EXAMINING ATTORNEY



David J. Kyffers

Director of the United States Patent and Trademark Office

United States of America

United States Patent and Trademark Office

NATIONAL INSTITUTE FOR STUDENT CENTERED EDUCATION (NISCE)

Reg. No. 4,205,376

Registered Sep. 11, 2012

Int. Cl.: 41

SERVICE MARK

PRINCIPAL REGISTER

SCHOOLS FOR CHILDREN, INC. (MASSACHUSETTS CORPORATION)
SUITE 200
20 ACADEMY STREET
ARLINGTON, MA 01890

FOR: EDUCATION SERVICES, NAMELY, PROVIDING LIVE, ONLINE AND WRITTEN TRAINING, SEMINARS AND DISTRIBUTION OF TRAINING MATERIALS IN CONNECTION THEREWITH, ALL IN THE FIELD OF STUDENT CENTERED EDUCATION, IN CLASS 41 (U.S. CLS. 100, 101 AND 107).

FIRST USE 0-0-2012; IN COMMERCE 0-0-2012.

THE MARK CONSISTS OF STANDARD CHARACTERS WITHOUT CLAIM TO ANY PARTICULAR FONT, STYLE, SIZE, OR COLOR.

NO CLAIM IS MADE TO THE EXCLUSIVE RIGHT TO USE "NATIONAL INSTITUTE FOR STUDENT CENTERED EDUCATION", APART FROM THE MARK AS SHOWN.

SER. NO. 85-531,089, FILED 2-1-2012.

FONG HSU, EXAMINING ATTORNEY



David J. Kybas

Director of the United States Patent and Trademark Office

United States of America

United States Patent and Trademark Office

SPATULA DAD

Reg. No. 4,205,377

SPATULA DAD, LLC (TEXAS LIMITED LIABILITY COMPANY)
2903 RICHARD LANE
AUSTIN, TX 78703

Registered Sep. 11, 2012

Int. Cl.: 41

FOR: PROVIDING A WEB SITE FEATURING ON-LINE COURSES OF INSTRUCTION IN THE FIELD OF COOKING, IN CLASS 41 (U.S. CLS. 100, 101 AND 107).

SERVICE MARK

FIRST USE 6-4-2010; IN COMMERCE 6-4-2010.

PRINCIPAL REGISTER

THE MARK CONSISTS OF STANDARD CHARACTERS WITHOUT CLAIM TO ANY PARTICULAR FONT, STYLE, SIZE, OR COLOR.

SER. NO. 85-531,097, FILED 2-1-2012.

LESLIE RICHARDS, EXAMINING ATTORNEY



David J. Kybas

Director of the United States Patent and Trademark Office

United States of America

United States Patent and Trademark Office

Hue and Harmony

Reg. No. 4,205,378

ZENCOLOR CORPORATION (DELAWARE CORPORATION)
2711 CENTERVILLE ROAD, SUITE 400
WILMINGTON, DE 19808

Registered Sep. 11, 2012

Int. Cl.: 45

FOR: COLOR ANALYSIS FOR WARDROBE AND FASHION SELECTION, IN CLASS 45
(U.S. CLS. 100 AND 101).

SERVICE MARK

FIRST USE 1-10-2009; IN COMMERCE 1-10-2009.

PRINCIPAL REGISTER

THE MARK CONSISTS OF STANDARD CHARACTERS WITHOUT CLAIM TO ANY PARTICULAR FONT, STYLE, SIZE, OR COLOR.

SER. NO. 85-531,116, FILED 2-1-2012.

FONG HSU, EXAMINING ATTORNEY



David J. Kybas

Director of the United States Patent and Trademark Office

United States of America

United States Patent and Trademark Office

FDL

Reg. No. 4,205,379

Registered Sep. 11, 2012

Int. Cl.: 6

TRADEMARK

PRINCIPAL REGISTER

FACTORY DIRECT LOGISTICS, LLC (DELAWARE LIMITED LIABILITY COMPANY), DBA
FDL FASTENERS
900 ESTES COURT
SCHAUMBURG, IL 60193

FOR: METAL INTERNALLY AND EXTERNALLY THREADED FASTENERS, NAMELY,
NUTS AND BOLTS, AND METAL HARDWARE, NAMELY, WASHERS, IN CLASS 6 (U.S.
CLS. 2, 12, 13, 14, 23, 25 AND 50).

FIRST USE 11-1-2011; IN COMMERCE 3-1-2012.

THE MARK CONSISTS OF STANDARD CHARACTERS WITHOUT CLAIM TO ANY PAR-
TICULAR FONT, STYLE, SIZE, OR COLOR.

SER. NO. 85-531,155, FILED 2-1-2012.

KATINA MISTER, EXAMINING ATTORNEY



David J. Kyffers

Director of the United States Patent and Trademark Office

United States of America

United States Patent and Trademark Office

AppMatrix

Reg. No. 4,205,380

APPMATRIX, INC. (CALIFORNIA CORPORATION)
920 RESERVE DR. SUITE 180
ROSEVILLE, CA 95678

Registered Sep. 11, 2012

Int. Cls.: 9 and 42

FOR: COMPUTER APPLICATION SOFTWARE FOR MOBILE PHONES, PORTABLE MEDIA PLAYERS, HANDHELD COMPUTERS, AND TABLET COMPUTERS, NAMELY, SOFTWARE FOR USE IN COMMERCIAL, BUSINESS TO BUSINESS AND MOBILE ADVERTISING, IN CLASS 9 (U.S. CLS. 21, 23, 26, 36 AND 38).

TRADEMARK

SERVICE MARK

FIRST USE 5-24-2011; IN COMMERCE 5-24-2011.

PRINCIPAL REGISTER

FOR: COMPUTER SOFTWARE DEVELOPMENT IN THE FIELD OF MOBILE APPLICATIONS, IN CLASS 42 (U.S. CLS. 100 AND 101).

FIRST USE 5-24-2011; IN COMMERCE 5-24-2011.

THE MARK CONSISTS OF STANDARD CHARACTERS WITHOUT CLAIM TO ANY PARTICULAR FONT, STYLE, SIZE, OR COLOR.

SER. NO. 85-531,158, FILED 2-1-2012.

DAVID MURRAY, EXAMINING ATTORNEY



David J. Kybas

Director of the United States Patent and Trademark Office

United States of America

United States Patent and Trademark Office

NEOX

Reg. No. 4,205,381

Registered Sep. 11, 2012

Int. Cl.: 5

TRADEMARK

PRINCIPAL REGISTER

AMNIOX MEDICAL, INC. (DELAWARE CORPORATION)
2221 NEWMARKET PARKWAY, SUITE 106
MARIETTA, GA 30067

FOR: BIOLOGICAL TISSUE GRAFTS; BIOLOGICAL HUMAN AMNIOTIC MEMBRANE TISSUE PREPARATIONS INTENDED FOR SUBSEQUENT IMPLANTATION FOR SURGERY, WOUND CARE, TISSUE REPAIR AND FOR THE TREATMENT OF INFLAMMATORY DISEASES; SPINAL AND ORTHOPEDIC IMPLANTS MADE OF HUMAN AMNIOTIC MEMBRANE TISSUE; WOUND COVERINGS MADE OF HUMAN AMNIOTIC MEMBRANE TISSUE, NAMELY, TENDON, LIGAMENT AND NERVE WRAPS, IN CLASS 5 (U.S. CLS. 6, 18, 44, 46, 51 AND 52).

FIRST USE 7-31-2011; IN COMMERCE 7-31-2011.

THE MARK CONSISTS OF STANDARD CHARACTERS WITHOUT CLAIM TO ANY PARTICULAR FONT, STYLE, SIZE, OR COLOR.

SER. NO. 85-531,160, FILED 2-1-2012.

MICHAEL WEBSTER, EXAMINING ATTORNEY



David J. Kyffers

Director of the United States Patent and Trademark Office

United States of America

United States Patent and Trademark Office

Comforting the World A Wrap at a Time

Reg. No. 4,205,382

SKYLYNCO LLC (OKLAHOMA LIMITED LIABILITY COMPANY)
20914 E RANCH LN

Registered Sep. 11, 2012

BLANCHARD, OK 73010

Int. Cl.: 10

FOR: THERAPEUTIC HOT AND COLD THERAPY PACKS, IN CLASS 10 (U.S. CLS. 26, 39 AND 44).

TRADEMARK

FIRST USE 1-8-2012; IN COMMERCE 1-8-2012.

PRINCIPAL REGISTER

THE MARK CONSISTS OF STANDARD CHARACTERS WITHOUT CLAIM TO ANY PARTICULAR FONT, STYLE, SIZE, OR COLOR.

SER. NO. 85-531,184, FILED 2-1-2012.

MIDGE BUTLER, EXAMINING ATTORNEY



David J. Kyffers

Director of the United States Patent and Trademark Office

United States of America

United States Patent and Trademark Office

NEXT LEVEL VOLLEYBALL CLUB

Reg. No. 4,205,383

NLVBC, INC. (WISCONSIN CORPORATION)

Registered Sep. 11, 2012

3768 SOUTH 91ST STREET
MILWAUKEE, WI 53228

Int. Cl.: 41

FOR: AMATEUR YOUTH VOLLEYBALL SPORTS SERVICES, NAMELY, ORGANIZING AND PROVIDING YOUTH SPORTS ACTIVITIES; COACHING, INSTRUCTION AND TRAINING IN THE FIELD OF AMATEUR YOUTH VOLLEYBALL, IN CLASS 41 (U.S. CLS. 100, 101 AND 107).

SERVICE MARK

PRINCIPAL REGISTER

FIRST USE 10-31-2003; IN COMMERCE 1-31-2004.

THE MARK CONSISTS OF STANDARD CHARACTERS WITHOUT CLAIM TO ANY PARTICULAR FONT, STYLE, SIZE, OR COLOR.

NO CLAIM IS MADE TO THE EXCLUSIVE RIGHT TO USE "VOLLEYBALL CLUB", APART FROM THE MARK AS SHOWN.

SER. NO. 85-531,190, FILED 2-1-2012.

DAVID H. STINE, EXAMINING ATTORNEY



David J. Kyffers

Director of the United States Patent and Trademark Office

United States of America

United States Patent and Trademark Office

neox

Reg. No. 4,205,384

Registered Sep. 11, 2012

Int. Cl.: 5

TRADEMARK

PRINCIPAL REGISTER

AMNIOX MEDICAL, INC. (DELAWARE CORPORATION)
2221 NEWMARKET PARKWAY, SUITE 106
MARIETTA, GA 30067

FOR: BIOLOGICAL TISSUE GRAFTS; BIOLOGICAL HUMAN AMNIOTIC MEMBRANE TISSUE PREPARATIONS INTENDED FOR SUBSEQUENT IMPLANTATION FOR SURGERY, WOUND CARE, TISSUE REPAIR AND FOR THE TREATMENT OF INFLAMMATORY DISEASES; SPINAL AND ORTHOPEDIC IMPLANTS MADE OF HUMAN AMNIOTIC MEMBRANE TISSUE; WOUND COVERINGS MADE OF HUMAN AMNIOTIC MEMBRANE TISSUE, NAMELY, TENDON, LIGAMENT AND NERVE WRAPS, IN CLASS 5 (U.S. CLS. 6, 18, 44, 46, 51 AND 52).

FIRST USE 7-31-2011; IN COMMERCE 7-31-2011.

THE MARK CONSISTS OF "NEOX" IN LOWER CASE LETTERS, WHERE THE "X" IS FORMED USING TWO CONCAVE LINES.

SER. NO. 85-531,192, FILED 2-1-2012.

MICHAEL WEBSTER, EXAMINING ATTORNEY



David J. Kyffers

Director of the United States Patent and Trademark Office

United States of America

United States Patent and Trademark Office

IT'S ALL GOOD COOKED ON WOOD

Reg. No. 4,205,385

BABY BACK BLUES, INC. (ILLINOIS CORPORATION)
16200 S. LINCOLN HIGHWAY
PLAINFIELD, IL 60586

Registered Sep. 11, 2012

Int. Cl.: 43

FOR: RESTAURANT SERVICES, IN CLASS 43 (U.S. CLS. 100 AND 101).

SERVICE MARK

FIRST USE 6-30-2007; IN COMMERCE 6-30-2007.

PRINCIPAL REGISTER

THE MARK CONSISTS OF STANDARD CHARACTERS WITHOUT CLAIM TO ANY PARTICULAR FONT, STYLE, SIZE, OR COLOR.

SER. NO. 85-531,238, FILED 2-1-2012.

NAKIA HENRY, EXAMINING ATTORNEY



David J. Kyffers

Director of the United States Patent and Trademark Office

United States of America

United States Patent and Trademark Office

Steve ELLÉ

Reg. No. 4,205,386

Registered Sep. 11, 2012

Int. Cl.: 25

TRADEMARK

PRINCIPAL REGISTER

STEVIE LANCASTER JR. (ILLINOIS SOLE PROPRIETORSHIP), DBA STEVE ELLÉ
23 PUBLIC SQUARE SUITE 220
WWW.STEEVEELLE.COM
BELLEVILLE, IL 62220

FOR: WEARABLE GARMENTS AND CLOTHING, NAMELY, SHIRTS, IN CLASS 25 (U.S. CLS. 22 AND 39).

FIRST USE 8-2-1999; IN COMMERCE 1-1-2010.

THE MARK CONSISTS OF STANDARD CHARACTERS WITHOUT CLAIM TO ANY PARTICULAR FONT, STYLE, SIZE, OR COLOR.

THE NAME "STEVE ELLE" DOES NOT IDENTIFY A LIVING INDIVIDUAL.

SER. NO. 85-531,240, FILED 2-1-2012.

NAKIA HENRY, EXAMINING ATTORNEY



David J. Kybas

Director of the United States Patent and Trademark Office

United States of America

United States Patent and Trademark Office



Reg. No. 4,205,387

NLVBC, INC. (WISCONSIN CORPORATION)
3768 SOUTH 91ST STREET
MILWAUKEE, WI 53228

Registered Sep. 11, 2012

Int. Cl.: 41

FOR: AMATEUR YOUTH VOLLEYBALL SPORTS SERVICES, NAMELY, ORGANIZING AND PROVIDING YOUTH SPORTS ACTIVITIES; COACHING, INSTRUCTION AND TRAINING IN THE FIELD OF AMATEUR YOUTH VOLLEYBALL, IN CLASS 41 (U.S. CLS. 100, 101 AND 107).

SERVICE MARK

PRINCIPAL REGISTER

FIRST USE 10-31-2003; IN COMMERCE 1-31-2004.

NO CLAIM IS MADE TO THE EXCLUSIVE RIGHT TO USE "VOLLEYBALL CLUB", APART FROM THE MARK AS SHOWN.

THE MARK CONSISTS OF THE WORDS "NEXT LEVEL VOLLEYBALL CLUB" WHERE THE LETTER "L" IN THE WORD "LEVEL" HAS BEEN REPLACED BY THE IMAGE OF VOLLEYBALL PLAYER IN MOTION, JUMPING TO SPIKE A VOLLEYBALL.

SER. NO. 85-531,267, FILED 2-1-2012.

DAVID H. STINE, EXAMINING ATTORNEY



David J. Kyffers

Director of the United States Patent and Trademark Office

United States of America

United States Patent and Trademark Office



Reg. No. 4,205,388

Registered Sep. 11, 2012

Int. Cl.: 41

SERVICE MARK

PRINCIPAL REGISTER

HUNTINGTON MARK, LLC (DELAWARE LIMITED LIABILITY COMPANY)
496 KINDERKAMACK ROAD
ORADELL, NJ 07649

FOR: EDUCATIONAL SERVICES, NAMELY, PROVIDING TUTORING IN THE FIELDS OF READING, WRITING, STUDY SKILLS, MATH, PHONICS, SPELLING, VOCABULARY, PRE-ALGEBRA, ALGEBRA, GEOMETRY, TRIGONOMETRY, PRE-CALCULUS, CALCULUS, GENERAL SCIENCE, EARTH SCIENCE, BIOLOGY, CHEMISTRY, AND PHYSICS; CONDUCTING CLASSES, SEMINARS, WORKSHOPS, AND TUTORING IN THE FIELD OF PREPARATION FOR STANDARDIZED EXAMS, IN CLASS 41 (U.S. CLS. 100, 101 AND 107).

FIRST USE 4-8-1985; IN COMMERCE 4-8-1985.

OWNER OF U.S. REG. NO. 1,425,199.

THE MARK CONSISTS OF THE STYLIZED DESIGN OF THREE TREE LEAVES.

SER. NO. 85-531,275, FILED 2-1-2012.

SUSAN LESLIE DUBOIS, EXAMINING ATTORNEY



David J. Kyffers

Director of the United States Patent and Trademark Office

United States of America

United States Patent and Trademark Office

AgileRemote

Reg. No. 4,205,389

KELLEY, JOHN (UNITED STATES INDIVIDUAL)
625 BIRCH LANE
CLARKESVILLE, GA 30523

Registered Sep. 11, 2012

Int. Cl.: 42

FOR: COMPUTER SOFTWARE DEVELOPMENT, IN CLASS 42 (U.S. CLS. 100 AND 101).

SERVICE MARK

FIRST USE 4-10-2010; IN COMMERCE 8-4-2010.

PRINCIPAL REGISTER

THE MARK CONSISTS OF STANDARD CHARACTERS WITHOUT CLAIM TO ANY PARTICULAR FONT, STYLE, SIZE, OR COLOR.

SER. NO. 85-531,295, FILED 2-1-2012.

ANDREA HACK, EXAMINING ATTORNEY



David J. Kyffers

Director of the United States Patent and Trademark Office

United States of America

United States Patent and Trademark Office



Reg. No. 4,205,390

Registered Sep. 11, 2012

Int. Cl.: 25

TRADEMARK

PRINCIPAL REGISTER

TOP GUN INTELLECTUAL PROPERTIES, LLC (NEW YORK LIMITED LIABILITY COMPANY)
31-65 STEINWAY STREET
ASTORIA, NY 11103

FOR: BELTS; CAPS; FOOTWEAR; JACKETS; JEANS; LEATHER JACKETS; PANTS; SHIRTS; SWEATSHIRTS; T-SHIRTS; UNDERWEAR, IN CLASS 25 (U.S. CLS. 22 AND 39).

FIRST USE 11-30-2011; IN COMMERCE 12-15-2011.

OWNER OF U.S. REG. NOS. 2,817,325, 3,297,277 AND OTHERS.

THE MARK CONSISTS OF AN ARROWHEAD POINTING UPWARD. THERE IS A SINGLE FIVE-POINT STAR CENTERED IN THE UPPER PART OF THE ARROWHEAD.

SER. NO. 85-531,299, FILED 2-1-2012.

KATHERINE CONNOLLY, EXAMINING ATTORNEY



David J. Kyffers

Director of the United States Patent and Trademark Office

United States of America

United States Patent and Trademark Office

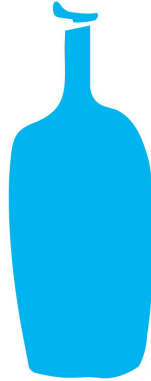

Reg. No. 4,205,391

Registered Sep. 11, 2012

Int. Cls.: 35 and 43

SERVICE MARK

PRINCIPAL REGISTER

BLUE BOTTLE COFFEE, LLC (CALIFORNIA LIMITED LIABILITY COMPANY)
300 WEBSTER ST.
OAKLAND, CA 94607

FOR: ONLINE RETAIL STORE SERVICES FEATURING COFFEE AND RELATED GOODS,
IN CLASS 35 (U.S. CLS. 100, 101 AND 102).

FIRST USE 9-1-2002; IN COMMERCE 9-1-2002.

FOR: CAFE SERVICES; COFFEE SHOPS; PROVIDING CAFE SERVICES VIA A MOBILE
TRAILER, IN CLASS 43 (U.S. CLS. 100 AND 101).

FIRST USE 8-15-2002; IN COMMERCE 8-15-2002.

THE MARK CONSISTS OF A BLUE BOTTLE. THE WHITE IN THE DRAWING REPRESENTS
BACKGROUND OR TRANSPARENT AREAS AND IS NOT CLAIMED AS PART OF THE
MARK.

THE COLOR(S) BLUE IS/ARE CLAIMED AS A FEATURE OF THE MARK.

SER. NO. 85-531,318, FILED 2-1-2012.

BRIAN NEVILLE, EXAMINING ATTORNEY



David J. Kybas

Director of the United States Patent and Trademark Office

United States of America

United States Patent and Trademark Office

PRACTICE OF IMMEDIACY IN THE ARTS

Reg. No. 4,205,392

NICOLEE MCMAHON (UNITED STATES INDIVIDUAL)
9543 VISTA SECUNDA
SAN DIEGO, CA 92129

Registered Sep. 11, 2012

Int. Cl.: 41

FOR: EDUCATIONAL SERVICES, NAMELY, PROVIDING ONLINE INSTRUCTION IN THE FIELD OF THE ARTS; WORKSHOPS AND SEMINARS IN THE FIELD OF THE ARTS, IN CLASS 41 (U.S. CLS. 100, 101 AND 107).

SERVICE MARK

FIRST USE 0-0-1997; IN COMMERCE 0-0-1997.

PRINCIPAL REGISTER

THE MARK CONSISTS OF STANDARD CHARACTERS WITHOUT CLAIM TO ANY PARTICULAR FONT, STYLE, SIZE, OR COLOR.

SER. NO. 85-531,330, FILED 2-1-2012.

ANGELA DUONG, EXAMINING ATTORNEY



David J. Kyffers

Director of the United States Patent and Trademark Office

United States of America

United States Patent and Trademark Office

E-Z-STEP DOWN

Reg. No. 4,205,393

Registered Sep. 11, 2012

Int. Cl.: 6

TRADEMARK

PRINCIPAL REGISTER

GUTTER GUARD SYSTEMS, INC. (MISSOURI CORPORATION)
#1 WAGNER INDUSTRIAL CT.
ST. CLAIR, MO 63077

FOR: METAL DEBRIS GUARDS FOR GUTTERS, IN CLASS 6 (U.S. CLS. 2, 12, 13, 14, 23, 25 AND 50).

FIRST USE 1-19-2005; IN COMMERCE 1-19-2005.

THE MARK CONSISTS OF STANDARD CHARACTERS WITHOUT CLAIM TO ANY PARTICULAR FONT, STYLE, SIZE, OR COLOR.

OWNER OF U.S. REG. NO. 1,423,614.

SER. NO. 85-531,348, FILED 2-1-2012.

CURTIS FRENCH, EXAMINING ATTORNEY



David J. Kyffers

Director of the United States Patent and Trademark Office

United States of America

United States Patent and Trademark Office

Pink Cloud

Reg. No. 4,205,394

Registered Sep. 11, 2012

Int. Cls.: 35 and 41

SERVICE MARK

PRINCIPAL REGISTER

PINK CLOUD, INC. (CALIFORNIA CORPORATION), DBA PINK CLOUD EVENTS
2806 CLEARWATER STREET
LOS ANGELES, CA 90039

FOR: EVENT PLANNING AND MANAGEMENT FOR MARKETING, BRANDING, PROMOTING OR ADVERTISING THE GOODS AND SERVICES OF OTHERS, IN CLASS 35 (U.S. CLS. 100, 101 AND 102).

FIRST USE 9-12-2006; IN COMMERCE 10-20-2006.

FOR: SPECIAL EVENT PLANNING FOR SOCIAL ENTERTAINMENT PURPOSES, IN CLASS 41 (U.S. CLS. 100, 101 AND 107).

FIRST USE 9-12-2006; IN COMMERCE 10-20-2006.

THE MARK CONSISTS OF STANDARD CHARACTERS WITHOUT CLAIM TO ANY PARTICULAR FONT, STYLE, SIZE, OR COLOR.

SER. NO. 85-531,356, FILED 2-1-2012.

TOBY BULLOFF, EXAMINING ATTORNEY



David J. Kyffers

Director of the United States Patent and Trademark Office

United States of America

United States Patent and Trademark Office

Soulwraps

Reg. No. 4,205,395

SOULWRAPS LLC (NEVADA LIMITED LIABILITY COMPANY)
9303 GILCREASE AVE., NO. 1062
LAS VEGAS, NV 89149

Registered Sep. 11, 2012

Int. Cl.: 25

FOR: RUANAS; SCARVES; SHOULDER WRAPS; WOVEN TOPS; WRAPS, IN CLASS 25
(U.S. CLS. 22 AND 39).

TRADEMARK

FIRST USE 12-8-2008; IN COMMERCE 4-11-2009.

PRINCIPAL REGISTER

THE MARK CONSISTS OF STANDARD CHARACTERS WITHOUT CLAIM TO ANY PARTICULAR FONT, STYLE, SIZE, OR COLOR.

SER. NO. 85-531,367, FILED 2-1-2012.

KAREN BRACEY, EXAMINING ATTORNEY



David J. Kybas

Director of the United States Patent and Trademark Office

United States of America

United States Patent and Trademark Office

CAR074

Reg. No. 4,205,396

Registered Sep. 11, 2012

Int. Cl.: 14

TRADEMARK

PRINCIPAL REGISTER

SIMON GOLUB & SONS, INC. (WASHINGTON CORPORATION)
5506 SIXTH AVENUE SOUTH
SEATTLE, WA 98108

FOR: CUT DIAMONDS; DIAMONDS; JEWELRY, IN CLASS 14 (U.S. CLS. 2, 27, 28 AND 50).

FIRST USE 6-1-2006; IN COMMERCE 5-6-2007.

THE MARK CONSISTS OF STANDARD CHARACTERS WITHOUT CLAIM TO ANY PARTICULAR FONT, STYLE, SIZE, OR COLOR.

OWNER OF U.S. REG. NO. 3,368,612.

THE ENGLISH TRANSLATION OF "CARO" IN THE MARK IS "BELOVED".

SER. NO. 85-531,375, FILED 2-1-2012.

KATHERINE E. HALMEN, EXAMINING ATTORNEY



David J. Kyffers

Director of the United States Patent and Trademark Office

United States of America

United States Patent and Trademark Office

E-Z-SLIDE

Reg. No. 4,205,397

Registered Sep. 11, 2012

Int. Cl.: 6

TRADEMARK

PRINCIPAL REGISTER

GUTTER GUARD SYSTEMS, INC. (MISSOURI CORPORATION)
#1 WAGNER INDUSTRIAL CT.
ST. CLAIR, MO 63077

FOR: METAL DEBRIS GUARDS FOR GUTTERS, IN CLASS 6 (U.S. CLS. 2, 12, 13, 14, 23, 25 AND 50).

FIRST USE 11-0-1998; IN COMMERCE 11-0-1998.

THE MARK CONSISTS OF STANDARD CHARACTERS WITHOUT CLAIM TO ANY PARTICULAR FONT, STYLE, SIZE, OR COLOR.

OWNER OF U.S. REG. NO. 1,423,614.

SER. NO. 85-531,382, FILED 2-1-2012.

CURTIS FRENCH, EXAMINING ATTORNEY



David J. Kybas

Director of the United States Patent and Trademark Office

United States of America
United States Patent and Trademark Office

CROSSLINE

Reg. No. 4,205,398

LAMKIN CORPORATION (DELAWARE CORPORATION)
6530 GATEWAY PARK DRIVE
SAN DIEGO, CA 92173

Registered Sep. 11, 2012

Int. Cl.: 28

FOR: GOLF GRIPS, NAMELY, HAND GRIPS FOR GOLF CLUBS, IN CLASS 28 (U.S. CLS. 22, 23, 38 AND 50).

TRADEMARK

FIRST USE 6-1-1997; IN COMMERCE 6-1-1997.

PRINCIPAL REGISTER

THE MARK CONSISTS OF STANDARD CHARACTERS WITHOUT CLAIM TO ANY PARTICULAR FONT, STYLE, SIZE, OR COLOR.

OWNER OF U.S. REG. NO. 2,196,076.

SER. NO. 85-531,387, FILED 2-1-2012.

MORGAN WYNNE, EXAMINING ATTORNEY



David J. Kyffers

Director of the United States Patent and Trademark Office

United States of America

United States Patent and Trademark Office

E-Z-LEAF SWEEP

Reg. No. 4,205,399

Registered Sep. 11, 2012

Int. Cl.: 6

TRADEMARK

PRINCIPAL REGISTER

GUTTER GUARD SYSTEMS, INC. (MISSOURI CORPORATION)
#1 WAGNER INDUSTRIAL CT.
ST. CLAIR, MO 63077

FOR: METAL DEBRIS GUARDS FOR GUTTERS, IN CLASS 6 (U.S. CLS. 2, 12, 13, 14, 23, 25 AND 50).

FIRST USE 2-7-2007; IN COMMERCE 2-7-2007.

THE MARK CONSISTS OF STANDARD CHARACTERS WITHOUT CLAIM TO ANY PARTICULAR FONT, STYLE, SIZE, OR COLOR.

OWNER OF U.S. REG. NO. 1,423,614.

SER. NO. 85-531,391, FILED 2-1-2012.

CURTIS FRENCH, EXAMINING ATTORNEY



David J. Kyffers

Director of the United States Patent and Trademark Office

United States of America

United States Patent and Trademark Office

The sign on our door reads
"Attorneys At Law." But to
our clients, we're much
more.

Reg. No. 4,205,400

OFFIT KURMAN, P.A. (MARYLAND CORPORATION), AKA OFFIT KURMAN
8171 MAPLE LAWN BOULEVARD, SUITE 200
MAPLE LAWN, MD 20759

Registered Sep. 11, 2012

Int. Cl.: 45

FOR: LEGAL SERVICES, IN CLASS 45 (U.S. CLS. 100 AND 101).

SERVICE MARK

FIRST USE 9-0-2005; IN COMMERCE 9-0-2005.

PRINCIPAL REGISTER

THE MARK CONSISTS OF STANDARD CHARACTERS WITHOUT CLAIM TO ANY PARTICULAR FONT, STYLE, SIZE, OR COLOR.

SER. NO. 85-531,393, FILED 2-1-2012.

JEAN IM, EXAMINING ATTORNEY



David J. Kyffers

Director of the United States Patent and Trademark Office

United States of America

United States Patent and Trademark Office

SAVE THE TA-TAS

Reg. No. 4,205,401

HAWKWILD, LLC (CALIFORNIA LIMITED LIABILITY COMPANY)
21128 VANOWEN STREET
CANOGA PARK, CA 91303

Registered Sep. 11, 2012

Int. Cl.: 14

FOR: JEWELRY; BRACELETS; BRACELETS MADE OF RUBBER; BRACELETS MADE OF SILICON; CHARITY BRACELETS; ORNAMENTAL PINS, IN CLASS 14 (U.S. CLS. 2, 27, 28 AND 50).

TRADEMARK

FIRST USE 12-0-2009; IN COMMERCE 12-0-2009.

PRINCIPAL REGISTER

THE MARK CONSISTS OF STANDARD CHARACTERS WITHOUT CLAIM TO ANY PARTICULAR FONT, STYLE, SIZE, OR COLOR.

SER. NO. 85-531,398, FILED 2-1-2012.

BRIAN NEVILLE, EXAMINING ATTORNEY



David J. Kyffers

Director of the United States Patent and Trademark Office

United States of America

United States Patent and Trademark Office

E-Z-UNDER

Reg. No. 4,205,402

Registered Sep. 11, 2012

Int. Cl.: 6

TRADEMARK

PRINCIPAL REGISTER

GUTTER GUARD SYSTEMS, INC. (MISSOURI CORPORATION)
#1 WAGNER INDUSTRIAL CT.
ST. CLAIR, MO 63077

FOR: METAL DEBRIS GUARDS FOR GUTTERS, IN CLASS 6 (U.S. CLS. 2, 12, 13, 14, 23, 25 AND 50).

FIRST USE 1-19-2005; IN COMMERCE 1-19-2005.

THE MARK CONSISTS OF STANDARD CHARACTERS WITHOUT CLAIM TO ANY PARTICULAR FONT, STYLE, SIZE, OR COLOR.

OWNER OF U.S. REG. NO. 1,423,614.

SER. NO. 85-531,403, FILED 2-1-2012.

CURTIS FRENCH, EXAMINING ATTORNEY



David J. Kyffers

Director of the United States Patent and Trademark Office

United States of America

United States Patent and Trademark Office

Amoretti

Reg. No. 4,205,403

Registered Sep. 11, 2012

Int. Cl.: 30

TRADEMARK

PRINCIPAL REGISTER

JAMARA LICENSING, LLC (NEVADA LIMITED LIABILITY COMPANY)
SUITE 259
4936 VERDUGO WAY
CAMARILLO, CA 93012

FOR: FLAVORING SYRUPS; VINEGAR; VINAIGRETTE, IN CLASS 30 (U.S. CL. 46).

FIRST USE 3-22-2011; IN COMMERCE 3-22-2011.

OWNER OF U.S. REG. NOS. 1,659,954, 2,586,461 AND OTHERS.

THE MARK CONSISTS OF "AMORETTI" IN STYLIZED FORM.

THE ENGLISH TRANSLATION OF "AMORETTI" IN THE MARK IS "LITTLE LOVE".

SER. NO. 85-531,437, FILED 2-1-2012.

Laurie Kaufman, Examining Attorney



David J. Kybas

Director of the United States Patent and Trademark Office

United States of America

United States Patent and Trademark Office

The Bagabond

Reg. No. 4,205,404

Registered Sep. 11, 2012

Int. Cl.: 25

TRADEMARK

PRINCIPAL REGISTER

BENNETT, RACHEL (UNITED STATES INDIVIDUAL)
APT 17
6855 SW RALEIGHWOOD WAY
PORTLAND, OR 97225

FOR: BOOT BAGS, IN CLASS 25 (U.S. CLS. 22 AND 39).

FIRST USE 6-1-2011; IN COMMERCE 10-1-2011.

THE MARK CONSISTS OF STANDARD CHARACTERS WITHOUT CLAIM TO ANY PARTICULAR FONT, STYLE, SIZE, OR COLOR.

SER. NO. 85-531,443, FILED 2-1-2012.

CHERYL CLAYTON, EXAMINING ATTORNEY



David J. Kybas

Director of the United States Patent and Trademark Office

United States of America

United States Patent and Trademark Office

Simplepractice

Reg. No. 4,205,405

Registered Sep. 11, 2012

Int. Cl.: 42

SERVICE MARK

PRINCIPAL REGISTER

ZIMMERMANN, RALPH (AUSTRIA INDIVIDUAL)
APT 1414
278 E COLORADO BLVD
PASADENA, CA 91101

FOR: PROVIDING ON-LINE NON-DOWNLOADABLE SOFTWARE FOR PRACTICE MANAGEMENT AND COLLABORATION, IN CLASS 42 (U.S. CLS. 100 AND 101).

FIRST USE 1-18-2012; IN COMMERCE 1-18-2012.

THE MARK CONSISTS OF STANDARD CHARACTERS WITHOUT CLAIM TO ANY PARTICULAR FONT, STYLE, SIZE, OR COLOR.

SER. NO. 85-531,459, FILED 2-1-2012.

CHERYL CLAYTON, EXAMINING ATTORNEY



David J. Kyffers

Director of the United States Patent and Trademark Office

United States of America

United States Patent and Trademark Office



Reg. No. 4,205,406

Registered Sep. 11, 2012

Int. Cls.: 37 and 42

SERVICE MARK

PRINCIPAL REGISTER

DRF INSTALLATIONS, INC. (ILLINOIS CORPORATION)
10242 SOUTH BODE ROAD
PLAINFIELD, IL 60585

FOR: IRRIGATION SERVICES, NAMELY, THE INSTALLATION, MAINTENANCE AND REPAIR OF COMMERCIAL AND RESIDENTIAL IRRIGATION SYSTEMS AND REVERSE PRESSURE ZONE WATER BACKFLOW VALVES; RESIDENTIAL AND COMMERCIAL PLUMBING SERVICES AND WATER HEATER INSTALLATION SERVICES; WATER FILTRATION SERVICES, NAMELY, INSTALLATION AND REPAIR OF WATER FILTRATION SYSTEMS; IRON STAIN REMOVAL SERVICES; HEATING, VENTILATION AND AIR CONDITIONING SERVICES, NAMELY, THE INSTALLATION, MAINTENANCE AND REPAIR OF RESIDENTIAL AND COMMERCIAL HEATING, VENTILATION AND AIR CONDITIONING SYSTEMS, BOILERS, CONTROLS, AIR PURIFIERS AND HUMIDIFIERS; ELECTRICAL CONTRACTING SERVICES, IN CLASS 37 (U.S. CLS. 100, 103 AND 106).

FIRST USE 10-7-2009; IN COMMERCE 10-7-2009.

FOR: IRRIGATION SERVICES, NAMELY, THE DESIGN OF COMMERCIAL AND RESIDENTIAL IRRIGATION SYSTEMS AND REVERSE PRESSURE ZONE WATER BACKFLOW VALVES; TECHNICAL MONITORING SERVICES FOR CONDITION OF WATER; HEATING, VENTILATION AND AIR CONDITIONING SERVICES, NAMELY, THE DESIGN OF RESIDENTIAL AND COMMERCIAL HEATING, VENTILATION AND AIR CONDITIONING SYSTEMS, BOILERS, CONTROLS, AIR PURIFIERS AND HUMIDIFIERS; ANALYSIS OF THE QUALITY OF HOME AND COMMERCIAL WATER SUPPLY, IN CLASS 42 (U.S. CLS. 100 AND 101).

FIRST USE 10-7-2009; IN COMMERCE 10-7-2009.

OWNER OF U.S. REG. NOS. 3,916,399 AND 3,970,558.

THE MARK CONSISTS OF A DRAWING IN CHIAROSCURO OF THE UPPER TORSO AND HEAD OF A MAN, WHO IS WEARING A HARD HAT AND WHOSE FACE IS DIRECTED TO HIS LEFT. THE MAN IS WEARING A CREW NECK SHIRT WITH "DRF" BELOW THE LEFT SHOULDER. THE MAN IS POSED BEFORE A SUNBURST DESIGN WHICH IS ENCLOSED IN A CIRCLE. THE CIRCLE IS BROKEN BY A HORIZONTAL BANNER UNDER THE MAN'S UPPER TORSO. THE BANNER CONTAINS THE LETTERS DRF, IN A LARGE



David J. Kyffers

Director of the United States Patent and Trademark Office

Reg. No. 4,205,406 BOLD FONT. THE BANNER IS BORDERED BY TOP AND BOTTOM HORIZONTAL LINES.
A THIRD HORIZONTAL LINE RUNS BELOW DRF.

SER. NO. 85-531,462, FILED 2-1-2012.

DAVID COLLIER, EXAMINING ATTORNEY

United States of America

United States Patent and Trademark Office

SHIFTREWARDS

Reg. No. 4,205,407

CONCERRO, INC. (CALIFORNIA CORPORATION)
9276 SCRANTON RD., SUITE 400
SAN DIEGO, CA 92121

Registered Sep. 11, 2012

Int. Cl.: 35

FOR: BUSINESS STAFFING CONSULTING SERVICES FOR PROVIDING SCHEDULING DECISIONS FOR EMPLOYEES IN AN INSTITUTIONAL SETTING NAMELY USING INCENTIVE-BASED STAFFING, IN CLASS 35 (U.S. CLS. 100, 101 AND 102).

SERVICE MARK

FIRST USE 7-1-2005; IN COMMERCE 7-1-2005.

PRINCIPAL REGISTER

THE MARK CONSISTS OF STANDARD CHARACTERS WITHOUT CLAIM TO ANY PARTICULAR FONT, STYLE, SIZE, OR COLOR.

SER. NO. 85-531,479, FILED 2-1-2012.

ALLISON SCHRODY, EXAMINING ATTORNEY



David J. Kyffers

Director of the United States Patent and Trademark Office

United States of America

United States Patent and Trademark Office

GEEKLIST

Reg. No. 4,205,408

GEEKLIST, INC. (DELAWARE CORPORATION)
7825 FAY AVE., SUITE 200
LA JOLLA, CA 92037

Registered Sep. 11, 2012

Int. Cls.: 35, 42 and 45

FOR: ONLINE BUSINESS NETWORKING SERVICES, IN CLASS 35 (U.S. CLS. 100, 101 AND 102).

SERVICE MARK

FIRST USE 4-8-2011; IN COMMERCE 4-8-2011.

PRINCIPAL REGISTER

FOR: COMPUTER SERVICES, NAMELY, CREATING AN ON-LINE COMMUNITY FOR REGISTERED USERS TO PARTICIPATE IN DISCUSSIONS, GET FEEDBACK FROM THEIR PEERS, FORM VIRTUAL COMMUNITIES, AND ENGAGE IN SOCIAL NETWORKING SERVICES IN THE FIELD OF COMPUTER CODE DEVELOPERS, WEB SITE DEVELOPERS, COMPUTER SOFTWARE DEVELOPERS; COMPUTER SERVICES, NAMELY, PROVIDING A SEARCH ENGINE TO ALLOW USERS TO SEARCH CONTENT OF WEB SITE FOR PEOPLE WITH SPECIFIC EXPERIENCE, IN CLASS 42 (U.S. CLS. 100 AND 101).

FIRST USE 4-8-2011; IN COMMERCE 4-8-2011.

FOR: PROVIDING INFORMATION IN THE FIELD OF PERSONAL DEVELOPMENT AND ACHIEVEMENTS; ON-LINE SOCIAL NETWORKING SERVICES, IN CLASS 45 (U.S. CLS. 100 AND 101).

FIRST USE 4-8-2011; IN COMMERCE 4-8-2011.

THE MARK CONSISTS OF STANDARD CHARACTERS WITHOUT CLAIM TO ANY PARTICULAR FONT, STYLE, SIZE, OR COLOR.

SER. NO. 85-531,481, FILED 2-1-2012.

CHERYL CLAYTON, EXAMINING ATTORNEY



David J. Kybas

Director of the United States Patent and Trademark Office

United States of America

United States Patent and Trademark Office

BLUE VINE FINANCIAL

Reg. No. 4,205,409

Registered Sep. 11, 2012

Int. Cl.: 36

SERVICE MARK

PRINCIPAL REGISTER

BLUE VINE FINANCIAL, LLC (GEORGIA LIMITED LIABILITY COMPANY)
330 GREENMONT CIRCLE
ALPHARETTA, GA 30009

FOR: ADVICE RELATING TO INVESTMENTS; INVESTMENT ADVICE; INVESTMENT ADVISORY SERVICES; INVESTMENT CONSULTATION, IN CLASS 36 (U.S. CLS. 100, 101 AND 102).

FIRST USE 12-19-2011; IN COMMERCE 1-2-2012.

THE MARK CONSISTS OF STANDARD CHARACTERS WITHOUT CLAIM TO ANY PARTICULAR FONT, STYLE, SIZE, OR COLOR.

NO CLAIM IS MADE TO THE EXCLUSIVE RIGHT TO USE "FINANCIAL", APART FROM THE MARK AS SHOWN.

SER. NO. 85-531,527, FILED 2-1-2012.

MIAH ROSENBERG, EXAMINING ATTORNEY



David J. Kybas

Director of the United States Patent and Trademark Office

United States of America

United States Patent and Trademark Office

ACT 67

Reg. No. 4,205,410

ACT-67 LLC (PENNSYLVANIA LIMITED LIABILITY COMPANY)
107 WEYMOUTH ROAD
DARBY, PA 19023

Registered Sep. 11, 2012

Int. Cl.: 25

FOR: CLOTHING, NAMELY, T-SHIRTS, SWEATSHIRTS, SWEAT PANTS, CARGO PANTS, JEANS, HOODED SWEATSHIRTS, JACKETS, BUTTON DOWN SHIRTS, THERMAL UNDERWEAR, THERMAL SHIRTS, THERMAL PANTS; BEANIES , IN CLASS 25 (U.S. CLS. 22 AND 39).

TRADEMARK

PRINCIPAL REGISTER

FIRST USE 1-1-2007; IN COMMERCE 1-1-2007.

THE MARK CONSISTS OF STANDARD CHARACTERS WITHOUT CLAIM TO ANY PARTICULAR FONT, STYLE, SIZE, OR COLOR.

SER. NO. 85-531,551, FILED 2-1-2012.

JENNY PARK, EXAMINING ATTORNEY



David J. Kyffers

Director of the United States Patent and Trademark Office

United States of America

United States Patent and Trademark Office

reThinkSpa

Reg. No. 4,205,411

NONTOXIQUE BEAUTY, LLC (MINNESOTA LIMITED LIABILITY COMPANY)
2003 SOUTH SHERIDAN AVENUE, SUITE 2
MINNEAPOLIS, MN 55405

Registered Sep. 11, 2012

Int. Cl.: 35

FOR: BUSINESS MANAGEMENT AND CONSULTATION IN THE FIELD OF COSMETOLOGY AND SPAS, IN CLASS 35 (U.S. CLS. 100, 101 AND 102).

SERVICE MARK

FIRST USE 12-15-2011; IN COMMERCE 12-15-2011.

PRINCIPAL REGISTER

THE MARK CONSISTS OF STANDARD CHARACTERS WITHOUT CLAIM TO ANY PARTICULAR FONT, STYLE, SIZE, OR COLOR.

SER. NO. 85-531,573, FILED 2-1-2012.

TINA MAI, EXAMINING ATTORNEY



David J. Kybas

Director of the United States Patent and Trademark Office

United States of America

United States Patent and Trademark Office

SHIFTPREDICT

Reg. No. 4,205,412

CONCERRO, INC. (CALIFORNIA CORPORATION)
9276 SCRANTON RD., SUITE 400
SAN DIEGO, CA 92121

Registered Sep. 11, 2012

Int. Cls.: 35 and 42

FOR: BUSINESS STAFFING CONSULTING SERVICES FOR PROVIDING SCHEDULING DECISIONS FOR EMPLOYEES BASED ON THE USE OF STAFFING EFFECTIVENESS STANDARDS AND HISTORICAL CENSUS AND INTENSITY OF CARE DATA TO MODEL PREDICTIVE STAFFING NEEDS, IN CLASS 35 (U.S. CLS. 100, 101 AND 102).

SERVICE MARK

PRINCIPAL REGISTER

FIRST USE 11-1-2011; IN COMMERCE 11-1-2011.

FOR: PROVIDING ONLINE WEB-BASED NON-DOWNLOADABLE COMPUTER SOFTWARE FOR MANAGING THE PRACTICE AND SCHEDULING OF HEALTH CARE PROFESSIONALS, NAMELY, THE USE OF HISTORICAL CENSUS AND INTENSITY OF CARE DATA TO MODEL PREDICTIVE STAFFING NEEDS, IN CLASS 42 (U.S. CLS. 100 AND 101).

FIRST USE 11-1-2011; IN COMMERCE 11-1-2011.

THE MARK CONSISTS OF STANDARD CHARACTERS WITHOUT CLAIM TO ANY PARTICULAR FONT, STYLE, SIZE, OR COLOR.

SER. NO. 85-531,584, FILED 2-1-2012.

ALLISON SCHRODY, EXAMINING ATTORNEY



David J. Kybas

Director of the United States Patent and Trademark Office

United States of America

United States Patent and Trademark Office

AngryStudents

Reg. No. 4,205,413

Registered Sep. 11, 2012

Int. Cl.: 45

SERVICE MARK

PRINCIPAL REGISTER

LES ENTREPRISES PERPIGNAND CORP. (FLORIDA CORPORATION), DBA
ANGRYSTUDENTS
11535 SW 135TH CT
MIAMI, FL 33186

FOR: ON-LINE SOCIAL NETWORKING SERVICES, IN CLASS 45 (U.S. CLS. 100 AND 101).

FIRST USE 11-28-2011; IN COMMERCE 11-28-2011.

THE MARK CONSISTS OF STANDARD CHARACTERS WITHOUT CLAIM TO ANY PARTICULAR FONT, STYLE, SIZE, OR COLOR.

SER. NO. 85-531,618, FILED 2-1-2012.

MATTHEW KLINE, EXAMINING ATTORNEY



David J. Kypas

Director of the United States Patent and Trademark Office

United States of America

United States Patent and Trademark Office

TECHBIRD

Reg. No. 4,205,414

Registered Sep. 11, 2012

Int. Cl.: 9

TRADEMARK

PRINCIPAL REGISTER

TECHBIRD, LLC (GEORGIA LIMITED LIABILITY COMPANY)
#B7-135
6586 HWY 40 EAST
SAINT MARY'S, GA 31558

FOR: COMPUTER APPLICATION SOFTWARE FOR MOBILE PHONES, COMPUTERS, AND TABLET COMPUTERS, NAMELY, SOFTWARE FOR USE IN MONITORING OF COMPUTING DEVICE USER ACTIVITY , IN CLASS 9 (U.S. CLS. 21, 23, 26, 36 AND 38).

FIRST USE 1-1-2012; IN COMMERCE 1-1-2012.

THE MARK CONSISTS OF STANDARD CHARACTERS WITHOUT CLAIM TO ANY PARTICULAR FONT, STYLE, SIZE, OR COLOR.

SER. NO. 85-531,620, FILED 2-1-2012.

LOURDES AYALA, EXAMINING ATTORNEY



David J. Kyjars

Director of the United States Patent and Trademark Office

United States of America

United States Patent and Trademark Office



Reg. No. 4,205,415

Registered Sep. 11, 2012

Int. Cl.: 3

TRADEMARK

PRINCIPAL REGISTER

URPIN TRADING CO., LTD. (TAIWAN CORPORATION)
9F., NO. 29-1
LN. 169, KANGNING ST., XIZHI DIST.,
NEW TAIPEI CITY, TAIWAN 221

FOR: FACIAL CLEANSERS; NATURAL SOAP BARS; SHOWER GELS; HAIR CARE PREPARATIONS; CONDITIONERS IN THE FORM OF SPRAYS FOR THE SCALP; HAIR SHAMPOO; HAIR CONDITIONERS, IN CLASS 3 (U.S. CLS. 1, 4, 6, 50, 51 AND 52).

FIRST USE 4-7-2010; IN COMMERCE 2-1-2012.

THE MARK CONSISTS OF A LIGHT BROWN RECTANGLE BORDERED WITH A BEIGE FRAME, A BEIGE FLOWER DESIGN WITHIN THE RECTANGLE, AND THE WORD "FASUN" IN WHITE IN THE CENTER OF THE RECTANGLE.

THE COLOR(S) BEIGE, LIGHT BROWN, AND WHITE IS/ARE CLAIMED AS A FEATURE OF THE MARK.

SER. NO. 85-531,637, FILED 2-1-2012.

LOURDES AYALA, EXAMINING ATTORNEY



David J. Kybas

Director of the United States Patent and Trademark Office

United States of America

United States Patent and Trademark Office

THE QUEEN'S FLOWERS

Reg. No. 4,205,416

Registered Sep. 11, 2012

Int. Cl.: 31

TRADEMARK

PRINCIPAL REGISTER

THE QUEEN'S FLOWERS, INC. (FLORIDA CORPORATION)
2750 NW 79TH AVENUE
MIAMI, FL 33122

FOR: FRESH CUT FLOWERS, IN CLASS 31 (U.S. CLS. 1 AND 46).

FIRST USE 12-31-1983; IN COMMERCE 12-31-1983.

THE MARK CONSISTS OF STANDARD CHARACTERS WITHOUT CLAIM TO ANY PARTICULAR FONT, STYLE, SIZE, OR COLOR.

NO CLAIM IS MADE TO THE EXCLUSIVE RIGHT TO USE "FLOWERS", APART FROM THE MARK AS SHOWN.

SER. NO. 85-531,638, FILED 2-1-2012.

PAUL MORENO, EXAMINING ATTORNEY



David J. Kyffers

Director of the United States Patent and Trademark Office

United States of America

United States Patent and Trademark Office

SYGENA

Reg. No. 4,205,417

Registered Sep. 11, 2012

Int. Cl.: 42

SERVICE MARK

PRINCIPAL REGISTER

SYGENA LLC (NEW JERSEY LIMITED LIABILITY COMPANY)
29 PATERSON PL
NEWTON, NJ 07860

FOR: COMPUTER SERVICES, NAMELY, COMPUTER SYSTEM ADMINISTRATION FOR OTHERS; COMPUTER SERVICES, NAMELY, ON-SITE MANAGEMENT OF INFORMATION TECHNOLOGY (IT) SYSTEMS; COMPUTER SERVICES, NAMELY, REMOTE MANAGEMENT OF THE INFORMATION TECHNOLOGY (IT) SYSTEMS OF OTHERS; PROFESSIONAL COMPUTER SERVICES, NAMELY, NETWORK ANALYSIS, LAN/WAN DESIGN, WIRELESS ENGINEERING, VIRTUALIZATION AND COMPUTER PROJECT MANAGEMENT, IN CLASS 42 (U.S. CLS. 100 AND 101).

FIRST USE 1-31-2012; IN COMMERCE 1-31-2012.

THE MARK CONSISTS OF STANDARD CHARACTERS WITHOUT CLAIM TO ANY PARTICULAR FONT, STYLE, SIZE, OR COLOR.

SER. NO. 85-531,640, FILED 2-1-2012.

MIAH ROSENBERG, EXAMINING ATTORNEY



David J. Kybas

Director of the United States Patent and Trademark Office

United States of America

United States Patent and Trademark Office

SKOGIES

Reg. No. 4,205,418

Registered Sep. 11, 2012

Int. Cl.: 43

SERVICE MARK

PRINCIPAL REGISTER

LAKESIDE RESTAURANTS, INC. (GEORGIA CORPORATION)
2260 MARS HILL ROAD
WATKINSVILLE, GA 30677

FOR: RESTAURANT SERVICES; RESTAURANT SERVICES FEATURING FISH, CHICKEN, SEAFOOD, SANDWICHES, SIDE DISHES, SALADS; RESTAURANT SERVICES, INCLUDING SIT-DOWN SERVICE OF FOOD AND TAKE-OUT RESTAURANT SERVICES; RESTAURANT SERVICES, NAMELY, PROVIDING OF FOOD AND BEVERAGES FOR CONSUMPTION ON AND OFF THE PREMISES, IN CLASS 43 (U.S. CLS. 100 AND 101).

FIRST USE 7-31-2005; IN COMMERCE 7-31-2005.

THE MARK CONSISTS OF STANDARD CHARACTERS WITHOUT CLAIM TO ANY PARTICULAR FONT, STYLE, SIZE, OR COLOR.

SER. NO. 85-531,642, FILED 2-1-2012.

CAROLYN CATALDO, EXAMINING ATTORNEY



David J. Kyffers

Director of the United States Patent and Trademark Office

United States of America

United States Patent and Trademark Office



Reg. No. 4,205,419

Registered Sep. 11, 2012

Int. Cl.: 43

SERVICE MARK

PRINCIPAL REGISTER

LAKESIDE RESTAURANTS, INC. (GEORGIA CORPORATION)
2260 MARS HILL ROAD
WATKINSVILLE, GA 30677

FOR: RESTAURANT SERVICES; RESTAURANT SERVICES FEATURING FISH, CHICKEN, SEAFOOD, SANDWICHES, SIDE DISHES, SALADS; RESTAURANT SERVICES, INCLUDING SIT-DOWN SERVICE OF FOOD AND TAKE-OUT RESTAURANT SERVICES; RESTAURANT SERVICES, NAMELY, PROVIDING OF FOOD AND BEVERAGES FOR CONSUMPTION ON AND OFF THE PREMISES, IN CLASS 43 (U.S. CLS. 100 AND 101).

FIRST USE 7-31-2005; IN COMMERCE 7-31-2005.

THE MARK CONSISTS OF A STYLISTIC RENDERING OF A FISH WITH THE STYLISTIC LITERAL ELEMENT "SKOGIES" INTEGRATED INTO THE STYLISTIC RENDERING OF THE FISH WITH THE LOWER PORTION OF THE FIRST "S" AND THE DESCENDING PORTION OF THE "G" FORMING PORTIONS OF THE BELLY OF THE STYLISTIC RENDERING OF THE FISH AND THE SECOND "S" FORMING THE TAIL OF THE STYLISTIC RENDERING OF THE FISH, THE STYLISTIC RENDERING OF THE FISH INCLUDING A FIN ON THE TOP AND VARIOUS SIZED BUBBLES OVER THE FRONT OF THE STYLISTIC RENDERING OF THE FISH.

SER. NO. 85-531,647, FILED 2-1-2012.

CAROLYN CATALDO, EXAMINING ATTORNEY



David J. Kybas

Director of the United States Patent and Trademark Office

United States of America

United States Patent and Trademark Office

Pump Camp

Reg. No. 4,205,420

Registered Sep. 11, 2012

Int. Cl.: 41

SERVICE MARK

PRINCIPAL REGISTER

AISHA FRANCIS (UNITED STATES INDIVIDUAL)
SUITE 350
4821 LANKERSHIM BLVD
NORTH HOLLYWOOD, CA 91601

FOR: EDUCATIONAL SERVICES, NAMELY, CONDUCTING CLASSES AND WORKSHOPS
IN THE FIELD OF DANCE AND MOVEMENT, IN CLASS 41 (U.S. CLS. 100, 101 AND 107).

FIRST USE 1-1-2011; IN COMMERCE 1-1-2011.

THE MARK CONSISTS OF STANDARD CHARACTERS WITHOUT CLAIM TO ANY PAR-
TICULAR FONT, STYLE, SIZE, OR COLOR.

SER. NO. 85-531,651, FILED 2-1-2012.

CAROLYN CATALDO, EXAMINING ATTORNEY



David J. Kyffers

Director of the United States Patent and Trademark Office

United States of America

United States Patent and Trademark Office

Next Nutrition

Reg. No. 4,205,421

ROTH, JOHN H. (UNITED STATES INDIVIDUAL)
10105 ALBEE AVE.
TUSTIN, CA 92782

Registered Sep. 11, 2012

Int. Cl.: 5

FOR: VITAMIN AND MINERAL SUPPLEMENTS, IN CLASS 5 (U.S. CLS. 6, 18, 44, 46, 51 AND 52).

TRADEMARK

FIRST USE 1-5-2012; IN COMMERCE 1-10-2012.

PRINCIPAL REGISTER

THE MARK CONSISTS OF STANDARD CHARACTERS WITHOUT CLAIM TO ANY PARTICULAR FONT, STYLE, SIZE, OR COLOR.

NO CLAIM IS MADE TO THE EXCLUSIVE RIGHT TO USE "NUTRITION", APART FROM THE MARK AS SHOWN.

SER. NO. 85-531,655, FILED 2-2-2012.

CHARLOTTE CORWIN, EXAMINING ATTORNEY



David J. Kyffers

Director of the United States Patent and Trademark Office

United States of America

United States Patent and Trademark Office



Reg. No. 4,205,422

BOKEBOWL LLC (OREGON LIMITED LIABILITY COMPANY)
1028 SE WATER AVENUE, SUITE 120
PORTLAND, OR 97214

Registered Sep. 11, 2012

Int. Cl.: 43

FOR: RESTAURANT SERVICES, IN CLASS 43 (U.S. CLS. 100 AND 101).

SERVICE MARK

FIRST USE 3-30-2011; IN COMMERCE 3-30-2011.

PRINCIPAL REGISTER

SER. NO. 85-531,664, FILED 2-2-2012.

KIM MONINGHOFF, EXAMINING ATTORNEY

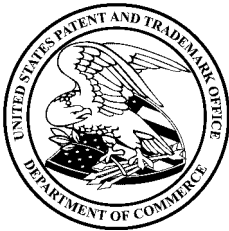

David J. Kyffers

Director of the United States Patent and Trademark Office

United States of America

United States Patent and Trademark Office

HANDBAKED

Reg. No. 4,205,423

ASSOCIATE INC. (DELAWARE CORPORATION), DBA HANDBAKED
4630 GEARY BLVD. #101

Registered Sep. 11, 2012

SAN FRANCISCO, CA 94118

Int. Cl.: 42

FOR: COMPUTER SOFTWARE DEVELOPMENT IN THE FIELD OF MOBILE APPLICATIONS;
PROGRAMMING OF MULTIMEDIA APPLICATIONS, IN CLASS 42 (U.S. CLS. 100 AND
101).

SERVICE MARK

FIRST USE 10-26-2011; IN COMMERCE 12-7-2011.

PRINCIPAL REGISTER

THE MARK CONSISTS OF STANDARD CHARACTERS WITHOUT CLAIM TO ANY PAR-
TICULAR FONT, STYLE, SIZE, OR COLOR.

SER. NO. 85-531,667, FILED 2-2-2012.

KATHERINE STOIDES, EXAMINING ATTORNEY



David J. Kyffers

Director of the United States Patent and Trademark Office

United States of America

United States Patent and Trademark Office

Michelle's Gateways

Reg. No. 4,205,424

BEASON, MICHELLE DAWN (UNITED STATES INDIVIDUAL)
2459 SKY ROAD

Registered Sep. 11, 2012

WALNUT CREEK, CA 94597

Int. Cl.: 41

FOR: ENTERTAINMENT, NAMELY, PRODUCTION OF AN ADVENTURE TRAVEL TELEVISION SHOW; PRODUCTION AND DISTRIBUTION OF TELEVISION SHOWS AND MOVIES, IN CLASS 41 (U.S. CLS. 100, 101 AND 107).

SERVICE MARK

FIRST USE 2-1-2012; IN COMMERCE 2-1-2012.

PRINCIPAL REGISTER

THE MARK CONSISTS OF STANDARD CHARACTERS WITHOUT CLAIM TO ANY PARTICULAR FONT, STYLE, SIZE, OR COLOR.

SER. NO. 85-531,672, FILED 2-2-2012.

MICHELE SWAIN, EXAMINING ATTORNEY



David J. Kyffers

Director of the United States Patent and Trademark Office

United States of America

United States Patent and Trademark Office

FULL ON

Reg. No. 4,205,425

NEFF, ANA (UNITED STATES INDIVIDUAL)
3 HILLCREST ST.

Registered Sep. 11, 2012

ASHLAND, OR 97520

Int. Cl.: 41

FOR: EDUCATIONAL SERVICES, NAMELY, CONDUCTING WORKSHOPS AND SEMINARS IN THE FIELD OF BUSINESS, MOTIVATION, SELF-HELP AND PERSONAL EMPOWERMENT AND DISTRIBUTION OF COURSE MATERIAL IN CONNECTION THEREWITH; LIFE COACHING SERVICES IN THE FIELD OF MOTIVATION, SELF-HELP AND PERSONAL EMPOWERMENT; ON-LINE JOURNALS, NAMELY, BLOGS FEATURING INFORMATION IN THE FIELD OF BUSINESS, MOTIVATION, SELF-HELP AND PERSONAL EMPOWERMENT; PERSONAL COACHING SERVICES IN THE FIELD OF MOTIVATION, SELF-HELP AND PERSONAL EMPOWERMENT MOTIVATION, SELF-HELP AND PERSONAL EMPOWERMENT; PROFESSIONAL COACHING SERVICES IN THE FIELD OF MOTIVATION, SELF-HELP AND PERSONAL EMPOWERMENT; PROVIDING ONLINE NEWSLETTERS IN THE FIELD OF BUSINESS, MOTIVATION, SELF-HELP AND PERSONAL EMPOWERMENT VIA E-MAIL, IN CLASS 41 (U.S. CLS. 100, 101 AND 107).

SERVICE MARK

PRINCIPAL REGISTER

FIRST USE 6-1-2008; IN COMMERCE 8-8-2010.

THE MARK CONSISTS OF STANDARD CHARACTERS WITHOUT CLAIM TO ANY PARTICULAR FONT, STYLE, SIZE, OR COLOR.

SER. NO. 85-531,686, FILED 2-2-2012.

BILL DAWE, EXAMINING ATTORNEY



David J. Kyffers

Director of the United States Patent and Trademark Office

United States of America

United States Patent and Trademark Office

AUNT SADIE'S

Reg. No. 4,205,426

AUNT SADIE'S, INC. (VERMONT CORPORATION)
108 S. LUNENBURG ROAD
LUNENBURG, VT 05906

Registered Sep. 11, 2012

Int. Cl.: 4

FOR: CANDLES, IN CLASS 4 (U.S. CLS. 1, 6 AND 15).

TRADEMARK

FIRST USE 11-1-1997; IN COMMERCE 11-1-1997.

PRINCIPAL REGISTER

THE MARK CONSISTS OF STANDARD CHARACTERS WITHOUT CLAIM TO ANY PARTICULAR FONT, STYLE, SIZE, OR COLOR.

SER. NO. 85-531,701, FILED 2-2-2012.

HOWARD SMIGA, EXAMINING ATTORNEY



David J. Kyffers

Director of the United States Patent and Trademark Office

United States of America

United States Patent and Trademark Office

CATCH-UP LOGISTICS

Reg. No. 4,205,427

ICE LAND, INC. (PENNSYLVANIA CORPORATION)
618 MELLON STREET
PITTSBURGH, PA 15206

Registered Sep. 11, 2012

Int. Cls.: 35 and 39

FOR: PROCUREMENT, NAMELY, PURCHASING RAW FOOD PRODUCTS AND FOOD INGREDIENTS FOR OTHERS, IN CLASS 35 (U.S. CLS. 100, 101 AND 102).

SERVICE MARK

FIRST USE 1-5-1996; IN COMMERCE 1-5-1996.

PRINCIPAL REGISTER

FOR: TRANSPORT OF RAW FOOD PRODUCTS AND FOOD INGREDIENTS FOR OTHERS BY MEANS OF TRUCK, AIR, SHIP AND RAIL; STORAGE OF RAW FOOD PRODUCTS AND FOOD INGREDIENTS FOR OTHERS, IN CLASS 39 (U.S. CLS. 100 AND 105).

FIRST USE 1-5-1996; IN COMMERCE 1-5-1996.

THE MARK CONSISTS OF STANDARD CHARACTERS WITHOUT CLAIM TO ANY PARTICULAR FONT, STYLE, SIZE, OR COLOR.

NO CLAIM IS MADE TO THE EXCLUSIVE RIGHT TO USE "LOGISTICS", APART FROM THE MARK AS SHOWN.

SER. NO. 85-531,708, FILED 2-2-2012.

KELLY BOULTON, EXAMINING ATTORNEY



David J. Kybas

Director of the United States Patent and Trademark Office

United States of America

United States Patent and Trademark Office

FLEXOGEN

Reg. No. 4,205,428

Registered Sep. 11, 2012

Int. Cl.: 17

TRADEMARK

PRINCIPAL REGISTER

ROBERT BOSCH TOOL CORPORATION (DELAWARE CORPORATION)
1800 WEST CENTRAL ROAD
MOUNT PROSPECT, IL 600562230

FOR: GARDEN HOSES, IN CLASS 17 (U.S. CLS. 1, 5, 12, 13, 35 AND 50).

FIRST USE 5-22-1967; IN COMMERCE 5-22-1967.

THE MARK CONSISTS OF STANDARD CHARACTERS WITHOUT CLAIM TO ANY PARTICULAR FONT, STYLE, SIZE, OR COLOR.

SER. NO. 85-531,735, FILED 2-2-2012.

ERIN FALK, EXAMINING ATTORNEY



David J. Kyffers

Director of the United States Patent and Trademark Office

United States of America

United States Patent and Trademark Office

AUTO-TRACK

Reg. No. 4,205,429

AMES TRUE TEMPER, INC. (DELAWARE CORPORATION)
465 RAILROAD AVENUE
CAMP HILL, PA 17011

Registered Sep. 11, 2012

Int. Cl.: 6

FOR: MANUALLY OPERATED METAL HOSE REELS, IN CLASS 6 (U.S. CLS. 2, 12, 13, 14, 23, 25 AND 50).

TRADEMARK

FIRST USE 12-0-2008; IN COMMERCE 12-0-2008.

PRINCIPAL REGISTER

THE MARK CONSISTS OF STANDARD CHARACTERS WITHOUT CLAIM TO ANY PARTICULAR FONT, STYLE, SIZE, OR COLOR.

SER. NO. 85-531,740, FILED 2-2-2012.

CHRIS WELLS, EXAMINING ATTORNEY



David J. Kybas

Director of the United States Patent and Trademark Office

United States of America

United States Patent and Trademark Office

Parejas Para Cristo

Reg. No. 4,205,430

Registered Sep. 11, 2012

Int. Cl.: 45

SERVICE MARK

PRINCIPAL REGISTER

COUPLES FOR CHRIST, METROPOLITAN-WASHINGTON, D.C., INCORPORATED
(MARYLAND CORPORATION)
14 GOODPORT LANE
GAITHERSBURG, MD 20878

FOR: RELIGIOUS AND SPIRITUAL SERVICES, NAMELY, PROVIDING GATHERINGS AND RETREATS TO DEVELOP AND ENHANCE THE SPIRITUAL LIVES OF INDIVIDUALS, IN CLASS 45 (U.S. CLS. 100 AND 101).

FIRST USE 1-21-2011; IN COMMERCE 1-21-2011.

THE MARK CONSISTS OF STANDARD CHARACTERS WITHOUT CLAIM TO ANY PARTICULAR FONT, STYLE, SIZE, OR COLOR.

THE ENGLISH TRANSLATION OF PAREJAS PARA CRISTO IN THE MARK IS COUPLES FOR CHRIST.

SER. NO. 85-531,752, FILED 2-2-2012.

MIDGE BUTLER, EXAMINING ATTORNEY



David J. Kybas

Director of the United States Patent and Trademark Office

United States of America

United States Patent and Trademark Office

LMBRI

Reg. No. 4,205,431

Registered Sep. 11, 2012

Int. Cl.: 35

SERVICE MARK

PRINCIPAL REGISTER

LANA MANAGEMENT & BUSINESS RESEARCH INTERNATIONAL, LLC
(MASSACHUSETTS LIMITED LIABILITY COMPANY)
55 WOOD LANE, SUITE 202
ACTON, MA 01720

FOR: BUSINESS STRATEGIC PLANNING SERVICES; BUSINESS RISK MANAGEMENT CONSULTATION; MARKET ANALYSIS AND RESEARCH SERVICES; BUSINESS ADVICE AND ANALYSIS OF MARKETS; CUSTOMER RELATIONSHIP MANAGEMENT; PROVIDING BUSINESS MANAGEMENT INFORMATION IN CONNECTION WITH CONSULTING AND ADVISORY SERVICES IN THE FIELD OF STRATEGIC PLANNING; BUSINESS MANAGEMENT CONSULTANCY AS WELL AS DEVELOPMENT OF PROCESSES FOR THE ANALYSIS AND THE IMPLEMENTATION OF STRATEGY PLANS AND MANAGEMENT PROJECTS; PROVIDING INFORMATION AND NEWS IN THE FIELD OF BUSINESS, NAMELY, INFORMATION AND NEWS ON CURRENT EVENTS AND ON ECONOMIC, LEGISLATIVE, AND REGULATORY DEVELOPMENTS AS IT RELATES TO AND CAN IMPACT BUSINESSES; BUSINESS CONSULTING AND MANAGEMENT IN THE FIELD OF CLINICAL TRIALS, NAMELY, CLINICAL DATA AND REGULATORY SUBMISSION MANAGEMENT ON BEHALF OF MEDICAL, BIOPHARMACEUTICAL AND BIOTECHNOLOGY COMPANIES TO ASSIST THEM WITH CLINICAL RESEARCH, CLINICAL TRIALS AND APPLICATIONS FOR DRUG APPROVAL; ADVICE CONCERNING CHEMICAL PRODUCT MARKETING; PROVIDING CONSULTING SERVICES IN THE FIELD OF REGULATORY SUBMISSION MANAGEMENT TO MEDICAL COMPANIES TO ASSIST THEM WITH APPLICATIONS FOR MEDICAL DEVICE APPROVAL; PROMOTING COLLABORATION WITHIN THE SCIENTIFIC, RESEARCH AND MEDICAL COMMUNITIES TO ACHIEVE ADVANCES IN THE FIELD OF HEALTHCARE, IN CLASS 35 (U.S. CLS. 100, 101 AND 102).



FIRST USE 5-0-2009; IN COMMERCE 5-0-2009.

THE MARK CONSISTS OF STANDARD CHARACTERS WITHOUT CLAIM TO ANY PARTICULAR FONT, STYLE, SIZE, OR COLOR.

SER. NO. 85-531,758, FILED 2-2-2012.

ELISSA GARBER KON, EXAMINING ATTORNEY

David J. Kyjars

Director of the United States Patent and Trademark Office

United States of America

United States Patent and Trademark Office

A LAB ON FIRE

Reg. No. 4,205,432

NOBUKAZU F. SHIOYA (UNITED STATES INDIVIDUAL)
453 PALMER AVENUE
MAMARONECK, NY 10543

Registered Sep. 11, 2012

Int. Cl.: 3

FOR: FRAGRANCES, NAMELY, PERFUMES, COLOGNES AND TOILET WATER, IN CLASS 3 (U.S. CLS. 1, 4, 6, 50, 51 AND 52).

TRADEMARK

FIRST USE 10-29-2010; IN COMMERCE 10-29-2010.

PRINCIPAL REGISTER

THE MARK CONSISTS OF STANDARD CHARACTERS WITHOUT CLAIM TO ANY PARTICULAR FONT, STYLE, SIZE, OR COLOR.

SER. NO. 85-531,759, FILED 2-2-2012.

JOHN WILKE, EXAMINING ATTORNEY



David J. Kybas

Director of the United States Patent and Trademark Office

United States of America

United States Patent and Trademark Office



Reg. No. 4,205,433

Registered Sep. 11, 2012

Int. Cl.: 35

SERVICE MARK

PRINCIPAL REGISTER

JOHNNY BENCH 5, INC. (OHIO CORPORATION)
255 EAST FIFTH STREET, SUITE 2400
CINCINNATI, OH 45202

FOR: ON-LINE RETAIL STORE SERVICES FEATURING BASEBALL MEMORABILIA AND COLLECTIBLES, INCLUDING JOHNNY BENCH MEMORABILIA AND COLLECTIBLES, IN CLASS 35 (U.S. CLS. 100, 101 AND 102).

FIRST USE 1-30-2012; IN COMMERCE 1-30-2012.

THE NAME JOHNNY BENCH IDENTIFIES A LIVING INDIVIDUAL WHOSE CONSENT IS OF RECORD.

THE MARK CONSISTS OF THE NUMBER 5 WITH A CROUCHING CATCHER OVER A LINE ATOP JOHNNY ATOP BENCH OVER A LINE ATOP "CATCH YA LATER!".

SER. NO. 85-531,831, FILED 2-2-2012.

TRICIA SONNEBORN, EXAMINING ATTORNEY



David J. Kybas

Director of the United States Patent and Trademark Office

United States of America

United States Patent and Trademark Office



Reg. No. 4,205,434

Registered Sep. 11, 2012

Int. Cl.: 5

TRADEMARK

PRINCIPAL REGISTER

NANOTHERAPEUTICS, INC. (FLORIDA CORPORATION)
13859 PROGRESS BLVD., SUITE 300
ALACHUA, FL 32615

FOR: PHARMACEUTICAL DELIVERY SYSTEMS, NAMELY, TOPICAL GEL FOR LOCAL DELIVERY OF DOXYCYCLINE FOR USE IN THE TREATMENT OF LOCAL WOUND HEALING, IN CLASS 5 (U.S. CLS. 6, 18, 44, 46, 51 AND 52).

FIRST USE 1-4-2012; IN COMMERCE 1-4-2012.

OWNER OF U.S. REG. NOS. 3,926,171, 3,959,227, AND 4,038,864.

THE MARK CONSISTS OF THREE CRESCENT DESIGNS NEXT TO THE STYLIZED TERM "NANODOX".

SER. NO. 85-531,852, FILED 2-2-2012.

JOHN E. MICHOS, EXAMINING ATTORNEY



David J. Kyffers

Director of the United States Patent and Trademark Office

United States of America

United States Patent and Trademark Office



Reg. No. 4,205,435

Registered Sep. 11, 2012

Int. Cls.: 35 and 39

SERVICE MARK

PRINCIPAL REGISTER

THE ORIGINAL 3 MEN MOVERS, LTD. (TEXAS LIMITED PARTNERSHIP)
6853-1/2 SOUTHWEST FREEWAY
HOUSTON, TX 77074

FOR: MOVING AND RELOCATION SERVICES, NAMELY, PLANNING AND IMPLEMENTING MOVES OF HOMES AND OFFICES, IN CLASS 35 (U.S. CLS. 100, 101 AND 102).

FIRST USE 10-19-1988; IN COMMERCE 10-19-1988.

FOR: MOVING COMPANY SERVICES; MOVING VAN SERVICES; MOVING VAN TRANSPORT; PACKING ARTICLES FOR TRANSPORTATION; PROVIDING SELF-STORAGE FACILITIES FOR OTHERS; RENTAL OF STORAGE CONTAINERS; TRANSPORTATION AND STORAGE OF GOODS, IN CLASS 39 (U.S. CLS. 100 AND 105).

FIRST USE 10-19-1988; IN COMMERCE 10-19-1988.

THE MARK CONSISTS OF THREE STYLIZED HUMAN FIGURES THAT APPEAR TO BE RUNNING.

SER. NO. 85-531,854, FILED 2-2-2012.

SANJEEV VOHRA, EXAMINING ATTORNEY



David J. Kyros

Director of the United States Patent and Trademark Office

United States of America

United States Patent and Trademark Office

RoughRiders

Reg. No. 4,205,436

Registered Sep. 11, 2012

Int. Cl.: 41

SERVICE MARK

PRINCIPAL REGISTER

NEWCO RIDERS, LLC (COLORADO LIMITED LIABILITY COMPANY)
8250 GREENWOOD PLACE
8250 GREENWOOD PLACE
NIWOT, CO 80503

FOR: ENTERTAINMENT IN THE NATURE OF HOCKEY GAMES, IN CLASS 41 (U.S. CLS. 100, 101 AND 107).

FIRST USE 9-1-1999; IN COMMERCE 9-1-1999.

THE MARK CONSISTS OF STANDARD CHARACTERS WITHOUT CLAIM TO ANY PARTICULAR FONT, STYLE, SIZE, OR COLOR.

SER. NO. 85-531,857, FILED 2-2-2012.

BERYL GARDNER, EXAMINING ATTORNEY



David J. Kyffers

Director of the United States Patent and Trademark Office

United States of America

United States Patent and Trademark Office

PEEPSPLUS.COM THE INFO YOU
WANT FROM THE PEOPLE YOU
TRUST

Reg. No. 4,205,437

LAWRENCE, KEN (UNITED STATES INDIVIDUAL)
246 DEBBIE DR.

Registered Sep. 11, 2012

MERIDEN, CT 06451

Int. Cl.: 35

FOR: ADVERTISING AND PROMOTIONAL SERVICES, IN CLASS 35 (U.S. CLS. 100, 101 AND 102).

SERVICE MARK

FIRST USE 1-0-2012; IN COMMERCE 1-0-2012.

PRINCIPAL REGISTER

THE MARK CONSISTS OF STANDARD CHARACTERS WITHOUT CLAIM TO ANY PARTICULAR FONT, STYLE, SIZE, OR COLOR.

SER. NO. 85-531,863, FILED 2-2-2012.

JOHN E. MICHOS, EXAMINING ATTORNEY



David J. Kybas

Director of the United States Patent and Trademark Office

United States of America

United States Patent and Trademark Office

SITEMASON

Reg. No. 4,205,438

Registered Sep. 11, 2012

Int. Cl.: 42

SERVICE MARK

PRINCIPAL REGISTER

SITEMASON, INC. (TENNESSEE CORPORATION)
SUITE 5
110 30TH AVENUE NORTH
NASHVILLE, TN 37203

FOR: APPLICATION SERVICE PROVIDER, NAMELY, PROVIDING, HOSTING, MANAGING, DEVELOPING AND MAINTAINING APPLICATIONS, SOFTWARE, WEBSITES AND DATABASES IN THE FIELDS OF ECOMMERCE, ONLINE PAYMENTS, ORDER QUEUING, WEBSITE DESIGN, DATA STORAGE, SHARED COMPUTING CAPACITY SCALING, MESSAGING SERVICES AND CALCULATION OF WEBSITE RANKING BASED ON USER TRAFFIC, IN CLASS 42 (U.S. CLS. 100 AND 101).

FIRST USE 1-1-2001; IN COMMERCE 1-1-2001.

THE MARK CONSISTS OF STANDARD CHARACTERS WITHOUT CLAIM TO ANY PARTICULAR FONT, STYLE, SIZE, OR COLOR.

SER. NO. 85-531,867, FILED 2-2-2012.

AISHA CLARKE, EXAMINING ATTORNEY



David J. Kyffers

Director of the United States Patent and Trademark Office

United States of America

United States Patent and Trademark Office

ON THE EDGE

Reg. No. 4,205,439

PFEFFER, PATRICK (UNITED STATES INDIVIDUAL)
8813 THOMAS DRIVE

Registered Sep. 11, 2012

PANAMA CITY BEACH, FL 32408

Int. Cl.: 41

FOR: ENTERTAINMENT, NAMELY, A CONTINUING MUSIC SHOW BROADCAST OVER RADIO, SATELLITE, AND INTERNET, IN CLASS 41 (U.S. CLS. 100, 101 AND 107).

SERVICE MARK

FIRST USE 8-1-1995; IN COMMERCE 8-1-1995.

PRINCIPAL REGISTER

THE MARK CONSISTS OF STANDARD CHARACTERS WITHOUT CLAIM TO ANY PARTICULAR FONT, STYLE, SIZE, OR COLOR.

SER. NO. 85-531,879, FILED 2-2-2012.

ALEX KEAM, EXAMINING ATTORNEY



David J. Kyffers

Director of the United States Patent and Trademark Office

United States of America

United States Patent and Trademark Office

BUILD ON US

Reg. No. 4,205,440

Registered Sep. 11, 2012

Int. Cl.: 42

SERVICE MARK

PRINCIPAL REGISTER

SITEMASON, INC. (TENNESSEE CORPORATION)
SUITE 5
110 30TH AVENUE NORTH
NASHVILLE, TN 37203

FOR: APPLICATION SERVICE PROVIDER, NAMELY, PROVIDING, HOSTING, MANAGING, DEVELOPING AND MAINTAINING APPLICATIONS, SOFTWARE, WEBSITES AND DATABASES IN THE FIELDS OF ECOMMERCE, ONLINE PAYMENTS, ORDER QUEUING, WEBSITE DESIGN, DATA STORAGE, SHARED COMPUTING CAPACITY SCALING, MESSAGING SERVICES AND CALCULATION OF WEBSITE RANKING BASED ON USER TRAFFIC, IN CLASS 42 (U.S. CLS. 100 AND 101).

FIRST USE 1-9-2012; IN COMMERCE 1-9-2012.

THE MARK CONSISTS OF STANDARD CHARACTERS WITHOUT CLAIM TO ANY PARTICULAR FONT, STYLE, SIZE, OR COLOR.

SER. NO. 85-531,885, FILED 2-2-2012.

AISHA CLARKE, EXAMINING ATTORNEY



David J. Kyffers

Director of the United States Patent and Trademark Office

United States of America

United States Patent and Trademark Office

DRINK KING DISTRIBUTING

Reg. No. 4,205,441

NTH DEGREE INNOVATIONS, INC. (NEW JERSEY CORPORATION)
3 FISHER DRIVE
MILLTOWN, NJ 08550

Registered Sep. 11, 2012

Int. Cl.: 39

FOR: DISTRIBUTION SERVICES, NAMELY, DELIVERY OF BEVERAGES AND DIETARY SUPPLEMENTS, IN CLASS 39 (U.S. CLS. 100 AND 105).

SERVICE MARK

FIRST USE 1-31-2012; IN COMMERCE 1-31-2012.

PRINCIPAL REGISTER

THE MARK CONSISTS OF STANDARD CHARACTERS WITHOUT CLAIM TO ANY PARTICULAR FONT, STYLE, SIZE, OR COLOR.

NO CLAIM IS MADE TO THE EXCLUSIVE RIGHT TO USE "DRINK" AND "DISTRIBUTING", APART FROM THE MARK AS SHOWN.

SER. NO. 85-531,888, FILED 2-2-2012.

MYRIAH HABEEB, EXAMINING ATTORNEY



David J. Kybas

Director of the United States Patent and Trademark Office

United States of America

United States Patent and Trademark Office

QUICKTABS

Reg. No. 4,205,442

Registered Sep. 11, 2012

Int. Cl.: 9

TRADEMARK

PRINCIPAL REGISTER

TABS GROUP, INC. (CONNECTICUT CORPORATION)
SUITE 254
2 CORPORATE DRIVE
SHELTON, CT 06484

FOR: SOFTWARE FOR ANALYSIS OF MARKET SHARE, PRODUCT SALES AND PRODUCT DISTRIBUTION, IN CLASS 9 (U.S. CLS. 21, 23, 26, 36 AND 38).

FIRST USE 10-0-1998; IN COMMERCE 10-0-1998.

THE MARK CONSISTS OF STANDARD CHARACTERS WITHOUT CLAIM TO ANY PARTICULAR FONT, STYLE, SIZE, OR COLOR.

SER. NO. 85-531,889, FILED 2-2-2012.

WILLIAM BRECKENFELD, EXAMINING ATTORNEY



David J. Kyffers

Director of the United States Patent and Trademark Office

United States of America

United States Patent and Trademark Office

DKP Critical Insights

Reg. No. 4,205,443

D.K. PIERCE & ASSOCIATES, INC. (INDIANA CORPORATION)
112 N. NINTH STREET
ZIONSVILLE, IN 46077

Registered Sep. 11, 2012

Int. Cl.: 36

FOR: PROVIDING A DATABASE FOR TRACKING, MONITORING, AND GENERATING REPORTS ON INFORMATION AND STATISTICS ABOUT PATIENT REIMBURSEMENT AND INSURANCE COVERAGE FOR PHARMACEUTICALS AND MEDICAL DEVICES, IN CLASS 36 (U.S. CLS. 100, 101 AND 102).

SERVICE MARK

PRINCIPAL REGISTER

FIRST USE 10-31-2011; IN COMMERCE 10-31-2011.

THE MARK CONSISTS OF STANDARD CHARACTERS WITHOUT CLAIM TO ANY PARTICULAR FONT, STYLE, SIZE, OR COLOR.

SER. NO. 85-531,901, FILED 2-2-2012.

MARILYN IZZI, EXAMINING ATTORNEY



David J. Kybas

Director of the United States Patent and Trademark Office

United States of America

United States Patent and Trademark Office

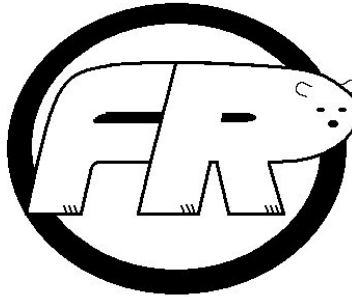

Reg. No. 4,205,444

PERKINS, ANDREW W. (UNITED STATES INDIVIDUAL)
610 CIELO VISTA CT.
LAS CRUCES, NM 88005

Registered Sep. 11, 2012

Int. Cl.: 37

FOR: INSTALLATION AND REPAIR OF HEATING, VENTILATING AND AIR CONDITIONING EQUIPMENT, IN CLASS 37 (U.S. CLS. 100, 103 AND 106).

SERVICE MARK

FIRST USE 1-17-2012; IN COMMERCE 1-17-2012.

PRINCIPAL REGISTER

THE MARK CONSISTS OF A CIRCLE WITH A POLAR BEAR WITHIN THE CIRCLE, FORMED BY THE LETTERS "F" AND "R". THE HORIZONTAL "BARS" OF THE "F" JOIN TO THE LEFT VERTICAL "BAR" OF THE "R". THE POLAR BEAR'S HEAD IS AT THE END OF THE LOOP OF THE "R" WHILE THREE LEGS OF THE POLAR BEAR ARE FORMED BY THE BOTTOM "PILLARS" OF THE "F" AND "R".

SER. NO. 85-531,911, FILED 2-2-2012.

GISELLE AGOSTO, EXAMINING ATTORNEY



David J. Kybas

Director of the United States Patent and Trademark Office

United States of America

United States Patent and Trademark Office

FACE BUCKS

Reg. No. 4,205,445

Registered Sep. 11, 2012

Int. Cl.: 16

TRADEMARK

PRINCIPAL REGISTER

URCUTE ENTERTAINMENT, LLC (CONNECTICUT LIMITED LIABILITY COMPANY)
100 CHATHAM TERRACE
BRIDGEPORT, CT 06606

FOR: STICKERS, NAMELY, STICKER SHEETS CONTAINING STICKERS SHAPED FOR CONTAINING A PORTRAIT AND PLACEMENT ON PAPER CURRENCY, IN CLASS 16 (U.S. CLS. 2, 5, 22, 23, 29, 37, 38 AND 50).

FIRST USE 10-25-2011; IN COMMERCE 10-25-2011.

THE MARK CONSISTS OF STANDARD CHARACTERS WITHOUT CLAIM TO ANY PARTICULAR FONT, STYLE, SIZE, OR COLOR.

SER. NO. 85-531,919, FILED 2-2-2012.

AHSEN KHAN, EXAMINING ATTORNEY



David J. Kyffers

Director of the United States Patent and Trademark Office

United States of America

United States Patent and Trademark Office

IRON KNEES

Reg. No. 4,205,446

Registered Sep. 11, 2012

Int. Cl.: 25

TRADEMARK

PRINCIPAL REGISTER

LANDS' END DIRECT MERCHANTS, INC. (DELAWARE CORPORATION)
820 W. 78TH STREET
RICHFIELD, MN 55423

FOR: PANTS, IN CLASS 25 (U.S. CLS. 22 AND 39).

FIRST USE 4-1-2011; IN COMMERCE 4-1-2011.

THE MARK CONSISTS OF STANDARD CHARACTERS WITHOUT CLAIM TO ANY PARTICULAR FONT, STYLE, SIZE, OR COLOR.

NO CLAIM IS MADE TO THE EXCLUSIVE RIGHT TO USE "KNEES", APART FROM THE MARK AS SHOWN.

SER. NO. 85-531,925, FILED 2-2-2012.

AHSEN KHAN, EXAMINING ATTORNEY



David J. Kyffers

Director of the United States Patent and Trademark Office

United States of America

United States Patent and Trademark Office

kaitydoo

Reg. No. 4,205,447

Registered Sep. 11, 2012

Int. Cl.: 18

TRADEMARK

PRINCIPAL REGISTER

DOOLITTLE, KAITY (UNITED STATES INDIVIDUAL)
APT. 401
1315 COMMONWEALTH AVENUE
ALLSTON, MA 02123

FOR: CLUTCHES; HANDBAGS; PURSES; SPORT BAGS, IN CLASS 18 (U.S. CLS. 1, 2, 3, 22 AND 41).

FIRST USE 9-9-2002; IN COMMERCE 8-16-2010.

THE MARK CONSISTS OF STANDARD CHARACTERS WITHOUT CLAIM TO ANY PARTICULAR FONT, STYLE, SIZE, OR COLOR.

SER. NO. 85-531,939, FILED 2-2-2012.

ALEX KEAM, EXAMINING ATTORNEY



David J. Kybas

Director of the United States Patent and Trademark Office

United States of America

United States Patent and Trademark Office

BUDDHA'S CUP

Reg. No. 4,205,448

COLEMAN, CHRISTINE (UNITED STATES INDIVIDUAL), DBA BUDDHA'S SANCTUARY
78-1377 BISHOP ROAD
HULUALOA, HI 96725

Registered Sep. 11, 2012

Int. Cl.: 30

FOR: COFFEE, IN CLASS 30 (U.S. CL. 46).

TRADEMARK

FIRST USE 10-0-2004; IN COMMERCE 10-0-2004.

PRINCIPAL REGISTER

THE MARK CONSISTS OF STANDARD CHARACTERS WITHOUT CLAIM TO ANY PARTICULAR FONT, STYLE, SIZE, OR COLOR.

SER. NO. 85-531,949, FILED 2-2-2012.

JAY FLOWERS, EXAMINING ATTORNEY



David J. Kyffers

Director of the United States Patent and Trademark Office

United States of America

United States Patent and Trademark Office

Derby Strong

Reg. No. 4,205,449

Registered Sep. 11, 2012

Int. Cls.: 16 and 25

TRADEMARK

PRINCIPAL REGISTER

THE TULSA DERBY LEAGUE (OKLAHOMA CORPORATION)
UNIT B
401 E BROADWAY CT.
SAND SPRINGS, OK 74063

FOR: POSTERS, IN CLASS 16 (U.S. CLS. 2, 5, 22, 23, 29, 37, 38 AND 50).

FIRST USE 8-1-2008; IN COMMERCE 9-1-2008.

FOR: BEANIES; HATS; HOODED SWEAT SHIRTS; SOCKS; T-SHIRTS, IN CLASS 25 (U.S. CLS. 22 AND 39).

FIRST USE 8-1-2008; IN COMMERCE 9-1-2008.

THE MARK CONSISTS OF STANDARD CHARACTERS WITHOUT CLAIM TO ANY PARTICULAR FONT, STYLE, SIZE, OR COLOR.

SER. NO. 85-531,953, FILED 2-2-2012.

JAY FLOWERS, EXAMINING ATTORNEY



David J. Kyffers

Director of the United States Patent and Trademark Office

United States of America

United States Patent and Trademark Office

PEEK'N PEAK

Reg. No. 4,205,450

Registered Sep. 11, 2012

Int. Cl.: 41

SERVICE MARK

PRINCIPAL REGISTER

SCOTT'S PEEK'N PEAK, LLC (NEW YORK LIMITED LIABILITY COMPANY)
6TH FLOOR
HILTON GARDEN INN, 2225 DOWNS DRIVE
ERIE, PA 16509

FOR: GOLF COURSES; SKI RESORTS, IN CLASS 41 (U.S. CLS. 100, 101 AND 107).

FIRST USE 0-0-1964; IN COMMERCE 0-0-1964.

THE MARK CONSISTS OF STANDARD CHARACTERS WITHOUT CLAIM TO ANY PARTICULAR FONT, STYLE, SIZE, OR COLOR.

SER. NO. 85-531,954, FILED 1-30-2012.

MATTHEW EINSTEIN, EXAMINING ATTORNEY



David J. Kyffers

Director of the United States Patent and Trademark Office

United States of America

United States Patent and Trademark Office

Psychic Johnna

Reg. No. 4,205,451

Registered Sep. 11, 2012

Int. Cl.: 45

SERVICE MARK

PRINCIPAL REGISTER

WHITE, JOHNNA K. (UNITED STATES INDIVIDUAL), DBA PSYCHIC JOHNNA
10030 CHERRY HILLS AVENUE CIRC
10030 CHERRY HILLS AVENUE CIRC
BRADENTON, MA 34202

FOR: PSYCHIC READING SERVICES; TAROT CARD READING SERVICES, IN CLASS 45
(U.S. CLS. 100 AND 101).

FIRST USE 1-1-2011; IN COMMERCE 11-1-2011.

THE MARK CONSISTS OF STANDARD CHARACTERS WITHOUT CLAIM TO ANY PARTICULAR FONT, STYLE, SIZE, OR COLOR.

SER. NO. 85-531,960, FILED 2-2-2012.

JAY FLOWERS, EXAMINING ATTORNEY



David J. Kyffers

Director of the United States Patent and Trademark Office

United States of America

United States Patent and Trademark Office

Ports of Cause

Reg. No. 4,205,452

Registered Sep. 11, 2012

Int. Cl.: 35

SERVICE MARK

PRINCIPAL REGISTER

CLEAR GROUP INTERNATIONAL, LLC (CONNECTICUT LIMITED LIABILITY COMPANY)
BLDG. 4, 1ST FLOOR
480 BARNUM AVE.
BRIDGEPORT, CT 06608

FOR: PROMOTING PUBLIC AWARENESS OF PRESERVING AND ENHANCING THE ECOSPHERE OF THE OCEANS, SEAS AND INLAND NAVIGABLE WATERS OF THE WORLD AND BROAD SPECTRUM OF URGENT ISSUES AROUND THE WORLD, IN CLASS 35 (U.S. CLS. 100, 101 AND 102).

FIRST USE 11-1-2011; IN COMMERCE 11-1-2011.

THE MARK CONSISTS OF STANDARD CHARACTERS WITHOUT CLAIM TO ANY PARTICULAR FONT, STYLE, SIZE, OR COLOR.

SER. NO. 85-531,962, FILED 2-2-2012.

JAY FLOWERS, EXAMINING ATTORNEY



David J. Kyffers

Director of the United States Patent and Trademark Office

United States of America

United States Patent and Trademark Office

RFG Collaborate!

Reg. No. 4,205,453

Registered Sep. 11, 2012

Int. Cls.: 35 and 45

SERVICE MARK

PRINCIPAL REGISTER

THE REGULATORY FUNDAMENTALS GROUP LLC (DELAWARE LIMITED LIABILITY COMPANY)
222 PARK AVENUE SOUTH, SUITE 7E
NEW YORK, NY 10003

FOR: BUSINESS RISK MANAGEMENT CONSULTING, IN CLASS 35 (U.S. CLS. 100, 101 AND 102).

FIRST USE 1-10-2012; IN COMMERCE 1-10-2012.

FOR: REGULATORY COMPLIANCE CONSULTING FOR BUSINESS; TRACKING AND MONITORING REGULATORY REQUIREMENTS FOR BUSINESS FOR REGULATORY COMPLIANCE PURPOSES, IN CLASS 45 (U.S. CLS. 100 AND 101).

FIRST USE 1-10-2012; IN COMMERCE 1-10-2012.

THE MARK CONSISTS OF STANDARD CHARACTERS WITHOUT CLAIM TO ANY PARTICULAR FONT, STYLE, SIZE, OR COLOR.

SER. NO. 85-531,964, FILED 2-2-2012.

JAY FLOWERS, EXAMINING ATTORNEY



David J. Kyfos

Director of the United States Patent and Trademark Office

United States of America

United States Patent and Trademark Office

WHAT WILL YOU SEA?

Reg. No. 4,205,454

TULSA ZOO MANAGEMENT, INC. (OKLAHOMA CORPORATION)
6421 EAST 36TH STREET NORTH
TULSA, OK 74115

Registered Sep. 11, 2012

Int. Cl.: 41

FOR: ZOOS; EDUCATIONAL AND ENTERTAINMENT SERVICES, NAMELY, PROVIDING EXHIBITS, LIVE SHOWS, CLASSES, EVENTS, PROGRAMS, AND LECTURES IN THE FIELDS OF WILDLIFE AND WILDLIFE CONSERVATION, IN CLASS 41 (U.S. CLS. 100, 101 AND 107).

SERVICE MARK

PRINCIPAL REGISTER

FIRST USE 2-6-2012; IN COMMERCE 2-6-2012.

THE MARK CONSISTS OF STANDARD CHARACTERS WITHOUT CLAIM TO ANY PARTICULAR FONT, STYLE, SIZE, OR COLOR.

SER. NO. 85-531,965, FILED 2-2-2012.

JAY FLOWERS, EXAMINING ATTORNEY



David J. Kyffers

Director of the United States Patent and Trademark Office

United States of America

United States Patent and Trademark Office

Conscious Grieving

Reg. No. 4,205,455

KOREN PAALMAN (UNITED STATES INDIVIDUAL)
339 BROOKS AVE, COTTAGE C
VENICE, CA 90291

Registered Sep. 11, 2012

Int. Cls.: 41 and 45

FOR: EDUCATIONAL SERVICES, NAMELY, CONDUCTING CLASSES, WORKSHOPS, AND SEMINARS IN THE FIELD OF YOGA AND GRIEVING; YOGA INSTRUCTION, IN CLASS 41 (U.S. CLS. 100, 101 AND 107).

SERVICE MARK

FIRST USE 1-1-2010; IN COMMERCE 1-1-2010.

PRINCIPAL REGISTER

FOR: GRIEF COUNSELING; PROVIDING SPIRITUAL RETREATS IN THE FIELD OF YOGA AND GRIEVING, IN CLASS 45 (U.S. CLS. 100 AND 101).

FIRST USE 1-1-2010; IN COMMERCE 1-1-2010.

THE MARK CONSISTS OF STANDARD CHARACTERS WITHOUT CLAIM TO ANY PARTICULAR FONT, STYLE, SIZE, OR COLOR.

NO CLAIM IS MADE TO THE EXCLUSIVE RIGHT TO USE "GRIEVING", APART FROM THE MARK AS SHOWN.

SER. NO. 85-531,969, FILED 2-2-2012.

JAY FLOWERS, EXAMINING ATTORNEY



David J. Kyros

Director of the United States Patent and Trademark Office

United States of America

United States Patent and Trademark Office

HARRELL'S CAR WASH SYSTEMS

Reg. No. 4,205,456

HARRELL'S EQUIPMENT & SUPPLY CO., INC. (INDIANA CORPORATION)
1339 COUNTRY CLUB ROAD
INDIANAPOLIS, IN 462341620

Registered Sep. 11, 2012

Int. Cls.: 35 and 37

FOR: RETAIL DISTRIBUTORSHIP FEATURING COMMERCIAL MACHINES AND RELATED EQUIPMENT USED TO CLEAN AND WASH MOTOR VEHICLES, IN CLASS 35 (U.S. CLS. 100, 101 AND 102).

SERVICE MARK

FIRST USE 6-25-1990; IN COMMERCE 6-25-1990.

PRINCIPAL REGISTER

FOR: MAINTENANCE AND REPAIR OF COMMERCIAL MACHINES AND RELATED EQUIPMENT USED TO CLEAN AND WASH MOTOR VEHICLES, IN CLASS 37 (U.S. CLS. 100, 103 AND 106).

FIRST USE 6-25-1990; IN COMMERCE 6-25-1990.

THE MARK CONSISTS OF STANDARD CHARACTERS WITHOUT CLAIM TO ANY PARTICULAR FONT, STYLE, SIZE, OR COLOR.

NO CLAIM IS MADE TO THE EXCLUSIVE RIGHT TO USE "CAR WASH SYSTEMS", APART FROM THE MARK AS SHOWN.

THE NAME(S), PORTRAIT(S), AND/OR SIGNATURE(S) SHOWN IN THE MARK DOES NOT IDENTIFY A PARTICULAR LIVING INDIVIDUAL.

SEC. 2(F) AS TO "HARRELL'S".

SER. NO. 85-531,985, FILED 2-2-2012.

GISELLE AGOSTO, EXAMINING ATTORNEY



David J. Kybas

Director of the United States Patent and Trademark Office

United States of America

United States Patent and Trademark Office

FORGIVING FORWARD

Unleashing the Forgiveness Revolution

Reg. No. 4,205,457

HEBEL, INC. (GEORGIA CORPORATION)
125 HICKORY HOLLOW DR.
FAYETTEVILLE, GA 30214

Registered Sep. 11, 2012

Int. Cl.: 45

FOR: CHRISTIAN MINISTRY SERVICES, IN CLASS 45 (U.S. CLS. 100 AND 101).

SERVICE MARK

FIRST USE 5-0-2009; IN COMMERCE 2-21-2010.

PRINCIPAL REGISTER

THE MARK CONSISTS OF THE STYLIZED TEXT "FORGIVING" ABOVE THE STYLIZED TEXT "FOR ARD" WITH A HORIZONTAL LINE TO THE LEFT OF THE TEXT AND A FAST FORWARD SYMBOL, TWO TRIANGLES, BETWEEN THE FIRST LETTER "R" AND THE LETTER "A". BELOW THIS TEXT IS THE STYLIZED TEXT "UNLEASHING THE FORGIVENESS REVOLUTION".

SER. NO. 85-531,993, FILED 2-2-2012.

GISELLE AGOSTO, EXAMINING ATTORNEY



David J. Kybas

Director of the United States Patent and Trademark Office

United States of America
United States Patent and Trademark Office

VAGISIL

Reg. No. 4,205,458

Registered Sep. 11, 2012

Int. Cl.: 3

TRADEMARK

PRINCIPAL REGISTER

COMBE INCORPORATED (DELAWARE CORPORATION)
1101 WESTCHESTER AVENUE
WHITE PLAINS, NY 10604

FOR: MOISTURIZERS FOR THE SKIN AT THE EXTERNAL VAGINAL AREA, IN CLASS 3
(U.S. CLS. 1, 4, 6, 50, 51 AND 52).

FIRST USE 7-24-1995; IN COMMERCE 7-24-1995.

THE MARK CONSISTS OF STANDARD CHARACTERS WITHOUT CLAIM TO ANY PARTICULAR FONT, STYLE, SIZE, OR COLOR.

OWNER OF U.S. REG. NOS. 1,104,172, 2,971,826 AND OTHERS.

SER. NO. 85-532,058, FILED 2-2-2012.

KIMBERLY PERRY, EXAMINING ATTORNEY



David J. Kybas

Director of the United States Patent and Trademark Office

United States of America

United States Patent and Trademark Office

Better Nest, Better Health, Better You.

Reg. No. 4,205,459

Registered Sep. 11, 2012

Int. Cl.: 29

TRADEMARK

PRINCIPAL REGISTER

BENEVOLENCE FOOD PRODUCTS, LLC (CALIFORNIA LIMITED LIABILITY COMPANY),
AKA BENEVOLENCE NESTS, LONG PHUNG YEN
722 S. BIXEL STREET, 603A
LOS ANGELES, CA 90017

FOR: EDIBLE BIRD'S NESTS, IN CLASS 29 (U.S. CL. 46).

FIRST USE 4-30-2011; IN COMMERCE 4-30-2011.

THE MARK CONSISTS OF STANDARD CHARACTERS WITHOUT CLAIM TO ANY PARTICULAR FONT, STYLE, SIZE, OR COLOR.

SER. NO. 85-532,079, FILED 2-2-2012.

SEAN CROWLEY, EXAMINING ATTORNEY



David J. Kyffers

Director of the United States Patent and Trademark Office

United States of America

United States Patent and Trademark Office



Reg. No. 4,205,460

Registered Sep. 11, 2012

Int. Cl.: 36

SERVICE MARK

PRINCIPAL REGISTER

SUPPORT OUR TROOPS FOUNDATION, INC (FLORIDA CORPORATION)
P. O. BOX 30
DAYTONA BEACH, FL 321150030

FOR: CHARITABLE FUNDRAISING, IN CLASS 36 (U.S. CLS. 100, 101 AND 102).

FIRST USE 10-2-2005; IN COMMERCE 10-2-2005.

THE MARK CONSISTS OF A GROUP OF SOLDIERS STANDING SIDE BY SIDE, FACING THE VIEWER, EACH HOLDING A GUN, AND WITH ONE SOLDIER SQUATTING AT EACH END.

SER. NO. 85-532,106, FILED 2-2-2012.

JOHN DALIER, EXAMINING ATTORNEY



David J. Kyffers

Director of the United States Patent and Trademark Office

United States of America

United States Patent and Trademark Office

HCXTREME

Reg. No. 4,205,461

Registered Sep. 11, 2012

Int. Cl.: 9

TRADEMARK

PRINCIPAL REGISTER

OFS FITEL, LLC (DELAWARE LIMITED LIABILITY COMPANY)
INTELLECTUAL PROPERTY LAW DIVISION
2000 NORTHEAST EXPRESSWAY
NORCROSS, GA 30071

FOR: OPTICAL FIBER CABLES; OPTICAL FIBERS; OPTICAL FIBERS SOLD AS A COMPONENT OF FIBER OPTICAL CABLES, IN CLASS 9 (U.S. CLS. 21, 23, 26, 36 AND 38).

FIRST USE 5-8-2007; IN COMMERCE 9-5-2008.

THE MARK CONSISTS OF STANDARD CHARACTERS WITHOUT CLAIM TO ANY PARTICULAR FONT, STYLE, SIZE, OR COLOR.

SER. NO. 85-532,127, FILED 2-2-2012.

CHARLES L. JENKINS, EXAMINING ATTORNEY



David J. Kyffers

Director of the United States Patent and Trademark Office

United States of America

United States Patent and Trademark Office

Aqualete

Reg. No. 4,205,462

Registered Sep. 11, 2012

Int. Cl.: 11

TRADEMARK

PRINCIPAL REGISTER

STORM DRAIN TECHNOLOGIES, L.L.C. (NEW JERSEY LIMITED LIABILITY COMPANY)
SUITE 109
1602 LAWRENCE AVENUE
OCEAN, NJ 07712

FOR: EXTERNAL FILTERING DEVICE FOR USE IN A LOCAL CONTAINMENT AREA FOR REMOVING OIL AND OTHER CONTAMINANTS FROM STORM DRAIN EFFLUENT AS IT EXITS STORM WATER SYSTEMS; WATER PURIFICATION AND FILTRATION APPARATUS; WATER PURIFICATION, SEDIMENTATION AND FILTRATION APPARATUS FOR CLARIFICATION, THICKENING AND FILTRATION OF WATER, WASTE WATER AND INDUSTRIAL WATER; WATER TREATMENT EQUIPMENT, NAMELY, WATER FILTRATION UNITS, IN CLASS 11 (U.S. CLS. 13, 21, 23, 31 AND 34).

FIRST USE 6-1-2011; IN COMMERCE 7-1-2011.

THE MARK CONSISTS OF STANDARD CHARACTERS WITHOUT CLAIM TO ANY PARTICULAR FONT, STYLE, SIZE, OR COLOR.

SER. NO. 85-532,136, FILED 2-2-2012.

ANNE E. GUSTASON, EXAMINING ATTORNEY



David J. Kypos

Director of the United States Patent and Trademark Office

United States of America

United States Patent and Trademark Office



Reg. No. 4,205,463

Registered Sep. 11, 2012

Int. Cl.: 9

TRADEMARK

PRINCIPAL REGISTER

MYGUIDES, LLC (FLORIDA LIMITED LIABILITY COMPANY)
8985 SW 207TH ST
MIAMI, FL 33189

FOR: DOWNLOADABLE SOFTWARE IN THE NATURE OF A MOBILE APPLICATION FOR PROVIDING SELF GUIDED TOURS, IN CLASS 9 (U.S. CLS. 21, 23, 26, 36 AND 38).

FIRST USE 9-0-2011; IN COMMERCE 9-0-2011.

THE MARK CONSISTS OF A HALF BLACK, HALF GREEN STYLIZED ARROW POINTING RIGHT.

THE COLOR(S) GREEN AND BLACK IS/ARE CLAIMED AS A FEATURE OF THE MARK.

SER. NO. 85-532,142, FILED 2-2-2012.

SETH A. RAPPAPORT, EXAMINING ATTORNEY



David J. Kyffers

Director of the United States Patent and Trademark Office

United States of America

United States Patent and Trademark Office

SPEECHACCESS

Reg. No. 4,205,464

Registered Sep. 11, 2012

Int. Cl.: 36

SERVICE MARK

PRINCIPAL REGISTER

AMERICA FIRST CREDIT UNION (UTAH CORPORATION)
P.O. BOX 9199
OGDEN, UT 84409

FOR: CREDIT UNION SERVICES, NAMELY, PROVIDING PERSONAL ACCOUNT INFORMATION TO CREDIT UNION MEMBERS VIA TELEPHONE, IN CLASS 36 (U.S. CLS. 100, 101 AND 102).

FIRST USE 7-1-2002; IN COMMERCE 7-1-2002.

THE MARK CONSISTS OF STANDARD CHARACTERS WITHOUT CLAIM TO ANY PARTICULAR FONT, STYLE, SIZE, OR COLOR.

OWNER OF U.S. REG. NO. 2,660,949.

SEC. 2(F).

SER. NO. 85-532,143, FILED 2-2-2012.

SETH A. RAPPAPORT, EXAMINING ATTORNEY



David J. Kyffers

Director of the United States Patent and Trademark Office

United States of America

United States Patent and Trademark Office

DHP

Reg. No. 4,205,465

Registered Sep. 11, 2012

Int. Cls.: 9 and 16

TRADEMARK

PRINCIPAL REGISTER

DISCOVERY HOUSE PUBLISHERS (MICHIGAN CORPORATION)
P.O. BOX 22
3000 KRAFT AVENUE, SE
GRAND RAPIDS, MI 495550001

FOR: PRE-RECORDED AUDIO AND VIDEO CDS AND DVDS FEATURING RELIGIOUS TOPICS, IN CLASS 9 (U.S. CLS. 21, 23, 26, 36 AND 38).

FIRST USE 9-1-1988; IN COMMERCE 9-1-1988.

FOR: PRINTED BOOKS AND BOOKLETS, CARDS, STATIONERY, DAY PLANNERS, AND CALENDARS FEATURING RELIGIOUS TOPICS, IN CLASS 16 (U.S. CLS. 2, 5, 22, 23, 29, 37, 38 AND 50).

FIRST USE 9-1-1988; IN COMMERCE 9-1-1988.

THE MARK CONSISTS OF STANDARD CHARACTERS WITHOUT CLAIM TO ANY PARTICULAR FONT, STYLE, SIZE, OR COLOR.

SER. NO. 85-532,146, FILED 2-2-2012.

TARAH HARDY, EXAMINING ATTORNEY



David J. Kyfos

Director of the United States Patent and Trademark Office

United States of America

United States Patent and Trademark Office

RANCHO VIEJO

Reg. No. 4,205,466

Registered Sep. 11, 2012

Int. Cl.: 29

TRADEMARK

PRINCIPAL REGISTER

MIO FOODS INC. (CALIFORNIA CORPORATION)
5020 CAMPUS DRIVE
NEWPORT BEACH, CA 92660

FOR: CHEESE, IN CLASS 29 (U.S. CL. 46).

FIRST USE 1-15-2012; IN COMMERCE 1-15-2012.

THE MARK CONSISTS OF STANDARD CHARACTERS WITHOUT CLAIM TO ANY PARTICULAR FONT, STYLE, SIZE, OR COLOR.

THE ENGLISH TRANSLATION OF "RANCHO VIEJO" IN THE MARK IS "OLD RANCH".

SER. NO. 85-532,152, FILED 2-2-2012.

DORITT L. CARROLL, EXAMINING ATTORNEY



David J. Kyffers

Director of the United States Patent and Trademark Office

United States of America

United States Patent and Trademark Office

Rob Thomas

Reg. No. 4,205,467

Registered Sep. 11, 2012

Int. Cl.: 41

SERVICE MARK

PRINCIPAL REGISTER

BIDNIS HOLDINGS, INC. (NEW YORK CORPORATION)
C/O GLADSTONE MICHEL, ATTN.: OWEN SLOANE
4551 GLENCOE AVENUE, SUITE 300
MARINA DEL REY, CA 90292

FOR: ENTERTAINMENT SERVICES IN THE NATURE OF LIVE MUSICAL AND VOCAL PERFORMANCES BY A MUSICAL BAND , IN CLASS 41 (U.S. CLS. 100, 101 AND 107).

FIRST USE 2-1-2005; IN COMMERCE 4-1-2005.

THE MARK CONSISTS OF STANDARD CHARACTERS WITHOUT CLAIM TO ANY PARTICULAR FONT, STYLE, SIZE, OR COLOR.

THE NAME(S), PORTRAIT(S), AND/OR SIGNATURE(S) SHOWN IN THE MARK IDENTIFIES ROB THOMAS, WHOSE CONSENT(S) TO REGISTER IS MADE OF RECORD.

SER. NO. 85-532,174, FILED 2-2-2012.

HOWARD B. LEVINE, EXAMINING ATTORNEY



David J. Kyffers

Director of the United States Patent and Trademark Office

United States of America
United States Patent and Trademark Office

HOTELIER

Reg. No. 4,205,468

Registered Sep. 11, 2012

Int. Cl.: 37

SERVICE MARK

PRINCIPAL REGISTER

HOTELIER CONSULTING SERVICES LLC (FLORIDA LIMITED LIABILITY COMPANY),
DBA HOTELIER LINEN SERVICES LLC
14640 NW 60TH AVENUE
MIAMI LAKES, FL 33014

FOR: LAUNDRY SERVICES, IN CLASS 37 (U.S. CLS. 100, 103 AND 106).

FIRST USE 1-1-2008; IN COMMERCE 1-1-2008.

THE MARK CONSISTS OF STANDARD CHARACTERS WITHOUT CLAIM TO ANY PARTICULAR FONT, STYLE, SIZE, OR COLOR.

SER. NO. 85-532,193, FILED 2-2-2012.

FRANK LATTUCA, EXAMINING ATTORNEY



David J. Kybas

Director of the United States Patent and Trademark Office

United States of America

United States Patent and Trademark Office



Reg. No. 4,205,469

Registered Sep. 11, 2012

Int. Cl.: 40

SERVICE MARK

PRINCIPAL REGISTER

CATHETER RESEARCH, INC. (INDIANA CORPORATION)
5610 WEST 82ND STREET
INDIANAPOLIS, IN 46278

FOR: CONTRACT MANUFACTURING IN THE FIELD OF MEDICAL DEVICES, IN CLASS 40 (U.S. CLS. 100, 103 AND 106).

FIRST USE 1-31-1995; IN COMMERCE 1-31-1995.

OWNER OF U.S. REG. NO. 1,692,754.

THE MARK CONSISTS OF THE LOWER CASE LETTERS "CRI", APPEARING AS THOUGH THE LETTERS WERE CREATED BY TUBING, WITH THE CENTER OF EACH LETTER AN EMPTY SPACE.

SER. NO. 85-532,202, FILED 2-2-2012.

GEORGE LORENZO, EXAMINING ATTORNEY



David J. Kyffers

Director of the United States Patent and Trademark Office

United States of America

United States Patent and Trademark Office

DESIGNING EXPERIENCES. GENERATING VALUE.

Reg. No. 4,205,470

Registered Sep. 11, 2012

Int. Cl.: 42

SERVICE MARK

PRINCIPAL REGISTER

ROSSETTI ASSOCIATES INCORPORATED (MICHIGAN CORPORATION)
TWO TOWNE SQUARE, SUITE 200
SOUTHFIELD, MI 48076

FOR: ARCHITECTURAL CONSULTANCY, IN CLASS 42 (U.S. CLS. 100 AND 101).

FIRST USE 11-4-2011; IN COMMERCE 11-4-2011.

THE MARK CONSISTS OF STANDARD CHARACTERS WITHOUT CLAIM TO ANY PARTICULAR FONT, STYLE, SIZE, OR COLOR.

SER. NO. 85-532,245, FILED 2-2-2012.

TARAH HARDY, EXAMINING ATTORNEY



David J. Kyffers

Director of the United States Patent and Trademark Office

United States of America

United States Patent and Trademark Office



Reg. No. 4,205,471

SOUTHERN CLASSIC FOOD GROUP, LLC (DELAWARE LIMITED LIABILITY COMPANY)
P.O. BOX 158
BRUNDIDGE, AL 36010

Registered Sep. 11, 2012

Int. Cl.: 30

FOR: MAYONNAISE, SALAD DRESSINGS, BARBEQUE SAUCE, HONEY MUSTARD SAUCE, TARTAR SAUCE, COCKTAIL SAUCE, IN CLASS 30 (U.S. CL. 46).

TRADEMARK

FIRST USE 0-0-2001; IN COMMERCE 0-0-2001.

PRINCIPAL REGISTER

THE MARK CONSISTS OF THE ARTISTIC RENDERING OF A MAGNOLIA IN GREEN, WHITE, YELLOW AND BLACK.

THE COLOR(S) GREEN, WHITE, YELLOW AND BLACK IS/ARE CLAIMED AS A FEATURE OF THE MARK.

SER. NO. 85-532,265, FILED 2-2-2012.

KATHLEEN M. VANSTON, EXAMINING ATTORNEY



David J. Kybas

Director of the United States Patent and Trademark Office

United States of America

United States Patent and Trademark Office



Reg. No. 4,205,472

SOL MAYA CORPORATION (MARYLAND CORPORATION)
17621 MACDUFF AVENUE
OLNEY, MD 20832

Registered Sep. 11, 2012

Int. Cl.: 43

FOR: RESTAURANT SERVICES, IN CLASS 43 (U.S. CLS. 100 AND 101).

SERVICE MARK

FIRST USE 10-0-2010; IN COMMERCE 10-0-2010.

PRINCIPAL REGISTER

THE MARK CONSISTS OF THE WORDS "VILLA MAYA" IN STYLIZED LETTERING WITH THE DESIGN OF A STYLIZED FORK ABOVE THE LETTERS "AYA", AND A HORIZONTAL BORDER ABOVE AND BELOW THE WORDS FORMED BY A SERIES OF INVERTED HALF-DIAMOND DESIGNS.

SER. NO. 85-532,269, FILED 2-2-2012.

WILLIAM VERHOSEK, EXAMINING ATTORNEY



David J. Kyffers

Director of the United States Patent and Trademark Office

United States of America

United States Patent and Trademark Office

ColorEyes

Reg. No. 4,205,473

Registered Sep. 11, 2012

Int. Cl.: 9

TRADEMARK

PRINCIPAL REGISTER

INTEGRATED COLOR CORPORATION (MASSACHUSETTS CORPORATION)
87 ROGERS STREET
NORTH BILLERICA, MA 01862

FOR: COMPUTER SOFTWARE FOR CALIBRATING COMPUTER MONITORS FOR COLOR ACCURACY; COMPUTER APPLICATION SOFTWARE FOR MOBILE PHONES, PORTABLE MEDIA PLAYERS, HANDHELD COMPUTERS, TABLETS, NAMELY, SOFTWARE FOR CALIBRATING MOBILE DEVICE SCREENS FOR COLOR ACCURACY, IN CLASS 9 (U.S. CLS. 21, 23, 26, 36 AND 38).

FIRST USE 5-1-2000; IN COMMERCE 5-1-2000.

THE MARK CONSISTS OF STANDARD CHARACTERS WITHOUT CLAIM TO ANY PARTICULAR FONT, STYLE, SIZE, OR COLOR.

SER. NO. 85-532,273, FILED 2-2-2012.

WILLIAM VERHOSEK, EXAMINING ATTORNEY



David J. Kybas

Director of the United States Patent and Trademark Office

United States of America

United States Patent and Trademark Office

EATING AWAY AT POVERTY

Reg. No. 4,205,474

FEED ADAM LLC (IOWA LIMITED LIABILITY COMPANY)
516 DELAWARE AVENUE NW
ORANGE CITY, IA 51041

Registered Sep. 11, 2012

Int. Cl.: 35

FOR: ON-LINE RETAIL STORE SERVICES FEATURING FOOD PRODUCTS; RETAIL STORE SERVICES FEATURING FOOD PRODUCTS; WHOLESALE FOOD DISTRIBUTORSHIP SERVICES; WHOLESALE STORE SERVICES FEATURING FOOD PRODUCTS, IN CLASS 35 (U.S. CLS. 100, 101 AND 102).

SERVICE MARK

PRINCIPAL REGISTER

FIRST USE 7-0-2011; IN COMMERCE 7-0-2011.

THE MARK CONSISTS OF STANDARD CHARACTERS WITHOUT CLAIM TO ANY PARTICULAR FONT, STYLE, SIZE, OR COLOR.

SER. NO. 85-532,277, FILED 2-2-2012.

APRIL HESIK, EXAMINING ATTORNEY



David J. Kyffers

Director of the United States Patent and Trademark Office

United States of America

United States Patent and Trademark Office

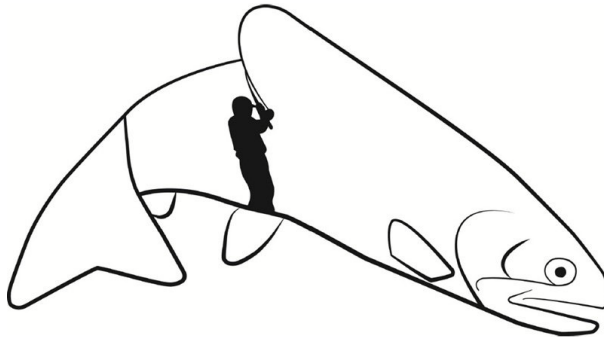

Reg. No. 4,205,475

Registered Sep. 11, 2012

Int. Cls.: 28 and 41

TRADEMARK

SERVICE MARK

PRINCIPAL REGISTER

TOWNSEND, MARYANN M. (UNITED STATES INDIVIDUAL)
409 BRIAN CT.
WENTZVILLE, MO 63385

FOR: FISHING RODS; FISHING TACKLE, IN CLASS 28 (U.S. CLS. 22, 23, 38 AND 50).

FIRST USE 9-0-2011; IN COMMERCE 9-0-2011.

FOR: EDUCATIONAL SERVICES, NAMELY, CONDUCTING COURSES, CLASSES, SEMINARS, AND WORKSHOPS IN THE FIELD OF FISHING, FLY TYING, FLY CASTING, FISHING ROD BUILDING, AND FLY ROD BUILDING AND DISTRIBUTION OF COURSE MATERIAL IN CONNECTION THEREWITH, IN CLASS 41 (U.S. CLS. 100, 101 AND 107).

FIRST USE 12-0-2011; IN COMMERCE 12-0-2011.

THE MARK CONSISTS OF A FISHERMAN CASTING A LINE WITH A FISHING ROD THAT MAKES UP A FISH ENCOMPASSING HIM.

SER. NO. 85-532,299, FILED 2-2-2012.

KIMBERLY PERRY, EXAMINING ATTORNEY



David J. Kybas

Director of the United States Patent and Trademark Office

United States of America

United States Patent and Trademark Office

SCREENSAFE

Reg. No. 4,205,476

EKEHOLM AND ASSOCIATES, LLC (GEORGIA LIMITED LIABILITY COMPANY)
P.O. BOX 221

Registered Sep. 11, 2012

ALPHARETTA, GA 30009

Int. Cl.: 45

FOR: BACKGROUND INVESTIGATION AND RESEARCH SERVICES; BACKGROUND INVESTIGATION SERVICES; DETECTIVE INVESTIGATIONS; DMV RECORD INVESTIGATION SERVICES; EMPLOYEE MISCONDUCT INVESTIGATION SERVICES; INFIDELITY INVESTIGATION SERVICES IN THE FIELD OF PERSONAL RELATIONSHIPS; INVESTIGATION OF ASSETS, CREDIT REPORTS, FISCAL ASSESSMENTS, AND COLLECTION REPORTS FOR SECURITY OR AUTHENTICATION PURPOSES; INVESTIGATION OR SURVEILLANCE ON BACKGROUND PROFILES; INVESTIGATION SERVICES RELATED TO INSURANCE CLAIMS; ON-LINE IDENTITY RELIABILITY INVESTIGATION IN THE FIELD OF ON-LINE DATING AND CLAIMS MADE ABOUT AGE, GENDER; PERSONAL BACKGROUND INVESTIGATIONS; PRE-EMPLOYMENT BACKGROUND INVESTIGATION SERVICES; PRIVATE INVESTIGATION; PUBLIC RECORD INVESTIGATION SERVICES; WORKERS COMPENSATION FRAUD INVESTIGATION SERVICES, IN CLASS 45 (U.S. CLS. 100 AND 101).

SERVICE MARK

PRINCIPAL REGISTER

FIRST USE 12-5-2003; IN COMMERCE 12-5-2003.

THE MARK CONSISTS OF STANDARD CHARACTERS WITHOUT CLAIM TO ANY PARTICULAR FONT, STYLE, SIZE, OR COLOR.



OWNER OF U.S. REG. NO. 2,979,711.

SER. NO. 85-532,301, FILED 2-2-2012.

KIMBERLY PERRY, EXAMINING ATTORNEY

David J. Kybas

Director of the United States Patent and Trademark Office

United States of America

United States Patent and Trademark Office

MILDLY ARTISTIC

Reg. No. 4,205,477

Registered Sep. 11, 2012

Int. Cl.: 35

SERVICE MARK

PRINCIPAL REGISTER

HIEBERT, TIMOTHY H. (UNITED STATES INDIVIDUAL)
TWO INTERNATIONAL PLACE, 23RD FLOOR
BOSTON, MA 021104104

FOR: ON-LINE ART GALLERIES, IN CLASS 35 (U.S. CLS. 100, 101 AND 102).

FIRST USE 6-16-2010; IN COMMERCE 6-16-2010.

THE MARK CONSISTS OF STANDARD CHARACTERS WITHOUT CLAIM TO ANY PARTICULAR FONT, STYLE, SIZE, OR COLOR.

NO CLAIM IS MADE TO THE EXCLUSIVE RIGHT TO USE "ARTISTIC", APART FROM THE MARK AS SHOWN.

SER. NO. 85-532,303, FILED 2-2-2012.

KATHLEEN M. VANSTON, EXAMINING ATTORNEY



David J. Kyffers

Director of the United States Patent and Trademark Office

United States of America

United States Patent and Trademark Office



Reg. No. 4,205,478

Registered Sep. 11, 2012

Int. Cl.: 29

J&B WHOLESALE DISTRIBUTING, INC. (MINNESOTA CORPORATION)
P.O. BOX 212
13200 43RD STREET NE
ST. MICHAEL, MN 55376

FOR: MEAT; BEEF; POULTRY; PORK, IN CLASS 29 (U.S. CL. 46).

TRADEMARK

FIRST USE 0-0-1985, THE MARK WAS FIRST USED ANYWHERE IN A DIFFERENT FORM OTHER THAN THAT SOUGHT TO BE REGISTERED AT LEAST AS EARLY AS 00/00/1985; IN COMMERCE 0-0-1985, THE MARK WAS FIRST USED IN COMMERCE IN A DIFFERENT FORM OTHER THAN THAT SOUGHT TO BE REGISTERED AT LEAST AS EARLY AS 00/00/1985.

PRINCIPAL REGISTER

NO CLAIM IS MADE TO THE EXCLUSIVE RIGHT TO USE THE PICTORIAL REPRESENTATION OF THE STATE OF MINNESOTA AND "PREMIUM QUALITY", APART FROM THE MARK AS SHOWN.

THE MARK CONSISTS OF A RECTANGULAR DESIGN WITH CURVED HORIZONTAL EDGES. A SLIGHTLY CURVED BAR BEARING THE WORDS "MINNESOTA FARMS" CROSSES THE RECTANGLE. AN OBLONG DESIGN APPEARS ON EITHER SIDE OF THE WORD "FARMS". UNDERNEATH THE BAR THERE APPEARS A PICTURE OF THE SHAPE OF THE STATE OF "MINNESOTA", WITH THE UNDERLINED WORDS "PREMIUM QUALITY" APPEARING ON EITHER SIDE OF THE PICTURE.



SEC. 2(F) AS TO "MINNESOTA FARMS".

SER. NO. 85-532,318, FILED 2-2-2012.

SAMUEL E. SHARPER JR., EXAMINING ATTORNEY

David J. Kybas

Director of the United States Patent and Trademark Office

United States of America

United States Patent and Trademark Office

THE HELMSLEY SANDCASTLE HOTEL

Reg. No. 4,205,479

PARK LANE HOTEL, INC. (NEW YORK CORPORATION)
230 PARK AVENUE
NEW YORK, NY 10169

Registered Sep. 11, 2012

Int. Cl.: 43

FOR: HOTEL SERVICES, IN CLASS 43 (U.S. CLS. 100 AND 101).

SERVICE MARK

FIRST USE 10-1-2002; IN COMMERCE 10-1-2002.

PRINCIPAL REGISTER

THE MARK CONSISTS OF STANDARD CHARACTERS WITHOUT CLAIM TO ANY PARTICULAR FONT, STYLE, SIZE, OR COLOR.

OWNER OF U.S. REG. NO. 3,665,513.

NO CLAIM IS MADE TO THE EXCLUSIVE RIGHT TO USE "HOTEL", APART FROM THE MARK AS SHOWN.

SER. NO. 85-532,326, FILED 2-2-2012.

JOHN DWYER, EXAMINING ATTORNEY



David J. Kyffers

Director of the United States Patent and Trademark Office

United States of America

United States Patent and Trademark Office

CATS

Reg. No. 4,205,480

Registered Sep. 11, 2012

Int. Cls.: 35 and 41

SERVICE MARK

PRINCIPAL REGISTER

BAKER & TAYLOR, INC. (DELAWARE CORPORATION)
SUITE 300
2550 WEST TYVOLA ROAD
CHARLOTTE, NC 28217

FOR: WHOLESALE ORDERING SERVICES IN THE FIELD OF YOUTH AND YOUNG ADULT BOOKS, AUDIOVISUAL, AND DIGITAL MATERIALS FOR LIBRARIES, IN CLASS 35 (U.S. CLS. 100, 101 AND 102).

FIRST USE 1-0-2009; IN COMMERCE 1-0-2009.

FOR: CONSULTING SERVICES FOR LIBRARIES, NAMELY, SELECTION ASSISTANCE AND COLLECTION DEVELOPMENT OF YOUTH AND YOUNG ADULT BOOK, AUDIOVISUAL, AND DIGITAL TITLES, IN CLASS 41 (U.S. CLS. 100, 101 AND 107).

FIRST USE 1-0-2009; IN COMMERCE 1-0-2009.

THE MARK CONSISTS OF STANDARD CHARACTERS WITHOUT CLAIM TO ANY PARTICULAR FONT, STYLE, SIZE, OR COLOR.

SER. NO. 85-532,329, FILED 2-2-2012.

DORITT L. CARROLL, EXAMINING ATTORNEY



David J. Kyros

Director of the United States Patent and Trademark Office

United States of America

United States Patent and Trademark Office

DAYCO

Reg. No. 4,205,481

Registered Sep. 11, 2012

Int. Cls.: 7 and 12

TRADEMARK

PRINCIPAL REGISTER

DAYCO PRODUCTS, LLC (DELAWARE LIMITED LIABILITY COMPANY)
SUITE 500, 4500 SOUTH GARNETT ROAD
TULSA, OK 74146

FOR: BELTS, PULLEYS AND BELT TENSIONERS FOR MOTORS AND ENGINES, USED IN INDUSTRIAL MACHINES AND/OR APPLICATIONS, IN CLASS 7 (U.S. CLS. 13, 19, 21, 23, 31, 34 AND 35).

FIRST USE 4-1-1960; IN COMMERCE 4-1-1960.

FOR: BELTS, PULLEYS AND BELT TENSIONERS FOR LAND VEHICLES, IN CLASS 12 (U.S. CLS. 19, 21, 23, 31, 35 AND 44).

FIRST USE 4-16-1945; IN COMMERCE 4-16-1945.

THE MARK CONSISTS OF STANDARD CHARACTERS WITHOUT CLAIM TO ANY PARTICULAR FONT, STYLE, SIZE, OR COLOR.

OWNER OF U.S. REG. NOS. 1,391,387, 1,647,865, AND 1,689,837.

SER. NO. 85-532,340, FILED 2-2-2012.

MEGHAN REINHART, EXAMINING ATTORNEY



David J. Kypos

Director of the United States Patent and Trademark Office

United States of America

United States Patent and Trademark Office



THE HELMSLEY SANDCASTLE HOTEL

Reg. No. 4,205,482

PARK LANE HOTEL, INC. (NEW YORK CORPORATION)
230 PARK AVENUE
NEW YORK, NY 10169

Registered Sep. 11, 2012

Int. Cl.: 43

FOR: HOTEL SERVICES, IN CLASS 43 (U.S. CLS. 100 AND 101).

SERVICE MARK

FIRST USE 10-1-2002; IN COMMERCE 10-1-2002.

PRINCIPAL REGISTER

OWNER OF U.S. REG. NO. 3,665,513.

NO CLAIM IS MADE TO THE EXCLUSIVE RIGHT TO USE "HOTEL", APART FROM THE MARK AS SHOWN.

THE MARK CONSISTS OF THE WORDS "THE HELMSLEY SANDCASTLE" IN STYLIZED LETTERING BELOW A DESIGN OF A CASTLE AND ABOVE A HORIZONTAL LINE BELOW WHICH IS THE WORD "HOTEL" IN STYLIZED LETTERING.

SER. NO. 85-532,360, FILED 2-2-2012.

JOHN DWYER, EXAMINING ATTORNEY



David J. Kybas

Director of the United States Patent and Trademark Office

United States of America

United States Patent and Trademark Office



Reg. No. 4,205,483

EPPERSON, KELLY (UNITED STATES INDIVIDUAL)
PO BOX 2324

Registered Sep. 11, 2012

LOVES PARK, IL 61131

Int. Cl.: 41

FOR: PERSONAL COACHING SERVICES IN THE FIELD OF MIND, BODY, AND SPIRIT WELL-BEING, IN CLASS 41 (U.S. CLS. 100, 101 AND 107).

SERVICE MARK

FIRST USE 1-1-2011; IN COMMERCE 1-1-2011.

PRINCIPAL REGISTER

THE MARK CONSISTS OF THE STYLIZED WORD "JOY" WITH THE LETTER "O" AS A DESIGN OF A COLORWHEEL/PINWHEEL. UNDERNEATH IS THE STYLIZED TEXT "BEYOND YOUR DREAMS".

SER. NO. 85-532,364, FILED 2-2-2012.

JOHN DWYER, EXAMINING ATTORNEY



David J. Kybas

Director of the United States Patent and Trademark Office

United States of America

United States Patent and Trademark Office

re:design

Reg. No. 4,205,484

MITCHELL, JEFFREY R (UNITED STATES INDIVIDUAL)
2129 W. 31ST AVE.
DENVER, CO 80211

Registered Sep. 11, 2012

Int. Cl.: 42

FOR: GRAPHIC AND MULTIMEDIA DESIGN SERVICES FOR THE PURPOSE OF PROMOTING THE GOODS AND SERVICES OF OTHERS, IN CLASS 42 (U.S. CLS. 100 AND 101).

SERVICE MARK

FIRST USE 10-1-2011; IN COMMERCE 10-1-2011.

PRINCIPAL REGISTER

THE MARK CONSISTS OF STANDARD CHARACTERS WITHOUT CLAIM TO ANY PARTICULAR FONT, STYLE, SIZE, OR COLOR.

SER. NO. 85-532,372, FILED 2-2-2012.

JESSICA A. POWERS, EXAMINING ATTORNEY



David J. Kybas

Director of the United States Patent and Trademark Office

United States of America

United States Patent and Trademark Office

SIZEMORE

Reg. No. 4,205,485

SIZEMORE, INC. (GEORGIA CORPORATION)

Registered Sep. 11, 2012

2116 WALTON WAY
AUGUSTA, GA 30904

Int. Cls.: 35, 37 and 45

FOR: EMPLOYMENT AGENCY SERVICES, NAMELY, FILLING THE TEMPORARY AND PERMANENT STAFFING NEEDS OF BUSINESSES, IN CLASS 35 (U.S. CLS. 100, 101 AND 102).

SERVICE MARK

FIRST USE 0-0-1980; IN COMMERCE 0-0-1980.

PRINCIPAL REGISTER

FOR: JANITORIAL SERVICES, IN CLASS 37 (U.S. CLS. 100, 103 AND 106).

FIRST USE 0-0-1991; IN COMMERCE 0-0-1991.

FOR: SECURITY SERVICES, NAMELY, SECURITY GUARD SERVICES, SECURITY INSPECTION SERVICES, SURVEILLANCE AND CONFIDENTIAL INVESTIGATIONS, MOBILE PATROL, FIRE PROTECTION, AND CONSULTING SERVICES THEREFOR, IN CLASS 45 (U.S. CLS. 100 AND 101).

FIRST USE 0-0-1968; IN COMMERCE 0-0-1968.

THE MARK CONSISTS OF STANDARD CHARACTERS WITHOUT CLAIM TO ANY PARTICULAR FONT, STYLE, SIZE, OR COLOR.

OWNER OF U.S. REG. NO. 3,751,652.

SEC. 2(F).

SER. NO. 85-532,405, FILED 2-2-2012.

ZACHARY BELLO, EXAMINING ATTORNEY



David J. Kypos

Director of the United States Patent and Trademark Office

United States of America

United States Patent and Trademark Office

RECOGNITION@WORK

Reg. No. 4,205,486

Registered Sep. 11, 2012

Int. Cls.: 35 and 42

SERVICE MARK

PRINCIPAL REGISTER

O.C. TANNER COMPANY (UTAH CORPORATION)
1930 SOUTH STATE STREET
SALT LAKE CITY, UT 84115

FOR: CONDUCTING AN EMPLOYEE RECOGNITION AND INCENTIVE AWARD PROGRAM FOR OTHERS ACCESSIBLE VIA AN ON-LINE COMPUTER NETWORK TO PROMOTE EMPLOYEE ACHIEVEMENT, PRODUCTIVITY, PERFORMANCE, SALES, SERVICE, CUSTOMER SATISFACTION, QUALITY, SAFETY, RETIREMENT; CREATION OF RECOGNITION AND INCENTIVE AWARD PROGRAMS FOR OTHERS, NAMELY, EMPLOYEE ACHIEVEMENT, PRODUCTIVITY, PERFORMANCE, SALES, SERVICE, CUSTOMER SATISFACTION, QUALITY, SAFETY, RETIREMENT, EVENT, AND OTHER RECOGNITION AND INCENTIVE AWARD PROGRAMS; ADMINISTRATION OF RECOGNITION AND INCENTIVE AWARD PROGRAMS FOR OTHERS TO PROMOTE JOB SAFETY, QUALITY, PRODUCTIVITY, PERFORMANCE, SALES, SERVICE, AND CUSTOMER SATISFACTION, IN CLASS 35 (U.S. CLS. 100, 101 AND 102).

FIRST USE 1-16-2006; IN COMMERCE 1-16-2006.

FOR: PROVIDING TEMPORARY USE OF NON-DOWNLOADABLE COMPUTER SOFTWARE THAT FACILITATES EMPLOYEE NOMINATION, AWARD SELECTION AND AWARD FULFILLMENT, AND PROGRAM ADMINISTRATION AND REPORTING, IN CLASS 42 (U.S. CLS. 100 AND 101).

FIRST USE 1-16-2006; IN COMMERCE 1-16-2006.

THE MARK CONSISTS OF STANDARD CHARACTERS WITHOUT CLAIM TO ANY PARTICULAR FONT, STYLE, SIZE, OR COLOR.

OWNER OF U.S. REG. NO. 3,074,918.

SEC. 2(F).

SER. NO. 85-532,444, FILED 2-2-2012.

BARBARA A. GOLD, EXAMINING ATTORNEY



David J. Kyros

Director of the United States Patent and Trademark Office

United States of America

United States Patent and Trademark Office

A CONNECTED VIEW

Reg. No. 4,205,487

FIRST WESTERN FINANCIAL, INC. (COLORADO CORPORATION)
1200 17TH STREET, SUITE 2650
DENVER, CO 80202

Registered Sep. 11, 2012

Int. Cl.: 36

FOR: FULL SERVICE BANKING SERVICES, NAMELY, CHECKING, SAVINGS AND MORTGAGE BANKING SERVICES; TRUST SERVICES, NAMELY, ESTATE TRUST MANAGEMENT SERVICES AND REAL ESTATE TRUSTEE SERVICES; FINANCIAL SERVICES, NAMELY, FINANCIAL ANALYSIS AND CONSULTATION, FINANCIAL FORECASTING, FINANCIAL INFORMATION PROVIDED BY ELECTRONIC MEANS, COMMERCIAL AND PRIVATE FINANCIAL LENDING SERVICES, CONSTRUCTION LOANS, HOME EQUITY LOANS, LINES OF CREDIT, CREDIT CARD SERVICES, LETTERS OF CREDIT AND FINANCIAL INVESTMENT ADVISORY SERVICES, IN CLASS 36 (U.S. CLS. 100, 101 AND 102).

SERVICE MARK

PRINCIPAL REGISTER

FIRST USE 2-1-2012; IN COMMERCE 2-1-2012.

THE MARK CONSISTS OF STANDARD CHARACTERS WITHOUT CLAIM TO ANY PARTICULAR FONT, STYLE, SIZE, OR COLOR.

SER. NO. 85-532,485, FILED 2-2-2012.

JESSICA A. POWERS, EXAMINING ATTORNEY



David J. Kybas

Director of the United States Patent and Trademark Office

United States of America

United States Patent and Trademark Office

ConnectView

Reg. No. 4,205,488

FIRST WESTERN FINANCIAL, INC. (COLORADO CORPORATION)
1200 17TH STREET, SUITE 2650
DENVER, CO 80202

Registered Sep. 11, 2012

Int. Cl.: 36

FOR: FULL SERVICE BANKING SERVICES, NAMELY, CHECKING, SAVINGS AND MORTGAGE BANKING SERVICES; TRUST SERVICES, NAMELY, ESTATE TRUST MANAGEMENT SERVICES AND REAL ESTATE TRUSTEE SERVICES; FINANCIAL SERVICES, NAMELY, FINANCIAL ANALYSIS AND CONSULTATION, FINANCIAL FORECASTING, FINANCIAL INFORMATION PROVIDED BY ELECTRONIC MEANS, COMMERCIAL AND PRIVATE FINANCIAL LENDING SERVICES, CONSTRUCTION LOANS, HOME EQUITY LOANS, LINES OF CREDIT, CREDIT CARD SERVICES, LETTERS OF CREDIT AND FINANCIAL INVESTMENT ADVISORY SERVICES, IN CLASS 36 (U.S. CLS. 100, 101 AND 102).

SERVICE MARK

PRINCIPAL REGISTER

FIRST USE 2-1-2012; IN COMMERCE 2-1-2012.

THE MARK CONSISTS OF STANDARD CHARACTERS WITHOUT CLAIM TO ANY PARTICULAR FONT, STYLE, SIZE, OR COLOR.

SER. NO. 85-532,493, FILED 2-2-2012.

JESSICA A. POWERS, EXAMINING ATTORNEY



David J. Kyjars

Director of the United States Patent and Trademark Office

United States of America

United States Patent and Trademark Office

bump-i-doodle

Reg. No. 4,205,489

AIRTEX DESIGN GROUP, INC. (MINNESOTA CORPORATION)
861 EAST HENNEPIN AVE
MINNEAPOLIS, MN 55414

Registered Sep. 11, 2012

Int. Cl.: 20

FOR: CUSHIONS, SEATS, UPHOLSTERED FURNITURE, PILLOWS, IN CLASS 20 (U.S. CLS. 2, 13, 22, 25, 32 AND 50).

TRADEMARK

FIRST USE 2-1-2009; IN COMMERCE 2-1-2009.

PRINCIPAL REGISTER

THE MARK CONSISTS OF STANDARD CHARACTERS WITHOUT CLAIM TO ANY PARTICULAR FONT, STYLE, SIZE, OR COLOR.

SER. NO. 85-532,549, FILED 2-2-2012.

MARC LEIPZIG, EXAMINING ATTORNEY



David J. Kyffers

Director of the United States Patent and Trademark Office

United States of America
United States Patent and Trademark Office

AsureForce

Reg. No. 4,205,490

Registered Sep. 11, 2012

Int. Cl.: 42

SERVICE MARK

PRINCIPAL REGISTER

ASURE SOFTWARE, INC. (DELAWARE CORPORATION)
SUITE 100
110 WILD BASIN ROAD
AUSTIN, TX 78746

FOR: SOFTWARE AS A SERVICE (SAAS) SERVICES FEATURING SOFTWARE FOR WORKFORCE MANAGEMENT, NAMELY, TIME AND ATTENDANCE, PAYROLL, LABOR MANAGEMENT, HUMAN RESOURCES AND ADMINISTRATION, AND PROJECT MANAGEMENT, IN CLASS 42 (U.S. CLS. 100 AND 101).

FIRST USE 1-23-2012; IN COMMERCE 1-23-2012.

THE MARK CONSISTS OF STANDARD CHARACTERS WITHOUT CLAIM TO ANY PARTICULAR FONT, STYLE, SIZE, OR COLOR.

OWNER OF U.S. REG. NO. 3,568,332.

SER. NO. 85-532,563, FILED 2-2-2012.

MARC LEIPZIG, EXAMINING ATTORNEY



David J. Kybas

Director of the United States Patent and Trademark Office

United States of America

United States Patent and Trademark Office

HEROES IN THE HOME

Reg. No. 4,205,491

Registered Sep. 11, 2012

Int. Cl.: 41

SERVICE MARK

PRINCIPAL REGISTER

CURA HOME CARE SERVICES, LLC (ARIZONA LIMITED LIABILITY COMPANY), DBA
NORTH VALLEY HOMEWATCH CAREGIVERS
4545 E. SHEA BLVD., SUITE 260
PHOENIX, AZ 85028

FOR: AWARDS PROGRAM FOR INDIVIDUALS WHO HAVE MADE SIGNIFICANT CONTRIBUTIONS AS FAMILY CAREGIVERS , IN CLASS 41 (U.S. CLS. 100, 101 AND 107).

FIRST USE 6-6-2011; IN COMMERCE 6-6-2011.

THE MARK CONSISTS OF STANDARD CHARACTERS WITHOUT CLAIM TO ANY PARTICULAR FONT, STYLE, SIZE, OR COLOR.

SER. NO. 85-532,567, FILED 2-2-2012.

ELISSA GARBER KON, EXAMINING ATTORNEY



David J. Kybas

Director of the United States Patent and Trademark Office

United States of America

United States Patent and Trademark Office

A COMMUNITY CELEBRATION OF CAREGIVING

Reg. No. 4,205,492

Registered Sep. 11, 2012

Int. Cl.: 41

SERVICE MARK

PRINCIPAL REGISTER

CURA HOME CARE SERVICES, LLC (ARIZONA LIMITED LIABILITY COMPANY), DBA
NORTH VALLEY HOMEWATCH CAREGIVERS
4545 E. SHEA BLVD., SUITE 260
PHOENIX, AZ 85028

FOR: AWARDS PROGRAM FOR INDIVIDUALS WHO HAVE MADE SIGNIFICANT CONTRIBUTIONS AS FAMILY CAREGIVERS , IN CLASS 41 (U.S. CLS. 100, 101 AND 107).

FIRST USE 6-6-2011; IN COMMERCE 6-6-2011.

THE MARK CONSISTS OF STANDARD CHARACTERS WITHOUT CLAIM TO ANY PARTICULAR FONT, STYLE, SIZE, OR COLOR.

SER. NO. 85-532,577, FILED 2-2-2012.

ELISSA GARBER KON, EXAMINING ATTORNEY



David J. Kyffers

Director of the United States Patent and Trademark Office

United States of America

United States Patent and Trademark Office

CARTER MARIO INJURY LAWYERS

Reg. No. 4,205,493

Registered Sep. 11, 2012

Int. Cl.: 45

SERVICE MARK

PRINCIPAL REGISTER

CARTER MARIO INJURY LAWYERS, P.C. (CONNECTICUT PROFESSIONAL CORPORATION)
158 CHERRY STREET
MILFORD, CT 06460

FOR: LEGAL SERVICES, IN CLASS 45 (U.S. CLS. 100 AND 101).

FIRST USE 6-1-2002; IN COMMERCE 6-1-2002.

THE MARK CONSISTS OF STANDARD CHARACTERS WITHOUT CLAIM TO ANY PARTICULAR FONT, STYLE, SIZE, OR COLOR.

NO CLAIM IS MADE TO THE EXCLUSIVE RIGHT TO USE "INJURY LAWYERS", APART FROM THE MARK AS SHOWN.

THE NAME(S), PORTRAIT(S), AND/OR SIGNATURE(S) SHOWN IN THE MARK IDENTIFIES CARTER MARIO, WHOSE CONSENT(S) TO REGISTER IS MADE OF RECORD.

SER. NO. 85-532,584, FILED 2-2-2012.

RONALD MCMORROW, EXAMINING ATTORNEY



David J. Kybas

Director of the United States Patent and Trademark Office

United States of America

United States Patent and Trademark Office

TASMANIAN FORCE

Reg. No. 4,205,494

PORTLAND BOTTLING COMPANY (OREGON CORPORATION)
1321 NE COUCH ST.
PORTLAND, OR 97232

Registered Sep. 11, 2012

Int. Cl.: 32

FOR: NON-ALCOHOLIC BEVERAGES, NAMELY, ENERGY DRINKS, IN CLASS 32 (U.S. CLS. 45, 46 AND 48).

TRADEMARK

FIRST USE 2-13-2008; IN COMMERCE 2-13-2008.

PRINCIPAL REGISTER

THE MARK CONSISTS OF STANDARD CHARACTERS WITHOUT CLAIM TO ANY PARTICULAR FONT, STYLE, SIZE, OR COLOR.

SER. NO. 85-532,594, FILED 2-2-2012.

RONALD MCMORROW, EXAMINING ATTORNEY



David J. Kyffers

Director of the United States Patent and Trademark Office

United States of America

United States Patent and Trademark Office

MCDIVITT LAW FIRM

Reg. No. 4,205,495

Registered Sep. 11, 2012

Int. Cl.: 45

SERVICE MARK

PRINCIPAL REGISTER

MCDIVITT LAW FIRM, P.C. (COLORADO PROFESSIONAL CORPORATION)
19 E. CIMARRON
COLORADO SPRINGS, CO 80903

FOR: LEGAL SERVICES, IN CLASS 45 (U.S. CLS. 100 AND 101).

FIRST USE 11-5-1993; IN COMMERCE 11-5-1993.

THE MARK CONSISTS OF STANDARD CHARACTERS WITHOUT CLAIM TO ANY PARTICULAR FONT, STYLE, SIZE, OR COLOR.

NO CLAIM IS MADE TO THE EXCLUSIVE RIGHT TO USE "LAW FIRM", APART FROM THE MARK AS SHOWN.

SEC. 2(F).

SER. NO. 85-532,612, FILED 2-2-2012.

SUSAN STIGLITZ, EXAMINING ATTORNEY



David J. Kybas

Director of the United States Patent and Trademark Office

United States of America

United States Patent and Trademark Office



Reg. No. 4,205,496

Registered Sep. 11, 2012

Int. Cl.: 3

TRADEMARK

PRINCIPAL REGISTER

SORHAINDO, GAVIN (UNITED STATES INDIVIDUAL)
92 VANDAM STREET FLOOR 2
NEW YORK, NY 10013 AND

UZZARDI, JOSEPH (UNITED STATES INDIVIDUAL)
92 VANDAM STREET FLOOR 2
NEW YORK, NY 10013

FOR: COSMETIC CREAMS; COSMETIC CREAMS FOR SKIN CARE; COSMETIC HAND CREAMS; COSMETIC MASKS; COSMETIC MASSAGE CREAMS; COSMETIC OILS; COSMETICS; COSMETICS IN GENERAL, INCLUDING PERFUMES; EAU DE PERFUME; LIQUID PERFUMES; PERFUME; PERFUME OILS; PERFUMED CREAMS; PERFUMES; PERFUMES AND COLOGNES; PERFUMES AND TOILET WATERS; PERFUMES, AFTERSHAVES AND COLOGNES; PERFUMES, EAU DE COLOGNES AND AFTERSHAVES, IN CLASS 3 (U.S. CLS. 1, 4, 6, 50, 51 AND 52).

FIRST USE 8-1-2007; IN COMMERCE 8-1-2007.

THE MARK CONSISTS OF THE NUMBER SIX AND THE AMPERSAND SIGN.

SER. NO. 85-532,619, FILED 2-2-2012.

FLORENTINA BLANDU, EXAMINING ATTORNEY



David J. Kyjars

Director of the United States Patent and Trademark Office

United States of America

United States Patent and Trademark Office



Reg. No. 4,205,497

ZYLLION, INC. (CALIFORNIA CORPORATION)
5 CORDOBA
IRVINE, CA 92614

Registered Sep. 11, 2012

Int. Cl.: 10

FOR: ELECTRIC MASSAGERS, IN CLASS 10 (U.S. CLS. 26, 39 AND 44).

TRADEMARK

FIRST USE 11-22-2011; IN COMMERCE 11-22-2011.

PRINCIPAL REGISTER

THE MARK CONSISTS OF ELEVEN IRREGULAR SHAPES THAT FORM A Z SHAPE INSIDE OF A CIRCLE. TO THE RIGHT IS THE STYLIZED TEXT "ZYLLION".

SER. NO. 85-532,628, FILED 2-2-2012.

FLORENTINA BLANDU, EXAMINING ATTORNEY



David J. Kybas

Director of the United States Patent and Trademark Office

United States of America

United States Patent and Trademark Office

AR · Logix

Reg. No. 4,205,498

AR LOGIX INC (PENNSYLVANIA CORPORATION)
900 CORPORATE DRIVE
READING, PA 19605

Registered Sep. 11, 2012

Int. Cl.: 36

FOR: FINANCIAL AFFAIRS AND MONETARY AFFAIRS, NAMELY, FINANCIAL INFORMATION, MANAGEMENT AND ANALYSIS SERVICES, IN CLASS 36 (U.S. CLS. 100, 101 AND 102).

SERVICE MARK

FIRST USE 11-17-2011; IN COMMERCE 11-17-2011.

PRINCIPAL REGISTER

THE MARK CONSISTS OF STANDARD CHARACTERS WITHOUT CLAIM TO ANY PARTICULAR FONT, STYLE, SIZE, OR COLOR.

SER. NO. 85-532,693, FILED 2-2-2012.

STEVEN PEREZ, EXAMINING ATTORNEY



David J. Kyffers

Director of the United States Patent and Trademark Office

United States of America

United States Patent and Trademark Office



Reg. No. 4,205,499

IRONRIDGE, INC. (CALIFORNIA CORPORATION)
1435 BAECHTEL ROAD
WILLITS, CA 95490

Registered Sep. 11, 2012

Int. Cl.: 6

FOR: METAL STRUCTURES FOR MOUNTING SOLAR PANELS; SOLAR PANEL MOUNTS
MADE OF METAL, IN CLASS 6 (U.S. CLS. 2, 12, 13, 14, 23, 25 AND 50).

TRADEMARK

FIRST USE 4-1-2008; IN COMMERCE 4-1-2008.

PRINCIPAL REGISTER

THE MARK CONSISTS OF A GRAPHIC DEPICTION OF A MOUNTAIN RANGE. TO THE
RIGHT SIDE OF THE GRAPHICAL ELEMENT IS THE LITERAL ELEMENT "IRONRIDGE".

SER. NO. 85-532,696, FILED 2-2-2012.

STEVEN PEREZ, EXAMINING ATTORNEY



David J. Kybas

Director of the United States Patent and Trademark Office

United States of America

United States Patent and Trademark Office

We cool our beer with the
sun

Reg. No. 4,205,500

MCELROY, JOHN (UNITED STATES INDIVIDUAL)
P.O. BOX 204
BLAKESLEE, PA 18610

Registered Sep. 11, 2012

Int. Cl.: 35

FOR: RETAIL CONVENIENCE STORES, IN CLASS 35 (U.S. CLS. 100, 101 AND 102).

SERVICE MARK

FIRST USE 6-1-2011; IN COMMERCE 6-1-2011.

PRINCIPAL REGISTER

THE MARK CONSISTS OF STANDARD CHARACTERS WITHOUT CLAIM TO ANY PARTICULAR FONT, STYLE, SIZE, OR COLOR.

SER. NO. 85-532,699, FILED 2-2-2012.

LEIGH CAROLINE CASE, EXAMINING ATTORNEY



David J. Kyffers

Director of the United States Patent and Trademark Office

United States of America

United States Patent and Trademark Office

WARRIORS LIVE ON

Reg. No. 4,205,501

WARRIORS LIVE ON, INC. (CALIFORNIA CORPORATION)

Registered Sep. 11, 2012

1940 32ND STREET
SAN DIEGO, CA 92102

Int. Cl.: 44

FOR: ART THERAPY; BODYWORK THERAPY SERVICES, NAMELY, STRUCTURAL INTEGRATION THERAPY AND MOVEMENT THERAPY; COGNITIVE THERAPY SERVICES; DANCE MOVEMENT THERAPY SERVICES; DREAM ANALYSIS THERAPY SERVICES; INSOMNIA THERAPY SERVICES; NUTRITIONAL THERAPY SERVICES; PHYSICAL THERAPY; PHYSICAL THERAPY IN THE NATURE OF MOVEMENT THERAPY; STRESS REDUCTION THERAPY; THERAPY FOR HUMANS WITH USE OF HORSES; VITAMIN THERAPY, IN CLASS 44 (U.S. CLS. 100 AND 101).

SERVICE MARK

PRINCIPAL REGISTER

FIRST USE 12-1-2011; IN COMMERCE 1-1-2012.

THE MARK CONSISTS OF STANDARD CHARACTERS WITHOUT CLAIM TO ANY PARTICULAR FONT, STYLE, SIZE, OR COLOR.

SER. NO. 85-532,712, FILED 2-2-2012.

JUDITH HELFMAN, EXAMINING ATTORNEY



David J. Kyros

Director of the United States Patent and Trademark Office

United States of America

United States Patent and Trademark Office

workbuddy

Reg. No. 4,205,502

Registered Sep. 11, 2012

Int. Cl.: 42

SERVICE MARK

PRINCIPAL REGISTER

PROJECT DIRECT, LLC (NEVADA LIMITED LIABILITY COMPANY)
SUITE 100, BOX 4470
297 KINGSBURY GRADE
STATELINE, NV 30306

FOR: DESIGN, CREATION, HOSTING, MAINTENANCE OF WEBSITES FOR OTHERS; PLANNING, DESIGN, DEVELOPMENT, MAINTENANCE AND OPTIMIZATION OF ONLINE WEBSITES FOR THIRD PARTIES; PROVIDING A WEBSITE FEATURING INFORMATION IN THE FIELD OF INTERIOR DESIGN AND ARCHITECTURE FOR USE BY INTERIOR DESIGNERS AND ARCHITECTS; PROVIDING A WEBSITE FEATURING INFORMATION ABOUT GREEN ARCHITECTURE, INTERIOR DESIGN, SUSTAINABLE COMMUNITY PLANNING AND INFRASTRUCTURE DEVELOPMENT; PROVIDING AN INTERNET WEBSITE PORTAL OFFERING INFORMATION IN THE FIELD OF COMPUTER AIDED DESIGN; WEBSITE DESIGN AND DEVELOPMENT FOR OTHERS; GRAPHIC DESIGN SERVICES; COMPUTER GRAPHICS DESIGN SERVICES ; DIGITAL IMAGE CORRECTION SERVICES OF VIDEOS ; PROVIDING A WEB SITE FEATURING TECHNOLOGY THAT ENABLES INTERNET USERS TO SHARE DOCUMENTS, IMAGES AND VIDEOS; APPLICATION SERVICE PROVIDER, NAMELY, HOSTING, MANAGING, DEVELOPING, ANALYZING, AND MAINTAINING APPLICATIONS, SOFTWARE, AND WEB SITES, OF OTHERS IN THE FIELDS OF ADVERTISING AND MARKETING; VISUAL DESIGN SERVICES IN THE NATURE OF DESIGNING VISUAL ELEMENTS FOR ON-LINE, BROADCAST, PRINT, OUTDOOR AND OTHER COMMUNICATION MEDIA; SOCIAL BOOKMARKING WEBSITE SERVICES, NAMELY, PROVIDING A WEBSITE FEATURING TECHNOLOGY THAT ENABLES USERS TO ORGANIZE, STORE, MANAGE, SHARE AND SEARCH FOR BOOKMARKS OF RESOURCES ONLINE; COMPUTER SERVICES, NAMELY, DESIGNING AND IMPLEMENTING WEBSITES, WEBPAGES, HOME PAGES, INTERNET SITES, SOCIAL MEDIA PAGES, BLOGS, AND VIDEO ARCHIVING FOR OTHERS; CREATING AND MAINTAINING INTERNET SITES FOR OTHERS; DESIGN, CREATION, HOSTING AND MAINTENANCE OF INTERNET SITES FOR THIRD PARTIES; DESIGNING AND DEVELOPING WEBPAGES ON THE INTERNET; DESIGNING INTERNET SITES FOR OTHERS; HOSTING INTERNET SITES FOR OTHERS; HOSTING OF DIGITAL CONTENT ON THE INTERNET; HOSTING WEBSITES ON THE INTERNET; INSTALLATION AND MAINTENANCE OF INTERNET ACCESS SOFTWARE; WEB PUBLISHING, NAMELY, CREATING A WEBSITE AND UPLOADING IT ONTO AN INTERNET SERVER; PROVIDING A WEB SITE FEATURING TECHNOLOGY THAT ENABLES INTERNET USERS TO SHARE DOCUMENTS, IMAGES AND VIDEOS; PROVIDING A WEB SITE FEATURING TECHNOLOGY THAT ENABLES INTERNET USERS TO CREATE, BOOKMARK, ANNOTATE, AND PUBLICLY



David J. Kybas

Director of the United States Patent and Trademark Office

Reg. No. 4,205,502 SHARE DATA; MAINTENANCE OF SOFTWARE FOR INTERNET ACCESS, IN CLASS 42
(U.S. CLS. 100 AND 101).

FIRST USE 9-27-2011; IN COMMERCE 9-27-2011.

THE MARK CONSISTS OF STANDARD CHARACTERS WITHOUT CLAIM TO ANY PARTICULAR FONT, STYLE, SIZE, OR COLOR.

SER. NO. 85-532,714, FILED 2-2-2012.

RAUL CORDOVA, EXAMINING ATTORNEY

United States of America

United States Patent and Trademark Office



Warriors Live On

Reg. No. 4,205,503

WARRIORS LIVE ON, INC. (CALIFORNIA CORPORATION)
1940 32ND STREET
SAN DIEGO, CA 92102

Registered Sep. 11, 2012

Int. Cl.: 44

FOR: ART THERAPY; BODYWORK THERAPY; DANCE MOVEMENT THERAPY SERVICES; DREAM ANALYSIS THERAPY SERVICES; INSOMNIA THERAPY SERVICES; MASSAGE THERAPY SERVICES; MENTAL HEALTH THERAPY SERVICES; MUSIC THERAPY FOR PHYSICAL, PSYCHOLOGICAL AND COGNITIVE PURPOSES; NUTRITIONAL THERAPY SERVICES; PHYSICAL THERAPY; PHYSICAL THERAPY IN THE NATURE OF MOVEMENT THERAPY; STRESS REDUCTION THERAPY; THERAPY FOR HUMANS WITH USE OF HORSES; VITAMIN THERAPY, IN CLASS 44 (U.S. CLS. 100 AND 101).

SERVICE MARK

PRINCIPAL REGISTER

FIRST USE 12-1-2011; IN COMMERCE 1-9-2012.

THE MARK CONSISTS OF A HALF SUNBURST WITH RAYS OF YELLOW, ORANGE AND LIGHT ORANGE DEPICTED AS EXTENDING FROM A WHITE HALF CIRCLE ABOVE THE WORDS "WARRIORS LIVE ON" IN BROWN ALL ON A WHITE BACKGROUND.

THE COLOR(S) BROWN, ORANGE, LIGHT ORANGE, YELLOW, WHITE IS/ARE CLAIMED AS A FEATURE OF THE MARK.

SER. NO. 85-532,725, FILED 2-2-2012.

JUDITH HELFMAN, EXAMINING ATTORNEY



David J. Kyjars

Director of the United States Patent and Trademark Office

United States of America

United States Patent and Trademark Office

Rob Thomas

Reg. No. 4,205,504

Registered Sep. 11, 2012

Int. Cl.: 16

TRADEMARK

PRINCIPAL REGISTER

BIDNIS HOLDINGS, INC. (NEW YORK CORPORATION)
C/O GLADSTONE MICHEL, ATTN. OWEN SLOANE
4551 GLENCOE AVENUE, SUITE 300
MARINA DEL REY, CA 90292

FOR: PAPER GOODS AND PRINTED MATTER, NAMELY SOUVENIR PROGRAMS FOR MUSICAL CONCERTS, SONG BOOKS, POSTCARDS, POSTAGE STAMPS, POSTERS, STICKERS AND DECALS, GREETING CARDS, AND FAN CLUB NEWSLETTERS, IN CLASS 16 (U.S. CLS. 2, 5, 22, 23, 29, 37, 38 AND 50).

FIRST USE 2-1-2005; IN COMMERCE 4-1-2005.

THE MARK CONSISTS OF STANDARD CHARACTERS WITHOUT CLAIM TO ANY PARTICULAR FONT, STYLE, SIZE, OR COLOR.

THE NAME(S), PORTRAIT(S), AND/OR SIGNATURE(S) SHOWN IN THE MARK IDENTIFIES "ROB THOMAS", WHOSE CONSENT(S) TO REGISTER IS MADE OF RECORD.

SER. NO. 85-532,767, FILED 2-2-2012.

HOWARD B. LEVINE, EXAMINING ATTORNEY



David J. Kyffers

Director of the United States Patent and Trademark Office

United States of America

United States Patent and Trademark Office

401K Tune-Up

Reg. No. 4,205,505

Registered Sep. 11, 2012

Int. Cl.: 36

SERVICE MARK

PRINCIPAL REGISTER

INDEPENDENT RETIREMENT ADVISERS LLC (NEW JERSEY LIMITED LIABILITY COMPANY)
16 MEADOWBROOK DR
SHAMONG, NJ 08088

FOR: ADVICE RELATING TO INVESTMENTS, IN CLASS 36 (U.S. CLS. 100, 101 AND 102).

FIRST USE 2-21-2011; IN COMMERCE 2-21-2011.

THE MARK CONSISTS OF STANDARD CHARACTERS WITHOUT CLAIM TO ANY PARTICULAR FONT, STYLE, SIZE, OR COLOR.

NO CLAIM IS MADE TO THE EXCLUSIVE RIGHT TO USE "401K", APART FROM THE MARK AS SHOWN.

SER. NO. 85-532,789, FILED 2-2-2012.

HOWARD B. LEVINE, EXAMINING ATTORNEY



David J. Kyffers

Director of the United States Patent and Trademark Office

United States of America

United States Patent and Trademark Office

Good toys make good people

Reg. No. 4,205,506

HOLMAN, CASSANDRA (UNITED STATES INDIVIDUAL)
439 WESTCOTT ST.
SYRACUSE, NY 13210

Registered Sep. 11, 2012

Int. Cl.: 28

FOR: BENDABLE TOYS; CASES FOR TOY STRUCTURES; CHILDREN'S MULTIPLE ACTIVITY TOYS; TOY BUILDING BLOCKS; TOY BUILDING BLOCKS CAPABLE OF INTERCONNECTION; TOY BUILDING STRUCTURES AND TOY VEHICLE TRACKS; TOY CONSTRUCTION BLOCKS; TOY CONSTRUCTION SETS; TOY SETS OF CARPENTERS' TOOLS; TOY TOOLS, IN CLASS 28 (U.S. CLS. 22, 23, 38 AND 50).

TRADEMARK

PRINCIPAL REGISTER

FIRST USE 8-3-2009; IN COMMERCE 8-3-2009.

THE MARK CONSISTS OF STANDARD CHARACTERS WITHOUT CLAIM TO ANY PARTICULAR FONT, STYLE, SIZE, OR COLOR.

SER. NO. 85-532,796, FILED 2-2-2012.

HENRY S. ZAK, EXAMINING ATTORNEY



David J. Kyffers

Director of the United States Patent and Trademark Office

United States of America

United States Patent and Trademark Office

Inventory Advisor

Reg. No. 4,205,507

Registered Sep. 11, 2012

Int. Cl.: 42

SERVICE MARK

PRINCIPAL REGISTER

TEAPPLIX INC (CALIFORNIA CORPORATION)
1852 BRET HARTE STREET
1852 BRET HARTE STREET
PALO ALTO, CA 94303

FOR: PROVIDING ON-LINE NON-DOWNLOADABLE SOFTWARE FOR MANAGING E-COMMERCE CATALOG AND INVENTORY, IN CLASS 42 (U.S. CLS. 100 AND 101).

FIRST USE 2-2-2012; IN COMMERCE 2-2-2012.

THE MARK CONSISTS OF STANDARD CHARACTERS WITHOUT CLAIM TO ANY PARTICULAR FONT, STYLE, SIZE, OR COLOR.

SER. NO. 85-532,797, FILED 2-2-2012.

HENRY S. ZAK, EXAMINING ATTORNEY



David J. Kyffers

Director of the United States Patent and Trademark Office

United States of America

United States Patent and Trademark Office

Forget the Spa

Reg. No. 4,205,508

Registered Sep. 11, 2012

Int. Cl.: 44

SERVICE MARK

PRINCIPAL REGISTER

SANCHEZ & ASSOCIATES, LLC (MASSACHUSETTS LIMITED LIABILITY COMPANY),
DBA FORGET THE SPA
204 HESPERUS AVE UNIT 3
204 HESPERUS AVENUE UNIT 3
GLOUCESTER, MA 01930

FOR: HEALTH SPA SERVICES FOR HEALTH AND WELLNESS OF THE BODY AND SPIRIT, NAMELY, PROVIDING MASSAGE, FACIAL AND BODY TREATMENT SERVICES, COSMETIC BODY CARE SERVICES, IN CLASS 44 (U.S. CLS. 100 AND 101).

FIRST USE 12-6-2011; IN COMMERCE 12-6-2011.

THE MARK CONSISTS OF STANDARD CHARACTERS WITHOUT CLAIM TO ANY PARTICULAR FONT, STYLE, SIZE, OR COLOR.

SER. NO. 85-532,806, FILED 2-2-2012.

MARK SHINER, EXAMINING ATTORNEY



David J. Kyffers

Director of the United States Patent and Trademark Office

United States of America

United States Patent and Trademark Office

CASCADANCE

Reg. No. 4,205,509

CRAWFORD, JANET (UNITED STATES INDIVIDUAL), DBA CASCADANCE
415 VIEWPARK CT.

Registered Sep. 11, 2012

MILL VALLEY, CA 94941

Int. Cls.: 35 and 41

FOR: PROVIDING BUSINESS INFORMATION IN THE FIELD OF ORGANIZATIONAL EFFECTIVENESS AND CULTURE BASED ON HUMAN BIOLOGY AND NEUROSCIENCE PRINCIPLES TO THE CORPORATE AND NON-PROFIT SECTORS, IN CLASS 35 (U.S. CLS. 100, 101 AND 102).

SERVICE MARK

PRINCIPAL REGISTER

FIRST USE 10-12-2003; IN COMMERCE 10-12-2003.

FOR: EDUCATIONAL AND ENTERTAINMENT SERVICES, NAMELY, PROVIDING MOTIVATIONAL SPEAKING SERVICES IN THE FIELD OF ORGANIZATIONAL EFFECTIVENESS AND CULTURE BASED ON HUMAN BIOLOGY AND NEUROSCIENCE PRINCIPLES, IN CLASS 41 (U.S. CLS. 100, 101 AND 107).

FIRST USE 10-12-2003; IN COMMERCE 10-12-2003.

THE MARK CONSISTS OF STANDARD CHARACTERS WITHOUT CLAIM TO ANY PARTICULAR FONT, STYLE, SIZE, OR COLOR.

SER. NO. 85-532,808, FILED 2-2-2012.

LYNDSEY KUYKENDALL, EXAMINING ATTORNEY



David J. Kyffers

Director of the United States Patent and Trademark Office

United States of America

United States Patent and Trademark Office

TA-TAS

Reg. No. 4,205,510

Registered Sep. 11, 2012

Int. Cl.: 14

TRADEMARK

PRINCIPAL REGISTER

HAWKWILD, LLC (CALIFORNIA LIMITED LIABILITY COMPANY)
21128 VANOWEN STREET
CANOGA PARK, CA 91303

FOR: JEWELRY; BRACELETS; BRACELETS MADE OF RUBBER; BRACELETS MADE OF SILICON; CHARITY BRACELETS; ORNAMENTAL PINS, IN CLASS 14 (U.S. CLS. 2, 27, 28 AND 50).

FIRST USE 5-0-2007; IN COMMERCE 5-0-2007.

THE MARK CONSISTS OF STANDARD CHARACTERS WITHOUT CLAIM TO ANY PARTICULAR FONT, STYLE, SIZE, OR COLOR.

OWNER OF U.S. REG. NOS. 3,173,090, 3,471,059, AND 3,904,365.

SER. NO. 85-532,812, FILED 2-2-2012.

BRIAN NEVILLE, EXAMINING ATTORNEY



David J. Kyffers

Director of the United States Patent and Trademark Office

United States of America

United States Patent and Trademark Office

The most efficient way from point A to B

Reg. No. 4,205,511

ABLE BODY MOVING AND DELIVERY LLC (ALABAMA LIMITED LIABILITY COMPANY)
3029 BROOK HIGHLAND DR.
BIRMINGHAM, AL 35242

Registered Sep. 11, 2012

Int. Cl.: 39

FOR: MOVING COMPANY SERVICES, IN CLASS 39 (U.S. CLS. 100 AND 105).

SERVICE MARK

FIRST USE 7-1-2011; IN COMMERCE 7-1-2011.

PRINCIPAL REGISTER

THE MARK CONSISTS OF STANDARD CHARACTERS WITHOUT CLAIM TO ANY PARTICULAR FONT, STYLE, SIZE, OR COLOR.

SER. NO. 85-532,823, FILED 2-3-2012.

SETH A. RAPPAPORT, EXAMINING ATTORNEY



David J. Kyffers

Director of the United States Patent and Trademark Office

United States of America

United States Patent and Trademark Office

XEMC

Reg. No. 4,205,512

Registered Sep. 11, 2012

Int. Cls.: 7, 9 and 12

TRADEMARK

PRINCIPAL REGISTER

XIANGTAN ELECTRIC MANUFACTURING GROUP CO., LTD. (CHINA CORPORATION)
NO.302, ST.XIASHESI, DISTRICT YUETANG
XIANGTAN CITY, HUNAN, CHINA

FOR: ELECTRICITY GENERATORS; ELEVATORS; ENGINES, OTHER THAN FOR LAND VEHICLES; HYDRAULIC TURBINES; MINE BORERS; MOTORS OTHER THAN FOR LAND VEHICLES; PUMPS FOR MACHINES; WIND-POWERED ELECTRICITY GENERATORS, IN CLASS 7 (U.S. CLS. 13, 19, 21, 23, 31, 34 AND 35).

FIRST USE 3-18-2009; IN COMMERCE 3-18-2009.

FOR: ELECTRIC CONVERTERS; ELECTRIC INSTALLATIONS FOR THE REMOTE CONTROL OF INDUSTRIAL OPERATIONS; ELECTRIC WIRE AND CABLE; ELECTRONIC CONTROLLER TO MANAGE THE POWER, MOVEMENT AND FUNCTIONS OF AN ELEVATOR; INDUCTION VOLTAGE REGULATORS; PLATES FOR BATTERIES; RECTIFIERS; SILICON CHIPS; SOLAR BATTERIES, IN CLASS 9 (U.S. CLS. 21, 23, 26, 36 AND 38).

FIRST USE 3-18-2009; IN COMMERCE 3-18-2009.

FOR: AERIAL CONVEYORS; AIR-CUSHION VEHICLES; AUTOMOBILE ENGINES; AUTOMOBILES; BUSES; ELECTRIC VEHICLES, NAMELY, ELECTRIC BUSES; LOCOMOTIVES; MOTOR CARS FOR TRANSPORT ON LAND; TROLLEYS; VEHICLE BODIES, IN CLASS 12 (U.S. CLS. 19, 21, 23, 31, 35 AND 44).

FIRST USE 3-18-2009; IN COMMERCE 3-18-2009.

THE MARK CONSISTS OF STYLIZED LETTERS "XEMC".

SER. NO. 85-532,835, FILED 2-3-2012.

SUE LAWRENCE, EXAMINING ATTORNEY



David J. Kybas

Director of the United States Patent and Trademark Office

United States of America

United States Patent and Trademark Office



Reg. No. 4,205,513

Registered Sep. 11, 2012

Int. Cls.: 7, 9 and 12

TRADEMARK

PRINCIPAL REGISTER

XIANGTAN ELECTRIC MANUFACTURING GROUP CO., LTD. (CHINA CORPORATION)
NO.302, ST.XIASHESI, DISTRICT YUETANG
XIANGTAN CITY, HUNAN, CHINA

FOR: ELECTRICITY GENERATORS; ELEVATORS; ENGINES, OTHER THAN FOR LAND VEHICLES; HYDRAULIC TURBINES; MINE BORERS; MOTORS OTHER THAN FOR LAND VEHICLES; PUMPS FOR MACHINES; WIND-POWERED ELECTRICITY GENERATORS, IN CLASS 7 (U.S. CLS. 13, 19, 21, 23, 31, 34 AND 35).

FIRST USE 3-18-2009; IN COMMERCE 3-18-2009.

FOR: ELECTRIC CONVERTERS; ELECTRIC INSTALLATIONS FOR THE REMOTE CONTROL OF INDUSTRIAL OPERATIONS; ELECTRIC WIRE AND CABLE; ELECTRONIC CONTROLLER TO MANAGE THE POWER, MOVEMENT AND FUNCTIONS OF AN ELEVATOR; INDUCTION VOLTAGE REGULATORS; PLATES FOR BATTERIES; RECTIFIERS; SILICON CHIPS; SOLAR BATTERIES, IN CLASS 9 (U.S. CLS. 21, 23, 26, 36 AND 38).

FIRST USE 3-18-2009; IN COMMERCE 3-18-2009.

FOR: AERIAL CONVEYORS; AIR-CUSHION VEHICLES; AUTOMOBILE ENGINES; AUTOMOBILES; BUSES; ELECTRIC VEHICLES, NAMELY, ELECTRIC BUSES; LOCOMOTIVES; MOTOR CARS FOR TRANSPORT ON LAND; TROLLEYS; VEHICLE BODIES, IN CLASS 12 (U.S. CLS. 19, 21, 23, 31, 35 AND 44).

FIRST USE 3-18-2009; IN COMMERCE 3-18-2009.

THE MARK CONSISTS OF A CIRCLE DESIGN AND THERE IS RIVER IN IT.

SER. NO. 85-532,841, FILED 2-3-2012.

SUE LAWRENCE, EXAMINING ATTORNEY



David J. Kyfos

Director of the United States Patent and Trademark Office

United States of America

United States Patent and Trademark Office

ENIVATION

Reg. No. 4,205,514

NPC, INC. (PENNSYLVANIA CORPORATION)
13710 DUNNINGS HIGHWAY
CLAYSBURG, PA 16625

Registered Sep. 11, 2012

Int. Cls.: 39 and 42

FOR: STORAGE SERVICES FOR ARCHIVING ELECTRONIC DATA, IN CLASS 39 (U.S. CLS. 100 AND 105).

SERVICE MARK

FIRST USE 11-3-2011; IN COMMERCE 11-3-2011.

PRINCIPAL REGISTER

FOR: CONVERSION OF DATA OR DOCUMENTS FROM PHYSICAL TO ELECTRONIC MEDIA, IN CLASS 42 (U.S. CLS. 100 AND 101).

FIRST USE 11-3-2011; IN COMMERCE 11-3-2011.

THE MARK CONSISTS OF STANDARD CHARACTERS WITHOUT CLAIM TO ANY PARTICULAR FONT, STYLE, SIZE, OR COLOR.

SER. NO. 85-532,876, FILED 2-3-2012.

SHAVELL MCPHERSON, EXAMINING ATTORNEY



David J. Kyfos

Director of the United States Patent and Trademark Office

United States of America

United States Patent and Trademark Office

PINK UP THE PACE

Reg. No. 4,205,515

PINK UP THE PACE, INC. (FLORIDA LIMITED LIABILITY COMPANY)
125 KINGS QUARRY LANE
ST. AUGUSTINE, FL 32080

Registered Sep. 11, 2012

Int. Cl.: 41

FOR: ATHLETIC AND SPORTS EVENT SERVICES, NAMELY, ARRANGING, ORGANIZING, OPERATING AND CONDUCTING MARATHON RACES, IN CLASS 41 (U.S. CLS. 100, 101 AND 107).

SERVICE MARK

FIRST USE 8-26-2009; IN COMMERCE 8-26-2009.

PRINCIPAL REGISTER

THE MARK CONSISTS OF THE PHRASE "PINK UP THE PACE" WITH THE I IN PINK BEING A RIBBON.

SER. NO. 85-532,901, FILED 2-3-2012.

MATTHEW KLINE, EXAMINING ATTORNEY



David J. Kybas

Director of the United States Patent and Trademark Office

United States of America

United States Patent and Trademark Office

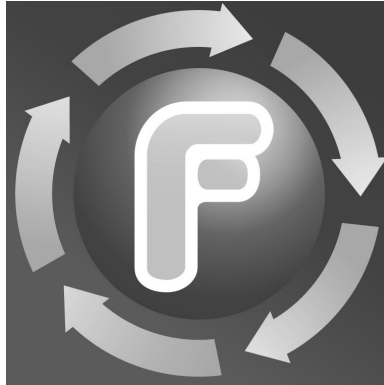

Reg. No. 4,205,516

Registered Sep. 11, 2012

Int. Cl.: 9

TRADEMARK

PRINCIPAL REGISTER

ALTOVA GMBH (AUSTRIA GMBH)
RUDOLFSPLATZ 13A/9, A-1010
WIEN (VIENNA), AUSTRIA

FOR: COMPUTER SOFTWARE FOR AUTOMATING INFORMATION, DATA, AND DOCUMENT WORKFLOW; COMPUTER SOFTWARE FOR USE AS A DATA INTEGRATION SERVER TO TRANSFORM, ACCESS, AND MANIPULATE DATA EXPRESSED IN A PARTICULAR DATA STORAGE FORMAT INTO THAT OF ANOTHER DATA STORAGE FORMAT; COMPUTER SOFTWARE FOR FACILITATING AUTO-GENERATED SOFTWARE CODE REQUIRED TO IMPLEMENT SUCH DATA TRANSFERS FROM ONE ELECTRONIC FORMAT IN A RUN-TIME ENVIRONMENT, THROUGH THE GENERATION OF CUSTOMIZED OUTPUT CODE IN A VARIETY OF DIFFERENT OUTPUT LANGUAGES, IN CLASS 9 (U.S. CLS. 21, 23, 26, 36 AND 38).

FIRST USE 10-19-2011; IN COMMERCE 10-19-2011.

THE MARK CONSISTS OF THE LETTER "F" WITH FIVE (5) ARROWS FORMING A CIRCLE AROUND THE LETTER ALL POINTING IN A CLOCKWISE ORIENTATION.

SER. NO. 85-532,916, FILED 2-3-2012.

JORDAN BAKER, EXAMINING ATTORNEY



David J. Kyros

Director of the United States Patent and Trademark Office

United States of America

United States Patent and Trademark Office

ECO-COASTERS

Reg. No. 4,205,517

ECOACCENTS, LLC (NORTH CAROLINA LIMITED LIABILITY COMPANY)
P.O. BOX 1615
RALEIGH, NC 27602

Registered Sep. 11, 2012

Int. Cl.: 16

FOR: PAPER COASTERS, IN CLASS 16 (U.S. CLS. 2, 5, 22, 23, 29, 37, 38 AND 50).

TRADEMARK

FIRST USE 6-0-2011; IN COMMERCE 1-6-2012.

PRINCIPAL REGISTER

THE MARK CONSISTS OF STANDARD CHARACTERS WITHOUT CLAIM TO ANY PARTICULAR FONT, STYLE, SIZE, OR COLOR.

SER. NO. 85-532,931, FILED 2-3-2012.

MARK SHINER, EXAMINING ATTORNEY



David J. Kybas

Director of the United States Patent and Trademark Office

United States of America

United States Patent and Trademark Office

MCDIVITT MAKES A DIFFERENCE

Reg. No. 4,205,518

Registered Sep. 11, 2012

Int. Cl.: 45

SERVICE MARK

PRINCIPAL REGISTER

MCDIVITT LAW FIRM, P.C. (COLORADO PROFESSIONAL CORPORATION)
19 E. CIMARRON
COLORADO SPRINGS, CO 80903

FOR: LEGAL SERVICES, IN CLASS 45 (U.S. CLS. 100 AND 101).

FIRST USE 1-21-2010; IN COMMERCE 1-21-2010.

THE MARK CONSISTS OF STANDARD CHARACTERS WITHOUT CLAIM TO ANY PARTICULAR FONT, STYLE, SIZE, OR COLOR.

SER. NO. 85-532,951, FILED 2-3-2012.

SUSAN STIGLITZ, EXAMINING ATTORNEY



David J. Kyffers

Director of the United States Patent and Trademark Office

United States of America

United States Patent and Trademark Office

EVOLUTION OF SMOOTH

Reg. No. 4,205,519

THE KIND GROUP, LLC (NEW YORK LIMITED LIABILITY COMPANY)
307 FIFTH AVENUE, 5TH FLOOR
NEW YORK, NY 10016

Registered Sep. 11, 2012

Int. Cl.: 3

FOR: LIP BALMS, PREPARATIONS AND TREATMENTS; SHAVING PRODUCTS, NAMELY, SHAVING AND PRESHAVING CREAMS; BODY CARE PRODUCTS, NAMELY, HAND AND BODY LOTION , IN CLASS 3 (U.S. CLS. 1, 4, 6, 50, 51 AND 52).

TRADEMARK

FIRST USE 3-2-2008; IN COMMERCE 3-2-2008.

PRINCIPAL REGISTER

THE MARK CONSISTS OF STANDARD CHARACTERS WITHOUT CLAIM TO ANY PARTICULAR FONT, STYLE, SIZE, OR COLOR.

SER. NO. 85-532,959, FILED 2-3-2012.

HENRY S. ZAK, EXAMINING ATTORNEY



David J. Kyjars

Director of the United States Patent and Trademark Office

United States of America

United States Patent and Trademark Office

EVOLUTION OF SMOOTH

Reg. No. 4,205,520

THE KIND GROUP, LLC (NEW YORK LIMITED LIABILITY COMPANY)
307 FIFTH AVENUE, 5TH FLOOR
NEW YORK, NY 10016

Registered Sep. 11, 2012

Int. Cl.: 5

FOR: MEDICATED LIP BALMS, PREPARATIONS AND TREATMENTS, IN CLASS 5 (U.S. CLS. 6, 18, 44, 46, 51 AND 52).

TRADEMARK

FIRST USE 10-1-2010; IN COMMERCE 10-1-2010.

PRINCIPAL REGISTER

THE MARK CONSISTS OF STANDARD CHARACTERS WITHOUT CLAIM TO ANY PARTICULAR FONT, STYLE, SIZE, OR COLOR.

SER. NO. 85-532,967, FILED 2-3-2012.

HENRY S. ZAK, EXAMINING ATTORNEY



David J. Kybas

Director of the United States Patent and Trademark Office

United States of America

United States Patent and Trademark Office

AXIOM

Reg. No. 4,205,521

Registered Sep. 11, 2012

Int. Cl.: 13

TRADEMARK

PRINCIPAL REGISTER

ALLIANT TECHSYSTEMS INC. (DELAWARE CORPORATION)
7480 FLYING CLOUD DRIVE
MINNEAPOLIS, MN 55344

FOR: GUN STOCKS, IN CLASS 13 (U.S. CLS. 2 AND 9).

FIRST USE 1-28-2005; IN COMMERCE 1-28-2005.

THE MARK CONSISTS OF STANDARD CHARACTERS WITHOUT CLAIM TO ANY PARTICULAR FONT, STYLE, SIZE, OR COLOR.

SER. NO. 85-532,975, FILED 2-3-2012.

LOURDES AYALA, EXAMINING ATTORNEY



David J. Kybas

Director of the United States Patent and Trademark Office

United States of America

United States Patent and Trademark Office

WISH I MAY

Reg. No. 4,205,522

WISH I MAY (MISSOURI CORPORATION)
1700 W. WALNUT
SPRINGFIELD, MO 65806

Registered Sep. 11, 2012

Int. Cl.: 41

FOR: CHARITABLE SERVICES, NAMELY, COLLABORATING WITH OTHER NOT FOR PROFIT ORGANIZATIONS TO PROVIDE PARENTS AND GUARDIANS OF UNDERPRIVILEGED CHILDREN WITH THE SUPPLIES THEY NEED TO GIVE THEIR CHILDREN BIRTHDAY CELEBRATIONS, IN CLASS 41 (U.S. CLS. 100, 101 AND 107).

SERVICE MARK

PRINCIPAL REGISTER

FIRST USE 6-15-2011; IN COMMERCE 9-6-2011.

THE MARK CONSISTS OF STANDARD CHARACTERS WITHOUT CLAIM TO ANY PARTICULAR FONT, STYLE, SIZE, OR COLOR.

SER. NO. 85-532,994, FILED 2-3-2012.

SALLY SHIH, EXAMINING ATTORNEY



David J. Kyffers

Director of the United States Patent and Trademark Office

United States of America

United States Patent and Trademark Office

BEHIND THE SCENES CARE AND DISCOVERY AT NATIONAL JEWISH HEALTH

Reg. No. 4,205,523

NATIONAL JEWISH HEALTH (COLORADO NON-PROFIT CORPORATION)
1400 JACKSON STREET
DENVER, CO 80206

Registered Sep. 11, 2012

Int. Cl.: 36

FOR: CHARITABLE FUNDRAISING SERVICES BY MEANS OF ORGANIZING AND CONDUCTING TOURS AND SPECIAL EVENTS, IN CLASS 36 (U.S. CLS. 100, 101 AND 102).

SERVICE MARK

FIRST USE 2-1-2012; IN COMMERCE 2-1-2012.

PRINCIPAL REGISTER

THE MARK CONSISTS OF STANDARD CHARACTERS WITHOUT CLAIM TO ANY PARTICULAR FONT, STYLE, SIZE, OR COLOR.

OWNER OF U.S. REG. NOS. 2,155,433 AND 3,512,437.

SER. NO. 85-533,000, FILED 2-3-2012.

JEFFREY LOOK, EXAMINING ATTORNEY



David J. Kybas

Director of the United States Patent and Trademark Office

United States of America

United States Patent and Trademark Office

Self-Revealization Acceptance

Reg. No. 4,205,524

Registered Sep. 11, 2012

Int. Cl.: 44

SERVICE MARK

PRINCIPAL REGISTER

KAUFMAN, STEPHEN (UNITED STATES INDIVIDUAL)
3E
404 EAAST 75TH STREET
NEW YORK, NY 10021

FOR: CONSULTING IN THE FIELD OF HEALTH AND WELLNESS TO BRING ABOUT PERSONAL HAPPINESS, IN CLASS 44 (U.S. CLS. 100 AND 101).

FIRST USE 4-22-1993; IN COMMERCE 4-22-1993.

THE MARK CONSISTS OF STANDARD CHARACTERS WITHOUT CLAIM TO ANY PARTICULAR FONT, STYLE, SIZE, OR COLOR.

SER. NO. 85-533,007, FILED 2-3-2012.

JEFFREY LOOK, EXAMINING ATTORNEY



David J. Kyffers

Director of the United States Patent and Trademark Office

United States of America

United States Patent and Trademark Office

Go Gray in May

Reg. No. 4,205,525

Registered Sep. 11, 2012

Int. Cl.: 36

SERVICE MARK

PRINCIPAL REGISTER

THE JOHN MCNICHOLAS PEDIATRIC BRAIN TUMOR FOUNDATION (ILLINOIS CORPORATION), AKA LIVELIKEJOHN.ORG
9007 S. LEAVITT
CHICAGO, IL 60643

FOR: CHARITABLE FUNDRAISING SERVICES BY MEANS OF SELLING GOODS TO RAISE FUNDS FOR PEDIATRIC BRAIN TUMOR RESEARCH; CHARITABLE FUNDRAISING SERVICES FOR PROMOTING RESEARCH, EDUCATION AND OTHER ACTIVITIES RELATING TO PEDIATRIC BRAIN TUMORS; CHARITABLE FUNDRAISING TO SUPPORT RESEARCH INTO THE TREATMENT AND CURE OF PEDIATRIC BRAIN TUMORS, IN CLASS 36 (U.S. CLS. 100, 101 AND 102).

FIRST USE 4-18-2011; IN COMMERCE 4-18-2011.

THE MARK CONSISTS OF STANDARD CHARACTERS WITHOUT CLAIM TO ANY PARTICULAR FONT, STYLE, SIZE, OR COLOR.

SER. NO. 85-533,013, FILED 2-3-2012.

GENE MACIOL, EXAMINING ATTORNEY



David J. Kyffers

Director of the United States Patent and Trademark Office

United States of America

United States Patent and Trademark Office

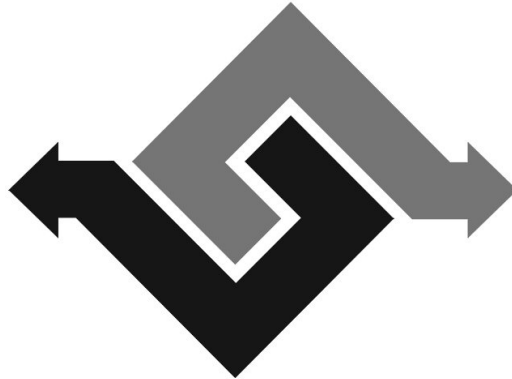

Reg. No. 4,205,526

Registered Sep. 11, 2012

Int. Cl.: 42

SERVICE MARK

PRINCIPAL REGISTER

DIGITAL COMMUNITY HOLDINGS INC. (IOWA CORPORATION)
316 S. MAIN
INWOOD, IA 51240

FOR: TEMPORARY USE OF NON-DOWNLOADABLE COMPUTER SOFTWARE FOR MANAGING INVENTORY VIA COMPUTER NETWORKS, IN CLASS 42 (U.S. CLS. 100 AND 101).

FIRST USE 0-0-1999; IN COMMERCE 0-0-1999.

THE MARK CONSISTS OF TWO "U" SHAPED FIGURES, EACH TERMINATING IN AN ARROW. ONE U IS ON TOP OF THE OTHER WITH THEIR INNER PORTIONS INTERLOCKING.

SER. NO. 85-533,025, FILED 2-3-2012.

ANDREA HACK, EXAMINING ATTORNEY



David J. Kyffers

Director of the United States Patent and Trademark Office

United States of America

United States Patent and Trademark Office



Reg. No. 4,205,527

Registered Sep. 11, 2012

Int. Cl.: 41

SERVICE MARK

PRINCIPAL REGISTER

WISH I MAY (MISSOURI CORPORATION)
1700 W. WALNUT
SPRINGFIELD, MO 65806

FOR: CHARITABLE SERVICES, NAMELY, COLLABORATING WITH OTHER NOT FOR PROFIT ORGANIZATIONS TO PROVIDE PARENTS AND GUARDIANS OF UNDERPRIVILEGED CHILDREN WITH THE SUPPLIES THEY NEED TO GIVE THEIR CHILDREN BIRTHDAY CELEBRATIONS, IN CLASS 41 (U.S. CLS. 100, 101 AND 107).

FIRST USE 10-14-2011; IN COMMERCE 12-5-2011.

THE MARK CONSISTS OF A CUPCAKE WITH ONE CANDLE ON TOP THAT HAS A STAR IN PLACE OF THE FLAME, AND THE WORD "WISH" TO THE LEFT OF THE CUPCAKE AND THE WORDS "I MAY" TO THE RIGHT OF THE CUPCAKE, WITH LINES ABOVE AND BELOW THE WORDS.

SER. NO. 85-533,032, FILED 2-3-2012.

SALLY SHIH, EXAMINING ATTORNEY



David J. Kyros

Director of the United States Patent and Trademark Office

United States of America

United States Patent and Trademark Office

PERFORMANCE AS A SERVICE

Reg. No. 4,205,528

INTERSCAPE TECHNOLOGIES INC. (NEW JERSEY CORPORATION)
3 TOWER ROAD
MARTINSVILLE, NJ 08836

Registered Sep. 11, 2012

Int. Cl.: 9

FOR: COMPUTER SOFTWARE TECHNOLOGY CONSULTING, IN CLASS 9 (U.S. CLS. 21, 23, 26, 36 AND 38).

TRADEMARK

FIRST USE 8-1-2010; IN COMMERCE 8-1-2010.

PRINCIPAL REGISTER

THE MARK CONSISTS OF STANDARD CHARACTERS WITHOUT CLAIM TO ANY PARTICULAR FONT, STYLE, SIZE, OR COLOR.

SER. NO. 85-533,033, FILED 2-3-2012.

SALLY SHIH, EXAMINING ATTORNEY



David J. Kybas

Director of the United States Patent and Trademark Office

United States of America

United States Patent and Trademark Office

ELECTROLINX

Reg. No. 4,205,529

Registered Sep. 11, 2012

Int. Cl.: 9

TRADEMARK

PRINCIPAL REGISTER

WILLIAMS-PYRO, INC. (TEXAS CORPORATION)
200 GREENLEAF STREET
FORT WORTH, TX 76107

FOR: CONNECTIVITY AND AUTOMATED TEST SYSTEMS, COMPRISED OF CABLE ASSEMBLIES, CONNECTORS, ADAPTERS, ELECTRONIC VOLTAGE, CURRENT AND SIGNAL TESTERS, AND AUTOMATED TEST EQUIPMENT, USED TO TEST PRINTED CIRCUIT BOARDS, INTEGRATED CIRCUITS OR ANY OTHER RELATED ELECTRONIC COMPONENTS OR MODULES FOR USE IN THE AEROSPACE, DEFENSE AND ENERGY INDUSTRIES, IN CLASS 9 (U.S. CLS. 21, 23, 26, 36 AND 38).

FIRST USE 6-2-2011; IN COMMERCE 6-2-2011.

THE MARK CONSISTS OF STANDARD CHARACTERS WITHOUT CLAIM TO ANY PARTICULAR FONT, STYLE, SIZE, OR COLOR.

SER. NO. 85-533,041, FILED 2-3-2012.

B. PARADEWELAI, EXAMINING ATTORNEY



David J. Kyffers

Director of the United States Patent and Trademark Office

United States of America

United States Patent and Trademark Office

InSource Move Management

Reg. No. 4,205,530

Registered Sep. 11, 2012

Int. Cl.: 39

SERVICE MARK

PRINCIPAL REGISTER

INSOURCE MOVE MANAGEMENT (MICHIGAN LIMITED LIABILITY COMPANY)
AMY VANDEFIFER/IMM MOVE MANAGEMENT TEAM
200 RENAISSANCE CENTER, STE 2200
DETROIT, MI 48243

FOR: TRANSPORT, PACKAGING, TRUCKING HAULING AND STORAGE OF GOODS, NAMELY, DOMESTIC AND INTERNATIONAL HOUSEHOLD GOODS AND COMMERCIAL FREIGHT; MOVING, STORAGE, AND TRANSPORTATION SERVICES BY TRUCK, RAIL, AIR AND BOAT, WAREHOUSING SERVICES, FREIGHT AND TRANSPORTATION BROKERAGE SERVICES AND FREIGHT FORWARDING SERVICES ALL FEATURING THE TRANSPORTATION OF GOODS AND PERSONAL EFFECTS FOR OTHERS, FOR GENERAL FREIGHT AND HOUSEHOLD GOODS; TRANSPORTATION OF GOODS BY TRUCK, AIR, RAIL AND BOAT; PACKING ARTICLES OTHER THAN HOUSEHOLD GOODS FOR TRANSPORTATION AND STORAGE; FREIGHT STATION SERVICES, NAMELY, CARGO HANDLING IN THE NATURE OF PICKUP, RECEIVING, CONSOLIDATION AND DISTRIBUTION THEREOF DOMESTICALLY AND INTERNATIONALLY; MOVE MANAGEMENT, NAMELY, TRANSPORTATION OF HOUSEHOLD GOODS AND COMMERCIAL PREMISES GOODS BY TRUCK, AIR, RAIL AND BOAT, IN CLASS 39 (U.S. CLS. 100 AND 105).

FIRST USE 2-18-2003; IN COMMERCE 2-18-2003.

THE MARK CONSISTS OF STANDARD CHARACTERS WITHOUT CLAIM TO ANY PARTICULAR FONT, STYLE, SIZE, OR COLOR.

NO CLAIM IS MADE TO THE EXCLUSIVE RIGHT TO USE "MOVE MANAGEMENT" , APART FROM THE MARK AS SHOWN.

SER. NO. 85-533,054, FILED 2-3-2012.

KATHRYN COWARD, EXAMINING ATTORNEY



David J. Kyjars

Director of the United States Patent and Trademark Office

United States of America

United States Patent and Trademark Office

HEALTHGLOBE

Reg. No. 4,205,531

HEALTH GLOBE (MASSACHUSETTS CORPORATION)
204 NEWBURY STREET, SUITE 364
BOSTON, MA 02115

Registered Sep. 11, 2012

Int. Cl.: 39

FOR: MEDICAL TOURISM SERVICES, NAMELY, MAKING TRANSPORTATION RESERVATIONS AND BOOKINGS FOR TRAVEL TO ANOTHER COUNTRY IN ORDER TO OBTAIN HEALTH CARE, IN CLASS 39 (U.S. CLS. 100 AND 105).

SERVICE MARK

FIRST USE 7-1-2010; IN COMMERCE 7-1-2010.

PRINCIPAL REGISTER

THE MARK CONSISTS OF STANDARD CHARACTERS WITHOUT CLAIM TO ANY PARTICULAR FONT, STYLE, SIZE, OR COLOR.

SER. NO. 85-533,060, FILED 2-3-2012.

SETH A. RAPPAPORT, EXAMINING ATTORNEY



David J. Kyffers

Director of the United States Patent and Trademark Office

United States of America

United States Patent and Trademark Office



Reg. No. 4,205,532

BENCHMARK PEST CONTROL, INC (CALIFORNIA CORPORATION)
2028 JASON STREET
BAKERSFIELD, CA 93312

Registered Sep. 11, 2012

Int. Cl.: 37

FOR: PEST CONTROL; ANIMAL CONTROL SERVICES, NAMELY, RODENT CONTROL AND TRAPPING, IN CLASS 37 (U.S. CLS. 100, 103 AND 106).

SERVICE MARK

FIRST USE 1-1-2008; IN COMMERCE 1-1-2008.

PRINCIPAL REGISTER

THE MARK CONSISTS OF AN ANGRY BEE IN GOLD, WHITE, BLACK, AND RED.

THE COLOR(S) GOLD, WHITE, BLACK, AND RED IS/ARE CLAIMED AS A FEATURE OF THE MARK.

SER. NO. 85-533,091, FILED 2-3-2012.

AMY C. KEAN, EXAMINING ATTORNEY



David J. Kappas

Director of the United States Patent and Trademark Office

United States of America
United States Patent and Trademark Office

ILLUSION

Reg. No. 4,205,533

KINGDOM ANIMALIA, LLC (CALIFORNIA LIMITED LIABILITY COMPANY)
1401 MAIN STREET
VENICE, CA 90291

Registered Sep. 11, 2012

Int. Cl.: 3

FOR: COSMETICS, NAMELY, A TINTED MOISTURIZER FOR FACIAL USE, IN CLASS 3
(U.S. CLS. 1, 4, 6, 50, 51 AND 52).

TRADEMARK

FIRST USE 1-0-2009; IN COMMERCE 1-0-2009.

PRINCIPAL REGISTER

THE MARK CONSISTS OF STANDARD CHARACTERS WITHOUT CLAIM TO ANY PARTICULAR FONT, STYLE, SIZE, OR COLOR.

SER. NO. 85-533,111, FILED 2-3-2012.

ROBERT C. CLARK JR., EXAMINING ATTORNEY



David J. Kybas

Director of the United States Patent and Trademark Office

United States of America

United States Patent and Trademark Office

LITTLE BLACK DRESS

Reg. No. 4,205,534

AUSTRALIAN GOLD, LLC (INDIANA LIMITED LIABILITY COMPANY)
6270 CORPORATE DRIVE
INDIANAPOLIS, IN 46278

Registered Sep. 11, 2012

Int. Cl.: 3

FOR: INDOOR AND OUTDOOR NON-MEDICATED SKIN TANNING PREPARATIONS, IN CLASS 3 (U.S. CLS. 1, 4, 6, 50, 51 AND 52).

TRADEMARK

FIRST USE 11-1-2011; IN COMMERCE 11-1-2011.

PRINCIPAL REGISTER

THE MARK CONSISTS OF STANDARD CHARACTERS WITHOUT CLAIM TO ANY PARTICULAR FONT, STYLE, SIZE, OR COLOR.

SER. NO. 85-533,145, FILED 2-3-2012.

LINDA ORNDORFF, EXAMINING ATTORNEY



David J. Kybas

Director of the United States Patent and Trademark Office

United States of America

United States Patent and Trademark Office

Paranormal-EFX

Reg. No. 4,205,535

AMINOGENESIS SKIN CARE (CALIFORNIA LIMITED LIABILITY COMPANY)
3419 VIA LIDO #219

Registered Sep. 11, 2012

NEWPORT BEACH, CA 92656

Int. Cl.: 3

FOR: ANTI-AGING CREAM; ANTI-WRINKLE CREAMS; BEAUTY CREAMS; FACE CREAMS,
IN CLASS 3 (U.S. CLS. 1, 4, 6, 50, 51 AND 52).

TRADEMARK

FIRST USE 10-21-2011; IN COMMERCE 10-21-2011.

PRINCIPAL REGISTER

THE MARK CONSISTS OF STANDARD CHARACTERS WITHOUT CLAIM TO ANY PAR-
TICULAR FONT, STYLE, SIZE, OR COLOR.

SER. NO. 85-533,157, FILED 2-3-2012.

NICHOLAS COLEMAN, EXAMINING ATTORNEY



David J. Kybas

Director of the United States Patent and Trademark Office

United States of America

United States Patent and Trademark Office

The logo for KWINK, featuring the word "kwink" in a lowercase, bold, serif font. Above the letters "i" and "n" is a stylized, wavy line representing an eyelid.

Reg. No. 4,205,536

Registered Sep. 11, 2012

Int. Cl.: 45

SERVICE MARK

PRINCIPAL REGISTER

KWINK, LLC (ARIZONA LIMITED LIABILITY COMPANY)
9304 E. VERDE GROVE VIEW
SCOTTSDALE, AZ 85255

FOR: COMPUTER DATING SERVICES, IN CLASS 45 (U.S. CLS. 100 AND 101).

FIRST USE 5-17-2011; IN COMMERCE 5-17-2011.

OWNER OF U.S. REG. NO. 4,026,500.

THE MARK CONSISTS OF THE WORD "KWINK" WITH A TILDE-SHAPED EYELID ABOVE THE WORD AND A CIRCULAR EYE FORMING THE DOT ON THE LETTER "I".

SER. NO. 85-533,176, FILED 2-3-2012.

ANDREW LEASER, EXAMINING ATTORNEY



David J. Kyffers

Director of the United States Patent and Trademark Office

United States of America

United States Patent and Trademark Office

ACUITY

Reg. No. 4,205,537

Registered Sep. 11, 2012

Int. Cl.: 42

SERVICE MARK

PRINCIPAL REGISTER

TOUCH POINT ONE, LLC (INDIANA LIMITED LIABILITY COMPANY)
SUITE 2000
101 WEST OHIO STREET
INDIANAPOLIS, IN 46204

FOR: PROVIDING TEMPORARY USE OF ON-LINE NON-DOWNLOADABLE SOFTWARE FOR DATABASE DRIVEN DATA AGGREGATION, DATA MANAGEMENT, DATA ANALYSIS AND DATA VISUALIZATION, FOR USE BY CALL CENTERS AND SERVICE CENTERS IN ANALYZING FRONT-LINE OPERATIONS, IN CLASS 42 (U.S. CLS. 100 AND 101).

FIRST USE 11-30-2010; IN COMMERCE 11-30-2010.

THE MARK CONSISTS OF STANDARD CHARACTERS WITHOUT CLAIM TO ANY PARTICULAR FONT, STYLE, SIZE, OR COLOR.

SER. NO. 85-533,178, FILED 2-3-2012.

JORDAN BAKER, EXAMINING ATTORNEY



David J. Kybas

Director of the United States Patent and Trademark Office

United States of America

United States Patent and Trademark Office

Turbinator

Reg. No. 4,205,538

KYONG MI CHOI (UNITED STATES INDIVIDUAL)
2327 SE 175TH AVE.
VANCOUVER, WA 98683

Registered Sep. 11, 2012

Int. Cl.: 9

FOR: GLOVES FOR PROTECTION AGAINST ACCIDENTS; PROTECTIVE GLOVES FOR INDUSTRIAL USE; PROTECTIVE WORK GLOVES, IN CLASS 9 (U.S. CLS. 21, 23, 26, 36 AND 38).

TRADEMARK

FIRST USE 10-1-2011; IN COMMERCE 10-1-2011.

PRINCIPAL REGISTER

THE MARK CONSISTS OF STANDARD CHARACTERS WITHOUT CLAIM TO ANY PARTICULAR FONT, STYLE, SIZE, OR COLOR.

SER. NO. 85-533,187, FILED 2-3-2012.

KATHERINE CHANG, EXAMINING ATTORNEY



David J. Kyffers

Director of the United States Patent and Trademark Office

United States of America

United States Patent and Trademark Office

STEELIE

Reg. No. 4,205,539

BLACKGLASS, LLC (COLORADO LIMITED LIABILITY COMPANY)
3026 VALMONT ROAD
BOULDER, CO 80301

Registered Sep. 11, 2012

Int. Cl.: 9

FOR: HOLDERS AND STANDS SPECIALLY ADAPTED FOR USE WITH MOBILE COMMUNICATION DEVICES AND DEVICES FOR CAPTURING DIGITAL IMAGES, IN CLASS 9 (U.S. CLS. 21, 23, 26, 36 AND 38).

TRADEMARK

FIRST USE 1-11-2011; IN COMMERCE 1-11-2011.

PRINCIPAL REGISTER

THE MARK CONSISTS OF STANDARD CHARACTERS WITHOUT CLAIM TO ANY PARTICULAR FONT, STYLE, SIZE, OR COLOR.

SER. NO. 85-533,189, FILED 2-3-2012.

MARC LEIPZIG, EXAMINING ATTORNEY



David J. Kyffers

Director of the United States Patent and Trademark Office

United States of America

United States Patent and Trademark Office

TOUCH IT, YOU'LL LOVE IT!

Reg. No. 4,205,540

ADVANCED INNOVATION AND MANUFACTURING, INC. (OHIO CORPORATION)
9940 YORK ALPHA DRIVE
NORTH ROYALTON, OH 44133

Registered Sep. 11, 2012

Int. Cl.: 13

FOR: FIREARM ATTACHMENTS, NAMELY, MODULAR EXTERNAL RAIL ATTACHMENTS, GRIPS AND MOUNTS FOR SWITCHES, WIRES AND DEVICES FOR FIREARMS, IN CLASS 13 (U.S. CLS. 2 AND 9).

TRADEMARK

FIRST USE 7-1-2010; IN COMMERCE 7-1-2010.

PRINCIPAL REGISTER

THE MARK CONSISTS OF STANDARD CHARACTERS WITHOUT CLAIM TO ANY PARTICULAR FONT, STYLE, SIZE, OR COLOR.

SER. NO. 85-533,220, FILED 2-3-2012.

MARIA-VICTORIA SUAREZ, EXAMINING ATTORNEY



David J. Kyffers

Director of the United States Patent and Trademark Office

United States of America

United States Patent and Trademark Office

NOURISH +

Reg. No. 4,205,541

Registered Sep. 11, 2012

Int. Cl.: 3

TRADEMARK

PRINCIPAL REGISTER

JOHNSON & JOHNSON (NEW JERSEY CORPORATION)
ONE JOHNSON & JOHNSON PLAZA
NEW BRUNSWICK, NJ 089337001

FOR: HAIR CARE PRODUCTS, NAMELY, SHAMPOO, CONDITIONER, LEAVE-IN TREATMENT, HAIR SPRAY AND GEL CREAM, IN CLASS 3 (U.S. CLS. 1, 4, 6, 50, 51 AND 52).

FIRST USE 3-30-2009; IN COMMERCE 3-30-2009.

THE MARK CONSISTS OF STANDARD CHARACTERS WITHOUT CLAIM TO ANY PARTICULAR FONT, STYLE, SIZE, OR COLOR.

SER. NO. 85-533,255, FILED 2-3-2012.

ALICE BENMAMAN, EXAMINING ATTORNEY



David J. Kyffers

Director of the United States Patent and Trademark Office

United States of America

United States Patent and Trademark Office



Reg. No. 4,205,542

Registered Sep. 11, 2012

Int. Cl.: 35

SERVICE MARK

PRINCIPAL REGISTER

U.S. MARINE CORPS, A COMPONENT OF THE U.S. DEPARTMENT OF THE NAVY (UNITED STATES AGENCY OF THE UNITED STATES GOVERNMENT)
ROOM 4B548
3000 MARINE CORPS PENTAGON
WASHINGTON, DC 20350

FOR: RETAIL DEPARTMENT STORE SERVICES, IN CLASS 35 (U.S. CLS. 100, 101 AND 102).

FIRST USE 11-19-2008; IN COMMERCE 11-19-2008.

THE MARK CONSISTS OF THE WORDS THE NEW (IN RED) SITTING ATOP A BLUE LETTER X, WITH A RED HORIZONTAL BAND ACROSS THE MIDDLE OF THE X, AND THE WORDS WE'VE TRANSFORMED! (IN RED) BENEATH THE X.

THE COLOR(S) RED AND BLUE IS/ARE CLAIMED AS A FEATURE OF THE MARK.

SER. NO. 85-533,265, FILED 2-3-2012.

MATTHEW KLINE, EXAMINING ATTORNEY



David J. Kyffers

Director of the United States Patent and Trademark Office

United States of America

United States Patent and Trademark Office

METAYOGICS

Reg. No. 4,205,543

CARNEY, DANA MARIE (UNITED STATES INDIVIDUAL)
5514 LOMOND

Registered Sep. 11, 2012

DOWNERS GROVE, IL 60515

Int. Cl.: 41

FOR: PROVIDING PHYSICAL FITNESS AND EXERCISE SERVICE, NAMELY, INDOOR CYCLING AND YOGA INSTRUCTION, IN CLASS 41 (U.S. CLS. 100, 101 AND 107).

SERVICE MARK

FIRST USE 1-9-2012; IN COMMERCE 1-9-2012.

PRINCIPAL REGISTER

THE MARK CONSISTS OF STANDARD CHARACTERS WITHOUT CLAIM TO ANY PARTICULAR FONT, STYLE, SIZE, OR COLOR.

SER. NO. 85-533,279, FILED 2-3-2012.

ANDREW LAWRENCE, EXAMINING ATTORNEY



David J. Kybas

Director of the United States Patent and Trademark Office

United States of America

United States Patent and Trademark Office

LARRY THE CABLE GUY

Reg. No. 4,205,544

Registered Sep. 11, 2012

Int. Cl.: 30

TRADEMARK

PRINCIPAL REGISTER

GIT-R-DONE PRODUCTIONS, INC. (FLORIDA CORPORATION)
1050 CROWN POINTE PKWY SUITE 1000
ATLANTA, GA 30338

FOR: BREAD MIXES, IN CLASS 30 (U.S. CL. 46).

FIRST USE 9-30-2011; IN COMMERCE 9-30-2011.

THE MARK CONSISTS OF STANDARD CHARACTERS WITHOUT CLAIM TO ANY PARTICULAR FONT, STYLE, SIZE, OR COLOR.

SER. NO. 85-533,284, FILED 2-3-2012.

GIANCARLO CASTRO, EXAMINING ATTORNEY



David J. Kybas

Director of the United States Patent and Trademark Office

United States of America

United States Patent and Trademark Office



Reg. No. 4,205,545

Registered Sep. 11, 2012

Int. Cl.: 33

TRADEMARK

PRINCIPAL REGISTER

TAKARA HOLDINGS INC. (JAPAN CORPORATION)
20 NAGINATAHOKO-CHO, SHIJO-DORI
KARASUMA HIGASHI-IRU, SHIMOGYO-KU
KYOTO, JAPAN

FOR: SAKE; WINES; JAPANESE WHITE LIQUOR (SHOCHU); SPIRITS; LIQUEURS; PREPARED ALCOHOLIC COCKTAIL; JAPANESE SHOCHU-BASED MIXED LIQUOR (MIRIN), IN CLASS 33 (U.S. CLS. 47 AND 49).

FIRST USE 10-1-2006; IN COMMERCE 10-1-2006.

THE MARK CONSISTS OF A KABUKI FACE IN RED AND BLACK, WHERE THE COLOR BLACK IS USED FOR UPPER EYELIDS AND PORTIONS OF LOWER EYELIDS AND MOUTH, AND THE COLOR RED IS USED FOR OTHER PARTS.

THE COLOR(S) RED AND BLACK IS/ARE CLAIMED AS A FEATURE OF THE MARK.

SER. NO. 85-533,306, FILED 2-3-2012.

GIANCARLO CASTRO, EXAMINING ATTORNEY



David J. Kyffers

Director of the United States Patent and Trademark Office

United States of America

United States Patent and Trademark Office

ALMOND+PLUS

Reg. No. 4,205,546

TURTLE MOUNTAIN, LLC (DELAWARE LIMITED LIABILITY COMPANY)
P.O. BOX 21938
EUGENE, OR 97402

Registered Sep. 11, 2012

Int. Cls.: 29 and 32

FOR: NUT-BASED MILK; PROCESSED ALMONDS; PROCESSED NUTS, IN CLASS 29 (U.S. CL. 46).

TRADEMARK

FIRST USE 1-2-2012; IN COMMERCE 1-2-2012.

PRINCIPAL REGISTER

FOR: MILK OF ALMONDS FOR BEVERAGE, IN CLASS 32 (U.S. CLS. 45, 46 AND 48).

FIRST USE 1-2-2012; IN COMMERCE 1-2-2012.

THE MARK CONSISTS OF STANDARD CHARACTERS WITHOUT CLAIM TO ANY PARTICULAR FONT, STYLE, SIZE, OR COLOR.

SER. NO. 85-533,308, FILED 2-3-2012.

GIANCARLO CASTRO, EXAMINING ATTORNEY



David J. Kyffers

Director of the United States Patent and Trademark Office

United States of America

United States Patent and Trademark Office

LARRY THE CABLE GUY

Reg. No. 4,205,547

Registered Sep. 11, 2012

Int. Cl.: 30

TRADEMARK

PRINCIPAL REGISTER

GIT-R-DONE PRODUCTIONS, INC. (FLORIDA CORPORATION)
1050 CROWN POINTE PKWY SUITE 1000
ATLANTA, GA 30338

FOR: CORN BREAD; MUFFIN MIXES, IN CLASS 30 (U.S. CL. 46).

FIRST USE 9-30-2011; IN COMMERCE 9-30-2011.

THE MARK CONSISTS OF STANDARD CHARACTERS WITHOUT CLAIM TO ANY PARTICULAR FONT, STYLE, SIZE, OR COLOR.

SER. NO. 85-533,312, FILED 2-3-2012.

GIANCARLO CASTRO, EXAMINING ATTORNEY



David J. Kybas

Director of the United States Patent and Trademark Office

United States of America

United States Patent and Trademark Office

Secret of the Islands

Reg. No. 4,205,548

Registered Sep. 11, 2012

Int. Cl.: 3

TRADEMARK

PRINCIPAL REGISTER

SECRET OF THE ISLANDS, LLC (SOUTH CAROLINA LIMITED LIABILITY COMPANY)
550A RIVERMONT DRIVE
COLUMBIA, SC 29210

FOR: AFTER SUN CREAMS; ANTI-WRINKLE CREAMS; AROMATIC BODY CARE PRODUCTS, NAMELY, BODY LOTION, SHOWER GEL, CUTICLE CREAM, SHAMPOO, CONDITIONER, NON-MEDICATED LIP BALM, SOAP, BODY POLISH, BODY AND FOOT SCRUB AND NON-MEDICATED FOOT CREAM; AROMATIC PREPARATIONS, NAMELY, LOTION; BABY HAND SOAP; BATH AND SHOWER GELS AND SALTS NOT FOR MEDICAL PURPOSES; BATH OILS AND BATH SALTS; BATH SALTS; BATH SALTS; BEAUTY CREAMS; BEAUTY CREAMS FOR BODY CARE; BODY CREAM; BODY CREAMS; BODY MASK CREAM; BODY SCRUB; CLEANING PREPARATIONS FOR HAND; COSMETIC BATH SALTS; COSMETIC CREAMS; COSMETIC CREAMS FOR SKIN CARE; COSMETIC HAND CREAMS; COSMETIC MASSAGE CREAMS; COSMETIC NOURISHING CREAMS; EXFOLIANT CREAMS; EXFOLIANTS FOR SKIN; FACE AND BODY BEAUTY CREAMS; FACE AND BODY CREAMS; FACE AND BODY LOTIONS; FACE CREAMS; FACIAL SCRUBS; FOOT SCRUBS; FRAGRANCED BODY CARE PREPARATIONS, NAMELY, HAND, FOOT AND BODY CREAM; FRAGRANCED FACE CARE PREPARATIONS, NAMELY, HAND, FOOT AND BODY CREAM; HAND CLEANERS; HAND CLEANING GELS; HAND CLEANING PREPARATIONS; HAND CREAM; HAND CREAMS; HAND LOTIONS; HAND SCRUBS; HAND SOAPS; LIQUID SOAPS FOR HANDS AND FACE; LIQUID SOAPS FOR HANDS, FACE AND BODY; LOTIONS FOR FACE AND BODY CARE; MINERAL SALT IN THE NATURE OF BATH SALTS NOT FOR MEDICAL PURPOSES; NON-MEDICATED BATH SALTS; SCENTED BATHING SALTS, IN CLASS 3 (U.S. CLS. 1, 4, 6, 50, 51 AND 52).

FIRST USE 4-1-2009; IN COMMERCE 4-1-2009.

THE MARK CONSISTS OF STANDARD CHARACTERS WITHOUT CLAIM TO ANY PARTICULAR FONT, STYLE, SIZE, OR COLOR.

SER. NO. 85-533,322, FILED 2-3-2012.

TASNEEM HUSSAIN, EXAMINING ATTORNEY



David J. Kyffers

Director of the United States Patent and Trademark Office

United States of America

United States Patent and Trademark Office

SO DELICIOUS ALMOND+PLUS

Reg. No. 4,205,549

TURTLE MOUNTAIN, LLC (DELAWARE LIMITED LIABILITY COMPANY)
P.O. BOX 21938
EUGENE, OR 97402

Registered Sep. 11, 2012

Int. Cls.: 29 and 32

FOR: NUT-BASED MILK; PROCESSED ALMONDS; PROCESSED NUTS, IN CLASS 29 (U.S. CL. 46).

TRADEMARK

FIRST USE 1-2-2012; IN COMMERCE 1-2-2012.

PRINCIPAL REGISTER

FOR: MILK OF ALMONDS FOR BEVERAGE, IN CLASS 32 (U.S. CLS. 45, 46 AND 48).

FIRST USE 1-2-2012; IN COMMERCE 1-2-2012.

THE MARK CONSISTS OF STANDARD CHARACTERS WITHOUT CLAIM TO ANY PARTICULAR FONT, STYLE, SIZE, OR COLOR.

OWNER OF U.S. REG. NOS. 3,197,705, 3,867,331 AND OTHERS.

SER. NO. 85-533,336, FILED 2-3-2012.

GIANCARLO CASTRO, EXAMINING ATTORNEY



David J. Kybas

Director of the United States Patent and Trademark Office

United States of America

United States Patent and Trademark Office

LARRY THE CABLE GUY

Reg. No. 4,205,550

Registered Sep. 11, 2012

Int. Cl.: 30

TRADEMARK

PRINCIPAL REGISTER

GIT-R-DONE PRODUCTIONS, INC. (FLORIDA CORPORATION)
1050 CROWN POINTE PKWY SUITE 1000
ATLANTA, GA 30338

FOR: MEAL KITS CONSISTING PRIMARILY OF NOODLES; PACKAGED MEAL KITS CONSISTING PRIMARILY OF PASTA OR RICE; PACKAGED MEAL MIXES CONSISTING PRIMARILY OF PASTA OR RICE, IN CLASS 30 (U.S. CL. 46).

FIRST USE 9-30-2011; IN COMMERCE 9-30-2011.

THE MARK CONSISTS OF STANDARD CHARACTERS WITHOUT CLAIM TO ANY PARTICULAR FONT, STYLE, SIZE, OR COLOR.

SER. NO. 85-533,338, FILED 2-3-2012.

GIANCARLO CASTRO, EXAMINING ATTORNEY



David J. Kybas

Director of the United States Patent and Trademark Office

United States of America

United States Patent and Trademark Office

LARRY THE CABLE GUY

Reg. No. 4,205,551

Registered Sep. 11, 2012

Int. Cl.: 30

TRADEMARK

PRINCIPAL REGISTER

GIT-R-DONE PRODUCTIONS, INC. (FLORIDA CORPORATION)
1050 CROWN POINTE PKWY SUITE 1000
ATLANTA, GA 30338

FOR: MIXES FOR MAKING BATTERS FOR FRIED FOODS, IN CLASS 30 (U.S. CL. 46).

FIRST USE 9-30-2011; IN COMMERCE 9-30-2011.

THE MARK CONSISTS OF STANDARD CHARACTERS WITHOUT CLAIM TO ANY PARTICULAR FONT, STYLE, SIZE, OR COLOR.

SER. NO. 85-533,356, FILED 2-3-2012.

GIANCARLO CASTRO, EXAMINING ATTORNEY



David J. Kyffers

Director of the United States Patent and Trademark Office

United States of America

United States Patent and Trademark Office



Reg. No. 4,205,552

Registered Sep. 11, 2012

Int. Cl.: 33

TRADEMARK

PRINCIPAL REGISTER

PACIFIC RIM WINEMAKERS, INC. (WASHINGTON CORPORATION), DBA VINMOTION
1111 E. BURNSIDE ST.
PORTLAND, OR 97214

FOR: WINE, IN CLASS 33 (U.S. CLS. 47 AND 49).

FIRST USE 12-15-2010; IN COMMERCE 12-15-2010.

NO CLAIM IS MADE TO THE EXCLUSIVE RIGHT TO USE "SWEET PINK WINE", APART FROM THE MARK AS SHOWN.

THE COLOR(S) GREEN, RED, PINK, WHITE, TAN, BROWN IS/ARE CLAIMED AS A FEATURE OF THE MARK.

THE MARK CONSISTS OF A DRAWING OF A RED STRAWBERRY WITH TAN SEEDS, GREEN HULL AND STEM GROWING FROM TOP OF THE FRUIT, AND A GREEN LEAF BEHIND THE BERRY. THE BOTTOM OF THE STRAWBERRY IS COVERED WITH WHITE AND TAN MELTED CHOCOLATE DRIPPING AT THE BOTTOM. BELOW THE FRUIT ARE THE WORDS SWEET PINK WINE IN PINK AND WHITE. THE LITERAL ELEMENT AND THE FRUIT SIT ON A WHITE BACKGROUND INSIDE A BROWN RECTANGULAR BORDER.

SER. NO. 85-533,369, FILED 2-3-2012.

KEVON CHISOLM, EXAMINING ATTORNEY



David J. Kybas

Director of the United States Patent and Trademark Office

United States of America

United States Patent and Trademark Office



Reg. No. 4,205,553

Registered Sep. 11, 2012

Int. Cl.: 35

SERVICE MARK

PRINCIPAL REGISTER

DIGITAL COMMUNITY HOLDINGS INC. (IOWA CORPORATION)
316 S. MAIN
INWOOD, IA 51240

FOR: ADVERTISING SERVICES, NAMELY, DEVELOPMENT, OPERATION AND ADMINISTRATION OF DIGITAL ADVERTISING SYSTEMS FOR OTHERS, NAMELY, PROVIDING ADVERTISING SPACE BY ELECTRONIC MEANS AND GLOBAL COMPUTER INFORMATION NETWORKS, INVENTORY MANAGEMENT, IN CLASS 35 (U.S. CLS. 100, 101 AND 102).

FIRST USE 1-30-2012; IN COMMERCE 1-30-2012.

THE MARK CONSISTS OF THE STYLIZED LETTERS "D", "C", AND "H", THE "D" SHOWN AS THE RIGHT HALF OF A CIRCLE, THE "C" BEING THE LEFT HALF OF A CIRCLE, AND THE "H" BEING THE TWO HALF-CIRCLES CONNECTING.

SER. NO. 85-533,378, FILED 2-3-2012.

ANDREA HACK, EXAMINING ATTORNEY



David J. Kyffers

Director of the United States Patent and Trademark Office

United States of America

United States Patent and Trademark Office



Reg. No. 4,205,554

Registered Sep. 11, 2012

Int. Cl.: 33

TRADEMARK

PRINCIPAL REGISTER

PACIFIC RIM WINEMAKERS, INC. (WASHINGTON CORPORATION), DBA VINMOTION
1111 E. BURNSIDE ST.
PORTLAND, OR 97214

FOR: WINE, IN CLASS 33 (U.S. CLS. 47 AND 49).

FIRST USE 8-19-2010; IN COMMERCE 8-19-2010.

NO CLAIM IS MADE TO THE EXCLUSIVE RIGHT TO USE "SWEET RED WINE", APART FROM THE MARK AS SHOWN.

THE COLOR(S) RED, BROWN, GREEN, YELLOW, WHITE IS/ARE CLAIMED AS A FEATURE OF THE MARK.

THE MARK CONSISTS OF A DRAWING OF A RED CHERRY WITH A GREEN, BROWN AND YELLOW STEM GROWING FROM THE TOP CENTER OF THE FRUIT. THE BOTTOM HALF OF THE FRUIT IS COVERED WITH BROWN MELTED CHOCOLATE DRIPPING AT THE BOTTOM. BELOW THE FRUIT ARE THE WORDS SWEET RED WINE IN RED AND WHITE. THE LITERAL ELEMENT AND THE FRUIT SIT ON A WHITE BACKGROUND INSIDE A BROWN RECTANGULAR BORDER.

SER. NO. 85-533,382, FILED 2-3-2012.

KEVON CHISOLM, EXAMINING ATTORNEY



David J. Kybas

Director of the United States Patent and Trademark Office

United States of America

United States Patent and Trademark Office

PRETTY BROWN GIRL

Reg. No. 4,205,555

PRETTY BROWN GIRL L.L.C. (MICHIGAN LIMITED LIABILITY COMPANY)
47132 MANHATTAN CIRCLE
NOVI, MI 48374

Registered Sep. 11, 2012

Int. Cl.: 35

FOR: ON-LINE RETAIL STORE SERVICES FEATURING A WIDE VARIETY OF CONSUMER GOODS OF OTHERS, IN CLASS 35 (U.S. CLS. 100, 101 AND 102).

SERVICE MARK

FIRST USE 10-30-2011; IN COMMERCE 10-30-2011.

PRINCIPAL REGISTER

THE MARK CONSISTS OF STANDARD CHARACTERS WITHOUT CLAIM TO ANY PARTICULAR FONT, STYLE, SIZE, OR COLOR.

SER. NO. 85-533,383, FILED 2-3-2012.

C. DIONNE CLYBURN, EXAMINING ATTORNEY



David J. Kyffers

Director of the United States Patent and Trademark Office

United States of America

United States Patent and Trademark Office

GoPrinter

Reg. No. 4,205,556

Registered Sep. 11, 2012

Int. Cl.: 42

SERVICE MARK

PRINCIPAL REGISTER

SENECORE LLC (NEW JERSEY LIMITED LIABILITY COMPANY)
345 STATE ROUTE 17 SOUTH
UPPER SADDLE RIVER, NJ 07458

FOR: APPLICATION SERVICE PROVIDER (ASP) FEATURING SOFTWARE FOR USE IN CONNECTION WITH PREPARATION, STORAGE, AND COMMUNICATION OF ELECTRONIC DOCUMENTS TO FACILITATE PRINTING OF SAID DOCUMENTS ON PAPER OR OTHER MEDIA USING A CONVENTIONAL PRINTING DEVICE CONNECTED TO A COMPUTER OR NETWORK.; COMPUTER SOFTWARE DEVELOPMENT IN THE FIELD OF MOBILE APPLICATIONS, IN CLASS 42 (U.S. CLS. 100 AND 101).

FIRST USE 11-4-2011; IN COMMERCE 2-1-2012.

THE MARK CONSISTS OF STANDARD CHARACTERS WITHOUT CLAIM TO ANY PARTICULAR FONT, STYLE, SIZE, OR COLOR.

SER. NO. 85-533,386, FILED 2-3-2012.

C. DIONNE CLYBURN, EXAMINING ATTORNEY



David J. Kyffers

Director of the United States Patent and Trademark Office

United States of America

United States Patent and Trademark Office



Reg. No. 4,205,557

AMY CADY (UNITED STATES INDIVIDUAL)
27601 FORBES RD. #21
LAGUNA NIGUEL, CA 92677

Registered Sep. 11, 2012

Int. Cl.: 41

FOR: PHYSICAL FITNESS STUDIO SERVICES, NAMELY, PROVIDING EXERCISE CLASSES, BODY SCULPTING CLASSES, AND GROUP FITNESS CLASSES; PRODUCTION OF DVDS, VIDEOTAPES AND TELEVISION PROGRAMS FEATURING FITNESS EXERCISES AND PILATES TECHNIQUES, IN CLASS 41 (U.S. CLS. 100, 101 AND 107).

SERVICE MARK

PRINCIPAL REGISTER

FIRST USE 5-1-2009; IN COMMERCE 5-1-2009.

THE MARK CONSISTS OF PERSON IN THE PILATES HUNDREDS POSITION WITH FOUR ITERATIONS OF LEG POSITIONS IN GREEN AND WHITE.

THE COLOR(S) GREEN AND WHITE IS/ARE CLAIMED AS A FEATURE OF THE MARK.

SER. NO. 85-533,389, FILED 2-3-2012.

KEVON CHISOLM, EXAMINING ATTORNEY



David J. Kyffers

Director of the United States Patent and Trademark Office

United States of America

United States Patent and Trademark Office

A Simple Concept, A Superb Experience

Reg. No. 4,205,558

SIMPLY SOUTHERN RESTAURANT GROUP, INC. (ALABAMA CORPORATION)
852 N. DEAN ROAD, SUITE 200
AUBURN, AL 36830

Registered Sep. 11, 2012

Int. Cl.: 43

FOR: RESTAURANT SERVICES, IN CLASS 43 (U.S. CLS. 100 AND 101).

SERVICE MARK

FIRST USE 4-0-2011; IN COMMERCE 4-0-2011.

PRINCIPAL REGISTER

THE MARK CONSISTS OF STANDARD CHARACTERS WITHOUT CLAIM TO ANY PARTICULAR FONT, STYLE, SIZE, OR COLOR.

SER. NO. 85-533,393, FILED 2-3-2012.

JENNIFER VASQUEZ, EXAMINING ATTORNEY



David J. Kyffers

Director of the United States Patent and Trademark Office

United States of America

United States Patent and Trademark Office

MADEWELL

Reg. No. 4,205,559

Registered Sep. 11, 2012

Int. Cls.: 9 and 35

MADEWELL INC. (DELAWARE CORPORATION)
C/O J. CREW GROUP, INC.
770 BROADWAY
NEW YORK, NY 10003

FOR: MAGNETIC CODED GIFT CARDS, IN CLASS 9 (U.S. CLS. 21, 23, 26, 36 AND 38).

TRADEMARK

FIRST USE 8-0-2006; IN COMMERCE 8-0-2006.

SERVICE MARK

FOR: ISSUING GIFT CERTIFICATES WHICH MAY THEN BE REDEEMED FOR GOODS OR SERVICES, IN CLASS 35 (U.S. CLS. 100, 101 AND 102).

PRINCIPAL REGISTER

FIRST USE 8-0-2006; IN COMMERCE 8-0-2006.

THE MARK CONSISTS OF STANDARD CHARACTERS WITHOUT CLAIM TO ANY PARTICULAR FONT, STYLE, SIZE, OR COLOR.

OWNER OF U.S. REG. NOS. 968,685, 3,957,991 AND OTHERS.

SER. NO. 85-533,426, FILED 2-3-2012.

JENNIFER VASQUEZ, EXAMINING ATTORNEY



David J. Kyros

Director of the United States Patent and Trademark Office

United States of America

United States Patent and Trademark Office

Dutch Value

Reg. No. 4,205,560

DUTCH VALLEY FOOD DISTRIBUTORS INC. (PENNSYLVANIA CORPORATION)
7615 LANCASTER AVENUE, P.O. BOX 465
MYERSTOWN, PA 17067

Registered Sep. 11, 2012

Int. Cls.: 29 and 30

FOR: PROCESSED COCONUT, IN CLASS 29 (U.S. CL. 46).

FIRST USE 1-3-2011; IN COMMERCE 1-3-2011.

TRADEMARK

FOR: CAPPUCCINO; CHAI TEA; HOT CHOCOLATE, IN CLASS 30 (U.S. CL. 46).

PRINCIPAL REGISTER

FIRST USE 1-3-2011; IN COMMERCE 1-3-2011.

THE MARK CONSISTS OF STANDARD CHARACTERS WITHOUT CLAIM TO ANY PARTICULAR FONT, STYLE, SIZE, OR COLOR.

OWNER OF U.S. REG. NOS. 2,993,861 AND 3,844,549.

SER. NO. 85-533,427, FILED 2-3-2012.

ELLEN PERKINS, EXAMINING ATTORNEY



David J. Kyffers

Director of the United States Patent and Trademark Office

United States of America

United States Patent and Trademark Office

THE CHALKBOARD

Reg. No. 4,205,561

THE CHALKBOARD PROJECT, LLC (CALIFORNIA LIMITED LIABILITY COMPANY)
2306 COTNER AVENUE
LOS ANGELES, CA 90064

Registered Sep. 11, 2012

Int. Cl.: 41

FOR: PROVIDING A WEBSITE FEATURING BLOGS AND NON-DOWNLOADABLE PUBLICATIONS AND MEDIA IN THE NATURE OF ARTICLES, VIDEO, AND NEWSLETTERS IN THE FIELDS OF HEALTH, WELLNESS, FITNESS, LIFESTYLE, BEAUTY, NUTRITION, AND PHILANTHROPY, IN CLASS 41 (U.S. CLS. 100, 101 AND 107).

SERVICE MARK

PRINCIPAL REGISTER

FIRST USE 1-16-2012; IN COMMERCE 1-16-2012.

THE MARK CONSISTS OF STANDARD CHARACTERS WITHOUT CLAIM TO ANY PARTICULAR FONT, STYLE, SIZE, OR COLOR.

SER. NO. 85-533,449, FILED 2-3-2012.

MIDGE BUTLER, EXAMINING ATTORNEY



David J. Kyffers

Director of the United States Patent and Trademark Office

United States of America

United States Patent and Trademark Office

PROMOLOGOMUGS

Reg. No. 4,205,562

PROMOSHADE INC (ARIZONA CORPORATION)
10197 E. SAN SALVADOR DRIVE
SCOTTSDALE, AZ 85258

Registered Sep. 11, 2012

Int. Cl.: 35

FOR: PREPARATION OF CUSTOMIZED PROMOTIONAL AND MERCHANDISING MATERIALS FOR OTHERS, IN CLASS 35 (U.S. CLS. 100, 101 AND 102).

SERVICE MARK

FIRST USE 12-26-2007; IN COMMERCE 12-26-2007.

PRINCIPAL REGISTER

THE MARK CONSISTS OF STANDARD CHARACTERS WITHOUT CLAIM TO ANY PARTICULAR FONT, STYLE, SIZE, OR COLOR.

SER. NO. 85-533,481, FILED 2-3-2012.

BILL DAWE, EXAMINING ATTORNEY



David J. Kyffers

Director of the United States Patent and Trademark Office

United States of America

United States Patent and Trademark Office

WannaBeeSocial

Reg. No. 4,205,563

WANNABEESOCIAL, LLC (FLORIDA LIMITED LIABILITY COMPANY)
617 POWDER HORN ROW
LAKELAND, FL 33809

Registered Sep. 11, 2012

Int. Cl.: 35

FOR: ADVERTISING AND MARKETING SERVICES PROVIDED BY MEANS OF INDIRECT METHODS OF MARKETING COMMUNICATIONS, NAMELY, SOCIAL MEDIA, SEARCH ENGINE MARKETING, INQUIRY MARKETING, INTERNET MARKETING, MOBILE MARKETING, BLOGGING AND OTHER FORMS OF PASSIVE, SHARABLE OR VIRAL COMMUNICATIONS CHANNELS; SOCIAL MEDIA STRATEGY AND MARKETING CONSULTANCY FOCUSING ON HELPING CLIENTS CREATE AND EXTEND THEIR PRODUCT AND BRAND STRATEGIES BY BUILDING VIRALLY ENGAGING MARKETING SOLUTIONS, IN CLASS 35 (U.S. CLS. 100, 101 AND 102).

SERVICE MARK

PRINCIPAL REGISTER

FIRST USE 2-15-2010; IN COMMERCE 2-15-2010.

THE MARK CONSISTS OF STANDARD CHARACTERS WITHOUT CLAIM TO ANY PARTICULAR FONT, STYLE, SIZE, OR COLOR.

SER. NO. 85-533,501, FILED 2-3-2012.

JOSETTE BEVERLY, EXAMINING ATTORNEY



David J. Kyros

Director of the United States Patent and Trademark Office

United States of America

United States Patent and Trademark Office

SHARELENDAR

Reg. No. 4,205,564

SHARELENDAR, INC. (FLORIDA CORPORATION)
19126 SUNTERRA DRIVE
LAND O'LAKES, FL 34638

Registered Sep. 11, 2012

Int. Cl.: 45

FOR: ONLINE SOCIAL NETWORKING SERVICES PROVIDED THROUGH A COMMUNITY WEBSITE, IN CLASS 45 (U.S. CLS. 100 AND 101).

SERVICE MARK

FIRST USE 5-23-2011; IN COMMERCE 5-23-2011.

PRINCIPAL REGISTER

THE MARK CONSISTS OF STANDARD CHARACTERS WITHOUT CLAIM TO ANY PARTICULAR FONT, STYLE, SIZE, OR COLOR.

SER. NO. 85-533,518, FILED 2-3-2012.

FONG HSU, EXAMINING ATTORNEY



David J. Kybas

Director of the United States Patent and Trademark Office

United States of America

United States Patent and Trademark Office



Reg. No. 4,205,565

YADEGAR BROTHERS INC. (CALIFORNIA CORPORATION)
1610 W. ROSECRANS AVENUE
COMPTON, CA 90220

Registered Sep. 11, 2012

Int. Cl.: 35

FOR: ON-LINE RETAIL STORE SERVICES FEATURING CLOTHING, IN CLASS 35 (U.S. CLS. 100, 101 AND 102).

SERVICE MARK

FIRST USE 1-28-2011; IN COMMERCE 1-28-2011.

PRINCIPAL REGISTER

THE MARK CONSISTS OF THE WORDS "THE PRICE TAG", AND BELOW IT THE WORDS "CHIC FOR LESS," WITH THE OUTLINE OF A PRICE TAG OVERLYING THE WORD "PRICE".

SER. NO. 85-533,526, FILED 2-3-2012.

ANGELA DUONG, EXAMINING ATTORNEY



David J. Kybas

Director of the United States Patent and Trademark Office

United States of America

United States Patent and Trademark Office

BuildBot

Reg. No. 4,205,566

BRUHA ROBOTICS, INC. (DELAWARE CORPORATION)
19662 DORADO DRIVE
FOOTHILL RANCH, CA 92679

Registered Sep. 11, 2012

Int. Cl.: 9

FOR: COMPUTER PRINTERS; DIGITAL INPUT AND OUTPUT SCANNERS; PRINTERS FOR USE WITH COMPUTERS; SCANNERS, IN CLASS 9 (U.S. CLS. 21, 23, 26, 36 AND 38).

TRADEMARK

FIRST USE 1-23-2012; IN COMMERCE 2-3-2012.

PRINCIPAL REGISTER

THE MARK CONSISTS OF STANDARD CHARACTERS WITHOUT CLAIM TO ANY PARTICULAR FONT, STYLE, SIZE, OR COLOR.

SER. NO. 85-533,540, FILED 2-3-2012.

DAVID I, EXAMINING ATTORNEY



David J. Kyffers

Director of the United States Patent and Trademark Office

United States of America
United States Patent and Trademark Office

GREENTAIN

Reg. No. 4,205,567

SUSTAINING SPACES, LLC (MISSOURI LIMITED LIABILITY COMPANY)
739 VISTA GLEN COURT
EUREKA, MO 63025

Registered Sep. 11, 2012

Int. Cl.: 41

FOR: EDUCATIONAL SERVICES, NAMELY, PROVIDING ONLINE INSTRUCTION IN THE FIELD OF REAL ESTATE, NAMELY, TEACHING CUSTOMERS TO MAKE HOMES MORE LIVABLE, MORE SUSTAINABLE AND MORE SELLABLE AND TEACHING CUSTOMERS TO EVALUATE HOME MAINTENANCE, HOME INSURANCE, HOME REMODELING AND HOME IMPROVEMENT, IN CLASS 41 (U.S. CLS. 100, 101 AND 107).

SERVICE MARK

PRINCIPAL REGISTER

FIRST USE 10-21-2011; IN COMMERCE 11-16-2011.

THE MARK CONSISTS OF STANDARD CHARACTERS WITHOUT CLAIM TO ANY PARTICULAR FONT, STYLE, SIZE, OR COLOR.

SER. NO. 85-533,614, FILED 2-3-2012.

MIDGE BUTLER, EXAMINING ATTORNEY



David J. Kyffers

Director of the United States Patent and Trademark Office

United States of America

United States Patent and Trademark Office

ScoreBroker

Reg. No. 4,205,568

SCOREBROKER, LLC (TEXAS LIMITED LIABILITY COMPANY)
P.O. BOX 166175
IRVING, TX 75016

Registered Sep. 11, 2012

Int. Cl.: 41

FOR: ENTERTAINMENT SERVICES IN THE NATURE OF FANTASY SPORTS LEAGUES,
IN CLASS 41 (U.S. CLS. 100, 101 AND 107).

SERVICE MARK

FIRST USE 1-1-2012; IN COMMERCE 1-1-2012.

PRINCIPAL REGISTER

THE MARK CONSISTS OF STANDARD CHARACTERS WITHOUT CLAIM TO ANY PAR-
TICULAR FONT, STYLE, SIZE, OR COLOR.

SER. NO. 85-533,626, FILED 2-3-2012.

TEJBIR SINGH, EXAMINING ATTORNEY



David J. Kybas

Director of the United States Patent and Trademark Office

United States of America

United States Patent and Trademark Office

energuy

Reg. No. 4,205,569

HISCOCK, CAMERON C. (CANADA INDIVIDUAL)
3077 KEYNES CRES

Registered Sep. 11, 2012

MISSISSAUGA, ONTARIO, CANADA L5N2Z9

Int. Cl.: 35

FOR: ENERGY AUDITING; HOME ENERGY ASSESSMENT SERVICES FOR THE PURPOSE OF DETERMINING ENERGY EFFICIENCY OR USAGE MANAGEMENT, IN CLASS 35 (U.S. CLS. 100, 101 AND 102).

SERVICE MARK

FIRST USE 1-1-2003; IN COMMERCE 1-1-2003.

PRINCIPAL REGISTER

THE MARK CONSISTS OF STANDARD CHARACTERS WITHOUT CLAIM TO ANY PARTICULAR FONT, STYLE, SIZE, OR COLOR.

SER. NO. 85-533,628, FILED 2-3-2012.

JENNIFER VASQUEZ, EXAMINING ATTORNEY



David J. Kyffers

Director of the United States Patent and Trademark Office

United States of America

United States Patent and Trademark Office

CHOICE

Reg. No. 4,205,570

CAROTRON INC (SOUTH CAROLINA CORPORATION)
3204 ROCKY RIVER ROAD
HEATH SPRINGS, FL 29058

Registered Sep. 11, 2012

Int. Cl.: 9

FOR: THREE-PHASE INPUT CONTROLS FOR D.C. MOTORS, IN CLASS 9 (U.S. CLS. 21, 23, 26, 36 AND 38).

TRADEMARK

FIRST USE 5-2-1990; IN COMMERCE 5-2-1990.

PRINCIPAL REGISTER

THE MARK CONSISTS OF STANDARD CHARACTERS WITHOUT CLAIM TO ANY PARTICULAR FONT, STYLE, SIZE, OR COLOR.

SER. NO. 85-533,670, FILED 2-3-2012.

KATHERINE CONNOLLY, EXAMINING ATTORNEY



David J. Kybas

Director of the United States Patent and Trademark Office

United States of America

United States Patent and Trademark Office

Campine

Reg. No. 4,205,571

CAMPINE CATERING, LLC, (CALIFORNIA LIMITED LIABILITY COMPANY)
404 14TH ST.

Registered Sep. 11, 2012

SAN DIEGO, CA 92101

Int. Cl.: 43

FOR: CATERING SERVICES, IN CLASS 43 (U.S. CLS. 100 AND 101).

SERVICE MARK

FIRST USE 7-31-2011; IN COMMERCE 7-31-2011.

PRINCIPAL REGISTER

THE MARK CONSISTS OF STANDARD CHARACTERS WITHOUT CLAIM TO ANY PARTICULAR FONT, STYLE, SIZE, OR COLOR.

SER. NO. 85-533,678, FILED 2-3-2012.

RAUL CORDOVA, EXAMINING ATTORNEY



David J. Kybas

Director of the United States Patent and Trademark Office

United States of America

United States Patent and Trademark Office

MATHENGINE

Reg. No. 4,205,572

Registered Sep. 11, 2012

Int. Cl.: 42

SERVICE MARK

PRINCIPAL REGISTER

MICROSTRAIN, INC. (VERMONT CORPORATION)
459 HURRICANE LANE, SUITE 102
WILLISTON, VT 05495

FOR: COMPUTER SERVICES, NAMELY, HOSTING AN INTERACTIVE WEB SITE THAT ALLOWS VISITORS TO ACCESS, CONSOLIDATE, MAINTAIN, MANAGE, PROCESS, SHARE, AND TRACK STATISTICAL INFORMATION; COMPUTER SERVICES, NAMELY, PROVIDING SEARCH PLATFORMS TO ALLOW USERS TO ACCESS, CONSOLIDATE, MAINTAIN, MANAGE, PROCESS, SHARE, AND TRACK STATISTICAL INFORMATION; PROVIDING A WEB-BASED DATA AGGREGATION SERVICE FEATURING TECHNOLOGY THAT ENABLES USERS TO REDUCE OPERATING COSTS AND IMPROVE OVERALL QUALITY, EFFICIENCY AND SAFETY OF A WIDE RANGE OF MACHINES, VEHICLES, THE ENVIRONMENT AND CIVIL STRUCTURES; PROVIDING A WEB-BASED SERVICE FEATURING TECHNOLOGY THAT ENABLES USERS TO VIEW, MANAGE, PROCESS AND STORE DATA FOR ANALYSIS, ALERTS, HISTORIC TRENDS, POST PROCESSING, TROUBLESHOOTING AND CONTROL OF SENSOR NETWORKS THAT ARE MONITORING THE CONDITION AND PERFORMANCE OF THE ENVIRONMENT, PLANTS, ANIMALS, STRUCTURES AND MACHINES; PROVIDING A WEB-BASED SERVICE FEATURING TECHNOLOGY THAT ENABLES USERS TO VIEW, MANAGE, PROCESS AND STORE DATA FROM WIRED AND WIRELESS SENSOR NETWORKS; PROVIDING USE OF A WEB-BASED INTEGRATED DEVELOPMENT ENVIRONMENT THAT ALLOWS USERS TO CREATE, EDIT, UPLOAD, SAVE, COMPILE, DEVELOP, DEBUG, SHARE, MONITOR, COLLABORATE, EXECUTE, AND SCHEDULE PROGRAMS AND APPLICATIONS FOR PERSONAL, INSTITUTIONAL, EDUCATIONAL, GOVERNMENT, MEDICAL, THERAPEUTIC AND INVESTIGATIVE USE AND USE IN COOPERATIVE AND SOCIAL NETWORKS ALL FOR ACCESSING, CONSOLIDATING, MAINTAINING, MANAGING, PROCESSING, SHARING, AND TRACKING INFORMATION AND DATA, IN CLASS 42 (U.S. CLS. 100 AND 101).

FIRST USE 6-6-2011; IN COMMERCE 6-6-2011.

THE MARK CONSISTS OF STANDARD CHARACTERS WITHOUT CLAIM TO ANY PARTICULAR FONT, STYLE, SIZE, OR COLOR.

SER. NO. 85-533,701, FILED 2-3-2012.

MARK SHINER, EXAMINING ATTORNEY



David J. Kyros

Director of the United States Patent and Trademark Office

United States of America

United States Patent and Trademark Office

TASTE TWO

Reg. No. 4,205,573

Registered Sep. 11, 2012

Int. Cl.: 29

TRADEMARK

PRINCIPAL REGISTER

COSI, INC. (DELAWARE CORPORATION)
SUITE 600
1751 LAKE COOK ROAD
DEERFIELD, IL 60015

FOR: COMBINATION MEALS, CONSISTING PRIMARILY OF SOUP, A SANDWICH OR A SALAD FOR CONSUMPTION ON OR OFF PREMISES, IN CLASS 29 (U.S. CL. 46).

FIRST USE 1-9-2012; IN COMMERCE 1-9-2012.

THE MARK CONSISTS OF STANDARD CHARACTERS WITHOUT CLAIM TO ANY PARTICULAR FONT, STYLE, SIZE, OR COLOR.

SER. NO. 85-533,703, FILED 2-3-2012.

DAVID MURRAY, EXAMINING ATTORNEY



David J. Kyfos

Director of the United States Patent and Trademark Office

United States of America

United States Patent and Trademark Office

DURA-SHIELD

Reg. No. 4,205,574

DALEN PRODUCTS, INC. (TENNESSEE CORPORATION)
700 DALEN LANE
KNOXVILLE, TN 37923

Registered Sep. 11, 2012

Int. Cl.: 19

FOR: GEOTEXTILES, NAMELY, FABRIC AND SHEETING FOR LANDSCAPING AND NURSERIES, IN CLASS 19 (U.S. CLS. 1, 12, 33 AND 50).

TRADEMARK

FIRST USE 2-1-2012; IN COMMERCE 2-1-2012.

PRINCIPAL REGISTER

THE MARK CONSISTS OF STANDARD CHARACTERS WITHOUT CLAIM TO ANY PARTICULAR FONT, STYLE, SIZE, OR COLOR.

SER. NO. 85-533,713, FILED 2-3-2012.

MIDGE BUTLER, EXAMINING ATTORNEY



David J. Kyffers

Director of the United States Patent and Trademark Office

United States of America

United States Patent and Trademark Office

My Southern Pantry

Reg. No. 4,205,575

Registered Sep. 11, 2012

Int. Cl.: 30

VIRGINIA WILLIS CULINARY PRODUCTIONS, LLC (GEORGIA LIMITED LIABILITY COMPANY), DBA MY SOUTHERN PANTRY
THISISREAL VIRGINIA WILLIS
3074 VININGS RIDGE DR SE
ATLANTA, GA 30339

TRADEMARK

FOR: GRITS; MIXES FOR BAKERY GOODS; SALT; SEASONING MIXES; SPICE RUBS, IN CLASS 30 (U.S. CL. 46).

PRINCIPAL REGISTER

FIRST USE 6-9-2010; IN COMMERCE 11-1-2010.

THE MARK CONSISTS OF STANDARD CHARACTERS WITHOUT CLAIM TO ANY PARTICULAR FONT, STYLE, SIZE, OR COLOR.

SER. NO. 85-533,725, FILED 2-3-2012.

ANDREA HACK, EXAMINING ATTORNEY



David J. Kyffers

Director of the United States Patent and Trademark Office

United States of America

United States Patent and Trademark Office

The logo for "biofresh" is written in a bold, lowercase, sans-serif font. The letters are slanted upwards from left to right. The letter "i" is dotted with a starburst-like design. A faint drop shadow is visible behind the text.

Reg. No. 4,205,576

IMPACT ABSORBENTS, INC. (CALIFORNIA CORPORATION)
5255 TRAFFIC WAY
ATASCADERO, CA 93422

Registered Sep. 11, 2012

Int. Cl.: 1

FOR: GRANULAR ABSORBENT MINERAL-BASED COMPOSITION FOR ABSORBING SPILLS FROM FLOORS, IN CLASS 1 (U.S. CLS. 1, 5, 6, 10, 26 AND 46).

TRADEMARK

FIRST USE 12-1-2011; IN COMMERCE 12-7-2011.

PRINCIPAL REGISTER

THE MARK CONSISTS OF THE WORDING "BIOFRESH" ANGLED IN AN UPWARD WAVE. THE LETTER "I" IN THE MARK IS DOTTED BY A STARBURST-LIKE DESIGN. A FAINT DROP SHADOW APPEARS AROUND THE LOGO.

SER. NO. 85-533,774, FILED 2-3-2012.

DAVID H. STINE, EXAMINING ATTORNEY



David J. Kybas

Director of the United States Patent and Trademark Office

United States of America

United States Patent and Trademark Office

Mr. Stacky

Reg. No. 4,205,577

XING, YAPING (UNITED STATES INDIVIDUAL)
228 SW WATERFORD CT., SUITE 107
LAKE CITY, FL 32055

Registered Sep. 11, 2012

Int. Cl.: 21

FOR: CLAY POTS; FLOWER AND PLANT CULTIVATION TRAYS; FLOWER POT HOLDERS; FLOWER POTS; HOLDERS FOR FLOWERS AND PLANTS; PLANT BASKETS; PLANTERS FOR FLOWERS AND PLANTS; PLASTIC LIDS FOR PLANT POTS; POTS; RAISED GARDEN BEDS, NAMELY, RAISED CONTAINERS FOR PLANTING CONTAINED GARDENS; RAISED GARDEN PLANTERS, IN CLASS 21 (U.S. CLS. 2, 13, 23, 29, 30, 33, 40 AND 50).

TRADEMARK

PRINCIPAL REGISTER

FIRST USE 4-1-2010; IN COMMERCE 4-1-2010.

THE MARK CONSISTS OF STANDARD CHARACTERS WITHOUT CLAIM TO ANY PARTICULAR FONT, STYLE, SIZE, OR COLOR.

SER. NO. 85-533,793, FILED 2-3-2012.

JIM RINGLE, EXAMINING ATTORNEY



David J. Kyffers

Director of the United States Patent and Trademark Office

United States of America

United States Patent and Trademark Office

ASHLEY COOPER

Reg. No. 4,205,578

Registered Sep. 11, 2012

Int. Cl.: 26

TRADEMARK

PRINCIPAL REGISTER

BOSCOV'S INVESTMENT COMPANY, INC. (DELAWARE CORPORATION)
2751 CENTERVILLE ROAD, SUITE 3217
WILMINGTON, DE 19808

FOR: ARTIFICIAL FLOWER ARRANGEMENTS; ARTIFICIAL FLOWER ARRANGEMENTS IN CONTAINERS; ARTIFICIAL FLOWER WREATHS; ARTIFICIAL FLOWERS; ARTIFICIAL FLOWERS OF PAPER; ARTIFICIAL FLOWERS OF PLASTICS; ARTIFICIAL FLOWERS OF TEXTILE; ARTIFICIAL FRUIT; ARTIFICIAL GARLANDS; ARTIFICIAL GARLANDS AND WREATHS; ARTIFICIAL PLANTS; ARTIFICIAL TOPIARIES; ARTIFICIAL TREES; ARTIFICIAL WREATHS, IN CLASS 26 (U.S. CLS. 37, 39, 40, 42 AND 50).

FIRST USE 1-0-2005; IN COMMERCE 1-0-2005.

THE MARK CONSISTS OF STANDARD CHARACTERS WITHOUT CLAIM TO ANY PARTICULAR FONT, STYLE, SIZE, OR COLOR.

THE NAME(S), PORTRAIT(S), AND/OR SIGNATURE(S) SHOWN IN THE MARK DOES NOT IDENTIFY A PARTICULAR LIVING INDIVIDUAL.

SER. NO. 85-533,805, FILED 2-3-2012.

MICHAEL WIENER, EXAMINING ATTORNEY



David J. Kyffers

Director of the United States Patent and Trademark Office

United States of America

United States Patent and Trademark Office

Seraph

Reg. No. 4,205,579

Registered Sep. 11, 2012

Int. Cl.: 8

TRADEMARK

PRINCIPAL REGISTER

ZERMENO KNIVES LLC (TEXAS LIMITED LIABILITY COMPANY)
9131 GLENSHADOW DRIVE
HOUSTON, TX 77088

FOR: FIXED BLADE KNIVES; FOLDING KNIVES, IN CLASS 8 (U.S. CLS. 23, 28 AND 44).

FIRST USE 11-17-2011; IN COMMERCE 1-20-2012.

THE MARK CONSISTS OF STANDARD CHARACTERS WITHOUT CLAIM TO ANY PARTICULAR FONT, STYLE, SIZE, OR COLOR.

SER. NO. 85-533,807, FILED 2-3-2012.

KATHY DE JONGE, EXAMINING ATTORNEY



David J. Kybas

Director of the United States Patent and Trademark Office

United States of America

United States Patent and Trademark Office

GET THINGS FILED

Reg. No. 4,205,580

Registered Sep. 11, 2012

Int. Cl.: 9

TRADEMARK

PRINCIPAL REGISTER

MCCOLLOUGH, LANCE (UNITED STATES INDIVIDUAL)
32209 CAMINO CALIARI
TEMECULA, CA 92592

FOR: DOWNLOADABLE SOFTWARE FOR ORGANIZING, LISTING AND LOCATING DOCUMENTS AND THINGS STORED IN A MECHANICAL FILE STORAGE SYSTEM, IN CLASS 9 (U.S. CLS. 21, 23, 26, 36 AND 38).

FIRST USE 1-24-2012; IN COMMERCE 1-24-2012.

THE MARK CONSISTS OF STANDARD CHARACTERS WITHOUT CLAIM TO ANY PARTICULAR FONT, STYLE, SIZE, OR COLOR.

SER. NO. 85-533,833, FILED 2-3-2012.

APRIL ROACH, EXAMINING ATTORNEY



David J. Kyffers

Director of the United States Patent and Trademark Office

United States of America

United States Patent and Trademark Office

Beauty and The Ink

Reg. No. 4,205,581

Registered Sep. 11, 2012

Int. Cl.: 44

SERVICE MARK

PRINCIPAL REGISTER

ADVANCED LITHO PRINTING & BINDERY (CALIFORNIA CORPORATION)
SUITE 110 & 112
20996 BAKE PARKWAY
LAKE FOREST, CA 92630

FOR: BEAUTY SALONS; TATTOO STUDIOS, IN CLASS 44 (U.S. CLS. 100 AND 101).

FIRST USE 6-1-2010; IN COMMERCE 6-1-2010.

THE MARK CONSISTS OF STANDARD CHARACTERS WITHOUT CLAIM TO ANY PARTICULAR FONT, STYLE, SIZE, OR COLOR.

SER. NO. 85-533,840, FILED 2-3-2012.

DEBORAH LOBO, EXAMINING ATTORNEY



David J. Kyffers

Director of the United States Patent and Trademark Office

United States of America

United States Patent and Trademark Office

The Institution

Reg. No. 4,205,582

Registered Sep. 11, 2012

Int. Cl.: 41

SERVICE MARK

PRINCIPAL REGISTER

WILSON, JASON (UNITED STATES INDIVIDUAL)
SUITE E3-259
601 VAN NESS AVE, OPERA PLAZA
SAN FRANCISCO, CA 94102

FOR: ENTERTAINMENT, NAMELY, LIVE PERFORMANCES BY A MUSICAL BAND, IN CLASS 41 (U.S. CLS. 100, 101 AND 107).

FIRST USE 1-1-2003; IN COMMERCE 1-1-2005.

THE MARK CONSISTS OF STANDARD CHARACTERS WITHOUT CLAIM TO ANY PARTICULAR FONT, STYLE, SIZE, OR COLOR.

SER. NO. 85-533,845, FILED 2-3-2012.

BRIAN CALLAGHAN, EXAMINING ATTORNEY



David J. Kyffers

Director of the United States Patent and Trademark Office

United States of America

United States Patent and Trademark Office

Statwack

Reg. No. 4,205,583

LIEBER, CHRISTOPHER (UNITED STATES INDIVIDUAL)
N22W28282 BEACH PARK CIRCLE
PEWAUKEE, WI 53072

Registered Sep. 11, 2012

Int. Cl.: 42

FOR: PROVIDING A WEBSITE FEATURING TECHNOLOGY THAT ENABLES USERS TO CREATE PROFILES FOR ENTERING AND TRACKING THEIR STATISTICS AND RELATED INFORMATION FOR SPORTS, ACTIVITIES AND HOBBIES, IN CLASS 42 (U.S. CLS. 100 AND 101).

SERVICE MARK

PRINCIPAL REGISTER

FIRST USE 1-12-2011; IN COMMERCE 1-12-2011.

THE MARK CONSISTS OF STANDARD CHARACTERS WITHOUT CLAIM TO ANY PARTICULAR FONT, STYLE, SIZE, OR COLOR.

SER. NO. 85-533,889, FILED 2-3-2012.

KEVIN DINALLO, EXAMINING ATTORNEY



David J. Kybas

Director of the United States Patent and Trademark Office

United States of America

United States Patent and Trademark Office

Freewheelin

Reg. No. 4,205,584

CLINTON "BUD" WILCOX (UNITED STATES INDIVIDUAL)
13395 BASS TRAIL
GRASS VALLEY, CA 95945

Registered Sep. 11, 2012

Int. Cl.: 9

FOR: HEADSETS FOR WIRELESS CELLULAR PHONES AND PORTABLE MUSIC PLAYERS,
IN CLASS 9 (U.S. CLS. 21, 23, 26, 36 AND 38).

TRADEMARK

FIRST USE 1-31-2012; IN COMMERCE 1-31-2012.

PRINCIPAL REGISTER

THE MARK CONSISTS OF STANDARD CHARACTERS WITHOUT CLAIM TO ANY PARTICULAR FONT, STYLE, SIZE, OR COLOR.

SER. NO. 85-533,894, FILED 2-3-2012.

APRIL ROACH, EXAMINING ATTORNEY



David J. Kyffers

Director of the United States Patent and Trademark Office

United States of America

United States Patent and Trademark Office

VitaPastor

Reg. No. 4,205,585

OLLIE'S HEALTH, LLC (WASHINGTON LIMITED LIABILITY COMPANY)
5716 MCKINLEY CT
PASCO, WA 99301

Registered Sep. 11, 2012

Int. Cl.: 5

FOR: MIXED VITAMIN PREPARATIONS; MULTI-VITAMIN PREPARATIONS; VITAMIN AND MINERAL SUPPLEMENTS; VITAMIN B PREPARATIONS; VITAMIN C PREPARATIONS; VITAMIN D PREPARATIONS; VITAMIN SUPPLEMENTS, IN CLASS 5 (U.S. CLS. 6, 18, 44, 46, 51 AND 52).

TRADEMARK

PRINCIPAL REGISTER

FIRST USE 9-0-2011; IN COMMERCE 1-10-2012.

THE MARK CONSISTS OF STANDARD CHARACTERS WITHOUT CLAIM TO ANY PARTICULAR FONT, STYLE, SIZE, OR COLOR.

SER. NO. 85-533,899, FILED 2-3-2012.

ANGELA DUONG, EXAMINING ATTORNEY



David J. Kyjars

Director of the United States Patent and Trademark Office

United States of America

United States Patent and Trademark Office



FUSION

Reg. No. 4,205,586

JASON SOBEL (UNITED STATES INDIVIDUAL)
4644 CIELO CIRCLE
CALABASAS, CA 91302

Registered Sep. 11, 2012

Int. Cls.: 41 and 45

FOR: PROVIDING ON-LINE RELIGIOUS INSTRUCTION PROMOTING CHRISTIAN AND FAMILY VALUES, IN CLASS 41 (U.S. CLS. 100, 101 AND 107).

SERVICE MARK

FIRST USE 10-0-2011; IN COMMERCE 10-0-2011.

PRINCIPAL REGISTER

FOR: CONDUCTING RELIGIOUS PRAYER SERVICES; RELIGIOUS AND SPIRITUAL SERVICES, NAMELY, CONDUCTING RELIGIOUS WORSHIP, MARRIAGE CEREMONIES, BAPTISMAL CEREMONIES, BABY DEDICATIONS, BEREAVEMENT CEREMONIES, AND RELIGIOUS COUNSELING, IN CLASS 45 (U.S. CLS. 100 AND 101).

FIRST USE 10-0-2011; IN COMMERCE 10-0-2011.

THE MARK CONSISTS OF ARTISTIC DESIGN OF A LIGHTED MATCH ABOVE THE WORD FUSION.

SER. NO. 85-533,900, FILED 2-3-2012.

THEODORE MCBRIDE, EXAMINING ATTORNEY



David J. Kybas

Director of the United States Patent and Trademark Office

United States of America

United States Patent and Trademark Office



Reg. No. 4,205,587

Registered Sep. 11, 2012

Int. Cl.: 41

SERVICE MARK

PRINCIPAL REGISTER

JOY2DANCE (NEW JERSEY LIMITED LIABILITY COMPANY)
14 HEMLOCK LANE
SOMERSET, NJ 08873

FOR: DANCE STUDIOS, IN CLASS 41 (U.S. CLS. 100, 101 AND 107).

FIRST USE 4-15-2011; IN COMMERCE 4-15-2011.

NO CLAIM IS MADE TO THE EXCLUSIVE RIGHT TO USE "DANCE" , APART FROM THE MARK AS SHOWN.

THE MARK CONSISTS OF AN ABSTRACT BACKGROUND WITH THE SILHOUETTE OF A MAN DANCING WITH A WOMAN, AND WITH THE STYLIZED TEXT "JOY2DANCE".

SER. NO. 85-533,950, FILED 2-3-2012.

TEJBIR SINGH, EXAMINING ATTORNEY



David J. Kyffers

Director of the United States Patent and Trademark Office

United States of America

United States Patent and Trademark Office



Reg. No. 4,205,588

Registered Sep. 11, 2012

Int. Cl.: 27

TRADEMARK

PRINCIPAL REGISTER

BRECKINRIDGE TAYLOR LLC (TEXAS LIMITED LIABILITY COMPANY)
5211 BONITA
DALLAS, TX 75206

FOR: AREA RUGS; BATH MATS; CARPETS AND RUGS; CARPETS, RUGS, MATS AND MATTING, LINOLEUM FOR COVERING EXISTING FLOORS; FLOOR MATS; FUR RUGS; NON-TEXTILE WALL COVERINGS; RESILIENT HARD SURFACE COVERING FOR FLOORS, WALLS AND OTHER SURFACES; RUGS, NAMELY, FLOOR RUNNERS; TEXTILE FLOOR MATS FOR USE IN THE HOME; WALLPAPER; WALLPAPER IN THE NATURE OF ROOMSIZE DECORATIVE ADHESIVE WALL COVERINGS, IN CLASS 27 (U.S. CLS. 19, 20, 37, 42 AND 50).

FIRST USE 12-0-2010; IN COMMERCE 12-0-2010.

THE MARK CONSISTS OF THE SHAPE OF A SOLID COLOR CAPITAL LETTER "B" CONTAINING THE SHAPE OF A CAPITAL LETTER "T" ANGLED AT APPROXIMATELY 45 DEGREES TO THE LEFT IN THE UPPER PORTION OF THE SOLID LETTER "B", WITH THE "T" SHOWN IN A LIGHT SHADED CONTRASTING COLOR OR SHOWN IN THE NEGATIVE AS THE ABSENCE OF THE DARK COLOR USED FOR THE "B" (IF USED ON A COLORED BACKGROUND).

SER. NO. 85-533,973, FILED 2-3-2012.

JOHN DALIER, EXAMINING ATTORNEY



David J. Kybas

Director of the United States Patent and Trademark Office

United States of America

United States Patent and Trademark Office

RIPKIT

Reg. No. 4,205,589

Registered Sep. 11, 2012

Int. Cl.: 35

SERVICE MARK

PRINCIPAL REGISTER

BUSINESS INSTINCTS GROUP INC. (CANADA CORPORATION)
200 - 5970 CENTRE STREET S.E.
CALGARY, ALBERTA, CANADA T2H0C1

FOR: BUSINESS CONSULTING SERVICES, NAMELY, THE SUPPLY OF BUSINESS SERVICES DESIGNED TO CREATE, CLARIFY AND ALIGN A BUSINESS' GOALS AND THE IMPLEMENTATION OF MANAGEMENT PROCESSES, MARKETING AND INTERNET-BASED STRATEGIES AND MEASUREMENT SYSTEMS DESIGNED TO ADVANCE AND MEASURE THE BUSINESS' GOALS, IN CLASS 35 (U.S. CLS. 100, 101 AND 102).

FIRST USE 4-4-2010; IN COMMERCE 3-19-2011.

THE MARK CONSISTS OF STANDARD CHARACTERS WITHOUT CLAIM TO ANY PARTICULAR FONT, STYLE, SIZE, OR COLOR.

SER. NO. 85-533,990, FILED 2-4-2012.

DAVID I, EXAMINING ATTORNEY



David J. Kyfos

Director of the United States Patent and Trademark Office

United States of America

United States Patent and Trademark Office

BEFORE THE FALL

Reg. No. 4,205,590

AZULAY, NAOMI (UNITED STATES INDIVIDUAL), DBA NAOMI AZULAY PT
6 W. 107TH ST. #2B
NEW YORK, NY 10025

Registered Sep. 11, 2012

Int. Cls.: 41 and 44

FOR: PHYSICAL FITNESS TRAINING OF INDIVIDUALS AND GROUPS, IN CLASS 41 (U.S. CLS. 100, 101 AND 107).

SERVICE MARK

FIRST USE 1-2-2011; IN COMMERCE 1-2-2011.

PRINCIPAL REGISTER

FOR: PHYSICAL THERAPY EVALUATION AND TREATMENT OF PROBLEMS WITH BALANCE, IN CLASS 44 (U.S. CLS. 100 AND 101).

FIRST USE 10-20-2010; IN COMMERCE 10-20-2010.

THE MARK CONSISTS OF STANDARD CHARACTERS WITHOUT CLAIM TO ANY PARTICULAR FONT, STYLE, SIZE, OR COLOR.

SER. NO. 85-533,994, FILED 2-4-2012.

KATINA MISTER, EXAMINING ATTORNEY



David J. Kybas

Director of the United States Patent and Trademark Office

United States of America

United States Patent and Trademark Office

RECLAIMING APHRODITE

Reg. No. 4,205,591

GRACE, AMRITA (UNITED STATES INDIVIDUAL)
114 MANO DR.
KULA, HI 96790

Registered Sep. 11, 2012

Int. Cl.: 41

FOR: CONDUCTING WORKSHOPS AND SEMINARS THAT ASSIST WOMEN IN RECOVERING FROM SEXUAL ABUSE, IN CLASS 41 (U.S. CLS. 100, 101 AND 107).

SERVICE MARK

FIRST USE 9-9-2009; IN COMMERCE 9-9-2009.

PRINCIPAL REGISTER

THE MARK CONSISTS OF STANDARD CHARACTERS WITHOUT CLAIM TO ANY PARTICULAR FONT, STYLE, SIZE, OR COLOR.

SER. NO. 85-534,006, FILED 2-4-2012.

LUCY ARANT, EXAMINING ATTORNEY



David J. Kyffers

Director of the United States Patent and Trademark Office

United States of America

United States Patent and Trademark Office



Reg. No. 4,205,592

CYBERTEX, INC. (TEXAS CORPORATION)
6300 LA CALMA DRIVE, SUITE 350
AUSTIN, TX 78752

Registered Sep. 11, 2012

Int. Cl.: 41

FOR: VOCATIONAL EDUCATION IN THE FIELD OF HEALTHCARE, MEDICINE, INFORMATION TECHNOLOGY AND IT CONSULTING; COMPUTER EDUCATION TRAINING SERVICES; EDUCATION SERVICES IN THE NATURE OF COURSES AT THE UNIVERSITY LEVEL, IN CLASS 41 (U.S. CLS. 100, 101 AND 107).

SERVICE MARK

PRINCIPAL REGISTER

FIRST USE 6-14-1999; IN COMMERCE 6-14-1999.

THE MARK CONSISTS OF AN IMAGE OF A SOLID CIRCLE WITH THREE CURVED LINES COMING OUT FROM BEHIND ON THE LEFT SIDE PARTIALLY SURROUNDING IT, ENDING IN THE MIDDLE PART OF THE CIRCLE WITH TIPS LIKE FISH HOOKS AND THE UPPER RIGHT PORTION OF THE CIRCLE IS HIGHLIGHTED AS SHOWN IN THE MARK.

SER. NO. 85-534,009, FILED 2-4-2012.

STEVEN PEREZ, EXAMINING ATTORNEY



David J. Kybas

Director of the United States Patent and Trademark Office

United States of America

United States Patent and Trademark Office

EUROJET

Reg. No. 4,205,593

Registered Sep. 11, 2012

Int. Cl.: 7

TRADEMARK

PRINCIPAL REGISTER

STASIS, INC. (WEST VIRGINIA CORPORATION)
500 MOTORSPORT PARK CIRCLE
SUMMIT POINT, WV 25446

FOR: AUTOMOTIVE EXHAUST PIPE; ENGINE EXHAUST SYSTEMS COMPRISING PIPES AND MUFFLERS; ENGINE EXHAUST TIPS; CATALYTIC CONVERTER UNITS FOR VEHICLE EXHAUSTS; ACCESSORIES FOR AUTOMOTIVE POSITIVE CRANKCASE VENTILATION (PCV) SYSTEMS, NAMELY, LINK PLATES, CATCH CANS, AND HOSE KITS; AUTOMOBILE ENGINE VALVE COVERS; INTERCOOLERS FOR AUTOMOBILE ENGINES; ENGINE AIR INTAKE SYSTEMS COMPRISING TUBES AND AIR FILTERS; AIR FILTERS FOR AUTOMOBILE ENGINES; THROTTLE BODY HOSES FOR AUTOMOBILE ENGINES; TURBOCHARGERS FOR AUTOMOBILE ENGINES; AND TURBO DISCHARGE PIPES FOR AUTOMOBILE ENGINES, IN CLASS 7 (U.S. CLS. 13, 19, 21, 23, 31, 34 AND 35).

FIRST USE 2-5-2011; IN COMMERCE 2-5-2011.

THE MARK CONSISTS OF STANDARD CHARACTERS WITHOUT CLAIM TO ANY PARTICULAR FONT, STYLE, SIZE, OR COLOR.

SER. NO. 85-534,030, FILED 2-4-2012.

PATRICIA EVANKO, EXAMINING ATTORNEY



David J. Kyros

Director of the United States Patent and Trademark Office

United States of America

United States Patent and Trademark Office



Reg. No. 4,205,594

Registered Sep. 11, 2012

Int. Cl.: 7

TRADEMARK

PRINCIPAL REGISTER

STASIS, INC. (WEST VIRGINIA CORPORATION)
500 MOTORSPORT PARK CIRCLE
SUMMIT POINT, WV 25446

FOR: AUTOMOTIVE EXHAUST PIPE; ENGINE EXHAUST SYSTEMS COMPRISING PIPES AND MUFFLERS; ENGINE EXHAUST TIPS; CATALYTIC CONVERTER UNITS FOR VEHICLE EXHAUSTS; ACCESSORIES FOR AUTOMOTIVE POSITIVE CRANKCASE VENTILATION (PCV) SYSTEMS, NAMELY, LINK PLATES, CATCH CANS, AND HOSE KITS; AUTOMOBILE ENGINE VALVE COVERS; INTERCOOLERS FOR AUTOMOBILE ENGINES; ENGINE AIR INTAKE SYSTEMS COMPRISING TUBES AND AIR FILTERS; AIR FILTERS FOR AUTOMOBILE ENGINES; THROTTLE BODY HOSES FOR AUTOMOBILE ENGINES; TURBOCHARGERS FOR AUTOMOBILE ENGINES; AND TURBO DISCHARGE PIPES FOR AUTOMOBILE ENGINES, IN CLASS 7 (U.S. CLS. 13, 19, 21, 23, 31, 34 AND 35).

FIRST USE 2-5-2011; IN COMMERCE 2-5-2011.

THE MARK CONSISTS OF A SHIELD WITH A FIVE-POINTED STAR INSIDE, THE POINTS OF THE STAR TRUNCATED BY THE EDGES OF THE SHIELD.

SER. NO. 85-534,032, FILED 2-4-2012.

PATRICIA EVANKO, EXAMINING ATTORNEY



David J. Kyffers

Director of the United States Patent and Trademark Office

United States of America

United States Patent and Trademark Office

MLN

Reg. No. 4,205,595

Registered Sep. 11, 2012

Int. Cl.: 35

SERVICE MARK

PRINCIPAL REGISTER

NETWORK ASSOCIATES, INC. (SOUTH CAROLINA CORPORATION)
222 WEST COLEMAN BOULEVARD
MOUNT PLEASANT, SC 29464

FOR: PROVIDING A WEB SITE WHICH FEATURES ADVERTISEMENTS FOR THE GOODS AND SERVICES OF OTHERS ON A GLOBAL COMPUTER NETWORK, IN CLASS 35 (U.S. CLS. 100, 101 AND 102).

FIRST USE 10-30-2005; IN COMMERCE 10-30-2005.

THE MARK CONSISTS OF STANDARD CHARACTERS WITHOUT CLAIM TO ANY PARTICULAR FONT, STYLE, SIZE, OR COLOR.

OWNER OF U.S. REG. NOS. 1,661,941 AND 2,226,373.

SER. NO. 85-534,056, FILED 2-4-2012.

KATHRYN COWARD, EXAMINING ATTORNEY



David J. Kyffers

Director of the United States Patent and Trademark Office

United States of America

United States Patent and Trademark Office

THRILL OF LIBERATION

Reg. No. 4,205,596

Registered Sep. 11, 2012

Int. Cl.: 25

TRADEMARK

PRINCIPAL REGISTER

PARKER, AYANNA (UNITED STATES INDIVIDUAL)
55 POPLAR STREET
879 LAFAYETTE AVENUE
BROOKLYN, NY 11221

FOR: ATHLETIC APPAREL, NAMELY, SHIRTS, PANTS, JACKETS, FOOTWEAR, HATS AND CAPS, ATHLETIC UNIFORMS; DENIMS; HATS; HOODED SWEAT SHIRTS; POLO SHIRTS; SHORTS; SWEAT SHIRTS; T-SHIRTS; WOMEN'S UNDERWEAR, IN CLASS 25 (U.S. CLS. 22 AND 39).

FIRST USE 1-3-2012; IN COMMERCE 1-3-2012.

THE MARK CONSISTS OF STANDARD CHARACTERS WITHOUT CLAIM TO ANY PARTICULAR FONT, STYLE, SIZE, OR COLOR.

SER. NO. 85-534,078, FILED 2-4-2012.

LAURIE KAUFMAN, EXAMINING ATTORNEY



David J. Kyffers

Director of the United States Patent and Trademark Office

United States of America

United States Patent and Trademark Office

Limca

Reg. No. 4,205,597

Registered Sep. 11, 2012

Int. Cl.: 32

TRADEMARK

PRINCIPAL REGISTER

MEENAXI ENTERPRISE, INC. (NEW JERSEY CORPORATION), DBA MEENAXI
ENTERPRISE, INC.
2500B HAMILTON BOULEVARD
SOUTH PLAINFIELD, NJ 07080

FOR: CONCENTRATES, SYRUPS OR POWDERS USED IN THE PREPARATION OF SOFT
DRINKS; SOFT DRINKS, NAMELY, SODAS, IN CLASS 32 (U.S. CLS. 45, 46 AND 48).

FIRST USE 1-1-2008; IN COMMERCE 1-1-2008.

THE MARK CONSISTS OF STANDARD CHARACTERS WITHOUT CLAIM TO ANY PAR-
TICULAR FONT, STYLE, SIZE, OR COLOR.

THE WORDING LIMCA HAS NO MEANING IN A FOREIGN LANGUAGE.

SER. NO. 85-534,110, FILED 2-4-2012.

GINA HAYES, EXAMINING ATTORNEY



David J. Kybas

Director of the United States Patent and Trademark Office

United States of America

United States Patent and Trademark Office

Thums Up

Reg. No. 4,205,598

Registered Sep. 11, 2012

Int. Cl.: 32

TRADEMARK

PRINCIPAL REGISTER

MEENAXI ENTERPRISE, INC. (NEW JERSEY CORPORATION), DBA MEENAXI
ENTERPRISE, INC.
2500B HAMILTON BOULEVARD
SOUTH PLAINFIELD, NJ 07080

FOR: COLAS; CONCENTRATES, SYRUPS OR POWDERS USED IN THE PREPARATION
OF SOFT DRINKS; SOFT DRINKS, NAMELY, SODAS, IN CLASS 32 (U.S. CLS. 45, 46 AND
48).

FIRST USE 1-1-2008; IN COMMERCE 1-1-2008.

THE MARK CONSISTS OF STANDARD CHARACTERS WITHOUT CLAIM TO ANY PAR-
TICULAR FONT, STYLE, SIZE, OR COLOR.

SER. NO. 85-534,116, FILED 2-4-2012.

GINA HAYES, EXAMINING ATTORNEY



David J. Kyffers

Director of the United States Patent and Trademark Office

United States of America

United States Patent and Trademark Office

IF IT'S TOO LOUD YOU'RE TOO OLD

Reg. No. 4,205,599

AUDIOVOX ELECTRONICS CORPORATION (DELAWARE CORPORATION)
150 MARCUS BOULEVARD
HAUPPAUGE, NY 11788

Registered Sep. 11, 2012

Int. Cl.: 9

FOR: AMPLIFIERS; LOUDSPEAKERS; RECEIVERS FOR AUDIO; VIDEO MONITORS, IN CLASS 9 (U.S. CLS. 21, 23, 26, 36 AND 38).

TRADEMARK

FIRST USE 1-1-1996; IN COMMERCE 1-1-1996.

PRINCIPAL REGISTER

THE MARK CONSISTS OF STANDARD CHARACTERS WITHOUT CLAIM TO ANY PARTICULAR FONT, STYLE, SIZE, OR COLOR.

SER. NO. 85-534,150, FILED 2-4-2012.

JACQUELINE A. LAVINE, EXAMINING ATTORNEY



David J. Kybas

Director of the United States Patent and Trademark Office

United States of America

United States Patent and Trademark Office

LH

Reg. No. 4,205,600

Registered Sep. 11, 2012

Int. Cl.: 18

TRADEMARK

PRINCIPAL REGISTER

HATCH, LOREN E. (COLOMBIA INDIVIDUAL)
1350 BEVERLY ROAD, SUITE 115-250
MCLEAN, VA 22101

FOR: BACKPACKS, BOOK BAGS, SPORTS BAGS, BUM BAGS, WALLETS AND HANDBAGS; FITTED PROTECTIVE COVERS FOR HANDBAGS, BRIEFCASES, VALISES, SUITCASES, AND BRIEFCASE-LIKE PORTFOLIOS; HANDBAG FRAMES; HANDBAGS FOR LADIES; HANDBAGS FOR MEN; HANDBAGS, PURSES AND WALLETS; INTERCHANGEABLE DECORATIVE COVERS FOR ACCESSORIZATION PURPOSES THAT ARE SPECIALLY ADAPTED TO HANDBAGS; STRAPS FOR HANDBAGS, IN CLASS 18 (U.S. CLS. 1, 2, 3, 22 AND 41).

FIRST USE 12-23-2010; IN COMMERCE 12-23-2010.

THE MARK CONSISTS OF STANDARD CHARACTERS WITHOUT CLAIM TO ANY PARTICULAR FONT, STYLE, SIZE, OR COLOR.

SER. NO. 85-534,174, FILED 2-4-2012.

ALICE BENMAMAN, EXAMINING ATTORNEY



David J. Kybas

Director of the United States Patent and Trademark Office

United States of America

United States Patent and Trademark Office

Jerrycan

Reg. No. 4,205,601

REVELATE DESIGNS LLC (ALASKA LIMITED LIABILITY COMPANY)
1510 COLUMBINE STREET
ANCHORAGE, AK 99508

Registered Sep. 11, 2012

Int. Cl.: 12

FOR: BAG MOUNTED DIRECTLY TO A BICYCLE, IN CLASS 12 (U.S. CLS. 19, 21, 23, 31, 35 AND 44).

TRADEMARK

FIRST USE 2-4-2012; IN COMMERCE 2-4-2012.

PRINCIPAL REGISTER

THE MARK CONSISTS OF STANDARD CHARACTERS WITHOUT CLAIM TO ANY PARTICULAR FONT, STYLE, SIZE, OR COLOR.

SER. NO. 85-534,183, FILED 2-5-2012.

VIVIAN MICZNIK FIRST, EXAMINING ATTORNEY



David J. Kyffers

Director of the United States Patent and Trademark Office

United States of America

United States Patent and Trademark Office

Steered Straight, Inc.

Reg. No. 4,205,602

MICHAEL R DELEON (NEW JERSEY CORPORATION), DBA STEERED STRAIGHT, INC.
P. O. BOX 842
MILLVILLE, NJ 08332

Registered Sep. 11, 2012

Int. Cl.: 41

FOR: EDUCATIONAL SERVICES, NAMELY, CONDUCTING SEMINARS AND PRESENTATIONS IN THE FIELD OF GANGS, ALCOHOL, DRUGS AND BULLYING, IN CLASS 41 (U.S. CLS. 100, 101 AND 107).

SERVICE MARK

FIRST USE 1-1-2000; IN COMMERCE 1-1-2000.

PRINCIPAL REGISTER

THE MARK CONSISTS OF STANDARD CHARACTERS WITHOUT CLAIM TO ANY PARTICULAR FONT, STYLE, SIZE, OR COLOR.

NO CLAIM IS MADE TO THE EXCLUSIVE RIGHT TO USE "INC.", APART FROM THE MARK AS SHOWN.

SER. NO. 85-534,207, FILED 2-5-2012.

LYNDSEY KUYKENDALL, EXAMINING ATTORNEY



David J. Kyffers

Director of the United States Patent and Trademark Office

United States of America

United States Patent and Trademark Office

ALPHAPLEX

Reg. No. 4,205,603

ALPHAPLEX INC (COLORADO CORPORATION)

Registered Sep. 11, 2012

6575 DENIM DRIVE
COLORADO SPRINGS, CO 80918

Int. Cl.: 42

FOR: DESIGN OF HOME PAGES, COMPUTER SOFTWARE AND WEB SITES; DESIGN, CREATION, HOSTING, MAINTENANCE OF WEBSITES FOR OTHERS, IN CLASS 42 (U.S. CLS. 100 AND 101).

SERVICE MARK

FIRST USE 2-1-1997; IN COMMERCE 7-1-1997.

PRINCIPAL REGISTER

THE MARK CONSISTS OF STANDARD CHARACTERS WITHOUT CLAIM TO ANY PARTICULAR FONT, STYLE, SIZE, OR COLOR.

OWNER OF U.S. REG. NO. 2,588,578.

SER. NO. 85-534,227, FILED 2-5-2012.

MICHAEL ENGEL, EXAMINING ATTORNEY



David J. Kyffers

Director of the United States Patent and Trademark Office

United States of America

United States Patent and Trademark Office

SAFE-T-PULL

Reg. No. 4,205,604

Registered Sep. 11, 2012

Int. Cl.: 12

TRADEMARK

PRINCIPAL REGISTER

KRINGSTAD IRONWORKS, INC. (NORTH DAKOTA CORPORATION)
406 TOWER STREET
PARK RIVER, ND 58270

FOR: VEHICLE TOW BARS, IN CLASS 12 (U.S. CLS. 19, 21, 23, 31, 35 AND 44).

FIRST USE 1-1-1997; IN COMMERCE 1-1-1997.

THE MARK CONSISTS OF STANDARD CHARACTERS WITHOUT CLAIM TO ANY PARTICULAR FONT, STYLE, SIZE, OR COLOR.

SER. NO. 85-534,267, FILED 2-5-2012.

ANNE MADDEN, EXAMINING ATTORNEY



David J. Kyffers

Director of the United States Patent and Trademark Office

United States of America

United States Patent and Trademark Office

FairyCamp

Reg. No. 4,205,605

MACMILLAN, JOSEPHINE BENNETT (UNITED STATES INDIVIDUAL)
2431 9TH STREET
BERKELEY, CA 94710

Registered Sep. 11, 2012

Int. Cl.: 41

FOR: PROVIDING EDUCATIONAL INFORMATION IN THE ACADEMIC FIELD OF ECOLOGICAL SUSTAINABILITY FOR THE PURPOSE OF ACADEMIC STUDY, IN CLASS 41 (U.S. CLS. 100, 101 AND 107).

SERVICE MARK

FIRST USE 3-21-2004; IN COMMERCE 3-21-2004.

PRINCIPAL REGISTER

THE MARK CONSISTS OF STANDARD CHARACTERS WITHOUT CLAIM TO ANY PARTICULAR FONT, STYLE, SIZE, OR COLOR.

SER. NO. 85-534,285, FILED 2-5-2012.

DAWN FELDMAN, EXAMINING ATTORNEY



David J. Kyros

Director of the United States Patent and Trademark Office

United States of America

United States Patent and Trademark Office

GOOD HAPPENS

Reg. No. 4,205,606

Registered Sep. 11, 2012

Int. Cl.: 43

SERVICE MARK

PRINCIPAL REGISTER

THE ORANGE COUNTY CENTER FOR LIVING PEACE FOUNDATION (CALIFORNIA
NON-PROFIT CORPORATION)
270 N. CANON DRIVE THIRD FLOOR
BEVERLY HILLS, CA 90210

FOR: PROVIDING COMMUNITY CENTERS FOR SOCIAL GATHERINGS AND MEETINGS,
IN CLASS 43 (U.S. CLS. 100 AND 101).

FIRST USE 1-25-2009; IN COMMERCE 1-25-2009.

THE MARK CONSISTS OF STANDARD CHARACTERS WITHOUT CLAIM TO ANY PAR-
TICULAR FONT, STYLE, SIZE, OR COLOR.

SER. NO. 85-534,289, FILED 2-5-2012.

DAWN FELDMAN, EXAMINING ATTORNEY



David J. Kyffers

Director of the United States Patent and Trademark Office

United States of America

United States Patent and Trademark Office

confernet

Reg. No. 4,205,607

CONFERNET PTY LTD (AUSTRALIA LIMITED LIABILITY COMPANY)
PO BOX 554 NORTH SYDNEY
SYDNEY, AUSTRALIA 2059

Registered Sep. 11, 2012

Int. Cl.: 38

FOR: TELECOMMUNICATION SERVICES, NAMELY, TRANSMISSION OF VOICE, DATA, GRAPHICS, IMAGES, AUDIO AND VIDEO BY MEANS OF TELECOMMUNICATIONS NETWORKS, WIRELESS COMMUNICATION NETWORKS, AND THE INTERNET, IN CLASS 38 (U.S. CLS. 100, 101 AND 104).

SERVICE MARK

PRINCIPAL REGISTER

FIRST USE 1-13-2012; IN COMMERCE 1-13-2012.

THE MARK CONSISTS OF STANDARD CHARACTERS WITHOUT CLAIM TO ANY PARTICULAR FONT, STYLE, SIZE, OR COLOR.

SER. NO. 85-534,306, FILED 2-5-2012.

DAVID I, EXAMINING ATTORNEY



David J. Kyfos

Director of the United States Patent and Trademark Office

United States of America

United States Patent and Trademark Office

MAKE A BOW BEFORE TYING THE KNOT

Reg. No. 4,205,608

VAN HORN, EARL P. (UNITED STATES INDIVIDUAL)
612 BALDWIN AVE, #39-B
SAFETY HARBOR, FL 34695

Registered Sep. 11, 2012

Int. Cl.: 41

FOR: PARTY AND WEDDING PLANNING, COORDINATION AND CONSULTATION SERVICES, IN CLASS 41 (U.S. CLS. 100, 101 AND 107).

SERVICE MARK

FIRST USE 1-5-2012; IN COMMERCE 1-5-2012.

PRINCIPAL REGISTER

THE MARK CONSISTS OF STANDARD CHARACTERS WITHOUT CLAIM TO ANY PARTICULAR FONT, STYLE, SIZE, OR COLOR.

SER. NO. 85-534,324, FILED 2-5-2012.

LAKEISHA LEWIS, EXAMINING ATTORNEY



David J. Kyffers

Director of the United States Patent and Trademark Office

United States of America

United States Patent and Trademark Office

Monsieur Singh

Reg. No. 4,205,609

Registered Sep. 11, 2012

Int. Cl.: 29

TRADEMARK

PRINCIPAL REGISTER

MONSIEUR SINGH, LLC (NEW YORK LIMITED LIABILITY COMPANY)
APT 9M
784 COLUMBUS AVENUE
NEW YORK, NY 10025

FOR: BEVERAGES CONSISTING PRINCIPALLY OF MILK; BEVERAGES HAVING A MILK BASE; BEVERAGES MADE FROM YOGHURT; BEVERAGES MADE WITH YOGHURT; DAIRY-BASED BEVERAGES; MILK BEVERAGES CONTAINING FRUITS; YOGURT-BASED BEVERAGES, IN CLASS 29 (U.S. CL. 46).

FIRST USE 7-9-2011; IN COMMERCE 2-2-2012.

THE MARK CONSISTS OF STANDARD CHARACTERS WITHOUT CLAIM TO ANY PARTICULAR FONT, STYLE, SIZE, OR COLOR.

SER. NO. 85-534,333, FILED 2-6-2012.

ANDREW LEASER, EXAMINING ATTORNEY



David J. Kybas

Director of the United States Patent and Trademark Office

United States of America

United States Patent and Trademark Office

Endorsed Daily by a Billion Indians

Reg. No. 4,205,610

Registered Sep. 11, 2012

Int. Cl.: 29

TRADEMARK

PRINCIPAL REGISTER

MONSIEUR SINGH, LLC (NEW YORK LIMITED LIABILITY COMPANY)
APT 9M
784 COLUMBUS AVENUE
NEW YORK, NY 10025

FOR: BEVERAGES HAVING A MILK BASE; BEVERAGES MADE FROM YOGHURT;
BEVERAGES MADE WITH YOGHURT; DAIRY-BASED BEVERAGES; MILK BASED
BEVERAGES CONTAINING FRUIT JUICE; MILK BEVERAGES CONTAINING FRUITS;
SOY-BASED FOOD BEVERAGE USED AS A MILK SUBSTITUTE; YOGURT-BASED
BEVERAGES, IN CLASS 29 (U.S. CL. 46).

FIRST USE 7-9-2011; IN COMMERCE 2-2-2012.

THE MARK CONSISTS OF STANDARD CHARACTERS WITHOUT CLAIM TO ANY PAR-
TICULAR FONT, STYLE, SIZE, OR COLOR.

SER. NO. 85-534,346, FILED 2-6-2012.

ANDREW LEASER, EXAMINING ATTORNEY



David J. Kyffers

Director of the United States Patent and Trademark Office

United States of America

United States Patent and Trademark Office

InvestRent

Reg. No. 4,205,611

Registered Sep. 11, 2012

Int. Cl.: 36

SERVICE MARK

PRINCIPAL REGISTER

POVIENG, DONALD (UNITED STATES INDIVIDUAL)
407 17TH STREET
HUNTINGTON BEACH, CA 92648

FOR: EVALUATION OF REAL PROPERTY; FINANCIAL DUE DILIGENCE SERVICES IN THE FIELD OF REAL ESTATE; FINANCIAL INVESTMENT IN THE FIELD OF REAL ESTATE SECURITIES; REAL ESTATE ACQUISITION SERVICES; REAL ESTATE BROKERAGE; REAL ESTATE EQUITY SHARING, NAMELY, MANAGING AND ARRANGING FOR CO-OWNERSHIP OF REAL ESTATE; REAL ESTATE FUNDS INVESTMENT SERVICES; REAL ESTATE INVESTMENT SERVICES; REAL ESTATE INVESTMENT TRUST SERVICES; REAL ESTATE RENTAL SERVICES, NAMELY, RENTAL OF RESIDENTIAL HOUSING; REAL ESTATE SYNDICATION; REAL ESTATE TIME-SHARING, IN CLASS 36 (U.S. CLS. 100, 101 AND 102).

FIRST USE 2-6-2012; IN COMMERCE 3-29-2012.

THE MARK CONSISTS OF STANDARD CHARACTERS WITHOUT CLAIM TO ANY PARTICULAR FONT, STYLE, SIZE, OR COLOR.

SER. NO. 85-534,358, FILED 2-6-2012.

ANDREW LEASER, EXAMINING ATTORNEY



David J. Kypos

Director of the United States Patent and Trademark Office

United States of America

United States Patent and Trademark Office

Stratstore

Reg. No. 4,205,612

OMNISTRAT INCORPORATED (DELAWARE CORPORATION)
1 TANNERY BROOK ROW, UNIT 2B
SOMERVILLE, MA 02114

Registered Sep. 11, 2012

Int. Cl.: 42

FOR: SOFTWARE AS A SERVICE (SAAS) SERVICES FEATURING SOFTWARE FOR ORGANIZATIONAL STRATEGY, PLANNING AND EXECUTION, IN CLASS 42 (U.S. CLS. 100 AND 101).

SERVICE MARK

FIRST USE 12-1-2011; IN COMMERCE 12-1-2011.

PRINCIPAL REGISTER

THE MARK CONSISTS OF STANDARD CHARACTERS WITHOUT CLAIM TO ANY PARTICULAR FONT, STYLE, SIZE, OR COLOR.

SER. NO. 85-534,360, FILED 2-6-2012.

ANDREW LEASER, EXAMINING ATTORNEY



David J. Kyffers

Director of the United States Patent and Trademark Office

United States of America

United States Patent and Trademark Office

PITSLINGER

Reg. No. 4,205,613

QUICK ACCESSORIES PTY LTD (AUSTRALIA CORPORATION)
31 TUGRAH ROAD
DEVONPORT, AUSTRALIA

Registered Sep. 11, 2012

Int. Cl.: 25

FOR: ATHLETIC APPAREL, NAMELY, SHIRTS, PANTS, JACKETS, FOOTWEAR, HATS AND CAPS, ATHLETIC UNIFORMS; BASEBALL CAPS AND HATS; HOODED SWEAT SHIRTS; SHORT-SLEEVED OR LONG-SLEEVED T-SHIRTS; SPORTS SHIRTS; SWEAT SHIRTS; T-SHIRTS, IN CLASS 25 (U.S. CLS. 22 AND 39).

TRADEMARK

PRINCIPAL REGISTER

THE MARK CONSISTS OF STANDARD CHARACTERS WITHOUT CLAIM TO ANY PARTICULAR FONT, STYLE, SIZE, OR COLOR.

OWNER OF AUSTRALIA REG. NO. 1427268, DATED 9-9-2011, EXPIRES 5-25-2021.

SER. NO. 85-534,363, FILED 2-6-2012.

ANDREW LEASER, EXAMINING ATTORNEY



David J. Kyfos

Director of the United States Patent and Trademark Office

United States of America

United States Patent and Trademark Office



Reg. No. 4,205,614

Registered Sep. 11, 2012

Int. Cl.: 35

SERVICE MARK

PRINCIPAL REGISTER

GHIGLIAZZA, RICARDO ANDRES (ARGENTINA INDIVIDUAL)
SAN MARTIN 793 PISO 9 B
BUENOS AIRES, ARGENTINA 1004

FOR: HUMAN RESOURCE ANALYSIS AND CONSULTING SERVICES; HUMAN RESOURCES SERVICES, NAMELY, PERSONNEL SELECTION FOR OTHERS, IN CLASS 35 (U.S. CLS. 100, 101 AND 102).

OWNER OF ARGENTINA REG. NO. 2348699, DATED 2-25-2010, EXPIRES 2-25-2020.

THE COLOR(S) GREY, GREEN, BLUE AND BLACK IS/ARE CLAIMED AS A FEATURE OF THE MARK.

THE MARK CONSISTS OF THE LITERAL ELEMENT "HUMAN" IN BLACK, THE LITERAL ELEMENT "SCORING" IN GREY, AND THERE ARE FOUR REPRESENTATIONS OF PERSONS. STARTING FROM THE LEFT, THE FIRST PERSON IS BLACK, THE SECOND IS BLUE, THE THIRD ONE IS GREEN AND THE LAST ONE IS GREY.

SER. NO. 85-534,372, FILED 2-6-2012.

ANDREW LEASER, EXAMINING ATTORNEY



David J. Kybas

Director of the United States Patent and Trademark Office

United States of America

United States Patent and Trademark Office

Shake To Change

Reg. No. 4,205,615

SEREN MOTUS LLC (TENNESSEE LIMITED LIABILITY COMPANY), DBA BARREAMPED
256 SEABOARD LN, A-103
FRANKLIN, TN 37067

Registered Sep. 11, 2012

Int. Cl.: 41

FOR: PHYSICAL FITNESS STUDIO SERVICES, NAMELY, PROVIDING EXERCISE CLASSES, BODY SCULPTING CLASSES, AND GROUP FITNESS CLASSES, IN CLASS 41 (U.S. CLS. 100, 101 AND 107).

SERVICE MARK

FIRST USE 12-3-2011; IN COMMERCE 1-15-2012.

PRINCIPAL REGISTER

THE MARK CONSISTS OF STANDARD CHARACTERS WITHOUT CLAIM TO ANY PARTICULAR FONT, STYLE, SIZE, OR COLOR.

SER. NO. 85-534,444, FILED 2-6-2012.

ANNE E. GUSTASON, EXAMINING ATTORNEY



David J. Kyffers

Director of the United States Patent and Trademark Office

United States of America

United States Patent and Trademark Office

MAMA

Reg. No. 4,205,616

NYSE TECHNOLOGIES, INC. (DELAWARE CORPORATION)
11 WALL STREET
NEW YORK, NY 10005

Registered Sep. 11, 2012

Int. Cl.: 9

FOR: COMPUTER SOFTWARE, NAMELY, APPLICATION PROGRAMMING INTERFACE (API) AND ABSTRACTION LAYER THAT PROVIDES A SINGLE INTERFACE TO MULTIPLE MESSAGE ORIENTED MIDDLEWARES AND ALLOWS MULTIPLE MIDDLEWARES TO COEXIST IN A SINGLE APPLICATION, IN CLASS 9 (U.S. CLS. 21, 23, 26, 36 AND 38).

TRADEMARK

PRINCIPAL REGISTER

FIRST USE 3-28-2007; IN COMMERCE 3-28-2007.

THE MARK CONSISTS OF STANDARD CHARACTERS WITHOUT CLAIM TO ANY PARTICULAR FONT, STYLE, SIZE, OR COLOR.

SER. NO. 85-534,445, FILED 2-6-2012.

ANNE E. GUSTASON, EXAMINING ATTORNEY



David J. Kyjars

Director of the United States Patent and Trademark Office

United States of America

United States Patent and Trademark Office

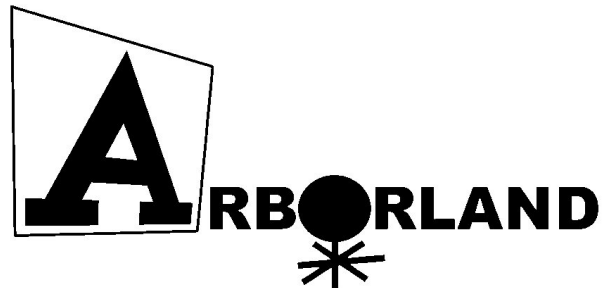

Reg. No. 4,205,617

Registered Sep. 11, 2012

Int. Cl.: 35

SERVICE MARK

PRINCIPAL REGISTER

HAGEN, DARREN (UNITED STATES INDIVIDUAL)
#2P
220 WEST 24TH STREET
NEW YORK, NY 10011

FOR: MANAGEMENT OF PERFORMING AND RECORDING ARTISTS, IN CLASS 35 (U.S. CLS. 100, 101 AND 102).

FIRST USE 5-14-2008; IN COMMERCE 5-14-2008.

THE MARK CONSISTS OF THE STYLIZED TEXT "ARBORLAND" IN WHICH THE LETTER "A" IS ENCLOSED IN A QUADRANGLE BORDER. THE LETTER "O" IS REPRESENTED BY A SOLID CIRCLE WITH A STEM AT THE BOTTOM CREATING A TREE-LIKE IMAGE.

SER. NO. 85-534,449, FILED 2-6-2012.

JORDAN BAKER, EXAMINING ATTORNEY



David J. Kyffers

Director of the United States Patent and Trademark Office

United States of America

United States Patent and Trademark Office

SPIRIT ISLAND

Reg. No. 4,205,618

Registered Sep. 11, 2012

Int. Cls.: 41 and 43

SERVICE MARK

PRINCIPAL REGISTER

GREAT LAKES SERVICES, LLC (DELAWARE LIMITED LIABILITY COMPANY)
SOUTH TOWER, SUITE 6000
525 JUNCTION ROAD
MADISON, WI 53717

FOR: ENTERTAINMENT SERVICES IN THE NATURE OF A WATER PARK, IN CLASS 41
(U.S. CLS. 100, 101 AND 107).

FIRST USE 5-0-1997; IN COMMERCE 5-0-1997.

FOR: RESORT HOTEL SERVICES; RESTAURANT SERVICES, IN CLASS 43 (U.S. CLS. 100
AND 101).

FIRST USE 3-0-2003; IN COMMERCE 3-0-2003.

THE MARK CONSISTS OF STANDARD CHARACTERS WITHOUT CLAIM TO ANY PAR-
TICULAR FONT, STYLE, SIZE, OR COLOR.

SER. NO. 85-534,500, FILED 2-6-2012.

KAREN K. BUSH, EXAMINING ATTORNEY



David J. Kyffers

Director of the United States Patent and Trademark Office

United States of America

United States Patent and Trademark Office

TUFF GONG WORLDWIDE

Reg. No. 4,205,619

Registered Sep. 11, 2012

Int. Cl.: 16

TRADEMARK

PRINCIPAL REGISTER

FIFTY-SIX HOPE ROAD MUSIC, LIMITED (BAHAMAS CORPORATION)
AQUAMARINE HOUSE
CABLE BEACH, NASSAU, BAHAMAS

FOR: BOOKS IN THE FIELD OF FICTIONAL AND CHILDREN'S STORIES; COMIC BOOKS;
PHOTOGRAPHIC PRINTS; POSTERS; STICKERS; UNMOUNTED AND MOUNTED PHOTO-
GRAPHS, IN CLASS 16 (U.S. CLS. 2, 5, 22, 23, 29, 37, 38 AND 50).

FIRST USE 1-1-2006; IN COMMERCE 1-1-2006.

THE MARK CONSISTS OF STANDARD CHARACTERS WITHOUT CLAIM TO ANY PAR-
TICULAR FONT, STYLE, SIZE, OR COLOR.

NO CLAIM IS MADE TO THE EXCLUSIVE RIGHT TO USE "WORLDWIDE", APART FROM
THE MARK AS SHOWN.

SER. NO. 85-534,512, FILED 2-6-2012.

SUNG IN, EXAMINING ATTORNEY



David J. Kyffers

Director of the United States Patent and Trademark Office

United States of America

United States Patent and Trademark Office

PURVEYORS OF THE BEAUTIFUL LIFE

Reg. No. 4,205,620

LBV HOLDINGS, LLC (DELAWARE LIMITED LIABILITY COMPANY)
1265 WOODLAND AVE SE
ATLANTA, GA 30316

Registered Sep. 11, 2012

Int. Cl.: 35

FOR: WHOLESALE AND RETAIL STORE SERVICES FEATURING CLOTHING, IN CLASS 35 (U.S. CLS. 100, 101 AND 102).

SERVICE MARK

FIRST USE 1-8-2012; IN COMMERCE 1-8-2012.

PRINCIPAL REGISTER

THE MARK CONSISTS OF STANDARD CHARACTERS WITHOUT CLAIM TO ANY PARTICULAR FONT, STYLE, SIZE, OR COLOR.

SER. NO. 85-534,516, FILED 2-6-2012.

WILLIAM ROSSMAN, EXAMINING ATTORNEY



David J. Kyfos

Director of the United States Patent and Trademark Office

United States of America

United States Patent and Trademark Office



Reg. No. 4,205,621

Registered Sep. 11, 2012

Int. Cl.: 6

TRADEMARK

PRINCIPAL REGISTER

HEB GROCERY COMPANY, LP (TEXAS LIMITED PARTNERSHIP)
CORPORATE LAW DEPARTMENT
646 S. MAIN
SAN ANTONIO, TX 78204

FOR: ALUMINUM FOIL, IN CLASS 6 (U.S. CLS. 2, 12, 13, 14, 23, 25 AND 50).

FIRST USE 11-2-2008; IN COMMERCE 11-2-2008.

OWNER OF U.S. REG. NOS. 1,519,398, 1,867,930 AND OTHERS.

THE COLOR(S) RED AND WHITE IS/ARE CLAIMED AS A FEATURE OF THE MARK.

THE MARK CONSISTS OF THE LETTERS "H-E-B" IN WHITE LETTERS WITHIN A RED OVAL DESIGN.

SER. NO. 85-534,526, FILED 2-6-2012.

ANGELA M. MICHELI, EXAMINING ATTORNEY



David J. Kyffers

Director of the United States Patent and Trademark Office

United States of America

United States Patent and Trademark Office

AT THE END OF THE DAY IT
COMES DOWN TO K-D-A
Knowledge. Discipline. Ability

Reg. No. 4,205,622

Registered Sep. 11, 2012

Int. Cl.: 41

SERVICE MARK

PRINCIPAL REGISTER

SOUTHEAST LINEMAN TRAINING CENTER, LLC (GEORGIA LIMITED LIABILITY COMPANY)
9481 HIGHWAY 11
TRENTON, GA 30752

FOR: VOCATIONAL EDUCATION IN THE FIELD OF LINEMAN APPRENTICE TRAINING, IN CLASS 41 (U.S. CLS. 100, 101 AND 107).

FIRST USE 4-18-2011; IN COMMERCE 4-18-2011.

THE MARK CONSISTS OF STANDARD CHARACTERS WITHOUT CLAIM TO ANY PARTICULAR FONT, STYLE, SIZE, OR COLOR.

SER. NO. 85-534,546, FILED 2-6-2012.

BRIAN NEVILLE, EXAMINING ATTORNEY



David J. Kyffers

Director of the United States Patent and Trademark Office

United States of America

United States Patent and Trademark Office

The Smallest Executable Step

Reg. No. 4,205,623

THE MEDICI GROUP LLC (NEW YORK LIMITED LIABILITY COMPANY)
215 PARK AVENUE SOUTH, SUITE 1901
NEW YORK, NY 10003

Registered Sep. 11, 2012

Int. Cl.: 16

FOR: EDUCATIONAL AND LEARNING TOOL, NAMELY QUESTIONNAIRES IN THE FIELD OF BUSINESS EDUCATION, DEVELOPMENT OF BUSINESS STRATEGIES AND CREATIVE IDEATION; PAPER TEACHING MATERIAL IN THE FIELD OF BUSINESS EDUCATION, DEVELOPMENT OF BUSINESS STRATEGIES DEVELOPMENT AND CREATIVE IDEATION, IN CLASS 16 (U.S. CLS. 2, 5, 22, 23, 29, 37, 38 AND 50).

TRADEMARK

PRINCIPAL REGISTER

FIRST USE 11-18-2011; IN COMMERCE 11-18-2011.

THE MARK CONSISTS OF STANDARD CHARACTERS WITHOUT CLAIM TO ANY PARTICULAR FONT, STYLE, SIZE, OR COLOR.

SER. NO. 85-534,550, FILED 2-6-2012.

BRIAN NEVILLE, EXAMINING ATTORNEY



David J. Kyffers

Director of the United States Patent and Trademark Office

United States of America

United States Patent and Trademark Office

athletiConnect

Reg. No. 4,205,624

Registered Sep. 11, 2012

Int. Cl.: 45

SERVICE MARK

PRINCIPAL REGISTER

ATHLETICCONNECT, LLC (TEXAS LIMITED LIABILITY COMPANY)
130-340
391 EAST LAS COLINAS BLVD.
IRVING, TX 75039

FOR: ON-LINE SOCIAL NETWORKING SERVICES, IN CLASS 45 (U.S. CLS. 100 AND 101).

FIRST USE 12-15-2011; IN COMMERCE 12-15-2011.

THE MARK CONSISTS OF STANDARD CHARACTERS WITHOUT CLAIM TO ANY PARTICULAR FONT, STYLE, SIZE, OR COLOR.

SER. NO. 85-534,594, FILED 2-6-2012.

ANNE MADDEN, EXAMINING ATTORNEY



David J. Kybas

Director of the United States Patent and Trademark Office

United States of America

United States Patent and Trademark Office

MOST

Reg. No. 4,205,625

Registered Sep. 11, 2012

Int. Cl.: 35

SERVICE MARK

PRINCIPAL REGISTER

UNITY PRODUCTIONS FOUNDATION (CALIFORNIA CORPORATION), AKA UPF
LOWER LEVEL #2
1200 29TH ST. NW
WASHINGTON, DC 20007

FOR: PROMOTING PUBLIC AWARENESS OF THE NEED AND MEANS OF PURSUING
PEACE AND CULTURAL UNDERSTANDING THROUGH MEDIA, IN CLASS 35 (U.S. CLS.
100, 101 AND 102).

FIRST USE 2-15-2007; IN COMMERCE 2-15-2007.

THE MARK CONSISTS OF STANDARD CHARACTERS WITHOUT CLAIM TO ANY PAR-
TICULAR FONT, STYLE, SIZE, OR COLOR.

SER. NO. 85-534,598, FILED 2-6-2012.

DAVID TAYLOR, EXAMINING ATTORNEY



David J. Kybas

Director of the United States Patent and Trademark Office

United States of America

United States Patent and Trademark Office

CAPTIVATE CLASSICS

Reg. No. 4,205,626

Registered Sep. 11, 2012

Int. Cl.: 25

TRADEMARK

PRINCIPAL REGISTER

NICHOLAS MULLINS (UNITED STATES INDIVIDUAL), DBA CAPTIVATE CLASSICS
4026 N. FRIJO AVE.
COVINA, CA 91722

FOR: T-SHIRTS, IN CLASS 25 (U.S. CLS. 22 AND 39).

FIRST USE 1-28-2010; IN COMMERCE 1-28-2010.

THE MARK CONSISTS OF STANDARD CHARACTERS WITHOUT CLAIM TO ANY PARTICULAR FONT, STYLE, SIZE, OR COLOR.

SER. NO. 85-534,617, FILED 2-6-2012.

DEZMONA MIZELLE, EXAMINING ATTORNEY



David J. Kyffers

Director of the United States Patent and Trademark Office

United States of America

United States Patent and Trademark Office

We Know.

Reg. No. 4,205,627

Registered Sep. 11, 2012

Int. Cl.: 35

SERVICE MARK

PRINCIPAL REGISTER

TRAVISWOLFF LLP (TEXAS LIMITED LIABILITY PARTNERSHIP)
SUITE 600
15950 N. DALLAS PARKWAY
DALLAS, TX 75248

FOR: ACCOUNTING SERVICES; BUSINESS APPRAISALS AND EVALUATIONS IN BUSINESS MATTERS; BUSINESS AUDITING; FORENSIC ACCOUNTING SERVICES; TAX ADVISORY SERVICES, IN CLASS 35 (U.S. CLS. 100, 101 AND 102).

FIRST USE 8-26-2011; IN COMMERCE 8-26-2011.

THE MARK CONSISTS OF A STYLIZED CAPITAL "W", SMALL "E", SPACE, CAPITAL "K", SMALL "NOW", AND A PERIOD AT THE END.

SER. NO. 85-534,636, FILED 2-6-2012.

ANNE MADDEN, EXAMINING ATTORNEY



David J. Kyffers

Director of the United States Patent and Trademark Office

United States of America

United States Patent and Trademark Office

Seven Peaks

Reg. No. 4,205,628

Registered Sep. 11, 2012

Int. Cl.: 41

SERVICE MARK

PRINCIPAL REGISTER

SEVEN PEAKS PLACE, LC (UTAH LIMITED LIABILITY COMPANY)
SUITE 650
3214 N. UNIVERSITY AVE.
PROVO, UT 84604

FOR: ENTERTAINMENT IN THE NATURE OF A WATER PARK AND AMUSEMENT CENTER, IN CLASS 41 (U.S. CLS. 100, 101 AND 107).

FIRST USE 9-1-1999; IN COMMERCE 9-1-1999.

THE MARK CONSISTS OF STANDARD CHARACTERS WITHOUT CLAIM TO ANY PARTICULAR FONT, STYLE, SIZE, OR COLOR.

SER. NO. 85-534,643, FILED 2-6-2012.

JESSICA FATHY, EXAMINING ATTORNEY



David J. Kyros

Director of the United States Patent and Trademark Office

United States of America

United States Patent and Trademark Office

SCREENLAND

Reg. No. 4,205,629

FILM ROW, L.L.C. (MISSOURI LIMITED LIABILITY COMPANY)
1204 W. 52ND ST.

Registered Sep. 11, 2012

KANSAS CITY, MO 64112

Int. Cls.: 25 and 30

FOR: CAPS; HATS; SWEAT PANTS; SWEAT SHIRTS; T-SHIRTS, IN CLASS 25 (U.S. CLS. 22 AND 39).

TRADEMARK

FIRST USE 4-16-2010; IN COMMERCE 4-16-2010.

PRINCIPAL REGISTER

FOR: CANDY; COOKIES; NACHOS; POPCORN, IN CLASS 30 (U.S. CL. 46).

FIRST USE 4-10-2010; IN COMMERCE 4-10-2010.

THE MARK CONSISTS OF STANDARD CHARACTERS WITHOUT CLAIM TO ANY PARTICULAR FONT, STYLE, SIZE, OR COLOR.

OWNER OF U.S. REG. NO. 3,013,134.

SER. NO. 85-534,664, FILED 2-6-2012.

TAMARA FRAZIER, EXAMINING ATTORNEY



David J. Kybas

Director of the United States Patent and Trademark Office

United States of America

United States Patent and Trademark Office

Tsunami Jim's

Reg. No. 4,205,630

Registered Sep. 11, 2012

Int. Cl.: 35

SERVICE MARK

PRINCIPAL REGISTER

TSUNAMI JIM'S, LLC (OHIO LIMITED LIABILITY COMPANY)
331 CIRCLEWOOD LANE
CINCINNATI, OH 45215

FOR: RETAIL STORE SERVICES FEATURING SWIMMING POOLS AND ACCESSORIES THEREFOR, HOT TUBS, SPAS, SAUNAS AND ACCESSORIES THEREFOR, LANDSCAPING ARTICLES AND ACCESSORIES THEREFOR, IN CLASS 35 (U.S. CLS. 100, 101 AND 102).

FIRST USE 1-31-2012; IN COMMERCE 1-31-2012.

THE MARK CONSISTS OF STANDARD CHARACTERS WITHOUT CLAIM TO ANY PARTICULAR FONT, STYLE, SIZE, OR COLOR.

SER. NO. 85-534,668, FILED 2-6-2012.

TAMARA FRAZIER, EXAMINING ATTORNEY



David J. Kyros

Director of the United States Patent and Trademark Office

United States of America

United States Patent and Trademark Office

All You Need is Us!

Reg. No. 4,205,631

COLLINS COMMUNITY CREDIT UNION (IOWA CREDIT UNION)
1150 42ND STREET NE
CEDAR RAPIDS, IA 52402

Registered Sep. 11, 2012

Int. Cl.: 36

FOR: CREDIT UNION SERVICES, IN CLASS 36 (U.S. CLS. 100, 101 AND 102).

SERVICE MARK

FIRST USE 1-1-1982; IN COMMERCE 1-1-1982.

PRINCIPAL REGISTER

THE MARK CONSISTS OF STANDARD CHARACTERS WITHOUT CLAIM TO ANY PARTICULAR FONT, STYLE, SIZE, OR COLOR.

SER. NO. 85-534,675, FILED 2-6-2012.

INGA ERVIN, EXAMINING ATTORNEY



David J. Kybas

Director of the United States Patent and Trademark Office

United States of America

United States Patent and Trademark Office

FIND YOUR SWEET SPOT

Reg. No. 4,205,632

GID DEVELOPMENT CORP. (NEVADA CORPORATION), DBA BODYDOCK.COM
3720 PROSPECT AVENUE
YORBA LINDA, CA 92886

Registered Sep. 11, 2012

Int. Cl.: 9

FOR: DOCKING MECHANISMS FOR MOBILE DEVICES, NAMELY MAGNETIC DOCKING MECHANISM FOR MOBILE PHONES, PORTABLE MUSIC PLAYERS, AND PORTABLE TABLETS, IN CLASS 9 (U.S. CLS. 21, 23, 26, 36 AND 38).

TRADEMARK

FIRST USE 12-14-2011; IN COMMERCE 12-14-2011.

PRINCIPAL REGISTER

THE MARK CONSISTS OF STANDARD CHARACTERS WITHOUT CLAIM TO ANY PARTICULAR FONT, STYLE, SIZE, OR COLOR.

SER. NO. 85-534,680, FILED 2-6-2012.

JOHN WILKE, EXAMINING ATTORNEY



David J. Kyros

Director of the United States Patent and Trademark Office

United States of America

United States Patent and Trademark Office

TOY BOX PRODUCTIONS

Reg. No. 4,205,633

HUTCHINSON, CHERYL J. (UNITED STATES INDIVIDUAL)
225 WOODLAKE DRIVE
GALATIN, TN 37066

Registered Sep. 11, 2012

Int. Cl.: 16

FOR: CHILDREN'S BOOKS; CHILDREN'S INTERACTIVE EDUCATIONAL BOOKS; EDUCATIONAL KITS SOLD AS A UNIT IN THE FIELD OF HISTORY CONSISTING PRIMARILY OF PRINTED INSTRUCTIONAL MATERIALS AND ALSO INCLUDING AUDIO CDS, IN CLASS 16 (U.S. CLS. 2, 5, 22, 23, 29, 37, 38 AND 50).

TRADEMARK

PRINCIPAL REGISTER

FIRST USE 3-15-1995; IN COMMERCE 3-15-1995.

THE MARK CONSISTS OF STANDARD CHARACTERS WITHOUT CLAIM TO ANY PARTICULAR FONT, STYLE, SIZE, OR COLOR.

NO CLAIM IS MADE TO THE EXCLUSIVE RIGHT TO USE "PRODUCTIONS", APART FROM THE MARK AS SHOWN.

SER. NO. 85-534,686, FILED 2-6-2012.

MATTHEW KLINE, EXAMINING ATTORNEY



David J. Kyffers

Director of the United States Patent and Trademark Office

United States of America

United States Patent and Trademark Office

IREVIVAL

Reg. No. 4,205,634

LUSH INVESTMENTS, INC. (TEXAS CORPORATION), DBA ADVANCED SKIN FITNESS
2928 OAK LAWN AVE
DALLAS, TX 75219

Registered Sep. 11, 2012

Int. Cl.: 44

FOR: MINIMALLY INVASIVE COSMETIC MEDICAL PROCEDURE COMBINING FRACTIONAL LASER RESURFACING AND THE INJECTION OF BLOOD-DERIVED GROWTH FACTORS INCLUDING PLATELET RICH FIBRIN MATRIX, IN CLASS 44 (U.S. CLS. 100 AND 101).

SERVICE MARK

PRINCIPAL REGISTER

FIRST USE 1-27-2012; IN COMMERCE 1-27-2012.

THE MARK CONSISTS OF STANDARD CHARACTERS WITHOUT CLAIM TO ANY PARTICULAR FONT, STYLE, SIZE, OR COLOR.

SER. NO. 85-534,689, FILED 2-6-2012.

JEFFREY LOOK, EXAMINING ATTORNEY



David J. Kyffers

Director of the United States Patent and Trademark Office

United States of America

United States Patent and Trademark Office

iN2L

Reg. No. 4,205,635

Registered Sep. 11, 2012

Int. Cl.: 9

TRADEMARK

PRINCIPAL REGISTER

IT'S NEVER 2 LATE, LLC (COLORADO LIMITED LIABILITY COMPANY)
SUITE "O"
7330 SOUTH ALTON WAY
CENTENNIAL, CO 80112

FOR: COMPUTER SOFTWARE AND HARDWARE SYSTEMS, NAMELY SYSTEMS FOR NURSING HOMES, ASSISTED AND INDEPENDENT SENIOR LIVING COMMUNITIES, MEMORY CARE SETTINGS, AND ADULT DAY PROGRAMS, WHICH SYSTEMS ARE STRATEGICALLY DESIGNED AND DEVELOPED TO PROMOTE WELLNESS AND ENGAGE ELDERS, IN CLASS 9 (U.S. CLS. 21, 23, 26, 36 AND 38).

FIRST USE 6-1-2002; IN COMMERCE 6-1-2002.

THE MARK CONSISTS OF STANDARD CHARACTERS WITHOUT CLAIM TO ANY PARTICULAR FONT, STYLE, SIZE, OR COLOR.

SER. NO. 85-534,709, FILED 2-6-2012.

NATALIE POLZER, EXAMINING ATTORNEY



David J. Kyffers

Director of the United States Patent and Trademark Office

United States of America

United States Patent and Trademark Office

CoCo Cheznaynay

Reg. No. 4,205,636

MARTINES, SUUZ T (UNITED STATES INDIVIDUAL)
307 W TREMONT AVE #C
CHARLOTTE, NC 28203

Registered Sep. 11, 2012

Int. Cls.: 16 and 25

FOR: NOTEPADS, GREETING CARDS, FICTIONAL INSPIRATIONAL BOOKS, IN CLASS 16 (U.S. CLS. 2, 5, 22, 23, 29, 37, 38 AND 50).

TRADEMARK

FIRST USE 7-31-1999; IN COMMERCE 7-31-1999.

PRINCIPAL REGISTER

FOR: SHIRTS, HATS, SKIRTS, PANTS, IN CLASS 25 (U.S. CLS. 22 AND 39).

FIRST USE 7-31-1999; IN COMMERCE 7-31-1999.

THE MARK CONSISTS OF STANDARD CHARACTERS WITHOUT CLAIM TO ANY PARTICULAR FONT, STYLE, SIZE, OR COLOR.

THE NAME "COCO CHEZNAYNAY" DOES NOT IDENTIFY A LIVING INDIVIDUAL.

THE WORDING "COCO CHEZNAYNAY" HAS NO MEANING IN A FOREIGN LANGUAGE.

SER. NO. 85-534,714, FILED 2-6-2012.

JEFFREY LOOK, EXAMINING ATTORNEY



David J. Kyffers

Director of the United States Patent and Trademark Office

United States of America

United States Patent and Trademark Office

NUSURFACE

Reg. No. 4,205,637

LUSH INVESTMENTS, INC. (TEXAS CORPORATION), DBA ADVANCED SKIN FITNESS
2928 OAK LAWN AVE
DALLAS, TX 75219

Registered Sep. 11, 2012

Int. Cl.: 44

FOR: MINIMALLY INVASIVE COSMETIC MEDICAL PROCEDURE COMBINING FRACTIONAL LASER RESURFACING AND THE INJECTION OF BLOOD-DERIVED GROWTH FACTORS INCLUDING PLATELET RICH FIBRIN MATRIX, IN CLASS 44 (U.S. CLS. 100 AND 101).

SERVICE MARK

PRINCIPAL REGISTER

FIRST USE 1-27-2012; IN COMMERCE 1-27-2012.

THE MARK CONSISTS OF STANDARD CHARACTERS WITHOUT CLAIM TO ANY PARTICULAR FONT, STYLE, SIZE, OR COLOR.

SER. NO. 85-534,718, FILED 2-6-2012.

JEFFREY LOOK, EXAMINING ATTORNEY



David J. Kyffers

Director of the United States Patent and Trademark Office

United States of America

United States Patent and Trademark Office



Reg. No. 4,205,638

Registered Sep. 11, 2012

Int. Cl.: 16

TRADEMARK

PRINCIPAL REGISTER

HUTCHINSON, CHERYL J. (UNITED STATES INDIVIDUAL)
225 WOODLAKE DRIVE
GALATIN, TN 37066

FOR: CHILDREN'S BOOKS; CHILDREN'S INTERACTIVE EDUCATIONAL BOOKS; EDUCATIONAL KITS SOLD AS A UNIT IN THE FIELD OF HISTORY CONSISTING PRIMARILY OF PRINTED INSTRUCTIONAL MATERIALS AND ALSO INCLUDING AUDIO CDS, IN CLASS 16 (U.S. CLS. 2, 5, 22, 23, 29, 37, 38 AND 50).

FIRST USE 3-15-1995; IN COMMERCE 3-15-1995.

NO CLAIM IS MADE TO THE EXCLUSIVE RIGHT TO USE "PRODUCTIONS", APART FROM THE MARK AS SHOWN.

THE MARK CONSISTS OF A STYLIZED TOY BOX CONTAINING MULTIPLE IMAGES OF TOYS EMERGING FROM THE TOP OF THE BOX, INCLUDING A STRIPED BALL, A DRUM, A TOY TRAIN, A TOP, A BOX WITH A TURN HANDLE, A TOY SOLDIER, A BOAT, A BASEBALL BAT AND A TEDDY BEAR HANGING FROM THE RIGHT SIDE OF THE TOY BOX. THE WORD TOY APPEARS STYLIZED NEXT TO THE BEAR ON THE BOX. ON THE GROUND NEXT TO THE BOTTOM LEFT OF THE BOX IS AN UPRIGHT STUFFED DOLL THAT IS SMILING. NEXT TO THE DOLL ARE 3 STYLIZED BLOCKS, EACH CONTAINING A SEPARATE LETTER SPELLING OUT BOX AND EACH CASTING A SHADOW, ABOVE THE STYLIZED WORD PRODUCTIONS.

SER. NO. 85-534,727, FILED 2-6-2012.

MATTHEW KLINE, EXAMINING ATTORNEY



David J. Kypas

Director of the United States Patent and Trademark Office

United States of America

United States Patent and Trademark Office

Conterra

Reg. No. 4,205,639

Registered Sep. 11, 2012

Int. Cl.: 9

TRADEMARK

PRINCIPAL REGISTER

ORIENTE, LLC (NEW YORK LIMITED LIABILITY COMPANY)
120 WEST AVE.
SARATOGA SPRINGS, NY 12866

FOR: COMPUTER APPLICATION SOFTWARE FOR MOBILE PHONES, HANDHELD COMPUTERS, NAMELY, SOFTWARE FOR ENTERPRISE CONTENT MANAGEMENT, DOCUMENT MANAGEMENT, BUSINESS PROCESS MANAGEMENT, RECORD MANAGEMENT, HUMAN RESOURCES MANAGEMENT, CONTRACT MANAGEMENT; COMPUTER HARDWARE AND SOFTWARE SYSTEMS FOR ENTERPRISE CONTENT MANAGEMENT, DOCUMENT MANAGEMENT, BUSINESS PROCESS MANAGEMENT, RECORD MANAGEMENT, HUMAN RESOURCES MANAGEMENT, CONTRACT MANAGEMENT; COMPUTER SOFTWARE FOR ACCESSING INFORMATION DIRECTORIES THAT MAY BE DOWNLOADED FROM THE GLOBAL COMPUTER NETWORK; COMPUTER SOFTWARE FOR APPLICATION AND DATABASE INTEGRATION; COMPUTER SOFTWARE FOR CREATING SEARCHABLE DATABASES OF INFORMATION AND DATA; COMPUTER SOFTWARE FOR MANIPULATING DIGITAL AUDIO INFORMATION FOR USE IN AUDIO MEDIA APPLICATIONS; COMPUTER SOFTWARE FOR PROVIDING AN ON-LINE DATABASE IN THE FIELD OF TRANSACTION PROCESSING TO UPLOAD TRANSACTIONAL DATA, PROVIDE STATISTICAL ANALYSIS, AND PRODUCE NOTIFICATIONS AND REPORTS; COMPUTER SOFTWARE FOR THE COLLECTION, EDITING, ORGANIZING, MODIFYING, BOOK MARKING, TRANSMISSION, STORAGE AND SHARING OF DATA AND INFORMATION; COMPUTER SOFTWARE FOR USE IN CUSTOMER RELATIONSHIP MANAGEMENT (CRM); COMPUTER SOFTWARE FOR USE IN THE ENCRYPTION AND DECRYPTION OF DIGITAL FILES, INCLUDING AUDIO, VIDEO, TEXT, BINARY, STILL IMAGES, GRAPHICS AND MULTIMEDIA FILES; COMPUTER SOFTWARE FOR USE IN THE SAFEGUARDING OF DIGITAL FILES, INCLUDING AUDIO, VIDEO, TEXT, BINARY, STILL IMAGES, GRAPHICS AND MULTIMEDIA FILES; COMPUTER SOFTWARE FOR ENTERPRISE CONTENT MANAGEMENT, DOCUMENT MANAGEMENT, BUSINESS PROCESS MANAGEMENT, RECORD MANAGEMENT, HUMAN RESOURCES MANAGEMENT, CONTRACT MANAGEMENT; COMPUTER SOFTWARE FOR ENTERPRISE CONTENT MANAGEMENT, DOCUMENT MANAGEMENT, BUSINESS PROCESS MANAGEMENT, RECORD MANAGEMENT, HUMAN RESOURCES MANAGEMENT, CONTRACT MANAGEMENT THAT MAY BE DOWNLOADED FROM A GLOBAL COMPUTER NETWORK; COMPUTER SOFTWARE THAT PROVIDES REAL-TIME, INTEGRATED BUSINESS MANAGEMENT INTELLIGENCE BY COMBINING INFORMATION FROM VARIOUS DATABASES AND PRESENTING IT IN AN EASY-TO-UNDERSTAND USER INTERFACE, IN CLASS 9 (U.S. CLS. 21, 23, 26, 36 AND 38).



David J. Kybas

Director of the United States Patent and Trademark Office

Reg. No. 4,205,639 FIRST USE 9-12-2011; IN COMMERCE 9-12-2011.

THE MARK CONSISTS OF STANDARD CHARACTERS WITHOUT CLAIM TO ANY PARTICULAR FONT, STYLE, SIZE, OR COLOR.

THE ENGLISH TRANSLATION OF "CONTERRA" IN THE MARK IS "WILL CONTAIN".

SER. NO. 85-534,757, FILED 2-6-2012.

TINA MAI, EXAMINING ATTORNEY

United States of America

United States Patent and Trademark Office

POWERAPP

Reg. No. 4,205,640

IOREVOLUTION INC. (DELAWARE CORPORATION)
13345 FOX GLOVE STREET
WINTER GARDEN, FL 34787

Registered Sep. 11, 2012

Int. Cl.: 9

FOR: COMPUTER SOFTWARE PLATFORMS FOR ENABLING INTERACTIVE CONTENT TO RUN INSIDE EMAILS, IN CLASS 9 (U.S. CLS. 21, 23, 26, 36 AND 38).

TRADEMARK

FIRST USE 1-17-2011; IN COMMERCE 2-26-2011.

PRINCIPAL REGISTER

THE MARK CONSISTS OF STANDARD CHARACTERS WITHOUT CLAIM TO ANY PARTICULAR FONT, STYLE, SIZE, OR COLOR.

SER. NO. 85-534,780, FILED 2-6-2012.

JACQUELINE A. LAVINE, EXAMINING ATTORNEY



David J. Kybas

Director of the United States Patent and Trademark Office

United States of America

United States Patent and Trademark Office



Reg. No. 4,205,641

RETIREMENT LIVING TV, LLC (MARYLAND LIMITED LIABILITY COMPANY)
5525 RESEARCH PARK DRIVE
BALTIMORE, MD 21228

Registered Sep. 11, 2012

Int. Cl.: 38

FOR: CABLE TELEVISION BROADCASTING SERVICES, IN CLASS 38 (U.S. CLS. 100, 101 AND 104).

SERVICE MARK

FIRST USE 10-20-2011; IN COMMERCE 10-20-2011.

PRINCIPAL REGISTER

THE MARK CONSISTS OF THE LETTERS "RLTV" ON THE FIRST LINE WITH THE WORDS "REDEFINE LIFE," WITH A DASH BEFORE AND AFTER, ON THE SECOND LINE CENTERED BELOW; THE LITERAL AND OTHER ELEMENTS OF THE MARK ARE IN THE COLOR GOLD ON THE FACE OF THE LETTERS OF THE LITERAL ELEMENT OF THE MARK AND THE DASHES, WITH A THIN BLACK LINE ON THE LEFT AND UNDERSIDE OF THE LETTERS OF THE LITERAL ELEMENT AND THE DASHES, AND A SOLID DARKER GOLD THIN LINE ON PARTS OF THE RIGHT SIDE AND UPPER PORTIONS OF THE LETTERS OF THE LITERAL ELEMENT AND THE DASHES .

THE COLOR(S) GOLD, DARKER GOLD AND BLACK IS/ARE CLAIMED AS A FEATURE OF THE MARK.

SER. NO. 85-534,791, FILED 2-6-2012.

JAY FLOWERS, EXAMINING ATTORNEY



David J. Kyffers

Director of the United States Patent and Trademark Office

United States of America

United States Patent and Trademark Office

SYSTEMSONE

Reg. No. 4,205,642

SYSTEMONE, LLC (FLORIDA LIMITED LIABILITY COMPANY)
200 SW ATLANTA AVENUE
STUART, FL 34994

Registered Sep. 11, 2012

Int. Cl.: 9

FOR: COMPUTER SOFTWARE AND HARDWARE, FOR USE WITH MEDICAL PATIENT MONITORING EQUIPMENT, FOR RECEIVING, PROCESSING, TRANSMITTING AND DISPLAYING DATA, IN CLASS 9 (U.S. CLS. 21, 23, 26, 36 AND 38).

TRADEMARK

FIRST USE 5-31-2005; IN COMMERCE 5-31-2005.

PRINCIPAL REGISTER

THE MARK CONSISTS OF STANDARD CHARACTERS WITHOUT CLAIM TO ANY PARTICULAR FONT, STYLE, SIZE, OR COLOR.

SER. NO. 85-534,793, FILED 2-6-2012.

KATHLEEN M. VANSTON, EXAMINING ATTORNEY



David J. Kyffers

Director of the United States Patent and Trademark Office

United States of America

United States Patent and Trademark Office

CIGAVETTE

Reg. No. 4,205,643

BRAINBOX INDUSTRIES, LLC (NEVADA LIMITED LIABILITY COMPANY)
3565 LAS VEGAS BLVD S. SUITE 268
LAS VEGAS, NV 89109

Registered Sep. 11, 2012

Int. Cl.: 34

FOR: ELECTRIC CIGARETTES; SMOKELESS CIGARETTE VAPORIZER PIPE, IN CLASS 34 (U.S. CLS. 2, 8, 9 AND 17).

TRADEMARK

FIRST USE 6-28-2011; IN COMMERCE 6-28-2011.

PRINCIPAL REGISTER

THE MARK CONSISTS OF STANDARD CHARACTERS WITHOUT CLAIM TO ANY PARTICULAR FONT, STYLE, SIZE, OR COLOR.

SER. NO. 85-534,794, FILED 2-6-2012.

JAY FLOWERS, EXAMINING ATTORNEY



David J. Kyffers

Director of the United States Patent and Trademark Office

United States of America
United States Patent and Trademark Office



Reg. No. 4,205,644

BIGSTUB, INC. (CALIFORNIA CORPORATION)
1336 N MOORPARK ROAD #336
THOUSAND OAKS, CA 91360

Registered Sep. 11, 2012

Int. Cl.: 41

FOR: TICKET AGENCY SERVICES FOR ENTERTAINMENT EVENTS, IN CLASS 41 (U.S. CLS. 100, 101 AND 107).

SERVICE MARK

FIRST USE 0-0-2006; IN COMMERCE 0-0-2006.

PRINCIPAL REGISTER

THE MARK CONSISTS OF THE STYLIZED WORD "BIG" IN BLACK WITH THE DOT IN THE "I" BEING THE ARTISTIC RENDERING OF A STAR IN RED. THE WORD "BIG" IS FOLLOWED BY THE WORD "STUB" IN RED. THE "B" IN THE WORD "STUB" APPEARS INSIDE THE ARTISTIC RENDERING OF A TICKET IN BLACK.

THE COLOR(S) RED AND BLACK IS/ARE CLAIMED AS A FEATURE OF THE MARK.

SER. NO. 85-534,795, FILED 2-6-2012.

JAY FLOWERS, EXAMINING ATTORNEY



David J. Kyros

Director of the United States Patent and Trademark Office

United States of America

United States Patent and Trademark Office

ProjectBaby

Reg. No. 4,205,645

Registered Sep. 11, 2012

Int. Cl.: 41

SERVICE MARK

PRINCIPAL REGISTER

PROJECT BABY ENTERPRISES (CALIFORNIA LIMITED LIABILITY COMPANY),
FORMERLY MEDIA SPEEDWAY
2501 VIA VIESTA
LA JOLLA, CA 92037

FOR: ENTERTAINMENT IN THE NATURE OF AN ONGOING TELEVISION PROGRAM WHERE EACH EPISODE FOLLOWS REAL LIFE COUPLES AND COVERS ALL ASPECTS OF STARTING A FAMILY, NAMELY, NATURAL REPRODUCTION AND ALL FORMS OF ASSISTED REPRODUCTION; PROVIDING AN INTERNET WEB SITE THAT FEATURES AN ONGOING TELEVISION PROGRAM WHERE EACH EPISODE FOLLOWS REAL LIFE COUPLES AND COVERS ALL ASPECTS OF STARTING A FAMILY, NAMELY, NATURAL REPRODUCTION AND ALL FORMS OF ASSISTED REPRODUCTION, PODCASTS AND ONLINE JOURNALS, NAMELY, BLOGS ABOUT TRYING TO START A FAMILY, IN CLASS 41 (U.S. CLS. 100, 101 AND 107).

FIRST USE 12-4-2004; IN COMMERCE 6-14-2005.

OWNER OF U.S. REG. NO. 3,456,365.

THE COLOR(S) BLUE AND ORANGE IS/ARE CLAIMED AS A FEATURE OF THE MARK.

THE MARK CONSISTS OF THE WORDS "PROJECT BABY" WITH THE FIRST WORD "PROJECT" IN THE COLOR BLUE AND THE SECOND WORD "BABY" IN THE COLOR ORANGE AND THE SECOND LETTER "A" FOR THE WORD "BABY" IS TILED TO THE RIGHT.

SER. NO. 85-534,796, FILED 2-6-2012.

JAY FLOWERS, EXAMINING ATTORNEY



David J. Kyffers

Director of the United States Patent and Trademark Office

United States of America

United States Patent and Trademark Office

APRIADIRECT

Reg. No. 4,205,646

APRIA HEALTHCARE GROUP INC. (DELAWARE CORPORATION)
26220 ENTERPRISE COURT
LAKE FOREST, CA 92630

Registered Sep. 11, 2012

Int. Cl.: 35

FOR: ONLINE RETAIL STORE SERVICES FEATURING HOME HEALTHCARE PRODUCTS AND ACCESSORIES, IN CLASS 35 (U.S. CLS. 100, 101 AND 102).

SERVICE MARK

FIRST USE 10-23-2010; IN COMMERCE 10-23-2010.

PRINCIPAL REGISTER

THE MARK CONSISTS OF STANDARD CHARACTERS WITHOUT CLAIM TO ANY PARTICULAR FONT, STYLE, SIZE, OR COLOR.

SER. NO. 85-534,800, FILED 2-6-2012.

JAY FLOWERS, EXAMINING ATTORNEY



David J. Kyffers

Director of the United States Patent and Trademark Office

United States of America

United States Patent and Trademark Office

MINIS

Reg. No. 4,205,647

Registered Sep. 11, 2012

Int. Cl.: 21

TRADEMARK

PRINCIPAL REGISTER

STAINO, LLC (NEW YORK LIMITED LIABILITY COMPANY)
11617 STATE ROUTE 97
LONG EDDY, NY 12760

FOR: INTERDENTAL BRUSHES, IN CLASS 21 (U.S. CLS. 2, 13, 23, 29, 30, 33, 40 AND 50).

FIRST USE 9-0-2006; IN COMMERCE 9-0-2006.

THE MARK CONSISTS OF STANDARD CHARACTERS WITHOUT CLAIM TO ANY PARTICULAR FONT, STYLE, SIZE, OR COLOR.

OWNER OF U.S. REG. NO. 3,270,551.

SEC. 2(F).

SER. NO. 85-534,816, FILED 2-6-2012.

ELIZABETH KAJUBI, EXAMINING ATTORNEY



David J. Kyffers

Director of the United States Patent and Trademark Office

United States of America

United States Patent and Trademark Office

SOURCE INTERNATIONAL

Reg. No. 4,205,648

Registered Sep. 11, 2012

Int. Cl.: 40

SERVICE MARK

PRINCIPAL REGISTER

MIDWEST TRUCK & AUTO PARTS, INC. (ILLINOIS CORPORATION)
1001 W. EXCHANGE AVE.
CHICAGO, IL 60609

FOR: CONTRACT MANUFACTURING OF PARTS, COMPONENTS AND ASSEMBLIES IN THE AGRICULTURE, AUTOMOTIVE, CONSTRUCTION AND MARINE EQUIPMENT FIELDS; CUSTOM FABRICATION AND PRODUCTION OF PARTS AND ASSEMBLIES IN THE AGRICULTURE, AUTOMOTIVE, CONSTRUCTION AND MARINE EQUIPMENT FIELDS; MANUFACTURING SERVICES FOR OTHERS IN THE AGRICULTURE, AUTOMOTIVE, CONSTRUCTION AND MARINE EQUIPMENT FIELDS, IN CLASS 40 (U.S. CLS. 100, 103 AND 106).

FIRST USE 0-0-1997; IN COMMERCE 0-0-1997.

THE MARK CONSISTS OF STANDARD CHARACTERS WITHOUT CLAIM TO ANY PARTICULAR FONT, STYLE, SIZE, OR COLOR.

SEC. 2(F).

SER. NO. 85-534,819, FILED 2-6-2012.

BRIAN CALLAGHAN, EXAMINING ATTORNEY



David J. Kyffers

Director of the United States Patent and Trademark Office

United States of America

United States Patent and Trademark Office

YOU GROW IT, WE KNOW IT!

Reg. No. 4,205,649

Registered Sep. 11, 2012

Int. Cl.: 35

SERVICE MARK

PRINCIPAL REGISTER

DETROIT HYDROPONICS, INC. (MICHIGAN CORPORATION), DBA THE CULTIVATION STATION
23529 LITTLE MACK
ST. CLAIRE SHORES, MI 48080

FOR: ON-LINE RETAIL STORE SERVICES FEATURING HYDROPONIC AND GARDENING SUPPLIES; RETAIL STORE SERVICES FEATURING HYDROPONIC AND GARDENING SUPPLIES, IN CLASS 35 (U.S. CLS. 100, 101 AND 102).

FIRST USE 8-5-1998; IN COMMERCE 8-5-1998.

THE MARK CONSISTS OF STANDARD CHARACTERS WITHOUT CLAIM TO ANY PARTICULAR FONT, STYLE, SIZE, OR COLOR.

SER. NO. 85-534,820, FILED 2-6-2012.

SALLY SHIH, EXAMINING ATTORNEY



David J. Kyffers

Director of the United States Patent and Trademark Office

United States of America

United States Patent and Trademark Office

THE CULTIVATION STATION

Reg. No. 4,205,650

Registered Sep. 11, 2012

Int. Cl.: 35

SERVICE MARK

PRINCIPAL REGISTER

DETROIT HYDROPONICS, INC. (MICHIGAN CORPORATION), DBA THE CULTIVATION STATION
23529 LITTLE MACK
ST. CLAIRE SHORES, MI 48080

FOR: ON-LINE RETAIL STORE SERVICES FEATURING HYDROPONIC AND GARDENING SUPPLIES; RETAIL STORE SERVICES FEATURING HYDROPONIC AND GARDENING SUPPLIES, IN CLASS 35 (U.S. CLS. 100, 101 AND 102).

FIRST USE 8-5-1998; IN COMMERCE 8-5-1998.

THE MARK CONSISTS OF STANDARD CHARACTERS WITHOUT CLAIM TO ANY PARTICULAR FONT, STYLE, SIZE, OR COLOR.

SER. NO. 85-534,822, FILED 2-6-2012.

SALLY SHIH, EXAMINING ATTORNEY



David J. Kyffers

Director of the United States Patent and Trademark Office

United States of America

United States Patent and Trademark Office



Reg. No. 4,205,651

THE MEADOWS OF WICKENBURG, INC. (DELAWARE CORPORATION)
1655 N. TEGNER ST.
WICKENBURG, AZ 85390

Registered Sep. 11, 2012

Int. Cl.: 44

FOR: MENTAL HEALTH AND SUBSTANCE ABUSE TREATMENT CENTER SERVICES,
IN CLASS 44 (U.S. CLS. 100 AND 101).

SERVICE MARK

FIRST USE 3-19-2012; IN COMMERCE 3-19-2012.

PRINCIPAL REGISTER

OWNER OF U.S. REG. NOS. 2,013,513, 2,212,272, AND 2,981,057.

THE MARK CONSISTS OF THE WORDS "THE MEADOWS" UNDER A DESIGN OF A SUN
WITH TWO WAVY LINES.

SER. NO. 85-534,827, FILED 2-6-2012.

KATHRYN COWARD, EXAMINING ATTORNEY



David J. Kyjars

Director of the United States Patent and Trademark Office

United States of America

United States Patent and Trademark Office

!!!MANIC SALAMANDER

Reg. No. 4,205,652

Registered Sep. 11, 2012

Int. Cl.: 9

TRADEMARK

PRINCIPAL REGISTER

!!!MANIC SALAMANDER, INC. (MINNESOTA CORPORATION), DBA !!!MANIC
SALAMANDER
PO BOX 14720
MINNEAPOLIS, MN 55414

FOR: ELECTRICAL POWER MANAGEMENT DEVICES; ELECTRIC CHARGING CABLES;
ELECTRIC CONNECTIONS AND CONNECTORS; ELECTRIC OUTLETS FOR VEHICLES;
ELECTRICAL ACCESSORIES FOR VEHICLES, IN CLASS 9 (U.S. CLS. 21, 23, 26, 36 AND
38).

FIRST USE 5-31-2003; IN COMMERCE 9-7-2003.

THE MARK CONSISTS OF STANDARD CHARACTERS WITHOUT CLAIM TO ANY PAR-
TICULAR FONT, STYLE, SIZE, OR COLOR.

SER. NO. 85-534,845, FILED 2-6-2012.

THOMAS MANOR, EXAMINING ATTORNEY



David J. Kyffers

Director of the United States Patent and Trademark Office

United States of America

United States Patent and Trademark Office

GYPSY 05

Reg. No. 4,205,653

GYPSY 05, INC. (CALIFORNIA CORPORATION)
3200 UNION PACIFIC AVENUE
LOS ANGELES, CA 90023

Registered Sep. 11, 2012

Int. Cl.: 18

FOR: BAGS, NAMELY, HANDBAGS, SHOULDER BAGS, PURSES, CLUTCHES, WALLETS
AND BACKPACKS, IN CLASS 18 (U.S. CLS. 1, 2, 3, 22 AND 41).

TRADEMARK

FIRST USE 7-29-2011; IN COMMERCE 7-29-2011.

PRINCIPAL REGISTER

THE MARK CONSISTS OF STANDARD CHARACTERS WITHOUT CLAIM TO ANY PAR-
TICULAR FONT, STYLE, SIZE, OR COLOR.

OWNER OF U.S. REG. NOS. 3,106,284, 3,642,608, AND 4,016,896.

SER. NO. 85-534,851, FILED 2-6-2012.

KEVIN DINALLO, EXAMINING ATTORNEY



David J. Kyros

Director of the United States Patent and Trademark Office

United States of America

United States Patent and Trademark Office

THE RECIPE FOR A LONG & HAPPY LIFE TOGETHER

Reg. No. 4,205,654

DARFORD INDUSTRIES LTD. (CANADA CORPORATION)
1150 KALAMALKA LAKE ROAD, SUITE 100
VERNON, BC, CANADA V1T-6V2

Registered Sep. 11, 2012

Int. Cl.: 31

FOR: PET FOOD; EDIBLE PET TREATS, IN CLASS 31 (U.S. CLS. 1 AND 46).

TRADEMARK

FIRST USE 4-14-2012; IN COMMERCE 4-14-2012.

PRINCIPAL REGISTER

THE MARK CONSISTS OF STANDARD CHARACTERS WITHOUT CLAIM TO ANY PARTICULAR FONT, STYLE, SIZE, OR COLOR.

SER. NO. 85-534,857, FILED 2-6-2012.

KEVIN DINALLO, EXAMINING ATTORNEY



David J. Kybas

Director of the United States Patent and Trademark Office

United States of America

United States Patent and Trademark Office

!!!MANIC SALAMANDER

Reg. No. 4,205,655

Registered Sep. 11, 2012

Int. Cl.: 12

TRADEMARK

PRINCIPAL REGISTER

!!!MANIC SALAMANDER, INC. (MINNESOTA CORPORATION), DBA !!!MANIC
SALAMANDER
PO BOX 14720
MINNEAPOLIS, MN 55414

FOR: HANDLEBAR ACCESSORIES FOR MOTORIZED VEHICLES, IN CLASS 12 (U.S. CLS.
19, 21, 23, 31, 35 AND 44).

FIRST USE 5-31-2003; IN COMMERCE 9-7-2003.

THE MARK CONSISTS OF STANDARD CHARACTERS WITHOUT CLAIM TO ANY PAR-
TICULAR FONT, STYLE, SIZE, OR COLOR.

SER. NO. 85-534,861, FILED 2-6-2012.

THOMAS MANOR, EXAMINING ATTORNEY



David J. Kyffers

Director of the United States Patent and Trademark Office

United States of America

United States Patent and Trademark Office

SMOOTH CITY

Reg. No. 4,205,656

Registered Sep. 11, 2012

Int. Cl.: 12

TRADEMARK

PRINCIPAL REGISTER

!!!MANIC SALAMANDER, INC. (MINNESOTA CORPORATION), DBA !!!MANIC
SALAMANDER
PO BOX 14720
MINNEAPOLIS, MN 55414

FOR: HANDLEBAR ACCESSORIES FOR MOTORIZED VEHICLES, IN CLASS 12 (U.S. CLS.
19, 21, 23, 31, 35 AND 44).

FIRST USE 4-30-2008; IN COMMERCE 3-7-2010.

THE MARK CONSISTS OF STANDARD CHARACTERS WITHOUT CLAIM TO ANY PAR-
TICULAR FONT, STYLE, SIZE, OR COLOR.

SER. NO. 85-534,868, FILED 2-6-2012.

THOMAS MANOR, EXAMINING ATTORNEY



David J. Kyffers

Director of the United States Patent and Trademark Office

United States of America

United States Patent and Trademark Office

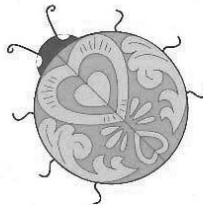

Reg. No. 4,205,657

LADIBUGS, INCORPORATED (MINNESOTA CORPORATION)
15387 AQUILA AVE.
SAVAGE, MN 55738

Registered Sep. 11, 2012

Int. Cl.: 3

FOR: HAIR CARE KITS COMPRISING NON-MEDICATED HAIR CARE PREPARATIONS, NAMELY, SHAMPOO, CONDITIONER, AND NON-MEDICATED HAIR CARE PREPARATIONS; HAIR CARE LOTIONS; HAIR CARE PREPARATIONS; HAIR SHAMPOOS AND CONDITIONERS, IN CLASS 3 (U.S. CLS. 1, 4, 6, 50, 51 AND 52).

TRADEMARK

PRINCIPAL REGISTER

FIRST USE 5-3-2010; IN COMMERCE 5-3-2010.

THE MARK CONSISTS OF A DESIGN OF A LADYBUG INCORPORATING THREE HEARTS.

SER. NO. 85-534,879, FILED 2-6-2012.

THOMAS MANOR, EXAMINING ATTORNEY



David J. Kyros

Director of the United States Patent and Trademark Office

United States of America

United States Patent and Trademark Office

SVCD

Reg. No. 4,205,658

WHEATLEY, MICHAEL T (UNITED STATES INDIVIDUAL), DBA CREATIVE DESIGNS
1337 ECHO VALLEY DR
SAN JOSE, CA 95120

Registered Sep. 11, 2012

Int. Cl.: 14

FOR: JEWELRY, IN CLASS 14 (U.S. CLS. 2, 27, 28 AND 50).

TRADEMARK

FIRST USE 4-1-2011; IN COMMERCE 4-1-2011.

PRINCIPAL REGISTER

THE MARK CONSISTS OF STANDARD CHARACTERS WITHOUT CLAIM TO ANY PARTICULAR FONT, STYLE, SIZE, OR COLOR.

SER. NO. 85-534,881, FILED 2-6-2012.

THOMAS MANOR, EXAMINING ATTORNEY



David J. Kyffers

Director of the United States Patent and Trademark Office

United States of America

United States Patent and Trademark Office

Pass Of All Passes

Reg. No. 4,205,659

Registered Sep. 11, 2012

Int. Cl.: 41

SERVICE MARK

PRINCIPAL REGISTER

SEVEN PEAKS PLACE LC (UTAH LIMITED LIABILITY COMPANY)
615
3214 NORTH UNIVERSITY AVE.
PROVO, UT 84604

FOR: ENTERTAINMENT SERVICES, NAMELY, ARRANGING FOR TICKET RESERVATIONS FOR WATER PARKS AND AMUSEMENT CENTERS, IN CLASS 41 (U.S. CLS. 100, 101 AND 107).

FIRST USE 8-1-2010; IN COMMERCE 8-1-2010.

THE MARK CONSISTS OF STANDARD CHARACTERS WITHOUT CLAIM TO ANY PARTICULAR FONT, STYLE, SIZE, OR COLOR.

SER. NO. 85-534,886, FILED 2-6-2012.

CHERYL CLAYTON, EXAMINING ATTORNEY



David J. Kyffers

Director of the United States Patent and Trademark Office

United States of America

United States Patent and Trademark Office

inControl

Reg. No. 4,205,660

Registered Sep. 11, 2012

Int. Cl.: 10

TRADEMARK

PRINCIPAL REGISTER

HEB GROCERY COMPANY, LP (TEXAS LIMITED PARTNERSHIP)
CORPORATE LAW DEPARTMENT
646 S. MAIN
SAN ANTONIO, TX 78204

FOR: BLOOD PRESSURE MONITORS, INJECTION NEEDLES FOR MEDICAL USE, IN CLASS 10 (U.S. CLS. 26, 39 AND 44).

FIRST USE 5-12-2007; IN COMMERCE 5-12-2007.

THE MARK CONSISTS OF STANDARD CHARACTERS WITHOUT CLAIM TO ANY PARTICULAR FONT, STYLE, SIZE, OR COLOR.

OWNER OF U.S. REG. NOS. 2,875,244 AND 3,105,225.

SER. NO. 85-534,903, FILED 2-6-2012.

MARK SPARACINO, EXAMINING ATTORNEY



David J. Kyffers

Director of the United States Patent and Trademark Office

United States of America

United States Patent and Trademark Office

Trafalga

Reg. No. 4,205,661

Registered Sep. 11, 2012

Int. Cl.: 41

SERVICE MARK

PRINCIPAL REGISTER

SEVEN PEAKS PLACE LC (UTAH LIMITED LIABILITY COMPANY)
SUITE 615
3214 NORTH UNIVERSITY AVE.
PROVO, UT 84604

FOR: ENTERTAINMENT SERVICES IN THE NATURE OF AN AMUSEMENT PARK ATTRACTION, NAMELY, A THEMED AREA, IN CLASS 41 (U.S. CLS. 100, 101 AND 107).

FIRST USE 5-1-1999; IN COMMERCE 5-1-1999.

THE MARK CONSISTS OF STANDARD CHARACTERS WITHOUT CLAIM TO ANY PARTICULAR FONT, STYLE, SIZE, OR COLOR.

SER. NO. 85-534,914, FILED 2-6-2012.

CHERYL CLAYTON, EXAMINING ATTORNEY



David J. Kyffers

Director of the United States Patent and Trademark Office

United States of America

United States Patent and Trademark Office

CrumplePop

Reg. No. 4,205,662

CRUMPLEPOP (MINNESOTA LIMITED LIABILITY COMPANY)
4204 E. 34TH ST.

Registered Sep. 11, 2012

MINNEAPOLIS, MN 55406

Int. Cl.: 9

FOR: COMPUTER SOFTWARE FOR USE IN DIGITAL VIDEO EDITING THAT MAY BE DOWNLOADED FROM A GLOBAL COMPUTER NETWORK, IN CLASS 9 (U.S. CLS. 21, 23, 26, 36 AND 38).

TRADEMARK

FIRST USE 10-1-2011; IN COMMERCE 10-1-2011.

PRINCIPAL REGISTER

THE MARK CONSISTS OF STANDARD CHARACTERS WITHOUT CLAIM TO ANY PARTICULAR FONT, STYLE, SIZE, OR COLOR.

SER. NO. 85-534,933, FILED 2-6-2012.

MARC LEIPZIG, EXAMINING ATTORNEY



David J. Kyffers

Director of the United States Patent and Trademark Office

United States of America
United States Patent and Trademark Office

CSTOWN

Reg. No. 4,205,663

CSTOWN USA (NEVADA CORPORATION)
2880 BICENTENIAL PKWY, UNIT 100-232
HENDERSON, NV 89044

Registered Sep. 11, 2012

Int. Cls.: 16 and 25

FOR: DECALS; STICKERS AND TRANSFERS; IRON-ON TRANSFERS, IN CLASS 16 (U.S. CLS. 2, 5, 22, 23, 29, 37, 38 AND 50).

TRADEMARK

FIRST USE 3-0-2011; IN COMMERCE 3-0-2011.

PRINCIPAL REGISTER

FOR: DRESSES, IN CLASS 25 (U.S. CLS. 22 AND 39).

FIRST USE 3-0-2011; IN COMMERCE 3-0-2011.

THE MARK CONSISTS OF STANDARD CHARACTERS WITHOUT CLAIM TO ANY PARTICULAR FONT, STYLE, SIZE, OR COLOR.

SER. NO. 85-534,947, FILED 2-6-2012.

KAREN K. BUSH, EXAMINING ATTORNEY



David J. Kyros

Director of the United States Patent and Trademark Office

United States of America

United States Patent and Trademark Office

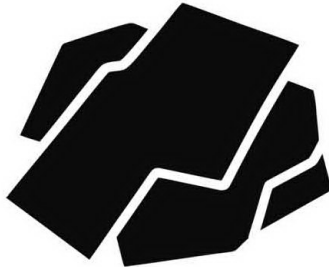

Reg. No. 4,205,664

Registered Sep. 11, 2012

Int. Cl.: 9

TRADEMARK

PRINCIPAL REGISTER

CRUMPLEPOP (MINNESOTA LIMITED LIABILITY COMPANY)
4204 E. 34TH ST.
MINNEAPOLIS, MN 55406

FOR: COMPUTER SOFTWARE FOR USE IN DIGITAL VIDEO EDITING THAT MAY BE DOWNLOADED FROM A GLOBAL COMPUTER NETWORK, IN CLASS 9 (U.S. CLS. 21, 23, 26, 36 AND 38).

FIRST USE 10-1-2011; IN COMMERCE 10-1-2011.

THE MARK CONSISTS OF A GEOMETRICAL SHAPE RESEMBLING A CRUMPLED PIECE OF PAPER.

SER. NO. 85-534,955, FILED 2-6-2012.

MARC LEIPZIG, EXAMINING ATTORNEY



David J. Kyffers

Director of the United States Patent and Trademark Office

United States of America

United States Patent and Trademark Office

CIPHERTEX

Reg. No. 4,205,665

KANER, JERRY (UNITED STATES INDIVIDUAL)
21350 NORDHOFF STREET, #112
CHATSWORTH, CA 91311

Registered Sep. 11, 2012

Int. Cls.: 9 and 42

FOR: COMPUTER DISC DRIVES; COMPUTER HARDWARE; COMPUTER SOFTWARE AND HARDWARE FOR CAPTURING, STORING, DISTRIBUTING, PROTECTING, TRANSFERRING, AND ACCESSING DATA; ELECTRONIC COMPONENTS FOR COMPUTERS; SOLID STATE DRIVES, IN CLASS 9 (U.S. CLS. 21, 23, 26, 36 AND 38).

TRADEMARK

SERVICE MARK

FIRST USE 3-1-2010; IN COMMERCE 3-1-2010.

PRINCIPAL REGISTER

FOR: COMPUTER CONSULTATION IN THE FIELD OF COMPUTER SECURITY; COMPUTER FORENSIC SERVICES; COMPUTER SECURITY CONSULTANCY; COMPUTER SECURITY SERVICE, NAMELY, RESTRICTING ACCESS TO AND BY COMPUTER NETWORKS TO AND OF UNDESIRE WEB SITES, MEDIA AND INDIVIDUALS AND FACILITIES, IN CLASS 42 (U.S. CLS. 100 AND 101).

FIRST USE 3-1-2010; IN COMMERCE 3-1-2010.

THE MARK CONSISTS OF STANDARD CHARACTERS WITHOUT CLAIM TO ANY PARTICULAR FONT, STYLE, SIZE, OR COLOR.

OWNER OF U.S. REG. NO. 3,973,322.

SER. NO. 85-534,959, FILED 2-6-2012.

JENNIFER WILLISTON, EXAMINING ATTORNEY



David J. Kyros

Director of the United States Patent and Trademark Office

United States of America

United States Patent and Trademark Office

CSTOWN

Reg. No. 4,205,666

CSTOWN USA (NEVADA CORPORATION)
2880 BICENTENIAL PKWY, UNIT 100-232
HENDERSON, NV 89044

Registered Sep. 11, 2012

Int. Cls.: 16 and 25

FOR: DECALS; STICKERS AND TRANSFERS; IRON-ON TRANSFERS, IN CLASS 16 (U.S. CLS. 2, 5, 22, 23, 29, 37, 38 AND 50).

TRADEMARK

FIRST USE 3-0-2011; IN COMMERCE 3-0-2011.

PRINCIPAL REGISTER

FOR: DRESSES, IN CLASS 25 (U.S. CLS. 22 AND 39).

FIRST USE 3-0-2011; IN COMMERCE 3-0-2011.

THE MARK CONSISTS OF THE STYLIZED WORD CSTOWN, CS AND OWN IN BLACK AND T IN RED.

THE COLOR(S) RED AND BLACK IS/ARE CLAIMED AS A FEATURE OF THE MARK.

SER. NO. 85-534,979, FILED 2-6-2012.

KAREN K. BUSH, EXAMINING ATTORNEY



David J. Kybas

Director of the United States Patent and Trademark Office

United States of America

United States Patent and Trademark Office

Loli&theBean

Reg. No. 4,205,667

LOLI AND THE BEAN, INCORPORATED (FLORIDA CORPORATION)
1400 VILLAGE SQUARE BLVD
TALLAHASSEE, FL 32312

Registered Sep. 11, 2012

Int. Cl.: 35

FOR: RETAIL STORE SERVICES FEATURING GIFTS, IN CLASS 35 (U.S. CLS. 100, 101 AND 102).

SERVICE MARK

FIRST USE 8-0-2006; IN COMMERCE 8-0-2006.

PRINCIPAL REGISTER

THE MARK CONSISTS OF STANDARD CHARACTERS WITHOUT CLAIM TO ANY PARTICULAR FONT, STYLE, SIZE, OR COLOR.

SER. NO. 85-534,995, FILED 2-6-2012.

KATHLEEN LORENZO, EXAMINING ATTORNEY



David J. Kybas

Director of the United States Patent and Trademark Office

United States of America

United States Patent and Trademark Office

Generosity Footprints

Reg. No. 4,205,668

Registered Sep. 11, 2012

Int. Cl.: 41

SERVICE MARK

PRINCIPAL REGISTER

LOYAL CHRISTIAN BENEFIT ASSOCIATION (PENNSYLVANIA CORPORATION), AKA
LCBA
700 PEACH STREET
ERIE, PA 16501

FOR: PROVIDING RECOGNITION AND INCENTIVES BY THE WAY OF AWARDS AND CONTESTS TO DEMONSTRATE EXCELLENCE IN THE FIELD OF ORGANIZED NON-PROFIT SERVICE AND INDIVIDUAL VOLUNTEERISM, IN CLASS 41 (U.S. CLS. 100, 101 AND 107).

FIRST USE 8-15-2011; IN COMMERCE 1-1-2012.

THE MARK CONSISTS OF STANDARD CHARACTERS WITHOUT CLAIM TO ANY PARTICULAR FONT, STYLE, SIZE, OR COLOR.

SER. NO. 85-535,000, FILED 2-6-2012.

LINDA E. BLOHM, EXAMINING ATTORNEY



David J. Kyffers

Director of the United States Patent and Trademark Office

United States of America

United States Patent and Trademark Office

MUSICFUEL

Reg. No. 4,205,669

PATERSON, LISA (UNITED STATES INDIVIDUAL)
11261 RYE ST.

Registered Sep. 11, 2012

STUDIO CITY, CA 91602

Int. Cl.: 41

FOR: PROVIDING A WEBSITE FEATURING ENTERTAINMENT INFORMATION;
PROVIDING EDUCATIONAL MENTORING SERVICES AND PROGRAMS IN THE FIELD
OF MUSIC FOR UNDERPRIVILEGED TEENS, IN CLASS 41 (U.S. CLS. 100, 101 AND 107).

SERVICE MARK

FIRST USE 9-0-2011; IN COMMERCE 11-0-2011.

PRINCIPAL REGISTER

THE MARK CONSISTS OF STANDARD CHARACTERS WITHOUT CLAIM TO ANY PAR-
TICULAR FONT, STYLE, SIZE, OR COLOR.

SER. NO. 85-535,008, FILED 2-6-2012.

AMY HELLA, EXAMINING ATTORNEY



David J. Kyffers

Director of the United States Patent and Trademark Office

United States of America

United States Patent and Trademark Office

Gift Of All Gifts

Reg. No. 4,205,670

Registered Sep. 11, 2012

Int. Cl.: 41

SERVICE MARK

PRINCIPAL REGISTER

SEVEN PEAKS PLACE LC (UTAH LIMITED LIABILITY COMPANY)
SUITE 615
3214 NORTH UNIVERSITY AVE.
PROVO, UT 84604

FOR: ENTERTAINMENT SERVICES, NAMELY, ARRANGING FOR TICKET RESERVATIONS FOR WATER PARKS AND AMUSEMENT CENTERS, IN CLASS 41 (U.S. CLS. 100, 101 AND 107).

FIRST USE 12-1-2010; IN COMMERCE 12-1-2010.

THE MARK CONSISTS OF STANDARD CHARACTERS WITHOUT CLAIM TO ANY PARTICULAR FONT, STYLE, SIZE, OR COLOR.

SER. NO. 85-535,019, FILED 2-6-2012.

CHERYL CLAYTON, EXAMINING ATTORNEY



David J. Kyffers

Director of the United States Patent and Trademark Office

United States of America

United States Patent and Trademark Office

AUTOSYNAPSE

Reg. No. 4,205,671

MICROBRIGHTFIELD, INC. (VERMONT CORPORATION)
185 ALLEN BROOK LANE, SUITE 101
WILLISTON, VT 05495

Registered Sep. 11, 2012

Int. Cl.: 9

FOR: COMPUTER SOFTWARE TO ANALYZE BIOLOGICAL TISSUE SAMPLES FOR RESEARCH PURPOSES NAMELY, ANALYSIS OF PRE-SYNAPTIC AND POST-SYNAPTIC STRUCTURES IN IMAGES OBTAINED FROM A MICROSCOPE, IN CLASS 9 (U.S. CLS. 21, 23, 26, 36 AND 38).

TRADEMARK

PRINCIPAL REGISTER

FIRST USE 2-3-2012; IN COMMERCE 2-3-2012.

THE MARK CONSISTS OF STANDARD CHARACTERS WITHOUT CLAIM TO ANY PARTICULAR FONT, STYLE, SIZE, OR COLOR.

SER. NO. 85-535,020, FILED 2-6-2012.

CHERYL CLAYTON, EXAMINING ATTORNEY



David J. Kyffers

Director of the United States Patent and Trademark Office

United States of America

United States Patent and Trademark Office

JOIN ME ON THE BRIDGE

Reg. No. 4,205,672

Registered Sep. 11, 2012

Int. Cl.: 36

SERVICE MARK

PRINCIPAL REGISTER

WOMEN FOR WOMEN INTERNATIONAL (D.C. CHARITABLE, NON-PROFIT CORPORATION)

4455 CONNECTICUT AVENUE, N.W.

SUITE 200

WASHINGTON, DC 20008

FOR: CHARITABLE FUNDRAISING SERVICES TO ASSIST WOMEN VICTIMS OF WAR AND CIVIL STRIFE; ESTABLISHING AND ADMINISTERING MONETARY CHARITABLE PROGRAMS TO PROVIDE INCOME-GENERATING SUPPORT AND MICRO CREDIT LOANS TO BENEFIT WOMEN VICTIMS OF WAR AND CIVIL STRIFE, IN CLASS 36 (U.S. CLS. 100, 101 AND 102).

FIRST USE 1-1-2010; IN COMMERCE 1-1-2010.

THE MARK CONSISTS OF STANDARD CHARACTERS WITHOUT CLAIM TO ANY PARTICULAR FONT, STYLE, SIZE, OR COLOR.

SER. NO. 85-535,031, FILED 2-6-2012.

MATTHEW PAPPAS, EXAMINING ATTORNEY



David J. Kyffers

Director of the United States Patent and Trademark Office

United States of America

United States Patent and Trademark Office

Simply Exceptional Connections

Reg. No. 4,205,673

PAVLOV MEDIA, INC. (DELAWARE CORPORATION)
206 N RANDOLPH ST.
CHAMPAIGN, IL 61824

Registered Sep. 11, 2012

Int. Cl.: 38

FOR: INTERNET SERVICE PROVIDER (ISP); INTERNET TELEPHONY SERVICES; TELEVISION TRANSMISSION SERVICES, IN CLASS 38 (U.S. CLS. 100, 101 AND 104).

SERVICE MARK

FIRST USE 3-2-2010; IN COMMERCE 3-2-2010.

PRINCIPAL REGISTER

THE MARK CONSISTS OF STANDARD CHARACTERS WITHOUT CLAIM TO ANY PARTICULAR FONT, STYLE, SIZE, OR COLOR.

SER. NO. 85-535,048, FILED 2-6-2012.

DAVID TAYLOR, EXAMINING ATTORNEY



David J. Kyros

Director of the United States Patent and Trademark Office

United States of America

United States Patent and Trademark Office

THE CAT'S MEOW

Reg. No. 4,205,674

RIVER LIGHT V, L.P. (DELAWARE LIMITED PARTNERSHIP)
11 WEST 19TH STREET, 7TH FLOOR
NEW YORK, NY 10011

Registered Sep. 11, 2012

Int. Cl.: 41

FOR: ON-LINE JOURNALS, NAMELY, BLOGS FEATURING NEWS, INFORMATION, AND INTERVIEWS REGARDING POPULAR CULTURE, FASHION, AND CELEBRITIES , IN CLASS 41 (U.S. CLS. 100, 101 AND 107).

SERVICE MARK

FIRST USE 8-16-2010; IN COMMERCE 8-16-2010.

PRINCIPAL REGISTER

THE MARK CONSISTS OF STANDARD CHARACTERS WITHOUT CLAIM TO ANY PARTICULAR FONT, STYLE, SIZE, OR COLOR.

OWNER OF U.S. REG. NO. 4,042,226.

SER. NO. 85-535,049, FILED 2-6-2012.

SUE LAWRENCE, EXAMINING ATTORNEY



David J. Kyffers

Director of the United States Patent and Trademark Office

United States of America
United States Patent and Trademark Office

THE HOOK

Reg. No. 4,205,675

MAHONEY, SEAN (UNITED STATES INDIVIDUAL)
1711 PAGOLA AVENUE
MANTECA, CA 95337

Registered Sep. 11, 2012

Int. Cl.: 9

FOR: MICROPHONE BOOM POLES; MICROPHONE STANDS; MICROPHONE CLAMPS,
IN CLASS 9 (U.S. CLS. 21, 23, 26, 36 AND 38).

TRADEMARK

FIRST USE 3-1-2011; IN COMMERCE 3-1-2011.

PRINCIPAL REGISTER

THE MARK CONSISTS OF STANDARD CHARACTERS WITHOUT CLAIM TO ANY PAR-
TICULAR FONT, STYLE, SIZE, OR COLOR.

SER. NO. 85-535,054, FILED 2-6-2012.

JACQUELINE A. LAVINE, EXAMINING ATTORNEY



David J. Kybas

Director of the United States Patent and Trademark Office

United States of America

United States Patent and Trademark Office

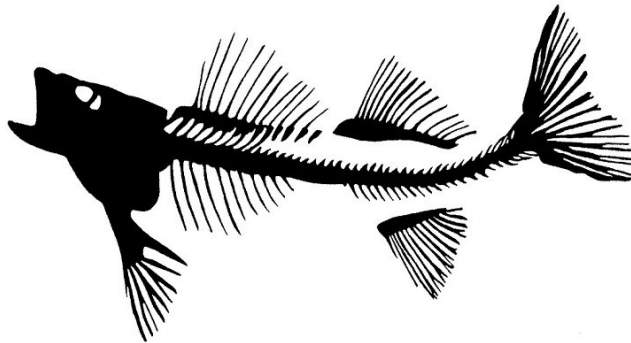

Reg. No. 4,205,676

PICKRON, ADAM (UNITED STATES INDIVIDUAL)
18127 FRED CARTER ROAD
ANDALUSIA, AL 36420

Registered Sep. 11, 2012

Int. Cl.: 25

FOR: BOTTOMS; CAPS; HATS; PANTS; SHIRTS; SHORTS; TOPS, IN CLASS 25 (U.S. CLS. 22 AND 39).

TRADEMARK

FIRST USE 4-15-2011; IN COMMERCE 4-15-2011.

PRINCIPAL REGISTER

THE MARK CONSISTS OF THE STYLIZED DESIGN OF A FISH SKELETON.

SER. NO. 85-535,071, FILED 2-6-2012.

MATTHEW PAPPAS, EXAMINING ATTORNEY



David J. Kyffers

Director of the United States Patent and Trademark Office

United States of America
United States Patent and Trademark Office

WISHBONE

Reg. No. 4,205,677

MAHONEY, SEAN (UNITED STATES INDIVIDUAL)
1711 PAGOLA AVENUE
MANTECA, CA 95337

Registered Sep. 11, 2012

Int. Cl.: 9

FOR: MICROPHONE STANDS; MICROPHONE BOOMS; MICROPHONE CLAMPS, IN CLASS 9 (U.S. CLS. 21, 23, 26, 36 AND 38).

TRADEMARK

FIRST USE 3-0-2009; IN COMMERCE 3-0-2009.

PRINCIPAL REGISTER

THE MARK CONSISTS OF STANDARD CHARACTERS WITHOUT CLAIM TO ANY PARTICULAR FONT, STYLE, SIZE, OR COLOR.

SER. NO. 85-535,077, FILED 2-6-2012.

JACQUELINE A. LAVINE, EXAMINING ATTORNEY



David J. Kybas

Director of the United States Patent and Trademark Office

United States of America

United States Patent and Trademark Office



Reg. No. 4,205,678

CHINE DAH INDUSTRY CO., LTD (TAIWAN CORPORATION)
NO. 73, JHONGLUN, ANDING DIST.
TAINAN CITY, TAIWAN

Registered Sep. 11, 2012

Int. Cl.: 12

FOR: BICYCLE PARTS, NAMELY, CHANGE-SPEED GEARS; BICYCLE PARTS, NAMELY, TUBES AND CONNECTORS FOR BICYCLE FRAMES; BICYCLE PARTS, NAMELY, HANDLE BARS; BICYCLE PEDALS; CLUTCHES FOR LAND VEHICLES; ELECTRIC MOTORCYCLES; FITTED MOTORCYCLE COVERS; GEARS FOR VEHICLES; MOTORCYCLE ACCESSORIES, NAMELY, FRONT AND SIDE PLATES; PARTS OF MOTORCYCLES, NAMELY, BRAKE PEDALS; PARTS OF MOTORCYCLES, NAMELY, CLUTCH CABLES; PARTS OF MOTORCYCLES, NAMELY, HANDLE BAR GRIPS; PARTS OF MOTORCYCLES, NAMELY, HANDLE BARS; SHOCK ABSORBERS FOR MOTORCYCLES; VEHICLE PARTS, NAMELY, SHOCK ABSORBERS, IN CLASS 12 (U.S. CLS. 19, 21, 23, 31, 35 AND 44).

TRADEMARK

PRINCIPAL REGISTER

FIRST USE 5-2-2006; IN COMMERCE 6-22-2007.

THE MARK CONSISTS OF THE WORD "AKINNA" IN STYLIZED PRINT FONT, IN ALL CAPITAL LETTERS, WITH A HIGHLY STYLIZED DESIGN OF A PERSON WITH HALF OF A FACE FORMED BY A HALF CIRCLE WITH PORTIONS FILLED IN AND AN OUTLINE OF ARMS AND LEGS FORMED BY TWO HALF FILLED IN CIRCLES.

SER. NO. 85-535,090, FILED 2-6-2012.

DARRYL SPRUILL, EXAMINING ATTORNEY



David J. Kyffers

Director of the United States Patent and Trademark Office

United States of America

United States Patent and Trademark Office

THE NEW HOW

Reg. No. 4,205,679

ITX CORP. (NEW YORK CORPORATION)
1169 PITTSFORD-VICTOR ROAD, SUITE 100
PITTSFORD, NY 14534

Registered Sep. 11, 2012

Int. Cl.: 38

FOR: E-MAIL DATA SERVICES; PROVIDING MULTIPLE USER DIAL-UP AND DEDICATED ACCESS TO THE INTERNET, IN CLASS 38 (U.S. CLS. 100, 101 AND 104).

SERVICE MARK

FIRST USE 0-0-2001; IN COMMERCE 0-0-2002.

PRINCIPAL REGISTER

THE MARK CONSISTS OF STANDARD CHARACTERS WITHOUT CLAIM TO ANY PARTICULAR FONT, STYLE, SIZE, OR COLOR.

SER. NO. 85-535,104, FILED 2-6-2012.

LUCY ARANT, EXAMINING ATTORNEY



David J. Kyffers

Director of the United States Patent and Trademark Office

United States of America

United States Patent and Trademark Office

STRIKEZONE

Reg. No. 4,205,680

CATALINA YACHTS, INC. (CALIFORNIA CORPORATION)
7200 BRYAN DAIRY ROAD
SEMINOLE, FL 33777

Registered Sep. 11, 2012

Int. Cl.: 12

FOR: SAILBOATS, IN CLASS 12 (U.S. CLS. 19, 21, 23, 31, 35 AND 44).

TRADEMARK

FIRST USE 1-19-2012; IN COMMERCE 1-19-2012.

PRINCIPAL REGISTER

THE MARK CONSISTS OF STANDARD CHARACTERS WITHOUT CLAIM TO ANY PARTICULAR FONT, STYLE, SIZE, OR COLOR.

SER. NO. 85-535,106, FILED 2-6-2012.

WILLIAM BRECKENFELD, EXAMINING ATTORNEY



David J. Kyfos

Director of the United States Patent and Trademark Office

United States of America

United States Patent and Trademark Office

THE NEW HOW

Reg. No. 4,205,681

ITX CORP. (NEW YORK CORPORATION)
1169 PITTSFORD-VICTOR ROAD, SUITE 100
PITTSFORD, NY 14534

Registered Sep. 11, 2012

Int. Cl.: 35

SERVICE MARK

PRINCIPAL REGISTER

FOR: TECHNOLOGY-RELATED ADVERTISING AND PROMOTION SERVICES AND RELATED CONSULTING; TECHNOLOGY-RELATED ADVERTISING SERVICES, NAMELY, CREATING CORPORATE AND BRAND IDENTITY FOR OTHERS; CONSULTING SERVICES IN THE FIELD OF INTERNET MARKETING; TECHNOLOGY-RELATED BUSINESS MARKETING CONSULTING SERVICES; TECHNOLOGY-RELATED MARKETING CONSULTING; PLANNING, DESIGN, DEVELOPMENT, MAINTENANCE, TRACKING AND REPORTING OF ONLINE MARKETING ACTIVITIES FOR THIRD PARTIES; PROMOTING THE TECHNOLOGY-RELATED GOODS AND SERVICES OF OTHERS THROUGH SEARCH ENGINE REFERRAL TRAFFIC ANALYSIS AND REPORTING; PROVIDING TECHNOLOGY-RELATED ADVERTISING, MARKETING AND PROMOTIONAL SERVICES, NAMELY, DEVELOPMENT OF ADVERTISING CAMPAIGNS PROVIDED THROUGH CABLE TELEVISION BROADCAST, WEB CASTS, RADIO BROADCASTS, NEWSPAPERS, MAGAZINES, ONLINE BANNERS, OUTDOOR BILLBOARDS, WILD POSTINGS, BUS AND SUBWAY ADS; PROVIDING ONLINE, TECHNOLOGY-RELATED BUSINESS MANAGEMENT SERVICES FOR OTHERS, NAMELY, ACCOUNTING, MARKETING, BUSINESS PROJECT MANAGEMENT, AND BUSINESS DEVELOPMENT; DESIGN OF TECHNOLOGY-RELATED ADVERTISING MATERIALS FOR OTHERS; TECHNOLOGY-RELATED BUSINESS MANAGEMENT CONSULTING WITH RELATION TO STRATEGY, MARKETING, SALES, OPERATION, PRODUCT DESIGN PARTICULARLY SPECIALIZING IN THE USE OF ANALYTIC AND STATISTIC MODELS FOR THE UNDERSTANDING AND PREDICTING OF CONSUMERS, BUSINESSES, AND MARKET TRENDS AND ACTIONS; PROVIDING AN ONLINE BUSINESS ACCOUNT ADMINISTRATION SERVICE FOR OTHERS IN THE FIELD OF HOSTING AND MANAGEMENT OF COMPUTER HARDWARE, COMPUTER OPERATING SYSTEMS, AND COMPUTER APPLICATION INFRASTRUCTURE; CUSTOMER SERVICES, NAMELY, RESPONDING TO CUSTOMERS INQUIRIES FOR OTHERS IN THE FIELD OF WEBSITE HOSTING SERVICES; CUSTOMER SERVICES, NAMELY, RESPONDING TO CUSTOMERS INQUIRIES FOR OTHERS IN THE FIELD OF LEASING AND CUSTOMIZING COMPUTER HARDWARE, OPERATING SYSTEMS, AND COMPUTER SOFTWARE APPLICATION INFRASTRUCTURE; CUSTOMER SERVICES, NAMELY, RESPONDING TO CUSTOMERS INQUIRIES FOR OTHERS IN THE FIELD OF BANDWIDTH PROVISION TO OTHERS. CUSTOMER SERVICES, NAMELY, RESPONDING TO CUSTOMERS INQUIRIES FOR OTHERS IN THE FIELD OF LEASING SPACE TO HOUSE COMPUTER HARDWARE, OPERATING SYSTEMS, AND SOFTWARE APPLICATION INFRASTRUCTURE IN DATA CENTERS WITH A STABLE



David J. Kyjars

Director of the United States Patent and Trademark Office

Reg. No. 4,205,681 OPERATING ENVIRONMENT; CUSTOMER SERVICES, NAMELY, RESPONDING TO CUSTOMERS INQUIRIES FOR OTHERS IN THE FIELD OF MANAGED COMPUTER STORAGE, IN CLASS 35 (U.S. CLS. 100, 101 AND 102).

FIRST USE 0-0-2001; IN COMMERCE 0-0-2002.

THE MARK CONSISTS OF STANDARD CHARACTERS WITHOUT CLAIM TO ANY PARTICULAR FONT, STYLE, SIZE, OR COLOR.

SER. NO. 85-535,113, FILED 2-6-2012.

LUCY ARANT, EXAMINING ATTORNEY

United States of America

United States Patent and Trademark Office

YULIMADE

Reg. No. 4,205,682

GUO, YULI (CHINA INDIVIDUAL)
99 2ND ST

Registered Sep. 11, 2012

WOODRIDGE, NJ 07075

Int. Cl.: 3

FOR: BAR SOAP; BATH SOAPS; BODY WASH; LIP BALM; SHAMPOOS; SOAPS, IN CLASS 3 (U.S. CLS. 1, 4, 6, 50, 51 AND 52).

TRADEMARK

FIRST USE 12-0-2011; IN COMMERCE 12-0-2011.

PRINCIPAL REGISTER

THE MARK CONSISTS OF STANDARD CHARACTERS WITHOUT CLAIM TO ANY PARTICULAR FONT, STYLE, SIZE, OR COLOR.

SER. NO. 85-535,115, FILED 2-6-2012.

WILLIAM BRECKENFELD, EXAMINING ATTORNEY



David J. Kybas

Director of the United States Patent and Trademark Office

United States of America

United States Patent and Trademark Office

A FLAVOR FOR EVERY TASTE

Reg. No. 4,205,683

POLAR CORP. (MASSACHUSETTS CORPORATION)
1001 SOUTHBRIDGE STREET
WORCESTER, MA 01610

Registered Sep. 11, 2012

Int. Cl.: 32

FOR: CARBONATED WATERS; FRUIT FLAVOURED CARBONATED DRINKS, IN CLASS 32 (U.S. CLS. 45, 46 AND 48).

TRADEMARK

FIRST USE 9-0-2002; IN COMMERCE 9-0-2002.

PRINCIPAL REGISTER

THE MARK CONSISTS OF STANDARD CHARACTERS WITHOUT CLAIM TO ANY PARTICULAR FONT, STYLE, SIZE, OR COLOR.

SER. NO. 85-535,136, FILED 2-6-2012.

JESSICA A. POWERS, EXAMINING ATTORNEY



David J. Kyros

Director of the United States Patent and Trademark Office

United States of America

United States Patent and Trademark Office

THE RISING

Reg. No. 4,205,684

Registered Sep. 11, 2012

Int. Cl.: 41

SERVICE MARK

PRINCIPAL REGISTER

TOM VITORINO MANAGEMENT, INC (CALIFORNIA CORPORATION), DBA THE RISING
11606 VIMY ROAD, GRANADA HILLS, CA 91344
11606 VIMY ROAD, GRANADA HILLS, CA 91344
GRANADA HILLS, CA 91344

FOR: ENTERTAINMENT IN THE NATURE OF VISUAL AND AUDIO PERFORMANCES,
NAMELY, MUSICAL BAND, ROCK GROUP, GYMNASTIC, DANCE, AND BALLET PER-
FORMANCES, IN CLASS 41 (U.S. CLS. 100, 101 AND 107).

FIRST USE 9-3-2010; IN COMMERCE 9-3-2010.

THE MARK CONSISTS OF STANDARD CHARACTERS WITHOUT CLAIM TO ANY PAR-
TICULAR FONT, STYLE, SIZE, OR COLOR.

SER. NO. 85-535,181, FILED 2-6-2012.

JENNIFER VASQUEZ, EXAMINING ATTORNEY



David J. Kyffers

Director of the United States Patent and Trademark Office

United States of America

United States Patent and Trademark Office

ePure

Reg. No. 4,205,685

Registered Sep. 11, 2012

Int. Cl.: 11

TRADEMARK

PRINCIPAL REGISTER

SUPERIOR FIBERS, LLC (DELAWARE LIMITED LIABILITY COMPANY), DBA SUPERIOR FIBERS
499 NORTH BROAD STREET
BREMEN, OH 43107

FOR: AIR CLEANING UNITS CONTAINING AN AIR FILTER, ULTRAVIOLET LIGHTS AND A PHOTOCATALYTIC FILTER; AIR FILTERS FOR AIR CONDITIONING UNITS; AIR FILTERS FOR DOMESTIC USE; AIR FILTERS FOR INDUSTRIAL INSTALLATIONS; AIR PURIFYING APPARATUS; FILTERS AND FILTERING DEVICES FOR AIR AND GAS CONDITIONING; FILTERS FOR AIR CONDITIONING; FILTERS FOR AIR EXTRACTOR HOODS; HOUSEHOLD AIR CLEANERS; INDUSTRIAL AIR FILTER MACHINES, IN CLASS 11 (U.S. CLS. 13, 21, 23, 31 AND 34).

FIRST USE 1-23-2012; IN COMMERCE 1-23-2012.

THE MARK CONSISTS OF THE WORD "EPURE" WITH THE FIRST LETTER "E" IN BLUE AND THE LETTERS "P", "U", "R" AND "E" IN GREEN.

THE COLOR(S) BLUE AND GREEN IS/ARE CLAIMED AS A FEATURE OF THE MARK.

SER. NO. 85-535,189, FILED 2-6-2012.

ADA HAN, EXAMINING ATTORNEY



David J. Kyffers

Director of the United States Patent and Trademark Office

United States of America

United States Patent and Trademark Office

INFRARED

Reg. No. 4,205,686

Registered Sep. 11, 2012

Int. Cl.: 14

TRADEMARK

PRINCIPAL REGISTER

PACIFIC-CONCEPTS, INC. (NEW YORK CORPORATION)
SUITE 703
390 FIFTH AVENUE
NEW YORK, NY 10018

FOR: CHRONOGRAPHS AS WATCHES; CHRONOGRAPHS FOR USE AS WATCHES; CHRONOMETRIC INSTRUMENTS AND WATCH MOVEMENTS; CLOCKS AND WATCHES; COMPLICATION WATCHES; DIVING WATCHES; DRESS WATCHES; EQUESTRIAN WATCHES; INEXPENSIVE NON-JEWELRY WATCHES; JEWELLERY AND WATCHES; JEWELLERY, CLOCKS AND WATCHES; JEWELRY WATCHES; MECHANICAL AND AUTOMATIC WATCHES; POCKET WATCHES; PRECIOUS STONES AND WATCHES; SPORTS WATCHES; STOP WATCHES; WATCHES; WATCHES AND CLOCKS; WATCHES AND JEWELLERY; WATCHES AND JEWELRY; WATCHES FOR OUTDOOR USE; WATCHES FOR SPORTING USE; WATCHES MADE OF PRECIOUS METALS OR COATED THEREWITH; WATCHES, CLOCKS; WATCHES, CLOCKS, JEWELLERY AND IMITATION JEWELLERY; WATCHES, CLOCKS, JEWELRY AND IMITATION JEWELRY; WOMEN'S WATCHES; WRIST WATCHES, IN CLASS 14 (U.S. CLS. 2, 27, 28 AND 50).

FIRST USE 11-1-2011; IN COMMERCE 11-1-2011.

THE MARK CONSISTS OF STANDARD CHARACTERS WITHOUT CLAIM TO ANY PARTICULAR FONT, STYLE, SIZE, OR COLOR.

SER. NO. 85-535,194, FILED 2-6-2012.

MICHAEL WIENER, EXAMINING ATTORNEY



David J. Kyffers

Director of the United States Patent and Trademark Office

United States of America

United States Patent and Trademark Office

LIGHTWAY PRODUCTS

Reg. No. 4,205,687

JORDAN, VEDRIC L. (UNITED STATES INDIVIDUAL)
509 N WESTOVER
ALBANY, GA 31707

Registered Sep. 11, 2012

Int. Cl.: 35

FOR: ON-LINE RETAIL STORE SERVICES FEATURING A WIDE VARIETY OF CONSUMER GOODS OF OTHERS, IN CLASS 35 (U.S. CLS. 100, 101 AND 102).

SERVICE MARK

FIRST USE 10-15-2010; IN COMMERCE 10-15-2010.

PRINCIPAL REGISTER

THE MARK CONSISTS OF STANDARD CHARACTERS WITHOUT CLAIM TO ANY PARTICULAR FONT, STYLE, SIZE, OR COLOR.

NO CLAIM IS MADE TO THE EXCLUSIVE RIGHT TO USE "PRODUCTS", APART FROM THE MARK AS SHOWN.

SER. NO. 85-535,196, FILED 2-6-2012.

GISELLE AGOSTO, EXAMINING ATTORNEY



David J. Kyffers

Director of the United States Patent and Trademark Office

United States of America

United States Patent and Trademark Office

BOOM BUCKS

Reg. No. 4,205,688

ELISSA BURDA (UNITED STATES INDIVIDUAL)
14500 LAPLAISANCE ROAD, SUITE B-100
MONROE, MI 48161

Registered Sep. 11, 2012

Int. Cl.: 35

FOR: ARRANGING AND CONDUCTING INCENTIVE REWARD PROGRAMS TO PROMOTE THE SALE OF FIREWORKS, IN CLASS 35 (U.S. CLS. 100, 101 AND 102).

SERVICE MARK

FIRST USE 6-28-2010; IN COMMERCE 6-28-2010.

PRINCIPAL REGISTER

THE MARK CONSISTS OF STANDARD CHARACTERS WITHOUT CLAIM TO ANY PARTICULAR FONT, STYLE, SIZE, OR COLOR.

SER. NO. 85-535,232, FILED 2-6-2012.

DOMINIC J. FERRAIUOLO, EXAMINING ATTORNEY



David J. Kyffers

Director of the United States Patent and Trademark Office

United States of America

United States Patent and Trademark Office

THE NEW HOW

Reg. No. 4,205,689

ITX CORP. (NEW YORK CORPORATION)
1169 PITTSFORD-VICTOR ROAD, SUITE 100
PITTSFORD, NY 14534

Registered Sep. 11, 2012

Int. Cl.: 42

SERVICE MARK

PRINCIPAL REGISTER

FOR: COMPUTER SERVICES, NAMELY, PROVIDING MOBILE TECHNOLOGY SOLUTIONS, NAMELY, COMPUTER SOFTWARE DESIGN FOR OTHERS; HOSTING OF DIGITAL CONTENT ON THE INTERNET; HOSTING OF SOFTWARE, WEBSITES, INTERNET WEB SOFTWARE APPLICATIONS, ELECTRONIC DATABASES, BUSINESS COMPUTER SOFTWARE APPLICATIONS AND OTHER COMPUTER APPLICATIONS ON THE INTERNET AND ON A VIRTUAL PRIVATE SERVER; RECOVERY OF COMPUTER DATA; COMPUTER SERVICES, NAMELY, MONITORING AND REPORTING ON THE PERFORMANCE, AVAILABILITY, AND ERRORS OF COMPUTER SOFTWARE, INTERNET WEB SOFTWARE APPLICATIONS, ELECTRONIC DATABASES, BUSINESS COMPUTER SOFTWARE APPLICATIONS, DIGITAL CONTENT AND THE WEB SITES OF OTHERS; COMPUTER VIRUS PROTECTION SERVICES; COMPUTER SERVICES, NAMELY, PROVIDING A WEB SITE FOR OTHERS IN THE FIELD OF HOSTING AND MANAGEMENT OF COMPUTER HARDWARE, COMPUTER OPERATING SYSTEMS, AND COMPUTER APPLICATION INFRASTRUCTURE, NAMELY, PROVIDING SECURE ACCESS TO INFORMATION AND CONTROLS TO MONITOR AND HELP OPTIMIZE THE PERFORMANCE OF COMPUTER HARDWARE AND SOFTWARE THAT SUPPORTS HOSTED COMPUTER SOFTWARE, INTERNET WEBSITES, INTERNET WEB SOFTWARE APPLICATIONS, ELECTRONIC DATABASES, DIGITAL CONTENT, AND BUSINESS COMPUTER SOFTWARE APPLICATIONS OF OTHERS THAT ARE ACCESSIBLE VIA THE INTERNET; COMPUTER PROGRAMMING; COMPUTER HARDWARE DEVELOPMENT; RENTAL OF COMPUTER SOFTWARE AND PROGRAMS; COMPUTER SYSTEMS INTEGRATION SERVICES; COMPUTER SYSTEMS ENGINEERING SERVICES; DATA ENCRYPTION SERVICES, IN CLASS 42 (U.S. CLS. 100 AND 101).



FIRST USE 0-0-2001; IN COMMERCE 0-0-2002.

THE MARK CONSISTS OF STANDARD CHARACTERS WITHOUT CLAIM TO ANY PARTICULAR FONT, STYLE, SIZE, OR COLOR.

SER. NO. 85-535,236, FILED 2-6-2012.

LUCY ARANT, EXAMINING ATTORNEY

David J. Kyros

Director of the United States Patent and Trademark Office

United States of America

United States Patent and Trademark Office

RuleGate

Reg. No. 4,205,690

CENTRIPETAL NETWORKS (DELAWARE CORPORATION)
PO BOX 2040

Registered Sep. 11, 2012

RESTON, VA 201952040

Int. Cl.: 9

FOR: COMPUTER HARDWARE FOR COMPUTER NETWORKING, IP NETWORK FILTERING, COMPUTER NETWORK SECURITY; COMPUTER NETWORKING HARDWARE, IN CLASS 9 (U.S. CLS. 21, 23, 26, 36 AND 38).

TRADEMARK

FIRST USE 7-0-2011; IN COMMERCE 8-0-2011.

PRINCIPAL REGISTER

THE MARK CONSISTS OF STANDARD CHARACTERS WITHOUT CLAIM TO ANY PARTICULAR FONT, STYLE, SIZE, OR COLOR.

SER. NO. 85-535,273, FILED 2-6-2012.

DOUGLAS LEE, EXAMINING ATTORNEY



David J. Kyffers

Director of the United States Patent and Trademark Office

United States of America

United States Patent and Trademark Office



Reg. No. 4,205,691

Registered Sep. 11, 2012

Int. Cl.: 35

SERVICE MARK

PRINCIPAL REGISTER

GIVE IT UP LLC (INDIANA LIMITED LIABILITY COMPANY)
ATTN: CHRIS PIAZZA
111 E. 16TH STREET
INDIANAPOLIS, IN 46202

FOR: PROMOTING THE CHARITABLE SERVICES OF OTHERS, NAMELY, PROVIDING INDIVIDUALS WITH INFORMATION ABOUT VARIOUS CHARITIES FOR THE PURPOSE OF MAKING DONATIONS TO CHARITIES, IN CLASS 35 (U.S. CLS. 100, 101 AND 102).

FIRST USE 11-22-2011; IN COMMERCE 12-22-2011.

THE MARK CONSISTS OF A STYLIZED GLOBE WITH BLACK LAND MASSES, BLACK LONGITUDE AND LATITUDE LINES, AND LIGHT BLUE IN THE AREAS COVERED WITH WATER. REACHING AROUND THE GLOBE ARE TWO DEEP ORANGE ARMS REACHING FOR EACH OTHER. ON THE ARM ON THE LEFT IS THE STYLIZED TEXT "GIVE" IN WHITE. TO THE RIGHT IS THE STYLIZED TEXT "IT" IN WHITE WRITTEN ON THE AFRICAN CONTINENT, FOLLOWED THE STYLIZED TEXT "UP!" IN WHITE WRITTEN ON THE ARM ON THE RIGHT. ARCHING ABOVE THE GLOBE IS THE STYLIZED TEXT "IF EVERYONE GIVES A LITTLE," IN BLUE, AND ARCHING BELOW THE GLOBE IS THE STYLIZED TEXT "WE ALL GET A LOT." IN BLUE.

THE COLOR(S) BLACK, LIGHT BLUE, DEEP ORANGE, WHITE, BLUE IS/ARE CLAIMED AS A FEATURE OF THE MARK.

SER. NO. 85-535,278, FILED 2-6-2012.

KATHRYN COWARD, EXAMINING ATTORNEY



David J. Kyjars

Director of the United States Patent and Trademark Office

United States of America

United States Patent and Trademark Office

SimpliciTea

Reg. No. 4,205,692

FLINN, DAVID VALENTINO (UNITED STATES INDIVIDUAL)
1407 LAURA ST.
WRIGHTWOOD, CA 92397

Registered Sep. 11, 2012

Int. Cl.: 43

FOR: TEA ROOMS, IN CLASS 43 (U.S. CLS. 100 AND 101).

SERVICE MARK

FIRST USE 1-1-2012; IN COMMERCE 1-1-2012.

PRINCIPAL REGISTER

THE MARK CONSISTS OF THE STYLIZED TEXT "SIMPLICITEA" WITH A VINE UNDERLINING THE WORD. EACH LETTER "T" IS DOTTED WITH A SMALL LEAF.

SER. NO. 85-535,282, FILED 2-6-2012.

NAKIA HENRY, EXAMINING ATTORNEY



David J. Kybas

Director of the United States Patent and Trademark Office

United States of America

United States Patent and Trademark Office

iTek

Reg. No. 4,205,693

INNOVATEK, INC. (WASHINGTON CORPORATION)
3100 GEORGE WASHINGTON WAY, SUITE 108
RICHLAND, WA 99354

Registered Sep. 11, 2012

Int. Cl.: 1

FOR: CATALYSTS FOR CHEMICAL AND BIOCHEMICAL PROCESSES, IN CLASS 1 (U.S. CLS. 1, 5, 6, 10, 26 AND 46).

TRADEMARK

FIRST USE 3-2-2007; IN COMMERCE 11-19-2007.

PRINCIPAL REGISTER

THE MARK CONSISTS OF STANDARD CHARACTERS WITHOUT CLAIM TO ANY PARTICULAR FONT, STYLE, SIZE, OR COLOR.

SER. NO. 85-535,285, FILED 2-6-2012.

NAKIA HENRY, EXAMINING ATTORNEY



David J. Kybas

Director of the United States Patent and Trademark Office

United States of America

United States Patent and Trademark Office

SWEETBOTTOMS

Reg. No. 4,205,694

Registered Sep. 11, 2012

Int. Cl.: 35

SERVICE MARK

PRINCIPAL REGISTER

SWEETBOTTOMS BABY BOUTIQUE, LLC (NORTH CAROLINA LIMITED LIABILITY COMPANY)
4140 PARKLAKE AVENUE, STE. 600
RALEIGH, NC 27612

FOR: COMPUTERIZED ON-LINE ORDERING FEATURING GENERAL MERCHANDISE AND GENERAL CONSUMER GOODS, IN CLASS 35 (U.S. CLS. 100, 101 AND 102).

FIRST USE 3-17-2010; IN COMMERCE 3-17-2010.

THE MARK CONSISTS OF STANDARD CHARACTERS WITHOUT CLAIM TO ANY PARTICULAR FONT, STYLE, SIZE, OR COLOR.

SER. NO. 85-535,300, FILED 2-6-2012.

SUZANNE BLANE, EXAMINING ATTORNEY



David J. Kyffers

Director of the United States Patent and Trademark Office

United States of America

United States Patent and Trademark Office

CURATEL

Reg. No. 4,205,695

Registered Sep. 11, 2012

Int. Cl.: 38

SERVICE MARK

PRINCIPAL REGISTER

ADIR INTERNATIONAL, LLC (DELAWARE LIMITED LIABILITY COMPANY)
SUITE 600
1605 OLYMPIC BOULEVARD
LOS ANGELES, CA 90015

FOR: TELECOMMUNICATION SERVICES, NAMELY, LOCAL AND LONG DISTANCE TRANSMISSION OF VOICE, DATA, GRAPHICS BY MEANS OF TELEPHONE, TELEGRAPHIC, CABLE, SATELLITE TRANSMISSIONS, AND PROVIDING INTERNET ACCESS VIA BROADBAND OPTICAL OR WIRELESS NETWORKS, IN CLASS 38 (U.S. CLS. 100, 101 AND 104).

FIRST USE 12-15-2001; IN COMMERCE 1-1-2005.

THE MARK CONSISTS OF STANDARD CHARACTERS WITHOUT CLAIM TO ANY PARTICULAR FONT, STYLE, SIZE, OR COLOR.

SER. NO. 85-535,305, FILED 2-6-2012.

LINDSEY RUBIN, EXAMINING ATTORNEY



David J. Kybas

Director of the United States Patent and Trademark Office

United States of America

United States Patent and Trademark Office

Masters Equestrian

Reg. No. 4,205,696

MASTERS EQUESTRIAN LLC (CALIFORNIA LIMITED LIABILITY COMPANY)
1708 GAGE ROAD
MONTEBELLO, CA 90640

Registered Sep. 11, 2012

Int. Cl.: 25

FOR: HATS; HOODED SWEATSHIRTS; JACKETS; JEANS; JODHPURS; PANTS; POLO SHIRTS; SHORT-SLEEVED OR LONG-SLEEVED T-SHIRTS; SHORTS; SOCKS; SWEATSHIRTS; T-SHIRTS; TANK TOPS; UNDERWEAR; VESTS, IN CLASS 25 (U.S. CLS. 22 AND 39).

TRADEMARK

PRINCIPAL REGISTER

FIRST USE 8-23-2010; IN COMMERCE 2-3-2012.

THE MARK CONSISTS OF STANDARD CHARACTERS WITHOUT CLAIM TO ANY PARTICULAR FONT, STYLE, SIZE, OR COLOR.

NO CLAIM IS MADE TO THE EXCLUSIVE RIGHT TO USE "EQUESTRIAN", APART FROM THE MARK AS SHOWN.

SER. NO. 85-535,349, FILED 2-6-2012.

EMILY CARLSEN, EXAMINING ATTORNEY



David J. Kybas

Director of the United States Patent and Trademark Office

United States of America

United States Patent and Trademark Office

LaceyClaireDesigns

Reg. No. 4,205,697

Registered Sep. 11, 2012

Int. Cl.: 16

TRADEMARK

PRINCIPAL REGISTER

KORNICK, LACEY C (UNITED STATES INDIVIDUAL), DBA LACEYCLAIREDESIGNS
2253 COTTAGE GROVE DRIVE
CLEVELAND HEIGHTS, OH 44118

FOR: BOXES OF CARDBOARD OR PAPER; BOXES OF PAPER OR CARDBOARD; CARDBOARD BOXES; CARDBOARD CAKE BOXES; DESK STANDS AND HOLDERS FOR PENS, PENCILS, AND INK; GIFT BOXES; GIFT BOXES MADE OF CARDBOARD; MEMORY BOXES, NAMELY, CARDBOARD BOXES CONTAINING CARDBOARD CARDS FOR DISPLAYING AND STORING WEDDING, SPECIAL EVENTS, OR PARTY KEEPSAKES AND MEMENTOS; PEN STANDS; PENS; STANDS FOR PENS; WEDDING ALBUMS; WEDDING BOOKS, IN CLASS 16 (U.S. CLS. 2, 5, 22, 23, 29, 37, 38 AND 50).

FIRST USE 8-2-2010; IN COMMERCE 8-31-2010.

THE MARK CONSISTS OF STANDARD CHARACTERS WITHOUT CLAIM TO ANY PARTICULAR FONT, STYLE, SIZE, OR COLOR.

SER. NO. 85-535,383, FILED 2-6-2012.

JACQUELINE A. LAVINE, EXAMINING ATTORNEY



David J. Kyros

Director of the United States Patent and Trademark Office

United States of America

United States Patent and Trademark Office

IT'S A PLEASURE... DOING PLEASURE WITH YOU

Reg. No. 4,205,698

LE PETIT IP, LLC (CALIFORNIA LIMITED LIABILITY COMPANY)
8822 CYNTHIA STREET
WEST HOLLYWOOD, CA 90069

Registered Sep. 11, 2012

Int. Cl.: 43

FOR: HOTEL SERVICES, IN CLASS 43 (U.S. CLS. 100 AND 101).

SERVICE MARK

FIRST USE 10-0-2009; IN COMMERCE 10-0-2009.

PRINCIPAL REGISTER

THE MARK CONSISTS OF STANDARD CHARACTERS WITHOUT CLAIM TO ANY PARTICULAR FONT, STYLE, SIZE, OR COLOR.

SER. NO. 85-535,392, FILED 2-6-2012.

BARBARA GAYNOR, EXAMINING ATTORNEY



David J. Kybas

Director of the United States Patent and Trademark Office

United States of America

United States Patent and Trademark Office

NOWONCAMPUS

Reg. No. 4,205,699

JDALEXANDER ENTERPRISES, LLC (GEORGIA LIMITED LIABILITY COMPANY)
400 INTERSTATE NORTH PARKWAY SE
ATLANTA, GA 30339

Registered Sep. 11, 2012

Int. Cl.: 35

FOR: PROMOTING THE PARTIES AND SPECIAL EVENTS OF OTHERS, IN CLASS 35 (U.S. CLS. 100, 101 AND 102).

SERVICE MARK

FIRST USE 4-12-2011; IN COMMERCE 4-12-2011.

PRINCIPAL REGISTER

THE MARK CONSISTS OF STANDARD CHARACTERS WITHOUT CLAIM TO ANY PARTICULAR FONT, STYLE, SIZE, OR COLOR.

SER. NO. 85-535,438, FILED 2-6-2012.

KAREN K. BUSH, EXAMINING ATTORNEY



David J. Kyjars

Director of the United States Patent and Trademark Office

United States of America

United States Patent and Trademark Office

CrossStrike

Reg. No. 4,205,700

EASY STRIKE CO., LTD. (TAIWAN CORPORATION)

Registered Sep. 11, 2012

NO. 1, ALLEY 66, LANE 216, GONG YEH RD.
LONG-CHING, TAICHUNG, TAIWAN

Int. Cl.: 8

FOR: HAMMERS; SLEDGEHAMMERS; NAIL PULLER BARS; AXES; MATTOCKS; MAULS;
NAIL PULLERS, IN CLASS 8 (U.S. CLS. 23, 28 AND 44).

TRADEMARK

FIRST USE 12-5-2011; IN COMMERCE 1-30-2012.

PRINCIPAL REGISTER

THE MARK CONSISTS OF STANDARD CHARACTERS WITHOUT CLAIM TO ANY PARTICULAR FONT, STYLE, SIZE, OR COLOR.

SER. NO. 85-535,460, FILED 2-7-2012.

GRETTA YAO, EXAMINING ATTORNEY



David J. Kybas

Director of the United States Patent and Trademark Office

United States of America

United States Patent and Trademark Office

CAN I STREAM.IT?

Reg. No. 4,205,701

URBAN PIXELS, LLC (DELAWARE LIMITED LIABILITY COMPANY)
342 BROADWAY STE 291
NEW YORK, NY 10013

Registered Sep. 11, 2012

Int. Cl.: 9

FOR: DOWNLOADABLE SOFTWARE IN THE NATURE OF A MOBILE APPLICATION FOR SEARCHING FOR MEDIA CONTENT; DOWNLOADABLE SOFTWARE IN THE NATURE OF A MOBILE APPLICATION FOR REQUESTING NOTIFICATIONS REGARDING THE AVAILABILITY OF MEDIA CONTENT FOR PURCHASE, RENT, OR INSTANT VIEWING ONLINE, IN CLASS 9 (U.S. CLS. 21, 23, 26, 36 AND 38).

TRADEMARK

PRINCIPAL REGISTER

FIRST USE 11-29-2011; IN COMMERCE 11-29-2011.

THE MARK CONSISTS OF STANDARD CHARACTERS WITHOUT CLAIM TO ANY PARTICULAR FONT, STYLE, SIZE, OR COLOR.

SER. NO. 85-535,466, FILED 2-7-2012.

TASHIA BUNCH, EXAMINING ATTORNEY



David J. Kyffers

Director of the United States Patent and Trademark Office

United States of America

United States Patent and Trademark Office

REAL WOMEN HAVE MUSCLES

Reg. No. 4,205,702

MUSCLES BY SARA, LLC (OREGON LIMITED LIABILITY COMPANY)
3162 NE STONEBROOK
BEND, OR 97701

Registered Sep. 11, 2012

Int. Cl.: 25

FOR: CLOTHING, NAMELY, T-SHIRTS, IN CLASS 25 (U.S. CLS. 22 AND 39).

TRADEMARK

FIRST USE 1-1-2009; IN COMMERCE 11-1-2009.

PRINCIPAL REGISTER

THE MARK CONSISTS OF STANDARD CHARACTERS WITHOUT CLAIM TO ANY PARTICULAR FONT, STYLE, SIZE, OR COLOR.

SER. NO. 85-535,470, FILED 2-7-2012.

TASHIA BUNCH, EXAMINING ATTORNEY



David J. Kyffers

Director of the United States Patent and Trademark Office

United States of America

United States Patent and Trademark Office

EVER DRY

Reg. No. 4,205,703

EVERDRY MARKETING & MANAGEMENT, INC. (OHIO CORPORATION)
365 EAST HIGHLAND ROAD
MACEDONIA, OH 44056

Registered Sep. 11, 2012

Int. Cl.: 37

FOR: BASEMENT AND BELOW GRADE WATERPROOFING SERVICES, IN CLASS 37 (U.S. CLS. 100, 103 AND 106).

SERVICE MARK

FIRST USE 12-31-1998; IN COMMERCE 12-31-1998.

PRINCIPAL REGISTER

OWNER OF U.S. REG. NOS. 1,412,615, 3,196,495 AND OTHERS.

THE MARK CONSISTS OF THE WORDS "EVER" AND "DRY" WITH A STYLIZED WATER DROPLET POSITIONED BETWEEN THE TWO WORDS.

SER. NO. 85-535,522, FILED 2-7-2012.

ALYSSA STEEL, EXAMINING ATTORNEY



David J. Kybas

Director of the United States Patent and Trademark Office

United States of America

United States Patent and Trademark Office

HOW CIVIL IS YOUR UNION?

Reg. No. 4,205,704

Registered Sep. 11, 2012

Int. Cl.: 45

SERVICE MARK

PRINCIPAL REGISTER

CORRI FETMAN & ASSOCIATES, LTD. (ILLINOIS CORPORATION)
SUITE 200
33 WEST JACKSON BOULEVARD
CHICAGO, IL 60604

FOR: LEGAL SERVICES, IN CLASS 45 (U.S. CLS. 100 AND 101).

FIRST USE 11-3-2011; IN COMMERCE 11-3-2011.

THE MARK CONSISTS OF STANDARD CHARACTERS WITHOUT CLAIM TO ANY PARTICULAR FONT, STYLE, SIZE, OR COLOR.

SER. NO. 85-535,523, FILED 2-7-2012.

JESSICA FATHY, EXAMINING ATTORNEY



David J. Kybas

Director of the United States Patent and Trademark Office

United States of America

United States Patent and Trademark Office

FAR AWAY FROM CLOSE

Reg. No. 4,205,705

Registered Sep. 11, 2012

Int. Cl.: 25

TRADEMARK

PRINCIPAL REGISTER

U.O. MERCHANDISE, INC. (PENNSYLVANIA CORPORATION)
5000 SOUTH BROAD STREET
PHILADELPHIA, PA 191121495

FOR: SWEATERS, IN CLASS 25 (U.S. CLS. 22 AND 39).

FIRST USE 9-22-2011; IN COMMERCE 9-22-2011.

THE MARK CONSISTS OF STANDARD CHARACTERS WITHOUT CLAIM TO ANY PARTICULAR FONT, STYLE, SIZE, OR COLOR.

SER. NO. 85-535,524, FILED 2-7-2012.

MARK T. MULLEN, EXAMINING ATTORNEY



David J. Kybas

Director of the United States Patent and Trademark Office

United States of America

United States Patent and Trademark Office

ACTABLE

Reg. No. 4,205,706

QUAD/GRAPHICS, INC. (WISCONSIN CORPORATION)
N61 W23044 HARRY'S WAY
SUSSEX, WI 53089

Registered Sep. 11, 2012

Int. Cl.: 9

FOR: DOWNLOADABLE SOFTWARE IN THE NATURE OF A MOBILE APPLICATION FOR INTERACTIVE PRINT SOLUTIONS, NAMELY, NEAR FIELD COMMUNICATION TECHNOLOGY, SCANNING OF QUICK RESPONSE CODES, IMAGE RECOGNITION, AND DISPLAYING AUGMENTED REALITY, IN CLASS 9 (U.S. CLS. 21, 23, 26, 36 AND 38).

TRADEMARK

PRINCIPAL REGISTER

FIRST USE 1-9-2012; IN COMMERCE 1-9-2012.

THE MARK CONSISTS OF STANDARD CHARACTERS WITHOUT CLAIM TO ANY PARTICULAR FONT, STYLE, SIZE, OR COLOR.

SER. NO. 85-535,558, FILED 2-7-2012.

TARAH HARDY, EXAMINING ATTORNEY



David J. Kyffers

Director of the United States Patent and Trademark Office

United States of America

United States Patent and Trademark Office

NRHS

Reg. No. 4,205,707

Registered Sep. 11, 2012

Int. Cl.: 41

SERVICE MARK

PRINCIPAL REGISTER

NATIONAL RAILWAY HISTORICAL SOCIETY (MARYLAND CORPORATION)
4TH FLOOR
100 NORTH 20TH STREET
PHILADELPHIA, PA 19103

FOR: EDUCATIONAL SERVICES, NAMELY, PROVIDING WORKSHOPS AND CULTURAL SEMINARS, ALL RELATING TO THE RAILROADING INDUSTRY AND ITS HISTORICAL EVOLUTION, AND ORGANIZING HISTORICAL RAILROAD EXHIBITIONS FOR ENTERTAINMENT IN INTERNATIONAL CLASS 41, IN CLASS 41 (U.S. CLS. 100, 101 AND 107).

FIRST USE 6-21-2010; IN COMMERCE 6-21-2010.

THE MARK CONSISTS OF THE STYLIZED LETTERS "NRHS". THE HORIZONTAL LINES THROUGH THE LETTERS ARE A FEATURE OF THE MARK AND DO NOT INDICATE COLOR.

SER. NO. 85-535,561, FILED 2-7-2012.

PAM WILLIS, EXAMINING ATTORNEY



David J. Kyjars

Director of the United States Patent and Trademark Office

United States of America

United States Patent and Trademark Office



Reg. No. 4,205,708

DOCTOR'S ASSOCIATES INC. (FLORIDA CORPORATION)
325 BIC DRIVE
MILFORD, CT 06461

Registered Sep. 11, 2012

Int. Cl.: 43

FOR: RESTAURANT SERVICES, IN CLASS 43 (U.S. CLS. 100 AND 101).

SERVICE MARK

FIRST USE 11-28-2006; IN COMMERCE 11-28-2006.

PRINCIPAL REGISTER

OWNER OF U.S. REG. NOS. 1,174,608, 3,869,196 AND OTHERS.

NO CLAIM IS MADE TO THE EXCLUSIVE RIGHT TO USE "FRESH" AND "FOR KIDS", APART FROM THE MARK AS SHOWN.

THE MARK CONSISTS OF THE WORD "SUBWAY" WITH ARROWS EMANATING OUTWARDLY FROM THE BOTTOM OF THE "S" AND THE TOP OF THE "Y", IN THE UPPER PORTION OF AN OVAL CONTAINING THE WORDING "FRESH FIT" IN THE CENTER AND "FOR KIDS" AT THE LOWER RIGHT OF THE OVAL.

SER. NO. 85-535,563, FILED 2-7-2012.

TARAH HARDY, EXAMINING ATTORNEY



David J. Kyffers

Director of the United States Patent and Trademark Office

United States of America

United States Patent and Trademark Office



Reg. No. 4,205,709

QUAD/GRAPHICS, INC. (WISCONSIN CORPORATION)
N61 W23044 HARRY'S WAY
SUSSEX, WI 53089

Registered Sep. 11, 2012

Int. Cl.: 9

FOR: DOWNLOADABLE SOFTWARE IN THE NATURE OF A MOBILE APPLICATION FOR INTERACTIVE PRINT SOLUTIONS, NAMELY, NEAR FIELD COMMUNICATION TECHNOLOGY, SCANNING OF QUICK RESPONSE CODES, IMAGE RECOGNITION, AND DISPLAYING AUGMENTED REALITY, IN CLASS 9 (U.S. CLS. 21, 23, 26, 36 AND 38).

TRADEMARK

PRINCIPAL REGISTER

FIRST USE 1-9-2012; IN COMMERCE 1-9-2012.

THE MARK CONSISTS OF A DESIGN CONSISTING OF A PLUS SYMBOL SURROUNDED BY FOUR DROPLETS.

SER. NO. 85-535,567, FILED 2-7-2012.

TARAH HARDY, EXAMINING ATTORNEY



David J. Kyffers

Director of the United States Patent and Trademark Office

United States of America

United States Patent and Trademark Office



Reg. No. 4,205,710

FRIEDRICHSEN ENTERPRISES, INC. (IOWA CORPORATION)
475 320TH STREET
PERRY, IA 50220

Registered Sep. 11, 2012

Int. Cl.: 40

FOR: CUSTOM CAKE DECORATING SERVICES, IN CLASS 40 (U.S. CLS. 100, 103 AND 106).

SERVICE MARK

FIRST USE 9-15-2010; IN COMMERCE 9-15-2010.

PRINCIPAL REGISTER

THE MARK CONSISTS OF THE WORDS CAKE ME I'M YOURS WITH "CAKE ME" APPEARING OVER "I'M YOURS" WITH AN EXCLAMATION POINT AFTER THE WORD "YOURS." AN IMAGE OF A TWO-TIERED CAKE APPEARS TO THE RIGHT OF THE MARK WITH A FLOWER-LIKE FIGURE OVER THE TOP-LAYER OF THE CAKE; A CURVED LINE APPEARS UNDER THE MARK RUNNING FROM THE LEFT OF THE BOTTOM-LAYER OF THE CAKE TO THE RIGHT OF THE WORD "YOURS!" WITH THE LINE SPLITTING INTO TWO CURLED ENDS, ONE CURLING UPWARD AND ONE CURLING DOWNWARD; THREE DOTS APPEARS WHERE THE LINE SPLITS INTO THE CURLED ENDS.

SER. NO. 85-535,574, FILED 2-7-2012.

LINDA MICKLEBURGH, EXAMINING ATTORNEY



David J. Kybas

Director of the United States Patent and Trademark Office

United States of America

United States Patent and Trademark Office

Cake Me I'm Yours!

Reg. No. 4,205,711

FRIEDRICHSEN ENTERPRISES, INC. (IOWA CORPORATION)
475 320TH STREET
PERRY, IA 50220

Registered Sep. 11, 2012

Int. Cl.: 40

FOR: CUSTOM CAKE DECORATING SERVICES, IN CLASS 40 (U.S. CLS. 100, 103 AND 106).

SERVICE MARK

FIRST USE 9-15-2004; IN COMMERCE 9-15-2004.

PRINCIPAL REGISTER

THE MARK CONSISTS OF STANDARD CHARACTERS WITHOUT CLAIM TO ANY PARTICULAR FONT, STYLE, SIZE, OR COLOR.

SER. NO. 85-535,577, FILED 2-7-2012.

LINDA MICKLEBURGH, EXAMINING ATTORNEY



David J. Kyffers

Director of the United States Patent and Trademark Office

United States of America

United States Patent and Trademark Office

Jesus Charms
wear . give . tell

Reg. No. 4,205,712

JESUS CHARMS LLC (GEORGIA LIMITED LIABILITY COMPANY)
288 REGENT SQUARE
WOODSTOCK, GA 30188

Registered Sep. 11, 2012

Int. Cl.: 14

FOR: JEWELRY, IN CLASS 14 (U.S. CLS. 2, 27, 28 AND 50).

TRADEMARK

FIRST USE 9-0-2011; IN COMMERCE 9-0-2011.

PRINCIPAL REGISTER

NO CLAIM IS MADE TO THE EXCLUSIVE RIGHT TO USE "CHARMS" , APART FROM THE MARK AS SHOWN.

THE MARK CONSISTS OF THE WORDS "JESUS CHARMS" WRITTEN IN A STYLIZED CURSIVE FONT AND UNDERNEATH THE WORDS "JESUS CHARMS" ARE THE WORDS "WEAR", "GIVE" AND "TELL" WITH A PERIOD BETWEEN EACH WORD.

SER. NO. 85-535,590, FILED 2-7-2012.

SUSAN STIGLITZ, EXAMINING ATTORNEY



David J. Kyffers

Director of the United States Patent and Trademark Office

United States of America

United States Patent and Trademark Office

JourneyMates

Reg. No. 4,205,713

ENNIS, JENNIFER (UNITED STATES INDIVIDUAL)
9418 HARVEST ACRES COURT
RALEIGH, NC 27617

Registered Sep. 11, 2012

Int. Cl.: 45

FOR: RELIGIOUS AND SPIRITUAL SERVICES, NAMELY, PROVIDING GATHERINGS AND RETREATS TO DEVELOP AND ENHANCE THE SPIRITUAL LIVES OF INDIVIDUALS; SPIRITUAL COUNSELING, IN CLASS 45 (U.S. CLS. 100 AND 101).

SERVICE MARK

FIRST USE 1-1-2006; IN COMMERCE 1-1-2006.

PRINCIPAL REGISTER

THE MARK CONSISTS OF THE WORDS, JOURNEYMATES, AS ONE WORD, IN A EDWARDS-SCRIPT ITC FONT.

SER. NO. 85-535,604, FILED 2-7-2012.

TOBY BULLOFF, EXAMINING ATTORNEY



David J. Kyffers

Director of the United States Patent and Trademark Office

United States of America

United States Patent and Trademark Office

ROSTER

Reg. No. 4,205,714

Registered Sep. 11, 2012

Int. Cl.: 35

SERVICE MARK

PRINCIPAL REGISTER

COLOR, INC. (MASSACHUSETTS CORPORATION)
SUITE #100
47 OCTOBER HILL ROAD
HOLLISTON, MA 01746

FOR: RETAIL STORE SERVICES OF FASHION SPORTS APPAREL, FOR OTHERS; RETAIL STORE SERVICES FEATURING GENUINE SPORTS TEAM BRANDED ITEMS, FOR OTHERS, IN CLASS 35 (U.S. CLS. 100, 101 AND 102).

FIRST USE 10-3-2009; IN COMMERCE 10-3-2009.

THE MARK CONSISTS OF STANDARD CHARACTERS WITHOUT CLAIM TO ANY PARTICULAR FONT, STYLE, SIZE, OR COLOR.

SER. NO. 85-535,605, FILED 2-7-2012.

MARK T. MULLEN, EXAMINING ATTORNEY



David J. Kybas

Director of the United States Patent and Trademark Office

United States of America

United States Patent and Trademark Office

LuckPin

Reg. No. 4,205,715

JEROME GEATHERS (UNITED STATES INDIVIDUAL)
12333 SOJOURN COURT
HUNTERSVILLE, NC 28078

Registered Sep. 11, 2012

Int. Cl.: 14

FOR: LAPEL PINS, IN CLASS 14 (U.S. CLS. 2, 27, 28 AND 50).

TRADEMARK

FIRST USE 2-4-2011; IN COMMERCE 1-24-2012.

PRINCIPAL REGISTER

THE MARK CONSISTS OF STANDARD CHARACTERS WITHOUT CLAIM TO ANY PARTICULAR FONT, STYLE, SIZE, OR COLOR.

SER. NO. 85-535,626, FILED 2-7-2012.

JIM RINGLE, EXAMINING ATTORNEY



David J. Kyffers

Director of the United States Patent and Trademark Office

United States of America

United States Patent and Trademark Office

Xyla

Reg. No. 4,205,716

Registered Sep. 11, 2012

Int. Cls.: 9 and 42

TRADEMARK

SERVICE MARK

PRINCIPAL REGISTER

XYLA ENTERTAINMENT, LLC (NEW JERSEY LIMITED LIABILITY COMPANY),
FORMERLY XYLA ENTERTAINMENTS, LLC
38 LIVINGSTON STREET
TRENTON, NJ 08611

FOR: COMPUTER GAME SOFTWARE FOR PERSONAL COMPUTERS AND HOME VIDEO GAME CONSOLES; COMPUTER GAME SOFTWARE FOR USE ON MOBILE AND CELLULAR PHONES; INTERACTIVE GAME SOFTWARE, IN CLASS 9 (U.S. CLS. 21, 23, 26, 36 AND 38).

FIRST USE 9-25-2011; IN COMMERCE 11-23-2011.

FOR: COMPUTER WEBSITE DESIGN; DATABASE DESIGN AND DEVELOPMENT; VIDEO GAME DEVELOPMENT SERVICES; VIDEO GAME PROGRAMMING DEVELOPMENT SERVICES, IN CLASS 42 (U.S. CLS. 100 AND 101).

FIRST USE 9-25-2011; IN COMMERCE 9-25-2011.

THE MARK CONSISTS OF STANDARD CHARACTERS WITHOUT CLAIM TO ANY PARTICULAR FONT, STYLE, SIZE, OR COLOR.

SER. NO. 85-535,648, FILED 2-7-2012.

MICHAEL ENGEL, EXAMINING ATTORNEY



David J. Kyffers

Director of the United States Patent and Trademark Office

United States of America

United States Patent and Trademark Office

Ask A Nerd

Reg. No. 4,205,717

Registered Sep. 11, 2012

Int. Cl.: 41

SERVICE MARK

PRINCIPAL REGISTER

EUREKA EQUITIES INC (NEW YORK CORPORATION)
300
40 CUTTERMILL ROAD
GREAT NECK, NY 11021

FOR: EDUCATION SERVICES, NAMELY, PROVIDING ONLINE TUTORING IN THE FIELD OF WRITING AND EDITING, IN CLASS 41 (U.S. CLS. 100, 101 AND 107).

FIRST USE 9-1-2009; IN COMMERCE 9-1-2009.

THE MARK CONSISTS OF STANDARD CHARACTERS WITHOUT CLAIM TO ANY PARTICULAR FONT, STYLE, SIZE, OR COLOR.

SER. NO. 85-535,659, FILED 2-7-2012.

KATHRYN COWARD, EXAMINING ATTORNEY



David J. Kyffers

Director of the United States Patent and Trademark Office

United States of America

United States Patent and Trademark Office

LOCALS KNOW

Reg. No. 4,205,718

Registered Sep. 11, 2012

Int. Cl.: 9

TRADEMARK

PRINCIPAL REGISTER

IMMERSION PROJECT (DELAWARE CORPORATION)
12751 KELLY SANDS WAY
FORT MYERS, FL 33908

FOR: DOWNLOADABLE SOFTWARE IN THE NATURE OF A MOBILE APPLICATION FOR STREAMING AND DOWNLOADING AUDIO, VIDEO, PICTURES, MAPS, AND TEXT THAT TELL A STORY ABOUT A PERSON, PLACE OR THING THAT CAN BE PINPOINTED TO A PARTICULAR GLOBAL POSITION; DOWNLOADABLE SOFTWARE IN THE NATURE OF A MOBILE APPLICATION FOR USERS TO CREATE AND SHARE CONTENT WITH AN ONLINE COMMUNITY, IN CLASS 9 (U.S. CLS. 21, 23, 26, 36 AND 38).

FIRST USE 8-1-2011; IN COMMERCE 8-1-2011.

THE MARK CONSISTS OF STANDARD CHARACTERS WITHOUT CLAIM TO ANY PARTICULAR FONT, STYLE, SIZE, OR COLOR.

SER. NO. 85-535,660, FILED 2-7-2012.

GRETTA YAO, EXAMINING ATTORNEY



David J. Kyffers

Director of the United States Patent and Trademark Office

United States of America

United States Patent and Trademark Office

My Doggy Dumpster

Reg. No. 4,205,719

ERICHSEN, STEPHEN (UNITED STATES INDIVIDUAL)
250 IVY LANE

Registered Sep. 11, 2012

TEANECK, NJ 07666

Int. Cl.: 21

FOR: SCOOPS FOR THE DISPOSAL OF PET WASTE, IN CLASS 21 (U.S. CLS. 2, 13, 23, 29, 30, 33, 40 AND 50).

TRADEMARK

FIRST USE 4-1-2011; IN COMMERCE 11-3-2011.

PRINCIPAL REGISTER

THE MARK CONSISTS OF STANDARD CHARACTERS WITHOUT CLAIM TO ANY PARTICULAR FONT, STYLE, SIZE, OR COLOR.

SER. NO. 85-535,675, FILED 2-7-2012.

GRETTA YAO, EXAMINING ATTORNEY



David J. Kyffers

Director of the United States Patent and Trademark Office

United States of America

United States Patent and Trademark Office



Reg. No. 4,205,720

AKESO CONSULTING (VIRGINIA LIMITED LIABILITY COMPANY)
9636 MASTERWORKS DR.
VIENNA, VA 22181

Registered Sep. 11, 2012

Int. Cl.: 35

FOR: PUBLIC POLICY CONSULTANCY SERVICES; PUBLIC POLICY RESEARCH SERVICES,
IN CLASS 35 (U.S. CLS. 100, 101 AND 102).

SERVICE MARK

FIRST USE 10-27-2011; IN COMMERCE 10-27-2011.

PRINCIPAL REGISTER

THE MARK CONSISTS OF A PURPLE ART DECO-STYLE SEATED PROFILE PICTURE OF
THE GREEK GODDESS AKESO, WITH IVORY OUTLINES.

THE COLOR(S) PURPLE AND IVORY IS/ARE CLAIMED AS A FEATURE OF THE MARK.

SER. NO. 85-535,685, FILED 2-7-2012.

MIDGE BUTLER, EXAMINING ATTORNEY



David J. Kyffers

Director of the United States Patent and Trademark Office

United States of America

United States Patent and Trademark Office

valgab

Reg. No. 4,205,721

M & J SUNSHINE, CORP. (FLORIDA CORPORATION)
7391 NW 78 STREET
MEDLEY, FL 33166

Registered Sep. 11, 2012

Int. Cl.: 4

FOR: MOTOR OIL, IN CLASS 4 (U.S. CLS. 1, 6 AND 15).

TRADEMARK

FIRST USE 10-1-2011; IN COMMERCE 10-1-2011.

PRINCIPAL REGISTER

THE MARK CONSISTS OF STANDARD CHARACTERS WITHOUT CLAIM TO ANY PARTICULAR FONT, STYLE, SIZE, OR COLOR.

SER. NO. 85-535,690, FILED 2-7-2012.

MIDGE BUTLER, EXAMINING ATTORNEY



David J. Kyffers

Director of the United States Patent and Trademark Office

United States of America

United States Patent and Trademark Office

New
Wave
of Real Estate

Reg. No. 4,205,722

CDRE TM LLC (DELAWARE LIMITED LIABILITY COMPANY)
27271 LAS RAMBLAS, SUITE 132
MISSION VIEJO, CA 92691

Registered Sep. 11, 2012

Int. Cl.: 36

FOR: REAL ESTATE BROKERAGE, IN CLASS 36 (U.S. CLS. 100, 101 AND 102).

SERVICE MARK

FIRST USE 7-12-2011; IN COMMERCE 7-12-2011.

PRINCIPAL REGISTER

THE MARK CONSISTS OF THE PHRASE "NEW WAVE", WITH THE WORD "NEW" IN GREEN AND THE WORD "WAVE" IN BLUE, AND A STYLIZED LIGHT BLUE WAVE BEHIND THE WORD "WAVE", ALL ABOVE THE PHRASE "OF REAL ESTATE" IN DARK BLUE.

THE COLOR(S) GREEN, BLUE, LIGHT BLUE AND DARK BLUE IS/ARE CLAIMED AS A FEATURE OF THE MARK.

SER. NO. 85-535,694, FILED 2-7-2012.

LYNDSEY KUYKENDALL, EXAMINING ATTORNEY



David J. Kyffers

Director of the United States Patent and Trademark Office

United States of America

United States Patent and Trademark Office



Reg. No. 4,205,723

Registered Sep. 11, 2012

Int. Cl.: 35

SERVICE MARK

PRINCIPAL REGISTER

OUTLOUD ENTERPRISES (FLORIDA LIMITED LIABILITY COMPANY)
SUITE 200
11555 HERON BAY BLVD.
CORAL SPRINGS, FL 33076

FOR: PROMOTING THE GOODS AND SERVICES OF BUSINESSES GEARED TOWARD THE GAY COMMUNITY BY PROVIDING A WEBSITE FEATURING COUPONS, REBATES, DAILY SPECIAL DEALS, PRICE-COMPARISON INFORMATION, PRODUCT REVIEWS, LINKS TO THE RETAIL WEB SITES OF OTHERS, AND DISCOUNT INFORMATION, IN CLASS 35 (U.S. CLS. 100, 101 AND 102).

FIRST USE 11-17-2011; IN COMMERCE 1-30-2012.

THE MARK CONSISTS OF THE LETTERS SNAP WITH AN UPPER-CASE S FOLLOWED BY THE LOWERCASE LETTERS NAP. TO THE RIGHT OF THESE LETTERS IS A STYLIZED EXCLAMATION POINT WHICH DOES NOT HAVE THE TRADITIONAL DOT BELOW THE UPPER PART OF THE EXCLAMATION POINT. NEAR THE BOTTOM OF AND PARTIALLY COVERED BY THE EXCLAMATION POINT IS AN ELLIPTICAL SHAPE REPRESENTING A SHADOW. INSIDE THE UPPER PART OF THE EXCLAMATION POINT IS A CIRCULAR SHAPE AND INSIDE THAT IS A SECOND SMALLER CIRCULAR SHAPE WHICH PARTLY OVERLAPS AN OVAL SHAPE WHICH IS ALSO WITHIN THE LARGER CIRCLE. BELOW THE LETTERS SNA ARE THE LETTERS SNAPQPON.COM, WITH THE LOWER-CASE LETTERS SNAP FOLLOWED BY A STYLIZED UPPER-CASE Q, FOLLOWED BY THE LOWER-CASE LETTERS PON, FOLLOWED BY A PERIOD, FOLLOWED BY THE LOWER-CASE LETTERS COM.



SER. NO. 85-535,739, FILED 2-7-2012.

CHRISTINA SOBRAL, EXAMINING ATTORNEY

David J. Kybas

Director of the United States Patent and Trademark Office

United States of America

United States Patent and Trademark Office

ZINAZ

Reg. No. 4,205,724

Registered Sep. 11, 2012

Int. Cl.: 33

TRADEMARK

PRINCIPAL REGISTER

ENGELMAN, BRET (UNITED STATES INDIVIDUAL), DBA ENGELMANN CELLARS
3275 N. ROLINDA AVE.
FRESNO, CA 93722

FOR: WINE, IN CLASS 33 (U.S. CLS. 47 AND 49).

FIRST USE 5-31-2002; IN COMMERCE 5-31-2002.

THE MARK CONSISTS OF STANDARD CHARACTERS WITHOUT CLAIM TO ANY PARTICULAR FONT, STYLE, SIZE, OR COLOR.

THE WORDING ZINAZ HAS NO MEANING IN A FOREIGN LANGUAGE.

SER. NO. 85-535,750, FILED 2-7-2012.

HANNO RITTNER, EXAMINING ATTORNEY



David J. Kyffers

Director of the United States Patent and Trademark Office

United States of America

United States Patent and Trademark Office

J-LuckBears

Reg. No. 4,205,725

JEROME GEATHERS (UNITED STATES INDIVIDUAL)
12333 SOJOURN COURT
HUNTERSVILLE, NC 28078

Registered Sep. 11, 2012

Int. Cl.: 28

FOR: STUFFED DOLLS AND ANIMALS, IN CLASS 28 (U.S. CLS. 22, 23, 38 AND 50).

TRADEMARK

FIRST USE 1-16-2011; IN COMMERCE 9-22-2011.

PRINCIPAL REGISTER

THE MARK CONSISTS OF STANDARD CHARACTERS WITHOUT CLAIM TO ANY PARTICULAR FONT, STYLE, SIZE, OR COLOR.

SER. NO. 85-535,755, FILED 2-7-2012.

JIM RINGLE, EXAMINING ATTORNEY



David J. Kyffers

Director of the United States Patent and Trademark Office

United States of America

United States Patent and Trademark Office



Reg. No. 4,205,726

Registered Sep. 11, 2012

Int. Cl.: 25

TRADEMARK

PRINCIPAL REGISTER

OHAYO SANGYO LLC (CALIFORNIA LIMITED LIABILITY COMPANY)
SUITE 160
2370 WEST CARSON STREET
TORRANCE, CA 90501

FOR: ACTIVE SPORTSWEAR CLOTHING FOR MEN, WOMEN, AND CHILDREN, NAMELY, SHIRTS, SHORTS, SINGLETS, JACKETS, PANTS, TIGHTS, SWEAT SHIRTS, HATS, CAPS, SWIMWEAR, SOCKS, AND FOOTWEAR, IN CLASS 25 (U.S. CLS. 22 AND 39).

FIRST USE 1-1-1996; IN COMMERCE 1-1-1996.

THE MARK CONSISTS OF A STYLIZED LETTER "R".

SER. NO. 85-535,759, FILED 2-7-2012.

KIM MONINGHOFF, EXAMINING ATTORNEY



David J. Kybas

Director of the United States Patent and Trademark Office

United States of America

United States Patent and Trademark Office

SUSHI POPPER

Reg. No. 4,205,727

Registered Sep. 11, 2012

Int. Cl.: 30

TRADEMARK

PRINCIPAL REGISTER

POPPER FOODS LLC (DELAWARE LIMITED LIABILITY COMPANY)
230 APENNINE PLACE
LAS VEGAS, NV 89138

FOR: SUSHI, IN CLASS 30 (U.S. CL. 46).

FIRST USE 3-22-2009; IN COMMERCE 7-2-2009.

THE MARK CONSISTS OF STANDARD CHARACTERS WITHOUT CLAIM TO ANY PARTICULAR FONT, STYLE, SIZE, OR COLOR.

NO CLAIM IS MADE TO THE EXCLUSIVE RIGHT TO USE "SUSHI", APART FROM THE MARK AS SHOWN.

SER. NO. 85-535,763, FILED 2-7-2012.

MARK SHINER, EXAMINING ATTORNEY



David J. Kybas

Director of the United States Patent and Trademark Office

United States of America

United States Patent and Trademark Office

IBC

Reg. No. 4,205,728

THE ICE BOX COMPANY, INC. (SOUTH CAROLINA CORPORATION)
POST OFFICE BOX 7074
SUNSET BEACH, NC 28468

Registered Sep. 11, 2012

Int. Cl.: 16

FOR: PLASTIC BAGS FOR PACKAGING ICE, IN CLASS 16 (U.S. CLS. 2, 5, 22, 23, 29, 37, 38 AND 50).

TRADEMARK

FIRST USE 4-26-1986; IN COMMERCE 4-26-1986.

PRINCIPAL REGISTER

THE MARK CONSISTS OF STANDARD CHARACTERS WITHOUT CLAIM TO ANY PARTICULAR FONT, STYLE, SIZE, OR COLOR.

SER. NO. 85-535,776, FILED 2-7-2012.

JULIE VEPPUMTHARA, EXAMINING ATTORNEY



David J. Kyffers

Director of the United States Patent and Trademark Office

United States of America

United States Patent and Trademark Office

LaunchHER

Reg. No. 4,205,729

ZITNICK, KARA J. JENSEN (UNITED STATES INDIVIDUAL)
311 CONCORDE PLACE
BURNSVILLE, MN 55337

Registered Sep. 11, 2012

Int. Cl.: 41

FOR: PROVIDING A WEBSITE FEATURING BLOGS AND NON-DOWNLOADABLE PUBLICATIONS IN THE NATURE OF ARTICLES IN THE FIELD(S) OF ENTREPRENEURSHIP, MARKETING, INTELLECTUAL PROPERTY, AND WOMEN-OWNED BUSINESSES, IN CLASS 41 (U.S. CLS. 100, 101 AND 107).

SERVICE MARK

PRINCIPAL REGISTER

FIRST USE 1-1-2010; IN COMMERCE 1-1-2010.

THE MARK CONSISTS OF STANDARD CHARACTERS WITHOUT CLAIM TO ANY PARTICULAR FONT, STYLE, SIZE, OR COLOR.

SER. NO. 85-535,837, FILED 2-7-2012.

VERNA BETH RIRIE, EXAMINING ATTORNEY



David J. Kybas

Director of the United States Patent and Trademark Office

United States of America

United States Patent and Trademark Office

ECOCAMEL

Reg. No. 4,205,730

ECOCAMEL LIMITED (UNITED KINGDOM LIMITED COMPANY (LTD.))
233 WOODHOUSE ROAD

Registered Sep. 11, 2012

LONDON, UNITED KINGDOM N129BD

Int. Cl.: 11

FOR: SHOWERHEADS AND COMPONENTS THEREOF, IN CLASS 11 (U.S. CLS. 13, 21, 23, 31 AND 34).

TRADEMARK

FIRST USE 2-0-2009; IN COMMERCE 2-0-2009.

PRINCIPAL REGISTER

THE MARK CONSISTS OF STANDARD CHARACTERS WITHOUT CLAIM TO ANY PARTICULAR FONT, STYLE, SIZE, OR COLOR.

SER. NO. 85-535,841, FILED 2-7-2012.

JANICE L. MCMORROW, EXAMINING ATTORNEY



David J. Kyffers

Director of the United States Patent and Trademark Office

United States of America

United States Patent and Trademark Office

EYKON

Reg. No. 4,205,731

ARTON SOUTH, INC. (TENNESSEE CORPORATION)
5675 EAST SHELBY DR
MEMPHIS, TN 38141

Registered Sep. 11, 2012

Int. Cl.: 35

FOR: WHOLESALE DISTRIBUTORSHIPS FEATURING WALL COVERINGS, IN CLASS 35
(U.S. CLS. 100, 101 AND 102).

SERVICE MARK

FIRST USE 7-1-2000; IN COMMERCE 7-1-2000.

PRINCIPAL REGISTER

THE MARK CONSISTS OF STANDARD CHARACTERS WITHOUT CLAIM TO ANY PARTICULAR FONT, STYLE, SIZE, OR COLOR.

SER. NO. 85-535,857, FILED 2-7-2012.

KATHY DE JONGE, EXAMINING ATTORNEY



David J. Kybas

Director of the United States Patent and Trademark Office

United States of America

United States Patent and Trademark Office



Reg. No. 4,205,732

Registered Sep. 11, 2012

Int. Cl.: 29

TRADEMARK

PRINCIPAL REGISTER

CHARLITO, LLC (NORTH CAROLINA LIMITED LIABILITY COMPANY)
622 GLASCOCK STREET
RALEIGH, NC 27604

FOR: CHARCUTERIE, IN CLASS 29 (U.S. CL. 46).

FIRST USE 9-1-2011; IN COMMERCE 9-1-2011.

THE MARK CONSISTS OF A DRAWING OF A HEAD OF A PIG IN A CIRCLE.

SER. NO. 85-535,868, FILED 2-7-2012.

BRIAN PINO, EXAMINING ATTORNEY



David J. Kyffers

Director of the United States Patent and Trademark Office

United States of America

United States Patent and Trademark Office

BASE REVOLU

Reg. No. 4,205,733

BASE APPAREL CO., LTD (CHINA LIMITED COMPANY (LTD.))
LEVEL 4 NO.6 ZENGCHA ROAD, LUOCHONGWEI,
GUANGZHOU, CHINA

Registered Sep. 11, 2012

Int. Cl.: 25

FOR: CLOTHING, NAMELY, FOOTWEAR, SHOES, HEAD WEAR, HATS, TOPS, BOTTOMS, SHIRTS, T-SHIRTS, POLO SHIRTS, PANTS, JEANS, BELTS, JACKETS, AND SWEATERS , IN CLASS 25 (U.S. CLS. 22 AND 39).

TRADEMARK

FIRST USE 4-9-2006; IN COMMERCE 4-9-2006.

PRINCIPAL REGISTER

THE MARK CONSISTS OF STANDARD CHARACTERS WITHOUT CLAIM TO ANY PARTICULAR FONT, STYLE, SIZE, OR COLOR.

SER. NO. 85-535,870, FILED 2-7-2012.

KEVON CHISOLM, EXAMINING ATTORNEY



David J. Kyffers

Director of the United States Patent and Trademark Office

United States of America

United States Patent and Trademark Office



ChristianEducation.com

Reg. No. 4,205,734

EDUCATIONDYNAMICS, LLC (DELAWARE LIMITED LIABILITY COMPANY)
5 MARINE VIEW PLAZA, SUITE 212
HOBOKEN, NJ 07030

Registered Sep. 11, 2012

Int. Cls.: 35 and 41

FOR: PROVIDING AN ON-LINE DIRECTORY INFORMATION SERVICE FEATURING INFORMATION AND LINKS TO THE WEB SITES OF OTHERS PERTAINING TO EDUCATION, EDUCATIONAL OPPORTUNITIES, EDUCATIONAL RESOURCES AND FAITH BASED PROGRAMS; ADVERTISING, MARKETING AND PROMOTION SERVICES, IN CLASS 35 (U.S. CLS. 100, 101 AND 102).

SERVICE MARK

PRINCIPAL REGISTER

FIRST USE 11-16-2011; IN COMMERCE 11-16-2011.

FOR: PROVISION OF INFORMATION RELATING TO EDUCATION, EDUCATIONAL OPPORTUNITIES, EDUCATIONAL RESOURCES AND FAITH BASED EDUCATIONAL PROGRAMS, IN CLASS 41 (U.S. CLS. 100, 101 AND 107).

FIRST USE 11-16-2011; IN COMMERCE 11-16-2011.

NO CLAIM IS MADE TO THE EXCLUSIVE RIGHT TO USE "CHRISTIANEDUCATION.COM", APART FROM THE MARK AS SHOWN.

THE MARK CONSISTS OF A DESIGN OF A BIRD OVER AND TO THE RIGHT OF THE TERM "CHRISTIANEDUCATION.COM".

SER. NO. 85-535,872, FILED 2-7-2012.

KEVON CHISOLM, EXAMINING ATTORNEY



David J. Kyffers

Director of the United States Patent and Trademark Office

United States of America

United States Patent and Trademark Office

LUCID

Reg. No. 4,205,735

Registered Sep. 11, 2012

Int. Cl.: 9

TRADEMARK

PRINCIPAL REGISTER

LG ELECTRONICS INC. (REPUBLIC OF KOREA CORPORATION)
20 YEUIDO-DONG YEONGDEUNGPO-GU
SEOUL 150-721, REPUBLIC OF KOREA

FOR: SMART PHONES; MOBILE PHONES, IN CLASS 9 (U.S. CLS. 21, 23, 26, 36 AND 38).

FIRST USE 3-29-2012; IN COMMERCE 3-29-2012.

THE MARK CONSISTS OF STANDARD CHARACTERS WITHOUT CLAIM TO ANY PARTICULAR FONT, STYLE, SIZE, OR COLOR.

SER. NO. 85-535,888, FILED 2-7-2012.

MORGAN WYNNE, EXAMINING ATTORNEY



David J. Kybas

Director of the United States Patent and Trademark Office

United States of America

United States Patent and Trademark Office

Moufy

Reg. No. 4,205,736

Registered Sep. 11, 2012

Int. Cls.: 9 and 41

TRADEMARK

SERVICE MARK

PRINCIPAL REGISTER

CAMERON P LOVETT-WOODSUM (UNITED STATES INDIVIDUAL)
21 COMMONWEALTH AVE
BOSTON, MA 02116

FOR: AUDIO AND VIDEO RECORDINGS FEATURING MUSIC AND ARTISTIC PERFORMANCES; DIGITAL MUSIC DOWNLOADABLE FROM THE INTERNET; DOWNLOADABLE MUSICAL SOUND RECORDINGS; DOWNLOADABLE RING TONES, GRAPHICS AND MUSIC VIA A GLOBAL COMPUTER NETWORK AND WIRELESS DEVICES, IN CLASS 9 (U.S. CLS. 21, 23, 26, 36 AND 38).

FIRST USE 3-27-2011; IN COMMERCE 3-27-2011.

FOR: ENTERTAINMENT SERVICES IN THE NATURE OF LIVE MUSICAL PERFORMANCES; ENTERTAINMENT SERVICES, NAMELY, PROVIDING NON-DOWNLOADABLE PLAYBACK OF MUSIC VIA GLOBAL COMMUNICATIONS NETWORKS; PRESENTATION OF LIVE SHOW PERFORMANCES; PRODUCTION OF MUSICAL VIDEOS, IN CLASS 41 (U.S. CLS. 100, 101 AND 107).

FIRST USE 12-11-2010; IN COMMERCE 12-11-2010.

THE MARK CONSISTS OF STANDARD CHARACTERS WITHOUT CLAIM TO ANY PARTICULAR FONT, STYLE, SIZE, OR COLOR.

SER. NO. 85-535,899, FILED 2-7-2012.

JOHN WILKE, EXAMINING ATTORNEY



David J. Kyffers

Director of the United States Patent and Trademark Office

United States of America

United States Patent and Trademark Office

Nitridox

Reg. No. 4,205,737

CONTROLLED THERMAL TECHNOLOGY (ARIZONA CORPORATION)
2617 WEST CYPRESS STREET
PHOENIX, AZ 85009

Registered Sep. 11, 2012

Int. Cl.: 40

FOR: METAL HEAT TREATING SERVICES BY MEANS OF FERRITIC NITROCARBURIZING;
METAL TREATING; METAL TREATMENT; TREATMENT OF METAL, IN CLASS 40 (U.S.
CLS. 100, 103 AND 106).

SERVICE MARK

FIRST USE 6-1-2011; IN COMMERCE 6-1-2011.

PRINCIPAL REGISTER

THE MARK CONSISTS OF STANDARD CHARACTERS WITHOUT CLAIM TO ANY PAR-
TICULAR FONT, STYLE, SIZE, OR COLOR.

SER. NO. 85-535,901, FILED 2-7-2012.

KAPIL BHANOT, EXAMINING ATTORNEY



David J. Kybas

Director of the United States Patent and Trademark Office

United States of America

United States Patent and Trademark Office

PUNTO DE VISTA

Reg. No. 4,205,738

Registered Sep. 11, 2012

Int. Cl.: 43

SERVICE MARK

PRINCIPAL REGISTER

PUNTO DE VISTA LUXURY SERVICES LTDA. (COSTA RICA LIMITED LIABILITY COMPANY)
7801 NW 37TH ST.
MIAMI, FL 33166

FOR: PROVIDING TEMPORARY ACCOMMODATIONS AND LODGING IN THE NATURE OF A PRIVATE LUXURY VILLA, IN CLASS 43 (U.S. CLS. 100 AND 101).

FIRST USE 1-0-2010; IN COMMERCE 1-0-2010.

THE MARK CONSISTS OF STANDARD CHARACTERS WITHOUT CLAIM TO ANY PARTICULAR FONT, STYLE, SIZE, OR COLOR.

THE ENGLISH TRANSLATION OF "PUNTO DE VISTA" IN THE MARK IS "POINT OF VIEW".

SER. NO. 85-535,905, FILED 2-7-2012.

Laurie Kaufman, Examining Attorney



David J. Kyffers

Director of the United States Patent and Trademark Office

United States of America

United States Patent and Trademark Office

Who's Doing

Reg. No. 4,205,739

WHO'S DOING, LLC (TEXAS LIMITED LIABILITY COMPANY)
16414 LA AVENIDA DRIVE
HOUSTON, TX 77062

Registered Sep. 11, 2012

Int. Cl.: 42

FOR: PROVIDING A WEB SITE FEATURING TECHNOLOGY THAT ENABLES USERS TO SHARE INFORMATION AND COMMUNICATE WITH OTHER USERS, IN CLASS 42 (U.S. CLS. 100 AND 101).

SERVICE MARK

FIRST USE 1-24-2012; IN COMMERCE 1-24-2012.

PRINCIPAL REGISTER

THE MARK CONSISTS OF STANDARD CHARACTERS WITHOUT CLAIM TO ANY PARTICULAR FONT, STYLE, SIZE, OR COLOR.

SER. NO. 85-535,909, FILED 2-7-2012.

JOHN WILKE, EXAMINING ATTORNEY



David J. Kyffers

Director of the United States Patent and Trademark Office

United States of America

United States Patent and Trademark Office

Gr8-White

Reg. No. 4,205,740

Registered Sep. 11, 2012

Int. Cl.: 6

TRADEMARK

PRINCIPAL REGISTER

XWERX, LLC (FLORIDA LIMITED LIABILITY COMPANY), DBA GR8-WHITE, LLC
3893 MANNIX DRIVE, SUITE 517
3893 MANNIX DRIVE, SUITE 517
NAPLES, FL 34114

FOR: METAL STEPLADDERS AND LADDERS, IN CLASS 6 (U.S. CLS. 2, 12, 13, 14, 23, 25 AND 50).

FIRST USE 7-18-2011; IN COMMERCE 7-18-2011.

THE MARK CONSISTS OF STANDARD CHARACTERS WITHOUT CLAIM TO ANY PARTICULAR FONT, STYLE, SIZE, OR COLOR.

SER. NO. 85-535,936, FILED 2-7-2012.

GRETCHEN ULRICH, EXAMINING ATTORNEY



David J. Kyffers

Director of the United States Patent and Trademark Office

United States of America

United States Patent and Trademark Office

POSITIVE INFLUENCE

Reg. No. 4,205,741

FERRO, ZACHARY (UNITED STATES INDIVIDUAL)

Registered Sep. 11, 2012

4113 SCARLETT DRIVE
TALLAHASSEE, FL 32303

Int. Cl.: 35

FOR: ON-LINE RETAIL STORE SERVICES FEATURING CLOTHING, MUGS, AUDIO CDS,
MUSIC DVDS, PHOTOS, IN CLASS 35 (U.S. CLS. 100, 101 AND 102).

SERVICE MARK

FIRST USE 2-1-2012; IN COMMERCE 2-1-2012.

PRINCIPAL REGISTER

THE MARK CONSISTS OF STANDARD CHARACTERS WITHOUT CLAIM TO ANY PAR-
TICULAR FONT, STYLE, SIZE, OR COLOR.

SER. NO. 85-535,938, FILED 2-7-2012.

VERNA BETH RIRIE, EXAMINING ATTORNEY



David J. Kybas

Director of the United States Patent and Trademark Office

United States of America

United States Patent and Trademark Office

MILLENNIUM COLOR WORKS

Reg. No. 4,205,742

Registered Sep. 11, 2012

Int. Cl.: 2

TRADEMARK

PRINCIPAL REGISTER

TECHNICAL INTERNATIONAL SUPPLY CORP. (NEW YORK CORPORATION), DBA
TECHNICAL TATTOO SUPPLY, INC.
68 CABOT STREET
WEST BABYLON, NY 11704

FOR: TATTOO INKS, IN CLASS 2 (U.S. CLS. 6, 11 AND 16).

FIRST USE 12-0-1999; IN COMMERCE 12-0-1999.

THE MARK CONSISTS OF STANDARD CHARACTERS WITHOUT CLAIM TO ANY PARTICULAR FONT, STYLE, SIZE, OR COLOR.

SER. NO. 85-535,953, FILED 2-7-2012.

SALLY SHIH, EXAMINING ATTORNEY



David J. Kybas

Director of the United States Patent and Trademark Office

United States of America

United States Patent and Trademark Office

SAVI

Reg. No. 4,205,743

Registered Sep. 11, 2012

Int. Cl.: 8

TRADEMARK

PRINCIPAL REGISTER

OMEGA TECHNOLOGIES, INC. (CALIFORNIA CORPORATION)
#905
31125 VIA COLINAS
WESTLAKE VILLAGE, CA 91362

FOR: HAND TOOLS, NAMELY, SOCKET SETS, IN CLASS 8 (U.S. CLS. 23, 28 AND 44).

FIRST USE 5-1-2010; IN COMMERCE 5-1-2010.

THE MARK CONSISTS OF STANDARD CHARACTERS WITHOUT CLAIM TO ANY PARTICULAR FONT, STYLE, SIZE, OR COLOR.

SER. NO. 85-535,983, FILED 2-7-2012.

JORDAN BAKER, EXAMINING ATTORNEY



David J. Kyffers

Director of the United States Patent and Trademark Office

United States of America

United States Patent and Trademark Office

ULTRA PLUS

Reg. No. 4,205,744

ABRO INDUSTRIES, INC. (INDIANA CORPORATION)
3580 BLACKTHORN COURT
SOUTH BEND, IN 46628

Registered Sep. 11, 2012

Int. Cl.: 17

FOR: LIQUID GASKET MAKING COMPOUNDS IN THE NATURE OF ADHESIVE SEALANTS FOR AUTOMOTIVE ENGINE AND MACHINE USE, IN CLASS 17 (U.S. CLS. 1, 5, 12, 13, 35 AND 50).

TRADEMARK

FIRST USE 7-0-2008; IN COMMERCE 7-0-2008.

PRINCIPAL REGISTER

THE MARK CONSISTS OF STANDARD CHARACTERS WITHOUT CLAIM TO ANY PARTICULAR FONT, STYLE, SIZE, OR COLOR.

SER. NO. 85-535,993, FILED 2-7-2012.

RUSS HERMAN, EXAMINING ATTORNEY



David J. Kyffers

Director of the United States Patent and Trademark Office

United States of America

United States Patent and Trademark Office

COLLEGE AVE

Reg. No. 4,205,745

Registered Sep. 11, 2012

Int. Cl.: 24

TRADEMARK

PRINCIPAL REGISTER

DORM COMPANY (NEW YORK CORPORATION)
9150 HILLVIEW DR
CLARENCE, NY 14031

FOR: BED BLANKETS; BED SHEETS; BED SPREADS; BED THROWS; BEDSHEETS;
COMFORTERS; COVERLETS; DUVET COVERS; DUVETS; FITTED BED SHEETS; FLAT
BED SHEETS; MATTRESS COVERS; MATTRESS PADS; QUILT COVERS; QUILTS, IN
CLASS 24 (U.S. CLS. 42 AND 50).

FIRST USE 12-12-2011; IN COMMERCE 2-1-2012.

THE MARK CONSISTS OF STANDARD CHARACTERS WITHOUT CLAIM TO ANY PAR-
TICULAR FONT, STYLE, SIZE, OR COLOR.

SER. NO. 85-535,995, FILED 2-7-2012.

MATTHEW KLINE, EXAMINING ATTORNEY



David J. Kyffers

Director of the United States Patent and Trademark Office

United States of America

United States Patent and Trademark Office

CHIC-KETTS

Reg. No. 4,205,746

Registered Sep. 11, 2012

Int. Cl.: 29

TRADEMARK

PRINCIPAL REGISTER

KELLOGG NORTH AMERICA COMPANY (DELAWARE CORPORATION)
ONE KELLOGG SQUARE, PO BOX 3599
BATTLE CREEK, MI 490163599

FOR: MEAT SUBSTITUTES, IN CLASS 29 (U.S. CL. 46).

FIRST USE 12-31-1972; IN COMMERCE 12-31-1972.

THE MARK CONSISTS OF STANDARD CHARACTERS WITHOUT CLAIM TO ANY PARTICULAR FONT, STYLE, SIZE, OR COLOR.

SER. NO. 85-536,002, FILED 2-7-2012.

LINDA ORNDORFF, EXAMINING ATTORNEY



David J. Kybas

Director of the United States Patent and Trademark Office

United States of America

United States Patent and Trademark Office

AB Unlimited

Reg. No. 4,205,747

AB UNLIMITED (CALIFORNIA CORPORATION)
2602 1/2 GLEN GREEN STREET
LOS ANGELES, CA 90068

Registered Sep. 11, 2012

Int. Cl.: 35

FOR: PREPARATION OF CUSTOMIZED PROMOTIONAL AND MERCHANDISING MATERIALS FOR OTHERS, IN CLASS 35 (U.S. CLS. 100, 101 AND 102).

SERVICE MARK

FIRST USE 9-1-2004; IN COMMERCE 9-1-2009.

PRINCIPAL REGISTER

THE MARK CONSISTS OF STANDARD CHARACTERS WITHOUT CLAIM TO ANY PARTICULAR FONT, STYLE, SIZE, OR COLOR.

SER. NO. 85-536,004, FILED 2-7-2012.

BRIDGETT SMITH, EXAMINING ATTORNEY



David J. Kyros

Director of the United States Patent and Trademark Office

United States of America
United States Patent and Trademark Office

WHOLEY

Reg. No. 4,205,748

Registered Sep. 11, 2012

Int. Cl.: 43

SERVICE MARK

PRINCIPAL REGISTER

ROBERT WHOLEY & CO., INC. (PENNSYLVANIA CORPORATION)
1737 PENN AVENUE
PITTSBURGH, PA 15222

FOR: RESTAURANT SERVICES, IN CLASS 43 (U.S. CLS. 100 AND 101).

FIRST USE 0-0-1960; IN COMMERCE 0-0-1960.

THE MARK CONSISTS OF STANDARD CHARACTERS WITHOUT CLAIM TO ANY PARTICULAR FONT, STYLE, SIZE, OR COLOR.

OWNER OF U.S. REG. NOS. 2,479,494 AND 2,492,163.

SEC. 2(F).

SER. NO. 85-536,007, FILED 2-7-2012.

BRIDGETT SMITH, EXAMINING ATTORNEY



David J. Kyffers

Director of the United States Patent and Trademark Office

United States of America

United States Patent and Trademark Office

CHOPLETS

Reg. No. 4,205,749

Registered Sep. 11, 2012

Int. Cl.: 29

TRADEMARK

PRINCIPAL REGISTER

KELLOGG NORTH AMERICA COMPANY (DELAWARE CORPORATION)
ONE KELLOGG SQUARE, PO BOX 3599
BATTLE CREEK, MI 490163599

FOR: MEAT SUBSTITUTES, IN CLASS 29 (U.S. CL. 46).

FIRST USE 12-30-1946; IN COMMERCE 12-30-1946.

THE MARK CONSISTS OF STANDARD CHARACTERS WITHOUT CLAIM TO ANY PARTICULAR FONT, STYLE, SIZE, OR COLOR.

SER. NO. 85-536,011, FILED 2-7-2012.

LINDA ORNDORFF, EXAMINING ATTORNEY



David J. Kybas

Director of the United States Patent and Trademark Office

United States of America

United States Patent and Trademark Office

JupiterBounce

Reg. No. 4,205,750

JUPITERBOUNCE.COM (FLORIDA LIMITED LIABILITY COMPANY)
927 TURNER QUAY
JUPITER, FL 33458

Registered Sep. 11, 2012

Int. Cl.: 41

FOR: RENTAL OF AMUSEMENT MACHINES AND APPARATUSES, NAMELY, BOUNCE HOUSES IN THE NATURE OF AN AIR INFLATED CUSHION IN AN AIR INFLATED STRUCTURE, IN CLASS 41 (U.S. CLS. 100, 101 AND 107).

SERVICE MARK

FIRST USE 4-10-2006; IN COMMERCE 4-10-2006.

PRINCIPAL REGISTER

THE MARK CONSISTS OF STANDARD CHARACTERS WITHOUT CLAIM TO ANY PARTICULAR FONT, STYLE, SIZE, OR COLOR.

SER. NO. 85-536,020, FILED 2-7-2012.

KIM MONINGHOFF, EXAMINING ATTORNEY



David J. Kyros

Director of the United States Patent and Trademark Office

United States of America

United States Patent and Trademark Office

DataLink360

Reg. No. 4,205,751

REAL SOURCING NETWORK LLC (DELAWARE LIMITED LIABILITY COMPANY)
445 PARK AVE. 10TH FLOOR
NEW YORK, NY 10022

Registered Sep. 11, 2012

Int. Cl.: 9

FOR: COMPUTER SOFTWARE THAT PROVIDES WEB-BASED ACCESS TO APPLICATIONS AND SERVICES THROUGH A WEB OPERATING SYSTEM OR PORTAL INTERFACE , IN CLASS 9 (U.S. CLS. 21, 23, 26, 36 AND 38).

TRADEMARK

FIRST USE 12-0-2011; IN COMMERCE 12-0-2011.

PRINCIPAL REGISTER

THE MARK CONSISTS OF STANDARD CHARACTERS WITHOUT CLAIM TO ANY PARTICULAR FONT, STYLE, SIZE, OR COLOR.

SER. NO. 85-536,069, FILED 2-7-2012.

SHAILA SETTLES, EXAMINING ATTORNEY



David J. Kyffers

Director of the United States Patent and Trademark Office

United States of America
United States Patent and Trademark Office

CAROOO

Reg. No. 4,205,752

Registered Sep. 11, 2012

Int. Cl.: 25

TRADEMARK

PRINCIPAL REGISTER

SHOESZOO FOOTWEAR, INC. (CANADA CORPORATION)
RICHMOND
8080 ST ALBANS RD
BRITISH COLUMBIA, CANADA V6Y2K9

FOR: SHOES, IN CLASS 25 (U.S. CLS. 22 AND 39).

FIRST USE 0-0-2003; IN COMMERCE 0-0-2003.

THE MARK CONSISTS OF STANDARD CHARACTERS WITHOUT CLAIM TO ANY PARTICULAR FONT, STYLE, SIZE, OR COLOR.

SER. NO. 85-536,078, FILED 2-7-2012.

EMILY CARLSEN, EXAMINING ATTORNEY



David J. Kyffers

Director of the United States Patent and Trademark Office

United States of America

United States Patent and Trademark Office

ENHANCING LIFE THROUGH BIRTH

Reg. No. 4,205,753

BIOD, LLC (DELAWARE LIMITED LIABILITY COMPANY)
7740A TRINITY ROAD, SUITE 107
CORDOVA, TN 38018

Registered Sep. 11, 2012

Int. Cl.: 5

FOR: HUMAN ALLOGRAFT TISSUE, IN CLASS 5 (U.S. CLS. 6, 18, 44, 46, 51 AND 52).

TRADEMARK

FIRST USE 4-0-2011; IN COMMERCE 4-0-2011.

PRINCIPAL REGISTER

THE MARK CONSISTS OF STANDARD CHARACTERS WITHOUT CLAIM TO ANY PARTICULAR FONT, STYLE, SIZE, OR COLOR.

SER. NO. 85-536,115, FILED 2-7-2012.

WILLIAM BRECKENFELD, EXAMINING ATTORNEY



David J. Kyffers

Director of the United States Patent and Trademark Office

United States of America

United States Patent and Trademark Office

BY LOCALS. FOR LOCALS

Reg. No. 4,205,754

Registered Sep. 11, 2012

Int. Cl.: 33

TRADEMARK

PRINCIPAL REGISTER

H.D.D. LLC (CALIFORNIA LIMITED LIABILITY COMPANY), DBA TRUETT HURST
WINERY
5610 DRY CREEK ROAD
HEALDSBURG, CA 95448

FOR: ALCOHOLIC BEVERAGES EXCEPT BEERS, IN CLASS 33 (U.S. CLS. 47 AND 49).

FIRST USE 9-30-2011; IN COMMERCE 9-30-2011.

THE MARK CONSISTS OF STANDARD CHARACTERS WITHOUT CLAIM TO ANY PARTICULAR FONT, STYLE, SIZE, OR COLOR.

SER. NO. 85-536,117, FILED 2-7-2012.

WILLIAM BRECKENFELD, EXAMINING ATTORNEY



David J. Kybas

Director of the United States Patent and Trademark Office

United States of America

United States Patent and Trademark Office

CORN PUP

Reg. No. 4,205,755

KRYSTAL TRADEMARK COMPANY (NEVADA CORPORATION)
2215-B RENAISSANCE DRIVE
LAS VEGAS, NV 89119

Registered Sep. 11, 2012

Int. Cl.: 30

FOR: MINIATURE FRANKFURTERS, ENCASED IN A BREAD CRUST ON A STICK, IN CLASS 30 (U.S. CL. 46).

TRADEMARK

FIRST USE 3-30-1992; IN COMMERCE 3-30-1992.

PRINCIPAL REGISTER

THE MARK CONSISTS OF STANDARD CHARACTERS WITHOUT CLAIM TO ANY PARTICULAR FONT, STYLE, SIZE, OR COLOR.

OWNER OF U.S. REG. NO. 1,809,407.

NO CLAIM IS MADE TO THE EXCLUSIVE RIGHT TO USE "CORN", APART FROM THE MARK AS SHOWN.

SEC. 2(F).

SER. NO. 85-536,127, FILED 2-7-2012.

BRIAN CALLAGHAN, EXAMINING ATTORNEY



David J. Kyffers

Director of the United States Patent and Trademark Office

United States of America

United States Patent and Trademark Office



Reg. No. 4,205,756

UMOJA, INC. (MISSISSIPPI CORPORATION)
1780 DORGAN ST.
JACKSON, MS 39203

Registered Sep. 11, 2012

Int. Cl.: 9

FOR: EARPHONES AND HEADPHONES, IN CLASS 9 (U.S. CLS. 21, 23, 26, 36 AND 38).

FIRST USE 12-0-2010; IN COMMERCE 12-0-2010.

TRADEMARK

THE MARK CONSISTS OF THE WORD "UMOJA" ABOVE AN ABSTRACT SHAPE THAT CONSISTS OF A ROUNDED BOTTOM AND TWO POINTS AT THE TOP. INSIDE OF THE ABSTRACT SHAPE IS A WHIRLPOOL.

PRINCIPAL REGISTER

THE ENGLISH TRANSLATION OF "UMOJA" IN THE MARK IS "UNITED".

SER. NO. 85-536,155, FILED 2-7-2012.

CURTIS FRENCH, EXAMINING ATTORNEY



David J. Kyffers

Director of the United States Patent and Trademark Office

United States of America

United States Patent and Trademark Office



Reg. No. 4,205,757

Registered Sep. 11, 2012

Int. Cl.: 41

SERVICE MARK

PRINCIPAL REGISTER

SOUTH DAKOTA BOARD OF REGENTS (SOUTH DAKOTA STATE AGENCY)
306 E. CAPITOL AVENUE
PIERRE, SD 575012545

FOR: ENTERTAINMENT SERVICES, NAMELY, A COLLEGE HOMECOMING FESTIVAL FEATURING ENTERTAINMENT IN THE NATURE OF A FOOTBALL GAME, PICNIC, LIVE MUSICAL PERFORMANCE, AND PARADE, IN CLASS 41 (U.S. CLS. 100, 101 AND 107).

FIRST USE 0-0-1962; IN COMMERCE 0-0-1962.

THE MARK CONSISTS OF A CARICATURE OF A MAN'S HEAD COMMONLY KNOWN AS A 'HOBO'.

SER. NO. 85-536,160, FILED 2-7-2012.

INGA ERVIN, EXAMINING ATTORNEY



David J. Kyffers

Director of the United States Patent and Trademark Office

United States of America

United States Patent and Trademark Office

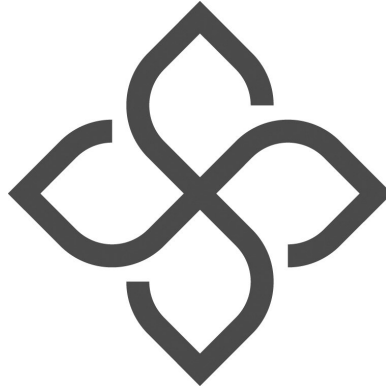

Reg. No. 4,205,758

FLAGEOLI CLASSIC LIMITED, LLC (NEVADA LIMITED LIABILITY COMPANY)
7310 SMOKE RANCH RD. - STE. "I"
LAS VEGAS, NV 89128

Registered Sep. 11, 2012

Int. Cls.: 3 and 5

FOR: NON-MEDICATED PREPARATIONS ALL FOR THE CARE OF SKIN, HAIR AND SCALP, IN CLASS 3 (U.S. CLS. 1, 4, 6, 50, 51 AND 52).

TRADEMARK

FIRST USE 9-14-2011; IN COMMERCE 9-14-2011.

PRINCIPAL REGISTER

FOR: MEDICATED SKIN CARE PREPARATIONS, NAMELY, CREAMS, LOTIONS, GELS, TONERS, CLEANERS AND PEELS, IN CLASS 5 (U.S. CLS. 6, 18, 44, 46, 51 AND 52).

FIRST USE 9-14-2011; IN COMMERCE 9-14-2011.

THE MARK CONSISTS OF AN ABSTRACT IMAGE OF A FLOWER BLOSSOM IN A FOUR POINT CONFIGURATION.

SER. NO. 85-536,180, FILED 2-7-2012.

SUE LAWRENCE, EXAMINING ATTORNEY



David J. Kybas

Director of the United States Patent and Trademark Office

United States of America

United States Patent and Trademark Office

ASCEND

Reg. No. 4,205,759

ASCEND OCG, INC. (ARIZONA CORPORATION)
3302 N 35TH AVE
PHOENIX, AZ 85019

Registered Sep. 11, 2012

Int. Cl.: 35

FOR: CONSULTING IN THE FIELD OF HUMAN RESOURCES; PERSONNEL PLACEMENT AND RECRUITMENT, IN CLASS 35 (U.S. CLS. 100, 101 AND 102).

SERVICE MARK

FIRST USE 1-31-2010; IN COMMERCE 1-31-2010.

PRINCIPAL REGISTER

THE MARK CONSISTS OF STANDARD CHARACTERS WITHOUT CLAIM TO ANY PARTICULAR FONT, STYLE, SIZE, OR COLOR.

SER. NO. 85-536,181, FILED 2-7-2012.

DOUGLAS LEE, EXAMINING ATTORNEY



David J. Kyffers

Director of the United States Patent and Trademark Office

United States of America

United States Patent and Trademark Office

EMC MADE SIMPLE

Reg. No. 4,205,760

MONTROSE COMPLIANCE SERVICES, INC. (CALIFORNIA CORPORATION)
2353 MISSION GLEN DRIVE
SANTA CLARA, CA 95051

Registered Sep. 11, 2012

Int. Cl.: 42

FOR: CONSULTING IN THE FIELD OF ELECTRICAL ENGINEERING, IN CLASS 42 (U.S. CLS. 100 AND 101).

SERVICE MARK

FIRST USE 2-6-2012; IN COMMERCE 2-6-2012.

PRINCIPAL REGISTER

THE MARK CONSISTS OF STANDARD CHARACTERS WITHOUT CLAIM TO ANY PARTICULAR FONT, STYLE, SIZE, OR COLOR.

SER. NO. 85-536,239, FILED 2-7-2012.

VIVIAN MICZNIK FIRST, EXAMINING ATTORNEY



David J. Kyffers

Director of the United States Patent and Trademark Office

United States of America

United States Patent and Trademark Office

28in28

Reg. No. 4,205,761

Registered Sep. 11, 2012

Int. Cls.: 5, 41 and 44

TRADEMARK

SERVICE MARK

PRINCIPAL REGISTER

28 IN 28 LLC (FLORIDA LIMITED LIABILITY COMPANY)
SUITE 257
2655 ULMERTON RD
CLEARWATER, FL 33762

FOR: DIETARY AND NUTRITIONAL SUPPLEMENTS USED FOR WEIGHT LOSS; WEIGHT MANAGEMENT SUPPLEMENTS , IN CLASS 5 (U.S. CLS. 6, 18, 44, 46, 51 AND 52).

FIRST USE 5-11-2011; IN COMMERCE 11-1-2011.

FOR: CONSULTING SERVICES IN THE FIELDS OF FITNESS AND EXERCISE; PROVIDING A WEBSITE FEATURING INFORMATION ON EXERCISE AND FITNESS; PROVIDING INFORMATION IN THE FIELD OF EXERCISE TRAINING; PROVIDING INFORMATION ON PHYSICAL EXERCISE, IN CLASS 41 (U.S. CLS. 100, 101 AND 107).

FIRST USE 5-11-2011; IN COMMERCE 11-1-2011.

FOR: PROVIDING A WEBSITE FEATURING INFORMATION AND ADVICE IN THE FIELDS OF DIET, WEIGHT LOSS, DIET PLANNING AND LIFESTYLE WELLNESS; PROVIDING AN INTERACTIVE WEBSITE FEATURING INFORMATION AND LINKS RELATING TO HEALTHY LIVING AND WEIGHT LOSS; PROVIDING INFORMATION ON MAINTAINING A HEALTHY LIFESTYLE AND LOSING WEIGHT; PROVIDING WEIGHT LOSS PROGRAM SERVICES; WEIGHT MANAGEMENT SERVICES, NAMELY, PROVIDING WEIGHT LOSS AND/OR WEIGHT MAINTENANCE PROGRAMS; WEIGHT REDUCTION DIET PLANNING AND SUPERVISION, IN CLASS 44 (U.S. CLS. 100 AND 101).

FIRST USE 5-11-2011; IN COMMERCE 11-1-2011.

THE MARK CONSISTS OF THE NUMBER "28" IN TWO SHADES OF BLUE, THEN WORD "IN" IN GREY, AND THE NUMBER "28" AGAIN IN TWO SHADES OF GREEN.

THE COLOR(S) BLUE, GREEN, AND GREY IS/ARE CLAIMED AS A FEATURE OF THE MARK.

SER. NO. 85-536,254, FILED 2-7-2012.

GINA FINK, EXAMINING ATTORNEY



David J. Kyros

Director of the United States Patent and Trademark Office

United States of America

United States Patent and Trademark Office

CHIK

Reg. No. 4,205,762

KRYSTAL TRADEMARK COMPANY (NEVADA CORPORATION)
2215-B RENAISSANCE DRIVE
LAS VEGAS, NV 89119

Registered Sep. 11, 2012

Int. Cl.: 30

FOR: SPECIALLY PREPARED SANDWICHES, IN CLASS 30 (U.S. CL. 46).

FIRST USE 3-30-1998; IN COMMERCE 3-30-1998.

TRADEMARK

THE MARK CONSISTS OF STANDARD CHARACTERS WITHOUT CLAIM TO ANY PARTICULAR FONT, STYLE, SIZE, OR COLOR.

PRINCIPAL REGISTER

OWNER OF U.S. REG. NOS. 2,232,312 AND 2,535,180.

SEC. 2(F).

SER. NO. 85-536,255, FILED 2-7-2012.

BRIAN CALLAGHAN, EXAMINING ATTORNEY



David J. Kyffers

Director of the United States Patent and Trademark Office

United States of America

United States Patent and Trademark Office

House of AlpacaWear

Reg. No. 4,205,763

Registered Sep. 11, 2012

Int. Cl.: 35

SERVICE MARK

PRINCIPAL REGISTER

MERELINDA FARM, LLC (MICHIGAN LIMITED LIABILITY COMPANY)
3888 W. NORTH TERRITORIAL ROAD
WHITMORE LAKE, MI 48189

FOR: RETAIL AND WHOLESALE STORE SERVICES FEATURING CLOTHING MADE OF ALPACA FLEECE, ACCESSIBLE ON-LINE AND BY TELEPHONE, FACSIMILE, AND MAIL ORDER, IN CLASS 35 (U.S. CLS. 100, 101 AND 102).

FIRST USE 1-1-2002; IN COMMERCE 1-1-2002.

THE MARK CONSISTS OF STANDARD CHARACTERS WITHOUT CLAIM TO ANY PARTICULAR FONT, STYLE, SIZE, OR COLOR.

OWNER OF U.S. REG. NOS. 2,588,250, 3,743,540 AND OTHERS.

SEC. 2(F) AS TO "ALPACAWEAR".

SER. NO. 85-536,298, FILED 2-7-2012.

KATINA MISTER, EXAMINING ATTORNEY



David J. Kybas

Director of the United States Patent and Trademark Office

United States of America

United States Patent and Trademark Office



Reg. No. 4,205,764

Registered Sep. 11, 2012

Int. Cl.: 40

SERVICE MARK

PRINCIPAL REGISTER

KG CREATIVE DESIGN LTD. (NEW YORK CORPORATION)
579 FIFTH AVENUE, STE 988
NEW YORK, NY 10017

FOR: JEWELRY CASTING, IN CLASS 40 (U.S. CLS. 100, 103 AND 106).

FIRST USE 12-1-1987; IN COMMERCE 12-1-1987.

THE MARK CONSISTS OF SPECIAL MARK WITH THE LETTERS "K" AND "G" INFUSED TOGETHER WITH DOUBLE BLACK BORDERS.

SER. NO. 85-536,306, FILED 2-7-2012.

HELENE LIWINSKI, EXAMINING ATTORNEY



David J. Kyffers

Director of the United States Patent and Trademark Office

United States of America

United States Patent and Trademark Office

YOUNG & NEW

Reg. No. 4,205,765

BRANDON SCOTT MCLEAN (UNITED STATES INDIVIDUAL)
13200 STRICKLAND RD. 114-291
RALEIGH, NC 27613

Registered Sep. 11, 2012

Int. Cl.: 41

FOR: ENTERTAINMENT SERVICES, NAMELY LIVE PERFORMANCES BY A MUSICAL BAND, IN CLASS 41 (U.S. CLS. 100, 101 AND 107).

SERVICE MARK

FIRST USE 2-2-2012; IN COMMERCE 2-2-2012.

PRINCIPAL REGISTER

THE MARK CONSISTS OF STANDARD CHARACTERS WITHOUT CLAIM TO ANY PARTICULAR FONT, STYLE, SIZE, OR COLOR.

SER. NO. 85-536,311, FILED 2-7-2012.

MARK SPARACINO, EXAMINING ATTORNEY



David J. Kyffers

Director of the United States Patent and Trademark Office

United States of America

United States Patent and Trademark Office



Reg. No. 4,205,766

Registered Sep. 11, 2012

Int. Cl.: 41

SERVICE MARK

PRINCIPAL REGISTER

SOUTH DAKOTA BOARD OF REGENTS (SOUTH DAKOTA STATE AGENCY)
306 E. CAPITOL AVENUE
PIERRE, SD 575012545

FOR: ENTERTAINMENT SERVICES, NAMELY, A COLLEGE HOMECOMING FESTIVAL FEATURING ENTERTAINMENT IN THE NATURE OF A FOOTBALL GAME, PICNIC, LIVE MUSICAL PERFORMANCE, AND PARADE, IN CLASS 41 (U.S. CLS. 100, 101 AND 107).

FIRST USE 0-0-1996; IN COMMERCE 0-0-1996.

THE MARK CONSISTS OF A CARICATURE OF A WOMAN'S HEAD.

SER. NO. 85-536,348, FILED 2-7-2012.

INGA ERVIN, EXAMINING ATTORNEY



David J. Kybas

Director of the United States Patent and Trademark Office

United States of America

United States Patent and Trademark Office

THE RIGHT TAXES THE FIRST TIME

Reg. No. 4,205,767

TEKNON CORPORATION (ARIZONA CORPORATION), DBA SYMMETRY SOFTWARE
14350 N. 87TH STREET, SUITE 170
SCOTTSDALE, AZ 85260

Registered Sep. 11, 2012

Int. Cl.: 42

FOR: PROVIDING TEMPORARY USE OF ONLINE, NON-DOWNLOADABLE SOFTWARE WHICH: DETERMINES ALL PAYROLL TAXES ASSOCIATED WITH A SPECIFIC ADDRESS OR ADDRESSES VIA THE INTERNET; ALLOWS THE USER TO MAKE PAYROLL-RELATED CALCULATIONS VIA THE INTERNET, IN CLASS 42 (U.S. CLS. 100 AND 101).

SERVICE MARK

PRINCIPAL REGISTER

FIRST USE 5-27-2009; IN COMMERCE 5-27-2009.

THE MARK CONSISTS OF STANDARD CHARACTERS WITHOUT CLAIM TO ANY PARTICULAR FONT, STYLE, SIZE, OR COLOR.

SER. NO. 85-536,349, FILED 2-7-2012.

EDWARD FENNESSY, EXAMINING ATTORNEY



David J. Kyfos

Director of the United States Patent and Trademark Office

United States of America

United States Patent and Trademark Office

CLEAR OFFER

Reg. No. 4,205,768

CLEAR OFFER (NEVADA CORPORATION)

Registered Sep. 11, 2012

848 N RAINBOW BLVD #2708
LAS VEGAS, NV 89107

Int. Cl.: 42

FOR: PROVIDING A SECURE ELECTRONIC ONLINE SYSTEM FEATURING TECHNOLOGY WHICH ALLOWS BUYERS AND SELLERS TO NEGOTIATE SALES PRICE AND TERMS OF BOTH REAL AND PERSONAL PROPERTY DIRECTLY , IN CLASS 42 (U.S. CLS. 100 AND 101).

SERVICE MARK

PRINCIPAL REGISTER

FIRST USE 2-6-2012; IN COMMERCE 2-6-2012.

THE MARK CONSISTS OF STANDARD CHARACTERS WITHOUT CLAIM TO ANY PARTICULAR FONT, STYLE, SIZE, OR COLOR.

SER. NO. 85-536,370, FILED 2-7-2012.

IRA J. GOODSaid, EXAMINING ATTORNEY



David J. Kyffers

Director of the United States Patent and Trademark Office

United States of America

United States Patent and Trademark Office

PearHaven

Reg. No. 4,205,769

PEAR INNOVATIONS, LLC (TEXAS LIMITED LIABILITY COMPANY)
1360 PATTERSON ROAD
AUSTIN, TX 78733

Registered Sep. 11, 2012

Int. Cl.: 45

FOR: ON-LINE SOCIAL NETWORKING SERVICES, IN CLASS 45 (U.S. CLS. 100 AND 101).

SERVICE MARK

FIRST USE 10-15-2011; IN COMMERCE 12-16-2011.

PRINCIPAL REGISTER

THE MARK CONSISTS OF STANDARD CHARACTERS WITHOUT CLAIM TO ANY PARTICULAR FONT, STYLE, SIZE, OR COLOR.

SER. NO. 85-536,374, FILED 2-7-2012.

MARK T. MULLEN, EXAMINING ATTORNEY



David J. Kybas

Director of the United States Patent and Trademark Office

United States of America

United States Patent and Trademark Office

Platinum People

Reg. No. 4,205,770

PLATINUM PEOPLE LLC (TENNESSEE LIMITED LIABILITY COMPANY)

Registered Sep. 11, 2012

4636 LEBANON PIKE, #192
HERMITAGE, TN 370761316

Int. Cl.: 35

FOR: EMPLOYMENT STAFFING IN THE FIELD OF INFORMATION TECHNOLOGY;
TALENT RECRUITING SERVICES IN THE FIELD OF INFORMATION TECHNOLOGY , IN
CLASS 35 (U.S. CLS. 100, 101 AND 102).

SERVICE MARK

FIRST USE 11-22-2006; IN COMMERCE 11-22-2006.

PRINCIPAL REGISTER

THE MARK CONSISTS OF STANDARD CHARACTERS WITHOUT CLAIM TO ANY PAR-
TICULAR FONT, STYLE, SIZE, OR COLOR.

SER. NO. 85-536,392, FILED 2-7-2012.

IRA J. GOODSaid, EXAMINING ATTORNEY



David J. Kyffers

Director of the United States Patent and Trademark Office

United States of America

United States Patent and Trademark Office

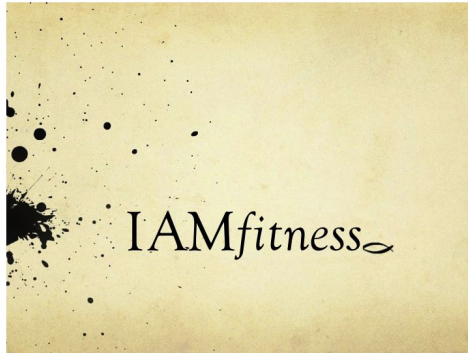

Reg. No. 4,205,771

BARON, IVANNA (UNITED STATES INDIVIDUAL)
17297 EAST KANSAS PLACE
AURORA, CO 80017 AND

Registered Sep. 11, 2012

Int. Cl.: 41

BARON, GERMAINE (UNITED STATES INDIVIDUAL)
15196 EAST BAILS PLACE
AURORA, CO 80012

SERVICE MARK

PRINCIPAL REGISTER

FOR: PERSONAL FITNESS TRAINING SERVICES AND CONSULTANCY , IN CLASS 41
(U.S. CLS. 100, 101 AND 107).

FIRST USE 4-19-2012; IN COMMERCE 4-19-2012.

THE MARK CONSISTS OF THE BLACK STYLIZED TEXT "IAMFITNESS" AGAINST A RECTANGLE-SHAPED RUSTIC BEIGE BACKGROUND. TO THE RIGHT OF THE TEXT IS A BLACK CHRISTIAN FISH SYMBOL. AT THE LEFT SIDE OF THE RECTANGLE IS A BLACK INK SPLATTER DESIGN.

THE COLOR(S) RUSTIC BEIGE AND BLACK IS/ARE CLAIMED AS A FEATURE OF THE MARK.

SER. NO. 85-536,408, FILED 2-7-2012.

ADA HAN, EXAMINING ATTORNEY



David J. Kybas

Director of the United States Patent and Trademark Office

United States of America

United States Patent and Trademark Office



Reg. No. 4,205,772

Registered Sep. 11, 2012

Int. Cl.: 45

SERVICE MARK

PRINCIPAL REGISTER

PECK, RYON (UNITED STATES INDIVIDUAL)
#210
1738 N. CANYON DR.
LOS ANGELES, CA 90028

FOR: ONLINE SOCIAL NETWORKING SERVICES IN THE FIELD OF HEALTH, NUTRITION,
AND WELLNESS PROVIDED VIA A WEBSITE, IN CLASS 45 (U.S. CLS. 100 AND 101).

FIRST USE 7-13-2011; IN COMMERCE 7-13-2011.

THE MARK CONSISTS OF THE LETTERS "VQ", WITH GRASS GROWING OUT OF THE V
AND THE A LEAF MAKING THE LETTER Q WITH A DROP OF WATER AT THE TIP OF
THE LEAF. TO THE RIGHT OF THE DESIGN IS THE TEXT "VEGGIEQUARIAN CONSCIOUS
FOOD FOR THE SOUL."

SER. NO. 85-536,416, FILED 2-7-2012.

GEOFFREY FOSDICK, EXAMINING ATTORNEY



David J. Kyffers

Director of the United States Patent and Trademark Office

United States of America

United States Patent and Trademark Office

BronyCon

Reg. No. 4,205,773

Registered Sep. 11, 2012

Int. Cl.: 41

SERVICE MARK

PRINCIPAL REGISTER

BLANK, JESSICA (UNITED STATES INDIVIDUAL)
APT. 3
1263 HERKIMER ST
BROOKLYN, NY 11233

FOR: ARRANGING, ORGANIZING, CONDUCTING, AND HOSTING SOCIAL ENTERTAINMENT EVENTS, IN CLASS 41 (U.S. CLS. 100, 101 AND 107).

FIRST USE 6-3-2011; IN COMMERCE 6-25-2011.

THE MARK CONSISTS OF STANDARD CHARACTERS WITHOUT CLAIM TO ANY PARTICULAR FONT, STYLE, SIZE, OR COLOR.

SER. NO. 85-536,426, FILED 2-7-2012.

SUNG IN, EXAMINING ATTORNEY



David J. Kyffers

Director of the United States Patent and Trademark Office

United States of America

United States Patent and Trademark Office

T//A

Reg. No. 4,205,774

CAREY, BRIAN F. (UNITED STATES INDIVIDUAL)
310 TYBURN PLACE
DANVILLE, CA 94526

Registered Sep. 11, 2012

Int. Cl.: 25

FOR: SHIRTS; T-SHIRTS, IN CLASS 25 (U.S. CLS. 22 AND 39).

TRADEMARK

FIRST USE 3-7-2012; IN COMMERCE 3-7-2012.

PRINCIPAL REGISTER

THE MARK CONSISTS OF STANDARD CHARACTERS WITHOUT CLAIM TO ANY PARTICULAR FONT, STYLE, SIZE, OR COLOR.

SER. NO. 85-536,428, FILED 2-7-2012.

SUNG IN, EXAMINING ATTORNEY



David J. Kyffers

Director of the United States Patent and Trademark Office

United States of America

United States Patent and Trademark Office

Transcend

Reg. No. 4,205,775

STRAYHORN, MASON (UNITED STATES INDIVIDUAL)
623 WEST MAIN STREET
CABOT, AR 72023 AND

Registered Sep. 11, 2012

Int. Cl.: 41

HOWARD, SETH (UNITED STATES INDIVIDUAL)
623 WEST MAIN STREET
CABOT, AR 72023 AND

SERVICE MARK

PRINCIPAL REGISTER

BRATCHER, JUSTIN (UNITED STATES INDIVIDUAL)
623 WEST MAIN STREET
CABOT, AZ 72023 AND

GRAVES, JOSH (UNITED STATES INDIVIDUAL)
623 WEST MAIN STREET
CABOT, AR 72023

FOR: ENTERTAINMENT, NAMELY, LIVE PERFORMANCES BY A MUSICAL BAND, IN CLASS 41 (U.S. CLS. 100, 101 AND 107).

FIRST USE 3-1-2011; IN COMMERCE 10-1-2011.

THE MARK CONSISTS OF STANDARD CHARACTERS WITHOUT CLAIM TO ANY PARTICULAR FONT, STYLE, SIZE, OR COLOR.

SER. NO. 85-536,430, FILED 2-7-2012.

SUNG IN, EXAMINING ATTORNEY



David J. Kyros

Director of the United States Patent and Trademark Office

United States of America

United States Patent and Trademark Office

GROW YOUR PASSION

Reg. No. 4,205,776

AGRI SERVICE (CALIFORNIA CORPORATION)
380 S. MELROSE DRIVE #203
VISTA, CA 92081

Registered Sep. 11, 2012

Int. Cl.: 41

FOR: EDUCATION SERVICES, NAMELY, PROVIDING CLASSES AND WORKSHOPS IN THE FIELD OF GARDENING, IN CLASS 41 (U.S. CLS. 100, 101 AND 107).

SERVICE MARK

FIRST USE 12-1-2011; IN COMMERCE 1-4-2012.

PRINCIPAL REGISTER

THE MARK CONSISTS OF STANDARD CHARACTERS WITHOUT CLAIM TO ANY PARTICULAR FONT, STYLE, SIZE, OR COLOR.

SER. NO. 85-536,452, FILED 2-7-2012.

SUNG IN, EXAMINING ATTORNEY



David J. Kyfos

Director of the United States Patent and Trademark Office

United States of America

United States Patent and Trademark Office

TAG

Reg. No. 4,205,777

MARVELOUS MUSIC GROUP (FLORIDA LIMITED LIABILITY COMPANY)
9208 NW 55TH STREET
SUNRISE, FL 33351

Registered Sep. 11, 2012

Int. Cl.: 41

FOR: ENTERTAINMENT IN THE NATURE OF LIVE MUSICAL PERFORMANCES, IN CLASS 41 (U.S. CLS. 100, 101 AND 107).

SERVICE MARK

FIRST USE 2-10-2010; IN COMMERCE 2-10-2010.

PRINCIPAL REGISTER

THE MARK CONSISTS OF STANDARD CHARACTERS WITHOUT CLAIM TO ANY PARTICULAR FONT, STYLE, SIZE, OR COLOR.

SER. NO. 85-536,453, FILED 2-7-2012.

SUNG IN, EXAMINING ATTORNEY



David J. Kyfos

Director of the United States Patent and Trademark Office

United States of America

United States Patent and Trademark Office

BITCHES



ME

Reg. No. 4,205,778

Registered Sep. 11, 2012

Int. Cl.: 18

TRADEMARK

PRINCIPAL REGISTER

RUFF RUFF & MEOW LLC (CALIFORNIA LIMITED LIABILITY COMPANY)
C-2
2060 PLACENTIA AVE
COSTA MESA, CA 92627

FOR: DOG APPAREL; DOG CLOTHING; DOG COLLARS; DOG COLLARS AND LEADS;
NECKWEAR FOR DOGS, IN CLASS 18 (U.S. CLS. 1, 2, 3, 22 AND 41).

FIRST USE 8-1-2003; IN COMMERCE 8-1-2003.

THE MARK CONSISTS OF THE WORD "BITCHES" IN ALL CAPITAL LETTERS WITH A
SYMBOL OF A HEART CENTERED DIRECTLY BELOW THE WORD "BITCHES" AND THE
WORD "ME" IN ALL CAPITAL LETTERS CENTERED DIRECTLY BELOW THE SYMBOL
OF THE HEART.

SEC. 2(F).

SER. NO. 85-536,462, FILED 2-7-2012.

THEODORE MCBRIDE, EXAMINING ATTORNEY



David J. Kybas

Director of the United States Patent and Trademark Office

United States of America

United States Patent and Trademark Office

promcity.com

Reg. No. 4,205,779

ATR HOLDINGS LTD. (VIRGINIA CORPORATION)
1556 LASKIN ROAD
VIRGINIA BEACH, VA 23451

Registered Sep. 11, 2012

Int. Cl.: 35

FOR: ON-LINE RETAIL STORE SERVICES FEATURING PROM AND SPECIAL OCCASION DRESSES, GOWNS AND ACCESSORIES; RETAIL STORE SERVICES FEATURING PROM AND SPECIAL OCCASION DRESSES, GOWNS AND ACCESSORIES, IN CLASS 35 (U.S. CLS. 100, 101 AND 102).

SERVICE MARK

PRINCIPAL REGISTER

FIRST USE 10-30-1999; IN COMMERCE 12-15-2011.

THE MARK CONSISTS OF STANDARD CHARACTERS WITHOUT CLAIM TO ANY PARTICULAR FONT, STYLE, SIZE, OR COLOR.

SER. NO. 85-536,479, FILED 2-7-2012.

SUNG IN, EXAMINING ATTORNEY



David J. Kyffers

Director of the United States Patent and Trademark Office

United States of America

United States Patent and Trademark Office

Daily Sweat

Reg. No. 4,205,780

SARA BROIHIER & ASSOCIATES LLC (CALIFORNIA LIMITED LIABILITY COMPANY)
1105 4TH STREET
SANTA MONICA, CA 90403

Registered Sep. 11, 2012

Int. Cl.: 9

FOR: DIGITAL MEDIA, NAMELY, DVDS FEATURING FITNESS TRAINING, IN CLASS 9
(U.S. CLS. 21, 23, 26, 36 AND 38).

TRADEMARK

FIRST USE 11-1-2011; IN COMMERCE 2-1-2012.

PRINCIPAL REGISTER

THE MARK CONSISTS OF STANDARD CHARACTERS WITHOUT CLAIM TO ANY PARTICULAR FONT, STYLE, SIZE, OR COLOR.

SER. NO. 85-536,489, FILED 2-7-2012.

BERYL GARDNER, EXAMINING ATTORNEY



David J. Kyffers

Director of the United States Patent and Trademark Office

United States of America

United States Patent and Trademark Office

ASSOCIATED SKIN CARE PROFESSIONALS

Reg. No. 4,205,781

Registered Sep. 11, 2012

**COLLECTIVE
MEMBERSHIP**

PRINCIPAL REGISTER

ASSOCIATED BODYWORK & MASSAGE PROFESSIONALS, INC. (COLORADO CORPORATION)
25188 GENESEE TRAIL ROAD
GOLDEN, CO 80401

FOR: INDICATING MEMBERSHIP IN AN ORGANIZATION OF SKIN CARE PRACTITIONERS, IN CLASS 200 (U.S. CL. 200).

FIRST USE 1-0-2007; IN COMMERCE 1-0-2007.

THE MARK CONSISTS OF STANDARD CHARACTERS WITHOUT CLAIM TO ANY PARTICULAR FONT, STYLE, SIZE, OR COLOR.

OWNER OF U.S. REG. NO. 3,429,977.

SEC. 2(F).

SER. NO. 85-536,498, FILED 2-7-2012.

ROBIN CHOSID, EXAMINING ATTORNEY



David J. Kyffers

Director of the United States Patent and Trademark Office

United States of America

United States Patent and Trademark Office

Expecting More

Reg. No. 4,205,782

SARA BROIHIER & ASSOCIATES LLC (CALIFORNIA LIMITED LIABILITY COMPANY)
1105 4TH STREET
SANTA MONICA, CA 90403

Registered Sep. 11, 2012

Int. Cl.: 9

FOR: DIGITAL MEDIA, NAMELY, DVDS FEATURING FITNESS TRAINING, IN CLASS 9
(U.S. CLS. 21, 23, 26, 36 AND 38).

TRADEMARK

FIRST USE 11-1-2011; IN COMMERCE 2-1-2012.

PRINCIPAL REGISTER

THE MARK CONSISTS OF STANDARD CHARACTERS WITHOUT CLAIM TO ANY PARTICULAR FONT, STYLE, SIZE, OR COLOR.

SER. NO. 85-536,499, FILED 2-7-2012.

BERYL GARDNER, EXAMINING ATTORNEY



David J. Kyffers

Director of the United States Patent and Trademark Office

United States of America

United States Patent and Trademark Office

Continental Divide

Reg. No. 4,205,783

40 DAYS, LLC (ARKANSAS LIMITED LIABILITY COMPANY)
2530 PINNACLE HILLS PARKWAY, SUITE 100
ROGERS, AR 72758

Registered Sep. 11, 2012

Int. Cl.: 30

FOR: COFFEE, IN CLASS 30 (U.S. CL. 46).

TRADEMARK

FIRST USE 8-1-2011; IN COMMERCE 11-15-2011.

PRINCIPAL REGISTER

THE MARK CONSISTS OF STANDARD CHARACTERS WITHOUT CLAIM TO ANY PARTICULAR FONT, STYLE, SIZE, OR COLOR.

SER. NO. 85-536,520, FILED 2-7-2012.

ALLISON SCHRODY, EXAMINING ATTORNEY



David J. Kybas

Director of the United States Patent and Trademark Office

United States of America

United States Patent and Trademark Office

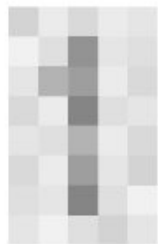

FIRST
IMPRESSION

Reg. No. 4,205,784

ENGAGE BDR, INC. (CALIFORNIA CORPORATION)
9000 WEST SUNSET BLVD., SUITE 525
WEST HOLLYWOOD, CA 90069

Registered Sep. 11, 2012

Int. Cl.: 42

FOR: HOSTING A SOFTWARE PLATFORM THAT ENABLES ADVERTISERS TO TARGET
ONLINE AND MOBILE INVENTORY, IN CLASS 42 (U.S. CLS. 100 AND 101).

SERVICE MARK

FIRST USE 12-1-2011; IN COMMERCE 12-1-2011.

PRINCIPAL REGISTER

THE MARK CONSISTS OF THE WORD FIRST AND THE WORD IMPRESSION AT THE
BOTTOM AND AN UPRIGHT RECTANGLE TO THE LEFT.

SER. NO. 85-536,523, FILED 2-7-2012.

NAKIA HENRY, EXAMINING ATTORNEY



David J. Kybas

Director of the United States Patent and Trademark Office

United States of America

United States Patent and Trademark Office

HELP THY NEIGHBORS

Reg. No. 4,205,785

Registered Sep. 11, 2012

Int. Cl.: 39

SERVICE MARK

PRINCIPAL REGISTER

HELP THY NEIGHBORS (NORTH CAROLINA CORPORATION)
UNIT 417
309 EAST MOREHEAD STREET
CHARLOTTE, NC 28202

FOR: PROVIDING FREE OR LOW COST TRANSPORTATION FOR ELDERLY PERSONS, DISABLED PERSONS, AND PERSONS WITH HEALTH CONCERNS, IN CLASS 39 (U.S. CLS. 100 AND 105).

FIRST USE 2-6-2012; IN COMMERCE 2-6-2012.

THE MARK CONSISTS OF STANDARD CHARACTERS WITHOUT CLAIM TO ANY PARTICULAR FONT, STYLE, SIZE, OR COLOR.

SER. NO. 85-536,534, FILED 2-7-2012.

ALYSSA STEEL, EXAMINING ATTORNEY



David J. Kybas

Director of the United States Patent and Trademark Office

United States of America
United States Patent and Trademark Office

BASH

Reg. No. 4,205,786

Registered Sep. 11, 2012

Int. Cl.: 41

SERVICE MARK

PRINCIPAL REGISTER

BASH, LLC (VIRGINIA LIMITED LIABILITY COMPANY)
1400 S. BARTON STREET, NO. 417
ARLINGTON, VA 22204

FOR: PARTY AND WEDDING PLANNING, COORDINATION AND CONSULTATION SERVICES; PROVIDING INFORMATION IN THE FIELD OF WEDDING PARTY PLANNING , IN CLASS 41 (U.S. CLS. 100, 101 AND 107).

FIRST USE 1-3-2008; IN COMMERCE 1-14-2008.

THE MARK CONSISTS OF STANDARD CHARACTERS WITHOUT CLAIM TO ANY PARTICULAR FONT, STYLE, SIZE, OR COLOR.

SER. NO. 85-536,619, FILED 2-8-2012.

DORITT L. CARROLL, EXAMINING ATTORNEY



David J. Kybas

Director of the United States Patent and Trademark Office

United States of America

United States Patent and Trademark Office

MeridianMassage

Reg. No. 4,205,787

NAGLE, KIERA (UNITED STATES INDIVIDUAL)
209-04 42 AVE
BAYSIDE, NY 11361

Registered Sep. 11, 2012

Int. Cls.: 41 and 44

FOR: EDUCATION SERVICES, NAMELY, PROVIDING SEMINARS AND WORKSHOPS IN THE FIELD OF MASSAGE THERAPY, IN CLASS 41 (U.S. CLS. 100, 101 AND 107).

SERVICE MARK

FIRST USE 1-1-2012; IN COMMERCE 2-1-2012.

PRINCIPAL REGISTER

FOR: MASSAGE THERAPY SERVICES, IN CLASS 44 (U.S. CLS. 100 AND 101).

FIRST USE 1-1-2012; IN COMMERCE 2-1-2012.

THE MARK CONSISTS OF STANDARD CHARACTERS WITHOUT CLAIM TO ANY PARTICULAR FONT, STYLE, SIZE, OR COLOR.

SER. NO. 85-536,683, FILED 2-8-2012.

ZACHARY BELLO, EXAMINING ATTORNEY



David J. Kyffers

Director of the United States Patent and Trademark Office

United States of America

United States Patent and Trademark Office

Forgot Your Password?



Reg. No. 4,205,788

C G PUBLISHING LLC (OHIO LIMITED LIABILITY COMPANY)
1803 HAZELTON ETNA ROAD NW
PATASKALA, OH 43062

Registered Sep. 11, 2012

Int. Cls.: 16 and 25

FOR: PENS; PERSONALIZED WRITING JOURNALS, IN CLASS 16 (U.S. CLS. 2, 5, 22, 23, 29, 37, 38 AND 50).

TRADEMARK

FIRST USE 11-11-2011; IN COMMERCE 11-11-2011.

PRINCIPAL REGISTER

FOR: T-SHIRTS, IN CLASS 25 (U.S. CLS. 22 AND 39).

FIRST USE 11-11-2011; IN COMMERCE 11-11-2011.

THE MARK CONSISTS OF THE STYLIZED WORDS "FORGOT YOUR PASSWORD?". THE WORDS ARE UNDERLINED. AN IMAGE OF AN ARROW POINTING UPWARDS TOWARDS THE LETTER "SS" IN THE WORD "PASSWORD".

SER. NO. 85-536,688, FILED 2-8-2012.

ASMAT KHAN, EXAMINING ATTORNEY



David J. Kyffers

Director of the United States Patent and Trademark Office

United States of America

United States Patent and Trademark Office

zPatient

Reg. No. 4,205,789

ALTAPOINT DATA SYSTEMS, LLC (UTAH LIMITED LIABILITY COMPANY)
1100 E SOUTH UNION AVENUE
MIDVALE, UT 84047

Registered Sep. 11, 2012

Int. Cl.: 44

FOR: MAINTAINING PATIENT MEDICAL RECORDS AND FILES, IN CLASS 44 (U.S. CLS. 100 AND 101).

SERVICE MARK

FIRST USE 1-6-2010; IN COMMERCE 1-6-2010.

PRINCIPAL REGISTER

THE MARK CONSISTS OF STANDARD CHARACTERS WITHOUT CLAIM TO ANY PARTICULAR FONT, STYLE, SIZE, OR COLOR.

SER. NO. 85-536,690, FILED 2-8-2012.

ASMAT KHAN, EXAMINING ATTORNEY



David J. Kybas

Director of the United States Patent and Trademark Office

United States of America

United States Patent and Trademark Office

SELECTURE

Reg. No. 4,205,790

Registered Sep. 11, 2012

Int. Cl.: 11

TRADEMARK

PRINCIPAL REGISTER

SELECTURE, INC. (TEXAS CORPORATION)
191 CHAUCER CT
COPPELL, TX 75019

FOR: ELECTRIC FANS, IN CLASS 11 (U.S. CLS. 13, 21, 23, 31 AND 34).

FIRST USE 2-6-2012; IN COMMERCE 2-6-2012.

THE MARK CONSISTS OF STANDARD CHARACTERS WITHOUT CLAIM TO ANY PARTICULAR FONT, STYLE, SIZE, OR COLOR.

SER. NO. 85-536,712, FILED 2-8-2012.

JACQUELINE A. LAVINE, EXAMINING ATTORNEY



David J. Kybas

Director of the United States Patent and Trademark Office

United States of America

United States Patent and Trademark Office

think.change.think again.

Reg. No. 4,205,791

STARK, WILLIAM R. (UNITED STATES INDIVIDUAL)
PO BOX 824
TAMPA, FL 33601

Registered Sep. 11, 2012

Int. Cl.: 35

FOR: MANAGEMENT CONSULTING AND ADVISORY SERVICES IN THE AREAS OF CORPORATE GROWTH STRATEGY, INNOVATION AND GROWTH PROCESSES, ORGANIZATIONAL TRANSFORMATION, AND TALENT MANAGEMENT AND DEVELOPMENT STRATEGIES, IN CLASS 35 (U.S. CLS. 100, 101 AND 102).

SERVICE MARK

PRINCIPAL REGISTER

FIRST USE 9-1-1999; IN COMMERCE 1-5-2000.

THE MARK CONSISTS OF STANDARD CHARACTERS WITHOUT CLAIM TO ANY PARTICULAR FONT, STYLE, SIZE, OR COLOR.

SER. NO. 85-536,724, FILED 2-8-2012.

NAPOLEON SHARMA, EXAMINING ATTORNEY



David J. Kybas

Director of the United States Patent and Trademark Office

United States of America

United States Patent and Trademark Office

ClearSplint

Reg. No. 4,205,792

Registered Sep. 11, 2012

Int. Cl.: 10

TRADEMARK

PRINCIPAL REGISTER

ASTRON DENTAL CORPORATION (DELAWARE CORPORATION)
UNIT G
815 OAKWOOD RD.
LAKE ZURICH, IL 60047

FOR: SPLINTS, IN CLASS 10 (U.S. CLS. 26, 39 AND 44).

FIRST USE 5-1-1998; IN COMMERCE 5-1-1998.

THE MARK CONSISTS OF STANDARD CHARACTERS WITHOUT CLAIM TO ANY PARTICULAR FONT, STYLE, SIZE, OR COLOR.

SER. NO. 85-536,757, FILED 2-8-2012.

NAKIA HENRY, EXAMINING ATTORNEY



David J. Kyffers

Director of the United States Patent and Trademark Office

United States of America

United States Patent and Trademark Office

SNOW & NEALLEY

Reg. No. 4,205,793

SOUTH STREET, INC. (MAINE CORPORATION), DBA SNOW & NEALLEY COMPANY
7027 STANHOPE PLACE
UNIVERSITY PARK, FL 34201

Registered Sep. 11, 2012

Int. Cl.: 8

FOR: AXES; HAND TOOLS, NAMELY, MAULS, IN CLASS 8 (U.S. CLS. 23, 28 AND 44).

TRADEMARK

FIRST USE 1-1-1864; IN COMMERCE 1-1-1864.

PRINCIPAL REGISTER

THE MARK CONSISTS OF STANDARD CHARACTERS WITHOUT CLAIM TO ANY PARTICULAR FONT, STYLE, SIZE, OR COLOR.

SER. NO. 85-536,766, FILED 2-8-2012.

ALICIA COLLINS, EXAMINING ATTORNEY



David J. Kyffers

Director of the United States Patent and Trademark Office

United States of America

United States Patent and Trademark Office

OURBEST

Reg. No. 4,205,794

SOUTH STREET, INC. (MAINE CORPORATION), DBA SNOW & NEALLEY COMPANY
7027 STANHOPE PLACE
UNIVERSITY PARK, FL 34201

Registered Sep. 11, 2012

Int. Cl.: 8

FOR: AXES; HAND TOOLS, NAMELY, MAULS, IN CLASS 8 (U.S. CLS. 23, 28 AND 44).

TRADEMARK

FIRST USE 1-1-1952; IN COMMERCE 1-1-1952.

PRINCIPAL REGISTER

THE MARK CONSISTS OF STANDARD CHARACTERS WITHOUT CLAIM TO ANY PARTICULAR FONT, STYLE, SIZE, OR COLOR.

SER. NO. 85-536,771, FILED 2-8-2012.

ALICIA COLLINS, EXAMINING ATTORNEY



David J. Kyffers

Director of the United States Patent and Trademark Office

United States of America

United States Patent and Trademark Office

AZPECS

Reg. No. 4,205,795

Registered Sep. 11, 2012

Int. Cl.: 41

SERVICE MARK

PRINCIPAL REGISTER

RAPP, MARION (UNITED STATES INDIVIDUAL)
7428 TALLGRASS DRIVE
TEMPERANCE, MI 48182

FOR: PHOTOGRAPHY SERVICES, IN CLASS 41 (U.S. CLS. 100, 101 AND 107).

FIRST USE 2-8-2012; IN COMMERCE 2-8-2012.

THE MARK CONSISTS OF STANDARD CHARACTERS WITHOUT CLAIM TO ANY PARTICULAR FONT, STYLE, SIZE, OR COLOR.

SER. NO. 85-536,780, FILED 2-8-2012.

ROSELLE HERRERA, EXAMINING ATTORNEY



David J. Kybas

Director of the United States Patent and Trademark Office

United States of America

United States Patent and Trademark Office

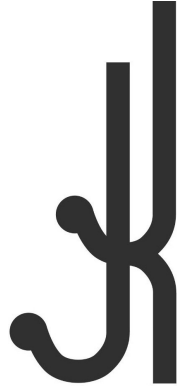

Reg. No. 4,205,796

Registered Sep. 11, 2012

Int. Cl.: 37

SERVICE MARK

PRINCIPAL REGISTER

KIRLIN GROUP, LLC (DELAWARE LIMITED LIABILITY COMPANY)
515 DOVER ROAD, SUITE 2100
ROCKVILLE, MD 20850

FOR: BUILDING CONSTRUCTION SERVICES, IN CLASS 37 (U.S. CLS. 100, 103 AND 106).

FIRST USE 1-1-1970; IN COMMERCE 1-1-1970.

THE MARK CONSISTS OF STYLIZED LETTERS J, J AND K INTERTWINED.

SER. NO. 85-536,795, FILED 2-8-2012.

FRANK LATTUCA, EXAMINING ATTORNEY



David J. Kyffers

Director of the United States Patent and Trademark Office

United States of America

United States Patent and Trademark Office

Blocmate

Reg. No. 4,205,797

BLOCMATE, INC. (MASSACHUSETTS CORPORATION)
5 KINNAIRD STREET
CAMBRIDGE, MA 02139

Registered Sep. 11, 2012

Int. Cl.: 45

FOR: INTERNET-BASED SOCIAL NETWORKING SERVICES; ON-LINE SOCIAL NETWORKING SERVICES, IN CLASS 45 (U.S. CLS. 100 AND 101).

SERVICE MARK

FIRST USE 11-30-2010; IN COMMERCE 3-31-2011.

PRINCIPAL REGISTER

THE MARK CONSISTS OF STANDARD CHARACTERS WITHOUT CLAIM TO ANY PARTICULAR FONT, STYLE, SIZE, OR COLOR.

SER. NO. 85-536,800, FILED 2-8-2012.

NAKIA HENRY, EXAMINING ATTORNEY



David J. Kybas

Director of the United States Patent and Trademark Office

United States of America

United States Patent and Trademark Office

FELIX

Reg. No. 4,205,798

Registered Sep. 11, 2012

Int. Cl.: 35

SERVICE MARK

PRINCIPAL REGISTER

FELIX CALLS, LLC (DELAWARE LIMITED LIABILITY COMPANY)
75 NINTH AVENUE
7TH FLOOR
NEW YORK, NY 10011

FOR: ADVERTISING, MARKETING AND PROMOTION SERVICES; ON-LINE ADVERTISING AND MARKETING SERVICES; ONLINE MARKETING SERVICES, NAMELY, AFFILIATE MARKETING SERVICES WHEREBY AN AFFILIATE IS REWARDED FOR EACH VISITOR OR CUSTOMER BROUGHT ABOUT BY THE AFFILIATE'S OWN MARKETING SERVICES; DISSEMINATION OF ADVERTISING FOR OTHERS VIA THE INTERNET AND MOBILE COMMUNICATIONS DEVICES; ANALYSIS OF ADVERTISING RESPONSE; ANALYZING AND COMPILING DATA FOR MEASURING RESPONSES RECEIVED FROM ONLINE ADVERTISEMENTS, ONLINE ADVERTISING GUIDES AND ONLINE COMMERCIAL INFORMATION DIRECTORIES; ADVERTISING AND COMMERCIAL INFORMATION SERVICES, VIA THE INTERNET AND MOBILE COMMUNICATION DEVICES; PROVIDING A SEARCHABLE ONLINE ADVERTISING GUIDE FEATURING THE GOODS AND SERVICES OF OTHERS; PROVIDING BUSINESS INFORMATION, NAMELY, PROVIDING PHONE NUMBERS, MAILING ADDRESSES, ELECTRONIC MAIL ADDRESSES, BUSINESS PROFILES AND WEBSITE LINKS FOR A WIDE VARIETY OF LOCAL BUSINESSES AND ORGANIZATIONS VIA THE INTERNET AND MOBILE COMMUNICATION DEVICES; BUSINESS SERVICES, NAMELY, TRACKING AND MONITORING OF PHONE CALLS OF OTHERS IN RESPONSE TO ADVERTISING, AND TRANSCRIPTION OF SUCH PHONE CALLS FOR OTHERS; PAY PER CALL ADVERTISING MANAGEMENT SERVICES, IN CLASS 35 (U.S. CLS. 100, 101 AND 102).

FIRST USE 4-9-2012; IN COMMERCE 4-9-2012.

THE MARK CONSISTS OF STANDARD CHARACTERS WITHOUT CLAIM TO ANY PARTICULAR FONT, STYLE, SIZE, OR COLOR.

SER. NO. 85-536,803, FILED 2-8-2012.

NAKIA HENRY, EXAMINING ATTORNEY



David J. Kyros

Director of the United States Patent and Trademark Office

United States of America

United States Patent and Trademark Office



Reg. No. 4,205,799

Registered Sep. 11, 2012

Int. Cl.: 41

SERVICE MARK

PRINCIPAL REGISTER

MINDFIELD PRODUCTIONS, INC. (NEW YORK CORPORATION)
#209
250 W. 88TH ST.
NEW YORK, NY 10024

FOR: FILM AND VIDEO PRODUCTION; FILM AND VIDEO PRODUCTION CONSULTING SERVICES; FILM EDITING, IN CLASS 41 (U.S. CLS. 100, 101 AND 107).

FIRST USE 0-0-2011; IN COMMERCE 0-0-2011.

NO CLAIM IS MADE TO THE EXCLUSIVE RIGHT TO USE "CREATIVE PRODUCTIONS", APART FROM THE MARK AS SHOWN.

THE COLOR(S) BLUE AND WHITE IS/ARE CLAIMED AS A FEATURE OF THE MARK.

THE MARK CONSISTS OF BLUE CLOUD WITH "MINDFIELD" IN WHITE STYLIZED FONT. FROM THE "M" IS A THOUGHT CLOUD WITH "MF" IN BLUE STYLIZED LETTERS WITHIN IT. BELOW "MINDFIELD" IS A WHITE LINE WITH "CREATIVE PRODUCTIONS" IN WHITE STYLIZED LETTERS BELOW THE LINE.

SER. NO. 85-536,822, FILED 2-8-2012.

CARYN GLASSER, EXAMINING ATTORNEY



David J. Kyros

Director of the United States Patent and Trademark Office

United States of America

United States Patent and Trademark Office

iTailor

Reg. No. 4,205,800

Registered Sep. 11, 2012

Int. Cl.: 25

TRADEMARK

PRINCIPAL REGISTER

PRO INDUSTRIAL CO. LTD. (THAILAND CORPORATION)
222 M 2 T. YANGNEANG A. SARAPHI
CHIANGMAI, THAILAND 50140

FOR: MEN'S SHIRTS, MEN'S SUITS, MEN'S PANTS, MEN'S VESTS, MEN'S JACKETS, MEN'S OVERCOATS, MEN'S TIES, MEN'S JEANS, MEN'S POLO SHIRTS, MEN'S SHOES, WOMEN'S BLOUSES, WOMEN'S JACKETS, WOMEN'S PANTS, WOMEN'S SKIRTS, WOMEN'S OVERCOATS, WOMEN'S SUITS, WOMEN'S JEANS, WOMEN'S POLO SHIRTS, IN CLASS 25 (U.S. CLS. 22 AND 39).

FIRST USE 5-1-2010; IN COMMERCE 6-1-2010.

THE MARK CONSISTS OF STANDARD CHARACTERS WITHOUT CLAIM TO ANY PARTICULAR FONT, STYLE, SIZE, OR COLOR.

SER. NO. 85-536,827, FILED 2-8-2012.

GINA FINK, EXAMINING ATTORNEY



David J. Kybas

Director of the United States Patent and Trademark Office

United States of America

United States Patent and Trademark Office

YOUR CHILD CAN LEARN

Reg. No. 4,205,801

Registered Sep. 11, 2012

Int. Cl.: 41

SERVICE MARK

PRINCIPAL REGISTER

HUNTINGTON MARK, LLC (DELAWARE LIMITED LIABILITY COMPANY)
496 KINDERKAMACK ROAD
ORADELL, NJ 07649

FOR: EDUCATIONAL SERVICES, NAMELY, PROVIDING TUTORING IN THE FIELDS OF READING, WRITING, STUDY SKILLS, MATH, PHONICS, SPELLING, VOCABULARY, PRE-ALGEBRA, ALGEBRA, GEOMETRY, TRIGONOMETRY, PRE-CALCULUS, CALCULUS, GENERAL SCIENCE, EARTH SCIENCE, BIOLOGY, CHEMISTRY, AND PHYSICS; CONDUCTING CLASSES, SEMINARS, WORKSHOPS, AND TUTORING IN THE FIELD OF PREPARATION FOR STANDARDIZED EXAMS, IN CLASS 41 (U.S. CLS. 100, 101 AND 107).

FIRST USE 1-19-1995; IN COMMERCE 1-19-1995.

THE MARK CONSISTS OF STANDARD CHARACTERS WITHOUT CLAIM TO ANY PARTICULAR FONT, STYLE, SIZE, OR COLOR.

OWNER OF U.S. REG. NO. 3,103,102.

SER. NO. 85-536,828, FILED 2-8-2012.

SUSAN LESLIE DUBOIS, EXAMINING ATTORNEY



David J. Kyffers

Director of the United States Patent and Trademark Office

United States of America

United States Patent and Trademark Office

THE MIGHTY SPECTOR

Reg. No. 4,205,802

Registered Sep. 11, 2012

Int. Cl.: 28

TRADEMARK

PRINCIPAL REGISTER

MATTEL, INC. (DELAWARE CORPORATION)
M1-1518
333 CONTINENTAL BOULEVARD
EL SEGUNDO, CA 90245

FOR: TOY ACTION FIGURES AND ACCESSORIES THEREFOR, IN CLASS 28 (U.S. CLS. 22, 23, 38 AND 50).

FIRST USE 5-15-2012; IN COMMERCE 5-15-2012.

THE MARK CONSISTS OF STANDARD CHARACTERS WITHOUT CLAIM TO ANY PARTICULAR FONT, STYLE, SIZE, OR COLOR.

SER. NO. 85-536,841, FILED 2-8-2012.

CAROLYN CATALDO, EXAMINING ATTORNEY



David J. Kyffers

Director of the United States Patent and Trademark Office

United States of America

United States Patent and Trademark Office

OEUF

Reg. No. 4,205,803

Registered Sep. 11, 2012

Int. Cl.: 20

TRADEMARK

PRINCIPAL REGISTER

OEUF LLC (NEW YORK LIMITED LIABILITY COMPANY)
SUITE 301
119 8TH STREET
BROOKLYN, NY 11215

FOR: FURNITURE, IN CLASS 20 (U.S. CLS. 2, 13, 22, 25, 32 AND 50).

FIRST USE 8-19-2003; IN COMMERCE 8-19-2003.

THE MARK CONSISTS OF STANDARD CHARACTERS WITHOUT CLAIM TO ANY PARTICULAR FONT, STYLE, SIZE, OR COLOR.

OWNER OF U.S. REG. NO. 3,180,051.

THE ENGLISH TRANSLATION OF "OEUF" IN THE MARK IS "EGG".

SER. NO. 85-536,860, FILED 2-8-2012.

ODESSA BIBBINS, EXAMINING ATTORNEY



David J. Kyffers

Director of the United States Patent and Trademark Office

United States of America
United States Patent and Trademark Office

CAPFUZION

Reg. No. 4,205,804

CAPFUZION, LLC (NORTH CAROLINA LIMITED LIABILITY COMPANY)
15630 PRESCOTT HILL AVE.
CHARLOTTE, NC 28277

Registered Sep. 11, 2012

Int. Cls.: 14 and 26

FOR: BRACELETS; BROACHES; CHARMS; CHARMS FOR COLLAR JEWELRY AND BRACELET; JEWEL PENDANTS; JEWELRY; JEWELRY FOR ATTACHMENT TO CLOTHING; KEY CHAINS AS JEWELLERY; NECKLACES; PENDANTS; PINS BEING JEWELRY; RINGS; RINGS BEING JEWELRY, IN CLASS 14 (U.S. CLS. 2, 27, 28 AND 50).

TRADEMARK

PRINCIPAL REGISTER

FIRST USE 8-1-2010; IN COMMERCE 10-1-2010.

FOR: CLOTHING ACCESSORIES, NAMELY, CHARMS FOR ATTACHMENT TO ZIPPER PULLS AND BUTTONS; ZIPPER PULLS, IN CLASS 26 (U.S. CLS. 37, 39, 40, 42 AND 50).

FIRST USE 8-1-2010; IN COMMERCE 10-1-2010.

THE MARK CONSISTS OF STANDARD CHARACTERS WITHOUT CLAIM TO ANY PARTICULAR FONT, STYLE, SIZE, OR COLOR.

SER. NO. 85-536,865, FILED 2-8-2012.

ODESSA BIBBINS, EXAMINING ATTORNEY



David J. Kyros

Director of the United States Patent and Trademark Office

United States of America

United States Patent and Trademark Office

el Buho

Reg. No. 4,205,805

HENRY STEELE IMPORTS LLC (NEW YORK LIMITED LIABILITY COMPANY)
386 SOUTH 2ND AVE., FL 1
BROOKLYN, NY 11211

Registered Sep. 11, 2012

Int. Cl.: 33

FOR: ALCOHOLIC BEVERAGES EXCEPT BEERS, IN CLASS 33 (U.S. CLS. 47 AND 49).

TRADEMARK

FIRST USE 12-6-2011; IN COMMERCE 12-6-2011.

PRINCIPAL REGISTER

THE MARK CONSISTS OF STANDARD CHARACTERS WITHOUT CLAIM TO ANY PARTICULAR FONT, STYLE, SIZE, OR COLOR.

THE ENGLISH TRANSLATION OF "EL BUHO" IN THE MARK IS "THE OWL".

SER. NO. 85-536,866, FILED 2-8-2012.

ODESSA BIBBINS, EXAMINING ATTORNEY



David J. Kyffers

Director of the United States Patent and Trademark Office

United States of America

United States Patent and Trademark Office

FUSION SCIENCE AND TECHNOLOGY

Reg. No. 4,205,806

AMERICAN NUCLEAR SOCIETY INCORPORATED (NEW YORK CORPORATION)
555 NORTH KENSINGTON AVENUE
LA GRANGE PARK, IL 60526

Registered Sep. 11, 2012

Int. Cl.: 16

FOR: JOURNAL CONCERNING SCIENTIFIC AND ENGINEERING SUBJECTS, IN CLASS
16 (U.S. CLS. 2, 5, 22, 23, 29, 37, 38 AND 50).

TRADEMARK

FIRST USE 6-15-2001; IN COMMERCE 6-15-2001.

PRINCIPAL REGISTER

THE MARK CONSISTS OF STANDARD CHARACTERS WITHOUT CLAIM TO ANY PAR-
TICULAR FONT, STYLE, SIZE, OR COLOR.

OWNER OF U.S. REG. NO. 2,637,671.

SEC. 2(F).

SER. NO. 85-536,887, FILED 2-8-2012.

LINDA POWELL, EXAMINING ATTORNEY



David J. Kyffers

Director of the United States Patent and Trademark Office

United States of America

United States Patent and Trademark Office

GOLDEN FIT

Reg. No. 4,205,807

Registered Sep. 11, 2012

Int. Cl.: 30

TRADEMARK

PRINCIPAL REGISTER

CEREALS Y PASTAS, S.A. DE C.V. (MEXICO CORPORATION)
AVENIDA MEXICO - JAPON NO. 400-A
COL. CIUDAD INDUSTRIAL CELAYA
CELAYA GUANJUATO, MEXICO 38010

FOR: PROCESSED CEREAL-BASED FOOD TO BE USED AS A BREAKFAST FOOD, SNACK FOOD OR INGREDIENT FOR MAKING OTHER FOODS, IN CLASS 30 (U.S. CL. 46).

THE MARK CONSISTS OF STANDARD CHARACTERS WITHOUT CLAIM TO ANY PARTICULAR FONT, STYLE, SIZE, OR COLOR.

OWNER OF MEXICO REG. NO. 1233975, DATED 4-6-2011, EXPIRES 4-6-2021.

SER. NO. 85-536,890, FILED 2-8-2012.

LINDA POWELL, EXAMINING ATTORNEY



David J. Kybas

Director of the United States Patent and Trademark Office

United States of America

United States Patent and Trademark Office

CLEAR



Reg. No. 4,205,808

Registered Sep. 11, 2012

Int. Cl.: 38

SERVICE MARK

PRINCIPAL REGISTER

CLEARWIRE COMMUNICATIONS LLC (DELAWARE LIMITED LIABILITY COMPANY)
1475 120TH AVENUE NORTHEAST
BELLEVUE, WA 98005

FOR: TELECOMMUNICATIONS SERVICES, NAMELY, PROVIDING HIGH-SPEED ACCESS TO AREA NETWORKS AND GLOBAL COMPUTER INFORMATION NETWORKS; ELECTRONIC, ELECTRIC AND DIGITAL TRANSMISSION OF DATA, IMAGES, VOICE, SIGNALS, AND MESSAGES, IN CLASS 38 (U.S. CLS. 100, 101 AND 104).

FIRST USE 4-8-2009; IN COMMERCE 4-8-2009.

OWNER OF U.S. REG. NO. 3,782,759.

THE COLOR(S) GRAY, GREEN AND WHITE IS/ARE CLAIMED AS A FEATURE OF THE MARK.

THE MARK CONSISTS OF THE WORD CLEAR IN GRAY TO THE LEFT OF A GREEN SPHERE WITH A WHITE SPIRAL DESIGN.

SER. NO. 85-536,911, FILED 2-8-2012.

DOMINICK J. SALEMI, EXAMINING ATTORNEY



David J. Kybas

Director of the United States Patent and Trademark Office

United States of America

United States Patent and Trademark Office

MILLIANA

Reg. No. 4,205,809

Registered Sep. 11, 2012

Int. Cl.: 30

TRADEMARK

PRINCIPAL REGISTER

INDIANA SUGARS, INC. (INDIANA CORPORATION)
PO BOX M799
GARY, IN 46401

FOR: BROWN SUGAR; POWDERED SUGAR; SUGAR, IN CLASS 30 (U.S. CL. 46).

FIRST USE 1-1-1985; IN COMMERCE 1-1-1985.

THE MARK CONSISTS OF STANDARD CHARACTERS WITHOUT CLAIM TO ANY PARTICULAR FONT, STYLE, SIZE, OR COLOR.

SER. NO. 85-536,913, FILED 2-8-2012.

GINA FINK, EXAMINING ATTORNEY



David J. Kyffers

Director of the United States Patent and Trademark Office

United States of America

United States Patent and Trademark Office

The logo for iTailor, featuring the word "iTailor" in a stylized, lowercase font. The "i" is a simple dot and vertical line, while the "T" is a tall, thin vertical bar with a horizontal top bar. The "a", "i", "l", "o", and "r" are rounded and lowercase. The entire logo is set against a dark rectangular background.

Reg. No. 4,205,810

PRO INDUSTRIAL CO. LTD. (THAILAND CORPORATION)
222 M 2 T. YANGNEANG A. SARAPHI
CHIANGMAI, THAILAND 50140

Registered Sep. 11, 2012

Int. Cl.: 25

FOR: MEN'S SHIRTS, MEN'S SUITS, MEN'S PANTS, MEN'S VESTS, MEN'S JACKETS, MEN'S OVERCOATS, MEN'S TIES, MEN'S JEANS, MEN'S POLO SHIRTS, MEN'S SHOES, WOMEN'S BLOUSES, WOMEN'S JACKETS, WOMEN'S PANTS, WOMEN'S SKIRTS, WOMEN'S OVERCOATS, WOMEN'S SUITS, WOMEN'S JEANS, WOMEN'S POLO SHIRTS, IN CLASS 25 (U.S. CLS. 22 AND 39).

TRADEMARK

PRINCIPAL REGISTER

FIRST USE 5-1-2010; IN COMMERCE 6-1-2010.

THE MARK CONSISTS OF THE WORDING "ITAILOR" WITH STYLIZED LETTERING USING A LOWERCASE "I", AN UPPERCASE "T", AND LOWERCASE "AILOR".

SER. NO. 85-536,914, FILED 2-8-2012.

GINA FINK, EXAMINING ATTORNEY



David J. Kybas

Director of the United States Patent and Trademark Office

United States of America

United States Patent and Trademark Office

TestoBoost

Reg. No. 4,205,811

Registered Sep. 11, 2012

Int. Cl.: 5

TRADEMARK

PRINCIPAL REGISTER

VISIONSTAR, INC. (CALIFORNIA CORPORATION)
#701
3255 WILSHIRE BLVD.
LOS ANGELES, CA 90010

FOR: DIETARY FOOD SUPPLEMENTS, IN CLASS 5 (U.S. CLS. 6, 18, 44, 46, 51 AND 52).

FIRST USE 12-1-2010; IN COMMERCE 12-1-2010.

THE MARK CONSISTS OF STANDARD CHARACTERS WITHOUT CLAIM TO ANY PARTICULAR FONT, STYLE, SIZE, OR COLOR.

SER. NO. 85-536,928, FILED 2-8-2012.

COLLEEN DOMBROW, EXAMINING ATTORNEY



David J. Kyffers

Director of the United States Patent and Trademark Office

United States of America

United States Patent and Trademark Office

ALES WITHOUT BORDERS

Reg. No. 4,205,812

4 HANDS BREWING COMPANY, LLC (MISSOURI LIMITED LIABILITY COMPANY)
1220 S. 8TH STREET
SAINT LOUIS, MO 63104

Registered Sep. 11, 2012

Int. Cl.: 43

FOR: BAR SERVICES, IN CLASS 43 (U.S. CLS. 100 AND 101).

SERVICE MARK

FIRST USE 11-11-2011; IN COMMERCE 11-11-2011.

PRINCIPAL REGISTER

THE MARK CONSISTS OF STANDARD CHARACTERS WITHOUT CLAIM TO ANY PARTICULAR FONT, STYLE, SIZE, OR COLOR.

SER. NO. 85-536,937, FILED 2-8-2012.

MICHAEL WEBSTER, EXAMINING ATTORNEY



David J. Kybas

Director of the United States Patent and Trademark Office

United States of America

United States Patent and Trademark Office

MANIA

Reg. No. 4,205,813

SARA'S CITY WORKOUT, INC. (ILLINOIS CORPORATION)
3675 COMMERCIAL AVENUE
NORTHBROOK, IL 60062

Registered Sep. 11, 2012

Int. Cls.: 21, 35 and 41

FOR: REUSABLE PLASTIC WATER BOTTLES SOLD EMPTY, IN CLASS 21 (U.S. CLS. 2, 13, 23, 29, 30, 33, 40 AND 50).

TRADEMARK

FIRST USE 0-0-2008; IN COMMERCE 0-0-2008.

SERVICE MARK

FOR: ARRANGING AND CONDUCTING TRADE SHOW EXHIBITIONS IN THE FIELD OF PHYSICAL FITNESS; ARRANGING AND CONDUCTING TRADE SHOWS IN THE FIELD OF PHYSICAL FITNESS EDUCATION; ORGANIZING BUSINESS EXPOSITIONS FOR PHYSICAL FITNESS PROFESSIONALS, IN CLASS 35 (U.S. CLS. 100, 101 AND 102).

PRINCIPAL REGISTER

FIRST USE 10-0-1988; IN COMMERCE 10-0-1988.

FOR: EDUCATIONAL SERVICES, NAMELY, CONDUCTING CLASSES, SEMINARS, CONFERENCES, WORKSHOPS AND CONVENTIONS IN THE FIELD OF PHYSICAL FITNESS; EDUCATIONAL SERVICES, NAMELY, PROVIDING TRAINING OF FITNESS PROFESSIONALS FOR CERTIFICATION IN THE FIELD OF PHYSICAL FITNESS INSTRUCTION; PHYSICAL FITNESS INSTRUCTION; PHYSICAL FITNESS TRAINING OF INDIVIDUALS AND GROUPS; PHYSICAL FITNESS TRAINING SERVICES; PROVIDING A WEBSITE FEATURING INFORMATION ON EXERCISE AND FITNESS, IN CLASS 41 (U.S. CLS. 100, 101 AND 107).

FIRST USE 10-0-1988; IN COMMERCE 10-0-1988.

THE MARK CONSISTS OF STANDARD CHARACTERS WITHOUT CLAIM TO ANY PARTICULAR FONT, STYLE, SIZE, OR COLOR.

SER. NO. 85-536,938, FILED 2-8-2012.

DOMINICK J. SALEMI, EXAMINING ATTORNEY



David J. Kyros

Director of the United States Patent and Trademark Office

United States of America

United States Patent and Trademark Office



Reg. No. 4,205,814

Registered Sep. 11, 2012

Int. Cl.: 39

SERVICE MARK

PRINCIPAL REGISTER

JUNK MAN LLC (NEVADA LIMITED LIABILITY COMPANY)
101
950 W. WARM SPRINGS ROAD
HENDERSON, NV 89011

FOR: JUNK REMOVAL; JUNK, TRASH AND DEBRIS REMOVAL, IN CLASS 39 (U.S. CLS. 100 AND 105).

FIRST USE 12-10-2011; IN COMMERCE 1-9-2012.

THE MARK CONSISTS OF A TRUCK WITH THE STYLIZED TEXT "JUNKMAN".

SER. NO. 85-536,948, FILED 2-8-2012.

DOMINICK J. SALEMI, EXAMINING ATTORNEY



David J. Kyffers

Director of the United States Patent and Trademark Office

United States of America

United States Patent and Trademark Office

Fill 'n Brew

Reg. No. 4,205,815

LAMI PRODUCTS INC. (PENNSYLVANIA CORPORATION)
860 WELSH ROAD

Registered Sep. 11, 2012

HUNTINGDON VALLEY, PA 19006

Int. Cl.: 11

FOR: COFFEE FILTERS NOT OF PAPER BEING PART OF ELECTRIC COFFEE MAKERS,
IN CLASS 11 (U.S. CLS. 13, 21, 23, 31 AND 34).

TRADEMARK

FIRST USE 5-3-2011; IN COMMERCE 1-8-2012.

PRINCIPAL REGISTER

THE MARK CONSISTS OF STANDARD CHARACTERS WITHOUT CLAIM TO ANY PAR-
TICULAR FONT, STYLE, SIZE, OR COLOR.

SER. NO. 85-536,951, FILED 2-8-2012.

DOMINICK J. SALEMI, EXAMINING ATTORNEY



David J. Kybas

Director of the United States Patent and Trademark Office

United States of America

United States Patent and Trademark Office

the tomkat studio

Reg. No. 4,205,816

Registered Sep. 11, 2012

Int. Cl.: 41

SERVICE MARK

PRINCIPAL REGISTER

THE TOMKAT STUDIO, LLC (ARIZONA LIMITED LIABILITY COMPANY)
11310 EAST FLINTLOCK DRIVE
CHANDLER, AZ 85249

FOR: PROVIDING A WEB SITE THAT FEATURES INFORMAL INSTRUCTION ON SOCIAL ENTERTAINING, PARTY STYLING, AND PARTY PLANNING, IN CLASS 41 (U.S. CLS. 100, 101 AND 107).

FIRST USE 12-20-2008; IN COMMERCE 12-20-2008.

THE MARK CONSISTS OF STANDARD CHARACTERS WITHOUT CLAIM TO ANY PARTICULAR FONT, STYLE, SIZE, OR COLOR.

SER. NO. 85-536,952, FILED 2-8-2012.

ANDREW LEASER, EXAMINING ATTORNEY



David J. Kyffers

Director of the United States Patent and Trademark Office

United States of America

United States Patent and Trademark Office

between

Reg. No. 4,205,817

CHRISTIAN CALVINO (ARGENTINA INDIVIDUAL)

Registered Sep. 11, 2012

SAN LORENZO 3775

MAR DEL PLATA, BS.AS., ARGENTINA 7600

Int. Cl.: 42

FOR: COMPUTER WEBSITE DESIGN; CREATING AND DESIGNING WEB PAGES FOR OTHERS; CREATING, DESIGNING AND MAINTAINING WEB SITES; CREATION, DESIGN, DEVELOPMENT AND MAINTENANCE OF WEB SITES FOR THIRD PARTIES; DESIGN AND CREATING WEB SITES FOR OTHERS; DESIGN AND DEVELOPMENT OF GRAPHIC USER INTERFACE; DESIGN AND MAINTENANCE OF WEB SITES FOR OTHERS; DESIGN OF HOME PAGES AND WEB SITES; DESIGN OF INFORMATION GRAPHICS AND DATA VISUALIZATION MATERIALS; GRAPHIC DESIGN SERVICES FOR CREATING GRAPHIC ELEMENTS OF CORPORATE, SERVICE, AND PRODUCT LOGOS, IN CLASS 42 (U.S. CLS. 100 AND 101).

SERVICE MARK

PRINCIPAL REGISTER

FIRST USE 10-24-2011; IN COMMERCE 10-24-2011.

THE MARK CONSISTS OF STANDARD CHARACTERS WITHOUT CLAIM TO ANY PARTICULAR FONT, STYLE, SIZE, OR COLOR.

SER. NO. 85-536,974, FILED 2-8-2012.

BERNICE MIDDLETON, EXAMINING ATTORNEY



David J. Kybas

Director of the United States Patent and Trademark Office

United States of America

United States Patent and Trademark Office

CABALLERO

Reg. No. 4,205,818

A & P EQUITY GROUP, LLC (ARIZONA LIMITED LIABILITY COMPANY)
22818 EAST IVANHOE STREET
MESA, AZ 85212

Registered Sep. 11, 2012

Int. Cl.: 43

FOR: RESTAURANT SERVICES; TAKE-OUT RESTAURANT SERVICES, IN CLASS 43 (U.S. CLS. 100 AND 101).

SERVICE MARK

FIRST USE 8-12-2009; IN COMMERCE 8-12-2009.

PRINCIPAL REGISTER

THE MARK CONSISTS OF STANDARD CHARACTERS WITHOUT CLAIM TO ANY PARTICULAR FONT, STYLE, SIZE, OR COLOR.

SER. NO. 85-536,975, FILED 2-8-2012.

VIVIAN MICZNIK FIRST, EXAMINING ATTORNEY



David J. Kybas

Director of the United States Patent and Trademark Office

United States of America

United States Patent and Trademark Office

Caballero Grill

Reg. No. 4,205,819

A & P EQUITY GROUP, LLC (ARIZONA LIMITED LIABILITY COMPANY)
22818 EAST IVANHOE STREET
MESA, AZ 85212

Registered Sep. 11, 2012

Int. Cl.: 43

FOR: RESTAURANT SERVICES; TAKE-OUT RESTAURANT SERVICES, IN CLASS 43 (U.S. CLS. 100 AND 101).

SERVICE MARK

FIRST USE 8-12-2009; IN COMMERCE 8-12-2009.

PRINCIPAL REGISTER

THE MARK CONSISTS OF STANDARD CHARACTERS WITHOUT CLAIM TO ANY PARTICULAR FONT, STYLE, SIZE, OR COLOR.

NO CLAIM IS MADE TO THE EXCLUSIVE RIGHT TO USE "GRILL", APART FROM THE MARK AS SHOWN.

SER. NO. 85-536,984, FILED 2-8-2012.

VIVIAN MICZNIK FIRST, EXAMINING ATTORNEY



David J. Kyffers

Director of the United States Patent and Trademark Office

United States of America

United States Patent and Trademark Office

CVOX

Reg. No. 4,205,820

Registered Sep. 11, 2012

Int. Cl.: 35

SERVICE MARK

PRINCIPAL REGISTER

CVOX GROUP LLC (FLORIDA LIMITED LIABILITY COMPANY)
2700 N. MIAMI AVENUE UNIT 608
MIAMI, FL 33127

FOR: ADVERTISING AND MARKETING CONSULTANCY; ADVERTISING AND MARKETING SERVICES PROVIDED BY MEANS OF INDIRECT METHODS OF MARKETING COMMUNICATIONS, NAMELY, SOCIAL MEDIA, SEARCH ENGINE MARKETING, INQUIRY MARKETING, INTERNET MARKETING, MOBILE MARKETING, BLOGGING AND OTHER FORMS OF PASSIVE, SHARABLE OR VIRAL COMMUNICATIONS CHANNELS; ADVERTISING AND MARKETING SERVICES, NAMELY, PROMOTING THE GOODS AND SERVICES OF OTHERS; CONSULTATION SERVICES, NAMELY, CREATIVE AND STRATEGIC CONSULTATION REGARDING DEVELOPMENT AND PRODUCTION OF MARKETING CAMPAIGNS FOR OTHERS; PUBLIC RELATIONS; PUBLICITY CONSULTATION, IN CLASS 35 (U.S. CLS. 100, 101 AND 102).

FIRST USE 7-31-2007; IN COMMERCE 7-31-2007.

THE MARK CONSISTS OF STANDARD CHARACTERS WITHOUT CLAIM TO ANY PARTICULAR FONT, STYLE, SIZE, OR COLOR.

SER. NO. 85-536,991, FILED 2-8-2012.

JAY BESCH, EXAMINING ATTORNEY



David J. Kybas

Director of the United States Patent and Trademark Office

United States of America

United States Patent and Trademark Office

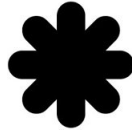

logical things

Reg. No. 4,205,821

Registered Sep. 11, 2012

Int. Cl.: 42

SERVICE MARK

PRINCIPAL REGISTER

LOGICAL THINGS, INC. (TEXAS CORPORATION)
C/O ART THOMPSON, JR.
2802 BRINWOOD AVENUE
AUSTIN, TX 78704

FOR: WEB SITE DESIGN SERVICES FOR OTHERS; GRAPHIC ART DESIGN SERVICES; WEB SITE DEVELOPMENT CONSULTING SERVICES; GRAPHIC DESIGN CONSULTING SERVICES; AND THE CREATION OF ANIMATED DESIGNS FOR OTHERS, IN CLASS 42 (U.S. CLS. 100 AND 101).

FIRST USE 1-1-2008; IN COMMERCE 1-1-2008.

THE MARK CONSISTS OF THE WORDS "LOGICAL THINGS" WITH A STAR ABOVE THE WORDS.

SER. NO. 85-537,001, FILED 2-8-2012.

ERNEST SHOSHO, EXAMINING ATTORNEY



David J. Kyffers

Director of the United States Patent and Trademark Office

United States of America

United States Patent and Trademark Office

CVOX

Reg. No. 4,205,822

Registered Sep. 11, 2012

Int. Cl.: 41

SERVICE MARK

PRINCIPAL REGISTER

CVOX GROUP LLC (FLORIDA LIMITED LIABILITY COMPANY)
2700 N. MIAMI AVENUE UNIT 608
MIAMI, FL 33127

FOR: MEDIA PRODUCTION SERVICES, NAMELY, VIDEO AND FILM PRODUCTION;
PRODUCTION OF RADIO OR TELEVISION PROGRAMS, IN CLASS 41 (U.S. CLS. 100, 101
AND 107).

FIRST USE 7-31-2007; IN COMMERCE 7-31-2007.

THE MARK CONSISTS OF STANDARD CHARACTERS WITHOUT CLAIM TO ANY PAR-
TICULAR FONT, STYLE, SIZE, OR COLOR.

SER. NO. 85-537,014, FILED 2-8-2012.

JAY BESCH, EXAMINING ATTORNEY



David J. Kyffers

Director of the United States Patent and Trademark Office

United States of America

United States Patent and Trademark Office



Reg. No. 4,205,823

Registered Sep. 11, 2012

Int. Cl.: 45

SERVICE MARK

PRINCIPAL REGISTER

NTD PATENT & TRADEMARK AGENCY LIMITED (HONG KONG CORPORATION)
UNITS 1805-6, 18TH FL., GREENFIELD TOWER
CONCORDIA PLAZA, NO. 1 SCIENCE MUSEUM RD
TSIMSHATSUI E, KOWLOON, HONG KONG

FOR: INTELLECTUAL PROPERTY CONSULTATION; LEGAL CONSULTATION SERVICES; LEGAL SERVICES; LITIGATION CONSULTATION; LITIGATION SUPPORT SERVICES; PATENT AGENT SERVICES; PATENT AND INDUSTRIAL PROPERTY CONSULTATION; PROVIDING ASSISTANCE IN THE PROSECUTION OF TRADEMARK APPLICATIONS; PROVIDING INFORMATION RELATING TO LEGAL AFFAIRS; PROVIDING INFORMATION ABOUT INTELLECTUAL AND INDUSTRIAL PROPERTY RIGHTS; PROVIDING INFORMATION IN THE FIELD OF INTELLECTUAL PROPERTY; PROVIDING INFORMATION IN THE FIELD OF INTELLECTUAL PROPERTY LEGAL SERVICES; TRADEMARK WATCH SERVICES; ARBITRATION SERVICES; CONSULTING IN THE FIELD OF INTELLECTUAL PROPERTY LICENSING; COPYRIGHT MANAGEMENT CONSULTATION; DOMAIN NAME REGISTRATION SERVICES; INTELLECTUAL PROPERTY WATCH SERVICES; INVESTIGATION OR SURVEILLANCE ON BACKGROUND PROFILES; LEGAL DOCUMENT PREPARATION AND RESEARCH SERVICES FOR ATTORNEYS; LEGAL RESEARCH; LICENSING OF COMPUTER SOFTWARE (LEGAL SERVICES); LICENSING OF INTELLECTUAL PROPERTY (LEGAL SERVICES); ON-SITE LEGAL SERVICES; PARALEGAL SERVICES; PATENT LICENSING (LEGAL SERVICES); PERSONAL BACKGROUND INVESTIGATIONS; PROVIDING A WEB SITE FEATURING INFORMATION ABOUT PATENTS AND PATENT APPLICATIONS; PROVIDING AN ON-LINE INTERACTIVE DATABASE FEATURING LEGAL INFORMATION; PROVIDING ON-LINE INFORMATION AND NEWS IN THE FIELD OF LAW; PROVIDING ON-LINE INFORMATION IN THE FIELD OF INTELLECTUAL PROPERTY; PROVIDING ON-LINE INFORMATION IN THE FIELD OF INTELLECTUAL PROPERTY LEGAL SERVICES, IN CLASS 45 (U.S. CLS. 100 AND 101).



FIRST USE 6-26-1987; IN COMMERCE 9-8-1997.

NO CLAIM IS MADE TO THE EXCLUSIVE RIGHT TO USE "INTELLECTUAL PROPERTY", APART FROM THE MARK AS SHOWN.

David J. Kyjars

THE MARK CONSISTS OF THE WORDS "NTD INTELLECTUAL PROPERTY" AND A STYLIZED DESIGN OF A LETTER "N"; IN THE MIDDLE OF THE LETTER "N" ALSO CONSIST OF CURVE LINES; THE LETTER "N" DESIGN IS PARTIALLY SHADED.

Reg. No. 4,205,823 SER. NO. 85-537,018, FILED 2-8-2012.

SANDRA BUJA, EXAMINING ATTORNEY

United States of America

United States Patent and Trademark Office

LOCATIONiq

Reg. No. 4,205,824

STARCOM MEDIAVEST GROUP, INC. (DELAWARE CORPORATION)
35 W. WACKER DRIVE
CHICAGO, IL 60601

Registered Sep. 11, 2012

Int. Cl.: 35

FOR: MARKETING SERVICES, NAMELY, COMPILATION AND ONGOING MANAGEMENT OF LOCAL BUSINESS-LEVEL DATA FOR THE PURPOSE OF ORGANIC CONTENT MANAGEMENT ACROSS ONLINE, MOBILE, TABLET AND NAVIGATION DEVICES, IN CLASS 35 (U.S. CLS. 100, 101 AND 102).

SERVICE MARK

PRINCIPAL REGISTER

FIRST USE 9-30-2011; IN COMMERCE 9-30-2011.

THE MARK CONSISTS OF STANDARD CHARACTERS WITHOUT CLAIM TO ANY PARTICULAR FONT, STYLE, SIZE, OR COLOR.

SER. NO. 85-537,023, FILED 2-8-2012.

KEVIN DINALLO, EXAMINING ATTORNEY



David J. Kyffers

Director of the United States Patent and Trademark Office

United States of America

United States Patent and Trademark Office

GRIPPOSTAD

Reg. No. 4,205,825

Registered Sep. 11, 2012

Int. Cl.: 5

TRADEMARK

PRINCIPAL REGISTER

STADA ARZNEIMITTEL AG (FED REP GERMANY CORPORATION)
STADASTRASSE 2-18
BAD VILBEL, FED REP GERMANY 61118

FOR: PHARMACEUTICAL PREPARATIONS FOR THE TREATMENT OF COUGH AND
COLDS, IN CLASS 5 (U.S. CLS. 6, 18, 44, 46, 51 AND 52).

THE MARK CONSISTS OF STANDARD CHARACTERS WITHOUT CLAIM TO ANY PAR-
TICULAR FONT, STYLE, SIZE, OR COLOR.

OWNER OF FED REP GERMANY REG. NO. 740021, DATED 9-8-1960, EXPIRES 10-31-2019.

OWNER OF U.S. REG. NO. 3,034,865.

SER. NO. 85-537,086, FILED 2-8-2012.

TOBY BULLOFF, EXAMINING ATTORNEY



David J. Kybas

Director of the United States Patent and Trademark Office

United States of America

United States Patent and Trademark Office

KAMISTAD

Reg. No. 4,205,826

STADA ARZNEIMITTEL AG (FED REP GERMANY CORPORATION)
STADASTRASSE 2-18

Registered Sep. 11, 2012

BAD VILBEL, FED REP GERMANY 61118

Int. Cl.: 5

FOR: PHARMACEUTICAL PREPARATIONS, NAMELY, AN ORAL THERAPEUTIC GEL FOR THE TREATMENT OF PAINFUL AND INFLAMMATORY GUMS, THE ORAL MUCOUS MEMBRANE, AND THE LIPS, IN CLASS 5 (U.S. CLS. 6, 18, 44, 46, 51 AND 52).

TRADEMARK

THE MARK CONSISTS OF STANDARD CHARACTERS WITHOUT CLAIM TO ANY PARTICULAR FONT, STYLE, SIZE, OR COLOR.

PRINCIPAL REGISTER

OWNER OF FED REP GERMANY REG. NO. 30330181, DATED 11-26-2003, EXPIRES 6-30-2013.

OWNER OF U.S. REG. NO. 3,034,866.

SER. NO. 85-537,088, FILED 2-8-2012.

TOBY BULLOFF, EXAMINING ATTORNEY



David J. Kyffers

Director of the United States Patent and Trademark Office

United States of America
United States Patent and Trademark Office

FRADAN

Reg. No. 4,205,827

FRADAN MANUFACTURING CORP. (NEW YORK CORPORATION)
499 FIFTH AVE
NEW ROCHELLE, NY 10801

Registered Sep. 11, 2012

Int. Cl.: 7

FOR: POWER BLOWERS FOR LAWN DEBRIS; VACUUM SHREDDERS FOR CLEARING DEBRIS, IN CLASS 7 (U.S. CLS. 13, 19, 21, 23, 31, 34 AND 35).

TRADEMARK

FIRST USE 11-30-1991; IN COMMERCE 11-30-1991.

PRINCIPAL REGISTER

THE MARK CONSISTS OF STANDARD CHARACTERS WITHOUT CLAIM TO ANY PARTICULAR FONT, STYLE, SIZE, OR COLOR.

SER. NO. 85-537,091, FILED 2-8-2012.

TOBY BULLOFF, EXAMINING ATTORNEY



David J. Kybas

Director of the United States Patent and Trademark Office

United States of America

United States Patent and Trademark Office

GENUINE VALUE . . . EVERY
DAY.

Reg. No. 4,205,828

VF OUTLET, INC. (DELAWARE CORPORATION)
801 HILL AVENUE
WYOMISSING, PA 19610

Registered Sep. 11, 2012

Int. Cl.: 35

FOR: RETAIL STORE SERVICES IN THE FIELD OF APPAREL AND ACCESSORIES, BEDDING, LINENS, SHOES AND FURNITURE; PROVIDING CONSUMER PRODUCT INFORMATION VIA THE INTERNET, IN CLASS 35 (U.S. CLS. 100, 101 AND 102).

SERVICE MARK

FIRST USE 12-22-2011; IN COMMERCE 12-22-2011.

PRINCIPAL REGISTER

THE MARK CONSISTS OF STANDARD CHARACTERS WITHOUT CLAIM TO ANY PARTICULAR FONT, STYLE, SIZE, OR COLOR.

SER. NO. 85-537,119, FILED 2-8-2012.

WILLIAM ROSSMAN, EXAMINING ATTORNEY



David J. Kyros

Director of the United States Patent and Trademark Office

United States of America

United States Patent and Trademark Office

Find your sweet spot!

Reg. No. 4,205,829

Registered Sep. 11, 2012

Int. Cl.: 9

TRADEMARK

PRINCIPAL REGISTER

GID DEVELOPMENT CORP. (NEVADA CORPORATION), DBA BODYDOCK.COM
3720 PROSPECT AVENUE
YORBA LINDA, CA 92886

FOR: DOCKING MECHANISMS FOR MOBILE DEVICES, NAMELY MAGNETIC DOCKING MECHANISM FOR MOBILE PHONES, PORTABLE MUSIC PLAYERS, AND PORTABLE TABLETS, IN CLASS 9 (U.S. CLS. 21, 23, 26, 36 AND 38).

FIRST USE 12-14-2011; IN COMMERCE 12-14-2011.

THE MARK CONSISTS OF THE WORDS "FIND YOUR SWEET SPOT" WITH AN EXCLAMATION POINT AT THE END. THE O IN "SPOT" IS A TARGET.

SER. NO. 85-537,130, FILED 2-8-2012.

JOHN WILKE, EXAMINING ATTORNEY



David J. Kybas

Director of the United States Patent and Trademark Office

United States of America

United States Patent and Trademark Office



Reg. No. 4,205,830

SOUTHERN ARKANSAS UNIVERSITY (ARKANSAS STATE UNIVERSITY)
100 EAST UNIVERSITY
MAGNOLIA, AR 71753

Registered Sep. 11, 2012

Int. Cl.: 41

FOR: EDUCATIONAL SERVICES, NAMELY PROVIDING COURSES OF INSTRUCTION AT THE COLLEGE LEVEL, AND ENTERTAINMENT SERVICES, NAMELY ORGANIZING AND CONDUCTING COLLEGE LEVEL SPORTING EVENTS, IN CLASS 41 (U.S. CLS. 100, 101 AND 107).

SERVICE MARK

PRINCIPAL REGISTER

FIRST USE 12-31-2004; IN COMMERCE 12-31-2004.

THE MARK CONSISTS OF A RIDER ON A BUCKING MULE FRAMED BY A MULE SHOE.

SER. NO. 85-537,137, FILED 2-8-2012.

ROBIN CHOSID, EXAMINING ATTORNEY



David J. Kyffers

Director of the United States Patent and Trademark Office

United States of America

United States Patent and Trademark Office

HTX

Reg. No. 4,205,831

Registered Sep. 11, 2012

Int. Cl.: 3

TRADEMARK

PRINCIPAL REGISTER

NIOXIN RESEARCH LABORATORIES, INC (GEORGIA CORPORATION)
2124 SKYVIEW DRIVE
LITHIA SPRINGS, GA 30122

FOR: HAIR CARE PREPARATIONS, IN CLASS 3 (U.S. CLS. 1, 4, 6, 50, 51 AND 52).

FIRST USE 1-31-2012; IN COMMERCE 1-31-2012.

THE MARK CONSISTS OF STANDARD CHARACTERS WITHOUT CLAIM TO ANY PARTICULAR FONT, STYLE, SIZE, OR COLOR.

SER. NO. 85-537,139, FILED 2-8-2012.

JIM RINGLE, EXAMINING ATTORNEY



David J. Kyffers

Director of the United States Patent and Trademark Office

United States of America

United States Patent and Trademark Office

BottleCote

Reg. No. 4,205,832

CAROLYN WOLF (UNITED STATES INDIVIDUAL)
15560 W. DESERT MIRAGE DR
SURPRISE, AZ 85379

Registered Sep. 11, 2012

Int. Cl.: 21

FOR: BOTTLE SLEEVES COMPOSED OF LIQUID-ABSORBING MICRO FIBER FABRIC,
IN CLASS 21 (U.S. CLS. 2, 13, 23, 29, 30, 33, 40 AND 50).

TRADEMARK

FIRST USE 1-15-2011; IN COMMERCE 11-15-2011.

PRINCIPAL REGISTER

THE MARK CONSISTS OF STANDARD CHARACTERS WITHOUT CLAIM TO ANY PAR-
TICULAR FONT, STYLE, SIZE, OR COLOR.

SER. NO. 85-537,142, FILED 2-8-2012.

LUCY ARANT, EXAMINING ATTORNEY



David J. Kybas

Director of the United States Patent and Trademark Office

United States of America

United States Patent and Trademark Office

DIAMAX

Reg. No. 4,205,833

Registered Sep. 11, 2012

Int. Cl.: 3

TRADEMARK

PRINCIPAL REGISTER

NIOXIN RESEARCH LABORATORIES, INC (GEORGIA CORPORATION)
2124 SKYVIEW DRIVE
LITHIA SPRINGS, GA 30122

FOR: HAIR CARE PREPARATIONS, IN CLASS 3 (U.S. CLS. 1, 4, 6, 50, 51 AND 52).

FIRST USE 1-31-2012; IN COMMERCE 1-31-2012.

THE MARK CONSISTS OF STANDARD CHARACTERS WITHOUT CLAIM TO ANY PARTICULAR FONT, STYLE, SIZE, OR COLOR.

SER. NO. 85-537,145, FILED 2-8-2012.

JIM RINGLE, EXAMINING ATTORNEY



David J. Kyffers

Director of the United States Patent and Trademark Office

United States of America

United States Patent and Trademark Office



Leveraging the power of culture to optimize the bottom line.

Reg. No. 4,205,834

Registered Sep. 11, 2012

Int. Cl.: 35

SERVICE MARK

PRINCIPAL REGISTER

HUMMEL, DENISE PIRROTI (UNITED STATES INDIVIDUAL), DBA UNIVERSAL
CONSENSUS
2890 CORTE MORERA
CARLSBAD, CA 92009

FOR: ASSISTANCE AND ADVICE REGARDING BUSINESS ORGANIZATION AND MANAGEMENT; BUSINESS ORGANIZATION ADVICE; BUSINESS ORGANIZATION AND MANAGEMENT CONSULTANCY INCLUDING PERSONNEL MANAGEMENT; BUSINESS ORGANIZATION AND MANAGEMENT CONSULTING; BUSINESS ORGANIZATION AND OPERATION CONSULTANCY; BUSINESS ORGANIZATION CONSULTING, IN CLASS 35 (U.S. CLS. 100, 101 AND 102).

FIRST USE 2-1-2009; IN COMMERCE 2-1-2009.

OWNER OF U.S. REG. NO. 4,005,945.

THE COLOR(S) ORANGE, LIGHT GREEN, DARK GREEN, BLACK AND TAN IS/ARE CLAIMED AS A FEATURE OF THE MARK.

THE MARK CONSISTS OF A STYLIZED EYE, WITH ORANGE EYELIDS AND A GREEN PUPIL IN THE SHAPE OF PANGEA, WITH THE LAND PORTIONS IN LIGHT GREEN AND THE OCEAN PORTIONS IN DARK GREEN, WITH THE WORD "UNIVERSAL" IN BLACK, THE WORD "CONSENSUS" IN TAN, AND THE PHRASE "LEVERAGING THE POWER OF CULTURE TO OPTIMIZE THE BOTTOM LINE." ALSO IN BLACK.

SER. NO. 85-537,208, FILED 2-8-2012.

HANNO RITTNER, EXAMINING ATTORNEY



David J. Kybas

Director of the United States Patent and Trademark Office

United States of America

United States Patent and Trademark Office

COCO LARUE

Reg. No. 4,205,835

Registered Sep. 11, 2012

Int. Cl.: 35

SERVICE MARK

PRINCIPAL REGISTER

THE LARUE CORPORATION (TENNESSEE CORPORATION)
8 ACADEMY PLACE, STUDIO 212
NASHVILLE, TN 37210

FOR: ON-LINE RETAIL STORE SERVICES FEATURING CLOTHING, FASHION ACCESSORIES, AND HAIRPIECES; RETAIL CLOTHING BOUTIQUES; RETAIL STORE SERVICES FEATURING CLOTHING, FASHION ACCESSORIES, AND HAIRPIECES, IN CLASS 35 (U.S. CLS. 100, 101 AND 102).

FIRST USE 0-0-2008; IN COMMERCE 0-0-2008.

THE MARK CONSISTS OF STANDARD CHARACTERS WITHOUT CLAIM TO ANY PARTICULAR FONT, STYLE, SIZE, OR COLOR.

THE NAME "COCO LARUE" IDENTIFIES A LIVING INDIVIDUAL WHOSE CONSENT IS OF RECORD.

SER. NO. 85-537,209, FILED 2-8-2012.

JENNY PARK, EXAMINING ATTORNEY



David J. Kyffers

Director of the United States Patent and Trademark Office

United States of America

United States Patent and Trademark Office



Reg. No. 4,205,836

CAPINTELLECT COMMUNICATIONS, INC. (NEVADA CORPORATION)
5460 DESERT POINT DRIVE
LAS VEGAS, NV 89118

Registered Sep. 11, 2012

Int. Cl.: 35

FOR: ADVERTISING AND MARKET RESEARCH SERVICES, IN CLASS 35 (U.S. CLS. 100, 101 AND 102).

SERVICE MARK

FIRST USE 4-12-2012; IN COMMERCE 4-12-2012.

PRINCIPAL REGISTER

OWNER OF U.S. REG. NOS. 3,859,696 AND 3,859,697.

THE MARK CONSISTS OF THE WORD "LETIZIA" SUPERIMPOSED OVER A ZIG ZAG LINE.

SER. NO. 85-537,221, FILED 2-8-2012.

HANNO RITTNER, EXAMINING ATTORNEY



David J. Kyffers

Director of the United States Patent and Trademark Office

United States of America

United States Patent and Trademark Office

T-Sense

Reg. No. 4,205,837

Registered Sep. 11, 2012

Int. Cl.: 9

TRADEMARK

PRINCIPAL REGISTER

IBUTTONLINK, LLC. (WISCONSIN LIMITED LIABILITY COMPANY)
N8921 STONE SCHOOL ROAD
EAST TROY, WI 53120

FOR: TEMPERATURE SENSORS, IN CLASS 9 (U.S. CLS. 21, 23, 26, 36 AND 38).

FIRST USE 11-19-2007; IN COMMERCE 11-19-2007.

THE MARK CONSISTS OF STANDARD CHARACTERS WITHOUT CLAIM TO ANY PARTICULAR FONT, STYLE, SIZE, OR COLOR.

SER. NO. 85-537,222, FILED 2-8-2012.

EMILY CARLSEN, EXAMINING ATTORNEY



David J. Kyffers

Director of the United States Patent and Trademark Office

United States of America

United States Patent and Trademark Office

NeuroMix

Reg. No. 4,205,838

WANCA, FRANK M (UNITED STATES INDIVIDUAL)
355 SOUTH KIHEI ROAD
KIHEI, HI 96753

Registered Sep. 11, 2012

Int. Cl.: 9

FOR: COMPUTER APPLICATION SOFTWARE FOR MOBILE PHONES, NAMELY, SOFTWARE FOR NEURAL STIMULATION INTEGRATION; COMPUTER APPLICATION SOFTWARE FOR NEURAL STIMULATION, NAMELY, SOFTWARE FOR NEURAL STIMULATION INTEGRATION, IN CLASS 9 (U.S. CLS. 21, 23, 26, 36 AND 38).

TRADEMARK

PRINCIPAL REGISTER

FIRST USE 12-1-2011; IN COMMERCE 1-15-2012.

THE MARK CONSISTS OF STANDARD CHARACTERS WITHOUT CLAIM TO ANY PARTICULAR FONT, STYLE, SIZE, OR COLOR.

SER. NO. 85-537,224, FILED 2-8-2012.

HANNO RITTNER, EXAMINING ATTORNEY



David J. Kyffers

Director of the United States Patent and Trademark Office

United States of America

United States Patent and Trademark Office

UNCLE GIUSEPPE'S

Reg. No. 4,205,839

Registered Sep. 11, 2012

Int. Cl.: 29

TRADEMARK

PRINCIPAL REGISTER

EAST MEADOW CORP. (NEW YORK CORPORATION), DBA UNCLE GIUSEPPE'S
SUITE 2C
475 MAIN STREET
FARMINGDALE, NY 11735

FOR: MARINATED VEGETABLES, IN CLASS 29 (U.S. CL. 46).

FIRST USE 11-1-1998; IN COMMERCE 11-1-1998.

THE MARK CONSISTS OF STANDARD CHARACTERS WITHOUT CLAIM TO ANY PARTICULAR FONT, STYLE, SIZE, OR COLOR.

OWNER OF U.S. REG. NOS. 4,052,777, 4,082,817 AND OTHERS.

SER. NO. 85-537,264, FILED 2-8-2012.

DORITT L. CARROLL, EXAMINING ATTORNEY



David J. Kybas

Director of the United States Patent and Trademark Office

United States of America

United States Patent and Trademark Office

JVZOO

Reg. No. 4,205,840

BBC SYSTEMS, INC. (FLORIDA CORPORATION)
1451 CANAL CROSS COURT
OVIEDO, FL 32766

Registered Sep. 11, 2012

Int. Cl.: 35

FOR: PROVIDING A SEARCHABLE WEBSITE FEATURING THE GOODS AND SERVICES OF OTHER VENDORS, IN CLASS 35 (U.S. CLS. 100, 101 AND 102).

SERVICE MARK

FIRST USE 3-0-2011; IN COMMERCE 3-0-2011.

PRINCIPAL REGISTER

THE MARK CONSISTS OF STANDARD CHARACTERS WITHOUT CLAIM TO ANY PARTICULAR FONT, STYLE, SIZE, OR COLOR.

SER. NO. 85-537,271, FILED 2-8-2012.

MIAH ROSENBERG, EXAMINING ATTORNEY



David J. Kybas

Director of the United States Patent and Trademark Office

United States of America

United States Patent and Trademark Office

Flasher-PRO

Reg. No. 4,205,841

DREW TECHNOLOGIES, INC. (MICHIGAN CORPORATION)
3915 RESEARCH PARK DRIVE
ANN ARBOR, MI 48108

Registered Sep. 11, 2012

Int. Cl.: 9

FOR: VEHICLE DIAGNOSTIC APPARATUS, NAMELY COMPUTERS FOR USE IN DIAGNOSING VEHICLE MECHANICAL AND ELECTRICAL PROBLEMS, IN CLASS 9 (U.S. CLS. 21, 23, 26, 36 AND 38).

TRADEMARK

FIRST USE 3-26-2008; IN COMMERCE 3-26-2008.

PRINCIPAL REGISTER

THE MARK CONSISTS OF STANDARD CHARACTERS WITHOUT CLAIM TO ANY PARTICULAR FONT, STYLE, SIZE, OR COLOR.

SER. NO. 85-537,299, FILED 2-8-2012.

MATTHEW KLINE, EXAMINING ATTORNEY



David J. Kyffers

Director of the United States Patent and Trademark Office

United States of America

United States Patent and Trademark Office

ALUMINUM IN ITS MOST SENSUAL FORM

Reg. No. 4,205,842

Registered Sep. 11, 2012

Int. Cl.: 20

TRADEMARK

PRINCIPAL REGISTER

SALVATI, ANTONIO PLAZA (UNITED STATES INDIVIDUAL)
#1602
2200 BENJAMIN FRANKLIN PARKWAY
PHILADELPHIA, PA 19130

FOR: FURNITURE AND WINE RACKS, IN CLASS 20 (U.S. CLS. 2, 13, 22, 25, 32 AND 50).

FIRST USE 4-1-2009; IN COMMERCE 4-1-2009.

THE MARK CONSISTS OF STANDARD CHARACTERS WITHOUT CLAIM TO ANY PARTICULAR FONT, STYLE, SIZE, OR COLOR.

NO CLAIM IS MADE TO THE EXCLUSIVE RIGHT TO USE "ALUMINUM", APART FROM THE MARK AS SHOWN.

SER. NO. 85-537,301, FILED 2-8-2012.

TOBY BULLOFF, EXAMINING ATTORNEY



David J. Kyfos

Director of the United States Patent and Trademark Office

United States of America

United States Patent and Trademark Office

SALVATI MOBILI DESIGN

Reg. No. 4,205,843

Registered Sep. 11, 2012

Int. Cl.: 20

TRADEMARK

PRINCIPAL REGISTER

SALVATI, ANTONIO PLAZA (UNITED STATES INDIVIDUAL)
#1602
2200 BENJAMIN FRANKLIN PARKWAY
PHILADELPHIA, PA 19130

FOR: FURNITURE AND WINE RACKS, IN CLASS 20 (U.S. CLS. 2, 13, 22, 25, 32 AND 50).

FIRST USE 4-1-2009; IN COMMERCE 4-1-2009.

THE MARK CONSISTS OF STANDARD CHARACTERS WITHOUT CLAIM TO ANY PARTICULAR FONT, STYLE, SIZE, OR COLOR.

NO CLAIM IS MADE TO THE EXCLUSIVE RIGHT TO USE "MOBILI DESIGN", APART FROM THE MARK AS SHOWN.

THE ENGLISH TRANSLATION OF "MOBILI" IN THE MARK IS "FURNITURE".

SER. NO. 85-537,313, FILED 2-8-2012.

TOBY BULLOFF, EXAMINING ATTORNEY



David J. Kyffers

Director of the United States Patent and Trademark Office

United States of America

United States Patent and Trademark Office

THANK YOU FOR SEEING ME

Reg. No. 4,205,844

FOWLER, KATHERINE (UNITED STATES INDIVIDUAL)
2206 GIBSON AVENUE
WILMINGTON, NC 28403

Registered Sep. 11, 2012

Int. Cl.: 25

FOR: T-SHIRTS, IN CLASS 25 (U.S. CLS. 22 AND 39).

TRADEMARK

FIRST USE 3-1-2011; IN COMMERCE 3-1-2011.

PRINCIPAL REGISTER

THE MARK CONSISTS OF STANDARD CHARACTERS WITHOUT CLAIM TO ANY PARTICULAR FONT, STYLE, SIZE, OR COLOR.

SER. NO. 85-537,321, FILED 2-8-2012.

MATTHEW KLINE, EXAMINING ATTORNEY



David J. Kyffers

Director of the United States Patent and Trademark Office

United States of America

United States Patent and Trademark Office

MOLLY MOON'S HOMEMADE ICE CREAM

Reg. No. 4,205,845

Registered Sep. 11, 2012

Int. Cl.: 43

SERVICE MARK

PRINCIPAL REGISTER

MOLLY MOON'S HOMEMADE ICE CREAM LLC (WASHINGTON LIMITED LIABILITY COMPANY)
1122 E. PIKE STREET, #1448
SEATTLE, WA 981223934

FOR: ICE CREAM PARLORS; ICE CREAM SHOP SERVICES IN THE NATURE OF A RESTAURANT, IN CLASS 43 (U.S. CLS. 100 AND 101).

FIRST USE 1-19-2008; IN COMMERCE 1-19-2008.

THE MARK CONSISTS OF STANDARD CHARACTERS WITHOUT CLAIM TO ANY PARTICULAR FONT, STYLE, SIZE, OR COLOR.

NO CLAIM IS MADE TO THE EXCLUSIVE RIGHT TO USE "HOMEMADE ICE CREAM", APART FROM THE MARK AS SHOWN.

SER. NO. 85-537,327, FILED 2-8-2012.

GRETCHEN ULRICH, EXAMINING ATTORNEY



David J. Kyffers

Director of the United States Patent and Trademark Office

United States of America

United States Patent and Trademark Office

ENDING ALL ROADS TO SILENCE

Reg. No. 4,205,846

TECIMER, NATALIE (UNITED STATES INDIVIDUAL)
1905 VIA VISALIA

Registered Sep. 11, 2012

PALOS VERDES ESTATES, CA 90274

Int. Cl.: 36

FOR: CHARITABLE FUNDRAISING SERVICES, NAMELY, RAISING FUNDS FOR PROVIDING DEAF AND HARD OF HEARING CHILDREN WITH HEARING AIDS, AUDIOLOGICAL SERVICES, SPEECH THERAPY, AND HEALTH CARE SERVICES, IN CLASS 36 (U.S. CLS. 100, 101 AND 102).

SERVICE MARK

PRINCIPAL REGISTER

FIRST USE 9-1-2011; IN COMMERCE 9-1-2011.

THE MARK CONSISTS OF STANDARD CHARACTERS WITHOUT CLAIM TO ANY PARTICULAR FONT, STYLE, SIZE, OR COLOR.

SER. NO. 85-537,351, FILED 2-8-2012.

NICHOLAS ALTREE, EXAMINING ATTORNEY



David J. Kybas

Director of the United States Patent and Trademark Office

United States of America

United States Patent and Trademark Office

MAGIC ON MAIN

Reg. No. 4,205,847

METRAMATRIX, INC. (KENTUCKY CORPORATION)
3505 RIDGE TOP COURT
LOUISVILLE, KY 40241

Registered Sep. 11, 2012

Int. Cl.: 41

FOR: ENTERTAINMENT IN THE NATURE OF PROVIDING MAGIC SHOWS AND VENUES FOR MAGIC SHOWS; ENTERTAINMENT IN THE NATURE OF A NATIONAL MAGIC FESTIVAL, IN CLASS 41 (U.S. CLS. 100, 101 AND 107).

SERVICE MARK

FIRST USE 11-14-2011; IN COMMERCE 11-14-2011.

PRINCIPAL REGISTER

THE MARK CONSISTS OF STANDARD CHARACTERS WITHOUT CLAIM TO ANY PARTICULAR FONT, STYLE, SIZE, OR COLOR.

SER. NO. 85-537,387, FILED 2-8-2012.

DEIRDRE ROBERTSON, EXAMINING ATTORNEY



David J. Kyffers

Director of the United States Patent and Trademark Office

United States of America

United States Patent and Trademark Office

b&j

Reg. No. 4,205,848

Registered Sep. 11, 2012

Int. Cl.: 14

TRADEMARK

PRINCIPAL REGISTER

WILLIAMS, BRENT A. (UNITED STATES INDIVIDUAL)
4 BARBARA STREET
TOPSHAM, ME 04086 AND

WILLIAMS, JESSICA C. (UNITED STATES INDIVIDUAL)
4 BARBARA STREET
TOPSHAM, ME 04086

FOR: JEWELRY, IN CLASS 14 (U.S. CLS. 2, 27, 28 AND 50).

FIRST USE 8-17-2011; IN COMMERCE 11-9-2011.

THE MARK CONSISTS OF STANDARD CHARACTERS WITHOUT CLAIM TO ANY PARTICULAR FONT, STYLE, SIZE, OR COLOR.

SER. NO. 85-537,412, FILED 2-8-2012.

LIEF MARTIN, EXAMINING ATTORNEY



David J. Kyffers

Director of the United States Patent and Trademark Office

United States of America

United States Patent and Trademark Office

goodgood

Reg. No. 4,205,849

Registered Sep. 11, 2012

Int. Cl.: 35

SERVICE MARK

PRINCIPAL REGISTER

GOODGOOD, LLC (MASSACHUSETTS LIMITED LIABILITY COMPANY)
NO. 102
346 CONGRESS STREET
BOSTON, MA 02210

FOR: ADVERTISING AND PUBLICITY SERVICES, NAMELY, PROMOTING THE GOODS, SERVICES, BRAND IDENTITY AND COMMERCIAL INFORMATION AND NEWS OF THIRD PARTIES THROUGH PRINT, AUDIO, VIDEO, DIGITAL AND ON-LINE MEDIUM; ADVERTISING SERVICES, NAMELY, CREATING CORPORATE AND BRAND IDENTITY FOR OTHERS; ARRANGING AND CONDUCTING TRADE SHOW EXHIBITIONS IN THE FIELD OF ART AND GRAPHIC DESIGN; BRAND CONCEPT AND BRAND DEVELOPMENT SERVICES FOR CORPORATE AND INDIVIDUAL CLIENTS; BRAND EVALUATION SERVICES; BRAND POSITIONING SERVICES; BRANDING SERVICES, NAMELY, CONSULTING, DEVELOPMENT, MANAGEMENT AND MARKETING OF BRANDS FOR BUSINESSES; BUSINESS CARD DESIGN SERVICES; BUSINESS SERVICES FOR FUNDRAISING PROGRAMS, NAMELY, DEVELOPING FUNDRAISING PROGRAM CATALOGS, BROCHURES, PRICE SHEETS, ORDER FORMS, AND OTHER DOCUMENTS FOR NOT-FOR-PROFIT ORGANIZATIONS; COMMISSIONING OF WORKS OF ART; CREATIVE MARKETING DESIGN SERVICES; DESIGN OF ADVERTISING BROCHURES FOR OTHERS; DESIGN OF ADVERTISING FLYERS FOR OTHERS; DESIGN OF ADVERTISING MATERIALS FOR OTHERS; DEVELOPMENT OF MARKETING STRATEGIES, CONCEPTS AND TACTICS, NAMELY, AUDIENCE DEVELOPMENT, BRAND AWARENESS, ONLINE COMMUNITY BUILDING AND DIGITAL WORD OF MOUTH COMMUNICATIONS; DISSEMINATION OF ADVERTISEMENTS AND OF ADVERTISING MATERIAL; RETAIL SHOP WINDOW DISPLAY ARRANGEMENT SERVICES; SOCIAL MEDIA STRATEGY AND MARKETING CONSULTANCY FOCUSING ON HELPING CLIENTS CREATE AND EXTEND THEIR PRODUCT AND BRAND STRATEGIES BY BUILDING VIRALLY ENGAGING MARKETING SOLUTIONS, IN CLASS 35 (U.S. CLS. 100, 101 AND 102).



FIRST USE 5-1-2008; IN COMMERCE 5-1-2009.

THE MARK CONSISTS OF STANDARD CHARACTERS WITHOUT CLAIM TO ANY PARTICULAR FONT, STYLE, SIZE, OR COLOR.

David J. Kyros

SER. NO. 85-537,415, FILED 2-8-2012.

NELSON SNYDER, EXAMINING ATTORNEY

Director of the United States Patent and Trademark Office

United States of America
United States Patent and Trademark Office

RECKLESS

Reg. No. 4,205,850

Registered Sep. 11, 2012

Int. Cl.: 28

TRADEMARK

PRINCIPAL REGISTER

RIEDEL SHOES, INC. (MINNESOTA CORPORATION)
PO BOX 21
122 CANNON RIVER AVENUE
RED WING, MN 55066

FOR: ROLLER SKATE WHEELS, IN CLASS 28 (U.S. CLS. 22, 23, 38 AND 50).

FIRST USE 7-21-2011; IN COMMERCE 7-21-2011.

THE MARK CONSISTS OF STANDARD CHARACTERS WITHOUT CLAIM TO ANY PARTICULAR FONT, STYLE, SIZE, OR COLOR.

SER. NO. 85-537,450, FILED 2-8-2012.

CHRISTINE MARTIN, EXAMINING ATTORNEY



David J. Kybas

Director of the United States Patent and Trademark Office

United States of America

United States Patent and Trademark Office

PRECISION

Reg. No. 4,205,851

THE TOPPS COMPANY, INC. (DELAWARE CORPORATION)
ONE WHITEHALL STREET
NEW YORK, NY 10004

Registered Sep. 11, 2012

Int. Cl.: 16

FOR: TRADING CARDS, IN CLASS 16 (U.S. CLS. 2, 5, 22, 23, 29, 37, 38 AND 50).

TRADEMARK

FIRST USE 2-1-2012; IN COMMERCE 2-1-2012.

PRINCIPAL REGISTER

THE MARK CONSISTS OF STANDARD CHARACTERS WITHOUT CLAIM TO ANY PARTICULAR FONT, STYLE, SIZE, OR COLOR.

SER. NO. 85-537,464, FILED 2-8-2012.

MARK SPARACINO, EXAMINING ATTORNEY



David J. Kybas

Director of the United States Patent and Trademark Office

United States of America

United States Patent and Trademark Office

MetricIntent

Reg. No. 4,205,852

NAFISI, JENNIFER (UNITED STATES INDIVIDUAL)
24546 LADERA DRV
MISSION VIEJO, CA 92691

Registered Sep. 11, 2012

Int. Cl.: 42

FOR: COMPUTER PROGRAMMING; COMPUTER SERVICES, NAMELY, SEARCH ENGINE OPTIMIZATION; WEBSITE DESIGN AND DEVELOPMENT FOR OTHERS, IN CLASS 42 (U.S. CLS. 100 AND 101).

SERVICE MARK

FIRST USE 4-16-2010; IN COMMERCE 1-1-2011.

PRINCIPAL REGISTER

THE MARK CONSISTS OF STANDARD CHARACTERS WITHOUT CLAIM TO ANY PARTICULAR FONT, STYLE, SIZE, OR COLOR.

SER. NO. 85-537,492, FILED 2-8-2012.

JAY BESCH, EXAMINING ATTORNEY



David J. Kybas

Director of the United States Patent and Trademark Office

United States of America

United States Patent and Trademark Office



Reg. No. 4,205,853

Registered Sep. 11, 2012

Int. Cl.: 40

SERVICE MARK

PRINCIPAL REGISTER

GIDDY UP INC (COLORADO CORPORATION)
#103
10500 E 56TH AVE.
DENVER, CO 80239

FOR: CUSTOMIZED PRINTING OF COMPANY NAMES AND LOGOS FOR PROMOTIONAL AND ADVERTISING PURPOSES ON THE GOODS OF OTHERS; EMBROIDERY SERVICES; SCREEN PRINTING, IN CLASS 40 (U.S. CLS. 100, 103 AND 106).

FIRST USE 10-1-2008; IN COMMERCE 10-1-2008.

THE MARK CONSISTS OF A GIRL ON A REARING BRONC HORSE INSIDE OF TWO CIRCLES AND TWO STARS INSIDE OF THE FIRST CIRCLE, THE TEXT "GIDDY" AT THE TOP AND "UP" AT THE BOTTOM, BETWEEN THE CIRCLES.

SER. NO. 85-537,500, FILED 2-8-2012.

JOHN E. MICHOS, EXAMINING ATTORNEY



David J. Kyffers

Director of the United States Patent and Trademark Office

United States of America

United States Patent and Trademark Office

LEADING CONSCIOUSLY. LIVING CONSCIOUSLY.

Reg. No. 4,205,854

Registered Sep. 11, 2012

Int. Cl.: 35

SERVICE MARK

PRINCIPAL REGISTER

CONSCIOUS LEADER NETWORK (CALIFORNIA LIMITED LIABILITY COMPANY)
5699 KANAN ROAD, SUITE 368
AGOURA HILLS, CA 91301

FOR: CONSULTING SERVICES IN BUSINESS LEADERSHIP DEVELOPMENT AND BUSINESS MANAGEMENT; PROVIDING INFORMATION ABOUT COMMERCIAL BUSINESS AND COMMERCIAL INFORMATION VIA THE GLOBAL COMPUTER NETWORK; BUSINESS CONSULTATION IN THE FIELD OF BUSINESS LEADERSHIP DEVELOPMENT; BUSINESS SERVICES, NAMELY PROVIDING AN ONLINE NETWORK FOR BUSINESS LEADERS TO DEVELOP BUSINESS LEADERSHIP SKILLS; MEMBERSHIP SERVICES, NAMELY, PROVIDING INFORMATION TO MEMBERS IN THE FIELD OF BUSINESS DEVELOPMENT, BUSINESS LEADERSHIP AND MARKETING, IN CLASS 35 (U.S. CLS. 100, 101 AND 102).

FIRST USE 1-1-2012; IN COMMERCE 1-1-2012.

THE MARK CONSISTS OF STANDARD CHARACTERS WITHOUT CLAIM TO ANY PARTICULAR FONT, STYLE, SIZE, OR COLOR.

SER. NO. 85-537,511, FILED 2-8-2012.

JOHN E. MICHOS, EXAMINING ATTORNEY



David J. Kyfos

Director of the United States Patent and Trademark Office

United States of America

United States Patent and Trademark Office

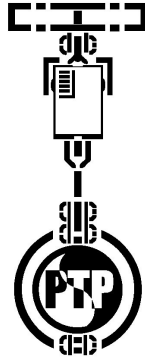

Reg. No. 4,205,855

PIPING TECHNOLOGY & PRODUCTS, INC. (TEXAS CORPORATION)
3701 HOLMES RD.
HOUSTON, TX 77234

Registered Sep. 11, 2012

Int. Cl.: 6

FOR: METAL EXPANSION JOINTS FOR PIPING AND DUCTING, IN CLASS 6 (U.S. CLS. 2, 12, 13, 14, 23, 25 AND 50).

TRADEMARK

FIRST USE 8-30-2004; IN COMMERCE 8-30-2004.

PRINCIPAL REGISTER

THE MARK CONSISTS OF A STYLIZED/LOGO VERSION OF A PIPE SUPPORT WITH THE TEXT "PTP" IN THE CIRCULAR PART OF THE BOTTOM OF THE DESIGN.

SER. NO. 85-537,515, FILED 2-8-2012.

TASNEEM HUSSAIN, EXAMINING ATTORNEY



David J. Kybas

Director of the United States Patent and Trademark Office

United States of America

United States Patent and Trademark Office



Reg. No. 4,205,856

Registered Sep. 11, 2012

Int. Cl.: 6

TRADEMARK

PRINCIPAL REGISTER

INE S.P.A. (ITALY SOCIETÀ PER AZIONI (SPA))
VIA FACCA 10
CITTADELLA, ITALY 35013

FOR: WELDING WIRE, IN CLASS 6 (U.S. CLS. 2, 12, 13, 14, 23, 25 AND 50).

FIRST USE 0-0-1951; IN COMMERCE 7-24-2003.

THE MARK CONSISTS OF THE LETTERS "INE" BETWEEN TWO HALF-OVAL SHAPED BARS ALL INSIDE A RECTANGULAR BOX WITH TWO CURVED SIDES.

SER. NO. 85-537,518, FILED 2-8-2012.

LINDA ESTRADA, EXAMINING ATTORNEY



David J. Kyffers

Director of the United States Patent and Trademark Office

United States of America

United States Patent and Trademark Office

CITY HOPPER

Reg. No. 4,205,857

Registered Sep. 11, 2012

Int. Cl.: 12

TRADEMARK

PRINCIPAL REGISTER

MAPLE'S SALES, INC. (CALIFORNIA CORPORATION)
12000 WOODRUFF AVE. UNIT D
DOWNEY, CA 90241

FOR: BICYCLES, IN CLASS 12 (U.S. CLS. 19, 21, 23, 31, 35 AND 44).

FIRST USE 1-1-2012; IN COMMERCE 1-1-2012.

THE MARK CONSISTS OF STANDARD CHARACTERS WITHOUT CLAIM TO ANY PARTICULAR FONT, STYLE, SIZE, OR COLOR.

SER. NO. 85-537,526, FILED 2-8-2012.

FLORENTINA BLANDU, EXAMINING ATTORNEY



David J. Kybas

Director of the United States Patent and Trademark Office

United States of America

United States Patent and Trademark Office

FRESH NATION

Reg. No. 4,205,858

FRESH NATION LLC (CONNECTICUT LIMITED LIABILITY COMPANY)
27 STILES LANE
GREENWICH, CT 06831

Registered Sep. 11, 2012

Int. Cl.: 35

FOR: ADVERTISING AND MARKETING SERVICES, NAMELY, PROMOTING THE GOODS AND SERVICES OF OTHERS, IN CLASS 35 (U.S. CLS. 100, 101 AND 102).

SERVICE MARK

FIRST USE 10-25-2011; IN COMMERCE 10-25-2011.

PRINCIPAL REGISTER

THE MARK CONSISTS OF STANDARD CHARACTERS WITHOUT CLAIM TO ANY PARTICULAR FONT, STYLE, SIZE, OR COLOR.

SER. NO. 85-537,528, FILED 2-8-2012.

FLORENTINA BLANDU, EXAMINING ATTORNEY



David J. Kybas

Director of the United States Patent and Trademark Office

United States of America

United States Patent and Trademark Office

Suddenly Organized

Reg. No. 4,205,859

SUDDENLY ORGANIZED LLC (NEW JERSEY LIMITED LIABILITY COMPANY)
6 HAMILTON COURT
SOUTHAMPTON, NJ 08088

Registered Sep. 11, 2012

Int. Cl.: 45

FOR: ORGANIZATIONAL SERVICES FOR HOME OR PERSONAL PURPOSES, NAMELY,
ORGANIZING HOME AND LIVING SPACE, IN CLASS 45 (U.S. CLS. 100 AND 101).

SERVICE MARK

FIRST USE 9-1-2011; IN COMMERCE 1-1-2012.

PRINCIPAL REGISTER

THE MARK CONSISTS OF STANDARD CHARACTERS WITHOUT CLAIM TO ANY PARTICULAR FONT, STYLE, SIZE, OR COLOR.

SER. NO. 85-537,539, FILED 2-8-2012.

VIVIAN MICZNIK FIRST, EXAMINING ATTORNEY



David J. Kyffers

Director of the United States Patent and Trademark Office

United States of America

United States Patent and Trademark Office

ADVENT

Reg. No. 4,205,860

Registered Sep. 11, 2012

Int. Cl.: 11

TRADEMARK

PRINCIPAL REGISTER

ELECTRONICS TRADEMARK HOLDING COMPANY, LLC (DELAWARE LIMITED LIABILITY COMPANY)
180 MARCUS BOULEVARD
HAUPPAUGE, NY 11788

FOR: MICROWAVE OVENS, IN CLASS 11 (U.S. CLS. 13, 21, 23, 31 AND 34).

FIRST USE 6-17-2011; IN COMMERCE 6-17-2011.

THE MARK CONSISTS OF STANDARD CHARACTERS WITHOUT CLAIM TO ANY PARTICULAR FONT, STYLE, SIZE, OR COLOR.

SER. NO. 85-537,545, FILED 2-8-2012.

ASMAT KHAN, EXAMINING ATTORNEY



David J. Kyffers

Director of the United States Patent and Trademark Office

United States of America

United States Patent and Trademark Office

WATCHTIME

Reg. No. 4,205,861

EBNER PUBLISHING INTERNATIONAL, INC. (NEW YORK CORPORATION)
274 MADISON AVENUE, SUITE 804
NEW YORK, NY 10016

Registered Sep. 11, 2012

Int. Cls.: 9 and 16

FOR: DOWNLOADABLE ELECTRONIC PUBLICATION IN THE NATURE OF A MAGAZINE
FEATURING WRISTWATCHES , IN CLASS 9 (U.S. CLS. 21, 23, 26, 36 AND 38).

TRADEMARK

FIRST USE 12-31-2010; IN COMMERCE 12-31-2010.

PRINCIPAL REGISTER

FOR: MAGAZINE FEATURING WRISTWATCHES, IN CLASS 16 (U.S. CLS. 2, 5, 22, 23, 29,
37, 38 AND 50).

FIRST USE 12-31-1999; IN COMMERCE 12-31-1999.

THE MARK CONSISTS OF STANDARD CHARACTERS WITHOUT CLAIM TO ANY PAR-
TICULAR FONT, STYLE, SIZE, OR COLOR.

SER. NO. 85-537,546, FILED 2-8-2012.

MARTHA FROMM, EXAMINING ATTORNEY



David J. Kyffers

Director of the United States Patent and Trademark Office

United States of America

United States Patent and Trademark Office



Reg. No. 4,205,862

Registered Sep. 11, 2012

Int. Cl.: 45

SERVICE MARK

PRINCIPAL REGISTER

CLARENCE E. MCCLENDON MINISTRIES FULL HARVEST INTERNATIONAL CHURCH
(CALIFORNIA CORPORATION), FORMERLY HARVEST FIRE INCORPORATION
P.O. BOX 78398
LOS ANGELES, CA 90016

FOR: CHRISTIAN MINISTRY SERVICES, IN CLASS 45 (U.S. CLS. 100 AND 101).

FIRST USE 4-26-2001; IN COMMERCE 4-26-2001.

THE MARK CONSISTS OF PURPLE LINES ENCIRCLING BLACK LINES THAT ENCIRCLE A STYLIZED SHIELD EMBOSSED WITH SLANTED MUTED GOLD AND VANILLA CREAM QUADRILATERALS WITH THE APPEARANCE OF RAYS OVERLAYED WITH PURPLE STYLIZED GEOMETRIC FIGURES FORMING FACING HANDS, THE PURPLE WORDS AND LETTERS "PRAYERFORCE", A PURPLE QUADRILATERAL WITH THE WORDS "A CALL TO ACTION" IN GOLD LETTERS, VANILLA CREAM QUADRILATERAL WITH A MUTED GOLD ARROWED-END CROSS, BARS AND LINES.

THE COLOR(S) BLACK, MUTED GOLD, PURPLE, VANILLA CREAM IS/ARE CLAIMED AS A FEATURE OF THE MARK.

SER. NO. 85-537,622, FILED 2-8-2012.

DOUGLAS LEE, EXAMINING ATTORNEY



David J. Kyffers

Director of the United States Patent and Trademark Office

United States of America

United States Patent and Trademark Office

INE AK-10

Reg. No. 4,205,863

INE S.P.A. (ITALY SOCIETÀ PER AZIONI (SPA))

Registered Sep. 11, 2012

VIA FACCA 10
CITTADELLA, ITALY 35013

Int. Cl.: 6

FOR: WELDING WIRE, IN CLASS 6 (U.S. CLS. 2, 12, 13, 14, 23, 25 AND 50).

TRADEMARK

FIRST USE 7-24-2003; IN COMMERCE 7-24-2003.

PRINCIPAL REGISTER

THE MARK CONSISTS OF STANDARD CHARACTERS WITHOUT CLAIM TO ANY PARTICULAR FONT, STYLE, SIZE, OR COLOR.

SER. NO. 85-537,628, FILED 2-8-2012.

LINDA ESTRADA, EXAMINING ATTORNEY



David J. Kyffers

Director of the United States Patent and Trademark Office

United States of America

United States Patent and Trademark Office

"Taste the Creamy Center of the Universe!"

Reg. No. 4,205,864

THE ASHLAND CUPCAKE CAR (VIRGINIA LIMITED LIABILITY COMPANY)
12378 ELMONT RD
ASHLAND, VA 23005

Registered Sep. 11, 2012

Int. Cl.: 30

FOR: CUP CAKES, IN CLASS 30 (U.S. CL. 46).

TRADEMARK

FIRST USE 9-19-2011; IN COMMERCE 9-19-2011.

PRINCIPAL REGISTER

THE MARK CONSISTS OF STANDARD CHARACTERS WITHOUT CLAIM TO ANY PARTICULAR FONT, STYLE, SIZE, OR COLOR.

SER. NO. 85-537,637, FILED 2-8-2012.

CHRISIE B. KING, EXAMINING ATTORNEY



David J. Kyffers

Director of the United States Patent and Trademark Office

United States of America
United States Patent and Trademark Office

geekdom

Reg. No. 4,205,865

Registered Sep. 11, 2012

Int. Cl.: 35

SERVICE MARK

PRINCIPAL REGISTER

GEEKDOM LC (TEXAS LIMITED LIABILITY COMPANY)
112 EAST PECAN STREET
SUITE 175
SAN ANTONIO, TX 78205

FOR: INCUBATION SERVICES, NAMELY, PROVIDING WORK SPACE CONTAINING BUSINESS EQUIPMENT TO FREELANCERS, START-UPS, EXISTING BUSINESSES AND NON-PROFITS, IN CLASS 35 (U.S. CLS. 100, 101 AND 102).

FIRST USE 11-5-2011; IN COMMERCE 12-20-2011.

THE MARK CONSISTS OF THE STYLIZED COMBINATION OF THE WORD "GEEK" WITH THE SUFFIX "DOM" WHERE THE "O" IS CAPPED WITH A CROWN COMPRISING A CROWN BODY RISING TO A PLURALITY OF POINTS TERMINATED WITH VARIOUS SIZED SPHERES.

SER. NO. 85-537,679, FILED 2-8-2012.

SIMON TENG, EXAMINING ATTORNEY



David J. Kyffers

Director of the United States Patent and Trademark Office

United States of America

United States Patent and Trademark Office

"A UNIQUE PLACE TO LIVE,
LEARN, WORK & PLAY"

Reg. No. 4,205,866

CITY OF PALM BEACH GARDENS (FLORIDA MUNICIPAL CORPORATION)
10500 NORTH MILITARY TRAIL

Registered Sep. 11, 2012

PALM BEACH GARDENS, FL 33410

Int. Cl.: 35

FOR: MUNICIPAL SERVICES, NAMELY, BUSINESS MARKETING AND PROMOTING THE ECONOMIC DEVELOPMENT AND GROWTH OF PALM BEACH GARDENS, FLORIDA; PROMOTING BUSINESS AND TOURISM IN THE CITY OF PALM BEACH GARDENS, FLORIDA, IN CLASS 35 (U.S. CLS. 100, 101 AND 102).

SERVICE MARK

PRINCIPAL REGISTER

FIRST USE 9-29-2011; IN COMMERCE 10-6-2011.

THE MARK CONSISTS OF STANDARD CHARACTERS WITHOUT CLAIM TO ANY PARTICULAR FONT, STYLE, SIZE, OR COLOR.

SER. NO. 85-537,720, FILED 2-8-2012.

DORITT L. CARROLL, EXAMINING ATTORNEY



David J. Kybas

Director of the United States Patent and Trademark Office

United States of America

United States Patent and Trademark Office

THIS WAY TO AMAZING

Reg. No. 4,205,867

Registered Sep. 11, 2012

Int. Cl.: 39

SERVICE MARK

PRINCIPAL REGISTER

CONTIKI TOURS INTERNATIONAL LIMITED (GUERNSEY CORPORATION)
PICQUET HOUSE
ST. PETER PORT, GUERNSEY GY11AF

FOR: TRAVEL SERVICES, NAMELY, ORGANIZING, ARRANGING, AND OPERATING
ESCORTED TOURS, IN CLASS 39 (U.S. CLS. 100 AND 105).

FIRST USE 10-0-2011; IN COMMERCE 10-0-2011.

THE MARK CONSISTS OF STANDARD CHARACTERS WITHOUT CLAIM TO ANY PAR-
TICULAR FONT, STYLE, SIZE, OR COLOR.

SER. NO. 85-537,727, FILED 2-8-2012.

ELI HELLMAN, EXAMINING ATTORNEY



David J. Kybas

Director of the United States Patent and Trademark Office

United States of America

United States Patent and Trademark Office



Reg. No. 4,205,868

LDH HAWAII INC. (HAWAII CORPORATION)
88 PIKOI STREET, SUITE 911
HONOLULU, HI 96814

Registered Sep. 11, 2012

Int. Cls.: 9, 18, 24 and 25

FOR: CELLULAR PHONE ACCESSORY CHARMS, IN CLASS 9 (U.S. CLS. 21, 23, 26, 36 AND 38).

TRADEMARK

FIRST USE 4-1-2011; IN COMMERCE 4-1-2011.

PRINCIPAL REGISTER

FOR: TOTE BAGS, IN CLASS 18 (U.S. CLS. 1, 2, 3, 22 AND 41).

FIRST USE 4-1-2011; IN COMMERCE 4-1-2011.

FOR: BEACH TOWELS, IN CLASS 24 (U.S. CLS. 42 AND 50).

FIRST USE 4-1-2011; IN COMMERCE 4-1-2011.

FOR: FLIP FLOPS; HATS; SHORTS; SWEATSHIRTS; T-SHIRTS, IN CLASS 25 (U.S. CLS. 22 AND 39).

FIRST USE 4-1-2011; IN COMMERCE 4-1-2011.

THE MARK CONSISTS OF PARTIALLY OVERLAPPING NUMBERS 2 AND 4 IN THE CENTER OF A CIRCLE.

SER. NO. 85-537,734, FILED 2-8-2012.

PAM WILLIS, EXAMINING ATTORNEY



David J. Kybas

Director of the United States Patent and Trademark Office

United States of America

United States Patent and Trademark Office

ALLIED OSI LABS

Reg. No. 4,205,869

POSITRAX, INC (INDIANA CORPORATION)
6299 GUION ROAD
INDIANAPOLIS, IN 46268

Registered Sep. 11, 2012

Int. Cl.: 10

FOR: ORTHOPEDIC BRACES; ORTHOTICS FOR FEET, IN CLASS 10 (U.S. CLS. 26, 39 AND 44).

TRADEMARK

FIRST USE 10-31-1989; IN COMMERCE 10-31-1989.

PRINCIPAL REGISTER

THE MARK CONSISTS OF STANDARD CHARACTERS WITHOUT CLAIM TO ANY PARTICULAR FONT, STYLE, SIZE, OR COLOR.

OWNER OF U.S. REG. NO. 1,688,908.

NO CLAIM IS MADE TO THE EXCLUSIVE RIGHT TO USE "LABS", APART FROM THE MARK AS SHOWN.

SER. NO. 85-537,742, FILED 2-8-2012.

JENNY PARK, EXAMINING ATTORNEY



David J. Kyffers

Director of the United States Patent and Trademark Office

United States of America

United States Patent and Trademark Office

LIFE IS BETTER WITH FRIENDS

Reg. No. 4,205,870

GOBA LLC (TENNESSEE LIMITED LIABILITY COMPANY)
113 29TH AVENUE SOUTH
NASHVILLE, TN 37212

Registered Sep. 11, 2012

Int. Cl.: 45

FOR: ON-LINE SOCIAL NETWORKING SERVICES, IN CLASS 45 (U.S. CLS. 100 AND 101).

SERVICE MARK

FIRST USE 6-6-2011; IN COMMERCE 6-6-2011.

PRINCIPAL REGISTER

THE MARK CONSISTS OF STANDARD CHARACTERS WITHOUT CLAIM TO ANY PARTICULAR FONT, STYLE, SIZE, OR COLOR.

SER. NO. 85-537,757, FILED 2-8-2012.

ERNEST SHOSHO, EXAMINING ATTORNEY



David J. Kyffers

Director of the United States Patent and Trademark Office

United States of America

United States Patent and Trademark Office

Vacations Are Not Cheap

Reg. No. 4,205,871

Registered Sep. 11, 2012

Int. Cl.: 16

TRADEMARK

PRINCIPAL REGISTER

ORIGINAL COUPON BOOK INC. (HAWAII CORPORATION)
109B-313
5095 NAPILHAU STREET
LAHAINA, HI 96761

FOR: COUPON BOOKS, IN CLASS 16 (U.S. CLS. 2, 5, 22, 23, 29, 37, 38 AND 50).

FIRST USE 2-14-2010; IN COMMERCE 2-14-2010.

THE MARK CONSISTS OF STANDARD CHARACTERS WITHOUT CLAIM TO ANY PARTICULAR FONT, STYLE, SIZE, OR COLOR.

SER. NO. 85-537,778, FILED 2-9-2012.

JENNIFER VASQUEZ, EXAMINING ATTORNEY



David J. Kybas

Director of the United States Patent and Trademark Office

United States of America

United States Patent and Trademark Office

Greening Our Built World

Reg. No. 4,205,872

Registered Sep. 11, 2012

Int. Cl.: 35

SERVICE MARK

PRINCIPAL REGISTER

CAPITAL - E (D.C. LIMITED LIABILITY COMPANY)
SUITE 300
1250 24TH STREET NW
WASHINGTON, DC 20037

FOR: CONSULTING SERVICES IN THE FIELDS OF ENERGY CONSUMPTION AND USAGE CONSERVATION TO IMPROVE ENERGY EFFICIENCY, IN CLASS 35 (U.S. CLS. 100, 101 AND 102).

FIRST USE 1-1-2010; IN COMMERCE 1-1-2010.

THE MARK CONSISTS OF STANDARD CHARACTERS WITHOUT CLAIM TO ANY PARTICULAR FONT, STYLE, SIZE, OR COLOR.

SER. NO. 85-537,825, FILED 2-9-2012.

GIANCARLO CASTRO, EXAMINING ATTORNEY



David J. Kybas

Director of the United States Patent and Trademark Office

United States of America

United States Patent and Trademark Office



Reg. No. 4,205,873

1ST AMERICAN LEASING, LLC (FLORIDA LIMITED LIABILITY COMPANY)
341 INTERSTATE BOULEVARD
SARASOTA, FL 34240

Registered Sep. 11, 2012

Int. Cl.: 36

FOR: MERCHANT SERVICES, NAMELY, PAYMENT TRANSACTION PROCESSING SERVICES, IN CLASS 36 (U.S. CLS. 100, 101 AND 102).

SERVICE MARK

FIRST USE 2-6-2012; IN COMMERCE 2-6-2012.

PRINCIPAL REGISTER

THE MARK CONSISTS OF A STYLIZED LOWER CASE LETTER E IN BLUE FOLLOWED BY THE STYLIZED UPPER CASE LETTERS CE IN GREEN.

THE COLOR(S) BLUE AND GREEN IS/ARE CLAIMED AS A FEATURE OF THE MARK.

SER. NO. 85-537,849, FILED 2-9-2012.

JEAN IM, EXAMINING ATTORNEY



David J. Kyffers

Director of the United States Patent and Trademark Office

United States of America

United States Patent and Trademark Office



Reg. No. 4,205,874

Registered Sep. 11, 2012

Int. Cl.: 36

SERVICE MARK

PRINCIPAL REGISTER

SOUTHCITY BANK (ALABAMA CORPORATION)
1360 MONTGOMERY HIGHWAY, SUITE 100
VESTAVIA HILLS, AL 35216

FOR: BANKING SERVICES, IN CLASS 36 (U.S. CLS. 100, 101 AND 102).

FIRST USE 2-8-2012; IN COMMERCE 2-8-2012.

THE MARK CONSISTS OF A STYLIZED "P" RADIATING IN A CIRCLE FROM A SHARED POINT IN THE CENTER.

SER. NO. 85-537,851, FILED 2-9-2012.

KARANENDRA S. CHHINA, EXAMINING ATTORNEY



David J. Kyffers

Director of the United States Patent and Trademark Office

United States of America

United States Patent and Trademark Office



Reg. No. 4,205,875

BELLAMY, STEVE (UNITED STATES INDIVIDUAL)
123 PIERPONT AVENUE, PO BOX 656
SUMMERLAND, CA 93067

Registered Sep. 11, 2012

Int. Cl.: 45

FOR: ON-LINE SOCIAL NETWORKING SERVICES, IN CLASS 45 (U.S. CLS. 100 AND 101).

SERVICE MARK

FIRST USE 1-1-2012; IN COMMERCE 1-1-2012.

PRINCIPAL REGISTER

THE MARK CONSISTS OF A STYLIZED RED LETTER "F.", CASTING A GRAY SHADOW. TO THE RIGHT OF THE LETTER F, IS A BLUE STYLIZED DOG WITH WHITE AND BLUE EYE, A RED TONGUE, A RED COLLAR WITH A CIRCULAR YELLOW NAME TAG ATTACHED, CASTING A GRAY SHADOW. THERE ARE SMALL BLUE MARKS NEXT TO EITHER SIDE OF THE TAIL TO INDICATE THE TAIL IS WAGGING. TO THE RIGHT OF THE DOG, IS THE RED STYLIZED WORD "FUNVITE.COM", ABOVE THE SMALLER BLUE STYLIZED WORDS "THE FUN WAY TO SAY LET'S PLAY".

THE COLOR(S) BLUE, RED, GRAY, YELLOW AND WHITE IS/ARE CLAIMED AS A FEATURE OF THE MARK.

SER. NO. 85-537,855, FILED 2-9-2012.

KARANENDRA S. CHHINA, EXAMINING ATTORNEY



David J. Kybas

Director of the United States Patent and Trademark Office

United States of America

United States Patent and Trademark Office

SEIZE EVERY OPPORTUNITY

Reg. No. 4,205,876

Registered Sep. 11, 2012

Int. Cl.: 42

SERVICE MARK

PRINCIPAL REGISTER

LINKDEX LIMITED (UNITED KINGDOM LIMITED COMPANY (LTD.))
B121 MACMILLAN HOUSE, PADDINGTON STATION
LONDON, UNITED KINGDOM W21FT

FOR: COMPUTER SERVICES, NAMELY, SEARCH ENGINE OPTIMIZATION; CONSULTING SERVICES IN THE FIELD OF SEARCH ENGINE OPTIMIZATION, IN CLASS 42 (U.S. CLS. 100 AND 101).

FIRST USE 0-0-2011; IN COMMERCE 0-0-2011.

THE MARK CONSISTS OF STANDARD CHARACTERS WITHOUT CLAIM TO ANY PARTICULAR FONT, STYLE, SIZE, OR COLOR.

SER. NO. 85-537,870, FILED 2-9-2012.

LUCY ARANT, EXAMINING ATTORNEY



David J. Kyffers

Director of the United States Patent and Trademark Office

United States of America

United States Patent and Trademark Office

CHIRP CHIRP

Reg. No. 4,205,877

BALL STATE UNIVERSITY (INDIANA STATE UNIVERSITY)
2000 WEST UNIVERSITY AVENUE
MUNCIE, IN 47306

Registered Sep. 11, 2012

Int. Cls.: 21 and 25

FOR: BEVERAGE GLASSWARE, IN CLASS 21 (U.S. CLS. 2, 13, 23, 29, 30, 33, 40 AND 50).

FIRST USE 1-1-2010; IN COMMERCE 1-1-2010.

TRADEMARK

FOR: ATHLETIC APPAREL, NAMELY, SHIRTS, PANTS, JACKETS, FOOTWEAR, HATS AND CAPS, ATHLETIC UNIFORMS, IN CLASS 25 (U.S. CLS. 22 AND 39).

PRINCIPAL REGISTER

FIRST USE 1-1-2010; IN COMMERCE 1-1-2010.

THE MARK CONSISTS OF STANDARD CHARACTERS WITHOUT CLAIM TO ANY PARTICULAR FONT, STYLE, SIZE, OR COLOR.

SER. NO. 85-537,898, FILED 2-9-2012.

REBECCA SMITH, EXAMINING ATTORNEY



David J. Kyros

Director of the United States Patent and Trademark Office

United States of America

United States Patent and Trademark Office



Reg. No. 4,205,878

DEBBIE DOGRUL ASSOCIATES, LLC (VIRGINIA LIMITED LIABILITY COMPANY)
4402 NUTTALL ROAD
FAIRFAX, VA 22032

Registered Sep. 11, 2012

Int. Cl.: 36

FOR: RESIDENTIAL REAL ESTATE AGENCY SERVICES, IN CLASS 36 (U.S. CLS. 100, 101 AND 102).

SERVICE MARK

FIRST USE 12-0-2011; IN COMMERCE 12-0-2011.

PRINCIPAL REGISTER

THE MARK CONSISTS OF A STYLIZED RED HOUSE CONTAINING A STYLIZED WHITE LETTER "D".

THE COLOR(S) RED AND WHITE IS/ARE CLAIMED AS A FEATURE OF THE MARK.

SER. NO. 85-537,908, FILED 2-9-2012.

WILLIAM VERHOSEK, EXAMINING ATTORNEY



David J. Kyffers

Director of the United States Patent and Trademark Office

United States of America

United States Patent and Trademark Office

Phoetics

Reg. No. 4,205,879

SEGAL, NANCY LEE (UNITED STATES INDIVIDUAL)
2605 BURLAWN COURT
COLUMBUS, OH 43235

Registered Sep. 11, 2012

Int. Cl.: 45

FOR: SPIRITUAL COUNSELING, IN CLASS 45 (U.S. CLS. 100 AND 101).

SERVICE MARK

FIRST USE 10-1-2009; IN COMMERCE 2-1-2010.

PRINCIPAL REGISTER

THE MARK CONSISTS OF STANDARD CHARACTERS WITHOUT CLAIM TO ANY PARTICULAR FONT, STYLE, SIZE, OR COLOR.

SER. NO. 85-537,913, FILED 2-9-2012.

SIMON TENG, EXAMINING ATTORNEY



David J. Kybas

Director of the United States Patent and Trademark Office

United States of America

United States Patent and Trademark Office

SAFE-T-GARD

Reg. No. 4,205,880

GEORGIA-PACIFIC CONSUMER PRODUCTS LP (GEORGIA LIMITED PARTNERSHIP)
133 PEACHTREE STREET, N.E.
ATLANTA, GA 303031804

Registered Sep. 11, 2012

Int. Cl.: 16

FOR: PAPER TISSUES, IN CLASS 16 (U.S. CLS. 2, 5, 22, 23, 29, 37, 38 AND 50).

TRADEMARK

FIRST USE 0-0-2004; IN COMMERCE 0-0-2004.

PRINCIPAL REGISTER

THE MARK CONSISTS OF STANDARD CHARACTERS WITHOUT CLAIM TO ANY PARTICULAR FONT, STYLE, SIZE, OR COLOR.

OWNER OF U.S. REG. NO. 3,211,831.

SER. NO. 85-537,914, FILED 2-9-2012.

ANN E. SAPPENFIELD, EXAMINING ATTORNEY



David J. Kyffers

Director of the United States Patent and Trademark Office

United States of America

United States Patent and Trademark Office

Fastino's

Reg. No. 4,205,881

TRINITY GROUP, LLC (NEW MEXICO LIMITED LIABILITY COMPANY)
4201 CIBOLA VILLAGE, NE
ALBUQUERQUE, NM 87111

Registered Sep. 11, 2012

Int. Cl.: 43

FOR: RESTAURANT SERVICES, IN CLASS 43 (U.S. CLS. 100 AND 101).

SERVICE MARK

FIRST USE 12-7-2009; IN COMMERCE 12-7-2009.

PRINCIPAL REGISTER

THE MARK CONSISTS OF STANDARD CHARACTERS WITHOUT CLAIM TO ANY PARTICULAR FONT, STYLE, SIZE, OR COLOR.

SER. NO. 85-537,931, FILED 2-9-2012.

KEVON CHISOLM, EXAMINING ATTORNEY



David J. Kybas

Director of the United States Patent and Trademark Office

United States of America

United States Patent and Trademark Office



Reg. No. 4,205,882

Registered Sep. 11, 2012

Int. Cl.: 12

TRADEMARK

PRINCIPAL REGISTER

DENNY, RUSS (UNITED STATES INDIVIDUAL)
1312 RIVERSTONE CT
HEMET, CA 92545

FOR: BICYCLE FRAMES, IN CLASS 12 (U.S. CLS. 19, 21, 23, 31, 35 AND 44).

FIRST USE 1-2-1987; IN COMMERCE 1-2-1987.

THE MARK CONSISTS OF THE WORD "FUSO" AND A DESIGN OF MOLTEN LIQUID POURING FROM A MELTING POT ABOVE A FLAME.

THE ENGLISH TRANSLATION OF "FUSO" IN THE MARK IS "MOUTON".

SER. NO. 85-537,938, FILED 2-9-2012.

KEVON CHISOLM, EXAMINING ATTORNEY



David J. Kybas

Director of the United States Patent and Trademark Office

United States of America

United States Patent and Trademark Office

ANOMIA

Reg. No. 4,205,883

ANOMIA PRESS LLC (MASSACHUSETTS LIMITED LIABILITY COMPANY)
647 SOUTH STREET
ROSLINDALE, MA 02131

Registered Sep. 11, 2012

Int. Cl.: 28

FOR: CARD GAMES; PLAYING CARDS AND CARD GAMES, IN CLASS 28 (U.S. CLS. 22, 23, 38 AND 50).

TRADEMARK

FIRST USE 11-12-2009; IN COMMERCE 11-12-2009.

PRINCIPAL REGISTER

THE MARK CONSISTS OF STANDARD CHARACTERS WITHOUT CLAIM TO ANY PARTICULAR FONT, STYLE, SIZE, OR COLOR.

SER. NO. 85-537,976, FILED 2-9-2012.

DEIRDRE ROBERTSON, EXAMINING ATTORNEY



David J. Kybas

Director of the United States Patent and Trademark Office

United States of America
United States Patent and Trademark Office

LOADHOG

Reg. No. 4,205,884

4FRONT ENGINEERED SOLUTIONS, INC. (WISCONSIN CORPORATION)
N56W24701 NORTH CORPORATE CIRCLE
SUSSEX, WI 53089

Registered Sep. 11, 2012

Int. Cl.: 6

FOR: METAL DOCK BRIDGES, IN CLASS 6 (U.S. CLS. 2, 12, 13, 14, 23, 25 AND 50).

TRADEMARK

FIRST USE 8-13-2004; IN COMMERCE 8-13-2004.

PRINCIPAL REGISTER

THE MARK CONSISTS OF STANDARD CHARACTERS WITHOUT CLAIM TO ANY PARTICULAR FONT, STYLE, SIZE, OR COLOR.

OWNER OF U.S. REG. NO. 3,091,926.

SER. NO. 85-537,977, FILED 2-9-2012.

ANDREW RHIM, EXAMINING ATTORNEY



David J. Kyffers

Director of the United States Patent and Trademark Office

United States of America

United States Patent and Trademark Office

SHEKHINAH

Reg. No. 4,205,885

Registered Sep. 11, 2012

Int. Cl.: 44

SERVICE MARK

PRINCIPAL REGISTER

SHEKHINAH FOUNDATION, INC. (COLORADO NON-PROFIT CORPORATION)
21110 BISCAYNE BLVD, SUITE 304
AVENTURA, FL 33180

FOR: THERAPEUTIC SERVICES FOR INDIVIDUALS WITH COGNITIVE OR EMOTIONAL DISABILITIES IN A RESIDENTIAL COMMUNITY SETTING, IN CLASS 44 (U.S. CLS. 100 AND 101).

FIRST USE 11-30-2010; IN COMMERCE 11-30-2010.

THE MARK CONSISTS OF STANDARD CHARACTERS WITHOUT CLAIM TO ANY PARTICULAR FONT, STYLE, SIZE, OR COLOR.

THE ENGLISH TRANSLATION OF SHEKHINAH IN THE MARK IS DWELLING OR PLACE WITH DIVINE/CREATIVE PRESENCE AND LIGHT.

SER. NO. 85-537,992, FILED 2-9-2012.

LAKEISHA LEWIS, EXAMINING ATTORNEY



David J. Kybas

Director of the United States Patent and Trademark Office

United States of America

United States Patent and Trademark Office



Reg. No. 4,205,886

Registered Sep. 11, 2012

Int. Cl.: 44

SERVICE MARK

PRINCIPAL REGISTER

SHEKHINAH FOUNDATION, INC. (COLORADO NON-PROFIT CORPORATION)
21110 BISCAYNE BLVD, SUITE 304
AVENTURA, FL 33180

FOR: THERAPEUTIC SERVICES FOR INDIVIDUALS WITH COGNITIVE OR EMOTIONAL DISABILITIES IN A RESIDENTIAL COMMUNITY SETTING, IN CLASS 44 (U.S. CLS. 100 AND 101).

FIRST USE 11-30-2010; IN COMMERCE 11-30-2010.

THE MARK CONSISTS OF A STYLIZED DRAWING OF A TREE CONTAINED WITHIN A CIRCULAR BORDER.

SER. NO. 85-537,996, FILED 2-9-2012.

LAKEISHA LEWIS, EXAMINING ATTORNEY



David J. Kybas

Director of the United States Patent and Trademark Office

United States of America

United States Patent and Trademark Office

R&R NEW AND USED TIRES & RIMS

Reg. No. 4,205,887

ALEJO, ROMEO (UNITED STATES INDIVIDUAL)
1616 GADWELL CT
CHESAPEAKE, VA 23320

Registered Sep. 11, 2012

Int. Cl.: 35

FOR: RETAIL STORE SERVICES FEATURING TIRES AND WHEEL RIMS, IN CLASS 35
(U.S. CLS. 100, 101 AND 102).

SERVICE MARK

FIRST USE 12-5-2011; IN COMMERCE 12-5-2011.

PRINCIPAL REGISTER

THE MARK CONSISTS OF STANDARD CHARACTERS WITHOUT CLAIM TO ANY PARTICULAR FONT, STYLE, SIZE, OR COLOR.

NO CLAIM IS MADE TO THE EXCLUSIVE RIGHT TO USE "NEW AND USED TIRES & RIMS", APART FROM THE MARK AS SHOWN.

SER. NO. 85-538,030, FILED 2-9-2012.

CHARLES L. JENKINS, EXAMINING ATTORNEY



David J. Kyffers

Director of the United States Patent and Trademark Office

United States of America

United States Patent and Trademark Office

YESTERDAYZE

Reg. No. 4,205,888

KINLAW, ALEXANDER W. (UNITED STATES INDIVIDUAL)

Registered Sep. 11, 2012

P. O. BOX 213
TERRA CEIA, FL 34250

Int. Cl.: 41

FOR: ENTERTAINMENT IN THE NATURE OF A MUSICAL GROUP; ENTERTAINMENT SERVICES IN THE NATURE OF LIVE MUSICAL PERFORMANCES; ENTERTAINMENT, NAMELY, LIVE PERFORMANCES BY A MUSICAL BAND, IN CLASS 41 (U.S. CLS. 100, 101 AND 107).

SERVICE MARK

PRINCIPAL REGISTER

FIRST USE 9-22-2007; IN COMMERCE 9-22-2007.

THE MARK CONSISTS OF STANDARD CHARACTERS WITHOUT CLAIM TO ANY PARTICULAR FONT, STYLE, SIZE, OR COLOR.

SER. NO. 85-538,031, FILED 2-9-2012.

CHARLES L. JENKINS, EXAMINING ATTORNEY



David J. Kyffers

Director of the United States Patent and Trademark Office

United States of America

United States Patent and Trademark Office



Reg. No. 4,205,889

Registered Sep. 11, 2012

Int. Cl.: 31

TRADEMARK

PRINCIPAL REGISTER

HEB GROCERY COMPANY, LP (TEXAS LIMITED PARTNERSHIP)
CORPORATE LAW DEPARTMENT
646 SOUTH MAIN
SAN ANTONIO, TX 78204

FOR: LIVE PLANTS, PET FOOD, PET TREATS, FLOWERS, CUT FLOWERS, SHRUBS, LIVE TREES, IN CLASS 31 (U.S. CLS. 1 AND 46).

FIRST USE 4-5-1998; IN COMMERCE 4-5-1998.

OWNER OF U.S. REG. NOS. 1,519,398, 1,867,930 AND OTHERS.

THE COLOR(S) RED AND WHITE IS/ARE CLAIMED AS A FEATURE OF THE MARK.

THE MARK CONSISTS OF THE LETTERS "H-E-B" IN WHITE LETTERS WITHIN A RED OVAL DESIGN.

SER. NO. 85-538,034, FILED 2-9-2012.

ANGELA M. MICHELI, EXAMINING ATTORNEY



David J. Kyros

Director of the United States Patent and Trademark Office

United States of America

United States Patent and Trademark Office

ORANGETTE

Reg. No. 4,205,890

GRAPETTE INTERNATIONAL, INC. (ARKANSAS CORPORATION)
101 INDUSTRIAL DRIVE
ROCKPORT, AR 72104

Registered Sep. 11, 2012

Int. Cl.: 32

FOR: SOFT DRINKS; CONCENTRATES FOR MAKING SOFT DRINKS, IN CLASS 32 (U.S. CLS. 45, 46 AND 48).

TRADEMARK

FIRST USE 0-0-1947; IN COMMERCE 0-0-1947.

PRINCIPAL REGISTER

THE MARK CONSISTS OF STANDARD CHARACTERS WITHOUT CLAIM TO ANY PARTICULAR FONT, STYLE, SIZE, OR COLOR.

OWNER OF U.S. REG. NO. 730,872.

SER. NO. 85-538,039, FILED 2-9-2012.

HELENE LIWINSKI, EXAMINING ATTORNEY



David J. Kybas

Director of the United States Patent and Trademark Office

United States of America

United States Patent and Trademark Office

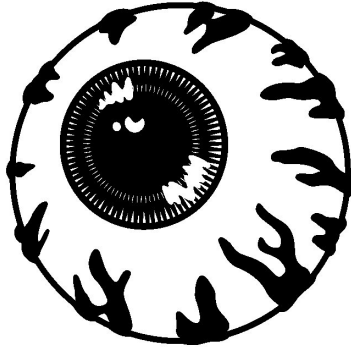

Reg. No. 4,205,891

Registered Sep. 11, 2012

Int. Cls.: 18 and 25

TRADEMARK

PRINCIPAL REGISTER

DEATH ADDERS INC. (NEW YORK CORPORATION)
350 BROADWAY
BROOKLYN, NY 11211

FOR: BACKPACKS; DUFFEL BAGS; MESSENGER BAGS, IN CLASS 18 (U.S. CLS. 1, 2, 3, 22 AND 41).

FIRST USE 2-1-2007; IN COMMERCE 2-1-2007.

FOR: HATS; JACKETS; POLO SHIRTS; SHIRTS, IN CLASS 25 (U.S. CLS. 22 AND 39).

FIRST USE 2-1-2007; IN COMMERCE 2-1-2007.

THE MARK CONSISTS OF AN IMAGE OF A STYLIZED EYEBALL LOOKING TOWARDS THE TOP RIGHT.

SER. NO. 85-538,059, FILED 2-9-2012.

JILL PRATER, EXAMINING ATTORNEY



David J. Kybas

Director of the United States Patent and Trademark Office

United States of America

United States Patent and Trademark Office

Overdone By The Fun

Reg. No. 4,205,892

HELM JR, RICHARD N. (UNITED STATES INDIVIDUAL)
10082 CHASE ST
WESTMINSTER, CO 80020

Registered Sep. 11, 2012

Int. Cl.: 25

FOR: JACKETS; SWEATSHIRTS; T-SHIRTS, IN CLASS 25 (U.S. CLS. 22 AND 39).

TRADEMARK

FIRST USE 4-1-2010; IN COMMERCE 4-1-2010.

PRINCIPAL REGISTER

THE MARK CONSISTS OF STANDARD CHARACTERS WITHOUT CLAIM TO ANY PARTICULAR FONT, STYLE, SIZE, OR COLOR.

SER. NO. 85-538,076, FILED 2-9-2012.

EDWARD NELSON, EXAMINING ATTORNEY



David J. Kyffers

Director of the United States Patent and Trademark Office

United States of America

United States Patent and Trademark Office

Devil's attorney

Reg. No. 4,205,893

1337 GAME DESIGN AB (SWEDEN CORPORATION)
OXHAGSGATAN 39

Registered Sep. 11, 2012

GOTHENBURG, SWEDEN 41475

Int. Cl.: 9

FOR: COMPUTER GAME SOFTWARE, IN CLASS 9 (U.S. CLS. 21, 23, 26, 36 AND 38).

TRADEMARK

FIRST USE 5-30-2011; IN COMMERCE 5-30-2011.

PRINCIPAL REGISTER

THE MARK CONSISTS OF STANDARD CHARACTERS WITHOUT CLAIM TO ANY PARTICULAR FONT, STYLE, SIZE, OR COLOR.

SER. NO. 85-538,112, FILED 2-9-2012.

ANGELA DUONG, EXAMINING ATTORNEY



David J. Kyffers

Director of the United States Patent and Trademark Office

United States of America

United States Patent and Trademark Office

Kings of Wheels

Reg. No. 4,205,894

SHADOW INDUSTRIES, INC. (CALIFORNIA CORPORATION)
8941 ELECTRIC STREET
CYPRESS, CA 90630

Registered Sep. 11, 2012

Int. Cl.: 35

FOR: ON-LINE RETAIL STORE SERVICES FEATURING AUTOMOTIVE WHEELS, TIRES FOR TRAILERS, TRACTORS, ATVS, OFF ROAD VEHICLES, CARS, TRUCKS, GOLF CARTS, SEMI-TRAILERS, AND MOTORCYCLES, IN CLASS 35 (U.S. CLS. 100, 101 AND 102).

SERVICE MARK

FIRST USE 1-12-2008; IN COMMERCE 1-12-2008.

PRINCIPAL REGISTER

THE MARK CONSISTS OF STANDARD CHARACTERS WITHOUT CLAIM TO ANY PARTICULAR FONT, STYLE, SIZE, OR COLOR.

SER. NO. 85-538,123, FILED 2-9-2012.

DEIRDRE ROBERTSON, EXAMINING ATTORNEY



David J. Kyjars

Director of the United States Patent and Trademark Office

United States of America

United States Patent and Trademark Office

CAN CHOCOLATE CHANGE THE WORLD?

Reg. No. 4,205,895

Registered Sep. 11, 2012

Int. Cl.: 30

TRADEMARK

PRINCIPAL REGISTER

FULL CIRCLE EXCHANGE, LLC (NEVADA LIMITED LIABILITY COMPANY)
P. O. BOX 1640
EAGLE, ID 83616

FOR: BLACK TEA; CAFFEINE-FREE COFFEE; CHAI TEA; CHOCOLATE; CHOCOLATE AND CHOCOLATES; CHOCOLATE BARK CONTAINING GROUND COFFEE BEANS; CHOCOLATE BARS; CHOCOLATE CANDIES; CHOCOLATE COVERED FRUIT; CHOCOLATE COVERED NUTS; CHOCOLATE COVERED ROASTED COFFEE BEANS; CHOCOLATE POWDER; CHOCOLATES AND CHOCOLATE BASED READY TO EAT CANDIES AND SNACKS; COFFEE; COFFEE AND TEA; COFFEE BEANS; CONFECTIONERIES, NAMELY, SNACK FOODS, NAMELY, CHOCOLATE; FILLED CHOCOLATE; FRUIT TEAS; GREEN TEA; GROUND COFFEE BEANS; HOT CHOCOLATE; ICED COFFEE; ICED TEA; INSTANT COFFEE; INSTANT TEA; JAPANESE GREEN TEA; MILK CHOCOLATE; OOLONG TEA; ROASTED COFFEE BEANS; SAGE TEA; SNACK FOODS, NAMELY, CHOCOLATE-BASED SNACK FOODS; SUGAR-COATED COFFEE BEANS; TEA; TEA BAGS; TEA EXTRACTS; TEA FOR INFUSIONS; UNROASTED COFFEE, IN CLASS 30 (U.S. CL. 46).

FIRST USE 10-15-2009; IN COMMERCE 10-15-2009.

THE MARK CONSISTS OF STANDARD CHARACTERS WITHOUT CLAIM TO ANY PARTICULAR FONT, STYLE, SIZE, OR COLOR.

SER. NO. 85-538,160, FILED 2-9-2012.

NAAKWAMA ANKRAH, EXAMINING ATTORNEY



David J. Kyffers

Director of the United States Patent and Trademark Office

United States of America

United States Patent and Trademark Office

IS YOUR CHOCOLATE FREE?

Reg. No. 4,205,896

Registered Sep. 11, 2012

Int. Cl.: 30

TRADEMARK

PRINCIPAL REGISTER

FULL CIRCLE EXCHANGE, LLC (NEVADA LIMITED LIABILITY COMPANY)
P. O. BOX 1640
EAGLE, ID 83616

FOR: BLACK TEA; CAFFEINE-FREE COFFEE; CHAI TEA; CHOCOLATE; CHOCOLATE AND CHOCOLATES; CHOCOLATE BARK CONTAINING GROUND COFFEE BEANS; CHOCOLATE BARS; CHOCOLATE CANDIES; CHOCOLATE COVERED FRUIT; CHOCOLATE COVERED NUTS; CHOCOLATE COVERED ROASTED COFFEE BEANS; CHOCOLATE POWDER; CHOCOLATES AND CHOCOLATE BASED READY TO EAT CANDIES AND SNACKS; COFFEE; COFFEE AND TEA; COFFEE BEANS; CONFECTIONERIES, NAMELY, SNACK FOODS, NAMELY, CHOCOLATE; FILLED CHOCOLATE; FRUIT TEAS; GREEN TEA; GROUND COFFEE BEANS; HOT CHOCOLATE; ICED COFFEE; ICED TEA; INSTANT COFFEE; INSTANT TEA; JAPANESE GREEN TEA; MILK CHOCOLATE; OOLONG TEA; ROASTED COFFEE BEANS; SAGE TEA; SNACK FOODS, NAMELY, CHOCOLATE-BASED SNACK FOODS; SUGAR-COATED COFFEE BEANS; TEA; TEA BAGS; TEA EXTRACTS; TEA FOR INFUSIONS; UNROASTED COFFEE, IN CLASS 30 (U.S. CL. 46).

FIRST USE 10-15-2009; IN COMMERCE 10-15-2009.

THE MARK CONSISTS OF STANDARD CHARACTERS WITHOUT CLAIM TO ANY PARTICULAR FONT, STYLE, SIZE, OR COLOR.

SER. NO. 85-538,169, FILED 2-9-2012.

NAAKWAMA ANKRAH, EXAMINING ATTORNEY



David J. Kyffers

Director of the United States Patent and Trademark Office

United States of America

United States Patent and Trademark Office

blikki

Reg. No. 4,205,897

Registered Sep. 11, 2012

Int. Cl.: 44

SERVICE MARK

PRINCIPAL REGISTER

ALEXANDER, JOYCE (UNITED STATES INDIVIDUAL)
STE C185
849 ALMAR AVE
SANTA CRUZ, CA 95060

FOR: PROVIDING A WEBSITE FEATURING INFORMATION ABOUT HEALTH, WELLNESS AND NUTRITION, IN CLASS 44 (U.S. CLS. 100 AND 101).

FIRST USE 1-17-2012; IN COMMERCE 1-24-2012.

THE MARK CONSISTS OF STANDARD CHARACTERS WITHOUT CLAIM TO ANY PARTICULAR FONT, STYLE, SIZE, OR COLOR.

SER. NO. 85-538,171, FILED 2-9-2012.

SUNG IN, EXAMINING ATTORNEY



David J. Kyfos

Director of the United States Patent and Trademark Office

United States of America

United States Patent and Trademark Office



Reg. No. 4,205,898

CORASH & HOLLENDER, P.C. (NEW YORK CORPORATION)
1200 SOUTH AVENUE, SUITE 201
STATEN ISLAND, NY 10314

Registered Sep. 11, 2012

Int. Cl.: 45

FOR: ATTORNEY SERVICES; LEGAL CONSULTATION SERVICES; LEGAL SERVICES,
IN CLASS 45 (U.S. CLS. 100 AND 101).

SERVICE MARK

FIRST USE 0-0-1999; IN COMMERCE 0-0-1999.

PRINCIPAL REGISTER

THE MARK CONSISTS OF A CONTOUR OF A FERRY BOAT WITH THE LITERAL ELEMENT
"SILAWFIRM.COM" INSIDE OF THE MARK.

SER. NO. 85-538,184, FILED 2-9-2012.

NAAKWAMA ANKRAH, EXAMINING ATTORNEY



David J. Kyffers

Director of the United States Patent and Trademark Office

United States of America

United States Patent and Trademark Office

UM Continuum

Reg. No. 4,205,899

MEDICALL, A CALIFORNIA CORPORATION (CALIFORNIA CORPORATION)
6160 STONERIDGE MALL RD. #120
PLEASANTON, CA 94588

Registered Sep. 11, 2012

Int. Cls.: 35 and 36

FOR: MANAGED CARE SERVICES, NAMELY, UTILIZATION REVIEW AND PRE-CERTIFICATION SERVICES, IN CLASS 35 (U.S. CLS. 100, 101 AND 102).

SERVICE MARK

FIRST USE 1-5-2011; IN COMMERCE 1-5-2011.

PRINCIPAL REGISTER

FOR: MEDICAL INSURANCE CASE AND UTILIZATION REVIEW AND INSURANCE CLAIMS ADJUSTMENT SERVICES FOR HEALTHCARE PURCHASERS AND PAYORS AND PROVIDERS AND MEDICARE BENEFICIARIES, IN CLASS 36 (U.S. CLS. 100, 101 AND 102).

FIRST USE 9-5-2010; IN COMMERCE 1-5-2011.

THE MARK CONSISTS OF STANDARD CHARACTERS WITHOUT CLAIM TO ANY PARTICULAR FONT, STYLE, SIZE, OR COLOR.

SER. NO. 85-538,185, FILED 2-9-2012.

NAAKWAMA ANKRAH, EXAMINING ATTORNEY



David J. Kyffers

Director of the United States Patent and Trademark Office

United States of America

United States Patent and Trademark Office

HAWAIIAN ISLAND WEDDING PLANNERS

Reg. No. 4,205,900

Registered Sep. 11, 2012

Int. Cl.: 41

SERVICE MARK

PRINCIPAL REGISTER

ROGERS, TORI (UNITED STATES INDIVIDUAL)
1215 S. KIHEI RD. SUITE O-430
KIHEI, HI 96753

FOR: PARTY AND WEDDING PLANNING AND COORDINATION SERVICES; PARTY AND WEDDING PLANNING CONSULTATION SERVICES; PARTY AND WEDDING PLANNING, COORDINATION AND CONSULTATION SERVICES; PROVIDING INFORMATION IN THE FIELD OF WEDDING PARTY PLANNING; PROVIDING INFORMATION REGARDING WEDDING PLANNING FOR WEDDING PARTIES; WEDDING PLANNING AND COORDINATION SERVICES, IN CLASS 41 (U.S. CLS. 100, 101 AND 107).

FIRST USE 5-1-1998; IN COMMERCE 5-1-1998.

THE MARK CONSISTS OF STANDARD CHARACTERS WITHOUT CLAIM TO ANY PARTICULAR FONT, STYLE, SIZE, OR COLOR.

NO CLAIM IS MADE TO THE EXCLUSIVE RIGHT TO USE "WEDDING PLANNERS", APART FROM THE MARK AS SHOWN.

SEC. 2(F).

SER. NO. 85-538,196, FILED 2-9-2012.

KAREN K. BUSH, EXAMINING ATTORNEY



David J. Kybas

Director of the United States Patent and Trademark Office

United States of America

United States Patent and Trademark Office

ACHIEVE MORE

Reg. No. 4,205,901

Registered Sep. 11, 2012

Int. Cl.: 41

SERVICE MARK

PRINCIPAL REGISTER

COLLEGE OF WESTERN IDAHO (IDAHO STATE AGENCY)
SUITE 312, MAIL STOP 1000
P. O. BOX 3010
NAMPA, ID 83653

FOR: EDUCATIONAL SERVICES, NAMELY, PROVIDING COURSES OF INSTRUCTION THROUGH CLASSES, SEMINARS AND WORKSHOPS AT THE COMMUNITY COLLEGE LEVEL, IN CLASS 41 (U.S. CLS. 100, 101 AND 107).

FIRST USE 8-20-2008; IN COMMERCE 8-20-2008.

THE MARK CONSISTS OF STANDARD CHARACTERS WITHOUT CLAIM TO ANY PARTICULAR FONT, STYLE, SIZE, OR COLOR.

SER. NO. 85-538,206, FILED 2-9-2012.

CHRISTOPHER BUONGIORNO, EXAMINING ATTORNEY



David J. Kybas

Director of the United States Patent and Trademark Office

United States of America

United States Patent and Trademark Office



Reg. No. 4,205,902

ROGERS, TORI (UNITED STATES INDIVIDUAL)
1215 S. KIHEI RD. SUITE O-430
KIHEI, HI 96753

Registered Sep. 11, 2012

Int. Cl.: 41

FOR: PARTY AND WEDDING PLANNING AND COORDINATION SERVICES; PARTY AND WEDDING PLANNING CONSULTATION SERVICES; PARTY AND WEDDING PLANNING, COORDINATION AND CONSULTATION SERVICES; PROVIDING INFORMATION IN THE FIELD OF WEDDING PARTY PLANNING; PROVIDING INFORMATION REGARDING WEDDING PLANNING FOR WEDDING PARTIES; WEDDING PLANNING AND COORDINATION SERVICES, IN CLASS 41 (U.S. CLS. 100, 101 AND 107).

SERVICE MARK

PRINCIPAL REGISTER

FIRST USE 1-0-2011; IN COMMERCE 1-0-2011.

THE MARK CONSISTS OF THE STYLIZED LETTER "H" IN BLACK, NEXT TO A STYLIZED DESIGN OF A PINK FLOWER WITH A WHITE CENTER.

THE COLOR(S) BLACK, WHITE AND PINK IS/ARE CLAIMED AS A FEATURE OF THE MARK.

SER. NO. 85-538,235, FILED 2-9-2012.

KAREN K. BUSH, EXAMINING ATTORNEY



David J. Kyffers

Director of the United States Patent and Trademark Office

United States of America

United States Patent and Trademark Office

CWI

Reg. No. 4,205,903

Registered Sep. 11, 2012

Int. Cl.: 41

SERVICE MARK

PRINCIPAL REGISTER

COLLEGE OF WESTERN IDAHO (IDAHO STATE AGENCY)
SUITE 312, MAIL STOP 1000
P. O. BOX 3010
NAMPA, ID 83653

FOR: EDUCATIONAL SERVICES, NAMELY, PROVIDING COURSES OF INSTRUCTION THROUGH CLASSES, SEMINARS AND WORKSHOPS AT THE COMMUNITY COLLEGE LEVEL, IN CLASS 41 (U.S. CLS. 100, 101 AND 107).

FIRST USE 4-2-2008; IN COMMERCE 4-2-2008.

THE MARK CONSISTS OF STANDARD CHARACTERS WITHOUT CLAIM TO ANY PARTICULAR FONT, STYLE, SIZE, OR COLOR.

SER. NO. 85-538,236, FILED 2-9-2012.

CHRISTOPHER BUONGIORNO, EXAMINING ATTORNEY



David J. Kybas

Director of the United States Patent and Trademark Office

United States of America
United States Patent and Trademark Office

HAIRADK

Reg. No. 4,205,904

HAIRADK LLC (NEVADA LIMITED LIABILITY COMPANY)
9632 SWAN BAY DRIVE
LAS VEGAS, NV 89117

Registered Sep. 11, 2012

Int. Cl.: 26

FOR: HAIR EXTENSIONS, IN CLASS 26 (U.S. CLS. 37, 39, 40, 42 AND 50).

TRADEMARK

FIRST USE 6-0-2011; IN COMMERCE 6-0-2011.

PRINCIPAL REGISTER

THE MARK CONSISTS OF STANDARD CHARACTERS WITHOUT CLAIM TO ANY PARTICULAR FONT, STYLE, SIZE, OR COLOR.

SER. NO. 85-538,285, FILED 2-9-2012.

JUDITH HELFMAN, EXAMINING ATTORNEY



David J. Kyffers

Director of the United States Patent and Trademark Office

United States of America

United States Patent and Trademark Office

CONVERSATION BRIDGE

Reg. No. 4,205,905

Registered Sep. 11, 2012

Int. Cl.: 9

TRADEMARK

PRINCIPAL REGISTER

VIRTUAL HOLD TECHNOLOGY, LLC (DELAWARE LIMITED LIABILITY COMPANY)
SUITE 305, 3875 EMBASSY PARKWAY
AKRON, OH 44333

FOR: SOFTWARE FOR USE IN MANAGING AND CONNECTING CUSTOMERS USING
SELSERVICE ON THE INTERNET, MOBILE COMMUNICATIONS, AND SOCIAL OR
VOICE CHANNELS, TO THE APPROPRIATE INTERNAL RESOURCE IN A COMPANY
WHO CAN MOST IMMEDIATELY HELP THAT CUSTOMER BY IDENTIFYING AND CO-
ORDINATING QUEUE POSITION AND COMMUNICATION ROUTING, IN CLASS 9 (U.S.
CLS. 21, 23, 26, 36 AND 38).

FIRST USE 5-1-2012; IN COMMERCE 5-1-2012.

THE MARK CONSISTS OF STANDARD CHARACTERS WITHOUT CLAIM TO ANY PAR-
TICULAR FONT, STYLE, SIZE, OR COLOR.

SER. NO. 85-538,311, FILED 2-9-2012.

FRANK LATTUCA, EXAMINING ATTORNEY



David J. Kyffers

Director of the United States Patent and Trademark Office

United States of America

United States Patent and Trademark Office



Reg. No. 4,205,906

Registered Sep. 11, 2012

Int. Cl.: 36

SERVICE MARK

PRINCIPAL REGISTER

RODGERS LEMON & MCCLUNG LLC (OHIO LIMITED LIABILITY COMPANY)
23550 CENTER RIDGE ROAD, SUITE #204
WESTLAKE, OH 44145

FOR: ACCOUNTS PAYABLE DEBITING SERVICES; COLLECTION OF DEBTS, IN CLASS
36 (U.S. CLS. 100, 101 AND 102).

FIRST USE 12-1-2010; IN COMMERCE 12-1-2010.

THE MARK CONSISTS OF A DOUBLE-BLADED BATTLE AXE AND A BROAD SWORD
CROSSED DIAGONALLY IN FRONT OF A SHIELD, WHICH IS DIVIDED BY A CROSS INTO
FOUR PANELS, WITH EACH PANEL DECORATED IN TARTAN PLAID.

SER. NO. 85-538,312, FILED 2-9-2012.

ANGELA M. MICHELI, EXAMINING ATTORNEY



David J. Kyffers

Director of the United States Patent and Trademark Office

United States of America

United States Patent and Trademark Office

CALLINGO

Reg. No. 4,205,907

Registered Sep. 11, 2012

Int. Cl.: 38

SERVICE MARK

PRINCIPAL REGISTER

NGC, INC. (VIRGINIA CORPORATION), DBA NEXT GENERATION COMMUNICATIONS
3931 AVION PARK CT. SUITE C116
CHANTILLY, VA 20151

FOR: TELECOMMUNICATION SERVICES, NAMELY, WIRELESS TELEPHONE SERVICES;
TELECOMMUNICATIONS SERVICES, NAMELY, PROVIDING PREPAID MINUTES FOR
USE ON CELL PHONES ABROAD; TELEPHONE COMMUNICATION SERVICES; WIRELESS
TELEPHONE TELECOMMUNICATIONS SERVICES, NAMELY, WIRELESS MOBILE
TELEPHONE CALLING PLANS, IN CLASS 38 (U.S. CLS. 100, 101 AND 104).

FIRST USE 0-0-2005; IN COMMERCE 5-0-2007.

THE MARK CONSISTS OF STANDARD CHARACTERS WITHOUT CLAIM TO ANY PAR-
TICULAR FONT, STYLE, SIZE, OR COLOR.

SER. NO. 85-538,347, FILED 2-9-2012.

JEFFREY LOOK, EXAMINING ATTORNEY



David J. Kyffers

Director of the United States Patent and Trademark Office

United States of America

United States Patent and Trademark Office

A GESTURE OF KINDNESS

Reg. No. 4,205,908

Registered Sep. 11, 2012

Int. Cl.: 30

TRADEMARK

PRINCIPAL REGISTER

HINT MINT, INC. (CALIFORNIA CORPORATION)
2432 EAST 8TH STREET
LOS ANGELES, CA 90021

FOR: CANDY MINTS, IN CLASS 30 (U.S. CL. 46).

FIRST USE 2-15-2000; IN COMMERCE 2-15-2000.

THE MARK CONSISTS OF STANDARD CHARACTERS WITHOUT CLAIM TO ANY PARTICULAR FONT, STYLE, SIZE, OR COLOR.

SER. NO. 85-538,349, FILED 2-9-2012.

AMY HELLA, EXAMINING ATTORNEY



David J. Kyffers

Director of the United States Patent and Trademark Office

United States of America

United States Patent and Trademark Office

COMPEL

Reg. No. 4,205,909

Registered Sep. 11, 2012

Int. Cl.: 20

TRADEMARK

PRINCIPAL REGISTER

COMPEL OFFICE FURNITURE, INC. (ILLINOIS CORPORATION)
7540 ROOSEVELT ROAD
FOREST PARK, IL 60130

FOR: FURNITURE, IN CLASS 20 (U.S. CLS. 2, 13, 22, 25, 32 AND 50).

FIRST USE 3-1-2005; IN COMMERCE 3-1-2005.

THE MARK CONSISTS OF STANDARD CHARACTERS WITHOUT CLAIM TO ANY PARTICULAR FONT, STYLE, SIZE, OR COLOR.

SER. NO. 85-538,350, FILED 2-9-2012.

JEFFREY LOOK, EXAMINING ATTORNEY



David J. Kybas

Director of the United States Patent and Trademark Office

United States of America

United States Patent and Trademark Office

FlowJo

Reg. No. 4,205,910

TREESTAR INC. (OREGON CORPORATION)
340 A ST.

Registered Sep. 11, 2012

ASHLAND, OR 97520

Int. Cl.: 9

FOR: COMPUTER SOFTWARE PLATFORMS FOR THE ANALYSIS OF FLOW CYTOMETRY DATA, IN CLASS 9 (U.S. CLS. 21, 23, 26, 36 AND 38).

TRADEMARK

FIRST USE 7-1-1994; IN COMMERCE 6-1-1995.

PRINCIPAL REGISTER

THE MARK CONSISTS OF STANDARD CHARACTERS WITHOUT CLAIM TO ANY PARTICULAR FONT, STYLE, SIZE, OR COLOR.

SER. NO. 85-538,359, FILED 2-9-2012.

KAREN SEVERSON, EXAMINING ATTORNEY



David J. Kybas

Director of the United States Patent and Trademark Office

United States of America
United States Patent and Trademark Office

RAMKO

Reg. No. 4,205,911

RAMKO DISTRIBUTORS, INC. (OHIO CORPORATION)
3840 LAGRANGE
TOLEDO, OH 43612

Registered Sep. 11, 2012

Int. Cl.: 35

FOR: WHOLESALE DISTRIBUTORSHIPS FEATURING CONSUMER ELECTRONICS, IN CLASS 35 (U.S. CLS. 100, 101 AND 102).

SERVICE MARK

FIRST USE 5-0-1989; IN COMMERCE 5-0-1989.

PRINCIPAL REGISTER

THE MARK CONSISTS OF STANDARD CHARACTERS WITHOUT CLAIM TO ANY PARTICULAR FONT, STYLE, SIZE, OR COLOR.

SER. NO. 85-538,376, FILED 2-9-2012.

PATRICIA EVANKO, EXAMINING ATTORNEY



David J. Kybas

Director of the United States Patent and Trademark Office

United States of America

United States Patent and Trademark Office

YOU NEED THIS MINT

Reg. No. 4,205,912

HINT MINT, INC. (CALIFORNIA CORPORATION)
2432 EAST 8TH STREET
LOS ANGELES, CA 90021

Registered Sep. 11, 2012

Int. Cl.: 30

FOR: CANDY MINTS, IN CLASS 30 (U.S. CL. 46).

TRADEMARK

FIRST USE 2-15-2000; IN COMMERCE 2-15-2000.

PRINCIPAL REGISTER

THE MARK CONSISTS OF STANDARD CHARACTERS WITHOUT CLAIM TO ANY PARTICULAR FONT, STYLE, SIZE, OR COLOR.

SER. NO. 85-538,377, FILED 2-9-2012.

AMY HELLA, EXAMINING ATTORNEY



David J. Kybas

Director of the United States Patent and Trademark Office

United States of America
United States Patent and Trademark Office

BOOST

Reg. No. 4,205,913

G.I. SKINCARE, LLC (NEW YORK LIMITED LIABILITY COMPANY)
1009 FIFTH AVENUE
NEW YORK, NY 10028

Registered Sep. 11, 2012

Int. Cl.: 3

FOR: NON-MEDICATED SKIN CARE PREPARATIONS, IN CLASS 3 (U.S. CLS. 1, 4, 6, 50, 51 AND 52).

TRADEMARK

FIRST USE 9-18-2009; IN COMMERCE 9-28-2009.

PRINCIPAL REGISTER

THE MARK CONSISTS OF STANDARD CHARACTERS WITHOUT CLAIM TO ANY PARTICULAR FONT, STYLE, SIZE, OR COLOR.

OWNER OF U.S. REG. NO. 3,779,441.

SER. NO. 85-538,387, FILED 2-9-2012.

DEIRDRE ROBERTSON, EXAMINING ATTORNEY



David J. Kyfos

Director of the United States Patent and Trademark Office

United States of America

United States Patent and Trademark Office

SUKOTTO

Reg. No. 4,205,914

SUKOTTO PRODUCTS, INC. (FLORIDA CORPORATION)
800 PARKVIEW DRIVE #108
HALLANDALE, FL 33009

Registered Sep. 11, 2012

Int. Cl.: 8

FOR: BAGS AND CASES SPECIALLY ADAPTED FOR HOLDING OR CARRYING HAIR CUTTING SCISSORS AND SHEARS; ELECTRIC HAIR CURLING IRONS; ELECTRIC HAIR STRAIGHTENING IRONS; ELECTRIC IRONS FOR STYLING HAIR; HAIR CUTTING SCISSORS; RAZOR CASES; RAZORS; SCISSORS, IN CLASS 8 (U.S. CLS. 23, 28 AND 44).

TRADEMARK

PRINCIPAL REGISTER

FIRST USE 3-1-2007; IN COMMERCE 4-1-2007.

THE MARK CONSISTS OF STANDARD CHARACTERS WITHOUT CLAIM TO ANY PARTICULAR FONT, STYLE, SIZE, OR COLOR.

SER. NO. 85-538,394, FILED 2-9-2012.

ANDREA HACK, EXAMINING ATTORNEY



David J. Kyffers

Director of the United States Patent and Trademark Office

United States of America

United States Patent and Trademark Office



Reg. No. 4,205,915

GRAMERCYONE TECHNOLOGY CORP. (DELAWARE CORPORATION)
257 PARK AVENUE SOUTH
NEW YORK, NY 10010

Registered Sep. 11, 2012

Int. Cl.: 42

FOR: PROVIDING ONLINE NON-DOWNLOADABLE SOFTWARE FOR USE IN SCHEDULING AND MANAGEMENT OF RESERVATIONS FOR CUSTOMERS, POINT-OF-SALE SOLUTIONS FOR FLOOR AND MANAGEMENT STAFF, INVENTORY MANAGEMENT, CUSTOMER RELATIONSHIP MANAGEMENT, SOCIAL MEDIA INTEGRATION, MANAGEMENT OF EMPLOYEES SCHEDULES, CREATING REPORTS, CREATING AND PROVIDING GIFT CERTIFICATES, COUPONS AND PROMOTIONAL SPECIALS, AND MANAGING DISCOUNT PROGRAMS, IN CLASS 42 (U.S. CLS. 100 AND 101).

SERVICE MARK

PRINCIPAL REGISTER

FIRST USE 10-30-2010; IN COMMERCE 10-30-2010.

THE MARK CONSISTS OF THE STYLIZED WORD "GO" WITH "G" IN BLACK AND "O" IN GRAY WITH A STYLIZED NUMBER "1" VERTICALLY DISSECTING THE WORD THROUGH THE LETTER "O". THE TOP HALF OF THE NUMBER "1" IS FORMED BY CIRCLES IN BLUE, ORANGE AND GREEN AT THE TOP WITH A PURPLE AND YELLOW CIRCLE FORMING THE BOTTOM HALF OF THE NUMBER "1".

THE COLOR(S) BLACK, GRAY, BLUE, GREEN, ORANGE, PURPLE AND YELLOW IS/ARE CLAIMED AS A FEATURE OF THE MARK.



SER. NO. 85-538,402, FILED 2-9-2012.

MICHAEL KEATING, EXAMINING ATTORNEY

David J. Kyjars

Director of the United States Patent and Trademark Office

United States of America

United States Patent and Trademark Office

SAVESTA

Reg. No. 4,205,916

Registered Sep. 11, 2012

Int. Cl.: 5

TRADEMARK

PRINCIPAL REGISTER

SAVESTA LIFESCIENCES, INC. (DELAWARE CORPORATION)
SUITE 28
9601 OWENSMOUTH AVE.
CHATSWORTH, CA 91311

FOR: DIETARY SUPPLEMENTS, IN CLASS 5 (U.S. CLS. 6, 18, 44, 46, 51 AND 52).

FIRST USE 1-31-2012; IN COMMERCE 1-31-2012.

THE MARK CONSISTS OF STANDARD CHARACTERS WITHOUT CLAIM TO ANY PARTICULAR FONT, STYLE, SIZE, OR COLOR.

SER. NO. 85-538,430, FILED 2-9-2012.

SUE LAWRENCE, EXAMINING ATTORNEY



David J. Kybas

Director of the United States Patent and Trademark Office

United States of America

United States Patent and Trademark Office

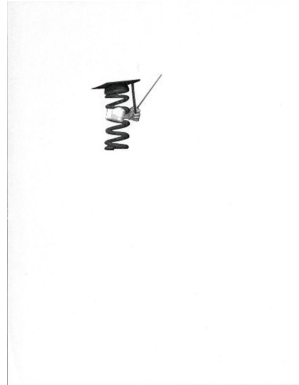

Reg. No. 4,205,917

ORIGINAL MATTRESS COMPANY LLC (OHIO LIMITED LIABILITY COMPANY)
4930 STATE ROAD
CLEVELAND, OH 44134

Registered Sep. 11, 2012

Int. Cl.: 35

FOR: WHOLESALE AND RETAIL STORE SERVICES FEATURING BOX SPRINGS AND MATTRESSES, AND OTHER BEDDING, IN CLASS 35 (U.S. CLS. 100, 101 AND 102).

SERVICE MARK

FIRST USE 6-30-2007; IN COMMERCE 6-30-2007.

PRINCIPAL REGISTER

OWNER OF U.S. REG. NOS. 3,292,065, 4,002,101 AND OTHERS.

THE MARK CONSISTS OF A STYLIZED COIL CHARACTER WEARING A SQUARE GRADUATION CAP HAVING A TASSEL, WITH A RIGHT AND LEFT HAND, THE LEFT HAND HOLDING A POINTER IN AN UPRIGHT POSITION.

SER. NO. 85-538,434, FILED 2-9-2012.

SUE LAWRENCE, EXAMINING ATTORNEY



David J. Kyffers

Director of the United States Patent and Trademark Office

United States of America

United States Patent and Trademark Office



Reg. No. 4,205,918

Registered Sep. 11, 2012

Int. Cl.: 16

TRADEMARK

PRINCIPAL REGISTER

GISH, STEVE (UNITED STATES INDIVIDUAL), DBA RECORD FOR THE DATE
408 E. 5TH STREET
PORT ANGELES, WA 98362 AND

GISH, JEANETTE (UNITED STATES INDIVIDUAL), DBA RECORD FOR THE DATE
408 E. 5TH STREET
PORT ANGELES, WA 98362

FOR: PAPER BANNERS , IN CLASS 16 (U.S. CLS. 2, 5, 22, 23, 29, 37, 38 AND 50).

FIRST USE 2-9-2012; IN COMMERCE 2-9-2012.

THE MARK CONSISTS OF THE WORDS "RECORD FOR THE DATE". THE WORDS ARE ENCLOSED IN A CIRCLE.

SER. NO. 85-538,477, FILED 2-9-2012.

SALLY SHIH, EXAMINING ATTORNEY



David J. Kyffers

Director of the United States Patent and Trademark Office

United States of America

United States Patent and Trademark Office

PEDAL ON THE PIER

Reg. No. 4,205,919

Registered Sep. 11, 2012

Int. Cl.: 36

SERVICE MARK

PRINCIPAL REGISTER

HAROLD ROBINSON FOUNDATION, INC. (CALIFORNIA CORPORATION)
SUITE 324
10008 NATIONAL BOULEVARD
LOS ANGELES, CA 90034

FOR: CHARITABLE FUNDRAISING SERVICES, IN CLASS 36 (U.S. CLS. 100, 101 AND 102).

FIRST USE 6-5-2011; IN COMMERCE 6-5-2011.

THE MARK CONSISTS OF STANDARD CHARACTERS WITHOUT CLAIM TO ANY PARTICULAR FONT, STYLE, SIZE, OR COLOR.

SER. NO. 85-538,483, FILED 2-9-2012.

SALLY SHIH, EXAMINING ATTORNEY



David J. Kybas

Director of the United States Patent and Trademark Office

United States of America

United States Patent and Trademark Office

STEVEN & WILLIAM

Reg. No. 4,205,920

Registered Sep. 11, 2012

Int. Cls.: 14 and 18

STEVEN AND WILLIAM LADD INCORPORATED (NEW YORK CORPORATION), DBA
STEVEN AND WILLIAM
STEVEN LADD
338 BERRY STREET, #13
BROOKLYN, NY 11249

TRADEMARK

FOR: JEWELRY AND FASHION JEWELRY, BRACELETS, NECKLACES, PENDANTS, IN
CLASS 14 (U.S. CLS. 2, 27, 28 AND 50).

PRINCIPAL REGISTER

FIRST USE 1-31-2001; IN COMMERCE 1-31-2001.

FOR: LEATHER AND NON-LEATHER HANDBAGS, TOTE BAGS, WALLETS, CLUTCH
PURSES, COIN PURSES, TRAVEL BAGS, LUGGAGE, IN CLASS 18 (U.S. CLS. 1, 2, 3, 22
AND 41).

FIRST USE 1-31-2001; IN COMMERCE 1-31-2001.

THE MARK CONSISTS OF STANDARD CHARACTERS WITHOUT CLAIM TO ANY PAR-
TICULAR FONT, STYLE, SIZE, OR COLOR.

SER. NO. 85-538,494, FILED 2-9-2012.

KATHLEEN KOLACZ, EXAMINING ATTORNEY



David J. Kybas

Director of the United States Patent and Trademark Office

United States of America

United States Patent and Trademark Office

BIGCHURCH.COM

Reg. No. 4,205,921

Registered Sep. 11, 2012

Int. Cl.: 45

SERVICE MARK

PRINCIPAL REGISTER

GLOBAL ALPHABET, INC. (CALIFORNIA CORPORATION)
220 HUMBOLDT COURT
SUNNYVALE, CA 94089

FOR: COMPUTER DATING SERVICES; PROVIDING AN ON-LINE ELECTRONIC DATABASE ON GLOBAL COMPUTER NETWORKS IN THE FIELD OF INTERPERSONAL RELATIONSHIPS; ON-LINE SOCIAL NETWORKING SERVICES AND DATING SERVICES; PROVIDING AN ON-LINE COMPUTER DATABASE IN THE FIELDS OF SOCIAL NETWORKING, DATING AND RELATIONSHIPS, IN CLASS 45 (U.S. CLS. 100 AND 101).

FIRST USE 0-0-1996; IN COMMERCE 0-0-1996.

THE MARK CONSISTS OF STANDARD CHARACTERS WITHOUT CLAIM TO ANY PARTICULAR FONT, STYLE, SIZE, OR COLOR.

SER. NO. 85-538,515, FILED 2-9-2012.

ANNE E. GUSTASON, EXAMINING ATTORNEY



David J. Kybas

Director of the United States Patent and Trademark Office

United States of America

United States Patent and Trademark Office



Reg. No. 4,205,922

Registered Sep. 11, 2012

Int. Cls.: 35, 36 and 37

SERVICE MARK

PRINCIPAL REGISTER

KAMLA HOTELS, INC (CALIFORNIA CORPORATION)
12644 S LAKEWOOD BLVD. SUITE 100
12644 S LAKEWOOD BLVD. SUITE 100
DOWNEY, CA 90242

FOR: HOTEL, RESORT, SPA, RESTAURANT AND BAR MANAGEMENT FOR OTHERS; PROJECT MANAGEMENT SERVICES IN THE FIELD OF REAL ESTATE, NAMELY, BUSINESS MANAGEMENT OF HOTEL RENOVATION AND RECONSTRUCTION PROJECTS FOR OTHERS, IN CLASS 35 (U.S. CLS. 100, 101 AND 102).

FIRST USE 11-23-2010; IN COMMERCE 11-23-2010.

FOR: INVESTMENT SERVICES, NAMELY REAL ESTATE INVESTMENT FOR HOTELS, RESORTS, SPAS, RESTAURANTS AND BARS, MARKETED TO INVESTORS IN COMMERCIAL REAL ESTATE, IN CLASS 36 (U.S. CLS. 100, 101 AND 102).

FIRST USE 11-23-2010; IN COMMERCE 11-23-2010.

FOR: REAL ESTATE DEVELOPMENT AND CONSTRUCTION OF COMMERCIAL, RESIDENTIAL AND HOTEL PROPERTY, IN CLASS 37 (U.S. CLS. 100, 103 AND 106).

FIRST USE 11-23-2010; IN COMMERCE 11-23-2010.

THE STIPPLING IS A FEATURE OF THE MARK AND DOES NOT INDICATE COLOR; THE STIPPLING IS FOR SHADING PURPOSES ONLY.

THE MARK CONSISTS OF A STYLIZED LOTUS FLOWER.

SER. NO. 85-538,527, FILED 2-9-2012.

REBECCA SMITH, EXAMINING ATTORNEY



David J. Kyjars

Director of the United States Patent and Trademark Office

United States of America

United States Patent and Trademark Office

STORE TO DOOR

Reg. No. 4,205,923

BOXSTAR, LLC (TEXAS LIMITED LIABILITY COMPANY), DBA BOXSTAR
8835 LAKEMONT DR.
DALLAS, TX 75209

Registered Sep. 11, 2012

Int. Cl.: 35

FOR: ADVERTISING AGENCIES SPECIALIZING IN PLACING ADVERTISEMENTS ON BOXES OF ITEMS BEING SHIPPED; MARKETING CONSULTING, NAMELY, TEACHING OTHERS HOW TO EFFECTIVELY ADVERTISE BY PLACING ADVERTISEMENTS ON BOXES BEING SHIPPED, IN CLASS 35 (U.S. CLS. 100, 101 AND 102).

SERVICE MARK

PRINCIPAL REGISTER

FIRST USE 9-1-2011; IN COMMERCE 1-1-2012.

THE MARK CONSISTS OF STANDARD CHARACTERS WITHOUT CLAIM TO ANY PARTICULAR FONT, STYLE, SIZE, OR COLOR.

SER. NO. 85-538,534, FILED 2-9-2012.

RENEE MCCRAY, EXAMINING ATTORNEY



David J. Kyffers

Director of the United States Patent and Trademark Office

United States of America

United States Patent and Trademark Office

KOOLMASTER

Reg. No. 4,205,924

Registered Sep. 11, 2012

Int. Cl.: 9

TRADEMARK

PRINCIPAL REGISTER

ACME ENGINEERING & MANUFACTURING CORPORATION (OKLAHOMA CORPORATION)
P.O. BOX 978
MUSKOGEE, OK 74402

FOR: CONTROL UNITS FOR REGULATING ENVIRONMENTAL CONDITIONS WITHIN HORTICULTURAL/AGRICULTURAL INSTALLATIONS, IN CLASS 9 (U.S. CLS. 21, 23, 26, 36 AND 38).

FIRST USE 12-11-2002; IN COMMERCE 12-11-2002.

THE MARK CONSISTS OF STANDARD CHARACTERS WITHOUT CLAIM TO ANY PARTICULAR FONT, STYLE, SIZE, OR COLOR.

SER. NO. 85-538,558, FILED 2-9-2012.

YAT SYE, LEE, EXAMINING ATTORNEY



David J. Kybas

Director of the United States Patent and Trademark Office

United States of America

United States Patent and Trademark Office

OUR SOLDIERS SPEAK

Reg. No. 4,205,925

Registered Sep. 11, 2012

Int. Cl.: 41

SERVICE MARK

PRINCIPAL REGISTER

OUR SOLDIERS SPEAK, INC. (DELAWARE NON-PROFIT CORPORATION)
24TH FLOOR
1410 BROADWAY
NEW YORK, NY 10018

FOR: EDUCATIONAL SERVICES, NAMELY, CONDUCTING SEMINARS, LECTURES AND WORKSHOPS FROM THE PERSPECTIVE OF ISRAELI COMBAT VETERANS FROM THE FRONT LINES OF ISRAELI BATTLEFIELDS TO PROVIDE THE PUBLIC WITH AN APOLITICAL VIEWPOINT OF CURRENT ISRAELI MILITARY STRUGGLES, REAL TIME BATTLEFIELD DILEMMAS AND THE DIFFERENCES BETWEEN MEDIA HEADLINES AND THE REALITIES OF COMBAT ZONES, IN CLASS 41 (U.S. CLS. 100, 101 AND 107).

FIRST USE 1-1-2009; IN COMMERCE 1-1-2009.

THE MARK CONSISTS OF STANDARD CHARACTERS WITHOUT CLAIM TO ANY PARTICULAR FONT, STYLE, SIZE, OR COLOR.

SER. NO. 85-538,559, FILED 2-9-2012.

ELLEN B. AWRICH, EXAMINING ATTORNEY



David J. Kyros

Director of the United States Patent and Trademark Office

United States of America

United States Patent and Trademark Office

BORN REDNECK

Reg. No. 4,205,926

LILLY, RONALD R. (UNITED STATES INDIVIDUAL)
9402 A HWY 87N
PITTSBORO, NC 27312

Registered Sep. 11, 2012

Int. Cl.: 16

FOR: STICKERS, IN CLASS 16 (U.S. CLS. 2, 5, 22, 23, 29, 37, 38 AND 50).

TRADEMARK

FIRST USE 11-20-2011; IN COMMERCE 11-20-2011.

PRINCIPAL REGISTER

THE MARK CONSISTS OF STANDARD CHARACTERS WITHOUT CLAIM TO ANY PARTICULAR FONT, STYLE, SIZE, OR COLOR.

SER. NO. 85-538,596, FILED 2-9-2012.

TARAH HARDY, EXAMINING ATTORNEY



David J. Kyffers

Director of the United States Patent and Trademark Office

United States of America

United States Patent and Trademark Office

RASSINÉ

Reg. No. 4,205,927

MAPLE'S SALES, INC. (CALIFORNIA CORPORATION)
12000 WOODRUFF AVE. UNIT D
DOWNEY, CA 90241

Registered Sep. 11, 2012

Int. Cl.: 12

FOR: BICYCLES, IN CLASS 12 (U.S. CLS. 19, 21, 23, 31, 35 AND 44).

TRADEMARK

FIRST USE 10-10-2011; IN COMMERCE 1-23-2012.

PRINCIPAL REGISTER

THE MARK CONSISTS OF STANDARD CHARACTERS WITHOUT CLAIM TO ANY PARTICULAR FONT, STYLE, SIZE, OR COLOR.

SER. NO. 85-538,623, FILED 2-9-2012.

FLORENTINA BLANDU, EXAMINING ATTORNEY



David J. Kyffers

Director of the United States Patent and Trademark Office

United States of America

United States Patent and Trademark Office

RESET

Reg. No. 4,205,928

Registered Sep. 11, 2012

Int. Cl.: 44

SERVICE MARK

PRINCIPAL REGISTER

DR. ADAM SCHEINER (UNITED STATES INDIVIDUAL)
13014 N. DALE MABRY HIGHWAY
TAMPA, FL 33618

FOR: COSMETIC AND PLASTIC SURGERY, IN CLASS 44 (U.S. CLS. 100 AND 101).

FIRST USE 12-31-2011; IN COMMERCE 12-31-2011.

THE MARK CONSISTS OF STANDARD CHARACTERS WITHOUT CLAIM TO ANY PARTICULAR FONT, STYLE, SIZE, OR COLOR.

SER. NO. 85-538,626, FILED 2-9-2012.

BARBARA BROWN, EXAMINING ATTORNEY



David J. Kybas

Director of the United States Patent and Trademark Office

United States of America

United States Patent and Trademark Office



Reg. No. 4,205,929

Registered Sep. 11, 2012

Int. Cl.: 30

TRADEMARK

PRINCIPAL REGISTER

HINT MINT, INC. (CALIFORNIA CORPORATION)
2432 EAST 8TH STREET
LOS ANGELES, CA 90021

FOR: CANDY MINTS, IN CLASS 30 (U.S. CL. 46).

FIRST USE 2-15-2000; IN COMMERCE 2-15-2000.

THE MARK CONSISTS OF THE DESIGN OF A LEAF.

SER. NO. 85-538,652, FILED 2-9-2012.

AMY HELLA, EXAMINING ATTORNEY



David J. Kyffers

Director of the United States Patent and Trademark Office

United States of America

United States Patent and Trademark Office

AFTERMATH

Reg. No. 4,205,930

Registered Sep. 11, 2012

Int. Cls.: 9 and 41

TRADEMARK

SERVICE MARK

PRINCIPAL REGISTER

ARY, INC. (CALIFORNIA CORPORATION), DBA AFTERMATH ENTERTAINMENT
C/O NIGRO KARLIN SEGAL & FELDSTEIN, LLP
10960 WILSHIRE BLVD., 5TH FLOOR
LOS ANGELES, CA 90024

FOR: MUSICAL SOUND RECORDINGS; DOWNLOADABLE MUSICAL SOUND RECORDINGS, IN CLASS 9 (U.S. CLS. 21, 23, 26, 36 AND 38).

FIRST USE 0-0-1996; IN COMMERCE 0-0-1996.

FOR: PROVIDING A WEBSITE FEATURING NON-DOWNLOADABLE AUDIO AND AUDIOVISUAL RECORDINGS FEATURING MUSIC AND MUSICAL-BASED ENTERTAINMENT; PROVIDING PICTURES AND INFORMATION ON A RECORD LABEL, MUSIC, MUSICAL ARTISTS, MUSIC VIDEOS, RECORD PRODUCERS AND NEWS RELATING TO THE MUSIC AND ENTERTAINMENT INDUSTRIES; PROVIDING A WEBSITE WHERE USERS CAN POST COMMENTS ABOUT RECORDINGS, MUSICAL ARTISTS AND COMMENTS ABOUT THE MUSIC INDUSTRY; ONLINE JOURNALS, NAMELY, BLOGS IN THE FIELD OF MUSIC AND THE MUSIC INDUSTRY; PRODUCTION OF AUDIO RECORDINGS, IN CLASS 41 (U.S. CLS. 100, 101 AND 107).

FIRST USE 0-0-2001; IN COMMERCE 0-0-2001.

THE MARK CONSISTS OF STANDARD CHARACTERS WITHOUT CLAIM TO ANY PARTICULAR FONT, STYLE, SIZE, OR COLOR.

OWNER OF U.S. REG. NO. 1,692,053.

SER. NO. 85-538,708, FILED 2-9-2012.

CAROLINE WOOD, EXAMINING ATTORNEY



David J. Kyffers

Director of the United States Patent and Trademark Office

United States of America

United States Patent and Trademark Office

GLACIATOR

Reg. No. 4,205,931

Registered Sep. 11, 2012

Int. Cl.: 25

TRADEMARK

PRINCIPAL REGISTER

K-SWISS INC. (DELAWARE CORPORATION)
31248 OAK CREST DRIVE
WESTLAKE VILLAGE, CA 91361

FOR: SHOES, IN CLASS 25 (U.S. CLS. 22 AND 39).

FIRST USE 11-15-2000; IN COMMERCE 11-15-2000.

THE MARK CONSISTS OF STANDARD CHARACTERS WITHOUT CLAIM TO ANY PARTICULAR FONT, STYLE, SIZE, OR COLOR.

SER. NO. 85-538,717, FILED 2-9-2012.

FRED CARL, EXAMINING ATTORNEY



David J. Kyffers

Director of the United States Patent and Trademark Office

United States of America

United States Patent and Trademark Office



Reg. No. 4,205,932

MODERNIZED MEDIA (UTAH LIMITED LIABILITY COMPANY)
3372 BRUCE STREET
SALT LAKE CITY, UT 84124

Registered Sep. 11, 2012

Int. Cl.: 35

FOR: ADVERTISING AND PUBLICITY SERVICES, NAMELY, PROMOTING THE GOODS, SERVICES, BRAND IDENTITY AND COMMERCIAL INFORMATION OF THIRD PARTIES THROUGH PRINT, AUDIO, VIDEO, DIGITAL AND ON-LINE MEDIA, IN CLASS 35 (U.S. CLS. 100, 101 AND 102).

SERVICE MARK

PRINCIPAL REGISTER

FIRST USE 7-20-2010; IN COMMERCE 7-20-2010.

THE MARK CONSISTS OF STYLIZED M.

SER. NO. 85-538,721, FILED 2-9-2012.

SUSAN STIGLITZ, EXAMINING ATTORNEY



David J. Kyffers

Director of the United States Patent and Trademark Office

United States of America

United States Patent and Trademark Office

Epyon Royal

Reg. No. 4,205,933

EPYON ROYAL, LLC (MICHIGAN LIMITED LIABILITY COMPANY)
46336 CHADSWORTH
MACOMB, MI 48044

Registered Sep. 11, 2012

Int. Cl.: 25

FOR: BEANIES; BELTS; HATS; HOODED SWEATSHIRTS; JACKETS; PANTS; SHIRTS;
SOCKS; SWEATSHIRTS; T-SHIRTS, IN CLASS 25 (U.S. CLS. 22 AND 39).

TRADEMARK

FIRST USE 6-1-2009; IN COMMERCE 5-10-2010.

PRINCIPAL REGISTER

THE MARK CONSISTS OF STANDARD CHARACTERS WITHOUT CLAIM TO ANY PARTICULAR FONT, STYLE, SIZE, OR COLOR.

SER. NO. 85-538,739, FILED 2-9-2012.

CAROLINE WOOD, EXAMINING ATTORNEY



David J. Kybas

Director of the United States Patent and Trademark Office

United States of America

United States Patent and Trademark Office

STEWART & STEWART ATTORNEYS

Reg. No. 4,205,934

Registered Sep. 11, 2012

Int. Cl.: 45

SERVICE MARK

PRINCIPAL REGISTER

DAVID W. STEWART (UNITED STATES INDIVIDUAL)
931 S. RANGELINE ROAD
CARMEL, IN 46032

FOR: LEGAL SERVICES, IN CLASS 45 (U.S. CLS. 100 AND 101).

FIRST USE 0-0-2000; IN COMMERCE 0-0-2000.

THE MARK CONSISTS OF STANDARD CHARACTERS WITHOUT CLAIM TO ANY PARTICULAR FONT, STYLE, SIZE, OR COLOR.

NO CLAIM IS MADE TO THE EXCLUSIVE RIGHT TO USE "ATTORNEYS", APART FROM THE MARK AS SHOWN.

SER. NO. 85-538,752, FILED 2-9-2012.

CURTIS FRENCH, EXAMINING ATTORNEY



David J. Kyffers

Director of the United States Patent and Trademark Office

United States of America

United States Patent and Trademark Office



Reg. No. 4,205,935

Registered Sep. 11, 2012

Int. Cl.: 35

SERVICE MARK

PRINCIPAL REGISTER

JULIE KREBS (UNITED STATES INDIVIDUAL), DBA VIRTUAL BRAND ADVISORS
P.O. BOX 701, 169 EGGLESTON ROAD
AURORA, OH 44202

FOR: MARKETING CONSULTING, NAMELY, BRAND DEVELOPMENT AND CREATION FOR OTHERS, AND DESIGN, DEVELOPMENT AND EXECUTION OF MARKETING AND MEDIA PLANS FOR OTHERS, AND ALL FORMS OF MASS AND ONE-TO-ONE COMMUNICATIONS THEREIN, IN CLASS 35 (U.S. CLS. 100, 101 AND 102).

FIRST USE 8-24-2011; IN COMMERCE 8-30-2011.

THE MARK CONSISTS OF A WHITE LETTER "B" OVERLAYING A GRAY PYRAMID WITH A TRIANGLE REMOVED FROM THE CENTER TO DEPICT THE LETTER "A," AND AN UPSIDE-DOWN MAROON PYRAMID TO DEPICT THE LETTER "V." THE OVERLAPPING PORTIONS OF THE PYRAMIDS WHICH ARE NOT COVERED BY THE WHITE LETTER "B" ARE DARK GRAY.

THE COLOR(S) WHITE, GRAY, MAROON AND DARK GRAY IS/ARE CLAIMED AS A FEATURE OF THE MARK.

SER. NO. 85-538,805, FILED 2-9-2012.

JULIE GUTTADAURO, EXAMINING ATTORNEY



David J. Kyffers

Director of the United States Patent and Trademark Office

United States of America

United States Patent and Trademark Office

The Chef's Source

Reg. No. 4,205,936

Registered Sep. 11, 2012

Int. Cl.: 29

TRADEMARK

PRINCIPAL REGISTER

JARVICO, INC (FLORIDA CORPORATION)
BAY 7
2046 MCKINLEY STREET
HOLLYWOOD, FL 33020

FOR: SEAFOOD, IN CLASS 29 (U.S. CL. 46).

FIRST USE 10-3-2011; IN COMMERCE 10-3-2011.

THE MARK CONSISTS OF STANDARD CHARACTERS WITHOUT CLAIM TO ANY PARTICULAR FONT, STYLE, SIZE, OR COLOR.

SER. NO. 85-538,827, FILED 2-9-2012.

JESSICA A. POWERS, EXAMINING ATTORNEY



David J. Kyffers

Director of the United States Patent and Trademark Office

United States of America

United States Patent and Trademark Office

PIER PILOT

Reg. No. 4,205,937

COLEMAN, DAN L. (UNITED STATES INDIVIDUAL)
300 NORTH ORANGE AVENUE
DUNN, NC 28334

Registered Sep. 11, 2012

Int. Cl.: 25

FOR: CLOTHING, NAMELY, SHIRTS, PANTS, SWEATERS, SWEATSHIRTS, SWEAT PANTS, PARKAS, ANORAKS, COATS, JACKETS, SLACKS, RAIN COATS, CAPS, HATS, HEAD-BANDS, VISORS, RUNNING SHOES, SWIMSUITS, SWIM TRUNKS, PAJAMAS, GLOVES, ROBES, SANDALS, SLIPPERS, SHOWER SHOES, NECKTIES, SCARVES, SOCKS, IN CLASS 25 (U.S. CLS. 22 AND 39).

TRADEMARK

PRINCIPAL REGISTER

FIRST USE 10-12-1999; IN COMMERCE 10-12-1999.

THE MARK CONSISTS OF STANDARD CHARACTERS WITHOUT CLAIM TO ANY PARTICULAR FONT, STYLE, SIZE, OR COLOR.

SER. NO. 85-538,829, FILED 2-9-2012.

JAMES A. RAUEN, EXAMINING ATTORNEY



David J. Kybas

Director of the United States Patent and Trademark Office

United States of America

United States Patent and Trademark Office

We Proudly Present

Reg. No. 4,205,938

ENDERSEN, SHARINE (UNITED STATES INDIVIDUAL)
10845 E SONRISA AVE
MESA, AZ 85212

Registered Sep. 11, 2012

Int. Cl.: 35

FOR: ADVERTISING AGENCIES, NAMELY, PROMOTING THE GOODS AND SERVICES OF OTHERS, IN CLASS 35 (U.S. CLS. 100, 101 AND 102).

SERVICE MARK

FIRST USE 7-28-1992; IN COMMERCE 7-28-1992.

PRINCIPAL REGISTER

THE MARK CONSISTS OF THE TEXT "WE" IN THE UPPER LEFT, "PROUDLY" IN THE MIDDLE, AND "PRESENT" IN THE LOWER RIGHT IN FANCY CURSIVE FONT.

SER. NO. 85-538,833, FILED 2-9-2012.

JAMES A. RAUEN, EXAMINING ATTORNEY



David J. Kybas

Director of the United States Patent and Trademark Office

United States of America

United States Patent and Trademark Office

PREPARE, SURVIVE, EMERGE!

Reg. No. 4,205,939

Registered Sep. 11, 2012

Int. Cl.: 45

SERVICE MARK

PRINCIPAL REGISTER

SURVIVAL, PREPAREDNESS, EMERGENCY KITS, LLC (ARIZONA LIMITED LIABILITY COMPANY)
12 76 S. VIA ESTRELLA BLANCA
TUCSON, AZ 85713

FOR: PROVIDING A WEBSITE FEATURING INFORMATION ON SURVIVAL SKILLS AND SURVIVAL PREPAREDNESS, IN CLASS 45 (U.S. CLS. 100 AND 101).

FIRST USE 1-26-2012; IN COMMERCE 1-26-2012.

THE MARK CONSISTS OF STANDARD CHARACTERS WITHOUT CLAIM TO ANY PARTICULAR FONT, STYLE, SIZE, OR COLOR.

SER. NO. 85-538,835, FILED 2-9-2012.

JAMES A. RAUEN, EXAMINING ATTORNEY



David J. Kyffers

Director of the United States Patent and Trademark Office

United States of America

United States Patent and Trademark Office

BONK BREAKER

Reg. No. 4,205,940

BONK BREAKER, LLC (DELAWARE LIMITED LIABILITY COMPANY)
9835 OWENSMOUTH AVENUE
CHATSWORTH, CA 91311

Registered Sep. 11, 2012

Int. Cl.: 5

FOR: NUTRITIONAL SUPPLEMENT ENERGY BARS, IN CLASS 5 (U.S. CLS. 6, 18, 44, 46, 51 AND 52).

TRADEMARK

FIRST USE 0-0-2006; IN COMMERCE 0-0-2006.

PRINCIPAL REGISTER

THE MARK CONSISTS OF STANDARD CHARACTERS WITHOUT CLAIM TO ANY PARTICULAR FONT, STYLE, SIZE, OR COLOR.

SER. NO. 85-538,845, FILED 2-9-2012.

ZACHARY BELLO, EXAMINING ATTORNEY



David J. Kyffers

Director of the United States Patent and Trademark Office

United States of America

United States Patent and Trademark Office

ARSENALE

Reg. No. 4,205,941

Registered Sep. 11, 2012

Int. Cl.: 9

TRADEMARK

PRINCIPAL REGISTER

ARSENALE SYSTEMS INC. (NEVADA CORPORATION)
25 GOLDEN HIND PASSAGE
CORTE MADERA, CA 94925

FOR: COMPUTER APPLICATION SOFTWARE FOR MOBILE PHONES, NAMELY, SOFTWARE FOR USE IN EDITING OF DATA AND FILES; COMPUTER APPLICATION SOFTWARE FOR COMPUTERS AND HANDHELD COMPUTERS, NAMELY, SOFTWARE FOR USE IN EDITING OF DATA AND FILES; COMPUTER PROGRAMS FOR PRIORITIZING, ASSIGNING, TRACKING, REPORTING AND AUDITING ISSUES RELATING TO BUSINESS INFORMATION TECHNOLOGY; COMPUTER SOFTWARE DEVELOPMENT TOOLS; COMPUTER SOFTWARE FOR CONTROLLING AND MANAGING ACCESS SERVER APPLICATIONS; COMPUTER SOFTWARE FOR MANIPULATION OF ELECTRONIC DATA; COMPUTER SOFTWARE FOR THE COLLECTION, EDITING, ORGANIZING, MODIFYING, BOOK MARKING, TRANSMISSION, STORAGE, AND SHARING OF DATA AND INFORMATION; COMPUTER SOFTWARE FOR THE COLLECTION, EDITING, ORGANIZING, MODIFYING, BOOK MARKING, TRANSMISSION, STORAGE, AND SHARING OF DATA AND INFORMATION THAT MAY BE DOWNLOADED FROM A GLOBAL COMPUTER NETWORK; DOWNLOADABLE COMPUTER SOFTWARE FOR EDITING DATA AND FILES; DOWNLOADABLE COMPUTER SOFTWARE FOR PRIORITIZING, ASSIGNING, TRACKING, REPORTING AND AUDITING ISSUES RELATING TO BUSINESS INFORMATION TECHNOLOGY, CREATING AND SHARING ELECTRONIC PAGES, DOCUMENTS AND RICH CONTENT WITH OTHER USERS; DOWNLOADABLE COMPUTER SOFTWARE FOR MANIPULATION OF ELECTRONIC DATA; DOWNLOADABLE ELECTRONIC PUBLICATIONS IN THE NATURE OF MANUALS, BROCHURES, NEWSLETTERS, TECHNICAL DATA SHEETS AND PRODUCT SPECIFICATIONS SHEETS IN THE FIELD OF COMPUTER SOFTWARE PROGRAMS AND APPLICATIONS, SUPPLIED ONLINE; DOWNLOADABLE SOFTWARE IN THE NATURE OF A MOBILE APPLICATION FOR MANIPULATION OF ELECTRONIC DATA; ELECTRONIC SOFTWARE UPDATES, NAMELY, DOWNLOADABLE COMPUTER SOFTWARE AND ASSOCIATED DATA FILES FOR UPDATING COMPUTER SOFTWARE IN THE FIELDS OF EDITING OF DATA, MANIPULATION OF DATA, PROVIDED VIA COMPUTER AND COMMUNICATION NETWORKS; ELECTRONIC PUBLICATIONS, NAMELY, NEWSLETTERS FEATURING INFORMATION IN THE FIELD OF COMPUTER SOFTWARE PROGRAMS AND APPLICATIONS RECORDED ON COMPUTER MEDIA; PRE-RECORDED ELECTRONIC MEDIA FEATURING MANUALS, BROCHURES, NEWSLETTERS, TECHNICAL DATA SHEETS AND PRODUCT SPECIFICATIONS, IN THE FIELD OF BUSINESS INFORMATION TECHNOLOGY, IN CLASS 9 (U.S. CLS. 21, 23, 26, 36 AND 38).



David J. Kyjars

Director of the United States Patent and Trademark Office

Reg. No. 4,205,941 FIRST USE 2-1-2011; IN COMMERCE 2-15-2011.

THE MARK CONSISTS OF STANDARD CHARACTERS WITHOUT CLAIM TO ANY PARTICULAR FONT, STYLE, SIZE, OR COLOR.

THE ENGLISH TRANSLATION OF "ARSENALE" IN THE MARK IS "DOCKYARD", "ARESNALE", "ARMORY".

SER. NO. 85-538,847, FILED 2-9-2012.

ZACHARY BELLO, EXAMINING ATTORNEY

United States of America

United States Patent and Trademark Office

MDT5

Reg. No. 4,205,942

Registered Sep. 11, 2012

Int. Cl.: 3

TRADEMARK

PRINCIPAL REGISTER

SOMME INC. (NEW YORK CORPORATION)
3RD FLOOR
969 THIRD AVENUE
NEW YORK, NY 10022

FOR: SKIN CARE PRODUCTS, NAMELY, CLEANSERS, EXFOLIANTS, NON-MEDICATED SERUMS, AND MOISTURIZERS, IN CLASS 3 (U.S. CLS. 1, 4, 6, 50, 51 AND 52).

FIRST USE 0-0-1999; IN COMMERCE 0-0-2000.

THE MARK CONSISTS OF STANDARD CHARACTERS WITHOUT CLAIM TO ANY PARTICULAR FONT, STYLE, SIZE, OR COLOR.

SER. NO. 85-538,860, FILED 2-9-2012.

ZACHARY BELLO, EXAMINING ATTORNEY



David J. Kyffers

Director of the United States Patent and Trademark Office

United States of America

United States Patent and Trademark Office

OX BOX

Reg. No. 4,205,943

DASH FIT, LLC (WASHINGTON LIMITED LIABILITY COMPANY), DBA OX BOX GYM
1942 WESTLAKE AVENUE, APT. 2602
SEATTLE, WA 98101

Registered Sep. 11, 2012

Int. Cls.: 41 and 44

FOR: PHYSICAL FITNESS TRAINING SERVICES, IN CLASS 41 (U.S. CLS. 100, 101 AND 107).

SERVICE MARK

FIRST USE 10-30-2011; IN COMMERCE 10-30-2011.

PRINCIPAL REGISTER

FOR: MASSAGE THERAPY SERVICES, IN CLASS 44 (U.S. CLS. 100 AND 101).

FIRST USE 10-30-2011; IN COMMERCE 10-30-2011.

THE MARK CONSISTS OF STANDARD CHARACTERS WITHOUT CLAIM TO ANY PARTICULAR FONT, STYLE, SIZE, OR COLOR.

SER. NO. 85-538,875, FILED 2-9-2012.

JOHN DWYER, EXAMINING ATTORNEY



David J. Kybas

Director of the United States Patent and Trademark Office

United States of America

United States Patent and Trademark Office

Walk Tall Mountains

Reg. No. 4,205,944

MCCLURE, GERRY, S. (UNITED STATES INDIVIDUAL)
898 CENTRILLION DRIVE
MCLEAN, VA 22102

Registered Sep. 11, 2012

Int. Cl.: 16

FOR: A SERIES OF BOOKS AND WRITTEN ARTICLES IN THE FIELD OF INSPIRATION;
A SERIES OF BOOKS, WRITTEN ARTICLES, HANDOUTS AND WORKSHEETS IN THE
FIELD OF INSPIRATION; SERIES OF NON-FICTION BOOKS IN THE FIELD OF INSPIRA-
TION, IN CLASS 16 (U.S. CLS. 2, 5, 22, 23, 29, 37, 38 AND 50).

TRADEMARK

PRINCIPAL REGISTER

FIRST USE 6-1-2011; IN COMMERCE 6-1-2011.

THE MARK CONSISTS OF STANDARD CHARACTERS WITHOUT CLAIM TO ANY PAR-
TICULAR FONT, STYLE, SIZE, OR COLOR.

SER. NO. 85-538,883, FILED 2-9-2012.

COLLEEN KEARNEY, EXAMINING ATTORNEY



David J. Kyffers

Director of the United States Patent and Trademark Office

United States of America

United States Patent and Trademark Office

Sneaky Leaker

Reg. No. 4,205,945

Registered Sep. 11, 2012

Int. Cl.: 20

TRADEMARK

PRINCIPAL REGISTER

MILLER, JASON B. (UNITED STATES INDIVIDUAL)
4502 BUTLER SPRINGS LANE
KATY, TX 77494 AND

MIXON, RICHARD C. (UNITED STATES INDIVIDUAL)
16270 COPPERHEAD RD.
INDEPENDENCE, LA 70443

FOR: PLASTIC URINARY DEVICE ENABLING USERS TO STAND WHILE URINATING ,
IN CLASS 20 (U.S. CLS. 2, 13, 22, 25, 32 AND 50).

FIRST USE 1-2-1997; IN COMMERCE 10-15-2000.

THE MARK CONSISTS OF STANDARD CHARACTERS WITHOUT CLAIM TO ANY PAR-
TICULAR FONT, STYLE, SIZE, OR COLOR.

SER. NO. 85-538,935, FILED 2-9-2012.

BARBARA A. GOLD, EXAMINING ATTORNEY



David J. Kyjars

Director of the United States Patent and Trademark Office

United States of America

United States Patent and Trademark Office

iSWAG

Reg. No. 4,205,946

Registered Sep. 11, 2012

Int. Cl.: 35

SERVICE MARK

PRINCIPAL REGISTER

INTERNATIONAL SOCIETY FOR WEALTH AFTER GRADUATION (TEXAS CORPORATION), AKA ISWAG
210 SAINT MARY'S DRIVE
HUTTO, TX 78634

FOR: PROVIDING CAREER INFORMATION, IN CLASS 35 (U.S. CLS. 100, 101 AND 102).

FIRST USE 7-30-2010; IN COMMERCE 7-30-2010.

THE MARK CONSISTS OF STANDARD CHARACTERS WITHOUT CLAIM TO ANY PARTICULAR FONT, STYLE, SIZE, OR COLOR.

SER. NO. 85-538,937, FILED 2-9-2012.

MARK SHINER, EXAMINING ATTORNEY



David J. Kybas

Director of the United States Patent and Trademark Office

United States of America

United States Patent and Trademark Office

We help the cash flow

Reg. No. 4,205,947

Registered Sep. 11, 2012

Int. Cl.: 36

SERVICE MARK

PRINCIPAL REGISTER

SUPPORT COLLECTORS INC (MINNESOTA CORPORATION), DBA SUMMIT ACCOUNT
RESOLUTION
12201 CHAMPLIN DRIVE
CHAMPLIN, MN 55316

FOR: DEBT RECOVERY AND COLLECTION AGENCIES, IN CLASS 36 (U.S. CLS. 100, 101
AND 102).

FIRST USE 10-13-2008; IN COMMERCE 10-13-2008.

THE MARK CONSISTS OF STANDARD CHARACTERS WITHOUT CLAIM TO ANY PAR-
TICULAR FONT, STYLE, SIZE, OR COLOR.

SER. NO. 85-538,957, FILED 2-9-2012.

DORITT L. CARROLL, EXAMINING ATTORNEY



David J. Kyffers

Director of the United States Patent and Trademark Office

United States of America

United States Patent and Trademark Office

The Tourist Best Friend

Reg. No. 4,205,948

Registered Sep. 11, 2012

Int. Cl.: 16

TRADEMARK

PRINCIPAL REGISTER

ORIGINAL COUPON BOOK INC. (HAWAII CORPORATION)
109B-313
5095 NAPILIHAIU STREET
LAHAINA, HI 96761

FOR: COUPON BOOKS, IN CLASS 16 (U.S. CLS. 2, 5, 22, 23, 29, 37, 38 AND 50).

FIRST USE 2-14-2010; IN COMMERCE 2-14-2010.

THE MARK CONSISTS OF STANDARD CHARACTERS WITHOUT CLAIM TO ANY PARTICULAR FONT, STYLE, SIZE, OR COLOR.

SER. NO. 85-538,961, FILED 2-9-2012.

JENNIFER VASQUEZ, EXAMINING ATTORNEY



David J. Kyffers

Director of the United States Patent and Trademark Office

United States of America

United States Patent and Trademark Office

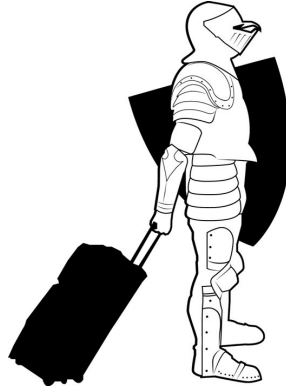

Reg. No. 4,205,949

Registered Sep. 11, 2012

Int. Cl.: 16

TRADEMARK

PRINCIPAL REGISTER

ORIGINAL COUPON BOOK INC. (HAWAII CORPORATION)
109B-313
5095 NAPILHAU STREET
LAHAINA, HI 96761

FOR: COUPON BOOKS, IN CLASS 16 (U.S. CLS. 2, 5, 22, 23, 29, 37, 38 AND 50).

FIRST USE 2-14-2010; IN COMMERCE 2-14-2010.

THE MARK CONSISTS OF: TRAVELING KNIGHT IN SUIT OF ARMOR CARRYING SHIELD AND PULLING ROLLING LUGGAGE.

SER. NO. 85-538,970, FILED 2-10-2012.

JENNIFER VASQUEZ, EXAMINING ATTORNEY



David J. Kyffers

Director of the United States Patent and Trademark Office

United States of America

United States Patent and Trademark Office

IDE PROGREEN

Reg. No. 4,205,950

Registered Sep. 11, 2012

Int. Cl.: 11

TRADEMARK

PRINCIPAL REGISTER

I.D.E. TECHNOLOGIES LTD. (ISRAEL LIMITED COMPANY (LTD.))
HASHARON INDUSTRIAL PARK
HAMATECHET STREET, P.O.B. 5016
KADIMA, ISRAEL 60920

FOR: DESALINATION UNITS; FAUCETS; FILTERS FOR DRINKING WATER; HOT WATER TANKS; PIPES BEING PARTS OF SANITARY FACILITIES; PLUMBING FITTINGS, NAMELY, VALVES; WATER DESALINATION PLANTS; WATER FILTERING APPARATUS; WATER FILTERING UNITS FOR DOMESTIC AND INDUSTRIAL USE; WATER FILTERS; WATER PURIFICATION INSTALLATIONS, IN CLASS 11 (U.S. CLS. 13, 21, 23, 31 AND 34).

THE MARK CONSISTS OF STANDARD CHARACTERS WITHOUT CLAIM TO ANY PARTICULAR FONT, STYLE, SIZE, OR COLOR.

OWNER OF ERPN CMNTY TM OFC REG. NO. 010255651, DATED 1-15-2012, EXPIRES 9-11-2021.

SER. NO. 85-538,973, FILED 2-10-2012.

CURTIS FRENCH, EXAMINING ATTORNEY



David J. Kyfos

Director of the United States Patent and Trademark Office

United States of America

United States Patent and Trademark Office

WEBSAM

Reg. No. 4,205,951

ALASKA TEXTILES INCORPORATED (ALASKA CORPORATION)
620 WEST FIREWEED LANE
ANCHORAGE, AK 99503

Registered Sep. 11, 2012

Int. Cl.: 42

FOR: PROVIDING A WEBSITE FEATURING NON-DOWNLOADABLE SOFTWARE FOR CORPORATE APPAREL ADMINISTRATION AND REPORTING, IN CLASS 42 (U.S. CLS. 100 AND 101).

SERVICE MARK

FIRST USE 10-10-2011; IN COMMERCE 10-10-2011.

PRINCIPAL REGISTER

THE MARK CONSISTS OF STANDARD CHARACTERS WITHOUT CLAIM TO ANY PARTICULAR FONT, STYLE, SIZE, OR COLOR.

SER. NO. 85-538,979, FILED 2-10-2012.

CURTIS FRENCH, EXAMINING ATTORNEY



David J. Kyfos

Director of the United States Patent and Trademark Office

United States of America

United States Patent and Trademark Office



Reg. No. 4,205,952

Registered Sep. 11, 2012

Int. Cl.: 9

TRADEMARK

PRINCIPAL REGISTER

WANG, HEQIU (UNITED STATES INDIVIDUAL)
20065 SEVENTH CREEK BLVD, BLDG.C
STE.1C
CUPERTINO, CA 95014

FOR: ADAPTERS; APPARATUS AND INSTRUMENTS FOR CONVEYING, DISTRIBUTING, TRANSFORMING, STORING, REGULATING OR CONTROLLING ELECTRIC CURRENT; BATTERY CHARGERS; COMPUTER PERIPHERAL DEVICES; ELECTRONIC APPARATUS FOR THE REMOTE CONTROL OF INDUSTRIAL OPERATIONS; ELECTRONIC MONITORS AND MONITOR MODULES FOR MONITORING ELECTRIC CURRENT AND ELECTRICAL SIGNALS; ELECTRONIC TEST AND MEASUREMENT DEVICES FOR USE IN THE FIELDS OF NETWORKS AND TELECOMMUNICATIONS, NAMELY, INSTRUMENTATION USED TO TEST AND CERTIFY NEW AND EXISTING DATA AND VOICE COMMUNICATION CABLE AND COAXIAL CABLE; OPTICAL COMMUNICATIONS SYSTEMS COMPRISED OF OPTICAL AND ELECTRONIC HARDWARE AND COMPUTER SOFTWARE FOR THE TRANSMISSION OF DATA BETWEEN TWO POINTS; POWER INVERTERS; POWER SUPPLIES, IN CLASS 9 (U.S. CLS. 21, 23, 26, 36 AND 38).

FIRST USE 4-17-2011; IN COMMERCE 12-23-2011.

THE MARK CONSISTS OF THE WORD "ASPOWER" AND A TRAPEZIUM ATOP WHEREAS THE TRAPEZIUM IS SEPARATED BY A LIGHTNING SYMBOL.

THE WORDING "ASPOWER" HAS NO MEANING IN A FOREIGN LANGUAGE.

SER. NO. 85-539,023, FILED 2-10-2012.

INGA ERVIN, EXAMINING ATTORNEY



David J. Kybas

Director of the United States Patent and Trademark Office

United States of America

United States Patent and Trademark Office

UNTAMED HEARTS

Reg. No. 4,205,953

Registered Sep. 11, 2012

Int. Cl.: 25

TRADEMARK

PRINCIPAL REGISTER

ASHLEY BURTON (UNITED STATES INDIVIDUAL), DBA ASHLEY HEARTS
1200 GLENEAGLE ROAD
BALTIMORE, MD 21239

FOR: APPAREL FOR DANCERS, NAMELY, TEE SHIRTS, SWEATSHIRTS, PANTS, LEGGINGS, SHORTS AND JACKETS; BABIES' PANTS; BUTTON DOWN SHIRTS; CAPRI PANTS; COLLARED SHIRTS; DRESS SHIRTS; HOODED SWEAT SHIRTS; KNIT SHIRTS; LONG-SLEEVED SHIRTS; OPEN-NECKED SHIRTS; PIQUE SHIRTS; POLO SHIRTS; RUGBY SHIRTS; SHIRTS; SHIRTS AND SHORT-SLEEVED SHIRTS; SHIRTS FOR INFANTS, BABIES, TODDLERS AND CHILDREN; SHORT-SLEEVED OR LONG-SLEEVED T-SHIRTS; SHORT-SLEEVED SHIRTS; SWEATPANTS; T-SHIRTS; T-SHIRTS FOR WOMEN, CHILDREN; TEE SHIRTS; WOMEN'S CLOTHING, NAMELY, SHIRTS, DRESSES, SKIRTS, BLOUSES, IN CLASS 25 (U.S. CLS. 22 AND 39).

FIRST USE 12-23-2011; IN COMMERCE 1-24-2012.

THE MARK CONSISTS OF STANDARD CHARACTERS WITHOUT CLAIM TO ANY PARTICULAR FONT, STYLE, SIZE, OR COLOR.

SER. NO. 85-539,042, FILED 2-10-2012.

ELISSA GARBER KON, EXAMINING ATTORNEY



David J. Kypos

Director of the United States Patent and Trademark Office

United States of America

United States Patent and Trademark Office

LEDBETTER BY DIRECTCONNECT

Reg. No. 4,205,954

ELECTRONIC CUSTOM DISTRIBUTORS, INC. (TEXAS CORPORATION)
4747 WESTPARK DRIVE
HOUSTON, TX 77027

Registered Sep. 11, 2012

Int. Cl.: 11

FOR: LED LIGHTING SYSTEMS, NAMELY, LED MODULES, POWER SUPPLIES, AND WIRING, IN CLASS 11 (U.S. CLS. 13, 21, 23, 31 AND 34).

TRADEMARK

FIRST USE 12-27-2011; IN COMMERCE 12-27-2011.

PRINCIPAL REGISTER

THE MARK CONSISTS OF STANDARD CHARACTERS WITHOUT CLAIM TO ANY PARTICULAR FONT, STYLE, SIZE, OR COLOR.

SER. NO. 85-539,075, FILED 2-10-2012.

JAMES GRIFFIN, EXAMINING ATTORNEY



David J. Kyffers

Director of the United States Patent and Trademark Office

United States of America

United States Patent and Trademark Office

OGGO MAKES DIRT AND GERMS SIMPLY GO GO

Reg. No. 4,205,955

Registered Sep. 11, 2012

Int. Cl.: 3

TRADEMARK

PRINCIPAL REGISTER

DOGGONIT PRODUCTS, LLC (ILLINOIS LIMITED LIABILITY COMPANY)
SUITE 302
825 N. CASS AVENUE
WESTMONT, IL 60559

FOR: CLEANING PREPARATIONS FOR HOUSEHOLD PURPOSES, IN CLASS 3 (U.S. CLS. 1, 4, 6, 50, 51 AND 52).

FIRST USE 2-9-2012; IN COMMERCE 2-9-2012.

THE MARK CONSISTS OF STANDARD CHARACTERS WITHOUT CLAIM TO ANY PARTICULAR FONT, STYLE, SIZE, OR COLOR.

SER. NO. 85-539,130, FILED 2-10-2012.

DAVID H. STINE, EXAMINING ATTORNEY



David J. Kyffers

Director of the United States Patent and Trademark Office

United States of America

United States Patent and Trademark Office

PROFESSOR HACK HARDDRIVE'S

Reg. No. 4,205,956

DAVIDS, PAUL JEFFREY (UNITED STATES INDIVIDUAL)
435 HOLLAND AVENUE
LOS ANGELES, CA 90042

Registered Sep. 11, 2012

Int. Cl.: 9

FOR: DIGITAL MEDIA, NAMELY, CDS, DVDS, AND DOWNLOADABLE AUDIO FILES FEATURING MUSIC. DOWNLOADABLE BOOKS FEATURING FICTIONAL STORIES, POETRY, HUMOR, AND DRAWINGS, IN CLASS 9 (U.S. CLS. 21, 23, 26, 36 AND 38).

TRADEMARK

FIRST USE 9-16-2011; IN COMMERCE 9-22-2011.

PRINCIPAL REGISTER

THE MARK CONSISTS OF STANDARD CHARACTERS WITHOUT CLAIM TO ANY PARTICULAR FONT, STYLE, SIZE, OR COLOR.

SER. NO. 85-539,142, FILED 2-10-2012.

JULIE WATSON, EXAMINING ATTORNEY



David J. Kybas

Director of the United States Patent and Trademark Office

United States of America

United States Patent and Trademark Office

Bite Responsibly.

Reg. No. 4,205,957

WICKED CONFECTIONS (FLORIDA PARTNERSHIP)

Registered Sep. 11, 2012

4380 NE 11 AVE
FORT LAUDERDALE, FL 33334

Int. Cl.: 30

FOR: BAKERY GOODS, NAMELY, PETITE CAKES SERVED IN SHOT CUPS AND CAKE
POPS, IN CLASS 30 (U.S. CL. 46).

TRADEMARK

FIRST USE 8-0-2011; IN COMMERCE 8-0-2011.

PRINCIPAL REGISTER

THE MARK CONSISTS OF STANDARD CHARACTERS WITHOUT CLAIM TO ANY PAR-
TICULAR FONT, STYLE, SIZE, OR COLOR.

SER. NO. 85-539,147, FILED 2-10-2012.

KEVON CHISOLM, EXAMINING ATTORNEY



David J. Kybas

Director of the United States Patent and Trademark Office

United States of America
United States Patent and Trademark Office

WELLCO

Reg. No. 4,205,958

WELLCO (MICHIGAN CORPORATION)
3406 WOODLAND AVENUE
ROYAL OAK, MI 48073

Registered Sep. 11, 2012

Int. Cl.: 44

FOR: HEALTH CARE SERVICES, NAMELY, WELLNESS PROGRAMS, IN CLASS 44 (U.S. CLS. 100 AND 101).

SERVICE MARK

FIRST USE 5-1-1996; IN COMMERCE 9-9-1997.

PRINCIPAL REGISTER

THE MARK CONSISTS OF STANDARD CHARACTERS WITHOUT CLAIM TO ANY PARTICULAR FONT, STYLE, SIZE, OR COLOR.

SER. NO. 85-539,149, FILED 2-10-2012.

KEVON CHISOLM, EXAMINING ATTORNEY



David J. Kybas

Director of the United States Patent and Trademark Office

United States of America

United States Patent and Trademark Office

UberFacts

Reg. No. 4,205,959

SANCHEZ, KRISTOFER J (UNITED STATES INDIVIDUAL), DBA UBERFACTS
458 NEPTUNE AVENUE APT 3E
BROOKLYN, NY 11224

Registered Sep. 11, 2012

Int. Cl.: 35

FOR: ADVERTISING AND MARKETING SERVICES PROVIDED BY MEANS OF INDIRECT METHODS OF MARKETING COMMUNICATIONS, NAMELY, SOCIAL MEDIA, SEARCH ENGINE MARKETING, INQUIRY MARKETING, INTERNET MARKETING, MOBILE MARKETING, BLOGGING AND OTHER FORMS OF PASSIVE, SHARABLE OR VIRAL COMMUNICATIONS CHANNELS, IN CLASS 35 (U.S. CLS. 100, 101 AND 102).

SERVICE MARK

PRINCIPAL REGISTER

FIRST USE 1-1-2010; IN COMMERCE 1-10-2012.

THE MARK CONSISTS OF STANDARD CHARACTERS WITHOUT CLAIM TO ANY PARTICULAR FONT, STYLE, SIZE, OR COLOR.

SER. NO. 85-539,150, FILED 2-10-2012.

KEVON CHISOLM, EXAMINING ATTORNEY



David J. Kyros

Director of the United States Patent and Trademark Office

United States of America

United States Patent and Trademark Office

FURINSIDER.COM

Reg. No. 4,205,960

Registered Sep. 11, 2012

Int. Cls.: 35 and 41

SERVICE MARK

PRINCIPAL REGISTER

FUR INFORMATION COUNCIL OF AMERICA (ILLINOIS NON-PROFIT ORGANIZATION)
8424-A SANTA MONICA BLVD, #860
WEST HOLLYWOOD, CA 90069

FOR: PROMOTING THE GOODS AND SERVICES OF OTHERS BY PROVIDING HYPERLINKS TO WEB SITES OF OTHERS FEATURING FASHION APPAREL AND ACCESSORIES, IN CLASS 35 (U.S. CLS. 100, 101 AND 102).

FIRST USE 12-1-2010; IN COMMERCE 12-1-2010.

FOR: ONLINE JOURNALS, NAMELY BLOGS FEATURING INFORMATION, NEWS, ARTICLES, AND COMMENTARY IN THE FIELD OF FASHION, IN CLASS 41 (U.S. CLS. 100, 101 AND 107).

FIRST USE 12-1-2010; IN COMMERCE 12-1-2010.

THE MARK CONSISTS OF STANDARD CHARACTERS WITHOUT CLAIM TO ANY PARTICULAR FONT, STYLE, SIZE, OR COLOR.

SER. NO. 85-539,156, FILED 2-10-2012.

KATHERINE E. HALMEN, EXAMINING ATTORNEY



David J. Kybas

Director of the United States Patent and Trademark Office

United States of America

United States Patent and Trademark Office

Antler

Reg. No. 4,205,961

Registered Sep. 11, 2012

Int. Cl.: 35

SERVICE MARK

PRINCIPAL REGISTER

ANTLER AGENCY, LLC (DELAWARE LIMITED LIABILITY COMPANY)
181 SOUTH STREET
BOSTON, MA 02111

FOR: ADVERTISING AGENCIES SPECIALIZING IN DIGITAL MARKETING AND SOCIAL MEDIA SERVICES, EVENT MARKETING AND PRODUCTION SERVICES, WEBSITE DESIGN AND DEVELOPMENT SERVICES, PROMOTIONAL SERVICES, MARKETING STRATEGY AND CONSULTING SERVICES, CREATIVE DESIGN AND ADVERTISING PRODUCTION SERVICES, MEDIA RELATIONS AND MEDIA BUYING SERVICES, INTERACTIVE TECHNOLOGY SERVICES, BRAND DEVELOPMENT AND BRAND DESIGN SERVICES CONSISTING OF DEVELOPMENT AND DESIGN OF LOGOS, PRODUCT PACKAGING, AND BUSINESS IDENTITY OF THIRD PARTY CLIENTS; ADVERTISING AGENCY SPECIALIZING IN THE DESIGN AND EXECUTION OF WORD OF MOUTH, VIRAL, BUZZ AND EXPERIENTIAL MARKETING PROGRAMS; ADVERTISING AND MARKETING; ADVERTISING AND MARKETING SERVICES PROVIDED BY MEANS OF INDIRECT METHODS OF MARKETING COMMUNICATIONS, NAMELY, SOCIAL MEDIA, SEARCH ENGINE MARKETING, INQUIRY MARKETING, INTERNET MARKETING, MOBILE MARKETING, BLOGGING AND OTHER FORMS OF PASSIVE, SHARABLE OR VIRAL COMMUNICATIONS CHANNELS; ADVERTISING AND MARKETING SERVICES, NAMELY, PROMOTING THE GOODS AND SERVICES OF OTHERS; ADVERTISING, MARKETING AND PROMOTION SERVICES; ADVERTISING, MARKETING, AND PROMOTING THE GOODS AND SERVICES OF OTHERS VIA PROMOTIONAL EVENTS, CONTESTS AND SWEEPSTAKES, SOCIAL MEDIA, INTERACTIVE TECHNOLOGIES, AND EXPERIENTIAL TACTICS; ARRANGING AND CONDUCTING MARKETING PROMOTIONAL EVENTS FOR OTHERS; BRANDING SERVICES, NAMELY, CONSULTING, DEVELOPMENT, MANAGEMENT AND MARKETING OF BRANDS FOR BUSINESSES; BUSINESS MARKETING SERVICES; CONSULTATION SERVICES, NAMELY, CREATIVE AND STRATEGIC CONSULTATION REGARDING DEVELOPMENT AND PRODUCTION OF MARKETING CAMPAIGNS FOR OTHERS; CREATIVE MARKETING DESIGN SERVICES; DEVELOPMENT OF MARKETING STRATEGIES AND CONCEPTS; DEVELOPMENT OF MARKETING STRATEGIES, CONCEPTS AND TACTICS, NAMELY, AUDIENCE DEVELOPMENT, BRAND AWARENESS, ONLINE COMMUNITY BUILDING AND DIGITAL WORD OF MOUTH COMMUNICATIONS; EVENT PLANNING AND MANAGEMENT FOR MARKETING, BRANDING, PROMOTING OR ADVERTISING THE GOODS AND SERVICES OF OTHERS; MARKETING CONSULTING; MARKETING SERVICES, NAMELY, PROMOTING OR ADVERTISING THE GOODS AND SERVICES OF OTHERS; PROMOTING, ADVERTISING AND MARKETING OF THE BRANDS, PRODUCTS, SERVICES AND ONLINE WEBSITES OF INDIVIDUALS, BUSINESSES AND NONPROFIT



David J. Kybas

Director of the United States Patent and Trademark Office

Reg. No. 4,205,961 ORGANIZATIONS; PROMOTION AND MARKETING SERVICES AND RELATED CONSULTING; PROVIDING MARKETING AND PROMOTION OF SPECIAL EVENTS; SOCIAL MEDIA STRATEGY AND MARKETING CONSULTANCY FOCUSING ON HELPING CLIENTS CREATE AND EXTEND THEIR PRODUCT AND BRAND STRATEGIES BY BUILDING VIRALLY ENGAGING MARKETING SOLUTIONS, IN CLASS 35 (U.S. CLS. 100, 101 AND 102).

FIRST USE 1-1-2010; IN COMMERCE 2-26-2010.

THE MARK CONSISTS OF STANDARD CHARACTERS WITHOUT CLAIM TO ANY PARTICULAR FONT, STYLE, SIZE, OR COLOR.

SER. NO. 85-539,253, FILED 2-10-2012.

FRANK LATTUCA, EXAMINING ATTORNEY

United States of America

United States Patent and Trademark Office

Heartland Showcase

Reg. No. 4,205,962

HEARTLAND YOUTH FOUNDATION (MISSOURI NON-PROFIT CORPORATION)
7401 S. COOK RD.

Registered Sep. 11, 2012

GRAIN VALLEY, MO 64029

Int. Cl.: 41

FOR: ENTERTAINMENT IN THE NATURE OF SOFTBALL TOURNAMENTS, IN CLASS 41
(U.S. CLS. 100, 101 AND 107).

SERVICE MARK

FIRST USE 6-0-2001; IN COMMERCE 6-0-2001.

PRINCIPAL REGISTER

THE MARK CONSISTS OF STANDARD CHARACTERS WITHOUT CLAIM TO ANY PARTICULAR FONT, STYLE, SIZE, OR COLOR.

NO CLAIM IS MADE TO THE EXCLUSIVE RIGHT TO USE "SHOWCASE", APART FROM THE MARK AS SHOWN.

SER. NO. 85-539,257, FILED 2-10-2012.

FRANK LATTUCA, EXAMINING ATTORNEY



David J. Kyffers

Director of the United States Patent and Trademark Office

United States of America

United States Patent and Trademark Office



Reg. No. 4,205,963

BIN IT LLC (NEW JERSEY LIMITED LIABILITY COMPANY)
47 HARRISON STREET
HOBOKEN, NJ 07030

Registered Sep. 11, 2012

Int. Cl.: 39

FOR: RENTAL SERVICES, NAMELY, RENTAL OF PLASTIC STORAGE CONTAINERS,
WARDROBE BINS AND MOVING DOLLIES, IN CLASS 39 (U.S. CLS. 100 AND 105).

SERVICE MARK

FIRST USE 7-1-2011; IN COMMERCE 7-1-2011.

PRINCIPAL REGISTER

THE MARK CONSISTS OF THE WORDS BIN IT STYLIZED WITH AN ARROW ON THE
RIGHT FACING THE WORDS.

SER. NO. 85-539,263, FILED 2-10-2012.

JOHN HWANG, EXAMINING ATTORNEY



David J. Kybas

Director of the United States Patent and Trademark Office

United States of America

United States Patent and Trademark Office

BIN-IT

Reg. No. 4,205,964

BIN IT LLC (NEW JERSEY LIMITED LIABILITY COMPANY)
47 HARRISON STREET
HOBOKEN, NJ 07030

Registered Sep. 11, 2012

Int. Cl.: 39

FOR: RENTAL SERVICES, NAMELY, RENTAL OF PLASTIC STORAGE CONTAINERS, WARDROBE BINS AND MOVING DOLLIES, IN CLASS 39 (U.S. CLS. 100 AND 105).

SERVICE MARK

FIRST USE 7-1-2011; IN COMMERCE 7-1-2011.

PRINCIPAL REGISTER

THE MARK CONSISTS OF STANDARD CHARACTERS WITHOUT CLAIM TO ANY PARTICULAR FONT, STYLE, SIZE, OR COLOR.

SER. NO. 85-539,267, FILED 2-10-2012.

JOHN HWANG, EXAMINING ATTORNEY



David J. Kybas

Director of the United States Patent and Trademark Office

United States of America

United States Patent and Trademark Office

313Energy

Reg. No. 4,205,965

313ENERGY (MICHIGAN PARTNERSHIP)
31725 NOTTINGHAM DR
FRANKLIN, MI 48025

Registered Sep. 11, 2012

Int. Cl.: 32

FOR: ENERGY DRINKS, IN CLASS 32 (U.S. CLS. 45, 46 AND 48).

TRADEMARK

FIRST USE 1-19-2012; IN COMMERCE 2-9-2012.

PRINCIPAL REGISTER

THE MARK CONSISTS OF STANDARD CHARACTERS WITHOUT CLAIM TO ANY PARTICULAR FONT, STYLE, SIZE, OR COLOR.

SER. NO. 85-539,319, FILED 2-10-2012.

ANDREW LEASER, EXAMINING ATTORNEY



David J. Kybas

Director of the United States Patent and Trademark Office

United States of America

United States Patent and Trademark Office

PRIMARY CARE INSIGHT

Reg. No. 4,205,966

Registered Sep. 11, 2012

Int. Cl.: 41

SERVICE MARK

PRINCIPAL REGISTER

THE GENERAL HOSPITAL CORPORATION (MASSACHUSETTS CORPORATION)
32 FRUIT STREET
BOSTON, MA 02114

FOR: ON-LINE ELECTRONIC NEWSLETTERS DELIVERED BY E-MAIL IN THE FIELD OF PRIMARY HEALTH CARE; PROVIDING ON-LINE NEWSLETTERS IN THE FIELD OF PRIMARY HEALTH CARE; PROVIDING ON-LINE PUBLICATIONS IN THE NATURE OF ARTICLES AND REPORTS IN THE FIELD OF PRIMARY HEALTH CARE, IN CLASS 41 (U.S. CLS. 100, 101 AND 107).

FIRST USE 1-0-2012; IN COMMERCE 1-0-2012.

THE MARK CONSISTS OF STANDARD CHARACTERS WITHOUT CLAIM TO ANY PARTICULAR FONT, STYLE, SIZE, OR COLOR.

NO CLAIM IS MADE TO THE EXCLUSIVE RIGHT TO USE "PRIMARY CARE", APART FROM THE MARK AS SHOWN.

SER. NO. 85-539,332, FILED 2-10-2012.

ANDREW LEASER, EXAMINING ATTORNEY



David J. Kyros

Director of the United States Patent and Trademark Office

United States of America

United States Patent and Trademark Office

LIVE THE ADVANTAGED LIFE

Reg. No. 4,205,967

NEW TROPICANA HOLDINGS, INC. (DELAWARE CORPORATION)
8345 WEST SUNSET ROAD

Registered Sep. 11, 2012

LAS VEGAS, NV 89113

Int. Cls.: 35 and 41

FOR: ADMINISTRATION OF A CUSTOMER LOYALTY PROGRAM WHICH PROVIDES REPEAT CUSTOMERS WITH LOYALTY POINTS THAT ARE REDEEMABLE TOWARDS CASINO, HOTEL, BAR, AND RESTAURANT BENEFITS, IN CLASS 35 (U.S. CLS. 100, 101 AND 102).

SERVICE MARK

PRINCIPAL REGISTER

FIRST USE 7-1-2010; IN COMMERCE 7-1-2010.

FOR: PROVIDING CASINO SERVICES FEATURING A CASINO PLAYERS REWARDS PROGRAM, IN CLASS 41 (U.S. CLS. 100, 101 AND 107).

FIRST USE 7-1-2010; IN COMMERCE 7-1-2010.

THE MARK CONSISTS OF STANDARD CHARACTERS WITHOUT CLAIM TO ANY PARTICULAR FONT, STYLE, SIZE, OR COLOR.

SER. NO. 85-539,392, FILED 2-10-2012.

CORY BOONE, EXAMINING ATTORNEY



David J. Kybas

Director of the United States Patent and Trademark Office

United States of America

United States Patent and Trademark Office

SHELL RIDGE

Reg. No. 4,205,968

Registered Sep. 11, 2012

Int. Cl.: 33

TRADEMARK

PRINCIPAL REGISTER

LC TM HOLDING, LLC (DELAWARE LIMITED LIABILITY COMPANY)
LEGAL DEPARTMENT
421 AVIATION BLVD
SANTA ROSA, CA 95403

FOR: ALCOHOLIC BEVERAGES EXCEPT BEERS, IN CLASS 33 (U.S. CLS. 47 AND 49).

FIRST USE 1-15-2011; IN COMMERCE 1-15-2011.

THE MARK CONSISTS OF STANDARD CHARACTERS WITHOUT CLAIM TO ANY PARTICULAR FONT, STYLE, SIZE, OR COLOR.

SER. NO. 85-539,408, FILED 2-10-2012.

TINA L. SNAPP, EXAMINING ATTORNEY



David J. Kybas

Director of the United States Patent and Trademark Office

United States of America

United States Patent and Trademark Office

ARCANA ACADEMY

Reg. No. 4,205,969

ARCANA ACADEMY, LLC. (CALIFORNIA LIMITED LIABILITY COMPANY)
13323 WASHINGTON BOULEVARD, SUITE 301
LOS ANGELES, CA 90066

Registered Sep. 11, 2012

Int. Cl.: 35

FOR: ADVERTISING SERVICES, IN CLASS 35 (U.S. CLS. 100, 101 AND 102).

SERVICE MARK

FIRST USE 11-11-2011; IN COMMERCE 11-15-2011.

PRINCIPAL REGISTER

THE MARK CONSISTS OF STANDARD CHARACTERS WITHOUT CLAIM TO ANY PARTICULAR FONT, STYLE, SIZE, OR COLOR.

SER. NO. 85-539,454, FILED 2-10-2012.

ALEX KEAM, EXAMINING ATTORNEY



David J. Kybas

Director of the United States Patent and Trademark Office

United States of America

United States Patent and Trademark Office

Open Your Browser to a New Way of Doing Business

Reg. No. 4,205,970

PIC BUSINESS SYSTEMS, INC. (TEXAS CORPORATION)
5119 BECKWITH BLVD., #106
SAN ANTONIO, TX 78249

Registered Sep. 11, 2012

Int. Cl.: 42

FOR: PROVIDING ONLINE NON-DOWNLOADABLE ENTERPRISE RESOURCE PLANNING SOFTWARE FOR MANUFACTURERS FOR INVENTORY CONTROL, ORDER ENTRY, ACCOUNTS RECEIVABLE AND PAYABLE, GENERAL LEDGER, AND PURCHASING, IN CLASS 42 (U.S. CLS. 100 AND 101).

SERVICE MARK

PRINCIPAL REGISTER

FIRST USE 1-1-2005; IN COMMERCE 1-1-2005.

THE MARK CONSISTS OF STANDARD CHARACTERS WITHOUT CLAIM TO ANY PARTICULAR FONT, STYLE, SIZE, OR COLOR.

SER. NO. 85-539,486, FILED 2-10-2012.

ALEX KEAM, EXAMINING ATTORNEY



David J. Kybas

Director of the United States Patent and Trademark Office

United States of America

United States Patent and Trademark Office

Martine's Dream

Reg. No. 4,205,971

HARDY DEBBIE MARTINE (UNITED STATES INDIVIDUAL)
625 ST. MARKS AVE APT 1
BROOKLYN, NY 11216

Registered Sep. 11, 2012

Int. Cls.: 24 and 25

FOR: HOME GOODS, NAMELY, BEDSHEETS, THROWS, PILLOW COVERS, DRAPES, CURTAINS, TABLECLOTHS, MATS, CUSHION COVERS, TEXTILE WALL HANGINGS, FABRIC SHOWER CURTAINS, BLANKETS AND DUVET COVERS, IN CLASS 24 (U.S. CLS. 42 AND 50).

TRADEMARK

PRINCIPAL REGISTER

FIRST USE 5-4-2006; IN COMMERCE 4-5-2008.

FOR: CLOTHING, NAMELY, DRESSES, PANTS, JUMPSUITS, SHIRTS, BLOUSES, SKIRTS, SHORTS, SCARFS, PONCHOS, SHAWLS, T-SHIRTS, ROBES, PAJAMAS, SWIMWEAR, FABRIC BELTS, HATS, JACKETS, SLEEPWEAR, PULLOVERS, SWEATERS AND LEGGINGS, IN CLASS 25 (U.S. CLS. 22 AND 39).

FIRST USE 5-4-2006; IN COMMERCE 4-5-2008.

THE MARK CONSISTS OF MARTINE'S DREAM IN STYLIZED FONTS.

SER. NO. 85-539,487, FILED 2-10-2012.

ANNE E. GUSTASON, EXAMINING ATTORNEY



David J. Kyfos

Director of the United States Patent and Trademark Office

United States of America

United States Patent and Trademark Office



Reg. No. 4,205,972

Registered Sep. 11, 2012

Int. Cl.: 2

TRADEMARK

PRINCIPAL REGISTER

WAZANA BROTHERS INTERNATIONAL, INC. (CALIFORNIA CORPORATION), DBA
MICRO SOLUTIONS ENTERPRISES
8201 WOODLEY AVENUE
VAN NUYS, CA 91406

FOR: INK CARTRIDGES FOR PRINTERS; PHOTOCOPIER TONER IN CARTRIDGES; TONER
CARTRIDGES; TONER FOR COPIERS; TONERS, IN CLASS 2 (U.S. CLS. 6, 11 AND 16).

FIRST USE 12-1-2008; IN COMMERCE 12-1-2008.

NO CLAIM IS MADE TO THE EXCLUSIVE RIGHT TO USE "ISO 14001", APART FROM
THE MARK AS SHOWN.

THE MARK CONSISTS OF THE WORDING "ISO 14001" IN DARK LETTERS ON A LIGHT
BACKGROUND, ABOVE THE WORDING "ENVIRONMENTAL COMMITMENT" IN LIGHT
LETTERS ON A DARK BACKGROUND, ALL WITHIN A RECTANGULAR BORDER WITH
ROUNDED CORNERS.

SER. NO. 85-539,500, FILED 2-10-2012.

AMY KELLY, EXAMINING ATTORNEY



David J. Kyffers

Director of the United States Patent and Trademark Office

United States of America
United States Patent and Trademark Office

EASKOOT

Reg. No. 4,205,973

Registered Sep. 11, 2012

Int. Cl.: 33

TRADEMARK

PRINCIPAL REGISTER

SCHINDLER WEISSMAN CO., LLC (CALIFORNIA LIMITED LIABILITY COMPANY), DBA
WINEMONGER
164 SLEEPY HOLLOW DRIVE
SAN ANSELMO, CA 94960

FOR: WINE, IN CLASS 33 (U.S. CLS. 47 AND 49).

FIRST USE 10-9-2008; IN COMMERCE 10-9-2008.

THE MARK CONSISTS OF STANDARD CHARACTERS WITHOUT CLAIM TO ANY PARTICULAR FONT, STYLE, SIZE, OR COLOR.

SER. NO. 85-539,517, FILED 2-10-2012.

MARGERY A. TIERNEY, EXAMINING ATTORNEY



David J. Kybas

Director of the United States Patent and Trademark Office

United States of America

United States Patent and Trademark Office

TRUSTED AUTHORITY

Reg. No. 4,205,974

Registered Sep. 11, 2012

Int. Cls.: 9 and 41

TRADEMARK

SERVICE MARK

PRINCIPAL REGISTER

SIMPLEWEALTH INC. (CANADA CORPORATION)
SUITE 300, 1716 - 16 AVENUE NW
CALGARY, ALBERTA, CANADA T2M0L7

FOR: DIGITAL MATERIALS, NAMELY, DOWNLOADABLE AUDIO AND TEXT FILES FEATURING INFORMATION AND RESOURCES IN THE FIELD OF MARKETING AND ENTREPRENEURISM; DOWNLOADABLE ELECTRONIC NEWSLETTERS DELIVERED BY E-MAIL IN THE FIELD OF MARKETING AND ENTREPRENEURISM, IN CLASS 9 (U.S. CLS. 21, 23, 26, 36 AND 38).

FIRST USE 9-1-2010; IN COMMERCE 9-1-2010.

FOR: EDUCATION SERVICES, NAMELY, PROVIDING CLASSES, WORKSHOPS, SEMINARS, LECTURES, WEBINARS, TELESEMINARS, TRAINING AND PERSONAL AND PROFESSIONAL COACHING IN THE FIELD OF MARKETING AND ENTREPRENEURISM AND THE DISTRIBUTION OF COURSE AND TRAINING MATERIALS IN CONNECTION THEREWITH; ON-LINE JOURNALS, NAMELY, BLOGS IN THE FIELD OF MARKETING AND ENTREPRENEURISM; ON-LINE ELECTRONIC NEWSLETTERS DELIVERED BY E-MAIL IN THE FIELD OF MARKETING AND ENTREPRENEURISM, IN CLASS 41 (U.S. CLS. 100, 101 AND 107).

FIRST USE 9-1-2010; IN COMMERCE 9-1-2010.

THE MARK CONSISTS OF STANDARD CHARACTERS WITHOUT CLAIM TO ANY PARTICULAR FONT, STYLE, SIZE, OR COLOR.

SER. NO. 85-539,525, FILED 2-10-2012.

JULIE WATSON, EXAMINING ATTORNEY



David J. Kybas

Director of the United States Patent and Trademark Office

United States of America

United States Patent and Trademark Office

SUBWAY POS

Reg. No. 4,205,975

DOCTOR'S ASSOCIATES INC. (FLORIDA CORPORATION)
325 BIC DRIVE
MILFORD, CT 06461

Registered Sep. 11, 2012

Int. Cl.: 9

FOR: COMPUTER SOFTWARE FOR BUSINESS MANAGEMENT AND OFFICE AUTOMATION, IN CLASS 9 (U.S. CLS. 21, 23, 26, 36 AND 38).

TRADEMARK

FIRST USE 9-14-2011; IN COMMERCE 9-14-2011.

PRINCIPAL REGISTER

THE MARK CONSISTS OF STANDARD CHARACTERS WITHOUT CLAIM TO ANY PARTICULAR FONT, STYLE, SIZE, OR COLOR.

NO CLAIM IS MADE TO THE EXCLUSIVE RIGHT TO USE "POS", APART FROM THE MARK AS SHOWN.

SER. NO. 85-539,566, FILED 2-10-2012.

TARAH HARDY, EXAMINING ATTORNEY



David J. Kyffers

Director of the United States Patent and Trademark Office

United States of America

United States Patent and Trademark Office

LUE

Reg. No. 4,205,976

JERROD CORNISH (UNITED STATES INDIVIDUAL)
123 S SYCAMORE AVE
LOS ANGELES, CA 90036

Registered Sep. 11, 2012

Int. Cl.: 25

FOR: BOTTOMS; COATS FOR MEN AND WOMEN; FOOTWEAR FOR WOMEN; JACKETS; MEN'S AND WOMEN'S JACKETS, COATS, TROUSERS, VESTS; T-SHIRTS FOR MEN AND WOMEN; TOPS; WOMEN'S CLOTHING, NAMELY, SHIRTS, DRESSES, SKIRTS, BLOUSES, IN CLASS 25 (U.S. CLS. 22 AND 39).

TRADEMARK

PRINCIPAL REGISTER

FIRST USE 1-31-2012; IN COMMERCE 1-31-2012.

THE MARK CONSISTS OF STANDARD CHARACTERS WITHOUT CLAIM TO ANY PARTICULAR FONT, STYLE, SIZE, OR COLOR.

SER. NO. 85-539,594, FILED 2-10-2012.

BENJAMIN OKEKE, EXAMINING ATTORNEY



David J. Kybas

Director of the United States Patent and Trademark Office

United States of America

United States Patent and Trademark Office

PRIORITY 7

Reg. No. 4,205,977

Registered Sep. 11, 2012

Int. Cl.: 44

SERVICE MARK

PRINCIPAL REGISTER

GILSBAR, INC. (LOUISIANA CORPORATION)
2100 CONVINGTON CENTRE
COVINGTON, LA 70433

FOR: CONSULTING IN THE FIELD OF HEALTH AND WELLNESS TO BRING ABOUT PERSONAL HAPPINESS; CONSULTING SERVICES IN THE FIELD OF MENTAL HEALTH AND WELLNESS; COUNSELING SERVICES IN THE FIELDS OF HEALTH, HERBALISM, AND LIFESTYLE WELLNESS; HEALTH CARE SERVICES, NAMELY, WELLNESS PROGRAMS; HEALTH SPA SERVICES FOR HEALTH AND WELLNESS OF THE BODY AND SPIRIT; WELLNESS AND HEALTH-RELATED CONSULTING SERVICES, IN CLASS 44 (U.S. CLS. 100 AND 101).

FIRST USE 5-0-2009; IN COMMERCE 5-0-2009.

THE MARK CONSISTS OF STANDARD CHARACTERS WITHOUT CLAIM TO ANY PARTICULAR FONT, STYLE, SIZE, OR COLOR.

SER. NO. 85-539,660, FILED 2-10-2012.

ALLISON SCHRODY, EXAMINING ATTORNEY



David J. Kyffers

Director of the United States Patent and Trademark Office

United States of America

United States Patent and Trademark Office

Monster Drop

Reg. No. 4,205,978

BENCHMARK ENTERTAINMENT, L.C. (FLORIDA LIMITED LIABILITY COMPANY)
51 HYPOLUXO RD.

Registered Sep. 11, 2012

HYPOLUXO, FL 33462

Int. Cl.: 28

FOR: AMUSEMENT GAME MACHINES, IN CLASS 28 (U.S. CLS. 22, 23, 38 AND 50).

TRADEMARK

FIRST USE 1-1-2011; IN COMMERCE 1-1-2011.

PRINCIPAL REGISTER

THE MARK CONSISTS OF STANDARD CHARACTERS WITHOUT CLAIM TO ANY PARTICULAR FONT, STYLE, SIZE, OR COLOR.

SER. NO. 85-539,663, FILED 2-10-2012.

CHRISTINE MARTIN, EXAMINING ATTORNEY



David J. Kybas

Director of the United States Patent and Trademark Office

United States of America

United States Patent and Trademark Office

JBMR

Reg. No. 4,205,979

Registered Sep. 11, 2012

Int. Cl.: 16

AMERICAN SOCIETY FOR BONE AND MINERAL RESEARCH (MISSOURI NON-PROFIT CORPORATION), AKA ASBMR

#800

2025 M ST., NW

WASHINGTON, DC 20036

TRADEMARK

FOR: PUBLICATIONS, NAMELY, RESEARCH ANALYSES AND JOURNAL ARTICLES IN THE FIELDS OF SCIENCE, AND PARTICULARLY BONE AND MINERAL SCIENCE, IN CLASS 16 (U.S. CLS. 2, 5, 22, 23, 29, 37, 38 AND 50).

PRINCIPAL REGISTER

FIRST USE 1-1-1997; IN COMMERCE 1-1-1997.

THE MARK CONSISTS OF STANDARD CHARACTERS WITHOUT CLAIM TO ANY PARTICULAR FONT, STYLE, SIZE, OR COLOR.

SER. NO. 85-539,711, FILED 2-10-2012.

ANNE E. GUSTASON, EXAMINING ATTORNEY



David J. Kyffers

Director of the United States Patent and Trademark Office

United States of America

United States Patent and Trademark Office

ScanBot

Reg. No. 4,205,980

BRUHA ROBOTICS, INC. (DELAWARE CORPORATION)
19662 DORADO DR.

Registered Sep. 11, 2012

TRABUCO CANYON, CA 92679

Int. Cl.: 9

FOR: LASER SCANNERS FOR INDUSTRIAL INSPECTION; SCANNERS, IN CLASS 9 (U.S. CLS. 21, 23, 26, 36 AND 38).

TRADEMARK

FIRST USE 2-10-2012; IN COMMERCE 2-10-2012.

PRINCIPAL REGISTER

THE MARK CONSISTS OF STANDARD CHARACTERS WITHOUT CLAIM TO ANY PARTICULAR FONT, STYLE, SIZE, OR COLOR.

SER. NO. 85-539,712, FILED 2-10-2012.

DAVID I, EXAMINING ATTORNEY



David J. Kyfos

Director of the United States Patent and Trademark Office

United States of America

United States Patent and Trademark Office



Reg. No. 4,205,981

Registered Sep. 11, 2012

Int. Cl.: 41

SERVICE MARK

PRINCIPAL REGISTER

PICTOMETRY INTERNATIONAL CORP. (DELAWARE CORPORATION)
SUITE A
100 TOWN CENTRE DRIVE
ROCHESTER, NY 146234260

FOR: DIGITAL IMAGING SERVICES; AERIAL IMAGERY SERVICES; EDUCATIONAL SERVICES, NAMELY, CONDUCTING CONFERENCES AND WORKSHOPS IN THE FIELD OF GEO-REFERENCED, ORTHOGONAL, AND OBLIQUE AERIAL IMAGING, IN CLASS 41 (U.S. CLS. 100, 101 AND 107).

FIRST USE 10-22-2011; IN COMMERCE 10-22-2011.

THE MARK CONSISTS OF THE LETTER "P" AND FOUR COLORED GEOMETRIC SHAPES. THE GEOMETRIC SHAPES ARE POSITIONED AROUND THE LEFT PORTION OF THE "P".

SER. NO. 85-539,717, FILED 2-10-2012.

HENRY S. ZAK, EXAMINING ATTORNEY



David J. Kyffers

Director of the United States Patent and Trademark Office

United States of America

United States Patent and Trademark Office

POP PUTONPIECES

Reg. No. 4,205,982

Registered Sep. 11, 2012

Int. Cl.: 26

TRADEMARK

PRINCIPAL REGISTER

CELEBRITY SIGNATURES INTERNATIONAL, INC. (DELAWARE CORPORATION)
5900 EQUITABLE ROAD
KANSAS CITY, MO 64120

FOR: WIGS, HAIRPIECES, AND ADD-IN AND ADD-ON HAIR ACCESSORIES CONSTRUCTED PRIMARILY OF SYNTHETIC AND/OR HUMAN HAIR, IN CLASS 26 (U.S. CLS. 37, 39, 40, 42 AND 50).

FIRST USE 8-0-2005; IN COMMERCE 8-0-2005.

THE MARK CONSISTS OF STANDARD CHARACTERS WITHOUT CLAIM TO ANY PARTICULAR FONT, STYLE, SIZE, OR COLOR.

OWNER OF U.S. REG. NOS. 2,616,906 AND 3,943,778.

SER. NO. 85-539,719, FILED 2-10-2012.

EUGENIA MARTIN, EXAMINING ATTORNEY



David J. Kyffers

Director of the United States Patent and Trademark Office

United States of America

United States Patent and Trademark Office



Reg. No. 4,205,983

Registered Sep. 11, 2012

Int. Cl.: 2

TRADEMARK

PRINCIPAL REGISTER

WAZANA BROTHERS INTERNATIONAL, INC. (CALIFORNIA CORPORATION), DBA
MICRO SOLUTIONS ENTERPRISES
8201 WOODLEY AVENUE
VAN NUYS, CA 91406

FOR: FILLED INK CARTRIDGES; INK CARTRIDGES FOR PRINTERS; PHOTOCOPIER
TONER; TONER CARTRIDGES; TONER FOR COPIERS, IN CLASS 2 (U.S. CLS. 6, 11 AND
16).

FIRST USE 12-1-2008; IN COMMERCE 12-1-2008.

NO CLAIM IS MADE TO THE EXCLUSIVE RIGHT TO USE "ISO 14001", APART FROM
THE MARK AS SHOWN.

THE COLOR(S) GREEN AND WHITE IS/ARE CLAIMED AS A FEATURE OF THE MARK.

THE MARK CONSISTS OF THE WORDING "ISO 14001" IN GREEN LETTERS ON A WHITE
BACKGROUND, ABOVE THE WORDING "ENVIRONMENTAL COMMITMENT" IN WHITE
LETTERS ON A GREEN BACKGROUND, ALL WITHIN A GREEN RECTANGULAR BORDER
WITH ROUNDED CORNERS.

SER. NO. 85-539,740, FILED 2-10-2012.

AMY KELLY, EXAMINING ATTORNEY



David J. Kyjars

Director of the United States Patent and Trademark Office

United States of America

United States Patent and Trademark Office

Mama's Black Sheep

Reg. No. 4,205,984

Registered Sep. 11, 2012

Int. Cl.: 41

SERVICE MARK

PRINCIPAL REGISTER

MAMA'S BLACK SHEEP (MARYLAND PARTNERSHIP), AKA LAURA J. CERULLI AND
M. ASHLAND MILLER
P.O. BOX 42533
BALTIMORE, MD 21284

FOR: ENTERTAINMENT SERVICES IN THE NATURE OF LIVE MUSICAL PERFORMANCES,
IN CLASS 41 (U.S. CLS. 100, 101 AND 107).

FIRST USE 10-24-2008; IN COMMERCE 10-24-2008.

THE MARK CONSISTS OF STANDARD CHARACTERS WITHOUT CLAIM TO ANY PAR-
TICULAR FONT, STYLE, SIZE, OR COLOR.

SER. NO. 85-539,762, FILED 2-10-2012.

REBECCA GILBERT, EXAMINING ATTORNEY



David J. Kyffers

Director of the United States Patent and Trademark Office

United States of America

United States Patent and Trademark Office



Reg. No. 4,205,985

Registered Sep. 11, 2012

Int. Cls.: 36 and 37

SERVICE MARK

PRINCIPAL REGISTER

WILMORITE MANAGEMENT GROUP, LLC (NEW YORK LIMITED LIABILITY COMPANY)
1265 SCOTTSVILLE RD
ROCHESTER, NY 14624

FOR: REAL ESTATE LEASING AND MANAGEMENT, IN CLASS 36 (U.S. CLS. 100, 101 AND 102).

FIRST USE 4-30-2007; IN COMMERCE 2-5-2008.

FOR: REAL ESTATE DEVELOPMENT AND COMMERCIAL REAL ESTATE CONSTRUCTION, IN CLASS 37 (U.S. CLS. 100, 103 AND 106).

FIRST USE 4-30-2007; IN COMMERCE 2-5-2008.

THE MARK CONSISTS OF LIME GREEN, BROWN AND YELLOW OVAL SHAPES OVERLAID IN THE PATTERN OF A LEAF.

THE COLOR(S) LIME GREEN, BROWN AND YELLOW IS/ARE CLAIMED AS A FEATURE OF THE MARK.

SER. NO. 85-539,793, FILED 2-10-2012.

KRISTIN DAHLING, EXAMINING ATTORNEY



David J. Kybas

Director of the United States Patent and Trademark Office

United States of America

United States Patent and Trademark Office

HISTORY IN A GLASS

Reg. No. 4,205,986

Registered Sep. 11, 2012

Int. Cl.: 41

SERVICE MARK

PRINCIPAL REGISTER

JACKSON FAMILY FARMS, LLC (CALIFORNIA LIMITED LIABILITY COMPANY)
LEGAL DEPARTMENT
421 AVIATION BLVD
SANTA ROSA, CA 95403

FOR: ENTERTAINMENT SERVICES, NAMELY, WINE TASTINGS, IN CLASS 41 (U.S. CLS. 100, 101 AND 107).

FIRST USE 10-1-2009; IN COMMERCE 10-1-2009.

THE MARK CONSISTS OF STANDARD CHARACTERS WITHOUT CLAIM TO ANY PARTICULAR FONT, STYLE, SIZE, OR COLOR.

SER. NO. 85-539,802, FILED 2-10-2012.

PAM WILLIS, EXAMINING ATTORNEY



David J. Kyffers

Director of the United States Patent and Trademark Office

United States of America

United States Patent and Trademark Office

Slam-A-Winner

Reg. No. 4,205,987

BENCHMARK ENTERTAINMENT, L.C. (FLORIDA LIMITED LIABILITY COMPANY)
51 HYPOLUXO RD.
51 HYPOLUXO RD.
HYPOLUXO, FL 33462

Registered Sep. 11, 2012

Int. Cl.: 28

FOR: AMUSEMENT GAME MACHINES, IN CLASS 28 (U.S. CLS. 22, 23, 38 AND 50).

TRADEMARK

FIRST USE 3-1-2009; IN COMMERCE 3-1-2009.

PRINCIPAL REGISTER

THE MARK CONSISTS OF STANDARD CHARACTERS WITHOUT CLAIM TO ANY PARTICULAR FONT, STYLE, SIZE, OR COLOR.

SER. NO. 85-539,839, FILED 2-10-2012.

CHRISTINE MARTIN, EXAMINING ATTORNEY



David J. Kybas

Director of the United States Patent and Trademark Office

United States of America

United States Patent and Trademark Office

REXTON

Reg. No. 4,205,988

SIEMENS MEDICAL INSTRUMENTS PTE. LTD. (SINGAPORE CORPORATION)
BLOCK 28, AYER RAJAH CRESCENT NO. 06-08
SINGAPORE, SINGAPORE

Registered Sep. 11, 2012

Int. Cl.: 10

FOR: MEDICAL HEARING AIDS AND PARTS THEREOF, IN CLASS 10 (U.S. CLS. 26, 39 AND 44).

TRADEMARK

FIRST USE 3-0-2009; IN COMMERCE 3-0-2009.

PRINCIPAL REGISTER

THE MARK CONSISTS OF STANDARD CHARACTERS WITHOUT CLAIM TO ANY PARTICULAR FONT, STYLE, SIZE, OR COLOR.

SER. NO. 85-539,850, FILED 2-10-2012.

MARC LEIPZIG, EXAMINING ATTORNEY



David J. Kybas

Director of the United States Patent and Trademark Office

United States of America

United States Patent and Trademark Office

RiteLend

Reg. No. 4,205,989

Registered Sep. 11, 2012

Int. Cl.: 36

SERVICE MARK

PRINCIPAL REGISTER

RITE LEND, INC. (WYOMING CORPORATION)
2040 MAIN STREET, SUITE 820
IRVINE, CA 92614

FOR: MORTGAGE BANKING SERVICES, NAMELY, ORIGINATION, ACQUISITION, SERVICING, SECURITIZATION AND BROKERAGE OF MORTGAGE LOANS, IN CLASS 36 (U.S. CLS. 100, 101 AND 102).

FIRST USE 9-1-2010; IN COMMERCE 9-1-2010.

THE MARK CONSISTS OF STANDARD CHARACTERS WITHOUT CLAIM TO ANY PARTICULAR FONT, STYLE, SIZE, OR COLOR.

SER. NO. 85-539,859, FILED 2-10-2012.

JANICE L. MCMORROW, EXAMINING ATTORNEY



David J. Kybas

Director of the United States Patent and Trademark Office

United States of America

United States Patent and Trademark Office

SYSTRONIX

Reg. No. 4,205,990

Registered Sep. 11, 2012

Int. Cl.: 9

TRADEMARK

PRINCIPAL REGISTER

SYSTRONIX, INC. (UTAH CORPORATION)
939 EDISON STREET
SALT LAKE CITY, UT 841114216

FOR: COMPUTER HARDWARE AND INDUSTRIAL CONTROL SYSTEMS, NAMELY, EMBEDDED CONTROL SYSTEMS, RAPID DEVELOPMENT HARDWARE FOR EMBEDDED CONTROL SYSTEMS AND CUSTOMIZED OEM CONTROL SYSTEMS, EMBEDDED CONTROL OEM SYSTEMS, EXPANSION BOARDS INCLUDING MEZZANINE BOARDS, READY-TO-USE ENCLOSURES, KEYPADS, LCDS, CABLES, SOCKET ADAPTERS TO ALLOW USE OF A CONTROLLER WITH A DIFFERING SOCKET, AND PROGRAMMERS FOR MICRO-PROCESSORS, ALL SOLD PRIMARILY VIA DIRECT SALES TO USERS, IN CLASS 9 (U.S. CLS. 21, 23, 26, 36 AND 38).

FIRST USE 0-0-1990; IN COMMERCE 0-0-1990.

THE MARK CONSISTS OF STANDARD CHARACTERS WITHOUT CLAIM TO ANY PARTICULAR FONT, STYLE, SIZE, OR COLOR.

OWNER OF U.S. REG. NO. 1,739,552.

SER. NO. 85-539,872, FILED 2-10-2012.

CHRIS WELLS, EXAMINING ATTORNEY



David J. Kypos

Director of the United States Patent and Trademark Office

United States of America

United States Patent and Trademark Office

GET STEWART

Reg. No. 4,205,991

DAVID W. STEWART (UNITED STATES INDIVIDUAL)
931 S. RANGELINE ROAD
CARMEL, IN 46032

Registered Sep. 11, 2012

Int. Cl.: 45

FOR: LEGAL SERVICES, IN CLASS 45 (U.S. CLS. 100 AND 101).

SERVICE MARK

FIRST USE 10-0-2007; IN COMMERCE 10-0-2007.

PRINCIPAL REGISTER

THE MARK CONSISTS OF STANDARD CHARACTERS WITHOUT CLAIM TO ANY PARTICULAR FONT, STYLE, SIZE, OR COLOR.

SER. NO. 85-539,900, FILED 2-10-2012.

CURTIS FRENCH, EXAMINING ATTORNEY



David J. Kybas

Director of the United States Patent and Trademark Office

United States of America

United States Patent and Trademark Office

SENSOTHERAPY

Reg. No. 4,205,992

Registered Sep. 11, 2012

Int. Cl.: 5

TRADEMARK

PRINCIPAL REGISTER

SENSOTHERAPY PRODUCTS, LLC (TEXAS LIMITED LIABILITY COMPANY)
SUITE 201
607 WEST MAGNOLIA AVE.
FORT WORTH, TX 76104

FOR: THERAPEUTIC AGENTS FOR WEIGHT CONTROL AND APPETITE SUPPRESSION;
WEIGHT MANAGEMENT SUPPLEMENTS, IN CLASS 5 (U.S. CLS. 6, 18, 44, 46, 51 AND 52).

FIRST USE 1-1-2007; IN COMMERCE 1-1-2007.

THE MARK CONSISTS OF STANDARD CHARACTERS WITHOUT CLAIM TO ANY PARTICULAR FONT, STYLE, SIZE, OR COLOR.

SER. NO. 85-539,921, FILED 2-10-2012.

SHAILA SETTLES, EXAMINING ATTORNEY



David J. Kyjars

Director of the United States Patent and Trademark Office

United States of America
United States Patent and Trademark Office

geeklist

Reg. No. 4,205,993

GEEKLIST, INC. (DELAWARE CORPORATION)
7825 FAY AVE., SUITE 200
LA JOLLA, CA 92037

Registered Sep. 11, 2012

Int. Cls.: 35, 42 and 45

FOR: ONLINE BUSINESS NETWORKING SERVICES, IN CLASS 35 (U.S. CLS. 100, 101 AND 102).

SERVICE MARK

FIRST USE 4-8-2011; IN COMMERCE 4-8-2011.

PRINCIPAL REGISTER

FOR: COMPUTER SERVICES, NAMELY, CREATING AN ON-LINE COMMUNITY FOR REGISTERED USERS TO PARTICIPATE IN DISCUSSIONS, GET FEEDBACK FROM THEIR PEERS, FORM VIRTUAL COMMUNITIES, AND ENGAGE IN SOCIAL NETWORKING SERVICES IN THE FIELD OF COMPUTER CODE DEVELOPERS, WEB SITE DEVELOPERS, COMPUTER SOFTWARE DEVELOPERS; COMPUTER SERVICES, NAMELY, PROVIDING A SEARCH ENGINE TO ALLOW USERS TO SEARCH CONTENT OF WEB SITE FOR PEOPLE WITH SPECIFIC EXPERIENCE, IN CLASS 42 (U.S. CLS. 100 AND 101).

FIRST USE 4-8-2011; IN COMMERCE 4-8-2011.

FOR: PROVIDING INFORMATION IN THE FIELD OF PERSONAL DEVELOPMENT AND ACHIEVEMENTS; ON-LINE SOCIAL NETWORKING SERVICES, IN CLASS 45 (U.S. CLS. 100 AND 101).

FIRST USE 4-8-2011; IN COMMERCE 4-8-2011.

THE MARK CONSISTS OF THE WORD GEEKLIST IN LOWER CASE LETTERS WITH A PERIOD BETWEEN THE "I" AND "S".

SER. NO. 85-539,938, FILED 2-10-2012.

CHERYL CLAYTON, EXAMINING ATTORNEY



David J. Kybas

Director of the United States Patent and Trademark Office

United States of America

United States Patent and Trademark Office



Reg. No. 4,205,994

GEEKLIST, INC. (DELAWARE CORPORATION)
7825 FAY AVE., SUITE 200
LA JOLLA, CA 92037

Registered Sep. 11, 2012

Int. Cls.: 35, 42 and 45

FOR: ONLINE BUSINESS NETWORKING SERVICES, IN CLASS 35 (U.S. CLS. 100, 101 AND 102).

SERVICE MARK

FIRST USE 4-8-2011; IN COMMERCE 4-8-2011.

PRINCIPAL REGISTER

FOR: COMPUTER SERVICES, NAMELY, CREATING AN ON-LINE COMMUNITY FOR REGISTERED USERS TO PARTICIPATE IN DISCUSSIONS, GET FEEDBACK FROM THEIR PEERS, FORM VIRTUAL COMMUNITIES, AND ENGAGE IN SOCIAL NETWORKING SERVICES IN THE FIELD OF COMPUTER CODE DEVELOPERS, WEB SITE DEVELOPERS, COMPUTER SOFTWARE DEVELOPERS; COMPUTER SERVICES, NAMELY, PROVIDING A SEARCH ENGINE TO ALLOW USERS TO SEARCH CONTENT OF WEB SITE FOR PEOPLE WITH SPECIFIC EXPERIENCE, IN CLASS 42 (U.S. CLS. 100 AND 101).

FIRST USE 4-8-2011; IN COMMERCE 4-8-2011.

FOR: PROVIDING INFORMATION IN THE FIELD OF PERSONAL DEVELOPMENT AND ACHIEVEMENTS; ON-LINE SOCIAL NETWORKING SERVICES, IN CLASS 45 (U.S. CLS. 100 AND 101).

FIRST USE 4-8-2011; IN COMMERCE 4-8-2011.

THE MARK CONSISTS OF A BLACK FILLED CIRCLE WITH THE LETTERS GG IN LOWER CASE BACK TO BACK IN WHITE.

SER. NO. 85-539,963, FILED 2-10-2012.

CHERYL CLAYTON, EXAMINING ATTORNEY



David J. Kybas

Director of the United States Patent and Trademark Office

United States of America

United States Patent and Trademark Office



GatherCraft

Reg. No. 4,205,995

Registered Sep. 11, 2012

Int. Cl.: 20

TRADEMARK

PRINCIPAL REGISTER

JMH TRADING COMPANY INTERNATIONAL (TEXAS LIMITED LIABILITY COMPANY),
DBA GATHERCRAFT
7376 BRAYS LANDING
EL PASO, TX 79911

FOR: FURNITURE; OUTDOOR FURNITURE; PATIO FURNITURE, IN CLASS 20 (U.S. CLS. 2, 13, 22, 25, 32 AND 50).

FIRST USE 7-1-2011; IN COMMERCE 7-1-2011.

THE MARK CONSISTS OF THE STYLIZED WORD "GATHERCRAFT" CENTERED BELOW A DRAWING OF TWO INCOMPLETE CONCENTRIC CIRCLES OPEN TO THE RIGHT WITH THE BOTTOM END POINT OF THE OUTSIDE CIRCLE FORMED INTO A LEAF REPRESENTING THE LETTERS "GC".

SER. NO. 85-539,968, FILED 2-10-2012.

LINDA M. KING, EXAMINING ATTORNEY



David J. Kybas

Director of the United States Patent and Trademark Office

United States of America

United States Patent and Trademark Office

INNER BEAUTY IS SUSTAINABLE

Reg. No. 4,205,996

INSIDE OUT SALON (CALIFORNIA CORPORATION)
6683 LEXINGTON AVENUE
LOS ANGELES, CA 90038

Registered Sep. 11, 2012

Int. Cl.: 44

FOR: HAIR SALON SERVICES; HAIR STYLING; BEAUTY SALON SERVICES, IN CLASS 44 (U.S. CLS. 100 AND 101).

SERVICE MARK

FIRST USE 4-15-2009; IN COMMERCE 6-10-2010.

PRINCIPAL REGISTER

THE MARK CONSISTS OF STANDARD CHARACTERS WITHOUT CLAIM TO ANY PARTICULAR FONT, STYLE, SIZE, OR COLOR.

SER. NO. 85-540,004, FILED 2-10-2012.

YAT SYE, LEE, EXAMINING ATTORNEY



David J. Kyffers

Director of the United States Patent and Trademark Office

United States of America

United States Patent and Trademark Office

DAILY ECLIPSE

Reg. No. 4,205,997

DERMAMED SOLUTIONS, LLC (PENNSYLVANIA LIMITED LIABILITY COMPANY)
394 PARKMOUNT ROAD
LENNI, PA 19052

Registered Sep. 11, 2012

Int. Cl.: 3

FOR: SUN BLOCK; SUN-BLOCK LOTIONS, IN CLASS 3 (U.S. CLS. 1, 4, 6, 50, 51 AND 52).

FIRST USE 10-14-2002; IN COMMERCE 10-14-2002.

TRADEMARK

THE MARK CONSISTS OF STANDARD CHARACTERS WITHOUT CLAIM TO ANY PARTICULAR FONT, STYLE, SIZE, OR COLOR.

PRINCIPAL REGISTER

SER. NO. 85-540,006, FILED 2-10-2012.

YAT SYE, LEE, EXAMINING ATTORNEY



David J. Kyffers

Director of the United States Patent and Trademark Office

United States of America

United States Patent and Trademark Office

IUNA

Reg. No. 4,205,998

Registered Sep. 11, 2012

Int. Cl.: 41

SERVICE MARK

PRINCIPAL REGISTER

INTERNATIONAL UNIVERSITY OF NORTH AMERICA, INC. (CALIFORNIA CORPORATION)
3333 BOWERS AVE. #130
SANTA CLARA, CA 95054

FOR: EDUCATION SERVICES, NAMELY, PROVIDING ON-LINE CLASSES IN THE FIELD OF BUSINESS AND MANAGEMENT, EDUCATION, HEALTHCARE ADMINISTRATION, AND INFORMATION TECHNOLOGY; EDUCATIONAL SERVICES, NAMELY, CONDUCTING DISTANCE LEARNING INSTRUCTION AT THE UNIVERSITY LEVEL; EDUCATIONAL SERVICES, NAMELY, CONDUCTING ONLINE MASTER'S DEGREE AND CONTINUING EDUCATION CLASSES IN THE FIELDS OF BUSINESS AND MANAGEMENT, EDUCATION, HEALTHCARE ADMINISTRATION, AND INFORMATION TECHNOLOGY AND DISTRIBUTION OF TRAINING MATERIALS IN CONNECTION THEREWITH, IN CLASS 41 (U.S. CLS. 100, 101 AND 107).

FIRST USE 1-23-2012; IN COMMERCE 1-23-2012.

THE MARK CONSISTS OF STANDARD CHARACTERS WITHOUT CLAIM TO ANY PARTICULAR FONT, STYLE, SIZE, OR COLOR.

SER. NO. 85-540,011, FILED 2-10-2012.

APRIL ROACH, EXAMINING ATTORNEY



David J. Kyros

Director of the United States Patent and Trademark Office

United States of America

United States Patent and Trademark Office

Hips On Deck

Reg. No. 4,205,999

HODGE, ANDRES DOMINIC JR. (UNITED STATES INDIVIDUAL), DBA HIPS ON DECK
P.O. BOX 8471
PITTSBURG, CA 94565

Registered Sep. 11, 2012

Int. Cl.: 16

FOR: GENERAL FEATURE MAGAZINE IN THE FIELD OF MEN'S ENTERTAINMENT, IN CLASS 16 (U.S. CLS. 2, 5, 22, 23, 29, 37, 38 AND 50).

TRADEMARK

FIRST USE 1-1-2008; IN COMMERCE 12-1-2010.

PRINCIPAL REGISTER

THE MARK CONSISTS OF STANDARD CHARACTERS WITHOUT CLAIM TO ANY PARTICULAR FONT, STYLE, SIZE, OR COLOR.

SER. NO. 85-540,034, FILED 2-10-2012.

LAURIE KAUFMAN, EXAMINING ATTORNEY



David J. Kybas

Director of the United States Patent and Trademark Office

United States of America

United States Patent and Trademark Office

ENDURING WILDS

Reg. No. 4,206,000

IGT (NEVADA CORPORATION)
9295 PROTOTYPE DRIVE
RENO, NV 895218986

Registered Sep. 11, 2012

Int. Cl.: 28

FOR: A FEATURE OF GAMING MACHINES, NAMELY, DEVICES WHICH ACCEPT A WAGER, IN CLASS 28 (U.S. CLS. 22, 23, 38 AND 50).

TRADEMARK

FIRST USE 11-29-2011; IN COMMERCE 11-29-2011.

PRINCIPAL REGISTER

THE MARK CONSISTS OF STANDARD CHARACTERS WITHOUT CLAIM TO ANY PARTICULAR FONT, STYLE, SIZE, OR COLOR.

OWNER OF U.S. REG. NOS. 3,471,939, 4,019,959, AND 4,028,724.

SER. NO. 85-540,042, FILED 2-10-2012.

ERIN FALK, EXAMINING ATTORNEY



David J. Kybas

Director of the United States Patent and Trademark Office

United States of America

United States Patent and Trademark Office



RiteLend

Reg. No. 4,206,001

RITE LEND, INC. (WYOMING CORPORATION)
2040 MAIN STREET, SUITE 820
IRVINE, CA 92614

Registered Sep. 11, 2012

Int. Cl.: 36

FOR: MORTGAGE BANKING SERVICES, NAMELY, ORIGINATION, ACQUISITION, SERVICING, SECURITIZATION AND BROKERAGE OF MORTGAGE LOANS, IN CLASS 36 (U.S. CLS. 100, 101 AND 102).

SERVICE MARK

FIRST USE 9-1-2010; IN COMMERCE 9-1-2010.

PRINCIPAL REGISTER

THE MARK CONSISTS OF STYLIZED R WITH A CIRCLE AROUND IT, VERTICAL SEPARATION LINE, RITELEND.

SER. NO. 85-540,068, FILED 2-10-2012.

JANICE L. MCMORROW, EXAMINING ATTORNEY



David J. Kybas

Director of the United States Patent and Trademark Office

United States of America

United States Patent and Trademark Office

STEINS & VINES

Reg. No. 4,206,002

STEINS AND VINES (SOUTH DAKOTA SOLE PROPRIETORSHIP)
2307 W MADISON
SIOUX FALLS, SD 57104

Registered Sep. 11, 2012

Int. Cl.: 35

FOR: RETAIL STORE SERVICES FEATURING HOME BREWING SUPPLIES AND INGREDIENTS AND GARDEN SUPPLIES, IN CLASS 35 (U.S. CLS. 100, 101 AND 102).

SERVICE MARK

FIRST USE 6-1-2010; IN COMMERCE 6-1-2010.

PRINCIPAL REGISTER

THE MARK CONSISTS OF STANDARD CHARACTERS WITHOUT CLAIM TO ANY PARTICULAR FONT, STYLE, SIZE, OR COLOR.

SER. NO. 85-540,079, FILED 2-10-2012.

ZACHARY BELLO, EXAMINING ATTORNEY



David J. Kybas

Director of the United States Patent and Trademark Office

United States of America

United States Patent and Trademark Office

Vital Movement

Reg. No. 4,206,003

Registered Sep. 11, 2012

Int. Cl.: 41

SERVICE MARK

PRINCIPAL REGISTER

BERNARD, A SEBASTIAN (UNITED STATES INDIVIDUAL)
PO BOX 941
PO BOX 941
NEW YORK, NY 10113

FOR: PHYSICAL FITNESS INSTRUCTION AND CONSULTATION WORKSHOPS AND CLASSES WITH EMPHASIS ON THE INTEGRATION OF MENTAL AND PHYSICAL AWARENESS, IN CLASS 41 (U.S. CLS. 100, 101 AND 107).

FIRST USE 3-24-2001; IN COMMERCE 3-24-2001.

THE MARK CONSISTS OF STANDARD CHARACTERS WITHOUT CLAIM TO ANY PARTICULAR FONT, STYLE, SIZE, OR COLOR.

SER. NO. 85-540,086, FILED 2-10-2012.

ZACHARY BELLO, EXAMINING ATTORNEY



David J. Kyffers

Director of the United States Patent and Trademark Office

United States of America

United States Patent and Trademark Office

SDAR

Reg. No. 4,206,004

SAN DIEGO ASSOCIATION OF REALTORS (CALIFORNIA CORPORATION)
4845 RONSON COURT
SAN DIEGO, CA 92111

Registered Sep. 11, 2012

Int. Cls.: 35 and 41

FOR: TRADE ASSOCIATION SERVICES, NAMELY, PROMOTING AND SERVING THE INTERESTS OF REAL ESTATE AGENTS AND BROKERS, IN CLASS 35 (U.S. CLS. 100, 101 AND 102).

SERVICE MARK

FIRST USE 3-7-1991; IN COMMERCE 3-7-1991.

PRINCIPAL REGISTER

FOR: EDUCATION AND TRAINING SERVICES, NAMELY, PROVIDING PROGRAMS IN THE FIELD OF REAL ESTATE, IN CLASS 41 (U.S. CLS. 100, 101 AND 107).

FIRST USE 3-7-1991; IN COMMERCE 3-7-1991.

THE MARK CONSISTS OF STANDARD CHARACTERS WITHOUT CLAIM TO ANY PARTICULAR FONT, STYLE, SIZE, OR COLOR.

SER. NO. 85-540,087, FILED 2-10-2012.

KIM MONINGHOFF, EXAMINING ATTORNEY



David J. Kybas

Director of the United States Patent and Trademark Office

United States of America

United States Patent and Trademark Office

SEATTLE HI-FI

Reg. No. 4,206,005

Registered Sep. 11, 2012

Int. Cls.: 35 and 37

SERVICE MARK

PRINCIPAL REGISTER

GOODMAN, BURT (WASHINGTON SOLE PROPRIETORSHIP), DBA SEATTLE HI-FI
1110 R ST NW
AUBURN, WA 980013848

FOR: ON-LINE RETAIL STORE SERVICES FEATURING AUDIO EQUIPMENT, TELEVISION, DVD AND VIDEO EQUIPMENT, HOME THEATERS, CONSUMER ELECTRONICS, MOBILE ELECTRONICS, COMPUTERS, COMPUTER NETWORKS, COMMUNICATIONS EQUIPMENT, HOME AND MOBILE ENTERTAINMENT EQUIPMENT, CONVERGENCE APPLIANCES, AND SOFTWARE FOR USE IN STORING AND DISPLAYING MULTI-MEDIA PROGRAMS AND SUBSCRIPTIONS TO INFORMATION MEDIA PACKAGES, IN CLASS 35 (U.S. CLS. 100, 101 AND 102).

FIRST USE 6-30-2000; IN COMMERCE 12-2-2003.

FOR: INSTALLATION, MAINTENANCE AND REPAIR OF AUDIO EQUIPMENT, TELEVISION, DVD AND VIDEO EQUIPMENT, AND HOME THEATERS, CONSUMER ELECTRONICS, MOBILE ELECTRONICS, COMPUTERS, COMPUTER NETWORKS, COMMUNICATIONS EQUIPMENT, HOME ENTERTAINMENT EQUIPMENT, AND CONVERGENCE APPLIANCES, IN CLASS 37 (U.S. CLS. 100, 103 AND 106).

FIRST USE 6-30-2000; IN COMMERCE 12-2-2003.

THE MARK CONSISTS OF STANDARD CHARACTERS WITHOUT CLAIM TO ANY PARTICULAR FONT, STYLE, SIZE, OR COLOR.

SEC. 2(F).

SER. NO. 85-540,094, FILED 2-10-2012.

ZACHARY BELLO, EXAMINING ATTORNEY



David J. Kypos

Director of the United States Patent and Trademark Office

United States of America

United States Patent and Trademark Office

POLAR POLE

Reg. No. 4,206,006

Registered Sep. 11, 2012

Int. Cl.: 30

TRADEMARK

PRINCIPAL REGISTER

RICH ICE CREAM COMPANY, INC. (FLORIDA CORPORATION)
2915 S. DIXIE HIGHWAY
WEST PALM BEACH, FL 33405

FOR: ICE CREAM AND FROZEN CONFECTIONS, IN CLASS 30 (U.S. CL. 46).

FIRST USE 2-26-1999; IN COMMERCE 4-25-2000.

THE MARK CONSISTS OF STANDARD CHARACTERS WITHOUT CLAIM TO ANY PARTICULAR FONT, STYLE, SIZE, OR COLOR.

SER. NO. 85-540,104, FILED 2-10-2012.

BRIDGETT SMITH, EXAMINING ATTORNEY



David J. Kyffers

Director of the United States Patent and Trademark Office

United States of America

United States Patent and Trademark Office

MR. G'S

Reg. No. 4,206,007

Registered Sep. 11, 2012

Int. Cl.: 30

TRADEMARK

PRINCIPAL REGISTER

GHIRINGHELLI BROTHERS PIZZA INC. (CALIFORNIA CORPORATION)
14000 SAN PABLO AVENUE
SAN PABLO, CA 94806

FOR: GARLIC SAUCE, IN CLASS 30 (U.S. CL. 46).

FIRST USE 3-16-2001; IN COMMERCE 5-14-2002.

THE MARK CONSISTS OF STANDARD CHARACTERS WITHOUT CLAIM TO ANY PARTICULAR FONT, STYLE, SIZE, OR COLOR.

SER. NO. 85-540,115, FILED 2-10-2012.

SAMUEL E. SHARPER JR., EXAMINING ATTORNEY



David J. Kyffers

Director of the United States Patent and Trademark Office

United States of America

United States Patent and Trademark Office

ANY DISPUTE, ANYWHERE IN
THE WORLD

Reg. No. 4,206,008

ADLI LAW GROUP P.C. (CALIFORNIA CORPORATION)
633 WEST FIFTH STREET, SUITE 6900
LOS ANGELES, CA 90071

Registered Sep. 11, 2012

Int. Cl.: 45

FOR: LEGAL SERVICES, IN CLASS 45 (U.S. CLS. 100 AND 101).

SERVICE MARK

FIRST USE 11-30-2011; IN COMMERCE 11-30-2011.

PRINCIPAL REGISTER

THE MARK CONSISTS OF STANDARD CHARACTERS WITHOUT CLAIM TO ANY PARTICULAR FONT, STYLE, SIZE, OR COLOR.

SER. NO. 85-540,141, FILED 2-10-2012.

BRIDGETT SMITH, EXAMINING ATTORNEY



David J. Kybas

Director of the United States Patent and Trademark Office

United States of America

United States Patent and Trademark Office

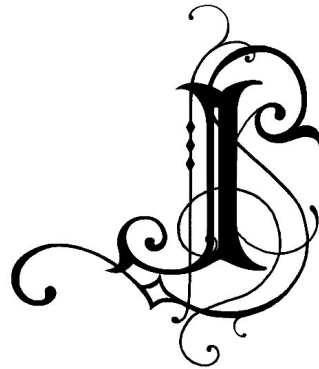

Reg. No. 4,206,009

Registered Sep. 11, 2012

Int. Cl.: 33

TRADEMARK

PRINCIPAL REGISTER

JACKSON WINE ESTATES INTERNATIONAL LIMITED (IRELAND CORPORATION)
CHERRYWOOD BUSINESS PARK BUILDING D
LOUGHLINSTOWN, DUBLIN, IRELAND

FOR: ALCOHOLIC BEVERAGES EXCEPT BEERS, IN CLASS 33 (U.S. CLS. 47 AND 49).

FIRST USE 1-1-2010; IN COMMERCE 1-1-2010.

OWNER OF U.S. REG. NO. 3,219,811.

THE MARK CONSISTS OF A STYLIZED LETTER J.

SER. NO. 85-540,155, FILED 2-10-2012.

CARYN GLASSER, EXAMINING ATTORNEY



David J. Kyffers

Director of the United States Patent and Trademark Office

United States of America

United States Patent and Trademark Office



Reg. No. 4,206,010

Registered Sep. 11, 2012

Int. Cl.: 35

SERVICE MARK

PRINCIPAL REGISTER

NATURAL WONDERS GALLERY, INC. (NEVADA CORPORATION)
SUITE 200
800 BELLEVUE WAY NE
BELLEVUE, WA 98004

FOR: ART GALLERY SERVICES; ON-LINE ART GALLERIES, IN CLASS 35 (U.S. CLS. 100, 101 AND 102).

FIRST USE 12-1-2011; IN COMMERCE 12-1-2011.

THE MARK CONSISTS OF A TREE BRANCH WITH LEAVES AND FLOWERS.

SER. NO. 85-540,162, FILED 2-10-2012.

RON FAIRBANKS, EXAMINING ATTORNEY



David J. Kybas

Director of the United States Patent and Trademark Office

United States of America

United States Patent and Trademark Office

Inspired By Nature, Defined By The Collector

Reg. No. 4,206,011

Registered Sep. 11, 2012

Int. Cl.: 35

SERVICE MARK

PRINCIPAL REGISTER

NATURAL WONDERS GALLERY, INC. (NEVADA CORPORATION)
SUITE 200
800 BELLEVUE WAY NE
BELLEVUE, WA 98004

FOR: ART GALLERIES; ON-LINE ART GALLERIES, IN CLASS 35 (U.S. CLS. 100, 101 AND 102).

FIRST USE 11-1-2010; IN COMMERCE 11-1-2010.

THE MARK CONSISTS OF STANDARD CHARACTERS WITHOUT CLAIM TO ANY PARTICULAR FONT, STYLE, SIZE, OR COLOR.

SER. NO. 85-540,165, FILED 2-10-2012.

RON FAIRBANKS, EXAMINING ATTORNEY



David J. Kyffers

Director of the United States Patent and Trademark Office

United States of America

United States Patent and Trademark Office

Rockin' with the Ages

Reg. No. 4,206,012

Registered Sep. 11, 2012

Int. Cl.: 41

SERVICE MARK

PRINCIPAL REGISTER

GOLDBERG, JACKIE (UNITED STATES INDIVIDUAL), AKA THE PINK LADY
#100F
23241 VENTURA BOULEVARD
WOODLAND HILLS, CA 91364

FOR: ENTERTAINMENT IN THE NATURE OF VISUAL AND AUDIO PERFORMANCES,
AND MUSICAL, VARIETY, NEWS AND COMEDY SHOWS; ENTERTAINMENT, NAMELY,
LIVE MUSIC CONCERTS; ENTERTAINMENT, NAMELY, PRODUCTION OF MUSICAL
SHOWS, IN CLASS 41 (U.S. CLS. 100, 101 AND 107).

FIRST USE 7-1-2009; IN COMMERCE 7-1-2009.

THE MARK CONSISTS OF STANDARD CHARACTERS WITHOUT CLAIM TO ANY PAR-
TICULAR FONT, STYLE, SIZE, OR COLOR.

SER. NO. 85-540,199, FILED 2-11-2012.

ASMAT KHAN, EXAMINING ATTORNEY



David J. Kyffers

Director of the United States Patent and Trademark Office

United States of America

United States Patent and Trademark Office

Plumrocket

Reg. No. 4,206,013

PLUMROCKET INC (NEW YORK CORPORATION)

Registered Sep. 11, 2012

P.O. BOX 286293
NEW YORK, NY 10128

Int. Cl.: 42

FOR: BUILDING AND MAINTAINING WEBSITES, IN CLASS 42 (U.S. CLS. 100 AND 101).

SERVICE MARK

FIRST USE 5-26-2010; IN COMMERCE 5-26-2010.

PRINCIPAL REGISTER

THE MARK CONSISTS OF STANDARD CHARACTERS WITHOUT CLAIM TO ANY PARTICULAR FONT, STYLE, SIZE, OR COLOR.

SER. NO. 85-540,202, FILED 2-11-2012.

ASMAT KHAN, EXAMINING ATTORNEY



David J. Kyffers

Director of the United States Patent and Trademark Office

United States of America

United States Patent and Trademark Office



Reg. No. 4,206,014

Registered Sep. 11, 2012

Int. Cl.: 37

SERVICE MARK

PRINCIPAL REGISTER

GVI GUTTER-VAC INTERNATIONAL PTY LTD (ARUBA PROPRIETARY LIMITED COMPANY), DBA G-VAC
50 MAWARRA STREET
ALBION, AUSTRALIA QLD4010

FOR: CLEANING SERVICES, NAMELY, CLEANING OF RESIDENTIAL AND COMMERCIAL PROPERTIES, IN CLASS 37 (U.S. CLS. 100, 103 AND 106).

FIRST USE 8-23-2010; IN COMMERCE 8-23-2010.

OWNER OF U.S. REG. NO. 3,946,157.

THE MARK CONSISTS OF THE STYLIZED WORDING OF "G-VAC" WITH A LINE DRAWING OF A ROOF TOP WITH A CHIMNEY OVER THE "VAC" LETTERS.

SER. NO. 85-540,207, FILED 2-11-2012.

KIM SAITO, EXAMINING ATTORNEY



David J. Kyffers

Director of the United States Patent and Trademark Office

United States of America

United States Patent and Trademark Office

shootdotedit

Reg. No. 4,206,015

SHOOTDOTEDIT LLC (CALIFORNIA LIMITED LIABILITY COMPANY)
444 SOUTH CEDROS AVENUE #210
SOLANA BEACH, CA 92075

Registered Sep. 11, 2012

Int. Cl.: 40

FOR: PHOTOGRAPHIC PROCESSING; PHOTOGRAPHIC RETOUCHING, IN CLASS 40 (U.S. CLS. 100, 103 AND 106).

SERVICE MARK

FIRST USE 1-0-2012; IN COMMERCE 1-0-2012.

PRINCIPAL REGISTER

OWNER OF U.S. REG. NO. 4,041,696.

THE MARK CONSISTS OF THE WORDS "SHOOT" "DOT" AND "EDIT", WITH THE WORD "DOT" BEING FORMED WITHIN A DARKENED CIRCLE.

SER. NO. 85-540,277, FILED 2-11-2012.

JENNIFER MARTIN, EXAMINING ATTORNEY



David J. Kybas

Director of the United States Patent and Trademark Office

United States of America

United States Patent and Trademark Office

SNACS by 5 shapes. numbers. alphabet. colors. sounds

Reg. No. 4,206,016

Registered Sep. 11, 2012

Int. Cl.: 28

TRADEMARK

PRINCIPAL REGISTER

NGUYEN, DIANA D. P. (UNITED STATES INDIVIDUAL)
15207 VALLEY STREAM DRIVE
WOODBIDGE, VA 22191 AND

NGUYEN, JENNIFER D.P. (UNITED STATES INDIVIDUAL)
35 WEST SHORE DRIVE
PENNINGTON, NJ 08534

FOR: CARD GAMES; EQUIPMENT SOLD AS A UNIT FOR PLAYING A MEMORY GAME;
EQUIPMENT SOLD AS A UNIT FOR PLAYING CARD GAMES; GAME CARDS; MANIPU-
LATIVE GAMES; MEMORY GAMES, IN CLASS 28 (U.S. CLS. 22, 23, 38 AND 50).

FIRST USE 10-12-2011; IN COMMERCE 2-7-2012.

THE MARK CONSISTS OF STANDARD CHARACTERS WITHOUT CLAIM TO ANY PAR-
TICULAR FONT, STYLE, SIZE, OR COLOR.

SER. NO. 85-540,281, FILED 2-11-2012.

CHRISTINE MARTIN, EXAMINING ATTORNEY



David J. Kybas

Director of the United States Patent and Trademark Office

United States of America

United States Patent and Trademark Office



triptuner

Reg. No. 4,206,017

Registered Sep. 11, 2012

Int. Cl.: 39

SERVICE MARK

PRINCIPAL REGISTER

KIJAGO LLC (DELAWARE LIMITED LIABILITY COMPANY)
1380 MONROE STREET NW #227
WASHINGTON, DC 20010

FOR: BOOKING OF TRAVEL TICKETS ; ON-LINE TRANSPORTATION RESERVATION AND TRAVEL TICKET RESERVATION SERVICES; ORGANISATION OF TRAVEL; PROVIDING AN ON-LINE SEARCHABLE COMPUTER DATABASE FEATURING INFORMATION ON TRAVEL; PROVIDING INFORMATION, NEWS AND COMMENTARY IN THE FIELD OF TRAVEL; TRAVEL BOOKING AGENCIES; TRAVEL GUIDE AND TRAVEL INFORMATION SERVICES; TRAVEL ROUTE PLANNING, IN CLASS 39 (U.S. CLS. 100 AND 105).

FIRST USE 4-8-2011; IN COMMERCE 4-8-2011.

THE MARK CONSISTS OF A CIRCLE CONTAINING TWO VERTICAL LINES, EACH CROSSED BY A SHORT HORIZONTAL LINE AS IN THE LETTER "T", WITH THE STYLIZED WORDING "TRIPTUNER" APPEARING TO THE RIGHT OF THE CIRCLE.

SER. NO. 85-540,294, FILED 2-11-2012.

CHRISIE B. KING, EXAMINING ATTORNEY



David J. Kyffers

Director of the United States Patent and Trademark Office

United States of America

United States Patent and Trademark Office

diva Pearl

Reg. No. 4,206,018

Registered Sep. 11, 2012

Int. Cls.: 16 and 18

TRADEMARK

PRINCIPAL REGISTER

GATTUSO, VICKI L. (SOUTH CAROLINA SOLE PROPRIETORSHIP)
#D129
3575 MAYBANK HWY.
JOHNS ISLAND, SC 29455

FOR: PORTRAITS, IN CLASS 16 (U.S. CLS. 2, 5, 22, 23, 29, 37, 38 AND 50).

FIRST USE 1-3-2012; IN COMMERCE 1-3-2012.

FOR: DOG APPAREL, IN CLASS 18 (U.S. CLS. 1, 2, 3, 22 AND 41).

FIRST USE 1-3-2012; IN COMMERCE 1-3-2012.

THE MARK CONSISTS OF STANDARD CHARACTERS WITHOUT CLAIM TO ANY PARTICULAR FONT, STYLE, SIZE, OR COLOR.

SER. NO. 85-540,300, FILED 2-11-2012.

CYNTHIA TRIPI, EXAMINING ATTORNEY



David J. Kyros

Director of the United States Patent and Trademark Office

United States of America

United States Patent and Trademark Office

Diztronic

Reg. No. 4,206,019

Registered Sep. 11, 2012

Int. Cl.: 9

TRADEMARK

PRINCIPAL REGISTER

DIZTRONIC LLC (WISCONSIN LIMITED LIABILITY COMPANY)
1106 N GAMMON RD
MADISON, WI 53717

FOR: CELL PHONE CASES, IN CLASS 9 (U.S. CLS. 21, 23, 26, 36 AND 38).

FIRST USE 1-2-2011; IN COMMERCE 1-2-2011.

THE MARK CONSISTS OF STANDARD CHARACTERS WITHOUT CLAIM TO ANY PARTICULAR FONT, STYLE, SIZE, OR COLOR.

SER. NO. 85-540,302, FILED 2-11-2012.

ODESSA BIBBINS, EXAMINING ATTORNEY



David J. Kyffers

Director of the United States Patent and Trademark Office

United States of America

United States Patent and Trademark Office

LIVE WELL, LAUGH OFTEN,
LOVE MUCH

Reg. No. 4,206,020

D-GENERATION, INC. (FLORIDA CORPORATION)

Registered Sep. 11, 2012

P.O. BOX 30
DAYTONA BEACH, FL 321150030

Int. Cl.: 16

FOR: ART PRINTS ON CANVAS; DECALS; STICKERS, IN CLASS 16 (U.S. CLS. 2, 5, 22, 23, 29, 37, 38 AND 50).

TRADEMARK

FIRST USE 8-5-1999; IN COMMERCE 8-5-1999.

PRINCIPAL REGISTER

THE MARK CONSISTS OF STANDARD CHARACTERS WITHOUT CLAIM TO ANY PARTICULAR FONT, STYLE, SIZE, OR COLOR.

OWNER OF U.S. REG. NO. 4,090,303.

SER. NO. 85-540,306, FILED 2-11-2012.

CYNTHIA TRIPI, EXAMINING ATTORNEY



David J. Kyffers

Director of the United States Patent and Trademark Office

United States of America

United States Patent and Trademark Office

LIVE WELL, LAUGH OFTEN,
LOVE MUCH

Reg. No. 4,206,021

D-GENERATION, INC. (FLORIDA CORPORATION)

Registered Sep. 11, 2012

P.O. BOX 30
DAYTONA BEACH, FL 321150030

Int. Cl.: 20

FOR: NON-METAL KEY RINGS; PICTURE AND PHOTOGRAPH FRAMES; PLASTIC KEY TAGS; VINYL APPLIQUES FOR ATTACHMENT TO WINDOWS, MIRRORS, AND OTHER SOLID SURFACES; WALL PLAQUES MADE OF PLASTER, PLASTIC, AND WOOD, IN CLASS 20 (U.S. CLS. 2, 13, 22, 25, 32 AND 50).

TRADEMARK

PRINCIPAL REGISTER

FIRST USE 9-4-2002; IN COMMERCE 9-4-2002.

THE MARK CONSISTS OF STANDARD CHARACTERS WITHOUT CLAIM TO ANY PARTICULAR FONT, STYLE, SIZE, OR COLOR.

OWNER OF U.S. REG. NO. 4,090,303.

SER. NO. 85-540,308, FILED 2-11-2012.

CYNTHIA TRIPI, EXAMINING ATTORNEY



David J. Kyffers

Director of the United States Patent and Trademark Office

United States of America

United States Patent and Trademark Office

Enica

Reg. No. 4,206,022

Registered Sep. 11, 2012

Int. Cls.: 35 and 42

SERVICE MARK

PRINCIPAL REGISTER

ENICA, LLC (NEW YORK LIMITED LIABILITY COMPANY), DBA ENICA CONSULTING
SUITE 1600
100 PARK AVENUE
NEW YORK, NY 10017

FOR: CONSULTING SERVICES USED IN THE FIELD OF FACILITY MANAGEMENT AND ENERGY EFFICIENCY NAMELY TO IDENTIFY, ANALYZE AND IMPLEMENT STRATEGIES AIMED AT REDUCING THE COST OF OPERATING A COMMERCIAL, INSTITUTIONAL, OR INDUSTRIAL FACILITY, IN CLASS 35 (U.S. CLS. 100, 101 AND 102).

FIRST USE 6-23-2010; IN COMMERCE 6-23-2010.

FOR: ENGINEERING SERVICES USED IN THE FIELDS OF BUILDING AND PROPERTY CONDITION ASSESSMENT, REPAIRS AND UPGRADES, BUILDING INSTRUMENTATION AND MONITORING, BUILDING SYSTEMS AND EQUIPMENT CONTROLS OPTIMIZATION, FACILITY MANAGEMENT, CONSTRUCTION MANAGEMENT, ALTERNATIVE ENERGY, ENERGY CONSERVATION, AND ENVIRONMENTAL CONSULTING, IN CLASS 42 (U.S. CLS. 100 AND 101).

FIRST USE 6-23-2010; IN COMMERCE 6-23-2010.

THE MARK CONSISTS OF STANDARD CHARACTERS WITHOUT CLAIM TO ANY PARTICULAR FONT, STYLE, SIZE, OR COLOR.

SER. NO. 85-540,313, FILED 2-11-2012.

MICHAEL WIENER, EXAMINING ATTORNEY



David J. Kyros

Director of the United States Patent and Trademark Office

United States of America

United States Patent and Trademark Office

A GREATER YOU, A GREATER
WORLD.

Reg. No. 4,206,023

THE ARTIVIST NETWORK (CALIFORNIA CORPORATION)
PO BOX 910
HOLLYWOOD, CA 90078

Registered Sep. 11, 2012

Int. Cl.: 35

FOR: ON-LINE RETAIL STORE SERVICES FEATURING A WIDE VARIETY OF CONSUMER
GOODS OF OTHERS, IN CLASS 35 (U.S. CLS. 100, 101 AND 102).

SERVICE MARK

FIRST USE 5-3-2011; IN COMMERCE 5-3-2011.

PRINCIPAL REGISTER

THE MARK CONSISTS OF STANDARD CHARACTERS WITHOUT CLAIM TO ANY PAR-
TICULAR FONT, STYLE, SIZE, OR COLOR.

SER. NO. 85-540,323, FILED 2-11-2012.

CYNTHIA TRIPI, EXAMINING ATTORNEY



David J. Kyffers

Director of the United States Patent and Trademark Office

United States of America

United States Patent and Trademark Office

NYS

Reg. No. 4,206,024

SSP ENTERPRISES - AYS, L.L.C. (ARIZONA LIMITED LIABILITY COMPANY)
15224 N 59TH AVE #12
GLENDALE, AZ 85306

Registered Sep. 11, 2012

Int. Cl.: 41

FOR: AMATEUR YOUTH SPORTS SERVICES, NAMELY, ORGANIZING AND PROVIDING YOUTH SPORTS ACTIVITIES, IN CLASS 41 (U.S. CLS. 100, 101 AND 107).

SERVICE MARK

FIRST USE 2-1-2010; IN COMMERCE 2-1-2010.

PRINCIPAL REGISTER

THE MARK CONSISTS OF STANDARD CHARACTERS WITHOUT CLAIM TO ANY PARTICULAR FONT, STYLE, SIZE, OR COLOR.

SER. NO. 85-540,336, FILED 2-11-2012.

GRETTA YAO, EXAMINING ATTORNEY



David J. Kyffers

Director of the United States Patent and Trademark Office

United States of America

United States Patent and Trademark Office



Reg. No. 4,206,025

SSP ENTERPRISES - AYS, L.L.C. (ARIZONA LIMITED LIABILITY COMPANY)
15224 N 59TH AVE #12
GLENDALE, AZ 85306

Registered Sep. 11, 2012

Int. Cl.: 41

FOR: AMATEUR YOUTH SPORTS SERVICES, NAMELY, ORGANIZING AND PROVIDING YOUTH SPORTS ACTIVITIES, IN CLASS 41 (U.S. CLS. 100, 101 AND 107).

SERVICE MARK

FIRST USE 2-1-2010; IN COMMERCE 2-1-2010.

PRINCIPAL REGISTER

THE MARK CONSISTS OF THE LETTERS "NYS" IN OUTLINED BLOCK LETTER FORM.

SER. NO. 85-540,340, FILED 2-11-2012.

GRETTA YAO, EXAMINING ATTORNEY



David J. Kyffers

Director of the United States Patent and Trademark Office

United States of America

United States Patent and Trademark Office

Bournvita

Reg. No. 4,206,026

Registered Sep. 11, 2012

Int. Cls.: 29 and 30

TRADEMARK

PRINCIPAL REGISTER

MEENAXI ENTERPRISE, INC. (NEW JERSEY CORPORATION), DBA MEENAXI
ENTERPRISE, INC.
2500B HAMILTON BOULEVARD
SOUTH PLAINFIELD, NJ 07080

FOR: BASES FOR MAKING MILK SHAKES; BEVERAGES CONSISTING PRINCIPALLY OF MILK; BEVERAGES HAVING A MILK BASE; CHOCOLATE MILK; DRIED MILK POWDER; MILK BEVERAGES CONTAINING FRUITS; MILK DRINKS CONTAINING FRUITS; MILK POWDER; MILK SHAKES; MILK-BASED BEVERAGES WITH CHOCOLATE; MILK-BASED BEVERAGES WITH HIGH MILK CONTENT; MILK-BASED ENERGY DRINKS; NUT-BASED MILK; POWDERED MILK; PROTEIN MILK; STRAWBERRY MILK; VANILLA MILK, IN CLASS 29 (U.S. CL. 46).

FIRST USE 1-1-2008; IN COMMERCE 1-1-2008.

FOR: CHOCOLATE POWDER; CHOCOLATE-BASED BEVERAGES; CHOCOLATE-BASED BEVERAGES WITH MILK; COCOA; COCOA BEVERAGES WITH MILK; COCOA POWDER; COCOA-BASED BEVERAGES; COCOA-BASED CONDIMENTS AND SEASONINGS FOR FOOD AND DRINK; HOT CHOCOLATE, IN CLASS 30 (U.S. CL. 46).

FIRST USE 1-1-2008; IN COMMERCE 1-1-2008.

THE MARK CONSISTS OF STANDARD CHARACTERS WITHOUT CLAIM TO ANY PARTICULAR FONT, STYLE, SIZE, OR COLOR.

THE WORDING "BOURNVITA" HAS NO MEANING IN A FOREIGN LANGUAGE.

SER. NO. 85-540,380, FILED 2-11-2012.

GINA HAYES, EXAMINING ATTORNEY



David J. Kyffers

Director of the United States Patent and Trademark Office

United States of America
United States Patent and Trademark Office

AIRIGATION

Reg. No. 4,206,027

Registered Sep. 11, 2012

Int. Cl.: 44

SERVICE MARK

PRINCIPAL REGISTER

VAHE' OHANESSIAN (UNITED STATES INDIVIDUAL)
6327 HARMAN DRIVE
TUJUNGA, CA 91042

FOR: COSMETIC DENTISTRY; DENTIST SERVICES; DENTISTRY; HEALTHCARE; MEDICAL SERVICES, NAMELY, TREATMENT OF BAD BREATH AND HALITOSIS, IN CLASS 44 (U.S. CLS. 100 AND 101).

FIRST USE 2-10-2012; IN COMMERCE 2-10-2012.

THE MARK CONSISTS OF STANDARD CHARACTERS WITHOUT CLAIM TO ANY PARTICULAR FONT, STYLE, SIZE, OR COLOR.

SER. NO. 85-540,400, FILED 2-11-2012.

GEOFFREY FOSDICK, EXAMINING ATTORNEY



David J. Kyffers

Director of the United States Patent and Trademark Office

United States of America

United States Patent and Trademark Office

TREAT YOUR BREATH TO FRESHNESS

Reg. No. 4,206,028

Registered Sep. 11, 2012

Int. Cl.: 44

SERVICE MARK

PRINCIPAL REGISTER

VAHE' OHANESSIAN (UNITED STATES INDIVIDUAL)
6327 HARMAN DRIVE
TUJUNGA, CA 91042

FOR: COSMETIC DENTISTRY; DENTIST SERVICES; DENTISTRY; HEALTHCARE; MEDICAL SERVICES, NAMELY, TREATMENT OF BAD BREATH AND HALITOSIS, IN CLASS 44 (U.S. CLS. 100 AND 101).

FIRST USE 2-10-2012; IN COMMERCE 2-10-2012.

THE MARK CONSISTS OF STANDARD CHARACTERS WITHOUT CLAIM TO ANY PARTICULAR FONT, STYLE, SIZE, OR COLOR.

SER. NO. 85-540,404, FILED 2-12-2012.

GEOFFREY FOSDICK, EXAMINING ATTORNEY



David J. Kyros

Director of the United States Patent and Trademark Office

United States of America

United States Patent and Trademark Office

STAND & SERVE

Reg. No. 4,206,029

Registered Sep. 11, 2012

Int. Cl.: 35

SERVICE MARK

PRINCIPAL REGISTER

PEER SOLUTIONS INC. (ARIZONA NON-PROFIT ORGANIZATION)
PO BOX 24148, PHOENIX, ARIZONA 85074
2229 NORTH 22ND STREET
PHOENIX, AZ 85006

FOR: PUBLIC ADVOCACY TO PROMOTE AWARENESS OF CHILD ABUSE, SEXUAL VIOLENCE, SUBSTANCE ABUSE, RELATIONSHIP VIOLENCE, BULLYING, HOMELESSNESS, GANG AND GUN VIOLENCE, OPPRESSION, IN CLASS 35 (U.S. CLS. 100, 101 AND 102).

FIRST USE 6-1-1996; IN COMMERCE 6-1-1996.

THE MARK CONSISTS OF STANDARD CHARACTERS WITHOUT CLAIM TO ANY PARTICULAR FONT, STYLE, SIZE, OR COLOR.

SER. NO. 85-540,411, FILED 2-12-2012.

LOURDES AYALA, EXAMINING ATTORNEY



David J. Kybas

Director of the United States Patent and Trademark Office

United States of America

United States Patent and Trademark Office

SWAG-A-LIFE

Reg. No. 4,206,030

Registered Sep. 11, 2012

Int. Cl.: 9

TRADEMARK

PRINCIPAL REGISTER

REID, LOYLIN R (CANADA INDIVIDUAL), AKA L-TEE
452 RUTHERFORD ROAD NORTH
BRAMPTON, ONTARIO, CANADA

FOR: AUDIO AND VIDEO RECORDINGS FEATURING MUSIC AND ARTISTIC PERFORMANCES; AUDIO TAPES FEATURING MUSIC; COMPACT DISCS FEATURING MUSIC; DIGITAL MUSIC DOWNLOADABLE FROM THE INTERNET; DOWNLOADABLE MUSIC FILES; DOWNLOADABLE MUSICAL SOUND RECORDINGS; DOWNLOADABLE RING TONES, GRAPHICS AND MUSIC VIA A GLOBAL COMPUTER NETWORK AND WIRELESS DEVICES; MUSICAL RECORDINGS; MUSICAL SOUND RECORDINGS; PRERECORDED AUDIO TAPES FEATURING MUSIC, IN CLASS 9 (U.S. CLS. 21, 23, 26, 36 AND 38).

FIRST USE 11-6-2009; IN COMMERCE 2-25-2011.

THE MARK CONSISTS OF STANDARD CHARACTERS WITHOUT CLAIM TO ANY PARTICULAR FONT, STYLE, SIZE, OR COLOR.

SER. NO. 85-540,412, FILED 2-12-2012.

SETH A. RAPPAPORT, EXAMINING ATTORNEY



David J. Kyffers

Director of the United States Patent and Trademark Office

United States of America

United States Patent and Trademark Office

ThermoCoat

Reg. No. 4,206,031

NOLKE IVANA (UNITED STATES INDIVIDUAL)
1705 RANDOLPH COURT
LEAVENWORTH, KS 66048

Registered Sep. 11, 2012

Int. Cl.: 18

FOR: CLOTHING FOR ANIMALS; CLOTHING FOR DOMESTIC PETS; DOG APPAREL;
DOG CLOTHING; DOG COATS; DOG PARKAS; PET CLOTHING, IN CLASS 18 (U.S. CLS.
1, 2, 3, 22 AND 41).

TRADEMARK

FIRST USE 2-17-2003; IN COMMERCE 2-17-2003.

PRINCIPAL REGISTER

THE MARK CONSISTS OF STANDARD CHARACTERS WITHOUT CLAIM TO ANY PAR-
TICULAR FONT, STYLE, SIZE, OR COLOR.

SER. NO. 85-540,469, FILED 2-12-2012.

ALICE BENMAMAN, EXAMINING ATTORNEY



David J. Kyffers

Director of the United States Patent and Trademark Office

United States of America

United States Patent and Trademark Office

MEIMEET

Reg. No. 4,206,032

MEETINGS & EVENTS INTERNATIONAL, INC (INDIANA CORPORATION)
1314 BURCH DRIVE
EVANSVILLE, IN 47725

Registered Sep. 11, 2012

Int. Cl.: 35

FOR: BUSINESS MEETING PLANNING, IN CLASS 35 (U.S. CLS. 100, 101 AND 102).

SERVICE MARK

FIRST USE 3-1-2011; IN COMMERCE 3-1-2011.

PRINCIPAL REGISTER

THE MARK CONSISTS OF STANDARD CHARACTERS WITHOUT CLAIM TO ANY PARTICULAR FONT, STYLE, SIZE, OR COLOR.

SER. NO. 85-540,501, FILED 2-12-2012.

LINDA LAVACHE, EXAMINING ATTORNEY



David J. Kyjars

Director of the United States Patent and Trademark Office

United States of America

United States Patent and Trademark Office

Golden Openings

Reg. No. 4,206,033

Registered Sep. 11, 2012

Int. Cl.: 35

SERVICE MARK

PRINCIPAL REGISTER

GOLDEN OPENINGS, INC. (IOWA CORPORATION)
14947 NORTHVIEW DRIVE
14947 NORTHVIEW DRIVE
URBANDALE, IA 50323

FOR: COMPUTERIZED ON-LINE RETAIL STORE SERVICES IN THE FIELD OF CEREMONIAL PRODUCTS, IN CLASS 35 (U.S. CLS. 100, 101 AND 102).

FIRST USE 2-27-1997; IN COMMERCE 2-27-1997.

THE MARK CONSISTS OF STANDARD CHARACTERS WITHOUT CLAIM TO ANY PARTICULAR FONT, STYLE, SIZE, OR COLOR.

SER. NO. 85-540,527, FILED 2-12-2012.

KIMBERLY PERRY, EXAMINING ATTORNEY



David J. Kyffers

Director of the United States Patent and Trademark Office

United States of America

United States Patent and Trademark Office

IQMatics

Reg. No. 4,206,034

MURANSKI, MICHAL G (UNITED STATES INDIVIDUAL)
837 N MAPLE AVE
PALATINE, IL 60067 AND

Registered Sep. 11, 2012

Int. Cl.: 20

MURANSKI, RAE K (UNITED STATES INDIVIDUAL)
837 N MAPLE AVE
PALATINE, IL 60067

TRADEMARK

FOR: FURNITURE, IN CLASS 20 (U.S. CLS. 2, 13, 22, 25, 32 AND 50).

PRINCIPAL REGISTER

FIRST USE 7-1-2001; IN COMMERCE 7-1-2001.

THE MARK CONSISTS OF STANDARD CHARACTERS WITHOUT CLAIM TO ANY PARTICULAR FONT, STYLE, SIZE, OR COLOR.

SER. NO. 85-540,553, FILED 2-12-2012.

CHRISTINE MARTIN, EXAMINING ATTORNEY



David J. Kyffers

Director of the United States Patent and Trademark Office

United States of America

United States Patent and Trademark Office



Reg. No. 4,206,035

CHEN, YU-HUA (TAIWAN INDIVIDUAL)

Registered Sep. 11, 2012

#13, ALY.9, LN 200, LUNPING S. RD.,
CHANGHUA COUNTY, TAIWAN 500

Int. Cl.: 3

FOR: AROMATIC ESSENTIAL OILS; CLEANSING MILK FOR TOILET PURPOSES; COSMETICS; ESSENTIAL OILS; PLANT AND HERB EXTRACTS SOLD AS COMPONENTS OF COSMETICS; POTPOURRI; RUST REMOVING PREPARATIONS; SKIN WHITENING CREAMS, IN CLASS 3 (U.S. CLS. 1, 4, 6, 50, 51 AND 52).

TRADEMARK

PRINCIPAL REGISTER

FIRST USE 12-20-2010; IN COMMERCE 11-1-2011.

THE MARK CONSISTS OF THE LETTERS "YCM" WITH THE LETTER "C" WRITTEN AS A GEOMETRIC SYMBOL (A FIGURE THAT IS KNOWN AS A GLOBE). ON THE ABOVE OF THE LETTER "C" SETTING A SAPLING. THE LETTER "Y" IS IN BLUE; THE LETTERS "CM" ARE IN GREEN.

THE COLOR(S) BLUE AND GREEN IS/ARE CLAIMED AS A FEATURE OF THE MARK.

SER. NO. 85-540,554, FILED 2-12-2012.

NAAKWAMA ANKRAH, EXAMINING ATTORNEY



David J. Kyffers

Director of the United States Patent and Trademark Office

United States of America

United States Patent and Trademark Office

LOCKS & TOX

Reg. No. 4,206,036

PRYOR, LONDON (UNITED STATES INDIVIDUAL)
8507 GREENPORT WAY
ROCKFORD, IL 61108

Registered Sep. 11, 2012

Int. Cl.: 44

FOR: PHYSICIAN SERVICES, IN CLASS 44 (U.S. CLS. 100 AND 101).

SERVICE MARK

FIRST USE 12-1-2010; IN COMMERCE 12-1-2010.

PRINCIPAL REGISTER

THE MARK CONSISTS OF STANDARD CHARACTERS WITHOUT CLAIM TO ANY PARTICULAR FONT, STYLE, SIZE, OR COLOR.

SER. NO. 85-540,557, FILED 2-12-2012.

NAAKWAMA ANKRAH, EXAMINING ATTORNEY



David J. Kyffers

Director of the United States Patent and Trademark Office

United States of America

United States Patent and Trademark Office

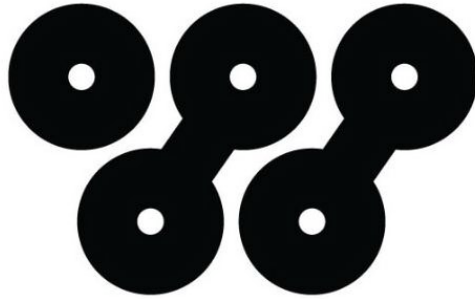

Reg. No. 4,206,037

Registered Sep. 11, 2012

Int. Cl.: 42

SERVICE MARK

PRINCIPAL REGISTER

WHO'S DOING, LLC (TEXAS LIMITED LIABILITY COMPANY)
16414 LA AVENIDA DRIVE
HOUSTON, TX 77062

FOR: PROVIDING A WEB SITE FEATURING TECHNOLOGY THAT ENABLES USERS TO SHARE INFORMATION AND COMMUNICATE WITH OTHER USERS, IN CLASS 42 (U.S. CLS. 100 AND 101).

FIRST USE 1-24-2012; IN COMMERCE 1-24-2012.

THE MARK CONSISTS OF FIVE CIRCLES, THREE OF WHICH COMPRISE A TOP ROW AND TWO OF WHICH COMPRISE A BOTTOM ROW WHICH IS PARALLEL TO THE TOP ROW. THE TWO ROWS OF CIRCLES ARE OFFSET SLIGHTLY AS IF EACH CIRCLE WERE AT THE END OF EACH LINE IN THE LETTER "W". THERE IS AN ADDITIONAL SMALL CIRCLE IN THE CENTER OF EACH OF THE FIVE CIRCLES. THERE ARE TWO LINES PRESENT. ONE OF WHICH CONNECTS THE TOP RIGHT AND BOTTOM RIGHT CIRCLES. THE OTHER LINE CONNECTS THE TOP MIDDLE AND BOTTOM LEFT CIRCLES.

SER. NO. 85-540,602, FILED 2-13-2012.

JOHN WILKE, EXAMINING ATTORNEY



David J. Kybas

Director of the United States Patent and Trademark Office

United States of America

United States Patent and Trademark Office

NATIONAL DENTAL ASSOCIATION

Reg. No. 4,206,038

Registered Sep. 11, 2012

Int. Cl.: 35

SERVICE MARK

PRINCIPAL REGISTER

NATIONAL DENTAL ASSOCIATION, INC. (VIRGINIA CORPORATION)
3517 16TH STREET, NW
WASHINGTON, DC 20010

FOR: ASSOCIATION SERVICES, NAMELY, PROMOTING THE INTERESTS OF DENTAL PROFESSIONALS AND DISSEMINATING INFORMATION ABOUT ORAL HEALTH TO THE PUBLIC, IN CLASS 35 (U.S. CLS. 100, 101 AND 102).

FIRST USE 5-12-1937; IN COMMERCE 5-12-1937.

THE MARK CONSISTS OF STANDARD CHARACTERS WITHOUT CLAIM TO ANY PARTICULAR FONT, STYLE, SIZE, OR COLOR.

NO CLAIM IS MADE TO THE EXCLUSIVE RIGHT TO USE "ASSOCIATION", APART FROM THE MARK AS SHOWN.

SEC. 2(F).

SER. NO. 85-540,815, FILED 2-13-2012.

RON FAIRBANKS, EXAMINING ATTORNEY



David J. Kyffers

Director of the United States Patent and Trademark Office

United States of America

United States Patent and Trademark Office

city of gods

Reg. No. 4,206,039

FRAZIER, TERRANCE (UNITED STATES INDIVIDUAL)
6812 BARNETT RD

Registered Sep. 11, 2012

BALTIMORE, MD 21239

Int. Cl.: 25

FOR: CLOTHING, NAMELY, T-SHIRTS, HOODED SWEATSHIRTS, HATS, JEANS, SOCKS, SWEATERS, OUTERWEAR JACKETS, DRESS SHIRTS, DRESSES, SHORTS, PANTS, BELTS, NECKTIES AND SCARVES, IN CLASS 25 (U.S. CLS. 22 AND 39).

TRADEMARK

FIRST USE 6-1-2007; IN COMMERCE 6-1-2007.

PRINCIPAL REGISTER

THE MARK CONSISTS OF STANDARD CHARACTERS WITHOUT CLAIM TO ANY PARTICULAR FONT, STYLE, SIZE, OR COLOR.

SER. NO. 85-540,901, FILED 2-13-2012.

SUNG IN, EXAMINING ATTORNEY



David J. Kyffers

Director of the United States Patent and Trademark Office

United States of America

United States Patent and Trademark Office

CONTENT LOCKER

Reg. No. 4,206,040

INCENTIVIZE, INC. (FLORIDA CORPORATION)
18741 TITUS ROAD
HUDSON, FL 346676376

Registered Sep. 11, 2012

Int. Cl.: 35

FOR: ADVERTISING, MARKETING AND PROMOTION SERVICES, IN CLASS 35 (U.S. CLS. 100, 101 AND 102).

SERVICE MARK

FIRST USE 2-1-2012; IN COMMERCE 2-1-2012.

PRINCIPAL REGISTER

THE MARK CONSISTS OF STANDARD CHARACTERS WITHOUT CLAIM TO ANY PARTICULAR FONT, STYLE, SIZE, OR COLOR.

SER. NO. 85-540,970, FILED 2-13-2012.

MAYUR VAGHANI, EXAMINING ATTORNEY



David J. Kyffers

Director of the United States Patent and Trademark Office

United States of America

United States Patent and Trademark Office

ONE GOOD TURN

Reg. No. 4,206,041

SOCIETE DES PRODUITS NESTLE S.A. (SWITZERLAND CORPORATION)
CASE POSTALE 353
1800 VEVEY, SWITZERLAND

Registered Sep. 11, 2012

Int. Cl.: 35

FOR: ARRANGING AND CONDUCTING INCENTIVE REWARD PROGRAMS TO PROMOTE
THE SALE OF FOOD, IN CLASS 35 (U.S. CLS. 100, 101 AND 102).

SERVICE MARK

FIRST USE 7-31-2011; IN COMMERCE 7-31-2011.

PRINCIPAL REGISTER

THE MARK CONSISTS OF STANDARD CHARACTERS WITHOUT CLAIM TO ANY PAR-
TICULAR FONT, STYLE, SIZE, OR COLOR.

SER. NO. 85-541,316, FILED 2-13-2012.

WENDY JUN, EXAMINING ATTORNEY



David J. Kyffers

Director of the United States Patent and Trademark Office

United States of America

United States Patent and Trademark Office

LOUVRE

Reg. No. 4,206,042

LAERA, VITO (UNITED STATES INDIVIDUAL)
5960 SW 32 TERRACE

Registered Sep. 11, 2012

FORT LAUDERDALE, FL 33312

Int. Cl.: 11

FOR: FAUCET AERATORS; FAUCET HANDLES; FAUCET SPRAYERS; FAUCETS; KITCHEN SINK SPRAYERS; KITCHEN SINKS; PLUMBING FITTINGS, NAMELY, AERATORS FOR FAUCETS; PLUMBING FITTINGS, NAMELY, DRAINS; PLUMBING FITTINGS, NAMELY, FAUCET FILTERS; PLUMBING FITTINGS, NAMELY, SINK STRAINERS; PLUMBING FIXTURES, NAMELY, SINK SPRAYERS; PLUMBING FIXTURES, NAMELY, SINK TRAPS; PLUMBING SUPPLIES, NAMELY, SINK STRAINERS; SINGLE LEVER FIXTURES FOR LAVATORIES AND SINKS; SINKS; SINKS INTEGRATED INTO COUNTERS OR COUNTER-TOPS; STAINLESS STEEL BOTTOM GRIDS SPECIALLY ADAPTED AND SHAPED FOR USE IN SINKS; TAP WATER FAUCETS; TAPS, IN CLASS 11 (U.S. CLS. 13, 21, 23, 31 AND 34).

TRADEMARK

PRINCIPAL REGISTER

FIRST USE 1-1-2007; IN COMMERCE 1-1-2007.

THE MARK CONSISTS OF STANDARD CHARACTERS WITHOUT CLAIM TO ANY PARTICULAR FONT, STYLE, SIZE, OR COLOR.

SER. NO. 85-541,326, FILED 2-13-2012.

WON TEAK OH, EXAMINING ATTORNEY



David J. Kyffers

Director of the United States Patent and Trademark Office

United States of America

United States Patent and Trademark Office

tran Doorri

Reg. No. 4,206,043

SPICE, LLC (CALIFORNIA LIMITED LIABILITY COMPANY)

Registered Sep. 11, 2012

PO BOX 305
SAUSALITO, CA 94966

Int. Cl.: 30

FOR: DRY SPICE RUB FOR MEATS AND FISH; EDIBLE SPICES; SPICE BLENDS; SPICE RUBS; SPICES, IN CLASS 30 (U.S. CL. 46).

TRADEMARK

FIRST USE 1-3-2011; IN COMMERCE 1-3-2011.

PRINCIPAL REGISTER

THE MARK CONSISTS OF STANDARD CHARACTERS WITHOUT CLAIM TO ANY PARTICULAR FONT, STYLE, SIZE, OR COLOR.

SER. NO. 85-541,561, FILED 2-13-2012.

THOMAS MANOR, EXAMINING ATTORNEY



David J. Kyffers

Director of the United States Patent and Trademark Office

United States of America

United States Patent and Trademark Office

QM-720

Reg. No. 4,206,044

SUNRISE MEDICAL (US) LLC (D.C. CORPORATION)
2842 BUSINESS PARK AVENUE
FRESNO, CA 937271328

Registered Sep. 11, 2012

Int. Cl.: 12

FOR: MOTORIZED WHEELCHAIRS FOR THE DISABLED AND THOSE WITH MOBILITY DIFFICULTIES; WHEELCHAIRS, IN CLASS 12 (U.S. CLS. 19, 21, 23, 31, 35 AND 44).

TRADEMARK

FIRST USE 2-13-2012; IN COMMERCE 2-13-2012.

PRINCIPAL REGISTER

THE MARK CONSISTS OF STANDARD CHARACTERS WITHOUT CLAIM TO ANY PARTICULAR FONT, STYLE, SIZE, OR COLOR.

SER. NO. 85-543,096, FILED 2-15-2012.

KIMBERLY PERRY, EXAMINING ATTORNEY



David J. Kybas

Director of the United States Patent and Trademark Office

United States of America

United States Patent and Trademark Office

DENTON VACUUM

Reg. No. 4,206,045

DENTON VACUUM, L.L.C. (NEW JERSEY LIMITED LIABILITY COMPANY)
1259 NORTH CHURCH STREET
MOORESTOWN, NJ 08057

Registered Sep. 11, 2012

Int. Cl.: 9

FOR: AUTOMATED APPARATUS AND INSTRUMENT FOR THIN FILM DEPOSITION, NAMELY, DEPOSIT OF METAL AND DIELECTRIC COATINGS BY MEANS OF PLASMA ENHANCED CHEMICAL VAPOR DEPOSITION OR SPUTTERING FROM METAL AND METAL ALLOYS, IN CLASS 9 (U.S. CLS. 21, 23, 26, 36 AND 38).

TRADEMARK

PRINCIPAL REGISTER

FIRST USE 3-0-1964; IN COMMERCE 3-0-1964.

THE MARK CONSISTS OF STANDARD CHARACTERS WITHOUT CLAIM TO ANY PARTICULAR FONT, STYLE, SIZE, OR COLOR.

OWNER OF U.S. REG. NO. 3,697,990.

NO CLAIM IS MADE TO THE EXCLUSIVE RIGHT TO USE "VACUUM", APART FROM THE MARK AS SHOWN.

SER. NO. 85-544,714, FILED 2-16-2012.

SIMON TENG, EXAMINING ATTORNEY



David J. Kyffers

Director of the United States Patent and Trademark Office

United States of America

United States Patent and Trademark Office

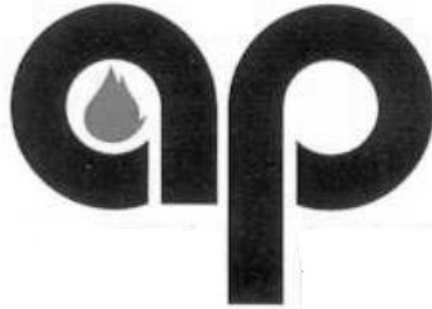

Reg. No. 4,206,046

Registered Sep. 11, 2012

Int. Cl.: 40

SERVICE MARK

PRINCIPAL REGISTER

APPLIED PROCESS, INC. (MICHIGAN CORPORATION)
12238 NEWBURGH ROAD
LIVONIA, MI 481501046

FOR: METAL HEAT TREATING SERVICES BY MEANS OF AUSTEMPERING, SALT BATH QUENCH, TO PRODUCE HARDENED METALS FOR USE IN MOTORIZED VEHICLES, TRUCKING, CONSTRUCTION, MINING, RAILWAY, SHIPPING, WIND TURBINES, WEAPONS, HEAVING EQUIPMENT, BRIDGES, AERONAUTICS, DRILLING POWER TOOLS, AND RIGGING, IN CLASS 40 (U.S. CLS. 100, 103 AND 106).

FIRST USE 0-0-2010; IN COMMERCE 0-0-2010.

THE MARK CONSISTS OF STYLIZED LOWERCASE "A" "P" WITH A FLAME IN THE CENTER OF THE "A".

SER. NO. 85-547,913, FILED 2-21-2012.

ROBIN MITTLER, EXAMINING ATTORNEY



David J. Kyffers

Director of the United States Patent and Trademark Office

United States of America

United States Patent and Trademark Office

HMC

Reg. No. 4,206,047

Registered Sep. 11, 2012

Int. Cl.: 13

TRADEMARK

PRINCIPAL REGISTER

HORNADY MANUFACTURING COMPANY (NEBRASKA CORPORATION)
PO BOX 1848
GRAND ISLAND, NE 688021848

FOR: AMMUNITION, IN CLASS 13 (U.S. CLS. 2 AND 9).

FIRST USE 5-9-2006; IN COMMERCE 5-9-2006.

THE MARK CONSISTS OF STANDARD CHARACTERS WITHOUT CLAIM TO ANY PARTICULAR FONT, STYLE, SIZE, OR COLOR.

SER. NO. 85-549,314, FILED 2-22-2012.

JOHN KELLY, EXAMINING ATTORNEY



David J. Kybas

Director of the United States Patent and Trademark Office

United States of America

United States Patent and Trademark Office

Salento

Reg. No. 4,206,048

Registered Sep. 11, 2012

Int. Cl.: 19

TRADEMARK

PRINCIPAL REGISTER

GLASSCRAFT DOOR I (TEXAS LIMITED PARTNERSHIP), DBA GLASSCRAFT DOOR
COMPANY
2002 BRITTMOORE ROAD
HOUSTON, TX 77043

FOR: INSULATED GLASS, IN CLASS 19 (U.S. CLS. 1, 12, 33 AND 50).

FIRST USE 2-1-2012; IN COMMERCE 2-1-2012.

THE MARK CONSISTS OF STANDARD CHARACTERS WITHOUT CLAIM TO ANY PAR-
TICULAR FONT, STYLE, SIZE, OR COLOR.

SER. NO. 85-549,457, FILED 2-22-2012.

CURTIS FRENCH, EXAMINING ATTORNEY



David J. Kybas

Director of the United States Patent and Trademark Office

United States of America

United States Patent and Trademark Office

Renaissance Lites

Reg. No. 4,206,049

Registered Sep. 11, 2012

Int. Cl.: 19

TRADEMARK

PRINCIPAL REGISTER

GLASSCRAFT DOOR I (TEXAS LIMITED PARTNERSHIP), DBA GLASSCRAFT DOOR COMPANY
2002 BRITTMOORE ROAD
HOUSTON, TX 77043

FOR: DECORATIVE GLASS PANELS FOR USE IN DOORS AND WINDOWS, IN CLASS 19 (U.S. CLS. 1, 12, 33 AND 50).

FIRST USE 9-7-2010; IN COMMERCE 9-7-2010.

THE MARK CONSISTS OF STANDARD CHARACTERS WITHOUT CLAIM TO ANY PARTICULAR FONT, STYLE, SIZE, OR COLOR.

NO CLAIM IS MADE TO THE EXCLUSIVE RIGHT TO USE "LITES", APART FROM THE MARK AS SHOWN.

SER. NO. 85-549,494, FILED 2-22-2012.

CURTIS FRENCH, EXAMINING ATTORNEY



David J. Kyffers

Director of the United States Patent and Trademark Office

United States of America

United States Patent and Trademark Office

Casablanca

Reg. No. 4,206,050

Registered Sep. 11, 2012

Int. Cl.: 19

TRADEMARK

PRINCIPAL REGISTER

GLASSCRAFT DOOR I (TEXAS LIMITED PARTNERSHIP), DBA GLASSCRAFT DOOR COMPANY
2002 BRITTMOORE ROAD
HOUSTON, TX 77043

FOR: INSULATED GLASS, IN CLASS 19 (U.S. CLS. 1, 12, 33 AND 50).

FIRST USE 1-1-2008; IN COMMERCE 1-1-2008.

THE MARK CONSISTS OF STANDARD CHARACTERS WITHOUT CLAIM TO ANY PARTICULAR FONT, STYLE, SIZE, OR COLOR.

SER. NO. 85-549,531, FILED 2-22-2012.

CURTIS FRENCH, EXAMINING ATTORNEY



David J. Kybas

Director of the United States Patent and Trademark Office

United States of America

United States Patent and Trademark Office

FOX BARREL

Reg. No. 4,206,051

Registered Sep. 11, 2012

Int. Cl.: 33

TRADEMARK

PRINCIPAL REGISTER

CRISPIN CIDER COMPANY (MINNESOTA CORPORATION)
1213 SOUTH AUBURN STREET
SUITE A
COLFAX, CA 95713

FOR: HARD CIDER, IN CLASS 33 (U.S. CLS. 47 AND 49).

FIRST USE 11-20-2004; IN COMMERCE 11-20-2004.

THE MARK CONSISTS OF STANDARD CHARACTERS WITHOUT CLAIM TO ANY PARTICULAR FONT, STYLE, SIZE, OR COLOR.

OWNER OF U.S. REG. NO. 3,221,350.

SER. NO. 85-550,648, FILED 2-23-2012.

GINA HAYES, EXAMINING ATTORNEY



David J. Kyffers

Director of the United States Patent and Trademark Office

United States of America

United States Patent and Trademark Office

PIECE & LOVE

Reg. No. 4,206,052

Registered Sep. 11, 2012

Int. Cl.: 14

TRADEMARK

PRINCIPAL REGISTER

RIDDEL, HOLLY M. (UNITED STATES INDIVIDUAL)
#162
311 N. ROBERTSON BLVD.,
BEVERLY HILLS, CA 90211

FOR: JEWELRY, IN CLASS 14 (U.S. CLS. 2, 27, 28 AND 50).

FIRST USE 2-7-2012; IN COMMERCE 2-7-2012.

THE MARK CONSISTS OF STANDARD CHARACTERS WITHOUT CLAIM TO ANY PARTICULAR FONT, STYLE, SIZE, OR COLOR.

SER. NO. 85-550,920, FILED 2-23-2012.

KIM MONINGHOFF, EXAMINING ATTORNEY



David J. Kybas

Director of the United States Patent and Trademark Office

United States of America

United States Patent and Trademark Office

JOHN PAUL PET

Reg. No. 4,206,053

JOHN PAUL PRODUCTS, LLC (CALIFORNIA LIMITED LIABILITY COMPANY)
1183 PITTSFIELD LANE
VENTURA, CA 93001

Registered Sep. 11, 2012

Int. Cl.: 3

FOR: PET CARE KITS COMPRISING SHAMPOO, CONDITIONER, BODY SPRAY; PET SHAMPOO AND CONDITIONER, IN CLASS 3 (U.S. CLS. 1, 4, 6, 50, 51 AND 52).

TRADEMARK

FIRST USE 5-1-2003; IN COMMERCE 5-1-2003.

PRINCIPAL REGISTER

THE MARK CONSISTS OF STANDARD CHARACTERS WITHOUT CLAIM TO ANY PARTICULAR FONT, STYLE, SIZE, OR COLOR.

NO CLAIM IS MADE TO THE EXCLUSIVE RIGHT TO USE "PET", APART FROM THE MARK AS SHOWN.

THE NAME(S), PORTRAIT(S), AND/OR SIGNATURE(S) SHOWN IN THE MARK IDENTIFIES "JOHN PAUL" DEJORIA, WHOSE CONSENT(S) TO REGISTER IS MADE OF RECORD.

SER. NO. 85-552,843, FILED 2-25-2012.

JENNIFER VASQUEZ, EXAMINING ATTORNEY



David J. Kyffers

Director of the United States Patent and Trademark Office

United States of America

United States Patent and Trademark Office



Reg. No. 4,206,054

FRANKIN, GUY (BELGIUM INDIVIDUAL)
9 IMPASSE DE LA SOURCE
ENTRE DEUX, FRANCE 97414

Registered Sep. 11, 2012

Int. Cl.: 45

FOR: DOMAIN NAME REGISTRATION SERVICES FEATURING THE REGISTRATION OF DOMAIN NAMES WITH THE GTLD THAT APPEARS IN THE MARK, IN CLASS 45 (U.S. CLS. 100 AND 101).

SERVICE MARK

FIRST USE 2-13-2012; IN COMMERCE 2-13-2012.

PRINCIPAL REGISTER

NO CLAIM IS MADE TO THE EXCLUSIVE RIGHT TO USE ".RE" AND "REAL ESTATE", APART FROM THE MARK AS SHOWN.

THE COLOR(S) RED AND BLACK IS/ARE CLAIMED AS A FEATURE OF THE MARK.

THE MARK CONSISTS OF THE WORDING ".RE" IN RED INSIDE A DESIGN OF A HOUSE IN BLACK. AN EQUAL SIGN APPEARS TO THE RIGHT OF THE HOUSE DESIGN IN BLACK. THE WORDING "REAL ESTATE" APPEARS TO THE RIGHT OF THE EQUAL SIGN. THE LETTER "R" IN "REAL" AND THE LETTER "E" IN "ESTATE" ARE IN RED WHILE THE REMAINDER OF THOSE TERMS ARE IN BLACK.

SER. NO. 85-553,081, FILED 2-26-2012.

SETH A. RAPPAPORT, EXAMINING ATTORNEY



David J. Kyros

Director of the United States Patent and Trademark Office

United States of America

United States Patent and Trademark Office

TermPAY

Reg. No. 4,206,055

PAYMENT ALLIANCE INTERNATIONAL, INC. (DELAWARE CORPORATION)
6060 DUTCHMANS LANE, STE 320
LOUISVILLE, KY 40205

Registered Sep. 11, 2012

Int. Cl.: 36

FOR: FINANCIAL SERVICES, NAMELY, ELECTRONIC REMOTE CHECK DEPOSIT SERVICES, IN CLASS 36 (U.S. CLS. 100, 101 AND 102).

SERVICE MARK

FIRST USE 2-22-2012; IN COMMERCE 2-22-2012.

PRINCIPAL REGISTER

THE MARK CONSISTS OF STANDARD CHARACTERS WITHOUT CLAIM TO ANY PARTICULAR FONT, STYLE, SIZE, OR COLOR.

SER. NO. 85-554,563, FILED 2-28-2012.

CYNTHIA TRIPI, EXAMINING ATTORNEY



David J. Kybas

Director of the United States Patent and Trademark Office

United States of America

United States Patent and Trademark Office

HEROIC MISSION

Reg. No. 4,206,056

MICHAEL KEANE (UNITED STATES INDIVIDUAL)
7247 POPPY HILLS COURT
BLACKLICK, OH 43004

Registered Sep. 11, 2012

Int. Cl.: 35

FOR: BUSINESS MANAGEMENT CONSULTANCY, ALSO VIA THE INTERNET, IN CLASS 35 (U.S. CLS. 100, 101 AND 102).

SERVICE MARK

FIRST USE 10-19-2011; IN COMMERCE 10-19-2011.

PRINCIPAL REGISTER

THE MARK CONSISTS OF STANDARD CHARACTERS WITHOUT CLAIM TO ANY PARTICULAR FONT, STYLE, SIZE, OR COLOR.

SER. NO. 85-556,112, FILED 2-29-2012.

JACQUELINE A. LAVINE, EXAMINING ATTORNEY



David J. Kybas

Director of the United States Patent and Trademark Office

United States of America
United States Patent and Trademark Office

KRASDALE

Reg. No. 4,206,057

KRASDALE FOODS, INC. (DELAWARE CORPORATION)
65 WEST RED OAK LANE
WHITE PLAINS, NY 10604

Registered Sep. 11, 2012

Int. Cl.: 6

FOR: ALUMINUM FOIL; ALUMINUM FOIL PAPER; METAL FOIL, IN CLASS 6 (U.S. CLS. 2, 12, 13, 14, 23, 25 AND 50).

TRADEMARK

FIRST USE 9-0-1924; IN COMMERCE 0-0-1974.

PRINCIPAL REGISTER

THE MARK CONSISTS OF STANDARD CHARACTERS WITHOUT CLAIM TO ANY PARTICULAR FONT, STYLE, SIZE, OR COLOR.

OWNER OF U.S. REG. NOS. 1,243,353, 2,694,649 AND OTHERS.

SER. NO. 85-557,006, FILED 2-29-2012.

GENE MACIOL, EXAMINING ATTORNEY



David J. Kybas

Director of the United States Patent and Trademark Office

United States of America

United States Patent and Trademark Office

RATTLESNAKE

Reg. No. 4,206,058

TECHNOLOGY LICENSING CORP. (OHIO CORPORATION)
3607 CHURCH STREET, SUITE 300
CINCINNATI, OH 45244

Registered Sep. 11, 2012

Int. Cl.: 7

FOR: ARTIFICIAL TURF REMOVAL DEVICE, NAMELY, A MECHANISM FOR REMOVING AND COLLECTING PARTICULATE INFILL FROM ARTIFICIAL TURF, IN CLASS 7 (U.S. CLS. 13, 19, 21, 23, 31, 34 AND 35).

TRADEMARK

FIRST USE 2-24-2012; IN COMMERCE 2-24-2012.

PRINCIPAL REGISTER

THE MARK CONSISTS OF STANDARD CHARACTERS WITHOUT CLAIM TO ANY PARTICULAR FONT, STYLE, SIZE, OR COLOR.

SER. NO. 85-557,207, FILED 3-1-2012.

KIM SAITO, EXAMINING ATTORNEY



David J. Kyffers

Director of the United States Patent and Trademark Office

United States of America

United States Patent and Trademark Office

DOUBLE UP

Reg. No. 4,206,059

Registered Sep. 11, 2012

Int. Cl.: 28

TRADEMARK

PRINCIPAL REGISTER

EBSCO INDUSTRIES, INC. (DELAWARE CORPORATION)
LEGAL SERVICES
5724 HIGHWAY 280 EAST
BIRMINGHAM, AL 35242

FOR: FISHING LURES, IN CLASS 28 (U.S. CLS. 22, 23, 38 AND 50).

FIRST USE 2-10-2012; IN COMMERCE 2-10-2012.

THE MARK CONSISTS OF STANDARD CHARACTERS WITHOUT CLAIM TO ANY PARTICULAR FONT, STYLE, SIZE, OR COLOR.

SER. NO. 85-557,876, FILED 3-1-2012.

MARTHA FROMM, EXAMINING ATTORNEY



David J. Kyffers

Director of the United States Patent and Trademark Office

United States of America

United States Patent and Trademark Office

YUMBRELLA

Reg. No. 4,206,060

Registered Sep. 11, 2012

Int. Cl.: 28

TRADEMARK

PRINCIPAL REGISTER

EBSCO INDUSTRIES, INC. (DELAWARE CORPORATION)
LEGAL SERVICES
5724 HIGHWAY 280 EAST
BIRMINGHAM, AL 35242

FOR: FISHING LURES, IN CLASS 28 (U.S. CLS. 22, 23, 38 AND 50).

FIRST USE 12-14-2011; IN COMMERCE 12-14-2011.

THE MARK CONSISTS OF STANDARD CHARACTERS WITHOUT CLAIM TO ANY PARTICULAR FONT, STYLE, SIZE, OR COLOR.

SER. NO. 85-557,888, FILED 3-1-2012.

MARTHA FROMM, EXAMINING ATTORNEY



David J. Kyffers

Director of the United States Patent and Trademark Office

United States of America

United States Patent and Trademark Office

EPIC

Reg. No. 4,206,061

Registered Sep. 11, 2012

Int. Cl.: 42

SERVICE MARK

PRINCIPAL REGISTER

EPIC SYSTEMS CORPORATION (WISCONSIN CORPORATION)
1979 MILKY WAY
VERONA, WI 53558

FOR: DESIGN AND DEVELOPMENT OF COMPUTER SOFTWARE FOR USE IN THE HEALTHCARE FIELD; IMPLEMENTATION AND MAINTENANCE OF COMPUTER SOFTWARE FOR USE IN THE HEALTHCARE FIELD; TECHNICAL SUPPORT, NAMELY, TROUBLESHOOTING OF COMPUTER SOFTWARE PROBLEMS RELATIVE TO SOFTWARE USED BY HEALTHCARE ORGANIZATIONS; CONSULTING SERVICES ON THE SUBJECT OF DESIGN, IMPLEMENTATION, OPERATION, MAINTENANCE AND TROUBLESHOOTING OF COMPUTER SOFTWARE USED BY HEALTHCARE ORGANIZATIONS, IN CLASS 42 (U.S. CLS. 100 AND 101).

FIRST USE 2-1-1979; IN COMMERCE 6-1-1979.

THE MARK CONSISTS OF STANDARD CHARACTERS WITHOUT CLAIM TO ANY PARTICULAR FONT, STYLE, SIZE, OR COLOR.

OWNER OF U.S. REG. NOS. 1,791,373, 2,601,981 AND OTHERS.

SER. NO. 85-558,050, FILED 3-1-2012.

DAVID TAYLOR, EXAMINING ATTORNEY



David J. Kypos

Director of the United States Patent and Trademark Office

United States of America

United States Patent and Trademark Office

LIVING SPARKLE

Reg. No. 4,206,062

MERCK KGAA (FED REP GERMANY KOMMANDITGESELLSCHAFT AUF AKTIEN (KGAA))
FRANKFURTER STR. 250
64293 DARMSTADT, FED REP GERMANY

Registered Sep. 11, 2012

Int. Cl.: 2

FOR: PAINTS, VARNISHES, LACQUERS; COLORANTS; PIGMENTS, IN CLASS 2 (U.S. CLS. 6, 11 AND 16).

TRADEMARK

THE MARK CONSISTS OF STANDARD CHARACTERS WITHOUT CLAIM TO ANY PARTICULAR FONT, STYLE, SIZE, OR COLOR.

PRINCIPAL REGISTER

PRIORITY CLAIMED UNDER SEC. 44(D) ON ERPN CMNTY TM OFC APPLICATION NO. 010293827, FILED 9-27-2011, REG. NO. 010293827, DATED 2-7-2012, EXPIRES 9-27-2021.

NO CLAIM IS MADE TO THE EXCLUSIVE RIGHT TO USE "SPARKLE", APART FROM THE MARK AS SHOWN.

SER. NO. 85-558,270, FILED 3-2-2012.

DOUGLAS LEE, EXAMINING ATTORNEY



David J. Kyfos

Director of the United States Patent and Trademark Office

United States of America

United States Patent and Trademark Office

RED OAK

Reg. No. 4,206,063

JOHNSON CREEK ENTERPRISES, LLC (WISCONSIN LIMITED LIABILITY COMPANY)
455 E. INDUSTRIAL DR., SUITE #2
HARTLAND, WI 53029

Registered Sep. 11, 2012

Int. Cl.: 1

FOR: A GLYCERIN-BASED LIQUID USED IN ELECTRONIC SMOKING DEVICES TO PRODUCE THE VAPOR AND SUPPLY THE FLAVORING, IN CLASS 1 (U.S. CLS. 1, 5, 6, 10, 26 AND 46).

TRADEMARK

FIRST USE 2-1-2010; IN COMMERCE 2-1-2010.

PRINCIPAL REGISTER

THE MARK CONSISTS OF STANDARD CHARACTERS WITHOUT CLAIM TO ANY PARTICULAR FONT, STYLE, SIZE, OR COLOR.

SER. NO. 85-559,050, FILED 3-2-2012.

THEODORE MCBRIDE, EXAMINING ATTORNEY



David J. Kyffers

Director of the United States Patent and Trademark Office

United States of America

United States Patent and Trademark Office



Reg. No. 4,206,064

Registered Sep. 11, 2012

Int. Cl.: 33

TRADEMARK

PRINCIPAL REGISTER

E. & J. GALLO WINERY (CALIFORNIA CORPORATION)
600 YOSEMITE BOULEVARD
MODESTO, CA 95354

FOR: ALCOHOLIC BEVERAGES EXCEPT BEERS, IN CLASS 33 (U.S. CLS. 47 AND 49).

FIRST USE 11-29-2011; IN COMMERCE 11-29-2011.

THE MARK CONSISTS OF THREE RINGS SURROUNDING A CIRCLE. A STYLIZED LETTER "F" AND A STYLIZED LETTER "B" APPEAR IN THE CENTER OF THE CIRCLE.

SER. NO. 85-560,213, FILED 3-5-2012.

DAVID H. STINE, EXAMINING ATTORNEY



David J. Kyros

Director of the United States Patent and Trademark Office

United States of America

United States Patent and Trademark Office



Reg. No. 4,206,065

Registered Sep. 11, 2012

Int. Cl.: 41

SERVICE MARK

PRINCIPAL REGISTER

HARPER, WENDY (UNITED STATES INDIVIDUAL)
9214 PERFECT HOUR
COLUMBIA, MD 21045

FOR: EDUCATION AND ENTERTAINMENT SERVICES, NAMELY, WORKSHOPS, CLASSES, AND SEMINARS IN THE FIELD OF HOLISTIC HEALING, IN CLASS 41 (U.S. CLS. 100, 101 AND 107).

FIRST USE 1-1-2012; IN COMMERCE 1-1-2012.

NO CLAIM IS MADE TO THE EXCLUSIVE RIGHT TO USE "HEALING" AND "FOUR ELEMENTS SHAMANIC HEALING", APART FROM THE MARK AS SHOWN.

THE COLOR(S) GREEN, BLUE, WHITE AND INDIGO IS/ARE CLAIMED AS A FEATURE OF THE MARK.

THE MARK CONSISTS OF A CIRCULAR FLOWER DESIGN WITH THE WORDING "HUNABKU" CENTERED BELOW IT AND THE WORD "HEALING" CENTERED BELOW THE WORD "HUNABKU" WHERE THE WORDS "HUNABKU" AND "HEALING" SHARE THE SAME LETTER "H". THE WORDING "HUNABKU HEALING" APPEARS IN BLUE FADING INTO INDIGO FROM TOP TO BOTTOM. THE WORDING "FOUR ELEMENTS SHAMANIC HEALING" APPEARS IN BLUE CENTERED BELOW THE LETTERS "HEALIN" IN THE WORDING "HEALING". THE CENTER OF THE FLOWER DESIGN CONTAINS A GREEN AND WHITE SWIRL AND DIAGONAL LINE DESIGN. THERE IS A BLUE BORDER AROUND THE CENTER CIRCLE. THERE ARE SIX ROWS OF WHITE PETALS WHICH ARE OUTLINED IN DIFFERENT COLORS EXTENDING OUTWARD FROM THE CENTER CIRCLE. THE FIRST ROW IS BLUE, THE SECOND IS LIGHT GREEN, THE THIRD ROW IS BLUE, THE FOURTH ROW IS INDIGO, THE FIFTH ROW IS BLUE AND SIXTH ROW IS GREEN.

SER. NO. 85-562,366, FILED 3-7-2012.

TINA BROWN, EXAMINING ATTORNEY



David J. Kyffers

Director of the United States Patent and Trademark Office

United States of America

United States Patent and Trademark Office

S.T.E.P.S.

Reg. No. 4,206,066

CELGENE CORPORATION (DELAWARE CORPORATION)
86 MORRIS AVENUE
SUMMIT, NJ 07901

Registered Sep. 11, 2012

Int. Cl.: 41

FOR: EDUCATIONAL CLASSES AND PROGRAMS IN THE FIELD OF THALIDOMIDE AND SAFETY ISSUES PERTAINING TO THALIDOMIDE, AND DISTRIBUTION OF WRITTEN MATERIALS THEREWITH, IN CLASS 41 (U.S. CLS. 100, 101 AND 107).

SERVICE MARK

FIRST USE 9-29-1998; IN COMMERCE 9-29-1998.

PRINCIPAL REGISTER

OWNER OF U.S. REG. NO. 2,463,707.

THE MARK CONSISTS OF "S" PERIOD "T" PERIOD "E" PERIOD "P" PERIOD "S" PERIOD ALL IN ITALICS.

SER. NO. 85-562,777, FILED 3-7-2012.

KELLY TRUSILO, EXAMINING ATTORNEY



David J. Kyffers

Director of the United States Patent and Trademark Office

United States of America

United States Patent and Trademark Office

GCF GLOBAL

Reg. No. 4,206,067

GOODWILL COMMUNITY FOUNDATION, INC. (NORTH CAROLINA CORPORATION)
4808 CHIN PAGE ROAD
DURHAM, NC 27703

Registered Sep. 11, 2012

Int. Cls.: 35 and 36

FOR: CHARITABLE SERVICES, NAMELY, COORDINATION OF NON-MONETARY CONTRIBUTIONS TO CHARITIES AND NON-PROFITS; CHARITABLE SERVICES, NAMELY, PROVIDING OFFICE EQUIPMENT TO THOSE IN NEED; PROVIDING BUSINESS CONSULTING RELATING TO CHARITABLE FUNDRAISING TO NON-PROFIT ORGANIZATIONS, IN CLASS 35 (U.S. CLS. 100, 101 AND 102).

SERVICE MARK

PRINCIPAL REGISTER

FIRST USE 11-14-2011; IN COMMERCE 11-14-2011.

FOR: CHARITABLE FUNDRAISING; CHARITABLE FUNDRAISING SERVICES BY MEANS OF COLLECTING AND REDEEMING RECYCLABLES FOR DONATION OF REDEMPTION PROCEEDS TO CHARITABLE ORGANIZATIONS; CHARITABLE FUNDRAISING SERVICES BY MEANS OF ORGANIZING AND CONDUCTING SPECIAL EVENTS; CHARITABLE FUNDRAISING SERVICES BY MEANS OF COLLECTING AND REDEEMING RECYCLABLES FOR DONATION OF REDEMPTION PROCEEDS TO NON-PROFIT CHARITABLE ORGANIZATIONS; CHARITABLE FUNDRAISING SERVICES BY MEANS OF PROVIDING GRANTS TO NON-PROFIT CHARITABLE ORGANIZATIONS; PROVIDING PHILANTHROPY AND FINANCIAL CONSULTING RELATING TO CHARITABLE FUNDRAISING TO NON-PROFIT ORGANIZATIONS; CHARITABLE FUNDRAISING TO SUPPORT EDUCATION, EMPLOYMENT AND LIFE ENRICHMENT OPPORTUNITIES FOR PERSONS WITH DISABILITIES OR OTHER DISADVANTAGING CIRCUMSTANCES, IN CLASS 36 (U.S. CLS. 100, 101 AND 102).

FIRST USE 11-14-2011; IN COMMERCE 11-14-2011.

THE MARK CONSISTS OF STANDARD CHARACTERS WITHOUT CLAIM TO ANY PARTICULAR FONT, STYLE, SIZE, OR COLOR.

OWNER OF U.S. REG. NOS. 2,624,347, 2,627,919 AND OTHERS.

NO CLAIM IS MADE TO THE EXCLUSIVE RIGHT TO USE "GLOBAL", APART FROM THE MARK AS SHOWN.

SER. NO. 85-563,142, FILED 3-7-2012.



David J. Kyjars

Director of the United States Patent and Trademark Office

Reg. No. 4,206,067 LAURIE MAYES, EXAMINING ATTORNEY

United States of America

United States Patent and Trademark Office

SUMMIT MUSIC PUBLISHING

Reg. No. 4,206,068

Registered Sep. 11, 2012

Int. Cl.: 41

SERVICE MARK

PRINCIPAL REGISTER

SUMMIT ENTERTAINMENT, LLC (DELAWARE LIMITED LIABILITY COMPANY)
1630 STEWART STREET
SUITE 120
SANTA MONICA, CA 90404

FOR: MUSIC PUBLISHING SERVICES, IN CLASS 41 (U.S. CLS. 100, 101 AND 107).

FIRST USE 1-6-2009; IN COMMERCE 1-6-2009.

THE MARK CONSISTS OF STANDARD CHARACTERS WITHOUT CLAIM TO ANY PARTICULAR FONT, STYLE, SIZE, OR COLOR.

OWNER OF U.S. REG. NOS. 2,097,423, 3,756,889 AND OTHERS.

NO CLAIM IS MADE TO THE EXCLUSIVE RIGHT TO USE "MUSIC PUBLISHING", APART FROM THE MARK AS SHOWN.

SER. NO. 85-566,178, FILED 3-10-2012.

MAUREEN DALL, EXAMINING ATTORNEY



David J. Kybas

Director of the United States Patent and Trademark Office

United States of America

United States Patent and Trademark Office

MADISON MUSKIES

Reg. No. 4,206,069

Registered Sep. 11, 2012

Int. Cl.: 25

TRADEMARK

PRINCIPAL REGISTER

NATIONAL ASSOCIATION OF PROFESSIONAL BASEBALL LEAGUES, INC. (FLORIDA
NON-PROFIT CORPORATION)
9550 16TH STREET N.
ST. PETERSBURG, FL 33716

FOR: CLOTHING, NAMELY, T-SHIRTS, IN CLASS 25 (U.S. CLS. 22 AND 39).

FIRST USE 8-15-2011; IN COMMERCE 8-15-2011.

THE MARK CONSISTS OF STANDARD CHARACTERS WITHOUT CLAIM TO ANY PARTICULAR FONT, STYLE, SIZE, OR COLOR.

SER. NO. 85-568,302, FILED 3-13-2012.

ALAIN LAPTER, EXAMINING ATTORNEY



David J. Kybas

Director of the United States Patent and Trademark Office

United States of America

United States Patent and Trademark Office

The Greenbrier Golf Academy

Reg. No. 4,206,070

GREENBRIER IA, INC. (DELAWARE CORPORATION)
136 CARRIAGE LANE

Registered Sep. 11, 2012

WHITE SULPHUR SPRING, WV 24986

Int. Cl.: 41

FOR: FITTING OF GOLF CLUBS TO INDIVIDUAL USERS; GOLF DRIVING RANGE SERVICES; GOLF FITNESS INSTRUCTION; GOLF INSTRUCTION; PROVIDING A WEBSITE FEATURING INFORMATION ON GOLF AND GOLF INSTRUCTION; PROVIDING GOLF FACILITIES, IN CLASS 41 (U.S. CLS. 100, 101 AND 107).

SERVICE MARK

PRINCIPAL REGISTER

FIRST USE 3-1-2008; IN COMMERCE 3-1-2008.

THE MARK CONSISTS OF STANDARD CHARACTERS WITHOUT CLAIM TO ANY PARTICULAR FONT, STYLE, SIZE, OR COLOR.

OWNER OF U.S. REG. NOS. 1,482,046, 1,633,507 AND OTHERS.

NO CLAIM IS MADE TO THE EXCLUSIVE RIGHT TO USE "GOLF ACADEMY", APART FROM THE MARK AS SHOWN.

SER. NO. 85-570,592, FILED 3-15-2012.

MATTHEW MCDOWELL, EXAMINING ATTORNEY



David J. Kybas

Director of the United States Patent and Trademark Office

United States of America

United States Patent and Trademark Office

Word Technology

Reg. No. 4,206,071

SAIDI, AISHA (UNITED STATES INDIVIDUAL), DBA WORD TECHNOLOGY
757 TRIPPTOWN RD.
HIRAM, ME 04041

Registered Sep. 11, 2012

Int. Cl.: 41

FOR: CUSTOM WRITING SERVICES, IN CLASS 41 (U.S. CLS. 100, 101 AND 107).

SERVICE MARK

FIRST USE 7-5-2011; IN COMMERCE 8-8-2011.

PRINCIPAL REGISTER

THE MARK CONSISTS OF STANDARD CHARACTERS WITHOUT CLAIM TO ANY PARTICULAR FONT, STYLE, SIZE, OR COLOR.

SER. NO. 85-571,313, FILED 3-16-2012.

DARRYL SPRUILL, EXAMINING ATTORNEY



David J. Kyffers

Director of the United States Patent and Trademark Office

United States of America

United States Patent and Trademark Office

TRACK SELECTOR GAME

Reg. No. 4,206,072

FMR LLC (DELAWARE LIMITED LIABILITY COMPANY)
82 DEVONSHIRE STREET
BOSTON, MA 02109

Registered Sep. 11, 2012

Int. Cl.: 28

FOR: CARD GAMES, IN CLASS 28 (U.S. CLS. 22, 23, 38 AND 50).

TRADEMARK

FIRST USE 2-28-2012; IN COMMERCE 2-28-2012.

PRINCIPAL REGISTER

THE MARK CONSISTS OF STANDARD CHARACTERS WITHOUT CLAIM TO ANY PARTICULAR FONT, STYLE, SIZE, OR COLOR.

NO CLAIM IS MADE TO THE EXCLUSIVE RIGHT TO USE "GAME", APART FROM THE MARK AS SHOWN.

SER. NO. 85-571,855, FILED 3-16-2012.

TINA MAI, EXAMINING ATTORNEY



David J. Kyffers

Director of the United States Patent and Trademark Office

United States of America

United States Patent and Trademark Office

GABRIELLE

Reg. No. 4,206,073

SUBERI BROTHERS LLC (NEW YORK LIMITED LIABILITY COMPANY)
902 BROADWAY, 14TH FLOOR
NEW YORK, NY 10010

Registered Sep. 11, 2012

Int. Cl.: 14

FOR: DIAMOND JEWELRY, IN CLASS 14 (U.S. CLS. 2, 27, 28 AND 50).

TRADEMARK

FIRST USE 1-1-1997; IN COMMERCE 1-1-1997.

PRINCIPAL REGISTER

THE MARK CONSISTS OF STANDARD CHARACTERS WITHOUT CLAIM TO ANY PARTICULAR FONT, STYLE, SIZE, OR COLOR.

SER. NO. 85-571,906, FILED 3-16-2012.

AMY KERTGATE, EXAMINING ATTORNEY



David J. Kyffers

Director of the United States Patent and Trademark Office

United States of America

United States Patent and Trademark Office

DSC

Reg. No. 4,206,074

F5 NETWORKS, INC. (WASHINGTON CORPORATION)
401 ELLIOT AVE WEST
SEATTLE, WA 98119

Registered Sep. 11, 2012

Int. Cl.: 9

FOR: COMPUTER SOFTWARE AND COMPUTER HARDWARE FOR USE IN MANAGING NETWORK COMMUNICATIONS TRAFFIC OVER THE INTERNET, NETWORKS, CLOUD SERVERS, AND APPLICATIONS; COMPUTER SOFTWARE AND COMPUTER HARDWARE FOR USE IN IMPROVING THE AVAILABILITY, SECURITY, AND PERFORMANCE OF INTERNET, NETWORKS, CLOUD SERVERS, AND APPLICATIONS; AND COMPUTER SOFTWARE AND COMPUTER HARDWARE FOR USE IN MANAGING STORAGE VIRTUALIZATION DEVICES AND APPLICATIONS, IN CLASS 9 (U.S. CLS. 21, 23, 26, 36 AND 38).

TRADEMARK

PRINCIPAL REGISTER

FIRST USE 11-15-2011; IN COMMERCE 11-15-2011.

THE MARK CONSISTS OF STANDARD CHARACTERS WITHOUT CLAIM TO ANY PARTICULAR FONT, STYLE, SIZE, OR COLOR.

SER. NO. 85-573,770, FILED 3-19-2012.

ELIZABETH KAJUBI, EXAMINING ATTORNEY



David J. Kyjars

Director of the United States Patent and Trademark Office

United States of America

United States Patent and Trademark Office

ACTIGEN

Reg. No. 4,206,075

ALLTECH, INC. (KENTUCKY CORPORATION)
3031 CATNIP HILL PIKE
LEXINGTON, KY 40356

Registered Sep. 11, 2012

Int. Cl.: 5

FOR: ANIMAL FEED SUPPLEMENTS, IN CLASS 5 (U.S. CLS. 6, 18, 44, 46, 51 AND 52).

TRADEMARK

FIRST USE 4-8-2009; IN COMMERCE 4-8-2009.

PRINCIPAL REGISTER

THE MARK CONSISTS OF STANDARD CHARACTERS WITHOUT CLAIM TO ANY PARTICULAR FONT, STYLE, SIZE, OR COLOR.

SER. NO. 85-574,089, FILED 3-20-2012.

KELLEY WELLS, EXAMINING ATTORNEY



David J. Kyffers

Director of the United States Patent and Trademark Office

United States of America

United States Patent and Trademark Office

ACTIGEN

Reg. No. 4,206,076

ALLTECH, INC. (KENTUCKY CORPORATION)
3031 CATNIP HILL PIKE
LEXINGTON, KY 40356

Registered Sep. 11, 2012

Int. Cl.: 31

FOR: YEAST AND YEAST EXTRACTS FOR ANIMAL CONSUMPTION, IN CLASS 31 (U.S. CLS. 1 AND 46).

TRADEMARK

FIRST USE 4-8-2009; IN COMMERCE 4-8-2009.

PRINCIPAL REGISTER

THE MARK CONSISTS OF STANDARD CHARACTERS WITHOUT CLAIM TO ANY PARTICULAR FONT, STYLE, SIZE, OR COLOR.

SER. NO. 85-574,095, FILED 3-20-2012.

KELLEY WELLS, EXAMINING ATTORNEY



David J. Kybas

Director of the United States Patent and Trademark Office

United States of America

United States Patent and Trademark Office

TRIDENT

Reg. No. 4,206,077

Registered Sep. 11, 2012

Int. Cl.: 41

SERVICE MARK

PRINCIPAL REGISTER

NEVER QUIT NEVER LLC (FLORIDA LIMITED LIABILITY COMPANY)
888
1015 ATLANTIC BLVD
ATLANTIC BEACH, FL 32233

FOR: AMATEUR YOUTH SPORTS SERVICES, NAMELY, ORGANIZING AND PROVIDING YOUTH SPORTS ACTIVITIES; ATHLETIC AND SPORTS EVENT SERVICES, NAMELY, ARRANGING, ORGANIZING, OPERATING AND CONDUCTING MARATHON RACES; ENTERTAINMENT IN THE NATURE OF SPORTING AND PHYSICAL FITNESS GAMES; ORGANISATION OF SPORTS COMPETITIONS; ORGANIZATION OF SPORTS COMPETITIONS; ORGANIZING COMMUNITY FESTIVALS FEATURING A VARIETY OF ACTIVITIES, NAMELY, SPORTING EVENTS, ART EXHIBITIONS, FLEA MARKETS, ETHNIC DANCES AND THE LIKE; ORGANIZING SPORTING EVENTS, NAMELY, TRIATHLONS; ORGANIZING SPORTING EVENTS, NAMELY, RUNNING, SWIMMING, WALKING, HIKING, PADDLING, BIKING, BICYCLING, PULL UPS, PUSH UPS, PULL UPS, LOW CRAWL; ORGANIZING, ARRANGING, AND CONDUCTING SPORTING EVENTS; PROVIDING A WEB SITE FEATURING SPORTING INFORMATION; PROVIDING A WEBSITE FEATURING INFORMATION RELATING TO THE SPORT OF RUNNING, SWIMMING, PADDLING, BICYCLING, WALKING, PUSH UPS, PULL UPS, SIT UPS, LOW CRAWLS, IN CLASS 41 (U.S. CLS. 100, 101 AND 107).

FIRST USE 4-29-2007; IN COMMERCE 4-30-2007.

THE MARK CONSISTS OF STANDARD CHARACTERS WITHOUT CLAIM TO ANY PARTICULAR FONT, STYLE, SIZE, OR COLOR.

SER. NO. 85-575,265, FILED 3-21-2012.

GINA HAYES, EXAMINING ATTORNEY



David J. Kyros

Director of the United States Patent and Trademark Office

United States of America

United States Patent and Trademark Office

lalanne

Reg. No. 4,206,078

Registered Sep. 11, 2012

Int. Cl.: 3

TRADEMARK

PRINCIPAL REGISTER

BEFIT ENTERPRISES (CALIFORNIA CORPORATION)
785 QUINTANA ROAD
MORRO BAY, CA 93442

FOR: COSMETIC CREAMS FOR SKIN CARE, IN CLASS 3 (U.S. CLS. 1, 4, 6, 50, 51 AND 52).

FIRST USE 0-0-1955; IN COMMERCE 0-0-1955.

THE MARK CONSISTS OF STANDARD CHARACTERS WITHOUT CLAIM TO ANY PARTICULAR FONT, STYLE, SIZE, OR COLOR.

OWNER OF U.S. REG. NOS. 1,351,946, 3,034,163, AND 3,161,990.

SEC. 2(F).

SER. NO. 85-575,907, FILED 3-21-2012.

NICHOLAS COLEMAN, EXAMINING ATTORNEY



David J. Kybas

Director of the United States Patent and Trademark Office

United States of America

United States Patent and Trademark Office



Reg. No. 4,206,079

Registered Sep. 11, 2012

Int. Cl.: 35

SERVICE MARK

PRINCIPAL REGISTER

BRECKINRIDGE TAYLOR LLC (TEXAS LIMITED LIABILITY COMPANY)
5211 BONITA
DALLAS, TX 75206

FOR: ON-LINE RETAIL STORE SERVICES FEATURING FURNITURE, HOME FURNISHINGS, HOME AND OFFICE ACCESSORIES AND DECORATIVE ITEMS; RETAIL FURNITURE STORES; RETAIL STORE SERVICES FEATURING FURNITURE, HOME FURNISHINGS, HOME AND OFFICE ACCESSORIES AND DECORATIVE ITEMS, IN CLASS 35 (U.S. CLS. 100, 101 AND 102).

FIRST USE 12-0-2010; IN COMMERCE 12-0-2010.

THE MARK CONSISTS OF THE SHAPE OF A SOLID COLOR CAPITAL LETTER "B" CONTAINING THE SHAPE OF A CAPITAL LETTER "T" ANGLED AT APPROXIMATELY 45 DEGREES TO THE LEFT IN THE UPPER PORTION OF THE SOLID LETTER "B", WITH THE "T" SHOWN IN A LIGHT SHADED CONTRASTING COLOR OR SHOWN IN THE NEGATIVE AS THE ABSENCE OF THE DARK COLOR USED FOR THE "B" (IF USED ON A COLORED BACKGROUND).

SER. NO. 85-576,252, FILED 3-21-2012.

JOHN DALIER, EXAMINING ATTORNEY



David J. Kybas

Director of the United States Patent and Trademark Office

United States of America

United States Patent and Trademark Office

BREWING A BETTER WORLD

Reg. No. 4,206,080

Registered Sep. 11, 2012

Int. Cl.: 30

TRADEMARK

PRINCIPAL REGISTER

GREEN MOUNTAIN COFFEE ROASTERS, INC. (VERMONT CORPORATION)
33 COFFEE LANE
WATERBURY, VT 05676

FOR: COFFEE, IN CLASS 30 (U.S. CL. 46).

FIRST USE 9-30-2008; IN COMMERCE 9-30-2008.

THE MARK CONSISTS OF STANDARD CHARACTERS WITHOUT CLAIM TO ANY PARTICULAR FONT, STYLE, SIZE, OR COLOR.

SER. NO. 85-576,935, FILED 3-22-2012.

ELLEN B. AWRICH, EXAMINING ATTORNEY



David J. Kyffers

Director of the United States Patent and Trademark Office

United States of America

United States Patent and Trademark Office



Reg. No. 4,206,081

BRECKINRIDGE TAYLOR LLC (TEXAS LIMITED LIABILITY COMPANY)
5211 BONITA
DALLAS, TX 75206

Registered Sep. 11, 2012

Int. Cl.: 42

FOR: CONSULTING IN THE FIELD OF COMMERCIAL AND RESIDENTIAL INTERIOR DESIGN; DESIGN OF INTERIOR DECOR; DESIGN OF TEXTILES; FURNITURE DESIGN SERVICES; INTERIOR DESIGN SERVICES; INTERIOR DESIGN SERVICES INCLUDING SPACE PLANNING, FURNITURE SELECTION, MATERIAL AND SURFACE SELECTION; INTERIOR DESIGN SERVICES, NAMELY, DESIGN CUSTOM FURNITURE, RUGS, TEXTILES, HOME FURNISHING PRODUCTS AND ACCESSORIES; LANDSCAPE ARCHITECTURAL DESIGN, IN CLASS 42 (U.S. CLS. 100 AND 101).

SERVICE MARK

PRINCIPAL REGISTER

FIRST USE 12-0-2010; IN COMMERCE 12-0-2010.

THE MARK CONSISTS OF THE SHAPE OF A SOLID COLOR CAPITAL LETTER "B" CONTAINING THE SHAPE OF A CAPITAL LETTER "T" ANGLED AT APPROXIMATELY 45 DEGREES TO THE LEFT IN THE UPPER PORTION OF THE SOLID LETTER "B", WITH THE "T" SHOWN IN A LIGHT SHADED CONTRASTING COLOR OR SHOWN IN THE NEGATIVE AS THE ABSENCE OF THE DARK COLOR USED FOR THE "B" (IF USED ON A COLORED BACKGROUND).

SER. NO. 85-578,676, FILED 3-23-2012.

JOHN DALIER, EXAMINING ATTORNEY



David J. Kybas

Director of the United States Patent and Trademark Office

United States of America

United States Patent and Trademark Office

DISH

Reg. No. 4,206,082

Registered Sep. 11, 2012

Int. Cl.: 37

SERVICE MARK

PRINCIPAL REGISTER

DISH NETWORK L.L.C. (COLORADO LIMITED LIABILITY COMPANY)
9601 S MERIDIAN BLVD
ENGLEWOOD, CO 80112

FOR: INSTALLATION SERVICES FOR RESIDENTIAL AND COMMERCIAL SATELLITE RECEIVERS; INSTALLATION OF HOME THEATRES AND RELATED STRUCTURED WIRING; INSTALLATION OF COMPUTER NETWORKING HARDWARE, IN CLASS 37 (U.S. CLS. 100, 103 AND 106).

FIRST USE 5-0-1996; IN COMMERCE 5-0-1996.

THE MARK CONSISTS OF STANDARD CHARACTERS WITHOUT CLAIM TO ANY PARTICULAR FONT, STYLE, SIZE, OR COLOR.

OWNER OF U.S. REG. NO. 3,440,594.

SEC. 2(F).

SER. NO. 85-578,890, FILED 3-23-2012.

ANDREW RHIM, EXAMINING ATTORNEY



David J. Kyffers

Director of the United States Patent and Trademark Office

United States of America

United States Patent and Trademark Office

TENDERFLO

Reg. No. 4,206,083

GF HEALTH PRODUCTS, INC. (DELAWARE CORPORATION), AKA GRAHAM FIELD
2935 NORTHEAST PARKWAY
ATLANTA, GA 30360

Registered Sep. 11, 2012

Int. Cl.: 10

FOR: MEDICAL PRODUCTS, NAMELY, THERAPEUTIC MATTRESSES, BEDS, SEATS AND CUSHIONS, IN CLASS 10 (U.S. CLS. 26, 39 AND 44).

TRADEMARK

FIRST USE 4-20-1988; IN COMMERCE 4-20-1988.

PRINCIPAL REGISTER

THE MARK CONSISTS OF STANDARD CHARACTERS WITHOUT CLAIM TO ANY PARTICULAR FONT, STYLE, SIZE, OR COLOR.

SER. NO. 85-581,314, FILED 3-27-2012.

DAWN HAN, EXAMINING ATTORNEY



David J. Kybas

Director of the United States Patent and Trademark Office

United States of America

United States Patent and Trademark Office

ODYNE

Reg. No. 4,206,084

Registered Sep. 11, 2012

Int. Cl.: 11

TRADEMARK

PRINCIPAL REGISTER

AFKA GROUP INTERNATIONAL, INC. (CALIFORNIA CORPORATION)
32610 MCRAE LANE
WILDOMAR, CA 92595

FOR: HOME APPLIANCES, NAMELY, REFRIGERATORS, FREEZERS, AIR CONDITIONERS, MICROWAVE OVENS, ELECTRIC TOASTERS, ELECTRIC TOASTER OVENS, COOKING OVENS, WINE COOLERS IN THE NATURE OF REFRIGERATED CABINETS CONTAINING RACKS FOR WINE BOTTLES, ELECTRIC COFFEE MAKERS; LAUNDRY CENTERS, NAMELY, A CLOTHES DRYER COMBINED WITH A CLOTHES WASHER, IN CLASS 11 (U.S. CLS. 13, 21, 23, 31 AND 34).

FIRST USE 1-30-2009; IN COMMERCE 1-30-2009.

THE MARK CONSISTS OF STANDARD CHARACTERS WITHOUT CLAIM TO ANY PARTICULAR FONT, STYLE, SIZE, OR COLOR.

SER. NO. 85-581,501, FILED 3-27-2012.

AHSEN KHAN, EXAMINING ATTORNEY



David J. Kyffers

Director of the United States Patent and Trademark Office

United States of America

United States Patent and Trademark Office

DOUBLE UP

Reg. No. 4,206,085

Registered Sep. 11, 2012

Int. Cl.: 28

TRADEMARK

PRINCIPAL REGISTER

EBSCO INDUSTRIES, INC. (DELAWARE CORPORATION)
LEGAL SERVICES
5724 HIGHWAY 280 EAST
BIRMINGHAM, AL 35242

FOR: FISHING TACKLE, IN CLASS 28 (U.S. CLS. 22, 23, 38 AND 50).

FIRST USE 2-10-2012; IN COMMERCE 2-10-2012.

THE MARK CONSISTS OF STANDARD CHARACTERS WITHOUT CLAIM TO ANY PARTICULAR FONT, STYLE, SIZE, OR COLOR.

SER. NO. 85-581,857, FILED 3-28-2012.

MARTHA FROMM, EXAMINING ATTORNEY



David J. Kyffers

Director of the United States Patent and Trademark Office

United States of America

United States Patent and Trademark Office

Simplicity Under Stress

Reg. No. 4,206,086

DARK ANGEL MEDICAL, LLC (COLORADO LIMITED LIABILITY COMPANY)
2722 MEADOW MTN TROL
LAFAYETTE, CO 80026

Registered Sep. 11, 2012

Int. Cl.: 5

FOR: FIRST AID KITS, IN CLASS 5 (U.S. CLS. 6, 18, 44, 46, 51 AND 52).

TRADEMARK

FIRST USE 8-16-2011; IN COMMERCE 1-10-2012.

PRINCIPAL REGISTER

THE MARK CONSISTS OF STANDARD CHARACTERS WITHOUT CLAIM TO ANY PARTICULAR FONT, STYLE, SIZE, OR COLOR.

SER. NO. 85-583,607, FILED 3-29-2012.

ESTHER BELENKER, EXAMINING ATTORNEY



David J. Kyffers

Director of the United States Patent and Trademark Office

United States of America

United States Patent and Trademark Office



Reg. No. 4,206,087

Registered Sep. 11, 2012

Int. Cls.: 29, 30 and 32

TRADEMARK

PRINCIPAL REGISTER

DEAN FOODS COMPANY (DELAWARE CORPORATION)
2711 NORTH HASKELL AVENUE, SUITE 3400
DALLAS, TX 75204

FOR: DAIRY PRODUCTS EXCLUDING ICE CREAM, ICE MILK AND FROZEN YOGURT,
IN CLASS 29 (U.S. CL. 46).

FIRST USE 0-0-2001; IN COMMERCE 0-0-2001.

FOR: ICE CREAM, IN CLASS 30 (U.S. CL. 46).

FIRST USE 0-0-2001; IN COMMERCE 0-0-2001.

FOR: FRUIT JUICES, IN CLASS 32 (U.S. CLS. 45, 46 AND 48).

FIRST USE 0-0-2001; IN COMMERCE 0-0-2001.

OWNER OF U.S. REG. NO. 1,199,735.

THE MARK CONSISTS OF A STYLIZED LETTER "R" IN A CIRCLE.

SER. NO. 85-583,693, FILED 3-29-2012.

MEGHAN REINHART, EXAMINING ATTORNEY



David J. Kybas

Director of the United States Patent and Trademark Office

United States of America

United States Patent and Trademark Office

SURFACE STRIKE

Reg. No. 4,206,088

JENUWINE ARTICLES, INC. (MICHIGAN CORPORATION)
1134 EAST BIG BEAVER ROAD
TROY, MI 48083

Registered Sep. 11, 2012

Int. Cl.: 3

FOR: NON-TOXIC BOAT HULL CLEANER, IN CLASS 3 (U.S. CLS. 1, 4, 6, 50, 51 AND 52).

TRADEMARK

FIRST USE 1-1-2012; IN COMMERCE 1-1-2012.

PRINCIPAL REGISTER

THE MARK CONSISTS OF STANDARD CHARACTERS WITHOUT CLAIM TO ANY PARTICULAR FONT, STYLE, SIZE, OR COLOR.

SER. NO. 85-585,398, FILED 3-30-2012.

LINDA E. BLOHM, EXAMINING ATTORNEY



David J. Kyffers

Director of the United States Patent and Trademark Office

United States of America

United States Patent and Trademark Office

BALANCE NOT BIAS

Reg. No. 4,206,089

SOUTHERN CALIFORNIA PUBLIC RADIO (MINNESOTA NON-PROFIT CORPORATION)
474 S. RAYMOND AVENUE
PASADENA, CA 91105

Registered Sep. 11, 2012

Int. Cl.: 41

FOR: PROVIDING ON-GOING RADIO SHOWS RELATING TO NEWS AND CURRENT EVENTS, BROADCAST OVER THE MEDIA OF RADIO AND VIA A GLOBAL COMPUTER NETWORK; PROVIDING ONLINE INFORMATION IN THE FIELDS OF NEWS AND CURRENT EVENTS, IN CLASS 41 (U.S. CLS. 100, 101 AND 107).

SERVICE MARK

PRINCIPAL REGISTER

FIRST USE 1-0-2012; IN COMMERCE 1-0-2012.

THE MARK CONSISTS OF STANDARD CHARACTERS WITHOUT CLAIM TO ANY PARTICULAR FONT, STYLE, SIZE, OR COLOR.

SER. NO. 85-586,127, FILED 4-2-2012.

JAY FLOWERS, EXAMINING ATTORNEY



David J. Kyffers

Director of the United States Patent and Trademark Office

United States of America

United States Patent and Trademark Office

IDEAS NOT IDEOLOGY

Reg. No. 4,206,090

SOUTHERN CALIFORNIA PUBLIC RADIO (MINNESOTA NON-PROFIT CORPORATION)
474 S. RAYMOND AVENUE
PASADENA, CA 91105

Registered Sep. 11, 2012

Int. Cl.: 41

FOR: PROVIDING ON-GOING RADIO SHOWS RELATING TO NEWS AND CURRENT EVENTS, BROADCAST OVER THE MEDIA OF RADIO AND VIA A GLOBAL COMPUTER NETWORK; PROVIDING ONLINE INFORMATION IN THE FIELDS OF NEWS AND CURRENT EVENTS, IN CLASS 41 (U.S. CLS. 100, 101 AND 107).

SERVICE MARK

PRINCIPAL REGISTER

FIRST USE 1-0-2012; IN COMMERCE 1-0-2012.

THE MARK CONSISTS OF STANDARD CHARACTERS WITHOUT CLAIM TO ANY PARTICULAR FONT, STYLE, SIZE, OR COLOR.

SER. NO. 85-586,128, FILED 4-2-2012.

JAY FLOWERS, EXAMINING ATTORNEY



David J. Kyffers

Director of the United States Patent and Trademark Office

United States of America

United States Patent and Trademark Office

SheChanges

Reg. No. 4,206,091

JEPSON, LAEL COUPER (UNITED STATES INDIVIDUAL), DBA SHECHANGES
67 WOODMONT ST.

Registered Sep. 11, 2012

PORTLAND, ME 04102

Int. Cl.: 35

FOR: CONSULTING SERVICES IN BUSINESS LEADERSHIP DEVELOPMENT AND BUSINESS MANAGEMENT, IN CLASS 35 (U.S. CLS. 100, 101 AND 102).

SERVICE MARK

FIRST USE 1-1-2006; IN COMMERCE 5-1-2007.

PRINCIPAL REGISTER

THE MARK CONSISTS OF STANDARD CHARACTERS WITHOUT CLAIM TO ANY PARTICULAR FONT, STYLE, SIZE, OR COLOR.

SER. NO. 85-587,708, FILED 4-3-2012.

SKYE YOUNG, EXAMINING ATTORNEY



David J. Kybas

Director of the United States Patent and Trademark Office

United States of America
United States Patent and Trademark Office

RIOMUNE

Reg. No. 4,206,092

RIO RANCH SUPPLY INC. (MINNESOTA CORPORATION)
165 HIGHWAY 195
VESTA, MN 56292

Registered Sep. 11, 2012

Int. Cl.: 5

FOR: ANIMAL FEED SUPPLEMENTS; DIETARY SUPPLEMENTS FOR ANIMALS, IN CLASS 5 (U.S. CLS. 6, 18, 44, 46, 51 AND 52).

TRADEMARK

FIRST USE 1-1-2008; IN COMMERCE 1-1-2008.

PRINCIPAL REGISTER

THE MARK CONSISTS OF STANDARD CHARACTERS WITHOUT CLAIM TO ANY PARTICULAR FONT, STYLE, SIZE, OR COLOR.

SER. NO. 85-588,121, FILED 4-3-2012.

KEVIN DINALLO, EXAMINING ATTORNEY



David J. Kybas

Director of the United States Patent and Trademark Office

United States of America

United States Patent and Trademark Office

RUMENGUARD

Reg. No. 4,206,093

RIO RANCH SUPPLY INC. (MINNESOTA CORPORATION)
165 HIGHWAY 195
VESTA, MN 56292

Registered Sep. 11, 2012

Int. Cl.: 5

FOR: ANIMAL FEED SUPPLEMENTS; DIETARY SUPPLEMENTS FOR ANIMALS, IN CLASS 5 (U.S. CLS. 6, 18, 44, 46, 51 AND 52).

TRADEMARK

FIRST USE 1-1-2008; IN COMMERCE 1-1-2008.

PRINCIPAL REGISTER

THE MARK CONSISTS OF STANDARD CHARACTERS WITHOUT CLAIM TO ANY PARTICULAR FONT, STYLE, SIZE, OR COLOR.

SER. NO. 85-588,126, FILED 4-3-2012.

KEVIN DINALLO, EXAMINING ATTORNEY



David J. Kyffers

Director of the United States Patent and Trademark Office

United States of America

United States Patent and Trademark Office



Reg. No. 4,206,094

PERICOM SEMICONDUCTOR CORPORATION (DELAWARE CORPORATION)
3545 N FIRST ST
SAN JOSE, CA 95134

Registered Sep. 11, 2012

Int. Cl.: 9

FOR: COMPUTER HARDWARE; INTEGRATED CIRCUITS; SEMICONDUCTOR CHIPS;
SEMICONDUCTORS, IN CLASS 9 (U.S. CLS. 21, 23, 26, 36 AND 38).

TRADEMARK

FIRST USE 0-0-1993; IN COMMERCE 0-0-1993.

PRINCIPAL REGISTER

THE MARK CONSISTS OF THE STYLIZED LETTER "P" WITH A SPARK DESIGN.

SER. NO. 85-589,604, FILED 4-4-2012.

REBECCA GILBERT, EXAMINING ATTORNEY



David J. Kyffers

Director of the United States Patent and Trademark Office

United States of America

United States Patent and Trademark Office

atop

Reg. No. 4,206,095

Registered Sep. 11, 2012

Int. Cl.: 26

TRADEMARK

PRINCIPAL REGISTER

CHEN, KEVIN (TAIWAN INDIVIDUAL)
NO.11, LANE 188, GONGYE RD., LONGJING DI
TAICHUNG CITY, TAIWAN 434

FOR: METAL FASTENERS FOR SHOES AND BOOTS; SHOE LACES; BOBBIN LACE; LACES FOR FOOTWEAR; BUTTONS; SHOE BUCKLES; HAT BUCKLES; RIBBONS; BRAIDS , IN CLASS 26 (U.S. CLS. 37, 39, 40, 42 AND 50).

FIRST USE 9-3-2008; IN COMMERCE 3-23-2009.

THE MARK CONSISTS OF STANDARD CHARACTERS WITHOUT CLAIM TO ANY PARTICULAR FONT, STYLE, SIZE, OR COLOR.

SER. NO. 85-590,793, FILED 4-6-2012.

MORGAN WYNNE, EXAMINING ATTORNEY



David J. Kybas

Director of the United States Patent and Trademark Office

United States of America

United States Patent and Trademark Office

COURSECONNECT FLASH

Reg. No. 4,206,096

Registered Sep. 11, 2012

Int. Cl.: 9

TRADEMARK

PRINCIPAL REGISTER

PEARSON EDUCATION, INC. (DELAWARE CORPORATION)
ONE LAKE STREET
UPPER SADDLE RIVER, NJ 07458

FOR: DOWNLOADABLE EDUCATIONAL SOFTWARE FOR MOBILE DEVICES FEATURING STUDY GUIDES IN THE FIELDS OF SOCIAL SCIENCES AND HUMANITIES, IN CLASS 9 (U.S. CLS. 21, 23, 26, 36 AND 38).

FIRST USE 2-1-2012; IN COMMERCE 2-1-2012.

THE MARK CONSISTS OF STANDARD CHARACTERS WITHOUT CLAIM TO ANY PARTICULAR FONT, STYLE, SIZE, OR COLOR.

SER. NO. 85-592,134, FILED 4-9-2012.

JORDAN BAKER, EXAMINING ATTORNEY



David J. Kybas

Director of the United States Patent and Trademark Office

United States of America

United States Patent and Trademark Office

WORLD SERIES OF SALES

Reg. No. 4,206,097

Registered Sep. 11, 2012

Int. Cl.: 41

SERVICE MARK

PRINCIPAL REGISTER

ADVISORS EXCEL, LLC (KANSAS LIMITED LIABILITY COMPANY)
SUITE 200
1300 SW ARROWHEAD ROAD
TOPEKA, KS 66604

FOR: TRAINING SERVICES IN THE FIELD OF INSURANCE FOR AGENTS, IN CLASS 41
(U.S. CLS. 100, 101 AND 107).

FIRST USE 7-1-2007; IN COMMERCE 7-1-2007.

THE MARK CONSISTS OF STANDARD CHARACTERS WITHOUT CLAIM TO ANY PARTICULAR FONT, STYLE, SIZE, OR COLOR.

SER. NO. 85-594,596, FILED 4-11-2012.

KRISTINA MORRIS, EXAMINING ATTORNEY



David J. Kyffers

Director of the United States Patent and Trademark Office

United States of America

United States Patent and Trademark Office

AE INSIDER

Reg. No. 4,206,098

Registered Sep. 11, 2012

Int. Cl.: 16

TRADEMARK

PRINCIPAL REGISTER

ADVISORS EXCEL, LLC (KANSAS LIMITED LIABILITY COMPANY)
SUITE 200
1300 SW ARROWHEAD ROAD
TOPEKA, KS 66604

FOR: MAGAZINES IN THE FIELD OF INSURANCE AND FINANCIAL SERVICES, IN CLASS 16 (U.S. CLS. 2, 5, 22, 23, 29, 37, 38 AND 50).

FIRST USE 2-22-2011; IN COMMERCE 2-22-2011.

THE MARK CONSISTS OF STANDARD CHARACTERS WITHOUT CLAIM TO ANY PARTICULAR FONT, STYLE, SIZE, OR COLOR.

SER. NO. 85-594,684, FILED 4-11-2012.

KRISTINA MORRIS, EXAMINING ATTORNEY



David J. Kyffers

Director of the United States Patent and Trademark Office

United States of America
United States Patent and Trademark Office

MAGNETO

Reg. No. 4,206,099

NAIL ALLIANCE, LLC (DELAWARE LIMITED LIABILITY COMPANY)
6840 N OAK
GLADSTONE, MO 64118

Registered Sep. 11, 2012

Int. Cl.: 3

FOR: NAIL CARE PREPARATIONS, IN CLASS 3 (U.S. CLS. 1, 4, 6, 50, 51 AND 52).

TRADEMARK

FIRST USE 1-31-2012; IN COMMERCE 1-31-2012.

PRINCIPAL REGISTER

THE MARK CONSISTS OF STANDARD CHARACTERS WITHOUT CLAIM TO ANY PARTICULAR FONT, STYLE, SIZE, OR COLOR.

SER. NO. 85-595,764, FILED 4-12-2012.

JAMES GRIFFIN, EXAMINING ATTORNEY



David J. Kyffers

Director of the United States Patent and Trademark Office

United States of America

United States Patent and Trademark Office

18G

Reg. No. 4,206,100

NAIL ALLIANCE, LLC (DELAWARE LIMITED LIABILITY COMPANY)
6840 N OAK
GLADSTONE, MO 64118

Registered Sep. 11, 2012

Int. Cl.: 11

FOR: APPARATUS FOR DRYING/HARDENING NAIL FINISHES, POLISHES AND VARNISHES, INCLUDING DESICCATE APPARATUS, DRYING APPARATUS, LED TYPE NAIL DRYERS, DRYING APPARATUS AND INSTALLATIONS, AND LAMPS, IN CLASS 11 (U.S. CLS. 13, 21, 23, 31 AND 34).

TRADEMARK

PRINCIPAL REGISTER

FIRST USE 10-31-2011; IN COMMERCE 10-31-2011.

THE MARK CONSISTS OF STANDARD CHARACTERS WITHOUT CLAIM TO ANY PARTICULAR FONT, STYLE, SIZE, OR COLOR.

SER. NO. 85-595,822, FILED 4-12-2012.

JAMES GRIFFIN, EXAMINING ATTORNEY



David J. Kyffers

Director of the United States Patent and Trademark Office

United States of America

United States Patent and Trademark Office

TATTOO VANISH

Reg. No. 4,206,101

TATTOO VANISH, INC. (NEVADA CORPORATION)
6879 WEST CHARLESTON, SUITE A
LAS VEGAS, NV 89117

Registered Sep. 11, 2012

Int. Cl.: 44

FOR: TATTOO REMOVAL SERVICE UTILIZING A SPECIALLY FORMULATED SOLUTION,
IN CLASS 44 (U.S. CLS. 100 AND 101).

SERVICE MARK

FIRST USE 1-15-1993; IN COMMERCE 1-15-1993.

PRINCIPAL REGISTER

THE MARK CONSISTS OF STANDARD CHARACTERS WITHOUT CLAIM TO ANY PAR-
TICULAR FONT, STYLE, SIZE, OR COLOR.

OWNER OF U.S. REG. NO. 3,806,058.

NO CLAIM IS MADE TO THE EXCLUSIVE RIGHT TO USE "TATTOO", APART FROM THE
MARK AS SHOWN.

SER. NO. 85-600,494, FILED 4-17-2012.

NAAKWAMA ANKRAH, EXAMINING ATTORNEY



David J. Kyffers

Director of the United States Patent and Trademark Office

United States of America

United States Patent and Trademark Office

ARCANUM

Reg. No. 4,206,102

Registered Sep. 11, 2012

Int. Cl.: 33

TRADEMARK

PRINCIPAL REGISTER

JACKSON WINE ESTATES INTERNATIONAL LIMITED (IRELAND CORPORATION)
CHERRYWOOD BUSINESS PARK, BUILDING D
LOUGHLINSTOWN
COUNTY DUBLIN, IRELAND

FOR: ALCOHOLIC BEVERAGES EXCEPT BEERS, IN CLASS 33 (U.S. CLS. 47 AND 49).

FIRST USE 2-28-2004; IN COMMERCE 2-28-2004.

THE MARK CONSISTS OF STANDARD CHARACTERS WITHOUT CLAIM TO ANY PARTICULAR FONT, STYLE, SIZE, OR COLOR.

OWNER OF U.S. REG. NO. 3,080,331.

SER. NO. 85-608,034, FILED 4-25-2012.

CARYN GLASSER, EXAMINING ATTORNEY



David J. Kyffers

Director of the United States Patent and Trademark Office

United States of America
United States Patent and Trademark Office

ARCENO

Reg. No. 4,206,103

Registered Sep. 11, 2012

Int. Cl.: 33

TRADEMARK

PRINCIPAL REGISTER

JACKSON WINE ESTATES INTERNATIONAL LIMITED (IRELAND CORPORATION)
CHERRYWOOD BUSINESS PARK, BUILDING D
LOUGHLINSTOWN
COUNTY DUBLIN, IRELAND

FOR: ALCOHOLIC BEVERAGES EXCEPT BEERS, IN CLASS 33 (U.S. CLS. 47 AND 49).

FIRST USE 5-21-2001; IN COMMERCE 5-21-2001.

THE MARK CONSISTS OF STANDARD CHARACTERS WITHOUT CLAIM TO ANY PARTICULAR FONT, STYLE, SIZE, OR COLOR.

OWNER OF U.S. REG. NO. 3,668,621.

SER. NO. 85-608,090, FILED 4-25-2012.

CARYN GLASSER, EXAMINING ATTORNEY



David J. Kyffers

Director of the United States Patent and Trademark Office

United States of America

United States Patent and Trademark Office

HIGH SANDS

Reg. No. 4,206,104

Registered Sep. 11, 2012

Int. Cl.: 33

TRADEMARK

PRINCIPAL REGISTER

JACKSON WINE ESTATES INTERNATIONAL LIMITED (IRELAND CORPORATION)
CHERRYWOOD BUSINESS PARK, BUILDING D
LOUGHLINSTOWN
COUNTY DUBLIN, IRELAND

FOR: ALCOHOLIC BEVERAGES EXCEPT BEERS, IN CLASS 33 (U.S. CLS. 47 AND 49).

FIRST USE 1-1-2008; IN COMMERCE 1-1-2008.

THE MARK CONSISTS OF STANDARD CHARACTERS WITHOUT CLAIM TO ANY PARTICULAR FONT, STYLE, SIZE, OR COLOR.

OWNER OF U.S. REG. NO. 3,486,521.

SER. NO. 85-608,480, FILED 4-25-2012.

CARYN GLASSER, EXAMINING ATTORNEY



David J. Kyffers

Director of the United States Patent and Trademark Office

United States of America

United States Patent and Trademark Office

BEYOND

Reg. No. 4,206,105

BEYOND PILATES, LLC (TEXAS LIMITED LIABILITY COMPANY)
4314 LOVERS LANE
DALLAS, TX 75225

Registered Sep. 11, 2012

Int. Cl.: 41

FOR: PROVIDING FITNESS AND EXERCISE STUDIO SERVICES, NAMELY, PILATES INSTRUCTION AND TRAINING; PHYSICAL FITNESS STUDIO SERVICES, NAMELY, PROVIDING GROUP EXERCISE INSTRUCTION, EQUIPMENT, AND FACILITIES; PROVIDING PHYSICAL FITNESS AND EXERCISE SERVICE, NAMELY, INDOOR CYCLING AND YOGA INSTRUCTION, IN CLASS 41 (U.S. CLS. 100, 101 AND 107).

SERVICE MARK

PRINCIPAL REGISTER

FIRST USE 5-29-2010; IN COMMERCE 5-29-2010.

THE MARK CONSISTS OF THE WORD "BEYOND" IN A TURQUOISE COLOR SUCH THAT THE LETTER "Y" IS UPSIDE DOWN AND THE LETTER "N" IS INVERTED.

THE COLOR(S) TURQUOISE IS/ARE CLAIMED AS A FEATURE OF THE MARK.

SER. NO. 85-976,493, FILED 9-2-2011.

NORA BUCHANAN WILL, EXAMINING ATTORNEY



David J. Kybas

Director of the United States Patent and Trademark Office

United States of America

United States Patent and Trademark Office

Mr. Agile

Reg. No. 4,206,106

Registered Sep. 11, 2012

Int. Cl.: 41

SERVICE MARK

PRINCIPAL REGISTER

LAYTON, MARK (UNITED STATES INDIVIDUAL)
SUITE 704
5318 E. 2ND STREET
LONG BEACH, CA 90803

FOR: EDUCATION SERVICES, NAMELY, CONDUCTING TRAINING SEMINARS, WORKSHOPS AND CLASSES ALL IN THE FIELDS OF PROJECT MANAGEMENT, COMPUTER SOFTWARE DEVELOPMENT, AND PROJECT MANAGEMENT TRAINING, IN CLASS 41 (U.S. CLS. 100, 101 AND 107).

FIRST USE 1-5-2001; IN COMMERCE 1-7-2008.

THE MARK CONSISTS OF STANDARD CHARACTERS WITHOUT CLAIM TO ANY PARTICULAR FONT, STYLE, SIZE, OR COLOR.

NO CLAIM IS MADE TO THE EXCLUSIVE RIGHT TO USE "AGILE", APART FROM THE MARK AS SHOWN.

SER. NO. 85-976,529, FILED 9-14-2010.

BERYL GARDNER, EXAMINING ATTORNEY



David J. Kyffers

Director of the United States Patent and Trademark Office

United States of America

United States Patent and Trademark Office

thirty-one

Reg. No. 4,206,107

THIRTY-ONE GIFTS LLC (OHIO LIMITED LIABILITY COMPANY)
3425 MORSE CROSSING
COLUMBUS, OH 43219

Registered Sep. 11, 2012

**Int. Cls.: 8, 9, 16, 18, 20,
21 and 35**

FOR: NAIL FILES; MANICURE SETS, IN CLASS 8 (U.S. CLS. 23, 28 AND 44).

FIRST USE 9-1-2007; IN COMMERCE 9-1-2007.

TRADEMARK

FOR: LAPTOP CARRYING CASES; CASES FOR EYEGLASSES AND SUNGLASSES; CASES WITH INTERIOR THERMAL LINING FOR STORING OR CARRYING ELECTRIC FLAT IRONS OR ELECTRIC CURLING IRONS, IN CLASS 9 (U.S. CLS. 21, 23, 26, 36 AND 38).

SERVICE MARK

PRINCIPAL REGISTER

FIRST USE 2-1-2009; IN COMMERCE 2-1-2009.

FOR: STATIONERY; ADDRESS LABELS; NOTEPADS; NOTE CARDS; PERSONAL ORGANIZERS; PADFOLIOS; PENCIL POUCHES, IN CLASS 16 (U.S. CLS. 2, 5, 22, 23, 29, 37, 38 AND 50).

FIRST USE 4-1-2004; IN COMMERCE 4-1-2004.

FOR: TOTE BAGS; WALLETS; COIN PURSES; CLUTCHES; COSMETIC BAGS SOLD EMPTY; JEWELRY ROLLS FOR TRAVEL; JEWELRY POUCHES; LUGGAGE TAGS; BACK PACKS; SACK PACKS, NAMELY, DRAWSTRING BAGS USED AS BACKPACKS; UMBRELLAS; PURSES; SHOULDER BAGS; WHEELED TOTE BAGS; WRISTLET BAGS; SHOULDER STRAPS; ALL-PURPOSE CARRYING BAGS; HANDBAGS; INTERCHANGEABLE DECORATIVE COVERS FOR ACCESSORIZATION PURPOSES THAT ARE SPECIALLY ADAPTED TO HANDBAGS; TOILETRY BAGS SOLD EMPTY; MESSENGER BAGS; DECORATIVE ORNAMENTS FOR ATTACHING TO HANDBAGS, PURSES, OR BACKPACKS, IN CLASS 18 (U.S. CLS. 1, 2, 3, 22 AND 41).

FIRST USE 4-1-2004; IN COMMERCE 4-1-2004.

FOR: KEY FOBS, NOT OF METAL; PERSONAL COMPACT MIRRORS; NON-METAL FABRIC HANGING ORGANIZER; PLASTIC HANG TAGS, IN CLASS 20 (U.S. CLS. 2, 13, 22, 25, 32 AND 50).

FIRST USE 9-1-2007; IN COMMERCE 9-1-2007.



David J. Kappas

Director of the United States Patent and Trademark Office

Reg. No. 4,206,107 FOR: COASTERS NOT OF PAPER AND NOT BEING TABLE LINEN; COLLAPSIBLE STORAGE CONTAINERS FOR DOMESTIC USE; THERMAL INSULATED BAGS FOR FOOD OR BEVERAGES; THERMAL INSULATED CONTAINERS FOR FOOD OR BEVERAGES; BASKETS FOR DOMESTIC USE, NOT OF METAL; GENERAL PURPOSE STORAGE BINS FOR HOUSEHOLD USE; FITTED FABRIC BASKET LINERS FOR DECORATIVE PURPOSES, IN CLASS 21 (U.S. CLS. 2, 13, 23, 29, 30, 33, 40 AND 50).

FIRST USE 4-1-2004; IN COMMERCE 4-1-2004.

FOR: SHOP-AT-HOME PARTIES FEATURING PURSES, INTERCHANGEABLE DECORATIVE PURSE COVERS, WALLETS, HANDBAGS, TOTES, LAPTOP BAGS, SHOULDER BAGS, BACKPACKS, SACK PACKS, STATIONERY, STORAGE CONTAINERS, THERMAL INSULATED CONTAINERS, ORGANIZERS, BLANKETS, MIRROR COMPACTS, MANICURE SETS, JEWELRY ROLLS, JEWELRY POUCHES, LUGGAGE TAGS, KEY FOBS, COASTERS, APRONS, AND SCARVES, IN CLASS 35 (U.S. CLS. 100, 101 AND 102).

FIRST USE 12-31-2002; IN COMMERCE 12-31-2002.

THE MARK CONSISTS OF THE STYLIZED WORDING "THIRTY-ONE".

SER. NO. 85-976,703, FILED 9-26-2011.

BRIAN PINO, EXAMINING ATTORNEY

United States of America

United States Patent and Trademark Office

OUT WITH THE OLD...IN WITH RENNOU

Reg. No. 4,206,108

THEOCORP HOLDING COMPANY, LLC (LOUISIANA LIMITED LIABILITY COMPANY)
3512 8TH STREET
METAIRIE, LA 70002

Registered Sep. 11, 2012

Int. Cl.: 3

FOR: DENTAL CARE PRODUCTS, NAMELY, TOOTHPASTE HAVING COMPOUNDS CONTAINING NATURAL OR SYNTHESIZED THEOBROMINE, IN CLASS 3 (U.S. CLS. 1, 4, 6, 50, 51 AND 52).

TRADEMARK

FIRST USE 1-2-2012; IN COMMERCE 1-2-2012.

PRINCIPAL REGISTER

THE MARK CONSISTS OF STANDARD CHARACTERS WITHOUT CLAIM TO ANY PARTICULAR FONT, STYLE, SIZE, OR COLOR.

SER. NO. 85-976,711, FILED 9-14-2011.

MAYUR VAGHANI, EXAMINING ATTORNEY



David J. Kybas

Director of the United States Patent and Trademark Office

United States of America

United States Patent and Trademark Office

MUMBAI MONKEY

Reg. No. 4,206,109

HOT CHAAT, LLC (ILLINOIS LIMITED LIABILITY COMPANY)
2631 WILLIAMSBURG AVE., #301
GENEVA, IL 60134

Registered Sep. 11, 2012

Int. Cls.: 25, 35 and 41

FOR: WEARABLE GARMENTS AND CLOTHING, NAMELY, SHIRTS, IN CLASS 25 (U.S. CLS. 22 AND 39).

TRADEMARK

FIRST USE 6-24-2011; IN COMMERCE 6-24-2011.

SERVICE MARK

FOR: ONLINE RETAIL STORE SERVICES FEATURING CLOTHING, NAMELY SHIRTS, EDUCATIONAL AND ENTERTAINING VIDEOS AND RELATED GOODS, IN CLASS 35 (U.S. CLS. 100, 101 AND 102).

PRINCIPAL REGISTER

FIRST USE 6-24-2011; IN COMMERCE 6-24-2011.

FOR: EDUCATIONAL AND ENTERTAINMENT SERVICES, NAMELY, PROVIDING ON-LINE, NON-DOWNLOADABLE INTERACTIVE CHILDREN'S VIDEOS IN THE FIELD OF LANGUAGES, HEALTHY LIFESTYLES AND CREATIVITY, IN CLASS 41 (U.S. CLS. 100, 101 AND 107).

FIRST USE 6-21-2011; IN COMMERCE 6-21-2011.

THE MARK CONSISTS OF STANDARD CHARACTERS WITHOUT CLAIM TO ANY PARTICULAR FONT, STYLE, SIZE, OR COLOR.

SER. NO. 85-976,755, FILED 7-29-2011.

JAMES GRIFFIN, EXAMINING ATTORNEY



David J. Kyffers

Director of the United States Patent and Trademark Office

United States of America

United States Patent and Trademark Office

WHERE'S IT @?

Reg. No. 4,206,110

WHERE'S IT @? MEDIA, LLC (MISSOURI LIMITED LIABILITY COMPANY)

Registered Sep. 11, 2012

#18 BRIGHTON WAY
ST. LOUIS, MO 63105

Int. Cl.: 41

FOR: BOOK PUBLISHING; PUBLICATION OF BOOKS AND OTHER PRINTED MATTER;
ONLINE ELECTRONIC PUBLISHING OF BOOKS AND PERIODICALS; CHARITABLE
SERVICES, NAMELY, PROVIDING BOOKS TO PEOPLE; CUSTOM WRITING SERVICES,
IN CLASS 41 (U.S. CLS. 100, 101 AND 107).

SERVICE MARK

PRINCIPAL REGISTER

FIRST USE 4-15-2010; IN COMMERCE 11-30-2010.

THE MARK CONSISTS OF STANDARD CHARACTERS WITHOUT CLAIM TO ANY PAR-
TICULAR FONT, STYLE, SIZE, OR COLOR.

SER. NO. 85-976,810, FILED 8-2-2011.

DAVID YONTEF, EXAMINING ATTORNEY



David J. Kyffers

Director of the United States Patent and Trademark Office

United States of America

United States Patent and Trademark Office

GUSSI ITALIA

Reg. No. 4,206,111

SYNTEC INDUSTRIES, LLC (GEORGIA LIMITED LIABILITY COMPANY)
438 LAVENDER DRIVE
ROME, GA 30165

Registered Sep. 11, 2012

Int. Cl.: 12

FOR: STEERING WHEELS FOR BOATS, IN CLASS 12 (U.S. CLS. 19, 21, 23, 31, 35 AND 44).

FIRST USE 10-7-2009; IN COMMERCE 10-7-2009.

TRADEMARK

THE MARK CONSISTS OF STANDARD CHARACTERS WITHOUT CLAIM TO ANY PARTICULAR FONT, STYLE, SIZE, OR COLOR.

PRINCIPAL REGISTER

NO CLAIM IS MADE TO THE EXCLUSIVE RIGHT TO USE "ITALIA", APART FROM THE MARK AS SHOWN.

SER. NO. 85-977,227, FILED 5-10-2011.

SHAUNIA CARLYLE, EXAMINING ATTORNEY



David J. Kybas

Director of the United States Patent and Trademark Office

United States of America

United States Patent and Trademark Office

MODERN TRIBE

Reg. No. 4,206,112

Registered Sep. 11, 2012

Int. Cls.: 9 and 42

TRADEMARK

SERVICE MARK

PRINCIPAL REGISTER

SHANE & PETER INC. (CALIFORNIA CORPORATION)
200 WEST CLIFF DR. #14
SANTA CRUZ, CA 95060

FOR: COMPUTER PROGRAMS AND SOFTWARE FOR EXTENDING AND ENHANCING FUNCTIONALITY OF APPLICATIONS AND WEBSITES, AND DOWNLOADABLE WEBCASTS AND VIDEO FILES REGARDING THE ART AND BUSINESS OF FREELANCING AND SMALL BUSINESS ENTREPRENEURSHIP, IN CLASS 9 (U.S. CLS. 21, 23, 26, 36 AND 38).

FIRST USE 3-1-2011; IN COMMERCE 10-12-2011.

FOR: TECHNICAL DESIGN, RESEARCH AND DEVELOPMENT SERVICES FOR CUSTOM SOFTWARE APPLICATIONS ACROSS A VARIETY OF PLATFORMS, IN CLASS 42 (U.S. CLS. 100 AND 101).

FIRST USE 3-1-2011; IN COMMERCE 10-12-2011.

THE MARK CONSISTS OF STANDARD CHARACTERS WITHOUT CLAIM TO ANY PARTICULAR FONT, STYLE, SIZE, OR COLOR.

NO CLAIM IS MADE TO THE EXCLUSIVE RIGHT TO USE "TRIBE", APART FROM THE MARK AS SHOWN.

SER. NO. 85-977,238, FILED 11-2-2011.

APRIL ROACH, EXAMINING ATTORNEY



David J. Kyfos

Director of the United States Patent and Trademark Office

United States of America

United States Patent and Trademark Office

SANDRA LEE SEMI-HOMEMADE

Reg. No. 4,206,113

Registered Sep. 11, 2012

Int. Cls.: 16 and 41

TRADEMARK

SERVICE MARK

PRINCIPAL REGISTER

SANDRA LEE REVOCABLE TRUST, THE (CALIFORNIA TRUST)
578 WASHINGTON BOULEVARD
SUITE 345
MARINA DEL RAY, CA 90292

FOR: COOKBOOKS; MAGAZINES FEATURING HOMEMAKING, HOME CARE, ORGANIZING, COOKING, RECIPES, BEAUTY, FLORAL, HOUSEKEEPING, DECORATING, GARDENING, ENTERTAINING, CRAFTS, AND HOLIDAY PLANNING, IN CLASS 16 (U.S. CLS. 2, 5, 22, 23, 29, 37, 38 AND 50).

FIRST USE 4-0-1997; IN COMMERCE 4-0-1997.

FOR: ENTERTAINMENT IN THE NATURE OF ON-GOING TELEVISION PROGRAMS FEATURING HOMEMAKING, HOME CARE, ORGANIZING, COOKING, BEAUTY, FLORAL, HOUSEKEEPING, DECORATING, GARDENING, ENTERTAINING, CRAFTS, AND HOLIDAY PLANNING; PROVIDING ON-LINE JOURNALS, NAMELY, BLOGS AND NON-DOWNLOADABLE PUBLICATIONS IN THE NATURE OF ARTICLES IN THE FIELDS OF HOMEMAKING, HOME CARE, ORGANIZING, COOKING, RECIPES, BEAUTY, FLORAL, HOUSEKEEPING, DECORATING, GARDENING, ENTERTAINING, CRAFTS, AND HOLIDAY PLANNING; ENTERTAINMENT SERVICES, NAMELY, PROVIDING A WEB SITE FEATURING PHOTOGRAPHIC, VIDEO AND PROSE PRESENTATIONS FEATURING HOMEMAKING, HOME CARE, ORGANIZING, COOKING, BEAUTY, FLORAL, HOUSEKEEPING, DECORATING, GARDENING, ENTERTAINING, CRAFTS, AND HOLIDAY PLANNING, IN CLASS 41 (U.S. CLS. 100, 101 AND 107).

FIRST USE 4-0-1997; IN COMMERCE 4-0-1997.

THE MARK CONSISTS OF STANDARD CHARACTERS WITHOUT CLAIM TO ANY PARTICULAR FONT, STYLE, SIZE, OR COLOR.

THE NAME "SANDRA LEE" IDENTIFIES A LIVING INDIVIDUAL WHOSE CONSENT IS OF RECORD.

SEC. 2(F) AS TO "SEMI-HOMEMADE".

SER. NO. 85-977,284, FILED 3-4-2011.

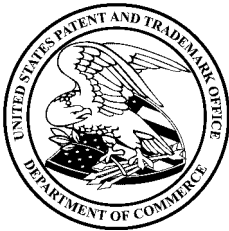

David J. Kyffers

Director of the United States Patent and Trademark Office

Reg. No. 4,206,113 AMY KELLY, EXAMINING ATTORNEY

United States of America

United States Patent and Trademark Office

SAM CHOY'S

Reg. No. 4,206,114

Registered Sep. 11, 2012

**Int. Cls.: 16, 30, 41, 43
and 45**

KONA DAZE, LLC (HAWAII LIMITED LIABILITY COMPANY)
1515 NORTH ACADEMY BLVD
SUITE 400
COLORADO SPRINGS, CO 809092749

FOR: COOKBOOKS; PRINTED RECIPES, IN CLASS 16 (U.S. CLS. 2, 5, 22, 23, 29, 37, 38 AND 50).

TRADEMARK

FIRST USE 2-15-1980; IN COMMERCE 2-15-1980.

SERVICE MARK

FOR: NOODLES, SAUCE, AND PROCESSED VEGETABLES COMBINED IN UNITARY PACKAGES; FRIED RICE; SAUCES; SALAD DRESSINGS, IN CLASS 30 (U.S. CL. 46).

PRINCIPAL REGISTER

FIRST USE 1-1-2001; IN COMMERCE 1-1-2001.

FOR: PROVIDING EDUCATIONAL COOKING DEMONSTRATIONS; PROVIDING COOKING CLASSES; ENTERTAINMENT SERVICES IN THE NATURE OF PROVIDING COOKING SHOWS FEATURING DEMONSTRATIONS AND RECIPES DURING GUEST APPEARANCES ON TELEVISION SHOWS; ENTERTAINMENT SERVICES IN THE NATURE OF PROVIDING COOKING SHOWS FEATURING DEMONSTRATIONS AND SERVICES DURING GUEST APPEARANCES AT CHARITABLE EVENTS, IN CLASS 41 (U.S. CLS. 100, 101 AND 107).

FIRST USE 12-25-1985; IN COMMERCE 11-1-1989.

FOR: BAR AND RESTAURANT SERVICES; CONSULTATION SERVICES IN THE FIELD OF RESTAURANT MENU DEVELOPMENT; FOOD PREPARATION SERVICES; PROVIDING AN ONLINE COMPUTER DATABASE TO CONSUMERS CONCERNING RECIPES, INGREDIENTS AND COOKING INFORMATION; RESTAURANT SERVICES, INCLUDING SIT-DOWN SERVICES OF FOOD AND TAKE-OUT RESTAURANT SERVICES; PROVIDING COOKING SERVICES FOR INDIVIDUALS AND GROUPS, NAMELY, CATERING SERVICES, IN CLASS 43 (U.S. CLS. 100 AND 101).

FIRST USE 5-15-1991; IN COMMERCE 4-28-2010.

FOR: PROVIDING COOKING SERVICES FOR INDIVIDUALS AND GROUPS, NAMELY, PERSONAL CHEF SERVICES, IN CLASS 45 (U.S. CLS. 100 AND 101).



David J. Kybas

Director of the United States Patent and Trademark Office

Reg. No. 4,206,114 FIRST USE 12-25-1985; IN COMMERCE 11-1-1989.

THE MARK CONSISTS OF STANDARD CHARACTERS WITHOUT CLAIM TO ANY PARTICULAR FONT, STYLE, SIZE, OR COLOR.

THE NAME(S), PORTRAIT(S), AND/OR SIGNATURE(S) SHOWN IN THE MARK IDENTIFIES "SAM CHOY", WHOSE CONSENT(S) TO REGISTER IS MADE OF RECORD.

SER. NO. 85-977,318, FILED 12-10-2010.

HEATHER BIDDULPH, EXAMINING ATTORNEY

United States of America

United States Patent and Trademark Office

COBRA

Reg. No. 4,206,115

Registered Sep. 11, 2012

Int. Cl.: 9

TRADEMARK

PRINCIPAL REGISTER

COBRA ELECTRONICS CORPORATION (DELAWARE CORPORATION)
6500 WEST CORTLAND STREET
CHICAGO, IL 60707

FOR: REMOTE CONTROL SYSTEMS, CONSISTING PRIMARILY OF RADIO RECEIVER, TRANSMITTER AND ANTENNA, TELEMATIC SYSTEMS, CONSISTING PRIMARILY OF RADIO RECEIVER, TRANSMITTER AND ANTENNA, AND POSITION CONTROL AND MONITORING SYSTEMS, CONSISTING PRIMARILY OF RADIO RECEIVER, TRANSMITTER AND ANTENNA FOR VEHICLES AND COMPONENT PARTS THEREFOR; VEHICLE LOCATING AND TRACKING SYSTEM COMPRISED OF AN ANTENNA AND RADIO TRANSMITTER TO BE PLACED IN A VEHICLE, IN CLASS 9 (U.S. CLS. 21, 23, 26, 36 AND 38).

FIRST USE 12-31-2008; IN COMMERCE 12-31-2008.

SN 76-385,363, FILED 3-21-2002.

JULIE WATSON, EXAMINING ATTORNEY



David J. Kyffers

Director of the United States Patent and Trademark Office

United States of America

United States Patent and Trademark Office



Reg. No. 4,206,116

GALLETAS DE CALIDAD, SACV. (MEXICO CORPORATION)
PONIENTE 122 NO. 489
COL. COLTONGO 02630, MEXICO

Registered Sep. 11, 2012

Int. Cl.: 30

FOR: COOKIES, BISCUITS AND PASTRIES, IN CLASS 30 (U.S. CL. 46).

FIRST USE 6-21-2012; IN COMMERCE 6-21-2012.

TRADEMARK

THE MARK CONSISTS OF THE STYLIZED WORDING "ORIGENS", WITH A LEAF SWIRLING OUT OF THE LETTER "O". THE COLOR ORANGE APPEARS WITHIN THE WORDING "ORIGENS", AND THE COLOR GREEN APPEARS WITHIN THE LEAF.

PRINCIPAL REGISTER

THE COLOR(S) ORANGE AND GREEN IS/ARE CLAIMED AS A FEATURE OF THE MARK.

THE ENGLISH TRANSLATION OF THE WORD "ORIGENES" IN THE MARK IS ORIGINS.

SN 76-669,048, FILED 11-15-2006.

KEVON CHISOLM, EXAMINING ATTORNEY



David J. Kybas

Director of the United States Patent and Trademark Office

United States of America

United States Patent and Trademark Office

WELLDQC

Reg. No. 4,206,117

Registered Sep. 11, 2012

Int. Cl.: 9

TRADEMARK

PRINCIPAL REGISTER

WELLDQC, INC. (MARYLAND CORPORATION)
1501 ST. PAUL STREET
SUITE 118
BALTIMORE, MD 21202

FOR: COMPUTER SOFTWARE FOR THE RECEIPT AND TRANSMISSION OF DATA WHICH HAS THE CAPABILITY OF TRANSMITTING, RECEIVING, AND ANALYZING VIDEO AND TWO-WAY VIDEO CONFERENCING COMMUNICATIONS; COMPUTER SOFTWARE FOR THE RECEIPT AND TRANSMISSION OF DATA WHICH HAS THE CAPABILITY OF TRANSMITTING, RECEIVING, AND ANALYZING VOICE AND TEXT COMMUNICATIONS, IN CLASS 9 (U.S. CLS. 21, 23, 26, 36 AND 38).

FIRST USE 9-1-2011; IN COMMERCE 9-1-2011.

THE MARK CONSISTS OF STANDARD CHARACTERS WITHOUT CLAIM TO ANY PARTICULAR FONT, STYLE, SIZE, OR COLOR.

OWNER OF U.S. REG. NO. 3,534,689.

SN 76-692,952, FILED 9-18-2008.

JEFFERY COWARD, EXAMINING ATTORNEY



David J. Kybas

Director of the United States Patent and Trademark Office

United States of America

United States Patent and Trademark Office

RIBBONTIP

Reg. No. 4,206,118

APTARGROUP, INC (DELAWARE CORPORATION)
475 W TERRA COTTA AVENUE, SUITE E
CRYSTAL LAKE, IL 60014

Registered Sep. 11, 2012

Int. Cl.: 20

FOR: NON-METAL AND NON-PAPER CLOSURES FOR CONTAINERS, IN CLASS 20 (U.S. CLS. 2, 13, 22, 25, 32 AND 50).

TRADEMARK

FIRST USE 4-19-2011; IN COMMERCE 4-19-2011.

PRINCIPAL REGISTER

THE MARK CONSISTS OF STANDARD CHARACTERS WITHOUT CLAIM TO ANY PARTICULAR FONT, STYLE, SIZE, OR COLOR.

SN 76-698,503, FILED 7-20-2009.

JOHN KELLY, EXAMINING ATTORNEY



David J. Kybas

Director of the United States Patent and Trademark Office

United States of America

United States Patent and Trademark Office

BETEK Tools

Reg. No. 4,206,119

Registered Sep. 11, 2012

Int. Cl.: 7

TRADEMARK

PRINCIPAL REGISTER

BETEK GMBH & CO. KG (FED REP GERMANY CORPORATION)
SULGENER STR. 21-23
AICHHALDEN, FED REP GERMANY 78733

FOR: PARTS OF POWER OPERATED MACHINES, NAMELY, CUTTING BITS AND WEARING WASHERS FOR ROAD MILLING MACHINES; CUTTING BITS AND WEARING WASHERS FOR SURFACE MINING MACHINES; CUTTING BITS AND WEARING WASHERS FOR SOIL STABILIZING MACHINES AND COLD RECYCLING MACHINES; ROUND SHANK BITS, WELDING BARS, QUICK CHANGE BARS AND HOLDERS, WELD-ON CASING CROWNS, STOP WEDGES AND SCREW CONNECTIONS FOR FOUNDATION DRILLING MACHINES; ROUND SHANK BITS, BIT HOLDERS AND WELD-ON TEETH FOR HORIZONTAL DIRECTIONAL DRILLING MACHINES; CUTTING TEETH AND TEETH HOLDERS FOR DIAPHRAGM WALL CUTTING MACHINES; ROUND SHANK BITS AND BIT HOLDERS FOR TRENCHING MACHINES; ROUND SHANK BITS AND CUTTING TEETH FOR MINING AND TUNNELING MACHINES; ROUND SHANK BITS AND BIT HOLDERS FOR HYDRAULIC MILLING CUTTERS; AND CUTTING TEETH FOR TREE STUMP GRINDING MACHINES, MULCHING MACHINES, WOOD SHREDDING MACHINES, STONE CRUSHING MACHINES AND PAPER ROLL CORE SHREDDING MACHINES, IN CLASS 7 (U.S. CLS. 13, 19, 21, 23, 31, 34 AND 35).

FIRST USE 6-19-2012; IN COMMERCE 6-19-2012.

THE MARK CONSISTS OF STANDARD CHARACTERS WITHOUT CLAIM TO ANY PARTICULAR FONT, STYLE, SIZE, OR COLOR.

OWNER OF U.S. REG. NO. 2,845,766.

NO CLAIM IS MADE TO THE EXCLUSIVE RIGHT TO USE "TOOLS", APART FROM THE MARK AS SHOWN.

SN 76-703,005, FILED 5-18-2010.

FLORENTINA BLANDU, EXAMINING ATTORNEY



David J. Kyffers

Director of the United States Patent and Trademark Office

United States of America

United States Patent and Trademark Office

PROLINE

Reg. No. 4,206,120

Registered Sep. 11, 2012

Int. Cls.: 1, 3, and 5

TRADEMARK

PRINCIPAL REGISTER

NAMCO, LLC (CONNECTICUT LIMITED LIABILITY COMPANY)
100 SANRICO DRIVE
MANCHESTER, CT 06042

FOR: CHEMICAL BUFFERING AGENTS FOR ADJUSTING THE PH AND FOR CHELATING IRON AND OTHER METALS IN SWIMMING POOL AND SPA WATER, CHEMICAL ADDITIVES IN THE NATURE OF FLOCCULANTS FOR SWIMMING POOL AND SPA WATER TO REMOVE SUSPENDED IMPURITIES; WATER-SOLUBLE SYNTHETIC RESIN AGGLOMERATING AGENT COMPOSITIONS FOR CLARIFYING SWIMMING POOL WATER; CHEMICAL COMPOSITIONS FOR ADDITION TO COAL AND SAND FILTERS TO FUNCTION AS FILTER ADDITIVES IN THE FILTRATION OF SWIMMING POOL AND SPA WATER, IN CLASS 1 (U.S. CLS. 1, 5, 6, 10, 26 AND 46).

FIRST USE 4-10-2011; IN COMMERCE 4-10-2011.

FOR: CLEANING COMPOSITIONS FOR SWIMMING POOL TILE AND VINYL LINERS, IN CLASS 3 (U.S. CLS. 1, 4, 6, 50, 51 AND 52).

FIRST USE 4-10-2011; IN COMMERCE 4-10-2011.

FOR: SWIMMING POOL AND SPA WATER PURIFIER USED AS BACTERICIDE, DISINFECTANT AND ALGAEICIDES FOR SWIMMING POOL AND SPA WATER, IN CLASS 5 (U.S. CLS. 6, 18, 44, 46, 51 AND 52).

FIRST USE 4-10-2011; IN COMMERCE 4-10-2011.

THE MARK CONSISTS OF STANDARD CHARACTERS WITHOUT CLAIM TO ANY PARTICULAR FONT, STYLE, SIZE, OR COLOR.

OWNER OF U.S. REG. NOS. 1,674,393, 1,864,126, AND OTHERS.

SN 76-703,269, FILED 6-7-2010.

BARNEY CHARLON, EXAMINING ATTORNEY



David J. Kypos

Director of the United States Patent and Trademark Office

United States of America

United States Patent and Trademark Office



Reg. No. 4,206,121

Registered Sep. 11, 2012

Int. Cls.: 1, 3, and 5

TRADEMARK

PRINCIPAL REGISTER

NAMCO, LLC (CONNECTICUT LIMITED LIABILITY COMPANY)
100 SANRICO DRIVE
MANCHESTER, CT 06042

FOR: CHEMICAL BUFFERING AGENTS FOR ADJUSTING THE PH AND FOR CHELATING IRON AND OTHER METALS IN SWIMMING POOL AND SPA WATER, CHEMICAL ADDITIVES IN THE NATURE OF FLOCCULANTS FOR SWIMMING POOL AND SPA WATER TO REMOVE SUSPENDED IMPURITIES; WATER-SOLUBLE SYNTHETIC RESIN AGGLOMERATING AGENT COMPOSITIONS FOR CLARIFYING SWIMMING POOL WATER; CHEMICAL COMPOSITIONS FOR ADDITION TO COAL AND SAND FILTERS TO FUNCTION AS FILTER ADDITIVES IN THE FILTRATION OF SWIMMING POOL AND SPA WATER, IN CLASS 1 (U.S. CLS. 1, 5, 6, 10, 26 AND 46).

FIRST USE 4-10-2011; IN COMMERCE 4-10-2011.

FOR: CLEANING COMPOSITIONS FOR SWIMMING POOL TILE AND VINYL LINERS, IN CLASS 3 (U.S. CLS. 1, 4, 6, 50, 51 AND 52).

FIRST USE 4-10-2011; IN COMMERCE 4-10-2011.

FOR: SWIMMING POOL AND SPA WATER PURIFIER USED AS BACTERICIDE, DISINFECTANT AND ALGAEICIDES FOR SWIMMING POOL AND SPA WATER, IN CLASS 5 (U.S. CLS. 6, 18, 44, 46, 51 AND 52).

FIRST USE 4-10-2011; IN COMMERCE 4-10-2011.

THE MARK COMPRISES THE WORD "PROLINE" SUPERIMPOSED ON A DIAMOND-SHAPED BACKGROUND IN A FANCIFUL ILLUSTRATION OF WATER DROPLETS ON THE LEFT SIDE AND AN UNDULATING ELEMENT BELOW THE WORD.

SN 76-703,270, FILED 6-7-2010.

BARNEY CHARLON, EXAMINING ATTORNEY



David J. Kyffers

Director of the United States Patent and Trademark Office

United States of America

United States Patent and Trademark Office

EROS MOBILE

Reg. No. 4,206,122

Registered Sep. 11, 2012

Int. Cl.: 41

SERVICE MARK

PRINCIPAL REGISTER

GROUP KAITU, LLC (DELAWARE LIMITED LIABILITY COMPANY)
9702 GAYTON ROAD, SUITE 167
RICHMOND, VA 23233

FOR: ENTERTAINMENT SERVICES, NAMELY, PROVIDING INFORMATION ABOUT ENTERTAINERS AND PROVIDING MARKET SPECIFIC INFORMATION ON ENTERTAINERS IN THE FIELD OF ADULT-THEMED ENTERTAINMENT VIA MOBILE AND WIRELESS DEVICES; ENTERTAINMENT SERVICES, NAMELY, NON-DOWNLOADABLE TEXT AND IMAGES CONTAINING INFORMATION ABOUT ENTERTAINERS AND THEIR GEOGRAPHIC LOCATION AS PRESENTED TO MOBILE COMMUNICATIONS DEVICES VIA A GLOBAL COMPUTER NETWORK AND WIRELESS NETWORKS; ENTERTAINMENT SERVICES, NAMELY, NON-DOWNLOADABLE AUDIO RECORDINGS IN THE NATURE OF VOICE RECORDINGS AS PRESENTED TO MOBILE COMMUNICATIONS DEVICES VIA A GLOBAL COMPUTER NETWORK AND WIRELESS NETWORKS, IN CLASS 41 (U.S. CLS. 100, 101 AND 107).

FIRST USE 5-22-2012; IN COMMERCE 5-22-2012.

THE MARK CONSISTS OF STANDARD CHARACTERS WITHOUT CLAIM TO ANY PARTICULAR FONT, STYLE, SIZE, OR COLOR.

OWNER OF U.S. REG. NOS. 2,793,831, 3,134,894, AND OTHERS.

NO CLAIM IS MADE TO THE EXCLUSIVE RIGHT TO USE "MOBILE", APART FROM THE MARK AS SHOWN.

SN 76-703,378, FILED 6-15-2010.

AMEEN IMAM, EXAMINING ATTORNEY



David J. Kypos

Director of the United States Patent and Trademark Office

United States of America

United States Patent and Trademark Office

GREENSMART

Reg. No. 4,206,123

KENERGY SCIENTIFIC, INC. (NEW JERSEY CORPORATION)
6 MINNEAKONING ROAD
FLEMINGTON, NJ 08822

Registered Sep. 11, 2012

Int. Cl.: 35

FOR: RETAIL STORE SERVICES FEATURING SOLAR POWERED PRODUCTS, WIND POWERED PRODUCTS, AND CLOTHING AND FASHION ACCESSORIES MADE FROM RECYCLED FABRICS AND METALS, AND EXCLUDING RECYCLED PAPER PRODUCTS AND EXCLUDING ALL FOOD PRODUCTS, IN CLASS 35 (U.S. CLS. 100, 101 AND 102).

SERVICE MARK

PRINCIPAL REGISTER

FIRST USE 12-1-2011; IN COMMERCE 12-1-2011.

THE MARK CONSISTS OF STANDARD CHARACTERS WITHOUT CLAIM TO ANY PARTICULAR FONT, STYLE, SIZE, OR COLOR.

SN 76-704,169, FILED 8-18-2010.

TINA BROWN, EXAMINING ATTORNEY



David J. Kybas

Director of the United States Patent and Trademark Office

United States of America

United States Patent and Trademark Office



Reg. No. 4,206,124

Registered Sep. 11, 2012

Int. Cl.: 35

SERVICE MARK

PRINCIPAL REGISTER

JDR VENTURES, LLC (MICHIGAN LIMITED LIABILITY COMPANY)
5770 RAVEN ROAD
BLOOMFIELD HILLS, MI 48301

FOR: ADVERTISING AND BUSINESS SERVICES, NAMELY, MATCHING MERCHANTS' PRODUCTS WITH CONSUMERS BASED ON TARGET DEMOGRAPHICS DEFINED BY MERCHANTS, IN CLASS 35 (U.S. CLS. 100, 101 AND 102).

FIRST USE 9-1-2010; IN COMMERCE 9-1-2010.

THE MARK CONSISTS OF THE STYLIZED TERM "!T" ENCLOSED IN A ROUNDED-CORNER SQUARE WITH A CURVED BAND ACROSS THE TOP OF THE SQUARE.

SN 76-704,692, FILED 9-27-2010.

MYRIAH HABEEB, EXAMINING ATTORNEY



David J. Kyros

Director of the United States Patent and Trademark Office

United States of America

United States Patent and Trademark Office



Reg. No. 4,206,125

LOUDER, MARY (UNITED STATES INDIVIDUAL)
1012 KATY LANE
LONGMONT, CO 80504

Registered Sep. 11, 2012

Int. Cl.: 3

FOR: NON-MEDICATED DIAPER RASH CREAMS AND LOTIONS, IN CLASS 3 (U.S. CLS. 1, 4, 6, 50, 51 AND 52).

TRADEMARK

FIRST USE 8-1-2010; IN COMMERCE 8-1-2010.

PRINCIPAL REGISTER

NO CLAIM IS MADE TO THE EXCLUSIVE RIGHT TO USE "CREAM", APART FROM THE MARK AS SHOWN.

"DR. MARY" IDENTIFIES A LIVING INDIVIDUAL WHOSE CONSENT IS OF RECORD.

THE MARK CONSISTS OF THE WORDS "DR. MARY'S" AND "CHEEKY CREAM". THE WORDS "DR. MARY'S" IS WITHIN THE BORDER OF A CIRCLE WITH A DRAWING OF A MONKEY'S HEAD IN THE MIDDLE OF THE CIRCLE; THE WORD "CHEEKY" IS ON THE LEFT SIDE OF THE HEAD AND THE WORD "CREAM" IS ON THE RIGHT SIDE OF THE HEAD, BETWEEN THE TWO LINES.

SN 76-705,142, FILED 10-29-2010.

CARYN GLASSER, EXAMINING ATTORNEY



David J. Kyffers

Director of the United States Patent and Trademark Office

United States of America

United States Patent and Trademark Office

THE WORD COLLAGE



Reg. No. 4,206,126

BROWN, SHIRLEY J. (UNITED STATES INDIVIDUAL)
631 65TH STREET
OAKLAND, CA 94609

Registered Sep. 11, 2012

Int. Cl.: 16

FOR: GREETING CARDS, IN CLASS 16 (U.S. CLS. 2, 5, 22, 23, 29, 37, 38 AND 50).

TRADEMARK

FIRST USE 4-14-2011; IN COMMERCE 5-8-2012.

PRINCIPAL REGISTER

THE MARK CONSISTS OF THE WORDING "THE WORD COLLAGE TWC" IN A STYLIZED FONT.

SN 76-705,264, FILED 11-8-2010.

THEODORE MCBRIDE, EXAMINING ATTORNEY



David J. Kyffers

Director of the United States Patent and Trademark Office

United States of America

United States Patent and Trademark Office

NITEHAWK

Reg. No. 4,206,127

NITEHAWK BROOKLYN LLC (NEW YORK LIMITED LIABILITY COMPANY)
136 METROPOLITAN AVENUE, APT 3B
BROOKLYN, NY 11211

Registered Sep. 11, 2012

Int. Cl.: 41

FOR: ENTERTAINMENT SERVICES, NAMELY, MOTION PICTURE THEATERS, IN CLASS 41 (U.S. CLS. 100, 101 AND 107).

SERVICE MARK

FIRST USE 7-31-2011; IN COMMERCE 7-31-2011.

PRINCIPAL REGISTER

THE MARK CONSISTS OF STANDARD CHARACTERS WITHOUT CLAIM TO ANY PARTICULAR FONT, STYLE, SIZE, OR COLOR.

SN 76-705,487, FILED 11-26-2010.

MARLENE BELL, EXAMINING ATTORNEY



David J. Kybas

Director of the United States Patent and Trademark Office

United States of America

United States Patent and Trademark Office

CONVERSATIONS OF SIGNIFICANCE

Reg. No. 4,206,128

Registered Sep. 11, 2012

Int. Cl.: 41

SERVICE MARK

PRINCIPAL REGISTER

LIPSCOMB UNIVERSITY (TENNESSEE CORPORATION)
3901 GRANNY WHITE PIKE
NASHVILLE, TN 372043951

FOR: CONDUCTING LECTURES, FORUMS AND SEMINARS IN THE FIELD OF CHRISTIAN SPIRITUALITY, YELLOW RIBBON/VETERANS AFFAIRS, HEALTHCARE, ART, THEATER, PERFORMING ARTS, HISTORY, POLITICS AND PHILOSOPHY, CIVIC LEADERSHIP, INTERCULTURAL ENGAGEMENT, LATINO AFFAIRS, ENGINEERING, EDUCATION, BUSINESS, GLOBAL LEARNING, HEALTH SCIENCE, PHARMACY, COMMUNICATION AND JOURNALISM, LAW, JUSTICE AND SOCIETY, CONFLICT MANAGEMENT, CONFLICT RESOLUTION, SUSTAINABILITY, CORPORATE GOVERNANCE AND INTEGRITY, GLOBAL BUSINESS, PROFESSIONAL STUDIES, EMERGING STUDIES, AGING STUDIES, AND SPIRITUAL FORMATION, IN CLASS 41 (U.S. CLS. 100, 101 AND 107).

FIRST USE 1-12-2009; IN COMMERCE 1-12-2009.

THE MARK CONSISTS OF STANDARD CHARACTERS WITHOUT CLAIM TO ANY PARTICULAR FONT, STYLE, SIZE, OR COLOR.

SN 76-705,552, FILED 12-3-2010.

MICHAEL KEATING, EXAMINING ATTORNEY



David J. Kybas

Director of the United States Patent and Trademark Office

United States of America

United States Patent and Trademark Office

KC

Reg. No. 4,206,129

Registered Sep. 11, 2012

Int. Cl.: 12

TRADEMARK

PRINCIPAL REGISTER

JANCO & WINNEX INC. (CALIFORNIA CORPORATION)
637 VINELAND AVENUE
LA PUENTE, CA 91746

FOR: BICYCLES, BICYCLE PARTS, NAMELY, BELTS FOR BELT DRIVEN BICYCLES, BRAKES, FRAMES, HANDLEBAR GRIPS, GEARS, HORNS, KICKSTANDS, TUBE AND CONNECTORS FOR BICYCLE FRAMES, GEAR WHEELS, DRIVE CHAINS DISK WHEELS, HANDLE BAR ENDS, BRAKE SHOES, CHANGE-SPEED GEARS, DRIVE TRAINS, FORK CROWN COVERS, FORKS, FRONT FORK JOINTS, HANDLE BAR STEMS, SPROCKETS, DERAILLEURS, PEDALS, SADDLES, SEATS, WHEELS, RIMS AND STRUCTURAL PARTS THEREFOR; MIRRORS FOR VEHICLES, NAMELY, REAR VIEW, SIDE VIEW AND VANITY MIRRORS; TIRES FOR AUTOMOBILES, TWO-WHEELED MOTOR VEHICLES, CHILDREN'S BICYCLE, VEHICLES AND LAND VEHICLES; WHEELS FOR AUTOMOBILES, RAILWAY CARS, BICYCLE, CYCLES AND SCOOTERS; SPOKES AND SPOKE CLIPS FOR BICYCLE WHEELS, BICYCLE CHAINS, BICYCLE GRIP TAPE, BICYCLE PUMPS, BICYCLE CARGO RACKS, BICYCLE SADDLE COVERS, BICYCLE SEAT POSTS, BICYCLE TAGS, BICYCLE TRAILERS, BICYCLE TRAINING HARNESSSES, BICYCLE TRAINING WHEELS, BICYCLE WATER BOTTLE CAGES, BICYCLE-MOUNTED PET SEAT, MOUNTAIN BICYCLE, MOTORS FOR BICYCLE, RACING BICYCLE, ROAD RACING BICYCLE, ROWING BIKES, SADDLEBAGS FOR BICYCLE, SADDLES FOR BICYCLE, SAFETY PADS FOR BICYCLE, TOURING BICYCLES, TRICYCLES, MOTOR SCOOTERS, MOTOR BIKES, SCOOTERS, SCOOTERS AND STRUCTURAL PARTS THEREFOR, AND MOTORS FOR BICYCLE, IN CLASS 12 (U.S. CLS. 19, 21, 23, 31, 35 AND 44).

FIRST USE 6-29-2012; IN COMMERCE 6-29-2012.

THE MARK CONSISTS OF STANDARD CHARACTERS WITHOUT CLAIM TO ANY PARTICULAR FONT, STYLE, SIZE, OR COLOR.

SN 76-705,949, FILED 1-10-2011.

JEAN IM, EXAMINING ATTORNEY



David J. Kyffers

Director of the United States Patent and Trademark Office

United States of America

United States Patent and Trademark Office

MDAllergy Drops

Reg. No. 4,206,130

ALLERGY ADVANCES MEDICAL P.C. (NEW YORK CORPORATION)
57 W. 57TH STREET, SUITE 601
NEW YORK, NY 10019

Registered Sep. 11, 2012

Int. Cl.: 41

FOR: EDUCATIONAL SERVICES FOR DOCTORS, NAMELY, COURSES OF INSTRUCTION AND WORKSHOPS IN THE FIELD OF ALLERGY RELIEF, IN CLASS 41 (U.S. CLS. 100, 101 AND 107).

SERVICE MARK

FIRST USE 4-5-2009; IN COMMERCE 4-5-2009.

PRINCIPAL REGISTER

THE MARK CONSISTS OF STANDARD CHARACTERS WITHOUT CLAIM TO ANY PARTICULAR FONT, STYLE, SIZE, OR COLOR.

NO CLAIM IS MADE TO THE EXCLUSIVE RIGHT TO USE "DROPS", APART FROM THE MARK AS SHOWN.

SN 76-706,797, FILED 3-14-2011.

REBECCA SMITH, EXAMINING ATTORNEY



David J. Kybas

Director of the United States Patent and Trademark Office

United States of America

United States Patent and Trademark Office



Reg. No. 4,206,131

Registered Sep. 11, 2012

Int. Cl.: 25

TRADEMARK

PRINCIPAL REGISTER

EATON, IRIS A. (UNITED STATES INDIVIDUAL)
4029 GRAND ISLE DRIVE
CHESAPEAKE, VA 23323

FOR: CHILDREN'S AND INFANTS' CLOTH BIBS, IN CLASS 25 (U.S. CLS. 22 AND 39).

FIRST USE 11-7-2011; IN COMMERCE 2-27-2012.

THE MARK CONSISTS OF THE WORDING "GARDEN OF EATON" IN GREEN AND A DESIGN ELEMENT FEATURING GREEN PLANTS, WITH PINK, YELLOW AND PURPLE FLOWERS, AND FOUR FLYING BEIGE CHERUBS PLAYING A YELLOW TO BLACK TRUMPET WITH YELLOW HAIR AND BLUE WINGS ON A WHITE BACKGROUND. BELOW THE WORDING IS A DESIGN OF FOUR IVY WITH GREEN LEAVES AND VINES.

THE COLOR(S) PINK, BEIGE, GREEN, YELLOW, WHITE, BLUE, PURPLE AND BLACK IS/ARE CLAIMED AS A FEATURE OF THE MARK.

SN 76-707,252, FILED 4-13-2011.

LOURDES AYALA, EXAMINING ATTORNEY



David J. Kybas

Director of the United States Patent and Trademark Office

United States of America

United States Patent and Trademark Office

ErgoBAGSTAND

Reg. No. 4,206,132

Registered Sep. 11, 2012

Int. Cl.: 6

TRADEMARK

PRINCIPAL REGISTER

PROVIDENT MARKETING, INC. (PENNSYLVANIA CORPORATION)
BOX 1101
DOYLESTOWN, PA 18901

FOR: OPENWORK FRAMES FOR HOLDING TRASH BAGS, NAMELY, A METAL FRAME TO SUPPORT AND ACCOMMODATE USE OF PLASTIC GARBAGE BAGS, IN CLASS 6 (U.S. CLS. 2, 12, 13, 14, 23, 25 AND 50).

FIRST USE 2-29-2012; IN COMMERCE 2-29-2012.

THE MARK CONSISTS OF STANDARD CHARACTERS WITHOUT CLAIM TO ANY PARTICULAR FONT, STYLE, SIZE, OR COLOR.

SN 76-707,630, FILED 5-16-2011.

SEAN CROWLEY, EXAMINING ATTORNEY



David J. Kyffers

Director of the United States Patent and Trademark Office

United States of America

United States Patent and Trademark Office

METAINTEGRAL

Reg. No. 4,206,133

SEAN ESBJORN-HARGENS (UNITED STATES INDIVIDUAL)
817 JONIVE ROAD
SEBASTOPOL, CA 95472

Registered Sep. 11, 2012

Int. Cls.: 35, 36, and 41

FOR: BUSINESS ASSISTANCE, ADVISORY AND CONSULTING SERVICES IN THE FIELD OF INTEGRAL THEORY, IN CLASS 35 (U.S. CLS. 100, 101 AND 102).

SERVICE MARK

FIRST USE 6-8-2012; IN COMMERCE 6-8-2012.

PRINCIPAL REGISTER

FOR: PROVIDING GRANTS TO PROMOTE THE RESEARCH AND APPLICATION OF INTEGRAL THEORY, IN CLASS 36 (U.S. CLS. 100, 101 AND 102).

FIRST USE 6-8-2012; IN COMMERCE 6-8-2012.

FOR: EDUCATIONAL SERVICES, NAMELY, CONDUCTING SEMINARS AND TRAINING IN THE FIELD OF INTEGRAL THEORY, AND THE DISTRIBUTION COURSE MATERIALS IN CONNECTION THEREWITH; AND PUBLISHING AND ISSUING OF SCIENTIFIC PAPERS IN RELATION TO INTEGRAL THEORY, IN CLASS 41 (U.S. CLS. 100, 101 AND 107).

FIRST USE 6-8-2012; IN COMMERCE 6-8-2012.

THE MARK CONSISTS OF STANDARD CHARACTERS WITHOUT CLAIM TO ANY PARTICULAR FONT, STYLE, SIZE, OR COLOR.

SN 76-707,854, FILED 6-6-2011.

KATHERINE STOIDES, EXAMINING ATTORNEY



David J. Kyros

Director of the United States Patent and Trademark Office

United States of America

United States Patent and Trademark Office

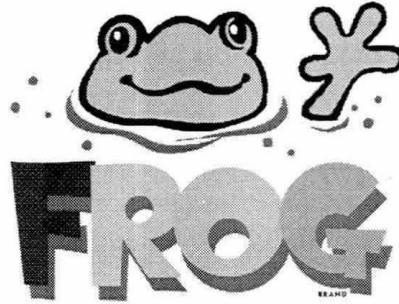

Reg. No. 4,206,134

Registered Sep. 11, 2012

Int. Cl.: 11

TRADEMARK

PRINCIPAL REGISTER

KING TECHNOLOGY, INC. (MINNESOTA CORPORATION)
530 11TH AVENUE SOUTH
HOPKINS, MN 55343

FOR: SWIMMING POOL EQUIPMENT, NAMELY, VALVES FOR DISPENSING WATER PURIFICATION MATERIAL IN SWIMMING POOLS, INLINE CHEMICAL FEEDING VALVES AND CARTRIDGES FOR INLINE CHEMICAL FEEDING VALVES FOR SANITIZING POOLS, SPAS AND ALGAECIDES AND BACTERICIDES FOR SWIMMING POOLS AND SPA, IN CLASS 11 (U.S. CLS. 13, 21, 23, 31 AND 34).

FIRST USE 9-7-2011; IN COMMERCE 10-20-2011.

OWNER OF U.S. REG. NOS. 2,122,417, 3,315,257, AND OTHERS.

NO CLAIM IS MADE TO THE EXCLUSIVE RIGHT TO USE "BRAND", APART FROM THE MARK AS SHOWN.

THE MARK COMPRISES A STYLIZED FROG'S HEAD AND HAND WITH A WATERLINE LOCATED BELOW THE FROG'S HEAD AND HAND AND BUBBLES SURROUNDING THE FROG'S HEAD. THE WORD "FROG" IS IN STYLIZED FORM AND IS LOCATED BELOW THE FROG'S HEAD AND HAND. THE WORD "BRAND" APPEARS BENEATH THE LETTER "G".

SN 76-707,963, FILED 6-13-2011.

SKYE YOUNG, EXAMINING ATTORNEY



David J. Kybas

Director of the United States Patent and Trademark Office

United States of America

United States Patent and Trademark Office

FELLOWSHIP CUP

Reg. No. 4,206,135

Registered Sep. 11, 2012

Int. Cl.: 21

LIFEWAY CHRISTIAN RESOURCES OF THE SOUTHERN BAPTIST CONVENTION
(TENNESSEE CORPORATION)
ONE LIFEWAY PLAZA
MSN 187
NASHVILLE, TN 372340187

TRADEMARK

FOR: COMMUNION CUPS NOT MADE OF PRECIOUS METAL, IN CLASS 21 (U.S. CLS. 2, 13, 23, 29, 30, 33, 40 AND 50).

PRINCIPAL REGISTER

FIRST USE 9-30-2011; IN COMMERCE 9-30-2011.

THE MARK CONSISTS OF STANDARD CHARACTERS WITHOUT CLAIM TO ANY PARTICULAR FONT, STYLE, SIZE, OR COLOR.

NO CLAIM IS MADE TO THE EXCLUSIVE RIGHT TO USE "CUP", APART FROM THE MARK AS SHOWN.

SN 76-707,977, FILED 6-14-2011.

ANTHONY RINKER, EXAMINING ATTORNEY



David J. Kyffers

Director of the United States Patent and Trademark Office

United States of America

United States Patent and Trademark Office



Reg. No. 4,206,136

Registered Sep. 11, 2012

Int. Cl.: 41

SERVICE MARK

PRINCIPAL REGISTER

GREEN LIFE PUBLICATIONS LLC (MISSOURI CORPORATION)
111 GLEN HAVEN DRIVE
WAYNESVILLE, MO 65583

FOR: PUBLISHING OF EDUCATIONAL BOOK, INSTRUCTIONAL MANUALS, PAMPHLETS NOT FOR PUBLICITY PURPOSES, AND LESSON PLANS; AND THE ELECTRONIC PUBLISHING SERVICES, NAMELY, PUBLISHING THE TEXT AND GRAPHIC WORKS OF OTHERS ON CDS AND DVDS FEATURING EDUCATIONAL MATERIALS, IN CLASS 41 (U.S. CLS. 100, 101 AND 107).

FIRST USE 4-1-2011; IN COMMERCE 12-1-2011.

THE MARK CONSISTS OF THE LETTERS "GL" AND A LEAF DESIGN TOGETHER WITH THE TERMS "GREEN LIFE".

SN 76-708,223, FILED 7-5-2011.

JANICE L. MCMORROW, EXAMINING ATTORNEY



David J. Kybas

Director of the United States Patent and Trademark Office

United States of America

United States Patent and Trademark Office

TIME SAVERS

Reg. No. 4,206,137

Registered Sep. 11, 2012

Int. Cl.: 29

TRADEMARK

PRINCIPAL REGISTER

B & E POULTRY, INC. (PENNSYLVANIA CORPORATION)
154 WEST MAIN STREET
FREDERICKSBURG, PA 17026

FOR: FULLY COOKED READY TO HEAT, AND READY TO EAT, POULTRY CUTS, IN CLASS 29 (U.S. CL. 46).

FIRST USE 9-30-2011; IN COMMERCE 9-30-2011.

THE MARK CONSISTS OF STANDARD CHARACTERS WITHOUT CLAIM TO ANY PARTICULAR FONT, STYLE, SIZE, OR COLOR.

SN 76-708,813, FILED 8-22-2011.

JANICE L. MCMORROW, EXAMINING ATTORNEY



David J. Kybas

Director of the United States Patent and Trademark Office

United States of America

United States Patent and Trademark Office

SMOKIN BROTHERS

Reg. No. 4,206,138

Registered Sep. 11, 2012

Int. Cls.: 4, 11, and 30

TRADEMARK

PRINCIPAL REGISTER

SMOKIN BROTHERS, INC. (MISSOURI CORPORATION)
1012 E. US HIGHWAY 62
PO BOX 1767
SIKESTON, MO 63801

FOR: WOOD PELLETS FOR USE IN BARBEQUE SMOKER, IN CLASS 4 (U.S. CLS. 1, 6 AND 15).

FIRST USE 7-0-2011; IN COMMERCE 7-0-2011.

FOR: BARBEQUE GRILLS AND SMOKERS, IN CLASS 11 (U.S. CLS. 13, 21, 23, 31 AND 34).

FIRST USE 7-0-2011; IN COMMERCE 7-0-2011.

FOR: BARBEQUE SAUCES AND SEASONINGS, IN CLASS 30 (U.S. CL. 46).

FIRST USE 7-0-2011; IN COMMERCE 7-0-2011.

THE MARK CONSISTS OF STANDARD CHARACTERS WITHOUT CLAIM TO ANY PARTICULAR FONT, STYLE, SIZE, OR COLOR.

SN 76-709,425, FILED 10-18-2011.

JOHN DWYER, EXAMINING ATTORNEY



David J. Kyffers

Director of the United States Patent and Trademark Office

United States of America

United States Patent and Trademark Office



Reg. No. 4,206,139

Registered Sep. 11, 2012

Int. Cl.: 16

TRADEMARK

PRINCIPAL REGISTER

JONES, RICHARD D. (UNITED STATES INDIVIDUAL), DBA LIFE MINISTRIES,
10110 LAINGTREE DRIVE
DALLAS, TX 75243 AND

JONES, DOROTHY H.E. (UNITED STATES INDIVIDUAL), DBA LIFE MINISTRIES,
10110 LAINGTREE DRIVE
DALLAS, TX 75243

FOR: PACKAGED KITS COMPRISING PRINTED INSTRUCTIONAL, EDUCATIONAL, AND TEACHING MATERIALS AND TOOLS FOR EDUCATIONAL ACTIVITIES IN THE FIELD OF TEACHING FAITH-BASED PERSONAL FINANCIAL MANAGEMENT TO CHILDREN, IN CLASS 16 (U.S. CLS. 2, 5, 22, 23, 29, 37, 38 AND 50).

FIRST USE 10-19-2011; IN COMMERCE 5-1-2012.

THE MARK CONSISTS OF A RECTANGULAR SHAPE DIVIDED INTO QUADRANTS WITH A CROSS SHAPE SUPERIMPOSED IN THE CENTER OF THE RECTANGLE. THE UPPER LEFT QUADRANT IS YELLOW, THE UPPER RIGHT QUADRANT IS GREEN, THE LOWER LEFT QUADRANT IS BLUE, THE LOWER RIGHT QUADRANT IS PINK, AND THE SUPERIMPOSED CROSS IS WHITE WITH BLACK PARTIAL BORDERS AS SHADING.

THE COLOR(S) YELLOW, GREEN, BLUE, PINK, WHITE AND BLACK IS/ARE CLAIMED AS A FEATURE OF THE MARK.

SN 76-709,626, FILED 11-2-2011.

GEOFFREY FOSDICK, EXAMINING ATTORNEY



David J. Kybas

Director of the United States Patent and Trademark Office

United States of America

United States Patent and Trademark Office

KILIMANJARO

Reg. No. 4,206,140

TUCKER-ROCKY CORPORATION, INC. (DELAWARE CORPORATION)
103 FOULK ROAD, SUITE 202
WILMINGTON, DE 19803

Registered Sep. 11, 2012

Int. Cl.: 25

FOR: GLOVES AND BOOTS SPECIFICALLY CONSTRUCTED AND ADAPTED FOR WEARING BY MOTORCYCLE RIDERS, IN CLASS 25 (U.S. CLS. 22 AND 39).

TRADEMARK

FIRST USE 0-0-2003; IN COMMERCE 0-0-2003.

PRINCIPAL REGISTER

THE MARK CONSISTS OF STANDARD CHARACTERS WITHOUT CLAIM TO ANY PARTICULAR FONT, STYLE, SIZE, OR COLOR.

OWNER OF U.S. REG. NO. 2,164,211.

SN 76-979,200, FILED 2-19-2009.

SUE LAWRENCE, EXAMINING ATTORNEY



David J. Kyffers

Director of the United States Patent and Trademark Office

United States of America

United States Patent and Trademark Office

ROAD RAGE

Reg. No. 4,206,141

Registered Sep. 11, 2012

Int. Cl.: 5

TRADEMARK

PRINCIPAL REGISTER

FUNNY NAMES, INC. (CALIFORNIA CORPORATION)
SUITE 307
4652 VIA MARINA
MARINA DEL REY, CA 90292

FOR: NUTRITIONAL, DIETARY, AND NUTRACEUTICAL SUPPLEMENTS DELIVERED IN THE FORM OF A PILL, CHEWABLE TABLET, CAPSULE, LIQUID, GUM, MINT, NUTRITIONALLY AND VITAMIN FORTIFIED BEVERAGES AS A CARRIER FOR NUTRITIONAL SUPPLEMENTS AND VITAMINS, NUTRITIONALLY AND VITAMIN FORTIFIED WATER AS A CARRIER FOR NUTRITIONAL SUPPLEMENTS AND VITAMINS, NUTRITIONALLY AND VITAMIN FORTIFIED DRINK MIX FOR USE IN MAKING A BEVERAGE, AND NUTRITIONALLY FORTIFIED FOOD BARS, IN CLASS 5 (U.S. CLS. 6, 18, 44, 46, 51 AND 52).

FIRST USE 4-24-2012; IN COMMERCE 4-24-2012.

THE MARK CONSISTS OF STANDARD CHARACTERS WITHOUT CLAIM TO ANY PARTICULAR FONT, STYLE, SIZE, OR COLOR.

SN 77-097,273, FILED 2-1-2007.

MIAH ROSENBERG, EXAMINING ATTORNEY



David J. Kypos

Director of the United States Patent and Trademark Office

United States of America

United States Patent and Trademark Office



Reg. No. 4,206,142

THE FINAL CONNECTION, INC. (NEW YORK CORPORATION)
41-08 12TH STREET #1E
LONG ISLAND CITY, NY 11101

Registered Sep. 11, 2012

Int. Cl.: 18

FOR: ALL PURPOSE SPORT BAGS; ALL-PURPOSE CARRYING BAGS; SHOULDER BAGS;
TOTE BAGS, IN CLASS 18 (U.S. CLS. 1, 2, 3, 22 AND 41).

TRADEMARK

FIRST USE 1-19-2011; IN COMMERCE 1-19-2011.

PRINCIPAL REGISTER

NO CLAIM IS MADE TO THE EXCLUSIVE RIGHT TO USE "EDITION", APART FROM THE
MARK AS SHOWN.

THE MARK CONSISTS OF "THE PATRIOT MEMORIAL EDITION" WITH FADED AND/OR
MOCK CAMOUFLAGED TYPESET AND VERTICAL BAYONET RIFLE WITH DOGTAGS
AND HELMET ATTACHED THERETO AND COMBAT BOOTS ASTRIDE BAYONET.

SN 77-136,454, FILED 3-21-2007.

FRED CARL, EXAMINING ATTORNEY



David J. Kyros

Director of the United States Patent and Trademark Office

United States of America

United States Patent and Trademark Office



BLACK YAK
DESIGNED BY MOUNTAINEERS

Reg. No. 4,206,143

Registered Sep. 11, 2012

Int. Cls.: 18 and 25

TRADEMARK

PRINCIPAL REGISTER

BLACK YAK CO., LTD. (DEM REP OF KOREA LIMITED LIABILITY COMPANY)
3FL., STAR VALLEY, 60-11 GASAN-DONG
SEOUL, DEM REP OF KOREA 153-777

FOR: HIKING RUCKSACKS; BACKPACKS; ALL PURPOSE CARRYING BAGS; MOUNTAIN-
EERING STICKS; WALKING STICKS; WALKING STICK HANDLES; HIKING STICKS;
HIKING POLES; ALL OF THE FOREGOING GOODS EXCLUDING PRODUCTS MADE FROM
OR COMPRISING LEATHER, HIDE, ANIMAL HAIR AND/OR WOOL, IN CLASS 18 (U.S.
CLS. 1, 2, 3, 22 AND 41).

FIRST USE 6-1-1997; IN COMMERCE 3-12-2012.

FOR: SHOE SOLES; SHOES; INNER SOLES; TRAINING SHOES; FOOTWEAR FOR
MOUNTAINEERING; GLOVES; UNDERSHIRTS; SOCKS; JACKETS; WIND JACKETS; RAIN
JACKETS; CAPS; WIND-RESISTANT JACKETS; JACKETS FOR MOUNTAINEERING;
SLACKS; SLACKS FOR MOUNTAINEERING; PANTS; PANTS FOR MOUNTAINEERING;
TROUSERS; WIND VESTS; GLOVES; CAPS; CAPS FOR MOUNTAINEERING; HATS;
HATS FOR MOUNTAINEERING; SOCKS; THERMAL SOCKS; SOCKS FOR MOUNTAINEERING;
UNDERWEAR; UNDERSHIRTS; UNDERPANTS; THERMAL UNDERWEAR; UNDERWEAR
FOR MOUNTAINEERING; SHIRTS; SHIRTS FOR MOUNTAINEERING; ALL OF THE
FOREGOING GOODS EXCLUDING PRODUCTS MADE FROM OR COMPRISING LEATHER,
HIDE, ANIMAL HAIR, AND/OR WOOL, IN CLASS 25 (U.S. CLS. 22 AND 39).

FIRST USE 6-17-1997; IN COMMERCE 3-12-2012.

NO CLAIM IS MADE TO THE EXCLUSIVE RIGHT TO USE "DESIGNED BY MOUNTAIN-
EERS", APART FROM THE MARK AS SHOWN.

THE COLOR(S) RED, BLACK AND WHITE IS/ARE CLAIMED AS A FEATURE OF THE
MARK.

THE MARK CONSISTS OF A RED RECTANGULAR BACKGROUND, OUTLINED IN BLACK,
ON WHICH IS SUPERIMPOSED THE FRONTAL VIEW OF THE HEAD OF A YAK. THE
YAK'S MANE AND THE RIGHT SIDE OF THE HEAD IS BLACK, WITH A WHITE EYE AND
NOSTRIL, AND THE LEFT SIDE OF THE HEAD, THE LEFT HORN AND LEFT EAR IS
WHITE, WITH A BLACK EYE AND NOSTRIL. THE WORDS "BLACK YAK", IN WHICH A
FANCIFUL REPRESENTATION OF A MOUNTAIN IS SUBSTITUTED FOR THE LETTER



David J. Kybas

Director of the United States Patent and Trademark Office

Reg. No. 4,206,143 "A" IN BLACK AND "YAK", ARE IN BLACK, AND THE WORDS "DESIGNED BY MOUNTAINEERS" ARE IN RED.

SN 77-147,450, FILED 4-3-2007.

TIMOTHY FINNEGAN, EXAMINING ATTORNEY

United States of America

United States Patent and Trademark Office

STIFFY

Reg. No. 4,206,144

Registered Sep. 11, 2012

Int. Cl.: 16

TRADEMARK

PRINCIPAL REGISTER

PROFORM TECHNOLOGIES, INC. (WYOMING CORPORATION)
315 RAILROAD AVENUE
RIVERTON, WY 82501

FOR: PAINT BRUSHES, IN CLASS 16 (U.S. CLS. 2, 5, 22, 23, 29, 37, 38 AND 50).

FIRST USE 12-31-2008; IN COMMERCE 7-5-2012.

THE MARK CONSISTS OF STANDARD CHARACTERS WITHOUT CLAIM TO ANY PARTICULAR FONT, STYLE, SIZE, OR COLOR.

SN 77-218,039, FILED 6-28-2007.

MICHELE SWAIN, EXAMINING ATTORNEY



David J. Kybas

Director of the United States Patent and Trademark Office

United States of America

United States Patent and Trademark Office

IMPACT 500 AWARD

Reg. No. 4,206,145

Registered Sep. 11, 2012

Int. Cl.: 35

WILL VENTURES, LLC. (NEVADA LIMITED LIABILITY COMPANY), DBA IMPACT
SYSTEMS INSTITUTE,
SUITE 160
250 PILOT ROAD
LAS VEGAS, NV 89119

SERVICE MARK

PRINCIPAL REGISTER

FOR: CONDUCTING BUSINESS AWARD SURVEYS THROUGH EVALUATION SURVEYS
TO ASSESS THE POSITIVE AND SIGNIFICANT IMPACT OF BUSINESS LEADERS ON
THEIR CUSTOMERS, EMPLOYEES AND COMMUNITIES, IN CLASS 35 (U.S. CLS. 100, 101
AND 102).

FIRST USE 2-28-2012; IN COMMERCE 2-28-2012.

THE MARK CONSISTS OF STANDARD CHARACTERS WITHOUT CLAIM TO ANY PAR-
TICULAR FONT, STYLE, SIZE, OR COLOR.

NO CLAIM IS MADE TO THE EXCLUSIVE RIGHT TO USE "500 AWARD", APART FROM
THE MARK AS SHOWN.

SN 77-230,832, FILED 7-16-2007.

B. PARADEWELAI, EXAMINING ATTORNEY



David J. Kyffers

Director of the United States Patent and Trademark Office

United States of America

United States Patent and Trademark Office

SAGENT

Reg. No. 4,206,146

Registered Sep. 11, 2012

Int. Cl.: 5

TRADEMARK

PRINCIPAL REGISTER

SAGENT PHARMACEUTICALS, INC. (DELAWARE CORPORATION)
1901 NORTH ROSELLE ROAD
SUITE 700
SCHAUMBURG, IL 60195

FOR: PHARMACEUTICALS, NAMELY, ANESTHETICS, ANTI-INFECTIVES, ANTIEMETICS, ANTIPSYCHOTICS, BLOOD MODIFIERS, CARDIOVASCULARS, AND ONCOLYTICS; PRE-FILLED SYRINGES SOLD FILLED WITH CARDIOVASCULARS; PHARMACEUTICALS FOR TREATMENT OF CANCER; INJECTABLE DRUGS AND THERAPEUTIC SOLUTIONS FOR THE TREATMENT OF CANCER, CARDIOVASCULAR DISEASE, INFECTIONS, PAIN, AND PSYCHOTIC DISORDERS; INJECTABLE DRUGS AND THERAPEUTIC SOLUTIONS FOR THE TREATMENT OF INFECTIONS SOLD IN KITS COMPRISING PRE-FILLED IV BAGS WITH DEVICES FOR INTRAVENOUS ADMINISTRATION, NAMELY, TRANSFER PINS, VIALS, NEEDLES, AND ADAPTORS, IN CLASS 5 (U.S. CLS. 6, 18, 44, 46, 51 AND 52).

FIRST USE 12-10-2007; IN COMMERCE 12-10-2007.

THE MARK CONSISTS OF STANDARD CHARACTERS WITHOUT CLAIM TO ANY PARTICULAR FONT, STYLE, SIZE, OR COLOR.

SN 77-256,750, FILED 8-16-2007.

MICHELE SWAIN, EXAMINING ATTORNEY



David J. Kyjars

Director of the United States Patent and Trademark Office

United States of America

United States Patent and Trademark Office



Reg. No. 4,206,147

Registered Sep. 11, 2012

Int. Cl.: 25

TRADEMARK

PRINCIPAL REGISTER

GARAN SERVICES CORP. (DELAWARE CORPORATION)
350 FIFTH AVENUE, 19TH FLOOR
NEW YORK, NY 10118

FOR: SWEATERS, JEANS, BATHING SUITS, SWIMWEAR, SLEEPWEAR, ROMPERS, UNDERWEAR, HOSIERY, OUTERWEAR, NAMELY, COATS, JACKETS, SCARVES; HEADWEAR, NAMELY, HATS, EARMUFFS, SKI MASKS; GLOVES, BELTS, SOCKS, IN CLASS 25 (U.S. CLS. 22 AND 39).

FIRST USE 12-0-2008; IN COMMERCE 12-0-2008.

THE MARK CONSISTS OF THE COLORS BROWN, WHITE, TAN, BLACK, GREY, PINK AND GREEN WHICH APPEAR IN THE DESIGN OF THE BEAR. THE HEAD, LEGS AND ARMS OF THE BEAR ARE PRIMARILY BROWN. THE TORSO OF THE BEAR IS COLORED PRIMARILY TAN. THE CHEST PADS WORN BY THE BEAR ARE COLORED GREY. THE BEAR HAS A BLACK NOSE AND HAS BLACK FACE PAINT MARKINGS. THE BEAR'S EYES ARE COLORED BLACK AND GREEN. THE BEAR'S TONGUE IS COLORED PINK. THE BEAR IS HOLDING A FOOTBALL IN ITS LEFT PAW ABOVE ITS HEAD. THE FOOTBALL IS COLORED BROWN WITH WHITE CIRCLES AND STITCHING.

THE COLOR(S) BROWN, TAN, BLACK, WHITE, GREEN, GREY AND PINK IS/ARE CLAIMED AS A FEATURE OF THE MARK.

SN 77-290,812, FILED 9-27-2007.

JERI J. FICKES, EXAMINING ATTORNEY



David J. Kybas

Director of the United States Patent and Trademark Office

United States of America

United States Patent and Trademark Office



Reg. No. 4,206,148

Registered Sep. 11, 2012

Int. Cl.: 28

TRADEMARK

PRINCIPAL REGISTER

HOGY LURE COMPANY, LLC (MASSACHUSETTS LIMITED LIABILITY COMPANY)
P.O. BOX 1052
FALMOUTH, MA 02541

FOR: ARTIFICIAL FISHING LURES; FISHING LURE PARTS; FISHING LURES; FISHING HOOKS; ARTIFICIAL FISHING BAIT, IN CLASS 28 (U.S. CLS. 22, 23, 38 AND 50).

FIRST USE 6-23-2012; IN COMMERCE 6-23-2012.

NO CLAIM IS MADE TO THE EXCLUSIVE RIGHT TO USE "FISH" AND "SOFT PLASTIC", APART FROM THE MARK AS SHOWN.

THE COLOR(S) YELLOW, RED AND BLACK IS/ARE CLAIMED AS A FEATURE OF THE MARK.

THE MARK CONSISTS OF A YELLOW OVAL WITH A RED FISH IN THE BACKGROUND AND WITH THE FOLLOWING TEXT AND IMAGE IN BLACK: "FISH BIG! HOGY BIG SOFT PLASTICS", WHERE THE "Y" IN "HOGY" EXTENDED BENEATH THE OTHER LETTERS TO CREATE AN UNDERSCORE EFFECT IN THE IMAGE OF A LURE.

SN 77-311,472, FILED 10-23-2007.

ALEXANDER L. POWERS, EXAMINING ATTORNEY



David J. Kyros

Director of the United States Patent and Trademark Office

United States of America

United States Patent and Trademark Office

DURA

Reg. No. 4,206,149

Registered Sep. 11, 2012

Int. Cl.: 20

TRADEMARK

PRINCIPAL REGISTER

PRECISION DYNAMICS CORPORATION (CALIFORNIA CORPORATION)
27770 N. ENTERTAINMENT DRIVE
VALENCIA, CA 91355

FOR: NON-METALLIC IDENTIFICATION BRACELETS, IN CLASS 20 (U.S. CLS. 2, 13, 22, 25, 32 AND 50).

FIRST USE 6-30-2012; IN COMMERCE 6-30-2012.

THE MARK CONSISTS OF STANDARD CHARACTERS WITHOUT CLAIM TO ANY PARTICULAR FONT, STYLE, SIZE, OR COLOR.

OWNER OF U.S. REG. NO. 1,977,049.

SN 77-337,506, FILED 11-27-2007.

ADA HAN, EXAMINING ATTORNEY



David J. Kybas

Director of the United States Patent and Trademark Office

United States of America

United States Patent and Trademark Office

FINGERPRINT

Reg. No. 4,206,150

Registered Sep. 11, 2012

Int. Cl.: 42

SERVICE MARK

PRINCIPAL REGISTER

ELSEVIER INC. (DELAWARE CORPORATION)
360 PARK AVENUE SOUTH
NEW YORK, NY 10010

FOR: PROVIDING TEMPORARY USE OF ON-LINE DOWNLOADABLE SOFTWARE FOR DATABASE MANAGEMENT, DATABASE SEARCHING, AGGREGATION, FILTERING, PRIORITIZING, CATEGORIZING, AND ANALYSIS; PROVIDING TEMPORARY USE OF ON-LINE NON-DOWNLOADABLE SOFTWARE FOR DATABASE MANAGEMENT, DATABASE SEARCHING, AGGREGATION, FILTERING, PRIORITIZING, CATEGORIZING, AND ANALYSIS; PROVIDING APPLICATION SERVICE PROVIDER FEATURING SOFTWARE FOR DATABASE MANAGEMENT, DATABASE SEARCHING, AGGREGATION, FILTERING, PRIORITIZING, CATEGORIZING, AND ANALYSIS, IN CLASS 42 (U.S. CLS. 100 AND 101).

FIRST USE 10-31-2011; IN COMMERCE 10-31-2011.

THE MARK CONSISTS OF STANDARD CHARACTERS WITHOUT CLAIM TO ANY PARTICULAR FONT, STYLE, SIZE, OR COLOR.

SN 77-342,940, FILED 12-3-2007.

CURTIS FRENCH, EXAMINING ATTORNEY



David J. Kyffers

Director of the United States Patent and Trademark Office

United States of America

United States Patent and Trademark Office



Reg. No. 4,206,151

Registered Sep. 11, 2012

Int. Cl.: 9

TRADEMARK

PRINCIPAL REGISTER

MICHAEL WADDELL, LLC (GEORGIA LIMITED LIABILITY COMPANY)
4200 MBL DRIVE
OTTAWA, IL 61350

FOR: OPTICAL APPARATUSES AND INSTRUMENTS, NAMELY, CHRONOGRAPHS, NAMELY, SPECIALIZED TIME RECORDING APPARATUSES, IN CLASS 9 (U.S. CLS. 21, 23, 26, 36 AND 38).

FIRST USE 5-31-2010; IN COMMERCE 5-31-2010.

OWNER OF U.S. REG. NO. 3,217,764.

THE NAME "MICHAEL WADDELL" IDENTIFIES A LIVING INDIVIDUAL WHOSE CONSENT IS OF RECORD.

THE MARK CONSISTS OF DEER HEAD SKELETON WITH ANTLERS, FEATURING EYE AND NOSE SOCKETS OF A SKULL BETWEEN THE ANTLERS, WITH THE SIGNATURE OF "MICHAEL WADDELL" (IN POSSESSIVE FORM) ON THE RIGHT SIDE OF THE DEER HEAD, AND THE PHRASE "BONE COLLECTOR" UNDERNEATH THE SIGNATURE.

SN 77-382,776, FILED 1-29-2008.

KATHLEEN M. VANSTON, EXAMINING ATTORNEY



David J. Kyros

Director of the United States Patent and Trademark Office

United States of America

United States Patent and Trademark Office

Sensei Science

Reg. No. 4,206,152

Registered Sep. 11, 2012

Int. Cl.: 41

SERVICE MARK

PRINCIPAL REGISTER

FERRARI, ALICIA (UNITED STATES INDIVIDUAL)
APT 4E
44 WEST 10TH STREET
NEW YORK, NY 10011

FOR: PROVIDING NEWSLETTERS VIA EMAIL IN THE FIELD OF PROMOTING CAREERS IN NON-HEALTH RELATED SCIENCE DIRECTED TO HIGH SCHOOL AND UNIVERSITY STUDENTS, IN CLASS 41 (U.S. CLS. 100, 101 AND 107).

FIRST USE 6-1-2012; IN COMMERCE 6-1-2012.

THE MARK CONSISTS OF STANDARD CHARACTERS WITHOUT CLAIM TO ANY PARTICULAR FONT, STYLE, SIZE, OR COLOR.

NO CLAIM IS MADE TO THE EXCLUSIVE RIGHT TO USE "SCIENCE", APART FROM THE MARK AS SHOWN.

SN 77-388,551, FILED 2-5-2008.

BRENDAN MCCAULEY, EXAMINING ATTORNEY



David J. Kyros

Director of the United States Patent and Trademark Office

United States of America

United States Patent and Trademark Office

OKIEDOG

Reg. No. 4,206,153

Registered Sep. 11, 2012

Int. Cl.: 28

TRADEMARK

PRINCIPAL REGISTER

OKIEDOG LIMITED (HONG KONG PRIVATE LIMITED COMPANY)
603 HARBOR CRYSTAL CTR., 100 GRANVILLE RD
TSIM SHA TSUI EAST, HONG KONG SAR

FOR: TOYS, NAMELY, BALLOONS, TOY BUILDING BLOCKS, DOLLS AND ACCESSORIES THEREFOR, DOLL HOUSES, DOLL HOUSE FURNISHINGS, JIGSAW PUZZLES, KALEIDOSCOPIES, MARIONETTES, TOY MOBILES, PINATAS, PLAY BALLS, PLUSH TOYS, NOVELTY ITEMS, NAMELY, TOY MASKS AND TOY PISTOLS, PUPPETS, BABY RATTLES, ROCKING HORSES, BUBBLE MAKING WAND AND SOLUTION SETS, SPINNING TOPS, PLAY SWIMMING POOLS, SWINGS, TEDDY BEARS, TOY VEHICLES; GAMES, NAMELY, BOARD GAMES, BUILDING GAMES, PLAYING CARDS, CHECKER SETS, MARBLES FOR GAMES, RING GAMES; GYMNASIAC AND SPORTING ARTICLES NOT INCLUDED IN OTHER CLASSES, NAMELY, SPORT BALLS, BATS FOR GAMES, BATTING GLOVES, BODY BOARDS, BODY-BUILDING APPARATUS, BODY-TRAINING APPARATUS, SKATING BOOTS WITH SKATES ATTACHED, ELBOW GUARDS FOR ATHLETIC USE, FLYING DISCS, IN-LINE ROLLER SKATES, KNEE GUARDS FOR ATHLETIC USE, PROTECTIVE PADDING FOR PLAYING BASEBALL, HOCKEY, SOFTBALL, BASKETBALL, ROLLER BLADING AND SKATE BOARDING, ROLLER SKATES, ROLLERS FOR STATIONARY EXERCISE BICYCLES, TOY SCOOTERS, SKATEBOARDS, BOB-SLEIGHS, PLAYGROUND EQUIPMENT, NAMELY, SLIDES, SLING SHOTS, SOLE COVERINGS FOR SKIS, SWIMMING FLIPPERS; DECORATIONS FOR CHRISTMAS TREES EXCEPT CONFECTIONERY OR ILLUMINATION ARTICLES, IN CLASS 28 (U.S. CLS. 22, 23, 38 AND 50).

FIRST USE 5-0-2012; IN COMMERCE 5-0-2012.

THE MARK CONSISTS OF STANDARD CHARACTERS WITHOUT CLAIM TO ANY PARTICULAR FONT, STYLE, SIZE, OR COLOR.

SN 77-391,688, FILED 2-7-2008.

STEPHANIE ALI, EXAMINING ATTORNEY



David J. Kyros

Director of the United States Patent and Trademark Office

United States of America

United States Patent and Trademark Office



Reg. No. 4,206,154

Registered Sep. 11, 2012

Int. Cl.: 28

TRADEMARK

PRINCIPAL REGISTER

OKIEDOG LIMITED (HONG KONG PRIVATE LIMITED COMPANY)
603 HARBOR CRYSTAL CTR., 100 GRANVILLE RD
TSIM SHA TSUI EAST, HONG KONG SAR

FOR: TOYS, NAMELY, BALLOONS, TOY BUILDING BLOCKS, DOLLS AND ACCESSORIES THEREFOR, DOLL HOUSES, DOLL HOUSE FURNISHINGS, JIGSAW PUZZLES, KALEIDOSCOPIES, MARIONETTES, TOY MOBILES, PINATAS, PLAY BALLS, PLUSH TOYS, NOVELTY ITEMS, NAMELY, TOY MASKS AND TOY PISTOLS, PUPPETS, BABY RATTLES, ROCKING HORSES, BUBBLE MAKING WAND AND SOLUTION SETS, SPINNING TOPS, PLAY SWIMMING POOLS, SWINGS, TEDDY BEARS, TOY VEHICLES; GAMES, NAMELY, BOARD GAMES, BUILDING GAMES, PLAYING CARDS, CHECKER SETS, MARBLES FOR GAMES, RING GAMES; GYMNASTIC AND SPORTING ARTICLES NOT INCLUDED IN OTHER CLASSES, NAMELY, SPORT BALLS, BATS FOR GAMES, BATTING GLOVES, BODY BOARDS, BODY-BUILDING APPARATUS, BODY-TRAINING APPARATUS, SKATING BOOTS WITH SKATES ATTACHED, ELBOW GUARDS FOR ATHLETIC USE, FLYING DISCS, IN-LINE ROLLER SKATES, KNEE GUARDS FOR ATHLETIC USE, PROTECTIVE PADDING FOR PLAYING BASEBALL, HOCKEY, SOFTBALL, BASKETBALL, ROLLER BLADING AND SKATE BOARDING, ROLLER SKATES, ROLLERS FOR STATIONARY EXERCISE BICYCLES, TOY SCOOTERS, SKATEBOARDS, BOB-SLEIGHS, PLAYGROUND EQUIPMENT, NAMELY, SLIDES, SLING SHOTS, SOLE COVERINGS FOR SKIS, SWIMMING FLIPPERS; DECORATIONS FOR CHRISTMAS TREES EXCEPT CONFECTIONERY OR ILLUMINATION ARTICLES, IN CLASS 28 (U.S. CLS. 22, 23, 38 AND 50).

FIRST USE 5-0-2012; IN COMMERCE 5-0-2012.

THE MARK CONSISTS OF THE COLORS ORANGE, GREEN, BLACK AND WHITE, WITH THE COLOR ORANGE APPEARING IN THE WORDING "OKIEDOG", THE COLOR GREEN APPEARING IN THE CHARACTER FIGURE, THE COLOR BLACK OUTLINING "OKIEDOG" AND THE CHARACTER FIGURE ON A WHITE BACKGROUND.

THE COLOR(S) ORANGE, GREEN, BLACK AND WHITE IS/ARE CLAIMED AS A FEATURE OF THE MARK.

SN 77-391,704, FILED 2-7-2008.

STEPHANIE ALI, EXAMINING ATTORNEY



David J. Kybas

Director of the United States Patent and Trademark Office

United States of America

United States Patent and Trademark Office

DEQ

Reg. No. 4,206,155

DEQ SYSTÈMES CORP. (CANADA CORPORATION)

Registered Sep. 11, 2012

1840 1ST STREET, SUITE 103A
ST-ROMUALD, CANADA G6W5M6

Int. Cl.: 41

FOR: LEASING GAMING EQUIPMENT TO OTHERS, IN CLASS 41 (U.S. CLS. 100, 101 AND 107).

SERVICE MARK

FIRST USE 2-7-2008; IN COMMERCE 2-7-2008.

PRINCIPAL REGISTER

PRIORITY CLAIMED UNDER SEC. 44(D) ON CANADA APPLICATION NO. 1371309, FILED 11-8-2007.

SN 77-393,072, FILED 2-9-2008.

JANICE L. MCMORROW, EXAMINING ATTORNEY



David J. Kyffers

Director of the United States Patent and Trademark Office

United States of America

United States Patent and Trademark Office

NEATNIK

Reg. No. 4,206,156

Registered Sep. 11, 2012

Int. Cl.: 9

TRADEMARK

PRINCIPAL REGISTER

CENTRACCO, ZAHIA (UNITED STATES INDIVIDUAL), DBA CENTRACCO, COOKIE,
1811 W. WILSHIRE BLVD.
OKLAHOMA CITY, OK 73116 AND

BATCHELOR, DANIELLE (UNITED STATES INDIVIDUAL)
3764 RICE BLVD.
HOUSTON, TX 77005

FOR: COMPUTER GAME SOFTWARE, COMPUTER ANIMATION SOFTWARE, NAMELY,
COMPUTER SOFTWARE FOR USE IN RELATION TO ANIMATION AND SPECIAL EFFECTS
OF IMAGES, IN CLASS 9 (U.S. CLS. 21, 23, 26, 36 AND 38).

FIRST USE 4-15-2012; IN COMMERCE 4-15-2012.

THE MARK CONSISTS OF STANDARD CHARACTERS WITHOUT CLAIM TO ANY PAR-
TICULAR FONT, STYLE, SIZE, OR COLOR.

SN 77-426,415, FILED 3-19-2008.

DEZMONA MIZELLE, EXAMINING ATTORNEY



David J. Kybas

Director of the United States Patent and Trademark Office

United States of America

United States Patent and Trademark Office

JACK BB DAKOTA

Reg. No. 4,206,157

Registered Sep. 11, 2012

Int. Cl.: 25

TRADEMARK

PRINCIPAL REGISTER

B.B. DAKOTA, INC. (CALIFORNIA CORPORATION)
1638 POMONA AVENUE
COSTA MESA, CA 92627

FOR: APPAREL, NAMELY, TOPS, BOTTOMS, SHIRTS, DRESSES, COATS, SWEATERS, T-SHIRTS, SHIRTS, SHORTS, AND PANTS, IN CLASS 25 (U.S. CLS. 22 AND 39).

FIRST USE 0-0-2007; IN COMMERCE 0-0-2007.

THE MARK CONSISTS OF STANDARD CHARACTERS WITHOUT CLAIM TO ANY PARTICULAR FONT, STYLE, SIZE, OR COLOR.

OWNER OF U.S. REG. NO. 1,460,138.

THE NAME(S), PORTRAIT(S), AND/OR SIGNATURE(S) SHOWN IN THE MARK DOES NOT IDENTIFY A PARTICULAR LIVING INDIVIDUAL.

SN 77-434,863, FILED 3-28-2008.

ELISSA GARBER KON, EXAMINING ATTORNEY



David J. Kybas

Director of the United States Patent and Trademark Office

United States of America

United States Patent and Trademark Office

CEFIRO

Reg. No. 4,206,158

Registered Sep. 11, 2012

Int. Cl.: 33

TRADEMARK

PRINCIPAL REGISTER

VIÑA SANTA CAROLINA S.A (CHILE CORPORATION)
TIL-TIL NO 2228 MACUL
SANTIAGO, CHILE

FOR: WINES, IN CLASS 33 (U.S. CLS. 47 AND 49).

FIRST USE 10-27-2010; IN COMMERCE 10-27-2010.

THE MARK CONSISTS OF STANDARD CHARACTERS WITHOUT CLAIM TO ANY PARTICULAR FONT, STYLE, SIZE, OR COLOR.

THE ENGLISH TRANSLATION OF "CEFIRO" IS "SOFT AND PLACID WIND".

SN 77-435,776, FILED 3-31-2008.

TRICIA SONNEBORN, EXAMINING ATTORNEY



David J. Kyffers

Director of the United States Patent and Trademark Office

United States of America

United States Patent and Trademark Office

JUNIPER

Reg. No. 4,206,159

WESTPORT LIGHT DUTY INC. (CANADA CORPORATION)
1750 WEST 75TH STREET
VANCOUVER, CANADA V6P6G2

Registered Sep. 11, 2012

Int. Cls.: 7, 9, 12, and 42

FOR: MOTORS AND ENGINES OTHER THAN FOR LAND VEHICLES, NAMELY, COMBUSTION ENGINES FOR MACHINES, INTERNAL COMBUSTION ENGINES FOR MACHINES, MOTORS AND ENGINES FOR GENERATION OF ELECTRICITY AND OPERATION OF MACHINES; REPLACEMENT PARTS FOR THE MOTORS AND ENGINES; FUEL SYSTEMS CONSISTING OF FUEL INJECTION MODULES AND FUEL INJECTORS FOR INTERNAL COMBUSTION ENGINES; FUEL CONVERSION MECHANISM FOR INTERNAL COMBUSTION ENGINES; FUEL AIR CONTROLS, NAMELY, FUEL AND OIL FILTERS FOR INTERNAL COMBUSTION ENGINES, IN CLASS 7 (U.S. CLS. 13, 19, 21, 23, 31, 34 AND 35).

TRADEMARK

SERVICE MARK

PRINCIPAL REGISTER

FIRST USE 1-12-2009; IN COMMERCE 1-12-2009.

FOR: ELECTRONIC CONTROLS FOR MOTORS FOR LAND VEHICLES, IN CLASS 9 (U.S. CLS. 21, 23, 26, 36 AND 38).

FIRST USE 7-0-2010; IN COMMERCE 7-0-2010.

FOR: ENGINES FOR LAND VEHICLES; COMBUSTION ENGINES FOR LAND VEHICLES; AND ENGINES FOR CONSTRUCTION LAND VEHICLES, IN CLASS 12 (U.S. CLS. 19, 21, 23, 31, 35 AND 44).

FIRST USE 1-12-2009; IN COMMERCE 1-12-2009.

FOR: ENGINE DESIGN AND DEVELOPMENT SERVICES; DESIGN AND DEVELOPMENT OF FUEL SYSTEMS INCLUDING FUEL INJECTORS, IN CLASS 42 (U.S. CLS. 100 AND 101).

FIRST USE 7-25-2011; IN COMMERCE 7-25-2011.

THE MARK CONSISTS OF STANDARD CHARACTERS WITHOUT CLAIM TO ANY PARTICULAR FONT, STYLE, SIZE, OR COLOR.

SN 77-452,392, FILED 4-18-2008.



David J. Kyjars

Director of the United States Patent and Trademark Office

Reg. No. 4,206,159 VIVIAN MICZNIK FIRST, EXAMINING ATTORNEY

United States of America

United States Patent and Trademark Office

TRUST PROVIDERS

Reg. No. 4,206,160

EBAY INC. (DELAWARE CORPORATION)
2145 HAMILTON AVE
SAN JOSE, CA 95125

Registered Sep. 11, 2012

Int. Cl.: 35

FOR: ON-LINE BUSINESS DIRECTORIES FEATURING DEMOGRAPHIC INFORMATION IN THE FIELD OF ETHICAL, ARTISAN, AGRICULTURAL AND ENVIRONMENTAL PRODUCTS FOR SELLERS, PRODUCERS, AND ORGANIZATIONS INVOLVED IN THE PRODUCTION, OVERSIGHT AND SALE OF SUCH PRODUCTS, IN CLASS 35 (U.S. CLS. 100, 101 AND 102).

SERVICE MARK

PRINCIPAL REGISTER

FIRST USE 3-31-2008; IN COMMERCE 3-31-2008.

THE MARK CONSISTS OF STANDARD CHARACTERS WITHOUT CLAIM TO ANY PARTICULAR FONT, STYLE, SIZE, OR COLOR.

SN 77-453,965, FILED 4-21-2008.

PAULA MAHONEY, EXAMINING ATTORNEY



David J. Kyros

Director of the United States Patent and Trademark Office

United States of America

United States Patent and Trademark Office

patagonia



Reg. No. 4,206,161

Registered Sep. 11, 2012

Int. Cl.: 25

TRADEMARK

PRINCIPAL REGISTER

PATAGONIA, INC. (CALIFORNIA CORPORATION)
259 W. SANTA CLARA ST.
LEGAL DEPT.
VENTURA, CA 93001

FOR: FOOTWEAR, IN CLASS 25 (U.S. CLS. 22 AND 39).

FIRST USE 5-0-2008; IN COMMERCE 5-0-2008.

OWNER OF U.S. REG. NOS. 2,260,188, 2,662,619, AND OTHERS.

THE MARK CONSISTS OF THE WORD "PATAGONIA" ABOVE A STYLIZED DRAWING OF A BOAR CARRYING A SPEAR.

SN 77-454,648, FILED 4-22-2008.

JOHN WILKE, EXAMINING ATTORNEY



David J. Kyffers

Director of the United States Patent and Trademark Office

United States of America

United States Patent and Trademark Office

KYOWA KIRIN

Reg. No. 4,206,162

Registered Sep. 11, 2012

Int. Cls.: 42 and 45

SERVICE MARK

PRINCIPAL REGISTER

KIRIN HOLDINGS KABUSHIKI KAISHA (JAPAN CORPORATION), DBA KIRIN HOLDINGS CO., LTD.,
10-1, SHINKAWA 2-CHOME, CHUO-KU
TOKYO, JAPAN

FOR: DEVELOPMENT OF TECHNOLOGY FOR OTHERS IN THE FIELD OF HUMAN ANTIBODIES AND BIOTECHNOLOGY; MEDICAL RESEARCH, IN CLASS 42 (U.S. CLS. 100 AND 101).

FIRST USE 10-1-2008; IN COMMERCE 1-13-2009.

FOR: PATENT LICENSING; LICENSING OF HUMAN ANTIBODY PRODUCTS FOR USE IN THE DEVELOPMENT OF PHARMACEUTICALS, IN CLASS 45 (U.S. CLS. 100 AND 101).

FIRST USE 10-1-2008; IN COMMERCE 10-18-2008.

THE MARK CONSISTS OF STANDARD CHARACTERS WITHOUT CLAIM TO ANY PARTICULAR FONT, STYLE, SIZE, OR COLOR.

"KIRIN" IS THE JAPANESE TRANSLITERATION OF A CHINESE WORD FOR A MYTHICAL ANIMAL AND DOES NOT HAVE ANY OTHER MEANING OR SIGNIFICANCE IN THE INDUSTRY IN WHICH THE GOODS OR SERVICES ARE MANUFACTURED OR PROVIDED.

OWNER OF U.S. REG. NOS. 3,098,412, 3,487,366, AND OTHERS.

THE ENGLISH TRANSLATION OF "KYOWA" IN THE MARK IS "HARMONY".

SN 77-463,987, FILED 5-2-2008.

BRENDAN MCCAULEY, EXAMINING ATTORNEY



David J. Kypos

Director of the United States Patent and Trademark Office

United States of America

United States Patent and Trademark Office

lumina sphere

Reg. No. 4,206,163

LUMINA SPHERE LLC (ARIZONA LIMITED LIABILITY COMPANY)
3655 W. ANTHEM WAY, SUITE A109-419
ANTHEM, AZ 85086

Registered Sep. 11, 2012

Int. Cl.: 6

FOR: SCULPTURES OF METAL, IN CLASS 6 (U.S. CLS. 2, 12, 13, 14, 23, 25 AND 50).

TRADEMARK

FIRST USE 1-7-2009; IN COMMERCE 9-28-2011.

PRINCIPAL REGISTER

THE MARK CONSISTS OF STANDARD CHARACTERS WITHOUT CLAIM TO ANY PARTICULAR FONT, STYLE, SIZE, OR COLOR.

SN 77-468,408, FILED 5-7-2008.

KIM MONINGHOFF, EXAMINING ATTORNEY



David J. Kyffers

Director of the United States Patent and Trademark Office

United States of America

United States Patent and Trademark Office



Reg. No. 4,206,164

NATIONAL HOT ROD ASSOCIATION (CALIFORNIA CORPORATION)
2035 FINANCIAL WAY
GLEN DORA, CA 91741

Registered Sep. 11, 2012

Int. Cl.: 25

FOR: CLOTHING, NAMELY, HEADWEAR, SHIRTS, JACKETS, SWEATSHIRTS, IN CLASS 25 (U.S. CLS. 22 AND 39).

TRADEMARK

FIRST USE 8-0-2005; IN COMMERCE 8-0-2005.

PRINCIPAL REGISTER

OWNER OF U.S. REG. NOS. 3,072,072, 3,300,207, AND OTHERS.

THE MARK CONSISTS OF A STYLIZED REPRESENTATION OF TWO AUTOMOBILES AND THE WORDS "NATIONAL HOT ROD ASSOCIATION DEDICATED TO SAFETY".

SN 77-469,717, FILED 5-8-2008.

ALICE BENMAMAN, EXAMINING ATTORNEY



David J. Kybas

Director of the United States Patent and Trademark Office

United States of America

United States Patent and Trademark Office

SAMBA

Reg. No. 4,206,165

FUJIFILM DIMATIX, INC. (DELAWARE CORPORATION)
109 ETNA ROAD
LEBANON, NH 03766

Registered Sep. 11, 2012

Int. Cl.: 9

FOR: COMPONENT PARTS FOR PRINTERS, NAMELY, PRINT HEADS AND PARTS THEREOF, PRINT HEAD MODULES AND PARTS THEREOF, AND CLUSTERS OF PRINT HEAD MODULES FOR USE IN PRINTERS; PRINT HEADS FOR DISPENSING FLUIDS, LIQUIDS, AND MICROPARTICLES IN THE FIELD OF MATERIALS PRINTING; HARDWARE FOR PRINTERS AND HARDWARE FOR COMPONENT PARTS FOR PRINTERS, NAMELY, PRINT HEADS, PRINT HEAD MODULES, CLUSTERS OF PRINT HEAD MODULES, AND PARTS THEREOF, IN CLASS 9 (U.S. CLS. 21, 23, 26, 36 AND 38).

TRADEMARK

PRINCIPAL REGISTER

FIRST USE 6-24-2012; IN COMMERCE 6-24-2012.

THE MARK CONSISTS OF STANDARD CHARACTERS WITHOUT CLAIM TO ANY PARTICULAR FONT, STYLE, SIZE, OR COLOR.

SN 77-473,163, FILED 5-13-2008.

LINDA MICKLEBURGH, EXAMINING ATTORNEY



David J. Kyffers

Director of the United States Patent and Trademark Office

United States of America
United States Patent and Trademark Office



samba

Reg. No. 4,206,166

FUJIFILM DIMATIX, INC. (DELAWARE CORPORATION)
109 ETNA ROAD

Registered Sep. 11, 2012

LEBANON, NH 03766

Int. Cl.: 9

FOR: COMPONENT PARTS FOR PRINTERS, NAMELY, PRINT HEADS AND PARTS THEREOF, PRINT HEAD MODULES AND PARTS THEREOF, AND CLUSTERS OF PRINT HEAD MODULES FOR USE IN PRINTERS; PRINT HEADS FOR DISPENSING FLUIDS, LIQUIDS, AND MICROPARTICLES IN THE FIELD OF MATERIALS PRINTING; HARDWARE FOR PRINTERS AND HARDWARE FOR COMPONENT PARTS FOR PRINTERS, NAMELY, PRINT HEADS, PRINT HEAD MODULES, CLUSTERS OF PRINT HEAD MODULES, AND PARTS THEREOF, IN CLASS 9 (U.S. CLS. 21, 23, 26, 36 AND 38).

TRADEMARK

PRINCIPAL REGISTER

FIRST USE 6-24-2012; IN COMMERCE 6-24-2012.

THE MARK CONSISTS OF THE WORD "SAMBA" WITH FOUR ROWS OF SEGMENTED BLOCKS ABOVE IT.

SN 77-473,174, FILED 5-13-2008.

LINDA MICKLEBURGH, EXAMINING ATTORNEY



David J. Kyffers

Director of the United States Patent and Trademark Office

United States of America

United States Patent and Trademark Office



samba

Reg. No. 4,206,167

FUJIFILM DIMATIX, INC. (DELAWARE CORPORATION)
109 ETNA ROAD
LEBANON, NH 03766

Registered Sep. 11, 2012

Int. Cl.: 9

FOR: COMPONENT PARTS FOR PRINTERS, NAMELY, PRINT HEADS AND PARTS THEREOF, PRINT HEAD MODULES AND PARTS THEREOF, AND CLUSTERS OF PRINT HEAD MODULES FOR USE IN PRINTERS; PRINT HEADS FOR DISPENSING FLUIDS, LIQUIDS, AND MICROPARTICLES IN THE FIELD OF MATERIALS PRINTING; HARDWARE FOR PRINTERS AND HARDWARE FOR COMPONENT PARTS FOR PRINTERS, NAMELY, PRINT HEADS, PRINT HEAD MODULES, CLUSTERS OF PRINT HEAD MODULES, AND PARTS THEREOF, IN CLASS 9 (U.S. CLS. 21, 23, 26, 36 AND 38).

TRADEMARK

PRINCIPAL REGISTER

FIRST USE 6-24-2012; IN COMMERCE 6-24-2012.

THE MARK CONSISTS OF THE WORD "SAMBA" IN BLACK WITH FOUR ROWS OF COLORED SEGMENTED BLOCKS ABOVE IT, THE TOP ROW BEING BLUE, THE SECOND PINK, THE THIRD YELLOW, AND THE BOTTOM BLACK, ALL BLOCKS FADING FROM LEFT TO RIGHT.

THE COLOR(S) BLUE, PINK, YELLOW, AND BLACK IS/ARE CLAIMED AS A FEATURE OF THE MARK.

SN 77-473,180, FILED 5-13-2008.

LINDA MICKLEBURGH, EXAMINING ATTORNEY



David J. Kyjars

Director of the United States Patent and Trademark Office

United States of America

United States Patent and Trademark Office

PCD

Reg. No. 4,206,168

Registered Sep. 11, 2012

Int. Cl.: 14

TRADEMARK

PRINCIPAL REGISTER

PUSSYCAT DOLLS, LLC (DELAWARE LIMITED LIABILITY COMPANY)
C/O UMG RECORDINGS, LLC
2220 COLORADO AVENUE
SANTA MONICA, CA 90404

FOR: JEWELRY CASES; CLOCKS; JEWELRY; WATCHES, IN CLASS 14 (U.S. CLS. 2, 27, 28 AND 50).

FIRST USE 4-0-2011; IN COMMERCE 4-0-2011.

THE MARK CONSISTS OF STANDARD CHARACTERS WITHOUT CLAIM TO ANY PARTICULAR FONT, STYLE, SIZE, OR COLOR.

SN 77-473,247, FILED 5-13-2008.

ROBERT C. CLARK JR., EXAMINING ATTORNEY



David J. Kyffers

Director of the United States Patent and Trademark Office

United States of America

United States Patent and Trademark Office

EASY COMFORTS STYLE

Reg. No. 4,206,169

Registered Sep. 11, 2012

Int. Cl.: 25

TRADEMARK

PRINCIPAL REGISTER

MILES KIMBALL COMPANY (WISCONSIN CORPORATION)
41 WEST EIGHTH AVE.
OSHKOSH, WI 54906

FOR: CLOTHING, NAMELY, BLOUSES; SLIPPERS, IN CLASS 25 (U.S. CLS. 22 AND 39).

FIRST USE 1-31-2012; IN COMMERCE 1-31-2012.

THE MARK CONSISTS OF STANDARD CHARACTERS WITHOUT CLAIM TO ANY PARTICULAR FONT, STYLE, SIZE, OR COLOR.

OWNER OF U.S. REG. NO. 3,336,284.

NO CLAIM IS MADE TO THE EXCLUSIVE RIGHT TO USE "STYLE", APART FROM THE MARK AS SHOWN.

SN 77-478,255, FILED 5-19-2008.

DOMINIC J. FERRAIUOLO, EXAMINING ATTORNEY



David J. Kyffers

Director of the United States Patent and Trademark Office

United States of America

United States Patent and Trademark Office

POWER OF 2

Reg. No. 4,206,170

Registered Sep. 11, 2012

Int. Cl.: 5

TRADEMARK

PRINCIPAL REGISTER

ADVANTIVA GLOBAL PRODUCTS, LLC (CALIFORNIA LIMITED LIABILITY COMPANY)
P.O. BOX 4744
DIAMOND BAR, CA 91765

FOR: NUTRITIONAL SUPPLEMENTS; NUTRITIONALLY FORTIFIED BEVERAGES; NUTRITIONALLY FORTIFIED WATER, VITAMIN AND MINERAL SUPPLEMENTS; PROTEIN SUPPLEMENTS; MEAL REPLACEMENT ENERGY SHAKES; NUTRITIONAL ENERGY BARS FOR USE AS A MEAL SUBSTITUTE; VITAMIN ENRICHED WATER; VITAMIN FORTIFIED BEVERAGES, IN CLASS 5 (U.S. CLS. 6, 18, 44, 46, 51 AND 52).

FIRST USE 1-23-2012; IN COMMERCE 1-23-2012.

THE MARK CONSISTS OF STANDARD CHARACTERS WITHOUT CLAIM TO ANY PARTICULAR FONT, STYLE, SIZE, OR COLOR.

SN 77-479,226, FILED 5-20-2008.

CHRIS DONINGER, EXAMINING ATTORNEY



David J. Kybas

Director of the United States Patent and Trademark Office

United States of America

United States Patent and Trademark Office

Pashnu

Reg. No. 4,206,171

Registered Sep. 11, 2012

Int. Cl.: 35

SERVICE MARK

PRINCIPAL REGISTER

PASHNU, LLC (VIRGINIA LIMITED LIABILITY COMPANY)
#110-322
4201 WILSON BLVD
ARLINGTON, VA 22203

FOR: ADVERTISING AND COMMERCIAL INFORMATION SERVICES, VIA THE INTERNET; AN INTERACTIVE WEB SITE FOR USERS TO REVIEW AND RATE INTERNET CONTENT, PEOPLE, COMPANIES, PRODUCTS AND/OR SERVICES UTILIZING A SOFTWARE APPLICATION TO AWARD POINTS WHEREBY WEB SITE USERS ARE ELIGIBLE TO EXCHANGE POINTS EARNED FOR PROMOTIONAL ITEMS CONSISTING; OF COUPONS, REBATES, DISCOUNTS OR SPECIAL OFFERINGS ON GOODS AND/OR SERVICE PROVIDED BY WEB SITE SPONSORS; DESIGN OF INTERNET ADVERTISING; FACILITATING THE EXCHANGE OF NEEDED INFORMATION FOR FINANCIAL COMPENSATION VIA THE INTERNET; INTERNET ADVERTISING SERVICES; PROVIDING A SEARCHABLE ONLINE ADVERTISING GUIDE FEATURING THE GOODS AND SERVICES OF OTHER ON-LINE VENDORS ON THE INTERNET; PROVISION OF SPACE ON WEBSITES FOR ADVERTISING GOODS AND SERVICES; THE BRINGING TOGETHER, FOR THE BENEFIT OF OTHERS, OF A VARIETY OF GOODS AND SERVICES, ENABLING CUSTOMERS TO CONVENIENTLY VIEW AND PURCHASE THOSE GOODS AND SERVICES FROM AN INTERNET WEB SITE PARTICULARLY SPECIALIZING IN THE MARKETING OF THE SALE OF GOODS AND SERVICES OF OTHERS, IN CLASS 35 (U.S. CLS. 100, 101 AND 102).

FIRST USE 4-1-2010; IN COMMERCE 6-1-2010.

THE MARK CONSISTS OF STANDARD CHARACTERS WITHOUT CLAIM TO ANY PARTICULAR FONT, STYLE, SIZE, OR COLOR.

THE WORDING "PASHNU" HAS NO MEANING IN A FOREIGN LANGUAGE.

SN 77-488,121, FILED 6-1-2008.

ANDREA BUTLER, EXAMINING ATTORNEY



David J. Kyffers

Director of the United States Patent and Trademark Office

United States of America

United States Patent and Trademark Office

WIRELESS WATER

Reg. No. 4,206,172

GREEN, RON (CANADA INDIVIDUAL)
202 - 1551 WEST 11TH AVENUE
VANCOUVER, BC, CANADA V6J2B5

Registered Sep. 11, 2012

Int. Cls.: 9 and 42

FOR: DOWNLOADABLE ELECTRONIC REPORTS REPORTING TO SUBSCRIBERS THE RESULTS OF QUALITY TESTING OF WATER, WASTEWATER OR SOIL SAMPLES , IN CLASS 9 (U.S. CLS. 21, 23, 26, 36 AND 38).

TRADEMARK

FIRST USE 11-5-2010; IN COMMERCE 6-20-2012.

SERVICE MARK

FOR: MAINTAINING AND OPERATING AN ON-LINE DATABASE AND DATABASE MANAGEMENT SYSTEM ENABLING OTHERS, NAMELY, CONSULTANTS AND UTILITIES, TO ANALYZE DATA AND TO PRODUCE REPORTS BASED ON WATER, WASTEWATER AND SOIL QUALITY TEST RESULTS, IN CLASS 42 (U.S. CLS. 100 AND 101).

PRINCIPAL REGISTER

FIRST USE 11-5-2010; IN COMMERCE 6-20-2012.

THE MARK CONSISTS OF STANDARD CHARACTERS WITHOUT CLAIM TO ANY PARTICULAR FONT, STYLE, SIZE, OR COLOR.

OWNER OF CANADA REG. NO. TMA784347, DATED 12-7-2010, EXPIRES 12-7-2025.

NO CLAIM IS MADE TO THE EXCLUSIVE RIGHT TO USE "WATER", APART FROM THE MARK AS SHOWN.

SN 77-489,085, FILED 6-2-2008.

C. DIONNE CLYBURN, EXAMINING ATTORNEY



David J. Kybas

Director of the United States Patent and Trademark Office

United States of America

United States Patent and Trademark Office

BOTKIER

Reg. No. 4,206,173

BOTKIER, MONICA (UNITED STATES INDIVIDUAL)
C/O COZEN O'CONNOR, 277 PARK AVENUE
NEW YORK, NY 10172

Registered Sep. 11, 2012

Int. Cl.: 18

FOR: PURSES; COSMETIC CASES SOLD EMPTY, IN CLASS 18 (U.S. CLS. 1, 2, 3, 22 AND 41).

TRADEMARK

FIRST USE 0-0-2004; IN COMMERCE 0-0-2004.

PRINCIPAL REGISTER

THE MARK CONSISTS OF STANDARD CHARACTERS WITHOUT CLAIM TO ANY PARTICULAR FONT, STYLE, SIZE, OR COLOR.

SN 77-492,900, FILED 6-6-2008.

LAURIE KAUFMAN, EXAMINING ATTORNEY



David J. Kybas

Director of the United States Patent and Trademark Office

United States of America

United States Patent and Trademark Office



Reg. No. 4,206,174

Registered Sep. 11, 2012

Int. Cls.: 14 and 25

TRADEMARK

PRINCIPAL REGISTER

LIVIBRANCE CENTER, LLC (FLORIDA LIMITED LIABILITY COMPANY)
200 BEACH DRIVE NE
UNIT #9
ST. PETERSBURG, FL 33701

FOR: JEWELRY, IN CLASS 14 (U.S. CLS. 2, 27, 28 AND 50).

FIRST USE 6-10-2012; IN COMMERCE 6-10-2012.

FOR: CLOTHING, NAMELY, SHIRTS, T-SHIRTS, HATS, CAPS AND BANDANAS, IN CLASS 25 (U.S. CLS. 22 AND 39).

FIRST USE 6-10-2012; IN COMMERCE 6-10-2012.

THE MARK CONSISTS OF A MUSIC NOTE WITHIN A FANCIFUL DESIGN.

SN 77-496,232, FILED 6-11-2008.

PAUL E. FAHRENKOPF, EXAMINING ATTORNEY



David J. Kybas

Director of the United States Patent and Trademark Office

United States of America

United States Patent and Trademark Office

AZUA RON

Reg. No. 4,206,175

KOOHYAR, ALI (UNITED STATES INDIVIDUAL)
P.O. BOX 640657
SAN FRANCISCO, CA 94164

Registered Sep. 11, 2012

Int. Cl.: 33

FOR: RUM, IN CLASS 33 (U.S. CLS. 47 AND 49).

TRADEMARK

FIRST USE 2-4-2012; IN COMMERCE 2-4-2012.

PRINCIPAL REGISTER

THE MARK CONSISTS OF STANDARD CHARACTERS WITHOUT CLAIM TO ANY PARTICULAR FONT, STYLE, SIZE, OR COLOR.

NO CLAIM IS MADE TO THE EXCLUSIVE RIGHT TO USE "RON", APART FROM THE MARK AS SHOWN.

THE FOREIGN WORDING IN THE MARK TRANSLATES INTO ENGLISH AS "RUM".

SN 77-497,544, FILED 6-12-2008.

DEIRDRE ROBERTSON, EXAMINING ATTORNEY



David J. Kybas

Director of the United States Patent and Trademark Office

United States of America

United States Patent and Trademark Office

EL SHADDAI

Reg. No. 4,206,176

Registered Sep. 11, 2012

Int. Cl.: 9

TRADEMARK

PRINCIPAL REGISTER

IGNITION ENTERTAINMENT LTD. (CALIFORNIA LIMITED LIABILITY COMPANY)
500 N. CENTRAL AVE
SUITE 930
GLENDALE, CA 91203

FOR: COMPUTER PROGRAMS, NAMELY, GAME SOFTWARE FOR USE ON COMPUTERS AND VIDEO GAME PLAYERS; COMPUTER PROGRAMS FOR PRE-RECORDED GAMES; INTERACTIVE VIDEO GAME PROGRAMS; PRE-RECORDED VIDEOTAPES, AUDIO TAPES, CDS AND DVDS FEATURING SOUND AND VIDEO IN THE FIELDS OF MUSIC, LIVE ACTION PROGRAMS, MOTION PICTURES AND ANIMATED CARTOONS; MOTION PICTURE FILMS FEATURING COMEDY, DRAMA, ACTION, ADVENTURE AND ANIMATION; AND COVERS SPECIALLY ADAPTED FOR COMPUTER GAME CONSOLES AND PERIPHERALS, NAMELY, GAME CONTROLLERS, IN CLASS 9 (U.S. CLS. 21, 23, 26, 36 AND 38).

FIRST USE 8-16-2011; IN COMMERCE 8-16-2011.

THE MARK CONSISTS OF STANDARD CHARACTERS WITHOUT CLAIM TO ANY PARTICULAR FONT, STYLE, SIZE, OR COLOR.

THE ENGLISH TRANSLATION OF THE WORD "EL SHADDAI" IN THE MARK IS "ALMIGHTY GOD".

SN 77-497,670, FILED 6-12-2008.

MARCIE MILONE, EXAMINING ATTORNEY



David J. Kyffers

Director of the United States Patent and Trademark Office

United States of America

United States Patent and Trademark Office

THE JACK

Reg. No. 4,206,177

Registered Sep. 11, 2012

Int. Cls.: 41 and 43

SERVICE MARK

PRINCIPAL REGISTER

JACK DANIEL'S PROPERTIES, INC. (DELAWARE CORPORATION)
4040 CIVIC CENTER DRIVE, SUITE 528
SAN RAFAEL, CA 94903

FOR: ORGANIZING AND CONDUCTING COMMUNITY BARBECUE FESTIVALS FEATURING A VARIETY OF ACTIVITIES, NAMELY, A FESTIVAL FEATURING MUSIC IN THE NATURE OF LIVE ENTERTAINMENT BY MUSICAL GROUPS, CHILDREN'S ENTERTAINMENT AND GAMES IN THE NATURE OF CARNIVAL GAMES, ARTS AND CRAFTS, COOKING DEMONSTRATIONS, BARBECUE COOKING CONTEST, DESSERT MAKING CONTEST AND SAUCE MAKING CONTEST, IN CLASS 41 (U.S. CLS. 100, 101 AND 107).

FIRST USE 10-24-2009; IN COMMERCE 10-24-2009.

FOR: PROVISION OF FOOD AT BARBECUE FESTIVALS, IN CLASS 43 (U.S. CLS. 100 AND 101).

FIRST USE 10-24-2009; IN COMMERCE 10-24-2009.

THE MARK CONSISTS OF STANDARD CHARACTERS WITHOUT CLAIM TO ANY PARTICULAR FONT, STYLE, SIZE, OR COLOR.

SN 77-507,719, FILED 6-25-2008.

KRISTIN DAHLING, EXAMINING ATTORNEY



David J. Kybas

Director of the United States Patent and Trademark Office

United States of America
United States Patent and Trademark Office

STRESS-FIX

Reg. No. 4,206,178

AVEDA CORPORATION (DELAWARE CORPORATION)
4000 PHEASANT RIDGE DRIVE
MINNEAPOLIS, MN 55449

Registered Sep. 11, 2012

Int. Cl.: 3

FOR: NON-MEDICATED SKIN CARE PREPARATIONS; NON-MEDICATED TOILETRIES,
IN CLASS 3 (U.S. CLS. 1, 4, 6, 50, 51 AND 52).

TRADEMARK

FIRST USE 10-1-2011; IN COMMERCE 10-1-2011.

PRINCIPAL REGISTER

THE MARK CONSISTS OF STANDARD CHARACTERS WITHOUT CLAIM TO ANY PAR-
TICULAR FONT, STYLE, SIZE, OR COLOR.

SN 77-511,084, FILED 6-30-2008.

MARK SPARACINO, EXAMINING ATTORNEY



David J. Kyffers

Director of the United States Patent and Trademark Office

United States of America

United States Patent and Trademark Office

X-BLADE

Reg. No. 4,206,179

SUPER MICRO COMPUTER, INC. (DELAWARE CORPORATION)
980 ROCK AVENUE
SAN JOSE, CA 95131

Registered Sep. 11, 2012

Int. Cl.: 9

FOR: COMPUTER SERVERS FOR USE WITH COMPUTER NETWORKS AND COMPUTER WORKSTATIONS, IN CLASS 9 (U.S. CLS. 21, 23, 26, 36 AND 38).

TRADEMARK

FIRST USE 9-1-2011; IN COMMERCE 9-1-2011.

PRINCIPAL REGISTER

THE MARK CONSISTS OF STANDARD CHARACTERS WITHOUT CLAIM TO ANY PARTICULAR FONT, STYLE, SIZE, OR COLOR.

SN 77-518,944, FILED 7-10-2008.

AISHA CLARKE, EXAMINING ATTORNEY



David J. Kybas

Director of the United States Patent and Trademark Office

United States of America

United States Patent and Trademark Office

BPURE

Reg. No. 4,206,180

LIFESTYLE NUTRITION, LLC (DELAWARE LIMITED LIABILITY COMPANY)
#211 VIA DE VENTURA, SUITE F110
SCOTTSDALE, AZ 85258

Registered Sep. 11, 2012

Int. Cl.: 5

FOR: DIETARY SUPPLEMENTS; MINERAL SUPPLEMENTS; NUTRITIONAL SUPPLEMENTS; VITAMINS, IN CLASS 5 (U.S. CLS. 6, 18, 44, 46, 51 AND 52).

TRADEMARK

FIRST USE 6-0-2012; IN COMMERCE 6-0-2012.

PRINCIPAL REGISTER

THE MARK CONSISTS OF STANDARD CHARACTERS WITHOUT CLAIM TO ANY PARTICULAR FONT, STYLE, SIZE, OR COLOR.

SN 77-521,083, FILED 7-14-2008.

B. PARADEWELAI, EXAMINING ATTORNEY



David J. Kyffers

Director of the United States Patent and Trademark Office

United States of America

United States Patent and Trademark Office

BE PURE

Reg. No. 4,206,181

LIFESTYLE NUTRITION, LLC (DELAWARE LIMITED LIABILITY COMPANY)
#211 VIA DE VENTURA, SUITE F110
SCOTTSDALE, AZ 85258

Registered Sep. 11, 2012

Int. Cl.: 5

FOR: DIETARY SUPPLEMENTS; MINERAL SUPPLEMENTS; NUTRITIONAL SUPPLEMENTS; VITAMINS, IN CLASS 5 (U.S. CLS. 6, 18, 44, 46, 51 AND 52).

TRADEMARK

FIRST USE 7-2-2012; IN COMMERCE 7-2-2012.

PRINCIPAL REGISTER

THE MARK CONSISTS OF STANDARD CHARACTERS WITHOUT CLAIM TO ANY PARTICULAR FONT, STYLE, SIZE, OR COLOR.

SN 77-522,155, FILED 7-15-2008.

B. PARADEWELAI, EXAMINING ATTORNEY



David J. Kybas

Director of the United States Patent and Trademark Office

United States of America

United States Patent and Trademark Office



Reg. No. 4,206,182

Registered Sep. 11, 2012

Int. Cl.: 29

TRADEMARK

PRINCIPAL REGISTER

REVOLUTION FOODS, INC. (DELAWARE CORPORATION)
8383 CAPWELL DRIVE
OAKLAND, CA 94621

FOR: FOOD PRODUCTS, NAMELY, PREPARED MEALS CONSISTING PRIMARILY OF MEAT, AND VEGETABLES, SOUPS, IN CLASS 29 (U.S. CL. 46).

FIRST USE 8-8-2006; IN COMMERCE 8-8-2006.

OWNER OF U.S. REG. NO. 3,473,564.

NO CLAIM IS MADE TO THE EXCLUSIVE RIGHT TO USE "FOODS", APART FROM THE MARK AS SHOWN.

THE MARK CONSISTS OF A HUMAN FIGURE AND AN APPLE, WITH THE WORDS "REVOLUTION FOODS".

SN 77-528,480, FILED 7-22-2008.

VIVIAN MICZNIK FIRST, EXAMINING ATTORNEY



David J. Kybas

Director of the United States Patent and Trademark Office

United States of America

United States Patent and Trademark Office

UNITEDHEALTH EDUCATIONAL PUBLISHING GROUP

Reg. No. 4,206,183

Registered Sep. 11, 2012

Int. Cl.: 9

TRADEMARK

PRINCIPAL REGISTER

UNITEDHEALTH GROUP INCORPORATED (MINNESOTA CORPORATION)
9900 BREN ROAD EAST, MN008-T202
MINNETONKA, MN 55343

FOR: DOWNLOADABLE ELECTRONIC PUBLICATIONS, NAMELY, BOOKLETS, PAMPHLETS, BULLETINS AND BROCHURES FEATURING INFORMATION IN THE FIELD OF HEALTH AND WELLNESS, IN CLASS 9 (U.S. CLS. 21, 23, 26, 36 AND 38).

FIRST USE 0-0-2008; IN COMMERCE 0-0-2008.

THE MARK CONSISTS OF STANDARD CHARACTERS WITHOUT CLAIM TO ANY PARTICULAR FONT, STYLE, SIZE, OR COLOR.

OWNER OF U.S. REG. NOS. 2,248,887, 3,224,586, AND OTHERS.

NO CLAIM IS MADE TO THE EXCLUSIVE RIGHT TO USE "EDUCATIONAL PUBLISHING GROUP", APART FROM THE MARK AS SHOWN.

SN 77-529,279, FILED 7-23-2008.

WILLIAM VERHOSEK, EXAMINING ATTORNEY



David J. Kyfos

Director of the United States Patent and Trademark Office

United States of America

United States Patent and Trademark Office

Pentax SmartPath

Reg. No. 4,206,184

PENTAX OF AMERICA, INC. (DELAWARE CORPORATION)
102 CHESTNUT RIDGE ROAD
MONTVALE, NJ 07645

Registered Sep. 11, 2012

Int. Cl.: 35

FOR: RETAIL STORE SERVICES FEATURING MEDICAL EQUIPMENT, IN CLASS 35 (U.S. CLS. 100, 101 AND 102).

SERVICE MARK

FIRST USE 5-26-2009; IN COMMERCE 5-26-2009.

PRINCIPAL REGISTER

THE MARK CONSISTS OF STANDARD CHARACTERS WITHOUT CLAIM TO ANY PARTICULAR FONT, STYLE, SIZE, OR COLOR.

SN 77-530,719, FILED 7-24-2008.

ANDREA HACK, EXAMINING ATTORNEY



David J. Kybas

Director of the United States Patent and Trademark Office

United States of America

United States Patent and Trademark Office

NuGrip

Reg. No. 4,206,185

Registered Sep. 11, 2012

Int. Cl.: 10

TRADEMARK

PRINCIPAL REGISTER

ASCENSION ORTHOPEDICS, INC. (DELAWARE CORPORATION)
8700 CAMERON ROAD, SUITE 100
AUSTIN, TX 78754

FOR: ORTHOPEDIC IMPLANTS COMPOSED OF ARTIFICIAL MATERIALS FOR BONE-JOINT APPLICATIONS, NAMELY, THE REPLACEMENT OF THE METACARPAL BONE AT THE BASE OF THE THUMB, IN CLASS 10 (U.S. CLS. 26, 39 AND 44).

FIRST USE 11-30-2010; IN COMMERCE 11-30-2010.

THE MARK CONSISTS OF STANDARD CHARACTERS WITHOUT CLAIM TO ANY PARTICULAR FONT, STYLE, SIZE, OR COLOR.

SN 77-535,227, FILED 7-30-2008.

JAMES MACFARLANE, EXAMINING ATTORNEY



David J. Kybas

Director of the United States Patent and Trademark Office

United States of America

United States Patent and Trademark Office

OFFMYDESK

Reg. No. 4,206,186

Registered Sep. 11, 2012

Int. Cl.: 42

SERVICE MARK

PRINCIPAL REGISTER

DST DIRECT LLC (MISSOURI LIMITED LIABILITY COMPANY)
5TH FLOOR
333 WEST 11TH STREET
KANSAS CITY, MO 64105

FOR: COMPUTER SERVICES, NAMELY, PROVIDING A WEB-BASED ONLINE PORTAL FOR CUSTOMERS TO REMOTELY MANAGE, ADMINISTER, MODIFY AND CONTROL THEIR END USER COMPUTER DEVICES, DATA, AND SOFTWARE APPLICATIONS, NAMELY, TO PRINT AND MAIL TRANSACTIONAL COMMUNICATIONS USING PRE-FORMATTED TEMPLATES FOR STATEMENTS, INVOICES AND LETTERS, IN CLASS 42 (U.S. CLS. 100 AND 101).

FIRST USE 6-12-2012; IN COMMERCE 6-12-2012.

THE MARK CONSISTS OF STANDARD CHARACTERS WITHOUT CLAIM TO ANY PARTICULAR FONT, STYLE, SIZE, OR COLOR.

SN 77-541,826, FILED 8-7-2008.

ERIN FALK, EXAMINING ATTORNEY



David J. Kyros

Director of the United States Patent and Trademark Office

United States of America

United States Patent and Trademark Office



Reg. No. 4,206,187

Registered Sep. 11, 2012

Int. Cl.: 43

SERVICE MARK

PRINCIPAL REGISTER

HRHH IP, LLC (DELAWARE LIMITED LIABILITY COMPANY)
200 VESEY STREET, 11TH FLOOR
THREE WORLD FINANCIAL CENTER
NEW YORK, NY 102811021

FOR: RESTAURANT, BAR AND CATERING SERVICES, IN CLASS 43 (U.S. CLS. 100 AND 101).

FIRST USE 3-10-1995; IN COMMERCE 3-10-1995.

OWNER OF U.S. REG. NO. 2,181,672.

NO CLAIM IS MADE TO THE EXCLUSIVE RIGHT TO USE "THE JOINT" AND "LAS VEGAS", APART FROM THE MARK AS SHOWN.

THE MARK CONSISTS OF THE WORDS "THE JOINT" ABOVE A SPADE CONTAINING THE WORDS "LAS VEGAS" WITH FLAMES EMANATING FROM THE SPADE.

SN 77-549,679, FILED 8-18-2008.

AMY HELLA, EXAMINING ATTORNEY



David J. Kyffers

Director of the United States Patent and Trademark Office

United States of America

United States Patent and Trademark Office

O SO SLIM

Reg. No. 4,206,188

Registered Sep. 11, 2012

Int. Cl.: 25

TRADEMARK

PRINCIPAL REGISTER

THARANCO DRESS GROUP LLC (DELAWARE LIMITED LIABILITY COMPANY)
SECTION 5
99 HOOK ROAD
BAYONNE, NJ 07002

FOR: WOMEN'S CLOTHING, NAMELY, DRESSES, SKIRTS, TOPS, SUITS, BLOUSES,
PANTSUITS, PANTS, JUMPSUITS, JUMPERS, ROMPERS AND JACKETS, IN CLASS 25
(U.S. CLS. 22 AND 39).

FIRST USE 7-1-2010; IN COMMERCE 1-1-2011.

THE MARK CONSISTS OF STANDARD CHARACTERS WITHOUT CLAIM TO ANY PAR-
TICULAR FONT, STYLE, SIZE, OR COLOR.

SN 77-558,403, FILED 8-28-2008.

GEOFFREY FOSDICK, EXAMINING ATTORNEY



David J. Kyffers

Director of the United States Patent and Trademark Office

United States of America

United States Patent and Trademark Office

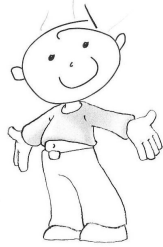

Reg. No. 4,206,189

Registered Sep. 11, 2012

Int. Cls.: 16 and 25

TRADEMARK

PRINCIPAL REGISTER

KAITIDE ENTERPRISES, INC. (NORTH CAROLINA CORPORATION)
503 STUART RIDGE
CRAMERTON, NC 28032

FOR: PRINTED MATTER, NAMELY, EDUCATIONAL AND INFORMATIVE MANUALS IN THE FIELD OF CORPORATE PROMOTION, POSTERS, PAPER DESK MATS, COLORING BOOKS, BOOK AND NOTEBOOK COVERS, BOOK MARKERS, NOTEPADS, POSTCARDS, MAGNETIC NOTEPADS, STATIONERY, GREETING CARDS, STICKERS, LEAFLETS, BROCHURES, AND ADVERTISING SIGNS OF PAPER OR CARDBOARD IN THE FIELD OF CORPORATE PROMOTION, IN CLASS 16 (U.S. CLS. 2, 5, 22, 23, 29, 37, 38 AND 50).

FIRST USE 6-26-2012; IN COMMERCE 6-26-2012.

FOR: APPAREL FOR MEN, WOMEN AND CHILDREN, NAMELY, T-SHIRTS, POLO SHIRTS, GOLF SHIRTS, KNIT SHIRTS, SWEAT SHIRTS, SWEAT PANTS, JACKETS, SWEATERS, SHORTS, BELTS, SOCKS, TANK TOPS, SPORTS BRAS, HOUSE SLIPPERS, EAR MUFFS, GLOVES, BATHROBES, PAJAMAS, NIGHTGOWNS, UNDERWEAR, SWIMSUITS, SUSPENDERS, WRIST BANDS, HEADBANDS, BEANIES, HATS, VISORS, AND SKULL CAPS, IN CLASS 25 (U.S. CLS. 22 AND 39).

FIRST USE 6-26-2012; IN COMMERCE 6-26-2012.

THE MARK CONSISTS OF A DRAWING OF A BOY CHILD WITH HIS ARMS OUT-STRETCHED.

SN 77-562,403, FILED 9-4-2008.

MATTHEW KLINE, EXAMINING ATTORNEY



David J. Kybas

Director of the United States Patent and Trademark Office

United States of America

United States Patent and Trademark Office

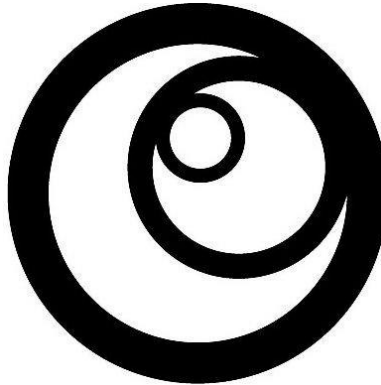

Reg. No. 4,206,190

Registered Sep. 11, 2012

Int. Cl.: 9

TRADEMARK

PRINCIPAL REGISTER

GLOBALSCHOLAR INC. (DELAWARE CORPORATION)
ATTN: LEGAL DEPARTMENT
1100 12TH AVENUE NE, SUITE 100 SOUTH
BELLEVUE, WA 98004

FOR: COMPUTER SOFTWARE FOR THE CREATION AND DELIVERY OF EDUCATIONAL COURSES AND TRAINING; COMPUTER SOFTWARE FOR CREATING, MAINTAINING, AND DELIVERING TEACHER LESSON PLANS, EVALUATING STUDENT PROGRESS ASSESSMENT AND GRADING STUDENT TESTS, ASSIGNMENTS, AND ATTENDANCE; COMPUTER SPREADSHEET AND DATABASE MANAGEMENT SOFTWARE IN THE FIELD OF CLASSROOM MANAGEMENT FOR EDUCATIONAL INSTITUTIONS; COMPUTER SPREADSHEET AND DATABASE MANAGEMENT SOFTWARE TO IMPROVE STUDENT LEARNING, REDUCE INSTITUTIONAL COSTS, AND COMPARE AND IMPROVE INSTITUTIONAL PERFORMANCE, IN CLASS 9 (U.S. CLS. 21, 23, 26, 36 AND 38).

FIRST USE 6-24-2012; IN COMMERCE 6-24-2012.

THE MARK CONSISTS OF THREE NON-CONCENTRIC CIRCLES THAT APPEAR INSIDE EACH OTHER.

SN 77-562,883, FILED 9-4-2008.

NELSON SNYDER, EXAMINING ATTORNEY



David J. Kybas

Director of the United States Patent and Trademark Office

United States of America

United States Patent and Trademark Office

GREENCHOICE BANK

Reg. No. 4,206,191

GREENCHOICE HOLDING COMPANY, INC. (ILLINOIS CORPORATION)
5225 WEST 25TH STREET
CICERO, IL 60804

Registered Sep. 11, 2012

Int. Cl.: 36

FOR: BANKING AND FINANCING SERVICES, EXCLUDING CREDIT AND DEBIT CARD SERVICES, IN CLASS 36 (U.S. CLS. 100, 101 AND 102).

SERVICE MARK

FIRST USE 2-1-2011; IN COMMERCE 2-1-2011.

PRINCIPAL REGISTER

THE MARK CONSISTS OF STANDARD CHARACTERS WITHOUT CLAIM TO ANY PARTICULAR FONT, STYLE, SIZE, OR COLOR.

NO CLAIM IS MADE TO THE EXCLUSIVE RIGHT TO USE "BANK", APART FROM THE MARK AS SHOWN.

SN 77-567,593, FILED 9-11-2008.

ANDREA BUTLER, EXAMINING ATTORNEY



David J. Kybas

Director of the United States Patent and Trademark Office

United States of America

United States Patent and Trademark Office

CHEMOFINITO

Reg. No. 4,206,192

Registered Sep. 11, 2012

Int. Cl.: 25

TRADEMARK

PRINCIPAL REGISTER

VITAL OPTIONS INTERNATIONAL (CALIFORNIA CORPORATION)
4419 COLDWATER CANYON AVENUE, SUITE I
STUDIO CITY, CA 916041479

FOR: APPAREL, NAMELY, TOPS AND SHIRTS, IN CLASS 25 (U.S. CLS. 22 AND 39).

FIRST USE 9-10-2011; IN COMMERCE 9-10-2011.

THE MARK CONSISTS OF STANDARD CHARACTERS WITHOUT CLAIM TO ANY PARTICULAR FONT, STYLE, SIZE, OR COLOR.

SN 77-568,260, FILED 9-11-2008.

KYLE PEETE, EXAMINING ATTORNEY



David J. Kyffers

Director of the United States Patent and Trademark Office

United States of America

United States Patent and Trademark Office



Reg. No. 4,206,193

RAHMI OGUZ CAPAN (TURKEY INDIVIDUAL)
BEYAZ EV SOK. NO: 5 ARMUTALAN
48700 MARMARIS MUGLA, TURKEY

Registered Sep. 11, 2012

Int. Cls.: 11, 37, 40, and 42

FOR: SOLAR COLLECTORS; SOLAR HEAT COLLECTION PANELS; SOLAR THERMAL INSTALLATIONS, NAMELY, SOLAR THERMAL MODULES; SOLAR THERMAL-BASED POWER PLANTS; STEAM GENERATING INSTALLATIONS; STEAM GENERATORS; STEAM HEATING APPARATUS FOR INDUSTRIAL PURPOSES; STEAM SUPER HEATERS FOR INDUSTRIAL PURPOSES, IN CLASS 11 (U.S. CLS. 13, 21, 23, 31 AND 34).

TRADEMARK

SERVICE MARK

FIRST USE 4-3-2012; IN COMMERCE 4-3-2012.

PRINCIPAL REGISTER

FOR: INSTALLATION AND MAINTENANCE OF SOLAR ENERGY BASED POWER PLANTS; INSTALLATION AND MAINTENANCE OF SOLAR THERMAL HYBRID INSTALLATIONS; INSTALLATION, REPAIR AND MAINTENANCE OF CONDENSING APPARATUS AND STEAM CONDENSERS; INSTALLATION AND MAINTENANCE OF SOLAR THERMAL INSTALLATIONS, IN CLASS 37 (U.S. CLS. 100, 103 AND 106).

FIRST USE 4-3-2012; IN COMMERCE 4-3-2012.

FOR: GENERATION OF ENERGY, IN CLASS 40 (U.S. CLS. 100, 103 AND 106).

FIRST USE 4-3-2012; IN COMMERCE 4-3-2012.

FOR: TECHNICAL PLANNING OF SOLAR THERMAL HYBRID INSTALLATIONS; TECHNICAL PLANNING OF SOLAR THERMAL INSTALLATIONS; TECHNOLOGY PLANNING AND CONSULTING IN THE FIELD OF SOLAR ENERGY AND SOLAR COLLECTORS; TECHNICAL PLANNING OF SOLAR ENERGY BASED POWER PLANTS, IN CLASS 42 (U.S. CLS. 100 AND 101).

FIRST USE 4-3-2012; IN COMMERCE 4-3-2012.

NO CLAIM IS MADE TO THE EXCLUSIVE RIGHT TO USE "SOLAR ENERJI", APART FROM THE MARK AS SHOWN.

THE COLOR(S) RED, ORANGE AND GOLD IS/ARE CLAIMED AS A FEATURE OF THE MARK.



David J. Kyjars

Director of the United States Patent and Trademark Office

Reg. No. 4,206,193 THE MARK CONSISTS OF A FANCIFUL CIRCULAR DESIGN CONTAINING A GEOMETRIC PATTERN WITHIN ITS BORDER AND ARCHITECTURAL EMBELLISHMENTS RESEMBLING ONION DOMES SPACED AROUND THE OUTSIDE OF THE BORDER. THE CIRCULAR DESIGN IS CENTERED ABOVE AND APPEARS TO REST UPON A STYLIZED DEPICTION OF THE WORD "HITTITE" CENTERED ABOVE THE WORDING "SOLAR ENERJI". THE COLOR RED APPEARS AT THE BOTTOM OF THE MARK WITH THE WORDING "SOLAR ENERJI" AND BEGINS TO TURN ORANGE MIDWAY THROUGH THE WORD "HITTITE", GRADUALLY TURNING MORE ORANGE AND THEN GOLD AS THE TOP OF THE CIRCULAR DESIGN AND ITS EMBELLISHMENTS ARE REACHED.

THE ENGLISH TRANSLATION OF "ENERJI" IN THE MARK IS "ENERGY".

SN 77-573,487, FILED 9-18-2008.

FRANK LATTUCA, EXAMINING ATTORNEY

United States of America

United States Patent and Trademark Office

C BURST

Reg. No. 4,206,194

Registered Sep. 11, 2012

Int. Cl.: 5

TRADEMARK

PRINCIPAL REGISTER

SERVICE AND SALES ASSOCIATES, LLC (GEORGIA LIMITED LIABILITY COMPANY)
965 MOORES MILL ROAD, NW
ATLANTA, GA 303271625

FOR: DECONGESTANT NASAL SPRAY, IN CLASS 5 (U.S. CLS. 6, 18, 44, 46, 51 AND 52).

FIRST USE 3-0-2012; IN COMMERCE 6-1-2012.

THE MARK CONSISTS OF STANDARD CHARACTERS WITHOUT CLAIM TO ANY PARTICULAR FONT, STYLE, SIZE, OR COLOR.

NO CLAIM IS MADE TO THE EXCLUSIVE RIGHT TO USE "C", APART FROM THE MARK AS SHOWN.

SN 77-576,032, FILED 9-22-2008.

ERIN FALK, EXAMINING ATTORNEY



David J. Kybas

Director of the United States Patent and Trademark Office

United States of America

United States Patent and Trademark Office

SURF SPOT

Reg. No. 4,206,195

Registered Sep. 11, 2012

Int. Cls.: 41 and 43

SERVICE MARK

PRINCIPAL REGISTER

SURF SPOT, LLC (CALIFORNIA LIMITED LIABILITY COMPANY)
4625 COAST HIGHWAY
PACIFICA, CA 94044

FOR: ENTERTAINMENT SERVICES, NAMELY, OPERATING A CONCERT VENUE; ENTERTAINMENT SERVICES, NAMELY, LIVE MUSIC CONCERT SERVICES; SPORTS AND ENTERTAINMENT SERVICES, NAMELY, PROVIDING RECREATIONAL ACTIVITIES IN THE NATURE OF VOLLEYBALL GAMES; ARRANGING AND CONDUCTING OF CONCERTS, IN CLASS 41 (U.S. CLS. 100, 101 AND 107).

FIRST USE 6-23-2012; IN COMMERCE 6-23-2012.

FOR: RESTAURANT AND BAR SERVICES; PROVIDING FACILITIES FOR CONCERTS, IN CLASS 43 (U.S. CLS. 100 AND 101).

FIRST USE 6-19-2012; IN COMMERCE 6-19-2012.

THE MARK CONSISTS OF STANDARD CHARACTERS WITHOUT CLAIM TO ANY PARTICULAR FONT, STYLE, SIZE, OR COLOR.

SN 77-576,115, FILED 9-22-2008.

CHERYL CLAYTON, EXAMINING ATTORNEY



David J. Kybas

Director of the United States Patent and Trademark Office

United States of America

United States Patent and Trademark Office



Reg. No. 4,206,196

Registered Sep. 11, 2012

Int. Cl.: 30

TRADEMARK

PRINCIPAL REGISTER

MARATHON PETROLEUM COMPANY LP (DELAWARE LIMITED PARTNERSHIP)
539 SOUTH MAIN STREET
FINDLAY, OH 45840

FOR: CAPPUCCINO; COFFEE AND TEA; COFFEE BASED BEVERAGES; COFFEE BEVERAGES WITH MILK; ESPRESSO; TEA-BASED BEVERAGES WITH FRUIT FLAVORING, IN CLASS 30 (U.S. CL. 46).

FIRST USE 5-18-2012; IN COMMERCE 5-18-2012.

THE MARK CONSISTS OF THE CHARACTERS ") (\---" AND THE LETTER "P" WHICH FORMS A DESIGN OF A CUP OF COFFEE, COFFEE-BASED BEVERAGE OR TEA WITH STEAM RISING FROM IT.

SN 77-576,255, FILED 9-23-2008.

SEAN CROWLEY, EXAMINING ATTORNEY



David J. Kybas

Director of the United States Patent and Trademark Office

United States of America

United States Patent and Trademark Office

YOGUITTO

Reg. No. 4,206,197

MARQUEZ BROTHERS INTERNATIONAL, INC. (CALIFORNIA CORPORATION)
5801 RUE FERRARI
SAN JOSE, CA 95138

Registered Sep. 11, 2012

Int. Cl.: 29

FOR: YOGURT, DRINKING YOGURT, YOGURT-BASED BEVERAGES, MILK BASED BEVERAGES CONTAINING FRUIT JUICE, MILK BASED BEVERAGES CONTAINING FRUITS, MILK DRINKS CONTAINING FRUITS, IN CLASS 29 (U.S. CL. 46).

TRADEMARK

FIRST USE 3-9-2012; IN COMMERCE 3-9-2012.

PRINCIPAL REGISTER

THE MARK CONSISTS OF STANDARD CHARACTERS WITHOUT CLAIM TO ANY PARTICULAR FONT, STYLE, SIZE, OR COLOR.

THE WORD "YOGUITTO" HAS NO MEANING IN ENGLISH.

SN 77-579,760, FILED 9-26-2008.

JASON LOTT, EXAMINING ATTORNEY



David J. Kyffers

Director of the United States Patent and Trademark Office

United States of America

United States Patent and Trademark Office

LITTLEMISSMATCHED

Reg. No. 4,206,198

Registered Sep. 11, 2012

Int. Cl.: 24

TRADEMARK

PRINCIPAL REGISTER

MISS MATCHED, INC. (DELAWARE CORPORATION)
SUITE 501
307 7TH AVENUE
NEW YORK, NY 10001

FOR: TEXTILE AND TEXTILE GOODS, NAMELY, BATH TOWELS, BEACH TOWELS, WASH CLOTHS, QUILTS, CRIB BUMPERS, SHOWER CURTAINS, IN CLASS 24 (U.S. CLS. 42 AND 50).

FIRST USE 11-3-2010; IN COMMERCE 11-3-2010.

THE MARK CONSISTS OF STANDARD CHARACTERS WITHOUT CLAIM TO ANY PARTICULAR FONT, STYLE, SIZE, OR COLOR.

OWNER OF U.S. REG. NOS. 3,475,092, 3,565,830, AND 3,565,831.

SN 77-597,677, FILED 10-22-2008.

DARRYL SPRUILL, EXAMINING ATTORNEY



David J. Kybas

Director of the United States Patent and Trademark Office

United States of America

United States Patent and Trademark Office

SECUREPLUS BENEFIT ACCESS

Reg. No. 4,206,199

LIFE INSURANCE COMPANY OF THE SOUTHWEST (TEXAS CORPORATION)
1300 WEST MOCKINGBIRD LANE
DALLAS, TX 75247

Registered Sep. 11, 2012

Int. Cl.: 36

FOR: ISSUANCE AND ADMINISTRATION OF ANNUITIES, IN CLASS 36 (U.S. CLS. 100, 101 AND 102).

SERVICE MARK

FIRST USE 0-0-2011; IN COMMERCE 0-0-2011.

PRINCIPAL REGISTER

THE MARK CONSISTS OF STANDARD CHARACTERS WITHOUT CLAIM TO ANY PARTICULAR FONT, STYLE, SIZE, OR COLOR.

OWNER OF U.S. REG. NOS. 2,218,582, 3,020,990, AND OTHERS.

NO CLAIM IS MADE TO THE EXCLUSIVE RIGHT TO USE "BENEFIT ACCESS", APART FROM THE MARK AS SHOWN.

SN 77-599,861, FILED 10-24-2008.

TAMARA FRAZIER, EXAMINING ATTORNEY



David J. Kybas

Director of the United States Patent and Trademark Office

United States of America

United States Patent and Trademark Office

RETIREMAX BENEFIT ACCESS

Reg. No. 4,206,200

LIFE INSURANCE COMPANY OF THE SOUTHWEST (TEXAS CORPORATION)
1300 WEST MOCKINGBIRD LANE
DALLAS, TX 75247

Registered Sep. 11, 2012

Int. Cl.: 36

FOR: ISSUANCE AND ADMINISTRATION OF ANNUITIES, IN CLASS 36 (U.S. CLS. 100, 101 AND 102).

SERVICE MARK

FIRST USE 10-0-2011; IN COMMERCE 10-0-2011.

PRINCIPAL REGISTER

THE MARK CONSISTS OF STANDARD CHARACTERS WITHOUT CLAIM TO ANY PARTICULAR FONT, STYLE, SIZE, OR COLOR.

OWNER OF U.S. REG. NOS. 1,419,448, 3,374,964, AND OTHERS.

NO CLAIM IS MADE TO THE EXCLUSIVE RIGHT TO USE "BENEFIT ACCESS", APART FROM THE MARK AS SHOWN.

SN 77-599,889, FILED 10-24-2008.

TAMARA FRAZIER, EXAMINING ATTORNEY



David J. Kybas

Director of the United States Patent and Trademark Office

United States of America

United States Patent and Trademark Office

SOPOTITAN

Reg. No. 4,206,201

SOPOGY, INC. (DELAWARE CORPORATION)
2660 WAIWAI LOOP
HONOLULU, HI 96819

Registered Sep. 11, 2012

Int. Cl.: 11

FOR: SOLAR HEAT COLLECTION PANELS, IN CLASS 11 (U.S. CLS. 13, 21, 23, 31 AND 34).

TRADEMARK

FIRST USE 11-14-2011; IN COMMERCE 11-14-2011.

PRINCIPAL REGISTER

THE MARK CONSISTS OF STANDARD CHARACTERS WITHOUT CLAIM TO ANY PARTICULAR FONT, STYLE, SIZE, OR COLOR.

SN 77-602,248, FILED 10-28-2008.

COURTNEY ALVAREZ, EXAMINING ATTORNEY



David J. Kybas

Director of the United States Patent and Trademark Office

United States of America

United States Patent and Trademark Office

SARATOGA SOAPSTONE

Reg. No. 4,206,202

ARCHITECTURAL GRANITE & MARBLE, LTD. (TEXAS LIMITED PARTNERSHIP)
19012 HWY. 71 WEST
AUSTIN, TX 78669

Registered Sep. 11, 2012

Int. Cl.: 19

FOR: ROCK MATERIALS USED IN THE MANUFACTURE OF COUNTER TOPS. FURNITURE PARTS, NAMELY, COUNTER TOPS, IN CLASS 19 (U.S. CLS. 1, 12, 33 AND 50).

TRADEMARK

FIRST USE 4-22-2009; IN COMMERCE 4-22-2009.

PRINCIPAL REGISTER

THE MARK CONSISTS OF STANDARD CHARACTERS WITHOUT CLAIM TO ANY PARTICULAR FONT, STYLE, SIZE, OR COLOR.

NO CLAIM IS MADE TO THE EXCLUSIVE RIGHT TO USE "SOAPSTONE", APART FROM THE MARK AS SHOWN.

SN 77-609,290, FILED 11-6-2008.

KHANH LE, EXAMINING ATTORNEY



David J. Kybas

Director of the United States Patent and Trademark Office

United States of America

United States Patent and Trademark Office



Reg. No. 4,206,203

ALDI INC. (ILLINOIS CORPORATION)
1200 N. KIRK ROAD
BATAVIA, IL 60510

Registered Sep. 11, 2012

Int. Cl.: 16

FOR: PAINTBRUSHES; ROLLERS FOR APPLYING PAINTS AND OTHER COATING COMPOUNDS, IN CLASS 16 (U.S. CLS. 2, 5, 22, 23, 29, 37, 38 AND 50).

TRADEMARK

FIRST USE 12-30-2011; IN COMMERCE 12-30-2011.

PRINCIPAL REGISTER

THE MARK CONSISTS OF THE WORDING "DECO STYLE" IN STYLIZED FONT, ON ADJACENT RECTANGLES, WITH THE TERM "DECO" APPEARING ON THE LEFT RECTANGLE AND THE TERM "STYLE" APPEARING ON THE RIGHT RECTANGLE AND WITH THE LEFT RECTANGLE SLIGHTLY ABOVE AND SLIGHTLY OVERLAPPING THE RIGHT TRIANGLE.

SN 77-612,511, FILED 11-12-2008.

KAREN SEVERSON, EXAMINING ATTORNEY



David J. Kybas

Director of the United States Patent and Trademark Office

United States of America

United States Patent and Trademark Office



Reg. No. 4,206,204

Registered Sep. 11, 2012

Int. Cl.: 30

TRADEMARK

PRINCIPAL REGISTER

BLUE DIAMOND GROWERS (CALIFORNIA CORPORATION)
1802 C STREET
SACRAMENTO, CA 95811

FOR: ALMOND MEAL, IN CLASS 30 (U.S. CL. 46).

FIRST USE 3-29-2009; IN COMMERCE 3-29-2009.

OWNER OF U.S. REG. NOS. 159,301, 3,131,688, AND OTHERS.

NO CLAIM IS MADE TO THE EXCLUSIVE RIGHT TO USE "ALMONDS", APART FROM THE MARK AS SHOWN.

THE MARK CONSISTS OF A DIAMOND DESIGN WITH THE WORDS "BLUE DIAMOND" INSIDE PLUS A BANNER OVER THE BOTTOM QUARTER WITH THE WORD "ALMONDS" INSIDE.

SN 77-612,724, FILED 11-12-2008.

MATTHEW PAPPAS, EXAMINING ATTORNEY



David J. Kyffers

Director of the United States Patent and Trademark Office

United States of America

United States Patent and Trademark Office

In Balance

Reg. No. 4,206,205

Registered Sep. 11, 2012

Int. Cl.: 9

TRADEMARK

PRINCIPAL REGISTER

ABLE PLANET, INCORPORATED (DELAWARE CORPORATION)
9500 WEST 49TH AVENUE
BUILDING B-102
WHEAT RIDGE, CO 80033

FOR: AUDIO AND COMMUNICATION DEVICES FOR IMPROVING ACOUSTIC CLARITY AND AUDIO TRANSMISSION AND RECEPTION FOR ASSISTING PERSONS WITH SENSORY OR COGNITIVE IMPAIRMENTS AND TO PRESERVE HEARING LEVELS, NAMELY, WIRED AND WIRELESS ADAPTED HEADPHONES AND HEADSETS FOR USE IN AUDIO, CELLULAR VOICE OVER INTERNET PROTOCOL AND TELECOMMUNICATIONS; AND CORDED AND CORDLESS ADAPTED TELEPHONES, IN CLASS 9 (U.S. CLS. 21, 23, 26, 36 AND 38).

FIRST USE 1-5-2012; IN COMMERCE 1-5-2012.

THE MARK CONSISTS OF STANDARD CHARACTERS WITHOUT CLAIM TO ANY PARTICULAR FONT, STYLE, SIZE, OR COLOR.

SN 77-612,997, FILED 11-12-2008.

CHRISTINA SOBRAL, EXAMINING ATTORNEY



David J. Kyjars

Director of the United States Patent and Trademark Office

United States of America

United States Patent and Trademark Office

NOT YOUR FATHER'S TIE

Reg. No. 4,206,206

TAO, RICHARD (UNITED STATES INDIVIDUAL)
490 OAKWOOD AVENUE
WEBSTER GROVES, MO 63119

Registered Sep. 11, 2012

Int. Cl.: 25

FOR: CLOTHING FOR MEN, NAMELY, NECKTIES, IN CLASS 25 (U.S. CLS. 22 AND 39).

TRADEMARK

FIRST USE 3-15-2012; IN COMMERCE 3-15-2012.

PRINCIPAL REGISTER

THE MARK CONSISTS OF STANDARD CHARACTERS WITHOUT CLAIM TO ANY PARTICULAR FONT, STYLE, SIZE, OR COLOR.

NO CLAIM IS MADE TO THE EXCLUSIVE RIGHT TO USE "TIE", APART FROM THE MARK AS SHOWN.

SN 77-613,718, FILED 11-13-2008.

KATHERINE E. HALMEN, EXAMINING ATTORNEY



David J. Kybas

Director of the United States Patent and Trademark Office

United States of America

United States Patent and Trademark Office

TI2

Reg. No. 4,206,207

Registered Sep. 11, 2012

Int. Cl.: 25

TRADEMARK

PRINCIPAL REGISTER

TAO, RICHARD (UNITED STATES INDIVIDUAL)
490 OAKWOOD AVENUE
WEBSTER GROVES, MO 63119

FOR: CLOTHING, NAMELY, NECKTIES, IN CLASS 25 (U.S. CLS. 22 AND 39).

FIRST USE 3-15-2012; IN COMMERCE 3-15-2012.

THE MARK CONSISTS OF STANDARD CHARACTERS WITHOUT CLAIM TO ANY PARTICULAR FONT, STYLE, SIZE, OR COLOR.

SN 77-613,876, FILED 11-13-2008.

KATHERINE E. HALMEN, EXAMINING ATTORNEY



David J. Kybas

Director of the United States Patent and Trademark Office

United States of America

United States Patent and Trademark Office

MAXIMIZE YOUR IMPACT

Reg. No. 4,206,208

NEVCO, INC. (ILLINOIS CORPORATION)
301 E. HARRIS AVE.
GREENVILLE, IL 62246

Registered Sep. 11, 2012

Int. Cl.: 9

FOR: ELECTRONIC SCOREBOARDS; ELECTRONIC MESSAGE CENTERS AND DISPLAYS, NAMELY, ELECTRONIC LED DISPLAYS; ELECTRONIC VIDEO DISPLAYS, NAMELY, FLAT PANEL DISPLAY SCREENS; ELECTRONIC TIMERS, IN CLASS 9 (U.S. CLS. 21, 23, 26, 36 AND 38).

TRADEMARK

PRINCIPAL REGISTER

FIRST USE 3-0-2009; IN COMMERCE 3-0-2009.

THE MARK CONSISTS OF STANDARD CHARACTERS WITHOUT CLAIM TO ANY PARTICULAR FONT, STYLE, SIZE, OR COLOR.

SN 77-615,068, FILED 11-14-2008.

MARK RADEMACHER, EXAMINING ATTORNEY



David J. Kyffers

Director of the United States Patent and Trademark Office

United States of America

United States Patent and Trademark Office

CHI ACADEMY

Reg. No. 4,206,209

FAROUK SYSTEMS, INC. (TEXAS CORPORATION)
250 PENNBRIGHT, SUITE 150
HOUSTON, TX 77090

Registered Sep. 11, 2012

Int. Cl.: 16

FOR: EDUCATIONAL PUBLICATIONS IN THE NATURE OF TEXT BOOKS, HANDOUTS, MANUALS, BOOKS, WORK BOOKS, AND TRAINING MATERIALS IN THE FIELDS OF HAIR CARE, HAIR STYLING, HAIR CUTTING, AND HAIR COLORING, IN CLASS 16 (U.S. CLS. 2, 5, 22, 23, 29, 37, 38 AND 50).

TRADEMARK

PRINCIPAL REGISTER

FIRST USE 12-1-2009; IN COMMERCE 12-1-2009.

THE MARK CONSISTS OF STANDARD CHARACTERS WITHOUT CLAIM TO ANY PARTICULAR FONT, STYLE, SIZE, OR COLOR.

OWNER OF U.S. REG. NOS. 2,660,257, 3,426,769, AND OTHERS.

NO CLAIM IS MADE TO THE EXCLUSIVE RIGHT TO USE "ACADEMY", APART FROM THE MARK AS SHOWN.

SN 77-615,146, FILED 11-14-2008.

MICHAEL ENGEL, EXAMINING ATTORNEY



David J. Kybas

Director of the United States Patent and Trademark Office

United States of America

United States Patent and Trademark Office



Reg. No. 4,206,210

Registered Sep. 11, 2012

Int. Cl.: 16

TRADEMARK

PRINCIPAL REGISTER

CCS DIRECT LLC (WISCONSIN LIMITED LIABILITY COMPANY)
111 SOUTH FIRST AVENUE
WAUSAU, WI 54401

FOR: PRINTED MATTER, NAMELY, MAGAZINES, NEWSLETTERS, GUIDES AND CATALOGS, ALL RELATING TO SPORTS, INCLUDING SKATEBOARDING AND SNOW BOARDING , IN CLASS 16 (U.S. CLS. 2, 5, 22, 23, 29, 37, 38 AND 50).

FIRST USE 0-0-2008; IN COMMERCE 0-0-2008.

THE MARK CONSISTS OF THE STYLIZED LETTERS "CCS" INSIDE A PAIR OF BRACKETS.

SN 77-617,807, FILED 11-19-2008.

LIEF MARTIN, EXAMINING ATTORNEY



David J. Kyffers

Director of the United States Patent and Trademark Office

United States of America

United States Patent and Trademark Office

RAPX

Reg. No. 4,206,211

Registered Sep. 11, 2012

Int. Cls.: 35 and 36

SERVICE MARK

PRINCIPAL REGISTER

RAPAPORT MARTIN (UNITED STATES INDIVIDUAL)
133 E.WARM SPRINGS ROAD
LAS VEGAS, NV 89119

FOR: OPERATING ONLINE MARKETPLACES FOR THE TRADING OF DIAMONDS, PRECIOUS GEMS, AND JEWELRY; NEGOTIATION AND SETTLEMENT OF COMMERCIAL TRANSACTIONS FOR THIRD PARTIES, NAMELY, TRANSACTIONS INVOLVING DIAMONDS, PRECIOUS GEMS AND JEWELRY; PROVIDING AN ONLINE COMPUTER DATABASE FEATURING TRADE INFORMATION IN THE FIELD OF JEWELRY, DIAMONDS, PRECIOUS GEMSTONES, SEMI-PRECIOUS GEMSTONES, PRECIOUS GEMS, SEMI-PRECIOUS GEMS, WATCHES AND PRE-OWNED, USED, SECOND-HAND AND ESTATE JEWELRY; PROVIDING INFORMATION MANAGEMENT SERVICES, NAMELY, TRANSACTION INFORMATION, SHIPMENT PROCESSING, PREPARING SHIPPING DOCUMENTS AND INVOICES, TRACKING DOCUMENTS, PACKAGES AND FREIGHT OVER COMPUTER NETWORKS, INTRANETS AND INTERNETS; MAINTAINING ONLINE WEBSITE FEATURING DATA AND INFORMATION IN THE FIELD OF DIAMONDS, PRECIOUS GEMS AND JEWELRY, NAMELY, PRICING, AVAILABILITY AND MARKET REPORTS; COMPILATION AND PROVISION OF TRADE AND BUSINESS PRICE AND STATISTICAL INFORMATION RELATED TO DIAMONDS, PRECIOUS GEMS AND JEWELRY, NAMELY, ASKING PRICES, TRANSACTION PRICES, PRICES STATISTICS AND TRENDS, AND PRICE INDICES, IN CLASS 35 (U.S. CLS. 100, 101 AND 102).

FIRST USE 2-1-2012; IN COMMERCE 2-1-2012.



FOR: DIAMOND AND PRECIOUS GEM APPRAISAL; PROVIDING ONLINE BROKERAGE AND FINANCIAL CLEARING HOUSE SERVICES IN THE FIELD OF DIAMONDS, PRECIOUS GEMS AND JEWELRY; PROVIDING FINANCIAL INFORMATION IN THE FIELD OF DIAMONDS, PRECIOUS GEMS AND JEWELRY; PROVIDING A DATABASE OF APPRAISAL INFORMATION IN THE FIELD OF DIAMONDS, PRECIOUS GEMS AND JEWELRY, IN CLASS 36 (U.S. CLS. 100, 101 AND 102).

FIRST USE 2-1-2012; IN COMMERCE 2-1-2012.

David J. Kyffers

THE MARK CONSISTS OF STANDARD CHARACTERS WITHOUT CLAIM TO ANY PARTICULAR FONT, STYLE, SIZE, OR COLOR.

SN 77-618,203, FILED 11-20-2008.

Reg. No. 4,206,211 ANDREW LEASER, EXAMINING ATTORNEY

United States of America

United States Patent and Trademark Office

SoftTop

Reg. No. 4,206,212

HELLAS CONSTRUCTION, INC. (TEXAS CORPORATION)
12710 RESEARCH BOULEVARD, SUITE 240
AUSTIN, TX 78727

Registered Sep. 11, 2012

Int. Cl.: 27

FOR: SYNTHETIC TURF; REMOVABLE SYNTHETIC TURF, IN CLASS 27 (U.S. CLS. 19, 20, 37, 42 AND 50).

TRADEMARK

FIRST USE 6-30-2007; IN COMMERCE 8-31-2007.

PRINCIPAL REGISTER

THE MARK CONSISTS OF STANDARD CHARACTERS WITHOUT CLAIM TO ANY PARTICULAR FONT, STYLE, SIZE, OR COLOR.

SN 77-618,254, FILED 11-20-2008.

LEIGH CAROLINE CASE, EXAMINING ATTORNEY



David J. Kyffers

Director of the United States Patent and Trademark Office

United States of America

United States Patent and Trademark Office

HIGHLIGHTS

Reg. No. 4,206,213

Registered Sep. 11, 2012

Int. Cl.: 16

TRADEMARK

PRINCIPAL REGISTER

HIGHLIGHTS FOR CHILDREN, INC. (DELAWARE CORPORATION)
1800 WATERMARK DRIVE
COLUMBUS, OH 43215

FOR: NOTE PADS, NOTE PAPER, NOTEBOOKS, ART AND CRAFT PAINT KITS, BABY BOOKS, BOOKMARKS, CALENDARS, CHILDREN'S BOOKS, CHILDREN'S INTERACTIVE EDUCATIONAL BOOKS, COLORING BOOKS, PENCILS, DECALS, DESKTOP ORGANIZERS, DRAWING RULERS, MARKERS, FLASH CARDS, GREETING CARDS AND POSTCARDS, PEN AND PENCIL CASES, CRAYONS, POSTERS, SCHOOL SUPPLY KITS CONTAINING VARIOUS COMBINATIONS OF SELECTED SCHOOL SUPPLIES, NAMELY, WRITING INSTRUMENTS, PENS, PENCILS, MECHANICAL PENCILS, ERASERS, MARKERS, CRAYONS, HIGHLIGHTERS, FOLDERS, NOTEBOOKS, PAPER, PROTRACTORS, PAPER CLIPS, PENCIL SHARPENERS, WRITING GRIPS, GLUE AND BOOK MARKS, STAMP PADS, STENCILS, STICKERS, IN CLASS 16 (U.S. CLS. 2, 5, 22, 23, 29, 37, 38 AND 50).

FIRST USE 0-0-1968; IN COMMERCE 0-0-1968.

THE MARK CONSISTS OF STANDARD CHARACTERS WITHOUT CLAIM TO ANY PARTICULAR FONT, STYLE, SIZE, OR COLOR.

OWNER OF U.S. REG. NOS. 1,550,972, 3,505,349, AND OTHERS.

SN 77-622,775, FILED 11-26-2008.

EDWARD NELSON, EXAMINING ATTORNEY



David J. Kyros

Director of the United States Patent and Trademark Office

United States of America

United States Patent and Trademark Office

PRAKTIKOS INSTITUTE

Reg. No. 4,206,214

Registered Sep. 11, 2012

Int. Cl.: 44

SERVICE MARK

PRINCIPAL REGISTER

PRAKTIKOS INSTITUTE (VIRGINIA CORPORATION)
P. O. BOX 118
MT. JACKSON, VA 228420118

FOR: PROVIDING A WEBSITE FEATURING INFORMATION IN THE FIELD OF NUTRITIONALLY BASED MEDICINE AND ALTERNATIVE MEDICINE, PROVIDING A WEBSITE PORTAL FEATURING LINKS TO AND REVIEWS OF NEWS STORIES AND ARTICLES IN THE FIELD OF NUTRITIONALLY BASED MEDICINE AND ALTERNATIVE MEDICINE, IN CLASS 44 (U.S. CLS. 100 AND 101).

FIRST USE 7-2-2012; IN COMMERCE 7-2-2012.

THE MARK CONSISTS OF STANDARD CHARACTERS WITHOUT CLAIM TO ANY PARTICULAR FONT, STYLE, SIZE, OR COLOR.

NO CLAIM IS MADE TO THE EXCLUSIVE RIGHT TO USE "INSTITUTE", APART FROM THE MARK AS SHOWN.

THE ENGLISH TRANSLATION OF "PRAKTIKOS" IN THE MARK IS PRACTICAL.

SN 77-624,328, FILED 12-2-2008.

KRISTIN DAHLING, EXAMINING ATTORNEY



David J. Kyjars

Director of the United States Patent and Trademark Office

United States of America

United States Patent and Trademark Office

PurchasePoint

Reg. No. 4,206,215

Registered Sep. 11, 2012

Int. Cl.: 42

SERVICE MARK

PRINCIPAL REGISTER

PROACTIS GROUP LIMITED (UNITED KINGDOM LIMITED PARTNERSHIP)
HOLTBY MANOR, STAMFORD BRIDGE ROAD
DUNNINGTON, YORK, UNITED KINGDOM

FOR: COMPUTER SOFTWARE DESIGN FOR OTHERS; COMPUTER SOFTWARE CONSULTATION; COMPUTER SOFTWARE PROJECT MANAGEMENT SERVICES, NAMELY, THE PLANNING, MONITORING AND CONTROL OF ALL ASPECTS OF THE PROJECT AND THE MOTIVATION OF ALL THOSE INVOLVED IN IT TO ACHIEVE THE PROJECT OBJECTIVES ON TIME AND TO THE SPECIFIED COST, QUALITY AND PERFORMANCE; INSTALLATION OF COMPUTER SOFTWARE; TECHNICAL SUPPORT SERVICES, NAMELY, TROUBLESHOOTING OF COMPUTER SOFTWARE PROBLEMS, ASSISTANCE IN INSTALLATION AND USE OF COMPUTER SOFTWARE; MAINTENANCE OF COMPUTER SOFTWARE; ALL RELATING TO COMPUTER SOFTWARE FOR FINANCIAL AND ACCOUNTING PURPOSES; PROVIDING USE OF NON-DOWNLOADABLE COMPUTER SOFTWARE FOR USE IN CAPTURE, STORAGE, RECORDING, PROCESSING, MANIPULATION, ANALYSIS, RETRIEVAL AND REPORTING OF DATA, ALL FOR FINANCIAL AND ACCOUNTING PURPOSES, NAMELY, TRANSACTION PROCESSING, INCLUDING TENDER MANAGEMENT, CONTRACT MANAGEMENT, SOURCING AND PROCUREMENT OF GOODS AND SERVICES, MANAGEMENT OF FINANCIAL TRANSACTIONS AND BUSINESS SYSTEMS INTEGRATION, IN CLASS 42 (U.S. CLS. 100 AND 101).

FIRST USE 11-30-2008; IN COMMERCE 1-31-2011.

THE MARK CONSISTS OF STANDARD CHARACTERS WITHOUT CLAIM TO ANY PARTICULAR FONT, STYLE, SIZE, OR COLOR.

SN 77-625,834, FILED 12-3-2008.

DEIRDRE ROBERTSON, EXAMINING ATTORNEY



David J. Kyros

Director of the United States Patent and Trademark Office

United States of America

United States Patent and Trademark Office

SAY "IT'S OVER" FROM A SAFE DISTANCE

Reg. No. 4,206,216

MARK FUSELLO (UNITED STATES INDIVIDUAL)
888 WAVELAND

Registered Sep. 11, 2012

LAKE FOREST, IL 60045

Int. Cl.: 38

FOR: PROVIDING AN INTERACTIVE WEB SITE FOR MESSAGING RELATED OR DIRECTED TO A STATUS CHANGE IN A PERSONAL RELATIONSHIP, IN CLASS 38 (U.S. CLS. 100, 101 AND 104).

SERVICE MARK

FIRST USE 7-6-2012; IN COMMERCE 7-6-2012.

PRINCIPAL REGISTER

THE MARK CONSISTS OF STANDARD CHARACTERS WITHOUT CLAIM TO ANY PARTICULAR FONT, STYLE, SIZE, OR COLOR.

SN 77-626,330, FILED 12-4-2008.

MELISSA VALLILLO, EXAMINING ATTORNEY



David J. Kyffers

Director of the United States Patent and Trademark Office

United States of America

United States Patent and Trademark Office

JELLYSPINE

Reg. No. 4,206,217

MARK FUSELLO (UNITED STATES INDIVIDUAL)
888 WAVELAND

Registered Sep. 11, 2012

LAKE FOREST, IL 60045

Int. Cl.: 38

FOR: PROVIDING AN INTERACTIVE WEB SITE FOR MESSAGING RELATED OR DIRECTED TO A STATUS CHANGE IN A PERSONAL RELATIONSHIP, IN CLASS 38 (U.S. CLS. 100, 101 AND 104).

SERVICE MARK

FIRST USE 7-6-2012; IN COMMERCE 7-6-2012.

PRINCIPAL REGISTER

THE MARK CONSISTS OF STANDARD CHARACTERS WITHOUT CLAIM TO ANY PARTICULAR FONT, STYLE, SIZE, OR COLOR.

SN 77-626,336, FILED 12-4-2008.

MELISSA VALLILLO, EXAMINING ATTORNEY



David J. Kyffers

Director of the United States Patent and Trademark Office

United States of America

United States Patent and Trademark Office

FROM MOM AND POP TO MILLIONAIRE

Reg. No. 4,206,218

YOUNG EXPLORERS INTELLECTUAL PROPERTIES, INC. (NEVADA CORPORATION)
2470 WRONDEL WAY, #114

Registered Sep. 11, 2012

RENO, NV 89502

Int. Cl.: 16

FOR: NON-FICTION BOOKS, NAMELY, MEMOIRS AND AUTOBIOGRAPHICAL STORIES,
IN CLASS 16 (U.S. CLS. 2, 5, 22, 23, 29, 37, 38 AND 50).

TRADEMARK

FIRST USE 11-30-2011; IN COMMERCE 11-30-2011.

PRINCIPAL REGISTER

THE MARK CONSISTS OF STANDARD CHARACTERS WITHOUT CLAIM TO ANY PAR-
TICULAR FONT, STYLE, SIZE, OR COLOR.

SN 77-626,572, FILED 12-4-2008.

CHERYL CLAYTON, EXAMINING ATTORNEY



David J. Kybas

Director of the United States Patent and Trademark Office

United States of America

United States Patent and Trademark Office

Godslayer

Reg. No. 4,206,219

Registered Sep. 11, 2012

Int. Cl.: 28

TRADEMARK

PRINCIPAL REGISTER

MEGALITH GAMES LTD. (UNITED KINGDOM LIMITED LIABILITY COMPANY)
HANDCROSS
73 WEST PARK ROAD
HAYWARDS HEATH, UNITED KINGDOM RH176DN

FOR: TABLETOP GAMES, IN CLASS 28 (U.S. CLS. 22, 23, 38 AND 50).

FIRST USE 6-27-2012; IN COMMERCE 6-27-2012.

THE MARK CONSISTS OF STANDARD CHARACTERS WITHOUT CLAIM TO ANY PARTICULAR FONT, STYLE, SIZE, OR COLOR.

SN 77-627,895, FILED 12-5-2008.

BARBARA RUTLAND, EXAMINING ATTORNEY



David J. Kyffers

Director of the United States Patent and Trademark Office

United States of America

United States Patent and Trademark Office

Insurance On Demand

Reg. No. 4,206,220

KENNETH R. STRECH (UNITED STATES INDIVIDUAL)
31566 RAILROAD CANYON ROAD SUITE 305
CANYON LAKE, CA 92587

Registered Sep. 11, 2012

Int. Cl.: 36

FOR: PROVIDING INSURANCE, NAMELY, AN INSURANCE AGENCY AND BROKERAGE THAT FACTORS IN ALL TYPES OF RISK IN DETERMINING THE COST OF THE INSURANCE, ESPECIALLY RISK OF AN INTERMITTENT NATURE, IN CLASS 36 (U.S. CLS. 100, 101 AND 102).

SERVICE MARK

PRINCIPAL REGISTER

FIRST USE 10-1-2008; IN COMMERCE 6-27-2012.

THE MARK CONSISTS OF STANDARD CHARACTERS WITHOUT CLAIM TO ANY PARTICULAR FONT, STYLE, SIZE, OR COLOR.

NO CLAIM IS MADE TO THE EXCLUSIVE RIGHT TO USE "INSURANCE", APART FROM THE MARK AS SHOWN.

SN 77-628,136, FILED 12-7-2008.

JEAN IM, EXAMINING ATTORNEY



David J. Kyros

Director of the United States Patent and Trademark Office

United States of America

United States Patent and Trademark Office

EA SPORTS

Reg. No. 4,206,221

Registered Sep. 11, 2012

Int. Cl.: 9

TRADEMARK

PRINCIPAL REGISTER

ELECTRONIC ARTS INC. (DELAWARE CORPORATION)
LEGAL DEPARTMENT
209 REDWOOD SHORES PARKWAY
REDWOOD CITY, CA 94065

FOR: FITTED PLASTIC FILMS KNOWN AS SKINS FOR COVERING AND PROVIDING A SCRATCH PROOF BARRIER OR PROTECTION FOR ELECTRONIC DEVICES, NAMELY, MOBILE TELEPHONES, SMART TELEPHONES, IN CLASS 9 (U.S. CLS. 21, 23, 26, 36 AND 38).

FIRST USE 12-18-2011; IN COMMERCE 12-18-2011.

THE MARK CONSISTS OF STANDARD CHARACTERS WITHOUT CLAIM TO ANY PARTICULAR FONT, STYLE, SIZE, OR COLOR.

OWNER OF U.S. REG. NOS. 2,663,929, 3,244,220, AND OTHERS.

SN 77-629,428, FILED 12-9-2008.

MARY CRAWFORD, EXAMINING ATTORNEY



David J. Kyffers

Director of the United States Patent and Trademark Office

United States of America

United States Patent and Trademark Office

CHATTY GOURMET

Reg. No. 4,206,222

THE CHATTY GOURMET, LLC (TEXAS LIMITED LIABILITY COMPANY)
11407 LAKE LOUISE COURT
CYPRESS, TX 77433

Registered Sep. 11, 2012

Int. Cl.: 35

FOR: COMPUTERIZED ON-LINE RETAIL STORE SERVICES IN THE FIELD OF COOKING, NAMELY, FOOD, AND INGREDIENTS FOR FOOD, IN CLASS 35 (U.S. CLS. 100, 101 AND 102).

SERVICE MARK

FIRST USE 6-29-2012; IN COMMERCE 6-29-2012.

PRINCIPAL REGISTER

THE MARK CONSISTS OF STANDARD CHARACTERS WITHOUT CLAIM TO ANY PARTICULAR FONT, STYLE, SIZE, OR COLOR.

NO CLAIM IS MADE TO THE EXCLUSIVE RIGHT TO USE "GOURMET", APART FROM THE MARK AS SHOWN.

SN 77-629,477, FILED 12-9-2008.

MICHAEL WEBSTER, EXAMINING ATTORNEY



David J. Kyros

Director of the United States Patent and Trademark Office

United States of America

United States Patent and Trademark Office

IPREDICT

Reg. No. 4,206,223

Registered Sep. 11, 2012

Int. Cl.: 9

TRADEMARK

PRINCIPAL REGISTER

SCIENTIFIC MONITORING, INC. (ARIZONA CORPORATION)
8777 E. VIA DE VENTURA DRIVE, SUITE 120
SCOTTSDALE, AZ 85258

FOR: COMPUTER SERVERS; COMPUTER SOFTWARE FOR DATA ANALYSIS AND INTERPRETATION, MAINTENANCE SCHEDULING, HEALTH MANAGEMENT PLANNING, AND VALIDATION AND VERIFICATION IN THE FIELDS OF TRANSPORTATION, POWER GENERATION, AND HEALTHCARE, IN CLASS 9 (U.S. CLS. 21, 23, 26, 36 AND 38).

FIRST USE 7-6-2012; IN COMMERCE 7-6-2012.

THE MARK CONSISTS OF STANDARD CHARACTERS WITHOUT CLAIM TO ANY PARTICULAR FONT, STYLE, SIZE, OR COLOR.

OWNER OF U.S. REG. NO. 3,184,730.

SN 77-630,900, FILED 12-11-2008.

ALICIA COLLINS, EXAMINING ATTORNEY



David J. Kyjars

Director of the United States Patent and Trademark Office

United States of America

United States Patent and Trademark Office

CINEPLAN

Reg. No. 4,206,224

Registered Sep. 11, 2012

Int. Cls.: 35, 36, and 42

SERVICE MARK

PRINCIPAL REGISTER

CINEPLAN, LLC (DELAWARE LIMITED LIABILITY COMPANY)
C/O FROSS ZELNICK LEHRMAN & ZISSU, P.C.
866 UNITED NATIONS PLAZA
NEW YORK, NY 10017

FOR: COMPILATION AND SYSTEMIZATION OF INFORMATION INTO COMPUTER DATABASES; PROVIDING STATISTICAL INFORMATION FOR BUSINESS PURPOSES, IN CLASS 35 (U.S. CLS. 100, 101 AND 102).

FIRST USE 7-16-2012; IN COMMERCE 7-16-2012.

FOR: PROVIDING ONLINE FINANCIAL DATABASES; FINANCIAL INFORMATION PROVIDED THROUGH ELECTRONIC MEANS; PROVIDING A WEBSITE IN THE FIELD OF FINANCE, IN CLASS 36 (U.S. CLS. 100, 101 AND 102).

FIRST USE 7-16-2012; IN COMMERCE 7-16-2012.

FOR: SOFTWARE AS A SERVICE (SAAS) SERVICES FOR FINANCIAL ANALYSIS, FINANCIAL MODELING, FINANCIAL FORECASTING, FINANCIAL REPORTING, ACCESSING COMPUTERIZED DATABASES AND OTHER INDEXES OF INFORMATION, CREATING SEARCHABLE DATABASES OF INFORMATION AND DATA AND PERFORMING PERSONAL COMPUTING APPLICATIONS IN THE FIELD OF FINANCE, AND ALLOWING ONLINE CONNECTION TO INFORMATION DATABASES; COMPUTER SERVICES, NAMELY, CREATING AND HOSTING AN ONLINE COMMUNITY WEBSITE IN THE FIELD OF FINANCE AND BUSINESS; COMPUTER SERVICES, NAMELY, CREATING AND HOSTING AN ONLINE COMMUNITY FOR USERS TO PARTICIPATE IN DISCUSSION, GET FEEDBACK FROM THEIR PEERS, FORM VIRTUAL COMMUNITIES AND PUBLISH AND SHARE THEIR OWN CONTENT AND IMAGES ON-LINE, IN CLASS 42 (U.S. CLS. 100 AND 101).

FIRST USE 7-16-2012; IN COMMERCE 7-16-2012.

THE MARK CONSISTS OF STANDARD CHARACTERS WITHOUT CLAIM TO ANY PARTICULAR FONT, STYLE, SIZE, OR COLOR.

SN 77-630,966, FILED 12-11-2008.

SAMUEL E. SHARPER JR., EXAMINING ATTORNEY



David J. Kyros

Director of the United States Patent and Trademark Office

United States of America

United States Patent and Trademark Office

WAIST KILLER

Reg. No. 4,206,225

INFINITI CLASSICS INTERNATIONAL, INC. (NEW YORK CORPORATION)
1365 - 38TH STREET
BROOKLYN, NY 11218

Registered Sep. 11, 2012

Int. Cl.: 25

FOR: HOSIERY AND BODY WEAR, NAMELY, PANTIES, UNDERSHIRTS, CAMISOLES, BRAS, AND BODY SUITS, IN CLASS 25 (U.S. CLS. 22 AND 39).

TRADEMARK

FIRST USE 6-1-2012; IN COMMERCE 6-1-2012.

PRINCIPAL REGISTER

THE MARK CONSISTS OF STANDARD CHARACTERS WITHOUT CLAIM TO ANY PARTICULAR FONT, STYLE, SIZE, OR COLOR.

NO CLAIM IS MADE TO THE EXCLUSIVE RIGHT TO USE "WAIST", APART FROM THE MARK AS SHOWN.

SN 77-631,924, FILED 12-12-2008.

LOURDES AYALA, EXAMINING ATTORNEY



David J. Kyjars

Director of the United States Patent and Trademark Office

United States of America

United States Patent and Trademark Office

The Lobster

Reg. No. 4,206,226

KLINGELE, JOSEPH A. (UNITED STATES INDIVIDUAL)
2105 EVENING SUN
PLANO, TX 75093

Registered Sep. 11, 2012

Int. Cl.: 28

FOR: GOLF CLUBS, IN CLASS 28 (U.S. CLS. 22, 23, 38 AND 50).

TRADEMARK

FIRST USE 1-24-2012; IN COMMERCE 1-24-2012.

PRINCIPAL REGISTER

THE MARK CONSISTS OF STANDARD CHARACTERS WITHOUT CLAIM TO ANY PARTICULAR FONT, STYLE, SIZE, OR COLOR.

SN 77-634,815, FILED 12-17-2008.

RENEE SERVANCE, EXAMINING ATTORNEY



David J. Kyffers

Director of the United States Patent and Trademark Office

United States of America

United States Patent and Trademark Office

HEART HILL VINEYARD

Reg. No. 4,206,227

NINER WINE ESTATES, LLC (CALIFORNIA LIMITED LIABILITY COMPANY)
2400 HIGHWAY 46 WEST
PASO ROBLES, CA 93446

Registered Sep. 11, 2012

Int. Cls.: 16 and 25

FOR: POSTCARDS, NOTECARDS, PAPER NAPKINS, IN CLASS 16 (U.S. CLS. 2, 5, 22, 23, 29, 37, 38 AND 50).

TRADEMARK

FIRST USE 6-20-2012; IN COMMERCE 6-20-2012.

PRINCIPAL REGISTER

FOR: T-SHIRTS, POLO SHIRTS, SHIRTS, HATS, JACKETS, SWEATSHIRTS, IN CLASS 25 (U.S. CLS. 22 AND 39).

FIRST USE 6-20-2012; IN COMMERCE 6-20-2012.

THE MARK CONSISTS OF STANDARD CHARACTERS WITHOUT CLAIM TO ANY PARTICULAR FONT, STYLE, SIZE, OR COLOR.

NO CLAIM IS MADE TO THE EXCLUSIVE RIGHT TO USE "VINEYARD", APART FROM THE MARK AS SHOWN.

SN 77-635,459, FILED 12-17-2008.

ANDREW RHIM, EXAMINING ATTORNEY



David J. Kyffers

Director of the United States Patent and Trademark Office

United States of America

United States Patent and Trademark Office

JINGLE BITES

Reg. No. 4,206,228

Registered Sep. 11, 2012

Int. Cl.: 31

TRADEMARK

PRINCIPAL REGISTER

CRUNCHKINS, INC. (CALIFORNIA CORPORATION)
SUITE 103-199
72877 DINAH SHORE DR.
RANCHO MIRAGE, CA 92270

FOR: PET TREATS, NAMELY, EDIBLE HANGING ORNAMENTS, IN CLASS 31 (U.S. CLS. 1 AND 46).

FIRST USE 4-1-2012; IN COMMERCE 4-1-2012.

THE MARK CONSISTS OF STANDARD CHARACTERS WITHOUT CLAIM TO ANY PARTICULAR FONT, STYLE, SIZE, OR COLOR.

NO CLAIM IS MADE TO THE EXCLUSIVE RIGHT TO USE "BITES", APART FROM THE MARK AS SHOWN.

SN 77-637,746, FILED 12-22-2008.

CHRISTINE COOPER, EXAMINING ATTORNEY



David J. Kyros

Director of the United States Patent and Trademark Office

United States of America

United States Patent and Trademark Office

TOPSY TURVY ZOO

Reg. No. 4,206,229

Registered Sep. 11, 2012

Int. Cl.: 28

TRADEMARK

PRINCIPAL REGISTER

TOPSY TURVY ZOO, INC. (NEW YORK CORPORATION)
539 86TH STREET
BROOKLYN, NY 11209

FOR: STUFFED TOYS, IN CLASS 28 (U.S. CLS. 22, 23, 38 AND 50).

FIRST USE 7-13-2012; IN COMMERCE 7-13-2012.

THE MARK CONSISTS OF STANDARD CHARACTERS WITHOUT CLAIM TO ANY PARTICULAR FONT, STYLE, SIZE, OR COLOR.

OWNER OF U.S. REG. NO. 3,525,912.

SN 77-638,197, FILED 12-22-2008.

MARK SHINER, EXAMINING ATTORNEY



David J. Kybas

Director of the United States Patent and Trademark Office

United States of America
United States Patent and Trademark Office

THUMPER

Reg. No. 4,206,230

SKILLING, JAY EDWARD (UNITED STATES INDIVIDUAL)
11554 ROUSSEAU
SAN ANTONIO, TX 78251

Registered Sep. 11, 2012

Int. Cl.: 28

FOR: PAINTBALL GUNS, IN CLASS 28 (U.S. CLS. 22, 23, 38 AND 50).

TRADEMARK

FIRST USE 1-31-2012; IN COMMERCE 1-31-2012.

PRINCIPAL REGISTER

THE MARK CONSISTS OF STANDARD CHARACTERS WITHOUT CLAIM TO ANY PARTICULAR FONT, STYLE, SIZE, OR COLOR.

SN 77-639,224, FILED 12-23-2008.

KEVIN CORWIN, EXAMINING ATTORNEY



David J. Kybas

Director of the United States Patent and Trademark Office

United States of America

United States Patent and Trademark Office

HEALTHY EDGE

Reg. No. 4,206,231

Registered Sep. 11, 2012

Int. Cl.: 9

TRADEMARK

PRINCIPAL REGISTER

KABUSHIKI KAISHA TANITA (JAPAN CORPORATION)
14-2, 1-CHOME, MAENOCHO, ITABASHI-KU
TOKYO, JAPAN

FOR: DOWNLOADABLE COMPUTER PROGRAMS AND DOWNLOADABLE COMPUTER SOFTWARE WHICH SYNCHRONIZE INDIVIDUAL USER DATA OBTAINED FROM BODY WEIGHT SCALES, BODY FAT MONITORS, BODY FAT ANALYZERS WITH ELECTRONIC DEVICES USED FOR EXERCISE MONITORING FOR USE IN MANAGING AND ANALYZING PERSONAL DATA FOR HEALTH CARE, MANAGING AND ANALYZING PERSONAL DATA SUCH AS BODY WEIGHT, BODY COMPOSITION, THE NUMBER OF STEPS, AND BLOOD PRESSURE, FOR PROVIDING ADVICE BASED ON SYNCHRONIZED INDIVIDUAL USER DATA FOR HEALTH CARE AND FOR PROVIDING ADVICE BASED ON INDIVIDUAL USER DATA FOR HEALTH CARE SUCH AS BODY WEIGHT, BODY COMPOSITION, THE NUMBER OF STEPS AND BLOOD PRESSURE; COMPUTER PROGRAMS AND COMPUTER SOFTWARE RECORDED ON ELECTRONIC CIRCUITS, IC CARDS, MAGNETIC TAPES, MAGNETIC DISCS, OPTICAL DISCS, MAGNETIC OPTICAL DISCS, CD-ROMS OR DVDS WHICH SYNCHRONIZE INDIVIDUAL USER DATA OBTAINED FROM BODY WEIGHT SCALES, BODY FAT MONITORS, BODY FAT ANALYZERS WITH ELECTRONIC DEVICES USED FOR EXERCISE MONITORING FOR USE IN MANAGING AND ANALYZING PERSONAL DATA FOR HEALTH CARE, MANAGING AND ANALYZING PERSONAL DATA SUCH AS BODY WEIGHT, BODY COMPOSITION, THE NUMBER OF STEPS, AND BLOOD PRESSURE, FOR PROVIDING ADVICE BASED ON SYNCHRONIZED PERSONAL DATA FOR HEALTH CARE AND FOR PROVIDING ADVICE BASED ON INDIVIDUAL USER DATA FOR HEALTH CARE SUCH AS BODY WEIGHT, BODY COMPOSITION, THE NUMBER OF STEPS AND BLOOD PRESSURE, IN CLASS 9 (U.S. CLS. 21, 23, 26, 36 AND 38).



FIRST USE 3-0-2009; IN COMMERCE 9-0-2009.

THE MARK CONSISTS OF STANDARD CHARACTERS WITHOUT CLAIM TO ANY PARTICULAR FONT, STYLE, SIZE, OR COLOR.

SN 77-640,919, FILED 12-29-2008.

ELLEN PERKINS, EXAMINING ATTORNEY

David J. Kyros

Director of the United States Patent and Trademark Office

United States of America

United States Patent and Trademark Office

POKER DICE

Reg. No. 4,206,232

MCCALL, DAVID R. (UNITED STATES INDIVIDUAL)
63416 SEA SPRAY DRIVE
COOSBAY, OR 97420

Registered Sep. 11, 2012

Int. Cl.: 9

FOR: ELECTRONIC GAME SOFTWARE, NAMELY, A POKER GAME, IN CLASS 9 (U.S. CLS. 21, 23, 26, 36 AND 38).

TRADEMARK

FIRST USE 10-4-2011; IN COMMERCE 10-4-2011.

PRINCIPAL REGISTER

THE MARK CONSISTS OF STANDARD CHARACTERS WITHOUT CLAIM TO ANY PARTICULAR FONT, STYLE, SIZE, OR COLOR.

NO CLAIM IS MADE TO THE EXCLUSIVE RIGHT TO USE "POKER", APART FROM THE MARK AS SHOWN.

SN 77-642,192, FILED 12-31-2008.

PAM WILLIS, EXAMINING ATTORNEY



David J. Kyffers

Director of the United States Patent and Trademark Office

United States of America

United States Patent and Trademark Office



Reg. No. 4,206,233

Registered Sep. 11, 2012

Int. Cl.: 41

SERVICE MARK

PRINCIPAL REGISTER

HANEY, ROY E. (UNITED STATES INDIVIDUAL), DBA BLUE BUFFALO PUBLISHING,
P.O. BOX 56725
HAYWARD, CA 94545

FOR: BOOK PUBLISHING, IN CLASS 41 (U.S. CLS. 100, 101 AND 107).

FIRST USE 11-9-2011; IN COMMERCE 11-9-2011.

NO CLAIM IS MADE TO THE EXCLUSIVE RIGHT TO USE "PUBLISHING", APART FROM
THE MARK AS SHOWN.

THE COLOR(S) BLACK AND WHITE IS/ARE CLAIMED AS A FEATURE OF THE MARK.

THE MARK CONSISTS OF A BLACK BACKGROUND WITH A WHITE BUFFALO IN THE
CENTER. THE STYLIZED WORDS "BLUE BUFFALO PUBLISHING" ARE WHITE. THE
STYLIZED WORDS "BLUE BUFFALO" ARE WRITTEN ABOVE THE WHITE BUFFALO
AND THE STYLIZED WORD "PUBLISHING" IS WRITTEN BELOW THE WHITE BUFFALO.

SN 77-642,426, FILED 1-1-2009.

BERYL GARDNER, EXAMINING ATTORNEY



David J. Kybas

Director of the United States Patent and Trademark Office

United States of America

United States Patent and Trademark Office

KENSIE

Reg. No. 4,206,234

Registered Sep. 11, 2012

Int. Cl.: 24

TRADEMARK

PRINCIPAL REGISTER

KMJ BRAND HOLDINGS LLC (NEW YORK LIMITED LIABILITY COMPANY)
1370 BROADWAY, SUITE 1107
NEW YORK, NY 10018

FOR: BATH LINEN; BATH SHEETS; BATH TOWELS; BED AND TABLE LINEN; BED AND TABLE LINEN, WALL HANGINGS OF TEXTILE; BED BLANKETS; BED COVERS; BED SHEETS; BED SKIRTS; BED SPREADS; BLANKET THROWS; COMFORTERS; CURTAIN TIE-BACKS; CURTAINS AND TOWELS; DINING LINENS; DRAPERY; DUVET COVERS; KITCHEN LINENS; KITCHEN TOWELS; PILLOW CASES; PILLOW COVERS; PILLOW SHAMS; PLACE MATS OF TEXTILE MATERIAL; POT HOLDERS; SHAMS; SHOWER CURTAINS; TABLE CLOTHS NOT OF PAPER; TABLE LINEN; TABLE MATS NOT OF PAPER; TABLE NAPKINS OF TEXTILE; TOWELS; UPHOLSTERY FABRICS, IN CLASS 24 (U.S. CLS. 42 AND 50).

FIRST USE 2-1-2012; IN COMMERCE 2-1-2012.

THE MARK CONSISTS OF STANDARD CHARACTERS WITHOUT CLAIM TO ANY PARTICULAR FONT, STYLE, SIZE, OR COLOR.

OWNER OF U.S. REG. NOS. 3,494,084 AND 3,521,103.

THE NAME(S), PORTRAIT(S), AND/OR SIGNATURE(S) SHOWN IN THE MARK DOES NOT IDENTIFY A PARTICULAR LIVING INDIVIDUAL.

SN 77-643,323, FILED 1-5-2009.

WENDY JUN, EXAMINING ATTORNEY



David J. Kyros

Director of the United States Patent and Trademark Office

United States of America

United States Patent and Trademark Office

SHAME ON ICE

Reg. No. 4,206,235

Registered Sep. 11, 2012

Int. Cl.: 35

SERVICE MARK

PRINCIPAL REGISTER

JACOBSON, DERK (UNITED STATES INDIVIDUAL)
3816 FRANCE PLACE
BROOKLYN CENTER, MN 55429

FOR: COORDINATION OF RECREATIONAL SPORTING OPPORTUNITIES FOR INDIVIDUALS WHO WISH TO PARTICIPATE IN TEAM LEAGUE SPORTS, IN CLASS 35 (U.S. CLS. 100, 101 AND 102).

FIRST USE 6-4-2004; IN COMMERCE 6-4-2004.

THE MARK CONSISTS OF STANDARD CHARACTERS WITHOUT CLAIM TO ANY PARTICULAR FONT, STYLE, SIZE, OR COLOR.

OWNER OF U.S. REG. NO. 3,585,004.

SN 77-643,473, FILED 1-5-2009.

INGRID C. EULIN, EXAMINING ATTORNEY



David J. Kybas

Director of the United States Patent and Trademark Office

United States of America

United States Patent and Trademark Office

LA FÉE VERTE

Reg. No. 4,206,236

Registered Sep. 11, 2012

Int. Cl.: 25

TRADEMARK

PRINCIPAL REGISTER

167986 CANADA INC. (CANADA CORPORATION)
1901 TRANS-CANADA HIGHWAY
DORVAL, PROVINCE OF QUEBEC, CANADA H9P 1J1 AND

SAKARA, ADAM (CANADA INDIVIDUAL)
2587 BOURGOIN STREET
VILLE ST. LAURENT, PROVINCE OF QUEBEC, CANADA H4R 2C2

FOR: LINGERIE , IN CLASS 25 (U.S. CLS. 22 AND 39).

FIRST USE 1-13-2009; IN COMMERCE 7-22-2009.

THE MARK CONSISTS OF STANDARD CHARACTERS WITHOUT CLAIM TO ANY PARTICULAR FONT, STYLE, SIZE, OR COLOR.

OWNER OF CANADA REG. NO. TMA755263, DATED 12-14-2009, EXPIRES 12-14-2024.

THE ENGLISH TRANSLATION OF "LA FÉE VERTE" IS "THE GREEN FAIRY".

SN 77-648,487, FILED 1-13-2009.

MAUREEN DALL, EXAMINING ATTORNEY



David J. Kyros

Director of the United States Patent and Trademark Office

United States of America

United States Patent and Trademark Office

CIVIL TWILIGHT

Reg. No. 4,206,237

Registered Sep. 11, 2012

Int. Cl.: 9

TRADEMARK

PRINCIPAL REGISTER

MCKELLAR, STEVEN (UNITED STATES INDIVIDUAL)
1900 AVENUE OF THE STARS, 25TH FLOOR
KING, HOLMES, PATERNO & BERLINER LLP
LOS ANGELES, CA 90067 AND

MCKELLAR, ANDREW (UNITED STATES INDIVIDUAL)
1900 AVENUE OF THE STARS, 25TH FLOOR
KING, HOLMES, PATERNO & BERLINER LLP
LOS ANGELES, CA 90067 AND

WOUTERS, RICHARD (NETHERLANDS INDIVIDUAL)
1900 AVENUE OF THE STARS, 25TH FLOOR
KING, HOLMES, PATERNO & BERLINER LLP
LOS ANGELES, CA 90067

FOR: MUSICAL SOUND RECORDINGS; AUDIO-VISUAL RECORDINGS, NAMELY, COMPACT DISCS AND MP3S FEATURING MUSIC; DOWNLOADABLE MUSICAL SOUND RECORDINGS, IN CLASS 9 (U.S. CLS. 21, 23, 26, 36 AND 38).

FIRST USE 3-26-2012; IN COMMERCE 3-26-2012.

THE MARK CONSISTS OF STANDARD CHARACTERS WITHOUT CLAIM TO ANY PARTICULAR FONT, STYLE, SIZE, OR COLOR.

SN 77-650,476, FILED 1-15-2009.

JOHN SCHUYLER YARD, EXAMINING ATTORNEY



David J. Kyros

Director of the United States Patent and Trademark Office

United States of America

United States Patent and Trademark Office

WILD RIVER CONSULTING

Reg. No. 4,206,238

KURT E. HEIKKILA (UNITED STATES INDIVIDUAL)
1823 BUERKLE ROAD
WHITE BEAR LAKE, MN 55110

Registered Sep. 11, 2012

Int. Cls.: 40 and 42

FOR: MANUFACTURING OF CUSTOM COMPOSITES AND POLYMERS TO THE ORDER AND SPECIFICATION OF OTHERS, IN CLASS 40 (U.S. CLS. 100, 103 AND 106).

SERVICE MARK

FIRST USE 6-28-2012; IN COMMERCE 6-28-2012.

PRINCIPAL REGISTER

FOR: ENGINEERING CONSULTING SERVICES; COMPOSITE METALS MATERIAL DEVELOPMENT CONSULTING SERVICES; LABORATORY RESEARCH SERVICES, IN CLASS 42 (U.S. CLS. 100 AND 101).

FIRST USE 6-28-2012; IN COMMERCE 6-28-2012.

THE MARK CONSISTS OF STANDARD CHARACTERS WITHOUT CLAIM TO ANY PARTICULAR FONT, STYLE, SIZE, OR COLOR.

NO CLAIM IS MADE TO THE EXCLUSIVE RIGHT TO USE "CONSULTING", APART FROM THE MARK AS SHOWN.

SN 77-652,064, FILED 1-19-2009.

RUDY R. SINGLETON, EXAMINING ATTORNEY



David J. Kybas

Director of the United States Patent and Trademark Office

United States of America

United States Patent and Trademark Office

E V O V E

Reg. No. 4,206,239

Registered Sep. 11, 2012

Int. Cl.: 11

TRADEMARK

PRINCIPAL REGISTER

SOUTH ASIA INTERNATIONAL (H.K.) LTD. (HONG KONG LIMITED LIABILITY COMPANY)
UNIT 1101-1105, 11/F, PENINSULA SQUARE
18 SUNG ON STREET
HUNGHOM, KOWLOON, HONG KONG

FOR: AIR PURIFIERS, IN CLASS 11 (U.S. CLS. 13, 21, 23, 31 AND 34).

FIRST USE 12-4-2011; IN COMMERCE 12-4-2011.

THE MARK CONSISTS OF THE WORD "EVOVE" IN CAPITAL LETTERS WITH THE LAST "E" REVERSED AND A VERTICAL LINE BISECTING THE LETTER "O".

SN 77-652,977, FILED 1-20-2009.

TEJBIR SINGH, EXAMINING ATTORNEY



David J. Kyffers

Director of the United States Patent and Trademark Office

United States of America

United States Patent and Trademark Office

TIME BOMB

Reg. No. 4,206,240

FEDERICI BRANDS LLC (DELAWARE LIMITED LIABILITY COMPANY)
57 DANBURY ROAD
WILTON, CT 06897

Registered Sep. 11, 2012

Int. Cl.: 3

FOR: NON-MEDICATED SKIN CARE PREPARATIONS; COSMETIC CREAMS FOR SKIN CARE, IN CLASS 3 (U.S. CLS. 1, 4, 6, 50, 51 AND 52).

TRADEMARK

FIRST USE 6-19-2007; IN COMMERCE 11-17-2011.

PRINCIPAL REGISTER

THE MARK CONSISTS OF STANDARD CHARACTERS WITHOUT CLAIM TO ANY PARTICULAR FONT, STYLE, SIZE, OR COLOR.

SN 77-657,712, FILED 1-27-2009.

KIM MONINGHOFF, EXAMINING ATTORNEY



David J. Kyffers

Director of the United States Patent and Trademark Office

United States of America

United States Patent and Trademark Office

SYMCAP

Reg. No. 4,206,241

Registered Sep. 11, 2012

Int. Cls.: 1 and 3

TRADEMARK

PRINCIPAL REGISTER

SYMRISE AG (FED REP GERMANY AKTIENGESELLSCHAFT)
MUHLENFELDSTRASSE 1
HOLZMINDEN 37603, FED REP GERMANY

FOR: PROCESSED NATURAL RESINS FOR USE AS A FRAGRANCE IN THE MANUFACTURING OF PERFUMERY AND COSMETICS, IN CLASS 1 (U.S. CLS. 1, 5, 6, 10, 26 AND 46).

FIRST USE 9-22-2011; IN COMMERCE 9-22-2011.

FOR: PERFUMERY; ESSENTIAL OILS FOR PERSONAL AND HOUSEHOLD USE; ESSENTIAL OILS FOR USE IN THE MANUFACTURE OF SCENTED PRODUCTS; SCENTS AND PERFUME SUBSTANCES FOR LAUNDRY USE, NAMELY, DETERGENTS, BLEACHES AND FABRIC SOFTENERS; BODY SOAPS; COSMETICS; HAIR LOTIONS; DENTIFRICES; NON-MEDICATED MOUTH CARE PRODUCTS, NAMELY, TOOTHPASTE AND MOUTHWASH; PROCESSED NATURAL RESINS FOR USE AS A FRAGRANCE FOR PERSONAL USE, IN CLASS 3 (U.S. CLS. 1, 4, 6, 50, 51 AND 52).

FIRST USE 9-22-2011; IN COMMERCE 9-22-2011.

THE MARK CONSISTS OF STANDARD CHARACTERS WITHOUT CLAIM TO ANY PARTICULAR FONT, STYLE, SIZE, OR COLOR.

SN 77-659,880, FILED 1-30-2009.

NICHOLAS ALTREE, EXAMINING ATTORNEY



David J. Kybas

Director of the United States Patent and Trademark Office

United States of America

United States Patent and Trademark Office

PURPLE DAWG

Reg. No. 4,206,242

Registered Sep. 11, 2012

Int. Cl.: 33

TRADEMARK

PRINCIPAL REGISTER

BISON CAPITAL LLC (FLORIDA LIMITED LIABILITY COMPANY)
SUITE 200
735 E VENICE AVE
VENICE, FL 34285

FOR: DISTILLED SPIRITS, IN CLASS 33 (U.S. CLS. 47 AND 49).

FIRST USE 4-16-2012; IN COMMERCE 4-16-2012.

THE MARK CONSISTS OF STANDARD CHARACTERS WITHOUT CLAIM TO ANY PARTICULAR FONT, STYLE, SIZE, OR COLOR.

SN 77-663,688, FILED 2-4-2009.

FRED CARL, EXAMINING ATTORNEY



David J. Kybas

Director of the United States Patent and Trademark Office

United States of America

United States Patent and Trademark Office

NACHITOS

Reg. No. 4,206,243

Registered Sep. 11, 2012

Int. Cl.: 30

TRADEMARK

PRINCIPAL REGISTER

SNACK KING CORP. (DELAWARE CORPORATION)
16150 E. STEPHENS STREET
CITY OF INDUSTRY, CA 91745

FOR: CORN CHIPS; CORN STICKS, TORTILLA CHIPS; SEASONED PUFFED CORN SNACKS; WHEAT BASED SNACK FOODS; VARIOUS COMBINATION GRAIN BASED SNACK FOODS, NAMELY, MULTIGRAIN CHIPS, MULTIGRAIN PUFFS; PRETZELS; CRACKERS AND MIXES CONSISTING PRIMARILY OF PRETZELS AND CRACKERS; RICE PUFFS; CORN PUFFS; CORN CURLS; CORN CHIPS; GRAIN BASED CHIPS; TACO CHIPS; TORTILLA CHIPS; FLOUR BASED CHIPS; POPPED POPCORN; WHEAT CHIPS; FLOUR BASED SNACKS, NAMELY, CHIPS, PUFFS, CRACKERS; EXTRUDED SNACKS MADE OF WHEAT, CORN, RICE, MULTIGRAIN, IN CLASS 30 (U.S. CL. 46).

FIRST USE 5-8-2012; IN COMMERCE 5-8-2012.

THE MARK CONSISTS OF STANDARD CHARACTERS WITHOUT CLAIM TO ANY PARTICULAR FONT, STYLE, SIZE, OR COLOR.

SN 77-664,383, FILED 2-5-2009.

DAVID I, EXAMINING ATTORNEY



David J. Kyfos

Director of the United States Patent and Trademark Office

United States of America

United States Patent and Trademark Office

RADIO EXITOS

Reg. No. 4,206,244

Registered Sep. 11, 2012

Int. Cl.: 38

SERVICE MARK

PRINCIPAL REGISTER

GRUPO RADIO CENTRO, S.A. B DE C.V. (MEXICO SOCIEDAD ANONIMA (SA DE CV)))
AV. CONTITUYENTES #1154
COL. LOMAS ALTAS,, MEXICO C.P.11950

FOR: RADIO BROADCASTING SERVICES, IN CLASS 38 (U.S. CLS. 100, 101 AND 104).

FIRST USE 6-8-2012; IN COMMERCE 6-8-2012.

THE MARK CONSISTS OF STANDARD CHARACTERS WITHOUT CLAIM TO ANY PARTICULAR FONT, STYLE, SIZE, OR COLOR.

NO CLAIM IS MADE TO THE EXCLUSIVE RIGHT TO USE "RADIO", APART FROM THE MARK AS SHOWN.

THE ENGLISH TRANSLATION OF THE WORD "EXITOS" IN THE MARK IS "SUCCESS".

SN 77-682,234, FILED 3-3-2009.

REBECCA SMITH, EXAMINING ATTORNEY



David J. Kyffers

Director of the United States Patent and Trademark Office

United States of America

United States Patent and Trademark Office

KORU

Reg. No. 4,206,245

Registered Sep. 11, 2012

Int. Cl.: 7

TRADEMARK

PRINCIPAL REGISTER

AGFA GRAPHICS N.V. (BELGIUM CORPORATION)
SEPTESTAAT 27
MORTSEL, BELGIUM B-2640

FOR: PRINTING PLATES, IN CLASS 7 (U.S. CLS. 13, 19, 21, 23, 31, 34 AND 35).

FIRST USE 4-0-2010; IN COMMERCE 4-0-2010.

THE MARK CONSISTS OF STANDARD CHARACTERS WITHOUT CLAIM TO ANY PARTICULAR FONT, STYLE, SIZE, OR COLOR.

PRIORITY CLAIMED UNDER SEC. 44(D) ON BENELUX APPLICATION NO. 1177602, FILED 3-10-2009, REG. NO. 0859932, DATED 6-10-2009, EXPIRES 3-10-2019.

THE ENGLISH TRANSLATION OF THE WORD "KORU" IN THE MARK IS "SPIRAL", "NEW BEGINNINGS", "GROWTH", "HARMONY", "PEACE AND TRANQUILITY".

SN 77-689,846, FILED 3-12-2009.

MARK SPARACINO, EXAMINING ATTORNEY



David J. Kyfos

Director of the United States Patent and Trademark Office

United States of America

United States Patent and Trademark Office

Tiny Tomes

Reg. No. 4,206,246

WILDER, CONSTANCE (UNITED STATES INDIVIDUAL)
170 BEACH ROAD, UNIT 51
SALISBURY, MA 01952

Registered Sep. 11, 2012

Int. Cl.: 16

FOR: BOOKS ABOUT PERSONAL LIFE EXPERIENCES, SUCH AS MOTHERHOOD AND GRANDMOTHERHOOD, TRAVEL, GRIEF, MONEY, AGING, RETIREMENT, AND SO FORTH, IN CLASS 16 (U.S. CLS. 2, 5, 22, 23, 29, 37, 38 AND 50).

TRADEMARK

FIRST USE 3-23-2012; IN COMMERCE 6-23-2012.

PRINCIPAL REGISTER

THE MARK CONSISTS OF STANDARD CHARACTERS WITHOUT CLAIM TO ANY PARTICULAR FONT, STYLE, SIZE, OR COLOR.

SN 77-696,696, FILED 3-23-2009.

CORY BOONE, EXAMINING ATTORNEY



David J. Kybas

Director of the United States Patent and Trademark Office

United States of America

United States Patent and Trademark Office

BARCO'S NIGHTINGALES

Reg. No. 4,206,247

BARCO UNIFORMS, INC. (DELAWARE CORPORATION)
350 W. ROSECRANS AVENUE
GARDENA, CA 90248

Registered Sep. 11, 2012

Int. Cl.: 36

FOR: CHARITABLE SERVICES, NAMELY, PROVIDING FUND RAISING ACTIVITIES TO SUPPORT MEDICAL RESEARCH AND PROCEDURES FOR THOSE IN NEED; PHILANTHROPIC SERVICES, NAMELY, CHARITABLE FUNDRAISING TO SUPPORT MEDICAL RESEARCH AND PROCEDURES FOR THOSE IN NEED, IN CLASS 36 (U.S. CLS. 100, 101 AND 102).

SERVICE MARK

PRINCIPAL REGISTER

FIRST USE 11-17-2010; IN COMMERCE 11-17-2010.

THE MARK CONSISTS OF STANDARD CHARACTERS WITHOUT CLAIM TO ANY PARTICULAR FONT, STYLE, SIZE, OR COLOR.

SN 77-696,762, FILED 3-23-2009.

DAVID TAYLOR, EXAMINING ATTORNEY



David J. Kyffers

Director of the United States Patent and Trademark Office

United States of America

United States Patent and Trademark Office

HEALTHLOCK

Reg. No. 4,206,248

Registered Sep. 11, 2012

Int. Cl.: 45

SERVICE MARK

PRINCIPAL REGISTER

INSURANCEASSIST, INC. (CALIFORNIA CORPORATION), DBA INASSIST,
STE. 110
3480 TORRANCE BLVD
TORRANCE, CA 905035501

FOR: FRAUD DETECTION SERVICES RELATING TO MEDICAL CLAIMS, IN CLASS 45
(U.S. CLS. 100 AND 101).

FIRST USE 6-4-2012; IN COMMERCE 6-4-2012.

THE MARK CONSISTS OF STANDARD CHARACTERS WITHOUT CLAIM TO ANY PAR-
TICULAR FONT, STYLE, SIZE, OR COLOR.

SN 77-700,148, FILED 3-26-2009.

HOWARD SMIGA, EXAMINING ATTORNEY



David J. Kybas

Director of the United States Patent and Trademark Office

United States of America

United States Patent and Trademark Office

PHILADELPHIA POPS

Reg. No. 4,206,249

FINGER PRINCE, INC. (PENNSYLVANIA CORPORATION)
202 HIDDEN ACRES LANE
MEDIA, PA 190631666

Registered Sep. 11, 2012

Int. Cl.: 41

FOR: ENTERTAINMENT IN THE NATURE OF LIVE PERFORMANCES AND SHOWS BY A MUSICAL BAND, IN CLASS 41 (U.S. CLS. 100, 101 AND 107).

SERVICE MARK

FIRST USE 7-3-2011; IN COMMERCE 7-3-2011.

PRINCIPAL REGISTER

THE MARK CONSISTS OF STANDARD CHARACTERS WITHOUT CLAIM TO ANY PARTICULAR FONT, STYLE, SIZE, OR COLOR.

SEC. 2(F).

OWNER OF U.S. REG. NOS. 2,197,233 AND 2,650,910.

NO CLAIM IS MADE TO THE EXCLUSIVE RIGHT TO USE "POPS", APART FROM THE MARK AS SHOWN.

SN 77-706,201, FILED 4-3-2009.

NICHOLAS COLEMAN, EXAMINING ATTORNEY



David J. Kyffers

Director of the United States Patent and Trademark Office

United States of America

United States Patent and Trademark Office

INSTANT YOUTH POTION

Reg. No. 4,206,250

INTERNATIONAL EDGE, INC. (NEW JERSEY CORPORATION)
79 TWO BRIDGES ROAD
FAIRFIELD, NJ 07004

Registered Sep. 11, 2012

Int. Cl.: 3

FOR: FACIAL MASK AND FACE CREAM, IN CLASS 3 (U.S. CLS. 1, 4, 6, 50, 51 AND 52).

TRADEMARK

FIRST USE 4-4-2012; IN COMMERCE 4-4-2012.

PRINCIPAL REGISTER

THE MARK CONSISTS OF STANDARD CHARACTERS WITHOUT CLAIM TO ANY PARTICULAR FONT, STYLE, SIZE, OR COLOR.

SN 77-709,767, FILED 4-8-2009.

SOPHIA S. KIM, EXAMINING ATTORNEY



David J. Kybas

Director of the United States Patent and Trademark Office

United States of America

United States Patent and Trademark Office

PACIFIC GEM

Reg. No. 4,206,251

Registered Sep. 11, 2012

Int. Cl.: 29

TRADEMARK

PRINCIPAL REGISTER

POCINO FOODS COMPANY (CALIFORNIA CORPORATION)
14250 LOMITAS AVE
CITY OF INDUSTRY, CA 91746

FOR: PREPARED MEAT, IN CLASS 29 (U.S. CL. 46).

FIRST USE 7-16-2012; IN COMMERCE 7-16-2012.

THE MARK CONSISTS OF STANDARD CHARACTERS WITHOUT CLAIM TO ANY PARTICULAR FONT, STYLE, SIZE, OR COLOR.

SN 77-711,757, FILED 4-10-2009.

JENNIFER MARTIN, EXAMINING ATTORNEY



David J. Kyffers

Director of the United States Patent and Trademark Office

United States of America

United States Patent and Trademark Office

B.

Reg. No. 4,206,252

BATTAT INCORPORATED (DELAWARE CORPORATION)
1560 MILITARY TURNPIKE
PLATTSBURGH, NY 12901

Registered Sep. 11, 2012

Int. Cl.: 16

FOR: CHILDREN'S BOOKS NOT RELATING TO BASEBALL OR SOFTBALL OR TO A SPORTS TEAM, IN CLASS 16 (U.S. CLS. 2, 5, 22, 23, 29, 37, 38 AND 50).

TRADEMARK

FIRST USE 11-30-2009; IN COMMERCE 11-30-2009.

PRINCIPAL REGISTER

THE MARK CONSISTS OF STANDARD CHARACTERS WITHOUT CLAIM TO ANY PARTICULAR FONT, STYLE, SIZE, OR COLOR.

OWNER OF U.S. REG. NOS. 3,929,573, 4,151,304, AND OTHERS.

SN 77-715,520, FILED 4-16-2009.

LINDA POWELL, EXAMINING ATTORNEY



David J. Kyjars

Director of the United States Patent and Trademark Office

United States of America

United States Patent and Trademark Office

SPRINGFIELD ARMOR

Reg. No. 4,206,253

Registered Sep. 11, 2012

Int. Cl.: 25

TRADEMARK

PRINCIPAL REGISTER

NBA DEVELOPMENT LEAGUE, LLC (DELAWARE LIMITED LIABILITY COMPANY)
100 PLAZA DRIVE
SECAUCUS, NJ 07094

FOR: CLOTHING, NAMELY, HOSIERY, FOOTWEAR, BASKETBALL SHOES, BASKETBALL SNEAKERS, T-SHIRTS, SHIRTS, POLO SHIRTS, SWEATSHIRTS, SWEATPANTS, PANTS, TANK TOPS, JERSEYS, SHORTS, PAJAMAS, SPORT SHIRTS, RUGBY SHIRTS, SWEATERS, BELTS, TIES, NIGHTSHIRTS, HATS, CAPS, VISORS, WARM-UP SUITS, WARM-UP PANTS, WARM-UP TOPS/SHOOTING SHIRTS, JACKETS, WIND RESISTANT JACKETS, PARKAS, COATS, BABY BIBS NOT OF PAPER, HEAD BANDS, WRIST BANDS, APRONS, UNDERGARMENTS, BOXER SHORTS, SLACKS, EAR MUFFS, GLOVES, MITTENS, SCARVES, WOVEN AND KNIT SHIRTS, JERSEY DRESSES, DRESSES, CHEERLEADING DRESSES AND UNIFORMS, SWIM WEAR, BATHING SUITS, SWIMSUITS, BIKINIS, TANKINIS, SWIM TRUNKS, BATHING TRUNKS, BOARD SHORTS, WET SUITS, BEACH COVER-UPS, BATHING SUIT COVER-UPS, BATHING SUIT WRAPS, SANDALS, BEACH SANDALS, BEACH HATS, SUN VISORS, SWIM CAPS, BATHING CAPS, NOVELTY HEADWEAR WITH ATTACHED WIGS, ALL OF THE FOREGOING TO BE USED TO PROMOTE THE SPORT OF BASKETBALL IN CONNECTION WITH THE TRADEMARK OWNER'S PROFESSIONAL BASKETBALL TEAM, IN CLASS 25 (U.S. CLS. 22 AND 39).

FIRST USE 11-1-2009; IN COMMERCE 11-1-2009.

THE MARK CONSISTS OF STANDARD CHARACTERS WITHOUT CLAIM TO ANY PARTICULAR FONT, STYLE, SIZE, OR COLOR.

NO CLAIM IS MADE TO THE EXCLUSIVE RIGHT TO USE "SPRINGFIELD", APART FROM THE MARK AS SHOWN.

SN 77-716,175, FILED 4-17-2009.

PRISCILLA MILTON, EXAMINING ATTORNEY



David J. Kyros

Director of the United States Patent and Trademark Office

United States of America

United States Patent and Trademark Office

 nsoro

It's just good business.

A  Mastec COMPANY

Reg. No. 4,206,254

Registered Sep. 11, 2012

Int. Cl.: 35

SERVICE MARK

PRINCIPAL REGISTER

NSORO MASTEC, LLC (FLORIDA LIMITED LIABILITY COMPANY)
800 DOUGLAS ROAD, #1200
CORAL GABLES, FL 33145

FOR: INVENTORY CONTROL AND MANAGEMENT FOR CELL SITES AND SHELTERS; BUSINESS CONSULTING AND MANAGEMENT IN THE FIELD OF TELECOMMUNICATIONS, NAMELY, FACILITIES MANAGEMENT OF WIRELESS COMMUNICATION SITES FOR OTHERS; INVENTORY CONTROL AND MANAGEMENT IN THE FIELD OF TELECOMMUNICATIONS AND WIRELESS COMMUNICATIONS; PROVIDING AN ONLINE COMPUTER DATABASE FEATURING INFORMATION IN THE FIELD OF INVENTORY CONTROL AND MANAGEMENT OF WIRELESS TELECOMMUNICATIONS SYSTEMS AND WIRELESS TELECOMMUNICATIONS SITES; PROVIDING A WEB-BASED PORTAL FOR MONITORING, TRACKING, MANAGING AND REPORTING EQUIPMENT INVENTORY IN THE FIELD OF TELECOMMUNICATIONS; EMPLOYMENT HIRING, RECRUITING, PLACEMENT, STAFFING AND CAREER NETWORKING SERVICES; PROVIDING AN ON-LINE COMPUTER DATABASE IN THE FIELD OF CAREER STAFFING; DISASTER RECOVERY SERVICES, NAMELY, BUSINESS PLANNING AND BUSINESS CONTINUITY CONSULTING INCLUDING PRE-DISASTER PREVENTATIVE MAINTENANCE AND SITE ASSESSMENTS; NEGOTIATION AND RENEGOTIATION OF LEASES AND SUBLEASES AND OF THE PURCHASE AND SALE OF BUILDINGS, IN CLASS 35 (U.S. CLS. 100, 101 AND 102).

FIRST USE 12-1-2008; IN COMMERCE 12-1-2008.

NO CLAIM IS MADE TO THE EXCLUSIVE RIGHT TO USE "COMPANY", APART FROM THE MARK AS SHOWN.

THE MARK CONSISTS OF A STYLIZED LETTER "N" AND THE TERM "NSORO" ABOVE A HORIZONTAL LINE, WITH THE WORDING "IT'S JUST GOOD BUSINESS." BELOW THE LINE. THE WORDING "A MASTEC COMPANY" APPEARS IN STYLIZED FORM BELOW THE WORDS "IT'S JUST GOOD BUSINESS." FOUR SMALL SHADED SQUARES ARRANGED IN A DIAMOND ARRANGEMENT APPEAR TO THE LEFT OF THE LETTER "M", AND THE LETTER "M" HAS A SMALL MISSING SPACE IN ITS LEFTMOST VERTICAL LEG.

SN 77-717,857, FILED 4-20-2009.

ESTHER BELENKER, EXAMINING ATTORNEY



David J. Kyffers

Director of the United States Patent and Trademark Office

United States of America

United States Patent and Trademark Office

 nsoro

It's just good business.

A  Mastec COMPANY

Reg. No. 4,206,255

Registered Sep. 11, 2012

Int. Cl.: 37

SERVICE MARK

PRINCIPAL REGISTER

NSORO MASTEC, LLC (FLORIDA LIMITED LIABILITY COMPANY)
800 DOUGLAS ROAD, #1200
CORAL GABLES, FL 33134

FOR: CELL SITE FACILITY CONSTRUCTION SERVICES, NAMELY, CONSTRUCTION OF TELECOMMUNICATIONS TOWERS; INSTALLATION, MAINTENANCE, AND REPAIR OF CELL SITES, TELECOMMUNICATIONS SYSTEMS, WIRELESS NETWORKS, APPARATUS, AND INSTRUMENTS, NAMELY, ANTENNAS, TOWER MOUNTED AMPLIFIERS, DIPLEXERS, AND COAXIAL AND FIBER OPTIC CABLES; CELL SITE MAINTENANCE, NAMELY, HVAC AND GENERATOR MAINTENANCE AND BATTERY RECHARGE SERVICES; BUILDING CONSTRUCTION SERVICES, NAMELY, FACILITY MAINTENANCE, REPAIR, INSPECTION AND SUPERVISION; CONSTRUCTION CONSULTANCY AND MANAGEMENT; PROVIDING TURNKEY CONSTRUCTION MANAGEMENT SERVICES TO OTHERS; CONSTRUCTION OF ROADS AND UNDERGROUND UTILITIES; PROVIDING TURNKEY REAL ESTATE SERVICES, NAMELY, SITE SELECTION; REAL ESTATE SITE SELECTION, NAMELY, SELECTING SITES FOR THE PLACEMENT OF WIRELESS ANTENNA AND NETWORK COMMUNICATIONS EQUIPMENT AND TELECOMMUNICATIONS TOWERS FOR OTHERS; PROVIDING AN ONLINE COMPUTER DATABASE FEATURING INFORMATION IN THE FIELD OF MAINTENANCE OF WIRELESS TELECOMMUNICATIONS SYSTEMS AND WIRELESS COMMUNICATIONS SITES, IN CLASS 37 (U.S. CLS. 100, 103 AND 106).

FIRST USE 12-1-2008; IN COMMERCE 12-1-2008.

NO CLAIM IS MADE TO THE EXCLUSIVE RIGHT TO USE "COMPANY", APART FROM THE MARK AS SHOWN.

THE MARK CONSISTS OF A STYLIZED LETTER "N" AND THE TERM "NSORO" ABOVE A HORIZONTAL LINE, WITH THE WORDING "IT'S JUST GOOD BUSINESS." BELOW THE LINE. THE WORDING "A MASTEC COMPANY" APPEARS IN STYLIZED FORM BELOW THE WORDS "IT'S JUST GOOD BUSINESS." FOUR SMALL SHADED SQUARES ARRANGED IN A DIAMOND ARRANGEMENT APPEAR TO THE LEFT OF THE LETTER "M", AND THE LETTER "M" HAS A SMALL MISSING SPACE IN ITS LEFTMOST VERTICAL LEG.



David J. Kyffers

Director of the United States Patent and Trademark Office

SN 77-717,868, FILED 4-20-2009.

ESTHER BELENKER, EXAMINING ATTORNEY

United States of America

United States Patent and Trademark Office

 nsoro

It's just good business.

A  Mastec COMPANY

Reg. No. 4,206,256

Registered Sep. 11, 2012

Int. Cl.: 38

SERVICE MARK

PRINCIPAL REGISTER

NSORO MASTEC, LLC (FLORIDA LIMITED LIABILITY COMPANY)
800 DOUGLAS ROAD, #1200
CORAL GABLES, FL 33134

FOR: TELECOMMUNICATIONS AND WIRELESS COMMUNICATIONS SERVICES, NAMELY, PROVIDING LOCAL AND LONG DISTANCE TRANSMISSION OF VOICE, DATA, GRAPHICS AND VIDEO BY MEANS OF BROADBAND, COPPER AND OPTICAL OR WIRELESS NETWORKS AND SATELLITE TRANSMISSION; PROVIDING INTERNET ACCESS VIA BROADBAND OPTICAL OR WIRELESS NETWORKS; TELECOMMUNICATIONS ACCESS SERVICES; WIRELESS BROADBAND COMMUNICATION SERVICES; TELECOMMUNICATIONS CONSULTANCY; PROVIDING A WEBSITE FEATURING INFORMATION ABOUT TELECOMMUNICATIONS, IN CLASS 38 (U.S. CLS. 100, 101 AND 104).

FIRST USE 12-1-2008; IN COMMERCE 12-1-2008.

NO CLAIM IS MADE TO THE EXCLUSIVE RIGHT TO USE "COMPANY" , APART FROM THE MARK AS SHOWN.

THE MARK CONSISTS OF A STYLIZED LETTER "N" AND THE TERM "NSORO" ABOVE A HORIZONTAL LINE, WITH THE WORDING "IT'S JUST GOOD BUSINESS." BELOW THE LINE. THE WORDING "A MASTEC COMPANY" APPEARS IN STYLIZED FORM BELOW THE WORDS "IT'S JUST GOOD BUSINESS." FOUR SMALL SHADED SQUARES ARRANGED IN A DIAMOND ARRANGEMENT APPEAR TO THE LEFT OF THE LETTER "M", AND THE LETTER "M" HAS A SMALL MISSING SPACE IN ITS LEFTMOST VERTICAL LEG.

SN 77-717,876, FILED 4-20-2009.

ESTHER BELENKER, EXAMINING ATTORNEY



David J. Kypos

Director of the United States Patent and Trademark Office

United States of America

United States Patent and Trademark Office

 nsoro

It's just good business.

A  Mastec COMPANY

Reg. No. 4,206,257

Registered Sep. 11, 2012

Int. Cl.: 42

SERVICE MARK

PRINCIPAL REGISTER

NSORO MASTEC, LLC (FLORIDA LIMITED LIABILITY COMPANY)
800 DOUGLAS ROAD, #1200
CORAL GABLES, FL 33134

FOR: INSPECTION OF CELL SITE FACILITIES; BASIC AND APPLIED RESEARCH IN THE FIELDS OF TELECOMMUNICATIONS, ENGINEERING, AND INFORMATION TECHNOLOGY; RESEARCH AND DEVELOPMENT OF NEW PRODUCTS FOR OTHERS IN THE FIELD OF TELECOMMUNICATION AND INFORMATION TECHNOLOGY; TECHNICAL CONSULTING IN THE FIELD OF TELECOMMUNICATIONS, INFORMATION TECHNOLOGY, ARCHITECTURE, ENGINEERING AND ENVIRONMENTAL SCIENCE; ARCHITECTURAL AND ENGINEERING SERVICES FOR OTHERS, NAMELY, BUILDING CONDITION ASSESSMENT AND FACILITY MANAGEMENT, REPAIR AND RESTORATION; CONDUCTING ENGINEERING SURVEYS FOR OTHERS; PROVIDING TURNKEY ENGINEERING AND ARCHITECTURE SERVICES TO OTHERS; LOCATING AND MARKING PLACEMENT OF UNDERGROUND UTILITY PIPES, CABLE AND WIRES; QUALITY CONTROL FOR OTHERS IN THE FIELD OF TELECOMMUNICATIONS; COMPUTER SOFTWARE DESIGN AND DEVELOPMENT IN THE FIELD OF TELECOMMUNICATIONS; LAND SURVEYING; LAND USE PLANNING SERVICES; PROVIDING TEMPORARY USE OF ONLINE AND NON-DOWNLOADABLE COMPUTER SOFTWARE TO COLLECT, MANAGE, QUERY, ANALYZE, GRAPH, REPORT AND ASSESS DATA AND INFORMATION RELATING TO THE MANAGEMENT AND INVENTORY CONTROL OF WIRELESS NETWORK COMMUNICATIONS EQUIPMENT, SYSTEMS AND SITES, IN CLASS 42 (U.S. CLS. 100 AND 101).

FIRST USE 12-1-2008; IN COMMERCE 12-1-2008.

NO CLAIM IS MADE TO THE EXCLUSIVE RIGHT TO USE "COMPANY", APART FROM THE MARK AS SHOWN.

THE MARK CONSISTS OF A STYLIZED LETTER "N" AND THE TERM "NSORO" ABOVE A HORIZONTAL LINE, WITH THE WORDING "IT'S JUST GOOD BUSINESS." BELOW THE LINE. THE WORDING "A MASTEC COMPANY" APPEARS IN STYLIZED FORM BELOW THE WORDS "IT'S JUST GOOD BUSINESS." FOUR SMALL SHADED SQUARES ARRANGED IN A DIAMOND ARRANGEMENT APPEAR TO THE LEFT OF THE LETTER "M", AND THE LETTER "M" HAS A SMALL MISSING SPACE IN ITS LEFTMOST VERTICAL LEG.

SN 77-717,880, FILED 4-20-2009.



David J. Kyffers

Director of the United States Patent and Trademark Office

Reg. No. 4,206,257 ESTHER BELENKER, EXAMINING ATTORNEY

United States of America

United States Patent and Trademark Office

 nsoro

It's just good business.

A  Mastec COMPANY

Reg. No. 4,206,258

Registered Sep. 11, 2012

Int. Cl.: 45

SERVICE MARK

PRINCIPAL REGISTER

NSORO MASTEC, LLC (FLORIDA LIMITED LIABILITY COMPANY)
800 DOUGLAS ROAD, #1200
CORAL GABLES, FL 33134

FOR: PROVIDING TURNKEY REAL ESTATE SERVICES, NAMELY, OBTAINING GOVERNMENTAL PERMITS FOR DEVELOPMENTAL PROJECTS AND REVIEWING STANDARDS AND PRACTICES TO ASSURE COMPLIANCE WITH ZONING LAWS AND REGULATIONS; SECURITY INSPECTION SERVICES OF CELL SITES FOR OTHERS, IN CLASS 45 (U.S. CLS. 100 AND 101).

FIRST USE 12-1-2008; IN COMMERCE 12-1-2008.

NO CLAIM IS MADE TO THE EXCLUSIVE RIGHT TO USE "COMPANY", APART FROM THE MARK AS SHOWN.

THE MARK CONSISTS OF A STYLIZED LETTER "N" AND THE TERM "NSORO" ABOVE A HORIZONTAL LINE, WITH THE WORDING "IT'S JUST GOOD BUSINESS." BELOW THE LINE. THE WORDING "A MASTEC COMPANY" APPEARS IN STYLIZED FORM BELOW THE WORDS "IT'S JUST GOOD BUSINESS." FOUR SMALL SHADED SQUARES ARRANGED IN A DIAMOND ARRANGEMENT APPEAR TO THE LEFT OF THE LETTER "M", AND THE LETTER "M" HAS A SMALL MISSING SPACE IN ITS LEFTMOST VERTICAL LEG.

SN 77-717,885, FILED 4-20-2009.

ESTHER BELENKER, EXAMINING ATTORNEY



David J. Kypos

Director of the United States Patent and Trademark Office

United States of America

United States Patent and Trademark Office

Shrike Industries

Reg. No. 4,206,259

Registered Sep. 11, 2012

Int. Cl.: 9

TRADEMARK

PRINCIPAL REGISTER

SHRIKE INDUSTRIES, INC. (CALIFORNIA CORPORATION)
STE. F-487
28241 CROWN VALLEY PKWY
LAGUNA NIGUEL, CA 92677

FOR: TACTICAL GEAR FOR MILITARY, SECURITY AND POLICE USE, NAMELY, PROTECTIVE GEAR FOR ATTACHMENT TO PROTECTIVE HELMETS IN THE NATURE OF A COUNTERWEIGHT FOR HELMET WEIGHT DISPLACEMENT; AND PROTECTIVE WORK GLOVES, IN CLASS 9 (U.S. CLS. 21, 23, 26, 36 AND 38).

FIRST USE 1-31-2010; IN COMMERCE 1-31-2010.

THE MARK CONSISTS OF STANDARD CHARACTERS WITHOUT CLAIM TO ANY PARTICULAR FONT, STYLE, SIZE, OR COLOR.

NO CLAIM IS MADE TO THE EXCLUSIVE RIGHT TO USE "INDUSTRIES", APART FROM THE MARK AS SHOWN.

SN 77-724,827, FILED 4-29-2009.

KEVIN DINALLO, EXAMINING ATTORNEY



David J. Kypos

Director of the United States Patent and Trademark Office

United States of America

United States Patent and Trademark Office



Reg. No. 4,206,260

Registered Sep. 11, 2012

Int. Cl.: 9

TRADEMARK

PRINCIPAL REGISTER

SHRIKE INDUSTRIES, INC. (CALIFORNIA CORPORATION)
STE. F-487
28241 CROWN VALLEY PKWY
LAGUNA NIGUEL, CA 92677

FOR: TACTICAL GEAR FOR MILITARY, SECURITY AND POLICE USE, NAMELY, PROTECTIVE GEAR FOR ATTACHMENT TO PROTECTIVE HELMETS IN THE NATURE OF A COUNTERWEIGHT FOR HELMET WEIGHT DISPLACEMENT; AND PROTECTIVE WORK GLOVES, IN CLASS 9 (U.S. CLS. 21, 23, 26, 36 AND 38).

FIRST USE 1-31-2010; IN COMMERCE 1-31-2010.

NO CLAIM IS MADE TO THE EXCLUSIVE RIGHT TO USE "INDUSTRIES", APART FROM THE MARK AS SHOWN.

THE MARK CONSISTS OF A SHIELD-LIKE SHAPE CONTAINING THE LETTER "S" IN ITS CENTER WITH A BANNER EXTENDING UP BOTH LOWER LEFT AND RIGHT SIDES OF SAID SHIELD AND CONTAINING STARS ACROSS IT; THE WORDS "SHRIKE INDUSTRIES" PLACED IN ALL CAPS TO THE RIGHT OF SAID SHIELD WITH THE WORD "SHRIKE" IN LARGER FONT DIRECTLY ABOVE THE WORD "INDUSTRIES".

SN 77-724,834, FILED 4-29-2009.

KEVIN DINALLO, EXAMINING ATTORNEY



David J. Kyffers

Director of the United States Patent and Trademark Office

United States of America

United States Patent and Trademark Office

DIAMOND NIGHTS

Reg. No. 4,206,261

IGT (NEVADA CORPORATION)
9295 PROTOTYPE DRIVE
RENO, NV 895218986

Registered Sep. 11, 2012

Int. Cl.: 9

FOR: GAMING MACHINES, NAMELY, DEVICES WHICH ACCEPT A WAGER, IN CLASS 9 (U.S. CLS. 21, 23, 26, 36 AND 38).

TRADEMARK

FIRST USE 6-20-2012; IN COMMERCE 6-20-2012.

PRINCIPAL REGISTER

THE MARK CONSISTS OF STANDARD CHARACTERS WITHOUT CLAIM TO ANY PARTICULAR FONT, STYLE, SIZE, OR COLOR.

SN 77-728,876, FILED 5-5-2009.

MELISSA VALLILLO, EXAMINING ATTORNEY



David J. Kybas

Director of the United States Patent and Trademark Office

United States of America

United States Patent and Trademark Office

ARTSCOUT

Reg. No. 4,206,262

SWANSTROM, BETH (UNITED STATES INDIVIDUAL)
136 SULLIVAN STREET, #3
NEW YORK, NY 10583

Registered Sep. 11, 2012

Int. Cl.: 41

FOR: ENTERTAINMENT SERVICES, NAMELY, PROVIDING AN ON-GOING TELEVISION PROGRAM IN THE FIELD OF ART AND DESIGN VIA A GLOBAL COMPUTER NETWORK; ON-LINE JOURNALS, NAMELY, BLOGS FEATURING INFORMATION, RESOURCES AND MULTIMEDIA MATERIALS IN THE FIELD OF ART AND DESIGN; PRODUCTION OF TELEVISION PROGRAMS; PROVIDING A WEBSITE IN THE FIELD OF ART WHICH INCLUDES MULTIMEDIA MATERIALS, IN CLASS 41 (U.S. CLS. 100, 101 AND 107).

SERVICE MARK

PRINCIPAL REGISTER

FIRST USE 5-31-2009; IN COMMERCE 5-31-2009.

THE MARK CONSISTS OF STANDARD CHARACTERS WITHOUT CLAIM TO ANY PARTICULAR FONT, STYLE, SIZE, OR COLOR.

SN 77-730,175, FILED 5-6-2009.

SOPHIA S. KIM, EXAMINING ATTORNEY



David J. Kyffers

Director of the United States Patent and Trademark Office

United States of America

United States Patent and Trademark Office

TOD'S POINT CAPITAL

Reg. No. 4,206,263

Registered Sep. 11, 2012

Int. Cl.: 36

SERVICE MARK

PRINCIPAL REGISTER

TOD'S POINT CAPITAL HOLDING COMPANY LLC (DELAWARE LIMITED LIABILITY COMPANY)
53 FOREST AVENUE - SUITE 301
OLD GREENWICH, CT 06870

FOR: FINANCIAL SERVICES, NAMELY, SECURITIES BROKER-DEALER SERVICES, IN CLASS 36 (U.S. CLS. 100, 101 AND 102).

FIRST USE 9-30-2011; IN COMMERCE 9-30-2011.

THE MARK CONSISTS OF STANDARD CHARACTERS WITHOUT CLAIM TO ANY PARTICULAR FONT, STYLE, SIZE, OR COLOR.

NO CLAIM IS MADE TO THE EXCLUSIVE RIGHT TO USE "CAPITAL", APART FROM THE MARK AS SHOWN.

SN 77-732,535, FILED 5-8-2009.

COLLEEN KEARNEY, EXAMINING ATTORNEY



David J. Kyros

Director of the United States Patent and Trademark Office

United States of America

United States Patent and Trademark Office

ONBRAND

Reg. No. 4,206,264

Registered Sep. 11, 2012

Int. Cls.: 35 and 42

SERVICE MARK

PRINCIPAL REGISTER

ROSS, DAN (UNITED STATES INDIVIDUAL)
323 SACKETT STREET
BROOKLYN, NY 11231

FOR: CONSULTING SERVICES IN THE FIELD OF MARKETING, ADVERTISING AND BRANDING; SALES PROMOTION SERVICES; DESIGN OF ADVERTISING MATERIALS FOR OTHERS; MARKETING SERVICES, NAMELY, PROMOTING THE GOODS AND SERVICES OF OTHERS BY PREPARING, CREATING AND PLACING ADVERTISEMENTS FOR DISSEMINATION THROUGH ALL FORMS OF MEDIA; MARKET RESEARCH SERVICES; BUSINESS MANAGEMENT CONSULTING, NAMELY, RESEARCH AND STRATEGIC CONSULTING SERVICES FOR OTHERS IN THE FIELD OF ADVERTISING, MARKETING COMMUNICATIONS, PROMOTIONS, PUBLIC RELATIONS, INTERACTIVE AND DIGITAL MEDIA ADVERTISING DISSEMINATION; PREPARATION AND REALIZATION OF MEDIA AND ADVERTISING PLANS AND CONCEPTS; WRITING AND EDITING OF PUBLICITY TEXTS, IN CLASS 35 (U.S. CLS. 100, 101 AND 102).

FIRST USE 6-4-2012; IN COMMERCE 6-4-2012.

FOR: GRAPHIC ARTS DESIGN SERVICES FOR PROMOTING, MARKETING AND ADVERTISING THE GOODS AND SERVICES OF OTHERS THROUGH ALL FORMS OF MEDIA; COMPUTER SERVICES, NAMELY, DESIGNING AND IMPLEMENTING NETWORK WEB SITES; COMPUTER AIDED GRAPHIC DESIGN SERVICES, NAMELY, PRODUCING DIGITAL PROMOTIONAL AND ADVERTISING CONTENT FOR NETWORK WEB SITES THAT PROMOTE, MARKET AND ADVERTISE THE GOODS AND SERVICES OF OTHERS, IN CLASS 42 (U.S. CLS. 100 AND 101).

FIRST USE 6-4-2012; IN COMMERCE 6-4-2012.

THE MARK CONSISTS OF STANDARD CHARACTERS WITHOUT CLAIM TO ANY PARTICULAR FONT, STYLE, SIZE, OR COLOR.

SN 77-736,353, FILED 5-13-2009.

MEGHAN REINHART, EXAMINING ATTORNEY



David J. Kyffers

Director of the United States Patent and Trademark Office

United States of America

United States Patent and Trademark Office

GREEN MOUNTAIN FREEDOM 5

Reg. No. 4,206,265

NATIONAL LIFE INSURANCE COMPANY (VERMONT CORPORATION)
NATIONAL LIFE DRIVE
MONTPELIER, VT 05604

Registered Sep. 11, 2012

Int. Cl.: 36

FOR: ISSUANCE AND ADMINISTRATION OF ANNUITIES, IN CLASS 36 (U.S. CLS. 100, 101 AND 102).

SERVICE MARK

FIRST USE 6-0-2012; IN COMMERCE 6-0-2012.

PRINCIPAL REGISTER

THE MARK CONSISTS OF STANDARD CHARACTERS WITHOUT CLAIM TO ANY PARTICULAR FONT, STYLE, SIZE, OR COLOR.

SEC. 2(F) AS TO "GREEN MOUNTAIN".

OWNER OF U.S. REG. NOS. 1,944,715, 1,944,717, AND OTHERS.

SN 77-739,311, FILED 5-18-2009.

RAUL CORDOVA, EXAMINING ATTORNEY



David J. Kybas

Director of the United States Patent and Trademark Office

United States of America

United States Patent and Trademark Office



SPINFRESH
A FRESH SPIN ON FOOD

Reg. No. 4,206,266

Registered Sep. 11, 2012

Int. Cl.: 11

TRADEMARK

PRINCIPAL REGISTER

SPINFRY, INC. (NEVADA CORPORATION)
215 AMBRIDGEFELD ROAD
KELOWNA, B.C., CANADA V1W 4J5

FOR: COOKING EQUIPMENT, NAMELY, ELECTRICAL DEEP FRYERS, IN CLASS 11 (U.S. CLS. 13, 21, 23, 31 AND 34).

FIRST USE 11-0-2011; IN COMMERCE 11-0-2011.

THE MARK CONSISTS OF A PINWHEEL DESIGN CENTERED ABOVE THE WORD "SPINFRESH" IN LARGE TYPE, WITH THE "SPIN" PORTION IN ITALICS, AND THE WORDS "A FRESH SPIN ON FOOD" CENTERED BELOW IN SMALLER TYPE.

SN 77-740,661, FILED 5-19-2009.

NICHOLAS COLEMAN, EXAMINING ATTORNEY



David J. Kybas

Director of the United States Patent and Trademark Office

United States of America

United States Patent and Trademark Office

TRIPLE TIME PROGRESSIVES

Reg. No. 4,206,267

IGT (NEVADA CORPORATION)
9295 PROTOTYPE DRIVE
RENO, NV 895218986

Registered Sep. 11, 2012

Int. Cl.: 9

FOR: GAMING MACHINES, NAMELY, DEVICES WHICH ACCEPT A WAGER, IN CLASS 9 (U.S. CLS. 21, 23, 26, 36 AND 38).

TRADEMARK

FIRST USE 3-16-2011; IN COMMERCE 5-24-2012.

PRINCIPAL REGISTER

THE MARK CONSISTS OF STANDARD CHARACTERS WITHOUT CLAIM TO ANY PARTICULAR FONT, STYLE, SIZE, OR COLOR.

OWNER OF U.S. REG. NOS. 2,871,900 AND 3,034,870.

NO CLAIM IS MADE TO THE EXCLUSIVE RIGHT TO USE "PROGRESSIVES", APART FROM THE MARK AS SHOWN.

SN 77-743,570, FILED 5-22-2009.

NICHOLAS COLEMAN, EXAMINING ATTORNEY



David J. Kybas

Director of the United States Patent and Trademark Office

United States of America

United States Patent and Trademark Office

TRUESKIN MD

Reg. No. 4,206,268

Registered Sep. 11, 2012

Int. Cl.: 44

SERVICE MARK

PRINCIPAL REGISTER

TRUESKIN DERMATOLOGY AND SURGERY, INC. (UTAH CORPORATION)
SUITE 200
10011 S. CENTENNIAL PKWY
SANDY, UT 84070

FOR: MEDICAL SERVICES, NAMELY, DERMATOLOGICAL MEDICAL SERVICES, IN CLASS 44 (U.S. CLS. 100 AND 101).

FIRST USE 7-20-2012; IN COMMERCE 7-20-2012.

THE MARK CONSISTS OF STANDARD CHARACTERS WITHOUT CLAIM TO ANY PARTICULAR FONT, STYLE, SIZE, OR COLOR.

NO CLAIM IS MADE TO THE EXCLUSIVE RIGHT TO USE "MD", APART FROM THE MARK AS SHOWN.

SN 77-744,165, FILED 5-26-2009.

MATTHEW KLINE, EXAMINING ATTORNEY



David J. Kappas

Director of the United States Patent and Trademark Office

United States of America

United States Patent and Trademark Office

AsepticSure

Reg. No. 4,206,269

MEDIZONE INTERNATIONAL INC. (NEVADA CORPORATION)
144 BUENA VISTA
STINSON BEACH, CA 94970

Registered Sep. 11, 2012

Int. Cl.: 11

FOR: STERILIZATION UNITS FOR BUILDINGS IN THE NATURE OF APPARATUS THAT FLOODS A ROOM OR SPACE WITH ANTI-BACTERIAL GAS THAT ELIMINATES ALL BACTERIA IN THE ROOM OR SPACE, IN CLASS 11 (U.S. CLS. 13, 21, 23, 31 AND 34).

TRADEMARK

FIRST USE 6-29-2012; IN COMMERCE 6-29-2012.

PRINCIPAL REGISTER

THE MARK CONSISTS OF STANDARD CHARACTERS WITHOUT CLAIM TO ANY PARTICULAR FONT, STYLE, SIZE, OR COLOR.

SN 77-746,089, FILED 5-27-2009.

LAKEISHA LEWIS, EXAMINING ATTORNEY



David J. Kyffers

Director of the United States Patent and Trademark Office

United States of America

United States Patent and Trademark Office

THE SKINNY

Reg. No. 4,206,270

A & H SPORTSWEAR CO., INC. (PENNSYLVANIA CORPORATION)
110 COMMERCE WAY
STOCKERTOWN, PA 18083

Registered Sep. 11, 2012

Int. Cl.: 25

FOR: SWIMWEAR, IN CLASS 25 (U.S. CLS. 22 AND 39).

TRADEMARK

FIRST USE 2-23-2012; IN COMMERCE 2-23-2012.

PRINCIPAL REGISTER

THE MARK CONSISTS OF STANDARD CHARACTERS WITHOUT CLAIM TO ANY PARTICULAR FONT, STYLE, SIZE, OR COLOR.

SN 77-749,898, FILED 6-2-2009.

PAM WILLIS, EXAMINING ATTORNEY



David J. Kybas

Director of the United States Patent and Trademark Office

United States of America

United States Patent and Trademark Office

HEALTHY. SUSTAINED. ENERGY.

Reg. No. 4,206,271

MONAVIE LLC (DELAWARE LIMITED LIABILITY COMPANY)
10855 S. RIVER FRONT PARKWAY, SUITE 100
SOUTH JORDAN, UT 84095

Registered Sep. 11, 2012

Int. Cl.: 5

FOR: DIETARY AND NUTRITIONAL SUPPLEMENTS SOLD ONLY THROUGH DIRECT SELLING CHANNELS AND NOT FOR RETAIL SALE IN TRADITIONAL RETAIL CHANNELS , IN CLASS 5 (U.S. CLS. 6, 18, 44, 46, 51 AND 52).

TRADEMARK

FIRST USE 6-12-2009; IN COMMERCE 6-12-2009.

PRINCIPAL REGISTER

THE MARK CONSISTS OF STANDARD CHARACTERS WITHOUT CLAIM TO ANY PARTICULAR FONT, STYLE, SIZE, OR COLOR.

NO CLAIM IS MADE TO THE EXCLUSIVE RIGHT TO USE "HEALTHY" OR "ENERGY," APART FROM THE MARK AS SHOWN.

SN 77-751,171, FILED 6-3-2009.

VERNA BETH RIRIE, EXAMINING ATTORNEY



David J. Kybas

Director of the United States Patent and Trademark Office

United States of America

United States Patent and Trademark Office

POWERED BY SERVICE

Reg. No. 4,206,272

USHER'S NEW LOOK, INC. (GEORGIA CORPORATION)
3700 CRESTWOOD PARKWAY, SUITE 460
DULUTH, GA 30096

Registered Sep. 11, 2012

Int. Cls.: 35 and 36

FOR: CHARITABLE SERVICES, NAMELY, PROMOTING PUBLIC AWARENESS OF THE NEED FOR COMMUNITY SERVICE AND ORGANIZING AND CONDUCTING VOLUNTEER PROGRAMS AND COMMUNITY SERVICE PROJECTS, IN CLASS 35 (U.S. CLS. 100, 101 AND 102).

SERVICE MARK

PRINCIPAL REGISTER

FIRST USE 9-1-2009; IN COMMERCE 9-1-2009.

FOR: CHARITABLE FUNDRAISING SERVICES, IN CLASS 36 (U.S. CLS. 100, 101 AND 102).

FIRST USE 9-1-2009; IN COMMERCE 9-1-2009.

THE MARK CONSISTS OF STANDARD CHARACTERS WITHOUT CLAIM TO ANY PARTICULAR FONT, STYLE, SIZE, OR COLOR.

SN 77-758,379, FILED 6-12-2009.

KHANH LE, EXAMINING ATTORNEY



David J. Kybas

Director of the United States Patent and Trademark Office

United States of America

United States Patent and Trademark Office

SNAG MORE BUSINESS

Reg. No. 4,206,273

SNAG, INC. (FLORIDA CORPORATION)

Registered Sep. 11, 2012

14843 HIGHWAY 10
TALLEQUAH, OK 74464

Int. Cl.: 35

FOR: ADVERTISING, MARKETING AND PROMOTIONAL SERVICES IN THE FIELD OF GOLF, IN CLASS 35 (U.S. CLS. 100, 101 AND 102).

SERVICE MARK

FIRST USE 6-15-2012; IN COMMERCE 6-15-2012.

PRINCIPAL REGISTER

THE MARK CONSISTS OF STANDARD CHARACTERS WITHOUT CLAIM TO ANY PARTICULAR FONT, STYLE, SIZE, OR COLOR.

OWNER OF U.S. REG. NOS. 2,687,974 AND 2,872,151.

SN 77-759,030, FILED 6-13-2009.

MATTHEW MCDOWELL, EXAMINING ATTORNEY



David J. Kybas

Director of the United States Patent and Trademark Office

United States of America

United States Patent and Trademark Office

DONNA KARAN MODERN ICONS

Reg. No. 4,206,274

GABRIELLE STUDIO, INC. (NEW YORK CORPORATION)
550 SEVENTH AVENUE
NEW YORK, NY 10018

Registered Sep. 11, 2012

Int. Cl.: 25

FOR: COATS, RAINCOATS, BLAZERS, JACKETS, TOPS, KNIT TOPS, SUITS, DRESSES, EVENING GOWNS, SKIRTS, PANTS, SHORTS, SWEATERS, SHIRTS, BLOUSES, TANK TOPS AND BODYSUITS, IN CLASS 25 (U.S. CLS. 22 AND 39).

TRADEMARK

FIRST USE 1-0-2007; IN COMMERCE 1-0-2007.

PRINCIPAL REGISTER

THE MARK CONSISTS OF STANDARD CHARACTERS WITHOUT CLAIM TO ANY PARTICULAR FONT, STYLE, SIZE, OR COLOR.

OWNER OF U.S. REG. NOS. 1,790,498, 3,069,157, AND OTHERS.

THE NAME(S), PORTRAIT(S), AND/OR SIGNATURE(S) SHOWN IN THE MARK IDENTIFIES "DONNA KARAN", WHOSE CONSENT(S) TO REGISTER IS MADE OF RECORD.

SN 77-762,487, FILED 6-17-2009.

KIM SAITO, EXAMINING ATTORNEY



David J. Kybas

Director of the United States Patent and Trademark Office

United States of America

United States Patent and Trademark Office



Reg. No. 4,206,275

BIO-GEA, LLC (FLORIDA LIMITED LIABILITY COMPANY)
3340 HIBISCUS DRIVE EAST
BELLEAIR BEACH, FL 33786

Registered Sep. 11, 2012

Int. Cl.: 29

FOR: FOODS, NAMELY, OLIVE OILS, OLIVES, CHEESE, OLIVE PATE, CANNED OR BOTTLED FRUIT AND VEGETABLES, AND YOGURT, IN CLASS 29 (U.S. CL. 46).

TRADEMARK

FIRST USE 6-17-2012; IN COMMERCE 6-17-2012.

PRINCIPAL REGISTER

THE MARK CONSISTS OF THE WORDS "BIO-GEA" WITH A CURVED LINE UNDER THE WORDS AND A FIGURE PERSON ON THE LEFT SIDE OF THE WORDS.

SN 77-764,852, FILED 6-22-2009.

WILLIAM VERHOSEK, EXAMINING ATTORNEY



David J. Kyffers

Director of the United States Patent and Trademark Office

United States of America

United States Patent and Trademark Office

ZENYA

Reg. No. 4,206,276

INFO.COM LIMITED (UNITED KINGDOM LIMITED LIABILITY COMPANY)
170-172 VICTORIA STREET
LONDON, ENGLAND SW1E5LB

Registered Sep. 11, 2012

Int. Cl.: 42

FOR: CONSULTATION SERVICES IN THE FIELD OF SEARCH ENGINE OPTIMIZATION,
IN CLASS 42 (U.S. CLS. 100 AND 101).

SERVICE MARK

FIRST USE 10-30-2011; IN COMMERCE 10-30-2011.

PRINCIPAL REGISTER

THE MARK CONSISTS OF STANDARD CHARACTERS WITHOUT CLAIM TO ANY PARTICULAR FONT, STYLE, SIZE, OR COLOR.

SN 77-765,299, FILED 6-22-2009.

ALEXANDER L. POWERS, EXAMINING ATTORNEY



David J. Kyffers

Director of the United States Patent and Trademark Office

United States of America

United States Patent and Trademark Office

F&S 1871

Reg. No. 4,206,277

Registered Sep. 11, 2012

Int. Cl.: 25

TRADEMARK

PRINCIPAL REGISTER

FIELD & STREAM LICENSES COMPANY, LLC (CONNECTICUT LIMITED LIABILITY COMPANY)
18 KINGS HIGHWAY N
WESTPORT, CT 06830

FOR: MEN'S OUTDOOR CLOTHING AND SPORTSWEAR APPAREL, NAMELY, JACKETS, SHIRTS, PANTS, SHORTS, HOODED JACKETS, WAXED JACKETS, FLANNEL JACKETS, CANVAS JACKETS, PULLOVERS, PADDED VESTS, HUNTING VESTS, WATER RESISTANT RAINWEAR, JERSEYS, T-SHIRTS, POLO SHIRTS, HATS, CAPS, IN CLASS 25 (U.S. CLS. 22 AND 39).

FIRST USE 6-25-2009; IN COMMERCE 6-25-2009.

THE MARK CONSISTS OF STANDARD CHARACTERS WITHOUT CLAIM TO ANY PARTICULAR FONT, STYLE, SIZE, OR COLOR.

NO CLAIM IS MADE TO THE EXCLUSIVE RIGHT TO USE "1871", APART FROM THE MARK AS SHOWN.

SN 77-765,892, FILED 6-23-2009.

KATHRYN COWARD, EXAMINING ATTORNEY



David J. Kyros

Director of the United States Patent and Trademark Office

United States of America

United States Patent and Trademark Office

RESONATE ME

Reg. No. 4,206,278

Registered Sep. 11, 2012

Int. Cl.: 35

SERVICE MARK

PRINCIPAL REGISTER

RESONATE MOBILE, INC. (DELAWARE CORPORATION)
215 CHURCH ST.
SUITE 301
PHILADELPHIA, PA 19106

FOR: MOBILE PHONE ADVERTISING SERVICES, NAMELY, USING SMS, MMS, GPS, WAP PUSH, INSTANT MESSAGING, AND PROPRIETARY MOBILE PHONE APPLICATIONS TO ENABLE INTERACTIVE ADVERTISING BETWEEN CONSUMERS AND ADVERTISERS VIA THE MOBILE PHONE DEVICE, EXCLUDING WEB-PAGE BASED DISPLAY ADVERTISING AND MARKETING CONSULTING SERVICES, IN CLASS 35 (U.S. CLS. 100, 101 AND 102).

FIRST USE 9-1-2009; IN COMMERCE 9-1-2009.

THE MARK CONSISTS OF STANDARD CHARACTERS WITHOUT CLAIM TO ANY PARTICULAR FONT, STYLE, SIZE, OR COLOR.

SN 77-766,919, FILED 6-24-2009.

BRIAN CALLAGHAN, EXAMINING ATTORNEY



David J. Kyros

Director of the United States Patent and Trademark Office

United States of America

United States Patent and Trademark Office

RESONATE ME

Reg. No. 4,206,279

Registered Sep. 11, 2012

Int. Cl.: 38

SERVICE MARK

PRINCIPAL REGISTER

RESONATE MOBILE, INC. (DELAWARE CORPORATION)
215 CHURCH ST.
SUITE 301
PHILADELPHIA, PA 19106

FOR: MOBILE TELEPHONE SERVICES, IN CLASS 38 (U.S. CLS. 100, 101 AND 104).

FIRST USE 9-1-2009; IN COMMERCE 9-1-2009.

THE MARK CONSISTS OF STANDARD CHARACTERS WITHOUT CLAIM TO ANY PARTICULAR FONT, STYLE, SIZE, OR COLOR.

SN 77-766,922, FILED 6-24-2009.

BRIAN CALLAGHAN, EXAMINING ATTORNEY



David J. Kybas

Director of the United States Patent and Trademark Office

United States of America

United States Patent and Trademark Office

DARK AGNES

Reg. No. 4,206,280

Registered Sep. 11, 2012

Int. Cl.: 16

TRADEMARK

PRINCIPAL REGISTER

ROBERT E HOWARD PROPERTIES INC. (DELAWARE CORPORATION)
8484 WILSHIRE BOULEVARD
STE 870
BEVERLY HILLS, CA 90211

FOR: BOOKS RELATED TO ACTION-ADVENTURE FICTIONAL FANTASY CHARACTERS,
IN CLASS 16 (U.S. CLS. 2, 5, 22, 23, 29, 37, 38 AND 50).

FIRST USE 6-25-2012; IN COMMERCE 6-25-2012.

THE MARK CONSISTS OF STANDARD CHARACTERS WITHOUT CLAIM TO ANY PAR-
TICULAR FONT, STYLE, SIZE, OR COLOR.

SN 77-767,092, FILED 6-24-2009.

MARTHA FROMM, EXAMINING ATTORNEY



David J. Kyffers

Director of the United States Patent and Trademark Office

United States of America

United States Patent and Trademark Office

BOLLYHOOD

Reg. No. 4,206,281

Registered Sep. 11, 2012

Int. Cl.: 25

TRADEMARK

PRINCIPAL REGISTER

PARMAR, RAJE SHWARI (UNITED STATES INDIVIDUAL)
230 N. MAPLE AVE.
SUITE 294
MARLTON, NJ 08053

FOR: CLOTHING, NAMELY, TEE SHIRTS, SHIRTS, JEANS, JACKETS, COATS, PANTS, HATS, SWEAT SHIRTS, SWEAT PANTS, DRESSES, SKIRTS, SOCKS, UNDERWEAR AND FOOTWEAR, IN CLASS 25 (U.S. CLS. 22 AND 39).

FIRST USE 7-1-2008; IN COMMERCE 6-2-2012.

THE MARK CONSISTS OF STANDARD CHARACTERS WITHOUT CLAIM TO ANY PARTICULAR FONT, STYLE, SIZE, OR COLOR.

SN 77-768,885, FILED 6-26-2009.

WENDY JUN, EXAMINING ATTORNEY



David J. Kyffers

Director of the United States Patent and Trademark Office

United States of America

United States Patent and Trademark Office

VIVIENNE TAM

Reg. No. 4,206,282

VIVIENNE TAM (UNITED STATES INDIVIDUAL)

Registered Sep. 11, 2012

260 W 39TH STREET
NEW YORK, NY 10018

Int. Cl.: 9

FOR: ACCESSORIES FOR COMPUTERS, NAMELY, COMPUTER CASES, IN CLASS 9 (U.S. CLS. 21, 23, 26, 36 AND 38).

TRADEMARK

FIRST USE 3-31-2011; IN COMMERCE 3-31-2011.

PRINCIPAL REGISTER

THE MARK CONSISTS OF STANDARD CHARACTERS WITHOUT CLAIM TO ANY PARTICULAR FONT, STYLE, SIZE, OR COLOR.

OWNER OF U.S. REG. NOS. 1,869,482 AND 2,914,995.

THE NAME "VIVIENNE TAM" IDENTIFIES A LIVING INDIVIDUAL WHOSE CONSENT IS OF RECORD.

SN 77-769,182, FILED 6-26-2009.

JAMES A. RAUEN, EXAMINING ATTORNEY



David J. Kybas

Director of the United States Patent and Trademark Office

United States of America
United States Patent and Trademark Office

HELLION

Reg. No. 4,206,283

SHELBY GROUP INTERNATIONAL, INC. (TENNESSEE CORPORATION)
5321 E. SHELBY DRIVE
MEMPHIS, TN 38118

Registered Sep. 11, 2012

Int. Cl.: 9

FOR: PROTECTIVE EYEWEAR, IN CLASS 9 (U.S. CLS. 21, 23, 26, 36 AND 38).

TRADEMARK

FIRST USE 5-3-2012; IN COMMERCE 5-3-2012.

PRINCIPAL REGISTER

THE MARK CONSISTS OF STANDARD CHARACTERS WITHOUT CLAIM TO ANY PARTICULAR FONT, STYLE, SIZE, OR COLOR.

SN 77-772,579, FILED 7-1-2009.

AISHA CLARKE, EXAMINING ATTORNEY



David J. Kyffers

Director of the United States Patent and Trademark Office

United States of America

United States Patent and Trademark Office

Don't Fear Me Fear The Consequence

Reg. No. 4,206,284

VAUDAGNA, MICHAEL (UNITED STATES INDIVIDUAL)
1617 COMFORT
CANYON LAKE, TX 78133

Registered Sep. 11, 2012

Int. Cl.: 25

FOR: HATS; SHORTS; T-SHIRTS, IN CLASS 25 (U.S. CLS. 22 AND 39).

TRADEMARK

FIRST USE 8-13-2010; IN COMMERCE 8-13-2010.

PRINCIPAL REGISTER

THE MARK CONSISTS OF STANDARD CHARACTERS WITHOUT CLAIM TO ANY PARTICULAR FONT, STYLE, SIZE, OR COLOR.

SN 77-775,668, FILED 7-7-2009.

MARGERY A. TIERNEY, EXAMINING ATTORNEY



David J. Kybas

Director of the United States Patent and Trademark Office

United States of America

United States Patent and Trademark Office

EQUIP LEADERSHIP

Reg. No. 4,206,285

EQUIP LEADERSHIP, INC. (FLORIDA CORPORATION)

Registered Sep. 11, 2012

5400 LAUREL SPRINGS PKWY, SUITE 301
SUWANEE, GA 30024

Int. Cl.: 41

SERVICE MARK

PRINCIPAL REGISTER

FOR: PROVIDING A WEB SITE FEATURING NON-DOWNLOADABLE EDUCATIONAL INSTRUCTIONAL AUDIO AND VIDEO RECORDINGS IN THE FIELDS OF LEADERSHIP DEVELOPMENT AND TRAINING, ORGANIZATIONAL DEVELOPMENT, COMMUNICATIONS, INTERPERSONAL RELATIONSHIPS, FUNDRAISING AND NONPROFIT DONOR DEVELOPMENT VIA A GLOBAL COMMUNICATIONS NETWORK; EDUCATIONAL SERVICES, NAMELY, A CONTINUING AUDIO PROGRAM IN THE FIELDS OF LEADERSHIP DEVELOPMENT AND TRAINING, ORGANIZATIONAL DEVELOPMENT, COMMUNICATIONS, INTERPERSONAL RELATIONSHIPS, FUNDRAISING AND NONPROFIT DONOR DEVELOPMENT ACCESSIBLE BY RADIO BROADCAST AND A GLOBAL COMMUNICATIONS NETWORK; PROVIDING NON-DOWNLOADABLE EDUCATIONAL TRAINING RADIO BROADCAST TRANSCRIPTS IN THE FIELDS OF LEADERSHIP DEVELOPMENT AND TRAINING, ORGANIZATIONAL DEVELOPMENT, COMMUNICATIONS, INTERPERSONAL RELATIONSHIPS, FUNDRAISING AND NONPROFIT DONOR DEVELOPMENT VIA A GLOBAL COMMUNICATIONS NETWORK; PROVIDING NEWSLETTERS VIA E-MAIL IN THE FIELDS OF LEADERSHIP DEVELOPMENT AND TRAINING, ORGANIZATIONAL DEVELOPMENT, COMMUNICATIONS, INTERPERSONAL RELATIONSHIPS, FUNDRAISING AND NONPROFIT DONOR DEVELOPMENT, IN CLASS 41 (U.S. CLS. 100, 101 AND 107).

FIRST USE 5-0-2010; IN COMMERCE 5-0-2010.

THE MARK CONSISTS OF STANDARD CHARACTERS WITHOUT CLAIM TO ANY PARTICULAR FONT, STYLE, SIZE, OR COLOR.

OWNER OF U.S. REG. NOS. 2,239,712, 2,251,921, AND OTHERS.

NO CLAIM IS MADE TO THE EXCLUSIVE RIGHT TO USE "LEADERSHIP", APART FROM THE MARK AS SHOWN.

SN 77-777,801, FILED 7-9-2009.

ROBERT C. CLARK JR., EXAMINING ATTORNEY



David J. Kyffers

Director of the United States Patent and Trademark Office

United States of America

United States Patent and Trademark Office

MariaDB

Reg. No. 4,206,286

MONTY PROGRAM AB (FINLAND CORPORATION)
DAALINTIE 14
TUUSULA, FINLAND 04360

Registered Sep. 11, 2012

Int. Cls.: 9, 35, and 42

FOR: COMPUTER SOFTWARE FOR CREATING, MANAGING, EDITING AND OPERATING DATABASES, IN CLASS 9 (U.S. CLS. 21, 23, 26, 36 AND 38).

TRADEMARK

FIRST USE 10-1-2008; IN COMMERCE 10-1-2008.

SERVICE MARK

FOR: DATABASE MANAGEMENT SERVICES, IN CLASS 35 (U.S. CLS. 100, 101 AND 102).

PRINCIPAL REGISTER

FIRST USE 10-1-2008; IN COMMERCE 10-1-2008.

FOR: (BASED ON 44(E)) SCIENTIFIC, TECHNOLOGICAL, RESEARCH AND DEVELOPMENT SERVICES RELATING TO COMPUTER SOFTWARE, NAMELY, SCIENTIFIC RESEARCH AND DEVELOPMENT AND TECHNOLOGICAL CONSULTATION IN THE TECHNOLOGY FIELD OF COMPUTER SOFTWARE, IN CLASS 42 (U.S. CLS. 100 AND 101).

PRIORITY CLAIMED UNDER SEC. 44(D) ON ERPN CMNTY TM OFC APPLICATION NO. 8267395, FILED 4-30-2009, REG. NO. 008267395, DATED 11-10-2009, EXPIRES 4-30-2019.

THE MARK CONSISTS OF THE LETTER "M" IN UPPERCASE, THE LETTERS "ARIA" IN LOWERCASE, AND THE LETTERS "DB" IN UPPERCASE.

SN 77-778,553, FILED 7-10-2009.

TASNEEM HUSSAIN, EXAMINING ATTORNEY



David J. Kyjars

Director of the United States Patent and Trademark Office

United States of America

United States Patent and Trademark Office



Reg. No. 4,206,287

Registered Sep. 11, 2012

Int. Cl.: 25

TRADEMARK

PRINCIPAL REGISTER

UNDER ARMOUR, INC. (MARYLAND CORPORATION)
1020 HULL STREET
BALTIMORE, MD 21230

FOR: BANDANAS; BASEBALL SHOES; BASKETBALL SNEAKERS; BEACHWEAR; BIB OVERALLS FOR HUNTING; BIKINIS; CAMOUFLAGE GLOVES; CAMOUFLAGE JACKETS; CAMOUFLAGE PANTS; CAMOUFLAGE SHIRTS; CAMOUFLAGE VESTS; CLEATS FOR ATTACHMENT TO SPORTS SHOES; FISHING SHIRTS; FOOTBALL SHOES; GOLF SHORTS; HUNTING JACKETS; HUNTING PANTS; HUNTING SHIRTS; MEN'S DRESS SOCKS; SNEAKERS; SWIMWEAR; VOLLEYBALL JERSEYS; YOGA PANTS; YOGA SHIRTS, IN CLASS 25 (U.S. CLS. 22 AND 39).

FIRST USE 6-0-2005; IN COMMERCE 6-0-2005.

OWNER OF U.S. REG. NOS. 2,727,031, 3,630,507, AND OTHERS.

THE MARK CONSISTS OF A STYLIZED LETTER "U" VERTICALLY OVERLAPPING A STYLIZED LETTER "A".

SN 77-779,877, FILED 7-13-2009.

GIANCARLO CASTRO, EXAMINING ATTORNEY



David J. Kyffers

Director of the United States Patent and Trademark Office

United States of America

United States Patent and Trademark Office

MARIA Y JUANA

Reg. No. 4,206,288

Registered Sep. 11, 2012

Int. Cl.: 34

UETA, INC. (PANAMA CORPORATION)
CALLE 50, PISO #36
EDIFICIO TORRE GLOBAL BANK
PANAMA, PANAMA

FOR: CIGARETTES, IN CLASS 34 (U.S. CLS. 2, 8, 9 AND 17).

TRADEMARK

FIRST USE 7-1-2012; IN COMMERCE 7-1-2012.

PRINCIPAL REGISTER

THE MARK CONSISTS OF STANDARD CHARACTERS WITHOUT CLAIM TO ANY PARTICULAR FONT, STYLE, SIZE, OR COLOR.

THE ENGLISH TRANSLATION OF "Y" IN THE MARK IS "AND."

SN 77-787,407, FILED 7-22-2009.

SETH A. RAPPAPORT, EXAMINING ATTORNEY



David J. Kybas

Director of the United States Patent and Trademark Office

United States of America

United States Patent and Trademark Office

ZETONNA

Reg. No. 4,206,289

SUNOVION PHARMACEUTICALS INC. (DELAWARE CORPORATION)
84 WATERFORD DRIVE
MARLBOROUGH, MA 01752

Registered Sep. 11, 2012

Int. Cl.: 5

FOR: ANTI-INFLAMMATORIES; PHARMACEUTICAL PREPARATIONS FOR THE PREVENTION AND TREATMENT OF DISORDERS AND DISEASES OF THE RESPIRATORY SYSTEM; PHARMACEUTICAL PREPARATIONS FOR THE PREVENTION AND TREATMENT OF ALLERGIC DISORDERS AND DISEASES, IN CLASS 5 (U.S. CLS. 6, 18, 44, 46, 51 AND 52).

TRADEMARK

PRINCIPAL REGISTER

FIRST USE 7-16-2012; IN COMMERCE 7-16-2012.

THE MARK CONSISTS OF STANDARD CHARACTERS WITHOUT CLAIM TO ANY PARTICULAR FONT, STYLE, SIZE, OR COLOR.

SN 77-790,189, FILED 7-27-2009.

MATTHEW KLINE, EXAMINING ATTORNEY



David J. Kypos

Director of the United States Patent and Trademark Office

United States of America

United States Patent and Trademark Office

ECO CAST

Reg. No. 4,206,290

Registered Sep. 11, 2012

Int. Cl.: 42

SERVICE MARK

PRINCIPAL REGISTER

BREAKDOWN SERVICES, LTD. (CALIFORNIA CORPORATION)
THIRD FLOOR
2140 COTNER AVENUE
LOS ANGELES, CA 90025

FOR: PROVIDING A WEBSITE FEATURING ON-LINE NON-DOWNLOADABLE SOFTWARE THAT ALLOWS ACTORS TO PRE-RECORD VIDEO AUDITIONS, UPLOAD THE RECORDED VIDEO AUDITIONS INTO AN ONLINE DATABASE WHERE THE VIDEO AUDITIONS ARE STORED WITH PHOTOGRAPHS AND RESUMES OF THE ACTORS APPEARING IN THE VIDEO AUDITIONS, AND ALLOWS ALL OF THE FOREGOING MATERIALS TO BE MADE AVAILABLE FOR ON-LINE VIEWING BY AGENTS, DIRECTORS, PRODUCERS, CASTING DIRECTORS AND ADVERTISING AGENCIES, THEREBY REDUCING THE NEED FOR ACTORS TO TRAVEL TO LIVE AUDITIONS, IN CLASS 42 (U.S. CLS. 100 AND 101).

FIRST USE 4-23-2010; IN COMMERCE 4-23-2010.

THE MARK CONSISTS OF STANDARD CHARACTERS WITHOUT CLAIM TO ANY PARTICULAR FONT, STYLE, SIZE, OR COLOR.

NO CLAIM IS MADE TO THE EXCLUSIVE RIGHT TO USE "CAST", APART FROM THE MARK AS SHOWN.

SN 77-793,864, FILED 7-30-2009.

JAY BESCH, EXAMINING ATTORNEY



David J. Kybas

Director of the United States Patent and Trademark Office

United States of America

United States Patent and Trademark Office



Reg. No. 4,206,291

DAYSTAR PRODUCTS INTERNATIONAL, INC. (ARIZONA CORPORATION)
841 SOUTH 71ST AVE.
PHOENIX, AZ 85043

Registered Sep. 11, 2012

Int. Cl.: 20

FOR: CONTAINERS FOR INDUSTRIAL AND COMMERCIAL LIQUIDS NOT MADE OF METAL, IN CLASS 20 (U.S. CLS. 2, 13, 22, 25, 32 AND 50).

TRADEMARK

FIRST USE 11-1-2011; IN COMMERCE 11-1-2011.

PRINCIPAL REGISTER

NO CLAIM IS MADE TO THE EXCLUSIVE RIGHT TO USE "CAM CAN", APART FROM THE MARK AS SHOWN.

THE MARK CONSISTS OF THE TERM "CAM CAN" AS PART OF A DESIGN ENCIRCLING THE IMAGE OF A CONTAINER.

SN 77-793,871, FILED 7-30-2009.

MARCIE MILONE, EXAMINING ATTORNEY



David J. Kybas

Director of the United States Patent and Trademark Office

United States of America

United States Patent and Trademark Office



Reg. No. 4,206,292

Registered Sep. 11, 2012

Int. Cl.: 41

SERVICE MARK

PRINCIPAL REGISTER

HEYDAY ENTERTAINMENT LLC (OKLAHOMA LIMITED LIABILITY COMPANY)
3959 WARWICK
NORMAN, OK 73072

FOR: PROVIDING FACILITIES FOR RECREATION ACTIVITIES, NAMELY, LASER TAG, MINIATURE GOLF, VIDEO ARCADE GAME SERVICES; ENTERTAINMENT SERVICES IN THE NATURE OF CONDUCTING BIRTHDAY PARTIES AND CORPORATE PARTIES; EDUCATIONAL SERVICES, NAMELY, EDUCATIONAL SERVICES IN THE NATURE OF PROVIDING TEAM BUILDING WORKSHOPS, AND PROVIDING INSTRUCTION PROGRAMS IN THE FIELD OF LASERS AND LIGHTS, IN CLASS 41 (U.S. CLS. 100, 101 AND 107).

FIRST USE 12-31-2011; IN COMMERCE 12-31-2011.

THE MARK CONSISTS OF THE STYLIZED LETTERS "HD" SET INSIDE TWO CONCENTRIC CIRCLES; THE OUTER CIRCLE AND THE INNERMOST CIRCLE ARE SHADED AND CONTAIN A SPLATTER DESIGN OF DOTS AND STREAKS.

SN 77-795,787, FILED 8-3-2009.

MICHAEL LITZAU, EXAMINING ATTORNEY



David J. Kybas

Director of the United States Patent and Trademark Office

United States of America

United States Patent and Trademark Office



Reg. No. 4,206,293

SASSY, INC. (ILLINOIS CORPORATION)
2101 WAUKEGAN ROAD, SUITE 203
BANNOCKBURN, IL 60015

Registered Sep. 11, 2012

**Int. Cls.: 8, 10, 16, 20, 21,
and 28**

FOR: CHILDREN'S AND INFANTS' FEEDING AND EATING UTENSILS, NAMELY, FORKS AND SPOONS FOR CHILDREN; BABY MANICURE SCISSORS, IN CLASS 8 (U.S. CLS. 23, 28 AND 44).

TRADEMARK

FIRST USE 1-15-2010; IN COMMERCE 1-15-2010.

PRINCIPAL REGISTER

FOR: TEETHING RINGS FOR BABIES; NASAL ASPIRATORS; SYRINGE ACTUATED BABY BOTTLES, BABY NURSERS, IN CLASS 10 (U.S. CLS. 26, 39 AND 44).

FIRST USE 9-16-2010; IN COMMERCE 9-16-2010.

FOR: DISPOSABLE PADS FOR CHANGING DIAPERS; PLASTIC DISPOSABLE DIAPER BAGS; PHOTO ALBUMS; CHILDREN'S ACTIVITY BOOKS, IN CLASS 16 (U.S. CLS. 2, 5, 22, 23, 29, 37, 38 AND 50).

FIRST USE 9-23-2010; IN COMMERCE 9-23-2010.

FOR: DOORWAY BOUNCER SEATS, IN CLASS 20 (U.S. CLS. 2, 13, 22, 25, 32 AND 50).

FIRST USE 3-25-2011; IN COMMERCE 3-25-2011.

FOR: SOAP DISPENSER BOTTLE; BOTTLE NIPPLE CLEANING BRUSH; PLATES, BOWLS, CUPS, MUGS FOR CHILDREN; BABY FEEDING DEVICES; BABY FOOD STORAGE CONTAINERS FOR HOUSEHOLD USE, VINYL BABY BATH TUBS; CHILDREN'S AND INFANTS' FEEDING BOWLS, IN CLASS 21 (U.S. CLS. 2, 13, 23, 29, 30, 33, 40 AND 50).

FIRST USE 8-23-2011; IN COMMERCE 8-23-2011.

FOR: PLUSH TOYS; PLUSH TOY ANIMALS; SOFT SCULPTURE TOYS; BABY AND CHILDREN'S MULTIPLE ACTIVITY TOYS; TOYS, NAMELY, PLUSH TOYS, STUFFED TOYS, AND MUSICAL STUFFED TOYS; INFANTS' TOYS; STUFFED TOY ANIMALS; BATH TOYS AND BATH TUB TOYS, NAMELY, WATER TOYS THAT FLOAT, BOB, SQUIRT, CREATE PLAYFUL OR MUSICAL SOUNDS, INDICATE WATER TEMPERATURE, TOYS



David J. Kybas

Director of the United States Patent and Trademark Office

Reg. No. 4,206,293 THAT ARE CONFIGURED TO SERVE AS BATH TUB, SINK AND SHOWER SPRAYERS AND SPOUT GUARDS, TOYS THAT ADHERE TO A TUB TO EDUCATE A CHILD, AND TOYS THAT SERVE AS VISORS FOR THE PURPOSE OF KEEPING WATER AND SUDS OUT OF CHILDREN'S EYES; TOYS AND PLAYTHINGS FOR INFANTS AND TODDLERS, NAMELY, BABY MULTIPLE ACTIVITY TOYS, CHILDREN'S RING TOYS, PLUSH TOYS AND SOFT SCULPTURE PLUSH TOYS USED TO PACIFY, SOOTHE, AND CALM; MANIPULATIVE PUZZLES; PLAY RINGS; RATTLES; PULL TOYS; PUSH TOYS; CRIB TOYS; TOY BUCKETS; BATH TOYS; TOY BALLS; BABY TOY KEYS; MUSICAL TOYS; FLOOR PLAYMATS TO FACILITATE CHILD DEVELOPMENT, IN CLASS 28 (U.S. CLS. 22, 23, 38 AND 50).

FIRST USE 9-30-2010; IN COMMERCE 9-30-2010.

OWNER OF U.S. REG. NOS. 2,296,588, 3,006,201, AND OTHERS.

THE MARK CONSISTS OF THE DESIGN OF A LADYBUG AND THE WORD "SASSY".

SN 77-808,544, FILED 8-19-2009.

HEATHER THOMPSON, EXAMINING ATTORNEY

United States of America

United States Patent and Trademark Office

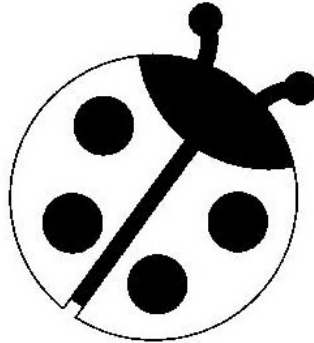

Reg. No. 4,206,294

SASSY, INC. (ILLINOIS CORPORATION)
2101 WAUKEGAN ROAD, SUITE 203
BANNOCKBURN, IL 60015

Registered Sep. 11, 2012

**Int. Cls.: 8, 10, 16, 20, 21,
and 28**

FOR: CHILDREN'S AND INFANTS' FEEDING AND EATING UTENSILS, NAMELY, FORKS AND SPOONS FOR CHILDREN; BABY MANICURE SCISSORS, IN CLASS 8 (U.S. CLS. 23, 28 AND 44).

TRADEMARK

FIRST USE 1-15-2010; IN COMMERCE 1-15-2010.

PRINCIPAL REGISTER

FOR: TEETHING RINGS FOR BABIES; NASAL ASPIRATORS; SYRINGE ACTUATED BABY BOTTLES, BABY NURSERS, IN CLASS 10 (U.S. CLS. 26, 39 AND 44).

FIRST USE 9-16-2010; IN COMMERCE 9-16-2010.

FOR: DISPOSABLE PADS FOR CHANGING DIAPERS; PLASTIC DISPOSABLE DIAPER BAGS; PHOTO ALBUMS; CHILDREN'S ACTIVITY BOOKS, IN CLASS 16 (U.S. CLS. 2, 5, 22, 23, 29, 37, 38 AND 50).

FIRST USE 9-23-2010; IN COMMERCE 9-23-2010.

FOR: DOORWAY BOUNCER SEATS, IN CLASS 20 (U.S. CLS. 2, 13, 22, 25, 32 AND 50).

FIRST USE 3-25-2011; IN COMMERCE 3-25-2011.

FOR: SOAP DISPENSER BOTTLE; BOTTLE NIPPLE CLEANING BRUSH; PLATES, BOWLS, CUPS, MUGS FOR CHILDREN; BABY FEEDING DEVICES; BABY FOOD STORAGE CONTAINERS FOR HOUSEHOLD USE, VINYL BABY BATH TUBS; CHILDREN'S AND INFANTS' FEEDING BOWLS, IN CLASS 21 (U.S. CLS. 2, 13, 23, 29, 30, 33, 40 AND 50).

FIRST USE 8-23-2011; IN COMMERCE 8-23-2011.

FOR: PLUSH TOYS; PLUSH TOY ANIMALS; SOFT SCULPTURE TOYS; BABY AND CHILDREN'S MULTIPLE ACTIVITY TOYS; TOYS, NAMELY, PLUSH TOYS, STUFFED TOYS, AND MUSICAL STUFFED TOYS; INFANTS' TOYS; STUFFED TOY ANIMALS; BATH TOYS AND BATH TUB TOYS, NAMELY, WATER TOYS THAT FLOAT, BOB, SQUIRT, CREATE PLAYFUL OR MUSICAL SOUNDS, INDICATE WATER TEMPERATURE, TOYS



David J. Kybas

Director of the United States Patent and Trademark Office

Reg. No. 4,206,294 THAT ARE CONFIGURED TO SERVE AS BATH TUB, SINK AND SHOWER SPRAYERS AND SPOUT GUARDS, TOYS THAT ADHERE TO A TUB TO EDUCATE A CHILD, AND TOYS THAT SERVE AS VISORS FOR THE PURPOSE OF KEEPING WATER AND SUDS OUT OF CHILDREN'S EYES; TOYS AND PLAYTHINGS FOR INFANTS AND TODDLERS, NAMELY, BABY MULTIPLE ACTIVITY TOYS, CHILDREN'S RING TOYS, PLUSH TOYS AND SOFT SCULPTURE PLUSH TOYS USED TO PACIFY, SOOTHE, AND CALM; MANIPULATIVE PUZZLES; PLAY RINGS; RATTLES; PULL TOYS; PUSH TOYS; CRIB TOYS; TOY BUCKETS; BATH TOYS; TOY BALLS; BABY TOY KEYS; MUSICAL TOYS; FLOOR PLAYMATS TO FACILITATE CHILD DEVELOPMENT, IN CLASS 28 (U.S. CLS. 22, 23, 38 AND 50).

FIRST USE 9-30-2010; IN COMMERCE 9-30-2010.

THE MARK CONSISTS OF THE DESIGN OF A LADYBUG.

SN 77-808,566, FILED 8-19-2009.

HEATHER THOMPSON, EXAMINING ATTORNEY

United States of America

United States Patent and Trademark Office

METASWITCH NETWORKS

Reg. No. 4,206,295

Registered Sep. 11, 2012

Int. Cls.: 9, 35, 38, and 42

TRADEMARK

SERVICE MARK

PRINCIPAL REGISTER

METASWITCH NETWORKS LTD (UNITED KINGDOM CORPORATION)
100 CHURCH STREET
ENFIELD, MIDDLESEX, UNITED KINGDOM EN26BQ

FOR: COMPUTER OPERATING SOFTWARE FOR A TELEPHONY SYSTEM; TELECOMMUNICATIONS HARDWARE AND SOFTWARE FOR TRANSMISSION, SWITCHING, RECEPTION AND PROCESSING OF VOICE CALLS; ELECTRONIC EQUIPMENT FOR VOICE COMMUNICATION, NAMELY, TELECOMMUNICATIONS NETWORKING HARDWARE IN THE NATURE OF DEVICES FOR TRANSPORTING AND AGGREGATING VOICE COMMUNICATIONS ACROSS MULTIPLE NETWORK INFRASTRUCTURES AND COMMUNICATIONS PROTOCOLS; TELECOMMUNICATION NETWORK EXCHANGE, TRANSMISSION AND SWITCHING EQUIPMENT, NAMELY, AUTOMATIC TELEPHONE EXCHANGES, AUTOMATIC SWITCHING APPARATUS FOR TELECOMMUNICATIONS; COMPUTER SOFTWARE AND HARDWARE FOR PERFORMING TELEPHONY SWITCHING AND PROVIDING TELEPHONY SERVICES FOR TELECOMMUNICATIONS NETWORKS AND NETWORK SWITCHES; COMPUTER SOFTWARE AND HARDWARE FOR USE IN NETWORK ARCHITECTURES AND IN INTERFACING AND INTEGRATION BETWEEN AND AMONG VARIOUS COMPUTER ENVIRONMENTS AND VARIOUS COMPUTER HARDWARE; COMPUTER NETWORKING AND TELECOMMUNICATIONS SOFTWARE; COMPUTER SOFTWARE FOR THE DIAGNOSIS OF FAULTS IN COMPUTER AND TELECOMMUNICATION SYSTEMS; COMPUTER SOFTWARE FOR MARKETING, BUSINESS PLANNING, BUSINESS ADMINISTRATION, PRODUCT DEVELOPMENT, PUBLIC RELATIONS, MARKET RESEARCH AND BUSINESS DEVELOPMENT, IN CLASS 9 (U.S. CLS. 21, 23, 26, 36 AND 38).

FIRST USE 8-27-2009; IN COMMERCE 8-27-2009.

FOR: OPERATION AND ADMINISTRATION OF TELECOMMUNICATION SYSTEMS AND TELECOMMUNICATION NETWORKS; ADMINISTRATION OF TELECOMMUNICATIONS APPARATUS IN THE NATURE OF EQUIPMENT FOR TRANSMITTING, RECEIVING, RECORDING AND MONITORING VOICE, DATA, INFORMATION, IMAGES, SIGNALS, MESSAGES, COMPRISED OF DATA AND WORD PROCESSORS AND COMPUTER PROGRAMS FOR USE IN OPERATING AND ACCESSING TELECOMMUNICATIONS SYSTEMS AND TELECOMMUNICATIONS HARDWARE AND SOFTWARE FOR USE IN THE TELECOMMUNICATIONS INDUSTRY; BUSINESS CONSULTANCY SERVICES IN THE FIELD OF BUSINESS PLANNING, BUSINESS ADMINISTRATION, PRODUCT DEVELOPMENT, PUBLIC RELATIONS AND BUSINESS DEVELOPMENT; BUSINESS PLANNING SERVICES;



David J. Kybas

Director of the United States Patent and Trademark Office

Reg. No. 4,206,295 BUSINESS ADMINISTRATION AND MANAGEMENT SERVICES; PUBLIC RELATIONS SERVICES; PROVIDING INFORMATION RELATING TO ALL THE AFORESAID SERVICES; PROVIDING DATABASE SERVICES FEATURING BUSINESS, COMMERCIAL, ENTERPRISE AND GOVERNMENT CONTACT INFORMATION, IN CLASS 35 (U.S. CLS. 100, 101 AND 102).

FIRST USE 8-27-2009; IN COMMERCE 8-27-2009.

FOR: TELECOMMUNICATIONS SERVICES BY TELEPHONE AND VIA THE INTERNET AND PUBLIC SWITCHED TELEPHONE NETWORKS, NAMELY, LOCAL AND LONG DISTANCE TELEPHONE SERVICES; PROVIDING CENTRAL SWITCHING SERVICES FOR THE TELEPHONY AND ELECTRONIC COMMUNICATIONS NETWORKS OF OTHERS; PROVIDING INTERFACE SERVICES FOR ELECTRONIC COMMUNICATIONS NETWORK SERVICES PROVIDERS, NAMELY, AUTOMATIC TELECOMMUNICATION SWITCHING SERVICES AND PROVIDING AUTOMATIC ELECTRONIC COMMUNICATIONS INTERFACE SERVICES IN THE NATURE OF TELECOMMUNICATIONS ROUTING AND JUNCTION SERVICES AND TELECOMMUNICATIONS GATEWAY SERVICES; PROVIDING TELECOMMUNICATION CONNECTION TO THE INTERNET AND DATABASES; PROFESSIONAL CONSULTANCY RELATING TO TELECOMMUNICATIONS, IN CLASS 38 (U.S. CLS. 100, 101 AND 104).

FIRST USE 8-27-2009; IN COMMERCE 8-27-2009.

FOR: INTEGRATION OF COMPUTER SYSTEMS AND NETWORKS; INFORMATION AND CONSULTANCY SERVICES RELATING TO THE AFORESAID SERVICES; DESIGN AND DEVELOPMENT SERVICES IN THE FIELDS OF COMPUTER NETWORK ARCHITECTURES AND COMPUTER SYSTEMS INTERFACING AND INTEGRATION, IN CLASS 42 (U.S. CLS. 100 AND 101).

FIRST USE 8-27-2009; IN COMMERCE 8-27-2009.

THE MARK CONSISTS OF STANDARD CHARACTERS WITHOUT CLAIM TO ANY PARTICULAR FONT, STYLE, SIZE, OR COLOR.

OWNER OF U.S. REG. NO. 2,586,362.

NO CLAIM IS MADE TO THE EXCLUSIVE RIGHT TO USE "NETWORKS", APART FROM THE MARK AS SHOWN.

SN 77-813,963, FILED 8-27-2009.

ALLISON HOLTZ, EXAMINING ATTORNEY

United States of America

United States Patent and Trademark Office



Reg. No. 4,206,296

Registered Sep. 11, 2012

Int. Cl.: 9

CT MIAMI LLC (FLORIDA LIMITED LIABILITY COMPANY)
10814 NW 33 STREET
UNIT 100
MIAMI, FL 33172

FOR: CELLULAR PHONES, IN CLASS 9 (U.S. CLS. 21, 23, 26, 36 AND 38).

TRADEMARK

FIRST USE 11-14-2008; IN COMMERCE 6-15-2009.

PRINCIPAL REGISTER

NO CLAIM IS MADE TO THE EXCLUSIVE RIGHT TO USE "MOBILE", APART FROM THE MARK AS SHOWN.

THE MARK CONSISTS OF THE WORDING "ACE MOBILE" WITH A SPADE DESIGN WHICH ENCOMPASSES THE LETTER "A" OF "ACE".

SN 77-814,871, FILED 8-28-2009.

SUE LAWRENCE, EXAMINING ATTORNEY



David J. Kybas

Director of the United States Patent and Trademark Office

United States of America

United States Patent and Trademark Office

SMARTY PANTS

Reg. No. 4,206,297

CHARLOTTE SMARTY PANTS, LLC (NORTH CAROLINA LIMITED LIABILITY COMPANY)
4616 MAGNOLIA BRIDGE ROAD
CHARLOTTE, NC 28210

Registered Sep. 11, 2012

Int. Cl.: 41

FOR: ON-LINE JOURNAL, NAMELY, A BLOG FEATURING ADVICE AND INFORMATION ON ACTIVITIES, EVENTS, AND TOPICS FOR MOTHERS AND EXPECTANT MOTHERS , IN CLASS 41 (U.S. CLS. 100, 101 AND 107).

SERVICE MARK

FIRST USE 5-0-2011; IN COMMERCE 5-0-2011.

PRINCIPAL REGISTER

THE MARK CONSISTS OF STANDARD CHARACTERS WITHOUT CLAIM TO ANY PARTICULAR FONT, STYLE, SIZE, OR COLOR.

SN 77-817,978, FILED 9-1-2009.

MICHAEL WIENER, EXAMINING ATTORNEY



David J. Kybas

Director of the United States Patent and Trademark Office

United States of America

United States Patent and Trademark Office



Reg. No. 4,206,298

Registered Sep. 11, 2012

Int. Cls.: 10, 42, and 44

TRADEMARK

SERVICE MARK

PRINCIPAL REGISTER

CNS THERAPEUTICS, INC. (DELAWARE CORPORATION)
SUITE W1750
332 MINNESOTA STREET
ST. PAUL, MN 55101

FOR: MEDICAL APPARATUS FOR INTRODUCING PHARMACEUTICAL PREPARATIONS INTO THE HUMAN BODY , IN CLASS 10 (U.S. CLS. 26, 39 AND 44).

FIRST USE 10-2-2009; IN COMMERCE 10-30-2011.

FOR: PHARMACEUTICAL DRUG DEVELOPMENT SERVICES; PHARMACEUTICAL RESEARCH AND DEVELOPMENT, IN CLASS 42 (U.S. CLS. 100 AND 101).

FIRST USE 10-1-2009; IN COMMERCE 10-30-2011.

FOR: DISPENSING OF PHARMACEUTICALS, IN CLASS 44 (U.S. CLS. 100 AND 101).

FIRST USE 10-2-2009; IN COMMERCE 10-30-2011.

NO CLAIM IS MADE TO THE EXCLUSIVE RIGHT TO USE "CNS THERAPEUTICS", APART FROM THE MARK AS SHOWN.

THE COLOR(S) WHITE, BLUE AND BLACK IS/ARE CLAIMED AS A FEATURE OF THE MARK.

THE MARK CONSISTS OF THE LETTERS "CNS" SHOWN IN WHITE WITHIN A BLUE CIRCULAR-SHAPED DESIGN FEATURING A RIGHT ANGLE IN THE UPPER RIGHT QUADRANT AND THE WORD "THERAPEUTICS" APPEARING IN THE COLOR BLACK.

SN 77-818,727, FILED 9-2-2009.

DAVID YONTEF, EXAMINING ATTORNEY



David J. Kyfos

Director of the United States Patent and Trademark Office

United States of America

United States Patent and Trademark Office

SDIX

Reg. No. 4,206,299

Registered Sep. 11, 2012

Int. Cls.: 1, 39, 40, and 42

TRADEMARK

SERVICE MARK

PRINCIPAL REGISTER

STRATEGIC DIAGNOSTICS INC. (DELAWARE CORPORATION)
111 PENCADER DRIVE
NEWARK, DE 19702

FOR: TEST KITS CONSISTING PRIMARILY OF REAGENTS FOR SCIENTIFIC USE; DIAGNOSTIC PREPARATIONS IN THE NATURE OF ANTIBODIES FOR INDUSTRIAL, SCIENTIFIC AND RESEARCH USE; ANTIBODY COMPOSITIONS FOR THE DISCOVERY AND DEVELOPMENT OF BIOMARKERS AND CREATION OF BIOMARKER ASSAYS FOR SCIENTIFIC OR RESEARCH USE, IN CLASS 1 (U.S. CLS. 1, 5, 6, 10, 26 AND 46).

FIRST USE 2-10-2010; IN COMMERCE 2-10-2010.

FOR: HYBRIDOMA CELL LINE STORAGE, IN CLASS 39 (U.S. CLS. 100 AND 105).

FIRST USE 2-10-2010; IN COMMERCE 2-10-2010.

FOR: CUSTOM ANTIBODY PRODUCTION AND GENERATION; CUSTOM MANUFACTURE OF ANTIBODIES FOR OTHERS; ANTIBODY PURIFICATION; ANTIBODY FRAGMENTATION; CUSTOM MANUFACTURE OF MONOCLONAL AND POLYCLONAL ANTIBODIES FOR OTHERS, IN CLASS 40 (U.S. CLS. 100, 103 AND 106).

FIRST USE 2-10-2010; IN COMMERCE 2-10-2010.

FOR: SCIENTIFIC LABORATORIES PERFORMING ANTIBODY SCREENING, ANTIBODY LABELING, ANTIBODY TESTING AND HYBRIDOMA CELL LINE DEVELOPMENT; SCIENTIFIC RESEARCH AND DEVELOPMENT, NAMELY, DEVELOPMENT OF MONOCLONAL AND POLYCLONAL ANTIBODIES FOR OTHERS; SCIENTIFIC RESEARCH AND DEVELOPMENT, NAMELY, DEVELOPMENT OF IMMUNOASSAY TESTING PROCEDURES FOR OTHERS; RESEARCH AND DEVELOPMENT OF THERAPEUTICS, IN CLASS 42 (U.S. CLS. 100 AND 101).

FIRST USE 2-10-2010; IN COMMERCE 2-10-2010.

THE MARK CONSISTS OF STANDARD CHARACTERS WITHOUT CLAIM TO ANY PARTICULAR FONT, STYLE, SIZE, OR COLOR.

OWNER OF U.S. REG. NO. 1,978,330.



David J. Kyros

Director of the United States Patent and Trademark Office

Reg. No. 4,206,299 SN 77-835,235, FILED 9-25-2009.

DEZMONA MIZELLE, EXAMINING ATTORNEY

United States of America

United States Patent and Trademark Office



Reg. No. 4,206,300

Registered Sep. 11, 2012

Int. Cl.: 28

TRADEMARK

PRINCIPAL REGISTER

BLUE BOX TOY FACTORY LIMITED (HONG KONG CORPORATION)
98 GRANVILLE ROAD, TSIM SHA TSUI EAST
ROOM 1203, EAST OCEAN CENTRE
KOWLOON, HONG KONG

FOR: GAMES AND PLAYTHINGS FOR INFANTS AND PRE-SCHOOL CHILDREN, NAMELY, BABY MULTIPLE ACTIVITY TOYS, BATH TOYS, BATHTUB TOYS, CHILDREN'S MULTIPLE ACTIVITY TOYS, CRIB TOYS, INFANT ACTION CRIB TOYS, INFANT DEVELOPMENT TOYS, INFANT TOYS, SQUEEZABLE SQUEAKING TOYS, BABY RATTLES INCORPORATING TEETHING RINGS, BABY RATTLES, INFANT'S RATTLES, PLUSH TOYS, SOFT TOYS, NAMELY, MULTI-ACTIVITY TOYS, JUNGLE GYMS, MOBILES, AND BABY RATTLES, AND PLASTIC TOYS, NAMELY, MULTI-ACTIVITY TOYS, BATH TOYS, BABY RATTLES, IN CLASS 28 (U.S. CLS. 22, 23, 38 AND 50).

FIRST USE 1-0-2010; IN COMMERCE 0-0-2010.

NO CLAIM IS MADE TO THE EXCLUSIVE RIGHT TO USE "KIDS", APART FROM THE MARK AS SHOWN.

THE MARK CONSISTS OF A LARGE LETTER "B" ABOVE THE WORD "KIDS" IN LOWERCASE LETTERS WITHIN A RECTANGULAR BACKGROUND DESIGN.

SN 77-835,267, FILED 9-25-2009.

KATHERINE STOIDES, EXAMINING ATTORNEY



David J. Kybas

Director of the United States Patent and Trademark Office

United States of America

United States Patent and Trademark Office

OB-X

Reg. No. 4,206,301

Registered Sep. 11, 2012

Int. Cl.: 5

TRADEMARK

PRINCIPAL REGISTER

ANGIOLAB., INC. (REPUBLIC OF KOREA CORPORATION)
EXPO PARK, 3-1 DORYONG-DONG, YUSEONG-GU
BIO-DIAGNOSTIC FUSION CENTER
DAEJEON, REPUBLIC OF KOREA 305340

FOR: PHARMACEUTICAL PREPARATIONS FOR THE TREATMENT OF ANGIOGENESIS-DEPENDENT DISEASES, NAMELY, OBESITY, CANCER, ARTHRITIS, PSORIASIS, AND OCULAR DISEASES, AND DIAGNOSTIC PREPARATIONS FOR VETERINARY USE FOR THE TREATMENT OF ANGIOGENESIS-DEPENDENT DISEASES; DIETARY SUPPLEMENTS AND DIETETIC FOODS ADAPTED FOR MEDICAL USE FOR THE TREATMENT OF ANGIOGENESIS-DEPENDENT DISEASES, NAMELY, OBESITY, CANCER, ARTHRITIS, PSORIASIS, AND OCULAR DISEASES, IN CLASS 5 (U.S. CLS. 6, 18, 44, 46, 51 AND 52).

FIRST USE 4-5-2006; IN COMMERCE 1-0-2010.

THE MARK CONSISTS OF STANDARD CHARACTERS WITHOUT CLAIM TO ANY PARTICULAR FONT, STYLE, SIZE, OR COLOR.

SN 77-838,545, FILED 9-30-2009.

SETH A. RAPPAPORT, EXAMINING ATTORNEY



David J. Kyjars

Director of the United States Patent and Trademark Office

United States of America

United States Patent and Trademark Office

Do-It-Together

Reg. No. 4,206,302

MOOMAH LLC (NEW YORK LIMITED LIABILITY COMPANY)
161 HUDSON ST. #1C
NEW YORK, NY 10013

Registered Sep. 11, 2012

Int. Cls.: 16, 20, and 24

FOR: ARTS AND CRAFTS PUPPET KITS COMPRISED PRIMARILY OF PAPER, GLUE FOR HOUSEHOLD USE, CRAYONS, YARN, STICKERS, FELT CLOTH, COTTON FABRIC, SYNTHETIC FIBER FABRIC, SEWING THREADS, SEWING NEEDLES, PRE-CUT PAPER DIE CUT SHAPES, PRE-CUT PLASTIC SHAPES IN THE NATURE OF STENCILS, DECORATIVE GLITTER, BUTTONS, WRITING IMPLEMENTS, DECORATIVE STICKERS, AND STUFFING MADE OF SYNTHETIC OR NATURAL FIBER; ARTS AND CRAFTS COLLAGE KITS, COMPRISED PRIMARILY OF PAPER, GLUE FOR HOUSEHOLD USE, PAPER DIE-CUT SHAPES; ARTS AND CRAFTS DECOUPAGE KITS, NAMELY, ARTS AND CRAFTS PAINT KITS; ARTS AND CRAFTS SILHOUETTE KITS, COMPRISED PRIMARILY OF PAPER, GLUE FOR HOUSEHOLD USE, TRACING PAPER, PAPER DIE-CUT SHAPES; ARTS AND CRAFTS PAINT KITS; ARTS AND CRAFTS SCIENCE KITS COMPRISED PRIMARILY OF PAPER, GLUE FOR HOUSEHOLD USE, TRACING PAPER, DRAWING RULERS, PAPER DIE-CUT SHAPES, WRITING IMPLEMENTS; ARTS AND CRAFTS KITS COMPRISED PRIMARILY OF CRAYONS, PAPER, PRE-CUT WOOD SHAPES IN THE NATURE OF STENCILS AND GLUE FOR HOUSEHOLD USE AND ALSO CONTAINING FINGER PAINTS, OIL-BASED PAINTS AND WATER-BASED PAINTS, FRAMES MADE OF PLASTIC OR METAL TO HOLD FABRIC IN PLACE FOR EMBROIDERY, THREADS, NEEDLES FOR SEWING OR EMBROIDERY, FELT CLOTH, COTTON FABRIC, SYNTHETIC FIBER FABRIC, BEADS FOR HANDICRAFT WORK, UNPROCESSED GRAINS FOR DECORATIVE USE, AND ITEMS OCCURRING IN NATURE FOR ORNAMENTATION, NAMELY, FEATHERS, PINE CONES, PLANTS, SHELLS, SOILS, SEEDS, ROCKS, AND SAND ALL FOR DECORATIVE USE, IN CLASS 16 (U.S. CLS. 2, 5, 22, 23, 29, 37, 38 AND 50).

TRADEMARK

PRINCIPAL REGISTER



FIRST USE 5-0-2009; IN COMMERCE 5-0-2009.

FOR: ARTS AND CRAFTS SHADOWBOX KITS COMPRISED PRIMARILY OF SHADOW BOXES, FIGURINES MADE OF PLASTIC, PAPER OR FABRIC, SHADOW BOX BACKGROUND PATTERNS AND IMAGES, BEING SOLD AS A UNIT, IN CLASS 20 (U.S. CLS. 2, 13, 22, 25, 32 AND 50).

FIRST USE 5-0-2009; IN COMMERCE 5-0-2009.

David J. Kyffers

Director of the United States Patent and Trademark Office

Reg. No. 4,206,302 FOR: ARTS AND CRAFTS EMBROIDERY KITS, COMPRISED PRIMARILY OF EMBROIDERY CANVAS, FRAMES MADE OF PLASTIC OR METAL TO HOLD FABRIC IN PLACE FOR EMBROIDERY, EMBROIDERY THREAD, WOVEN FABRICS IN THE NATURE OF BURLAP, STENCILS, STAMPING INK, WRITING INK AND FELT, SOLD AS A UNIT; ARTS AND CRAFTS SEWING KITS, COMPRISED PRIMARILY OF TEXTILE FABRICS FOR USE IN MAKING CLOTHING AND HOUSEHOLD FURNISHINGS, SEWING THREAD, ALL-PURPOSE CARRYING BAGS, BOOK BAGS, SCHOOL BAGS, LUNCH BAGS, PAPER BAGS, GIFT BAGS MADE OF PAPER, PLASTIC OR SYNTHETIC FIBER FABRIC AND GOODIE BAGS MADE OF PAPER, PLASTIC OR SYNTHETIC FIBER FABRIC, APRONS, AND BACKPACKS ON WHICH TO SEW DECORATIVE DESIGNS, BUTTONS, STENCILS, AND FABRIC PAINTS, SOLD AS A UNIT, IN CLASS 24 (U.S. CLS. 42 AND 50).

FIRST USE 5-0-2009; IN COMMERCE 5-0-2009.

THE MARK CONSISTS OF STANDARD CHARACTERS WITHOUT CLAIM TO ANY PARTICULAR FONT, STYLE, SIZE, OR COLOR.

SN 77-840,356, FILED 10-2-2009.

KATHERINE E. HALMEN, EXAMINING ATTORNEY

United States of America

United States Patent and Trademark Office

XTS

Reg. No. 4,206,303

GENERAL MOTORS LLC (DELAWARE LIMITED LIABILITY COMPANY)
300 RENAISSANCE CENTER
DETROIT, MI 482653000

Registered Sep. 11, 2012

Int. Cl.: 12

FOR: MOTOR LAND VEHICLES, NAMELY, AUTOMOBILES, SPORT UTILITY VEHICLES, TRUCKS AND VANS, IN CLASS 12 (U.S. CLS. 19, 21, 23, 31, 35 AND 44).

TRADEMARK

FIRST USE 5-31-2012; IN COMMERCE 5-31-2012.

PRINCIPAL REGISTER

THE MARK CONSISTS OF STANDARD CHARACTERS WITHOUT CLAIM TO ANY PARTICULAR FONT, STYLE, SIZE, OR COLOR.

SN 77-850,143, FILED 10-16-2009.

ZHALEH DELANEY, EXAMINING ATTORNEY



David J. Kybas

Director of the United States Patent and Trademark Office

United States of America

United States Patent and Trademark Office

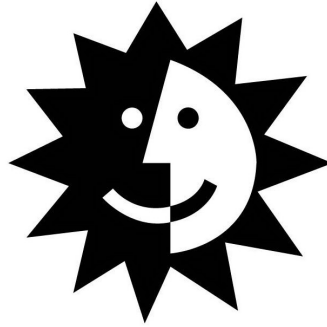

Reg. No. 4,206,304

Registered Sep. 11, 2012

Int. Cls.: 9, 39, 40, and 42

TRADEMARK

SERVICE MARK

PRINCIPAL REGISTER

ADVANCED SEMICONDUCTOR ENGINEERING, INC. (TAIWAN CORPORATION)
NO.26, JINGSAN RD., NANTZ CHIU
KAOHSIUNG, TAIWAN 811

FOR: CIRCUIT BOARD; SEMICONDUCTOR; SEMICONDUCTOR SUBSTRATE; MICRO-CIRCUIT; INTEGRATED CIRCUIT; ELECTRONIC CIRCUIT; PRINTED CIRCUIT BOARD; SEMICONDUCTOR CHIP; SEMICONDUCTOR COMPONENT; INTEGRATED CIRCUIT BOARD; SEMICONDUCTOR WAFERS; WAFER BUMPS BEING COMPONENTS OF SEMICONDUCTOR CHIPS AND SEMICONDUCTOR DEVICES; SEMICONDUCTOR PACKAGE CONTAINING SEMICONDUCTORS, SEMICONDUCTOR CHIP, OR SEMICONDUCTOR DEVICE, IN CLASS 9 (U.S. CLS. 21, 23, 26, 36 AND 38).

FIRST USE 5-1-2012; IN COMMERCE 5-1-2012.

FOR: PROCESSING OF SEMICONDUCTOR PACKAGING AND INTEGRATED CIRCUIT PACKAGING, NAMELY, PACKAGING ARTICLES TO THE ORDER AND SPECIFICATION OF OTHERS, IN CLASS 39 (U.S. CLS. 100 AND 105).

FIRST USE 5-1-2012; IN COMMERCE 5-1-2012.

FOR: ETCHING AND PROCESSING IN THE NATURE OF CUSTOM MANUFACTURE OF SEMICONDUCTOR WAFERS; ETCHING AND PROCESSING IN THE NATURE OF CUSTOM MANUFACTURE OF INTEGRATED CIRCUITS; PROCESSING IN THE NATURE OF CUSTOM MANUFACTURE OF SEMICONDUCTOR WAFERS; CUSTOM WAFER MANUFACTURING; CUSTOM MANUFACTURING AND PROCESSING IN THE NATURE OF CUSTOM MANUFACTURE OF SUBSTRATES; MANUFACTURE OF SUBSTRATES, SEMICONDUCTORS, INTEGRATED CIRCUITS, INTEGRATED CIRCUIT BOARDS AND SEMICONDUCTOR WAFERS TO THE ORDER AND SPECIFICATION OF OTHERS, IN CLASS 40 (U.S. CLS. 100, 103 AND 106).

FIRST USE 5-1-2012; IN COMMERCE 5-1-2012.

FOR: RESEARCH AND DEVELOPMENT FOR OTHERS OF SEMICONDUCTORS AND RELATED PRODUCTS; SEMICONDUCTOR PACKAGING DESIGN FOR OTHERS; INTEGRATED CIRCUIT DESIGN FOR OTHERS; SUBSTRATE DESIGN FOR OTHERS; QUALITY EVALUATION FOR OTHERS OF SEMICONDUCTORS AND RELATED PRODUCTS; TESTING OF NEW PRODUCTS IN THE NATURE OF SEMICONDUCTORS AND RELATED PRODUCTS,



David J. Kyffers

Director of the United States Patent and Trademark Office

Reg. No. 4,206,304 FOR OTHERS; QUALITY CONTROL FOR OTHERS IN THE FIELD OF SEMICONDUCTORS AND RELATED PRODUCTS; TECHNICAL CONSULTATION IN THE FIELD OF SEMICONDUCTOR PACKAGING TECHNOLOGY, IN CLASS 42 (U.S. CLS. 100 AND 101).

FIRST USE 5-1-2012; IN COMMERCE 5-1-2012.

THE MARK CONSISTS OF A HALF SUN, HALF MOON CHARACTER WITH A SMILING FACE.

SN 77-852,432, FILED 10-20-2009.

ALICE BENMAMAN, EXAMINING ATTORNEY

United States of America

United States Patent and Trademark Office

TRIVIA TONITE

Reg. No. 4,206,305

WISE, JOHN (UNITED STATES INDIVIDUAL)
1125 WHITTINGHAM PL.
ROSWELL, GA 30075

Registered Sep. 11, 2012

Int. Cl.: 41

FOR: ENTERTAINMENT SERVICES, NAMELY, HOSTING A LIVE TRIVIA GAME PLAYED IN EATING AND DRINKING ESTABLISHMENTS, IN CLASS 41 (U.S. CLS. 100, 101 AND 107).

SERVICE MARK

FIRST USE 5-31-2012; IN COMMERCE 5-31-2012.

PRINCIPAL REGISTER

THE MARK CONSISTS OF STANDARD CHARACTERS WITHOUT CLAIM TO ANY PARTICULAR FONT, STYLE, SIZE, OR COLOR.

NO CLAIM IS MADE TO THE EXCLUSIVE RIGHT TO USE "TRIVIA", APART FROM THE MARK AS SHOWN.

SN 77-852,686, FILED 10-20-2009.

MICHAEL SOUDERS, EXAMINING ATTORNEY



David J. Kybas

Director of the United States Patent and Trademark Office

United States of America

United States Patent and Trademark Office

INTERNATIONAL ICON

Reg. No. 4,206,306

Registered Sep. 11, 2012

Int. Cls.: 9 and 41

TRADEMARK

SERVICE MARK

PRINCIPAL REGISTER

UNGER, PAULA (UNITED STATES INDIVIDUAL)
C/O KOENIG & ASSOCIATES
920 GARDEN STREET, SUITE A
SANTA BARBARA, CA 93101

FOR: PRE-RECORDED DIGITAL VIDEO DISCS OR DVDS, FEATURING ENTERTAINMENT FOR CHILDREN, NAMELY, MUSIC, STORIES, AND ANIMATION, PERFORMANCES, FOR CHILDREN; SOUND RECORDINGS, NAMELY, MUSICAL SOUND RECORDINGS; DOWNLOADABLE FILMS AND TELEVISION PROGRAMS FEATURING COMEDY, DRAMA, ACTION, ADVENTURE AND ANIMATION PROVIDED VIA A VIDEO-ON-DEMAND SERVICE, IN CLASS 9 (U.S. CLS. 21, 23, 26, 36 AND 38).

FIRST USE 4-9-2012; IN COMMERCE 4-9-2012.

FOR: ENTERTAINMENT AND EDUCATION SERVICES IN THE NATURE OF ON-LINE MUSICAL PERFORMANCES FROM CARTOON CHARACTERS; ENTERTAINMENT SERVICES IN THE NATURE OF AN ANIMATION PROGRAM PROVIDED THROUGH THE GLOBAL COMPUTER INFORMATION NETWORK, INTERNET STREAMING, AND VIDEO-ON-DEMAND; ENTERTAINMENT SERVICES, NAMELY, PROVIDING A WEB SITE FEATURING MUSICAL PERFORMANCES, MUSICAL VIDEOS, RELATED FILM CLIPS, PHOTOGRAPHS, AND OTHER MULTIMEDIA MATERIALS FEATURING ANIMATED CHARACTERS; ENTERTAINMENT SERVICES, NAMELY, THE PROVISION OF CONTINUING PROGRAMS, VIDEOS, VIDEO AND AUDIO SEGMENTS, MOVIES, AND ONLINE SHOWS FEATURING ANIMATION, COMEDY, ETC. DELIVERED BY ONLINE MEDIA, NAMELY, TELEVISION, RADIO, SATELLITE, THE INTERNET, AND LIVE; ENTERTAINMENT SERVICES, NAMELY, PROVIDING NONDOWNLOADABLE PRERECORDED MUSIC ON-LINE VIA A GLOBAL COMPUTER NETWORK; ENTERTAINMENT SERVICES, NAMELY, PROVIDING AN ONGOING ON-LINE VIDEO PROGRAM IN THE NATURE OF INTERSTITIALS IN THE FIELDS OF ANIMATED CARTOONS, IN CLASS 41 (U.S. CLS. 100, 101 AND 107).

FIRST USE 4-9-2012; IN COMMERCE 4-9-2012.

THE MARK CONSISTS OF STANDARD CHARACTERS WITHOUT CLAIM TO ANY PARTICULAR FONT, STYLE, SIZE, OR COLOR.

SN 77-861,872, FILED 10-30-2009.



David J. Kyros

Director of the United States Patent and Trademark Office

Reg. No. 4,206,306 WANDA KAY PRICE, EXAMINING ATTORNEY

United States of America

United States Patent and Trademark Office

WALLFLOWER

Reg. No. 4,206,307

Registered Sep. 11, 2012

Int. Cls.: 38 and 45

SERVICE MARK

PRINCIPAL REGISTER

THEODOR K. SEDLMAYR (UNITED STATES INDIVIDUAL)
200 PARK AVENUE SOUTH, SUITE 1408
C/O SEDLMAYR & ASSOCIATES, P.C.
NEW YORK, NY 10003

FOR: MOBILE SOCIAL NETWORKING SERVICES, NAMELY, PROVIDING WIRELESS DIGITAL MESSAGING SERVICES, IN CLASS 38 (U.S. CLS. 100, 101 AND 104).

FIRST USE 3-21-2012; IN COMMERCE 3-21-2012.

FOR: ONLINE AND MOBILE PHONE BASED SOCIAL NETWORKING SERVICES, IN CLASS 45 (U.S. CLS. 100 AND 101).

FIRST USE 3-21-2012; IN COMMERCE 3-21-2012.

THE MARK CONSISTS OF STANDARD CHARACTERS WITHOUT CLAIM TO ANY PARTICULAR FONT, STYLE, SIZE, OR COLOR.

SN 77-865,582, FILED 11-5-2009.

KIMBERLY FRYE, EXAMINING ATTORNEY



David J. Kyros

Director of the United States Patent and Trademark Office

United States of America

United States Patent and Trademark Office

LFD

Reg. No. 4,206,308

Registered Sep. 11, 2012

Int. Cl.: 9

TRADEMARK

PRINCIPAL REGISTER

SAMSUNG ELECTRONICS CO., LTD. (REPUBLIC OF KOREA CORPORATION)
416 MAETAN-DONG, YEONGTONG-GU, SUWON-SI
GYEONGGI-DO, REPUBLIC OF KOREA

FOR: LARGE SIZE DISPLAY APPARATUS, NAMELY, LCD LARGE-SCREEN DISPLAYS;
LARGE SIZE ELECTRIC BULLETIN BOARDS, IN CLASS 9 (U.S. CLS. 21, 23, 26, 36 AND
38).

FIRST USE 6-30-2005; IN COMMERCE 6-30-2005.

THE MARK CONSISTS OF STANDARD CHARACTERS WITHOUT CLAIM TO ANY PAR-
TICULAR FONT, STYLE, SIZE, OR COLOR.

SN 77-865,811, FILED 11-5-2009.

JESSICA FATHY, EXAMINING ATTORNEY



David J. Kyros

Director of the United States Patent and Trademark Office

United States of America
United States Patent and Trademark Office

ROBOTAP

Reg. No. 4,206,309

Registered Sep. 11, 2012

Int. Cl.: 37

SERVICE MARK

PRINCIPAL REGISTER

WPW, LLC (COLORADO LIMITED LIABILITY COMPANY)
68 CONTINENTAL COURT
UNIT B9
BRECKENRIDGE, CO 80424

FOR: WATER MAIN REHABILITATION SERVICES, IN CLASS 37 (U.S. CLS. 100, 103 AND 106).

FIRST USE 1-0-2010; IN COMMERCE 1-0-2010.

THE MARK CONSISTS OF STANDARD CHARACTERS WITHOUT CLAIM TO ANY PARTICULAR FONT, STYLE, SIZE, OR COLOR.

SN 77-867,339, FILED 11-6-2009.

JIM RINGLE, EXAMINING ATTORNEY



David J. Kybas

Director of the United States Patent and Trademark Office

United States of America

United States Patent and Trademark Office

SNAPRODUCTS

Reg. No. 4,206,310

SALES & PRODUCT SOLUTIONS, INC., (ILLINOIS CORPORATION)
3180 MACARTHUR BLVD
NORTHBROOK, IL 60062

Registered Sep. 11, 2012

Int. Cl.: 3

FOR: BATH AND BODY CARE PRODUCTS AND ACCESSORIES, NAMELY, HOT AND COLD REUSABLE EYE COMPRESSES FOR BEAUTY AND COSMETIC USES, COSMETICS, COSMETIC PADS, BUBBLE BATHS, BATH GELS, BATH LOTIONS, NON-MEDICATED BATH SALTS, BATH PEARLS, SKIN SOAPS, BODY LOTIONS, SKIN CREAMS, BODY WASHES, BODY SPRAYS, PUMICE STONES FOR PERSONAL USE, BODY SCRUBS, IN CLASS 3 (U.S. CLS. 1, 4, 6, 50, 51 AND 52).

TRADEMARK

PRINCIPAL REGISTER

FIRST USE 12-0-2007; IN COMMERCE 12-0-2007.

THE MARK CONSISTS OF STANDARD CHARACTERS WITHOUT CLAIM TO ANY PARTICULAR FONT, STYLE, SIZE, OR COLOR.

SN 77-868,534, FILED 11-9-2009.

TARAH HARDY, EXAMINING ATTORNEY



David J. Kyros

Director of the United States Patent and Trademark Office

United States of America

United States Patent and Trademark Office

PROGRESSIVE PRO-STIM PLUS

Reg. No. 4,206,311

Registered Sep. 11, 2012

Int. Cl.: 10

TRADEMARK

PRINCIPAL REGISTER

PROGRESSIVE ORTHOPEDIC SOLUTIONS, LLC (CALIFORNIA LIMITED LIABILITY COMPANY)

12155 MORA DRIVE, SUITE 6
SANTA FE SPRINGS, CA 90670

FOR: ELECTROMEDICAL REHABILITATIVE AND PAIN MANAGEMENT PRODUCTS FOR CLINICAL AND HOME USE, NAMELY, ELECTRICAL NERVE AND MUSCLE STIMULATORS, ULTRASONIC STIMULATORS, MAGNET THERAPY STIMULATORS AND LASER THERAPY STIMULATORS, IN CLASS 10 (U.S. CLS. 26, 39 AND 44).

FIRST USE 1-1-2008; IN COMMERCE 1-1-2008.

THE MARK CONSISTS OF STANDARD CHARACTERS WITHOUT CLAIM TO ANY PARTICULAR FONT, STYLE, SIZE, OR COLOR.

SN 77-868,796, FILED 11-9-2009.

SHARON MEIER, EXAMINING ATTORNEY



David J. Kybas

Director of the United States Patent and Trademark Office

United States of America

United States Patent and Trademark Office

OPTIMUM REHAB KIT

Reg. No. 4,206,312

Registered Sep. 11, 2012

Int. Cl.: 10

TRADEMARK

PRINCIPAL REGISTER

PROGRESSIVE ORTHOPEDIC SOLUTIONS, LLC (CALIFORNIA LIMITED LIABILITY COMPANY)

12155 MORA DRIVE, SUITE 6
SANTA FE SPRINGS, CA 90670

FOR: PHYSICAL REHABILITATION, PHYSICAL THERAPY AND SPORTS MEDICINE EQUIPMENT ALL DESIGNED SPECIFICALLY FOR MEDICAL USE, NAMELY, SHOULDER STRETCHER USING A CABLE; PHYSICAL REHABILITATION, PHYSICAL THERAPY AND SPORTS MEDICINE EQUIPMENT ALL DESIGNED SPECIFICALLY FOR MEDICAL USE, NAMELY, SHOULDER STRETCHER USING RESISTANCE CABLES, IN CLASS 10 (U.S. CLS. 26, 39 AND 44).

FIRST USE 1-1-2010; IN COMMERCE 1-1-2011.

THE MARK CONSISTS OF STANDARD CHARACTERS WITHOUT CLAIM TO ANY PARTICULAR FONT, STYLE, SIZE, OR COLOR.

NO CLAIM IS MADE TO THE EXCLUSIVE RIGHT TO USE "REHAB KIT", APART FROM THE MARK AS SHOWN.

SN 77-869,593, FILED 11-10-2009.

SHARON MEIER, EXAMINING ATTORNEY



David J. Kybas

Director of the United States Patent and Trademark Office

United States of America

United States Patent and Trademark Office

HAT-TRICK THERAPY SYSTEM

Reg. No. 4,206,313

Registered Sep. 11, 2012

Int. Cl.: 10

TRADEMARK

PRINCIPAL REGISTER

PROGRESSIVE ORTHOPEDIC SOLUTIONS, LLC (CALIFORNIA LIMITED LIABILITY COMPANY)

12155 MORA DRIVE, SUITE 6
SANTA FE SPRINGS, CA 90670

FOR: ELECTROTHERAPY DEVICES FOR PROVIDING TRANSCUTANEOUS ELECTRICAL NERVE STIMULATION, INFRARED HEAT AND COMPRESSION, IN CLASS 10 (U.S. CLS. 26, 39 AND 44).

FIRST USE 9-1-2009; IN COMMERCE 9-1-2009.

THE MARK CONSISTS OF STANDARD CHARACTERS WITHOUT CLAIM TO ANY PARTICULAR FONT, STYLE, SIZE, OR COLOR.

NO CLAIM IS MADE TO THE EXCLUSIVE RIGHT TO USE "THERAPY SYSTEM", APART FROM THE MARK AS SHOWN.

SN 77-869,599, FILED 11-10-2009.

SHARON MEIER, EXAMINING ATTORNEY



David J. Kybas

Director of the United States Patent and Trademark Office

United States of America

United States Patent and Trademark Office

PROTETITE

Reg. No. 4,206,314

Registered Sep. 11, 2012

Int. Cl.: 5

TRADEMARK

PRINCIPAL REGISTER

RBS CO., LTD. (JAPAN CORPORATION)
2-2-41, KOSHIBARA, MATSUE-SHI
SHIMANE, JAPAN

FOR: DIETARY SUPPLEMENTS CONTAINING COLLAGEN IN THE FORM OF POWDER; DIETARY SUPPLEMENTS CONTAINING APATITE EXTRACTED FROM FISH SCALES IN THE FORM OF POWDER; DIETARY SUPPLEMENTS CONTAINING MINERAL INGREDIENTS EXTRACTED FROM FISH SCALES IN THE FORM OF POWDER; DIETARY SUPPLEMENTS CONTAINING COLLAGEN AND APATITE EXTRACTED FROM FISH SCALES IN THE FORM OF POWDER; DIETARY SUPPLEMENTS CONTAINING COLLAGEN AND MINERAL INGREDIENTS EXTRACTED FROM FISH SCALES IN THE FORM OF POWDER, IN CLASS 5 (U.S. CLS. 6, 18, 44, 46, 51 AND 52).

FIRST USE 1-20-2007; IN COMMERCE 8-10-2011.

THE MARK CONSISTS OF STANDARD CHARACTERS WITHOUT CLAIM TO ANY PARTICULAR FONT, STYLE, SIZE, OR COLOR.

SN 77-870,873, FILED 11-12-2009.

DAVID HOFFMAN, EXAMINING ATTORNEY



David J. Kyfos

Director of the United States Patent and Trademark Office

United States of America

United States Patent and Trademark Office

PIC A COLOUR

Reg. No. 4,206,315

MBA BEAUTY, INC. (DELAWARE CORPORATION)
4400 NORTHCORP PKWY
PALM BEACH GARDENS, FL 33410

Registered Sep. 11, 2012

Int. Cl.: 3

FOR: COSMETICS, IN CLASS 3 (U.S. CLS. 1, 4, 6, 50, 51 AND 52).

TRADEMARK

FIRST USE 9-15-2011; IN COMMERCE 9-15-2011.

PRINCIPAL REGISTER

THE MARK CONSISTS OF STANDARD CHARACTERS WITHOUT CLAIM TO ANY PARTICULAR FONT, STYLE, SIZE, OR COLOR.

SN 77-870,925, FILED 11-12-2009.

JAMES A. RAUEN, EXAMINING ATTORNEY



David J. Kyffers

Director of the United States Patent and Trademark Office

United States of America

United States Patent and Trademark Office

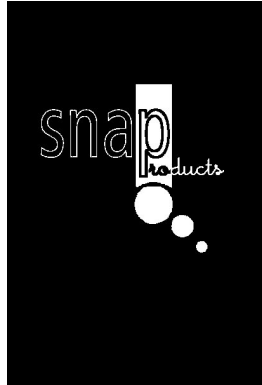

Reg. No. 4,206,316

Registered Sep. 11, 2012

Int. Cl.: 14

TRADEMARK

PRINCIPAL REGISTER

SALES & PRODUCT SOLUTIONS, INC., (ILLINOIS CORPORATION)
3180 MACARTHUR BLVD
NORTHBROOK, IL 60062

FOR: COSTUME JEWELRY, IN CLASS 14 (U.S. CLS. 2, 27, 28 AND 50).

FIRST USE 8-0-2008; IN COMMERCE 8-0-2008.

THE MARK CONSISTS OF THE WORD "SNAPRODUCTS" IN A RECTANGLE WITH AN EXCLAMATION MARK OVER THE LETTER "P" WITH THREE DOTS BELOW THE EXCLAMATION MARK.

SN 77-870,949, FILED 11-12-2009.

TARAH HARDY, EXAMINING ATTORNEY



David J. Kyffers

Director of the United States Patent and Trademark Office

United States of America

United States Patent and Trademark Office

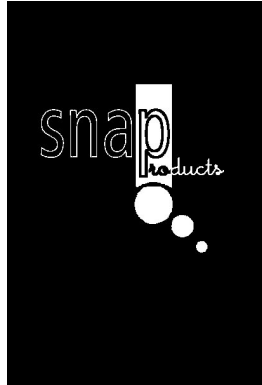

Reg. No. 4,206,317

Registered Sep. 11, 2012

Int. Cl.: 25

TRADEMARK

PRINCIPAL REGISTER

SALES & PRODUCT SOLUTIONS, INC., (ILLINOIS CORPORATION)
3180 MACARTHUR BLVD
NORTHBROOK, IL 60062

FOR: ADULT APPAREL, NAMELY, SCARVES, MITTENS AND HOSIERY; CHILDREN'S APPAREL, NAMELY, SLIPPERS AND HOSIERY; ADULT AND CHILDREN'S CASUAL FOOTWEAR; COTTON GLOVES FOR USE AFTER APPLYING MOISTURIZING LOTIONS, COTTON BOOTIES FOR USE AFTER APPLYING MOISTURIZING LOTIONS AND SLEEP MASKS, IN CLASS 25 (U.S. CLS. 22 AND 39).

FIRST USE 5-0-2010; IN COMMERCE 5-0-2010.

THE MARK CONSISTS OF THE WORD "SNAPRODUCTS" IN A RECTANGLE WITH AN EXCLAMATION MARK OVER THE LETTER "P" WITH THREE DOTS BELOW THE EXCLAMATION MARK.

SN 77-870,956, FILED 11-12-2009.

TARAH HARDY, EXAMINING ATTORNEY



David J. Kyjars

Director of the United States Patent and Trademark Office

United States of America

United States Patent and Trademark Office

LAURA SCOTT

Reg. No. 4,206,318

SEARS BRANDS, LLC (ILLINOIS LIMITED LIABILITY COMPANY)
3333 BEVERLY ROAD
HOFFMAN ESTATES, IL 60179

Registered Sep. 11, 2012

Int. Cl.: 25

FOR: FOOTWEAR, IN CLASS 25 (U.S. CLS. 22 AND 39).

TRADEMARK

FIRST USE 0-0-2006; IN COMMERCE 0-0-2006.

PRINCIPAL REGISTER

THE MARK CONSISTS OF STANDARD CHARACTERS WITHOUT CLAIM TO ANY PARTICULAR FONT, STYLE, SIZE, OR COLOR.

THE NAME(S), PORTRAIT(S), AND/OR SIGNATURE(S) SHOWN IN THE MARK DOES NOT IDENTIFY A PARTICULAR LIVING INDIVIDUAL.

SN 77-871,268, FILED 11-12-2009.

MARY CRAWFORD, EXAMINING ATTORNEY



David J. Kyffers

Director of the United States Patent and Trademark Office

United States of America

United States Patent and Trademark Office

PRET

Reg. No. 4,206,319

Registered Sep. 11, 2012

Int. Cl.: 9

TRADEMARK

PRINCIPAL REGISTER

PRET, INC. (DELAWARE CORPORATION)
P.O. BOX 680477
PARK CITY, UT 84068

FOR: PROTECTIVE HELMETS FOR SPORTS; SPORTS HELMETS; SAFETY HELMETS, IN CLASS 9 (U.S. CLS. 21, 23, 26, 36 AND 38).

FIRST USE 2-7-2010; IN COMMERCE 11-15-2011.

THE MARK CONSISTS OF STANDARD CHARACTERS WITHOUT CLAIM TO ANY PARTICULAR FONT, STYLE, SIZE, OR COLOR.

THE ENGLISH TRANSLATION OF "PRET" IN THE MARK IS "READY".

SN 77-878,884, FILED 11-23-2009.

JOHN WILKE, EXAMINING ATTORNEY



David J. Kybas

Director of the United States Patent and Trademark Office

United States of America

United States Patent and Trademark Office



Reg. No. 4,206,320

Registered Sep. 11, 2012

**Int. Cls.: 7, 8, 9, 17, 20,
and 22**

TRADEMARK

PRINCIPAL REGISTER

CITY ELECTRICAL FACTORS LIMITED (UNITED KINGDOM LIMITED COMPANY (LTD.))
141 FARMER WARD ROAD, KENILWORTH
WARWICKSHIRE, UNITED KINGDOM CV82SU

FOR: POWER OPERATED DRILLS; DRILL BITS FOR POWER OPERATED DRILLS; ELECTRIC DRILLS; CORDLESS ELECTRIC DRILLS; ELECTRIC HAND DRILLS; POWER OPERATED MITRE SAWS; CIRCULAR SAWS; ELECTRIC HOLE SAWS; ELECTRIC SAWS; MOTOR DRIVEN SAWS; POWER OPERATED SAWS; POWER OPERATED ANGLE GRINDERS; POWER TOOLS, NAMELY, ROUTERS; ELECTRIC SANDERS; LAWNMOWERS; JIGSAWS, IN CLASS 7 (U.S. CLS. 13, 19, 21, 23, 31, 34 AND 35).

FIRST USE 12-0-2009; IN COMMERCE 12-0-2009.

FOR: HAND OPERATED DRILLS AND DRILL BITS THEREOF; HAND TOOLS, NAMELY, AXES, PICK AXES, PICKS, CHISELS, SCREWDRIVERS, NUT DRIVERS, SPANNERS, WRENCHES, HAMMERS; HAND OPERATED GARDEN TOOLS, NAMELY, SHOVELS, SPADES, TROWELS, HOSE AND FORKS; EDGING TOOLS, NAMELY, HAND OPERATED LAWN EDGERS AND LAWN CLIPPERS; HAND TOOLS IN THE NATURE OF SCRAPERS; PRUNING SHEARS; SCISSORS; BLADES FOR HAND OPERATED CABLE CUTTERS; KNIVES; HAND TOOLS, NAMELY, CABLE CUTTERS, PIPE BENDERS, PIPE CUTTERS, WIRE STRIPPERS, PLIERS, SNIPS, CABLE PULLERS WITH MESH GRIP, FISH TAPE FOR PULLING CABLES, TERMINAL CRIMPERS, IN CLASS 8 (U.S. CLS. 23, 28 AND 44).

FIRST USE 12-0-2009; IN COMMERCE 12-0-2009.

FOR: LEVEL INDICATORS; MEASURING TOOLS, NAMELY, INSTRUMENTS FOR MEASURING LENGTH AND INSTRUMENTS FOR MEASURING ELECTRICAL CURRENT, TAPE MEASURES; ELECTRICAL TERMINALS IN THE NATURE OF ELECTRIC CONNECTORS AND EARTH TERMINALS, IN CLASS 9 (U.S. CLS. 21, 23, 26, 36 AND 38).

FIRST USE 12-0-2009; IN COMMERCE 12-0-2009.

FOR: CONDUCTING ELECTRICAL TAPE; PVC ELECTRICAL TAPE; INSULATING TAPE; ADHESIVES, NAMELY, SILICONE BASED ADHESIVES; COMMERCIAL AND INDUSTRIAL ADHESIVE TAPES FOR PACKING AND WRAPPING; SEALANTS, NAMELY, ADHESIVE SEALANTS FOR GENERAL USE, IN CLASS 17 (U.S. CLS. 1, 5, 12, 13, 35 AND 50).



David J. Kyros

Director of the United States Patent and Trademark Office

Reg. No. 4,206,320 FIRST USE 12-0-2009; IN COMMERCE 12-0-2009.

FOR: FASTENERS, NAMELY, NON METAL THREADED FASTENERS, IN CLASS 20 (U.S. CLS. 2, 13, 22, 25, 32 AND 50).

FIRST USE 12-0-2009; IN COMMERCE 12-0-2009.

FOR: CABLE TIES FOR FASTENING AND SECURING OBJECTS SUCH AS BUNDLES OF WIRE OR CABLE TOGETHER, IN CLASS 22 (U.S. CLS. 1, 2, 7, 19, 22, 42 AND 50).

FIRST USE 12-0-2009; IN COMMERCE 12-0-2009.

THE MARK CONSISTS OF "F4P" WITH THE WORDS "FIRST FOR PERFORMANCE" BELOW ALL IN A BOX.

SN 77-880,886, FILED 11-25-2009.

BRIAN PINO, EXAMINING ATTORNEY

United States of America

United States Patent and Trademark Office



Reg. No. 4,206,321

Registered Sep. 11, 2012

Int. Cl.: 33

TRADEMARK

PRINCIPAL REGISTER

CLOSED JOINT-STOCK COMPANY "BOUQUET OF MOLDOVA" (REPUBLIC MOLDOVA CORPORATION)
109 SVERDLOV STREET
DUBOSSARY, REPUBLIC MOLDOVA MD-4500

FOR: ALCOHOLIC BEVERAGES EXCEPT BEERS, IN CLASS 33 (U.S. CLS. 47 AND 49).

FIRST USE 5-12-2012; IN COMMERCE 5-12-2012.

NO CLAIM IS MADE TO THE EXCLUSIVE RIGHT TO USE THE NON-LATIN CHARACTERS THAT TRANSLITERATE TO "MOLDAVII DUBOSSARY", APART FROM THE MARK AS SHOWN.

THE COLOR(S) RED, WHITE, BLUE, BLACK AND GOLD IS/ARE CLAIMED AS A FEATURE OF THE MARK.

THE NON-LATIN CHARACTERS IN THE MARK TRANSLITERATE TO "BUKET MOLDAVII DUBOSSARY" AND THIS MEANS BOUQUET OF MOLDOVA DUBOSSARY IN ENGLISH.

THE MARK CONSISTS OF A RECTANGLE CONSISTING OF A RED TRIANGLE ABOVE A BLUE TRIANGLE, WHEREIN THE RECTANGLE IS SURROUNDED BY A GOLD FRAME AND CONTAINS WHITE CYRILLIC CHARACTERS; AND A RED BANNER WHICH CONTAINS WHITE CYRILLIC CHARACTERS AND IS CENTERED BENEATH THE RECTANGLE; THE RECTANGLE, THE CYRILLIC CHARACTERS AND THE BANNER ARE ALL OUTLINED IN BLACK.

SN 77-881,428, FILED 11-27-2009.

APRIL ROACH, EXAMINING ATTORNEY



David J. Kyros

Director of the United States Patent and Trademark Office

United States of America

United States Patent and Trademark Office

SUPERLIZZY

Reg. No. 4,206,322

Registered Sep. 11, 2012

Int. Cl.: 7

TRADEMARK

PRINCIPAL REGISTER

C.M.S. S.P.A. (ITALY CORPORATION)
VIA P. MIANI 254
41054 MARANO SUL PANARO
MODENA, ITALY

FOR: MACHINES FOR WASTE COMPACTING; SYSTEMS FOR WASTE COMPACTING,
NAMELY, WASTE COMPACTORS, IN CLASS 7 (U.S. CLS. 13, 19, 21, 23, 31, 34 AND 35).

FIRST USE 4-19-2012; IN COMMERCE 4-19-2012.

THE MARK CONSISTS OF STANDARD CHARACTERS WITHOUT CLAIM TO ANY PAR-
TICULAR FONT, STYLE, SIZE, OR COLOR.

SN 77-881,571, FILED 11-27-2009.

KEVIN CORWIN, EXAMINING ATTORNEY



David J. Kybas

Director of the United States Patent and Trademark Office

United States of America

United States Patent and Trademark Office

THEY'RE GR-R-REAT!

Reg. No. 4,206,323

Registered Sep. 11, 2012

Int. Cls.: 9, 21, and 25

TRADEMARK

PRINCIPAL REGISTER

KELLOGG NORTH AMERICA COMPANY (DELAWARE CORPORATION)
ONE KELLOGG SQUARE
PO BOX 3599
BATTLE CREEK, MI 49016

FOR: DECORATIVE MAGNETS, IN CLASS 9 (U.S. CLS. 21, 23, 26, 36 AND 38).

FIRST USE 6-30-2009; IN COMMERCE 6-30-2009.

FOR: BEVERAGEWARE, IN CLASS 21 (U.S. CLS. 2, 13, 23, 29, 30, 33, 40 AND 50).

FIRST USE 6-17-2008; IN COMMERCE 6-17-2008.

FOR: SHIRTS, IN CLASS 25 (U.S. CLS. 22 AND 39).

FIRST USE 1-25-2007; IN COMMERCE 1-25-2007.

THE MARK CONSISTS OF STANDARD CHARACTERS WITHOUT CLAIM TO ANY PARTICULAR FONT, STYLE, SIZE, OR COLOR.

OWNER OF U.S. REG. NO. 1,331,096.

SN 77-882,451, FILED 11-30-2009.

RAUL CORDOVA, EXAMINING ATTORNEY



David J. Kybas

Director of the United States Patent and Trademark Office

United States of America

United States Patent and Trademark Office



Reg. No. 4,206,324

Registered Sep. 11, 2012

Int. Cl.: 25

TRADEMARK

PRINCIPAL REGISTER

CRAZY PINEAPPLES, L.L.C. (NEW JERSEY LIMITED LIABILITY COMPANY)
146 STATE ROUTE 34
HOLMDEL, NJ 07733

FOR: SHIRTS, IN CLASS 25 (U.S. CLS. 22 AND 39).

FIRST USE 2-12-2012; IN COMMERCE 2-12-2012.

THE MARK CONSISTS OF TWO SMILING PINEAPPLES WITH MARKS INDICATING MOVEMENT AS IF THE PINEAPPLES ARE DANCING AND HAPPY.

SN 77-885,970, FILED 12-4-2009.

SCOTT BIBB, EXAMINING ATTORNEY



David J. Kybas

Director of the United States Patent and Trademark Office

United States of America

United States Patent and Trademark Office



Reg. No. 4,206,325

Registered Sep. 11, 2012

Int. Cl.: 30

TRADEMARK

PRINCIPAL REGISTER

HOSTESS BRANDS, INC. (DELAWARE CORPORATION)
6031 CONNECTION DRIVE, SUITE 600
IRVING, TX 75039

FOR: BAKERY GOODS, IN CLASS 30 (U.S. CL. 46).

FIRST USE 1-9-2011; IN COMMERCE 1-9-2011.

THE MARK CONSISTS OF A STYLIZED FIGURE WITH THE BODY BEING A BROWN CUPCAKE OUTLINED IN BLACK; THE FACIAL FEATURES OF EYES, MOUTH, SWIRLED MOUSTACHE AND EYEBROWS BEING BLACK AND WHITE, THE NOSE BEING A BLACK OUTLINE, AND THE BEARD BEING A WHITE SWIRL DESIGN OUTLINED IN BLACK EXTENDING THE LENGTH OF THE CUPCAKE; THE FEET BEING BLACK; THE ARMS HAVING BLUE SLEEVES WITH TWO YELLOW BANDS ON EACH, THE HANDS ARE WHITE OUTLINED IN BLACK; ON THE SHOULDERS ARE PURPLE EPAULETS OUTLINED IN BLACK, WITH A WHITE SWIRLED DESIGN AND A ROUND DESIGN ON EACH EPAULET, ALL OUTLINED IN BLACK; ATOP THE CUPCAKE FIGURE IS A BLUE HAT WITH A WHITE SWIRLED DESIGN OUTLINED IN BLACK ON THE FRONT OF THE HAT IS A BLACK BAND AND BILL WITH THE WORD "CAPTAIN" IN YELLOW ON THE BAND.

THE COLOR(S) BROWN, BLUE, PURPLE, YELLOW, BLACK AND WHITE IS/ARE CLAIMED AS A FEATURE OF THE MARK.

SN 77-887,729, FILED 12-7-2009.

DEZMONA MIZELLE, EXAMINING ATTORNEY



David J. Kyffers

Director of the United States Patent and Trademark Office

United States of America

United States Patent and Trademark Office



Reg. No. 4,206,326

Registered Sep. 11, 2012

Int. Cl.: 19

TRADEMARK

PRINCIPAL REGISTER

CERTAINTEED CORPORATION (DELAWARE CORPORATION)
750 E. SWEDESFORD ROAD
VALLEY FORGE, PA 194820101

FOR: ROOFING UNDERLAYMENT, IN CLASS 19 (U.S. CLS. 1, 12, 33 AND 50).

FIRST USE 1-15-2012; IN COMMERCE 1-15-2012.

THE MARK CONSISTS OF THE WORD "DRYROOF" AND A ROOF DESIGN.

SN 77-888,756, FILED 12-8-2009.

CHARLES L. JENKINS, EXAMINING ATTORNEY



David J. Kybas

Director of the United States Patent and Trademark Office

United States of America

United States Patent and Trademark Office



Reg. No. 4,206,327

Registered Sep. 11, 2012

Int. Cls.: 38 and 42

SERVICE MARK

PRINCIPAL REGISTER

TYZE PERSONAL NETWORKS LTD. (CANADA LIMITED COMPANY (LTD.))
6TH FLOOR - 210 W. BROADWAY
VANCOUVER, BC, CANADA V5Y3W2

FOR: PROVIDING INTERACTIVE DISCUSSIONS, NAMELY, ONLINE CHAT ROOMS, INSTANT MESSAGING AND ELECTRONIC BULLETIN BOARDS FOR TRANSMISSION OF MESSAGES AMONG NETWORK MEMBERS IN THE FIELD OF GENERAL INTEREST; PROVIDING ONLINE CHAT ROOMS AND ELECTRONIC BULLETIN BOARDS FOR TRANSMISSION OF MESSAGES AMONG USERS FOR THE PURPOSES OF BUILDING PERSONAL NETWORKS AND SHARING STORIES; PROVIDING ONLINE ELECTRONIC BULLETIN BOARDS FOR TRANSMISSION OF MESSAGES TO ENABLE ONLINE STORY TELLING, IN CLASS 38 (U.S. CLS. 100, 101 AND 104).

FIRST USE 6-1-2008; IN COMMERCE 2-1-2009.

FOR: PROVIDING AN ONLINE COMPUTER DATABASE FEATURING INFORMATION REGARDING COMMUNITIES, NAMELY, FEATURING INFORMATION REGARDING HOSTING ON-LINE COMMUNITY WEBSITES AND BEST PRACTICES FOR THE PURPOSE OF BUILDING PERSONAL NETWORKS AND SHARING STORIES; PROVIDING CUSTOMIZED ONLINE WEB PAGES FEATURING USER-DEFINED INFORMATION; PROVIDING AN ONLINE COMPUTER DATABASE FEATURING MEDIA SHARING, NAMELY, PROVIDING AN ONLINE NETWORK ENVIRONMENT THAT FEATURES TECHNOLOGY THAT ENABLES USERS TO SHARE DATA IN THE NATURE OF DIGITAL MEDIA; PROVIDING SERVICES RELATED TO THE DELIVERY OF MICROSITES FOR LOCALIZED USERS, NAMELY, PROVIDING AN ONLINE WEBSITE FOR CREATING AND HOSTING MICRO WEBSITES FOR LOCALIZED USERS; PROVIDING AN ONLINE COMPUTER DATABASE FEATURING ONLINE CALENDAR AND EVENT COORDINATION, NAMELY, HOSTING ONLINE INTERACTIVE PRIVATE CALENDARS THAT ALLOW MULTIPLE PARTICIPANTS TO SHARE EVENT SCHEDULES, STORIES, TASKS, GOALS, PERSONAL REQUESTS FOR SUPPORT AND TRANSPORTATION REQUESTS, IN CLASS 42 (U.S. CLS. 100 AND 101).

FIRST USE 6-1-2008; IN COMMERCE 2-1-2009.

THE MARK CONSISTS OF A FLOWER DESIGN MADE UP OF SOLID CIRCLES OF VARIOUS SIZES CONNECTED BY CURVED LINES AND CONTAINING DOTS, WITH THE LETTERS "TYZE" IN STYLIZED FONT TO THE RIGHT OF THE DESIGN.



David J. Kappas

Director of the United States Patent and Trademark Office

Reg. No. 4,206,327 THE WORDING "TYZE" HAS NO MEANING IN A FOREIGN LANGUAGE.

SN 77-893,199, FILED 12-14-2009.

JAMES MACFARLANE, EXAMINING ATTORNEY

United States of America

United States Patent and Trademark Office

TYZE

Reg. No. 4,206,328

Registered Sep. 11, 2012

Int. Cls.: 38 and 42

SERVICE MARK

PRINCIPAL REGISTER

TYZE PERSONAL NETWORKS LTD. (CANADA LIMITED COMPANY (LTD.))
6TH FLOOR - 210 W. BROADWAY
VANCOUVER, BC, CANADA V5Y3W2

FOR: PROVIDING INTERACTIVE DISCUSSIONS, NAMELY, ONLINE CHAT ROOMS, INSTANT MESSAGING AND ELECTRONIC BULLETIN BOARDS FOR TRANSMISSION OF MESSAGES AMONG NETWORK MEMBERS IN THE FIELD OF GENERAL INTEREST; PROVIDING ONLINE CHAT ROOMS AND ELECTRONIC BULLETIN BOARDS FOR TRANSMISSION OF MESSAGES AMONG USERS FOR THE PURPOSES OF BUILDING PERSONAL NETWORKS AND SHARING STORIES; PROVIDING ONLINE ELECTRONIC BULLETIN BOARDS FOR TRANSMISSION OF MESSAGES TO ENABLE ONLINE STORY TELLING, IN CLASS 38 (U.S. CLS. 100, 101 AND 104).

FIRST USE 6-1-2008; IN COMMERCE 2-1-2009.

FOR: PROVIDING AN ONLINE COMPUTER DATABASE FEATURING INFORMATION REGARDING COMMUNITIES, NAMELY, FEATURING INFORMATION REGARDING HOSTING ON-LINE COMMUNITY WEBSITES AND BEST PRACTICES FOR THE PURPOSE OF BUILDING PERSONAL NETWORKS AND SHARING STORIES; PROVIDING CUSTOMIZED ONLINE WEB PAGES FEATURING USER-DEFINED INFORMATION; PROVIDING AN ONLINE COMPUTER DATABASE FEATURING MEDIA SHARING, NAMELY, PROVIDING AN ONLINE NETWORK ENVIRONMENT THAT FEATURES TECHNOLOGY THAT ENABLES USERS TO SHARE DATA IN THE NATURE OF DIGITAL MEDIA; PROVIDING SERVICES RELATED TO THE DELIVERY OF MICROSITES FOR LOCALIZED USERS, NAMELY, PROVIDING AN ONLINE WEBSITE FOR CREATING AND HOSTING MICRO WEBSITES FOR LOCALIZED USERS; PROVIDING AN ONLINE COMPUTER DATABASE FEATURING ONLINE CALENDAR AND EVENT COORDINATION, NAMELY, HOSTING ONLINE INTERACTIVE PRIVATE CALENDARS THAT ALLOW MULTIPLE PARTICIPANTS TO SHARE EVENT SCHEDULES, STORIES, TASKS, GOALS, PERSONAL REQUESTS FOR SUPPORT AND TRANSPORTATION REQUESTS, IN CLASS 42 (U.S. CLS. 100 AND 101).

FIRST USE 6-1-2008; IN COMMERCE 2-1-2009.

THE MARK CONSISTS OF STANDARD CHARACTERS WITHOUT CLAIM TO ANY PARTICULAR FONT, STYLE, SIZE, OR COLOR.



David J. Kybas

Director of the United States Patent and Trademark Office

Reg. No. 4,206,328 THE WORDING "TYZE" HAS NO MEANING IN A FOREIGN LANGUAGE.

SN 77-893,202, FILED 12-14-2009.

JAMES MACFARLANE, EXAMINING ATTORNEY

United States of America

United States Patent and Trademark Office

POSITIVE AMERICAN

Reg. No. 4,206,329

PEDERSON, SCOTT (UNITED STATES INDIVIDUAL)
3135 DENTON PLACE
ROSWELL, GA 30075

Registered Sep. 11, 2012

Int. Cl.: 25

FOR: BANDANAS; BELTS; CAPS; CHILDREN'S AND INFANT'S APPAREL, NAMELY, JUMPERS, OVERALL SLEEPWEAR, PAJAMAS, ROMPERS AND ONE-PIECE GARMENTS; HATS; HEAD SWEATBANDS; HOODED SWEAT SHIRTS; JACKETS; JERSEYS; PANTS; SCARVES; SHIRTS; SHORT SETS; SHORTS; SWEAT JACKETS; SWEAT PANTS; SWEAT SHIRTS; SWEAT SHORTS; SWEAT SUITS; SWEATERS; T-SHIRTS; TIES; TOPS; UNDER GARMENTS; VESTS; VISORS; WRISTBANDS, IN CLASS 25 (U.S. CLS. 22 AND 39).

TRADEMARK

PRINCIPAL REGISTER

FIRST USE 5-12-2012; IN COMMERCE 5-12-2012.

THE MARK CONSISTS OF STANDARD CHARACTERS WITHOUT CLAIM TO ANY PARTICULAR FONT, STYLE, SIZE, OR COLOR.

NO CLAIM IS MADE TO THE EXCLUSIVE RIGHT TO USE "AMERICAN", APART FROM THE MARK AS SHOWN.

SN 77-894,198, FILED 12-15-2009.

NICHOLAS COLEMAN, EXAMINING ATTORNEY



David J. Kyffers

Director of the United States Patent and Trademark Office

United States of America

United States Patent and Trademark Office

5TH SEASON

Reg. No. 4,206,330

CABRIO COMPANIES LLC (WISCONSIN LIMITED LIABILITY COMPANY)
127 NORTH MAIN STREET
RIVER FALLS, WI 54022

Registered Sep. 11, 2012

Int. Cl.: 6

FOR: PREFABRICATED BUILDINGS MADE SUBSTANTIALLY OF METAL, IN CLASS 6
(U.S. CLS. 2, 12, 13, 14, 23, 25 AND 50).

TRADEMARK

FIRST USE 6-20-2012; IN COMMERCE 6-29-2012.

PRINCIPAL REGISTER

THE MARK CONSISTS OF STANDARD CHARACTERS WITHOUT CLAIM TO ANY PARTICULAR FONT, STYLE, SIZE, OR COLOR.

SN 77-896,811, FILED 12-18-2009.

ANNE FARRELL, EXAMINING ATTORNEY



David J. Kybas

Director of the United States Patent and Trademark Office

United States of America

United States Patent and Trademark Office



Reg. No. 4,206,331

Registered Sep. 11, 2012

Int. Cl.: 7

TRADEMARK

PRINCIPAL REGISTER

BLOUNT, INC. (DELAWARE CORPORATION)
4909 SE INTERNATIONAL WAY
PORTLAND, RI 02872

FOR: LAWNMOWER BLADES, IN CLASS 7 (U.S. CLS. 13, 19, 21, 23, 31, 34 AND 35).

FIRST USE 8-0-2011; IN COMMERCE 8-0-2011.

THE MARK CONSISTS OF "G6" IN WHITE WITH SHADING OF BLACK AND GRAY ON A RED RECTANGULAR BACKGROUND.

THE COLOR(S) RED, BLACK, WHITE, GRAY IS/ARE CLAIMED AS A FEATURE OF THE MARK.

SN 77-896,882, FILED 12-18-2009.

SHARON MEIER, EXAMINING ATTORNEY



David J. Kyffers

Director of the United States Patent and Trademark Office

United States of America

United States Patent and Trademark Office

CargoLive

Reg. No. 4,206,332

Registered Sep. 11, 2012

**Int. Cls.: 35, 36, 37, 39,
and 45**

SERVICE MARK

PRINCIPAL REGISTER

ROCK-IT CARGO USA LLC (DELAWARE LIMITED LIABILITY COMPANY)
1800 BYBERRY ROAD, SUITE 810
HUNTINGDON VALLEY, PA 19006

FOR: IMPORT AND EXPORT AGENCY SERVICES, NAMELY, PROVIDING TEMPORARY IMPORT BOND FACILITIES; CUSTOMS CLEARANCE SERVICES, NAMELY, PREPARATION OF IMPORT, EXPORT AND CUSTOMS FORMALITIES AND DOCUMENTATION; TRANSPORTATION LOGISTICS SERVICES, NAMELY, ARRANGING THE TRANSPORTATION OF GOODS FOR OTHERS; TRANSPORTATION MANAGEMENT SERVICES, NAMELY, PLANNING AND COORDINATING TRANSPORTATION OF PEOPLE FOR OTHERS; FREIGHT LOGISTICS MANAGEMENT; TRANSPORTATION MANAGEMENT SERVICES, NAMELY, PLANNING AND COORDINATING TRANSPORTATION OF PEOPLE FOR OTHERS; BUSINESS MANAGEMENT IN THE FIELD OF TRANSPORT AND DELIVERY; PROVIDING INFORMATION RELATING TO CUSTOMS CLEARANCE SERVICES; PROVIDING BUSINESS ADVICE RELATING TO IMPORT AND EXPORT AGENCIES, CUSTOMS CLEARANCE SERVICES, TRANSPORTATION LOGISTICS SERVICES, TRANSPORTATION MANAGEMENT SERVICES, FREIGHT LOGISTICS MANAGEMENT, AND BUSINESS MANAGEMENT TO THIRD PARTIES AND OTHER ENTITIES IN THE ENTERTAINMENT INDUSTRY, IN CLASS 35 (U.S. CLS. 100, 101 AND 102).

FIRST USE 7-2-2009; IN COMMERCE 7-2-2009.



FOR: PROVIDING TEMPORARY IMPORT BOND FACILITIES, NAMELY, RECLAMATION OF IMPORT DUTIES FOR OTHERS; PROVIDING FINANCIAL INFORMATION AND ADVICE RELATING TO CUSTOMS BROKERAGE; PROVIDING FINANCIAL INFORMATION AND ADVICE RELATING TO CUSTOMS BROKERAGE SERVICES AND MAIL HANDLING TO THIRD PARTIES AND OTHER ENTITIES IN THE ENTERTAINMENT INDUSTRY, IN CLASS 36 (U.S. CLS. 100, 101 AND 102).

FIRST USE 7-2-2009; IN COMMERCE 7-2-2009.

FOR: INSTALLATION OF STANDS FOR EXHIBITIONS, TRADE FAIRS AND SHOWS; INSTALLATION OF TEMPORARY STRUCTURES FOR EXHIBITIONS, TRADE FAIRS, CONCERTS, SHOWS, AND LIVE ENTERTAINMENT VENUES, IN CLASS 37 (U.S. CLS. 100, 103 AND 106).

FIRST USE 7-2-2009; IN COMMERCE 7-2-2009.

David J. Kyjars

Director of the United States Patent and Trademark Office

Reg. No. 4,206,332 FOR: AIR FREIGHT SHIPPING SERVICES; FREIGHT AND TRANSPORT BROKERAGE; GLOBAL TRANSPORTATION OF FREIGHT FOR OTHERS BY ALL AVAILABLE MEANS; CARGO HANDLING; TRANSPORTATION OF FREIGHT BY AIR, LAND AND SEA; FORWARDING AND DELIVERY OF FREIGHT; FORWARDING OF FREIGHT TO TRADE FAIRS, EXHIBITIONS, CONCERTS, SHOWS AND OTHER LIVE ENTERTAINMENT VENUES; TRANSPORT OF FREIGHT BY TRUCK, TRAIN AND AIR TO TRADE FAIRS, EXHIBITIONS, CONCERTS, SHOWS AND OTHER LIVE ENTERTAINMENT VENUES; AIR FREIGHT SHIPPING SERVICES; PACKING, STORAGE AND WAREHOUSING OF FREIGHT; RENTAL OF WAREHOUSE SPACE; VEHICLE ROUTING BY COMPUTER ON DATA NETWORKS; PROVIDING INFORMATION CONCERNING COLLECTION AND DELIVERY OF ASSETS IN TRANSIT, NAMELY, VEHICLES, TRAILERS, DRIVERS, CARGO AND DELIVERY CONTAINERS; GUARDED TRANSPORTATION OF VALUABLES; COURIER SERVICES; RENTAL OF STORAGE CONTAINERS; STORAGE AND DELIVERY OF PACKING MATERIALS; LEASING OF FIXED AND MOVABLE STORAGE CONTAINERS TO COMMERCIAL USERS; TRANSPORT OF PACKING MATERIALS BY TRUCK AND PLANE; DOCUMENT DELIVERY, NAMELY, DISTRIBUTION FOR OTHERS OF SHIPPING INSTRUCTIONS TO CARRIERS; ON-SITE CARGO HANDLING SERVICES; TRANSPORT OF PACKING MATERIALS BY TRUCK AND PLANE, DOCUMENT DELIVERY, NAMELY, DISTRIBUTION OF SHIPPING INSTRUCTIONS FOR OTHERS TO CARRIERS, ON-SITE CARGO HANDLING SERVICES TO THIRD PARTIES AND OTHER ENTITIES IN THE ENTERTAINMENT INDUSTRY, IN CLASS 39 (U.S. CLS. 100 AND 105).

FIRST USE 7-2-2009; IN COMMERCE 7-2-2009.

FOR: PROVIDING INFORMATION AND ADVICE RELATING TO CUSTOMS LAWS; LEGAL SERVICES, NAMELY, PROVIDING LEGAL ADVICE TO THIRD PARTIES AND OTHER ENTITIES IN THE ENTERTAINMENT INDUSTRY IN THE FIELDS OF CUSTOMS BROKERAGE, TEMPORARY IMPORT BOND FACILITIES, PREPARATION OF IMPORT, EXPORT AND CUSTOMS FORMALITIES AND DOCUMENTATION; VEHICLE FLEET MONITORING SERVICES FOR SAFETY PURPOSES , IN CLASS 45 (U.S. CLS. 100 AND 101).

FIRST USE 7-2-2009; IN COMMERCE 7-2-2009.

SN 77-898,191, FILED 12-21-2009.

KELLEY WELLS, EXAMINING ATTORNEY

United States of America

United States Patent and Trademark Office

arena

Reg. No. 4,206,333

Registered Sep. 11, 2012

Int. Cls.: 9, 18, 25, and 28

TRADEMARK

PRINCIPAL REGISTER

ARENA DISTRIBUTION S.A. (SWITZERLAND CORPORATION)
VIA MAGGIO 1
LUGANO, SWITZERLAND CH6900

FOR: EYEGLASS AND SUNGLASSES; ACCESSORIES FOR SWIMMING AND DIVING, NAMELY, SWIMMING GOGGLES, MASKS, DIVING GLOVES, DIVING HELMETS, SCUBA DIVING MASKS, DIVING SUITS, NOSE CLIPS FOR DIVERS AND SWIMMERS, SNORKEL TUBES, EAR PLUGS; EYE PROTECTION WEAR FOR SPORTS, NAMELY, GOGGLES FOR WATER SKIING, SURFING, SAILING, BOARD SAILING, BOATING; CORRECTIVE LENSES FOR EYE PROTECTION WEAR FOR SPORTS, NAMELY, GOGGLES WITH CORRECTIVE LENSES FOR WATER SKIING, SURFING, SAILING, BOARD SAILING, BOATING, EYEGLASS NECK CORDS; PROTECTION AND SAFETY SWIMMING AIDS, NAMELY, INFLATABLE FLOTATION DEVICES AND SWIMMING TRAINING LIFE BUOYS INFLATABLE OR NOT, FLOTATION LIFE BELTS, SWIM FLOTATION VESTS; SPORTS HELMETS, DIVING GLOVES; PROTECTIVE CLOTHING, IN CLASS 9 (U.S. CLS. 21, 23, 26, 36 AND 38).

FIRST USE 1-1-1973; IN COMMERCE 7-28-1984.

FOR: SPORT BAGS, TRUNKS, TRAVELLING BAGS, LEISURE BAGS, NAMELY, ALL-PURPOSE CARRYING BAGS, ALL PURPOSE SPORTS BAGS AND HANDBAGS, RUCKSACKS, CARRYING BAGS FOR BATHING TRUNKS, IN CLASS 18 (U.S. CLS. 1, 2, 3, 22 AND 41).

FIRST USE 1-1-1973; IN COMMERCE 7-28-1984.

FOR: CLOTHING FOR LEISURE WEAR, NAMELY, SWIMWEAR, BEACHWEAR, TRACKSUITS, SHIRTS, SHORTS, POLO SHIRTS, SPORTS AND LEISURE SHOES, SANDALS, SWIMMING CAPS, HATS, SWIMMING SUITS FOR COMPETITION, SWIMMING SUITS FOR MEN, WOMEN AND CHILDREN, SWIMMING TRUNKS, T-SHIRTS, SPORT SHORTS, WARM UP SUITS, GYMNAS TIC SUITS FOR WOMEN, SLIPPERS, BOOTS, LEGGINGS, SOCKS, SWEAT SHORTS, SKIRTS, DRESSES, BATHING COSTUMES, BATHING GARMENTS, NAMELY, BATHING SUITS, PANTS, BATH WRAPS, BEACH ARTICLES, NAMELY, BEACH FOOTWEAR, DRESSING GOWNS, BATHING CAPS; CAPS, BONNETS, IN CLASS 25 (U.S. CLS. 22 AND 39).

FIRST USE 1-1-1973; IN COMMERCE 7-28-1984.



David J. Kyffers

Director of the United States Patent and Trademark Office

Reg. No. 4,206,333 FOR: SWIMMING AND DIVING ACCESSORIES, NAMELY, FINS; GYMNASTIC AND SPORTS ARTICLES, NAMELY, SMALL PADDLE BALLS, BALLS FOR WATER POLO, VOLLEYBALL AND BEACH VOLLEYBALL; SCUBA FLIPPERS, PADDLE BOARDS, KICK BOARDS, SWIMMING BOARDS, SWIMMING AND DIVING DEVICES, NAMELY, FLIPPERS AND SWIMMING GLOVES, CARRYING BAGS FOR SPORT EQUIPMENT; BAGS SPECIFICALLY ADAPTED FOR SPORT, IN CLASS 28 (U.S. CLS. 22, 23, 38 AND 50).

FIRST USE 1-1-1973; IN COMMERCE 7-28-1984.

OWNER OF U.S. REG. NOS. 920,759, 1,255,900, AND OTHERS.

THE MARK CONSISTS OF THE WORDING "ARENA".

SN 77-899,081, FILED 12-22-2009.

JOHN DWYER, EXAMINING ATTORNEY

United States of America

United States Patent and Trademark Office

BULLETSTORM

Reg. No. 4,206,334

PEOPLE CAN FLY SP. Z.O.O. (POLAND LIMITED LIABILITY COMPANY)

Registered Sep. 11, 2012

ALEJA JANA PAWLA II 61 UNIT 241
WARSAW, POLAND 01-031

Int. Cl.: 16

FOR: PRINTED MATERIALS, NAMELY, USER MANUALS RELATED TO COMPUTER GAMES, IN CLASS 16 (U.S. CLS. 2, 5, 22, 23, 29, 37, 38 AND 50).

TRADEMARK

FIRST USE 2-22-2011; IN COMMERCE 2-22-2011.

PRINCIPAL REGISTER

THE MARK CONSISTS OF STANDARD CHARACTERS WITHOUT CLAIM TO ANY PARTICULAR FONT, STYLE, SIZE, OR COLOR.

SN 77-899,803, FILED 12-23-2009.

GISELLE AGOSTO, EXAMINING ATTORNEY



David J. Kybas

Director of the United States Patent and Trademark Office

United States of America

United States Patent and Trademark Office

STM Complete

Reg. No. 4,206,335

HCC INSURANCE HOLDINGS, INC. (DELAWARE CORPORATION)
13403 NORTHWEST FREEWAY
HOUSTON, TX 77040

Registered Sep. 11, 2012

Int. Cl.: 36

FOR: INSURANCE SERVICES, NAMELY, UNDERWRITING, ISSUING, AND ADMINISTRATION OF MEDICAL INSURANCE, IN CLASS 36 (U.S. CLS. 100, 101 AND 102).

SERVICE MARK

FIRST USE 4-6-2011; IN COMMERCE 4-6-2011.

PRINCIPAL REGISTER

THE MARK CONSISTS OF STANDARD CHARACTERS WITHOUT CLAIM TO ANY PARTICULAR FONT, STYLE, SIZE, OR COLOR.

NO CLAIM IS MADE TO THE EXCLUSIVE RIGHT TO USE "STM", APART FROM THE MARK AS SHOWN.

SN 77-900,662, FILED 12-23-2009.

JASON LOTT, EXAMINING ATTORNEY



David J. Kybas

Director of the United States Patent and Trademark Office

United States of America

United States Patent and Trademark Office

GEMINI

Reg. No. 4,206,336

Registered Sep. 11, 2012

Int. Cls.: 9, 41, and 42

TRADEMARK

SERVICE MARK

PRINCIPAL REGISTER

AMERICAN SCIENCE AND ENGINEERING, INC. (MASSACHUSETTS CORPORATION)
829 MIDDLESEX TURNPIKE
BILLERICA, MA 01821

FOR: SECURITY INSPECTION APPARATUS FOR DETECTING OR CHARACTERIZING MATERIALS OR PERSONS THROUGH THE USE OF X-RAY TECHNOLOGY, NOT USED FOR MEDICAL PURPOSES, IN CLASS 9 (U.S. CLS. 21, 23, 26, 36 AND 38).

FIRST USE 5-17-2006; IN COMMERCE 5-17-2006.

FOR: EDUCATIONAL SERVICES, NAMELY, TRAINING IN THE USE AND OPERATION OF A SECURITY INSPECTION APPARATUS FOR DETECTING OR CHARACTERIZING MATERIALS AND PERSONS THROUGH THE USE OF X-RAY TECHNOLOGY, IN CLASS 41 (U.S. CLS. 100, 101 AND 107).

FIRST USE 12-31-2006; IN COMMERCE 12-31-2006.

FOR: TECHNICAL SUPPORT SERVICES, NAMELY, TROUBLESHOOTING IN THE NATURE OF DIAGNOSING PROBLEMS IN SECURITY INSPECTION APPARATUS FOR DETECTING OR CHARACTERIZING MATERIALS AND PERSONS THROUGH THE USE OF X-RAY TECHNOLOGY; PROVIDING TECHNICAL CONSULTING SERVICES REGARDING THE FUNCTIONALITY AND TECHNOLOGY OF INSPECTION APPARATUS FOR DETECTING OR CHARACTERIZING MATERIALS AND PERSONS THROUGH THE USE OF X-RAY TECHNOLOGY, IN CLASS 42 (U.S. CLS. 100 AND 101).

FIRST USE 12-31-2006; IN COMMERCE 12-31-2006.

THE MARK CONSISTS OF STANDARD CHARACTERS WITHOUT CLAIM TO ANY PARTICULAR FONT, STYLE, SIZE, OR COLOR.

SN 77-903,128, FILED 12-30-2009.

HELENE LIWINSKI, EXAMINING ATTORNEY



David J. Kyffers

Director of the United States Patent and Trademark Office

United States of America

United States Patent and Trademark Office

Galway Bay

Reg. No. 4,206,337

PRILLAMAN, TERRY (UNITED STATES INDIVIDUAL)
5900 WINDWARD PARKWAY, SUITE 120
ALPHARETTA, GA 30005

Registered Sep. 11, 2012

Int. Cl.: 25

FOR: MOISTURE-WICKING SPORTS PANTS; WATERPROOF JACKETS AND PANTS; WIND PANTS, IN CLASS 25 (U.S. CLS. 22 AND 39).

TRADEMARK

FIRST USE 1-1-2011; IN COMMERCE 1-1-2011.

PRINCIPAL REGISTER

THE MARK CONSISTS OF STANDARD CHARACTERS WITHOUT CLAIM TO ANY PARTICULAR FONT, STYLE, SIZE, OR COLOR.

SN 77-903,933, FILED 1-2-2010.

CHARLOTTE CORWIN, EXAMINING ATTORNEY



David J. Kyffers

Director of the United States Patent and Trademark Office

United States of America

United States Patent and Trademark Office

MEAN GENE'S

Reg. No. 4,206,338

Registered Sep. 11, 2012

Int. Cl.: 43

SERVICE MARK

PRINCIPAL REGISTER

OKERLUND, EUGENE (UNITED STATES INDIVIDUAL)
49 OSPREY POINT DRIVE
OSPREY, FL 34229

FOR: RESTAURANT SERVICES, IN CLASS 43 (U.S. CLS. 100 AND 101).

FIRST USE 4-28-1997; IN COMMERCE 4-28-1997.

THE MARK CONSISTS OF STANDARD CHARACTERS WITHOUT CLAIM TO ANY PARTICULAR FONT, STYLE, SIZE, OR COLOR.

OWNER OF U.S. REG. NO. 3,666,798.

SN 77-904,629, FILED 1-4-2010.

RENEE MCCRAY, EXAMINING ATTORNEY



David J. Kyros

Director of the United States Patent and Trademark Office

United States of America

United States Patent and Trademark Office

TITAN MOVES THE MILITARY

Reg. No. 4,206,339

Registered Sep. 11, 2012

Int. Cl.: 12

TRADEMARK

PRINCIPAL REGISTER

TITAN INTERNATIONAL, INC. (ILLINOIS CORPORATION)
2701 SPRUCE ST.
QUINCY, IL 62301

FOR: TIRES, IN CLASS 12 (U.S. CLS. 19, 21, 23, 31, 35 AND 44).

FIRST USE 12-30-2011; IN COMMERCE 12-30-2011.

THE MARK CONSISTS OF STANDARD CHARACTERS WITHOUT CLAIM TO ANY PARTICULAR FONT, STYLE, SIZE, OR COLOR.

SN 77-905,479, FILED 1-5-2010.

CHRIS DONINGER, EXAMINING ATTORNEY



David J. Kyffers

Director of the United States Patent and Trademark Office

United States of America

United States Patent and Trademark Office

DCE Platform

Reg. No. 4,206,340

CONCERT PHARMACEUTICALS, INC. (DELAWARE CORPORATION)
99 HAYDEN AVENUE, SUITE 500
LEXINGTON, MA 02421

Registered Sep. 11, 2012

Int. Cl.: 42

FOR: SCIENTIFIC AND MEDICAL RESEARCH SERVICES; MEDICAL TESTING SERVICES FOR RESEARCH PURPOSES; CONDUCTING EARLY EVALUATIONS IN THE FIELD OF NEW PHARMACEUTICALS; DRUG DISCOVERY SERVICES; PHARMACEUTICAL RESEARCH SERVICES, IN CLASS 42 (U.S. CLS. 100 AND 101).

SERVICE MARK

PRINCIPAL REGISTER

FIRST USE 4-1-2012; IN COMMERCE 4-1-2012.

THE MARK CONSISTS OF STANDARD CHARACTERS WITHOUT CLAIM TO ANY PARTICULAR FONT, STYLE, SIZE, OR COLOR.

NO CLAIM IS MADE TO THE EXCLUSIVE RIGHT TO USE "PLATFORM", APART FROM THE MARK AS SHOWN.

SN 77-907,107, FILED 1-7-2010.

LEIGH LOWRY, EXAMINING ATTORNEY



David J. Kyfos

Director of the United States Patent and Trademark Office

United States of America

United States Patent and Trademark Office

SERENITY STAR

Reg. No. 4,206,341

Registered Sep. 11, 2012

Int. Cl.: 9

TRADEMARK

PRINCIPAL REGISTER

ADEN & ANAIS, INC. (NEW YORK CORPORATION)
4 WATER STREET
SUITE 5B
BROOKLYN, NY 11201

FOR: MULTI-FUNCTION ELECTRONIC DEVICE FOR USE IN CHILDREN'S ROOMS COMPRISING A SOUND PRODUCING FUNCTION, TEMPERATURE GAUGE AND ALSO INCLUDING A CLOCK AND NIGHTLIGHT, IN CLASS 9 (U.S. CLS. 21, 23, 26, 36 AND 38).

FIRST USE 1-7-2010; IN COMMERCE 6-1-2010.

THE MARK CONSISTS OF STANDARD CHARACTERS WITHOUT CLAIM TO ANY PARTICULAR FONT, STYLE, SIZE, OR COLOR.

SN 77-907,501, FILED 1-7-2010.

DOMINIC J. FERRAIUOLO, EXAMINING ATTORNEY



David J. Kyffers

Director of the United States Patent and Trademark Office

United States of America

United States Patent and Trademark Office

TRUSOURCE

Reg. No. 4,206,342

MEDRAD, INC. (DELAWARE CORPORATION)
ONE MEDRAD DRIVE
INDIANOLA, PA 15051

Registered Sep. 11, 2012

Int. Cl.: 42

FOR: DIAGNOSTIC AND VALIDATION TESTING SERVICES FOR MEDICAL DEVICES,
IN CLASS 42 (U.S. CLS. 100 AND 101).

SERVICE MARK

FIRST USE 5-29-2012; IN COMMERCE 5-29-2012.

PRINCIPAL REGISTER

THE MARK CONSISTS OF STANDARD CHARACTERS WITHOUT CLAIM TO ANY PARTICULAR FONT, STYLE, SIZE, OR COLOR.

SN 77-907,547, FILED 1-8-2010.

LINDSEY RUBIN, EXAMINING ATTORNEY



David J. Kyffers

Director of the United States Patent and Trademark Office

United States of America

United States Patent and Trademark Office

CHESS 76

Reg. No. 4,206,343

ACADEMY OF INTELLECTUAL GAMES, INC. (ILLINOIS NON-PROFIT CORPORATION)
709 DRAE COURT
WHEELING, IL 60090

Registered Sep. 11, 2012

Int. Cls.: 16 and 28

FOR: PRINTED PUBLICATIONS, NAMELY, PAMPHLETS IN THE FIELD OF SPORT MIND GAMES, IN CLASS 16 (U.S. CLS. 2, 5, 22, 23, 29, 37, 38 AND 50).

TRADEMARK

FIRST USE 8-31-2010; IN COMMERCE 5-17-2011.

PRINCIPAL REGISTER

FOR: BOARD GAMES, IN CLASS 28 (U.S. CLS. 22, 23, 38 AND 50).

FIRST USE 5-11-2011; IN COMMERCE 5-31-2012.

THE MARK CONSISTS OF STANDARD CHARACTERS WITHOUT CLAIM TO ANY PARTICULAR FONT, STYLE, SIZE, OR COLOR.

NO CLAIM IS MADE TO THE EXCLUSIVE RIGHT TO USE "CHESS", APART FROM THE MARK AS SHOWN.

SN 77-909,170, FILED 1-11-2010.

BILL DAWE, EXAMINING ATTORNEY



David J. Kybas

Director of the United States Patent and Trademark Office

United States of America

United States Patent and Trademark Office

CATAPULT

Reg. No. 4,206,344

FREEDOM INNOVATIONS, LLC (DELAWARE LIMITED LIABILITY COMPANY)
30 FAIRBANKS, STE. 114
IRVINE, CA 92618

Registered Sep. 11, 2012

Int. Cl.: 10

FOR: MEDICAL DEVICES, NAMELY, PROSTHETIC FEET, IN CLASS 10 (U.S. CLS. 26, 39 AND 44).

TRADEMARK

FIRST USE 7-16-2012; IN COMMERCE 7-16-2012.

PRINCIPAL REGISTER

THE MARK CONSISTS OF STANDARD CHARACTERS WITHOUT CLAIM TO ANY PARTICULAR FONT, STYLE, SIZE, OR COLOR.

SN 77-909,199, FILED 1-11-2010.

SETH A. RAPPAPORT, EXAMINING ATTORNEY



David J. Kybas

Director of the United States Patent and Trademark Office

United States of America

United States Patent and Trademark Office

KIDS ZONE

Reg. No. 4,206,345

AGC, LLC (DELAWARE LIMITED LIABILITY COMPANY)
ONE AMERICAN ROAD
CLEVELAND, OH 44144

Registered Sep. 11, 2012

Int. Cl.: 16

FOR: GIFT WRAPPING PAPER; GREETING CARDS; PAPER BOWS FOR GIFT WRAP; PAPER GIFT BAGS; TISSUE PAPER, IN CLASS 16 (U.S. CLS. 2, 5, 22, 23, 29, 37, 38 AND 50).

TRADEMARK

FIRST USE 3-31-2012; IN COMMERCE 3-31-2012.

PRINCIPAL REGISTER

THE MARK CONSISTS OF STANDARD CHARACTERS WITHOUT CLAIM TO ANY PARTICULAR FONT, STYLE, SIZE, OR COLOR.

OWNER OF U.S. REG. NO. 1,576,344.

SN 77-909,361, FILED 1-11-2010.

REGINA DRUMMOND, EXAMINING ATTORNEY



David J. Kybas

Director of the United States Patent and Trademark Office

United States of America

United States Patent and Trademark Office

JUNK GYPSY

Reg. No. 4,206,346

Registered Sep. 11, 2012

Int. Cl.: 41

SERVICE MARK

PRINCIPAL REGISTER

SIKES, INC. (TEXAS CORPORATION), DBA JUNK GYPSY,
4345 ALEXIS COURT
COLLEGE STATION, TX 77845

FOR: ENTERTAINMENT, NAMELY, ONGOING REALITY AND UNSCRIPTED TELEVISION PROGRAMS FEATURING LIVE ACTION, MUSIC, COMEDY, DRAMA, AND/OR THE SEARCH FOR COLLECTIBLE ITEMS FOR YOUR HOME OR OFFICE; PERSONAL APPEARANCES BY AN COMEDIAN, REALITY-STAR PERSONALITY, SPORTS CELEBRITY OR MOVIE STAR, IN CLASS 41 (U.S. CLS. 100, 101 AND 107).

FIRST USE 11-27-2011; IN COMMERCE 11-27-2011.

THE MARK CONSISTS OF STANDARD CHARACTERS WITHOUT CLAIM TO ANY PARTICULAR FONT, STYLE, SIZE, OR COLOR.

SN 77-909,866, FILED 1-12-2010.

GENE MACIOL, EXAMINING ATTORNEY



David J. Kyffers

Director of the United States Patent and Trademark Office

United States of America

United States Patent and Trademark Office



BUSINESS CONNECTIONS

Reg. No. 4,206,347

Registered Sep. 11, 2012

Int. Cl.: 45

SERVICE MARK

PRINCIPAL REGISTER

HALLMARK LICENSING LLC (KANSAS LIMITED LIABILITY COMPANY)
2440 PERSHING ROAD
MD 339
KANSAS CITY, MO 64108

FOR: PROVIDING A SELECTION OF ON-LINE ELECTRONIC GREETING CARDS, IN CLASS 45 (U.S. CLS. 100 AND 101).

FIRST USE 1-31-2010; IN COMMERCE 1-31-2010.

OWNER OF U.S. REG. NOS. 525,798, 2,825,717, AND OTHERS.

THE MARK CONSISTS OF A FIVE-POINTED, OPEN CROWN DESIGN OVER THE WORK "HALLMARK" IN SCRIPT, OVER THE WORDS "BUSINESS CONNECTIONS" IN BLOCK LETTERS.

SN 77-910,212, FILED 1-12-2010.

SETH A. RAPPAPORT, EXAMINING ATTORNEY



David J. Kyffers

Director of the United States Patent and Trademark Office

United States of America

United States Patent and Trademark Office

RAIN LOGIC

Reg. No. 4,206,348

MARMOT MOUNTAIN, LLC (DELAWARE LIMITED LIABILITY COMPANY)
4202 6TH AVE S
SEATTLE, WA 98108

Registered Sep. 11, 2012

Int. Cl.: 25

FOR: CLOTHING, NAMELY, COATS, JACKETS, VESTS, IN CLASS 25 (U.S. CLS. 22 AND 39).

TRADEMARK

FIRST USE 8-0-2010; IN COMMERCE 8-0-2010.

PRINCIPAL REGISTER

THE MARK CONSISTS OF STANDARD CHARACTERS WITHOUT CLAIM TO ANY PARTICULAR FONT, STYLE, SIZE, OR COLOR.

NO CLAIM IS MADE TO THE EXCLUSIVE RIGHT TO USE "RAIN", APART FROM THE MARK AS SHOWN.

SN 77-910,240, FILED 1-12-2010.

MARY CRAWFORD, EXAMINING ATTORNEY



David J. Kybas

Director of the United States Patent and Trademark Office

United States of America

United States Patent and Trademark Office

STORM LOGIC

Reg. No. 4,206,349

MARMOT MOUNTAIN, LLC (DELAWARE LIMITED LIABILITY COMPANY)
4202 6TH AVE S
SEATTLE, WA 98108

Registered Sep. 11, 2012

Int. Cl.: 25

FOR: CLOTHING, NAMELY, COATS, JACKETS, VESTS, IN CLASS 25 (U.S. CLS. 22 AND 39).

TRADEMARK

FIRST USE 8-0-2010; IN COMMERCE 8-0-2010.

PRINCIPAL REGISTER

THE MARK CONSISTS OF STANDARD CHARACTERS WITHOUT CLAIM TO ANY PARTICULAR FONT, STYLE, SIZE, OR COLOR.

NO CLAIM IS MADE TO THE EXCLUSIVE RIGHT TO USE "STORM", APART FROM THE MARK AS SHOWN.

SN 77-910,244, FILED 1-12-2010.

MARY CRAWFORD, EXAMINING ATTORNEY



David J. Kyffers

Director of the United States Patent and Trademark Office

United States of America

United States Patent and Trademark Office

WIND LOGIC

Reg. No. 4,206,350

MARMOT MOUNTAIN, LLC (DELAWARE LIMITED LIABILITY COMPANY)
4202 6TH AVE S
SEATTLE, WA 98108

Registered Sep. 11, 2012

Int. Cl.: 25

FOR: CLOTHING, NAMELY, COATS, JACKETS, VESTS, IN CLASS 25 (U.S. CLS. 22 AND 39).

TRADEMARK

FIRST USE 8-0-2010; IN COMMERCE 8-0-2010.

PRINCIPAL REGISTER

THE MARK CONSISTS OF STANDARD CHARACTERS WITHOUT CLAIM TO ANY PARTICULAR FONT, STYLE, SIZE, OR COLOR.

NO CLAIM IS MADE TO THE EXCLUSIVE RIGHT TO USE "WIND", APART FROM THE MARK AS SHOWN.

SN 77-910,245, FILED 1-12-2010.

MARY CRAWFORD, EXAMINING ATTORNEY



David J. Kybas

Director of the United States Patent and Trademark Office

United States of America

United States Patent and Trademark Office

BHGRE COMMERCIAL

Reg. No. 4,206,351

Registered Sep. 11, 2012

Int. Cl.: 36

SERVICE MARK

PRINCIPAL REGISTER

MEREDITH CORPORATION (IOWA CORPORATION)
1716 LOCUST STREET
DES MOINES, IA 503093023

FOR: RESIDENTIAL AND COMMERCIAL PROPERTY MANAGEMENT SERVICES; REAL ESTATE BROKERAGE SERVICES; MORTGAGE BROKERAGE SERVICES; ARRANGING FOR TITLE INSURANCE AND REAL ESTATE FINANCING FOR OTHERS; REAL ESTATE AGENCY SERVICES; RENTAL OF HOMES, APARTMENTS AND COMMERCIAL SPACE; REAL ESTATE VALUATION; REAL ESTATE MANAGEMENT SERVICES; INSURANCE BROKERAGE SERVICES; MORTGAGE LENDING, AND REAL ESTATE ESCROW SERVICES; FINANCIAL PLANNING AND MANAGEMENT RELATING TO REAL ESTATE BROKERAGE, IN CLASS 36 (U.S. CLS. 100, 101 AND 102).

FIRST USE 6-0-2011; IN COMMERCE 6-0-2011.

THE MARK CONSISTS OF STANDARD CHARACTERS WITHOUT CLAIM TO ANY PARTICULAR FONT, STYLE, SIZE, OR COLOR.

NO CLAIM IS MADE TO THE EXCLUSIVE RIGHT TO USE "COMMERCIAL", APART FROM THE MARK AS SHOWN.

SN 77-910,969, FILED 1-13-2010.

RENEE MCCRAY, EXAMINING ATTORNEY



David J. Kyffers

Director of the United States Patent and Trademark Office

United States of America
United States Patent and Trademark Office

PENGUIN

Reg. No. 4,206,352

BOSTON SCOTT CORPORATION (MASSACHUSETTS CORPORATION)
1 E. MELVIN STREET
WAKEFIELD, MA 01880

Registered Sep. 11, 2012

Int. Cl.: 10

FOR: MEDICAL AND SURGICAL DEVICES AND APPARATUS, NAMELY, CATHETERS AND GUIDEWIRES, IN CLASS 10 (U.S. CLS. 26, 39 AND 44).

TRADEMARK

FIRST USE 7-16-2012; IN COMMERCE 7-16-2012.

PRINCIPAL REGISTER

THE MARK CONSISTS OF STANDARD CHARACTERS WITHOUT CLAIM TO ANY PARTICULAR FONT, STYLE, SIZE, OR COLOR.

SN 77-911,305, FILED 1-13-2010.

DEIRDRE ROBERTSON, EXAMINING ATTORNEY



David J. Kybas

Director of the United States Patent and Trademark Office

United States of America

United States Patent and Trademark Office

HENRY DAVID THUMB

Reg. No. 4,206,353

CORCETTO ENTERPRISES LTD. (PENNSYLVANIA CORPORATION)
3 SKYWIND DRIVE
REINHOLDS, PA 17569

Registered Sep. 11, 2012

Int. Cl.: 16

FOR: ART PRINTS; CALENDARS; DATE BOOKS; GREETING CARDS; NOTE CARDS;
PICTURE BOOKS; POSTERS, IN CLASS 16 (U.S. CLS. 2, 5, 22, 23, 29, 37, 38 AND 50).

TRADEMARK

FIRST USE 12-1-2011; IN COMMERCE 12-1-2011.

PRINCIPAL REGISTER

THE MARK CONSISTS OF STANDARD CHARACTERS WITHOUT CLAIM TO ANY PARTICULAR FONT, STYLE, SIZE, OR COLOR.

THE NAME "HENRY DAVID THUMB" DOES NOT IDENTIFY A LIVING INDIVIDUAL.

SN 77-911,526, FILED 1-13-2010.

COLLEEN DOMBROW, EXAMINING ATTORNEY



David J. Kyffers

Director of the United States Patent and Trademark Office

United States of America

United States Patent and Trademark Office

PRINCESS PEEPS

Reg. No. 4,206,354

Registered Sep. 11, 2012

Int. Cl.: 16

TRADEMARK

PRINCIPAL REGISTER

PEEPS EYEWEAR, LLC (WISCONSIN LIMITED LIABILITY COMPANY)
100 SOUTH BALDWIN
SUITE 200
MADISON, WI 53703

FOR: ADHESIVE LABELS; BABY BOOKS; CARICATURES; CHILDREN'S ACTIVITY BOOKS; CHILDREN'S BOOKS; CHILDREN'S INTERACTIVE EDUCATIONAL BOOKS; CHILDREN'S STORYBOOKS; COLORING BOOKS; CORRUGATED CARDBOARD BOXES; FABRIC GIFT BAGS; GIFT BOXES; GIFT WRAP PAPER; HALLOWEEN GOODIE BAGS OF PAPER OR PLASTIC; LETTER PAPER; LUNCH BAGS; LUNCH BAGS MADE OF TEXTILE; PAPER FOR WRAPPING AND PACKAGING; PAPER GIFT BAGS; PAPER PARTY BAGS; PAPER PARTY DECORATIONS; PAPER STATIONERY; PAPER TAGS; PRINTED MATERIALS, NAMELY, CURRICULA IN THE FIELD OF PROMOTING YOUTH SELF-ESTEEM, IMAGINATION, SELF-EXPRESSION AND FASHION FEATURING STORIES ABOUT PRINCESSES WHO WEAR GLASSES; PRINTED MATERIALS, NAMELY, PRESS RELEASES FEATURING PROMOTING YOUTH SELF-ESTEEM, IMAGINATION, SELF-EXPRESSION AND FASHION FEATURING STORIES ABOUT PRINCESSES WHO WEAR GLASSES; STATIONERY; STICKERS; STICKERS AND STICKER ALBUMS; STORY BOOKS; TALKING CHILDREN'S BOOKS, IN CLASS 16 (U.S. CLS. 2, 5, 22, 23, 29, 37, 38 AND 50).

FIRST USE 1-1-2012; IN COMMERCE 1-1-2012.

THE MARK CONSISTS OF STANDARD CHARACTERS WITHOUT CLAIM TO ANY PARTICULAR FONT, STYLE, SIZE, OR COLOR.

SN 77-914,088, FILED 1-18-2010.

CIMMERIAN COLEMAN, EXAMINING ATTORNEY



David J. Kypos

Director of the United States Patent and Trademark Office

United States of America
United States Patent and Trademark Office

AIR-WHEEL

Reg. No. 4,206,355

PBS BIOTECH, INC. (CALIFORNIA CORPORATION)
4023 CAMINO RANCHERO, SUITE I
CAMARILLO, CA 930125153

Registered Sep. 11, 2012

Int. Cl.: 9

FOR: BIOREACTORS FOR CELL CULTURING; COMPUTER HARDWARE FOR BIOREACTORS, IN CLASS 9 (U.S. CLS. 21, 23, 26, 36 AND 38).

TRADEMARK

FIRST USE 7-11-2012; IN COMMERCE 7-11-2012.

PRINCIPAL REGISTER

THE MARK CONSISTS OF STANDARD CHARACTERS WITHOUT CLAIM TO ANY PARTICULAR FONT, STYLE, SIZE, OR COLOR.

SN 77-915,187, FILED 1-19-2010.

BRENDAN MCCAULEY, EXAMINING ATTORNEY



David J. Kybas

Director of the United States Patent and Trademark Office

United States of America

United States Patent and Trademark Office

COMFORT MOTION

Reg. No. 4,206,356

Registered Sep. 11, 2012

Int. Cl.: 12

TRADEMARK

PRINCIPAL REGISTER

INNOVATIVE BIOMECHANICAL SOLUTIONS LLC (INDIANA LIMITED LIABILITY COMPANY)
2701 ENTERPRISE DR.
ANDERSON, IN 46013

FOR: VEHICLE SEATS, IN CLASS 12 (U.S. CLS. 19, 21, 23, 31, 35 AND 44).

FIRST USE 3-22-2012; IN COMMERCE 3-22-2012.

THE MARK CONSISTS OF STANDARD CHARACTERS WITHOUT CLAIM TO ANY PARTICULAR FONT, STYLE, SIZE, OR COLOR.

SN 77-915,494, FILED 1-20-2010.

MICHAEL KEATING, EXAMINING ATTORNEY



David J. Kyffers

Director of the United States Patent and Trademark Office

United States of America

United States Patent and Trademark Office

Laplace Capital Partners

Reg. No. 4,206,357

Registered Sep. 11, 2012

Int. Cl.: 36

SERVICE MARK

PRINCIPAL REGISTER

LAPLACE CAPITAL PARTNERS LIMITED (CAYMAN ISLANDS LIMITED COMPANY (LTD.))
GRAND PAVILION COMMERCIAL CENTRE
1ST FL, 802 WEST BAY RD., P.O. BOX 30599
KY1-1203, GRAND CAYMAN, CAYMAN ISLANDS

FOR: FINANCIAL INVESTMENT SERVICES IN THE FIELDS OF ASSET MANAGEMENT, PRIVATE EQUITY FUNDS, SECURITIES, ALTERNATIVE INVESTMENTS, AND INVESTMENT BANKING; HEDGE FUND AND PRIVATE EQUITY FUND INVESTMENT SERVICES; FINANCIAL INVESTMENT SERVICES, NAMELY, ASSET ACQUISITION AND INVESTMENT MANAGEMENT SERVICES; FUND INVESTMENT SERVICES, IN CLASS 36 (U.S. CLS. 100, 101 AND 102).

FIRST USE 6-6-2012; IN COMMERCE 6-6-2012.

THE MARK CONSISTS OF STANDARD CHARACTERS WITHOUT CLAIM TO ANY PARTICULAR FONT, STYLE, SIZE, OR COLOR.

NO CLAIM IS MADE TO THE EXCLUSIVE RIGHT TO USE "CAPITAL PARTNERS", APART FROM THE MARK AS SHOWN.

SN 77-916,151, FILED 1-20-2010.

DAVID MURRAY, EXAMINING ATTORNEY



David J. Kyffers

Director of the United States Patent and Trademark Office

United States of America

United States Patent and Trademark Office

Racquet Tatts

Reg. No. 4,206,358

BULLINGTON, J.D. (UNITED STATES INDIVIDUAL)
P.O. BOX 9534
SANTA FE, NM 875049534

Registered Sep. 11, 2012

Int. Cl.: 16

FOR: STENCILS USED TO APPLY DESIGNS ONTO TENNIS RACKETS, IN CLASS 16 (U.S. CLS. 2, 5, 22, 23, 29, 37, 38 AND 50).

TRADEMARK

FIRST USE 1-12-2012; IN COMMERCE 1-12-2012.

PRINCIPAL REGISTER

THE MARK CONSISTS OF STANDARD CHARACTERS WITHOUT CLAIM TO ANY PARTICULAR FONT, STYLE, SIZE, OR COLOR.

NO CLAIM IS MADE TO THE EXCLUSIVE RIGHT TO USE "RACQUET", APART FROM THE MARK AS SHOWN.

SN 77-916,652, FILED 1-21-2010.

SETH A. RAPPAPORT, EXAMINING ATTORNEY



David J. Kybas

Director of the United States Patent and Trademark Office

United States of America

United States Patent and Trademark Office



Reg. No. 4,206,359

ZERO CHROMA, LLC (MARYLAND LIMITED LIABILITY COMPANY)
619 WEST OLD LIBERTY ROAD
SYKESVILLE, MD 21784

Registered Sep. 11, 2012

Int. Cl.: 9

FOR: PROTECTIVE CARRYING CASES AND COVERS SPECIFICALLY DESIGNED FOR MOBILE ELECTRONIC DEVICES, NAMELY, COMPUTERS, MOBILE PHONES, PORTABLE MUSIC DEVICES, PORTABLE GAMING DEVICES, TOUCH SCREEN DEVICES, COMPUTER MONITORS, CAMERAS, AND PERSONAL DIGITAL ASSISTANTS, IN CLASS 9 (U.S. CLS. 21, 23, 26, 36 AND 38).

TRADEMARK

PRINCIPAL REGISTER

FIRST USE 11-1-2009; IN COMMERCE 11-1-2009.

THE MARK CONSISTS OF A SEGMENTED LETTER "O" WITH A DIAGONAL LINE THROUGH IT.

SN 77-916,828, FILED 1-21-2010.

JAMES A. RAUEN, EXAMINING ATTORNEY



David J. Kybas

Director of the United States Patent and Trademark Office

United States of America

United States Patent and Trademark Office

METROPOLITAN

Reg. No. 4,206,360

Registered Sep. 11, 2012

Int. Cl.: 9

TRADEMARK

PRINCIPAL REGISTER

OWP BRILLEN GMBH (FED REP GERMANY GESELLSCHAFT MIT BESCHRÄNKTER
HAFTUNG (GMBH))
SPITALHOFSTRASSE 94
PASSAU, FED REP GERMANY 94032

FOR: EYEGLASS CASES; EYEGLASS FRAMES; EYEGLASSES; EYEWEAR; FRAMES FOR
SPECTACLES AND SUNGLASSES; OPTICAL FRAMES; SPECTACLES; SPORTS GLASSES;
SUNGLASSES, IN CLASS 9 (U.S. CLS. 21, 23, 26, 36 AND 38).

FIRST USE 8-0-2006; IN COMMERCE 1-1-2011.

THE MARK CONSISTS OF STANDARD CHARACTERS WITHOUT CLAIM TO ANY PAR-
TICULAR FONT, STYLE, SIZE, OR COLOR.

SN 77-918,351, FILED 1-22-2010.

THEODORE MCBRIDE, EXAMINING ATTORNEY



David J. Kyffers

Director of the United States Patent and Trademark Office

United States of America

United States Patent and Trademark Office

100X100
ARGENTINA

Reg. No. 4,206,361

Registered Sep. 11, 2012

Int. Cl.: 33

TRADEMARK

PRINCIPAL REGISTER

MUÑOZ DE TORO WINES S.A. (ARGENTINA CORPORATION)
ALICIA MOREAU DE JUSTO 740
LOFT 212, PUERTO MADERO AVENUE
BUENOS AIRES, ARGENTINA C1107AAP

FOR: WINE, IN CLASS 33 (U.S. CLS. 47 AND 49).

FIRST USE 4-27-2010; IN COMMERCE 4-27-2010.

NO CLAIM IS MADE TO THE EXCLUSIVE RIGHT TO USE "ARGENTINA", APART FROM THE MARK AS SHOWN.

THE MARK CONSISTS OF THE NUMBER "100" FOLLOWED BY AN STYLIZED LETTER "X" FOLLOWED BY THE NUMBER "100". THE WORD "ARGENTINA" APPEARS BELOW. ALL OF THE TEXT IS IN STYLIZED LETTERS.

SN 77-918,364, FILED 1-22-2010.

DAVID C. REIHNER, EXAMINING ATTORNEY



David J. Kybas

Director of the United States Patent and Trademark Office

United States of America

United States Patent and Trademark Office

DATA DETECTIVE

Reg. No. 4,206,362

CENTRIC GROUP, L.L.C. (DELAWARE LIMITED LIABILITY COMPANY)
1260 ANDES BLVD.

Registered Sep. 11, 2012

ST. LOUIS, MO 63132

Int. Cl.: 42

FOR: COMPUTER SERVICES, NAMELY, PROVIDING A WEB-BASED SYSTEM AND ON-LINE PORTAL FEATURING ON-LINE NON-DOWNLOADABLE SOFTWARE THAT ALLOWS CORRECTIONAL FACILITIES TO TRACK AND ANALYZE COMMUNICATIONS AND TRANSACTIONS INVOLVING RESIDENTS OF CORRECTIONAL FACILITIES, IN CLASS 42 (U.S. CLS. 100 AND 101).

SERVICE MARK

PRINCIPAL REGISTER

FIRST USE 0-0-2011; IN COMMERCE 0-0-2011.

THE MARK CONSISTS OF STANDARD CHARACTERS WITHOUT CLAIM TO ANY PARTICULAR FONT, STYLE, SIZE, OR COLOR.

NO CLAIM IS MADE TO THE EXCLUSIVE RIGHT TO USE "DATA", APART FROM THE MARK AS SHOWN.

SN 77-919,412, FILED 1-25-2010.

SALLY SHIH, EXAMINING ATTORNEY



David J. Kyros

Director of the United States Patent and Trademark Office

United States of America

United States Patent and Trademark Office

Grilled Cheesus

Reg. No. 4,206,363

Registered Sep. 11, 2012

Int. Cl.: 11

TRADEMARK

PRINCIPAL REGISTER

OLD MILL ROAD, INC. (NEW YORK CORPORATION)
76 FRANKLIN STREET
#3R
BROOKLYN, NY 11222

FOR: ELECTRIC GRILLS, IN CLASS 11 (U.S. CLS. 13, 21, 23, 31 AND 34).

FIRST USE 4-20-2012; IN COMMERCE 5-25-2012.

THE MARK CONSISTS OF STANDARD CHARACTERS WITHOUT CLAIM TO ANY PARTICULAR FONT, STYLE, SIZE, OR COLOR.

NO CLAIM IS MADE TO THE EXCLUSIVE RIGHT TO USE "GRILLED", APART FROM THE MARK AS SHOWN.

SN 77-923,009, FILED 1-28-2010.

TEJBIR SINGH, EXAMINING ATTORNEY



David J. Kybas

Director of the United States Patent and Trademark Office

United States of America

United States Patent and Trademark Office

TEAM SWITZERLAND

Reg. No. 4,206,364

SUMMIT ENTERTAINMENT, LLC (DELAWARE LIMITED LIABILITY COMPANY)
1630 STEWART STREET, SUITE 120
SANTA MONICA, CA 90404

Registered Sep. 11, 2012

Int. Cl.: 24

FOR: BLANKETS, NAMELY, BED BLANKETS, BLANKET THROWS, AND LAP BLANKETS,
IN CLASS 24 (U.S. CLS. 42 AND 50).

TRADEMARK

FIRST USE 11-1-2009; IN COMMERCE 11-1-2009.

PRINCIPAL REGISTER

THE MARK CONSISTS OF STANDARD CHARACTERS WITHOUT CLAIM TO ANY PARTICULAR FONT, STYLE, SIZE, OR COLOR.

SN 77-928,656, FILED 2-4-2010.

HELENE LIWINSKI, EXAMINING ATTORNEY



David J. Kybas

Director of the United States Patent and Trademark Office

United States of America

United States Patent and Trademark Office

BUZZ

Reg. No. 4,206,365

Registered Sep. 11, 2012

Int. Cl.: 9

TRADEMARK

PRINCIPAL REGISTER

KLEIN ELECTRONICS, INC. (CALIFORNIA CORPORATION)
349 N. VINEWOOD STREET
ESCONDIDO, CA 92029

FOR: TWO-WAY RADIOS, IN CLASS 9 (U.S. CLS. 21, 23, 26, 36 AND 38).

FIRST USE 1-31-2012; IN COMMERCE 1-31-2012.

THE MARK CONSISTS OF STANDARD CHARACTERS WITHOUT CLAIM TO ANY PARTICULAR FONT, STYLE, SIZE, OR COLOR.

SN 77-930,459, FILED 2-8-2010.

LAKEISHA LEWIS, EXAMINING ATTORNEY



David J. Kybas

Director of the United States Patent and Trademark Office

United States of America

United States Patent and Trademark Office

GET MORE CONTROL

Reg. No. 4,206,366

Registered Sep. 11, 2012

Int. Cl.: 9

TRADEMARK

PRINCIPAL REGISTER

REMOTE TECHNOLOGIES INCORPORATED (MINNESOTA CORPORATION)
5775 12TH AVE. EAST, SUITE 180
SHAKOPEE, MN 55379

FOR: HOME AND OFFICE AUTOMATION SYSTEMS AND COMPONENTS COMPRISING WIRELESS AND WIRED CONTROLLERS, CONTROLLED DEVICES, SYSTEM CONTROLLERS AND/OR SOFTWARE FOR LIGHTING, HVAC, SECURITY, SAFETY, AUDIO, VIDEO, THEATER AND/OR OTHER HOME AND OFFICE MONITORING AND CONTROL APPLICATIONS, IN CLASS 9 (U.S. CLS. 21, 23, 26, 36 AND 38).

FIRST USE 12-30-2011; IN COMMERCE 12-30-2011.

THE MARK CONSISTS OF STANDARD CHARACTERS WITHOUT CLAIM TO ANY PARTICULAR FONT, STYLE, SIZE, OR COLOR.

SN 77-930,634, FILED 2-8-2010.

REBECCA SMITH, EXAMINING ATTORNEY



David J. Kyffers

Director of the United States Patent and Trademark Office

United States of America

United States Patent and Trademark Office



Reg. No. 4,206,367

Registered Sep. 11, 2012

Int. Cl.: 36

SERVICE MARK

PRINCIPAL REGISTER

TOP LINE VENTURES INCORPORATED (TEXAS CORPORATION)
6428 CASTLEMERE DR
PLANO, TX 75093

FOR: CURRENCY TRANSFER SERVICES; ELECTRONIC FUNDS TRANSFER; ELECTRONIC FUNDS TRANSFER BY TELECOMMUNICATIONS; ELECTRONIC TRANSFER OF FUNDS; ELECTRONIC TRANSFER OF MONEY; ELECTRONIC TRANSFERS OF MONEY; EXCHANGING MONEY; FINANCIAL SERVICES, NAMELY, INVESTMENT FUND TRANSFER AND TRANSACTION SERVICES; MONEY EXCHANGE SERVICES; MONEY TRANSFER, IN CLASS 36 (U.S. CLS. 100, 101 AND 102).

FIRST USE 3-1-2009; IN COMMERCE 12-17-2011.

THE MARK CONSISTS OF THE WORD "THE" IN BLACK AND "VAULT" IN GOLD COLOR NEXT TO A TREASURE CHEST IN BROWN WITH SILVER AND BLACK HASP, BLACK AND WHITE HINGES, FILLED WITH GOLD COINS AND WITH GOLD COINS OUTLINED IN BLACK SCATTERED AROUND THE CHEST.

THE COLOR(S) BLACK, GOLD, BROWN, SILVER, AND WHITE IS/ARE CLAIMED AS A FEATURE OF THE MARK.

SN 77-932,272, FILED 2-10-2010.

CHRISTINE COOPER, EXAMINING ATTORNEY



David J. Kybas

Director of the United States Patent and Trademark Office

United States of America

United States Patent and Trademark Office

EXPLORER

Reg. No. 4,206,368

BOSTON SCIENTIFIC SCIMED, INC. (MINNESOTA CORPORATION)
ONE SCIMED PLACE
MAPLE GROVE, MN 55311

Registered Sep. 11, 2012

Int. Cl.: 10

FOR: MEDICAL CATHETERS AND MEDICAL DIAGNOSTIC CATHETERS, IN CLASS 10
(U.S. CLS. 26, 39 AND 44).

TRADEMARK

FIRST USE 7-1-1996; IN COMMERCE 7-1-1996.

PRINCIPAL REGISTER

THE MARK CONSISTS OF STANDARD CHARACTERS WITHOUT CLAIM TO ANY PARTICULAR FONT, STYLE, SIZE, OR COLOR.

SN 77-932,657, FILED 2-10-2010.

ELIZABETH KAJUBI, EXAMINING ATTORNEY



David J. Kybas

Director of the United States Patent and Trademark Office

United States of America

United States Patent and Trademark Office

SWEET BEE

Reg. No. 4,206,369

Registered Sep. 11, 2012

Int. Cl.: 28

TRADEMARK

PRINCIPAL REGISTER

MATTEL, INC. (DELAWARE CORPORATION)
M1-1518
333 CONTINENTAL BOULEVARD
EL SEGUNDO, CA 90245

FOR: TOYS, GAMES AND PLAYTHINGS, NAMELY, TOY ACTION FIGURES AND ACCESSORIES THEREFOR, IN CLASS 28 (U.S. CLS. 22, 23, 38 AND 50).

FIRST USE 6-30-2012; IN COMMERCE 6-30-2012.

THE MARK CONSISTS OF STANDARD CHARACTERS WITHOUT CLAIM TO ANY PARTICULAR FONT, STYLE, SIZE, OR COLOR.

NO CLAIM IS MADE TO THE EXCLUSIVE RIGHT TO USE "BEE", APART FROM THE MARK AS SHOWN.

SN 77-934,348, FILED 2-12-2010.

LINDA LAVACHE, EXAMINING ATTORNEY



David J. Kyjars

Director of the United States Patent and Trademark Office

United States of America

United States Patent and Trademark Office

NATURALINE

Reg. No. 4,206,370

MULTI-CHEM GROUP, LLC (TEXAS LIMITED LIABILITY COMPANY)
2905 SOUTHWEST BLVD.
SAN ANGELO, TX 76904

Registered Sep. 11, 2012

Int. Cl.: 1

FOR: A HOUSE MARK FOR CHEMICALS FOR USE IN OIL AND GAS PRODUCTION, IN CLASS 1 (U.S. CLS. 1, 5, 6, 10, 26 AND 46).

TRADEMARK

FIRST USE 6-25-2010; IN COMMERCE 6-25-2010.

PRINCIPAL REGISTER

THE MARK CONSISTS OF STANDARD CHARACTERS WITHOUT CLAIM TO ANY PARTICULAR FONT, STYLE, SIZE, OR COLOR.

SN 77-939,726, FILED 2-19-2010.

LEIGH CAROLINE CASE, EXAMINING ATTORNEY



David J. Kybas

Director of the United States Patent and Trademark Office

United States of America

United States Patent and Trademark Office



Reg. No. 4,206,371

Registered Sep. 11, 2012

Int. Cl.: 41

SERVICE MARK

PRINCIPAL REGISTER

JIM PARKER MUSIC, LLC (ALABAMA LIMITED LIABILITY COMPANY)
208 CROWNDRIDGE DRIVE
MADISON, AL 35756

FOR: ENTERTAINMENT AND EDUCATION SERVICES IN THE NATURE OF LIVE DANCE AND MUSICAL PERFORMANCES; ENTERTAINMENT AND EDUCATIONAL SERVICES, NAMELY, PROVIDING ADVICE AND INFORMATION FOR MUSIC, VIDEO AND FILM CONCEPT AND SCRIPT DEVELOPMENT; ENTERTAINMENT IN THE NATURE OF AN ON-GOING SPECIAL VARIETY, NEWS, MUSIC OR COMEDY SHOW FEATURING PERFORMING SONGWRITERS, MUSICIANS, AND MUSIC BROADCAST OVER TELEVISION, SATELLITE, AUDIO, AND VIDEO MEDIA; ENTERTAINMENT IN THE NATURE OF VISUAL AND AUDIO PERFORMANCES, AND MUSICAL, VARIETY, NEWS AND COMEDY SHOWS; ENTERTAINMENT IN THE NATURE OF VISUAL AND AUDIO PERFORMANCES, NAMELY, MUSICAL BAND, ROCK GROUP, GYMNASTIC, DANCE, AND BALLET PERFORMANCES; ENTERTAINMENT IN THE NATURE OF PERFORMING SONGWRITERS, MUSICIANS, AND MUSIC; ENTERTAINMENT INFORMATION SERVICES, NAMELY, PROVIDING INFORMATION AND NEWS RELEASES ABOUT A MUSICAL ARTIST; ENTERTAINMENT SERVICES IN THE NATURE OF LIVE MUSICAL PERFORMANCES; ENTERTAINMENT SERVICES, NAMELY, AN ON-LINE ACTIVITY WHERE YOU CREATE YOUR OWN MUSIC VIDEOS; ENTERTAINMENT SERVICES, NAMELY, PROVIDING A WEB SITE FEATURING NON-DOWNLOADABLE MUSICAL PERFORMANCES, MUSICAL VIDEOS, RELATED FILM CLIPS, PHOTOGRAPHS, AND OTHER MULTIMEDIA MATERIALS FEATURING PERFORMING SONGWRITERS, MUSICIANS, AND MUSIC; ENTERTAINMENT SERVICES, NAMELY, PROVIDING NON-DOWNLOADABLE PLAYBACK OF MUSIC VIA GLOBAL COMMUNICATIONS NETWORKS; ENTERTAINMENT SERVICES, NAMELY, PROVIDING NONDOWNLOADABLE PRERECORDED MUSIC, INFORMATION IN THE FIELD OF MUSIC, AND COMMENTARY AND ARTICLES ABOUT MUSIC, ALL ON-LINE VIA A GLOBAL COMPUTER NETWORK; ENTERTAINMENT, NAMELY, LIVE MUSIC CONCERTS; ENTERTAINMENT, NAMELY, LIVE PERFORMANCES BY A MUSICAL BAND; ENTERTAINMENT, NAMELY, LIVE PERFORMANCES BY MUSICAL BANDS; MULTIMEDIA ENTERTAINMENT SERVICES IN THE NATURE OF RECORDING, PRODUCTION AND POST-PRODUCTION SERVICES IN THE FIELDS OF MUSIC, VIDEO, AND FILMS; MULTIMEDIA PUBLISHING OF BOOKS, MAGAZINES, JOURNALS, SOFTWARE, GAMES, MUSIC, AND ELECTRONIC PUBLICATIONS; MUSIC COMPOSITION AND TRANSCRIPTION FOR OTHERS; MUSIC COMPOSITION FOR OTHERS; MUSIC PRODUCTION SERVICES; MUSIC PUBLISHING SERVICES; PRESENTATION OF MUSICAL PERFORMANCE; PRODUCTION OF MUSICAL SOUND RECORDING; PRODUCTION OF SOUND AND MUSIC VIDEO RE-



David J. Kappas

Director of the United States Patent and Trademark Office

Reg. No. 4,206,371 RECORDINGS; PROVIDING AN INTERNET WEBSITE PORTAL FEATURING LINKS TO MUSICAL ARTIST WEBSITES AND MUSIC PERFORMANCE TICKET INFORMATION; PROVIDING AN INTERNET WEBSITE PORTAL IN THE FIELD OF MUSIC; PROVIDING FACILITIES FOR MOVIES, SHOWS, PLAYS, MUSIC OR EDUCATIONAL TRAINING; PROVISION OF INFORMATION RELATING TO LIVE PERFORMANCES, ROAD SHOWS, LIVE STAGE EVENTS, THEATRICAL PERFORMANCES, LIVE MUSIC CONCERTS AND AUDIENCE PARTICIPATION IN SUCH EVENTS; PROVISION OF INFORMATION RELATING TO MUSIC; PUBLISHING OF BOOKS, E-BOOKS, AUDIO BOOKS, MUSIC AND ILLUSTRATIONS, IN CLASS 41 (U.S. CLS. 100, 101 AND 107).

FIRST USE 4-12-2010; IN COMMERCE 4-12-2010.

NO CLAIM IS MADE TO THE EXCLUSIVE RIGHT TO USE "2004", APART FROM THE MARK AS SHOWN.

THE COLOR(S) RED, ORANGE, YELLOW, GREEN, BLUE, BLACK, WHITE AND PINK IS/ARE CLAIMED AS A FEATURE OF THE MARK.

THE NAME, PORTRAIT, AND/OR SIGNATURE SHOWN IN THE MARK IDENTIFIES "ALAN RHODY KOHNHORST", WHOSE CONSENT IS MADE OF RECORD.

THE MARK CONSISTS OF A COLORFUL, VIVID, WHIMSICAL, ABSTRACT PAINTED IMAGE OF A HUMAN FACE AND TWO GUITARS ON A BACKGROUND OF THICK WAVY PAINTED LINES AND MULTICOLOR SHAPES OF COLOR. THE FACE IS LOCATED ON THE RIGHT HALF OF THE IMAGE. ONE GUITAR IS POSITIONED WITH THE NECK POINTED DOWNWARD AND TO THE RIGHT BENEATH THE IMAGE OF THE FACE. THE OTHER GUITAR IS LOCATED IN AN UPRIGHT POSITION ON THE LEFT HALF OF THE IMAGE. THE LEFT HALF OF THE HUMAN FIGURE'S FACE IS RED WITH A BLACK AND WHITE EYE AND BLUE EYELID. THE RIGHT HALF OF THE FACE IS YELLOW WITH A THICK PINK LOCK OF HAIR RUNNING ALONG THE RIGHT SIDE OF THE FACE. THE TWO GUITARS ARE RED, BLACK, GREEN, PINK, YELLOW AND ORANGE. THE REMAINDER IS INTERSPERSED WITH MANY VIVID WAVY PAINTSTROKES AND CURVED GEOMETRIC SHAPES IN PINK, BLUE, GREEN, RED, YELLOW AND BLACK. THE WORDING "ALAN RHODY KOHNHORST 2004" APPEARS IN BLACK AT THE BOTTOM OF THE GUITAR ON THE LEFT.

SN 77-941,052, FILED 2-22-2010.

WILLIAM BRECKENFELD, EXAMINING ATTORNEY

United States of America

United States Patent and Trademark Office

GLOBAL ELITE

Reg. No. 4,206,372

WELLA AKTIENGESELLSCHAFT (FED REP GERMANY CORPORATION)
BERLINER ALLEE 65

Registered Sep. 11, 2012

DARMSTADT, FED REP GERMANY 64274

Int. Cl.: 35

FOR: PROVIDING INCENTIVE AWARD PROGRAMS FOR CUSTOMERS THROUGH ISSUANCE AND PROCESSING OF LOYALTY POINTS FOR ON-LINE PURCHASE OF COMPANY'S GOODS AND SERVICES, IN CLASS 35 (U.S. CLS. 100, 101 AND 102).

SERVICE MARK

FIRST USE 7-1-2010; IN COMMERCE 7-1-2010.

PRINCIPAL REGISTER

THE MARK CONSISTS OF STANDARD CHARACTERS WITHOUT CLAIM TO ANY PARTICULAR FONT, STYLE, SIZE, OR COLOR.

NO CLAIM IS MADE TO THE EXCLUSIVE RIGHT TO USE "GLOBAL", APART FROM THE MARK AS SHOWN.

SN 77-942,906, FILED 2-23-2010.

ANDREA HACK, EXAMINING ATTORNEY



David J. Kyjars

Director of the United States Patent and Trademark Office

United States of America

United States Patent and Trademark Office

PROPCLIP

Reg. No. 4,206,373

NORTHTREAL, INC. (DELAWARE CORPORATION)
201 WEST PASSAIC ST., SUITE 404
ROCHELLE PARK, NJ 07662

Registered Sep. 11, 2012

Int. Cl.: 42

FOR: APPLICATION SERVICE PROVIDER (ASP) FEATURING SOFTWARE AND WEB BROWSER TOOL BAR SOFTWARE APPLICATIONS FOR USE IN THE FIELDS OF REAL ESTATE PROPERTY INFORMATION AND ONLINE REAL ESTATE CLASSIFIED ADVERTISEMENTS, IN CLASS 42 (U.S. CLS. 100 AND 101).

SERVICE MARK

PRINCIPAL REGISTER

FIRST USE 6-15-2012; IN COMMERCE 6-15-2012.

THE MARK CONSISTS OF STANDARD CHARACTERS WITHOUT CLAIM TO ANY PARTICULAR FONT, STYLE, SIZE, OR COLOR.

SN 77-944,100, FILED 2-24-2010.

MICHAEL ENGEL, EXAMINING ATTORNEY



David J. Kybas

Director of the United States Patent and Trademark Office

United States of America

United States Patent and Trademark Office

ViperSTAT

Reg. No. 4,206,374

Registered Sep. 11, 2012

Int. Cl.: 5

TRADEMARK

PRINCIPAL REGISTER

BIOVETERIA LIFE SCIENCES, LLC (ARIZONA LIMITED LIABILITY COMPANY)
1042 WILLOW CREEK RD.
A101-482
PRESCOTT, AZ 86301

FOR: THERAPEUTIC PHARMACEUTICAL FOR THE TREATMENT OF SNAKEBITES, IN CLASS 5 (U.S. CLS. 6, 18, 44, 46, 51 AND 52).

FIRST USE 6-18-2012; IN COMMERCE 6-18-2012.

THE MARK CONSISTS OF STANDARD CHARACTERS WITHOUT CLAIM TO ANY PARTICULAR FONT, STYLE, SIZE, OR COLOR.

SN 77-947,098, FILED 3-1-2010.

MARK T. MULLEN, EXAMINING ATTORNEY



David J. Kyffers

Director of the United States Patent and Trademark Office

United States of America

United States Patent and Trademark Office



Reg. No. 4,206,375

SEATTLE'S BEST COFFEE LLC (WASHINGTON LIMITED LIABILITY COMPANY)
2401 UTAH AVENUE SOUTH
SEATTLE, WA 98134

Registered Sep. 11, 2012

**Int. Cls.: 7, 9, 11, 16, 21,
29, 30, 32, 35, and 43**

FOR: ELECTRIC COFFEE GRINDERS FOR COMMERCIAL USE, IN CLASS 7 (U.S. CLS. 13, 19, 21, 23, 31, 34 AND 35).

FIRST USE 3-31-2011; IN COMMERCE 3-31-2011.

TRADEMARK

FOR: VENDING MACHINES, IN CLASS 9 (U.S. CLS. 21, 23, 26, 36 AND 38).

SERVICE MARK

FIRST USE 3-31-2011; IN COMMERCE 3-31-2011.

PRINCIPAL REGISTER

FOR: ELECTRICAL APPLIANCES, NAMELY, ESPRESSO MAKERS AND COFFEE MAKERS FOR COMMERCIAL USE, IN CLASS 11 (U.S. CLS. 13, 21, 23, 31 AND 34).

FIRST USE 3-31-2011; IN COMMERCE 3-31-2011.

FOR: PAPER BAGS, IN CLASS 16 (U.S. CLS. 2, 5, 22, 23, 29, 37, 38 AND 50).

FIRST USE 9-30-2010; IN COMMERCE 9-30-2010.

FOR: COFFEE CUPS; TEA CUPS AND MUGS; DISHES; CUPS; CUP-SLEEVES, IN CLASS 21 (U.S. CLS. 2, 13, 23, 29, 30, 33, 40 AND 50).

FIRST USE 7-20-2011; IN COMMERCE 7-20-2011.

FOR: FLAVORED MILK AND MILK BASED BEVERAGES; LIQUID BEVERAGE MIXES USED TO MAKE MILK-BASED FOOD BEVERAGES EXCLUDING MILK SHAKES, IN CLASS 29 (U.S. CL. 46).

FIRST USE 7-20-2011; IN COMMERCE 7-20-2011.

FOR: GROUND AND WHOLE BEAN COFFEE; COCOA; HERBAL AND NON-HERBAL TEA; COFFEE, TEA, COCOA AND ESPRESSO BEVERAGES, AND BEVERAGES MADE WITH A BASE OF COFFEE AND/OR ESPRESSO; BEVERAGES MADE WITH A BASE OF TEA; SAUCES TO ADD TO BEVERAGES; CHOCOLATE SYRUP; FLAVORING SYRUPS TO ADD



David J. Kybas

Director of the United States Patent and Trademark Office

Reg. No. 4,206,375 TO BEVERAGES; BAKED GOODS INCLUDING MUFFINS, SCONES, BISCUITS, COOKIES, PASTRIES AND BREADS; READY-TO-DRINK COFFEE; CHOCOLATE; CANDY; FRUIT SAUCES EXCLUDING CRANBERRY SAUCE AND APPLESAUCE, IN CLASS 30 (U.S. CL. 46).

FIRST USE 11-10-2010; IN COMMERCE 11-10-2010.

FOR: NON-ALCOHOLIC DRINKS, NAMELY, FRUIT JUICE BASED BEVERAGES; FRUIT DRINKS; FRUIT DRINKS CONTAINING FRUIT JUICES; SAUCES FOR MAKING BEVERAGES; FLAVORING SYRUPS FOR MAKING BEVERAGES; FROZEN FRUIT BEVERAGES AND FROZEN FRUIT-BASED BEVERAGES, IN CLASS 32 (U.S. CLS. 45, 46 AND 48).

FIRST USE 7-20-2011; IN COMMERCE 7-20-2011.

FOR: BUSINESS ADMINISTRATION; BUSINESS MANAGEMENT; FRANCHISING, NAMELY, PROVIDING BUSINESS MANAGEMENT ASSISTANCE IN THE ESTABLISHMENT AND OR OPERATION OF RESTAURANTS, CAFES, COFFEE HOUSES AND SNACK BARS; RETAIL STORE SERVICES IN THE FIELD OF COFFEE, TEA, COCOA, PACKAGED AND PREPARED FOODS, NON-ELECTRIC APPLIANCES, HOUSEWARES, KITCHENWARE, BOOKS, MUSICAL RECORDINGS; WHOLESALE DISTRIBUTORSHIPS AND WHOLESALE ORDERING SERVICES ALL IN THE FIELD OF COFFEE, TEA, COCOA; COMPUTERIZED ON-LINE ORDERING SERVICES, COMPUTERIZED ON-LINE RETAIL STORE SERVICES, ON-LINE ORDERING SERVICES ALL IN THE FIELD OF COFFEE, TEA, COCOA, ELECTRIC APPLIANCES, HOUSEWARES, KITCHENWARE; RETAIL STORE SERVICES FEATURING CARRY OUT FOODS AND BEVERAGES, IN CLASS 35 (U.S. CLS. 100, 101 AND 102).

FIRST USE 5-12-2012; IN COMMERCE 5-12-2012.

FOR: RESTAURANT, CAFE, CAFETERIA, SNACK BAR, COFFEE BAR AND COFFEE HOUSE, CARRY OUT RESTAURANT, AND TAKE OUT RESTAURANT SERVICES; CATERING SERVICES; COFFEE SUPPLY SERVICES FOR OFFICES; CONTRACT FOOD SERVICES; FOOD PREPARATION; PREPARATION OF CARRY OUT FOODS AND BEVERAGES, IN CLASS 43 (U.S. CLS. 100 AND 101).

FIRST USE 11-10-2010; IN COMMERCE 11-10-2010.

THE MARK CONSISTS OF A CIRCULAR BAND SURROUNDING AN INTERNAL CIRCLE IN WHICH THE BOTTOM HALF CONTAINS A HALF CIRCLE AND TEAR DROP.

SN 77-950,764, FILED 3-4-2010.

MATTHEW PAPPAS, EXAMINING ATTORNEY

United States of America

United States Patent and Trademark Office

BRATTITUDE

Reg. No. 4,206,376

Registered Sep. 11, 2012

Int. Cl.: 29

TRADEMARK

PRINCIPAL REGISTER

JOHNSONVILLE SAUSAGE, LLC (DELAWARE LIMITED LIABILITY COMPANY)
P.O. BOX 906
SHEBOYGAN FALLS, WI 53085

FOR: MEAT, IN CLASS 29 (U.S. CL. 46).

FIRST USE 7-23-2012; IN COMMERCE 7-23-2012.

THE MARK CONSISTS OF STANDARD CHARACTERS WITHOUT CLAIM TO ANY PARTICULAR FONT, STYLE, SIZE, OR COLOR.

SN 77-959,197, FILED 3-15-2010.

TIMOTHY FINNEGAN, EXAMINING ATTORNEY



David J. Kyffers

Director of the United States Patent and Trademark Office

United States of America

United States Patent and Trademark Office

Shapes 'n Spaces put into Places

Reg. No. 4,206,377

Registered Sep. 11, 2012

Int. Cl.: 42

SERVICE MARK

PRINCIPAL REGISTER

THOMAS NEWTON CARTER (MINNESOTA LIMITED LIABILITY COMPANY), DBA/
SHAPES N SPACES, LLC,
5540 CLINTON AVE. S.
MINNEAPOLIS, MN 55419

FOR: PROVIDING TEMPORARY USE OF ON-LINE NON-DOWNLOADABLE COMPUTER SOFTWARE FOR THE DATABASING, VISUALIZATION, MANIPULATION, VIRTUAL REALITY IMMERSION AND INTEGRATION OF GEOGRAPHIC INFORMATION WITH ON-LINE MEMBER COMMUNITIES, IN CLASS 42 (U.S. CLS. 100 AND 101).

FIRST USE 1-1-2011; IN COMMERCE 10-4-2011.

THE MARK CONSISTS OF STANDARD CHARACTERS WITHOUT CLAIM TO ANY PARTICULAR FONT, STYLE, SIZE, OR COLOR.

SN 77-962,250, FILED 3-18-2010.

ZHALEH DELANEY, EXAMINING ATTORNEY



David J. Kyffers

Director of the United States Patent and Trademark Office

United States of America

United States Patent and Trademark Office

DEWAN

Reg. No. 4,206,378

Registered Sep. 11, 2012

Int. Cls.: 29 and 30

TRADEMARK

PRINCIPAL REGISTER

FAHMAN ENTERPRISES (TEXAS CORPORATION)
209 CRYSTAL COURT
RICHARDSON, TX 75081

FOR: DRIED FRUITS; DRIED VEGETABLES; PROCESSED NUTS; RAISINS; JAMS; JELLIES;
MARMALADE; PICKLES, IN CLASS 29 (U.S. CL. 46).

FIRST USE 1-19-2010; IN COMMERCE 1-19-2010.

FOR: CINNAMON; CINNAMON POWDER; CLOVE POWDER; COOKIES; CURRY POWDER;
DRY SPICE RUB FOR MEATS AND FISH; EDIBLE SPICES; HOT PEPPER POWDER; MUS-
TARD POWDER; PEPPER; PEPPER POWDER; SPICES; CHUTNEY; KETCHUP; RICE; RUSKS,
IN CLASS 30 (U.S. CL. 46).

FIRST USE 7-0-2009; IN COMMERCE 7-0-2009.

THE MARK CONSISTS OF STANDARD CHARACTERS WITHOUT CLAIM TO ANY PAR-
TICULAR FONT, STYLE, SIZE, OR COLOR.

THE ENGLISH TRANSLATION OF "DEWAN" IS BUNDLE OR COLLECTION OF SHEETS.

SN 77-965,061, FILED 3-22-2010.

TRICIA SONNEBORN, EXAMINING ATTORNEY



David J. Kybas

Director of the United States Patent and Trademark Office

United States of America

United States Patent and Trademark Office

CHOCOLATE BOX

Reg. No. 4,206,379

Registered Sep. 11, 2012

Int. Cl.: 32

TRADEMARK

PRINCIPAL REGISTER

ROCLAND WINE IMPORTS (CALIFORNIA CORPORATION)
601 MONTGOMERY ST., STE. 777
SAN FRANCISCO, CA 94111

FOR: BEER, IN CLASS 32 (U.S. CLS. 45, 46 AND 48).

FIRST USE 7-13-2012; IN COMMERCE 7-13-2012.

THE MARK CONSISTS OF STANDARD CHARACTERS WITHOUT CLAIM TO ANY PARTICULAR FONT, STYLE, SIZE, OR COLOR.

OWNER OF U.S. REG. NO. 3,602,783.

SN 77-965,397, FILED 3-22-2010.

COLLEEN DOMBROW, EXAMINING ATTORNEY



David J. Kybas

Director of the United States Patent and Trademark Office

United States of America

United States Patent and Trademark Office

FRESH WAVE

Reg. No. 4,206,380

Registered Sep. 11, 2012

Int. Cl.: 3

TRADEMARK

PRINCIPAL REGISTER

GLAXOSMITHKLINE LLC (UNITED STATES LIMITED LIABILITY COMPANY)
2711 CENTERVILLE ROAD, SUITE 400
CORPORATION SERVICE COMPANY
WILMINGTON, DE 19808

FOR: ORAL CARE PREPARATIONS, NAMELY, TOOTHPASTE, IN CLASS 3 (U.S. CLS. 1, 4, 6, 50, 51 AND 52).

FIRST USE 3-31-2011; IN COMMERCE 3-31-2011.

THE MARK CONSISTS OF STANDARD CHARACTERS WITHOUT CLAIM TO ANY PARTICULAR FONT, STYLE, SIZE, OR COLOR.

SN 77-965,665, FILED 3-23-2010.

JIM RINGLE, EXAMINING ATTORNEY



David J. Kyffers

Director of the United States Patent and Trademark Office

United States of America

United States Patent and Trademark Office

ENSO

Reg. No. 4,206,381

Registered Sep. 11, 2012

Int. Cls.: 9 and 41

TRADEMARK

SERVICE MARK

PRINCIPAL REGISTER

FUJIKURA COMPOSITE AMERICA, INC. (DELAWARE CORPORATION)
SUITE 103
1483 POINSETTIA AVENUE
VISTA, CA 92081

FOR: COMPUTER SOFTWARE AND HARDWARE FOR FITTING GOLF EQUIPMENT;
VIDEO CAMERAS AND VIDEO RECORDERS , IN CLASS 9 (U.S. CLS. 21, 23, 26, 36 AND
38).

FIRST USE 11-0-2009; IN COMMERCE 9-0-2011.

FOR: FITTING OF GOLF EQUIPMENT TO INDIVIDUAL USERS; CONSULTING IN THE
FIELD OF GOLF AND THE FITTING OF GOLF EQUIPMENT, IN CLASS 41 (U.S. CLS. 100,
101 AND 107).

FIRST USE 11-0-2009; IN COMMERCE 11-0-2011.

THE MARK CONSISTS OF STANDARD CHARACTERS WITHOUT CLAIM TO ANY PAR-
TICULAR FONT, STYLE, SIZE, OR COLOR.

THE ENGLISH TRANSLATION OF "ENSO" IN THE MARK IS "CIRCLE".

SN 77-968,861, FILED 3-25-2010.

MATTHEW MCDOWELL, EXAMINING ATTORNEY



David J. Kyros

Director of the United States Patent and Trademark Office

United States of America

United States Patent and Trademark Office

SAFE CAN STILL BE SEXY

Reg. No. 4,206,382

INVISIBLE GADGET GUARD, INC. (UTAH CORPORATION)
3939 SOUTH WASATCH BLVD.
SALT LAKE CITY, UT 84124

Registered Sep. 11, 2012

Int. Cl.: 9

FOR: COVERS FOR CELL PHONES AND MP3 PLAYERS, IN CLASS 9 (U.S. CLS. 21, 23, 26, 36 AND 38).

TRADEMARK

FIRST USE 4-1-2010; IN COMMERCE 4-1-2010.

PRINCIPAL REGISTER

THE MARK CONSISTS OF STANDARD CHARACTERS WITHOUT CLAIM TO ANY PARTICULAR FONT, STYLE, SIZE, OR COLOR.

SN 77-969,266, FILED 3-26-2010.

BERNICE MIDDLETON, EXAMINING ATTORNEY



David J. Kyffers

Director of the United States Patent and Trademark Office

United States of America

United States Patent and Trademark Office

VALHALLA BRANDYWINE

Reg. No. 4,206,383

Registered Sep. 11, 2012

Int. Cls.: 36 and 37

SERVICE MARK

PRINCIPAL REGISTER

VALHALLA BRANDYWINE PARTNERS, L.P. (PENNSYLVANIA LIMITED PARTNERSHIP)
SUITE LM
1500 CHESTNUT STREET
PHILADELPHIA, PA 19103

FOR: REAL ESTATE BROKERAGE SERVICES, NAMELY, BROKERAGE CONDOMINIUMS, HOUSES, RESIDENTIAL PROPERTIES AND COMMERCIAL PROPERTIES IN PLANNED COMMUNITIES, IN CLASS 36 (U.S. CLS. 100, 101 AND 102).

FIRST USE 8-20-2007; IN COMMERCE 8-20-2007.

FOR: PLANNING AND LAYING OUT RESIDENTIAL COMMUNITIES FOR OTHERS AND CUSTOM HOME CONSTRUCTION SERVICES, IN CLASS 37 (U.S. CLS. 100, 103 AND 106).

FIRST USE 8-20-2007; IN COMMERCE 8-20-2007.

THE MARK CONSISTS OF STANDARD CHARACTERS WITHOUT CLAIM TO ANY PARTICULAR FONT, STYLE, SIZE, OR COLOR.

NO CLAIM IS MADE TO THE EXCLUSIVE RIGHT TO USE "BRANDYWINE" , APART FROM THE MARK AS SHOWN.

SN 77-976,799, FILED 1-8-2008.

ALICE BENMAMAN, EXAMINING ATTORNEY



David J. Kybas

Director of the United States Patent and Trademark Office

United States of America

United States Patent and Trademark Office

DALET

Reg. No. 4,206,384

DALET S.A. (FRANCE SOCIÉTÉ ANONYME (SA))
16 RUE RIVAY

Registered Sep. 11, 2012

LEVALLOIS-PERRET, FRANCE 92300

Int. Cl.: 9

FOR: COMPUTER HARDWARE AND COMPUTER SOFTWARE FOR BACK-OFFICE AND HUMAN TASKS WORKFLOW ORCHESTRATION IN THE FIELD OF BUSINESS PROCESS MANAGEMENT, IN CLASS 9 (U.S. CLS. 21, 23, 26, 36 AND 38).

TRADEMARK

FIRST USE 4-16-2012; IN COMMERCE 4-16-2012.

PRINCIPAL REGISTER

THE MARK CONSISTS OF STANDARD CHARACTERS WITHOUT CLAIM TO ANY PARTICULAR FONT, STYLE, SIZE, OR COLOR.

SN 77-980,590, FILED 12-22-2009.

GENE MACIOL, EXAMINING ATTORNEY



David J. Kyffers

Director of the United States Patent and Trademark Office

United States of America

United States Patent and Trademark Office

SUPERBY DR. NICHOLAS PERRICONE

Reg. No. 4,206,385

N.V. PERRICONE LLC (DELAWARE LIMITED LIABILITY COMPANY)
639 RESEARCH PARKWAY
MERIDEN, CT 06450

Registered Sep. 11, 2012

Int. Cl.: 3

FOR: BEAUTY SERUMS; COSMETIC CREAMS FOR SKIN CARE; COSMETIC PREPARATIONS FOR SKIN RENEWAL; SKIN CLEANSERS; SKIN CONDITIONERS; SKIN CREAM; SKIN LOTION; SKIN MOISTURIZER; SKIN TONERS, IN CLASS 3 (U.S. CLS. 1, 4, 6, 50, 51 AND 52).

TRADEMARK

PRINCIPAL REGISTER

FIRST USE 10-14-2010; IN COMMERCE 10-14-2010.

THE MARK CONSISTS OF STANDARD CHARACTERS WITHOUT CLAIM TO ANY PARTICULAR FONT, STYLE, SIZE, OR COLOR.

OWNER OF U.S. REG. NOS. 2,237,822, 2,674,550, AND 3,126,999.

THE NAME SHOWN IN THE MARK IDENTIFIES A PARTICULAR LIVING INDIVIDUAL, "DR. NICHOLAS PERRICONE", WHOSE CONSENT IS OF RECORD.

SN 77-983,085, FILED 2-10-2010.

SUSAN RICHARDS, EXAMINING ATTORNEY



David J. Kybas

Director of the United States Patent and Trademark Office

United States of America

United States Patent and Trademark Office

GIGMOR

Reg. No. 4,206,386

TRYBE, LLC (CALIFORNIA LIMITED LIABILITY COMPANY)
844 BERKLEY STREET
SANTA MONICA, CA 90403

Registered Sep. 11, 2012

Int. Cl.: 42

FOR: PROVIDING A WEBSITE FEATURING NON-DOWNLOADABLE PROPRIETARY SOFTWARE THAT ALLOWS USERS TO BE MATCHED WITH MUSICIANS USING USER-SPECIFIED CRITERIA, IN CLASS 42 (U.S. CLS. 100 AND 101).

SERVICE MARK

FIRST USE 10-5-2011; IN COMMERCE 10-5-2011.

PRINCIPAL REGISTER

THE MARK CONSISTS OF STANDARD CHARACTERS WITHOUT CLAIM TO ANY PARTICULAR FONT, STYLE, SIZE, OR COLOR.

SN 77-983,194, FILED 3-26-2010.

PAM WILLIS, EXAMINING ATTORNEY



David J. Kyffers

Director of the United States Patent and Trademark Office

United States of America

United States Patent and Trademark Office

LIVING SPACES

Reg. No. 4,206,387

Registered Sep. 11, 2012

Int. Cls.: 17 and 19

TRADEMARK

PRINCIPAL REGISTER

CERTAINTEED CORPORATION (DELAWARE CORPORATION)
750 E. SWEDESFORD ROAD
VALLEY FORGE, PA 194820101

FOR: DECKING, IN CLASS 17 (U.S. CLS. 1, 5, 12, 13, 35 AND 50).

FIRST USE 10-0-2009; IN COMMERCE 10-0-2009.

FOR: VINYL FENCING AND DECKING; NON-METAL RAILINGS FOR DECKS, PORCHES, BALCONIES, DOCKS, GAZEBOS, PATIOS, RAMPS AND ROOF DECKS; CEMENT BONDED PARTICLE BOARDS; VINYL SIDING, SOFFITS AND ACCESSORIES, NAMELY, FASCIA, J-CHANNELS, F-CHANNELS, CORNER POSTS; NON-METAL SILL TRIM AND DOOR AND WINDOW CASINGS; WALL AND CEILING PANELS NOT OF METAL; SIDING PARTITIONS; NON-METAL ARCHITECTURAL MOULDINGS; FIBER CEMENT SIDING, IN CLASS 19 (U.S. CLS. 1, 12, 33 AND 50).

FIRST USE 10-0-2009; IN COMMERCE 10-0-2009.

THE MARK CONSISTS OF STANDARD CHARACTERS WITHOUT CLAIM TO ANY PARTICULAR FONT, STYLE, SIZE, OR COLOR.

SN 77-983,217, FILED 11-30-2009.

CHARLES L. JENKINS, EXAMINING ATTORNEY



David J. Kybas

Director of the United States Patent and Trademark Office

United States of America

United States Patent and Trademark Office



Reg. No. 4,206,388

Registered Sep. 11, 2012

Int. Cl.: 32

SOCIEDAD COOPERATIVA TRABAJADORES DE PASCUAL, S.C.L. (MEXICO CORPORATION)
COLONIA TRANSITO
CLAVIJERO NO. 75
MEXICO CITY, MEXICO 06820

TRADEMARK

FOR: CARBONATED AND NON-CARBONATED FRUIT DRINKS, IN CLASS 32 (U.S. CLS. 45, 46 AND 48).

PRINCIPAL REGISTER

FIRST USE 6-30-2012; IN COMMERCE 6-30-2012.

OWNER OF U.S. REG. NO. 1,923,975.

THE COLOR(S) WHITE, BROWN, PINK, BLACK, BLUE, TAN, AND GRAY IS/ARE CLAIMED AS A FEATURE OF THE MARK.

THE MARK CONSISTS OF A DRAWING OF A TAN DUCK WITH BROWN AND WHITE EYES AND BLACK PUPILS IN A BLUE HAT FACING BACKWARDS WITH TAN AND PINK ACCENTS. BELOW THE DUCK ARE THE WORDS "PATO PASCUAL" IN BLUE SCRIPT, WITH EACH WORD SHARING THE LARGE LETTER "P". THE WORDING "PATO PASCUAL" HAS GRAY SHADING.

THE ENGLISH TRANSLATION OF "PATO" IN THE MARK IS "DUCK".

SN 77-983,291, FILED 5-7-2008.

MARIA-VICTORIA SUAREZ, EXAMINING ATTORNEY



David J. Kybas

Director of the United States Patent and Trademark Office

United States of America

United States Patent and Trademark Office

PEACE BAG

Reg. No. 4,206,389

Registered Sep. 11, 2012

Int. Cl.: 18

TRADEMARK

PRINCIPAL REGISTER

INDONESIAN IMPORTS, INC. (DELAWARE CORPORATION)
440 ALABAMA STREET
SAN FRANCISCO, CA 94111

FOR: HANDBAGS AND PURSES, IN CLASS 18 (U.S. CLS. 1, 2, 3, 22 AND 41).

FIRST USE 1-17-2012; IN COMMERCE 1-17-2012.

THE MARK CONSISTS OF STANDARD CHARACTERS WITHOUT CLAIM TO ANY PARTICULAR FONT, STYLE, SIZE, OR COLOR.

NO CLAIM IS MADE TO THE EXCLUSIVE RIGHT TO USE "BAG", APART FROM THE MARK AS SHOWN.

SN 77-983,298, FILED 9-19-2006.

MICHAEL ENGEL, EXAMINING ATTORNEY



David J. Kyffers

Director of the United States Patent and Trademark Office

United States of America

United States Patent and Trademark Office

CHANGING YOUR LIFE ONE STORY AT A TIME

Reg. No. 4,206,390

Registered Sep. 11, 2012

Int. Cls.: 41 and 45

SERVICE MARK

PRINCIPAL REGISTER

CHICKEN SOUP FOR THE SOUL PUBLISHING, LLC (CONNECTICUT LIMITED LIABILITY COMPANY)
132 EAST PUTNAM AVENUE
COS COB, CT 06807

FOR: PROVIDING ON-LINE NON-DOWNLOADABLE PUBLICATIONS IN THE NATURE OF NEWSLETTERS, ARTICLES, JOURNALS, BROCHURES AND MAGAZINES IN THE FIELD OF INSPIRATION AND SELF-ESTEEM, IN CLASS 41 (U.S. CLS. 100, 101 AND 107).

FIRST USE 4-22-2011; IN COMMERCE 4-22-2011.

FOR: PROVIDING A WEBSITE FEATURING INFORMATION IN THE FIELDS OF SPIRITUALITY, PERSONAL EMPOWERMENT, PERSONAL GROWTH, PERSONAL MOTIVATION, AND SELF-FULFILLMENT, IN CLASS 45 (U.S. CLS. 100 AND 101).

FIRST USE 2-16-2012; IN COMMERCE 2-16-2012.

THE MARK CONSISTS OF STANDARD CHARACTERS WITHOUT CLAIM TO ANY PARTICULAR FONT, STYLE, SIZE, OR COLOR.

SN 77-983,311, FILED 2-1-2010.

JAMES LOVELACE, EXAMINING ATTORNEY



David J. Kyros

Director of the United States Patent and Trademark Office

United States of America
United States Patent and Trademark Office

CASALE

Reg. No. 4,206,391

Registered Sep. 11, 2012

Int. Cl.: 29

TRADEMARK

PRINCIPAL REGISTER

R.L.E. CORP. (NEW YORK CORPORATION)
1301 BROAD STREET
UTICA, NY 13501

FOR: CANNED WHOLE CLAMS AND CALAMARI; CLAM JUICE; DELI MEATS; PROSCIUTTO; JARRED GOURMET VEGETABLES AND VEGETABLE SALADS; TOMATO PASTE; VEGETABLE OIL, IN CLASS 29 (U.S. CL. 46).

FIRST USE 11-4-2010; IN COMMERCE 11-4-2010.

THE MARK CONSISTS OF STANDARD CHARACTERS WITHOUT CLAIM TO ANY PARTICULAR FONT, STYLE, SIZE, OR COLOR.

OWNER OF U.S. REG. NO. 2,934,180.

THE ENGLISH TRANSLATION OF "CASALE" IN THE MARK IS COUNTRY HOUSE.

SN 77-983,319, FILED 8-24-2009.

NAAKWAMA ANKRAH, EXAMINING ATTORNEY



David J. Kyfos

Director of the United States Patent and Trademark Office

United States of America

United States Patent and Trademark Office

DUBSHOP

Reg. No. 4,206,392

Registered Sep. 11, 2012

Int. Cl.: 35

SERVICE MARK

PRINCIPAL REGISTER

DUB PUBLISHING, INC. (CALIFORNIA CORPORATION)
16815 JOHNSON DRIVE
CITY OF INDUSTRY, CA 91745

FOR: RETAIL STORE SERVICES FEATURING AUTOMOTIVE WHEELS, TIRES, CAR AUDIO AND VIDEO EQUIPMENT, AUTOMOBILE ACCESSORIES, APPAREL, WINDOW DECALS, DVD'S AND MAGAZINES, IN CLASS 35 (U.S. CLS. 100, 101 AND 102).

FIRST USE 7-0-2004; IN COMMERCE 7-0-2004.

THE MARK CONSISTS OF STANDARD CHARACTERS WITHOUT CLAIM TO ANY PARTICULAR FONT, STYLE, SIZE, OR COLOR.

SN 78-388,739, FILED 3-22-2004.

DANNEAN HETZEL, EXAMINING ATTORNEY



David J. Kyffers

Director of the United States Patent and Trademark Office

United States of America

United States Patent and Trademark Office



Reg. No. 4,206,393

ESPN, INC. (DELAWARE CORPORATION)
ESPN PLAZA
BRISTOL, CT 06010

Registered Sep. 11, 2012

**Int. Cls.: 6, 9, 12, 14, 16,
18, 24, 25, 28, and 32**

FOR: BICYCLE LOCKS, IN CLASS 6 (U.S. CLS. 2, 12, 13, 14, 23, 25 AND 50).

FIRST USE 0-0-2005; IN COMMERCE 0-0-2005.

TRADEMARK

FOR: OPTICAL WEAR, NAMELY, EYEGLASSES, SUNGLASSES AND FRAMES FOR EYEGLASSES AND SUNGLASSES; EYEWEAR, NAMELY, SPORTS EYEWEAR, PROTECTIVE EYEWEAR; CELLULAR TELEPHONE FACEPLATES; SOFT CARRYING CASES AND SHOULDER STRAPS FOR USE IN CONNECTION WITH THE OPERATION OF CELLULAR TELEPHONES; MOUSE PADS; PROTECTIVE HELMETS FOR SPORTS AND OTHER PROTECTIVE HELMETS, IN CLASS 9 (U.S. CLS. 21, 23, 26, 36 AND 38).

FIRST USE 0-0-2005; IN COMMERCE 0-0-2005.

PRINCIPAL REGISTER

FOR: BICYCLES; BICYCLE PEDALS; BICYCLE PEGS; BICYCLE GRIPS, IN CLASS 12 (U.S. CLS. 19, 21, 23, 31, 35 AND 44).

FIRST USE 0-0-2005; IN COMMERCE 0-0-2005.

FOR: WATCHES, IN CLASS 14 (U.S. CLS. 2, 27, 28 AND 50).

FIRST USE 0-0-2010; IN COMMERCE 0-0-2010.

FOR: STICKERS; CALENDARS; DESK CALENDARS, IN CLASS 16 (U.S. CLS. 2, 5, 22, 23, 29, 37, 38 AND 50).

FIRST USE 0-0-2010; IN COMMERCE 0-0-2010.

FOR: SPORT BAGS; ALL-PURPOSE ATHLETIC BAGS; LUGGAGE; BACKPACKS; DUFFLE BAGS; TRUNKS; TRAVELING BAGS; GARMENT BAGS; TOTE BAGS; OVERNIGHT BAGS; HANDBAGS; SHOULDER BAGS; FANNY PACKS; ATTACHE CASES; BRIEFCASES; BEACH BAGS; BOOK BAGS; MESSENGER BAGS; WALLETS; KEY CASES; UMBRELLAS; BICYCLE MESSENGER SACHELS, IN CLASS 18 (U.S. CLS. 1, 2, 3, 22 AND 41).



David J. Kyffers

Director of the United States Patent and Trademark Office

Reg. No. 4,206,393 FIRST USE 0-0-2007; IN COMMERCE 0-0-2007.

FOR: BED LINENS; BED COVERS OF FABRIC; BED SPREADS; DUVETS; DUVET COVERS; COMFORTERS; BED BLANKETS; QUILTS; BED SHEETS; DUST RUFFLES; PILLOW CASES; PILLOW SHAMS, IN CLASS 24 (U.S. CLS. 42 AND 50).

FIRST USE 0-0-2009; IN COMMERCE 0-0-2009.

FOR: CLOTHING FOR MEN, WOMEN AND CHILDREN, NAMELY, T-SHIRTS, SHIRTS, BLOUSES, SWEATERS, CARDIGANS, TURTLENECKS, VESTS, SWEAT SHIRTS, TANK TOPS, JERSEYS, BASEBALL SHIRTS, GOLF SHIRTS, JOGGING SHIRTS, SKIRTS, SHORTS, GYM SHORTS, TENNIS SHORTS, JEANS, PANTS, WORK PANTS, TROUSERS, SLACKS, TUNICS, SWEATSHIRTS, SWEAT PANTS, SWEAT SUITS, WARM-UP SUITS, GLOVES, MITTENS, SCARVES, COATS, SKI JACKETS, SKI PANTS, PARKAS, CAPES, PONCHOS, RUNNING SUITS, RAIN WEAR, UNDERWEAR, HOSIERY, SOCKS, TIGHTS, BABY CLOTHES, SNOWBOARD PANTS AND SNOWBOARD JACKETS, SKATEBOARD PANTS, SKATEBOARD SHORTS; BELTS, BANDANNAS, NECKBANDS, WRISTBANDS, SUSPENDERS, BEACH WEAR, SHOES, SNEAKERS, ATHLETIC SHOES, BOOTS, SANDALS, SKATEBOARD FOOTWEAR, SLIPPERS AND BOOTIES, CAPS, HATS, BEANIES, HEADBANDS, SWEATBANDS, BANDANAS, EAR MUFFS, VISORS AND SUN VISORS, BICYCLE GLOVES, SKI BOOTS, IN CLASS 25 (U.S. CLS. 22 AND 39).

FIRST USE 0-0-2007; IN COMMERCE 0-0-2007.

FOR: TOYS, GAMES AND PLAYTHINGS, NAMELY, BOARD GAMES, RIDE-ON TOYS; ATHLETIC PROTECTIVE ELBOW, WRIST AND KNEE PADS, SKATEBOARDS, SNOWBOARDS, IN CLASS 28 (U.S. CLS. 22, 23, 38 AND 50).

FIRST USE 0-0-2005; IN COMMERCE 0-0-2005.

FOR: MINERAL AND AERATED WATERS AND OTHER NON-ALCOHOLIC DRINKS, IN CLASS 32 (U.S. CLS. 45, 46 AND 48).

FIRST USE 0-0-2010; IN COMMERCE 0-0-2010.

NO CLAIM IS MADE TO THE EXCLUSIVE RIGHT TO USE "GAMES", APART FROM THE MARK AS SHOWN.

THE MARK CONSISTS OF A STYLIZED "X" WITH A GLOBE DEVICE, WITH THE WORD "GAMES" APPEARING UNDER IT.

SN 78-476,987, FILED 9-1-2004.

THEODORE MCBRIDE, EXAMINING ATTORNEY

United States of America

United States Patent and Trademark Office



Reg. No. 4,206,394

Registered Sep. 11, 2012

**Int. Cls.: 6, 9, 12, 14, 18,
24, 25, 28, and 32**

ESPN, INC. (DELAWARE CORPORATION)
ESPN PLAZA
BRISTOL, CT 06010

FOR: BICYCLE LOCKS, IN CLASS 6 (U.S. CLS. 2, 12, 13, 14, 23, 25 AND 50).

FIRST USE 0-0-2005; IN COMMERCE 0-0-2005.

TRADEMARK

PRINCIPAL REGISTER

FOR: OPTICAL WEAR, NAMELY, EYEGLASSES, SUNGLASSES AND FRAMES FOR EYEGLASSES AND SUNGLASSES; EYEWEAR, NAMELY, SPORTS EYEWEAR, PROTECTIVE EYEWEAR; CELLULAR TELEPHONE FACEPLATES; SOFT CARRYING CASES AND SHOULDER STRAPS FOR USE IN CONNECTION WITH THE OPERATION OF CELLULAR TELEPHONES; MOUSE PADS; CD- ROM CASES; PROTECTIVE HELMETS FOR SPORTS AND OTHER PROTECTIVE HELMETS, IN CLASS 9 (U.S. CLS. 21, 23, 26, 36 AND 38).

FIRST USE 0-0-2008; IN COMMERCE 0-0-2008.

FOR: BICYCLES; BICYCLE PEGS; BICYCLE GRIPS, IN CLASS 12 (U.S. CLS. 19, 21, 23, 31, 35 AND 44).

FIRST USE 0-0-2005; IN COMMERCE 0-0-2005.

FOR: WATCHES, IN CLASS 14 (U.S. CLS. 2, 27, 28 AND 50).

FIRST USE 0-0-2010; IN COMMERCE 0-0-2010.

FOR: SPORT BAGS; ALL-PURPOSE ATHLETIC BAGS; LUGGAGE; BACKPACKS; DUFFLE BAGS; TRUNKS; TRAVELING BAGS; GARMENT BAGS; TOTE BAGS; OVERNIGHT BAGS; HANDBAGS; SHOULDER BAGS; FANNY PACKS; ATTACHE CASES; BRIEFCASES; BEACH BAGS; MESH, TEXTILE AND LEATHER SHOPPING BAGS; BOOK BAGS; MESSENGER BAGS; WALLETS; KEY CASES; UMBRELLAS; BICYCLE MESSENGER SACHELS, IN CLASS 18 (U.S. CLS. 1, 2, 3, 22 AND 41).

FIRST USE 0-0-2007; IN COMMERCE 0-0-2007.



David J. Kyffers

Director of the United States Patent and Trademark Office

Reg. No. 4,206,394 FOR: BATH TOWELS; BED LINENS; BED COVERS OF FABRIC; BED SPREADS; DUVETS; DUVET COVERS; COMFORTERS; BED BLANKETS; QUILTS; BED SHEETS; DUST RUFFLES; PILLOW CASES; PILLOW SHAMS, IN CLASS 24 (U.S. CLS. 42 AND 50).

FIRST USE 0-0-2009; IN COMMERCE 0-0-2009.

FOR: CLOTHING FOR MEN, WOMEN AND CHILDREN, NAMELY, T-SHIRTS, SHIRTS, SWEATERS, CARDIGANS, TURTLENECKS, VESTS, SWEAT SHIRTS, TANK TOPS, JERSEYS, BASEBALL SHIRTS, GOLF SHIRTS, JOGGING SHIRTS, SHORTS, GYM SHORTS, TENNIS SHORTS, JEANS, PANTS, WORK PANTS, TROUSERS, SLACKS, TUNICS, SUN SUITS, COVERALLS, OVERALLS, SWEATSHIRTS, SWEAT PANTS, SWEAT SUITS, WARM-UP SUITS, JACKETS, BLAZERS, GLOVES, MITTENS, SCARVES, COATS, SKI JACKETS, SKI PANTS, PARKAS, CAPES, PONCHOS, RUNNING SUITS, RAIN WEAR, UNDERWEAR, SOCKS, LEGGINGS, LEG WARMERS, SLEEPWEAR, ROBES, DRESSING GOWNS, SWIMWEAR, BABY CLOTHES, SNOWBOARD PANTS AND SNOWBOARD JACKETS, SKATEBOARD PANTS, SKATEBOARD SHORTS; BELTS, BANDANNAS, NECKBANDS, WRISTBANDS, SUSPENDERS, BEACH WEAR, SHOES, SNEAKERS, ATHLETIC SHOES, BOOTS, SANDALS, SKATEBOARD FOOTWEAR, SLIPPERS AND BOOTIES, CAPS, HATS, BEANIES, HEADBANDS, SWEATBANDS, BANDANAS, EAR MUFFS, VISORS AND SUN VISORS, BICYCLE GLOVES, SKI BOOTS, IN CLASS 25 (U.S. CLS. 22 AND 39).

FIRST USE 0-0-2007; IN COMMERCE 0-0-2007.

FOR: TOYS, GAMES AND PLAYTHINGS, NAMELY, BOARD GAMES; ATHLETIC PROTECTIVE ELBOW, WRIST AND KNEE PADS, SKATEBOARDS, SNOWBOARDS, WAKEBOARDS, TOY SCOOTERS, IN CLASS 28 (U.S. CLS. 22, 23, 38 AND 50).

FIRST USE 0-0-2005; IN COMMERCE 0-0-2005.

FOR: MINERAL AND AERATED WATERS AND OTHER NON-ALCOHOLIC DRINKS, IN CLASS 32 (U.S. CLS. 45, 46 AND 48).

FIRST USE 0-0-2010; IN COMMERCE 0-0-2010.

THE MARK CONSISTS OF A STYLIZED "X" WITH A GLOBE DESIGN IN THE MIDDLE.

SN 78-476,991, FILED 9-1-2004.

THEODORE MCBRIDE, EXAMINING ATTORNEY

United States of America

United States Patent and Trademark Office



SANCTUARY
SPA COVENT GARDEN

Reg. No. 4,206,395

Registered Sep. 11, 2012

Int. Cls.: 3 and 8

TRADEMARK

PRINCIPAL REGISTER

THE SANCTUARY AT COVENT GARDEN LIMITED (ENGLAND CORPORATION)
12 FLORAL STREET
LONDON, UNITED KINGDOM WC2E 9DH

FOR: SOAPS, BATH GEL AND OIL RELAXERS, BODY SCRUBS, BATH SALT SCRUBS, BODY CREAM SOUFFLES, SALT SCRUB SOAP BARS, BATH SOAPS, HOT SUGAR BODY SCRUBS, SPONGES IMPREGNATED WITH COSMETICS, NON-MEDICATED FOOT SOAKS, FOOT LOTIONS, FOOT SCRUBS, FOOT POWDER, BODY LOTIONS, SKIN CLEANSERS, SKIN MOISTURIZING CREAMS, TANNING CREAMS, TANNING LOTIONS, BEAUTY MASKS, FACIAL MASKS, MUD BEAUTY MASKS, TONERS, SCRUBS AND PUMICE STONES, IN CLASS 3 (U.S. CLS. 1, 4, 6, 50, 51 AND 52).

FIRST USE 0-0-2006; IN COMMERCE 0-0-2006.

FOR: MANICURE SETS, ELECTRIC MANICURE SETS, NAIL BUFFERS, NAIL CLIPPERS, NAIL FILES, ELECTRIC NAIL FILES, PEDICURE SETS, SCISSORS, TWEEZERS, IN CLASS 8 (U.S. CLS. 23, 28 AND 44).

FIRST USE 11-29-2011; IN COMMERCE 11-29-2011.

NO CLAIM IS MADE TO THE EXCLUSIVE RIGHT TO USE "SPA" AND "COVENT GARDEN", APART FROM THE MARK AS SHOWN.

THE STIPLING IS FOR SHADING PURPOSES ONLY.

THE MARK CONSISTS OF THE REPRESENTATION OF A KOI CARP FISH IN AN OVAL ABOVE THE WORDS "THE SANCTUARY SPA COVENT GARDEN".

SN 78-797,706, FILED 1-24-2006.

ELI HELLMAN, EXAMINING ATTORNEY



David J. Kybas

Director of the United States Patent and Trademark Office

United States of America

United States Patent and Trademark Office



Reg. No. 4,206,396

THRIVENT FINANCIAL FOR LUTHERANS (WISCONSIN FRATERNAL BENEFITS SOCIETY)
625 FOURTH STREET AVENUE SOUTH
MINNEAPOLIS, MN 55415

Registered Sep. 11, 2012

Int. Cls.: 16, 36, and 41

FOR: PRINTED PUBLICATION, NAMELY, NEWSLETTERS, BROCHURES, BOOKLETS AND TEACHING MATERIALS IN THE FIELD OF FINANCIAL PLANNING, IN CLASS 16 (U.S. CLS. 2, 5, 22, 23, 29, 37, 38 AND 50).

TRADEMARK

FIRST USE 2-0-2005; IN COMMERCE 2-0-2005.

SERVICE MARK

FOR: FINANCIAL SERVICES, NAMELY, PROVIDING FINANCIAL PLANNING INFORMATION AND PROVIDING ONLINE INFORMATION IN THE FIELD OF FINANCIAL SERVICES, IN CLASS 36 (U.S. CLS. 100, 101 AND 102).

PRINCIPAL REGISTER

FIRST USE 2-0-2005; IN COMMERCE 2-0-2005.

FOR: EDUCATIONAL SERVICES, NAMELY, PROVIDING SEMINARS AND WORKSHOP PROGRAMS IN THE FIELD OF FINANCIAL PLANNING, IN CLASS 41 (U.S. CLS. 100, 101 AND 107).

FIRST USE 2-0-2005; IN COMMERCE 2-0-2005.

OWNER OF U.S. REG. NOS. 2,792,314, 3,662,081, AND OTHERS.

THE COLOR(S) ORANGE AND BLACK IS/ARE CLAIMED AS A FEATURE OF THE MARK.

NO CLAIM IS MADE TO THE EXCLUSIVE RIGHT TO USE "FINANCIAL" AND "CLUB", APART FROM THE MARK AS SHOWN.

THE MARK CONSISTS OF THE FOLLOWING: THE TERMS "THRIVENT FINANCIAL FITNESS SHAPE UP YOUR FUTURE" IN BLACK, AND A DESIGN ELEMENT AND THE TERM "CLUB" IN ORANGE.

SN 78-934,555, FILED 7-21-2006.

JANICE L. MCMORROW, EXAMINING ATTORNEY



David J. Kyros

Director of the United States Patent and Trademark Office

United States of America

United States Patent and Trademark Office

WITHOUT THE JUICE

Reg. No. 4,206,397

Registered Sep. 11, 2012

Int. Cl.: 25

TRADEMARK

PRINCIPAL REGISTER

SMD INVESTMENT ENTERPRISES, INC. (ILLINOIS CORPORATION)
47 GOLF ROAD
CLARENDON HILLS, IL 60514

FOR: CLOTHING, NAMELY, HATS AND T-SHIRTS, IN CLASS 25 (U.S. CLS. 22 AND 39).

FIRST USE 4-30-2007; IN COMMERCE 4-30-2007.

THE MARK CONSISTS OF STANDARD CHARACTERS WITHOUT CLAIM TO ANY PARTICULAR FONT, STYLE, SIZE, OR COLOR.

SEC. 2(F).

SN 78-967,018, FILED 9-5-2006.

TEJBIR SINGH, EXAMINING ATTORNEY



David J. Kyffers

Director of the United States Patent and Trademark Office

United States of America

United States Patent and Trademark Office

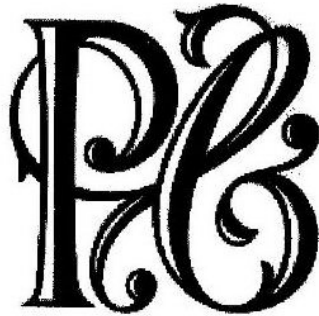

Reg. No. 4,206,398

Registered Sep. 11, 2012

Int. Cl.: 30

TRADEMARK

PRINCIPAL REGISTER

PENINSULA INTERNATIONAL (USA) LIMITED (DELAWARE CORPORATION)
CORPORATION TRUST CENTER, 1209 ORANGE ST.
WILMINGTON, DE 19801

FOR: COCOA, AND PREPARED COCOA AND COCOA-BASED BEVERAGES; CHOCOLATE POWDER, STARCH BASED CANDIES; BAKERY DESSERTS, DESSERT PUDDINGS, DESSERT MOUSSE, AND DESSERT SOUFFLES; COCOA-BASED BEVERAGES WITH MILK; NON-ALCOHOLIC CHOCOLATE-BASED FOOD BEVERAGES NOT BEING DAIRY OR VEGETABLE BASED; PUDDINGS, IN CLASS 30 (U.S. CL. 46).

FIRST USE 12-0-2009; IN COMMERCE 12-0-2009.

THE MARK CONSISTS OF THE LETTERS "PC" IN STYLIZED FORM.

SN 78-971,747, FILED 9-11-2006.

ZHALEH DELANEY, EXAMINING ATTORNEY



David J. Kyffers

Director of the United States Patent and Trademark Office

United States of America

United States Patent and Trademark Office



Reg. No. 4,206,399

Registered Sep. 11, 2012

Int. Cls.: 29 and 30

TRADEMARK

PRINCIPAL REGISTER

LT OVERSEAS NORTH AMERICA, INC. (CALIFORNIA CORPORATION)
1211 MCGAW AVENUE
IRVINE, CA 926145536

FOR: DRIED FRUIT, IN CLASS 29 (U.S. CL. 46).

FIRST USE 2-13-2005; IN COMMERCE 2-13-2005.

FOR: SPICES, IN CLASS 30 (U.S. CL. 46).

FIRST USE 4-16-2012; IN COMMERCE 4-16-2012.

THE MARK CONSISTS OF A WOMAN'S HEAD WITH A HEADDRESS.

SN 85-001,813, FILED 3-30-2010.

VIVIAN MICZNIK FIRST, EXAMINING ATTORNEY



David J. Kybas

Director of the United States Patent and Trademark Office

United States of America

United States Patent and Trademark Office



Reg. No. 4,206,400

TERRY PRECISION BICYCLES FOR WOMEN, INC. (NEW YORK CORPORATION)
47 MAPLE STREET
BURLINGTON, VT 05401

Registered Sep. 11, 2012

Int. Cl.: 12

FOR: BICYCLE SADDLES; BICYCLES, IN CLASS 12 (U.S. CLS. 19, 21, 23, 31, 35 AND 44).

FIRST USE 5-1-2010; IN COMMERCE 5-1-2010.

TRADEMARK

THE MARK CONSISTS OF A PINK RECTANGLE WITH THE WORD "TERRY" IN WHITE CENTERED WITHIN THE PINK RECTANGLE AND DISPLAYED IN AN UPPER CASE SCRIPT TYPE WITH THE SECOND "R" OMITTING ITS VERTICAL BAR.

PRINCIPAL REGISTER

THE COLOR(S) PINK AND WHITE IS/ARE CLAIMED AS A FEATURE OF THE MARK.

SN 85-002,241, FILED 3-30-2010.

HELENE LIWINSKI, EXAMINING ATTORNEY



David J. Kybas

Director of the United States Patent and Trademark Office

United States of America

United States Patent and Trademark Office

THOMAGREEN

Reg. No. 4,206,401

Registered Sep. 11, 2012

Int. Cl.: 19

TRADEMARK

PRINCIPAL REGISTER

THOMAS CONCRETE INDUSTRIES, INC. (DELAWARE CORPORATION)
SUITE 200
2500 CUMBERLAND PARKWAY
ATLANTA, GA 30339

FOR: READY-MIX CONCRETE CONTAINING ENVIRONMENTALLY FRIENDLY MATERIALS, IN CLASS 19 (U.S. CLS. 1, 12, 33 AND 50).

FIRST USE 4-25-2012; IN COMMERCE 4-25-2012.

THE MARK CONSISTS OF STANDARD CHARACTERS WITHOUT CLAIM TO ANY PARTICULAR FONT, STYLE, SIZE, OR COLOR.

SN 85-002,838, FILED 3-31-2010.

LEIGH LOWRY, EXAMINING ATTORNEY



David J. Kyffers

Director of the United States Patent and Trademark Office

United States of America

United States Patent and Trademark Office

FIBERTRON

Reg. No. 4,206,402

Registered Sep. 11, 2012

Int. Cl.: 19

TRADEMARK

PRINCIPAL REGISTER

THOMAS CONCRETE INDUSTRIES, INC. (DELAWARE CORPORATION)
SUITE 200
2500 CUMBERLAND PARKWAY
ATLANTA, GA 30339

FOR: READY-MIX CONCRETE CONTAINING STRENGTH-ENHANCING FIBERS, IN CLASS 19 (U.S. CLS. 1, 12, 33 AND 50).

FIRST USE 4-25-2012; IN COMMERCE 4-25-2012.

THE MARK CONSISTS OF STANDARD CHARACTERS WITHOUT CLAIM TO ANY PARTICULAR FONT, STYLE, SIZE, OR COLOR.

SN 85-002,857, FILED 3-31-2010.

LEIGH LOWRY, EXAMINING ATTORNEY



David J. Kybas

Director of the United States Patent and Trademark Office

United States of America

United States Patent and Trademark Office

Chunkee Junkee

Reg. No. 4,206,403

ROSENBERG, JENNIFER (UNITED STATES INDIVIDUAL)
3927 WEST ASH LANE
ORANGE VILLAGE, OH 44122

Registered Sep. 11, 2012

Int. Cl.: 30

FOR: CANDY; CANDY COATED POPCORN; SNACK MIX CONSISTING PRIMARILY OF CRACKERS, PRETZELS, CANDIED NUTS AND/OR POPPED POPCORN, IN CLASS 30 (U.S. CL. 46).

TRADEMARK

FIRST USE 1-1-2011; IN COMMERCE 1-1-2011.

PRINCIPAL REGISTER

THE MARK CONSISTS OF STANDARD CHARACTERS WITHOUT CLAIM TO ANY PARTICULAR FONT, STYLE, SIZE, OR COLOR.

SN 85-003,212, FILED 3-31-2010.

KATHLEEN LORENZO, EXAMINING ATTORNEY



David J. Kyffers

Director of the United States Patent and Trademark Office

United States of America

United States Patent and Trademark Office



Reg. No. 4,206,404

Registered Sep. 11, 2012

Int. Cls.: 9 and 11

TRADEMARK

PRINCIPAL REGISTER

CONAIR CORPORATION (DELAWARE CORPORATION)
ONE CUMMINGS POINT ROAD
STAMFORD, CT 06902

FOR: ELECTRIC HAND-HELD HAIR STYLING IRONS, IN CLASS 9 (U.S. CLS. 21, 23, 26, 36 AND 38).

FIRST USE 4-12-2010; IN COMMERCE 4-12-2010.

FOR: HAND-HELD ELECTRIC HAIR DRYERS, IN CLASS 11 (U.S. CLS. 13, 21, 23, 31 AND 34).

FIRST USE 10-31-2010; IN COMMERCE 10-31-2010.

NO CLAIM IS MADE TO THE EXCLUSIVE RIGHT TO USE "CRYSTAL CERAMIC", APART FROM THE MARK AS SHOWN.

THE MARK CONSISTS OF THE WORDS "CRYSTAL CERAMIC" WITH A DIAMOND-LIKE DESIGN; THE STYLIZED "C" IN THE WORD "CRYSTAL", AND A LINE BETWEEN THE WORDS "CRYSTAL" AND "CERAMIC".

SN 85-003,957, FILED 4-1-2010.

STEVEN JACKSON, EXAMINING ATTORNEY



David J. Kybas

Director of the United States Patent and Trademark Office

United States of America

United States Patent and Trademark Office



Reg. No. 4,206,405

Registered Sep. 11, 2012

Int. Cl.: 36

SERVICE MARK

PRINCIPAL REGISTER

PACIFIC SPECIALTY INSURANCE COMPANY (CALIFORNIA CORPORATION), DBA
PACIFIC SPECIALTY INSURANCE COMPANY, THE MCGRAW GROUP OF AFFILIATED
COMPANIES,
3601 HAVEN AVENUE
MENLO PARK, CA 94025

FOR: INSURANCE SERVICES, NAMELY, UNDERWRITING, CLAIMS ADMINISTRATION,
AND AGENCY SERVICES FOR PROPERTY AND CASUALTY, AUTOMOBILE, MOTOR-
CYCLE, WATERCRAFT, EARTHQUAKE, FLOOD, WORKERS' COMPENSATION, COMMERCIAL,
RENTER'S, TOWNHOUSE, CONDOMINIUM, AND HOMEOWNER'S INSURANCE,
IN CLASS 36 (U.S. CLS. 100, 101 AND 102).

FIRST USE 5-1-2010; IN COMMERCE 5-1-2010.

THE MARK CONSISTS OF TWO WAVY BANDS FORMING A CONNECTIVE DOWNWARD
POINTING APEX ON THE RIGHT SIDE.

SN 85-004,640, FILED 4-1-2010.

ANNE FARRELL, EXAMINING ATTORNEY



David J. Kybas

Director of the United States Patent and Trademark Office

United States of America

United States Patent and Trademark Office

KONICA MINOLTA

Reg. No. 4,206,406

KONICA MINOLTA HOLDINGS, INC. (JAPAN JOINT STOCK COMPANY)
1-6-1 MARUNOUCHI, CHIYODA-KU
TOKYO 100-0005, JAPAN

Registered Sep. 11, 2012

Int. Cl.: 10

FOR: APPARATUS AND INSTRUMENTS FOR MEDICAL ANALYSIS AND DIAGNOSIS AND PERIPHERAL DEVICES THERETO, NAMELY, MAMMOGRAPHY MAGNETIC RESONANCE IMAGERS AND CT SCANNERS, IN CLASS 10 (U.S. CLS. 26, 39 AND 44).

TRADEMARK

FIRST USE 1-12-2012; IN COMMERCE 1-12-2012.

PRINCIPAL REGISTER

THE MARK CONSISTS OF STANDARD CHARACTERS WITHOUT CLAIM TO ANY PARTICULAR FONT, STYLE, SIZE, OR COLOR.

OWNER OF U.S. REG. NOS. 3,490,699, 3,600,435, AND OTHERS.

SN 85-005,212, FILED 4-2-2010.

TINA L. SNAPP, EXAMINING ATTORNEY



David J. Kybas

Director of the United States Patent and Trademark Office

United States of America

United States Patent and Trademark Office



Reg. No. 4,206,407

Registered Sep. 11, 2012

Int. Cl.: 10

TRADEMARK

PRINCIPAL REGISTER

KONICA MINOLTA HOLDINGS, INC. (JAPAN JOINT STOCK COMPANY)
1-6-1 MARUNOUCHI, CHIYODA-KU
TOKYO 100-0005, JAPAN

FOR: APPARATUS AND INSTRUMENTS FOR MEDICAL ANALYSIS AND DIAGNOSIS AND PERIPHERAL DEVICES THERETO, NAMELY, MAMMOGRAPHY MAGNETIC RESONANCE IMAGERS AND CT SCANNERS, IN CLASS 10 (U.S. CLS. 26, 39 AND 44).

FIRST USE 1-12-2012; IN COMMERCE 1-12-2012.

OWNER OF U.S. REG. NOS. 1,309,549, 3,494,176, AND OTHERS.

THE MARK CONSISTS OF AN OVAL-LIKE CIRCULAR DESIGN, CONTAINING FIVE CENTERED HORIZONTAL BANDS.

SN 85-005,220, FILED 4-2-2010.

TINA L. SNAPP, EXAMINING ATTORNEY



David J. Kybas

Director of the United States Patent and Trademark Office

United States of America

United States Patent and Trademark Office

XT-27

Reg. No. 4,206,408

Registered Sep. 11, 2012

Int. Cl.: 10

TRADEMARK

PRINCIPAL REGISTER

STRYKER CORPORATION (IRELAND CORPORATION)
2825 AIRVIEW BOULEVARD
KALAMAZOO, MI 49002 AND

STRYKER NV OPERATIONS LIMITED (IRELAND CORPORATION)
ARTHUR COX BUILDING, EARLSFORT TERRACE
DUBLIN 2, IRELAND

FOR: MICROCATHETER, IN CLASS 10 (U.S. CLS. 26, 39 AND 44).

FIRST USE 5-7-2012; IN COMMERCE 5-7-2012.

THE MARK CONSISTS OF STANDARD CHARACTERS WITHOUT CLAIM TO ANY PARTICULAR FONT, STYLE, SIZE, OR COLOR.

SN 85-006,388, FILED 4-5-2010.

FLORENTINA BLANDU, EXAMINING ATTORNEY



David J. Kybas

Director of the United States Patent and Trademark Office

United States of America

United States Patent and Trademark Office

BENEFICIOS EXTRACARE PARA DIABETES

Reg. No. 4,206,409

Registered Sep. 11, 2012

Int. Cls.: 35 and 44

SERVICE MARK

PRINCIPAL REGISTER

CVS PHARMACY, INC. (RHODE ISLAND CORPORATION)
ONE CVS DRIVE
WOONSOCKET, RI 02895

FOR: PROMOTING PUBLIC AWARENESS OF THE IMPORTANCE OF DIABETES MANAGEMENT AND CARE; PROMOTING DIABETES-RELATED CONSUMER AND PHARMACEUTICAL GOODS OF OTHERS THROUGH DISTRIBUTION OF DISCOUNT CARDS AND COUPONS AND THE ADMINISTRATION OF INCENTIVE AWARD PROGRAMS, IN CLASS 35 (U.S. CLS. 100, 101 AND 102).

FIRST USE 5-31-2010; IN COMMERCE 5-31-2010.

FOR: PROVIDING INFORMATION IN THE FIELD OF DIABETES; DIABETES MONITORING SERVICES, IN CLASS 44 (U.S. CLS. 100 AND 101).

FIRST USE 5-31-2010; IN COMMERCE 5-31-2010.

THE MARK CONSISTS OF STANDARD CHARACTERS WITHOUT CLAIM TO ANY PARTICULAR FONT, STYLE, SIZE, OR COLOR.

NO CLAIM IS MADE TO THE EXCLUSIVE RIGHT TO USE "DIABETES", APART FROM THE MARK AS SHOWN.

THE ENGLISH TRANSLATION OF "BENEFICIOS EXTRACARE PARA DIABETES" IN THE MARK IS "EXTRACARE ADVANTAGE FOR DIABETES".

SN 85-007,119, FILED 4-6-2010.

THOMAS MANOR, EXAMINING ATTORNEY



David J. Kyros

Director of the United States Patent and Trademark Office

United States of America

United States Patent and Trademark Office

LIGHT REIMAGINED

Reg. No. 4,206,410

Registered Sep. 11, 2012

**Int. Cls.: 9, 11, 37, and
42**

TRADEMARK

SERVICE MARK

PRINCIPAL REGISTER

RSL FIBER SYSTEMS, LLC (CONNECTICUT LIMITED LIABILITY COMPANY)
255 PITKIN STREET
EAST HARTFORD, CT 06108

FOR: FIBER OPTICS, IN CLASS 9 (U.S. CLS. 21, 23, 26, 36 AND 38).

FIRST USE 6-3-2012; IN COMMERCE 6-3-2012.

FOR: FIBER OPTIC LIGHTING FIXTURES FOR ILLUMINATION, SIGNALING, AND INSPECTION; FIBER OPTIC ILLUMINATION SYSTEMS COMPRISED OF ELECTRICAL ILLUMINATORS FOR USE WITH FIBER OPTIC LIGHTING FIXTURES, FIBER OPTIC CABLES, FIBER OPTICS, FIBER OPTIC LIGHTING FIXTURES, FIBER OPTIC CONNECTORS, IN CLASS 11 (U.S. CLS. 13, 21, 23, 31 AND 34).

FIRST USE 6-3-2012; IN COMMERCE 6-3-2012.

FOR: INSTALLATION, MAINTENANCE AND REPAIR OF FIBER OPTIC ILLUMINATION SYSTEMS, IN CLASS 37 (U.S. CLS. 100, 103 AND 106).

FIRST USE 7-2-2012; IN COMMERCE 7-2-2012.

FOR: DESIGN OF FIBER OPTIC LIGHTING SYSTEMS FOR ILLUMINATION, SIGNALING AND INSPECTION FOR OTHERS; CUSTOM DESIGN AND ENGINEERING OF FIBER OPTIC ILLUMINATION SYSTEMS, IN CLASS 42 (U.S. CLS. 100 AND 101).

FIRST USE 7-2-2012; IN COMMERCE 7-2-2012.

THE MARK CONSISTS OF STANDARD CHARACTERS WITHOUT CLAIM TO ANY PARTICULAR FONT, STYLE, SIZE, OR COLOR.

NO CLAIM IS MADE TO THE EXCLUSIVE RIGHT TO USE "LIGHT" , APART FROM THE MARK AS SHOWN.

SN 85-009,165, FILED 4-8-2010.

KATHERINE E. HALMEN, EXAMINING ATTORNEY



David J. Kyros

Director of the United States Patent and Trademark Office

United States of America

United States Patent and Trademark Office

The Alliance for a Healthier Minnesota

Reg. No. 4,206,411

Registered Sep. 11, 2012

Int. Cls.: 16, 41, and 44

ALLIANCE FOR A HEALTHIER MINNESOTA, LLC (MINNESOTA LIMITED LIABILITY COMPANY)
800 NICOLLET MALL
SUITE 2690
MINNEAPOLIS, MN 55402

TRADEMARK

FOR: BOOKS, BROCHURES AND NEWSLETTERS IN THE FIELD OF HEALTH AND WELLNESS, IN CLASS 16 (U.S. CLS. 2, 5, 22, 23, 29, 37, 38 AND 50).

SERVICE MARK

FIRST USE 5-24-2010; IN COMMERCE 5-24-2010.

PRINCIPAL REGISTER

FOR: ARRANGING AND CONDUCTING EDUCATIONAL CONFERENCES RELATED TO HEALTH AND WELLNESS, IN CLASS 41 (U.S. CLS. 100, 101 AND 107).

FIRST USE 11-14-2011; IN COMMERCE 11-14-2011.

FOR: PROVIDING ASSISTANCE, FITNESS EVALUATION AND CONSULTATION TO CORPORATE CLIENTS TO HELP THEIR EMPLOYEES MAKE HEALTH, WELLNESS AND NUTRITIONAL CHANGES IN THEIR DAILY LIVING TO IMPROVE HEALTH; HEALTH AND WELLNESS SERVICES, NAMELY, ORGANIZING COMPETITIONS TO PROMOTE WEIGHT LOSS, IN CLASS 44 (U.S. CLS. 100 AND 101).

FIRST USE 5-28-2010; IN COMMERCE 5-28-2010.

THE MARK CONSISTS OF STANDARD CHARACTERS WITHOUT CLAIM TO ANY PARTICULAR FONT, STYLE, SIZE, OR COLOR.

NO CLAIM IS MADE TO THE EXCLUSIVE RIGHT TO USE "THE ALLIANCE" AND "MINNESOTA", APART FROM THE MARK AS SHOWN.

SN 85-009,180, FILED 4-8-2010.

KHANH LE, EXAMINING ATTORNEY



David J. Kybas

Director of the United States Patent and Trademark Office

United States of America

United States Patent and Trademark Office



Reg. No. 4,206,412

Registered Sep. 11, 2012

Int. Cl.: 11

TRADEMARK

PRINCIPAL REGISTER

OPTOMA TECHNOLOGY, INC. (CALIFORNIA CORPORATION)
715 SYCAMORE DRIVE
MILPITAS, CA 95035

FOR: LED STREET LIGHTS; LED VEHICLE LIGHTS, NAMELY, HEADLIGHTS, TAILLIGHTS; LED LIGHT FIXTURES FOR INDICATOR LIGHTS; LED LIGHT ASSEMBLY MODULES FOR STREET LIGHTS; LED LIGHT ASSEMBLY MODULE FOR VEHICLE HEADLIGHTS, TAILLIGHTS, INDICATOR LIGHTS; LED LIGHT FIXTURES FOR UNDER WATER LIGHTING FOR POOLS AND AQUARIUMS; FOG LIGHTS FOR VEHICLES; LED LIGHT FIXTURES FOR MINE LIGHTING EXCLUDING FLUORESCENT LAMPS OR BULBS; LIGHT FIXTURES DESIGNED FOR USE IN HIGH HEAT AREA LIGHTING, IN CLASS 11 (U.S. CLS. 13, 21, 23, 31 AND 34).

FIRST USE 5-25-2011; IN COMMERCE 5-25-2011.

THE MARK CONSISTS OF "OPTOMA" WITH A DESIGN ELEMENT BEFORE THE WORD.

SN 85-010,105, FILED 4-9-2010.

LIEF MARTIN, EXAMINING ATTORNEY



David J. Kyffers

Director of the United States Patent and Trademark Office

United States of America

United States Patent and Trademark Office

The flavor that brings you
home

Reg. No. 4,206,413

HOT SAAS LLC (NEW JERSEY LIMITED LIABILITY COMPANY)
61 WAYSIDE PL.
MONTCLAIR, NJ 07042

Registered Sep. 11, 2012

Int. Cls.: 25 and 30

FOR: SWEAT SHIRTS; TEE SHIRTS, IN CLASS 25 (U.S. CLS. 22 AND 39).

TRADEMARK

FIRST USE 3-1-2008; IN COMMERCE 3-30-2008.

PRINCIPAL REGISTER

FOR: HOT SAUCE, IN CLASS 30 (U.S. CL. 46).

FIRST USE 3-1-2008; IN COMMERCE 3-30-2008.

THE MARK CONSISTS OF STANDARD CHARACTERS WITHOUT CLAIM TO ANY PARTICULAR FONT, STYLE, SIZE, OR COLOR.

NO CLAIM IS MADE TO THE EXCLUSIVE RIGHT TO USE "FLAVOR" IN INTERNATIONAL CLASS 30 ONLY, APART FROM THE MARK AS SHOWN.

SN 85-012,086, FILED 4-12-2010.

MEGHAN REINHART, EXAMINING ATTORNEY



David J. Kyffers

Director of the United States Patent and Trademark Office

United States of America

United States Patent and Trademark Office

JWATCH

Reg. No. 4,206,414

Registered Sep. 11, 2012

Int. Cls.: 9 and 41

TRADEMARK

SERVICE MARK

PRINCIPAL REGISTER

MASSACHUSETTS MEDICAL SOCIETY (MASSACHUSETTS CORPORATION)
860 WINTER STREET
WALTHAM, MA 024511411

FOR: PROVIDING DOWNLOADABLE CONTENT, NAMELY, ELECTRONIC PUBLICATIONS IN THE NATURE OF JOURNALS AND NEWSLETTERS IN THE FIELDS OF MEDICAL NEWS, MEDICAL RESEARCH, AND MEDICAL DEVELOPMENTS OVER THE INTERNET VIA A SUBSCRIPTION BASIS FOR PERSONAL DATA ASSISTANTS, PERSONAL COMPUTERS, HANDHELD COMPUTERS, MOBILE TELEPHONES, SMARTPHONES, IN CLASS 9 (U.S. CLS. 21, 23, 26, 36 AND 38).

FIRST USE 10-14-2011; IN COMMERCE 10-14-2011.

FOR: ON-LINE ELECTRONIC PUBLICATIONS IN THE NATURE OF JOURNALS AND NEWSLETTERS IN THE FIELD OF MEDICAL NEWS, MEDICAL RESEARCH, AND MEDICAL DEVELOPMENTS, IN CLASS 41 (U.S. CLS. 100, 101 AND 107).

FIRST USE 10-14-2011; IN COMMERCE 10-14-2011.

THE MARK CONSISTS OF STANDARD CHARACTERS WITHOUT CLAIM TO ANY PARTICULAR FONT, STYLE, SIZE, OR COLOR.

OWNER OF U.S. REG. NOS. 3,033,823, 3,236,630, AND 3,636,866.

SN 85-013,682, FILED 4-14-2010.

ANNE FARRELL, EXAMINING ATTORNEY



David J. Kyros

Director of the United States Patent and Trademark Office

United States of America

United States Patent and Trademark Office

DIAMOND DIAMOND

Reg. No. 4,206,415

IGT (NEVADA CORPORATION)
9295 PROTOTYPE DRIVE
RENO, NV 895218986

Registered Sep. 11, 2012

Int. Cl.: 9

FOR: GAMING MACHINES, NAMELY, DEVICES WHICH ACCEPT A WAGER, IN CLASS 9 (U.S. CLS. 21, 23, 26, 36 AND 38).

TRADEMARK

FIRST USE 6-1-2012; IN COMMERCE 6-1-2012.

PRINCIPAL REGISTER

THE MARK CONSISTS OF STANDARD CHARACTERS WITHOUT CLAIM TO ANY PARTICULAR FONT, STYLE, SIZE, OR COLOR.

OWNER OF U.S. REG. NOS. 2,029,173, 2,085,175, AND 2,106,091.

SN 85-015,209, FILED 4-15-2010.

JOSETTE BEVERLY, EXAMINING ATTORNEY



David J. Kybas

Director of the United States Patent and Trademark Office

United States of America

United States Patent and Trademark Office

NIGHTCLUB CITY

Reg. No. 4,206,416

Registered Sep. 11, 2012

Int. Cls.: 9, 35, 41, and 42

TRADEMARK

SERVICE MARK

PRINCIPAL REGISTER

BOOYAH, INC. (DELAWARE CORPORATION)
139 TOWNSEND STREET, 3RD FLOOR
SAN FRANCISCO, CA 94107

FOR: COMPUTER GAME SOFTWARE; VIDEO GAME SOFTWARE; DOWNLOADABLE VIDEO GAME SOFTWARE; DOWNLOADABLE VIDEO GAME SOFTWARE FOR USE ON MOBILE TELEPHONES, SMARTPHONES, PAGERS, MOBILE AND HANDHELD COMPUTERS, PDAS, AND OTHER MOBILE AND HANDHELD COMMUNICATIONS DEVICES; COMPUTER SOFTWARE, NAMELY, SOFTWARE DEVELOPMENT TOOLS FOR THE CREATION OF MOBILE AND INTERNET APPLICATIONS AND CLIENT INTERFACES; TELECOMMUNICATIONS AND SOCIAL NETWORKING SOFTWARE FOR USE IN CONNECTION WITH ONLINE SOCIAL GAMES FOR TRANSPORTING AND AGGREGATING VOICE, DATA AND VIDEO COMMUNICATION ACROSS GLOBAL COMPUTER NETWORKS; COMPUTER SOFTWARE FOR CREATING VIRTUAL COMMUNITIES AND FOR CREATING AND INTERACTING WITH OTHER METAGAME PLAYERS VIA DIGITAL PERSONAS AND AVATARS; COMPUTER SOFTWARE TO ENABLE UPLOADING, POSTING, SHOWING, DISPLAYING, TAGGING, BLOGGING, OR SHARING ELECTRONIC MEDIA OR INFORMATION REGARDING THE FIELDS OF VIRTUAL COMMUNITIES, ELECTRONIC GAMING, ENTERTAINMENT, AND GENERAL INTEREST VIA THE INTERNET OR OTHER COMMUNICATIONS NETWORKS WITH THIRD PARTIES; DOWNLOADABLE VIRTUAL GOODS, NAMELY, COMPUTER PROGRAMS FEATURING CLOTHING, ACCESSORIES, LAND, BUILDINGS, OBJECTS, TOOLS, CHARACTERS, AND CURRENCY FOR USE IN ONLINE VIRTUAL WORLDS, IN CLASS 9 (U.S. CLS. 21, 23, 26, 36 AND 38).

FIRST USE 4-12-2010; IN COMMERCE 4-12-2010.

FOR: ADVERTISING SERVICES, NAMELY, PROMOTING THE GOODS AND SERVICES OF OTHERS ONLINE AND VIA MOBILE AND HANDHELD WIRELESS COMMUNICATIONS DEVICES; ARRANGING AND CONDUCTING INCENTIVE REWARD PROGRAMS THAT PROMOTE THE SALE OF GOODS AND SERVICES OF OTHERS; PROMOTING THE EXCHANGE OF INFORMATION AND RESOURCES BETWEEN AND AMONG REGISTERED PARTICIPANTS IN THE FIELD OF SOCIAL GAMING TO ACHIEVE PERSONALLY-DEFINED AND GROUP-DEFINED GOALS, PURSUITS AND CHALLENGES IN THE FIELD OF SOCIAL GAMING AND ONLINE SOCIAL GAMING; ONLINE RETAIL STORE SERVICES FEATURING DOWNLOADABLE SOUND, MUSIC, IMAGE, VIDEO, AND GAME FILES, BOOKS, MUSIC, TOYS, GAMES, CLOTHING, AND SOUVENIR ITEMS; ONLINE RETAIL STORE SERVICES FEATURING VIRTUAL GOODS, NAMELY, CLOTHING, ACCESSORIES, LAND, BUILDINGS,



David J. Kyjars

Director of the United States Patent and Trademark Office

Reg. No. 4,206,416 OBJECTS, TOOLS, CHARACTERS, AND CURRENCY FOR USE IN ONLINE VIRTUAL WORLDS, IN CLASS 35 (U.S. CLS. 100, 101 AND 102).

FIRST USE 4-12-2010; IN COMMERCE 4-12-2010.

FOR: ENTERTAINMENT SERVICES, NAMELY, PROVIDING TEMPORARY USE OF NON-DOWNLOADABLE VIDEO GAMES; ENTERTAINMENT SERVICES, NAMELY, PROVIDING ONLINE, NON-DOWNLOADABLE VIRTUAL CLOTHING, ACCESSORIES, LAND, BUILDINGS, OBJECTS, TOOLS, CHARACTERS, AND CURRENCY, FOR USE IN VIRTUAL ENVIRONMENTS CREATED FOR ENTERTAINMENT PURPOSES; PROVIDING AN INTERNET WEBSITE PORTAL IN THE FIELD OF COMPUTER GAMES AND GAMING; PROVIDING INFORMATION ONLINE RELATING TO COMPUTER GAMES AND COMPUTER ENHANCEMENTS FOR GAMES; ENTERTAINMENT SERVICES, NAMELY, PROVIDING VIRTUAL ENVIRONMENTS IN WHICH USERS CAN INTERACT THROUGH SOCIAL GAMES FOR RECREATIONAL, LEISURE, OR ENTERTAINMENT PURPOSES; ENTERTAINMENT SERVICES, NAMELY, PROVIDING NON-DOWNLOADABLE AUDIO, VIDEO AND GRAPHICS FEATURING MUSIC PERFORMANCES AND ONLINE VIDEO GAMES TO MOBILE COMMUNICATIONS DEVICES VIA WIRELESS NETWORKS AND A GLOBAL COMPUTER NETWORK; ENTERTAINMENT SERVICES, NAMELY, CONDUCTING CONTESTS; ONLINE JOURNALS, NAMELY, BLOGS FEATURING USER-DEFINED CONTENT REGARDING GAMES, GAMING, SOCIAL NETWORKING, AND VIRTUAL COMMUNITIES; PROVIDING AN ONLINE MAGAZINE IN THE FIELDS OF MOBILE AND WIRELESS COMMUNICATIONS, WIRELESS COMMUNICATIONS SOFTWARE, SOCIAL NETWORKING, CREATING DIGITAL PERSONAS AND AVATARS, MOBILE AND ONLINE COMMUNICATION METHODS AND SERVICES, VIDEO GAMES, SOFTWARE, AND ONLINE GAMES; PROVIDING RECOGNITION AND INCENTIVE AWARDS WHEREBY PARTICIPANTS IN AUGMENTED REALITY AND SOCIAL GAMING IN THE NATURE OF ONLINE VIDEO GAMES CAN EARN VIRTUAL REWARDS FOR DEMONSTRATING EXTRAORDINARY SKILL OR EXCELLENCE REGARDING USER-DEFINED GOALS AND GROUP-DEFINED GOALS, IN CLASS 41 (U.S. CLS. 100, 101 AND 107).

FIRST USE 4-12-2010; IN COMMERCE 4-12-2010.

FOR: COMPUTER SERVICES, NAMELY, CREATING AN ON-LINE COMMUNITY FOR REGISTERED USERS TO PARTICIPATE IN DISCUSSIONS, COMPETITIONS, AND INDIVIDUAL AND GROUP CHALLENGES, SHOWCASE AND IMPROVE THEIR SKILLS, GET FEEDBACK FROM THEIR PEERS, FORM VIRTUAL COMMUNITIES, AND ENGAGE IN SOCIAL NETWORKING; PROVIDING A WEBSITE FEATURING NON-DOWNLOADABLE SOFTWARE TOOLS FOR USE IN ACCESSING, PLAYING, AND TRACKING PERFORMANCE OF COMPUTER GAMES; APPLICATION SERVICE PROVIDER FEATURING SOFTWARE FOR SOCIAL NETWORKING AND VIDEO GAMES, TO ENABLE UPLOADING, POSTING, SHOWING, DISPLAYING, TAGGING, BLOGGING, OR SHARING ELECTRONIC MEDIA OR INFORMATION VIA THE INTERNET, IN CLASS 42 (U.S. CLS. 100 AND 101).

FIRST USE 4-12-2010; IN COMMERCE 5-13-2011.

THE MARK CONSISTS OF STANDARD CHARACTERS WITHOUT CLAIM TO ANY PARTICULAR FONT, STYLE, SIZE, OR COLOR.

NO CLAIM IS MADE TO THE EXCLUSIVE RIGHT TO USE "NIGHTCLUB", APART FROM THE MARK AS SHOWN.

SN 85-018,199, FILED 4-20-2010.

WILLIAM VERHOSEK, EXAMINING ATTORNEY

United States of America
United States Patent and Trademark Office

Dawgraffiti

Reg. No. 4,206,417

ARMSTRONG, KAY (UNITED STATES INDIVIDUAL)
P.O. BOX 184
OREGON CITY, OR 97045 AND

Registered Sep. 11, 2012

Int. Cl.: 25

ARMSTRONG, BOB (UNITED STATES INDIVIDUAL)
P.O. BOX 184
OREGON, OR 97045

TRADEMARK

PRINCIPAL REGISTER

FOR: CAPS; JACKETS; SWEAT SHIRTS; T-SHIRTS, IN CLASS 25 (U.S. CLS. 22 AND 39).

FIRST USE 1-2-2011; IN COMMERCE 1-10-2011.

THE MARK CONSISTS OF STANDARD CHARACTERS WITHOUT CLAIM TO ANY PARTICULAR FONT, STYLE, SIZE, OR COLOR.

SN 85-018,806, FILED 4-20-2010.

GINA HAYES, EXAMINING ATTORNEY



David J. Kybas

Director of the United States Patent and Trademark Office

United States of America

United States Patent and Trademark Office

GOLD BOND ULTIMATE SHEER RIBBONS

Reg. No. 4,206,418

Registered Sep. 11, 2012

Int. Cl.: 3

TRADEMARK

PRINCIPAL REGISTER

CHATTEM, INC. (TENNESSEE CORPORATION)
1715 WEST 38TH STREET
CHATTANOOGA, TN 37409

FOR: BODY LOTIONS; HAND LOTIONS, IN CLASS 3 (U.S. CLS. 1, 4, 6, 50, 51 AND 52).

FIRST USE 6-1-2011; IN COMMERCE 6-1-2011.

THE MARK CONSISTS OF STANDARD CHARACTERS WITHOUT CLAIM TO ANY PARTICULAR FONT, STYLE, SIZE, OR COLOR.

OWNER OF U.S. REG. NOS. 1,209,453, 3,050,451, AND OTHERS.

SN 85-019,587, FILED 4-21-2010.

BERNICE MIDDLETON, EXAMINING ATTORNEY



David J. Kyffers

Director of the United States Patent and Trademark Office

United States of America

United States Patent and Trademark Office



Advanced Practice Advisors

Registered Investment Advisor

Reg. No. 4,206,419

Registered Sep. 11, 2012

Int. Cl.: 36

SERVICE MARK

PRINCIPAL REGISTER

APA, LLC (CALIFORNIA LIMITED LIABILITY COMPANY)
12250 EL CAMINO REAL #160
ATTEN: PAUL SPITZER
SAN DIEGO, CA 92130

FOR: ADVICE RELATING TO INVESTMENTS; FINANCIAL PLANNING AND INVESTMENT ADVISORY SERVICES; FINANCIAL SERVICES, NAMELY, WEALTH MANAGEMENT SERVICES; INVESTMENT ADVICE, IN CLASS 36 (U.S. CLS. 100, 101 AND 102).

FIRST USE 5-1-2010; IN COMMERCE 5-1-2010.

NO CLAIM IS MADE TO THE EXCLUSIVE RIGHT TO USE "ADVANCED PRACTICE ADVISORS" AND "REGISTERED INVESTMENT ADVISOR", APART FROM THE MARK AS SHOWN.

THE COLOR(S) BLACK, GOLD AND BROWN IS/ARE CLAIMED AS A FEATURE OF THE MARK.

THE MARK CONSISTS OF LETTERS "A P A" IN GOLD CASCADING TO THE RIGHT WITHIN A SQUARE BOX OUTLINED IN GOLD; THE BACKGROUND OF THE INNER AREA IS BLACK. THE OUTER FRAME BORDER OF THE REGION IS BROWN. TO THE RIGHT OF THE BOX ARE THE WORDS "ADVANCED PRACTICE ADVISORS" IN BROWN AND UNDERLINED IN BROWN. BELOW ARE THE WORDS "REGISTERED INVESTMENT ADVISOR" IN BLACK.

SN 85-021,945, FILED 4-23-2010.

CHERYL CLAYTON, EXAMINING ATTORNEY



David J. Kyjars

Director of the United States Patent and Trademark Office

United States of America

United States Patent and Trademark Office

TIME 2 SLEEP

Reg. No. 4,206,420

Registered Sep. 11, 2012

Int. Cl.: 5

TRADEMARK

PRINCIPAL REGISTER

SAM SCHWARTZ (UNITED STATES INDIVIDUAL), DBA MASADA HEALTH & BEAUTY CORP.,
P.O. BOX 4118
CHATSWORTH, CA 91313

FOR: HOMEOPATHIC BODY CREAM USED AS A SLEEP AID, IN CLASS 5 (U.S. CLS. 6, 18, 44, 46, 51 AND 52).

FIRST USE 7-15-2010; IN COMMERCE 7-15-2010.

THE MARK CONSISTS OF STANDARD CHARACTERS WITHOUT CLAIM TO ANY PARTICULAR FONT, STYLE, SIZE, OR COLOR.

SN 85-022,838, FILED 4-26-2010.

ANGELA M. MICHELI, EXAMINING ATTORNEY



David J. Kyffers

Director of the United States Patent and Trademark Office

United States of America

United States Patent and Trademark Office

GREENERU

Reg. No. 4,206,421

Registered Sep. 11, 2012

Int. Cls.: 35, 37, and 42

SERVICE MARK

PRINCIPAL REGISTER

GREENERU, INC. (DELAWARE CORPORATION)
ONE MOODY STREET
WALTHAM, MA 02453

FOR: BUSINESS MANAGEMENT AND MANAGEMENT CONSULTATION SERVICES IN THE FIELDS OF ENERGY AND WATER USAGE MANAGEMENT, ENERGY EFFICIENCY, WATER EFFICIENCY, POWER DEMAND; BUSINESS CONSULTATION SERVICES, NAMELY, ANALYZING, PLANNING AND MONITORING RESOURCE INVESTMENT FOR PROGRAMS USED IN FACILITY MANAGEMENT; ENERGY AUDITING; ENERGY MANAGEMENT SERVICES, NAMELY, DEVELOPMENT AND IMPLEMENTATION OF MANAGEMENT PROGRAMS FOR ENERGY AND WATER CONSERVATION, IN CLASS 35 (U.S. CLS. 100, 101 AND 102).

FIRST USE 3-1-2011; IN COMMERCE 3-1-2011.

FOR: CONSTRUCTION MANAGEMENT SERVICES, NAMELY, SUPERVISION AND MANAGEMENT OF CONSTRUCTION, RENOVATION, MAINTENANCE, AND REPAIR OF FACILITIES; CONSTRUCTION SUPERVISION AND MANAGEMENT SERVICES, NAMELY, SUPERVISION AND MANAGEMENT OF CONSTRUCTION AND INSTALLATION OF ENERGY AND WATER CONSERVATION, GENERATION AND OPERATION FACILITIES, IN CLASS 37 (U.S. CLS. 100, 103 AND 106).

FIRST USE 8-1-2011; IN COMMERCE 8-1-2011.

FOR: ENGINEERING SERVICES IN THE FIELDS OF ENERGY MANAGEMENT, ENERGY CONSERVATION, ENERGY EFFICIENCY, AND WATER CONSERVATION; DESIGN FOR OTHERS IN THE FIELD OF ENERGY ENGINEERING; DESIGNING AND IMPLEMENTING ENERGY CONSERVATION, WATER CONSERVATION, AND SUSTAINABILITY PROGRAMS; CONDUCTING OF PRELIMINARY ENERGY FEASIBILITY STUDIES, IN CLASS 42 (U.S. CLS. 100 AND 101).

FIRST USE 3-1-2011; IN COMMERCE 3-1-2011.

THE MARK CONSISTS OF STANDARD CHARACTERS WITHOUT CLAIM TO ANY PARTICULAR FONT, STYLE, SIZE, OR COLOR.

SN 85-024,405, FILED 4-27-2010.



David J. Kyros

Director of the United States Patent and Trademark Office

Reg. No. 4,206,421 BRIAN CALLAGHAN, EXAMINING ATTORNEY

United States of America

United States Patent and Trademark Office

YOUR GATEWAY TO CITYCENTER

Reg. No. 4,206,422

VICTORIA PARTNERS (NEVADA PARTNERSHIP)
3770 LAS VEGAS BOULEVARD SOUTH
LAS VEGAS, NV 89109

Registered Sep. 11, 2012

Int. Cl.: 43

FOR: HOTEL AND HOTEL RESORT SERVICES; RESTAURANT AND BAR SERVICES, IN CLASS 43 (U.S. CLS. 100 AND 101).

SERVICE MARK

FIRST USE 11-20-2009; IN COMMERCE 11-20-2009.

PRINCIPAL REGISTER

THE MARK CONSISTS OF STANDARD CHARACTERS WITHOUT CLAIM TO ANY PARTICULAR FONT, STYLE, SIZE, OR COLOR.

SN 85-024,650, FILED 4-27-2010.

ANDREA K. NADELMAN, EXAMINING ATTORNEY



David J. Kyffers

Director of the United States Patent and Trademark Office

United States of America

United States Patent and Trademark Office

PLUMSLICE

Reg. No. 4,206,423

Registered Sep. 11, 2012

Int. Cl.: 42

SERVICE MARK

PRINCIPAL REGISTER

BLUEFIN ASSOCIATES (DELAWARE CORPORATION)
SUITE 1200
580 CALIFORNIA STREET
SAN FRANCISCO, CA 94104

FOR: SOFTWARE AS A SERVICE (SAAS) SERVICES, NAMELY, HOSTING SOFTWARE FOR USE BY OTHERS FOR USE OF MANAGING PROCESSES AND INFORMATION RELATED TO PRODUCT LIFECYCLE MANAGEMENT BUSINESS PROCESS, IN CLASS 42 (U.S. CLS. 100 AND 101).

FIRST USE 1-2-2012; IN COMMERCE 5-1-2012.

THE MARK CONSISTS OF STANDARD CHARACTERS WITHOUT CLAIM TO ANY PARTICULAR FONT, STYLE, SIZE, OR COLOR.

SN 85-026,832, FILED 4-29-2010.

ANDREW LEASER, EXAMINING ATTORNEY



David J. Kybas

Director of the United States Patent and Trademark Office

United States of America

United States Patent and Trademark Office



ecofab

Reg. No. 4,206,424

Registered Sep. 11, 2012

Int. Cls.: 12 and 37

TRADEMARK

SERVICE MARK

PRINCIPAL REGISTER

ECOFAB COVERS INTERNATIONAL INC. (BARBADOS CORPORATION)
WHITEPARK HOUSE, WHITE PARK ROAD
BRIDGETOWN, BARBADOS

FOR: FITTED COVERS FOR VEHICLES, NAMELY, FITTED COVERS FOR RAIL VEHICLES;
STRUCTURAL PARTS FOR RAIL VEHICLES, IN CLASS 12 (U.S. CLS. 19, 21, 23, 31, 35 AND
44).

FIRST USE 3-1-2002; IN COMMERCE 3-1-2002.

FOR: INSTALLATION, REMOVAL, AND MAINTENANCE OF RAIL VEHICLE COVERS;
RAIL VEHICLE FLEET MANAGEMENT, NAMELY, VEHICLE REPAIR AND MAINTENANCE,
IN CLASS 37 (U.S. CLS. 100, 103 AND 106).

FIRST USE 3-1-2002; IN COMMERCE 3-1-2002.

THE MARK CONSISTS OF AN ARC ABOVE AND TO THE LEFT OF THE WORD "ECOFAB".

SN 85-027,660, FILED 4-30-2010.

KATINA MISTER, EXAMINING ATTORNEY



David J. Kybas

Director of the United States Patent and Trademark Office

United States of America

United States Patent and Trademark Office

FASTBACK

Reg. No. 4,206,425

DIETRICH INDUSTRIES, INC. (PENNSYLVANIA CORPORATION)
200 OLD WILSON BRIDGE ROAD
COLUMBUS, OH 43085

Registered Sep. 11, 2012

Int. Cl.: 6

FOR: METAL CLIPS FOR CONSTRUCTION, IN CLASS 6 (U.S. CLS. 2, 12, 13, 14, 23, 25 AND 50).

TRADEMARK

FIRST USE 4-1-2008; IN COMMERCE 4-1-2008.

PRINCIPAL REGISTER

THE MARK CONSISTS OF STANDARD CHARACTERS WITHOUT CLAIM TO ANY PARTICULAR FONT, STYLE, SIZE, OR COLOR.

SN 85-029,406, FILED 5-4-2010.

REBECCA SMITH, EXAMINING ATTORNEY



David J. Kybas

Director of the United States Patent and Trademark Office

United States of America

United States Patent and Trademark Office

UNWINDING PROTOCOL

Reg. No. 4,206,426

WEISBART, PAUL (UNITED STATES INDIVIDUAL)
440 KAKURA ROAD
HAIKU, HI 96708

Registered Sep. 11, 2012

Int. Cl.: 41

FOR: CONDUCTING EDUCATIONAL SEMINARS IN THE USE OF LASERS TO REGENERATE CELLS IN THE BODY TO PROVIDE RELIEF FROM INJURY, PAIN, STRESS AND DISEASE, IN CLASS 41 (U.S. CLS. 100, 101 AND 107).

SERVICE MARK

FIRST USE 6-1-2010; IN COMMERCE 6-1-2010.

PRINCIPAL REGISTER

THE MARK CONSISTS OF STANDARD CHARACTERS WITHOUT CLAIM TO ANY PARTICULAR FONT, STYLE, SIZE, OR COLOR.

NO CLAIM IS MADE TO THE EXCLUSIVE RIGHT TO USE "PROTOCOL", APART FROM THE MARK AS SHOWN.

SN 85-030,428, FILED 5-5-2010.

DAVID HOFFMAN, EXAMINING ATTORNEY



David J. Kyffers

Director of the United States Patent and Trademark Office

United States of America

United States Patent and Trademark Office

P6

Reg. No. 4,206,427

EQUAL EXCHANGE, INC. (MASSACHUSETTS CORPORATION)
50 UNITED DRIVE

Registered Sep. 11, 2012

WEST BRIDGEWATER, MA 02379

Int. Cl.: 35

FOR: COOPERATIVE ADVERTISING AND MARKETING, IN CLASS 35 (U.S. CLS. 100, 101 AND 102).

SERVICE MARK

FIRST USE 9-1-2011; IN COMMERCE 9-1-2011.

PRINCIPAL REGISTER

THE MARK CONSISTS OF STANDARD CHARACTERS WITHOUT CLAIM TO ANY PARTICULAR FONT, STYLE, SIZE, OR COLOR.

SN 85-031,333, FILED 5-6-2010.

KATHERINE E. HALMEN, EXAMINING ATTORNEY



David J. Kyffers

Director of the United States Patent and Trademark Office

United States of America

United States Patent and Trademark Office

DUCKBACK

Reg. No. 4,206,428

Registered Sep. 11, 2012

Int. Cls.: 1, 2, and 3

TRADEMARK

PRINCIPAL REGISTER

DUCKBACK ACQUISITION CORP. (DELAWARE CORPORATION)
2644 HEGAN LANE
P.O. BOX 980
CHICO, CA 95927

FOR: WATERPROOF, MILDEW RESISTING AND ULTRAVIOLET REFLECTIVE CHEMICAL COMPOSITIONS FOR WOOD, CONCRETE, BRICK, COMPOSITE AND PLASTIC PRODUCTS, IN CLASS 1 (U.S. CLS. 1, 5, 6, 10, 26 AND 46).

FIRST USE 2-4-2011; IN COMMERCE 2-4-2011.

FOR: INTERIOR AND EXTERIOR SHELLACS, FINISHES, STAINS, VARNISHES, WOOD FILLERS AND PRIMERS FOR USE AS SURFACE COATINGS ON WOOD, CONCRETE, COMPOSITE AND PLASTIC; OILS FOR PRESERVATION OF WOODS; PAINT FILLERS FOR WOOD, CONCRETE, BRICK, COMPOSITE AND PLASTIC; WOOD PRESERVATIVES; WOOD PRESERVATIVES FOR FENCES AND OTHER WOOD PRODUCTS; COATINGS, NAMELY, PAINTS, STAINS, FINISHES, SEALERS AND WATER REPELLENT PAINTS, FOR USE ON WOOD, CONCRETE, BRICK, COMPOSITE AND PLASTIC, IN CLASS 2 (U.S. CLS. 6, 11 AND 16).

FIRST USE 2-4-2011; IN COMMERCE 2-4-2011.

FOR: STRIPPING AND CLEANING PREPARATIONS FOR USE ON WOOD, CONCRETE, BRICK, COMPOSITE AND PLASTIC; WOOD AND COMPOSITE BRIGHTENERS; STAIN REMOVERS, PAINT AND VARNISH STRIPPING OR REMOVING PREPARATIONS FOR USE ON WOOD, CONCRETE, BRICK, COMPOSITE AND PLASTIC, IN CLASS 3 (U.S. CLS. 1, 4, 6, 50, 51 AND 52).

FIRST USE 2-4-2011; IN COMMERCE 2-4-2011.

THE MARK CONSISTS OF STANDARD CHARACTERS WITHOUT CLAIM TO ANY PARTICULAR FONT, STYLE, SIZE, OR COLOR.

SN 85-031,732, FILED 5-6-2010.

LINDA E. BLOHM, EXAMINING ATTORNEY



David J. Kyfos

Director of the United States Patent and Trademark Office

United States of America

United States Patent and Trademark Office

THE MAGICAL CLASSROOM

Reg. No. 4,206,429

SMART TECHNOLOGIES ULC (CANADA CORPORATION)
3636 RESEARCH ROAD NW
CALGARY, ALBERTA, CANADA T2L1Y1

Registered Sep. 11, 2012

Int. Cl.: 41

FOR: PROVIDING AN INTERACTIVE WEBSITE FEATURING INFORMATION IN THE FIELD OF EDUCATION, IN CLASS 41 (U.S. CLS. 100, 101 AND 107).

SERVICE MARK

FIRST USE 5-31-2010; IN COMMERCE 5-31-2010.

PRINCIPAL REGISTER

THE MARK CONSISTS OF STANDARD CHARACTERS WITHOUT CLAIM TO ANY PARTICULAR FONT, STYLE, SIZE, OR COLOR.

NO CLAIM IS MADE TO THE EXCLUSIVE RIGHT TO USE "CLASSROOM", APART FROM THE MARK AS SHOWN.

SN 85-032,137, FILED 5-6-2010.

COURTNEY ALVAREZ, EXAMINING ATTORNEY



David J. Kybas

Director of the United States Patent and Trademark Office

United States of America

United States Patent and Trademark Office

REINVENT LOCAL

Reg. No. 4,206,430

FISHER COMMUNICATIONS, INC. (WASHINGTON CORPORATION)
140 FOURTH AVENUE NORTH, SUITE 500
SEATTLE, WA 98109

Registered Sep. 11, 2012

Int. Cl.: 41

FOR: ENTERTAINMENT SERVICES IN THE NATURE OF DEVELOPMENT, CREATION, PRODUCTION AND POST-PRODUCTION SERVICES OF MULTIMEDIA ENTERTAINMENT CONTENT; ENTERTAINMENT SERVICES, NAMELY, THE PROVISION OF CONTINUING PROGRAMS FEATURING NEWS ON TOPICS OF GENERAL INTEREST AND INFORMATION ABOUT CURRENT EVENTS DELIVERED BY TELEVISION, INTERNET, WEBCASTS MOBILE PHONES AND MOBILE DEVICES; PRODUCTION OF RADIO AND TELEVISION PROGRAMS, IN CLASS 41 (U.S. CLS. 100, 101 AND 107).

SERVICE MARK

PRINCIPAL REGISTER

FIRST USE 5-1-2010; IN COMMERCE 10-1-2010.

THE MARK CONSISTS OF STANDARD CHARACTERS WITHOUT CLAIM TO ANY PARTICULAR FONT, STYLE, SIZE, OR COLOR.

SN 85-032,267, FILED 5-6-2010.

ANTHONY RINKER, EXAMINING ATTORNEY



David J. Kyffers

Director of the United States Patent and Trademark Office

United States of America

United States Patent and Trademark Office

reinvent 
LOCAL

Reg. No. 4,206,431

FISHER COMMUNICATIONS, INC. (WASHINGTON CORPORATION)
140 FOURTH AVENUE NORTH, SUITE 500
SEATTLE, WA 98109

Registered Sep. 11, 2012

Int. Cl.: 41

FOR: ENTERTAINMENT SERVICES IN THE NATURE OF DEVELOPMENT, CREATION, PRODUCTION AND POST-PRODUCTION SERVICES OF MULTIMEDIA ENTERTAINMENT CONTENT; ENTERTAINMENT SERVICES, NAMELY, THE PROVISION OF CONTINUING PROGRAMS FEATURING NEWS ON TOPICS OF GENERAL INTEREST AND INFORMATION ABOUT CURRENT EVENTS DELIVERED BY TELEVISION, INTERNET, WEBCASTS MOBILE PHONES AND MOBILE DEVICES; PRODUCTION OF RADIO AND TELEVISION PROGRAMS, IN CLASS 41 (U.S. CLS. 100, 101 AND 107).

SERVICE MARK

PRINCIPAL REGISTER

FIRST USE 5-1-2010; IN COMMERCE 10-31-2010.

THE MARK CONSISTS OF THE WORD "REINVENT" IN LOWERCASE LETTERS, FOLLOWED BY THE SILHOUETTE OF A SMALL HOUSE NEXT TO A SILHOUETTE OF A HOUSE TWICE AS BIG AS THE FIRST, ALL ON TOP OF THE WORD "LOCAL" IN LARGE UPPERCASE LETTERS.

SN 85-032,279, FILED 5-6-2010.

ANTHONY RINKER, EXAMINING ATTORNEY



David J. Kybas

Director of the United States Patent and Trademark Office

United States of America

United States Patent and Trademark Office

WHITECLOUD OUTCOME MAPS

Reg. No. 4,206,432

Registered Sep. 11, 2012

Int. Cl.: 35

SERVICE MARK

PRINCIPAL REGISTER

WHITECLOUD ANALYTICS INC. (DELAWARE CORPORATION)
225 N. 9TH STREET
SUITE 200
BOISE, ID 83702

FOR: BUSINESS MANAGEMENT CONSULTING WITH RELATION TO OPERATION, STRATEGY, AND APPLICATION, PARTICULARLY SPECIALIZING IN THE USE OF ANALYTIC MODELS TO IMPROVE AND REACH A DESIRED CLINICAL AND OPERATIONAL BUSINESS PERFORMANCE IN THE FIELD OF HEALTHCARE, IN CLASS 35 (U.S. CLS. 100, 101 AND 102).

FIRST USE 10-31-2009; IN COMMERCE 10-31-2009.

THE MARK CONSISTS OF STANDARD CHARACTERS WITHOUT CLAIM TO ANY PARTICULAR FONT, STYLE, SIZE, OR COLOR.

NO CLAIM IS MADE TO THE EXCLUSIVE RIGHT TO USE "OUTCOME MAPS", APART FROM THE MARK AS SHOWN.

SN 85-032,788, FILED 5-7-2010.

SIMON TENG, EXAMINING ATTORNEY



David J. Kybas

Director of the United States Patent and Trademark Office

United States of America
United States Patent and Trademark Office

LIIVQ

Reg. No. 4,206,433

LIIVQUE CORPORATION (DELAWARE CORPORATION)
301 ROUTE 17

Registered Sep. 11, 2012

NORTH RUTHERFORD, NJ 07070

Int. Cls.: 9 and 38

FOR: COMPUTER SOFTWARE FOR COMPUTER SOFTWARE FOR HOSTING, JOINING, MANAGING, SCHEDULING, AND STREAMING COMPUTER NETWORK CONFERENCE CALLS, INSTANT MESSAGING VIA THE INTERNET, IN CLASS 9 (U.S. CLS. 21, 23, 26, 36 AND 38).

TRADEMARK

SERVICE MARK

FIRST USE 4-9-2010; IN COMMERCE 5-1-2011.

PRINCIPAL REGISTER

FOR: INTERNET TELEPHONY SERVICES; VOICE OVER INTERNET PROTOCOL (VOIP) SERVICES, IN CLASS 38 (U.S. CLS. 100, 101 AND 104).

FIRST USE 4-9-2010; IN COMMERCE 5-1-2011.

THE MARK CONSISTS OF THE WORD "LIIVQ".

SN 85-033,818, FILED 5-9-2010.

DOMINICK J. SALEMI, EXAMINING ATTORNEY



David J. Kyfos

Director of the United States Patent and Trademark Office

United States of America

United States Patent and Trademark Office

SKY FERREIRA

Reg. No. 4,206,434

Registered Sep. 11, 2012

Int. Cl.: 25

TRADEMARK

PRINCIPAL REGISTER

THIRD DEGREE BURN LLC (CALIFORNIA LIMITED LIABILITY COMPANY)
1001 BRIGGS ROAD, SUITE 220
MOUNT LAUREL, NJ 08054

FOR: CLOTHING, NAMELY, T-SHIRTS, BASEBALL JERSEYS, HOODED SWEATSHIRTS, CREW SWEATSHIRTS, BASEBALL CAPS AND HATS, IN CLASS 25 (U.S. CLS. 22 AND 39).

FIRST USE 2-10-2006; IN COMMERCE 2-10-2006.

THE MARK CONSISTS OF STANDARD CHARACTERS WITHOUT CLAIM TO ANY PARTICULAR FONT, STYLE, SIZE, OR COLOR.

THE NAME(S), PORTRAIT(S), AND/OR SIGNATURE(S) SHOWN IN THE MARK IDENTIFIES "SKY FERREIRA", WHOSE CONSENT(S) TO REGISTER IS MADE OF RECORD.

SN 85-034,361, FILED 5-10-2010.

KRISTINA MORRIS, EXAMINING ATTORNEY



David J. Kybas

Director of the United States Patent and Trademark Office

United States of America

United States Patent and Trademark Office

SKY FERREIRA

Reg. No. 4,206,435

THIRD DEGREE BURN LLC (CALIFORNIA LIMITED LIABILITY COMPANY)
1001 BRIGGS ROAD, SUITE 220
MOUNT LAUREL, NJ 08054

Registered Sep. 11, 2012

Int. Cl.: 41

FOR: ENTERTAINMENT, NAMELY, PROVIDING LIVE CONCERTS AND MUSICAL AND VOCAL PERFORMANCES, IN CLASS 41 (U.S. CLS. 100, 101 AND 107).

SERVICE MARK

FIRST USE 2-10-2006; IN COMMERCE 2-10-2006.

PRINCIPAL REGISTER

THE MARK CONSISTS OF STANDARD CHARACTERS WITHOUT CLAIM TO ANY PARTICULAR FONT, STYLE, SIZE, OR COLOR.

THE NAME(S), PORTRAIT(S), AND/OR SIGNATURE(S) SHOWN IN THE MARK IDENTIFIES "SKY FERREIRA", WHOSE CONSENT(S) TO REGISTER IS MADE OF RECORD.

SN 85-034,367, FILED 5-10-2010.

KRISTINA MORRIS, EXAMINING ATTORNEY



David J. Kyffers

Director of the United States Patent and Trademark Office

United States of America

United States Patent and Trademark Office

REPEAT DAT

Reg. No. 4,206,436

HARVEY, ARTHUR (UNITED STATES INDIVIDUAL)
317 RIVERVILLAGE DRIVE
DESTREHAN, LA 70047

Registered Sep. 11, 2012

Int. Cl.: 14

FOR: RUBBER OR SILICON WRISTBANDS IN THE NATURE OF A BRACELET, IN CLASS 14 (U.S. CLS. 2, 27, 28 AND 50).

TRADEMARK

FIRST USE 5-10-2010; IN COMMERCE 5-10-2010.

PRINCIPAL REGISTER

THE MARK CONSISTS OF STANDARD CHARACTERS WITHOUT CLAIM TO ANY PARTICULAR FONT, STYLE, SIZE, OR COLOR.

SN 85-034,800, FILED 5-10-2010.

SUE LAWRENCE, EXAMINING ATTORNEY



David J. Kyffers

Director of the United States Patent and Trademark Office

United States of America

United States Patent and Trademark Office



Reg. No. 4,206,437

Registered Sep. 11, 2012

Int. Cl.: 43

SERVICE MARK

PRINCIPAL REGISTER

BENNIGAN'S IP, LLC (DELAWARE LIMITED LIABILITY COMPANY)
SUITE 300
5151 BELTLINE ROAD
DALLAS, TX 75254

FOR: RESTAURANT AND BAR SERVICES, IN CLASS 43 (U.S. CLS. 100 AND 101).

FIRST USE 1-0-2011; IN COMMERCE 1-0-2011.

OWNER OF U.S. REG. NOS. 1,088,917, 1,979,644, AND OTHERS.

NO CLAIM IS MADE TO THE EXCLUSIVE RIGHT TO USE "AMERICAN FARE" AND "HOSPITALITY", APART FROM THE MARK AS SHOWN.

THE MARK CONSISTS OF THE FANCIFUL INITIAL "B" ON A BEER GLASS INSIDE A CIRCULAR CARRIER WITH THE WORD "BENNIGAN'S" APPEARING ABOVE THE INITIAL "B" AND WITH THE WORDS "AMERICAN FARE IRISH HOSPITALITY" APPEARING BELOW THE INITIAL "B". THERE IS A DIAMOND SHAPE SEPARATING THE WORDS "AMERICAN FARE" AND "IRISH HOSPITALITY".

SN 85-035,258, FILED 5-11-2010.

SETH A. RAPPAPORT, EXAMINING ATTORNEY



David J. Kyffers

Director of the United States Patent and Trademark Office

United States of America

United States Patent and Trademark Office

R.O.P.E.

Reg. No. 4,206,438

Registered Sep. 11, 2012

Int. Cl.: 35

SERVICE MARK

PRINCIPAL REGISTER

PARTS LIFE, INCORPORATED (NEW JERSEY CORPORATION)
THE PRESIDENTIAL CENTER, SUITE 9
101 ROUTE 130 SOUTH
CINNAMINSON, NJ 08077

FOR: BUSINESS ADVISORY SERVICES, NAMELY, SEARCH FOR AND SELECTION OF THE BEST POTENTIAL SUPPLIERS FOR OTHERS, IN CLASS 35 (U.S. CLS. 100, 101 AND 102).

FIRST USE 8-7-2007; IN COMMERCE 8-20-2007.

THE MARK CONSISTS OF STANDARD CHARACTERS WITHOUT CLAIM TO ANY PARTICULAR FONT, STYLE, SIZE, OR COLOR.

SN 85-035,336, FILED 5-11-2010.

TARAH HARDY, EXAMINING ATTORNEY



David J. Kyros

Director of the United States Patent and Trademark Office

United States of America

United States Patent and Trademark Office

MICHAEL PAGE

Reg. No. 4,206,439

Registered Sep. 11, 2012

**Int. Cls.: 35, 38, 39, and
42**

MICHAEL PAGE RECRUITMENT GROUP LIMITED (UNITED KINGDOM PRIVATE LIMITED COMPANY)

THE BOURNE BUSINESS PARK
PAGE HOUSE, 1 DASHWOOD LANG ROAD
ADDLESTONE, SURREY, UNITED KINGDOM KT152QW

FOR: EMPLOYMENT AGENCY SERVICES, IN CLASS 35 (U.S. CLS. 100, 101 AND 102).

SERVICE MARK

FIRST USE 8-28-1988; IN COMMERCE 1-1-1997.

PRINCIPAL REGISTER

FOR: COMMUNICATION SERVICES BETWEEN COMPUTERS, NAMELY, ELECTRONIC TRANSMISSION OF DATA AND DOCUMENTS AMONG USERS OF COMPUTERS; TRANSMISSION OF MESSAGES, DATA AND INFORMATION STORED IN A DATABANK VIA TELECOMMUNICATIONS NETWORKS; ELECTRONIC TRANSMISSION OF DATA, IMAGES AND TEXTS VIA DATA PROCESSING EQUIPMENT AND COMPUTER TERMINALS; ELECTRONIC MAIL SERVICES; ELECTRONIC TRANSMISSION OF TEXT MESSAGES AND IMAGES VIA COMPUTER TERMINALS AND SMS; ELECTRONIC TRANSMISSION OF JOB VACANCY ANNOUNCEMENTS AND ELECTRONIC TRANSMISSION OF RESUMES TO PROSPECTIVE EMPLOYERS; MESSAGE SENDING SERVICES; ELECTRONIC TRANSMISSION OF CURRICULUM VITAE AND OF RESPONSES IN CONNECTION THEREWITH, IN CLASS 38 (U.S. CLS. 100, 101 AND 104).

FIRST USE 8-28-1988; IN COMMERCE 1-1-1997.

FOR: ELECTRONIC STORAGE OF DATA, DOCUMENTS, FILES AND MESSAGES, IN CLASS 39 (U.S. CLS. 100 AND 105).

FIRST USE 8-28-1988; IN COMMERCE 1-1-1997.

FOR: CREATION OF INTERNET AND INTRA-NET WEB-SITES RELATED TO HUMAN RESOURCES MANAGEMENT FOR OTHERS; COMPUTER PROGRAMMING AND DEVELOPMENT OF SOFTWARE-BASED SYSTEMS PARTICULARLY FOR USE IN HUMAN RESOURCE MANAGEMENT; CONSULTANCY AND ADVISORY SERVICES ALL RELATING TO COMPUTER SOFTWARE, COMPUTER HARDWARE, COMPUTER SYSTEMS, COMPUTER PERIPHERALS AND COMPUTER NETWORKS AND TECHNICAL SUPPORT IN THE NATURE OF DIAGNOSING COMPUTER SOFTWARE AND HARDWARE PROBLEMS;



David J. Kyffers

Director of the United States Patent and Trademark Office

Reg. No. 4,206,439 ADVISORY, CONSULTANCY AND INFORMATION SERVICES RELATING TO THE ABOVE,
IN CLASS 42 (U.S. CLS. 100 AND 101).

FIRST USE 8-28-1988; IN COMMERCE 1-1-1997.

THE MARK CONSISTS OF STANDARD CHARACTERS WITHOUT CLAIM TO ANY PARTICULAR FONT, STYLE, SIZE, OR COLOR.

OWNER OF U.S. REG. NO. 2,940,342.

THE NAME "MICHAEL PAGE" IDENTIFIES A LIVING INDIVIDUAL WHOSE CONSENT IS OF RECORD.

SN 85-035,692, FILED 5-11-2010.

MARY CRAWFORD, EXAMINING ATTORNEY

United States of America

United States Patent and Trademark Office

PLAY WELL. LIVE WELL.

Reg. No. 4,206,440

Registered Sep. 11, 2012

Int. Cls.: 9 and 35

TRADEMARK

SERVICE MARK

PRINCIPAL REGISTER

HYPERKIN INC. (CALIFORNIA CORPORATION)
1918 FRANK STILES STREET
SOUTH EL MONTE, CA 91733

FOR: VIDEO GAME ACCESSORIES, NAMELY, AC ADAPTERS; VIDEO GAME ACCESSORIES, NAMELY, CABLES, SENSOR BARS, BATTERIES AND VGA CONVERTERS; VIDEO GAME SYSTEMS FOR USE WITH AN EXTERNAL DISPLAY SCREEN OR MONITOR COMPRISED PRIMARILY OF VIDEO GAME UNITS AND CONTROLLERS; VIDEO GAME CONTROLLERS FOR ELECTRONIC VIDEO GAME MACHINES IN THE NATURE OF BOXING GLOVES, SWORDS AND PADDLES; COMPUTER STYLUS PENS; BAGS AND PROTECTIVE CARRYING CASES FOR VIDEO GAME CONSOLES FOR USE WITH AN EXTERNAL DISPLAY SCREEN OR MONITOR, IN CLASS 9 (U.S. CLS. 21, 23, 26, 36 AND 38).

FIRST USE 4-20-2010; IN COMMERCE 4-20-2010.

FOR: ONLINE RETAIL AND WHOLESALE STORE SERVICES IN THE FIELD OF VIDEO GAMES, VIDEO GAME PLAYERS, VIDEO GAME ACCESSORIES, CONSUMER ELECTRONICS AND ACCESSORIES AND DANCE AND EXERCISE MATS, IN CLASS 35 (U.S. CLS. 100, 101 AND 102).

FIRST USE 4-20-2010; IN COMMERCE 4-20-2010.

THE MARK CONSISTS OF STANDARD CHARACTERS WITHOUT CLAIM TO ANY PARTICULAR FONT, STYLE, SIZE, OR COLOR.

SN 85-035,701, FILED 5-11-2010.

HOWARD B. LEVINE, EXAMINING ATTORNEY



David J. Kyros

Director of the United States Patent and Trademark Office

United States of America

United States Patent and Trademark Office

FIBRBUNDLE

Reg. No. 4,206,441

FYFE CO. LLC (DELAWARE LIMITED LIABILITY COMPANY)
8380 MIRALANI DRIVE
SAN DIEGO, CA 92126

Registered Sep. 11, 2012

Int. Cl.: 19

FOR: NON-METAL BUILDING MATERIALS, NAMELY, TOWS OF CARBON FIBERS FOR STRENGTHENING BRIDGES, BUILDINGS, AND OTHER STRUCTURES, IN CLASS 19 (U.S. CLS. 1, 12, 33 AND 50).

TRADEMARK

FIRST USE 2-20-2009; IN COMMERCE 2-20-2009.

PRINCIPAL REGISTER

THE MARK CONSISTS OF STANDARD CHARACTERS WITHOUT CLAIM TO ANY PARTICULAR FONT, STYLE, SIZE, OR COLOR.

SN 85-035,827, FILED 5-11-2010.

JASON BLAIR, EXAMINING ATTORNEY



David J. Kyffers

Director of the United States Patent and Trademark Office

United States of America

United States Patent and Trademark Office

YO KEVA

Reg. No. 4,206,442

KEVA JUICE SOUTHWEST, LLC (NEW MEXICO LIMITED LIABILITY COMPANY)
201 THIRD STREET, N.W. SUITE 430
ALBUQUERQUE, NM 87102

Registered Sep. 11, 2012

Int. Cl.: 43

FOR: FROZEN YOGURT SHOP SERVICES IN THE NATURE OF A RESTAURANT, IN CLASS 43 (U.S. CLS. 100 AND 101).

SERVICE MARK

FIRST USE 6-27-2010; IN COMMERCE 6-27-2010.

PRINCIPAL REGISTER

THE MARK CONSISTS OF STANDARD CHARACTERS WITHOUT CLAIM TO ANY PARTICULAR FONT, STYLE, SIZE, OR COLOR.

SN 85-036,517, FILED 5-12-2010.

ALYSSA STEEL, EXAMINING ATTORNEY



David J. Kyffers

Director of the United States Patent and Trademark Office

United States of America

United States Patent and Trademark Office

PLATFORMZ

Reg. No. 4,206,443

GAMESTREAMER INC. (DELAWARE CORPORATION)
240 N. WASHINGTON BLVD, SUITE 200
SARASOTA, FL 34236

Registered Sep. 11, 2012

Int. Cl.: 9

FOR: COMPUTER GAME SOFTWARE DOWNLOADABLE FROM A GLOBAL COMPUTER NETWORK, IN CLASS 9 (U.S. CLS. 21, 23, 26, 36 AND 38).

TRADEMARK

FIRST USE 4-19-2010; IN COMMERCE 3-5-2012.

PRINCIPAL REGISTER

THE MARK CONSISTS OF STANDARD CHARACTERS WITHOUT CLAIM TO ANY PARTICULAR FONT, STYLE, SIZE, OR COLOR.

SN 85-037,130, FILED 5-12-2010.

SANJEEV VOHRA, EXAMINING ATTORNEY



David J. Kyffers

Director of the United States Patent and Trademark Office

United States of America

United States Patent and Trademark Office

DOTTIE SEATTLE LAGER

Reg. No. 4,206,444

Registered Sep. 11, 2012

Int. Cl.: 32

TRADEMARK

PRINCIPAL REGISTER

EMERALD CITY BEER COMPANY, LLC (WASHINGTON LIMITED LIABILITY COMPANY)
3100 AIRPORT WAY SOUTH, STE. 8100
SEATTLE, WA 98134

FOR: BEER, IN CLASS 32 (U.S. CLS. 45, 46 AND 48).

FIRST USE 9-25-2010; IN COMMERCE 9-25-2010.

THE MARK CONSISTS OF STANDARD CHARACTERS WITHOUT CLAIM TO ANY PARTICULAR FONT, STYLE, SIZE, OR COLOR.

NO CLAIM IS MADE TO THE EXCLUSIVE RIGHT TO USE "SEATTLE LAGER", APART FROM THE MARK AS SHOWN.

SN 85-039,326, FILED 5-14-2010.

AMEEN IMAM, EXAMINING ATTORNEY



David J. Kyffers

Director of the United States Patent and Trademark Office

United States of America

United States Patent and Trademark Office

REVOLUTION

Reg. No. 4,206,445

LE CREUSET OF AMERICA, INC (DELAWARE CORPORATION)
114 BOB GIFFORD BLVD
EARLY BRANCH, SC 29916

Registered Sep. 11, 2012

Int. Cls.: 8 and 21

FOR: COOKING SPOONS, IN CLASS 8 (U.S. CLS. 23, 28 AND 44).

FIRST USE 4-15-2012; IN COMMERCE 4-15-2012.

TRADEMARK

FOR: KITCHEN UTENSILS, NAMELY, SPATULAS AND BRUSHES FOR DISTRIBUTION OF SAUCES TO FOODS, IN CLASS 21 (U.S. CLS. 2, 13, 23, 29, 30, 33, 40 AND 50).

PRINCIPAL REGISTER

FIRST USE 4-15-2012; IN COMMERCE 4-15-2012.

THE MARK CONSISTS OF STANDARD CHARACTERS WITHOUT CLAIM TO ANY PARTICULAR FONT, STYLE, SIZE, OR COLOR.

SN 85-039,992, FILED 5-17-2010.

VIVIAN MICZNIK FIRST, EXAMINING ATTORNEY



David J. Kyffers

Director of the United States Patent and Trademark Office

United States of America

United States Patent and Trademark Office

GROWUMS

Reg. No. 4,206,446

Registered Sep. 11, 2012

Int. Cl.: 44

SERVICE MARK

PRINCIPAL REGISTER

PREFERRED COMMERCE, INC. (FLORIDA CORPORATION)
1655 PALM BEACH LAKES BLVD., SUITE 800
WEST PALM BEACH, FL 33401

FOR: PROVIDING A WEBSITE FEATURING INFORMATION ABOUT GARDENING, GARDENING PRODUCTS, SELECTING PLANTS, INCLUDING VEGETABLES, FRUITS, HERBS, AND FLOWERS, FOR GARDENING, SELECTING LOCATIONS FOR GARDENING, AND THE EFFECT OF THE WEATHER ON GARDENING; PROVIDING A WEBSITE THAT ALLOWS USERS TO LOG AND TRACK THE USER'S GARDENING ACTIVITIES, REMINDERS, DEADLINES, AND KEY DATES, IN CLASS 44 (U.S. CLS. 100 AND 101).

FIRST USE 4-23-2010; IN COMMERCE 4-23-2010.

THE MARK CONSISTS OF STANDARD CHARACTERS WITHOUT CLAIM TO ANY PARTICULAR FONT, STYLE, SIZE, OR COLOR.

SN 85-040,665, FILED 5-17-2010.

LESLEY LAMOTHE, EXAMINING ATTORNEY



David J. Kyffers

Director of the United States Patent and Trademark Office

United States of America

United States Patent and Trademark Office

VOLUNTARY PURCHASING GROUPS, INC.

Reg. No. 4,206,447

VOLUNTARY PURCHASING GROUPS, INC. (TEXAS CORPORATION)
230 FM 87

Registered Sep. 11, 2012

BONHAM, TX 75418

Int. Cl.: 35

FOR: WHOLESALE STORE SERVICES FEATURING FERTILIZERS, SOIL AMENDMENTS, FUNGICIDES, HERBICIDES, INSECTICIDES, AND PESTICIDES, IN CLASS 35 (U.S. CLS. 100, 101 AND 102).

SERVICE MARK

FIRST USE 6-24-1968; IN COMMERCE 6-24-1968.

PRINCIPAL REGISTER

THE MARK CONSISTS OF STANDARD CHARACTERS WITHOUT CLAIM TO ANY PARTICULAR FONT, STYLE, SIZE, OR COLOR.

NO CLAIM IS MADE TO THE EXCLUSIVE RIGHT TO USE "PURCHASING GROUPS, INC.", APART FROM THE MARK AS SHOWN.

SN 85-042,276, FILED 5-19-2010.

ELLEN BURNS, EXAMINING ATTORNEY



David J. Kyros

Director of the United States Patent and Trademark Office

United States of America

United States Patent and Trademark Office

POWERREACH

Reg. No. 4,206,448

Registered Sep. 11, 2012

Int. Cl.: 7

TRADEMARK

PRINCIPAL REGISTER

HALLIBURTON ENERGY SERVICES, INC. (DELAWARE CORPORATION)
1-B-121
2601 BELTLINE ROAD
CARROLLTON, TX 75006

FOR: OIL AND GAS WELL EQUIPMENT IN THE NATURE OF A PIPE DEPLOYMENT SYSTEM COMPRISED OF SPOOLABLE CONNECTORS, CABLES, PROBES, SPINNERS, IMAGER, CASING COLLAR LOCATOR, SENSORS, PUMPS, INJECTOR HEAD, FIRING HEADS AND GUNS, WHICH SYSTEM IS CAPABLE OF RUNNING BOTH JOINTED PIPE AND COILED TUBING IN A SINGLE STRING FOR STIMULATION AND WELL INTERVENTION PROCESSES FOR THE OIL AND GAS INDUSTRY, IN CLASS 7 (U.S. CLS. 13, 19, 21, 23, 31, 34 AND 35).

FIRST USE 7-9-2012; IN COMMERCE 7-9-2012.

THE MARK CONSISTS OF STANDARD CHARACTERS WITHOUT CLAIM TO ANY PARTICULAR FONT, STYLE, SIZE, OR COLOR.

SN 85-043,529, FILED 5-20-2010.

MATTHEW MCDOWELL, EXAMINING ATTORNEY



David J. Kybas

Director of the United States Patent and Trademark Office

United States of America

United States Patent and Trademark Office

THE BOLD NETWORK STRATEGY

Reg. No. 4,206,449

Registered Sep. 11, 2012

Int. Cl.: 36

SERVICE MARK

PRINCIPAL REGISTER

CRAWFORD & COMPANY (GEORGIA CORPORATION)
1001 SUMMIT BOULEVARD, 9TH FLOOR
ATLANTA, GA 30319

FOR: PROVIDING INSURANCE RELATED SERVICES RENDERED TO INSURERS, INSURED ENTITIES, AND SELF-INSURED EMPLOYERS SUPPORTING THE ADMINISTRATION AND MANAGEMENT OF WORKERS COMPENSATION CLAIMS AND MITIGATION OF MEDICAL COST DRIVERS THROUGH A CUSTOM PPO NETWORK STRATEGY; PROVIDING AN ON-LINE COMPUTER DATABASE OF WORKERS COMPENSATION INSURANCE INFORMATION TO INSURERS, INSURED ENTITIES, AND SELF-INSURED EMPLOYERS, IN CLASS 36 (U.S. CLS. 100, 101 AND 102).

FIRST USE 6-0-2010; IN COMMERCE 6-0-2010.

THE MARK CONSISTS OF STANDARD CHARACTERS WITHOUT CLAIM TO ANY PARTICULAR FONT, STYLE, SIZE, OR COLOR.

NO CLAIM IS MADE TO THE EXCLUSIVE RIGHT TO USE "NETWORK STRATEGY", APART FROM THE MARK AS SHOWN.

SN 85-044,860, FILED 5-21-2010.

ANNE MADDEN, EXAMINING ATTORNEY



David J. Kybas

Director of the United States Patent and Trademark Office

United States of America

United States Patent and Trademark Office

FLYBOYS BY BULLSEYE

Reg. No. 4,206,450

RICHARD A. CLEMENS, LLC (MASSACHUSETTS LIMITED LIABILITY COMPANY)
7 HADDOW ROAD
ROCKPORT, MA 01966

Registered Sep. 11, 2012

Int. Cl.: 9

FOR: REFLECTIVE CLOTHING FOR SAFETY PURPOSES, NAMELY, REFLECTIVE SAFETY SCARVES FOR OUTDOOR ACTIVITIES AND RECREATIONAL SPORTS FOR PROTECTION AGAINST ACCIDENTS OR INJURY, IN CLASS 9 (U.S. CLS. 21, 23, 26, 36 AND 38).

TRADEMARK

FIRST USE 9-30-2010; IN COMMERCE 9-30-2010.

PRINCIPAL REGISTER

THE MARK CONSISTS OF STANDARD CHARACTERS WITHOUT CLAIM TO ANY PARTICULAR FONT, STYLE, SIZE, OR COLOR.

SN 85-045,057, FILED 5-21-2010.

MARY CRAWFORD, EXAMINING ATTORNEY



David J. Kybas

Director of the United States Patent and Trademark Office

United States of America

United States Patent and Trademark Office



Reg. No. 4,206,451

RICHARD A. CLEMENS, LLC (MASSACHUSETTS LIMITED LIABILITY COMPANY)
7 HADDOW ROAD
ROCKPORT, MA 01966

Registered Sep. 11, 2012

Int. Cl.: 9

FOR: REFLECTIVE CLOTHING FOR SAFETY PURPOSES, NAMELY, REFLECTIVE SAFETY SCARVES FOR OUTDOOR ACTIVITIES AND RECREATIONAL SPORTS FOR PROTECTION AGAINST ACCIDENTS OR INJURY, IN CLASS 9 (U.S. CLS. 21, 23, 26, 36 AND 38).

TRADEMARK

FIRST USE 9-30-2010; IN COMMERCE 9-30-2010.

PRINCIPAL REGISTER

SN 85-045,097, FILED 5-21-2010.

MARY CRAWFORD, EXAMINING ATTORNEY



David J. Kybas

Director of the United States Patent and Trademark Office

United States of America

United States Patent and Trademark Office

EDC-CONTACT

Reg. No. 4,206,452

Registered Sep. 11, 2012

Int. Cl.: 9

TRADEMARK

PRINCIPAL REGISTER

ENTERPRISE DATABASE CORPORATION (VIRGINIA CORPORATION)
7900 SUDLEY ROAD, 8TH FLOOR
MANASSAS, VA 20109

FOR: COMPUTER AND DATA NETWORKING HARDWARE IN THE NATURE OF DEVICES FOR TRANSPORTING AND AGGREGATING DATA, VOICE OR WIRELESS COMMUNICATIONS ACROSS MULTIPLE NETWORK INFRASTRUCTURES AND COMMUNICATIONS PROTOCOLS; COMPUTER HARDWARE AND SOFTWARE AND DATA NETWORKING HARDWARE AND SOFTWARE IN THE NATURE OF DEVICES, FOR USE WITH PERSONAL COMPUTERS, FOR TRANSMITTING, RECEIVING, RECORDING AND MONITORING VOICE, DATA, INFORMATION, IMAGES, SIGNALS, AND MESSAGES; ELECTRONIC COMMUNICATIONS SYSTEMS COMPRISED OF COMPUTER HARDWARE AND SOFTWARE FOR THE TRANSMISSION OF DATA BETWEEN TWO POINTS; COMPUTER SOFTWARE TO MANAGE, ANALYZE, RETRIEVE, MONITOR, MAINTAIN, REPORT ON, STRUCTURE, MODEL, FORECAST, PRESENT AND DISPLAY DATA AND INFORMATION FROM VARIOUS DATABASES; COMPUTER SOFTWARE THAT PROVIDES WEB-BASED ACCESS TO APPLICATIONS AND SERVICES THROUGH A WEB OPERATING SYSTEM OR PORTAL INTERFACE; COMPUTER SOFTWARE THAT PROVIDES REAL-TIME, INTEGRATED BUSINESS MANAGEMENT INTELLIGENCE BY COMBINING INFORMATION FROM VARIOUS DATABASES AND PRESENTING IT IN AN EASY-TO-UNDERSTAND USER INTERFACE; COMPUTER SOFTWARE FOR CREATING SEARCHABLE DATABASES OF INFORMATION AND DATA; COMPUTER SOFTWARE TO AUTOMATE DATA WAREHOUSING; COMPUTER SOFTWARE FOR USE IN DATABASE MANAGEMENT; COMPUTER SOFTWARE FOR COMPUTER SYSTEMS AND APPLICATION DEVELOPMENT, DEPLOYMENT AND MANAGEMENT; AND INSTRUCTIONAL MANUALS SOLD AS A UNIT THEREWITH, IN CLASS 9 (U.S. CLS. 21, 23, 26, 36 AND 38).



FIRST USE 5-21-2010; IN COMMERCE 5-21-2010.

THE MARK CONSISTS OF STANDARD CHARACTERS WITHOUT CLAIM TO ANY PARTICULAR FONT, STYLE, SIZE, OR COLOR.

SN 85-045,289, FILED 5-21-2010.

RAUL CORDOVA, EXAMINING ATTORNEY

David J. Kyros

Director of the United States Patent and Trademark Office

United States of America

United States Patent and Trademark Office

Playing in the Dirt

Reg. No. 4,206,453

PLAYING IN THE DIRT, INC. (MISSOURI CORPORATION)
3619 NORTH HIGH ST.
JACKSON, MO 63755

Registered Sep. 11, 2012

**Int. Cls.: 18, 21, 24, 25,
and 35**

FOR: BAGS FOR CARRYING BABIES' ACCESSORIES; BEACH BAGS; CARRY-ALL BAGS; DIAPER BAGS; OVERNIGHT BAGS; PET PRODUCTS, NAMELY, PET RESTRAINING DEVICES CONSISTING OF LEASHES, COLLARS, HARNESSSES, RESTRAINING STRAPS, AND LEASHES WITH LOCKING DEVICES; SHOULDER BAGS; SOUVENIR BAGS; SPORT BAGS; TOTE BAGS, IN CLASS 18 (U.S. CLS. 1, 2, 3, 22 AND 41).

TRADEMARK

SERVICE MARK

FIRST USE 5-16-2012; IN COMMERCE 5-16-2012.

PRINCIPAL REGISTER

FOR: BEER MUGS; BOTTLES, SOLD EMPTY; BOWLS; CUPS AND MUGS; INSULATED BAGS FOR FOOD OR BEVERAGE FOR DOMESTIC USE; INSULATED CONTAINERS FOR BEVERAGE CANS FOR DOMESTIC USE; INSULATED CONTAINERS FOR FOOD OR BEVERAGE FOR DOMESTIC USE; PET FEEDING AND DRINKING BOWLS; PET FEEDING DISHES; PET TREAT JARS; PLASTIC WATER BOTTLES SOLD EMPTY; SPORTS BOTTLES SOLD EMPTY, IN CLASS 21 (U.S. CLS. 2, 13, 23, 29, 30, 33, 40 AND 50).

FIRST USE 5-25-2012; IN COMMERCE 5-25-2012.

FOR: BEACH TOWELS, IN CLASS 24 (U.S. CLS. 42 AND 50).

FIRST USE 5-25-2012; IN COMMERCE 5-25-2012.

FOR: ATHLETIC APPAREL, NAMELY, SHIRTS, PANTS, JACKETS, FOOTWEAR, HATS AND CAPS, ATHLETIC UNIFORMS; BASEBALL CAPS AND HATS; FLIP FLOPS; HATS; HATS FOR INFANTS, BABIES, TODDLERS AND CHILDREN; HOODED SWEAT SHIRTS; LONG-SLEEVED SHIRTS; POLO SHIRTS; SHIRTS; SHIRTS AND SHORT-SLEEVED SHIRTS; SHIRTS FOR INFANTS, BABIES, TODDLERS AND CHILDREN; SHORT-SLEEVED OR LONG-SLEEVED T-SHIRTS; SHORT-SLEEVED SHIRTS; SPORT SHIRTS, IN CLASS 25 (U.S. CLS. 22 AND 39).

FIRST USE 7-30-2010; IN COMMERCE 7-30-2010.

FOR: ON-LINE WHOLESALE AND RETAIL STORE SERVICES FEATURING CLOTHING AND FASHION ACCESSORIES; RETAIL STORE SERVICES FEATURING CLOTHING AND



David J. Kyffers

Director of the United States Patent and Trademark Office

Reg. No. 4,206,453 FASHION ACCESSORIES; WHOLESALE AND RETAIL STORE SERVICES AND ON-LINE RETAIL AND WHOLESALE STORE SERVICES FEATURING CLOTHING AND FASHION ACCESSORIES; WHOLESALE AND RETAIL STORE SERVICES FEATURING CLOTHING AND FASHION ACCESSORIES, IN CLASS 35 (U.S. CLS. 100, 101 AND 102).

FIRST USE 7-30-2010; IN COMMERCE 7-30-2010.

THE MARK CONSISTS OF STANDARD CHARACTERS WITHOUT CLAIM TO ANY PARTICULAR FONT, STYLE, SIZE, OR COLOR.

SN 85-046,143, FILED 5-24-2010.

KATHERINE CHANG, EXAMINING ATTORNEY

United States of America

United States Patent and Trademark Office

MORSOLUTIONS

Reg. No. 4,206,454

Registered Sep. 11, 2012

Int. Cls.: 38 and 41

SERVICE MARK

PRINCIPAL REGISTER

MORSOLUTIONS LLC (D.C. LIMITED LIABILITY COMPANY)
1025 VERMONT AVENUE NW, SUITE 830
WASHINGTON, DC 20005

FOR: PROVIDING AN ON-LINE EDUCATIONAL FORUM FOR TRANSMISSION OF MESSAGES AMONG COMPUTER USERS CONCERNING BUSINESS, INDUSTRY, AND PUBLIC POLICY, IN CLASS 38 (U.S. CLS. 100, 101 AND 104).

FIRST USE 5-24-2010; IN COMMERCE 5-24-2010.

FOR: EDUCATIONAL SERVICES, NAMELY, ORGANIZING AND CONDUCTING SEMINARS, WORKSHOPS, CLASSES, COURSES, CONFERENCES, EDUCATIONAL FORUMS AND BRIEFINGS, TUTORING AND MENTORING AND DISTRIBUTING COURSE MATERIALS IN CONNECTION THEREWITH IN THE FIELD OF BUSINESS, INDUSTRY, PUBLIC POLICY AND GOVERNMENT; EDUCATIONAL RESEARCH IN THE FIELD OF BUSINESS, INDUSTRY, PUBLIC POLICY AND GOVERNMENT; PROVIDING ON-LINE PUBLICATIONS, NAMELY, MONOGRAPHS, MAGAZINES, NEWSLETTERS, PAMPHLETS, BOOKLETS, ARTICLES, RESEARCH PAPERS, WHITE PAPERS, AND SCIENTIFIC PAPERS IN THE FIELD OF BUSINESS, INDUSTRY, PUBLIC POLICY AND GOVERNMENT, IN CLASS 41 (U.S. CLS. 100, 101 AND 107).

FIRST USE 5-24-2010; IN COMMERCE 5-24-2010.

THE MARK CONSISTS OF STANDARD CHARACTERS WITHOUT CLAIM TO ANY PARTICULAR FONT, STYLE, SIZE, OR COLOR.

SN 85-046,220, FILED 5-24-2010.

BRENDAN MCCAULEY, EXAMINING ATTORNEY



David J. Kyffers

Director of the United States Patent and Trademark Office

United States of America
United States Patent and Trademark Office

SKYJUMP

Reg. No. 4,206,455

W2007 STRATOSPHERE PROPCO., L.P. (DELAWARE LIMITED PARTNERSHIP)
2000 LAS VEGAS BOULEVARD SOUTH
LAS VEGAS, NV 89104

Registered Sep. 11, 2012

Int. Cl.: 25

FOR: BOTTOMS; FOOTWEAR; HEADWEAR; LOUNGEWEAR; SCARVES; SLEEPWEAR;
SWIMWEAR; TOPS; UNDERGARMENTS, IN CLASS 25 (U.S. CLS. 22 AND 39).

TRADEMARK

FIRST USE 4-1-2010; IN COMMERCE 4-1-2010.

PRINCIPAL REGISTER

THE MARK CONSISTS OF STANDARD CHARACTERS WITHOUT CLAIM TO ANY PARTICULAR FONT, STYLE, SIZE, OR COLOR.

OWNER OF U.S. REG. NOS. 3,996,211, 4,109,368, AND 4,112,461.

SN 85-046,662, FILED 5-24-2010.

LOURDES AYALA, EXAMINING ATTORNEY



David J. Kybas

Director of the United States Patent and Trademark Office

United States of America

United States Patent and Trademark Office



Reg. No. 4,206,456

W2007 STRATOSPHERE PROPCO., L.P. (DELAWARE LIMITED PARTNERSHIP)
2000 LAS VEGAS BOULEVARD SOUTH
LAS VEGAS, NV 89104

Registered Sep. 11, 2012

Int. Cl.: 25

FOR: BOTTOMS; FOOTWEAR; HEADWEAR; LOUNGEWEAR; SCARVES; SLEEPWEAR;
SWIMWEAR; TOPS; UNDERGARMENTS, IN CLASS 25 (U.S. CLS. 22 AND 39).

TRADEMARK

FIRST USE 4-1-2010; IN COMMERCE 4-1-2010.

PRINCIPAL REGISTER

OWNER OF U.S. REG. NOS. 3,996,209, 3,996,210, AND 4,109,368.

NO CLAIM IS MADE TO THE EXCLUSIVE RIGHT TO USE "LAS VEGAS", APART FROM
THE MARK AS SHOWN.

THE MARK CONSISTS OF THE STYLIZED WORDS "SKY JUMP" STAGGERED HORIZONTAL-
ALLY POSITIONED OVER A TARGET AND FIVE VERTICALLY POSITIONED INVERTED
LONG TRIANGLES AND THE WORDS "LAS VEGAS" UNDER THE WORD "SKY" AND A
DOTTED BACKGROUND ON THE BOTTOM.

SN 85-046,673, FILED 5-24-2010.

LOURDES AYALA, EXAMINING ATTORNEY



David J. Kyffers

Director of the United States Patent and Trademark Office

United States of America

United States Patent and Trademark Office

SKYJUMP LAS VEGAS

Reg. No. 4,206,457

W2007 STRATOSPHERE PROPCO., L.P. (DELAWARE LIMITED PARTNERSHIP)
2000 LAS VEGAS BOULEVARD SOUTH
LAS VEGAS, NV 89104

Registered Sep. 11, 2012

Int. Cl.: 25

FOR: BOTTOMS; FOOTWEAR; HEADWEAR; LOUNGEWEAR; SCARVES; SLEEPWEAR;
SWIMWEAR; TOPS; UNDERGARMENTS, IN CLASS 25 (U.S. CLS. 22 AND 39).

TRADEMARK

FIRST USE 4-1-2010; IN COMMERCE 4-1-2010.

PRINCIPAL REGISTER

THE MARK CONSISTS OF STANDARD CHARACTERS WITHOUT CLAIM TO ANY PARTICULAR FONT, STYLE, SIZE, OR COLOR.

OWNER OF U.S. REG. NOS. 3,996,209, 3,996,210, AND 4,109,368.

NO CLAIM IS MADE TO THE EXCLUSIVE RIGHT TO USE "LAS VEGAS", APART FROM THE MARK AS SHOWN.

SN 85-046,691, FILED 5-24-2010.

LOURDES AYALA, EXAMINING ATTORNEY



David J. Kybas

Director of the United States Patent and Trademark Office

United States of America
United States Patent and Trademark Office

SKYJUMP

Reg. No. 4,206,458

W2007 STRATOSPHERE PROPCO., L.P. (DELAWARE LIMITED PARTNERSHIP)
2000 LAS VEGAS BOULEVARD SOUTH
LAS VEGAS, NV 89104

Registered Sep. 11, 2012

Int. Cl.: 21

FOR: BEVERAGeware; SHOT GLASSES, IN CLASS 21 (U.S. CLS. 2, 13, 23, 29, 30, 33, 40 AND 50).

TRADEMARK

FIRST USE 4-1-2010; IN COMMERCE 4-1-2010.

PRINCIPAL REGISTER

THE MARK CONSISTS OF STANDARD CHARACTERS WITHOUT CLAIM TO ANY PARTICULAR FONT, STYLE, SIZE, OR COLOR.

OWNER OF U.S. REG. NOS. 3,996,211, 4,109,369, AND 4,112,461.

SN 85-046,721, FILED 5-24-2010.

LOURDES AYALA, EXAMINING ATTORNEY



David J. Kybas

Director of the United States Patent and Trademark Office

United States of America

United States Patent and Trademark Office

ASHTON & ELSA

Reg. No. 4,206,459

Registered Sep. 11, 2012

Int. Cl.: 16

TRADEMARK

PRINCIPAL REGISTER

COLLEEN KARIS DESIGNS, LLC (CALIFORNIA LIMITED LIABILITY COMPANY)
#493
137 NORTH LARCHMONT BLVD.
LOS ANGELES, CA 90004

FOR: PRINTS, ARTWORK ON CANVAS AND MEMO BOARDS, IN CLASS 16 (U.S. CLS. 2, 5, 22, 23, 29, 37, 38 AND 50).

FIRST USE 11-0-2010; IN COMMERCE 11-0-2010.

THE MARK CONSISTS OF STANDARD CHARACTERS WITHOUT CLAIM TO ANY PARTICULAR FONT, STYLE, SIZE, OR COLOR.

SN 85-049,065, FILED 5-27-2010.

LINDA M. KING, EXAMINING ATTORNEY



David J. Kyffers

Director of the United States Patent and Trademark Office

United States of America

United States Patent and Trademark Office

EASYDPS

Reg. No. 4,206,460

Registered Sep. 11, 2012

Int. Cl.: 9

TRADEMARK

PRINCIPAL REGISTER

ENTERPRISE DATABASE CORPORATION (VIRGINIA CORPORATION)
7900 SUDLEY ROAD, 8TH FLOOR
MANASSAS, VA 20109

FOR: COMPUTER AND DATA NETWORKING HARDWARE IN THE NATURE OF DEVICES FOR TRANSPORTING AND AGGREGATING DATA, VOICE OR WIRELESS COMMUNICATIONS ACROSS MULTIPLE NETWORK INFRASTRUCTURES AND COMMUNICATIONS PROTOCOLS; COMPUTER HARDWARE AND SOFTWARE AND DATA NETWORKING HARDWARE AND SOFTWARE IN THE NATURE OF DEVICES, FOR USE WITH PERSONAL COMPUTERS, FOR TRANSMITTING, RECEIVING, RECORDING AND MONITORING VOICE, DATA, INFORMATION, IMAGES, SIGNALS, AND MESSAGES; ELECTRONIC COMMUNICATIONS SYSTEMS COMPRISED OF COMPUTER HARDWARE AND SOFTWARE FOR THE TRANSMISSION OF DATA BETWEEN TWO POINTS; COMPUTER SOFTWARE TO MANAGE, ANALYZE, RETRIEVE, MONITOR, MAINTAIN, REPORT ON, STRUCTURE, MODEL, FORECAST, PRESENT AND DISPLAY DATA AND INFORMATION FROM VARIOUS DATABASES; COMPUTER SOFTWARE THAT PROVIDES WEB-BASED ACCESS TO APPLICATIONS AND SERVICES THROUGH A WEB OPERATING SYSTEM OR PORTAL INTERFACE; COMPUTER SOFTWARE THAT PROVIDES REAL-TIME, INTEGRATED BUSINESS MANAGEMENT INTELLIGENCE BY COMBINING INFORMATION FROM VARIOUS DATABASES AND PRESENTING IT IN AN EASY-TO-UNDERSTAND USER INTERFACE; COMPUTER SOFTWARE FOR CREATING SEARCHABLE DATABASES OF INFORMATION AND DATA; COMPUTER SOFTWARE TO AUTOMATE DATA WAREHOUSING; COMPUTER SOFTWARE FOR USE IN DATABASE MANAGEMENT; COMPUTER SOFTWARE FOR COMPUTER SYSTEMS AND APPLICATION DEVELOPMENT, DEPLOYMENT AND MANAGEMENT; AND INSTRUCTIONAL MANUALS SOLD AS A UNIT THEREWITH, IN CLASS 9 (U.S. CLS. 21, 23, 26, 36 AND 38).



FIRST USE 5-21-2010; IN COMMERCE 5-21-2010.

THE MARK CONSISTS OF STANDARD CHARACTERS WITHOUT CLAIM TO ANY PARTICULAR FONT, STYLE, SIZE, OR COLOR.

SN 85-049,629, FILED 5-27-2010.

RAUL CORDOVA, EXAMINING ATTORNEY

David J. Kyppas

Director of the United States Patent and Trademark Office

United States of America

United States Patent and Trademark Office

The logo consists of the text "EASYDPS" in a bold, sans-serif font, centered within a rounded rectangular border with a slight 3D effect.

Reg. No. 4,206,461

Registered Sep. 11, 2012

Int. Cl.: 9

TRADEMARK

PRINCIPAL REGISTER

ENTERPRISE DATABASE CORPORATION (VIRGINIA CORPORATION)
7900 SUDLEY ROAD, 8TH FLOOR
MANASSAS, VA 20109

FOR: COMPUTER AND DATA NETWORKING HARDWARE IN THE NATURE OF DEVICES FOR TRANSPORTING AND AGGREGATING DATA, VOICE OR WIRELESS COMMUNICATIONS ACROSS MULTIPLE NETWORK INFRASTRUCTURES AND COMMUNICATIONS PROTOCOLS; COMPUTER HARDWARE AND SOFTWARE AND DATA NETWORKING HARDWARE AND SOFTWARE IN THE NATURE OF DEVICES, FOR USE WITH PERSONAL COMPUTERS, FOR TRANSMITTING, RECEIVING, RECORDING AND MONITORING VOICE, DATA, INFORMATION, IMAGES, SIGNALS, AND MESSAGES; ELECTRONIC COMMUNICATIONS SYSTEMS COMPRISED OF COMPUTER HARDWARE AND SOFTWARE FOR THE TRANSMISSION OF DATA BETWEEN TWO POINTS; COMPUTER SOFTWARE TO MANAGE, ANALYZE, RETRIEVE, MONITOR, MAINTAIN, REPORT ON, STRUCTURE, MODEL, FORECAST, PRESENT AND DISPLAY DATA AND INFORMATION FROM VARIOUS DATABASES; COMPUTER SOFTWARE THAT PROVIDES WEB-BASED ACCESS TO APPLICATIONS AND SERVICES THROUGH A WEB OPERATING SYSTEM OR PORTAL INTERFACE; COMPUTER SOFTWARE THAT PROVIDES REAL-TIME, INTEGRATED BUSINESS MANAGEMENT INTELLIGENCE BY COMBINING INFORMATION FROM VARIOUS DATABASES AND PRESENTING IT IN AN EASY-TO-UNDERSTAND USER INTERFACE; COMPUTER SOFTWARE FOR CREATING SEARCHABLE DATABASES OF INFORMATION AND DATA; COMPUTER SOFTWARE TO AUTOMATE DATA WAREHOUSING; COMPUTER SOFTWARE FOR USE IN DATABASE MANAGEMENT; COMPUTER SOFTWARE FOR COMPUTER SYSTEMS AND APPLICATION DEVELOPMENT, DEPLOYMENT AND MANAGEMENT; AND INSTRUCTIONAL MANUALS SOLD AS A UNIT THEREWITH, IN CLASS 9 (U.S. CLS. 21, 23, 26, 36 AND 38).

FIRST USE 5-21-2010; IN COMMERCE 5-21-2010.

THE MARK CONSISTS OF THE TEXT "EASYDPS" WITHIN A GEOMETRIC BORDER IN THE GENERAL SHAPE OF A ROUNDED RECTANGLE.

SN 85-049,644, FILED 5-27-2010.

RAUL CORDOVA, EXAMINING ATTORNEY



David J. Kappas

Director of the United States Patent and Trademark Office

United States of America

United States Patent and Trademark Office

EDC
AGENT LINK

Reg. No. 4,206,462

ENTERPRISE DATABASE CORPORATION (VIRGINIA CORPORATION)
7900 SUDLEY ROAD, 8TH FLOOR
MANASSAS, VA 20109

Registered Sep. 11, 2012

Int. Cl.: 9

FOR: COMPUTER AND DATA NETWORKING HARDWARE IN THE NATURE OF DEVICES FOR TRANSPORTING AND AGGREGATING DATA, VOICE OR WIRELESS COMMUNICATIONS ACROSS MULTIPLE NETWORK INFRASTRUCTURES AND COMMUNICATIONS PROTOCOLS; COMPUTER HARDWARE AND SOFTWARE AND DATA NETWORKING HARDWARE AND SOFTWARE IN THE NATURE OF DEVICES, FOR USE WITH PERSONAL COMPUTERS, FOR TRANSMITTING, RECEIVING, RECORDING AND MONITORING VOICE, DATA, INFORMATION, IMAGES, SIGNALS, AND MESSAGES; ELECTRONIC COMMUNICATIONS SYSTEMS COMPRISED OF COMPUTER HARDWARE AND SOFTWARE FOR THE TRANSMISSION OF DATA BETWEEN TWO POINTS; COMPUTER SOFTWARE TO MANAGE, ANALYZE, RETRIEVE, MONITOR, MAINTAIN, REPORT ON, STRUCTURE, MODEL, FORECAST, PRESENT AND DISPLAY DATA AND INFORMATION FROM VARIOUS DATABASES; COMPUTER SOFTWARE THAT PROVIDES WEB-BASED ACCESS TO APPLICATIONS AND SERVICES THROUGH A WEB OPERATING SYSTEM OR PORTAL INTERFACE; COMPUTER SOFTWARE THAT PROVIDES REAL-TIME, INTEGRATED BUSINESS MANAGEMENT INTELLIGENCE BY COMBINING INFORMATION FROM VARIOUS DATABASES AND PRESENTING IT IN AN EASY-TO-UNDERSTAND USER INTERFACE; COMPUTER SOFTWARE FOR CREATING SEARCHABLE DATABASES OF INFORMATION AND DATA; COMPUTER SOFTWARE TO AUTOMATE DATA WAREHOUSING; COMPUTER SOFTWARE FOR USE IN DATABASE MANAGEMENT; COMPUTER SOFTWARE FOR COMPUTER SYSTEMS AND APPLICATION DEVELOPMENT, DEPLOYMENT AND MANAGEMENT; AND INSTRUCTIONAL MANUALS SOLD AS A UNIT THEREWITH, IN CLASS 9 (U.S. CLS. 21, 23, 26, 36 AND 38).

TRADEMARK

PRINCIPAL REGISTER



FIRST USE 5-21-2010; IN COMMERCE 5-21-2010.

THE MARK CONSISTS OF THE WORDS "EDC AGENT LINK" IN STYLIZED LETTERING ON TWO LINES WITH "EDC" ONE THIRD THE SIZE OF "AGENTLINK" AND TO THE LEFT. A CABLE RUNS FROM THE TOP OF THE "G" IN "AGENT" TO THE TOP OF THE "L" IN "LINK" WITH A CONNECTION RECEIVER MIDWAY DOWN THE "L".

David J. Kypos

SN 85-049,652, FILED 5-27-2010.

RAUL CORDOVA, EXAMINING ATTORNEY

United States of America

United States Patent and Trademark Office



Reg. No. 4,206,463

ENTERPRISE DATABASE CORPORATION (VIRGINIA CORPORATION)
7900 SUDLEY ROAD, 8TH FLOOR
MANASSAS, VA 20109

Registered Sep. 11, 2012

Int. Cl.: 9

TRADEMARK

PRINCIPAL REGISTER

FOR: COMPUTER AND DATA NETWORKING HARDWARE IN THE NATURE OF DEVICES FOR TRANSPORTING AND AGGREGATING DATA, VOICE OR WIRELESS COMMUNICATIONS ACROSS MULTIPLE NETWORK INFRASTRUCTURES AND COMMUNICATIONS PROTOCOLS; COMPUTER HARDWARE AND SOFTWARE AND DATA NETWORKING HARDWARE AND SOFTWARE IN THE NATURE OF DEVICES, FOR USE WITH PERSONAL COMPUTERS, FOR TRANSMITTING, RECEIVING, RECORDING AND MONITORING VOICE, DATA, INFORMATION, IMAGES, SIGNALS, AND MESSAGES; ELECTRONIC COMMUNICATIONS SYSTEMS COMPRISED OF COMPUTER HARDWARE AND SOFTWARE FOR THE TRANSMISSION OF DATA BETWEEN TWO POINTS; COMPUTER SOFTWARE TO MANAGE, ANALYZE, RETRIEVE, MONITOR, MAINTAIN, REPORT ON, STRUCTURE, MODEL, FORECAST, PRESENT AND DISPLAY DATA AND INFORMATION FROM VARIOUS DATABASES; COMPUTER SOFTWARE THAT PROVIDES WEB-BASED ACCESS TO APPLICATIONS AND SERVICES THROUGH A WEB OPERATING SYSTEM OR PORTAL INTERFACE; COMPUTER SOFTWARE THAT PROVIDES REAL-TIME, INTEGRATED BUSINESS MANAGEMENT INTELLIGENCE BY COMBINING INFORMATION FROM VARIOUS DATABASES AND PRESENTING IT IN AN EASY-TO-UNDERSTAND USER INTERFACE; COMPUTER SOFTWARE FOR CREATING SEARCHABLE DATABASES OF INFORMATION AND DATA; COMPUTER SOFTWARE TO AUTOMATE DATA WAREHOUSING; COMPUTER SOFTWARE FOR USE IN DATABASE MANAGEMENT; COMPUTER SOFTWARE FOR COMPUTER SYSTEMS AND APPLICATION DEVELOPMENT, DEPLOYMENT AND MANAGEMENT; AND INSTRUCTIONAL MANUALS SOLD AS A UNIT THEREWITH, IN CLASS 9 (U.S. CLS. 21, 23, 26, 36 AND 38).



FIRST USE 5-21-2010; IN COMMERCE 5-21-2010.

THE MARK CONSISTS OF A SQUARE WITH ROUNDED CORNERS WITHIN WHICH IS LOCATED A STYLIZED CAPITAL "A" FROM WHICH A CABLE ASCENDS UP THE LEFT SIDE OF THE SQUARE AROUND THE CORNER AND OVER BEYOND THE "A" TO A TERMINUS LOCATED JUST OUTSIDE THE CROSSBAR OF THE "A".

David J. Kyros

SN 85-049,661, FILED 5-27-2010.

Director of the United States Patent and Trademark Office

RAUL CORDOVA, EXAMINING ATTORNEY

United States of America

United States Patent and Trademark Office

LAUGHING MAN

Reg. No. 4,206,464

LAUGHING MAN WORLDWIDE LLC (NEW YORK LIMITED LIABILITY COMPANY)
184 DUANE STREET
NEW YORK, NY 10013

Registered Sep. 11, 2012

Int. Cls.: 21, 25, and 30

FOR: COFFEE CUPS AND MUGS; TEA CUPS AND MUGS, IN CLASS 21 (U.S. CLS. 2, 13, 23, 29, 30, 33, 40 AND 50).

TRADEMARK

FIRST USE 10-12-2011; IN COMMERCE 10-12-2011.

PRINCIPAL REGISTER

FOR: T-SHIRTS; SWEATSHIRTS; HATS, IN CLASS 25 (U.S. CLS. 22 AND 39).

FIRST USE 10-12-2011; IN COMMERCE 10-12-2011.

FOR: HOT AND ICED COFFEE AND COFFEE-BASED BEVERAGES; HOT AND ICED TEA AND TEA-BASED BEVERAGES; HOT CHOCOLATE; CHOCOLATE-BASED BEVERAGES; COCOA AND COCOA-BASED BEVERAGES, IN CLASS 30 (U.S. CL. 46).

FIRST USE 10-12-2011; IN COMMERCE 10-12-2011.

THE MARK CONSISTS OF STANDARD CHARACTERS WITHOUT CLAIM TO ANY PARTICULAR FONT, STYLE, SIZE, OR COLOR.

SN 85-050,315, FILED 5-28-2010.

MATTHEW MCDOWELL, EXAMINING ATTORNEY



David J. Kybas

Director of the United States Patent and Trademark Office

United States of America

United States Patent and Trademark Office

ChildLock

Reg. No. 4,206,465

MIKOI LLC (MICHIGAN LIMITED LIABILITY COMPANY)
2639 IVY HILL DR.

Registered Sep. 11, 2012

COMMERCE TOWNSHIP, MI 48382

Int. Cl.: 9

FOR: COMPUTER HARDWARE AND SOFTWARE SYSTEM FOR TRACKING PEOPLE, OBJECTS AND PETS USING GPS DATA ON A DEVICE ON THE TRACKED PEOPLE, OBJECTS AND PETS, IN CLASS 9 (U.S. CLS. 21, 23, 26, 36 AND 38).

TRADEMARK

FIRST USE 5-26-2010; IN COMMERCE 5-6-2012.

PRINCIPAL REGISTER

THE MARK CONSISTS OF STANDARD CHARACTERS WITHOUT CLAIM TO ANY PARTICULAR FONT, STYLE, SIZE, OR COLOR.

SN 85-051,331, FILED 6-1-2010.

CAROLINE WOOD, EXAMINING ATTORNEY



David J. Kybas

Director of the United States Patent and Trademark Office

United States of America

United States Patent and Trademark Office

Yū Mē

Reg. No. 4,206,466

Registered Sep. 11, 2012

Int. Cl.: 20

TRADEMARK

PRINCIPAL REGISTER

MATTRESS FIRM, INC. (DELAWARE CORPORATION)
5815 GULF FREEWAY
HOUSTON, TX 77023

FOR: MATTRESSES, MATTRESSES THAT HEAT AND COOL, MATTRESS FRAMES, MATTRESS FOUNDATIONS, BOX SPRINGS, AND PILLOWS, IN CLASS 20 (U.S. CLS. 2, 13, 22, 25, 32 AND 50).

FIRST USE 9-19-2010; IN COMMERCE 9-19-2010.

THE MARK CONSISTS OF STANDARD CHARACTERS WITHOUT CLAIM TO ANY PARTICULAR FONT, STYLE, SIZE, OR COLOR.

THE WORDING IN THE MARK HAS NO MEANING IN A FOREIGN LANGUAGE.

SN 85-052,068, FILED 6-1-2010.

CHRISTINE MARTIN, EXAMINING ATTORNEY



David J. Kybas

Director of the United States Patent and Trademark Office

United States of America

United States Patent and Trademark Office

CUNNINGHAM TECHNIQUE

Reg. No. 4,206,467

MERCE CUNNINGHAM (NEW YORK TRUST)
55 BETHUNE STREET
NEW YORK CITY, NY 10014

Registered Sep. 11, 2012

Int. Cl.: 41

FOR: ENTERTAINMENT SERVICES, NAMELY, PROVIDING CONSULTING IN THE FIELD OF DANCE; EDUCATIONAL SERVICES, NAMELY, PROVIDING ADVICE AND INFORMATION IN THE FIELD OF DANCE, PROVIDING INSTRUCTION, LECTURES, SEMINARS, CLASSES AND WORKSHOPS IN THE FIELD OF DANCE AND DISTRIBUTING COURSE MATERIALS IN CONNECTION THEREWITH; EDUCATIONAL SERVICES IN THE NATURE OF PERFORMANCE DANCE SCHOOL; DANCE STUDIO SERVICES, IN CLASS 41 (U.S. CLS. 100, 101 AND 107).

SERVICE MARK

PRINCIPAL REGISTER

FIRST USE 9-30-1969; IN COMMERCE 9-30-1969.

THE MARK CONSISTS OF STANDARD CHARACTERS WITHOUT CLAIM TO ANY PARTICULAR FONT, STYLE, SIZE, OR COLOR.

NO CLAIM IS MADE TO THE EXCLUSIVE RIGHT TO USE "TECHNIQUE", APART FROM THE MARK AS SHOWN.

SN 85-052,216, FILED 6-1-2010.

KATHLEEN LORENZO, EXAMINING ATTORNEY



David J. Kybas

Director of the United States Patent and Trademark Office

United States of America

United States Patent and Trademark Office

CBM

Reg. No. 4,206,468

CENTURY BRASS MANUFACTURING CO., LTD. (NEW YORK CORPORATION)
41-07 BOWNE STREET, #2G
FLUSHING, NY 11355

Registered Sep. 11, 2012

Int. Cl.: 11

FOR: PLUMBING FITTINGS, NAMELY, HOSE BIBS, GATE VALVES, BALL VALVES, STOP VALVES, BOILER DRAIN VALVES AND SILLCOCK VALVES; PLUMBING FITTINGS, NAMELY, GARDEN VALVES, ICE MAKER VALVES, WASHING MACHINE VALVES AND VACUUM BREAKER VALVES, IN CLASS 11 (U.S. CLS. 13, 21, 23, 31 AND 34).

TRADEMARK

PRINCIPAL REGISTER

FIRST USE 5-23-2012; IN COMMERCE 5-23-2012.

THE MARK CONSISTS OF STANDARD CHARACTERS WITHOUT CLAIM TO ANY PARTICULAR FONT, STYLE, SIZE, OR COLOR.

OWNER OF U.S. REG. NO. 2,798,599.

SN 85-052,530, FILED 6-2-2010.

BERYL GARDNER, EXAMINING ATTORNEY



David J. Kyffers

Director of the United States Patent and Trademark Office

United States of America

United States Patent and Trademark Office

MEDFORECASTER

Reg. No. 4,206,469

Registered Sep. 11, 2012

Int. Cls.: 35 and 44

SERVICE MARK

PRINCIPAL REGISTER

MEDIMPACT HEALTHCARE SYSTEMS, INC. (CALIFORNIA CORPORATION)
10680 TREENA STREET
SUITE 500
SAN DIEGO, CA 921312447

FOR: ADMINISTERING HEALTHCARE MANAGEMENT PROGRAMS, NAMELY, PROVIDING HEALTHCARE BENEFIT COST CONSULTATION, MANAGEMENT AND TRACKING, IN CLASS 35 (U.S. CLS. 100, 101 AND 102).

FIRST USE 9-30-2006; IN COMMERCE 9-30-2006.

FOR: HEALTHCARE MANAGEMENT SERVICES IN THE NATURE OF PROVIDING INFORMATION AND CONSULTATION IN THE FIELD OF HEALTH, IN CLASS 44 (U.S. CLS. 100 AND 101).

FIRST USE 9-30-2006; IN COMMERCE 9-30-2006.

THE MARK CONSISTS OF STANDARD CHARACTERS WITHOUT CLAIM TO ANY PARTICULAR FONT, STYLE, SIZE, OR COLOR.

OWNER OF U.S. REG. NOS. 2,411,133, 3,340,735, AND 3,376,382.

SN 85-052,644, FILED 6-2-2010.

JEFFERY COWARD, EXAMINING ATTORNEY



David J. Kyros

Director of the United States Patent and Trademark Office

United States of America

United States Patent and Trademark Office

PREVENT

Reg. No. 4,206,470

Registered Sep. 11, 2012

Int. Cls.: 16 and 42

TRADEMARK

SERVICE MARK

PRINCIPAL REGISTER

JOHNSON & JOHNSON (NEW JERSEY CORPORATION)
ONE JOHNSON & JOHNSON PLAZA
NEW BRUNSWICK, NJ 089337001

FOR: PRINTED EDUCATIONAL MATERIALS IN THE FIELD OF CLINICAL TRIAL RESEARCH AND INFORMATION, IN CLASS 16 (U.S. CLS. 2, 5, 22, 23, 29, 37, 38 AND 50).

FIRST USE 8-12-2010; IN COMMERCE 8-12-2010.

FOR: MEDICAL AND SCIENTIFIC RESEARCH, NAMELY, CONDUCTING CLINICAL TRIALS, IN CLASS 42 (U.S. CLS. 100 AND 101).

FIRST USE 8-12-2010; IN COMMERCE 8-12-2010.

THE MARK CONSISTS OF STANDARD CHARACTERS WITHOUT CLAIM TO ANY PARTICULAR FONT, STYLE, SIZE, OR COLOR.

SN 85-052,729, FILED 6-2-2010.

SUSAN STIGLITZ, EXAMINING ATTORNEY



David J. Kyjars

Director of the United States Patent and Trademark Office

United States of America

United States Patent and Trademark Office

TURN AROUND

Reg. No. 4,206,471

COMMERCIAL PRO, INC. (MASSACHUSETTS CORPORATION)
46 FAIRHILL DRIVE
LONGMEADOW, MA 01160

Registered Sep. 11, 2012

Int. Cl.: 45

FOR: LEGAL SERVICES, IN CLASS 45 (U.S. CLS. 100 AND 101).

SERVICE MARK

FIRST USE 8-4-2008; IN COMMERCE 8-4-2008.

PRINCIPAL REGISTER

THE MARK CONSISTS OF STANDARD CHARACTERS WITHOUT CLAIM TO ANY PARTICULAR FONT, STYLE, SIZE, OR COLOR.

SN 85-052,908, FILED 6-2-2010.

GINA HAYES, EXAMINING ATTORNEY



David J. Kyffers

Director of the United States Patent and Trademark Office

United States of America

United States Patent and Trademark Office



Reg. No. 4,206,472

W2007 STRATOSPHERE PROPCO., L.P. (DELAWARE LIMITED PARTNERSHIP)
2000 LAS VEGAS BOULEVARD SOUTH
LAS VEGAS, NV 89104

Registered Sep. 11, 2012

Int. Cl.: 9

FOR: DIGITAL MEDIA, NAMELY, CDS AND DVDS FEATURING SOUVENIR PICTURES AND VIDEOS; MAGNETS, IN CLASS 9 (U.S. CLS. 21, 23, 26, 36 AND 38).

TRADEMARK

FIRST USE 5-10-2010; IN COMMERCE 5-10-2010.

PRINCIPAL REGISTER

NO CLAIM IS MADE TO THE EXCLUSIVE RIGHT TO USE "LAS VEGAS", APART FROM THE MARK AS SHOWN.

THE MARK CONSISTS OF THE WORDS "SKY JUMP" STAGGERED AND HORIZONTALLY POSITIONED OVER A TARGET AND THE WORDS "LAS VEGAS".

SN 85-053,130, FILED 6-2-2010.

EMILY CHUO, EXAMINING ATTORNEY



David J. Kyffers

Director of the United States Patent and Trademark Office

United States of America

United States Patent and Trademark Office



Reg. No. 4,206,473

MARINE MD, LLC (FLORIDA LIMITED LIABILITY COMPANY)
3861 N. 31ST TERRACE
HOLLYWOOD, FL 33021

Registered Sep. 11, 2012

Int. Cl.: 44

FOR: PROVIDING MEDICAL SERVICES TO INDIVIDUALS, IN CLASS 44 (U.S. CLS. 100 AND 101).

SERVICE MARK

FIRST USE 6-20-2012; IN COMMERCE 6-20-2012.

PRINCIPAL REGISTER

NO CLAIM IS MADE TO THE EXCLUSIVE RIGHT TO USE "MD", APART FROM THE MARK AS SHOWN.

THE COLOR(S) LIGHT BLUE, RED, AND DARK BLUE IS/ARE CLAIMED AS A FEATURE OF THE MARK.

THE MARK CONSISTS OF TWO TRIANGULAR SHAPES EACH HAVING CURVED SIDES, WITH THE SMALLER TRIANGLE SLIGHTLY ABOVE THE OTHER AND BOTH REPRESENTED IN LIGHT BLUE, BOTH ARE ABOVE AN IRREGULAR HORIZONTAL LINE IN RED WITH THE WORDS "MARINE MD" APPEARING BELOW. THE WORD "MARINE" IS DISPLAYED IN LIGHT BLUE AND "MD" IS DISPLAYED IN DARK BLUE.

SN 85-054,065, FILED 6-3-2010.

VIVIAN MICZNIK FIRST, EXAMINING ATTORNEY



David J. Kybas

Director of the United States Patent and Trademark Office

United States of America

United States Patent and Trademark Office

VTC

Reg. No. 4,206,474

Registered Sep. 11, 2012

**Int. Cls.: 14, 16, 18, 21,
25, 41, 42, and 44**

VIRGINIA TECH CARILION SCHOOL OF MEDICINE, INC. (VIRGINIA CORPORATION)
2 RIVERSIDE CIRCLE, SUITE M140
ROANOKE, VA 24016

FOR: PRECIOUS METALS; JEWELRY, NAMELY, GOLD PINS, GOLD EARRINGS, TIE TACKS, CHARMS AND RINGS; WATCHES AND CLOCKS, IN CLASS 14 (U.S. CLS. 2, 27, 28 AND 50).

TRADEMARK

FIRST USE 5-1-2010; IN COMMERCE 8-1-2010.

SERVICE MARK

FOR: PAPER ARTICLES, NAMELY, WRITING PAPER, FOLDERS, NOTE PADS, STATIONERY AND LOOSE-LEAF BINDERS; DECALS; BUMPER STICKERS; NOTE BOOKS; CALENDARS; POST CARDS; POSTERS AND PENS, IN CLASS 16 (U.S. CLS. 2, 5, 22, 23, 29, 37, 38 AND 50).

PRINCIPAL REGISTER

FIRST USE 5-8-2008; IN COMMERCE 5-8-2008.

FOR: LEATHER AND IMITATION LEATHER GOODS, NAMELY, BRIEF CASE TYPE PORTFOLIO COVERS AND BRIEF CASES, TRAVEL BAGS, BACKPACKS, WALLETS AND UMBRELLAS, IN CLASS 18 (U.S. CLS. 1, 2, 3, 22 AND 41).

FIRST USE 7-5-2010; IN COMMERCE 8-1-2010.

FOR: DRINKING GLASSES; MUGS; PLASTIC CUPS; INSULATING SLEEVE HOLDERS FOR BEVERAGE CANS; PLATES AND WASTE PAPER BASKETS, IN CLASS 21 (U.S. CLS. 2, 13, 23, 29, 30, 33, 40 AND 50).

FIRST USE 7-5-2010; IN COMMERCE 8-1-2010.

FOR: CLOTHING, NAMELY, T-SHIRTS, SPORT SHIRTS, SWEAT PANTS, SWEAT SHIRTS, SWEATERS, JERSEYS, PANTS, TIES, BABY BIBS NOT OF PAPER, CAPS, HATS, SHOES, JACKETS AND BATH ROBES, IN CLASS 25 (U.S. CLS. 22 AND 39).

FIRST USE 7-5-2010; IN COMMERCE 8-1-2010.

FOR: MEDICAL AND GRADUATE BIOMEDICAL SCIENCES EDUCATION SERVICES, NAMELY, PROVIDING COURSES AT THE UNIVERSITY AND POST GRADUATE LEVELS



David J. Kyffers

Director of the United States Patent and Trademark Office

Reg. No. 4,206,474 IN THE FIELD OF MEDICINE, BIOMEDICAL SCIENCES AND DISTRIBUTING COURSE MATERIALS IN CONNECTION THEREWITH; MEDICAL TRAINING, GRADUATE AND POSTGRADUATE BIOMEDICAL RESEARCH TRAINING AND TEACHING; ORGANIZATION OF CONFERENCES AND SYMPOSIA IN THE FIELD OF MEDICAL SCIENCE AND BIOMEDICAL AND BEHAVIORAL RESEARCH; PROVIDING CONTINUING MEDICAL EDUCATION COURSES AND POSTGRADUATE RESEARCH TRAINING COURSES AND PUBLISHING AND ISSUING SCIENTIFIC PAPERS IN RELATION TO BIOMEDICAL SCIENCE AND BEHAVIORAL RESEARCH AND MEDICAL TECHNOLOGY, IN CLASS 41 (U.S. CLS. 100, 101 AND 107).

FIRST USE 6-4-2009; IN COMMERCE 6-4-2009.

FOR: MEDICAL AND SCIENTIFIC RESEARCH SERVICES IN THE FIELDS OF ADDICTION AND SUBSTANCE ABUSE, GENETICS, INFLAMMATION, INFECTIOUS DISEASE, NEUROSCIENCE, BEHAVIORAL SCIENCES AND DECISION-MAKING, CARDIOVASCULAR SCIENCE AND CARDIOLOGY, DEVELOPMENTAL BIOLOGY, ENDOCRINOLOGY, NANOSCIENCE AND NANOTECHNOLOGY, REGENERATIVE BIOLOGY AND MEDICINE, SOCIAL COGNITION, COMPUTATIONAL PSYCHIATRY, OSTEOLOGY, BIOINFORMATICS, COMPUTER MODELING, BIOIMAGING, MEDICAL IMAGING, NAMELY, MAGNETIC RESONANCE IMAGING, CELLULAR AND MOLECULAR OPTICAL IMAGING, CANCER BIOLOGY, TREATMENT AND DIAGNOSIS, DEVELOPMENTAL DISORDERS, INJURY RESEARCH, SLEEP BIOLOGY AND DISORDERS, METABOLISM, SATIETY AND OBESITY, METABOLIC SYNDROME, HYPERTENSION AND DYSLIPIDEMIA; MEDICAL LABORATORY SERVICES; MEDICAL AND SCIENTIFIC RESEARCH, NAMELY, CONDUCTING BASIC BIOMEDICAL AND TRANSLATIONAL RESEARCH ON ISOLATED MOLECULES, CELLS, TISSUES, IN ANIMAL MODELS AND IN CONTROL HUMAN SUBJECTS AND PATIENTS, AND CONDUCTING CLINICAL TRIALS; GENETIC TESTING FOR RESEARCH PURPOSES; MEDICAL IMAGING FOR RESEARCH PURPOSES, IN CLASS 42 (U.S. CLS. 100 AND 101).

FIRST USE 6-4-2009; IN COMMERCE 6-4-2009.

FOR: MEDICAL SERVICES; EMERGENCY MEDICAL ASSISTANCE; SURGERY; EMERGENCY MEDICAL RESPONSE SERVICES; COMPREHENSIVE HEALTH CARE SERVICES, NAMELY, HOSPITAL MEDICAL SERVICES AND MEDICAL CLINIC SERVICES; GENETIC TESTING FOR MEDICAL PURPOSES; MEDICAL IMAGING SERVICES; AND MEDICAL CLINICS, IN CLASS 44 (U.S. CLS. 100 AND 101).

FIRST USE 6-4-2009; IN COMMERCE 6-4-2009.

THE MARK CONSISTS OF STANDARD CHARACTERS WITHOUT CLAIM TO ANY PARTICULAR FONT, STYLE, SIZE, OR COLOR.

SN 85-054,094, FILED 6-3-2010.

JEFF DEFORD, EXAMINING ATTORNEY

United States of America

United States Patent and Trademark Office

WTC

Reg. No. 4,206,475

VIRGINIA TECH CARILION SCHOOL OF MEDICINE, INC. (VIRGINIA CORPORATION)
2 RIVERSIDE CIRCLE, SUITE M 140
ROANOKE, VA 24016

Registered Sep. 11, 2012

**Int. Cls.: 14, 16, 18, 21,
25, 41, 42, and 44**

FOR: PRECIOUS METALS; JEWELRY, NAMELY, GOLD PINS, GOLD EARRINGS, TIE TACKS, CHARMS AND RINGS; WATCHES AND CLOCKS, IN CLASS 14 (U.S. CLS. 2, 27, 28 AND 50).

TRADEMARK

FIRST USE 8-1-2010; IN COMMERCE 8-1-2010.

SERVICE MARK

FOR: PAPER ARTICLES, NAMELY, WRITING PAPER, FOLDERS, NOTE PADS, STATIONERY AND LOOSE-LEAF BINDERS; DECALS; BUMPER STICKERS; NOTE BOOKS; CALENDARS; POST CARDS; POSTERS AND PENS, IN CLASS 16 (U.S. CLS. 2, 5, 22, 23, 29, 37, 38 AND 50).

PRINCIPAL REGISTER

FIRST USE 5-8-2008; IN COMMERCE 5-8-2008.

FOR: LEATHER AND IMITATION LEATHER GOODS, NAMELY, BRIEF CASE TYPE PORTFOLIO COVERS AND BRIEF CASES, TRAVEL BAGS, BACKPACKS, WALLETS AND UMBRELLAS, IN CLASS 18 (U.S. CLS. 1, 2, 3, 22 AND 41).

FIRST USE 7-5-2010; IN COMMERCE 7-5-2010.

FOR: DRINKING GLASSES; MUGS; PLASTIC CUPS; INSULATING SLEEVE HOLDERS FOR BEVERAGE CANS; PLATES AND WASTE PAPER BASKETS, IN CLASS 21 (U.S. CLS. 2, 13, 23, 29, 30, 33, 40 AND 50).

FIRST USE 8-1-2010; IN COMMERCE 8-1-2010.

FOR: CLOTHING, NAMELY, T-SHIRTS, SPORT SHIRTS, SWEAT PANTS, SWEAT SHIRTS, SWEATERS, JERSEYS, PANTS, TIES, BABY BIBS NOT OF PAPER, CAPS, HATS, SHOES, JACKETS AND BATH ROBES, IN CLASS 25 (U.S. CLS. 22 AND 39).

FIRST USE 8-1-2010; IN COMMERCE 8-1-2010.

FOR: MEDICAL AND GRADUATE BIOMEDICAL SCIENCES EDUCATION SERVICES, NAMELY, PROVIDING COURSES AT THE UNIVERSITY AND POST GRADUATE LEVELS



David J. Kyffers

Director of the United States Patent and Trademark Office

Reg. No. 4,206,475 IN THE FIELD OF MEDICINE, BIOMEDICAL SCIENCES AND DISTRIBUTING COURSE MATERIALS IN CONNECTION THEREWITH; MEDICAL TRAINING, GRADUATE AND POSTGRADUATE BIOMEDICAL RESEARCH TRAINING AND TEACHING; ORGANIZATION OF CONFERENCES AND SYMPOSIA IN THE FIELD OF MEDICAL SCIENCE AND BIOMEDICAL AND BEHAVIORAL RESEARCH; PROVIDING CONTINUING MEDICAL EDUCATION COURSES AND POSTGRADUATE RESEARCH TRAINING COURSES AND PUBLISHING AND ISSUING SCIENTIFIC PAPERS IN RELATION TO BIOMEDICAL SCIENCE AND BEHAVIORAL RESEARCH AND MEDICAL TECHNOLOGY, IN CLASS 41 (U.S. CLS. 100, 101 AND 107).

FIRST USE 6-4-2009; IN COMMERCE 6-4-2009.

FOR: MEDICAL AND SCIENTIFIC RESEARCH SERVICES IN THE FIELDS OF ADDICTION AND SUBSTANCE ABUSE, GENETICS, INFLAMMATION, INFECTIOUS DISEASE, NEUROSCIENCE, BEHAVIORAL SCIENCES AND DECISION-MAKING, CARDIOVASCULAR SCIENCE AND CARDIOLOGY, DEVELOPMENTAL BIOLOGY, ENDOCRINOLOGY, NANOSCIENCE AND NANOTECHNOLOGY, REGENERATIVE BIOLOGY AND MEDICINE, SOCIAL COGNITION, COMPUTATIONAL PSYCHIATRY, OSTEOLOGY, BIOINFORMATICS, COMPUTER MODELING, BIOIMAGING, MEDICAL IMAGING, NAMELY, MAGNETIC RESONANCE IMAGING, CELLULAR AND MOLECULAR OPTICAL IMAGING, CANCER BIOLOGY, TREATMENT AND DIAGNOSIS, DEVELOPMENTAL DISORDERS, INJURY RESEARCH, SLEEP BIOLOGY AND DISORDERS, METABOLISM, SATIETY AND OBESITY, METABOLIC SYNDROME, HYPERTENSION AND DYSLIPIDEMIA; MEDICAL LABORATORY SERVICES; MEDICAL AND SCIENTIFIC RESEARCH, NAMELY, CONDUCTING BASIC BIOMEDICAL AND TRANSLATIONAL RESEARCH ON ISOLATED MOLECULES, CELLS, TISSUES, IN ANIMAL MODELS AND IN CONTROL HUMAN SUBJECTS AND PATIENTS, AND CONDUCTING CLINICAL TRIALS; GENETIC TESTING FOR RESEARCH PURPOSES; MEDICAL IMAGING FOR RESEARCH PURPOSES, IN CLASS 42 (U.S. CLS. 100 AND 101).

FIRST USE 6-4-2009; IN COMMERCE 6-4-2009.

FOR: MEDICAL SERVICES; EMERGENCY MEDICAL ASSISTANCE; SURGERY; EMERGENCY MEDICAL RESPONSE SERVICES; COMPREHENSIVE HEALTH CARE SERVICES, NAMELY, HOSPITAL MEDICAL SERVICES AND MEDICAL CLINIC SERVICES; GENETIC TESTING FOR MEDICAL PURPOSES; MEDICAL IMAGING SERVICES; AND MEDICAL CLINICS, IN CLASS 44 (U.S. CLS. 100 AND 101).

FIRST USE 6-4-2009; IN COMMERCE 6-4-2009.

THE MARK CONSISTS OF THE LETTERS "VTC" IN FRONT OF A DOWNWARD SLOPING LINE.

SN 85-054,126, FILED 6-3-2010.

JEFF DEFORD, EXAMINING ATTORNEY

United States of America

United States Patent and Trademark Office



Reg. No. 4,206,476

JOHNSON & JOHNSON (NEW JERSEY CORPORATION)
ONE JOHNSON & JOHNSON PLAZA
NEW BRUNSWICK, NJ 089337001

Registered Sep. 11, 2012

Int. Cl.: 3

FOR: NON-MEDICATED SKIN CARE PREPARATIONS, NAMELY, LOTIONS, AND SUN CARE PREPARATIONS, IN CLASS 3 (U.S. CLS. 1, 4, 6, 50, 51 AND 52).

TRADEMARK

FIRST USE 6-8-2010; IN COMMERCE 6-8-2010.

PRINCIPAL REGISTER

THE MARK CONSISTS OF A BEAN POD DESIGN.

SN 85-056,278, FILED 6-7-2010.

DOMINIC FATHY, EXAMINING ATTORNEY



David J. Kyffers

Director of the United States Patent and Trademark Office

United States of America

United States Patent and Trademark Office

Andrew & Audrey

Reg. No. 4,206,477

Registered Sep. 11, 2012

Int. Cl.: 25

TRADEMARK

PRINCIPAL REGISTER

PIONEER GARMENT CO., LTD. (THAILAND CORPORATION)
PARKKLONG, PASIJAREON
202/22-25 PHETKASEM ROAD
BANGKOK, THAILAND 10160

FOR: APPAREL, NAMELY, TOPS, SHIRTS, PANTS, JEANS, SKIRTS; KNITS, NAMELY, SWEATERS, LEGGINGS, PANTS, TOPS, DRESSES, HATS, GLOVES, SCARVES, SOCKS, JACKETS; JUMPSUITS, SWEATERS, SHORTS, DRESSES, JACKETS, COATS, SWEATSHIRTS, SWEATPANTS, VESTS, HEADWEAR, HATS, UNDERWEAR, BRASSIERES, HOSIERY, SLEEPWEAR, SCARVES, GLOVES, MITTENS, BATHROBES, SLIPPERS, T-SHIRTS, TANK-TOPS, SHAWLS, BELTS, BLOUSES, LOUNGEWEAR, SWIMWEAR, HEADBANDS; SHOES; SHOWER CAPS, PONCHOS, EAR WARMERS, SOCKS, APRONS; CLOTH BIBS; LEG WARMERS, IN CLASS 25 (U.S. CLS. 22 AND 39).

FIRST USE 12-31-2010; IN COMMERCE 12-31-2010.

THE MARK CONSISTS OF STANDARD CHARACTERS WITHOUT CLAIM TO ANY PARTICULAR FONT, STYLE, SIZE, OR COLOR.

SN 85-056,587, FILED 6-7-2010.

APRIL ROACH, EXAMINING ATTORNEY



David J. Kyfos

Director of the United States Patent and Trademark Office

United States of America

United States Patent and Trademark Office

LUSCOMBE



Reg. No. 4,206,478

Registered Sep. 11, 2012

Int. Cl.: 32

TRADEMARK

PRINCIPAL REGISTER

LUSCOMBE CIDER LIMITED (UNITED KINGDOM LIMITED LIABILITY COMPANY)
LUSCOMBE FARM
BUCKFASTLEIGH, DEVON, UNITED KINGDOM TQ110LP

FOR: NON-ALCOHOLIC DRINKS; FRUIT DRINKS; FRUIT JUICES; FRUIT NECTARS; PREPARATIONS FOR MAKING BEVERAGES, NAMELY, FRUIT BASED SYRUPS; BEVERAGES CONSISTING OF A BLEND OF FRUIT AND VEGETABLE JUICES; BEVERAGES CONSISTING OF VEGETABLE JUICES; BEVERAGES CONSISTING PRINCIPALLY OF FRUIT JUICES; BEVERAGES CONTAINING ADDED MINERALS, NOT FOR MEDICAL PURPOSES; BEVERAGES CONTAINING ADDED VITAMINS, NOT FOR MEDICAL PURPOSES; BEVERAGES HAVING A BASE OF FRUIT JUICE; BEVERAGES HAVING A BASE OF VEGETABLE JUICE; BEVERAGES MADE FROM FRUIT CONCENTRATE; NON-ALCOHOLIC BEVERAGES, NAMELY, CARBONATED BEVERAGES; FRUIT CONCENTRATES FOR MAKING BEVERAGES; FRUIT JUICE EXTRACTS; FRUIT SYRUP; HOP CONCENTRATES FOR USE IN THE PREPARATION OF BEVERAGES; LEMON JUICE; NON-ALCOHOLIC BEVERAGES CONTAINING CITRUS FRUITS, PLANTS AND MARINE ALGAE; NON-ALCOHOLIC BEVERAGES CONTAINING MINERAL WATER; NON-ALCOHOLIC BEVERAGES MADE FROM SYRUPS, NAMELY, FRUIT FLAVORED SODA AND CARBONATED AND NON-CARBONATED FRUIT BEVERAGE; NON-ALCOHOLIC COCKTAIL BASES FOR FROZEN BEVERAGES; NON-ALCOHOLIC LOW CALORIE CONTENT BEVERAGES, NAMELY, FRUIT FLAVORED SODA AND CARBONATED AND NON-CARBONATED FRUIT BEVERAGE NOT FOR MEDICAL USE; SHERBERT IN THE FORM OF BEVERAGES; SORBETS IN THE FORM OF BEVERAGES ; SPRING WATER, NOT FOR MEDICAL PURPOSES; CORDIALS; WATERS; GINGER BEER; NON-ALCOHOLIC MALT BEVERAGES; PREPARATIONS FOR USE IN THE PRODUCTION OF BEER; ROOT BEER, IN CLASS 32 (U.S. CLS. 45, 46 AND 48).

FIRST USE 9-15-2010; IN COMMERCE 9-15-2010.

THE MARK CONSISTS OF THE WORD "LUSCOMBE" WITH A BAR EXTENDING ABOVE AND BELOW THE "MB" PORTION OF THE MARK AT A SLIGHT ANGLE, AND WITH TWO PIGS ON EITHER SIDE OF A PIECE OF FRUIT WITH WINGS, POSITIONED OVER THE "CO".

SN 85-057,177, FILED 6-8-2010.

KEVON CHISOLM, EXAMINING ATTORNEY



David J. Kyppas

Director of the United States Patent and Trademark Office

United States of America

United States Patent and Trademark Office

gOLD

Reg. No. 4,206,479

Registered Sep. 11, 2012

Int. Cls.: 9 and 16

TRADEMARK

PRINCIPAL REGISTER

GETZOV, HARRY J. (UNITED STATES INDIVIDUAL)
C/O ALLMARK TRADEMARK
2089 AVY AVE.
MENLO PARK, CA 94025

FOR: DOWNLOADABLE ELECTRONIC PUBLICATIONS IN THE NATURE OF E-BOOKS AND E-MAGAZINES, IN THE FIELDS OF LIFE EXPERIENCE, GERONTOLOGY, AGING, AND ORAL HISTORIES AND INTERVIEWS OF SENIOR CITIZENS; AUDIO AND VIDEO RECORDINGS IN THE FIELDS OF LIFE EXPERIENCE, GERONTOLOGY, AGING, AND ORAL HISTORIES AND INTERVIEWS OF SENIOR CITIZENS, IN CLASS 9 (U.S. CLS. 21, 23, 26, 36 AND 38).

FIRST USE 6-26-2012; IN COMMERCE 6-26-2012.

FOR: PRINTED MATTER, NAMELY, BOOKS, MAGAZINES, WORKBOOKS, AND TEACHING MATERIALS, ALL IN THE FIELDS OF LIFE EXPERIENCE, GERONTOLOGY, AGING, AND ORAL HISTORIES AND INTERVIEWS OF SENIOR CITIZENS, IN CLASS 16 (U.S. CLS. 2, 5, 22, 23, 29, 37, 38 AND 50).

FIRST USE 2-15-2012; IN COMMERCE 2-15-2012.

THE MARK CONSISTS OF STANDARD CHARACTERS WITHOUT CLAIM TO ANY PARTICULAR FONT, STYLE, SIZE, OR COLOR.

SN 85-057,294, FILED 6-8-2010.

CHARLOTTE CORWIN, EXAMINING ATTORNEY



David J. Kyjars

Director of the United States Patent and Trademark Office

United States of America

United States Patent and Trademark Office



Reg. No. 4,206,480

Registered Sep. 11, 2012

CERTIFICATION MARK

SERVICES

PRINCIPAL REGISTER

AIR BARRIER ASSOCIATION OF AMERICA (MASSACHUSETTS NOT-FOR-PROFIT TRADE ORGANIZATION)
1600 BOSTON PROVIDENCE HWY
WALPOLE, MA 02081

FOR: INSTALLATION OF MOISTURE AND AIR BARRIER FABRICS FOR BUILDINGS, IN CLASS B (U.S. CL. B).

FIRST USE 1-0-2011; IN COMMERCE 1-0-2011.

NO CLAIM IS MADE TO THE EXCLUSIVE RIGHT TO USE "AIR BARRIER ASSOCIATION OF AMERICA" OR "ACCREDITED", APART FROM THE MARK AS SHOWN.

THE MARK CONSISTS OF A CIRCLE CONTAINING THE TERMS "AIR BARRIER ASSOCIATION OF AMERICA" IN SMALL LOWER CASE LETTERS BETWEEN TWO SMALL STARS IN AN ARC AT THE TOP OF THE CIRCLE AND THE TERMS "ABAA" IN LARGE LOWER CASE LETTERS AND "ACCREDITED" IN SMALLER UPPER CASE LETTERS IN STACKED FORMAT IN THE CENTER OF THE CIRCLE AND ABOVE ONE LARGE STAR BETWEEN TWO SMALLER STARS AT THE BASE OF THE CIRCLE.

THE CERTIFICATION MARK, AS USED OR INTENDED TO BE USED BY PERSONS AND ENTITIES AUTHORIZED BY THE CERTIFIER, CERTIFIES OR IS INTENDED TO CERTIFY THAT THE SERVICES PROVIDED HAVE MET CERTIFIER'S ACCREDITATION CRITERIA AS TO QUALITY ASSURANCE, PROFESSIONAL CONDUCT, MAINTENANCE OF REQUIRED LEVELS OF LIABILITY INSURANCE, AND FINANCIAL SOUNDNESS, AND STANDARDS AS TO PROFESSIONAL EDUCATION, KNOWLEDGE AND EXPERIENCE, COMPLIANCE WITH "AIR BARRIER ASSOCIATION OF AMERICA" AND/OR MANUFACTURER RECOMMENDATIONS, AND "AIR BARRIER ASSOCIATION OF AMERICA" REPORTING AND OVERSIGHT OBLIGATIONS IN THE FIELD OF INSTALLATION OF MOISTURE AND AIR BARRIER SYSTEMS

SN 85-057,597, FILED 6-8-2010.

CHRISTINE MARTIN, EXAMINING ATTORNEY



David J. Kyffers

Director of the United States Patent and Trademark Office

United States of America

United States Patent and Trademark Office

TIERRA DEL SOL

Reg. No. 4,206,481

Registered Sep. 11, 2012

Int. Cl.: 41

SERVICE MARK

PRINCIPAL REGISTER

TIERRA DEL SOL FOUR WHEEL DRIVE CLUB (CALIFORNIA CORPORATION)
3211 FREEMAN STREET
SAN DIEGO, CA 92106

FOR: EDUCATIONAL SERVICES, NAMELY, PROVIDING WORKSHOPS FOR SHARING INFORMATION, NEWS, AND COMMENTARY IN THE FIELDS OF RESPONSIBLE OFF ROAD VEHICLE ACTIVITIES AND ENVIRONMENTAL CONSERVATION; PROVIDING INFORMATION, NEWS AND COMMENTARY IN THE FIELD OF RECREATION AND LEISURE ACTIVITIES, IN CLASS 41 (U.S. CLS. 100, 101 AND 107).

FIRST USE 12-31-2011; IN COMMERCE 12-31-2011.

THE MARK CONSISTS OF STANDARD CHARACTERS WITHOUT CLAIM TO ANY PARTICULAR FONT, STYLE, SIZE, OR COLOR.

THE ENGLISH TRANSLATION OF "TIERRA DEL SOL" IN THE MARK IS "LAND OF THE SUN".

SN 85-060,165, FILED 6-10-2010.

CORY BOONE, EXAMINING ATTORNEY



David J. Kybas

Director of the United States Patent and Trademark Office

United States of America

United States Patent and Trademark Office

TDS DESERT SAFARI

Reg. No. 4,206,482

TIERRA DEL SOL FOUR WHEEL DRIVE CLUB (CALIFORNIA CORPORATION)
3211 FREEMAN STREET
SAN DIEGO, CA 92106

Registered Sep. 11, 2012

Int. Cl.: 41

FOR: RECREATIONAL SERVICES IN THE NATURE OF ARRANGING RECREATIONAL OFF ROAD VEHICLE EXCURSIONS FOR ENTERTAINMENT PURPOSES, NOT FOR TRAVEL OR TOUR PURPOSES , IN CLASS 41 (U.S. CLS. 100, 101 AND 107).

SERVICE MARK

FIRST USE 12-31-1965; IN COMMERCE 12-31-1965.

PRINCIPAL REGISTER

THE MARK CONSISTS OF STANDARD CHARACTERS WITHOUT CLAIM TO ANY PARTICULAR FONT, STYLE, SIZE, OR COLOR.

NO CLAIM IS MADE TO THE EXCLUSIVE RIGHT TO USE "DESERT SAFARI", APART FROM THE MARK AS SHOWN.

SN 85-060,184, FILED 6-10-2010.

CORY BOONE, EXAMINING ATTORNEY



David J. Kybas

Director of the United States Patent and Trademark Office

United States of America

United States Patent and Trademark Office

MYSINGLEBUDDY.COM

Reg. No. 4,206,483

Registered Sep. 11, 2012

Int. Cls.: 38 and 45

SERVICE MARK

PRINCIPAL REGISTER

MYSINGLEBUDDY.COM LLC (DELAWARE LIMITED LIABILITY COMPANY)
C/O THE CORPORATION TRUST COMPANY
1209 ORANGE STREET
WILMINGTON, DE 198011120

FOR: TELECOMMUNICATIONS, NAMELY, THE ELECTRONIC TRANSMISSION OF DATA, SOUND, TEXT, IMAGES AND VIDEO BY MEANS OF FIBER OPTIC, COAXIAL CABLE, SATELLITE, BROADCAST AND TRANSMISSION MEDIA, AND VIA WIRELESS DEVICES; TELECOMMUNICATIONS VIA INTERNET NETWORKS, NAMELY, TELECOMMUNICATIONS ACCESS SERVICES, COMMUNICATIONS BY COMPUTER TERMINALS; PROVISION OF ACCESS TO ELECTRONIC MESSAGING SYSTEMS, NAMELY, PROVISION OF ACCESS TO A GLOBAL COMPUTER NETWORK; INSTANT MESSAGING SERVICES; ELECTRONIC ON-LINE SERVICES FOR THE RECEIPT AND DELIVERY OF MESSAGES, DOCUMENTS, IMAGES AND OTHER DATA BY ELECTRONIC TRANSMISSION, NAMELY, THE ELECTRONIC TRANSMISSION OF DATA, SOUND, TEXT, IMAGES AND VIDEO BY MEANS OF FIBER OPTIC, COAXIAL CABLE, SATELLITE, BROADCAST AND TRANSMISSION MEDIA, AND VIA WIRELESS DEVICES; ELECTRONIC MAIL SERVICES; PROVIDING MULTIPLE-USERS ACCESS TO A GLOBAL COMPUTER INFORMATION NETWORK; ELECTRONIC MESSAGING SERVICES; PROVIDING ACCESS VIA A GLOBAL COMPUTER NETWORK TO ELECTRONIC BULLETIN BOARDS; PROVIDING COMMUNICATION SERVICES TO WEB COMMUNITIES; INFORMATION, ADVICE AND CONSULTANCY RELATING TO ALL THE AFORESAID, NAMELY, INFORMATION, ADVICE AND CONSULTATION IN THE FIELD OF TELECOMMUNICATIONS AND ELECTRONIC MESSAGING SERVICES; PROVIDING INTERNET CHAT ROOMS AND CHAT ROOM SERVICES FOR SOCIAL NETWORKING, IN CLASS 38 (U.S. CLS. 100, 101 AND 104).

FIRST USE 7-1-2011; IN COMMERCE 7-1-2011.

FOR: PROVIDING SOCIAL INTRODUCTION AND DATE-ARRANGING SERVICES; ADMINISTERING PERSONALITY AND PHYSICAL ATTRACTIVENESS TESTING AND CREATING PERSONALITY AND PHYSICAL ATTRACTIVENESS PROFILES OF OTHERS, NAMELY, ATTRACTIVENESS AND PERSONALITY TESTING AND PROFILING FOR SOCIAL PURPOSES; DATING AGENCY SERVICES; MATCH-MAKING SERVICES; COMPUTER DATING SERVICES; PROVISION OF DATING AGENCY SERVICES VIA THE INTERNET; PROVISION OF DATING AGENCY SERVICES VIA TELEVISION, RADIO AND TELEPHONE; AGENCY SERVICES WHICH ARRANGE PERSONAL INTRODUCTIONS, NAMELY, FOR SOCIAL PURPOSES; SOCIAL ESCORTING SERVICES; INFORMATION AND ADVISORY SERVICES



David J. Kyffers

Director of the United States Patent and Trademark Office

Reg. No. 4,206,483 RELATING TO THE AFORESAID SERVICES, NAMELY, INFORMATION AND ADVICE IN THE FIELD OF DATING SERVICES; PROVIDING INFORMATION REGARDING AND IN THE NATURE OF, ON-LINE DATING AND SOCIAL INTRODUCTION SERVICES FOR SOCIAL PURPOSES; SOCIAL NETWORKING SERVICES, IN CLASS 45 (U.S. CLS. 100 AND 101).

FIRST USE 7-1-2011; IN COMMERCE 7-1-2011.

THE MARK CONSISTS OF STANDARD CHARACTERS WITHOUT CLAIM TO ANY PARTICULAR FONT, STYLE, SIZE, OR COLOR.

SN 85-060,395, FILED 6-11-2010.

SEAN CROWLEY, EXAMINING ATTORNEY

United States of America

United States Patent and Trademark Office

iBG★STAR

Reg. No. 4,206,484

SANOFI (FRANCE SOCIETE ANONYME)
54 RUE LA BOÉTIE
PARIS, FRANCE 75008

Registered Sep. 11, 2012

Int. Cls.: 9 and 10

FOR: SOFTWARE DOWNLOADABLE VIA THE INTERNET OR MOBILE PHONE APPLICATIONS FOR MONITORING AND TRACKING BLOOD GLUCOSE LEVELS, IN CLASS 9 (U.S. CLS. 21, 23, 26, 36 AND 38).

TRADEMARK

FIRST USE 4-0-2012; IN COMMERCE 4-0-2012.

PRINCIPAL REGISTER

FOR: BLOOD GLUCOSE MONITORS SOLD AS A UNIT WITH BLOOD GLUCOSE MONITOR KITS COMPRISING STRIPS FOR MEASURING BLOOD GLUCOSE CONCENTRATIONS, LANCETS AND CONTROL SOLUTION, IN CLASS 10 (U.S. CLS. 26, 39 AND 44).

FIRST USE 4-0-2012; IN COMMERCE 4-0-2012.

OWNER OF U.S. REG. NO. 3,787,454.

SN 85-060,922, FILED 6-11-2010.

REBECCA POVARCHUK, EXAMINING ATTORNEY



David J. Kybas

Director of the United States Patent and Trademark Office

United States of America

United States Patent and Trademark Office

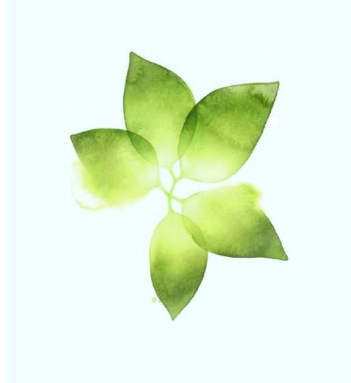

Reg. No. 4,206,485

Registered Sep. 11, 2012

Int. Cl.: 3

TRADEMARK

PRINCIPAL REGISTER

JOHNSON & JOHNSON (NEW JERSEY CORPORATION)
ONE JOHNSON & JOHNSON PLAZA
NEW BRUNSWICK, NJ 089337001

FOR: FACIAL CLEANSER; SKIN MOISTURIZER; COSMETIC CLEANSING PADS IMPREGNATED WITH A SKIN CLEANSER; FACIAL SCRUB; FACIAL CREAMS; EYE CREAMS , IN CLASS 3 (U.S. CLS. 1, 4, 6, 50, 51 AND 52).

FIRST USE 7-18-2011; IN COMMERCE 7-18-2011.

THE MARK CONSISTS OF A GREEN LEAF DESIGN WHERE THE CENTER PORTION OF THE DESIGN GIVES THE IMPRESSION THAT A WATER DROP HAS SMUDGED THE DESIGN.

THE COLOR(S) GREEN IS/ARE CLAIMED AS A FEATURE OF THE MARK.

SN 85-061,722, FILED 6-14-2010.

AMY HELLA, EXAMINING ATTORNEY



David J. Kyros

Director of the United States Patent and Trademark Office

United States of America

United States Patent and Trademark Office

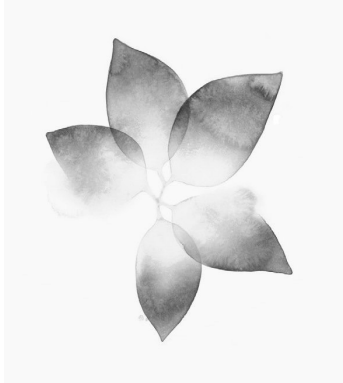

Reg. No. 4,206,486

Registered Sep. 11, 2012

Int. Cl.: 3

TRADEMARK

PRINCIPAL REGISTER

JOHNSON & JOHNSON (NEW JERSEY CORPORATION)
ONE JOHNSON & JOHNSON PLAZA
NEW BRUNSWICK, NJ 089337001

FOR: FACIAL CLEANSER; SKIN MOISTURIZER; COSMETIC CLEANSING PADS IMPREGNATED WITH A SKIN CLEANSER; FACIAL SCRUB; FACIAL CREAMS; EYE CREAMS , IN CLASS 3 (U.S. CLS. 1, 4, 6, 50, 51 AND 52).

FIRST USE 7-18-2011; IN COMMERCE 7-18-2011.

THE MARK CONSISTS OF A LEAF DESIGN WHERE THE CENTER PORTION OF THE DESIGN GIVES THE IMPRESSION THAT A WATER DROP HAS SMUDGED THE DESIGN.

SN 85-061,727, FILED 6-14-2010.

AMY HELLA, EXAMINING ATTORNEY



David J. Kybas

Director of the United States Patent and Trademark Office

United States of America

United States Patent and Trademark Office

Under Think It

Reg. No. 4,206,487

Registered Sep. 11, 2012

Int. Cl.: 25

TRADEMARK

PRINCIPAL REGISTER

BODNAR, KATHY (UNITED STATES INDIVIDUAL)
SUITE 405
333 WASHINGTON AVENUE NORTH
MINNEAPOLIS, MN 55401

FOR: ATHLETIC APPAREL, NAMELY, SHIRTS, HATS AND CAPS, BASEBALL CAPS AND HATS, TOPS, IN CLASS 25 (U.S. CLS. 22 AND 39).

FIRST USE 6-28-2012; IN COMMERCE 6-28-2012.

THE MARK CONSISTS OF STANDARD CHARACTERS WITHOUT CLAIM TO ANY PARTICULAR FONT, STYLE, SIZE, OR COLOR.

SN 85-061,820, FILED 6-14-2010.

STEVEN R. FINE, EXAMINING ATTORNEY



David J. Kybas

Director of the United States Patent and Trademark Office

United States of America

United States Patent and Trademark Office

AltaMed

Reg. No. 4,206,488

Registered Sep. 11, 2012

Int. Cl.: 44

SERVICE MARK

PRINCIPAL REGISTER

ALTAMED HEALTH SERVICES CORPORATION (CALIFORNIA CORPORATION)
2040 CAMFIELD AVENUE
LOS ANGELES, CA 90047

FOR: HEALTH CARE AND MEDICAL SERVICES, NAMELY, PRIMARY HEALTH CARE SERVICES, DENTAL SERVICES, NAMELY, DENTISTRY, COSMETIC DENTISTRY, DENTAL HYGIENIST SERVICES, ORAL SURGERY AND DENTAL IMPLANT SERVICES, NEUROMUSCULAR DENTISTRY AND SPORTS DENTISTRY, MATERNAL AND CHILD HEALTH CARE, LONG-TERM CARE AND GERIATRIC PROGRAMS, SUBSTANCE ABUSE PREVENTION AND TREATMENT, HEALTH EDUCATION AND WELLNESS PROGRAMS, IN CLASS 44 (U.S. CLS. 100 AND 101).

FIRST USE 3-5-2010; IN COMMERCE 3-5-2010.

THE MARK CONSISTS OF STANDARD CHARACTERS WITHOUT CLAIM TO ANY PARTICULAR FONT, STYLE, SIZE, OR COLOR.

SN 85-062,169, FILED 6-14-2010.

KATINA MISTER, EXAMINING ATTORNEY



David J. Kyros

Director of the United States Patent and Trademark Office

United States of America

United States Patent and Trademark Office

12 NTM

Reg. No. 4,206,489

Registered Sep. 11, 2012

Int. Cls.: 30 and 32

TRADEMARK

PRINCIPAL REGISTER

TWELVE BEVERAGE LLC (DELAWARE LIMITED LIABILITY COMPANY)
ONE DOCK STREET
STAMFORD, CT 06902

FOR: TEA-BASED BEVERAGES WITH FRUIT FLAVORING, IN CLASS 30 (U.S. CL. 46).

FIRST USE 7-31-2011; IN COMMERCE 7-31-2011.

FOR: NON-ALCOHOLIC BEVERAGES WITH TEA OR FRUIT FLAVOR, IN CLASS 32 (U.S. CLS. 45, 46 AND 48).

FIRST USE 7-31-2011; IN COMMERCE 7-31-2011.

THE MARK CONSISTS OF STANDARD CHARACTERS WITHOUT CLAIM TO ANY PARTICULAR FONT, STYLE, SIZE, OR COLOR.

SN 85-062,447, FILED 6-14-2010.

DAVID TAYLOR, EXAMINING ATTORNEY



David J. Kyfos

Director of the United States Patent and Trademark Office

United States of America

United States Patent and Trademark Office

DUKE ZA DAISY

Reg. No. 4,206,490

LORTSCHER, CHANDRIKA (UNITED STATES INDIVIDUAL)
18037 MARTHA STREET
ENCINO, CA 91316

Registered Sep. 11, 2012

Int. Cl.: 20

FOR: DECORATIVE PLASTIC YARD SIGNS AND PLASTIC SIGN POSTS, IN CLASS 20
(U.S. CLS. 2, 13, 22, 25, 32 AND 50).

TRADEMARK

FIRST USE 12-31-2011; IN COMMERCE 12-31-2011.

PRINCIPAL REGISTER

THE MARK CONSISTS OF STANDARD CHARACTERS WITHOUT CLAIM TO ANY PARTICULAR FONT, STYLE, SIZE, OR COLOR.

SN 85-063,711, FILED 6-15-2010.

BARBARA RUTLAND, EXAMINING ATTORNEY



David J. Kybas

Director of the United States Patent and Trademark Office

United States of America

United States Patent and Trademark Office

STAAR

Reg. No. 4,206,491

TEXAS EDUCATION AGENCY (TEXAS STATE AGENCY)
1701 NORTH CONGRESS AVENUE
AUSTIN, TX 787011494

Registered Sep. 11, 2012

Int. Cl.: 16

FOR: PRINTED INSTRUCTIONAL, EDUCATIONAL, AND TEACHING MATERIALS FOR THE ASSESSMENT, NAMELY, BENCHMARK TESTING, OF THE EDUCATIONAL DEVELOPMENT IN CHILDREN , IN CLASS 16 (U.S. CLS. 2, 5, 22, 23, 29, 37, 38 AND 50).

TRADEMARK

FIRST USE 1-26-2010; IN COMMERCE 3-26-2012.

PRINCIPAL REGISTER

THE MARK CONSISTS OF STANDARD CHARACTERS WITHOUT CLAIM TO ANY PARTICULAR FONT, STYLE, SIZE, OR COLOR.

SN 85-064,215, FILED 6-16-2010.

GINA HAYES, EXAMINING ATTORNEY



David J. Kyffers

Director of the United States Patent and Trademark Office

United States of America

United States Patent and Trademark Office

A NEW PERSPECTIVE ON NEW YORK

Reg. No. 4,206,492

TISHMAN SPEYER PROPERTIES, L.P. (NEW YORK LIMITED PARTNERSHIP)
45 ROCKEFELLER PLAZA
NEW YORK, NY 10011

Registered Sep. 11, 2012

Int. Cls.: 36, 37, and 42

FOR: REAL ESTATE SERVICES, NAMELY, LEASING, BROKERAGE, MANAGEMENT, CONSULTATION, AND FINANCING IN THE FIELD OF REAL ESTATE; LEASING OF FULLY EQUIPPED EXECUTIVE OFFICE SPACE, IN CLASS 36 (U.S. CLS. 100, 101 AND 102).

SERVICE MARK

FIRST USE 2-28-2012; IN COMMERCE 2-28-2012.

PRINCIPAL REGISTER

FOR: REAL ESTATE SERVICES, NAMELY, CONSTRUCTION AND RENOVATION OF BUILDINGS; CONSTRUCTION PLANNING AND CONSTRUCTION SUPERVISION OF OFFICE BUILDINGS; AND DEVELOPMENT OF COMMERCIAL BUILDINGS FOR OTHERS, IN CLASS 37 (U.S. CLS. 100, 103 AND 106).

FIRST USE 2-28-2012; IN COMMERCE 2-28-2012.

FOR: CONSTRUCTION DRAFTING; AND DESIGN OF COMMERCIAL BUILDINGS FOR OTHERS, IN CLASS 42 (U.S. CLS. 100 AND 101).

FIRST USE 2-28-2012; IN COMMERCE 2-28-2012.

THE MARK CONSISTS OF STANDARD CHARACTERS WITHOUT CLAIM TO ANY PARTICULAR FONT, STYLE, SIZE, OR COLOR.

NO CLAIM IS MADE TO THE EXCLUSIVE RIGHT TO USE "NEW YORK", APART FROM THE MARK AS SHOWN.

SN 85-064,505, FILED 6-16-2010.

REGINA DRUMMOND, EXAMINING ATTORNEY



David J. Kybas

Director of the United States Patent and Trademark Office

United States of America

United States Patent and Trademark Office

EZ MOBILE

Reg. No. 4,206,493

Registered Sep. 11, 2012

Int. Cl.: 36

SERVICE MARK

PRINCIPAL REGISTER

ERIE FEDERAL CREDIT UNION (UNITED STATES FEDERALLY CHARTERED CREDIT UNION)
1959 EAST 36TH STREET
ERIE, PA 165102663

FOR: CREDIT UNION SERVICES PROVIDED BY MOBILE TELEPHONE CONNECTIONS, IN CLASS 36 (U.S. CLS. 100, 101 AND 102).

FIRST USE 10-1-2010; IN COMMERCE 10-1-2010.

THE MARK CONSISTS OF STANDARD CHARACTERS WITHOUT CLAIM TO ANY PARTICULAR FONT, STYLE, SIZE, OR COLOR.

NO CLAIM IS MADE TO THE EXCLUSIVE RIGHT TO USE "MOBILE", APART FROM THE MARK AS SHOWN.

SN 85-066,209, FILED 6-18-2010.

ANTHONY RINKER, EXAMINING ATTORNEY



David J. Kybas

Director of the United States Patent and Trademark Office

United States of America

United States Patent and Trademark Office



Reg. No. 4,206,494

Registered Sep. 11, 2012

Int. Cl.: 14

TRADEMARK

PRINCIPAL REGISTER

SARAH GROVES (CANADA INDIVIDUAL)
621 LAKEWOOD DRIVE
VANCOUVER, BC, CANADA V5L4L9

FOR: DECORATIVE ORNAMENTS MADE OF COPPER, SILVER, GOLD AND THEIR ALLOYS, NAMELY, WINDOW ORNAMENTS; JEWELRY BOXES AND KEY CHAINS MADE OF COPPER, SILVER, GOLD AND THEIR ALLOYS, IN CLASS 14 (U.S. CLS. 2, 27, 28 AND 50).

FIRST USE 6-28-2010; IN COMMERCE 6-28-2010.

OWNER OF CANADA REG. NO. TMA659,888, DATED 3-1-2006, EXPIRES 3-1-2021.

THE MARK CONSISTS OF THE LETTERS "SG" IN A CIRCULAR SHAPE.

SN 85-066,849, FILED 6-18-2010.

MATTHEW MCDOWELL, EXAMINING ATTORNEY



David J. Kybas

Director of the United States Patent and Trademark Office

United States of America

United States Patent and Trademark Office



Reg. No. 4,206,495

PAUTESTA, PHILIPPE E. (FRANCE INDIVIDUAL)
800 BRICKELL AVENUE, SUITE 701
MIAMI, FL 33131

Registered Sep. 11, 2012

Int. Cl.: 35

FOR: DISTRIBUTORSHIP SERVICES IN THE FIELD OF FOOD; WHOLESALE FOOD DISTRIBUTORSHIP SERVICES, IN CLASS 35 (U.S. CLS. 100, 101 AND 102).

SERVICE MARK

FIRST USE 2-28-2011; IN COMMERCE 2-28-2011.

PRINCIPAL REGISTER

NO CLAIM IS MADE TO THE EXCLUSIVE RIGHT TO USE "EVERYDAY GOURMAND", APART FROM THE MARK AS SHOWN.

THE MARK CONSISTS OF THE LOGO.

THE ENGLISH TRANSLATION OF "GOURMAND" IN THE MARK IS "A LOVER OF GOOD FOOD".

SN 85-069,524, FILED 6-23-2010.

C. DIONNE CLYBURN, EXAMINING ATTORNEY



David J. Kybas

Director of the United States Patent and Trademark Office

United States of America

United States Patent and Trademark Office

BLUE BANANA FROZEN YOGURT

Reg. No. 4,206,496

BLUE BANANA FROZEN YOGURT INC (ARIZONA CORPORATION)
945 W. EUCALYPTUS PL.
TUCSON, AZ 85704

Registered Sep. 11, 2012

Int. Cl.: 43

FOR: FROZEN YOGURT SHOP SERVICES IN THE NATURE OF A RESTAURANT, IN CLASS
43 (U.S. CLS. 100 AND 101).

SERVICE MARK

FIRST USE 9-1-2010; IN COMMERCE 1-1-2011.

PRINCIPAL REGISTER

THE MARK CONSISTS OF STANDARD CHARACTERS WITHOUT CLAIM TO ANY PAR-
TICULAR FONT, STYLE, SIZE, OR COLOR.

NO CLAIM IS MADE TO THE EXCLUSIVE RIGHT TO USE "FROZEN YOGURT", APART
FROM THE MARK AS SHOWN.

SN 85-070,568, FILED 6-24-2010.

MARTHA FROMM, EXAMINING ATTORNEY



David J. Kyffers

Director of the United States Patent and Trademark Office

United States of America

United States Patent and Trademark Office



Reg. No. 4,206,497

Registered Sep. 11, 2012

Int. Cl.: 5

TRADEMARK

PRINCIPAL REGISTER

JOHNSON & JOHNSON (NEW JERSEY CORPORATION)
ONE JOHNSON & JOHNSON PLAZA
NEW BRUNSWICK, NJ 089337001

FOR: WOUND DRESSINGS, NAMELY, GAUZE PADS, IN CLASS 5 (U.S. CLS. 6, 18, 44, 46, 51 AND 52).

FIRST USE 1-21-2011; IN COMMERCE 1-21-2011.

OWNER OF U.S. REG. NOS. 568,161, 1,671,045, AND OTHERS.

THE COLOR(S) RED, WHITE AND BLUE IS/ARE CLAIMED AS A FEATURE OF THE MARK.

NO CLAIM IS MADE TO THE EXCLUSIVE RIGHT TO USE THE PICTORIAL REPRESENTATION OF GAUZE, APART FROM THE MARK AS SHOWN.

THE MARK CONSISTS OF THE STYLIZED WORDS "JOHNSON & JOHNSON" IN WHITE IN A RED CROSS WITH A WHITE GAUZE DESIGN AND LIGHT BLUE AT THE BOTTOM.

SN 85-072,577, FILED 6-28-2010.

BENJAMIN OKEKE, EXAMINING ATTORNEY



David J. Kyffers

Director of the United States Patent and Trademark Office

United States of America

United States Patent and Trademark Office

DOG GONE GOOD BEER

Reg. No. 4,206,498

Registered Sep. 11, 2012

Int. Cl.: 32

TRADEMARK

PRINCIPAL REGISTER

FRANKENMUTH BREWERY INTELLECTUAL PROPERTY, LLC (MICHIGAN LIMITED LIABILITY COMPANY)
21 EAST LONG LAKE ROAD, STE. #200
BLOOMFIELD HILLS, MI 48304

FOR: BEER, IN CLASS 32 (U.S. CLS. 45, 46 AND 48).

FIRST USE 11-30-2010; IN COMMERCE 11-30-2010.

THE MARK CONSISTS OF STANDARD CHARACTERS WITHOUT CLAIM TO ANY PARTICULAR FONT, STYLE, SIZE, OR COLOR.

NO CLAIM IS MADE TO THE EXCLUSIVE RIGHT TO USE "BEER", APART FROM THE MARK AS SHOWN.

SN 85-074,170, FILED 6-29-2010.

TARAH HARDY, EXAMINING ATTORNEY



David J. Kybas

Director of the United States Patent and Trademark Office

United States of America

United States Patent and Trademark Office

BELITA

Reg. No. 4,206,499

Registered Sep. 11, 2012

Int. Cl.: 14

TRADEMARK

PRINCIPAL REGISTER

VALUEVISION MEDIA, INC. (MINNESOTA CORPORATION)
6740 SHADY OAK ROAD
EDEN PRAIRIE, MN 55344

FOR: JEWELRY, IN CLASS 14 (U.S. CLS. 2, 27, 28 AND 50).

FIRST USE 7-10-2010; IN COMMERCE 7-10-2010.

THE MARK CONSISTS OF STANDARD CHARACTERS WITHOUT CLAIM TO ANY PARTICULAR FONT, STYLE, SIZE, OR COLOR.

THE NAME(S), PORTRAIT(S), AND/OR SIGNATURE(S) SHOWN IN THE MARK DOES NOT IDENTIFY A PARTICULAR LIVING INDIVIDUAL.

SN 85-074,558, FILED 6-30-2010.

MAYUR VAGHANI, EXAMINING ATTORNEY



David J. Kyffers

Director of the United States Patent and Trademark Office

United States of America

United States Patent and Trademark Office

HELICAL ROBOTICS

Reg. No. 4,206,500

Registered Sep. 11, 2012

Int. Cl.: 7

TRADEMARK

PRINCIPAL REGISTER

HELICAL ROBOTICS, LLC (WISCONSIN LIMITED LIABILITY COMPANY)
722 RINPOCHE LANE
OREGON, WI 53575

FOR: INDUSTRIAL ROBOTS, IN CLASS 7 (U.S. CLS. 13, 19, 21, 23, 31, 34 AND 35).

FIRST USE 5-22-2011; IN COMMERCE 5-22-2011.

THE MARK CONSISTS OF STANDARD CHARACTERS WITHOUT CLAIM TO ANY PARTICULAR FONT, STYLE, SIZE, OR COLOR.

NO CLAIM IS MADE TO THE EXCLUSIVE RIGHT TO USE "ROBOTICS", APART FROM THE MARK AS SHOWN.

SN 85-075,155, FILED 6-30-2010.

EMILY CHUO, EXAMINING ATTORNEY



David J. Kyffers

Director of the United States Patent and Trademark Office

United States of America

United States Patent and Trademark Office

Sexiness is contagious

Reg. No. 4,206,501

S.I.C. INTERNATIONAL LLC (DELAWARE LIMITED LIABILITY COMPANY)

Registered Sep. 11, 2012

261 W 28TH ST., 4C
NEW YORK, NY 10001

Int. Cl.: 25

FOR: BLAZERS; BLOUSES; COATS; SKIRTS AND DRESSES; SLACKS; SWEATERS, IN CLASS 25 (U.S. CLS. 22 AND 39).

TRADEMARK

FIRST USE 10-31-2011; IN COMMERCE 10-31-2011.

PRINCIPAL REGISTER

THE MARK CONSISTS OF STANDARD CHARACTERS WITHOUT CLAIM TO ANY PARTICULAR FONT, STYLE, SIZE, OR COLOR.

SN 85-075,182, FILED 6-30-2010.

DOMINIC FATHY, EXAMINING ATTORNEY



David J. Kybas

Director of the United States Patent and Trademark Office

United States of America

United States Patent and Trademark Office

SECURIX

Reg. No. 4,206,502

Registered Sep. 11, 2012

Int. Cl.: 9

TRADEMARK

PRINCIPAL REGISTER

IDIS CO., LTD. (REPUBLIC OF KOREA CORPORATION)
1301, GWANPYEONG-DONG, YOUSUNG-GU
DAEJON, REPUBLIC OF KOREA

FOR: COMPUTER OPERATING, MONITORING AND RECORDING SOFTWARE FOR VIDEO SURVEILLANCE SYSTEMS; APPARATUS FOR THE RECORDING, TRANSMISSION AND REPRODUCTION OF IMAGES AND SOUND, NAMELY, A VIDEO SURVEILLANCE SYSTEM COMPRISED OF DVR (DIGITAL VIDEO RECORDER), CAMERA AND MONITOR, IN CLASS 9 (U.S. CLS. 21, 23, 26, 36 AND 38).

FIRST USE 10-1-2011; IN COMMERCE 10-1-2011.

THE MARK CONSISTS OF THE WORD "SECURIX" IN STYLIZED FORM.

SN 85-075,716, FILED 7-1-2010.

TRACY WHITTAKER-BROWN, EXAMINING ATTORNEY



David J. Kybas

Director of the United States Patent and Trademark Office

United States of America

United States Patent and Trademark Office



Reg. No. 4,206,503

Registered Sep. 11, 2012

Int. Cl.: 28

TRADEMARK

PRINCIPAL REGISTER

ERICSON, STACI (UNITED STATES INDIVIDUAL)
923 MOUNTAIN VIEW DRIVE
LAFAYETTE, CA 94549

FOR: CARD GAMES, IN CLASS 28 (U.S. CLS. 22, 23, 38 AND 50).

FIRST USE 3-6-2010; IN COMMERCE 9-26-2010.

THE MARK CONSISTS OF THE WORDING "GOLLY GEEPERS" ABOVE "WE'VE GOT KIDS' MANNERS IN THE BAG" ALL IN STYLIZED FORM WITH HAND DRAWN STAR APPEARING ABOVE THE LETTER "G" IN "GEEPERS" AND BELOW THE WORDS "GOLLY GEEPERS" APPEARS THE PHRASE "WE'VE GOT KIDS' MANNERS IN THE BAG".

SN 85-076,000, FILED 7-1-2010.

JEFF DEFORD, EXAMINING ATTORNEY



David J. Kybas

Director of the United States Patent and Trademark Office

United States of America

United States Patent and Trademark Office

SITEVIEW

Reg. No. 4,206,504

OPENGATE DATA SYSTEMS LLC (MASSACHUSETTS LIMITED LIABILITY COMPANY)
53 DOGWOOD ROAD NORTH
HUBBARDSTON, MA 01452

Registered Sep. 11, 2012

Int. Cl.: 9

FOR: COMPUTER HARDWARE AND SOFTWARE FOR USE IN MONITORING, TRENDING AND ALARMING FOR MULTIPLE DEVICES WITHIN A NETWORK AND DATA CENTER , IN CLASS 9 (U.S. CLS. 21, 23, 26, 36 AND 38).

TRADEMARK

FIRST USE 11-29-2008; IN COMMERCE 1-6-2009.

PRINCIPAL REGISTER

THE MARK CONSISTS OF STANDARD CHARACTERS WITHOUT CLAIM TO ANY PARTICULAR FONT, STYLE, SIZE, OR COLOR.

SN 85-076,832, FILED 7-2-2010.

LINDA MICKLEBURGH, EXAMINING ATTORNEY



David J. Kyjars

Director of the United States Patent and Trademark Office

United States of America

United States Patent and Trademark Office

VALAR

Reg. No. 4,206,505

VALAR VENTURES MANAGEMENT LLC (DELAWARE LIMITED LIABILITY COMPANY)
ONE LETTERMAN DRIVE, BUILDING C, STE 400
SAN FRANCISCO, CA 94129

Registered Sep. 11, 2012

Int. Cls.: 35 and 36

FOR: NEW BUSINESS VENTURE DEVELOPMENT CONSULTING SERVICES, IN CLASS 35 (U.S. CLS. 100, 101 AND 102).

SERVICE MARK

FIRST USE 10-0-2010; IN COMMERCE 10-0-2010.

PRINCIPAL REGISTER

FOR: FINANCIAL SERVICES, NAMELY, INVESTMENT ADVICE, INVESTMENT MANAGEMENT, INVESTMENT CONSULTATION AND INVESTMENT OF FUNDS FOR OTHERS, INCLUDING PRIVATE EQUITY, VENTURE CAPITAL AND DEBT INVESTMENT SERVICES, IN CLASS 36 (U.S. CLS. 100, 101 AND 102).

FIRST USE 10-0-2010; IN COMMERCE 10-0-2010.

THE MARK CONSISTS OF STANDARD CHARACTERS WITHOUT CLAIM TO ANY PARTICULAR FONT, STYLE, SIZE, OR COLOR.

SN 85-076,887, FILED 7-2-2010.

ANDREA HACK, EXAMINING ATTORNEY



David J. Kybas

Director of the United States Patent and Trademark Office

United States of America

United States Patent and Trademark Office

SIMPLICITY

Reg. No. 4,206,506

ADERANS CO., LTD. (JAPAN CORPORATION)
13-4 ARAKI-CHO SHINJUKU-KU
TOKYO, JAPAN 160-007

Registered Sep. 11, 2012

Int. Cl.: 26

FOR: ADD-IN AND ADD-ON HAIR ACCESSORIES, NAMELY, ARTIFICIAL HAIR CONSTRUCTED PRIMARILY OF HUMAN HAIR, IN CLASS 26 (U.S. CLS. 37, 39, 40, 42 AND 50).

TRADEMARK

FIRST USE 12-31-2006; IN COMMERCE 12-31-2006.

PRINCIPAL REGISTER

THE MARK CONSISTS OF STANDARD CHARACTERS WITHOUT CLAIM TO ANY PARTICULAR FONT, STYLE, SIZE, OR COLOR.

PRIORITY CLAIMED UNDER SEC. 44(D) ON JAPAN APPLICATION NO. 2010-52278, FILED 7-1-2010, REG. NO. 5376599, DATED 12-17-2010, EXPIRES 12-17-2020.

SN 85-078,130, FILED 7-6-2010.

NICHOLAS COLEMAN, EXAMINING ATTORNEY



David J. Kybas

Director of the United States Patent and Trademark Office

United States of America

United States Patent and Trademark Office

Hypothesis

Reg. No. 4,206,507

Registered Sep. 11, 2012

Int. Cl.: 33

TRADEMARK

PRINCIPAL REGISTER

ROOTS RUN DEEP LLC (CALIFORNIA LIMITED LIABILITY COMPANY)
BUILDING C, SUITE F & S
6795 WASHINGTON STREET
YOUNTVILLE, CA 94599

FOR: WINE, IN CLASS 33 (U.S. CLS. 47 AND 49).

FIRST USE 2-20-2012; IN COMMERCE 2-20-2012.

THE MARK CONSISTS OF STANDARD CHARACTERS WITHOUT CLAIM TO ANY PARTICULAR FONT, STYLE, SIZE, OR COLOR.

SN 85-078,971, FILED 7-6-2010.

JENNIFER MARTIN, EXAMINING ATTORNEY



David J. Kybas

Director of the United States Patent and Trademark Office

United States of America

United States Patent and Trademark Office

No Worries

Reg. No. 4,206,508

FAMIGLIETTI ARMAND G (UNITED STATES INDIVIDUAL)
630 FIRST AVENUE APT. 4F
NEW YORK, NY 10016

Registered Sep. 11, 2012

Int. Cl.: 25

FOR: HATS, T-SHIRTS, IN CLASS 25 (U.S. CLS. 22 AND 39).

TRADEMARK

FIRST USE 12-8-2011; IN COMMERCE 5-11-2012.

PRINCIPAL REGISTER

THE MARK CONSISTS OF STANDARD CHARACTERS WITHOUT CLAIM TO ANY PARTICULAR FONT, STYLE, SIZE, OR COLOR.

SN 85-078,974, FILED 7-6-2010.

CHARLES L. JENKINS, EXAMINING ATTORNEY



David J. Kybas

Director of the United States Patent and Trademark Office

United States of America

United States Patent and Trademark Office

M.O.E.

Reg. No. 4,206,509

Registered Sep. 11, 2012

Int. Cl.: 35

SERVICE MARK

PRINCIPAL REGISTER

BUNGE OILS, INC. (DELAWARE CORPORATION)
11720 BORMAN DRIVE
ST. LOUIS, MO 63146

FOR: WHOLESALE AND DISTRIBUTORSHIP SERVICES FEATURING OIL PRODUCTS, EDIBLE OILS, EDIBLE FATS AND MARGARINES; MARKETING SERVICES, NAMELY, PROVIDING INFORMATIONAL WEB PAGES DESIGNED TO GENERATE SALES TRAFFIC VIA HYPERLINKS TO OTHER WEB SITES RELATING TO OIL PRODUCTS, IN CLASS 35 (U.S. CLS. 100, 101 AND 102).

FIRST USE 5-22-2010; IN COMMERCE 5-22-2010.

THE MARK CONSISTS OF STANDARD CHARACTERS WITHOUT CLAIM TO ANY PARTICULAR FONT, STYLE, SIZE, OR COLOR.

SN 85-079,227, FILED 7-7-2010.

JEAN IM, EXAMINING ATTORNEY



David J. Kybas

Director of the United States Patent and Trademark Office

United States of America

United States Patent and Trademark Office



Reg. No. 4,206,510

BEL-AIR ASSOCIATION (CALIFORNIA CORPORATION)
100 BEL AIR ROAD
LOS ANGELES, CA 90077

Registered Sep. 11, 2012

Int. Cl.: 25

FOR: T-SHIRTS, IN CLASS 25 (U.S. CLS. 22 AND 39).

TRADEMARK

FIRST USE 1-30-2012; IN COMMERCE 1-30-2012.

PRINCIPAL REGISTER

THE MARK CONSISTS OF A WHITE FRONT WITH A FACE AT THE TOP WITH AN ORNAMENTAL DESIGN. WITHIN THE FRONT IS THE WORDING "BEL AIR" IN BLACK.

THE COLOR(S) BLACK, WHITE IS/ARE CLAIMED AS A FEATURE OF THE MARK.

SEC. 2(F) AS TO "BEL AIR".

SN 85-079,564, FILED 7-7-2010.

KAPIL BHANOT, EXAMINING ATTORNEY



David J. Kybas

Director of the United States Patent and Trademark Office

United States of America

United States Patent and Trademark Office

K-RAIL

Reg. No. 4,206,511

Registered Sep. 11, 2012

Int. Cl.: 20

TRADEMARK

PRINCIPAL REGISTER

LF, LLC (DELAWARE LIMITED LIABILITY COMPANY)
P.O. BOX 39
MOUNT MOURNE, NC 28123

FOR: NON-METAL RAILS, NON-METAL HOOKS AND NON-METAL MOUNTING BRACKETS, ALL FOR USE IN WALL MOUNTED ORGANIZATION SYSTEMS; WALL MOUNTED ORGANIZATION SYSTEMS CONSISTING OF NON-METAL RAILS, NON-METAL MOUNTING BRACKET AND NON-METAL HOOKS, SOLD AS A UNIT, IN CLASS 20 (U.S. CLS. 2, 13, 22, 25, 32 AND 50).

FIRST USE 2-0-2010; IN COMMERCE 2-0-2010.

THE MARK CONSISTS OF STANDARD CHARACTERS WITHOUT CLAIM TO ANY PARTICULAR FONT, STYLE, SIZE, OR COLOR.

SN 85-079,685, FILED 7-7-2010.

RAUL CORDOVA, EXAMINING ATTORNEY



David J. Kyffers

Director of the United States Patent and Trademark Office

United States of America

United States Patent and Trademark Office



Reg. No. 4,206,512

VITAL PHARMACEUTICALS, INC. (FLORIDA CORPORATION)
1600 NORTH PARK DRIVE
WESTON, FL 33326

Registered Sep. 11, 2012

Int. Cl.: 5

FOR: DIETARY AND NUTRITIONAL SUPPLEMENTS, IN CLASS 5 (U.S. CLS. 6, 18, 44, 46, 51 AND 52).

TRADEMARK

FIRST USE 6-22-2006; IN COMMERCE 6-22-2006.

PRINCIPAL REGISTER

OWNER OF U.S. REG. NO. 3,295,283.

THE COLOR(S) BLACK, RED, WHITE, BLUE AND SILVER IS/ARE CLAIMED AS A FEATURE OF THE MARK.

THE MARK CONSISTS OF THE WORDS "NO SHOTGUN" IN WHITE BLOCK CAPITALS, WITH RED THEN BLACK OUTLINE, RED 3D STRING OF BEADS OUTLINED IN BLACK ABOVE THE LETTERS "H" AND "O" CONNECTING TO BLUE 3D STRING OF BEADS OUTLINED IN BLACK ABOVE THE LETTERS "G" AND "U" ENCLOSING THE WHITE AND SILVER LETTERS "NO" WHICH IS OUTLINED IN RED AND BLACK, AND WITH VERTICAL 3D BLUE, SILVER AND WHITE CYLINDER DESIGNS OUTLINED IN BLACK BEHIND THE LETTERS "NO". THE SILVER BACKGROUND IS NOT PART OF THE MARK.

SN 85-081,649, FILED 7-9-2010.

DOUGLAS LEE, EXAMINING ATTORNEY



David J. Kyros

Director of the United States Patent and Trademark Office

United States of America

United States Patent and Trademark Office



Reg. No. 4,206,513

VITAL PHARMACEUTICALS, INC. (FLORIDA CORPORATION)
1600 NORTH PARK DRIVE
WESTON, FL 33326

Registered Sep. 11, 2012

Int. Cl.: 5

FOR: DIETARY AND NUTRITIONAL SUPPLEMENTS, IN CLASS 5 (U.S. CLS. 6, 18, 44, 46, 51 AND 52).

TRADEMARK

FIRST USE 9-26-2007; IN COMMERCE 9-27-2007.

PRINCIPAL REGISTER

OWNER OF U.S. REG. NO. 3,411,037.

THE COLOR(S) RED, BLUE, WHITE, BLACK AND SILVER IS/ARE CLAIMED AS A FEATURE OF THE MARK.

THE MARK CONSISTS OF THE WORD "SYNTHESIZE" IN WHITE BLOCK CAPITALS WITH BLUE, THEN BLACK OUTLINE, ABOVE THE LETTER "N" RED 3D STRING OF BEADS WITH BLACK OUTLINE CONNECTING TO LARGE BLUE 3D STRING OF BEADS WITH BLACK OUTLINE, ENCLOSING THE WHITE AND SILVER LETTERS "NO" WHICH IS OUTLINED IN RED AND BLACK, AND CONNECTING ABOVE THE LETTER "S" WITH VERTICAL 3D BLUE, SILVER AND WHITE CYLINDER DESIGNS OUTLINED IN BLACK BEHIND THE LETTERS "NO". THE SILVER BACKGROUND IS NOT PART OF THE MARK.

SN 85-081,676, FILED 7-9-2010.

DOUGLAS LEE, EXAMINING ATTORNEY



David J. Kyffers

Director of the United States Patent and Trademark Office

United States of America

United States Patent and Trademark Office



Reg. No. 4,206,514

Registered Sep. 11, 2012

Int. Cls.: 25 and 35

TRADEMARK

SERVICE MARK

PRINCIPAL REGISTER

LINE SHIFT MANAGEMENT GROUP, INC. (COLORADO CORPORATION)
20269 E SMOKY HILL RD., STE 117B
CENTENNIAL, CO 80015

FOR: APPAREL FOR DANCERS, NAMELY, TEE SHIRTS AND JACKETS; ATHLETIC APPAREL, NAMELY, JACKETS, HATS AND CAPS, ATHLETIC UNIFORMS; BABY BOTTOMS; BABY TOPS; CAMP SHIRTS; LONG-SLEEVED SHIRTS; SHIRTS FOR INFANTS, BABIES, TODDLERS AND CHILDREN; POLO SHIRTS, SOCKS; SPORT SHIRTS; SPORTS CAPS AND HATS; TANK TOPS; TOPS, IN CLASS 25 (U.S. CLS. 22 AND 39).

FIRST USE 6-0-2010; IN COMMERCE 1-0-2011.

FOR: PROMOTING THE GOODS AND SERVICES OF OTHERS BY PROVIDING A WEBSITE AT WHICH USERS CAN LINK TO THE WEBSITES OF OTHERS AND BY PROVIDING INFORMATION; PROMOTING THE SPECIAL EVENTS OF OTHERS; PROMOTING CULTURAL EVENTS, RESTAURANTS, SHOPPING, AND TRAVEL BY MEANS OF PROVIDING AN ONLINE EVENTS CALENDAR AND INFORMATION ABOUT CULTURAL EVENTS, RESTAURANTS, SHOPPING, AND TRAVEL EVENTS VIA AN INTERNET WEBSITE; PROVIDING ADVERTISING SPACE TO DISTRIBUTE ADVERTISEMENT REGARDING CULTURAL EVENTS, RESTAURANTS, SHOPPING, AND TRAVEL EVENT INFORMATION FOR DISPLAY ELECTRONICALLY, NAMELY, IN WEBSITES, EVENT LISTINGS, BLOGS, MULTIMEDIA MESSAGES, AND SOCIAL NETWORKS; CREATION OF MARKETING TOOLS DESIGNED TO INCREASE A CLIENT COMPANY'S KNOWLEDGE OF CUSTOMER NEEDS, AND ITS COMPETITORS' PRODUCTS AND SERVICES, PRICING, ADVERTISING STRATEGY AND SALES STRATEGY; PROVIDING ANALYTICS REPORTS RELATING TO BUSINESS MATTERS; BUSINESS INFORMATION MANAGEMENT, NAMELY, ELECTRONIC REPORTING OF BUSINESS INFORMATION; ADVERTISING SERVICES, NAMELY, PROMOTING AND MARKETING THE GOODS AND SERVICES OF OTHERS IN THE FIELD OF UPSCALE CHOICES SUCH AS CULTURAL EVENTS, RESTAURANTS, SHOPPING, AND TRAVEL VIA PRINT AND ELECTRONIC MEDIA; MARKETING, ADVERTISING AND PROMOTING THE GOODS AND SERVICES OF OTHERS IN THE FIELD OF TRAVEL AND TOURISM, NAMELY, PROVIDING INFORMATION VIA MAIL AND ELECTRONIC MAIL; PROVIDING BUSINESS AND COMMERCIAL INFORMATION IN THE FIELD OF BUSINESS TRAVEL MANAGEMENT AND THE BUSINESS TRAVEL INDUSTRY; PUBLIC RELATIONS, ADVERTISING AND MARKETING SERVICES FOR THE VARIOUS PUBLIC EVENTS, IN CLASS 35 (U.S. CLS. 100, 101 AND 102).



David J. Kyffers

Director of the United States Patent and Trademark Office

Reg. No. 4,206,514 FIRST USE 6-0-2010; IN COMMERCE 1-0-2011.

THE MARK CONSISTS OF STYLIZED WORDS "I WAS THERE" IN THREE ROWS, WITH THE WORD "I" IN THE FIRST ROW, "WAS" IN THE SECOND ROW, "THERE" IN THE THIRD ROW AND A DOT UNDER LETTER "H" IN THE WORD "THERE".

SN 85-083,946, FILED 7-13-2010.

JANICE KIM, EXAMINING ATTORNEY

United States of America

United States Patent and Trademark Office

OxyBurn

Reg. No. 4,206,515

REED, DENEEN (UNITED STATES INDIVIDUAL)
2900 SUNRIDGE HEIGHTS PKWY #736
HENDERSON, NV 89052

Registered Sep. 11, 2012

Int. Cl.: 5

FOR: VITAMIN AND MINERAL SUPPLEMENTS; NONE OF THE ABOVE FOR SKIN CARE AND ACNE CARE, IN CLASS 5 (U.S. CLS. 6, 18, 44, 46, 51 AND 52).

TRADEMARK

FIRST USE 7-5-2012; IN COMMERCE 7-5-2012.

PRINCIPAL REGISTER

THE MARK CONSISTS OF STANDARD CHARACTERS WITHOUT CLAIM TO ANY PARTICULAR FONT, STYLE, SIZE, OR COLOR.

SN 85-083,955, FILED 7-13-2010.

DOUGLAS LEE, EXAMINING ATTORNEY



David J. Kybas

Director of the United States Patent and Trademark Office

United States of America

United States Patent and Trademark Office



Reg. No. 4,206,516

CLEMSON ALUMNI ASSOCIATION (SOUTH CAROLINA NON-PROFIT CORPORATION)
109 DANIEL DRIVE
CLEMSON, SC 29631

Registered Sep. 11, 2012

Int. Cls.: 16, 25, and 35

FOR: DECALS, STICKERS, BUMPER STICKERS, IN CLASS 16 (U.S. CLS. 2, 5, 22, 23, 29, 37, 38 AND 50).

TRADEMARK

FIRST USE 2-12-2009; IN COMMERCE 4-17-2009.

SERVICE MARK

FOR: CLOTHING, NAMELY, T-SHIRTS, SHORTS, SWEAT PANTS, SWEAT SHIRTS AND HATS, IN CLASS 25 (U.S. CLS. 22 AND 39).

PRINCIPAL REGISTER

FIRST USE 2-12-2009; IN COMMERCE 4-17-2009.

FOR: ASSOCIATION SERVICES, NAMELY, PROMOTING THE INTERESTS OF ALUMNI OF A UNIVERSITY, IN CLASS 35 (U.S. CLS. 100, 101 AND 102).

FIRST USE 2-12-2009; IN COMMERCE 4-17-2009.

OWNER OF U.S. REG. NO. 1,347,679.

NO CLAIM IS MADE TO THE EXCLUSIVE RIGHT TO USE "ALUMNI" , APART FROM THE MARK AS SHOWN.

THE MARK CONSISTS OF THE WORDING "CLEMSON ALUMNI" IN STYLIZED FORMAT WITH A DESIGN OF A PAW ON A FLAG TO THE LEFT OF THE TERM "ALUMNI".

SN 85-084,166, FILED 7-14-2010.

BENJAMIN OKEKE, EXAMINING ATTORNEY



David J. Kybas

Director of the United States Patent and Trademark Office

United States of America

United States Patent and Trademark Office



Reg. No. 4,206,517

Registered Sep. 11, 2012

Int. Cls.: 21 and 25

TRADEMARK

PRINCIPAL REGISTER

CLEMSON ALUMNI ASSOCIATION (SOUTH CAROLINA NON-PROFIT CORPORATION)
109 DANIEL DRIVE
CLEMSON, SC 29631

FOR: DRINKING UTENSILS, NAMELY, DRINKING CUPS, DRINKING MUGS AND DRINKING GLASSES, IN CLASS 21 (U.S. CLS. 2, 13, 23, 29, 30, 33, 40 AND 50).

FIRST USE 2-12-2009; IN COMMERCE 4-17-2009.

FOR: CLOTHING, NAMELY, T-SHIRTS, SWEATSHIRTS AND HATS, IN CLASS 25 (U.S. CLS. 22 AND 39).

FIRST USE 2-12-2009; IN COMMERCE 4-17-2009.

THE MARK CONSISTS OF THE WORDING "HEAR US ROAR" IN STYLIZED FONT WITH A DESIGN OF A PAW ON A FLAG TO THE BOTTOM RIGHT OF THE TERM "ROAR".

SN 85-084,190, FILED 7-14-2010.

BENJAMIN OKEKE, EXAMINING ATTORNEY



David J. Kybas

Director of the United States Patent and Trademark Office

United States of America

United States Patent and Trademark Office

THE CASUAL INTELLECTUAL

Reg. No. 4,206,518

Registered Sep. 11, 2012

Int. Cl.: 25

TRADEMARK

PRINCIPAL REGISTER

THE CASUAL INTELLECTUAL (TEXAS LIMITED LIABILITY COMPANY)
10812 COLONY WOOD PLACE
THE WOODLANDS, TX 77380

FOR: SHIRTS; T-SHIRTS, IN CLASS 25 (U.S. CLS. 22 AND 39).

FIRST USE 7-8-2012; IN COMMERCE 7-8-2012.

THE MARK CONSISTS OF STANDARD CHARACTERS WITHOUT CLAIM TO ANY PARTICULAR FONT, STYLE, SIZE, OR COLOR.

SN 85-084,814, FILED 7-14-2010.

MEGHAN REINHART, EXAMINING ATTORNEY



David J. Kyffers

Director of the United States Patent and Trademark Office

United States of America

United States Patent and Trademark Office

OCEUS NETWORKS

Reg. No. 4,206,519

Registered Sep. 11, 2012

**Int. Cls.: 9, 35, 38, and
42**

TRADEMARK

SERVICE MARK

PRINCIPAL REGISTER

OCEUS NETWORKS INC. (DELAWARE CORPORATION)
1895 PRESTON WHITE DRIVE
SUITE 300
RESTON, VA 20191

FOR: TELECOMMUNICATIONS AND DATA NETWORKING HARDWARE, NAMELY, DEVICES FOR TRANSPORTING AND AGGREGATING VOICE, DATA, AND VIDEO COMMUNICATIONS ACROSS MULTIPLE NETWORK INFRASTRUCTURES AND COMMUNICATIONS PROTOCOLS; WIRELESS ADAPTERS USED TO LINK COMPUTERS TO A TELECOMMUNICATIONS NETWORK; COMPUTER HARDWARE EQUIPMENT USED IN COMMUNICATIONS TECHNOLOGY NETWORKS AND COMPUTER SOFTWARE FOR OPERATING COMMUNICATIONS TECHNOLOGY NETWORKS; BROADBAND POWER LINE COMMUNICATION SYSTEMS FOR TRANSFERRING BROADBAND DATA OVER ELECTRICAL POWER LINES, COMPRISED OF COMPUTER HARDWARE, SOFTWARE AND MODEMS; BROADBAND RADIOS; BROADBAND WIRELESS EQUIPMENT, NAMELY, TELECOMMUNICATIONS BASE STATION EQUIPMENT FOR CELLULAR AND FIXED NETWORKING AND COMMUNICATIONS APPLICATIONS; WIRELESS BROADBAND RADIOS, IN CLASS 9 (U.S. CLS. 21, 23, 26, 36 AND 38).

FIRST USE 1-0-2011; IN COMMERCE 1-0-2011.

FOR: TELECOMMUNICATIONS NETWORK MANAGEMENT SERVICES, NAMELY, THE OPERATION AND ADMINISTRATION OF TELECOMMUNICATION SYSTEMS AND NETWORKS FOR OTHERS, IN CLASS 35 (U.S. CLS. 100, 101 AND 102).

FIRST USE 1-0-2011; IN COMMERCE 1-0-2011.

FOR: COMMUNICATION SERVICES, NAMELY, TRANSMISSION OF VOICE, AUDIO, VISUAL IMAGES AND DATA BY TELECOMMUNICATIONS NETWORKS, WIRELESS COMMUNICATION NETWORKS, THE INTERNET, INFORMATION SERVICES NETWORKS AND DATA NETWORKS; DIGITAL NETWORK TELECOMMUNICATIONS SERVICES; ELECTRONIC EXCHANGE OF DATA STORED IN DATABASES ACCESSIBLE VIA TELECOMMUNICATION NETWORKS; PROVIDING ACCESS TO TELECOMMUNICATION NETWORKS; PROVIDING TELECOMMUNICATIONS CONNECTIONS TO A GLOBAL COMPUTER NETWORK; TELECOMMUNICATION SERVICES, NAMELY, TRANSMISSION OF VOICE, DATA, GRAPHICS, SOUND AND VIDEO BY MEANS OF BROADBAND POWER LINE OR WIRELESS NETWORKS; TELECOMMUNICATION SERVICES, NAMELY,



David J. Kyffers

Director of the United States Patent and Trademark Office

Reg. No. 4,206,519 TRANSMISSION OF VOICE, DATA, GRAPHICS, IMAGES, AUDIO AND VIDEO BY MEANS OF TELECOMMUNICATIONS NETWORKS, WIRELESS COMMUNICATION NETWORKS, AND THE INTERNET; WIRELESS BROADBAND COMMUNICATION SERVICES; BROADBAND RADIO COMMUNICATION SERVICES, IN CLASS 38 (U.S. CLS. 100, 101 AND 104).

FIRST USE 1-0-2011; IN COMMERCE 1-0-2011.

FOR: COMPUTER PROJECT MANAGEMENT SERVICES IN THE FIELD OF TELECOMMUNICATION NETWORKS FOR OTHERS; DESIGNING ENHANCED COMPUTER HARDWARE FOR COMMUNICATIONS TECHNOLOGY NETWORKS; COMPUTER SERVICES, NAMELY, OPERATING COMMUNICATION COMPUTER NETWORKS FEATURING BROADBAND TRANSMISSION SOFTWARE FOR OTHERS; TECHNICAL SUPPORT SERVICES, NAMELY, TROUBLESHOOTING OF COMPUTER SOFTWARE PROBLEMS RELATING TO BROADBAND, IN CLASS 42 (U.S. CLS. 100 AND 101).

FIRST USE 1-0-2011; IN COMMERCE 1-0-2011.

THE MARK CONSISTS OF STANDARD CHARACTERS WITHOUT CLAIM TO ANY PARTICULAR FONT, STYLE, SIZE, OR COLOR.

NO CLAIM IS MADE TO THE EXCLUSIVE RIGHT TO USE "NETWORKS", APART FROM THE MARK AS SHOWN.

SN 85-084,936, FILED 7-14-2010.

SIMON TENG, EXAMINING ATTORNEY

United States of America

United States Patent and Trademark Office

TRIM SWITCH

Reg. No. 4,206,520

MARQUIP, LLC (WISCONSIN LIMITED LIABILITY COMPANY)
1300 N. AIRPORT ROAD
PHILLIPS, WI 54555

Registered Sep. 11, 2012

Int. Cl.: 7

FOR: SLITTING MACHINES FOR THE CONVERSION OF CORRUGATED PAPERBOARD,
IN CLASS 7 (U.S. CLS. 13, 19, 21, 23, 31, 34 AND 35).

TRADEMARK

FIRST USE 10-7-2011; IN COMMERCE 6-30-2012.

PRINCIPAL REGISTER

THE MARK CONSISTS OF STANDARD CHARACTERS WITHOUT CLAIM TO ANY PARTICULAR FONT, STYLE, SIZE, OR COLOR.

SN 85-086,184, FILED 7-16-2010.

TEJBIR SINGH, EXAMINING ATTORNEY



David J. Kybas

Director of the United States Patent and Trademark Office

United States of America
United States Patent and Trademark Office

MYOHEAT

Reg. No. 4,206,521

MYOPOWER, INC. (NEVADA CORPORATION)
564 WEDGE LANE
FERNLEY, NV 89408

Registered Sep. 11, 2012

Int. Cl.: 10

FOR: THERMAL PACKS FOR MEDICAL PURPOSES, IN CLASS 10 (U.S. CLS. 26, 39 AND 44).

TRADEMARK

FIRST USE 7-25-2012; IN COMMERCE 7-25-2012.

PRINCIPAL REGISTER

THE MARK CONSISTS OF STANDARD CHARACTERS WITHOUT CLAIM TO ANY PARTICULAR FONT, STYLE, SIZE, OR COLOR.

SN 85-086,422, FILED 7-16-2010.

DOUGLAS LEE, EXAMINING ATTORNEY



David J. Kyffers

Director of the United States Patent and Trademark Office

United States of America

United States Patent and Trademark Office

STUDENT'S CHOICE

Reg. No. 4,206,522

SOCIETE BIC (FRANCE SOCIÉTÉ ANONYME (SA))
14, RUE JEANNE D'ASNIERES
CLICHY, FRANCE 92110

Registered Sep. 11, 2012

Int. Cl.: 16

FOR: WRITING INSTRUMENTS, NAMELY, MECHANICAL PENCILS AND LEAD FOR PENCILS, IN CLASS 16 (U.S. CLS. 2, 5, 22, 23, 29, 37, 38 AND 50).

TRADEMARK

FIRST USE 1-1-2011; IN COMMERCE 1-1-2011.

PRINCIPAL REGISTER

THE MARK CONSISTS OF STANDARD CHARACTERS WITHOUT CLAIM TO ANY PARTICULAR FONT, STYLE, SIZE, OR COLOR.

NO CLAIM IS MADE TO THE EXCLUSIVE RIGHT TO USE "STUDENT'S", APART FROM THE MARK AS SHOWN.

SN 85-086,454, FILED 7-16-2010.

VIVIAN MICZNIK FIRST, EXAMINING ATTORNEY



David J. Kyffers

Director of the United States Patent and Trademark Office

United States of America
United States Patent and Trademark Office

ABREOJOS

Reg. No. 4,206,523

ABREOJOS SPIRITS, LLC (CALIFORNIA LIMITED LIABILITY COMPANY)
27071 CABOT ROAD SUITE 105
LAGUNA HILLS, CA 92653

Registered Sep. 11, 2012

Int. Cl.: 33

FOR: TEQUILA, IN CLASS 33 (U.S. CLS. 47 AND 49).

TRADEMARK

FIRST USE 7-20-2012; IN COMMERCE 7-20-2012.

PRINCIPAL REGISTER

THE MARK CONSISTS OF STANDARD CHARACTERS WITHOUT CLAIM TO ANY PARTICULAR FONT, STYLE, SIZE, OR COLOR.

THE ENGLISH TRANSLATION OF "ABREOJOS" IN THE MARK IS "EYE-OPENER".

SN 85-087,004, FILED 7-16-2010.

MICHAEL SOUDERS, EXAMINING ATTORNEY



David J. Kyffers

Director of the United States Patent and Trademark Office

United States of America
United States Patent and Trademark Office

TaaS

Reg. No. 4,206,524

Registered Sep. 11, 2012

Int. Cls.: 36 and 42

SERVICE MARK

PRINCIPAL REGISTER

GANART TECHNOLOGIES (DELAWARE CORPORATION)
1700 COLUMBIAN CLUB DR.
CARROLLTON, TX 75006

FOR: FINANCIAL SERVICES, NAMELY, ELECTRONIC TRANSFER OF FINANCIAL INSTRUMENTS AND INFORMATION AND CONSULTING RELATING THERETO, IN CLASS 36 (U.S. CLS. 100, 101 AND 102).

FIRST USE 8-0-2010; IN COMMERCE 8-0-2010.

FOR: COMPUTER SERVICES, NAMELY, ACTING AS AN APPLICATION SERVICE PROVIDER FEATURING SOFTWARE FOR PRICING, RENDERING, MONITORING, AND FULFILLING VALUE EXCHANGES BETWEEN THIRD PARTIES AND FOR PROVIDING COLLECTING, PAYING AND BILLING SERVICES RELATED TO AFORESAID VALUE EXCHANGES; DEVELOPING AND HOSTING SERVERS ON A COMPUTER NETWORK FOR THE PURPOSE OF PROVIDING E-COMMERCE APPLICATIONS FOR OTHERS VIA SUCH A SERVER , IN CLASS 42 (U.S. CLS. 100 AND 101).

FIRST USE 8-0-2010; IN COMMERCE 8-0-2010.

THE MARK CONSISTS OF THE LETTERS "TAAS" IN STYLIZED FORM, WITH THE LETTERS "T" AND "S" IN UPPER CASE AND WITH THE TWO LETTERS "A" IN LOWER CASE.

SN 85-089,066, FILED 7-20-2010.

JULIE WATSON, EXAMINING ATTORNEY



David J. Kyffers

Director of the United States Patent and Trademark Office

United States of America

United States Patent and Trademark Office

FLUIDSURE

Reg. No. 4,206,525

Registered Sep. 11, 2012

Int. Cl.: 7

TRADEMARK

PRINCIPAL REGISTER

I & J FISNAR, INC. (NEW JERSEY CORPORATION)
SUITE E
WAYNE, NJ 74070

FOR: FLUID PUMPS AND FLUID PUMP ACCESSORIES SPECIALLY DESIGNED FOR USE WITH LIQUID DISPENSING MACHINES AND SYSTEMS FOR USE IN INDUSTRIAL APPLICATIONS SUCH AS ADHESIVE, GLUE, CYANOACRYLATES, SILICONE, RTV, ANAEROBIC RESIN, EPOXY, UV CURE FORMULATIONS AND MANY MORE FLUIDS, IN CLASS 7 (U.S. CLS. 13, 19, 21, 23, 31, 34 AND 35).

FIRST USE 1-1-2012; IN COMMERCE 1-1-2012.

THE MARK CONSISTS OF STANDARD CHARACTERS WITHOUT CLAIM TO ANY PARTICULAR FONT, STYLE, SIZE, OR COLOR.

SN 85-090,859, FILED 7-22-2010.

LINDA M. KING, EXAMINING ATTORNEY



David J. Kybas

Director of the United States Patent and Trademark Office

United States of America

United States Patent and Trademark Office



Reg. No. 4,206,526

BIORESTORATIVE THERAPIES, INC. (NEVADA CORPORATION)
555 HERITAGE DRIVE, SUITE 130
JUPITER, FL 33458

Registered Sep. 11, 2012

Int. Cls.: 42 and 44

FOR: MEDICAL AND SCIENTIFIC RESEARCH SERVICES RELATED TO THE USE OF HUMAN STEM CELLS FOR THERAPEUTIC PURPOSES; MEDICAL LABORATORY SERVICES, IN CLASS 42 (U.S. CLS. 100 AND 101).

SERVICE MARK

FIRST USE 8-17-2011; IN COMMERCE 8-17-2011.

PRINCIPAL REGISTER

FOR: MEDICAL SERVICES, NAMELY, STEM CELL TREATMENT, STEM CELL TRANSPLANTATION, AND STEM CELL THERAPY; MEDICAL SERVICES USING STEM CELLS AND STEM CELL PRODUCTS, IN CLASS 44 (U.S. CLS. 100 AND 101).

FIRST USE 4-11-2012; IN COMMERCE 4-11-2012.

NO CLAIM IS MADE TO THE EXCLUSIVE RIGHT TO USE "THERAPIES", APART FROM THE MARK AS SHOWN.

THE MARK CONSISTS OF A STYLIZED DRAGONFLY DESIGN, BENEATH WHICH IS "BIORESTORATIVE THERAPIES". THE SECOND LETTER "I" IN "BIORESTORATIVE" IS COMPRISED OF THE TAIL OF THE DRAGONFLY.

SN 85-090,971, FILED 7-22-2010.

REBECCA POVARCHUK, EXAMINING ATTORNEY



David J. Kybas

Director of the United States Patent and Trademark Office

United States of America

United States Patent and Trademark Office



Reg. No. 4,206,527

REPUBLIC OF CAKE, LLC (CALIFORNIA LIMITED LIABILITY COMPANY)
2 THEATRE SQUARE, SUITE 151
ORINDA, CA 94563

Registered Sep. 11, 2012

Int. Cls.: 21, 25, and 43

FOR: COFFEE MUGS, IN CLASS 21 (U.S. CLS. 2, 13, 23, 29, 30, 33, 40 AND 50).

TRADEMARK

FIRST USE 12-31-2009; IN COMMERCE 8-18-2011.

SERVICE MARK

FOR: BASEBALL CAPS AND HATS; SHORT-SLEEVED OR LONG-SLEEVED T-SHIRTS,
IN CLASS 25 (U.S. CLS. 22 AND 39).

PRINCIPAL REGISTER

FIRST USE 12-31-2009; IN COMMERCE 8-18-2011.

FOR: RESTAURANT SERVICES, NAMELY, PROVIDING OF FOOD AND BEVERAGES FOR
CONSUMPTION ON AND OFF THE PREMISES, IN CLASS 43 (U.S. CLS. 100 AND 101).

FIRST USE 12-1-2009; IN COMMERCE 10-11-2011.

NO CLAIM IS MADE TO THE EXCLUSIVE RIGHT TO USE "CAKE", APART FROM THE
MARK AS SHOWN.

THE COLOR(S) DARK RED AND LIGHT RED IS/ARE CLAIMED AS A FEATURE OF THE
MARK.

THE MARK CONSISTS OF A SQUARE WITH A DARK RED BORDER SET AGAINST A
TRANSPARENT BACKGROUND WITH THE WORDS "REPUBLIC OF CAKE" STACKED
ON TOP OF EACH OTHER AT THE BOTTOM OF THE SQUARE, JUSTIFIED TO THE LEFT
HAND BORDER, WITH ALL LETTERS OF EACH WORD CAPITALIZED, THE INITIAL
LETTER OF EACH WORD IN LIGHT RED COLOR, AND THE REMAINING LETTER OF
EACH WORD IN THE DARK RED COLOR MATCHING THE BORDER.

SN 85-091,038, FILED 7-22-2010.

TOBY BULLOFF, EXAMINING ATTORNEY



David J. Kyffers

Director of the United States Patent and Trademark Office

United States of America

United States Patent and Trademark Office



Reg. No. 4,206,528

SOLD ON PHILADELPHIA (PENNSYLVANIA LIMITED LIABILITY COMPANY)
731 S. HICKS STREET
PHILADELPHIA, PA 19146

Registered Sep. 11, 2012

Int. Cls.: 21, 25, and 39

FOR: MUGS; SHOT GLASSES, IN CLASS 21 (U.S. CLS. 2, 13, 23, 29, 30, 33, 40 AND 50).

TRADEMARK

FIRST USE 2-23-2011; IN COMMERCE 2-23-2011.

SERVICE MARK

FOR: T-SHIRTS, IN CLASS 25 (U.S. CLS. 22 AND 39).

PRINCIPAL REGISTER

FIRST USE 2-23-2011; IN COMMERCE 2-23-2011.

FOR: TOUR GUIDE SERVICES, IN CLASS 39 (U.S. CLS. 100 AND 105).

FIRST USE 2-23-2011; IN COMMERCE 2-23-2011.

OWNER OF U.S. REG. NOS. 3,722,984 AND 3,847,550.

NO CLAIM IS MADE TO THE EXCLUSIVE RIGHT TO USE "LOS ANGELES" AND THE PICTORIAL REPRESENTATION OF THE STATE OF CALIFORNIA, APART FROM THE MARK AS SHOWN.



THE MARK CONSISTS OF THE STYLIZED WORDS "SOLD ON LOS ANGELES" WRITTEN ACROSS THE MIDDLE OF A PICTORIAL REPRESENTATION OF THE STATE OF CALIFORNIA WITH A STAR DESIGN DENOTING LOS ANGELES AT THE BOTTOM OF THE STATE.

SN 85-091,100, FILED 7-22-2010.

Laurie Kaufman, Examining Attorney

David J. Kybas

Director of the United States Patent and Trademark Office

United States of America

United States Patent and Trademark Office

HAMPTON NATURALS

Reg. No. 4,206,529

Registered Sep. 11, 2012

Int. Cl.: 3

ALAN J. PIVEN MANAGEMENT GROUP, LLC (NEW YORK LIMITED LIABILITY COMPANY)
APT. 15B
341 WEST 24TH STREET
NEW YORK, NY 10011

TRADEMARK

FOR: BODY CREAM; BODY LOTIONS; FACE CREAMS; FACIAL CREAMS; SKIN CLEANSERS; SKIN LOTIONS; SKIN MOISTURIZER, IN CLASS 3 (U.S. CLS. 1, 4, 6, 50, 51 AND 52).

PRINCIPAL REGISTER

FIRST USE 7-9-2012; IN COMMERCE 7-9-2012.

THE MARK CONSISTS OF STANDARD CHARACTERS WITHOUT CLAIM TO ANY PARTICULAR FONT, STYLE, SIZE, OR COLOR.

OWNER OF U.S. REG. NO. 3,838,309.

NO CLAIM IS MADE TO THE EXCLUSIVE RIGHT TO USE "NATURALS", APART FROM THE MARK AS SHOWN.

SN 85-092,953, FILED 7-26-2010.

DORITT L. CARROLL, EXAMINING ATTORNEY



David J. Kyffers

Director of the United States Patent and Trademark Office

United States of America

United States Patent and Trademark Office

CROWDPARK

Reg. No. 4,206,530

Registered Sep. 11, 2012

Int. Cl.: 41

SERVICE MARK

PRINCIPAL REGISTER

CROWDPARK GMBH (FED REP GERMANY CORPORATION)
ROTHERSTR 18
ALEX IVANOV
BERLIN, FED REP GERMANY

FOR: ENTERTAINMENT SERVICES, NAMELY, PROVIDING ONLINE COMPUTER GAMES, ENHANCEMENTS FOR COMPUTER GAMES, GAME APPLICATIONS IN THE NATURE OF ONLINE COMPUTER GAMES, REVIEWS OF COMPUTER GAMES, INFORMATION RELATING TO COMPUTER GAMES AND ONLINE COMPUTER GAMES; PROVIDING AN INTERNET WEBSITE PORTAL IN THE FIELD OF COMPUTER GAMES, AND GAMING; ENTERTAINMENT SERVICES, NAMELY, PROVIDING VIRTUAL ENVIRONMENTS IN WHICH USERS CAN INTERACT THROUGH SOCIAL GAMES FOR RECREATIONAL, LEISURE OR ENTERTAINMENT PURPOSES; PUBLISHING OF PRESS ARTICLES, BOOKS, NEWSPAPERS, REVIEWS, MAGAZINES, PERIODICALS, GUIDES, GLOSSARIES, FACT SHEETS, COLLECTIONS OF TEXTS AND ELECTRONIC PUBLICATION; PROVIDING ELECTRONIC NON-DOWNLOADABLE PUBLICATIONS ONLINE IN THE NATURE OF PRESS ARTICLES, BOOKS, NEWSPAPERS, REVIEWS, MAGAZINES, PERIODICALS, GUIDES, GLOSSARIES, FACT SHEETS, AND COLLECTIONS OF TEXTS IN THE FIELD OF OPINION POLLING, MARKETING CAMPAIGNS, MARKET STUDIES, SALES PROMOTIONS, DATA ANALYSIS AND MARKET SURVEY AND RESEARCH; ENTERTAINMENT SERVICES, NAMELY, PROVIDING ONLINE COMPUTER GAMES; BETTING SERVICES, NAMELY, ON-LINE, COMPUTER, INTERNET, AND WIRELESS BETTING SERVICES, IN CLASS 41 (U.S. CLS. 100, 101 AND 107).

FIRST USE 7-27-2010; IN COMMERCE 7-27-2010.

THE MARK CONSISTS OF STANDARD CHARACTERS WITHOUT CLAIM TO ANY PARTICULAR FONT, STYLE, SIZE, OR COLOR.

SN 85-094,116, FILED 7-27-2010.

SUE LAWRENCE, EXAMINING ATTORNEY



David J. Kyffers

Director of the United States Patent and Trademark Office

United States of America

United States Patent and Trademark Office



Reg. No. 4,206,531

Registered Sep. 11, 2012

Int. Cl.: 41

SERVICE MARK

PRINCIPAL REGISTER

TRICKSTAR INNOVATIONS LLC (NEW YORK LIMITED LIABILITY COMPANY),
FORMERLY TRICKSTAR INC.,
P.O. BOX 120
WOODMERE, NY 11598

FOR: EDUCATION SERVICES, NAMELY, PROVIDING ON-LINE INTERACTIVE TUTORIAL SESSIONS AND TUTORIAL SESSIONS FEATURING TEST QUESTIONS IN THE FIELD OF MATHEMATICS; PROVIDING EDUCATIONAL INFORMATION AND TEST QUESTIONS IN THE ACADEMIC FIELD OF MATHEMATICS, IN CLASS 41 (U.S. CLS. 100, 101 AND 107).

FIRST USE 10-6-2011; IN COMMERCE 10-6-2011.

THE MARK CONSISTS OF WORD "TRICKOMATICS" IN UPPER-CASE LETTERS, WITH MINUS SIGN "-" IN THE "R", MULTIPLICATION SIGN "X" IN THE "O", DIVISION SIGN "÷" IN THE "A", PLUS SIGN "+" IN THE SECOND AND LAST "C", WITH THE NUMBER "1" TWICE USED TO REPRESENT THE LETTER "I", AND HAVING THE "TRICKO" IN OFF-WHITE, THE "MATICS" IN LIME AND THE BACKGROUND IN GREEN.

THE COLOR(S) OFF-WHITE, LIME AND GREEN IS/ARE CLAIMED AS A FEATURE OF THE MARK.

SN 85-094,187, FILED 7-27-2010.

SOPHIA S. KIM, EXAMINING ATTORNEY



David J. Kyros

Director of the United States Patent and Trademark Office

United States of America

United States Patent and Trademark Office

INTEGRITY IN RESEARCH

Reg. No. 4,206,532

Registered Sep. 11, 2012

Int. Cl.: 35

SERVICE MARK

PRINCIPAL REGISTER

LANGER RESEARCH ASSOCIATES LLC (NEW YORK LIMITED LIABILITY COMPANY)
140 W. 74TH. ST.
#1E
NEW YORK, NY 10023

FOR: PUBLIC OPINION SURVEYS; ANALYSIS OF DATA, RESEARCH DATA AND STATISTICS RELATED TO PUBLIC OPINION SURVEYS AND POLLS, NAMELY, CONSULTING ON THE DESIGN, MANAGEMENT AND ANALYSIS OF SUCH SURVEYS FOR USE IN THE MEASUREMENT OF PUBLIC ATTITUDES AND BEHAVIOR, IN CLASS 35 (U.S. CLS. 100, 101 AND 102).

FIRST USE 6-28-2011; IN COMMERCE 6-28-2011.

THE MARK CONSISTS OF STANDARD CHARACTERS WITHOUT CLAIM TO ANY PARTICULAR FONT, STYLE, SIZE, OR COLOR.

NO CLAIM IS MADE TO THE EXCLUSIVE RIGHT TO USE "RESEARCH", APART FROM THE MARK AS SHOWN.

SN 85-096,221, FILED 7-29-2010.

SUZANNE BLANE, EXAMINING ATTORNEY



David J. Kyffers

Director of the United States Patent and Trademark Office

United States of America

United States Patent and Trademark Office

SHIFT

Reg. No. 4,206,533

Registered Sep. 11, 2012

Int. Cl.: 34

TRADEMARK

PRINCIPAL REGISTER

FAIRMONT HOLDINGS, INC. (FLORIDA CORPORATION)
3400 S.W. 26TH TERRACE, #A-1
DANIA, FL 33312

FOR: CIGARS, TOBACCO, CIGAR BOXES, CIGAR CUTTERS AND CIGAR TUBES, IN CLASS 34 (U.S. CLS. 2, 8, 9 AND 17).

FIRST USE 7-1-2012; IN COMMERCE 7-1-2012.

THE MARK CONSISTS OF STANDARD CHARACTERS WITHOUT CLAIM TO ANY PARTICULAR FONT, STYLE, SIZE, OR COLOR.

SN 85-097,057, FILED 7-30-2010.

MATTHEW KLINE, EXAMINING ATTORNEY



David J. Kappas

Director of the United States Patent and Trademark Office

United States of America

United States Patent and Trademark Office

GRACIE COMBATIVES

Reg. No. 4,206,534

Registered Sep. 11, 2012

Int. Cl.: 9

TRADEMARK

PRINCIPAL REGISTER

GRACIE, RORION (UNITED STATES INDIVIDUAL)
C/O KOENIG & ASSOCIATES
920 GARDEN STREET, SUITE A
SANTA BARBARA, CA 93101

FOR: DVDS FEATURING LIVE ACTION AND SPORTS ENTERTAINMENT; PRE-RECORDED AUDIO VIDEO DISC FEATURING FIGHT SEQUENCES; PRE-RECORDED LASER DISKS AND DVDS FEATURING LIVE ACTION, MARTIAL ARTS, AND SPORTS ENTERTAINMENT; PRE-RECORDED OPTICAL DISCS FEATURING ENTERTAINMENT CONTENT, NAMELY, FIGHT SEQUENCES AND MARTIAL ARTS; PRE-RECORDED DIGITAL MATERIALS, NAMELY, DVDS, DOWNLOADABLE AUDIO AND VIDEO FILES, VIDEO CASSETTES, DIGITAL VIDEO DISCS, DIGITAL VERSATILE DISCS, DOWNLOADABLE AUDIO AND VIDEO RECORDINGS, AND HIGH DEFINITION DIGITAL DISKS FEATURING FIGHT SEQUENCES, AND SPORTS STORIES; PRE-RECORDED DVDS FEATURING SPORTS, MIXED MARTIAL ARTS, AND FIGHT RELATED EVENTS; PRE-RECORDED PERFORMANCES FEATURING MIXED MARTIAL ARTS ON AUDIO AND VIDEO MEDIA CARTRIDGES, LASER DISCS, COMPUTER DISCS FEATURING SPORTS AND ENTERTAINMENT AND MARTIAL ARTS PROGRAMS; PRE-RECORDED DIGITAL MEDIA, DIGITAL VIDEO DISCS, DIGITAL VERSATILE DISCS, AND DVD'S ALL FEATURING SPORTS, ENTERTAINMENT, INSTRUCTIONAL AND TRAINING PROGRAMS ON THE SUBJECTS OF THE ART OF JIU-JITSU, MARTIAL ARTS, NON-LETHAL MARTIAL ARTS TECHNIQUES, SELF-DEFENSE, ATTACK PREVENTION, SEXUAL ASSAULT PREVENTION, PHYSICAL ATTACK ESCAPE TECHNIQUES, PERSONAL SAFETY, RAPE PREVENTION, PHYSICAL EXERCISE AND PHYSICAL FITNESS; PRERECORDED VIDEOS AND DVD'S FEATURING ENTERTAINMENT, INSTRUCTIONAL AND TRAINING PROGRAMS IN THE ART OF JIU-JITSU, MARTIAL ARTS, NON-LETHAL MARTIAL ARTS TECHNIQUES, SELF-DEFENSE, ATTACK PREVENTION, SEXUAL ASSAULT PREVENTION, PHYSICAL ATTACK ESCAPE TECHNIQUES, PERSONAL SAFETY, RAPE PREVENTION, PHYSICAL EXERCISE AND EDUCATION, AND PHYSICAL FITNESS; PRE-RECORDED DVDS AND VIDEO DISCS IN THE FIELD OF MARTIAL ARTS; PRE-RECORDED VIDEO RECORDINGS FEATURING SPORTS, MIXED MARTIAL ARTS, AND FIGHT EVENTS, IN CLASS 9 (U.S. CLS. 21, 23, 26, 36 AND 38).



David J. Kyjars

Director of the United States Patent and Trademark Office

FIRST USE 11-21-2008; IN COMMERCE 11-21-2008.

THE MARK CONSISTS OF STANDARD CHARACTERS WITHOUT CLAIM TO ANY PARTICULAR FONT, STYLE, SIZE, OR COLOR.

Reg. No. 4,206,534 OWNER OF U.S. REG. NO. 3,359,775.

NO CLAIM IS MADE TO THE EXCLUSIVE RIGHT TO USE "COMBATIVES", APART FROM
THE MARK AS SHOWN.

SN 85-097,333, FILED 7-30-2010.

DAVID MURRAY, EXAMINING ATTORNEY

United States of America

United States Patent and Trademark Office



Reg. No. 4,206,535

Registered Sep. 11, 2012

**Int. Cls.: 9, 35, 38, and
42**

TRADEMARK

SERVICE MARK

PRINCIPAL REGISTER

OCEUS NETWORKS INC. (DELAWARE CORPORATION)
1895 PRESTON WHITE DRIVE
SUITE 300
RESTON, VA 20191

FOR: TELECOMMUNICATIONS AND DATA NETWORKING HARDWARE, NAMELY, DEVICES FOR TRANSPORTING AND AGGREGATING VOICE, DATA, AND VIDEO COMMUNICATIONS ACROSS MULTIPLE NETWORK INFRASTRUCTURES AND COMMUNICATIONS PROTOCOLS; WIRELESS ADAPTERS USED TO LINK COMPUTERS TO A TELECOMMUNICATIONS NETWORK; COMPUTER HARDWARE EQUIPMENT USED IN COMMUNICATIONS TECHNOLOGY NETWORKS AND COMPUTER SOFTWARE FOR OPERATING COMMUNICATIONS TECHNOLOGY NETWORKS; BROADBAND POWER LINE COMMUNICATION SYSTEMS FOR TRANSFERRING BROADBAND DATA OVER ELECTRICAL POWER LINES, COMPRISED OF COMPUTER HARDWARE, SOFTWARE AND MODEMS; BROADBAND RADIOS; BROADBAND WIRELESS EQUIPMENT, NAMELY, TELECOMMUNICATIONS BASE STATION EQUIPMENT FOR CELLULAR AND FIXED NETWORKING AND COMMUNICATIONS APPLICATIONS; WIRELESS BROADBAND RADIOS, IN CLASS 9 (U.S. CLS. 21, 23, 26, 36 AND 38).

FIRST USE 1-0-2011; IN COMMERCE 1-0-2011.

FOR: TELECOMMUNICATIONS NETWORK MANAGEMENT SERVICES, NAMELY, THE OPERATION AND ADMINISTRATION OF TELECOMMUNICATION SYSTEMS AND NETWORKS FOR OTHERS, IN CLASS 35 (U.S. CLS. 100, 101 AND 102).

FIRST USE 1-0-2011; IN COMMERCE 1-0-2011.

FOR: COMMUNICATION SERVICES, NAMELY, TRANSMISSION OF VOICE, AUDIO, VISUAL IMAGES AND DATA BY TELECOMMUNICATIONS NETWORKS, WIRELESS COMMUNICATION NETWORKS, THE INTERNET, INFORMATION SERVICES NETWORKS AND DATA NETWORKS; DIGITAL NETWORK TELECOMMUNICATIONS SERVICES; ELECTRONIC EXCHANGE OF DATA STORED IN DATABASES ACCESSIBLE VIA TELECOMMUNICATION NETWORKS; PROVIDING ACCESS TO TELECOMMUNICATION NETWORKS; PROVIDING TELECOMMUNICATIONS CONNECTIONS TO A GLOBAL COMPUTER NETWORK; TELECOMMUNICATION SERVICES, NAMELY, TRANSMISSION OF VOICE, DATA, GRAPHICS, SOUND AND VIDEO BY MEANS OF BROADBAND POWER LINE OR WIRELESS NETWORKS; TELECOMMUNICATION SERVICES, NAMELY,



David J. Kybas

Director of the United States Patent and Trademark Office

Reg. No. 4,206,535 TRANSMISSION OF VOICE, DATA, GRAPHICS, IMAGES, AUDIO AND VIDEO BY MEANS OF TELECOMMUNICATIONS NETWORKS, WIRELESS COMMUNICATION NETWORKS, AND THE INTERNET; WIRELESS BROADBAND COMMUNICATION SERVICES; BROADBAND RADIO COMMUNICATION SERVICES, IN CLASS 38 (U.S. CLS. 100, 101 AND 104).

FIRST USE 1-0-2011; IN COMMERCE 1-0-2011.

FOR: COMPUTER PROJECT MANAGEMENT SERVICES IN THE FIELD OF TELECOMMUNICATION NETWORKS FOR OTHERS; DESIGNING ENHANCED COMPUTER HARDWARE FOR COMMUNICATIONS TECHNOLOGY NETWORKS; COMPUTER SERVICES, NAMELY, OPERATING COMMUNICATION COMPUTER NETWORKS FEATURING BROADBAND TRANSMISSION SOFTWARE FOR OTHERS; TECHNICAL SUPPORT SERVICES, NAMELY, TROUBLESHOOTING OF COMPUTER SOFTWARE PROBLEMS RELATING TO BROADBAND, IN CLASS 42 (U.S. CLS. 100 AND 101).

FIRST USE 1-0-2011; IN COMMERCE 1-0-2011.

THE MARK CONSISTS OF A STYLIZED THREE-BAND BLUE 3-D LIKE DESIGN WITH A WHITE CENTER AND THREE ENDS PARTIALLY COLORED IN BLACK.

THE COLOR(S) WHITE, BLACK AND BLUE IS/ARE CLAIMED AS A FEATURE OF THE MARK.

SN 85-097,605, FILED 7-31-2010.

SIMON TENG, EXAMINING ATTORNEY

United States of America

United States Patent and Trademark Office



Reg. No. 4,206,536

Registered Sep. 11, 2012

**Int. Cls.: 9, 35, 38, and
42**

TRADEMARK

SERVICE MARK

PRINCIPAL REGISTER

OCEUS NETWORKS INC. (DELAWARE CORPORATION)
1895 PRESTON WHITE DRIVE
SUITE 300
RESTON, VA 20191

FOR: TELECOMMUNICATIONS AND DATA NETWORKING HARDWARE, NAMELY, DEVICES FOR TRANSPORTING AND AGGREGATING VOICE, DATA, AND VIDEO COMMUNICATIONS ACROSS MULTIPLE NETWORK INFRASTRUCTURES AND COMMUNICATIONS PROTOCOLS; WIRELESS ADAPTERS USED TO LINK COMPUTERS TO A TELECOMMUNICATIONS NETWORK; COMPUTER HARDWARE EQUIPMENT USED IN COMMUNICATIONS TECHNOLOGY NETWORKS AND COMPUTER SOFTWARE FOR OPERATING COMMUNICATIONS TECHNOLOGY NETWORKS; BROADBAND POWER LINE COMMUNICATION SYSTEMS FOR TRANSFERRING BROADBAND DATA OVER ELECTRICAL POWER LINES, COMPRISED OF COMPUTER HARDWARE, SOFTWARE AND MODEMS; BROADBAND RADIOS; BROADBAND WIRELESS EQUIPMENT, NAMELY, TELECOMMUNICATIONS BASE STATION EQUIPMENT FOR CELLULAR AND FIXED NETWORKING AND COMMUNICATIONS APPLICATIONS; WIRELESS BROADBAND RADIOS, IN CLASS 9 (U.S. CLS. 21, 23, 26, 36 AND 38).

FIRST USE 1-0-2011; IN COMMERCE 1-0-2011.

FOR: TELECOMMUNICATIONS NETWORK MANAGEMENT SERVICES, NAMELY, THE OPERATION AND ADMINISTRATION OF TELECOMMUNICATION SYSTEMS AND NETWORKS FOR OTHERS, IN CLASS 35 (U.S. CLS. 100, 101 AND 102).

FIRST USE 1-0-2011; IN COMMERCE 1-0-2011.

FOR: COMMUNICATION SERVICES, NAMELY, TRANSMISSION OF VOICE, AUDIO, VISUAL IMAGES AND DATA BY TELECOMMUNICATIONS NETWORKS, WIRELESS COMMUNICATION NETWORKS, THE INTERNET, INFORMATION SERVICES NETWORKS AND DATA NETWORKS; DIGITAL NETWORK TELECOMMUNICATIONS SERVICES; ELECTRONIC EXCHANGE OF DATA STORED IN DATABASES ACCESSIBLE VIA TELECOMMUNICATION NETWORKS; PROVIDING ACCESS TO TELECOMMUNICATION NETWORKS; PROVIDING TELECOMMUNICATIONS CONNECTIONS TO A GLOBAL COMPUTER NETWORK; TELECOMMUNICATION SERVICES, NAMELY, TRANSMISSION OF VOICE, DATA, GRAPHICS, SOUND AND VIDEO BY MEANS OF BROADBAND POWER LINE OR WIRELESS NETWORKS; TELECOMMUNICATION SERVICES, NAMELY,



David J. Kybas

Director of the United States Patent and Trademark Office

Reg. No. 4,206,536 TRANSMISSION OF VOICE, DATA, GRAPHICS, IMAGES, AUDIO AND VIDEO BY MEANS OF TELECOMMUNICATIONS NETWORKS, WIRELESS COMMUNICATION NETWORKS, AND THE INTERNET; WIRELESS BROADBAND COMMUNICATION SERVICES; BROADBAND RADIO COMMUNICATION SERVICES, IN CLASS 38 (U.S. CLS. 100, 101 AND 104).

FIRST USE 1-0-2011; IN COMMERCE 1-0-2011.

FOR: COMPUTER PROJECT MANAGEMENT SERVICES IN THE FIELD OF TELECOMMUNICATION NETWORKS FOR OTHERS; DESIGNING ENHANCED COMPUTER HARDWARE FOR COMMUNICATIONS TECHNOLOGY NETWORKS; COMPUTER SERVICES, NAMELY, OPERATING COMMUNICATION COMPUTER NETWORKS FEATURING BROADBAND TRANSMISSION SOFTWARE FOR OTHERS; TECHNICAL SUPPORT SERVICES, NAMELY, TROUBLESHOOTING OF COMPUTER SOFTWARE PROBLEMS RELATING TO BROADBAND, IN CLASS 42 (U.S. CLS. 100 AND 101).

FIRST USE 1-0-2011; IN COMMERCE 1-0-2011.

NO CLAIM IS MADE TO THE EXCLUSIVE RIGHT TO USE "NETWORKS", APART FROM THE MARK AS SHOWN.

THE STIPPLING IS FOR SHADING PURPOSES ONLY.

SN 85-097,609, FILED 8-1-2010.

SIMON TENG, EXAMINING ATTORNEY

United States of America

United States Patent and Trademark Office

Intelligent Peak LED

Reg. No. 4,206,537

SONY CORPORATION (JAPAN CORPORATION)
1-7-1 KONAN, MINATO-KU
TOKYO, JAPAN

Registered Sep. 11, 2012

Int. Cl.: 9

FOR: TELEVISION SETS; LCD TELEVISION SETS, IN CLASS 9 (U.S. CLS. 21, 23, 26, 36 AND 38).

TRADEMARK

FIRST USE 5-31-2011; IN COMMERCE 5-31-2011.

PRINCIPAL REGISTER

THE MARK CONSISTS OF STANDARD CHARACTERS WITHOUT CLAIM TO ANY PARTICULAR FONT, STYLE, SIZE, OR COLOR.

NO CLAIM IS MADE TO THE EXCLUSIVE RIGHT TO USE "LED", APART FROM THE MARK AS SHOWN.

SN 85-097,934, FILED 8-2-2010.

INGRID C. EULIN, EXAMINING ATTORNEY



David J. Kyffers

Director of the United States Patent and Trademark Office

United States of America

United States Patent and Trademark Office

DELTA UNIT

Reg. No. 4,206,538

Registered Sep. 11, 2012

Int. Cls.: 6 and 19

TRADEMARK

PRINCIPAL REGISTER

HESCO BASTION LIMITED (UNITED KINGDOM COMPANY)
UNIT 37, KNOWSTHORPE GATE
CROSS GREEN INDUSTRIAL ESTATE
LEEDS LS9 0NP, UNITED KINGDOM

FOR: STRUCTURES MADE PRIMARILY OF METAL, NAMELY, SHORELINE AND WETLAND PROTECTION BARRIERS, SHORELINE AND WETLAND RESTORATION BARRIERS, AND ARTICULATED BARRIERS FOR SHORELINE AND WETLAND PROTECTION OR RESTORATION, IN CLASS 6 (U.S. CLS. 2, 12, 13, 14, 23, 25 AND 50).

FIRST USE 3-15-2012; IN COMMERCE 3-15-2012.

FOR: NON-METAL STRUCTURES, NAMELY, SHORELINE AND WETLAND PROTECTION BARRIERS, SHORELINE AND WETLAND RESTORATION BARRIERS, AND ARTICULATED BARRIERS FOR SHORELINE AND WETLAND PROTECTION OR RESTORATION, IN CLASS 19 (U.S. CLS. 1, 12, 33 AND 50).

FIRST USE 3-15-2012; IN COMMERCE 3-15-2012.

THE MARK CONSISTS OF STANDARD CHARACTERS WITHOUT CLAIM TO ANY PARTICULAR FONT, STYLE, SIZE, OR COLOR.

PRIORITY CLAIMED UNDER SEC. 44(D) ON ERPN CMNTY TM OFC APPLICATION NO. 9285297, FILED 7-30-2010, REG. NO. 9285297, DATED 9-25-2011, EXPIRES 7-30-2020.

NO CLAIM IS MADE TO THE EXCLUSIVE RIGHT TO USE "UNIT", APART FROM THE MARK AS SHOWN.

SN 85-098,421, FILED 8-2-2010.

JAMES GRIFFIN, EXAMINING ATTORNEY



David J. Kyffers

Director of the United States Patent and Trademark Office

United States of America

United States Patent and Trademark Office

ACI Payment Systems

Reg. No. 4,206,539

Registered Sep. 11, 2012

Int. Cl.: 9

TRADEMARK

PRINCIPAL REGISTER

ACI WORLDWIDE CORP. (NEBRASKA CORPORATION)
6060 COVENTRY DRIVE
ELKHORN, NE 68022

FOR: COMPUTER SOFTWARE, NAMELY, COMPUTER SOFTWARE FOR USE IN ENABLING ORGANIZATIONS TO INITIATE, MANAGE, SECURE AND OPERATE ELECTRONIC PAYMENTS ACROSS MULTIPLE CHANNELS; DOWNLOADABLE COMPUTER SOFTWARE FOR USE IN ENABLING ORGANIZATIONS TO INITIATE, MANAGE, SECURE AND OPERATE ELECTRONIC PAYMENTS ACROSS MULTIPLE CHANNELS; AND COMPUTER SOFTWARE THAT PROVIDES WEB-BASED ACCESS TO APPLICATIONS AND SERVICES THROUGH A WEB PORTAL INTERFACE FOR USE IN ENABLING ORGANIZATIONS TO INITIATE, MANAGE, SECURE AND OPERATE ELECTRONIC PAYMENTS ACROSS MULTIPLE CHANNELS, IN CLASS 9 (U.S. CLS. 21, 23, 26, 36 AND 38).

FIRST USE 9-15-2010; IN COMMERCE 9-15-2010.

THE MARK CONSISTS OF STANDARD CHARACTERS WITHOUT CLAIM TO ANY PARTICULAR FONT, STYLE, SIZE, OR COLOR.

NO CLAIM IS MADE TO THE EXCLUSIVE RIGHT TO USE "PAYMENT SYSTEMS", APART FROM THE MARK AS SHOWN.

SN 85-098,747, FILED 8-3-2010.

EDWARD FENNESSY, EXAMINING ATTORNEY



David J. Kyfos

Director of the United States Patent and Trademark Office

United States of America

United States Patent and Trademark Office

Stretto

Reg. No. 4,206,540

WILLIAM S. EVERITT (UNITED STATES INDIVIDUAL)
5106 KELSEY ROAD
DALLAS, TX 75229

Registered Sep. 11, 2012

Int. Cl.: 15

FOR: MUSICAL INSTRUMENTS; MUSICAL INSTRUMENTS, NAMELY, WOODWIND PADS AND STRING INSTRUMENT ACCESSORIES, NAMELY, STANDS, CASES, CARRYING BAGS AND MAINTENANCE SUPPLY KITS COMPRISED OF MUSICAL INSTRUMENT ROSIN, SWABS, AND OILS, IN CLASS 15 (U.S. CLS. 2, 21 AND 36).

TRADEMARK

PRINCIPAL REGISTER

FIRST USE 6-1-2012; IN COMMERCE 6-1-2012.

THE MARK CONSISTS OF STANDARD CHARACTERS WITHOUT CLAIM TO ANY PARTICULAR FONT, STYLE, SIZE, OR COLOR.

SN 85-101,380, FILED 8-5-2010.

CURTIS FRENCH, EXAMINING ATTORNEY



David J. Kybas

Director of the United States Patent and Trademark Office

United States of America

United States Patent and Trademark Office

PERMITEXPRESS

Reg. No. 4,206,541

DRI-STICK DECAL CORP. (ILLINOIS CORPORATION), DBA RYDIN DECAL,
700 PHOENIX LAKE AVE.
STREAMWOOD, IL 60107

Registered Sep. 11, 2012

Int. Cl.: 35

FOR: ORDER FULFILLMENT SERVICES IN THE FIELD OF PARKING PERMITS AND
EVENT PARKING PASSES, IN CLASS 35 (U.S. CLS. 100, 101 AND 102).

SERVICE MARK

FIRST USE 4-3-2011; IN COMMERCE 4-3-2011.

PRINCIPAL REGISTER

THE MARK CONSISTS OF STANDARD CHARACTERS WITHOUT CLAIM TO ANY PAR-
TICULAR FONT, STYLE, SIZE, OR COLOR.

SN 85-102,104, FILED 8-6-2010.

SETH A. RAPPAPORT, EXAMINING ATTORNEY



David J. Kybas

Director of the United States Patent and Trademark Office

United States of America

United States Patent and Trademark Office



RYDIN DECAL

Reg. No. 4,206,542

Registered Sep. 11, 2012

Int. Cl.: 42

SERVICE MARK

PRINCIPAL REGISTER

DRI-STICK DECAL CORP. (ILLINOIS CORPORATION), DBA RYDIN DECAL,
700 PHOENIX LAKE AVE.
STREAMWOOD, IL 60107

FOR: PROVIDING TEMPORARY USE OF ON-LINE DOWNLOADABLE COMPUTER SOFTWARE FOR USE IN PARKING MANAGEMENT, NAMELY, TRACKING CUSTOMERS INFORMATION, ISSUING AND TRACKING PARKING PERMITS AND CITATIONS AND APPLYING LATE FEES, IN CLASS 42 (U.S. CLS. 100 AND 101).

FIRST USE 1-3-2011; IN COMMERCE 1-3-2011.

NO CLAIM IS MADE TO THE EXCLUSIVE RIGHT TO USE "DECAL", APART FROM THE MARK AS SHOWN.

THE COLOR(S) BLUE, GOLD, AND WHITE IS/ARE CLAIMED AS A FEATURE OF THE MARK.

THE MARK CONSISTS OF THE WORD "RYDIN" IN WHITE ABOVE A TILTED LETTER "R" IN BLUE BOTH INSIDE A FIRST GOLD SQUARE WITH WHITE BORDER WHICH IN TURN IS INSIDE A SECOND GOLD SQUARE, THE LOWER RIGHT CORNER OF SAID FIRST AND SECOND SQUARES DEPICTED AS PEELED BACK REVEALING A BLUE BACKING WITH THE PEELED BACK PORTION BEING IN WHITE; ALL OF THE AFORESAID IS FOLLOWED BY THE WORDS "RYDIN DECAL" IN BLUE TO THE RIGHT.

SN 85-102,209, FILED 8-6-2010.

SETH A. RAPPAPORT, EXAMINING ATTORNEY



David J. Kybas

Director of the United States Patent and Trademark Office

United States of America

United States Patent and Trademark Office



Reg. No. 4,206,543

Registered Sep. 11, 2012

Int. Cl.: 9

TRADEMARK

PRINCIPAL REGISTER

ACI WORLDWIDE CORP. (NEBRASKA CORPORATION)
6060 COVENTRY DRIVE
ELKHORN, NE 68022

FOR: COMPUTER SOFTWARE, NAMELY, COMPUTER SOFTWARE FOR USE IN ENABLING ORGANIZATIONS TO INITIATE, MANAGE, SECURE AND OPERATE ELECTRONIC PAYMENTS ACROSS MULTIPLE CHANNELS; DOWNLOADABLE COMPUTER SOFTWARE FOR USE IN ENABLING ORGANIZATIONS TO INITIATE, MANAGE, SECURE AND OPERATE ELECTRONIC PAYMENTS ACROSS MULTIPLE CHANNELS; AND COMPUTER SOFTWARE THAT PROVIDES WEB-BASED ACCESS TO APPLICATIONS AND SERVICES THROUGH A WEB PORTAL INTERFACE FOR USE IN ENABLING ORGANIZATIONS TO INITIATE, MANAGE, SECURE AND OPERATE ELECTRONIC PAYMENTS ACROSS MULTIPLE CHANNELS, IN CLASS 9 (U.S. CLS. 21, 23, 26, 36 AND 38).

FIRST USE 9-15-2010; IN COMMERCE 9-15-2010.

OWNER OF U.S. REG. NO. 2,420,572.

NO CLAIM IS MADE TO THE EXCLUSIVE RIGHT TO USE "PAYMENT SYSTEMS", APART FROM THE MARK AS SHOWN.

THE MARK CONSISTS OF THE CAPITAL LETTERS "ACI" WITH THE "A" STYLIZED WITHOUT A CENTER BAR AND A BREAK AT THE TOP BETWEEN THE TWO LEGS. THE WORDS "PAYMENT SYSTEMS" IN LOWER CASE LETTERS ARE BELOW THE LETTERS "ACI".

SN 85-103,241, FILED 8-9-2010.

EDWARD FENNESSY, EXAMINING ATTORNEY



David J. Kyros

Director of the United States Patent and Trademark Office

United States of America

United States Patent and Trademark Office



Reg. No. 4,206,544

GENERAL ELECTRIC COMPANY (NEW YORK CORPORATION)
1 RIVER ROAD
SCHENECTADY, NY 12345

Registered Sep. 11, 2012

Int. Cl.: 37

FOR: CHARGING STATION SERVICES FOR ELECTRIC VEHICLES; INSTALLATION OF WIRING AND POWER SUPPLY EQUIPMENT FOR TRANSMISSION AND DISTRIBUTION OF ELECTRICITY SUITABLE FOR ELECTRIC VEHICLE RECHARGING STATIONS, IN CLASS 37 (U.S. CLS. 100, 103 AND 106).

SERVICE MARK

PRINCIPAL REGISTER

FIRST USE 2-28-2012; IN COMMERCE 2-28-2012.

OWNER OF U.S. REG. NOS. 3,296,336, 3,775,123, AND OTHERS.

THE MARK CONSISTS OF THE STYLIZED LETTERS "GE" IN A CIRCLE WITH 4 CUR-LICUES.

SN 85-103,775, FILED 8-10-2010.

ANDREA HACK, EXAMINING ATTORNEY



David J. Kyros

Director of the United States Patent and Trademark Office

United States of America

United States Patent and Trademark Office

CLEVER CAP

Reg. No. 4,206,545

COMPLIANCE MEDS TECHNOLOGIES LLC (FLORIDA LIMITED LIABILITY COMPANY)
5 ISLAND AVENUE, 2D
MIAMI, FL 33139

Registered Sep. 11, 2012

Int. Cls.: 9, 20, and 21

FOR: ELECTRONIC DEVICE FOR MONITORING USAGE, DOSAGE, AND DIRECTIONS FOR USE AND REFILL OF PHARMACEUTICAL PILLS, IN CLASS 9 (U.S. CLS. 21, 23, 26, 36 AND 38).

TRADEMARK

FIRST USE 7-1-2012; IN COMMERCE 7-1-2012.

PRINCIPAL REGISTER

FOR: PLASTIC BOTTLE CAPS; NON-METAL BOTTLE CAPS; PLASTIC PILL BOTTLES AND CAPS FOR COMMERCIAL USE, IN CLASS 20 (U.S. CLS. 2, 13, 22, 25, 32 AND 50).

FIRST USE 7-1-2012; IN COMMERCE 7-1-2012.

FOR: PERSONAL DISPENSERS FOR PILLS FOR DOMESTIC USE, PILL BOXES FOR PERSONAL USE, IN CLASS 21 (U.S. CLS. 2, 13, 23, 29, 30, 33, 40 AND 50).

FIRST USE 7-1-2012; IN COMMERCE 7-1-2012.

THE MARK CONSISTS OF STANDARD CHARACTERS WITHOUT CLAIM TO ANY PARTICULAR FONT, STYLE, SIZE, OR COLOR.

NO CLAIM IS MADE TO THE EXCLUSIVE RIGHT TO USE "CAP", APART FROM THE MARK AS SHOWN.

SN 85-104,544, FILED 8-10-2010.

TASNEEM HUSSAIN, EXAMINING ATTORNEY



David J. Kyros

Director of the United States Patent and Trademark Office

United States of America

United States Patent and Trademark Office



Reg. No. 4,206,546

Registered Sep. 11, 2012

Int. Cl.: 42

SERVICE MARK

PRINCIPAL REGISTER

SOCIAS, MIGUEL (CHILE INDIVIDUAL)
P.O. BOX 60901
PALO ALTO, CA 94306

FOR: APPLICATION SERVICE PROVIDER (ASP) FEATURING SOFTWARE FOR USE FOR DATA ANALYSIS AND RESEARCH; APPLICATION SERVICE PROVIDER, NAMELY, HOSTING, MANAGING, DEVELOPING, AND MAINTAINING APPLICATIONS, SOFTWARE, AND WEB SITES, IN THE FIELDS OF PERSONAL PRODUCTIVITY, WIRELESS COMMUNICATION, MOBILE INFORMATION ACCESS, AND REMOTE DATA MANAGEMENT FOR WIRELESS DELIVERY OF CONTENT TO HANDHELD COMPUTERS, LAPTOPS AND MOBILE ELECTRONIC DEVICES; COMPUTER SERVICE, NAMELY, ACTING AS AN APPLICATION SERVICE PROVIDER IN THE FIELD OF KNOWLEDGE MANAGEMENT TO HOST COMPUTER APPLICATION SOFTWARE FOR CREATING SEARCHABLE DATABASES OF INFORMATION AND DATA; COMPUTER SERVICES, NAMELY, CREATING AN ON-LINE COMMUNITY FOR REGISTERED USERS TO PARTICIPATE IN DISCUSSIONS, GET FEEDBACK FROM THEIR PEERS, FORM VIRTUAL COMMUNITIES, AND ENGAGE IN SOCIAL NETWORKING; COMPUTER SERVICES, NAMELY, HOSTING AND MAINTAINING AN ON-LINE WEB SITE FOR OTHERS TO PERFORM AND SHARE DATA ANALYSIS AND RESEARCH; CONSULTING SERVICES IN THE FIELD OF SOFTWARE AS A SERVICE (SAAS); PROVIDING A WEBSITE FEATURING TECHNOLOGY THAT ENABLES USERS TO PERFORM AND SHARE DATA ANALYSIS AND RESEARCH; SOFTWARE AS A SERVICE (SAAS) SERVICES FEATURING SOFTWARE IN THE FIELD OF DATA ANALYSIS AND RESEARCH, IN CLASS 42 (U.S. CLS. 100 AND 101).

FIRST USE 6-15-2012; IN COMMERCE 6-15-2012.

THE MARK CONSISTS OF PERSON SITTING IN MEDITATION IN BLACK ON A WHITE BACKGROUND.

THE COLOR(S) BLACK AND WHITE IS/ARE CLAIMED AS A FEATURE OF THE MARK.

SN 85-104,582, FILED 8-10-2010.

LESLEY LAMOTHE, EXAMINING ATTORNEY



David J. Kyjars

Director of the United States Patent and Trademark Office

United States of America

United States Patent and Trademark Office

DASH

Reg. No. 4,206,547

Registered Sep. 11, 2012

Int. Cl.: 9

TRADEMARK

PRINCIPAL REGISTER

ADVANCE MAGAZINE PUBLISHERS INC. (NEW YORK CORPORATION)
FOUR TIMES SQUARE
NEW YORK, NY 10036

FOR: DOWNLOADABLE SOFTWARE IN THE NATURE OF MOBILE APPLICATIONS FOR USE WITH SMART PHONES, PDA DEVICES, TABLET COMPUTERS AND OTHER PORTABLE HANDHELD DIGITAL ELECTRONIC COMMUNICATION DEVICES, FEATURING CONTENT FROM MAGAZINES IN THE FIELDS OF FOOD, BEVERAGES AND RECIPES, IN CLASS 9 (U.S. CLS. 21, 23, 26, 36 AND 38).

FIRST USE 5-3-2012; IN COMMERCE 5-3-2012.

THE MARK CONSISTS OF STANDARD CHARACTERS WITHOUT CLAIM TO ANY PARTICULAR FONT, STYLE, SIZE, OR COLOR.

SN 85-105,192, FILED 8-11-2010.

ELISSA GARBER KON, EXAMINING ATTORNEY



David J. Kybas

Director of the United States Patent and Trademark Office

United States of America

United States Patent and Trademark Office

AKAONA

Reg. No. 4,206,548

Registered Sep. 11, 2012

Int. Cl.: 3

TRADEMARK

PRINCIPAL REGISTER

KHATAN II INC DBA ANNAM DISCOUNT BEAUTY SUPPLY (FLORIDA CORPORATION)
YESCOTO@WORLDPERFUMESUS.COM
1101 NW 22ND ST
MIAMI, FL 33127

FOR: COSMETICS IN GENERAL, INCLUDING PERFUMES, IN CLASS 3 (U.S. CLS. 1, 4, 6, 50, 51 AND 52).

FIRST USE 11-29-2011; IN COMMERCE 11-29-2011.

THE MARK CONSISTS OF STANDARD CHARACTERS WITHOUT CLAIM TO ANY PARTICULAR FONT, STYLE, SIZE, OR COLOR.

THE WORDING "AKAONA" HAS NO MEANING IN A FOREIGN LANGUAGE.

SN 85-105,258, FILED 8-11-2010.

JERI J. FICKES, EXAMINING ATTORNEY



David J. Kyffers

Director of the United States Patent and Trademark Office

United States of America

United States Patent and Trademark Office

LANGUAGE LAB

Reg. No. 4,206,549

Registered Sep. 11, 2012

Int. Cl.: 16

TRADEMARK

PRINCIPAL REGISTER

SUPER DUPER INC. (SOUTH CAROLINA CORPORATION), DBA SUPER DUPER PUBLICATIONS,
5201 PELHAM ROAD
GREENVILLE, SC 29615

FOR: PRINTED EDUCATIONAL INSTRUCTIONAL MANUALS, POSTER, AND CARDS FOR USE IN THE INSTRUCTION OF STUDENTS ON SPEECH AND LANGUAGE FOR USE BY THE GENERAL PUBLIC, PUBLIC AND PRIVATE TEACHERS, HEALTH PROFESSIONALS, OR THERAPISTS, IN CLASS 16 (U.S. CLS. 2, 5, 22, 23, 29, 37, 38 AND 50).

FIRST USE 1-27-2012; IN COMMERCE 1-27-2012.

THE MARK CONSISTS OF STANDARD CHARACTERS WITHOUT CLAIM TO ANY PARTICULAR FONT, STYLE, SIZE, OR COLOR.

NO CLAIM IS MADE TO THE EXCLUSIVE RIGHT TO USE "LANGUAGE", APART FROM THE MARK AS SHOWN.

SN 85-105,706, FILED 8-12-2010.

GINA HAYES, EXAMINING ATTORNEY



David J. Kyffers

Director of the United States Patent and Trademark Office

United States of America

United States Patent and Trademark Office

BRANDBOARDS

Reg. No. 4,206,550

TIMOTHY SCHOEN (UNITED STATES INDIVIDUAL)
1215 WALNUT HILL FARM DRIVE
CHESTERFIELD, MO 63005

Registered Sep. 11, 2012

Int. Cl.: 35

FOR: PROVIDING ADVERTISING SPACE THAT MAY BE UPDATED ONLINE ON ELECTRONIC BILLBOARDS IN PUBLIC PLACES, STADIUMS, AND ARENAS; ADVERTISING SERVICES, NAMELY, RENTAL OF STADIUM AND ARENA ADVERTISING SPACE TO OTHERS, IN CLASS 35 (U.S. CLS. 100, 101 AND 102).

SERVICE MARK

PRINCIPAL REGISTER

FIRST USE 5-15-2012; IN COMMERCE 5-15-2012.

THE MARK CONSISTS OF STANDARD CHARACTERS WITHOUT CLAIM TO ANY PARTICULAR FONT, STYLE, SIZE, OR COLOR.

SN 85-106,913, FILED 8-13-2010.

VERNA BETH RIRIE, EXAMINING ATTORNEY



David J. Kyffers

Director of the United States Patent and Trademark Office

United States of America

United States Patent and Trademark Office

CATALYS

Reg. No. 4,206,551

OPTIMEDICA CORPORATION (DELAWARE CORPORATION)
1310 MOFFETT PARK DRIVE
SUNNYVALE, CA 95089

Registered Sep. 11, 2012

Int. Cl.: 10

FOR: MEDICAL DEVICES FOR OPHTHALMIC USE, NAMELY, LASER SYSTEMS COMPRISED OF SCANNING, IMAGING, GUIDING DEVICES AND LASERS, AND STRUCTURAL PARTS THEREOF, IN CLASS 10 (U.S. CLS. 26, 39 AND 44).

TRADEMARK

FIRST USE 9-1-2010; IN COMMERCE 11-16-2011.

PRINCIPAL REGISTER

THE MARK CONSISTS OF STANDARD CHARACTERS WITHOUT CLAIM TO ANY PARTICULAR FONT, STYLE, SIZE, OR COLOR.

SN 85-107,557, FILED 8-13-2010.

SUNG IN, EXAMINING ATTORNEY



David J. Kyfos

Director of the United States Patent and Trademark Office

United States of America
United States Patent and Trademark Office

LIPODOX

Reg. No. 4,206,552

Registered Sep. 11, 2012

Int. Cl.: 5

SUN PHARMACEUTICALS INDUSTRIES LTD (INDIA LIMITED LIABILITY COMPANY),
TA SUN PHARMACEUTICALS INDUSTRIES LTD,
ACME PLAZA, ANDHERI-KURLA ROAD,
ANDHERI (EAST),
MUMBAI- 400059, INDIA

TRADEMARK

FOR: PHARMACEUTICAL PREPARATIONS FOR THE TREATMENT OF CANCER , IN
CLASS 5 (U.S. CLS. 6, 18, 44, 46, 51 AND 52).

PRINCIPAL REGISTER

FIRST USE 10-7-2004; IN COMMERCE 2-22-2012.

THE MARK CONSISTS OF STANDARD CHARACTERS WITHOUT CLAIM TO ANY PAR-
TICULAR FONT, STYLE, SIZE, OR COLOR.

OWNER OF INDIA REG. NO. 1252259, DATED 11-28-2003, EXPIRES 11-28-2013.

SN 85-107,661, FILED 8-14-2010.

INGA ERVIN, EXAMINING ATTORNEY



David J. Kyfos

Director of the United States Patent and Trademark Office

United States of America

United States Patent and Trademark Office

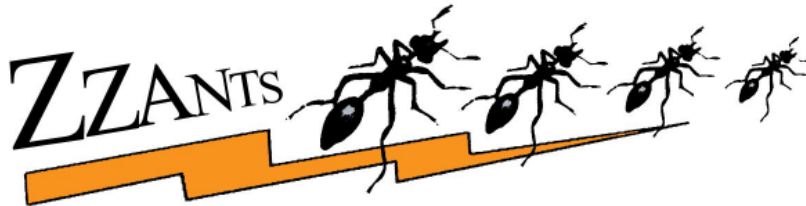

Reg. No. 4,206,553

Registered Sep. 11, 2012

Int. Cl.: 21

TRADEMARK

PRINCIPAL REGISTER

SHAHAR & PELES TECHNOLOGY DEVELOPMENT LTD. (ISRAEL LIMITED LIABILITY COMPANY)
28 HAMELACHA ST.
CARMIEL, ISRAEL 52522

FOR: PLASTIC CONTAINERS AND DISHES FOR DISPENSING FOOD TO PETS, IN CLASS 21 (U.S. CLS. 2, 13, 23, 29, 30, 33, 40 AND 50).

FIRST USE 5-21-2012; IN COMMERCE 5-21-2012.

THE MARK CONSISTS OF THE WORDING "ZZANTS" IN THE COLOR BLACK AND FOUR ANTS OF DIMINISHING SIZE IN THE COLOR BLACK ABOVE AN ORANGE LIGHTNING BOLT.

THE COLOR(S) ORANGE AND BLACK IS/ARE CLAIMED AS A FEATURE OF THE MARK.

SN 85-107,899, FILED 8-16-2010.

JOSETTE BEVERLY, EXAMINING ATTORNEY



David J. Kyros

Director of the United States Patent and Trademark Office

United States of America

United States Patent and Trademark Office

Bloodline

Reg. No. 4,206,554

MORLAN OUTDOORS (MISSOURI LIMITED LIABILITY COMPANY)
140 PINTAIL POINTE
CAPE GIRARDEAU, MO 63701

Registered Sep. 11, 2012

Int. Cl.: 35

FOR: ADVERTISING AND BUSINESS SERVICES, NAMELY, SECURING AIRTIME ON ALL FORMS OF MEDIA COMMUNICATIONS STATIONS, SYSTEMS, NETWORKS, AND SERVICES FOR THE PURPOSE OF PROMOTING THE GOODS AND SERVICES OF OTHERS, IN CLASS 35 (U.S. CLS. 100, 101 AND 102).

SERVICE MARK

PRINCIPAL REGISTER

FIRST USE 2-11-2010; IN COMMERCE 2-11-2010.

THE MARK CONSISTS OF STANDARD CHARACTERS WITHOUT CLAIM TO ANY PARTICULAR FONT, STYLE, SIZE, OR COLOR.

SN 85-111,270, FILED 8-19-2010.

SOPHIA S. KIM, EXAMINING ATTORNEY



David J. Kyffers

Director of the United States Patent and Trademark Office

United States of America

United States Patent and Trademark Office

WHAT DO YOUR WALLS SAY ABOUT YOU?

Reg. No. 4,206,555

MORGAN BATTISTI (UNITED STATES INDIVIDUAL)
8101 FLINT ROAD
COLUMBUS, OH 43235

Registered Sep. 11, 2012

Int. Cl.: 35

FOR: RETAIL AND ON-LINE RETAIL STORE SERVICES FEATURING DECORATIVE ADHESIVE VINYL SHEETS AND DECALS, IN CLASS 35 (U.S. CLS. 100, 101 AND 102).

SERVICE MARK

FIRST USE 11-28-2010; IN COMMERCE 11-28-2010.

PRINCIPAL REGISTER

THE MARK CONSISTS OF STANDARD CHARACTERS WITHOUT CLAIM TO ANY PARTICULAR FONT, STYLE, SIZE, OR COLOR.

SN 85-112,844, FILED 8-21-2010.

APRIL ROACH, EXAMINING ATTORNEY



David J. Kybas

Director of the United States Patent and Trademark Office

United States of America

United States Patent and Trademark Office

THE VOICE

Reg. No. 4,206,556

Registered Sep. 11, 2012

Int. Cl.: 38

SERVICE MARK

PRINCIPAL REGISTER

RYAN SEACREST FOUNDATION, INC. (GEORGIA CORPORATION)
SUITE 450
56 PERIMETER CENTER EAST
ATLANTA, GA 30346

FOR: TRANSMISSION OF AUDIO AND VIDEO CONTENT, NAMELY, CHILDREN'S ENTERTAINMENT, VIA CLOSED CIRCUIT NETWORKS IN CHILDREN'S HOSPITALS, IN CLASS 38 (U.S. CLS. 100, 101 AND 104).

FIRST USE 11-5-2010; IN COMMERCE 11-5-2010.

THE MARK CONSISTS OF STANDARD CHARACTERS WITHOUT CLAIM TO ANY PARTICULAR FONT, STYLE, SIZE, OR COLOR.

SN 85-113,607, FILED 8-23-2010.

JIM RINGLE, EXAMINING ATTORNEY



David J. Kybas

Director of the United States Patent and Trademark Office

United States of America

United States Patent and Trademark Office

SOLARSPEC

Reg. No. 4,206,557

MOLEX INCORPORATED (DELAWARE CORPORATION)
2222 WELLINGTON COURT
LISLE, IL 60532

Registered Sep. 11, 2012

Int. Cl.: 9

FOR: ELECTRICAL CONNECTORS, ELECTRICAL JUNCTION BOXES, ELECTRICAL CABLES AND CORDSETS, AND CABLE ASSEMBLIES, ALL THE FOREGOING DESIGNED FOR USE WITH SOLAR PANELS FOR PRODUCTION OF ELECTRICITY, IN CLASS 9 (U.S. CLS. 21, 23, 26, 36 AND 38).

TRADEMARK

PRINCIPAL REGISTER

FIRST USE 12-0-2011; IN COMMERCE 12-0-2011.

THE MARK CONSISTS OF STANDARD CHARACTERS WITHOUT CLAIM TO ANY PARTICULAR FONT, STYLE, SIZE, OR COLOR.

SN 85-114,110, FILED 8-23-2010.

C. DIONNE CLYBURN, EXAMINING ATTORNEY



David J. Kybas

Director of the United States Patent and Trademark Office

United States of America

United States Patent and Trademark Office

DIGNITY

Reg. No. 4,206,558

MEEHL, DR. CHRIS (UNITED STATES INDIVIDUAL)
70 MAIN STREET
LYNNFIELD, MA 01940

Registered Sep. 11, 2012

**Int. Cls.: 5, 31, 43, and
44**

FOR: DIETARY SUPPLEMENTS FOR PETS, IN CLASS 5 (U.S. CLS. 6, 18, 44, 46, 51 AND 52).

FIRST USE 6-4-2012; IN COMMERCE 6-4-2012.

TRADEMARK

FOR: PET FOOD, IN CLASS 31 (U.S. CLS. 1 AND 46).

SERVICE MARK

FIRST USE 6-4-2012; IN COMMERCE 6-4-2012.

PRINCIPAL REGISTER

FOR: PET CARE, NAMELY, BOARDING FOR PETS, IN CLASS 43 (U.S. CLS. 100 AND 101).

FIRST USE 6-4-2012; IN COMMERCE 6-4-2012.

FOR: VETERINARY SERVICES INCLUDING MEDICAL AND SURGICAL SERVICES; PET CARE, NAMELY, PET GROOMING SERVICES, IN CLASS 44 (U.S. CLS. 100 AND 101).

FIRST USE 6-4-2012; IN COMMERCE 6-4-2012.

THE MARK CONSISTS OF STANDARD CHARACTERS WITHOUT CLAIM TO ANY PARTICULAR FONT, STYLE, SIZE, OR COLOR.

SN 85-114,367, FILED 8-24-2010.

TARAH HARDY, EXAMINING ATTORNEY



David J. Kyros

Director of the United States Patent and Trademark Office

United States of America

United States Patent and Trademark Office

TAKE COVER

Reg. No. 4,206,559

GLOBAL TRADEMARKS, INC. (NEVADA CORPORATION)
110 COMMERCE WAY
STOCKERTOWN, PA 18083

Registered Sep. 11, 2012

Int. Cl.: 25

FOR: BEACH COVER-UPS; SWIMWEAR, IN CLASS 25 (U.S. CLS. 22 AND 39).

TRADEMARK

FIRST USE 12-7-2011; IN COMMERCE 12-7-2011.

PRINCIPAL REGISTER

THE MARK CONSISTS OF STANDARD CHARACTERS WITHOUT CLAIM TO ANY PARTICULAR FONT, STYLE, SIZE, OR COLOR.

SN 85-114,679, FILED 8-24-2010.

MARK T. MULLEN, EXAMINING ATTORNEY



David J. Kyffers

Director of the United States Patent and Trademark Office

United States of America

United States Patent and Trademark Office

VICTORIA ORTIZ "LA MALA"

Reg. No. 4,206,560

ORTIZ, IRMA M. (MEXICO INDIVIDUAL)
10 E. BONITA AVENUE
SIERRA MADRE, CA 91024

Registered Sep. 11, 2012

Int. Cls.: 9 and 41

FOR: DIGITAL MATERIALS, NAMELY, CDS, DVDS, DOWNLOADABLE AUDIO FILES AND RING TONES FEATURING MUSIC, IN CLASS 9 (U.S. CLS. 21, 23, 26, 36 AND 38).

TRADEMARK

FIRST USE 5-5-2010; IN COMMERCE 6-5-2010.

SERVICE MARK

FOR: ENTERTAINMENT SERVICES, NAMELY, LIVE, RADIO, INTERNET, TELEVISED AND MOVIE APPEARANCES BY A PROFESSIONAL ENTERTAINER; ENTERTAINMENT IN THE NATURE OF LIVE PERFORMANCES BY PROFESSIONAL ENTERTAINER; ENTERTAINMENT SERVICES, NAMELY, PROVIDING A WEB SITE FEATURING PHOTOGRAPHIC, AUDIO, VIDEO AND PROSE PRESENTATIONS FEATURING MUSICAL PERFORMANCES, IN CLASS 41 (U.S. CLS. 100, 101 AND 107).

PRINCIPAL REGISTER

FIRST USE 5-5-2010; IN COMMERCE 6-5-2010.

THE MARK CONSISTS OF STANDARD CHARACTERS WITHOUT CLAIM TO ANY PARTICULAR FONT, STYLE, SIZE, OR COLOR.

THE NAME "VICTORIA ORTIZ" IDENTIFIES A LIVING INDIVIDUAL WHOSE CONSENT IS OF RECORD.

THE ENGLISH TRANSLATION OF "LA MALA" IN THE MARK IS "THE BAD GIRL".

SN 85-114,878, FILED 8-24-2010.

NAAKWAMA ANKRAH, EXAMINING ATTORNEY



David J. Kypos

Director of the United States Patent and Trademark Office

United States of America

United States Patent and Trademark Office

WHEN FINDING THE RIGHT PATIENTS MATTERS.

Reg. No. 4,206,561

JAXRESEARCH SYSTEMS, LLC (FLORIDA LIMITED LIABILITY COMPANY)
4085 UNIVERSITY BLVD., SOUTH
JACKSONVILLE, FL 32216

Registered Sep. 11, 2012

Int. Cl.: 38

FOR: PROVIDING A TELECOMMUNICATIONS LINK BETWEEN PROVIDERS OF HEALTH PRODUCTS AND SERVICES AND GROUPS OF PATIENTS USING A PHYSICIAN SUPERVISED WEB-BASED SYSTEM, IN CLASS 38 (U.S. CLS. 100, 101 AND 104).

SERVICE MARK

FIRST USE 7-21-2010; IN COMMERCE 7-21-2010.

PRINCIPAL REGISTER

THE MARK CONSISTS OF STANDARD CHARACTERS WITHOUT CLAIM TO ANY PARTICULAR FONT, STYLE, SIZE, OR COLOR.

SN 85-120,082, FILED 8-31-2010.

ANNE MADDEN, EXAMINING ATTORNEY



David J. Kyjars

Director of the United States Patent and Trademark Office

United States of America

United States Patent and Trademark Office



Reg. No. 4,206,562

Registered Sep. 11, 2012

Int. Cl.: 45

SERVICE MARK

PRINCIPAL REGISTER

APPLE INC. (CALIFORNIA CORPORATION)
1 INFINITE LOOP
CUPERTINO, CA 95014

FOR: PERSONAL AND SOCIAL SERVICES RENDERED BY OTHERS TO MEET THE NEEDS OF INDIVIDUALS, NAMELY, ONLINE SOCIAL NETWORKING AND INTRODUCTION SERVICES; ONLINE SOCIAL NETWORKING SERVICES, NAMELY, FACILITATING SOCIAL INTERACTION AMONG INDIVIDUALS, SOCIAL INTRODUCTIONS, AND FOR FINDING PERSONS WITH PARTICULAR HOBBIES, INTERESTS AND BACKGROUNDS; PROVIDING A SOCIAL NETWORKING WEBSITE FOR ENTERTAINMENT PURPOSES; SECURITY SERVICES FOR THE PROTECTION OF PROPERTY, NAMELY, MONITORING OF COMPUTERIZED DATA FOR SECURITY PURPOSES, IN CLASS 45 (U.S. CLS. 100 AND 101).

FIRST USE 9-1-2010; IN COMMERCE 9-1-2010.

THE MARK CONSISTS OF THE DESIGN OF AN APPLE WITH A BITE REMOVED.

SN 85-120,250, FILED 8-31-2010.

AMY KERTGATE, EXAMINING ATTORNEY



David J. Kybas

Director of the United States Patent and Trademark Office

United States of America

United States Patent and Trademark Office

elmrox

Reg. No. 4,206,563

ELMROX MEDIA LLC (DELAWARE LIMITED LIABILITY COMPANY)
280 PARK AVE SOUTH SUITE 8J
NEW YORK, NY 10010

Registered Sep. 11, 2012

Int. Cl.: 41

FOR: ONLINE ELECTRONIC PUBLISHING OF BOOKS AND PERIODICALS, IN CLASS 41
(U.S. CLS. 100, 101 AND 107).

SERVICE MARK

FIRST USE 0-0-2009; IN COMMERCE 0-0-2009.

PRINCIPAL REGISTER

THE MARK CONSISTS OF STANDARD CHARACTERS WITHOUT CLAIM TO ANY PARTICULAR FONT, STYLE, SIZE, OR COLOR.

SN 85-120,279, FILED 8-31-2010.

SUNG IN, EXAMINING ATTORNEY



David J. Kyffers

Director of the United States Patent and Trademark Office

United States of America

United States Patent and Trademark Office

Jesus Rocks My Soul

Reg. No. 4,206,564

DEANE, ANTHONY (UNITED STATES INDIVIDUAL)
1360 N. CRESCENT HEIGHTS BLVD. 5C
LOS ANGELES, CA 90046

Registered Sep. 11, 2012

Int. Cls.: 14 and 25

FOR: NECKLACES; RUBBER OR SILICON WRISTBANDS IN THE NATURE OF A BRACELET, IN CLASS 14 (U.S. CLS. 2, 27, 28 AND 50).

TRADEMARK

FIRST USE 4-29-2012; IN COMMERCE 4-29-2012.

PRINCIPAL REGISTER

FOR: HATS; SWEATSHIRTS; T-SHIRTS; WRISTBANDS, IN CLASS 25 (U.S. CLS. 22 AND 39).

FIRST USE 4-29-2012; IN COMMERCE 4-29-2012.

THE MARK CONSISTS OF STANDARD CHARACTERS WITHOUT CLAIM TO ANY PARTICULAR FONT, STYLE, SIZE, OR COLOR.

SN 85-122,356, FILED 9-2-2010.

MARK RADEMACHER, EXAMINING ATTORNEY



David J. Kyros

Director of the United States Patent and Trademark Office

United States of America

United States Patent and Trademark Office

DREAM IT. BUILD IT. DRIVE
IT.

Reg. No. 4,206,565

Registered Sep. 11, 2012

**Int. Cls.: 12, 35, 40, and
42**

BAYERISCHE MOTOREN WERKE AKTIENGESELLSCHAFT (FED REP GERMANY
CORPORATION)

AJ-35

PETUELRING 130

80809 MUNICH, FED REP GERMANY

TRADEMARK

SERVICE MARK

PRINCIPAL REGISTER

FOR: AUTOMOBILES; CUSTOMIZED EQUIPMENT PACKAGES FOR AUTOMOBILES
COMPRISED OF AUTOMOBILE BUMPERS, WINDSHIELD WIPERS, VEHICLE SEAT
COVERS, EXTERIOR AND INTERIOR VEHICLE TRIM, ENGINE, TRANSMISSION,
STEERING WHEEL, SEATS, WINDOW SHADES, ROOF RAILS, SUNROOF, REAR AND SIDE
VIEW MIRRORS, ROOF RACKS, BICYCLE RACKS, AND AERO-DYNAMIC KITS COM-
PRISED OF SPOILERS, SIDE SKIRTS, FRONT SPLITTERS, AIR DUCTS, MIRROR CAPS
AND WHEELS, IN CLASS 12 (U.S. CLS. 19, 21, 23, 31, 35 AND 44).

FIRST USE 11-15-2010; IN COMMERCE 11-15-2010.

FOR: RETAIL STORE SERVICES IN THE FIELD OF AUTOMOBILES; PROMOTION, AD-
VERTISING AND MARKETING OF VEHICLES AND SERVICES FOR VEHICLE CUSTOM-
IZATION, IN CLASS 35 (U.S. CLS. 100, 101 AND 102).

FIRST USE 11-15-2010; IN COMMERCE 11-15-2010.

FOR: CUSTOM MANUFACTURE OF AUTOMOBILES, IN CLASS 40 (U.S. CLS. 100, 103
AND 106).

FIRST USE 11-15-2010; IN COMMERCE 11-15-2010.

FOR: PROVIDING AN ONLINE NON-DOWNLOADABLE INTERACTIVE COMPUTER
SOFTWARE PROGRAM TO ALLOW CUSTOMERS TO CONFIGURE AND CUSTOMIZE
VEHICLES, IN CLASS 42 (U.S. CLS. 100 AND 101).

FIRST USE 11-15-2010; IN COMMERCE 11-15-2010.

THE MARK CONSISTS OF STANDARD CHARACTERS WITHOUT CLAIM TO ANY PAR-
TICULAR FONT, STYLE, SIZE, OR COLOR.

SN 85-123,532, FILED 9-6-2010.

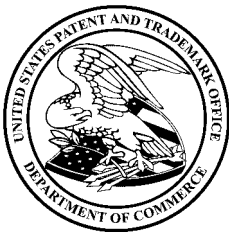

David J. Kyjars

Director of the United States Patent and Trademark Office

Reg. No. 4,206,565 JEAN IM, EXAMINING ATTORNEY

United States of America

United States Patent and Trademark Office

Rockaoke

Reg. No. 4,206,566

GILMORE, TIM (UNITED STATES INDIVIDUAL)
9813 BECKFORD AVE
NORTHRIDGE, CA 91324

Registered Sep. 11, 2012

Int. Cl.: 41

FOR: ENTERTAINMENT, NAMELY, LIVE PERFORMANCES BY A MUSICAL BAND, IN CLASS 41 (U.S. CLS. 100, 101 AND 107).

SERVICE MARK

FIRST USE 10-1-2010; IN COMMERCE 10-1-2010.

PRINCIPAL REGISTER

THE MARK CONSISTS OF STANDARD CHARACTERS WITHOUT CLAIM TO ANY PARTICULAR FONT, STYLE, SIZE, OR COLOR.

SN 85-124,328, FILED 9-7-2010.

REBECCA POVARCHUK, EXAMINING ATTORNEY



David J. Kybas

Director of the United States Patent and Trademark Office

United States of America

United States Patent and Trademark Office

MPRO-HD

Reg. No. 4,206,567

MULTICOM, INC (FLORIDA CORPORATION)
1076 FLORIDA CENTRAL PARKWAY
LONGWOOD, FL 32750

Registered Sep. 11, 2012

Int. Cl.: 42

FOR: ENCRYPTED HD TELEVISION SERVICE AND MONITORING, NAMELY, COMPUTER MONITORING SERVICE WHICH TRACKS APPLICATION HD TELEVISION SOFTWARE PERFORMANCE, PERFORMS PERIODIC MAINTENANCE AND PROVIDES REPORTS AND ALERTS CONCERNING SUCH PERFORMANCE, IN CLASS 42 (U.S. CLS. 100 AND 101).

SERVICE MARK

PRINCIPAL REGISTER

FIRST USE 2-25-2011; IN COMMERCE 2-25-2011.

THE MARK CONSISTS OF STANDARD CHARACTERS WITHOUT CLAIM TO ANY PARTICULAR FONT, STYLE, SIZE, OR COLOR.

SN 85-124,853, FILED 9-8-2010.

INGRID C. EULIN, EXAMINING ATTORNEY



David J. Kyffers

Director of the United States Patent and Trademark Office

United States of America

United States Patent and Trademark Office

YOUR DECK... YOUR NEW DECK!!!!

Reg. No. 4,206,568

Registered Sep. 11, 2012

Int. Cl.: 37

SERVICE MARK

PRINCIPAL REGISTER

TIMKO, BENJAMIN J. (UNITED STATES INDIVIDUAL)
CLEARFIELD MALL
1800 DAISY STREET
CLEARFIELD, PA 16830

FOR: RESURFACING DECKS OF ANY TYPE OF CONSTRUCTION, IN CLASS 37 (U.S. CLS. 100, 103 AND 106).

FIRST USE 9-17-2010; IN COMMERCE 9-17-2010.

THE MARK CONSISTS OF STANDARD CHARACTERS WITHOUT CLAIM TO ANY PARTICULAR FONT, STYLE, SIZE, OR COLOR.

NO CLAIM IS MADE TO THE EXCLUSIVE RIGHT TO USE "DECK", APART FROM THE MARK AS SHOWN.

SN 85-126,066, FILED 9-9-2010.

DOUGLAS LEE, EXAMINING ATTORNEY



David J. Kybas

Director of the United States Patent and Trademark Office

United States of America

United States Patent and Trademark Office

HULDRA

Reg. No. 4,206,569

FLEET WHOLESALE SUPPLY CO., INC. (WISCONSIN CORPORATION)
1300 SOUTH LYNNDALE DRIVE
APPLETON, WI 54914

Registered Sep. 11, 2012

Int. Cl.: 25

FOR: CLOTHING, NAMELY, SHIRTS, SWEATERS, T-SHIRTS, PANTS, JACKETS, HATS,
AND BOOTS, IN CLASS 25 (U.S. CLS. 22 AND 39).

TRADEMARK

FIRST USE 1-27-2012; IN COMMERCE 2-7-2012.

PRINCIPAL REGISTER

THE MARK CONSISTS OF STANDARD CHARACTERS WITHOUT CLAIM TO ANY PAR-
TICULAR FONT, STYLE, SIZE, OR COLOR.

SN 85-126,325, FILED 9-9-2010.

MATTHEW KLINE, EXAMINING ATTORNEY



David J. Kappas

Director of the United States Patent and Trademark Office

United States of America

United States Patent and Trademark Office

THE SILVER SAGES

Reg. No. 4,206,570

Registered Sep. 11, 2012

Int. Cl.: 25

TRADEMARK

PRINCIPAL REGISTER

JOHNSON, MELLANIA (UNITED STATES INDIVIDUAL)
DRMELL@EARTHLINK.NET
3028 ABBEY PARK
VESTAVIA, AL 35243

FOR: BASEBALL CAPS; T-SHIRTS; UNDERPANTS, IN CLASS 25 (U.S. CLS. 22 AND 39).

FIRST USE 8-1-2010; IN COMMERCE 8-1-2010.

THE MARK CONSISTS OF STANDARD CHARACTERS WITHOUT CLAIM TO ANY PARTICULAR FONT, STYLE, SIZE, OR COLOR.

SN 85-126,430, FILED 9-9-2010.

WILLIAM P. SHANAHAN, EXAMINING ATTORNEY



David J. Kybas

Director of the United States Patent and Trademark Office

United States of America

United States Patent and Trademark Office

WHEN FINDING PATIENTS THE RIGHT WAY MATTERS

Reg. No. 4,206,571

Registered Sep. 11, 2012

Int. Cl.: 38

SERVICE MARK

PRINCIPAL REGISTER

JAXRESEARCH SYSTEMS, LLC (FLORIDA LIMITED LIABILITY COMPANY)
4085 UNIVERSITY BLVD., SOUTH
SUITE 1
JACKSONVILLE, FL 32216

FOR: PROVIDING A TELECOMMUNICATIONS LINK BETWEEN PROVIDERS OF HEALTH PRODUCTS AND SERVICES AND GROUPS OF PATIENTS USING A PHYSICIAN SUPERVISED WEB-BASED SYSTEM, IN CLASS 38 (U.S. CLS. 100, 101 AND 104).

FIRST USE 10-7-2010; IN COMMERCE 10-7-2010.

THE MARK CONSISTS OF STANDARD CHARACTERS WITHOUT CLAIM TO ANY PARTICULAR FONT, STYLE, SIZE, OR COLOR.

SN 85-128,465, FILED 9-13-2010.

ANNE MADDEN, EXAMINING ATTORNEY



David J. Kyffers

Director of the United States Patent and Trademark Office

United States of America

United States Patent and Trademark Office

DYNASTY CUT

Reg. No. 4,206,572

LEON MEGE, INC. (NEW YORK CORPORATION)
2 WEST 47TH STREET #1408
NEW YORK, NY 10036

Registered Sep. 11, 2012

Int. Cl.: 14

FOR: CUT DIAMONDS, IN CLASS 14 (U.S. CLS. 2, 27, 28 AND 50).

TRADEMARK

FIRST USE 5-15-2011; IN COMMERCE 5-20-2011.

PRINCIPAL REGISTER

THE MARK CONSISTS OF STANDARD CHARACTERS WITHOUT CLAIM TO ANY PARTICULAR FONT, STYLE, SIZE, OR COLOR.

NO CLAIM IS MADE TO THE EXCLUSIVE RIGHT TO USE "CUT", APART FROM THE MARK AS SHOWN.

SN 85-129,609, FILED 9-14-2010.

SCOTT BIBB, EXAMINING ATTORNEY



David J. Kyffers

Director of the United States Patent and Trademark Office

United States of America

United States Patent and Trademark Office

AWKWARD FAMILY PET PHOTOS

Reg. No. 4,206,573

Registered Sep. 11, 2012

Int. Cl.: 16

TRADEMARK

PRINCIPAL REGISTER

AWKWARD FAMILY, LLC (CALIFORNIA LIMITED LIABILITY COMPANY)
9200 SUNSET BLVD., SUITE 1200
LICHTER GROSSMAN NICHOLS ADLER & FELDMAN
WEST HOLLYWOOD, CA 90069

FOR: ANNOUNCEMENT CARDS; BLANK CARDS; BLANK NOTE CARDS; CARDS BEARING UNIVERSAL GREETINGS; CORRESPONDENCE CARDS; GIFT CARDS; GREETING CARDS; GREETINGS CARDS AND POSTCARDS; NOTE CARDS; SOCIAL NOTE CARDS; POSTERS; CALENDARS; DESK CALENDARS; SERIES OF NON-FICTION BOOKS IN THE FIELD OF HUMOR, SOCIAL SATIRE, NEWS, AND COMEDY, IN CLASS 16 (U.S. CLS. 2, 5, 22, 23, 29, 37, 38 AND 50).

FIRST USE 7-0-2011; IN COMMERCE 7-0-2011.

THE MARK CONSISTS OF STANDARD CHARACTERS WITHOUT CLAIM TO ANY PARTICULAR FONT, STYLE, SIZE, OR COLOR.

NO CLAIM IS MADE TO THE EXCLUSIVE RIGHT TO USE "FAMILY PET PHOTOS", APART FROM THE MARK AS SHOWN.

SN 85-130,445, FILED 9-15-2010.

DAVID H. STINE, EXAMINING ATTORNEY



David J. Kyffers

Director of the United States Patent and Trademark Office

United States of America

United States Patent and Trademark Office

WILD & BREEZY

Reg. No. 4,206,574

VICTORIA'S SECRET STORES BRAND MANAGEMENT, INC. (DELAWARE CORPORATION)
FOUR LIMITED PARKWAY
REYNOLDSBURG, OH 43068

Registered Sep. 11, 2012

Int. Cl.: 3

FOR: BODY LOTIONS; BODY SPRAYS; NON-MEDICATED SKIN CARE PREPARATION,
NAMELY, BODY MIST, IN CLASS 3 (U.S. CLS. 1, 4, 6, 50, 51 AND 52).

TRADEMARK

FIRST USE 6-22-2012; IN COMMERCE 6-22-2012.

PRINCIPAL REGISTER

THE MARK CONSISTS OF STANDARD CHARACTERS WITHOUT CLAIM TO ANY PAR-
TICULAR FONT, STYLE, SIZE, OR COLOR.

SN 85-133,481, FILED 9-20-2010.

ANTHONY RINKER, EXAMINING ATTORNEY



David J. Kybas

Director of the United States Patent and Trademark Office

United States of America

United States Patent and Trademark Office



NATIONAL LAND REALTY

Reg. No. 4,206,575

NATIONAL LAND REALTY, LLC (SOUTH CAROLINA LIMITED LIABILITY COMPANY)
103 LAUREL AVEUNE
GOOSE CREEK, SC 29445

Registered Sep. 11, 2012

Int. Cl.: 36

FOR: REAL ESTATE SERVICES, NAMELY, REAL ESTATE BROKERAGE, IN CLASS 36
(U.S. CLS. 100, 101 AND 102).

SERVICE MARK

FIRST USE 7-1-2011; IN COMMERCE 7-1-2011.

PRINCIPAL REGISTER

NO CLAIM IS MADE TO THE EXCLUSIVE RIGHT TO USE "NATIONAL LAND REALTY",
APART FROM THE MARK AS SHOWN.

THE MARK CONSISTS OF THE WORD "NATIONAL" WITH A TREE COMING OUT OF
THE "I" IN "NATIONAL". THE WORD "NATIONAL" IS UNDERLINED AND UNDERNEATH
THAT IS THE WORDING "LAND REALTY".

SN 85-134,238, FILED 9-21-2010.

DEZMONA MIZELLE, EXAMINING ATTORNEY



David J. Kybas

Director of the United States Patent and Trademark Office

United States of America

United States Patent and Trademark Office

AMBIT ADVANTAGES

Reg. No. 4,206,576

AMBIT ENERGY HOLDINGS, L.L.C. (TEXAS LIMITED LIABILITY COMPANY)
1801 N. LAMAR STREET, SUITE 200
DALLAS, TX 75202

Registered Sep. 11, 2012

Int. Cl.: 39

FOR: DISTRIBUTION OF ENERGY, NAMELY, PROVIDING ELECTRICAL ENERGY AND NATURAL GAS TO RESIDENTIAL AND COMMERCIAL USERS, IN CLASS 39 (U.S. CLS. 100 AND 105).

SERVICE MARK

FIRST USE 6-0-2010; IN COMMERCE 6-0-2010.

PRINCIPAL REGISTER

THE MARK CONSISTS OF STANDARD CHARACTERS WITHOUT CLAIM TO ANY PARTICULAR FONT, STYLE, SIZE, OR COLOR.

OWNER OF U.S. REG. NOS. 3,389,005, 3,443,624, AND 3,786,848.

NO CLAIM IS MADE TO THE EXCLUSIVE RIGHT TO USE "ADVANTAGES", APART FROM THE MARK AS SHOWN.

SN 85-134,310, FILED 9-21-2010.

LINDA MICKLEBURGH, EXAMINING ATTORNEY



David J. Kyffers

Director of the United States Patent and Trademark Office

United States of America

United States Patent and Trademark Office

CHIVEL

Reg. No. 4,206,577

Registered Sep. 11, 2012

Int. Cl.: 18

TRADEMARK

PRINCIPAL REGISTER

CARRYING SOLUTION, INC. (CALIFORNIA CORPORATION)
14595 EXCELSIOR AVE.,
CHINO, CA 91710

FOR: LUGGAGE, COSMETIC CASES SOLD EMPTY, GARMENT BAGS FOR TRAVEL, TOTE BAGS AND ATTACHÉ CASES; MEN'S SHAVING BAGS SOLD EMPTY; COSMETICS BAGS SOLD EMPTY; GROOMING ORGANIZERS FOR TRAVEL; LUGGAGE IN THE NATURE OF SHOE CASES FOR TRAVEL; JEWELRY ORGANIZERS FOR TRAVEL; COLLAPSIBLE RE-USEABLE SHOPPING BAGS; LUGGAGE STRAPS; LUGGAGE TAGS; LUGGAGE STRAP SHOULDER PROTECTORS; FOLDABLE TRAVEL UMBRELLAS; UMBRELLAS; BILLFOLDS, KEY CASES, CREDIT CARD CASES, BUSINESS CARD CASES, SHOE COVER BAGS FOR TRAVEL; WAIST PACKS; BACKPACKS, WHEELED BACKPACKS, MESSENGER BAGS, WHEELED MESSENGER BAGS, DUFFLE BAGS, WHEELED DUFFLE BAGS, TOTE BAGS, SHOULDER BAGS, COSMETIC CARRYING CASES SOLD EMPTY, WALLETS, DOCUMENT CASES, BOOK BAGS, SCHOOL BAGS, SHOE BAGS FOR TRAVEL, BOOT BAGS FOR TRAVEL; BRIEFCASES, KEY CASES, COIN PURSES, HANDBAGS, PURSES, ORGANIZER TOTE BAGS, COLLAPSIBLE TEXTILE SHOPPING BAGS, IN CLASS 18 (U.S. CLS. 1, 2, 3, 22 AND 41).

FIRST USE 5-14-2010; IN COMMERCE 3-26-2012.

THE MARK CONSISTS OF STANDARD CHARACTERS WITHOUT CLAIM TO ANY PARTICULAR FONT, STYLE, SIZE, OR COLOR.

SN 85-135,101, FILED 9-21-2010.

JOHN SCHUYLER YARD, EXAMINING ATTORNEY



David J. Kypos

Director of the United States Patent and Trademark Office

United States of America
United States Patent and Trademark Office

USAir

Reg. No. 4,206,578

Registered Sep. 11, 2012

Int. Cl.: 25

TRADEMARK

PRINCIPAL REGISTER

US AIRWAYS, INC. (DELAWARE CORPORATION)
111 W. RIO SALADO PARKWAY
TEMPE, AZ 85281

FOR: HATS, IN CLASS 25 (U.S. CLS. 22 AND 39).

FIRST USE 2-14-2012; IN COMMERCE 2-14-2012.

OWNER OF U.S. REG. NO. 1,243,867.

THE MARK CONSISTS OF A STYLIZED VERSION OF THE WORD "USAIR" WITH THE LETTERS "I" AND "R" IN LOWER CASE.

SN 85-137,862, FILED 9-24-2010.

ALLISON HOLTZ, EXAMINING ATTORNEY



David J. Kyffers

Director of the United States Patent and Trademark Office

United States of America

United States Patent and Trademark Office

Snow Crunch

Reg. No. 4,206,579

MICK FINK (UNITED STATES INDIVIDUAL)
4732 FALLING ACORN CIRCLE
LAKE MARY, FL 32746

Registered Sep. 11, 2012

Int. Cl.: 30

FOR: CHOCOLATE; CHOCOLATES AND CHOCOLATE BASED READY TO EAT CANDIES AND SNACKS; CONFECTIONERIES, NAMELY, SNACK FOODS, NAMELY, CHOCOLATE; SNACK FOODS, NAMELY, CHOCOLATE-BASED SNACK FOODS, IN CLASS 30 (U.S. CL. 46).

TRADEMARK

PRINCIPAL REGISTER

FIRST USE 9-30-2009; IN COMMERCE 9-30-2009.

THE MARK CONSISTS OF STANDARD CHARACTERS WITHOUT CLAIM TO ANY PARTICULAR FONT, STYLE, SIZE, OR COLOR.

NO CLAIM IS MADE TO THE EXCLUSIVE RIGHT TO USE "CRUNCH", APART FROM THE MARK AS SHOWN.

SN 85-142,132, FILED 9-30-2010.

KATHY DE JONGE, EXAMINING ATTORNEY



David J. Kybas

Director of the United States Patent and Trademark Office

United States of America

United States Patent and Trademark Office

PIEDRA AZUL

Reg. No. 4,206,580

Registered Sep. 11, 2012

Int. Cl.: 33

TRADEMARK

PRINCIPAL REGISTER

THE WINE GROUP LLC (DELAWARE LIMITED LIABILITY COMPANY)
4596 S. TRACY BOULEVARD
TRACY, CA 95377

FOR: TEQUILA, IN CLASS 33 (U.S. CLS. 47 AND 49).

FIRST USE 7-19-2012; IN COMMERCE 7-19-2012.

THE MARK CONSISTS OF STANDARD CHARACTERS WITHOUT CLAIM TO ANY PARTICULAR FONT, STYLE, SIZE, OR COLOR.

THE ENGLISH TRANSLATION OF "PIEDRA AZUL" IN THE MARK IS "LAPIS LAZULI".

SN 85-142,880, FILED 10-1-2010.

SUNG IN, EXAMINING ATTORNEY



David J. Kyffers

Director of the United States Patent and Trademark Office

United States of America

United States Patent and Trademark Office

SHARE THE EXPERIENCE

Reg. No. 4,206,581

EVOLVED SONIC SOLUTIONS LLC (TEXAS LIMITED LIABILITY COMPANY)
122 CREEKSIDE
VICTORIA, TX 77904

Registered Sep. 11, 2012

Int. Cl.: 9

FOR: ELECTROACOUSTIC TRANSDUCERS; CONSUMER ELECTRONIC PRODUCTS, NAMELY, AUDIO AMPLIFIERS, ELECTRICAL AUDIO CABLES AND CONNECTORS; CASES FOR ELECTROACOUSTIC TRANSDUCERS, IN CLASS 9 (U.S. CLS. 21, 23, 26, 36 AND 38).

TRADEMARK

PRINCIPAL REGISTER

FIRST USE 11-1-2010; IN COMMERCE 11-1-2010.

THE MARK CONSISTS OF STANDARD CHARACTERS WITHOUT CLAIM TO ANY PARTICULAR FONT, STYLE, SIZE, OR COLOR.

SN 85-143,196, FILED 10-1-2010.

MATTHEW MCDOWELL, EXAMINING ATTORNEY



David J. Kyffers

Director of the United States Patent and Trademark Office

United States of America

United States Patent and Trademark Office



Reg. No. 4,206,582

Registered Sep. 11, 2012

**Int. Cls.: 9, 16, 18, 21, 25,
and 26**

THE ASSOCIATION OF PET DOG TRAINERS (NEW JERSEY CORPORATION)
101 N. MAIN STREET, SUITE 610
GREENVILLE, SC 29601

FOR: MAGNETS, MOUSE PADS, IN CLASS 9 (U.S. CLS. 21, 23, 26, 36 AND 38).

FIRST USE 1-0-2011; IN COMMERCE 1-0-2011.

TRADEMARK

FOR: BLANK JOURNALS, IN CLASS 16 (U.S. CLS. 2, 5, 22, 23, 29, 37, 38 AND 50).

PRINCIPAL REGISTER

FIRST USE 1-0-2011; IN COMMERCE 1-0-2011.

FOR: GYM BAGS, BEACH TOTE BAGS, TOTE BAGS, T-SHIRTS FOR DOGS, MESSENGER BAGS, IN CLASS 18 (U.S. CLS. 1, 2, 3, 22 AND 41).

FIRST USE 1-0-2011; IN COMMERCE 1-0-2011.

FOR: MUGS, CERAMIC TRAVEL MUGS, PET FEEDING AND DRINKING BOWLS, PLASTIC AND ALUMINUM WATER BOTTLES SOLD EMPTY, IN CLASS 21 (U.S. CLS. 2, 13, 23, 29, 30, 33, 40 AND 50).

FIRST USE 1-0-2011; IN COMMERCE 1-0-2011.

FOR: CLOTHING, NAMELY, JERSEYS, CAPS, T-SHIRTS, GOLF SHIRTS, SWEATSHIRTS, HATS, INFANT WEAR, IN CLASS 25 (U.S. CLS. 22 AND 39).

FIRST USE 1-0-2011; IN COMMERCE 1-0-2011.

FOR: BUTTONS, IN CLASS 26 (U.S. CLS. 37, 39, 40, 42 AND 50).

FIRST USE 1-0-2011; IN COMMERCE 1-0-2011.

THE MARK CONSISTS OF A CROUCHING HUMAN FACING A DOG STANDING ON ITS HIND LEGS.

SN 85-143,874, FILED 10-3-2010.



David J. Kybas

Director of the United States Patent and Trademark Office

Reg. No. 4,206,582 WENDY JUN, EXAMINING ATTORNEY

United States of America

United States Patent and Trademark Office

CT GUIDE

Reg. No. 4,206,583

Registered Sep. 11, 2012

Int. Cl.: 10

TRADEMARK

PRINCIPAL REGISTER

ACTIVIEWS LTD. (ISRAEL CORPORATION)
BEIT ITZHAK, 7 NAHUM HAAT ST.
HAIFA, ISRAEL 31905

FOR: MEDICAL DEVICES, NAMELY, AN OPTICAL NAVIGATION SYSTEM FOR ASSISTANCE IN PERFORMING PERCUTANEOUS SURGICAL INTERVENTIONS; MEDICAL DEVICES IN THE FIELD OF IMAGE ASSISTANCE IN INTERVENTIONAL RADIOLOGY PROCEDURES, NAMELY, X-RAY BIOPSY DEVICES, MRI BIOPSY DEVICES; MEDICAL AND SURGICAL APPARATUS AND INSTRUMENTS, NAMELY, MEDICAL APPARATUS AND INSTRUMENTS FOR USE IN MEDICAL IMAGING; MEDICAL APPARATUS AND INSTRUMENTS FOR USE IN INTERVENTIONAL RADIOLOGY; MEDICAL APPARATUS AND INSTRUMENTS FOR USE IN IMAGE ASSISTED SURGICAL PROCEDURES; MEDICAL APPARATUS AND INSTRUMENTS FOR USE IN COMPUTER ASSISTED SURGICAL PROCEDURES; MEDICAL APPARATUS AND INSTRUMENTS FOR USE WITHIN A MAGNETIC RESONANCE APPARATUS, NAMELY, IMAGING DEVICES FOR PERFORMING INTERVENTIONAL RADIOLOGY PROCEDURES; MEDICAL APPARATUS AND INSTRUMENTS FOR USE WITHIN MAMMOGRAPHY APPARATUS, NAMELY, DEVICES FOR PERFORMING DIAGNOSTIC AND THERAPEUTIC PROCEDURES IN THE NATURE OF IMAGE ASSISTED BIOPSIES AND TUMOR ABLATION; MEDICAL APPARATUS AND INSTRUMENTS FOR USE WITHIN FLUOROSCOPY IMAGING DEVICES, NAMELY, DEVICES FOR PERFORMING DIAGNOSTIC AND THERAPEUTIC PROCEDURES IN THE NATURE OF IMAGE ASSISTED BIOPSIES AND TUMOR ABLATION; MEDICAL APPARATUS AND INSTRUMENTS FOR USE WITHIN ULTRASOUND IMAGING DEVICES, NAMELY, DEVICES FOR PERFORMING DIAGNOSTIC AND THERAPEUTIC PROCEDURES IN THE NATURE OF IMAGE ASSISTED BIOPSIES AND TUMOR ABLATION, IN CLASS 10 (U.S. CLS. 26, 39 AND 44).



FIRST USE 7-13-2011; IN COMMERCE 7-13-2011.

THE MARK CONSISTS OF STANDARD CHARACTERS WITHOUT CLAIM TO ANY PARTICULAR FONT, STYLE, SIZE, OR COLOR.

NO CLAIM IS MADE TO THE EXCLUSIVE RIGHT TO USE "CT", APART FROM THE MARK AS SHOWN.

SN 85-143,999, FILED 10-4-2010.

NAAKWAMA ANKRAH, EXAMINING ATTORNEY

David J. Kypos

Director of the United States Patent and Trademark Office

United States of America

United States Patent and Trademark Office

MM&I. Me myself and I . Its all about you

Reg. No. 4,206,584

Registered Sep. 11, 2012

Int. Cl.: 25

TRADEMARK

PRINCIPAL REGISTER

ISOLINO ROBERT S. (UNITED STATES INDIVIDUAL), DBA MM&I. ME MYSELF AND I
. IT'S ALL ABOUT YOU.,
PO BOX 230787
NEW YORK, NY 10023

FOR: MENS' AND BOYS' CLOTHING APPAREL, NAMELY, WOVEN AND KNIT TOPS AND
JACKETS, IN CLASS 25 (U.S. CLS. 22 AND 39).

FIRST USE 1-10-2011; IN COMMERCE 9-30-2011.

THE MARK CONSISTS OF STANDARD CHARACTERS WITHOUT CLAIM TO ANY PAR-
TICULAR FONT, STYLE, SIZE, OR COLOR.

SN 85-144,115, FILED 10-4-2010.

EDWARD NELSON, EXAMINING ATTORNEY



David J. Kyffers

Director of the United States Patent and Trademark Office

United States of America

United States Patent and Trademark Office

SMART PLAN

Reg. No. 4,206,585

SEARS BRANDS, LLC (ILLINOIS LIMITED LIABILITY COMPANY)

Registered Sep. 11, 2012

3333 BEVERLY ROAD
HOFFMAN ESTATES, IL 60179

Int. Cl.: 36

FOR: EXTENDED WARRANTY SERVICES, NAMELY, SERVICE CONTRACTS; PROVIDING EXTENDED WARRANTIES ON CONSUMER ELECTRONIC PRODUCTS, MAJOR AND SMALL APPLIANCES, JEWELRY AND WATCHES, SPORTING GOODS, TOYS, HEALTH AND BEAUTY PRODUCTS, LAWN AND GARDEN EQUIPMENT, OUTDOOR POWER EQUIPMENT, FLOORCARE EQUIPMENT, POWER TOOLS, HOME IMPROVEMENT PRODUCTS, AUTOMOTIVE PARTS AND ACCESSORIES, HEATERS, FANS, PAPER SHREDDERS, BABY MONITORS AND SEASONAL DECORATIONS, IN CLASS 36 (U.S. CLS. 100, 101 AND 102).

SERVICE MARK

PRINCIPAL REGISTER

FIRST USE 11-1-1996; IN COMMERCE 11-1-1996.

THE MARK CONSISTS OF STANDARD CHARACTERS WITHOUT CLAIM TO ANY PARTICULAR FONT, STYLE, SIZE, OR COLOR.

NO CLAIM IS MADE TO THE EXCLUSIVE RIGHT TO USE "PLAN", APART FROM THE MARK AS SHOWN.

SN 85-144,984, FILED 10-5-2010.

JOHN HWANG, EXAMINING ATTORNEY



David J. Kypos

Director of the United States Patent and Trademark Office

United States of America

United States Patent and Trademark Office



Reg. No. 4,206,586

Registered Sep. 11, 2012

Int. Cl.: 31

TRADEMARK

PRINCIPAL REGISTER

SAN JOSE TROPICAL FRUITS, LLC (TEXAS LIMITED LIABILITY COMPANY)
SUITE 902
501 N BRIDGE ST
HIDALGO, TX 78557

FOR: FRESH TOMATOES, IN CLASS 31 (U.S. CLS. 1 AND 46).

FIRST USE 6-0-2011; IN COMMERCE 6-0-2011.

NO CLAIM IS MADE TO THE EXCLUSIVE RIGHT TO USE "TOMATOES" AND THE PICTORIAL REPRESENTATION OF A TOMATO, APART FROM THE MARK AS SHOWN.

THE MARK CONSISTS OF A TOMATO ON A FIELD WITH A SUN AND CLOUDS, ALL WITHIN A CIRCLE. THE WORDS "SUN TOMATOS" ON A BANNER, IN FRONT.

SN 85-145,249, FILED 10-5-2010.

MARLENE BELL, EXAMINING ATTORNEY



David J. Kybas

Director of the United States Patent and Trademark Office

United States of America

United States Patent and Trademark Office



Reg. No. 4,206,587

Registered Sep. 11, 2012

Int. Cl.: 3

TRADEMARK

PRINCIPAL REGISTER

JOHNSON & JOHNSON (NEW JERSEY CORPORATION)
ONE JOHNSON & JOHNSON PLAZA
NEW BRUNSWICK, NJ 089337001

FOR: GIFT BOX CONTAINING BABY PRODUCTS, NAMELY, BODY WASH AND SKIN CLEANSER, HAIR SHAMPOO, BODY LOTION AND CREAM, NON-MEDICATED DIAPER RASH CREAM, AND POWDER, IN CLASS 3 (U.S. CLS. 1, 4, 6, 50, 51 AND 52).

FIRST USE 5-8-2012; IN COMMERCE 5-8-2012.

OWNER OF U.S. REG. NOS. 620,110, 3,729,122, AND OTHERS.

THE MARK CONSISTS OF THREE OVERLAPPING STYLIZED TEAR DROPS WITH THE STYLIZED WORD "JOHNSON'S" OVER IT.

SN 85-146,988, FILED 10-7-2010.

LAKEISHA LEWIS, EXAMINING ATTORNEY



David J. Kybas

Director of the United States Patent and Trademark Office

United States of America

United States Patent and Trademark Office

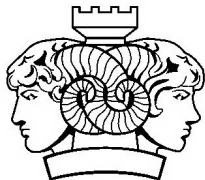

SAVOY

Reg. No. 4,206,588

Registered Sep. 11, 2012

Int. Cl.: 14

TRADEMARK

PRINCIPAL REGISTER

SAVOY, PASCAL (SWITZERLAND INDIVIDUAL)
SUITE 502
2455 E. SUNRISE BLVD.
FORT LAUDERDALE, FL 33304

FOR: JEWELRY; WATCHES, IN CLASS 14 (U.S. CLS. 2, 27, 28 AND 50).

FIRST USE 10-31-2011; IN COMMERCE 10-31-2011.

THE MARK CONSISTS OF OPPOSITE MALE AND FEMALE'S HEAD WITH RAM'S HORNS
IN FRONT OF A TOWER AND THE STYLIZED TEXT "SAVOY" UNDERNEATH.

SN 85-147,166, FILED 10-7-2010.

EMILY CHUO, EXAMINING ATTORNEY



David J. Kybas

Director of the United States Patent and Trademark Office

United States of America

United States Patent and Trademark Office

FIVE BROTHERS

Reg. No. 4,206,589

UNILEVER N.V. (NETHERLANDS NAAMLOZE VENNOOTSCHAP (NV))
WEENA 455

Registered Sep. 11, 2012

ROTTERDAM 3013 AL, NETHERLANDS

Int. Cl.: 30

FOR: PASTA SAUCE, IN CLASS 30 (U.S. CL. 46).

TRADEMARK

FIRST USE 6-0-1995; IN COMMERCE 6-0-1995.

PRINCIPAL REGISTER

THE MARK CONSISTS OF STANDARD CHARACTERS WITHOUT CLAIM TO ANY PARTICULAR FONT, STYLE, SIZE, OR COLOR.

OWNER OF U.S. REG. NO. 2,054,587.

SN 85-148,079, FILED 10-8-2010.

IRA J. GOODSaid, EXAMINING ATTORNEY



David J. Kyffers

Director of the United States Patent and Trademark Office

United States of America

United States Patent and Trademark Office

THE BREWS KEY

Reg. No. 4,206,590

SHINIE HINIE LLC (TEXAS LIMITED LIABILITY COMPANY)

Registered Sep. 11, 2012

9631 MCCULLOUGH
SAN ANTONIO, TX 782164444

Int. Cls.: 21 and 30

FOR: FLAVORING APPLICATORS IN THE NATURE OF HAND-OPERATED PRESS-LIKE DEVICES FOR APPLYING FLAVORINGS TO BEER, ALCOHOLIC BEVERAGES, AND NON-ALCOHOLIC BEVERAGES AND TO CONTAINERS FOR THE SAME, IN CLASS 21 (U.S. CLS. 2, 13, 23, 29, 30, 33, 40 AND 50).

TRADEMARK

PRINCIPAL REGISTER

FIRST USE 5-22-2012; IN COMMERCE 5-22-2012.

FOR: FLAVORINGS FOR BEVERAGES, NAMELY, FLAVORINGS SOLD IN PLASTIC CARTRIDGES, IN CLASS 30 (U.S. CL. 46).

FIRST USE 5-22-2012; IN COMMERCE 5-22-2012.

THE MARK CONSISTS OF STANDARD CHARACTERS WITHOUT CLAIM TO ANY PARTICULAR FONT, STYLE, SIZE, OR COLOR.

SN 85-148,103, FILED 10-8-2010.

SUSAN RICHARDS, EXAMINING ATTORNEY



David J. Kybas

Director of the United States Patent and Trademark Office

United States of America

United States Patent and Trademark Office

UNLOCK THE FLAVOR OF YOUR BEER

Reg. No. 4,206,591

SHINIE HINIE LLC (TEXAS LIMITED LIABILITY COMPANY)

Registered Sep. 11, 2012

9631 MCCULLOUGH
SAN ANTONIO, TX 782164444

Int. Cls.: 21 and 30

FOR: FLAVORING APPLICATORS IN THE NATURE OF HAND-OPERATED PRESS-LIKE DEVICES FOR APPLYING FLAVORINGS TO BEER, ALCOHOLIC BEVERAGES, AND NON-ALCOHOLIC BEVERAGES AND TO CONTAINERS FOR THE SAME, IN CLASS 21 (U.S. CLS. 2, 13, 23, 29, 30, 33, 40 AND 50).

TRADEMARK

PRINCIPAL REGISTER

FIRST USE 5-22-2012; IN COMMERCE 5-22-2012.

FOR: FLAVORINGS FOR BEVERAGES, NAMELY, FLAVORINGS SOLD IN PLASTIC CARTRIDGES, IN CLASS 30 (U.S. CL. 46).

FIRST USE 5-22-2012; IN COMMERCE 5-22-2012.

THE MARK CONSISTS OF STANDARD CHARACTERS WITHOUT CLAIM TO ANY PARTICULAR FONT, STYLE, SIZE, OR COLOR.

NO CLAIM IS MADE TO THE EXCLUSIVE RIGHT TO USE "BEER" , APART FROM THE MARK AS SHOWN.

SN 85-148,106, FILED 10-8-2010.

SUSAN RICHARDS, EXAMINING ATTORNEY



David J. Kybas

Director of the United States Patent and Trademark Office

United States of America

United States Patent and Trademark Office

TRANSWITCHER

Reg. No. 4,206,592

SOUTHERN STATES, LLC (GEORGIA CORPORATION)
30 GEORGIA AVENUE
HAMPTON, GA 30028

Registered Sep. 11, 2012

Int. Cl.: 9

FOR: ELECTRICAL SWITCH GEAR, NAMELY, HIGH VOLTAGE SWITCHING APPARATUS, IN CLASS 9 (U.S. CLS. 21, 23, 26, 36 AND 38).

TRADEMARK

FIRST USE 6-19-2010; IN COMMERCE 6-19-2010.

PRINCIPAL REGISTER

THE MARK CONSISTS OF STANDARD CHARACTERS WITHOUT CLAIM TO ANY PARTICULAR FONT, STYLE, SIZE, OR COLOR.

SN 85-149,377, FILED 10-11-2010.

ODESSA BIBBINS, EXAMINING ATTORNEY



David J. Kybas

Director of the United States Patent and Trademark Office

United States of America

United States Patent and Trademark Office

CLR CHORE WARS

Reg. No. 4,206,593

JELMAR LLC (ILLINOIS LIMITED LIABILITY COMPANY)
5550 W. TOUHY AVE.
SKOKIE, IL 60077

Registered Sep. 11, 2012

Int. Cls.: 1 and 3

FOR: CHEMICAL COMPOSITIONS FOR REMOVING DEPOSITS OF CALCIUM, LIME AND RUST STAINS FROM GLASS, PORCELAIN, CEMENT, STUCCO, CHROME AND METAL SURFACES, IN CLASS 1 (U.S. CLS. 1, 5, 6, 10, 26 AND 46).

TRADEMARK

FIRST USE 4-4-2012; IN COMMERCE 4-4-2012.

PRINCIPAL REGISTER

FOR: ALL PURPOSE CLEANING, POLISHING, TARNISHING AND STAIN REMOVING PREPARATIONS; AEROSOL DRAIN OPENERS; CLEANING PREPARATIONS FOR REMOVING DEPOSIT BUILDUPS FROM SEPTIC RETAINING TANKS; CHEMICAL COMPOSITIONS IN THE NATURE OF CLEANERS USED TO REMOVE DEPOSITS OF CALCIUM, LIME AND RUST STAINS FROM GLASS, PORCELAIN, CEMENT, STUCCO, CHROME AND METAL SURFACES, IN CLASS 3 (U.S. CLS. 1, 4, 6, 50, 51 AND 52).

FIRST USE 4-4-2012; IN COMMERCE 4-4-2012.

THE MARK CONSISTS OF STANDARD CHARACTERS WITHOUT CLAIM TO ANY PARTICULAR FONT, STYLE, SIZE, OR COLOR.

OWNER OF U.S. REG. NOS. 1,922,799, 2,060,031, AND 3,084,266.

SN 85-149,456, FILED 10-11-2010.

BRENDAN MCCAULEY, EXAMINING ATTORNEY



David J. Kybas

Director of the United States Patent and Trademark Office

United States of America

United States Patent and Trademark Office

SMILE UNIVERSITY

Reg. No. 4,206,594

Registered Sep. 11, 2012

Int. Cl.: 41

SERVICE MARK

PRINCIPAL REGISTER

SMILE BRANDS INC. (WASHINGTON CORPORATION)
8105 IRVINE CENTER DRIVE, 15TH FLOOR
IRVINE, CA 92618

FOR: EDUCATIONAL SERVICES, NAMELY, CONDUCTING CLASSES, SEMINARS, WORKSHOPS, CONFERENCES AND SYMPOSIA IN THE FIELD OF DENTISTRY AND DENTAL HEALTH CARE, BUSINESS MANAGEMENT, HUMAN RESOURCE MANAGEMENT, MARKETING AND LEADERSHIP, AND DISTRIBUTION OF COURSE MATERIALS IN CONNECTION THEREWITH; PROVIDING CONTINUING DENTAL EDUCATION COURSES, AND DISTRIBUTING COURSE MATERIALS IN CONNECTION THEREWITH; PROVIDING TRAINING ON ENSURING PATIENT SATISFACTION IN THE FIELD OF DENTISTRY, IN CLASS 41 (U.S. CLS. 100, 101 AND 107).

FIRST USE 1-14-2011; IN COMMERCE 1-14-2011.

THE MARK CONSISTS OF STANDARD CHARACTERS WITHOUT CLAIM TO ANY PARTICULAR FONT, STYLE, SIZE, OR COLOR.

NO CLAIM IS MADE TO THE EXCLUSIVE RIGHT TO USE "UNIVERSITY", APART FROM THE MARK AS SHOWN.

SN 85-149,469, FILED 10-11-2010.

BRENDAN MCCAULEY, EXAMINING ATTORNEY



David J. Kyffers

Director of the United States Patent and Trademark Office

United States of America

United States Patent and Trademark Office



Reg. No. 4,206,595

Registered Sep. 11, 2012

Int. Cl.: 5

TRADEMARK

PRINCIPAL REGISTER

JOHNSON & JOHNSON (NEW JERSEY CORPORATION)
ONE JOHNSON & JOHNSON PLAZA
NEW BRUNSWICK, NJ 089337001

FOR: OPHTHALMIC PREPARATIONS, IN CLASS 5 (U.S. CLS. 6, 18, 44, 46, 51 AND 52).

FIRST USE 7-8-2010; IN COMMERCE 7-8-2010.

THE MARK CONSISTS OF DIFFERENT SIZED WATER DROPLETS ALL WITHIN A RECTANGLE.

SN 85-149,537, FILED 10-11-2010.

LAKEISHA LEWIS, EXAMINING ATTORNEY



David J. Kyffers

Director of the United States Patent and Trademark Office

United States of America

United States Patent and Trademark Office

DUO-TRAX

Reg. No. 4,206,596

VISION WHEEL, INC. (ALABAMA CORPORATION)
3512 SIXTH AVENUE SE
DECATUR, AL 35603

Registered Sep. 11, 2012

Int. Cl.: 12

FOR: TIRES, IN CLASS 12 (U.S. CLS. 19, 21, 23, 31, 35 AND 44).

TRADEMARK

FIRST USE 3-5-2012; IN COMMERCE 3-5-2012.

PRINCIPAL REGISTER

THE MARK CONSISTS OF STANDARD CHARACTERS WITHOUT CLAIM TO ANY PARTICULAR FONT, STYLE, SIZE, OR COLOR.

SN 85-149,611, FILED 10-11-2010.

CHRISIE B. KING, EXAMINING ATTORNEY



David J. Kyffers

Director of the United States Patent and Trademark Office

United States of America

United States Patent and Trademark Office

3P

Reg. No. 4,206,597

Registered Sep. 11, 2012

Int. Cls.: 3 and 5

TRADEMARK

PRINCIPAL REGISTER

PIERRE FABRE DERMO-COSMETIQUE (FRANCE SOCIÉTÉ PAR ACTIONS SIMPLIFIÉE (SAS))
45, PLACE ABEL GANCE
BOULOGNE, FRANCE 92100

FOR: NON-MEDICATED COSMETIC AND CLEANING PREPARATION FOR TREATING ACNE, IN CLASS 3 (U.S. CLS. 1, 4, 6, 50, 51 AND 52).

FIRST USE 1-0-2011; IN COMMERCE 1-0-2011.

FOR: PHARMACEUTICAL PREPARATION FOR TREATING ACNE, IN CLASS 5 (U.S. CLS. 6, 18, 44, 46, 51 AND 52).

FIRST USE 1-0-2011; IN COMMERCE 1-0-2011.

THE MARK CONSISTS OF STANDARD CHARACTERS WITHOUT CLAIM TO ANY PARTICULAR FONT, STYLE, SIZE, OR COLOR.

SN 85-150,804, FILED 10-12-2010.

GENE MACIOL, EXAMINING ATTORNEY



David J. Kyros

Director of the United States Patent and Trademark Office

United States of America

United States Patent and Trademark Office



The Center for Humane Living
An open hand to humanity

Reg. No. 4,206,598

THE CENTER FOR HUMANE LIVING (ARIZONA CORPORATION)
6750 NORTH LOST DUTCHMAN ROAD
PARADISE VALLEY, AZ 85253

Registered Sep. 11, 2012

Int. Cls.: 25, 36, and 41

FOR: CLOTHING FOR WEAR IN MARTIAL ARTS PRACTICES, NAMELY, SHIRTS, PANTS, SUITS, COATS, JACKETS, SWEATERS, BODY SUITS, SWEATSHIRTS, SWEATPANTS, SHORTS, TOPS, BOTTOMS, SLEEPWEAR, UNDERWEAR, LINGERIE, SWIMWEAR, BEACH COVER-UPS, SOCKS, GLOVES, NECKTIES, SCARVES, HATS, VISORS, AND FOOTWEAR, IN CLASS 25 (U.S. CLS. 22 AND 39).

TRADEMARK

SERVICE MARK

PRINCIPAL REGISTER

FIRST USE 11-1-2011; IN COMMERCE 11-1-2011.

FOR: CHARITABLE FUNDRAISING, IN CLASS 36 (U.S. CLS. 100, 101 AND 102).

FIRST USE 5-1-2011; IN COMMERCE 5-1-2011.

FOR: EDUCATIONAL SERVICES, NAMELY, CONDUCTING CLASSES IN THE FIELD OF MARTIAL ARTS, FITNESS, WELLNESS, SPIRITUALITY, SELF-HELP, HUMANITARIAN EFFORTS, ANTI-BULLYING AND PHILOSOPHY IN STUDIO AND VIA ELECTRONIC FORMAT, IN CLASS 41 (U.S. CLS. 100, 101 AND 107).

FIRST USE 5-1-2011; IN COMMERCE 5-1-2011.

NO CLAIM IS MADE TO THE EXCLUSIVE RIGHT TO USE "THE CENTER FOR HUMANE LIVING", APART FROM THE MARK AS SHOWN.

THE MARK CONSISTS OF THE DESIGN OF AN OPEN HAND ABOVE THE WORDS "THE CENTER FOR HUMANE LIVING" ABOVE THE WORDS "AN OPEN HAND TO HUMANITY".

SN 85-151,070, FILED 10-12-2010.

GRETCHEN ULRICH, EXAMINING ATTORNEY



David J. Kyjars

Director of the United States Patent and Trademark Office

United States of America

United States Patent and Trademark Office

PERSONAL

Reg. No. 4,206,599

Registered Sep. 11, 2012

Int. Cl.: 42

SERVICE MARK

PRINCIPAL REGISTER

PERSONAL, INC. (DELAWARE CORPORATION)
1010 WISCONSIN AVE. NW, FIRST FLOOR
WASHINGTON, DC 20007

FOR: PROVIDING A WEBSITE FEATURING TECHNOLOGY THAT ENABLES USERS TO MANAGE AND SHARE THEIR PROFILES AND DATA IN ORDER TO RECEIVE TARGETED COUPONS, REBATES, DISCOUNTS, PROMOTIONAL MESSAGES AND ADVERTISING FROM THIRD PARTY RETAILERS, MARKETERS AND SERVICE PROVIDERS AND TO RECEIVE TARGETED CONTENT AND INFORMATION FROM PUBLISHERS, MEDIA AND CONTENT SERVICE PROVIDERS, IN CLASS 42 (U.S. CLS. 100 AND 101).

FIRST USE 8-11-2010; IN COMMERCE 11-11-2011.

THE MARK CONSISTS OF STANDARD CHARACTERS WITHOUT CLAIM TO ANY PARTICULAR FONT, STYLE, SIZE, OR COLOR.

SN 85-151,607, FILED 10-13-2010.

REBECCA POVARCHUK, EXAMINING ATTORNEY



David J. Kyjars

Director of the United States Patent and Trademark Office

United States of America

United States Patent and Trademark Office

IMPACT TRAKKER

Reg. No. 4,206,600

INSIGHT RESEARCH CORPORATION (TEXAS CORPORATION)
POST OFFICE BOX 61
ALLEN, TX 75013

Registered Sep. 11, 2012

Int. Cl.: 16

FOR: ECONOMIC ANALYSIS REPORTS, NAMELY, PRINTED REPORTS FEATURING ECONOMIC, EMPLOYMENT AND INVESTMENT GRADE TAX REVENUE IMPACT STUDY AND BUSINESS SITE LOCATION REPORTS, IN CLASS 16 (U.S. CLS. 2, 5, 22, 23, 29, 37, 38 AND 50).

TRADEMARK

PRINCIPAL REGISTER

FIRST USE 0-0-2008; IN COMMERCE 0-0-2008.

THE MARK CONSISTS OF STANDARD CHARACTERS WITHOUT CLAIM TO ANY PARTICULAR FONT, STYLE, SIZE, OR COLOR.

NO CLAIM IS MADE TO THE EXCLUSIVE RIGHT TO USE "IMPACT", APART FROM THE MARK AS SHOWN.

SN 85-152,049, FILED 10-13-2010.

KATHERINE E. HALMEN, EXAMINING ATTORNEY



David J. Kybas

Director of the United States Patent and Trademark Office

United States of America

United States Patent and Trademark Office

FLEXTRAK DSM

Reg. No. 4,206,601

Registered Sep. 11, 2012

Int. Cl.: 36

SERVICE MARK

PRINCIPAL REGISTER

INSIGHT RESEARCH CORPORATION (TEXAS CORPORATION)
POST OFFICE BOX 61
DALLAS, TX 75013

FOR: INVESTMENT GRADE TAX REVENUE STUDIES, NAMELY, FINANCIAL FORECASTING STUDIES FOR LOCAL GOVERNMENTS REGARDING REVENUES AND COSTS BASED ON ALTERNATIVE EXPECTATIONS OF LAND USE, IN CLASS 36 (U.S. CLS. 100, 101 AND 102).

FIRST USE 10-1-2002; IN COMMERCE 10-1-2002.

THE MARK CONSISTS OF STANDARD CHARACTERS WITHOUT CLAIM TO ANY PARTICULAR FONT, STYLE, SIZE, OR COLOR.

SN 85-152,113, FILED 10-13-2010.

KATHERINE E. HALMEN, EXAMINING ATTORNEY



David J. Kybas

Director of the United States Patent and Trademark Office

United States of America

United States Patent and Trademark Office

CAN YOUR CITY AFFORD ITS FUTURE?

Reg. No. 4,206,602

INSIGHT RESEARCH CORPORATION (TEXAS CORPORATION)

Registered Sep. 11, 2012

POST OFFICE BOX 61
ALLEN, TX 75013

Int. Cls.: 35 and 36

FOR: ECONOMIC ANALYSIS SERVICES, NAMELY, PROVIDING BUSINESS DATA ANALYSIS THROUGH COST/BENEFIT ANALYSIS, ECONOMIC, EMPLOYMENT AND INVESTMENT GRADE TAX REVENUE IMPACT STUDIES, AND BUSINESS SITE LOCATION STUDIES, IN CLASS 35 (U.S. CLS. 100, 101 AND 102).

SERVICE MARK

PRINCIPAL REGISTER

FIRST USE 10-1-2002; IN COMMERCE 10-1-2002.

FOR: PROVIDING FINANCIAL ANALYSIS THROUGH COST/BENEFIT ANALYSIS, ECONOMIC, EMPLOYMENT AND INVESTMENT GRADE TAX REVENUE IMPACT STUDIES, AND BUSINESS SITE LOCATION STUDIES, IN CLASS 36 (U.S. CLS. 100, 101 AND 102).

FIRST USE 10-1-2002; IN COMMERCE 10-1-2002.

THE MARK CONSISTS OF STANDARD CHARACTERS WITHOUT CLAIM TO ANY PARTICULAR FONT, STYLE, SIZE, OR COLOR.

SN 85-152,127, FILED 10-13-2010.

KATHERINE E. HALMEN, EXAMINING ATTORNEY



David J. Kybas

Director of the United States Patent and Trademark Office

United States of America

United States Patent and Trademark Office



RUSSELL MUNSON

Reg. No. 4,206,603

Registered Sep. 11, 2012

Int. Cl.: 41

SERVICE MARK

PRINCIPAL REGISTER

MUNSON, RUSSELL W., JR. (UNITED STATES INDIVIDUAL)
6TH FLOOR
458 BROADWAY
NEW YORK, NY 10013

FOR: ENTERTAINMENT SERVICES, NAMELY, PROVIDING A WEB SITE FEATURING NON-DOWNLOADABLE AVIATION, AERIAL AND NATURE-THEMED PHOTOGRAPHS; AERIAL PHOTOGRAPHY; PHOTOGRAPHY SERVICES; AVIATION PHOTOGRAPHY, IN CLASS 41 (U.S. CLS. 100, 101 AND 107).

FIRST USE 7-13-2012; IN COMMERCE 7-13-2012.

THE STIPPLING IS FOR SHADING PURPOSES ONLY.

THE NAME "RUSSELL MUNSON" IDENTIFIES A LIVING INDIVIDUAL WHOSE CONSENT IS OF RECORD.

THE MARK CONSISTS OF THE IMAGE OF A FLYING SEAGULL TO THE LEFT OF THE LITERAL ELEMENT "RUSSELL MUNSON".

SN 85-152,134, FILED 10-13-2010.

MARGERY A. TIERNEY, EXAMINING ATTORNEY



David J. Kybas

Director of the United States Patent and Trademark Office

United States of America

United States Patent and Trademark Office

CLARITY PAL

Reg. No. 4,206,604

Registered Sep. 11, 2012

Int. Cl.: 9

TRADEMARK

PRINCIPAL REGISTER

PLANTRONICS, INC. (DELAWARE CORPORATION)
LEGAL DEPARTMENT
345 ENCINAL STREET
SANTA CRUZ, CA 95060

FOR: HANDHELD ELECTRONIC DEVICES, NAMELY, MOBILE PHONES FOR THE
SENDING AND RECEIVING OF TELEPHONE CALLS, IN CLASS 9 (U.S. CLS. 21, 23, 26, 36
AND 38).

FIRST USE 7-9-2012; IN COMMERCE 7-9-2012.

THE MARK CONSISTS OF STANDARD CHARACTERS WITHOUT CLAIM TO ANY PAR-
TICULAR FONT, STYLE, SIZE, OR COLOR.

OWNER OF U.S. REG. NOS. 1,581,278, 3,772,198, AND OTHERS.

SN 85-152,142, FILED 10-13-2010.

DAVID ELTON, EXAMINING ATTORNEY



David J. Kyffers

Director of the United States Patent and Trademark Office

United States of America

United States Patent and Trademark Office

DEADLINE

Reg. No. 4,206,605

Registered Sep. 11, 2012

Int. Cl.: 16

TRADEMARK

PRINCIPAL REGISTER

PENSKE MEDIA CORPORATION (DELAWARE CORPORATION)
9800 S. LA CIENEGA BLVD.
14TH FLOOR
INGLEWOOD, CA 90203

FOR: PROVIDING A MAGAZINE IN THE FIELD OF ENTERTAINMENT, NAMELY, NEWS AND CURRENT EVENTS IN ENTERTAINMENT AND LIFESTYLE INCLUDING AWARD SHOWS, LIVE EVENTS, TELEVISION, MOVIES, INTERVIEWS, REVIEWS, COMMENTARY AND ALL OTHER FORMS OF ENTERTAINMENT, IN CLASS 16 (U.S. CLS. 2, 5, 22, 23, 29, 37, 38 AND 50).

FIRST USE 1-1-2010; IN COMMERCE 1-1-2010.

THE MARK CONSISTS OF THE STYLIZED WORD "DEADLINE".

SN 85-152,206, FILED 10-13-2010.

RENEE MCCRAY, EXAMINING ATTORNEY



David J. Kyffers

Director of the United States Patent and Trademark Office

United States of America

United States Patent and Trademark Office

DEADLINE

Reg. No. 4,206,606

Registered Sep. 11, 2012

Int. Cl.: 16

TRADEMARK

PRINCIPAL REGISTER

PENSKE MEDIA CORPORATION (DELAWARE CORPORATION)
14TH FLOOR
9800 S. LA CIENEGA BLVD.
INGLEWOOD, CA 90203

FOR: PROVIDING A MAGAZINE IN THE FIELD OF ENTERTAINMENT, NAMELY, NEWS AND CURRENT EVENTS IN ENTERTAINMENT AND LIFESTYLE INCLUDING AWARD SHOWS, LIVE EVENTS, TELEVISION, MOVIES, INTERVIEWS, REVIEWS, COMMENTARY AND ALL OTHER FORMS OF ENTERTAINMENT, IN CLASS 16 (U.S. CLS. 2, 5, 22, 23, 29, 37, 38 AND 50).

FIRST USE 1-1-2010; IN COMMERCE 1-1-2010.

THE MARK CONSISTS OF STANDARD CHARACTERS WITHOUT CLAIM TO ANY PARTICULAR FONT, STYLE, SIZE, OR COLOR.

SN 85-152,207, FILED 10-13-2010.

RENEE MCCRAY, EXAMINING ATTORNEY



David J. Kybas

Director of the United States Patent and Trademark Office

United States of America

United States Patent and Trademark Office

SILHOUETTE

Reg. No. 4,206,607

KIMBERLY-CLARK WORLDWIDE, INC. (DELAWARE CORPORATION)
2300 WINCHESTER ROAD
NEENAH, WI 54956

Registered Sep. 11, 2012

Int. Cl.: 5

FOR: INCONTINENT PADS, NAMELY, ABSORBENT PERSONAL PADS FOR INVOLUNTARY
BLADDER ELIMINATION; DISPOSABLE INCONTINENCE UNDERGARMENTS, IN CLASS
5 (U.S. CLS. 6, 18, 44, 46, 51 AND 52).

TRADEMARK

FIRST USE 3-4-2012; IN COMMERCE 3-4-2012.

PRINCIPAL REGISTER

THE MARK CONSISTS OF STANDARD CHARACTERS WITHOUT CLAIM TO ANY PAR-
TICULAR FONT, STYLE, SIZE, OR COLOR.

SN 85-152,435, FILED 10-14-2010.

SHANNON TWOHIG, EXAMINING ATTORNEY



David J. Kyffers

Director of the United States Patent and Trademark Office

United States of America

United States Patent and Trademark Office

REAL FIT

Reg. No. 4,206,608

KIMBERLY-CLARK WORLDWIDE, INC. (DELAWARE CORPORATION)
2300 WINCHESTER ROAD
NEENAH, WI 54956

Registered Sep. 11, 2012

Int. Cl.: 5

FOR: INCONTINENT PADS, NAMELY, ABSORBENT PERSONAL PADS FOR INVOLUNTARY BLADDER ELIMINATION; DISPOSABLE INCONTINENCE UNDERGARMENTS, IN CLASS 5 (U.S. CLS. 6, 18, 44, 46, 51 AND 52).

TRADEMARK

FIRST USE 3-4-2012; IN COMMERCE 3-4-2012.

PRINCIPAL REGISTER

THE MARK CONSISTS OF STANDARD CHARACTERS WITHOUT CLAIM TO ANY PARTICULAR FONT, STYLE, SIZE, OR COLOR.

SN 85-152,442, FILED 10-14-2010.

SHANNON TWOHIG, EXAMINING ATTORNEY



David J. Kybas

Director of the United States Patent and Trademark Office

United States of America

United States Patent and Trademark Office

AMAR DE NUEVO

Reg. No. 4,206,609

PROMOFILM US LLC (FLORIDA LIMITED LIABILITY COMPANY)
7291 NW 74TH STREET
MIAMI, FL 331662407

Registered Sep. 11, 2012

Int. Cl.: 41

FOR: ENTERTAINMENT SERVICES IN THE FORM OF A TELEVISION SOAP OPERA SERIES, IN CLASS 41 (U.S. CLS. 100, 101 AND 107).

SERVICE MARK

FIRST USE 3-1-2011; IN COMMERCE 3-1-2011.

PRINCIPAL REGISTER

THE MARK CONSISTS OF STANDARD CHARACTERS WITHOUT CLAIM TO ANY PARTICULAR FONT, STYLE, SIZE, OR COLOR.

THE ENGLISH TRANSLATION OF "AMAR DE NUEVO" IN THE MARK IS "TO LOVE AGAIN".

SN 85-152,949, FILED 10-14-2010.

CHARLOTTE CORWIN, EXAMINING ATTORNEY



David J. Kybas

Director of the United States Patent and Trademark Office

United States of America

United States Patent and Trademark Office

XDURANCE

Reg. No. 4,206,610

Registered Sep. 11, 2012

Int. Cl.: 32

TRADEMARK

PRINCIPAL REGISTER

WEINER, RUSSELL G. (UNITED STATES INDIVIDUAL)
P.O. BOX 27740
101 CONVENTION CENTER DRIVE, SUITE 777
LAS VEGAS, NV 89126

FOR: ENERGY DRINKS, IN CLASS 32 (U.S. CLS. 45, 46 AND 48).

FIRST USE 1-1-2012; IN COMMERCE 1-1-2012.

THE MARK CONSISTS OF STANDARD CHARACTERS WITHOUT CLAIM TO ANY PARTICULAR FONT, STYLE, SIZE, OR COLOR.

SN 85-153,181, FILED 10-14-2010.

JAMES STEIN, EXAMINING ATTORNEY



David J. Kybas

Director of the United States Patent and Trademark Office

United States of America

United States Patent and Trademark Office

MAXX PHONE CARD

Reg. No. 4,206,611

SOHEL DISTRIBUTOR INC (NEW YORK CORPORATION)

Registered Sep. 11, 2012

1091 YONKERS AVE
YONKERS, NY 10704

Int. Cl.: 38

FOR: TELEPHONE TELECOMMUNICATIONS SERVICES PROVIDED VIA PREPAID TELEPHONE CALLING CARDS, IN CLASS 38 (U.S. CLS. 100, 101 AND 104).

SERVICE MARK

FIRST USE 10-17-2010; IN COMMERCE 10-17-2010.

PRINCIPAL REGISTER

THE MARK CONSISTS OF STANDARD CHARACTERS WITHOUT CLAIM TO ANY PARTICULAR FONT, STYLE, SIZE, OR COLOR.

NO CLAIM IS MADE TO THE EXCLUSIVE RIGHT TO USE "PHONE CARD", APART FROM THE MARK AS SHOWN.

SN 85-153,780, FILED 10-15-2010.

MARCIE MILONE, EXAMINING ATTORNEY



David J. Kybas

Director of the United States Patent and Trademark Office

United States of America

United States Patent and Trademark Office

DOUBLE-SEE

Reg. No. 4,206,612

Registered Sep. 11, 2012

Int. Cl.: 19

TRADEMARK

PRINCIPAL REGISTER

GEORG FISCHER SLOANE LLC (ARKANSAS LIMITED LIABILITY COMPANY)
7777 SLOANE DRIVE
LITTLE ROCK, AR 72206

FOR: VINYL DOUBLE CONTAINMENT PIPING SYSTEMS FEATURING PRIMARILY RIGID VINYL PIPES AND STRUCTURAL COMPONENTS THEREOF; VINYL PIPE, VINYL PIPE FITTINGS, VINYL CENTRALIZERS FOR CENTRALIZING AN INNER PIPE WITHIN AN OUTER PIPE, AND VINYL DOUBLE CONTAINMENT VALVE BOXES ALL FOR USE IN THE CONTAINMENT PIPING FIELD, IN CLASS 19 (U.S. CLS. 1, 12, 33 AND 50).

FIRST USE 9-0-2011; IN COMMERCE 9-0-2011.

THE MARK CONSISTS OF STANDARD CHARACTERS WITHOUT CLAIM TO ANY PARTICULAR FONT, STYLE, SIZE, OR COLOR.

SN 85-153,842, FILED 10-15-2010.

JANICE KIM, EXAMINING ATTORNEY



David J. Kyffers

Director of the United States Patent and Trademark Office

United States of America

United States Patent and Trademark Office

www.kalbefarma.com

Reg. No. 4,206,613

Registered Sep. 11, 2012

Int. Cl.: 35

SERVICE MARK

PRINCIPAL REGISTER

P.T. KALBE FARMA, TBK. (INDONESIA COMPANY)
KAWASAN INDUSTRI DELTA SILICON
JL. M.H. THAMRIN BLOK A3-1
LIPPO CIKARANG, BEKASI, INDONESIA 17550

FOR: PROMOTION AND MARKETING OF PHARMACEUTICAL PRODUCTS AND HEALTH SERVICES; PROMOTION AND MARKETING OF PHARMACEUTICAL PRODUCTS AND HEALTH SERVICES BY WEBSITE; MANAGEMENT, NAMELY, MEDICAL COST MANAGEMENT; BUSINESS MANAGEMENT; PROMOTION AND MARKETING SERVICES, IN CLASS 35 (U.S. CLS. 100, 101 AND 102).

FIRST USE 8-10-2001; IN COMMERCE 8-1-2005.

THE MARK CONSISTS OF STANDARD CHARACTERS WITHOUT CLAIM TO ANY PARTICULAR FONT, STYLE, SIZE, OR COLOR.

SN 85-153,906, FILED 10-15-2010.

JENNIFER MARTIN, EXAMINING ATTORNEY



David J. Kybas

Director of the United States Patent and Trademark Office

United States of America

United States Patent and Trademark Office

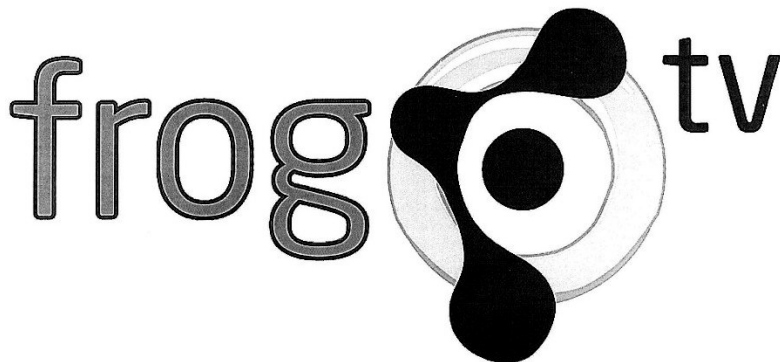

Reg. No. 4,206,614

Registered Sep. 11, 2012

Int. Cls.: 41 and 44

SERVICE MARK

PRINCIPAL REGISTER

COOPERATIVE REGIONS OF ORGANIC PRODUCER POOLS (WISCONSIN COOPERATIVE CORPORATION)
ONE ORGANIC WAY
LA FARGE, WI 54639

FOR: ENTERTAINMENT SERVICES, NAMELY, PROVIDING ON-GOING WEBISODES FEATURING FOOD, HEALTH, AND THE ENVIRONMENT VIA A GLOBAL COMPUTER NETWORK, IN CLASS 41 (U.S. CLS. 100, 101 AND 107).

FIRST USE 1-9-2011; IN COMMERCE 1-9-2011.

FOR: PROVIDING A WEB SITE FEATURING INFORMATION ABOUT FOOD, NAMELY, INFORMATION REGARDING NUTRITION AND DIET; PROVIDING A WEB SITE FEATURING INFORMATION ABOUT HEALTH, IN CLASS 44 (U.S. CLS. 100 AND 101).

FIRST USE 1-9-2011; IN COMMERCE 1-9-2011.

NO CLAIM IS MADE TO THE EXCLUSIVE RIGHT TO USE "TV", APART FROM THE MARK AS SHOWN.

THE MARK CONSISTS OF THE TERM "FROG" FOLLOWED BY A FANCIFUL BULLS-EYE DESIGN FOLLOWED BY THE TERM "TV".

SN 85-155,093, FILED 10-18-2010.

MARK SHINER, EXAMINING ATTORNEY



David J. Kybas

Director of the United States Patent and Trademark Office

United States of America

United States Patent and Trademark Office

SIMPLY LAVENDER

Reg. No. 4,206,615

FIT FOR LIFE SLEEP, INC. (VIRGINIA CORPORATION)
1112 KINGWOOD AVENUE
NORFOLK, VA 23502

Registered Sep. 11, 2012

Int. Cl.: 20

FOR: MATTRESSES, MATTRESS FOUNDATIONS; BOX SPRINGS; MATTRESS TOPPERS;
PILLOWS, IN CLASS 20 (U.S. CLS. 2, 13, 22, 25, 32 AND 50).

TRADEMARK

FIRST USE 12-31-2011; IN COMMERCE 12-31-2011.

PRINCIPAL REGISTER

THE MARK CONSISTS OF STANDARD CHARACTERS WITHOUT CLAIM TO ANY PARTICULAR FONT, STYLE, SIZE, OR COLOR.

NO CLAIM IS MADE TO THE EXCLUSIVE RIGHT TO USE "LAVENDER", APART FROM THE MARK AS SHOWN.

SN 85-156,714, FILED 10-20-2010.

NAAKWAMA ANKRAH, EXAMINING ATTORNEY



David J. Kyffers

Director of the United States Patent and Trademark Office

United States of America

United States Patent and Trademark Office

"WE MAKE THE BOXES THAT
YOU THINK OUTSIDE OF."

Reg. No. 4,206,616

HARBOR PACKAGING INC (CALIFORNIA CORPORATION)
13100 DANIELSON STREET
POWAY, CA 92064

Registered Sep. 11, 2012

Int. Cl.: 16

FOR: CORRUGATED BOXES, IN CLASS 16 (U.S. CLS. 2, 5, 22, 23, 29, 37, 38 AND 50).

TRADEMARK

FIRST USE 2-1-2011; IN COMMERCE 2-1-2011.

PRINCIPAL REGISTER

THE MARK CONSISTS OF STANDARD CHARACTERS WITHOUT CLAIM TO ANY PARTICULAR FONT, STYLE, SIZE, OR COLOR.

SN 85-157,872, FILED 10-21-2010.

DAVID HOFFMAN, EXAMINING ATTORNEY



David J. Kyffers

Director of the United States Patent and Trademark Office

United States of America

United States Patent and Trademark Office

AUSSIE SOULS

Reg. No. 4,206,617

Registered Sep. 11, 2012

Int. Cl.: 25

TRADEMARK

PRINCIPAL REGISTER

AUSSIE SOLES HOLDINGS PTY LTD (AUSTRALIA PROPRIETARY LIMITED COMPANY
(P/L OR PTY. LTD.))
3 / 4 LYSAGHT STREET
COOLUM, QUEENSLAND, AUSTRALIA 4573

FOR: FOOTWEAR, IN CLASS 25 (U.S. CLS. 22 AND 39).

FIRST USE 2-25-2011; IN COMMERCE 2-25-2011.

THE MARK CONSISTS OF STANDARD CHARACTERS WITHOUT CLAIM TO ANY PARTICULAR FONT, STYLE, SIZE, OR COLOR.

SN 85-158,338, FILED 10-21-2010.

LEIGH LOWRY, EXAMINING ATTORNEY



David J. Kyffers

Director of the United States Patent and Trademark Office

United States of America

United States Patent and Trademark Office



Reg. No. 4,206,618

SALEM TOOLS, INC. (VIRGINIA CORPORATION)
1602 MIDLAND ROAD
SALEM, VA 24153

Registered Sep. 11, 2012

Int. Cl.: 35

FOR: DISTRIBUTORSHIP SERVICES IN THE FIELD OF PUNCHING AND DIE SUPPLIES IN THE NATURE OF ABRASIVES, COOLANTS, AND STANDARD AND SPECIAL CUTTING TOOLS, IN CLASS 35 (U.S. CLS. 100, 101 AND 102).

SERVICE MARK

FIRST USE 5-12-2011; IN COMMERCE 5-12-2011.

PRINCIPAL REGISTER

NO CLAIM IS MADE TO THE EXCLUSIVE RIGHT TO USE "LOGISTICS", APART FROM THE MARK AS SHOWN.

THE COLOR(S) BLUE, SILVER AND BLACK IS/ARE CLAIMED AS A FEATURE OF THE MARK.

THE MARK CONSISTS OF THE WORDING "CUTTING EDGE" IN BLUE SITTING ON A THIN SILVER SHEET OF METAL WITH BLACK SHADING ABOVE THE WORDING "LOGISTICS" IN BLUE.

SN 85-158,465, FILED 10-21-2010.

TRACY FLETCHER, EXAMINING ATTORNEY



David J. Kyros

Director of the United States Patent and Trademark Office

United States of America

United States Patent and Trademark Office

BIOMED BRIDGE

Reg. No. 4,206,619

Registered Sep. 11, 2012

Int. Cl.: 41

SERVICE MARK

PRINCIPAL REGISTER

BIOMED BRIDGE, LLC (ARIZONA LIMITED LIABILITY COMPANY)
3700 QUEBEC STREET #100-230
DENVER, CO 80207

FOR: CUSTOM WRITING SERVICES, WRITTEN TEXT EDITING, AND EDUCATIONAL SERVICES FEATURING REVIEW AND TUTORING RELATED TO WRITTEN DOCUMENTS, WRITING, EDITING AND RELATED EDUCATIONAL COUNSELING, AND GENERAL TRAINING IN THE MEDICAL AND BIOLOGICAL FIELDS, IN CLASS 41 (U.S. CLS. 100, 101 AND 107).

FIRST USE 10-14-2010; IN COMMERCE 10-14-2010.

THE MARK CONSISTS OF STANDARD CHARACTERS WITHOUT CLAIM TO ANY PARTICULAR FONT, STYLE, SIZE, OR COLOR.

NO CLAIM IS MADE TO THE EXCLUSIVE RIGHT TO USE "BIOMED", APART FROM THE MARK AS SHOWN.

SN 85-158,491, FILED 10-21-2010.

ZACHARY BELLO, EXAMINING ATTORNEY



David J. Kypos

Director of the United States Patent and Trademark Office

United States of America

United States Patent and Trademark Office

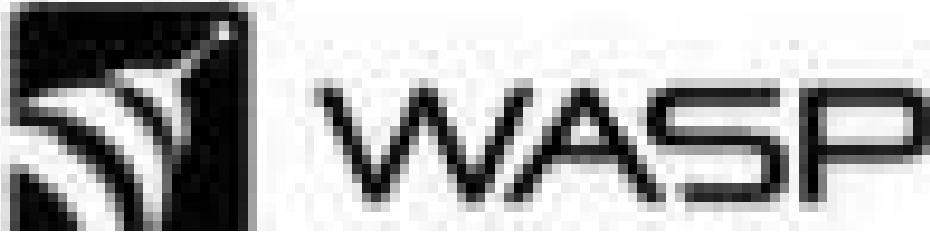

Reg. No. 4,206,620

Registered Sep. 11, 2012

Int. Cl.: 9

TRADEMARK

PRINCIPAL REGISTER

BOSS PACKAGING INC. (CANADA CORPORATION)
1450 - 28 STREET N.E.
BAY 8
CALGARY, ALBERTA, CANADA T2A7W6

FOR: AN INSTRUMENT, NAMELY, A SENSORY DEVICE FOR REMOTELY MEASURING VELOCITY, ACCELERATION AND TEMPERATURE, IN CLASS 9 (U.S. CLS. 21, 23, 26, 36 AND 38).

FIRST USE 11-1-2010; IN COMMERCE 6-1-2011.

OWNER OF U.S. REG. NO. 3,869,023.

THE MARK CONSISTS OF THE STYLIZED WORD "WASP" WITH THREE QUARTER MOONS WITHIN A SOLID SQUARE TO THE LEFT THEREOF.

SN 85-158,733, FILED 10-22-2010.

DOMINICK J. SALEMI, EXAMINING ATTORNEY



David J. Kybas

Director of the United States Patent and Trademark Office

United States of America

United States Patent and Trademark Office

TOTALLY RANDOM

Reg. No. 4,206,621

COLLEEN KARIS DESIGNS, LLC (CALIFORNIA LIMITED LIABILITY COMPANY)
137 NORTH LARCHMONT BLVD., #493
LOS ANGELES, CA 90004

Registered Sep. 11, 2012

Int. Cls.: 16 and 20

FOR: PRINTS, ARTWORK ON CANVAS, PRINTED GROWTH CHARTS, MEMO BOARDS,
IN CLASS 16 (U.S. CLS. 2, 5, 22, 23, 29, 37, 38 AND 50).

TRADEMARK

FIRST USE 10-0-2010; IN COMMERCE 10-0-2010.

PRINCIPAL REGISTER

FOR: NON-METAL WALL CLOTHING HOOKS, IN CLASS 20 (U.S. CLS. 2, 13, 22, 25, 32
AND 50).

FIRST USE 6-0-2011; IN COMMERCE 6-0-2011.

THE MARK CONSISTS OF STANDARD CHARACTERS WITHOUT CLAIM TO ANY PAR-
TICULAR FONT, STYLE, SIZE, OR COLOR.

SN 85-159,457, FILED 10-22-2010.

MAYUR VAGHANI, EXAMINING ATTORNEY



David J. Kyffers

Director of the United States Patent and Trademark Office

United States of America

United States Patent and Trademark Office

SECONDMARKET

Reg. No. 4,206,622

SECONDMARKET HOLDINGS, INC. (DELAWARE CORPORATION)

Registered Sep. 11, 2012

26 BROADWAY, 12TH FLOOR
NEW YORK, NY 10004

Int. Cl.: 42

FOR: PROVIDING ONLINE NON-DOWNLOADABLE SOFTWARE FOR USE IN THE TRADING OF SECURITIES, TRADE CLAIMS, FINANCIAL ASSETS, ILLIQUID ASSETS AND FINANCIAL INTERESTS, IN CLASS 42 (U.S. CLS. 100 AND 101).

SERVICE MARK

FIRST USE 9-17-2008; IN COMMERCE 9-17-2008.

PRINCIPAL REGISTER

THE MARK CONSISTS OF STANDARD CHARACTERS WITHOUT CLAIM TO ANY PARTICULAR FONT, STYLE, SIZE, OR COLOR.

SEC. 2(F).

OWNER OF U.S. REG. NO. 3,871,879.

SN 85-159,481, FILED 10-22-2010.

CAROLINE WOOD, EXAMINING ATTORNEY



David J. Kyffers

Director of the United States Patent and Trademark Office

United States of America

United States Patent and Trademark Office



Reg. No. 4,206,623

Registered Sep. 11, 2012

Int. Cl.: 41

SERVICE MARK

PRINCIPAL REGISTER

CITY OF BEVERLY HILLS (CALIFORNIA MUNICIPAL CORPORATION)
455 N. REXFORD DRIVE, SUITE 220
BEVERLY HILLS, CA 90210

FOR: ORGANIZING AND CONDUCTING COMMUNITY AND RECREATIONAL EVENTS IN THE NATURE OF COMMUNITY FESTIVALS FEATURING A VARIETY OF ACTIVITIES, NAMELY, FOOD TASTING AND DEMONSTRATIONS, MUSICAL PERFORMANCES, ART EXHIBITIONS, LECTURES AND THE LIKE; PROVIDING INFORMATION ABOUT THE CURRENT EVENTS, CIVIC EVENTS, AND EDUCATION SERVICES PROVIDED BY THE COMMUNITY OF THE CITY OF BEVERLY HILLS, IN CLASS 41 (U.S. CLS. 100, 101 AND 107).

FIRST USE 8-31-2010; IN COMMERCE 7-31-2010.

OWNER OF U.S. REG. NOS. 2,766,280, 2,768,789, AND 2,774,666.

NO CLAIM IS MADE TO THE EXCLUSIVE RIGHT TO USE "BEVERLY HILLS" AND "CITY", APART FROM THE MARK AS SHOWN.

THE MARK CONSISTS OF A STYLIZED SHIELD WITH SCROLLWORK ABOVE AND BELOW THE SHIELD AND THE STYLIZED WORDS "BEVERLY HILLS" CONTAINED WITHIN THE SHIELD IN VERTICAL ALIGNMENT, WITH THE STYLIZED WORDS "THE SMART CITY" LOCATED BELOW THE SHIELD.

SN 85-160,572, FILED 10-25-2010.

APRIL HESIK, EXAMINING ATTORNEY



David J. Kybas

Director of the United States Patent and Trademark Office

United States of America

United States Patent and Trademark Office

Medidata Coder

Reg. No. 4,206,624

MEDIDATA SOLUTIONS, INC. (DELAWARE CORPORATION)

Registered Sep. 11, 2012

79 FIFTH AVENUE
NEW YORK, NY 10003

Int. Cl.: 42

FOR: PROVIDING AN ONLINE NON-DOWNLOADABLE INTERNET-BASED SYSTEM APPLICATION FEATURING TECHNOLOGY ENABLING USERS TO MANAGE PROCESSES IN THE FIELD OF MEDICAL CLINICAL TRIALS AND RESEARCH; PROVIDING ON-LINE, NON-DOWNLOADABLE, INTERNET-BASED SOFTWARE APPLICATION FOR MEDICAL BILLING FOR PHYSICIANS AND HEALTH CARE INSTITUTIONS; PROVIDING TEMPORARY USE OF A WEB-BASED SOFTWARE APPLICATION FOR MEDICAL CODING, FOR COLLECTING, ANALYZING AND REPORTING DATA, AND FOR GENERATING REPORTS IN THE FIELD OF MEDICAL CLINICAL TRIALS AND RESEARCH; PROVIDING TEMPORARY USE OF ON-LINE NON-DOWNLOADABLE SOFTWARE FOR MEDICAL CODING, FOR COLLECTING, ANALYZING AND REPORTING DATA, AND FOR GENERATING REPORTS IN THE FIELD OF MEDICAL CLINICAL TRIALS AND RESEARCH, IN CLASS 42 (U.S. CLS. 100 AND 101).

SERVICE MARK

PRINCIPAL REGISTER

FIRST USE 8-0-2011; IN COMMERCE 8-0-2011.

THE MARK CONSISTS OF STANDARD CHARACTERS WITHOUT CLAIM TO ANY PARTICULAR FONT, STYLE, SIZE, OR COLOR.

OWNER OF U.S. REG. NOS. 2,509,348, 3,211,323, AND OTHERS.

NO CLAIM IS MADE TO THE EXCLUSIVE RIGHT TO USE "CODER", APART FROM THE MARK AS SHOWN.

SN 85-162,270, FILED 10-27-2010.

DAVID TOOLEY, EXAMINING ATTORNEY



David J. Kyffers

Director of the United States Patent and Trademark Office

United States of America

United States Patent and Trademark Office



medidata
Coder

Reg. No. 4,206,625

Registered Sep. 11, 2012

Int. Cl.: 42

SERVICE MARK

PRINCIPAL REGISTER

MEDIDATA SOLUTIONS, INC. (DELAWARE CORPORATION)
79 FIFTH AVENUE
NEW YORK, NY 10003

FOR: PROVIDING AN ONLINE NON-DOWNLOADABLE INTERNET-BASED SYSTEM APPLICATION FEATURING TECHNOLOGY ENABLING USERS TO MANAGE PROCESSES IN THE FIELD OF MEDICAL CLINICAL TRIALS AND RESEARCH; PROVIDING ON-LINE, NON-DOWNLOADABLE, INTERNET-BASED SOFTWARE APPLICATION FOR MEDICAL BILLING FOR PHYSICIANS AND HEALTH CARE INSTITUTIONS; PROVIDING TEMPORARY USE OF A WEB-BASED SOFTWARE APPLICATION FOR MEDICAL CODING, FOR COLLECTING, ANALYZING AND REPORTING DATA, AND FOR GENERATING REPORTS IN THE FIELD OF MEDICAL CLINICAL TRIALS AND RESEARCH; PROVIDING TEMPORARY USE OF ON-LINE NON-DOWNLOADABLE SOFTWARE FOR MEDICAL CODING, FOR COLLECTING, ANALYZING AND REPORTING DATA, AND FOR GENERATING REPORTS IN THE FIELD OF MEDICAL CLINICAL TRIALS AND RESEARCH, IN CLASS 42 (U.S. CLS. 100 AND 101).

FIRST USE 8-0-2011; IN COMMERCE 8-0-2011.

OWNER OF U.S. REG. NOS. 2,509,348, 3,211,323, AND OTHERS.

THE COLOR(S) WHITE, GREEN AND BLUE IS/ARE CLAIMED AS A FEATURE OF THE MARK.

NO CLAIM IS MADE TO THE EXCLUSIVE RIGHT TO USE "CODER", APART FROM THE MARK AS SHOWN.

THE MARK CONSISTS OF THE GREEN STYLIZED WORD "MEDIDATA" ABOVE THE BLUE STYLIZED WORD "CODER" ALL TO THE RIGHT OF A ROUNDED BLUE SQUARE CONTAINING A GREEN AND WHITE CLOSED BOOK.

SN 85-162,760, FILED 10-27-2010.

DAVID TOOLEY, EXAMINING ATTORNEY



David J. Kyffers

Director of the United States Patent and Trademark Office

United States of America

United States Patent and Trademark Office

Aroma Rice

Reg. No. 4,206,626

AROMA RICE, INC (BHUTAN CORPORATION), DBA AROMA RICE,
4592 LODOVICO CT
FREMONT, CA 94555

Registered Sep. 11, 2012

Int. Cl.: 30

FOR: RICE, IN CLASS 30 (U.S. CL. 46).

TRADEMARK

FIRST USE 4-24-2011; IN COMMERCE 4-24-2011.

PRINCIPAL REGISTER

THE MARK CONSISTS OF STANDARD CHARACTERS WITHOUT CLAIM TO ANY PARTICULAR FONT, STYLE, SIZE, OR COLOR.

NO CLAIM IS MADE TO THE EXCLUSIVE RIGHT TO USE "RICE", APART FROM THE MARK AS SHOWN.

SN 85-163,444, FILED 10-28-2010.

CHRISTINA SOBRAL, EXAMINING ATTORNEY



David J. Kyffers

Director of the United States Patent and Trademark Office

United States of America

United States Patent and Trademark Office

SLEEK

Reg. No. 4,206,627

Registered Sep. 11, 2012

Int. Cl.: 9

TRADEMARK

PRINCIPAL REGISTER

GI SPORTZ, INC. (CANADA CORPORATION)
1375 32ND AVE.
LACHINE, QUEBEC, CANADA H8T3H2

FOR: EYE COVERS FOR PROTECTIVE PURPOSES; FACE-PROTECTION SHIELDS; GOGGLES FOR SPORTS; PROTECTION MASKS; PROTECTIVE EYEWEAR; PROTECTIVE FACE MASKS NOT FOR MEDICAL PURPOSES; PROTECTIVE FACE-SHIELDS FOR PROTECTIVE HELMETS; PROTECTIVE HELMETS; PROTECTIVE HELMETS FOR SPORTS; SAFETY EYEWEAR; SPORT GOGGLES FOR USE IN PAINTBALL AND AIRSOFT; AND SPORTS EYEWEAR, IN CLASS 9 (U.S. CLS. 21, 23, 26, 36 AND 38).

FIRST USE 12-31-2010; IN COMMERCE 9-30-2011.

THE MARK CONSISTS OF STANDARD CHARACTERS WITHOUT CLAIM TO ANY PARTICULAR FONT, STYLE, SIZE, OR COLOR.

SN 85-163,520, FILED 10-28-2010.

AMY HELLA, EXAMINING ATTORNEY



David J. Kybas

Director of the United States Patent and Trademark Office

United States of America

United States Patent and Trademark Office

HEALTHY MOO

Reg. No. 4,206,628

GUIDA-SEIBERT DAIRY COMPANY, THE (CONNECTICUT CORPORATION)
433 PARK AVENUE
NEW BRITAIN, CT 06050

Registered Sep. 11, 2012

Int. Cl.: 29

FOR: DAIRY PRODUCTS EXCLUDING ICE CREAM, ICE MILK AND FROZEN YOGURT,
IN CLASS 29 (U.S. CL. 46).

TRADEMARK

FIRST USE 2-0-2011; IN COMMERCE 2-0-2011.

PRINCIPAL REGISTER

THE MARK CONSISTS OF STANDARD CHARACTERS WITHOUT CLAIM TO ANY PAR-
TICULAR FONT, STYLE, SIZE, OR COLOR.

SN 85-164,551, FILED 10-29-2010.

PAUL E. FAHRENKOPF, EXAMINING ATTORNEY



David J. Kybas

Director of the United States Patent and Trademark Office

United States of America

United States Patent and Trademark Office



Reg. No. 4,206,629

Registered Sep. 11, 2012

Int. Cls.: 9 and 37

TRADEMARK

SERVICE MARK

PRINCIPAL REGISTER

DELSOLAR CO., LTD. (TAIWAN CORPORATION)
3F, NO.2, R&D 2ND RD.
SCIENCE PARK
HSIN-CHU, TAIWAN 30076

FOR: SILICON WAFERS, PHOTOVOLTAIC CELLS; SOLAR CELLS; PANELS, NAMELY, PHOTOVOLTAIC PANELS AND SOLAR CELL PANELS FOR GENERATING ELECTRICITY; SOLAR MODULES FOR ELECTRICITY GENERATION; SOLAR SYSTEMS FOR GENERATION OF ELECTRICITY, NAMELY, SOLAR MODULES, INVERTERS; MODULES, NAMELY, PHOTOVOLTAIC MODULES AND SOLAR CELL MODULES; PHOTOVOLTAIC INSTALLATION APPARATUS FOR ELECTRICITY GENERATION, NAMELY, SOLAR MODULES FOR PRODUCTION OF ELECTRICITY, SOLAR THERMAL AND ELECTRIC RECEIVERS, PHOTOVOLTAIC CONCENTRATORS; PHOTOVOLTAIC CONCENTRATORS; SEMICONDUCTORS; ELECTRONIC CONTROL MECHANISMS FOR THERMAL AND PHOTOVOLTAIC SOLAR SYSTEMS; THIN-FILM SOLAR CELLS; ELECTRICAL CONNECTING PARTS FOR ELECTRIC CONDUITS, NAMELY, ELECTRICAL CONNECTORS, CONNECTING ELECTRICAL CABLES; ELECTRIC ACCUMULATORS; ELECTRIC BATTERIES; INVERTERS; CHARGERS FOR ELECTRIC BATTERIES; ELECTRICITY COLLECTORS; ELECTRICITY LIMITERS; ELECTRIC COMMUTATORS; CIRCUIT BREAKERS; POWER INVERTERS; VOLTAGE SURGE PROTECTORS; ELECTRICITY CONDUITS; ELECTRIC CONDUCTORS; ELECTRIC MONITORING APPARATUS FOR MONITORING ELECTRIC CURRENTS; ELECTRONIC TRANSISTORS; JUNCTION SLEEVES FOR ELECTRIC CABLES; ELECTRIC PLUGS FOR ELECTRIC CABLES; ELECTRIC SWITCHES; ELECTRIC WIRES; ELECTRIC CABLES; CLAMP METERS FOR MEASURING ELECTRICITY; INTEGRATED CIRCUITS, IN CLASS 9 (U.S. CLS. 21, 23, 26, 36 AND 38).

FIRST USE 10-0-2010; IN COMMERCE 10-18-2011.

FOR: SOLAR POWER INSTALLATIONS, NAMELY, INSTALLATION OF SOLAR ENERGY BASED POWER PLANTS, IN CLASS 37 (U.S. CLS. 100, 103 AND 106).

FIRST USE 10-0-2010; IN COMMERCE 10-18-2011.

THE MARK CONSISTS OF A STYLIZED, FEATURELESS BODY AND HEAD OF A CHILD.

SN 85-164,945, FILED 10-29-2010.



David J. Kybas

Director of the United States Patent and Trademark Office

Reg. No. 4,206,629 EMILY CHUO, EXAMINING ATTORNEY

United States of America

United States Patent and Trademark Office

Corbin's Coeds

Reg. No. 4,206,630

Registered Sep. 11, 2012

Int. Cl.: 41

SERVICE MARK

PRINCIPAL REGISTER

LIBERTY MEDIA HOLDINGS, LLC (CALIFORNIA CORPORATION), DBA CORBIN FISHER,
C/O RANDAZZA LEGAL GROUP
2 SOUTH BISCAYNE BLVD., SUITE 2600
MIAMI, FL 33131

FOR: PRODUCTION OF DVDS, VIDEOTAPES AND TELEVISION PROGRAMS FEATURING ADULT ENTERTAINMENT; PROVIDING AN ONLINE ADULT WEBSITE FEATURING PHOTOGRAPHS AND VIDEOS IN THE FIELD OF ADULT ENTERTAINMENT; ENTERTAINMENT SERVICES IN THE NATURE OF PROVIDING A WEBSITE ON THE GLOBAL COMPUTER NETWORKS FEATURING INFORMATION IN THE FIELD OF ADULT ENTERTAINMENT; PROVIDING AN ONLINE WEBSITE OF INFORMATION COMPRISING ADULT MATERIAL AND VIEWING THEREOF, AND OTHER ADULT ENTERTAINMENT RELATED MATERIAL, IN CLASS 41 (U.S. CLS. 100, 101 AND 107).

FIRST USE 5-31-2011; IN COMMERCE 1-31-2012.

THE MARK CONSISTS OF STANDARD CHARACTERS WITHOUT CLAIM TO ANY PARTICULAR FONT, STYLE, SIZE, OR COLOR.

OWNER OF U.S. REG. NOS. 3,196,073 AND 3,200,827.

NO CLAIM IS MADE TO THE EXCLUSIVE RIGHT TO USE "COEDS", APART FROM THE MARK AS SHOWN.

THE NAME "CORBIN" DOES NOT IDENTIFY A LIVING INDIVIDUAL.

SN 85-165,325, FILED 10-29-2010.

CHERYL CLAYTON, EXAMINING ATTORNEY



David J. Kybas

Director of the United States Patent and Trademark Office

United States of America

United States Patent and Trademark Office

1 LINERS

Reg. No. 4,206,631

STROSCHEIN, RON (UNITED STATES INDIVIDUAL)
20509 AUDREY LANE
DEER PARK, IL 60010

Registered Sep. 11, 2012

Int. Cl.: 25

FOR: HATS; HOODED SWEAT SHIRTS; SHIRTS; SWEATSHIRTS; T-SHIRTS; TRACK JACKETS, IN CLASS 25 (U.S. CLS. 22 AND 39).

TRADEMARK

FIRST USE 9-1-2010; IN COMMERCE 1-1-2011.

PRINCIPAL REGISTER

THE MARK CONSISTS OF STANDARD CHARACTERS WITHOUT CLAIM TO ANY PARTICULAR FONT, STYLE, SIZE, OR COLOR.

SN 85-165,334, FILED 10-29-2010.

WILLIAM BRECKENFELD, EXAMINING ATTORNEY



David J. Kybas

Director of the United States Patent and Trademark Office

United States of America

United States Patent and Trademark Office

GOTTAGUY

Reg. No. 4,206,632

AGRIFOLIO, FRANK (UNITED STATES INDIVIDUAL)
727 JORALEMON STREET
BELLEVILLE, NJ 07109

Registered Sep. 11, 2012

Int. Cl.: 25

FOR: HATS; JERSEYS; SHIRTS, IN CLASS 25 (U.S. CLS. 22 AND 39).

TRADEMARK

FIRST USE 11-1-2010; IN COMMERCE 11-1-2010.

PRINCIPAL REGISTER

THE MARK CONSISTS OF STANDARD CHARACTERS WITHOUT CLAIM TO ANY PARTICULAR FONT, STYLE, SIZE, OR COLOR.

SN 85-165,792, FILED 11-1-2010.

SETH A. RAPPAPORT, EXAMINING ATTORNEY



David J. Kyffers

Director of the United States Patent and Trademark Office

United States of America

United States Patent and Trademark Office

Wheatpaste

Reg. No. 4,206,633

Registered Sep. 11, 2012

Int. Cl.: 35

SERVICE MARK

PRINCIPAL REGISTER

NO BOUNDARIES INC (CALIFORNIA CORPORATION)
789 GATEWAY CENTER WAY
SAN DIEGO, CA 92102

FOR: ONLINE RETAIL STORE SERVICES, MAIL ORDER CATALOG SERVICES, AND CATALOG ORDERING SERVICES ALL FEATURING WALL DÉCOR, POSTERS, ART PRINTS, ORIGINAL ART, ART REPRODUCTIONS, LITHOGRAPHS, ADHESIVE ART, DRAWINGS, DECORATIVE ART OBJECTS, WALL DECALS, WALL MURALS, PHOTOGRAPHS, NOTE CARDS, PLAQUES, TAPESTRIES, MIRRORS, PATTERNS AND ART PRINT FRAMES, IN CLASS 35 (U.S. CLS. 100, 101 AND 102).

FIRST USE 1-31-2011; IN COMMERCE 6-1-2011.

THE MARK CONSISTS OF STANDARD CHARACTERS WITHOUT CLAIM TO ANY PARTICULAR FONT, STYLE, SIZE, OR COLOR.

SN 85-166,523, FILED 11-1-2010.

LINDA POWELL, EXAMINING ATTORNEY



David J. Kyffers

Director of the United States Patent and Trademark Office

United States of America

United States Patent and Trademark Office



Reg. No. 4,206,634

Registered Sep. 11, 2012

Int. Cl.: 29

TRADEMARK

PRINCIPAL REGISTER

JACK'S GOURMET LLC (NEW YORK LIMITED LIABILITY COMPANY)
773 MONTGOMERY STREET
BROOKLYN, NY 11213

FOR: KOSHER SAUSAGES AND LUNCHEON MEATS, IN CLASS 29 (U.S. CL. 46).

FIRST USE 11-23-2010; IN COMMERCE 11-23-2010.

NO CLAIM IS MADE TO THE EXCLUSIVE RIGHT TO USE "GOURMET DELICIOUS AND KOSHER", APART FROM THE MARK AS SHOWN.

THE MARK CONSISTS OF THE WORDS "JACK'S GOURMET DELICIOUS AND KOSHER" IN STYLIZED FONT BOLD LETTERS. THE WORDS "JACK'S GOURMET" IS LOCATED IN THE UPPER PART OF THE DESIGN WITHIN A RECTANGULAR SHAPE WITH HERALDIC ORNAMENTATION DESIGN CENTERED ABOVE; THE WORD "JACK'S" APPEARS LARGER IN SIZE THAN THE WORD "GOURMET" RIGHT BELOW IT. THE WORDS "DELICIOUS AND KOSHER" APPEAR ON THE SAME LINE AFFIXED IN A BANNER RIGHT BELOW THE WORD "GOURMET".

SN 85-167,396, FILED 11-2-2010.

CHRISTINE MARTIN, EXAMINING ATTORNEY



David J. Kyros

Director of the United States Patent and Trademark Office

United States of America

United States Patent and Trademark Office

JACK'S GOURMET DELICIOUS AND KOSHER

Reg. No. 4,206,635

JACK'S GOURMET LLC (NEW YORK LIMITED LIABILITY COMPANY)
773 MONTGOMERY STREET
BROOKLYN, NY 11213

Registered Sep. 11, 2012

Int. Cl.: 29

FOR: KOSHER SAUSAGES AND LUNCHEON MEATS, IN CLASS 29 (U.S. CL. 46).

TRADEMARK

FIRST USE 11-23-2010; IN COMMERCE 11-23-2010.

PRINCIPAL REGISTER

THE MARK CONSISTS OF STANDARD CHARACTERS WITHOUT CLAIM TO ANY PARTICULAR FONT, STYLE, SIZE, OR COLOR.

NO CLAIM IS MADE TO THE EXCLUSIVE RIGHT TO USE "GOURMET DELICIOUS AND KOSHER", APART FROM THE MARK AS SHOWN.

SN 85-167,418, FILED 11-2-2010.

CHRISTINE MARTIN, EXAMINING ATTORNEY



David J. Kyffers

Director of the United States Patent and Trademark Office

United States of America

United States Patent and Trademark Office

MIGHTYBELL

Reg. No. 4,206,636

MIGHTY SOFTWARE, INC. (DELAWARE CORPORATION)

Registered Sep. 11, 2012

828 ADDISON AVENUE
PALO ALTO, CA 94301

Int. Cls.: 42 and 45

FOR: COMPUTER SERVICES, NAMELY, CREATING AN ON-LINE COMMUNITY FOR REGISTERED USERS TO PARTICIPATE IN DISCUSSIONS, GET FEEDBACK FROM THEIR PEERS, FORM VIRTUAL COMMUNITIES, AND ENGAGE IN SOCIAL NETWORKING, IN CLASS 42 (U.S. CLS. 100 AND 101).

SERVICE MARK

PRINCIPAL REGISTER

FIRST USE 9-8-2011; IN COMMERCE 9-8-2011.

FOR: PROVIDING A WEB SITE FOR USERS TO SET PERSONAL GOALS, TRACK PROGRESS TOWARD THOSE GOALS, AND KEEP A RECORD OF PERSONAL ACCOMPLISHMENTS, IN CLASS 45 (U.S. CLS. 100 AND 101).

FIRST USE 9-8-2011; IN COMMERCE 9-8-2011.

THE MARK CONSISTS OF STANDARD CHARACTERS WITHOUT CLAIM TO ANY PARTICULAR FONT, STYLE, SIZE, OR COLOR.

SN 85-167,877, FILED 11-3-2010.

ALLISON HOLTZ, EXAMINING ATTORNEY



David J. Kybas

Director of the United States Patent and Trademark Office

United States of America

United States Patent and Trademark Office

PASSPORT

Reg. No. 4,206,637

UNIVERSAL TRAILER CARGO GROUP, INC. (DELAWARE CORPORATION)
11590 CENTURY BOULEVARD
CINCINNATI, OH 45246

Registered Sep. 11, 2012

Int. Cl.: 12

FOR: TRAILERS, NAMELY, CARGO AND UTILITY TRAILERS, IN CLASS 12 (U.S. CLS. 19, 21, 23, 31, 35 AND 44).

TRADEMARK

FIRST USE 2-17-2011; IN COMMERCE 2-17-2011.

PRINCIPAL REGISTER

THE MARK CONSISTS OF STANDARD CHARACTERS WITHOUT CLAIM TO ANY PARTICULAR FONT, STYLE, SIZE, OR COLOR.

SN 85-167,953, FILED 11-3-2010.

CURTIS FRENCH, EXAMINING ATTORNEY



David J. Kyffers

Director of the United States Patent and Trademark Office

United States of America

United States Patent and Trademark Office

My Kid Mozart

Reg. No. 4,206,638

MOZART NETWORKS, LLC (NEW YORK LIMITED LIABILITY COMPANY)
P.O. BOX 3452

Registered Sep. 11, 2012

NEW YORK, NY 10163

Int. Cl.: 42

FOR: PROVIDING A WEBSITE FEATURING TECHNOLOGY THAT ENABLES USERS TO CREATE, UPLOAD, EXCHANGE AND SHARE PHOTOS, VIDEOS, AND OTHER MEDIA, IN CLASS 42 (U.S. CLS. 100 AND 101).

SERVICE MARK

FIRST USE 12-23-2010; IN COMMERCE 12-23-2010.

PRINCIPAL REGISTER

THE MARK CONSISTS OF STANDARD CHARACTERS WITHOUT CLAIM TO ANY PARTICULAR FONT, STYLE, SIZE, OR COLOR.

NO CLAIM IS MADE TO THE EXCLUSIVE RIGHT TO USE "KID MOZART", APART FROM THE MARK AS SHOWN.

SN 85-168,176, FILED 11-3-2010.

KATHERINE CHANG, EXAMINING ATTORNEY



David J. Kybas

Director of the United States Patent and Trademark Office

United States of America

United States Patent and Trademark Office

MiMa

Reg. No. 4,206,639

THE RELATED COMPANIES, L.P. (NEW YORK LIMITED PARTNERSHIP)
60 COLUMBUS CIRCLE
NEW YORK, NY 10023

Registered Sep. 11, 2012

Int. Cls.: 36 and 45

FOR: LEASING OF REAL ESTATE; REAL ESTATE BROKERAGE; REAL ESTATE MANAGEMENT SERVICES, IN CLASS 36 (U.S. CLS. 100, 101 AND 102).

SERVICE MARK

FIRST USE 3-1-2011; IN COMMERCE 3-1-2011.

PRINCIPAL REGISTER

FOR: CONCIERGE SERVICES FOR OTHERS COMPRISING MAKING REQUESTED PERSONAL ARRANGEMENTS AND RESERVATIONS AND PROVIDING CUSTOMER-SPECIFIC INFORMATION TO MEET INDIVIDUAL NEEDS RENDERED TOGETHER IN A APARTMENT COMPLEX, IN CLASS 45 (U.S. CLS. 100 AND 101).

FIRST USE 3-1-2011; IN COMMERCE 3-1-2011.

THE MARK CONSISTS OF STANDARD CHARACTERS WITHOUT CLAIM TO ANY PARTICULAR FONT, STYLE, SIZE, OR COLOR.

SN 85-168,327, FILED 11-3-2010.

JESSICA FATHY, EXAMINING ATTORNEY



David J. Kybas

Director of the United States Patent and Trademark Office

United States of America

United States Patent and Trademark Office

PURE + REFRESHING

Reg. No. 4,206,640

Registered Sep. 11, 2012

Int. Cl.: 32

TRADEMARK

PRINCIPAL REGISTER

DS WATERS OF AMERICA, INC. (DELAWARE CORPORATION)
5660 NEW NORTHSIDE DRIVE, SUITE 500
ATLANTA, GA 30328

FOR: BOTTLED WATER, IN CLASS 32 (U.S. CLS. 45, 46 AND 48).

FIRST USE 2-18-2011; IN COMMERCE 2-18-2011.

THE MARK CONSISTS OF STANDARD CHARACTERS WITHOUT CLAIM TO ANY PARTICULAR FONT, STYLE, SIZE, OR COLOR.

SN 85-168,356, FILED 11-3-2010.

BARBARA RUTLAND, EXAMINING ATTORNEY



David J. Kyffers

Director of the United States Patent and Trademark Office

United States of America

United States Patent and Trademark Office

chromID

Reg. No. 4,206,641

BIOMÉRIEUX (FRANCE SOCIÉTÉ ANONYME À CONSEIL D'ADMINISTRATION)
69280

Registered Sep. 11, 2012

MARCY L'ETOILE, FRANCE

Int. Cls.: 9 and 10

FOR: SCIENTIFIC APPARATUS AND INSTRUMENTS, NAMELY, DIAGNOSTIC APPARATUS FOR CHECKING AND DETECTING CONTAMINANTS IN INDUSTRIAL, PHARMACEUTICAL AND AGRI-FOOD PREPARATIONS AND IN THE ENVIRONMENT IN WHICH THESE PREPARATIONS ARE PRODUCED, NAMELY, WATER, AIR AND WORK SURFACES; PETRI DISHES AND FLASKS FOR LABORATORY USE FOR CULTURE MEDIA FOR IN-VITRO DIAGNOSTICS, IN CLASS 9 (U.S. CLS. 21, 23, 26, 36 AND 38).

TRADEMARK

PRINCIPAL REGISTER

FIRST USE 3-1-2010; IN COMMERCE 3-1-2010.

FOR: MEDICAL APPARATUS AND INSTRUMENTS FOR CLINICAL DIAGNOSIS; PETRI DISHES AND FLASKS FOR MEDICAL USE FOR CULTURE MEDIA FOR IN-VITRO DIAGNOSTICS, IN CLASS 10 (U.S. CLS. 26, 39 AND 44).

FIRST USE 8-1-2010; IN COMMERCE 8-1-2010.

THE MARK CONSISTS OF THE LETTERS "CHROMID" WITH A SEMI-CIRCULAR DESIGN TO THE RIGHT SIDE OF THE LETTERS.

SN 85-168,457, FILED 11-3-2010.

NICHOLAS COLEMAN, EXAMINING ATTORNEY



David J. Kybas

Director of the United States Patent and Trademark Office

United States of America

United States Patent and Trademark Office

HAMMERHEAD

Reg. No. 4,206,642

Registered Sep. 11, 2012

Int. Cl.: 12

TRADEMARK

PRINCIPAL REGISTER

ENGINEERING TECHNOLOGIES ENTERPRISES L.L.C. (MICHIGAN LIMITED LIABILITY COMPANY)
620 EAST RILEY THOMPSON ROAD
MUSKEGON, MI 49445

FOR: CAR POWER TRAIN MECHANISM COMPRISED OF CLUTCH, TRANSMISSION, DRIVE SHAFT, AND DIFFERENTIAL , IN CLASS 12 (U.S. CLS. 19, 21, 23, 31, 35 AND 44).

FIRST USE 6-22-2012; IN COMMERCE 6-22-2012.

THE MARK CONSISTS OF STANDARD CHARACTERS WITHOUT CLAIM TO ANY PARTICULAR FONT, STYLE, SIZE, OR COLOR.

SN 85-168,549, FILED 11-3-2010.

JANET LEE, EXAMINING ATTORNEY



David J. Kyffers

Director of the United States Patent and Trademark Office

United States of America

United States Patent and Trademark Office

DURAFINISH

Reg. No. 4,206,643

Registered Sep. 11, 2012

Int. Cl.: 11

TRADEMARK

PRINCIPAL REGISTER

ATLAS LIGHTING PRODUCTS, INC. (NORTH CAROLINA CORPORATION), FORMERLY
ATLAS ELECTRIC CORPORATION,
1406 S. MEBANE STREET
BURLINGTON, NC 27215

FOR: POLYESTER POWDER COATINGS FOR DIE CAST HOUSINGS SOLD AS AN INTEGRAL COMPONENT OF LIGHT FIXTURES , IN CLASS 11 (U.S. CLS. 13, 21, 23, 31 AND 34).

FIRST USE 6-4-2004; IN COMMERCE 6-4-2004.

THE MARK CONSISTS OF STANDARD CHARACTERS WITHOUT CLAIM TO ANY PARTICULAR FONT, STYLE, SIZE, OR COLOR.

SN 85-169,217, FILED 11-4-2010.

MARCIE MILONE, EXAMINING ATTORNEY



David J. Kyffers

Director of the United States Patent and Trademark Office

United States of America

United States Patent and Trademark Office

XTEK

Reg. No. 4,206,644

Registered Sep. 11, 2012

Int. Cl.: 6

TRADEMARK

PRINCIPAL REGISTER

GRABBER CONSTRUCTION PRODUCTS, INC. (NEVADA CORPORATION)
SUITE 200
20 WEST MAIN STREET COURT
ALPINE, UT 840041889

FOR: METAL SCREWS NOT FOR USE AS MACHINE PARTS, IN CLASS 6 (U.S. CLS. 2, 12, 13, 14, 23, 25 AND 50).

FIRST USE 1-14-2010; IN COMMERCE 1-14-2010.

THE MARK CONSISTS OF STANDARD CHARACTERS WITHOUT CLAIM TO ANY PARTICULAR FONT, STYLE, SIZE, OR COLOR.

SN 85-169,346, FILED 11-4-2010.

MEGHAN REINHART, EXAMINING ATTORNEY



David J. Kyffers

Director of the United States Patent and Trademark Office

United States of America

United States Patent and Trademark Office

360 FITNESS

Reg. No. 4,206,645

Registered Sep. 11, 2012

Int. Cls.: 9 and 28

TRADEMARK

PRINCIPAL REGISTER

ARGENTO SC BY SICURA INC. (NEW YORK CORPORATION)
1407 BROADWAY
SUITE 2201
NEW YORK, NY 10018

FOR: WEIGHT SCALES, PEDOMETERS, ARMBANDS AND HOLDERS FOR CELLULAR PHONES AND PORTABLE AND HANDHELD DIGITAL ELECTRONIC DEVICES, IN CLASS 9 (U.S. CLS. 21, 23, 26, 36 AND 38).

FIRST USE 3-1-2011; IN COMMERCE 3-1-2011.

FOR: FITNESS EQUIPMENT, NAMELY, JUMP ROPES, RESISTANCE TUBES, RESISTANCE ROPES, STRETCH BANDS, LIGHT EXERCISE WEIGHTS, LIGHT WEIGHT LIFTING EXERCISE BARS, EXERCISE CUFF AND ANKLE WEIGHTS, EXERCISE MATS, EXERCISE STEPS, BALANCE BALLS, KETTLEBALLS, PULL-UP BARS AND PUSH-UP BARS, IN CLASS 28 (U.S. CLS. 22, 23, 38 AND 50).

FIRST USE 3-1-2011; IN COMMERCE 3-1-2011.

THE MARK CONSISTS OF STANDARD CHARACTERS WITHOUT CLAIM TO ANY PARTICULAR FONT, STYLE, SIZE, OR COLOR.

NO CLAIM IS MADE TO THE EXCLUSIVE RIGHT TO USE "FITNESS", APART FROM THE MARK AS SHOWN.

SN 85-169,932, FILED 11-5-2010.

LESLEY LAMOTHE, EXAMINING ATTORNEY



David J. Kyffers

Director of the United States Patent and Trademark Office

United States of America

United States Patent and Trademark Office

COLOR TOUCH

Reg. No. 4,206,646

THE ECHO DESIGN GROUP, INC. (NEW YORK CORPORATION)
10 EAST 40TH STREET
NEW YORK, NY 10016

Registered Sep. 11, 2012

Int. Cl.: 25

FOR: OUTDOOR COLD-WEATHER GLOVES, DESIGNED TO ENABLE THE WEARER TO ACCESS A TOUCH SCREEN DEVICE, NOT FOR MEDICAL, DENTAL OR INDUSTRIAL USE, IN CLASS 25 (U.S. CLS. 22 AND 39).

TRADEMARK

FIRST USE 8-31-2011; IN COMMERCE 8-31-2011.

PRINCIPAL REGISTER

THE MARK CONSISTS OF STANDARD CHARACTERS WITHOUT CLAIM TO ANY PARTICULAR FONT, STYLE, SIZE, OR COLOR.

OWNER OF U.S. REG. NO. 3,832,753.

NO CLAIM IS MADE TO THE EXCLUSIVE RIGHT TO USE "TOUCH", APART FROM THE MARK AS SHOWN.

SN 85-170,363, FILED 11-5-2010.

DAVID H. STINE, EXAMINING ATTORNEY



David J. Kyffers

Director of the United States Patent and Trademark Office

United States of America

United States Patent and Trademark Office

KRISTALBELLI

Reg. No. 4,206,647

JYP FOODS INC. (NEW YORK CORPORATION)
526 WINDSOR DRIVE
PALISADES PARK, NJ 07650

Registered Sep. 11, 2012

Int. Cl.: 43

FOR: RESTAURANT SERVICES, IN CLASS 43 (U.S. CLS. 100 AND 101).

SERVICE MARK

FIRST USE 3-26-2012; IN COMMERCE 3-26-2012.

PRINCIPAL REGISTER

THE MARK CONSISTS OF STANDARD CHARACTERS WITHOUT CLAIM TO ANY PARTICULAR FONT, STYLE, SIZE, OR COLOR.

SN 85-170,421, FILED 11-5-2010.

DAVID COLLIER, EXAMINING ATTORNEY



David J. Kyfos

Director of the United States Patent and Trademark Office

United States of America

United States Patent and Trademark Office

FRIENDESHA

Reg. No. 4,206,648

Registered Sep. 11, 2012

**Int. Cls.: 14, 16, 21, 25,
41, and 45**

FRIENDESHA MEDIA, INC. (FLORIDA CORPORATION)
320 TIMBERWOOD COURT
PALM BEACH GARDENS, FL 33418

FOR: JEWELRY, IN CLASS 14 (U.S. CLS. 2, 27, 28 AND 50).

FIRST USE 1-31-2011; IN COMMERCE 1-31-2011.

TRADEMARK

FOR: BOOKS IN THE FIELD OF PERSONAL IMPROVEMENT, INTERPERSONAL RELATIONSHIPS, PROMOTING FRIENDSHIP AND GOODWILL, AND COOKBOOKS; MAGAZINES IN THE FIELD OF PERSONAL IMPROVEMENT, INTERPERSONAL RELATIONSHIPS, AND PROMOTING FRIENDSHIP AND GOODWILL; POSTERS, RUBBER STAMPS, GREETING CARDS, GIFT BAGS, ART PRINTS AND ETCHINGS, IN CLASS 16 (U.S. CLS. 2, 5, 22, 23, 29, 37, 38 AND 50).

SERVICE MARK

FIRST USE 4-1-2011; IN COMMERCE 4-1-2011.

PRINCIPAL REGISTER

FOR: CUPS AND MUGS, IN CLASS 21 (U.S. CLS. 2, 13, 23, 29, 30, 33, 40 AND 50).

FIRST USE 1-31-2011; IN COMMERCE 1-31-2011.

FOR: CLOTHING, NAMELY, SHIRTS, T-SHIRTS, POLO SHIRTS, SWEATSHIRTS, FLEECE JACKETS, HATS, CAPS, AND BABY CLOTHING, NAMELY, ONE PIECE GARMENTS, IN CLASS 25 (U.S. CLS. 22 AND 39).

FIRST USE 1-31-2011; IN COMMERCE 1-31-2011.



FOR: EDUCATIONAL AND ENTERTAINMENT SERVICES, NAMELY, PROVIDING A WEBSITE FOR ENTERTAINMENT PURPOSES ONLY PROMOTING FRIENDSHIP AND GOODWILL THROUGH VERBAL AND WRITTEN EXPRESSIONS, MUSIC AND LITERATURE; ENTERTAINMENT SERVICES, NAMELY, PRODUCTION AND DISTRIBUTION OF MOVIES AND ONGOING TELEVISION PROGRAMS IN THE FIELD OF COMMUNITY INVOLVEMENT, COMMUNITY EVENTS, PROMOTING FRIENDSHIP AND GOODWILL, AND NEWS; ENTERTAINMENT SERVICES, NAMELY, PROVIDING ONLINE VIDEO GAMES, IN CLASS 41 (U.S. CLS. 100, 101 AND 107).

FIRST USE 11-8-2010; IN COMMERCE 11-8-2010.

David J. Kyffers

Director of the United States Patent and Trademark Office

Reg. No. 4,206,648 FOR: PROVIDING A WEBSITE FEATURING INFORMATION ABOUT INTERPERSONAL RELATIONSHIPS, NAMELY, PROVIDING A WEBSITE PROMOTING FRIENDSHIP AND GOODWILL THROUGH VERBAL AND WRITTEN EXPRESSIONS, MUSIC AND LITERATURE, IN CLASS 45 (U.S. CLS. 100 AND 101).

FIRST USE 11-8-2010; IN COMMERCE 11-8-2010.

THE MARK CONSISTS OF STANDARD CHARACTERS WITHOUT CLAIM TO ANY PARTICULAR FONT, STYLE, SIZE, OR COLOR.

SN 85-170,520, FILED 11-5-2010.

ALLISON SCHRODY, EXAMINING ATTORNEY

United States of America

United States Patent and Trademark Office

La Piccola Danza

Reg. No. 4,206,649

Registered Sep. 11, 2012

Int. Cl.: 25

TRADEMARK

PRINCIPAL REGISTER

NAY ET AL, INC. (CALIFORNIA CORPORATION)
2863 EAST 11TH STREET
LOS ANGELES, CA 90023

FOR: INFANT, TODDLER, AND CHILD CLOTHING, NAMELY, SHIRTS, BLOUSES, T-SHIRTS, TANK TOPS, PANTS, LEGGINGS, SKIRTED LEGGINGS, DRESSES, SKIRTS, SKIRTED COVERALLS, MINISKIRTS; KIMONO COVERALLS; ROMPERS; KIMONO SETS, COMPRISING ASSORTED COLORED KIMONOS; BODYSUITS; HATS; BLOOMER SETS COMPRISING ASSORTED COLORED BLOOMERS, CLOTH BIBS, CARDIGANS, SHOES, BEANIES; AND ACCESSORIES, NAMELY, BELTS AND GLOVES, IN CLASS 25 (U.S. CLS. 22 AND 39).

FIRST USE 12-31-2011; IN COMMERCE 12-31-2011.

THE MARK CONSISTS OF STANDARD CHARACTERS WITHOUT CLAIM TO ANY PARTICULAR FONT, STYLE, SIZE, OR COLOR.

THE ENGLISH TRANSLATION OF "LA PICCOLA DANZA" IN THE MARK IS "THE LITTLE ONE DANCING".

SN 85-171,075, FILED 11-8-2010.

ALICE BENMAMAN, EXAMINING ATTORNEY



David J. Kyros

Director of the United States Patent and Trademark Office

United States of America

United States Patent and Trademark Office

THE GLORIOUS

Reg. No. 4,206,650

ROCK AND ROLL RELIGION, INC. (CALIFORNIA CORPORATION)
3131 SOUTH BROADWAY
LOS ANGELES, CA 90007

Registered Sep. 11, 2012

Int. Cl.: 25

FOR: T-SHIRTS ALL RELATING TO AND FOR THE PROMOTION OF A MUSICAL GROUP, SOLD ONLY FROM VENUES ASSOCIATED WITH SUCH MUSICAL GROUP, IN CLASS 25 (U.S. CLS. 22 AND 39).

TRADEMARK

FIRST USE 12-2-2011; IN COMMERCE 12-12-2011.

PRINCIPAL REGISTER

THE MARK CONSISTS OF STANDARD CHARACTERS WITHOUT CLAIM TO ANY PARTICULAR FONT, STYLE, SIZE, OR COLOR.

SN 85-172,549, FILED 11-9-2010.

PRISCILLA MILTON, EXAMINING ATTORNEY



David J. Kybas

Director of the United States Patent and Trademark Office

United States of America

United States Patent and Trademark Office



Reg. No. 4,206,651

INDIAN INDUSTRIES, INC. (INDIANA CORPORATION)
817 MAXWELL AVENUE, P.O. BOX 889
EVANSVILLE, IN 47706

Registered Sep. 11, 2012

Int. Cl.: 28

FOR: SPORTS TRAINING EQUIPMENT, NAMELY, NET GOALS, REBOUNDING NETS, HITTING TRAINERS, FOOTBALL BLOCKING DUMMIES, AND APPARATUSES FOR REBOUNDING, CATCHING AND STOPPING BALLS, IN CLASS 28 (U.S. CLS. 22, 23, 38 AND 50).

TRADEMARK

PRINCIPAL REGISTER

FIRST USE 3-0-2011; IN COMMERCE 3-0-2011.

THE MARK CONSISTS OF A STYLIZED "G" IN ORANGE.

THE COLOR(S) ORANGE IS/ARE CLAIMED AS A FEATURE OF THE MARK.

SN 85-173,357, FILED 11-10-2010.

RONALD AIKENS, EXAMINING ATTORNEY



David J. Kyffers

Director of the United States Patent and Trademark Office

United States of America
United States Patent and Trademark Office

DUOFIT

Reg. No. 4,206,652

Registered Sep. 11, 2012

Int. Cl.: 11

TRADEMARK

PRINCIPAL REGISTER

TOTO, U.S.A., INC. (DELAWARE CORPORATION)
155 SOUTHERN ROAD
MORROW, GA 30260

FOR: TOILET TANK SYSTEM COMPRISED MAINLY OF A FLUSHING APPARATUS,
CONCEALED TANK, AND WALL MOUNTED BOWL; TOILETS, IN CLASS 11 (U.S. CLS.
13, 21, 23, 31 AND 34).

FIRST USE 10-13-2010; IN COMMERCE 10-13-2010.

THE MARK CONSISTS OF STANDARD CHARACTERS WITHOUT CLAIM TO ANY PAR-
TICULAR FONT, STYLE, SIZE, OR COLOR.

SN 85-173,464, FILED 11-10-2010.

DAVID TOOLEY, EXAMINING ATTORNEY



David J. Kyffers

Director of the United States Patent and Trademark Office

United States of America

United States Patent and Trademark Office

EQUIMACE

Reg. No. 4,206,653

Registered Sep. 11, 2012

Int. Cl.: 5

TRADEMARK

PRINCIPAL REGISTER

R & D LIFESCIENCES, LLC. (WISCONSIN LIMITED LIABILITY COMPANY)
4602 DOMAIN DRIVE
SUITE B
MENOMONIE, WI 54751

FOR: NON MEDICATED ADDITIVE FOR ANIMAL FEED FOR USE AS NUTRITIONAL SUPPLEMENT IN POWDER, LIQUID, GEL, CAPSULE, TABLET, BOLUS OR ANY OTHER FORM , IN CLASS 5 (U.S. CLS. 6, 18, 44, 46, 51 AND 52).

FIRST USE 11-4-2010; IN COMMERCE 8-8-2011.

THE MARK CONSISTS OF STANDARD CHARACTERS WITHOUT CLAIM TO ANY PARTICULAR FONT, STYLE, SIZE, OR COLOR.

OWNER OF U.S. REG. NOS. 3,837,619, 3,918,744, AND OTHERS.

SN 85-173,590, FILED 11-10-2010.

JULIE GUTTADAURO, EXAMINING ATTORNEY



David J. Kybas

Director of the United States Patent and Trademark Office

United States of America

United States Patent and Trademark Office

CIRCLE ONE

Reg. No. 4,206,654

DENIM GROUP, LTD. (NEW YORK CORPORATION)
1385 BROADWAY STE 1903
NEW YORK, NY 10018

Registered Sep. 11, 2012

Int. Cl.: 25

FOR: CLOTHING, NAMELY, PANTS, SHIRTS, SHORTS, SWEAT SHIRTS, TANK TOPS, TOPS, T-SHIRTS, IN CLASS 25 (U.S. CLS. 22 AND 39).

TRADEMARK

FIRST USE 2-17-2011; IN COMMERCE 2-17-2011.

PRINCIPAL REGISTER

THE MARK CONSISTS OF STANDARD CHARACTERS WITHOUT CLAIM TO ANY PARTICULAR FONT, STYLE, SIZE, OR COLOR.

SN 85-174,958, FILED 11-11-2010.

MATTHEW KLINE, EXAMINING ATTORNEY



David J. Kyffers

Director of the United States Patent and Trademark Office

United States of America

United States Patent and Trademark Office

29 MINUTE E.R. GUARANTEE DMC

Reg. No. 4,206,655

Registered Sep. 11, 2012

Int. Cl.: 44

SERVICE MARK

PRINCIPAL REGISTER

VHS OF MICHIGAN, INC. (DELAWARE CORPORATION)
C/O VANGUARD HEALTH SYSTEMS, 20 BURTON
HILLS, BLVD., SUITE 100
NASHVILLE, TN 37215

FOR: HOSPITAL SERVICES; MEDICAL SERVICES; EMERGENCY MEDICAL ASSISTANCE,
IN CLASS 44 (U.S. CLS. 100 AND 101).

FIRST USE 6-19-2012; IN COMMERCE 6-19-2012.

THE MARK CONSISTS OF STANDARD CHARACTERS WITHOUT CLAIM TO ANY PAR-
TICULAR FONT, STYLE, SIZE, OR COLOR.

NO CLAIM IS MADE TO THE EXCLUSIVE RIGHT TO USE "29 MINUTE E.R. GUARANTEE",
APART FROM THE MARK AS SHOWN.

SN 85-175,676, FILED 11-12-2010.

JULIE VEPPUMTHARA, EXAMINING ATTORNEY



David J. Kyffers

Director of the United States Patent and Trademark Office

United States of America

United States Patent and Trademark Office



29 minute E.R. guarantee

Reg. No. 4,206,656

Registered Sep. 11, 2012

Int. Cl.: 44

SERVICE MARK

PRINCIPAL REGISTER

VHS OF MICHIGAN, INC. (DELAWARE CORPORATION)
C/O VANGUARD HEALTH SYSTEMS, 20 BURTON
HILLS, BLVD., SUITE 100
NASHVILLE, TN 37215

FOR: HOSPITAL SERVICES; MEDICAL SERVICES; EMERGENCY MEDICAL ASSISTANCE,
IN CLASS 44 (U.S. CLS. 100 AND 101).

FIRST USE 6-19-2012; IN COMMERCE 6-12-2012.

NO CLAIM IS MADE TO THE EXCLUSIVE RIGHT TO USE "29 MINUTE E.R. GUARANTEE",
APART FROM THE MARK AS SHOWN.

THE MARK CONSISTS OF A PARTIAL STOPWATCH DESIGN, INCLUDING WORDS "29
MINUTE E.R. GUARANTEE" BELOW AND OFF TO THE SIDE.

SN 85-175,691, FILED 11-12-2010.

JULIE VEPPUMTHARA, EXAMINING ATTORNEY



David J. Kyros

Director of the United States Patent and Trademark Office

United States of America

United States Patent and Trademark Office

GROWING LITTLE BY LITTLE

Reg. No. 4,206,657

Registered Sep. 11, 2012

**Int. Cls.: 12, 18, 20, 21,
and 28**

TRADEMARK

PRINCIPAL REGISTER

JOIE INTERNATIONAL CO., LIMITED (HONG KONG LIMITED COMPANY)
31/F THE CENTER
99 QUEEN'S RD CENTRAL
HONG KONG, HONG KONG

FOR: WHEELS; WHEEL HUBS; HUB CAP SHIELDS; WHEEL RIM COVERS; HUB CAP COVERS; CAR SEAT HEADRESTS; CHILD SAFETY SEATS FOR CAR USE; SEAT COVERS USED IN VEHICLES, FENDERS FOR BICYCLES; FENDERS FOR MOTORCYCLES AND SCOOTERS; BIKE TRAILERS; BABY CARRIAGES; FOLDING BABY CARRIAGE; LIGHTWEIGHT BABY CARRIAGE; BABY CARRIAGE CANOPY; FOLDING BABY CARRIAGE CANOPY; LIGHTWEIGHT BABY CARRIAGE CANOPY; BABY CARRIAGE HOOD; FOLDING BABY CARRIAGE HOOD; TIRES; STROLLERS; BABY CARRIERS FOR USE IN STROLLERS; TRAVEL SYSTEMS FOR INFANTS AND CHILDREN, NAMELY, COMBINATION STROLLERS, CAR SEATS, CAR SEAT BASES, AND CARRIERS SOLD AS A UNIT; ACCESSORIES FOR STROLLERS AND BABY CARRIERS AND TRAVEL SYSTEMS ALL FOR INFANTS AND CHILDREN, NAMELY, SEAT PADS, NECK AND HEAD SUPPORTS, STORAGE COMPARTMENTS, CADDIES, TRAYS AND HOLDERS, PROTECTIVE SHIELDS AND COVERS; CHILDREN'S SAFETY HARNESSSES AND RESTRAINTS FOR THE SEATS OF VEHICLES; A COUPLER OR HITCH ON A BIKE THAT ATTACH A BABY TRAILER TO THE BIKE; A COUPLER OR HITCH ON A BIKE THAT CARRIES A BABY TRAILER; A BIKE WITH A CHILD BIKE SEAT; A RACK ON A BIKE THAT CARRIES A BABY CARRIER OR A STROLLER ON THE BIKE, IN CLASS 12 (U.S. CLS. 19, 21, 23, 31, 35 AND 44).

FIRST USE 5-0-2012; IN COMMERCE 5-0-2012.

FOR: BAGS FOR CARRYING BABIES, NAMELY, POUCH BABY CARRIER; BACKPACKS FOR CARRYING BABIES; BABY BELT CARRIERS WORN ON THE BODY; DIAPER BAGS FOR BABIES SOLD EMPTY, BAGS FOR CARRYING BABIES ACCESSORIES, IN CLASS 18 (U.S. CLS. 1, 2, 3, 22 AND 41).

FIRST USE 5-0-2012; IN COMMERCE 5-0-2012.

FOR: FURNITURE; TABLES; CHAIRS; ROCKING CHAIRS; BABY ROCKING BEDS; BABY SLEEPING BAGS; CRADLES; WOODEN BEDSTEAD; BABY HIGH CHAIRS; BABY WALKERS; MATTRESSES; CUSHIONS; PILLOWS; PADS FOR BABY PLAYPENS; CUSHIONED CHAIRS; HIGH CHAIR ACCESSORIES, NAMELY, SEAT PADS, SPILL PADS AND



David J. Kybas

Director of the United States Patent and Trademark Office

Reg. No. 4,206,657 TOY BARS THAT ATTACH TO HIGH CHAIRS; CHILDREN'S FEEDING SEATS, IN CLASS 20 (U.S. CLS. 2, 13, 22, 25, 32 AND 50).

FIRST USE 5-0-2012; IN COMMERCE 5-0-2012.

FOR: NON-METAL PLATES; CONTAINERS FOR DOMESTIC USE FOR HOLDING POWDERED MILK; PLASTIC WATER BOTTLES SOLD EMPTY; LARGE BOWLS; SALAD BOWLS; BOWLS; GLASS, CERAMIC, EARTHENWARE BOTTLES ALL SOLD EMPTY; THERMAL INSULATED CONTAINERS FOR FOOD OR BEVERAGES; VACUUM FLASKS; CUPS; PLATES; TRAYS FOR HOME USE; PORTABLE BABY BATHTUBS; BASKETS FOR DOMESTIC USE, NOT OF METAL, IN CLASS 21 (U.S. CLS. 2, 13, 23, 29, 30, 33, 40 AND 50).

FIRST USE 5-0-2012; IN COMMERCE 5-0-2012.

FOR: SWINGS; BABY SWINGS; BABY SWING ACCESSORIES, NAMELY, BASKETS ATTACHED TO BABY SWINGS; BABY SWING ACCESSORIES, NAMELY, SEAT PADS, NECK AND HEAD SUPPORTS, CARRYING BAGS, FABRIC AND NET COVERS THAT ATTACH TO SWINGS, BLANKETS THAT ATTACH TO BABY SWINGS, TOY BARS THAT ATTACH TO BABY SWINGS, ALL SOLD AS A UNIT; BABY SWINGS WITH A REMOVABLE, INTERCHANGEABLE INFANT CARRIER AND CRADLE; CHILDREN'S MULTIPLE ACTIVITY TOYS; BABY RATTLES INCORPORATING TEETHING RINGS; BABY RATTLES; BATH TOYS; CRIB MOBILES AND TOYS; DOLLS; DOLL FURNITURE AND ACCESSORIES; PLUSH TOYS; WIND-UP TOYS; MUSICAL TOYS; MANIPULATIVE PUZZLE FOR INFANTS; PULL/PUSH TOYS; AND PUPPETS, IN CLASS 28 (U.S. CLS. 22, 23, 38 AND 50).

FIRST USE 5-0-2012; IN COMMERCE 5-0-2012.

THE MARK CONSISTS OF STANDARD CHARACTERS WITHOUT CLAIM TO ANY PARTICULAR FONT, STYLE, SIZE, OR COLOR.

SN 85-175,857, FILED 11-12-2010.

PAM WILLIS, EXAMINING ATTORNEY

United States of America

United States Patent and Trademark Office

MISTA GREEN

Reg. No. 4,206,658

GREEN JR., AARON (UNITED STATES INDIVIDUAL)
10351 WINDY RIDGE LANE
NOKESVILLE, VA 20181

Registered Sep. 11, 2012

Int. Cl.: 9

FOR: DOWNLOADABLE MUSICAL SOUND RECORDINGS; DOWNLOADABLE VIDEO RECORDINGS FEATURING MUSIC; PRERECORDED CD'S FEATURING MUSIC, IN CLASS 9 (U.S. CLS. 21, 23, 26, 36 AND 38).

TRADEMARK

FIRST USE 5-15-2012; IN COMMERCE 5-15-2012.

PRINCIPAL REGISTER

THE MARK CONSISTS OF STANDARD CHARACTERS WITHOUT CLAIM TO ANY PARTICULAR FONT, STYLE, SIZE, OR COLOR.

SN 85-176,925, FILED 11-15-2010.

KATHERINE STOIDES, EXAMINING ATTORNEY



David J. Kybas

Director of the United States Patent and Trademark Office

United States of America

United States Patent and Trademark Office

E-BUSINESS NOW

Reg. No. 4,206,659

THE SCORE FOUNDATION (D.C. CORPORATION)
1175 HERNDON PARKWAY, SUITE 900
HERNDON, VA 20170

Registered Sep. 11, 2012

Int. Cls.: 35, 41, and 42

FOR: BUSINESS CONSULTATION; PROVIDING BUSINESS INFORMATION IN THE FIELDS OF E-COMMERCE AND ONLINE MARKETING COLLABORATION NETWORKS, IN CLASS 35 (U.S. CLS. 100, 101 AND 102).

SERVICE MARK

FIRST USE 3-16-2011; IN COMMERCE 3-16-2011.

PRINCIPAL REGISTER

FOR: BUSINESS TRAINING; PROVIDING EDUCATIONAL INFORMATION IN THE FIELD OF DIGITAL LITERACY; EDUCATIONAL SERVICES, NAMELY, PROVIDING WORKSHOPS AND CLASSES IN THE FIELDS OF DIGITAL LITERACY, E-COMMERCE, ONLINE COLLABORATION, INTERNET SEARCH OPTIMIZATION, BROADBAND USAGE AND CYBER-SECURITY, IN CLASS 41 (U.S. CLS. 100, 101 AND 107).

FIRST USE 3-16-2011; IN COMMERCE 3-16-2011.

FOR: PROVIDING INFORMATION IN THE FIELD OF INTERNET SEARCH ENGINE OPTIMIZATION; PROVIDING INFORMATION IN THE FIELD OF CYBER SECURITY, NAMELY, INFORMATION RELATED TO THE TESTING OF COMPUTERS AND NETWORKS TO ASSESS INFORMATION SECURITY VULNERABILITY; PROVIDING TECHNOLOGICAL INFORMATION IN THE FIELD OF BROADBAND USAGE, IN CLASS 42 (U.S. CLS. 100 AND 101).

FIRST USE 3-16-2011; IN COMMERCE 3-16-2011.

THE MARK CONSISTS OF STANDARD CHARACTERS WITHOUT CLAIM TO ANY PARTICULAR FONT, STYLE, SIZE, OR COLOR.

NO CLAIM IS MADE TO THE EXCLUSIVE RIGHT TO USE "E-BUSINESS", APART FROM THE MARK AS SHOWN.

SN 85-177,544, FILED 11-16-2010.

BRIAN CALLAGHAN, EXAMINING ATTORNEY



David J. Kyffers

Director of the United States Patent and Trademark Office

United States of America

United States Patent and Trademark Office



Reg. No. 4,206,660

WORLD WEAR PROJECT, LLC (TEXAS LIMITED LIABILITY COMPANY)

Registered Sep. 11, 2012

10777 SHADY TRAIL
DALLAS, TX 752201330

Int. Cl.: 36

FOR: FUNDRAISING SERVICES, NAMELY, PARTNERING WITH NON-PROFIT ORGANIZATIONS TO COLLECT CLOTHING AND FOOTWEAR, AND PAYING THE ORGANIZATIONS FOR THE COLLECTED CLOTHING AND FOOTWEAR, IN CLASS 36 (U.S. CLS. 100, 101 AND 102).

SERVICE MARK

PRINCIPAL REGISTER

FIRST USE 11-0-2011; IN COMMERCE 5-0-2012.

THE MARK CONSISTS OF A CLOTHES HANGER CONSISTING OF A PARTIAL RIBBON FOR THE HOOK OF THE HANGER AND A TRIANGLE FOR THE BODY OF THE HANGER. THE WORDS "CLOSETS FOR THE CAUSE" ARE POSITIONED BELOW THE DESIGN ELEMENT, WITH THE WORD "CLOSETS" PLACED ABOVE THE WORDS "FOR THE" AND THE WORD "CAUSE" PLACED BELOW THE WORDS "FOR THE".

SN 85-177,966, FILED 11-16-2010.

NICHOLAS COLEMAN, EXAMINING ATTORNEY



David J. Kybas

Director of the United States Patent and Trademark Office

United States of America

United States Patent and Trademark Office

zPERFORMANCE

Reg. No. 4,206,661

Registered Sep. 11, 2012

Int. Cl.: 25

TRADEMARK

PRINCIPAL REGISTER

ZUMBA FITNESS (FLORIDA LIMITED LIABILITY COMPANY)
LEGAL DEPARTMENT
800 SILKS RUN, SUITE 2310
HALLANDALE, FL 33009

FOR: CLOTHING, NAMELY, BRAS, LEGGINGS, TOPS, SHIRTS, PANTS, UNDER PANTS, UNDERWEAR, SHORTS, SOCKS, PULLOVERS, JACKETS, SWEATSHIRTS, CARGO PANTS, CAPRIS, HEADGEAR, NAMELY, HATS, VISORS, CAPS, HEADBANDS AND HEADWEAR, IN CLASS 25 (U.S. CLS. 22 AND 39).

FIRST USE 7-7-2011; IN COMMERCE 7-7-2011.

THE MARK CONSISTS OF STANDARD CHARACTERS WITHOUT CLAIM TO ANY PARTICULAR FONT, STYLE, SIZE, OR COLOR.

SN 85-178,051, FILED 11-16-2010.

Laurie Kaufman, Examining Attorney



David J. Kyffers

Director of the United States Patent and Trademark Office

United States of America

United States Patent and Trademark Office

THE RICHNESS OF LIFE

Reg. No. 4,206,662

PATTERSON, MARK A. (UNITED STATES INDIVIDUAL)
525 ATHENS PLACE
WESTFIELD, IN 46074

Registered Sep. 11, 2012

Int. Cls.: 36 and 41

FOR: FINANCIAL SERVICES, NAMELY, FINANCIAL ANALYSIS AND CONSULTATION; FINANCIAL RESEARCH; FINANCIAL INFORMATION PROVIDED BY ELECTRONIC MEANS; FINANCIAL INFORMATION PROCESSING; INVESTMENT FUND TRANSFER AND TRANSACTION SERVICES; SECURITY BROKERAGE; INSURANCE SERVICES, NAMELY, LIFE INSURANCE BROKERAGE; LIFE, HEALTH, PROPERTY AND CASUALTY INSURANCE UNDERWRITING; INSURANCE AGENCIES FOR HEALTH, PROPERTY AND CASUALTY INSURANCE; INSURANCE ACTUARIAL SERVICES; HEALTH, PROPERTY AND CASUALTY REINSURANCE UNDERWRITING; INSURANCE CONSULTING SERVICES; INVESTMENT MANAGEMENT SERVICES; FINANCIAL ASSET MANAGEMENT SERVICES; COMPREHENSIVE FINANCIAL RISK MANAGEMENT SERVICES FOCUSING ON ASSETS AND LIABILITIES INCLUDING COMBINING INSURANCE AND REINSURANCE SERVICES WITH DERIVATIVE FINANCIAL INSTRUMENTS; FINANCIAL CONSULTING SERVICES; BANKING SERVICES; MORTGAGE BANKING; REAL ESTATE MORTGAGE LENDING SERVICES; TRUST SERVICES, NAMELY, ESTATE TRUST MANAGEMENT, IN CLASS 36 (U.S. CLS. 100, 101 AND 102).

SERVICE MARK

PRINCIPAL REGISTER

FIRST USE 6-13-2012; IN COMMERCE 6-13-2012.



FOR: EDUCATIONAL SERVICES IN THE NATURE OF PROVIDING COURSES, TRAINING, SEMINARS AND WORKSHOPS IN THE FIELD OF FINANCIAL PLANNING AND LIFESTYLE MANAGEMENT, AND DISTRIBUTING COURSE MATERIALS IN CONNECTION THEREWITH, IN CLASS 41 (U.S. CLS. 100, 101 AND 107).

FIRST USE 6-13-2012; IN COMMERCE 6-13-2012.

THE MARK CONSISTS OF STANDARD CHARACTERS WITHOUT CLAIM TO ANY PARTICULAR FONT, STYLE, SIZE, OR COLOR.

SN 85-178,273, FILED 11-16-2010.

ODESSA BIBBINS, EXAMINING ATTORNEY

David J. Kyffers

Director of the United States Patent and Trademark Office

United States of America

United States Patent and Trademark Office



PHYSICIANS OF
EXCELLENCE

Reg. No. 4,206,663

Registered Sep. 11, 2012

**Int. Cls.: 9, 35, 41, and
44**

ZIEPO LLC (CALIFORNIA LIMITED LIABILITY COMPANY), DBA ASSOCIATION FOR
MEDICAL ETHICS,
SUITE 747
1601 NORTH SEPULVEDA BOULEVARD
MANHATTAN BEACH, CA 90266

FOR: AUDIO VISUAL RECORDINGS ABOUT MEDICAL ETHICS EDUCATION AND
MEDICAL EDUCATION, IN CLASS 9 (U.S. CLS. 21, 23, 26, 36 AND 38).

TRADEMARK

FIRST USE 1-31-2012; IN COMMERCE 1-31-2012.

SERVICE MARK

PRINCIPAL REGISTER

FOR: ADVERTISING AND MARKETING SERVICES, NAMELY, PROMOTING THE GOODS
AND SERVICES OF OTHERS IN THE FIELD OF MEDICINE AND HEALTH CARE;
PROVIDING PHYSICIAN AND HEALTH CARE PROVIDER REFERRALS, NAMELY, FOR-
WARDING INQUIRIES FROM PROSPECTIVE PATIENTS AND CLIENTS TO PHYSICIANS
AND HEALTH CARE PROVIDERS; MEDICAL ADVERTISING AND REFERRAL SERVICES
FOR PHYSICIANS AND HEALTH CARE PROVIDERS VIA A GLOBAL COMPUTER NET-
WORK; ONLINE REFERRAL SERVICES TO PHYSICIANS AND HEALTH CARE PROVIDERS;
ONLINE DIRECTORY OF PHYSICIANS AND HEALTH CARE PROVIDERS; ADVERTISING
SERVICES, NAMELY, PROVIDING ONLINE MARKETING SERVICES IN THE NATURE
OF BANNER ADVERTISING, DISPLAY ADVERTISING, LINK EXCHANGES AND SEARCH
ENGINE PLACEMENT SERVICES FOR PHYSICIANS AND HEALTH CARE PROVIDERS;
GENERAL BUSINESS NETWORKING REFERRAL SERVICES, NAMELY, PROMOTING
THE SERVICES OF OTHERS BY PASSING BUSINESS LEADS AND REFERRALS AMONG
GROUP MEMBERS; PROMOTING PUBLIC AWARENESS OF ISSUES RELATING TO
MEDICAL ETHICS VIA A WEBSITE, IN CLASS 35 (U.S. CLS. 100, 101 AND 102).

FIRST USE 1-31-2012; IN COMMERCE 1-31-2012.

FOR: PROVIDING A WEBSITE FEATURING NON-DOWNLOADABLE VIDEO PRESENTA-
TIONS IN THE FIELD OF MEDICAL ETHICS, IN CLASS 41 (U.S. CLS. 100, 101 AND 107).

FIRST USE 1-31-2012; IN COMMERCE 1-31-2012.

FOR: PROVIDING MEDICAL INFORMATION, MEDICAL NEWS, MEDICAL INFORMATION
EVALUATING DRUGS, MEDICAL INFORMATION EVALUATING MEDICAL DEVICES,
AND MEDICAL INFORMATION EVALUATING MEDICAL PROCEDURES VIA A WEBSITE;



David J. Kyjars

Director of the United States Patent and Trademark Office

Reg. No. 4,206,663 PROVIDING A WEBSITE FEATURING NON-DOWNLOADABLE VIDEOS FEATURING MEDICAL INFORMATION, IN CLASS 44 (U.S. CLS. 100 AND 101).

FIRST USE 1-31-2012; IN COMMERCE 1-31-2012.

OWNER OF U.S. REG. NO. 3,816,329.

NO CLAIM IS MADE TO THE EXCLUSIVE RIGHT TO USE "ASSOCIATION FOR MEDICAL ETHICS PHYSICIANS OF EXCELLENCE" AND THE SCALES OF JUSTICE AND CADUCEUS SYMBOL, APART FROM THE MARK AS SHOWN.

THE MARK CONSISTS OF THE WORDS "ASSOCIATION FOR MEDICAL ETHICS PHYSICIANS OF EXCELLENCE" AND A PARTIALLY SHADED CIRCULAR DESIGN INCLUDING A GRAPHIC IMAGE OF THE SCALES OF JUSTICE AND A CADUCEUS ON SHIELDS INSIDE THE CIRCLE; AND A WREATH OUTSIDE THE CIRCLE; AND CURVED LINES ON EITHER SIDE OF THE CIRCLE AND A VERTICAL LINE SEPARATING THE CIRCLE DESIGN AND "ASSOCIATION FOR MEDICAL ETHICS" AND "PHYSICIANS OF EXCELLENCE".

SN 85-178,961, FILED 11-17-2010.

ANNE FARRELL, EXAMINING ATTORNEY

United States of America

United States Patent and Trademark Office

EAU DE PREP

Reg. No. 4,206,664

1156662 FRAGRANCES, INC. (DELAWARE CORPORATION)
P.O. BOX 7792

Registered Sep. 11, 2012

NEW YORK, NY 10150

Int. Cl.: 3

FOR: EAU DE TOILETTE; FRAGRANCES FOR PERSONAL USE, IN CLASS 3 (U.S. CLS. 1, 4, 6, 50, 51 AND 52).

TRADEMARK

FIRST USE 8-19-2011; IN COMMERCE 8-19-2011.

PRINCIPAL REGISTER

THE MARK CONSISTS OF STANDARD CHARACTERS WITHOUT CLAIM TO ANY PARTICULAR FONT, STYLE, SIZE, OR COLOR.

THE ENGLISH TRANSLATION OF "EAU DE" IN THE MARK IS WATER OF.

SN 85-179,138, FILED 11-17-2010.

ALLISON HOLTZ, EXAMINING ATTORNEY



David J. Kybas

Director of the United States Patent and Trademark Office

United States of America
United States Patent and Trademark Office

Wealth 

Reg. No. 4,206,665

PATTERSON, MARK A. (UNITED STATES INDIVIDUAL)
525 ATHENS PLACE
WESTFIELD, IN 46074

Registered Sep. 11, 2012

Int. Cls.: 36 and 41

SERVICE MARK

PRINCIPAL REGISTER

FOR: FINANCIAL SERVICES, NAMELY, FINANCIAL ANALYSIS AND CONSULTATION; FINANCIAL RESEARCH; FINANCIAL INFORMATION PROVIDED BY ELECTRONIC MEANS; FINANCIAL INFORMATION PROCESSING; INVESTMENT FUND TRANSFER AND TRANSACTION SERVICES; SECURITY BROKERAGE; INSURANCE SERVICES, NAMELY, LIFE INSURANCE BROKERAGE; LIFE, HEALTH, PROPERTY AND CASUALTY INSURANCE UNDERWRITING; INSURANCE AGENCIES FOR HEALTH, PROPERTY AND CASUALTY INSURANCE; INSURANCE ACTUARIAL SERVICES; HEALTH, PROPERTY AND CASUALTY REINSURANCE UNDERWRITING; INSURANCE CONSULTING SERVICES; INVESTMENT MANAGEMENT SERVICES; FINANCIAL ASSET MANAGEMENT SERVICES; COMPREHENSIVE FINANCIAL RISK MANAGEMENT SERVICES FOCUSING ON ASSETS AND LIABILITIES INCLUDING COMBINING INSURANCE AND REINSURANCE SERVICES WITH DERIVATIVE FINANCIAL INSTRUMENTS; FINANCIAL CONSULTING SERVICES; BANKING SERVICES; MORTGAGE BANKING; REAL ESTATE MORTGAGE LENDING SERVICES; TRUST SERVICES, NAMELY, ESTATE TRUST MANAGEMENT, IN CLASS 36 (U.S. CLS. 100, 101 AND 102).

FIRST USE 6-13-2012; IN COMMERCE 6-13-2012.



FOR: EDUCATIONAL SERVICES IN THE NATURE OF PROVIDING COURSES, TRAINING, SEMINARS AND WORKSHOPS IN THE FIELD OF FINANCIAL PLANNING AND LIFESTYLE MANAGEMENT, AND DISTRIBUTING COURSE MATERIALS IN CONNECTION THEREWITH, IN CLASS 41 (U.S. CLS. 100, 101 AND 107).

FIRST USE 6-13-2012; IN COMMERCE 6-13-2012.

THE MARK CONSISTS OF THE TERM "WEALTH" WITH A SHADED SQUARE CONTAINING FOUR SHADED BANDS AND AN UNSHADED LETTER "N" AS A SUPERScript.

SN 85-179,291, FILED 11-17-2010.

David J. Kypos

ODESSA BIBBINS, EXAMINING ATTORNEY

United States of America

United States Patent and Trademark Office

**RIGHT STUFF. LOW PRICE.
EVERYDAY!**

Reg. No. 4,206,666

ACADEMY, LTD. (TEXAS LIMITED PARTNERSHIP)
1800 NORTH MASON ROAD
KATY, TX 77449

Registered Sep. 11, 2012

Int. Cl.: 35

FOR: ONLINE RETAIL STORE SERVICES FEATURING SPORTING GOODS, ATHLETIC EQUIPMENT, APPAREL AND FOOTWEAR, IN CLASS 35 (U.S. CLS. 100, 101 AND 102).

SERVICE MARK

FIRST USE 5-6-2011; IN COMMERCE 5-6-2011.

PRINCIPAL REGISTER

THE MARK CONSISTS OF STANDARD CHARACTERS WITHOUT CLAIM TO ANY PARTICULAR FONT, STYLE, SIZE, OR COLOR.

NO CLAIM IS MADE TO THE EXCLUSIVE RIGHT TO USE "LOW PRICE.", APART FROM THE MARK AS SHOWN.

SN 85-179,690, FILED 11-18-2010.

JENNIFER WILLISTON, EXAMINING ATTORNEY



David J. Kyffers

Director of the United States Patent and Trademark Office

United States of America

United States Patent and Trademark Office

WHAT THE HEX?

Reg. No. 4,206,667

Registered Sep. 11, 2012

Int. Cls.: 9, 14, and 18

TRADEMARK

PRINCIPAL REGISTER

AUGUST HAT COMPANY, INC. (CALIFORNIA CORPORATION)
3051 STURGIS ROAD
OXNARD, CA 93030

FOR: BANDS WORN ON THE BODY FOR CARRYING PERSONAL ELECTRONIC DEVICES; ARM AND WRIST BANDS FOR CARRYING PERSONAL ELECTRONIC DEVICES; BANDS WORN ON THE BODY FOR CARRYING PORTABLE, DIGITAL ELECTRONIC DEVICES; CASES, STRAPS, WRIST AND ARM BANDS FOR DIGITAL ELECTRONIC DEVICES FOR RECORDING, ORGANIZING, TRANSMITTING, MANIPULATING AND REVIEWING TEXT, DATA AND AUDIO FILES, TIMEKEEPING AND PLAYING MUSIC; WRIST BANDS AND STRAPS FOR HOLDING PERSONAL ELECTRONIC DEVICES; HEADPHONES, IN CLASS 9 (U.S. CLS. 21, 23, 26, 36 AND 38).

FIRST USE 6-18-2012; IN COMMERCE 6-18-2012.

FOR: WATCH BANDS AND STRAPS; BANDS AND STRAPS FOR CHRONOMETRIC INSTRUMENTS, IN CLASS 14 (U.S. CLS. 2, 27, 28 AND 50).

FIRST USE 6-18-2012; IN COMMERCE 6-18-2012.

FOR: BACK PACKS, TOTE BAGS, SACHELS, WALLETS, WAIST PACKS, IN CLASS 18 (U.S. CLS. 1, 2, 3, 22 AND 41).

FIRST USE 6-18-2012; IN COMMERCE 6-18-2012.

THE MARK CONSISTS OF STANDARD CHARACTERS WITHOUT CLAIM TO ANY PARTICULAR FONT, STYLE, SIZE, OR COLOR.

SN 85-180,150, FILED 11-18-2010.

DAVID TAYLOR, EXAMINING ATTORNEY



David J. Kyffers

Director of the United States Patent and Trademark Office

United States of America

United States Patent and Trademark Office

BOD

Reg. No. 4,206,668

PLASTECH INNOVATIONS, LLC (FLORIDA LIMITED LIABILITY COMPANY)
117 N.E. 1ST AVENUE, PH 1
MIAMI, FL 33132

Registered Sep. 11, 2012

Int. Cl.: 20

FOR: PACKAGING MADE PRIMARILY OF PLASTIC FOR WATER AND OTHER BEVERAGES, NAMELY, PLASTIC BASED CONTAINERS FOR COMMERCIAL PACKAGING SIMILAR IN NATURE TO BOTTLES OR POUCHES, IN CLASS 20 (U.S. CLS. 2, 13, 22, 25, 32 AND 50).

TRADEMARK

PRINCIPAL REGISTER

FIRST USE 10-19-2011; IN COMMERCE 10-19-2011.

THE MARK CONSISTS OF STANDARD CHARACTERS WITHOUT CLAIM TO ANY PARTICULAR FONT, STYLE, SIZE, OR COLOR.

SN 85-180,350, FILED 11-18-2010.

SUNG IN, EXAMINING ATTORNEY



David J. Kyffers

Director of the United States Patent and Trademark Office

United States of America

United States Patent and Trademark Office

FLATLINE

Reg. No. 4,206,669

CHRISTOPHER J. EASTERLING (UNITED STATES INDIVIDUAL), DBA FLATLINE,
319 MAR VISTA DR.
VISTA, CA 92083 AND

Registered Sep. 11, 2012

Int. Cl.: 32

RHONDA L. EASTERLING (UNITED STATES INDIVIDUAL), DBA FLATLINE,
319 MAR VISTA DR.
VISTA, CA 92083

TRADEMARK

FOR: ENERGY DRINKS, IN CLASS 32 (U.S. CLS. 45, 46 AND 48).

PRINCIPAL REGISTER

FIRST USE 11-1-2011; IN COMMERCE 5-1-2012.

THE MARK CONSISTS OF STANDARD CHARACTERS WITHOUT CLAIM TO ANY PARTICULAR FONT, STYLE, SIZE, OR COLOR.

SN 85-180,418, FILED 11-18-2010.

GENE MACIOL, EXAMINING ATTORNEY



David J. Kyffers

Director of the United States Patent and Trademark Office

United States of America

United States Patent and Trademark Office



Reg. No. 4,206,670

Registered Sep. 11, 2012

Int. Cl.: 25

TRADEMARK

PRINCIPAL REGISTER

WEALTHY WAR INTENTIONS (NORTH CAROLINA LIMITED LIABILITY COMPANY)
2024 SUMMIT RIDGE LANE
KANNAPOLIS, NC 28083

FOR: T-SHIRTS, IN CLASS 25 (U.S. CLS. 22 AND 39).

FIRST USE 12-17-2010; IN COMMERCE 1-1-2011.

THE MARK CONSISTS OF AN ARMY MAN WITH THE STYLIZED TEXT "WEALTHY WAR INTENTIONS".

SN 85-180,439, FILED 11-18-2010.

SUNG IN, EXAMINING ATTORNEY



David J. Kyfos

Director of the United States Patent and Trademark Office

United States of America

United States Patent and Trademark Office

ACMF

Reg. No. 4,206,671

Registered Sep. 11, 2012

Int. Cl.: 42

SERVICE MARK

PRINCIPAL REGISTER

CALIFORNIA ASSOCIATION OF COMMUNITY MANAGERS, INC. (CALIFORNIA CORPORATION)
23461 SOUTH POINTE DR., STE. 200
LAGUNA HILLS, CA 92653

FOR: TESTING, ANALYSIS, AND EVALUATION OF THE KNOWLEDGE SKILLS AND ABILITIES OF OTHERS FOR THE PURPOSE OF CERTIFICATION AND RE-CERTIFICATION IN THE FIELD OF MANAGEMENT OF HOMEOWNERS ASSOCIATION; ACCREDITATION SERVICES, NAMELY, DEVELOPING AND ADMINISTERING STANDARDS AND PROCEDURES FOR CERTIFYING PROFESSIONALS IN THE FIELD OF MANAGEMENT OF HOMEOWNERS ASSOCIATIONS, IN CLASS 42 (U.S. CLS. 100 AND 101).

FIRST USE 10-1-2011; IN COMMERCE 10-1-2011.

THE MARK CONSISTS OF STANDARD CHARACTERS WITHOUT CLAIM TO ANY PARTICULAR FONT, STYLE, SIZE, OR COLOR.

SN 85-180,557, FILED 11-18-2010.

SETH A. RAPPAPORT, EXAMINING ATTORNEY



David J. Kyffers

Director of the United States Patent and Trademark Office

United States of America

United States Patent and Trademark Office

POWERSCOUT

Reg. No. 4,206,672

POWERSCOUT SPORTS, INC. (CANADA CORPORATION)
1042 THISTLEWOOD DRIVE
VICTORIA, BC, CANADA V8X4T7

Registered Sep. 11, 2012

Int. Cls.: 35 and 41

FOR: BUSINESS CONSULTING SERVICES, NAMELY, ANALYSIS OF SPORTS STATISTICS FOR BUSINESS PURPOSES; PREPARING BUSINESS REPORTS CONTAINING ANALYSIS OF SPORTS STATISTICS, IN CLASS 35 (U.S. CLS. 100, 101 AND 102).

SERVICE MARK

FIRST USE 10-1-2010; IN COMMERCE 10-1-2010.

PRINCIPAL REGISTER

FOR: PROVIDING AN INTERACTIVE WEBSITE THAT PROVIDES SPORTS LEAGUE PLAYER STATISTICS, IN CLASS 41 (U.S. CLS. 100, 101 AND 107).

FIRST USE 10-1-2010; IN COMMERCE 10-1-2010.

THE MARK CONSISTS OF STANDARD CHARACTERS WITHOUT CLAIM TO ANY PARTICULAR FONT, STYLE, SIZE, OR COLOR.

OWNER OF CANADA REG. NO. TMA805536, DATED 8-30-2011, EXPIRES 8-30-2026.

SN 85-180,928, FILED 11-19-2010.

ALICIA COLLINS, EXAMINING ATTORNEY



David J. Kyjars

Director of the United States Patent and Trademark Office

United States of America

United States Patent and Trademark Office



Reg. No. 4,206,673

Registered Sep. 11, 2012

Int. Cls.: 35 and 41

SERVICE MARK

PRINCIPAL REGISTER

POWERSCOUT SPORTS, INC. (CALIFORNIA CORPORATION)
1042 THISTLEWOOD DRIVE
VICTORIA, BC, CANADA V8X4T7

FOR: BUSINESS CONSULTING SERVICES, NAMELY, ANALYSIS OF SPORTS STATISTICS FOR BUSINESS PURPOSES; PREPARING BUSINESS REPORTS CONTAINING ANALYSIS OF SPORTS STATISTICS, IN CLASS 35 (U.S. CLS. 100, 101 AND 102).

FIRST USE 10-1-2010; IN COMMERCE 10-1-2010.

FOR: PROVIDING AN INTERACTIVE WEBSITE THAT PROVIDES SPORTS LEAGUE PLAYER STATISTICS, IN CLASS 41 (U.S. CLS. 100, 101 AND 107).

FIRST USE 10-1-2010; IN COMMERCE 10-1-2010.

OWNER OF CANADA REG. NO. TMA805558, DATED 8-30-2011, EXPIRES 8-30-2026.

NO CLAIM IS MADE TO THE EXCLUSIVE RIGHT TO USE "HOCKEY.COM", APART FROM THE MARK AS SHOWN.

THE MARK CONSISTS OF THE STYLIZED WORD "POWERSCOUT" WITH A STYLIZED CURVED LINE AND THE WORDS "HOCKEY.COM" WITH THE PERIOD REPLACED WITH A STYLIZED IMAGE OF A HOCKEY PUCK.

SN 85-180,966, FILED 11-19-2010.

ALICIA COLLINS, EXAMINING ATTORNEY



David J. Kybas

Director of the United States Patent and Trademark Office

United States of America

United States Patent and Trademark Office

GARAGISTRY

Reg. No. 4,206,674

Registered Sep. 11, 2012

**Int. Cls.: 35, 38, 41, and
42**

SERVICE MARK

PRINCIPAL REGISTER

GARAGISTRY, LLC (GEORGIA LIMITED LIABILITY COMPANY)
STE 202, #263
12460 CRABAPPLE RD
ALPHARETTA, GA 300046646

FOR: PROVIDING A WEB SITE WHERE USERS CAN POST ITEMS FOR SALE THROUGH ON-LINE CLASSIFIED ADVERTISEMENTS; PROVIDING ON-LINE SEARCHABLE DATABASES FEATURING CLASSIFIED AD LISTINGS IN THE FIELD OF CLASSIC VEHICLES, NAMELY, MUSCLE CARS, HOT RODS, AUTOMOBILES, TRUCKS, BOATS, PLANES, AND MOTORCYCLES; PROVIDING AN INTERNET WEB SITE TO PROMOTE EVENTS RELATING TO CLASSIC VEHICLES, NAMELY, MUSCLE CARS, HOT RODS, AUTOMOBILES, TRUCKS, BOATS, PLANES, AND MOTORCYCLES, BY MEANS OF AN ONLINE EVENTS CALENDAR; PROVIDING AN ON-LINE DIRECTORY INFORMATION SERVICE FEATURING INFORMATION REGARDING CLASSIC VEHICLES, NAMELY, MUSCLE CARS, HOT RODS, AUTOMOBILES, TRUCKS, BOATS, PLANES, AND MOTORCYCLES, IN CLASS 35 (U.S. CLS. 100, 101 AND 102).

FIRST USE 10-22-2010; IN COMMERCE 7-3-2012.

FOR: PROVIDING ELECTRONIC BULLETIN BOARDS FOR TRANSMISSION OF MESSAGES AMONG USERS IN THE FIELD OF CLASSIC VEHICLES, NAMELY, MUSCLE CARS, HOT RODS, AUTOMOBILES, TRUCKS, BOATS, PLANES, AND MOTORCYCLES, IN CLASS 38 (U.S. CLS. 100, 101 AND 104).

FIRST USE 10-22-2010; IN COMMERCE 7-3-2012.

FOR: PROVIDING HISTORICAL AND ENTERTAINMENT INFORMATION IN THE FIELD OF CLASSIC VEHICLES, NAMELY, MUSCLE CARS, HOT RODS, AUTOMOBILES, TRUCKS, BOATS, PLANES, AND MOTORCYCLES; PROVIDING ON-LINE ELECTRONIC DATABASES IN THE FIELD OF CLASSIC VEHICLES, NAMELY, MUSCLE CARS, HOT RODS, AUTOMOBILES, TRUCKS, BOATS, PLANES, AND MOTORCYCLES, FEATURING HISTORICAL RECORDS, HISTORICAL PUBLICATIONS, PHOTOGRAPHS, VEHICLE OWNERSHIP RECORDS, VEHICLE OWNERS' NARRATIVES, VEHICLE MAINTENANCE HISTORIES, AND VEHICLE RESTORATION HISTORIES SUBMITTED BY USERS, PROVIDED ON THE GLOBAL COMPUTER NETWORK, IN CLASS 41 (U.S. CLS. 100, 101 AND 107).

FIRST USE 10-22-2010; IN COMMERCE 7-3-2012.



David J. Kyffers

Director of the United States Patent and Trademark Office

Reg. No. 4,206,674 FOR: COMPUTER SERVICES, NAMELY, CREATING AN ON-LINE COMMUNITY FOR REGISTERED USERS TO PARTICIPATE IN DISCUSSIONS, RECEIVE FEEDBACK FROM THEIR PEERS, SOLICIT ADVICE, FORM VIRTUAL COMMUNITIES, AND ENGAGE IN SOCIAL NETWORKING IN THE FIELD OF CLASSIC VEHICLES, NAMELY, MUSCLE CARS, HOT RODS, AUTOMOBILES, TRUCKS, BOATS, PLANES, AND MOTORCYCLES; COMPUTER SERVICES, NAMELY, CREATING AN ON-LINE COMMUNITY FOR REGISTERED USERS TO PARTICIPATE IN DISCUSSIONS, GET FEEDBACK FROM THEIR PEERS, FORM VIRTUAL COMMUNITIES, AND ENGAGE IN SOCIAL NETWORKING; COMPUTER SERVICES, NAMELY, HOSTING CUSTOMIZED WEB PAGES AND DATA FEEDS FEATURING USER-DEFINED INFORMATION, NAMELY, BLOG POSTS, PERSONAL PROFILES, NEW MEDIA CONTENT, AND ON-LINE CONTENT, ALL IN THE FIELD OF CLASSIC VEHICLES, NAMELY, MUSCLE CARS, HOT RODS, AUTOMOBILES, TRUCKS, BOATS, PLANES, AND MOTORCYCLES; COMPUTER SERVICES, NAMELY, HOSTING AN INTERACTIVE WEB SITE FOR USE IN CREATING, DISPLAYING, SHARING AND STORING MULTIMEDIA PRESENTATIONS THAT INCLUDE TEXT, PHOTOGRAPHS AND SOUND, ALL IN THE FIELD OF CLASSIC VEHICLES, NAMELY, MUSCLE CARS, HOT RODS, AUTOMOBILES, TRUCKS, BOATS, PLANES, AND MOTORCYCLES; HOSTING OF DIGITAL CONTENT ON THE INTERNET, NAMELY, HOSTING OF ON-LINE ARTICLES, JOURNALS, BULLETIN BOARDS, AND BLOGS IN THE FIELD OF CLASSIC VEHICLES, NAMELY, MUSCLE CARS, HOT RODS, AUTOMOBILES, TRUCKS, BOATS, PLANES, AND MOTORCYCLES; COMPUTER SERVICES, NAMELY, HOSTING AND MAINTAINING AN ONLINE WEBSITE FOR OTHERS TO ACCESS PHOTO ALBUMS AND CALENDARS; PROVIDING TEMPORARY USE OF NON-DOWNLOADABLE COMPUTER SOFTWARE FOR USE IN THE CREATION AND PUBLICATION OF ON-LINE JOURNALS, BLOGS, AND MULTI-MEDIA PRESENTATIONS IN THE FIELD OF CLASSIC VEHICLES, NAMELY, MUSCLE CARS, HOT RODS, AUTOMOBILES, TRUCKS, BOATS, PLANES, AND MOTORCYCLES, IN CLASS 42 (U.S. CLS. 100 AND 101).

FIRST USE 10-22-2010; IN COMMERCE 7-3-2012.

THE MARK CONSISTS OF STANDARD CHARACTERS WITHOUT CLAIM TO ANY PARTICULAR FONT, STYLE, SIZE, OR COLOR.

SN 85-181,030, FILED 11-19-2010.

JORDAN BAKER, EXAMINING ATTORNEY

United States of America

United States Patent and Trademark Office

THINK FISHER

Reg. No. 4,206,675

JOHN B. SANFILIPPO & SON, INC. (DELAWARE CORPORATION)
1703 N. RANDALL ROAD
ELGIN, IL 601237820

Registered Sep. 11, 2012

Int. Cls.: 29 and 30

FOR: SNACK MIX CONSISTING PRIMARILY OF PROCESSED FRUITS AND PROCESSED NUTS, IN CLASS 29 (U.S. CL. 46).

TRADEMARK

FIRST USE 12-14-2010; IN COMMERCE 12-14-2010.

PRINCIPAL REGISTER

FOR: SNACK MIXES CONSISTING PRIMARILY OF WHEAT-BASED OR RICE-BASED SNACK FOODS AND ALSO CONTAINING PROCESSED NUTS, IN CLASS 30 (U.S. CL. 46).

FIRST USE 12-14-2010; IN COMMERCE 12-14-2010.

THE MARK CONSISTS OF STANDARD CHARACTERS WITHOUT CLAIM TO ANY PARTICULAR FONT, STYLE, SIZE, OR COLOR.

SN 85-181,417, FILED 11-19-2010.

ANN E. SAPPENFIELD, EXAMINING ATTORNEY



David J. Kybas

Director of the United States Patent and Trademark Office

United States of America

United States Patent and Trademark Office

URITRAK

Reg. No. 4,206,676

STANBIO LABORATORY (TEXAS CORPORATION)
1261 NORTH MAIN STREET
BOERNE, TX 78006

Registered Sep. 11, 2012

Int. Cl.: 5

FOR: DIAGNOSTIC REAGENTS FOR CLINICAL OR MEDICAL USE AND TESTING, IN CLASS 5 (U.S. CLS. 6, 18, 44, 46, 51 AND 52).

TRADEMARK

FIRST USE 4-30-2012; IN COMMERCE 4-30-2012.

PRINCIPAL REGISTER

THE MARK CONSISTS OF STANDARD CHARACTERS WITHOUT CLAIM TO ANY PARTICULAR FONT, STYLE, SIZE, OR COLOR.

SN 85-181,737, FILED 11-19-2010.

STEPHANIE ALI, EXAMINING ATTORNEY



David J. Kyjars

Director of the United States Patent and Trademark Office

United States of America

United States Patent and Trademark Office

PIDDLE PLACE MAN'S BEST FRIEND'S BEST FRIEND

Reg. No. 4,206,677

Registered Sep. 11, 2012

Int. Cl.: 5

TRADEMARK

PRINCIPAL REGISTER

HILLMAN, KATHLEEN T (UNITED STATES INDIVIDUAL), DBA THE PIDDLE PLACE,
LLC,
18689 SE PALM ISLAND LANE
JUPITER, FL 33458

FOR: DEODORIZERS FOR HOUSEHOLD PET LITTER BOXES; DEODORIZING PREPARA-
TIONS FOR PET LITTER BOXES, IN CLASS 5 (U.S. CLS. 6, 18, 44, 46, 51 AND 52).

FIRST USE 3-30-2012; IN COMMERCE 3-30-2012.

THE MARK CONSISTS OF STANDARD CHARACTERS WITHOUT CLAIM TO ANY PAR-
TICULAR FONT, STYLE, SIZE, OR COLOR.

SN 85-182,128, FILED 11-22-2010.

PRISCILLA MILTON, EXAMINING ATTORNEY



David J. Kyffers

Director of the United States Patent and Trademark Office

United States of America

United States Patent and Trademark Office

SHORT ON CASH

Reg. No. 4,206,678

Registered Sep. 11, 2012

Int. Cl.: 36

SERVICE MARK

PRINCIPAL REGISTER

TMX FINANCE LLC (DELAWARE LIMITED LIABILITY COMPANY)
SUITE 200
15 BULL STREET
SAVANNAH, GA 31401

FOR: FINANCIAL SERVICES, NAMELY, AUTOMOBILE TITLE PAWN LOANS AND
AUTOMOBILE TITLE PLEDGE LOANS, IN CLASS 36 (U.S. CLS. 100, 101 AND 102).

FIRST USE 12-1-2010; IN COMMERCE 12-1-2010.

THE MARK CONSISTS OF STANDARD CHARACTERS WITHOUT CLAIM TO ANY PAR-
TICULAR FONT, STYLE, SIZE, OR COLOR.

SN 85-182,290, FILED 11-22-2010.

PAM WILLIS, EXAMINING ATTORNEY



David J. Kyffers

Director of the United States Patent and Trademark Office

United States of America

United States Patent and Trademark Office



Reg. No. 4,206,679

Registered Sep. 11, 2012

Int. Cls.: 44 and 45

SERVICE MARK

PRINCIPAL REGISTER

THE BUFFALO CITY CEMETERY, INC. (NEW YORK NOT-FOR-PROFIT CEMETERY CORPORATION)
1411 DELAWARE AVENUE
BUFFALO, NY 14209

FOR: CEMETERY SERVICES, NAMELY, CEMETERY PLOT BEAUTIFICATION, MAINTENANCE, AND PERPETUAL CARE SERVICES FOR CEMETERY PLOTS, GRAVES, MAUSOLEUMS, CRYPTS AND NICHES, IN CLASS 44 (U.S. CLS. 100 AND 101).

FIRST USE 10-0-2010; IN COMMERCE 10-0-2010.

FOR: PROVIDING SERVICES CONSISTING OF INTERNMENTS, BURIALS AND ENTOMBMENTS; CEMETERY SERVICES, NAMELY, PROVIDING GRAVE, PLOT, CRYPT AND NICHE SPACES, IN CLASS 45 (U.S. CLS. 100 AND 101).

FIRST USE 10-0-2010; IN COMMERCE 10-0-2010.

NO CLAIM IS MADE TO THE EXCLUSIVE RIGHT TO USE "CEMETERY", APART FROM THE MARK AS SHOWN.

THE MARK CONSISTS OF THE DESIGN OF TWO HANDS PLACED IN THE PRAYER POSITION INCORPORATED INTO THE DESIGN OF THE AMERICAN FLAG SURROUNDED BY TWO STYLIZED TREES BEARING LEAVES ALL ABOVE A HORIZONTAL SOLID LINE AND THE WORDS "ST. MATTHEW'S CEMETERY" IN STYLIZED LETTERING.

SN 85-182,382, FILED 11-22-2010.

KIM SAITO, EXAMINING ATTORNEY



David J. Kybas

Director of the United States Patent and Trademark Office

United States of America

United States Patent and Trademark Office



ST. MATTHEW'S
C E M E T E R Y

Dedicated to God, family and country.

Reg. No. 4,206,680

Registered Sep. 11, 2012

Int. Cls.: 44 and 45

SERVICE MARK

PRINCIPAL REGISTER

THE BUFFALO CITY CEMETERY, INC. (NEW YORK NOT-FOR-PROFIT CEMETERY CORPORATION)
1411 DELAWARE AVENUE
BUFFALO, NY 14209

FOR: CEMETERY SERVICES, NAMELY, CEMETERY PLOT BEAUTIFICATION, MAINTENANCE, AND PERPETUAL CARE SERVICES FOR CEMETERY PLOTS, GRAVES, MAUSOLEUMS, CRYPTS AND NICHES, IN CLASS 44 (U.S. CLS. 100 AND 101).

FIRST USE 10-0-2010; IN COMMERCE 10-0-2010.

FOR: PROVIDING SERVICES CONSISTING OF INTERNMENTS, BURIALS AND ENTOMBMENTS; CEMETERY SERVICES, NAMELY, PROVIDING GRAVE, PLOT, CRYPT AND NICHE SPACES, IN CLASS 45 (U.S. CLS. 100 AND 101).

FIRST USE 10-0-2010; IN COMMERCE 10-0-2010.

NO CLAIM IS MADE TO THE EXCLUSIVE RIGHT TO USE "CEMETERY", APART FROM THE MARK AS SHOWN.

THE MARK CONSISTS OF THE DESIGN OF TWO HANDS PLACED IN THE PRAYER POSITION INCORPORATED INTO THE DESIGN OF THE AMERICAN FLAG SURROUNDED BY TWO STYLIZED TREES BEARING LEAVES ALL ABOVE A HORIZONTAL SOLID LINE AND THE WORDS "ST. MATTHEW'S CEMETERY" IN STYLIZED LETTERING, ANOTHER HORIZONTAL SOLID LINE, AND THE WORDS "DEDICATED TO GOD, FAMILY AND COUNTRY" IN STYLIZED LETTERING.

SN 85-182,422, FILED 11-22-2010.

KIM SAITO, EXAMINING ATTORNEY



David J. Kybas

Director of the United States Patent and Trademark Office

United States of America

United States Patent and Trademark Office

EFFITIX

Reg. No. 4,206,681

VIRBAC (FRANCE SOCIÉTÉ ANONYME (SA))
1ÈRE AVENUE 2065M, L.I.D
06516 CARROS, FRANCE

Registered Sep. 11, 2012

Int. Cl.: 5

FOR: VETERINARY PREPARATIONS, NAMELY, DERMATOLOGICAL PREPARATIONS FOR VETERINARY USE FOR THE PREVENTION AND TREATMENT OF SKIN DISORDERS, IRRITATION AND ITCHING OF THE SKIN AND EARS OF ANIMALS; INTERNAL AND EXTERNAL ANTIPARASITICS FOR VETERINARY USE FOR ANIMALS, IN CLASS 5 (U.S. CLS. 6, 18, 44, 46, 51 AND 52).

TRADEMARK

PRINCIPAL REGISTER

FIRST USE 5-1-2012; IN COMMERCE 5-1-2012.

THE MARK CONSISTS OF STANDARD CHARACTERS WITHOUT CLAIM TO ANY PARTICULAR FONT, STYLE, SIZE, OR COLOR.

THE WORD(S) "EFFITIX" HAS NO MEANING IN A FOREIGN LANGUAGE.

SN 85-182,469, FILED 11-22-2010.

MICHAEL SOUDERS, EXAMINING ATTORNEY



David J. Kyros

Director of the United States Patent and Trademark Office

United States of America
United States Patent and Trademark Office

PLUTO

Reg. No. 4,206,682

DISNEY ENTERPRISES, INC. (DELAWARE CORPORATION)
500 SOUTH BUENA VISTA STREET
BURBANK, CA 91521

Registered Sep. 11, 2012

Int. Cl.: 20

FOR: DRINKING STRAWS; FIGURINES MADE OF PLASTIC; PICTURE FRAMES; WIND CHIMES, IN CLASS 20 (U.S. CLS. 2, 13, 22, 25, 32 AND 50).

TRADEMARK

FIRST USE 12-23-2009; IN COMMERCE 12-23-2009.

PRINCIPAL REGISTER

THE MARK CONSISTS OF STANDARD CHARACTERS WITHOUT CLAIM TO ANY PARTICULAR FONT, STYLE, SIZE, OR COLOR.

SN 85-182,818, FILED 11-22-2010.

ALICE BENMAMAN, EXAMINING ATTORNEY



David J. Kybas

Director of the United States Patent and Trademark Office

United States of America

United States Patent and Trademark Office

PARABELLUM

Reg. No. 4,206,683

Registered Sep. 11, 2012

Int. Cl.: 18

TRADEMARK

PRINCIPAL REGISTER

PARABELLUM COLLECTION, INC. (CALIFORNIA CORPORATION)
1147 WILCOX PLACE, UNIT A
LOS ANGELES, CA 90038

FOR: HANDBAGS FOR LADIES, IN CLASS 18 (U.S. CLS. 1, 2, 3, 22 AND 41).

FIRST USE 8-25-2011; IN COMMERCE 8-25-2011.

THE MARK CONSISTS OF STANDARD CHARACTERS WITHOUT CLAIM TO ANY PARTICULAR FONT, STYLE, SIZE, OR COLOR.

OWNER OF U.S. REG. NOS. 3,750,271 AND 3,750,702.

SN 85-183,315, FILED 11-23-2010.

COURTNEY ALVAREZ, EXAMINING ATTORNEY



David J. Kyffers

Director of the United States Patent and Trademark Office

United States of America

United States Patent and Trademark Office

RADAR RADIO

Reg. No. 4,206,684

Registered Sep. 11, 2012

Int. Cls.: 9 and 41

TRADEMARK

SERVICE MARK

PRINCIPAL REGISTER

NIKI BARR ENTERPRISES, LLC (MARYLAND LIMITED LIABILITY COMPANY)
1016 PINE CREST ROAD
ANNAPOLIS, MD 21403

FOR: SOUND AND VIDEO RECORDINGS FEATURING MUSIC; ONLINE DOWNLOADABLE SOUND AND VIDEO RECORDINGS FEATURING MUSIC; ELECTRONIC SOUND AND VIDEO RECORDINGS FEATURING MUSIC, IN CLASS 9 (U.S. CLS. 21, 23, 26, 36 AND 38).

FIRST USE 11-15-2010; IN COMMERCE 11-15-2010.

FOR: ENTERTAINMENT SERVICES, NAMELY, PROVIDING ONLINE, NON-DOWNLOADABLE PRERECORDED SOUND AND VIDEO RECORDINGS FEATURING MUSIC VIA A GLOBAL COMPUTER NETWORK, IN CLASS 41 (U.S. CLS. 100, 101 AND 107).

FIRST USE 11-15-2010; IN COMMERCE 11-15-2010.

THE MARK CONSISTS OF STANDARD CHARACTERS WITHOUT CLAIM TO ANY PARTICULAR FONT, STYLE, SIZE, OR COLOR.

NO CLAIM IS MADE TO THE EXCLUSIVE RIGHT TO USE "RADIO", APART FROM THE MARK AS SHOWN.

SN 85-183,528, FILED 11-23-2010.

KHANH LE, EXAMINING ATTORNEY



David J. Kybas

Director of the United States Patent and Trademark Office

United States of America

United States Patent and Trademark Office

ConvergeFlex

Reg. No. 4,206,685

QLOGIC, CORPORATION (DELAWARE CORPORATION)
26650 ALISO VIEJO PARKWAY
ALISO VIEJO, CA 92656

Registered Sep. 11, 2012

Int. Cl.: 9

FOR: NETWORK DEVICES, NAMELY, ADAPTERS, SWITCHES AND INTEGRATED CIRCUITS FOR NETWORK COMMUNICATION; COMPUTER FIRMWARE AND SOFTWARE FOR OPERATING AND MANAGING NETWORK DEVICES, IN CLASS 9 (U.S. CLS. 21, 23, 26, 36 AND 38).

TRADEMARK

PRINCIPAL REGISTER

FIRST USE 6-13-2012; IN COMMERCE 6-13-2012.

THE MARK CONSISTS OF STANDARD CHARACTERS WITHOUT CLAIM TO ANY PARTICULAR FONT, STYLE, SIZE, OR COLOR.

SN 85-184,039, FILED 11-23-2010.

CURTIS FRENCH, EXAMINING ATTORNEY



David J. Kyffers

Director of the United States Patent and Trademark Office

United States of America

United States Patent and Trademark Office

FlexOffload

Reg. No. 4,206,686

QLOGIC, CORPORATION (DELAWARE CORPORATION)
26650 ALISO VIEJO PARKWAY
ALISO VIEJO, CA 92656

Registered Sep. 11, 2012

Int. Cl.: 9

FOR: NETWORK DEVICES, NAMELY, ADAPTERS, SWITCHES AND INTEGRATED CIRCUITS FOR NETWORK COMMUNICATION; COMPUTER FIRMWARE AND SOFTWARE FOR OPERATING AND MANAGING NETWORK DEVICES, IN CLASS 9 (U.S. CLS. 21, 23, 26, 36 AND 38).

TRADEMARK

PRINCIPAL REGISTER

FIRST USE 6-13-2012; IN COMMERCE 6-13-2012.

THE MARK CONSISTS OF STANDARD CHARACTERS WITHOUT CLAIM TO ANY PARTICULAR FONT, STYLE, SIZE, OR COLOR.

SN 85-184,059, FILED 11-23-2010.

CURTIS FRENCH, EXAMINING ATTORNEY



David J. Kyffers

Director of the United States Patent and Trademark Office

United States of America

United States Patent and Trademark Office

Potty Button

Reg. No. 4,206,687

DELEO, DANIEL (UNITED STATES INDIVIDUAL)
20 DYER AVENUE
MILTON, MA 02186

Registered Sep. 11, 2012

Int. Cl.: 28

FOR: TRAINING AIDS AND PRODUCTS FOR POTTY TRAINING CHILDREN, NAMELY, TOYS IN THE NATURE OF PRESS-DOWN TOYS, NAMELY, AUDIBLE ELECTRONIC PRESS-DOWN TOYS AND ILLUMINATING ELECTRONIC PRESS-DOWN TOYS, MECHANICAL ACTION TOYS, MECHANICAL TOYS, MUSICAL TOYS, PUSH TOYS, TOY NOISEMAKERS, AND GAMES IN THE NATURE OF CHILD TRAINING ACTIVITIES, NAMELY, ROLE PLAYING GAMES AND MEMORY GAMES, GO GAMES, AND MANIPULATIVE GAMES, IN CLASS 28 (U.S. CLS. 22, 23, 38 AND 50).

TRADEMARK

PRINCIPAL REGISTER

FIRST USE 6-1-2012; IN COMMERCE 6-1-2012.

THE MARK CONSISTS OF STANDARD CHARACTERS WITHOUT CLAIM TO ANY PARTICULAR FONT, STYLE, SIZE, OR COLOR.

NO CLAIM IS MADE TO THE EXCLUSIVE RIGHT TO USE "POTTY" , APART FROM THE MARK AS SHOWN.

SN 85-184,192, FILED 11-23-2010.

JENNY PARK, EXAMINING ATTORNEY



David J. Kyffers

Director of the United States Patent and Trademark Office

United States of America

United States Patent and Trademark Office



Reg. No. 4,206,688

Registered Sep. 11, 2012

Int. Cl.: 35

SERVICE MARK

PRINCIPAL REGISTER

SCHWARTZ, MICHAEL J. (UNITED STATES INDIVIDUAL)
SUITE 2700
150 WEST FLAGLER STREET
MIAMI, FL 33130

FOR: MANAGEMENT AND AGENCY REPRESENTATION OF PROFESSIONAL ATHLETES,
IN CLASS 35 (U.S. CLS. 100, 101 AND 102).

FIRST USE 12-0-2010; IN COMMERCE 12-0-2010.

THE MARK CONSISTS OF A PENTAGON SURROUNDED BY A GREY BORDER INDICATING A BASEBALL BASE, NAMELY, A HOME BASE. INSIDE THE PENTAGON ARE TWO ORANGE SEMICIRCLES OUTLINED IN WHITE, EACH BISECTED WITH A WHITE LINE, INDICATING HALVES OF BASKETBALLS. IN THE MIDDLE, THERE ARE A SERIES OF WHITE LINES IN A BLACK FIELD RESEMBLING THE LACES OF A FOOTBALL.

THE COLOR(S) ORANGE, WHITE, GREY AND BLACK IS/ARE CLAIMED AS A FEATURE OF THE MARK.

SN 85-184,576, FILED 11-24-2010.

JANET LEE, EXAMINING ATTORNEY



David J. Kybas

Director of the United States Patent and Trademark Office

United States of America

United States Patent and Trademark Office



Reg. No. 4,206,689

Registered Sep. 11, 2012

Int. Cl.: 37

SERVICE MARK

PRINCIPAL REGISTER

CRAIG W. MINOLETTI (UNITED STATES INDIVIDUAL)
1641 DELMONTE
WOLVERINE LAKE, MI 48390

FOR: CAR WASH SERVICES, IN CLASS 37 (U.S. CLS. 100, 103 AND 106).

FIRST USE 8-0-2009; IN COMMERCE 8-0-2009.

THE MARK CONSISTS OF A GREEN FROG, OUTLINED IN BLACK, HAVING LIGHT GREEN SPOTS, BLUE HAIR, ORANGE HANDS AND FEET, ORANGE, BLACK AND WHITE EYES, AND WHITE TEETH; THE FROG SITS IN A PUDDLE OF BLUE WATER AND THE WORDS "WET WILLY'S" ARE DISPOSED, IN RED, ABOVE THE FROG.

THE COLOR(S) RED, GREEN, LIGHT GREEN, BLUE, ORANGE, BLACK AND WHITE IS/ARE CLAIMED AS A FEATURE OF THE MARK.

SN 85-185,419, FILED 11-26-2010.

THEODORE MCBRIDE, EXAMINING ATTORNEY



David J. Kyfos

Director of the United States Patent and Trademark Office

United States of America

United States Patent and Trademark Office

Marketing Rebel

Reg. No. 4,206,690

Registered Sep. 11, 2012

Int. Cl.: 9

TRADEMARK

PRINCIPAL REGISTER

MARKETING REBEL LLC (NEVADA LIMITED LIABILITY COMPANY)
561 KEYSTONE AVE, #282
RENO, NV 89503

FOR: AUDIO DISCS FEATURING COPYWRITING, MARKETING, BUSINESS, AND TECHNOLOGY INSTRUCTION; DOWNLOADABLE MULTIMEDIA FILE CONTAINING ARTWORK, TEXT, AUDIO, VIDEO, GAMES, AND INTERNET WEB LINKS RELATING TO COPYWRITING, MARKETING, BUSINESS, AND TECHNOLOGY INSTRUCTION; DOWNLOADABLE VIDEO RECORDINGS FEATURING COPYWRITING, MARKETING, BUSINESS, AND TECHNOLOGY INSTRUCTION; ELECTRONIC PUBLICATIONS, NAMELY, ARTICLES AND BOOKS FEATURING COPYWRITING, MARKETING, BUSINESS, AND TECHNOLOGY INSTRUCTION RECORDED ON COMPUTER MEDIA; VIDEO DISCS FEATURING COPYWRITING, MARKETING, BUSINESS, AND TECHNOLOGY INSTRUCTION, IN CLASS 9 (U.S. CLS. 21, 23, 26, 36 AND 38).

FIRST USE 11-15-2006; IN COMMERCE 11-15-2006.

THE MARK CONSISTS OF STANDARD CHARACTERS WITHOUT CLAIM TO ANY PARTICULAR FONT, STYLE, SIZE, OR COLOR.

OWNER OF U.S. REG. NO. 3,004,912.

NO CLAIM IS MADE TO THE EXCLUSIVE RIGHT TO USE "MARKETING", APART FROM THE MARK AS SHOWN.

SN 85-185,499, FILED 11-26-2010.

MARGARET POWER, EXAMINING ATTORNEY



David J. Kyffers

Director of the United States Patent and Trademark Office

United States of America

United States Patent and Trademark Office

Marketing Rebel Insider's Club

Reg. No. 4,206,691

Registered Sep. 11, 2012

Int. Cls.: 9 and 35

TRADEMARK

SERVICE MARK

PRINCIPAL REGISTER

MARKETING REBEL LLC (NEVADA LIMITED LIABILITY COMPANY)
316 CALIFORNIA AVENUE #114
RENO, NV 89509

FOR: DOWNLOADABLE MULTIMEDIA FILE CONTAINING ARTWORK, TEXT, AUDIO, VIDEO, GAMES, AND INTERNET WEB LINKS RELATING TO COPYWRITING, MARKETING, BUSINESS, AND TECHNOLOGY INSTRUCTION; DOWNLOADABLE VIDEO RECORDINGS FEATURING COPYWRITING, MARKETING, BUSINESS, AND TECHNOLOGY INSTRUCTION; ELECTRONIC PUBLICATIONS, NAMELY, ARTICLES AND BOOKS FEATURING COPYWRITING, MARKETING, BUSINESS, AND TECHNOLOGY INSTRUCTION RECORDED ON COMPUTER MEDIA, IN CLASS 9 (U.S. CLS. 21, 23, 26, 36 AND 38).

FIRST USE 1-29-2009; IN COMMERCE 1-29-2009.

FOR: ADVICE IN THE FIELD OF BUSINESS MANAGEMENT AND MARKETING; BUSINESS ADVISORY SERVICES, CONSULTANCY AND INFORMATION; PROVIDING A WEB SITE FEATURING BUSINESS INFORMATION IN THE FORM OF AUDIO AND VIDEO INTERVIEWS, TRANSCRIPTS AND OTHER EDUCATIONAL MATERIALS, IN CLASS 35 (U.S. CLS. 100, 101 AND 102).

FIRST USE 1-29-2009; IN COMMERCE 1-29-2009.

THE MARK CONSISTS OF STANDARD CHARACTERS WITHOUT CLAIM TO ANY PARTICULAR FONT, STYLE, SIZE, OR COLOR.

OWNER OF U.S. REG. NO. 3,004,912.

NO CLAIM IS MADE TO THE EXCLUSIVE RIGHT TO USE "MARKETING" AND "INSIDER'S CLUB", APART FROM THE MARK AS SHOWN.

SN 85-185,507, FILED 11-26-2010.

MARGARET POWER, EXAMINING ATTORNEY



David J. Kyffers

Director of the United States Patent and Trademark Office

United States of America

United States Patent and Trademark Office

allmyt

Reg. No. 4,206,692

Registered Sep. 11, 2012

Int. Cl.: 11

TRADEMARK

PRINCIPAL REGISTER

IONFARMS CO., LTD. (REPUBLIC OF KOREA CORPORATION)
#909 NAMKWANG CENTLEX B/D
440-4 CHEONGCHEON-DONG, BUPYEONG-GU
INCHEON, REPUBLIC OF KOREA

FOR: HOUSEHOLD ELECTRICAL APPARATUS, NAMELY, ELECTRIC WATER PURIFIERS FOR HOUSEHOLD PURPOSES; ELECTRIC DISH DISINFECTANT APPARATUS FOR HOUSEHOLD PURPOSES; ELECTRIC KETTLES FOR HOUSEHOLD PURPOSES; ELECTRIC HEATING PADS FOR HOUSEHOLD PURPOSES, NOT FOR MEDICAL PURPOSES, IN CLASS 11 (U.S. CLS. 13, 21, 23, 31 AND 34).

FIRST USE 2-1-2011; IN COMMERCE 5-1-2011.

THE MARK CONSISTS OF STANDARD CHARACTERS WITHOUT CLAIM TO ANY PARTICULAR FONT, STYLE, SIZE, OR COLOR.

SN 85-185,650, FILED 11-27-2010.

STEVEN PEREZ, EXAMINING ATTORNEY



David J. Kyros

Director of the United States Patent and Trademark Office

United States of America

United States Patent and Trademark Office



Reg. No. 4,206,693

Registered Sep. 11, 2012

Int. Cl.: 25

TRADEMARK

PRINCIPAL REGISTER

IBL HOLDINGS LLC (DELAWARE LIMITED LIABILITY COMPANY)
1201 N ORANGE ST.
SUITE 706
WILMINGTON, DE 19801

FOR: MEN'S AND WOMEN'S CLOTHING, NAMELY, SPANDEX STYLE SHAPEWEAR PANTS, IN CLASS 25 (U.S. CLS. 22 AND 39).

FIRST USE 6-27-2012; IN COMMERCE 6-27-2012.

THE STIPLING IS A FEATURE OF THE MARK AND DOES NOT INDICATE COLOR.

THE NAME(S), PORTRAIT(S), AND/OR SIGNATURE(S) SHOWN IN THE MARK DOES NOT IDENTIFY A PARTICULAR LIVING INDIVIDUAL.

THE MARK CONSISTS OF THE STYLIZED WORDS "LE' GAMBİ" IN UPPER AND LOWER CASE WITH AN ACCENT MARK OVER THE LETTER "E" AND IS WITHIN A BORDERED QUADRILATERAL BACKGROUND.

THE WORDING LE' GAMBİ HAS NO MEANING IN A FOREIGN LANGUAGE.

SN 85-185,778, FILED 11-28-2010.

DAVID TAYLOR, EXAMINING ATTORNEY



David J. Kybas

Director of the United States Patent and Trademark Office

United States of America

United States Patent and Trademark Office

Lady Lullaby

Reg. No. 4,206,694

JANE ROMAN PITT (UNITED STATES INDIVIDUAL)
41 W. ZIMMERMAN
FAIRFIELD, IA 52556

Registered Sep. 11, 2012

Int. Cl.: 41

FOR: ENTERTAINMENT SERVICES IN THE NATURE OF LIVE MUSICAL PERFORMANCES,
IN CLASS 41 (U.S. CLS. 100, 101 AND 107).

SERVICE MARK

FIRST USE 2-11-2012; IN COMMERCE 2-11-2012.

PRINCIPAL REGISTER

THE MARK CONSISTS OF STANDARD CHARACTERS WITHOUT CLAIM TO ANY PAR-
TICULAR FONT, STYLE, SIZE, OR COLOR.

SN 85-185,783, FILED 11-28-2010.

KATHERINE STOIDES, EXAMINING ATTORNEY



David J. Kybas

Director of the United States Patent and Trademark Office

United States of America

United States Patent and Trademark Office

TURN YOUR TITLE INTO BUCKS

Reg. No. 4,206,695

Registered Sep. 11, 2012

Int. Cl.: 36

SERVICE MARK

PRINCIPAL REGISTER

TMX FINANCE LLC (DELAWARE LIMITED LIABILITY COMPANY)
SUITE 200
15 BULL STREET
SAVANNAH, GA 31401

FOR: FINANCIAL SERVICES, NAMELY, AUTOMOBILE TITLE PAWN LOANS AND
AUTOMOBILE TITLE PLEDGE LOANS, IN CLASS 36 (U.S. CLS. 100, 101 AND 102).

FIRST USE 7-1-2009; IN COMMERCE 7-1-2009.

THE MARK CONSISTS OF STANDARD CHARACTERS WITHOUT CLAIM TO ANY PAR-
TICULAR FONT, STYLE, SIZE, OR COLOR.

SN 85-185,871, FILED 11-29-2010.

PAM WILLIS, EXAMINING ATTORNEY



David J. Kyffers

Director of the United States Patent and Trademark Office

United States of America

United States Patent and Trademark Office

JUDITH & CHARLES

Reg. No. 4,206,696

163972 CANADA INC. (CANADA CORPORATION)

Registered Sep. 11, 2012

9600 MEILLEUR STREET, SUITE 730
MONTRÉAL, QUÉBEC, CANADA H2N2E3

Int. Cl.: 25

FOR: WOMEN'S CLOTHING, NAMELY, DRESSES, SKIRTS, BLOUSES, SWEATERS, PANTS, TEE-SHIRTS, SHORTS, BLAZERS, VESTS, JACKETS, SCARVES, SHIRTS, IN CLASS 25 (U.S. CLS. 22 AND 39).

TRADEMARK

FIRST USE 1-28-2011; IN COMMERCE 1-28-2011.

PRINCIPAL REGISTER

THE MARK CONSISTS OF STANDARD CHARACTERS WITHOUT CLAIM TO ANY PARTICULAR FONT, STYLE, SIZE, OR COLOR.

SN 85-186,141, FILED 11-29-2010.

BENJAMIN OKEKE, EXAMINING ATTORNEY



David J. Kybas

Director of the United States Patent and Trademark Office

United States of America

United States Patent and Trademark Office

THE 212 SCENE

Reg. No. 4,206,697

CE MEDIA, LLC (FLORIDA LIMITED LIABILITY COMPANY)
6052 TURKEY LAKE ROAD
ORLANDO, FL 32819

Registered Sep. 11, 2012

Int. Cl.: 35

FOR: ADVERTISING AND PUBLICITY SERVICES, NAMELY, PROMOTING THE GOODS, SERVICES, BRAND IDENTITY AND COMMERCIAL INFORMATION AND NEWS OF THIRD PARTIES THROUGH PRINT, AUDIO, VIDEO, DIGITAL AND ON-LINE MEDIUM; ADVERTISING SERVICES, NAMELY, PROMOTING AND MARKETING THE GOODS AND SERVICES OF OTHERS IN THE FIELD OF UPSCALE CHOICES SUCH AS CULTURAL EVENTS, RESTAURANTS, SHOPPING, AND TRAVEL VIA PRINT AND ELECTRONIC MEDIA; ADVERTISING, MARKETING AND PROMOTION SERVICES; PRODUCTION OF TELEVISION COMMERCIALS; PROVIDING TELEVISION ADVERTISING FOR OTHERS, IN CLASS 35 (U.S. CLS. 100, 101 AND 102).

SERVICE MARK

PRINCIPAL REGISTER

FIRST USE 5-8-2012; IN COMMERCE 5-8-2012.

THE MARK CONSISTS OF STANDARD CHARACTERS WITHOUT CLAIM TO ANY PARTICULAR FONT, STYLE, SIZE, OR COLOR.

NO CLAIM IS MADE TO THE EXCLUSIVE RIGHT TO USE "212", APART FROM THE MARK AS SHOWN.

SN 85-186,617, FILED 11-29-2010.

ROSELLE HERRERA, EXAMINING ATTORNEY



David J. Kyros

Director of the United States Patent and Trademark Office

United States of America

United States Patent and Trademark Office

THE 305 SCENE

Reg. No. 4,206,698

Registered Sep. 11, 2012

Int. Cl.: 35

SERVICE MARK

PRINCIPAL REGISTER

CE MEDIA, LLC (FLORIDA LIMITED LIABILITY COMPANY)
6052 TURKEY LAKE ROAD
ORLANDO, FL 32819

FOR: ADVERTISING AND PUBLICITY SERVICES, NAMELY, PROMOTING THE GOODS, SERVICES, BRAND IDENTITY AND COMMERCIAL INFORMATION AND NEWS OF THIRD PARTIES THROUGH PRINT, AUDIO, VIDEO, DIGITAL AND ON-LINE MEDIUM; ADVERTISING SERVICES, NAMELY, PROMOTING AND MARKETING THE GOODS AND SERVICES OF OTHERS IN THE FIELD OF UPSCALE CHOICES SUCH AS CULTURAL EVENTS, RESTAURANTS, SHOPPING, AND TRAVEL VIA PRINT AND ELECTRONIC MEDIA; ADVERTISING, MARKETING AND PROMOTION SERVICES; PRODUCTION OF TELEVISION COMMERCIALS; PROVIDING TELEVISION ADVERTISING FOR OTHERS, IN CLASS 35 (U.S. CLS. 100, 101 AND 102).

FIRST USE 5-8-2012; IN COMMERCE 5-8-2012.

THE MARK CONSISTS OF STANDARD CHARACTERS WITHOUT CLAIM TO ANY PARTICULAR FONT, STYLE, SIZE, OR COLOR.

NO CLAIM IS MADE TO THE EXCLUSIVE RIGHT TO USE "305", APART FROM THE MARK AS SHOWN.

SN 85-186,635, FILED 11-29-2010.

ROSELLE HERRERA, EXAMINING ATTORNEY



David J. Kypos

Director of the United States Patent and Trademark Office

United States of America

United States Patent and Trademark Office

SAH ARCHIPEDIA

Reg. No. 4,206,699

Registered Sep. 11, 2012

Int. Cl.: 42

SERVICE MARK

PRINCIPAL REGISTER

SOCIETY OF ARCHITECTURAL HISTORIANS (ILLINOIS CORPORATION)
1365 NORTH ASTOR STREET
CHICAGO, IL 60610

FOR: PROVIDING AN ONLINE SEARCHABLE DATABASE IN THE FIELD OF ARCHITECTURAL INFORMATION FEATURING TEXT, ILLUSTRATIONS, NON-DOWNLOADABLE VIDEOS AND MULTIMEDIA IMAGES DOCUMENTING AND INTERPRETING SIGNIFICANT BUILDINGS, LANDSCAPES, AND URBAN GARDENS, PARKS, SCULPTURES AND STRUCTURES VIA A GLOBAL COMPUTER NETWORK AND MOBILE COMMUNICATIONS DEVICES, IN CLASS 42 (U.S. CLS. 100 AND 101).

FIRST USE 4-18-2012; IN COMMERCE 4-18-2012.

THE MARK CONSISTS OF STANDARD CHARACTERS WITHOUT CLAIM TO ANY PARTICULAR FONT, STYLE, SIZE, OR COLOR.

SN 85-186,661, FILED 11-29-2010.

PRISCILLA MILTON, EXAMINING ATTORNEY



David J. Kyffers

Director of the United States Patent and Trademark Office

United States of America

United States Patent and Trademark Office

WILLOW GARAGE

Reg. No. 4,206,700

WILLOW GARAGE, INC. (CALIFORNIA CORPORATION)
68 WILLOW ROAD
MENLO PARK, CA 94025

Registered Sep. 11, 2012

**Int. Cls.: 9, 37, 41, and
42**

FOR: ROBOTS FOR PERSONAL, EDUCATIONAL OR HOBBY USE AND STRUCTURAL PARTS THEREFOR; COMPUTER HARDWARE AND COMPUTERS FOR ROBOTIC SYSTEMS AND APPLICATIONS; SOFTWARE FOR USE IN CONTROLLING ROBOTIC SYSTEMS AND APPLICATIONS, IN CLASS 9 (U.S. CLS. 21, 23, 26, 36 AND 38).

TRADEMARK

FIRST USE 5-17-2007; IN COMMERCE 1-15-2010.

SERVICE MARK

PRINCIPAL REGISTER

FOR: REPAIR AND MAINTENANCE OF ROBOTS; REPAIR AND MAINTENANCE OF HARDWARE AND COMPUTERS FOR ROBOTIC SYSTEMS AND APPLICATIONS, IN CLASS 37 (U.S. CLS. 100, 103 AND 106).

FIRST USE 5-17-2007; IN COMMERCE 1-15-2010.

FOR: TRAINING IN THE USE OF ROBOTS; TRAINING IN THE USE OF SOFTWARE, HARDWARE AND COMPUTERS FOR ROBOTIC SYSTEMS AND APPLICATIONS, IN CLASS 41 (U.S. CLS. 100, 101 AND 107).

FIRST USE 5-17-2007; IN COMMERCE 1-15-2010.

FOR: RESEARCH, CONSULTATION AND ADVISORY SERVICES IN THE FIELD OF SOFTWARE, HARDWARE AND COMPUTERS FOR ROBOTIC SYSTEMS AND APPLICATIONS; DESIGN, TESTING AND DEVELOPMENT OF ROBOTS AND PARTS, HARDWARE AND SOFTWARE FOR ROBOTS; UPDATING SOFTWARE OF ROBOTS; PROVIDING INFORMATION CONCERNING ROBOTS, SOFTWARE, HARDWARE AND COMPUTERS FOR USE WITH ROBOTIC SYSTEMS AND APPLICATIONS; LEASING ROBOTS, SOFTWARE, HARDWARE AND COMPUTERS FOR ROBOTIC SYSTEMS AND APPLICATIONS; REPAIR AND MAINTENANCE OF SOFTWARE FOR ROBOTIC SYSTEMS AND APPLICATIONS, IN CLASS 42 (U.S. CLS. 100 AND 101).

FIRST USE 5-17-2007; IN COMMERCE 1-15-2010.

THE MARK CONSISTS OF STANDARD CHARACTERS WITHOUT CLAIM TO ANY PARTICULAR FONT, STYLE, SIZE, OR COLOR.



David J. Kyffers

Director of the United States Patent and Trademark Office

Reg. No. 4,206,700 SN 85-186,795, FILED 11-29-2010.

HOWARD B. LEVINE, EXAMINING ATTORNEY

United States of America

United States Patent and Trademark Office

PR2

Reg. No. 4,206,701

WILLOW GARAGE, INC. (CALIFORNIA CORPORATION)
68 WILLOW ROAD
MENLO PARK, CA 94025

Registered Sep. 11, 2012

Int. Cl.: 9

FOR: ROBOTS FOR EDUCATIONAL USE AND STRUCTURAL PARTS THEREFOR; COMPUTER HARDWARE AND COMPUTERS FOR ROBOTIC SYSTEMS AND APPLICATIONS; SOFTWARE FOR USE IN CONTROLLING ROBOTIC SYSTEMS AND APPLICATIONS, IN CLASS 9 (U.S. CLS. 21, 23, 26, 36 AND 38).

TRADEMARK

PRINCIPAL REGISTER

FIRST USE 10-18-2008; IN COMMERCE 1-15-2010.

THE MARK CONSISTS OF STANDARD CHARACTERS WITHOUT CLAIM TO ANY PARTICULAR FONT, STYLE, SIZE, OR COLOR.

SN 85-186,799, FILED 11-29-2010.

HOWARD B. LEVINE, EXAMINING ATTORNEY



David J. Kybas

Director of the United States Patent and Trademark Office

United States of America

United States Patent and Trademark Office

LOVE KILLS CANCER

Reg. No. 4,206,702

Registered Sep. 11, 2012

Int. Cl.: 25

TRADEMARK

PRINCIPAL REGISTER

JOHN KAPLAN / FLYING KAPLAN PRODUCTIONS LLC (FLORIDA LIMITED LIABILITY COMPANY)
4509 NW 53RD STREET
GAINESVILLE, FL 32606

FOR: T-SHIRTS, IN CLASS 25 (U.S. CLS. 22 AND 39).

FIRST USE 12-1-2011; IN COMMERCE 12-1-2011.

THE MARK CONSISTS OF STANDARD CHARACTERS WITHOUT CLAIM TO ANY PARTICULAR FONT, STYLE, SIZE, OR COLOR.

SN 85-186,931, FILED 11-30-2010.

KIMBERLY FRYE, EXAMINING ATTORNEY



David J. Kybas

Director of the United States Patent and Trademark Office

United States of America

United States Patent and Trademark Office

BOOMERATION GREETINGS

Reg. No. 4,206,703

BOOMERATION GREETINGS LLC. (NEW JERSEY LIMITED LIABILITY COMPANY)
26 W. SUMMERFIELD AVE.
COLLINGSWOOD, NJ 08108

Registered Sep. 11, 2012

Int. Cl.: 16

FOR: CARDS, NAMELY, GREETING CARDS, NOTE CARDS, AND BUSINESS CARDS, IN CLASS 16 (U.S. CLS. 2, 5, 22, 23, 29, 37, 38 AND 50).

TRADEMARK

FIRST USE 5-1-2011; IN COMMERCE 5-1-2011.

PRINCIPAL REGISTER

THE MARK CONSISTS OF STANDARD CHARACTERS WITHOUT CLAIM TO ANY PARTICULAR FONT, STYLE, SIZE, OR COLOR.

NO CLAIM IS MADE TO THE EXCLUSIVE RIGHT TO USE "GREETINGS", APART FROM THE MARK AS SHOWN.

SN 85-187,176, FILED 11-30-2010.

MARK RADEMACHER, EXAMINING ATTORNEY



David J. Kybas

Director of the United States Patent and Trademark Office

United States of America

United States Patent and Trademark Office



Reg. No. 4,206,704

LAKESHORE ENERGY SERVICES, L.L.C. (OKLAHOMA LIMITED LIABILITY COMPANY)
44444 HAYES RD.

Registered Sep. 11, 2012

CLINTON TOWNSHIP, MI 48038

Int. Cls.: 4 and 35

FOR: (BASED ON USE IN COMMERCE) NATURAL GAS, IN CLASS 4 (U.S. CLS. 1, 6 AND 15).

TRADEMARK

FIRST USE 4-1-2008; IN COMMERCE 4-1-2008.

SERVICE MARK

FOR: ENERGY MANAGEMENT SERVICES, NAMELY, PROVIDING A SERVICE THAT ALLOWS CUSTOMERS TO PURCHASE ENERGY, NAMELY, ELECTRICITY, NATURAL GAS AND RENEWABLE ENERGY, AT A FIXED PRICE, IN CLASS 35 (U.S. CLS. 100, 101 AND 102).

PRINCIPAL REGISTER

FIRST USE 4-1-2008; IN COMMERCE 11-1-2011.

NO CLAIM IS MADE TO THE EXCLUSIVE RIGHT TO USE "ENERGY", APART FROM THE MARK AS SHOWN.

THE COLOR(S) BLUE AND LIGHT BLUE IS/ARE CLAIMED AS A FEATURE OF THE MARK.

THE MARK CONSISTS OF THE IMAGE OF A BLUE LIGHT HOUSE WITH TWO DARK BLUE WAVY LINES UNDERNEATH, AND TO THE RIGHT SIDE OF THE LIGHTHOUSE, THE WORD "LAKESHORE" IN BLUE WITH THE WORD "ENERGY" UNDER IT IN LIGHT BLUE.

SN 85-187,223, FILED 11-30-2010.

MICHAEL WEBSTER, EXAMINING ATTORNEY



David J. Kybas

Director of the United States Patent and Trademark Office

United States of America

United States Patent and Trademark Office



boomeration greetings
greeting cards for baby boomers

Reg. No. 4,206,705

BOOMERATION GREETINGS LLC. (NEW JERSEY LIMITED LIABILITY COMPANY)
26 W. SUMMERFIELD AVE.
COLLINGSWOOD, NJ 08108

Registered Sep. 11, 2012

Int. Cl.: 16

FOR: CARDS, NAMELY, GREETING CARDS, NOTE CARDS, AND BUSINESS CARDS, IN CLASS 16 (U.S. CLS. 2, 5, 22, 23, 29, 37, 38 AND 50).

TRADEMARK

FIRST USE 5-1-2011; IN COMMERCE 5-1-2011.

PRINCIPAL REGISTER

NO CLAIM IS MADE TO THE EXCLUSIVE RIGHT TO USE "GREETINGS" OR "GREETING CARDS", APART FROM THE MARK AS SHOWN.

SN 85-187,281, FILED 11-30-2010.

MARK RADEMACHER, EXAMINING ATTORNEY



David J. Kybas

Director of the United States Patent and Trademark Office

United States of America

United States Patent and Trademark Office

CITYVILLE

Reg. No. 4,206,706

Registered Sep. 11, 2012

Int. Cls.: 9 and 41

TRADEMARK

SERVICE MARK

PRINCIPAL REGISTER

ZYNGA INC. (DELAWARE CORPORATION)
699 EIGHTH STREET
SAN FRANCISCO, CA 94103

FOR: COMPUTER GAME SOFTWARE; COMPUTER GAME PROGRAMS; ELECTRONIC GAME PROGRAMS; INTERACTIVE VIDEO GAME PROGRAMS; COMPUTER SOFTWARE PLATFORMS FOR SOCIAL NETWORKING, NAMELY, COMPUTER SOFTWARE TO ENABLE UPLOADING, POSTING, SHOWING, DISPLAYING, TAGGING, BLOGGING, SHARING OR OTHERWISE PROVIDING ELECTRONIC MEDIA OR INFORMATION IN THE FIELDS OF VIRTUAL COMMUNITIES, ELECTRONIC GAMING, ENTERTAINMENT, AND GENERAL INTEREST VIA THE INTERNET OR OTHER COMMUNICATIONS NETWORKS WITH THIRD PARTIES, IN CLASS 9 (U.S. CLS. 21, 23, 26, 36 AND 38).

FIRST USE 12-3-2010; IN COMMERCE 12-3-2010.

FOR: ENTERTAINMENT SERVICES, NAMELY, PROVIDING ONLINE COMPUTER AND ELECTRONIC GAMES AND PROVIDING ENHANCEMENTS WITHIN ONLINE COMPUTER AND ELECTRONIC GAMES; ENTERTAINMENT SERVICES, NAMELY, PROVIDING ONLINE INFORMATION RELATING TO COMPUTER GAMES; ENTERTAINMENT SERVICES, NAMELY, PROVIDING VIRTUAL ENVIRONMENTS IN WHICH USERS CAN INTERACT THROUGH SOCIAL GAMES FOR RECREATIONAL, LEISURE OR ENTERTAINMENT PURPOSES, IN CLASS 41 (U.S. CLS. 100, 101 AND 107).

FIRST USE 12-3-2010; IN COMMERCE 12-3-2010.

THE MARK CONSISTS OF STANDARD CHARACTERS WITHOUT CLAIM TO ANY PARTICULAR FONT, STYLE, SIZE, OR COLOR.

PRIORITY CLAIMED UNDER SEC. 44(D) ON TRINIDAD/TOBAGO APPLICATION NO. 42723, FILED 9-14-2010.

OWNER OF U.S. REG. NO. 3,994,661.

SN 85-187,572, FILED 11-30-2010.

KATHERINE CHANG, EXAMINING ATTORNEY



David J. Kyffers

Director of the United States Patent and Trademark Office

United States of America

United States Patent and Trademark Office



Reg. No. 4,206,707

QUICKTAKE LLC (DELAWARE LIMITED LIABILITY COMPANY)
6 RESEARCH DRIVE
SHELTON, CT 06484

Registered Sep. 11, 2012

Int. Cl.: 35

FOR: MARKET RESEARCH SERVICES, NAMELY, PROVIDING AN INTERACTIVE WEBSITE FOR ONLINE USER TO CONDUCT SURVEYS OF COMPANIES, PRODUCTS AND SERVICES; PROVIDING AN INTERACTIVE WEBSITE FOR ONLINE USER TO CONDUCT MARKET SURVEYS OF COMPANIES, PRODUCTS AND SERVICES, IN CLASS 35 (U.S. CLS. 100, 101 AND 102).

SERVICE MARK

PRINCIPAL REGISTER

FIRST USE 11-1-2010; IN COMMERCE 11-1-2010.

THE MARK CONSISTS OF A SNAIL AND STYLIZED LETTERING "QUICKTAKE".

SN 85-187,658, FILED 11-30-2010.

KEVON CHISOLM, EXAMINING ATTORNEY



David J. Kybas

Director of the United States Patent and Trademark Office

United States of America

United States Patent and Trademark Office

QUICKTAKE

Reg. No. 4,206,708

Registered Sep. 11, 2012

Int. Cl.: 35

SERVICE MARK

PRINCIPAL REGISTER

QUICKTAKE LLC (DELAWARE LIMITED LIABILITY COMPANY)
6 RESEARCH DRIVE
SHELTON, CT 06484

FOR: MARKET RESEARCH SERVICES, NAMELY, PROVIDING AN INTERACTIVE WEBSITE FOR ONLINE USER TO CONDUCT SURVEYS OF COMPANIES, PRODUCTS AND SERVICES; PROVIDING AN INTERACTIVE WEBSITE FOR ONLINE USER TO CONDUCT MARKET SURVEYS OF COMPANIES, PRODUCTS AND SERVICES, IN CLASS 35 (U.S. CLS. 100, 101 AND 102).

FIRST USE 11-1-2010; IN COMMERCE 11-1-2010.

THE MARK CONSISTS OF STANDARD CHARACTERS WITHOUT CLAIM TO ANY PARTICULAR FONT, STYLE, SIZE, OR COLOR.

SN 85-187,662, FILED 11-30-2010.

KEVON CHISOLM, EXAMINING ATTORNEY



David J. Kybas

Director of the United States Patent and Trademark Office

United States of America

United States Patent and Trademark Office

NEON BEACH

Reg. No. 4,206,709

Registered Sep. 11, 2012

Int. Cl.: 25

TRADEMARK

PRINCIPAL REGISTER

LISABELLE INTERNATIONAL LLC (NEW JERSEY LIMITED LIABILITY COMPANY)
525 PALMER AVENUE
MAYWOOD, NJ 07607

FOR: SWIMWEAR, IN CLASS 25 (U.S. CLS. 22 AND 39).

FIRST USE 2-22-2012; IN COMMERCE 2-22-2012.

THE MARK CONSISTS OF STANDARD CHARACTERS WITHOUT CLAIM TO ANY PARTICULAR FONT, STYLE, SIZE, OR COLOR.

SN 85-188,160, FILED 12-1-2010.

BARNEY CHARLON, EXAMINING ATTORNEY



David J. Kyffers

Director of the United States Patent and Trademark Office

United States of America
United States Patent and Trademark Office

BUILD

Reg. No. 4,206,710

Registered Sep. 11, 2012

Int. Cl.: 36

SERVICE MARK

PRINCIPAL REGISTER

HABITAT FOR HUMANITY INTERNATIONAL, INC. (GEORGIA NON-PROFIT CORPORATION)
121 HABITAT STREET
AMERICUS, GA 31709

FOR: CHARITABLE FUNDRAISING SERVICES, IN CLASS 36 (U.S. CLS. 100, 101 AND 102).

FIRST USE 5-1-2012; IN COMMERCE 5-1-2012.

THE MARK CONSISTS OF THE WORD "BUILD" IN BLOCK LETTERS.

SN 85-188,175, FILED 12-1-2010.

JANET LEE, EXAMINING ATTORNEY



David J. Kyffers

Director of the United States Patent and Trademark Office

United States of America
United States Patent and Trademark Office

VOCARE

Reg. No. 4,206,711

VOCARE, INC. (INDIANA CORPORATION)
1001 RANSELL ROAD
LEBANON, IN 46052

Registered Sep. 11, 2012

Int. Cl.: 9

FOR: WIRELESS TRANSCEIVERS FOR SAFETY MONITORING AND EMERGENCY COMMUNICATIONS, IN CLASS 9 (U.S. CLS. 21, 23, 26, 36 AND 38).

TRADEMARK

FIRST USE 6-25-2012; IN COMMERCE 6-25-2012.

PRINCIPAL REGISTER

THE MARK CONSISTS OF STANDARD CHARACTERS WITHOUT CLAIM TO ANY PARTICULAR FONT, STYLE, SIZE, OR COLOR.

THE WORDING "VOCARE" HAS NO MEANING IN A FOREIGN LANGUAGE.

SN 85-189,580, FILED 12-2-2010.

ANDREA K. NADELMAN, EXAMINING ATTORNEY



David J. Kyffers

Director of the United States Patent and Trademark Office

United States of America

United States Patent and Trademark Office

FLIP INTO GEAR

Reg. No. 4,206,712

JENNIFER LYNN ABBOTT (UNITED STATES INDIVIDUAL)
77 KNOLLWOOD CIRCLE
SIMI VALLEY, CA 930657367

Registered Sep. 11, 2012

Int. Cls.: 18 and 25

FOR: GYM BAGS, IN CLASS 18 (U.S. CLS. 1, 2, 3, 22 AND 41).

TRADEMARK

FIRST USE 10-0-2011; IN COMMERCE 10-0-2011.

PRINCIPAL REGISTER

FOR: APPAREL FOR DANCERS, NAMELY, T-SHIRTS, SWEATSHIRTS, PANTS, LEGGINGS, SHORTS, SKIRTS, SKORTS AND JACKETS; GYMNASTIC LEOTARDS, IN CLASS 25 (U.S. CLS. 22 AND 39).

FIRST USE 9-0-2011; IN COMMERCE 9-0-2011.

THE MARK CONSISTS OF STANDARD CHARACTERS WITHOUT CLAIM TO ANY PARTICULAR FONT, STYLE, SIZE, OR COLOR.

SN 85-189,593, FILED 12-2-2010.

MARIA-VICTORIA SUAREZ, EXAMINING ATTORNEY



David J. Kybas

Director of the United States Patent and Trademark Office

United States of America

United States Patent and Trademark Office

NICE LEGS

Reg. No. 4,206,713

Registered Sep. 11, 2012

Int. Cl.: 33

TRADEMARK

PRINCIPAL REGISTER

TERRAVANT WINE COMPANY, LLC (CALIFORNIA LIMITED LIABILITY COMPANY),
DBA NICE LEGS WINES,
C/O KOENIG & ASSOCIATES
920 GARDEN STREET, SUITE A
SANTA BARBARA, CA 93101

FOR: WINE; WINES, IN CLASS 33 (U.S. CLS. 47 AND 49).

FIRST USE 3-28-2012; IN COMMERCE 3-28-2012.

THE MARK CONSISTS OF STANDARD CHARACTERS WITHOUT CLAIM TO ANY PARTICULAR FONT, STYLE, SIZE, OR COLOR.

SN 85-189,679, FILED 12-2-2010.

KARANENDRA S. CHHINA, EXAMINING ATTORNEY



David J. Kyffers

Director of the United States Patent and Trademark Office

United States of America

United States Patent and Trademark Office

STOMPING GROUND

Reg. No. 4,206,714

Registered Sep. 11, 2012

Int. Cl.: 33

TRADEMARK

PRINCIPAL REGISTER

TERRAVANT WINE COMPANY, LLC (CALIFORNIA LIMITED LIABILITY COMPANY),
DBA STOMPING GROUND WINES,
C/O KOENIG & ASSOCIATES
920 GARDEN STREET, SUITE A
SANTA BARBARA, CA 93101

FOR: WINE; WINES, IN CLASS 33 (U.S. CLS. 47 AND 49).

FIRST USE 3-28-2012; IN COMMERCE 3-28-2012.

THE MARK CONSISTS OF STANDARD CHARACTERS WITHOUT CLAIM TO ANY PARTICULAR FONT, STYLE, SIZE, OR COLOR.

SN 85-189,681, FILED 12-2-2010.

KARANENDRA S. CHHINA, EXAMINING ATTORNEY



David J. Kyffers

Director of the United States Patent and Trademark Office

United States of America

United States Patent and Trademark Office

JUSTPERFECT MACHINE SET PRODUCT

Reg. No. 4,206,715

Registered Sep. 11, 2012

Int. Cl.: 14

JUST PERFECT MSP LTD. (NEW YORK CORPORATION)
64 WEST 48 STREET
TWELFTH FLOOR
NEW YORK, NY 10036

FOR: JEWELRY, IN CLASS 14 (U.S. CLS. 2, 27, 28 AND 50).

TRADEMARK

FIRST USE 11-30-2011; IN COMMERCE 11-30-2011.

PRINCIPAL REGISTER

THE MARK CONSISTS OF STANDARD CHARACTERS WITHOUT CLAIM TO ANY PARTICULAR FONT, STYLE, SIZE, OR COLOR.

NO CLAIM IS MADE TO THE EXCLUSIVE RIGHT TO USE "MACHINE SET PRODUCT", APART FROM THE MARK AS SHOWN.

SN 85-190,059, FILED 12-3-2010.

KATHERINE CHANG, EXAMINING ATTORNEY



David J. Kyjars

Director of the United States Patent and Trademark Office

United States of America

United States Patent and Trademark Office



Ugh or Yay
How Do You Feel?

Reg. No. 4,206,716

DAMIEN EDSALL (UNITED STATES INDIVIDUAL)
45 BELVEDERE STREET
JOHNSTON, RI 02919

Registered Sep. 11, 2012

Int. Cl.: 25

FOR: BASEBALL CAPS; BEANIES; KNITTED CAPS; SHORT-SLEEVED OR LONG-SLEEVED T-SHIRTS; SWEAT SHIRTS; T-SHIRTS, IN CLASS 25 (U.S. CLS. 22 AND 39).

TRADEMARK

FIRST USE 11-20-2010; IN COMMERCE 12-16-2010.

PRINCIPAL REGISTER

THE MARK CONSISTS OF A COMBINATION OF A SMILEY FACE AND A THEATRICAL MASK ENCLOSED IN A CIRCLE, WITH THE SAD FACE IN BLACK BACKGROUND ON THE LEFT HALF OF THE CIRCLE AND THE HAPPY FACE IN WHITE BACKGROUND ON THE RIGHT HALF OF THE CIRCLE, ALL ABOVE THE WORDS "UGH OR YAY", ALL ABOVE THE PHRASE, "HOW DO YOU FEEL?".

SN 85-190,258, FILED 12-3-2010.

PRISCILLA MILTON, EXAMINING ATTORNEY



David J. Kyffers

Director of the United States Patent and Trademark Office

United States of America

United States Patent and Trademark Office

MOUNT OLYMPUS

Reg. No. 4,206,717

Registered Sep. 11, 2012

Int. Cl.: 32

TRADEMARK

PRINCIPAL REGISTER

DS WATERS OF AMERICA, INC. (DELAWARE CORPORATION)
5660 NEW NORTHSIDE DRIVE, SUITE 500
ATLANTA, GA 30328

FOR: BOTTLED WATER, IN CLASS 32 (U.S. CLS. 45, 46 AND 48).

FIRST USE 12-0-1995; IN COMMERCE 12-0-1995.

THE MARK CONSISTS OF STANDARD CHARACTERS WITHOUT CLAIM TO ANY PARTICULAR FONT, STYLE, SIZE, OR COLOR.

OWNER OF U.S. REG. NO. 2,310,943.

SN 85-190,580, FILED 12-3-2010.

BARBARA RUTLAND, EXAMINING ATTORNEY



David J. Kyffers

Director of the United States Patent and Trademark Office

United States of America

United States Patent and Trademark Office

WATERDOG

Reg. No. 4,206,718

1ST STRIKE LURES, INC. (FLORIDA CORPORATION)
1200 S. FEDERAL HIGHWAY, SUITE 202
BOCA RATON, FL 33435

Registered Sep. 11, 2012

Int. Cl.: 28

FOR: FISHING LURES, FISHING TACKLE, IN CLASS 28 (U.S. CLS. 22, 23, 38 AND 50).

TRADEMARK

FIRST USE 7-1-2012; IN COMMERCE 7-1-2012.

PRINCIPAL REGISTER

THE MARK CONSISTS OF STANDARD CHARACTERS WITHOUT CLAIM TO ANY PARTICULAR FONT, STYLE, SIZE, OR COLOR.

SN 85-190,956, FILED 12-6-2010.

LINDA LAVACHE, EXAMINING ATTORNEY



David J. Kyffers

Director of the United States Patent and Trademark Office

United States of America

United States Patent and Trademark Office

VINTRY FINE WINES

Reg. No. 4,206,719

WEST STREET WINES AND SPIRITS, LLC (NEW YORK LIMITED LIABILITY COMPANY)
93 PEARL STREET, THIRD FLOOR
NEW YORK, NY 10004

Registered Sep. 11, 2012

Int. Cl.: 35

FOR: RETAIL STORES FEATURING WINE, IN CLASS 35 (U.S. CLS. 100, 101 AND 102).

SERVICE MARK

FIRST USE 1-14-2012; IN COMMERCE 1-14-2012.

PRINCIPAL REGISTER

THE MARK CONSISTS OF STANDARD CHARACTERS WITHOUT CLAIM TO ANY PARTICULAR FONT, STYLE, SIZE, OR COLOR.

NO CLAIM IS MADE TO THE EXCLUSIVE RIGHT TO USE "FINE WINES", APART FROM THE MARK AS SHOWN.

SN 85-192,088, FILED 12-7-2010.

VIVIAN MICZNIK FIRST, EXAMINING ATTORNEY



David J. Kyffers

Director of the United States Patent and Trademark Office

United States of America

United States Patent and Trademark Office

BETTER WHENEVER

Reg. No. 4,206,720

Registered Sep. 11, 2012

Int. Cl.: 25

TRADEMARK

PRINCIPAL REGISTER

CUPID FOUNDATIONS, INC. (NEW YORK CORPORATION)
475 PARK AVENUE SOUTH
NEW YORK, NY 10016

FOR: UNDERGARMENTS, IN CLASS 25 (U.S. CLS. 22 AND 39).

FIRST USE 3-15-2012; IN COMMERCE 3-15-2012.

THE MARK CONSISTS OF STANDARD CHARACTERS WITHOUT CLAIM TO ANY PARTICULAR FONT, STYLE, SIZE, OR COLOR.

SN 85-192,143, FILED 12-7-2010.

BARBARA BROWN, EXAMINING ATTORNEY



David J. Kybas

Director of the United States Patent and Trademark Office

United States of America

United States Patent and Trademark Office

METRO TOTAL PROTECTION

Reg. No. 4,206,721

METROPCS WIRELESS, INC. (DELAWARE CORPORATION)
2250 LAKESIDE BOULEVARD
RICHARDSON, TX 75082

Registered Sep. 11, 2012

Int. Cls.: 36 and 39

FOR: INSURANCE ADMINISTRATION IN THE FIELD OF CELLULAR PHONES, IN CLASS 36 (U.S. CLS. 100, 101 AND 102).

SERVICE MARK

FIRST USE 6-1-2011; IN COMMERCE 6-1-2011.

PRINCIPAL REGISTER

FOR: ELECTRONIC STORAGE OF MESSAGES AND DATA, IN CLASS 39 (U.S. CLS. 100 AND 105).

FIRST USE 6-1-2011; IN COMMERCE 6-1-2011.

THE MARK CONSISTS OF STANDARD CHARACTERS WITHOUT CLAIM TO ANY PARTICULAR FONT, STYLE, SIZE, OR COLOR.

NO CLAIM IS MADE TO THE EXCLUSIVE RIGHT TO USE "PROTECTION", APART FROM THE MARK AS SHOWN.

SN 85-192,287, FILED 12-7-2010.

ROSELLE HERRERA, EXAMINING ATTORNEY



David J. Kybas

Director of the United States Patent and Trademark Office

United States of America

United States Patent and Trademark Office

H.BROTHERS
華誼兄弟

Reg. No. 4,206,722

Registered Sep. 11, 2012

Int. Cl.: 9

TRADEMARK

PRINCIPAL REGISTER

HUAYI BROTHERS MEDIA CORPORATION (CHINA CORPORATION)
RM 908, TOWER A FULLLINK PLAZA
NO 18 CHAOYANG MEN WAI AVENUE
CHAOYANG DIST, BEIJING, CHINA

FOR: CAMCORDERS; COMPACT DISCS FEATURING MUSIC; DOWNLOADABLE ELECTRONIC DICTIONARIES; EDITING APPLIANCES FOR CINEMATOGRAPHIC FILMS; EXPOSED CINEMATOGRAPHIC FILM; LOUDSPEAKERS; PHONOGRAPH RECORDS FEATURING MUSIC; SOUND RECORDING APPARATUS; VIDEO DISKS AND VIDEO TAPES WITH RECORDED ANIMATED CARTOONS; VIDEO PROJECTORS, IN CLASS 9 (U.S. CLS. 21, 23, 26, 36 AND 38).

FIRST USE 2-7-2009; IN COMMERCE 12-26-2010.

THE MARK CONSISTS OF THE WORD "H.BROTHERS" WITH STYLIZED DESIGN AND FOUR CHINESE CHARACTERS BELOW.

THE NON-LATIN CHARACTERS IN THE MARK TRANSLITERATE TO HUA; YI; XIONG; DI AND THIS MEANS FLOWERY; FRIENDSHIP; ELDER BROTHER; YOUNGER "BROTHER" IN ENGLISH.

SN 85-192,799, FILED 12-8-2010.

ARETHA SOMERVILLE, EXAMINING ATTORNEY



David J. Kybas

Director of the United States Patent and Trademark Office

United States of America

United States Patent and Trademark Office



o'hara's

Reg. No. 4,206,723

Registered Sep. 11, 2012

Int. Cl.: 33

TRADEMARK

PRINCIPAL REGISTER

CARLOW CRAFT BREWERY LIMITED (IRELAND LIMITED LIABILITY COMPANY)
MUINE BHEAG BUSINESS PARK, ROYAL OAK
CARLOW, IRELAND

FOR: SPIRITS; SPIRITS AND LIQUEURS; WINE, IN CLASS 33 (U.S. CLS. 47 AND 49).

FIRST USE 1-1-2012; IN COMMERCE 1-1-2012.

OWNER OF U.S. REG. NO. 2,637,772.

THE COLOR(S) BLACK, WHITE, AND DARK GOLD IS/ARE CLAIMED AS A FEATURE OF THE MARK.

THE NAME SEAMUS "O'HARA" IDENTIFIES A LIVING INDIVIDUAL WHOSE CONSENT IS OF RECORD.

THE MARK CONSISTS OF A GAELIC SYMBOL ABOVE A SLASH, ALL IN DARK GOLD; ABOVE THE WORD, "O'HARA'S", IN LARGE, BLACK, LOWER-CASE LETTERS USING DOTS IN PLACE OF APOSTROPHES BELOW THE SLASH; ALL SET AGAINST A WHITE BACKGROUND.

SN 85-193,094, FILED 12-8-2010.

TRACY CROSS, EXAMINING ATTORNEY



David J. Kybas

Director of the United States Patent and Trademark Office

United States of America

United States Patent and Trademark Office

XTREME PONG SPORTS

Reg. No. 4,206,724

CAPPUCCIO, PAUL (UNITED STATES INDIVIDUAL)
120 SOUTH MONROE AVENUE
HAMMONTON, NJ 08037 AND

Registered Sep. 11, 2012

Int. Cl.: 28

WILLIS, RYAN (UNITED STATES INDIVIDUAL)
205 YORKSHIRE LANE
WILMINGTON, NC 28409

TRADEMARK

PRINCIPAL REGISTER

FOR: NON-COMPUTER ACTION SKILL GAME INVOLVING OBJECTS THROWN AT TARGETS; ACTION SKILL GAME INVOLVING BALLS; ALL OF THE FOREGOING FOR PLAYING ALCOHOLIC OR NON-ALCOHOLIC DRINKING GAMES, IN CLASS 28 (U.S. CLS. 22, 23, 38 AND 50).

FIRST USE 5-26-2011; IN COMMERCE 12-19-2011.

THE MARK CONSISTS OF STANDARD CHARACTERS WITHOUT CLAIM TO ANY PARTICULAR FONT, STYLE, SIZE, OR COLOR.

NO CLAIM IS MADE TO THE EXCLUSIVE RIGHT TO USE "PONG SPORTS", APART FROM THE MARK AS SHOWN.

SN 85-193,209, FILED 12-8-2010.

APRIL HESIK, EXAMINING ATTORNEY



David J. Kybas

Director of the United States Patent and Trademark Office

United States of America

United States Patent and Trademark Office

RPM

Reg. No. 4,206,725

Registered Sep. 11, 2012

Int. Cl.: 7

TRADEMARK

PRINCIPAL REGISTER

SEED CO., LTD. (JAPAN CORPORATION)
3-5-25, UCHINDAI-CHO, MIYAKOJIMA-KU
OSAKA-SHI, OSAKA, JAPAN

FOR: MACHINERY FOR THE MECHANICAL RECYCLING OF USED PAPER, NAMELY, MACHINES FOR PULP MAKING, PAPER SHREDDING MACHINES, CRUSHING UNITS AND BEATING UNITS FOR PULP MAKING MACHINES, AND BEATING MACHINES AND MASHING MACHINES FOR USE IN BEATING UNITS; MACHINES FOR PAPER MAKING; PAPER-MAKING MACHINERY, NAMELY, PAPER PULP FEEDING UNITS, PAPER MAKING NET CONVEYOR UNITS, DEWATERING ROLL UNITS, DRYING BELT CONVEYOR UNITS, SMOOTH SURFACE FINISHING ROLL UNITS AND HEATER PLATE UNITS FOR PAPER MAKING APPARATUS, MESH BELTS FOR PAPER MAKING NET CONVEYOR UNITS, DEWATERING ROLLS AND PRESS ROLLS FOR DEWATERING ROLL UNITS, SMOOTH SURFACE BELTS FOR DRYING BELT CONVEYOR UNITS, IN CLASS 7 (U.S. CLS. 13, 19, 21, 23, 31, 34 AND 35).

FIRST USE 6-12-2012; IN COMMERCE 6-12-2012.

THE MARK CONSISTS OF STANDARD CHARACTERS WITHOUT CLAIM TO ANY PARTICULAR FONT, STYLE, SIZE, OR COLOR.

SN 85-193,790, FILED 12-9-2010.

LINDA E. BLOHM, EXAMINING ATTORNEY



David J. Kybas

Director of the United States Patent and Trademark Office

United States of America

United States Patent and Trademark Office

PREPARED. FOR LIFE.

Reg. No. 4,206,726

Registered Sep. 11, 2012

Int. Cl.: 35

SERVICE MARK

PRINCIPAL REGISTER

BOY SCOUTS OF AMERICA (UNITED STATES CHARTERED BY ACT OF CONGRESS, 36 U.S.C. SECTION 21)
1325 WEST WALNUT HILL LANE
P.O. BOX 152079
IRVING, TX 750152079

FOR: ASSOCIATION SERVICES, NAMELY, PROMOTING THE INTERESTS OF A YOUTH DEVELOPMENT AND SERVICE ORGANIZATION AND PROMOTING THE INTERESTS OF ITS MEMBERS THEREOF, IN CLASS 35 (U.S. CLS. 100, 101 AND 102).

FIRST USE 1-3-2011; IN COMMERCE 1-3-2011.

THE MARK CONSISTS OF STANDARD CHARACTERS WITHOUT CLAIM TO ANY PARTICULAR FONT, STYLE, SIZE, OR COLOR.

SN 85-193,823, FILED 12-9-2010.

WILLIAM ROSSMAN, EXAMINING ATTORNEY



David J. Kyffers

Director of the United States Patent and Trademark Office

United States of America

United States Patent and Trademark Office

LOLO

Reg. No. 4,206,727

UNIFIED BRANDS, INC. (DELAWARE CORPORATION)
1055 MENDELL DAVIS DRIVE
JACKSON, MS 39272

Registered Sep. 11, 2012

Int. Cl.: 11

FOR: COMMERCIAL COOKING EQUIPMENT, NAMELY, CHARBROILERS, GRIDDLES, FRYERS AND HOT PLATES, IN CLASS 11 (U.S. CLS. 13, 21, 23, 31 AND 34).

TRADEMARK

FIRST USE 3-21-2011; IN COMMERCE 3-21-2011.

PRINCIPAL REGISTER

THE MARK CONSISTS OF STANDARD CHARACTERS WITHOUT CLAIM TO ANY PARTICULAR FONT, STYLE, SIZE, OR COLOR.

THE ENGLISH TRANSLATION OF "LOLO" IN THE MARK IS "TEENAGE BOY".

SN 85-193,832, FILED 12-9-2010.

SUZANNE BLANE, EXAMINING ATTORNEY



David J. Kyffers

Director of the United States Patent and Trademark Office

United States of America

United States Patent and Trademark Office

WINACEA

Reg. No. 4,206,728

Registered Sep. 11, 2012

Int. Cls.: 35 and 41

SERVICE MARK

PRINCIPAL REGISTER

WINACEA LLC (COLORADO LIMITED LIABILITY COMPANY)
1051 HESSEN DRIVE
FORT COLLINS, CO 80524

FOR: PROVIDING A WEBSITE FEATURING CONSUMER INFORMATION IN THE FIELD OF WINE AND WINE PURCHASING; PROMOTING AND MARKETING THE WINES AND WINERIES OF OTHERS VIA NOTIFICATION OF SPECIAL EVENTS, ON-LINE DISCOUNTS, SPECIAL AND SALE OFFERS, GIFTS, GIFT CARDS AND COUPONS, AND ON-LINE PRODUCT INFORMATION, COMPARISONS, AND REVIEWS; PROMOTING THE GOODS AND SERVICES OF OTHERS, NAMELY, PROVIDING LINKS TO THE WEBSITES OF OTHERS OFFERING WINE-RELATED PRODUCTS AND ACCESSORIES; ENDORSEMENT SERVICES, NAMELY, PROMOTING THE GOODS AND SERVICES OF OTHERS IN THE FIELDS OF WINES AND WINERIES, IN CLASS 35 (U.S. CLS. 100, 101 AND 102).

FIRST USE 1-1-2011; IN COMMERCE 1-1-2011.

FOR: ENTERTAINMENT SERVICES, NAMELY, ORGANIZING AND CONDUCTING PUBLIC AND PRIVATE WINE TASTINGS; EDUCATION SERVICES, NAMELY, PROVIDING CLASSES, WORKSHOPS, SEMINARS, FIELD TRIPS, DEMONSTRATIONS, AND EXHIBITS IN THE FIELD OF WINE; PROVIDING AN ON-LINE NEWSLETTER IN THE FIELD OF WINE, IN CLASS 41 (U.S. CLS. 100, 101 AND 107).

FIRST USE 1-1-2011; IN COMMERCE 1-1-2011.

THE MARK CONSISTS OF STANDARD CHARACTERS WITHOUT CLAIM TO ANY PARTICULAR FONT, STYLE, SIZE, OR COLOR.

SN 85-193,989, FILED 12-9-2010.

SOPHIA S. KIM, EXAMINING ATTORNEY



David J. Kybas

Director of the United States Patent and Trademark Office

United States of America

United States Patent and Trademark Office

WINE EDUCATION, ENTERTAINMENT AND ILLUMINATION

Reg. No. 4,206,729

WINACEA LLC (COLORADO LIMITED LIABILITY COMPANY)
1051 HESSEN DRIVE
FORT COLLINS, CO 80524

Registered Sep. 11, 2012

Int. Cls.: 35 and 41

FOR: PROVIDING A WEBSITE FEATURING CONSUMER INFORMATION IN THE FIELD OF WINE AND WINE PURCHASING; PROMOTING AND MARKETING THE WINES AND WINERIES OF OTHERS VIA NOTIFICATION OF SPECIAL EVENTS, ON-LINE DISCOUNTS, SPECIAL AND SALE OFFERS, GIFTS, GIFT CARDS AND COUPONS, AND ON-LINE PRODUCT INFORMATION, COMPARISONS, AND REVIEWS; PROMOTING THE GOODS AND SERVICES OF OTHERS, NAMELY, PROVIDING LINKS TO THE WEBSITES OF OTHERS OFFERING WINE-RELATED PRODUCTS AND ACCESSORIES; ENDORSEMENT SERVICES, NAMELY, PROMOTING THE GOODS AND SERVICES OF OTHERS IN THE FIELDS OF WINES AND WINERIES, IN CLASS 35 (U.S. CLS. 100, 101 AND 102).

SERVICE MARK

PRINCIPAL REGISTER

FIRST USE 1-1-2011; IN COMMERCE 1-1-2011.

FOR: ENTERTAINMENT SERVICES, NAMELY, ORGANIZING AND CONDUCTING PUBLIC AND PRIVATE WINE TASTINGS; EDUCATION SERVICES, NAMELY, PROVIDING CLASSES, WORKSHOPS, SEMINARS, FIELD TRIPS, DEMONSTRATIONS, AND EXHIBITS IN THE FIELD OF WINE; PROVIDING AN ON-LINE NEWSLETTER IN THE FIELD OF WINE, IN CLASS 41 (U.S. CLS. 100, 101 AND 107).

FIRST USE 1-1-2011; IN COMMERCE 1-1-2011.

THE MARK CONSISTS OF STANDARD CHARACTERS WITHOUT CLAIM TO ANY PARTICULAR FONT, STYLE, SIZE, OR COLOR.

NO CLAIM IS MADE TO THE EXCLUSIVE RIGHT TO USE "WINE EDUCATION, ENTERTAINMENT", APART FROM THE MARK AS SHOWN.

SN 85-194,007, FILED 12-9-2010.

SOPHIA S. KIM, EXAMINING ATTORNEY



David J. Kybas

Director of the United States Patent and Trademark Office

United States of America

United States Patent and Trademark Office



Reg. No. 4,206,730

Registered Sep. 11, 2012

Int. Cls.: 35 and 41

SERVICE MARK

PRINCIPAL REGISTER

WINACEA LLC (COLORADO LIMITED LIABILITY COMPANY)
1051 HESSEN DRIVE
FORT COLLINS, CO 80524

FOR: PROVIDING A WEBSITE FEATURING CONSUMER INFORMATION IN THE FIELD OF WINE AND WINE PURCHASING; PROMOTING AND MARKETING THE WINES AND WINERIES OF OTHERS VIA NOTIFICATION OF SPECIAL EVENTS, ON-LINE DISCOUNTS, SPECIAL AND SALE OFFERS, GIFTS, GIFT CARDS AND COUPONS, AND ON-LINE PRODUCT INFORMATION, COMPARISONS, AND REVIEWS; PROMOTING THE GOODS AND SERVICES OF OTHERS, NAMELY, PROVIDING LINKS TO THE WEBSITES OF OTHERS OFFERING WINE-RELATED PRODUCTS AND ACCESSORIES; ENDORSEMENT SERVICES, NAMELY, PROMOTING THE GOODS AND SERVICES OF OTHERS IN THE FIELDS OF WINES AND WINERIES, IN CLASS 35 (U.S. CLS. 100, 101 AND 102).

FIRST USE 1-1-2011; IN COMMERCE 1-1-2011.

FOR: ENTERTAINMENT SERVICES, NAMELY, ORGANIZING AND CONDUCTING PUBLIC AND PRIVATE WINE TASTINGS; EDUCATION SERVICES, NAMELY, PROVIDING CLASSES, WORKSHOPS, SEMINARS, FIELD TRIPS, DEMONSTRATIONS, AND EXHIBITS IN THE FIELD OF WINE; PROVIDING AN ON-LINE NEWSLETTER IN THE FIELD OF WINE, IN CLASS 41 (U.S. CLS. 100, 101 AND 107).

FIRST USE 1-1-2011; IN COMMERCE 1-1-2011.

THE MARK CONSISTS OF A CIRCLE WITH A GRAPHIC DESIGN BORDERING THE OUTER EDGE OF THE CIRCLE WITH AN IMAGE OF AN ANCIENT DRINKING CUP POSITIONED IN THE CENTER OF THE CIRCLE.

SN 85-194,027, FILED 12-9-2010.

SOPHIA S. KIM, EXAMINING ATTORNEY



David J. Kybas

Director of the United States Patent and Trademark Office

United States of America

United States Patent and Trademark Office

chameleon

CONSULTING CORP

SOLUTIONS FOR THE CONSTRUCTION INDUSTRY

Reg. No. 4,206,731

Registered Sep. 11, 2012

Int. Cls.: 35 and 42

SERVICE MARK

PRINCIPAL REGISTER

CHAMELEON SOFTWARE, INC. (MISSOURI CORPORATION)
1015 LOCUST
SUITE 700
ST. LOUIS, MO 63101

FOR: BUSINESS CONSULTING SERVICES FOR THE CONSTRUCTION INDUSTRY, IN CLASS 35 (U.S. CLS. 100, 101 AND 102).

FIRST USE 3-0-2011, THE MARK WAS FIRST USED ANYWHERE IN A DIFFERENT FORM OTHER THAN THAT SOUGHT TO BE REGISTERED AT LEAST AS EARLY AS 00/00/1987.; IN COMMERCE 3-0-2011, THE MARK WAS FIRST USED IN COMMERCE IN A DIFFERENT FORM OTHER THAN THAT SOUGHT TO BE REGISTERED AT LEAST AS EARLY AS 00/00/1987..

FOR: CONSULTING SERVICES IN THE FIELD OF COMPUTER-BASED INFORMATION SYSTEMS FOR BUSINESSES AND COMPUTER SOFTWARE FOR THE CONSTRUCTION INDUSTRY, IN CLASS 42 (U.S. CLS. 100 AND 101).

FIRST USE 3-0-2011; IN COMMERCE 3-0-2011.

NO CLAIM IS MADE TO THE EXCLUSIVE RIGHT TO USE "CONSULTING CORP" AND "SOLUTIONS FOR THE CONSTRUCTION INDUSTRY", APART FROM THE MARK AS SHOWN.

THE MARK CONSISTS OF THE WORDS "CHAMELEON CONSULTING CORP SOLUTIONS FOR THE CONSTRUCTION INDUSTRY" WITH THE WORDS "CONSULTING CORP" PLACED IN BETWEEN TWO HORIZONTAL BARS.

SN 85-194,474, FILED 12-9-2010.

MAYUR VAGHANI, EXAMINING ATTORNEY



David J. Kybas

Director of the United States Patent and Trademark Office

United States of America

United States Patent and Trademark Office

PRIMMERSIVE

Reg. No. 4,206,732

Registered Sep. 11, 2012

Int. Cls.: 35 and 42

SERVICE MARK

PRINCIPAL REGISTER

PRIMMERSIVE DESIGNWORKS, LLC (NEW JERSEY LIMITED LIABILITY COMPANY)
158 GEORGE STREET
NEW BRUNSWICK, NJ 08901

FOR: ON-LINE RETAIL STORE SERVICES FEATURING GRAPHIC ART AND DESIGN IMAGES AND RELATED SOFTWARE AND DOWNLOADABLE SOFTWARE MEDIA AND MATERIALS; RETAIL STORE SERVICES FEATURING GRAPHIC ART AND DESIGN IMAGES AND RELATED SOFTWARE DOWNLOADABLE SOFTWARE MEDIA AND MATERIALS, IN CLASS 35 (U.S. CLS. 100, 101 AND 102).

FIRST USE 4-15-2012; IN COMMERCE 4-15-2012.

FOR: COMPUTER GRAPHICS SERVICES; CONSULTING SERVICES IN THE FIELD OF THE DESIGN OF GRAPHIC ART AND DESIGN; DESIGN AND CREATING WEB SITES FOR OTHERS; GRAPHIC DESIGN SERVICES, IN CLASS 42 (U.S. CLS. 100 AND 101).

FIRST USE 2-1-2011; IN COMMERCE 2-1-2011.

THE MARK CONSISTS OF STANDARD CHARACTERS WITHOUT CLAIM TO ANY PARTICULAR FONT, STYLE, SIZE, OR COLOR.

SN 85-194,629, FILED 12-9-2010.

TOBY BULLOFF, EXAMINING ATTORNEY



David J. Kyffers

Director of the United States Patent and Trademark Office

United States of America

United States Patent and Trademark Office

LOGITECH FLUID CRYSTAL

Reg. No. 4,206,733

Registered Sep. 11, 2012

Int. Cl.: 9

TRADEMARK

PRINCIPAL REGISTER

LOGITECH INTERNATIONAL S.A. (SWITZERLAND CORPORATION)
LES CHÂTAGNIS
CH-1143 APPLES, SWITZERLAND

FOR: SOFTWARE AND COMPUTER HARDWARE FOR AUDIO AND VIDEO ENHANCEMENT SOLD AS AN INTEGRAL PART OF WEB CAMERAS AND VIDEO CAMERAS, IN CLASS 9 (U.S. CLS. 21, 23, 26, 36 AND 38).

FIRST USE 2-1-2011; IN COMMERCE 2-1-2011.

THE MARK CONSISTS OF STANDARD CHARACTERS WITHOUT CLAIM TO ANY PARTICULAR FONT, STYLE, SIZE, OR COLOR.

OWNER OF U.S. REG. NOS. 1,969,025 AND 2,835,047.

NO CLAIM IS MADE TO THE EXCLUSIVE RIGHT TO USE "FLUID CRYSTAL", APART FROM THE MARK AS SHOWN.

SN 85-194,832, FILED 12-10-2010.

Laurie Mayes, Examining Attorney



David J. Kybas

Director of the United States Patent and Trademark Office

United States of America

United States Patent and Trademark Office



fluid crystal
technology

Reg. No. 4,206,734

Registered Sep. 11, 2012

Int. Cl.: 9

TRADEMARK

PRINCIPAL REGISTER

LOGITECH INTERNATIONAL S.A. (SWITZERLAND CORPORATION)
LES CHÂTAGNIS
CH-1143 APPLES, SWITZERLAND

FOR: SOFTWARE AND COMPUTER HARDWARE FOR AUDIO AND VIDEO ENHANCEMENT SOLD AS AN INTEGRAL PART OF WEB CAMERAS AND VIDEO CAMERAS, IN CLASS 9 (U.S. CLS. 21, 23, 26, 36 AND 38).

FIRST USE 2-1-2011; IN COMMERCE 2-1-2011.

NO CLAIM IS MADE TO THE EXCLUSIVE RIGHT TO USE "FLUID CRYSTAL TECHNOLOGY", APART FROM THE MARK AS SHOWN.

THE MARK CONSISTS OF THE WORDING "FLUID CRYSTAL TECHNOLOGY" UNDERNEATH AN APERTURE DESIGN ENCASING A STYLIZED DESIGN OF A DIAMOND.

SN 85-194,836, FILED 12-10-2010.

Laurie Mayes, Examining Attorney



David J. Kybas

Director of the United States Patent and Trademark Office

United States of America

United States Patent and Trademark Office

Growing Healthy People

Reg. No. 4,206,735

ZIMMERMAN, ELY (UNITED STATES INDIVIDUAL)

Registered Sep. 11, 2012

2963 QUEENSBURY DR.
LOS ANGELES, CA 90064

Int. Cl.: 35

FOR: CONSULTING SERVICES, NAMELY, TO EMPLOYERS, COMMUNITY ORGANIZATIONS, AND BENEFICIARIES RELATED TO CONSUMER INFORMATION REGARDING HEALTH CARE PLAN OPTIONS, PRODUCTS AND PROGRAMS IN THE FIELD OF MANAGED CARE AND STATE AND FEDERAL MEDICAL CARE PROGRAMS, IN CLASS 35 (U.S. CLS. 100, 101 AND 102).

SERVICE MARK

PRINCIPAL REGISTER

FIRST USE 6-2-2012; IN COMMERCE 6-2-2012.

THE MARK CONSISTS OF STANDARD CHARACTERS WITHOUT CLAIM TO ANY PARTICULAR FONT, STYLE, SIZE, OR COLOR.

NO CLAIM IS MADE TO THE EXCLUSIVE RIGHT TO USE "HEALTHY", APART FROM THE MARK AS SHOWN.

SN 85-194,917, FILED 12-10-2010.

WILLIAM BRECKENFELD, EXAMINING ATTORNEY



David J. Kyffers

Director of the United States Patent and Trademark Office

United States of America

United States Patent and Trademark Office

CLASSROOM CHAMPIONS

Reg. No. 4,206,736

Registered Sep. 11, 2012

Int. Cl.: 41

SERVICE MARK

PRINCIPAL REGISTER

MESLER, STEVEN (UNITED STATES INDIVIDUAL)
3333 PIEDMONT RD., NE
SUITE 2500
ATLANTA, GA 30305

FOR: EDUCATIONAL AND ENTERTAINMENT SERVICES, NAMELY, PROVIDING MOTIVATIONAL AND EDUCATIONAL SPEAKERS; PROVIDING A WEBSITE FEATURING INFORMATION ABOUT EDUCATIONAL OPPORTUNITIES FOR SCHOOL-AGED CHILDREN, IN CLASS 41 (U.S. CLS. 100, 101 AND 107).

FIRST USE 12-0-2010; IN COMMERCE 12-0-2010.

THE MARK CONSISTS OF STANDARD CHARACTERS WITHOUT CLAIM TO ANY PARTICULAR FONT, STYLE, SIZE, OR COLOR.

NO CLAIM IS MADE TO THE EXCLUSIVE RIGHT TO USE "CLASSROOM", APART FROM THE MARK AS SHOWN.

SN 85-195,081, FILED 12-10-2010.

KATHLEEN M. VANSTON, EXAMINING ATTORNEY



David J. Kyffers

Director of the United States Patent and Trademark Office

United States of America

United States Patent and Trademark Office

DRIVEWISE

Reg. No. 4,206,737

THRIFTY, INC. (OKLAHOMA CORPORATION)
5330 E. 31ST STREET
TULSA, OK 74135

Registered Sep. 11, 2012

Int. Cl.: 35

FOR: AUTOMOBILE DEALERSHIPS, IN CLASS 35 (U.S. CLS. 100, 101 AND 102).

SERVICE MARK

FIRST USE 6-10-2012; IN COMMERCE 6-10-2012.

PRINCIPAL REGISTER

THE MARK CONSISTS OF STANDARD CHARACTERS WITHOUT CLAIM TO ANY PARTICULAR FONT, STYLE, SIZE, OR COLOR.

SN 85-195,083, FILED 12-10-2010.

KATHLEEN M. VANSTON, EXAMINING ATTORNEY



David J. Kyffers

Director of the United States Patent and Trademark Office

United States of America

United States Patent and Trademark Office



Reg. No. 4,206,738

UNIFIED BRANDS, INC. (DELAWARE CORPORATION)
1055 MENDELL DAVIS DRIVE
JACKSON, MS 39272

Registered Sep. 11, 2012

Int. Cl.: 11

FOR: COMMERCIAL COOKING EQUIPMENT, NAMELY, CHARBROILERS, GRIDDLES, FRYERS AND HOT PLATES, IN CLASS 11 (U.S. CLS. 13, 21, 23, 31 AND 34).

TRADEMARK

FIRST USE 3-21-2011; IN COMMERCE 3-21-2011.

PRINCIPAL REGISTER

THE MARK CONSISTS OF THE WORDING "LOLO" CENTERED IN A BLACK OVAL, WITH THE FIRST "LO" IN THE COLOR WHITE AND THE SECOND "LO" IN THE COLOR GREEN.

THE COLOR(S) BLACK, WHITE AND GREEN IS/ARE CLAIMED AS A FEATURE OF THE MARK.

THE ENGLISH TRANSLATION OF "LOLO" IN THE MARK IS "TEENAGE BOY".

SN 85-195,445, FILED 12-10-2010.

SUZANNE BLANE, EXAMINING ATTORNEY



David J. Kybas

Director of the United States Patent and Trademark Office

United States of America

United States Patent and Trademark Office



Reg. No. 4,206,739

Registered Sep. 11, 2012

Int. Cl.: 41

SERVICE MARK

PRINCIPAL REGISTER

XPEC ENTERTAINMENT INC (TAIWAN CORPORATION)
6F, NO 53, NANJING E. RD. SEC. 2
TAIPEI, TAIWAN

FOR: ENTERTAINMENT SERVICES, NAMELY, PROVIDING AN ON-LINE COMPUTER GAME; ENTERTAINMENT SERVICES, NAMELY, PROVIDING ON-LINE COMPUTER GAMES; ENTERTAINMENT SERVICES, NAMELY, PROVIDING ONLINE ELECTRONIC GAMES, IN CLASS 41 (U.S. CLS. 100, 101 AND 107).

FIRST USE 8-11-2011; IN COMMERCE 8-11-2011.

THE MARK CONSISTS OF THE WORDS "ETERNAL DESTINY" IN THE COLORS BRONZE, DARK BROWN, BROWN, MAROON, DARK ORANGE, ORANGE, AND WHITE TITLE CASE LETTERING AND OUTLINED IN BLACK, BEHIND WHICH APPEARS A YIN YANG SYMBOL IN THE COLORS TEAL, ETON BLUE, WHITE, LIME, PEACH AND OUTLINED IN BRONZE, WITH TWO CIRCLES LOCATED AT THE HEART OF THE YIN YANG SYMBOL IN COLORS DARK GREEN, GREEN AND OUTLINED IN POWDER BLUE, SURROUNDED BY SEVEN CLOUDS IN COLORS WHITE, SKY BLUE, POWDER BLUE AND OUTLINED IN BRONZE.

THE COLOR(S) TEAL, DARK GREEN, GREEN, ETON BLUE, WHITE, POWDER BLUE, SKY BLUE, BRONZE, DARK BROWN, MAROON, LIME, PEACH, BROWN, ORANGE, DARK ORANGE AND BLACK IS/ARE CLAIMED AS A FEATURE OF THE MARK.

SN 85-195,523, FILED 12-10-2010.

EDWARD FENNESSY, EXAMINING ATTORNEY



David J. Kybas

Director of the United States Patent and Trademark Office

United States of America

United States Patent and Trademark Office

POLLO
CAMPERO

Reg. No. 4,206,740

Registered Sep. 11, 2012

**Int. Cls.: 29, 30, 32, 35,
and 43**

TRADEMARK

SERVICE MARK

PRINCIPAL REGISTER

CAMPERO INTERNATIONAL LIMITED (BARBADOS CORPORATION)
2ND FLOOR, HASTINGS, CHRIST CHURCH
HASTINGS FINANCIAL CENTRE
BARBADOS, BARBADOS BB15154

FOR: COOKED POULTRY, COLE SLAW, PROCESSED POTATOES, SALADS, NAMELY, VEGETABLE SALADS, GARDEN SALADS, PROCESSED BEANS, COOKED VEGETABLES, FRENCH FRIED POTATOES, AND PREPARED ENTREES CONSISTING OF POULTRY OR VEGETABLES, IN CLASS 29 (U.S. CL. 46).

FIRST USE 10-4-2011; IN COMMERCE 10-4-2011.

FOR: BREADS, PASTRIES, SALSA, GRAIN-BASED BEVERAGES, AND BAKERY DESSERTS, IN CLASS 30 (U.S. CL. 46).

FIRST USE 10-4-2011; IN COMMERCE 10-4-2011.

FOR: BEVERAGES, NAMELY, FRUIT DRINKS, FRUIT PUNCH, LEMONADE AND DRINKING WATER, IN CLASS 32 (U.S. CLS. 45, 46 AND 48).

FIRST USE 10-4-2011; IN COMMERCE 10-4-2011.

FOR: RESTAURANT FRANCHISING, NAMELY, OFFERING BUSINESS MANAGEMENT ASSISTANCE IN THE ESTABLISHMENT AND/OR OPERATION OF RESTAURANTS, IN CLASS 35 (U.S. CLS. 100, 101 AND 102).

FIRST USE 10-4-2011; IN COMMERCE 10-4-2011.

FOR: RESTAURANT SERVICES, IN CLASS 43 (U.S. CLS. 100 AND 101).

FIRST USE 10-4-2011; IN COMMERCE 10-4-2011.

OWNER OF U.S. REG. NOS. 1,783,043, 3,508,553, AND OTHERS.

THE COLOR(S) BROWN AND GOLD IS/ARE CLAIMED AS A FEATURE OF THE MARK.



David J. Kyjars

Director of the United States Patent and Trademark Office

Reg. No. 4,206,740 NO CLAIM IS MADE TO THE EXCLUSIVE RIGHT TO USE "POLLO" FOR INTERNATIONAL CLASSES 29, 35 AND 43, APART FROM THE MARK AS SHOWN.

THE MARK CONSISTS OF THE WORD "POLLO" IN GOLD AND OUTLINED IN BROWN WITH THE WORD "CAMPERO" IN BROWN OUTLINED IN GOLD.

THE ENGLISH TRANSLATION OF "POLLO CAMPERO" IN THE MARK IS "COUNTRY CHICKEN".

SN 85-196,365, FILED 12-13-2010.

SARA BENJAMIN, EXAMINING ATTORNEY

United States of America

United States Patent and Trademark Office

WE'RE GOING TO THE CAPE

Reg. No. 4,206,741

STEPHEN F. SCHAEFER (UNITED STATES INDIVIDUAL)
430 LONDON ROAD

Registered Sep. 11, 2012

YORKTOWN HEIGHTS, NY 10598

Int. Cl.: 25

FOR: HEADGEAR, NAMELY, HATS AND CAPS; SWEATSHIRTS; T-SHIRTS, IN CLASS 25 (U.S. CLS. 22 AND 39).

TRADEMARK

FIRST USE 12-15-2011; IN COMMERCE 12-15-2011.

PRINCIPAL REGISTER

THE MARK CONSISTS OF STANDARD CHARACTERS WITHOUT CLAIM TO ANY PARTICULAR FONT, STYLE, SIZE, OR COLOR.

SN 85-196,433, FILED 12-13-2010.

TRACY WHITTAKER-BROWN, EXAMINING ATTORNEY



David J. Kybas

Director of the United States Patent and Trademark Office

United States of America

United States Patent and Trademark Office



Reg. No. 4,206,742

Registered Sep. 11, 2012

**Int. Cls.: 29, 30, 32, 35,
and 43**

TRADEMARK

SERVICE MARK

PRINCIPAL REGISTER

CAMPERO INTERNATIONAL LIMITED (BARBADOS CORPORATION)
2ND FLOOR, HASTINGS, CHRIST CHURCH
HASTINGS FINANCIAL CENTRE
BARBADOS, BARBADOS BB15154

FOR: COOKED POULTRY, COLE SLAW, PROCESSED POTATOES, SALADS, NAMELY, VEGETABLE SALADS, GARDEN SALADS, PROCESSED BEANS, COOKED VEGETABLES, FRENCH FRIED POTATOES, AND PREPARED ENTREES CONSISTING OF POULTRY OR VEGETABLES, IN CLASS 29 (U.S. CL. 46).

FIRST USE 10-4-2011; IN COMMERCE 10-4-2011.

FOR: BREADS, PASTRIES, SALSA, GRAIN-BASED BEVERAGES, AND BAKERY DESSERTS, IN CLASS 30 (U.S. CL. 46).

FIRST USE 10-4-2011; IN COMMERCE 10-4-2011.

FOR: BEVERAGES, NAMELY, FRUIT DRINKS, FRUIT PUNCH, LEMONADE AND DRINKING WATER, IN CLASS 32 (U.S. CLS. 45, 46 AND 48).

FIRST USE 10-4-2011; IN COMMERCE 10-4-2011.

FOR: RESTAURANT FRANCHISING, NAMELY, OFFERING BUSINESS MANAGEMENT ASSISTANCE IN THE ESTABLISHMENT AND/OR OPERATION OF RESTAURANTS, IN CLASS 35 (U.S. CLS. 100, 101 AND 102).

FIRST USE 10-4-2011; IN COMMERCE 10-4-2011.

FOR: RESTAURANT SERVICES, IN CLASS 43 (U.S. CLS. 100 AND 101).

FIRST USE 10-4-2011; IN COMMERCE 10-4-2011.

OWNER OF U.S. REG. NOS. 1,783,043, 3,508,553, AND OTHERS.

NO CLAIM IS MADE TO THE EXCLUSIVE RIGHT TO USE "POLLO" FOR INTERNATIONAL CLASSES 29, 35 AND 43, APART FROM THE MARK AS SHOWN.



David J. Kyjars

Director of the United States Patent and Trademark Office

Reg. No. 4,206,742 THE MARK CONSISTS OF A RECTANGLE WITH LINES INSIDE OF IT FORMING THE LETTERS "PC" AND A CHICKEN, WITH OTHER LINES FORMING ABSTRACT DESIGNS WITHIN THE RECTANGLE. TO THE RIGHT OF THE RECTANGLE DESIGN ARE THE WORDS "POLLO CAMPERO".

THE ENGLISH TRANSLATION OF "POLLO CAMPERO" IN THE MARK IS "COUNTRY CHICKEN".

SN 85-196,605, FILED 12-13-2010.

SARA BENJAMIN, EXAMINING ATTORNEY

United States of America

United States Patent and Trademark Office

MOJO BOWL

Reg. No. 4,206,743

Registered Sep. 11, 2012

Int. Cl.: 43

SERVICE MARK

PRINCIPAL REGISTER

MR. SCOTT SCHRAML (UNITED STATES INDIVIDUAL)
N31 W23577 ROUGH HILL ROAD
PEWAUKEE, WI 53072

FOR: RESTAURANT SERVICES; MOBILE RESTAURANT SERVICES FEATURING A MOBILE FOOD CART; MOBILE CAFE SERVICES FOR PROVIDING FOOD AND DRINK; FOOD CATERING SERVICES; FOOD PREPARATION SERVICES MADE TO ORDER FOR DELIVERY OR PICKUP; CONSULTATION SERVICES IN THE FIELD OF RESTAURANT MENU DEVELOPMENT, IN CLASS 43 (U.S. CLS. 100 AND 101).

FIRST USE 5-15-2011; IN COMMERCE 5-15-2011.

THE MARK CONSISTS OF STANDARD CHARACTERS WITHOUT CLAIM TO ANY PARTICULAR FONT, STYLE, SIZE, OR COLOR.

SN 85-197,176, FILED 12-14-2010.

SUNG IN, EXAMINING ATTORNEY



David J. Kyfos

Director of the United States Patent and Trademark Office

United States of America

United States Patent and Trademark Office

MAKE TODAY A SUNNY DAY

Reg. No. 4,206,744

SUNNY DELIGHT BEVERAGES CO. (FLORIDA CORPORATION)
10300 ALLIANCE ROAD, SUITE 500
CINCINNATI, OH 45242

Registered Sep. 11, 2012

Int. Cl.: 32

FOR: FRUIT JUICE DRINKS CONTAINING WATER; FRUIT PUNCH, IN CLASS 32 (U.S. CLS. 45, 46 AND 48).

TRADEMARK

FIRST USE 6-21-2011; IN COMMERCE 6-21-2011.

PRINCIPAL REGISTER

THE MARK CONSISTS OF STANDARD CHARACTERS WITHOUT CLAIM TO ANY PARTICULAR FONT, STYLE, SIZE, OR COLOR.

OWNER OF U.S. REG. NO. 3,360,943.

SN 85-197,520, FILED 12-14-2010.

JANICE L. MCMORROW, EXAMINING ATTORNEY



David J. Kybas

Director of the United States Patent and Trademark Office

United States of America

United States Patent and Trademark Office

SPOILZ OF WAR

Reg. No. 4,206,745

BURKE, ROBERT WILLIAM (UNITED STATES INDIVIDUAL)
1020 11TH AVE. SE
ALTOONA, IA 50009

Registered Sep. 11, 2012

Int. Cl.: 25

FOR: BANDANAS; BEANIES; BOXER BRIEFS; BOXER SHORTS; CAPS; COLLARED SHIRTS; FOOTWEAR; GLOVES; HATBANDS; HATS; HOODED SWEATSHIRTS; JACKETS; LONG-SLEEVED SHIRTS; PANTS; SHIRTS AND SHORT-SLEEVED SHIRTS; SHORTS; SWEAT PANTS; SWEAT SHIRTS; T-SHIRTS; TANK TOPS; VESTS; WRAPS, IN CLASS 25 (U.S. CLS. 22 AND 39).

TRADEMARK

PRINCIPAL REGISTER

FIRST USE 10-15-2011; IN COMMERCE 3-5-2012.

THE MARK CONSISTS OF STANDARD CHARACTERS WITHOUT CLAIM TO ANY PARTICULAR FONT, STYLE, SIZE, OR COLOR.

SN 85-197,574, FILED 12-14-2010.

KELLY BOULTON, EXAMINING ATTORNEY



David J. Kybas

Director of the United States Patent and Trademark Office

United States of America

United States Patent and Trademark Office



Reg. No. 4,206,746

Registered Sep. 11, 2012

Int. Cl.: 25

TRADEMARK

PRINCIPAL REGISTER

BURKE, ROBERT WILLIAM (UNITED STATES INDIVIDUAL)
1020 11TH AVE. SE
ALTOONA, IA 50009

FOR: BANDANAS; BEANIES; BOXER BRIEFS; BOXER SHORTS; CAPS; COLLARED SHIRTS; FOOTWEAR; GLOVES; HATBANDS; HATS; HOODED SWEATSHIRTS; JACKETS; LONG-SLEEVED SHIRTS; PANTS; SHIRTS; SHORT-SLEEVED SHIRTS; SHORTS; SOCKS; SWEAT PANTS; SWEAT SHIRTS; T-SHIRTS; TANK-TOPS; VESTS; WRAPS, IN CLASS 25 (U.S. CLS. 22 AND 39).

FIRST USE 10-15-2011; IN COMMERCE 3-5-2012.

THE MARK CONSISTS OF THE WORD ELEMENT "SPOILZ OF WAR" OVERLAYING A STYLIZED "Z" IN WHICH THE ENDS OF THE "Z" TERMINATE IN BARBED POINTS. A NECKLACE CONSISTING OF A STRING AND SEVEN HUMAN EARS IS ARRANGED BELOW THE WORD ELEMENT IN A SEMI-CIRCULAR FASHION, WHEREIN THE ENDS OF THE NECKLACE ARE POSITIONED BETWEEN THE "S" AND "P" OF THE WORD ELEMENT ON THE LEFT HAND SIDE AND THE "A" AND "R" ON THE RIGHT HAND SIDE.

SN 85-197,685, FILED 12-14-2010.

KELLY BOULTON, EXAMINING ATTORNEY



David J. Kyjars

Director of the United States Patent and Trademark Office

United States of America

United States Patent and Trademark Office

BUCHULIFE

Reg. No. 4,206,747

CAPE KINGDOM NUTRACEUTICALS LLC (FLORIDA LIMITED LIABILITY COMPANY)
10381 NW 62ND DRIVE
PARKLAND, FL 33076

Registered Sep. 11, 2012

Int. Cls.: 5 and 32

FOR: MEDICATED DRINKING WATERS FEATURING BUCHU FOR USE AS ANTI-INFLAMMATORIES AND ANTISEPTICS AND FOR USE IN TREATING URINARY TRACT INFECTIONS; MEDICATED HERBAL PREPARATIONS FEATURING BUCHU; PHARMACEUTICAL CAPSULES AND GELS FEATURING BUCHU, NAMELY, PAIN-RELIEF CAPSULES, ANTI-INFLAMMATORY CAPSULES, ANTI-INFLAMMATORY, ANTISEPTIC AND ANTI-FUNGAL GELS AND URINARY TRACT INFECTION MEDICATION, IN CLASS 5 (U.S. CLS. 6, 18, 44, 46, 51 AND 52).

TRADEMARK

PRINCIPAL REGISTER

FIRST USE 6-1-2012; IN COMMERCE 6-1-2012.

FOR: BEVERAGES FEATURING BUCHU, NAMELY, DRINKING WATER, MINERAL WATERS, SPRING WATERS, STILL WATERS, FLAVORED WATERS AND HERBAL JUICES , IN CLASS 32 (U.S. CLS. 45, 46 AND 48).

FIRST USE 6-1-2012; IN COMMERCE 6-1-2012.

THE MARK CONSISTS OF STANDARD CHARACTERS WITHOUT CLAIM TO ANY PARTICULAR FONT, STYLE, SIZE, OR COLOR.

SN 85-197,917, FILED 12-14-2010.

MARTHA FROMM, EXAMINING ATTORNEY



David J. Kyffers

Director of the United States Patent and Trademark Office

United States of America

United States Patent and Trademark Office

WHAT ENERGY BILL?

Reg. No. 4,206,748

Registered Sep. 11, 2012

Int. Cl.: 35

SERVICE MARK

PRINCIPAL REGISTER

IBACOS, INC. (PENNSYLVANIA CORPORATION)
2214 LIBERTY AVENUE
PITTSBURGH, PA 15222

FOR: HOME ENERGY ASSESSMENT SERVICES FOR THE PURPOSE OF DETERMINING ENERGY EFFICIENCY OR USAGE MANAGEMENT, IN CLASS 35 (U.S. CLS. 100, 101 AND 102).

FIRST USE 11-30-2010; IN COMMERCE 11-30-2010.

THE MARK CONSISTS OF STANDARD CHARACTERS WITHOUT CLAIM TO ANY PARTICULAR FONT, STYLE, SIZE, OR COLOR.

SN 85-198,096, FILED 12-15-2010.

ALEXANDER L. POWERS, EXAMINING ATTORNEY



David J. Kyffers

Director of the United States Patent and Trademark Office

United States of America

United States Patent and Trademark Office

HOME QUALITY + PERFORMANCE

Reg. No. 4,206,749

Registered Sep. 11, 2012

Int. Cl.: 37

SERVICE MARK

PRINCIPAL REGISTER

IBACOS, INC. (PENNSYLVANIA CORPORATION)
2214 LIBERTY AVENUE
PITTSBURGH, PA 15222

FOR: CONSULTATION SERVICES IN THE FIELD OF CONSTRUCTION OF ENVIRONMENTALLY-CONSCIOUS RESIDENTIAL BUILDINGS; RESIDENTIAL CONSTRUCTION CONSULTING FEATURING SAFER, HEALTHY, COMFORTABLE, DURABLE, EFFICIENT, RESPONSIBLE AND/OR AFFORDABLE HOUSING, IN CLASS 37 (U.S. CLS. 100, 103 AND 106).

FIRST USE 3-0-2009; IN COMMERCE 3-0-2009.

THE MARK CONSISTS OF STANDARD CHARACTERS WITHOUT CLAIM TO ANY PARTICULAR FONT, STYLE, SIZE, OR COLOR.

OWNER OF U.S. REG. NO. 2,698,941.

NO CLAIM IS MADE TO THE EXCLUSIVE RIGHT TO USE "HOME", APART FROM THE MARK AS SHOWN.

SN 85-198,118, FILED 12-15-2010.

ALEXANDER L. POWERS, EXAMINING ATTORNEY



David J. Kyros

Director of the United States Patent and Trademark Office

United States of America

United States Patent and Trademark Office

THE CYNICAL ASS

Reg. No. 4,206,750

OSTROWSKI, MICHAEL S. (UNITED STATES INDIVIDUAL)
94 MILLER STREET
LUDLOW, MA 01056

Registered Sep. 11, 2012

Int. Cl.: 28

FOR: NOVELTY TOYS, NAMELY, FAKE NOSES AND LIPS, IN CLASS 28 (U.S. CLS. 22, 23, 38 AND 50).

TRADEMARK

FIRST USE 6-1-2012; IN COMMERCE 6-1-2012.

PRINCIPAL REGISTER

THE MARK CONSISTS OF STANDARD CHARACTERS WITHOUT CLAIM TO ANY PARTICULAR FONT, STYLE, SIZE, OR COLOR.

SN 85-198,123, FILED 12-15-2010.

LINDA LAVACHE, EXAMINING ATTORNEY



David J. Kyffers

Director of the United States Patent and Trademark Office

United States of America

United States Patent and Trademark Office

HEINIE SMOOCHER

Reg. No. 4,206,751

OSTROWSKI, MICHAEL S. (UNITED STATES INDIVIDUAL)
94 MILLER STREET
LUDLOW, MA 01056

Registered Sep. 11, 2012

Int. Cl.: 28

FOR: NOVELTY TOYS, NAMELY, FAKE LIPS, IN CLASS 28 (U.S. CLS. 22, 23, 38 AND 50).

TRADEMARK

FIRST USE 6-1-2012; IN COMMERCE 6-1-2012.

PRINCIPAL REGISTER

THE MARK CONSISTS OF STANDARD CHARACTERS WITHOUT CLAIM TO ANY PARTICULAR FONT, STYLE, SIZE, OR COLOR.

SN 85-198,130, FILED 12-15-2010.

LINDA LAVACHE, EXAMINING ATTORNEY



David J. Kybas

Director of the United States Patent and Trademark Office

United States of America

United States Patent and Trademark Office

WONDER WALL

Reg. No. 4,206,752

BRANDED, LLC. (GEORGIA LIMITED LIABILITY COMPANY)
3333 LEE PARKWAY 6TH FLOOR
DALLAS, TX 75219

Registered Sep. 11, 2012

Int. Cl.: 25

FOR: PANTS, JEANS, SHIRTS, SKIRTS, SHORTS, DRESSES, SWEATERS, HOSIERY, JACKETS, OUTERWEAR IN THE NATURE OF PARKAS AND RAINCOATS, COATS, FOOTWEAR, HEADWEAR, GLOVES, SCARVES, SOCKS, TRACKSUITS, SWIMWEAR, BEACHWEAR, SANDALS, SLIPPERS, PAJAMAS, BELTS, UNDERWEAR, IN CLASS 25 (U.S. CLS. 22 AND 39).

TRADEMARK

PRINCIPAL REGISTER

FIRST USE 6-20-2012; IN COMMERCE 6-20-2012.

THE MARK CONSISTS OF STANDARD CHARACTERS WITHOUT CLAIM TO ANY PARTICULAR FONT, STYLE, SIZE, OR COLOR.

SN 85-198,349, FILED 12-15-2010.

DAWN FELDMAN, EXAMINING ATTORNEY



David J. Kyffers

Director of the United States Patent and Trademark Office

United States of America

United States Patent and Trademark Office

Hard Corps

Reg. No. 4,206,753

BRANDED, LLC (GEORGIA LIMITED LIABILITY COMPANY)
3333 LEE PARKWAY 6TH FLOOR
DALLAS, TX 75219

Registered Sep. 11, 2012

Int. Cl.: 25

FOR: BELTS; COATS; FOOTWEAR; HEADWEAR; JACKETS; PANTS; SCARVES; SHIRTS; SHORTS; SOCKS; SWEATERS; SWEATSHIRTS; T-SHIRTS, IN CLASS 25 (U.S. CLS. 22 AND 39).

TRADEMARK

FIRST USE 6-20-2012; IN COMMERCE 6-20-2012.

PRINCIPAL REGISTER

THE MARK CONSISTS OF STANDARD CHARACTERS WITHOUT CLAIM TO ANY PARTICULAR FONT, STYLE, SIZE, OR COLOR.

SN 85-198,369, FILED 12-15-2010.

ANN E. SAPPENFIELD, EXAMINING ATTORNEY



David J. Kybas

Director of the United States Patent and Trademark Office

United States of America

United States Patent and Trademark Office

Learningsmith

Reg. No. 4,206,754

BRANDED, LLC (GEORGIA LIMITED LIABILITY COMPANY)
3333 LEE PARKWAY 6TH FLOOR
DALLAS, TX 75219

Registered Sep. 11, 2012

Int. Cl.: 28

FOR: FULL LINE OF TOYS AND GAMES FOR ADULTS AND CHILDREN, IN CLASS 28 (U.S. CLS. 22, 23, 38 AND 50).

TRADEMARK

FIRST USE 6-20-2012; IN COMMERCE 6-20-2012.

PRINCIPAL REGISTER

THE MARK CONSISTS OF STANDARD CHARACTERS WITHOUT CLAIM TO ANY PARTICULAR FONT, STYLE, SIZE, OR COLOR.

SN 85-198,381, FILED 12-15-2010.

ANN E. SAPPENFIELD, EXAMINING ATTORNEY



David J. Kybas

Director of the United States Patent and Trademark Office

United States of America

United States Patent and Trademark Office

Authentic Issue

Reg. No. 4,206,755

BRANDED, LLC (GEORGIA LIMITED LIABILITY COMPANY)
3333 LEE PARKWAY 6TH FLOOR
DALLAS, TX 75219

Registered Sep. 11, 2012

Int. Cl.: 25

FOR: CLOTHING, NAMELY, T-SHIRTS, SHIRTS, BLOUSES, SWEATERS, TOPS, PANTS, SHORTS, JEANS, DRESSES, SKIRTS, JACKETS, BLAZERS, SUITS, COATS, LOUNGEWEAR, SWEATSHIRTS, SOCKS, BELTS, SCARVES; FOOTWEAR; HEADWEAR, IN CLASS 25 (U.S. CLS. 22 AND 39).

TRADEMARK

PRINCIPAL REGISTER

FIRST USE 6-20-2012; IN COMMERCE 6-20-2012.

THE MARK CONSISTS OF STANDARD CHARACTERS WITHOUT CLAIM TO ANY PARTICULAR FONT, STYLE, SIZE, OR COLOR.

SN 85-198,396, FILED 12-15-2010.

ANN E. SAPPENFIELD, EXAMINING ATTORNEY



David J. Kyffers

Director of the United States Patent and Trademark Office

United States of America

United States Patent and Trademark Office

Hit or Miss

Reg. No. 4,206,756

BRANDED, LLC (GEORGIA LIMITED LIABILITY COMPANY)
3333 LEE PARKWAY 6TH FLOOR
DALLAS, TX 75219

Registered Sep. 11, 2012

Int. Cl.: 25

FOR: CLOTHING, NAMELY, T-SHIRTS, SHIRTS, BLOUSES, SWEATERS, TOPS, PANTS, SHORTS, JEANS, DRESSES, SKIRTS, JACKETS, BLAZERS, SUITS, COATS, LOUNGEWEAR, SWEATSHIRTS, SOCKS, BELTS, SCARVES; FOOTWEAR; HEADWEAR, IN CLASS 25 (U.S. CLS. 22 AND 39).

TRADEMARK

PRINCIPAL REGISTER

FIRST USE 6-20-2012; IN COMMERCE 6-20-2012.

THE MARK CONSISTS OF STANDARD CHARACTERS WITHOUT CLAIM TO ANY PARTICULAR FONT, STYLE, SIZE, OR COLOR.

SN 85-198,406, FILED 12-15-2010.

ANN E. SAPPENFIELD, EXAMINING ATTORNEY



David J. Kyffers

Director of the United States Patent and Trademark Office

United States of America

United States Patent and Trademark Office

Coda

Reg. No. 4,206,757

BRANDED, LLC (GEORGIA LIMITED LIABILITY COMPANY)
3333 LEE PARKWAY 6TH FL
DALLAS, TX 75219

Registered Sep. 11, 2012

Int. Cl.: 25

FOR: CLOTHING, NAMELY, T-SHIRTS, SHIRTS, BLOUSES, SWEATERS, TOPS, PANTS, SHORTS, JEANS, DRESSES, SKIRTS, JACKET, BLAZERS, SUITS, COATS, LOUNGEWEAR, SWEATSHIRTS, SOCKS, BELTS, SCARVES; FOOTWEAR; HEADWEAR, IN CLASS 25 (U.S. CLS. 22 AND 39).

TRADEMARK

PRINCIPAL REGISTER

FIRST USE 6-20-2012; IN COMMERCE 6-20-2012.

THE MARK CONSISTS OF STANDARD CHARACTERS WITHOUT CLAIM TO ANY PARTICULAR FONT, STYLE, SIZE, OR COLOR.

SN 85-198,942, FILED 12-15-2010.

SAIMA MAKHDOOM, EXAMINING ATTORNEY



David J. Kyffers

Director of the United States Patent and Trademark Office

United States of America

United States Patent and Trademark Office

Studio B

Reg. No. 4,206,758

BRANDED, LLC (GEORGIA LIMITED LIABILITY COMPANY)
3333 LEE PARKWAY 6TH FLOOR
DALLAS, TX 75219

Registered Sep. 11, 2012

Int. Cl.: 25

FOR: CLOTHING, NAMELY, T-SHIRTS, SHIRTS, BLOUSES, SWEATERS, TOPS, PANTS, SHORTS, JEANS, DRESSES, SKIRTS, JACKET, BLAZERS, SUITS, COATS, LOUNGEWEAR, SWEATSHIRTS, SOCKS, BELTS, SCARVES; FOOTWEAR; HEADWEAR, IN CLASS 25 (U.S. CLS. 22 AND 39).

TRADEMARK

PRINCIPAL REGISTER

FIRST USE 6-20-2012; IN COMMERCE 6-20-2012.

THE MARK CONSISTS OF STANDARD CHARACTERS WITHOUT CLAIM TO ANY PARTICULAR FONT, STYLE, SIZE, OR COLOR.

SN 85-198,992, FILED 12-15-2010.

SAIMA MAKHDOOM, EXAMINING ATTORNEY



David J. Kyros

Director of the United States Patent and Trademark Office

United States of America

United States Patent and Trademark Office

Merry Go Round

Reg. No. 4,206,759

BRANDED, LLC (GEORGIA LIMITED LIABILITY COMPANY)
3333 LEE PARKWAY 6TH FL
DALLAS, TX 75219

Registered Sep. 11, 2012

Int. Cl.: 25

FOR: CLOTHING, NAMELY, T-SHIRTS, SHIRTS, BLOUSES, SWEATERS, TOPS, PANTS, SHORTS, JEANS, DRESSES, SKIRTS, JACKETS, BLAZERS, SUITS, COATS, LOUNGEWEAR, SWEATSHIRTS, SOCKS, BELTS, SCARVES; FOOTWEAR; HEADWEAR, IN CLASS 25 (U.S. CLS. 22 AND 39).

TRADEMARK

PRINCIPAL REGISTER

FIRST USE 6-20-2012; IN COMMERCE 6-20-2012.

THE MARK CONSISTS OF STANDARD CHARACTERS WITHOUT CLAIM TO ANY PARTICULAR FONT, STYLE, SIZE, OR COLOR.

SN 85-199,021, FILED 12-15-2010.

RAMONA ORTIGA, EXAMINING ATTORNEY



David J. Kybas

Director of the United States Patent and Trademark Office

United States of America

United States Patent and Trademark Office



Reg. No. 4,206,760

FRICKE, CHRISTOPHER (UNITED STATES INDIVIDUAL)
23 PAUL'S WAY
LIMINGTON, ME 04049

Registered Sep. 11, 2012

Int. Cl.: 27

FOR: OILCLOTH MAT WITH A NONSKID NON ADHESIVE PADDING TO STABILIZE PETS, IN CLASS 27 (U.S. CLS. 19, 20, 37, 42 AND 50).

TRADEMARK

FIRST USE 1-1-2012; IN COMMERCE 1-1-2012.

PRINCIPAL REGISTER

NO CLAIM IS MADE TO THE EXCLUSIVE RIGHT TO USE "PET VET MAT", APART FROM THE MARK AS SHOWN.

THE MARK CONSISTS OF AN OVAL AND A DOG'S PAW WITH THE STYLIZED TEXT "EZEE~VISIT PET VET MAT".

SN 85-199,334, FILED 12-16-2010.

DOMINIC J. FERRAIUOLO, EXAMINING ATTORNEY



David J. Kyffers

Director of the United States Patent and Trademark Office

United States of America

United States Patent and Trademark Office



Tap Into Your Body

FOR OPTIMAL HEALTH

Reg. No. 4,206,761

Registered Sep. 11, 2012

Int. Cl.: 44

SERVICE MARK

PRINCIPAL REGISTER

RAYDARENTERPRISES (NEW JERSEY LIMITED LIABILITY COMPANY)
19 NORTH 13TH STREET
NEWARK, NJ 07107

FOR: PROVIDING A WEBSITE FEATURING INFORMATION ABOUT HEALTH AND THE EFFICACY OF HEALTH-RELATED PRODUCTS FOR TREATING SPECIFIC BODILY ORGANS, IN CLASS 44 (U.S. CLS. 100 AND 101).

FIRST USE 5-26-2012; IN COMMERCE 5-26-2012.

NO CLAIM IS MADE TO THE EXCLUSIVE RIGHT TO USE "OPTIMAL HEALTH", APART FROM THE MARK AS SHOWN.

THE MARK CONSISTS OF AN IMAGE OF A PERSON WITH THEIR HANDS RAISED OVER THEIR HEAD AND LEGS OPEN WITH THE RAYS OF THE SUN RADIATING FROM THEIR BODY WITH THE WORDING "TAP INTO YOUR BODY FOR OPTIMAL HEALTH" APPEARING BENEATH.

SN 85-199,461, FILED 12-16-2010.

GENE MACIOL, EXAMINING ATTORNEY



David J. Kybas

Director of the United States Patent and Trademark Office

United States of America

United States Patent and Trademark Office



Reg. No. 4,206,762

JAKE'S JOINT, INC. (TEXAS CORPORATION)
990 S. SHERMAN ST.
RICHARDSON, TX 75081

Registered Sep. 11, 2012

Int. Cl.: 43

FOR: RESTAURANT AND BAR SERVICES, IN CLASS 43 (U.S. CLS. 100 AND 101).

SERVICE MARK

FIRST USE 5-16-2011; IN COMMERCE 5-16-2011.

PRINCIPAL REGISTER

NO CLAIM IS MADE TO THE EXCLUSIVE RIGHT TO USE "JOINT" , APART FROM THE MARK AS SHOWN.

THE MARK CONSISTS OF THE PHRASE "JAKE'S JOINT" WRITTEN IN BLACK CONTAINED WITHIN A HORIZONTALLY ORIENTED RECTANGLE COMPOSED OF TWO BLACK PARALLEL LINES WITH "JAKE'S JOINT" CENTERED BELOW THE PARALLEL LINES IN THE UPPER INSIDE PART OF THE RECTANGLE. UNDER THE PHRASE "JAKE'S JOINT" IS A YELLOW BANNER OUTLINED IN BLACK WITH THE PHRASE "FOOD FIT FOR A KING" WRITTEN ON IT IN BLACK. THE PARALLEL LINES AT THE CORNERS OR THE RECTANGULAR SHAPE ARE CUT AWAY AND A BLACK GRAPHIC IS PLACED IN EACH CORNER. A STYLIZED "4" SUPERIMPOSED OVER THE LETTER "K" IS PLACED AT THE TOP RIGHT CORNER AND BOTTOM LEFT CORNER OF THE RECTANGLE. A STYLIZED OUTLINE OF A WOLF SUPERIMPOSED ON A CIRCLE IS PLACED IN THE TOP LEFT CORNER AND BOTTOM RIGHT CORNER OF THE RECTANGLE.

SN 85-199,558, FILED 12-16-2010.

ANTHONY RINKER, EXAMINING ATTORNEY



David J. Kybas

Director of the United States Patent and Trademark Office

United States of America

United States Patent and Trademark Office

WATER HONCHO

Reg. No. 4,206,763

DNR CONSULTING, LLC (CALIFORNIA LIMITED LIABILITY COMPANY)
1959 VERDE VIA
ESCONDIDO, CA 92027

Registered Sep. 11, 2012

Int. Cl.: 9

FOR: ELECTRONIC VALVES FOR CONTROLLING GAS OR FLUIDS, IN CLASS 9 (U.S. CLS. 21, 23, 26, 36 AND 38).

TRADEMARK

FIRST USE 5-31-2012; IN COMMERCE 5-31-2012.

PRINCIPAL REGISTER

THE MARK CONSISTS OF STANDARD CHARACTERS WITHOUT CLAIM TO ANY PARTICULAR FONT, STYLE, SIZE, OR COLOR.

NO CLAIM IS MADE TO THE EXCLUSIVE RIGHT TO USE "WATER", APART FROM THE MARK AS SHOWN.

SN 85-199,634, FILED 12-16-2010.

BARNEY CHARLON, EXAMINING ATTORNEY



David J. Kybas

Director of the United States Patent and Trademark Office

United States of America

United States Patent and Trademark Office

SFP

Reg. No. 4,206,764

Registered Sep. 11, 2012

CERTIFICATION MARK

SERVICES

PRINCIPAL REGISTER

INTERNATIONAL FACILITY MANAGEMENT ASSOCIATION (MICHIGAN NON-PROFIT CORPORATION)
1 EAST GREENWAY PLAZA, SUITE 1100
HOUSTON, TX 77046

FOR: FACILITY MANAGEMENT SERVICES, IN CLASS B (U.S. CL. B).

FIRST USE 11-1-2011; IN COMMERCE 11-1-2011.

THE MARK CONSISTS OF STANDARD CHARACTERS WITHOUT CLAIM TO ANY PARTICULAR FONT, STYLE, SIZE, OR COLOR.

THE CERTIFICATION MARK, AS INTENDED TO BE USED BY AUTHORIZED PERSONS, IS INTENDED TO CERTIFY THAT THE PERSON(S) HAS DEMONSTRATED KNOWLEDGE IN THE FIELD OF SUSTAINABLE FACILITY MANAGEMENT PRACTICES THROUGH CONTINUING EDUCATION AND THE ABILITY TO PASS COMPREHENSIVE EXAMS IN THREE AREAS.

SN 85-199,764, FILED 12-16-2010.

LINDA E. BLOHM, EXAMINING ATTORNEY



David J. Kyffers

Director of the United States Patent and Trademark Office

United States of America

United States Patent and Trademark Office

DEVIL SPEAR

Reg. No. 4,206,765

PURE FISHING, INC. (IOWA CORPORATION)
1900 18TH STREET
SPIRIT LAKE, IA 51360

Registered Sep. 11, 2012

Int. Cl.: 28

FOR: ARTIFICIAL FISHING BAIT; FISHING TACKLE, IN CLASS 28 (U.S. CLS. 22, 23, 38 AND 50).

TRADEMARK

FIRST USE 11-30-2010; IN COMMERCE 11-30-2010.

PRINCIPAL REGISTER

THE MARK CONSISTS OF STANDARD CHARACTERS WITHOUT CLAIM TO ANY PARTICULAR FONT, STYLE, SIZE, OR COLOR.

SN 85-200,443, FILED 12-17-2010.

KRISTIN DAHLING, EXAMINING ATTORNEY



David J. Kybas

Director of the United States Patent and Trademark Office

United States of America

United States Patent and Trademark Office

EMBANKMENT

Reg. No. 4,206,766

Registered Sep. 11, 2012

Int. Cl.: 33

TRADEMARK

PRINCIPAL REGISTER

GOLDSCHMIDT VINEYARDS LLC (CALIFORNIA LIMITED LIABILITY COMPANY)
152 PIPER STREET, SUITE C
HEALDSBURG, CA 95448

FOR: WINES, IN CLASS 33 (U.S. CLS. 47 AND 49).

FIRST USE 5-25-2012; IN COMMERCE 5-25-2012.

THE MARK CONSISTS OF STANDARD CHARACTERS WITHOUT CLAIM TO ANY PARTICULAR FONT, STYLE, SIZE, OR COLOR.

SN 85-200,543, FILED 12-17-2010.

TINA BROWN, EXAMINING ATTORNEY



David J. Kybas

Director of the United States Patent and Trademark Office

United States of America

United States Patent and Trademark Office

CENTIPEDE MATH

Reg. No. 4,206,767

CENTIVISION ENTERPRISES, LLC (NORTH CAROLINA LIMITED LIABILITY COMPANY)
3436 WASHBURN AVENUE #3
CHARLOTTE, NC 28205

Registered Sep. 11, 2012

Int. Cl.: 41

FOR: EDUCATION SERVICES, NAMELY, PROVIDING INSTRUCTION IN THE FIELD OF MATHEMATICS, IN CLASS 41 (U.S. CLS. 100, 101 AND 107).

SERVICE MARK

FIRST USE 1-31-2012; IN COMMERCE 1-31-2012.

PRINCIPAL REGISTER

THE MARK CONSISTS OF STANDARD CHARACTERS WITHOUT CLAIM TO ANY PARTICULAR FONT, STYLE, SIZE, OR COLOR.

NO CLAIM IS MADE TO THE EXCLUSIVE RIGHT TO USE "MATH", APART FROM THE MARK AS SHOWN.

SN 85-200,733, FILED 12-17-2010.

JANICE KIM, EXAMINING ATTORNEY



David J. Kyffers

Director of the United States Patent and Trademark Office

United States of America

United States Patent and Trademark Office

EXPRESS LANE

Reg. No. 4,206,768

Registered Sep. 11, 2012

Int. Cl.: 37

SERVICE MARK

PRINCIPAL REGISTER

APPLE INC. (CALIFORNIA CORPORATION)
1 INFINITE LOOP
CUPERTINO, CA 95014

FOR: INSTALLATION, REPAIR, MAINTENANCE AND SERVICING OF COMPUTERS AND OF ELECTRONIC, ELECTROMECHANICAL, OPTICAL, MAGNETIC AND ELECTRICAL EQUIPMENT FOR USE WITH COMPUTERS; TECHNICAL SERVICES AND SUPPORT, NAMELY, TECHNICAL ADVICE RELATED TO THE INSTALLATION AND REPAIR OF COMPUTER HARDWARE, COMPUTER PERIPHERALS, COMPUTER NETWORKS, AND CONSUMER ELECTRONIC DEVICES; TECHNICAL SUPPORT SERVICES AVAILABLE VIA COMPUTER NETWORK OR THE INTERNET, OR OVER A TELECOMMUNICATIONS NETWORK, NAMELY, TROUBLESHOOTING IN THE NATURE OF THE REPAIR OF COMPUTER HARDWARE, COMPUTER PERIPHERALS, COMPUTER NETWORKS, AND CONSUMER ELECTRONIC DEVICES; MULTIMEDIA TECHNICAL SUPPORT SERVICES AND SUPPORT, NAMELY, TECHNICAL ADVICE RELATED TO THE REPAIR OF COMPUTER HARDWARE, COMPUTER PERIPHERALS, COMPUTER NETWORKS, AND CONSUMER ELECTRONIC DEVICES; INFORMATION RELATING TO INSTALLATION, MAINTENANCE, REPAIR, SERVICING AND UPDATING OF COMPUTERS TRANSMITTED THROUGH E-MAIL UPDATES, E-MAIL SUPPORT NOTICES, AND OVER TELECOMMUNICATIONS NETWORKS; INSTALLATION, MAINTENANCE, REPAIR AND SERVICING OF COMPUTER HARDWARE, COMPUTER PERIPHERAL DEVICES, PHOTOGRAPHIC, APPARATUS AND EQUIPMENT, APPARATUS AND EQUIPMENT FOR RECORDING AND/OR REPRODUCING SOUND AND/OR IMAGES, AND TELECOMMUNICATION APPARATUS AND EQUIPMENT; COMPUTER HARDWARE INSTALLATION SERVICES; COMPUTER MAINTENANCE SERVICES; COMPUTER REPAIR SERVICES; ADVISORY, INFORMATION AND CONSULTANCY SERVICES RELATED TO THE AFORESAID, IN CLASS 37 (U.S. CLS. 100, 103 AND 106).

FIRST USE 9-12-2010; IN COMMERCE 9-12-2010.

THE MARK CONSISTS OF STANDARD CHARACTERS WITHOUT CLAIM TO ANY PARTICULAR FONT, STYLE, SIZE, OR COLOR.

PRIORITY CLAIMED UNDER SEC. 44(D) ON TRINIDAD/TOBAGO APPLICATION NO. 42395, FILED 6-28-2010.

SN 85-200,810, FILED 12-17-2010.



David J. Kyjars

Director of the United States Patent and Trademark Office

Reg. No. 4,206,768 KATINA MISTER, EXAMINING ATTORNEY

United States of America

United States Patent and Trademark Office

ULTIMATENINJA IMPACT

Reg. No. 4,206,769

NAMCO BANDAI GAMES INC. (JAPAN CORPORATION)
4-5-15 HIGASHI SHINAGAWA

Registered Sep. 11, 2012

SHINAGAWA-KU TOKYO, JAPAN 140-8590

Int. Cl.: 9

FOR: COMPUTER GAME PROGRAMS; COMPUTER GAME SOFTWARE; DOWNLOADABLE
COMPUTER GAME PROGRAMS; DOWNLOADABLE COMPUTER GAME SOFTWARE VIA
A GLOBAL COMPUTER NETWORK AND WIRELESS DEVICES; VIDEO GAME SOFTWARE,
IN CLASS 9 (U.S. CLS. 21, 23, 26, 36 AND 38).

TRADEMARK

PRINCIPAL REGISTER

FIRST USE 10-18-2011; IN COMMERCE 10-18-2011.

THE MARK CONSISTS OF STANDARD CHARACTERS WITHOUT CLAIM TO ANY PAR-
TICULAR FONT, STYLE, SIZE, OR COLOR.

OWNER OF U.S. REG. NOS. 3,299,720 AND 3,399,281.

SN 85-200,856, FILED 12-17-2010.

PRISCILLA MILTON, EXAMINING ATTORNEY



David J. Kybas

Director of the United States Patent and Trademark Office

United States of America

United States Patent and Trademark Office

EXPRESS LANE

Reg. No. 4,206,770

APPLE INC. (CALIFORNIA CORPORATION)

Registered Sep. 11, 2012

1 INFINITE LOOP
CUPERTINO, CA 95014

Int. Cl.: 42

FOR: TECHNICAL SUPPORT SERVICES, NAMELY, TROUBLESHOOTING IN THE NATURE OF DIAGNOSING PROBLEMS RELATING TO COMPUTER HARDWARE, COMPUTER PERIPHERALS, CONSUMER ELECTRONIC DEVICES, COMPUTER SOFTWARE AND COMPUTER NETWORKS; COMPUTER SERVICES, NAMELY, PROVIDING ONLINE PORTAL FOR TROUBLESHOOTING IN THE NATURE OF DIAGNOSING PROBLEMS RELATING TO COMPUTER HARDWARE, COMPUTER PERIPHERALS, CONSUMER ELECTRONIC DEVICES, COMPUTER SOFTWARE AND COMPUTER NETWORKS; PROVIDING TECHNICAL SUPPORT AND TROUBLESHOOTING INFORMATION VIA THE INTERNET AND VOICE TELECOMMUNICATIONS NETWORKS FOR FIXING PROBLEMS RELATING TO COMPUTER SOFTWARE AND COMPUTER NETWORKS; COMPUTER CONSULTATION, NAMELY, SERVICES FOR OPTIMIZING THE PERFORMANCE AND FUNCTIONALITY OF COMPUTER HARDWARE, COMPUTER PERIPHERALS, CONSUMER ELECTRONIC DEVICES, COMPUTER SOFTWARE AND COMPUTER NETWORKS; INSTALLATION, REPAIR, UPDATING AND MAINTENANCE OF COMPUTER SOFTWARE, IN CLASS 42 (U.S. CLS. 100 AND 101).

SERVICE MARK

PRINCIPAL REGISTER

FIRST USE 9-12-2010; IN COMMERCE 9-12-2010.

THE MARK CONSISTS OF STANDARD CHARACTERS WITHOUT CLAIM TO ANY PARTICULAR FONT, STYLE, SIZE, OR COLOR.

PRIORITY CLAIMED UNDER SEC. 44(D) ON TRINIDAD/TOBAGO APPLICATION NO. 42395, FILED 6-28-2010.

SN 85-200,890, FILED 12-17-2010.

KATINA MISTER, EXAMINING ATTORNEY



David J. Kyffers

Director of the United States Patent and Trademark Office

United States of America

United States Patent and Trademark Office

VOICEPASS

Reg. No. 4,206,771

APPLE INC. (CALIFORNIA CORPORATION)
1 INFINITE LOOP
CUPERTINO, CA 95014

Registered Sep. 11, 2012

Int. Cl.: 37

FOR: TECHNICAL SUPPORT SERVICES AVAILABLE VIA COMPUTER NETWORK OR THE INTERNET, OR OVER A TELECOMMUNICATIONS NETWORK, NAMELY, TROUBLESHOOTING IN THE NATURE OF THE REPAIR OF COMPUTER HARDWARE, COMPUTER PERIPHERALS, COMPUTER NETWORKS, AND CONSUMER ELECTRONIC DEVICES; MULTIMEDIA TECHNICAL SUPPORT SERVICES AND SUPPORT, NAMELY, TECHNICAL ADVICE RELATED TO THE REPAIR OF COMPUTER HARDWARE, COMPUTER PERIPHERALS, COMPUTER NETWORKS, AND CONSUMER ELECTRONIC DEVICES, IN CLASS 37 (U.S. CLS. 100, 103 AND 106).

SERVICE MARK

PRINCIPAL REGISTER

FIRST USE 9-12-2010; IN COMMERCE 9-12-2010.

THE MARK CONSISTS OF STANDARD CHARACTERS WITHOUT CLAIM TO ANY PARTICULAR FONT, STYLE, SIZE, OR COLOR.

PRIORITY CLAIMED UNDER SEC. 44(D) ON TRINIDAD/TOBAGO APPLICATION NO. 42396, FILED 6-28-2010.

SN 85-200,930, FILED 12-17-2010.

KATINA MISTER, EXAMINING ATTORNEY



David J. Kybas

Director of the United States Patent and Trademark Office

United States of America

United States Patent and Trademark Office

NO MORE TALK

Reg. No. 4,206,772

NX LEVEL, INC. (ARIZONA CORPORATION)

Registered Sep. 11, 2012

P.O. BOX 48903
PHOENIX, AZ 85075

Int. Cl.: 25

FOR: CLOTHING, NAMELY, T-SHIRTS, SWEATSHIRTS, GOLF SHORTS, HATS, ATHLETIC SOCKS, SWEAT BANDS, POLO-STYLE SHIRTS, BASKETBALL SHORTS, TENNIS SHORTS, SWEAT SUITS, AND WARM-UP SUITS, IN CLASS 25 (U.S. CLS. 22 AND 39).

TRADEMARK

FIRST USE 11-11-2011; IN COMMERCE 11-11-2011.

PRINCIPAL REGISTER

THE MARK CONSISTS OF STANDARD CHARACTERS WITHOUT CLAIM TO ANY PARTICULAR FONT, STYLE, SIZE, OR COLOR.

SN 85-201,310, FILED 12-18-2010.

ARETHA SOMERVILLE, EXAMINING ATTORNEY



David J. Kyffers

Director of the United States Patent and Trademark Office

United States of America

United States Patent and Trademark Office

CLEARCHOICE FEDERAL CREDIT UNION

Reg. No. 4,206,773

Registered Sep. 11, 2012

Int. Cl.: 36

SERVICE MARK

PRINCIPAL REGISTER

CLEARCHOICE FEDERAL CREDIT UNION (PENNSYLVANIA FEDERALLY CHARTERED CREDIT UNION)
1981 STATE HILL ROAD
WYOMISSING, PA 19610

FOR: CREDIT UNIONS, EXCLUDING DEBIT AND CREDIT CARD SERVICES, IN CLASS 36 (U.S. CLS. 100, 101 AND 102).

FIRST USE 2-1-2012; IN COMMERCE 2-1-2012.

THE MARK CONSISTS OF STANDARD CHARACTERS WITHOUT CLAIM TO ANY PARTICULAR FONT, STYLE, SIZE, OR COLOR.

NO CLAIM IS MADE TO THE EXCLUSIVE RIGHT TO USE "FEDERAL CREDIT UNION", APART FROM THE MARK AS SHOWN.

SN 85-201,522, FILED 12-20-2010.

REBECCA POVARCHUK, EXAMINING ATTORNEY



David J. Kyros

Director of the United States Patent and Trademark Office

United States of America

United States Patent and Trademark Office

GET REAL

Reg. No. 4,206,774

Registered Sep. 11, 2012

Int. Cl.: 35

SERVICE MARK

PRINCIPAL REGISTER

THE INTERNATIONAL ANTICOUNTERFEITING COALITION, INC. (NEW YORK CORPORATION)
1730 M STREET NW # 1020
WASHINGTON, DC 20036

FOR: ARRANGING AND CONDUCTING BUSINESS CONFERENCES; ASSOCIATION SERVICES, NAMELY, PROMOTING THE INTERESTS OF A COALITION FOR THE PREVENTION OF TRADEMARK COUNTERFEITING; ORGANIZATION OF EXHIBITIONS FOR COMMERCIAL OR ADVERTISING PURPOSES, IN CLASS 35 (U.S. CLS. 100, 101 AND 102).

FIRST USE 2-28-2005; IN COMMERCE 2-8-2005.

THE MARK CONSISTS OF STANDARD CHARACTERS WITHOUT CLAIM TO ANY PARTICULAR FONT, STYLE, SIZE, OR COLOR.

SN 85-201,658, FILED 12-20-2010.

WARREN L. OLANDRIA, EXAMINING ATTORNEY



David J. Kyffers

Director of the United States Patent and Trademark Office

United States of America

United States Patent and Trademark Office

Kansai

Reg. No. 4,206,775

Registered Sep. 11, 2012

Int. Cl.: 25

TRADEMARK

PRINCIPAL REGISTER

BRANDED LLC (GEORGIA LIMITED LIABILITY COMPANY)
3333 LEE PARKWAY 6TH FLOOR
DALLAS, TX 75219

FOR: CLOTHING, NAMELY, T-SHIRTS, SHIRTS, BLOUSES, SWEATERS, TOPS, PANTS, SHORTS, JEANS, DRESSES, SKIRTS, JACKET, BLAZERS, SUITS, COATS, LOUNGEWEAR, SWEATSHIRTS, SOCKS, BELTS, SCARVES; FOOTWEAR, HEADWEAR, IN CLASS 25 (U.S. CLS. 22 AND 39).

FIRST USE 6-20-2012; IN COMMERCE 6-20-2012.

THE MARK CONSISTS OF STANDARD CHARACTERS WITHOUT CLAIM TO ANY PARTICULAR FONT, STYLE, SIZE, OR COLOR.

THE WORDING "KANSAI" HAS NO MEANING IN A FOREIGN LANGUAGE.

SN 85-202,415, FILED 12-21-2010.

WILLIAM VERHOSEK, EXAMINING ATTORNEY



David J. Kyros

Director of the United States Patent and Trademark Office

United States of America

United States Patent and Trademark Office

±ONE

Reg. No. 4,206,776

Registered Sep. 11, 2012

Int. Cl.: 9

TRADEMARK

PRINCIPAL REGISTER

PRECISION ONE LIFECARE LIMITED (HONG KONG LIMITED COMPANY (LTD.))
UNIT A, 13/F, EIB CENTRE
NO. 40-44 BONHAM STRAND
SHEUNG WAN, HONG KONG

FOR: BODY SCALES; KITCHEN SCALES; INSTRUMENTS FOR MEASURING LENGTH; INSTRUMENTS FOR MEASURING WEIGHT, NAMELY, SCALES AND BALANCES; INSTRUMENTS FOR MEASURING DISTANCE, NAMELY, DISTANCE MEASURING APPARATUS; INSTRUMENTS FOR MEASURING VOLUME, NAMELY, WEIGHT TO VOLUME CONVERTERS FOR HOUSEHOLD USE; INSTRUMENTS FOR MEASURING TEMPERATURE, NAMELY, THERMOMETERS; INSTRUMENTS FOR MEASURING PRESSURE, NAMELY, PRESSURE GAUGES; INSTRUMENTS FOR MEASURING QUANTITY, NAMELY, WEIGHT TO QUANTITY CONVERTERS FOR HOUSEHOLD USE, IN CLASS 9 (U.S. CLS. 21, 23, 26, 36 AND 38).

FIRST USE 1-0-2012; IN COMMERCE 1-0-2012.

THE MARK CONSISTS OF STANDARD CHARACTERS WITHOUT CLAIM TO ANY PARTICULAR FONT, STYLE, SIZE, OR COLOR.

SN 85-202,419, FILED 12-21-2010.

ELIZABETH KAJUBI, EXAMINING ATTORNEY



David J. Kybas

Director of the United States Patent and Trademark Office

United States of America

United States Patent and Trademark Office

Illustrations

Reg. No. 4,206,777

BRANDED, LLC (GEORGIA LIMITED LIABILITY COMPANY)
3333 LEE PARKWAY 6TH FL
DALLAS, TX 75219

Registered Sep. 11, 2012

Int. Cl.: 25

FOR: CLOTHING, NAMELY, T-SHIRTS, SHIRTS, BLOUSES, SWEATERS, TOPS, PANTS, SHORTS, JEANS, DRESSES, SKIRTS, JACKETS, BLAZERS, SUITS, COATS, LOUNGEWEAR, SWEATSHIRTS, SOCKS, BELTS, SCARVES; FOOTWEAR, HEADWEAR, IN CLASS 25 (U.S. CLS. 22 AND 39).

TRADEMARK

PRINCIPAL REGISTER

FIRST USE 6-20-2012; IN COMMERCE 6-20-2012.

THE MARK CONSISTS OF STANDARD CHARACTERS WITHOUT CLAIM TO ANY PARTICULAR FONT, STYLE, SIZE, OR COLOR.

SN 85-202,436, FILED 12-21-2010.

RAMONA ORTIGA, EXAMINING ATTORNEY



David J. Kyjars

Director of the United States Patent and Trademark Office

United States of America

United States Patent and Trademark Office

Bundeswehr

Reg. No. 4,206,778

BRANDED LLC (GEORGIA LIMITED LIABILITY COMPANY)
3333 LEE PARKWAY 6TH FLOOR
DALLAS, TX 75219

Registered Sep. 11, 2012

Int. Cl.: 25

FOR: CLOTHING, NAMELY, T-SHIRTS, SHIRTS, BLOUSES, SWEATERS, TOPS, PANTS, SHORTS, JEANS, DRESSES, SKIRTS, JACKETS, BLAZERS, SUITS, COATS, LOUNGEWEAR, SWEATSHIRTS, SOCKS, BELTS, SCARVES; FOOTWEAR, HEADWEAR, IN CLASS 25 (U.S. CLS. 22 AND 39).

TRADEMARK

PRINCIPAL REGISTER

FIRST USE 6-20-2012; IN COMMERCE 6-20-2012.

THE MARK CONSISTS OF STANDARD CHARACTERS WITHOUT CLAIM TO ANY PARTICULAR FONT, STYLE, SIZE, OR COLOR.

THE ENGLISH TRANSLATION OF "BUNDESWEHR" IN THE MARK IS "FEDERAL DEFENSE".

SN 85-202,445, FILED 12-21-2010.

WILLIAM VERHOSEK, EXAMINING ATTORNEY



David J. Kyffers

Director of the United States Patent and Trademark Office

United States of America

United States Patent and Trademark Office

Kissing Koolers

Reg. No. 4,206,779

BRANDED LLC (GEORGIA LIMITED LIABILITY COMPANY)
3333 LEE PARKWAY 6TH FLOOR
DALLAS, TX 75219

Registered Sep. 11, 2012

Int. Cl.: 3

FOR: LIP GLOSS, IN CLASS 3 (U.S. CLS. 1, 4, 6, 50, 51 AND 52).

TRADEMARK

FIRST USE 6-20-2012; IN COMMERCE 6-20-2012.

PRINCIPAL REGISTER

THE MARK CONSISTS OF STANDARD CHARACTERS WITHOUT CLAIM TO ANY PARTICULAR FONT, STYLE, SIZE, OR COLOR.

SN 85-202,459, FILED 12-21-2010.

WILLIAM VERHOSEK, EXAMINING ATTORNEY



David J. Kyfos

Director of the United States Patent and Trademark Office

United States of America

United States Patent and Trademark Office

Mountain Goat

Reg. No. 4,206,780

BRANDED, LLC (GEORGIA LIMITED LIABILITY COMPANY)
3333 LEE PARKWAY 6TH FLOOR
DALLAS, TX 75219

Registered Sep. 11, 2012

Int. Cl.: 18

FOR: ALL PURPOSE SPORT BAGS; ALL-PURPOSE ATHLETIC BAGS; ALL-PURPOSE CARRYING BAGS; BACK PACKS; DRAWSTRING POUCHES; FANNY PACKS; SPORTS PACKS; TOTE BAGS; WAIST PACKS, IN CLASS 18 (U.S. CLS. 1, 2, 3, 22 AND 41).

TRADEMARK

FIRST USE 6-20-2012; IN COMMERCE 6-20-2012.

PRINCIPAL REGISTER

THE MARK CONSISTS OF STANDARD CHARACTERS WITHOUT CLAIM TO ANY PARTICULAR FONT, STYLE, SIZE, OR COLOR.

SN 85-202,470, FILED 12-21-2010.

RAMONA ORTIGA, EXAMINING ATTORNEY



David J. Kyffers

Director of the United States Patent and Trademark Office

United States of America

United States Patent and Trademark Office

Mountain Goat

Reg. No. 4,206,781

BRANDED, LLC (GEORGIA LIMITED LIABILITY COMPANY)
3333 LEE PARKWAY 6TH FLOOR
DALLAS, TX 75219

Registered Sep. 11, 2012

Int. Cl.: 25

FOR: CLOTHING, NAMELY, PANTS, SHORTS, SHIRTS, TANKS; OUTERWEAR, NAMELY, SKIWEAR, RAINWEAR, JACKETS, VESTS, BALACLAVAS, GLOVES, FOOTWEAR, HEADWEAR, IN CLASS 25 (U.S. CLS. 22 AND 39).

TRADEMARK

FIRST USE 6-20-2012; IN COMMERCE 6-20-2012.

PRINCIPAL REGISTER

THE MARK CONSISTS OF STANDARD CHARACTERS WITHOUT CLAIM TO ANY PARTICULAR FONT, STYLE, SIZE, OR COLOR.

SN 85-202,478, FILED 12-21-2010.

RAMONA ORTIGA, EXAMINING ATTORNEY



David J. Kyros

Director of the United States Patent and Trademark Office

United States of America

United States Patent and Trademark Office



Reg. No. 4,206,782

Registered Sep. 11, 2012

Int. Cl.: 25

TRADEMARK

PRINCIPAL REGISTER

CARVELLI STEPHEN (UNITED STATES INDIVIDUAL)
PO BOX 333
OAKLYN, NJ 08107

FOR: APPAREL FOR DANCERS, NAMELY, TEE SHIRTS, SWEATSHIRTS, PANTS, LEGGINGS, SHORTS AND JACKETS; COLLARED SHIRTS, IN CLASS 25 (U.S. CLS. 22 AND 39).

FIRST USE 8-1-2011; IN COMMERCE 8-15-2011.

NO CLAIM IS MADE TO THE EXCLUSIVE RIGHT TO USE "WEAR", APART FROM THE MARK AS SHOWN.

THE COLOR(S) RED, BLACK, GOLD IS/ARE CLAIMED AS A FEATURE OF THE MARK.

THE MARK CONSISTS OF A MODIFIED PENTAGON FIGURE IN WHICH THE TOP TWO SIDES ARE CURVED INWARD FORMING A POINT ON TOP. LETTERS "D" AND "W" ARE RED IN COLOR AND CENTERED IN THE MARK. A SOLID, GOLD COLORED FIVE POINT STAR IS BETWEEN THE LETTERS AND PARTIALLY OVERLAPS BOTH LETTERS. THE WORDS "DEPRESSION WEAR" ARE GOLD IN COLOR AND CENTERED BELOW THE LETTERS AND STAR WITHIN THE MARK. MARK HAS A BLACK BACKGROUND INTERIOR AND A RED BORDER.

SN 85-202,956, FILED 12-21-2010.

RAUL CORDOVA, EXAMINING ATTORNEY



David J. Kybas

Director of the United States Patent and Trademark Office

United States of America

United States Patent and Trademark Office

STUDIOVOX

Reg. No. 4,206,783

STUDIOVOX, INC. (CALIFORNIA CORPORATION)
311 NORTH ROBERTSON BLVD., SUITE 642
BEVERLY HILLS, CA 90211

Registered Sep. 11, 2012

Int. Cls.: 35 and 45

FOR: ADVERTISING AND PROMOTIONAL SERVICES, IN CLASS 35 (U.S. CLS. 100, 101 AND 102).

SERVICE MARK

FIRST USE 5-13-2011; IN COMMERCE 5-13-2011.

PRINCIPAL REGISTER

FOR: ON-LINE SOCIAL NETWORKING SERVICES, IN CLASS 45 (U.S. CLS. 100 AND 101).

FIRST USE 5-13-2011; IN COMMERCE 5-13-2011.

THE MARK CONSISTS OF STANDARD CHARACTERS WITHOUT CLAIM TO ANY PARTICULAR FONT, STYLE, SIZE, OR COLOR.

SN 85-203,306, FILED 12-21-2010.

MARK T. MULLEN, EXAMINING ATTORNEY



David J. Kybas

Director of the United States Patent and Trademark Office

United States of America

United States Patent and Trademark Office

CHOQUES EXTREMOS

Reg. No. 4,206,784

Registered Sep. 11, 2012

Int. Cl.: 41

SERVICE MARK

PRINCIPAL REGISTER

MIGHTY OAK ENTERTAINMENT, INC. (CALIFORNIA CORPORATION)
UNIT B365
2549 EAST BLUFF DRIVE
NEWPORT BEACH, CA 92660

FOR: ENTERTAINMENT IN THE NATURE OF ON-GOING TELEVISION PROGRAMS IN THE FIELD OF ATHLETIC AND STUNT FOOTAGE; ENTERTAINMENT SERVICES, NAMELY, PROVIDING ON-GOING TELEVISION PROGRAMS IN THE FIELD OF ATHLETIC AND STUNT FOOTAGE VIA A GLOBAL COMPUTER NETWORK; PROVIDING A WEB SITE FEATURING SPORTING INFORMATION, IN CLASS 41 (U.S. CLS. 100, 101 AND 107).

FIRST USE 1-2-2011; IN COMMERCE 1-2-2011.

THE MARK CONSISTS OF STANDARD CHARACTERS WITHOUT CLAIM TO ANY PARTICULAR FONT, STYLE, SIZE, OR COLOR.

THE ENGLISH TRANSLATION OF "CHOQUES EXTREMOS" IN THE MARK IS "EXTREME SHOCK".

SN 85-203,354, FILED 12-21-2010.

NAPOLEON SHARMA, EXAMINING ATTORNEY



David J. Kyffers

Director of the United States Patent and Trademark Office

United States of America

United States Patent and Trademark Office

10 MINUTES TEN REASONS

Reg. No. 4,206,785

ADVANTAGE DIRECT 365, CORP. (INDIANA CORPORATION)
200 6TH STREET

Registered Sep. 11, 2012

FORT WAYNE, IN 46808

Int. Cl.: 35

FOR: PROMOTING, ADVERTISING AND MARKETING THE ON-LINE DATABASES OF OTHERS, IN CLASS 35 (U.S. CLS. 100, 101 AND 102).

SERVICE MARK

FIRST USE 1-1-2011; IN COMMERCE 1-1-2011.

PRINCIPAL REGISTER

THE MARK CONSISTS OF STANDARD CHARACTERS WITHOUT CLAIM TO ANY PARTICULAR FONT, STYLE, SIZE, OR COLOR.

SN 85-203,518, FILED 12-22-2010.

LAKEISHA LEWIS, EXAMINING ATTORNEY



David J. Kybas

Director of the United States Patent and Trademark Office

United States of America

United States Patent and Trademark Office

QUADRA

Reg. No. 4,206,786

TYCO ELECTRONICS CORPORATION (PENNSYLVANIA CORPORATION)
1050 WESTLAKES DRIVE
BERWYN, PA 19312

Registered Sep. 11, 2012

Int. Cl.: 9

FOR: CONNECTORS FOR COMMUNICATIONS AND DATA CENTER EQUIPMENT, IN CLASS 9 (U.S. CLS. 21, 23, 26, 36 AND 38).

TRADEMARK

FIRST USE 8-4-2011; IN COMMERCE 8-4-2011.

PRINCIPAL REGISTER

THE MARK CONSISTS OF STANDARD CHARACTERS WITHOUT CLAIM TO ANY PARTICULAR FONT, STYLE, SIZE, OR COLOR.

SN 85-203,671, FILED 12-22-2010.

DOUGLAS LEE, EXAMINING ATTORNEY



David J. Kybas

Director of the United States Patent and Trademark Office

United States of America

United States Patent and Trademark Office

DOGOLOGIC

Reg. No. 4,206,787

DOUGLAS A. BOWERS (UNITED STATES INDIVIDUAL)
102 E. LONGDEN AVE.
ARCADIA, CA 91006

Registered Sep. 11, 2012

Int. Cl.: 16

FOR: PRINTED MATTER, NAMELY, PAPER SIGNS, BOOKS, MANUALS, CURRICULUM, NEWSLETTERS, INFORMATIONAL CARDS AND BROCHURES IN THE FIELD OF BUSINESS EDUCATION AND TRAINING SERVICES, IN CLASS 16 (U.S. CLS. 2, 5, 22, 23, 29, 37, 38 AND 50).

TRADEMARK

PRINCIPAL REGISTER

FIRST USE 1-15-2011; IN COMMERCE 1-15-2011.

THE MARK CONSISTS OF STANDARD CHARACTERS WITHOUT CLAIM TO ANY PARTICULAR FONT, STYLE, SIZE, OR COLOR.

SN 85-204,412, FILED 12-22-2010.

WILLIAM ROSSMAN, EXAMINING ATTORNEY



David J. Kyffers

Director of the United States Patent and Trademark Office

United States of America

United States Patent and Trademark Office

WE MAKE INVENTION ACCESSIBLE

Reg. No. 4,206,788

Registered Sep. 11, 2012

Int. Cl.: 42

SERVICE MARK

PRINCIPAL REGISTER

QUIRKY, INC. (DELAWARE CORPORATION)
606 WEST 28TH STREET, 7TH FLOOR
NEW YORK, NY 10001

FOR: PRODUCT DEVELOPMENT, RESEARCH, DESIGN AND ENGINEERING SERVICES FOR OTHERS; CONSULTATION IN THE FIELD OF NEW PRODUCT DEVELOPMENT, RESEARCH, DESIGN AND ENGINEERING; INNOVATION CONSULTING SERVICES, NAMELY, ADVISING OTHERS IN THE AREAS OF PRODUCT DEVELOPMENT; COMPUTER SERVICES, NAMELY, CREATING AN ONLINE COMMUNITY FOR REGISTERED USERS TO PARTICIPATE IN DISCUSSIONS, GET FEEDBACK FROM THEIR PEERS, FORM VIRTUAL COMMUNITIES, AND ENGAGE IN SOCIAL NETWORKING FEATURING THE CONTRIBUTION OF IDEAS, SUGGESTIONS, AND COMMENTS INTENDED TO ENHANCE PRODUCT DESIGN AND DEVELOPMENT AND BRINGING PRODUCTS TO MARKET, IN CLASS 42 (U.S. CLS. 100 AND 101).

FIRST USE 10-21-2010; IN COMMERCE 10-21-2010.

THE MARK CONSISTS OF STANDARD CHARACTERS WITHOUT CLAIM TO ANY PARTICULAR FONT, STYLE, SIZE, OR COLOR.

SN 85-204,861, FILED 12-23-2010.

HANNO RITTNER, EXAMINING ATTORNEY



David J. Kybas

Director of the United States Patent and Trademark Office

United States of America

United States Patent and Trademark Office

LOCHENHEATH

Reg. No. 4,206,789

Registered Sep. 11, 2012

Int. Cls.: 35, 41, and 43

SERVICE MARK

PRINCIPAL REGISTER

LOCHENVEST LLC (MICHIGAN LIMITED LIABILITY COMPANY)
7874 TURNBERRY CIRCLE
WILLIAMSBURG, MI 49690

FOR: RETAIL STORE SERVICES AND ONLINE RETAIL STORE SERVICES FEATURING CLOTHING, CLOTHING ACCESSORIES, HATS, FOOTWEAR, TOWELS, SPORTING GOODS, GLASSWARE, DRINKWARE, HOUSEHOLD UTENSILS, GOLF EQUIPMENT AND ACCESSORIES, ORNAMENTS, GAMES, WALLETS, BAGS, LUGGAGE, OFFICE SUPPLIES, BOOKS, POSTCARDS, POSTERS, MUSICAL AND VIDEO RECORDINGS, COMPUTER SOFTWARE, KEY RINGS, JEWELRY, MAGNETS, ART, CANDLES, PERSONAL CARE PRODUCTS, COSMETICS, GIFT BASKETS, TROPHIES AND PLAQUES, RETAIL FOOD AND ALCOHOLIC BEVERAGE CONCESSION STAND AND KIOSK SERVICES; PROVIDING FACILITIES FOR BUSINESS MEETINGS, IN CLASS 35 (U.S. CLS. 100, 101 AND 102).

FIRST USE 7-12-2012; IN COMMERCE 7-12-2012.

FOR: COUNTRY CLUB SERVICES, NAMELY, PROVIDING GOLF FACILITIES; ENTERTAINMENT SERVICES, NAMELY, ORGANIZING AND CONDUCTING GOLF TOURNAMENTS; EDUCATIONAL SERVICES, NAMELY, INSTRUCTION IN GOLF; RENTAL OF GOLF EQUIPMENT; PROVIDING A WEBSITE THROUGH WHICH GOLFERS RESERVE TEE TIMES AT GOLF COURSES; PROVIDING A WEBSITE THROUGH WHICH GOLFERS LOCATE INFORMATION ABOUT GOLF COURSES AND GOLF TOURNAMENTS; PROVIDING INFORMATION IN THE FIELDS OF GOLF, GOLF RESORTS, GOLF INSTRUCTION, GOLF COURSES, AND GOLF TOURNAMENTS; ENTERTAINMENT IN THE NATURE OF GOLF TOURNAMENTS; AND PROVIDING ONLINE NEWSLETTERS IN THE FIELD OF GOLF; PROVIDING RECREATION MEETING ROOM FACILITIES, IN CLASS 41 (U.S. CLS. 100, 101 AND 107).

FIRST USE 5-31-2011; IN COMMERCE 5-31-2011.

FOR: RESTAURANT AND BAR SERVICES, IN CLASS 43 (U.S. CLS. 100 AND 101).

FIRST USE 5-31-2012; IN COMMERCE 5-31-2012.

THE MARK CONSISTS OF STANDARD CHARACTERS WITHOUT CLAIM TO ANY PARTICULAR FONT, STYLE, SIZE, OR COLOR.



David J. Kybas

Director of the United States Patent and Trademark Office

Reg. No. 4,206,789 THE WORDING "LOCHENHEATH" HAS NO MEANING IN A FOREIGN LANGUAGE.

SN 85-205,166, FILED 12-23-2010.

TRICIA SONNEBORN, EXAMINING ATTORNEY

United States of America

United States Patent and Trademark Office

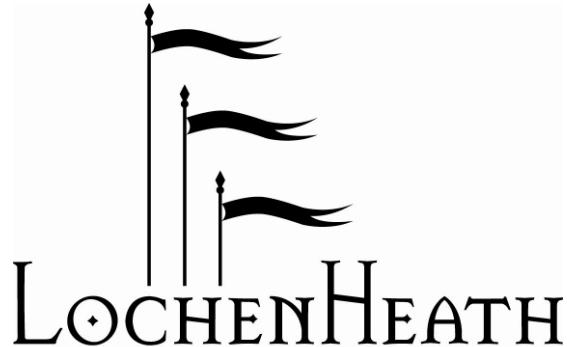

Reg. No. 4,206,790

Registered Sep. 11, 2012

Int. Cls.: 35, 41, and 43

SERVICE MARK

PRINCIPAL REGISTER

LOCHENVEST LLC (MICHIGAN LIMITED LIABILITY COMPANY)
7874 TURNBERRY CIRCLE
WILLIAMSBURG, MI 49690

FOR: RETAIL STORE SERVICES AND ONLINE RETAIL STORE SERVICES FEATURING CLOTHING, CLOTHING ACCESSORIES, HATS, FOOTWEAR, TOWELS, SPORTING GOODS, GLASSWARE, DRINKWARE, HOUSEHOLD UTENSILS, GOLF EQUIPMENT AND ACCESSORIES, ORNAMENTS, GAMES, WALLETS, BAGS, LUGGAGE, OFFICE SUPPLIES, BOOKS, POSTCARDS, POSTERS, MUSICAL AND VIDEO RECORDINGS, COMPUTER SOFTWARE, KEY RINGS, JEWELRY, MAGNETS, ART, CANDLES, PERSONAL CARE PRODUCTS, COSMETICS, GIFT BASKETS, TROPHIES AND PLAQUES, RETAIL FOOD AND ALCOHOLIC BEVERAGE CONCESSION STAND AND KIOSK SERVICES; PROVIDING FACILITIES FOR BUSINESS MEETINGS, IN CLASS 35 (U.S. CLS. 100, 101 AND 102).

FIRST USE 7-12-2012; IN COMMERCE 7-12-2012.

FOR: COUNTRY CLUB SERVICES, NAMELY, PROVIDING GOLF FACILITIES; ENTERTAINMENT SERVICES, NAMELY, ORGANIZING AND CONDUCTING GOLF TOURNAMENTS; EDUCATIONAL SERVICES, NAMELY, INSTRUCTION IN GOLF; RENTAL OF GOLF EQUIPMENT; PROVIDING A WEBSITE THROUGH WHICH GOLFERS RESERVE TEE TIMES AT GOLF COURSES; PROVIDING A WEBSITE THROUGH WHICH GOLFERS LOCATE INFORMATION ABOUT GOLF COURSES AND GOLF TOURNAMENTS; PROVIDING INFORMATION IN THE FIELDS OF GOLF, GOLF RESORTS, GOLF INSTRUCTION, GOLF COURSES, AND GOLF TOURNAMENTS; ENTERTAINMENT IN THE NATURE OF GOLF TOURNAMENTS; AND PROVIDING ONLINE NEWSLETTERS IN THE FIELD OF GOLF; PROVIDING RECREATION MEETING ROOM FACILITIES, IN CLASS 41 (U.S. CLS. 100, 101 AND 107).

FIRST USE 5-31-2011; IN COMMERCE 5-31-2011.

FOR: RESTAURANT AND BAR SERVICES, IN CLASS 43 (U.S. CLS. 100 AND 101).

FIRST USE 5-31-2012; IN COMMERCE 5-31-2012.

THE MARK CONSISTS OF THE WORD "LOCHENHEATH" IN A STYLIZED FONT APPEARING UNDERNEATH A DESIGN CONSISTING OF THREE WAVING FLAGS.



David J. Kybas

Director of the United States Patent and Trademark Office

Reg. No. 4,206,790 THE WORDING "LOCHENHEATH" HAS NO MEANING IN A FOREIGN LANGUAGE.

SN 85-205,167, FILED 12-23-2010.

TRICIA SONNEBORN, EXAMINING ATTORNEY

United States of America

United States Patent and Trademark Office

TRADITION DU THÉ

Reg. No. 4,206,791

EBEL INTERNATIONAL LIMITED (BERMUDA CORPORATION)
CEDAR HOUSE, 41 CEDAR AVENUE
HAMILTON, BERMUDA HM12

Registered Sep. 11, 2012

Int. Cl.: 3

FOR: PERFUMES, FRAGRANCES, COLOGNE, EAU DE PARFUM, EAU DE TOILETTE, IN CLASS 3 (U.S. CLS. 1, 4, 6, 50, 51 AND 52).

TRADEMARK

FIRST USE 11-28-2011; IN COMMERCE 11-28-2011.

PRINCIPAL REGISTER

THE MARK CONSISTS OF STANDARD CHARACTERS WITHOUT CLAIM TO ANY PARTICULAR FONT, STYLE, SIZE, OR COLOR.

THE ENGLISH TRANSLATION OF "THÉ" IN THE MARK IS "TEA".

SN 85-205,270, FILED 12-23-2010.

REGINA DRUMMOND, EXAMINING ATTORNEY



David J. Kybas

Director of the United States Patent and Trademark Office

United States of America

United States Patent and Trademark Office

CHOCOLATE CHOCOBAR STEELE

Reg. No. 4,206,792

STEELE MUSIC, INC. (NEW YORK CORPORATION)

Registered Sep. 11, 2012

267 EAST 49TH STREET
BROOKLYN, NY 11203

Int. Cl.: 41

FOR: ENTERTAINMENT SERVICES, NAMELY, PERFORMANCES AND PUBLIC APPEARANCES BY A LIVE MUSICAL ARTIST AND PROVIDING NON-DOWNLOADABLE PRERECORDED MUSIC ONLINE AND INFORMATION REGARDING A MUSICAL ARTIST ONLINE VIA A GLOBAL COMPUTER NETWORK, IN CLASS 41 (U.S. CLS. 100, 101 AND 107).

SERVICE MARK

PRINCIPAL REGISTER

FIRST USE 6-22-2012; IN COMMERCE 6-22-2012.

THE MARK CONSISTS OF STANDARD CHARACTERS WITHOUT CLAIM TO ANY PARTICULAR FONT, STYLE, SIZE, OR COLOR.

THE NAME(S), PORTRAIT(S), AND/OR SIGNATURE(S) SHOWN IN THE MARK IDENTIFIES "ERICA STEELE", WHOSE CONSENT(S) TO REGISTER IS MADE OF RECORD.

SN 85-205,278, FILED 12-23-2010.

GIANCARLO CASTRO, EXAMINING ATTORNEY



David J. Kybas

Director of the United States Patent and Trademark Office

United States of America

United States Patent and Trademark Office

BAMIN

Reg. No. 4,206,793

Registered Sep. 11, 2012

Int. Cl.: 35

SERVICE MARK

PRINCIPAL REGISTER

BAMIN INC (DELAWARE CORPORATION)
SUITE 1103
225 CENTRAL PARK WEST
NEW YORK, NY 10024

FOR: RETAIL STORE AND ON-LINE RETAIL STORE SERVICES FEATURING COMPONENTS CONSISTING OF FABRIC PANELS TO MAKE CLOTHES, BAGS AND ACCESSORIES THAT MAY BE CUSTOMIZED AND ASSEMBLED BY CONSUMERS, IN CLASS 35 (U.S. CLS. 100, 101 AND 102).

FIRST USE 6-30-2012; IN COMMERCE 7-10-2012.

THE MARK CONSISTS OF STANDARD CHARACTERS WITHOUT CLAIM TO ANY PARTICULAR FONT, STYLE, SIZE, OR COLOR.

SN 85-205,585, FILED 12-24-2010.

JENNY PARK, EXAMINING ATTORNEY



David J. Kybas

Director of the United States Patent and Trademark Office

United States of America

United States Patent and Trademark Office

OGMENTO

Reg. No. 4,206,794

Registered Sep. 11, 2012

Int. Cl.: 9

TRADEMARK

PRINCIPAL REGISTER

OGMENTO, INC. (DELAWARE CORPORATION)
134 SPRING STREET, SUITE 301
NEW YORK, NY 10012

FOR: COMPUTER GAME DISCS; COMPUTER GAME SOFTWARE; DOWNLOADABLE COMPUTER GAME SOFTWARE VIA A GLOBAL COMPUTER NETWORK; INTERACTIVE MULTIMEDIA COMPUTER GAME PROGRAMS; INTERACTIVE VIDEO GAME PROGRAMS; VIDEO GAME DISCS; VIDEO GAME SOFTWARE; VIRTUAL REALITY GAME SOFTWARE, IN CLASS 9 (U.S. CLS. 21, 23, 26, 36 AND 38).

FIRST USE 10-1-2009; IN COMMERCE 10-1-2009.

THE MARK CONSISTS OF STANDARD CHARACTERS WITHOUT CLAIM TO ANY PARTICULAR FONT, STYLE, SIZE, OR COLOR.

THE WORDING "OGMENTO" HAS NO MEANING IN A FOREIGN LANGUAGE.

SN 85-205,987, FILED 12-27-2010.

ROBERT C. CLARK JR., EXAMINING ATTORNEY



David J. Kyffers

Director of the United States Patent and Trademark Office

United States of America

United States Patent and Trademark Office

REFLEX

Reg. No. 4,206,795

4 PILLAR DYNASTY LLC (NEW YORK LIMITED LIABILITY COMPANY)
246 W. 35TH STREET
NEW YORK, NY 10001

Registered Sep. 11, 2012

Int. Cl.: 25

FOR: ATHLETIC TIGHTS; BLOUSES; COATS; DRESSES; GLOVES; HOSIERY; JACKETS;
JEANS; KNIT BOTTOMS; LINGERIE; LOUNGEWEAR; RAINWEAR; SCARVES; SKIRTS;
SLEEPWEAR; SOCKS; SWEATERS; SWIMWEAR; TOPS; VESTS, IN CLASS 25 (U.S. CLS.
22 AND 39).

TRADEMARK

PRINCIPAL REGISTER

FIRST USE 3-1-2012; IN COMMERCE 3-1-2012.

THE MARK CONSISTS OF STANDARD CHARACTERS WITHOUT CLAIM TO ANY PARTICULAR FONT, STYLE, SIZE, OR COLOR.

SN 85-206,002, FILED 12-27-2010.

INGA ERVIN, EXAMINING ATTORNEY



David J. Kybas

Director of the United States Patent and Trademark Office

United States of America

United States Patent and Trademark Office

QUATTRO TASTI

Reg. No. 4,206,796

KEYNOTE HOLDINGS, LLC (TEXAS LIMITED LIABILITY COMPANY)
120 HAZELNUT TRAIL
FORNEY, TX 75126

Registered Sep. 11, 2012

Int. Cl.: 43

FOR: RESTAURANT AND CATERING SERVICES, IN CLASS 43 (U.S. CLS. 100 AND 101).

SERVICE MARK

FIRST USE 1-7-2012; IN COMMERCE 1-7-2012.

PRINCIPAL REGISTER

THE MARK CONSISTS OF STANDARD CHARACTERS WITHOUT CLAIM TO ANY PARTICULAR FONT, STYLE, SIZE, OR COLOR.

THE ENGLISH TRANSLATION OF "QUATTRO TASTI" IN THE MARK IS "FOUR KEYS".

SN 85-206,415, FILED 12-28-2010.

TINA BROWN, EXAMINING ATTORNEY



David J. Kyffers

Director of the United States Patent and Trademark Office

United States of America

United States Patent and Trademark Office

SPRINGLEAF DIRECT

Reg. No. 4,206,797

SPRINGLEAF FINANCE, INC. (INDIANA CORPORATION)
601 N.W. SECOND STREET
EVANSVILLE, IN 47708

Registered Sep. 11, 2012

Int. Cl.: 36

FOR: CONSUMER LENDING SERVICES; INSURANCE UNDERWRITING IN THE FIELD OF LIFE, ACCIDENTAL DEATH AND DISMEMBERMENT, DISABILITY AND CREDIT INSURANCE, IN CLASS 36 (U.S. CLS. 100, 101 AND 102).

SERVICE MARK

FIRST USE 6-30-2011; IN COMMERCE 6-30-2011.

PRINCIPAL REGISTER

THE MARK CONSISTS OF STANDARD CHARACTERS WITHOUT CLAIM TO ANY PARTICULAR FONT, STYLE, SIZE, OR COLOR.

NO CLAIM IS MADE TO THE EXCLUSIVE RIGHT TO USE "DIRECT", APART FROM THE MARK AS SHOWN.

SN 85-206,633, FILED 12-28-2010.

NAKIA HENRY, EXAMINING ATTORNEY



David J. Kybas

Director of the United States Patent and Trademark Office

United States of America

United States Patent and Trademark Office

MINICAPT

Reg. No. 4,206,798

Registered Sep. 11, 2012

Int. Cl.: 9

TRADEMARK

PRINCIPAL REGISTER

PARTICLE MEASURING SYSTEMS, INC. (COLORADO CORPORATION)
5475 AIRPORT BOULEVARD
BOULDER, CO 80301

FOR: AEROSOL AND GAS SAMPLING AND MONITORING SAMPLERS AND COLLECTORS, NAMELY, AIR AND GAS SAMPLERS FOR PARTICLE COLLECTION INSTRUMENTATION FOR MONITORING AND COLLECTING PARTICULATE OR BIOLOGICAL SAMPLES IN AIR OR GAS, INCLUDING SOURCE AIR OR GAS SAMPLING MACHINES AND PORTABLE AIR OR GAS SAMPLERS FOR MONITORING THE QUALITY OF AIR SAMPLES, COLLECTION OF PARTICLE OR BIOLOGICAL SAMPLES, OR MONITORING AND COLLECTION OF PARTICLE OR BIOLOGICAL SAMPLES IN AIR OR GAS FOR ANALYSIS, IN CLASS 9 (U.S. CLS. 21, 23, 26, 36 AND 38).

FIRST USE 9-10-2008; IN COMMERCE 6-15-2009.

THE MARK CONSISTS OF STANDARD CHARACTERS WITHOUT CLAIM TO ANY PARTICULAR FONT, STYLE, SIZE, OR COLOR.

SN 85-206,762, FILED 12-28-2010.

PAUL E. FAHRENKOPF, EXAMINING ATTORNEY



David J. Kypos

Director of the United States Patent and Trademark Office

United States of America
United States Patent and Trademark Office

ATARAXIS

Reg. No. 4,206,799

MARTINEZ, KYLE (UNITED STATES INDIVIDUAL)
P.O. BOX 55

Registered Sep. 11, 2012

MORRISON, CO 80465

Int. Cl.: 25

FOR: HATS; HOODED SWEATSHIRTS; LONG-SLEEVED SHIRTS; SHIRTS; SHORT-SLEEVED OR LONG-SLEEVED T-SHIRTS; SHORT-SLEEVED SHIRTS; T-SHIRTS; WRISTBANDS, IN CLASS 25 (U.S. CLS. 22 AND 39).

TRADEMARK

FIRST USE 9-14-2011; IN COMMERCE 9-14-2011.

PRINCIPAL REGISTER

THE MARK CONSISTS OF STANDARD CHARACTERS WITHOUT CLAIM TO ANY PARTICULAR FONT, STYLE, SIZE, OR COLOR.

SN 85-206,797, FILED 12-28-2010.

ANDREA HACK, EXAMINING ATTORNEY



David J. Kyros

Director of the United States Patent and Trademark Office

United States of America

United States Patent and Trademark Office

Doodle Cones

Reg. No. 4,206,800

LACER, MARGIE (UNITED STATES INDIVIDUAL)
9609 PAULINE DRIVE
CYPRESS, CA 90630

Registered Sep. 11, 2012

Int. Cl.: 21

FOR: SCOOPS FOR THE DISPOSAL OF PET WASTE, IN CLASS 21 (U.S. CLS. 2, 13, 23, 29, 30, 33, 40 AND 50).

TRADEMARK

FIRST USE 5-15-2012; IN COMMERCE 5-15-2012.

PRINCIPAL REGISTER

THE MARK CONSISTS OF STANDARD CHARACTERS WITHOUT CLAIM TO ANY PARTICULAR FONT, STYLE, SIZE, OR COLOR.

SN 85-207,205, FILED 12-29-2010.

JAMES GRIFFIN, EXAMINING ATTORNEY



David J. Kybas

Director of the United States Patent and Trademark Office

United States of America

United States Patent and Trademark Office



LUXTOP

Reg. No. 4,206,801

Registered Sep. 11, 2012

Int. Cl.: 11

TRADEMARK

PRINCIPAL REGISTER

GENERAL-FITTING(S) CO., LTD. (TAIWAN CORPORATION)
10F.-7, NO. 3, YUANCYU ST.
NANGANG DISTRICT
TAIPEI CITY 11560, TAIWAN

FOR: AUTOMOTIVE LIGHTING HEADLIGHTS FOR VEHICLES; BACKUP LIGHTS FOR LAND VEHICLES; CEILING LIGHTS; CHANDELIERS; ELECTRIC DISCHARGE TUBES FOR LIGHTING; ELECTRIC LIGHT BULBS; ELECTRIC LIGHTING FIXTURES; FLUORESCENT LIGHTING TUBES; HALOGEN LIGHT BULBS; HEADLIGHTS FOR VEHICLES; INCANDESCENT LAMPS AND THEIR FITTINGS; LAMP SHADES; LED LIGHTING FIXTURES FOR INDOOR AND OUTDOOR LIGHTING APPLICATIONS; LIGHT BULBS; LIGHTING APPARATUS FOR VEHICLES; LIGHTING APPARATUS FOR THEATRES, CLUBS AND DISCOTHEQUES; LIGHTING DEVICES FOR THEATRICAL PRODUCTIONS; LIGHTING FIXTURES; LIGHTING FIXTURES WITH MOTION DETECTION; ORNAMENTAL DECORATIONS SPECIALLY ADAPTED FOR AFFIXATION TO CHANDELIERS; PROJECTOR LAMPS; REAR LIGHTS FOR VEHICLES; RUNNING LIGHTS FOR LAND VEHICLES; SOLAR LIGHT FIXTURES, NAMELY, INDOOR AND OUTDOOR SOLAR POWERED LIGHTING UNITS AND FIXTURES; SOLAR-POWERED ALL-WEATHER LIGHTS; SPOT LIGHTS; STREET LAMPS; TABLE LAMPS; TAIL LIGHTS FOR LAND VEHICLES; VEHICLE REFLECTORS; VEHICLE TURN-SIGNAL LIGHT BULBS, IN CLASS 11 (U.S. CLS. 13, 21, 23, 31 AND 34).

FIRST USE 4-10-2012; IN COMMERCE 4-10-2012.

THE MARK CONSISTS OF A DESIGN OF A DOTTED "L" PATTERN IN A CIRCLE FOLLOWED BY WORDING "LUXTOP" IN STYLIZED FONT.

SN 85-207,259, FILED 12-29-2010.

NATALIE POLZER, EXAMINING ATTORNEY



David J. Kyros

Director of the United States Patent and Trademark Office

United States of America

United States Patent and Trademark Office

NO GLUG JUG

Reg. No. 4,206,802

JAZ PRODUCTS, INC. (CALIFORNIA CORPORATION)
1212 E. SANTA PAULA STREET
SANTA PAULA, CA 93060

Registered Sep. 11, 2012

Int. Cl.: 20

FOR: NON-METAL LIQUID FUEL CONTAINERS FOR RACING INDUSTRY, NAMELY, PORTABLE FUEL CONTAINERS FOR USE IN FAST-FILLING OF OFF-ROAD RACE CARS, IN CLASS 20 (U.S. CLS. 2, 13, 22, 25, 32 AND 50).

TRADEMARK

FIRST USE 12-30-2011; IN COMMERCE 12-30-2011.

PRINCIPAL REGISTER

THE MARK CONSISTS OF STANDARD CHARACTERS WITHOUT CLAIM TO ANY PARTICULAR FONT, STYLE, SIZE, OR COLOR.

NO CLAIM IS MADE TO THE EXCLUSIVE RIGHT TO USE "JUG", APART FROM THE MARK AS SHOWN.

SN 85-207,506, FILED 12-29-2010.

ALICE BENMAMAN, EXAMINING ATTORNEY



David J. Kyffers

Director of the United States Patent and Trademark Office

United States of America

United States Patent and Trademark Office



Reg. No. 4,206,803

Registered Sep. 11, 2012

Int. Cl.: 11

TRADEMARK

PRINCIPAL REGISTER

RESTAURANT TECHNOLOGIES, INC. (DELAWARE CORPORATION)
2250 PILOT KNOB ROAD
SUITE 100
MENDOTA HEIGHTS, MN 55120

FOR: FILTERS, PUMPS, AND TANKS SOLD IN COMBINATION FOR USE IN RESTAURANT COOKING OIL HANDLING SYSTEMS, IN CLASS 11 (U.S. CLS. 13, 21, 23, 31 AND 34).

FIRST USE 12-1-2011; IN COMMERCE 12-1-2011.

THE MARK CONSISTS OF THE LETTERS "RTI", ENCIRCLED BY TWO CURVES FORMING AN ELLIPSE THAT OPENS TO THE RIGHT OF THE LETTER "I".

SN 85-207,518, FILED 12-29-2010.

ANNE MADDEN, EXAMINING ATTORNEY



David J. Kyjars

Director of the United States Patent and Trademark Office

United States of America

United States Patent and Trademark Office

RTI

Reg. No. 4,206,804

Registered Sep. 11, 2012

Int. Cl.: 11

TRADEMARK

PRINCIPAL REGISTER

RESTAURANT TECHNOLOGIES, INC. (DELAWARE CORPORATION)
2250 PILOT KNOB ROAD
SUITE 100
MENDOTA HEIGHTS, MN 55120

FOR: FILTERS, PUMPS, AND TANKS SOLD IN COMBINATION FOR USE IN RESTAURANT COOKING OIL HANDLING SYSTEMS, IN CLASS 11 (U.S. CLS. 13, 21, 23, 31 AND 34).

FIRST USE 1-1-2003; IN COMMERCE 1-1-2003.

THE MARK CONSISTS OF STANDARD CHARACTERS WITHOUT CLAIM TO ANY PARTICULAR FONT, STYLE, SIZE, OR COLOR.

SN 85-207,532, FILED 12-29-2010.

ANNE MADDEN, EXAMINING ATTORNEY



David J. Kyffers

Director of the United States Patent and Trademark Office

United States of America

United States Patent and Trademark Office

SE-FIT

Reg. No. 4,206,805

Registered Sep. 11, 2012

Int. Cl.: 9

TRADEMARK

PRINCIPAL REGISTER

PORTLAND STATE UNIVERSITY (OREGON STATE AGENCY)
FINANCE AND ADMINISTRATION
P.O. BOX 751
PORTLAND, OR 972070751

FOR: SOFTWARE FOR ANALYSIS OF FLUID INTERFACE CONFIGURATION, IN CLASS 9 (U.S. CLS. 21, 23, 26, 36 AND 38).

FIRST USE 1-10-2011; IN COMMERCE 1-10-2011.

THE MARK CONSISTS OF STANDARD CHARACTERS WITHOUT CLAIM TO ANY PARTICULAR FONT, STYLE, SIZE, OR COLOR.

SN 85-207,924, FILED 12-30-2010.

SETH A. RAPPAPORT, EXAMINING ATTORNEY



David J. Kybas

Director of the United States Patent and Trademark Office

United States of America

United States Patent and Trademark Office

WOK & SAUCE

Reg. No. 4,206,806

Registered Sep. 11, 2012

Int. Cl.: 30

TRADEMARK

PRINCIPAL REGISTER

KNUCKLE SANDWICH, LLC (CALIFORNIA LIMITED LIABILITY COMPANY)
SUITE 202
575 W. COLLEGE AVENUE
SANTA ROSA, CA 95401

FOR: SAUCES, IN CLASS 30 (U.S. CL. 46).

FIRST USE 4-1-2011; IN COMMERCE 4-1-2011.

THE MARK CONSISTS OF STANDARD CHARACTERS WITHOUT CLAIM TO ANY PARTICULAR FONT, STYLE, SIZE, OR COLOR.

NO CLAIM IS MADE TO THE EXCLUSIVE RIGHT TO USE "SAUCE", APART FROM THE MARK AS SHOWN.

SN 85-208,199, FILED 12-30-2010.

CHARLES L. JENKINS, EXAMINING ATTORNEY



David J. Kyffers

Director of the United States Patent and Trademark Office

United States of America

United States Patent and Trademark Office

COMMANDO BEER

Reg. No. 4,206,807

Registered Sep. 11, 2012

Int. Cl.: 32

TRADEMARK

PRINCIPAL REGISTER

COMMANDO BREWING, L.L.C. (NEVADA LIMITED LIABILITY COMPANY)
8370 W CHEYENNE AVE.
STE. 109-292
LAS VEGAS, NV 89129

FOR: BEER, ALE, LAGER, STOUT, PORTER, SHANDY, IN CLASS 32 (U.S. CLS. 45, 46 AND 48).

FIRST USE 4-1-2008; IN COMMERCE 5-1-2012.

THE MARK CONSISTS OF STANDARD CHARACTERS WITHOUT CLAIM TO ANY PARTICULAR FONT, STYLE, SIZE, OR COLOR.

NO CLAIM IS MADE TO THE EXCLUSIVE RIGHT TO USE "BEER", APART FROM THE MARK AS SHOWN.

SN 85-208,433, FILED 12-31-2010.

IRA J. GOODSaid, EXAMINING ATTORNEY



David J. Kyffers

Director of the United States Patent and Trademark Office

United States of America

United States Patent and Trademark Office

Bona Recoat System

Remove • Rinse • Refortify

Reg. No. 4,206,808

Registered Sep. 11, 2012

Int. Cls.: 2 and 3

TRADEMARK

PRINCIPAL REGISTER

BONA AB (SWEDEN CORPORATION)
P.O. BOX 21074, MURMANSGATAN 130
SE-200 21 MALMÖ, SWEDEN

FOR: WOOD FLOOR FINISHES, IN CLASS 2 (U.S. CLS. 6, 11 AND 16).

FIRST USE 5-11-2012; IN COMMERCE 5-11-2012.

FOR: WOOD FLOOR CLEANERS, IN CLASS 3 (U.S. CLS. 1, 4, 6, 50, 51 AND 52).

FIRST USE 6-30-2011; IN COMMERCE 6-30-2011.

OWNER OF U.S. REG. NOS. 1,640,991, 3,457,098, AND OTHERS.

NO CLAIM IS MADE TO THE EXCLUSIVE RIGHT TO USE "RECOAT SYSTEM REMOVE RINSE REFORTIFY", APART FROM THE MARK AS SHOWN.

THE MARK CONSISTS OF THE WORDING "BONA RECOAT SYSTEM" IN STYLIZED FONT WITH A STYLIZED AND SHADED SUPERSCRIPIT NUMERAL "3" POSITIONED AFTER THE LETTER "R" IN THE WORD "RECOAT". THE WORDING "REMOVE RINSE REFORTIFY" IN STYLIZED FONT AND WITH CENTERED DOTS POSITIONED BETWEEN THE WORDS APPEARS UNDERNEATH. THE TWO LINES OF WORDING ARE SEPARATED BY A HORIZONTAL LINE WHICH FADES AWAY AT EACH END.

SN 85-208,632, FILED 12-31-2010.

JULIE WATSON, EXAMINING ATTORNEY



David J. Kyffers

Director of the United States Patent and Trademark Office

United States of America

United States Patent and Trademark Office



Madame Edamame

Reg. No. 4,206,809

Registered Sep. 11, 2012

Int. Cl.: 29

TRADEMARK

PRINCIPAL REGISTER

THE WU CHILDREN'S TRUS-MAY 5, 2009 (CALIFORNIA TRUST)
3 DOLOMITI
NEW PORT BEACH, CA 92657

FOR: PROCESSED EDAMAME, IN CLASS 29 (U.S. CL. 46).

FIRST USE 8-0-2010; IN COMMERCE 8-0-2010.

NO CLAIM IS MADE TO THE EXCLUSIVE RIGHT TO USE "EDAMAME", APART FROM THE MARK AS SHOWN.

THE NAME(S), PORTRAIT(S), AND/OR SIGNATURE(S) SHOWN IN THE MARK DOES NOT IDENTIFY A PARTICULAR LIVING INDIVIDUAL.

THE MARK CONSISTS OF THE STYLIZED WORDING "MADAME EDAMAME" AND THE DESIGN A FEMALE CHEF.

SN 85-209,648, FILED 1-4-2011.

DARRYL SPRUILL, EXAMINING ATTORNEY



David J. Kyffers

Director of the United States Patent and Trademark Office

United States of America
United States Patent and Trademark Office

ECHELON

Reg. No. 4,206,810

Registered Sep. 11, 2012

Int. Cl.: 8

TRADEMARK

PRINCIPAL REGISTER

KAI U.S.A., LTD. (OREGON CORPORATION), DBA KERSHAW KNIVES,
18600 SOUTHWEST TETON AVENUE
TUALATIN, OR 97062

FOR: KNIVES, IN CLASS 8 (U.S. CLS. 23, 28 AND 44).

FIRST USE 1-5-2012; IN COMMERCE 1-5-2012.

THE MARK CONSISTS OF STANDARD CHARACTERS WITHOUT CLAIM TO ANY PARTICULAR FONT, STYLE, SIZE, OR COLOR.

SN 85-210,410, FILED 1-4-2011.

GILBERT SWIFT, EXAMINING ATTORNEY



David J. Kyffers

Director of the United States Patent and Trademark Office

United States of America

United States Patent and Trademark Office

MILK-BONE

Reg. No. 4,206,811

DEL MONTE CORPORATION (DELAWARE CORPORATION)
P.O. BOX 193575

Registered Sep. 11, 2012

SAN FRANCISCO, CA 941193575

Int. Cls.: 14 and 28

FOR: ORNAMENTS OF PRECIOUS METAL, IN CLASS 14 (U.S. CLS. 2, 27, 28 AND 50).

FIRST USE 5-3-2011; IN COMMERCE 5-3-2011.

TRADEMARK

FOR: CHRISTMAS TREE ORNAMENTS, IN CLASS 28 (U.S. CLS. 22, 23, 38 AND 50).

PRINCIPAL REGISTER

FIRST USE 5-3-2011; IN COMMERCE 5-3-2011.

THE MARK CONSISTS OF STANDARD CHARACTERS WITHOUT CLAIM TO ANY PARTICULAR FONT, STYLE, SIZE, OR COLOR.

OWNER OF U.S. REG. NOS. 218,468, 3,749,792, AND OTHERS.

SN 85-210,490, FILED 1-4-2011.

APRIL HESIK, EXAMINING ATTORNEY



David J. Kybas

Director of the United States Patent and Trademark Office

United States of America

United States Patent and Trademark Office



Reg. No. 4,206,812

Registered Sep. 11, 2012

TTM ANDREAS MAYER (SWITZERLAND SOLE PROPRIETORSHIP)
FOHRHOLZLISTRASSE 14B
5443 NIEDERROHRDORF, SWITZERLAND

CERTIFICATION MARK

GOODS

PRINCIPAL REGISTER

FOR: EXHAUST GAS PURIFYING SYSTEMS FOR AUTOMOBILES; CATALYTIC CONVERTERS FOR AUTOMOBILES; DIESEL PARTICLE FILTERS FOR LAND AND NON-LAND VEHICLES; EXHAUST GAS PURIFYING SYSTEMS FOR LAND VEHICLES; CATALYTIC CONVERTERS FOR LAND VEHICLES; DIESEL PARTICLE FILTERS FOR LAND VEHICLES, IN CLASS A (U.S. CL. A).

FIRST USE 8-27-2010; IN COMMERCE 2-11-2011.

NO CLAIM IS MADE TO THE EXCLUSIVE RIGHT TO USE "VERT" AND "VERT CERTIFIED PARTICLE FILTER FOR HEALTH AND CLIMATE", APART FROM THE MARK AS SHOWN.

THE MARK CONSISTS OF A CIRCULAR MARK HAVING A CHECKMARK ENCLOSED WITHIN A CIRCLE HAVING THE WORD "VERT" DISPOSED IN THE LONG PORTION OF THE CHECKMARK WITH WORDS "VERT CERTIFIED PARTICLE FILTER FOR HEALTH AND CLIMATE" AND THE LETTERS "J F M A M J J A S O N D" DISPOSED OUTSIDE THE CIRCLE WITHIN THE CIRCULAR MARK.

THE ENGLISH TRANSLATION OF "VERT" IS "GREEN".

THE CERTIFICATION MARK, AS INTENDED TO BE USED BY AUTHORIZED PERSONS, IS INTENDED TO CERTIFY THAT THE GOODS MEET QUALITY REQUIREMENTS AS TO THE OPERATION, FILTER EFFICIENCY, EMISSION LIMITS, NOISE ATTENUATION AND DURABILITY OF THE GOODS AS ESTABLISHED BY THE CERTIFIER.

SN 85-210,505, FILED 1-4-2011.

KELLEY WELLS, EXAMINING ATTORNEY



David J. Kybas

Director of the United States Patent and Trademark Office

United States of America
United States Patent and Trademark Office

OUTSKIRTS

Reg. No. 4,206,813

OUTSKIRTS, LLC (OREGON LIMITED LIABILITY COMPANY)
8505 SW 8TH AVE.

Registered Sep. 11, 2012

PORTLAND, OR 97219

Int. Cl.: 25

FOR: WOMEN'S APPAREL, NAMELY, TANK TOPS, UNDER GARMENTS, LINGERIE, SLIPS,
SKIRTS AND SCARVES, IN CLASS 25 (U.S. CLS. 22 AND 39).

TRADEMARK

FIRST USE 6-0-2012; IN COMMERCE 6-0-2012.

PRINCIPAL REGISTER

THE MARK CONSISTS OF STANDARD CHARACTERS WITHOUT CLAIM TO ANY PAR-
TICULAR FONT, STYLE, SIZE, OR COLOR.

SN 85-210,717, FILED 1-5-2011.

SIMON TENG, EXAMINING ATTORNEY



David J. Kyffers

Director of the United States Patent and Trademark Office

United States of America

United States Patent and Trademark Office

EASY

Reg. No. 4,206,814

Registered Sep. 11, 2012

Int. Cl.: 41

SERVICE MARK

PRINCIPAL REGISTER

THE MCGRAW-HILL COMPANIES, INC. (NEW YORK CORPORATION)
1221 AVENUE OF THE AMERICAS
NEW YORK, NY 10020

FOR: EDUCATIONAL SERVICES, NAMELY, ON-LINE TEST PREPARATION IN THE FIELDS OF MEDICINE, RADIOLOGY, AND PHYSICIAN'S ASSISTANT CERTIFICATION AND RE-CERTIFICATION, IN CLASS 41 (U.S. CLS. 100, 101 AND 107).

FIRST USE 6-0-2011; IN COMMERCE 6-0-2011.

THE MARK CONSISTS OF STANDARD CHARACTERS WITHOUT CLAIM TO ANY PARTICULAR FONT, STYLE, SIZE, OR COLOR.

SN 85-210,802, FILED 1-5-2011.

SUNG IN, EXAMINING ATTORNEY



David J. Kyffers

Director of the United States Patent and Trademark Office

United States of America

United States Patent and Trademark Office

NiCaTea

Reg. No. 4,206,815

ANTHONY MORROW (UNITED STATES INDIVIDUAL)
865 HARWELL
ABILENE, TX 79601

Registered Sep. 11, 2012

Int. Cl.: 34

FOR: SMOKELESS TOBACCO; TOBACCO POUCHES, IN CLASS 34 (U.S. CLS. 2, 8, 9 AND 17).

TRADEMARK

FIRST USE 5-15-2012; IN COMMERCE 5-15-2012.

PRINCIPAL REGISTER

THE MARK CONSISTS OF STANDARD CHARACTERS WITHOUT CLAIM TO ANY PARTICULAR FONT, STYLE, SIZE, OR COLOR.

THE WORDING "NICATEA" HAS NO MEANING IN A FOREIGN LANGUAGE.

SN 85-211,115, FILED 1-5-2011.

LAURA KOVALSKY, EXAMINING ATTORNEY



David J. Kybas

Director of the United States Patent and Trademark Office

United States of America
United States Patent and Trademark Office

HECKLERS

Reg. No. 4,206,816

BROOKS, ROBERT (UNITED STATES INDIVIDUAL)
8611 N. 17TH PLACE
PHOENIX, AZ 85020

Registered Sep. 11, 2012

Int. Cls.: 28 and 41

FOR: GOLF CLUBS; GOLF BALLS; GOLF TEES; GOLF BAGS; GOLF BAG PULL CARTS; GOLF GLOVES; GOLF ACCESSORIES, NAMELY, GOLF DIVOT REPAIR TOOLS, GOLF BALL MARKERS, GOLF CLUB GRIPS AND GOLF CLUB COVERS, IN CLASS 28 (U.S. CLS. 22, 23, 38 AND 50).

TRADEMARK

SERVICE MARK

FIRST USE 5-21-2011; IN COMMERCE 5-21-2011.

PRINCIPAL REGISTER

FOR: (BASED ON USE IN COMMERCE) ORGANIZATION OF GOLF TOURNAMENTS, IN CLASS 41 (U.S. CLS. 100, 101 AND 107).

FIRST USE 12-14-2010; IN COMMERCE 12-14-2010.

THE MARK CONSISTS OF STANDARD CHARACTERS WITHOUT CLAIM TO ANY PARTICULAR FONT, STYLE, SIZE, OR COLOR.

SN 85-211,244, FILED 1-5-2011.

JOHN GARTNER, EXAMINING ATTORNEY



David J. Kybas

Director of the United States Patent and Trademark Office

United States of America

United States Patent and Trademark Office

COMFORTMARK

Reg. No. 4,206,817

VALSPAR SOURCING, INC. (MINNESOTA CORPORATION)
P.O. BOX 1461

Registered Sep. 11, 2012

MINNEAPOLIS, MN 55440

Int. Cl.: 24

FOR: MATTRESS PROTECTORS; PILLOW PROTECTORS; BOX SPRING ENCASEMENTS,
IN CLASS 24 (U.S. CLS. 42 AND 50).

TRADEMARK

FIRST USE 10-0-2010; IN COMMERCE 10-0-2010.

PRINCIPAL REGISTER

THE MARK CONSISTS OF STANDARD CHARACTERS WITHOUT CLAIM TO ANY PAR-
TICULAR FONT, STYLE, SIZE, OR COLOR.

SN 85-212,131, FILED 1-6-2011.

PATRICIA EVANKO, EXAMINING ATTORNEY



David J. Kybas

Director of the United States Patent and Trademark Office

United States of America

United States Patent and Trademark Office

Stow & Go Pet Leash

Reg. No. 4,206,818

CUMMINGS, MICHAEL (UNITED STATES INDIVIDUAL)
621 NORTH 10 STREET
MANITOWOC, WI 54220 AND

Registered Sep. 11, 2012

Int. Cl.: 18

CUMMINGS, MEGAN (UNITED STATES INDIVIDUAL)
621 NORTH 10 STREET
MANITOWOC, WI 54220

TRADEMARK

PRINCIPAL REGISTER

FOR: PET ACCESSORIES, NAMELY, SPECIALLY DESIGNED CANVAS, VINYL OR LEATHER BAGS ATTACHED TO ANIMAL LEASHES FOR HOLDING SMALL ITEMS SUCH AS KEYS, CREDIT CARDS, MONEY OR DISPOSABLE BAGS FOR DISPOSING OF PET WASTE, IN CLASS 18 (U.S. CLS. 1, 2, 3, 22 AND 41).

FIRST USE 5-15-2012; IN COMMERCE 5-15-2012.

THE MARK CONSISTS OF STANDARD CHARACTERS WITHOUT CLAIM TO ANY PARTICULAR FONT, STYLE, SIZE, OR COLOR.

NO CLAIM IS MADE TO THE EXCLUSIVE RIGHT TO USE "PET LEASH", APART FROM THE MARK AS SHOWN.

SN 85-212,668, FILED 1-7-2011.

PATRICIA EVANKO, EXAMINING ATTORNEY



David J. Kyros

Director of the United States Patent and Trademark Office

United States of America

United States Patent and Trademark Office



Reg. No. 4,206,819

PLANT HEALTH ALTERNATIVES, LLC (NEW JERSEY LIMITED LIABILITY COMPANY)
P.O. BOX 90
MORRIS PLAINS, NJ 07950

Registered Sep. 11, 2012

Int. Cl.: 41

FOR: MULTIMEDIA PUBLISHING OF BOOKS AND ELECTRONIC PUBLICATIONS, IN CLASS 41 (U.S. CLS. 100, 101 AND 107).

SERVICE MARK

FIRST USE 5-26-2011; IN COMMERCE 6-3-2011.

PRINCIPAL REGISTER

NO CLAIM IS MADE TO THE EXCLUSIVE RIGHT TO USE "PLANT KINGDOM COMMUNICATIONS", APART FROM THE MARK AS SHOWN.

THE MARK CONSISTS OF THE WORDS "PLANT KINGDOM COMMUNICATIONS" ABOVE A DESIGN OF A TREE AND TWO STICK FIGURES.

SN 85-213,510, FILED 1-8-2011.

TRACY FLETCHER, EXAMINING ATTORNEY



David J. Kyffers

Director of the United States Patent and Trademark Office

United States of America

United States Patent and Trademark Office

HARMONY. UNITY. COMMUNITY.

Reg. No. 4,206,820

CENTRAL PARK TAEKWONDO LLC (NEW YORK LIMITED LIABILITY COMPANY)
50 WEST 72ND STREET
NEW YORK, NY 10023

Registered Sep. 11, 2012

Int. Cl.: 41

FOR: MARTIAL ARTS INSTRUCTION, IN CLASS 41 (U.S. CLS. 100, 101 AND 107).

SERVICE MARK

FIRST USE 8-0-2011; IN COMMERCE 8-0-2011.

PRINCIPAL REGISTER

THE MARK CONSISTS OF STANDARD CHARACTERS WITHOUT CLAIM TO ANY PARTICULAR FONT, STYLE, SIZE, OR COLOR.

SN 85-213,774, FILED 1-10-2011.

APRIL ROACH, EXAMINING ATTORNEY



David J. Kyffers

Director of the United States Patent and Trademark Office

United States of America

United States Patent and Trademark Office



Reg. No. 4,206,821

Registered Sep. 11, 2012

Int. Cl.: 25

TRADEMARK

PRINCIPAL REGISTER

LEXI-LUU DESIGNS, INC. (NEVADA CORPORATION)
6040 E. MAIN STREET, #446
MESA, AZ 85205

FOR: BATHING SUITS; CAPRIS; DANCE COSTUMES; HATS; HEADBANDS; LEG WARMERS; LEGGINGS; LEOTARDS; SCARFS; SHORTS; SHRUGS; SKIRTS; SOCKS; TIGHTS; TOPS; UNITARDS, IN CLASS 25 (U.S. CLS. 22 AND 39).

FIRST USE 7-1-2008; IN COMMERCE 7-1-2008.

THE NAME "LEXI LUU" DOES NOT IDENTIFY A LIVING INDIVIDUAL

THE MARK CONSISTS OF AN ANIMATED GIRL WITH LONG HAIR WEARING A DRESS AND HOLDING A FLOWER WITH THE STYLIZED WORK "LEXI" TO HER LEFT AND THE STYLIZED WORD "LUU" TO HER RIGHT.

SN 85-213,854, FILED 1-10-2011.

MICHAEL KEATING, EXAMINING ATTORNEY



David J. Kybas

Director of the United States Patent and Trademark Office

United States of America

United States Patent and Trademark Office

LINEA NATURALE

Reg. No. 4,206,822

Registered Sep. 11, 2012

Int. Cl.: 25

TRADEMARK

PRINCIPAL REGISTER

ASTRO APPAREL, INC. (PENNSYLVANIA CORPORATION)
300 BROOK STREET
SCRANTON, PA 18505

FOR: CLOTHING, NAMELY, BELTS, IN CLASS 25 (U.S. CLS. 22 AND 39).

FIRST USE 4-17-2012; IN COMMERCE 4-17-2012.

THE MARK CONSISTS OF STANDARD CHARACTERS WITHOUT CLAIM TO ANY PARTICULAR FONT, STYLE, SIZE, OR COLOR.

SEC. 2(F).

OWNER OF U.S. REG. NO. 2,322,732.

THE ENGLISH TRANSLATION OF "LINEA NATURALE" IN THE MARK IS "NATURAL LINE".

SN 85-213,904, FILED 1-10-2011.

JEAN IM, EXAMINING ATTORNEY



David J. Kyffers

Director of the United States Patent and Trademark Office

United States of America

United States Patent and Trademark Office

LIVE.SHAPE.HAPPY.

Reg. No. 4,206,823

TIMES THREE CLOTHIER, LLC (NEW YORK LIMITED LIABILITY COMPANY)
561 SEVENTH AVENUE, 12TH FLOOR
NEW YORK, NY 10022

Registered Sep. 11, 2012

Int. Cl.: 25

FOR: CLOTHING, NAMELY, DRESSES, SHIRTS, PANTS, UNDERGARMENTS, LINGERIE, SLEEPWEAR, SHORTS, SKIRTS, HOSIERY, LEGGINGS AND BODYSUITS, IN CLASS 25 (U.S. CLS. 22 AND 39).

TRADEMARK

FIRST USE 12-31-2010; IN COMMERCE 12-31-2010.

PRINCIPAL REGISTER

THE MARK CONSISTS OF STANDARD CHARACTERS WITHOUT CLAIM TO ANY PARTICULAR FONT, STYLE, SIZE, OR COLOR.

SN 85-213,939, FILED 1-10-2011.

PATRICIA EVANKO, EXAMINING ATTORNEY



David J. Kybas

Director of the United States Patent and Trademark Office

United States of America

United States Patent and Trademark Office

INVISIBLE MONEY CLIP

Reg. No. 4,206,824

Registered Sep. 11, 2012

Int. Cl.: 16

TRADEMARK

PRINCIPAL REGISTER

INVISIBLE MONEY CLIP LLC (NEW YORK LIMITED LIABILITY COMPANY)
23 PENNY LANE
SCARSDALE, NY 10583

FOR: MONEY CLIPS, IN CLASS 16 (U.S. CLS. 2, 5, 22, 23, 29, 37, 38 AND 50).

FIRST USE 10-28-2011; IN COMMERCE 10-28-2011.

THE MARK CONSISTS OF STANDARD CHARACTERS WITHOUT CLAIM TO ANY PARTICULAR FONT, STYLE, SIZE, OR COLOR.

NO CLAIM IS MADE TO THE EXCLUSIVE RIGHT TO USE "MONEY CLIP", APART FROM THE MARK AS SHOWN.

SN 85-214,104, FILED 1-10-2011.

ROBERT C. CLARK JR., EXAMINING ATTORNEY



David J. Kyffers

Director of the United States Patent and Trademark Office

United States of America

United States Patent and Trademark Office

DURANGUENSE

Reg. No. 4,206,825

Registered Sep. 11, 2012

Int. Cl.: 29

TRADEMARK

PRINCIPAL REGISTER

NUESTRO QUESO, LLC (DELAWARE LIMITED LIABILITY COMPANY)
752 N. KENT RD.
KENT, IL 61044

FOR: CHEESE, IN CLASS 29 (U.S. CL. 46).

FIRST USE 11-0-2010; IN COMMERCE 11-0-2010.

THE MARK CONSISTS OF STANDARD CHARACTERS WITHOUT CLAIM TO ANY PARTICULAR FONT, STYLE, SIZE, OR COLOR.

SN 85-215,028, FILED 1-11-2011.

KIM MONINGHOFF, EXAMINING ATTORNEY



David J. Kyffers

Director of the United States Patent and Trademark Office

United States of America

United States Patent and Trademark Office

ULTIMATEONE

Reg. No. 4,206,826

Registered Sep. 11, 2012

Int. Cl.: 11

TRADEMARK

PRINCIPAL REGISTER

SELKIRK CORPORATION (DELAWARE CORPORATION)
5030 CORPORATE EXCHANGE BLVD. SE
GRAND RAPIDS, MI 49512

FOR: FLUES, CHIMNEY AND VENT PIPES BEING PART OF HEATING AND VENTILATION INSTALLATIONS AND STRUCTURAL PARTS THEREOF, NAMELY, PRESSURE REDUCER VALVES, SAFETY VALVES, CLAMPS, T-PIECES, CONNECTORS, REDUCERS, DRIP CAPS, STEAM VALVES, ELBOW JOINTS, TEE JOINTS, REDUCING COUPLINGS AND DRIP CAPS, ALL FOR THE AFORESAID PIPES AND FLUES AND ALL SOLD AS A UNIT; FURNACES; FIREPLACES; CHIMNEY FLUES; INTERNAL LINERS FOR METAL CHIMNEYS, ALL THE AFORESAID GOODS MADE WHOLLY OR PRINCIPALLY OF METAL, IN CLASS 11 (U.S. CLS. 13, 21, 23, 31 AND 34).

FIRST USE 5-11-2011; IN COMMERCE 5-11-2011.

THE MARK CONSISTS OF STANDARD CHARACTERS WITHOUT CLAIM TO ANY PARTICULAR FONT, STYLE, SIZE, OR COLOR.

SN 85-215,312, FILED 1-11-2011.

WILLIAM ROSSMAN, EXAMINING ATTORNEY



David J. Kyffers

Director of the United States Patent and Trademark Office

United States of America

United States Patent and Trademark Office

BODYROUTE

Reg. No. 4,206,827

STEFAN KWASNY (FED REP GERMANY INDIVIDUAL)
KORTUMSTR.46

Registered Sep. 11, 2012

ESSEN, FED REP GERMANY 45130

Int. Cl.: 44

FOR: PROVIDING A WEBSITE FEATURING INFORMATION AND ADVICE IN THE FIELDS OF DIET, WEIGHT LOSS, DIET PLANNING AND LIFESTYLE WELLNESS, IN CLASS 44 (U.S. CLS. 100 AND 101).

SERVICE MARK

FIRST USE 6-25-2012; IN COMMERCE 6-25-2012.

PRINCIPAL REGISTER

THE MARK CONSISTS OF STANDARD CHARACTERS WITHOUT CLAIM TO ANY PARTICULAR FONT, STYLE, SIZE, OR COLOR.

SN 85-215,440, FILED 1-11-2011.

MICHAEL TANNER, EXAMINING ATTORNEY



David J. Kybas

Director of the United States Patent and Trademark Office

United States of America

United States Patent and Trademark Office

Poochie & Co.

Reg. No. 4,206,828

Registered Sep. 11, 2012

Int. Cl.: 18

TRADEMARK

PRINCIPAL REGISTER

CUDLIE ACCESSORIES LLC (NEW YORK LIMITED LIABILITY COMPANY)
1 EAST 33RD STREET
NEW YORK, NY 10016

FOR: UMBRELLAS, HANDBAGS, CARRYING BAGS, BACKPACKS, WALLETS, COIN CASES, CLUTCH HANDBAGS AND PLUSH HANDBAGS FOR CHILDREN, IN CLASS 18 (U.S. CLS. 1, 2, 3, 22 AND 41).

FIRST USE 8-15-2010; IN COMMERCE 8-15-2010.

THE MARK CONSISTS OF STANDARD CHARACTERS WITHOUT CLAIM TO ANY PARTICULAR FONT, STYLE, SIZE, OR COLOR.

NO CLAIM IS MADE TO THE EXCLUSIVE RIGHT TO USE "CO.", APART FROM THE MARK AS SHOWN.

SN 85-215,775, FILED 1-12-2011.

REGINA DRUMMOND, EXAMINING ATTORNEY



David J. Kyffers

Director of the United States Patent and Trademark Office

United States of America

United States Patent and Trademark Office

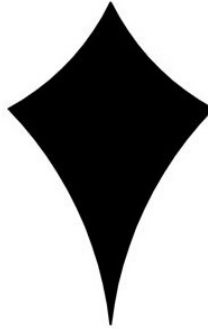

Reg. No. 4,206,829

Registered Sep. 11, 2012

Int. Cl.: 15

TRADEMARK

PRINCIPAL REGISTER

KAMOA UKULELE COMPANY (HAWAII CORPORATION)
4-1310 KUHIO HIGHWAY
KAPA'A, HI 96746

FOR: UKULELES SOLD IN RETAIL CHANNELS, IN CLASS 15 (U.S. CLS. 2, 21 AND 36).

FIRST USE 10-0-2010; IN COMMERCE 10-0-2010.

THE MARK CONSISTS OF AN ABSTRACT DIAMOND-SHAPED DESIGN WITH CONCAVE SIDES AND A LONGITUDINALLY EXTENDED LOWER PORTION.

SN 85-216,039, FILED 1-12-2011.

STEVEN PEREZ, EXAMINING ATTORNEY



David J. Kyffers

Director of the United States Patent and Trademark Office

United States of America

United States Patent and Trademark Office

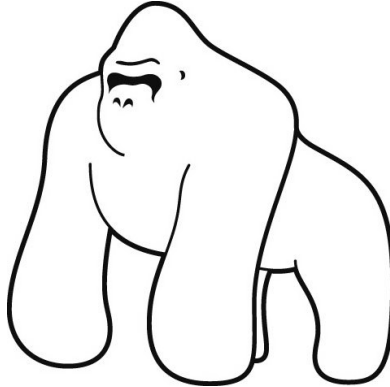

Reg. No. 4,206,830

GORILLA PEST CONTROL (CALIFORNIA JOINT VENTURE)
4853 NEOLA PL
LOS ANGELES, CA 90041

Registered Sep. 11, 2012

Int. Cl.: 37

FOR: PEST CONTROL AND EXTERMINATION OTHER THAN FOR AGRICULTURAL PURPOSES, IN CLASS 37 (U.S. CLS. 100, 103 AND 106).

SERVICE MARK

FIRST USE 9-1-2009; IN COMMERCE 9-1-2009.

PRINCIPAL REGISTER

THE MARK CONSISTS OF A CARICATURE OF A GORILLA.

SN 85-216,369, FILED 1-12-2011.

PAUL MORENO, EXAMINING ATTORNEY



David J. Kyffers

Director of the United States Patent and Trademark Office

United States of America

United States Patent and Trademark Office

IMShield

Reg. No. 4,206,831

Registered Sep. 11, 2012

Int. Cl.: 9

TRADEMARK

PRINCIPAL REGISTER

INFOSEC CO., LTD. (REPUBLIC OF KOREA CORPORATION)
7F, 1008-4, DAECHI-DONG, GANGNAM-GU
NAT'L COUNCIL OF SAEMAUL UNDONG MOVEMENT
SEOUL, REPUBLIC OF KOREA

FOR: COMPUTER SECURITY SOFTWARE FOR USE IN SECURING MOBILE TERMINALS FOR ELECTRONIC TRANSACTIONS BY MONITORING AND LOCATING LOST MOBILE TERMINALS, AS WELL AS PROVIDING BACKUP FILES FOR DATA ON MOBILE TERMINALS AND ENCRYPTION OF SAID MOBILE TERMINALS, IN CLASS 9 (U.S. CLS. 21, 23, 26, 36 AND 38).

FIRST USE 2-14-2011; IN COMMERCE 2-14-2011.

THE MARK CONSISTS OF STANDARD CHARACTERS WITHOUT CLAIM TO ANY PARTICULAR FONT, STYLE, SIZE, OR COLOR.

SN 85-216,552, FILED 1-13-2011.

LINDSEY RUBIN, EXAMINING ATTORNEY



David J. Kybas

Director of the United States Patent and Trademark Office

United States of America

United States Patent and Trademark Office

BESTLIFE

Reg. No. 4,206,832

GFA BRANDS, INC. (DELAWARE CORPORATION)
115 WEST CENTURY ROAD, SUITE 260
PARAMUS, NJ 07652

Registered Sep. 11, 2012

Int. Cl.: 5

FOR: NUTRITIONAL SUPPLEMENTS; VITAMIN AND MINERAL SUPPLEMENTS, IN CLASS 5 (U.S. CLS. 6, 18, 44, 46, 51 AND 52).

TRADEMARK

FIRST USE 5-0-2011; IN COMMERCE 5-0-2011.

PRINCIPAL REGISTER

THE MARK CONSISTS OF STANDARD CHARACTERS WITHOUT CLAIM TO ANY PARTICULAR FONT, STYLE, SIZE, OR COLOR.

OWNER OF U.S. REG. NOS. 3,455,597 AND 3,455,598.

SN 85-216,790, FILED 1-13-2011.

GILBERT SWIFT, EXAMINING ATTORNEY



David J. Kybas

Director of the United States Patent and Trademark Office

United States of America

United States Patent and Trademark Office



Reg. No. 4,206,833

Registered Sep. 11, 2012

Int. Cl.: 41

EVERGLADES COLLEGE, INC. (FLORIDA CORPORATION), DBA EVERGLADES UNIVERSITY,
SUITE 600
1300 19TH STREET, N.W.
WASHINGTON, DC 20036

SERVICE MARK

FOR: EDUCATIONAL SERVICES, NAMELY, PROVIDING LIVE AND ON-LINE COURSES OF INSTRUCTION AT THE COLLEGE AND GRADUATE LEVEL, IN CLASS 41 (U.S. CLS. 100, 101 AND 107).

PRINCIPAL REGISTER

FIRST USE 1-1-2010; IN COMMERCE 1-1-2010.

NO CLAIM IS MADE TO THE EXCLUSIVE RIGHT TO USE "EVERGLADES UNIVERSITY", APART FROM THE MARK AS SHOWN.

THE COLOR(S) GREEN IS/ARE CLAIMED AS A FEATURE OF THE MARK.

THE MARK CONSISTS OF THE LETTERS "EU" WITH A BIRD DESIGN WITHIN THE LETTER "E" TO THE RIGHT OF THE STACKED WORDS "EVERGLADES" AND "UNIVERSITY" ALL IN THE COLOR GREEN.

SN 85-217,108, FILED 1-13-2011.

DAVID TAYLOR, EXAMINING ATTORNEY



David J. Kyffers

Director of the United States Patent and Trademark Office

United States of America

United States Patent and Trademark Office



Reg. No. 4,206,834

Registered Sep. 11, 2012

Int. Cl.: 41

EVERGLADES COLLEGE, INC. (FLORIDA CORPORATION), DBA EVERGLADES UNIVERSITY,
SUITE 100
5002 T-REX AVENUE
BOCA RATON, FL 33431

SERVICE MARK

FOR: EDUCATIONAL SERVICES, NAMELY, PROVIDING LIVE AND ON-LINE COURSES OF INSTRUCTION AT THE COLLEGE AND GRADUATE LEVEL, IN CLASS 41 (U.S. CLS. 100, 101 AND 107).

PRINCIPAL REGISTER

FIRST USE 1-1-2010; IN COMMERCE 1-1-2010.

NO CLAIM IS MADE TO THE EXCLUSIVE RIGHT TO USE "EVERGLADES UNIVERSITY", APART FROM THE MARK AS SHOWN.

THE MARK CONSISTS OF THE LETTERS "EU" WITH A BIRD DESIGN WITHIN THE LETTER "E" TO THE RIGHT OF THE STACKED WORDS "EVERGLADES" AND "UNIVERSITY".

SN 85-217,141, FILED 1-13-2011.

DAVID TAYLOR, EXAMINING ATTORNEY



David J. Kyffers

Director of the United States Patent and Trademark Office

United States of America

United States Patent and Trademark Office

POTLUCK

Reg. No. 4,206,835

Registered Sep. 11, 2012

Int. Cl.: 33

TRADEMARK

PRINCIPAL REGISTER

BEVERAGE INFOSYSTEMS (D.C. LIMITED LIABILITY COMPANY)
SUITE 77
501 SILVERSIDE ROAD
WILMINGTON, DE 19809

FOR: WINES, IN CLASS 33 (U.S. CLS. 47 AND 49).

FIRST USE 6-2-2011; IN COMMERCE 6-2-2011.

THE MARK CONSISTS OF STANDARD CHARACTERS WITHOUT CLAIM TO ANY PARTICULAR FONT, STYLE, SIZE, OR COLOR.

SN 85-217,263, FILED 1-13-2011.

JAMES LOVELACE, EXAMINING ATTORNEY



David J. Kybas

Director of the United States Patent and Trademark Office

United States of America

United States Patent and Trademark Office



Reg. No. 4,206,836

Registered Sep. 11, 2012

Int. Cl.: 41

SERVICE MARK

PRINCIPAL REGISTER

EVERGLADES COLLEGE, INC. (FLORIDA CORPORATION), DBA EVERGLADES UNIVERSITY,
SUITE 100
5002 T-REX AVENUE
BOCA RATON, FL 33431

FOR: EDUCATIONAL SERVICES, NAMELY, PROVIDING LIVE AND ON-LINE COURSES OF INSTRUCTION AT THE COLLEGE AND GRADUATE LEVEL, IN CLASS 41 (U.S. CLS. 100, 101 AND 107).

FIRST USE 1-1-2010; IN COMMERCE 1-1-2010.

NO CLAIM IS MADE TO THE EXCLUSIVE RIGHT TO USE "EVERGLADES UNIVERSITY", APART FROM THE MARK AS SHOWN.

THE MARK CONSISTS OF A SHIELD DESIGN WITH DESIGNS OF A BIRD IN FLIGHT, A FLAME DESIGN AND A BOOK DESIGN WITHIN THE SHIELD, THE WORDS "EVERGLADES UNIVERSITY" ABOVE THE SHIELD AND THE WORDS "SAPIENTIA VERITAS INTEGRITAS" BELOW THE SHIELD.

THE ENGLISH TRANSLATION OF "SAPIENTIA VERITAS INTEGRITAS" IN THE MARK IS "WISDOM TRUTH INTEGRITY".

SN 85-217,670, FILED 1-14-2011.

DAVID TAYLOR, EXAMINING ATTORNEY



David J. Kyffers

Director of the United States Patent and Trademark Office

United States of America

United States Patent and Trademark Office



Reg. No. 4,206,837

Registered Sep. 11, 2012

Int. Cl.: 41

SERVICE MARK

PRINCIPAL REGISTER

EVERGLADES COLLEGE, INC. (FLORIDA CORPORATION), DBA EVERGLADES UNIVERSITY,
SUITE 100
5002 T-REX AVENUE
BOCA RATON, FL 33431

FOR: EDUCATIONAL SERVICES, NAMELY, PROVIDING LIVE AND ON-LINE COURSES OF INSTRUCTION AT THE COLLEGE AND GRADUATE LEVEL, IN CLASS 41 (U.S. CLS. 100, 101 AND 107).

FIRST USE 1-1-2010; IN COMMERCE 1-1-2010.

NO CLAIM IS MADE TO THE EXCLUSIVE RIGHT TO USE "EVERGLADES UNIVERSITY", APART FROM THE MARK AS SHOWN.

THE MARK CONSISTS OF THE LETTERS "EU" WITH A BIRD DESIGN WITHIN THE LETTER "E" STACKED OVER THE WORD "EVERGLADES" STACKED OVER THE WORD "UNIVERSITY".

SN 85-217,754, FILED 1-14-2011.

DAVID TAYLOR, EXAMINING ATTORNEY



David J. Kybas

Director of the United States Patent and Trademark Office

United States of America

United States Patent and Trademark Office

CONNECT TO THE POWER IN COLOR VALSPAR

Reg. No. 4,206,838

Registered Sep. 11, 2012

Int. Cl.: 2

TRADEMARK

PRINCIPAL REGISTER

THE VALSPAR CORPORATION (DELAWARE CORPORATION)
P.O. BOX 1461
MINNEAPOLIS, MN 55440

FOR: PAINTS AND COATINGS, NAMELY, STAINS AND CLEAR FINISHES FOR EXTERIOR AND INTERIOR USE ON A VARIETY OF SUBSTRATES, IN CLASS 2 (U.S. CLS. 6, 11 AND 16).

FIRST USE 3-28-2011; IN COMMERCE 3-28-2011.

THE MARK CONSISTS OF STANDARD CHARACTERS WITHOUT CLAIM TO ANY PARTICULAR FONT, STYLE, SIZE, OR COLOR.

OWNER OF U.S. REG. NO. 2,724,138.

SN 85-218,154, FILED 1-14-2011.

KATHERINE STOIDES, EXAMINING ATTORNEY



David J. Kyffers

Director of the United States Patent and Trademark Office

United States of America

United States Patent and Trademark Office

TANG OF SHANG

Reg. No. 4,206,839

Registered Sep. 11, 2012

Int. Cl.: 9

TRADEMARK

PRINCIPAL REGISTER

WMS GAMING INC. (DELAWARE CORPORATION)
800 SOUTH NORTHPOINT BOULEVARD
WAUKEGAN, IL 60085

FOR: COMPONENTS FOR GAMING MACHINES THAT GENERATE OR DISPLAY WAGER OUTCOMES, NAMELY, CONTROLLERS, DISPLAYS, BUTTON PANELS, BOLSTERS, ELECTRICAL WIRING, AND COMPUTER HARDWARE AND SOFTWARE ASSOCIATED THEREWITH; GAMING MACHINES, NAMELY, DEVICES WHICH ACCEPT A WAGER; GAMING SOFTWARE THAT GENERATES OR DISPLAYS WAGER OUTCOMES OF GAMING MACHINES, IN CLASS 9 (U.S. CLS. 21, 23, 26, 36 AND 38).

FIRST USE 9-23-2011; IN COMMERCE 9-23-2011.

THE MARK CONSISTS OF STANDARD CHARACTERS WITHOUT CLAIM TO ANY PARTICULAR FONT, STYLE, SIZE, OR COLOR.

SN 85-218,232, FILED 1-14-2011.

JOHN GARTNER, EXAMINING ATTORNEY



David J. Kyffers

Director of the United States Patent and Trademark Office

United States of America

United States Patent and Trademark Office



Reg. No. 4,206,840

Registered Sep. 11, 2012

Int. Cl.: 32

TRADEMARK

PRINCIPAL REGISTER

JONES SODA CO. (USA) INC (WASHINGTON CORPORATION)
1000 1ST AVENUE S.
SUITE 100
SEATTLE, WA 98134

FOR: ENERGY DRINKS, IN CLASS 32 (U.S. CLS. 45, 46 AND 48).

FIRST USE 5-9-2011; IN COMMERCE 5-9-2011.

OWNER OF U.S. REG. NOS. 2,842,065, 3,915,344, AND OTHERS.

NO CLAIM IS MADE TO THE EXCLUSIVE RIGHT TO USE "ZERO", APART FROM THE MARK AS SHOWN.

THE MARK CONSISTS OF A CROSSLIKE DESIGN WITH THE WORD "JONES" POSITIONED AT A FIRST END OF THE DESIGN, THE WORD "WHOOPASS" POSITIONED IN THE MIDDLE PORTION OF THE DESIGN, AND THE TERM "ZERO" POSITIONED AT A SECOND END OF THE DESIGN.

SN 85-218,423, FILED 1-14-2011.

WANDA KAY PRICE, EXAMINING ATTORNEY



David J. Kybas

Director of the United States Patent and Trademark Office

United States of America

United States Patent and Trademark Office

WHOO PASS ZERO

Reg. No. 4,206,841

Registered Sep. 11, 2012

Int. Cl.: 32

JONES SODA CO. (USA) INC. (WASHINGTON CORPORATION)
1000 1ST AVENUE S.
SUITE 100
SEATTLE, WA 98134

FOR: ENERGY DRINKS, IN CLASS 32 (U.S. CLS. 45, 46 AND 48).

TRADEMARK

FIRST USE 5-9-2011; IN COMMERCE 5-9-2011.

PRINCIPAL REGISTER

THE MARK CONSISTS OF STANDARD CHARACTERS WITHOUT CLAIM TO ANY PARTICULAR FONT, STYLE, SIZE, OR COLOR.

OWNER OF U.S. REG. NOS. 2,721,730, 3,915,344, AND OTHERS.

NO CLAIM IS MADE TO THE EXCLUSIVE RIGHT TO USE "ZERO", APART FROM THE MARK AS SHOWN.

SN 85-218,436, FILED 1-14-2011.

WANDA KAY PRICE, EXAMINING ATTORNEY



David J. Kybas

Director of the United States Patent and Trademark Office

United States of America

United States Patent and Trademark Office

SMART CREW

Reg. No. 4,206,842

Registered Sep. 11, 2012

Int. Cls.: 9 and 42

TRADEMARK

SERVICE MARK

PRINCIPAL REGISTER

UTILITY ASSOCIATES, INC. (DELAWARE CORPORATION)
1484 BROCKETT ROAD
TUCKER, GA 30084

FOR: INTEROPERABLE COMMUNICATION SYSTEM DESIGNED TO PROVIDE RADIO, STREAMING VIDEO, WIRELESS INTERNET, AND VOIP PHONE, IN CLASS 9 (U.S. CLS. 21, 23, 26, 36 AND 38).

FIRST USE 6-0-2012; IN COMMERCE 6-0-2012.

FOR: APPLICATION SERVICE PROVIDER, NAMELY, HOSTING, MANAGING, DEVELOPING, AND MAINTAINING APPLICATIONS, SOFTWARE, AND WEB SITES, IN THE FIELDS OF PERSONAL PRODUCTIVITY, WIRELESS COMMUNICATION, MOBILE INFORMATION ACCESS, AND REMOTE DATA MANAGEMENT FOR WIRELESS DELIVERY OF CONTENT TO HANDHELD COMPUTERS, LAPTOPS AND MOBILE ELECTRONIC DEVICES, IN CLASS 42 (U.S. CLS. 100 AND 101).

FIRST USE 6-0-2012; IN COMMERCE 6-0-2012.

THE MARK CONSISTS OF STANDARD CHARACTERS WITHOUT CLAIM TO ANY PARTICULAR FONT, STYLE, SIZE, OR COLOR.

SN 85-219,802, FILED 1-18-2011.

DOMINICK J. SALEMI, EXAMINING ATTORNEY



David J. Kyffers

Director of the United States Patent and Trademark Office

United States of America

United States Patent and Trademark Office

MAYACROPS

Reg. No. 4,206,843

Registered Sep. 11, 2012

Int. Cl.: 31

TRADEMARK

PRINCIPAL REGISTER

MAYACROPS, SA (GUATEMALA SOCIEDAD ANONIMA (SA))
ZONE 3
LA AVENIDA FINAL, ALDEA LAS ANONAS
SAN JOSE PINULA, GUATEMALA

FOR: FRESH FRUITS AND VEGETABLES, IN CLASS 31 (U.S. CLS. 1 AND 46).

FIRST USE 3-21-2011; IN COMMERCE 3-21-2011.

THE MARK CONSISTS OF STANDARD CHARACTERS WITHOUT CLAIM TO ANY PARTICULAR FONT, STYLE, SIZE, OR COLOR.

OWNER OF U.S. REG. NO. 2,704,207.

SN 85-220,129, FILED 1-18-2011.

GEORGE LORENZO, EXAMINING ATTORNEY



David J. Kyffers

Director of the United States Patent and Trademark Office

United States of America

United States Patent and Trademark Office

LANDSHARK SURFSHACK

Reg. No. 4,206,844

MARGARITAVILLE ENTERPRISES, LLC (DELAWARE LIMITED LIABILITY COMPANY)
256 WORTH AVENUE, SUITE Q-R
PALM BEACH, FL 33480

Registered Sep. 11, 2012

Int. Cl.: 35

FOR: RETAIL STORE SERVICES FEATURING A WIDE ARRAY OF MERCHANDISE IN THE NATURE OF NOVELTY ITEMS, SOUVENIRS, CLOTHING, HEADWEAR, BOOKS, RECORDINGS, BEVERAGEWARE, AND PRINTED MATERIAL, IN CLASS 35 (U.S. CLS. 100, 101 AND 102).

SERVICE MARK

PRINCIPAL REGISTER

FIRST USE 5-18-2011; IN COMMERCE 5-18-2011.

THE MARK CONSISTS OF STANDARD CHARACTERS WITHOUT CLAIM TO ANY PARTICULAR FONT, STYLE, SIZE, OR COLOR.

OWNER OF U.S. REG. NOS. 3,424,713, 3,773,466, AND 3,773,467.

SN 85-220,140, FILED 1-18-2011.

C. DIONNE CLYBURN, EXAMINING ATTORNEY



David J. Kyros

Director of the United States Patent and Trademark Office

United States of America

United States Patent and Trademark Office

HTC ARRIVE

Reg. No. 4,206,845

Registered Sep. 11, 2012

Int. Cl.: 9

TRADEMARK

PRINCIPAL REGISTER

HTC CORPORATION (TAIWAN CORPORATION)
NO. 23, XINGHUA ROAD
TAOYUAN CITY, TAIWAN

FOR: COMPUTER HARDWARE AND SOFTWARE FOR ENABLING, OPERATING, ENHANCING, CUSTOMIZING, UPDATING AND MANAGING MOBILE, PORTABLE, SMART, VOICE-OVER-INTERNET-PROTOCOL, AND WIRELESS DEVICES; USER INTERFACE SOFTWARE; COMPUTER HARDWARE AND SOFTWARE FOR DELIVERING, ENABLING, CREATING, ENHANCING, CUSTOMIZING, UPDATING, AND MANAGING USER INTERFACING, TELECOMMUNICATIONS AND TELECOMMUNICATIONS SERVICES; COMPUTER HARDWARE AND SOFTWARE FOR TRANSMITTING AND RECEIVING VOICE, IMAGE, DATA, AUDIO, VIDEO AND MULTIMEDIA CONTENT; WIRELESS MODEMS; ACCESSORIES FOR THE ABOVE GOODS, NAMELY, HEADSETS, HEADSETS WITH WIRELESS TRANSMISSION FUNCTION, CONNECTION CABLES, IN-CAR TELEPHONE HANDSET CRADLES, IN-CAR MOUNTS AND FACE PLATES FOR MOBILE PHONES, SMARTPHONES, CELLULAR PHONES AND PERSONAL DIGITAL ASSISTANTS, REPLACEMENT PARTS THEREFOR, BATTERIES, BATTERY CHARGER ADAPTORS, BATTERY CHARGERS, CASES, POUCHES SPECIFICALLY ADAPTED FOR CARRYING MOBILE PHONES, SMARTPHONES, CELLULAR PHONES AND PERSONAL DIGITAL ASSISTANTS, IN-VEHICLE BATTERY CHARGERS AND IN-VEHICLE HOLDERS, IN CLASS 9 (U.S. CLS. 21, 23, 26, 36 AND 38).

FIRST USE 3-20-2011; IN COMMERCE 3-20-2011.

THE MARK CONSISTS OF STANDARD CHARACTERS WITHOUT CLAIM TO ANY PARTICULAR FONT, STYLE, SIZE, OR COLOR.

OWNER OF U.S. REG. NOS. 3,584,880, 3,819,603, AND 3,890,684.

SN 85-220,297, FILED 1-18-2011.

DANNEAN HETZEL, EXAMINING ATTORNEY



David J. Kyffers

Director of the United States Patent and Trademark Office

United States of America

United States Patent and Trademark Office

Diamond Furr

Reg. No. 4,206,846

Registered Sep. 11, 2012

Int. Cl.: 6

TRADEMARK

PRINCIPAL REGISTER

RUTHERFORD, ROBERT (UNITED STATES INDIVIDUAL)
1641 SO. SINCLAIR STREET
ANAHEIM, CA 91806

FOR: METAL BUILDING MATERIAL, NAMELY, FURRING STRIP USED TO PROVIDE AN EVEN SUPPORT FOR LATH OR PROVIDE AN AIR SPACE BETWEEN THE WALL AND PLASTERWORK, IN CLASS 6 (U.S. CLS. 2, 12, 13, 14, 23, 25 AND 50).

FIRST USE 7-31-2010; IN COMMERCE 6-20-2012.

THE MARK CONSISTS OF STANDARD CHARACTERS WITHOUT CLAIM TO ANY PARTICULAR FONT, STYLE, SIZE, OR COLOR.

NO CLAIM IS MADE TO THE EXCLUSIVE RIGHT TO USE "FURR", APART FROM THE MARK AS SHOWN.

SN 85-220,449, FILED 1-18-2011.

TEJBIR SINGH, EXAMINING ATTORNEY



David J. Kyffers

Director of the United States Patent and Trademark Office

United States of America

United States Patent and Trademark Office

CHANKASKA CREEK RANCH & WINERY

Reg. No. 4,206,847

Registered Sep. 11, 2012

Int. Cl.: 33

TRADEMARK

PRINCIPAL REGISTER

CHANKASKA CREEK RANCH & WINERY, LLC (MINNESOTA LIMITED LIABILITY COMPANY)
221 MINNESOTA STREET
MANKATO, MN 56001

FOR: WINE, IN CLASS 33 (U.S. CLS. 47 AND 49).

FIRST USE 5-19-2012; IN COMMERCE 5-19-2012.

THE MARK CONSISTS OF STANDARD CHARACTERS WITHOUT CLAIM TO ANY PARTICULAR FONT, STYLE, SIZE, OR COLOR.

NO CLAIM IS MADE TO THE EXCLUSIVE RIGHT TO USE "RANCH & WINERY", APART FROM THE MARK AS SHOWN.

SN 85-220,724, FILED 1-19-2011.

MICHAEL KEATING, EXAMINING ATTORNEY



David J. Kyffers

Director of the United States Patent and Trademark Office

United States of America

United States Patent and Trademark Office



Reg. No. 4,206,848

Registered Sep. 11, 2012

Int. Cl.: 33

TRADEMARK

PRINCIPAL REGISTER

CHANKASKA CREEK RANCH & WINERY, LLC (MINNESOTA LIMITED LIABILITY COMPANY)
221 MINNESOTA STREET
MANKATO, MN 56001

FOR: WINE, IN CLASS 33 (U.S. CLS. 47 AND 49).

FIRST USE 5-19-2012; IN COMMERCE 5-19-2012.

NO CLAIM IS MADE TO THE EXCLUSIVE RIGHT TO USE "RANCH & WINERY", APART FROM THE MARK AS SHOWN.

THE MARK CONSISTS OF A CIRCULAR WINE STAIN FROM A BOTTLE OR GLASS OF WINE WITH THE WORDS "CHANKASKA CREEK RANCH & WINERY" BELOW THE WINE STAIN.

SN 85-220,813, FILED 1-19-2011.

MICHAEL KEATING, EXAMINING ATTORNEY



David J. Kybas

Director of the United States Patent and Trademark Office

United States of America

United States Patent and Trademark Office

ORGA WHITE

Reg. No. 4,206,849

Registered Sep. 11, 2012

Int. Cl.: 1

TRADEMARK

PRINCIPAL REGISTER

ORGANIK HOLDING ANONIM SIRKETI (TURKEY JOINT STOCK COMPANY)
BÜYÜKDERE CADDESİ MEYDAN SOKAK
PLAZA SPRING GİZ KAT: 18
MASLAK ISTANBUL, TURKEY

FOR: ORGANIC ACRYLIC POLYMER AND COPOLYMER EMULSION OPACIFIER USED IN INDUSTRY, NAMELY, ACRYLIC POLYMER AND COPOLYMER EMULSION OPACIFIER FOR USE IN MANUFACTURE OF PAINTS; ORGANIC ACRYLIC POLYMER AND COPOLYMER EMULSION OPACIFIER USED IN INDUSTRY, NAMELY, ACRYLIC POLYMER AND COPOLYMER EMULSION OPACIFIER FOR USE IN THE BUILDING, PACKING, LEATHER AND TEXTILE INDUSTRY, IN CLASS 1 (U.S. CLS. 1, 5, 6, 10, 26 AND 46).

FIRST USE 4-11-2012; IN COMMERCE 5-2-2012.

THE MARK CONSISTS OF STANDARD CHARACTERS WITHOUT CLAIM TO ANY PARTICULAR FONT, STYLE, SIZE, OR COLOR.

SN 85-221,124, FILED 1-19-2011.

SUSAN STIGLITZ, EXAMINING ATTORNEY



David J. Kyros

Director of the United States Patent and Trademark Office

United States of America

United States Patent and Trademark Office

Dermanovation

Reg. No. 4,206,850

Registered Sep. 11, 2012

Int. Cl.: 3

TRADEMARK

PRINCIPAL REGISTER

ISLAND KINETICS INC. (ARIZONA CORPORATION), DBA COVALENCE LABROATORIES,
460 S BENSON LANE SUITES 1-3
CHANDLER, AZ 85224

FOR: BEAUTY CREAMS FOR BODY CARE; BODY AND BEAUTY CARE COSMETICS;
COSMETIC CREAMS FOR SKIN CARE; COSMETIC PREPARATIONS FOR BODY CARE ,
IN CLASS 3 (U.S. CLS. 1, 4, 6, 50, 51 AND 52).

FIRST USE 2-14-2012; IN COMMERCE 2-14-2012.

THE MARK CONSISTS OF STANDARD CHARACTERS WITHOUT CLAIM TO ANY PAR-
TICULAR FONT, STYLE, SIZE, OR COLOR.

SN 85-221,431, FILED 1-19-2011.

MATTHEW PAPPAS, EXAMINING ATTORNEY



David J. Kyffers

Director of the United States Patent and Trademark Office

United States of America

United States Patent and Trademark Office



Reg. No. 4,206,851

Registered Sep. 11, 2012

Int. Cl.: 35

SERVICE MARK

PRINCIPAL REGISTER

MARGARITAVILLE ENTERPRISES, LLC (DELAWARE LIMITED LIABILITY COMPANY)
256 WORTH AVENUE, SUITE Q-R
PALM BEACH, FL 33480

FOR: RETAIL STORE SERVICES FEATURING A WIDE ARRAY OF MERCHANDISE IN THE NATURE OF NOVELTY ITEMS, SOUVENIRS, CLOTHING, HEADWEAR, BOOKS, RECORDINGS, BEVERAGEWARE, AND PRINTED MATERIAL, IN CLASS 35 (U.S. CLS. 100, 101 AND 102).

FIRST USE 5-18-2011; IN COMMERCE 5-18-2011.

OWNER OF U.S. REG. NOS. 3,301,624, 3,773,467, AND OTHERS.

THE MARK CONSISTS OF A BROKEN BANDED CIRCLE WITH THE WORDS "LANDSHARK SURF Shack" ALONG THE INSIDE PERIMETER OF THE CIRCLE WITH A STYLIZED DESIGN OF A FLOATING FIN ISLAND WITH TREES AND MOUNDS WITH THE APPEARANCE OF HILLS ON THE FIN ISLAND TOGETHER WITH LINES OF WAVES IN FRONT OF THE FIN ISLAND IN THE CENTER OF THE CIRCLE.

SN 85-222,008, FILED 1-20-2011.

C. DIONNE CLYBURN, EXAMINING ATTORNEY



David J. Kyffers

Director of the United States Patent and Trademark Office

United States of America

United States Patent and Trademark Office

LRP+

Reg. No. 4,206,852

STEPHEN RUFF (UNITED STATES INDIVIDUAL)
874 MILLS ESTATE PLACE
CHULUOTA, FL 32766

Registered Sep. 11, 2012

Int. Cl.: 36

FOR: INSURANCE INFORMATION, IN CLASS 36 (U.S. CLS. 100, 101 AND 102).

SERVICE MARK

FIRST USE 1-2-2012; IN COMMERCE 1-2-2012.

PRINCIPAL REGISTER

THE MARK CONSISTS OF STANDARD CHARACTERS WITHOUT CLAIM TO ANY PARTICULAR FONT, STYLE, SIZE, OR COLOR.

SN 85-222,855, FILED 1-21-2011.

WILLIAM VERHOSEK, EXAMINING ATTORNEY



David J. Kyffers

Director of the United States Patent and Trademark Office

United States of America

United States Patent and Trademark Office



Reg. No. 4,206,853

Registered Sep. 11, 2012

Int. Cl.: 35

SERVICE MARK

PRINCIPAL REGISTER

INOVA, LLC (OREGON LIMITED LIABILITY COMPANY)
C/O 121 SW MORRISON #600
PORTLAND, OR 97204

FOR: BUSINESS SERVICES FOR CREDIT UNIONS, NAMELY, ADMINISTRATION OF A PROGRAM FOR ENABLING CREDIT UNIONS TO RECEIVE EXPEDITED SERVICES IN THE FIELD OF MARKETING; BUSINESS SERVICES FOR CREDIT UNIONS, NAMELY, COMBINED STRATEGIC GOODS OR SERVICES SOURCING AND COOPERATIVE PURCHASING FOR CREDIT UNIONS; PROCUREMENT CONSULTATION FOR CREDIT UNIONS, NAMELY, ANALYSIS AND REDEFINITION OF PURCHASING PROCESSES WITHIN THE FRAMEWORK OF EXPENDITURE RATIONALIZATION PROJECTS, IN CLASS 35 (U.S. CLS. 100, 101 AND 102).

FIRST USE 6-7-2012; IN COMMERCE 6-7-2012.

THE MARK CONSISTS OF THE WORDS "INOVA", "INNOVATION", AND "COLLABORATION" IN DARK BLUE (PMS 540) PRINTED OVER AN INCOMPLETE OVAL IN LIME GREEN (PMS 382) WITH THREE SMALL CIRCLES IN DARK BLUE (PMS 540) ABOVE THE LEFT SIDE OF THE OVAL, WITH A SHADOW IN SILVER (PMS 877) BELOW THE OVAL. THE WORDING "INOVA" APPEARS ABOVE THE TERMS "INNOVATION" AND "COLLABORATION". A SMALL, DARK BLUE (PMS 540) CIRCLE APPEARS BETWEEN THE TERMS "INNOVATION" AND "COLLABORATION".

THE COLOR(S) DARK BLUE (PMS 540), LIME GREEN (PM S382) AND SILVER (PMS 877) IS/ARE CLAIMED AS A FEATURE OF THE MARK.

SN 85-223,461, FILED 1-21-2011.

SETH A. RAPPAPORT, EXAMINING ATTORNEY



David J. Kyffers

Director of the United States Patent and Trademark Office

United States of America

United States Patent and Trademark Office

Brings you closer to home

Reg. No. 4,206,854

NATIONAL BANK OF PAKISTAN (PAKISTAN CORPORATION)
100 WALL STREET
NEW YORK, NY 10005

Registered Sep. 11, 2012

Int. Cl.: 36

FOR: ON-LINE BANKING SERVICES, IN CLASS 36 (U.S. CLS. 100, 101 AND 102).

SERVICE MARK

FIRST USE 7-27-2011; IN COMMERCE 7-27-2011.

PRINCIPAL REGISTER

THE MARK CONSISTS OF STANDARD CHARACTERS WITHOUT CLAIM TO ANY PARTICULAR FONT, STYLE, SIZE, OR COLOR.

SN 85-223,829, FILED 1-22-2011.

ROBERT C. CLARK JR., EXAMINING ATTORNEY



David J. Kyffers

Director of the United States Patent and Trademark Office

United States of America

United States Patent and Trademark Office



Reg. No. 4,206,855

IBL HOLDINGS LLC (DELAWARE LIMITED LIABILITY COMPANY)
1201 N ORANGE ST., SUITE 706
WILMINGTON, DE 19801

Registered Sep. 11, 2012

Int. Cl.: 25

FOR: MEN'S AND WOMEN'S CLOTHING, NAMELY, SPANDEX STYLE SHAPEWEAR PANTS, IN CLASS 25 (U.S. CLS. 22 AND 39).

TRADEMARK

FIRST USE 6-21-2012; IN COMMERCE 6-21-2012.

PRINCIPAL REGISTER

NO CLAIM IS MADE TO THE EXCLUSIVE RIGHT TO USE "ORIGINAL", APART FROM THE MARK AS SHOWN.

THE STIPPLING IS A FEATURE OF THE MARK AND DOES NOT INDICATE COLOR.

THE MARK CONSISTS OF THE WORDS "A BOJEANGLES ORIGINAL SKIN-EASE" WITHIN A BORDERED QUADRILATERAL BACKGROUND. THE WORD "BOJEANGLES" IS LOWER CASE LETTERS, THE WORD "ORIGINAL" AND "SKIN-EASE" ARE STYLIZED.

SN 85-223,925, FILED 1-23-2011.

DAVID TAYLOR, EXAMINING ATTORNEY



David J. Kyros

Director of the United States Patent and Trademark Office

United States of America

United States Patent and Trademark Office

PURE GROWTH PARTNERS

Reg. No. 4,206,856

PURE GROWTH PARTNERS LLC (DELAWARE LIMITED LIABILITY COMPANY)
25 FIELD POINT DRIVE
FAIRFIELD, CT 06824

Registered Sep. 11, 2012

Int. Cl.: 36

FOR: FINANCIAL SERVICES, NAMELY, PROVIDING VENTURE CAPITAL INVESTMENT FUNDING AND PRIVATE EQUITY INVESTMENT FUNDING, IN CLASS 36 (U.S. CLS. 100, 101 AND 102).

SERVICE MARK

FIRST USE 4-30-2011; IN COMMERCE 4-30-2011.

PRINCIPAL REGISTER

THE MARK CONSISTS OF STANDARD CHARACTERS WITHOUT CLAIM TO ANY PARTICULAR FONT, STYLE, SIZE, OR COLOR.

NO CLAIM IS MADE TO THE EXCLUSIVE RIGHT TO USE "GROWTH PARTNERS", APART FROM THE MARK AS SHOWN.

SN 85-225,270, FILED 1-25-2011.

B. PARADEWELAI, EXAMINING ATTORNEY



David J. Kyros

Director of the United States Patent and Trademark Office

United States of America

United States Patent and Trademark Office

MARATHON 6

Reg. No. 4,206,857

LUCIDPORT TECHNOLOGY, INC. (DELAWARE CORPORATION)
485 EAST EVELYN AVENUE
SUNNYVALE, CA 94086

Registered Sep. 11, 2012

Int. Cl.: 9

FOR: SECURITY ENCRYPTION DEVICE, NAMELY, ELECTRONIC ENCRYPTION UNITS;
SOFTWARE FOR SECURITY ENCRYPTION DEVICES, NAMELY, OPERATING SOFTWARE
FOR ELECTRONIC ENCRYPTION UNITS; INTEGRATED CIRCUITS FOR SECURITY EN-
CRYPTION APPLICATIONS, IN CLASS 9 (U.S. CLS. 21, 23, 26, 36 AND 38).

TRADEMARK

PRINCIPAL REGISTER

FIRST USE 5-0-2011; IN COMMERCE 5-0-2011.

THE MARK CONSISTS OF STANDARD CHARACTERS WITHOUT CLAIM TO ANY PAR-
TICULAR FONT, STYLE, SIZE, OR COLOR.

SN 85-225,459, FILED 1-25-2011.

GRETCHEN ULRICH, EXAMINING ATTORNEY



David J. Kyffers

Director of the United States Patent and Trademark Office

United States of America

United States Patent and Trademark Office



Reg. No. 4,206,858

BUNGE OILS, INC. (DELAWARE CORPORATION)
11720 BORMAN DRIVE
ST. LOUIS, MO 63146

Registered Sep. 11, 2012

Int. Cl.: 30

FOR: PROCESSED GARLIC FOR USE AS SEASONING; MINCED GARLIC, REHYDRATED GARLIC; POWDERED GARLIC, IN CLASS 30 (U.S. CL. 46).

TRADEMARK

FIRST USE 4-0-2009; IN COMMERCE 4-0-2009.

PRINCIPAL REGISTER

OWNER OF U.S. REG. NOS. 2,374,882, 2,426,989, AND 3,834,087.

NO CLAIM IS MADE TO THE EXCLUSIVE RIGHT TO USE "GARLIC" AND THE PICTORIAL REPRESENTATION OF GARLIC, APART FROM THE MARK AS SHOWN.

THE MARK CONSISTS OF A REPRESENTATION OF A GLOBE OF THE WORLD SHOWING THE EASTERN HEMISPHERE AND WITH A BANNER LOCATED ABOVE THE GLOBE CONTAINING THE WORDS "OLD WORLD" AND A BANNER ACROSS THE BOTTOM OF THE GLOBE CONTAINING THE WORD "GARLIC". LOCATED ON EACH SIDE OF THE BOTTOM BANNER ARE TWO GARLIC CLOVES.

SN 85-225,757, FILED 1-25-2011.

KATHLEEN LORENZO, EXAMINING ATTORNEY



David J. Kyjars

Director of the United States Patent and Trademark Office

United States of America

United States Patent and Trademark Office

WHERE THE CART IS JUST THE START

Reg. No. 4,206,859

Registered Sep. 11, 2012

Int. Cls.: 9, 11, and 12

TRADEMARK

PRINCIPAL REGISTER

BUGGIES UNLIMITED LLC (KENTUCKY LIMITED LIABILITY COMPANY)
701 S. KEENELAND DR.
RICHMOND, KY 40475

FOR: AFTERMARKET PARTS FOR GAS, ELECTRIC AND HYBRID POWERED GOLF CARTS, LAND VEHICLES, AND ALL-TERRAIN VEHICLES, NAMELY, BATTERIES; BATTERY CHARGERS; BATTERY MAINTENANCE PARTS IN THE NATURE OF BATTERY REPLACEMENT PARTS IN THE NATURE OF CABLES AND CONNECTORS, BATTERY RODS, BATTERY CABLES; RADIOS; RADIO KITS COMPRISED OF RADIO RECEIVERS, ANTENNAS, SPEAKERS, WIRING, AND HARDWARE; ENGINE PARTS, NAMELY, AM-METERS, CAPACITORS AND CIRCUIT BREAKERS, FUSES FOR VEHICLES AND GOLF CARTS, DIODES, ELECTRICAL CABLES, HEAVY DUTY ELECTRONIC CONTROLLERS; CORD SETS COMPRISED OF ELECTRIC CHARGING CABLES FOR VEHICLES AND FOR GAS, ELECTRIC AND HYBRID POWERED GOLF CARTS, IN CLASS 9 (U.S. CLS. 21, 23, 26, 36 AND 38).

FIRST USE 10-1-2010; IN COMMERCE 3-1-2012.

FOR: KITS COMPRISED OF HALOGEN HEADLIGHTS AND TAIL LIGHTS PREMOUNTED IN PLASTIC BEZEL, A WIRING HARNESS, AND AN ON/OFF SWITCH; BRAKE LIGHTS, IN CLASS 11 (U.S. CLS. 13, 21, 23, 31 AND 34).

FIRST USE 10-1-2010; IN COMMERCE 3-1-2012.

FOR: AFTERMARKET PARTS FOR GAS, ELECTRIC AND HYBRID POWERED GOLF CARTS, LAND VEHICLES, AND ALL-TERRAIN VEHICLES, NAMELY, TIRES AND WHEELS; TIRE AND WHEEL ASSEMBLIES; TORQUE KITS COMPRISED OF MOTORS FOR VEHICLES AND GAS, ELECTRIC AND HYBRID POWERED GOLF CARTS, CONTROLLERS, CABLES, HEAVY DUTY SOLENOID, RESISTORS, FORWARD AND REVERSE ASSEMBLIES, JUMPER LEADS, AND HARDWARE; BRAKES FOR VEHICLES AND GAS, ELECTRIC AND HYBRID POWERED GOLF CARTS; STEERING WHEELS FOR VEHICLES AND GAS, ELECTRIC AND HYBRID POWERED GOLF CARTS AND STEERING WHEEL COVERS; WINDSHIELD WIPERS AND WINDSHIELD WIPER KITS COMPRISED OF WINDSHIELD WIPERS AND MOTOR; TURN SIGNAL KITS FOR GAS, ELECTRIC AND HYBRID POWERED GOLF CARTS, LAND VEHICLES, AND ALL-TERRAIN VEHICLES COMPRISED OF TURN SIGNAL HANDLES, SWITCH ASSEMBLIES, THREE-PIN HAZARD FLASHERS, AND ABS PLASTIC STEERING COLUMN SLEEVES; CLUTCHES FOR



David J. Kyjars

Director of the United States Patent and Trademark Office

Reg. No. 4,206,859 VEHICLES AND FOR GAS, ELECTRIC AND HYBRID POWERED GOLF CARTS; AFTER-MARKET PARTS/ACCESSORIES FOR GOLF CARTS, LAND VEHICLES, AND ALL-TERRAIN VEHICLES, NAMELY, ENCLOSURES IN THE NATURE OF PROTECTIVE COVERS FOR GAS, ELECTRIC AND HYBRID POWERED GOLF CARTS, LAND VEHICLES, AND ALL-TERRAIN VEHICLES; AFTERMARKET PARTS/ACCESSORIES FOR GAS, ELECTRIC AND HYBRID POWERED GOLF CARTS, LAND VEHICLES, AND ALL-TERRAIN VEHICLES, NAMELY, ENCLOSURES IN THE NATURE OF PROTECTIVE COVERS FOR GAS, ELECTRIC AND HYBRID POWERED GOLF CARTS, LAND VEHICLES, AND ALL-TERRAIN VEHICLES; LAND VEHICLE AND ELECTRIC AND HYBRID POWERED GOLF CART STORAGE SOLUTIONS IN THE NATURE OF UNDERSEAT STORAGE TRAYS, SHELF OVERHEAD STORAGE TRAYS, GLOVE BOX ORGANIZING TRAYS, TRUNKS, ATTACHABLE SEAT STORAGE BAGS; CARGO BASKETS ADAPTED FOR GAS, ELECTRIC AND HYBRID POWERED GOLF CARTS; REAR SEAT KITS COMPRISED OF A VEHICLE AND GOLF CART SEAT BACKS AND HARDWARE, IN CLASS 12 (U.S. CLS. 19, 21, 23, 31, 35 AND 44).

FIRST USE 10-1-2010; IN COMMERCE 3-1-2012.

THE MARK CONSISTS OF STANDARD CHARACTERS WITHOUT CLAIM TO ANY PARTICULAR FONT, STYLE, SIZE, OR COLOR.

SN 85-226,052, FILED 1-25-2011.

BRIDGETT SMITH, EXAMINING ATTORNEY

United States of America
United States Patent and Trademark Office

IDLEWILD

Reg. No. 4,206,860

Registered Sep. 11, 2012

Int. Cl.: 9

TRADEMARK

PRINCIPAL REGISTER

THE HOEFLER TYPE FOUNDRY, INC. (NEW YORK CORPORATION), DBA HOEFLER &
FRERE-JONES,
611 BROADWAY ROOM 725
NEW YORK, NY 100122608

FOR: FONTS, NAMELY, PRE-RECORDED ELECTRONIC AND DIGITAL MEDIA FEATURING
FONT TYPEFACES, TYPEFACE DESIGNS AND TYPOGRAPHICAL ORNAMENTS;
DOWNLOADABLE PRINTING FONTS, IN CLASS 9 (U.S. CLS. 21, 23, 26, 36 AND 38).

FIRST USE 6-5-2012; IN COMMERCE 6-5-2012.

THE MARK CONSISTS OF STANDARD CHARACTERS WITHOUT CLAIM TO ANY PAR-
TICULAR FONT, STYLE, SIZE, OR COLOR.

SN 85-228,739, FILED 1-28-2011.

KATHRYN COWARD, EXAMINING ATTORNEY



David J. Kybas

Director of the United States Patent and Trademark Office

United States of America

United States Patent and Trademark Office

NEWAVE

Reg. No. 4,206,861

DJB GROUP LLC (OHIO LIMITED LIABILITY COMPANY)
5566 CAPLESTONE LANE
DUBLIN, OH 43017 AND

Registered Sep. 11, 2012

**Int. Cls.: 9, 35, 37, 41,
and 42**

WISTRON NEWEB CORPORATION (TAIWAN CORPORATION)
20 PARK AVENUE II, HSINCHU SCIENCE PARK
HSINCHU 308, TAIWAN

TRADEMARK

SERVICE MARK

PRINCIPAL REGISTER

FOR: RADIO FREQUENCY IDENTIFICATION (RFID) SYSTEMS AND DEVICES, NAMELY, RADIO FREQUENCY (RFID) ANTENNAS, RADIO FREQUENCY IDENTIFICATION (RFID) CARDS AND READERS, RADIO FREQUENCY IDENTIFICATION (RFID) READERS AND TAGS; RADIO FREQUENCY IDENTIFICATION (RFID) NETWORKING SYSTEMS CONSISTING OF ADAPTERS, ACCESS POINTS, WIDE AREA NETWORK CIRCUIT BOARDS, RADIO FREQUENCY MODULES, PRINTER SHARING CIRCUIT BOARDS, A COMMUNICATION GATEWAY ROUTER, COMPUTER SERVERS, ANTENNAE, AND SOFTWARE, NAMELY, DRIVERS AND INSTALLATION, CONFIGURATION, AND DIAGNOSTIC PROGRAMS; OPERATING SYSTEM SOFTWARE FOR RADIO FREQUENCY IDENTIFICATION (RFID) TAGS AND SENSORS; RADIO NETWORKING SYSTEMS COMPRISED OF ROUTERS, RFID READERS, STATIONARY AND HAND-HELD READERS, ANTENNAE, TAGS, AND SENSORS FOR LOCAL AREA NETWORKS, METROPOLITAN AREA NETWORKS, AND WIDE AREA NETWORKS; ELECTRICAL SENSORS; VIDEO AND AUDIO SENSORS; SENSORS FOR FLOOR HEATING SYSTEMS; VIBRATION SENSORS; ULTRASONIC SENSORS; TIMING SENSORS; TEMPERATURE SENSORS; VELOCITY, POSITION, AND ACCELERATION SENSORS; SENSOR CHIPS FOR SCIENTIFIC USE; CHEMICAL SENSORS; SAFETY SENSORS; PRESSURE SENSORS; POLLUTANT SENSORS; PHOTOELECTRIC SENSORS; MOTION SENSORS; OPTICAL SENSORS; LIQUID LEVEL SENSORS; HUMIDITY SENSORS; SECURITY SENSORS; ELECTRONIC ARTICLE SURVEILLANCE SENSORS, IN CLASS 9 (U.S. CLS. 21, 23, 26, 36 AND 38).



FIRST USE 7-10-2012; IN COMMERCE 7-10-2012.

David J. Kybas

Director of the United States Patent and Trademark Office

FOR: DISTRIBUTORSHIP SERVICES FEATURING RFID AND ANTENNA TECHNOLOGY-BASED PRODUCTS AND HARDWARE; RESELLER SERVICES, NAMELY, DISTRIBUTORSHIP SERVICES IN THE FIELD OF RFID SENSING NETWORKS; VALUE-ADDED RESELLER SERVICES, NAMELY, DISTRIBUTORSHIP SERVICES FEATURING RFID ANTENNAE, READERS, TAGS AND SOFTWARE; WHOLESALE STORE SERVICES FEATURING RFID AND ANTENNA TECHNOLOGY-BASED PRODUCTS AND COMPONENTS, ANTENNAE,

Reg. No. 4,206,861 READERS, TAGS, ASSOCIATED SOFTWARE AND SUPPORT SERVICES; ON-LINE WHOLESALE STORE SERVICES FEATURING RFID AND ANTENNA TECHNOLOGY-BASED PRODUCTS AND COMPONENTS, ANTENNAE, READERS, TAGS, ASSOCIATED SOFTWARE AND SUPPORT SERVICES; PROVIDING A WEBSITE FEATURING CONSUMER INFORMATION ABOUT RFID AND ANTENNA TECHNOLOGY, RFID AND ANTENNA TECHNOLOGY-BASED PRODUCTS, AND RFID AND ANTENNA TECHNOLOGY APPLICATIONS, IN CLASS 35 (U.S. CLS. 100, 101 AND 102).

FIRST USE 7-10-2012; IN COMMERCE 7-10-2012.

FOR: INSTALLATION OF RFID-RELATED HARDWARE; TECHNICAL SUPPORT SERVICES, NAMELY, TROUBLESHOOTING IN THE NATURE OF THE REPAIR OF RFID AND RELATED COMPUTER HARDWARE; PROVIDING INFORMATION RELATED TO THE INSTALLATION, MAINTENANCE AND REPAIR OF RFID AND ANTENNA TECHNOLOGY AND RFID AND ANTENNA TECHNOLOGY-BASED PRODUCTS, IN CLASS 37 (U.S. CLS. 100, 103 AND 106).

FIRST USE 7-10-2012; IN COMMERCE 7-10-2012.

FOR: TRAINING SERVICES IN THE FIELD OF RFID HARDWARE, SOFTWARE, AND ASSOCIATED SUPPORT SERVICES, IN CLASS 41 (U.S. CLS. 100, 101 AND 107).

FIRST USE 7-10-2012; IN COMMERCE 7-10-2012.

FOR: INSTALLATION OF RFID-RELATED SOFTWARE; TECHNICAL SUPPORT SERVICES, NAMELY, TROUBLESHOOTING IN THE NATURE OF DIAGNOSING RFID AND RELATED COMPUTER HARDWARE AND SOFTWARE PROBLEMS; RFID AND RELATED COMPUTER TECHNOLOGY SUPPORT SERVICES, NAMELY, HELP DESK SERVICES; RESEARCH AND PRODUCT DEVELOPMENT SERVICES FOR OTHERS; TECHNICAL CONSULTING SERVICES IN THE FIELD OF RFID AND ANTENNA TECHNOLOGY AND APPLICATIONS THEREFORE; PROVIDING TECHNOLOGICAL AND SCIENTIFIC INFORMATION IN THE FIELD OF RFID AND ANTENNA TECHNOLOGY, RFID AND ANTENNA TECHNOLOGY-BASED PRODUCTS, RFID AND ANTENNA TECHNOLOGY APPLICATIONS, IN CLASS 42 (U.S. CLS. 100 AND 101).

FIRST USE 7-10-2012; IN COMMERCE 7-10-2012.

THE MARK CONSISTS OF STANDARD CHARACTERS WITHOUT CLAIM TO ANY PARTICULAR FONT, STYLE, SIZE, OR COLOR.

SN 85-228,877, FILED 1-28-2011.

CAROLINE WOOD, EXAMINING ATTORNEY

United States of America

United States Patent and Trademark Office

WORLD OF STAINS

Reg. No. 4,206,862

HAWLEY PARK, L.L.C. (UTAH LIMITED LIABILITY COMPANY)
9500 SOUTH HAWLEY PARK ROAD
WEST JORDAN, UT 84084

Registered Sep. 11, 2012

Int. Cl.: 2

FOR: COATINGS, NAMELY, STAINS AND CLEAR FINISHES FOR EXTERIOR AND INTERIOR USE ON A VARIETY OF SUBSTRATES, IN CLASS 2 (U.S. CLS. 6, 11 AND 16).

TRADEMARK

FIRST USE 9-0-2009; IN COMMERCE 9-0-2009.

PRINCIPAL REGISTER

THE MARK CONSISTS OF STANDARD CHARACTERS WITHOUT CLAIM TO ANY PARTICULAR FONT, STYLE, SIZE, OR COLOR.

NO CLAIM IS MADE TO THE EXCLUSIVE RIGHT TO USE "STAINS", APART FROM THE MARK AS SHOWN.

SN 85-228,988, FILED 1-28-2011.

DOMINICK J. SALEMI, EXAMINING ATTORNEY



David J. Kybas

Director of the United States Patent and Trademark Office

United States of America

United States Patent and Trademark Office

3-D MOVIE THEATER 3-D STORYBOOK & MOVIE PROJECTOR

Reg. No. 4,206,863

Registered Sep. 11, 2012

Int. Cl.: 16

TRADEMARK

PRINCIPAL REGISTER

THE READER'S DIGEST ASSOCIATION, INC. (DELAWARE CORPORATION)
LEGAL DEPT
44 SOUTH BROADWAY
WHITE PLAINS, NY 10601

FOR: CHILDREN'S BOOKS, IN CLASS 16 (U.S. CLS. 2, 5, 22, 23, 29, 37, 38 AND 50).

FIRST USE 8-2-2011; IN COMMERCE 8-2-2011.

THE MARK CONSISTS OF STANDARD CHARACTERS WITHOUT CLAIM TO ANY PARTICULAR FONT, STYLE, SIZE, OR COLOR.

OWNER OF U.S. REG. NO. 2,907,708.

NO CLAIM IS MADE TO THE EXCLUSIVE RIGHT TO USE "3-D STORYBOOK & MOVIE PROJECTOR", APART FROM THE MARK AS SHOWN.

SN 85-229,764, FILED 1-31-2011.

JEFFERY COWARD, EXAMINING ATTORNEY



David J. Kyros

Director of the United States Patent and Trademark Office

United States of America
United States Patent and Trademark Office

Quad 
 **PLUS**

Reg. No. 4,206,864

METAL MASTERS FOODSERVICE EQUIPMENT CO., INC. (DELAWARE CORPORATION)
100 INDUSTRIAL BOULEVARD
CLAYTON, DE 19938

Registered Sep. 11, 2012

Int. Cl.: 20

FOR: SHELVING, IN CLASS 20 (U.S. CLS. 2, 13, 22, 25, 32 AND 50).

TRADEMARK

FIRST USE 2-20-2012; IN COMMERCE 2-20-2012.

PRINCIPAL REGISTER

NO CLAIM IS MADE TO THE EXCLUSIVE RIGHT TO USE "QUAD", APART FROM THE MARK AS SHOWN.

SN 85-230,901, FILED 2-1-2011.

KATHERINE CHANG, EXAMINING ATTORNEY



David J. Kyros

Director of the United States Patent and Trademark Office

United States of America

United States Patent and Trademark Office

QUAD PLUS

Reg. No. 4,206,865

Registered Sep. 11, 2012

Int. Cl.: 20

TRADEMARK

PRINCIPAL REGISTER

METAL MASTERS FOODSERVICE EQUIPMENT CO., INC. (DELAWARE CORPORATION)
100 INDUSTRIAL BOULEVARD
CLAYTON, DE 19938

FOR: SHELVING, IN CLASS 20 (U.S. CLS. 2, 13, 22, 25, 32 AND 50).

FIRST USE 2-20-2012; IN COMMERCE 2-20-2012.

THE MARK CONSISTS OF STANDARD CHARACTERS WITHOUT CLAIM TO ANY PARTICULAR FONT, STYLE, SIZE, OR COLOR.

NO CLAIM IS MADE TO THE EXCLUSIVE RIGHT TO USE "QUAD", APART FROM THE MARK AS SHOWN.

SN 85-230,921, FILED 2-1-2011.

KATHERINE CHANG, EXAMINING ATTORNEY



David J. Kybas

Director of the United States Patent and Trademark Office

United States of America

United States Patent and Trademark Office



Reg. No. 4,206,866

OKE, IRMA (UNITED STATES INDIVIDUAL)
20028 GIANTSTEP TER
MONTGOMERY VILLAGE, MD 20886

Registered Sep. 11, 2012

Int. Cl.: 30

FOR: COOKIES AND CRACKERS, IN CLASS 30 (U.S. CL. 46).

TRADEMARK

FIRST USE 10-22-2011; IN COMMERCE 10-22-2011.

PRINCIPAL REGISTER

NO CLAIM IS MADE TO THE EXCLUSIVE RIGHT TO USE "CROUSTILLANTS" , APART FROM THE MARK AS SHOWN.

THE MARK CONSISTS OF THE STYLIZED TEXT "LES CROUSTILLANTS DU SOLEIL" WITH A HALF SUN WITH SPIKES.

THE ENGLISH TRANSLATION OF "LES CROUSTILLANTS DU SOLEIL" IN THE MARK IS "CRISPY FOODS OF THE SUN".

SN 85-231,047, FILED 2-1-2011.

INGRID C. EULIN, EXAMINING ATTORNEY



David J. Kybas

Director of the United States Patent and Trademark Office

United States of America

United States Patent and Trademark Office

SANGSIN Hi-Q

Reg. No. 4,206,867

Registered Sep. 11, 2012

Int. Cl.: 12

TRADEMARK

PRINCIPAL REGISTER

SANGSIN BRAKE CO.,LTD. (REPUBLIC OF KOREA CORPORATION)
1-37, BUK-RI, NONGONG-EUP, DALSEONG-GUN
DAEGU, REPUBLIC OF KOREA

FOR: BRAKE LININGS FOR VEHICLES; BRAKE PADS FOR VEHICLES; BRAKE SHOES ASSEMBLY FOR VEHICLES; HAND BRAKE SHOES ASSEMBLY FOR VEHICLES; BRAKE BRACKET ASSEMBLY FOR VEHICLES; BRAKES FOR AUTOMOBILES; PLASTIC PARTS FOR VEHICLES, NAMELY, EXTERIOR DECORATIVE SIDE TRIM FOR LAND VEHICLES; BLOCK BRAKES FOR VEHICLES; CONICAL BRAKES FOR VEHICLES; BRAKE FORKS FOR VEHICLES; DISK BRAKES FOR LAND VEHICLES; BAND BRAKES FOR VEHICLES; RUBBER TRANSMISSION BELTS FOR LAND VEHICLES; DRIVING CHAINS FOR LAND VEHICLES; ROLLER CHAINS FOR LAND VEHICLES; CLUTCHES FOR LAND VEHICLES; LEATHER SEAT BELTS FOR LAND VEHICLES; WINDSHIELD WIPERS FOR LAND VEHICLES; POWER TRANSMISSION BELT FOR AUTOMOBILE; SEAT COVERS FOR AUTOMOBILES; SAFETY SEATS FOR CHILDREN FOR AUTOMOBILES; SEATS FOR AUTOMOBILE, IN CLASS 12 (U.S. CLS. 19, 21, 23, 31, 35 AND 44).

FIRST USE 6-19-2011; IN COMMERCE 6-19-2011.

THE MARK CONSISTS OF STANDARD CHARACTERS WITHOUT CLAIM TO ANY PARTICULAR FONT, STYLE, SIZE, OR COLOR.

SN 85-231,270, FILED 2-1-2011.

AHSEN KHAN, EXAMINING ATTORNEY



David J. Kybas

Director of the United States Patent and Trademark Office

United States of America

United States Patent and Trademark Office

BONEMAP: BONE MEASUREMENT ASSESSMENT PROGRAM

Reg. No. 4,206,868

AMGEN INC. (DELAWARE CORPORATION)
ONE AMGEN CENTER DRIVE
THOUSAND OAKS, CA 913201799

Registered Sep. 11, 2012

Int. Cl.: 44

FOR: PROVIDING MEDICAL INFORMATION RELATING TO THE TREATMENT AND MANAGEMENT OF OSTEOPOROSIS AND BONE DISEASE; PROVIDING MEDICAL REPORTS REGARDING PATIENTS BEING TREATED FOR OSTEOPOROSIS AND BONE DISEASE, IN CLASS 44 (U.S. CLS. 100 AND 101).

SERVICE MARK

PRINCIPAL REGISTER

FIRST USE 10-31-2010; IN COMMERCE 10-31-2010.

THE MARK CONSISTS OF STANDARD CHARACTERS WITHOUT CLAIM TO ANY PARTICULAR FONT, STYLE, SIZE, OR COLOR.

NO CLAIM IS MADE TO THE EXCLUSIVE RIGHT TO USE "BONE MEASUREMENT ASSESSMENT PROGRAM", APART FROM THE MARK AS SHOWN.

SN 85-231,461, FILED 2-1-2011.

KEVON CHISOLM, EXAMINING ATTORNEY



David J. Kyffers

Director of the United States Patent and Trademark Office

United States of America

United States Patent and Trademark Office

TALOS
— DATA VAULT —



Reg. No. 4,206,869

Registered Sep. 11, 2012

Int. Cls.: 39 and 42

SERVICE MARK

PRINCIPAL REGISTER

ACH DIRECT, INC. (CALIFORNIA CORPORATION)
SUITE 200
500 W. BETHANY DRIVE
ALLEN, TX 75013

FOR: ELECTRONIC STORAGE OF PAYMENT TRANSACTION DATA AND PHYSICAL STORAGE OF ELECTRONICALLY-STORED DATA IN THE FIELD OF ELECTRONIC PAYMENTS, IN CLASS 39 (U.S. CLS. 100 AND 105).

FIRST USE 6-8-2012; IN COMMERCE 6-8-2012.

FOR: DATA ENCRYPTION AND DECRYPTION SERVICES IN THE FIELD OF ELECTRONIC PAYMENTS, IN CLASS 42 (U.S. CLS. 100 AND 101).

FIRST USE 6-8-2012; IN COMMERCE 6-8-2012.

NO CLAIM IS MADE TO THE EXCLUSIVE RIGHT TO USE "DATA", APART FROM THE MARK AS SHOWN.

THE MARK CONSISTS OF THE WORD "TALOS", IN ALL CAPITAL LETTERS AND HAVING A HORIZONTAL LINE ABOVE THE "O", ABOVE A PAIR OF HORIZONTAL LINES DISPOSED ON EITHER SIDE OF THE PHRASE "DATA VAULT", WHICH IS ALL TO THE LEFT OF A GREEK HELMET.

SN 85-231,515, FILED 2-1-2011.

APRIL HESIK, EXAMINING ATTORNEY



David J. Kyros

Director of the United States Patent and Trademark Office

United States of America

United States Patent and Trademark Office

STACK-IT: SOCIAL, TACTICAL AND CULTURAL KNOWLEDGE INFORMATION TOOLKIT

Reg. No. 4,206,870

CHI SYSTEMS INC. (PENNSYLVANIA CORPORATION)
1035 VIRGINIA DRIVE, SUITE 300
FORT WASHINGTON, PA 19034

Registered Sep. 11, 2012

Int. Cl.: 42

FOR: COMPUTER SERVICES, CREATING SOFTWARE FOR OTHERS TO SUPPORT THE ANALYSIS AND PRESENTATION OF TACTICAL, CULTURAL, SOCIAL, AND INTELLIGENCE INFORMATION BY APPLYING ADVANCED VISUALIZATION AND DECISION SUPPORT TECHNOLOGIES, IN CLASS 42 (U.S. CLS. 100 AND 101).

SERVICE MARK

PRINCIPAL REGISTER

FIRST USE 12-1-2011; IN COMMERCE 12-1-2011.

THE MARK CONSISTS OF STANDARD CHARACTERS WITHOUT CLAIM TO ANY PARTICULAR FONT, STYLE, SIZE, OR COLOR.

NO CLAIM IS MADE TO THE EXCLUSIVE RIGHT TO USE "SOCIAL, TACTICAL AND CULTURAL KNOWLEDGE INFORMATION TOOLKIT", APART FROM THE MARK AS SHOWN.

SN 85-233,208, FILED 2-3-2011.

DEIRDRE ROBERTSON, EXAMINING ATTORNEY



David J. Kybas

Director of the United States Patent and Trademark Office

United States of America

United States Patent and Trademark Office



Reg. No. 4,206,871

Registered Sep. 11, 2012

Int. Cl.: 39

SERVICE MARK

PRINCIPAL REGISTER

AMERICAN EXPRESS MARKETING & DEVELOPMENT CORP. (DELAWARE CORPORATION)
200 VESEY STREET
NEW YORK, NY 10285

FOR: ARRANGING TRAVEL TOURS FEATURING A CUSTOMIZED MYSTERY TRIP BASED ON RESPONSES TO A QUIZ; ARRANGING A CUSTOMIZED MYSTERY TRIP BASED ON RESPONSES TO A QUIZ, NAMELY, MAKING RESERVATIONS AND BOOKINGS FOR TRANSPORTATION, IN CLASS 39 (U.S. CLS. 100 AND 105).

FIRST USE 4-6-2011; IN COMMERCE 4-6-2011.

OWNER OF U.S. REG. NOS. 3,157,593, 3,473,542, AND OTHERS.

THE MARK CONSISTS OF THE TERM "RUSTIKEER" WITHIN A DIAMOND. THE BACKGROUND OF THE DIAMOND IS COVERED IN LETTERS SPELLING "AMERICAN EXPRESS".

SN 85-233,428, FILED 2-3-2011.

KYLE PEETE, EXAMINING ATTORNEY



David J. Kyjars

Director of the United States Patent and Trademark Office

United States of America

United States Patent and Trademark Office



Reg. No. 4,206,872

Registered Sep. 11, 2012

Int. Cl.: 39

SERVICE MARK

PRINCIPAL REGISTER

AMERICAN EXPRESS MARKETING & DEVELOPMENT CORP. (DELAWARE CORPORATION)
200 VESEY STREET
NEW YORK, NY 10285

FOR: ARRANGING TRAVEL TOURS, NAMELY, CUSTOMIZED MYSTERY TRIP BASED ON RESPONSES TO A QUIZ; CUSTOMIZED MYSTERY TRIP BASED ON RESPONSES TO A QUIZ, NAMELY, MAKING RESERVATIONS AND BOOKINGS FOR TRANSPORTATION, IN CLASS 39 (U.S. CLS. 100 AND 105).

FIRST USE 4-6-2011; IN COMMERCE 4-6-2011.

NO CLAIM IS MADE TO THE EXCLUSIVE RIGHT TO USE "TRAVEL", APART FROM THE MARK AS SHOWN.

THE MARK CONSISTS OF THE TERM "SCENESTER" AND SUNGLASSES WITHIN A BADGE. THE BACKGROUND OF THE BADGE IS COVERED IN LETTERS SPELLING "AMERICAN EXPRESS TRAVEL".

SN 85-233,448, FILED 2-3-2011.

KYLE PEETE, EXAMINING ATTORNEY



David J. Kyros

Director of the United States Patent and Trademark Office

United States of America

United States Patent and Trademark Office



Reg. No. 4,206,873

Registered Sep. 11, 2012

Int. Cl.: 39

SERVICE MARK

PRINCIPAL REGISTER

AMERICAN EXPRESS MARKETING & DEVELOPMENT CORP. (DELAWARE CORPORATION)
200 VESEY STREET
NEW YORK, NY 10285

FOR: ARRANGING TRAVEL TOURS FEATURING A CUSTOMIZED MYSTERY TRIP BASED ON RESPONSES TO A QUIZ; ARRANGING A CUSTOMIZED MYSTERY TRIP BASED ON RESPONSES TO A QUIZ, NAMELY, MAKING RESERVATIONS AND BOOKINGS FOR TRANSPORTATION, IN CLASS 39 (U.S. CLS. 100 AND 105).

FIRST USE 4-6-2011; IN COMMERCE 4-6-2011.

OWNER OF U.S. REG. NOS. 3,157,593, 3,473,542, AND OTHERS.

NO CLAIM IS MADE TO THE EXCLUSIVE RIGHT TO USE "CYBER", APART FROM THE MARK AS SHOWN.

THE MARK CONSISTS OF THE WORDING "CYBER SURVIVOR" WITHIN AN INDIAN TOTEM WITHIN A DIAMOND. THE BACKGROUND OF THE DIAMOND IS COVERED IN LETTERS SPELLING "AMERICAN EXPRESS".

SN 85-233,458, FILED 2-3-2011.

KYLE PEETE, EXAMINING ATTORNEY



David J. Kyffers

Director of the United States Patent and Trademark Office

United States of America

United States Patent and Trademark Office



Reg. No. 4,206,874

Registered Sep. 11, 2012

Int. Cl.: 39

SERVICE MARK

PRINCIPAL REGISTER

AMERICAN EXPRESS MARKETING & DEVELOPMENT CORP. (DELAWARE CORPORATION)
200 VESEY STREET
NEW YORK, NY 10285

FOR: ARRANGING TRAVEL TOURS FEATURING A CUSTOMIZED MYSTERY TRIP BASED ON RESPONSES TO A QUIZ; ARRANGING A CUSTOMIZED MYSTERY TRIP BASED ON RESPONSES TO A QUIZ, NAMELY, MAKING RESERVATIONS AND BOOKINGS FOR TRANSPORTATION, IN CLASS 39 (U.S. CLS. 100 AND 105).

FIRST USE 4-6-2011; IN COMMERCE 4-6-2011.

OWNER OF U.S. REG. NOS. 3,157,593, 3,473,542, AND OTHERS.

THE MARK CONSISTS OF THE TERM "CELEBUTANTE", A TOP HAT AND BOW TIE WITHIN A BADGE. THE BACKGROUND OF THE BADGE IS COVERED IN LETTERS SPELLING "AMERICAN EXPRESS".

SN 85-233,469, FILED 2-3-2011.

KYLE PEETE, EXAMINING ATTORNEY



David J. Kyjars

Director of the United States Patent and Trademark Office

United States of America

United States Patent and Trademark Office



Reg. No. 4,206,875

Registered Sep. 11, 2012

Int. Cl.: 39

SERVICE MARK

PRINCIPAL REGISTER

AMERICAN EXPRESS MARKETING & DEVELOPMENT CORP. (DELAWARE CORPORATION)
200 VESEY STREET
NEW YORK, NY 10285

FOR: ARRANGING TRAVEL TOURS FEATURING A CUSTOMIZED MYSTERY TRIP BASED ON RESPONSES TO A QUIZ; ARRANGING A CUSTOMIZED MYSTERY TRIP BASED ON RESPONSES TO A QUIZ, NAMELY, MAKING RESERVATIONS AND BOOKINGS FOR TRANSPORTATION, IN CLASS 39 (U.S. CLS. 100 AND 105).

FIRST USE 4-6-2011; IN COMMERCE 4-6-2011.

OWNER OF U.S. REG. NOS. 3,157,593, 3,473,542, AND OTHERS.

THE MARK CONSISTS OF THE TERM "HILOMAT" AND A CIRCLE WITHIN A BADGE. THE BACKGROUND OF THE BADGE IS COVERED IN LETTERS SPELLING "AMERICAN EXPRESS".

SN 85-233,489, FILED 2-3-2011.

KYLE PEETE, EXAMINING ATTORNEY



David J. Kyffers

Director of the United States Patent and Trademark Office

United States of America

United States Patent and Trademark Office



Reg. No. 4,206,876

Registered Sep. 11, 2012

Int. Cl.: 39

SERVICE MARK

PRINCIPAL REGISTER

AMERICAN EXPRESS MARKETING & DEVELOPMENT CORP. (DELAWARE CORPORATION)
200 VESEY STREET
NEW YORK, NY 10285

FOR: ARRANGING TRAVEL TOURS FEATURING A CUSTOMIZED MYSTERY TRIP BASED ON RESPONSES TO A QUIZ; ARRANGING A CUSTOMIZED MYSTERY TRIP BASED ON RESPONSES TO A QUIZ, NAMELY, MAKING RESERVATIONS AND BOOKINGS FOR TRANSPORTATION, IN CLASS 39 (U.S. CLS. 100 AND 105).

FIRST USE 4-6-2011; IN COMMERCE 4-6-2011.

OWNER OF U.S. REG. NOS. 3,157,593, 3,473,542, AND OTHERS.

THE MARK CONSISTS OF THE TERM "ADRENALISTA" WITH A HAND HOLDING A LIGHTNING BOLT WITHIN A BADGE. THE BACKGROUND OF THE BADGE IS COVERED IN LETTERS SPELLING "AMERICAN EXPRESS".

SN 85-233,549, FILED 2-3-2011.

KYLE PEETE, EXAMINING ATTORNEY



David J. Kyjars

Director of the United States Patent and Trademark Office

United States of America
United States Patent and Trademark Office

BAKEWISE
BRANDS

Reg. No. 4,206,877

BAKEWISE BRANDS, INC. (DELAWARE CORPORATION)
1688 NORTH WAYNEPORT ROAD
MACEDON, NY 145028765

Registered Sep. 11, 2012

Int. Cl.: 39

FOR: DISTRIBUTION SERVICES, NAMELY, DELIVERY OF WHOLESALE FOOD PRODUCTS, IN CLASS 39 (U.S. CLS. 100 AND 105).

SERVICE MARK

FIRST USE 6-30-2011; IN COMMERCE 6-30-2011.

PRINCIPAL REGISTER

NO CLAIM IS MADE TO THE EXCLUSIVE RIGHT TO USE "BRANDS", APART FROM THE MARK AS SHOWN.

THE MARK CONSISTS OF THE WORDS "BAKEWISE BRANDS" IN STYLIZED LETTERING WITH A STALK OF WHEAT FORMING THE LETTER "I" AND A HORIZONTAL LINE SEPARATING THE WORDS.

SN 85-233,654, FILED 2-3-2011.

IRA J. GOODSaid, EXAMINING ATTORNEY



David J. Kyffers

Director of the United States Patent and Trademark Office

United States of America

United States Patent and Trademark Office



Reg. No. 4,206,878

Registered Sep. 11, 2012

Int. Cls.: 9 and 41

TRADEMARK

SERVICE MARK

PRINCIPAL REGISTER

VANGUARD ENTERTAINMENT GROUP BV (NETHERLANDS CORPORATION)
TORENLAAN 9
1261 GA BLARICUM, NETHERLANDS

FOR: VIDEO GAME SOFTWARE, IN CLASS 9 (U.S. CLS. 21, 23, 26, 36 AND 38).

FIRST USE 5-11-2011; IN COMMERCE 5-11-2011.

FOR: ENTERTAINMENT SERVICES, NAMELY, PROVIDING AN ON-LINE COMPUTER GAME, IN CLASS 41 (U.S. CLS. 100, 101 AND 107).

FIRST USE 5-11-2011; IN COMMERCE 5-11-2011.

THE MARK CONSISTS OF THE WORDS "GATLING" AND "GEARS" AGAINST A GEAR-SHAPED METAL BACKGROUND IN WHICH THE LETTERS "G" HAVE THE FORM OF STYLIZED GEARS AND BULLET HOLES AND SPENT BULLET CASINGS ARE INTERSPERSED AMONG THE LETTERS.

SN 85-233,820, FILED 2-3-2011.

MELISSA VALLILLO, EXAMINING ATTORNEY



David J. Kybas

Director of the United States Patent and Trademark Office

United States of America

United States Patent and Trademark Office



Reg. No. 4,206,879

HAWLEY PARK, L.L.C. (UTAH LIMITED LIABILITY COMPANY)
9500 SOUTH HAWLEY PARK ROAD
WEST JORDAN, UT 84084

Registered Sep. 11, 2012

Int. Cl.: 2

FOR: COATINGS, NAMELY, STAINS AND CLEAR FINISHES FOR EXTERIOR AND INTERIOR USE ON A VARIETY OF SUBSTANCES, IN CLASS 2 (U.S. CLS. 6, 11 AND 16).

TRADEMARK

FIRST USE 9-0-2009; IN COMMERCE 9-0-2009.

PRINCIPAL REGISTER

NO CLAIM IS MADE TO THE EXCLUSIVE RIGHT TO USE "STAINS", APART FROM THE MARK AS SHOWN.

THE MARK CONSISTS OF A GLOBE WITH HORIZONTAL AND VERTICAL LINES WITH A BANNER IN THE MIDDLE OF THE GLOBE WITH THE WORDS "WORLD OF STAINS" INSIDE OF THE BANNER.

SN 85-237,773, FILED 2-9-2011.

DOMINICK J. SALEMI, EXAMINING ATTORNEY



David J. Kyffers

Director of the United States Patent and Trademark Office

United States of America

United States Patent and Trademark Office



Reg. No. 4,206,880

Registered Sep. 11, 2012

Int. Cl.: 29

TRADEMARK

PRINCIPAL REGISTER

SO BILL HOLDINGS, INC. (CANADA CORPORATION)
60 MELFORD DRIVE
SCARBOROUGH, ONTARIO, CANADA M1B3V3

FOR: DRIED AND FROZEN SEAFOOD, NAMELY, DRIED AND FROZEN SCALLOP, DRIED AND FROZEN OYSTER, DRIED AND SALTED FISH, FROZEN FISH, DRIED AND FROZEN CRAB MEAT, DRIED AND FROZEN SHRIMP, DRIED AND FROZEN ABALONE, DRIED AND FROZEN GEODUCK MEAT AND DRIED SHARK FIN, IN CLASS 29 (U.S. CL. 46).

FIRST USE 1-0-2012; IN COMMERCE 1-0-2012.

NO CLAIM IS MADE TO THE EXCLUSIVE RIGHT TO USE "CANADA", "SEAFOOD", OR THE NON-LATIN CHARACTERS THAT TRANSLITERATE TO "HOI CHAN", APART FROM THE MARK AS SHOWN.

THE NON-LATIN CHARACTERS IN THE MARK TRANSLITERATE TO "BILL SHUK HOI CHAN" AND THIS MEANS "UNCLE BILL SEAFOOD" IN ENGLISH.

THE NAME(S), PORTRAIT(S), AND/OR SIGNATURE(S) SHOWN IN THE MARK IDENTIFIES KENNETH SO, WHOSE CONSENT(S) TO REGISTER IS MADE OF RECORD.

THE MARK CONSISTS OF A CIRCULAR DESIGN WITH A RIBBON-LIKE BANNER UNDERNEATH IT; IN THE CENTER OF THE CIRCLE IS A DRAWING OF THE HEAD OF A WINKING MAN IN A SUIT SHOWING HIS LEFT HAND POINTED UPWARD; ABOVE THE MAN'S HEAD AND WITHIN THE INNER BLACK BAND OF THE CIRCLE IS THE WORD "CANADA" IN WHITE LETTERS; ON EITHER SIDE OF THE MAN'S HEAD APPEAR TWO WHITE DOTS IN THE MIDDLE OF THE BLACK CIRCLE; IN THE RIBBON-LIKE BLACK BANNER UNDERNEATH THE MAN'S HEAD ARE THE WORDS "UNCLE BILL" IN WHITE; BELOW THE BANNER ARE FOUR CHINESE CHARACTERS; THE WORD "SEAFOOD" IN A STYLIZED FONT APPEARS BELOW THE CHINESE CHARACTERS.



SN 85-238,103, FILED 2-9-2011.

JAMES A. RAUEN, EXAMINING ATTORNEY

David J. Kyros

Director of the United States Patent and Trademark Office

United States of America

United States Patent and Trademark Office

ANDROS

Reg. No. 4,206,881

ROTAM AGROCHEM INTERNATIONAL CO. LTD. (HONG KONG CORPORATION)
7/F CHEUNG TAT CENTRE, 18 CHEUNG LEE ST.
CHAI WAN, HONG KONG

Registered Sep. 11, 2012

Int. Cl.: 5

FOR: AGRICULTURAL HERBICIDES, INSECTICIDES AND FUNGICIDES, IN CLASS 5 (U.S. CLS. 6, 18, 44, 46, 51 AND 52).

TRADEMARK

FIRST USE 3-26-2012; IN COMMERCE 3-26-2012.

PRINCIPAL REGISTER

THE MARK CONSISTS OF STANDARD CHARACTERS WITHOUT CLAIM TO ANY PARTICULAR FONT, STYLE, SIZE, OR COLOR.

THE ENGLISH TRANSLATION OF "ANDROS" IN THE MARK IS "MAN".

SN 85-238,809, FILED 2-10-2011.

DORITT L. CARROLL, EXAMINING ATTORNEY



David J. Kyros

Director of the United States Patent and Trademark Office

United States of America

United States Patent and Trademark Office

EZ Fieldline

Reg. No. 4,206,882

JOHN KOPASZ (UNITED STATES INDIVIDUAL)
5730 FOX RUN COURT
PARKER, CO 80134

Registered Sep. 11, 2012

Int. Cl.: 28

FOR: SPORTS FIELD EQUIPMENT, NAMELY, STRING SYSTEM COMPRISED OF STRINGS, REEL, AND TIE DOWNS THAT LAY OUT STRINGS TO CREATE LINES ON SPORTING FIELDS THAT ARE TIED DOWN TO CREATE TEMPORARY LINES, IN CLASS 28 (U.S. CLS. 22, 23, 38 AND 50).

TRADEMARK

PRINCIPAL REGISTER

FIRST USE 6-18-2012; IN COMMERCE 6-18-2012.

THE MARK CONSISTS OF STANDARD CHARACTERS WITHOUT CLAIM TO ANY PARTICULAR FONT, STYLE, SIZE, OR COLOR.

NO CLAIM IS MADE TO THE EXCLUSIVE RIGHT TO USE "FIELDLINE", APART FROM THE MARK AS SHOWN.

SN 85-238,963, FILED 2-10-2011.

DANNEAN HETZEL, EXAMINING ATTORNEY



David J. Kopasz

Director of the United States Patent and Trademark Office

United States of America

United States Patent and Trademark Office

OPTICAP

Reg. No. 4,206,883

BABCOCK & WILCOX POWER GENERATION GROUP, INC. (DELAWARE CORPORATION)
20 S. VAN BUREN AVENUE
BARBERTON, OH 44203

Registered Sep. 11, 2012

Int. Cl.: 1

FOR: REGENERABLE LIQUID SOLVENT USED TO REMOVE GASEOUS CARBON DIOXIDE FROM FLUE GAS GENERATED BY THE COMBUSTION OF A FOSSIL FUEL FOR POWER AND/OR STEAM GENERATION PURPOSES, IN CLASS 1 (U.S. CLS. 1, 5, 6, 10, 26 AND 46).

TRADEMARK

FIRST USE 8-22-2011; IN COMMERCE 8-22-2011.

PRINCIPAL REGISTER

THE MARK CONSISTS OF STANDARD CHARACTERS WITHOUT CLAIM TO ANY PARTICULAR FONT, STYLE, SIZE, OR COLOR.

SN 85-238,965, FILED 2-10-2011.

JOHN WILKE, EXAMINING ATTORNEY



David J. Kyfos

Director of the United States Patent and Trademark Office

United States of America

United States Patent and Trademark Office



Reg. No. 4,206,884

Registered Sep. 11, 2012

Int. Cl.: 12

TRADEMARK

PRINCIPAL REGISTER

VEIN INCORPORATED (NORTH CAROLINA CORPORATION)
224 HIGH HOUSE ROAD
SUITE 210
CARY, NC 27513

FOR: BICYCLES AND BICYCLE PARTS, NAMELY, FRAMES, SEATS, SEAT POSTS, CRANKS, FORKS, HANDLEBARS, AXLE PEGS, WHEELS, HANDLEBAR STEMS, CHAIN SPROCKETS AND CHAIN GUARDS, HANDLEBAR GRIPS, PEDALS, CHAINS AND WHEEL HUBS, IN CLASS 12 (U.S. CLS. 19, 21, 23, 31, 35 AND 44).

FIRST USE 6-27-2011; IN COMMERCE 6-27-2011.

THE MARK CONSISTS OF STYLIZED TROJAN WAR HELMET WITH THE LETTER "G" INCORPORATED INTO THE DESIGN.

SN 85-239,300, FILED 2-10-2011.

JERI J. FICKES, EXAMINING ATTORNEY



David J. Kyffers

Director of the United States Patent and Trademark Office

United States of America
United States Patent and Trademark Office

ECOBOND

Reg. No. 4,206,885

Registered Sep. 11, 2012

Int. Cl.: 27

TRADEMARK

PRINCIPAL REGISTER

TANDUS FLOORING US, LLC (DELAWARE LIMITED LIABILITY COMPANY)
311 SMITH INDUSTRIAL BOULEVARD
DALTON, GA 307218661

FOR: BACKING FOR CARPET TILES, IN CLASS 27 (U.S. CLS. 19, 20, 37, 42 AND 50).

FIRST USE 7-30-2009; IN COMMERCE 7-30-2009.

THE MARK CONSISTS OF STANDARD CHARACTERS WITHOUT CLAIM TO ANY PARTICULAR FONT, STYLE, SIZE, OR COLOR.

SN 85-239,760, FILED 2-11-2011.

DAVID I, EXAMINING ATTORNEY



David J. Kyffers

Director of the United States Patent and Trademark Office

United States of America

United States Patent and Trademark Office

SNAGOLA

Reg. No. 4,206,886

Registered Sep. 11, 2012

Int. Cls.: 35 and 42

SERVICE MARK

PRINCIPAL REGISTER

SNAGOLA, LLC (CALIFORNIA LIMITED LIABILITY COMPANY)
10601 CALLE LEE, STE 190
LOS ALAMITOS, CA 90720

FOR: ADVERTISING, INCLUDING PROMOTION RELATING TO THE SALE OF ARTICLES AND SERVICES FOR THIRD PARTIES BY THE TRANSMISSION OF ADVERTISING MATERIAL AND THE DISSEMINATION OF ADVERTISING MESSAGES ON COMPUTER NETWORKS; CONTESTS AND INCENTIVE AWARD PROGRAMS TO PROMOTE THE SALE OF PRODUCTS AND SERVICES OF OTHERS; DISSEMINATION OF ADVERTISING FOR OTHERS VIA PUBLIC AND PRIVATE WIRELESS NETWORKS FOR DISPLAY ON MOBILE DEVICES; DISSEMINATION OF ADVERTISING MATTER; ELECTRONIC COMMERCE SERVICES, NAMELY, PROVIDING INFORMATION ABOUT PRODUCTS VIA TELECOMMUNICATION NETWORKS FOR ADVERTISING AND SALES PURPOSES; GENERAL BUSINESS NETWORKING REFERRAL SERVICES, NAMELY, PROMOTING THE GOODS AND SERVICES OF OTHERS BY PASSING BUSINESS LEADS AND REFERRALS AMONG GROUP MEMBERS; ONLINE ADVERTISING VIA A COMPUTER COMMUNICATIONS NETWORK; PREPARING AND PLACING OF ADVERTISEMENTS; PROMOTING THE GOODS AND SERVICES OF OTHERS BY MEANS OF A PREFERRED CUSTOMER PROGRAM FEATURING DISCOUNTS, COUPONS, DEALS AND GIFT CARDS FOR THE PRODUCTS OR SERVICES OF OTHERS; PROMOTING THE GOODS AND SERVICES OF OTHERS BY MEANS OF THE ISSUANCE OF LOYALTY REWARDS CARDS; PROMOTING THE GOODS AND SERVICES OF OTHERS BY PROVIDING A COMMUNITY-DRIVEN WEB SITE FEATURING USER-SUBMITTED CONTENT IN THE NATURE OF COUPONS, REBATES, PRICE-COMPARISON INFORMATION, PRODUCT REVIEWS, LINKS TO THE RETAIL WEB SITES OF OTHERS, AND DISCOUNT INFORMATION; PROMOTING THE GOODS AND SERVICES OF OTHERS BY PROVIDING A WEB SITE AT WHICH USERS CAN LINK TO THE WEBSITES OF OTHERS FOR THE PURPOSE OF OBTAINING DISCOUNTS, COUPONS, AND DEALS ON PRODUCTS OR SERVICES; PROMOTING THE GOODS AND SERVICES OF OTHERS BY PROVIDING A WEB SITE FEATURING COUPONS, REBATES, PRICE-COMPARISON INFORMATION, PRODUCT REVIEWS, LINKS TO THE RETAIL WEB SITES OF OTHERS, AND DISCOUNT INFORMATION; PROMOTING THE GOODS AND SERVICES OF OTHERS BY PROVIDING HYPERTEXT LINKS TO THE WEB SITES OF OTHERS; PROMOTING THE GOODS OF OTHERS, NAMELY, PROVIDING INFORMATION REGARDING DISCOUNTS, COUPONS, REBATES, VOUCHERS AND SPECIAL OFFERS FOR THE GOODS OF OTHERS; PROMOTIONAL SERVICES, NAMELY, PROMOTING THE GOODS OF OTHERS BY MEANS OF PROVIDING ONLINE GIFT CARDS; PROVIDING A SEARCHABLE ON-LINE ADVERTISING WEBSITE AND GUIDE FEATURING THE GOODS AND SERVICES OF OTHER



David J. Kypos

Director of the United States Patent and Trademark Office

Reg. No. 4,206,886 VENDORS VIA THE INTERNET; PROVIDING AN ON-LINE COMPUTER DATABASE IN THE FIELD OF LOCATING PRODUCTS, DESCRIBING PRODUCTS, RATING PRODUCTS, PRICING PRODUCTS AND COMPARING PRICES OF PRODUCTS; PROVIDING AN ON-LINE DIRECTORY INFORMATION SERVICE FEATURING INFORMATION REGARDING BARGAINS, DISCOUNTS, REBATES, COUPONS, SALE ITEMS AND PROVIDING PROMOTION CODES FOR THE GOODS AND SERVICES OF OTHERS; PROVIDING CONSUMER INFORMATION SERVICES AND MAKING REFERRALS IN THE FIELD OF ENTERTAINMENT SERVICES FOR PRODUCTS, SERVICES, EVENTS, ACTIVITIES, FACILITIES AND LOCATIONS; PROVIDING INFORMATION ABOUT COMMERCIAL BUSINESS AND COMMERCIAL INFORMATION VIA THE GLOBAL COMPUTER NETWORK, IN CLASS 35 (U.S. CLS. 100, 101 AND 102).

FIRST USE 5-23-2011; IN COMMERCE 5-23-2011.

FOR: COMPUTER SERVICES IN THE NATURE OF CUSTOMIZED WEB PAGES FEATURING USER-DEFINED INFORMATION, PERSONAL PROFILES AND INFORMATION; COMPUTER SERVICES, NAMELY, CREATING INDEXES OF INFORMATION, SITES AND OTHER RESOURCES AVAILABLE ON COMPUTER NETWORKS; COMPUTER SERVICES, NAMELY, HOSTING AND MAINTAINING AN ON-LINE WEB SITE FOR OTHERS TO INTERACT WITH OTHERS AND PROVIDE OR OBTAIN PROMOTION CODES FOR AND INFORMATION REGARDING GOODS AND SERVICES OFFERED BY OTHERS; COMPUTER SERVICES, NAMELY, INTERACTIVE HOSTING SERVICES WHICH ALLOW THE USER TO PUBLISH AND SHARE THEIR OWN CONTENT AND IMAGES ON-LINE; COMPUTER SERVICES, NAMELY, PROVIDING SEARCH PLATFORMS TO ALLOW USERS TO REQUEST CONTENT FROM AND RECEIVE CONTENT TO A MOBILE DEVICE; PROVIDING A WEBSITE FEATURING A MEDIA AGGREGATOR AND SEARCH ENGINE FOR INTERNET CONTENT; PROVIDING INFORMATION AT THE SPECIFIC REQUEST OF END-USERS BY MEANS OF TELEPHONE OR GLOBAL COMPUTER NETWORKS, IN CLASS 42 (U.S. CLS. 100 AND 101).

FIRST USE 5-23-2011; IN COMMERCE 5-23-2011.

THE MARK CONSISTS OF STANDARD CHARACTERS WITHOUT CLAIM TO ANY PARTICULAR FONT, STYLE, SIZE, OR COLOR.

SN 85-239,866, FILED 2-11-2011.

CURTIS FRENCH, EXAMINING ATTORNEY

United States of America

United States Patent and Trademark Office

WATTS IS GOLF

Reg. No. 4,206,887

EDWIN WATTS GOLF SHOPS, LLC (DELAWARE LIMITED LIABILITY COMPANY)
20 HILL AVENUE

Registered Sep. 11, 2012

FORT WALTON BEACH, FL 32548

Int. Cl.: 35

FOR: RETAIL STORE, ONLINE RETAIL STORE, AND MAIL ORDER SERVICES, ALL IN THE FIELDS OF SPORTING GOODS, GOLF EQUIPMENT AND ACCESSORIES, AND APPAREL, IN CLASS 35 (U.S. CLS. 100, 101 AND 102).

SERVICE MARK

FIRST USE 12-30-2010; IN COMMERCE 12-30-2010.

PRINCIPAL REGISTER

THE MARK CONSISTS OF STANDARD CHARACTERS WITHOUT CLAIM TO ANY PARTICULAR FONT, STYLE, SIZE, OR COLOR.

OWNER OF U.S. REG. NO. 2,569,451.

SN 85-239,921, FILED 2-11-2011.

KATHERINE CHANG, EXAMINING ATTORNEY



David J. Kybas

Director of the United States Patent and Trademark Office

United States of America

United States Patent and Trademark Office

SUMOMI

Reg. No. 4,206,888

SOCIAS, MIGUEL (CHILE INDIVIDUAL)

Registered Sep. 11, 2012

P.O. BOX 60901
PALO ALTO, CA 94306

Int. Cl.: 42

SERVICE MARK

PRINCIPAL REGISTER

FOR: APPLICATION SERVICE PROVIDER (ASP) FEATURING SOFTWARE FOR USE FOR DATA ANALYSIS AND RESEARCH; APPLICATION SERVICE PROVIDER, NAMELY, HOSTING, MANAGING, DEVELOPING, AND MAINTAINING APPLICATIONS, SOFTWARE, AND WEB SITES, IN THE FIELDS OF PERSONAL PRODUCTIVITY, WIRELESS COMMUNICATION, MOBILE INFORMATION ACCESS, AND REMOTE DATA MANAGEMENT FOR WIRELESS DELIVERY OF CONTENT TO HANDHELD COMPUTERS, LAPTOPS AND MOBILE ELECTRONIC DEVICES; COMPUTER SERVICE, NAMELY, ACTING AS AN APPLICATION SERVICE PROVIDER IN THE FIELD OF INFORMATION MANAGEMENT TO HOST COMPUTER APPLICATION SOFTWARE FOR THE PURPOSE OF CREATING SEARCHABLE DATABASES OF INFORMATION AND DATA; COMPUTER SERVICE, NAMELY, ACTING AS AN APPLICATION SERVICE PROVIDER IN THE FIELD OF KNOWLEDGE MANAGEMENT TO HOST COMPUTER APPLICATION SOFTWARE FOR CREATING SEARCHABLE DATABASES OF INFORMATION AND DATA; CONSULTING SERVICES IN THE FIELD OF SOFTWARE AS A SERVICE (SAAS); PROVIDING A WEBSITE FEATURING NON-DOWNLOADABLE SOFTWARE FOR ENABLING USERS TO PERFORM DATA ANALYSIS AND RESEARCH; SOFTWARE AS A SERVICE (SAAS) SERVICES FEATURING SOFTWARE IN THE FIELD OF DATA ANALYSIS AND RESEARCH, IN CLASS 42 (U.S. CLS. 100 AND 101).



FIRST USE 6-15-2012; IN COMMERCE 6-15-2012.

THE MARK CONSISTS OF STANDARD CHARACTERS WITHOUT CLAIM TO ANY PARTICULAR FONT, STYLE, SIZE, OR COLOR.

SN 85-240,657, FILED 2-11-2011.

JENNIFER MARTIN, EXAMINING ATTORNEY

David J. Kyros

Director of the United States Patent and Trademark Office

United States of America

United States Patent and Trademark Office

SEA DOG BREW PUB

Reg. No. 4,206,889

SEA DOG BRANDS, LLC (MAINE LIMITED LIABILITY COMPANY)
PO BOX 2808
SOUTH PORTLAND, ME 04116

Registered Sep. 11, 2012

Int. Cl.: 25

FOR: CLOTHING, NAMELY, TOPS, BOTTOMS AND HEADWEAR, IN CLASS 25 (U.S. CLS. 22 AND 39).

TRADEMARK

FIRST USE 12-31-2011; IN COMMERCE 12-31-2011.

PRINCIPAL REGISTER

THE MARK CONSISTS OF STANDARD CHARACTERS WITHOUT CLAIM TO ANY PARTICULAR FONT, STYLE, SIZE, OR COLOR.

SN 85-241,170, FILED 2-14-2011.

CAROLINE WOOD, EXAMINING ATTORNEY



David J. Kyffers

Director of the United States Patent and Trademark Office

United States of America

United States Patent and Trademark Office

OURTIME

Reg. No. 4,206,890

Registered Sep. 11, 2012

Int. Cl.: 45

SERVICE MARK

PRINCIPAL REGISTER

PEOPLE MEDIA, INC. (DELAWARE CORPORATION)
8800 SUNSET BOULEVARD
3RD FLOOR
WEST HOLLYWOOD, CA 90069

FOR: DATING SERVICES; INTERNET BASED SOCIAL NETWORKING, INTRODUCTION,
AND DATING SERVICES, IN CLASS 45 (U.S. CLS. 100 AND 101).

FIRST USE 5-13-2012; IN COMMERCE 5-13-2012.

THE MARK CONSISTS OF STANDARD CHARACTERS WITHOUT CLAIM TO ANY PAR-
TICULAR FONT, STYLE, SIZE, OR COLOR.

SN 85-241,731, FILED 2-14-2011.

SUSAN STIGLITZ, EXAMINING ATTORNEY



David J. Kyffers

Director of the United States Patent and Trademark Office

United States of America

United States Patent and Trademark Office

OURTIME.COM

Reg. No. 4,206,891

Registered Sep. 11, 2012

Int. Cl.: 45

SERVICE MARK

PRINCIPAL REGISTER

PEOPLE MEDIA, INC. (DELAWARE CORPORATION)
3RD FLOOR
8800 SUNSET BOULEVARD
WEST HOLLYWOOD, CA 90069

FOR: DATING SERVICES; INTERNET BASED SOCIAL NETWORKING, INTRODUCTION,
AND DATING SERVICES, IN CLASS 45 (U.S. CLS. 100 AND 101).

FIRST USE 2-23-2011; IN COMMERCE 2-23-2011.

THE MARK CONSISTS OF STANDARD CHARACTERS WITHOUT CLAIM TO ANY PAR-
TICULAR FONT, STYLE, SIZE, OR COLOR.

SN 85-241,743, FILED 2-14-2011.

SUSAN STIGLITZ, EXAMINING ATTORNEY



David J. Kyffers

Director of the United States Patent and Trademark Office

United States of America

United States Patent and Trademark Office



Reg. No. 4,206,892

LEAF BRANDS, LLC (CALIFORNIA LIMITED LIABILITY COMPANY)
47 OCEAN HEIGHT DRIVE
NEWPORT COAST, CA 92657

Registered Sep. 11, 2012

Int. Cl.: 30

FOR: CANDY; LOLLIPOPS, IN CLASS 30 (U.S. CL. 46).

TRADEMARK

FIRST USE 6-10-1962; IN COMMERCE 6-10-1962.

PRINCIPAL REGISTER

OWNER OF U.S. REG. NO. 922,460.

NO CLAIM IS MADE TO THE EXCLUSIVE RIGHT TO USE "POP" AND "ORIGINAL", APART FROM THE MARK AS SHOWN.

THE MARK CONSISTS OF THE WORDS "ASTRO POP" APPEARING ABOVE THE WORD "ORIGINAL", WITHIN AN OVAL BACKGROUND. THERE ARE 2 BROKEN INTERSECTING OVALS ENVELOPING THE OVAL BACKGROUND.

SN 85-242,438, FILED 2-15-2011.

B. PARADEWELAI, EXAMINING ATTORNEY



David J. Kyffers

Director of the United States Patent and Trademark Office

United States of America

United States Patent and Trademark Office

HAIR PERM CODE

Reg. No. 4,206,893

ROYAL IMEX INC. (CALIFORNIA CORPORATION)
12605 E. CLARK STREET
SANTA FE SPRINGS, CA 90670

Registered Sep. 11, 2012

Int. Cl.: 26

FOR: HAIR EXTENSIONS; HAIR PIECES; WIGS, IN CLASS 26 (U.S. CLS. 37, 39, 40, 42 AND 50).

TRADEMARK

FIRST USE 1-15-2011; IN COMMERCE 1-15-2011.

PRINCIPAL REGISTER

THE MARK CONSISTS OF STANDARD CHARACTERS WITHOUT CLAIM TO ANY PARTICULAR FONT, STYLE, SIZE, OR COLOR.

NO CLAIM IS MADE TO THE EXCLUSIVE RIGHT TO USE "HAIR PERM", APART FROM THE MARK AS SHOWN.

SN 85-242,609, FILED 2-15-2011.

KIM MONINGHOFF, EXAMINING ATTORNEY



David J. Kyffers

Director of the United States Patent and Trademark Office

United States of America

United States Patent and Trademark Office

PROTOUGH

Reg. No. 4,206,894

NORITZ AMERICA CORPORATION (CALIFORNIA CORPORATION)
11160 GRACE AVENUE
FOUNTAIN VALLEY, CA 92708

Registered Sep. 11, 2012

Int. Cl.: 11

FOR: WATER HEATERS; TANKLESS WATER HEATERS, IN CLASS 11 (U.S. CLS. 13, 21, 23, 31 AND 34).

TRADEMARK

FIRST USE 2-24-2012; IN COMMERCE 4-5-2012.

PRINCIPAL REGISTER

THE MARK CONSISTS OF STANDARD CHARACTERS WITHOUT CLAIM TO ANY PARTICULAR FONT, STYLE, SIZE, OR COLOR.

SN 85-242,686, FILED 2-15-2011.

GILBERT SWIFT, EXAMINING ATTORNEY



David J. Kyffers

Director of the United States Patent and Trademark Office

United States of America

United States Patent and Trademark Office

ENERGYVILLE

Reg. No. 4,206,895

Registered Sep. 11, 2012

Int. Cl.: 41

SERVICE MARK

PRINCIPAL REGISTER

CHEVRON INTELLECTUAL PROPERTY LLC (DELAWARE LIMITED LIABILITY COMPANY)
6001 BOLLINGER CANYON ROAD
SAN RAMON, CA 94583

FOR: EDUCATION, ENTERTAINMENT AND INFORMATION SERVICES, NAMELY, PROVIDING AN ON-LINE COMPUTER GAME PERTAINING TO ENERGY, IN CLASS 41 (U.S. CLS. 100, 101 AND 107).

FIRST USE 9-5-2007; IN COMMERCE 9-5-2007.

THE MARK CONSISTS OF STANDARD CHARACTERS WITHOUT CLAIM TO ANY PARTICULAR FONT, STYLE, SIZE, OR COLOR.

SN 85-242,723, FILED 2-15-2011.

JOHN WILKE, EXAMINING ATTORNEY



David J. Kybas

Director of the United States Patent and Trademark Office

United States of America

United States Patent and Trademark Office

XDRIFT

Reg. No. 4,206,896

VERSATILE INNOVATIONS (VIRGINIA LIMITED LIABILITY COMPANY)

Registered Sep. 11, 2012

P.O. BOX 511
RUCKERSVILLE, VA 22968

Int. Cl.: 28

FOR: MANUALLY-OPERATED EXERCISE EQUIPMENT; MANUALLY-OPERATED EXERCISE EQUIPMENT FOR PHYSICAL FITNESS PURPOSES, IN CLASS 28 (U.S. CLS. 22, 23, 38 AND 50).

TRADEMARK

FIRST USE 4-1-2011; IN COMMERCE 7-27-2011.

PRINCIPAL REGISTER

THE MARK CONSISTS OF STANDARD CHARACTERS WITHOUT CLAIM TO ANY PARTICULAR FONT, STYLE, SIZE, OR COLOR.

SN 85-242,757, FILED 2-15-2011.

JULIE VEPPUMTHARA, EXAMINING ATTORNEY



David J. Kyros

Director of the United States Patent and Trademark Office

United States of America

United States Patent and Trademark Office

INDEPENDENCE ENERGY

Reg. No. 4,206,897

Registered Sep. 11, 2012

Int. Cl.: 35

SERVICE MARK

PRINCIPAL REGISTER

INDEPENDENCE ENERGY GROUP LLC (DELAWARE LIMITED LIABILITY COMPANY)
3711 MARKET STREET, SUITE 1000
PHILADELPHIA, PA 19104

FOR: RETAIL ELECTRICITY PROVIDER SERVICES, NAMELY, PROVIDING A SERVICE THAT ALLOWS CUSTOMERS TO PURCHASE ENERGY, NAMELY, ELECTRICITY, GAS AND RENEWABLE ENERGY; CONSULTING AND ANALYSIS SERVICES, NAMELY, REVIEWING ENERGY NEEDS, USES AND COSTS, AND PROVIDING ADVICE AND RECOMMENDATIONS REGARDING ENERGY OPTIONS, SOLUTIONS TO PROBLEMS AND COST OBJECTIVES; PRICE ANALYSIS OF ENERGY SOURCES; CUSTOMER SERVICES IN THE FIELD OF ENERGY SERVICES; ENERGY PRICE COMPARISON SERVICES; PROVIDING INFORMATION AND ADVICE TO COMMERCIAL AND INDUSTRIAL USERS OF ELECTRICAL POWER, RELATING TO THE USERS' SELECTION OF ELECTRICAL POWER PROVIDERS AND PROGRAMS; ENERGY CONSULTING SERVICES FOR RESIDENTIAL, COMMERCIAL AND BUSINESS USERS IN THE AREAS OF ENERGY MANAGEMENT; ARRANGING AND CONDUCTING INCENTIVE REWARD PROGRAMS TO PROMOTE THE SALE OF ELECTRICITY, GAS AND RENEWABLE ENERGY, IN CLASS 35 (U.S. CLS. 100, 101 AND 102).

FIRST USE 2-28-2011; IN COMMERCE 2-28-2011.

THE MARK CONSISTS OF STANDARD CHARACTERS WITHOUT CLAIM TO ANY PARTICULAR FONT, STYLE, SIZE, OR COLOR.

NO CLAIM IS MADE TO THE EXCLUSIVE RIGHT TO USE "ENERGY" , APART FROM THE MARK AS SHOWN.

SN 85-244,073, FILED 2-16-2011.

VIVIAN MICZNIK FIRST, EXAMINING ATTORNEY



David J. Kypos

Director of the United States Patent and Trademark Office

United States of America

United States Patent and Trademark Office

INDEPENDENCE ENERGY ALLIANCE

Reg. No. 4,206,898

Registered Sep. 11, 2012

Int. Cl.: 36

SERVICE MARK

PRINCIPAL REGISTER

INDEPENDENCE ENERGY GROUP LLC (DELAWARE LIMITED LIABILITY COMPANY)
3711 MARKET STREET, SUITE 1000
PHILADELPHIA, PA 19104

FOR: ENERGY BROKERAGE SERVICES, IN CLASS 36 (U.S. CLS. 100, 101 AND 102).

FIRST USE 2-28-2011; IN COMMERCE 2-28-2011.

THE MARK CONSISTS OF STANDARD CHARACTERS WITHOUT CLAIM TO ANY PARTICULAR FONT, STYLE, SIZE, OR COLOR.

NO CLAIM IS MADE TO THE EXCLUSIVE RIGHT TO USE "ENERGY ALLIANCE", APART FROM THE MARK AS SHOWN.

SN 85-244,096, FILED 2-16-2011.

VIVIAN MICZNIK FIRST, EXAMINING ATTORNEY



David J. Kybas

Director of the United States Patent and Trademark Office

United States of America

United States Patent and Trademark Office



Reg. No. 4,206,899

Registered Sep. 11, 2012

Int. Cl.: 44

SERVICE MARK

PRINCIPAL REGISTER

OPTUM, INC. (DELAWARE CORPORATION)
9900 BREN ROAD EAST
MINNETONKA, MN 55343

FOR: HEALTH CARE SERVICES, NAMELY, DISEASE MANAGEMENT PROGRAMS; PROVIDING HEALTH INFORMATION; PROVIDING INFORMATION ON PHARMACEUTICALS AND HEALTHCARE; MEDICATION MANAGEMENT SERVICES FOR COST CONTAINMENT PURPOSES, NAMELY, ASSESSING MEDICATION USE HISTORY AND PROVIDING INFORMATION TO HEALTH CARE PROVIDERS AND PRESCRIPTION DRUG BENEFIT PLAN DESIGNERS REGARDING MEDICATION USE, OPTIONS, AND COST MANAGEMENT; PROVIDING INFORMATION TO PHYSICIANS REGARDING PRESCRIPTION DRUGS AND TREATMENT GUIDELINES, IN CLASS 44 (U.S. CLS. 100 AND 101).

FIRST USE 6-6-2011; IN COMMERCE 6-6-2011.

THE MARK CONSISTS OF THE WORDING "OPTUMRX" AND THE DESIGN OF A CURVED DIAMOND SHAPE WITH SMALLER DIAMOND SHAPES SET WITHIN THE BORDERS OF THE DESIGN.

THE WORDING "OPTUM" HAS NO MEANING IN A FOREIGN LANGUAGE.

SN 85-244,730, FILED 2-17-2011.

SEAN CROWLEY, EXAMINING ATTORNEY



David J. Kybas

Director of the United States Patent and Trademark Office

United States of America

United States Patent and Trademark Office

easier.

Reg. No. 4,206,900

Registered Sep. 11, 2012

Int. Cls.: 3 and 18

TRADEMARK

PRINCIPAL REGISTER

TED INC (NORTH CAROLINA CORPORATION)
PO BOX 98599
RALEIGH, NC 29624

FOR: NON-MEDICATED TOILETRIES, IN CLASS 3 (U.S. CLS. 1, 4, 6, 50, 51 AND 52).

FIRST USE 2-15-2011; IN COMMERCE 5-9-2012.

FOR: BACKPACKS; BACKPACKS, BOOK BAGS, SPORTS BAGS, BUM BAGS, WALLETS AND HANDBAGS; CARD WALLETS; HANDBAGS, PURSES AND WALLETS; LEATHER CREDIT CARD WALLETS; POCKET WALLETS; PURSES AND WALLETS; TOILETRY BAGS SOLD EMPTY; TOILETRY CASES SOLD EMPTY; WALLETS AND WALLET INSERTS; WALLETS INCLUDING CARD HOLDERS; WALLETS MADE OF LEATHER OR OTHER MATERIALS; WALLETS WITH CARD COMPARTMENTS; WASH BAGS FOR CARRYING TOILETRIES, IN CLASS 18 (U.S. CLS. 1, 2, 3, 22 AND 41).

FIRST USE 2-15-2011; IN COMMERCE 4-15-2012.

THE MARK CONSISTS OF STANDARD CHARACTERS WITHOUT CLAIM TO ANY PARTICULAR FONT, STYLE, SIZE, OR COLOR.

SN 85-244,979, FILED 2-17-2011.

JAMES STEIN, EXAMINING ATTORNEY



David J. Kyffers

Director of the United States Patent and Trademark Office

United States of America

United States Patent and Trademark Office

ALL THE NYCESSITIES

Reg. No. 4,206,901

JPMORGAN CHASE & CO. (DELAWARE CORPORATION)
270 PARK AVENUE
NEW YORK, NY 10017

Registered Sep. 11, 2012

Int. Cl.: 36

FOR: BANKING AND FINANCIAL SERVICES, IN CLASS 36 (U.S. CLS. 100, 101 AND 102).

SERVICE MARK

FIRST USE 7-13-2009; IN COMMERCE 7-13-2009.

PRINCIPAL REGISTER

THE MARK CONSISTS OF STANDARD CHARACTERS WITHOUT CLAIM TO ANY PARTICULAR FONT, STYLE, SIZE, OR COLOR.

SN 85-245,067, FILED 2-17-2011.

DANNEAN HETZEL, EXAMINING ATTORNEY



David J. Kybas

Director of the United States Patent and Trademark Office

United States of America

United States Patent and Trademark Office

CISCO SECUREX ARCHITECTURE

Reg. No. 4,206,902

CISCO TECHNOLOGY, INC. (CALIFORNIA CORPORATION)
170 WEST TASMAN DRIVE
SAN JOSE, CA 95134

Registered Sep. 11, 2012

Int. Cl.: 42

FOR: TECHNICAL SUPPORT SERVICES IN THE FIELDS OF COMPUTER, DATA, EMAIL, WEB AND NETWORK SECURITY, NAMELY, MONITORING OF NETWORK SYSTEMS FOR TECHNICAL AND COMPUTER SECURITY PURPOSES AND TROUBLESHOOTING IN THE NATURE OF DIAGNOSING COMPUTER HARDWARE AND SOFTWARE PROBLEMS; COMPUTER SERVICES, NAMELY, DETECTING, BLOCKING AND REMOVING COMPUTER VIRUSES AND THREATS, ENCRYPTING AND AUTHENTICATING DATA, PREVENTING DATA-LOSS, SECURING NETWORKS, AND DETECTING, FILTERING, ANALYZING, MANAGING AND BLOCKING ELECTRONIC COMMUNICATIONS; AND SOFTWARE AS A SERVICE (SAAS) SERVICES, NAMELY, HOSTING SOFTWARE FOR USE BY OTHERS FOR DETECTING, BLOCKING AND REMOVING COMPUTER VIRUSES AND THREATS, ENCRYPTING AND AUTHENTICATING DATA, PREVENTING DATA-LOSS, SECURING NETWORKS, AND DETECTING, FILTERING, ANALYZING, MANAGING AND BLOCKING ELECTRONIC COMMUNICATIONS; CONSULTING SERVICES IN THE FIELD OF DESIGN, SELECTION, IMPLEMENTATION, MANAGEMENT AND USE OF COMPUTER HARDWARE AND SOFTWARE SYSTEMS FOR OTHERS; COMPUTER NETWORK DESIGN FOR OTHERS, IN CLASS 42 (U.S. CLS. 100 AND 101).

SERVICE MARK

PRINCIPAL REGISTER

FIRST USE 2-0-2011; IN COMMERCE 2-0-2011.

THE MARK CONSISTS OF STANDARD CHARACTERS WITHOUT CLAIM TO ANY PARTICULAR FONT, STYLE, SIZE, OR COLOR.

OWNER OF U.S. REG. NOS. 3,709,076, 3,759,451, AND OTHERS.

NO CLAIM IS MADE TO THE EXCLUSIVE RIGHT TO USE "ARCHITECTURE", APART FROM THE MARK AS SHOWN.

SN 85-245,399, FILED 2-17-2011.

TRICIA SONNEBORN, EXAMINING ATTORNEY



David J. Kyros

Director of the United States Patent and Trademark Office

United States of America

United States Patent and Trademark Office

LIQWID

Reg. No. 4,206,903

LEFTSNRIGHTS, INC. (DELAWARE CORPORATION)
2150 SOUTH 1300 EAST
SALT LAKE CITY, UT 84106

Registered Sep. 11, 2012

Int. Cls.: 35 and 42

FOR: DISSEMINATION OF ADVERTISING FOR OTHERS VIA THE INTERNET; ON-LINE ADVERTISING AND MARKETING SERVICES; PROVIDING ADVERTISING SERVICES TO DISPLAY ADVERTISEMENTS AND PROMOTIONS ON THE INTERNET FOR OTHERS, NAMELY, IN WEBSITES; PROVIDING A DATABASE FEATURING ADVERTISEMENTS, IN CLASS 35 (U.S. CLS. 100, 101 AND 102).

SERVICE MARK

PRINCIPAL REGISTER

FIRST USE 3-4-2011; IN COMMERCE 3-4-2011.

FOR: APPLICATION SERVICE PROVIDER, NAMELY, MANAGING, DEVELOPING AND MAINTAINING APPLICATIONS AND SOFTWARE, OF OTHERS IN THE FIELDS OF ADVERTISING AND MARKETING; PROVIDING ON-LINE NON-DOWNLOADABLE SOFTWARE AND APPLICATIONS FOR USE IN ADVERTISING AND MARKETING, IN CLASS 42 (U.S. CLS. 100 AND 101).

FIRST USE 3-4-2011; IN COMMERCE 3-4-2011.

THE MARK CONSISTS OF STANDARD CHARACTERS WITHOUT CLAIM TO ANY PARTICULAR FONT, STYLE, SIZE, OR COLOR.

SN 85-246,400, FILED 2-18-2011.

GINA HAYES, EXAMINING ATTORNEY



David J. Kyros

Director of the United States Patent and Trademark Office

United States of America

United States Patent and Trademark Office

Kounterclockwise

Reg. No. 4,206,904

JOHNSON, DOUGLAS N. (UNITED STATES INDIVIDUAL), AKA DEACON BURNS,
24451 LAKESHORE BLVD. APT. 1518W.

Registered Sep. 11, 2012

EUCLID, OH 44123 AND

Int. Cl.: 41

GABRIEL, CARINE P. (UNITED STATES INDIVIDUAL), AKA KAYA ROGUE,
24451 LAKESHORE BLVD. APT. 1518W.

EUCLID, OH 44123

SERVICE MARK

PRINCIPAL REGISTER

FOR: ENTERTAINMENT, NAMELY, LIVE PERFORMANCES BY A MUSICAL BAND; AUDIO RECORDING AND PRODUCTION; ENTERTAINMENT IN THE NATURE OF VISUAL AND AUDIO PERFORMANCES BY OUR BAND CALLED KOUNTERCLOCKWISE; ENTERTAINMENT SERVICES BY A MUSICAL ARTIST AND PRODUCER, NAMELY, MUSICAL COMPOSITION FOR OTHERS AND PRODUCTION OF MUSICAL SOUND RECORDINGS; ENTERTAINMENT SERVICES IN THE NATURE OF RECORDING, PRODUCTION AND POST-PRODUCTION SERVICES IN THE FIELD OF MUSIC; MUSIC PRODUCTION SERVICES; PRODUCTION OF SOUND AND MUSIC VIDEO RECORDINGS, IN CLASS 41 (U.S. CLS. 100, 101 AND 107).

FIRST USE 5-5-2003; IN COMMERCE 1-13-2010.

THE MARK CONSISTS OF STANDARD CHARACTERS WITHOUT CLAIM TO ANY PARTICULAR FONT, STYLE, SIZE, OR COLOR.

SN 85-246,873, FILED 2-19-2011.

CAROLINE WOOD, EXAMINING ATTORNEY



David J. Kybas

Director of the United States Patent and Trademark Office

United States of America

United States Patent and Trademark Office

Jano India

Reg. No. 4,206,905

Registered Sep. 11, 2012

Int. Cls.: 16, 41, and 42

TRADEMARK

SERVICE MARK

PRINCIPAL REGISTER

RUCHITA PARAT (UNITED STATES INDIVIDUAL)
4177 HUBBARTT DRIVE
PALO ALTO, CA 94306

FOR: CHILDREN'S ACTIVITY BOOKS; CHILDREN'S BOOKS; CHILDREN'S INTERACTIVE EDUCATIONAL BOOKS; CHILDREN'S STORYBOOKS; EDUCATIONAL PUBLICATIONS, NAMELY, EDUCATIONAL LEARNING CARDS, FLASH CARDS, ACTIVITY CARDS, WORKBOOKS, TEXTBOOKS, ACTIVITY BOOKS, STORY BOOKS, PUZZLE BOOKS, PRINTED PUZZLES, TEACHER GUIDES, MANUALS, POSTERS AND EDUCATIONAL BOOKLETS IN THE FIELD OF INDIAN CULTURE AND INDIAN LANGUAGES; PRINTED INSTRUCTIONAL, EDUCATIONAL, AND TEACHING MATERIALS IN THE FIELD OF INDIAN CULTURE AND INDIAN LANGUAGE, IN CLASS 16 (U.S. CLS. 2, 5, 22, 23, 29, 37, 38 AND 50).

FIRST USE 12-1-2010; IN COMMERCE 1-20-2011.

FOR: CHILDREN'S EDUCATIONAL SERVICES, NAMELY, PROVIDING ACADEMIC PERFORMANCE EVALUATION, GUIDANCE AND MONITORING FOR CHILDREN PRE-KINDERGARTEN THROUGH GRADE 12 VIA THE INTERNET; EDUCATION IN THE FIELD OF INDIAN CULTURE AND INDIAN LANGUAGES RENDERED THROUGH CORRESPONDENCE COURSES; EDUCATION IN THE FIELD OF INDIAN CULTURE AND INDIAN LANGUAGE RENDERED THROUGH VIDEO CONFERENCE; EDUCATION SERVICES IN THE NATURE OF EARLY CHILDHOOD INSTRUCTION; EDUCATIONAL AND ENTERTAINMENT SERVICES, NAMELY, A CONTINUING PROGRAM ABOUT INDIAN CULTURE AND INDIAN LANGUAGE ACCESSIBLE BY RADIO, TELEVISION, SATELLITE, AUDIO, VIDEO AND COMPUTER NETWORKS; EDUCATIONAL AND ENTERTAINMENT SERVICES, NAMELY, PROVIDING ON-LINE INTERACTIVE CHILDREN'S STORIES; EDUCATIONAL SERVICES, NAMELY, PROVIDING COURSES OF INSTRUCTION AT THE PRESCHOOL, ELEMENTARY, SECONDARY, UNIVERSITY LEVEL; ENTERTAINMENT AND EDUCATION SERVICES IN THE NATURE OF A SERIES OF SHORT SHOWS FEATURING INDIAN CULTURE AND INDIAN LANGUAGE DISTRIBUTED TO MOBILE HANDSETS, WHICH MAY INCLUDE VIDEO, TEXT, PHOTOS, ILLUSTRATIONS OR HYPERTEXT; PROVIDING COURSES OF INSTRUCTION AT THE PRESCHOOL, ELEMENTARY, SECONDARY AND ADULT LEVEL; EDUCATION SERVICES, NAMELY, PROVIDING KINDERGARTEN THROUGH 12TH GRADE (K-12) CLASSROOM INSTRUCTION; EDUCATION SERVICES, NAMELY, PROVIDING LIVE AND ON-LINE CLASSES, SEMINARS AND WORKSHOPS, IN THE FIELD OF INDIAN CULTURE AND INDIAN LANGUAGE; EDUCATION SERVICES, NAMELY,



David J. Kybas

Director of the United States Patent and Trademark Office

Reg. No. 4,206,905 PROVIDING MENTORING, TUTORING, CLASSES, SEMINARS AND WORKSHOPS IN THE FIELD OF INDIAN CULTURE AND INDIAN LANGUAGE; EDUCATIONAL AND ENTERTAINMENT SERVICES FOR CHILDREN, NAMELY, PROVIDING INTERACTIVE PLAY AREAS, INSTRUCTIONAL CLASSES IN THE FIELD OF INDIAN CULTURE AND INDIAN LANGUAGE AND SOCIAL GATHERINGS FOR CHILDREN; EDUCATIONAL AND ENTERTAINMENT SERVICES, NAMELY, CONDUCTING WORKSHOPS, CLASSES AND CAMPS IN THE FIELD OF INDIAN CULTURE AND INDIAN LANGUAGE AND DISTRIBUTION OF COURSE MATERIALS IN CONNECTION THEREWITH, AND EDUCATION CONSULTING RELATED THERETO; EDUCATIONAL SERVICES, NAMELY, DEVELOPING CURRICULUM FOR OTHERS IN THE FIELD OF INDIAN CULTURE AND INDIAN LANGUAGE; EDUCATIONAL SERVICES, NAMELY, DEVELOPING CURRICULUM FOR TEACHERS; EDUCATIONAL SERVICES, NAMELY, DEVELOPING, ARRANGING, AND CONDUCTING EDUCATIONAL CONFERENCES AND PROGRAMS AND PROVIDING COURSES OF INSTRUCTION IN THE FIELD OF INDIAN CULTURE AND INDIAN LANGUAGE; EDUCATIONAL SERVICES, NAMELY, PROVIDING INTERNSHIPS AND APPRENTICESHIPS IN THE FIELD OF INDIAN CULTURE AND INDIAN LANGUAGE; PROVIDING AFTER SCHOOL EDUCATIONAL PROGRAMS IN THE FIELD OF INDIAN CULTURE AND INDIAN LANGUAGE AND PLAY FACILITIES FOR CHILDREN; ENTERTAINMENT SERVICES, NAMELY, PROVIDING A WEBSITE FEATURING NON-DOWNLOADABLE MUSICAL PERFORMANCES, MUSICAL VIDEOS, RELATED FILM CLIPS, PHOTOGRAPHS, AND OTHER MULTIMEDIA MATERIALS FEATURING EDUCATIONAL INFORMATION IN THE FIELD OF INDIAN CULTURE AND INDIAN LANGUAGES, IN CLASS 41 (U.S. CLS. 100, 101 AND 107).

FIRST USE 12-1-2010; IN COMMERCE 1-20-2011.

FOR: PROVIDING TEMPORARY USE OF ON-LINE NON-DOWNLOADABLE EDUCATIONAL SOFTWARE FEATURING INSTRUCTION IN INDIAN CULTURE AND INDIAN LANGUAGES, IN CLASS 42 (U.S. CLS. 100 AND 101).

FIRST USE 12-1-2010; IN COMMERCE 1-20-2011.

THE MARK CONSISTS OF STANDARD CHARACTERS WITHOUT CLAIM TO ANY PARTICULAR FONT, STYLE, SIZE, OR COLOR.

NO CLAIM IS MADE TO THE EXCLUSIVE RIGHT TO USE "INDIA", APART FROM THE MARK AS SHOWN.

THE ENGLISH TRANSLATION OF "JANO" IN THE MARK IS "KNOW".

SN 85-247,591, FILED 2-21-2011.

MARLENE BELL, EXAMINING ATTORNEY

United States of America

United States Patent and Trademark Office

MERCATTO

Reg. No. 4,206,906

BARONESS SMALL ESTATES, INC. (COLORADO CORPORATION)
2395 WEST 2ND AVENUE
DENVER, CO 80223

Registered Sep. 11, 2012

Int. Cl.: 33

FOR: WINE, IN CLASS 33 (U.S. CLS. 47 AND 49).

TRADEMARK

FIRST USE 5-8-2012; IN COMMERCE 5-8-2012.

PRINCIPAL REGISTER

THE MARK CONSISTS OF STANDARD CHARACTERS WITHOUT CLAIM TO ANY PARTICULAR FONT, STYLE, SIZE, OR COLOR.

SN 85-248,139, FILED 2-22-2011.

TAMARA FRAZIER, EXAMINING ATTORNEY



David J. Kybas

Director of the United States Patent and Trademark Office

United States of America

United States Patent and Trademark Office

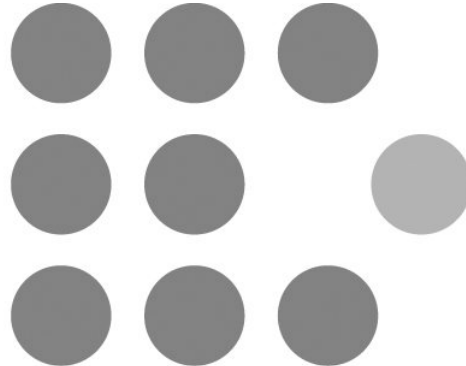

Reg. No. 4,206,907

Registered Sep. 11, 2012

Int. Cls.: 35 and 36

SERVICE MARK

PRINCIPAL REGISTER

INDEPENDENCE ENERGY GROUP LLC (DELAWARE LIMITED LIABILITY COMPANY)
3711 MARKET STREET, SUITE 1000
PHILADELPHIA, PA 19104

FOR: RETAIL ELECTRICITY PROVIDER SERVICES, NAMELY, PROVIDING A SERVICE THAT ALLOWS CUSTOMERS TO PURCHASE ENERGY, NAMELY, ELECTRICITY, GAS AND RENEWABLE ENERGY; CONSULTING AND ANALYSIS SERVICES IN THE FIELD OF ENERGY EFFICIENCY, NAMELY, REVIEWING ENERGY NEEDS, USES AND COSTS, AND PROVIDING ADVICE AND RECOMMENDATIONS REGARDING ENERGY OPTIONS, SOLUTIONS TO PROBLEMS AND COST OBJECTIVES; PRICE ANALYSIS OF ENERGY SOURCES; CUSTOMER SERVICES IN THE FIELD OF ENERGY SERVICES, NAMELY, ENERGY AUDITING; ENERGY PRICE COMPARISON SERVICES; PROVIDING INFORMATION AND ADVICE TO COMMERCIAL AND INDUSTRIAL USERS OF ELECTRICAL POWER, RELATING TO THE USERS' SELECTION OF ELECTRICAL POWER PROVIDERS AND PROGRAMS; ENERGY CONSULTING SERVICES FOR RESIDENTIAL, COMMERCIAL AND BUSINESS USERS IN THE AREAS OF ENERGY MANAGEMENT; ARRANGING AND CONDUCTING INCENTIVE REWARD PROGRAMS TO PROMOTE THE SALE OF ELECTRICITY, GAS AND RENEWABLE ENERGY, IN CLASS 35 (U.S. CLS. 100, 101 AND 102).

FIRST USE 2-28-2011; IN COMMERCE 2-28-2011.

FOR: ENERGY BROKERAGE SERVICES, IN CLASS 36 (U.S. CLS. 100, 101 AND 102).

FIRST USE 2-28-2011; IN COMMERCE 2-28-2011.

THE MARK CONSISTS OF NINE CIRCLES FORMING A GEOMETRIC PATTERN.

SN 85-249,178, FILED 2-23-2011.

VIVIAN MICZNIK FIRST, EXAMINING ATTORNEY



David J. Kybas

Director of the United States Patent and Trademark Office

United States of America

United States Patent and Trademark Office



Reg. No. 4,206,908

Registered Sep. 11, 2012

Int. Cl.: 14

TRADEMARK

PRINCIPAL REGISTER

TIMOTHY LINCECUM (UNITED STATES INDIVIDUAL)
131 S RODEO DRIVE, NO. 100
BEVERLY HILLS, CA 902122439

FOR: JEWELRY, NAMELY, LAPEL PINS; ORNAMENTAL LAPEL PINS; TIE PINS; TIE CLIPS; TIE BARS; TIE TACKS; TIE FASTENERS; CUFF-LINKS; SHIRT STUDS; BADGES OF PRECIOUS METAL; JEWELRY PINS FOR USE ON HATS; HAT ORNAMENTS OF PRECIOUS METAL; HOLIDAY ORNAMENTS OF PRECIOUS METAL; JEWELRY BOXES AND CASES; KEY HOLDERS OF PRECIOUS METALS; KEY CHAINS OF PRECIOUS METAL; WATCHES; WATCH BRACELETS; WATCH ACCESSORIES, NAMELY, PARTS OF WATCHES; WRISTWATCHES; POCKET WATCHES; STOP WATCHES; WATCH STRAPS AND BANDS; WATCH CHAINS AND FOBS; WATCH CASES; WATCH BOXES; CLOCKS; ALARM CLOCKS; CLOCKS INCORPORATING RADIOS; WALL CLOCKS; TIMEPIECES; BOXES FOR TIMEPIECES; FIGURINES, STATUES, AND STATUETTES, ALL OF THE FOREGOING OF PRECIOUS METAL, IN CLASS 14 (U.S. CLS. 2, 27, 28 AND 50).

FIRST USE 11-11-2011; IN COMMERCE 11-11-2011.

THE MARK CONSISTS OF AN ATHLETE DEPICTED AS A SILHOUETTE THROWING A BASEBALL IN ONE HAND, AND HOLDING A BASEBALL MITT IN THE OTHER HAND.

SN 85-249,916, FILED 2-23-2011.

ANNE MADDEN, EXAMINING ATTORNEY



David J. Kybas

Director of the United States Patent and Trademark Office

United States of America

United States Patent and Trademark Office

Changing lives for good

Reg. No. 4,206,909

Registered Sep. 11, 2012

Int. Cl.: 41

SERVICE MARK

PRINCIPAL REGISTER

THE TWO STATE YMCA (MASSACHUSETTS CORPORATION)
748 HAMILTON ROAD
BECKET, MA 01223

FOR: RECREATIONAL CAMPS, IN CLASS 41 (U.S. CLS. 100, 101 AND 107).

FIRST USE 11-0-2010; IN COMMERCE 11-0-2010.

THE MARK CONSISTS OF STANDARD CHARACTERS WITHOUT CLAIM TO ANY PARTICULAR FONT, STYLE, SIZE, OR COLOR.

SN 85-249,965, FILED 2-23-2011.

INGRID C. EULIN, EXAMINING ATTORNEY



David J. Kybas

Director of the United States Patent and Trademark Office

United States of America

United States Patent and Trademark Office

UNLEASH THE BEAST

Reg. No. 4,206,910

WILLIAM J. MARTIN (UNITED STATES INDIVIDUAL)
66 EAST SANTA CLARA ST
SAN JOSE, CA 95113

Registered Sep. 11, 2012

Int. Cl.: 1

FOR: TIRE SEALING COMPOUNDS, IN CLASS 1 (U.S. CLS. 1, 5, 6, 10, 26 AND 46).

TRADEMARK

FIRST USE 10-31-2011; IN COMMERCE 10-31-2011.

PRINCIPAL REGISTER

THE MARK CONSISTS OF STANDARD CHARACTERS WITHOUT CLAIM TO ANY PARTICULAR FONT, STYLE, SIZE, OR COLOR.

SN 85-250,102, FILED 2-23-2011.

JOHN DWYER, EXAMINING ATTORNEY



David J. Kyffers

Director of the United States Patent and Trademark Office

United States of America

United States Patent and Trademark Office



Scratchy Butt

Reg. No. 4,206,911

Registered Sep. 11, 2012

Int. Cl.: 5

TRADEMARK

PRINCIPAL REGISTER

KATHY ELLIS (UNITED STATES INDIVIDUAL)
21638C STATE HIGHWAY 249
HOUSTON, TX 77070

FOR: DIETARY SUPPLEMENTS FOR PETS, IN CLASS 5 (U.S. CLS. 6, 18, 44, 46, 51 AND 52).

FIRST USE 5-23-2012; IN COMMERCE 5-23-2012.

THE MARK CONSISTS OF A RED DOG WITH A GRAY OVAL SHADOW UNDERNEATH. THE WORDS "SCRATCHY BUTT" ARE IN BLACK BELOW THE DOG. ALL OF THESE ELEMENTS ARE ATOP A WHITE BACKGROUND.

THE COLOR(S) RED, GRAY, BLACK AND WHITE IS/ARE CLAIMED AS A FEATURE OF THE MARK.

SN 85-250,113, FILED 2-23-2011.

DOMINICK J. SALEMI, EXAMINING ATTORNEY



David J. Kyros

Director of the United States Patent and Trademark Office

United States of America

United States Patent and Trademark Office



Reg. No. 4,206,912

SPINAL RESOURCES, INC. (FLORIDA CORPORATION)
1325 N. HALIFAX AVENUE
DAYTONA BEACH, FL 32118

Registered Sep. 11, 2012

Int. Cl.: 10

FOR: MEDICAL APPARATUS AND INSTRUMENTS FOR USE IN SURGERY; MEDICAL INSTRUMENTS FOR USE IN SPINAL SURGERY, NAMELY, A PEDICLE SCREW SYSTEM, IN CLASS 10 (U.S. CLS. 26, 39 AND 44).

TRADEMARK

FIRST USE 4-15-2012; IN COMMERCE 4-15-2012.

PRINCIPAL REGISTER

THE MARK CONSISTS OF TWO VERTICAL LINES WITH TWO ARROWS POINTING UPWARD INSIDE THE TWO VERTICAL LINES, ALL TO THE LEFT OF THE WORD "SWEDGE".

SN 85-251,482, FILED 2-25-2011.

STEVEN PEREZ, EXAMINING ATTORNEY



David J. Kybas

Director of the United States Patent and Trademark Office

United States of America

United States Patent and Trademark Office



GARY SINISE
★ FOUNDATION ★

Reg. No. 4,206,913

Registered Sep. 11, 2012

Int. Cl.: 36

SERVICE MARK

PRINCIPAL REGISTER

THE GARY SINISE FOUNDATION (DELAWARE CORPORATION)
C/O LICKER & OZUROVICH
1901 AVENUE OF THE STARS, SUITE 1050
LOS ANGELES, CA 90067

FOR: CHARITABLE FUNDRAISING SERVICES; CHARITABLE FOUNDATION SERVICES, NAMELY, PROVIDING FUNDRAISING ACTIVITIES, FUNDING, SCHOLARSHIPS AND/OR FINANCIAL ASSISTANCE FOR MILITARY PERSONNEL AND THEIR FAMILIES, AND FOR CHARITABLE CAUSES AND PROGRAMS, IN CLASS 36 (U.S. CLS. 100, 101 AND 102).

FIRST USE 7-1-2011; IN COMMERCE 7-1-2011.

NO CLAIM IS MADE TO THE EXCLUSIVE RIGHT TO USE "FOUNDATION", APART FROM THE MARK AS SHOWN.

THE NAME "GARY SINISE" IDENTIFIES A LIVING INDIVIDUAL WHOSE CONSENT IS OF RECORD.

THE MARK CONSISTS OF THE WORDS "GARY SINISE FOUNDATION" AND A STYLIZED DESIGN OF AN EAGLE WITH THREE STARS ABOVE ITS HEAD AND WITH A STAR ON THE EACH SIDE OF THE WORD "FOUNDATION".

SN 85-252,094, FILED 2-25-2011.

KATINA MISTER, EXAMINING ATTORNEY



David J. Kybas

Director of the United States Patent and Trademark Office

United States of America

United States Patent and Trademark Office

Superstar Savers Kid's Club

Reg. No. 4,206,914

CY-FAIR FEDERAL CREDIT UNION (TEXAS CREDIT UNION)

Registered Sep. 11, 2012

9601 JONES ROAD
HOUSTON, TX 77065

Int. Cl.: 36

FOR: FINANCIAL SERVICES, NAMELY, SAVINGS PROGRAMS FOR YOUTHS, IN CLASS 36 (U.S. CLS. 100, 101 AND 102).

SERVICE MARK

FIRST USE 5-1-2011; IN COMMERCE 5-1-2011.

PRINCIPAL REGISTER

THE MARK CONSISTS OF STANDARD CHARACTERS WITHOUT CLAIM TO ANY PARTICULAR FONT, STYLE, SIZE, OR COLOR.

NO CLAIM IS MADE TO THE EXCLUSIVE RIGHT TO USE "SAVERS KID'S CLUB", APART FROM THE MARK AS SHOWN.

SN 85-252,236, FILED 2-25-2011.

CHARISMA HAMPTON, EXAMINING ATTORNEY



David J. Kyffers

Director of the United States Patent and Trademark Office

United States of America
United States Patent and Trademark Office

IRGASON

Reg. No. 4,206,915

CAMPBELL SCIENTIFIC, INC. (UTAH CORPORATION)
815 W 1800 N

Registered Sep. 11, 2012

LOGAN, UT 84321

Int. Cl.: 9

FOR: MEASUREMENT INSTRUMENTATION FOR QUANTIFYING GAS CONCENTRATIONS OR FLUID TRANSPORT, IN CLASS 9 (U.S. CLS. 21, 23, 26, 36 AND 38).

TRADEMARK

FIRST USE 2-6-2012; IN COMMERCE 2-6-2012.

PRINCIPAL REGISTER

THE MARK CONSISTS OF STANDARD CHARACTERS WITHOUT CLAIM TO ANY PARTICULAR FONT, STYLE, SIZE, OR COLOR.

SN 85-252,286, FILED 2-25-2011.

MARILYN IZZI, EXAMINING ATTORNEY



David J. Kybas

Director of the United States Patent and Trademark Office

United States of America

United States Patent and Trademark Office

H2O^T

Reg. No. 4,206,916

Registered Sep. 11, 2012

Int. Cl.: 11

TRADEMARK

PRINCIPAL REGISTER

PINDELL ENGINEERING INC. (WASHINGTON CORPORATION)
24 SETON ROAD
PORT TOWNSEND, WA 98368

FOR: MOISTURE REMOVAL DEVICE, NAMELY, A PORTABLE CONTAINER CONTAINING EXSICCATING MATERIAL FOR USE IN REMOVING MOISTURE FROM ENGINES, MACHINERY, TANKS, GENERATORS, HYDRAULIC SYSTEMS, DEHUMIDIFIERS, EQUIPMENT, SYSTEMS, DEVICES, BAGS, LOCKERS, FILTERS, COMPRESSORS, CASES, BOXES, AND SAFES, IN CLASS 11 (U.S. CLS. 13, 21, 23, 31 AND 34).

FIRST USE 9-9-2010; IN COMMERCE 9-0-2010.

THE MARK CONSISTS OF STANDARD CHARACTERS WITHOUT CLAIM TO ANY PARTICULAR FONT, STYLE, SIZE, OR COLOR.

SN 85-253,031, FILED 2-28-2011.

MEGHAN REINHART, EXAMINING ATTORNEY



David J. Kybas

Director of the United States Patent and Trademark Office

United States of America

United States Patent and Trademark Office

GESAWORLD

Reg. No. 4,206,917

GESAWORLD, S.A. (SPAIN CORPORATION)

Registered Sep. 11, 2012

C/ COMTE D'URGELL, 204 - 5 TO B
08036 BARCELONA, SPAIN

Int. Cl.: 35

FOR: ADVERTISING; BUSINESS MANAGEMENT; BUSINESS ADMINISTRATION; OFFICE FUNCTIONS, IN CLASS 35 (U.S. CLS. 100, 101 AND 102).

SERVICE MARK

FIRST USE 3-17-2011; IN COMMERCE 3-17-2011.

PRINCIPAL REGISTER

THE MARK CONSISTS OF STANDARD CHARACTERS WITHOUT CLAIM TO ANY PARTICULAR FONT, STYLE, SIZE, OR COLOR.

SN 85-253,481, FILED 2-28-2011.

KELLY BOULTON, EXAMINING ATTORNEY



David J. Kybas

Director of the United States Patent and Trademark Office

United States of America
United States Patent and Trademark Office

izomax

Reg. No. 4,206,918

Registered Sep. 11, 2012

Int. Cl.: 17

IZOMAKS YALITIM VE ENDUSTRI SANAYI TICARET ANONIM SIRKETI (TURKEY CORPORATION)

ORGANIZE SANAYI BOLGESI 2
KISIM, HEMA CADDESI, NO: 12/A
CERKEZKOY - TEKIRDAG, TURKEY

TRADEMARK

FOR: WATER PROOFING BITUMINOUS MEMBRANES FOR FOUNDATIONS OF BUILDINGS, IN CLASS 17 (U.S. CLS. 1, 5, 12, 13, 35 AND 50).

PRINCIPAL REGISTER

FIRST USE 1-0-2007; IN COMMERCE 9-0-2010.

THE MARK CONSISTS OF THE TERM "IZOMAX" IN RED, STYLIZED LETTERING.

THE COLOR(S) RED IS/ARE CLAIMED AS A FEATURE OF THE MARK.

SN 85-254,974, FILED 3-1-2011.

SIMON TENG, EXAMINING ATTORNEY



David J. Kybas

Director of the United States Patent and Trademark Office

United States of America

United States Patent and Trademark Office

ACUTRIGGER THERAPY

Reg. No. 4,206,919

ANZALDUA, DAVID (UNITED STATES INDIVIDUAL)
5823 CHAMBERTIN DR.
SAN JOSE, CA 95118

Registered Sep. 11, 2012

Int. Cl.: 44

FOR: MEDICAL, PHYSICAL REHABILITATION AND PHYSICAL THERAPY SERVICES;
ACUPUNCTURE SERVICES, IN CLASS 44 (U.S. CLS. 100 AND 101).

SERVICE MARK

FIRST USE 4-15-2012; IN COMMERCE 6-25-2012.

PRINCIPAL REGISTER

THE MARK CONSISTS OF STANDARD CHARACTERS WITHOUT CLAIM TO ANY PARTICULAR FONT, STYLE, SIZE, OR COLOR.

NO CLAIM IS MADE TO THE EXCLUSIVE RIGHT TO USE "THERAPY", APART FROM THE MARK AS SHOWN.

SN 85-255,049, FILED 3-1-2011.

BENJAMIN OKEKE, EXAMINING ATTORNEY



David J. Kyffers

Director of the United States Patent and Trademark Office

United States of America

United States Patent and Trademark Office



Reg. No. 4,206,920

Registered Sep. 11, 2012

Int. Cl.: 28

TRADEMARK

PRINCIPAL REGISTER

KELLY, BRENDAN (UNITED STATES INDIVIDUAL), DBA KELLY KONCEPTS,
135 E. HATHWAY LN
HAVERTOWN, PA 19083

FOR: PLAYING CARDS AND CARD GAMES, IN CLASS 28 (U.S. CLS. 22, 23, 38 AND 50).

FIRST USE 3-26-2012; IN COMMERCE 3-12-2012.

NO CLAIM IS MADE TO THE EXCLUSIVE RIGHT TO USE "GAME", APART FROM THE MARK AS SHOWN.

THE COLOR(S) RED, GREEN, BLUE, WHITE, BLACK IS/ARE CLAIMED AS A FEATURE OF THE MARK.

THE MARK CONSISTS OF A GREEN AND BLACK CIRCLE SURROUNDS A CENTERED RED AND BLUE STAR WITH THE WORDS "GAME ON" IN RED AND BLUE SUPERIMPOSED OVER AND WITHIN THE STAR, WITH A WHITE INTERIOR BACKGROUND.

SN 85-255,435, FILED 3-2-2011.

WARREN L. OLANDRIA, EXAMINING ATTORNEY



David J. Kyros

Director of the United States Patent and Trademark Office

United States of America

United States Patent and Trademark Office



Reg. No. 4,206,921

LA BREA BAKERY, INC. (DELAWARE CORPORATION)
15963 STRATHERN STREET
VAN NUYS, CA 91406

Registered Sep. 11, 2012

Int. Cl.: 30

FOR: BAKERY GOODS; BAKERY GOODS, NAMELY, BREAD SOLD TOGETHER WITH A BAG CAPABLE OF OVEN HEATING; BREAD, IN CLASS 30 (U.S. CL. 46).

TRADEMARK

FIRST USE 8-0-2011; IN COMMERCE 8-0-2011.

PRINCIPAL REGISTER

OWNER OF U.S. REG. NOS. 2,327,028, 2,486,112, AND OTHERS.

THE COLOR(S) RED AND YELLOW IS/ARE CLAIMED AS A FEATURE OF THE MARK.

NO CLAIM IS MADE TO THE EXCLUSIVE RIGHT TO USE "BAKE-ABLE BAG" AND "BAKERY", APART FROM THE MARK AS SHOWN.

THE MARK CONSISTS OF TWO CONCENTRIC CIRCLES, WITH A FLAME APPEARING INSIDE THE SMALLER CIRCLE, AND THE TERM "BAKE-ABLE BAG" APPEARING BETWEEN BOTH CIRCLES, ALL APPEARING ABOVE A BANNER THAT DISPLAYS THE COMPANY NAME "LA BREA BAKERY".

SN 85-256,338, FILED 3-2-2011.

ELI HELLMAN, EXAMINING ATTORNEY



David J. Kybas

Director of the United States Patent and Trademark Office

United States of America

United States Patent and Trademark Office

TIDE STAIN RELEASE BOOST

Reg. No. 4,206,922

Registered Sep. 11, 2012

Int. Cl.: 3

TRADEMARK

PRINCIPAL REGISTER

THE PROCTER & GAMBLE COMPANY (OHIO CORPORATION)
ONE PROCTER & GAMBLE PLAZA
CINCINNATI, OH 45202

FOR: LAUNDRY STAIN REMOVERS, IN CLASS 3 (U.S. CLS. 1, 4, 6, 50, 51 AND 52).

FIRST USE 9-30-2011; IN COMMERCE 9-30-2011.

THE MARK CONSISTS OF STANDARD CHARACTERS WITHOUT CLAIM TO ANY PARTICULAR FONT, STYLE, SIZE, OR COLOR.

OWNER OF U.S. REG. NOS. 424,339, 3,521,155, AND OTHERS.

NO CLAIM IS MADE TO THE EXCLUSIVE RIGHT TO USE "STAIN", APART FROM THE MARK AS SHOWN.

SN 85-256,511, FILED 3-3-2011.

LINDA MICKLEBURGH, EXAMINING ATTORNEY



David J. Kyffers

Director of the United States Patent and Trademark Office

United States of America
United States Patent and Trademark Office

LOLLI BAG

Reg. No. 4,206,923

Registered Sep. 11, 2012

Int. Cl.: 18

TRADEMARK

PRINCIPAL REGISTER

JILL JOANNE, LLC (CALIFORNIA LIMITED LIABILITY JOINT STOCK COMPANY)
22 EMERALD BAY
LAGUNA BEACH, CA 92651

FOR: HANDBAGS; PURSES, IN CLASS 18 (U.S. CLS. 1, 2, 3, 22 AND 41).

FIRST USE 3-3-2011; IN COMMERCE 3-17-2012.

THE MARK CONSISTS OF STANDARD CHARACTERS WITHOUT CLAIM TO ANY PARTICULAR FONT, STYLE, SIZE, OR COLOR.

NO CLAIM IS MADE TO THE EXCLUSIVE RIGHT TO USE "BAG", APART FROM THE MARK AS SHOWN.

SN 85-257,480, FILED 3-3-2011.

GIANCARLO CASTRO, EXAMINING ATTORNEY



David J. Kyffers

Director of the United States Patent and Trademark Office

United States of America

United States Patent and Trademark Office

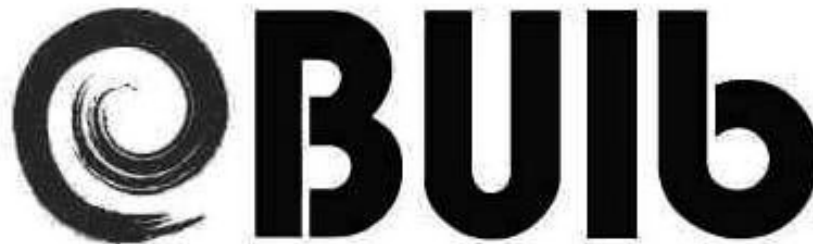

Reg. No. 4,206,924

Registered Sep. 11, 2012

Int. Cl.: 11

TRADEMARK

PRINCIPAL REGISTER

SHINING UNION LIMITED (HONG KONG LIMITED LIABILITY COMPANY)
SUITES 2601-2, 26/F, TOWER 2, NINA TOWER
TSUEN WAN, N.T., HK, HONG KONG

FOR: ELECTRIC LAMPS; LAMP BULBS; LAMPS; ELECTRIC BULBS; LIGHT BULBS; LAMP CASINGS; LUMINARIES; ELECTRIC LUMINARIES, IN CLASS 11 (U.S. CLS. 13, 21, 23, 31 AND 34).

FIRST USE 4-9-2010; IN COMMERCE 5-31-2010.

NO CLAIM IS MADE TO THE EXCLUSIVE RIGHT TO USE "BULB", APART FROM THE MARK AS SHOWN.

SN 85-257,626, FILED 3-3-2011.

SUE LAWRENCE, EXAMINING ATTORNEY



David J. Kyffers

Director of the United States Patent and Trademark Office

United States of America

United States Patent and Trademark Office

KleenLine

Reg. No. 4,206,925

WAXIE'S ENTERPRISES, INC. (ARIZONA CORPORATION)

Registered Sep. 11, 2012

9353 WAXIE WAY
SAN DIEGO, CA 92123

Int. Cl.: 7

FOR: PADS FOR FLOOR POLISHING MACHINES, IN CLASS 7 (U.S. CLS. 13, 19, 21, 23, 31, 34 AND 35).

TRADEMARK

FIRST USE 3-31-2011; IN COMMERCE 3-31-2011.

PRINCIPAL REGISTER

THE MARK CONSISTS OF STANDARD CHARACTERS WITHOUT CLAIM TO ANY PARTICULAR FONT, STYLE, SIZE, OR COLOR.

SN 85-258,721, FILED 3-4-2011.

SANDRA BUJA, EXAMINING ATTORNEY



David J. Kybas

Director of the United States Patent and Trademark Office

United States of America

United States Patent and Trademark Office



Reg. No. 4,206,926

FOR LIFE PRODUCTS, INC. (FLORIDA CORPORATION)
2301 SW 145TH AVENUE
MIRAMAR, FL 33027

Registered Sep. 11, 2012

Int. Cl.: 6

FOR: METAL DOOR STOPS, IN CLASS 6 (U.S. CLS. 2, 12, 13, 14, 23, 25 AND 50).

TRADEMARK

FIRST USE 9-14-2011; IN COMMERCE 9-14-2011.

PRINCIPAL REGISTER

NO CLAIM IS MADE TO THE EXCLUSIVE RIGHT TO USE "STOP" AND "HINGE PIN DOOR STOP", APART FROM THE MARK AS SHOWN.

THE MARK CONSISTS OF AN OCTAGON SHAPE WITH THE WORD "SMART" ON THE FIRST LINE; THE WORD "STOP" WITH AN IMAGE OF A HINGE PIN DOOR STOP IN PLACE OF THE LETTER "O" ON THE SECOND LINE; THE WORDS "HINGE PIN" ON THE THIRD LINE; AND THE WORDS "DOOR STOP" ON THE FOURTH LINE.

SN 85-259,523, FILED 3-7-2011.

FONG HSU, EXAMINING ATTORNEY



David J. Kyffers

Director of the United States Patent and Trademark Office

United States of America

United States Patent and Trademark Office

OCEAN SPORT

Reg. No. 4,206,927

HARRY WINSTON, INC. (NEW YORK CORPORATION)

Registered Sep. 11, 2012

718 FIFTH AVENUE
NEW YORK, NY 10019

Int. Cl.: 14

FOR: WATCHES, NAMELY, WRIST-WATCHES, WATCH-BRACELETS, BRACELETS-FASTENERS, WATCH-CASES AND WATCH-MOVEMENTS, IN CLASS 14 (U.S. CLS. 2, 27, 28 AND 50).

TRADEMARK

FIRST USE 3-31-2011; IN COMMERCE 3-31-2011.

PRINCIPAL REGISTER

THE MARK CONSISTS OF STANDARD CHARACTERS WITHOUT CLAIM TO ANY PARTICULAR FONT, STYLE, SIZE, OR COLOR.

OWNER OF U.S. REG. NOS. 2,461,192 AND 3,535,975.

NO CLAIM IS MADE TO THE EXCLUSIVE RIGHT TO USE "SPORT", APART FROM THE MARK AS SHOWN.

SN 85-259,952, FILED 3-7-2011.

ALEXANDER L. POWERS, EXAMINING ATTORNEY



David J. Kyffers

Director of the United States Patent and Trademark Office

United States of America

United States Patent and Trademark Office



Reg. No. 4,206,928

Registered Sep. 11, 2012

Int. Cl.: 25

TRADEMARK

PRINCIPAL REGISTER

ENNICO, SUZANNE (NEW JERSEY SOLE PROPRIETORSHIP), DBA SNUG-A-ROOS,
8-10 CEDAR STREET
FAIR LAWN, NJ 07410

FOR: INFANTWEAR, IN CLASS 25 (U.S. CLS. 22 AND 39).

FIRST USE 9-1-2011; IN COMMERCE 1-15-2012.

THE MARK CONSISTS OF THE FOLLOWING: THE TERM "SNUG-A-ROOS" IN A LIGHT BLUE CLOUD. THE TERM "SNUG" APPEARS IN THE COLOR PINK. THE HYPHENS APPEAR IN THE COLOR YELLOW. THE LETTER "A" APPEARS IN THE COLOR GREEN. THE LETTERS "R" AND "S" APPEAR IN THE COLOR DARK BLUE. THE FIRST "O" CONSISTS OF THE DESIGN OF A BABY WITH A BOW ON TOP IN PINK. THE SECOND "O" CONSISTS OF A BABY IN BLUE WITH YELLOW HAIR ON TOP. BACKGROUND IS WHITE.

THE COLOR(S) LIGHT BLUE, DARK BLUE, PINK, GREEN, YELLOW AND WHITE IS/ARE CLAIMED AS A FEATURE OF THE MARK.

SN 85-260,340, FILED 3-7-2011.

CAROLINE WOOD, EXAMINING ATTORNEY



David J. Kyffers

Director of the United States Patent and Trademark Office

United States of America

United States Patent and Trademark Office

WAGLETWORKS

Reg. No. 4,206,929

Registered Sep. 11, 2012

**Int. Cls.: 11, 12, 18, 20,
and 21**

TRADEMARK

PRINCIPAL REGISTER

WAGLET WORKS, LLC (FLORIDA LIMITED LIABILITY COMPANY)
1207 N.E. 89 STREET
MIAMI, FL 33138

FOR: FLASHLIGHT FOR LOCATING PET WASTE, IN CLASS 11 (U.S. CLS. 13, 21, 23, 31 AND 34).

FIRST USE 3-7-2012; IN COMMERCE 3-7-2012.

FOR: VEHICLE SEAT COVER FOR PETS, IN CLASS 12 (U.S. CLS. 19, 21, 23, 31, 35 AND 44).

FIRST USE 3-7-2012; IN COMMERCE 3-7-2012.

FOR: PET WASTE BELT BAG SYSTEM COMPRISING CLIP ON OR LOOP ON SUPPORT FOR HOLDING PET ACCESSORIES; AND PET ACCESSORIES, NAMELY, CARRY BAG FOR DISPENSING DISPOSABLE SOLID ANIMAL WASTE PLASTIC BAGS AND FOR CARRYING USED DISPOSABLE SOLID ANIMAL WASTE PLASTIC BAGS, TOTE BAGS FOR PET TOYS, IN CLASS 18 (U.S. CLS. 1, 2, 3, 22 AND 41).

FIRST USE 3-7-2012; IN COMMERCE 3-7-2012.

FOR: COMBINATION TRAVEL BED, IN CLASS 20 (U.S. CLS. 2, 13, 22, 25, 32 AND 50).

FIRST USE 3-7-2012; IN COMMERCE 3-7-2012.

FOR: WATER BOTTLE HOLDER, FOLDING WATER BOWL, WET WIPES HOLDER AND DISPENSER, PET SNACK BOWL, IN CLASS 21 (U.S. CLS. 2, 13, 23, 29, 30, 33, 40 AND 50).

FIRST USE 3-7-2012; IN COMMERCE 3-7-2012.

THE MARK CONSISTS OF STANDARD CHARACTERS WITHOUT CLAIM TO ANY PARTICULAR FONT, STYLE, SIZE, OR COLOR.

SN 85-261,183, FILED 3-8-2011.

NAAKWAMA ANKRAH, EXAMINING ATTORNEY



David J. Kyros

Director of the United States Patent and Trademark Office

United States of America

United States Patent and Trademark Office

TAKING THE OPEN OUT OF OPEN HEART

Reg. No. 4,206,930

Registered Sep. 11, 2012

Int. Cl.: 44

SERVICE MARK

PRINCIPAL REGISTER

MERCY HEALTH SYSTEM - NORTHERN REGION (OHIO NON-PROFIT CORPORATION),
DBA MERCY HEALTH PARTNERS,
2200 JEFFERSON AVENUE
TOLEDO, OH 43604

FOR: HEALTHCARE SERVICES, NAMELY, PROVIDING HEALTH INFORMATION, MEDICAL INFORMATION, MEDICAL TESTING FOR CORONARY ARTERY BYPASS, HEART VALVE REPAIR OR REPLACEMENT, ATRIAL FIBRILLATION ABLATION, ATRIAL SEPTAL DEFECT CLOSURE AND CARDIAC TUMOR REMOVAL, CONDUCTING MEDICAL PHYSICAL EVALUATION, MEDICAL DIAGNOSTIC TESTING, MONITORING, AND REPORTING SERVICES, MEDICAL SERVICES, SURGERY SERVICES, AND HOSPITAL SERVICES, IN CLASS 44 (U.S. CLS. 100 AND 101).

FIRST USE 5-22-2011; IN COMMERCE 5-22-2011.

THE MARK CONSISTS OF STANDARD CHARACTERS WITHOUT CLAIM TO ANY PARTICULAR FONT, STYLE, SIZE, OR COLOR.

NO CLAIM IS MADE TO THE EXCLUSIVE RIGHT TO USE "OPEN HEART", APART FROM THE MARK AS SHOWN.

SN 85-261,721, FILED 3-9-2011.

SUZANNE BLANE, EXAMINING ATTORNEY



David J. Kybas

Director of the United States Patent and Trademark Office

United States of America
United States Patent and Trademark Office

SOLSTICE

Reg. No. 4,206,931

SOLSTICE BEDDING, LLC (OHIO LIMITED LIABILITY COMPANY)
2652 FISHER ROAD
COLUMBUS, OH 43204

Registered Sep. 11, 2012

Int. Cl.: 20

FOR: BEDS, MATTRESSES, BOX SPRINGS, FUTONS, SLEEPER SOFAS, ROLLOUT BEDS
AND PILLOWS, IN CLASS 20 (U.S. CLS. 2, 13, 22, 25, 32 AND 50).

TRADEMARK

FIRST USE 5-1-2011; IN COMMERCE 5-1-2011.

PRINCIPAL REGISTER

THE MARK CONSISTS OF STANDARD CHARACTERS WITHOUT CLAIM TO ANY PAR-
TICULAR FONT, STYLE, SIZE, OR COLOR.

SN 85-262,971, FILED 3-10-2011.

KATHLEEN LORENZO, EXAMINING ATTORNEY



David J. Kybas

Director of the United States Patent and Trademark Office

United States of America

United States Patent and Trademark Office

INTONE

Reg. No. 4,206,932

Registered Sep. 11, 2012

Int. Cl.: 10

TRADEMARK

PRINCIPAL REGISTER

INCONTROL MEDICAL, LLC (WISCONSIN LIMITED LIABILITY COMPANY)
SUITE 250
3225 GATEWAY ROAD
BROOKFIELD, WI 53045

FOR: MEDICAL DEVICES FOR THE TREATMENT OF INCONTINENCE, NAMELY, ELECTROTHERAPY AND BIOFEEDBACK DEVICES FOR STRENGTHENING PELVIC FLOOR MUSCLES, IN CLASS 10 (U.S. CLS. 26, 39 AND 44).

FIRST USE 1-1-2011; IN COMMERCE 1-1-2011.

THE MARK CONSISTS OF STANDARD CHARACTERS WITHOUT CLAIM TO ANY PARTICULAR FONT, STYLE, SIZE, OR COLOR.

SN 85-263,563, FILED 3-10-2011.

AMY HELLA, EXAMINING ATTORNEY



David J. Kyffers

Director of the United States Patent and Trademark Office

United States of America

United States Patent and Trademark Office



Reg. No. 4,206,933

Registered Sep. 11, 2012

Int. Cl.: 30

TRADEMARK

PRINCIPAL REGISTER

CONCHITA FOODS, INC. (FLORIDA CORPORATION)
9115 NW 105 WAY
MIAMI, FL 33178

FOR: PASTRIES WITH GUAVA FRUIT, IN CLASS 30 (U.S. CL. 46).

FIRST USE 3-15-2011; IN COMMERCE 3-15-2011.

OWNER OF U.S. REG. NOS. 2,683,755 AND 2,954,609.

THE COLOR(S) YELLOW, RED, SCARLET, LIGHT RED, GREEN, WHITE, DARK BLUE AND LIGHT BLUE IS/ARE CLAIMED AS A FEATURE OF THE MARK.

NO CLAIM IS MADE TO THE EXCLUSIVE RIGHT TO USE "GUAVABITES" AND "GUAVA PASTE FILLED COOKIES" AND "GALLETICAS RELLENAS DE PASTA DE GUAYABA" AND THE PICTORIAL REPRESENTATION OF THE PASTRIES, APART FROM THE MARK AS SHOWN.

THE MARK CONSISTS OF THE FOLLOWING: THE COLOR YELLOW IS ON THE OUTSIDE OF TWO PASTRIES AND ON THE OUTSIDE OF ONE WHOLE AND ONE HALF GUAVA TO THE RIGHT OF THE PASTRIES AND ON A VERTICAL STRIPE BEHIND THE PASTRIES; RED IN THE BACKGROUND OF THE WORDING "CONCHITA" AND "GUAVABITES!" ON THE LEFT SIDE AND ON THE BACKGROUND OF A TEN-POINT STAR ON THE RIGHT SIDE; SCARLET ON THE AREAS REPRESENTING A TRANSVERSE CUT OF THE PASTRIES; LIGHT RED WITH YELLOW POINTS IN THE AREA REPRESENTING A TRANSVERSE CUT OF THE HALF GUAVA FRUIT; GREEN ON THE LEAVES OF THE GUAVA FRUIT AND ON THE TEN-POINT STAR TO THE RIGHT OF THE GUAVA FRUIT; "CONCHITA" IS ABOVE "GUAVA" AND IS WHITE OUTLINED IN YELLOW; "GUAVA" IS IN DARK BLUE AND "BITES!" IS IN LIGHT BLUE; WHITE IS IN THE BACKGROUND OF "GUAVABITES!"; THE WORDING "GUAVA PASTE FILLED COOKIES - GALLETICAS RELLENAS DE PASTA DE GUAYABA" IS IN YELLOW BELOW "GUAVABITES!"; DARK BLUE IS IN THE BACKGROUND OF THE PASTRIES AND THE GUAVA FRUIT.



David J. Kyffers

THE ENGLISH TRANSLATION OF "GALLETICAS RELLENAS DE PASTA DE GUAYABA" IN THE MARK IS "GUAVA PASTE FILLED COOKIES".

SN 85-263,634, FILED 3-10-2011.

Reg. No. 4,206,933 DAVID ELTON, EXAMINING ATTORNEY

United States of America

United States Patent and Trademark Office

Cool Vape

Reg. No. 4,206,934

LOVE, RONALD, C (UNITED STATES INDIVIDUAL), DBA HERBAL INNOVATIONS,
1069 GROVE ST.
HEALDSBURG, CA 95448

Registered Sep. 11, 2012

Int. Cl.: 34

FOR: SMOKELESS CIGARETTE VAPORIZER PIPE, IN CLASS 34 (U.S. CLS. 2, 8, 9 AND 17).

TRADEMARK

FIRST USE 3-1-2011; IN COMMERCE 5-1-2012.

PRINCIPAL REGISTER

THE MARK CONSISTS OF STANDARD CHARACTERS WITHOUT CLAIM TO ANY PARTICULAR FONT, STYLE, SIZE, OR COLOR.

SN 85-263,942, FILED 3-10-2011.

MIDGE BUTLER, EXAMINING ATTORNEY



David J. Kybas

Director of the United States Patent and Trademark Office

United States of America

United States Patent and Trademark Office

MUD ENERGY

Reg. No. 4,206,935

JEFF BONISA (UNITED STATES INDIVIDUAL)
260 CALLE CUERVO
SAN CLEMENTE, CA 92672

Registered Sep. 11, 2012

Int. Cl.: 5

FOR: ORALLY INGESTED GELS FOR BOOSTING ENERGY, IN CLASS 5 (U.S. CLS. 6, 18, 44, 46, 51 AND 52).

TRADEMARK

FIRST USE 4-8-2012; IN COMMERCE 5-6-2012.

PRINCIPAL REGISTER

THE MARK CONSISTS OF STANDARD CHARACTERS WITHOUT CLAIM TO ANY PARTICULAR FONT, STYLE, SIZE, OR COLOR.

NO CLAIM IS MADE TO THE EXCLUSIVE RIGHT TO USE "ENERGY", APART FROM THE MARK AS SHOWN.

SN 85-264,648, FILED 3-11-2011.

LAURA KOVALSKY, EXAMINING ATTORNEY



David J. Kybas

Director of the United States Patent and Trademark Office

United States of America
United States Patent and Trademark Office

VIRREYES

Reg. No. 4,206,936

TEQUILERA DON ROBERTO SA DE CV (MEXICO CORPORATION)
TEQUILA CARRATERA INTERNACIONAL 100
TEQUILA JALISCO, MEXICO 44700

Registered Sep. 11, 2012

Int. Cl.: 33

FOR: ALCOHOLIC BEVERAGES EXCEPT BEERS; ALCOHOLIC BEVERAGES MADE FROM AGAVE EXCEPT BEERS; AGAVE BASED ALCOHOLIC BEVERAGES EXCEPT BEERS; ALCOHOLIC BEVERAGES INCORPORATING AGAVE EXCEPT BEERS; TEQUILA, IN CLASS 33 (U.S. CLS. 47 AND 49).

TRADEMARK

PRINCIPAL REGISTER

FIRST USE 2-28-2012; IN COMMERCE 2-28-2012.

THE MARK CONSISTS OF STANDARD CHARACTERS WITHOUT CLAIM TO ANY PARTICULAR FONT, STYLE, SIZE, OR COLOR.

THE ENGLISH TRANSLATION OF "VIRREYES" IN THE MARK IS "VICEROYS".

SN 85-264,662, FILED 3-11-2011.

DAVID TOOLEY, EXAMINING ATTORNEY



David J. Kyffers

Director of the United States Patent and Trademark Office

United States of America

United States Patent and Trademark Office

AMERICAN EAGLE OUTFITTERS

OFF CAMPUS

Reg. No. 4,206,937

RETAIL ROYALTY COMPANY (NEVADA CORPORATION)
101 CONVENTION CENTER DRIVE
LAS VEGAS, NV 89109

Registered Sep. 11, 2012

Int. Cl.: 35

FOR: RETAIL STORE AND ON-LINE RETAIL STORE SERVICES FEATURING CLOTHING, CLOTHING ACCESSORIES, HEADWEAR, FOOTWEAR, SUNGLASSES, FRAGRANCES, JEWELRY, WATCHES, HEADPHONES, BAGS, BACKPACKS, UMBRELLAS, WALLETS, PURSES AND KEY CHAINS, IN CLASS 35 (U.S. CLS. 100, 101 AND 102).

SERVICE MARK

PRINCIPAL REGISTER

FIRST USE 4-0-2011; IN COMMERCE 4-0-2011.

OWNER OF U.S. REG. NOS. 2,050,115, 3,878,197, AND OTHERS.

NO CLAIM IS MADE TO THE EXCLUSIVE RIGHT TO USE "OUTFITTERS" IN CONNECTION WITH RETAIL STORE AND ON-LINE RETAIL STORE SERVICES FEATURING CLOTHING, CLOTHING ACCESSORIES, HEADWEAR, FOOTWEAR, SUNGLASSES, BAGS, BACKPACKS, UMBRELLAS, WALLETS, PURSES AND KEY CHAINS. , APART FROM THE MARK AS SHOWN.

THE MARK CONSISTS OF THE WORDS "AMERICAN EAGLE OUTFITTERS" ABOVE A BOX WITH THE WORDS "OFF CAMPUS" THEREIN SEPARATED BY A FLYING EAGLE DESIGN.

SN 85-264,733, FILED 3-11-2011.

FONG HSU, EXAMINING ATTORNEY



David J. Kyffers

Director of the United States Patent and Trademark Office

United States of America

United States Patent and Trademark Office

AMERICAN EAGLE OUTFITTERS **OFFY CAMPUS**

Reg. No. 4,206,938

RETAIL ROYALTY COMPANY (NEVADA CORPORATION)
101 CONVENTION CENTER DRIVE
LAS VEGAS, NV 89109

Registered Sep. 11, 2012

Int. Cl.: 35

FOR: RETAIL STORE AND ON-LINE RETAIL STORE SERVICES FEATURING CLOTHING, CLOTHING ACCESSORIES, HEADWEAR, FOOTWEAR, SUNGLASSES, FRAGRANCES, JEWELRY, WATCHES, HEADPHONES, BAGS, BACKPACKS, UMBRELLAS, WALLETS, PURSES AND KEY CHAINS, IN CLASS 35 (U.S. CLS. 100, 101 AND 102).

SERVICE MARK

PRINCIPAL REGISTER

FIRST USE 4-0-2011; IN COMMERCE 4-0-2011.

OWNER OF U.S. REG. NOS. 2,050,115, 3,878,197, AND OTHERS.

NO CLAIM IS MADE TO THE EXCLUSIVE RIGHT TO USE "OUTFITTERS" IN CONNECTION WITH RETAIL STORE AND ON-LINE RETAIL STORE SERVICES FEATURING CLOTHING, CLOTHING ACCESSORIES, HEADWEAR, FOOTWEAR, SUNGLASSES, BAGS, BACKPACKS, UMBRELLAS, WALLETS, PURSES AND KEY CHAINS. , APART FROM THE MARK AS SHOWN.

THE MARK CONSISTS OF THE WORDS "AMERICAN EAGLE OUTFITTERS" WITH A BOX TO THE RIGHT WITH THE WORDS "OFF CAMPUS" THEREIN SEPARATED BY A FLYING EAGLE DESIGN.

SN 85-264,739, FILED 3-11-2011.

FONG HSU, EXAMINING ATTORNEY



David J. Kyffers

Director of the United States Patent and Trademark Office

United States of America

United States Patent and Trademark Office

AFFIGENT

Reg. No. 4,206,939

Registered Sep. 11, 2012

Int. Cl.: 35

SERVICE MARK

PRINCIPAL REGISTER

AFFIGENT, LLC (ALASKA LIMITED LIABILITY COMPANY)
13873 PARK CENTER RD.
STE. 127
HERNDON, VA 20171

FOR: PROCUREMENT SERVICES, NAMELY, PURCHASING COMPUTER HARDWARE, COMPUTER SOFTWARE, COMPUTER NETWORKING SYSTEM COMPONENTS, AND TELECOMMUNICATION COMPONENTS FOR OTHERS; ADVERTISING AND MARKETING SERVICES, NAMELY, PROMOTING THE GOODS AND SERVICES OF OTHERS VIA GLOBAL COMPUTER NETWORK, TELEPHONE AND BY CONDUCTING LIVE SPECIAL EVENTS FOR BUSINESS PROMOTIONAL PURPOSES; PROMOTING THE GOODS AND SERVICES OF OTHERS BY ADVERTISING AND MARKETING CAMPAIGNS VIA GLOBAL COMPUTER NETWORK, TELEPHONE, PROMOTING THE SALE OF GOODS AND SERVICES OF OTHERS BY CONDUCTING LIVE SALES CALLS TO RESELL TECHNOLOGY PRODUCTS ON BEHALF OF THIRD PARTY MANUFACTURERS AND BY ARRANGING AND CONDUCTING SPECIAL EVENTS FOR BUSINESS PROMOTIONAL PURPOSES, AND LIVE TRADE SHOW CONFERENCES IN THE FIELDS OF INFORMATION TECHNOLOGY HARDWARE AND SOFTWARE, AND BY DISTRIBUTING ADVERTISING MATERIALS THROUGH CATALOGS AND PRINTED/ONLINE MATERIALS IN CONNECTION THEREWITH; CUSTOMER SERVICES, NAMELY, RESPONDING TO CUSTOMERS INQUIRIES FOR OTHERS ON BEHALF OF THE MANUFACTURER IN THE FIELD OF INFORMATION TECHNOLOGY, CABLING, PHYSICAL AND CYBER SECURITY, SOFTWARE, COMMUNICATIONS, COMPUTERS AND COMPUTER NETWORKING; AND DISTRIBUTORSHIPS FEATURING COMPUTER HARDWARE, COMPUTER SOFTWARE, COMPUTER NETWORKING EQUIPMENT AND TELECOMMUNICATION SYSTEM COMPONENTS FOR OTHERS, IN CLASS 35 (U.S. CLS. 100, 101 AND 102).

FIRST USE 4-26-2012; IN COMMERCE 4-26-2012.

THE MARK CONSISTS OF STANDARD CHARACTERS WITHOUT CLAIM TO ANY PARTICULAR FONT, STYLE, SIZE, OR COLOR.

SN 85-264,976, FILED 3-11-2011.

ELISSA GARBER KON, EXAMINING ATTORNEY



David J. Kypos

Director of the United States Patent and Trademark Office

United States of America

United States Patent and Trademark Office

EZ-DOH

Reg. No. 4,206,940

Registered Sep. 11, 2012

Int. Cl.: 11

TRADEMARK

PRINCIPAL REGISTER

PERKINS, GINNY (UNITED STATES INDIVIDUAL)
123 STANTON AVENUE
COLUMBIANA, OH 44408

FOR: BREAD BAKING MACHINES, IN CLASS 11 (U.S. CLS. 13, 21, 23, 31 AND 34).

FIRST USE 1-1-2012; IN COMMERCE 1-1-2012.

THE MARK CONSISTS OF STANDARD CHARACTERS WITHOUT CLAIM TO ANY PARTICULAR FONT, STYLE, SIZE, OR COLOR.

SN 85-266,710, FILED 3-14-2011.

KATHERINE STOIDES, EXAMINING ATTORNEY



David J. Kyffers

Director of the United States Patent and Trademark Office

United States of America

United States Patent and Trademark Office

ALT45

Reg. No. 4,206,941

DIAMOND DIRECT, LLC (NEW YORK LIMITED LIABILITY COMPANY)
145 WEST 45TH STREET
NEW YORK, NY 10036

Registered Sep. 11, 2012

Int. Cl.: 14

FOR: JEWELRY, NAMELY, JEWELRY OF PRECIOUS AND ALTERNATIVE METALS, IN CLASS 14 (U.S. CLS. 2, 27, 28 AND 50).

TRADEMARK

FIRST USE 6-3-2011; IN COMMERCE 10-1-2011.

PRINCIPAL REGISTER

THE MARK CONSISTS OF STANDARD CHARACTERS WITHOUT CLAIM TO ANY PARTICULAR FONT, STYLE, SIZE, OR COLOR.

SN 85-266,938, FILED 3-15-2011.

JOHN DWYER, EXAMINING ATTORNEY



David J. Kybas

Director of the United States Patent and Trademark Office

United States of America

United States Patent and Trademark Office

CornerStone Netlink

Reg. No. 4,206,942

SMITH, STEVE (UNITED STATES INDIVIDUAL)
401 E. CORPORATE DRIVE, SUITE 102
LEWISVILLE, TX 75051

Registered Sep. 11, 2012

Int. Cl.: 35

FOR: PROFESSIONAL STAFFING AND RECRUITING SERVICES; PROVIDING AN EMPLOYER WITH CANDIDATES OR POTENTIAL EMPLOYEES TO FILL TEMPORARY, CONTRACT AND PERMANENT POSITIONS, IN CLASS 35 (U.S. CLS. 100, 101 AND 102).

SERVICE MARK

FIRST USE 4-25-2011; IN COMMERCE 4-25-2011.

PRINCIPAL REGISTER

THE MARK CONSISTS OF STANDARD CHARACTERS WITHOUT CLAIM TO ANY PARTICULAR FONT, STYLE, SIZE, OR COLOR.

SN 85-267,020, FILED 3-15-2011.

WILLIAM BRECKENFELD, EXAMINING ATTORNEY



David J. Kyffers

Director of the United States Patent and Trademark Office

United States of America

United States Patent and Trademark Office

Zaarly

Reg. No. 4,206,943

Registered Sep. 11, 2012

Int. Cls.: 9 and 35

TRADEMARK

SERVICE MARK

PRINCIPAL REGISTER

ZAARLY, INC. (DELAWARE CORPORATION)
548 MARKET ST.
SAN FRANCISCO, CA 94104

FOR: COMPUTER E-COMMERCE SOFTWARE TO ALLOW USERS TO PERFORM ELECTRONIC BUSINESS TRANSACTIONS VIA A GLOBAL COMPUTER NETWORK, IN CLASS 9 (U.S. CLS. 21, 23, 26, 36 AND 38).

FIRST USE 2-24-2011; IN COMMERCE 5-18-2011.

FOR: PROVIDING A WEB-BASED SYSTEM AND ONLINE PORTALS IN THE FIELD OF CONSUMER-TO-BUSINESS COMMERCE FOR CONSUMERS TO ENTER, MANAGE AND MODIFY THEIR CONSUMER PREFERENCE INFORMATION FOR USE BY MERCHANTS TO CREATE AND MANAGE OFFERS FOR DELIVERY TO CONSUMERS, IN CLASS 35 (U.S. CLS. 100, 101 AND 102).

FIRST USE 2-24-2011; IN COMMERCE 5-18-2011.

THE MARK CONSISTS OF STANDARD CHARACTERS WITHOUT CLAIM TO ANY PARTICULAR FONT, STYLE, SIZE, OR COLOR.

SN 85-267,224, FILED 3-15-2011.

GISELLE AGOSTO, EXAMINING ATTORNEY



David J. Kybas

Director of the United States Patent and Trademark Office

United States of America

United States Patent and Trademark Office



Reg. No. 4,206,944

Registered Sep. 11, 2012

Int. Cl.: 36

SERVICE MARK

PRINCIPAL REGISTER

TRADESECURE (DELAWARE LIMITED LIABILITY COMPANY)
#301
1521 CONCORD PIKE
WILMINGTON, DE 19803

FOR: FOREIGN EXCHANGE INFORMATION SERVICES; FOREIGN EXCHANGE TRANSACTIONS, IN CLASS 36 (U.S. CLS. 100, 101 AND 102).

FIRST USE 4-5-2012; IN COMMERCE 4-5-2012.

NO CLAIM IS MADE TO THE EXCLUSIVE RIGHT TO USE "SECURE", "GLOBAL", AND "TRADING", APART FROM THE MARK AS SHOWN.

THE MARK CONSISTS OF THE TERM "TRADESECURE" ABOVE THE TERM "SECURE. GLOBAL. TRADING." ALL TO THE RIGHT OF A STYLIZED DEPICTION OF INTERLOCKING PARTIAL RINGS.

SN 85-267,936, FILED 3-15-2011.

JIM RINGLE, EXAMINING ATTORNEY



David J. Kyffers

Director of the United States Patent and Trademark Office

United States of America

United States Patent and Trademark Office



TANGESEIKI

Reg. No. 4,206,945

TANGE SEIKI CO., LTD. (JAPAN CORPORATION)

Registered Sep. 11, 2012

1-1-26, KURUMANO-CHO NISHI, SAKAI-KU
SAKAI-SHI, OSAKA, JAPAN

Int. Cl.: 12

FOR: BICYCLE HEADSETS AND BOTTOM BRACKETS SET AND OTHER STRUCTURAL FITTING PARTS AND ACCESSORIES THEREFOR, IN CLASS 12 (U.S. CLS. 19, 21, 23, 31, 35 AND 44).

TRADEMARK

FIRST USE 4-23-2012; IN COMMERCE 4-23-2012.

PRINCIPAL REGISTER

THE MARK CONSISTS OF THE COLOR BLUE APPLIED TO "TANGESEIKI" (TWICE) AND TO A DESIGN OF A CIRCLE THAT CONTAINS TWO CURVED SYMMETRICAL LINES OF INCREASING WIDTH.

THE COLOR(S) BLUE IS/ARE CLAIMED AS A FEATURE OF THE MARK.

SN 85-268,142, FILED 3-16-2011.

ZACHARY BELLO, EXAMINING ATTORNEY



David J. Kyffers

Director of the United States Patent and Trademark Office

United States of America

United States Patent and Trademark Office

PLANistry

Reg. No. 4,206,946

Registered Sep. 11, 2012

Int. Cl.: 35

SERVICE MARK

PRINCIPAL REGISTER

PLANISTRY, LLC (MARYLAND LIMITED LIABILITY COMPANY)
910 N. CALVERT STREET
BALTIMORE, MD 21202

FOR: EVENT PLANNING AND MANAGEMENT FOR MARKETING, BRANDING, PROMOTING OR ADVERTISING THE GOODS AND SERVICES OF OTHERS, IN CLASS 35 (U.S. CLS. 100, 101 AND 102).

FIRST USE 2-14-2011; IN COMMERCE 6-13-2012.

THE MARK CONSISTS OF STANDARD CHARACTERS WITHOUT CLAIM TO ANY PARTICULAR FONT, STYLE, SIZE, OR COLOR.

SN 85-269,344, FILED 3-17-2011.

ANNE E. GUSTASON, EXAMINING ATTORNEY



David J. Kyffers

Director of the United States Patent and Trademark Office

United States of America

United States Patent and Trademark Office



Reg. No. 4,206,947

Registered Sep. 11, 2012

Int. Cl.: 9

TRADEMARK

PRINCIPAL REGISTER

SARATOGA DATA SYSTEMS, INC. (DELAWARE CORPORATION)
#424
2530 BERRYESSA RD.
SAN JOSE, CA 95132

FOR: DOWNLOADABLE SOFTWARE THAT ACCELERATES COMMUNICATION OF COMPUTER DATA FILES OVER LONG DISTANCES, IN CLASS 9 (U.S. CLS. 21, 23, 26, 36 AND 38).

FIRST USE 3-1-2006; IN COMMERCE 5-15-2012.

NO CLAIM IS MADE TO THE EXCLUSIVE RIGHT TO USE "NETWORK OPTIMIZATION", APART FROM THE MARK AS SHOWN.

THE MARK CONSISTS OF THE WORD "FLUME" OVER WHICH THERE ARE TWO WAVY LINES AND UNDERNEATH WHICH IS THE WORDING "NETWORK OPTIMIZATION".

SN 85-270,164, FILED 3-17-2011.

LINDA POWELL, EXAMINING ATTORNEY



David J. Kybas

Director of the United States Patent and Trademark Office

United States of America

United States Patent and Trademark Office

Get Well Soon Tour

Reg. No. 4,206,948

YARMOVSKY, SHANNA (UNITED STATES INDIVIDUAL)
4 EMERSON PLACE
BOSTON, MA 02114

Registered Sep. 11, 2012

Int. Cl.: 41

FOR: CHARITABLE SERVICES IN THE NATURE OF ARRANGING AND CONDUCTING CONCERT TOURS FOR MUSICIANS TO PERFORM FOR THE BENEFIT OF HOSPITALIZED CHILDREN, IN CLASS 41 (U.S. CLS. 100, 101 AND 107).

SERVICE MARK

FIRST USE 2-14-2011; IN COMMERCE 2-14-2011.

PRINCIPAL REGISTER

THE MARK CONSISTS OF STANDARD CHARACTERS WITHOUT CLAIM TO ANY PARTICULAR FONT, STYLE, SIZE, OR COLOR.

NO CLAIM IS MADE TO THE EXCLUSIVE RIGHT TO USE "TOUR", APART FROM THE MARK AS SHOWN.

SN 85-270,844, FILED 3-18-2011.

MATTHEW MCDOWELL, EXAMINING ATTORNEY



David J. Kyfos

Director of the United States Patent and Trademark Office

United States of America

United States Patent and Trademark Office

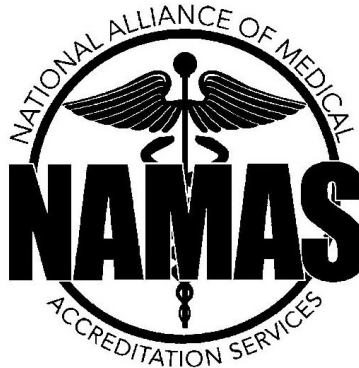

Reg. No. 4,206,949

DOCTORSMANAGEMENT, LLC (TENNESSEE LIMITED LIABILITY COMPANY)
10401 KINGSTON PIKE
KNOXVILLE, TN 37922

Registered Sep. 11, 2012

Int. Cl.: 41

FOR: PROVIDING CONTINUING MEDICAL EDUCATION COURSES AND DISTRIBUTING COURSE MATERIALS IN CONNECTION THEREWITH, IN CLASS 41 (U.S. CLS. 100, 101 AND 107).

SERVICE MARK

FIRST USE 4-0-2011; IN COMMERCE 5-0-2011.

PRINCIPAL REGISTER

NO CLAIM IS MADE TO THE EXCLUSIVE RIGHT TO USE "NATIONAL ALLIANCE OF MEDICAL ACCREDITATION SERVICES" AND THE CADUCEUS SYMBOL, APART FROM THE MARK AS SHOWN.

THE MARK CONSISTS OF CADUCEUS MEDICAL SYMBOL IN A CIRCLE WITH "NAMAS" ACROSS THE FRONT OF THE SYMBOL AND "NATIONAL ALLIANCE OF MEDICAL ACCREDITATION SERVICES" ALONG THE OUTSIDE PERIMETER OF THE CIRCLE.

SN 85-270,987, FILED 3-18-2011.

MICHAEL TANNER, EXAMINING ATTORNEY



David J. Kyffers

Director of the United States Patent and Trademark Office

United States of America

United States Patent and Trademark Office

GAMEWAVE

Reg. No. 4,206,950

CYBERAGENT AMERICA, INC. (CALIFORNIA CORPORATION)

Registered Sep. 11, 2012

221 MAIN ST. SUITE 240
SAN FRANCISCO, CA 94105

Int. Cl.: 42

SERVICE MARK

PRINCIPAL REGISTER

FOR: COMPUTER SERVICES, NAMELY, CREATING ON-LINE VIRTUAL COMMUNITIES FOR REGISTERED USERS TO ORGANIZE GROUPS AND EVENTS, PARTICIPATE IN DISCUSSIONS, AND ENGAGE IN SOCIAL, BUSINESS AND COMMUNITY NETWORKING; COMPUTER SERVICES, NAMELY, CREATING AN ON-LINE COMMUNITY FOR REGISTERED USERS TO PARTICIPATE IN DISCUSSION, GET FEEDBACK FROM THEIR PEERS; PROVIDING TEMPORARY USE OF NON-DOWNLOADABLE SOFTWARE APPLICATIONS FOR CLASSIFIEDS, VIRTUAL COMMUNITY, SOCIAL NETWORKING, PHOTO SHARING, AND TRANSMISSION OF PHOTOGRAPHIC IMAGES; COMPUTER SERVICES, NAMELY, HOSTING ONLINE WEB FACILITIES FOR OTHERS FOR ORGANIZING AND CONDUCTING ONLINE MEETINGS, GATHERINGS, AND INTERACTIVE DISCUSSIONS; AND COMPUTER SERVICES IN THE NATURE OF CUSTOMIZED WEB PAGES FEATURING USER-DEFINED INFORMATION, PERSONAL PROFILES AND INFORMATION; PEER-TO-BROWSER PHOTO SHARING SERVICES, NAMELY, PROVIDING A WEBSITE FEATURING TECHNOLOGY THAT ENABLES USERS TO UPLOAD AND SHARE VIDEO, PHOTOS, TEXT, GRAPHICS AND DATA; CREATING AND MAINTAINING BLOGS FOR OTHERS; COMPUTER SERVICES, NAMELY, HOSTING ELECTRONIC FACILITIES FOR OTHERS FOR ORGANIZING AND CONDUCTING MEETINGS, EVENTS AND INTERACTIVE DISCUSSIONS VIA COMMUNICATION NETWORKS; APPLICATION SERVICE PROVIDER (ASP) SERVICES, NAMELY, HOSTING COMPUTER SOFTWARE APPLICATIONS OF OTHERS; APPLICATION SERVICE PROVIDER (ASP) FEATURING SOFTWARE TO ENABLE OR FACILITATE THE UPLOADING, DOWNLOADING, STREAMING, POSTING, DISPLAYING, BLOGGING, LINKING, SHARING OR OTHERWISE PROVIDING ELECTRONIC MEDIA OR INFORMATION OVER COMMUNICATION NETWORKS; PROVIDING AN ONLINE NETWORK SERVICE THAT ENABLES USERS TO TRANSFER PERSONAL IDENTITY DATA TO AND SHARE PERSONAL IDENTITY DATA WITH AND AMONG MULTIPLE WEBSITES; PROVIDING A WEB SITE FEATURING TECHNOLOGY THAT ENABLES ON-LINE USERS TO CREATE PERSONAL PROFILES FEATURING SOCIAL NETWORKING INFORMATION AND TO TRANSFER AND SHARE SUCH INFORMATION AMONG MULTIPLE WEBSITES; COMPUTER SERVICES, NAMELY, CREATING INDEXES OF INFORMATION, SITES AND OTHER RESOURCES AVAILABLE ON COMPUTER NETWORKS; PROVIDING TEMPORARY USE OF NON-DOWNLOADABLE SOFTWARE APPLICATIONS FOR SOCIAL NETWORKING, CREATING A VIRTUAL COMMUNITY, AND TRANSMISSION OF AUDIO, VIDEO, PHOTOGRAPHIC IMAGES, TEXT, GRAPHICS AND DATA; COMPUTER



David J. Kyros

Director of the United States Patent and Trademark Office

Reg. No. 4,206,950 SERVICES IN THE NATURE OF CUSTOMIZED WEB PAGES FEATURING USER-DEFINED OR SPECIFIED INFORMATION, PERSONAL PROFILES, AUDIO, VIDEO, PHOTOGRAPHIC IMAGES, TEXT, GRAPHICS AND DATA, IN CLASS 42 (U.S. CLS. 100 AND 101).

FIRST USE 3-18-2011; IN COMMERCE 7-14-2011.

THE MARK CONSISTS OF STANDARD CHARACTERS WITHOUT CLAIM TO ANY PARTICULAR FONT, STYLE, SIZE, OR COLOR.

SN 85-271,298, FILED 3-18-2011.

DAWN FELDMAN, EXAMINING ATTORNEY

United States of America

United States Patent and Trademark Office

INSIDE VOLLEYBALL

Reg. No. 4,206,951

Registered Sep. 11, 2012

Int. Cl.: 16

TRADEMARK

PRINCIPAL REGISTER

INSIDE PUBLICATIONS, LLC OF GEORGIA (GEORGIA LIMITED LIABILITY COMPANY)
SUITE 1240
1050 CROWN POINTE PARKWAY
ATLANTA, GA 30338

FOR: PUBLICATIONS, NAMELY, MAGAZINES IN THE FIELDS OF VOLLEYBALL, IN CLASS 16 (U.S. CLS. 2, 5, 22, 23, 29, 37, 38 AND 50).

FIRST USE 3-5-2012; IN COMMERCE 3-5-2012.

THE MARK CONSISTS OF STANDARD CHARACTERS WITHOUT CLAIM TO ANY PARTICULAR FONT, STYLE, SIZE, OR COLOR.

NO CLAIM IS MADE TO THE EXCLUSIVE RIGHT TO USE "VOLLEYBALL", APART FROM THE MARK AS SHOWN.

SN 85-272,620, FILED 3-21-2011.

COLLEEN KEARNEY, EXAMINING ATTORNEY



David J. Kyffers

Director of the United States Patent and Trademark Office

United States of America

United States Patent and Trademark Office

SCALA RIDER G9

Reg. No. 4,206,952

CARDO SYSTEMS, INC. (CAYMAN ISLANDS CORPORATION)
100 HIGH TOWER BLVD., SUITE 301
PITTSBURGH, PA 15205

Registered Sep. 11, 2012

Int. Cl.: 9

FOR: WIRELESS NON-STATIONARY COMMUNICATION DEVICES, NAMELY, WIRELESS HEADSETS FOR HELMETS USED FOR COMMUNICATING VIA MOBILE PHONES AND INTERCOMS, AND LISTENING TO MUSIC VIA MP3 PLAYERS, AND LISTENING TO INFORMATION PROVIDED BY GPS DEVICES, IN CLASS 9 (U.S. CLS. 21, 23, 26, 36 AND 38).

TRADEMARK

PRINCIPAL REGISTER

FIRST USE 4-0-2012; IN COMMERCE 4-0-2012.

THE MARK CONSISTS OF STANDARD CHARACTERS WITHOUT CLAIM TO ANY PARTICULAR FONT, STYLE, SIZE, OR COLOR.

OWNER OF U.S. REG. NO. 3,176,248.

NO CLAIM IS MADE TO THE EXCLUSIVE RIGHT TO USE "RIDER", APART FROM THE MARK AS SHOWN.

THE ENGLISH TRANSLATION OF "SCALA" IN THE MARK IS "STAIRCASE, STAIRS".

SN 85-273,092, FILED 3-22-2011.

MICHELE SWAIN, EXAMINING ATTORNEY



David J. Kyffers

Director of the United States Patent and Trademark Office

United States of America

United States Patent and Trademark Office

ASCENT SUPPLY

Reg. No. 4,206,953

BATTERIES PLUS, LLC (WISCONSIN LIMITED LIABILITY COMPANY)
925 WALNUT RIDGE DRIVE
HARTLAND, WI 53029

Registered Sep. 11, 2012

Int. Cl.: 35

FOR: DISTRIBUTORSHIP SERVICES OF LIGHT BULBS AND BATTERIES, IN CLASS 35
(U.S. CLS. 100, 101 AND 102).

SERVICE MARK

FIRST USE 7-1-2011; IN COMMERCE 7-1-2011.

PRINCIPAL REGISTER

THE MARK CONSISTS OF STANDARD CHARACTERS WITHOUT CLAIM TO ANY PARTICULAR FONT, STYLE, SIZE, OR COLOR.

OWNER OF U.S. REG. NOS. 3,455,880 AND 3,529,047.

NO CLAIM IS MADE TO THE EXCLUSIVE RIGHT TO USE "SUPPLY", APART FROM THE MARK AS SHOWN.

SN 85-273,468, FILED 3-22-2011.

KEVIN DINALLO, EXAMINING ATTORNEY



David J. Kybas

Director of the United States Patent and Trademark Office

United States of America

United States Patent and Trademark Office

MAUIGRADIENT

Reg. No. 4,206,954

MAUI JIM, INC. (ILLINOIS CORPORATION)
ONE ALOHA LANE
PEORIA, IL 61615

Registered Sep. 11, 2012

Int. Cl.: 9

FOR: SUNGLASSES AND SUNGLASS LENSES, IN CLASS 9 (U.S. CLS. 21, 23, 26, 36 AND 38).

TRADEMARK

FIRST USE 1-1-2011; IN COMMERCE 1-1-2011.

PRINCIPAL REGISTER

THE MARK CONSISTS OF STANDARD CHARACTERS WITHOUT CLAIM TO ANY PARTICULAR FONT, STYLE, SIZE, OR COLOR.

OWNER OF U.S. REG. NOS. 1,404,711, 3,573,259, AND OTHERS.

SN 85-273,855, FILED 3-22-2011.

HENRY S. ZAK, EXAMINING ATTORNEY



David J. Kybas

Director of the United States Patent and Trademark Office

United States of America

United States Patent and Trademark Office

Christian Strength

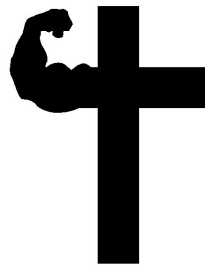

Reg. No. 4,206,955

JACOBS, JOE (UNITED STATES INDIVIDUAL)
2934 CAMBRIDGE ROAD
CAMERON PARK, CA 95682

Registered Sep. 11, 2012

Int. Cl.: 25

FOR: HATS; JACKETS; SHIRTS; SHOES; SOCKS; T-SHIRTS, IN CLASS 25 (U.S. CLS. 22 AND 39).

TRADEMARK

FIRST USE 3-1-2012; IN COMMERCE 4-18-2012.

PRINCIPAL REGISTER

THE MARK CONSISTS OF STYLIZED TEXT "CHRISTIAN STRENGTH" WITH THE "T" IN "CHRISTIAN" IN THE SHAPE OF A CROSS. BELOW THE WORDING IS A SECOND LARGER CROSS AND ONE OF THE ARMS OF THE CROSS DEPICTS A HUMAN ARM FLEXING.

SN 85-273,949, FILED 3-22-2011.

AMY HELLA, EXAMINING ATTORNEY



David J. Kybas

Director of the United States Patent and Trademark Office

United States of America

United States Patent and Trademark Office

CASEY RESEARCH

Reg. No. 4,206,956

Registered Sep. 11, 2012

Int. Cl.: 36

SERVICE MARK

PRINCIPAL REGISTER

CASEY RESEARCH, LLC (COLORADO LIMITED LIABILITY COMPANY)
C/OSHERMAN & HOWARD, L.L.C.
201 NORTH MILL STREET, SUITE 201
ASPEN, CO 81611

FOR: FINANCIAL CONSULTATION IN THE FIELD OF INVESTMENT ADVICE AND INFORMATION RELATING TO FINANCIAL INVESTMENT, FINANCIAL ANALYSIS, GLOBAL FINANCIAL TRENDS, GEOPOLITICAL ISSUES, NATURAL RESOURCES AND EMERGING INVESTMENT OPPORTUNITIES, IN CLASS 36 (U.S. CLS. 100, 101 AND 102).

FIRST USE 4-1-2004; IN COMMERCE 4-1-2004.

THE MARK CONSISTS OF STANDARD CHARACTERS WITHOUT CLAIM TO ANY PARTICULAR FONT, STYLE, SIZE, OR COLOR.

NO CLAIM IS MADE TO THE EXCLUSIVE RIGHT TO USE "RESEARCH", APART FROM THE MARK AS SHOWN.

SN 85-274,469, FILED 3-23-2011.

JOSETTE BEVERLY, EXAMINING ATTORNEY



David J. Kyffers

Director of the United States Patent and Trademark Office

United States of America

United States Patent and Trademark Office



FileRight

Reg. No. 4,206,957

FILE RIGHT LLC (DELAWARE LIMITED LIABILITY COMPANY)
364 N. MAIN STREET, SUITE 600
MIDDLETOWN, DE 19709

Registered Sep. 11, 2012

Int. Cl.: 45

FOR: PROVIDING A WEBSITE FEATURING GENERAL IMMIGRATION-RELATED LEGAL INFORMATION VIA A WEBSITE ON GLOBAL COMPUTER NETWORKS, IN CLASS 45 (U.S. CLS. 100 AND 101).

SERVICE MARK

FIRST USE 3-21-2011; IN COMMERCE 3-21-2011.

PRINCIPAL REGISTER

THE MARK CONSISTS OF CHECK MARK ON TOP OF THREE STACKED SHADOWED BOXES FOLLOWED BY THE WORDS "FILERIGHT".

SN 85-274,523, FILED 3-23-2011.

DEIRDRE ROBERTSON, EXAMINING ATTORNEY



David J. Kybas

Director of the United States Patent and Trademark Office

United States of America

United States Patent and Trademark Office



FileRight

Reg. No. 4,206,958

Registered Sep. 11, 2012

Int. Cl.: 45

SERVICE MARK

PRINCIPAL REGISTER

FILE RIGHT LLC (DELAWARE LIMITED LIABILITY COMPANY)
364 N. MAIN STREET, SUITE 600
MIDDLETOWN, DE 19709

FOR: LEGAL DOCUMENT PREPARATION SERVICES AND PROVIDING GENERAL IMMIGRATION-RELATED LEGAL INFORMATION VIA A WEBSITE ON GLOBAL COMPUTER NETWORKS , IN CLASS 45 (U.S. CLS. 100 AND 101).

FIRST USE 3-21-2011; IN COMMERCE 3-21-2011.

THE MARK CONSISTS OF CHECK MARK ON TOP OF THREE STACKED SHADOWED BOXES FOLLOWED BY THE WORDS "FILERIGHT".

SN 85-274,543, FILED 3-23-2011.

DEIRDRE ROBERTSON, EXAMINING ATTORNEY



David J. Kybas

Director of the United States Patent and Trademark Office

United States of America

United States Patent and Trademark Office

MY CHILD IS A STUDENT OF HONOR

Reg. No. 4,206,959

Registered Sep. 11, 2012

Int. Cl.: 25

TRADEMARK

PRINCIPAL REGISTER

RIVENDELL WORLDVIEW EDUCATION COMPANY, LLC (MINNESOTA LIMITED
LIABILITY COMPANY)
6820 AUTO CLUB ROAD, NO. 406
BLOOMINGTON, MN 55438

FOR: T-SHIRTS; SWEATSHIRTS, IN CLASS 25 (U.S. CLS. 22 AND 39).

FIRST USE 5-6-2012; IN COMMERCE 5-17-2012.

THE MARK CONSISTS OF STANDARD CHARACTERS WITHOUT CLAIM TO ANY PAR-
TICULAR FONT, STYLE, SIZE, OR COLOR.

SN 85-274,632, FILED 3-23-2011.

RAUL CORDOVA, EXAMINING ATTORNEY



David J. Kyffers

Director of the United States Patent and Trademark Office

United States of America

United States Patent and Trademark Office

A RARE COMMUNITY

Reg. No. 4,206,960

Registered Sep. 11, 2012

Int. Cls.: 35 and 36

SERVICE MARK

PRINCIPAL REGISTER

HISTIOCYTOSIS ASSOCIATION (NEW JERSEY CHARITABLE, NON-PROFIT CORPORATION)
332 NORTH BROADWAY
PITMAN, NJ 08071

FOR: ASSOCIATION SERVICES, NAMELY, PROMOTING THE PUBLIC INTEREST AND AWARENESS IN HISTIOCYTIC DISORDERS RESEARCH AND EDUCATION, AND FOR SUPPORTING AND FUNDING RESEARCH IN CONNECTION WITH HISTIOCYTIC DISORDERS, IN CLASS 35 (U.S. CLS. 100, 101 AND 102).

FIRST USE 6-14-2011; IN COMMERCE 6-14-2011.

FOR: CHARITABLE FUNDRAISING SERVICES RELATING TO HISTIOCYTOSIS RESEARCH AND EDUCATION, IN CLASS 36 (U.S. CLS. 100, 101 AND 102).

FIRST USE 6-14-2011; IN COMMERCE 6-14-2011.

THE MARK CONSISTS OF STANDARD CHARACTERS WITHOUT CLAIM TO ANY PARTICULAR FONT, STYLE, SIZE, OR COLOR.

NO CLAIM IS MADE TO THE EXCLUSIVE RIGHT TO USE "COMMUNITY", APART FROM THE MARK AS SHOWN.

SN 85-274,659, FILED 3-23-2011.

RAUL CORDOVA, EXAMINING ATTORNEY



David J. Kybas

Director of the United States Patent and Trademark Office

United States of America

United States Patent and Trademark Office



Reg. No. 4,206,961

FABRICAS AGRUPADAS DE MUNECAS DE ONIL, S.A. (SPAIN CORPORATION)
SAN ANTONIO, 8 03430-ONIL
ALICANTE, SPAIN

Registered Sep. 11, 2012

Int. Cl.: 28

FOR: GAMES AND PLAYTHINGS, NAMELY, MINIATURE DOLLS, MINIATURE TOY FIGURES, IN CLASS 28 (U.S. CLS. 22, 23, 38 AND 50).

TRADEMARK

FIRST USE 11-1-2011; IN COMMERCE 11-1-2011.

PRINCIPAL REGISTER

PRIORITY CLAIMED UNDER SEC. 44(D) ON ERPN CMNTY TM OFC APPLICATION NO. 009734336, FILED 2-14-2011, REG. NO. 009734336, DATED 9-5-2011, EXPIRES 9-5-2021.

THE COLOR(S) PINK IS/ARE CLAIMED AS A FEATURE OF THE MARK.

THE MARK CONSISTS OF THE TERM "PINYPON" IN PINK, STYLIZED LETTERING WITH AN OUTLINE OF THE LETTERING IN PINK. THE COLOR WHITE IS INTENDED TO INDICATE BACKGROUND, OUTLINING, SHADING OR TRANSPARENT AREAS AND IS NOT PART OF THE MARK.

THE WORDING "PINYPON" HAS NO MEANING IN A FOREIGN LANGUAGE.

SN 85-274,686, FILED 3-23-2011.

JOHN GARTNER, EXAMINING ATTORNEY



David J. Kybas

Director of the United States Patent and Trademark Office

United States of America

United States Patent and Trademark Office



Reg. No. 4,206,962

MIFFLIN COUNTY SCHOOL DISTRICT (PENNSYLVANIA MUNICIPAL AGENCY)
201 8TH ST., HIGHLAND PARK
LEWISTOWN, PA 17044

Registered Sep. 11, 2012

Int. Cl.: 25

FOR: ATHLETIC APPAREL, NAMELY, SHIRTS, PANTS, JACKETS, FOOTWEAR, HATS AND CAPS, ATHLETIC UNIFORMS, IN CLASS 25 (U.S. CLS. 22 AND 39).

TRADEMARK

FIRST USE 8-1-2011; IN COMMERCE 8-1-2011.

PRINCIPAL REGISTER

NO CLAIM IS MADE TO THE EXCLUSIVE RIGHT TO USE "MIFFLIN COUNTY", APART FROM THE MARK AS SHOWN.

THE COLOR(S) PURPLE (PANTONE 2627 PC), GRAY, BLACK, AND WHITE IS/ARE CLAIMED AS A FEATURE OF THE MARK.

THE MARK CONSISTS OF THE STYLIZED WORDING "MIFFLIN COUNTY HUSKIES" WITH THE WORDING "MIFFLIN COUNTY" IN SMALLER PURPLE LETTERING ABOVE THE WORDING "HUSKIES" IN LARGER GRAY AND WHITE LETTERING WITH PURPLE OUTLINING. ABOVE THE WORDING APPEARS A STYLIZED HUSKY HEAD WITH WHITE, GRAY, BLACK, AND PURPLE MARKINGS, FACING TO THE VIEWER'S LEFT, PEERING OUT OF A PURPLE CIRCLE, WITH EARS OUT OF AND IN FRONT OF CIRCLE, AND WITH ONE BOTTOM CANINE TOOTH SHOWING FROM AN OPEN MOUTH.

SN 85-275,359, FILED 3-24-2011.

NICHOLAS ALTREE, EXAMINING ATTORNEY



David J. Kybas

Director of the United States Patent and Trademark Office

United States of America

United States Patent and Trademark Office

MILANO SLICES

Reg. No. 4,206,963

Registered Sep. 11, 2012

Int. Cl.: 30

TRADEMARK

PRINCIPAL REGISTER

PEPPERIDGE FARM, INCORPORATED (CONNECTICUT CORPORATION)
595 WESTPORT AVENUE
NORWALK, CT 06851

FOR: COOKIES, IN CLASS 30 (U.S. CL. 46).

FIRST USE 4-30-2010; IN COMMERCE 10-0-2010.

THE MARK CONSISTS OF STANDARD CHARACTERS WITHOUT CLAIM TO ANY PARTICULAR FONT, STYLE, SIZE, OR COLOR.

SEC. 2(F) AS TO "MILANO".

OWNER OF U.S. REG. NOS. 655,071, 1,359,465, AND 3,948,833.

THE ENGLISH TRANSLATION OF THE WORD "MILANO" IN THE MARK IS "MILAN".

SN 85-275,548, FILED 3-24-2011.

CHRISTINA SOBRAL, EXAMINING ATTORNEY



David J. Kybas

Director of the United States Patent and Trademark Office

United States of America

United States Patent and Trademark Office

JAPPA TOTES

Reg. No. 4,206,964

ALSTON, VICKI L. (UNITED STATES INDIVIDUAL)
1713 SCARBOROUGH ROAD
HIGH POINT, NC 272652419

Registered Sep. 11, 2012

Int. Cl.: 18

FOR: TOTE BAGS, IN CLASS 18 (U.S. CLS. 1, 2, 3, 22 AND 41).

TRADEMARK

FIRST USE 7-29-2011; IN COMMERCE 7-29-2011.

PRINCIPAL REGISTER

THE MARK CONSISTS OF STANDARD CHARACTERS WITHOUT CLAIM TO ANY PARTICULAR FONT, STYLE, SIZE, OR COLOR.

NO CLAIM IS MADE TO THE EXCLUSIVE RIGHT TO USE "TOTES", APART FROM THE MARK AS SHOWN.

SN 85-276,097, FILED S.R. 3-24-2011; AM. P.R. 3-24-2011.

COURTNEY ALVAREZ, EXAMINING ATTORNEY



David J. Kybas

Director of the United States Patent and Trademark Office

United States of America

United States Patent and Trademark Office

UNCOVER A MYSTERY DISCOVER YOUR HISTORY

Reg. No. 4,206,965

BBNY GROUP, LLC (NEW YORK LIMITED LIABILITY COMPANY)
244 FIFTH AVENUE, B223
NEW YORK, NY 10001

Registered Sep. 11, 2012

Int. Cl.: 35

FOR: PROMOTING AND CONDUCTING TRADE SHOWS IN THE FIELD OF HISTORY,
FAMILY HISTORY AND GENEALOGY, IN CLASS 35 (U.S. CLS. 100, 101 AND 102).

SERVICE MARK

FIRST USE 10-1-2011; IN COMMERCE 1-1-2012.

PRINCIPAL REGISTER

THE MARK CONSISTS OF STANDARD CHARACTERS WITHOUT CLAIM TO ANY PAR-
TICULAR FONT, STYLE, SIZE, OR COLOR.

SN 85-276,656, FILED 3-25-2011.

REBECCA SMITH, EXAMINING ATTORNEY



David J. Kyffers

Director of the United States Patent and Trademark Office

United States of America

United States Patent and Trademark Office

DFENSE BLOK

Reg. No. 4,206,966

Registered Sep. 11, 2012

Int. Cl.: 2

TRADEMARK

PRINCIPAL REGISTER

ILLINOIS TOOL WORKS INC. (DELAWARE CORPORATION)
3600 WEST LAKE AVENUE
GLENVIEW, IL 600261215

FOR: ABRASION-RESISTANT AND WEAR-RESISTANT COATING COMPOSITIONS FOR USE ON METAL, CONCRETE, AND OTHER RIGID INDUSTRIAL EQUIPMENT SURFACES; EPOXY COATINGS FOR ABRASION RESISTANCE, WEAR RESISTANCE, AND REPAIR OF METAL, CONCRETE, AND OTHER RIGID INDUSTRIAL EQUIPMENT SURFACES; PROTECTIVE COATINGS FOR INDUSTRIAL USE, NAMELY, COATINGS FOR USE IN ABRASION RESISTANCE, WEAR RESISTANCE, AND REPAIR OF METAL, CONCRETE, AND OTHER RIGID INDUSTRIAL EQUIPMENT SURFACES; COATINGS IN THE NATURE OF INDUSTRIAL SEALANTS FOR SURFACE PROTECTION AND HARDENING; PROTECTIVE COATINGS FOR WEAR AND ABRASION RESISTANCE FOR USE ON METAL, CONCRETE, AND OTHER RIGID INDUSTRIAL EQUIPMENT SURFACES; CORROSION AND EROSION INHIBITORS IN THE NATURE OF A COATING; PRIMERS; EPOXY SYSTEMS FOR PROTECTION OF INDUSTRIAL EQUIPMENT, CONSISTING PRIMARILY OF AN EPOXY COATING FOR USE ON INDUSTRIAL EQUIPMENT; EPOXY SYSTEMS FOR WEAR AND ABRASION RESISTANCE, CONSISTING PRIMARILY OF EPOXY COATINGS FOR USE ON METAL, CONCRETE, AND OTHER RIGID INDUSTRIAL EQUIPMENT SURFACES; EPOXY SYSTEMS FOR EROSION AND CORROSION RESISTANCE CONSISTING PRIMARILY OF EPOXY COATINGS FOR USE ON METAL, CONCRETE, AND OTHER RIGID INDUSTRIAL EQUIPMENT SURFACES; COATINGS IN THE NATURE OF INDUSTRIAL EPOXY SEALANTS FOR USE ON METAL, CONCRETE, AND OTHER RIGID INDUSTRIAL EQUIPMENT SURFACES; ANTI-CORROSIVE COATINGS, IN CLASS 2 (U.S. CLS. 6, 11 AND 16).

FIRST USE 3-3-2011; IN COMMERCE 3-3-2011.

THE MARK CONSISTS OF STANDARD CHARACTERS WITHOUT CLAIM TO ANY PARTICULAR FONT, STYLE, SIZE, OR COLOR.

SN 85-276,956, FILED 3-25-2011.

MARC LEIPZIG, EXAMINING ATTORNEY



David J. Kyffers

Director of the United States Patent and Trademark Office

United States of America

United States Patent and Trademark Office

Mind Ya Business

Reg. No. 4,206,967

RENTAS, BELINDA (UNITED STATES INDIVIDUAL)
1306 MOUNT LAUREL RD
TEMPLE, PA 19560

Registered Sep. 11, 2012

Int. Cls.: 9, 21, and 25

FOR: EYEGLASSES; SUNGLASSES; MAGNETS; MOUSE PADS, IN CLASS 9 (U.S. CLS. 21, 23, 26, 36 AND 38).

TRADEMARK

FIRST USE 10-21-2011; IN COMMERCE 10-21-2011.

PRINCIPAL REGISTER

FOR: DRINKING GLASSES; SHOT GLASSES; CUPS AND MUGS; BEER MUGS; COASTERS NOT OF PAPER AND NOT BEING TABLE LINEN; PAPER PLATES, IN CLASS 21 (U.S. CLS. 2, 13, 23, 29, 30, 33, 40 AND 50).

FIRST USE 10-21-2011; IN COMMERCE 10-21-2011.

FOR: CLOTHING, NAMELY, T-SHIRTS, SHIRTS, SOCKS, PANTS, JOGGING PANTS, SHORTS, SWEATSHIRTS, SWEATPANTS, HOODED SWEATSHIRTS, LEGGINGS, BELTS, FOOTWEAR, BOOTS, SNEAKERS, SLIPPERS, HEADWEAR, CAPS, HATS, BOXER SHORTS, PANTIES, UNDERWEAR, BRAS, SPORTS BRAS, TIES, APRONS, WRISTBANDS, CLOTH BIBS, DRESSES, IN CLASS 25 (U.S. CLS. 22 AND 39).

FIRST USE 10-21-2011; IN COMMERCE 10-21-2011.

THE MARK CONSISTS OF STANDARD CHARACTERS WITHOUT CLAIM TO ANY PARTICULAR FONT, STYLE, SIZE, OR COLOR.

SN 85-277,812, FILED 3-26-2011.

KIMBERLY FRYE, EXAMINING ATTORNEY



David J. Kybas

Director of the United States Patent and Trademark Office

United States of America

United States Patent and Trademark Office

dog era

Reg. No. 4,206,968

Registered Sep. 11, 2012

Int. Cl.: 35

SERVICE MARK

PRINCIPAL REGISTER

STANKEE, ELI (UNITED STATES INDIVIDUAL)
5552 ELIZABETH AVENUE
SAINT LOUIS, MO 63110

FOR: ON-LINE RETAIL STORE SERVICES FEATURING DOG CLOTHES, DOG COLLARS, DOG LEASHES, DOG TREATS AND/OR FOOD, DOG TOYS, DOG BEDS, DOG CRATES, DOG HARNESSSES, DOG SHOES, DOG BOWLS, DOG CHEWS, DOG ACCESSORIES, AND OTHER DOG PRODUCTS, IN CLASS 35 (U.S. CLS. 100, 101 AND 102).

FIRST USE 8-1-2011; IN COMMERCE 8-1-2011.

THE MARK CONSISTS OF STANDARD CHARACTERS WITHOUT CLAIM TO ANY PARTICULAR FONT, STYLE, SIZE, OR COLOR.

NO CLAIM IS MADE TO THE EXCLUSIVE RIGHT TO USE "DOG", APART FROM THE MARK AS SHOWN.

SN 85-277,886, FILED 3-26-2011.

MIAH ROSENBERG, EXAMINING ATTORNEY



David J. Kybas

Director of the United States Patent and Trademark Office

United States of America

United States Patent and Trademark Office

COURAGE SHOTS

Reg. No. 4,206,969

COURAGE SPORTS, INC. (NEVADA CORPORATION)
P.O. BOX 1493

Registered Sep. 11, 2012

FAIRACRES, NM 88033

Int. Cls.: 5 and 32

FOR: NUTRITIONAL DRINKS, NAMELY, NUTRITIONALLY FORTIFIED BEVERAGES, IN CLASS 5 (U.S. CLS. 6, 18, 44, 46, 51 AND 52).

TRADEMARK

FIRST USE 1-4-2012; IN COMMERCE 1-4-2012.

PRINCIPAL REGISTER

FOR: SPORTS DRINKS, IN CLASS 32 (U.S. CLS. 45, 46 AND 48).

FIRST USE 1-4-2012; IN COMMERCE 1-4-2012.

THE MARK CONSISTS OF STANDARD CHARACTERS WITHOUT CLAIM TO ANY PARTICULAR FONT, STYLE, SIZE, OR COLOR.

OWNER OF U.S. REG. NOS. 2,719,471, 3,024,879, AND OTHERS.

NO CLAIM IS MADE TO THE EXCLUSIVE RIGHT TO USE "SHOTS", APART FROM THE MARK AS SHOWN.

SN 85-277,963, FILED 3-26-2011.

DANNEAN HETZEL, EXAMINING ATTORNEY



David J. Kyffers

Director of the United States Patent and Trademark Office

United States of America

United States Patent and Trademark Office

Kaseek

Reg. No. 4,206,970

Registered Sep. 11, 2012

Int. Cl.: 35

SERVICE MARK

PRINCIPAL REGISTER

KASEEK, LLC (NEW JERSEY LIMITED LIABILITY COMPANY)
STONECRESS CT
JACKSON, NJ 08527

FOR: PROMOTIONAL SERVICES, NAMELY, PROMOTING THE GOODS OF OTHERS BY MEANS OF PROVIDING ONLINE RESTAURANT MENUS; PROVIDING A WEBSITE WHERE USERS CAN POST RATINGS, REVIEWS AND RECOMMENDATIONS ON RESTAURANTS, FOOD AND WINE FOR COMMERCIAL PURPOSES, IN CLASS 35 (U.S. CLS. 100, 101 AND 102).

FIRST USE 6-21-2012; IN COMMERCE 7-16-2012.

THE MARK CONSISTS OF IN THE WORD OF "KASEEK", THE TWO LETTER "E"S HAVE A DOT ON EACH TO REPRESENT EYES.

SN 85-277,968, FILED 3-26-2011.

DANNEAN HETZEL, EXAMINING ATTORNEY



David J. Kyffers

Director of the United States Patent and Trademark Office

United States of America

United States Patent and Trademark Office

DIEBOLD WEATHERALERT

Reg. No. 4,206,971

DIEBOLD, INCORPORATED (OHIO CORPORATION)
5995 MAYFAIR ROAD
NORTH CANTON, OH 44720

Registered Sep. 11, 2012

Int. Cl.: 45

FOR: REMOTE MONITORING OF AUTOMATED BANKING MACHINES AND SECURITY SYSTEMS OF OTHERS FOR SECURITY PURPOSES, IN CLASS 45 (U.S. CLS. 100 AND 101).

SERVICE MARK

FIRST USE 10-31-2011; IN COMMERCE 10-31-2011.

PRINCIPAL REGISTER

THE MARK CONSISTS OF STANDARD CHARACTERS WITHOUT CLAIM TO ANY PARTICULAR FONT, STYLE, SIZE, OR COLOR.

NO CLAIM IS MADE TO THE EXCLUSIVE RIGHT TO USE "WEATHERALERT", APART FROM THE MARK AS SHOWN.

SN 85-278,037, FILED 3-27-2011.

JANICE L. MCMORROW, EXAMINING ATTORNEY



David J. Kybas

Director of the United States Patent and Trademark Office

United States of America

United States Patent and Trademark Office

SHEAR JOY

Reg. No. 4,206,972

HOLMES, KARINA JOY (UNITED STATES INDIVIDUAL)
9319 FOOTHILL BLVD. SUITE F
RANCHO CUCAMONGA, CA 91730

Registered Sep. 11, 2012

Int. Cl.: 44

FOR: HAIR CUTTING SERVICES; HAIR SALON SERVICES; HAIR SALON SERVICES, NAMELY, HAIR CUTTING, STYLING, COLORING, AND HAIR EXTENSION SERVICES; HAIR STYLING, IN CLASS 44 (U.S. CLS. 100 AND 101).

SERVICE MARK

FIRST USE 3-1-2011; IN COMMERCE 11-15-2011.

PRINCIPAL REGISTER

THE MARK CONSISTS OF STANDARD CHARACTERS WITHOUT CLAIM TO ANY PARTICULAR FONT, STYLE, SIZE, OR COLOR.

SN 85-278,102, FILED 3-27-2011.

JASON TURNER, EXAMINING ATTORNEY



David J. Kyffers

Director of the United States Patent and Trademark Office

United States of America

United States Patent and Trademark Office

Granivations

Reg. No. 4,206,973

WASTE TO VALUE STONE LLC (TENNESSEE LIMITED LIABILITY COMPANY)
114 MAGNOLIA GLEN CR

Registered Sep. 11, 2012

MANCHESTER, TN 37355

Int. Cl.: 19

FOR: GRANITE SCRAPS THAT ARE RECYCLED AND USED FOR STONE CLADDING, PAVING, FLOORING AND ALL VARIOUS INDOOR AND EXTERIOR SURFACE APPLICATIONS , IN CLASS 19 (U.S. CLS. 1, 12, 33 AND 50).

TRADEMARK

FIRST USE 11-1-2010; IN COMMERCE 11-1-2010.

PRINCIPAL REGISTER

THE MARK CONSISTS OF STANDARD CHARACTERS WITHOUT CLAIM TO ANY PARTICULAR FONT, STYLE, SIZE, OR COLOR.

SN 85-278,289, FILED 3-28-2011.

RAMONA ORTIGA, EXAMINING ATTORNEY



David J. Kyffers

Director of the United States Patent and Trademark Office

United States of America

United States Patent and Trademark Office

SERVING HONOR AND NEED

Reg. No. 4,206,974

Registered Sep. 11, 2012

Int. Cl.: 36

SERVICE MARK

PRINCIPAL REGISTER

THE GARY SINISE FOUNDATION (DELAWARE CORPORATION)
C/O LICKER & OZUROVICH
1901 AVENUE OF THE STARS, SUITE 1050
LOS ANGELES, CA 90067

FOR: CHARITABLE FUNDRAISING SERVICES; CHARITABLE FOUNDATION SERVICES, NAMELY, PROVIDING FUNDRAISING ACTIVITIES, FUNDING, SCHOLARSHIPS AND/OR FINANCIAL ASSISTANCE FOR MILITARY PERSONNEL AND THEIR FAMILIES, AND FOR CHARITABLE CAUSES AND PROGRAMS, IN CLASS 36 (U.S. CLS. 100, 101 AND 102).

FIRST USE 7-1-2011; IN COMMERCE 7-1-2011.

THE MARK CONSISTS OF STANDARD CHARACTERS WITHOUT CLAIM TO ANY PARTICULAR FONT, STYLE, SIZE, OR COLOR.

SN 85-278,906, FILED 3-28-2011.

KATINA MISTER, EXAMINING ATTORNEY



David J. Kybas

Director of the United States Patent and Trademark Office

United States of America

United States Patent and Trademark Office

ROSETTA MILLINGTON

Reg. No. 4,206,975

Registered Sep. 11, 2012

Int. Cl.: 25

TRADEMARK

PRINCIPAL REGISTER

ROSETTA CLOTHING LLC (CALIFORNIA LIMITED LIABILITY COMPANY)
SUITE 2575
101 HUNTINGTON AVENUE
BOSTON, MA 02199

FOR: COATS; DRESSES; GOWNS; HATS; PAJAMAS; PANTS; ROMPERS; SHIRTS; SHORTS;
SKIRTS; SWEATERS; SWIMWEAR; TOPS, IN CLASS 25 (U.S. CLS. 22 AND 39).

FIRST USE 5-24-1994; IN COMMERCE 5-24-1994.

THE MARK CONSISTS OF STANDARD CHARACTERS WITHOUT CLAIM TO ANY PARTICULAR FONT, STYLE, SIZE, OR COLOR.

THE NAME(S), PORTRAIT(S), AND/OR SIGNATURE(S) SHOWN IN THE MARK IDENTIFIES ROSETTA MILLINGTON GETTY, WHOSE CONSENT(S) TO REGISTER IS MADE OF RECORD.

SN 85-278,980, FILED 3-28-2011.

DOMINIC FATHY, EXAMINING ATTORNEY



David J. Kyffers

Director of the United States Patent and Trademark Office

United States of America

United States Patent and Trademark Office



Reg. No. 4,206,976

Registered Sep. 11, 2012

Int. Cl.: 25

HUNAN KINGEAGLE FASHION GROUP CO., LTD. (CHINA LIMITED LIABILITY COMPANY)
FLOOR 3, NEW CENTURY MASHION
NO.200 SECOND PERIOD OF FURONG MIDDLE ST
CHANGSHA, CHINA

TRADEMARK

PRINCIPAL REGISTER

FOR: ARTICLES OF CLOTHING, NAMELY, HOSIERY, SHIRTS, SINGLET, UNDERPANTS, TEE-SHIRTS, UNDERWEAR, TROUSERS, JACKETS, UNIFORMS; KNITWEAR, NAMELY, TOPS, SWEATERS, PANTS, SWEATPANTS, SOCKS, HATS, GLOVES, MITTENS, AND SCARVES, IN CLASS 25 (U.S. CLS. 22 AND 39).

FIRST USE 1-18-2011; IN COMMERCE 1-18-2011.

THE MARK CONSISTS OF A STYLIZED, ORNAMENTAL, OVAL SHAPED BORDER SURROUNDING THE WORD "WODESIKE" WITH CHINESE CHARACTERS BELOW THAT WORD.

THE NON-LATIN CHARACTERS IN THE MARK TRANSLITERATE TO "WODESIKE" AND THIS HAS NO MEANING IN A FOREIGN LANGUAGE.

SN 85-279,696, FILED 3-29-2011.

JENNIFER MARTIN, EXAMINING ATTORNEY



David J. Kybas

Director of the United States Patent and Trademark Office

United States of America

United States Patent and Trademark Office

If you don't got it. You
don't get it!

Reg. No. 4,206,977

UNIVERSITY OF ADHD, LLC (NEW JERSEY LIMITED LIABILITY COMPANY)
7 DEMPSTER ROAD
CHATHAM, NJ 07928

Registered Sep. 11, 2012

Int. Cls.: 16 and 25

FOR: BUMPER STICKERS AND DECALS FOR VEHICLE WINDOWS, IN CLASS 16 (U.S. CLS. 2, 5, 22, 23, 29, 37, 38 AND 50).

TRADEMARK

FIRST USE 6-6-2012; IN COMMERCE 6-6-2012.

PRINCIPAL REGISTER

FOR: APPAREL, NAMELY, SHIRTS, T-SHIRTS, POLO SHIRTS, TANK TOPS, BUTTON UP SHIRTS, PANTS, SWEAT PANTS AND SHIRTS, SHORTS, FLEECE TOPS, FLEECE VESTS, FLEECE BOTTOMS, VESTS, JACKETS, SPORTS JERSEY, SOCKS, LOUNGEWEAR AND SLEEPWEAR, UNDERWEAR, HATS, CAPS, VISORS, AND CHILDREN'S APPAREL, NAMELY, SHIRTS, T-SHIRTS, POLO SHIRTS, TANK TOPS, BUTTON UP SHIRTS, PANTS, SWEAT PANTS AND SHIRTS, SHORTS, JACKETS, SPORTS JERSEY, SOCKS, LOUNGE AND SLEEPWEAR, UNDERWEAR, HATS, CAPS AND VISORS , IN CLASS 25 (U.S. CLS. 22 AND 39).

FIRST USE 6-6-2012; IN COMMERCE 6-6-2012.

THE MARK CONSISTS OF STANDARD CHARACTERS WITHOUT CLAIM TO ANY PARTICULAR FONT, STYLE, SIZE, OR COLOR.

SN 85-280,096, FILED 3-29-2011.

LINDA ESTRADA, EXAMINING ATTORNEY



David J. Kybas

Director of the United States Patent and Trademark Office

United States of America

United States Patent and Trademark Office

EGO * SOLEIL

Reg. No. 4,206,978

ALFRED, DELBURT (UNITED STATES INDIVIDUAL)
16850 COLLINS AVE #608

Registered Sep. 11, 2012

SUNNY ISLES BEACH, FL 33160

Int. Cl.: 35

FOR: RETAIL STORE AND ON-LINE RETAIL STORE SERVICES FEATURING CLOTHING, SHOES, TOPS, DRESSES, PANTS, SHOE ACCESSORIES, JEWELRY, UNDERGARMENTS, BAGS, HANDBAGS, ELECTRONICS, WATCHES, HAIR AND MAKEUP PRODUCTS, IN CLASS 35 (U.S. CLS. 100, 101 AND 102).

SERVICE MARK

PRINCIPAL REGISTER

FIRST USE 1-7-2011; IN COMMERCE 4-15-2011.

THE MARK CONSISTS OF THE WORD "EGO" FOLLOWED BY AN 8 POINT STAR, FOLLOWED BY THE WORD "SOLEIL".

THE ENGLISH TRANSLATION OF THE WORD "SOLEIL" IN THE MARK IS SUN.

SN 85-280,567, FILED 3-29-2011.

JACLYN KIDWELL WALKER, EXAMINING ATTORNEY



David J. Kybas

Director of the United States Patent and Trademark Office

United States of America

United States Patent and Trademark Office

PYF

Reg. No. 4,206,979

MARSALLE, INC. (NEW YORK CORPORATION)
230 LIBERTY STREET
METUCHEN, NJ 08840

Registered Sep. 11, 2012

Int. Cl.: 35

FOR: RETAIL STORE SERVICES FEATURING EYEGLASSES, SUNGLASSES AND RELATED ACCESSORIES, IN CLASS 35 (U.S. CLS. 100, 101 AND 102).

SERVICE MARK

FIRST USE 4-15-2012; IN COMMERCE 6-1-2012.

PRINCIPAL REGISTER

THE MARK CONSISTS OF STANDARD CHARACTERS WITHOUT CLAIM TO ANY PARTICULAR FONT, STYLE, SIZE, OR COLOR.

SN 85-280,629, FILED 3-29-2011.

SANI KHOURI, EXAMINING ATTORNEY



David J. Kybas

Director of the United States Patent and Trademark Office

United States of America

United States Patent and Trademark Office

MOVEMENT MAPPING

Reg. No. 4,206,980

Registered Sep. 11, 2012

Int. Cls.: 16 and 44

TRADEMARK

SERVICE MARK

PRINCIPAL REGISTER

BRAINCHANGING LLC (DELAWARE LIMITED LIABILITY COMPANY)
4N625 BURR ROAD
ST. CHARLES, IL 60175

FOR: PRINTED EDUCATIONAL MATERIALS IN THE FIELDS OF FITNESS, EXERCISE, HEALTH, NUTRITION, AND PHYSICAL THERAPY , IN CLASS 16 (U.S. CLS. 2, 5, 22, 23, 29, 37, 38 AND 50).

FIRST USE 10-8-2011; IN COMMERCE 10-8-2011.

FOR: PROVIDING A WEBSITE WITH INFORMATION ABOUT HEALTH, NUTRITION, PHYSICAL THERAPY; WEIGHT MANAGEMENT SERVICES, NAMELY, PROVIDING WEIGHT LOSS AND/OR WEIGHT MAINTENANCE PROGRAMS, IN CLASS 44 (U.S. CLS. 100 AND 101).

FIRST USE 4-8-2012; IN COMMERCE 4-8-2012.

THE MARK CONSISTS OF STANDARD CHARACTERS WITHOUT CLAIM TO ANY PARTICULAR FONT, STYLE, SIZE, OR COLOR.

SN 85-280,823, FILED 3-30-2011.

MARGERY A. TIERNEY, EXAMINING ATTORNEY



David J. Kyros

Director of the United States Patent and Trademark Office

United States of America

United States Patent and Trademark Office



Reg. No. 4,206,981

AHKAH CO., LTD. (JAPAN CORPORATION)
4-13-23 NISHIAZABU, MINATO-KU
TOKYO, JAPAN

Registered Sep. 11, 2012

Int. Cl.: 14

FOR: JEWELLERY AND PRECIOUS STONES; ARTICLES MADE OF PRECIOUS METALS OR COATED THEREWITH, NAMELY, RINGS, BRACELETS, NECKLACES, EARRINGS, BROOCHES, PENDANTS, CUFF-LINKS, TIE CLIPS, KEY RINGS; WATCHES, WRIST-WATCHES, CLOCKS, ALLOYS OF PRECIOUS METALS, JEWELLERY CASES, SILVER ORNAMENTS, IN CLASS 14 (U.S. CLS. 2, 27, 28 AND 50).

TRADEMARK

PRINCIPAL REGISTER

FIRST USE 6-30-1997; IN COMMERCE 3-27-2012.

OWNER OF U.S. REG. NO. 3,489,027.

THE MARK CONSISTS OF THE WORDING "AHKAH" IN STYLIZED LETTERING.

SN 85-281,444, FILED 3-30-2011.

JANET LEE, EXAMINING ATTORNEY



David J. Kyros

Director of the United States Patent and Trademark Office

United States of America

United States Patent and Trademark Office



INOXPLATE

Reg. No. 4,206,982

RECUBRIMIENTOS PLASTICOS, S.A. (SPAIN CORPORATION)
CTRA. PAMPLONA-ESTELLA, KM. 11.- 31190
ASTRAIN (NAVARRA), SPAIN

Registered Sep. 11, 2012

Int. Cl.: 6

FOR: MULTILAYER DECORATIVE PANELS PRIMARILY MADE OF STEEL METAL FOR DOMESTIC APPLIANCES, DOORS, SHIPS, BOATS, ELEVATORS, CEILING, ROOF AND FENCES, NAMELY, PRE-COATED SHEET METAL, IN CLASS 6 (U.S. CLS. 2, 12, 13, 14, 23, 25 AND 50).

TRADEMARK

PRINCIPAL REGISTER

FIRST USE 12-31-2000; IN COMMERCE 7-31-2007.

NO CLAIM IS MADE TO THE EXCLUSIVE RIGHT TO USE "INOXPLATE", APART FROM THE MARK AS SHOWN.

THE MARK CONSISTS OF TWO OVERLAPPING QUADRILATERAL FIGURES, WITH THE LETTER "R" APPEARING AT THE INTERSECTION OF SUCH FIGURES. AT THE BOTTOM OF THE QUADRILATERALS, THE LITERAL ELEMENT "INOXPLATE" IS DISPLAYED, USING A SANS-SERIF FONT-TYPE.

SN 85-282,284, FILED 3-31-2011.

SOPHIA S. KIM, EXAMINING ATTORNEY



David J. Kybas

Director of the United States Patent and Trademark Office

United States of America

United States Patent and Trademark Office

CITATION NATION

Reg. No. 4,206,983

Registered Sep. 11, 2012

Int. Cl.: 45

SERVICE MARK

PRINCIPAL REGISTER

ULYSSES L. FELDER (UNITED STATES INDIVIDUAL)
UNIT 50
7306 COLLINS AVE
MIAMI BEACH, FL 33141

FOR: LEGAL SERVICES, IN CLASS 45 (U.S. CLS. 100 AND 101).

FIRST USE 3-21-2011; IN COMMERCE 3-21-2011.

THE MARK CONSISTS OF STANDARD CHARACTERS WITHOUT CLAIM TO ANY PARTICULAR FONT, STYLE, SIZE, OR COLOR.

SN 85-282,794, FILED 3-31-2011.

KATHERINE STOIDES, EXAMINING ATTORNEY



David J. Kybas

Director of the United States Patent and Trademark Office

United States of America

United States Patent and Trademark Office

SMART MOVE

Reg. No. 4,206,984

Registered Sep. 11, 2012

Int. Cl.: 42

SERVICE MARK

PRINCIPAL REGISTER

MUELLER INTERNATIONAL, INC. (DELAWARE CORPORATION)
1200 ABERNATHY ROAD
SUITE 1200
ATLANTA, GA 30328

FOR: HOSTING AN ONLINE WEBSITE USED BY UTILITY PROVIDERS TO TRACK UTILITY USAGE, DETECT LEAKS, PINPOINT OUTAGES AND PROVIDE UPDATES ON SERVICE RESTORATION; MANUAL UTILITY METER READING SERVICES, IN CLASS 42 (U.S. CLS. 100 AND 101).

FIRST USE 6-0-2011; IN COMMERCE 6-0-2011.

THE MARK CONSISTS OF STANDARD CHARACTERS WITHOUT CLAIM TO ANY PARTICULAR FONT, STYLE, SIZE, OR COLOR.

SN 85-282,846, FILED 3-31-2011.

JOHN SCHUYLER YARD, EXAMINING ATTORNEY



David J. Kyffers

Director of the United States Patent and Trademark Office

United States of America

United States Patent and Trademark Office

TOUGH STRUGGLE

Reg. No. 4,206,985

DANNY L. FRANKLIN (UNITED STATES INDIVIDUAL)

Registered Sep. 11, 2012

P.O. BOX 2854
WASHINGTON, DC 20013

Int. Cl.: 25

FOR: ANKLE SOCKS; ANKLETS; ATHLETIC APPAREL, NAMELY, SHIRTS, PANTS, JACKETS, FOOTWEAR, HATS AND CAPS, ATHLETIC UNIFORMS; BOMBER JACKETS; BOW TIES; BRIEFS; HATS; JACKETS AND SOCKS; LADIES' UNDERWEAR; LONG UNDERWEAR; MEN'S DRESS SOCKS; MEN'S SOCKS; MEN'S UNDERWEAR; SWEATPANTS; T-SHIRTS; THERMAL UNDERWEAR; THONGS; TIES, IN CLASS 25 (U.S. CLS. 22 AND 39).

TRADEMARK

PRINCIPAL REGISTER

FIRST USE 1-27-2012; IN COMMERCE 1-27-2012.

THE MARK CONSISTS OF STANDARD CHARACTERS WITHOUT CLAIM TO ANY PARTICULAR FONT, STYLE, SIZE, OR COLOR.

SN 85-283,379, FILED 4-1-2011.

LINDA M. KING, EXAMINING ATTORNEY



David J. Kybas

Director of the United States Patent and Trademark Office

United States of America

United States Patent and Trademark Office

RICHES OF THE KINGS

Reg. No. 4,206,986

Registered Sep. 11, 2012

Int. Cl.: 9

TRADEMARK

PRINCIPAL REGISTER

BALLY GAMING, INC (NEVADA CORPORATION), DBA BALLY TECHNOLOGIES,
ATT: LEGAL DEPARTMENT
6601 S. BERMUDA ROAD
LAS VEGAS, NV 89119

FOR: GAMING MACHINES, NAMELY, DEVICES WHICH ACCEPT A WAGER AND GAMING SOFTWARE THAT GENERATES OR DISPLAYS OUTCOMES FOR GAMING MACHINES, IN CLASS 9 (U.S. CLS. 21, 23, 26, 36 AND 38).

FIRST USE 3-5-2012; IN COMMERCE 3-5-2012.

THE MARK CONSISTS OF STANDARD CHARACTERS WITHOUT CLAIM TO ANY PARTICULAR FONT, STYLE, SIZE, OR COLOR.

SN 85-284,308, FILED 4-1-2011.

WENDY GOODMAN, EXAMINING ATTORNEY



David J. Kybas

Director of the United States Patent and Trademark Office

United States of America

United States Patent and Trademark Office

WHITE LABEL BURGER

Reg. No. 4,206,987

Registered Sep. 11, 2012

Int. Cl.: 30

ALTAMAREA INTELLECTUAL PROPERTY, LLC (NEW YORK LIMITED LIABILITY COMPANY)

C/O ALTAMAREA GROUP, LLC
415 WEST BROADWAY, FLOOR 5S
NEW YORK, NY 10012

TRADEMARK

FOR: HAMBURGER SANDWICHES FOR CONSUMPTION ON AND OFF THE PREMISE, IN CLASS 30 (U.S. CL. 46).

PRINCIPAL REGISTER

FIRST USE 11-0-2010; IN COMMERCE 11-0-2010.

THE MARK CONSISTS OF STANDARD CHARACTERS WITHOUT CLAIM TO ANY PARTICULAR FONT, STYLE, SIZE, OR COLOR.

NO CLAIM IS MADE TO THE EXCLUSIVE RIGHT TO USE "BURGER", APART FROM THE MARK AS SHOWN.

SN 85-284,361, FILED 4-1-2011.

ELIZABETH KAJUBI, EXAMINING ATTORNEY



David J. Kybas

Director of the United States Patent and Trademark Office

United States of America

United States Patent and Trademark Office

DELIVERING HEALTHCARE SOLUTIONS

Reg. No. 4,206,988

Registered Sep. 11, 2012

**Int. Cls.: 35, 37, 44, and
45**

SERVICE MARK

PRINCIPAL REGISTER

MEDILOGIX, LLC (DELAWARE LIMITED LIABILITY COMPANY)
SUITE 950
1512 LARIMER STREET
DENVER, CO 80202

FOR: WHOLESALE DISTRIBUTORSHIPS FEATURING MEDICAL EQUIPMENT; ASSET MANAGEMENT SERVICES IN THE FIELD OF MEDICAL EQUIPMENT; ASSET MANAGEMENT SERVICES, NAMELY, REPORTING ON SERVICE HISTORIES, UTILIZATION OF THE MEDICAL ASSETS, END OF PRODUCT LIFE INFORMATION AND REPLACEMENT COSTS ALL RELATED TO MEDICAL DIAGNOSTIC, CLINICAL AND BIOMEDICAL EQUIPMENT; LOGISTICS MANAGEMENT IN THE FIELD OF MEDICAL EQUIPMENT, IN CLASS 35 (U.S. CLS. 100, 101 AND 102).

FIRST USE 5-13-2011; IN COMMERCE 5-13-2011.

FOR: REPAIR AND MAINTENANCE OF MEDICAL EQUIPMENT, IN CLASS 37 (U.S. CLS. 100, 103 AND 106).

FIRST USE 5-13-2011; IN COMMERCE 5-13-2011.

FOR: LEASING OF MEDICAL EQUIPMENT TO MEDICAL CARE, LONG-TERM CARE, ACUTE CARE, SKILLED NURSING AND REHABILITATION FACILITIES AND SERVICE PROVIDERS; RENTAL OF MEDICAL EQUIPMENT TO MEDICAL CARE, LONG-TERM CARE, ACUTE CARE, SKILLED NURSING AND REHABILITATION FACILITIES AND SERVICE PROVIDERS; PROVIDING RESPIRATORY THERAPY SERVICES TO MEDICAL CARE, LONG-TERM CARE, ACUTE CARE, SKILLED NURSING AND REHABILITATION FACILITIES AND SERVICE PROVIDERS, IN CLASS 44 (U.S. CLS. 100 AND 101).

FIRST USE 5-13-2011; IN COMMERCE 5-13-2011.

FOR: CONSULTING SERVICES IN THE FIELD OF REGULATORY COMPLIANCE FOR MEDICAL EQUIPMENT, IN CLASS 45 (U.S. CLS. 100 AND 101).

FIRST USE 5-13-2011; IN COMMERCE 5-13-2011.

THE MARK CONSISTS OF STANDARD CHARACTERS WITHOUT CLAIM TO ANY PARTICULAR FONT, STYLE, SIZE, OR COLOR.



David J. Kyffers

Director of the United States Patent and Trademark Office

Reg. No. 4,206,988 SN 85-284,569, FILED 4-2-2011.

MARILYN IZZI, EXAMINING ATTORNEY

United States of America

United States Patent and Trademark Office



Reg. No. 4,206,989

Registered Sep. 11, 2012

Int. Cl.: 31

TRADEMARK

PRINCIPAL REGISTER

CHIQUITA BRANDS L.L.C. (DELAWARE LIMITED LIABILITY COMPANY)
250 EAST FIFTH STREET
CINCINNATI, OH 45202

FOR: FRESH FRUIT AND VEGETABLES, IN CLASS 31 (U.S. CLS. 1 AND 46).

FIRST USE 7-31-2011; IN COMMERCE 7-31-2011.

OWNER OF U.S. REG. NOS. 670,320, 2,424,101, AND OTHERS.

THE COLOR(S) YELLOW, WHITE AND BLUE IS/ARE CLAIMED AS A FEATURE OF THE MARK.

THE MARK CONSISTS OF A DESIGN OF A LADY WITH FRUITED HAT ABOVE THE WORDING "CHIQUITA", ALL WITHIN AN OVAL, WHERE THE DESIGN OF THE LADY AND THE INSIDE BORDER OF THE OVAL IS IN THE COLOR YELLOW, THE WORDING "CHIQUITA" IS IN THE COLOR WHITE, AND THE BACKGROUND OF THE OVAL IS IN THE COLOR BLUE.

THE ENGLISH TRANSLATION OF "CHIQUITA" IN THE MARK IS "LITTLE GIRL".

SN 85-285,425, FILED 4-4-2011.

JOHN GARTNER, EXAMINING ATTORNEY



David J. Kybas

Director of the United States Patent and Trademark Office

United States of America

United States Patent and Trademark Office

BAREFORM

Reg. No. 4,206,990

WOLVERINE OUTDOORS, INC. (MICHIGAN CORPORATION)

Registered Sep. 11, 2012

9341 COURTLAND DRIVE NE
ROCKFORD, MI 49351

Int. Cl.: 41

FOR: EDUCATIONAL SERVICES, NAMELY, CONDUCTING IN-PERSON AND ONLINE SESSIONS IN THE FIELD OF ATHLETIC TRAINING AND TECHNIQUES AND DISTRIBUTION OF PRINTED MATERIALS IN CONNECTION THEREWITH IN HARD COPY OR ELECTRONIC FORMAT ON THE SAME TOPICS, IN CLASS 41 (U.S. CLS. 100, 101 AND 107).

SERVICE MARK

PRINCIPAL REGISTER

FIRST USE 9-0-2011; IN COMMERCE 9-0-2011.

THE MARK CONSISTS OF STANDARD CHARACTERS WITHOUT CLAIM TO ANY PARTICULAR FONT, STYLE, SIZE, OR COLOR.

SN 85-285,667, FILED 4-4-2011.

SHAUNIA CARLYLE, EXAMINING ATTORNEY



David J. Kyffers

Director of the United States Patent and Trademark Office

United States of America

United States Patent and Trademark Office

ASSISTED TRANSITION

Reg. No. 4,206,991

ASSISTED TRANSITION, LLC (NEVADA LIMITED LIABILITY COMPANY)
320 PINE AVENUE, SUITE 1050
LONG BEACH, CA 90802

Registered Sep. 11, 2012

Int. Cl.: 35

FOR: PROVIDING RELOCATION AND PLACEMENT REFERRALS TO SENIORS FOR ASSISTED LIVING, INDEPENDENT LIVING, NURSING HOMES OR HOME CARE PROVIDERS, IN CLASS 35 (U.S. CLS. 100, 101 AND 102).

SERVICE MARK

FIRST USE 3-1-2011; IN COMMERCE 3-1-2011.

PRINCIPAL REGISTER

THE MARK CONSISTS OF STANDARD CHARACTERS WITHOUT CLAIM TO ANY PARTICULAR FONT, STYLE, SIZE, OR COLOR.

NO CLAIM IS MADE TO THE EXCLUSIVE RIGHT TO USE "ASSISTED", APART FROM THE MARK AS SHOWN.

SN 85-285,738, FILED 4-4-2011.

WILLIAM ROSSMAN, EXAMINING ATTORNEY



David J. Kyffers

Director of the United States Patent and Trademark Office

United States of America

United States Patent and Trademark Office

ladyhug

Reg. No. 4,206,992

WITH AN H, LLC (CALIFORNIA LIMITED LIABILITY COMPANY)
1709 E. 28TH ST.
SIGNAL HILL, CA 90755

Registered Sep. 11, 2012

Int. Cl.: 10

FOR: ADULT SEXUAL STIMULATION AIDS, NAMELY, VIBRATORS, IN CLASS 10 (U.S. CLS. 26, 39 AND 44).

TRADEMARK

FIRST USE 1-1-2012; IN COMMERCE 3-1-2012.

PRINCIPAL REGISTER

THE MARK CONSISTS OF STANDARD CHARACTERS WITHOUT CLAIM TO ANY PARTICULAR FONT, STYLE, SIZE, OR COLOR.

SN 85-285,842, FILED 4-4-2011.

LINDA M. KING, EXAMINING ATTORNEY



David J. Kyffers

Director of the United States Patent and Trademark Office

United States of America

United States Patent and Trademark Office

PIPSQUEAKS

Reg. No. 4,206,993

ROSS, LLOYD (UNITED STATES INDIVIDUAL)
3 SPYGLASS HILL
OAKLAND, CA 94618

Registered Sep. 11, 2012

Int. Cl.: 29

FOR: MEATS, NAMELY, PACKAGED MINI SAUSAGES, IN CLASS 29 (U.S. CL. 46).

TRADEMARK

FIRST USE 1-1-2012; IN COMMERCE 1-1-2012.

PRINCIPAL REGISTER

THE MARK CONSISTS OF STANDARD CHARACTERS WITHOUT CLAIM TO ANY PARTICULAR FONT, STYLE, SIZE, OR COLOR.

SN 85-286,053, FILED 4-5-2011.

GENE MACIOL, EXAMINING ATTORNEY



David J. Kyffers

Director of the United States Patent and Trademark Office

United States of America

United States Patent and Trademark Office

BBNY GROUP

Reg. No. 4,206,994

BBNY GROUP, LLC (NEW YORK LIMITED LIABILITY COMPANY)
244 FIFTH AVENUE, B223
NEW YORK, NY 10001

Registered Sep. 11, 2012

Int. Cl.: 35

FOR: PROMOTING AND CONDUCTING TRADE SHOWS IN THE FIELD OF HISTORY, FAMILY HISTORY AND GENEALOGY, IN CLASS 35 (U.S. CLS. 100, 101 AND 102).

SERVICE MARK

FIRST USE 10-1-2011; IN COMMERCE 1-1-2012.

PRINCIPAL REGISTER

THE MARK CONSISTS OF STANDARD CHARACTERS WITHOUT CLAIM TO ANY PARTICULAR FONT, STYLE, SIZE, OR COLOR.

NO CLAIM IS MADE TO THE EXCLUSIVE RIGHT TO USE "GROUP", APART FROM THE MARK AS SHOWN.

SN 85-286,220, FILED 4-5-2011.

REBECCA SMITH, EXAMINING ATTORNEY



David J. Kyffers

Director of the United States Patent and Trademark Office

United States of America

United States Patent and Trademark Office



Reg. No. 4,206,995

CAMBIA HEALTH SOLUTIONS, INC. (OREGON CORPORATION)
100 SW MARKET STREET
PORTLAND, OR 97201

Registered Sep. 11, 2012

Int. Cl.: 45

FOR: ONLINE SOCIAL NETWORKING SERVICES IN THE FIELD OF HEALTHY LIFE-
STYLES , IN CLASS 45 (U.S. CLS. 100 AND 101).

SERVICE MARK

FIRST USE 3-28-2011; IN COMMERCE 3-28-2011.

PRINCIPAL REGISTER

THE MARK CONSISTS OF A PENNANT SHAPE WITH THE WORD "HUBBUB" INSIDE
AND THE WORDS "PLAY WELL. TOGETHER." BELOW.

SN 85-287,708, FILED 4-6-2011.

CIMMERIAN COLEMAN, EXAMINING ATTORNEY



David J. Kyros

Director of the United States Patent and Trademark Office

United States of America

United States Patent and Trademark Office



Reg. No. 4,206,996

CAMBIA HEALTH SOLUTIONS, INC. (OREGON CORPORATION)
100 SW MARKET STREET
PORTLAND, OR 97201

Registered Sep. 11, 2012

Int. Cl.: 45

FOR: ONLINE SOCIAL NETWORKING SERVICES IN THE FIELD OF HEALTHY LIFESTYLES, IN CLASS 45 (U.S. CLS. 100 AND 101).

SERVICE MARK

FIRST USE 3-28-2011; IN COMMERCE 3-28-2011.

PRINCIPAL REGISTER

THE MARK CONSISTS OF A PENNANT SHAPE WITH THE WORD "HUBBUB" INSIDE.

SN 85-287,715, FILED 4-6-2011.

CIMMERIAN COLEMAN, EXAMINING ATTORNEY



David J. Kybas

Director of the United States Patent and Trademark Office

United States of America

United States Patent and Trademark Office

PRIORSMART

Reg. No. 4,206,997

RPX CORPORATION (DELAWARE CORPORATION)
STEUART TOWER - SUITE 700 ONE MARKET
SAN FRANCISCO, CA 94105

Registered Sep. 11, 2012

Int. Cl.: 42

FOR: COMPUTER SERVICES, NAMELY, PROVIDING SEARCH ENGINES FOR OBTAINING DATA ON A GLOBAL COMPUTER NETWORK; SEARCHING AND RETRIEVING INFORMATION, SITES, AND OTHER RESOURCES AVAILABLE ON COMPUTER NETWORKS FOR OTHERS, IN CLASS 42 (U.S. CLS. 100 AND 101).

SERVICE MARK

PRINCIPAL REGISTER

FIRST USE 4-1-2008; IN COMMERCE 4-1-2008.

THE MARK CONSISTS OF STANDARD CHARACTERS WITHOUT CLAIM TO ANY PARTICULAR FONT, STYLE, SIZE, OR COLOR.

SN 85-288,694, FILED 4-7-2011.

KELLY TRUSILO, EXAMINING ATTORNEY



David J. Kybas

Director of the United States Patent and Trademark Office

United States of America

United States Patent and Trademark Office

JAN NATURA

Reg. No. 4,206,998

DISPROMEDICA LLC (FLORIDA LIMITED LIABILITY COMPANY)
4640 SW 98 AVE
MIAMI, FL 33165

Registered Sep. 11, 2012

Int. Cl.: 3

FOR: BODY AND BEAUTY CARE COSMETICS, IN CLASS 3 (U.S. CLS. 1, 4, 6, 50, 51 AND 52).

TRADEMARK

FIRST USE 3-15-2012; IN COMMERCE 3-15-2012.

PRINCIPAL REGISTER

THE MARK CONSISTS OF STANDARD CHARACTERS WITHOUT CLAIM TO ANY PARTICULAR FONT, STYLE, SIZE, OR COLOR.

THE ENGLISH TRANSLATION OF NATURA IN THE MARK IS NATURE.

SN 85-288,715, FILED 4-7-2011.

JUDITH HELFMAN, EXAMINING ATTORNEY



David J. Kyffers

Director of the United States Patent and Trademark Office

United States of America

United States Patent and Trademark Office

DOUBLEHEADER

Reg. No. 4,206,999

EPSTEIN, VERNE (UNITED STATES INDIVIDUAL)
13128 BROADWAY
SAN DIEGO, CA 92101

Registered Sep. 11, 2012

Int. Cl.: 25

FOR: SPORTS CAPS AND HATS, IN CLASS 25 (U.S. CLS. 22 AND 39).

TRADEMARK

FIRST USE 3-1-2012; IN COMMERCE 3-1-2012.

PRINCIPAL REGISTER

THE MARK CONSISTS OF STANDARD CHARACTERS WITHOUT CLAIM TO ANY PARTICULAR FONT, STYLE, SIZE, OR COLOR.

SN 85-288,925, FILED 4-7-2011.

RICHARD WHITE, EXAMINING ATTORNEY



David J. Kybas

Director of the United States Patent and Trademark Office

United States of America

United States Patent and Trademark Office

Denim Island

Reg. No. 4,207,000

Registered Sep. 11, 2012

Int. Cl.: 25

TRADEMARK

PRINCIPAL REGISTER

DENIM ISLAND LIMITED (HONG KONG LIMITED LIABILITY COMPANY)
UNIT 13, 16/F CONCORDIA PLAZA
1 SCIENCE MUSEUM RD. TSIM SHA TSUI EAST
HONG KONG, HONG KONG

FOR: CLOTHING, NAMELY, JEANS, DENIM SKORTS, DENIM SKIRTS, DENIM COATS, DENIM KNIT SHIRTS, BLOUSES, COATS, DRESSES, JACKETS, JERSEYS, OVER COATS, POLO SHIRTS, PULL-OVERS, SHIRTS, SKIRTS, SKORTS, SLACKS, T-SHIRTS, UNIFORMS; FOOTWEAR; HATS; ALL OF THE AFOREMENTIONED GOODS ARE MADE IN WHOLE OR SUBSTANTIALLY IN PART OF DENIM, IN CLASS 25 (U.S. CLS. 22 AND 39).

FIRST USE 7-15-2011; IN COMMERCE 7-15-2011.

THE MARK CONSISTS OF STANDARD CHARACTERS WITHOUT CLAIM TO ANY PARTICULAR FONT, STYLE, SIZE, OR COLOR.

NO CLAIM IS MADE TO THE EXCLUSIVE RIGHT TO USE "DENIM", APART FROM THE MARK AS SHOWN.

SN 85-289,775, FILED 4-8-2011.

MICHAEL SOUDERS, EXAMINING ATTORNEY



David J. Kyffers

Director of the United States Patent and Trademark Office

United States of America

United States Patent and Trademark Office

AlumaLast

Reg. No. 4,207,001

Registered Sep. 11, 2012

Int. Cl.: 1

TRADEMARK

PRINCIPAL REGISTER

JJISCO INC. (WISCONSIN CORPORATION)
1815 EXECUTIVE DRIVE
OCONOMOWOC, WI 53066

FOR: ENGINEERED CERAMIC AND COMPOSITE MATERIALS FOR HEAT TRANSFER OR THERMAL MANAGEMENT APPLICATIONS, FOR USE IN PUMP, VALVE, AND MACHINERY INDUSTRIES, IN CLASS 1 (U.S. CLS. 1, 5, 6, 10, 26 AND 46).

FIRST USE 3-28-2011; IN COMMERCE 4-8-2011.

THE MARK CONSISTS OF STANDARD CHARACTERS WITHOUT CLAIM TO ANY PARTICULAR FONT, STYLE, SIZE, OR COLOR.

OWNER OF U.S. REG. NOS. 3,255,609, 3,258,177, AND OTHERS.

SN 85-291,497, FILED 4-11-2011.

CURTIS FRENCH, EXAMINING ATTORNEY



David J. Kypos

Director of the United States Patent and Trademark Office

United States of America

United States Patent and Trademark Office

SAMUEL ADAMS BONFIRE RAUCHBIER

Reg. No. 4,207,002

Registered Sep. 11, 2012

Int. Cl.: 32

TRADEMARK

PRINCIPAL REGISTER

BOSTON BEER CORPORATION (MASSACHUSETTS CORPORATION)
ONE DESIGN CENTER PLACE, SUITE 850
BOSTON, MA 02116

FOR: BEER, IN CLASS 32 (U.S. CLS. 45, 46 AND 48).

FIRST USE 8-1-2011; IN COMMERCE 8-1-2011.

THE MARK CONSISTS OF STANDARD CHARACTERS WITHOUT CLAIM TO ANY PARTICULAR FONT, STYLE, SIZE, OR COLOR.

OWNER OF U.S. REG. NOS. 1,987,061, 2,597,646, AND OTHERS.

NO CLAIM IS MADE TO THE EXCLUSIVE RIGHT TO USE "RAUCHBIER", APART FROM THE MARK AS SHOWN.

THE NAME(S), PORTRAIT(S), AND/OR SIGNATURE(S) SHOWN IN THE MARK DOES NOT IDENTIFY A PARTICULAR LIVING INDIVIDUAL.

THE ENGLISH TRANSLATION OF "RAUCHBIER" IN THE MARK IS "SMOKED BEER".

SN 85-292,637, FILED 4-12-2011.

LINDA POWELL, EXAMINING ATTORNEY



David J. Kybas

Director of the United States Patent and Trademark Office

United States of America

United States Patent and Trademark Office

AirBlue

Reg. No. 4,207,003

Registered Sep. 11, 2012

Int. Cl.: 9

TRADEMARK

PRINCIPAL REGISTER

APOGEE INC. (CALIFORNIA CORPORATION)
1405 PIONEER ST.
BREA, CA 92821

FOR: WIRELESS COMMUNICATION DEVICE FEATURING VOICE, DATA AND IMAGE TRANSMISSION INCLUDING VOICE, TEXT AND PICTURE MESSAGING, A VIDEO AND STILL IMAGE CAMERA, ALSO FUNCTIONAL TO PURCHASE MUSIC, GAMES, VIDEO AND SOFTWARE APPLICATIONS OVER THE AIR FOR DOWNLOADING TO THE DEVICE; WIRELESS COMMUNICATION DEVICES FOR VOICE, DATA OR IMAGE TRANSMISSION, IN CLASS 9 (U.S. CLS. 21, 23, 26, 36 AND 38).

FIRST USE 1-1-2010; IN COMMERCE 1-1-2010.

THE MARK CONSISTS OF STANDARD CHARACTERS WITHOUT CLAIM TO ANY PARTICULAR FONT, STYLE, SIZE, OR COLOR.

SN 85-292,944, FILED 4-12-2011.

CORY BOONE, EXAMINING ATTORNEY



David J. Kyffers

Director of the United States Patent and Trademark Office

United States of America

United States Patent and Trademark Office

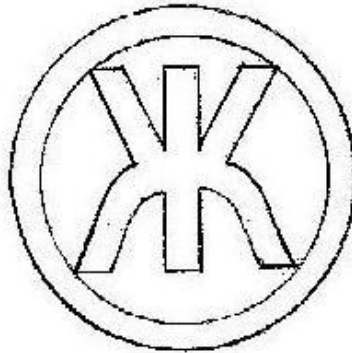

Reg. No. 4,207,004

KALIN MANCHEV (BULGARIA INDIVIDUAL)
53 PINE ISLE COURT
HENDERSON, NV 89074

Registered Sep. 11, 2012

Int. Cl.: 14

FOR: JEWELRY, IN CLASS 14 (U.S. CLS. 2, 27, 28 AND 50).

TRADEMARK

FIRST USE 5-10-2012; IN COMMERCE 5-10-2012.

PRINCIPAL REGISTER

THE MARK CONSISTS OF THE CYRILLIC LETTER "ZHE" SUPERIMPOSED UPON A TORIC RING.

SN 85-293,072, FILED 4-12-2011.

MARLENE BELL, EXAMINING ATTORNEY



David J. Kybas

Director of the United States Patent and Trademark Office

United States of America

United States Patent and Trademark Office

STRETCH
(LOCK)
STRETCH

Reg. No. 4,207,005

PLANTRA, INC. (MINNESOTA CORPORATION)
2508 NORTHLAND DRIVE
MENDOTA HEIGHTS, MN 55120

Registered Sep. 11, 2012

Int. Cl.: 22

FOR: SYNTHETIC TIES FOR USE IN AGRICULTURAL APPLICATIONS, IN CLASS 22 (U.S. CLS. 1, 2, 7, 19, 22, 42 AND 50).

TRADEMARK

FIRST USE 5-1-2012; IN COMMERCE 5-1-2012.

PRINCIPAL REGISTER

NO CLAIM IS MADE TO THE EXCLUSIVE RIGHT TO USE "STRETCH", APART FROM THE MARK AS SHOWN.

THE MARK CONSISTS OF THE WORD "LOCK" IN BOLD, THE WORD "STRETCH" IS DISPOSED ABOVE THE WORD "LOCK" AND THE WORD "STRETCH" IS DISPOSED BELOW THE WORD "LOCK"; EACH OF THE WORDS "STRETCH" ARE CONFIGURED TO FORM AN OVAL SHAPE AROUND THE WORD "LOCK"; A "T" SHAPED CONNECTOR IS DISPOSED TO THE RIGHT OF THE WORD "LOCK" AND A "T" SHAPED CONNECTOR IS DISPOSED TO THE LEFT OF THE WORD "LOCK" IN A CONFIGURATION THAT COMPLETES THE OVAL SHAPE.

SN 85-293,195, FILED 4-12-2011.

JENNY PARK, EXAMINING ATTORNEY



David J. Kyros

Director of the United States Patent and Trademark Office

United States of America

United States Patent and Trademark Office

FAMIGO

Reg. No. 4,207,006

Registered Sep. 11, 2012

Int. Cls.: 9 and 35

TRADEMARK

SERVICE MARK

PRINCIPAL REGISTER

FAMIGO, INC. (DELAWARE CORPORATION)
SUITE 3.11090
3925 WEST BRAKER LANE
AUSTIN, TX 787595316

FOR: DOWNLOADABLE COMPUTER SOFTWARE FOR USE BY FAMILIES AND CHILDREN IN THE FIELD OF MOBILE AND ONLINE FAMILY-FRIENDLY MEDIA IN THE NATURE OF SOFTWARE APPLICATIONS FOR DIGITAL BOOKS, DIGITAL VIDEOS AND EDUCATIONAL GAMES, IN CLASS 9 (U.S. CLS. 21, 23, 26, 36 AND 38).

FIRST USE 11-14-2011; IN COMMERCE 11-14-2011.

FOR: ADVERTISING AND MARKETING SERVICES, NAMELY, PROMOTING THE GOODS AND SERVICES OF OTHERS, NAMELY, FAMILY CONTENT AND APPLICATIONS SOFTWARE DIRECTED TOWARD THE FAMILY AND CHILDREN, IN CLASS 35 (U.S. CLS. 100, 101 AND 102).

FIRST USE 9-30-2011; IN COMMERCE 9-30-2011.

THE MARK CONSISTS OF STANDARD CHARACTERS WITHOUT CLAIM TO ANY PARTICULAR FONT, STYLE, SIZE, OR COLOR.

SN 85-293,978, FILED 4-13-2011.

GINA HAYES, EXAMINING ATTORNEY



David J. Kybas

Director of the United States Patent and Trademark Office

United States of America

United States Patent and Trademark Office

PACIFIC SHORES INVESTMENT ADVISORS

Reg. No. 4,207,007

COHEN, JONATHON (UNITED STATES INDIVIDUAL)
668 NORTH COAST HIGHWAY, SUITE 109
LAGUNA BEACH, CA 92651

Registered Sep. 11, 2012

Int. Cl.: 36

FOR: INVESTMENT ADVICE, FINANCIAL CONSULTATION, FINANCIAL SERVICES,
NAMELY, INVESTING THE FUNDS OF OTHERS, AND FINANCIAL PLANNING, IN CLASS
36 (U.S. CLS. 100, 101 AND 102).

SERVICE MARK

FIRST USE 6-28-2011; IN COMMERCE 6-28-2011.

PRINCIPAL REGISTER

THE MARK CONSISTS OF STANDARD CHARACTERS WITHOUT CLAIM TO ANY PAR-
TICULAR FONT, STYLE, SIZE, OR COLOR.

NO CLAIM IS MADE TO THE EXCLUSIVE RIGHT TO USE "INVESTMENT ADVISORS",
APART FROM THE MARK AS SHOWN.

SN 85-295,103, FILED 4-14-2011.

LESLEY LAMOTHE, EXAMINING ATTORNEY



David J. Kybas

Director of the United States Patent and Trademark Office

United States of America

United States Patent and Trademark Office

FOXIT PHANTOMPDF

Reg. No. 4,207,008

Registered Sep. 11, 2012

Int. Cl.: 9

TRADEMARK

PRINCIPAL REGISTER

FOXIT CORPORATION (CALIFORNIA CORPORATION)
39819 PASEO PADRE PARKWAY
FREMONT, CA 94538

FOR: COMPUTER SOFTWARE DEVELOPMENT TOOLS; COMPUTER SOFTWARE FOR CREATING, READING, EDITING, MANAGING, PRINTING, INDEXING AND RETRIEVING ELECTRONIC DOCUMENTS AND FILES; FOR USE WITH OPTICAL SCANNERS; FOR PAGE RECOGNITION AND RENDERING; FOR DOCUMENT MANAGEMENT FOR MOBILE DEVICES; FOR USE ON COMPUTERS AND DEVICES FOR ACCESSING, VIEWING AND CONTROLLING REMOTE COMPUTERS AND DEVICES; FOR THE TRANSMISSION, RECEPTION, CODING OR DECODING OF VOICE, DATA OR MULTIMEDIA CONTENT TO ALLOW REMOTE ACCESS TO, MONITORING OF, OR CONTROL OF, COMPUTER HARDWARE, COMPUTER SOFTWARE, ELECTRONIC DOCUMENTS, OR ELECTRONIC COMMUNICATIONS DEVICES; FOR FACILITATING BUSINESS TRANSACTIONS CONDUCTED VIA ELECTRONIC COMMUNICATIONS NETWORKS; COMPUTER SOFTWARE FOR CREATING, READING, EDITING, MANAGING, PRINTING, INDEXING AND RETRIEVING ELECTRONIC DOCUMENTS AND FILES; FOR USE WITH OPTICAL SCANNERS; FOR PAGE RECOGNITION AND RENDERING; FOR DOCUMENT MANAGEMENT FOR MOBILE DEVICES; FOR USE ON COMPUTERS AND DEVICES FOR ACCESSING, VIEWING AND CONTROLLING REMOTE COMPUTERS AND DEVICES; FOR THE TRANSMISSION, RECEPTION, CODING OR DECODING OF VOICE, DATA OR MULTIMEDIA CONTENT TO ALLOW REMOTE ACCESS TO, MONITORING OF, OR CONTROL OF, COMPUTER HARDWARE, COMPUTER SOFTWARE, ELECTRONIC DOCUMENTS, OR ELECTRONIC COMMUNICATIONS DEVICES; FOR FACILITATING BUSINESS TRANSACTIONS CONDUCTED VIA ELECTRONIC COMMUNICATIONS NETWORKS THAT MAY BE DOWNLOADED FROM A GLOBAL COMPUTER NETWORK; SOFTWARE FOR OPTICAL CHARACTER RECOGNITION, IN CLASS 9 (U.S. CLS. 21, 23, 26, 36 AND 38).



FIRST USE 5-26-2011; IN COMMERCE 5-26-2011.

THE MARK CONSISTS OF STANDARD CHARACTERS WITHOUT CLAIM TO ANY PARTICULAR FONT, STYLE, SIZE, OR COLOR.

OWNER OF U.S. REG. NO. 3,691,609.

SN 85-295,482, FILED 4-14-2011.

David J. Kybas

Director of the United States Patent and Trademark Office

Reg. No. 4,207,008 EDWARD NELSON, EXAMINING ATTORNEY

United States of America

United States Patent and Trademark Office

GHOST ROBOT

Reg. No. 4,207,009

Registered Sep. 11, 2012

Int. Cl.: 41

SERVICE MARK

PRINCIPAL REGISTER

GHOST ROBOT, INC (NEW YORK CORPORATION)
25 HOWARD STREET, 3RD FLOOR
NEW YORK, NY 10013

FOR: FILM AND VIDEO PRODUCTION; PRODUCTION OF MUSIC VIDEO RECORDINGS; ANIMATION PRODUCTION SERVICES; ENTERTAINMENT SERVICES, NAMELY, MULTIMEDIA PRODUCTION SERVICES; ENTERTAINMENT SERVICES, NAMELY, PRODUCTION OF COMPUTER-GENERATED IMAGERY FOR USE IN MOTION PICTURES; ENTERTAINMENT SERVICES, NAMELY, PRODUCTION OF SPECIAL EFFECTS INCLUDING MODEL-MAKING SERVICES; COMPUTER-GENERATED IMAGERY AND COMPUTER-GENERATED GRAPHICS FOR THE PRODUCTION OF MOTION PICTURES; VIDEOS, AND MOVIE TRAILERS; VIDEO GAME AND COMPUTER SOFTWARE GAME PRODUCTION; MUSIC PRODUCTION, IN CLASS 41 (U.S. CLS. 100, 101 AND 107).

FIRST USE 0-0-2002; IN COMMERCE 0-0-2002.

THE MARK CONSISTS OF STANDARD CHARACTERS WITHOUT CLAIM TO ANY PARTICULAR FONT, STYLE, SIZE, OR COLOR.

OWNER OF U.S. REG. NO. 3,953,093.

SN 85-295,970, FILED 4-15-2011.

TRICIA SONNEBORN, EXAMINING ATTORNEY



David J. Kyros

Director of the United States Patent and Trademark Office

United States of America

United States Patent and Trademark Office

STREET KING

Reg. No. 4,207,010

Registered Sep. 11, 2012

Int. Cl.: 32

TRADEMARK

PRINCIPAL REGISTER

STREET KING LLC (DELAWARE LIMITED LIABILITY COMPANY)
575 MADISON AVENUE
24TH FLOOR
NEW YORK, NY 10022

FOR: NON-ALCOHOLIC ENERGY DRINKS, IN CLASS 32 (U.S. CLS. 45, 46 AND 48).

FIRST USE 6-10-2011; IN COMMERCE 6-10-2011.

THE MARK CONSISTS OF STANDARD CHARACTERS WITHOUT CLAIM TO ANY PARTICULAR FONT, STYLE, SIZE, OR COLOR.

SN 85-296,194, FILED 4-15-2011.

CHRISTOPHER BUONGIORNO, EXAMINING ATTORNEY



David J. Kybas

Director of the United States Patent and Trademark Office

United States of America

United States Patent and Trademark Office

GREENLIGHT SIM

Reg. No. 4,207,011

Registered Sep. 11, 2012

Int. Cl.: 9

AMS RESEARCH CORPORATION (DELAWARE CORPORATION), DBA AMERICAN
MEDICAL SYSTEMS INC.,
PATENT DEPARTMENT
10700 BREN ROAD WEST
MINNETONKA, MN 55343

TRADEMARK

FOR: MEDICAL DIAGNOSTIC SIMULATORS FOR USE AS TEACHING AIDS FOR LASER
TISSUE ABLATION, IN CLASS 9 (U.S. CLS. 21, 23, 26, 36 AND 38).

PRINCIPAL REGISTER

FIRST USE 11-1-2011; IN COMMERCE 11-1-2011.

THE MARK CONSISTS OF STANDARD CHARACTERS WITHOUT CLAIM TO ANY PAR-
TICULAR FONT, STYLE, SIZE, OR COLOR.

SEC. 2(F) AS TO "GREENLIGHT".

OWNER OF U.S. REG. NOS. 3,421,221, 3,930,778, AND 4,052,114.

NO CLAIM IS MADE TO THE EXCLUSIVE RIGHT TO USE "SIM", APART FROM THE
MARK AS SHOWN.

SN 85-296,371, FILED 4-15-2011.

MARK SPARACINO, EXAMINING ATTORNEY



David J. Kyffers

Director of the United States Patent and Trademark Office

United States of America

United States Patent and Trademark Office

SEN

Reg. No. 4,207,012

ELAN INTERNATIONAL, INC. (FLORIDA CORPORATION)
15885 NW 13TH AVENUE
MIAMI GARDENS, FL 33169

Registered Sep. 11, 2012

Int. Cl.: 25

FOR: WOMEN'S CLOTHING, NAMELY, DRESSES, COVER UPS, TOPS AND BOTTOMS,
IN CLASS 25 (U.S. CLS. 22 AND 39).

TRADEMARK

FIRST USE 6-11-2012; IN COMMERCE 6-11-2012.

PRINCIPAL REGISTER

THE MARK CONSISTS OF STANDARD CHARACTERS WITHOUT CLAIM TO ANY PAR-
TICULAR FONT, STYLE, SIZE, OR COLOR.

SN 85-297,828, FILED 4-18-2011.

COLLEEN DOMBROW, EXAMINING ATTORNEY



David J. Kybas

Director of the United States Patent and Trademark Office

United States of America

United States Patent and Trademark Office

GIOVANNI RANA

Reg. No. 4,207,013

Registered Sep. 11, 2012

Int. Cls.: 30 and 43

TRADEMARK

**COLLECTIVE SERVICE
MARK**

PRINCIPAL REGISTER

PASTIFICIO RANA S.P.A. (ITALY SOCIETÀ PER AZIONI (SPA))
VIA PACINOTTI, 25
37057 SAN GIOVANNI LUPATOTO
VERONA, ITALY

FOR: PRECOOKED, FRESH, OR FROZEN MEALS CONSISTING PRIMARILY OF PASTA OR RICE; FROZEN CAKES AND PIZZA; PASTA; FROZEN, FRESH, DRIED AND VACUUM PACKED PASTA, PASTA WITH FILLINGS, NAMELY, TORTELLINI, TORTELLONI, RAVIOLI, CAPPELETTI, GNOCCHI; SALAD DRESSINGS; SPICES; CONDIMENTS, NAMELY, SAUCES; RICE AND TAPIOCA, IN CLASS 30 (U.S. CL. 46).

FIRST USE 0-0-2007; IN COMMERCE 0-0-2007.

FOR: RESTAURANT SERVICES, CATERING, BAR SERVICES, CAFE, CAFETERIAS, IN CLASS 43 (U.S. CLS. 100 AND 101).

FIRST USE 10-26-2011; IN COMMERCE 10-26-2011.

THE MARK CONSISTS OF STANDARD CHARACTERS WITHOUT CLAIM TO ANY PARTICULAR FONT, STYLE, SIZE, OR COLOR.

OWNER OF U.S. REG. NOS. 2,803,870, 3,174,320, AND OTHERS.

THE NAME(S), PORTRAIT(S), AND/OR SIGNATURE(S) SHOWN IN THE MARK IDENTIFIES "GIOVANNI RANA", WHOSE CONSENT(S) TO REGISTER IS MADE OF RECORD.

SN 85-298,429, FILED 4-19-2011.

KAREN K. BUSH, EXAMINING ATTORNEY



David J. Kybas

Director of the United States Patent and Trademark Office

United States of America

United States Patent and Trademark Office

MANNY O.

Reg. No. 4,207,014

Registered Sep. 11, 2012

**Int. Cls.: 18, 21, 25, and
33**

MANNY O. WINES LIMITED (HONG KONG PRIVATE LIMITED COMPANY)
ROOMS 1007-1012, 10/F, K. WAH CENTRE
191 JAVA ROAD
NORTH POINT, HONG KONG

FOR: UMBRELLAS; WINE BAGS WITH HANDLES FOR CARRYING OR HOLDING WINE
, IN CLASS 18 (U.S. CLS. 1, 2, 3, 22 AND 41).

TRADEMARK

FIRST USE 5-28-2012; IN COMMERCE 5-28-2012.

PRINCIPAL REGISTER

FOR: WINE GLASSES, WINE OPENERS, WINE DECANTERS, WINE BUCKETS, IN CLASS
21 (U.S. CLS. 2, 13, 23, 29, 30, 33, 40 AND 50).

FIRST USE 5-28-2012; IN COMMERCE 5-28-2012.

FOR: SHIRTS, T-SHIRTS, APRONS, HEADWEAR, IN CLASS 25 (U.S. CLS. 22 AND 39).

FIRST USE 5-28-2012; IN COMMERCE 5-28-2012.

FOR: WINE, IN CLASS 33 (U.S. CLS. 47 AND 49).

FIRST USE 5-28-2012; IN COMMERCE 5-28-2012.



THE MARK CONSISTS OF STANDARD CHARACTERS WITHOUT CLAIM TO ANY PAR-
TICULAR FONT, STYLE, SIZE, OR COLOR.

THE NAME SHOWN IN THE MARK IDENTIFIES "MANUEL H. OSMENA", WHOSE CON-
SENT IS MADE OF RECORD.

SN 85-298,499, FILED 4-19-2011.

DAVID I, EXAMINING ATTORNEY

David J. Kyfos

Director of the United States Patent and Trademark Office

United States of America

United States Patent and Trademark Office

KINETICOOMPH

Reg. No. 4,207,015

KINETIC OOMPH, LLC (DELAWARE LIMITED LIABILITY COMPANY)
229 DECATUR STREET, APT #2
BROOKLYN, NY 11233

Registered Sep. 11, 2012

Int. Cl.: 35

FOR: RETAIL STORE AND ON-LINE RETAIL STORE SERVICES FEATURING HATS AND VISORS, IN CLASS 35 (U.S. CLS. 100, 101 AND 102).

SERVICE MARK

FIRST USE 1-31-2011; IN COMMERCE 8-8-2011.

PRINCIPAL REGISTER

THE MARK CONSISTS OF STANDARD CHARACTERS WITHOUT CLAIM TO ANY PARTICULAR FONT, STYLE, SIZE, OR COLOR.

SN 85-298,504, FILED 4-19-2011.

KATINA MISTER, EXAMINING ATTORNEY



David J. Kybas

Director of the United States Patent and Trademark Office

United States of America

United States Patent and Trademark Office



Reg. No. 4,207,016

Registered Sep. 11, 2012

Int. Cl.: 37

SERVICE MARK

PRINCIPAL REGISTER

HOPKINS CONTRACTING (ARIZONA LIMITED LIABILITY COMPANY), DBA PHOENIX ROOFING SPECIALISTS,
3122 E CHARLESTON AVE.
PHOENIX, AZ 85032

FOR: ROOFING CONTRACTING, IN CLASS 37 (U.S. CLS. 100, 103 AND 106).

FIRST USE 10-10-2011; IN COMMERCE 10-10-2011.

NO CLAIM IS MADE TO THE EXCLUSIVE RIGHT TO USE "PHOENIX ROOFING SPECIALISTS", APART FROM THE MARK AS SHOWN.

THE MARK CONSISTS OF A "PHOENIX" BIRD APPEARING BELOW A ROOF TOP, WITH THE WORDS "PHOENIX ROOFING SPECIALIST" STACKED ON TOP OF EACH OTHER TO THE RIGHT OF THE BIRD; "ROOFING" IS IN LARGE FONT.

SN 85-298,771, FILED 4-19-2011.

JORDAN BAKER, EXAMINING ATTORNEY



David J. Kybas

Director of the United States Patent and Trademark Office

United States of America

United States Patent and Trademark Office

CONFIDENTLY CLEAN

Reg. No. 4,207,017

Registered Sep. 11, 2012

Int. Cl.: 3

TRADEMARK

PRINCIPAL REGISTER

THE PROCTER & GAMBLE COMPANY (OHIO CORPORATION)
ONE PROCTER & GAMBLE PLAZA
CINCINNATI, OH 45202

FOR: HAIR CARE PREPARATIONS, IN CLASS 3 (U.S. CLS. 1, 4, 6, 50, 51 AND 52).

FIRST USE 4-30-2012; IN COMMERCE 4-30-2012.

THE MARK CONSISTS OF STANDARD CHARACTERS WITHOUT CLAIM TO ANY PARTICULAR FONT, STYLE, SIZE, OR COLOR.

NO CLAIM IS MADE TO THE EXCLUSIVE RIGHT TO USE "CLEAN", APART FROM THE MARK AS SHOWN.

SN 85-298,872, FILED 4-19-2011.

WENDY GOODMAN, EXAMINING ATTORNEY



David J. Kybas

Director of the United States Patent and Trademark Office

United States of America

United States Patent and Trademark Office

MIRACULOUSLY SMOOTH

Reg. No. 4,207,018

Registered Sep. 11, 2012

Int. Cl.: 3

TRADEMARK

PRINCIPAL REGISTER

THE PROCTER & GAMBLE COMPANY (OHIO CORPORATION)
ONE PROCTER & GAMBLE PLAZA
CINCINNATI, OH 45202

FOR: HAIR CARE PREPARATIONS, IN CLASS 3 (U.S. CLS. 1, 4, 6, 50, 51 AND 52).

FIRST USE 4-30-2012; IN COMMERCE 4-30-2012.

THE MARK CONSISTS OF STANDARD CHARACTERS WITHOUT CLAIM TO ANY PARTICULAR FONT, STYLE, SIZE, OR COLOR.

SN 85-298,906, FILED 4-19-2011.

WENDY GOODMAN, EXAMINING ATTORNEY



David J. Kybas

Director of the United States Patent and Trademark Office

United States of America

United States Patent and Trademark Office

YOU CAN SHINE

Reg. No. 4,207,019

Registered Sep. 11, 2012

Int. Cl.: 3

TRADEMARK

PRINCIPAL REGISTER

THE PROCTER & GAMBLE COMPANY (OHIO CORPORATION)
ONE PROCTER & GAMBLE PLAZA
CINCINNATI, OH 45202

FOR: HAIR CARE PREPARATIONS, IN CLASS 3 (U.S. CLS. 1, 4, 6, 50, 51 AND 52).

FIRST USE 4-30-2012; IN COMMERCE 4-30-2012.

THE MARK CONSISTS OF STANDARD CHARACTERS WITHOUT CLAIM TO ANY PARTICULAR FONT, STYLE, SIZE, OR COLOR.

SN 85-298,915, FILED 4-19-2011.

WENDY GOODMAN, EXAMINING ATTORNEY



David J. Kybas

Director of the United States Patent and Trademark Office

United States of America

United States Patent and Trademark Office

THE ELLIOT AT RIVER'S EDGE

Reg. No. 4,207,020

ELLIOT HEALTH SYSTEM (NEW HAMPSHIRE CORPORATION)

Registered Sep. 11, 2012

1 ELLIOT WAY
MANCHESTER, NH 03101

Int. Cls.: 42 and 44

FOR: MEDICAL LABORATORY SERVICES, IN CLASS 42 (U.S. CLS. 100 AND 101).

SERVICE MARK

FIRST USE 11-1-2009; IN COMMERCE 11-1-2009.

PRINCIPAL REGISTER

FOR: MEDICAL SERVICES, NAMELY, AMBULATORY CARE AND OUTPATIENT MEDICAL TREATMENT SERVICES INCLUDING: BREAST HEALTH, CARDIAC REHABILITATION, DIAGNOSTIC IMAGING, ENDOSCOPY, GASTROENTEROLOGY, OCCUPATIONAL MEDICINE, PAIN MANAGEMENT, PHYSICAL REHABILITATION, PULMONARY FUNCTION AND MEDICINE, SLEEP DIAGNOSTIC TESTING; URGENT CARE, NAMELY, MEDICAL SERVICES PROVIDED BY EMERGENCY MEDICINE PROFESSIONALS FOR NON-LIFE THREATENING ILLNESSES, INJURIES AND CONDITIONS, IN A MORE COST EFFECTIVE AND EFFICIENT MANNER, IN CLASS 44 (U.S. CLS. 100 AND 101).

FIRST USE 11-1-2009; IN COMMERCE 11-1-2009.

THE MARK CONSISTS OF STANDARD CHARACTERS WITHOUT CLAIM TO ANY PARTICULAR FONT, STYLE, SIZE, OR COLOR.

SN 85-300,244, FILED 4-20-2011.

KIMBERLY FRYE, EXAMINING ATTORNEY



David J. Kybas

Director of the United States Patent and Trademark Office

United States of America

United States Patent and Trademark Office

BrandWave

Reg. No. 4,207,021

THERESA STRICKLAND (UNITED STATES INDIVIDUAL)
880 CHANDLER WAY
BURLINGAME, CA 94010

Registered Sep. 11, 2012

Int. Cl.: 35

SERVICE MARK

PRINCIPAL REGISTER

FOR: ADVERTISING AGENCY SPECIALIZING IN THE DESIGN AND EXECUTION OF WORD OF MOUTH, VIRAL, BUZZ AND EXPERIENTIAL MARKETING PROGRAMS; ADVERTISING AND MARKETING; ADVERTISING AND MARKETING CONSULTANCY; ADVERTISING AND MARKETING SERVICES PROVIDED BY MEANS OF INDIRECT METHODS OF MARKETING COMMUNICATIONS, NAMELY, SOCIAL MEDIA, SEARCH ENGINE MARKETING, INQUIRY MARKETING, INTERNET MARKETING, MOBILE MARKETING, BLOGGING AND OTHER FORMS OF PASSIVE, SHARABLE OR VIRAL COMMUNICATIONS CHANNELS; ADVERTISING AND MARKETING SERVICES, NAMELY, PROMOTING THE GOODS AND SERVICES OF OTHERS; ADVERTISING SERVICES, NAMELY, PROMOTING AND MARKETING THE GOODS AND SERVICES OF OTHERS IN THE FIELD OF UPSCALE CHOICES SUCH AS CULTURAL EVENTS, RESTAURANTS, SHOPPING, AND TRAVEL VIA PRINT AND ELECTRONIC MEDIA; ADVERTISING SERVICES, NAMELY, PROMOTING AND MARKETING THE GOODS AND SERVICES OF OTHERS THROUGH ALL PUBLIC COMMUNICATION MEANS; ADVERTISING SERVICES, PUBLIC RELATIONS AND MARKETING SERVICES, NAMELY, PROMOTING AND MARKETING THE GOODS AND SERVICES OF OTHERS THROUGH ALL PUBLIC COMMUNICATION MEANS; ADVERTISING, MARKETING AND PROMOTING THE GOODS AND SERVICES OF OTHERS USING KIOSKS; ADVERTISING, MARKETING AND PROMOTION SERVICES; ADVERTISING, MARKETING AND PROMOTION SERVICES, NAMELY, PROMOTING THE GOODS AND SERVICES OF OTHERS BY PROVIDING CUSTOMIZED EXHIBITS; ADVERTISING, MARKETING AND PROMOTIONAL SERVICES FOR AUTOMOTIVE DEALERSHIPS; ADVERTISING, MARKETING AND PROMOTIONAL SERVICES FOR LIGHT AND HEAVY EQUIPMENT DEALERSHIPS; ADVERTISING, MARKETING AND PROMOTIONAL SERVICES RELATED TO ALL INDUSTRIES FOR THE PURPOSE OF FACILITATING NETWORKING AND SOCIALIZING OPPORTUNITIES FOR BUSINESS PURPOSES; ADVERTISING, PROMOTION AND MARKETING SERVICES IN THE NATURE OF E-MAIL BLAST CAMPAIGNS FOR OTHERS; ADVICE IN THE FIELD OF BUSINESS MANAGEMENT AND MARKETING; ANALYSIS OF MARKET RESEARCH DATA AND STATISTICS; ARRANGING AND CONDUCTING MARKETING PROMOTIONAL EVENTS FOR OTHERS; ASSISTANCE, ADVISORY SERVICES AND CONSULTANCY WITH REGARD TO BUSINESS PLANNING, BUSINESS ANALYSIS, BUSINESS MANAGEMENT, BUSINESS ORGANIZATION, MARKETING AND CUSTOMER ANALYSIS; BRANDING SERVICES, NAMELY, CONSULTING, DEVELOPMENT, MANAGEMENT AND MARKETING OF BRANDS FOR



David J. Kyros

Director of the United States Patent and Trademark Office

Reg. No. 4,207,021 BUSINESSES; BUSINESS ADVICE AND ANALYSIS OF MARKETS; BUSINESS CONSULTATION AND MANAGEMENT REGARDING MARKETING ACTIVITIES AND LAUNCHING OF NEW PRODUCTS; BUSINESS MANAGEMENT CONSULTING WITH RELATION TO STRATEGY, MARKETING, PRODUCTION, PERSONNEL AND RETAIL SALE MATTERS; BUSINESS MANAGEMENT CONSULTING WITH RELATION TO STRATEGY, MARKETING, SALES, OPERATION, PRODUCT DESIGN PARTICULARLY SPECIALIZING IN THE USE OF ANALYTIC AND STATISTIC MODELS FOR THE UNDERSTANDING AND PREDICTING OF CONSUMERS, BUSINESSES, AND MARKET TRENDS AND ACTIONS; BUSINESS MARKETING AND DIRECT MAIL CONSULTING SERVICES; BUSINESS MARKETING CONSULTING SERVICES; BUSINESS MARKETING SERVICES; BUSINESS MONITORING AND CONSULTING SERVICES, NAMELY, TRACKING WEB SITES AND APPLICATIONS OF OTHERS TO PROVIDE STRATEGY, INSIGHT, MARKETING, SALES, OPERATION, PRODUCT DESIGN, PARTICULARLY SPECIALIZING IN THE USE OF ANALYTIC AND STATISTIC MODELS FOR THE UNDERSTANDING AND PREDICTING OF CONSUMERS, BUSINESSES, AND MARKET TRENDS AND ACTIONS; BUSINESS TO BUSINESS DIRECT MARKETING SERVICES; COLLECTION OF MARKET RESEARCH INFORMATION; COMMERCIAL INFORMATION AGENCIES; COMPUTERIZED MARKET RESEARCH SERVICES; CONDUCTING BUSINESS AND MARKET RESEARCH SURVEYS; CONDUCTING MARKET SURVEYS; CONDUCTING MARKETING STUDIES; CONSULTATION SERVICES, NAMELY, CREATIVE AND STRATEGIC CONSULTATION REGARDING DEVELOPMENT AND PRODUCTION OF MARKETING CAMPAIGNS FOR OTHERS; CONSULTING SERVICES IN THE FIELD OF INTERNET MARKETING; CONSUMER MARKETING RESEARCH AND CONSULTING RELATED THERETO; CREATIVE MARKETING DESIGN SERVICES; DEVELOPMENT OF MARKETING STRATEGIES AND CONCEPTS; DEVELOPMENT OF MARKETING STRATEGIES, CONCEPTS AND TACTICS, NAMELY, AUDIENCE DEVELOPMENT, BRAND AWARENESS, CUSTOMER RELATIONS, ONLINE COMMUNITY BUILDING AND DIGITAL WORD OF MOUTH COMMUNICATIONS; DIRECT MARKETING; DIRECT MARKETING CONSULTING SERVICES; ENTERTAINMENT MARKETING SERVICES, NAMELY, MARKETING, PROMOTION AND ADVERTISING FOR RECORDING AND PERFORMING ARTISTS; GENERAL BUSINESS MERCHANDISING SERVICES, NAMELY, MARKETING; INTERNATIONAL BUSINESS CONSULTING SERVICES RELATING TO MERCHANDISE TRADING, HUMAN RESOURCE INTERCHANGE, MANAGEMENT SUPPORT, MARKETING, ADVERTISING, PROMOTION, AND DOMESTIC AND INTERNATIONAL MARKET RESEARCH AND DEVELOPMENT; MARKET ANALYSIS; MARKET RESEARCH AND BUSINESS ANALYSES; MARKET RESEARCH CONSULTATION; MARKETING ANALYSIS SERVICES; MARKETING AND BRANDING SERVICES, NAMELY, PERFORMING CONSUMER INSIGHT AND BRAND STRATEGY OF COMPANY LOGOS; MARKETING AND BRANDING SERVICES, NAMELY, PROVIDING CUSTOMIZED COMMUNICATION PROGRAMS TO OBTAIN CONSUMER INSIGHTS AND DEVELOP BRANDING STRATEGIES; MARKETING AND CONSULTING SERVICES IN THE FIELD OF PROMOTING AND TRACKING THE GOODS, SERVICES, AND BRANDS OF OTHERS THROUGH ALL PUBLIC COMMUNICATION MEANS, PARTICULARLY SPECIALIZING IN THE USE OF MOBILE, SOCIAL, AND PRINT MEDIA TO DRIVE CONSUMER INTEREST, ENGAGEMENT AND ACTION; MARKETING CONSULTING; MARKETING PLAN DEVELOPMENT; PROMOTING, MARKETING AND ADVERTISING THE BRANDS AND GOODS OF OTHERS RELATED TO ALL INDUSTRIES, THROUGH ALL PUBLIC AND PRIVATE COMMUNICATION MEANS, NAMELY, PROMOTING THE BRANDS AND GOODS OF OTHERS MADE IN THE UNITED STATES; PROMOTIONAL MARKETING SERVICES USING AUDIOVISUAL MEDIA; PROVIDING ADVERTISING, MARKETING AND PROMOTIONAL SERVICES, NAMELY, DEVELOPMENT OF ADVERTISING CAMPAIGNS PROVIDED THROUGH CABLE TELEVISION BROADCAST, WEB CASTS, RADIO BROADCASTS, NEWSPAPERS, MAGAZINES, ONLINE BANNERS, OUTDOOR BILLBOARDS, WILD POSTINGS, BUS AND SUBWAY ADS; PROVISION OF MARKET RESEARCH INFORMATION, IN CLASS 35 (U.S. CLS. 100, 101 AND 102).

FIRST USE 1-1-2012; IN COMMERCE 1-1-2012.

Reg. No. 4,207,021 THE MARK CONSISTS OF STANDARD CHARACTERS WITHOUT CLAIM TO ANY PARTICULAR FONT, STYLE, SIZE, OR COLOR.

SN 85-300,248, FILED 4-20-2011.

ALYSSA STEEL, EXAMINING ATTORNEY

United States of America

United States Patent and Trademark Office

WINSPIRATION WELLNESS

Reg. No. 4,207,022

Registered Sep. 11, 2012

Int. Cl.: 44

SERVICE MARK

PRINCIPAL REGISTER

WINSPIRATION WELLNESS, LLC (KANSAS LIMITED LIABILITY COMPANY)
20523 W. 200TH STREET
SPRING HILL, KS 66083

FOR: COUNSELING AND CONSULTING SERVICES IN THE FIELDS OF HEALTH AND NUTRITION; PROVIDING INFORMATION, NEWS AND COMMENTARY IN THE FIELDS OF HEALTH AND NUTRITION; PROVIDING WELLNESS SERVICES FOR HEALTH PURPOSES, NAMELY, PERSONAL ASSESSMENTS, PERSONALIZED ROUTINES, AND MAINTENANCE SCHEDULES; PROVIDING AN INTERACTIVE WEBSITE FEATURING HEALTH AND NUTRITION INFORMATION; PROVIDING PATIENT BENEFIT INFORMATION CONCERNING ORGANIC AND HOLISTIC PRODUCTS AND SERVICES, IN CLASS 44 (U.S. CLS. 100 AND 101).

FIRST USE 6-0-2011; IN COMMERCE 6-0-2011.

THE MARK CONSISTS OF STANDARD CHARACTERS WITHOUT CLAIM TO ANY PARTICULAR FONT, STYLE, SIZE, OR COLOR.

NO CLAIM IS MADE TO THE EXCLUSIVE RIGHT TO USE "WELLNESS", APART FROM THE MARK AS SHOWN.

SN 85-300,281, FILED 4-20-2011.

KATHERINE CHANG, EXAMINING ATTORNEY



David J. Kyjars

Director of the United States Patent and Trademark Office

United States of America

United States Patent and Trademark Office

MyPaclitaxel

Because No Two Patients Are Alike

Reg. No. 4,207,023

Registered Sep. 11, 2012

Int. Cl.: 5

TRADEMARK

PRINCIPAL REGISTER

SALADAX BIOMEDICAL, INC. (DELAWARE CORPORATION)
116 RESEARCH DRIVE
BETHLEHEM, PA 18015

FOR: TEST KITS COMPRISED OF MEDICAL DIAGNOSTIC GRADE REAGENTS FOR DETERMINING THE CONCENTRATION OF DRUGS IN THE BLOOD OF CANCER PATIENTS, IN CLASS 5 (U.S. CLS. 6, 18, 44, 46, 51 AND 52).

FIRST USE 5-9-2012; IN COMMERCE 5-9-2012.

OWNER OF U.S. REG. NO. 3,926,868.

NO CLAIM IS MADE TO THE EXCLUSIVE RIGHT TO USE "PACLITAXEL", APART FROM THE MARK AS SHOWN.

THE MARK CONSISTS OF THE LITERAL ELEMENT "MYPACLITAXEL" POSITIONED ABOVE THE LITERAL ELEMENT "BECAUSE NO TWO PATIENTS ARE ALIKE". THE LETTER "Y" IS HIGHLY STYLIZED IN THE FORM OF A HUMAN FIGURE WITH OUT-STRETCHED ARMS.

SN 85-300,348, FILED 4-20-2011.

CHARLOTTE CORWIN, EXAMINING ATTORNEY



David J. Kyjars

Director of the United States Patent and Trademark Office

United States of America

United States Patent and Trademark Office

MyDocetaxel
Because No Two Patients Are Alike

Reg. No. 4,207,024

SALADAX BIOMEDICAL, INC. (DELAWARE CORPORATION)
116 RESEARCH DRIVE
BETHLEHEM, PA 18015

Registered Sep. 11, 2012

Int. Cl.: 5

FOR: TEST KITS COMPRISED OF MEDICAL DIAGNOSTIC GRADE REAGENTS FOR DETERMINING THE CONCENTRATION OF DRUGS IN THE BLOOD OF CANCER PATIENTS, IN CLASS 5 (U.S. CLS. 6, 18, 44, 46, 51 AND 52).

TRADEMARK

FIRST USE 5-9-2012; IN COMMERCE 5-9-2012.

PRINCIPAL REGISTER

OWNER OF U.S. REG. NO. 3,926,868.

NO CLAIM IS MADE TO THE EXCLUSIVE RIGHT TO USE "DOCETAXEL", APART FROM THE MARK AS SHOWN.

THE MARK CONSISTS OF THE LITERAL ELEMENT "MYDOCETAXEL" POSITIONED ABOVE THE LITERAL ELEMENT "BECAUSE NO TWO PATIENTS ARE ALIKE". THE LETTER "Y" IS HIGHLY STYLIZED IN THE FORM OF A HUMAN FIGURE WITH OUT-STRETCHED ARMS.

SN 85-300,372, FILED 4-20-2011.

CHARLOTTE CORWIN, EXAMINING ATTORNEY



David J. Kyjars

Director of the United States Patent and Trademark Office

United States of America

United States Patent and Trademark Office



HEROES UNDER GOD

Reg. No. 4,207,025

Registered Sep. 11, 2012

Int. Cl.: 35

SERVICE MARK

PRINCIPAL REGISTER

INTERNATIONAL CHRISTIAN BROADCASTING, INC. (CALIFORNIA NON-PROFIT CORPORATION)
2442 MICHELLE DRIVE
SANTA ANA, CA 92680

FOR: RETAIL STORE SERVICES FEATURING NOVELTY ITEMS, CLOTHING, HATS, MAGNETS, KEY CHAINS, PAPER GOODS AND PRINTED MATTER, IN CLASS 35 (U.S. CLS. 100, 101 AND 102).

FIRST USE 1-31-2009; IN COMMERCE 1-31-2009.

OWNER OF U.S. REG. NO. 3,916,666.

THE COLOR(S) BLUE, RED, WHITE AND BLACK IS/ARE CLAIMED AS A FEATURE OF THE MARK.

THE MARK CONSISTS OF A STYLIZED LETTER "H" OUTLINED IN BLACK WITH STAR-SHAPED CUTOUTS, WHITE STARS ON A BLUE BACKGROUND IN THE UPPER LEFT CORNER, AND RED AND WHITE STRIPES THROUGHOUT. THE BLACK WORDING "HEROES UNDER GOD" APPEARS IN BETWEEN TWO RED HORIZONTAL LINES WITH BLACK STARS BETWEEN THE WORDS. THE REMAINING WHITE REPRESENTS BACKGROUND AND DOES NOT FORM PART OF THE MARK.

SN 85-300,785, FILED 4-21-2011.

TRACY FLETCHER, EXAMINING ATTORNEY



David J. Kyjars

Director of the United States Patent and Trademark Office

United States of America

United States Patent and Trademark Office



Reg. No. 4,207,026

DETENTION DEVICE SYSTEMS, INC. (CALIFORNIA CORPORATION)
25545 SEABOARD LN.
HAYWARD, CA 94545

Registered Sep. 11, 2012

Int. Cl.: 6

FOR: METAL SUSPENDED CEILING SYSTEMS COMPRISING PANELS, IN CLASS 6 (U.S. CLS. 2, 12, 13, 14, 23, 25 AND 50).

TRADEMARK

FIRST USE 2-0-2012; IN COMMERCE 2-0-2012.

PRINCIPAL REGISTER

NO CLAIM IS MADE TO THE EXCLUSIVE RIGHT TO USE "DETENTION GRADE", APART FROM THE MARK AS SHOWN.

THE COLOR(S) GRAY, BLUE, PURPLE, AND LIGHT BLUE IS/ARE CLAIMED AS A FEATURE OF THE MARK.

THE MARK CONSISTS OF STYLIZED CRESCENTS OF PURPLE, BLUE AND LIGHT BLUE TO THE LEFT OF THE LITERAL ELEMENT "DETENTIONGRADE" WITH "DETENTION" IN GRAY STYLIZED LETTERS AND "GRADE" IN BLUE STYLIZED LETTERS.

SN 85-301,278, FILED 4-21-2011.

KATHLEEN M. VANSTON, EXAMINING ATTORNEY



David J. Kybas

Director of the United States Patent and Trademark Office

United States of America

United States Patent and Trademark Office



Reg. No. 4,207,027

Registered Sep. 11, 2012

Int. Cl.: 25

TRADEMARK

PRINCIPAL REGISTER

TRAIL BLAZERS, INC. (OREGON CORPORATION)
SUITE 200
ONE CENTER COURT
PORTLAND, OR 97227

FOR: CLOTHING, NAMELY, T-SHIRTS, SWEATSHIRTS, JACKETS, HATS, AND HEAD-BANDS, IN CLASS 25 (U.S. CLS. 22 AND 39).

FIRST USE 12-31-2010; IN COMMERCE 12-31-2010.

OWNER OF U.S. REG. NO. 4,060,019.

THE MARK CONSISTS OF TWO HANDS FORMING A PAIR OF GLASSES WHERE THE THUMBS AND POINTER FINGERS CONNECT TO MAKE THE EYEHOLE AND THE REMAINING FINGERS ARE IN AN UPRIGHT POSITION.

SN 85-301,728, FILED 4-21-2011.

NAKIA HENRY, EXAMINING ATTORNEY



David J. Kybas

Director of the United States Patent and Trademark Office

United States of America

United States Patent and Trademark Office



Reg. No. 4,207,028

SWINCKELS, JURGEN HUBERTUS GERARDUS JOHANNES (NETHERLANDS INDIVIDUAL)
354/2 EKKAMAI SOI 20

Registered Sep. 11, 2012

BANGKOK, THAILAND 10110

Int. Cls.: 5 and 18

FOR: INSECTICIDE TREATED FLY SHEETS, IN CLASS 5 (U.S. CLS. 6, 18, 44, 46, 51 AND 52).

TRADEMARK

FIRST USE 4-0-2012; IN COMMERCE 4-0-2012.

PRINCIPAL REGISTER

FOR: HORSE BLANKETS, IN CLASS 18 (U.S. CLS. 1, 2, 3, 22 AND 41).

FIRST USE 4-0-2012; IN COMMERCE 4-0-2012.

NO CLAIM IS MADE TO THE EXCLUSIVE RIGHT TO USE "HORSE", APART FROM THE MARK AS SHOWN.

THE COLOR(S) YELLOW AND BLACK IS/ARE CLAIMED AS A FEATURE OF THE MARK.

THE MARK CONSISTS OF A SHIELD IN YELLOW WITH A BLACK OUTLINE CONTAINING THE ARTISTIC RENDERING OF A HORSE HEAD IN BLACK. THE SHIELD IS FOLLOWED BY THE STYLIZED WORDS "HORSE ARMOR" IN YELLOW WITH A BLACK OUTLINE.

SN 85-301,822, FILED 4-21-2011.

LEIGH LOWRY, EXAMINING ATTORNEY



David J. Kybas

Director of the United States Patent and Trademark Office

United States of America

United States Patent and Trademark Office

GELATI JOE'S

Reg. No. 4,207,029

REW REAL ESTATE INVESTMENTS II, LLC (FLORIDA LIMITED LIABILITY COMPANY)
1260 CENTRAL FLORIDA PARKWAY
ORLANDO, FL 32837

Registered Sep. 11, 2012

Int. Cl.: 30

FOR: FROZEN CONFECTIONS, IN CLASS 30 (U.S. CL. 46).

TRADEMARK

FIRST USE 5-31-2012; IN COMMERCE 5-31-2012.

PRINCIPAL REGISTER

THE MARK CONSISTS OF STANDARD CHARACTERS WITHOUT CLAIM TO ANY PARTICULAR FONT, STYLE, SIZE, OR COLOR.

NO CLAIM IS MADE TO THE EXCLUSIVE RIGHT TO USE "GELATI", APART FROM THE MARK AS SHOWN.

THE NAME "GELATI JOE'S" DOES NOT IDENTIFY A LIVING INDIVIDUAL.

SN 85-302,626, FILED 4-22-2011.

NELSON SNYDER, EXAMINING ATTORNEY



David J. Kyfos

Director of the United States Patent and Trademark Office

United States of America

United States Patent and Trademark Office

GELATI JOE'S

Reg. No. 4,207,030

REW REAL ESTATE INVESTMENTS II, LLC (FLORIDA LIMITED LIABILITY COMPANY)
1260 CENTRAL FLORIDA PARKWAY
ORLANDO, FL 32837

Registered Sep. 11, 2012

Int. Cl.: 35

FOR: RETAIL STORE SERVICES FEATURING FROZEN CONFECTIONS, IN CLASS 35 (U.S. CLS. 100, 101 AND 102).

SERVICE MARK

FIRST USE 5-31-2012; IN COMMERCE 5-31-2012.

PRINCIPAL REGISTER

THE MARK CONSISTS OF STANDARD CHARACTERS WITHOUT CLAIM TO ANY PARTICULAR FONT, STYLE, SIZE, OR COLOR.

NO CLAIM IS MADE TO THE EXCLUSIVE RIGHT TO USE "GELATI", APART FROM THE MARK AS SHOWN.

THE NAME "GELATI JOE'S" DOES NOT IDENTIFY A LIVING INDIVIDUAL.

SN 85-302,637, FILED 4-22-2011.

NELSON SNYDER, EXAMINING ATTORNEY



David J. Kyffers

Director of the United States Patent and Trademark Office

United States of America

United States Patent and Trademark Office

GELATI JOE'S

Reg. No. 4,207,031

REW REAL ESTATE INVESTMENTS II, LLC (FLORIDA LIMITED LIABILITY COMPANY)
1260 CENTRAL FLORIDA PARKWAY
ORLANDO, FL 32837

Registered Sep. 11, 2012

Int. Cl.: 43

FOR: CATERING SERVICES; RESTAURANT SERVICES, IN CLASS 43 (U.S. CLS. 100 AND 101).

SERVICE MARK

FIRST USE 5-31-2012; IN COMMERCE 5-31-2012.

PRINCIPAL REGISTER

THE MARK CONSISTS OF STANDARD CHARACTERS WITHOUT CLAIM TO ANY PARTICULAR FONT, STYLE, SIZE, OR COLOR.

NO CLAIM IS MADE TO THE EXCLUSIVE RIGHT TO USE "GELATI", APART FROM THE MARK AS SHOWN.

THE NAME "GELATI JOE'S" DOES NOT IDENTIFY A LIVING INDIVIDUAL.

SN 85-302,650, FILED 4-22-2011.

NELSON SNYDER, EXAMINING ATTORNEY



David J. Kyfos

Director of the United States Patent and Trademark Office

United States of America

United States Patent and Trademark Office

RICHES OF EL DORADO

Reg. No. 4,207,032

CADILLAC JACK, INC. (GEORGIA CORPORATION)
2450 SATELLITE BOULEVARD
DULUTH, GA 30096

Registered Sep. 11, 2012

Int. Cl.: 9

FOR: GAMING DEVICES, NAMELY, GAMING MACHINES, SLOT MACHINES, BINGO MACHINES, WITH OR WITHOUT VIDEO OUTPUT, IN CLASS 9 (U.S. CLS. 21, 23, 26, 36 AND 38).

TRADEMARK

FIRST USE 3-29-2012; IN COMMERCE 3-29-2012.

PRINCIPAL REGISTER

THE MARK CONSISTS OF STANDARD CHARACTERS WITHOUT CLAIM TO ANY PARTICULAR FONT, STYLE, SIZE, OR COLOR.

SN 85-302,687, FILED 4-22-2011.

LOURDES AYALA, EXAMINING ATTORNEY



David J. Kyffers

Director of the United States Patent and Trademark Office

United States of America

United States Patent and Trademark Office

KARU KAI

Reg. No. 4,207,033

F M AMERICA CORP. (FLORIDA CORPORATION)
13120 SW 96TH AVE
MIAMI, FL 33176

Registered Sep. 11, 2012

Int. Cl.: 14

FOR: BRACELETS; EARRINGS; NECKLACES; RINGS, IN CLASS 14 (U.S. CLS. 2, 27, 28 AND 50).

TRADEMARK

FIRST USE 4-30-2012; IN COMMERCE 5-5-2012.

PRINCIPAL REGISTER

THE MARK CONSISTS OF STANDARD CHARACTERS WITHOUT CLAIM TO ANY PARTICULAR FONT, STYLE, SIZE, OR COLOR.

SN 85-303,466, FILED 4-25-2011.

CHRISTINE COOPER, EXAMINING ATTORNEY



David J. Kyfos

Director of the United States Patent and Trademark Office

United States of America

United States Patent and Trademark Office

AppReef The Cloud Ecosystem

Reg. No. 4,207,034

APPREEF (TEXAS LIMITED LIABILITY COMPANY)
848 MULLRANY DR.
COPPELL, TX 75019

Registered Sep. 11, 2012

Int. Cl.: 42

FOR: SOFTWARE PRODUCT DEVELOPMENT FOR OTHERS IN THE FIELD OF CLOUD COMPUTING; CONSULTING SERVICES IN THE FIELD OF CLOUD COMPUTING SOFTWARE, IN CLASS 42 (U.S. CLS. 100 AND 101).

SERVICE MARK

FIRST USE 6-29-2012; IN COMMERCE 6-29-2012.

PRINCIPAL REGISTER

THE MARK CONSISTS OF STANDARD CHARACTERS WITHOUT CLAIM TO ANY PARTICULAR FONT, STYLE, SIZE, OR COLOR.

NO CLAIM IS MADE TO THE EXCLUSIVE RIGHT TO USE "CLOUD", APART FROM THE MARK AS SHOWN.

SN 85-303,665, FILED 4-25-2011.

DAVID H. STINE, EXAMINING ATTORNEY



David J. Kyffers

Director of the United States Patent and Trademark Office

United States of America

United States Patent and Trademark Office

HPX-PT

Reg. No. 4,207,035

CONTINENTAL DISC CORPORATION (MISSOURI CORPORATION)
3160 W. HEARTLAND DRIVE
LIBERTY, MO 64068

Registered Sep. 11, 2012

Int. Cl.: 6

FOR: PRESSURE RELIEF DEVICES, NAMELY, RUPTURE DISCS AND RUPTURE DISC HOLDERS MADE OF METAL OR PRIMARILY OF METAL FOR PROTECTING GAS AND LIQUID PIPES FROM OVER PRESSURE, IN CLASS 6 (U.S. CLS. 2, 12, 13, 14, 23, 25 AND 50).

TRADEMARK

PRINCIPAL REGISTER

FIRST USE 7-8-2011; IN COMMERCE 7-8-2011.

THE MARK CONSISTS OF STANDARD CHARACTERS WITHOUT CLAIM TO ANY PARTICULAR FONT, STYLE, SIZE, OR COLOR.

OWNER OF U.S. REG. NOS. 4,005,247 AND 4,005,248.

SN 85-303,733, FILED 4-25-2011.

LEIGH LOWRY, EXAMINING ATTORNEY



David J. Kyffers

Director of the United States Patent and Trademark Office

United States of America

United States Patent and Trademark Office

SANITRX LPX

Reg. No. 4,207,036

CONTINENTAL DISC CORPORATION (MISSOURI CORPORATION)
3160 W. HEARTLAND DRIVE
LIBERTY, MO 64068

Registered Sep. 11, 2012

Int. Cl.: 6

FOR: PRESSURE RELIEF DEVICES, NAMELY, RUPTURE DISCS AND RUPTURE DISC HOLDERS MADE OF METAL OR PRIMARILY OF METAL FOR PROTECTING GAS AND LIQUID PIPES FROM OVER PRESSURE, IN CLASS 6 (U.S. CLS. 2, 12, 13, 14, 23, 25 AND 50).

TRADEMARK

PRINCIPAL REGISTER

FIRST USE 12-8-2011; IN COMMERCE 12-8-2011.

THE MARK CONSISTS OF STANDARD CHARACTERS WITHOUT CLAIM TO ANY PARTICULAR FONT, STYLE, SIZE, OR COLOR.

OWNER OF U.S. REG. NOS. 1,842,648, 2,874,828, AND 4,005,247.

SN 85-303,737, FILED 4-25-2011.

LEIGH LOWRY, EXAMINING ATTORNEY



David J. Kyfos

Director of the United States Patent and Trademark Office

United States of America

United States Patent and Trademark Office

STICKY LIPS

Reg. No. 4,207,037

Registered Sep. 11, 2012

Int. Cl.: 3

TRADEMARK

PRINCIPAL REGISTER

WAX RESEARCH, INC. (CALIFORNIA CORPORATION)
1965 KELLOGG AVE.
CARLSBAD, CA 92008

FOR: LIP BALM, IN CLASS 3 (U.S. CLS. 1, 4, 6, 50, 51 AND 52).

FIRST USE 9-28-2011; IN COMMERCE 9-28-2011.

THE MARK CONSISTS OF STANDARD CHARACTERS WITHOUT CLAIM TO ANY PARTICULAR FONT, STYLE, SIZE, OR COLOR.

NO CLAIM IS MADE TO THE EXCLUSIVE RIGHT TO USE "LIPS", APART FROM THE MARK AS SHOWN.

SN 85-305,131, FILED 4-26-2011.

LEIGH CAROLINE CASE, EXAMINING ATTORNEY



David J. Kyffers

Director of the United States Patent and Trademark Office

United States of America

United States Patent and Trademark Office

ENTICINGS

Reg. No. 4,207,038

SCHWAN'S IP, LLC (MINNESOTA LIMITED LIABILITY COMPANY)
115 W. COLLEGE DRIVE
MARSHALL, MN 56258

Registered Sep. 11, 2012

Int. Cl.: 30

FOR: ICE CREAM, FROZEN CONFECTIONS, FROZEN DESSERTS CONSISTING OF FRUIT AND CREAM OR CREAM SUBSTITUTE, IN CLASS 30 (U.S. CL. 46).

TRADEMARK

FIRST USE 8-1-2011; IN COMMERCE 8-1-2011.

PRINCIPAL REGISTER

THE MARK CONSISTS OF STANDARD CHARACTERS WITHOUT CLAIM TO ANY PARTICULAR FONT, STYLE, SIZE, OR COLOR.

SN 85-305,621, FILED 4-27-2011.

SEAN CROWLEY, EXAMINING ATTORNEY



David J. Kyffers

Director of the United States Patent and Trademark Office

United States of America

United States Patent and Trademark Office



Reg. No. 4,207,039

Registered Sep. 11, 2012

Int. Cl.: 25

TRADEMARK

PRINCIPAL REGISTER

A2B WEAR, INC. (FLORIDA CORPORATION)
218
10211 PINES BLVD
PEMBROKE PINES, FL 33026

FOR: BOXER BRIEFS; BOXER SHORTS; CLOTH BIBS; COVERALLS; FOOTWEAR; GLOVES; HATS; HEADBANDS; HOODED SWEATSHIRTS; HOSIERY; JACKETS; JEANS; JERSEYS; NIGHT SHIRTS; PAJAMAS; POLO SHIRTS; PULLOVERS; SHIRTS; SHORTS; SWEATBANDS; SWEATERS; SWEATPANTS; T-SHIRTS; TANK TOPS; WARM UP SUITS; WRISTBANDS, IN CLASS 25 (U.S. CLS. 22 AND 39).

FIRST USE 12-18-2011; IN COMMERCE 3-17-2012.

NO CLAIM IS MADE TO THE EXCLUSIVE RIGHT TO USE "WEAR", APART FROM THE MARK AS SHOWN.

THE STIPPLING IS FOR SHADING PURPOSES.

THE MARK CONSISTS OF THE STYLIZED TEXT "A2B WEAR" WITH A SILHOUETTE OF A MAN JUMPING OVER THE WORD "WEAR".

SN 85-305,759, FILED 4-27-2011.

KAREN K. BUSH, EXAMINING ATTORNEY



David J. Kyffers

Director of the United States Patent and Trademark Office

United States of America

United States Patent and Trademark Office

Etiquette Manor

Reg. No. 4,207,040

WELLS, ROBIN (UNITED STATES INDIVIDUAL)
6009 SAN VICENTE STREET
CORAL GABLES, FL 33146

Registered Sep. 11, 2012

Int. Cl.: 41

FOR: TRAINING SERVICES IN THE FIELD OF PROPER PERSONAL ETIQUETTE AND MANNERS, IN CLASS 41 (U.S. CLS. 100, 101 AND 107).

SERVICE MARK

FIRST USE 6-1-2011; IN COMMERCE 6-1-2011.

PRINCIPAL REGISTER

THE MARK CONSISTS OF STANDARD CHARACTERS WITHOUT CLAIM TO ANY PARTICULAR FONT, STYLE, SIZE, OR COLOR.

NO CLAIM IS MADE TO THE EXCLUSIVE RIGHT TO USE "ETIQUETTE", APART FROM THE MARK AS SHOWN.

SN 85-306,971, FILED 4-28-2011.

BRENDAN MCCAULEY, EXAMINING ATTORNEY



David J. Kybas

Director of the United States Patent and Trademark Office

United States of America

United States Patent and Trademark Office

ALVERIN

Reg. No. 4,207,041

PFIZER INC. (DELAWARE CORPORATION)
235 EAST 42ND STREET
NEW YORK, NY 10017

Registered Sep. 11, 2012

Int. Cl.: 5

FOR: VETERINARY PREPARATIONS AND SUBSTANCES FOR THE TREATMENT OF PARASITIC INFECTIONS, IN CLASS 5 (U.S. CLS. 6, 18, 44, 46, 51 AND 52).

TRADEMARK

FIRST USE 6-19-2012; IN COMMERCE 6-19-2012.

PRINCIPAL REGISTER

THE MARK CONSISTS OF STANDARD CHARACTERS WITHOUT CLAIM TO ANY PARTICULAR FONT, STYLE, SIZE, OR COLOR.

SN 85-307,269, FILED 4-28-2011.

GEORGE LORENZO, EXAMINING ATTORNEY



David J. Kybas

Director of the United States Patent and Trademark Office

United States of America

United States Patent and Trademark Office

IntegrityCircles

Reg. No. 4,207,042

Registered Sep. 11, 2012

Int. Cls.: 35 and 42

SERVICE MARK

PRINCIPAL REGISTER

THE RED FLAG GROUP LIMITED (HONG KONG CORPORATION)
SUITE 2204-2206 BONHAM TRADE CENTRE
50 BONHAM STRAND
SHEUNG WAN, HONG KONG 00001

FOR: BUSINESS RISK ASSESSMENT SERVICES; BUSINESS RISK MANAGEMENT CONSULTATION, IN CLASS 35 (U.S. CLS. 100, 101 AND 102).

FIRST USE 1-1-2011; IN COMMERCE 1-1-2011.

FOR: CONSULTING SERVICES RELATED TO DEVELOPMENT OF QUALITY CONTROL STANDARDS FOR BUSINESS ETHICS AND CONFORMING TO LEGAL AND REGULATORY STANDARDS AND REQUIREMENTS IN THE AREAS OF ANTI-CORRUPTION, EXPORT COMPLIANCE, PRIVACY AND PERSONAL DATA PROTECTION, PROTECTING CONFIDENTIAL INFORMATION, AVOIDING INSIDER TRADING, CONDUCTING INTERNAL BUSINESS COMPLIANCE INVESTIGATIONS, DUE DILIGENCE, AND DOING BUSINESS WITH THE FEDERAL AND FOREIGN GOVERNMENTS; CONSULTING RELATED TO DEVELOPMENT OF VOLUNTARY STANDARDS FOR BUSINESS ETHICS AND TESTING TO DETERMINE PROFESSIONAL COMPETENCY, IN CLASS 42 (U.S. CLS. 100 AND 101).

FIRST USE 1-1-2011; IN COMMERCE 1-1-2011.

THE MARK CONSISTS OF STANDARD CHARACTERS WITHOUT CLAIM TO ANY PARTICULAR FONT, STYLE, SIZE, OR COLOR.

SN 85-307,936, FILED 4-29-2011.

CHARLES L. JENKINS, EXAMINING ATTORNEY



David J. Kybas

Director of the United States Patent and Trademark Office

United States of America

United States Patent and Trademark Office

ARPIN

Reg. No. 4,207,043

WINONA FOODS (WISCONSIN CORPORATION)
1552 LINEVILLE ROAD
GREEN BAY, WI 54313

Registered Sep. 11, 2012

Int. Cl.: 29

FOR: DAIRY PRODUCTS, NAMELY, CHEESE, MILK, EGGS, CREAM, AND BUTTER, IN CLASS 29 (U.S. CL. 46).

TRADEMARK

FIRST USE 6-23-2012; IN COMMERCE 6-23-2012.

PRINCIPAL REGISTER

THE MARK CONSISTS OF STANDARD CHARACTERS WITHOUT CLAIM TO ANY PARTICULAR FONT, STYLE, SIZE, OR COLOR.

SN 85-308,065, FILED 4-29-2011.

DANNEAN HETZEL, EXAMINING ATTORNEY



David J. Kybas

Director of the United States Patent and Trademark Office

United States of America

United States Patent and Trademark Office

RAINIER PLANK

Reg. No. 4,207,044

Registered Sep. 11, 2012

Int. Cl.: 19

TRADEMARK

PRINCIPAL REGISTER

EDWIN ENTERPRISES INC. (WASHINGTON CORPORATION), DBA DEFIANCE FOREST PRODUCTS,
P.O. BOX 1696
TACOMA, WA 98401

FOR: BUILDING PRODUCTS, NAMELY, MILLWORK LUMBER, IN CLASS 19 (U.S. CLS. 1, 12, 33 AND 50).

FIRST USE 2-3-2011; IN COMMERCE 2-8-2012.

THE MARK CONSISTS OF STANDARD CHARACTERS WITHOUT CLAIM TO ANY PARTICULAR FONT, STYLE, SIZE, OR COLOR.

NO CLAIM IS MADE TO THE EXCLUSIVE RIGHT TO USE "PLANK", APART FROM THE MARK AS SHOWN.

SN 85-308,563, FILED 4-29-2011.

PAM WILLIS, EXAMINING ATTORNEY



David J. Kyffers

Director of the United States Patent and Trademark Office

United States of America

United States Patent and Trademark Office



Reg. No. 4,207,045

Registered Sep. 11, 2012

Int. Cl.: 19

TRADEMARK

PRINCIPAL REGISTER

EDWIN ENTERPRISES INC. (WASHINGTON CORPORATION), DBA DEFIANCE FOREST PRODUCTS,
P.O. BOX 1696
TACOMA, WA 98401

FOR: BUILDING PRODUCTS, NAMELY, MILLWORK LUMBER, IN CLASS 19 (U.S. CLS. 1, 12, 33 AND 50).

FIRST USE 2-3-2011; IN COMMERCE 2-8-2012.

NO CLAIM IS MADE TO THE EXCLUSIVE RIGHT TO USE "PLANK", APART FROM THE MARK AS SHOWN.

THE MARK CONSISTS OF THE STYLIZED WORDS "RAINIER PLANK" WITH EVERGREEN TREES BETWEEN.

SN 85-308,785, FILED 4-29-2011.

PAM WILLIS, EXAMINING ATTORNEY



David J. Kybas

Director of the United States Patent and Trademark Office

United States of America

United States Patent and Trademark Office

actrims
AMERICAS COMMITTEE FOR TREATMENT
AND RESEARCH IN MULTIPLE SCLEROSIS

Reg. No. 4,207,046

Registered Sep. 11, 2012

Int. Cls.: 41 and 42

SERVICE MARK

PRINCIPAL REGISTER

AMERICAS COMMITTEE FOR TREATMENT AND RESEARCH IN MULTIPLE SCLEROSIS,
INC. (WISCONSIN CORPORATION)
THIRD FLOOR
733 THIRD AVENUE
NEW YORK, NY 10017

FOR: EDUCATIONAL SERVICES, NAMELY, CONDUCTING CLASSES, SEMINARS, CON-
FERENCES, AND WORKSHOPS IN THE FIELD OF MULTIPLE SCLEROSIS AND DISTRI-
BUTION OF COURSE MATERIAL IN CONNECTION THEREWITH, IN CLASS 41 (U.S. CLS.
100, 101 AND 107).

FIRST USE 6-1-2012; IN COMMERCE 6-1-2012.

FOR: PROVIDING MEDICAL AND SCIENTIFIC RESEARCH INFORMATION IN THE FIELD
OF MULTIPLE SCLEROSIS TO PHYSICIANS AND RESEARCHERS, IN CLASS 42 (U.S. CLS.
100 AND 101).

FIRST USE 6-1-2012; IN COMMERCE 6-1-2012.

NO CLAIM IS MADE TO THE EXCLUSIVE RIGHT TO USE "AMERICAS COMMITTEE FOR
TREATMENT AND RESEARCH IN MULTIPLE SCLEROSIS", APART FROM THE MARK
AS SHOWN.

THE COLOR(S) ORANGE AND DARK GRAY IS/ARE CLAIMED AS A FEATURE OF THE
MARK.

THE MARK CONSISTS OF "ACTRIMS" IN STYLIZED LOWER-CASE TYPE ABOVE
"AMERICAS COMMITTEE FOR TREATMENT AND RESEARCH IN MULTIPLE SCLEROSIS"
IN BLOCK UPPER-CASE TYPE, WITH THE LETTERS "MS" AND THE DOT ABOVE THE
"I" IN "ACTRIMS" IN ORANGE AND THE REMAINDER OF THE LETTERS IN THE MARK
IN DARK GRAY.

SN 85-308,825, FILED 4-29-2011.

DAVID I, EXAMINING ATTORNEY



David J. Kypos

Director of the United States Patent and Trademark Office

United States of America

United States Patent and Trademark Office

BALL UP

Reg. No. 4,207,047

Registered Sep. 11, 2012

Int. Cl.: 28

TRADEMARK

PRINCIPAL REGISTER

BALL UP, LLC (TEXAS LIMITED LIABILITY COMPANY)
3301 AVONDALE AVE.
FORT WORTH, TX 76109

FOR: TOYS AND SPORTING GOODS IN THE NATURE OF BASKETBALL ACCESSORIES, NAMELY, BASKETBALLS, BAGS SPECIALLY ADAPTED FOR BASKETBALLS, BASKETBALL NETS, BASKETBALL KITS COMPRISED OF A BASKETBALL NET AND SPORTS WHISTLE, AND BASKETBALL BACKBOARDS; GOLF ACCESSORIES, NAMELY, GOLF BALL TEES AND MARKERS, GOLF GLOVES AND DIVOT REPAIR TOOLS, GOLF BAGS, GOLF CLUBS, GOLF BALLS; COLLECTIBLE BALLS, NAMELY, FOOTBALLS, BASKETBALLS, BASEBALLS AND SOCCER BALLS; COMPETITION AND LEATHER SPORTS BALLS, NAMELY, RUBBER BALLS, FOAM SPORT BALLS, PLAYGROUND BALLS, RUBBER ACTION BALLS AND FOAM ACTION PLAY BALLS; BALLS, NAMELY, VINYL PLAY BALLS, PLUSH PLAY BALLS, SPORTS BALLS AND TOY PLAY BALLS; PUMPS FOR INFLATING SPORTS EQUIPMENT, NAMELY, FOOTBALLS, SOCCER BALLS, PLUSH SPORTS AND TOY BALLS, VINYL SPORTS AND TOY BALLS; DOLLS; PLUSH MASCOT TOYS; ACTION FIGURES; FLYING DISCS; GAMES, NAMELY, BOARD GAMES, BASKETBALL TABLE TOP GAMES, PLAYING CARDS, PUZZLES, PARLOR AND MEMORY GAMES; STAND ALONE VIDEO GAME MACHINES AND ARCADE-TYPE VIDEO GAME MACHINES; HAND-HELD MOBILE VIDEO GAMES WITH LIQUID CRYSTAL DISPLAYS; ELECTRONIC VIDEO ARCADE GAME MACHINES; CHRISTMAS TREE ORNAMENTS AND CHRISTMAS TREE DECORATIONS, IN CLASS 28 (U.S. CLS. 22, 23, 38 AND 50).

FIRST USE 3-0-2012; IN COMMERCE 3-0-2012.

THE MARK CONSISTS OF STANDARD CHARACTERS WITHOUT CLAIM TO ANY PARTICULAR FONT, STYLE, SIZE, OR COLOR.

OWNER OF U.S. REG. NO. 3,409,186.

SN 85-309,156, FILED 4-30-2011.

JAY BESCH, EXAMINING ATTORNEY



David J. Kyros

Director of the United States Patent and Trademark Office

United States of America

United States Patent and Trademark Office



Reg. No. 4,207,048

Registered Sep. 11, 2012

Int. Cl.: 16

TRADEMARK

PRINCIPAL REGISTER

A.B.C. OFFICIALS & AFFILIATES INC. (MINNESOTA CORPORATION)
6319 83RD COURT N
BROOKLYN PARK, MN 55445

FOR: MAGAZINES IN THE FIELD OF ENTERTAINMENT AND UPCOMING TALENT THAT INCLUDES ARTISTS, MUSICIANS, INVENTORS, DESIGNERS, MODELS, ENTREPRENEURS, WRITERS, POETS, PHOTOGRAPHERS, VIDEOGRAPHERS, ACTORS, COMEDIANS AND OTHER FORMS OF TALENT. THE MAGAZINE WILL BE USED AS A TOOL FOR PROMOTING, MARKETING, ADVERTISING AND CREATING EXPOSURE FOR UPCOMING TALENT, IN CLASS 16 (U.S. CLS. 2, 5, 22, 23, 29, 37, 38 AND 50).

FIRST USE 2-14-2011; IN COMMERCE 8-21-2011.

THE MARK CONSISTS OF THE STYLIZED TEXT "'UR-IT" TTAG".

SN 85-309,594, FILED 5-2-2011.

CHARLOTTE CORWIN, EXAMINING ATTORNEY



David J. Kyffers

Director of the United States Patent and Trademark Office

United States of America

United States Patent and Trademark Office

FUN ZONE

Reg. No. 4,207,049

Registered Sep. 11, 2012

**Int. Cls.: 9, 14, 25, 29, 30,
32, 35, 39, 41, and 43**

TRADEMARK

SERVICE MARK

PRINCIPAL REGISTER

NEWPORT HARBOR NAUTICAL MUSEUM (CALIFORNIA CORPORATION), AKA
EXPLOROCEAN,
600 EAST BAY AVENUE
NEWPORT BEACH, CA 92661

FOR: BAGS FOR CAMERAS AND PHOTOGRAPHIC EQUIPMENT; BAGS FOR UNDERWATER CAMERA ENCLOSURES; CAMERA CASES; DIGITAL VIDEO CAMERAS; DISPOSABLE CAMERAS; LENS FILTERS; LENSES FOR CAMERAS; MULTIPLE PURPOSE CAMERAS; NAUTICAL AND PHOTOGRAPHIC APPARATUS AND INSTRUMENTS, NAMELY, UNDERWATER HOUSINGS FOR CAMERAS, UNDERWATER ENCLOSURES FOR CAMERAS AND UNDERWATER ENCLOSURES FOR PHOTOGRAPHIC LENSES; PHOTOGRAPHIC CAMERAS; SUNGLASS CHAINS AND CORDS; SUNGLASSES; UNDERWATER CAMERAS; VIDEO CAMERAS, IN CLASS 9 (U.S. CLS. 21, 23, 26, 36 AND 38).

FIRST USE 4-22-2012; IN COMMERCE 4-22-2012.

FOR: CASES FOR WATCHES AND CLOCKS; CHRONOGRAPHS FOR USE AS WATCHES; CLOCKS AND WATCHES; DIVING WATCHES; JEWELLERY AND WATCHES; MECHANICAL AND AUTOMATIC WATCHES; SPORTS WATCHES; STOP WATCHES; WATCH BANDS; WATCH BANDS AND STRAPS; WATCH CHAINS; WATCHES AND CLOCKS; WATCHES AND STRAPS FOR WATCHES; WATCHES FOR OUTDOOR USE; WATCHES FOR SPORTING USE; WATCHES, CLOCKS, JEWELRY AND IMITATION JEWELRY; WOMEN'S WATCHES; WRIST WATCHES, IN CLASS 14 (U.S. CLS. 2, 27, 28 AND 50).

FIRST USE 4-22-2012; IN COMMERCE 4-22-2012.

FOR: ATHLETIC APPAREL, NAMELY, SHIRTS, PANTS, JACKETS, FOOTWEAR, HATS AND CAPS, ATHLETIC UNIFORMS; ATHLETIC FOOTWEAR; ATHLETIC SHOES; BASEBALL CAPS AND HATS; BELTS; BOAT SHOES; CANVAS SHOES; DECK-SHOES; GOLF SHIRTS; HATS; HEADBANDS FOR CLOTHING; HOODED SWEAT SHIRTS; HOODS; JACKETS; JERSEYS; KNIT SHIRTS; LEATHER BELTS; LONG-SLEEVED SHIRTS; POLO SHIRTS; RUGBY SHIRTS; SANDALS AND BEACH SHOES; SHIRTS; SHORT-SLEEVED SHIRTS; SPORT SHIRTS; SPORTS CAPS AND HATS; T-SHIRTS; TENNIS SHOES; WATER REPELLING LEATHER SHOES AND BOOTS; WIND SHIRTS; WOMEN'S CLOTHING, NAMELY, SHIRTS, DRESSES, SKIRTS, BLOUSES; WOMEN'S HATS AND HOODS; WOMEN'S SHOES, IN CLASS 25 (U.S. CLS. 22 AND 39).



David J. Kyffers

Director of the United States Patent and Trademark Office

Reg. No. 4,207,049 FIRST USE 4-22-2012; IN COMMERCE 4-22-2012.

FOR: CANDIED FRUIT SNACKS; DRIED FRUITS; FRENCH FRIED POTATOES; FRUIT AND VEGETABLE SALADS; FRUIT SALADS; FRUIT-BASED SNACK FOOD; POTATO CHIPS; SNACK MIX CONSISTING OF DEHYDRATED FRUIT AND PROCESSED NUTS; SNACK MIX CONSISTING OF PRIMARILY OF PROCESSED NUTS, SEEDS, DRIED FRUIT AND ALSO INCLUDING CHOCOLATE; SNACK MIX CONSISTING PRIMARILY OF PROCESSED FRUITS, PROCESSED NUTS AND/OR RAISINS; VEGETABLE CHIPS, IN CLASS 29 (U.S. CL. 46).

FIRST USE 4-22-2012; IN COMMERCE 4-22-2012.

FOR: BEVERAGES MADE OF TEA; CANDY COATED APPLES; CANDY COATED POPCORN; COFFEE AND TEA; CONES FOR ICE CREAM; CORN CHIPS; COTTON CANDY; FLAVORED ICES; FLOUR-BASED CHIPS; FROZEN YOGHURT; FRUIT ICES; GRAIN-BASED CHIPS; ICE CREAM; ICE CREAM DESSERTS; ICE CREAMS; ICED TEA; TACO CHIPS; TORTILLA CHIPS, IN CLASS 30 (U.S. CL. 46).

FIRST USE 4-22-2012; IN COMMERCE 4-22-2012.

FOR: FRUIT DRINKS; FRUIT DRINKS AND FRUIT JUICES; FRUIT-BASED BEVERAGES; NON-ALCOHOLIC BEVERAGES CONTAINING FRUIT JUICES; NON-ALCOHOLIC BEVERAGES, NAMELY, CARBONATED BEVERAGES; ORANGE JUICE BEVERAGES; SARSAPARILLA; SHERBETS; SMOOTHIES; TOMATO JUICE; WATER BEVERAGES, IN CLASS 32 (U.S. CLS. 45, 46 AND 48).

FIRST USE 4-22-2012; IN COMMERCE 4-22-2012.

FOR: DESSERT SHOPS; PASTRY AND DESSERT SHOPS; RETAIL BAKERY SHOPS; RETAIL BOOK STORE SERVICES; RETAIL CANDY STORES; RETAIL CLOTHING BOUTIQUES; RETAIL CONVENIENCE STORES; RETAIL DELICATESSEN SERVICES; RETAIL FRUIT STANDS; RETAIL GIFT SHOPS; RETAIL ICE CREAM STORE SERVICES; RETAIL JEWELRY STORES; RETAIL MUSIC AND RECORD STORES; RETAIL SPORTING GOODS STORES; RETAIL VARIETY STORES; RETAIL CAMERA AND CLOTHING STORES; SELF-SERVE RETAIL BAKERY SHOPS , IN CLASS 35 (U.S. CLS. 100, 101 AND 102).

FIRST USE 4-22-2012; IN COMMERCE 4-22-2012.

FOR: MARINA SERVICES; RENTAL OF BOATS; RENTAL OF SAILBOATS, IN CLASS 39 (U.S. CLS. 100 AND 105).

FIRST USE 4-22-2012; IN COMMERCE 4-22-2012.

FOR: AMUSEMENT ARCADES; AMUSEMENT CENTERS; AMUSEMENT PARK AND THEME PARK SERVICES; AMUSEMENT PARKS; CHILDREN'S ENTERTAINMENT AND AMUSEMENT CENTERS, NAMELY, INTERACTIVE PLAY AREAS; ENTERTAINMENT AND EDUCATIONAL SERVICES IN THE NATURE OF ON-LINE COMPETITIONS IN THE FIELD OF ENTERTAINMENT, EDUCATION, CULTURE, SPORTS, AND OTHER NON-BUSINESS AND NON-COMMERCIAL FIELDS; ENTERTAINMENT IN THE NATURE OF A WATER PARK AND AMUSEMENT CENTER; ENTERTAINMENT IN THE NATURE OF YACHT RACES; ENTERTAINMENT SERVICES IN THE NATURE OF AN AMUSEMENT PARK ATTRACTION, NAMELY, A THEMED AREA; ENTERTAINMENT SERVICES IN THE NATURE OF AN AMUSEMENT PARK SHOW; ENTERTAINMENT SERVICES IN THE NATURE OF LIVE MUSICAL PERFORMANCES; ENTERTAINMENT SERVICES, NAMELY, ARRANGING AND CONDUCTING SPECIAL EVENTS AT AN AMUSEMENT PARK; ENTERTAINMENT SERVICES, NAMELY, CONDUCTING PARTIES; ENTERTAINMENT SERVICES, NAMELY, DISPLAYING A SERIES OF FILMS; ENTERTAINMENT SERVICES, NAMELY, MULTIMEDIA PRODUCTION SERVICES; ENTERTAINMENT, NAMELY, LIVE MUSIC

Reg. No. 4,207,049 CONCERTS; ORGANIZING AND ARRANGING EXHIBITIONS FOR ENTERTAINMENT PURPOSES; ORGANIZING AND HOSTING OF EVENTS FOR CULTURAL PURPOSES; ORGANIZING COMMUNITY FESTIVALS FEATURING A VARIETY OF ACTIVITIES, NAMELY, ART EXHIBITIONS, HERITAGE MARKETS, ETHNIC DANCES, AND THE LIKE; ORGANIZING COMMUNITY SPORTING AND CULTURAL EVENTS; ORGANIZING CULTURAL AND ARTS EVENTS; ORGANIZING ON-LINE EXHIBITIONS AND CONFERENCES IN THE FIELDS OF EDUCATION, CULTURE, SPORTS AND ENTERTAINMENT FOR NON-BUSINESS AND NON-COMMERCIAL PURPOSES; PROVISION OF INFORMATION RELATING TO CHILDREN'S ENTERTAINMENT; PROVISION OF INFORMATION RELATING TO THE ORGANIZING OF EDUCATIONAL, CULTURAL, SPORTING, OR ENTERTAINMENT EXHIBITIONS; RENTAL OF SNORKELS; RENTAL OF SPORTS EQUIPMENT; RENTAL OF SURF BOARDS, IN CLASS 41 (U.S. CLS. 100, 101 AND 107).

FIRST USE 4-22-2012; IN COMMERCE 4-22-2012.

FOR: BAR AND RESTAURANT SERVICES; CAFE AND RESTAURANT SERVICES; CARRY-OUT RESTAURANTS; COFFEE AND JUICE BAR SERVICES; COFFEE SHOPS; FAST-FOOD RESTAURANT SERVICES; FAST-FOOD RESTAURANTS AND SNACKBARS; FROZEN YOGURT SHOP SERVICES IN THE NATURE OF A RESTAURANT; ICE CREAM SHOP SERVICES IN THE NATURE OF A RESTAURANT; RESTAURANT AND BAR SERVICES; RESTAURANT SERVICES FEATURING SANDWICHES; RESTAURANT SERVICES, INCLUDING SIT-DOWN SERVICE OF FOOD AND TAKE-OUT RESTAURANT SERVICES; RESTAURANT SERVICES, NAMELY, PROVIDING OF FOOD AND BEVERAGES FOR CONSUMPTION ON AND OFF THE PREMISES, IN CLASS 43 (U.S. CLS. 100 AND 101).

FIRST USE 4-22-2012; IN COMMERCE 4-22-2012.

THE MARK CONSISTS OF STANDARD CHARACTERS WITHOUT CLAIM TO ANY PARTICULAR FONT, STYLE, SIZE, OR COLOR.

SN 85-310,283, FILED 5-2-2011.

HOWARD B. LEVINE, EXAMINING ATTORNEY

United States of America

United States Patent and Trademark Office

MACHINES FOR PEACE

Reg. No. 4,207,050

DEFRANCISCI MACHINE COMPANY, LLC (FLORIDA LIMITED LIABILITY COMPANY)
7610 CORAL DRIVE

Registered Sep. 11, 2012

WEST MELBOURNE, FL 329041102

Int. Cl.: 35

FOR: CHARITABLE SERVICES, NAMELY, COORDINATION OF THE PROCUREMENT AND DISTRIBUTION OF SURPLUS PASTA MACHINERY TO ORGANIZATIONS IN DEVELOPING COUNTRIES, IN CLASS 35 (U.S. CLS. 100, 101 AND 102).

SERVICE MARK

FIRST USE 4-0-2012; IN COMMERCE 4-0-2012.

PRINCIPAL REGISTER

THE MARK CONSISTS OF STANDARD CHARACTERS WITHOUT CLAIM TO ANY PARTICULAR FONT, STYLE, SIZE, OR COLOR.

SN 85-310,565, FILED 5-3-2011.

SUE LAWRENCE, EXAMINING ATTORNEY



David J. Kyffers

Director of the United States Patent and Trademark Office

United States of America
United States Patent and Trademark Office

PERFBOARD

Reg. No. 4,207,051

GREAT NORTHERN CORPORATION (WISCONSIN CORPORATION)
395 STROEBE ROAD
APPLETON, WI 54911

Registered Sep. 11, 2012

Int. Cl.: 16

FOR: LAMINATED PAPERBOARD EDGE PROTECTORS USED FOR SHIPPING AND PACKAGING, IN CLASS 16 (U.S. CLS. 2, 5, 22, 23, 29, 37, 38 AND 50).

TRADEMARK

FIRST USE 5-31-2011; IN COMMERCE 5-31-2011.

PRINCIPAL REGISTER

THE MARK CONSISTS OF STANDARD CHARACTERS WITHOUT CLAIM TO ANY PARTICULAR FONT, STYLE, SIZE, OR COLOR.

SN 85-310,622, FILED 5-3-2011.

ESTHER A. BORSUK, EXAMINING ATTORNEY



David J. Kybas

Director of the United States Patent and Trademark Office

United States of America

United States Patent and Trademark Office

NATURE'S BEST

Reg. No. 4,207,052

ANCHOR PACKAGING, INC. (MISSOURI CORPORATION)
13515 BARRETT PARKWAY DRIVE, SUITE 100
BALLWIN, MO 63021

Registered Sep. 11, 2012

Int. Cl.: 20

FOR: PLASTIC FOOD CONTAINERS FOR THE FOOD INDUSTRY, NAMELY, TAKE-OUT FOOD CONTAINERS FOR RESTAURANTS, GROCERIES AND DELIS, IN CLASS 20 (U.S. CLS. 2, 13, 22, 25, 32 AND 50).

TRADEMARK

FIRST USE 7-22-2011; IN COMMERCE 7-22-2011.

PRINCIPAL REGISTER

THE MARK CONSISTS OF STANDARD CHARACTERS WITHOUT CLAIM TO ANY PARTICULAR FONT, STYLE, SIZE, OR COLOR.

SN 85-310,703, FILED 5-3-2011.

DARRYL SPRUILL, EXAMINING ATTORNEY



David J. Kyffers

Director of the United States Patent and Trademark Office

United States of America

United States Patent and Trademark Office

GEHATI

Reg. No. 4,207,053

Registered Sep. 11, 2012

Int. Cl.: 14

TRADEMARK

PRINCIPAL REGISTER

GEHATI APPAREL & ACCESSORIES (GEORGIA LIMITED LIABILITY COMPANY)
1885 SEVERBROOK PLACE
LAWRENCEVILLE, GA 30043

FOR: COSTUME JEWELRY, IN CLASS 14 (U.S. CLS. 2, 27, 28 AND 50).

FIRST USE 3-6-2012; IN COMMERCE 3-6-2012.

THE MARK CONSISTS OF STANDARD CHARACTERS WITHOUT CLAIM TO ANY PARTICULAR FONT, STYLE, SIZE, OR COLOR.

SN 85-310,788, FILED 5-3-2011.

MICHELLE DUBOIS, EXAMINING ATTORNEY



David J. Kyffers

Director of the United States Patent and Trademark Office

United States of America

United States Patent and Trademark Office



Reg. No. 4,207,054

FORZA, LLC (NEVADA LIMITED LIABILITY COMPANY)
2960 W. SAHARA AVENUE
LAS VEGAS, NV 89102

Registered Sep. 11, 2012

Int. Cl.: 41

FOR: ENTERTAINMENT SERVICES, NAMELY, ARRANGING, CONDUCTING, ORGANIZING AND PRODUCING MARTIAL ARTS AND MIXED MARTIAL ARTS EVENTS AND COMPETITIONS; LIVE STAGE SHOWS AND PERFORMANCES FEATURING MARTIAL ARTS AND MIXED MARTIAL ARTS; PROVIDING A WEBSITE ON THE INTERNET FEATURING NEWS AND INFORMATION REGARDING MARTIAL ARTS AND MIXED MARTIAL ARTS EVENTS AND COMPETITIONS; PRODUCTION AND EXHIBITION OF MARTIAL ARTS AND MIXED MARTIAL ARTS EVENTS AND COMPETITIONS; PRODUCTION OF VIDEO CASSETTES AND DIGITAL VIDEO DISCS, NAMELY, DVDS, ALL RELATED TO MARTIAL ARTS AND MIXED MARTIAL ARTS EVENTS AND COMPETITIONS, IN CLASS 41 (U.S. CLS. 100, 101 AND 107).

SERVICE MARK

PRINCIPAL REGISTER

FIRST USE 10-31-2010; IN COMMERCE 10-31-2010.

THE MARK CONSISTS OF THE LETTER "S" CONTAINED INSIDE A SHIELD.

SN 85-310,846, FILED 5-3-2011.

ANNE MADDEN, EXAMINING ATTORNEY



David J. Kyros

Director of the United States Patent and Trademark Office

United States of America

United States Patent and Trademark Office

CHOOSE MORE. BREW MORE.
ENJOY MORE.

Reg. No. 4,207,055

KEURIG, INCORPORATED (DELAWARE CORPORATION)
55 WALKERS BROOK DRIVE
READING, MA 01867

Registered Sep. 11, 2012

Int. Cl.: 11

FOR: ELECTRIC BREWING MACHINES FOR BREWING BEVERAGES FOR DOMESTIC AND COMMERCIAL USE, IN CLASS 11 (U.S. CLS. 13, 21, 23, 31 AND 34).

TRADEMARK

FIRST USE 3-15-2012; IN COMMERCE 3-15-2012.

PRINCIPAL REGISTER

THE MARK CONSISTS OF STANDARD CHARACTERS WITHOUT CLAIM TO ANY PARTICULAR FONT, STYLE, SIZE, OR COLOR.

OWNER OF U.S. REG. NO. 3,118,137.

SN 85-311,138, FILED 5-3-2011.

PAM WILLIS, EXAMINING ATTORNEY



David J. Kyffers

Director of the United States Patent and Trademark Office

United States of America

United States Patent and Trademark Office

Clinic Masters

Reg. No. 4,207,056

EFFECTIVE PRACTICE SOLUTIONS, INC. (GEORGIA CORPORATION)

Registered Sep. 11, 2012

1601 HICKORY STREET
DALTON, GA 30720

Int. Cl.: 35

FOR: BUSINESS ASSISTANCE, ADVISORY AND CONSULTING SERVICES IN THE FIELD OF CHIROPRACTIC HEALTHCARE, IN CLASS 35 (U.S. CLS. 100, 101 AND 102).

SERVICE MARK

FIRST USE 4-15-2011; IN COMMERCE 11-18-2011.

PRINCIPAL REGISTER

THE MARK CONSISTS OF STANDARD CHARACTERS WITHOUT CLAIM TO ANY PARTICULAR FONT, STYLE, SIZE, OR COLOR.

NO CLAIM IS MADE TO THE EXCLUSIVE RIGHT TO USE "CLINIC", APART FROM THE MARK AS SHOWN.

SN 85-311,199, FILED 5-3-2011.

KATHRYN COWARD, EXAMINING ATTORNEY



David J. Kybas

Director of the United States Patent and Trademark Office

United States of America

United States Patent and Trademark Office



Reg. No. 4,207,057

TRACTOR SUPPLY CO. OF TEXAS, LP (TEXAS LIMITED PARTNERSHIP)
200 POWELL PLACE
BRENTWOOD, TN 37027

Registered Sep. 11, 2012

Int. Cl.: 8

FOR: FIREPLACE TOOL SETS SOLD AS A UNIT; FIREPLACE TOOLS, NAMELY, BELLOWS, POKERS, SHOVELS, IN CLASS 8 (U.S. CLS. 23, 28 AND 44).

TRADEMARK

FIRST USE 3-21-2010; IN COMMERCE 3-21-2010.

PRINCIPAL REGISTER

THE MARK CONSISTS OF THE WORD "RED" WITH A SMALL CIRCLE ABOVE AND TO THE RIGHT OF THE LETTER "D" IN "RED" AND THE WORD "STONE" APPEARING DIRECTLY UNDER THE WORD "RED".

SN 85-311,439, FILED 5-3-2011.

ROBERT C. CLARK JR., EXAMINING ATTORNEY



David J. Kybas

Director of the United States Patent and Trademark Office

United States of America

United States Patent and Trademark Office

Celebs with a Cause

Reg. No. 4,207,058

THE KRIM GROUP, INC. (CALIFORNIA CORPORATION)
7250 FRANKLIN AVE, #410
LOS ANGELES, CA 90046

Registered Sep. 11, 2012

Int. Cl.: 41

FOR: EDUCATIONAL AND ENTERTAINMENT SERVICES, NAMELY, A CONTINUING PROGRAM ABOUT NEWS CONCERNING THE CHARITABLE WORK OF CELEBRITIES ACCESSIBLE BY RADIO, TELEVISION, SATELLITE, AUDIO, VIDEO AND COMPUTER NETWORKS, IN CLASS 41 (U.S. CLS. 100, 101 AND 107).

SERVICE MARK

PRINCIPAL REGISTER

FIRST USE 12-12-2011; IN COMMERCE 12-12-2011.

THE MARK CONSISTS OF STANDARD CHARACTERS WITHOUT CLAIM TO ANY PARTICULAR FONT, STYLE, SIZE, OR COLOR.

NO CLAIM IS MADE TO THE EXCLUSIVE RIGHT TO USE "CELEBS", APART FROM THE MARK AS SHOWN.

SN 85-311,453, FILED 5-3-2011.

SETH A. RAPPAPORT, EXAMINING ATTORNEY



David J. Kypos

Director of the United States Patent and Trademark Office

United States of America
United States Patent and Trademark Office

SpeedSharp

Reg. No. 4,207,059

Registered Sep. 11, 2012

Int. Cl.: 16

TRADEMARK

PRINCIPAL REGISTER

HAMMER PRODUCTS INTERNATIONAL, LLC (PENNSYLVANIA LIMITED LIABILITY COMPANY)
981 SWAMP ROAD
NEWTOWN, PA 18940

FOR: PENCIL SHARPENERS, IN CLASS 16 (U.S. CLS. 2, 5, 22, 23, 29, 37, 38 AND 50).

FIRST USE 4-0-2011; IN COMMERCE 5-0-2012.

THE MARK CONSISTS OF STANDARD CHARACTERS WITHOUT CLAIM TO ANY PARTICULAR FONT, STYLE, SIZE, OR COLOR.

SN 85-311,505, FILED 5-3-2011.

KELLY BOULTON, EXAMINING ATTORNEY



David J. Kyffers

Director of the United States Patent and Trademark Office

United States of America

United States Patent and Trademark Office

Good Life

Reg. No. 4,207,060

Registered Sep. 11, 2012

Int. Cl.: 28

TRADEMARK

PRINCIPAL REGISTER

SHANDONG REALLEADER FITNESS CO., LTD (CHINA LIMITED COMPANY (LTD.))
NO.98,GUANGMING ROAD
ECONCMIC DEVELOPMENT ZONE
XINTAI CITY, SHANDONG, CHINA

FOR: BODY-TRAINING APPARATUS; BODY-TRAINING APPARATUS AND DEVICES FOR PHYSICAL EXERCISES, NAMELY, BASEBALL BATS AND BASEBALL SWING TRAINING DEVICES; CHEST EXPANDERS; DUMB-BELLS; ELLIPTICAL EXERCISE MACHINES; EXERCISE EQUIPMENT, NAMELY, CHEST PULLS; EXERCISE TABLES; EXERCISING EQUIPMENT, NAMELY, WEIGHT LIFTING MACHINES; SPORTING GOODS, NAMELY, A SPORTS TRAINING DEVICE TO IMPROVE STRENGTH, TONING, CONDITIONING, BALANCE, AND PROPRIOCEPTION; STATIONARY EXERCISE BICYCLES, IN CLASS 28 (U.S. CLS. 22, 23, 38 AND 50).

FIRST USE 11-30-2011; IN COMMERCE 11-30-2011.

THE MARK CONSISTS OF THE STYLIZED WORDING, "GOOD LIFE" WITH THE LETTER "G" ENCLOSED IN A CIRCLE AND THE LETTER "L" FORMED BY A CURVED BAND.

SN 85-311,597, FILED 5-3-2011.

JESSICA A. POWERS, EXAMINING ATTORNEY



David J. Kyffers

Director of the United States Patent and Trademark Office

United States of America

United States Patent and Trademark Office

CTMS@ SITE

Reg. No. 4,207,061

Registered Sep. 11, 2012

Int. Cl.: 42

SERVICE MARK

PRINCIPAL REGISTER

FORTE RESEARCH SYSTEMS, INC. (DELAWARE CORPORATION)
708 HEARTLAND TRAIL, SUITE 1800
MADISON, WI 53717

FOR: PROVIDING, HOSTING, MANAGING, DEVELOPING, AND MAINTAINING WEB SITES, SOFTWARE, APPLICATIONS, AND DATABASES FOR USE BY OTHERS IN THE DESIGN AND ADMINISTRATION OF SCIENTIFIC AND MEDICAL RESEARCH PROJECTS; PROVIDING, HOSTING, MANAGING, DEVELOPING, AND MAINTAINING WEB SITES, SOFTWARE, APPLICATIONS, AND DATABASES FOR USE BY OTHERS IN DATA COLLECTION, DATA SHARING, INFORMATION EXCHANGE, AND COLLABORATION REGARDING SCIENTIFIC AND MEDICAL RESEARCH PROJECTS; PROVIDING, HOSTING, MANAGING, DEVELOPING, AND MAINTAINING WEB SITES, SOFTWARE, AND APPLICATIONS FOR USE BY OTHERS IN THE TRACKING AND MANAGEMENT OF PATIENTS, SPECIMENS, EQUIPMENT, MATERIALS, FUNDING, SCHEDULES, AND PERFORMANCE MILESTONES AND METRICS INVOLVED IN SCIENTIFIC AND MEDICAL RESEARCH; PROVIDING, HOSTING, MANAGING, DEVELOPING, AND MAINTAINING WEB SITES, SOFTWARE, AND APPLICATIONS FOR USE BY OTHERS IN THE MONITORING AND REPORTING OF REGULATORY, STANDARDS, AND SAFETY COMPLIANCE IN SCIENTIFIC AND MEDICAL RESEARCH; CONSULTING SERVICES REGARDING ALL OF THE FOREGOING, IN CLASS 42 (U.S. CLS. 100 AND 101).

FIRST USE 6-13-2012; IN COMMERCE 6-13-2012.

THE MARK CONSISTS OF STANDARD CHARACTERS WITHOUT CLAIM TO ANY PARTICULAR FONT, STYLE, SIZE, OR COLOR.

NO CLAIM IS MADE TO THE EXCLUSIVE RIGHT TO USE "SITE", APART FROM THE MARK AS SHOWN.

SN 85-311,938, FILED 5-4-2011.

CHARLES L. JENKINS, EXAMINING ATTORNEY



David J. Kyjars

Director of the United States Patent and Trademark Office

United States of America

United States Patent and Trademark Office

CTMS@ NETWORK

Reg. No. 4,207,062

Registered Sep. 11, 2012

Int. Cl.: 42

SERVICE MARK

PRINCIPAL REGISTER

FORTE RESEARCH SYSTEMS, INC. (DELAWARE CORPORATION)
708 HEARTLAND TRAIL, SUITE 1800
MADISON, WI 53717

FOR: PROVIDING, HOSTING, MANAGING, DEVELOPING, AND MAINTAINING WEB SITES, SOFTWARE, APPLICATIONS, AND DATABASES FOR USE BY OTHERS IN THE DESIGN AND ADMINISTRATION OF SCIENTIFIC AND MEDICAL RESEARCH PROJECTS; PROVIDING, HOSTING, MANAGING, DEVELOPING, AND MAINTAINING WEB SITES, SOFTWARE, APPLICATIONS, AND DATABASES FOR USE BY OTHERS IN DATA COLLECTION, DATA SHARING, INFORMATION EXCHANGE, AND COLLABORATION REGARDING SCIENTIFIC AND MEDICAL RESEARCH PROJECTS; PROVIDING, HOSTING, MANAGING, DEVELOPING, AND MAINTAINING WEB SITES, SOFTWARE, AND APPLICATIONS FOR USE BY OTHERS IN THE TRACKING AND MANAGEMENT OF PATIENTS, SPECIMENS, EQUIPMENT, MATERIALS, FUNDING, SCHEDULES, AND PERFORMANCE MILESTONES AND METRICS INVOLVED IN SCIENTIFIC AND MEDICAL RESEARCH; PROVIDING, HOSTING, MANAGING, DEVELOPING, AND MAINTAINING WEB SITES, SOFTWARE, AND APPLICATIONS FOR USE BY OTHERS IN THE MONITORING AND REPORTING OF REGULATORY, STANDARDS, AND SAFETY COMPLIANCE IN SCIENTIFIC AND MEDICAL RESEARCH; CONSULTING SERVICES REGARDING ALL OF THE FOREGOING, IN CLASS 42 (U.S. CLS. 100 AND 101).

FIRST USE 12-22-2011; IN COMMERCE 12-22-2011.

THE MARK CONSISTS OF STANDARD CHARACTERS WITHOUT CLAIM TO ANY PARTICULAR FONT, STYLE, SIZE, OR COLOR.

NO CLAIM IS MADE TO THE EXCLUSIVE RIGHT TO USE "NETWORK", APART FROM THE MARK AS SHOWN.

SN 85-311,948, FILED 5-4-2011.

CHARLES L. JENKINS, EXAMINING ATTORNEY



David J. Kyros

Director of the United States Patent and Trademark Office

United States of America

United States Patent and Trademark Office

MYLIVEPD

Reg. No. 4,207,063

Registered Sep. 11, 2012

Int. Cl.: 41

SERVICE MARK

PRINCIPAL REGISTER

TUTOR.COM, INC. (DELAWARE CORPORATION)
2ND FLOOR
9 EAST 40TH STREET
NEW YORK, NY 10016

FOR: EDUCATIONAL SERVICES, NAMELY, PROVIDING A WEBSITE FEATURING REAL-TIME, ONLINE INTERACTIVE TEACHER TRAINING FOR CONTINUING EDUCATION PROGRAMS IN THE FIELD OF EDUCATION; EDUCATIONAL ACTIVITIES, NAMELY, INSTRUCTION AT THE POST-SECONDARY SCHOOL LEVEL FOR TEACHERS, EDUCATORS, AND ADMINISTRATORS, AND PERSONAL COACHING FOR TEACHERS, EDUCATORS, AND ADMINISTRATORS IN THE FIELD OF EDUCATION; EDUCATIONAL SERVICES, NAMELY, PROVIDING WEB-BASED EDUCATIONAL CONSULTING IN THE FIELDS OF CURRICULUM CONTENT, MASTERING EFFECTIVE TEACHING CONTENT, AND DEVELOPING LESSON PLANS AND THE DISTRIBUTION OF PRINTED MATERIALS IN CONNECTION THEREWITH IN HARD COPY OR ELECTRONIC FORMAT ON THE SAME TOPICS, IN CLASS 41 (U.S. CLS. 100, 101 AND 107).

FIRST USE 5-0-2011; IN COMMERCE 9-0-2011.

THE MARK CONSISTS OF STANDARD CHARACTERS WITHOUT CLAIM TO ANY PARTICULAR FONT, STYLE, SIZE, OR COLOR.

SN 85-312,887, FILED 5-5-2011.

FRED CARL, EXAMINING ATTORNEY



David J. Kyfos

Director of the United States Patent and Trademark Office

United States of America

United States Patent and Trademark Office



Reg. No. 4,207,064

Registered Sep. 11, 2012

Int. Cl.: 32

TRADEMARK

PRINCIPAL REGISTER

HECTOR MANUEL RIVERA SALAZAR (MEXICO INDIVIDUAL)
20 DE NOVIEMBRE NO. 113
TEPATITLAN, JALISCO, MEXICO 47600

FOR: ENERGY DRINKS, IN CLASS 32 (U.S. CLS. 45, 46 AND 48).

FIRST USE 7-8-2011; IN COMMERCE 5-19-2012.

NO CLAIM IS MADE TO THE EXCLUSIVE RIGHT TO USE "ENERGY", APART FROM THE MARK AS SHOWN.

THE COLOR(S) BLUE, YELLOW, RED, BLACK AND WHITE IS/ARE CLAIMED AS A FEATURE OF THE MARK.

THE MARK CONSISTS OF A BLACK AND WHITE LION'S HEAD OPENING ITS MOUTH WITH YELLOW EYES ABOVE THE WORD "HYDRATON" IN BLUE LETTERS, WITH WHITE AND RED OUTLINING OVER A YELLOW FLAG OUTLINED IN RED. BELOW THE WORD "ENERGY" APPEARS IN COLOR RED.

THE WORDING "HYDRATON" HAS NO MEANING IN A FOREIGN LANGUAGE.

SN 85-312,914, FILED 5-5-2011.

MARILYN IZZI, EXAMINING ATTORNEY



David J. Kyros

Director of the United States Patent and Trademark Office

United States of America

United States Patent and Trademark Office

SOUR PATCH KIDS

Reg. No. 4,207,065

Registered Sep. 11, 2012

Int. Cl.: 30

TRADEMARK

PRINCIPAL REGISTER

KRAFT CANADA INC. (CANADA CORPORATION)
95 MOATFIELD DRIVE
DON MILLS, ONTARIO, CANADA M363L6

FOR: FROZEN CONFECTIONS, IN CLASS 30 (U.S. CL. 46).

FIRST USE 3-1-2012; IN COMMERCE 3-1-2012.

THE MARK CONSISTS OF STANDARD CHARACTERS WITHOUT CLAIM TO ANY PARTICULAR FONT, STYLE, SIZE, OR COLOR.

OWNER OF U.S. REG. NOS. 2,304,261, 3,146,678, AND 3,847,304.

NO CLAIM IS MADE TO THE EXCLUSIVE RIGHT TO USE "SOUR", APART FROM THE MARK AS SHOWN.

SN 85-313,004, FILED 5-5-2011.

RICHARD WHITE, EXAMINING ATTORNEY



David J. Kybas

Director of the United States Patent and Trademark Office

United States of America
United States Patent and Trademark Office

KOOLTUUBZ

Reg. No. 4,207,066

GLOBUS ID, LLC (VIRGINIA LIMITED LIABILITY COMPANY)
14315 BROOKMERE DRIVE
CENTREVILLE, VA 20120

Registered Sep. 11, 2012

Int. Cl.: 11

FOR: REFRIGERATED SHIPPING CONTAINERS, IN CLASS 11 (U.S. CLS. 13, 21, 23, 31 AND 34).

TRADEMARK

FIRST USE 4-10-2012; IN COMMERCE 4-10-2012.

PRINCIPAL REGISTER

THE MARK CONSISTS OF STANDARD CHARACTERS WITHOUT CLAIM TO ANY PARTICULAR FONT, STYLE, SIZE, OR COLOR.

SN 85-313,390, FILED 5-5-2011.

SAMUEL E. SHARPER JR., EXAMINING ATTORNEY



David J. Kybas

Director of the United States Patent and Trademark Office

United States of America

United States Patent and Trademark Office

AQUAVI

Reg. No. 4,207,067

Registered Sep. 11, 2012

Int. Cl.: 10

TRADEMARK

PRINCIPAL REGISTER

MIRACLE-EAR, INC. (MINNESOTA CORPORATION)
5000 CHESHIRE PARKWAY NORTH
PLYMOUTH, MN 55446

FOR: HEARING AIDS, IN CLASS 10 (U.S. CLS. 26, 39 AND 44).

FIRST USE 8-15-2011; IN COMMERCE 8-15-2011.

THE MARK CONSISTS OF STANDARD CHARACTERS WITHOUT CLAIM TO ANY PARTICULAR FONT, STYLE, SIZE, OR COLOR.

SN 85-313,435, FILED 5-5-2011.

ROSELLE HERRERA, EXAMINING ATTORNEY



David J. Kybas

Director of the United States Patent and Trademark Office

United States of America

United States Patent and Trademark Office

WELL ON TRACK

Reg. No. 4,207,068

NJHA HEALTHCARE BUSINESS SOLUTIONS INC. (NEW JERSEY CORPORATION)
760 ALEXANDER ROAD
PRINCETON, NJ 08543

Registered Sep. 11, 2012

Int. Cl.: 42

FOR: PROVIDING TEMPORARY USE OF WEB-BASED NON-DOWNLOADABLE COMPUTER SOFTWARE APPLICATIONS USED TO TRACK THE HEALTH OF HOSPITAL AND/OR NURSING HOME PATIENTS FOLLOWING DISCHARGE, IN CLASS 42 (U.S. CLS. 100 AND 101).

SERVICE MARK

PRINCIPAL REGISTER

FIRST USE 4-6-2011; IN COMMERCE 4-6-2011.

THE MARK CONSISTS OF STANDARD CHARACTERS WITHOUT CLAIM TO ANY PARTICULAR FONT, STYLE, SIZE, OR COLOR.

SN 85-313,883, FILED 5-5-2011.

CHRISTINA SOBRAL, EXAMINING ATTORNEY



David J. Kyffers

Director of the United States Patent and Trademark Office

United States of America

United States Patent and Trademark Office



Reg. No. 4,207,069

Registered Sep. 11, 2012

Int. Cl.: 25

TRADEMARK

PRINCIPAL REGISTER

BRUHN, MAX (UNITED STATES INDIVIDUAL)
223 SMITH AVE
KINGSTON, NY 12401

FOR: BOTTOMS; BUTTON DOWN SHIRTS; HOODS; JACKETS; TOPS; WEARABLE GARMENTS AND CLOTHING, NAMELY, SHIRTS; WOMEN'S CLOTHING, NAMELY, SHIRTS, DRESSES, SKIRTS, BLOUSES, IN CLASS 25 (U.S. CLS. 22 AND 39).

FIRST USE 6-15-2012; IN COMMERCE 6-15-2012.

NO CLAIM IS MADE TO THE EXCLUSIVE RIGHT TO USE "NYC", APART FROM THE MARK AS SHOWN.

THE MARK CONSISTS OF SILHOUETTE OF AN AARDVARK WITH "AARDVARK NYC" BELOW.

SN 85-313,899, FILED 5-5-2011.

DAVID HOFFMAN, EXAMINING ATTORNEY



David J. Kybas

Director of the United States Patent and Trademark Office

United States of America

United States Patent and Trademark Office

BE PREPARED, NOT SCARED

Reg. No. 4,207,070

SECURITY EQUIPMENT CORPORATION (MISSOURI CORPORATION)
747 SUN PARK DRIVE
FENTON, MO 63026

Registered Sep. 11, 2012

Int. Cl.: 41

FOR: TRAINING IN THE USE AND OPERATION OF PERSONAL DEFENSE WEAPONS,
NAMELY, PEPPER SPRAY, IN CLASS 41 (U.S. CLS. 100, 101 AND 107).

SERVICE MARK

FIRST USE 7-31-2011; IN COMMERCE 7-31-2011.

PRINCIPAL REGISTER

THE MARK CONSISTS OF STANDARD CHARACTERS WITHOUT CLAIM TO ANY PAR-
TICULAR FONT, STYLE, SIZE, OR COLOR.

SN 85-314,396, FILED 5-6-2011.

MARILYN IZZI, EXAMINING ATTORNEY



David J. Kyffers

Director of the United States Patent and Trademark Office

United States of America

United States Patent and Trademark Office

MOVIE GEEK

Reg. No. 4,207,071

HARKINS REEL DEALS, LLC (ARIZONA LIMITED LIABILITY COMPANY)
7511 E MCDONALD DRIVE
SCOTTSDALE, AZ 85250

Registered Sep. 11, 2012

Int. Cl.: 41

FOR: PROVIDING A WEB SITE FEATURING CONTESTS RELATING TO MOVIE TRIVIA,
IN CLASS 41 (U.S. CLS. 100, 101 AND 107).

SERVICE MARK

FIRST USE 6-20-2012; IN COMMERCE 6-20-2012.

PRINCIPAL REGISTER

THE MARK CONSISTS OF STANDARD CHARACTERS WITHOUT CLAIM TO ANY PAR-
TICULAR FONT, STYLE, SIZE, OR COLOR.

NO CLAIM IS MADE TO THE EXCLUSIVE RIGHT TO USE "MOVIE", APART FROM THE
MARK AS SHOWN.

SN 85-314,781, FILED 5-6-2011.

SANI KHOURI, EXAMINING ATTORNEY



David J. Kyffers

Director of the United States Patent and Trademark Office

United States of America

United States Patent and Trademark Office

Second Martini

Reg. No. 4,207,072

HEAPHY, PATRICK (UNITED STATES INDIVIDUAL)
2 HARTSHORN LANE
WEST NYACK, NY 10994

Registered Sep. 11, 2012

Int. Cl.: 41

FOR: ENTERTAINMENT IN THE NATURE OF AN ONGOING REALITY, INTERVIEW, AND TALK SHOW TELEVISION SERIES, DELIVERED BY TELEVISION AND THE INTERNET, IN CLASS 41 (U.S. CLS. 100, 101 AND 107).

SERVICE MARK

FIRST USE 11-1-2009; IN COMMERCE 12-1-2011.

PRINCIPAL REGISTER

THE MARK CONSISTS OF STANDARD CHARACTERS WITHOUT CLAIM TO ANY PARTICULAR FONT, STYLE, SIZE, OR COLOR.

SN 85-314,944, FILED 5-6-2011.

CURTIS FRENCH, EXAMINING ATTORNEY



David J. Kyffers

Director of the United States Patent and Trademark Office

United States of America

United States Patent and Trademark Office

CROWN MEDALLION RESORTS

Reg. No. 4,207,073

CROWN MEDALLION RESORTS, LLC (NEVADA LIMITED LIABILITY COMPANY)
3225 MCLEOD DRIVE, SUITE 110

Registered Sep. 11, 2012

LAS VEGAS, NV 89121

Int. Cl.: 39

FOR: ORGANISATION OF TRAVEL; TRAVEL CLUBS, IN CLASS 39 (U.S. CLS. 100 AND 105).

SERVICE MARK

FIRST USE 0-0-2011; IN COMMERCE 0-0-2011.

PRINCIPAL REGISTER

THE MARK CONSISTS OF STANDARD CHARACTERS WITHOUT CLAIM TO ANY PARTICULAR FONT, STYLE, SIZE, OR COLOR.

NO CLAIM IS MADE TO THE EXCLUSIVE RIGHT TO USE "RESORTS", APART FROM THE MARK AS SHOWN.

SN 85-314,956, FILED 5-6-2011.

CURTIS FRENCH, EXAMINING ATTORNEY



David J. Kyffers

Director of the United States Patent and Trademark Office

United States of America

United States Patent and Trademark Office

SwingBox

Reg. No. 4,207,074

LEE, JOSEPH Y. (UNITED STATES INDIVIDUAL)
9 ROCKINGHORSE RD
RANCHO PALOS VERDES, CA 90275

Registered Sep. 11, 2012

Int. Cl.: 28

FOR: GOLF TRAINING APPARATUS, NAMELY, GOLF PRACTICE PLATFORMS; GOLF TRAINING EQUIPMENT, NAMELY, A GOLF TRAINING CAGE; NETS FOR BALL GAMES; NETS FOR SPORTING PURPOSES; NETS FOR SPORTS, IN CLASS 28 (U.S. CLS. 22, 23, 38 AND 50).

TRADEMARK

PRINCIPAL REGISTER

FIRST USE 10-24-2011; IN COMMERCE 10-24-2011.

THE MARK CONSISTS OF STANDARD CHARACTERS WITHOUT CLAIM TO ANY PARTICULAR FONT, STYLE, SIZE, OR COLOR.

SN 85-315,213, FILED 5-8-2011.

JAMES STEIN, EXAMINING ATTORNEY



David J. Kybas

Director of the United States Patent and Trademark Office

United States of America

United States Patent and Trademark Office

GENEROUS GARDENERS

Reg. No. 4,207,075

GENEROUS GARDENERS INCORPORATED (MASSACHUSETTS CORPORATION)
5 BROADWAY, SUITE 3
SAUGUS, MA 01906

Registered Sep. 11, 2012

Int. Cl.: 44

FOR: PROVIDING AN ONLINE WEBSITE FOR GARDENING PROFESSIONALS FEATURING A HORTICULTURAL DATABASE, INTERACTIVE HORTICULTURAL INFORMATION AND HORTICULTURAL INVENTORY MANAGEMENT SYSTEM, IN CLASS 44 (U.S. CLS. 100 AND 101).

SERVICE MARK

PRINCIPAL REGISTER

FIRST USE 2-14-2012; IN COMMERCE 2-14-2012.

THE MARK CONSISTS OF STANDARD CHARACTERS WITHOUT CLAIM TO ANY PARTICULAR FONT, STYLE, SIZE, OR COLOR.

NO CLAIM IS MADE TO THE EXCLUSIVE RIGHT TO USE "GARDENERS", APART FROM THE MARK AS SHOWN.

SN 85-315,463, FILED 5-9-2011.

HOWARD B. LEVINE, EXAMINING ATTORNEY



David J. Kyffers

Director of the United States Patent and Trademark Office

United States of America

United States Patent and Trademark Office

FIRE UP YOUR KNOWLEDGE

Reg. No. 4,207,076

TYCO FIRE PRODUCTS LP (DELAWARE LIMITED PARTNERSHIP)
1400 PENNBROOK PARKWAY
LANSDALE, PA 19446

Registered Sep. 11, 2012

Int. Cl.: 41

FOR: EDUCATION SERVICES, NAMELY, PROVIDING LIVE AND ON-LINE CLASSES, SEMINARS, WORKSHOPS IN THE FIELD OF FIRE PROTECTION; EDUCATIONAL SERVICES, NAMELY, CONDUCTING CLASSES, SEMINARS, CONFERENCES, WORKSHOPS, RETREATS, CAMPS AND FIELD TRIPS IN THE FIELD OF FIRE PROTECTION AND DISTRIBUTION OF TRAINING MATERIAL IN CONNECTION THEREWITH; EDUCATIONAL SERVICES, NAMELY, CONDUCTING INFORMAL PROGRAMS IN THE FIELDS OF FIRE PROTECTION, USING ON-LINE ACTIVITIES AND INTERACTIVE EXHIBITS, AND PRINTABLE MATERIALS DISTRIBUTED THEREWITH, IN CLASS 41 (U.S. CLS. 100, 101 AND 107).

SERVICE MARK

PRINCIPAL REGISTER

FIRST USE 6-0-2011; IN COMMERCE 6-0-2011.

THE MARK CONSISTS OF STANDARD CHARACTERS WITHOUT CLAIM TO ANY PARTICULAR FONT, STYLE, SIZE, OR COLOR.

SN 85-315,515, FILED 5-9-2011.

TIMOTHY FINNEGAN, EXAMINING ATTORNEY



David J. Kyros

Director of the United States Patent and Trademark Office

United States of America

United States Patent and Trademark Office



Reg. No. 4,207,077

Registered Sep. 11, 2012

Int. Cl.: 42

SERVICE MARK

PRINCIPAL REGISTER

DOLTAR, ROBERT (UNITED STATES INDIVIDUAL)
7790 SW WILSON AVENUE
BEAVERTON, OR 97008

FOR: PROVIDING ON-LINE NON-DOWNLOADABLE SOFTWARE FOR EDUCATIONAL INTERACTIVE COMPUTER SIMULATIONS IN THE FIELD OF SCIENCE, IN CLASS 42 (U.S. CLS. 100 AND 101).

FIRST USE 4-8-2011; IN COMMERCE 7-6-2011.

THE MARK CONSISTS OF A SILHOUETTE OF THE HEAD AND NECK OF A MAN IN PROFILE, WITH LIPS SLIGHTLY PARTED, FACING RIGHT, A PORTION OF THE HEAD IS MISSING FROM THE TOP OF THE FOREHEAD TO BACK OF THE HEAD AT THE OCCIPITAL AREA, THE LOWER CASE LETTER "E" IS PROTRUDING FROM THE UPPER LEFT OF THE HEAD AND THE RIGHT LOWER PORTION OF THE "E" IS NOT VISIBLE. THE WORD "EMIND" IS BELOW THE SILHOUETTE. THE "E" AT THE TOP OF THE HEAD IS GREEN, THE HEAD SILHOUETTE IS COLORED WITH SHADES OF BLUE, THE "E" IN "EMIND" IS BLUE AND THE "MIND" PORTION OF THE WORD IS BLACK.

THE COLOR(S) GREEN, BLUE AND BLACK IS/ARE CLAIMED AS A FEATURE OF THE MARK.

SN 85-316,163, FILED 5-9-2011.

DOMINIC J. FERRAIUOLO, EXAMINING ATTORNEY



David J. Kyjars

Director of the United States Patent and Trademark Office

United States of America

United States Patent and Trademark Office



torgpost.com

Reg. No. 4,207,078

AMERIJET HOLDINGS, INC. (FLORIDA CORPORATION)
2800 S. ANDREWS AVE.

Registered Sep. 11, 2012

FORT LAUDERDALE, FL 33316

Int. Cl.: 35

FOR: TRANSPORTATION LOGISTICS SERVICES, NAMELY, ARRANGING FOR THE RECEIPT AND DELIVERY OF GOODS PURCHASED BY OTHERS OVER THE INTERNET; AND PROVIDING SUPPLY CHAIN LOGISTICS AND REVERSE LOGISTICS SERVICES, NAMELY, ARRANGING FOR THE STORAGE, TRANSPORTATION AND DELIVERY OF GOODS PURCHASED BY OTHERS OVER THE INTERNET, IN CLASS 35 (U.S. CLS. 100, 101 AND 102).

SERVICE MARK

PRINCIPAL REGISTER

FIRST USE 8-22-2011; IN COMMERCE 8-22-2011.

SN 85-316,785, FILED 5-10-2011.

MARIA-VICTORIA SUAREZ, EXAMINING ATTORNEY



David J. Kybas

Director of the United States Patent and Trademark Office

United States of America

United States Patent and Trademark Office

CALNIN CALIFORNIA NANO INDUSTRY NETWORK

Reg. No. 4,207,079

Registered Sep. 11, 2012

Int. Cl.: 35

SERVICE MARK

PRINCIPAL REGISTER

B&C CONSORTIA MANAGEMENT, L.L.C. (D.C. LIMITED LIABILITY COMPANY)
SUITE 100W
2200 PENNSYLVANIA AVENUE, NW
WASHINGTON, DC 20037

FOR: BUSINESS ADMINISTRATIVE AND MANAGEMENT SERVICES FOR CONSORTIA
IN THE NANOTECH INDUSTRY IN NANOTECH LEGAL, REGULATORY, AND POLICY
INITIATIVES, IN CLASS 35 (U.S. CLS. 100, 101 AND 102).

FIRST USE 9-0-2011; IN COMMERCE 9-0-2011.

THE MARK CONSISTS OF STANDARD CHARACTERS WITHOUT CLAIM TO ANY PAR-
TICULAR FONT, STYLE, SIZE, OR COLOR.

NO CLAIM IS MADE TO THE EXCLUSIVE RIGHT TO USE "CALIFORNIA NANO INDUSTRY
NETWORK", APART FROM THE MARK AS SHOWN.

SN 85-317,032, FILED 5-10-2011.

ERIN FALK, EXAMINING ATTORNEY



David J. Kybas

Director of the United States Patent and Trademark Office

United States of America

United States Patent and Trademark Office

TURNSTILE

Reg. No. 4,207,080

AGENCYPORT INSURANCE SERVICES, INC. (DELAWARE CORPORATION)
51 SLEEPER STREET
BOSTON, MA 02210

Registered Sep. 11, 2012

Int. Cl.: 42

FOR: CROSS-PLATFORM CONVERSION OF DIGITAL CONTENT INTO OTHER FORMS OF DIGITAL CONTENT; PROVIDING A WEB SITE FEATURING TEMPORARY USE OF NON-DOWNLOADABLE SOFTWARE FOR CONVERSION OF DIGITAL CONTENT INTO OTHER FORMS OF DIGITAL CONTENT, IN CLASS 42 (U.S. CLS. 100 AND 101).

SERVICE MARK

PRINCIPAL REGISTER

FIRST USE 5-14-2012; IN COMMERCE 5-14-2012.

THE MARK CONSISTS OF STANDARD CHARACTERS WITHOUT CLAIM TO ANY PARTICULAR FONT, STYLE, SIZE, OR COLOR.

SN 85-317,122, FILED 5-10-2011.

SUSAN LESLIE DUBOIS, EXAMINING ATTORNEY



David J. Kyffers

Director of the United States Patent and Trademark Office

United States of America

United States Patent and Trademark Office

PROVEN 4 HEALTH

Reg. No. 4,207,081

PROFESSIONAL HEALTH AND NUTRITION, INC. (MICHIGAN CORPORATION)
4729 ALTON DR.
TROY, MI 48085

Registered Sep. 11, 2012

Int. Cl.: 5

FOR: VITAMINS; FOOD SUPPLEMENTS; PROTEIN SUPPLEMENTS; MINERAL SUPPLEMENTS; NUTRITIONAL SUPPLEMENTS; NUTRIENTS IN THE NATURE OF NUTRITIONAL SUPPLEMENTS; NUTRACEUTICALS FOR USE AS A DIETARY SUPPLEMENT; DIETARY SUPPLEMENT ENERGY TABLETS; VITAMIN SUPPLEMENT BEVERAGES, IN CLASS 5 (U.S. CLS. 6, 18, 44, 46, 51 AND 52).

TRADEMARK

PRINCIPAL REGISTER

FIRST USE 12-1-2011; IN COMMERCE 12-1-2011.

THE MARK CONSISTS OF STANDARD CHARACTERS WITHOUT CLAIM TO ANY PARTICULAR FONT, STYLE, SIZE, OR COLOR.

NO CLAIM IS MADE TO THE EXCLUSIVE RIGHT TO USE "HEALTH", APART FROM THE MARK AS SHOWN.

SN 85-317,322, FILED 5-10-2011.

BARBARA GAYNOR, EXAMINING ATTORNEY



David J. Kybas

Director of the United States Patent and Trademark Office

United States of America

United States Patent and Trademark Office

Vertical IQ

Reg. No. 4,207,082

Registered Sep. 11, 2012

Int. Cl.: 35

SERVICE MARK

PRINCIPAL REGISTER

VERTICAL IQ, INC. (NORTH CAROLINA CORPORATION)
4441 SIX FORKS ROAD, SUITE 106-171
RALEIGH, NC 27609

FOR: ONLINE BUSINESS SERVICES, NAMELY, PROVIDING ONLINE BUSINESS CONSULTING REGARDING INDUSTRY-BASED KNOWLEDGE TRANSFER, NAMELY, CONSULTING REGARDING THE TRANSFER OF BUSINESS KNOWLEDGE FROM ONE PARTY TO AN ORGANIZATION AND FURTHER TRANSFER OF SUCH BUSINESS KNOWLEDGE FROM ONE GROUP WITHIN THAT ORGANIZATION TO OTHER GROUPS WITHIN THAT ORGANIZATION, IN CLASS 35 (U.S. CLS. 100, 101 AND 102).

FIRST USE 6-2-2011; IN COMMERCE 6-2-2011.

THE MARK CONSISTS OF STANDARD CHARACTERS WITHOUT CLAIM TO ANY PARTICULAR FONT, STYLE, SIZE, OR COLOR.

SN 85-317,668, FILED 5-11-2011.

DANIEL CAPSHAW, EXAMINING ATTORNEY



David J. Kyros

Director of the United States Patent and Trademark Office

United States of America

United States Patent and Trademark Office

AMAZING GOO

Reg. No. 4,207,083

THE GOO GIRLS INC. (HAWAII CORPORATION)

Registered Sep. 11, 2012

PO BOX 684
KEALAKEKUA, HI 96750

Int. Cl.: 5

FOR: EDIBLE PASTE FOR PETS THAT DISSOLVES PILLS, IN CLASS 5 (U.S. CLS. 6, 18, 44, 46, 51 AND 52).

TRADEMARK

FIRST USE 3-0-2012; IN COMMERCE 3-0-2012.

PRINCIPAL REGISTER

THE MARK CONSISTS OF STANDARD CHARACTERS WITHOUT CLAIM TO ANY PARTICULAR FONT, STYLE, SIZE, OR COLOR.

SN 85-317,671, FILED 5-11-2011.

COLLEEN KEARNEY, EXAMINING ATTORNEY



David J. Kyffers

Director of the United States Patent and Trademark Office

United States of America

United States Patent and Trademark Office

REVEAL

Reg. No. 4,207,084

Registered Sep. 11, 2012

Int. Cl.: 12

TRADEMARK

PRINCIPAL REGISTER

INVACARE CORPORATION (OHIO CORPORATION)
LEGAL DEPARTMENT
ONE INVACARE WAY
ELYRIA, OH 44035

FOR: ADULT AND PEDIATRIC WHEELCHAIRS; PARTS FOR ADULT AND PEDIATRIC WHEELCHAIRS, IN CLASS 12 (U.S. CLS. 19, 21, 23, 31, 35 AND 44).

FIRST USE 11-15-2011; IN COMMERCE 11-15-2011.

THE MARK CONSISTS OF STANDARD CHARACTERS WITHOUT CLAIM TO ANY PARTICULAR FONT, STYLE, SIZE, OR COLOR.

SN 85-317,759, FILED 5-11-2011.

AISHA CLARKE, EXAMINING ATTORNEY



David J. Kyjars

Director of the United States Patent and Trademark Office

United States of America

United States Patent and Trademark Office

SMART SNAP

Reg. No. 4,207,085

MERKURY INNOVATIONS LLC (NEW YORK LIMITED LIABILITY COMPANY)
39 BROADWAY
NEW YORK, NY 10006

Registered Sep. 11, 2012

Int. Cl.: 9

FOR: CASES FOR TABLET COMPUTERS AND SMART PHONES, IN CLASS 9 (U.S. CLS. 21, 23, 26, 36 AND 38).

TRADEMARK

FIRST USE 7-31-2011; IN COMMERCE 7-31-2011.

PRINCIPAL REGISTER

THE MARK CONSISTS OF STANDARD CHARACTERS WITHOUT CLAIM TO ANY PARTICULAR FONT, STYLE, SIZE, OR COLOR.

NO CLAIM IS MADE TO THE EXCLUSIVE RIGHT TO USE "SMART", APART FROM THE MARK AS SHOWN.

SN 85-317,896, FILED 5-11-2011.

KATHY DE JONGE, EXAMINING ATTORNEY



David J. Kyffers

Director of the United States Patent and Trademark Office

United States of America

United States Patent and Trademark Office

SELL MORE BEER

Reg. No. 4,207,086

TAPHANDLES LLC (WASHINGTON LIMITED LIABILITY COMPANY)
1424 4TH AVE., STE. 201
SEATTLE, WA 98101

Registered Sep. 11, 2012

Int. Cl.: 19

FOR: NON-LUMINOUS, NON-MECHANICAL SIGNS NOT OF METAL, IN CLASS 19 (U.S. CLS. 1, 12, 33 AND 50).

TRADEMARK

FIRST USE 1-31-2011; IN COMMERCE 1-31-2011.

PRINCIPAL REGISTER

THE MARK CONSISTS OF STANDARD CHARACTERS WITHOUT CLAIM TO ANY PARTICULAR FONT, STYLE, SIZE, OR COLOR.

SN 85-318,089, FILED 5-11-2011.

DAWN FELDMAN, EXAMINING ATTORNEY



David J. Kyffers

Director of the United States Patent and Trademark Office

United States of America

United States Patent and Trademark Office

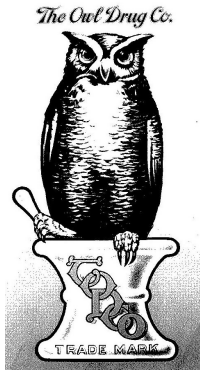

Reg. No. 4,207,087

Registered Sep. 11, 2012

Int. Cl.: 25

TRADEMARK

PRINCIPAL REGISTER

LEVINE'S RESTORATIONS (VIRGINIA SOLE PROPRIETORSHIP)
4801 7TH STREET NORTH
ARLINGTON, VA 22203

FOR: ANKLE SOCKS; ANKLETS; APPAREL FOR DANCERS, NAMELY, TEE SHIRTS, SWEATSHIRTS, PANTS, LEGGINGS, SHORTS AND JACKETS; ATHLETIC APPAREL, NAMELY, SHIRTS, PANTS, JACKETS, FOOTWEAR, HATS AND CAPS, ATHLETIC UNIFORMS; BASEBALL CAPS AND HATS; BOMBER JACKETS; CAMOUFLAGE JACKETS; CAMOUFLAGE PANTS; CAMOUFLAGE VESTS; CAMP SHIRTS; CAP VISORS; CAPS; CAPS WITH VISORS; CARGO PANTS; DENIM JACKETS; DENIMS; FISHERMEN'S JACKETS; FISHING VESTS; FLEECE VESTS; GOLF CAPS; GOLF PANTS, SHIRTS AND SKIRTS; GOLF SHIRTS; GYM PANTS; HATS; HEADGEAR, NAMELY, BEENIES; HOODED SWEAT SHIRTS; HUNTING JACKETS; HUNTING PANTS; HUNTING SHIRTS; HUNTING VESTS; JACKETS; JACKETS AND SOCKS; JEGGINGS, NAMELY, PANTS THAT ARE PARTIALLY JEANS AND PARTIALLY LEGGINGS; JOGGING PANTS; KNIT JACKETS; KNIT SHIRTS; KNITTED CAPS; LEATHER JACKETS; LEATHER VESTS; LONG JACKETS; LONG SLEEVED VESTS; LONG-SLEEVED SHIRTS; MEN'S AND WOMEN'S JACKETS, COATS, TROUSERS, VESTS; MEN'S SOCKS; MOISTURE-WICKING SPORTS SHIRTS; MOTORCYCLE JACKETS; NON-SLIP SOCKS; OPEN-NECKED SHIRTS; OUTER JACKETS; PANTS; POLO SHIRTS; QUILTED VESTS; RAIN JACKETS; REVERSIBLE JACKETS; RUGBY SHIRTS; SHELL JACKETS; SHIRT INSERTS, NAMELY, DICKIES; SHIRTS; SHIRTS AND SHORT-SLEEVED SHIRTS; SHORT-SLEEVED OR LONG-SLEEVED T-SHIRTS; SHORT-SLEEVED SHIRTS; SKI JACKETS; SKI PANTS; SKULL CAPS; SLEEP PANTS; SLEEVED OR SLEEVELESS JACKETS; SNOW PANTS; SNOWBOARD JACKETS; SNOWBOARD PANTS; SOCKS; SOCKS AND STOCKINGS; SPORT SHIRTS; SPORTS CAPS AND HATS; SPORTS JACKETS; SPORTS PANTS; SPORTS SHIRTS; SPORTS SHIRTS WITH SHORT SLEEVES; SPORTS VESTS; STRETCH PANTS; SWEAT JACKETS; SWEAT PANTS; SWEAT SHIRTS; SWEATSUITS; T-SHIRTS; T-SHIRTS FOR ADULTS, CHILDREN, WOMEN, MEN; TEE SHIRTS; THERMAL SOCKS; TOBOGGAN HATS, PANTS AND CAPS; TRACK JACKETS; TRACK PANTS; TURTLE NECK SHIRTS; VESTS; WEARABLE GARMENTS AND CLOTHING, NAMELY, SHIRTS; WIND RESISTANT JACKETS; WIND VESTS; WIND-JACKETS; WOMEN'S CLOTHING, NAMELY, SHIRTS, DRESSES, SKIRTS, BLOUSES; WOOLLEN SOCKS, IN CLASS 25 (U.S. CLS. 22 AND 39).



David J. Kybas

FIRST USE 4-30-2012; IN COMMERCE 4-30-2012.

Reg. No. 4,207,087 NO CLAIM IS MADE TO THE EXCLUSIVE RIGHT TO USE "CO" AND "TRADE MARK",
APART FROM THE MARK AS SHOWN.

THE MARK CONSISTS OF AN OWL PERCHED ON A MORTAR WITH A PESTLE PARTIALLY OUTSIDE THE MORTAR. ONE CLAW OF THE OWL IS HOLDING ONTO THE PESTLE WITH THE WORDS "THE OWL DRUG CO. TODCO TRADE MARK".

SN 85-318,126, FILED 5-11-2011.

ALICIA COLLINS, EXAMINING ATTORNEY

United States of America

United States Patent and Trademark Office

THERAPURE

Reg. No. 4,207,088

Registered Sep. 11, 2012

Int. Cl.: 11

TRADEMARK

PRINCIPAL REGISTER

INVACARE CORPORATION (OHIO CORPORATION)
ONE INVACARE WAY
LEGAL DEPARTMENT
ELYRIA, OH 44035

FOR: PIPELESS WHIRLPOOL BATHING TUBS FOR LONG-TERM CARE PATIENTS; PARTS FOR BATHING TUBS, IN CLASS 11 (U.S. CLS. 13, 21, 23, 31 AND 34).

FIRST USE 7-1-2010; IN COMMERCE 7-1-2010.

THE MARK CONSISTS OF STANDARD CHARACTERS WITHOUT CLAIM TO ANY PARTICULAR FONT, STYLE, SIZE, OR COLOR.

SN 85-318,285, FILED 5-11-2011.

AISHA CLARKE, EXAMINING ATTORNEY



David J. Kyjars

Director of the United States Patent and Trademark Office

United States of America

United States Patent and Trademark Office



it's junk, it's gone!

Reg. No. 4,207,089

Registered Sep. 11, 2012

Int. Cl.: 39

SERVICE MARK

PRINCIPAL REGISTER

IT'S JUNK, LLC (TEXAS LIMITED LIABILITY COMPANY)
15313 CHICHESTER
HOUSTON, TX 77040

FOR: JUNK, TRASH AND DEBRIS REMOVAL, IN CLASS 39 (U.S. CLS. 100 AND 105).

FIRST USE 7-2-2012; IN COMMERCE 7-2-2012.

NO CLAIM IS MADE TO THE EXCLUSIVE RIGHT TO USE "JUNK" , APART FROM THE MARK AS SHOWN.

THE MARK CONSISTS OF THE STYLIZED WORDING "IT'S JUNK" AND A DUMP TRUCK FULL OF JUNK, TRASH AND DEBRIS WITH THE WORD "JUNK" SUPERIMPOSED UPON THE TRUCK'S DUMP-BODY. THE STYLIZED WORDING "IT'S JUNK, IT'S GONE!" APPEARS BELOW.

SN 85-318,416, FILED 5-11-2011.

BRENDAN MCCAULEY, EXAMINING ATTORNEY



David J. Kybas

Director of the United States Patent and Trademark Office

United States of America

United States Patent and Trademark Office



Reg. No. 4,207,090

Registered Sep. 11, 2012

Int. Cl.: 33

TRADEMARK

PRINCIPAL REGISTER

CBTL EXPORTS (DOMINICAN REP PARTNERSHIP)
28TH FLOOR
40 WALL STREET
NEW YORK, NY 10005

FOR: ALCOHOLIC BEVERAGES EXCEPT BEERS; ALCOHOLIC BEVERAGES, NAMELY, RUM WITH SPICED TROPICAL ROOT, TREE BARK, LEAVES AND HERBS; LIQUOR AND LIQUEUR BEVERAGES, NAMELY, RUM WITH SPICED TROPICAL ROOTS, TREE BARK, LEAVES AND HERBS; RUM; SPIRITS, IN CLASS 33 (U.S. CLS. 47 AND 49).

FIRST USE 1-2-2012; IN COMMERCE 1-2-2012.

THE MARK CONSISTS OF A STYLIZED ANTHROPOMORPHIZED DEPICTION OF THE SUN CONTAINING TWO EYES AND MOUTH.

SN 85-318,417, FILED 5-11-2011.

ALICIA COLLINS, EXAMINING ATTORNEY



David J. Kyffers

Director of the United States Patent and Trademark Office

United States of America

United States Patent and Trademark Office

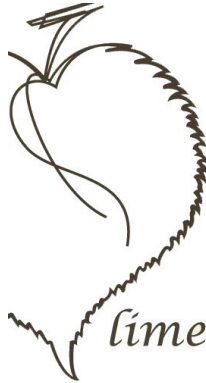

lime & vine

Reg. No. 4,207,091

Registered Sep. 11, 2012

Int. Cl.: 25

TRADEMARK

PRINCIPAL REGISTER

I-MAR LLC (CALIFORNIA LIMITED LIABILITY COMPANY)
5150 RANCHO RD
HUNTINGTON BEACH, CA 92647

FOR: BELTS; BLAZERS; BLOUSES; BOXER SHORTS; BRAS; CAPS; CARDIGANS; COATS; CROP TOPS; DRESSES; FOOTWEAR; GOLF SHIRTS; HEADWEAR; JACKETS; JEANS; JOGGING SUITS; KNIT TOPS; OVERALLS; PAJAMAS; PANTIES; PANTS; POLO SHIRTS; SHIRTS; SHORTS; SKIRTS; SOCKS; SUITS; SWEAT PANTS; SWEAT SHIRTS; SWEATERS; T-SHIRTS; TANK TOPS; TAP PANTS; TROUSERS; TURTLE NECK SHIRTS; UNDER GARMENTS; VESTS, IN CLASS 25 (U.S. CLS. 22 AND 39).

FIRST USE 7-1-2011; IN COMMERCE 5-22-2012.

THE MARK CONSISTS OF HALF OF A FRUIT WITH LEAVES AND THE STYLIZED TEXT "LIME & VINE".

SN 85-318,782, FILED 5-12-2011.

SCOTT BIBB, EXAMINING ATTORNEY



David J. Kybas

Director of the United States Patent and Trademark Office

United States of America

United States Patent and Trademark Office

FLOGROWN

Reg. No. 4,207,092

FLOGROWN LLC (FLORIDA LIMITED LIABILITY COMPANY)
1436 ROUSE RUN CIRCLE
ORLANDO, FL 32817

Registered Sep. 11, 2012

Int. Cl.: 25

FOR: CLOTHING, NAMELY, T-SHIRTS, IN CLASS 25 (U.S. CLS. 22 AND 39).

TRADEMARK

FIRST USE 4-30-2011; IN COMMERCE 4-30-2011.

PRINCIPAL REGISTER

THE MARK CONSISTS OF STANDARD CHARACTERS WITHOUT CLAIM TO ANY PARTICULAR FONT, STYLE, SIZE, OR COLOR.

SN 85-319,185, FILED 5-12-2011.

GINA FINK, EXAMINING ATTORNEY



David J. Kyffers

Director of the United States Patent and Trademark Office

United States of America

United States Patent and Trademark Office

SPRINGLEAF DENTAL SOLUTIONS

Reg. No. 4,207,093

SPRINGLEAF FINANCE, INC. (INDIANA CORPORATION)
601 N.W. SECOND STREET
EVANSVILLE, IN 47708

Registered Sep. 11, 2012

Int. Cl.: 36

FOR: CONSUMER LENDING SERVICES, IN CLASS 36 (U.S. CLS. 100, 101 AND 102).

SERVICE MARK

FIRST USE 6-30-2011; IN COMMERCE 6-30-2011.

PRINCIPAL REGISTER

THE MARK CONSISTS OF STANDARD CHARACTERS WITHOUT CLAIM TO ANY PARTICULAR FONT, STYLE, SIZE, OR COLOR.

SN 85-319,293, FILED 5-12-2011.

NAAKWAMA ANKRAH, EXAMINING ATTORNEY



David J. Kyffers

Director of the United States Patent and Trademark Office

United States of America

United States Patent and Trademark Office

MIND-SHARE

Reg. No. 4,207,094

HNI TECHNOLOGIES INC. (IOWA CORPORATION)
408 EAST 2ND STREET
MUSCATINE, IA 52761

Registered Sep. 11, 2012

Int. Cl.: 20

FOR: FURNITURE, IN CLASS 20 (U.S. CLS. 2, 13, 22, 25, 32 AND 50).

TRADEMARK

FIRST USE 8-20-2011; IN COMMERCE 8-20-2011.

PRINCIPAL REGISTER

THE MARK CONSISTS OF STANDARD CHARACTERS WITHOUT CLAIM TO ANY PARTICULAR FONT, STYLE, SIZE, OR COLOR.

SN 85-319,351, FILED 5-12-2011.

KIMBERLY FRYE, EXAMINING ATTORNEY



David J. Kyffers

Director of the United States Patent and Trademark Office

United States of America

United States Patent and Trademark Office

DON'T JUST WIN. DOMINATE!

Reg. No. 4,207,095

RAMBOD, HANY (UNITED STATES INDIVIDUAL)
1484 POLLARD RD #222
LOS GATOS, CA 95032

Registered Sep. 11, 2012

Int. Cl.: 5

FOR: DIETARY AND NUTRITIONAL SUPPLEMENTS; DIETARY SUPPLEMENTAL DRINKS,
IN CLASS 5 (U.S. CLS. 6, 18, 44, 46, 51 AND 52).

TRADEMARK

FIRST USE 5-0-2012; IN COMMERCE 5-0-2012.

PRINCIPAL REGISTER

THE MARK CONSISTS OF STANDARD CHARACTERS WITHOUT CLAIM TO ANY PAR-
TICULAR FONT, STYLE, SIZE, OR COLOR.

SN 85-319,927, FILED 5-13-2011.

MATTHEW PAPPAS, EXAMINING ATTORNEY



David J. Kypas

Director of the United States Patent and Trademark Office

United States of America

United States Patent and Trademark Office

Clean Water Community Challenge

Reg. No. 4,207,096

ECOSYSTEM SERVICES EXCHANGE, LLC (FLORIDA LIMITED LIABILITY COMPANY)
4970 59TH AVE. S.

Registered Sep. 11, 2012

ST. PETERSBURG, FL 33715

Int. Cl.: 35

FOR: PROMOTING PUBLIC AWARENESS OF THE NEED FOR AND METHOD OF IMPROVING THE QUALITY OF WATER AVAILABLE FOR PUBLIC USE AND CONSUMPTION , IN CLASS 35 (U.S. CLS. 100, 101 AND 102).

SERVICE MARK

FIRST USE 12-1-2011; IN COMMERCE 12-1-2011.

PRINCIPAL REGISTER

THE MARK CONSISTS OF STANDARD CHARACTERS WITHOUT CLAIM TO ANY PARTICULAR FONT, STYLE, SIZE, OR COLOR.

NO CLAIM IS MADE TO THE EXCLUSIVE RIGHT TO USE "CLEAN WATER", APART FROM THE MARK AS SHOWN.

SN 85-320,218, FILED 5-13-2011.

ANGELA M. MICHELI, EXAMINING ATTORNEY



David J. Kyros

Director of the United States Patent and Trademark Office

United States of America

United States Patent and Trademark Office

AIR RIDE BY ECP

Reg. No. 4,207,097

Registered Sep. 11, 2012

Int. Cl.: 18

TRADEMARK

PRINCIPAL REGISTER

EUROW & O'REILLY CORPORATION (CALIFORNIA CORPORATION), DBA EQUINE COMFORT PRODUCTS,
365-B CAMINO CARILLO
CAMARILLO, CA 93012

FOR: PADS FOR HORSE SADDLES, IN CLASS 18 (U.S. CLS. 1, 2, 3, 22 AND 41).

FIRST USE 6-12-2012; IN COMMERCE 6-12-2012.

THE MARK CONSISTS OF STANDARD CHARACTERS WITHOUT CLAIM TO ANY PARTICULAR FONT, STYLE, SIZE, OR COLOR.

OWNER OF U.S. REG. NO. 3,656,312.

SN 85-320,796, FILED 5-13-2011.

CHARLOTTE CORWIN, EXAMINING ATTORNEY



David J. Kyffers

Director of the United States Patent and Trademark Office

United States of America

United States Patent and Trademark Office

GOOD DYNAMICS

Reg. No. 4,207,098

GOOD TECHNOLOGY, INC. (DELAWARE CORPORATION)
430 N. MARY AVENUE, SUITE 200
SUNNYVALE, CA 94082

Registered Sep. 11, 2012

Int. Cls.: 9 and 42

FOR: COMPUTER SOFTWARE, NAMELY, SOFTWARE FOR THE CREATION AND DEVELOPMENT OF INFORMATION AND COMMUNICATIONS SECURITY FEATURES AND COMPONENTS FOR USE IN, BY OR WITH SOFTWARE APPLICATIONS, IN CLASS 9 (U.S. CLS. 21, 23, 26, 36 AND 38).

TRADEMARK

SERVICE MARK

FIRST USE 10-14-2011; IN COMMERCE 10-14-2011.

PRINCIPAL REGISTER

FOR: PROVIDING TEMPORARY USE OF NON-DOWNLOADABLE COMPUTER SOFTWARE, NAMELY, SOFTWARE FOR THE CREATION AND DEVELOPMENT OF INFORMATION AND COMMUNICATIONS SECURITY FEATURES AND COMPONENTS FOR USE IN, BY OR WITH SOFTWARE APPLICATIONS; SOFTWARE AS A SERVICES (SAAS) FOR USE IN THE CREATION AND DEVELOPMENT OF INFORMATION AND COMMUNICATIONS SECURITY FEATURES AND COMPONENTS FOR USE IN, BY OR WITH SOFTWARE APPLICATIONS, IN CLASS 42 (U.S. CLS. 100 AND 101).

FIRST USE 10-14-2011; IN COMMERCE 10-14-2011.

THE MARK CONSISTS OF STANDARD CHARACTERS WITHOUT CLAIM TO ANY PARTICULAR FONT, STYLE, SIZE, OR COLOR.

SN 85-320,965, FILED 5-13-2011.

PAM WILLIS, EXAMINING ATTORNEY



David J. Kybas

Director of the United States Patent and Trademark Office

United States of America

United States Patent and Trademark Office

PRIZMALINE

Reg. No. 4,207,099

Registered Sep. 11, 2012

Int. Cl.: 11

TRADEMARK

PRINCIPAL REGISTER

LIGHTING SCIENCE GROUP CORPORATION (DELAWARE CORPORATION)
1227 SOUTH PATRICK DRIVE
BUILDING 2A
SATELLITE BEACH, FL 32937

FOR: LIGHTING FIXTURES, IN CLASS 11 (U.S. CLS. 13, 21, 23, 31 AND 34).

FIRST USE 5-9-2012; IN COMMERCE 5-9-2012.

THE MARK CONSISTS OF STANDARD CHARACTERS WITHOUT CLAIM TO ANY PARTICULAR FONT, STYLE, SIZE, OR COLOR.

SN 85-321,285, FILED 5-15-2011.

DOMINICK J. SALEMI, EXAMINING ATTORNEY



David J. Kyffers

Director of the United States Patent and Trademark Office

United States of America
United States Patent and Trademark Office

OMOLULU

Reg. No. 4,207,100

CALEDA, BRYNNE (UNITED STATES INDIVIDUAL)
2202 SAINT LOUIS DRIVE
HONOLULU, HI 96816

Registered Sep. 11, 2012

Int. Cl.: 9

FOR: PRE-RECORDED DVDS FEATURING YOGA INSTRUCTION; PRE-RECORDED ELECTRONIC AND DIGITAL MEDIA FEATURING YOGA INSTRUCTION, IN CLASS 9 (U.S. CLS. 21, 23, 26, 36 AND 38).

TRADEMARK

FIRST USE 6-20-2012; IN COMMERCE 6-20-2012.

PRINCIPAL REGISTER

THE MARK CONSISTS OF STANDARD CHARACTERS WITHOUT CLAIM TO ANY PARTICULAR FONT, STYLE, SIZE, OR COLOR.

THE WORDING "OMOLULU" HAS NO MEANING IN A FOREIGN LANGUAGE.

SN 85-321,383, FILED 5-16-2011.

AMY KERTGATE, EXAMINING ATTORNEY



David J. Kyffers

Director of the United States Patent and Trademark Office

United States of America

United States Patent and Trademark Office

MUDRUNNER

Reg. No. 4,207,101

WITZIGMAN, PATRICK (UNITED STATES INDIVIDUAL)
373 VINTAGE CIRCLE

Registered Sep. 11, 2012

MYRTLE BEACH, SC 29579

Int. Cl.: 25

FOR: CLOTHING, NAMELY, SHIRTS, PANTS, SHORTS, UNDERWEAR, SOCKS, HATS, HEAD BANDS, WRIST BANDS, SWEATSHIRTS, HOODED SWEATSHIRTS, CAPS, LONG SLEEVE SHIRTS, TANK TOPS, SHOES, IN CLASS 25 (U.S. CLS. 22 AND 39).

TRADEMARK

FIRST USE 6-29-2011; IN COMMERCE 1-1-2012.

PRINCIPAL REGISTER

THE MARK CONSISTS OF STANDARD CHARACTERS WITHOUT CLAIM TO ANY PARTICULAR FONT, STYLE, SIZE, OR COLOR.

SN 85-321,388, FILED 5-16-2011.

SUSAN LESLIE DUBOIS, EXAMINING ATTORNEY



David J. Kyros

Director of the United States Patent and Trademark Office

United States of America

United States Patent and Trademark Office

TRAILRAIL

Reg. No. 4,207,102

Registered Sep. 11, 2012

Int. Cl.: 6

TRADEMARK

PRINCIPAL REGISTER

BASILE, VINCENT M. (UNITED STATES INDIVIDUAL)
16 INDUSTRIAL PARKWAY
EASTHAMPTON, MA 01027 AND

BASILE, JENNIFER A. (UNITED STATES INDIVIDUAL)
16 INDUSTRIAL PARKWAY
EASTHAMPTON, MA 01027

FOR: METAL COMPONENTS, NAMELY, BRACKETS, SUPPORT RINGS AND SCREWS FOR MOUNTING ACCESSORIES TO OUTDOOR RECREATIONAL VEHICLES, IN CLASS 6 (U.S. CLS. 2, 12, 13, 14, 23, 25 AND 50).

FIRST USE 5-10-2012; IN COMMERCE 5-10-2012.

THE MARK CONSISTS OF STANDARD CHARACTERS WITHOUT CLAIM TO ANY PARTICULAR FONT, STYLE, SIZE, OR COLOR.

SN 85-321,528, FILED 5-16-2011.

SAMUEL E. SHARPER JR., EXAMINING ATTORNEY



David J. Kyfos

Director of the United States Patent and Trademark Office

United States of America

United States Patent and Trademark Office

Derma-Grit

Reg. No. 4,207,103

TEN TWO ENTERPRISES, LLC (NORTH CAROLINA LIMITED LIABILITY COMPANY)
300 BALLY SHANNON WAY
APEX, NC 27539

Registered Sep. 11, 2012

Int. Cl.: 3

FOR: COATED ABRASIVES AND SANDPAPER IN THE FORM OF BELTS, SHEETS, ROLLS AND DISCS, IN CLASS 3 (U.S. CLS. 1, 4, 6, 50, 51 AND 52).

TRADEMARK

FIRST USE 3-1-2012; IN COMMERCE 3-1-2012.

PRINCIPAL REGISTER

THE MARK CONSISTS OF STANDARD CHARACTERS WITHOUT CLAIM TO ANY PARTICULAR FONT, STYLE, SIZE, OR COLOR.

SN 85-321,663, FILED 5-16-2011.

ANDREA HACK, EXAMINING ATTORNEY



David J. Kyffers

Director of the United States Patent and Trademark Office

United States of America

United States Patent and Trademark Office

VASCAZEN

Reg. No. 4,207,104

Registered Sep. 11, 2012

Int. Cl.: 5

TRADEMARK

PRINCIPAL REGISTER

PIVOTAL THERAPEUTICS, INC. (CANADA CORPORATION)
UNIT 10
81 ZENWAY BLVD.
WOODBIDGE, CANADA ONTL4H0S5

FOR: ORAL THERAPEUTIC AGENTS AND SPECIALTY PHARMACEUTICALS, NAMELY, OMEGA-3 CAPSULES; PRESCRIPTION MEDICAL FOOD AND SPECIALTY PHARMACEUTICALS FOR THE DIETARY MANAGEMENT OF PATIENTS WITH CARDIOVASCULAR DISEASE, IN CLASS 5 (U.S. CLS. 6, 18, 44, 46, 51 AND 52).

FIRST USE 11-0-2011; IN COMMERCE 11-0-2011.

THE MARK CONSISTS OF STANDARD CHARACTERS WITHOUT CLAIM TO ANY PARTICULAR FONT, STYLE, SIZE, OR COLOR.

SN 85-321,813, FILED 5-16-2011.

DORITT L. CARROLL, EXAMINING ATTORNEY



David J. Kyffers

Director of the United States Patent and Trademark Office

United States of America

United States Patent and Trademark Office

STUDY SERVE CELEBRATE

Reg. No. 4,207,105

NATIONAL ASSOCIATION OF COLLEGE STORES, INC. (OHIO CORPORATION)
500 EAST LORAIN STREET
OBERLIN, OH 44074

Registered Sep. 11, 2012

Int. Cl.: 35

FOR: PROMOTING PUBLIC AWARENESS OF SOCIALLY RESPONSIBLE BEHAVIOR AND EFFORTS; CONDUCTING AN ADVERTISING CAMPAIGN TO ENCOURAGE THE PUBLIC TO RECOGNIZE SOCIALLY RESPONSIBLE BEHAVIOR AMONG COLLEGE STUDENTS, IN CLASS 35 (U.S. CLS. 100, 101 AND 102).

SERVICE MARK

PRINCIPAL REGISTER

FIRST USE 6-1-2011; IN COMMERCE 6-1-2011.

THE MARK CONSISTS OF STANDARD CHARACTERS WITHOUT CLAIM TO ANY PARTICULAR FONT, STYLE, SIZE, OR COLOR.

SN 85-321,837, FILED 5-16-2011.

JANET LEE, EXAMINING ATTORNEY



David J. Kybas

Director of the United States Patent and Trademark Office

United States of America

United States Patent and Trademark Office

NATIONAL STUDENT DAY STUDY SERVE CELEBRATE

Reg. No. 4,207,106

Registered Sep. 11, 2012

Int. Cl.: 35

SERVICE MARK

PRINCIPAL REGISTER

NATIONAL ASSOCIATION OF COLLEGE STORES, INC. (OHIO CORPORATION)
500 EAST LORAIN STREET
OBERLIN, OH 44074

FOR: PROMOTING PUBLIC AWARENESS OF SOCIALLY RESPONSIBLE BEHAVIOR AND EFFORTS; CONDUCTING AN ADVERTISING CAMPAIGN TO ENCOURAGE THE PUBLIC TO RECOGNIZE SOCIALLY RESPONSIBLE BEHAVIOR AMONG COLLEGE STUDENTS, IN CLASS 35 (U.S. CLS. 100, 101 AND 102).

FIRST USE 6-1-2011; IN COMMERCE 6-1-2011.

THE MARK CONSISTS OF STANDARD CHARACTERS WITHOUT CLAIM TO ANY PARTICULAR FONT, STYLE, SIZE, OR COLOR.

NO CLAIM IS MADE TO THE EXCLUSIVE RIGHT TO USE "NATIONAL STUDENT DAY", APART FROM THE MARK AS SHOWN.

SN 85-321,843, FILED 5-16-2011.

JANET LEE, EXAMINING ATTORNEY



David J. Kybas

Director of the United States Patent and Trademark Office

United States of America

United States Patent and Trademark Office

GLOVE THE PLANET

Reg. No. 4,207,107

Registered Sep. 11, 2012

Int. Cls.: 9 and 35

TRADEMARK

SERVICE MARK

PRINCIPAL REGISTER

SEMPERMED USA, INC. (DELAWARE CORPORATION)
13900 49TH STREET NORTH
CLEARWATER, FL 33762

FOR: DISPOSABLE LATEX, VINYL AND NITRILE PROTECTIVE GLOVES FOR GENERAL INDUSTRIAL PURPOSES, IN CLASS 9 (U.S. CLS. 21, 23, 26, 36 AND 38).

FIRST USE 7-29-2011; IN COMMERCE 7-29-2011.

FOR: DISTRIBUTORSHIPS IN THE FIELD OF MEDICAL, SURGICAL, EXAMINATION AND INDUSTRIAL PROTECTIVE GLOVES; ONLINE ORDERING SERVICES IN THE FIELD OF MEDICAL, SURGICAL, EXAMINATION AND INDUSTRIAL PROTECTIVE GLOVES, IN CLASS 35 (U.S. CLS. 100, 101 AND 102).

FIRST USE 7-29-2011; IN COMMERCE 7-29-2011.

THE MARK CONSISTS OF STANDARD CHARACTERS WITHOUT CLAIM TO ANY PARTICULAR FONT, STYLE, SIZE, OR COLOR.

NO CLAIM IS MADE TO THE EXCLUSIVE RIGHT TO USE "GLOVE", APART FROM THE MARK AS SHOWN.

SN 85-321,887, FILED 5-16-2011.

RENEE MCCRAY, EXAMINING ATTORNEY



David J. Kybas

Director of the United States Patent and Trademark Office

United States of America

United States Patent and Trademark Office

TEACH ME TUESDAY

Reg. No. 4,207,108

SAN FRANCISCO REAL ESTATE BOARD (CALIFORNIA CORPORATION)
301 GROVE STREET
SAN FRANCISCO, CA 94102

Registered Sep. 11, 2012

Int. Cl.: 41

FOR: EDUCATIONAL SERVICES, NAMELY, PROVIDING CLASSES, SEMINARS AND WORKSHOPS IN THE FIELDS OF REAL ESTATE, SALES AND MARKETING OF REAL ESTATE, THE USE OF PRODUCTIVITY TOOLS IN THE SALE AND MARKETING OF REAL ESTATE, SERVICES AND BENEFITS FOR REAL ESTATE BROKERS AND REAL ESTATE AGENTS, PROFESSIONAL LIABILITY OF REAL ESTATE BROKERS AND AGENTS, RISK MANAGEMENT FOR REAL ESTATE BROKERS AND AGENTS, LEGAL OBLIGATIONS AND LEGAL ISSUES EFFECTING REAL ESTATE BROKERS AND AGENTS, GOVERNMENT LEGISLATION EFFECTING REAL ESTATE AND REAL ESTATE BROKERS AND AGENTS, AND DISTRIBUTION OF COURSE MATERIALS IN CONNECTION THEREWITH, IN CLASS 41 (U.S. CLS. 100, 101 AND 107).

SERVICE MARK

PRINCIPAL REGISTER

FIRST USE 11-29-2011; IN COMMERCE 11-29-2011.

THE MARK CONSISTS OF STANDARD CHARACTERS WITHOUT CLAIM TO ANY PARTICULAR FONT, STYLE, SIZE, OR COLOR.

NO CLAIM IS MADE TO THE EXCLUSIVE RIGHT TO USE "TUESDAY", APART FROM THE MARK AS SHOWN.

SN 85-322,695, FILED 5-17-2011.

KATHERINE M. DUBRAY, EXAMINING ATTORNEY



David J. Kyros

Director of the United States Patent and Trademark Office

United States of America

United States Patent and Trademark Office

FANWALLSKINZ

Reg. No. 4,207,109

ADVANCED GRAPHIC PRODUCTS INC. (TEXAS CORPORATION)
750 GATEWAY
COPPELL, TX 75019

Registered Sep. 11, 2012

Int. Cl.: 16

FOR: PRINTED MATERIALS, NAMELY, DECALS THAT CAN BE REMOVEABLY AFFIXED TO A SOLID SURFACE, IN CLASS 16 (U.S. CLS. 2, 5, 22, 23, 29, 37, 38 AND 50).

TRADEMARK

FIRST USE 5-16-2012; IN COMMERCE 5-16-2012.

PRINCIPAL REGISTER

THE MARK CONSISTS OF STANDARD CHARACTERS WITHOUT CLAIM TO ANY PARTICULAR FONT, STYLE, SIZE, OR COLOR.

NO CLAIM IS MADE TO THE EXCLUSIVE RIGHT TO USE "WALL SKINS", APART FROM THE MARK AS SHOWN.

SN 85-322,966, FILED 5-17-2011.

JOHN DWYER, EXAMINING ATTORNEY



David J. Kybas

Director of the United States Patent and Trademark Office

United States of America

United States Patent and Trademark Office

VEINLITE VEIN ACCESS

Reg. No. 4,207,110

TRANSLITE, LLC (DELAWARE LIMITED LIABILITY COMPANY)
719 SANTA MARIA
SUGAR LAND, TX 77478

Registered Sep. 11, 2012

Int. Cl.: 10

FOR: MEDICAL INSTRUMENTS FOR USE IN THE ILLUMINATION OF VEINS, IN CLASS 10 (U.S. CLS. 26, 39 AND 44).

TRADEMARK

FIRST USE 2-10-2011; IN COMMERCE 2-10-2011.

PRINCIPAL REGISTER

THE MARK CONSISTS OF STANDARD CHARACTERS WITHOUT CLAIM TO ANY PARTICULAR FONT, STYLE, SIZE, OR COLOR.

OWNER OF U.S. REG. NOS. 3,204,511, 3,367,690, AND OTHERS.

NO CLAIM IS MADE TO THE EXCLUSIVE RIGHT TO USE "VEIN ACCESS", APART FROM THE MARK AS SHOWN.

SN 85-323,092, FILED 5-17-2011.

KRISTIN CARLSON, EXAMINING ATTORNEY



David J. Kyros

Director of the United States Patent and Trademark Office

United States of America

United States Patent and Trademark Office

ILIF

Reg. No. 4,207,111

NUVASIVE INC. (DELAWARE CORPORATION)
7475 LUSK BLVD
SAN DIEGO, CA 92121

Registered Sep. 11, 2012

Int. Cl.: 44

FOR: SURGICAL SERVICES, IN CLASS 44 (U.S. CLS. 100 AND 101).

SERVICE MARK

FIRST USE 11-10-2009; IN COMMERCE 11-10-2009.

PRINCIPAL REGISTER

THE MARK CONSISTS OF STANDARD CHARACTERS WITHOUT CLAIM TO ANY PARTICULAR FONT, STYLE, SIZE, OR COLOR.

SN 85-323,114, FILED 5-17-2011.

SANI KHOURI, EXAMINING ATTORNEY



David J. Kybas

Director of the United States Patent and Trademark Office

United States of America

United States Patent and Trademark Office

STAY LOOSE

Reg. No. 4,207,112

Registered Sep. 11, 2012

Int. Cl.: 30

TRADEMARK

PRINCIPAL REGISTER

CHADO-EN LLC (CALIFORNIA LIMITED LIABILITY COMPANY)
P.O. BOX 5
BODEGA BAY, CA 94923

FOR: TEA, IN CLASS 30 (U.S. CL. 46).

FIRST USE 6-27-2011; IN COMMERCE 6-27-2011.

THE MARK CONSISTS OF STANDARD CHARACTERS WITHOUT CLAIM TO ANY PARTICULAR FONT, STYLE, SIZE, OR COLOR.

SN 85-323,127, FILED 5-17-2011.

DORITT L. CARROLL, EXAMINING ATTORNEY



David J. Kyffers

Director of the United States Patent and Trademark Office

United States of America

United States Patent and Trademark Office

KOOKIE KRITTERS

Reg. No. 4,207,113

HIGH POINT DESIGN LLC (NEW YORK LIMITED LIABILITY COMPANY)

Registered Sep. 11, 2012

1411 BROADWAY
NEW YORK, NY 10018

Int. Cl.: 25

FOR: SOCKS, SLIPPER SOCKS, SLIPPERS, SOFT SLIPPERS, MUKLUKS, AND LEG WARMERS, IN CLASS 25 (U.S. CLS. 22 AND 39).

TRADEMARK

FIRST USE 10-25-2011; IN COMMERCE 10-25-2011.

PRINCIPAL REGISTER

THE MARK CONSISTS OF STANDARD CHARACTERS WITHOUT CLAIM TO ANY PARTICULAR FONT, STYLE, SIZE, OR COLOR.

NO CLAIM IS MADE TO THE EXCLUSIVE RIGHT TO USE "CRITTERS", APART FROM THE MARK AS SHOWN.

SN 85-323,148, FILED 5-17-2011.

EMILY CARLSEN, EXAMINING ATTORNEY



David J. Kyffers

Director of the United States Patent and Trademark Office

United States of America

United States Patent and Trademark Office

A GROWING REPUTATION FOR QUALITY

Reg. No. 4,207,114

SUNBURST FARMS, INC. (DELAWARE CORPORATION)
2200 NW 70TH AVENUE
MIAMI, FL 33122

Registered Sep. 11, 2012

Int. Cl.: 31

FOR: CUT FLOWERS, IN CLASS 31 (U.S. CLS. 1 AND 46).

TRADEMARK

FIRST USE 6-1-1985; IN COMMERCE 6-1-1985.

PRINCIPAL REGISTER

THE MARK CONSISTS OF STANDARD CHARACTERS WITHOUT CLAIM TO ANY PARTICULAR FONT, STYLE, SIZE, OR COLOR.

SN 85-323,205, FILED 5-17-2011.

VERNA BETH RIRIE, EXAMINING ATTORNEY



David J. Kyffers

Director of the United States Patent and Trademark Office

United States of America

United States Patent and Trademark Office

HEADSHRINKER

Reg. No. 4,207,115

Registered Sep. 11, 2012

Int. Cl.: 33

TRADEMARK

PRINCIPAL REGISTER

THE WINE GROUP LLC (DELAWARE LIMITED LIABILITY COMPANY)
4596 S. TRACY BLVD.
TRACY, CA 95377

FOR: WINE, IN CLASS 33 (U.S. CLS. 47 AND 49).

FIRST USE 10-26-2011; IN COMMERCE 10-26-2011.

THE MARK CONSISTS OF STANDARD CHARACTERS WITHOUT CLAIM TO ANY PARTICULAR FONT, STYLE, SIZE, OR COLOR.

SN 85-323,239, FILED 5-17-2011.

KRISTIN DAHLING, EXAMINING ATTORNEY



David J. Kyffers

Director of the United States Patent and Trademark Office

United States of America

United States Patent and Trademark Office



Reg. No. 4,207,116

Registered Sep. 11, 2012

Int. Cl.: 16

TRADEMARK

PRINCIPAL REGISTER

LYDIA RUTH BATES (UNITED STATES INDIVIDUAL)
4 W. 48TH AVENUE
KENNEWICK, WA 99337

FOR: SERIES OF FICTION BOOKS; SERIES OF NON-FICTION BOOKS IN THE FIELD OF THE CHRISTIAN FAITH FOR ADULTS AND FOR CHILDREN, IN CLASS 16 (U.S. CLS. 2, 5, 22, 23, 29, 37, 38 AND 50).

FIRST USE 1-3-2012; IN COMMERCE 1-3-2012.

THE MARK CONSISTS OF JOINED RECTANGLES, ONE ABOVE THE OTHER. THE UPPER RECTANGLE ENCLOSING A CROWN. THE LOWER RECTANGLE ENCLOSING THE LITERAL ELEMENTS "LYASE EDWARDA JEWEL ALEXANDRA LYDIA RUTH BARTHOLOMEW BATES PRINCESS PRODUCTS" ALL IN GOLD.

THE COLOR(S) GOLD IS/ARE CLAIMED AS A FEATURE OF THE MARK.

SN 85-323,399, FILED 5-17-2011.

MATTHEW KLINE, EXAMINING ATTORNEY



David J. Kyffers

Director of the United States Patent and Trademark Office

United States of America

United States Patent and Trademark Office

File For

* FINAL * WISHES *

Reg. No. 4,207,117

FILE FOR FINAL WISHES, LLC (LOUISIANA LIMITED LIABILITY COMPANY)
213 NORTH COLLEGE ROAD
LAFAYETTE, LA 70506

Registered Sep. 11, 2012

Int. Cl.: 16

FOR: MULTI-POCKET EXPANDABLE FOLDERS HAVING TAB LABELS FOR EACH POCKET, AND A SLEEVE FOR HOLDING A COMPACT DISC, IN CLASS 16 (U.S. CLS. 2, 5, 22, 23, 29, 37, 38 AND 50).

TRADEMARK

FIRST USE 1-31-2012; IN COMMERCE 1-31-2012.

PRINCIPAL REGISTER

NO CLAIM IS MADE TO THE EXCLUSIVE RIGHT TO USE "FILE", APART FROM THE MARK AS SHOWN.

THE MARK CONSISTS OF THE WORDS "FILE FOR FINAL WISHES" PLUS A DESIGN COMPRISING A PLURALITY OF STARS.

SN 85-323,408, FILED 5-17-2011.

WENDY GOODMAN, EXAMINING ATTORNEY



David J. Kyjars

Director of the United States Patent and Trademark Office

United States of America

United States Patent and Trademark Office

LIFE ON THE POLE

Reg. No. 4,207,118

Registered Sep. 11, 2012

Int. Cl.: 16

TRADEMARK

PRINCIPAL REGISTER

RAVENNATI, LOU (UNITED STATES INDIVIDUAL)
116 WALNUT STREET
WASHINGTON, NJ 07676 AND

SALAMI, JOHNNIE (UNITED STATES INDIVIDUAL)
116 WALNUT STREET
WASHINGTON, NJ 07676

FOR: STORY BOOKS, IN CLASS 16 (U.S. CLS. 2, 5, 22, 23, 29, 37, 38 AND 50).

FIRST USE 6-6-2012; IN COMMERCE 6-6-2012.

THE MARK CONSISTS OF STANDARD CHARACTERS WITHOUT CLAIM TO ANY PARTICULAR FONT, STYLE, SIZE, OR COLOR.

SN 85-323,457, FILED 5-18-2011.

KRISTIN DAHLING, EXAMINING ATTORNEY



David J. Kybas

Director of the United States Patent and Trademark Office

United States of America

United States Patent and Trademark Office

RINK BLASTER

Reg. No. 4,207,119

RICHARD J. SETTEMBRE (UNITED STATES INDIVIDUAL)
4305 LUNA COURSE
LIVERPOOL, NY 13090

Registered Sep. 11, 2012

Int. Cl.: 8

FOR: SHOVELS, IN CLASS 8 (U.S. CLS. 23, 28 AND 44).

TRADEMARK

FIRST USE 11-1-2010; IN COMMERCE 11-1-2010.

PRINCIPAL REGISTER

THE MARK CONSISTS OF STANDARD CHARACTERS WITHOUT CLAIM TO ANY PARTICULAR FONT, STYLE, SIZE, OR COLOR.

NO CLAIM IS MADE TO THE EXCLUSIVE RIGHT TO USE "RINK", APART FROM THE MARK AS SHOWN.

SN 85-323,571, FILED 5-18-2011.

ZACHARY BELLO, EXAMINING ATTORNEY



David J. Kyffers

Director of the United States Patent and Trademark Office

United States of America

United States Patent and Trademark Office

SALLY HANSEN GEM CRUSH

Reg. No. 4,207,120

COTY US LLC (DELAWARE LIMITED LIABILITY COMPANY)
2 PARK AVENUE
NEW YORK, NY 10016

Registered Sep. 11, 2012

Int. Cl.: 3

FOR: NAIL CARE PREPARATIONS, NAMELY, HIGH GLOSS NAIL POLISH, IN CLASS 3
(U.S. CLS. 1, 4, 6, 50, 51 AND 52).

TRADEMARK

FIRST USE 12-30-2011; IN COMMERCE 12-30-2011.

PRINCIPAL REGISTER

THE MARK CONSISTS OF STANDARD CHARACTERS WITHOUT CLAIM TO ANY PARTICULAR FONT, STYLE, SIZE, OR COLOR.

OWNER OF U.S. REG. NOS. 688,093, 1,931,107, AND OTHERS.

THE NAME "SALLY HANSEN" DOES NOT IDENTIFY A LIVING INDIVIDUAL.

SN 85-323,584, FILED 5-18-2011.

SAMUEL E. SHARPER JR., EXAMINING ATTORNEY



David J. Kyros

Director of the United States Patent and Trademark Office

United States of America

United States Patent and Trademark Office

wikiesquire

Reg. No. 4,207,121

WIKIESQUIRE LLC (DELAWARE LIMITED LIABILITY COMPANY)
11699 BROOKHAVEN AVE. APT. 4
LOS ANGELES, CA 90064

Registered Sep. 11, 2012

Int. Cl.: 45

FOR: PROVIDING AN ON-LINE INTERACTIVE DATABASE FEATURING LEGAL INFORMATION, IN CLASS 45 (U.S. CLS. 100 AND 101).

SERVICE MARK

FIRST USE 5-1-2012; IN COMMERCE 5-1-2012.

PRINCIPAL REGISTER

THE MARK CONSISTS OF STANDARD CHARACTERS WITHOUT CLAIM TO ANY PARTICULAR FONT, STYLE, SIZE, OR COLOR.

SN 85-323,646, FILED 5-18-2011.

SKYE YOUNG, EXAMINING ATTORNEY



David J. Kybas

Director of the United States Patent and Trademark Office

United States of America

United States Patent and Trademark Office

Get off zero!

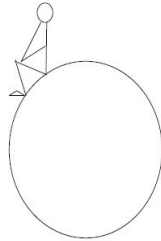

Reg. No. 4,207,122

Registered Sep. 11, 2012

Int. Cl.: 41

SERVICE MARK

PRINCIPAL REGISTER

INNERWORKINGS INSTITUTE LLC (NEW JERSEY LIMITED LIABILITY COMPANY)
6 MANSION HILL DR.
WEST TRENTON, NJ 08628

FOR: EDUCATION SERVICES, NAMELY, PROVIDING LIVE AND ON-LINE WEBINARS, COURSES, AND WORKSHOPS IN THE FIELD OF MOTIVATIONAL PROGRAMMING SUCH AS MEETING GOALS AND AVOIDING PROCRASTINATION; EDUCATIONAL SERVICES, NAMELY, PROVIDING EDUCATIONAL SPEAKERS IN THE FIELD OF MOTIVATIONAL PROGRAMMING SUCH AS MEETING GOALS AND AVOIDING PROCRASTINATION; LIFE COACHING SERVICES IN THE FIELD OF MEETING GOALS AND AVOIDING PROCRASTINATION, IN CLASS 41 (U.S. CLS. 100, 101 AND 107).

FIRST USE 5-1-2012; IN COMMERCE 5-1-2012.

THE MARK CONSISTS OF "GET OFF ZERO!" IN STYLIZED FONT. BELOW THE LITERAL ELEMENT IS A CIRCLE WITH A STYLIZED HUMAN FIGURE SITTING ON IT.

SN 85-323,749, FILED 5-18-2011.

ROBIN CHOSID, EXAMINING ATTORNEY



David J. Kyffers

Director of the United States Patent and Trademark Office

United States of America

United States Patent and Trademark Office

Stnless Bx
Hassle free dispenser holder

Reg. No. 4,207,123

ORTIZ, JUANA (UNITED STATES INDIVIDUAL)
2715 CASA LINDAN WAY
SAN MARCOS, CA 92069

Registered Sep. 11, 2012

Int. Cl.: 21

FOR: CONTAINERS FOR HOUSEHOLD OR KITCHEN USE OF PRECIOUS METAL, IN CLASS 21 (U.S. CLS. 2, 13, 23, 29, 30, 33, 40 AND 50).

TRADEMARK

FIRST USE 6-15-2011; IN COMMERCE 6-15-2011.

PRINCIPAL REGISTER

NO CLAIM IS MADE TO THE EXCLUSIVE RIGHT TO USE "STAINLESS BOX" AND "DISPENSER HOLDER", APART FROM THE MARK AS SHOWN.

THE MARK CONSISTS OF THE STYLIZED TEXT "STNLESS BX HASSLE FREE DISPENSER HOLDER" WITH A CURVED ZIGZAG UNDERNEATH THE STYLIZED TEXT "STNLESS".

SN 85-323,762, FILED 5-18-2011.

FLORENTINA BLANDU, EXAMINING ATTORNEY



David J. Kybas

Director of the United States Patent and Trademark Office

United States of America

United States Patent and Trademark Office

3rd Cup Café & Venue, "Let's get to the 3rd Cup"

Reg. No. 4,207,124

3RD CUP CAFE & VENUE LLC (HAWAII LIMITED LIABILITY COMPANY)
911051 MAKAHAIAKU STREET
KAPOLEI, HI 96707

Registered Sep. 11, 2012

Int. Cl.: 30

FOR: COFFEE BASED BEVERAGES, IN CLASS 30 (U.S. CL. 46).

TRADEMARK

FIRST USE 10-1-2010; IN COMMERCE 11-23-2011.

PRINCIPAL REGISTER

THE MARK CONSISTS OF STANDARD CHARACTERS WITHOUT CLAIM TO ANY PARTICULAR FONT, STYLE, SIZE, OR COLOR.

NO CLAIM IS MADE TO THE EXCLUSIVE RIGHT TO USE "CAFÉ & VENUE", APART FROM THE MARK AS SHOWN.

SN 85-323,826, FILED 5-18-2011.

MARGARET POWER, EXAMINING ATTORNEY



David J. Kyros

Director of the United States Patent and Trademark Office

United States of America

United States Patent and Trademark Office

THEORETICAL & APPLIED ORGANIZING (TAO)

Reg. No. 4,207,125

Registered Sep. 11, 2012

Int. Cl.: 41

SERVICE MARK

PRINCIPAL REGISTER

LAI, REX P. (UNITED STATES INDIVIDUAL)
8803 CASTLEFORD LANE
CINCINNATI, OH 45242

FOR: EDUCATION SERVICES, NAMELY, PROVIDING WORKSHOPS IN THE FIELDS OF COMMUNITY, GRASSROOTS AND UNION ORGANIZING, IN CLASS 41 (U.S. CLS. 100, 101 AND 107).

FIRST USE 10-0-2011; IN COMMERCE 10-0-2011.

THE MARK CONSISTS OF STANDARD CHARACTERS WITHOUT CLAIM TO ANY PARTICULAR FONT, STYLE, SIZE, OR COLOR.

NO CLAIM IS MADE TO THE EXCLUSIVE RIGHT TO USE "THEORETICAL & APPLIED ORGANIZING", APART FROM THE MARK AS SHOWN.

SN 85-324,570, FILED 5-19-2011.

TRICIA SONNEBORN, EXAMINING ATTORNEY



David J. Kyffers

Director of the United States Patent and Trademark Office

United States of America

United States Patent and Trademark Office

DATE FOR THE DANCE

Reg. No. 4,207,126

Registered Sep. 11, 2012

Int. Cl.: 28

TRADEMARK

PRINCIPAL REGISTER

MATTEL, INC. (DELAWARE CORPORATION)
M1-1518
333 CONTINENTAL BOULEVARD
EL SEGUNDO, CA 90245

FOR: DOLLS, DOLL CLOTHING AND DOLL ACCESSORIES, IN CLASS 28 (U.S. CLS. 22, 23, 38 AND 50).

FIRST USE 11-21-2011; IN COMMERCE 11-21-2011.

THE MARK CONSISTS OF STANDARD CHARACTERS WITHOUT CLAIM TO ANY PARTICULAR FONT, STYLE, SIZE, OR COLOR.

SN 85-324,657, FILED 5-19-2011.

STEPHANIE ALI, EXAMINING ATTORNEY



David J. Kyffers

Director of the United States Patent and Trademark Office

United States of America

United States Patent and Trademark Office

ANHELO

Reg. No. 4,207,127

Registered Sep. 11, 2012

Int. Cl.: 33

TRADEMARK

PRINCIPAL REGISTER

PETITO, THOMAS (UNITED STATES INDIVIDUAL)
7855 NORTH BOULEVARD EAST
NORTH BERGEN, NJ 07047

FOR: WINE, IN CLASS 33 (U.S. CLS. 47 AND 49).

FIRST USE 6-1-2012; IN COMMERCE 6-1-2012.

THE MARK CONSISTS OF STANDARD CHARACTERS WITHOUT CLAIM TO ANY PARTICULAR FONT, STYLE, SIZE, OR COLOR.

THE ENGLISH TRANSLATION OF "ANHELO" IN THE MARK IS "YEARNING".

SN 85-324,685, FILED 5-19-2011.

STEPHANIE ALI, EXAMINING ATTORNEY



David J. Kybas

Director of the United States Patent and Trademark Office

United States of America

United States Patent and Trademark Office

FINANCIAL PRESCRIPTIONS

Reg. No. 4,207,128

LIGGERO, ROBERT (UNITED STATES INDIVIDUAL)
389 12TH STREET

Registered Sep. 11, 2012

ATLANTIC BEACH, FL 32233

Int. Cl.: 36

FOR: FINANCIAL PLANNING, IN CLASS 36 (U.S. CLS. 100, 101 AND 102).

SERVICE MARK

FIRST USE 7-1-2011; IN COMMERCE 7-1-2011.

PRINCIPAL REGISTER

THE MARK CONSISTS OF STANDARD CHARACTERS WITHOUT CLAIM TO ANY PARTICULAR FONT, STYLE, SIZE, OR COLOR.

NO CLAIM IS MADE TO THE EXCLUSIVE RIGHT TO USE "FINANCIAL", APART FROM THE MARK AS SHOWN.

SN 85-324,907, FILED 5-19-2011.

BARBARA RUTLAND, EXAMINING ATTORNEY



David J. Kyffers

Director of the United States Patent and Trademark Office

United States of America

United States Patent and Trademark Office

AXXE

Reg. No. 4,207,129

Registered Sep. 11, 2012

Int. Cl.: 5

TRADEMARK

PRINCIPAL REGISTER

BIOSAFE SYSTEMS LLC (CONNECTICUT LIMITED LIABILITY COMPANY)
22 MEADOW STREET
EAST HARTFORD, CT 06108

FOR: HERBICIDES, IN CLASS 5 (U.S. CLS. 6, 18, 44, 46, 51 AND 52).

FIRST USE 4-1-2012; IN COMMERCE 4-1-2012.

THE MARK CONSISTS OF STANDARD CHARACTERS WITHOUT CLAIM TO ANY PARTICULAR FONT, STYLE, SIZE, OR COLOR.

SN 85-325,095, FILED 5-19-2011.

DAVID TAYLOR, EXAMINING ATTORNEY



David J. Kybas

Director of the United States Patent and Trademark Office

United States of America

United States Patent and Trademark Office

BRANDI RENEE DESIGNS

Reg. No. 4,207,130

BRANDI RENEE DESIGNS, L.L.C. (TEXAS LIMITED LIABILITY COMPANY)
500 NORTH KIMBALL AVE., SUITE 105
SOUTHLAKE, TX 76092

Registered Sep. 11, 2012

Int. Cls.: 20, 24, and 25

FOR: FURNITURE; OTTOMANS; PILLOWS, IN CLASS 20 (U.S. CLS. 2, 13, 22, 25, 32 AND 50).

TRADEMARK

FIRST USE 7-0-2011; IN COMMERCE 7-0-2011.

PRINCIPAL REGISTER

FOR: FABRIC TABLE RUNNERS; DRAPERY PANELS; THROWS; BEDSPREADS, IN CLASS 24 (U.S. CLS. 42 AND 50).

FIRST USE 7-0-2011; IN COMMERCE 7-0-2011.

FOR: SHOES; FLIP FLOPS; BOOTS; CLOTHING, NAMELY, SCARVES, DUSTERS, SHAWLS, JACKETS, COWBOY HATS, CAPS, HATS; BELTS, IN CLASS 25 (U.S. CLS. 22 AND 39).

FIRST USE 10-0-2011; IN COMMERCE 10-0-2011.

THE MARK CONSISTS OF STANDARD CHARACTERS WITHOUT CLAIM TO ANY PARTICULAR FONT, STYLE, SIZE, OR COLOR.

NO CLAIM IS MADE TO THE EXCLUSIVE RIGHT TO USE "DESIGNS", APART FROM THE MARK AS SHOWN.

THE NAME SHOWN IN THE MARK IDENTIFIES "BRANDI RENEE", WHOSE CONSENT IS MADE OF RECORD.

SN 85-325,234, FILED 5-19-2011.

SUSAN RICHARDS, EXAMINING ATTORNEY



David J. Kybas

Director of the United States Patent and Trademark Office

United States of America

United States Patent and Trademark Office

BR
BRANDI RENEE
Designs

Reg. No. 4,207,131

Registered Sep. 11, 2012

Int. Cls.: 20, 24, and 25

TRADEMARK

PRINCIPAL REGISTER

BRANDI RENEE DESIGNS, L.L.C. (TEXAS LIMITED LIABILITY COMPANY)
500 NORTH KIMBALL AVE., SUITE 105
SOUTHLAKE, TX 76092

FOR: FURNITURE; OTTOMANS; PILLOWS, IN CLASS 20 (U.S. CLS. 2, 13, 22, 25, 32 AND 50).

FIRST USE 7-0-2011; IN COMMERCE 7-0-2011.

FOR: FABRIC TABLE RUNNERS; DRAPERY PANELS; THROWS; BEDSPREADS, IN CLASS 24 (U.S. CLS. 42 AND 50).

FIRST USE 7-0-2011; IN COMMERCE 7-0-2011.

FOR: SHOES; FLIP FLOPS; BOOTS; CLOTHING, NAMELY, SCARVES, DUSTERS, SHAWLS, JACKETS, COWBOY HATS, CAPS, HATS; BELTS, IN CLASS 25 (U.S. CLS. 22 AND 39).

FIRST USE 10-0-2011; IN COMMERCE 10-0-2011.

NO CLAIM IS MADE TO THE EXCLUSIVE RIGHT TO USE "DESIGNS", APART FROM THE MARK AS SHOWN.

THE NAME SHOWN IN THE MARK IDENTIFIES "BRANDI RENEE", WHOSE CONSENT IS MADE OF RECORD.

THE MARK CONSISTS OF THE STYLIZED LETTERS "BR" ABOVE THE WORDS "BRANDI RENEE" AND "DESIGNS".

SN 85-325,245, FILED 5-19-2011.

SUSAN RICHARDS, EXAMINING ATTORNEY



David J. Kybas

Director of the United States Patent and Trademark Office

United States of America

United States Patent and Trademark Office

Moonlight Serenade

Reg. No. 4,207,132

Registered Sep. 11, 2012

Int. Cl.: 29

TRADEMARK

PRINCIPAL REGISTER

MATOSANTOS COMMERCIAL CORP. (PUERTO RICO CORPORATION)
CABO CARIBE INDUSTRIAL PARK
A STREET LOT 23
VEGA BAJA, PUERTO RICO 00693

FOR: FROZEN WHOLE BLUEBERRIES, IN CLASS 29 (U.S. CL. 46).

FIRST USE 9-0-2011; IN COMMERCE 9-0-2011.

THE MARK CONSISTS OF STANDARD CHARACTERS WITHOUT CLAIM TO ANY PARTICULAR FONT, STYLE, SIZE, OR COLOR.

SN 85-325,659, FILED 5-20-2011.

WILLIAM BRECKENFELD, EXAMINING ATTORNEY



David J. Kybas

Director of the United States Patent and Trademark Office

United States of America

United States Patent and Trademark Office

Sunrise Delight

Reg. No. 4,207,133

Registered Sep. 11, 2012

Int. Cl.: 29

TRADEMARK

PRINCIPAL REGISTER

MATOSANTOS COMMERCIAL CORP. (PUERTO RICO CORPORATION)
CABO CARIBE INDUSTRIAL PARK
A STREET LOT 23
VEGA BAJA, PUERTO RICO 00693

FOR: MIXTURE OF FROZEN MANGO CHUNKS, SLICED STRAWBERRIES AND SLICED PEACHES, IN CLASS 29 (U.S. CL. 46).

FIRST USE 9-0-2011; IN COMMERCE 9-0-2011.

THE MARK CONSISTS OF STANDARD CHARACTERS WITHOUT CLAIM TO ANY PARTICULAR FONT, STYLE, SIZE, OR COLOR.

SN 85-325,663, FILED 5-20-2011.

WILLIAM BRECKENFELD, EXAMINING ATTORNEY



David J. Kyffers

Director of the United States Patent and Trademark Office

United States of America

United States Patent and Trademark Office

Mister Collins

Reg. No. 4,207,134

Registered Sep. 11, 2012

Int. Cl.: 43

SERVICE MARK

PRINCIPAL REGISTER

YEAGER MANAGEMENT GROUP, LLC (FLORIDA LIMITED LIABILITY COMPANY)
UNIT 1505
17201 COLLINS AVE.
SUNNY ISLES, FL 33160

FOR: BAR AND RESTAURANT SERVICES, IN CLASS 43 (U.S. CLS. 100 AND 101).

FIRST USE 5-20-2011; IN COMMERCE 1-22-2012.

THE MARK CONSISTS OF STANDARD CHARACTERS WITHOUT CLAIM TO ANY PARTICULAR FONT, STYLE, SIZE, OR COLOR.

SN 85-325,775, FILED 5-20-2011.

EMILY CARLSEN, EXAMINING ATTORNEY



David J. Kybas

Director of the United States Patent and Trademark Office

United States of America

United States Patent and Trademark Office

EHC IX Plus

Reg. No. 4,207,135

Registered Sep. 11, 2012

Int. Cl.: 1

TRADEMARK

PRINCIPAL REGISTER

ECO FLUID CENTER LTD. (CANADA CORPORATION)
58 GARNOCK AVENUE
TORONTO, CANADA M4K1M2

FOR: ION-EXCHANGE RESINS, IN CLASS 1 (U.S. CLS. 1, 5, 6, 10, 26 AND 46).

FIRST USE 5-7-2011; IN COMMERCE 5-7-2011.

THE MARK CONSISTS OF STANDARD CHARACTERS WITHOUT CLAIM TO ANY PARTICULAR FONT, STYLE, SIZE, OR COLOR.

NO CLAIM IS MADE TO THE EXCLUSIVE RIGHT TO USE "EHC", APART FROM THE MARK AS SHOWN.

SN 85-325,890, FILED 5-20-2011.

BENJAMIN OKEKE, EXAMINING ATTORNEY



David J. Kyffers

Director of the United States Patent and Trademark Office

United States of America

United States Patent and Trademark Office

RISKCHECKNOW

Reg. No. 4,207,136

Registered Sep. 11, 2012

Int. Cls.: 35, 42, and 45

SERVICE MARK

PRINCIPAL REGISTER

APPRISS, INC. (DELAWARE CORPORATION)
10401 LINN STATION ROAD
LOUISVILLE, KY 40223

FOR: BUSINESS INFORMATION SERVICES, NAMELY, MONITORING AND REPORTING OF OFFENDER ARREST DATA FOR BUSINESSES AND INDIVIDUALS, IN CLASS 35 (U.S. CLS. 100, 101 AND 102).

FIRST USE 7-15-2011; IN COMMERCE 7-15-2011.

FOR: SOFTWARE AS A SERVICE (SAAS) SERVICES FEATURING SOFTWARE FOR PROVIDING CRIMINAL OFFENDER ARREST DATA, IN CLASS 42 (U.S. CLS. 100 AND 101).

FIRST USE 7-15-2011; IN COMMERCE 7-15-2011.

FOR: PROVIDING CRIMINAL OFFENDER ARREST DATA VIA A GLOBAL COMPUTER NETWORK, IN CLASS 45 (U.S. CLS. 100 AND 101).

FIRST USE 7-15-2011; IN COMMERCE 7-15-2011.

THE MARK CONSISTS OF STANDARD CHARACTERS WITHOUT CLAIM TO ANY PARTICULAR FONT, STYLE, SIZE, OR COLOR.

OWNER OF U.S. REG. NO. 3,225,958.

SN 85-325,931, FILED 5-20-2011.

BRENDAN MCCAULEY, EXAMINING ATTORNEY



David J. Kybas

Director of the United States Patent and Trademark Office

United States of America

United States Patent and Trademark Office

SEATOWN

Reg. No. 4,207,137

SEATOWN HULL LLC (MASSACHUSETTS LIMITED LIABILITY COMPANY)
105 MANOMET AVENUE
HULL, MA 02045

Registered Sep. 11, 2012

Int. Cl.: 25

FOR: HOODED SWEATSHIRTS; SHORT-SLEEVED OR LONG-SLEEVED T-SHIRTS;
SWEATSHIRTS; T-SHIRTS, IN CLASS 25 (U.S. CLS. 22 AND 39).

TRADEMARK

FIRST USE 6-1-2012; IN COMMERCE 6-1-2012.

PRINCIPAL REGISTER

THE MARK CONSISTS OF STANDARD CHARACTERS WITHOUT CLAIM TO ANY PARTICULAR FONT, STYLE, SIZE, OR COLOR.

SN 85-326,113, FILED 5-20-2011.

GISELLE AGOSTO, EXAMINING ATTORNEY



David J. Kyffers

Director of the United States Patent and Trademark Office

United States of America

United States Patent and Trademark Office

ALL BE HAPPY!

Reg. No. 4,207,138

LAUGHING MAN WORLDWIDE LLC (NEW YORK LIMITED LIABILITY COMPANY)
184 DUANE STREET
NEW YORK, NY 10013

Registered Sep. 11, 2012

Int. Cls.: 21, 25, and 30

FOR: COFFEE CUPS AND MUGS; TEA CUPS AND MUGS, IN CLASS 21 (U.S. CLS. 2, 13, 23, 29, 30, 33, 40 AND 50).

TRADEMARK

FIRST USE 10-12-2011; IN COMMERCE 10-12-2011.

PRINCIPAL REGISTER

FOR: T-SHIRTS; SWEATSHIRTS; HATS, IN CLASS 25 (U.S. CLS. 22 AND 39).

FIRST USE 10-12-2011; IN COMMERCE 10-12-2011.

FOR: COFFEE; HOT AND ICED COFFEE AND COFFEE-BASED BEVERAGES; TEA; HOT AND ICED TEA AND TEA-BASED BEVERAGES; HOT CHOCOLATE; CHOCOLATE-BASED BEVERAGES WITH MILK; COCOA AND COCOA-BASED BEVERAGES, IN CLASS 30 (U.S. CL. 46).

FIRST USE 10-12-2011; IN COMMERCE 10-12-2011.

THE MARK CONSISTS OF STANDARD CHARACTERS WITHOUT CLAIM TO ANY PARTICULAR FONT, STYLE, SIZE, OR COLOR.

SN 85-326,223, FILED 5-20-2011.

MICHAEL TANNER, EXAMINING ATTORNEY



David J. Kybas

Director of the United States Patent and Trademark Office

United States of America

United States Patent and Trademark Office

Stick Rx

Reg. No. 4,207,139

Registered Sep. 11, 2012

Int. Cls.: 28 and 41

TRADEMARK

SERVICE MARK

PRINCIPAL REGISTER

ARTHUR FAYGENHOLTZ DC INC. (CALIFORNIA CORPORATION)
SUITE 1B
831 BAY AVE.
CAPITOLA, CA 95010

FOR: PHYSICAL FITNESS EQUIPMENT, NAMELY, STICKS FOR USE IN PHYSICAL TRAINING AND CONDITIONING OF MUSCLES OF THE ENTIRE BODY; POSTURE CORRECTION DEVICE, NAMELY, AN ADJUSTABLE HARNESS TO CORRECT ONE'S POSTURE FOR SPORTS OR OTHER PHYSICAL TRAINING PURPOSES, IN CLASS 28 (U.S. CLS. 22, 23, 38 AND 50).

FIRST USE 5-23-2009; IN COMMERCE 6-20-2010.

FOR: COUNSELING SERVICES IN THE FIELD OF PHYSICAL FITNESS; PHYSICAL FITNESS CONDITIONING CLASSES; PHYSICAL FITNESS INSTRUCTION; PHYSICAL FITNESS STUDIO SERVICES, NAMELY, PROVIDING EXERCISE CLASSES, BODY SCULPTING CLASSES, AND GROUP FITNESS CLASSES; PHYSICAL FITNESS STUDIO SERVICES, NAMELY, PROVIDING GROUP EXERCISE INSTRUCTION, EQUIPMENT, AND FACILITIES; PHYSICAL FITNESS TRAINING OF INDIVIDUALS AND GROUPS; PHYSICAL FITNESS TRAINING SERVICES; PROVIDING ASSISTANCE, PERSONAL TRAINING AND PHYSICAL FITNESS CONSULTATION TO CORPORATE CLIENTS TO HELP THEIR EMPLOYEES MAKE PHYSICAL FITNESS, STRENGTH, CONDITIONING, AND EXERCISE ALTERATIONS IN THEIR DAILY LIVING; PROVIDING ASSISTANCE, PERSONAL TRAINING AND PHYSICAL FITNESS CONSULTATION TO INDIVIDUALS TO HELP THEM MAKE PHYSICAL FITNESS, STRENGTH, CONDITIONING, AND EXERCISE IMPROVEMENT IN THEIR DAILY LIVING; PROVIDING INFORMATION ON PHYSICAL EXERCISE; PROVIDING PHYSICAL FITNESS AND EXERCISE SERVICE, NAMELY, INDOOR CYCLING AND YOGA INSTRUCTION, IN CLASS 41 (U.S. CLS. 100, 101 AND 107).

FIRST USE 5-23-2009; IN COMMERCE 6-20-2010.

THE MARK CONSISTS OF STANDARD CHARACTERS WITHOUT CLAIM TO ANY PARTICULAR FONT, STYLE, SIZE, OR COLOR.

NO CLAIM IS MADE TO THE EXCLUSIVE RIGHT TO USE "STICK" , APART FROM THE MARK AS SHOWN.



David J. Kyjars

Director of the United States Patent and Trademark Office

Reg. No. 4,207,139 SN 85-326,301, FILED 5-20-2011.

JAY BESCH, EXAMINING ATTORNEY

United States of America

United States Patent and Trademark Office

THE POLLER BEAR

Reg. No. 4,207,140

MCMILLION RESEARCH LLC (WEST VIRGINIA LIMITED LIABILITY COMPANY)
1012 KANAWHA BLVD EAST, SUITE 301
CHARLESTON, WV 25301

Registered Sep. 11, 2012

Int. Cl.: 35

FOR: MARKET RESEARCH AND PUBLIC OPINION POLLING SERVICES, IN CLASS 35
(U.S. CLS. 100, 101 AND 102).

SERVICE MARK

FIRST USE 11-0-2010; IN COMMERCE 11-0-2010.

PRINCIPAL REGISTER

THE MARK CONSISTS OF STANDARD CHARACTERS WITHOUT CLAIM TO ANY PARTICULAR FONT, STYLE, SIZE, OR COLOR.

SN 85-326,466, FILED 5-20-2011.

RON FAIRBANKS, EXAMINING ATTORNEY



David J. Kybas

Director of the United States Patent and Trademark Office

United States of America

United States Patent and Trademark Office

WOOFSTICK

Reg. No. 4,207,141

Registered Sep. 11, 2012

Int. Cl.: 28

TRADEMARK

PRINCIPAL REGISTER

SIGN OF THE CRAB, LLC (CALIFORNIA LIMITED LIABILITY COMPANY)
3756 OMEC CIRCLE
RANCHO CORDOVA, CA 95742

FOR: PET TOYS, IN CLASS 28 (U.S. CLS. 22, 23, 38 AND 50).

FIRST USE 3-15-2012; IN COMMERCE 3-15-2012.

THE MARK CONSISTS OF STANDARD CHARACTERS WITHOUT CLAIM TO ANY PARTICULAR FONT, STYLE, SIZE, OR COLOR.

SN 85-326,555, FILED 5-20-2011.

ANN E. SAPPENFIELD, EXAMINING ATTORNEY



David J. Kybas

Director of the United States Patent and Trademark Office

United States of America

United States Patent and Trademark Office

Crucial Conversations

Reg. No. 4,207,142

VITALSMARTS, LC (UTAH LIMITED LIABILITY COMPANY)
282 RIVER BEND LANE, SUITE 100
PROVO, UT 84604

Registered Sep. 11, 2012

Int. Cl.: 9

FOR: DIGITAL MATERIALS, NAMELY, CDS, DVDS, DOWNLOADABLE AUDIO FILES, MULTIMEDIA FILES, TEXT FILES, WRITTEN DOCUMENTS, AUDIO MATERIAL, VIDEO MATERIAL AND GAMES FEATURING INFORMATION IN THE IN THE FIELD OF INTERPERSONAL COMMUNICATIONS, IN CLASS 9 (U.S. CLS. 21, 23, 26, 36 AND 38).

TRADEMARK

PRINCIPAL REGISTER

FIRST USE 7-31-2003; IN COMMERCE 7-31-2003.

THE MARK CONSISTS OF STANDARD CHARACTERS WITHOUT CLAIM TO ANY PARTICULAR FONT, STYLE, SIZE, OR COLOR.

OWNER OF U.S. REG. NOS. 2,707,306, 2,981,677, AND 3,894,043.

SN 85-326,654, FILED 5-21-2011.

MATTHEW EINSTEIN, EXAMINING ATTORNEY



David J. Kyffers

Director of the United States Patent and Trademark Office

United States of America

United States Patent and Trademark Office

Dealroo

Reg. No. 4,207,143

Registered Sep. 11, 2012

Int. Cls.: 9 and 42

TRADEMARK

SERVICE MARK

PRINCIPAL REGISTER

LAKUS, AHMET (AUSTRALIA INDIVIDUAL)
18 PAREENA CRS
MANSFIELD QUEENSLAND, AUSTRALIA 4122

FOR: DOWNLOADABLE SOFTWARE IN THE NATURE OF A MOBILE APPLICATION FOR MOBILE DEVICES, INCLUDING SMART PHONES, WHICH UTILIZES BOTH GPS TO LOCATE REDEEMABLE COUPONS AND TO PROVIDES REAL-TIME NOTIFICATIONS AND MESSAGING BETWEEN THE CATEGORIES OF USERS OF THE APPLICATION, IN CLASS 9 (U.S. CLS. 21, 23, 26, 36 AND 38).

FIRST USE 3-1-2012; IN COMMERCE 3-1-2012.

FOR: COMPUTER SERVICES, NAMELY, CREATING AN ON-LINE COMMUNITY FOR REGISTERED USERS TO PARTICIPATE IN DISCUSSIONS, ENGAGE IN SOCIAL NETWORKING, LOCATE DEALS AT NEARBY MERCHANTS, AND REDEEM COUPONS FOR SUCH DEALS, IN CLASS 42 (U.S. CLS. 100 AND 101).

FIRST USE 3-1-2012; IN COMMERCE 3-1-2012.

THE MARK CONSISTS OF STANDARD CHARACTERS WITHOUT CLAIM TO ANY PARTICULAR FONT, STYLE, SIZE, OR COLOR.

SN 85-326,899, FILED 5-22-2011.

LOURDES AYALA, EXAMINING ATTORNEY



David J. Kyjars

Director of the United States Patent and Trademark Office

United States of America

United States Patent and Trademark Office

B.A.S.H.

Reg. No. 4,207,144

WALTER MEIER (MANUFACTURING) INC. (WASHINGTON CORPORATION)
427 NEW SANFORD ROAD
LAVERGNE, TN 37086

Registered Sep. 11, 2012

Int. Cl.: 8

FOR: HAND TOOLS, NAMELY, HAMMERS, IN CLASS 8 (U.S. CLS. 23, 28 AND 44).

TRADEMARK

FIRST USE 9-0-2011; IN COMMERCE 9-0-2011.

PRINCIPAL REGISTER

THE MARK CONSISTS OF STANDARD CHARACTERS WITHOUT CLAIM TO ANY PARTICULAR FONT, STYLE, SIZE, OR COLOR.

SN 85-327,040, FILED 5-23-2011.

GIANCARLO CASTRO, EXAMINING ATTORNEY



David J. Kyffers

Director of the United States Patent and Trademark Office

United States of America

United States Patent and Trademark Office

WE INVENT ECO SOLUTIONS

Reg. No. 4,207,145

SHUERT INDUSTRIES, INC. (MICHIGAN CORPORATION)
6600 DOBRY

Registered Sep. 11, 2012

STERLING HEIGHTS, MI 48311

Int. Cl.: 42

FOR: DESIGNING CONTAINERS, TRAYS AND PALLETS FOR THE TRANSPORTATION AND STORAGE OF GOODS, IN CLASS 42 (U.S. CLS. 100 AND 101).

SERVICE MARK

FIRST USE 5-1-2012; IN COMMERCE 5-1-2012.

PRINCIPAL REGISTER

THE MARK CONSISTS OF STANDARD CHARACTERS WITHOUT CLAIM TO ANY PARTICULAR FONT, STYLE, SIZE, OR COLOR.

OWNER OF U.S. REG. NO. 2,249,754.

SN 85-327,458, FILED 5-23-2011.

KAREN BRACEY, EXAMINING ATTORNEY



David J. Kyffers

Director of the United States Patent and Trademark Office

United States of America

United States Patent and Trademark Office

M12

Reg. No. 4,207,146

Registered Sep. 11, 2012

Int. Cl.: 25

TRADEMARK

PRINCIPAL REGISTER

MILWAUKEE ELECTRIC TOOL CORPORATION (DELAWARE CORPORATION)
13135 W. LISBON ROAD
BROOKFIELD, WI 53005

FOR: CLOTHING, NAMELY, JACKETS, IN CLASS 25 (U.S. CLS. 22 AND 39).

FIRST USE 11-4-2010; IN COMMERCE 11-4-2010.

THE MARK CONSISTS OF STANDARD CHARACTERS WITHOUT CLAIM TO ANY PARTICULAR FONT, STYLE, SIZE, OR COLOR.

SN 85-327,765, FILED 5-23-2011.

MARLENE BELL, EXAMINING ATTORNEY



David J. Kybas

Director of the United States Patent and Trademark Office

United States of America

United States Patent and Trademark Office



Reg. No. 4,207,147

BELIZEARD, SAMSON (UNITED STATES INDIVIDUAL)
3121 CHIPPEWA ST
NEW ORLEANS, LA 70115

Registered Sep. 11, 2012

Int. Cls.: 18, 21, and 25

FOR: HARD-SIDED AND SOFT-SIDED CARRY-ON BAGS AND GYM BAGS, IN CLASS 18 (U.S. CLS. 1, 2, 3, 22 AND 41).

TRADEMARK

FIRST USE 6-26-2012; IN COMMERCE 6-26-2012.

PRINCIPAL REGISTER

FOR: PLASTIC WATER BOTTLES SOLD EMPTY, IN CLASS 21 (U.S. CLS. 2, 13, 23, 29, 30, 33, 40 AND 50).

FIRST USE 6-26-2012; IN COMMERCE 6-26-2012.

FOR: SHIRTS, IN CLASS 25 (U.S. CLS. 22 AND 39).

FIRST USE 6-26-2012; IN COMMERCE 6-26-2012.

THE MARK CONSISTS OF A STYLIZED HUMAN SILHOUETTE WITH STYLIZED PATTERNS FORMING THE LETTER "W" WITHIN.

SN 85-327,904, FILED 5-23-2011.

KEVIN DINALLO, EXAMINING ATTORNEY



David J. Kybas

Director of the United States Patent and Trademark Office

United States of America

United States Patent and Trademark Office

imperial delights

Reg. No. 4,207,148

Registered Sep. 11, 2012

Int. Cl.: 29

TRADEMARK

PRINCIPAL REGISTER

STAR SNACKS (NEW JERSEY LIMITED LIABILITY COMPANY)
105 HARBOR DR
JERSEY CITY, NJ 07305

FOR: PICKLED VEGETABLES; VEGETABLE JAMS; PROCESSED FRUITS; CANNED FRUITS AND VEGETABLES; CANNED FISH; CORN OIL; VEGETABLE OILS; OLIVE OILS, IN CLASS 29 (U.S. CL. 46).

FIRST USE 6-15-2012; IN COMMERCE 6-18-2012.

THE MARK CONSISTS OF STANDARD CHARACTERS WITHOUT CLAIM TO ANY PARTICULAR FONT, STYLE, SIZE, OR COLOR.

OWNER OF U.S. REG. NO. 2,852,714.

SN 85-327,928, FILED 5-23-2011.

KATHERINE E. HALMEN, EXAMINING ATTORNEY



David J. Kyffers

Director of the United States Patent and Trademark Office

United States of America

United States Patent and Trademark Office

CINÉPOLIS LUXURY CINEMAS

Reg. No. 4,207,149

Registered Sep. 11, 2012

Int. Cl.: 41

SERVICE MARK

PRINCIPAL REGISTER

CINEMAS DE LA REPÚBLICA, S.A. DE C.V. (MEXICO SOCIEDAD ANONIMA (SA DE CV)))
FRACCIONAMIENTO LAS AMÉRICAS
AVENIDA CAMELINAS 3527-902
MORELIA, MICHOACÁN, MEXICO C.P.58270

FOR: MOVIE THEATERS, IN CLASS 41 (U.S. CLS. 100, 101 AND 107).

FIRST USE 6-1-2011; IN COMMERCE 7-22-2011.

THE MARK CONSISTS OF STANDARD CHARACTERS WITHOUT CLAIM TO ANY PARTICULAR FONT, STYLE, SIZE, OR COLOR.

NO CLAIM IS MADE TO THE EXCLUSIVE RIGHT TO USE "LUXURY CINEMAS", APART FROM THE MARK AS SHOWN.

SN 85-327,938, FILED 5-23-2011.

MEGHAN REINHART, EXAMINING ATTORNEY



David J. Kybas

Director of the United States Patent and Trademark Office

United States of America

United States Patent and Trademark Office



Reg. No. 4,207,150

Registered Sep. 11, 2012

Int. Cl.: 30

TRADEMARK

PRINCIPAL REGISTER

JOHN, MARIETTA (PENNSYLVANIA SOLE PROPRIETORSHIP)
160 THOMAS ROAD
BERWICK, PA 186036403

FOR: A FROZEN, SCOOPABLE DESSERT OF LAYER CAKE, FROSTING AND FILLING, ALL GENTLY COMPRESSED INTO A BUCKET WITH A HANDLE, IN CLASS 30 (U.S. CL. 46).

FIRST USE 4-6-2011; IN COMMERCE 6-26-2011.

NO CLAIM IS MADE TO THE EXCLUSIVE RIGHT TO USE "BUCKETCAKE" AND "CAKE TO GO", APART FROM THE MARK AS SHOWN.

THE MARK CONSISTS OF A BUCKET HAVING A FACE AND TWO ARMS AND TWO LEGS, THE LEGS WEARING SNEAKERS AND THE BUCKET DRAWN TO BE IN RUNNING MOTION, FOLLOWED BY THE TERM "BUCKETCAKE" WITH THE PHRASE "CAKE TO GO" UNDERNEATH THE TERM "BUCKETCAKE".

SN 85-328,228, FILED 5-24-2011.

PATRICIA EVANKO, EXAMINING ATTORNEY



David J. Kyros

Director of the United States Patent and Trademark Office

United States of America

United States Patent and Trademark Office

Red State Blue State

Reg. No. 4,207,151

POLLARD, SHERRI (UNITED STATES INDIVIDUAL)
1303 WEST SWALLOW, APT. 3D
FORT COLLINS, CO 80526

Registered Sep. 11, 2012

Int. Cl.: 28

FOR: BOARD GAMES, IN CLASS 28 (U.S. CLS. 22, 23, 38 AND 50).

TRADEMARK

FIRST USE 4-7-2011; IN COMMERCE 1-10-2012.

PRINCIPAL REGISTER

THE MARK CONSISTS OF STANDARD CHARACTERS WITHOUT CLAIM TO ANY PARTICULAR FONT, STYLE, SIZE, OR COLOR.

SN 85-328,453, FILED 5-24-2011.

DOMINICK J. SALEMI, EXAMINING ATTORNEY



David J. Kyffers

Director of the United States Patent and Trademark Office

United States of America

United States Patent and Trademark Office

BE WELL BY DR. FRANK LIPMAN

Reg. No. 4,207,152

ELEVEN ELEVEN WELLNESS INC. (NEW YORK CORPORATION)
32 WEST 22ND STREET, 5TH FLOOR
NEW YORK, NY 10010

Registered Sep. 11, 2012

Int. Cl.: 5

FOR: DIETARY SUPPLEMENTS, IN CLASS 5 (U.S. CLS. 6, 18, 44, 46, 51 AND 52).

TRADEMARK

FIRST USE 5-25-2011; IN COMMERCE 5-25-2011.

PRINCIPAL REGISTER

THE MARK CONSISTS OF STANDARD CHARACTERS WITHOUT CLAIM TO ANY PARTICULAR FONT, STYLE, SIZE, OR COLOR.

THE NAME(S), PORTRAIT(S), AND/OR SIGNATURE(S) SHOWN IN THE MARK IDENTIFIES "FRANK LIPMAN", WHOSE CONSENT(S) TO REGISTER IS MADE OF RECORD.

SN 85-328,850, FILED 5-24-2011.

JEFFERY COWARD, EXAMINING ATTORNEY



David J. Kybas

Director of the United States Patent and Trademark Office

United States of America

United States Patent and Trademark Office

D DOLLHOUSE

Reg. No. 4,207,153

GOTHAM LICENSING GROUP, LLC (NEW YORK LIMITED LIABILITY COMPANY)
1407 BROADWAY

Registered Sep. 11, 2012

NEW YORK, NY 10018

Int. Cl.: 25

FOR: BOTTOMS; DENIM JACKETS; DENIMS; JEANS; JEGGINGS, NAMELY, PANTS THAT ARE PARTIALLY JEANS AND PARTIALLY LEGGINGS; T-SHIRTS; TOPS, IN CLASS 25 (U.S. CLS. 22 AND 39).

TRADEMARK

FIRST USE 12-15-2010; IN COMMERCE 12-15-2010.

PRINCIPAL REGISTER

THE MARK CONSISTS OF STANDARD CHARACTERS WITHOUT CLAIM TO ANY PARTICULAR FONT, STYLE, SIZE, OR COLOR.

OWNER OF U.S. REG. NOS. 2,201,406, 2,648,406, AND 3,079,142.

SN 85-328,976, FILED 5-24-2011.

BRENDAN MCCAULEY, EXAMINING ATTORNEY



David J. Kyffers

Director of the United States Patent and Trademark Office

United States of America

United States Patent and Trademark Office

Cool Wave

Reg. No. 4,207,154

BALL HORTICULTURAL COMPANY (ILLINOIS CORPORATION)
622 TOWN ROAD
WEST CHICAGO, IL 60185

Registered Sep. 11, 2012

Int. Cl.: 31

FOR: LIVE FLOWERING PLANTS; PLANT SEEDS, IN CLASS 31 (U.S. CLS. 1 AND 46).

TRADEMARK

FIRST USE 10-1-2011; IN COMMERCE 10-1-2011.

PRINCIPAL REGISTER

THE MARK CONSISTS OF STANDARD CHARACTERS WITHOUT CLAIM TO ANY PARTICULAR FONT, STYLE, SIZE, OR COLOR.

OWNER OF U.S. REG. NOS. 2,584,379, 3,327,778, AND OTHERS.

SN 85-329,094, FILED 5-24-2011.

DAVID TOOLEY, EXAMINING ATTORNEY



David J. Kyffers

Director of the United States Patent and Trademark Office

United States of America
United States Patent and Trademark Office

RADASH

Reg. No. 4,207,155

ASLAM, ARSHAD (UNITED STATES INDIVIDUAL)
21806 S. KINARD AVE
CARSON, CA 90745

Registered Sep. 11, 2012

Int. Cl.: 25

FOR: CLOTHING, NAMELY, TOPS, BOTTOMS, AND T-SHIRTS, IN CLASS 25 (U.S. CLS. 22 AND 39).

TRADEMARK

FIRST USE 5-27-2007; IN COMMERCE 5-27-2007.

PRINCIPAL REGISTER

THE MARK CONSISTS OF STANDARD CHARACTERS WITHOUT CLAIM TO ANY PARTICULAR FONT, STYLE, SIZE, OR COLOR.

SN 85-329,448, FILED 5-25-2011.

GEOFFREY FOSDICK, EXAMINING ATTORNEY



David J. Kybas

Director of the United States Patent and Trademark Office

United States of America

United States Patent and Trademark Office



Reg. No. 4,207,156

Registered Sep. 11, 2012

Int. Cls.: 7, 9, 37, and 42

TRADEMARK

SERVICE MARK

PRINCIPAL REGISTER

BELL AND HOWELL, LLC (DELAWARE LIMITED LIABILITY COMPANY)
3791 S. ALSTON AVENUE
DURHAM, NC 277131803

FOR: PAPER FOLDING MACHINES FOR COMMERCIAL OR INDUSTRIAL USE; MAIL AND ENVELOPE OPENING, STUFFING, INSERTING AND SEALING MACHINES FOR COMMERCIAL OR INDUSTRIAL USE; DOCUMENT AND MAIL SORTING, COLLATING, FEEDING, INSERTING, LABELING, FINISHING AND PROCESSING MACHINES FOR COMMERCIAL OR INDUSTRIAL USE; REPLACEMENT PARTS THEREFOR; NONE OF THE AFOREMENTIONED MACHINES ARE IN THE NATURE OF OFFICE REQUISITES AND NONE ARE FOR OFFICE USE; AND USER MANUALS SOLD AS A UNIT THEREWITH, IN CLASS 7 (U.S. CLS. 13, 19, 21, 23, 31, 34 AND 35).

FIRST USE 6-24-2011; IN COMMERCE 6-24-2011.

FOR: COMPUTER HARDWARE AND PERIPHERALS; COMPUTER SOFTWARE FOR USE IN IMAGING, PROCESSING, RECOGNITION, MANIPULATION, STORAGE AND RETRIEVAL OF DOCUMENTS AND IMAGES; COMPUTER SOFTWARE FOR USE IN OPERATING, PROGRAMMING, MONITORING AND CONTROLLING MACHINERY FOR MAIL AND DOCUMENT PROCESSING; OPERATING SYSTEM SOFTWARE; SOFTWARE FOR USE IN SORTING, ANALYZING, VERIFYING, ORGANIZING, TRACKING, MANAGING, MONITORING AND PROCESSING DOCUMENTS AND MAIL; COMPUTER SOFTWARE FOR DOCUMENT SCANNING AND OPTICAL CHARACTER RECOGNITION; NETWORK MANAGEMENT SOFTWARE; COMPUTER SOFTWARE FOR USE IN THE TRANSMISSION OF MESSAGES AND DATA BETWEEN TERMINALS; COMPUTER SOFTWARE FOR LOCATING, SEARCHING, RECEIVING AND RETRIEVING INFORMATION, DATA AND OTHER RESOURCES ON COMPUTER NETWORKS; DATA CONVERSION SOFTWARE; COMPUTER SOFTWARE FOR PROVIDING A GRAPHICAL USER INTERFACE FOR DOCUMENT AND MAIL PROCESSING SYSTEMS; OPTICAL SCANNERS; DOCUMENT SCANNERS; DOCUMENT AND MAIL WEIGHING APPARATUS; ELECTRONIC DATABASES RECORDED ON DIGITAL, OPTICAL AND MAGNETIC MEDIA FEATURING INFORMATION IN THE FIELDS OF DOCUMENT AND MAIL PROCESSING; ELECTRONIC DOCUMENT AND MAIL CODING AND ENCODING MACHINES; PRINTERS; AND USER GUIDES AND MANUALS SOLD AS A UNIT WITH THE FOREGOING, IN CLASS 9 (U.S. CLS. 21, 23, 26, 36 AND 38).

FIRST USE 6-24-2011; IN COMMERCE 6-24-2011.



David J. Kybas

Director of the United States Patent and Trademark Office

Reg. No. 4,207,156 FOR: INSTALLATION, UPGRADING, MAINTENANCE AND REPAIR OF COMPUTER HARDWARE, COMPUTER PERIPHERALS, MAIL PROCESSING MACHINERY AND DOCUMENT PROCESSING MACHINERY; TECHNICAL SUPPORT SERVICES, NAMELY, TROUBLESHOOTING IN THE NATURE OF REPAIR OF COMPUTER HARDWARE AND DOCUMENT AND MAIL PROCESSING MACHINES, IN CLASS 37 (U.S. CLS. 100, 103 AND 106).

FIRST USE 6-24-2011; IN COMMERCE 6-24-2011.

FOR: INSTALLATION, UPDATING, DESIGN, CUSTOMIZATION AND MAINTENANCE OF COMPUTER SOFTWARE FOR OTHERS; CONFIGURATION MANAGEMENT FOR COMPUTER HARDWARE, PERIPHERALS AND SOFTWARE; TECHNOLOGICAL CONSULTATION IN THE TECHNOLOGY FIELD OF COMPUTER HARDWARE SYSTEMS, COMPUTER SOFTWARE SYSTEMS, AND COMPUTER HARDWARE AND SOFTWARE SYSTEMS FOR DISASTER RECOVERY, MAIL PROCESSING AND DOCUMENT PROCESSING; TECHNICAL SUPPORT SERVICES, NAMELY, TROUBLESHOOTING IN THE NATURE OF DIAGNOSING OF COMPUTER HARDWARE AND COMPUTER SOFTWARE PROBLEMS; TECHNICAL SUPPORT SERVICES, NAMELY, TROUBLESHOOTING IN THE NATURE OF DIAGNOSING OF MAIL PROCESSING MACHINE AND DOCUMENT PROCESSING MACHINE PROBLEMS; COMPUTER DISASTER RECOVERY PLANNING SERVICES; HOSTING OF DIGITAL CONTENT ON THE INTERNET; PROVIDING ONLINE NON-DOWNLOADABLE COMPUTER SOFTWARE FOR USE IN SORTING, ANALYZING, VERIFYING, ORGANIZING, TRACKING, MANAGING, MONITORING AND PROCESSING DOCUMENTS AND MAIL; UPGRADING OF COMPUTER SOFTWARE, IN CLASS 42 (U.S. CLS. 100 AND 101).

FIRST USE 6-24-2011; IN COMMERCE 6-24-2011.

OWNER OF U.S. REG. NOS. 1,753,473, 3,274,461, AND OTHERS.

THE COLOR(S) BLUE AND WHITE IS/ARE CLAIMED AS A FEATURE OF THE MARK.

THE MARK CONSISTS OF THE DARK BLUE WORDS "BELL" AND "HOWELL" SEPARATED BY A WHITE STYLIZED PLUS DESIGN WITHIN A BLUE CIRCLE.

SN 85-329,511, FILED 5-25-2011.

NAKIA HENRY, EXAMINING ATTORNEY

United States of America

United States Patent and Trademark Office



Reg. No. 4,207,157

MERIDIAN RESEARCH & CONSULTING, INC. (MASSACHUSETTS CORPORATION)
204 VILLAGE ROAD EAST
NORWOOD, MA 02062

Registered Sep. 11, 2012

Int. Cl.: 35

FOR: MARKET ANALYSIS AND RESEARCH SERVICES, IN CLASS 35 (U.S. CLS. 100, 101 AND 102).

SERVICE MARK

FIRST USE 1-1-2012; IN COMMERCE 1-1-2012.

PRINCIPAL REGISTER

NO CLAIM IS MADE TO THE EXCLUSIVE RIGHT TO USE "RESEARCH & CONSULTING, INC.", APART FROM THE MARK AS SHOWN.

THE COLOR(S) RED, BLUE IS/ARE CLAIMED AS A FEATURE OF THE MARK.

THE MARK CONSISTS OF TWO LINES OF TEXT, ONE DIRECTLY BELOW THE OTHER. THE FIRST LINE HAS THE WORD "MERIDIAN" SPELLED OUT IN UPPER CASE, CASTELLAR FONT, SIZE 72, AND RED COLOR. THE LETTER "A" IN THE WORD "MERIDIAN" IS A DIAGRAM OF A QUARTER CURVATURE OF THE EARTH IN RED COLOR AND A PERFORATED BLUE ARROW, POINTING NORTH, RUNNING THROUGH THE CURVATURE AT A 23.5 DEGREE ANGLE. THE DIAGRAM REPRESENTS THE CALCULATION FOR THE TROPIC OF CANCER. THE SECOND LINE OF THE MARK STATES "RESEARCH & CONSULTING, INC.", IN UPPER CASE, BLUE COLOR, CASTELLAR FONT, SIZE 25.



SN 85-329,602, FILED 5-25-2011.

TINA L. SNAPP, EXAMINING ATTORNEY

David J. Kybas

Director of the United States Patent and Trademark Office

United States of America
United States Patent and Trademark Office

PEERSPAN

Reg. No. 4,207,158

Registered Sep. 11, 2012

Int. Cl.: 35

NATIONAL ASSOCIATION OF REAL ESTATE COMPANIES, INC. (MARYLAND CORPORATION)
216 WEST JACKSON BLVD
SUITE 625
CHICAGO, IL 60606

SERVICE MARK

PRINCIPAL REGISTER

FOR: ASSOCIATION SERVICES, NAMELY, PROMOTING THE INTERESTS OF REAL ESTATE FINANCE, TAX, AND ACCOUNTING PROFESSIONALS, IN CLASS 35 (U.S. CLS. 100, 101 AND 102).

FIRST USE 12-7-2011; IN COMMERCE 12-7-2011.

THE MARK CONSISTS OF STANDARD CHARACTERS WITHOUT CLAIM TO ANY PARTICULAR FONT, STYLE, SIZE, OR COLOR.

SN 85-329,667, FILED 5-25-2011.

JESSICA FATHY, EXAMINING ATTORNEY



David J. Kyffers

Director of the United States Patent and Trademark Office

United States of America

United States Patent and Trademark Office

PEERSPAN

Reg. No. 4,207,159

Registered Sep. 11, 2012

Int. Cl.: 41

NATIONAL ASSOCIATION OF REAL ESTATE COMPANIES, INC. (MARYLAND CORPORATION)
216 WEST JACKSON BLVD
SUITE 625
CHICAGO, IL 60606

SERVICE MARK

PRINCIPAL REGISTER

FOR: EDUCATIONAL SERVICES, NAMELY, CONDUCTING CONFERENCES AND SEMINARS IN THE FIELD OF THE REAL ESTATE INDUSTRY AND DISTRIBUTION OF COURSE MATERIALS IN CONNECTION THEREWITH, IN CLASS 41 (U.S. CLS. 100, 101 AND 107).

FIRST USE 12-7-2011; IN COMMERCE 12-7-2011.

THE MARK CONSISTS OF STANDARD CHARACTERS WITHOUT CLAIM TO ANY PARTICULAR FONT, STYLE, SIZE, OR COLOR.

SN 85-329,670, FILED 5-25-2011.

JESSICA FATHY, EXAMINING ATTORNEY



David J. Kyffers

Director of the United States Patent and Trademark Office

United States of America

United States Patent and Trademark Office

FUGITIVE

Reg. No. 4,207,160

Registered Sep. 11, 2012

Int. Cl.: 33

TRADEMARK

PRINCIPAL REGISTER

H.D.D. LLC (CALIFORNIA LIMITED LIABILITY COMPANY), DBA TRUETT HURST
WINERY,
5610 DRY CREEK ROAD
HEALDSBURG, CA 95448

FOR: ALCOHOLIC BEVERAGES EXCEPT BEERS, IN CLASS 33 (U.S. CLS. 47 AND 49).

FIRST USE 5-25-2012; IN COMMERCE 5-25-2012.

THE MARK CONSISTS OF STANDARD CHARACTERS WITHOUT CLAIM TO ANY PARTICULAR FONT, STYLE, SIZE, OR COLOR.

SN 85-329,705, FILED 5-25-2011.

NAAKWAMA ANKRAH, EXAMINING ATTORNEY



David J. Kyros

Director of the United States Patent and Trademark Office

United States of America

United States Patent and Trademark Office

DJ MAXIMUS PAYNE

Reg. No. 4,207,161

PAYNE, MATTHEW C (UNITED STATES INDIVIDUAL), AKA DJ MAXIMUS PAYNE,
8511 EASTERN AVE
KANSAS CITY, MO 64138

Registered Sep. 11, 2012

Int. Cl.: 41

FOR: ENTERTAINMENT SERVICES IN THE NATURE OF RECORDING, PRODUCTION
AND POST-PRODUCTION SERVICES IN THE FIELD OF MUSIC, IN CLASS 41 (U.S. CLS.
100, 101 AND 107).

SERVICE MARK

FIRST USE 11-1-2011; IN COMMERCE 12-1-2011.

PRINCIPAL REGISTER

THE MARK CONSISTS OF STANDARD CHARACTERS WITHOUT CLAIM TO ANY PAR-
TICULAR FONT, STYLE, SIZE, OR COLOR.

NO CLAIM IS MADE TO THE EXCLUSIVE RIGHT TO USE "DJ", APART FROM THE MARK
AS SHOWN.

THE NAME "DJ MAXIMUS PAYNE" IDENTIFIES A LIVING INDIVIDUAL WHOSE CONSENT
IS OF RECORD.

SN 85-330,212, FILED 5-25-2011.

JULIE VEPPUMTHARA, EXAMINING ATTORNEY



David J. Kybas

Director of the United States Patent and Trademark Office

United States of America

United States Patent and Trademark Office

VDS

Reg. No. 4,207,162

Registered Sep. 11, 2012

Int. Cl.: 10

TRADEMARK

PRINCIPAL REGISTER

VENE DENTAL SUPPLY, LLC (TEXAS LIMITED LIABILITY COMPANY)
2250 HOLLY HALL ST. #213
HOUSTON, TX 77054

FOR: DENTAL HANDPIECES, IN CLASS 10 (U.S. CLS. 26, 39 AND 44).

FIRST USE 4-11-2012; IN COMMERCE 4-11-2012.

THE MARK CONSISTS OF STANDARD CHARACTERS WITHOUT CLAIM TO ANY PARTICULAR FONT, STYLE, SIZE, OR COLOR.

SN 85-330,225, FILED 5-25-2011.

DARRYL SPRUILL, EXAMINING ATTORNEY



David J. Kyffers

Director of the United States Patent and Trademark Office

United States of America

United States Patent and Trademark Office

TalktUp

Reg. No. 4,207,163

Registered Sep. 11, 2012

Int. Cl.: 35

SERVICE MARK

PRINCIPAL REGISTER

TALKTUP LLC (WASHINGTON LIMITED LIABILITY COMPANY)
11636 SE 5TH ST.
BELLEVUE, WA 98005

FOR: ADMINISTRATION OF A CONSUMER LOYALTY PROGRAM TO PROMOTE RESTAURANT SERVICES AND RETAIL SERVICES OF OTHERS; ADMINISTRATION OF A DISCOUNT PROGRAM FOR ENABLING PARTICIPANTS TO OBTAIN DISCOUNTS ON GOODS AND SERVICES THROUGH USE OF A DISCOUNT MEMBERSHIP CARD; ADMINISTRATION OF A DISCOUNT PROGRAM FOR ENABLING PARTICIPANTS TO OBTAIN DISCOUNTS ON THE COST OF SERVICES OR RECEIVE IMPROVED SERVICES THROUGH USE OF A MEMBERSHIP CARD; ADMINISTRATION OF A PROGRAM FOR ENABLING PARTICIPANTS TO OBTAIN DISCOUNTS ON THE COST OF SERVICES OR RECEIVE IMPROVED SERVICES; ADVERTISEMENT VIA MOBILE PHONE NETWORKS; ADVERTISING AGENCY SPECIALIZING IN THE DESIGN AND EXECUTION OF WORD OF MOUTH, VIRAL, BUZZ AND EXPERIENTIAL MARKETING PROGRAMS; ADVERTISING AND MARKETING SERVICES PROVIDED BY MEANS OF INDIRECT METHODS OF MARKETING COMMUNICATIONS, NAMELY, SOCIAL MEDIA, SEARCH ENGINE MARKETING, INQUIRY MARKETING, INTERNET MARKETING, MOBILE MARKETING, BLOGGING AND OTHER FORMS OF PASSIVE, SHARABLE OR VIRAL COMMUNICATIONS CHANNELS; ADVERTISING AND MARKETING SERVICES, NAMELY, PROMOTING THE GOODS AND SERVICES OF OTHERS; ADVERTISING VIA ELECTRONIC MEDIA AND SPECIFICALLY THE INTERNET; CUSTOMER LOYALTY SERVICES AND CUSTOMER CLUB SERVICES, FOR COMMERCIAL, PROMOTIONAL AND/OR ADVERTISING PURPOSES; MARKETING, ADVERTISING, AND PROMOTING THE RETAIL GOODS AND SERVICES OF OTHERS TO WIRELESS ELECTRONIC DEVICES; MARKETING, PROMOTIONAL AND ADVERTISING SERVICES PROVIDED BY MOBILE TELEPHONE CONNECTIONS; PROMOTING AND MARKETING THE GOODS AND SERVICES OF OTHERS BY DISTRIBUTING ADVERTISING MATERIAL, COUPONS AND DISCOUNT OFFERS VIA TEXT MESSAGES; PROMOTING THE GOODS AND SERVICES OF OTHERS BY PROVIDING AN INTERACTIVE WEBSITE WHERE USERS CAN INCREASE THE CURRENT VALUE OF AN ONLINE DISCOUNT BEING OFFERED BY PURCHASING THE GOODS AND SERVICES ASSOCIATED WITH THAT DISCOUNT IN THE FORM OF AN ONLINE COUPON, VOUCHER OR GIFT CARD, IN CLASS 35 (U.S. CLS. 100, 101 AND 102).



David J. Kyjars

FIRST USE 6-2-2011; IN COMMERCE 6-2-2011.

Reg. No. 4,207,163 THE MARK CONSISTS OF STANDARD CHARACTERS WITHOUT CLAIM TO ANY PARTICULAR FONT, STYLE, SIZE, OR COLOR.

SN 85-330,432, FILED 5-25-2011.

KATINA MISTER, EXAMINING ATTORNEY

United States of America

United States Patent and Trademark Office

RESPONSEDX: MELANOMA

Reg. No. 4,207,164

RESPONSE GENETICS, INC. (DELAWARE CORPORATION)

Registered Sep. 11, 2012

1640 MARENGO STREET, SUITE 620
LOS ANGELES, CA 90033

Int. Cls.: 42 and 44

FOR: MEDICAL RESEARCH; SCIENTIFIC RESEARCH AND DEVELOPMENT, MEDICAL AND SCIENTIFIC RESEARCH CONSULTING; DRUG DISCOVERY ANALYSIS SERVICES; PHARMACEUTICAL DRUG DEVELOPMENT ANALYSIS SERVICES; DIAGNOSTIC TESTING SERVICES, NAMELY, PROVIDING REAGENT SAMPLE TESTING AND DIAGNOSTIC SERVICES FOR OTHERS IN THE FIELDS OF SCIENCE AND RESEARCH RELATED THERETO; PROVIDING SCIENTIFIC RESEARCH INFORMATION IN THE FIELD OF PHARMACEUTICALS AND CLINICAL TRIALS; PROVIDING AN ON-LINE COMPUTER DATABASE FOR OTHERS IN THE FIELDS OF MEDICINE DEVELOPMENT, PHARMACOGENOMICS IN THE NATURE OF SCIENTIFIC RESEARCH IN THE FIELD OF GENETICS, SCIENTIFIC RESEARCH INFORMATION IN THE FIELD OF CANCER DIAGNOSIS, SCIENTIFIC RESEARCH INFORMATION IN THE FIELD OF CLINICAL TRIAL DESIGN AND SCIENTIFIC RESEARCH INFORMATION IN THE FIELD OF BIOTECHNOLOGY; PRODUCT DEVELOPMENT SERVICES FOR OTHERS IN THE BIOMEDICAL, GENOMICS, PHARMACOGENOMICS, DIAGNOSTIC, CLINICAL TRIAL DESIGN AND BIOTECHNOLOGY FIELDS, IN CLASS 42 (U.S. CLS. 100 AND 101).

SERVICE MARK

PRINCIPAL REGISTER

FIRST USE 5-1-2011; IN COMMERCE 5-1-2011.



FOR: PROVIDING MEDICAL DIAGNOSTIC TESTING SERVICES FOR DIAGNOSTIC AND PROGNOSTIC PURPOSES; AND PROVIDING MEDICAL INFORMATION, IN CLASS 44 (U.S. CLS. 100 AND 101).

FIRST USE 5-1-2011; IN COMMERCE 5-1-2011.

THE MARK CONSISTS OF STANDARD CHARACTERS WITHOUT CLAIM TO ANY PARTICULAR FONT, STYLE, SIZE, OR COLOR.

NO CLAIM IS MADE TO THE EXCLUSIVE RIGHT TO USE "MELANOMA", APART FROM THE MARK AS SHOWN.

David J. Kyffers

SN 85-330,476, FILED 5-25-2011.

Director of the United States Patent and Trademark Office

KATHERINE STOIDES, EXAMINING ATTORNEY

United States of America

United States Patent and Trademark Office

STRUCTO-CRETE

Reg. No. 4,207,165

UNITED STATES GYPSUM COMPANY (DELAWARE CORPORATION)
550 WEST ADAMS STREET, DEPT 189
CHICAGO, IL 606613676

Registered Sep. 11, 2012

Int. Cl.: 19

FOR: BUILDING MATERIALS, NAMELY, CEMENT STRUCTURAL PANELS FOR WALLS, CEILINGS, FLOORS AND ROOFS, IN CLASS 19 (U.S. CLS. 1, 12, 33 AND 50).

TRADEMARK

FIRST USE 12-30-2011; IN COMMERCE 12-30-2011.

PRINCIPAL REGISTER

THE MARK CONSISTS OF STANDARD CHARACTERS WITHOUT CLAIM TO ANY PARTICULAR FONT, STYLE, SIZE, OR COLOR.

SN 85-330,484, FILED 5-25-2011.

RONALD MCMORROW, EXAMINING ATTORNEY



David J. Kybas

Director of the United States Patent and Trademark Office

United States of America

United States Patent and Trademark Office

MERCHANT SOCIETY

Reg. No. 4,207,166

Registered Sep. 11, 2012

Int. Cls.: 14, 18, and 25

ALEXA LOVES LLC (FLORIDA LIMITED LIABILITY COMPANY)
UNIT 5
75 17TH STREET NE
ATLANTA, GA 30309

FOR: JEWELRY, IN CLASS 14 (U.S. CLS. 2, 27, 28 AND 50).

TRADEMARK

FIRST USE 4-1-2012; IN COMMERCE 4-1-2012.

PRINCIPAL REGISTER

FOR: HANDBAGS , IN CLASS 18 (U.S. CLS. 1, 2, 3, 22 AND 41).

FIRST USE 4-1-2012; IN COMMERCE 4-1-2012.

FOR: SCARVES; TOPS; WOMEN'S CLOTHING, NAMELY, SHIRTS, DRESSES, SKIRTS, BLOUSES, IN CLASS 25 (U.S. CLS. 22 AND 39).

FIRST USE 4-1-2012; IN COMMERCE 4-1-2012.

THE MARK CONSISTS OF STANDARD CHARACTERS WITHOUT CLAIM TO ANY PARTICULAR FONT, STYLE, SIZE, OR COLOR.

SN 85-330,595, FILED 5-26-2011.

MARCIE MILONE, EXAMINING ATTORNEY



David J. Kyfos

Director of the United States Patent and Trademark Office

United States of America

United States Patent and Trademark Office

Ti

Reg. No. 4,207,167

BUSCH, WILLIAM (UNITED STATES INDIVIDUAL)
2000 SWIFT AVE

Registered Sep. 11, 2012

N KANSAS CITY, MO 64116

Int. Cl.: 10

FOR: MEDICAL WEARING APPAREL, NAMELY, SCRUB PANTS; MEDICAL WEARING APPAREL, NAMELY, SCRUB TOPS, IN CLASS 10 (U.S. CLS. 26, 39 AND 44).

TRADEMARK

FIRST USE 6-18-2012; IN COMMERCE 6-18-2012.

PRINCIPAL REGISTER

THE MARK CONSISTS OF STANDARD CHARACTERS WITHOUT CLAIM TO ANY PARTICULAR FONT, STYLE, SIZE, OR COLOR.

SN 85-330,597, FILED 5-26-2011.

MARCIE MILONE, EXAMINING ATTORNEY



David J. Kybas

Director of the United States Patent and Trademark Office

United States of America

United States Patent and Trademark Office

FENGFIT

Reg. No. 4,207,168

Registered Sep. 11, 2012

Int. Cl.: 43

SERVICE MARK

PRINCIPAL REGISTER

THE LU-JEAN FENG CLINIC, LLC (OHIO LIMITED LIABILITY COMPANY)
31200 PINE TREE RD.
PEPPER PIKE, OH 44124

FOR: TAKE-OUT RESTAURANT SERVICES, IN CLASS 43 (U.S. CLS. 100 AND 101).

FIRST USE 9-28-2011; IN COMMERCE 9-28-2011.

THE MARK CONSISTS OF STANDARD CHARACTERS WITHOUT CLAIM TO ANY PARTICULAR FONT, STYLE, SIZE, OR COLOR.

SN 85-330,611, FILED 5-26-2011.

STEPHANIE ALI, EXAMINING ATTORNEY



David J. Kybas

Director of the United States Patent and Trademark Office

United States of America

United States Patent and Trademark Office

GELFORM

Reg. No. 4,207,169

BERGAD, INC. (PENNSYLVANIA CORPORATION), AKA BERGAD SPECIALTY FOAMS,
747 ELJER WAY
FORD CITY, PA 16226

Registered Sep. 11, 2012

Int. Cls.: 17, 20, and 24

FOR: POLYURETHANE FOAM CONTAINING SHOCK ABSORBING CAPABILITIES FOR IMPACT AND SOUND ATTENUATING USED IN THE MANUFACTURE OF SEATING, MATTRESSES, MATTRESS TOPPERS, MATTRESS PADS, CUSHIONS, STRETCHERS, GURNEYS, AND TABLE PADS FOR COMMERCIAL, RESIDENTIAL, MEDICAL AND MILITARY APPLICATIONS, IN CLASS 17 (U.S. CLS. 1, 5, 12, 13, 35 AND 50).

TRADEMARK

PRINCIPAL REGISTER

FIRST USE 3-9-2012; IN COMMERCE 3-9-2012.

FOR: MATTRESSES; OTHER CUSHIONING DEVICES, NAMELY, BEDS, MATTRESSES, MATTRESS TOPPERS, PILLOWS, CUSHIONS, AND BOLSTERS, IN CLASS 20 (U.S. CLS. 2, 13, 22, 25, 32 AND 50).

FIRST USE 3-9-2012; IN COMMERCE 3-9-2012.

FOR: CUSHIONING DEVICES, NAMELY, MATTRESS PADS, MATTRESS COVERS, AND BED PADS, IN CLASS 24 (U.S. CLS. 42 AND 50).

FIRST USE 3-9-2012; IN COMMERCE 3-9-2012.

THE MARK CONSISTS OF STANDARD CHARACTERS WITHOUT CLAIM TO ANY PARTICULAR FONT, STYLE, SIZE, OR COLOR.

SN 85-330,624, FILED 5-26-2011.

ROBIN CHOSID, EXAMINING ATTORNEY



David J. Kybas

Director of the United States Patent and Trademark Office

United States of America

United States Patent and Trademark Office



JAVA PURA

Reg. No. 4,207,170

Registered Sep. 11, 2012

Int. Cls.: 30, 35, and 43

TRADEMARK

SERVICE MARK

PRINCIPAL REGISTER

JAVA PURA, LLC (TEXAS LIMITED LIABILITY COMPANY)
SUITE 4G
5250 GULFTON
HOUSTON, TX 77081

FOR: ROASTED COFFEE BEANS; ROASTED GROUND COFFEE; COFFEE; COFFEE BASED BEVERAGES; ESPRESSO; ESPRESSO DRINKS, IN CLASS 30 (U.S. CL. 46).

FIRST USE 8-31-2008; IN COMMERCE 8-31-2008.

FOR: ONLINE RETAIL AND WHOLESALE STORE SERVICES FEATURING ROASTED COFFEE BEANS, IN CLASS 35 (U.S. CLS. 100, 101 AND 102).

FIRST USE 8-31-2008; IN COMMERCE 8-31-2008.

FOR: COFFEE SUPPLY SERVICES FOR OFFICES; CATERING SERVICES FEATURING COFFEE, COFFEE BASED BEVERAGES, ESPRESSO, ESPRESSO DRINKS, SMOOTHIES AND SODAS; COFFEE AND ESPRESSO BARS, IN CLASS 43 (U.S. CLS. 100 AND 101).

FIRST USE 8-31-2008; IN COMMERCE 8-31-2008.

NO CLAIM IS MADE TO THE EXCLUSIVE RIGHT TO USE "JAVA", APART FROM THE MARK AS SHOWN.

THE MARK CONSISTS OF A DRAWING OF A HORSE REARING UP WITH A ROOSTER, OR COCK, RIDING ON ITS BACK AND THE WORDS "JAVA PURA" UNDERNEATH.

THE ENGLISH TRANSLATION OF "PURA" IN THE MARK IS "PURE".

SN 85-330,666, FILED 5-26-2011.

ELLEN BURNS, EXAMINING ATTORNEY



David J. Kybas

Director of the United States Patent and Trademark Office

United States of America

United States Patent and Trademark Office



Reg. No. 4,207,171

Registered Sep. 11, 2012

Int. Cl.: 18

TRADEMARK

PRINCIPAL REGISTER

RAWLINGS SPORTING GOODS COMPANY, INC. (DELAWARE CORPORATION)
510 MARYVILLE UNIVERSITY DRIVE, #110
ST. LOUIS, MO 63141

FOR: LEATHER LUGGAGE; LUGGAGE NOT OF LEATHER; LEATHER DUFFLE BAGS; DUFFLE BAGS, NOT OF LEATHER; LEATHER HANDBAGS; LEATHER BRIEFCASE-TYPE PORTFOLIOS; LEATHER WALLETS; LEATHER BRIEFCASES; LEATHER BACKPACKS; LEATHER SHAVE BAGS SOLD EMPTY; LEATHER LUGGAGE TAGS; LEATHER MESSENGER BAGS; LEATHER JOTTERS, NAMELY, BRIEF-CASE TYPE BUSINESS FOLDERS; LEATHER SPORT BAGS; ATTACHE CASES; ATTACHE CASES MADE OF LEATHER; ATHLETIC BAGS; BACKPACKS; BAGS AND HOLDALLS FOR SPORTING CLOTHING; UMBRELLAS, IN CLASS 18 (U.S. CLS. 1, 2, 3, 22 AND 41).

FIRST USE 5-2-2012; IN COMMERCE 5-2-2012.

OWNER OF U.S. REG. NOS. 412,343, 1,337,914, AND OTHERS.

THE MARK CONSISTS OF THE OUTLINE OF AN OVAL IN WHICH IS CONTAINED THE SCRIPT LETTER "R".

SN 85-330,753, FILED 5-26-2011.

TRACY FLETCHER, EXAMINING ATTORNEY



David J. Kyffers

Director of the United States Patent and Trademark Office

United States of America

United States Patent and Trademark Office



Reg. No. 4,207,172

Registered Sep. 11, 2012

Int. Cl.: 18

TRADEMARK

PRINCIPAL REGISTER

RAWLINGS SPORTING GOODS COMPANY, INC. (DELAWARE CORPORATION)
510 MARYVILLE UNIVERSITY DRIVE, #110
ST. LOUIS, MO 63141

FOR: LEATHER LUGGAGE; LUGGAGE NOT OF LEATHER; LEATHER DUFFLE BAGS; DUFFLE BAGS, NOT OF LEATHER; LEATHER HANDBAGS; LEATHER BRIEFCASE-TYPE PORTFOLIOS; LEATHER WALLETS; LEATHER BRIEFCASES; LEATHER BACKPACKS; LEATHER SHAVE BAGS SOLD EMPTY; LEATHER LUGGAGE TAGS; LEATHER MESSENGER BAGS; LEATHER JOTTERS, NAMELY, BRIEF-CASE TYPE BUSINESS FOLDERS; LEATHER SPORT BAGS; ATTACHE CASES; ATTACHE CASES MADE OF LEATHER; ATHLETIC BAGS; BACKPACKS; BAGS AND HOLDALLS FOR SPORTING CLOTHING; UMBRELLAS, IN CLASS 18 (U.S. CLS. 1, 2, 3, 22 AND 41).

FIRST USE 5-2-2012; IN COMMERCE 5-2-2012.

OWNER OF U.S. REG. NOS. 412,343, 1,337,914, AND OTHERS.

THE MARK CONSISTS OF THE SCRIPT WORD "RAWLINGS" AT A SLIGHT ANGLE UPWARDS FROM LOWER LEFT TO UPPER RIGHT. BELOW THE WORD "RAWLINGS" AND CUTTING ACROSS THE TAIL OF THE "R" IS AN OVAL CONTAINING A SCRIPT LETTER "R".

SN 85-330,754, FILED 5-26-2011.

TRACY FLETCHER, EXAMINING ATTORNEY



David J. Kyros

Director of the United States Patent and Trademark Office

United States of America

United States Patent and Trademark Office



Reg. No. 4,207,173

Registered Sep. 11, 2012

Int. Cl.: 18

TRADEMARK

PRINCIPAL REGISTER

RAWLINGS SPORTING GOODS COMPANY, INC. (DELAWARE CORPORATION)
510 MARYVILLE UNIVERSITY DRIVE, #110
ST. LOUIS, MO 63141

FOR: LEATHER LUGGAGE; LUGGAGE NOT OF LEATHER; LEATHER DUFFLE BAGS; DUFFLE BAGS, NOT OF LEATHER; LEATHER HANDBAGS; LEATHER BRIEFCASE-TYPE PORTFOLIOS; LEATHER WALLETS; LEATHER BRIEFCASES; LEATHER BACKPACKS; LEATHER SHAVE BAGS SOLD EMPTY; LEATHER LUGGAGE TAGS; LEATHER MESSENGER BAGS; LEATHER JOTTERS, NAMELY, BRIEF-CASE TYPE BUSINESS FOLDERS; LEATHER SPORT BAGS; ATTACHE CASES; ATTACHE CASES MADE OF LEATHER; ATHLETIC BAGS; BACKPACKS; BAGS AND HOLDALLS FOR SPORTING CLOTHING; UMBRELLAS, IN CLASS 18 (U.S. CLS. 1, 2, 3, 22 AND 41).

FIRST USE 5-2-2012; IN COMMERCE 5-2-2012.

OWNER OF U.S. REG. NOS. 412,343, 3,918,656, AND OTHERS.

NO CLAIM IS MADE TO THE EXCLUSIVE RIGHT TO USE "EST. 1887", APART FROM THE MARK AS SHOWN.

THE MARK CONSISTS OF A BACKGROUND IN THE MIDDLE OF WHICH IS A SCRIPT WORD "RAWLINGS" AT A SLIGHT ANGLE UPWARDS FROM LOWER LEFT TO UPPER RIGHT. BELOW THE WORD "RAWLINGS" AND CUTTING ACROSS THE TAIL OF THE "R" IS AN OVAL CONTAINING A SCRIPT LETTER "R". ABOVE AND BELOW THE CENTERED WORD AND LOGO ARE DOUBLE HORIZONTAL LINES FROM LOWER LEFT TO UPPER RIGHT. BELOW THE LOWER HORIZONTAL LINE IS THE LANGUAGE "EST. 1887".

SN 85-330,760, FILED 5-26-2011.

TRACY FLETCHER, EXAMINING ATTORNEY



David J. Kybas

Director of the United States Patent and Trademark Office

United States of America

United States Patent and Trademark Office

Datacist

Reg. No. 4,207,174

FLANSBAUM, CARL A. (UNITED STATES INDIVIDUAL)
904 40TH STREET
BELLINGHAM, WA 98229

Registered Sep. 11, 2012

Int. Cl.: 35

FOR: PHARMACEUTICAL COST MANAGEMENT SERVICES AND DRUG UTILIZATION REVIEW SERVICES, IN CLASS 35 (U.S. CLS. 100, 101 AND 102).

SERVICE MARK

FIRST USE 5-26-2011; IN COMMERCE 5-26-2011.

PRINCIPAL REGISTER

THE MARK CONSISTS OF STANDARD CHARACTERS WITHOUT CLAIM TO ANY PARTICULAR FONT, STYLE, SIZE, OR COLOR.

SN 85-330,769, FILED 5-26-2011.

ODESSA BIBBINS, EXAMINING ATTORNEY



David J. Kybas

Director of the United States Patent and Trademark Office

United States of America

United States Patent and Trademark Office

DEEP SEA CLIPPER

Reg. No. 4,207,175

JB DESIGN, LLC (ARIZONA LIMITED LIABILITY COMPANY)
9508 E. GARY STREET
MESA, AZ 85207

Registered Sep. 11, 2012

Int. Cl.: 28

FOR: FISHING EQUIPMENT, NAMELY, A DEVICE USED TO SECURE FISHING TACKLE TO A FISHING ROD, IN CLASS 28 (U.S. CLS. 22, 23, 38 AND 50).

TRADEMARK

FIRST USE 6-7-2012; IN COMMERCE 6-7-2012.

PRINCIPAL REGISTER

THE MARK CONSISTS OF STANDARD CHARACTERS WITHOUT CLAIM TO ANY PARTICULAR FONT, STYLE, SIZE, OR COLOR.

OWNER OF U.S. REG. NOS. 3,796,965 AND 3,896,263.

SN 85-330,942, FILED 5-26-2011.

KIMBERLY PERRY, EXAMINING ATTORNEY



David J. Kybas

Director of the United States Patent and Trademark Office

United States of America

United States Patent and Trademark Office

CURATE

Reg. No. 4,207,176

Registered Sep. 11, 2012

Int. Cl.: 20

TRADEMARK

PRINCIPAL REGISTER

ARTISTICA (CALIFORNIA CORPORATION)
3200 GOLF COURSE DRIVE
VENTURA, CA 93003

FOR: FURNITURE, NAMELY, WOODEN, IRON AND RATTAN DINING TABLES, CHAIRS, BARSTOOLS, BEDROOM HEADBOARDS AND FOOTBOARDS, CHESTS AND OCCASIONAL TABLES, IN CLASS 20 (U.S. CLS. 2, 13, 22, 25, 32 AND 50).

FIRST USE 4-25-2011; IN COMMERCE 4-25-2011.

THE MARK CONSISTS OF STANDARD CHARACTERS WITHOUT CLAIM TO ANY PARTICULAR FONT, STYLE, SIZE, OR COLOR.

SN 85-330,973, FILED 5-26-2011.

ALLISON HOLTZ, EXAMINING ATTORNEY



David J. Kyjars

Director of the United States Patent and Trademark Office

United States of America

United States Patent and Trademark Office

CUMBERLAND FARMS FARMHOUSE BAKERY

Reg. No. 4,207,177

Registered Sep. 11, 2012

Int. Cl.: 30

TRADEMARK

PRINCIPAL REGISTER

CUMBERLAND FARMS, INC. (DELAWARE CORPORATION)
100 CROSSING BOULEVARD
FRAMINGHAM, MA 01702

FOR: DONUTS, DANISH, MUFFINS, PASTRY, BROWNIES, SINGLE SERVE COOKIES AND BREAD, ROLLS, ENGLISH MUFFINS, BAGELS, PACKAGED COOKIES, IN CLASS 30 (U.S. CL. 46).

FIRST USE 11-0-2011; IN COMMERCE 11-0-2011.

THE MARK CONSISTS OF STANDARD CHARACTERS WITHOUT CLAIM TO ANY PARTICULAR FONT, STYLE, SIZE, OR COLOR.

OWNER OF U.S. REG. NOS. 907,638, 1,285,634, AND OTHERS.

NO CLAIM IS MADE TO THE EXCLUSIVE RIGHT TO USE "FARMHOUSE BAKERY", APART FROM THE MARK AS SHOWN.

SN 85-331,168, FILED 5-26-2011.

JEFF DEFORD, EXAMINING ATTORNEY



David J. Kyffers

Director of the United States Patent and Trademark Office

United States of America

United States Patent and Trademark Office

AZARA

Reg. No. 4,207,178

Registered Sep. 11, 2012

Int. Cls.: 35, 36, and 42

SERVICE MARK

PRINCIPAL REGISTER

AZARA HEALTHCARE, LLC (DELAWARE LIMITED LIABILITY COMPANY)
20 BLANCHARD ROAD
SUITE 10
BURLINGTON, MA 01803

FOR: BUSINESS MANAGEMENT SERVICES, NAMELY, HEALTH CARE PRACTICE MANAGEMENT, IN CLASS 35 (U.S. CLS. 100, 101 AND 102).

FIRST USE 5-18-2011; IN COMMERCE 5-18-2011.

FOR: FINANCIAL INFORMATION SERVICES IN THE FIELD OF HEALTH CARE FINANCIAL DATA, IN CLASS 36 (U.S. CLS. 100, 101 AND 102).

FIRST USE 5-18-2011; IN COMMERCE 5-18-2011.

FOR: APPLICATION SERVICE PROVIDER, NAMELY, HOSTING, MANAGING, DEVELOPING, AND MAINTAINING APPLICATIONS, SOFTWARE, AND WEB SITES, IN THE FIELDS OF REPORTING, ANALYZING HEALTH CARE, MEDICAL PRACTICE, AND HEALTH CARE FINANCIAL INFORMATION; APPLICATION SERVICE PROVIDER FEATURING DATABASE MANAGEMENT SOFTWARE IN THE NATURE OF ELECTRONIC MEDICAL RECORDS SOFTWARE, ELECTRONIC HEALTH RECORD SOFTWARE AND HEALTH CARE PRACTICE MANAGEMENT SOFTWARE, IN CLASS 42 (U.S. CLS. 100 AND 101).

FIRST USE 5-18-2011; IN COMMERCE 5-18-2011.

THE MARK CONSISTS OF STANDARD CHARACTERS WITHOUT CLAIM TO ANY PARTICULAR FONT, STYLE, SIZE, OR COLOR.

SN 85-331,227, FILED 5-26-2011.

TRACY WHITTAKER-BROWN, EXAMINING ATTORNEY



David J. Kybas

Director of the United States Patent and Trademark Office

United States of America

United States Patent and Trademark Office

EyeCons

Reg. No. 4,207,179

Registered Sep. 11, 2012

Int. Cl.: 9

TRADEMARK

PRINCIPAL REGISTER

HERSCH AND COMPANY (CALIFORNIA PARTNERSHIP)
1900 AVENUE OF THE STARS
1900 AVENUE OF THE STARS
LOS ANGELES, CA 90067

FOR: GAME SOFTWARE, IN CLASS 9 (U.S. CLS. 21, 23, 26, 36 AND 38).

FIRST USE 9-20-2010; IN COMMERCE 9-20-2010.

THE MARK CONSISTS OF STANDARD CHARACTERS WITHOUT CLAIM TO ANY PARTICULAR FONT, STYLE, SIZE, OR COLOR.

SN 85-331,296, FILED 5-26-2011.

LEIGH CAROLINE CASE, EXAMINING ATTORNEY



David J. Kybas

Director of the United States Patent and Trademark Office

United States of America

United States Patent and Trademark Office



lingualinx

Reg. No. 4,207,180

Registered Sep. 11, 2012

Int. Cl.: 41

SERVICE MARK

PRINCIPAL REGISTER

LINGUALINX LANGUAGE SOLUTIONS, INC. (NEW YORK CORPORATION)
122 REMSEN STREET
COHOES, NY 12047

FOR: BRAILLE TRANSCRIPTION; BRAILLE TRANSLATION; DESKTOP PUBLISHING FOR OTHERS; LANGUAGE INTERPRETATION; TRANSLATION SERVICES, IN CLASS 41 (U.S. CLS. 100, 101 AND 107).

FIRST USE 7-22-2011, THE MARK WAS FIRST USED ANYWHERE IN A DIFFERENT FORM OTHER THAN THAT SOUGHT TO BE REGISTERED AT LEAST AS EARLY AS 03/22/2002.; IN COMMERCE 7-22-2011, THE MARK WAS FIRST USED IN COMMERCE IN A DIFFERENT FORM OTHER THAN THAT SOUGHT TO BE REGISTERED AT LEAST AS EARLY AS 03/22/2002..

OWNER OF U.S. REG. NO. 3,724,758.

THE COLOR(S) BLACK AND BLUE IS/ARE CLAIMED AS A FEATURE OF THE MARK.

THE MARK CONSISTS OF THE WORD "LINGUALINX" IN BLACK STYLIZED LOWER CASE LETTERS WITH A BLUE GEOMETRIC SHAPE CENTERED ABOVE THE "N".

SN 85-331,309, FILED 5-26-2011.

CAROLINE WOOD, EXAMINING ATTORNEY



David J. Kyffers

Director of the United States Patent and Trademark Office

United States of America

United States Patent and Trademark Office

WORLD-READY LANGUAGE INTELLIGENCE

Reg. No. 4,207,181

LINGUALINX LANGUAGE SOLUTIONS, INC. (NEW YORK CORPORATION)
122 REMSEN STREET
COHOES, NY 12047

Registered Sep. 11, 2012

Int. Cl.: 41

FOR: BRAILLE TRANSCRIPTION; BRAILLE TRANSLATION; DESKTOP PUBLISHING FOR OTHERS; LANGUAGE INTERPRETATION; TRANSLATION SERVICES, IN CLASS 41 (U.S. CLS. 100, 101 AND 107).

SERVICE MARK

FIRST USE 9-14-2011; IN COMMERCE 9-14-2011.

PRINCIPAL REGISTER

THE MARK CONSISTS OF STANDARD CHARACTERS WITHOUT CLAIM TO ANY PARTICULAR FONT, STYLE, SIZE, OR COLOR.

NO CLAIM IS MADE TO THE EXCLUSIVE RIGHT TO USE "LANGUAGE INTELLIGENCE", APART FROM THE MARK AS SHOWN.

SN 85-331,322, FILED 5-26-2011.

CAROLINE WOOD, EXAMINING ATTORNEY



David J. Kyros

Director of the United States Patent and Trademark Office

United States of America

United States Patent and Trademark Office

Seeds of Wisdom

Reg. No. 4,207,182

Registered Sep. 11, 2012

Int. Cl.: 14

TRADEMARK

PRINCIPAL REGISTER

MEL BERNIE AND COMPANY, INC. (CALIFORNIA CORPORATION)
3000 W. EMPIRE AVENUE
BURBANK, CA 90504

FOR: JEWELRY, IN CLASS 14 (U.S. CLS. 2, 27, 28 AND 50).

FIRST USE 9-1-2011; IN COMMERCE 9-1-2011.

THE MARK CONSISTS OF STANDARD CHARACTERS WITHOUT CLAIM TO ANY PARTICULAR FONT, STYLE, SIZE, OR COLOR.

SN 85-331,362, FILED 5-26-2011.

JAMES STEIN, EXAMINING ATTORNEY



David J. Kybas

Director of the United States Patent and Trademark Office

United States of America
United States Patent and Trademark Office

アマノイ

Reg. No. 4,207,183

Registered Sep. 11, 2012

Int. Cls.: 30 and 32

TRADEMARK

PRINCIPAL REGISTER

TAMANOI VINEGAR CO., LTD. (JAPAN CORPORATION)
1-1-32, KURUMANOCHO NISHI
SAKAI-KU, SAKAI-SHI
OSAKA, JAPAN

FOR: FLUID VINEGAR; FLUID VINEGAR MIXED WITH FLUID JUICES; POWDERED VINEGAR AND OTHER SEASONINGS, IN CLASS 30 (U.S. CL. 46).

FIRST USE 10-0-2009; IN COMMERCE 10-0-2009.

FOR: BEER; NON-ALCOHOLIC BEVERAGES, NAMELY, CARBONATED BEVERAGES; NON-ALCOHOLIC FRUIT JUICE BEVERAGES; VEGETABLE JUICES; WHEY BEVERAGES; EXTRACTS OF HOPS FOR MAKING BEER, IN CLASS 32 (U.S. CLS. 45, 46 AND 48).

FIRST USE 5-0-2011; IN COMMERCE 5-0-2011.

OWNER OF JAPAN REG. NO. 3262803, DATED 2-24-1997, EXPIRES 2-24-2017.

THE NON-LATIN CHARACTERS IN THE MARK TRANSLITERATE TO "TAMANOI" AND THIS MEANS HAS NO MEANING IN ENGLISH.

OWNER OF JAPAN REG. NO. 3204217, DATED 9-30-1996, EXPIRES 9-30-2016.

THE MARK CONSISTS OF JAPANESE CHARACTERS FOR THE WORD "TAMANOI".

SN 85-331,597, FILED 5-26-2011.

JOHN E. MICHOS, EXAMINING ATTORNEY



David J. Kypos

Director of the United States Patent and Trademark Office

United States of America

United States Patent and Trademark Office



Reg. No. 4,207,184

Registered Sep. 11, 2012

Int. Cls.: 9, 35, and 42

TRADEMARK

SERVICE MARK

PRINCIPAL REGISTER

KYARAS LLC (PUERTO RICO LIMITED LIABILITY COMPANY)
VILLA FONTANA PARK
AVE. SANCHEZ OSORIO 5X-34
CAROLINA, PUERTO RICO 00983

FOR: COMPUTER SOFTWARE, NAMELY, DESKTOP SOFTWARE AND DOWNLOADABLE SOFTWARE PROGRAMS FOR USE IN CONDUCTING PAYROLL PROCESSING AND EMPLOYEE PAYROLL TAX FILING AND REPORTING; COMPUTER SOFTWARE, NAMELY, DESKTOP SOFTWARE AND DOWNLOADABLE SOFTWARE PROGRAMS FOR USE IN EMPLOYEE TIME AND ATTENDANCE DATA COLLECTION, CALCULATION, REPORTING AND RECORD KEEPING, IN CLASS 9 (U.S. CLS. 21, 23, 26, 36 AND 38).

FIRST USE 3-15-2012; IN COMMERCE 3-15-2012.

FOR: PROVIDING COMPUTING, DATA, AND PROFESSIONAL SERVICES TO EMPLOYERS NAMELY, PAYROLL PROCESSING SERVICES, EMPLOYEE PAYROLL TAX FILING SERVICES, HUMAN RESOURCES MANAGEMENT, COLLECTION, COMPILATION AND SYSTEMIZATION OF EMPLOYEE TIME AND ATTENDANCE DATA INTO COMPUTER DATABASES FOR OTHERS; BUSINESS SERVICES, NAMELY, CALCULATING EMPLOYEE TIME AND ATTENDANCE DATA AND BUSINESS RECORDS MANAGEMENT OF EMPLOYEE TIME AND ATTENDANCE RECORDS FOR OTHERS, IN CLASS 35 (U.S. CLS. 100, 101 AND 102).

FIRST USE 3-15-2012; IN COMMERCE 3-15-2012.

FOR: RENTAL AND LEASING OF COMPUTER TERMINALS WITH BIOMETRIC SENSORS; PROVIDING A WEBSITE FEATURING PAYROLL PROCESSING AND EMPLOYEE PAYROLL TAX FILING AND REPORTING SERVICES FOR EMPLOYERS AND APPLICATION SERVICE PROVIDER SERVICES, NAMELY, PROVIDING HOSTING, MANAGING, AND MAINTAINING SOFTWARE FOR USE IN COLLECTING TIME AND ATTENDANCE INFORMATION OF EMPLOYEES AND PROVIDING AUTOMATED CALCULATION AND REPORTING OF TIME AND LABOR DATA; PROVIDING A WEBSITE FEATURING NON-DOWNLOADABLE SOFTWARE PROGRAMS FOR USE IN CONDUCTING PAYROLL PROCESSING AND EMPLOYEE PAYROLL TAX FILING AND REPORTING; PROVIDING A WEBSITE FEATURING NON-DOWNLOADABLE SOFTWARE FOR USE IN EMPLOYEE TIME AND ATTENDANCE DATA COLLECTION, CALCULATION, REPORTING AND RECORD KEEPING, IN CLASS 42 (U.S. CLS. 100 AND 101).



David J. Kyffers

Director of the United States Patent and Trademark Office

Reg. No. 4,207,184 FIRST USE 3-15-2012; IN COMMERCE 3-15-2012.

THE MARK CONSISTS OF THE STYLIZED, CAPITAL LETTER "K" APPEARING ABOVE THE STYLIZED WORD "KIARAS" WITH A LINE UNDERNEATH THE TERM "KIARAS". THE COLOR YELLOW APPEARS IN THE LINE UNDERNEATH THE TERM "KIARAS". THE COLOR BLACK APPEARS IN THE WORDING "KIARAS". THE COLORS YELLOW AND BLACK APPEAR IN THE CAPITAL LETTER "K" WHICH ALSO HAS GREY SHADING. THE COLOR WHITE APPEARING THE MARK REPRESENTS BACKGROUND OR TRANSPARENT AREAS AND ARE NOT PART OF THE MARK.

THE COLOR(S) YELLOW, GREY, AND BLACK IS/ARE CLAIMED AS A FEATURE OF THE MARK.

THE WORDING "KIARAS" HAS NO MEANING IN A FOREIGN LANGUAGE.

SN 85-331,924, FILED 5-26-2011.

MICHAEL TANNER, EXAMINING ATTORNEY

United States of America

United States Patent and Trademark Office



Reg. No. 4,207,185

Registered Sep. 11, 2012

Int. Cl.: 35

SERVICE MARK

PRINCIPAL REGISTER

OUTWEST PROMOTIONS INC. (WASHINGTON CORPORATION)
6368 SUNDANCE DRIVE
NINE MILES FALLS, WA 99026

FOR: ADVERTISING AND MARKETING SERVICES, NAMELY, PROMOTING THE GOODS AND SERVICES OF OTHERS; INCENTIVE AWARD PROGRAMS TO PROMOTE THE SALE OF PRODUCTS AND SERVICES OF OTHERS; PROMOTING THE SALE OF GOODS AND SERVICES OF OTHERS THROUGH THE DISTRIBUTION OF PRINTED MATERIAL AND PROMOTIONAL CONTESTS, IN CLASS 35 (U.S. CLS. 100, 101 AND 102).

FIRST USE 6-1-2011; IN COMMERCE 6-1-2011.

THE MARK CONSISTS OF THE WORDS "FILL UP" APPEAR OVER THE WORDS "SPLASH DOWN" IN A RECTANGULAR FORM WITH AN AMPERSAND SIGN IN THE CENTER. WAVE DESIGNS APPEAR AT THE BOTTOM OF THE LOGO AND THE CENTER OF THE LOGO FEATURES CURVED SWOOPING RIBBON STYLE DESIGNS THAT ARE WIDER AT THE CENTER AND TAPER AT THE ENDS.

SN 85-331,926, FILED 5-26-2011.

SHARON MEIER, EXAMINING ATTORNEY



David J. Kyffers

Director of the United States Patent and Trademark Office

United States of America

United States Patent and Trademark Office



Reg. No. 4,207,186

SORENSEN COMMUNICATIONS, INC. (UTAH CORPORATION)
4192 SOUTH RIVERBOAT ROAD, SUITE 100
SALT LAKE CITY, UT 84123

Registered Sep. 11, 2012

Int. Cl.: 38

FOR: INTERNET BROADCASTING SERVICES, IN CLASS 38 (U.S. CLS. 100, 101 AND 104).

SERVICE MARK

FIRST USE 6-13-2012; IN COMMERCE 6-13-2012.

PRINCIPAL REGISTER

THE MARK CONSISTS OF CLUSTER OF CIRCLES WITH THE LETTERS "SN" TO THE RIGHT AND THE WORD "SIGNETWORK" BELOW THE LETTERS.

SN 85-332,042, FILED 5-27-2011.

MATTHEW EINSTEIN, EXAMINING ATTORNEY



David J. Kyffers

Director of the United States Patent and Trademark Office

United States of America

United States Patent and Trademark Office

MILES OF COURAGE

Reg. No. 4,207,187

SPEEDWAY PROPERTIES COMPANY, LLC (DELAWARE LIMITED LIABILITY COMPANY)
2265-B RENAISSANCE DRIVE
LAS VEGAS, NV 89119

Registered Sep. 11, 2012

Int. Cls.: 16, 25, 36, and 41

FOR: PAPER GOODS AND PRINTED MATERIALS, NAMELY, BROCHURES AND BOOKS ABOUT AUTOMOBILE RACING, IN CLASS 16 (U.S. CLS. 2, 5, 22, 23, 29, 37, 38 AND 50).

FIRST USE 10-0-2011; IN COMMERCE 10-0-2011.

TRADEMARK

FOR: CLOTHING, NAMELY, T-SHIRTS, CAPS, IN CLASS 25 (U.S. CLS. 22 AND 39).

SERVICE MARK

FIRST USE 9-0-2011; IN COMMERCE 9-0-2011.

PRINCIPAL REGISTER

FOR: CHARITABLE FUNDRAISING SERVICES, IN CLASS 36 (U.S. CLS. 100, 101 AND 102).

FIRST USE 9-12-2011; IN COMMERCE 9-12-2011.

FOR: ENTERTAINMENT SERVICES IN THE NATURE OF ORGANIZING AND CONDUCTING RACES AND EXHIBITIONS, IN CLASS 41 (U.S. CLS. 100, 101 AND 107).

FIRST USE 9-0-2011; IN COMMERCE 9-0-2011.

THE MARK CONSISTS OF STANDARD CHARACTERS WITHOUT CLAIM TO ANY PARTICULAR FONT, STYLE, SIZE, OR COLOR.

SN 85-332,086, FILED 5-27-2011.

JOHN WILKE, EXAMINING ATTORNEY



David J. Kybas

Director of the United States Patent and Trademark Office

United States of America

United States Patent and Trademark Office

LifePro

Reg. No. 4,207,188

Registered Sep. 11, 2012

Int. Cl.: 45

SERVICE MARK

PRINCIPAL REGISTER

ATLANTA DIGITAL SECURITY SYSTEMS, INC. (GEORGIA CORPORATION)
35 DUFFY DRIVE
MCDONOUGH, GA 30252

FOR: MEDICAL ALERT MONITORING SERVICE, IN CLASS 45 (U.S. CLS. 100 AND 101).

FIRST USE 4-27-2012; IN COMMERCE 4-27-2012.

THE MARK CONSISTS OF STANDARD CHARACTERS WITHOUT CLAIM TO ANY PARTICULAR FONT, STYLE, SIZE, OR COLOR.

SN 85-332,182, FILED 5-27-2011.

PATRICIA EVANKO, EXAMINING ATTORNEY



David J. Kybas

Director of the United States Patent and Trademark Office

United States of America

United States Patent and Trademark Office

TRUE CAST

Reg. No. 4,207,189

Registered Sep. 11, 2012

Int. Cl.: 7

TRADEMARK

PRINCIPAL REGISTER

UNITED RENTALS, INC. (DELAWARE CORPORATION)
4 GREENWICH OFFICE PARK
GREENWICH, CT 06830

FOR: BLADES FOR POWER SAWS, IN CLASS 7 (U.S. CLS. 13, 19, 21, 23, 31, 34 AND 35).

FIRST USE 9-2-2008; IN COMMERCE 9-2-2008.

THE MARK CONSISTS OF STANDARD CHARACTERS WITHOUT CLAIM TO ANY PARTICULAR FONT, STYLE, SIZE, OR COLOR.

SN 85-332,396, FILED 5-27-2011.

KAREN SEVERSON, EXAMINING ATTORNEY



David J. Kyffers

Director of the United States Patent and Trademark Office

United States of America

United States Patent and Trademark Office

STUPIDBETZ.COM

Reg. No. 4,207,190

JAYWALKING SQUIRRELS, LLC (FLORIDA LIMITED LIABILITY COMPANY)
1965 LAKE MARKHAM RESERVE TRAIL
SANFORD, FL 32771

Registered Sep. 11, 2012

Int. Cl.: 35

FOR: OPERATING AN ONLINE MARKETPLACE FOR SELLERS OF GOODS AND SERVICES;
PROVIDING A WEBSITE FEATURING AN ONLINE MARKETPLACE FOR USERS TO EX-
CHANGE GOODS AND SERVICES WITH OTHER USERS, IN CLASS 35 (U.S. CLS. 100, 101
AND 102).

SERVICE MARK

PRINCIPAL REGISTER

FIRST USE 10-0-2011; IN COMMERCE 11-0-2011.

THE MARK CONSISTS OF STANDARD CHARACTERS WITHOUT CLAIM TO ANY PAR-
TICULAR FONT, STYLE, SIZE, OR COLOR.

SN 85-332,539, FILED 5-27-2011.

SIMON TENG, EXAMINING ATTORNEY



David J. Kybas

Director of the United States Patent and Trademark Office

United States of America

United States Patent and Trademark Office



hydroponic
green valley
produce

Reg. No. 4,207,191

Registered Sep. 11, 2012

Int. Cl.: 44

SERVICE MARK

PRINCIPAL REGISTER

HYDROPONIC GREEN VALLEY PRODUCE S.A. DE C.V. (MEXICO CORPORATION)
AVENIDA VASCONCELOS ORIENTE 210 P5
RESIDENCIAL SAN AGUSTÍN, SAN PEDRO GARZA
NUEVO LEÓN, MEXICO

FOR: GREENHOUSE CULTIVATION OF FOOD PRODUCTS; GREENHOUSE SERVICES,
IN CLASS 44 (U.S. CLS. 100 AND 101).

FIRST USE 11-8-2011; IN COMMERCE 11-8-2011.

NO CLAIM IS MADE TO THE EXCLUSIVE RIGHT TO USE "HYDROPONIC" AND "PRODUCE", APART FROM THE MARK AS SHOWN.

THE MARK CONSISTS OF A CIRCLE DIVIDED INTO TWO HALVES, THE UPPER AND LOWER BY A HORIZONTAL LINE EXACTLY IN THE MIDDLE. IN THE UPPER HALF APPEAR SIX VERTICAL LINES THAT FORM SEVEN SPACES. THE CENTRAL SPACE CONTAINS A CURVED LINE. THE LOWER HALF OF THE CIRCLE CONTAINS 6 DIAGONAL LINES POSITIONED SO AS TO LOOK AS THE SHADOW OF THE UPPER HALF OF THE CIRCLE REFLECTED ON LOWER HALF. BELOW THE DESIGN APPEARS THE WORDING "HYDROPONIC GREEN VALLEY PRODUCE" IN STYLIZED LETTERS.

SN 85-332,667, FILED 5-27-2011.

LESLEY LAMOTHE, EXAMINING ATTORNEY



David J. Kybas

Director of the United States Patent and Trademark Office

United States of America

United States Patent and Trademark Office

FIRST PRESTON HT

Reg. No. 4,207,192

Registered Sep. 11, 2012

Int. Cls.: 35, 36, and 42

SERVICE MARK

PRINCIPAL REGISTER

FIRST PRESTON MANAGEMENT, INC. (TEXAS CORPORATION)
5140 ADDISON CIRCLE
SUITE 400
ADDISON, TX 75001

FOR: ACCOUNTING SERVICES; REAL ESTATE MARKETING SERVICES, NAMELY, ON-LINE SERVICES FEATURING TOURS OF RESIDENTIAL AND COMMERCIAL REAL ESTATE, IN CLASS 35 (U.S. CLS. 100, 101 AND 102).

FIRST USE 6-15-2011; IN COMMERCE 6-15-2011.

FOR: REAL ESTATE BROKERAGE; REAL ESTATE FINANCING SERVICES; REAL ESTATE MANAGEMENT SERVICES, IN CLASS 36 (U.S. CLS. 100, 101 AND 102).

FIRST USE 6-15-2011; IN COMMERCE 6-15-2011.

FOR: APPLICATION SERVICE PROVIDER (ASP) FEATURING SOFTWARE FOR USE IN PROVIDING, HOSTING, MANAGING, DEVELOPING, AND MAINTAINING APPLICATIONS, SOFTWARE, WEB SITES AND DATABASES IN THE FIELDS OF ONLINE AUCTIONS, SELECTION, BIDDING, OFFER MANAGEMENT, REAL ESTATE TRANSACTIONS, AND MANAGEMENT AND MARKETING OF REAL ESTATE ASSETS, IN CLASS 42 (U.S. CLS. 100 AND 101).

FIRST USE 6-15-2011; IN COMMERCE 6-15-2011.

THE MARK CONSISTS OF STANDARD CHARACTERS WITHOUT CLAIM TO ANY PARTICULAR FONT, STYLE, SIZE, OR COLOR.

OWNER OF U.S. REG. NO. 2,924,986.

SN 85-332,914, FILED 5-27-2011.

REBECCA EISINGER, EXAMINING ATTORNEY



David J. Kybas

Director of the United States Patent and Trademark Office

United States of America

United States Patent and Trademark Office



FIRST PRESTON HT

Reg. No. 4,207,193

Registered Sep. 11, 2012

Int. Cls.: 35, 36, and 42

SERVICE MARK

PRINCIPAL REGISTER

FIRST PRESTON MANAGEMENT, INC. (TEXAS CORPORATION)
5040 ADDISON CIRCLE
SUITE 400
ADDISON, TX 75001

FOR: ACCOUNTING SERVICES; REAL ESTATE MARKETING SERVICES, NAMELY, ON-LINE SERVICES FEATURING TOURS OF RESIDENTIAL AND COMMERCIAL REAL ESTATE, IN CLASS 35 (U.S. CLS. 100, 101 AND 102).

FIRST USE 6-15-2011; IN COMMERCE 6-15-2011.

FOR: REAL ESTATE BROKERAGE; REAL ESTATE FINANCING SERVICES; REAL ESTATE MANAGEMENT SERVICES, IN CLASS 36 (U.S. CLS. 100, 101 AND 102).

FIRST USE 6-15-2011; IN COMMERCE 6-15-2011.

FOR: APPLICATION SERVICE PROVIDER (ASP) FEATURING SOFTWARE FOR USE IN PROVIDING, HOSTING, MANAGING, DEVELOPING, AND MAINTAINING APPLICATIONS, SOFTWARE, WEB SITES AND DATABASES IN THE FIELDS OF ONLINE AUCTIONS, SELECTION, BIDDING, OFFER MANAGEMENT, REAL ESTATE TRANSACTIONS, AND MANAGEMENT AND MARKETING OF REAL ESTATE ASSETS, IN CLASS 42 (U.S. CLS. 100 AND 101).

FIRST USE 6-15-2011; IN COMMERCE 6-15-2011.

OWNER OF U.S. REG. NO. 2,924,986.

THE MARK CONSISTS OF THREE CURVED BANDS TO THE LEFT OF THE WORDS "FIRST PRESTON HT".

SN 85-332,916, FILED 5-27-2011.

REBECCA EISINGER, EXAMINING ATTORNEY



David J. Kybas

Director of the United States Patent and Trademark Office

United States of America

United States Patent and Trademark Office

Spiritual Sports Socks

Reg. No. 4,207,194

Registered Sep. 11, 2012

Int. Cl.: 25

TRADEMARK

PRINCIPAL REGISTER

C&T 413 LLC (MICHIGAN LIMITED LIABILITY COMPANY)
15611 STONE CROSSING DRIVE
SOUTHFIELD, MI 48075

FOR: ADULT NOVELTY GAG CLOTHING ITEM, NAMELY, SOCKS; ANKLE SOCKS; ANKLETS; ANTI-PERSPIRANT SOCKS; COMPRESSION GARMENTS FOR ATHLETIC OR OTHER NON-MEDICAL USE, NAMELY, BASKETBALL AND FOOTBALL; JACKETS AND SOCKS; JAPANESE STYLE SOCKS; MEN'S DRESS SOCKS; MEN'S SOCKS; NON-SLIP SOCKS; SLIPPER SOCKS; SOCKS; SOCKS AND STOCKINGS; THERMAL SOCKS; WATER SOCKS; WOOLLEN SOCKS, IN CLASS 25 (U.S. CLS. 22 AND 39).

FIRST USE 4-1-2012; IN COMMERCE 4-1-2012.

THE MARK CONSISTS OF STANDARD CHARACTERS WITHOUT CLAIM TO ANY PARTICULAR FONT, STYLE, SIZE, OR COLOR.

NO CLAIM IS MADE TO THE EXCLUSIVE RIGHT TO USE "SPORTS SOCKS", APART FROM THE MARK AS SHOWN.

SN 85-333,384, FILED 5-30-2011.

JAY FLOWERS, EXAMINING ATTORNEY



David J. Kyros

Director of the United States Patent and Trademark Office

United States of America

United States Patent and Trademark Office

Choco Letter

Reg. No. 4,207,195

Registered Sep. 11, 2012

Int. Cl.: 30

TRADEMARK

PRINCIPAL REGISTER

DR. HESS, MARKUS, G (FED REP GERMANY INDIVIDUAL)
RHEINSTRASSE 4
EGLISAU, SWITZERLAND 8193

FOR: ARRANGEMENTS OF CUT FRUIT COMPRISED OF FRESH FRUITS CUT INTO FLOWER SHAPES AND AT LEAST PARTIALLY COATED WITH CHOCOLATE; BAKED GOODS, NAMELY, CRUMBLES; BAKERY DESSERTS; BAKERY GOODS; BAKERY GOODS AND DESSERT ITEMS, NAMELY, CHEESECAKES FOR RETAIL AND WHOLESALE DISTRIBUTION AND CONSUMPTION ON OR OFF THE PREMISES; BAKERY GOODS, NAMELY, CHOCOLATE RELATED; BAKERY PRODUCTS; BAKERY PRODUCTS, NAMELY, SWEET BAKERY GOODS; BEVERAGES WITH A CHOCOLATE BASE; BROWN SUGAR; BROWNIE MIXES; BROWNIES; CANDIES; CANDY; CANDY BARS; CANDY CAKE DECORATIONS; CANDY COATED POPCORN; CANDY CONTAINING ALCOHOLIC BEVERAGE CONTENT AND FLAVOR; CANDY DECORATIONS FOR CAKES; CANDY FOR FOOD; CANDY MINTS; CANDY SPRINKLES; CANDY WITH CARAMEL; CANDY WITH COCOA; CANDY, NAMELY, DRAGÉES; CEREAL BASED SNACK FOOD; CEREAL-BASED SNACK FOODS; CHEWING GUM; CHEWING GUM WITH VITAMINS; CHEWING GUM, NOT FOR MEDICAL PURPOSES; CHEWING GUMS; CHOCOLATE; CHOCOLATE AND CHOCOLATES; CHOCOLATE BARK CONTAINING GROUND COFFEE BEANS; CHOCOLATE BARS; CHOCOLATE BASED INGREDIENT FOR USE IN CHOCOLATE; CHOCOLATE CANDIES; CHOCOLATE CHIPS; CHOCOLATE CONFECTIONS; CHOCOLATE CONFECTIONS, NAMELY, CHOCOLATE CANDY; CHOCOLATE COVERED COCOA NIBS; CHOCOLATE COVERED COOKIES; CHOCOLATE COVERED FRUIT; CHOCOLATE COVERED NUTS; CHOCOLATE COVERED POPCORN; CHOCOLATE COVERED PRETZELS; CHOCOLATE COVERED RAISINS; CHOCOLATE COVERED ROASTED COFFEE BEANS; CHOCOLATE FONDUE; CHOCOLATE FOOD BEVERAGES NOT BEING DAIRY-BASED OR VEGETABLE BASED; CHOCOLATE FOR CONFECTIONERY AND BREAD; CHOCOLATE FOR TOPPINGS; CHOCOLATE MOUSSE; CHOCOLATE PASTES; CHOCOLATE POWDER; CHOCOLATE SAUCE; CHOCOLATE SYRUP; CHOCOLATE TOPPED PRETZELS; CHOCOLATE TOPPING; CHOCOLATE TRUFFLES; CHOCOLATE-BASED BEVERAGES WITH MILK; CHOCOLATE-BASED FILLINGS FOR CAKES AND PIES; CHOCOLATE-BASED READY-TO-EAT FOOD BARS; CHOCOLATE-COVERED POTATO CHIPS; CHOCOLATES AND CHOCOLATE BASED READY TO EAT CANDIES AND SNACKS; CHOCOLATES CONTAINING NUTRIENTS; COCOA; COCOA; COCOA BEVERAGES WITH MILK; COCOA EXTRACTS FOR HUMAN CONSUMPTION; COCOA MIXES; COCOA POWDER; COCOA SPREADS; COCOA-BASED BEVERAGES; COCOA-BASED CONDIMENTS AND SEASONINGS FOR FOOD AND DRINK; COCOA-BASED INGREDIENT IN CONFECTIONERY PRODUCTS; COCONUT SUGAR;



David J. Kybas

Director of the United States Patent and Trademark Office

Reg. No. 4,207,195 COCONUT-BASED FRUIT ICE; COFFEE; COFFEE; COFFEE AND ARTIFICIAL COFFEE; COFFEE AND COFFEE SUBSTITUTES; COFFEE AND TEA; COFFEE BASED BEVERAGES; COFFEE BEANS; COFFEE BEVERAGES WITH MILK; COFFEE CAPSULES CONTAINING COFFEE FOR BREWING; COFFEE ESSENCES; COFFEE ESSENCES FOR USE AS SUBSTITUTES FOR COFFEE; COFFEE EXTRACTS; COFFEE EXTRACTS FOR USE AS SUBSTITUTES FOR COFFEE; COFFEE FLAVORED SYRUP USED IN MAKING FOOD BEVERAGES; COFFEE PODS; COFFEE SUBSTITUTES; COFFEE SUBSTITUTES; COFFEE-BASED BEVERAGE CONTAINING MILK; COFFEE-BASED BEVERAGES; CONES FOR ICE CREAM; CONES FOR ICECREAM; CONFECTIONER'S COATINGS IN THE NATURE OF EDIBLE SHELLAC COATINGS FOR FOODS; CONFECTIONERIES, NAMELY, SNACK FOODS, NAMELY, CHOCOLATE; CONFECTIONERY CHIPS FOR BAKING; CONFECTIONERY MADE OF SUGAR; CONFECTIONERY, NAMELY, PASTILLES; COOKIES; COOKIES AND CRACKERS; DANISH PASTRIES; DOUGHNUTS; FILLED CHOCOLATE; FRESH FRUITS CUT INTO FLOWER SHAPES AND AT LEAST PARTIALLY COATED WITH CHOCOLATE; FROZEN APPETIZERS CONSISTING PRIMARILY OF CORNMEAL; FROZEN BREADS; FROZEN CASHEW-BASED DESSERTS; FROZEN CONFECTIONERY; FROZEN CONFECTIONS; FROZEN CONFECTIONS, NAMELY, FREEZER BARS; FROZEN CONFECTIONS, NAMELY, FREEZER POPS; FROZEN CONFECTIONS, NAMELY, ICES; FROZEN COOKIE DOUGH; FROZEN COOKIE, BROWNIE AND BISCOTTI DOUGH; FROZEN CUSTARDS; FROZEN DESSERT CONSISTING OF FRUIT AND CREAM OR CREAM SUBSTITUTES; FROZEN DESSERTS CONSISTING OF FLAVORED ICE BLOCKS WITH TOPPINGS; FROZEN JUICE BARS; FROZEN SOY-BASED DESSERTS; FROZEN YOGHURT; FROZEN YOGURT; FROZEN YOGURT CONFECTIONS; FROZEN YOGURT MIXES; FROZEN YOGURT PIES AND CAKES; FRUCTOSE FOR FOOD; FRUIT BREADS; FRUIT CAKES; FRUIT COBBLERS; FRUIT ICE; FRUIT ICE BAR; FRUIT ICES; FRUIT JELLIES; GELATO; GIFT BASKETS CONTAINING CANDY; GRAIN-BASED FOOD BARS ALSO CONTAINING CHOCOLATE; HOT CHOCOLATE; ICE CANDIES; ICE CREAM; ICE CREAM DESSERTS; ICE CREAM DRINKS; ICE CREAM FLOATS; ICE CREAM MIXES; ICE CREAM POWDER; ICE CREAM SANDWICHES; ICE CREAM SUBSTITUTE; ICE CREAMS; ICE MILK BARS; ICE-CREAM; ICE-CREAM CAKES; MARZIPAN; MARZIPAN SUBSTITUTES; MILK CHOCOLATE; MUESLI; MUESLI BARS; MUFFINS; NOUGAT; PASTRIES; PASTRIES WITH FRUIT; PASTRIES, NAMELY, PASTIES; PASTRY; PASTRY MIXES; PRALINES; PROCESSED CACAO; PROCESSED CEREAL-BASED FOOD TO BE USED AS A BREAKFAST FOOD, SNACK FOOD OR INGREDIENT FOR MAKING OTHER FOODS; PROCESSED CEREALS; ROLLS; SNACK FOODS, NAMELY, CHOCOLATE-BASED SNACK FOODS; SPREAD CONTAINING CHOCOLATE AND NUTS; ZWIEBACK, IN CLASS 30 (U.S. CL. 46).

FIRST USE 4-15-2012; IN COMMERCE 6-1-2012.

THE MARK CONSISTS OF STANDARD CHARACTERS WITHOUT CLAIM TO ANY PARTICULAR FONT, STYLE, SIZE, OR COLOR.

SN 85-333,411, FILED 5-30-2011.

ANDREW LEASER, EXAMINING ATTORNEY

United States of America

United States Patent and Trademark Office

MyChangeNow

Reg. No. 4,207,196

MYCHANGENOW LLC (HAWAII LIMITED LIABILITY COMPANY)
1611 KEEAUMOKU ST. #305
HONOLULU, HI 96822

Registered Sep. 11, 2012

Int. Cl.: 45

FOR: ON-LINE SOCIAL NETWORKING SERVICES, IN CLASS 45 (U.S. CLS. 100 AND 101).

SERVICE MARK

FIRST USE 11-14-2011; IN COMMERCE 11-14-2011.

PRINCIPAL REGISTER

THE MARK CONSISTS OF STANDARD CHARACTERS WITHOUT CLAIM TO ANY PARTICULAR FONT, STYLE, SIZE, OR COLOR.

SN 85-333,472, FILED 5-30-2011.

JULIE GUTTADAURO, EXAMINING ATTORNEY



David J. Kyffers

Director of the United States Patent and Trademark Office

United States of America
United States Patent and Trademark Office

Somla

Reg. No. 4,207,197

LIMING TAO (CHINA INDIVIDUAL)
NO.73 FUCHUN ROAD, FUCHUN STREET,
FUYANG, ZHEJIANG,, CHINA

Registered Sep. 11, 2012

Int. Cl.: 20

FOR: COMPUTER FURNITURE; DISPLAY STANDS; FURNITURE; FURNITURE, NAMELY, SHOWCASES; MAGAZINE RACKS; METAL DISPLAY STANDS; NAMEPLATES, NOT OF METAL; NONMETAL AUDIO SPEAKER MOUNTS AND MOUNTING BRACKETS WITH SWIVELING BASES THEREFOR; PLACARDS OF WOOD OR PLASTIC; TEA TABLES; TELEVISION STANDS; WOODEN DISPLAY STANDS, IN CLASS 20 (U.S. CLS. 2, 13, 22, 25, 32 AND 50).

TRADEMARK

PRINCIPAL REGISTER

FIRST USE 1-7-2008; IN COMMERCE 1-20-2012.

THE WORDING "SOMLE" HAS NO MEANING IN A FOREIGN LANGUAGE.

SN 85-333,511, FILED 5-31-2011.

MELISSA VALLILLO, EXAMINING ATTORNEY



David J. Kyffers

Director of the United States Patent and Trademark Office

United States of America

United States Patent and Trademark Office

Where Producers Are King!

Reg. No. 4,207,198

LINDSEY, MARK (UNITED STATES INDIVIDUAL)
110 EAST 59TH STREET, 22ND FLOOR
NEW YORK, NY 10022

Registered Sep. 11, 2012

Int. Cl.: 35

FOR: ADVERTISING, MARKETING AND PROMOTION SERVICES, IN CLASS 35 (U.S. CLS. 100, 101 AND 102).

SERVICE MARK

FIRST USE 12-20-2011; IN COMMERCE 12-20-2011.

PRINCIPAL REGISTER

THE MARK CONSISTS OF STANDARD CHARACTERS WITHOUT CLAIM TO ANY PARTICULAR FONT, STYLE, SIZE, OR COLOR.

SN 85-333,630, FILED 5-31-2011.

JOHN GARTNER, EXAMINING ATTORNEY



David J. Kybas

Director of the United States Patent and Trademark Office

United States of America

United States Patent and Trademark Office

Style Away

Reg. No. 4,207,199

MACHALTUS PRODUCTS LLC (KANSAS LIMITED LIABILITY COMPANY)
6720 N OLIVER RD
WALTON, KS 67151

Registered Sep. 11, 2012

Int. Cl.: 21

FOR: PLASTIC BATH RACKS, NAMELY, RACKS FOR HOLDING HAIR DRIERS AND OTHER HAIR CARE ITEMS, IN CLASS 21 (U.S. CLS. 2, 13, 23, 29, 30, 33, 40 AND 50).

TRADEMARK

FIRST USE 12-18-2011; IN COMMERCE 12-18-2011.

PRINCIPAL REGISTER

THE MARK CONSISTS OF STANDARD CHARACTERS WITHOUT CLAIM TO ANY PARTICULAR FONT, STYLE, SIZE, OR COLOR.

SN 85-333,634, FILED 5-31-2011.

STEVEN JACKSON, EXAMINING ATTORNEY



David J. Kyffers

Director of the United States Patent and Trademark Office

United States of America

United States Patent and Trademark Office

I AM A BOOBIE FAN

Reg. No. 4,207,200

Registered Sep. 11, 2012

Int. Cl.: 36

SERVICE MARK

PRINCIPAL REGISTER

KING, FELICIA (UNITED STATES INDIVIDUAL)
1109 16TH AVENUE SOUTH
SUITE 4
NASHVILLE, TN 37212 AND

MONTES, LISA (UNITED STATES INDIVIDUAL)
1109 16TH AVENUE SOUTH
SUITE 4
NASHVILLE, TN 37212

FOR: CHARITABLE FUNDRAISING SERVICES; CHARITABLE FUNDRAISING SERVICES BY MEANS OF THE SALE OF CLOTHING ITEMS AND FASHION ACCESSORIES, IN CLASS 36 (U.S. CLS. 100, 101 AND 102).

FIRST USE 6-1-2011; IN COMMERCE 6-1-2011.

THE MARK CONSISTS OF STANDARD CHARACTERS WITHOUT CLAIM TO ANY PARTICULAR FONT, STYLE, SIZE, OR COLOR.

SN 85-333,835, FILED 5-31-2011.

JOHN HWANG, EXAMINING ATTORNEY



David J. Kyffers

Director of the United States Patent and Trademark Office

United States of America

United States Patent and Trademark Office



Reg. No. 4,207,201

Registered Sep. 11, 2012

Int. Cl.: 3

TRADEMARK

PRINCIPAL REGISTER

SHOWLINE SOAPS, INC. (NORTH CAROLINA CORPORATION)
SUITE 160
2114 ATLANTIC AVENUE
RALEIGH, NC 276041555

FOR: ALL-PURPOSE CLEANERS; AUTOMOBILE CLEANERS; CLEANER FOR USE ON INDUSTRIAL SURFACES; DEGREASING PREPARATIONS FOR HOUSEHOLD, AUTOMOTIVE, AND INDUSTRIAL SURFACES, IN CLASS 3 (U.S. CLS. 1, 4, 6, 50, 51 AND 52).

FIRST USE 3-5-2012; IN COMMERCE 3-5-2012.

THE MARK CONSISTS OF THE WORDS "QUICK STUFF" SUPERIMPOSED ON A TRIANGLE.

SN 85-333,848, FILED 5-31-2011.

JAMES LOVELACE, EXAMINING ATTORNEY



David J. Kyffers

Director of the United States Patent and Trademark Office

United States of America

United States Patent and Trademark Office

JABFAB

Reg. No. 4,207,202

Registered Sep. 11, 2012

Int. Cls.: 35 and 41

SERVICE MARK

PRINCIPAL REGISTER

JABFAB INC. (DELAWARE CORPORATION)
10004 CARPERS FARM COURT
VIENNA, VA 22182

FOR: PROVIDING AN ONLINE INTERACTIVE WEBSITE OBTAINING USERS' COMMENTS CONCERNING BUSINESS ORGANIZATIONS, SERVICE PROVIDERS, POLITICS AND GENERAL MATTERS OF IMPORTANCE TO THE USER, NAMELY, THE PURCHASE OF CONSUMER AND BUSINESS PRODUCTS AND SERVICES; PROVIDING INFORMATION, NAMELY, COMPILATIONS, RANKINGS, RATINGS, REVIEWS, REFERRALS AND RECOMMENDATIONS RELATING TO BUSINESS ORGANIZATIONS, SERVICE PROVIDERS, POLITICS AND GENERAL MATTERS OF IMPORTANCE TO THE USER, NAMELY, THE PURCHASE OF CONSUMER AND BUSINESS PRODUCTS AND SERVICES, USING A GLOBAL COMPUTER NETWORK, IN CLASS 35 (U.S. CLS. 100, 101 AND 102).

FIRST USE 12-7-2011; IN COMMERCE 12-7-2011.

FOR: PROVIDING AN ONLINE INTERACTIVE WEBSITE OBTAINING USERS' COMMENTS CONCERNING THE MEDIA, NAMELY, ENTERTAINMENT, TELEVISION, MOVIE, MUSIC AND VIDEO CONTENT, AND GENERAL MATTERS OF IMPORTANCE TO THE USER, NAMELY, CURRENT EVENTS; PROVIDING INFORMATION, NAMELY, COMPILATIONS, RANKINGS, RATINGS, REVIEWS, REFERRALS AND RECOMMENDATIONS RELATING TO THE MEDIA, NAMELY, ENTERTAINMENT, TELEVISION, MOVIE, MUSIC AND VIDEO CONTENT, AND GENERAL MATTERS OF IMPORTANCE TO THE USER, NAMELY, CURRENT EVENTS, USING A GLOBAL COMPUTER NETWORK, IN CLASS 41 (U.S. CLS. 100, 101 AND 107).

FIRST USE 12-7-2011; IN COMMERCE 12-7-2011.

THE MARK CONSISTS OF STANDARD CHARACTERS WITHOUT CLAIM TO ANY PARTICULAR FONT, STYLE, SIZE, OR COLOR.

SN 85-333,872, FILED 5-31-2011.

TINA BROWN, EXAMINING ATTORNEY



David J. Kyros

Director of the United States Patent and Trademark Office

United States of America

United States Patent and Trademark Office

JABFAB

Reg. No. 4,207,203

Registered Sep. 11, 2012

Int. Cl.: 42

SERVICE MARK

PRINCIPAL REGISTER

JABFAB INC. (DELAWARE CORPORATION)
10004 CARPERS FARM COURT
VIENNA, VA 22182

FOR: COMPUTER SERVICES, NAMELY, CREATING AN ON-LINE COMMUNITY FOR REGISTERED USERS TO PARTICIPATE IN DISCUSSIONS, GET FEEDBACK FROM THEIR PEERS, FORM VIRTUAL COMMUNITIES, AND ENGAGE IN SOCIAL NETWORKING SERVICES IN THE FIELD OF CONSUMER SENTIMENT, EXPERIENCES, RATINGS, AND OPINIONS RELATING TO BUSINESS ORGANIZATIONS, SERVICE PROVIDERS, AND CONSUMER PRODUCTS; PROVIDING A WEB SITE THAT GIVES COMPUTER USERS THE ABILITY TO UPLOAD, EXCHANGE AND SHARE PHOTOS, VIDEOS AND VIDEO LOGS, IN CLASS 42 (U.S. CLS. 100 AND 101).

FIRST USE 12-7-2011; IN COMMERCE 12-7-2011.

THE MARK CONSISTS OF STANDARD CHARACTERS WITHOUT CLAIM TO ANY PARTICULAR FONT, STYLE, SIZE, OR COLOR.

SN 85-333,885, FILED 5-31-2011.

TINA BROWN, EXAMINING ATTORNEY



David J. Kyros

Director of the United States Patent and Trademark Office

United States of America

United States Patent and Trademark Office

NetPac

Reg. No. 4,207,204

Registered Sep. 11, 2012

Int. Cl.: 9

TRADEMARK

PRINCIPAL REGISTER

TOSHIBA INTERNATIONAL CORPORATION (CALIFORNIA CORPORATION)
13131 WEST LITTLE YORK ROAD
HOUSTON, TX 77401

FOR: WIRELESS COMMUNICATIONS DEVICE, NAMELY, A WIRELESS DRIVE INTERFACE DEVICE USED TO FACILITATE COMMUNICATIONS BETWEEN MULTIPLE ADJUSTABLE SPEED DRIVES AND A CENTRAL COMPUTER THAT ALLOWS ONE TO MONITOR AND CONTROL THE ADJUSTABLE SPEED DRIVES, IN CLASS 9 (U.S. CLS. 21, 23, 26, 36 AND 38).

FIRST USE 9-19-2011; IN COMMERCE 9-19-2011.

THE MARK CONSISTS OF STANDARD CHARACTERS WITHOUT CLAIM TO ANY PARTICULAR FONT, STYLE, SIZE, OR COLOR.

SN 85-333,894, FILED 5-31-2011.

LINDA M. KING, EXAMINING ATTORNEY



David J. Kybas

Director of the United States Patent and Trademark Office

United States of America
United States Patent and Trademark Office

BLOOM

Reg. No. 4,207,205

Registered Sep. 11, 2012

Int. Cl.: 35

SERVICE MARK

PRINCIPAL REGISTER

XUBA, LLC (DELAWARE LIMITED LIABILITY COMPANY)
9394 WEST DODGE ROAD
SUITE 230
OMAHA, NE 68114

FOR: ON-LINE RETAIL STORE SERVICES FEATURING HEALTH AND BEAUTY PRODUCTS; PROVIDING A WEBSITE WHERE USERS CAN POST RATINGS, REVIEWS AND RECOMMENDATIONS ON HEALTH AND BEAUTY PRODUCTS, IN CLASS 35 (U.S. CLS. 100, 101 AND 102).

FIRST USE 4-1-2010; IN COMMERCE 4-1-2010.

THE MARK CONSISTS OF STANDARD CHARACTERS WITHOUT CLAIM TO ANY PARTICULAR FONT, STYLE, SIZE, OR COLOR.

SN 85-333,922, FILED 5-31-2011.

JENNIFER VASQUEZ, EXAMINING ATTORNEY



David J. Kyffers

Director of the United States Patent and Trademark Office

United States of America

United States Patent and Trademark Office

BLOOM

Reg. No. 4,207,206

Registered Sep. 11, 2012

Int. Cl.: 42

SERVICE MARK

PRINCIPAL REGISTER

XUBA, LLC (DELAWARE LIMITED LIABILITY COMPANY)
9394 WEST DODGE ROAD
SUITE 230
OMAHA, NE 68114

FOR: COMPUTER SERVICES, NAMELY, CREATING AN ON-LINE COMMUNITY FOR REGISTERED USERS TO PARTICIPATE IN DISCUSSIONS, GET FEEDBACK FROM THEIR PEERS, FORM VIRTUAL COMMUNITIES, AND ENGAGE IN SOCIAL NETWORKING IN THE FIELDS OF HEALTH AND BEAUTY PRODUCTS, IN CLASS 42 (U.S. CLS. 100 AND 101).

FIRST USE 4-1-2010; IN COMMERCE 4-1-2010.

THE MARK CONSISTS OF STANDARD CHARACTERS WITHOUT CLAIM TO ANY PARTICULAR FONT, STYLE, SIZE, OR COLOR.

SN 85-333,931, FILED 5-31-2011.

JENNIFER VASQUEZ, EXAMINING ATTORNEY



David J. Kybas

Director of the United States Patent and Trademark Office

United States of America

United States Patent and Trademark Office

BLOOM.COM

Reg. No. 4,207,207

Registered Sep. 11, 2012

Int. Cl.: 35

SERVICE MARK

PRINCIPAL REGISTER

XUBA, LLC (DELAWARE LIMITED LIABILITY COMPANY)
9394 WEST DODGE ROAD
SUITE 230
OMAHA, NE 68114

FOR: ON-LINE RETAIL STORE SERVICES FEATURING HEALTH AND BEAUTY PRODUCTS; PROVIDING A WEBSITE WHERE USERS CAN POST RATINGS, REVIEWS AND RECOMMENDATIONS ON HEALTH AND BEAUTY PRODUCTS, IN CLASS 35 (U.S. CLS. 100, 101 AND 102).

FIRST USE 4-1-2010; IN COMMERCE 4-1-2010.

THE MARK CONSISTS OF STANDARD CHARACTERS WITHOUT CLAIM TO ANY PARTICULAR FONT, STYLE, SIZE, OR COLOR.

SN 85-333,937, FILED 5-31-2011.

JENNIFER VASQUEZ, EXAMINING ATTORNEY



David J. Kyffers

Director of the United States Patent and Trademark Office

United States of America

United States Patent and Trademark Office



Reg. No. 4,207,208

Registered Sep. 11, 2012

Int. Cl.: 36

SERVICE MARK

PRINCIPAL REGISTER

MODULUS INFORMATICS, INC. (ARIZONA CORPORATION)
SUITE 100
9375 EAST SHEA BOULEVARD
SCOTTSDALE, AZ 85260

FOR: COMPUTER ANALYSES OF STOCK EXCHANGE INFORMATION; PROVISION OF INFORMATION AND DATA CONCERNING STOCK EXCHANGES; PROVISION OF STOCK MARKET INFORMATION, IN CLASS 36 (U.S. CLS. 100, 101 AND 102).

FIRST USE 2-2-2011; IN COMMERCE 8-11-2011.

NO CLAIM IS MADE TO THE EXCLUSIVE RIGHT TO USE "WALL ST", APART FROM THE MARK AS SHOWN.

THE COLOR(S) WHITE, BLUE, ORANGE, YELLOW AND BLACK IS/ARE CLAIMED AS A FEATURE OF THE MARK.

THE MARK CONSISTS OF THE WORDING "WALL ST BIRDS" WITH THE WORDS "WALL ST" APPEARING INSIDE OF A STREET SIGN. THE WORDS "WALL ST" APPEAR IN THE COLOR WHITE, THE WORD "BIRDS" APPEARS IN THE COLOR BLUE, AND THE STREET SIGN APPEARS IN THE COLOR BLUE WITH ITS RIGHT SIDE FORMING THE BLUE LETTER "B" IN "BIRDS". A BLUE BIRD HAVING A WHITE CHEST, AN ORANGE AND YELLOW BEAK, ORANGE LEGS AND FEET AND A BLACK DOT FOR AN EYE APPEARS OVER THE LETTER "I" IN THE WORD "BIRDS".

SN 85-333,996, FILED 5-31-2011.

ZHALEH DELANEY, EXAMINING ATTORNEY



David J. Kybas

Director of the United States Patent and Trademark Office

United States of America

United States Patent and Trademark Office

SARA MICHELLE

Reg. No. 4,207,209

Registered Sep. 11, 2012

Int. Cl.: 25

TRADEMARK

PRINCIPAL REGISTER

GLORIA LANCE, INC. (CALIFORNIA CORPORATION)
15616 S BROADWAY
GARDENA, CA 90248

FOR: TOPS, IN CLASS 25 (U.S. CLS. 22 AND 39).

FIRST USE 2-0-2011; IN COMMERCE 2-0-2011.

THE MARK CONSISTS OF STANDARD CHARACTERS WITHOUT CLAIM TO ANY PARTICULAR FONT, STYLE, SIZE, OR COLOR.

THE NAME(S), PORTRAIT(S), AND/OR SIGNATURE(S) SHOWN IN THE MARK IDENTIFIES "SARA MICHELLE LERMAN", WHOSE CONSENT(S) TO REGISTER IS MADE OF RECORD.

SN 85-334,264, FILED 5-31-2011.

KEVON CHISOLM, EXAMINING ATTORNEY



David J. Kyffers

Director of the United States Patent and Trademark Office

United States of America

United States Patent and Trademark Office

HoST

Reg. No. 4,207,210

SIMULATED SURGICAL SYSTEMS, LLC (DELAWARE LIMITED LIABILITY COMPANY)
5225 SHERIDAN DRIVE
WILLIAMSVILLE, NY 14221

Registered Sep. 11, 2012

Int. Cl.: 9

FOR: COMPUTER SOFTWARE FOR TRAINING RELATING TO ROBOTIC SURGICAL
TECHNIQUES, IN CLASS 9 (U.S. CLS. 21, 23, 26, 36 AND 38).

TRADEMARK

FIRST USE 4-2-2010; IN COMMERCE 6-1-2010.

PRINCIPAL REGISTER

THE MARK CONSISTS OF STANDARD CHARACTERS WITHOUT CLAIM TO ANY PAR-
TICULAR FONT, STYLE, SIZE, OR COLOR.

SN 85-334,332, FILED 5-31-2011.

ANGELA M. MICHELI, EXAMINING ATTORNEY



David J. Kybas

Director of the United States Patent and Trademark Office

United States of America

United States Patent and Trademark Office



Reg. No. 4,207,211

Registered Sep. 11, 2012

Int. Cl.: 3

TRADEMARK

PRINCIPAL REGISTER

NRCOMMUNICATION, CO. LTD. (REPUBLIC OF KOREA CORPORATION)
14TH FLOOR, BYC BLDG
648-1 YEOKSAM-DONG, GANGNAM-GU
SEOUL, REPUBLIC OF KOREA 135-080

FOR: AFTER SUN CREAMS; AFTER-SHAVE CREAMS; AFTER-SHAVE EMULSIONS; AFTER-SHAVE LOTIONS; AFTER-SUN LOTIONS; BABY OIL; BABY POWDER; BEAUTY LOTIONS; BLEACHING PREPARATIONS FOR THE HAIR; BLUSH; BODY LOTIONS; BODY MILKS; COMMON TOILET WATER; COSMETIC CREAMS FOR SKIN CARE; COSMETIC PREPARATIONS; COSMETIC PREPARATIONS FOR BATH AND SHOWER; COSMETIC PREPARATIONS FOR SKIN CARE; COSMETIC PREPARATIONS FOR SLIMMING PURPOSES; COSMETIC PREPARATIONS, NAMELY, FIRMLING CREAMS; COSMETIC SKIN FRESHENERS; COSMETIC SUN MILK LOTIONS; COSMETIC SUN-PROTECTING PREPARATIONS; COSMETIC SUN-TANNING PREPARATIONS; COSMETIC SUNSCREEN PREPARATIONS; COSMETIC WHITE FACE POWDER; COSMETICS IN THE FORM OF MILKS, LOTIONS AND EMULSIONS; DENTIFRICES; EYE CREAM; EYE LOTIONS; EYE MAKE-UP REMOVER; EYE SHADOWS; EYEBROW COSMETICS; EYES PENCILS; FACE AND BODY LOTIONS; FOUNDATIONS; HAIR BLEACHING PREPARATIONS; HAIR CARE LOTIONS; HAIR COLORANTS; HAIR COLOURING AND DYES; HAIR DYE; HAIR DYES; HAIR GEL AND HAIR MOUSSE; HAIR GELS; HAIR LOTIONS; HAIR RINSES; HAIR STYLING SPRAY; HAND CLEANERS; LIP LINER; LIPSTICKS; LOOSE FACE POWDER; LOTIONS FOR FACE AND BODY CARE; MAKE-UP; MAKE-UP FOUNDATIONS; MAKE-UP POWDER; MAKE-UP REMOVER; MASCARA; MASK PACK FOR COSMETIC PURPOSES; MASSAGE OIL; MOISTURIZING SOLUTIONS FOR THE SKIN; POWDER FOR MAKE-UP; PRESSED FACE POWDER; SHAMPOOS; SHAVING LOTIONS; SHOWER GELS; SKIN CREAMS; SKIN LOTIONS; SOLID POWDER FOR COMPACTS; SUN-BLOCK LOTIONS; SUNSCREEN CREAMS; TOILET WATER, IN CLASS 3 (U.S. CLS. 1, 4, 6, 50, 51 AND 52).

FIRST USE 6-20-2011; IN COMMERCE 6-20-2011.

THE MARK CONSISTS OF THE WORD "RENDREVIE" ON THE RIGHT SIDE OF A STYLIZED FLOWER DESIGN.

SN 85-334,423, FILED 5-31-2011.

ELI HELLMAN, EXAMINING ATTORNEY



David J. Kypos

Director of the United States Patent and Trademark Office

United States of America

United States Patent and Trademark Office

THE CELLIN

Reg. No. 4,207,212

Registered Sep. 11, 2012

Int. Cl.: 3

TRADEMARK

PRINCIPAL REGISTER

NRCOMMUNICATION, CO. LTD. (REPUBLIC OF KOREA CORPORATION)
14TH FLOOR, BYC BLDG
648-1 YEOKSAM-DONG, GANGNAM-GU
SEOUL, REPUBLIC OF KOREA 135-080

FOR: AFTER-SUN LOTIONS; BEAUTY LOTIONS; BODY LOTIONS; BODY OILS; CLEANSING CREAMS; COMMON TOILET WATER; COSMETIC CREAMS; COSMETIC CREAMS FOR SKIN CARE; COSMETIC PREPARATIONS; COSMETIC PREPARATIONS FOR SKIN CARE; COSMETIC SUN MILK LOTIONS; COSMETIC SUN-PROTECTING PREPARATIONS; COSMETIC SUN-TANNING PREPARATIONS; COSMETIC SUNSCREEN PREPARATIONS; COSMETICS IN THE FORM OF MILKS, LOTIONS AND EMULSIONS; FACE AND BODY LOTIONS; HAND LOTIONS; LIP LINER; LIPSTICKS; LOOSE FACE POWDER; LOTIONS FOR FACE AND BODY CARE; MAKE-UP; MAKE-UP FOUNDATIONS; MASCARA; MASK PACK FOR COSMETIC PURPOSES; MASSAGE GELS OTHER THAN FOR MEDICAL PURPOSES; MASSAGE LOTIONS; MASSAGE OILS; SKIN CREAMS; SKIN LOTIONS; SUN CARE LOTIONS; SUN-BLOCK LOTIONS; SUN-TANNING OILS AND LOTIONS; SUNSCREEN CREAMS; TOILET WATER, IN CLASS 3 (U.S. CLS. 1, 4, 6, 50, 51 AND 52).

FIRST USE 6-20-2011; IN COMMERCE 6-20-2011.

THE MARK CONSISTS OF STANDARD CHARACTERS WITHOUT CLAIM TO ANY PARTICULAR FONT, STYLE, SIZE, OR COLOR.

SN 85-334,445, FILED 5-31-2011.

ELI HELLMAN, EXAMINING ATTORNEY



David J. Kyros

Director of the United States Patent and Trademark Office

United States of America

United States Patent and Trademark Office

SOLAISE

Reg. No. 4,207,213

Registered Sep. 11, 2012

Int. Cl.: 36

SERVICE MARK

PRINCIPAL REGISTER

SOLAISE CAPITAL LIMITED (CAYMAN ISLANDS LIMITED COMPANY (LTD.))
UGLAND HOUSE
GEORGE TOWN, CAYMAN ISLANDS KY1-1104

FOR: HEDGE FUND INVESTMENT SERVICES, IN CLASS 36 (U.S. CLS. 100, 101 AND 102).

FIRST USE 11-17-2010; IN COMMERCE 6-9-2011.

THE MARK CONSISTS OF STANDARD CHARACTERS WITHOUT CLAIM TO ANY PARTICULAR FONT, STYLE, SIZE, OR COLOR.

OWNER OF ERPN CMNTY TM OFC REG. NO. 009572298, DATED 5-13-2011, EXPIRES 12-3-2020.

SN 85-334,795, FILED 6-1-2011.

MICHELE SWAIN, EXAMINING ATTORNEY



David J. Kybas

Director of the United States Patent and Trademark Office

United States of America

United States Patent and Trademark Office

ESSENTRIA

Reg. No. 4,207,214

ENVINCIO, LLC (NORTH CAROLINA LIMITED LIABILITY COMPANY)
2155 WEST CROFT CIRCLE
SPARTANBURG, NC 29302

Registered Sep. 11, 2012

Int. Cl.: 5

FOR: PESTICIDE AND INSECTICIDE FOR COMMERCIAL AND RESIDENTIAL USE AS INSECT CONTROL AND REPELLANT, IN CLASS 5 (U.S. CLS. 6, 18, 44, 46, 51 AND 52).

TRADEMARK

FIRST USE 9-30-2011; IN COMMERCE 9-30-2011.

PRINCIPAL REGISTER

THE MARK CONSISTS OF STANDARD CHARACTERS WITHOUT CLAIM TO ANY PARTICULAR FONT, STYLE, SIZE, OR COLOR.

SN 85-334,821, FILED 6-1-2011.

MARGARET POWER, EXAMINING ATTORNEY



David J. Kyffers

Director of the United States Patent and Trademark Office

United States of America

United States Patent and Trademark Office



Reg. No. 4,207,215

Registered Sep. 11, 2012

Int. Cl.: 41

SERVICE MARK

PRINCIPAL REGISTER

POWER ONE FAMILY MATTERS, INC. (SOUTH CAROLINA CORPORATION)
109 JACOB MCKIE ROAD
TRENTON, SC 29847

FOR: EDUCATION SERVICES, NAMELY, PROVIDING CLASSES, SEMINARS, WORKSHOPS, MENTORING, AND TRAINING IN THE FIELD OF APPLICATION SUBMISSIONS FOR EDUCATIONAL PURPOSES, EMPLOYMENT, SOCIAL SECURITY ADMINISTRATION BENEFITS, AND NON-MEDICAL VETERAN ADMINISTRATION BENEFITS, ALL TO HELP FAMILIES ACHIEVE SELF-SUFFICIENCY, IN CLASS 41 (U.S. CLS. 100, 101 AND 107).

FIRST USE 5-2-2011; IN COMMERCE 9-26-2011.

NO CLAIM IS MADE TO THE EXCLUSIVE RIGHT TO USE "FAMILY" AND "MINISTRIES, INC.", APART FROM THE MARK AS SHOWN.

THE MARK CONSISTS OF THE WORD "POWER" WITH A NUMBER "1" FORMING THE VERTICAL LINE IN THE LETTER "P", AND AN INCOMPLETE OVAL FORMING THE REST OF THE LETTER "P". THE LETTER "P" HAS THREE LIGHTNING BOLTS EMANATING FROM IT. THE LETTER "O" IN "POWER" ALSO FORMS THE WORD "ONE" VERTICALLY UNDERNEATH THE WORD "POWER". THE WORDING "FAMILY MATTERS MINISTRIES, INC." APPEARS TO THE RIGHT OF THE VERTICAL WORD "ONE" AND UNDERNEATH THE WORD "POWER". THE LETTER "T" IN "MINISTRIES" FORMS A CROSS.

SN 85-334,931, FILED 6-1-2011.

ZHALEH DELANEY, EXAMINING ATTORNEY



David J. Kyffers

Director of the United States Patent and Trademark Office

United States of America

United States Patent and Trademark Office

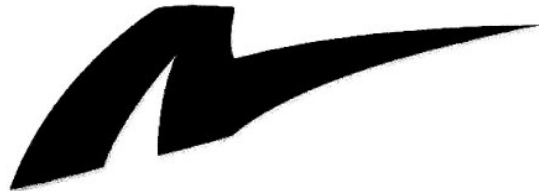

Reg. No. 4,207,216

Registered Sep. 11, 2012

Int. Cl.: 25

TRADEMARK

PRINCIPAL REGISTER

AMERICAN WEST INTERNATIONAL TRADES, LLC (UTAH LIMITED LIABILITY COMPANY)
1564 S 300 W
SALT LAKE CITY, UT 84115

FOR: ATHLETIC FOOTWEAR, IN CLASS 25 (U.S. CLS. 22 AND 39).

FIRST USE 7-0-2011; IN COMMERCE 2-28-2012.

THE MARK CONSISTS OF A SLASHING FLYING ARROW.

SN 85-334,984, FILED 6-1-2011.

COURTNEY ALVAREZ, EXAMINING ATTORNEY



David J. Kybas

Director of the United States Patent and Trademark Office

United States of America

United States Patent and Trademark Office

FIRE IN THE HOLE

Reg. No. 4,207,217

INGRAM ENTERPRISES, INC. (MISSOURI CORPORATION)
3010 N. INGRAM DRIVE
SPRINGFIELD, MO 65803

Registered Sep. 11, 2012

Int. Cl.: 13

FOR: FIREWORKS IN SHELL FORMS, IN CLASS 13 (U.S. CLS. 2 AND 9).

TRADEMARK

FIRST USE 5-26-2012; IN COMMERCE 5-26-2012.

PRINCIPAL REGISTER

THE MARK CONSISTS OF STANDARD CHARACTERS WITHOUT CLAIM TO ANY PARTICULAR FONT, STYLE, SIZE, OR COLOR.

SN 85-335,065, FILED 6-1-2011.

LEIGH CAROLINE CASE, EXAMINING ATTORNEY



David J. Kybas

Director of the United States Patent and Trademark Office

United States of America

United States Patent and Trademark Office

TEMPER TANTRUM

Reg. No. 4,207,218

INGRAM ENTERPRISES, INC. (MISSOURI CORPORATION)
3010 N. INGRAM DRIVE
SPRINGFIELD, MO 65803

Registered Sep. 11, 2012

Int. Cl.: 13

FOR: FIREWORKS IN SHELL FORMS, IN CLASS 13 (U.S. CLS. 2 AND 9).

TRADEMARK

FIRST USE 5-31-2012; IN COMMERCE 5-31-2012.

PRINCIPAL REGISTER

THE MARK CONSISTS OF STANDARD CHARACTERS WITHOUT CLAIM TO ANY PARTICULAR FONT, STYLE, SIZE, OR COLOR.

SN 85-335,077, FILED 6-1-2011.

LEIGH CAROLINE CASE, EXAMINING ATTORNEY



David J. Kybas

Director of the United States Patent and Trademark Office

United States of America

United States Patent and Trademark Office

Lady Power

Reg. No. 4,207,219

HOFFMAN, DAVID (UNITED STATES INDIVIDUAL)
5564 SALVIA CT.
GOLDEN, CO 80403

Registered Sep. 11, 2012

Int. Cl.: 9

FOR: CELL PHONE BATTERY CHARGERS; CELL PHONE BATTERY CHARGERS FOR USE IN VEHICLES; CELL PHONE CASES; CELL PHONE COVERS; CELL PHONE FACE-PLATES, IN CLASS 9 (U.S. CLS. 21, 23, 26, 36 AND 38).

TRADEMARK

FIRST USE 1-10-2012; IN COMMERCE 5-2-2012.

PRINCIPAL REGISTER

THE MARK CONSISTS OF STANDARD CHARACTERS WITHOUT CLAIM TO ANY PARTICULAR FONT, STYLE, SIZE, OR COLOR.

NO CLAIM IS MADE TO THE EXCLUSIVE RIGHT TO USE "POWER", APART FROM THE MARK AS SHOWN.

SN 85-335,109, FILED 6-1-2011.

KEVON CHISOLM, EXAMINING ATTORNEY



David J. Kyffers

Director of the United States Patent and Trademark Office

United States of America

United States Patent and Trademark Office

CANADIAN HARVEST

Reg. No. 4,207,220

SUNOPTA INGREDIENTS, INC. (DELAWARE CORPORATION)
100 APOLLO DRIVE
CHELMSFORD, MA 01824

Registered Sep. 11, 2012

Int. Cl.: 30

FOR: PROCESSED CORN BRAN, PROCESSED WHEAT BRAN, PROCESSED OAT BRAN, PROCESSED WHEAT GERM AND PROCESSED WHEAT GERM/BRAN BLENDS USED IN BAKED GOODS, BARS, BREADS, CEREALS, ROLLS, MUFFINS, PASTA, SNACKS, FIBER ENRICHED FOODS AND PET FOODS, IN CLASS 30 (U.S. CL. 46).

TRADEMARK

PRINCIPAL REGISTER

FIRST USE 2-29-2012; IN COMMERCE 2-29-2012.

THE MARK CONSISTS OF STANDARD CHARACTERS WITHOUT CLAIM TO ANY PARTICULAR FONT, STYLE, SIZE, OR COLOR.

OWNER OF U.S. REG. NO. 2,463,514.

NO CLAIM IS MADE TO THE EXCLUSIVE RIGHT TO USE "CANADIAN", APART FROM THE MARK AS SHOWN.

SN 85-335,134, FILED 6-1-2011.

KYLE PEETE, EXAMINING ATTORNEY



David J. Kyffers

Director of the United States Patent and Trademark Office

United States of America

United States Patent and Trademark Office



Reg. No. 4,207,221

Registered Sep. 11, 2012

Int. Cls.: 16 and 41

TRADEMARK

SERVICE MARK

PRINCIPAL REGISTER

JONES, TIMOTHY (UNITED STATES INDIVIDUAL)
6701 LA TIERRA BLVD 837
LOS ANGELES, CA 90045

FOR: A SERIES OF BOOKS IN THE FIELD OF SELF DEVELOPMENT, IN CLASS 16 (U.S. CLS. 2, 5, 22, 23, 29, 37, 38 AND 50).

FIRST USE 12-18-2011; IN COMMERCE 12-18-2011.

FOR: EDUCATIONAL SERVICES, NAMELY, CONDUCTING CLASSES, SEMINARS, AND WORKSHOPS IN THE FIELD OF SELF DEVELOPMENT AND DISTRIBUTION OF COURSE MATERIAL IN CONNECTION THEREWITH, IN CLASS 41 (U.S. CLS. 100, 101 AND 107).

FIRST USE 12-18-2011; IN COMMERCE 12-18-2011.

THE MARK CONSISTS OF THE LITERAL ELEMENTS "DONE", "WWW.WHATDOES-DONELOOKLIKE.COM" WHEREIN THE IMAGE CONSISTS OF A SUN IN YELLOW COLOR WITH RAYS AND A GREEN COLOR FIGURE ABOVE WHICH THE WORDS "DONE" ARE WRITTEN IN BLUE COLOR, BELOW THE IMAGE THERE IS A TAG LINE "WWW.WHATDOESDONELOOKLIKE.COM" IN BLUE AND GREEN ALTERNATE COLORS IS PLACED AS SHOWN IN THE MARK.

THE COLOR(S) BLUE, YELLOW, GREEN IS/ARE CLAIMED AS A FEATURE OF THE MARK.

SN 85-335,548, FILED 6-1-2011.

MARK SPARACINO, EXAMINING ATTORNEY



David J. Kyros

Director of the United States Patent and Trademark Office

United States of America
United States Patent and Trademark Office

KAPTURA

Reg. No. 4,207,222

ALLSTATE INSURANCE COMPANY (ILLINOIS CORPORATION)
ALLSTATE PLAZA
NORTHBROOK, IL 60062

Registered Sep. 11, 2012

Int. Cl.: 9

FOR: COMPUTER APPLICATION SOFTWARE FOR MOBILE PHONES, NAMELY, SOFTWARE FOR PLAYING VIDEO GAMES, IN CLASS 9 (U.S. CLS. 21, 23, 26, 36 AND 38).

TRADEMARK

FIRST USE 5-23-2012; IN COMMERCE 5-23-2012.

PRINCIPAL REGISTER

THE MARK CONSISTS OF STANDARD CHARACTERS WITHOUT CLAIM TO ANY PARTICULAR FONT, STYLE, SIZE, OR COLOR.

SN 85-335,927, FILED 6-2-2011.

SHAUNIA CARLYLE, EXAMINING ATTORNEY



David J. Kybas

Director of the United States Patent and Trademark Office

United States of America

United States Patent and Trademark Office

LAND TO ITS HIGHEST PURPOSE

Reg. No. 4,207,223

FORESTAR GROUP INC. (DELAWARE CORPORATION)
6300 BEE CAVE ROAD, BLDG TWO, SUITE 500
AUSTIN, TX 78746

Registered Sep. 11, 2012

**Int. Cls.: 4, 19, 35, 36, 37,
40, and 45**

FOR: CRUDE OIL; NATURAL GAS, IN CLASS 4 (U.S. CLS. 1, 6 AND 15).

FIRST USE 5-8-2012; IN COMMERCE 5-8-2012.

TRADEMARK

FOR: TIMBER, IN CLASS 19 (U.S. CLS. 1, 12, 33 AND 50).

SERVICE MARK

FIRST USE 5-8-2012; IN COMMERCE 5-8-2012.

PRINCIPAL REGISTER

FOR: EVALUATION OF STANDING TIMBER; FOREST MANAGEMENT, IN CLASS 35 (U.S. CLS. 100, 101 AND 102).

FIRST USE 5-8-2012; IN COMMERCE 5-8-2012.

FOR: AGENCIES OR BROKERAGE FOR LEASING OR RENTING OF LAND; AGENCIES OR BROKERAGE FOR RENTING OF BUILDINGS; APPRAISAL OF REAL ESTATE; ASSESSMENT AND MANAGEMENT OF REAL ESTATE; BUILDING LEASING; BUILDING MANAGEMENT; EVALUATION OF REAL PROPERTY; FINANCIAL INVESTMENT IN THE FIELD OF REAL ESTATE; FINANCIAL VALUATION OF PERSONAL PROPERTY AND REAL ESTATE; INVESTMENT SERVICES, NAMELY, ASSET ACQUISITION, CONSULTATION, DEVELOPMENT AND MANAGEMENT SERVICES; LAND ACQUISITION, NAMELY, REAL ESTATE BROKERAGE; LAND LEASING; LEASING OF OFFICE SPACE; LEASING OF REAL ESTATE; LEASING OF REAL PROPERTY; LEASING OR RENTING OF BUILDINGS; PROVIDING INFORMATION IN THE FIELD OF REAL ESTATE BY MEANS OF LINKING THE WEB SITE TO OTHER WEB SITES FEATURING REAL ESTATE INFORMATION; REAL ESTATE ACQUISITION SERVICES; REAL ESTATE AGENCIES; REAL ESTATE APPRAISAL; REAL ESTATE BROKERAGE; REAL ESTATE EQUITY SHARING, NAMELY, MANAGING AND ARRANGING FOR CO-OWNERSHIP OF REAL ESTATE; REAL ESTATE INVESTMENT SERVICES; REAL ESTATE LISTING; REAL ESTATE MANAGEMENT CONSULTATION; REAL ESTATE MANAGEMENT SERVICES; REAL ESTATE MULTIPLE LISTING SERVICES; REAL ESTATE PROCUREMENT FOR OTHERS; REAL ESTATE SERVICES, NAMELY, RENTAL OF VACATION HOMES, CONDOMINIUMS, CABINS, AND VILLAS USING PAY PER CLICK ADVERTISING ON A GLOBAL COMPUTER NETWORK; REAL ESTATE SYNDICATION; REAL ESTATE TIME-SHARING; REAL ESTATE TRUSTEE SERVICES;



David J. Kyros

Director of the United States Patent and Trademark Office

Reg. No. 4,207,223 REAL ESTATE VALUATION SERVICES; RENTAL OF APARTMENTS; RENTAL OF CABINS; RENTAL OF OFFICE SPACE; RENTAL OF SPACE IN MARKETPLACES FOR SELLERS OF GOODS AND/OR SERVICES; VACATION REAL ESTATE TIME SHARE EXCHANGE SERVICES; VACATION REAL ESTATE TIME-SHARING, IN CLASS 36 (U.S. CLS. 100, 101 AND 102).

FIRST USE 5-8-2012; IN COMMERCE 5-8-2012.

FOR: LAND DEVELOPMENT SERVICES, NAMELY, PLANNING AND LAYING OUT OF RESIDENTIAL AND/OR COMMERCIAL COMMUNITIES, IN CLASS 37 (U.S. CLS. 100, 103 AND 106).

FIRST USE 5-8-2012; IN COMMERCE 5-8-2012.

FOR: PROVIDING TECHNICAL INFORMATION IN THE FIELD OF MINERAL PROCESSING, IN CLASS 40 (U.S. CLS. 100, 103 AND 106).

FIRST USE 5-8-2012; IN COMMERCE 5-8-2012.

FOR: OBTAINING ENTITLEMENTS, NAMELY, GOVERNMENT AND REGULATORY PERMITS, LICENSES AND APPROVALS, TO BUILD SUBDIVISIONS, RESIDENTIAL AND/OR COMMERCIAL STRUCTURES FOR OTHERS, IN CLASS 45 (U.S. CLS. 100 AND 101).

FIRST USE 5-8-2012; IN COMMERCE 5-8-2012.

THE MARK CONSISTS OF STANDARD CHARACTERS WITHOUT CLAIM TO ANY PARTICULAR FONT, STYLE, SIZE, OR COLOR.

NO CLAIM IS MADE TO THE EXCLUSIVE RIGHT TO USE "LAND", APART FROM THE MARK AS SHOWN.

SN 85-336,066, FILED 6-2-2011.

SANJEEV VOHRA, EXAMINING ATTORNEY

United States of America

United States Patent and Trademark Office

VISIONVIDEO

Reg. No. 4,207,224

DIALOGIC INC. (DELAWARE CORPORATION)
926 ROCK AVENUE
SAN JOSE, CA 95131

Registered Sep. 11, 2012

Int. Cl.: 9

FOR: COMPUTER SOFTWARE FOR ANALYZING, MEASURING AND TRACKING VIDEO QUALITY AND CONTENT, IN CLASS 9 (U.S. CLS. 21, 23, 26, 36 AND 38).

TRADEMARK

FIRST USE 3-31-2011; IN COMMERCE 4-30-2012.

PRINCIPAL REGISTER

THE MARK CONSISTS OF STANDARD CHARACTERS WITHOUT CLAIM TO ANY PARTICULAR FONT, STYLE, SIZE, OR COLOR.

SN 85-336,075, FILED 6-2-2011.

PAUL E. FAHRENKOPF, EXAMINING ATTORNEY



David J. Kybas

Director of the United States Patent and Trademark Office

United States of America

United States Patent and Trademark Office

ENERGY SAVINGS IS A BREEZE

Reg. No. 4,207,225

NEW WIND, LLC (TENNESSEE LIMITED LIABILITY COMPANY)
4544 HARDING PIKE, SUITE 210
NASHVILLE, TN 37205

Registered Sep. 11, 2012

Int. Cl.: 7

FOR: WIND TURBINES, IN CLASS 7 (U.S. CLS. 13, 19, 21, 23, 31, 34 AND 35).

TRADEMARK

FIRST USE 7-1-2011; IN COMMERCE 7-1-2011.

PRINCIPAL REGISTER

THE MARK CONSISTS OF STANDARD CHARACTERS WITHOUT CLAIM TO ANY PARTICULAR FONT, STYLE, SIZE, OR COLOR.

SN 85-336,332, FILED 6-2-2011.

CHRISTINE COOPER, EXAMINING ATTORNEY



David J. Kyffers

Director of the United States Patent and Trademark Office

United States of America

United States Patent and Trademark Office

Goblin Snot

Reg. No. 4,207,226

MELISSA L. BOYACK (NEW YORK SOLE PROPRIETORSHIP), DBA OPAL & TWIG,
787 EDGEWOOD AVE
ROCHESTER, NY 14618

Registered Sep. 11, 2012

Int. Cl.: 28

FOR: TOYS, GAMES AND PLAYTHINGS FOR CHILDREN AND ADULTS, NAMELY, PRE-
TEND MAGIC POTIONS AND TALISMANS, IN CLASS 28 (U.S. CLS. 22, 23, 38 AND 50).

TRADEMARK

FIRST USE 11-15-2011; IN COMMERCE 11-15-2011.

PRINCIPAL REGISTER

THE MARK CONSISTS OF STANDARD CHARACTERS WITHOUT CLAIM TO ANY PAR-
TICULAR FONT, STYLE, SIZE, OR COLOR.

SN 85-336,652, FILED 6-2-2011.

BARBARA BROWN, EXAMINING ATTORNEY



David J. Kyffers

Director of the United States Patent and Trademark Office

United States of America

United States Patent and Trademark Office

Mermaid Tears

Reg. No. 4,207,227

MELISSA L. BOYACK (NEW YORK SOLE PROPRIETORSHIP), DBA OPAL & TWIG,
787 EDGEWOOD AVE
ROCHESTER, NY 14618

Registered Sep. 11, 2012

Int. Cl.: 28

FOR: TOYS, GAMES AND PLAYTHINGS FOR CHILDREN AND ADULTS, NAMELY, PRE-
TEND MAGIC POTIONS AND TALISMANS, IN CLASS 28 (U.S. CLS. 22, 23, 38 AND 50).

TRADEMARK

FIRST USE 11-15-2011; IN COMMERCE 11-15-2011.

PRINCIPAL REGISTER

THE MARK CONSISTS OF STANDARD CHARACTERS WITHOUT CLAIM TO ANY PAR-
TICULAR FONT, STYLE, SIZE, OR COLOR.

SN 85-336,657, FILED 6-2-2011.

BARBARA BROWN, EXAMINING ATTORNEY



David J. Kyffers

Director of the United States Patent and Trademark Office

United States of America

United States Patent and Trademark Office

Troll Sweat

Reg. No. 4,207,228

MELISSA L. BOYACK (NEW YORK SOLE PROPRIETORSHIP), DBA OPAL & TWIG,
797 EDGEWOOD AVE
ROCHESTER, NY 14618

Registered Sep. 11, 2012

Int. Cl.: 28

FOR: TOYS, GAMES AND PLAYTHINGS FOR CHILDREN AND ADULTS, NAMELY, PRE-
TEND MAGIC POTIONS AND TALISMANS, IN CLASS 28 (U.S. CLS. 22, 23, 38 AND 50).

TRADEMARK

FIRST USE 11-15-2011; IN COMMERCE 11-15-2011.

PRINCIPAL REGISTER

THE MARK CONSISTS OF STANDARD CHARACTERS WITHOUT CLAIM TO ANY PAR-
TICULAR FONT, STYLE, SIZE, OR COLOR.

SN 85-336,662, FILED 6-2-2011.

BARBARA BROWN, EXAMINING ATTORNEY



David J. Kybas

Director of the United States Patent and Trademark Office

United States of America

United States Patent and Trademark Office

Enchanted Forest Thicket

Reg. No. 4,207,229

MELISSA L. BOYACK (NEW YORK SOLE PROPRIETORSHIP), DBA OPAL & TWIG,
797 EDGEWOOD AVE.

Registered Sep. 11, 2012

ROCHESTER, NY 14618

Int. Cl.: 28

FOR: TOYS, GAMES AND PLAYTHINGS FOR CHILDREN AND ADULTS, NAMELY, PRE-
TEND MAGIC POTIONS AND TALISMANS, IN CLASS 28 (U.S. CLS. 22, 23, 38 AND 50).

TRADEMARK

FIRST USE 11-15-2011; IN COMMERCE 11-15-2011.

PRINCIPAL REGISTER

THE MARK CONSISTS OF STANDARD CHARACTERS WITHOUT CLAIM TO ANY PAR-
TICULAR FONT, STYLE, SIZE, OR COLOR.

SN 85-336,668, FILED 6-2-2011.

BARBARA BROWN, EXAMINING ATTORNEY



David J. Kybas

Director of the United States Patent and Trademark Office

United States of America

United States Patent and Trademark Office

Blackbeard's Brine

Reg. No. 4,207,230

MELISSA L. BOYACK (NEW YORK SOLE PROPRIETORSHIP), DBA OPAL & TWIG,
787 EDGEWOOD AVE
ROCHESTER, NY 14618

Registered Sep. 11, 2012

Int. Cl.: 28

FOR: TOYS, GAMES AND PLAYTHINGS FOR CHILDREN AND ADULTS, NAMELY, PRE-TEND MAGIC POTIONS AND TALISMANS, IN CLASS 28 (U.S. CLS. 22, 23, 38 AND 50).

TRADEMARK

FIRST USE 11-15-2011; IN COMMERCE 11-15-2011.

PRINCIPAL REGISTER

THE MARK CONSISTS OF STANDARD CHARACTERS WITHOUT CLAIM TO ANY PARTICULAR FONT, STYLE, SIZE, OR COLOR.

SN 85-336,674, FILED 6-2-2011.

BARBARA BROWN, EXAMINING ATTORNEY



David J. Kyffers

Director of the United States Patent and Trademark Office

United States of America

United States Patent and Trademark Office

Moonlight Mist

Reg. No. 4,207,231

MELISSA L. BOYACK (NEW YORK SOLE PROPRIETORSHIP), DBA OPAL & TWIG,
797 EDGEWOOD AVE
ROCHESTER, NY 14618

Registered Sep. 11, 2012

Int. Cl.: 28

FOR: TOYS, GAMES AND PLAYTHINGS FOR CHILDREN AND ADULTS, NAMELY, PRE-
TEND MAGIC POTIONS AND TALISMANS, IN CLASS 28 (U.S. CLS. 22, 23, 38 AND 50).

TRADEMARK

FIRST USE 11-15-2011; IN COMMERCE 11-15-2011.

PRINCIPAL REGISTER

THE MARK CONSISTS OF STANDARD CHARACTERS WITHOUT CLAIM TO ANY PAR-
TICULAR FONT, STYLE, SIZE, OR COLOR.

SN 85-336,678, FILED 6-2-2011.

BARBARA BROWN, EXAMINING ATTORNEY



David J. Kyffers

Director of the United States Patent and Trademark Office

United States of America

United States Patent and Trademark Office

Miracle Listening Serum

Reg. No. 4,207,232

MELISSA L. BOYACK (NEW YORK SOLE PROPRIETORSHIP), DBA OPAL & TWIG,
797 EDGEWOOD AVE
ROCHESTER, NY 14618

Registered Sep. 11, 2012

Int. Cl.: 28

FOR: TOYS, GAMES AND PLAYTHINGS FOR CHILDREN AND ADULTS, NAMELY, PRE-
TEND MAGIC POTIONS AND TALISMANS, IN CLASS 28 (U.S. CLS. 22, 23, 38 AND 50).

TRADEMARK

FIRST USE 11-15-2011; IN COMMERCE 11-15-2011.

PRINCIPAL REGISTER

THE MARK CONSISTS OF STANDARD CHARACTERS WITHOUT CLAIM TO ANY PAR-
TICULAR FONT, STYLE, SIZE, OR COLOR.

SN 85-336,681, FILED 6-2-2011.

BARBARA BROWN, EXAMINING ATTORNEY



David J. Kyffers

Director of the United States Patent and Trademark Office

United States of America

United States Patent and Trademark Office

Veil of Secrets

Reg. No. 4,207,233

MELISSA L. BOYACK (NEW YORK SOLE PROPRIETORSHIP), DBA OPAL & TWIG,
797 EDGEWOOD AVE.

Registered Sep. 11, 2012

ROCHESTER, NY 14618

Int. Cl.: 28

FOR: TOYS, GAMES AND PLAYTHINGS FOR CHILDREN AND ADULTS, NAMELY, PRE-
TEND MAGIC POTIONS AND TALISMANS, IN CLASS 28 (U.S. CLS. 22, 23, 38 AND 50).

TRADEMARK

FIRST USE 11-15-2011; IN COMMERCE 11-15-2011.

PRINCIPAL REGISTER

THE MARK CONSISTS OF STANDARD CHARACTERS WITHOUT CLAIM TO ANY PAR-
TICULAR FONT, STYLE, SIZE, OR COLOR.

SN 85-336,684, FILED 6-2-2011.

BARBARA BROWN, EXAMINING ATTORNEY



David J. Kyffers

Director of the United States Patent and Trademark Office

United States of America

United States Patent and Trademark Office

SLIM BOB & SKINNY CHICK'S

Reg. No. 4,207,234

MECCA, ED (UNITED STATES INDIVIDUAL)
7661 CANTERBURY LANE
DUBLIN, CA 94568

Registered Sep. 11, 2012

Int. Cl.: 32

FOR: NON-ALCOHOLIC COCKTAIL MIXES; NON-ALCOHOLIC FRUIT JUICE BEVERAGES,
IN CLASS 32 (U.S. CLS. 45, 46 AND 48).

TRADEMARK

FIRST USE 11-12-2009; IN COMMERCE 3-10-2011.

PRINCIPAL REGISTER

THE MARK CONSISTS OF STANDARD CHARACTERS WITHOUT CLAIM TO ANY PAR-
TICULAR FONT, STYLE, SIZE, OR COLOR.

SN 85-336,751, FILED 6-2-2011.

MAUREEN DALL, EXAMINING ATTORNEY



David J. Kybas

Director of the United States Patent and Trademark Office

United States of America

United States Patent and Trademark Office

TYAN

Reg. No. 4,207,235

Registered Sep. 11, 2012

Int. Cl.: 9

TRADEMARK

PRINCIPAL REGISTER

MITAC INTERNATIONAL CORP. (TAIWAN CORPORATION)
1, R & D ROAD 2, HSINCHU SCIENCE-BASED
INDUSTRIAL PARK
HSINCHU HSIEN, TAIWAN R.O.C.

FOR: COMPUTER HARDWARE; COMPUTER MOTHERBOARDS; COMPUTER EXPANSION BOARDS; COMPUTER EXPANSION CARDS; ELECTRONIC EQUIPMENTS AND DATA PROCESSING EQUIPMENTS, NAMELY, COMPUTERS, CIRCUIT BOARDS, INTERFACE BOARDS, DAUGHTERBOARDS, SUPERCOMPUTERS, SUPERMINICOMPUTERS; COMPUTER SERVERS FOR USE WITH COMPUTER NETWORKS AND COMPUTER WORKSTATIONS, NAMELY, COMPUTER SYSTEMS COMPRISED OF CLUSTERING MULTIPLE SERVERS MOTHERBOARDS AND COMPUTER MEMORIES; COMPUTER SERVER SYSTEMS, NAMELY, MOTHERBOARDS, COMPUTER CASES, CENTRAL PROCESSING UNITS, MEMORY MODULES, MEMORY CARDS, HARD DRIVES, SMALL COMPUTER SYSTEM INTERFACE CARDS SCSI CARDS, SERIAL ATTACHED SCSI AND REDUNDANT ARRAY OF INDEPENDENT DISKS CARDS SAS RAID CARDS, POWER SUPPLIES AND SYSTEM COOLING FANS; NETWORK CARDS FOR COMPUTERS; LOCAL WIRELESS NETWORK CARDS FOR COMPUTERS WLAN CARDS; GRAPHIC CARDS FOR COMPUTERS; CARDS WITH INTEGRATED CIRCUITS SMART CARDS; LOCAL NETWORK CARDS FOR COMPUTERS LAN CARDS; NETWORK INTERFACE CARDS; COMPUTER SOFTWARE FOR USE IN DEVELOPING, DEPLOYING, AND EXECUTING COMPUTER PROGRAMS VIA LOCAL AREA, WIDE AREA, AND GLOBAL COMPUTER NETWORKS, AND WIRELESS DEVICES, AND INSTRUCTION MANUALS RECORDED ON COMPUTER MEDIA SOLD THEREWITH; COMPUTER OPERATING PROGRAMS WITH ACCOMPANYING ACCESSORIES, NAMELY, INSTRUCTION MANUALS RECORDED ON COMPUTER MEDIA SOLD THEREWITH DISTRIBUTED THEREWITH; COMPUTER SOFTWARE FOR PROVIDING AND MANAGING ACCESS TO COMPUTER SOFTWARE AND HARDWARE ON OTHER SERVERS AMONG MULTIPLE COMPUTER SERVERS; COMPUTER SOFTWARE FOR MONITORING, MANAGING, MAINTAINING, CONFIGURING, PREVENTING, AND REACTING TO FAILURE OF COMPUTER SERVERS; COMPUTER UTILITY PROGRAMS FOR SERVER SYSTEMS WITH ACCOMPANYING DOCUMENTATION RECORDED ON COMPUTER MEDIA DISTRIBUTED THEREWITH; PORTABLE MULTIMEDIA PLAYERS, NAMELY, MEDIA PLAYERS, MP3 PLAYERS; MULTIMEDIA PLAYERS, NAMELY, MEDIA PLAYERS, MP3 PLAYERS; PORTABLE AND HANDHELD DIGITAL ELECTRONIC DEVICES FOR RECORDING, ORGANIZING, TRANSMITTING, MANIPULATING, AND REVIEWING TEXT, DATA, IMAGE, AND AUDIO FILES, IN CLASS 9 (U.S. CLS. 21, 23, 26, 36 AND 38).



David J. Kybas

Director of the United States Patent and Trademark Office

Reg. No. 4,207,235 FIRST USE 6-7-2011; IN COMMERCE 6-7-2011.

OWNER OF U.S. REG. NO. 2,442,653.

THE MARK CONSISTS OF THE WORD "TYAN" IN STYLIZED LETTERS WITH A CIRCLE SURROUNDED BY 2 PARTIAL CIRCLES.

SN 85-336,784, FILED 6-2-2011.

EDWARD NELSON, EXAMINING ATTORNEY

United States of America

United States Patent and Trademark Office

Errai2 The Next North Star

Reg. No. 4,207,236

EVANOFF, CAROL (UNITED STATES INDIVIDUAL)
801 THORNDYKE RD
PORT LUDLOW, WA 98365

Registered Sep. 11, 2012

Int. Cl.: 41

FOR: TRAINING SERVICES IN THE FIELD OF BUSINESS AND PROFESSIONAL DEVELOPMENT, IN CLASS 41 (U.S. CLS. 100, 101 AND 107).

SERVICE MARK

FIRST USE 6-1-2012; IN COMMERCE 6-1-2012.

PRINCIPAL REGISTER

THE MARK CONSISTS OF STANDARD CHARACTERS WITHOUT CLAIM TO ANY PARTICULAR FONT, STYLE, SIZE, OR COLOR.

SN 85-336,905, FILED 6-2-2011.

TRICIA SONNEBORN, EXAMINING ATTORNEY



David J. Kybas

Director of the United States Patent and Trademark Office

United States of America
United States Patent and Trademark Office

SCIMITAR

Reg. No. 4,207,237

HORIZON HOBBY, INC. (DELAWARE CORPORATION)
4105 FIELDSTONE ROAD
CHAMPAIGN, IL 61822

Registered Sep. 11, 2012

Int. Cl.: 28

FOR: REMOTE CONTROLLED HOBBY MODEL AIRCRAFT AND PARTS AND ACCESSORIES THEREFOR, IN CLASS 28 (U.S. CLS. 22, 23, 38 AND 50).

TRADEMARK

FIRST USE 11-29-2011; IN COMMERCE 11-29-2011.

PRINCIPAL REGISTER

THE MARK CONSISTS OF STANDARD CHARACTERS WITHOUT CLAIM TO ANY PARTICULAR FONT, STYLE, SIZE, OR COLOR.

SN 85-337,177, FILED 6-3-2011.

HOWARD SMIGA, EXAMINING ATTORNEY



David J. Kybas

Director of the United States Patent and Trademark Office

United States of America

United States Patent and Trademark Office

Wallflower Press

Reg. No. 4,207,238

Registered Sep. 11, 2012

Int. Cls.: 9 and 41

TRADEMARK

SERVICE MARK

PRINCIPAL REGISTER

COLUMBIA UNIVERSITY PRESS (NEW YORK NON-PROFIT CORPORATION)
61 WEST 62ND STREET
NEW YORK, NY 10019

FOR: DOWNLOADABLE ELECTRONIC PUBLICATIONS IN THE NATURE OF SCHOLARLY AND REFERENCE BOOKS CONTAINING GENERAL INFORMATION ON FILM, TV, VIDEO, DIRECTORS, PERFORMERS, CAMERA TECHNIQUES AND POPULAR CULTURE; BOOKS, PAMPHLETS ALL BEING OF A TRADE, SCHOLARLY AND PROFESSIONAL NATURE; DOWNLOADABLE ELECTRONIC PUBLICATIONS IN THE NATURE OF BOOKS AND PAMPHLETS, ALL BEING OF A TRADE, SCHOLARLY AND PROFESSIONAL NATURE IN THE FIELD OF FILM, TV, VIDEO, DIRECTORS, PERFORMERS, CAMERA TECHNIQUES AND POPULAR CULTURE, IN CLASS 9 (U.S. CLS. 21, 23, 26, 36 AND 38).

FIRST USE 12-31-2011; IN COMMERCE 12-31-2011.

FOR: ONLINE ELECTRONIC PUBLISHING SERVICES, NAMELY, PROVIDING A WEBSITE FEATURING NON-DOWNLOADABLE PUBLICATIONS IN THE NATURE OF IN THE NATURE OF SCHOLARLY AND REFERENCE BOOKS CONTAINING GENERAL INFORMATION ON FILM, TV, VIDEO, DIRECTORS, PERFORMERS, CAMERA TECHNIQUES AND POPULAR CULTURE; PROVIDING A WEBSITE FEATURING NON-DOWNLOADABLE PUBLICATIONS IN THE NATURE OF BOOKS, PAMPHLETS, ALL BEING OF A TRADE, SCHOLARLY AND PROFESSIONAL NATURE IN THE FIELD OF FILM, TV, VIDEO, DIRECTORS, PERFORMERS, CAMERA TECHNIQUES AND POPULAR CULTURE, IN CLASS 41 (U.S. CLS. 100, 101 AND 107).

FIRST USE 12-31-2011; IN COMMERCE 3-6-2012.

THE MARK CONSISTS OF STANDARD CHARACTERS WITHOUT CLAIM TO ANY PARTICULAR FONT, STYLE, SIZE, OR COLOR.

NO CLAIM IS MADE TO THE EXCLUSIVE RIGHT TO USE "PRESS", APART FROM THE MARK AS SHOWN.

SN 85-337,275, FILED 6-3-2011.

THEODORE MCBRIDE, EXAMINING ATTORNEY



David J. Kypos

Director of the United States Patent and Trademark Office

United States of America

United States Patent and Trademark Office

FUGU MALIBU

Reg. No. 4,207,239

Registered Sep. 11, 2012

Int. Cl.: 25

TRADEMARK

PRINCIPAL REGISTER

BLOWFISH LLC (DELAWARE LIMITED LIABILITY COMPANY)
1728 OLYMPIC BOULEVARD
SANTA MONICA, CA 90404

FOR: FOOTWEAR, IN CLASS 25 (U.S. CLS. 22 AND 39).

FIRST USE 2-10-2012; IN COMMERCE 2-10-2012.

THE MARK CONSISTS OF STANDARD CHARACTERS WITHOUT CLAIM TO ANY PARTICULAR FONT, STYLE, SIZE, OR COLOR.

NO CLAIM IS MADE TO THE EXCLUSIVE RIGHT TO USE "MALIBU", APART FROM THE MARK AS SHOWN.

SN 85-337,286, FILED 6-3-2011.

JACLYN KIDWELL WALKER, EXAMINING ATTORNEY



David J. Kyffers

Director of the United States Patent and Trademark Office

United States of America

United States Patent and Trademark Office

CRA-Z-FARM FUN

Reg. No. 4,207,240

Registered Sep. 11, 2012

Int. Cl.: 16

TRADEMARK

PRINCIPAL REGISTER

LAROSE INDUSTRIES, LLC (NEW JERSEY LIMITED LIABILITY COMPANY)
BUILDING 5
1578 SUSSEX TURNPIKE
RANDOLPH, NJ 07869

FOR: MODELING COMPOUNDS AND RELATED ACCESSORIES FOR USE WITH MODELING COMPOUNDS SOLD AS A UNIT, IN CLASS 16 (U.S. CLS. 2, 5, 22, 23, 29, 37, 38 AND 50).

FIRST USE 8-9-2011; IN COMMERCE 8-9-2011.

THE MARK CONSISTS OF STANDARD CHARACTERS WITHOUT CLAIM TO ANY PARTICULAR FONT, STYLE, SIZE, OR COLOR.

SN 85-337,459, FILED 6-3-2011.

TRACY FLETCHER, EXAMINING ATTORNEY



David J. Kybas

Director of the United States Patent and Trademark Office

United States of America
United States Patent and Trademark Office

BAMINGO

Reg. No. 4,207,241

KIDZ ON SAFARI NEW YORK, INC. (NEW YORK CORPORATION)
4755 DONOVAN COURT

Registered Sep. 11, 2012

OTTAWA, ONTARIO, CANADA K1J8W1

Int. Cl.: 25

FOR: CLOTHING FOR CHILDREN AND BABIES, NAMELY, HATS, BIBS NOT OF PAPER, SOCKS, BOOTIES, LEGGINGS, SHIRTS, BODY SUITS, PANTS, UNDERWEAR, SLEEPWEAR, PAJAMAS, INFANT SLEEPERS, ONE-PIECE GARMENTS, IN CLASS 25 (U.S. CLS. 22 AND 39).

TRADEMARK

PRINCIPAL REGISTER

FIRST USE 1-0-2011; IN COMMERCE 9-0-2011.

THE MARK CONSISTS OF STANDARD CHARACTERS WITHOUT CLAIM TO ANY PARTICULAR FONT, STYLE, SIZE, OR COLOR.

SN 85-337,573, FILED 6-3-2011.

JESSICA A. POWERS, EXAMINING ATTORNEY



David J. Kyffers

Director of the United States Patent and Trademark Office

United States of America

United States Patent and Trademark Office

Delsea Farms

Reg. No. 4,207,242

Registered Sep. 11, 2012

Int. Cl.: 32

TRADEMARK

PRINCIPAL REGISTER

CLEMENT PAPPAS AND COMPANY, INC. (NEW JERSEY CORPORATION)
SUITE 200
1 COLLINS DRIVE
CARNEYS POINT, NJ 08069

FOR: FRUIT JUICES AND FRUIT DRINKS, IN CLASS 32 (U.S. CLS. 45, 46 AND 48).

FIRST USE 7-12-2012; IN COMMERCE 7-12-2012.

THE MARK CONSISTS OF STANDARD CHARACTERS WITHOUT CLAIM TO ANY PARTICULAR FONT, STYLE, SIZE, OR COLOR.

OWNER OF U.S. REG. NOS. 3,361,019 AND 3,605,984.

NO CLAIM IS MADE TO THE EXCLUSIVE RIGHT TO USE "FARMS", APART FROM THE MARK AS SHOWN.

SN 85-337,615, FILED 6-3-2011.

DOUGLAS LEE, EXAMINING ATTORNEY



David J. Kyffers

Director of the United States Patent and Trademark Office

United States of America

United States Patent and Trademark Office

OWN IT FOR GOOD

Reg. No. 4,207,243

PRESTONE PRODUCTS GROUP (DELAWARE CORPORATION)
39 OLD RIDGEBURY ROAD
DANBURY, CT 06810

Registered Sep. 11, 2012

Int. Cl.: 36

FOR: CHARITABLE FUNDRAISING SERVICES BY MEANS OF ORGANIZING AND CONDUCTING SPECIAL EVENTS, IN CLASS 36 (U.S. CLS. 100, 101 AND 102).

SERVICE MARK

FIRST USE 9-0-2010; IN COMMERCE 9-0-2010.

PRINCIPAL REGISTER

THE MARK CONSISTS OF STANDARD CHARACTERS WITHOUT CLAIM TO ANY PARTICULAR FONT, STYLE, SIZE, OR COLOR.

SN 85-337,744, FILED 6-3-2011.

ESTHER BELENKER, EXAMINING ATTORNEY



David J. Kyffers

Director of the United States Patent and Trademark Office

United States of America

United States Patent and Trademark Office



Reg. No. 4,207,244

Registered Sep. 11, 2012

Int. Cls.: 21, 25, and 43

TRADEMARK

SERVICE MARK

PRINCIPAL REGISTER

MCNAMARA ENTERPRISES, INC. (VIRGINIA CORPORATION), TA THE MAIN STREET PUB,
7140 MAIN STREET
CLIFTON, VA 20124

FOR: BEER MUGS, COFFEE CUPS, MUGS, CUPS, CUPS AND MUGS, DINNERWARE, NAMELY, CUPS AND GLASSES, DRINKING CUPS, DRINKING GLASSES, SPORTS WATER BOTTLES SOLD EMPTY, PLASTIC, STAINLESS STEEL AND ALUMINUM WATER BOTTLES SOLD EMPTY, GLASS MUGS, GOBLETS, MUGS, PILSNER DRINKING GLASSES, IN CLASS 21 (U.S. CLS. 2, 13, 23, 29, 30, 33, 40 AND 50).

FIRST USE 7-8-2008; IN COMMERCE 7-8-2008.

FOR: CLOTHING, NAMELY, T-SHIRTS, GOLF SHIRTS, KNIT SHIRTS, SHORT-SLEEVED SHIRTS, LONG-SLEEVED SHIRTS, POLO SHIRTS, RUGBY SHIRTS, SHIRTS, SPORT SHIRTS, JERSEYS, TOPS, IN CLASS 25 (U.S. CLS. 22 AND 39).

FIRST USE 7-8-2008; IN COMMERCE 7-8-2008.

FOR: RESTAURANT AND BAR SERVICES; RESTAURANT SERVICES; RESTAURANTS; RESTAURANTS FEATURING HOME DELIVERY; CAFÉ RESTAURANTS; CARRY-OUT RESTAURANTS; LOUNGES; COCKTAIL LOUNGES, IN CLASS 43 (U.S. CLS. 100 AND 101).

FIRST USE 7-8-2008; IN COMMERCE 7-8-2008.

NO CLAIM IS MADE TO THE EXCLUSIVE RIGHT TO USE "MAIN STREET PUB", "CLIFTON, VIRGINIA" AND "SINCE 2008", APART FROM THE MARK AS SHOWN.

THE MARK CONSISTS OF CHECKERBOARD PATTERN OVERLAID WITH DIAMOND BEARING THE TEXT "THE MAIN STREET PUB CLIFTON, VIRGINIA SINCE 2008".

SN 85-337,750, FILED 6-3-2011.

KATHY DE JONGE, EXAMINING ATTORNEY



David J. Kyffers

Director of the United States Patent and Trademark Office

United States of America
United States Patent and Trademark Office

Crystalcello

Reg. No. 4,207,245

ELITE MUSICAL INSTRUMENTS, CORP. (CALIFORNIA CORPORATION)
20505 E. VALLEY BLVD. #101
WALNUT, CA 91789

Registered Sep. 11, 2012

Int. Cl.: 15

FOR: MUSICAL INSTRUMENTS: STRINGS, WOODWIND AND BRASS MUSICAL INSTRUMENTS, IN CLASS 15 (U.S. CLS. 2, 21 AND 36).

TRADEMARK

FIRST USE 2-8-2012; IN COMMERCE 2-8-2012.

PRINCIPAL REGISTER

THE MARK CONSISTS OF STANDARD CHARACTERS WITHOUT CLAIM TO ANY PARTICULAR FONT, STYLE, SIZE, OR COLOR.

SN 85-338,373, FILED 6-5-2011.

ZACHARY BELLO, EXAMINING ATTORNEY



David J. Kybas

Director of the United States Patent and Trademark Office

United States of America

United States Patent and Trademark Office

BIZCONNECTIONS.COOP

Reg. No. 4,207,246

Registered Sep. 11, 2012

Int. Cl.: 35

SERVICE MARK

PRINCIPAL REGISTER

NATIONAL RURAL ELECTRIC COOPERATIVE ASSOCIATION (D.C. INCORPORATED ASSOCIATION)
4301 WILSON BOULEVARD
ARLINGTON, VA 22203

FOR: ADMINISTRATION OF A PROGRAM FOR ENABLING PARTICIPANTS TO OBTAIN DISCOUNTS ON PRODUCTS AND SERVICES; PROVIDING BUSINESSES INFORMATION IN THE FIELD OF DISCOUNT PROGRAMS, IN CLASS 35 (U.S. CLS. 100, 101 AND 102).

FIRST USE 11-1-2011; IN COMMERCE 11-1-2011.

THE MARK CONSISTS OF STANDARD CHARACTERS WITHOUT CLAIM TO ANY PARTICULAR FONT, STYLE, SIZE, OR COLOR.

SN 85-338,430, FILED 6-6-2011.

MARK SPARACINO, EXAMINING ATTORNEY



David J. Kyffers

Director of the United States Patent and Trademark Office

United States of America

United States Patent and Trademark Office

THE ORIGINAL, OFFICIAL PREMIUM BRAND OF THE STRAIGHT GUY

Reg. No. 4,207,247

RECHTER, WILLIAM ERIC (UNITED STATES INDIVIDUAL)
3230 FOREST LANE
MURRYSVILLE, PA 15668

Registered Sep. 11, 2012

Int. Cl.: 25

FOR: CLOTHING, NAMELY, T-SHIRTS AND UNDERWEAR, IN CLASS 25 (U.S. CLS. 22 AND 39).

TRADEMARK

FIRST USE 9-1-2011; IN COMMERCE 9-1-2011.

PRINCIPAL REGISTER

THE MARK CONSISTS OF STANDARD CHARACTERS WITHOUT CLAIM TO ANY PARTICULAR FONT, STYLE, SIZE, OR COLOR.

OWNER OF U.S. REG. NO. 3,728,766.

SN 85-338,625, FILED 6-6-2011.

INGRID C. EULIN, EXAMINING ATTORNEY



David J. Kybas

Director of the United States Patent and Trademark Office

United States of America

United States Patent and Trademark Office

Unlock the Blocks

Reg. No. 4,207,248

JULIE GROOS (UNITED STATES INDIVIDUAL)
5504 KELCOURT DRIVE
FLOWER MOUND, TX 75022

Registered Sep. 11, 2012

Int. Cls.: 9, 16, and 41

FOR: PRERECORDED DVDS AND COMPACT DISKS FEATURING EDUCATIONAL MATERIAL, NAMELY, SKILLS FOR OVERCOMING PERCEIVED OBSTACLES AND SETBACKS IN BUSINESS AND LIFE, IN CLASS 9 (U.S. CLS. 21, 23, 26, 36 AND 38).

TRADEMARK

FIRST USE 6-15-2012; IN COMMERCE 6-15-2012.

SERVICE MARK

PRINCIPAL REGISTER

FOR: PAPER GOODS, NAMELY, NON-FICTION BOOKS, EDUCATIONAL ARTICLES AND WORKBOOKS FEATURING SKILLS FOR OVERCOMING PERCEIVED OBSTACLES AND SETBACKS IN BUSINESS AND LIFE, IN CLASS 16 (U.S. CLS. 2, 5, 22, 23, 29, 37, 38 AND 50).

FIRST USE 6-1-2012; IN COMMERCE 6-1-2012.

FOR: PROFESSIONAL COACHING AND TRAINING SERVICES IN THE FIELD OF PERSONAL GROWTH AND DEVELOPMENT, NAMELY, SKILLS FOR OVERCOMING PERCEIVED OBSTACLES AND SETBACKS IN BUSINESS AND LIFE; ON-LINE JOURNALS, NAMELY, EDUCATIONAL BLOGS FEATURING SKILLS FOR OVERCOMING PERCEIVED OBSTACLES AND SETBACKS IN BUSINESS AND LIFE, IN CLASS 41 (U.S. CLS. 100, 101 AND 107).

FIRST USE 6-1-2012; IN COMMERCE 6-1-2012.

THE MARK CONSISTS OF STANDARD CHARACTERS WITHOUT CLAIM TO ANY PARTICULAR FONT, STYLE, SIZE, OR COLOR.

SN 85-338,881, FILED 6-6-2011.

MICHAEL ENGEL, EXAMINING ATTORNEY

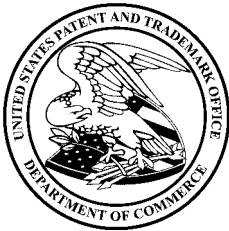

David J. Kyffers

Director of the United States Patent and Trademark Office

United States of America

United States Patent and Trademark Office

PRECIDIAN INVESTMENTS

Reg. No. 4,207,249

Registered Sep. 11, 2012

Int. Cls.: 36, 42, and 45

SERVICE MARK

PRINCIPAL REGISTER

PRECIDIAN INVESTMENTS LLC (DELAWARE LIMITED LIABILITY COMPANY)
350 MAIN STREET, SUITE 9
BEDMINSTER, NJ 07921

FOR: FINANCIAL MANAGEMENT SERVICES, NAMELY, PROVIDING CONSTRUCTION OF INVESTMENT PORTFOLIOS COMPRISED OF CERTAIN FINANCIAL INSTRUMENTS; DEVELOPMENT OF FINANCIAL INSTRUMENTS, NAMELY, EXCHANGE TRADED PRODUCTS (ETPS), MUTUAL FUNDS AND DERIVATIVES FOR OTHERS, NAMELY, RETAIL INVESTORS, REGISTERED INVESTMENT ADVISERS (RIAS), INSTITUTIONAL, PENSION AND ENDOWMENT INVESTORS; FINANCIAL CONSULTATION SERVICES, NAMELY, PROVIDING FINANCIAL ANALYSIS SERVICES TO OTHERS; FINANCIAL AND INVESTMENT CONSULTATION SERVICES, NAMELY, PROVIDING ANALYSIS OF POTENTIAL ASSET AND INVESTMENT ACQUISITIONS, IN CLASS 36 (U.S. CLS. 100, 101 AND 102).

FIRST USE 6-7-2011; IN COMMERCE 6-7-2011.

FOR: DEVELOPMENT OF TECHNOLOGIES IN THE FIELD OF TRADING OF FINANCIAL INSTRUMENTS, NAMELY, SCIENTIFIC RESEARCH FOR MATH ALGORITHMS AND DEVELOPING COMPUTER SOFTWARE IN CONNECTION WITH TRADING OR OTHER ACTIVITIES RELATED TO TRADING OF FINANCIAL INSTRUMENTS, IN CLASS 42 (U.S. CLS. 100 AND 101).

FIRST USE 6-7-2011; IN COMMERCE 6-7-2011.

FOR: LICENSING OF INTELLECTUAL PROPERTY USED IN THE CREATION OF FINANCIAL INSTRUMENTS, IN CLASS 45 (U.S. CLS. 100 AND 101).

FIRST USE 6-7-2011; IN COMMERCE 6-7-2011.

THE MARK CONSISTS OF STANDARD CHARACTERS WITHOUT CLAIM TO ANY PARTICULAR FONT, STYLE, SIZE, OR COLOR.

NO CLAIM IS MADE TO THE EXCLUSIVE RIGHT TO USE "INVESTMENTS", APART FROM THE MARK AS SHOWN.

SN 85-338,944, FILED 6-6-2011.



David J. Kyjars

Director of the United States Patent and Trademark Office

Reg. No. 4,207,249 MARGERY A. TIERNEY, EXAMINING ATTORNEY

United States of America

United States Patent and Trademark Office

PRECIDIAN FUNDS

Reg. No. 4,207,250

PRECIDIAN INVESTMENTS LLC (DELAWARE LIMITED LIABILITY COMPANY)
350 MAIN STREET, SUITE 9
BEDMINSTER, NJ 07921

Registered Sep. 11, 2012

Int. Cl.: 36

FOR: FINANCIAL ADVISORY SERVICES FOR EXCHANGE TRADED PRODUCTS (ETPS),
IN CLASS 36 (U.S. CLS. 100, 101 AND 102).

SERVICE MARK

FIRST USE 6-7-2011; IN COMMERCE 6-7-2011.

PRINCIPAL REGISTER

THE MARK CONSISTS OF STANDARD CHARACTERS WITHOUT CLAIM TO ANY PARTICULAR FONT, STYLE, SIZE, OR COLOR.

NO CLAIM IS MADE TO THE EXCLUSIVE RIGHT TO USE "FUNDS", APART FROM THE MARK AS SHOWN.

SN 85-338,975, FILED 6-6-2011.

MARGERY A. TIERNEY, EXAMINING ATTORNEY



David J. Kybas

Director of the United States Patent and Trademark Office

United States of America

United States Patent and Trademark Office

TASTE OF HOME

Reg. No. 4,207,251

REIMAN MEDIA GROUP, LLC (DELAWARE CORPORATION)
5400 SOUTH 60TH STREET
GREENDALE, WI 53129

Registered Sep. 11, 2012

Int. Cl.: 9

FOR: COMPUTER APPLICATION SOFTWARE FOR MOBILE DEVICES, NAMELY, SOFTWARE FOR ACCESSING AND SEARCHING RECIPES, IN CLASS 9 (U.S. CLS. 21, 23, 26, 36 AND 38).

TRADEMARK

FIRST USE 8-10-2011; IN COMMERCE 8-10-2011.

PRINCIPAL REGISTER

THE MARK CONSISTS OF STANDARD CHARACTERS WITHOUT CLAIM TO ANY PARTICULAR FONT, STYLE, SIZE, OR COLOR.

OWNER OF U.S. REG. NOS. 2,002,133, 2,955,195, AND OTHERS.

SN 85-339,638, FILED 6-7-2011.

CHRISTINE COOPER, EXAMINING ATTORNEY



David J. Kybas

Director of the United States Patent and Trademark Office

United States of America

United States Patent and Trademark Office

YourSafe

Reg. No. 4,207,252

SUMMITAS, LLC (DELAWARE LIMITED LIABILITY COMPANY)
335 MADISON AVENUE, SUITE 1432
NEW YORK, NY 10017

Registered Sep. 11, 2012

Int. Cl.: 9

FOR: COMPUTER APPLICATION SOFTWARE FOR MOBILE PHONES AND HANDHELD COMPUTERS, NAMELY, SOFTWARE FOR USE IN DOCUMENT MANAGEMENT AND ELECTRONIC STORAGE AND RETRIEVAL OF DOCUMENTS; COMPUTER SOFTWARE FOR DOCUMENT MANAGEMENT, IN CLASS 9 (U.S. CLS. 21, 23, 26, 36 AND 38).

TRADEMARK

PRINCIPAL REGISTER

FIRST USE 7-26-2011; IN COMMERCE 7-26-2011.

THE MARK CONSISTS OF STANDARD CHARACTERS WITHOUT CLAIM TO ANY PARTICULAR FONT, STYLE, SIZE, OR COLOR.

SN 85-339,908, FILED 6-7-2011.

CHRISTINA SOBRAL, EXAMINING ATTORNEY



David J. Kyffers

Director of the United States Patent and Trademark Office

United States of America

United States Patent and Trademark Office

The Adventures of Timmy: Run Kitty Run

Reg. No. 4,207,253

Registered Sep. 11, 2012

Int. Cl.: 9

TRADEMARK

PRINCIPAL REGISTER

CROSSBORDERS, LLC (DELAWARE LIMITED LIABILITY COMPANY)
SUITE 507
207 WEST 25TH STREET
NEW YORK, NY 10001

FOR: DOWNLOADABLE VIDEO GAME SOFTWARE FOR MOBILE DEVICES AND PERSONAL COMPUTERS; COMPUTER GAME SOFTWARE, COMPUTER GAME PROGRAMS; VIDEO GAME SOFTWARE, INTERACTIVE VIDEO GAME PROGRAMS; ELECTRONIC GAME SOFTWARE, ELECTRONIC GAME PROGRAMS, INTERACTIVE GAME SOFTWARE, INTERACTIVE GAME PROGRAMS, IN CLASS 9 (U.S. CLS. 21, 23, 26, 36 AND 38).

FIRST USE 10-1-2011; IN COMMERCE 10-1-2011.

THE MARK CONSISTS OF STANDARD CHARACTERS WITHOUT CLAIM TO ANY PARTICULAR FONT, STYLE, SIZE, OR COLOR.

SN 85-340,013, FILED 6-7-2011.

PAULA MAHONEY, EXAMINING ATTORNEY



David J. Kyffers

Director of the United States Patent and Trademark Office

United States of America

United States Patent and Trademark Office



Reg. No. 4,207,254

BOOMERANG BRANDS (ILLINOIS LIMITED LIABILITY COMPANY)
560 OAKMONT LANE
WESTMONT, IL 60521

Registered Sep. 11, 2012

Int. Cl.: 33

FOR: ALCOHOLIC MIXED BEVERAGES EXCEPT BEERS, IN CLASS 33 (U.S. CLS. 47 AND 49).

TRADEMARK

FIRST USE 12-1-2011; IN COMMERCE 3-27-2012.

PRINCIPAL REGISTER

NO CLAIM IS MADE TO THE EXCLUSIVE RIGHT TO USE "COCKTAIL", APART FROM THE MARK AS SHOWN.

THE MARK CONSISTS OF AN OUTER CIRCLE DEPICTING THE WORDS "SLIM" IN THE UPPER PORTION AND "COCKTAIL" IN THE LOWER PORTION; AN INNER CIRCLE DEPICTING TWO SMALLER STARS AND ONE LARGER STAR IN THE UPPER AND LOWER PORTION; A BANNER RUNNING EAST-WEST THROUGH BOTH CIRCLES DEPICTING THE WORDS "LIZZY'S".

SN 85-340,172, FILED 6-7-2011.

CHARLES L. JENKINS, EXAMINING ATTORNEY



David J. Kybas

Director of the United States Patent and Trademark Office

United States of America
United States Patent and Trademark Office

COMPAY

Reg. No. 4,207,255

Registered Sep. 11, 2012

Int. Cl.: 35

SERVICE MARK

PRINCIPAL REGISTER

DONEGAL MUTUAL INSURANCE COMPANY (PENNSYLVANIA CORPORATION)
P.O. BOX 302
1195 RIVER ROAD
MARIETTA, PA 17547

FOR: ADMINISTRATION SERVICES FOR PREMIUM PAYROLL DEDUCTIONS FOR WORKERS COMPENSATION POLICIES OF OTHERS, AND PREMIUM PAYMENT SERVICES, IN CLASS 35 (U.S. CLS. 100, 101 AND 102).

FIRST USE 10-7-2011; IN COMMERCE 10-7-2011.

THE MARK CONSISTS OF STANDARD CHARACTERS WITHOUT CLAIM TO ANY PARTICULAR FONT, STYLE, SIZE, OR COLOR.

SN 85-340,193, FILED 6-7-2011.

FRED CARL, EXAMINING ATTORNEY



David J. Kyfos

Director of the United States Patent and Trademark Office

United States of America

United States Patent and Trademark Office

ARMOLAN

Reg. No. 4,207,256

IGS CHEMICALS LLC (CALIFORNIA LIMITED LIABILITY COMPANY)
468 N. CAMDEN DR.

Registered Sep. 11, 2012

BEVERLY HILLS, CA 90210

Int. Cl.: 17

FOR: TINTED, LAMINATED AND REFLECTIVE PLASTIC FILMS FOR USE IN HOME OR AUTO WINDOWS, IN CLASS 17 (U.S. CLS. 1, 5, 12, 13, 35 AND 50).

TRADEMARK

FIRST USE 7-0-2011; IN COMMERCE 7-0-2011.

PRINCIPAL REGISTER

THE MARK CONSISTS OF STANDARD CHARACTERS WITHOUT CLAIM TO ANY PARTICULAR FONT, STYLE, SIZE, OR COLOR.

SN 85-340,217, FILED 6-7-2011.

FRED CARL, EXAMINING ATTORNEY



David J. Kyfos

Director of the United States Patent and Trademark Office

United States of America

United States Patent and Trademark Office

BRONCO BRAID

Reg. No. 4,207,257

REDBARN PET PRODUCTS INC. (CALIFORNIA CORPORATION)
3229 EAST SPRING ST. SUITE 310
LONG BEACH, CA 90806

Registered Sep. 11, 2012

Int. Cl.: 31

FOR: DOG AND PET FOOD TREATS, IN CLASS 31 (U.S. CLS. 1 AND 46).

TRADEMARK

FIRST USE 5-1-2012; IN COMMERCE 5-1-2012.

PRINCIPAL REGISTER

THE MARK CONSISTS OF STANDARD CHARACTERS WITHOUT CLAIM TO ANY PARTICULAR FONT, STYLE, SIZE, OR COLOR.

NO CLAIM IS MADE TO THE EXCLUSIVE RIGHT TO USE "BRAID", APART FROM THE MARK AS SHOWN.

SN 85-340,544, FILED 6-7-2011.

LEIGH LOWRY, EXAMINING ATTORNEY



David J. Kyffers

Director of the United States Patent and Trademark Office

United States of America

United States Patent and Trademark Office

SEX: A RENEWABLE RESOURCE

Reg. No. 4,207,258

MURDOCK, ROBERT (UNITED STATES INDIVIDUAL)
POST OFFICE BOX 334
MOUNT DORA, FL 327560334

Registered Sep. 11, 2012

Int. Cl.: 25

FOR: CLOTHING, NAMELY, TOPS, BOTTOMS, T-SHIRTS, POLO SHIRTS, JACKETS, SHORTS, WARMUP PANTS, HATS, PANTIES, THONGS, UNDERWEAR, TANK TOPS, SWEATSHIRTS, SWIM SUITS, BIKINIS, PAJAMAS, IN CLASS 25 (U.S. CLS. 22 AND 39).

TRADEMARK

FIRST USE 6-3-2011; IN COMMERCE 6-20-2012.

PRINCIPAL REGISTER

THE MARK CONSISTS OF STANDARD CHARACTERS WITHOUT CLAIM TO ANY PARTICULAR FONT, STYLE, SIZE, OR COLOR.

SN 85-340,625, FILED 6-8-2011.

LOURDES AYALA, EXAMINING ATTORNEY



David J. Kyffers

Director of the United States Patent and Trademark Office

United States of America

United States Patent and Trademark Office



Reg. No. 4,207,259

Registered Sep. 11, 2012

Int. Cl.: 13

TRADEMARK

PRINCIPAL REGISTER

YANKEE HILL MACHINE COMPANY, INC. (MASSACHUSETTS CORPORATION)
20 LADD AVENUE
FLORENCE, MA 01062

FOR: GUNS AND GUN PARTS, NAMELY, NON TELESCOPIC AND NON-OPTICAL SIGHTS, LOADING BLOCKS FOR WEAPONS, MOUNTS, NOISE SUPPRESSORS, GRIPS FOR PORTABLE FIREARMS, RAIL SYSTEM ADAPTORS FOR USE ON BARRELS TO ATTACH GUN ACCESSORIES, HAND GRIP EXTENSIONS FOR FIREARMS, RISERS, CLEANING RODS FOR FIREARMS, RECOIL SPACERS, MOUNTING SCREWS FOR GUN ACCESSORIES, NAMELY, FOR SIGHTS, BLOCKS, MOUNTS, SUPPRESSORS, GRIPS, RAIL SYSTEM ADAPTORS, EXTENSIONS, RISERS, CLEANING RODS AND SPACERS, IN CLASS 13 (U.S. CLS. 2 AND 9).

FIRST USE 6-25-2012; IN COMMERCE 6-25-2012.

THE MARK CONSISTS OF THE UPPERCASE LETTERS "YHM" DISPOSED WITHIN A DIAMOND SHAPE DESIGN WHICH IS SUPERIMPOSED OVER A SILHOUETTE OF A SOLDIER FROM THE WAIST UP LOOKING THROUGH THE SCOPE OF A FIREARM.

SN 85-341,061, FILED 6-8-2011.

JENNIFER MARTIN, EXAMINING ATTORNEY



David J. Kybas

Director of the United States Patent and Trademark Office

United States of America
United States Patent and Trademark Office

GATEWAY

Reg. No. 4,207,260

DORIC PRODUCTS, INC. (INDIANA CORPORATION)
201 WEST US HWY 40
MARSHALL, IL 62441

Registered Sep. 11, 2012

Int. Cl.: 19

FOR: BURIAL VAULTS NOT OF METAL, IN CLASS 19 (U.S. CLS. 1, 12, 33 AND 50).

TRADEMARK

FIRST USE 8-25-2011; IN COMMERCE 8-25-2011.

PRINCIPAL REGISTER

THE MARK CONSISTS OF STANDARD CHARACTERS WITHOUT CLAIM TO ANY PARTICULAR FONT, STYLE, SIZE, OR COLOR.

SN 85-341,257, FILED 6-8-2011.

TRACY CROSS, EXAMINING ATTORNEY



David J. Kyffers

Director of the United States Patent and Trademark Office

United States of America

United States Patent and Trademark Office

CHADWICK

Reg. No. 4,207,261

DORIC PRODUCTS, INC. (INDIANA CORPORATION)
201 WEST US HWY 40
MARSHALL, IL 62441

Registered Sep. 11, 2012

Int. Cl.: 19

FOR: BURIAL VAULTS NOT OF METAL, IN CLASS 19 (U.S. CLS. 1, 12, 33 AND 50).

TRADEMARK

FIRST USE 8-25-2011; IN COMMERCE 8-25-2011.

PRINCIPAL REGISTER

THE MARK CONSISTS OF STANDARD CHARACTERS WITHOUT CLAIM TO ANY PARTICULAR FONT, STYLE, SIZE, OR COLOR.

SN 85-341,261, FILED 6-8-2011.

TRACY CROSS, EXAMINING ATTORNEY



David J. Kyffers

Director of the United States Patent and Trademark Office

United States of America

United States Patent and Trademark Office

CLERMONT

Reg. No. 4,207,262

DORIC PRODUCTS, INC. (INDIANA CORPORATION)
201 WEST US HWY 40
MARSHALL, IL 62441

Registered Sep. 11, 2012

Int. Cl.: 19

FOR: BURIAL VAULTS NOT OF METAL, IN CLASS 19 (U.S. CLS. 1, 12, 33 AND 50).

TRADEMARK

FIRST USE 8-25-2011; IN COMMERCE 8-25-2011.

PRINCIPAL REGISTER

THE MARK CONSISTS OF STANDARD CHARACTERS WITHOUT CLAIM TO ANY PARTICULAR FONT, STYLE, SIZE, OR COLOR.

SN 85-341,263, FILED 6-8-2011.

TRACY CROSS, EXAMINING ATTORNEY



David J. Kyffers

Director of the United States Patent and Trademark Office

United States of America

United States Patent and Trademark Office

HUNTINGTON

Reg. No. 4,207,263

DORIC PRODUCTS, INC. (INDIANA CORPORATION)
201 WEST US HWY 40
MARSHALL, IL 62441

Registered Sep. 11, 2012

Int. Cl.: 19

FOR: BURIAL VAULTS NOT OF METAL, IN CLASS 19 (U.S. CLS. 1, 12, 33 AND 50).

TRADEMARK

FIRST USE 8-25-2011; IN COMMERCE 8-25-2011.

PRINCIPAL REGISTER

THE MARK CONSISTS OF STANDARD CHARACTERS WITHOUT CLAIM TO ANY PARTICULAR FONT, STYLE, SIZE, OR COLOR.

SN 85-341,304, FILED 6-8-2011.

TRACY CROSS, EXAMINING ATTORNEY



David J. Kyffers

Director of the United States Patent and Trademark Office

United States of America

United States Patent and Trademark Office

EMPIRE

Reg. No. 4,207,264

Registered Sep. 11, 2012

Int. Cl.: 19

TRADEMARK

PRINCIPAL REGISTER

DORIC PRODUCTS, INC. (INDIANA CORPORATION)
201 WEST US HWY 40
MARSHALL, IL 62441

FOR: BURIAL VAULTS NOT OF METAL, IN CLASS 19 (U.S. CLS. 1, 12, 33 AND 50).

FIRST USE 8-25-2011; IN COMMERCE 8-25-2011.

THE MARK CONSISTS OF STANDARD CHARACTERS WITHOUT CLAIM TO ANY PARTICULAR FONT, STYLE, SIZE, OR COLOR.

SN 85-341,306, FILED 6-8-2011.

TRACY CROSS, EXAMINING ATTORNEY



David J. Kyffers

Director of the United States Patent and Trademark Office

United States of America

United States Patent and Trademark Office

ZIPWIRE

Reg. No. 4,207,265

Registered Sep. 11, 2012

Int. Cl.: 13

TRADEMARK

PRINCIPAL REGISTER

REVO BRAND GROUP, LLC (MINNESOTA LIMITED LIABILITY COMPANY)
SUITE 150
10700 HIGHWAY 55
PLYMOUTH, MN 55441

FOR: GUN CLEANING KITS COMPRISED OF GUN CLEANING BRUSHES, BORE CLEANER, SOLVENTS AND LUBRICANTS, GUN CLEANING PATCHES, AND FLEXIBLE GUN CLEANING CABLES, IN CLASS 13 (U.S. CLS. 2 AND 9).

FIRST USE 6-25-2012; IN COMMERCE 6-25-2012.

THE MARK CONSISTS OF STANDARD CHARACTERS WITHOUT CLAIM TO ANY PARTICULAR FONT, STYLE, SIZE, OR COLOR.

SN 85-341,385, FILED 6-8-2011.

JUDITH HELFMAN, EXAMINING ATTORNEY



David J. Kyffers

Director of the United States Patent and Trademark Office

United States of America

United States Patent and Trademark Office

MARKET SHARE

Reg. No. 4,207,266

Registered Sep. 11, 2012

Int. Cl.: 35

SERVICE MARK

PRINCIPAL REGISTER

RICHARD AWN (UNITED STATES INDIVIDUAL)

1
116 FRANKLIN STREET
NEW YORK, NY 11222

FOR: INCUBATION SERVICES, NAMELY, PROVIDING WORK SPACE CONTAINING BUSINESS EQUIPMENT TO FREELANCERS, START-UPS, EXISTING BUSINESSES AND NON-PROFITS; RETAIL MARKETS FEATURING BAKED GOODS, BREAD, PASTRY, DESSERTS, SANDWICHES, SOUPS, SALADS, SIDES, ENTREES, CHEESE, MEAT, SNACK FOODS, AND GOURMET FOODS, IN CLASS 35 (U.S. CLS. 100, 101 AND 102).

FIRST USE 5-28-2011; IN COMMERCE 5-28-2011.

THE MARK CONSISTS OF STANDARD CHARACTERS WITHOUT CLAIM TO ANY PARTICULAR FONT, STYLE, SIZE, OR COLOR.

SN 85-341,536, FILED 6-8-2011.

KAPIL BHANOT, EXAMINING ATTORNEY



David J. Kybas

Director of the United States Patent and Trademark Office

United States of America

United States Patent and Trademark Office

LAUREN AND WENDY

Reg. No. 4,207,267

LAUREN AND WENDY LLC (CALIFORNIA LIMITED LIABILITY COMPANY)
16612 CALLE JERMAINE
PACIFIC PALISADES, CA 90272

Registered Sep. 11, 2012

Int. Cl.: 25

FOR: BATHING SUITS; BELTS; BLOUSES; BOTTOMS; DRESSES; EVENING DRESSES;
HEADWEAR; JACKETS; JUMPSUITS; NECKWEAR; PANTS; SCARVES; SHIRTS; SKIRTS;
SWEATPANTS; T-SHIRTS; TOPS, IN CLASS 25 (U.S. CLS. 22 AND 39).

TRADEMARK

FIRST USE 4-30-2012; IN COMMERCE 5-1-2012.

PRINCIPAL REGISTER

THE MARK CONSISTS OF STANDARD CHARACTERS WITHOUT CLAIM TO ANY PAR-
TICULAR FONT, STYLE, SIZE, OR COLOR.

SN 85-341,563, FILED 6-8-2011.

SUE LAWRENCE, EXAMINING ATTORNEY



David J. Kyffers

Director of the United States Patent and Trademark Office

United States of America

United States Patent and Trademark Office

WD-40 SPECIALIST

Reg. No. 4,207,268

Registered Sep. 11, 2012

Int. Cls.: 2, 3, and 4

TRADEMARK

PRINCIPAL REGISTER

WD-40 MANUFACTURING COMPANY (CALIFORNIA CORPORATION)
1061 CUDAHY PLACE
SAN DIEGO, CA 92110

FOR: PROTECTIVE COATINGS FOR RUST PREVENTION AND CORROSION CONTROL,
IN CLASS 2 (U.S. CLS. 6, 11 AND 16).

FIRST USE 9-30-2011; IN COMMERCE 9-30-2011.

FOR: CLEANING PREPARATION FOR USE ON METAL SURFACES, IN CLASS 3 (U.S. CLS.
1, 4, 6, 50, 51 AND 52).

FIRST USE 9-30-2011; IN COMMERCE 9-30-2011.

FOR: ALL-PURPOSE PENETRATING AND LUBRICATING OIL, IN CLASS 4 (U.S. CLS. 1,
6 AND 15).

FIRST USE 9-30-2011; IN COMMERCE 9-30-2011.

THE MARK CONSISTS OF STANDARD CHARACTERS WITHOUT CLAIM TO ANY PAR-
TICULAR FONT, STYLE, SIZE, OR COLOR.

OWNER OF U.S. REG. NOS. 670,503, 3,010,487, AND OTHERS.

SN 85-341,644, FILED 6-8-2011.

MARGARET POWER, EXAMINING ATTORNEY



David J. Kybas

Director of the United States Patent and Trademark Office

United States of America

United States Patent and Trademark Office

CROWNPOINT

Reg. No. 4,207,269

Registered Sep. 11, 2012

Int. Cl.: 20

TRADEMARK

PRINCIPAL REGISTER

CROWN POINT CABINETRY CORP. (NEW HAMPSHIRE CORPORATION)
462 RIVER ROAD
CLAREMONT, NH 03743

FOR: CUSTOM FURNITURE, IN CLASS 20 (U.S. CLS. 2, 13, 22, 25, 32 AND 50).

FIRST USE 6-19-2012; IN COMMERCE 6-19-2012.

THE MARK CONSISTS OF STANDARD CHARACTERS WITHOUT CLAIM TO ANY PARTICULAR FONT, STYLE, SIZE, OR COLOR.

SN 85-341,805, FILED 6-9-2011.

JEFFERY COWARD, EXAMINING ATTORNEY



David J. Kybas

Director of the United States Patent and Trademark Office

United States of America

United States Patent and Trademark Office

THERAWHEEL

Reg. No. 4,207,270

MYOPERFORMANCE SYSTEMS LLC (INDIANA LIMITED LIABILITY COMPANY)
1150 W. 86TH STREET

Registered Sep. 11, 2012

INDIANAPOLIS, IN 46260

Int. Cl.: 10

FOR: HAND HELD TISSUE MANIPULATION APPARATUS FOR USE ON MUSCLES, LIGAMENTS, TENDONS FOR MASSAGE, PHYSICAL THERAPY, ORTHOPEDIC TREATMENT AND THERAPEUTIC USE , IN CLASS 10 (U.S. CLS. 26, 39 AND 44).

TRADEMARK

FIRST USE 12-10-2011; IN COMMERCE 12-10-2011.

PRINCIPAL REGISTER

THE MARK CONSISTS OF STANDARD CHARACTERS WITHOUT CLAIM TO ANY PARTICULAR FONT, STYLE, SIZE, OR COLOR.

SN 85-341,824, FILED 6-9-2011.

LEIGH LOWRY, EXAMINING ATTORNEY



David J. Kyros

Director of the United States Patent and Trademark Office

United States of America

United States Patent and Trademark Office



Reg. No. 4,207,271

Registered Sep. 11, 2012

Int. Cls.: 35, 36, and 42

SERVICE MARK

PRINCIPAL REGISTER

FIRST PRESTON MANAGEMENT, INC. (TEXAS CORPORATION)
SUITE 400
5040 ADDISON CIRCLE
ADDISON, TX 75001

FOR: ACCOUNTING SERVICES; REAL ESTATE MARKETING SERVICES, NAMELY, ON-LINE SERVICES FEATURING TOURS OF RESIDENTIAL AND COMMERCIAL REAL ESTATE, IN CLASS 35 (U.S. CLS. 100, 101 AND 102).

FIRST USE 6-15-2011; IN COMMERCE 6-15-2011.

FOR: REAL ESTATE BROKERAGE; REAL ESTATE FINANCING SERVICES; REAL ESTATE MANAGEMENT SERVICES, IN CLASS 36 (U.S. CLS. 100, 101 AND 102).

FIRST USE 6-15-2011; IN COMMERCE 6-15-2011.

FOR: APPLICATION SERVICE PROVIDER (ASP) FEATURING SOFTWARE FOR USE IN PROVIDING, HOSTING, MANAGING, DEVELOPING, AND MAINTAINING APPLICATIONS, SOFTWARE, WEB SITES AND DATABASES IN THE FIELDS OF ONLINE AUCTIONS, SELECTION, BIDDING, OFFER MANAGEMENT, REAL ESTATE TRANSACTIONS, AND MANAGEMENT AND MARKETING OF REAL ESTATE ASSETS, IN CLASS 42 (U.S. CLS. 100 AND 101).

FIRST USE 6-15-2011; IN COMMERCE 6-15-2011.

THE MARK CONSISTS OF BLUE AND GREY CURVED BANDS.

THE COLOR(S) BLUE AND GREY IS/ARE CLAIMED AS A FEATURE OF THE MARK.

SN 85-341,959, FILED 6-9-2011.

REBECCA EISINGER, EXAMINING ATTORNEY



David J. Kybas

Director of the United States Patent and Trademark Office

United States of America

United States Patent and Trademark Office



Reg. No. 4,207,272

Registered Sep. 11, 2012

Int. Cl.: 5

TRADEMARK

PRINCIPAL REGISTER

DOJS HOLDINGS PTY LTD (AUSTRALIA CORPORATION)
49 RETREAT STREET
BRIDGEMAN DOWNS QLD, AUSTRALIA 4035

FOR: PRODUCTS CONTAINING HERBS AND PRODUCTS CONTAINING HERBAL EXTRACTS, ALL FOR MEDICINAL PURPOSES, NAMELY, MEDICINAL HERBS AND MEDICINAL HERBAL EXTRACTS, HERBAL SUPPLEMENTS; NUTRITIONAL ADDITIVES FOR MEDICINAL PURPOSES FOR USE IN FOOD AND DIETARY SUBSTANCES FOR HUMAN CONSUMPTION; MINERAL FOOD SUPPLEMENTS; SUBSTANCES FOR MEDICINAL PURPOSES, NAMELY, MEDICINAL TEA, ROOTS AND HERBS, IN CLASS 5 (U.S. CLS. 6, 18, 44, 46, 51 AND 52).

FIRST USE 10-21-2010; IN COMMERCE 9-14-2011.

THE MARK CONSISTS OF THE WORDING "BERGAMET" IN STYLIZED TYPE FACE IN THE COLOR BLUE, THE WORDING "MEGA" IN STYLIZED TYPE FACE IN THE COLOR WHITE WITH BLUE OUTLINE AND HANGING FRUIT IN THE COLORS ORANGE AND YELLOW ALL AGAINST AN OVAL BACKGROUND IN THE COLORS ORANGE AND YELLOW.

THE COLOR(S) BLUE, ORANGE, WHITE AND YELLOW IS/ARE CLAIMED AS A FEATURE OF THE MARK.

SN 85-342,209, FILED 6-9-2011.

APRIL ROACH, EXAMINING ATTORNEY



David J. Kyffers

Director of the United States Patent and Trademark Office

United States of America

United States Patent and Trademark Office

CAUSE THE EFFECT

Reg. No. 4,207,273

Registered Sep. 11, 2012

Int. Cls.: 35 and 42

SERVICE MARK

PRINCIPAL REGISTER

GMMB, INC. (D.C. CORPORATION)
SUITE 800
1010 WISCONSIN AVENUE, N.W.
WASHINGTON, DC 20007

FOR: CONSULTING SERVICES IN THE FIELDS OF ADVERTISING, PUBLIC RELATIONS, AND POLITICS AND CONSULTATION SERVICES REGARDING DEVELOPMENT OF MARKETING CAMPAIGNS, POLITICAL CAMPAIGN AND PUBLIC AWARENESS CAMPAIGNS THROUGH PUBLIC COMMUNICATION MEANS, IN CLASS 35 (U.S. CLS. 100, 101 AND 102).

FIRST USE 3-15-2011; IN COMMERCE 3-15-2011.

FOR: CONSULTING SERVICES IN THE FIELD OF WEB SITE DESIGN AND DEVELOPMENT OF WEBSITES, IN CLASS 42 (U.S. CLS. 100 AND 101).

FIRST USE 3-15-2011; IN COMMERCE 3-15-2011.

THE MARK CONSISTS OF STANDARD CHARACTERS WITHOUT CLAIM TO ANY PARTICULAR FONT, STYLE, SIZE, OR COLOR.

SN 85-342,393, FILED 6-9-2011.

BRENDAN MCCAULEY, EXAMINING ATTORNEY



David J. Kyjars

Director of the United States Patent and Trademark Office

United States of America

United States Patent and Trademark Office

PLUS

Reg. No. 4,207,274

Registered Sep. 11, 2012

Int. Cls.: 9, 16, 35, and 41

PROFESSIONAL LIABILITY UNDERWRITING SOCIETY (MINNESOTA NON-PROFIT CORPORATION)

5353 WAYZATA BOULEVARD
SUITE 600
MINNEAPOLIS, MN 55416

FOR: DOWNLOADABLE ELECTRONIC PUBLICATIONS IN THE NATURE OF JOURNALS FEATURING INFORMATION IN THE FIELD OF PROFESSIONAL LIABILITY, IN CLASS 9 (U.S. CLS. 21, 23, 26, 36 AND 38).

TRADEMARK

SERVICE MARK

FIRST USE 2-0-2011; IN COMMERCE 2-0-2011.

PRINCIPAL REGISTER

FOR: JOURNALS IN THE FIELD OF PROFESSIONAL LIABILITY, IN CLASS 16 (U.S. CLS. 2, 5, 22, 23, 29, 37, 38 AND 50).

FIRST USE 0-0-1986; IN COMMERCE 0-0-1986.

FOR: ASSOCIATION SERVICES, NAMELY, PROMOTING THE INTERESTS OF THE PROFESSIONAL LIABILITY UNDERWRITING INSURANCE INDUSTRY, IN CLASS 35 (U.S. CLS. 100, 101 AND 102).

FIRST USE 0-0-1986; IN COMMERCE 0-0-1986.

FOR: EDUCATIONAL SERVICES, NAMELY, PROVIDING CONTINUING EDUCATION COURSES IN THE FIELD OF PROFESSIONAL LIABILITY; DISTRIBUTION OF COURSE MATERIALS IN CONNECTION WITH ALL OF THE ABOVE SERVICES; PROVIDING ONLINE JOURNALS FEATURING INFORMATION IN THE FIELD OF PROFESSIONAL LIABILITY, IN CLASS 41 (U.S. CLS. 100, 101 AND 107).

FIRST USE 2-0-2001; IN COMMERCE 2-0-2001.

THE MARK CONSISTS OF STANDARD CHARACTERS WITHOUT CLAIM TO ANY PARTICULAR FONT, STYLE, SIZE, OR COLOR.

OWNER OF U.S. REG. NOS. 2,509,773, 2,606,639, AND 3,296,692.

SN 85-342,859, FILED 6-10-2011.



David J. Kyffers

Director of the United States Patent and Trademark Office

Reg. No. 4,207,274 NICHOLAS COLEMAN, EXAMINING ATTORNEY

United States of America

United States Patent and Trademark Office



Reg. No. 4,207,275

Registered Sep. 11, 2012

Int. Cl.: 35

SERVICE MARK

PRINCIPAL REGISTER

BAYLOR HEALTH CARE SYSTEM (TEXAS NON-PROFIT CORPORATION)
SUITE 300
4005 CRUTCHER STREET
DALLAS, TX 75246

FOR: PUBLIC ADVOCACY TO PROMOTE AWARENESS OF THE NEED TO CREATE AND IMPLEMENT STRATEGIES TO TREAT, PREVENT AND CURE BREAST CANCER AND OVARIAN CANCER, AND FOR EDUCATION AND RESEARCH; CHARITABLE SERVICES, NAMELY, PROMOTING PUBLIC AWARENESS ABOUT THE GENETIC LINK BETWEEN BREAST CANCER AND OVARIAN CANCER; PROVIDING INFORMATION ON THE TOPIC OF PROMOTING THE LINK BETWEEN BREAST CANCER AND OVARIAN CANCER, IN CLASS 35 (U.S. CLS. 100, 101 AND 102).

FIRST USE 9-1-2009; IN COMMERCE 9-1-2009.

NO CLAIM IS MADE TO THE EXCLUSIVE RIGHT TO USE "BREAST CANCER" AND "OVARIAN CANCER", APART FROM THE MARK AS SHOWN.

THE COLOR(S) PINK, TEAL, WHITE AND BLACK IS/ARE CLAIMED AS A FEATURE OF THE MARK.

THE MARK CONSISTS OF A PINK AND TEAL RIBBON WITH A WHITE OVAL IN THE MIDDLE OUTLINED IN BLACK. THE WHITE WORDS "HELP CONQUER" ARE ON THE TOP OF THE RIBBON, THE WHITE WORD "BREAST" IS ON THE TOP LEFT SIDE, THE WHITE WORD "CANCER" IS ON THE TOP RIGHT SIDE, THE WHITE WORD "OVARIAN" IS ON THE LEFT BOTTOM, THE WHITE WORD "CANCER" IS ON THE BOTTOM RIGHT.

SN 85-342,976, FILED 6-10-2011.

AMY HELLA, EXAMINING ATTORNEY



David J. Kybas

Director of the United States Patent and Trademark Office

United States of America

United States Patent and Trademark Office

REDE APP

Reg. No. 4,207,276

RED E PRODUCTIONS LLC (KENTUCKY LIMITED LIABILITY COMPANY)
12917 CRESTMOOR CIRCLE
PROSPECT, KY 40059

Registered Sep. 11, 2012

Int. Cls.: 9 and 38

FOR: COMPUTER SOFTWARE FOR SENDING, RECEIVING, AND MANAGING ELECTRONIC MESSAGES, IN CLASS 9 (U.S. CLS. 21, 23, 26, 36 AND 38).

TRADEMARK

FIRST USE 5-0-2012; IN COMMERCE 5-0-2012.

SERVICE MARK

FOR: ELECTRONIC TRANSMISSION OF MESSAGES, IN CLASS 38 (U.S. CLS. 100, 101 AND 104).

PRINCIPAL REGISTER

FIRST USE 5-0-2012; IN COMMERCE 5-0-2012.

THE MARK CONSISTS OF STANDARD CHARACTERS WITHOUT CLAIM TO ANY PARTICULAR FONT, STYLE, SIZE, OR COLOR.

NO CLAIM IS MADE TO THE EXCLUSIVE RIGHT TO USE "APP", APART FROM THE MARK AS SHOWN.

SN 85-342,984, FILED 6-10-2011.

MAYUR VAGHANI, EXAMINING ATTORNEY



David J. Kyros

Director of the United States Patent and Trademark Office

United States of America

United States Patent and Trademark Office

RISE AND HONOR

Reg. No. 4,207,277

Registered Sep. 11, 2012

Int. Cls.: 35 and 36

SERVICE MARK

PRINCIPAL REGISTER

ENTERTAINMENT INDUSTRY FOUNDATION (CALIFORNIA PUBLIC BENEFIT CORPORATION)

1201 WEST 5TH STREET
SUITE T700
LOS ANGELES, CA 90017

FOR: CHARITABLE SERVICES, NAMELY, PROMOTING PUBLIC AWARENESS ABOUT THE NEEDS OF VETERANS AND THEIR FAMILIES, IN CLASS 35 (U.S. CLS. 100, 101 AND 102).

FIRST USE 11-11-2011; IN COMMERCE 11-11-2011.

FOR: CHARITABLE FUNDRAISING SERVICES, NAMELY, TO RAISE FUNDS TO SUPPORT VETERANS AND THEIR FAMILIES, IN CLASS 36 (U.S. CLS. 100, 101 AND 102).

FIRST USE 11-11-2011; IN COMMERCE 11-11-2011.

THE MARK CONSISTS OF STANDARD CHARACTERS WITHOUT CLAIM TO ANY PARTICULAR FONT, STYLE, SIZE, OR COLOR.

SN 85-343,142, FILED 6-10-2011.

CIMMERIAN COLEMAN, EXAMINING ATTORNEY



David J. Kyfos

Director of the United States Patent and Trademark Office

United States of America

United States Patent and Trademark Office

ROYAL VELVET

Reg. No. 4,207,278

Registered Sep. 11, 2012

Int. Cl.: 24

TRADEMARK

PRINCIPAL REGISTER

OFFICIAL PILLOWTEX LLC (DELAWARE LIMITED LIABILITY COMPANY)
3RD FLOOR
1450 BROADWAY
NEW YORK, NY 10018

FOR: BEDDING, NAMELY, BED LINEN, COVERLETS, BED SKIRTS, DUVET COVERS, DUST RUFFLES, PILLOW COVERS; BATH ACCESSORIES, NAMELY, BATH LINEN, BATH SHEETS; TABLE LINENS; TEXTILE PLACEMATS; PLACEMATS NOT OF PAPER; TEXTILE NAPKINS, IN CLASS 24 (U.S. CLS. 42 AND 50).

FIRST USE 5-1-2012; IN COMMERCE 5-1-2012.

THE MARK CONSISTS OF STANDARD CHARACTERS WITHOUT CLAIM TO ANY PARTICULAR FONT, STYLE, SIZE, OR COLOR.

OWNER OF U.S. REG. NOS. 2,325,800, 3,646,693, AND OTHERS.

NO CLAIM IS MADE TO THE EXCLUSIVE RIGHT TO USE "VELVET", APART FROM THE MARK AS SHOWN.

SN 85-343,190, FILED 6-10-2011.

NATALIE POLZER, EXAMINING ATTORNEY



David J. Kybas

Director of the United States Patent and Trademark Office

United States of America

United States Patent and Trademark Office

GEOSTEER

Reg. No. 4,207,279

Registered Sep. 11, 2012

Int. Cl.: 9

TRADEMARK

PRINCIPAL REGISTER

NOVARIANT, INC. (CALIFORNIA CORPORATION)
45700 NORTHPORT LOOP EAST
FREMONT, CA 94538

FOR: PRECISION AGRICULTURE SYSTEMS AND COMPONENTS, NAMELY, GLOBAL POSITIONING SYSTEMS AND SATELLITE-CARRIER-SIGNAL RECEIVERS, TRANSMITTERS, ANTENNAE, CONTROL UNITS AND PROCESSORS, FOR THE PRECISE NAVIGATION AND AUTOMATED CONTROL OF FARMING VEHICLES; COMPUTER SOFTWARE FOR USE IN GENERATING AND PROCESSING SATELLITE CARRIER SIGNALS FOR THE PRECISE NAVIGATION AND AUTOMATED CONTROL OF FARMING VEHICLES; COMPUTER SOFTWARE AND COMPUTER HARDWARE COMPONENTS FOR INTEGRATED WIRELESS COMMUNICATIONS, DATA MANAGEMENT AND DATA COLLECTION, FOR USE IN CONTROLLING AGRICULTURE EQUIPMENT; COMPUTER SOFTWARE AND COMPUTER HARDWARE COMPONENTS FOR THE REMOTE DIAGNOSTIC AND SERVICE OF GLOBAL POSITIONING SYSTEMS AND SATELLITE-CARRIER-SIGNAL RECEIVERS, TRANSMITTERS, ANTENNAE CONTROL UNITS AND PROCESSORS, FOR THE PRECISE NAVIGATION AND AUTOMATED CONTROL OF FARMING VEHICLES, IN CLASS 9 (U.S. CLS. 21, 23, 26, 36 AND 38).

FIRST USE 5-18-2012; IN COMMERCE 5-18-2012.

THE MARK CONSISTS OF STANDARD CHARACTERS WITHOUT CLAIM TO ANY PARTICULAR FONT, STYLE, SIZE, OR COLOR.

SN 85-343,369, FILED 6-10-2011.

BARBARA BROWN, EXAMINING ATTORNEY



David J. Kyjars

Director of the United States Patent and Trademark Office

United States of America

United States Patent and Trademark Office

WATERPIK

Reg. No. 4,207,280

Registered Sep. 11, 2012

Int. Cl.: 11

TRADEMARK

PRINCIPAL REGISTER

WATER PIK, INC. (DELAWARE CORPORATION)
1730 EAST PROSPECT ROAD
FORT COLLINS, CO 805530001

FOR: FAUCETS; FAUCET HANDLES; SHOWER HEADS; HAND HELD SHOWER HEADS AND METAL HOSES SOLD AS A UNIT; SHOWER SYSTEMS CONSISTING PRIMARILY OF SHOWER HEAD, HOSE FOR SHOWER HEAD, BRACKETS, WATERWAY PLUMBING FITTINGS, NAMELY, SHOWER AND FAUCET CONTROL VALVES, FAUCET, SHOWER TRIM AND SPOUT, SOLD AS A UNIT; FAUCET SYSTEM CONSISTING PRIMARILY OF FAUCET, FAUCET HANDLES, DRAIN, WATERWAY PLUMBING FITTINGS, NAMELY, WATER INLET TUBE CONNECTOR, FILTER CARTRIDGES AND FAUCET CONTROL VALVES, SOLD AS A UNIT, IN CLASS 11 (U.S. CLS. 13, 21, 23, 31 AND 34).

FIRST USE 7-7-1972; IN COMMERCE 7-7-1972.

THE MARK CONSISTS OF STANDARD CHARACTERS WITHOUT CLAIM TO ANY PARTICULAR FONT, STYLE, SIZE, OR COLOR.

OWNER OF U.S. REG. NOS. 923,514, 3,881,316, AND OTHERS.

SN 85-343,409, FILED 6-10-2011.

SIMON TENG, EXAMINING ATTORNEY



David J. Kyffers

Director of the United States Patent and Trademark Office

United States of America

United States Patent and Trademark Office

waterpik

Reg. No. 4,207,281

Registered Sep. 11, 2012

Int. Cl.: 11

TRADEMARK

PRINCIPAL REGISTER

WATER PIK, INC. (DELAWARE CORPORATION)
1730 EAST PROSPECT ROAD
FORT COLLINS, CO 805530001

FOR: FAUCETS; FAUCET HANDLES; SHOWER HEADS; HAND HELD SHOWER HEADS AND METAL HOSES SOLD AS A UNIT; SHOWER SYSTEMS CONSISTING PRIMARILY OF SHOWER HEAD, HOSE FOR SHOWER HEAD, BRACKETS, WATERWAY PLUMBING FITTINGS, NAMELY, SHOWER AND FAUCET CONTROL VALVES, FAUCET, SHOWER TRIM AND SPOUT, SOLD AS A UNIT; FAUCET SYSTEM CONSISTING PRIMARILY OF FAUCET, FAUCET HANDLES, DRAIN, WATERWAY PLUMBING FITTINGS, NAMELY, WATER INLET TUBE CONNECTOR, FILTER CARTRIDGES AND FAUCET CONTROL VALVES, SOLD AS A UNIT, IN CLASS 11 (U.S. CLS. 13, 21, 23, 31 AND 34).

FIRST USE 8-1-2000; IN COMMERCE 8-1-2000.

OWNER OF U.S. REG. NOS. 2,515,115, 2,634,356, AND OTHERS.

SN 85-343,425, FILED 6-10-2011.

SIMON TENG, EXAMINING ATTORNEY



David J. Kybas

Director of the United States Patent and Trademark Office

United States of America

United States Patent and Trademark Office

GUDU POP FUEGO

Reg. No. 4,207,282

Registered Sep. 11, 2012

Int. Cl.: 30

TRADEMARK

PRINCIPAL REGISTER

PEPSICO, INC. (NORTH CAROLINA CORPORATION)
700 ANDERSON HILL ROAD
PURCHASE, NY 10577

FOR: CANDY; LOLLIPOPS, IN CLASS 30 (U.S. CL. 46).

FIRST USE 5-0-2012; IN COMMERCE 5-0-2012.

THE MARK CONSISTS OF STANDARD CHARACTERS WITHOUT CLAIM TO ANY PARTICULAR FONT, STYLE, SIZE, OR COLOR.

OWNER OF U.S. REG. NOS. 2,967,857 AND 4,003,095.

NO CLAIM IS MADE TO THE EXCLUSIVE RIGHT TO USE "POP", APART FROM THE MARK AS SHOWN.

THE ENGLISH TRANSLATION OF "FUEGO" IN THE MARK IS "FIRE".

SN 85-343,447, FILED 6-10-2011.

MATTHEW EINSTEIN, EXAMINING ATTORNEY



David J. Kybas

Director of the United States Patent and Trademark Office

United States of America

United States Patent and Trademark Office

FANNEX

Reg. No. 4,207,283

EMOTION MEDIA INC. (CANADA CORPORATION)
6320 SOUTHBOINE DR.
WINNIPEG, CANADA R3R2J6

Registered Sep. 11, 2012

Int. Cl.: 9

FOR: COMPUTER SOFTWARE APPLICATION FOR MOBILE PHONES, NAMELY, SOFTWARE FOR ENTERTAINMENT USE IN THE NATURE OF INTEGRATED AUDIO AND GRAPHICAL MEDIA, GAMES, AND TOOLS FOR USERS TO CREATE ILLUSTRATIONS, IN CLASS 9 (U.S. CLS. 21, 23, 26, 36 AND 38).

TRADEMARK

PRINCIPAL REGISTER

FIRST USE 2-5-2012; IN COMMERCE 2-5-2012.

THE MARK CONSISTS OF STANDARD CHARACTERS WITHOUT CLAIM TO ANY PARTICULAR FONT, STYLE, SIZE, OR COLOR.

SN 85-343,773, FILED 6-10-2011.

EMILY CARLSEN, EXAMINING ATTORNEY



David J. Kybas

Director of the United States Patent and Trademark Office

United States of America

United States Patent and Trademark Office

FRESH PLAY

Reg. No. 4,207,284

Registered Sep. 11, 2012

Int. Cl.: 28

TRADEMARK

PRINCIPAL REGISTER

FRESH PLAY, LLC (MASSACHUSETTS LIMITED LIABILITY COMPANY)
841 WORCESTER RD., #302
NATICK, MA 01760

FOR: BOARD GAMES, IN CLASS 28 (U.S. CLS. 22, 23, 38 AND 50).

FIRST USE 5-16-2012; IN COMMERCE 5-16-2012.

THE MARK CONSISTS OF STANDARD CHARACTERS WITHOUT CLAIM TO ANY PARTICULAR FONT, STYLE, SIZE, OR COLOR.

SN 85-343,861, FILED 6-11-2011.

SEAN CROWLEY, EXAMINING ATTORNEY



David J. Kyffers

Director of the United States Patent and Trademark Office

United States of America

United States Patent and Trademark Office

RAISE YOUR RAINBOW

Reg. No. 4,207,285

Registered Sep. 11, 2012

Int. Cl.: 28

TRADEMARK

PRINCIPAL REGISTER

FRESH PLAY, LLC (MASSACHUSETTS LIMITED LIABILITY COMPANY)
841 WORCESTER RD., #302
NATICK, MA 01760

FOR: BOARD GAMES, IN CLASS 28 (U.S. CLS. 22, 23, 38 AND 50).

FIRST USE 5-16-2012; IN COMMERCE 5-16-2012.

THE MARK CONSISTS OF STANDARD CHARACTERS WITHOUT CLAIM TO ANY PARTICULAR FONT, STYLE, SIZE, OR COLOR.

SN 85-343,863, FILED 6-11-2011.

SEAN CROWLEY, EXAMINING ATTORNEY



David J. Kybas

Director of the United States Patent and Trademark Office

United States of America

United States Patent and Trademark Office

COOL COATS

Reg. No. 4,207,286

Registered Sep. 11, 2012

Int. Cl.: 18

TRADEMARK

PRINCIPAL REGISTER

WILSON, VALERIE (CANADA INDIVIDUAL)
2920 MAJOR MACKENZIE DRIVE EAST, #7005
MARKHAM ON, CANADA L6C0G0

FOR: DOG COATS, IN CLASS 18 (U.S. CLS. 1, 2, 3, 22 AND 41).

FIRST USE 6-12-2011; IN COMMERCE 6-12-2011.

THE MARK CONSISTS OF STANDARD CHARACTERS WITHOUT CLAIM TO ANY PARTICULAR FONT, STYLE, SIZE, OR COLOR.

NO CLAIM IS MADE TO THE EXCLUSIVE RIGHT TO USE "COATS", APART FROM THE MARK AS SHOWN.

SN 85-344,003, FILED 6-12-2011.

JULIE GUTTADAURO, EXAMINING ATTORNEY



David J. Kyffers

Director of the United States Patent and Trademark Office

United States of America

United States Patent and Trademark Office

BEAT THE HEAT

Reg. No. 4,207,287

Registered Sep. 11, 2012

Int. Cl.: 18

TRADEMARK

PRINCIPAL REGISTER

WILSON, VALERIE (CANADA INDIVIDUAL)
2920 MAJOR MACKENZIE DRIVE EAST, #7005
MARKHAM ON, CANADA L6C0G0

FOR: DOG COATS, IN CLASS 18 (U.S. CLS. 1, 2, 3, 22 AND 41).

FIRST USE 6-12-2011; IN COMMERCE 6-12-2011.

THE MARK CONSISTS OF STANDARD CHARACTERS WITHOUT CLAIM TO ANY PARTICULAR FONT, STYLE, SIZE, OR COLOR.

SN 85-344,008, FILED 6-12-2011.

JULIE GUTTADAURO, EXAMINING ATTORNEY



David J. Kyffers

Director of the United States Patent and Trademark Office

United States of America

United States Patent and Trademark Office

One More Rep

Reg. No. 4,207,288

Registered Sep. 11, 2012

Int. Cl.: 25

TRADEMARK

PRINCIPAL REGISTER

LOPEZ, CARLOTA (UNITED STATES INDIVIDUAL)
#F
9927 PLACER STREET
RANCHO CUCAMONGA, CA 91730

FOR: HATS; HOODED SWEAT SHIRTS; SHIRTS; SHORTS; SWEAT PANTS; SWEAT SHIRTS;
SWEAT SUITS; TANK TOPS; THERMAL UNDERWEAR, IN CLASS 25 (U.S. CLS. 22 AND
39).

FIRST USE 7-4-2011; IN COMMERCE 7-4-2011.

THE MARK CONSISTS OF STANDARD CHARACTERS WITHOUT CLAIM TO ANY PAR-
TICULAR FONT, STYLE, SIZE, OR COLOR.

SN 85-344,247, FILED 6-13-2011.

SUE LAWRENCE, EXAMINING ATTORNEY



David J. Kyffers

Director of the United States Patent and Trademark Office

United States of America

United States Patent and Trademark Office

Egel

Reg. No. 4,207,289

ENGLANDER SLEEP PRODUCTS, L.L.C. (DELAWARE LIMITED LIABILITY COMPANY)
8300 INDUSTRIAL DRIVE
OLIVE BRANCH, MS 38654

Registered Sep. 11, 2012

Int. Cl.: 20

FOR: MATTRESSES, FOUNDATIONS AND PILLOWS, IN CLASS 20 (U.S. CLS. 2, 13, 22, 25, 32 AND 50).

TRADEMARK

FIRST USE 6-29-2011; IN COMMERCE 6-29-2011.

PRINCIPAL REGISTER

THE MARK CONSISTS OF STANDARD CHARACTERS WITHOUT CLAIM TO ANY PARTICULAR FONT, STYLE, SIZE, OR COLOR.

SN 85-344,264, FILED 6-13-2011.

ANN E. SAPPENFIELD, EXAMINING ATTORNEY



David J. Kybas

Director of the United States Patent and Trademark Office

United States of America

United States Patent and Trademark Office

RADIOACTIVE ARMOR

Reg. No. 4,207,290

Registered Sep. 11, 2012

Int. Cl.: 28

TRADEMARK

PRINCIPAL REGISTER

MATTEL, INC. (DELAWARE CORPORATION)
M1-1518
333 CONTINENTAL BOULEVARD
EL SEGUNDO, CA 90245

FOR: TOY ACTION FIGURES AND ACCESSORIES THEREFOR, IN CLASS 28 (U.S. CLS. 22, 23, 38 AND 50).

FIRST USE 5-10-2012; IN COMMERCE 5-10-2012.

THE MARK CONSISTS OF STANDARD CHARACTERS WITHOUT CLAIM TO ANY PARTICULAR FONT, STYLE, SIZE, OR COLOR.

SN 85-344,332, FILED 6-13-2011.

CURTIS FRENCH, EXAMINING ATTORNEY



David J. Kyffers

Director of the United States Patent and Trademark Office

United States of America

United States Patent and Trademark Office

MOTO JUMPER

Reg. No. 4,207,291

Registered Sep. 11, 2012

Int. Cl.: 28

TRADEMARK

PRINCIPAL REGISTER

MATTEL, INC. (DELAWARE CORPORATION)
M1-1518
333 CONTINENTAL BOULEVARD
EL SEGUNDO, CA 90245

FOR: TOY VEHICLES AND ACCESSORIES THEREFOR, IN CLASS 28 (U.S. CLS. 22, 23, 38 AND 50).

FIRST USE 12-6-2011; IN COMMERCE 12-6-2011.

THE MARK CONSISTS OF STANDARD CHARACTERS WITHOUT CLAIM TO ANY PARTICULAR FONT, STYLE, SIZE, OR COLOR.

SN 85-344,335, FILED 6-13-2011.

CURTIS FRENCH, EXAMINING ATTORNEY



David J. Kyffers

Director of the United States Patent and Trademark Office

United States of America

United States Patent and Trademark Office

COVERT ATTACK

Reg. No. 4,207,292

Registered Sep. 11, 2012

Int. Cl.: 28

TRADEMARK

PRINCIPAL REGISTER

MATTEL, INC. (DELAWARE CORPORATION)
M1-1518
333 CONTINENTAL BOULEVARD
EL SEGUNDO, CA 90245

FOR: TOY ACTION FIGURES AND ACCESSORIES THEREFOR, IN CLASS 28 (U.S. CLS. 22, 23, 38 AND 50).

FIRST USE 5-14-2012; IN COMMERCE 5-14-2012.

THE MARK CONSISTS OF STANDARD CHARACTERS WITHOUT CLAIM TO ANY PARTICULAR FONT, STYLE, SIZE, OR COLOR.

SN 85-344,340, FILED 6-13-2011.

CURTIS FRENCH, EXAMINING ATTORNEY



David J. Kybas

Director of the United States Patent and Trademark Office

United States of America

United States Patent and Trademark Office

AGATHA

Reg. No. 4,207,293

AGAVEROS Y TEQUILEROS UNIDOS DE LOS ALTOS SA DE CV (MEXICO CORPORATION)
CARRETERA ZAPOTLANEJO - TOTOTLAN KM 8.
PUEBLO VIEJO, MEXICO 45440

Registered Sep. 11, 2012

Int. Cl.: 33

FOR: ALCOHOLIC BEVERAGES, NAMELY, TEQUILA, IN CLASS 33 (U.S. CLS. 47 AND 49).

TRADEMARK

FIRST USE 5-12-2012; IN COMMERCE 5-12-2012.

PRINCIPAL REGISTER

THE MARK CONSISTS OF STANDARD CHARACTERS WITHOUT CLAIM TO ANY PARTICULAR FONT, STYLE, SIZE, OR COLOR.

THE NAME(S), PORTRAIT(S), AND/OR SIGNATURE(S) SHOWN IN THE MARK DOES NOT IDENTIFY A PARTICULAR LIVING INDIVIDUAL.

SN 85-345,008, FILED 6-13-2011.

ALLISON SCHRODY, EXAMINING ATTORNEY



David J. Kybas

Director of the United States Patent and Trademark Office

United States of America

United States Patent and Trademark Office



Reg. No. 4,207,294

Registered Sep. 11, 2012

Int. Cl.: 9

TRADEMARK

PRINCIPAL REGISTER

DOD TECH CO., LTD. (TAIWAN CORPORATION)
IF., NO. 129
SEC. 2, BADE RD., JHONGSHAN DISTRICT,
TAIPEI CITY, TAIWAN 104

FOR: GPS NAVIGATION DEVICE; STANDS FOR GPS NAVIGATION DEVICES; GPS SATELLITE RECEIVERS; CAMERAS; WEBCAMS; MINI DIGITAL VIDEO RECORDERS; DIGITAL CAMERAS; CAR VIDEO RECORDERS; GPS CAR VIDEO RECORDERS; STANDS FOR GPS CAR VIDEO RECORDERS; ELECTRIC ALARM MONITORING APPARATUS; ELECTRIC THEFT PREVENTION INSTALLATIONS IN THE NATURE OF ALARMS, NOT FOR MOTOR VEHICLES; FREQUENCY INDICATORS IN THE NATURE OF METERS; CLOSED CIRCUIT TELEVISION SURVEILLANCE CAMERAS FOR DETECTING INTRUDERS; SPY CAMERA DETECTORS; SPEED WARNING DEVICES FOR VEHICLES; RADAR OBJECT DETECTORS FOR USE ON VEHICLES; ELECTRIC OR ELECTRONIC DISPLAY SCREENS; ELECTRICAL WIRES WITH PLUGS; CABLES FOR VIDEO SIGNAL TRANSMISSION; BATTERY CHARGERS; EYE GLASSES, IN CLASS 9 (U.S. CLS. 21, 23, 26, 36 AND 38).

FIRST USE 4-12-2010; IN COMMERCE 8-15-2011.

THE MARK CONSISTS OF A "S" SHAPED DESIGN WHICH IS JOINT AT THE TAIL TO FORM A CIRCLE, WITH A BLACK DOT IN THE MIDDLE OF THE CIRCLE.

SN 85-345,186, FILED 6-14-2011.

FONG HSU, EXAMINING ATTORNEY



David J. Kyffers

Director of the United States Patent and Trademark Office

United States of America

United States Patent and Trademark Office

MAXIMUS CRUZ

Reg. No. 4,207,295

RECHTER, WILLIAM ERIC (UNITED STATES INDIVIDUAL)
3230 FOREST LANE
MURRYSVILLE, PA 15668

Registered Sep. 11, 2012

Int. Cl.: 25

FOR: CLOTHING, NAMELY, T-SHIRTS AND UNDERWEAR, IN CLASS 25 (U.S. CLS. 22 AND 39).

TRADEMARK

FIRST USE 9-1-2011; IN COMMERCE 9-1-2011.

PRINCIPAL REGISTER

THE MARK CONSISTS OF STANDARD CHARACTERS WITHOUT CLAIM TO ANY PARTICULAR FONT, STYLE, SIZE, OR COLOR.

THE NAME "MAXIMUS CRUZ" DOES NOT IDENTIFY A LIVING INDIVIDUAL.

SN 85-345,291, FILED 6-14-2011.

INGRID C. EULIN, EXAMINING ATTORNEY



David J. Kyffers

Director of the United States Patent and Trademark Office

United States of America

United States Patent and Trademark Office

SCHOOLSFIRST

FEDERAL CREDIT UNION

Reg. No. 4,207,296

Registered Sep. 11, 2012

Int. Cl.: 36

SERVICE MARK

PRINCIPAL REGISTER

SCHOOLSFIRST FEDERAL CREDIT UNION (UNITED STATES FEDERALLY CHARTERED CREDIT UNION)
P.O. BOX 11547
SANTA ANA, CA 92711

FOR: CREDIT UNION SERVICES; CONSUMER LENDING AND COMMERCIAL LENDING, IN CLASS 36 (U.S. CLS. 100, 101 AND 102).

FIRST USE 10-1-2011; IN COMMERCE 10-1-2011.

OWNER OF U.S. REG. NO. 3,535,203.

NO CLAIM IS MADE TO THE EXCLUSIVE RIGHT TO USE "FEDERAL CREDIT UNION", APART FROM THE MARK AS SHOWN.

THE MARK CONSISTS OF THE FOLLOWING: THE WORDING "SCHOOLSFIRST FEDERAL CREDIT UNION" AND AN OPEN BOOK DESIGN TO THE RIGHT-HAND SIDE.

SN 85-345,309, FILED 6-14-2011.

SOPHIA S. KIM, EXAMINING ATTORNEY



David J. Kybas

Director of the United States Patent and Trademark Office

United States of America

United States Patent and Trademark Office



Reg. No. 4,207,297

Registered Sep. 11, 2012

Int. Cl.: 36

SERVICE MARK

PRINCIPAL REGISTER

SCHOOLSFIRST FEDERAL CREDIT UNION (UNITED STATES FEDERALLY CHARTERED CREDIT UNION)
P.O. BOX 11547
SANTA ANA, CA 92711

FOR: CREDIT UNION SERVICES; CONSUMER LENDING AND COMMERCIAL LENDING, IN CLASS 36 (U.S. CLS. 100, 101 AND 102).

FIRST USE 10-1-2011; IN COMMERCE 10-1-2011.

THE MARK CONSISTS OF OPEN BOOK DESIGN.

SN 85-345,312, FILED 6-14-2011.

SOPHIA S. KIM, EXAMINING ATTORNEY



David J. Kybas

Director of the United States Patent and Trademark Office

United States of America

United States Patent and Trademark Office

COURTSHOP

Reg. No. 4,207,298

Registered Sep. 11, 2012

Int. Cls.: 18 and 25

TRADEMARK

PRINCIPAL REGISTER

COURTSHOP WILLIAMSBURG, INC. (NEW YORK CORPORATION)
260 W 52ND STREET, APT 15F
NEW YORK, NY 10019

FOR: HANDBAGS, IN CLASS 18 (U.S. CLS. 1, 2, 3, 22 AND 41).

FIRST USE 10-15-2010; IN COMMERCE 10-15-2010.

FOR: BLAZERS; BLOUSES; DENIMS; DRESSES; GLOVES; JACKETS; JEANS; MITTENS;
PANTS; POLO SHIRTS; SCARVES; SHIRTS; SHOES; SHORTS; SKIRTS; SOCKS; SWEATERS;
T-SHIRTS, IN CLASS 25 (U.S. CLS. 22 AND 39).

FIRST USE 10-15-2010; IN COMMERCE 10-15-2010.

THE MARK CONSISTS OF THE STYLIZED WORD "COURTSHOP".

SN 85-345,406, FILED 6-14-2011.

KELLY TRUSILO, EXAMINING ATTORNEY



David J. Kybas

Director of the United States Patent and Trademark Office

United States of America

United States Patent and Trademark Office

FLIP FORCE

Reg. No. 4,207,299

Registered Sep. 11, 2012

Int. Cl.: 28

TRADEMARK

PRINCIPAL REGISTER

WOWWEE GROUP LIMITED (HONG KONG CORPORATION)
UNIT 301-C ENERGY PLAZA
92 GRANVILLE RD, TSIM SHA TSUI EAST
KOWLOON, HONG KONG

FOR: TOY VEHICLES; TOY VEHICLES WITH TRANSFORMING PARTS, IN CLASS 28 (U.S. CLS. 22, 23, 38 AND 50).

FIRST USE 1-18-2012; IN COMMERCE 1-18-2012.

THE MARK CONSISTS OF STANDARD CHARACTERS WITHOUT CLAIM TO ANY PARTICULAR FONT, STYLE, SIZE, OR COLOR.

SN 85-345,560, FILED 6-14-2011.

SIMON TENG, EXAMINING ATTORNEY



David J. Kyffers

Director of the United States Patent and Trademark Office

United States of America

United States Patent and Trademark Office

ECO-CHIC CHARDONNAY

Reg. No. 4,207,300

RAVERTY, KENT (UNITED STATES INDIVIDUAL)
100 EAST TADDEI ROAD
ACAMPO, CA 95220 AND

Registered Sep. 11, 2012

Int. Cl.: 33

RAVERTY, TAMARA (UNITED STATES INDIVIDUAL)
100 EAST TADDEI ROAD
ACAMPO, CA 95220

TRADEMARK

PRINCIPAL REGISTER

FOR: WINE, IN CLASS 33 (U.S. CLS. 47 AND 49).

FIRST USE 6-1-2012; IN COMMERCE 6-1-2012.

THE MARK CONSISTS OF STANDARD CHARACTERS WITHOUT CLAIM TO ANY PARTICULAR FONT, STYLE, SIZE, OR COLOR.

NO CLAIM IS MADE TO THE EXCLUSIVE RIGHT TO USE "CHARDONNAY", APART FROM THE MARK AS SHOWN.

SN 85-345,655, FILED 6-14-2011.

VERNA BETH RIRIE, EXAMINING ATTORNEY



David J. Kyros

Director of the United States Patent and Trademark Office

United States of America

United States Patent and Trademark Office

SEMBLANCE

Reg. No. 4,207,301

BECKER DESIGNED, INC. (D.C. CORPORATION)
14954 BOGLE DRIVE
CHANTILLY, VA 20151

Registered Sep. 11, 2012

Int. Cl.: 20

FOR: FURNITURE, IN CLASS 20 (U.S. CLS. 2, 13, 22, 25, 32 AND 50).

TRADEMARK

FIRST USE 5-31-2012; IN COMMERCE 5-31-2012.

PRINCIPAL REGISTER

THE MARK CONSISTS OF STANDARD CHARACTERS WITHOUT CLAIM TO ANY PARTICULAR FONT, STYLE, SIZE, OR COLOR.

SN 85-345,729, FILED 6-14-2011.

DANNEAN HETZEL, EXAMINING ATTORNEY



David J. Kyffers

Director of the United States Patent and Trademark Office

United States of America

United States Patent and Trademark Office

5-POINT SAFETY SYSTEM

Reg. No. 4,207,302

SPORT MASKA INC. (CANADA CORPORATION)
ST. LAURENT 3400, RAYMOND LASNIER
QUEBEC, CANADA H4R3L3

Registered Sep. 11, 2012

Int. Cl.: 9

FOR: HOCKEY HELMETS; PROTECTIVE SPORTS HELMET ACCESSORIES THAT ATTACH TO HELMETS, NAMELY, FACE MASKS, IN CLASS 9 (U.S. CLS. 21, 23, 26, 36 AND 38).

TRADEMARK

FIRST USE 11-0-2010; IN COMMERCE 11-0-2010.

PRINCIPAL REGISTER

THE MARK CONSISTS OF STANDARD CHARACTERS WITHOUT CLAIM TO ANY PARTICULAR FONT, STYLE, SIZE, OR COLOR.

NO CLAIM IS MADE TO THE EXCLUSIVE RIGHT TO USE "SAFETY SYSTEM", APART FROM THE MARK AS SHOWN.

SN 85-345,785, FILED 6-14-2011.

REBECCA EISINGER, EXAMINING ATTORNEY



David J. Kybas

Director of the United States Patent and Trademark Office

United States of America

United States Patent and Trademark Office

SASSAB

Reg. No. 4,207,303

SASSAB, LLC (FLORIDA LIMITED LIABILITY COMPANY)
1871 WISCONSIN AVENUE
PALM HARBOR, FL 34683

Registered Sep. 11, 2012

Int. Cl.: 14

FOR: PERSONAL JEWELRY, NAMELY, CHARMS, IN CLASS 14 (U.S. CLS. 2, 27, 28 AND 50).

TRADEMARK

FIRST USE 10-28-2011; IN COMMERCE 5-1-2012.

PRINCIPAL REGISTER

THE MARK CONSISTS OF STANDARD CHARACTERS WITHOUT CLAIM TO ANY PARTICULAR FONT, STYLE, SIZE, OR COLOR.

THE WORDING "SASSAB" HAS NO MEANING IN A FOREIGN LANGUAGE.

SN 85-345,807, FILED 6-14-2011.

KATHY DE JONGE, EXAMINING ATTORNEY



David J. Kyffers

Director of the United States Patent and Trademark Office

United States of America

United States Patent and Trademark Office

REDPAW X-SERIES

Reg. No. 4,207,304

Registered Sep. 11, 2012

Int. Cl.: 31

TRADEMARK

PRINCIPAL REGISTER

REDPAW, INC. (WISCONSIN CORPORATION)
9640 SOUTH OAKWOOD PARK DRIVE
FRANKLIN, WI 53132

FOR: FOOD FOR ANIMALS, IN CLASS 31 (U.S. CLS. 1 AND 46).

FIRST USE 5-3-2012; IN COMMERCE 5-3-2012.

THE MARK CONSISTS OF STANDARD CHARACTERS WITHOUT CLAIM TO ANY PARTICULAR FONT, STYLE, SIZE, OR COLOR.

OWNER OF U.S. REG. NOS. 2,906,017 AND 3,739,318.

SN 85-345,977, FILED 6-14-2011.

LEIGH CAROLINE CASE, EXAMINING ATTORNEY



David J. Kyffers

Director of the United States Patent and Trademark Office

United States of America

United States Patent and Trademark Office



Reg. No. 4,207,305

Registered Sep. 11, 2012

Int. Cl.: 45

SERVICE MARK

PRINCIPAL REGISTER

WALLBALL WORLD LLC (NEW YORK LIMITED LIABILITY COMPANY)
PH
62 TARGEE STREET
STATEN ISLAND, NY 10304

FOR: INTERNET-BASED SOCIAL NETWORKING SERVICES, IN CLASS 45 (U.S. CLS. 100 AND 101).

FIRST USE 5-1-2011; IN COMMERCE 10-1-2011.

THE MARK CONSISTS OF THE "W" IN THE WORDS "WALLBALL" AND "WORLD" DESIGNED TO APPEAR AS FINGERS AND SIMULTANEOUSLY THE FIRST LETTERS OF BOTH WORDS CAPITALIZED.

SN 85-346,142, FILED 6-14-2011.

KELLY BOULTON, EXAMINING ATTORNEY



David J. Kyffers

Director of the United States Patent and Trademark Office

United States of America

United States Patent and Trademark Office

EVI

Reg. No. 4,207,306

Registered Sep. 11, 2012

Int. Cl.: 42

SERVICE MARK

PRINCIPAL REGISTER

EVI TECHNOLOGIES LIMITED (UNITED KINGDOM PRIVATE LIMITED COMPANY)
POSEIDON HOUSE, CASTLE PARK
CAMBRIDGE, UNITED KINGDOM CB30RD

FOR: COMPUTER SERVICES, NAMELY, SEARCH ENGINE SERVICES, IN CLASS 42 (U.S. CLS. 100 AND 101).

FIRST USE 1-17-2012; IN COMMERCE 1-17-2012.

THE MARK CONSISTS OF STANDARD CHARACTERS WITHOUT CLAIM TO ANY PARTICULAR FONT, STYLE, SIZE, OR COLOR.

SN 85-346,260, FILED 6-14-2011.

SUE LAWRENCE, EXAMINING ATTORNEY



David J. Kyffers

Director of the United States Patent and Trademark Office

United States of America

United States Patent and Trademark Office

KEEP CALM AND ACK NICE

Reg. No. 4,207,307

KEELY SMITH (GREAT BRITAIN INDIVIDUAL)
37 MILLBROOK ROAD
NANTUCKET, MA 02554

Registered Sep. 11, 2012

Int. Cl.: 25

FOR: T-SHIRTS, IN CLASS 25 (U.S. CLS. 22 AND 39).

TRADEMARK

FIRST USE 7-9-2011; IN COMMERCE 10-31-2011.

PRINCIPAL REGISTER

THE MARK CONSISTS OF STANDARD CHARACTERS WITHOUT CLAIM TO ANY PARTICULAR FONT, STYLE, SIZE, OR COLOR.

SN 85-346,472, FILED 6-15-2011.

FRED CARL, EXAMINING ATTORNEY



David J. Kyffers

Director of the United States Patent and Trademark Office

United States of America

United States Patent and Trademark Office

SNACK CRAZE

Reg. No. 4,207,308

Registered Sep. 11, 2012

Int. Cl.: 16

TRADEMARK

PRINCIPAL REGISTER

LAROSE INDUSTRIES, LLC (NEW JERSEY LIMITED LIABILITY COMPANY)
BUILDING 5, 1578 SUSSEX TURNPIKE
RANDOLPH, NJ 07869

FOR: MODELING COMPOUNDS AND RELATED ACCESSORIES FOR USE WITH MODELING COMPOUNDS SOLD AS A UNIT, IN CLASS 16 (U.S. CLS. 2, 5, 22, 23, 29, 37, 38 AND 50).

FIRST USE 8-26-2009; IN COMMERCE 8-26-2009.

THE MARK CONSISTS OF STANDARD CHARACTERS WITHOUT CLAIM TO ANY PARTICULAR FONT, STYLE, SIZE, OR COLOR.

SN 85-346,827, FILED 6-15-2011.

TRACY FLETCHER, EXAMINING ATTORNEY



David J. Kyffers

Director of the United States Patent and Trademark Office

United States of America

United States Patent and Trademark Office

DATABRACKET

Reg. No. 4,207,309

Registered Sep. 11, 2012

Int. Cl.: 42

SERVICE MARK

PRINCIPAL REGISTER

DATABRACKET LLC (NORTH CAROLINA LIMITED LIABILITY COMPANY)
GRAHAM 371
102 COUNTRY CLUB ROAD
CHAPEL HILL, NC 27514

FOR: DESIGN AND DEVELOPMENT OF COMPUTER SOFTWARE, IN CLASS 42 (U.S. CLS. 100 AND 101).

FIRST USE 7-29-2009; IN COMMERCE 7-29-2009.

THE MARK CONSISTS OF STANDARD CHARACTERS WITHOUT CLAIM TO ANY PARTICULAR FONT, STYLE, SIZE, OR COLOR.

SN 85-346,910, FILED 6-15-2011.

SHARON MEIER, EXAMINING ATTORNEY



David J. Kyffers

Director of the United States Patent and Trademark Office

United States of America

United States Patent and Trademark Office

SALUTE BY WACOAL

Reg. No. 4,207,310

WACOAL CORP. (JAPAN CORPORATION)
29, NAKAJIMA-CHO, KISSHOIN, MINAMI-KU
KYOTO-SHI, KYOTO, JAPAN 601-8530

Registered Sep. 11, 2012

Int. Cl.: 25

FOR: PANTIES MADE OF KNIT OR YARN; GARTER BELTS; BRASSIERES; PANTIES;
SLIPS; CAMISOLES, IN CLASS 25 (U.S. CLS. 22 AND 39).

TRADEMARK

FIRST USE 9-30-2011; IN COMMERCE 9-30-2011.

PRINCIPAL REGISTER

THE MARK CONSISTS OF STANDARD CHARACTERS WITHOUT CLAIM TO ANY PAR-
TICULAR FONT, STYLE, SIZE, OR COLOR.

OWNER OF U.S. REG. NOS. 1,245,293, 1,839,485, AND OTHERS.

SN 85-347,350, FILED 6-15-2011.

KIM SAITO, EXAMINING ATTORNEY



David J. Kybas

Director of the United States Patent and Trademark Office

United States of America

United States Patent and Trademark Office

So Wrong

Reg. No. 4,207,311

BREA, PABLO MARIANO (ARGENTINA INDIVIDUAL)
166 1/2 GLENDALE BLVD
LOS ANGELES, CA 90026

Registered Sep. 11, 2012

Int. Cl.: 41

FOR: ENTERTAINMENT SERVICES IN THE NATURE OF LIVE MUSICAL PERFORMANCES,
IN CLASS 41 (U.S. CLS. 100, 101 AND 107).

SERVICE MARK

FIRST USE 4-14-2011; IN COMMERCE 4-14-2011.

PRINCIPAL REGISTER

THE MARK CONSISTS OF STANDARD CHARACTERS WITHOUT CLAIM TO ANY PARTICULAR FONT, STYLE, SIZE, OR COLOR.

SN 85-347,353, FILED 6-15-2011.

ELI HELLMAN, EXAMINING ATTORNEY



David J. Kyffers

Director of the United States Patent and Trademark Office

United States of America
United States Patent and Trademark Office

Salute

Reg. No. 4,207,312

WACOAL CORP. (JAPAN CORPORATION)
29, NAKAJIMA-CHO, KISSHOIN, MINAMI-KU
KYOTO-SHI, KYOTO, JAPAN 601-8530

Registered Sep. 11, 2012

Int. Cl.: 25

FOR: PANTIES MADE OF KNIT OR YARN; GARTER BELTS; BRASSIERES; PANTIES;
SLIPS; CAMISOLES, IN CLASS 25 (U.S. CLS. 22 AND 39).

TRADEMARK

FIRST USE 3-0-1979; IN COMMERCE 9-30-2011.

PRINCIPAL REGISTER

THE MARK CONSISTS OF "SALUTE" IN STYLIZED LETTERING.

SN 85-347,354, FILED 6-15-2011.

KIM SAITO, EXAMINING ATTORNEY



David J. Kyffers

Director of the United States Patent and Trademark Office

United States of America

United States Patent and Trademark Office

PAPER WORK BRAND CO

Reg. No. 4,207,313

Registered Sep. 11, 2012

Int. Cl.: 25

TRADEMARK

PRINCIPAL REGISTER

DNR APPAREL, LLC (GEORGIA LIMITED LIABILITY COMPANY)
3651 PEACHTREE PARKWAY, SUITE E-382
SUWANEE, GA 30024 AND

SMOAK, MICHAEL M. (UNITED STATES INDIVIDUAL)
7819 TAYLOR CIR
RIVERDALE, GA 30274 AND

EVANS, DOUGLAS (UNITED STATES INDIVIDUAL)
506 ELM STREET
ATLANTA, GA 30318

FOR: BASEBALL CAPS; CLOTHING, NAMELY, KHAKIS; JACKETS; JEANS; JOGGING SUITS; PANTS; PULLOVERS; SHIRTS; SHORTS; SWEATERS; SWEATPANTS; T-SHIRTS; VESTS, IN CLASS 25 (U.S. CLS. 22 AND 39).

FIRST USE 3-1-2012; IN COMMERCE 3-1-2012.

THE MARK CONSISTS OF STANDARD CHARACTERS WITHOUT CLAIM TO ANY PARTICULAR FONT, STYLE, SIZE, OR COLOR.

NO CLAIM IS MADE TO THE EXCLUSIVE RIGHT TO USE "BRAND CO", APART FROM THE MARK AS SHOWN.

SN 85-347,401, FILED 6-15-2011.

JORDAN BAKER, EXAMINING ATTORNEY



David J. Kyffers

Director of the United States Patent and Trademark Office

United States of America

United States Patent and Trademark Office

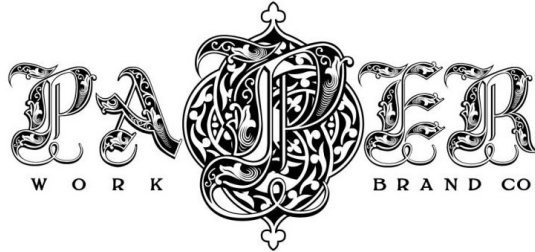

Reg. No. 4,207,314

Registered Sep. 11, 2012

Int. Cl.: 25

TRADEMARK

PRINCIPAL REGISTER

DNR APPAREL, LLC (GEORGIA LIMITED LIABILITY COMPANY)
3651 PEACHTREE PARKWAY, SUITE E-382
SUWANEE, GA 30024 AND

SMOAK, MICHAEL M. (UNITED STATES INDIVIDUAL)
7819 TAYLOR CIR
RIVERDALE, GA 30274 AND

EVANS, DOUGLAS (UNITED STATES INDIVIDUAL)
506 ELM STREET
ATLANTA, GA 30318

FOR: BASEBALL CAPS; CLOTHING, NAMELY, KHAKIS; JACKETS; JEANS; JOGGING SUITS; PANTS; PULLOVERS; SHIRTS; SHORTS; SWEATERS; SWEATPANTS; T-SHIRTS; VESTS, IN CLASS 25 (U.S. CLS. 22 AND 39).

FIRST USE 3-1-2012; IN COMMERCE 3-1-2012.

NO CLAIM IS MADE TO THE EXCLUSIVE RIGHT TO USE "BRAND CO", APART FROM THE MARK AS SHOWN.

THE MARK CONSISTS OF THE WORDING "PAPER WORK BRAND CO" WITH THE WORDING "PAPER" IN A STYLIZED FONT.

SN 85-347,441, FILED 6-15-2011.

JORDAN BAKER, EXAMINING ATTORNEY



David J. Kybas

Director of the United States Patent and Trademark Office

United States of America

United States Patent and Trademark Office

ROASTILICIOSO

Reg. No. 4,207,315

JAVIER CASTELLANOS GUTIERREZ (MEXICO INDIVIDUAL)

Registered Sep. 11, 2012

3664 SAN JUAN BOSCO
GUADALAJARA, JALISCO, MEXICO 45040

Int. Cl.: 43

FOR: BAR AND RESTAURANT SERVICES; CARRY-OUT RESTAURANTS; FAST-FOOD RESTAURANTS AND SNACKBARS; RESTAURANT AND BAR SERVICES, IN CLASS 43 (U.S. CLS. 100 AND 101).

SERVICE MARK

FIRST USE 9-18-2011; IN COMMERCE 9-18-2011.

PRINCIPAL REGISTER

THE MARK CONSISTS OF STANDARD CHARACTERS WITHOUT CLAIM TO ANY PARTICULAR FONT, STYLE, SIZE, OR COLOR.

SN 85-348,022, FILED 6-16-2011.

PAULA MAHONEY, EXAMINING ATTORNEY



David J. Kyros

Director of the United States Patent and Trademark Office

United States of America

United States Patent and Trademark Office

SUMMIT

Reg. No. 4,207,316

HUFOR, INC. (WISCONSIN CORPORATION)
2101 KENNEDY ROAD
JANESVILLE, WI 53547

Registered Sep. 11, 2012

Int. Cl.: 20

FOR: MOVABLE WALL PARTITIONS, IN CLASS 20 (U.S. CLS. 2, 13, 22, 25, 32 AND 50).

TRADEMARK

FIRST USE 4-30-2012; IN COMMERCE 4-30-2012.

PRINCIPAL REGISTER

THE MARK CONSISTS OF STANDARD CHARACTERS WITHOUT CLAIM TO ANY PARTICULAR FONT, STYLE, SIZE, OR COLOR.

SN 85-348,062, FILED 6-16-2011.

GISELLE AGOSTO, EXAMINING ATTORNEY



David J. Kybas

Director of the United States Patent and Trademark Office

United States of America

United States Patent and Trademark Office

JEWELBOOK

Reg. No. 4,207,317

MDK HOLDING, INC. (NEW YORK CORPORATION)
115 WEST 45TH STREET, 9TH FLOOR
NEW YORK, NY 10036

Registered Sep. 11, 2012

Int. Cl.: 14

FOR: JEWELRY AND WATCHES, IN CLASS 14 (U.S. CLS. 2, 27, 28 AND 50).

TRADEMARK

FIRST USE 6-1-2012; IN COMMERCE 6-1-2012.

PRINCIPAL REGISTER

THE MARK CONSISTS OF STANDARD CHARACTERS WITHOUT CLAIM TO ANY PARTICULAR FONT, STYLE, SIZE, OR COLOR.

SN 85-348,290, FILED 6-16-2011.

JOHN GARTNER, EXAMINING ATTORNEY



David J. Kyffers

Director of the United States Patent and Trademark Office

United States of America

United States Patent and Trademark Office

SPOTBOX

Reg. No. 4,207,318

SINTECH CONSULTING GROUP, LLC (DELAWARE LIMITED LIABILITY COMPANY)
1036 S. ESTATE LANE

Registered Sep. 11, 2012

LAKE FOREST, IL 60045

Int. Cl.: 9

FOR: DOWNLOADABLE SOFTWARE IN THE NATURE OF A MOBILE APPLICATION THAT ENABLES USERS TO GENERATE INFORMATION ON AVAILABLE PARKING SPACES AND PARKING GARAGES BASED ON THE USERS' GEOGRAPHIC LOCATION, IN CLASS 9 (U.S. CLS. 21, 23, 26, 36 AND 38).

TRADEMARK

PRINCIPAL REGISTER

FIRST USE 9-30-2011; IN COMMERCE 9-30-2011.

THE MARK CONSISTS OF STANDARD CHARACTERS WITHOUT CLAIM TO ANY PARTICULAR FONT, STYLE, SIZE, OR COLOR.

SN 85-348,502, FILED 6-16-2011.

HENRY S. ZAK, EXAMINING ATTORNEY



David J. Kyffers

Director of the United States Patent and Trademark Office

United States of America

United States Patent and Trademark Office

RIMES BDS

Reg. No. 4,207,319

RIMES TECHNOLOGIES CORPORATION (NEW YORK CORPORATION)
84 WOOSTER STREET
NEW YORK, NY 10012

Registered Sep. 11, 2012

Int. Cl.: 36

FOR: PROVIDING FINANCIAL INFORMATION SERVICES, NAMELY, PROVIDING FINANCIAL INDEX DATA FOR OTHERS, IN CLASS 36 (U.S. CLS. 100, 101 AND 102).

SERVICE MARK

FIRST USE 6-0-2011; IN COMMERCE 6-0-2011.

PRINCIPAL REGISTER

THE MARK CONSISTS OF STANDARD CHARACTERS WITHOUT CLAIM TO ANY PARTICULAR FONT, STYLE, SIZE, OR COLOR.

OWNER OF U.S. REG. NO. 2,224,914.

SN 85-348,528, FILED 6-16-2011.

ANDREA K. NADELMAN, EXAMINING ATTORNEY



David J. Kybas

Director of the United States Patent and Trademark Office

United States of America

United States Patent and Trademark Office



Reg. No. 4,207,320

Registered Sep. 11, 2012

Int. Cl.: 41

SERVICE MARK

PRINCIPAL REGISTER

GREGG RITZ IP, LLC (DELAWARE LIMITED LIABILITY COMPANY)
12 AUTUMN LANE
STRATHAM, NH 03885

FOR: ENTERTAINMENT SERVICES IN THE NATURE OF ONGOING TELEVISION SHOWS, PROGRAMS AND SERIES ABOUT HUNTING; ENTERTAINMENT SERVICES, NAMELY, PROVIDING ONGOING VIDEO SHOWS, PROGRAMS AND SERIES ABOUT HUNTING VIA SATELLITE TELEVISION, TELEVISION BROADCAST, AND CABLE TELEVISION; ENTERTAINMENT SERVICES, NAMELY, PROVIDING NON-DOWNLOADABLE VIDEOS ABOUT HUNTING VIA THE INTERNET; ENTERTAINMENT SERVICES, NAMELY, PROVIDING A WEB SITE FEATURING PHOTOGRAPHIC, AUDIO AND VIDEO PRESENTATIONS FEATURING HUNTING, IN CLASS 41 (U.S. CLS. 100, 101 AND 107).

FIRST USE 6-27-2011; IN COMMERCE 6-27-2011.

THE MARK CONSISTS OF A DESIGN OF A DEER'S HEAD WITH ANTLERS IN RIGHT-FACING PROFILE THAT CONTAINS THE PARTIAL PROFILE OF A MAN FACING LEFT.

SN 85-348,565, FILED 6-16-2011.

JAY FLOWERS, EXAMINING ATTORNEY



David J. Kybas

Director of the United States Patent and Trademark Office

United States of America

United States Patent and Trademark Office

AFFORD TO LOOK GREAT ANYTIME

Reg. No. 4,207,321

CENTURY 21 INC. (NEW YORK CORPORATION)
22 CORTLANDT STREET
NEW YORK, NY 10017

Registered Sep. 11, 2012

Int. Cl.: 35

FOR: ONLINE RETAIL DEPARTMENT STORE SERVICES FEATURING MEN'S, LADIES AND CHILDREN'S CLOTHING AND FOOTWEAR, LINGERIE, LINENS, COSMETICS, ACCESSORIES, HANDBAGS, LUGGAGE, HOUSEWARES, GIFTWARE, CONSUMER ELECTRONICS PRODUCTS, FURNITURE AND HOME FURNISHINGS, LAMPS AND FRAMED ART, IN CLASS 35 (U.S. CLS. 100, 101 AND 102).

SERVICE MARK

PRINCIPAL REGISTER

FIRST USE 6-5-2012; IN COMMERCE 6-5-2012.

THE MARK CONSISTS OF STANDARD CHARACTERS WITHOUT CLAIM TO ANY PARTICULAR FONT, STYLE, SIZE, OR COLOR.

SN 85-348,614, FILED 6-16-2011.

NELSON SNYDER, EXAMINING ATTORNEY



David J. Kyffers

Director of the United States Patent and Trademark Office

United States of America

United States Patent and Trademark Office

DriveAbility

Reg. No. 4,207,322

TOWERS PERRIN CAPITAL CORP. (DELAWARE CORPORATION)
1011 CENTRE ROAD, SUITE 325
WILMINGTON, DE 19805

Registered Sep. 11, 2012

Int. Cl.: 35

FOR: COMPILING AND ANALYZING VEHICLE USAGE DATA FOR USE IN THE FIELDS OF INSURANCE, MARKETING, SAFETY, COST AND PRICE ANALYSIS, CONSUMER RESEARCH, BUSINESS RESEARCH AND MARKET RESEARCH, IN CLASS 35 (U.S. CLS. 100, 101 AND 102).

SERVICE MARK

PRINCIPAL REGISTER

FIRST USE 6-22-2011; IN COMMERCE 6-22-2011.

THE MARK CONSISTS OF STANDARD CHARACTERS WITHOUT CLAIM TO ANY PARTICULAR FONT, STYLE, SIZE, OR COLOR.

SN 85-348,705, FILED 6-17-2011.

KYLE PEETE, EXAMINING ATTORNEY



David J. Kyffers

Director of the United States Patent and Trademark Office

United States of America

United States Patent and Trademark Office

JESUS THE BEST THING IN YOUR MEDICINE CABINET!

Reg. No. 4,207,323

ClAVOLA, MICHAEL P. (UNITED STATES INDIVIDUAL)
70 JAMES ST., UNIT 111C
WORCESTER, MA 01603

Registered Sep. 11, 2012

Int. Cl.: 21

FOR: CONTAINERS FOR HOUSEHOLD USE, IN CLASS 21 (U.S. CLS. 2, 13, 23, 29, 30, 33, 40 AND 50).

TRADEMARK

FIRST USE 9-22-2011; IN COMMERCE 9-22-2011.

PRINCIPAL REGISTER

THE MARK CONSISTS OF STANDARD CHARACTERS WITHOUT CLAIM TO ANY PARTICULAR FONT, STYLE, SIZE, OR COLOR.

NO CLAIM IS MADE TO THE EXCLUSIVE RIGHT TO USE "JESUS", APART FROM THE MARK AS SHOWN.

SN 85-349,154, FILED 6-17-2011.

ANDREW RHIM, EXAMINING ATTORNEY



David J. Kyffers

Director of the United States Patent and Trademark Office

United States of America

United States Patent and Trademark Office

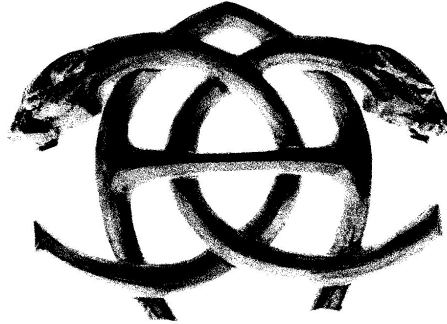

Reg. No. 4,207,324

Registered Sep. 11, 2012

Int. Cl.: 18

TRADEMARK

PRINCIPAL REGISTER

STEEN OLSEN, ANGELA (UNITED STATES INDIVIDUAL)
APT. 11A
110-11 QUEENS BLVD.
FOREST HILLS, NY 11375

FOR: HANDBAGS, IN CLASS 18 (U.S. CLS. 1, 2, 3, 22 AND 41).

FIRST USE 12-5-2011; IN COMMERCE 1-8-2012.

THE STIPLING IS FOR SHADING PURPOSES ONLY.

THE MARK CONSISTS OF THREE LETTERS- "A", "E", AND "E". THE LETTERS "E" ARE CONNECTED, REVERSED TO EACH OTHER ON BOTH SIDES OF LETTER "A" WITH PANTHER HEADS AT THE TOP OF LETTERS "E".

SN 85-349,271, FILED 6-17-2011.

KELLEY WELLS, EXAMINING ATTORNEY



David J. Kybas

Director of the United States Patent and Trademark Office

United States of America
United States Patent and Trademark Office

SILICORO

Reg. No. 4,207,325

Registered Sep. 11, 2012

Int. Cl.: 14

TRADEMARK

PRINCIPAL REGISTER

VALUEVISION MEDIA, INC. (MINNESOTA CORPORATION)
6740 SHADY OAK ROAD
EDEN PRAIRIE, MN 55344

FOR: JEWELRY, IN CLASS 14 (U.S. CLS. 2, 27, 28 AND 50).

FIRST USE 2-11-2011; IN COMMERCE 4-20-2011.

THE MARK CONSISTS OF STANDARD CHARACTERS WITHOUT CLAIM TO ANY PARTICULAR FONT, STYLE, SIZE, OR COLOR.

SN 85-349,396, FILED 6-17-2011.

BRENDAN MCCAULEY, EXAMINING ATTORNEY



David J. Kybas

Director of the United States Patent and Trademark Office

United States of America

United States Patent and Trademark Office

OHSO CUDDLY STUFF

Reg. No. 4,207,326

DALTON, DAVID J. (UNITED STATES INDIVIDUAL)
3505 W. 101ST TERRACE
LEAWOOD, KS 66206

Registered Sep. 11, 2012

Int. Cl.: 28

FOR: PLUSH TOYS, STUFFED TOY ANIMALS, DOLLS, AND PUPPETS, IN CLASS 28 (U.S. CLS. 22, 23, 38 AND 50).

TRADEMARK

FIRST USE 9-20-2011; IN COMMERCE 9-20-2011.

PRINCIPAL REGISTER

THE MARK CONSISTS OF STANDARD CHARACTERS WITHOUT CLAIM TO ANY PARTICULAR FONT, STYLE, SIZE, OR COLOR.

SN 85-349,453, FILED 6-17-2011.

ALYSSA STEEL, EXAMINING ATTORNEY



David J. Kybas

Director of the United States Patent and Trademark Office

United States of America

United States Patent and Trademark Office



Reg. No. 4,207,327

NORVENTO ENERGIA DISTRIBUIDA, S.L. (SPAIN CORPORATION)
RIBADEO, 2, ENTREPLANTA
LUGO, SPAIN 27001

Registered Sep. 11, 2012

Int. Cl.: 7

FOR: GENERATORS OF ELECTRICITY; GENERATORS OF RENEWABLE ENERGY,
NAMELY, WIND TURBINES, IN CLASS 7 (U.S. CLS. 13, 19, 21, 23, 31, 34 AND 35).

TRADEMARK

FIRST USE 9-0-2011; IN COMMERCE 11-0-2011.

PRINCIPAL REGISTER

NO CLAIM IS MADE TO THE EXCLUSIVE RIGHT TO USE "100", APART FROM THE MARK
AS SHOWN.

THE MARK CONSISTS OF STYLIZED TEXT OF THE WORDING "NED" ABOVE THE
NUMBER "100". ONE CURVED LINE IS LOCATED ABOVE THE WORDING "NED" AND
ANOTHER CURVED LINE IS LOCATED BELOW THE NUMBER "100" CREATING A CIR-
CULAR BORDER AROUND THE TEXT AND NUMBER.

THE WORDING "NED" HAS NO MEANING IN A FOREIGN LANGUAGE.

SN 85-349,582, FILED 6-17-2011.

STEVEN JACKSON, EXAMINING ATTORNEY



David J. Kybas

Director of the United States Patent and Trademark Office

United States of America

United States Patent and Trademark Office



Reg. No. 4,207,328

Registered Sep. 11, 2012

Int. Cl.: 25

TRADEMARK

PRINCIPAL REGISTER

FULL TURN PARTNERS, LLC. (NEVADA LIMITED LIABILITY COMPANY), DBA
LINKSOUL AND LINKSOUL CLUB,
701 WHITNEY ST.
SAN LEANDRO, CA 94577

FOR: HEADWEAR; PULLOVERS; SHIRTS; SWEAT SHIRTS; T-SHIRTS, IN CLASS 25 (U.S.
CLS. 22 AND 39).

FIRST USE 7-15-2011; IN COMMERCE 2-10-2012.

THE MARK CONSISTS OF A MIRROR IMAGE OF TWO FOLIAR OR RHOMBUS SHAPES
OF DIFFERENT SHADES.

SN 85-349,745, FILED 6-17-2011.

MICHAEL WIENER, EXAMINING ATTORNEY



David J. Kyffers

Director of the United States Patent and Trademark Office

United States of America

United States Patent and Trademark Office

BRANCH

Reg. No. 4,207,329

THOMAS O. PEYTON (UNITED STATES INDIVIDUAL)
PO BOX 1685
LAFAYETTE, IN 47902

Registered Sep. 11, 2012

Int. Cl.: 32

FOR: BOTTLED DRINKING WATER; STILL WATER; TABLE WATER, IN CLASS 32 (U.S. CLS. 45, 46 AND 48).

TRADEMARK

FIRST USE 3-1-2011; IN COMMERCE 6-15-2011.

PRINCIPAL REGISTER

THE MARK CONSISTS OF STANDARD CHARACTERS WITHOUT CLAIM TO ANY PARTICULAR FONT, STYLE, SIZE, OR COLOR.

SN 85-349,901, FILED 6-18-2011.

ELLEN PERKINS, EXAMINING ATTORNEY



David J. Kybas

Director of the United States Patent and Trademark Office

United States of America

United States Patent and Trademark Office

German Creek Knives

Reg. No. 4,207,330

YOCOM, GARY (UNITED STATES INDIVIDUAL)
403 WEST MAIN STREET
STANFORD, KY 40484

Registered Sep. 11, 2012

Int. Cl.: 8

FOR: POCKET KNIVES, IN CLASS 8 (U.S. CLS. 23, 28 AND 44).

TRADEMARK

FIRST USE 6-1-2011; IN COMMERCE 6-1-2012.

PRINCIPAL REGISTER

THE MARK CONSISTS OF STANDARD CHARACTERS WITHOUT CLAIM TO ANY PARTICULAR FONT, STYLE, SIZE, OR COLOR.

NO CLAIM IS MADE TO THE EXCLUSIVE RIGHT TO USE "KNIVES", APART FROM THE MARK AS SHOWN.

SN 85-350,223, FILED 6-20-2011.

LINDA MICKLEBURGH, EXAMINING ATTORNEY



David J. Kyffers

Director of the United States Patent and Trademark Office

United States of America

United States Patent and Trademark Office

SLIDE 'N' SURPRISE PLAYGROUND

Reg. No. 4,207,331

Registered Sep. 11, 2012

Int. Cl.: 28

TRADEMARK

PRINCIPAL REGISTER

MATTEL, INC. (DELAWARE CORPORATION)
333 CONTINENTAL BOULEVARD
M1-1518
EL SEGUNDO, CA 90245

FOR: ACTION FIGURES AND ACCESSORIES THEREFOR; TOY FIGURE PLAYSETS AND ACCESSORIES THEREFOR, IN CLASS 28 (U.S. CLS. 22, 23, 38 AND 50).

FIRST USE 6-6-2012; IN COMMERCE 6-6-2012.

THE MARK CONSISTS OF STANDARD CHARACTERS WITHOUT CLAIM TO ANY PARTICULAR FONT, STYLE, SIZE, OR COLOR.

SN 85-350,401, FILED 6-20-2011.

JESSICA FATHY, EXAMINING ATTORNEY



David J. Kyros

Director of the United States Patent and Trademark Office

United States of America

United States Patent and Trademark Office

Chicago Typewriter

Reg. No. 4,207,332

SAEILO ENTERPRISES, INC. (DELAWARE CORPORATION)
1 BLUE HILL PLAZA
PEARL RIVER, NY 10965

Registered Sep. 11, 2012

Int. Cl.: 13

FOR: FIREARMS, IN CLASS 13 (U.S. CLS. 2 AND 9).

TRADEMARK

FIRST USE 4-1-2012; IN COMMERCE 4-1-2012.

PRINCIPAL REGISTER

THE MARK CONSISTS OF STANDARD CHARACTERS WITHOUT CLAIM TO ANY PARTICULAR FONT, STYLE, SIZE, OR COLOR.

SN 85-350,848, FILED 6-20-2011.

MATTHEW MCDOWELL, EXAMINING ATTORNEY



David J. Kybas

Director of the United States Patent and Trademark Office

United States of America

United States Patent and Trademark Office

BLUE ROCK COMMUNICATIONS

Reg. No. 4,207,333

DPE LABEL HOLDING CORP. (NEW YORK CORPORATION)
232 BROADWAY
BROOKLYN, NY 11211

Registered Sep. 11, 2012

Int. Cl.: 38

FOR: TELEPHONE TELECOMMUNICATIONS SERVICES PROVIDED VIA PREPAID TELEPHONE CALLING CARDS, IN CLASS 38 (U.S. CLS. 100, 101 AND 104).

SERVICE MARK

FIRST USE 6-29-2012; IN COMMERCE 6-29-2012.

PRINCIPAL REGISTER

THE MARK CONSISTS OF STANDARD CHARACTERS WITHOUT CLAIM TO ANY PARTICULAR FONT, STYLE, SIZE, OR COLOR.

NO CLAIM IS MADE TO THE EXCLUSIVE RIGHT TO USE "COMMUNICATIONS", APART FROM THE MARK AS SHOWN.

SN 85-351,102, FILED 6-20-2011.

ANDREA K. NADELMAN, EXAMINING ATTORNEY



David J. Kyffers

Director of the United States Patent and Trademark Office

United States of America

United States Patent and Trademark Office

AQUADUET

Reg. No. 4,207,334

Registered Sep. 11, 2012

Int. Cl.: 5

TRADEMARK

PRINCIPAL REGISTER

CLARKE MOSQUITO CONTROL PRODUCTS, INC. (ILLINOIS CORPORATION)
FOURTH FLOOR
110 E. IRVING PARK ROAD
ROSELLE, IL 60172

FOR: PESTICIDES, NAMELY, INSECTICIDES, IN CLASS 5 (U.S. CLS. 6, 18, 44, 46, 51 AND 52).

FIRST USE 9-20-2011; IN COMMERCE 9-20-2011.

THE MARK CONSISTS OF STANDARD CHARACTERS WITHOUT CLAIM TO ANY PARTICULAR FONT, STYLE, SIZE, OR COLOR.

SN 85-351,393, FILED 6-21-2011.

JOHN DWYER, EXAMINING ATTORNEY



David J. Kyffers

Director of the United States Patent and Trademark Office

United States of America

United States Patent and Trademark Office



Reg. No. 4,207,335

Registered Sep. 11, 2012

Int. Cl.: 24

TRADEMARK

PRINCIPAL REGISTER

MART 5 LLC (MINNESOTA LIMITED LIABILITY COMPANY)
110 CHESHIRE LN #200
MINNETONKA, MN 553051041

FOR: LAP BLANKET WITH A POCKET OR POUCH FOR ONE'S FEET, IN CLASS 24 (U.S. CLS. 42 AND 50).

FIRST USE 8-17-2011; IN COMMERCE 8-17-2011.

THE MARK CONSISTS OF A SOFA WITH A PERSON COVERED UP WITH A POLKA-A-DOT BLANKET WITH ONLY THE PERSON'S SMILING FACE AND SIX FINGERS SHOWING. ABOVE THE SOFA IS AN OVAL DIALOG BOX STATING "KEEPS YOUR PIGGYS ROASTY TOESTY!" BELOW THE SOFA IS THE WORD "SOFASOX" IN UPPERCASE LETTERS.

SN 85-351,544, FILED 6-21-2011.

TINA BROWN, EXAMINING ATTORNEY



David J. Kyffers

Director of the United States Patent and Trademark Office

United States of America
United States Patent and Trademark Office

PROPLUS

Reg. No. 4,207,336

FERGUSON ENTERPRISES, INC. (VIRGINIA CORPORATION)
12500 JEFFERSON AVE.

Registered Sep. 11, 2012

NEWPORT NEWS, VA 23602

Int. Cl.: 35

FOR: ADMINISTRATION OF A CUSTOMER LOYALTY PROGRAM IN THE FIELD OF PLUMBING, LIGHTING AND HVAC FOR ENABLING CONTRACTORS AND BUILDERS TO OBTAIN DISCOUNTS ON PRODUCTS AND SERVICES, IN CLASS 35 (U.S. CLS. 100, 101 AND 102).

SERVICE MARK

PRINCIPAL REGISTER

FIRST USE 8-15-2011; IN COMMERCE 8-15-2011.

THE MARK CONSISTS OF STANDARD CHARACTERS WITHOUT CLAIM TO ANY PARTICULAR FONT, STYLE, SIZE, OR COLOR.

SN 85-351,834, FILED 6-21-2011.

INGRID C. EULIN, EXAMINING ATTORNEY



David J. Kyffers

Director of the United States Patent and Trademark Office

United States of America

United States Patent and Trademark Office

TWO FOXES BAKING COMPANY

Reg. No. 4,207,337

Registered Sep. 11, 2012

Int. Cl.: 30

TRADEMARK

PRINCIPAL REGISTER

TWO FOXES BAKING COMPANY LLC (MASSACHUSETTS LIMITED LIABILITY COMPANY)
25 MANTON ROAD
SWAMPSCOTT, MA 01907

FOR: MUFFINS, IN CLASS 30 (U.S. CL. 46).

FIRST USE 6-6-2012; IN COMMERCE 6-6-2012.

THE MARK CONSISTS OF STANDARD CHARACTERS WITHOUT CLAIM TO ANY PARTICULAR FONT, STYLE, SIZE, OR COLOR.

NO CLAIM IS MADE TO THE EXCLUSIVE RIGHT TO USE "BAKING COMPANY", APART FROM THE MARK AS SHOWN.

SN 85-351,981, FILED 6-21-2011.

JULIE VEPPUMTHARA, EXAMINING ATTORNEY



David J. Kybas

Director of the United States Patent and Trademark Office

United States of America

United States Patent and Trademark Office

RENZO PIANO

Reg. No. 4,207,338

RP SAFE SPA (ITALY CORPORATION)

Registered Sep. 11, 2012

VIA SANTA TECLA 4
MILANO, ITALY 20122

Int. Cl.: 42

FOR: INDUSTRIAL DESIGN SERVICES, IN CLASS 42 (U.S. CLS. 100 AND 101).

SERVICE MARK

FIRST USE 6-30-2011; IN COMMERCE 6-30-2011.

PRINCIPAL REGISTER

THE MARK CONSISTS OF STANDARD CHARACTERS WITHOUT CLAIM TO ANY PARTICULAR FONT, STYLE, SIZE, OR COLOR.

OWNER OF ERPN CMNTY TM OFC REG. NO. 000489351, DATED 2-24-1999, EXPIRES 3-10-2017.

OWNER OF U.S. REG. NOS. 2,668,342 AND 3,014,355.

THE NAME(S), PORTRAIT(S), AND/OR SIGNATURE(S) SHOWN IN THE MARK IDENTIFIES "MR. RENZO PIANO", WHOSE CONSENT(S) TO REGISTER IS MADE OF RECORD.

SN 85-352,044, FILED 6-21-2011.

MAYUR VAGHANI, EXAMINING ATTORNEY



David J. Kyffers

Director of the United States Patent and Trademark Office

United States of America

United States Patent and Trademark Office



Reg. No. 4,207,339

Registered Sep. 11, 2012

Int. Cl.: 25

TRADEMARK

PRINCIPAL REGISTER

ALEXANDER MYERS JR. (UNITED STATES INDIVIDUAL)
1006 N. 30TH AVENUE
HATTIESBURG, MS 39401

FOR: CLEATS FOR ATTACHMENT TO SPORTS SHOES; CLOTHING FOR WEAR IN JUDO PRACTICES; CLOTHING FOR WEAR IN WRESTLING GAMES; COMBATIVE SPORTS UNIFORMS; FOOTWEAR NOT FOR SPORTS; HEAD WEAR; INFANT WEAR; MOISTURE-WICKING SPORTS BRAS; MOISTURE-WICKING SPORTS PANTS; MOISTURE-WICKING SPORTS SHIRTS; PINNIES IN THE NATURE OF SCRIMMAGE VESTS FOR USE IN SPORTS; RAIN WEAR; SHOE COVERS FOR USE WHEN WEARING SHOES; SKI WEAR; SPORT COATS; SPORT SHIRTS; SPORT STOCKINGS; SPORTS BRA; SPORTS BRAS; SPORTS CAPS AND HATS; SPORTS JACKETS; SPORTS JERSEYS; SPORTS JERSEYS AND BREECHES FOR SPORTS; SPORTS OVER UNIFORMS; SPORTS OVERUNIFORMS; SPORTS PANTS; SPORTS SHIRTS; SPORTS SHIRTS WITH SHORT SLEEVES; SPORTS VESTS; SURF WEAR; SWIM WEAR; SWIM WEAR FOR GENTLEMEN AND LADIES; TENNIS WEAR, IN CLASS 25 (U.S. CLS. 22 AND 39).

FIRST USE 5-12-2012; IN COMMERCE 5-12-2012.

THE MARK CONSISTS OF THE CROSS VIBE WHISTLE IS A PLAIN WHISTLE WITH A SEMI RING AROUND IT. IT IS PLACED OVER THE WORD "CROSS VIBE". THE RING GOES THROUGH THE "V" AND COMES OUT THROUGH THE CENTER OF THE "V".

SN 85-352,267, FILED 6-21-2011.

SKYE YOUNG, EXAMINING ATTORNEY



David J. Kybas

Director of the United States Patent and Trademark Office

United States of America

United States Patent and Trademark Office

Y BLOCK

Reg. No. 4,207,340

Registered Sep. 11, 2012

Int. Cl.: 33

TRADEMARK

PRINCIPAL REGISTER

ROBERT N. LINDQUIST & ASSOCIATES (CALIFORNIA CORPORATION)
C/O KOENIG & ASSOCIATES
SANTA BARBARA, CA 93101

FOR: WINE; WINES, IN CLASS 33 (U.S. CLS. 47 AND 49).

FIRST USE 6-28-2002; IN COMMERCE 6-28-2002.

THE MARK CONSISTS OF STANDARD CHARACTERS WITHOUT CLAIM TO ANY PARTICULAR FONT, STYLE, SIZE, OR COLOR.

SN 85-352,270, FILED 6-21-2011.

SKYE YOUNG, EXAMINING ATTORNEY



David J. Kybas

Director of the United States Patent and Trademark Office

United States of America

United States Patent and Trademark Office

Dos Artes

Reg. No. 4,207,341

ALVARO MOLINA (UNITED STATES INDIVIDUAL)
633 S COLLEGE AV
CLAREMONT, CA 91711

Registered Sep. 11, 2012

Int. Cl.: 33

FOR: DISTILLED SPIRITS, IN CLASS 33 (U.S. CLS. 47 AND 49).

TRADEMARK

FIRST USE 4-24-2012; IN COMMERCE 4-24-2012.

PRINCIPAL REGISTER

THE MARK CONSISTS OF STANDARD CHARACTERS WITHOUT CLAIM TO ANY PARTICULAR FONT, STYLE, SIZE, OR COLOR.

THE ENGLISH TRANSLATION OF "DOS ARTES" IN THE MARK IS "TWO ARTS".

SN 85-352,282, FILED 6-21-2011.

ALYSSA STEEL, EXAMINING ATTORNEY



David J. Kyffers

Director of the United States Patent and Trademark Office

United States of America

United States Patent and Trademark Office

RIVER PILOT

Reg. No. 4,207,342

Registered Sep. 11, 2012

Int. Cl.: 33

TRADEMARK

PRINCIPAL REGISTER

MISSISSIPPI RIVER DISTILLING COMPANY (IOWA LIMITED LIABILITY COMPANY)
PO BOX 801
LECLAIRE, IA 52753

FOR: VODKA, IN CLASS 33 (U.S. CLS. 47 AND 49).

FIRST USE 10-1-2011; IN COMMERCE 10-1-2011.

THE MARK CONSISTS OF STANDARD CHARACTERS WITHOUT CLAIM TO ANY PARTICULAR FONT, STYLE, SIZE, OR COLOR.

SN 85-352,722, FILED 6-22-2011.

ANDREW LEASER, EXAMINING ATTORNEY



David J. Kybas

Director of the United States Patent and Trademark Office

United States of America

United States Patent and Trademark Office

FRE3DOM

Reg. No. 4,207,343

JACKSON NATIONAL LIFE INSURANCE COMPANY (MICHIGAN CORPORATION)
1 CORPORATE WAY
LANSING, MI 48951

Registered Sep. 11, 2012

Int. Cl.: 36

FOR: ANNUITY UNDERWRITING SERVICES, IN CLASS 36 (U.S. CLS. 100, 101 AND 102).

SERVICE MARK

FIRST USE 5-2-2011; IN COMMERCE 5-2-2011.

PRINCIPAL REGISTER

THE MARK CONSISTS OF STANDARD CHARACTERS WITHOUT CLAIM TO ANY PARTICULAR FONT, STYLE, SIZE, OR COLOR.

SN 85-352,853, FILED 6-22-2011.

SETH A. RAPPAPORT, EXAMINING ATTORNEY



David J. Kyffers

Director of the United States Patent and Trademark Office

United States of America

United States Patent and Trademark Office

Reclina-Pedic

Reg. No. 4,207,344

SOUTHERN MOTION, INC. (MISSISSIPPI CORPORATION)

Registered Sep. 11, 2012

P.O. BOX 1064
PONTOTOC, MS 38863

Int. Cl.: 20

FOR: MEMORY FOAM CUSHIONS, IN CLASS 20 (U.S. CLS. 2, 13, 22, 25, 32 AND 50).

TRADEMARK

FIRST USE 4-25-2011; IN COMMERCE 4-25-2011.

PRINCIPAL REGISTER

THE MARK CONSISTS OF STANDARD CHARACTERS WITHOUT CLAIM TO ANY PARTICULAR FONT, STYLE, SIZE, OR COLOR.

SN 85-352,866, FILED 6-22-2011.

MARK SPARACINO, EXAMINING ATTORNEY



David J. Kyffers

Director of the United States Patent and Trademark Office

United States of America

United States Patent and Trademark Office

Tri-Cliner

Reg. No. 4,207,345

SOUTHERN MOTION, INC. (MISSISSIPPI CORPORATION)

Registered Sep. 11, 2012

P.O. BOX 1064
PONTOTOC, MS 38863

Int. Cl.: 20

FOR: FURNITURE, NAMELY, RECLINING FURNITURE, IN CLASS 20 (U.S. CLS. 2, 13, 22, 25, 32 AND 50).

TRADEMARK

FIRST USE 6-13-2011; IN COMMERCE 6-13-2011.

PRINCIPAL REGISTER

THE MARK CONSISTS OF STANDARD CHARACTERS WITHOUT CLAIM TO ANY PARTICULAR FONT, STYLE, SIZE, OR COLOR.

SN 85-352,874, FILED 6-22-2011.

MARK SPARACINO, EXAMINING ATTORNEY



David J. Kybas

Director of the United States Patent and Trademark Office

United States of America

United States Patent and Trademark Office

SAPPHIMAX

Reg. No. 4,207,346

Registered Sep. 11, 2012

Int. Cl.: 14

TRADEMARK

PRINCIPAL REGISTER

SWISS DESIGN INTELLECTUAL HOLDINGS, LLC (OHIO LIMITED LIABILITY COMPANY)
SUITE 102
101 EAST MAPLE STREET
NORTH CANTON, OH 44720

FOR: WATCHES, AND PARTS THEREFOR, IN CLASS 14 (U.S. CLS. 2, 27, 28 AND 50).

FIRST USE 2-12-2012; IN COMMERCE 2-12-2012.

THE MARK CONSISTS OF STANDARD CHARACTERS WITHOUT CLAIM TO ANY PARTICULAR FONT, STYLE, SIZE, OR COLOR.

SN 85-353,040, FILED 6-22-2011.

MICHAEL ENGEL, EXAMINING ATTORNEY



David J. Kybas

Director of the United States Patent and Trademark Office

United States of America

United States Patent and Trademark Office



Reg. No. 4,207,347

Registered Sep. 11, 2012

Int. Cl.: 35

SERVICE MARK

PRINCIPAL REGISTER

CENTURYLINK, INC. (LOUISIANA CORPORATION)
100 CENTURYLINK DR.
MONROE, LA 71203

FOR: PROMOTING BUSINESS, SPORTS AND ENTERTAINMENT EVENTS OF OTHERS,
IN CLASS 35 (U.S. CLS. 100, 101 AND 102).

FIRST USE 6-23-2011; IN COMMERCE 6-23-2011.

THE MARK CONSISTS OF AN ARCH APPEARING ABOVE THREE CURVED LINES THAT
ARE INTERSECTED BY A SINGLE LINE ON AN IRREGULARLY-SHAPED QUADRILAT-
ERAL THAT IS OUTLINED BY A SINGLE LINE.

SN 85-353,092, FILED 6-22-2011.

RONALD MCMORROW, EXAMINING ATTORNEY



David J. Kybas

Director of the United States Patent and Trademark Office

United States of America

United States Patent and Trademark Office

TRUCLIP

Reg. No. 4,207,348

QUALITY EDGE, INC. (DELAWARE CORPORATION)
2712 WALKENT DRIVE, N.W.
WALKER, MI 49544

Registered Sep. 11, 2012

Int. Cl.: 6

FOR: METAL BUILDING TRIM AND SOFFITS, IN CLASS 6 (U.S. CLS. 2, 12, 13, 14, 23, 25 AND 50).

TRADEMARK

FIRST USE 6-1-2011; IN COMMERCE 6-1-2011.

PRINCIPAL REGISTER

THE MARK CONSISTS OF STANDARD CHARACTERS WITHOUT CLAIM TO ANY PARTICULAR FONT, STYLE, SIZE, OR COLOR.

SN 85-353,730, FILED 6-23-2011.

NORA BUCHANAN WILL, EXAMINING ATTORNEY



David J. Kybas

Director of the United States Patent and Trademark Office

United States of America

United States Patent and Trademark Office

AMYO

Reg. No. 4,207,349

NAM, GINA W. (UNITED STATES INDIVIDUAL)
137 JENKINS DR.

Registered Sep. 11, 2012

ENGLEWOOD CLIFFS, NJ 07632

Int. Cl.: 14

FOR: COSTUME JEWELRY, FASHION JEWELRY, IN CLASS 14 (U.S. CLS. 2, 27, 28 AND 50).

TRADEMARK

FIRST USE 1-30-2012; IN COMMERCE 1-30-2012.

PRINCIPAL REGISTER

THE MARK CONSISTS OF STANDARD CHARACTERS WITHOUT CLAIM TO ANY PARTICULAR FONT, STYLE, SIZE, OR COLOR.

SN 85-354,465, FILED 6-23-2011.

ANDREA HACK, EXAMINING ATTORNEY



David J. Kyffers

Director of the United States Patent and Trademark Office

United States of America

United States Patent and Trademark Office



Reg. No. 4,207,350

SOUTH DAKOTA BOARD OF REGENTS (SOUTH DAKOTA STATE AGENCY)
306 E. CAPITOL AVENUE
PIERRE, SD 575012545

Registered Sep. 11, 2012

Int. Cl.: 35

FOR: PROMOTING THE AWARENESS OF ISSUES RELATED TO THE ENVIRONMENT, CONSERVATION AND SUSTAINABILITY PRACTICES, IN CLASS 35 (U.S. CLS. 100, 101 AND 102).

SERVICE MARK

FIRST USE 4-0-2012; IN COMMERCE 4-0-2012.

PRINCIPAL REGISTER

THE MARK CONSISTS OF THE WORDS "YELLOW & BLUE MAKE GREEN" IN AN ARCH OVER A CIRCLE CONTAINING A CURVING ARROW.

SN 85-354,485, FILED 6-23-2011.

ANDREW LEASER, EXAMINING ATTORNEY



David J. Kybas

Director of the United States Patent and Trademark Office

United States of America

United States Patent and Trademark Office

SMART GEL

Reg. No. 4,207,351

POLY-GEL LLC (NEW JERSEY LIMITED LIABILITY COMPANY)
30 LESLIE COURT
WHIPPANY, NJ 07981

Registered Sep. 11, 2012

Int. Cls.: 5 and 10

FOR: CUSHIONS AND PADS, NAMELY, CORN PADS, CALLUS PADS AND BUNION PADS, IN CLASS 5 (U.S. CLS. 6, 18, 44, 46, 51 AND 52).

TRADEMARK

FIRST USE 2-1-2012; IN COMMERCE 2-1-2012.

PRINCIPAL REGISTER

FOR: ARCH SUPPORTS FOR BOOTS OR SHOES; ORTHOTIC INSERTS, NAMELY, INSOLES, HALF INSOLES, HEEL INSERTS IN THE NATURE OF HEEL LINERS, AND SHOE INSERTS FOR PRIMARILY ORTHOPEDIC PURPOSES IN THE NATURE OF FOREFOOT CUSHIONS, HEEL PADS AND HEEL CUSHIONS, SHOE PADDING, BALL OF FOOT CUSHIONS, AND HEEL PIECES FOR SHOES; ORTHOPEDIC SUPPORTS, NAMELY, HEEL PROTECTORS, IN CLASS 10 (U.S. CLS. 26, 39 AND 44).

FIRST USE 2-1-2012; IN COMMERCE 2-1-2012.

THE MARK CONSISTS OF STANDARD CHARACTERS WITHOUT CLAIM TO ANY PARTICULAR FONT, STYLE, SIZE, OR COLOR.

NO CLAIM IS MADE TO THE EXCLUSIVE RIGHT TO USE "GEL", APART FROM THE MARK AS SHOWN.

SN 85-354,675, FILED 6-23-2011.

EMILY CARLSEN, EXAMINING ATTORNEY



David J. Kybas

Director of the United States Patent and Trademark Office

United States of America

United States Patent and Trademark Office



Reg. No. 4,207,352

Registered Sep. 11, 2012

Int. Cls.: 9 and 41

TRADEMARK

SERVICE MARK

PRINCIPAL REGISTER

ZYNGA INC. (DELAWARE CORPORATION)
699 EIGHTH STREET
SAN FRANCISCO, CA 94103

FOR: COMPUTER GAME SOFTWARE; COMPUTER GAME PROGRAMS; ELECTRONIC GAME PROGRAMS; INTERACTIVE VIDEO GAME PROGRAMS; COMPUTER SOFTWARE PLATFORMS FOR SOCIAL NETWORKING; COMPUTER SOFTWARE TO ENABLE UPLOADING, POSTING, SHOWING, DISPLAYING, TAGGING, BLOGGING, SHARING OR OTHERWISE PROVIDING ELECTRONIC MEDIA OR INFORMATION IN THE FIELDS OF VIRTUAL COMMUNITIES, ELECTRONIC GAMING, ENTERTAINMENT, AND GENERAL INTEREST VIA THE INTERNET OR OTHER COMMUNICATIONS NETWORKS WITH THIRD PARTIES, IN CLASS 9 (U.S. CLS. 21, 23, 26, 36 AND 38).

FIRST USE 6-8-2011; IN COMMERCE 6-8-2011.

FOR: COMPUTER AND ELECTRONIC GAMES PROVIDED ONLINE, ENHANCEMENTS WITHIN ONLINE COMPUTER AND ELECTRONIC GAMES; INFORMATION RELATING TO COMPUTER GAMES PROVIDED ONLINE; VIRTUAL ENVIRONMENTS IN WHICH USERS CAN INTERACT THROUGH SOCIAL GAMES FOR RECREATIONAL, LEISURE OR ENTERTAINMENT PURPOSES, IN CLASS 41 (U.S. CLS. 100, 101 AND 107).

FIRST USE 6-8-2011; IN COMMERCE 6-8-2011.

THE MARK CONSISTS OF THE LETTERS "HANG" FOLLOWED BY A SHADOW IMAGE OF A PERSON HOLDING FOUR BALLOONS FOLLOWED BY THE LETTERS "NG" FOLLOWED BY THE WORD "WITH" OVER THE WORD "FRIENDS" WITHIN A THOUGHT BUBBLE.

SN 85-354,841, FILED 6-23-2011.

PAUL E. FAHRENKOPF, EXAMINING ATTORNEY



David J. Kyros

Director of the United States Patent and Trademark Office

United States of America

United States Patent and Trademark Office

Musketeer

Reg. No. 4,207,353

Registered Sep. 11, 2012

Int. Cl.: 1

TRADEMARK

PRINCIPAL REGISTER

SEPRO CORPORATION (INDIANA CORPORATION)
STE. 600
11550 N. MERIDIAN STREET
CARMEL, IN 46032

FOR: HORTICULTURAL PRODUCTS, NAMELY, SOIL AMENDMENTS THAT ARE INCORPORATED INTO OR ONTO A TURF, LAWN OR SOIL PROFILE FOR CREATING A HEALTH MEDIUM FOR INCREASED ROOT GROWTH AND/OR A SMOOTHER TURF OR LAWN SURFACE CUT OR APPEARANCE, IN CLASS 1 (U.S. CLS. 1, 5, 6, 10, 26 AND 46).

FIRST USE 2-21-2012; IN COMMERCE 2-21-2012.

THE MARK CONSISTS OF STANDARD CHARACTERS WITHOUT CLAIM TO ANY PARTICULAR FONT, STYLE, SIZE, OR COLOR.

SN 85-355,043, FILED 6-24-2011.

NATALIE POLZER, EXAMINING ATTORNEY



David J. Kyffers

Director of the United States Patent and Trademark Office

United States of America

United States Patent and Trademark Office

Where the Strip Began.

Reg. No. 4,207,354

FLAMINGO LAS VEGAS PROPCO, LLC (DELAWARE LIMITED LIABILITY COMPANY)
ONE CAESARS PALACE DRIVE
LAS VEGAS, NV 89109

Registered Sep. 11, 2012

Int. Cls.: 41 and 43

FOR: PROVIDING ENTERTAINMENT SERVICES IN THE NATURE OF CASINO GAMING;
CASINO SERVICES; CONDUCTING AND PROVIDING FACILITIES FOR SPECIAL EVENTS
FEATURING CASINO AND GAMING CONTESTS, IN CLASS 41 (U.S. CLS. 100, 101 AND
107).

SERVICE MARK

PRINCIPAL REGISTER

FIRST USE 3-16-2011; IN COMMERCE 3-16-2011.

FOR: HOTEL SERVICES; BAR AND RESTAURANT SERVICES; PROVISION OF CONFER-
ENCE, EXHIBITION AND MEETING FACILITIES, IN CLASS 43 (U.S. CLS. 100 AND 101).

FIRST USE 3-16-2011; IN COMMERCE 3-16-2011.

THE MARK CONSISTS OF STANDARD CHARACTERS WITHOUT CLAIM TO ANY PAR-
TICULAR FONT, STYLE, SIZE, OR COLOR.

SN 85-355,154, FILED 6-24-2011.

ELIZABETH KAJUBI, EXAMINING ATTORNEY



David J. Kyffers

Director of the United States Patent and Trademark Office

United States of America

United States Patent and Trademark Office

e-leaf

Reg. No. 4,207,355

Registered Sep. 11, 2012

Int. Cl.: 9

TRADEMARK

PRINCIPAL REGISTER

DEZAWY, LLC (NEW YORK LIMITED LIABILITY COMPANY), DBA THEWRITEDeAL,
THEWRITEDeAL.ORG, TWD,
2114 45TH AVENUE
LONG ISLAND CITY, NY 11101

FOR: DOWNLOADABLE MULTIMEDIA FILE CONTAINING ARTWORK, TEXT, AUDIO,
VIDEO, GAMES, AND INTERNET WEB LINKS RELATING TO ONLINE PUBLISHING AND
E-COMMERCE, IN CLASS 9 (U.S. CLS. 21, 23, 26, 36 AND 38).

FIRST USE 2-15-2012; IN COMMERCE 2-15-2012.

THE MARK CONSISTS OF STANDARD CHARACTERS WITHOUT CLAIM TO ANY PAR-
TICULAR FONT, STYLE, SIZE, OR COLOR.

SN 85-355,452, FILED 6-24-2011.

DORITT L. CARROLL, EXAMINING ATTORNEY



David J. Kyffers

Director of the United States Patent and Trademark Office

United States of America

United States Patent and Trademark Office

sputtens

Reg. No. 4,207,356

Registered Sep. 11, 2012

Int. Cl.: 25

TRADEMARK

PRINCIPAL REGISTER

THE SOCK PUPPET MITTEN COMPANY (NEW HAMPSHIRE LIMITED LIABILITY COMPANY), DBA THE SPUTTEN COMPANY,
PO BOX 7414
NASHUA, NH 030607414

FOR: MITTENS, IN CLASS 25 (U.S. CLS. 22 AND 39).

FIRST USE 12-1-2010; IN COMMERCE 6-21-2012.

THE MARK CONSISTS OF STANDARD CHARACTERS WITHOUT CLAIM TO ANY PARTICULAR FONT, STYLE, SIZE, OR COLOR.

SN 85-355,706, FILED 6-24-2011.

ANDREA HACK, EXAMINING ATTORNEY



David J. Kybas

Director of the United States Patent and Trademark Office

United States of America

United States Patent and Trademark Office



Reg. No. 4,207,357

Registered Sep. 11, 2012

Int. Cl.: 43

SERVICE MARK

PRINCIPAL REGISTER

DIPPINGO HOLDING COMPANY (DELAWARE LIMITED LIABILITY COMPANY)
72 VAN RIPPEN AVENUE
JERSEY CITY, NJ 07306

FOR: RESTAURANT SERVICES, IN CLASS 43 (U.S. CLS. 100 AND 101).

FIRST USE 5-15-2012; IN COMMERCE 5-15-2012.

NO CLAIM IS MADE TO THE EXCLUSIVE RIGHT TO USE "CHOCOLATE LOUNGE",
APART FROM THE MARK AS SHOWN.

THE MARK CONSISTS OF THE STYLIZED WORDING "DIPPINGO CHOCOLATE LOUNGE"
ON A CIRCLE BACKGROUND WITH CIRCLES AROUND THE LETTER "O" IN "DIPPINGO".

SN 85-356,776, FILED 6-27-2011.

BRENDAN MCCAULEY, EXAMINING ATTORNEY



David J. Kybas

Director of the United States Patent and Trademark Office

United States of America

United States Patent and Trademark Office

ULTRA*ROUND

Reg. No. 4,207,358

Registered Sep. 11, 2012

Int. Cl.: 19

TRADEMARK

PRINCIPAL REGISTER

CERTAINTEED CORPORATION (DELAWARE CORPORATION)
750 E. SWEDESFORD ROAD
VALLEY FORGE, PA 194820101

FOR: NON-METAL BUILDING MATERIALS, NAMELY, DUCT BOARD COMPOSED OF FIBER GLASS USED TO PREVENT UNWANTED HEAT FROM TRANSFERRING IN OR OUT OF AIR DUCTS, IN CLASS 19 (U.S. CLS. 1, 12, 33 AND 50).

FIRST USE 10-14-2011; IN COMMERCE 10-14-2011.

THE MARK CONSISTS OF STANDARD CHARACTERS WITHOUT CLAIM TO ANY PARTICULAR FONT, STYLE, SIZE, OR COLOR.

OWNER OF U.S. REG. NO. 3,792,087.

SN 85-356,923, FILED 6-27-2011.

WENDY GOODMAN, EXAMINING ATTORNEY



David J. Kyjars

Director of the United States Patent and Trademark Office

United States of America

United States Patent and Trademark Office

DeVoL

Reg. No. 4,207,359

Registered Sep. 11, 2012

Int. Cl.: 25

ABDELQADER, TARIK NASHAT (UNITED STATES INDIVIDUAL), DBA TARIK
ABDELQADER,
1 HOMESTEAD LANE
1 HOMESTEAD LANE
NEW CITY, NY 10956

TRADEMARK

FOR: ATHLETIC APPAREL, NAMELY, SHIRTS, PANTS, JACKETS, FOOTWEAR, HATS
AND CAPS, ATHLETIC UNIFORMS, IN CLASS 25 (U.S. CLS. 22 AND 39).

PRINCIPAL REGISTER

FIRST USE 6-25-2011; IN COMMERCE 1-13-2012.

THE MARK CONSISTS OF STANDARD CHARACTERS WITHOUT CLAIM TO ANY PAR-
TICULAR FONT, STYLE, SIZE, OR COLOR.

SN 85-356,948, FILED 6-27-2011.

MARLENE BELL, EXAMINING ATTORNEY



David J. Kyffers

Director of the United States Patent and Trademark Office

United States of America

United States Patent and Trademark Office

ARTBOX

Reg. No. 4,207,360

ARTBOX CO., LTD. (REPUBLIC OF KOREA CORPORATION)
1516-2, SEOCHO-DONG, SEOCHO-GU
SEOUL, REPUBLIC OF KOREA

Registered Sep. 11, 2012

**Int. Cls.: 14, 16, 18, 20,
21, 24, 25, and 35**

FOR: ALARM CLOCKS; CLOCKS AND WATCHES; STOP WATCHES; TABLE CLOCKS;
WATCH BANDS; WATCH CHAINS, IN CLASS 14 (U.S. CLS. 2, 27, 28 AND 50).

FIRST USE 2-0-2003; IN COMMERCE 6-0-2011.

TRADEMARK

SERVICE MARK

PRINCIPAL REGISTER

FOR: ADHESIVE LABELS; ADHESIVE TAPES FOR STATIONERY PURPOSES; BALLPOINT
PENS; CALENDARS; CARD FILES; CARDBOARD; CLIP BOARDS; CORRECTING FLUID
FOR TYPE; CRAYONS; DIARIES; DRAWING PAPER; EDUCATIONAL PUBLICATIONS,
NAMELY, EDUCATIONAL LEARNING CARDS, FLASH CARDS, ACTIVITY CARDS,
WORKBOOKS, TEXTBOOKS, ACTIVITY BOOKS AND EDUCATIONAL BOOKLETS IN
THE FIELDS OF WORD MEMORIZATION; ENVELOPES; GENERAL PURPOSE PLASTIC
BAGS; GIFT WRAPPING PAPER; GLUE FOR STATIONERY OR HOUSEHOLD USE;
GREETING CARDS; LETTER PAPER; LOOSE LEAF BINDERS; MEMO PADS; NAPKINS
OF PAPER FOR REMOVING MAKE-UP; NOTEBOOKS; PACKING PAPER; PAINT BOXES
AND BRUSHES; PAPER BAGS AND SACKS; PAPER GIFT BAGS; PAPER TOWELS; PARTY
GOODIE BAGS OF PAPER OR PLASTIC; PENCIL CASES; PENCIL SHARPENERS; PENCILS;
PENS; PHOTOGRAPH ALBUMS; PICTURE POSTCARDS; PLASTIC BAGS FOR PACKAGING;
POCKET MEMORANDUM BOOKS; POST CARDS; RUBBER ERASERS; SEALING STAMPS;
SKETCHBOOKS; STATIONERY; STATIONERY WRITING PAPER AND ENVELOPES;
STICKERS; TOILET PAPER; WRITING INSTRUMENTS, IN CLASS 16 (U.S. CLS. 2, 5, 22,
23, 29, 37, 38 AND 50).

FIRST USE 2-0-2003; IN COMMERCE 6-0-2011.

FOR: BACKPACKS; BEACH BAGS; BOSTON BAGS; COSMETIC CARRYING CASES SOLD
EMPTY; COSMETIC CASES SOLD EMPTY; CREDIT CARD CASES; NAME CARD CASES;
PARASOLS; PURSES; PURSES, NOT OF PRECIOUS METAL; SCHOOL SACHELS;
TRAVELING BAGS; TRAVELLING TRUNKS; UMBRELLAS, IN CLASS 18 (U.S. CLS. 1, 2,
3, 22 AND 41).

FIRST USE 2-0-2003; IN COMMERCE 6-0-2011.



David J. Kyjars

Director of the United States Patent and Trademark Office

Reg. No. 4,207,360 FOR: CLOTHES HANGERS; CUSHIONS; DISPLAY CASES; FANS FOR PERSONAL USE; HAND-HELD MIRRORS; MIRRORS; PICTURE FRAMES; PILLOWS; PLASTIC BOXES; SLEEPING MATS; UMBRELLA STANDS; WOOD BOXES, IN CLASS 20 (U.S. CLS. 2, 13, 22, 25, 32 AND 50).

FIRST USE 2-0-2003; IN COMMERCE 6-0-2011.

FOR: BROOMS; BUCKETS; COFFEE CUPS, TEA CUPS AND MUGS; COMBS; CUPS; GARBAGE CANS; INSULATED FLASKS; MESS-TINS; MUGS, NOT OF PRECIOUS METAL; NON-METAL PIGGY BANKS; PAPER CUPS; PAPER PLATES; PLASTIC CUPS; POWDER PUFFS; TOOTHBRUSH CASES; TOOTHBRUSHES, IN CLASS 21 (U.S. CLS. 2, 13, 23, 29, 30, 33, 40 AND 50).

FIRST USE 2-0-2003; IN COMMERCE 6-0-2011.

FOR: BED BLANKETS; BED COVERS; BLANKET THROWS; BLANKETS FOR OUTDOOR USE; HANDKERCHIEFS; MATTRESS COVERS; PILLOW SHAMS; QUILTS; TOWELS, IN CLASS 24 (U.S. CLS. 42 AND 50).

FIRST USE 2-0-2003; IN COMMERCE 6-0-2011.

FOR: BATH SLIPPERS; BATHING SUITS; BEACH SHOES; EAR MUFFS; GLOVES; LEG-GINGS; MITTENS; MUFFLERS; ONE-PIECE PLAY SUITS; OUTDOOR GLOVES; PAJAMAS; SANDALS; SLIPPERS; SOCKS; SUITS; T-SHIRTS; UNDERGARMENTS; UNDERWEAR, IN CLASS 25 (U.S. CLS. 22 AND 39).

FIRST USE 2-0-2003; IN COMMERCE 6-0-2011.

FOR: ADVERTISING, MARKETING AND PROMOTION SERVICES IN THE FIELD OF STATIONERY, OFFICE SUPPLIES, CLOCKS AND WATCHES, BAGS AND PURSES, FOOTWEAR, CLOTHING, UMBRELLAS, MIRRORS, CUPS, BEDDING; COMMERCIAL ADMINISTRATION OF THE LICENSING OF THE GOODS AND SERVICES OF OTHERS; COMMERCIAL ADMINISTRATION OF THE LICENSING OF STATIONERY, OFFICE SUPPLIES, CLOCKS AND WATCHES, BAGS AND PURSES, FOOTWEAR, CLOTHING, UMBRELLAS, MIRRORS, CUPS, BEDDING OF OTHERS; EXPORT AND IMPORT AGENCIES; FRANCHISING, NAMELY, OFFERING BUSINESS MANAGEMENT ASSISTANCE IN THE ESTABLISHMENT AND/OR OPERATION OF STORES IN THE FIELD OF STATIONERY, OFFICE SUPPLIES, CLOCKS AND WATCHES, BAGS AND PURSES, FOOTWEAR, CLOTHING, UMBRELLAS, MIRRORS, CUPS, BEDDING; WHOLESALE AND RETAIL STORE SERVICES FEATURING STATIONERY, OFFICE SUPPLIES, CLOCKS AND WATCHES, BAGS AND PURSES, FOOTWEAR, CLOTHING, UMBRELLAS, MIRRORS, CUPS, BEDDING, IN CLASS 35 (U.S. CLS. 100, 101 AND 102).

FIRST USE 2-0-2003; IN COMMERCE 6-0-2011.

OWNER OF U.S. REG. NO. 2,937,935.

NO CLAIM IS MADE TO THE EXCLUSIVE RIGHT TO USE "ART BOX" IN INTERNATIONAL CLASS 16 FOR PAINT BOXES AND IN INTERNATIONAL CLASS 20 FOR WOODEN AND PLASTIC BOXES, APART FROM THE MARK AS SHOWN.

THE MARK CONSISTS OF THE WORD "ARTBOX" WITH THE LETTERS "ARTBO" IN BLOCK STYLE FONT AND THE LETTER "X" WITH AN ADDITIONAL HORIZONTAL LINE PROTRUDING FROM THE MIDDLE OF THE RIGHT SIDE OF THE "X".

SN 85-357,100, FILED 6-27-2011.

DAVID COLLIER, EXAMINING ATTORNEY

United States of America

United States Patent and Trademark Office

LOUIS AT HOME

Reg. No. 4,207,361

LOUIS AT HOME LLC (FLORIDA LIMITED LIABILITY COMPANY)

Registered Sep. 11, 2012

3300 NW 41 STREET
MIAMI, FL 33142

Int. Cl.: 25

FOR: BATHROBES; LOUNGEWEAR; PAJAMAS; SLEEPWEAR; EYESHADES; MUFFLERS;
TOPS; WOMEN'S CLOTHING, NAMELY, SHIRTS, DRESSES, SKIRTS, BLOUSES; WRAPS,
IN CLASS 25 (U.S. CLS. 22 AND 39).

TRADEMARK

FIRST USE 8-1-2010; IN COMMERCE 8-1-2010.

PRINCIPAL REGISTER

THE MARK CONSISTS OF STANDARD CHARACTERS WITHOUT CLAIM TO ANY PAR-
TICULAR FONT, STYLE, SIZE, OR COLOR.

NO CLAIM IS MADE TO THE EXCLUSIVE RIGHT TO USE "AT HOME", APART FROM
THE MARK AS SHOWN.

SN 85-357,500, FILED 6-27-2011.

JESSICA A. POWERS, EXAMINING ATTORNEY



David J. Kybas

Director of the United States Patent and Trademark Office

United States of America

United States Patent and Trademark Office

CALIMAGIC

Reg. No. 4,207,362

GENERAL HYDROPONICS, INC. (CALIFORNIA CORPORATION)
P.O. BOX 1576
SEBASTOPOL, CA 954731576

Registered Sep. 11, 2012

Int. Cl.: 1

FOR: PLANT NUTRIENTS FOR HYDROPONIC AND SOIL-CULTIVATED PLANTS; PLANT NUTRITIONAL SUPPLEMENTS MADE FROM CALCIUM, IN CLASS 1 (U.S. CLS. 1, 5, 6, 10, 26 AND 46).

TRADEMARK

FIRST USE 9-6-2011; IN COMMERCE 9-6-2011.

PRINCIPAL REGISTER

THE MARK CONSISTS OF STANDARD CHARACTERS WITHOUT CLAIM TO ANY PARTICULAR FONT, STYLE, SIZE, OR COLOR.

OWNER OF U.S. REG. NO. 2,214,547.

SN 85-357,510, FILED 6-27-2011.

ALEX KEAM, EXAMINING ATTORNEY



David J. Kyffers

Director of the United States Patent and Trademark Office

United States of America

United States Patent and Trademark Office

RINDEX

Reg. No. 4,207,363

SVENSSON, BO KARL RAGNAR (SWEDEN INDIVIDUAL)
NYBROGATAN 75A 3TR.

Registered Sep. 11, 2012

STOCKHOLM, SWEDEN 11440

Int. Cl.: 7

FOR: MACHINE TOOLS, NAMELY, JAWS FOR USE IN THE PRECISION CLAMPING OF WORK PIECES, IN CLASS 7 (U.S. CLS. 13, 19, 21, 23, 31, 34 AND 35).

TRADEMARK

FIRST USE 9-19-2011; IN COMMERCE 6-4-2012.

PRINCIPAL REGISTER

THE MARK CONSISTS OF STANDARD CHARACTERS WITHOUT CLAIM TO ANY PARTICULAR FONT, STYLE, SIZE, OR COLOR.

SN 85-357,701, FILED 6-28-2011.

JOHN HWANG, EXAMINING ATTORNEY



David J. Kyffers

Director of the United States Patent and Trademark Office

United States of America

United States Patent and Trademark Office

Contents by Allegro

Reg. No. 4,207,364

CONAIR CORPORATION (DELAWARE CORPORATION)
ONE CUMMINGS POINT ROAD
STAMFORD, CT 06902

Registered Sep. 11, 2012

Int. Cl.: 18

FOR: CLUTCH BAGS; COSMETIC BAGS SOLD EMPTY; COSMETIC CARRYING CASES
SOLD EMPTY, IN CLASS 18 (U.S. CLS. 1, 2, 3, 22 AND 41).

TRADEMARK

FIRST USE 3-31-2011; IN COMMERCE 3-31-2011.

PRINCIPAL REGISTER

THE MARK CONSISTS OF STANDARD CHARACTERS WITHOUT CLAIM TO ANY PAR-
TICULAR FONT, STYLE, SIZE, OR COLOR.

OWNER OF U.S. REG. NO. 3,626,388.

SN 85-357,724, FILED 6-28-2011.

LINDA ORNDORFF, EXAMINING ATTORNEY



David J. Kyffers

Director of the United States Patent and Trademark Office

United States of America

United States Patent and Trademark Office

WebPark

Reg. No. 4,207,365

Registered Sep. 11, 2012

Int. Cls.: 36 and 39

SERVICE MARK

PRINCIPAL REGISTER

WEBPARK, INC. (GEORGIA CORPORATION)
2600 HARRIS TOWER, SUITE 2600
233 PEACHTREE STREET, NE
ATLANTA, GA 30303

FOR: PARKING ENFORCEMENT SERVICES, NAMELY, COLLECTING FINES FOR PARKING VIOLATIONS AND REMITTANCE OF COLLECTED FINES TO PARKING FACILITY OWNERS, IN CLASS 36 (U.S. CLS. 100, 101 AND 102).

FIRST USE 4-0-2011; IN COMMERCE 4-0-2011.

FOR: PARKING LOT SERVICES, NAMELY, PARKING PERMIT ISSUANCE SERVICES FOR THIRD PARTIES; PARKING ENFORCEMENT SERVICES, NAMELY, ISSUING TICKETS FOR VIOLATIONS OF RULES AND REGULATIONS FOR PRIVATE PARKING LOTS AND FACILITIES OF OTHERS; PARKING SPACE RESERVATION SERVICE; SPECIAL EVENT PARKING SPACE RESERVATION SERVICE, IN CLASS 39 (U.S. CLS. 100 AND 105).

FIRST USE 8-0-2010; IN COMMERCE 4-0-2012.

THE MARK CONSISTS OF THE TERM "WEBPARK" WITH THE LETTERS "WEB" IN BLUE, THE LETTER "P" IN WHITE WITHIN A GREEN CIRCLE, AND THE LETTERS "ARK" IN BLUE; THE BACKGROUND OF THE ENTIRE MARK IS TRANSLUCENT.

THE COLOR(S) BLUE, GREEN AND WHITE IS/ARE CLAIMED AS A FEATURE OF THE MARK.

SN 85-358,179, FILED 6-28-2011.

JIM RINGLE, EXAMINING ATTORNEY



David J. Kybas

Director of the United States Patent and Trademark Office

United States of America

United States Patent and Trademark Office

UNCOMMON SENSE

Reg. No. 4,207,366

Registered Sep. 11, 2012

Int. Cl.: 36

SERVICE MARK

PRINCIPAL REGISTER

WELLS FARGO & COMPANY (DELAWARE CORPORATION)
1700 WELLS FARGO CENTER, MAC N9305-176
SIXTH & MARQUETTE
MINNEAPOLIS, MN 55479

FOR: FINANCIAL PLANNING AND INVESTMENT ADVISORY SERVICES, FINANCIAL ASSET MANAGEMENT, INVESTMENT MANAGEMENT, INVESTMENT CONSULTATION, FINANCIAL PORTFOLIO MANAGEMENT SERVICES, WEALTH MANAGEMENT CONSULTING SERVICES, PROVIDING INFORMATION AND ADVICE IN THE FIELD OF FINANCE, FINANCIAL INVESTMENTS, FINANCIAL VALUATIONS, AND THE FINANCIAL ASPECTS OF RETIREMENT, IN CLASS 36 (U.S. CLS. 100, 101 AND 102).

FIRST USE 11-1-2011; IN COMMERCE 11-1-2011.

THE MARK CONSISTS OF STANDARD CHARACTERS WITHOUT CLAIM TO ANY PARTICULAR FONT, STYLE, SIZE, OR COLOR.

SN 85-358,208, FILED 6-28-2011.

ALLISON SCHRODY, EXAMINING ATTORNEY



David J. Kyjars

Director of the United States Patent and Trademark Office

United States of America

United States Patent and Trademark Office

Rock UR Face

Reg. No. 4,207,367

Registered Sep. 11, 2012

Int. Cl.: 16

TRADEMARK

PRINCIPAL REGISTER

NELSON, MARK (UNITED STATES INDIVIDUAL)
4210 LB MCLEOD RD 109
ORLANDO, FL 32811 AND

ZAVALZA, RAMON (UNITED STATES INDIVIDUAL)
4210 L.B. MCLEOD STE 109
4210 LB MCLEOD RD 109
ORLANDO, FL 32811

FOR: CHILDREN'S WALL STICKERS AND MURALS; DECALS; DECORATIVE DECALS FOR VEHICLE WINDOWS; DECORATIVE STICKERS FOR HELMETS; STICKERS, IN CLASS 16 (U.S. CLS. 2, 5, 22, 23, 29, 37, 38 AND 50).

FIRST USE 4-6-2009; IN COMMERCE 1-19-2012.

THE MARK CONSISTS OF STANDARD CHARACTERS WITHOUT CLAIM TO ANY PARTICULAR FONT, STYLE, SIZE, OR COLOR.

SN 85-358,218, FILED 6-28-2011.

CHRISTOPHER BUONGIORNO, EXAMINING ATTORNEY



David J. Kyffers

Director of the United States Patent and Trademark Office

United States of America

United States Patent and Trademark Office



J I V A A P O H A

Reg. No. 4,207,368

Registered Sep. 11, 2012

Int. Cl.: 3

TRADEMARK

PRINCIPAL REGISTER

JIVA-APOHA, INC. (NEW YORK CORPORATION)
SUITE 2A
155 HICKS STREET
BROOKLYN, NY 11201

FOR: NON-MEDICATED HERBAL BODY CARE PRODUCTS, NAMELY, ESSENTIAL OILS FOR THE BODY AND FACE, IN CLASS 3 (U.S. CLS. 1, 4, 6, 50, 51 AND 52).

FIRST USE 10-1-2011; IN COMMERCE 10-1-2011.

THE MARK CONSISTS OF THE WORDS "JIVA" FOLLOWED BY "APOHA" WITH THE IMAGE OF A FEATHER BETWEEN THE TWO WORDS.

THE ENGLISH TRANSLATION OF "JIVA APOHA" IN THE MARK IS SOUL HEALING.

SN 85-358,231, FILED 6-28-2011.

LINDSEY RUBIN, EXAMINING ATTORNEY



David J. Kybas

Director of the United States Patent and Trademark Office

United States of America

United States Patent and Trademark Office

ROOTGUARD

Reg. No. 4,207,369

LONG, DONALD (UNITED STATES INDIVIDUAL)
3010 SUTTONWOOD
PLANT CITY, FL 33566 AND

Registered Sep. 11, 2012

Int. Cl.: 1

DOLAN, TIM (UNITED STATES INDIVIDUAL)
P O BOX 567
SAFETY HARBOR, FL 34695

TRADEMARK

PRINCIPAL REGISTER

FOR: SOIL AMENDMENTS, IN CLASS 1 (U.S. CLS. 1, 5, 6, 10, 26 AND 46).

FIRST USE 3-3-2012; IN COMMERCE 3-3-2012.

THE MARK CONSISTS OF STANDARD CHARACTERS WITHOUT CLAIM TO ANY PARTICULAR FONT, STYLE, SIZE, OR COLOR.

SN 85-358,357, FILED 6-28-2011.

CURTIS FRENCH, EXAMINING ATTORNEY



David J. Kyffers

Director of the United States Patent and Trademark Office

United States of America

United States Patent and Trademark Office

Engineered Tax Solutions

Reg. No. 4,207,370

Registered Sep. 11, 2012

Int. Cl.: 35

SERVICE MARK

PRINCIPAL REGISTER

EDGAR J. LORENZ (UNITED STATES INDIVIDUAL), DBA THE CONCORDE GROUP,
SUITE 206
29500 SOUTHFIELD ROAD
SOUTHFIELD, MI 48076

FOR: BUSINESS TAX CONSULTATION SERVICES, IN CLASS 35 (U.S. CLS. 100, 101 AND 102).

FIRST USE 4-1-2012; IN COMMERCE 5-4-2012.

THE MARK CONSISTS OF STANDARD CHARACTERS WITHOUT CLAIM TO ANY PARTICULAR FONT, STYLE, SIZE, OR COLOR.

NO CLAIM IS MADE TO THE EXCLUSIVE RIGHT TO USE "TAX SOLUTIONS", APART FROM THE MARK AS SHOWN.

SN 85-358,360, FILED 6-28-2011.

JUDITH HELFMAN, EXAMINING ATTORNEY



David J. Kyfos

Director of the United States Patent and Trademark Office

United States of America

United States Patent and Trademark Office

TrickleTrade

Reg. No. 4,207,371

JSJ INTERNATIONAL (MONTANA PARTNERSHIP)
97 ARROWHEAD DRIVE
MISSOULA, MT 59803

Registered Sep. 11, 2012

Int. Cl.: 35

FOR: BARTER EXCHANGE SERVICES, NAMELY, PROVIDING COMMERCIAL BARTER AND TRADE EXCHANGE OF PRODUCTS AND SERVICES VIA A GLOBAL COMPUTER INFORMATION NETWORK, IN CLASS 35 (U.S. CLS. 100, 101 AND 102).

SERVICE MARK

FIRST USE 6-1-2012; IN COMMERCE 6-1-2012.

PRINCIPAL REGISTER

THE MARK CONSISTS OF STANDARD CHARACTERS WITHOUT CLAIM TO ANY PARTICULAR FONT, STYLE, SIZE, OR COLOR.

SN 85-358,825, FILED 6-28-2011.

LEIGH CAROLINE CASE, EXAMINING ATTORNEY



David J. Kyfos

Director of the United States Patent and Trademark Office

United States of America

United States Patent and Trademark Office



Reg. No. 4,207,372

Registered Sep. 11, 2012

Int. Cl.: 17

BEIJING HYSTON SCIENCE AND TECHNOLOGY DEVELOPMENT CO., LTD. (CHINA LIMITED COMPANY)

RM 1601, TOWER B, CAIZHI BUILDING
NO.18, ZHONGGUANCUN EAST ROAD
HAIDIAN DIST, BEIJING, CHINA 100083

TRADEMARK

PRINCIPAL REGISTER

FOR: ADHESIVE SEALANTS FOR GENERAL USE; ASBESTOS; EBONITE; FIRE HOSES; INSULATING MATERIALS; NON-METAL SEALING RINGS FOR USE AS CONNECTION SEALS; PADDING MATERIALS OF RUBBER OR PLASTIC; PIPE GASKETS; RUBBER; RUBBER THREAD, IN CLASS 17 (U.S. CLS. 1, 5, 12, 13, 35 AND 50).

FIRST USE 7-11-2011; IN COMMERCE 7-11-2011.

THE MARK CONSISTS OF A DESIGN COMPRISING THREE CONCENTRIC CIRCLES AND ONE RECTANGLE OVERLAPPING WITH THE TWO INNER CIRCLES ON THE LEFT, THE WORD "HYSTON" ON THE RIGHT, AND THE WORDS "FOCUS ON THE FUTURE" BELOW THE WORD "HYSTON".

THE WORDING "HYSTON" HAS NO MEANING IN A FOREIGN LANGUAGE.

SN 85-358,893, FILED 6-28-2011.

JERI J. FICKES, EXAMINING ATTORNEY



David J. Kybas

Director of the United States Patent and Trademark Office

United States of America

United States Patent and Trademark Office

RED SLATE

Reg. No. 4,207,373

Registered Sep. 11, 2012

Int. Cl.: 33

TRADEMARK

PRINCIPAL REGISTER

GEBR. LOOSEN GMBH (FED REP GERMANY CORPORATION)
ST. JOHANNISHOF
BERNKASTEL-KUES, FED REP GERMANY 54470

FOR: WINES, IN CLASS 33 (U.S. CLS. 47 AND 49).

FIRST USE 12-22-2011; IN COMMERCE 12-22-2011.

THE MARK CONSISTS OF STANDARD CHARACTERS WITHOUT CLAIM TO ANY PARTICULAR FONT, STYLE, SIZE, OR COLOR.

SN 85-358,925, FILED 6-29-2011.

JAY FLOWERS, EXAMINING ATTORNEY



David J. Kyros

Director of the United States Patent and Trademark Office

United States of America

United States Patent and Trademark Office



Reg. No. 4,207,374

GESNEGOCIO 5000, S.L. (SPAIN SOCIEDAD DE RESPONSABILIDAD LIMITADA (SL))
PAU CLARIS, 110, 4-2
08009 BARCELONA, SPAIN

Registered Sep. 11, 2012

Int. Cl.: 33

FOR: WINES; SPARKLING WINES, IN CLASS 33 (U.S. CLS. 47 AND 49).

TRADEMARK

FIRST USE 2-29-2012; IN COMMERCE 2-29-2012.

PRINCIPAL REGISTER

THE MARK CONSISTS OF THE TERM "LÉ", WRITTEN VERTICALLY IN ORANGE. ABOVE OF THE WORDING APPEARS AN ORANGE CIRCLE WITH A WHITE CENTER; ALL SET ON A DARK RED BACKGROUND CONTAINING A REPRESENTATION OF DROPLETS OF LIQUID AND FRAMED BY A RECTANGULAR THIN ORANGE LINE.

THE COLOR(S) ORANGE, WHITE AND DARK RED IS/ARE CLAIMED AS A FEATURE OF THE MARK.

SN 85-359,363, FILED 6-29-2011.

KELLY BOULTON, EXAMINING ATTORNEY



David J. Kybas

Director of the United States Patent and Trademark Office

United States of America

United States Patent and Trademark Office

GAMMAKED

Reg. No. 4,207,375

KEDRION S.P.A. (ITALY CORPORATION)
LOC AI CONTI 55051 CASTELVECCHIO PASCOLI
BARGA (LUCCA), ITALY

Registered Sep. 11, 2012

Int. Cl.: 5

FOR: GAMMA GLOBULIN-DERIVED PHARMACEUTICAL PREPARATIONS FOR
TREATING A VARIETY OF INFECTIONS AND INFLAMMATORY DISEASES AND
AUTOIMMUNE DISORDERS , IN CLASS 5 (U.S. CLS. 6, 18, 44, 46, 51 AND 52).

TRADEMARK

FIRST USE 8-5-2011; IN COMMERCE 8-5-2011.

PRINCIPAL REGISTER

THE MARK CONSISTS OF STANDARD CHARACTERS WITHOUT CLAIM TO ANY PAR-
TICULAR FONT, STYLE, SIZE, OR COLOR.

SN 85-359,561, FILED 6-29-2011.

CAROLINE WOOD, EXAMINING ATTORNEY



David J. Kyffers

Director of the United States Patent and Trademark Office

United States of America

United States Patent and Trademark Office

ALBUKED

Reg. No. 4,207,376

KEDRION S.P.A. (ITALY CORPORATION)
LOC AI CONTI 55051 CASTELVECCHIO PASCOLI
BARGA (LUCCA), ITALY

Registered Sep. 11, 2012

Int. Cl.: 5

FOR: ALBUMIN-DERIVED PHARMACEUTICAL PREPARATIONS FOR THE TREATMENT OF SHOCK AND BLOOD LOSS DUE TO TRAUMA, BURNS, AND SURGERY, IN CLASS 5 (U.S. CLS. 6, 18, 44, 46, 51 AND 52).

TRADEMARK

FIRST USE 8-5-2011; IN COMMERCE 8-5-2011.

PRINCIPAL REGISTER

THE MARK CONSISTS OF STANDARD CHARACTERS WITHOUT CLAIM TO ANY PARTICULAR FONT, STYLE, SIZE, OR COLOR.

SN 85-359,672, FILED 6-29-2011.

CAROLINE WOOD, EXAMINING ATTORNEY



David J. Kyros

Director of the United States Patent and Trademark Office

United States of America

United States Patent and Trademark Office

HARVEST YOUR AUTHENTIC BEAUTY

Reg. No. 4,207,377

BEE-ALIVE, INC. (NEW YORK CORPORATION)
7 NEW LAKE ROAD
VALLEY COTTAGE, NY 10989

Registered Sep. 11, 2012

Int. Cls.: 3 and 35

FOR: NON-MEDICATED SKIN CARE PRODUCTS, NAMELY, SKIN CLEANSER, SKIN TONER, SKIN MOISTURIZER, HAND LOTION, AND NON-MEDICATED PROFESSIONAL SKIN CARE PRODUCTS, NAMELY, AGE SPOT AND PIGMENT LIGHTENING GELS, EXFOLIATING CREAMS, MOISTURIZING AND ACNE PRONE SKIN FORMULA, NAMELY, LOTIONS, SERUMS, AND MOISTURIZERS; LOTIONS FOR BODY AND FACE, IN CLASS 3 (U.S. CLS. 1, 4, 6, 50, 51 AND 52).

TRADEMARK

SERVICE MARK

PRINCIPAL REGISTER

FIRST USE 1-16-2012; IN COMMERCE 1-16-2012.

FOR: CATALOG ORDERING SERVICE FEATURING SKIN CARE PRODUCTS, NON-MEDICATED SKIN CARE PRODUCTS, NAMELY, SKIN CLEANSER, SKIN TONER, SKIN MOISTURIZER, HAND LOTION, AND NON-MEDICATED PROFESSIONAL SKIN CARE PRODUCTS, NAMELY, AGE SPOT AND PIGMENT LIGHTENING GELS, EXFOLIATING CREAMS, MOISTURIZING AND ACNE PRONE SKIN FORMULA, NAMELY, LOTIONS, SERUMS, AND MOISTURIZERS, LOTIONS FOR BODY, AND FACE; ON-LINE RETAIL STORE SERVICES FEATURING SKIN CARE PRODUCTS, NON-MEDICATED SKIN CARE PRODUCTS, NAMELY, SKIN CLEANSER, SKIN TONER, SKIN MOISTURIZER, HAND LOTION, AND NON-MEDICATED PROFESSIONAL SKIN CARE PRODUCTS, NAMELY, AGE SPOT AND PIGMENT LIGHTENING GELS, EXFOLIATING CREAMS, MOISTURIZING AND ACNE PRONE SKIN FORMULA, NAMELY, LOTIONS, SERUMS, AND MOISTURIZERS, LOTIONS FOR BODY AND FACE, IN CLASS 35 (U.S. CLS. 100, 101 AND 102).

FIRST USE 1-16-2012; IN COMMERCE 1-16-2012.

THE MARK CONSISTS OF STANDARD CHARACTERS WITHOUT CLAIM TO ANY PARTICULAR FONT, STYLE, SIZE, OR COLOR.

SN 85-359,855, FILED 6-29-2011.

JENNY PARK, EXAMINING ATTORNEY



David J. Kyffers

Director of the United States Patent and Trademark Office

United States of America

United States Patent and Trademark Office

SHOP BIG. SHOP SMALL. SHOP
FRESH.

Reg. No. 4,207,378

SMART & FINAL STORES LLC (CALIFORNIA LIMITED LIABILITY COMPANY)
600 CITADEL DRIVE
COMMERCE, CA 90040

Registered Sep. 11, 2012

Int. Cl.: 35

FOR: RETAIL GROCERY STORES, IN CLASS 35 (U.S. CLS. 100, 101 AND 102).

SERVICE MARK

FIRST USE 5-2-2012; IN COMMERCE 5-2-2012.

PRINCIPAL REGISTER

THE MARK CONSISTS OF STANDARD CHARACTERS WITHOUT CLAIM TO ANY PARTICULAR FONT, STYLE, SIZE, OR COLOR.

SN 85-360,005, FILED 6-29-2011.

ESTHER A. BORSUK, EXAMINING ATTORNEY



David J. Kybas

Director of the United States Patent and Trademark Office

United States of America

United States Patent and Trademark Office

GASTRONOMIE 491

Reg. No. 4,207,379

AHRONEE, NICOLE (UNITED STATES INDIVIDUAL)
51 WEST 82ND STREET, APT. 5
NEW YORK, NY 10024

Registered Sep. 11, 2012

Int. Cls.: 35 and 43

FOR: RETAIL STORE SERVICES FEATURING PACKAGED AND FRESHLY MADE EDIBLE FOOD PRODUCTS, IN CLASS 35 (U.S. CLS. 100, 101 AND 102).

SERVICE MARK

FIRST USE 3-21-2012; IN COMMERCE 3-21-2012.

PRINCIPAL REGISTER

FOR: RESTAURANT SERVICES, NAMELY, PROVIDING OF FOOD AND BEVERAGES FOR CONSUMPTION ON AND OFF THE PREMISES, IN CLASS 43 (U.S. CLS. 100 AND 101).

FIRST USE 3-21-2012; IN COMMERCE 3-21-2012.

THE MARK CONSISTS OF STANDARD CHARACTERS WITHOUT CLAIM TO ANY PARTICULAR FONT, STYLE, SIZE, OR COLOR.

NO CLAIM IS MADE TO THE EXCLUSIVE RIGHT TO USE "GASTRONOMIE", APART FROM THE MARK AS SHOWN.

THE ENGLISH TRANSLATION OF "GASTRONOMIE" IN THE MARK IS "GASTRONOMY".

SN 85-360,243, FILED 6-30-2011.

MICHAEL WEBSTER, EXAMINING ATTORNEY



David J. Kybas

Director of the United States Patent and Trademark Office

United States of America

United States Patent and Trademark Office



Reg. No. 4,207,380

Registered Sep. 11, 2012

Int. Cl.: 9

TRADEMARK

PRINCIPAL REGISTER

MADMINDS (CALIFORNIA PARTNERSHIP)
13993 TOPEKA CT.
CORONA, CA 92880

FOR: BAGS AND CASES SPECIALLY ADAPTED FOR HOLDING OR CARRYING PORTABLE TELEPHONES AND TELEPHONE EQUIPMENT AND ACCESSORIES; CARRYING CASES FOR ELECTRONIC EQUIPMENT, NAMELY, LAPTOP COOLERS, PHONE OR TABLET COMPUTER CASES AND CONSUMER ELECTRONICS; CARRYING CASES FOR MOBILE COMPUTERS; CASES FOR MUSIC, AUDIO AND RELATED ELECTRONIC EQUIPMENT, NAMELY, CASES FOR AUDIO TUNERS, AUDIO RECEIVERS, AMPLIFIERS, TAPE PLAYERS, COMPACT DISC PLAYERS, MP3 CONTROLLERS/PLAYERS, AUDIO MIXERS, AUDIO SPEAKERS IN THE NATURE OF MUSIC STUDIO MONITORS, MICROPHONES, AUDIO SPEAKERS, COMPACT DISCS, AUDIO TAPES, PORTABLE COMPUTERS, ANTENNAS, PHONOGRAPHIC RECORD PLAYERS, AUDIO RECORDING EQUIPMENT, AND THE CABLES ASSOCIATED WITH ALL OF THE FOREGOING EQUIPMENT; CELL PHONE CASES; COMPUTER CARRYING CASES; COMPUTER PERIPHERALS; CUSHIONED SUPPORT BASE SPECIALLY ADAPTED TO PROP UP LAPTOP COMPUTERS; LAPTOP CARRYING CASES; NOTEBOOK COMPUTER COOLING PADS; PLASTIC MOLDED SUPPORT BASE SPECIALLY ADAPTED TO PROP UP LAPTOP COMPUTERS; PROTECTIVE COVERS AND CASES FOR CELL PHONES, LAPTOPS AND PORTABLE MEDIA PLAYERS; PROTECTIVE SLEEVES FOR LAPTOP COMPUTERS, IN CLASS 9 (U.S. CLS. 21, 23, 26, 36 AND 38).

FIRST USE 8-1-2011; IN COMMERCE 10-18-2011.



THE MARK CONSISTS OF AN ABSTRACT DEPICTION OF A BRAIN COMPRISING OF A SOLID CIRCLE WITH TWO SOLID, ROUNDED WING-LIKE POLYGONS SEMI-ENCIRCLING THE SOLID CIRCLE FROM ABOVE AND SLIGHTLY TO THE RIGHT, WITH THE WORDING "MADMINDS" ADJACENT TO THE RIGHT OF THE BRAIN.

SN 85-360,307, FILED 6-30-2011.

SUSAN LESLIE DUBOIS, EXAMINING ATTORNEY

David J. Kyjars

Director of the United States Patent and Trademark Office

United States of America

United States Patent and Trademark Office

DECISION SCIENCES

Reg. No. 4,207,381

Registered Sep. 11, 2012

Int. Cl.: 9

DECISION SCIENCES INTERNATIONAL CORPORATION (DELAWARE CORPORATION),
DBA DECISION SCIENCES,
SUITE 130
12345 FIRST AMERICAN WAY
POWAY, CA 92064

TRADEMARK

PRINCIPAL REGISTER

FOR: COMPUTER HARDWARE AND SOFTWARE FOR USE IN DETECTING SHIELDED AND UNSHIELDED NUCLEAR AND RADIOLOGICAL MATERIAL AND EXPLOSIVES; RADAR DETECTORS, IN CLASS 9 (U.S. CLS. 21, 23, 26, 36 AND 38).

FIRST USE 6-0-2009; IN COMMERCE 6-0-2009.

THE MARK CONSISTS OF STANDARD CHARACTERS WITHOUT CLAIM TO ANY PARTICULAR FONT, STYLE, SIZE, OR COLOR.

NO CLAIM IS MADE TO THE EXCLUSIVE RIGHT TO USE "SCIENCES", APART FROM THE MARK AS SHOWN.

SN 85-360,505, FILED 6-30-2011.

JOSETTE BEVERLY, EXAMINING ATTORNEY



David J. Kyffers

Director of the United States Patent and Trademark Office

United States of America

United States Patent and Trademark Office



Reg. No. 4,207,382

LYLES, MYKEL (UNITED STATES INDIVIDUAL)
115 WYNDHAM COVE
MURFREESBORO, TN 37129

Registered Sep. 11, 2012

Int. Cl.: 25

FOR: DRESSES; HATS; JERSEYS; PANTS; SHIRTS; SHOES, IN CLASS 25 (U.S. CLS. 22 AND 39).

TRADEMARK

FIRST USE 9-2-2011; IN COMMERCE 4-1-2012.

PRINCIPAL REGISTER

THE MARK CONSISTS OF THE UNDERLINED WORD "MAÜZE" IN A SIGNATURE FORM WITH A DISTINCT "M", AND TWO DOTS OVER THE "U".

SN 85-360,570, FILED 6-30-2011.

NAAKWAMA ANKRAH, EXAMINING ATTORNEY

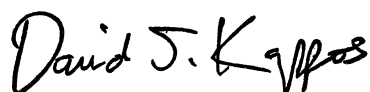

Director of the United States Patent and Trademark Office

United States of America

United States Patent and Trademark Office

bbf (be beautiful forever)

Reg. No. 4,207,383

JEFFREY M. ADELGLASS (UNITED STATES INDIVIDUAL)
2525 N. PEARL #902
DALLAS, TX 75201

Registered Sep. 11, 2012

Int. Cl.: 44

FOR: BEAUTY SPA SERVICES, NAMELY, COSMETIC BODY CARE, IN CLASS 44 (U.S. CLS. 100 AND 101).

SERVICE MARK

FIRST USE 1-25-2012; IN COMMERCE 1-25-2012.

PRINCIPAL REGISTER

THE MARK CONSISTS OF STANDARD CHARACTERS WITHOUT CLAIM TO ANY PARTICULAR FONT, STYLE, SIZE, OR COLOR.

SN 85-360,783, FILED 6-30-2011.

CURTIS FRENCH, EXAMINING ATTORNEY



David J. Kyros

Director of the United States Patent and Trademark Office

United States of America

United States Patent and Trademark Office

L Town

Reg. No. 4,207,384

Registered Sep. 11, 2012

Int. Cl.: 42

SERVICE MARK

PRINCIPAL REGISTER

SCHAB, COREY MORIARTY (DELAWARE LIMITED LIABILITY COMPANY), DBA L
TOWN,
109 MADISON AVE
LEWES, DE 19958

FOR: CUSTOM DESIGN OF APPAREL BASED ON PERSONAL SELECTIONS MADE BY
THE CUSTOMER, IN CLASS 42 (U.S. CLS. 100 AND 101).

FIRST USE 6-1-2006; IN COMMERCE 2-16-2011.

THE MARK CONSISTS OF STANDARD CHARACTERS WITHOUT CLAIM TO ANY PAR-
TICULAR FONT, STYLE, SIZE, OR COLOR.

SN 85-360,888, FILED 6-30-2011.

ODESSA BIBBINS, EXAMINING ATTORNEY



David J. Kyffers

Director of the United States Patent and Trademark Office

United States of America

United States Patent and Trademark Office

GALACINEMA

Reg. No. 4,207,385

UNIVISION COMMUNICATIONS INC. (DELAWARE CORPORATION)
5999 CENTER DRIVE
LOS ANGELES, CA 90045

Registered Sep. 11, 2012

Int. Cl.: 41

FOR: ENTERTAINMENT SERVICES, NAMELY, ONGOING TELEVISION PROGRAM
CONSISTING OF DRAMATIC, ACTION AND COMEDY MOTION PICTURES, IN CLASS 41
(U.S. CLS. 100, 101 AND 107).

SERVICE MARK

FIRST USE 8-20-2011; IN COMMERCE 8-20-2011.

PRINCIPAL REGISTER

THE MARK CONSISTS OF STANDARD CHARACTERS WITHOUT CLAIM TO ANY PAR-
TICULAR FONT, STYLE, SIZE, OR COLOR.

SN 85-360,894, FILED 6-30-2011.

ALLISON SCHRODY, EXAMINING ATTORNEY



David J. Kyffers

Director of the United States Patent and Trademark Office

United States of America

United States Patent and Trademark Office

WEST LOOP

Reg. No. 4,207,386

WALGREEN CO. (ILLINOIS CORPORATION)
200 WILMOT ROAD
DEERFIELD, IL 60015

Registered Sep. 11, 2012

Int. Cl.: 25

FOR: APPAREL, NAMELY, SHIRTS, PANTS, SHORTS, SKIRTS, DRESSES, FOOTWEAR, HEADWEAR, UNDERGARMENTS, AND HOSIERY; SWIMWEAR; SHOES; SANDALS, IN CLASS 25 (U.S. CLS. 22 AND 39).

TRADEMARK

FIRST USE 3-31-2011; IN COMMERCE 3-31-2011.

PRINCIPAL REGISTER

THE MARK CONSISTS OF STANDARD CHARACTERS WITHOUT CLAIM TO ANY PARTICULAR FONT, STYLE, SIZE, OR COLOR.

SN 85-361,137, FILED 6-30-2011.

VERNA BETH RIRIE, EXAMINING ATTORNEY



David J. Kyffers

Director of the United States Patent and Trademark Office

United States of America

United States Patent and Trademark Office

DONGWHA PHARM

Reg. No. 4,207,387

Registered Sep. 11, 2012

Int. Cl.: 30

TRADEMARK

PRINCIPAL REGISTER

DONG WHA PHARM. CO., LTD (REPUBLIC OF KOREA CORPORATION)
5 SOONWHA-DONG, JOONG-GU
SEOUL, REPUBLIC OF KOREA 100-130

FOR: HERBAL FOOD BEVERAGE, IN CLASS 30 (U.S. CL. 46).

FIRST USE 11-1-1981; IN COMMERCE 11-1-1981.

THE MARK CONSISTS OF STANDARD CHARACTERS WITHOUT CLAIM TO ANY PARTICULAR FONT, STYLE, SIZE, OR COLOR.

OWNER OF U.S. REG. NO. 3,005,657.

NO CLAIM IS MADE TO THE EXCLUSIVE RIGHT TO USE "PHARM", APART FROM THE MARK AS SHOWN.

THE WORDING "DONG WHA" HAS NO MEANING IN A FOREIGN LANGUAGE.

SN 85-361,601, FILED 7-1-2011.

LEIGH CAROLINE CASE, EXAMINING ATTORNEY



David J. Kyfos

Director of the United States Patent and Trademark Office

United States of America

United States Patent and Trademark Office

MAIL BLOCK

Reg. No. 4,207,388

SUNCREST CO., LTD (JAPAN KABUSHIKI KAISHA (K.K.))
12-42, MINAMI KAMI-KOSAKA

Registered Sep. 11, 2012

HIGASHI OSAKA, OSAKA, JAPAN 577-0814

Int. Cl.: 9

FOR: DISPLAY PROTECTOR TO PROVIDE SHADE AND PRIVACY FOR ELECTRONIC DEVICES HAVING SCREENS, IN CLASS 9 (U.S. CLS. 21, 23, 26, 36 AND 38).

TRADEMARK

FIRST USE 1-5-2006; IN COMMERCE 10-7-2011.

PRINCIPAL REGISTER

THE MARK CONSISTS OF STANDARD CHARACTERS WITHOUT CLAIM TO ANY PARTICULAR FONT, STYLE, SIZE, OR COLOR.

NO CLAIM IS MADE TO THE EXCLUSIVE RIGHT TO USE "BLOCK", APART FROM THE MARK AS SHOWN.

SN 85-361,678, FILED 7-1-2011.

ELIZABETH KAJUBI, EXAMINING ATTORNEY



David J. Kyros

Director of the United States Patent and Trademark Office

United States of America

United States Patent and Trademark Office

Arayací

Reg. No. 4,207,389

Registered Sep. 11, 2012

Int. Cls.: 14 and 18

TRADEMARK

PRINCIPAL REGISTER

ELEVEM LTD. (FINLAND LIMITED COMPANY (LTD.))
RIIPISENTIE 12
OULU, FINLAND 90540

FOR: JEWELRY, IN CLASS 14 (U.S. CLS. 2, 27, 28 AND 50).

FIRST USE 1-31-2012; IN COMMERCE 1-31-2012.

FOR: HANDBAGS, IN CLASS 18 (U.S. CLS. 1, 2, 3, 22 AND 41).

FIRST USE 1-31-2012; IN COMMERCE 1-31-2012.

THE MARK CONSISTS OF STANDARD CHARACTERS WITHOUT CLAIM TO ANY PARTICULAR FONT, STYLE, SIZE, OR COLOR.

THE WORDING "ARAYACI" HAS NO MEANING IN A FOREIGN LANGUAGE.

SN 85-362,647, FILED 7-4-2011.

MICHELE SWAIN, EXAMINING ATTORNEY



David J. Kybas

Director of the United States Patent and Trademark Office

United States of America

United States Patent and Trademark Office



Reg. No. 4,207,390

Registered Sep. 11, 2012

Int. Cl.: 35

SERVICE MARK

PRINCIPAL REGISTER

COMCAST CORPORATION (PENNSYLVANIA CORPORATION)
1701 JOHN F. KENNEDY BLVD.
PHILADELPHIA, PA 19103

FOR: ADVERTISING AND MARKETING SERVICES, NAMELY, PLACING THE ADVERTISEMENTS AND PROMOTIONAL MATERIALS OF OTHERS ON CABLE TELEVISION SYSTEMS, THE INTERNET, WIRELESS MOBILE DEVICES, INTERACTIVE TELEVISION, VIDEO-ON-DEMAND NETWORKS AND OTHER MULTI-CHANNEL VIDEO PROGRAMMING CONTENT AND INFORMATION DISTRIBUTION PLATFORMS, IN CLASS 35 (U.S. CLS. 100, 101 AND 102).

FIRST USE 7-11-2011; IN COMMERCE 7-11-2011.

THE MARK CONSISTS OF STYLIZED WHITE ROBOTIC CHARACTER, WITH AN OVAL SHAPED HEAD CONTAINING ONE EYE WITH AN IRIS IN GRADIENT SHADES OF THE COLORS BLUE, WHITE, GRAY AND BLACK AND A BLACK PUPIL, A CYLINDRICAL BODY WITH A NARROW STRIP OF BLACK ENCIRCLING ITS BASE, AND TWO MECHANICAL JOINTED ARMS, ALL ABOVE THREE SKY-BLUE OVAL RINGS SUSPENDED VERTICALLY AND IN DESCENDING SIZE. THE COLORS ARE USED TO SHADE THE MARK IN A WAY THAT SUGGESTS A THREE-DIMENSIONAL REPRESENTATION.

THE COLOR(S) BLUE, SKY BLUE, WHITE, GRAY AND BLACK IS/ARE CLAIMED AS A FEATURE OF THE MARK.

SN 85-362,845, FILED 7-5-2011.

SAMUEL E. SHARPER JR., EXAMINING ATTORNEY



David J. Kyffers

Director of the United States Patent and Trademark Office

United States of America

United States Patent and Trademark Office

TURBO-MAX

Reg. No. 4,207,391

GREAT PLAINS MANUFACTURING, INCORPORATED (KANSAS CORPORATION)
1525 E. NORTH STREET
SALINA, KS 674025060

Registered Sep. 11, 2012

Int. Cl.: 7

FOR: AGRICULTURAL MACHINERY, NAMELY, TRACTOR-DRAWN IMPLEMENT IN THE NATURE OF A CULTIVATOR FOR TILLING AND AERATING SOIL, IN CLASS 7 (U.S. CLS. 13, 19, 21, 23, 31, 34 AND 35).

TRADEMARK

FIRST USE 7-15-2011; IN COMMERCE 10-10-2011.

PRINCIPAL REGISTER

THE MARK CONSISTS OF STANDARD CHARACTERS WITHOUT CLAIM TO ANY PARTICULAR FONT, STYLE, SIZE, OR COLOR.

SN 85-362,931, FILED 7-5-2011.

SIMON TENG, EXAMINING ATTORNEY



David J. Kyfos

Director of the United States Patent and Trademark Office

United States of America

United States Patent and Trademark Office

OKAPI

Reg. No. 4,207,392

Registered Sep. 11, 2012

Int. Cl.: 33

TRADEMARK

PRINCIPAL REGISTER

JOHNSON JR., DANIEL (UNITED STATES INDIVIDUAL)
4193 BIG RANCH ROAD
NAPA, CA 94558

FOR: WINE, IN CLASS 33 (U.S. CLS. 47 AND 49).

FIRST USE 12-21-2011; IN COMMERCE 12-21-2011.

THE MARK CONSISTS OF STANDARD CHARACTERS WITHOUT CLAIM TO ANY PARTICULAR FONT, STYLE, SIZE, OR COLOR.

SN 85-363,349, FILED 7-5-2011.

DANNEAN HETZEL, EXAMINING ATTORNEY



David J. Kyffers

Director of the United States Patent and Trademark Office

United States of America

United States Patent and Trademark Office

8 DAYS A WEEK

Reg. No. 4,207,393

Registered Sep. 11, 2012

Int. Cl.: 41

SERVICE MARK

PRINCIPAL REGISTER

BLACK ENTERTAINMENT TELEVISION LLC (D.C. LIMITED LIABILITY COMPANY),
DBA BET,
ONE BET PLAZA, 1235 W STREET, N.E.
BUSINESS & LEGAL AFFAIRS
WASHINGTON, DC 20018

FOR: ENTERTAINMENT SERVICES, NAMELY, PROVIDING ON-GOING WEBISODES
FEATURING DRAMA VIA A GLOBAL COMPUTER NETWORK, IN CLASS 41 (U.S. CLS.
100, 101 AND 107).

FIRST USE 8-3-2011; IN COMMERCE 8-3-2011.

THE MARK CONSISTS OF STANDARD CHARACTERS WITHOUT CLAIM TO ANY PAR-
TICULAR FONT, STYLE, SIZE, OR COLOR.

SN 85-363,719, FILED 7-6-2011.

HANNO RITTNER, EXAMINING ATTORNEY



David J. Kybas

Director of the United States Patent and Trademark Office

United States of America
United States Patent and Trademark Office

PROPlus+

Reg. No. 4,207,394

FERGUSON ENTERPRISES, INC. (VIRGINIA CORPORATION)
12500 JEFFERSON AVE.

Registered Sep. 11, 2012

NEWPORT NEWS, VA 23602

Int. Cl.: 35

FOR: ADMINISTRATION OF A CUSTOMER LOYALTY PROGRAM IN THE FIELD OF PLUMBING, LIGHTING AND HVAC FOR ENABLING CONTRACTORS AND BUILDERS TO OBTAIN DISCOUNTS ON PRODUCTS AND SERVICES, IN CLASS 35 (U.S. CLS. 100, 101 AND 102).

SERVICE MARK

PRINCIPAL REGISTER

FIRST USE 8-15-2011; IN COMMERCE 8-15-2011.

THE MARK CONSISTS OF THE WORDS "PRO PLUS" WITH A PLUS SIGN.

SN 85-363,876, FILED 7-6-2011.

TASNEEM HUSSAIN, EXAMINING ATTORNEY



David J. Kyffers

Director of the United States Patent and Trademark Office

United States of America

United States Patent and Trademark Office

TRADEYA.COM

Reg. No. 4,207,395

Registered Sep. 11, 2012

Int. Cl.: 35

SERVICE MARK

PRINCIPAL REGISTER

TRADEYA LLC (CALIFORNIA LIMITED LIABILITY COMPANY)
1027 1/2 ABBOT KINNEY BLVD
VENICE, CA 90291

FOR: PROVIDING A WEBSITE ALLOWING BUSINESS AND INDIVIDUAL USERS TO BARTER GOODS AND SERVICES; PROVIDING MEMBERSHIP IN AN ONLINE BARTER NETWORK , IN CLASS 35 (U.S. CLS. 100, 101 AND 102).

FIRST USE 1-0-2012; IN COMMERCE 1-0-2012.

THE MARK CONSISTS OF STANDARD CHARACTERS WITHOUT CLAIM TO ANY PARTICULAR FONT, STYLE, SIZE, OR COLOR.

SN 85-364,336, FILED 7-6-2011.

SHANNON TWOHIG, EXAMINING ATTORNEY



David J. Kybas

Director of the United States Patent and Trademark Office

United States of America

United States Patent and Trademark Office

SPIRITUAL VITAMINS

Reg. No. 4,207,396

TRUTHSEEKERS, INC. (FLORIDA CORPORATION)
101 E. COLLEGE AVE.
TALLAHASSEE, FL 32301

Registered Sep. 11, 2012

Int. Cl.: 16

FOR: PAPER SCROLLS WITH INSPIRATIONAL MESSAGES IMPRINTED THEREON, IN CLASS 16 (U.S. CLS. 2, 5, 22, 23, 29, 37, 38 AND 50).

TRADEMARK

FIRST USE 7-24-2011; IN COMMERCE 7-24-2011.

PRINCIPAL REGISTER

THE MARK CONSISTS OF STANDARD CHARACTERS WITHOUT CLAIM TO ANY PARTICULAR FONT, STYLE, SIZE, OR COLOR.

SN 85-364,357, FILED 7-6-2011.

WILLIAM VERHOSEK, EXAMINING ATTORNEY



David J. Kyffers

Director of the United States Patent and Trademark Office

United States of America
United States Patent and Trademark Office

JAMBAGO

Reg. No. 4,207,397

JAMBA JUICE COMPANY (CALIFORNIA CORPORATION)
6475 CHRISTIE AVENUE, SUITE 150
EMERYVILLE, CA 94608

Registered Sep. 11, 2012

Int. Cl.: 35

FOR: VENDING IN THE FIELD OF SNACK FOOD AND BEVERAGES, IN CLASS 35 (U.S. CLS. 100, 101 AND 102).

SERVICE MARK

FIRST USE 4-8-2011; IN COMMERCE 4-8-2011.

PRINCIPAL REGISTER

THE MARK CONSISTS OF STANDARD CHARACTERS WITHOUT CLAIM TO ANY PARTICULAR FONT, STYLE, SIZE, OR COLOR.

SN 85-364,536, FILED 7-6-2011.

ODESSA BIBBINS, EXAMINING ATTORNEY



David J. Kyffers

Director of the United States Patent and Trademark Office

United States of America

United States Patent and Trademark Office

Jamba go

Reg. No. 4,207,398

JAMBA JUICE COMPANY (CALIFORNIA CORPORATION)
S6475 CHRISTIE AVENUE, SUITE 150
EMERYVILLE, CA 94608

Registered Sep. 11, 2012

Int. Cl.: 35

FOR: VENDING IN THE FIELD OF SNACK FOOD AND BEVERAGES, IN CLASS 35 (U.S. CLS. 100, 101 AND 102).

SERVICE MARK

FIRST USE 4-8-2011; IN COMMERCE 4-8-2011.

PRINCIPAL REGISTER

OWNER OF U.S. REG. NOS. 2,526,399, 3,367,108, AND OTHERS.

THE MARK CONSISTS OF THE SHADED WORD, "JAMBA" IN A STYLIZED FONT, TO THE LEFT OF THE UNSHADED WORD "GO" INSIDE A SHADED OVAL.

SN 85-364,541, FILED 7-6-2011.

ODESSA BIBBINS, EXAMINING ATTORNEY



David J. Kyffers

Director of the United States Patent and Trademark Office

United States of America

United States Patent and Trademark Office

SCARAH SCREAMS

Reg. No. 4,207,399

Registered Sep. 11, 2012

Int. Cl.: 28

TRADEMARK

PRINCIPAL REGISTER

MATTEL, INC. (DELAWARE CORPORATION)
M1-1518
333 CONTINENTAL BOULEVARD
EL SEGUNDO, CA 90245

FOR: DOLLS, DOLL CLOTHING AND DOLL ACCESSORIES, IN CLASS 28 (U.S. CLS. 22, 23, 38 AND 50).

FIRST USE 5-30-2012; IN COMMERCE 5-30-2012.

THE MARK CONSISTS OF STANDARD CHARACTERS WITHOUT CLAIM TO ANY PARTICULAR FONT, STYLE, SIZE, OR COLOR.

SN 85-365,620, FILED 7-7-2011.

STEPHANIE ALI, EXAMINING ATTORNEY



David J. Kybas

Director of the United States Patent and Trademark Office

United States of America

United States Patent and Trademark Office

ADVENTURE CRUISIN'

Reg. No. 4,207,400

Registered Sep. 11, 2012

Int. Cl.: 28

TRADEMARK

PRINCIPAL REGISTER

MATTEL, INC. (DELAWARE CORPORATION)
M1-1518
333 CONTINENTAL BOULEVARD
EL SEGUNDO, CA 90245

FOR: TOY VEHICLES AND ACCESSORIES THEREFOR; DOLLS, DOLL CLOTHING AND DOLL ACCESSORIES, IN CLASS 28 (U.S. CLS. 22, 23, 38 AND 50).

FIRST USE 11-21-2011; IN COMMERCE 11-21-2011.

THE MARK CONSISTS OF STANDARD CHARACTERS WITHOUT CLAIM TO ANY PARTICULAR FONT, STYLE, SIZE, OR COLOR.

SN 85-365,625, FILED 7-7-2011.

STEPHANIE ALI, EXAMINING ATTORNEY



David J. Kybas

Director of the United States Patent and Trademark Office

United States of America

United States Patent and Trademark Office

DUMPIN' A

Reg. No. 4,207,401

Registered Sep. 11, 2012

Int. Cl.: 28

TRADEMARK

PRINCIPAL REGISTER

MATTEL, INC. (DELAWARE CORPORATION)
M1-1518
333 CONTINENTAL BOULEVARD
EL SEGUNDO, CA 90245

FOR: TOY VEHICLES AND ACCESSORIES THEREFOR, IN CLASS 28 (U.S. CLS. 22, 23, 38 AND 50).

FIRST USE 6-6-2012; IN COMMERCE 6-6-2012.

THE MARK CONSISTS OF STANDARD CHARACTERS WITHOUT CLAIM TO ANY PARTICULAR FONT, STYLE, SIZE, OR COLOR.

SN 85-365,642, FILED 7-7-2011.

STEPHANIE ALI, EXAMINING ATTORNEY



David J. Kyffers

Director of the United States Patent and Trademark Office

United States of America

United States Patent and Trademark Office

HOME ELEMENTS

Reg. No. 4,207,402

Registered Sep. 11, 2012

Int. Cl.: 16

TRADEMARK

PRINCIPAL REGISTER

WALGREEN CO. (ILLINOIS CORPORATION)
200 WILMOT ROAD
DEERFIELD, IL 60015

FOR: PHOTO ALBUMS, IN CLASS 16 (U.S. CLS. 2, 5, 22, 23, 29, 37, 38 AND 50).

FIRST USE 3-3-2006; IN COMMERCE 3-3-2006.

THE MARK CONSISTS OF STANDARD CHARACTERS WITHOUT CLAIM TO ANY PARTICULAR FONT, STYLE, SIZE, OR COLOR.

OWNER OF U.S. REG. NOS. 3,602,447, 3,673,345, AND 3,920,560.

NO CLAIM IS MADE TO THE EXCLUSIVE RIGHT TO USE "HOME", APART FROM THE MARK AS SHOWN.

SN 85-365,847, FILED 7-7-2011.

VERNA BETH RIRIE, EXAMINING ATTORNEY



David J. Kyffers

Director of the United States Patent and Trademark Office

United States of America

United States Patent and Trademark Office

RECIPE FOR PRESS

Reg. No. 4,207,403

FLURRY, AMY (UNITED STATES INDIVIDUAL)
237 BARBER STREET
ATHENS, GA 30601

Registered Sep. 11, 2012

Int. Cls.: 35 and 41

FOR: CONSULTING SERVICES IN THE FIELDS OF MARKETING AND PROMOTION;
PROVIDING ONLINE WEBSITES IN THE FIELD OF MARKETING AND PROMOTION, IN
CLASS 35 (U.S. CLS. 100, 101 AND 102).

SERVICE MARK

FIRST USE 1-31-2012; IN COMMERCE 1-31-2012.

PRINCIPAL REGISTER

FOR: EDUCATIONAL SERVICES, NAMELY, PROVIDING SEMINARS, PRESENTATIONS,
SPEECHES, AND WORKSHOPS IN THE FIELDS OF MARKETING AND PROMOTION;
PROVIDING ONLINE BLOGS IN THE FIELD OF MARKETING AND PROMOTION, IN
CLASS 41 (U.S. CLS. 100, 101 AND 107).

FIRST USE 1-31-2012; IN COMMERCE 1-31-2012.

THE MARK CONSISTS OF STANDARD CHARACTERS WITHOUT CLAIM TO ANY PAR-
TICULAR FONT, STYLE, SIZE, OR COLOR.

SN 85-366,274, FILED 7-8-2011.

KEVIN DINALLO, EXAMINING ATTORNEY



David J. Kyros

Director of the United States Patent and Trademark Office

United States of America

United States Patent and Trademark Office

Skunk'd-911

Reg. No. 4,207,404

ARCANATURA LLC (CONNECTICUT LIMITED LIABILITY COMPANY)
37 SKYLINE DRIVE
GROTON, CT 06340

Registered Sep. 11, 2012

Int. Cl.: 5

FOR: VETERINARY PREPARATIONS FOR THE ELIMINATION OF SKUNK ODORS, IN CLASS 5 (U.S. CLS. 6, 18, 44, 46, 51 AND 52).

TRADEMARK

FIRST USE 11-15-2011; IN COMMERCE 11-15-2011.

PRINCIPAL REGISTER

THE MARK CONSISTS OF STANDARD CHARACTERS WITHOUT CLAIM TO ANY PARTICULAR FONT, STYLE, SIZE, OR COLOR.

SN 85-366,276, FILED 7-8-2011.

JOHN GARTNER, EXAMINING ATTORNEY



David J. Kybas

Director of the United States Patent and Trademark Office

United States of America

United States Patent and Trademark Office



Reg. No. 4,207,405

Registered Sep. 11, 2012

Int. Cls.: 41 and 45

SERVICE MARK

PRINCIPAL REGISTER

GRACEWAY (MISSOURI CORPORATION)
5460 BLUE RIDGE CUTOFF
RAYTOWN, MO 64133

FOR: EDUCATION SERVICES, NAMELY, PROVIDING CHILDREN'S AND ADULT CLASSES IN THE FIELD OF BIBLICAL, RELIGIOUS AND MINISTERIAL EDUCATION, IN CLASS 41 (U.S. CLS. 100, 101 AND 107).

FIRST USE 8-14-2011; IN COMMERCE 8-14-2011.

FOR: RELIGIOUS AND SPIRITUAL SERVICES, NAMELY, CONDUCTING RELIGIOUS WORSHIP, MARRIAGE CEREMONIES, BAPTISMAL CEREMONIES, BABY DEDICATIONS, BEREAVEMENT CEREMONIES, AND RELIGIOUS COUNSELING, IN CLASS 45 (U.S. CLS. 100 AND 101).

FIRST USE 8-14-2011; IN COMMERCE 8-14-2011.

THE MARK CONSISTS OF A STYLIZED UPPER-CASE LETTER "G" WITH THE LOWER RIGHT PART OF THE LETTER CONSISTING OF AN ARROW POINTING UP, OVER THE WORD GRACEWAY IN ALL LOWER-CASE LETTERS.

SN 85-366,319, FILED 7-8-2011.

CHRISTINA SOBRAL, EXAMINING ATTORNEY



David J. Kybas

Director of the United States Patent and Trademark Office

United States of America

United States Patent and Trademark Office

YOU BY CONAIR

Reg. No. 4,207,406

CONAIR CORPORATION (DELAWARE CORPORATION)
ONE CUMMINGS POINT ROAD
STAMFORD, CT 06902

Registered Sep. 11, 2012

Int. Cl.: 11

FOR: HAND-HELD ELECTRIC HAIR DRYERS, IN CLASS 11 (U.S. CLS. 13, 21, 23, 31 AND 34).

TRADEMARK

FIRST USE 9-30-2011; IN COMMERCE 9-30-2011.

PRINCIPAL REGISTER

THE MARK CONSISTS OF STANDARD CHARACTERS WITHOUT CLAIM TO ANY PARTICULAR FONT, STYLE, SIZE, OR COLOR.

OWNER OF U.S. REG. NOS. 994,007 AND 3,976,844.

SN 85-366,356, FILED 7-8-2011.

LINDA ORNDORFF, EXAMINING ATTORNEY



David J. Kyffers

Director of the United States Patent and Trademark Office

United States of America

United States Patent and Trademark Office



Reg. No. 4,207,407

Registered Sep. 11, 2012

Int. Cls.: 41 and 45

SERVICE MARK

PRINCIPAL REGISTER

GRACEWAY (MISSOURI CORPORATION)
5460 BLUE RIDGE CUTOFF
RAYTOWN, MO 64133

FOR: EDUCATION SERVICES, NAMELY, PROVIDING CHILDREN'S AND ADULT CLASSES IN THE FIELD OF BIBLICAL, RELIGIOUS AND MINISTERIAL EDUCATION, IN CLASS 41 (U.S. CLS. 100, 101 AND 107).

FIRST USE 8-14-2011; IN COMMERCE 8-14-2011.

FOR: RELIGIOUS AND SPIRITUAL SERVICES, NAMELY, CONDUCTING RELIGIOUS WORSHIP, MARRIAGE CEREMONIES, BAPTISMAL CEREMONIES, BABY DEDICATIONS, BEREAVEMENT CEREMONIES, AND RELIGIOUS COUNSELING, IN CLASS 45 (U.S. CLS. 100 AND 101).

FIRST USE 8-14-2011; IN COMMERCE 8-14-2011.

THE MARK CONSISTS OF A STYLIZED UPPER-CASE LETTER "G" WITH THE LOWER RIGHT PART OF THE LETTER CONSISTING OF AN ARROW POINTING UP.

SN 85-366,453, FILED 7-8-2011.

CHRISTINA SOBRAL, EXAMINING ATTORNEY



David J. Kybas

Director of the United States Patent and Trademark Office

United States of America

United States Patent and Trademark Office

KLONDIKE

Reg. No. 4,207,408

Registered Sep. 11, 2012

Int. Cl.: 6

TRADEMARK

PRINCIPAL REGISTER

ASC PROFILES, INC. (DELAWARE CORPORATION)
2110 ENTERPRISE BOULEVARD
WEST SACRAMENTO, CA 95691

FOR: METAL SIDING, IN CLASS 6 (U.S. CLS. 2, 12, 13, 14, 23, 25 AND 50).

FIRST USE 10-9-2011; IN COMMERCE 10-9-2011.

THE MARK CONSISTS OF STANDARD CHARACTERS WITHOUT CLAIM TO ANY PARTICULAR FONT, STYLE, SIZE, OR COLOR.

SN 85-366,608, FILED 7-8-2011.

REBECCA POVARCHUK, EXAMINING ATTORNEY



David J. Kyffers

Director of the United States Patent and Trademark Office

United States of America

United States Patent and Trademark Office

IGNITOR

Reg. No. 4,207,409

Registered Sep. 11, 2012

Int. Cls.: 35 and 42

SERVICE MARK

PRINCIPAL REGISTER

THE COCA-COLA COMPANY (DELAWARE CORPORATION)
ONE COCA-COLA COMPANY
ALTANTA, GA 30313

FOR: BUSINESS MANAGEMENT CONSULTING WITH RELATION TO STRATEGY, MARKETING, SALES, OPERATION, PRODUCT DESIGN PARTICULARLY SPECIALIZING IN THE USE OF VARIOUS MODELS FOR THE UNDERSTANDING AND PREDICTING OF CONSUMERS, BUSINESSES, AND MARKET TRENDS AND ACTIONS, IN CLASS 35 (U.S. CLS. 100, 101 AND 102).

FIRST USE 1-31-2007; IN COMMERCE 1-31-2007.

FOR: RESEARCH AND DESIGN SERVICES RELATING TO INDUSTRIAL ANALYSIS AND RESEARCH SERVICES, IN CLASS 42 (U.S. CLS. 100 AND 101).

FIRST USE 1-31-2007; IN COMMERCE 1-31-2007.

THE MARK CONSISTS OF STANDARD CHARACTERS WITHOUT CLAIM TO ANY PARTICULAR FONT, STYLE, SIZE, OR COLOR.

SN 85-366,851, FILED 7-8-2011.

GEOFFREY FOSDICK, EXAMINING ATTORNEY



David J. Kyfos

Director of the United States Patent and Trademark Office

United States of America
United States Patent and Trademark Office

thefairgoer

Reg. No. 4,207,410

FAIRGOER LLC (NEW YORK LIMITED LIABILITY COMPANY)
260 MOTT ST. #7

Registered Sep. 11, 2012

NEW YORK CITY, NY 10012

Int. Cl.: 42

FOR: PROVIDING A WEB SITE FEATURING TECHNOLOGY THAT ENABLES EXHIBITORS PARTICIPATING TO ART FAIRS TO SHARE IMAGES AND VIDEOS OF THEIR PRODUCTS, IN CLASS 42 (U.S. CLS. 100 AND 101).

SERVICE MARK

FIRST USE 3-30-2011; IN COMMERCE 10-10-2011.

PRINCIPAL REGISTER

THE MARK CONSISTS OF STANDARD CHARACTERS WITHOUT CLAIM TO ANY PARTICULAR FONT, STYLE, SIZE, OR COLOR.

SN 85-367,183, FILED 7-9-2011.

KATHRYN COWARD, EXAMINING ATTORNEY



David J. Kyros

Director of the United States Patent and Trademark Office

United States of America

United States Patent and Trademark Office

Bad Ass Customs

Reg. No. 4,207,411

JOHNSON, ARRON (UNITED STATES INDIVIDUAL)

Registered Sep. 11, 2012

19055 ORANGE AVE
SONOMA, CA 95476

Int. Cl.: 37

FOR: CUSTOM BUILDING OF AUTOMOBILES, IN CLASS 37 (U.S. CLS. 100, 103 AND 106).

SERVICE MARK

FIRST USE 7-1-2010; IN COMMERCE 10-9-2010.

PRINCIPAL REGISTER

THE MARK CONSISTS OF STANDARD CHARACTERS WITHOUT CLAIM TO ANY PARTICULAR FONT, STYLE, SIZE, OR COLOR.

NO CLAIM IS MADE TO THE EXCLUSIVE RIGHT TO USE "CUSTOMS", APART FROM THE MARK AS SHOWN.

SN 85-367,409, FILED 7-10-2011.

SALLY SHIH, EXAMINING ATTORNEY



David J. Kyffers

Director of the United States Patent and Trademark Office

United States of America

United States Patent and Trademark Office



Reg. No. 4,207,412

Registered Sep. 11, 2012

Int. Cl.: 35

SERVICE MARK

PRINCIPAL REGISTER

NOQOUSH FOR SOFTWARE AND TECHNOLOGICAL SERVICES (JORDAN CORPORATION)
OFFICE NO. 7, 1ST FL, ALHUSSEINI BLDG
50 ABDULLAH GOSHEH MAIN ST., AMMAN
P.O. BOX 142220, JORDAN

FOR: ADVERTISING SERVICES; BUSINESS MANAGEMENT, IN CLASS 35 (U.S. CLS. 100, 101 AND 102).

FIRST USE 10-6-2011; IN COMMERCE 11-16-2011.

THE MARK CONSISTS OF THE STYLIZED WORD "ADFALCON" WITH WHAT APPEARS TO BE FALCON-LIKE DESIGN ABOVE.

SN 85-368,062, FILED 7-11-2011.

MICHELE SWAIN, EXAMINING ATTORNEY



David J. Kyffers

Director of the United States Patent and Trademark Office

United States of America
United States Patent and Trademark Office

Amigo

Reg. No. 4,207,413

Registered Sep. 11, 2012

Int. Cl.: 10

TRADEMARK

PRINCIPAL REGISTER

CATHETER ROBOTICS, INC. (NEW JERSEY CORPORATION)
SUITE 255
500 INTERNATIONAL DRIVE
BUDD LAKE, NJ 07828

FOR: MEDICAL DEVICE NOT FOR USE WITH INSULIN PUMPS, NAMELY, A TELE-ROBOTIC SYSTEM CONSISTING OF A MOTORIZED CATHETER POSITIONER HAVING ROTATIONAL AND TRANSLATIONAL MOVEMENT CAPABILITY AND A TELE-ROBOTIC CONTROLLER WITH ROTATION, TRANSLATION AND DEFLECTION CONTROL BUTTONS, TO FACILITATE REMOTE CATHETERIZATIONS, IN CLASS 10 (U.S. CLS. 26, 39 AND 44).

FIRST USE 6-18-2012; IN COMMERCE 6-18-2012.

THE MARK CONSISTS OF THE STYLIZED TEXT "AMIGO".

SN 85-368,440, FILED 7-11-2011.

LEIGH CAROLINE CASE, EXAMINING ATTORNEY



David J. Kyros

Director of the United States Patent and Trademark Office

United States of America

United States Patent and Trademark Office

NEVER COAST

Reg. No. 4,207,414

FLYWHEEL SPORTS, INC. (DELAWARE CORPORATION)
PO BOX 1816

Registered Sep. 11, 2012

NEW YORK, NY 10113

Int. Cl.: 41

FOR: PROVIDING FITNESS AND EXERCISE STUDIO SERVICES, NAMELY, INDOOR CYCLING INSTRUCTION, PERSONAL TRAINING AND PHYSICAL FITNESS CLASSES; COUNSELING SERVICES IN THE FIELD OF EXERCISE, IN CLASS 41 (U.S. CLS. 100, 101 AND 107).

SERVICE MARK

PRINCIPAL REGISTER

FIRST USE 6-0-2011; IN COMMERCE 6-0-2011.

THE MARK CONSISTS OF STANDARD CHARACTERS WITHOUT CLAIM TO ANY PARTICULAR FONT, STYLE, SIZE, OR COLOR.

SN 85-368,554, FILED 7-11-2011.

TINA L. SNAPP, EXAMINING ATTORNEY



David J. Kyffers

Director of the United States Patent and Trademark Office

United States of America

United States Patent and Trademark Office

NEVER COAST

Reg. No. 4,207,415

FLYWHEEL SPORTS, INC. (DELAWARE CORPORATION)
PO BOX 1816
NEW YORK, NY 10113

Registered Sep. 11, 2012

Int. Cl.: 35

FOR: RETAIL STORE SERVICES FEATURING FITNESS APPAREL, IN CLASS 35 (U.S. CLS. 100, 101 AND 102).

SERVICE MARK

FIRST USE 6-0-2011; IN COMMERCE 6-0-2011.

PRINCIPAL REGISTER

THE MARK CONSISTS OF STANDARD CHARACTERS WITHOUT CLAIM TO ANY PARTICULAR FONT, STYLE, SIZE, OR COLOR.

SN 85-368,555, FILED 7-11-2011.

TINA L. SNAPP, EXAMINING ATTORNEY



David J. Kybas

Director of the United States Patent and Trademark Office

United States of America

United States Patent and Trademark Office

NEVER COAST

Reg. No. 4,207,416

FLYWHEEL SPORTS, INC. (DELAWARE CORPORATION)
PO BOX 1816
NEW YORK, NY 10113

Registered Sep. 11, 2012

Int. Cl.: 25

FOR: FITNESS APPAREL, NAMELY, SHIRTS, PANTS, SHORTS, HATS, JACKETS, FOOTWEAR, IN CLASS 25 (U.S. CLS. 22 AND 39).

TRADEMARK

FIRST USE 6-0-2011; IN COMMERCE 6-0-2011.

PRINCIPAL REGISTER

THE MARK CONSISTS OF STANDARD CHARACTERS WITHOUT CLAIM TO ANY PARTICULAR FONT, STYLE, SIZE, OR COLOR.

SN 85-368,557, FILED 7-11-2011.

TINA L. SNAPP, EXAMINING ATTORNEY



David J. Kybas

Director of the United States Patent and Trademark Office

United States of America

United States Patent and Trademark Office

ONE SMOOTH U

Reg. No. 4,207,417

Registered Sep. 11, 2012

Int. Cl.: 25

TRADEMARK

PRINCIPAL REGISTER

HBI BRANDED APPAREL ENTERPRISES, LLC (DELAWARE LIMITED LIABILITY COMPANY)
1000 EAST HANES MILL ROAD
WINSTON-SALEM, NC 27105

FOR: PANTIES; SHAPEWEAR, NAMELY, BRIEFS, THIGH SHAPERS, WAIST SHAPERS, CAMISOLES, SLIPS, BODY SUITS, TORSO SHAPERS, TANK TOPS, IN CLASS 25 (U.S. CLS. 22 AND 39).

FIRST USE 9-15-2011; IN COMMERCE 9-15-2011.

THE MARK CONSISTS OF STANDARD CHARACTERS WITHOUT CLAIM TO ANY PARTICULAR FONT, STYLE, SIZE, OR COLOR.

OWNER OF U.S. REG. NO. 3,941,937.

SN 85-368,696, FILED 7-12-2011.

SUSAN LESLIE DUBOIS, EXAMINING ATTORNEY



David J. Kybas

Director of the United States Patent and Trademark Office

United States of America

United States Patent and Trademark Office

Drumming up Business

Reg. No. 4,207,418

DRUMMING UP BUSINESS, LLC. (FLORIDA LIMITED LIABILITY COMPANY)
875 MILES AVE

Registered Sep. 11, 2012

WINTER PARK, FL 32789

Int. Cl.: 35

SERVICE MARK

PRINCIPAL REGISTER

FOR: ACQUISITION AND MERGER CONSULTATION; ADVERTISING AND BUSINESS MANAGEMENT CONSULTANCY; ADVERTISING AND MARKETING CONSULTANCY; ADVERTISING AND PROMOTION SERVICES AND RELATED CONSULTING; ADVERTISING CONSULTATION; ASSISTANCE, ADVISORY SERVICES AND CONSULTANCY WITH REGARD TO BUSINESS PLANNING, BUSINESS ANALYSIS, BUSINESS MANAGEMENT, AND BUSINESS ORGANIZATION; ASSISTANCE, ADVISORY SERVICES AND CONSULTANCY WITH REGARD TO BUSINESS PLANNING, BUSINESS ANALYSIS, BUSINESS MANAGEMENT, BUSINESS ORGANIZATION, MARKETING AND CUSTOMER ANALYSIS; BRAND IMAGERY CONSULTING SERVICES; BRANDING SERVICES, NAMELY, CONSULTING, DEVELOPMENT, MANAGEMENT AND MARKETING OF BRANDS FOR BUSINESSES; BUSINESS ACQUISITION AND MERGER CONSULTATION; BUSINESS ACQUISITIONS CONSULTATION; BUSINESS ADMINISTRATION CONSULTANCY; BUSINESS ADVISORY AND CONSULTANCY SERVICES RELATING TO EXPORT, EXPORT SERVICES, EXPORT PROMOTION INFORMATION AND SERVICES; BUSINESS ADVISORY SERVICES, CONSULTANCY AND INFORMATION; BUSINESS APPRAISAL CONSULTATION, IN CLASS 35 (U.S. CLS. 100, 101 AND 102).

FIRST USE 12-10-2011; IN COMMERCE 12-10-2011.

THE MARK CONSISTS OF STANDARD CHARACTERS WITHOUT CLAIM TO ANY PARTICULAR FONT, STYLE, SIZE, OR COLOR.

SN 85-368,798, FILED 7-12-2011.

KATHLEEN KOLACZ, EXAMINING ATTORNEY



David J. Kyjars

Director of the United States Patent and Trademark Office

United States of America

United States Patent and Trademark Office

The Little Host

Reg. No. 4,207,419

Registered Sep. 11, 2012

Int. Cl.: 16

TRADEMARK

PRINCIPAL REGISTER

RATNER, TAMMY (UNITED STATES INDIVIDUAL)
7545 IRVINE CENTER DRIVE, SUITE 200
IRVINE, CA 92618

FOR: BANNERS OF PAPER; ADVERTISING SIGNS OF PAPER OR CARDBOARD; PRINTED PAPER SIGNS, NAMELY, TABLE TENTS; PAPER STATIONERY; STICKERS; ADHESIVE LABELS, PAPER LABELS; PAPER HANG TAGS; PAPER GIFT BAGS; PAPER TOTE BAGS; PAPER CAKE DECORATIONS; PAPER PARTY BAGS; PAPER PARTY FAVORS; PARTY GOODIE BAGS OF PAPER OR PLASTIC; CARDBOARD BOXES; CARDBOARD CAKE BOXES; PAPER PARTY DECORATION; PAPER NAPKINS, IN CLASS 16 (U.S. CLS. 2, 5, 22, 23, 29, 37, 38 AND 50).

FIRST USE 2-23-2012; IN COMMERCE 2-23-2012.

THE MARK CONSISTS OF STANDARD CHARACTERS WITHOUT CLAIM TO ANY PARTICULAR FONT, STYLE, SIZE, OR COLOR.

SN 85-368,972, FILED 7-12-2011.

DOMINIC FATHY, EXAMINING ATTORNEY



David J. Kyros

Director of the United States Patent and Trademark Office

United States of America

United States Patent and Trademark Office

CHANKASKA WINES

Reg. No. 4,207,420

Registered Sep. 11, 2012

Int. Cl.: 33

TRADEMARK

PRINCIPAL REGISTER

CHANKASKA CREEK RANCH & WINERY, LLC (MINNESOTA LIMITED LIABILITY COMPANY)
221 MINNESOTA STREET
MANKATO, MN 56001

FOR: WINE, IN CLASS 33 (U.S. CLS. 47 AND 49).

FIRST USE 5-19-2012; IN COMMERCE 5-19-2012.

THE MARK CONSISTS OF STANDARD CHARACTERS WITHOUT CLAIM TO ANY PARTICULAR FONT, STYLE, SIZE, OR COLOR.

NO CLAIM IS MADE TO THE EXCLUSIVE RIGHT TO USE "WINES", APART FROM THE MARK AS SHOWN.

SN 85-369,251, FILED 7-12-2011.

ANDREW LEASER, EXAMINING ATTORNEY



David J. Kyffers

Director of the United States Patent and Trademark Office

United States of America

United States Patent and Trademark Office

EASTLAND

Reg. No. 4,207,421

LIST COMPANY, INC. (SOUTH CAROLINA CORPORATION)
106 PROSPERITY BLVD.
PIEDMONT, SC 29673

Registered Sep. 11, 2012

Int. Cl.: 21

FOR: BEVERAGE GLASSWARE, CANDLESTICKS OF GLASS, CONTAINERS FOR HOUSEHOLD OR KITCHEN USE, GLASS BOWLS, GLASS DISHES, GLASS JARS, WORKS OF ART MADE OF GLASS, DECORATIVE WORKS MADE OF GLASS, VASES, IN CLASS 21 (U.S. CLS. 2, 13, 23, 29, 30, 33, 40 AND 50).

TRADEMARK

PRINCIPAL REGISTER

FIRST USE 5-0-2012; IN COMMERCE 5-0-2012.

THE MARK CONSISTS OF STANDARD CHARACTERS WITHOUT CLAIM TO ANY PARTICULAR FONT, STYLE, SIZE, OR COLOR.

SN 85-369,273, FILED 7-12-2011.

ANDREW LEASER, EXAMINING ATTORNEY



David J. Kyffers

Director of the United States Patent and Trademark Office

United States of America

United States Patent and Trademark Office

TRAP & LOCK

Reg. No. 4,207,422

Registered Sep. 11, 2012

Int. Cl.: 16

TRADEMARK

PRINCIPAL REGISTER

THE PROCTER & GAMBLE COMPANY (OHIO CORPORATION)
ONE PROCTER & GAMBLE PLAZA
CINCINNATI, OH 45202

FOR: PAPER TOWELS, IN CLASS 16 (U.S. CLS. 2, 5, 22, 23, 29, 37, 38 AND 50).

FIRST USE 3-31-2012; IN COMMERCE 3-31-2012.

THE MARK CONSISTS OF STANDARD CHARACTERS WITHOUT CLAIM TO ANY PARTICULAR FONT, STYLE, SIZE, OR COLOR.

SN 85-369,322, FILED 7-12-2011.

ALYSSA STEEL, EXAMINING ATTORNEY



David J. Kybas

Director of the United States Patent and Trademark Office

United States of America

United States Patent and Trademark Office

SLABTIGHT

Reg. No. 4,207,423

RICHARDS, SCOTT (UNITED STATES INDIVIDUAL)
224-24 UNION TURNPIKE
BAYSIDE, NY 11364

Registered Sep. 11, 2012

Int. Cl.: 2

FOR: WATER-BASED NATURAL DEEP PENETRATING PRIMERS AND SEALER COATINGS FOR USE ON CONCRETE AND STONE, TO REACT WITH THE SUBSTRATES TO EFFECTIVELY STOP VAPOR AND METHANE EMISSIONS FROM PENETRATING CONCRETE SLABS AND OTHER SURFACES UNDER THE HARSHTEST CONDITIONS, IN CLASS 2 (U.S. CLS. 6, 11 AND 16).

TRADEMARK

PRINCIPAL REGISTER

FIRST USE 6-27-2012; IN COMMERCE 6-27-2012.

THE MARK CONSISTS OF STANDARD CHARACTERS WITHOUT CLAIM TO ANY PARTICULAR FONT, STYLE, SIZE, OR COLOR.

SN 85-369,945, FILED 7-13-2011.

TEJBIR SINGH, EXAMINING ATTORNEY



David J. Kybas

Director of the United States Patent and Trademark Office

United States of America

United States Patent and Trademark Office

enhanced+

Reg. No. 4,207,424

SOUTHERN BEVERAGE PACKERS, INC. (GEORGIA CORPORATION)
P.O. BOX 560
APPLING, GA 30802

Registered Sep. 11, 2012

Int. Cl.: 32

FOR: NON-ALCOHOLIC, FLAVORED DRINKING WATER, IN CLASS 32 (U.S. CLS. 45, 46 AND 48).

TRADEMARK

FIRST USE 11-17-2011; IN COMMERCE 11-17-2011.

PRINCIPAL REGISTER

NO CLAIM IS MADE TO THE EXCLUSIVE RIGHT TO USE "ENHANCED", APART FROM THE MARK AS SHOWN.

THE MARK CONSISTS OF THE WORD "ENHANCED" IN STYLIZED LETTERING SURROUNDED BY A BORDER FOLLOWED BY A PLUS SIGN WITHIN A CIRCLE.

SN 85-370,123, FILED 7-13-2011.

DAVID H. STINE, EXAMINING ATTORNEY



David J. Kyffers

Director of the United States Patent and Trademark Office

United States of America

United States Patent and Trademark Office

MAKE IT HAPPEN

Reg. No. 4,207,425

FERRANTE, RALPH M. (UNITED STATES INDIVIDUAL)
1031 ROUTE 9W

Registered Sep. 11, 2012

UPPER GRANDVIEW, NY 10960

Int. Cl.: 5

FOR: DIETARY SUPPLEMENTS, NUTRITION SUPPLEMENTS AND VITAMIN SUPPLEMENTS, IN CLASS 5 (U.S. CLS. 6, 18, 44, 46, 51 AND 52).

TRADEMARK

FIRST USE 3-31-2012; IN COMMERCE 3-31-2012.

PRINCIPAL REGISTER

THE MARK CONSISTS OF STANDARD CHARACTERS WITHOUT CLAIM TO ANY PARTICULAR FONT, STYLE, SIZE, OR COLOR.

SN 85-370,245, FILED 7-13-2011.

KARANENDRA S. CHHINA, EXAMINING ATTORNEY



David J. Kybas

Director of the United States Patent and Trademark Office

United States of America

United States Patent and Trademark Office

PIRATTITUDE

Reg. No. 4,207,426

Registered Sep. 11, 2012

Int. Cl.: 25

TRADEMARK

PRINCIPAL REGISTER

TIERNEY, SHANNON (UNITED STATES INDIVIDUAL)
302 PEAR TREE LANE
PIKEVILLE, NC 27863

FOR: CLOTHING; NAMELY, T-SHIRTS, HATS, SWEATSHIRTS, HOODED SWEATSHIRTS, TANK-TOPS, LONG SLEEVE SHIRTS, PANTS, SHORTS, IN CLASS 25 (U.S. CLS. 22 AND 39).

FIRST USE 8-15-2011; IN COMMERCE 8-15-2011.

THE MARK CONSISTS OF STANDARD CHARACTERS WITHOUT CLAIM TO ANY PARTICULAR FONT, STYLE, SIZE, OR COLOR.

SN 85-370,773, FILED 7-13-2011.

JOHN GARTNER, EXAMINING ATTORNEY



David J. Kyffers

Director of the United States Patent and Trademark Office

United States of America

United States Patent and Trademark Office

Aquamizer

Reg. No. 4,207,427

VAPOR CORP. (NEVADA CORPORATION)
3001 GRIFFIN ROAD

Registered Sep. 11, 2012

FT. LAUDERDALE, FL 33312

Int. Cl.: 34

FOR: ELECTRONIC CIGARETTES, IN CLASS 34 (U.S. CLS. 2, 8, 9 AND 17).

TRADEMARK

FIRST USE 7-14-2011; IN COMMERCE 3-28-2012.

PRINCIPAL REGISTER

THE MARK CONSISTS OF STANDARD CHARACTERS WITHOUT CLAIM TO ANY PARTICULAR FONT, STYLE, SIZE, OR COLOR.

SN 85-371,201, FILED 7-14-2011.

RAMONA ORTIGA, EXAMINING ATTORNEY



David J. Kyffers

Director of the United States Patent and Trademark Office

United States of America
United States Patent and Trademark Office

Aquatomizer

Reg. No. 4,207,428

VAPOR CORP. (NEVADA CORPORATION)
3001 GRIFFIN ROAD

Registered Sep. 11, 2012

FT. LAUDERDALE, FL 33312

Int. Cl.: 34

FOR: ELECTRONIC CIGARETTES, IN CLASS 34 (U.S. CLS. 2, 8, 9 AND 17).

TRADEMARK

FIRST USE 7-14-2011; IN COMMERCE 3-28-2012.

PRINCIPAL REGISTER

THE MARK CONSISTS OF STANDARD CHARACTERS WITHOUT CLAIM TO ANY PARTICULAR FONT, STYLE, SIZE, OR COLOR.

SN 85-371,206, FILED 7-14-2011.

RAMONA ORTIGA, EXAMINING ATTORNEY



David J. Kyffers

Director of the United States Patent and Trademark Office

United States of America

United States Patent and Trademark Office

Aquatek

Reg. No. 4,207,429

VAPOR CORP. (NEVADA CORPORATION)
3001 GRIFFIN ROAD
FT. LAUDERDALE, FL 33312

Registered Sep. 11, 2012

Int. Cl.: 34

FOR: ELECTRONIC CIGARETTES, IN CLASS 34 (U.S. CLS. 2, 8, 9 AND 17).

TRADEMARK

FIRST USE 7-14-2011; IN COMMERCE 3-28-2012.

PRINCIPAL REGISTER

THE MARK CONSISTS OF STANDARD CHARACTERS WITHOUT CLAIM TO ANY PARTICULAR FONT, STYLE, SIZE, OR COLOR.

SN 85-371,213, FILED 7-14-2011.

RAMONA ORTIGA, EXAMINING ATTORNEY



David J. Kybas

Director of the United States Patent and Trademark Office

United States of America

United States Patent and Trademark Office

CETERIX ORTHOPAEDICS

Reg. No. 4,207,430

CETERIX ORTHOPEDICS, INC. (DELAWARE CORPORATION)
959 HAMILTON AVENUE
MENLO PARK, CA 94025

Registered Sep. 11, 2012

Int. Cl.: 10

FOR: SURGICAL APPARATUS AND INSTRUMENTS FOR USE IN ORTHOPEDIC SURGERY,
IN CLASS 10 (U.S. CLS. 26, 39 AND 44).

TRADEMARK

FIRST USE 5-14-2012; IN COMMERCE 5-23-2012.

PRINCIPAL REGISTER

THE MARK CONSISTS OF STANDARD CHARACTERS WITHOUT CLAIM TO ANY PARTICULAR FONT, STYLE, SIZE, OR COLOR.

NO CLAIM IS MADE TO THE EXCLUSIVE RIGHT TO USE "ORTHOPAEDICS", APART FROM THE MARK AS SHOWN.

SN 85-371,672, FILED 7-14-2011.

JAY FLOWERS, EXAMINING ATTORNEY



David J. Kyffers

Director of the United States Patent and Trademark Office

United States of America

United States Patent and Trademark Office



Reg. No. 4,207,431

NEAT-OS (CALIFORNIA LIMITED LIABILITY COMPANY)
117 N. MANSFIELD AVENUE
LOS ANGELES, CA 90036

Registered Sep. 11, 2012

Int. Cl.: 22

FOR: CANVAS BAGS FOR FOOD STORAGE, IN CLASS 22 (U.S. CLS. 1, 2, 7, 19, 22, 42 AND 50).

TRADEMARK

FIRST USE 7-28-2011; IN COMMERCE 9-7-2011.

PRINCIPAL REGISTER

THE MARK CONSISTS OF THE WORD "NEAT-OS" WITH A CIRCLE THAT ISN'T CLOSED AROUND THE "N".

SN 85-371,906, FILED 7-14-2011.

MARY CRAWFORD, EXAMINING ATTORNEY



David J. Kyffers

Director of the United States Patent and Trademark Office

United States of America

United States Patent and Trademark Office

MAXIMIZE YOUR PERFORMANCE

Reg. No. 4,207,432

FERRANTE, RALPH M. (UNITED STATES INDIVIDUAL)
1031 ROUTE 9W

Registered Sep. 11, 2012

UPPER GRANDVIEW, NY 10960

Int. Cl.: 5

FOR: DIETARY SUPPLEMENTS, NUTRITION SUPPLEMENTS AND VITAMIN SUPPLEMENTS, IN CLASS 5 (U.S. CLS. 6, 18, 44, 46, 51 AND 52).

TRADEMARK

FIRST USE 3-31-2012; IN COMMERCE 3-31-2012.

PRINCIPAL REGISTER

THE MARK CONSISTS OF STANDARD CHARACTERS WITHOUT CLAIM TO ANY PARTICULAR FONT, STYLE, SIZE, OR COLOR.

SN 85-372,173, FILED 7-15-2011.

KARANENDRA S. CHHINA, EXAMINING ATTORNEY



David J. Kybas

Director of the United States Patent and Trademark Office

United States of America
United States Patent and Trademark Office

WHISPER

Reg. No. 4,207,433

SEALED AIR CORPORATION (US) (DELAWARE CORPORATION)
200 RIVERFRONT BOULEVARD
ELMWOOD PARK, NJ 07407

Registered Sep. 11, 2012

Int. Cl.: 17

FOR: FOAMED PLASTICS IN THE FORM OF SHEETS, PANELS AND PLANKS FOR USE IN AND AS ACOUSTIC INSULATORS, SOUND ABSORBERS AND VIBRATION DAMPENING MATERIALS FOR USE IN BUILDING CONSTRUCTION, ACOUSTICAL INSULATION BARRIER AND PLANKS, IN CLASS 17 (U.S. CLS. 1, 5, 12, 13, 35 AND 50).

TRADEMARK

PRINCIPAL REGISTER

FIRST USE 3-29-2012; IN COMMERCE 3-29-2012.

THE MARK CONSISTS OF STANDARD CHARACTERS WITHOUT CLAIM TO ANY PARTICULAR FONT, STYLE, SIZE, OR COLOR.

SN 85-372,725, FILED 7-15-2011.

SIMON TENG, EXAMINING ATTORNEY



David J. Kyffers

Director of the United States Patent and Trademark Office

United States of America

United States Patent and Trademark Office

CABELA'S DEER NATION

Reg. No. 4,207,434

Registered Sep. 11, 2012

Int. Cl.: 35

SERVICE MARK

PRINCIPAL REGISTER

CABELA'S INC. (DELAWARE CORPORATION)
ONE CABELA DRIVE
SIDNEY, NE 69160

FOR: WEB-BASED CATALOG SERVICES FEATURING DEER HUNTING PRODUCTS AND OUTDOOR GEAR; ON-LINE RETAIL STORE SERVICES FEATURING DEER HUNTING PRODUCTS AND OUTDOOR GEAR; ON-LINE ADVERTISING AND MARKETING SERVICES IN THE FIELD OF DEER HUNTING PRODUCTS AND OUTDOOR GEAR; AND PROVIDING ON-LINE INFORMATION IN THE FIELD DEER HUNTING PRODUCTS AND OUTDOOR GEAR, IN CLASS 35 (U.S. CLS. 100, 101 AND 102).

FIRST USE 8-0-2011; IN COMMERCE 8-0-2011.

THE MARK CONSISTS OF STANDARD CHARACTERS WITHOUT CLAIM TO ANY PARTICULAR FONT, STYLE, SIZE, OR COLOR.

OWNER OF U.S. REG. NOS. 1,151,981, 3,130,554, AND OTHERS.

NO CLAIM IS MADE TO THE EXCLUSIVE RIGHT TO USE "DEER", APART FROM THE MARK AS SHOWN.

SN 85-372,901, FILED 7-15-2011.

HOWARD SMIGA, EXAMINING ATTORNEY



David J. Kyffers

Director of the United States Patent and Trademark Office

United States of America

United States Patent and Trademark Office

KHANGARITAS

Reg. No. 4,207,435

GENGHIS GRILL FRANCHISE CONCEPTS, LP (TEXAS LIMITED PARTNERSHIP)
18900 DALLAS PARKWAY, SUITE 125
DALLAS, TX 75287

Registered Sep. 11, 2012

Int. Cl.: 33

FOR: PREPARED ALCOHOLIC COCKTAIL, IN CLASS 33 (U.S. CLS. 47 AND 49).

TRADEMARK

FIRST USE 9-29-2010; IN COMMERCE 10-30-2010.

PRINCIPAL REGISTER

THE MARK CONSISTS OF STANDARD CHARACTERS WITHOUT CLAIM TO ANY PARTICULAR FONT, STYLE, SIZE, OR COLOR.

SN 85-372,917, FILED 7-15-2011.

CHRISTINE COOPER, EXAMINING ATTORNEY



David J. Kybas

Director of the United States Patent and Trademark Office

United States of America

United States Patent and Trademark Office

WARRIORITA

Reg. No. 4,207,436

GENGHIS GRILL FRANCHISE CONCEPTS, LP (TEXAS LIMITED PARTNERSHIP)
18900 DALLAS PARKWAY, SUITE 125
DALLAS, TX 75287

Registered Sep. 11, 2012

Int. Cl.: 33

FOR: PREPARED ALCOHOLIC COCKTAIL, IN CLASS 33 (U.S. CLS. 47 AND 49).

TRADEMARK

FIRST USE 9-29-2010; IN COMMERCE 10-30-2010.

PRINCIPAL REGISTER

THE MARK CONSISTS OF STANDARD CHARACTERS WITHOUT CLAIM TO ANY PARTICULAR FONT, STYLE, SIZE, OR COLOR.

SN 85-372,940, FILED 7-15-2011.

CHRISTINE COOPER, EXAMINING ATTORNEY



David J. Kybas

Director of the United States Patent and Trademark Office

United States of America

United States Patent and Trademark Office

MONTGOMERY TRAPS

Reg. No. 4,207,437

ONEIDA VICTOR, INC., LTD. (OHIO CORPORATION)

Registered Sep. 11, 2012

P.O. BOX 32398
EUCLID, OH 41132

Int. Cl.: 6

FOR: WILD ANIMAL TRAPS, IN CLASS 6 (U.S. CLS. 2, 12, 13, 14, 23, 25 AND 50).

TRADEMARK

FIRST USE 6-13-2012; IN COMMERCE 6-13-2012.

PRINCIPAL REGISTER

THE MARK CONSISTS OF STANDARD CHARACTERS WITHOUT CLAIM TO ANY PARTICULAR FONT, STYLE, SIZE, OR COLOR.

NO CLAIM IS MADE TO THE EXCLUSIVE RIGHT TO USE "TRAPS", APART FROM THE MARK AS SHOWN.

SN 85-373,572, FILED 7-18-2011.

EDWARD NELSON, EXAMINING ATTORNEY



David J. Kyffers

Director of the United States Patent and Trademark Office

United States of America

United States Patent and Trademark Office

RESTORE LIFE'S BALANCE

Reg. No. 4,207,438

MEDTRONIC XOMED, INC. (DELAWARE CORPORATION)
6743 SOUTHPOINT DRIVE N.
JACKSONVILLE, FL 322160980

Registered Sep. 11, 2012

Int. Cl.: 10

FOR: MEDICAL APPARATUS, NAMELY, LOW PRESSURE PULSE GENERATOR FOR THE TREATMENT OF MENIERE'S DISEASE, IN CLASS 10 (U.S. CLS. 26, 39 AND 44).

TRADEMARK

FIRST USE 5-17-2012; IN COMMERCE 5-17-2012.

PRINCIPAL REGISTER

THE MARK CONSISTS OF STANDARD CHARACTERS WITHOUT CLAIM TO ANY PARTICULAR FONT, STYLE, SIZE, OR COLOR.

SN 85-373,717, FILED 7-18-2011.

FRED CARL, EXAMINING ATTORNEY



David J. Kyfos

Director of the United States Patent and Trademark Office

United States of America

United States Patent and Trademark Office

SENSOR / SOUND SHELF

Reg. No. 4,207,439

WHALEN FURNITURE MANUFACTURING INC. (CALIFORNIA CORPORATION)
1578 AIR WING ROAD
SAN DIEGO, CA 91254

Registered Sep. 11, 2012

Int. Cl.: 20

FOR: ENTERTAINMENT CENTERS; FURNITURE, NAMELY, GAMING AND THEATRE STANDS; SHELVES; TELEVISION STANDS; ALL EXCLUDING SEATING, IN CLASS 20 (U.S. CLS. 2, 13, 22, 25, 32 AND 50).

TRADEMARK

FIRST USE 9-11-2011; IN COMMERCE 9-11-2011.

PRINCIPAL REGISTER

THE MARK CONSISTS OF STANDARD CHARACTERS WITHOUT CLAIM TO ANY PARTICULAR FONT, STYLE, SIZE, OR COLOR.

NO CLAIM IS MADE TO THE EXCLUSIVE RIGHT TO USE "SHELF", APART FROM THE MARK AS SHOWN.

SN 85-373,954, FILED 7-18-2011.

GISELLE AGOSTO, EXAMINING ATTORNEY



David J. Kyffers

Director of the United States Patent and Trademark Office

United States of America

United States Patent and Trademark Office

COLGATE FRESH 'N PROTECT

Reg. No. 4,207,440

COLGATE-PALMOLIVE COMPANY (DELAWARE CORPORATION)
300 PARK AVENUE
NEW YORK, NY 10022

Registered Sep. 11, 2012

Int. Cl.: 21

FOR: TOOTHBRUSHES; ORAL HYGIENE DEVICES, NAMELY, INTERDENTAL CLEANERS,
IN CLASS 21 (U.S. CLS. 2, 13, 23, 29, 30, 33, 40 AND 50).

TRADEMARK

FIRST USE 2-7-2012; IN COMMERCE 2-7-2012.

PRINCIPAL REGISTER

THE MARK CONSISTS OF STANDARD CHARACTERS WITHOUT CLAIM TO ANY PARTICULAR FONT, STYLE, SIZE, OR COLOR.

OWNER OF U.S. REG. NOS. 427,475, 2,041,471, AND OTHERS.

SN 85-374,202, FILED 7-18-2011.

DEIRDRE ROBERTSON, EXAMINING ATTORNEY



David J. Kybas

Director of the United States Patent and Trademark Office

United States of America

United States Patent and Trademark Office

VALERA

Reg. No. 4,207,441

AS IP HOLDCO, LLC (DELAWARE LIMITED LIABILITY COMPANY)
1 CENTENNIAL AVENUE
PISCATAWAY, NJ 08855

Registered Sep. 11, 2012

Int. Cl.: 11

FOR: FAUCETS, IN CLASS 11 (U.S. CLS. 13, 21, 23, 31 AND 34).

TRADEMARK

FIRST USE 1-1-2012; IN COMMERCE 1-1-2012.

PRINCIPAL REGISTER

THE MARK CONSISTS OF STANDARD CHARACTERS WITHOUT CLAIM TO ANY PARTICULAR FONT, STYLE, SIZE, OR COLOR.

SN 85-375,863, FILED 7-20-2011.

THOMAS MANOR, EXAMINING ATTORNEY



David J. Kybas

Director of the United States Patent and Trademark Office

United States of America

United States Patent and Trademark Office

WESLEY

Reg. No. 4,207,442

AS IP HOLDCO, LLC (DELAWARE LIMITED LIABILITY COMPANY)
1 CENTENNIAL AVENUE
PISCATAWAY, NJ 08855

Registered Sep. 11, 2012

Int. Cl.: 11

FOR: FAUCETS, IN CLASS 11 (U.S. CLS. 13, 21, 23, 31 AND 34).

TRADEMARK

FIRST USE 1-1-2012; IN COMMERCE 1-1-2012.

PRINCIPAL REGISTER

THE MARK CONSISTS OF STANDARD CHARACTERS WITHOUT CLAIM TO ANY PARTICULAR FONT, STYLE, SIZE, OR COLOR.

SN 85-375,888, FILED 7-20-2011.

THOMAS MANOR, EXAMINING ATTORNEY



David J. Kyffers

Director of the United States Patent and Trademark Office

United States of America

United States Patent and Trademark Office

CWI

Reg. No. 4,207,443

THE CHEFS' WAREHOUSE, INC. (DELAWARE CORPORATION)
100 EAST RIDGE ROAD
RIDGEFIELD, CT 06877

Registered Sep. 11, 2012

Int. Cl.: 35

FOR: WHOLESALE DISTRIBUTORSHIPS FEATURING FOOD ITEMS AND FOOD INGREDIENTS, IN CLASS 35 (U.S. CLS. 100, 101 AND 102).

SERVICE MARK

FIRST USE 7-13-2012; IN COMMERCE 7-13-2012.

PRINCIPAL REGISTER

THE MARK CONSISTS OF STANDARD CHARACTERS WITHOUT CLAIM TO ANY PARTICULAR FONT, STYLE, SIZE, OR COLOR.

SN 85-376,083, FILED 7-20-2011.

ELLEN BURNS, EXAMINING ATTORNEY



David J. Kyros

Director of the United States Patent and Trademark Office

United States of America

United States Patent and Trademark Office

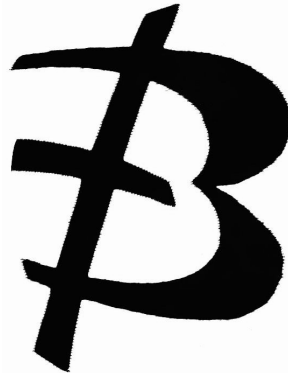

Reg. No. 4,207,444

Registered Sep. 11, 2012

Int. Cl.: 25

TRADEMARK

PRINCIPAL REGISTER

MORTON BERNARD EDMONDS (UNITED STATES INDIVIDUAL)
19069 VAN BUREN BLVD.
RIVERSIDE, CA 92508

FOR: CLOTHING FOR MEN, WOMEN AND CHILDREN, NAMELY, T-SHIRTS, SHORT SLEEVE SHIRTS, LONG SLEEVE SHIRTS, DRESS SHIRTS, POLO SHIRTS, SWEATERS, SWEATSHIRTS, HOODED PULLOVERS, SWEATPANTS, PANTS, SHORTS, SPORTSWEAR, NAMELY, ATHLETIC UNIFORMS, ACTIVEWEAR, NAMELY, JOGGING SUITS, JACKETS, BLAZERS, BLOUSES, CROP TOPS, TANK TOPS, HALTER TOPS, BELTS, AND HEADWEAR, NAMELY, HATS, CAPS, VISORS, BEANIES, SCARVES, BANDANAS, IN CLASS 25 (U.S. CLS. 22 AND 39).

FIRST USE 4-1-2012; IN COMMERCE 4-1-2012.

THE MARK CONSISTS OF A CROSS AND A DOVE, WHICH HELP FORM THE LETTER "B".

SN 85-376,170, FILED 7-20-2011.

DANNEAN HETZEL, EXAMINING ATTORNEY



David J. Kyffers

Director of the United States Patent and Trademark Office

United States of America

United States Patent and Trademark Office

BURIAL GROUNDS BOWFISHING

Reg. No. 4,207,445

TRENARY, TONY (UNITED STATES INDIVIDUAL)
6190 COUNTY ROAD 24
BUTLER, IN 46721

Registered Sep. 11, 2012

Int. Cl.: 25

FOR: HATS; HOODED SWEAT SHIRTS; SHIRTS; T-SHIRTS, IN CLASS 25 (U.S. CLS. 22 AND 39).

TRADEMARK

FIRST USE 1-0-2012; IN COMMERCE 1-0-2012.

PRINCIPAL REGISTER

THE MARK CONSISTS OF STANDARD CHARACTERS WITHOUT CLAIM TO ANY PARTICULAR FONT, STYLE, SIZE, OR COLOR.

SN 85-376,459, FILED 7-20-2011.

KATHLEEN M. VANSTON, EXAMINING ATTORNEY



David J. Kybas

Director of the United States Patent and Trademark Office

United States of America

United States Patent and Trademark Office



Allstate

House & Home Insurance

Reg. No. 4,207,446

Registered Sep. 11, 2012

Int. Cl.: 36

SERVICE MARK

PRINCIPAL REGISTER

ALLSTATE INSURANCE COMPANY (ILLINOIS CORPORATION)
ALLSTATE PLAZA
NORTHBROOK, IL 60062

FOR: INSURANCE SERVICES, NAMELY, UNDERWRITING, ISSUING AND ADMINISTERING PROPERTY AND CASUALTY INSURANCE, IN CLASS 36 (U.S. CLS. 100, 101 AND 102).

FIRST USE 9-26-2011; IN COMMERCE 9-26-2011.

NO CLAIM IS MADE TO THE EXCLUSIVE RIGHT TO USE "HOUSE & HOME INSURANCE", APART FROM THE MARK AS SHOWN.

THE MARK CONSISTS OF THE DESIGN OF CUPPED HANDS IN A CIRCLE ON THE LEFT SIDE OF THE WORD "ALLSTATE" IN STYLIZED LETTERS WITH A SLANT-"A", ABOVE A LINE, ABOVE THE WORDS "HOUSE & HOME INSURANCE".

SN 85-376,490, FILED 7-20-2011.

SHAUNIA CARLYLE, EXAMINING ATTORNEY



David J. Kyffers

Director of the United States Patent and Trademark Office

United States of America

United States Patent and Trademark Office

ALLSTATE HOUSE AND HOME

Reg. No. 4,207,447

ALLSTATE INSURANCE COMPANY (ILLINOIS CORPORATION)

Registered Sep. 11, 2012

ALLSTATE PLAZA
NORTHBROOK, IL 60062

Int. Cl.: 36

FOR: INSURANCE SERVICES, NAMELY, UNDERWRITING, ISSUING AND ADMINISTERING PROPERTY AND CASUALTY INSURANCE, IN CLASS 36 (U.S. CLS. 100, 101 AND 102).

SERVICE MARK

FIRST USE 9-26-2011; IN COMMERCE 9-26-2011.

PRINCIPAL REGISTER

THE MARK CONSISTS OF STANDARD CHARACTERS WITHOUT CLAIM TO ANY PARTICULAR FONT, STYLE, SIZE, OR COLOR.

NO CLAIM IS MADE TO THE EXCLUSIVE RIGHT TO USE "HOUSE AND HOME", APART FROM THE MARK AS SHOWN.

SN 85-376,503, FILED 7-20-2011.

SHAUNIA CARLYLE, EXAMINING ATTORNEY



David J. Kyros

Director of the United States Patent and Trademark Office

United States of America

United States Patent and Trademark Office

Confiserie eclectic gourmet

Reg. No. 4,207,448

CONFISERIE ECLECTIC GOURMET (GEORGIA PARTNERSHIP)
3218 WELLINGTON WALK SW
ATLANTA, GA 30331

Registered Sep. 11, 2012

Int. Cl.: 35

FOR: RETAIL BAKERY SHOPS, IN CLASS 35 (U.S. CLS. 100, 101 AND 102).

SERVICE MARK

FIRST USE 12-1-2011; IN COMMERCE 1-1-2012.

PRINCIPAL REGISTER

THE MARK CONSISTS OF STANDARD CHARACTERS WITHOUT CLAIM TO ANY PARTICULAR FONT, STYLE, SIZE, OR COLOR.

NO CLAIM IS MADE TO THE EXCLUSIVE RIGHT TO USE "CONFISERIE" AND "GOURMET", APART FROM THE MARK AS SHOWN.

THE ENGLISH TRANSLATION OF "CONFISERIE" IS "CONFECTIONERY".

SN 85-376,546, FILED 7-20-2011.

DAWN FELDMAN, EXAMINING ATTORNEY



David J. Kyros

Director of the United States Patent and Trademark Office

United States of America

United States Patent and Trademark Office

KADEN

Reg. No. 4,207,449

Registered Sep. 11, 2012

Int. Cl.: 12

TRADEMARK

PRINCIPAL REGISTER

HWA FONG RUBBER (USA), INC. (GEORGIA CORPORATION), DBA DURO TIRE & WHEEL,
14290 LOCHRIDGE BLVD.
COVINGTON, GA 30014

FOR: TIRES, IN CLASS 12 (U.S. CLS. 19, 21, 23, 31, 35 AND 44).

FIRST USE 1-17-2012; IN COMMERCE 1-17-2012.

THE MARK CONSISTS OF STANDARD CHARACTERS WITHOUT CLAIM TO ANY PARTICULAR FONT, STYLE, SIZE, OR COLOR.

SN 85-376,742, FILED 7-20-2011.

CHRISTOPHER LAW, EXAMINING ATTORNEY



David J. Kyfos

Director of the United States Patent and Trademark Office

United States of America

United States Patent and Trademark Office



Reg. No. 4,207,450

AUL, L.L.C. (NEVADA LIMITED LIABILITY COMPANY)
1250 MAIN STREET, SUITE 300
NAPA, CA 94559

Registered Sep. 11, 2012

Int. Cl.: 36

FOR: ADMINISTERING EXTENDED WARRANTY PROGRAMS FOR AUTOMOBILES, IN CLASS 36 (U.S. CLS. 100, 101 AND 102).

SERVICE MARK

FIRST USE 6-21-2011; IN COMMERCE 6-30-2011.

PRINCIPAL REGISTER

NO CLAIM IS MADE TO THE EXCLUSIVE RIGHT TO USE "LIFETIME WARRANTY", APART FROM THE MARK AS SHOWN.

THE COLOR(S) BLACK AND RED IS/ARE CLAIMED AS A FEATURE OF THE MARK.

THE MARK CONSISTS OF "AUL" IN BLACK INSIDE A TIMEPIECE ELEMENT IN THE COLORS BLACK AND RED WITH THE WORDS "LIFETIME WARRANTY" TO THE RIGHT AND BELOW WHERE "LIFETIME" APPEARS IN RED AND "WARRANTY" IN BLACK.

SN 85-376,788, FILED 7-20-2011.

EMILY CHUO, EXAMINING ATTORNEY



David J. Kyffers

Director of the United States Patent and Trademark Office

United States of America

United States Patent and Trademark Office

William & Wall

Reg. No. 4,207,451

LYLE, STEPHEN M. (UNITED STATES INDIVIDUAL)
12121 NORWOOD RD.

Registered Sep. 11, 2012

LEAWOOD, KS 66209

Int. Cl.: 35

FOR: RETAIL STORE AND ON-LINE RETAIL STORE SERVICES FEATURING NECKTIES, CUFFLINKS, POCKET SQUARES, MEN'S CLOTHING, AND ACCESSORIES, IN CLASS 35 (U.S. CLS. 100, 101 AND 102).

SERVICE MARK

FIRST USE 5-1-2011; IN COMMERCE 5-1-2011.

PRINCIPAL REGISTER

THE MARK CONSISTS OF STANDARD CHARACTERS WITHOUT CLAIM TO ANY PARTICULAR FONT, STYLE, SIZE, OR COLOR.

SN 85-377,007, FILED 7-21-2011.

JOHN DWYER, EXAMINING ATTORNEY



David J. Kyffers

Director of the United States Patent and Trademark Office

United States of America

United States Patent and Trademark Office

ADAPTIVE REPETITION

Reg. No. 4,207,452

Registered Sep. 11, 2012

Int. Cl.: 9

TRADEMARK

PRINCIPAL REGISTER

KNOWLEDGE FACTOR, INC. (DELAWARE CORPORATION)
SUITE 210
4775 WALNUT STREET
BOULDER, CO 80301

FOR: SOFTWARE AS A SERVICE (SAAS) SERVICES FEATURING SOFTWARE FOR PROVIDING LEARNING AND KNOWLEDGE ASSESSMENTS, NAMELY, SOFTWARE THAT INTERACTIVELY DELIVERS LEARNING CONTENT IN A PERSONALIZED AND DYNAMIC MANNER BASED IN PART ON HOW THE LEARNER RESPONDS TO PREVIOUS CONTENT, IN CLASS 9 (U.S. CLS. 21, 23, 26, 36 AND 38).

FIRST USE 2-0-2011; IN COMMERCE 8-0-2011.

THE MARK CONSISTS OF STANDARD CHARACTERS WITHOUT CLAIM TO ANY PARTICULAR FONT, STYLE, SIZE, OR COLOR.

SN 85-377,476, FILED 7-21-2011.

GEOFFREY FOSDICK, EXAMINING ATTORNEY



David J. Kyfos

Director of the United States Patent and Trademark Office

United States of America

United States Patent and Trademark Office

ECOFLAME

Reg. No. 4,207,453

SAFEGEL GROUP, LLC (FLORIDA LIMITED LIABILITY COMPANY)
6160 N.W. 74 AVENUE
MIAMI, FL 33166

Registered Sep. 11, 2012

Int. Cl.: 4

FOR: SOLID FUELS, IN CLASS 4 (U.S. CLS. 1, 6 AND 15).

TRADEMARK

FIRST USE 10-0-2011; IN COMMERCE 10-0-2011.

PRINCIPAL REGISTER

THE MARK CONSISTS OF STANDARD CHARACTERS WITHOUT CLAIM TO ANY PARTICULAR FONT, STYLE, SIZE, OR COLOR.

SN 85-378,335, FILED 7-22-2011.

KATHERINE E. HALMEN, EXAMINING ATTORNEY



David J. Kyffers

Director of the United States Patent and Trademark Office

United States of America

United States Patent and Trademark Office

HOMECONNEX

Reg. No. 4,207,454

Registered Sep. 11, 2012

Int. Cl.: 9

TRADEMARK

PRINCIPAL REGISTER

AIRTOUCH, INC. (CALIFORNIA CORPORATION)
SUITE 220
1401 DOVE STREET
NEWPORT BEACH, CA 92660

FOR: CORDLESS TELEPHONES, WIRELESS TELEPHONES, CELLULAR TELEPHONES, INTEGRATED TELEPHONE TERMINALS INCLUDING CORDLESS TELEPHONES AND CELLULAR OR WIRELESS TELEPHONES, NETWORK WIRELESS ROUTERS, TCP/IP PROTOCOL ROUTERS, AND TELEPHONE BRIDGE TERMINALS, NAMELY, TERMINALS THAT CONVERT SIGNALS BETWEEN CELLULAR SIGNALS, CORDLESS TELEPHONE SIGNALS, NETWORK SIGNALS, AND/OR TCP/IP SIGNALS, IN CLASS 9 (U.S. CLS. 21, 23, 26, 36 AND 38).

FIRST USE 1-1-2012; IN COMMERCE 1-1-2012.

THE MARK CONSISTS OF STANDARD CHARACTERS WITHOUT CLAIM TO ANY PARTICULAR FONT, STYLE, SIZE, OR COLOR.

SN 85-378,639, FILED 7-22-2011.

AHSEN KHAN, EXAMINING ATTORNEY



David J. Kyffers

Director of the United States Patent and Trademark Office

United States of America

United States Patent and Trademark Office

VALLEY FALLS

Reg. No. 4,207,455

FROST CUTLERY COMPANY LLC (TENNESSEE LIMITED LIABILITY COMPANY)
6861 MOUNTAIN VIEW ROAD
OOLTEWAH, TN 37363

Registered Sep. 11, 2012

Int. Cl.: 8

FOR: CUTLERY, NAMELY, POCKET KNIVES, BOOT KNIVES, HUNTING KNIVES AND COLLECTOR'S KNIVES, IN CLASS 8 (U.S. CLS. 23, 28 AND 44).

TRADEMARK

FIRST USE 2-28-2012; IN COMMERCE 2-28-2012.

PRINCIPAL REGISTER

THE MARK CONSISTS OF STANDARD CHARACTERS WITHOUT CLAIM TO ANY PARTICULAR FONT, STYLE, SIZE, OR COLOR.

SN 85-378,664, FILED 7-22-2011.

SETH A. RAPPAPORT, EXAMINING ATTORNEY



David J. Kybas

Director of the United States Patent and Trademark Office

United States of America

United States Patent and Trademark Office

Balanced Banking

Reg. No. 4,207,456

Registered Sep. 11, 2012

Int. Cl.: 36

SERVICE MARK

PRINCIPAL REGISTER

SUNTRUST BANKS INC (GEORGIA CORPORATION)
GA-ATL-643
303 PEACHTREE STREET, NE, SUITE 3600
ATLANTA, GA 30308

FOR: FINANCIAL SERVICES, NAMELY, CHECKING ACCOUNT SERVICES, IN CLASS 36
(U.S. CLS. 100, 101 AND 102).

FIRST USE 11-10-2011; IN COMMERCE 11-10-2011.

THE MARK CONSISTS OF STANDARD CHARACTERS WITHOUT CLAIM TO ANY PARTICULAR FONT, STYLE, SIZE, OR COLOR.

NO CLAIM IS MADE TO THE EXCLUSIVE RIGHT TO USE "BANKING", APART FROM THE MARK AS SHOWN.

SN 85-379,592, FILED 7-25-2011.

BRENDAN MCCAULEY, EXAMINING ATTORNEY



David J. Kybas

Director of the United States Patent and Trademark Office

United States of America

United States Patent and Trademark Office

Salon Eco Chic

Reg. No. 4,207,457

ESFANDIARI, NATALIE (UNITED STATES INDIVIDUAL)
150 SECOND AVENUE
NEW YORK, NY 10003

Registered Sep. 11, 2012

Int. Cl.: 44

FOR: BEAUTY SALON SERVICES; BEAUTY SALONS; HAIR COLOR SALON SERVICES; HAIR SALON SERVICES; HAIR SALON SERVICES, NAMELY, HAIR CUTTING, STYLING, COLORING, AND HAIR EXTENSION SERVICES; HAIR SALON SERVICES, NAMELY, TREATMENTS TO PROTECT HAIR FROM EFFECTS OF EXPOSURE TO SUNLIGHT, HEAT, HUMIDITY AND CHLORINATED WATER; HAIRDRESSING SALONS; HYGIENIC AND BEAUTY CARE; PROVIDING INFORMATION ABOUT BEAUTY; PROVIDING NEWS AND INFORMATION IN THE FIELD OF PERSONAL BEAUTY; PROVIDING ON-SITE BEAUTY SERVICES, NAMELY, HAIR STYLING AND MAKE-UP APPLICATION SERVICES; ALL THE ABOVE SERVICES USE ENVIRONMENTALLY-FRIENDLY METHODS, IN CLASS 44 (U.S. CLS. 100 AND 101).

SERVICE MARK

PRINCIPAL REGISTER

FIRST USE 4-17-2012; IN COMMERCE 4-17-2012.

THE MARK CONSISTS OF STANDARD CHARACTERS WITHOUT CLAIM TO ANY PARTICULAR FONT, STYLE, SIZE, OR COLOR.

NO CLAIM IS MADE TO THE EXCLUSIVE RIGHT TO USE "SALON ECO", APART FROM THE MARK AS SHOWN.

SN 85-379,887, FILED 7-25-2011.

NAAKWAMA ANKRAH, EXAMINING ATTORNEY



David J. Kyffers

Director of the United States Patent and Trademark Office

United States of America
United States Patent and Trademark Office

MĒME

Reg. No. 4,207,458

MONDOTTICA INTERNATIONAL LIMITED (HONG KONG CORPORATION)
LAWS COMM. PLAZA 788 CHENG SHA WAN ROAD
KOWLOON, HONG KONG

Registered Sep. 11, 2012

Int. Cl.: 9

FOR: EYEGLASSES, SUNGLASSES, FRAMES AND LENSES FOR EYEGLASSES AND
SUNGLASSES, EYEGLASS CASES, IN CLASS 9 (U.S. CLS. 21, 23, 26, 36 AND 38).

TRADEMARK

FIRST USE 5-29-2012; IN COMMERCE 5-29-2012.

PRINCIPAL REGISTER

THE MARK CONSISTS OF THE WORD "MEME" WITH A LINE OVER THE FIRST "E".

THE ENGLISH TRANSLATION OF "MEME" IN THE MARK IS "SAME".

SN 85-379,979, FILED 7-25-2011.

HENRY S. ZAK, EXAMINING ATTORNEY



David J. Kybas

Director of the United States Patent and Trademark Office

United States of America

United States Patent and Trademark Office

Saison Diego

Reg. No. 4,207,459

GREEN FLASH BREWING CO. (CALIFORNIA CORPORATION)
6550 MIRA MESA BLVD.
SAN DIEGO, CA 92121

Registered Sep. 11, 2012

Int. Cl.: 32

FOR: BEER, IN CLASS 32 (U.S. CLS. 45, 46 AND 48).

TRADEMARK

FIRST USE 11-2-2011; IN COMMERCE 3-23-2012.

PRINCIPAL REGISTER

THE MARK CONSISTS OF STANDARD CHARACTERS WITHOUT CLAIM TO ANY PARTICULAR FONT, STYLE, SIZE, OR COLOR.

NO CLAIM IS MADE TO THE EXCLUSIVE RIGHT TO USE "SAISON", APART FROM THE MARK AS SHOWN.

THE ENGLISH TRANSLATION OF "SAISON" IN THE MARK IS SEASON.

SN 85-380,125, FILED 7-25-2011.

COLLEEN KEARNEY, EXAMINING ATTORNEY



David J. Kyros

Director of the United States Patent and Trademark Office

United States of America

United States Patent and Trademark Office



Reg. No. 4,207,460

Registered Sep. 11, 2012

Int. Cl.: 7

TRADEMARK

PRINCIPAL REGISTER

NINGBO WT BEARING CO, LTD. (CHINA LIMITED COMPANY (LTD.))
INDUSTRIAL DEVELOPMENT WEST ZONE
SHENGSHAN, CIXI CITY
ZHEJIANG PROVINCE, CHINA

FOR: BEARING BRACKETS FOR MACHINES; BEARINGS FOR TRANSMISSION SHAFTS, BEING PARTS OF MACHINES; BEARINGS, AS PARTS OF MACHINES; ENGINE BEARINGS; MACHINE FLYWHEELS; MACHINE PARTS, NAMELY, BEARING HOUSINGS; MACHINE PARTS, NAMELY, BEARINGS AND BUSHINGS; MACHINE PARTS, NAMELY, ROLL MILL BEARINGS; MACHINE PARTS, NAMELY, ROLLER BEARINGS; VALVES BEING PARTS OF MACHINES, IN CLASS 7 (U.S. CLS. 13, 19, 21, 23, 31, 34 AND 35).

FIRST USE 5-10-2000; IN COMMERCE 10-8-2011.

THE MARK CONSISTS OF TWO STYLIZED LETTERS "WT" WITH TWO HORIZONTAL LINES AT THE BOTTOM OF THE LETTERS, ALL ON A CIRCULAR BACKGROUND.

SN 85-380,600, FILED 7-26-2011.

DAVID I, EXAMINING ATTORNEY



David J. Kyfos

Director of the United States Patent and Trademark Office

United States of America

United States Patent and Trademark Office

MISSION BBQ
The American Way.



Reg. No. 4,207,461

Registered Sep. 11, 2012

Int. Cl.: 43

SERVICE MARK

PRINCIPAL REGISTER

MISSION BBQ, LLC (MARYLAND LIMITED LIABILITY COMPANY)
7748 RITCHIE HIGHWAY
GLEN BURNIE, MD 21061

FOR: RESTAURANT SERVICES, IN CLASS 43 (U.S. CLS. 100 AND 101).

FIRST USE 9-7-2011; IN COMMERCE 9-7-2011.

NO CLAIM IS MADE TO THE EXCLUSIVE RIGHT TO USE "BBQ" , APART FROM THE MARK AS SHOWN.

THE COLOR(S) BLACK, WHITE AND ORANGE IS/ARE CLAIMED AS A FEATURE OF THE MARK.

THE MARK CONSISTS OF THE WORDS "MISSION BBQ" IN AN ERODED-LIKE FONT IN BLACK, BELOW WHICH IN SMALLER LETTERS THE WORDS "THE AMERICAN WAY" IN BLACK AND TO THE RIGHT A WHITE STAR PARTIALLY OUTLINED ABOVE LEFT IN ORANGE AND BELOW RIGHT IN BLACK, WITH THE TWO PORTIONS OF OUTLINING BEING SEPARATED BY A WHITE DIAGONAL LINE FROM UPPER RIGHT TO LOWER LEFT.

SN 85-380,632, FILED 7-26-2011.

MICHELE SWAIN, EXAMINING ATTORNEY



David J. Kybas

Director of the United States Patent and Trademark Office

United States of America

United States Patent and Trademark Office

HIP ASIAN

Reg. No. 4,207,462

BLUE BAMBOO, INC. (FLORIDA CORPORATION)
3820 SOUTHSIDE BLVD
JACKSONVILLE, FL 32216

Registered Sep. 11, 2012

Int. Cl.: 21

FOR: HOUSEHOLD UTENSILS, NAMELY, KITCHEN TONGS, IN CLASS 21 (U.S. CLS. 2, 13, 23, 29, 30, 33, 40 AND 50).

TRADEMARK

FIRST USE 6-1-2012; IN COMMERCE 6-1-2012.

PRINCIPAL REGISTER

THE MARK CONSISTS OF STANDARD CHARACTERS WITHOUT CLAIM TO ANY PARTICULAR FONT, STYLE, SIZE, OR COLOR.

SN 85-381,283, FILED 7-26-2011.

CHRISTINA SOBRAL, EXAMINING ATTORNEY



David J. Kyffers

Director of the United States Patent and Trademark Office

United States of America

United States Patent and Trademark Office

OPTILINK

Reg. No. 4,207,463

LYNN ELECTRONICS CORP. (PENNSYLVANIA CORPORATION)
154 RAILROAD DRIVE
IVYLAND, PA 18974

Registered Sep. 11, 2012

Int. Cl.: 9

FOR: COMPUTER CABLES; ELECTRONIC CABLES; ETHERNET CABLES; MODEM CABLES, IN CLASS 9 (U.S. CLS. 21, 23, 26, 36 AND 38).

TRADEMARK

FIRST USE 1-1-2012; IN COMMERCE 1-1-2012.

PRINCIPAL REGISTER

THE MARK CONSISTS OF STANDARD CHARACTERS WITHOUT CLAIM TO ANY PARTICULAR FONT, STYLE, SIZE, OR COLOR.

SN 85-381,516, FILED 7-26-2011.

KAPIL BHANOT, EXAMINING ATTORNEY



David J. Kybas

Director of the United States Patent and Trademark Office

United States of America

United States Patent and Trademark Office



Reg. No. 4,207,464

Registered Sep. 11, 2012

Int. Cl.: 25

TRADEMARK

PRINCIPAL REGISTER

PATRICOT, JILL (UNITED STATES INDIVIDUAL)
63 CHESTNUT AVENUE
LARCHMONT, NY 10538

FOR: PANTS; SKIRTS, IN CLASS 25 (U.S. CLS. 22 AND 39).

FIRST USE 2-14-2012; IN COMMERCE 2-14-2012.

THE MARK CONSISTS OF A FEMALE FIGURE FROM THE WAIST DOWN SHOWING A SKIRT AND LEGS. BELOW THIS IMAGE IS THE STYLIZED TEXT "SKOOTSKIRT".

SN 85-381,619, FILED 7-26-2011.

AMY ALFIERI, EXAMINING ATTORNEY



David J. Kyffers

Director of the United States Patent and Trademark Office

United States of America

United States Patent and Trademark Office

Inceptia

Reg. No. 4,207,465

Registered Sep. 11, 2012

**Int. Cls.: 35, 36, 41, and
45**

SERVICE MARK

PRINCIPAL REGISTER

NEBRASKA STUDENT LOAN PROGRAM, INC. (NEBRASKA NON-PROFIT CORPORATION),
DBA NATIONAL STUDENT LOAN PROGRAM,
1300 "O" STREET
LINCOLN, NE 68508

FOR: PROVIDING DATA MANAGEMENT SERVICES AND ADMINISTRATION SUPPORT SERVICES IN THE NATURE OF PROVIDING BUSINESS ADMINISTRATION ASSISTANCE TO INSTITUTIONS OF HIGHER LEARNING IN CONNECTION WITH STUDENT FINANCIAL AID PROGRAMS AND STUDENT LOAN PROGRAMS, IN CLASS 35 (U.S. CLS. 100, 101 AND 102).

FIRST USE 2-1-2012; IN COMMERCE 2-1-2012.

FOR: FINANCIAL SERVICES, NAMELY, PROVIDING INFORMATION ON STUDENT LOANS, IN CLASS 36 (U.S. CLS. 100, 101 AND 102).

FIRST USE 2-1-2012; IN COMMERCE 2-1-2012.

FOR: EDUCATIONAL SERVICES, NAMELY, PROVIDING IN-PERSON AND ONLINE COURSES ON PERSONAL FINANCE, CONDUCTING EDUCATIONAL PROGRAMS FOR ADMINISTRATORS AND INSTRUCTORS AT INSTITUTIONS OF HIGHER EDUCATION TO INSTRUCT THEM ON PROVIDING PERSONAL FINANCE COUNSELING TO COLLEGE STUDENTS, PROVIDING IN-PERSON AND ONLINE SEMINARS ON PERSONAL FINANCE, PROVIDING ONLINE WORKSHOPS ON PERSONAL FINANCE, AND DISTRIBUTING WRITTEN AND ONLINE EDUCATIONAL MATERIALS IN CONNECTION THEREWITH, IN CLASS 41 (U.S. CLS. 100, 101 AND 107).

FIRST USE 2-1-2012; IN COMMERCE 2-1-2012.

FOR: REGULATORY COMPLIANCE CONSULTING SERVICES TO INSTITUTIONS OF HIGHER LEARNING IN CONNECTION WITH STUDENT FINANCIAL AID PROGRAMS AND STUDENT LOAN PROGRAMS, IN CLASS 45 (U.S. CLS. 100 AND 101).

FIRST USE 2-1-2012; IN COMMERCE 2-1-2012.

THE MARK CONSISTS OF STANDARD CHARACTERS WITHOUT CLAIM TO ANY PARTICULAR FONT, STYLE, SIZE, OR COLOR.



David J. Kyjars

Director of the United States Patent and Trademark Office

Reg. No. 4,207,465 SN 85-381,941, FILED 7-27-2011.

Laurie Kaufman, Examining Attorney

United States of America

United States Patent and Trademark Office

THE UNSEARCH FIRM

Reg. No. 4,207,466

Registered Sep. 11, 2012

Int. Cl.: 35

SERVICE MARK

PRINCIPAL REGISTER

PLANNING FOR SUCCESSION INC. (CANADA CORPORATION)
SUITE 109
TORONTO, CANADA M5P3M1

FOR: BUSINESS CONSULTANCY SERVICES, NAMELY, BUSINESS SUCCESSION PLANNING SERVICES, BUSINESS SUCCESSION MANAGEMENT SERVICES AND BUSINESS LEADERSHIP DEVELOPMENT SERVICES; CONSULTING SERVICES, NAMELY, ASSISTING OTHER BUSINESSES IN DEVELOPING EMPLOYEES AND KEY PERSONNEL INTERNALLY, IN CLASS 35 (U.S. CLS. 100, 101 AND 102).

FIRST USE 9-15-2011; IN COMMERCE 10-1-2011.

THE MARK CONSISTS OF STANDARD CHARACTERS WITHOUT CLAIM TO ANY PARTICULAR FONT, STYLE, SIZE, OR COLOR.

PRIORITY CLAIMED UNDER SEC. 44(D) ON CANADA APPLICATION NO. 1535495, FILED 7-13-2011.

NO CLAIM IS MADE TO THE EXCLUSIVE RIGHT TO USE "FIRM", APART FROM THE MARK AS SHOWN.

SN 85-382,710, FILED 7-27-2011.

KATHERINE CHANG, EXAMINING ATTORNEY



David J. Kybas

Director of the United States Patent and Trademark Office

United States of America

United States Patent and Trademark Office

SYMPLYMAGIC

Reg. No. 4,207,467

SYMMETRY CORPORATION (CALIFORNIA CORPORATION)
14205 BURNET ROAD, SUITE 350
AUSTIN, TX 78728

Registered Sep. 11, 2012

Int. Cl.: 5

FOR: DIETARY SUPPLEMENTS, IN CLASS 5 (U.S. CLS. 6, 18, 44, 46, 51 AND 52).

TRADEMARK

FIRST USE 8-2-2011; IN COMMERCE 8-2-2011.

PRINCIPAL REGISTER

THE MARK CONSISTS OF STANDARD CHARACTERS WITHOUT CLAIM TO ANY PARTICULAR FONT, STYLE, SIZE, OR COLOR.

SN 85-383,266, FILED 7-28-2011.

SHAILA SETTLES, EXAMINING ATTORNEY



David J. Kyffers

Director of the United States Patent and Trademark Office

United States of America
United States Patent and Trademark Office

CUESEE

Reg. No. 4,207,468

EUROTROL B.V. (NETHERLANDS BESLOTEN VENNOOTSCHAP (B.V.))
KEPLERLAAN 20

Registered Sep. 11, 2012

EDE, NETHERLANDS 6716BS

Int. Cl.: 1

FOR: DIAGNOSTIC REAGENTS FOR CLINICAL OR MEDICAL LABORATORY USE, NAMELY, REAGENTS FOR TESTING, CALIBRATING AND DETERMINING THE QUALITY, ACCURACY AND EXACT COMPOSITION OF DIAGNOSTIC IN VITRO PREPARATIONS AND OF DIAGNOSTIC SYSTEMS, IN CLASS 1 (U.S. CLS. 1, 5, 6, 10, 26 AND 46).

TRADEMARK

PRINCIPAL REGISTER

FIRST USE 6-30-2011; IN COMMERCE 6-30-2011.

THE MARK CONSISTS OF STANDARD CHARACTERS WITHOUT CLAIM TO ANY PARTICULAR FONT, STYLE, SIZE, OR COLOR.

SN 85-383,463, FILED 7-28-2011.

KRISTIN DAHLING, EXAMINING ATTORNEY



David J. Kyjars

Director of the United States Patent and Trademark Office

United States of America

United States Patent and Trademark Office

OCuSOFT Baby

Reg. No. 4,207,469

OCUSOFT, INC. (TEXAS CORPORATION)
5311 AVENUE N
ROSENBERG, TX 77471

Registered Sep. 11, 2012

Int. Cls.: 3, 5, and 35

FOR: BODY AND BEAUTY CARE COSMETICS; SOAPS INCLUDING HAND SOAPS; HAIR CARE PREPARATIONS INCLUDING HAIR LOTIONS; FACIAL SCRUB, NAMELY, EYELID SCRUB; FOAMING FACIAL CLEANSERS, NAMELY, EYELID CLEANSERS; DISPOSABLE WIPES IMPREGNATED WITH CLEANSING COMPOUNDS FOR USE ON EYELIDS; FACIAL CLEANSERS, NAMELY, FOAMS, CREAMS, GELS, LOTIONS AND BALMS FOR EYELID AND EYELASH CLEANSING, IN CLASS 3 (U.S. CLS. 1, 4, 6, 50, 51 AND 52).

TRADEMARK

SERVICE MARK

PRINCIPAL REGISTER

FIRST USE 3-25-2012; IN COMMERCE 3-25-2012.

FOR: SANITARY STERILIZING PREPARATIONS; OPHTHALMIC LUBRICANTS IN THE FORMS OF GELS, SOLUTIONS, DROPS, CREAMS, AND OINTMENTS; EYE DROPS; MEDICATED FACIAL CLEANSERS, NAMELY, MEDICATED EYELID SCRUB; MEDICATED FACIAL CLEANSERS, NAMELY, MEDICATED LID SCRUB WITH FOAMING EYELID CLEANSER; MEDICATED OINTMENTS FOR TREATING DERMATOLOGICAL CONDITIONS OF THE EYELIDS; CONTACT LENS SOLUTION; EYE PATCHES FOR MEDICAL PURPOSES, NAMELY, WARM EYE COMPRESSES AND THERAPEUTIC EYE CARE PADS; ORAL NUTRITIONAL SUPPLEMENTS FOR THE SUPPORT OF DRY EYES; MEDICATED PRE-MOISTENED WIPES; MEDICATED FACIAL CLEANSERS, NAMELY, FOAMS, SOLUTIONS, CREAMS, GELS, LOTIONS AND OINTMENTS FOR EYELID CLEANSING AND REMOVAL OF ENCRUSTATION AND OTHER FOREIGN MATTER FROM THE EYELIDS, EYELASHES, AND PERIOcular AREA, IN CLASS 5 (U.S. CLS. 6, 18, 44, 46, 51 AND 52).

FIRST USE 3-25-2012; IN COMMERCE 3-25-2012.

FOR: WHOLESALE DISTRIBUTORSHIP SERVICES, ONLINE RETAIL STORE SERVICES, AND MAIL ORDER RETAIL SERVICES, ALL FEATURING BEAUTY PRODUCTS, TOILETRIES, AND OPHTHALMIC GOODS, IN CLASS 35 (U.S. CLS. 100, 101 AND 102).

FIRST USE 3-25-2012; IN COMMERCE 3-25-2012.

THE MARK CONSISTS OF STANDARD CHARACTERS WITHOUT CLAIM TO ANY PARTICULAR FONT, STYLE, SIZE, OR COLOR.



David J. Kybas

Director of the United States Patent and Trademark Office

Reg. No. 4,207,469 OWNER OF U.S. REG. NO. 1,500,086.

NO CLAIM IS MADE TO THE EXCLUSIVE RIGHT TO USE "BABY", APART FROM THE MARK AS SHOWN.

SN 85-383,504, FILED 7-28-2011.

CHRISTINA SOBRAL, EXAMINING ATTORNEY

United States of America

United States Patent and Trademark Office

SPEEDO BOOMS

Reg. No. 4,207,470

Registered Sep. 11, 2012

Int. Cl.: 25

TRADEMARK

PRINCIPAL REGISTER

SPEEDO INTERNATIONAL LTD. (UNITED KINGDOM COMPANY)
8 MANCHESTER SQUARE
LONDON, UNITED KINGDOM W1U3PH

FOR: FOOTWEAR, IN CLASS 25 (U.S. CLS. 22 AND 39).

FIRST USE 11-0-2011; IN COMMERCE 11-0-2011.

THE MARK CONSISTS OF STANDARD CHARACTERS WITHOUT CLAIM TO ANY PARTICULAR FONT, STYLE, SIZE, OR COLOR.

OWNER OF U.S. REG. NOS. 1,011,585, 1,647,484, AND OTHERS.

SN 85-384,542, FILED 7-29-2011.

JENNIFER MARTIN, EXAMINING ATTORNEY



David J. Kyffers

Director of the United States Patent and Trademark Office

United States of America

United States Patent and Trademark Office



Reg. No. 4,207,471

ROOT CORPS, LLP (OREGON PARTNERSHIP)
13619 MUKILTEO SPEEDWAY D5 #287
LYNNWOOD, WA 98054

Registered Sep. 11, 2012

Int. Cl.: 42

FOR: TECHNICAL SUPPORT SERVICES, NAMELY, TROUBLESHOOTING IN THE NATURE OF DIAGNOSING PROBLEMS WITH HANDHELD COMPUTERS AND MOBILE PHONES; TECHNICAL SUPPORT SERVICES, NAMELY, REPAIR OF COMPUTER SOFTWARE FOR HANDHELD COMPUTERS AND MOBILE PHONES, IN CLASS 42 (U.S. CLS. 100 AND 101).

SERVICE MARK

PRINCIPAL REGISTER

FIRST USE 6-10-2012; IN COMMERCE 6-11-2012.

THE MARK CONSISTS OF THE STYLIZED WORD "ROOTCORPS" WITH AN IMAGE OF TWO ABSTRACT ARCHES TO THE LEFT OF THE TEXT.

SN 85-385,106, FILED 7-29-2011.

KIMBERLY FRYE, EXAMINING ATTORNEY



David J. Kyros

Director of the United States Patent and Trademark Office

United States of America

United States Patent and Trademark Office

SOMETHING TO DRINK

Reg. No. 4,207,472

YOUTHFRONT, INC. (KANSAS CORPORATION)
4715 RAINBOW BLVD.

Registered Sep. 11, 2012

SHAWNEE MISSION, KS 66205

Int. Cls.: 35 and 45

FOR: CHARITABLE SERVICES, NAMELY, COORDINATION OF THE PROCUREMENT AND DISTRIBUTION OF SAFE DRINKING WATER TO NEEDY PEOPLE AND THOSE IN DEVELOPING COUNTRIES, IN CLASS 35 (U.S. CLS. 100, 101 AND 102).

SERVICE MARK

FIRST USE 4-24-2012; IN COMMERCE 4-24-2012.

PRINCIPAL REGISTER

FOR: MINISTERIAL SERVICES, IN CLASS 45 (U.S. CLS. 100 AND 101).

FIRST USE 4-24-2012; IN COMMERCE 4-24-2012.

THE MARK CONSISTS OF STANDARD CHARACTERS WITHOUT CLAIM TO ANY PARTICULAR FONT, STYLE, SIZE, OR COLOR.

SN 85-385,731, FILED 8-1-2011.

BARBARA RUTLAND, EXAMINING ATTORNEY



David J. Kybas

Director of the United States Patent and Trademark Office

United States of America

United States Patent and Trademark Office

REFRESH OPTIVE

Reg. No. 4,207,473

ALLERGAN, INC. (DELAWARE CORPORATION)
2525 DUPONT DRIVE
IRVINE, CA 92612

Registered Sep. 11, 2012

Int. Cl.: 5

FOR: LUBRICANT EYE DROPS, IN CLASS 5 (U.S. CLS. 6, 18, 44, 46, 51 AND 52).

TRADEMARK

FIRST USE 8-31-2006; IN COMMERCE 8-31-2006.

PRINCIPAL REGISTER

THE MARK CONSISTS OF STANDARD CHARACTERS WITHOUT CLAIM TO ANY PARTICULAR FONT, STYLE, SIZE, OR COLOR.

OWNER OF U.S. REG. NOS. 1,437,034, 1,870,318, AND OTHERS.

SN 85-386,233, FILED 8-1-2011.

LEIGH CAROLINE CASE, EXAMINING ATTORNEY



David J. Kyffers

Director of the United States Patent and Trademark Office

United States of America

United States Patent and Trademark Office

PLAYGROUND PALS

Reg. No. 4,207,474

DELTA GALIL USA, INC. (DELAWARE CORPORATION)
150 MEADOWLAND PARKWAY
SECAUCUS, NJ 07094

Registered Sep. 11, 2012

Int. Cl.: 25

FOR: CLOTHING, NAMELY, CHILDREN'S UNDERWEAR, UNDERGARMENTS, UNDERPANTS, UNDERSHIRTS, UNDERCLOTHES, BOXER BRIEFS, BOXER SHORTS, BRIEFS, LONG UNDERWEAR, THERMAL UNDERWEAR AND SOCKS, IN CLASS 25 (U.S. CLS. 22 AND 39).

TRADEMARK

PRINCIPAL REGISTER

FIRST USE 8-0-2011; IN COMMERCE 8-0-2011.

THE MARK CONSISTS OF STANDARD CHARACTERS WITHOUT CLAIM TO ANY PARTICULAR FONT, STYLE, SIZE, OR COLOR.

SN 85-386,760, FILED 8-2-2011.

ROBIN MITTLER, EXAMINING ATTORNEY



David J. Kybas

Director of the United States Patent and Trademark Office

United States of America

United States Patent and Trademark Office

CERTES TRUSTNET MANAGER

Reg. No. 4,207,475

Registered Sep. 11, 2012

Int. Cl.: 9

TRADEMARK

PRINCIPAL REGISTER

CERTES NETWORKS, INC. (DELAWARE CORPORATION)
300 CORPORATE CENTER DRIVE, SUITE 140
PITTSBURGH, PA 15108

FOR: COMPUTER SOFTWARE FOR SECURITY AND ENCRYPTION FUNCTIONS OVER
COMPUTER AND COMMUNICATIONS NETWORKS, IN CLASS 9 (U.S. CLS. 21, 23, 26, 36
AND 38).

FIRST USE 2-14-2012; IN COMMERCE 2-14-2012.

THE MARK CONSISTS OF STANDARD CHARACTERS WITHOUT CLAIM TO ANY PAR-
TICULAR FONT, STYLE, SIZE, OR COLOR.

NO CLAIM IS MADE TO THE EXCLUSIVE RIGHT TO USE "MANAGER", APART FROM
THE MARK AS SHOWN.

SN 85-386,891, FILED 8-2-2011.

AMY KELLY, EXAMINING ATTORNEY



David J. Kyffers

Director of the United States Patent and Trademark Office

United States of America

United States Patent and Trademark Office

Randomonium

Reg. No. 4,207,476

Registered Sep. 11, 2012

Int. Cl.: 28

TRADEMARK

PRINCIPAL REGISTER

REALLY BIG IDEAS LLC (MISSOURI LIMITED LIABILITY COMPANY)
815 SOUTH MERAMEC AVE
CLAYTON, MO 63105

FOR: BOARD GAMES; CARD GAMES; ELECTRONIC GAMES OTHER THAN THOSE ADAPTED FOR USE WITH TELEVISION RECEIVERS ONLY; GAME CARDS; HAND HELD UNITS FOR PLAYING ELECTRONIC GAMES OTHER THAN THOSE ADAPTED FOR USE WITH AN EXTERNAL DISPLAY SCREEN OR MONITOR; HAND HELD UNITS FOR PLAYING VIDEO GAMES OTHER THAN THOSE ADAPTED FOR USE WITH AN EXTERNAL DISPLAY SCREEN OR MONITOR; PARLOR GAMES; TABLETOP GAMES, IN CLASS 28 (U.S. CLS. 22, 23, 38 AND 50).

FIRST USE 10-10-2011; IN COMMERCE 5-14-2012.

THE MARK CONSISTS OF STANDARD CHARACTERS WITHOUT CLAIM TO ANY PARTICULAR FONT, STYLE, SIZE, OR COLOR.

SN 85-386,908, FILED 8-2-2011.

SKYE YOUNG, EXAMINING ATTORNEY



David J. Kyffers

Director of the United States Patent and Trademark Office

United States of America

United States Patent and Trademark Office



Reg. No. 4,207,477

TOMY COMPANY, LTD. (JAPAN CORPORATION)
7-9-10 TATEISHI, KATSUSHIKA-KU
TOKYO, JAPAN

Registered Sep. 11, 2012

Int. Cl.: 28

FOR: TOY SPINNING TOPS, PLAYSETS THEREFOR, NAMELY, SPINNERS FOR SPINNING TOY TOPS, AND PLAYING SURFACE BOARDS FOR PLAYING TOY TOPS THEREON; AND ACCESSORIES FOR TOY SPINNING TOPS, IN CLASS 28 (U.S. CLS. 22, 23, 38 AND 50).

TRADEMARK

PRINCIPAL REGISTER

FIRST USE 8-31-2011; IN COMMERCE 8-31-2011.

OWNER OF U.S. REG. NO. 3,002,216.

NO CLAIM IS MADE TO THE EXCLUSIVE RIGHT TO USE "TOP SYSTEM", APART FROM THE MARK AS SHOWN.

THE MARK CONSISTS OF A WAVE LIKE DESIGN ABOVE AND BELOW THE PHRASE "BEYBLADE EXTREME TOP SYSTEM" IN STYLIZED FONT AND A CIRCULAR DESIGN TO THE RIGHT OF THE PHRASE WITH THE WORDING "XTS" IN STYLIZED FONT ON THE CIRCULAR DESIGN.

SN 85-387,340, FILED 8-2-2011.

CHARLOTTE CORWIN, EXAMINING ATTORNEY



David J. Kyros

Director of the United States Patent and Trademark Office

United States of America

United States Patent and Trademark Office



Reg. No. 4,207,478

TOMY COMPANY, LTD. (JAPAN CORPORATION)
7-9-10 TATEISHI, KATSUSHIKA-KU
TOKYO, JAPAN

Registered Sep. 11, 2012

Int. Cl.: 28

FOR: TOY SPINNING TOPS, PLAYSETS THEREFOR, NAMELY, SPINNERS FOR SPINNING TOY TOPS, AND PLAYING SURFACE BOARDS FOR PLAYING TOY TOPS THEREON; AND ACCESSORIES FOR TOY SPINNING TOPS, IN CLASS 28 (U.S. CLS. 22, 23, 38 AND 50).

TRADEMARK

PRINCIPAL REGISTER

FIRST USE 8-31-2011; IN COMMERCE 8-31-2011.

OWNER OF U.S. REG. NO. 3,002,216.

NO CLAIM IS MADE TO THE EXCLUSIVE RIGHT TO USE "METAL", APART FROM THE MARK AS SHOWN.

THE MARK CONSISTS OF A WAVE LIKE DESIGN ABOVE AND BELOW THE PHRASE "BEYBLADE METAL MASTERS" IN STYLIZED FONT AND A CIRCULAR DESIGN TO THE RIGHT OF THE PHRASE COMPRISED OF A HORSE'S FACE.

SN 85-387,411, FILED 8-2-2011.

CHARLOTTE CORWIN, EXAMINING ATTORNEY



David J. Kybas

Director of the United States Patent and Trademark Office

United States of America

United States Patent and Trademark Office

Spirit and Logic, Inc.

Reg. No. 4,207,479

SABANKAYA, CHERA (UNITED STATES INDIVIDUAL)
12125 NORTH OLD STAGE ROAD
WEED, CA 96094

Registered Sep. 11, 2012

Int. Cls.: 44 and 45

FOR: MENTAL HEALTH THERAPY SERVICES; MENTAL HEALTH COUNSELING FOR CHILDREN AND ADULTS IN INDIVIDUAL AND FAMILY SESSIONS; PROVIDING MENTAL HEALTH COUNSELING TO CORPORATE CLIENTS THROUGH THE NATURE OF RETREATS, IN CLASS 44 (U.S. CLS. 100 AND 101).

SERVICE MARK

PRINCIPAL REGISTER

FIRST USE 1-1-2012; IN COMMERCE 1-1-2012.

FOR: EMOTIONAL THERAPY FOR HUMANS THROUGH THE USE OF EQUINE ASSISTANCE, IN CLASS 45 (U.S. CLS. 100 AND 101).

FIRST USE 1-1-2012; IN COMMERCE 1-1-2012.

THE MARK CONSISTS OF STANDARD CHARACTERS WITHOUT CLAIM TO ANY PARTICULAR FONT, STYLE, SIZE, OR COLOR.

NO CLAIM IS MADE TO THE EXCLUSIVE RIGHT TO USE "INC.", APART FROM THE MARK AS SHOWN.

SN 85-387,470, FILED 8-2-2011.

HANNO RITTNER, EXAMINING ATTORNEY



David J. Kybas

Director of the United States Patent and Trademark Office

United States of America

United States Patent and Trademark Office

CITIZENS PATROL

Reg. No. 4,207,480

TIMM ROSS (UNITED STATES INDIVIDUAL)
1044 SOUTHWEST SUWANNEE DOWNS DR.
LAKE CITY, FL 32024

Registered Sep. 11, 2012

Int. Cl.: 25

FOR: CLOTHING, NAMELY, SHIRTS, T-SHIRTS, SWEATSHIRTS, SWEATPANTS, HEADBANDS, HEADWEAR, TIES AND JACKETS, IN CLASS 25 (U.S. CLS. 22 AND 39).

TRADEMARK

FIRST USE 9-30-2011; IN COMMERCE 9-30-2011.

PRINCIPAL REGISTER

THE MARK CONSISTS OF STANDARD CHARACTERS WITHOUT CLAIM TO ANY PARTICULAR FONT, STYLE, SIZE, OR COLOR.

SN 85-387,946, FILED 8-3-2011.

DORITT L. CARROLL, EXAMINING ATTORNEY



David J. Kyros

Director of the United States Patent and Trademark Office

United States of America

United States Patent and Trademark Office

eri
e-rewardsinc

Reg. No. 4,207,481

Registered Sep. 11, 2012

Int. Cl.: 35

SERVICE MARK

PRINCIPAL REGISTER

E-REWARDS, INC. (DELAWARE CORPORATION)
5800 TENNYSON PARKWAY, SUITE 600
PLANO, TX 75024

FOR: BUSINESS INFORMATION SERVICES, NAMELY, DATA COLLECTION, SAMPLING AND REPORTING; BUSINESS RESEARCH AND SURVEYS; BUSINESS RESEARCH CONSULTATION; MARKET RESEARCH AND MARKET INTELLIGENCE SERVICES, IN CLASS 35 (U.S. CLS. 100, 101 AND 102).

FIRST USE 9-0-2011; IN COMMERCE 9-0-2011.

OWNER OF U.S. REG. NOS. 3,477,697, 3,669,917, AND OTHERS.

NO CLAIM IS MADE TO THE EXCLUSIVE RIGHT TO USE "INC", APART FROM THE MARK AS SHOWN.

THE MARK CONSISTS OF THE LETTERS "ERI" DISPLAYED IN STYLIZED FORMAT DIRECTLY ABOVE THE WORDING "E-REWARDS INC" DISPLAYED IN STYLIZED FORMAT.

SN 85-388,015, FILED 8-3-2011.

STEVEN R. FINE, EXAMINING ATTORNEY



David J. Kybas

Director of the United States Patent and Trademark Office

United States of America

United States Patent and Trademark Office



Reg. No. 4,207,482

JOHANSEN, JIM (UNITED STATES INDIVIDUAL)
10 PATRICIA DR

Registered Sep. 11, 2012

NEW CITY, NY 10956

Int. Cl.: 31

FOR: GROWING KITS CONSISTING OF SEEDS, BULBS, PLANTS TO INCLUDE POTS AND POTTING MEDIUM, IN CLASS 31 (U.S. CLS. 1 AND 46).

TRADEMARK

FIRST USE 12-2-2011; IN COMMERCE 3-12-2012.

PRINCIPAL REGISTER

THE MARK CONSISTS OF THE STYLIZED TEXT "PARTIESTOGROW" WITH A PARTY HAT ON THE "P" AND A LEAF ON "GROW" WITH STARS AND CONFETTI SHAPED LIKE QUADRILATERALS AND TRIANGLES AROUND THE WORDING "PARTIESTO".

SN 85-388,087, FILED 8-3-2011.

KELLY BOULTON, EXAMINING ATTORNEY



David J. Kybas

Director of the United States Patent and Trademark Office

United States of America

United States Patent and Trademark Office

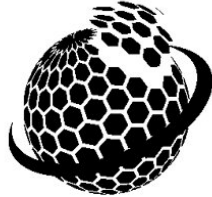

TIMITRON CORPORATION

Reg. No. 4,207,483

TIMITRON CORPORATION (VIRGINIA CORPORATION)
1317 DOMINION LAKES BLVD.
CHESAPEAKE, VA 23320

Registered Sep. 11, 2012

Int. Cl.: 42

FOR: ARCHITECTURAL DESIGN; COMPUTER PROJECT MANAGEMENT SERVICES; COMPUTER SERVICES, NAMELY, REMOTE AND ON-SITE MANAGEMENT OF THE INFORMATION TECHNOLOGY (IT) SYSTEMS OF OTHERS; ENGINEERING; IT CONSULTING SERVICES, IN CLASS 42 (U.S. CLS. 100 AND 101).

SERVICE MARK

PRINCIPAL REGISTER

FIRST USE 6-0-2011; IN COMMERCE 10-7-2011.

THE MARK CONSISTS OF A GLOBE MADE UP OF HEXAGONS, TILTED ABOUT AN IMAGINARY AXIS. PART OF THE GLOBE APPEARS AS IF IT IS BEING PUT TOGETHER (HAVING OTHER HEXAGONS ADDED) TO COMPLETE THE GLOBE. THERE EXISTS A RING AROUND THE GLOBE, AND THE TEXT "TIMITRON CORPORATION" TO THE RIGHT OF THE IMAGE.

SN 85-388,154, FILED 8-3-2011.

STEVEN R. FINE, EXAMINING ATTORNEY



David J. Kybas

Director of the United States Patent and Trademark Office

United States of America

United States Patent and Trademark Office

PER AMOR

Reg. No. 4,207,484

Registered Sep. 11, 2012

Int. Cl.: 33

TRADEMARK

PRINCIPAL REGISTER

BIAGIO CRU & ESTATE WINES, LLC (DELAWARE LIMITED LIABILITY COMPANY)
73 POWERHOUSE ROAD
ROSLYN HEIGHTS, NY 11577

FOR: SPIRITS AND LIQUEURS; WINES, IN CLASS 33 (U.S. CLS. 47 AND 49).

FIRST USE 12-27-2011; IN COMMERCE 12-27-2011.

THE MARK CONSISTS OF STANDARD CHARACTERS WITHOUT CLAIM TO ANY PARTICULAR FONT, STYLE, SIZE, OR COLOR.

THE ENGLISH TRANSLATION OF "PER AMOR" IS FOR LOVE.

SN 85-388,266, FILED 8-3-2011.

JERI J. FICKES, EXAMINING ATTORNEY



David J. Kyffers

Director of the United States Patent and Trademark Office

United States of America

United States Patent and Trademark Office

HOOKED ON THE BOOK

Reg. No. 4,207,485

HAGLER, JACK (UNITED STATES INDIVIDUAL), DBA HAGLER PUBLISHING,
22380 BERRY DRIVE
SALINAS, CA 93908

Registered Sep. 11, 2012

Int. Cl.: 16

FOR: CHILDREN'S BOOKS, IN CLASS 16 (U.S. CLS. 2, 5, 22, 23, 29, 37, 38 AND 50).

TRADEMARK

FIRST USE 6-5-2012; IN COMMERCE 6-5-2012.

PRINCIPAL REGISTER

THE MARK CONSISTS OF STANDARD CHARACTERS WITHOUT CLAIM TO ANY PARTICULAR FONT, STYLE, SIZE, OR COLOR.

NO CLAIM IS MADE TO THE EXCLUSIVE RIGHT TO USE "BOOK", APART FROM THE MARK AS SHOWN.

SN 85-388,313, FILED 8-3-2011.

LOURDES AYALA, EXAMINING ATTORNEY



David J. Kyffers

Director of the United States Patent and Trademark Office

United States of America

United States Patent and Trademark Office



Reg. No. 4,207,486

Registered Sep. 11, 2012

Int. Cl.: 35

SERVICE MARK

PRINCIPAL REGISTER

GTR STORE LLC (NEW JERSEY LIMITED LIABILITY COMPANY)
1135 HILLSBORO MILE
HILLSBORO BEACH, FL 33062

FOR: RETAIL STORE AND ON-LINE RETAIL STORE SERVICES FEATURING MUSICAL INSTRUMENTS, MUSIC EQUIPMENT AND MUSIC ACCESSORIES, IN CLASS 35 (U.S. CLS. 100, 101 AND 102).

FIRST USE 8-28-2011; IN COMMERCE 8-28-2011.

NO CLAIM IS MADE TO THE EXCLUSIVE RIGHT TO USE "GUITAR STORE.COM", APART FROM THE MARK AS SHOWN.

THE MARK CONSISTS OF THE LETTERS "GTR" WITH A SILHOUETTE OF A PORTION OF A GUITAR NECK, HEAD AND TUNING KEYS INSIDE THE LETTER "R" AND THE WORD "GTRSTORE.COM" APPEARING IN A SMALLER FONT BELOW THE LETTERS "GTR".

SN 85-388,335, FILED 8-3-2011.

ALEXANDER L. POWERS, EXAMINING ATTORNEY



David J. Kyffers

Director of the United States Patent and Trademark Office

United States of America

United States Patent and Trademark Office

GELOUS

Reg. No. 4,207,487

ENGLANDER SLEEP PRODUCTS, L.L.C. (DELAWARE LIMITED LIABILITY COMPANY)
8300 INDUSTRIAL DRIVE
OLIVE BRANCH, MS 38654

Registered Sep. 11, 2012

Int. Cl.: 20

FOR: MATTRESSES AND FOUNDATIONS, IN CLASS 20 (U.S. CLS. 2, 13, 22, 25, 32 AND 50).

TRADEMARK

FIRST USE 6-29-2011; IN COMMERCE 6-29-2011.

PRINCIPAL REGISTER

THE MARK CONSISTS OF STANDARD CHARACTERS WITHOUT CLAIM TO ANY PARTICULAR FONT, STYLE, SIZE, OR COLOR.

SN 85-388,414, FILED 8-3-2011.

ANN E. SAPPENFIELD, EXAMINING ATTORNEY



David J. Kyffers

Director of the United States Patent and Trademark Office

United States of America

United States Patent and Trademark Office

THE LONELY DOLL

Reg. No. 4,207,488

Registered Sep. 11, 2012

Int. Cl.: 41

SERVICE MARK

PRINCIPAL REGISTER

DARE WRIGHT MEDIA LLC (DELAWARE LIMITED LIABILITY COMPANY)
136 CEDAR LANE
SANTA BARBARA, CA 93108

FOR: ENTERTAINMENT SERVICES, NAMELY, MULTIMEDIA PUBLISHING OF CHILDREN'S BOOKS AND ELECTRONIC PUBLICATIONS; PROVIDING BIOGRAPHICAL INFORMATION ABOUT A PARTICULAR CHILDREN'S AUTHOR-PHOTOGRAPHER FOR EDUCATIONAL AND ENTERTAINMENT PURPOSES VIA A GLOBAL COMPUTER NETWORK; PROVIDING A WEBSITE FEATURING ENTERTAINMENT INFORMATION, INCLUDING ANIMATED ENTERTAINMENT INFORMATION; PROVISION OF NON-DOWNLOADABLE FILMS AND TELEVISION PROGRAMS FOR CHILDREN VIA A VIDEO-ON-DEMAND SERVICE, IN CLASS 41 (U.S. CLS. 100, 101 AND 107).

FIRST USE 1-30-2011; IN COMMERCE 1-30-2011.

THE MARK CONSISTS OF STANDARD CHARACTERS WITHOUT CLAIM TO ANY PARTICULAR FONT, STYLE, SIZE, OR COLOR.

OWNER OF U.S. REG. NO. 2,740,385.

NO CLAIM IS MADE TO THE EXCLUSIVE RIGHT TO USE "DOLL", APART FROM THE MARK AS SHOWN.

SN 85-388,886, FILED 8-3-2011.

ZHALEH DELANEY, EXAMINING ATTORNEY



David J. Kypos

Director of the United States Patent and Trademark Office

United States of America

United States Patent and Trademark Office

GELOUS?

Reg. No. 4,207,489

ENGLANDER SLEEP PRODUCTS, L.L.C. (DELAWARE LIMITED LIABILITY COMPANY)
8300 INDUSTRIAL DRIVE
OLIVE BRANCH, MS 38654

Registered Sep. 11, 2012

Int. Cl.: 20

FOR: MATTRESSES AND FOUNDATIONS, IN CLASS 20 (U.S. CLS. 2, 13, 22, 25, 32 AND 50).

TRADEMARK

FIRST USE 6-29-2011; IN COMMERCE 6-29-2011.

PRINCIPAL REGISTER

THE MARK CONSISTS OF STANDARD CHARACTERS WITHOUT CLAIM TO ANY PARTICULAR FONT, STYLE, SIZE, OR COLOR.

SN 85-389,864, FILED 8-4-2011.

ANN E. SAPPENFIELD, EXAMINING ATTORNEY



David J. Kyffers

Director of the United States Patent and Trademark Office

United States of America

United States Patent and Trademark Office



Reg. No. 4,207,490

Registered Sep. 11, 2012

Int. Cl.: 31

ARMOR SEED, LLC (ARKANSAS LIMITED LIABILITY COMPANY), FORMERLY CULLUM SEEDS, LLC,
2528 ALEXANDER DR.
JONESBORO, AR 724017175

FOR: AGRICULTURAL SEEDS, IN CLASS 31 (U.S. CLS. 1 AND 46).

TRADEMARK

PRINCIPAL REGISTER

FIRST USE 8-1-2010, THE MARK WAS FIRST USED ANYWHERE IN A DIFFERENT FORM OTHER THAN THAT SOUGHT TO BE REGISTERED AT LEAST AS EARLY AS 11/29/2001.; IN COMMERCE 8-1-2010, THE MARK WAS FIRST USED IN COMMERCE IN A DIFFERENT FORM OTHER THAN THAT SOUGHT TO BE REGISTERED AT LEAST AS EARLY AS 11/29/2001..

NO CLAIM IS MADE TO THE EXCLUSIVE RIGHT TO USE "SEED", APART FROM THE MARK AS SHOWN.

THE MARK CONSISTS OF A STYLIZED KNIGHT'S HELMET TO THE LEFT OF THE WORDS "ARMOR SEED".

SN 85-389,910, FILED 8-4-2011.

TRACY CROSS, EXAMINING ATTORNEY



David J. Kyffers

Director of the United States Patent and Trademark Office

United States of America

United States Patent and Trademark Office

TIGER'S LIST

Reg. No. 4,207,491

THE VENTURE ALLIANCE (CALIFORNIA CORPORATION)
220 NEWPORT CENTER DRIVE, SUITE #11-621
NEWPORT BEACH, CA 92660

Registered Sep. 11, 2012

Int. Cl.: 16

FOR: PRINTED PRODUCTS, NAMELY, LISTS FEATURING THE HIGHEST RATED INVESTMENT GRADE ENTREPRENEURS, IN CLASS 16 (U.S. CLS. 2, 5, 22, 23, 29, 37, 38 AND 50).

TRADEMARK

FIRST USE 7-1-2012; IN COMMERCE 7-1-2012.

PRINCIPAL REGISTER

THE MARK CONSISTS OF STANDARD CHARACTERS WITHOUT CLAIM TO ANY PARTICULAR FONT, STYLE, SIZE, OR COLOR.

NO CLAIM IS MADE TO THE EXCLUSIVE RIGHT TO USE "LIST", APART FROM THE MARK AS SHOWN.

SN 85-390,581, FILED 8-5-2011.

KATHERINE CHANG, EXAMINING ATTORNEY



David J. Kyffers

Director of the United States Patent and Trademark Office

United States of America

United States Patent and Trademark Office

PRICELESS CITIES

Reg. No. 4,207,492

Registered Sep. 11, 2012

Int. Cls.: 35 and 36

SERVICE MARK

PRINCIPAL REGISTER

MASTERCARD INTERNATIONAL INCORPORATED (DELAWARE CORPORATION)
2000 PURCHASE STREET
PURCHASE, NY 10577

FOR: PROMOTING THE GOODS AND SERVICES OF OTHERS BY MEANS OF COUPONS, DISCOUNTS, ADVERTISEMENTS, REWARDS AND INCENTIVES GENERATED IN CONNECTION WITH THE USE OF CREDIT AND DEBIT CARDS, ELECTRONIC LINKS TO MERCHANT AND RETAILER WEB SITES, AND THROUGH PROMOTIONAL CONTESTS, IN CLASS 35 (U.S. CLS. 100, 101 AND 102).

FIRST USE 7-11-2011; IN COMMERCE 7-11-2011.

FOR: FINANCIAL SERVICES, NAMELY, PAYMENT CARD SERVICES; CREDIT CARD AND DEBIT CARD SERVICES; ELECTRONIC PAYMENTS SERVICES, NAMELY, TRANSACTION AUTHORIZATION AND SETTLEMENT SERVICES, IN CLASS 36 (U.S. CLS. 100, 101 AND 102).

FIRST USE 7-11-2011; IN COMMERCE 7-11-2011.

THE MARK CONSISTS OF STANDARD CHARACTERS WITHOUT CLAIM TO ANY PARTICULAR FONT, STYLE, SIZE, OR COLOR.

OWNER OF U.S. REG. NOS. 2,370,508 AND 3,675,858.

SN 85-390,715, FILED 8-5-2011.

ANN E. SAPPENFIELD, EXAMINING ATTORNEY



David J. Kybas

Director of the United States Patent and Trademark Office

United States of America

United States Patent and Trademark Office

HANDHELD

Reg. No. 4,207,493

THE COCA-COLA COMPANY (DELAWARE CORPORATION)
ONE COCA-COLA PLAZA
ATLANTA, GA 30313

Registered Sep. 11, 2012

Int. Cl.: 32

FOR: NON-ALCOHOLIC BEVERAGES, NAMELY, SOFT DRINKS, IN CLASS 32 (U.S. CLS. 45, 46 AND 48).

TRADEMARK

FIRST USE 9-0-2011; IN COMMERCE 9-0-2011.

PRINCIPAL REGISTER

THE MARK CONSISTS OF STANDARD CHARACTERS WITHOUT CLAIM TO ANY PARTICULAR FONT, STYLE, SIZE, OR COLOR.

SN 85-390,736, FILED 8-5-2011.

GEOFFREY FOSDICK, EXAMINING ATTORNEY



David J. Kybas

Director of the United States Patent and Trademark Office

United States of America

United States Patent and Trademark Office

MEAN BEAN

Reg. No. 4,207,494

WILDGAME INNOVATIONS, LLC (LOUISIANA LIMITED LIABILITY COMPANY)
101 CASON ROAD, 1ST FLOOR
BROUSSARD, LA 70518

Registered Sep. 11, 2012

Int. Cl.: 31

FOR: MIXTURE OF FORAGE SEEDS USED IN FOOD PLOTS WHICH ARE PLANTED TO ATTRACT WILDLIFE, IN CLASS 31 (U.S. CLS. 1 AND 46).

TRADEMARK

FIRST USE 3-20-2012; IN COMMERCE 3-20-2012.

PRINCIPAL REGISTER

THE MARK CONSISTS OF STANDARD CHARACTERS WITHOUT CLAIM TO ANY PARTICULAR FONT, STYLE, SIZE, OR COLOR.

NO CLAIM IS MADE TO THE EXCLUSIVE RIGHT TO USE "BEAN", APART FROM THE MARK AS SHOWN.

SN 85-390,826, FILED 8-5-2011.

BRIAN CALLAGHAN, EXAMINING ATTORNEY



David J. Kyffers

Director of the United States Patent and Trademark Office

United States of America

United States Patent and Trademark Office

Fit4Algebra

Reg. No. 4,207,495

SYLVAN LEARNING, INC. (DELAWARE CORPORATION)
1001 FLEET STREET
BALTIMORE, MD 21202

Registered Sep. 11, 2012

Int. Cl.: 41

FOR: EDUCATIONAL SERVICES, NAMELY, PROVIDING AN ONLINE SCREENER, NAMELY, ONLINE EVALUATION AND SCORING OF TESTS AND EDUCATIONAL MATERIAL IN THE FIELD OF MATHEMATICS AND PRE-ALGEBRA; ON-LINE EDUCATIONAL SERVICES, NAMELY, PROVIDING A WEB SITE FOR ASSESSING READINESS FOR AND/OR KNOWLEDGE OF ALGEBRA FOR EDUCATIONAL PURPOSES; EDUCATIONAL SERVICES, NAMELY, CREATING, ADMINISTERING, SCORING, REPORTING AND EVALUATING TESTS AND TEST RESULTS TO HELP PARENTS ASSESS THEIR CHILD'S ALGEBRA READINESS, IN CLASS 41 (U.S. CLS. 100, 101 AND 107).

SERVICE MARK

PRINCIPAL REGISTER

FIRST USE 5-0-2012; IN COMMERCE 5-0-2012.

THE MARK CONSISTS OF STANDARD CHARACTERS WITHOUT CLAIM TO ANY PARTICULAR FONT, STYLE, SIZE, OR COLOR.

SN 85-391,010, FILED 8-5-2011.

SUE LAWRENCE, EXAMINING ATTORNEY



David J. Kyjars

Director of the United States Patent and Trademark Office

United States of America

United States Patent and Trademark Office

micro
 μ PMT
HAMAMATSU

Reg. No. 4,207,496

Registered Sep. 11, 2012

Int. Cl.: 9

TRADEMARK

PRINCIPAL REGISTER

HAMAMATSU PHOTONICS K.K. (JAPAN CORPORATION)
1126-1, ICHINO-CHO, HIGASHI-KU
HAMAMATSU-SHI
SHIZUOKA, JAPAN 435-8558

FOR: PHOTOMULTIPLIER TUBES, IN CLASS 9 (U.S. CLS. 21, 23, 26, 36 AND 38).

FIRST USE 6-14-2012; IN COMMERCE 6-14-2012.

OWNER OF U.S. REG. NOS. 1,523,229, 3,219,752, AND OTHERS.

THE NON-LATIN CHARACTERS IN THE MARK TRANSLITERATE TO "MU" AND THIS HAS NO MEANING IN A FOREIGN LANGUAGE.

THE MARK CONSISTS OF THE WORD "MICRO", THE GREEK LETTER WHICH TRANSLITERATES TO "MU" ATTACHED TO THE TERM "PMT", AND THE TERM "HAMAMATSU", ALL IN STYLIZED LETTERING.

THE ENGLISH TRANSLATION OF "HAMAMATSU" IN THE MARK IS "PINE TREE OF THE SEASHORE".

SN 85-391,286, FILED 8-5-2011.

MICHAEL WIENER, EXAMINING ATTORNEY



David J. Kybas

Director of the United States Patent and Trademark Office

United States of America

United States Patent and Trademark Office

SPEEDYGEL

Reg. No. 4,207,497

Registered Sep. 11, 2012

Int. Cls.: 3 and 8

TRADEMARK

PRINCIPAL REGISTER

AMAZING SHINE NAILS, INC. (CALIFORNIA CORPORATION)
13195 FLORES STREET
SANTA FE SPRINGS, CA 90670

FOR: NAIL POLISH REMOVER; ACETONE NAIL POLISH REMOVER FOR COSMETIC PURPOSES; COTTON FOR COSMETIC PURPOSES; COSMETIC NAIL POLISH PRIMERS; NON-MEDICATED NAIL CLEANSERS, IN CLASS 3 (U.S. CLS. 1, 4, 6, 50, 51 AND 52).

FIRST USE 7-0-2011; IN COMMERCE 7-0-2011.

FOR: NAIL FILES, IN CLASS 8 (U.S. CLS. 23, 28 AND 44).

FIRST USE 7-0-2011; IN COMMERCE 7-0-2011.

THE MARK CONSISTS OF STANDARD CHARACTERS WITHOUT CLAIM TO ANY PARTICULAR FONT, STYLE, SIZE, OR COLOR.

OWNER OF U.S. REG. NOS. 3,823,830 AND 3,986,878.

SN 85-391,301, FILED 8-5-2011.

REBECCA GILBERT, EXAMINING ATTORNEY



David J. Kyros

Director of the United States Patent and Trademark Office

United States of America

United States Patent and Trademark Office

FIT 4 ALGEBRA

Reg. No. 4,207,498

Registered Sep. 11, 2012

Int. Cl.: 41

SERVICE MARK

PRINCIPAL REGISTER

SYLVAN LEARNING, INC. (DELAWARE CORPORATION)
1001 FLEET STREET
BALTIMORE, MD 21202

FOR: EDUCATIONAL SERVICES, NAMELY, PROVIDING AN ONLINE SCREENER, NAMELY, ONLINE EVALUATION AND SCORING OF TESTS AND EDUCATIONAL MATERIAL IN THE FIELD OF MATHEMATICS AND PRE-ALGEBRA; ON-LINE EDUCATIONAL SERVICES, NAMELY, PROVIDING A WEB SITE FOR ASSESSING READINESS FOR AND/OR KNOWLEDGE OF ALGEBRA FOR EDUCATIONAL PURPOSES; EDUCATIONAL SERVICES, NAMELY, CREATING, ADMINISTERING, SCORING, REPORTING AND EVALUATING TESTS AND TEST RESULTS TO HELP PARENTS ASSESS THEIR CHILD'S ALGEBRA READINESS, IN CLASS 41 (U.S. CLS. 100, 101 AND 107).

FIRST USE 5-0-2012; IN COMMERCE 5-0-2012.

NO CLAIM IS MADE TO THE EXCLUSIVE RIGHT TO USE "ALGEBRA", APART FROM THE MARK AS SHOWN.

THE MARK CONSISTS OF THE WORD "FIT" FOLLOWED BY THE NUMBER "4" WITHIN A DARK RECTANGLE AND THE WORD "ALGEBRA" UNDERNEATH.

SN 85-391,801, FILED 8-8-2011.

SUE LAWRENCE, EXAMINING ATTORNEY



David J. Kyjars

Director of the United States Patent and Trademark Office

United States of America

United States Patent and Trademark Office

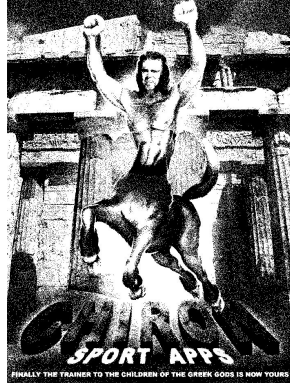

Reg. No. 4,207,499

Registered Sep. 11, 2012

Int. Cl.: 9

TRADEMARK

PRINCIPAL REGISTER

MCGINN SOLUTIONS LLC (NEW JERSEY LIMITED LIABILITY COMPANY)
1616 ELM AVE
POINT PLEASANT, NJ 08742

FOR: COMPUTER APPLICATION SOFTWARE FOR MOBILE PHONES, NAMELY, SOFTWARE FOR ELECTRONIC STORAGE OF DATA, TRAINING IN VARIOUS SPORTS, SOCIAL NETWORKING, SPACE FOR COMPANIES TO ADVERTISE AND BUY PRODUCTS, AN INTERACTIVE GAME FIGURE IN WHICH THE MORE THE APPLICATION IS USED THE FITTER THE CHARACTER GETS, AS WELL IT ALLOWS THE USER TO EARN POINTS TO BUY PRODUCT FOR THE CHARACTER, AND WILL TRACK CALORIE INTAKE, IN CLASS 9 (U.S. CLS. 21, 23, 26, 36 AND 38).

FIRST USE 6-14-2011; IN COMMERCE 6-14-2011.

NO CLAIM IS MADE TO THE EXCLUSIVE RIGHT TO USE "SPORT APPS", APART FROM THE MARK AS SHOWN.

THE STIPPLING IS FOR SHADING PURPOSES ONLY.

THE MARK CONSISTS OF A CHARACTER WHO IS HALF MAN HALF HORSE. THE CHARACTER IS JUMPING WITH HANDS RAISED IN FISTS. THE BACKGROUND IS THE GREEK PARTHENON. UNDER THE FIGURE IS THE STYLIZED TEXT "CHIRON". UNDER THIS TEXT IS THE STYLIZED TEXT "SPORT APPS" WHICH APPEARS ABOVE THE STYLIZED TEXT "FINALLY THE TRAINER TO THE CHILDREN OF THE GREEK GODS IS NOW YOURS".

SN 85-391,823, FILED 8-8-2011.

DOMINIC J. FERRAIUOLO, EXAMINING ATTORNEY



David J. Kyffers

Director of the United States Patent and Trademark Office

United States of America
United States Patent and Trademark Office

DUNKSTERS

Reg. No. 4,207,500

TOPCO HOLDINGS, INC. (WISCONSIN CORPORATION)
7711 GROSS POINT ROAD
SKOKIE, IL 60077

Registered Sep. 11, 2012

Int. Cl.: 30

FOR: SALTY SNACKS, NAMELY, CORN CHIPS, POTATO CHIPS, CHEESE FLAVORED PUFFED CORN SNACK, PRETZELS, IN CLASS 30 (U.S. CL. 46).

TRADEMARK

FIRST USE 10-0-2011; IN COMMERCE 10-0-2011.

PRINCIPAL REGISTER

THE MARK CONSISTS OF STANDARD CHARACTERS WITHOUT CLAIM TO ANY PARTICULAR FONT, STYLE, SIZE, OR COLOR.

OWNER OF U.S. REG. NOS. 2,595,156 AND 3,357,472.

SN 85-391,839, FILED 8-8-2011.

LESLEY LAMOTHE, EXAMINING ATTORNEY



David J. Kyros

Director of the United States Patent and Trademark Office

United States of America

United States Patent and Trademark Office

JazzE Bandz

Reg. No. 4,207,501

RODNEY THOMAS (UNITED STATES INDIVIDUAL)
2009 LEATHERBURY COURT
ANTIOCH, TN 37013 AND

Registered Sep. 11, 2012

Int. Cl.: 26

LAKISHA THOMAS (UNITED STATES INDIVIDUAL)
2009 LEATHERBURY COURT
ANTIOCH, TN 37013

TRADEMARK

PRINCIPAL REGISTER

FOR: HAIR ACCESSORIES, NAMELY, HAIR TIES; HAIR BANDS , IN CLASS 26 (U.S. CLS. 37, 39, 40, 42 AND 50).

FIRST USE 2-27-2012; IN COMMERCE 2-27-2012.

THE MARK CONSISTS OF STANDARD CHARACTERS WITHOUT CLAIM TO ANY PARTICULAR FONT, STYLE, SIZE, OR COLOR.

NO CLAIM IS MADE TO THE EXCLUSIVE RIGHT TO USE "BANDS", APART FROM THE MARK AS SHOWN.

SN 85-391,965, FILED 8-8-2011.

BENJAMIN OKEKE, EXAMINING ATTORNEY



David J. Kyros

Director of the United States Patent and Trademark Office

United States of America

United States Patent and Trademark Office

THE LOVE SUBPOENA

Reg. No. 4,207,502

SNUBCUBE, INC. (NEW YORK CORPORATION)
204 WESTBURY AVENUE
CARLE PLACE, NY 11514

Registered Sep. 11, 2012

Int. Cl.: 45

FOR: INTERNET BASED SOCIAL NETWORKING, INTRODUCTION, AND DATING SERVICES, IN CLASS 45 (U.S. CLS. 100 AND 101).

SERVICE MARK

FIRST USE 1-18-2012; IN COMMERCE 1-18-2012.

PRINCIPAL REGISTER

THE MARK CONSISTS OF STANDARD CHARACTERS WITHOUT CLAIM TO ANY PARTICULAR FONT, STYLE, SIZE, OR COLOR.

SN 85-392,012, FILED 8-8-2011.

THOMAS MANOR, EXAMINING ATTORNEY



David J. Kyros

Director of the United States Patent and Trademark Office

United States of America

United States Patent and Trademark Office

SGR-MAXBOND

Reg. No. 4,207,503

E-Z ON AUTO TOPS, INC. (SOUTH CAROLINA CORPORATION)

Registered Sep. 11, 2012

P.O. BOX 130
IVA, SC 29655

Int. Cl.: 12

FOR: A POLYMER COMPOSITE RING THAT IS MECHANICALLY ATTACHED BETWEEN THE FABRIC OF AN AUTOMOTIVE CONVERTIBLE TOP AND A PIECE OF TEMPERED AUTOMOTIVE GLASS, IN CLASS 12 (U.S. CLS. 19, 21, 23, 31, 35 AND 44).

TRADEMARK

FIRST USE 7-2-2012; IN COMMERCE 7-2-2012.

PRINCIPAL REGISTER

THE MARK CONSISTS OF STANDARD CHARACTERS WITHOUT CLAIM TO ANY PARTICULAR FONT, STYLE, SIZE, OR COLOR.

SN 85-392,240, FILED 8-8-2011.

ALEXANDER L. POWERS, EXAMINING ATTORNEY



David J. Kyffers

Director of the United States Patent and Trademark Office

United States of America

United States Patent and Trademark Office

Fleet Science

Reg. No. 4,207,504

Registered Sep. 11, 2012

Int. Cl.: 16

TRADEMARK

PRINCIPAL REGISTER

WABCO IP HOLDINGS LLC (DELAWARE LIMITED LIABILITY COMPANY)
ONE CENTENNIAL AVENUE
PISCATAWAY, NJ 08855

FOR: PUBLICATIONS, NAMELY, BROCHURES, BOOKLETS, AND TEACHING MATERIALS
IN THE FIELD OF SAFETY, PERFORMANCE AND VALUE FOR FLEETS OF COMMERCIAL
VEHICLES, IN CLASS 16 (U.S. CLS. 2, 5, 22, 23, 29, 37, 38 AND 50).

FIRST USE 10-1-2011; IN COMMERCE 10-1-2011.

THE MARK CONSISTS OF STANDARD CHARACTERS WITHOUT CLAIM TO ANY PAR-
TICULAR FONT, STYLE, SIZE, OR COLOR.

NO CLAIM IS MADE TO THE EXCLUSIVE RIGHT TO USE "FLEET", APART FROM THE
MARK AS SHOWN.

SN 85-392,352, FILED 8-8-2011.

THEODORE MCBRIDE, EXAMINING ATTORNEY



David J. Kyros

Director of the United States Patent and Trademark Office

United States of America

United States Patent and Trademark Office

LET YOUR STYLE SHINE

Reg. No. 4,207,505

THE PROCTER & GAMBLE COMPANY (OHIO CORPORATION)
ONE PROCTER & GAMBLE PLAZA
CINCINNATI, OH 45202

Registered Sep. 11, 2012

Int. Cl.: 5

FOR: CATAMENIAL PRODUCTS, NAMELY, MAXI PADS, MINI PADS, AND PANTILINERS,
IN CLASS 5 (U.S. CLS. 6, 18, 44, 46, 51 AND 52).

TRADEMARK

FIRST USE 4-30-2012; IN COMMERCE 4-30-2012.

PRINCIPAL REGISTER

THE MARK CONSISTS OF STANDARD CHARACTERS WITHOUT CLAIM TO ANY PAR-
TICULAR FONT, STYLE, SIZE, OR COLOR.

SN 85-392,462, FILED 8-8-2011.

STEPHANIE ALI, EXAMINING ATTORNEY



David J. Kybas

Director of the United States Patent and Trademark Office

United States of America

United States Patent and Trademark Office

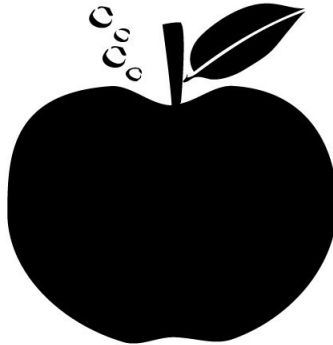

Reg. No. 4,207,506

Registered Sep. 11, 2012

Int. Cl.: 32

TRADEMARK

PRINCIPAL REGISTER

ZIWI ORGANIC NEW ZEALAND LIMITED (NEW ZEALAND LIMITED COMPANY (LTD.))
7 TAMARIKI AVE, LEVEL 2 TAMARIKI HOUSE
OREWA, NEW ZEALAND 0931

FOR: FRUIT JUICES; FRUIT NECTARS; FRUIT BASED BEVERAGES; VEGETABLE JUICE BEVERAGES; ORGANIC FRUIT JUICES; SYRUPS AND PREPARATIONS FOR MAKING FRUIT, VEGETABLE, AND SOFT DRINK BEVERAGES; CARBONATED FRUIT JUICES; FRESH AND CONCENTRATED FRUIT JUICES; FRESH AND CONCENTRATED VEGETABLE JUICES; SOFT DRINKS; LEMONADE; FRUIT PUNCH; SPORTS DRINKS; SPARKLING WATER; MINERAL WATER; SPRING WATER AND BOTTLED DRINKING WATER; FRESH AND CONCENTRATED FRUIT AND VEGETABLE JUICE COMBINATIONS; COCONUT WATER; ALOE VERA DRINKS, IN CLASS 32 (U.S. CLS. 45, 46 AND 48).

FIRST USE 0-0-2011; IN COMMERCE 0-0-2011.

THE MARK CONSISTS OF THE ARTISTIC RENDERING OF AN APPLE WITH A STEM AND A LEAF APPEARING ON THE RIGHT SIDE OF THE STEM. FOUR CIRCLES APPEAR TO THE LEFT OF THE STEM.

SN 85-392,605, FILED 8-8-2011.

JORDAN BAKER, EXAMINING ATTORNEY



David J. Kyffers

Director of the United States Patent and Trademark Office

United States of America

United States Patent and Trademark Office



Reg. No. 4,207,507

Registered Sep. 11, 2012

Int. Cls.: 3 and 30

TRADEMARK

PRINCIPAL REGISTER

API CULTURE HAUTES LAURENTIDES INC. (CANADA CORPORATION)
111 RANG 2 GRAVEL
FERME-NEUVE QC, CANADA J0W1C0

FOR: SOAP, LIP BALMS, BODY CREAM, BUBBLE BATH, SHAMPOOS, IN CLASS 3 (U.S. CLS. 1, 4, 6, 50, 51 AND 52).

FIRST USE 10-4-2011; IN COMMERCE 10-4-2011.

FOR: HONEY, ROYAL JELLY FOR FOOD PURPOSES, PROPOLIS FOR FOOD PURPOSES, BEESWAX, SPICE BREAD, COOKIES, HONEY MUSTARD, VINAIGRETTE, NOUGAT, CHOCOLATE, CANDIES, SPREAD CONTAINING HONEY AND NUTS, CAKES, IN CLASS 30 (U.S. CL. 46).

FIRST USE 10-4-2011; IN COMMERCE 10-4-2011.

NO CLAIM IS MADE TO THE EXCLUSIVE RIGHT TO USE "MIELS", APART FROM THE MARK AS SHOWN.

THE MARK CONSISTS OF DESIGN OF THE TOP OF A MOUNTAIN AND WORDS "MIELS D'ANICET".

THE ENGLISH TRANSLATION OF "MIELS D'" IN THE MARK IS "HONEY OF".

SN 85-393,308, FILED 8-9-2011.

CHERYL CLAYTON, EXAMINING ATTORNEY



David J. Kybas

Director of the United States Patent and Trademark Office

United States of America
United States Patent and Trademark Office

BACKLASH

Reg. No. 4,207,508

TEXTRON INC. (DELAWARE CORPORATION)
40 WESTMINSTER STREET
PROVIDENCE, RI 02903

Registered Sep. 11, 2012

Int. Cl.: 12

FOR: TIRES FOR GASOLINE AND ELECTRIC-POWERED VEHICLES USED AS GOLF CARS, GENERAL UTILITY AND MAINTENANCE CARS, MOTEL AND RESORT CARS, LOW-SPEED PERSONAL RESIDENTIAL AND NEIGHBORHOOD VEHICLES, PLANT PERSONNEL CARRIERS, BAGGAGE CARRIERS, LIGHT-TRANSPORTATION VEHICLES AND TURF MAINTENANCE VEHICLES, IN CLASS 12 (U.S. CLS. 19, 21, 23, 31, 35 AND 44).

TRADEMARK

PRINCIPAL REGISTER

FIRST USE 4-2-2012; IN COMMERCE 4-2-2012.

THE MARK CONSISTS OF STANDARD CHARACTERS WITHOUT CLAIM TO ANY PARTICULAR FONT, STYLE, SIZE, OR COLOR.

SN 85-393,784, FILED 8-9-2011.

CIMMERIAN COLEMAN, EXAMINING ATTORNEY



David J. Kyffers

Director of the United States Patent and Trademark Office

United States of America

United States Patent and Trademark Office

BACKLASH X

Reg. No. 4,207,509

Registered Sep. 11, 2012

Int. Cl.: 12

TRADEMARK

PRINCIPAL REGISTER

TEXTRON INC. (DELAWARE CORPORATION)
40 WESTMINSTER STREET
PROVIDENCE, RI 02903

FOR: TIRES FOR GASOLINE AND ELECTRIC-POWERED VEHICLES USED AS GOLF CARS, GENERAL UTILITY AND MAINTENANCE CARS, MOTEL AND RESORT CARS, LOW-SPEED PERSONAL RESIDENTIAL AND NEIGHBORHOOD VEHICLES, PLANT PERSONNEL CARRIERS, BAGGAGE CARRIERS, LIGHT-TRANSPORTATION VEHICLES AND TURF MAINTENANCE VEHICLES, IN CLASS 12 (U.S. CLS. 19, 21, 23, 31, 35 AND 44).

FIRST USE 4-2-2012; IN COMMERCE 4-2-2012.

THE MARK CONSISTS OF STANDARD CHARACTERS WITHOUT CLAIM TO ANY PARTICULAR FONT, STYLE, SIZE, OR COLOR.

SN 85-393,791, FILED 8-9-2011.

CIMMERIAN COLEMAN, EXAMINING ATTORNEY



David J. Kyffers

Director of the United States Patent and Trademark Office

United States of America

United States Patent and Trademark Office

TRAIL-A-DOG

Reg. No. 4,207,510

HERON SALES & MARKETING CO. (OHIO CORPORATION)
2360 SYDNEYS BEND DRIVE
MIAMISBURG, OH 45342

Registered Sep. 11, 2012

Int. Cl.: 28

FOR: EXERCISE TREADMILLS, IN CLASS 28 (U.S. CLS. 22, 23, 38 AND 50).

TRADEMARK

FIRST USE 1-31-2012; IN COMMERCE 1-31-2012.

PRINCIPAL REGISTER

THE MARK CONSISTS OF STANDARD CHARACTERS WITHOUT CLAIM TO ANY PARTICULAR FONT, STYLE, SIZE, OR COLOR.

SN 85-394,074, FILED 8-10-2011.

RICHARD WHITE, EXAMINING ATTORNEY



David J. Kyffers

Director of the United States Patent and Trademark Office

United States of America

United States Patent and Trademark Office



Reg. No. 4,207,511

Registered Sep. 11, 2012

Int. Cl.: 16

TRADEMARK

PRINCIPAL REGISTER

DAVID C COOK (ILLINOIS NON-PROFIT CORPORATION), FORMERLY COOK COMMUNICATIONS MINISTRIES,
4050 LEE VANCE VIEW
COLORADO SPRINGS, CO 80918

FOR: EDUCATIONAL PUBLICATIONS, NAMELY, WORKBOOKS, LEADER'S GUIDES, STUDENT JOURNALS, NEWSLETTERS, WORKSHEETS, AND BOOKS FEATURING CHILDREN'S CHURCH CURRICULUM IN THE FIELDS OF CHRISTIANITY, IN CLASS 16 (U.S. CLS. 2, 5, 22, 23, 29, 37, 38 AND 50).

FIRST USE 1-1-2012; IN COMMERCE 1-1-2012.

THE MARK CONSISTS OF A BLACK CIRCLE WITH THE WHITE WORDING "TRU" CONTAINED WITHIN THE CIRCLE AND THE YELLOW SHAPE OF A ROOFLINE ABOVE THE LETTER "U" WITH THE WORD "BLESSINGS" IN AQUA NEXT TO THE CIRCLE AND THE WORDS "INSPIRE. EQUIP. SUPPORT." IN BLACK BENEATH THE WORD "BLESSINGS".

THE COLOR(S) BLACK, WHITE, YELLOW, AND AQUA IS/ARE CLAIMED AS A FEATURE OF THE MARK.

SN 85-394,214, FILED 8-10-2011.

B. PARADEWELAI, EXAMINING ATTORNEY



David J. Kyffers

Director of the United States Patent and Trademark Office

United States of America

United States Patent and Trademark Office

everything ecommerce

Reg. No. 4,207,512

Registered Sep. 11, 2012

Int. Cl.: 42

SERVICE MARK

PRINCIPAL REGISTER

ATMOSPHERE SOLUTIONS (ARIZONA LIMITED LIABILITY COMPANY), DBA ATMOSOL,
5650 W CHANDLER BLVD SUITE 3
CHANDLER, AZ 85226

FOR: COMPUTER SERVICES, NAMELY, SEARCH ENGINE OPTIMIZATION; DESIGN, CREATION, HOSTING, MAINTENANCE OF WEBSITES FOR OTHERS; DESIGNING, CREATING, MAINTAINING, AND HOSTING ELECTRONIC COMMERCE WEBSITES FOR OTHERS; DEVELOPING AND HOSTING A SERVER ON A GLOBAL COMPUTER NETWORK FOR THE PURPOSE OF FACILITATING E-COMMERCE VIA SUCH A SERVER; HOSTING OF WEB SITES; WEB SITE DESIGN, IN CLASS 42 (U.S. CLS. 100 AND 101).

FIRST USE 3-5-2012; IN COMMERCE 3-5-2012.

THE MARK CONSISTS OF STANDARD CHARACTERS WITHOUT CLAIM TO ANY PARTICULAR FONT, STYLE, SIZE, OR COLOR.

NO CLAIM IS MADE TO THE EXCLUSIVE RIGHT TO USE "ECOMMERCE" , APART FROM THE MARK AS SHOWN.

SN 85-394,230, FILED 8-10-2011.

KATHERINE E. HALMEN, EXAMINING ATTORNEY



David J. Kybas

Director of the United States Patent and Trademark Office

United States of America

United States Patent and Trademark Office

VIVANDE

Reg. No. 4,207,513

Registered Sep. 11, 2012

Int. Cl.: 33

TRADEMARK

PRINCIPAL REGISTER

BRONCO WINE COMPANY (CALIFORNIA CORPORATION)
6342 BYSTRUM ROAD
CERES, CA 95307

FOR: WINE, IN CLASS 33 (U.S. CLS. 47 AND 49).

FIRST USE 5-17-2012; IN COMMERCE 5-17-2012.

THE MARK CONSISTS OF STANDARD CHARACTERS WITHOUT CLAIM TO ANY PARTICULAR FONT, STYLE, SIZE, OR COLOR.

THE ENGLISH TRANSLATION OF "VIVANDE" IN THE MARK IS "FOOD".

SN 85-394,660, FILED 8-10-2011.

KIMBERLY FRYE, EXAMINING ATTORNEY



David J. Kyffers

Director of the United States Patent and Trademark Office

United States of America

United States Patent and Trademark Office

UNBOTTLED

Reg. No. 4,207,514

ODELL BREWING COMPANY, INC. (COLORADO CORPORATION)
800 E. LINCOLN
FORT COLLINS, CO 80524

Registered Sep. 11, 2012

Int. Cls.: 16, 25, 28, and 41

FOR: PICTURE BOOKS; BOOKS FEATURING INFORMATION ABOUT BEER BREWING; BOOKS DIRECTED TO THE CONCEPT OF ADULT PLAY CONTAINING GAMES FOR FUN; POSTERS; COASTERS MADE OF PAPER; COASTERS MADE OF CARDBOARD; CARDBOARD ADVERTISING SIGNS; STICKERS; BUMPER STICKERS, IN CLASS 16 (U.S. CLS. 2, 5, 22, 23, 29, 37, 38 AND 50).

TRADEMARK

SERVICE MARK

FIRST USE 9-30-2011; IN COMMERCE 9-30-2011.

PRINCIPAL REGISTER

FOR: T-SHIRTS; SWEAT SHIRTS; JACKETS; VESTS; CAPS; HATS; HEAD BANDS; WRIST BANDS, IN CLASS 25 (U.S. CLS. 22 AND 39).

FIRST USE 9-30-2011; IN COMMERCE 9-30-2011.

FOR: FLYING DISKS; RUBBER BALLS; PROMOTIONAL GAME MATERIALS , IN CLASS 28 (U.S. CLS. 22, 23, 38 AND 50).

FIRST USE 9-30-2011; IN COMMERCE 9-30-2011.

FOR: ENTERTAINMENT, NAMELY, LIVE MUSIC CONCERTS; ARRANGING, ORGANIZING, CONDUCTING, AND HOSTING SOCIAL ENTERTAINMENT EVENTS, IN CLASS 41 (U.S. CLS. 100, 101 AND 107).

FIRST USE 9-30-2011; IN COMMERCE 5-22-2012.

THE MARK CONSISTS OF STANDARD CHARACTERS WITHOUT CLAIM TO ANY PARTICULAR FONT, STYLE, SIZE, OR COLOR.

SN 85-394,834, FILED 8-10-2011.

JOHN GARTNER, EXAMINING ATTORNEY



David J. Kyffers

Director of the United States Patent and Trademark Office

United States of America

United States Patent and Trademark Office

Math and More on the Move

Reg. No. 4,207,515

AMODO, AMANDA B. (UNITED STATES INDIVIDUAL)
2211 VISTA GRANDE DR.
VISTA, CA 92084

Registered Sep. 11, 2012

Int. Cl.: 41

FOR: CONDUCTING AFTER SCHOOL TUTORING PROGRAMS; EDUCATION SERVICES, NAMELY, PROVIDING TUTORING IN THE FIELD OF MATHEMATICS, IN CLASS 41 (U.S. CLS. 100, 101 AND 107).

SERVICE MARK

FIRST USE 11-1-2011; IN COMMERCE 11-7-2011.

PRINCIPAL REGISTER

THE MARK CONSISTS OF STANDARD CHARACTERS WITHOUT CLAIM TO ANY PARTICULAR FONT, STYLE, SIZE, OR COLOR.

NO CLAIM IS MADE TO THE EXCLUSIVE RIGHT TO USE "MATH", APART FROM THE MARK AS SHOWN.

SN 85-394,995, FILED 8-10-2011.

ZHALEH DELANEY, EXAMINING ATTORNEY



David J. Kybas

Director of the United States Patent and Trademark Office

United States of America

United States Patent and Trademark Office

BREATHE-DRI

Reg. No. 4,207,516

WRANGLER APPAREL CORP. (DELAWARE CORPORATION)
3411 SILVERSIDE ROAD
WILMINGTON, DE 19810

Registered Sep. 11, 2012

Int. Cl.: 25

FOR: CLOTHING, NAMELY, TOPS, IN CLASS 25 (U.S. CLS. 22 AND 39).

TRADEMARK

FIRST USE 2-15-2012; IN COMMERCE 2-16-2012.

PRINCIPAL REGISTER

THE MARK CONSISTS OF STANDARD CHARACTERS WITHOUT CLAIM TO ANY PARTICULAR FONT, STYLE, SIZE, OR COLOR.

SN 85-395,052, FILED 8-11-2011.

KAREN BRACEY, EXAMINING ATTORNEY



David J. Kybas

Director of the United States Patent and Trademark Office

United States of America

United States Patent and Trademark Office

Connecting Systems to Performance

Reg. No. 4,207,517

Registered Sep. 11, 2012

Int. Cl.: 35

SERVICE MARK

PRINCIPAL REGISTER

CENTRIS CONSULTING, INC. (DELAWARE CORPORATION)
800 JAMES AVENUE
SCRANTON, PA 18510

FOR: BUSINESS MANAGEMENT CONSULTING SERVICES; BUSINESS MANAGEMENT SYSTEMS CONSULTING SERVICES; AND BUSINESS INTELLIGENCE CONSULTING SERVICES, IN CLASS 35 (U.S. CLS. 100, 101 AND 102).

FIRST USE 10-0-2011; IN COMMERCE 10-0-2011.

THE MARK CONSISTS OF STANDARD CHARACTERS WITHOUT CLAIM TO ANY PARTICULAR FONT, STYLE, SIZE, OR COLOR.

SN 85-395,181, FILED 8-11-2011.

KAREN SEVERSON, EXAMINING ATTORNEY



David J. Kyjars

Director of the United States Patent and Trademark Office

United States of America

United States Patent and Trademark Office

PURE ENCLOSE

Reg. No. 4,207,518

Registered Sep. 11, 2012

Int. Cls.: 6 and 7

TRADEMARK

PRINCIPAL REGISTER

DORMA DOOR CONTROLS, INC. (PENNSYLVANIA CORPORATION)
DORMA DRIVE
REAMSTOWN, PA 17567

FOR: GLASS DOOR HARDWARE, NAMELY, METAL RAILS, FRAMES AND CLAMPS;
DOOR AND WINDOW HARDWARE, NAMELY, METAL HINGES, SLIDES, DAMPERS , IN
CLASS 6 (U.S. CLS. 2, 12, 13, 14, 23, 25 AND 50).

FIRST USE 1-30-2012; IN COMMERCE 1-30-2012.

FOR: HYDRAULIC DOOR OPENERS AND CLOSERS, IN CLASS 7 (U.S. CLS. 13, 19, 21, 23,
31, 34 AND 35).

FIRST USE 1-30-2012; IN COMMERCE 1-30-2012.

THE MARK CONSISTS OF STANDARD CHARACTERS WITHOUT CLAIM TO ANY PAR-
TICULAR FONT, STYLE, SIZE, OR COLOR.

NO CLAIM IS MADE TO THE EXCLUSIVE RIGHT TO USE "ENCLOSE", APART FROM
THE MARK AS SHOWN.

SN 85-395,280, FILED 8-11-2011.

DOMINICK J. SALEMI, EXAMINING ATTORNEY



David J. Kyjars

Director of the United States Patent and Trademark Office

United States of America

United States Patent and Trademark Office

TITAN

Reg. No. 4,207,519

SIMMERING, ROBERT (UNITED STATES INDIVIDUAL)
983 PINEHURST
BENNETT, CO 80102

Registered Sep. 11, 2012

Int. Cl.: 6

FOR: METAL LOCKS FOR DOORS, WINDOWS, IN CLASS 6 (U.S. CLS. 2, 12, 13, 14, 23, 25 AND 50).

TRADEMARK

FIRST USE 1-1-2012; IN COMMERCE 1-1-2012.

PRINCIPAL REGISTER

THE MARK CONSISTS OF STANDARD CHARACTERS WITHOUT CLAIM TO ANY PARTICULAR FONT, STYLE, SIZE, OR COLOR.

SN 85-395,282, FILED 8-11-2011.

DOMINICK J. SALEMI, EXAMINING ATTORNEY



David J. Kybas

Director of the United States Patent and Trademark Office

United States of America

United States Patent and Trademark Office

MACABITES

Reg. No. 4,207,520

MACABEE FOODS, LLC (NEW JERSEY LIMITED LIABILITY COMPANY)
140 WEST COMMERCIAL AVENUE
MOONACHIE, NJ 07074

Registered Sep. 11, 2012

Int. Cl.: 30

FOR: FROZEN HORS D'OEUVRES CONSISTING PRIMARILY OF TOMATO SAUCE WITH CHEESE, SPICES AND FLOUR SHELLS, IN CLASS 30 (U.S. CL. 46).

TRADEMARK

FIRST USE 6-25-2012; IN COMMERCE 6-25-2012.

PRINCIPAL REGISTER

THE MARK CONSISTS OF STANDARD CHARACTERS WITHOUT CLAIM TO ANY PARTICULAR FONT, STYLE, SIZE, OR COLOR.

SN 85-395,571, FILED 8-11-2011.

WILLIAM JACKSON, EXAMINING ATTORNEY



David J. Kyfos

Director of the United States Patent and Trademark Office

United States of America

United States Patent and Trademark Office

Just For Bucks

Reg. No. 4,207,521

Registered Sep. 11, 2012

Int. Cl.: 3

TRADEMARK

PRINCIPAL REGISTER

WALES INVESTMENTS (TEXAS LIMITED LIABILITY COMPANY)
1065 DOTY ROAD
VIDOR, TX 77662

FOR: BEAUTY CREAMS; BEAUTY CREAMS FOR BODY CARE; BODY CREAM; BODY DEODORANTS; BODY SPRAY USED AS A PERSONAL DEODORANT AND AS FRAGRANCE; DEODORANT FOR PERSONAL USE; DEODORANTS AND ANTIPERSPIRANTS FOR PERSONAL USE; DEODORANTS FOR BODY CARE; HAIR GEL; HAIR GEL AND HAIR MOUSSE; HAIR POMADES; HAIR RINSES; HAIR SHAMPOOS AND CONDITIONERS; HAIR SPRAYS; HAIR STYLING FIXATIVE IN THE NATURE OF HAIR WAX; HAIR STYLING PREPARATIONS; LOTIONS FOR FACE AND BODY CARE; LOTIONS FOR SKIN; NON-MEDICATED SKIN CARE PREPARATIONS, NAMELY, CREAMS, LOTIONS, GELS, TONERS, CLEANERS AND PEELS; NON-MEDICATED SKIN CARE PREPARATIONS, NAMELY, CREAMS, LOTIONS, GELS, TONERS, CLEANERS AND PEELS; PERSONAL DEODORANTS; SHAMPOO-CONDITIONERS; SHAMPOOS; SKIN CLEANSERS; SKIN CLEANSING LOTION; SKIN CREAM; SKIN CREAMS IN LIQUID AND IN SOLID FORM; SKIN MOISTURIZER; SKIN TONERS, IN CLASS 3 (U.S. CLS. 1, 4, 6, 50, 51 AND 52).

FIRST USE 8-11-2011; IN COMMERCE 1-1-2012.

THE MARK CONSISTS OF STANDARD CHARACTERS WITHOUT CLAIM TO ANY PARTICULAR FONT, STYLE, SIZE, OR COLOR.

SN 85-395,700, FILED 8-11-2011.

CHRIS WELLS, EXAMINING ATTORNEY



David J. Kypos

Director of the United States Patent and Trademark Office

United States of America

United States Patent and Trademark Office

Just For Bucks

Reg. No. 4,207,522

WALES INVESTMENTS (TEXAS LIMITED LIABILITY COMPANY)
1065 DOTY ROAD
VIDOR, TX 77662

Registered Sep. 11, 2012

Int. Cl.: 25

FOR: BELTS; HATS; JACKETS; PANTS; SHIRTS; SHOES; SHORTS; SOCKS; SWEATERS;
UNDERWEAR; VISORS, IN CLASS 25 (U.S. CLS. 22 AND 39).

TRADEMARK

FIRST USE 8-11-2011; IN COMMERCE 1-1-2012.

PRINCIPAL REGISTER

THE MARK CONSISTS OF STANDARD CHARACTERS WITHOUT CLAIM TO ANY PARTICULAR FONT, STYLE, SIZE, OR COLOR.

SN 85-395,710, FILED 8-11-2011.

CHRIS WELLS, EXAMINING ATTORNEY



David J. Kybas

Director of the United States Patent and Trademark Office

United States of America

United States Patent and Trademark Office

ECOGREEN

Reg. No. 4,207,523

SAFEGEL GROUP, LLC (FLORIDA LIMITED LIABILITY COMPANY)
6160 N.W. 74 AVENUE
MIAMI, FL 33166

Registered Sep. 11, 2012

Int. Cl.: 32

FOR: BOTTLED DRINKING WATER; BOTTLED WATER; MINERAL AND CARBONATED WATERS; MINERAL WATER; MINERAL WATERS; SPRING WATER; WATER BEVERAGES, IN CLASS 32 (U.S. CLS. 45, 46 AND 48).

TRADEMARK

FIRST USE 10-0-2011; IN COMMERCE 10-0-2011.

PRINCIPAL REGISTER

THE MARK CONSISTS OF STANDARD CHARACTERS WITHOUT CLAIM TO ANY PARTICULAR FONT, STYLE, SIZE, OR COLOR.

SN 85-396,187, FILED 8-12-2011.

KATHERINE E. HALMEN, EXAMINING ATTORNEY



David J. Kyffers

Director of the United States Patent and Trademark Office

United States of America

United States Patent and Trademark Office



Reg. No. 4,207,524

Registered Sep. 11, 2012

Int. Cl.: 28

TRADEMARK

PRINCIPAL REGISTER

MATTEL, INC. (DELAWARE CORPORATION)
M1-1518
333 CONTINENTAL BOULEVARD
EL SEGUNDO, CA 90245

FOR: TOY ACTION FIGURES AND ACCESSORIES THEREFOR; TOY VEHICLES AND ACCESSORIES THEREFOR, IN CLASS 28 (U.S. CLS. 22, 23, 38 AND 50).

FIRST USE 1-30-2012; IN COMMERCE 1-30-2012.

OWNER OF U.S. REG. NOS. 3,484,080, 3,929,863, AND OTHERS.

THE MARK CONSISTS OF THE WORDS "STEALTH STRIKE" WITHIN A BOX THAT HAS THREE FIN DESIGNS ACROSS THE TOP AND A SHATTERED CRACKED DESIGN IN THE LOWER RIGHT-HAND CORNER THAT CREATES LINES THROUGH THE "K" AND "E" IN "STRIKE".

SN 85-396,391, FILED 8-12-2011.

WENDY GOODMAN, EXAMINING ATTORNEY



David J. Kybas

Director of the United States Patent and Trademark Office

United States of America
United States Patent and Trademark Office

RUNWAY

Reg. No. 4,207,525

AG GLOBAL PRODUCTS, LLC (CALIFORNIA LIMITED LIABILITY COMPANY)
PO BOX 555837
LOS ANGELES, CA 90015

Registered Sep. 11, 2012

Int. Cl.: 11

FOR: HAIR DRYERS, IN CLASS 11 (U.S. CLS. 13, 21, 23, 31 AND 34).

TRADEMARK

FIRST USE 5-23-2012; IN COMMERCE 5-23-2012.

PRINCIPAL REGISTER

THE MARK CONSISTS OF STANDARD CHARACTERS WITHOUT CLAIM TO ANY PARTICULAR FONT, STYLE, SIZE, OR COLOR.

OWNER OF U.S. REG. NO. 3,745,815.

SN 85-397,055, FILED 8-12-2011.

GINA FINK, EXAMINING ATTORNEY



David J. Kyffers

Director of the United States Patent and Trademark Office

United States of America

United States Patent and Trademark Office

Dietitian On Wheels

Reg. No. 4,207,526

Registered Sep. 11, 2012

Int. Cl.: 44

SERVICE MARK

PRINCIPAL REGISTER

JCK PUBLISHING, INC. (MINNESOTA CORPORATION), DBA DIETITIAN ON WHEELS,
324 SOUTH CHURCH STREET
PETERSON, MN 55962

FOR: CONSULTING SERVICES IN THE FIELDS OF DIAGNOSTIC MEDICAL TESTING AND NUTRITION; CONSULTING SERVICES IN THE FIELDS OF HEALTH AND NUTRITION; COUNSELING SERVICES IN THE FIELDS OF HEALTH, NUTRITION AND LIFESTYLE WELLNESS; DIETARY AND NUTRITIONAL GUIDANCE; FOOD NUTRITION CONSULTATION; MEDICAL CLINIC PROVIDING WEIGHT LOSS SOLUTIONS, SERVICES AND PROGRAMS, NUTRITION COUNSELING, HORMONE THERAPY, INCLUDING, BIOIDENTICAL HORMONE REPLACEMENT, ANTI AGING THERAPY, AND NATURAL HORMONE THERAPY, MEDICAL AESTHETIC PROCEDURES, INCLUDING, LASER HAIR REMOVAL, LASER PEELS, BOTULINUM TOXIN TREATMENTS, MICRODERMABRASION, LIPOSUCTION, VEIN TREATMENTS, VEIN THERAPY, CELLULITE TREATMENTS, BODY CONTOURING TREATMENTS, INJECTABLE FILLER TREATMENTS, FACIALS, AND SKIN CARE; NUTRITION COUNSELING; NUTRITIONAL THERAPY SERVICES; PROVIDING A WEB SITE FEATURING EDUCATIONAL INFORMATION REGARDING NUTRITION AND GENETICS; PROVIDING A WEB SITE FEATURING INFORMATION ON HEALTH AND NUTRITION; PROVIDING A WEB SITE THAT FEATURES INFORMATION ON CHILDREN'S NUTRITION; PROVIDING A WEBSITE FEATURING INFORMATION ABOUT HEALTH, WELLNESS AND NUTRITION; PROVIDING AN ON-LINE COMPUTER DATABASE FEATURING INFORMATION REGARDING HEALTH AND NUTRITION; PROVIDING ASSISTANCE, FITNESS EVALUATION AND CONSULTATION TO CORPORATE CLIENTS TO HELP THEIR EMPLOYEES MAKE HEALTH, WELLNESS AND NUTRITIONAL CHANGES IN THEIR DAILY LIVING TO IMPROVE HEALTH; PROVIDING ASSISTANCE, FITNESS EVALUATION AND CONSULTATION TO INDIVIDUALS TO HELP THEM MAKE HEALTH, WELLNESS AND NUTRITIONAL CHANGES IN THEIR DAILY LIVING TO IMPROVE HEALTH; PROVIDING HEALTHY LIFESTYLE AND NUTRITION SERVICES, NAMELY, PERSONAL ASSESSMENTS, PERSONALIZED ROUTINES, MAINTENANCE SCHEDULES, AND COUNSELING; PROVIDING INFORMATION ABOUT DIETARY SUPPLEMENTS AND NUTRITION; PROVIDING INFORMATION, NEWS AND COMMENTARY IN THE FIELD OF NUTRITION, HEALTH AND WELLNESS, IN CLASS 44 (U.S. CLS. 100 AND 101).



David J. Kyjars

Director of the United States Patent and Trademark Office

FIRST USE 2-1-2012; IN COMMERCE 2-1-2012.

THE MARK CONSISTS OF STANDARD CHARACTERS WITHOUT CLAIM TO ANY PARTICULAR FONT, STYLE, SIZE, OR COLOR.

Reg. No. 4,207,526 NO CLAIM IS MADE TO THE EXCLUSIVE RIGHT TO USE "DIETITIAN", APART FROM THE MARK AS SHOWN.

SN 85-397,367, FILED 8-13-2011.

JEFFERY COWARD, EXAMINING ATTORNEY

United States of America

United States Patent and Trademark Office



Reg. No. 4,207,527

Registered Sep. 11, 2012

Int. Cl.: 9

TRADEMARK

PRINCIPAL REGISTER

THE INSTITUTE OF ELECTRICAL AND ELECTRONICS ENGINEERS, INC. (NEW YORK CORPORATION)
445 HOES LANE
PISCATAWAY, NJ 08855

FOR: DOWNLOADABLE PUBLICATIONS IN THE NATURE OF MAGAZINES, JOURNALS, AND NEWSLETTERS IN THE FIELD OF ENGINEERING FOR NAVIGATION SYSTEMS, AVIONICS SYSTEMS, MOBILE ELECTRIC POWER AND ELECTRONICS SYSTEMS, RADAR SYSTEMS, SONAR SYSTEMS, TELEMETRY SYSTEMS, AUTOMATIC TEST SYSTEMS, COMMAND AND CONTROL SYSTEMS, SIMULATOR SYSTEMS, AND SYSTEMS ENGINEERING, ALL FOR SPACE, AIR, OCEAN, AND GROUND ENVIRONMENTS, IN CLASS 9 (U.S. CLS. 21, 23, 26, 36 AND 38).

FIRST USE 2-28-2011; IN COMMERCE 2-28-2011.

THE MARK CONSISTS OF THE STYLIZED, UPPER-CASE LETTERS "AESS", WITH AN ARROW CURVING COUNTERCLOCKWISE IN AN ELLIPTICAL PATTERN, BEGINNING UNDER THE LETTER "A", CONTINUING UNDER THE LETTER "E", CROSSING THE FIRST LETTER "S" DIAGONALLY, FROM LEFT TO RIGHT, FROM BOTTOM TO TOP, ARCHING COUNTERCLOCKWISE OVER THE FIRST LETTER "S", WITH THE TIP OF THE ARROW ENDING ABOVE THE LETTER "E".

SN 85-397,666, FILED 8-15-2011.

MARK SHINER, EXAMINING ATTORNEY



David J. Kybas

Director of the United States Patent and Trademark Office

United States of America

United States Patent and Trademark Office



Reg. No. 4,207,528

Registered Sep. 11, 2012

Int. Cl.: 16

TRADEMARK

PRINCIPAL REGISTER

THE INSTITUTE OF ELECTRICAL AND ELECTRONICS ENGINEERS, INC. (NEW YORK CORPORATION)
445 HOES LANE
PISCATAWAY, NJ 08855

FOR: MAGAZINES IN THE FIELD OF ENGINEERING FOR NAVIGATION SYSTEMS, AVIONICS SYSTEMS, MOBILE ELECTRIC POWER AND ELECTRONICS SYSTEMS, RADAR SYSTEMS, SONAR SYSTEMS, TELEMETRY SYSTEMS, AUTOMATIC TEST SYSTEMS, COMMAND AND CONTROL SYSTEMS, SIMULATOR SYSTEMS, AND SYSTEMS ENGINEERING, ALL FOR SPACE, AIR, OCEAN, AND GROUND ENVIRONMENTS, IN CLASS 16 (U.S. CLS. 2, 5, 22, 23, 29, 37, 38 AND 50).

FIRST USE 2-28-2012; IN COMMERCE 2-28-2012.

THE MARK CONSISTS OF THE STYLIZED, UPPER-CASE LETTERS "AESS", WITH AN ARROW CURVING COUNTERCLOCKWISE IN AN ELLIPTICAL PATTERN, BEGINNING UNDER THE LETTER "A", CONTINUING UNDER THE LETTER "E", CROSSING THE FIRST LETTER "S" DIAGONALLY, FROM LEFT TO RIGHT, FROM BOTTOM TO TOP, ARCHING COUNTERCLOCKWISE OVER THE FIRST LETTER "S", WITH THE TIP OF THE ARROW ENDING ABOVE THE LETTER "E".

SN 85-397,680, FILED 8-15-2011.

MARK SHINER, EXAMINING ATTORNEY



David J. Kybas

Director of the United States Patent and Trademark Office

United States of America

United States Patent and Trademark Office



Reg. No. 4,207,529

Registered Sep. 11, 2012

Int. Cl.: 41

SERVICE MARK

PRINCIPAL REGISTER

THE INSTITUTE OF ELECTRICAL AND ELECTRONICS ENGINEERS, INC. (NEW YORK CORPORATION)
445 HOES LANE
PISCATAWAY, NJ 08855

FOR: EDUCATIONAL SERVICES, NAMELY, LECTURES, TUTORIALS, AND EDUCATIONAL CONFERENCES IN THE FIELD OF ENGINEERING FOR NAVIGATION SYSTEMS, AVIONICS SYSTEMS, MOBILE ELECTRIC POWER AND ELECTRONICS SYSTEMS, RADAR SYSTEMS, SONAR SYSTEMS, TELEMETRY SYSTEMS, AUTOMATIC TEST SYSTEMS, COMMAND AND CONTROL SYSTEMS, SIMULATOR SYSTEMS, AND SYSTEMS ENGINEERING, ALL FOR SPACE, AIR, OCEAN, AND GROUND ENVIRONMENTS, AND DISTRIBUTION OF TRAINING MATERIAL IN CONNECTION THEREWITH, IN CLASS 41 (U.S. CLS. 100, 101 AND 107).

FIRST USE 2-28-2011; IN COMMERCE 2-28-2011.

THE MARK CONSISTS OF THE STYLIZED, UPPER-CASE LETTERS "AESS", WITH AN ARROW CURVING COUNTERCLOCKWISE IN AN ELLIPTICAL PATTERN, BEGINNING UNDER THE LETTER "A", CONTINUING UNDER THE LETTER "E", CROSSING THE FIRST LETTER "S" DIAGONALLY, FROM LEFT TO RIGHT, FROM BOTTOM TO TOP, ARCHING COUNTERCLOCKWISE OVER THE FIRST LETTER "S", WITH THE TIP OF THE ARROW ENDING ABOVE THE LETTER "E".

SN 85-397,688, FILED 8-15-2011.

MARK SHINER, EXAMINING ATTORNEY



David J. Kybas

Director of the United States Patent and Trademark Office

United States of America

United States Patent and Trademark Office



Reg. No. 4,207,530

Registered Sep. 11, 2012

Int. Cl.: 42

SERVICE MARK

PRINCIPAL REGISTER

THE INSTITUTE OF ELECTRICAL AND ELECTRONICS ENGINEERS, INC. (NEW YORK CORPORATION)
445 HOES LANE
PISCATAWAY, NJ 08855

FOR: PROVIDING WEBSITES FEATURING INFORMATION AND NON-DOWNLOADABLE VIDEOS IN THE FIELD OF ENGINEERING FOR NAVIGATION SYSTEMS, AVIONICS SYSTEMS, MOBILE ELECTRIC POWER AND ELECTRONICS SYSTEMS, RADAR SYSTEMS, SONAR SYSTEMS, TELEMETRY SYSTEMS, AUTOMATIC TEST SYSTEMS, COMMAND AND CONTROL SYSTEMS, SIMULATOR SYSTEMS, AND SYSTEMS ENGINEERING, ALL FOR SPACE, AIR, OCEAN, AND GROUND ENVIRONMENTS, IN CLASS 42 (U.S. CLS. 100 AND 101).

FIRST USE 2-28-2011; IN COMMERCE 2-28-2011.

THE MARK CONSISTS OF THE STYLIZED, UPPER-CASE LETTERS "AESS", WITH AN ARROW CURVING COUNTERCLOCKWISE IN AN ELLIPTICAL PATTERN, BEGINNING UNDER THE LETTER "A", CONTINUING UNDER THE LETTER "E", CROSSING THE FIRST LETTER "S" DIAGONALLY, FROM LEFT TO RIGHT, FROM BOTTOM TO TOP, ARCHING COUNTERCLOCKWISE OVER THE FIRST LETTER "S", WITH THE TIP OF THE ARROW ENDING ABOVE THE LETTER "E".

SN 85-397,695, FILED 8-15-2011.

MARK SHINER, EXAMINING ATTORNEY



David J. Kyjars

Director of the United States Patent and Trademark Office

United States of America

United States Patent and Trademark Office

CLIPOHOLICS

Reg. No. 4,207,531

COURTROOM TELEVISION NETWORK, LLC (NEW YORK LIMITED LIABILITY COMPANY)
600 THIRD AVENUE
NEW YORK, NY 10016

Registered Sep. 11, 2012

Int. Cl.: 41

FOR: ENTERTAINMENT SERVICES, NAMELY, A CONTINUING SCRIPTED AND UNSCRIPTED TELEVISION PROGRAM SERIES IN THE FIELD OF COMEDY, DRAMA, ACTION, ADVENTURE AND/OR REALITY PROVIDED THROUGH CABLE TELEVISION, BROADCAST TELEVISION, INTERNET, VIDEO-ON-DEMAND, AND THROUGH OTHER DISTRIBUTION PLATFORMS; PROVIDING INFORMATION, NAMELY, ENTERTAINMENT INFORMATION OVER THE INTERNET, IN CLASS 41 (U.S. CLS. 100, 101 AND 107).

SERVICE MARK

PRINCIPAL REGISTER

FIRST USE 4-19-2012; IN COMMERCE 4-19-2012.

THE MARK CONSISTS OF STANDARD CHARACTERS WITHOUT CLAIM TO ANY PARTICULAR FONT, STYLE, SIZE, OR COLOR.

SN 85-397,760, FILED 8-15-2011.

WILLIAM BRECKENFELD, EXAMINING ATTORNEY



David J. Kyffers

Director of the United States Patent and Trademark Office

United States of America

United States Patent and Trademark Office

JONES STUDIO

Reg. No. 4,207,532

JONES INVESTMENT CO. INC. (DELAWARE CORPORATION)
1007 ORANGE STREET
WILMINGTON, DE 19801

Registered Sep. 11, 2012

Int. Cl.: 14

FOR: JEWELRY, IN CLASS 14 (U.S. CLS. 2, 27, 28 AND 50).

TRADEMARK

FIRST USE 8-25-2011; IN COMMERCE 8-25-2011.

PRINCIPAL REGISTER

THE MARK CONSISTS OF STANDARD CHARACTERS WITHOUT CLAIM TO ANY PARTICULAR FONT, STYLE, SIZE, OR COLOR.

OWNER OF U.S. REG. NO. 2,861,401.

NO CLAIM IS MADE TO THE EXCLUSIVE RIGHT TO USE "STUDIO", APART FROM THE MARK AS SHOWN.

SN 85-397,947, FILED 8-15-2011.

ALLISON HOLTZ, EXAMINING ATTORNEY



David J. Kybas

Director of the United States Patent and Trademark Office

United States of America

United States Patent and Trademark Office

AMERICAN BUTCHER BRAND

Reg. No. 4,207,533

SARACHIK, JEFFREY A (UNITED STATES INDIVIDUAL)
4 GRAY COURT
MANALAPAN, NJ 07726

Registered Sep. 11, 2012

Int. Cl.: 31

FOR: PET FOOD, IN CLASS 31 (U.S. CLS. 1 AND 46).

TRADEMARK

FIRST USE 6-1-2012; IN COMMERCE 6-1-2012.

PRINCIPAL REGISTER

THE MARK CONSISTS OF STANDARD CHARACTERS WITHOUT CLAIM TO ANY PARTICULAR FONT, STYLE, SIZE, OR COLOR.

NO CLAIM IS MADE TO THE EXCLUSIVE RIGHT TO USE "AMERICAN" OR "BRAND", APART FROM THE MARK AS SHOWN.

SN 85-398,320, FILED 8-15-2011.

ALYSSA STEEL, EXAMINING ATTORNEY



David J. Kybas

Director of the United States Patent and Trademark Office

United States of America

United States Patent and Trademark Office



Reg. No. 4,207,534

Registered Sep. 11, 2012

Int. Cls.: 30 and 43

TRADEMARK

SERVICE MARK

PRINCIPAL REGISTER

WITTENAUER, DOUGLAS (UNITED STATES INDIVIDUAL)
122 S MAIN STREET
POLAND, OH 44514

FOR: BAKERY DESSERTS; BAKERY GOODS, IN CLASS 30 (U.S. CL. 46).

FIRST USE 1-14-2012; IN COMMERCE 1-14-2012.

FOR: CAFÉ SERVICES , IN CLASS 43 (U.S. CLS. 100 AND 101).

FIRST USE 1-14-2012; IN COMMERCE 1-14-2012.

NO CLAIM IS MADE TO THE EXCLUSIVE RIGHT TO USE "THE CAFE AT", APART FROM THE MARK AS SHOWN.

THE MARK CONSISTS OF A TREE WITH LEAVES, BUT THOSE LEAVES HAVE BEEN REPLACED WITH IMAGES OF FORKS AND SPOONS. UNDER THE TREE IS THE STYLIZED TEXT "WITTENAUER'S". ABOVE THE "AUER" IN "WITTENAUER'S" IS THE STYLIZED TEXT "THE CAFE AT".

SN 85-398,370, FILED 8-15-2011.

SHANNON TWOHIG, EXAMINING ATTORNEY



David J. Kybas

Director of the United States Patent and Trademark Office

United States of America

United States Patent and Trademark Office

vagicons

Reg. No. 4,207,535

Registered Sep. 11, 2012

Int. Cl.: 25

TRADEMARK

PRINCIPAL REGISTER

TO THE STREAMS LLC (NEW YORK LIMITED LIABILITY COMPANY)
3015 HIGH STREET
MOHEGAN LAKE, NY 10547

FOR: BELTS; BOTTOMS; HATS; HOODS; JACKETS; TIES; TOPS, IN CLASS 25 (U.S. CLS. 22 AND 39).

FIRST USE 5-4-2009; IN COMMERCE 10-1-2011.

THE MARK CONSISTS OF STANDARD CHARACTERS WITHOUT CLAIM TO ANY PARTICULAR FONT, STYLE, SIZE, OR COLOR.

SN 85-398,697, FILED 8-16-2011.

MIDGE BUTLER, EXAMINING ATTORNEY



David J. Kyffers

Director of the United States Patent and Trademark Office

United States of America

United States Patent and Trademark Office

POSI-LOCK

Reg. No. 4,207,536

L&P PROPERTY MANAGEMENT COMPANY (DELAWARE CORPORATION)
4095 FIRESTONE BOULEVARD
SOUTH GATE, CA 90280

Registered Sep. 11, 2012

Int. Cl.: 20

FOR: METAL LOCKING DEVICE FOR SECURING BED FRAME KEYSLOT CROSSARMS
SOLD AS AN INTEGRAL COMPONENT OF BED FRAMES, IN CLASS 20 (U.S. CLS. 2, 13,
22, 25, 32 AND 50).

TRADEMARK

FIRST USE 1-30-2012; IN COMMERCE 1-30-2012.

PRINCIPAL REGISTER

THE MARK CONSISTS OF STANDARD CHARACTERS WITHOUT CLAIM TO ANY PAR-
TICULAR FONT, STYLE, SIZE, OR COLOR.

SN 85-398,733, FILED 8-16-2011.

SUSAN STIGLITZ, EXAMINING ATTORNEY



David J. Kyffers

Director of the United States Patent and Trademark Office

United States of America

United States Patent and Trademark Office

Boys and Girls Learn Differently!

Reg. No. 4,207,537

GURIAN, MICHAEL W. (UNITED STATES INDIVIDUAL)
417 W. 32ND AVENUE
SPOKANE, WA 99203

Registered Sep. 11, 2012

Int. Cl.: 41

FOR: EDUCATION SERVICES, NAMELY, PROVIDING ON-LINE, WORKSHOPS, SEMINARS AND TRAINING IN THE FIELD OF EDUCATIONAL THEORY AND TECHNIQUES TO EFFECTIVELY TEACH BOYS AND GIRLS, IN CLASS 41 (U.S. CLS. 100, 101 AND 107).

SERVICE MARK

FIRST USE 1-1-2001; IN COMMERCE 1-1-2001.

PRINCIPAL REGISTER

THE MARK CONSISTS OF STANDARD CHARACTERS WITHOUT CLAIM TO ANY PARTICULAR FONT, STYLE, SIZE, OR COLOR.

SN 85-398,936, FILED 8-16-2011.

MARLENE BELL, EXAMINING ATTORNEY



David J. Kyffers

Director of the United States Patent and Trademark Office

United States of America

United States Patent and Trademark Office

CIGA

Reg. No. 4,207,538

Registered Sep. 11, 2012

Int. Cl.: 25

TRADEMARK

PRINCIPAL REGISTER

CIGA ATHLETICA USA, INC. (WASHINGTON CORPORATION)
PIONEER SQUARE
P.O. BOX 4666
SEATTLE, WA 98194

FOR: FOOTWEAR, IN CLASS 25 (U.S. CLS. 22 AND 39).

FIRST USE 0-0-2002; IN COMMERCE 1-0-2010.

THE MARK CONSISTS OF STANDARD CHARACTERS WITHOUT CLAIM TO ANY PARTICULAR FONT, STYLE, SIZE, OR COLOR.

THE WORDING "CIGA" HAS NO MEANING IN A FOREIGN LANGUAGE.

SN 85-399,410, FILED 8-16-2011.

JAMES LOVELACE, EXAMINING ATTORNEY



David J. Kyffers

Director of the United States Patent and Trademark Office

United States of America

United States Patent and Trademark Office

Ucheckin

Reg. No. 4,207,539

Registered Sep. 11, 2012

Int. Cls.: 9 and 35

TRADEMARK

SERVICE MARK

PRINCIPAL REGISTER

SHENZHEN EE FUTURE TECHNOLOGIES CO., LTD. (CHINA CORPORATION)
RM 804, DJ ENVIR BLDG, 9# LANGSHAN RD.
SHENZHEN, CHINA

FOR: BATTERY CHARGERS; CELL PHONE BATTERY CHARGERS; CELL PHONE BATTERY CHARGERS FOR USE IN VEHICLES; COMPUTER APPLICATION SOFTWARE FOR HANDHELD COMPUTERS, NAMELY, SOFTWARE FOR ELECTRONIC STORAGE OF DATA; COMPUTER PERIPHERAL DEVICES; ELECTRIC BATTERIES; ELECTRONIC READERS AND CONTROLLERS FOR CONTROLLING ACCESS TO A PREMISES; ELECTRONIC TAGS FOR GOODS; INTEGRATED CIRCUITS; INTERFACES AND PERIPHERAL DEVICES FOR COMPUTERS; USER INTERFACES FOR ELECTROTECHNICAL AND ELECTRONIC DEVICES, IN CLASS 9 (U.S. CLS. 21, 23, 26, 36 AND 38).

FIRST USE 1-15-2012; IN COMMERCE 1-15-2012.

FOR: ADVERTISING AND MARKETING; BUSINESS APPRAISALS; BUSINESS INFORMATION AND INQUIRIES; BUSINESS INVESTIGATIONS; BUSINESS MANAGEMENT ASSISTANCE TO INDUSTRIAL OR COMMERCIAL COMPANIES; BUSINESS RESEARCH; COMMERCIAL INFORMATION AND ADVICE FOR CONSUMERS; COMPILATION OF STATISTICS; MARKET STUDY AND ANALYSIS OF MARKET STUDIES; ORGANIZING EXHIBITIONS FOR COMMERCIAL OR ADVERTISING PURPOSES, IN CLASS 35 (U.S. CLS. 100, 101 AND 102).

FIRST USE 1-15-2012; IN COMMERCE 1-15-2012.

THE MARK CONSISTS OF STANDARD CHARACTERS WITHOUT CLAIM TO ANY PARTICULAR FONT, STYLE, SIZE, OR COLOR.

SN 85-400,293, FILED 8-17-2011.

RONALD AIKENS, EXAMINING ATTORNEY



David J. Kyros

Director of the United States Patent and Trademark Office

United States of America

United States Patent and Trademark Office

HIGH CLASS

Reg. No. 4,207,540

Registered Sep. 11, 2012

Int. Cl.: 33

TRADEMARK

PRINCIPAL REGISTER

DON RAMON INC. (CALIFORNIA CORPORATION)
23202 OXNARD STREET
WOODLAND HILLS, CA 91367

FOR: GIN; TEQUILA; VODKA; WHISKEY, IN CLASS 33 (U.S. CLS. 47 AND 49).

FIRST USE 6-1-2012; IN COMMERCE 6-1-2012.

THE MARK CONSISTS OF STANDARD CHARACTERS WITHOUT CLAIM TO ANY PARTICULAR FONT, STYLE, SIZE, OR COLOR.

SN 85-400,351, FILED 8-17-2011.

JULIE WATSON, EXAMINING ATTORNEY



David J. Kyffers

Director of the United States Patent and Trademark Office

United States of America

United States Patent and Trademark Office

HOMEFUSION

Reg. No. 4,207,541

Registered Sep. 11, 2012

Int. Cl.: 38

SERVICE MARK

PRINCIPAL REGISTER

CELLCO PARTNERSHIP (DELAWARE PARTNERSHIP), DBA VERIZON WIRELESS,
VC52N058
ONE VERIZON WAY
BASKING RIDGE, NJ 079201097

FOR: WIRELESS COMMUNICATIONS SERVICE THAT DELIVERS BROADBAND SERVICES WIRELESSLY TO A HOME'S INTERNAL NON-WIRELESS PHONE SYSTEM, LAND LINE OR CORDLESS, WHICH WILL INCLUDE THE USE OF A CANTENNA, THAT INCREASES WIRELESS BROADBAND SIGNAL RECEPTION AT A HOME LOCATION, IN CLASS 38 (U.S. CLS. 100, 101 AND 104).

FIRST USE 3-15-2012; IN COMMERCE 3-15-2012.

THE MARK CONSISTS OF STANDARD CHARACTERS WITHOUT CLAIM TO ANY PARTICULAR FONT, STYLE, SIZE, OR COLOR.

SN 85-400,860, FILED 8-18-2011.

JIM RINGLE, EXAMINING ATTORNEY



David J. Kyffers

Director of the United States Patent and Trademark Office

United States of America

United States Patent and Trademark Office

POOF NATION

Reg. No. 4,207,542

Registered Sep. 11, 2012

Int. Cl.: 9

TRADEMARK

PRINCIPAL REGISTER

MARSALLE, INC. (NEW YORK CORPORATION), DBA NYS COLLECTION,
230 LIBERTY STREET
METUCHEN, NJ 08840

FOR: SUNGLASSES, IN CLASS 9 (U.S. CLS. 21, 23, 26, 36 AND 38).

FIRST USE 3-15-2012; IN COMMERCE 5-15-2012.

THE MARK CONSISTS OF STANDARD CHARACTERS WITHOUT CLAIM TO ANY PARTICULAR FONT, STYLE, SIZE, OR COLOR.

SN 85-401,378, FILED 8-18-2011.

ALLISON HOLTZ, EXAMINING ATTORNEY



David J. Kyffers

Director of the United States Patent and Trademark Office

United States of America

United States Patent and Trademark Office

SWEET KIDDLES

Reg. No. 4,207,543

ON-DEMAND CHILDCARE LLC (OHIO LIMITED LIABILITY COMPANY)
20373 DONEGAL LANE
STRONGSVILLE, OH 44149

Registered Sep. 11, 2012

Int. Cl.: 43

FOR: DAYCARE AND CHILD CARE CENTERS, IN CLASS 43 (U.S. CLS. 100 AND 101).

SERVICE MARK

FIRST USE 5-29-2012; IN COMMERCE 5-29-2012.

PRINCIPAL REGISTER

THE MARK CONSISTS OF STANDARD CHARACTERS WITHOUT CLAIM TO ANY PARTICULAR FONT, STYLE, SIZE, OR COLOR.

SN 85-401,669, FILED 8-18-2011.

DANNEAN HETZEL, EXAMINING ATTORNEY



David J. Kyffers

Director of the United States Patent and Trademark Office

United States of America

United States Patent and Trademark Office



Reg. No. 4,207,544

Registered Sep. 11, 2012

Int. Cl.: 9

TRADEMARK

PRINCIPAL REGISTER

UNIVERSAL ENTERTAINMENT CORPORATION (JAPAN CORPORATION)
3-7-26 ARIAKE
ARIAKE FRONTIER BUILDING, TOWER A
KOTO-KU, TOKYO, JAPAN 135-0063

FOR: SLOT MACHINES AND REPLACEMENT PARTS THEREFOR; VIDEO SLOT MACHINES AND REPLACEMENT PARTS THEREFOR; GAMING MACHINES AND REPLACEMENT PARTS THEREFOR; GAMING MACHINES WITH A LIQUID CRYSTAL DISPLAY AND REPLACEMENT PARTS THEREFOR; MECHANICAL REEL TYPE SLOT MACHINES WITH A LIQUID CRYSTAL DISPLAY AND REPLACEMENT PARTS THEREFOR, IN CLASS 9 (U.S. CLS. 21, 23, 26, 36 AND 38).

FIRST USE 10-4-2011; IN COMMERCE 10-4-2011.

THE MARK CONSISTS OF WORDS "THE FOUR HEAVENLY KINGS" WITH FLAMES AND CHINESE CHARACTERS ABOVE.

THE NON-LATIN CHARACTERS IN THE MARK TRANSLITERATE TO "SIDA TIANWANG" AND THIS MEANS "FOUR GREAT CELESTIAL DEITY" IN ENGLISH.

SN 85-402,420, FILED 8-19-2011.

RONALD AIKENS, EXAMINING ATTORNEY



David J. Kybas

Director of the United States Patent and Trademark Office

United States of America

United States Patent and Trademark Office

360 Tax Review

Reg. No. 4,207,545

Registered Sep. 11, 2012

Int. Cl.: 35

SERVICE MARK

PRINCIPAL REGISTER

AUTOMATED RENT MANAGEMENT SOLUTIONS, INC (OHIO CORPORATION), DBA
ARMS,
8643 PENFIELD DRIVE
SAGAMORE HILLS, OH 44067

FOR: INCOME TAX CONSULTATION; INCOME TAX PREPARATION; TAX ADVISORY
SERVICES; TAX AND TAXATION PLANNING, ADVICE, INFORMATION AND CON-
SULTANCY SERVICES; TAX ASSESSMENT; TAX CONSULTATION; TAX FILING SER-
VICES; TAX PREPARATION, IN CLASS 35 (U.S. CLS. 100, 101 AND 102).

FIRST USE 3-3-2012; IN COMMERCE 3-3-2012.

THE MARK CONSISTS OF STANDARD CHARACTERS WITHOUT CLAIM TO ANY PAR-
TICULAR FONT, STYLE, SIZE, OR COLOR.

NO CLAIM IS MADE TO THE EXCLUSIVE RIGHT TO USE "TAX REVIEW", APART FROM
THE MARK AS SHOWN.

SN 85-403,181, FILED 8-21-2011.

FONG HSU, EXAMINING ATTORNEY



David J. Kyros

Director of the United States Patent and Trademark Office

United States of America

United States Patent and Trademark Office

Haute Body

Reg. No. 4,207,546

HAHN, LESLIE (UNITED STATES INDIVIDUAL)
8409 PICKWICK LANE 313
DALLAS, TX 75225

Registered Sep. 11, 2012

Int. Cl.: 35

FOR: COMPUTERIZED ON-LINE RETAIL STORE SERVICES IN THE FIELD OF FITNESS FASHION, IN CLASS 35 (U.S. CLS. 100, 101 AND 102).

SERVICE MARK

FIRST USE 2-1-2012; IN COMMERCE 2-1-2012.

PRINCIPAL REGISTER

THE MARK CONSISTS OF STANDARD CHARACTERS WITHOUT CLAIM TO ANY PARTICULAR FONT, STYLE, SIZE, OR COLOR.

SN 85-403,237, FILED 8-22-2011.

AISHA CLARKE, EXAMINING ATTORNEY



David J. Kybas

Director of the United States Patent and Trademark Office

United States of America

United States Patent and Trademark Office

VILE

Reg. No. 4,207,547

Registered Sep. 11, 2012

Int. Cls.: 35 and 42

SERVICE MARK

PRINCIPAL REGISTER

BURTON, PAUL (UNITED STATES INDIVIDUAL)
4664 CREEKSIDE VILLAS WAY
SMYRNA, GA 30082

FOR: MARKETING, ADVERTISING, AND PROMOTIONAL SERVICES, IN CLASS 35 (U.S. CLS. 100, 101 AND 102).

FIRST USE 3-31-2012; IN COMMERCE 3-31-2012.

FOR: GRAPHIC DESIGN, COMPUTER AIDED GRAPHIC DESIGN, GRAPHIC ILLUSTRATION SERVICES FOR OTHERS, WEBSITE DESIGN AND DEVELOPMENT FOR OTHERS, IN CLASS 42 (U.S. CLS. 100 AND 101).

FIRST USE 3-31-2012; IN COMMERCE 3-31-2012.

THE MARK CONSISTS OF STANDARD CHARACTERS WITHOUT CLAIM TO ANY PARTICULAR FONT, STYLE, SIZE, OR COLOR.

SN 85-403,242, FILED 8-22-2011.

AISHA CLARKE, EXAMINING ATTORNEY



David J. Kybas

Director of the United States Patent and Trademark Office

United States of America
United States Patent and Trademark Office

MICOACH

Reg. No. 4,207,548

Registered Sep. 11, 2012

Int. Cl.: 9

TRADEMARK

PRINCIPAL REGISTER

ADIDAS INTERNATIONAL MARKETING B.V. (NETHERLANDS PRIVATE LIMITED
LIABILITY COMPANY)
P.O. BOX 12160
AMSTERDAM ZO, NETHERLANDS 1100AD

FOR: COMPUTER GAME SOFTWARE; VIDEO GAME SOFTWARE; DOWNLOADABLE
GAME SOFTWARE, IN CLASS 9 (U.S. CLS. 21, 23, 26, 36 AND 38).

FIRST USE 12-2-2011; IN COMMERCE 3-3-2012.

THE MARK CONSISTS OF STANDARD CHARACTERS WITHOUT CLAIM TO ANY PAR-
TICULAR FONT, STYLE, SIZE, OR COLOR.

OWNER OF U.S. REG. NO. 3,822,311.

SN 85-403,521, FILED 8-22-2011.

MICHAEL WEBSTER, EXAMINING ATTORNEY



David J. Kybas

Director of the United States Patent and Trademark Office

United States of America
United States Patent and Trademark Office

KUROKAGE

Reg. No. 4,207,549

Registered Sep. 11, 2012

Int. Cl.: 28

TRADEMARK

PRINCIPAL REGISTER

mitsubishi rayon kabushiki kaisha (japan corporation), ta mitsubishi
rayon co., ltd.,
6-41, konan 1-chose, minato-ku
tokyo, japan

FOR: SHAFTS FOR GOLF CLUBS, IN CLASS 28 (U.S. CLS. 22, 23, 38 AND 50).

FIRST USE 1-30-2012; IN COMMERCE 1-30-2012.

THE MARK CONSISTS OF STANDARD CHARACTERS WITHOUT CLAIM TO ANY PARTICULAR FONT, STYLE, SIZE, OR COLOR.

THE ENGLISH TRANSLATION OF "KUROKAGE" IS "BLACK SHADOW".

SN 85-403,532, FILED 8-22-2011.

DAVID ELTON, EXAMINING ATTORNEY



David J. Kyffers

Director of the United States Patent and Trademark Office

United States of America

United States Patent and Trademark Office

WINKING OWL

Reg. No. 4,207,550

Registered Sep. 11, 2012

Int. Cl.: 33

TRADEMARK

PRINCIPAL REGISTER

ALDI INC. (ILLINOIS CORPORATION)
1200 N. KIRK ROAD
BATAVIA, IL 60510

FOR: WINE, IN CLASS 33 (U.S. CLS. 47 AND 49).

FIRST USE 6-8-2004; IN COMMERCE 6-8-2004.

THE MARK CONSISTS OF STANDARD CHARACTERS WITHOUT CLAIM TO ANY PARTICULAR FONT, STYLE, SIZE, OR COLOR.

OWNER OF U.S. REG. NO. 2,974,593.

SN 85-403,543, FILED 8-22-2011.

LESLEY LAMOTHE, EXAMINING ATTORNEY



David J. Kyffers

Director of the United States Patent and Trademark Office

United States of America

United States Patent and Trademark Office

GRAMCL

Reg. No. 4,207,551

Registered Sep. 11, 2012

Int. Cl.: 9

TRADEMARK

PRINCIPAL REGISTER

GUANGDONG RISING ASSETS MANAGEMENT CO., LTD. (CHINA CORPORATION)
MINGYUE NO.1 ROAD, YUEXIU DISTRICT
FLOOR 15, RAMADA PEARL HOTEL, NO.9
GUANGZHOU, CHINA

FOR: CABINETS FOR LOUDSPEAKERS; CALCULATING MACHINES AND DATA PROCESSING EQUIPMENT; COMPUTER PERIPHERAL DEVICES; DVD PLAYERS; INTEGRATED CIRCUIT CARDS AND COMPONENTS; INTEGRATED CIRCUITS; SEMICONDUCTORS; SOUND TRANSMITTING APPARATUS; TELECOMMUNICATIONS TRANSMITTERS; TELEPHONE APPARATUS, IN CLASS 9 (U.S. CLS. 21, 23, 26, 36 AND 38).

FIRST USE 12-30-1999; IN COMMERCE 10-1-2011.

THE MARK CONSISTS OF STANDARD CHARACTERS WITHOUT CLAIM TO ANY PARTICULAR FONT, STYLE, SIZE, OR COLOR.

SN 85-404,007, FILED 8-22-2011.

TRACY FLETCHER, EXAMINING ATTORNEY



David J. Kybas

Director of the United States Patent and Trademark Office

United States of America

United States Patent and Trademark Office

YUAN SPA

Reg. No. 4,207,552

B&Z LLC (WASHINGTON LIMITED LIABILITY COMPANY)
P.O. BOX 581

Registered Sep. 11, 2012

KIRKLAND, WA 98083

Int. Cl.: 44

FOR: HEALTH SPA SERVICES, NAMELY, BODY WRAPS, MUD TREATMENTS, SEAWEED TREATMENTS, MASSAGE, HOT STONE THERAPY, HYDROTHERAPY BATHS, BODY SCRUBS, AND FACIALS, IN CLASS 44 (U.S. CLS. 100 AND 101).

SERVICE MARK

FIRST USE 11-13-2011; IN COMMERCE 2-29-2012.

PRINCIPAL REGISTER

THE MARK CONSISTS OF STANDARD CHARACTERS WITHOUT CLAIM TO ANY PARTICULAR FONT, STYLE, SIZE, OR COLOR.

NO CLAIM IS MADE TO THE EXCLUSIVE RIGHT TO USE "SPA", APART FROM THE MARK AS SHOWN.

THE ENGLISH TRANSLATION OF "YUAN" IN THE MARK IS SOURCE OF WATER.

SN 85-404,019, FILED 8-22-2011.

PAUL E. FAHRENKOPF, EXAMINING ATTORNEY



David J. Kyfos

Director of the United States Patent and Trademark Office

United States of America

United States Patent and Trademark Office

RAINSTORM SOLUTIONS

Reg. No. 4,207,553

ALDRIDGE, BILL (UNITED STATES INDIVIDUAL)
5901 OFFSHORE CT
WILMINGTON, NC 28409

Registered Sep. 11, 2012

Int. Cl.: 37

FOR: RAINWATER HARVESTING AND STORMWATER MANAGEMENT SERVICES, NAMELY, INSTALLATION AND MAINTENANCE OF RAINWATER CONTAINMENT CISTERNS, FILTERS, AND PUMPS, IN CLASS 37 (U.S. CLS. 100, 103 AND 106).

SERVICE MARK

FIRST USE 2-1-2012; IN COMMERCE 2-1-2012.

PRINCIPAL REGISTER

THE MARK CONSISTS OF STANDARD CHARACTERS WITHOUT CLAIM TO ANY PARTICULAR FONT, STYLE, SIZE, OR COLOR.

SN 85-404,338, FILED 8-23-2011.

SOPHIA S. KIM, EXAMINING ATTORNEY



David J. Kyffers

Director of the United States Patent and Trademark Office

United States of America

United States Patent and Trademark Office

United We Train Divided We Brawl

Reg. No. 4,207,554

JOHN PAUL MERKEL (UNITED STATES INDIVIDUAL)
3315 BERRIDGE LANE
ORLANDO, FL 32812

Registered Sep. 11, 2012

Int. Cl.: 25

FOR: CLOTHING, NAMELY, SHIRTS, T-SHIRTS, SWEAT SHIRTS, JACKETS, SHORTS, PANTS, CAPS, HATS, IN CLASS 25 (U.S. CLS. 22 AND 39).

TRADEMARK

FIRST USE 6-29-2012; IN COMMERCE 6-29-2012.

PRINCIPAL REGISTER

THE MARK CONSISTS OF STANDARD CHARACTERS WITHOUT CLAIM TO ANY PARTICULAR FONT, STYLE, SIZE, OR COLOR.

SN 85-404,384, FILED 8-23-2011.

KATHERINE CHANG, EXAMINING ATTORNEY



David J. Kybas

Director of the United States Patent and Trademark Office

United States of America
United States Patent and Trademark Office

COOL
wave

Reg. No. 4,207,555

BALL HORTICULTURAL COMPANY (ILLINOIS CORPORATION)
622 TOWN ROAD
WEST CHICAGO, IL 60185

Registered Sep. 11, 2012

Int. Cl.: 31

FOR: LIVING PLANTS; PLANT SEEDS, IN CLASS 31 (U.S. CLS. 1 AND 46).

TRADEMARK

FIRST USE 5-1-2012; IN COMMERCE 5-1-2012.

PRINCIPAL REGISTER

OWNER OF U.S. REG. NOS. 2,664,474, 2,848,076, AND OTHERS.

THE MARK CONSISTS OF THE WORD "COOL" ABOVE THE STYLIZED WORD "WAVE",
WITH THE DESIGN OF A WAVE UNDERNEATH.

SN 85-404,614, FILED 8-23-2011.

MARILYN IZZI, EXAMINING ATTORNEY



David J. Kyffers

Director of the United States Patent and Trademark Office

United States of America

United States Patent and Trademark Office

广晟

Reg. No. 4,207,556

Registered Sep. 11, 2012

Int. Cl.: 9

TRADEMARK

PRINCIPAL REGISTER

GUANGDONG RISING ASSETS MANAGEMENT CO., LTD. (CHINA CORPORATION)
MINGYUE NO.1 ROAD, YUEXIU DISTRICT
FLOOR 15, RAMADA PEARL HOTEL, NO.9
GUANGZHOU, CHINA

FOR: CABINETS FOR LOUDSPEAKERS; CALCULATING MACHINES AND DATA PROCESSING EQUIPMENT; COMPUTER PERIPHERAL DEVICES; DVD PLAYERS; INTEGRATED CIRCUIT CARDS AND COMPONENTS; INTEGRATED CIRCUITS; SEMICONDUCTORS; SOUND TRANSMITTING APPARATUS; TELECOMMUNICATIONS TRANSMITTERS; TELEPHONE APPARATUS, IN CLASS 9 (U.S. CLS. 21, 23, 26, 36 AND 38).

FIRST USE 12-30-1999; IN COMMERCE 10-1-2011.

THE MARK CONSISTS OF TWO CHINESE CHARACTERS.

THE NON-LATIN CHARACTERS IN THE MARK TRANSLITERATE TO "GUANG" (THE FIRST CHARACTER) AND "SHENG" (THE SECOND CHARACTER) AND THIS MEANS "WIDE" (IN THE CASE OF "GUANG") AND "BRIGHT" (IN THE CASE OF "SHENG") IN ENGLISH.

SN 85-404,920, FILED 8-23-2011.

TRACY FLETCHER, EXAMINING ATTORNEY



David J. Kyros

Director of the United States Patent and Trademark Office

United States of America

United States Patent and Trademark Office

TEAM TOSS

Reg. No. 4,207,557

SPIKER INC. (FLORIDA CORPORATION)
1100 SANDY ACRES
TALLAHASSEE, FL 32317

Registered Sep. 11, 2012

Int. Cl.: 28

FOR: ACTION SKILL GAMES, IN CLASS 28 (U.S. CLS. 22, 23, 38 AND 50).

TRADEMARK

FIRST USE 8-1-2011; IN COMMERCE 8-1-2011.

PRINCIPAL REGISTER

THE MARK CONSISTS OF STANDARD CHARACTERS WITHOUT CLAIM TO ANY PARTICULAR FONT, STYLE, SIZE, OR COLOR.

NO CLAIM IS MADE TO THE EXCLUSIVE RIGHT TO USE "TOSS", APART FROM THE MARK AS SHOWN.

SN 85-405,005, FILED 8-23-2011.

DOMINIC J. FERRAIUOLO, EXAMINING ATTORNEY



David J. Kyffers

Director of the United States Patent and Trademark Office

United States of America

United States Patent and Trademark Office



Reg. No. 4,207,558

Registered Sep. 11, 2012

Int. Cl.: 9

TRADEMARK

PRINCIPAL REGISTER

GUANGDONG RISING ASSETS MANAGEMENT CO., LTD. (CHINA CORPORATION)
MINGYUE NO.1 ROAD, YUEXIU DISTRICT
FLOOR 15, RAMADA PEARL HOTEL, NO.9
GUANGZHOU, CHINA

FOR: CABINETS FOR LOUDSPEAKERS; CALCULATING MACHINES AND DATA PROCESSING EQUIPMENT; COMPUTER PERIPHERAL DEVICES; DVD PLAYERS; INTEGRATED CIRCUIT CARDS AND COMPONENTS; INTEGRATED CIRCUITS; SEMICONDUCTORS; SOUND TRANSMITTING APPARATUS; TELECOMMUNICATIONS TRANSMITTERS; TELEPHONE APPARATUS, IN CLASS 9 (U.S. CLS. 21, 23, 26, 36 AND 38).

FIRST USE 12-30-1999; IN COMMERCE 10-1-2011.

THE MARK CONSISTS OF A DEVICE OF A CIRCLE WITH THREE LEAVES CROSSING THE UPPER RIGHT OF THE CIRCLE.

SN 85-405,008, FILED 8-23-2011.

TRACY FLETCHER, EXAMINING ATTORNEY



David J. Kybas

Director of the United States Patent and Trademark Office

United States of America

United States Patent and Trademark Office

THE DOG ZONE

Reg. No. 4,207,559

STARMARK PET PRODUCTS, INC. (TEXAS CORPORATION)
201 COUNTY ROAD 197
HUTTO, TX 78634

Registered Sep. 11, 2012

Int. Cl.: 28

FOR: RAISED PLATFORMS, CONSTRUCTED OF TUBULAR STEEL WITH A TOP SURFACE MADE OF NYLON OR OTHER FABRIC, USED AS DOG TRAINING DEVICES AND AS LOCATIONS FOR INTERACTIVE PLAY, IN CLASS 28 (U.S. CLS. 22, 23, 38 AND 50).

TRADEMARK

FIRST USE 9-13-2011; IN COMMERCE 9-13-2011.

PRINCIPAL REGISTER

THE MARK CONSISTS OF STANDARD CHARACTERS WITHOUT CLAIM TO ANY PARTICULAR FONT, STYLE, SIZE, OR COLOR.

NO CLAIM IS MADE TO THE EXCLUSIVE RIGHT TO USE "DOG", APART FROM THE MARK AS SHOWN.

SN 85-405,188, FILED 8-23-2011.

KEVON CHISOLM, EXAMINING ATTORNEY



David J. Kybas

Director of the United States Patent and Trademark Office

United States of America

United States Patent and Trademark Office

KLOAK KONSEALMENT

Reg. No. 4,207,560

Registered Sep. 11, 2012

Int. Cl.: 24

TRADEMARK

PRINCIPAL REGISTER

JT&O TECHNOLOGIES (TENNESSEE LIMITED LIABILITY COMPANY)
418 CHRISTIAN BEND
CHURCH HILL, TN 37642

FOR: FABRICS FOR TEXTILE USE, IN CLASS 24 (U.S. CLS. 42 AND 50).

FIRST USE 4-24-2012; IN COMMERCE 4-24-2012.

THE MARK CONSISTS OF STANDARD CHARACTERS WITHOUT CLAIM TO ANY PARTICULAR FONT, STYLE, SIZE, OR COLOR.

NO CLAIM IS MADE TO THE EXCLUSIVE RIGHT TO USE "CLOAK", APART FROM THE MARK AS SHOWN.

SN 85-405,242, FILED 8-23-2011.

MEGHAN REINHART, EXAMINING ATTORNEY



David J. Kybas

Director of the United States Patent and Trademark Office

United States of America

United States Patent and Trademark Office



Reg. No. 4,207,561

FERRANTE, RALPH M. (UNITED STATES INDIVIDUAL)
1031 ROUTE 9W

Registered Sep. 11, 2012

UPPER GRANDVIEW, NY 10960

Int. Cl.: 5

FOR: DIETARY SUPPLEMENTS, NUTRITION SUPPLEMENTS AND VITAMIN SUPPLEMENTS, IN CLASS 5 (U.S. CLS. 6, 18, 44, 46, 51 AND 52).

TRADEMARK

FIRST USE 3-31-2012; IN COMMERCE 3-31-2012.

PRINCIPAL REGISTER

THE MARK CONSISTS OF AN OVAL CONTAINING A FOUR-RINGED CHEMICAL STRUCTURE, AND THE WORDS "ADVANCED BIO" AND "DEVELOPMENT" SEPARATED BY A HORIZONTAL LINE.

SN 85-405,583, FILED 8-24-2011.

KARANENDRA S. CHHINA, EXAMINING ATTORNEY



David J. Kybas

Director of the United States Patent and Trademark Office

United States of America

United States Patent and Trademark Office



Reg. No. 4,207,562

FERRANTE, RALPH M. (UNITED STATES INDIVIDUAL)
1031 ROUTE 9W

Registered Sep. 11, 2012

UPPER GRANDVIEW, NY 10960

Int. Cl.: 5

FOR: DIETARY SUPPLEMENTS, NUTRITION SUPPLEMENTS AND VITAMIN SUPPLEMENTS, IN CLASS 5 (U.S. CLS. 6, 18, 44, 46, 51 AND 52).

TRADEMARK

FIRST USE 3-31-2012; IN COMMERCE 3-31-2012.

PRINCIPAL REGISTER

THE MARK CONSISTS OF A SHIELD CONTAINING AN "X" IN THE CENTER AND A "2" IN THE UPPER RIGHT CORNER, THE "X" AND "2" SEPARATED BY AN CURVED LINE.

SN 85-405,604, FILED 8-24-2011.

KARANENDRA S. CHHINA, EXAMINING ATTORNEY



David J. Kybas

Director of the United States Patent and Trademark Office

United States of America

United States Patent and Trademark Office

PAYDIANT

Reg. No. 4,207,563

Registered Sep. 11, 2012

Int. Cls.: 9 and 42

TRADEMARK

SERVICE MARK

PRINCIPAL REGISTER

PAYDIANT, INC. (DELAWARE CORPORATION)
40 WALNUT STREET, SUITE 400
WELLESLEY, MA 02481

FOR: DOWNLOADABLE COMPUTER APPLICATION SOFTWARE FOR MOBILE PHONES AND WIRELESS HANDHELD COMPUTERS FOR USE IN PROVIDING AN ELECTRONIC FINANCIAL PLATFORM THAT ACCOMMODATES MULTIPLE TYPES OF PAYMENT AND DEBT TRANSACTIONS FOR USE IN MAKING ELECTRONIC PAYMENTS AND THE RECEIPT, REDEMPTION AND MANAGEMENT OF ELECTRONIC PAYMENT RECEIPTS AND ELECTRONIC COUPONS, IN CLASS 9 (U.S. CLS. 21, 23, 26, 36 AND 38).

FIRST USE 8-0-2011; IN COMMERCE 8-0-2011.

FOR: APPLICATION SERVICE PROVIDER (ASP) SERVICES FEATURING MOBILE PHONE AND WIRELESS HANDHELD COMPUTER APPLICATIONS SOFTWARE FOR USE IN ENABLING USERS TO MAKE ELECTRONIC PAYMENTS AND TO RECEIVE, REDEEM, AND MANAGE ELECTRONIC RECEIPTS AND ELECTRONIC COUPONS; COMPUTER SERVICES, NAMELY, PROVIDING TECHNICAL SUPPORT TO MERCHANTS AND CONSUMER USERS OF A HOSTED MANAGED SERVICE USED IN CONJUNCTION WITH AN APPLICATION ON A MOBILE PHONE OR WIRELESS DEVICE THAT ENABLES USERS TO MAKE PAYMENTS, AND RECEIVE, REDEEM, AND MANAGE ELECTRONIC RECEIPTS AND ELECTRONIC COUPONS, NAMELY, TROUBLE SHOOTING OF COMPUTER SOFTWARE PROBLEMS, IN CLASS 42 (U.S. CLS. 100 AND 101).

FIRST USE 8-0-2011; IN COMMERCE 8-0-2011.

THE MARK CONSISTS OF STANDARD CHARACTERS WITHOUT CLAIM TO ANY PARTICULAR FONT, STYLE, SIZE, OR COLOR.

SN 85-405,863, FILED 8-24-2011.

AMY C. KEAN, EXAMINING ATTORNEY



David J. Kappas

Director of the United States Patent and Trademark Office

United States of America

United States Patent and Trademark Office



Reg. No. 4,207,564

Registered Sep. 11, 2012

Int. Cl.: 25

S. GOLDBERG & CO., INC (NEW JERSEY CORPORATION)
SUITE 400
3 UNIVERSITY PLAZA
HACKENSACK, NJ 076016221

FOR: FOOTWEAR, IN CLASS 25 (U.S. CLS. 22 AND 39).

TRADEMARK

FIRST USE 2-24-2012; IN COMMERCE 2-24-2012.

PRINCIPAL REGISTER

NO CLAIM IS MADE TO THE EXCLUSIVE RIGHT TO USE "TECHNOLOGY" , APART FROM THE MARK AS SHOWN.

THE MARK CONSIST OF THE WORD "AQUAFLO" FEATURING A WATER DROP INSIDE THE LETTER "O", A WAVY LINE AND THE WORD "TECHNOLOGY" ALL LOCATED WITHIN A LARGE DESIGN OF A WATER DROP.

SN 85-406,140, FILED 8-24-2011.

JEFF DEFORD, EXAMINING ATTORNEY



David J. Kybas

Director of the United States Patent and Trademark Office

United States of America

United States Patent and Trademark Office

Visualize Positive Results

Reg. No. 4,207,565

Registered Sep. 11, 2012

Int. Cl.: 25

TRADEMARK

PRINCIPAL REGISTER

HUNT, LAUREL (UNITED STATES INDIVIDUAL)
7528 SUNNY RIDGE LOOP
HIGHLAND, CA 92346

FOR: SHIRTS, IN CLASS 25 (U.S. CLS. 22 AND 39).

FIRST USE 6-1-2012; IN COMMERCE 6-1-2012.

THE MARK CONSISTS OF STANDARD CHARACTERS WITHOUT CLAIM TO ANY PARTICULAR FONT, STYLE, SIZE, OR COLOR.

SN 85-406,190, FILED 8-24-2011.

BRIDGETT SMITH, EXAMINING ATTORNEY



David J. Kyffers

Director of the United States Patent and Trademark Office

United States of America

United States Patent and Trademark Office

BMO HARRIS BANK CENTER

Reg. No. 4,207,566

Registered Sep. 11, 2012

Int. Cl.: 43

SERVICE MARK

PRINCIPAL REGISTER

BMO HARRIS BANK NATIONAL ASSOCIATION (UNITED STATES NATIONAL BANKING ASSOCIATION)
111 WEST MONROE STREET
CHICAGO, IL 60603

FOR: ARENA SERVICES, NAMELY, PROVIDING STADIUM FACILITIES FOR CONCERTS, CONVENTIONS, EXHIBITIONS, MEETINGS, SEMINARS, SPECTATOR EVENTS, AND SPORTING EVENTS, IN CLASS 43 (U.S. CLS. 100 AND 101).

FIRST USE 10-31-2011; IN COMMERCE 10-31-2011.

THE MARK CONSISTS OF STANDARD CHARACTERS WITHOUT CLAIM TO ANY PARTICULAR FONT, STYLE, SIZE, OR COLOR.

OWNER OF U.S. REG. NOS. 1,008,229, 3,248,907, AND OTHERS.

NO CLAIM IS MADE TO THE EXCLUSIVE RIGHT TO USE "BANK CENTER", APART FROM THE MARK AS SHOWN.

SN 85-406,438, FILED 8-24-2011.

CURTIS FRENCH, EXAMINING ATTORNEY



David J. Kybas

Director of the United States Patent and Trademark Office

United States of America

United States Patent and Trademark Office

BMO HARRIS BANK CENTER

Reg. No. 4,207,567

Registered Sep. 11, 2012

Int. Cl.: 43

SERVICE MARK

PRINCIPAL REGISTER

BMO HARRIS BANK NATIONAL ASSOCIATION (UNITED STATES NATIONAL BANKING ASSOCIATION)
111 WEST MONROE STREET
CHICAGO, IL 60603

FOR: ARENA SERVICES, NAMELY, PROVIDING STADIUM FACILITIES FOR CONCERTS, CONVENTIONS, EXHIBITIONS, MEETINGS, SEMINARS, SPECTATOR EVENTS, AND SPORTING EVENTS, IN CLASS 43 (U.S. CLS. 100 AND 101).

FIRST USE 10-31-2011; IN COMMERCE 10-31-2011.

OWNER OF U.S. REG. NOS. 1,008,229, 3,248,907, AND OTHERS.

NO CLAIM IS MADE TO THE EXCLUSIVE RIGHT TO USE "BANK CENTER", APART FROM THE MARK AS SHOWN.

THE MARK CONSISTS OF THE TERMS "BMO HARRIS BANK CENTER", WITH A CIRCULAR DESIGN CONTAINING A LETTER "M" AND A BAR APPEARING BETWEEN THE TERMS "BMO" AND "HARRIS".

SN 85-406,523, FILED 8-24-2011.

CURTIS FRENCH, EXAMINING ATTORNEY



David J. Kybas

Director of the United States Patent and Trademark Office

United States of America

United States Patent and Trademark Office

SOUR COOLERS

Reg. No. 4,207,568

Registered Sep. 11, 2012

Int. Cl.: 30

TRADEMARK

PRINCIPAL REGISTER

IMPACT CONFECTIONS, INC. (NEW MEXICO CORPORATION)
10822 W. TOLLER DRIVE, SUITE 350
LITTLETON, CO 80127

FOR: CANDY, IN CLASS 30 (U.S. CL. 46).

FIRST USE 7-1-2012; IN COMMERCE 7-1-2012.

THE MARK CONSISTS OF STANDARD CHARACTERS WITHOUT CLAIM TO ANY PARTICULAR FONT, STYLE, SIZE, OR COLOR.

NO CLAIM IS MADE TO THE EXCLUSIVE RIGHT TO USE "SOUR", APART FROM THE MARK AS SHOWN.

SN 85-406,896, FILED 8-25-2011.

IRA J. GOODSaid, EXAMINING ATTORNEY



David J. Kyffers

Director of the United States Patent and Trademark Office

United States of America

United States Patent and Trademark Office



Reg. No. 4,207,569

Registered Sep. 11, 2012

Int. Cl.: 35

SERVICE MARK

PRINCIPAL REGISTER

AUTOMATED RENT MANAGEMENT SOLUTIONS, INC (OHIO CORPORATION), DBA
ARMS,
8643 PENFIELD DRIVE
SAGAMORE HILLS, OH 44067

FOR: INCOME TAX CONSULTATION; INCOME TAX PREPARATION; MANAGEMENT OF
TAX FILES; TAX ADVISORY SERVICES; TAX AND TAXATION PLANNING, ADVICE,
INFORMATION AND CONSULTANCY SERVICES; TAX ASSESSMENT; TAX CONSULTA-
TION; TAX DECLARATION PROCEDURE SERVICES; TAX FILING SERVICES; TAX PRE-
PARATION, IN CLASS 35 (U.S. CLS. 100, 101 AND 102).

FIRST USE 3-7-2012; IN COMMERCE 3-7-2012.

NO CLAIM IS MADE TO THE EXCLUSIVE RIGHT TO USE "TAX", APART FROM THE
MARK AS SHOWN.

THE MARK CONSISTS OF THE NUMBER "360" ABOVE TEXT TAX CONTAINED WITHIN
A CIRCLE; THE NUMBER AND TEXT ARE SLIGHTLY ROTATED WITHIN THE CIRCLE;
TO THE RIGHT OF THE CIRCLE, THE NUMBER "360" AND TEXT "TAX"; TO THE RIGHT
OF "TAX 3" SMALLER CIRCLES LINED UP HORIZONTALLY; THE CIRCLE WHICH
CONTAINS "360" TAX HAS FROM THE BOTTOM RIGHT A STRAIGHT LINE EMANATING
WHICH UNDERLINES THE TEXT AND WORD OUTSIDE THE CIRCLE.

SN 85-407,123, FILED 8-25-2011.

FONG HSU, EXAMINING ATTORNEY



David J. Kyffers

Director of the United States Patent and Trademark Office

United States of America

United States Patent and Trademark Office

APOLLO RESEARCH INSTITUTE

Reg. No. 4,207,570

Registered Sep. 11, 2012

Int. Cls.: 9 and 41

TRADEMARK

SERVICE MARK

PRINCIPAL REGISTER

APOLLO GROUP, INC. (ARIZONA CORPORATION)
4025 SOUTH RIVERPOINT PARKWAY
PHOENIX, AZ 85040

FOR: ELECTRONIC PUBLICATIONS, NAMELY, DOWNLOADABLE ELECTRONIC FILES AND PRINTED PAPER CONSISTING OF RESEARCH STUDY PAPERS AND REPORTS, WHITE PAPERS, AND CONFERENCE PAPERS IN THE FIELD OF EDUCATION AND RESEARCH RELATING TO WORKING LEARNERS, HIGHER EDUCATION AND INDUSTRY, IN CLASS 9 (U.S. CLS. 21, 23, 26, 36 AND 38).

FIRST USE 11-4-2011; IN COMMERCE 11-4-2011.

FOR: EDUCATIONAL SERVICES, NAMELY, WORKSHOPS, CONFERENCES, SPEECHES, AND PRESENTATIONS IN THE FIELDS OF EDUCATION AND RESEARCH STUDIES AND REPORTS RELATING TO WORKING LEARNERS, HIGHER EDUCATION AND INDUSTRY, IN CLASS 41 (U.S. CLS. 100, 101 AND 107).

FIRST USE 11-4-2011; IN COMMERCE 11-4-2011.

THE MARK CONSISTS OF STANDARD CHARACTERS WITHOUT CLAIM TO ANY PARTICULAR FONT, STYLE, SIZE, OR COLOR.

NO CLAIM IS MADE TO THE EXCLUSIVE RIGHT TO USE "RESEARCH INSTITUTE", APART FROM THE MARK AS SHOWN.

SN 85-407,260, FILED 8-25-2011.

JENNY PARK, EXAMINING ATTORNEY



David J. Kybas

Director of the United States Patent and Trademark Office

United States of America

United States Patent and Trademark Office

FLEX CARE

Reg. No. 4,207,571

Registered Sep. 11, 2012

Int. Cl.: 36

SERVICE MARK

PRINCIPAL REGISTER

FLEXENERGY, INC. (DELAWARE CORPORATION)
9601 IRVINE CENTER DRIVE
IRVINE, CA 92618

FOR: PROVIDING SERVICE CONTRACTS FOR THE REPAIR, INSTALLATION, TUNING AND MAINTENANCE OF COMPONENTS, PARTS OR SYSTEMS IN STEAM AND GAS TURBINE GENERATORS, POWER PLANTS, POWER GENERATING EQUIPMENT, ELECTRICITY GENERATING EQUIPMENT, COMBINED HEAT AND POWER EQUIPMENT AND BOILERS, IN CLASS 36 (U.S. CLS. 100, 101 AND 102).

FIRST USE 12-6-2011; IN COMMERCE 12-6-2011.

THE MARK CONSISTS OF STANDARD CHARACTERS WITHOUT CLAIM TO ANY PARTICULAR FONT, STYLE, SIZE, OR COLOR.

NO CLAIM IS MADE TO THE EXCLUSIVE RIGHT TO USE "CARE", APART FROM THE MARK AS SHOWN.

SN 85-408,413, FILED 8-26-2011.

CHRIS DONINGER, EXAMINING ATTORNEY



David J. Kyffers

Director of the United States Patent and Trademark Office

United States of America

United States Patent and Trademark Office



Reg. No. 4,207,572

Registered Sep. 11, 2012

Int. Cl.: 44

SERVICE MARK

PRINCIPAL REGISTER

A CARING HOME CARE SERVICES, LLC (LOUISIANA LIMITED LIABILITY COMPANY)
205 WEST BRIDGE STREET
ST. MARTINVILLE, LA 70582

FOR: HOME HEALTH CARE SERVICES, IN CLASS 44 (U.S. CLS. 100 AND 101).

FIRST USE 6-13-2012; IN COMMERCE 6-13-2012.

NO CLAIM IS MADE TO THE EXCLUSIVE RIGHT TO USE "HOME CARE SERVICES",
APART FROM THE MARK AS SHOWN.

THE COLOR(S) RED, WHITE, AND BLUE IS/ARE CLAIMED AS A FEATURE OF THE
MARK.

THE MARK CONSISTS OF A DESIGN WITH AN OVERALL HEART SHAPE RESEMBLING
A LOCKET FORMED BY WAVY AND/OR CURVED BLUE LINES HAVING AN INCOMPLETE
RED OVAL AT ITS CENTER WITH A WHITE FIGURE INSIDE AND AN INCOMPLETE
RING AT THE TOP. THE INNER WHITE BACKGROUND OF THE LOCKET IS CLAIMED
AS A FEATURE OF THE MARK. THE WORDING "WE TAKE CARE OF YOU" APPEARS
IN CURVED BLUE LETTERING ABOVE THE HEART-SHAPED LOCKET. THE WORDING
"A CARING HOME CARE SERVICES" APPEARS IN BLUE LETTERING BELOW THE
HEART-SHAPED LOCKET WITH THE DOT OVER THE LETTER "I" IN "CARING" IN RED
AND THE WORD "SERVICES" ALSO IN RED.

SN 85-408,586, FILED 8-26-2011.

ZHALEH DELANEY, EXAMINING ATTORNEY



David J. Kyjars

Director of the United States Patent and Trademark Office

United States of America

United States Patent and Trademark Office

MERCURY

Reg. No. 4,207,573

KCG IP HOLDINGS LLC (DELAWARE LIMITED LIABILITY COMPANY)
131 SOUTH DEARBORN STREET
CHICAGO, IL 60603

Registered Sep. 11, 2012

Int. Cl.: 42

FOR: APPLICATION SERVICE PROVIDER (ASP) FEATURING SOFTWARE FOR USE IN EXECUTING TRADES OF FINANCIAL INSTRUMENTS; THE FOREGOING EXCLUDING FLORISTS, IN CLASS 42 (U.S. CLS. 100 AND 101).

SERVICE MARK

FIRST USE 9-1-2011; IN COMMERCE 9-1-2011.

PRINCIPAL REGISTER

THE MARK CONSISTS OF STANDARD CHARACTERS WITHOUT CLAIM TO ANY PARTICULAR FONT, STYLE, SIZE, OR COLOR.

SN 85-408,599, FILED 8-26-2011.

SUNG IN, EXAMINING ATTORNEY



David J. Kyfos

Director of the United States Patent and Trademark Office

United States of America

United States Patent and Trademark Office

SEER Program

Reg. No. 4,207,574

Registered Sep. 11, 2012

Int. Cl.: 36

SULLIVAN BROKERS WHOLESALE INSURANCE SOLUTIONS, INC. (CALIFORNIA CORPORATION)
SUITE 1800
800 WEST 6TH STREET
LOS ANGELES, CA 90017

SERVICE MARK

FOR: INSURANCE BROKERAGE IN THE FIELD OF SUSTAINABLE ENERGY AND ENVIRONMENTAL RISKS, IN CLASS 36 (U.S. CLS. 100, 101 AND 102).

PRINCIPAL REGISTER

FIRST USE 10-19-2011; IN COMMERCE 10-19-2011.

THE MARK CONSISTS OF STANDARD CHARACTERS WITHOUT CLAIM TO ANY PARTICULAR FONT, STYLE, SIZE, OR COLOR.

NO CLAIM IS MADE TO THE EXCLUSIVE RIGHT TO USE "PROGRAM", APART FROM THE MARK AS SHOWN.

SN 85-408,735, FILED 8-26-2011.

DEZMONA MIZELLE, EXAMINING ATTORNEY



David J. Kyffers

Director of the United States Patent and Trademark Office

United States of America

United States Patent and Trademark Office

UNCONDITIONAL CAT LITTER

Reg. No. 4,207,575

EQUUSTOCK, LLC (ILLINOIS LIMITED LIABILITY COMPANY)
8179 STARWOOD DRIVE, SUITE 1
LOVES PARK, IL 61111

Registered Sep. 11, 2012

Int. Cl.: 31

FOR: CAT LITTER AND LITTER FOR SMALL ANIMALS, IN CLASS 31 (U.S. CLS. 1 AND 46).

TRADEMARK

FIRST USE 11-15-2011; IN COMMERCE 11-15-2011.

PRINCIPAL REGISTER

THE MARK CONSISTS OF STANDARD CHARACTERS WITHOUT CLAIM TO ANY PARTICULAR FONT, STYLE, SIZE, OR COLOR.

NO CLAIM IS MADE TO THE EXCLUSIVE RIGHT TO USE "CAT LITTER", APART FROM THE MARK AS SHOWN.

SN 85-409,601, FILED 8-29-2011.

STEVEN JACKSON, EXAMINING ATTORNEY



David J. Kyffers

Director of the United States Patent and Trademark Office

United States of America

United States Patent and Trademark Office

Larger Than Life

Reg. No. 4,207,576

Registered Sep. 11, 2012

Int. Cl.: 41

SERVICE MARK

PRINCIPAL REGISTER

BRIAN MICHAEL DELAC (UNITED STATES INDIVIDUAL)
UNIT #2
25 SUDAN STREET
DORCHESTER, MA 02125

FOR: ENTERTAINMENT SERVICES IN THE NATURE OF RECORDING, PRODUCTION AND POST-PRODUCTION SERVICES IN THE FIELD OF MUSIC, IN CLASS 41 (U.S. CLS. 100, 101 AND 107).

FIRST USE 5-1-2011; IN COMMERCE 9-1-2011.

THE MARK CONSISTS OF STANDARD CHARACTERS WITHOUT CLAIM TO ANY PARTICULAR FONT, STYLE, SIZE, OR COLOR.

SN 85-409,674, FILED 8-29-2011.

RONALD DELGIZZI, EXAMINING ATTORNEY



David J. Kybas

Director of the United States Patent and Trademark Office

United States of America

United States Patent and Trademark Office

NORDIC DIESEL

Reg. No. 4,207,577

ST. PAUL PARK REFINING CO. LLC (DELAWARE LIMITED LIABILITY COMPANY)
38C GROVE STREET, SUITE 100
RIDGEFIELD, CT 06877

Registered Sep. 11, 2012

Int. Cl.: 4

FOR: DIESEL FUEL, IN CLASS 4 (U.S. CLS. 1, 6 AND 15).

TRADEMARK

FIRST USE 10-25-2011; IN COMMERCE 10-25-2011.

PRINCIPAL REGISTER

THE MARK CONSISTS OF STANDARD CHARACTERS WITHOUT CLAIM TO ANY PARTICULAR FONT, STYLE, SIZE, OR COLOR.

NO CLAIM IS MADE TO THE EXCLUSIVE RIGHT TO USE "DIESEL", APART FROM THE MARK AS SHOWN.

SN 85-410,820, FILED 8-30-2011.

NORA BUCHANAN WILL, EXAMINING ATTORNEY



David J. Kyffers

Director of the United States Patent and Trademark Office

United States of America

United States Patent and Trademark Office

SMARTSIGHT

Reg. No. 4,207,578

JACK HENRY SOFTWARE/COMMLINK, L.P. (TEXAS LIMITED PARTNERSHIP)
663 W. HWY. 60, P.O. BOX 807
MONETT, MO 65708

Registered Sep. 11, 2012

Int. Cls.: 9 and 42

FOR: COMPUTER SOFTWARE FOR USE BY FINANCIAL INSTITUTIONS TO MONITOR PAYMENTS MADE TO FINANCIAL INSTITUTION CUSTOMERS FOR DEPOSIT TO IDENTIFY POSSIBLE IRREGULARITIES IN SUCH PAYMENTS, IN CLASS 9 (U.S. CLS. 21, 23, 26, 36 AND 38).

TRADEMARK

SERVICE MARK

FIRST USE 10-18-2011; IN COMMERCE 10-18-2011.

PRINCIPAL REGISTER

FOR: SOFTWARE AS A SERVICE (SAAS) SERVICES, NAMELY, HOSTING SOFTWARE FOR USE BY FINANCIAL INSTITUTIONS TO MONITOR PAYMENTS MADE TO FINANCIAL INSTITUTION CUSTOMERS FOR DEPOSIT TO IDENTIFY POSSIBLE IRREGULARITIES IN SUCH PAYMENTS, IN CLASS 42 (U.S. CLS. 100 AND 101).

FIRST USE 10-18-2011; IN COMMERCE 10-18-2011.

THE MARK CONSISTS OF STANDARD CHARACTERS WITHOUT CLAIM TO ANY PARTICULAR FONT, STYLE, SIZE, OR COLOR.

SN 85-410,966, FILED 8-30-2011.

DEZMONA MIZELLE, EXAMINING ATTORNEY



David J. Kypos

Director of the United States Patent and Trademark Office

United States of America

United States Patent and Trademark Office

NORLUX

Reg. No. 4,207,579

CARMEN MATTHEW LLC (DELAWARE LIMITED LIABILITY COMPANY), DBA NORLUX,
575 RANDY ROAD
CAROL STREAM, IL 601882121

Registered Sep. 11, 2012

Int. Cl.: 11

FOR: LED LIGHT ASSEMBLIES FOR STREET LIGHTS, SIGNS, COMMERCIAL LIGHTING,
AUTOMOBILES, BUILDINGS, AND OTHER ARCHITECTURAL USES; LED LIGHT ENGINES;
LED LIGHTING SYSTEMS, NAMELY, LED MODULES, POWER SUPPLIES, AND WIRING,
IN CLASS 11 (U.S. CLS. 13, 21, 23, 31 AND 34).

TRADEMARK

PRINCIPAL REGISTER

FIRST USE 3-1-2005; IN COMMERCE 2-1-2011.

OWNER OF U.S. REG. NO. 2,794,236.

THE COLOR(S) GRAY AND BLUE IS/ARE CLAIMED AS A FEATURE OF THE MARK.

THE MARK CONSISTS OF A GRAY CAPITAL LETTER "N", BLUE FANCIFUL "O" THAT
LOOKS LIKE A HALF MOON, GRAY CAPITAL LETTERS "R", "L", "U", "X".

SN 85-411,416, FILED 8-31-2011.

MIDGE BUTLER, EXAMINING ATTORNEY



David J. Kyfos

Director of the United States Patent and Trademark Office

United States of America

United States Patent and Trademark Office

YHN

Reg. No. 4,207,580

Registered Sep. 11, 2012

Int. Cl.: 41

SERVICE MARK

PRINCIPAL REGISTER

YOUNG HOLLYWOOD, LLC (CALIFORNIA LIMITED LIABILITY COMPANY)
1627 PONTIUS AVE. 1ST FLOOR
LOS ANGELES, CA 90025

FOR: PROVIDING INFORMATION AND CONTENT ACCESSIBLE VIA A GLOBAL COMPUTER NETWORK, WEBCASTS, TELEVISION, CABLE TRANSMISSION, AN ON-LINE COMPUTER DATABASE, OR FOR TRANSMISSION TO WIRELESS MOBILE DEVICES IN THE FIELDS OF CURRENT EVENTS, CULTURAL EVENTS AND ENTERTAINMENT-RELATED TOPICS; PRODUCTION AND DISTRIBUTION OF NON-DOWNLOADABLE VIDEOS AND IMAGES TRANSMITTED VIA THE INTERNET, WIRELESS COMMUNICATION NETWORKS, VIA CABLE TRANSMISSION, AND TELEVISION IN THE FIELDS OF LIVE AND RECORDED AUDIO VISUAL PERFORMANCES, MUSIC, FASHION, COMEDY, SPORTS, LIFESTYLE, VIDEO GAMES, WEBISODE SERIES, CELEBRITY APPEARANCES, TALK SHOWS AND INTERVIEWS, ENTERTAINMENT, MOVIES, TELEVISION AND RADIO; PRODUCTION OF TELEVISION PROGRAMS AND AUDIO-VISUAL RECORDINGS FOR USE VIA THE INTERNET, WIRELESS COMMUNICATION NETWORKS, VIA CABLE TRANSMISSION IN THE FIELDS OF LIVE AND RECORDED AUDIO VISUAL PERFORMANCES, MUSIC, FASHION, COMEDY, SPORTS, LIFESTYLE, VIDEO GAMES, WEBISODE SERIES, CELEBRITY APPEARANCES, TALK SHOWS AND INTERVIEWS, ENTERTAINMENT, MOVIES, TELEVISION AND RADIO, IN CLASS 41 (U.S. CLS. 100, 101 AND 107).

FIRST USE 1-16-2012; IN COMMERCE 1-16-2012.

THE MARK CONSISTS OF STANDARD CHARACTERS WITHOUT CLAIM TO ANY PARTICULAR FONT, STYLE, SIZE, OR COLOR.

SN 85-411,498, FILED 8-31-2011.

Alice Benmaman, Examining Attorney



David J. Kyros

Director of the United States Patent and Trademark Office

United States of America

United States Patent and Trademark Office

Terminator

Reg. No. 4,207,581

Registered Sep. 11, 2012

Int. Cl.: 13

TRADEMARK

PRINCIPAL REGISTER

SOFT AIR USA, INC. (TEXAS CORPORATION)
SUITE 100
1452 HUGHES RD
GRAPEVINE, TX 76051

FOR: WEAPONS, NAMELY, BLOW GUNS FOR SHOOTING PROJECTILES IN THE NATURE OF METAL TIPPED DARTS, IN CLASS 13 (U.S. CLS. 2 AND 9).

FIRST USE 1-1-2012; IN COMMERCE 1-3-2012.

THE MARK CONSISTS OF STANDARD CHARACTERS WITHOUT CLAIM TO ANY PARTICULAR FONT, STYLE, SIZE, OR COLOR.

SN 85-411,773, FILED 8-31-2011.

BARBARA A. GOLD, EXAMINING ATTORNEY



David J. Kyffers

Director of the United States Patent and Trademark Office

United States of America

United States Patent and Trademark Office

Jophiel

Reg. No. 4,207,582

ATCHLEY, DEBORAH (UNITED STATES INDIVIDUAL)
2408 BELLA VISTA LN.
KNOXVILLE, TN 37914

Registered Sep. 11, 2012

Int. Cl.: 16

FOR: PENCILS; PENS; STATIONERY, IN CLASS 16 (U.S. CLS. 2, 5, 22, 23, 29, 37, 38 AND 50).

TRADEMARK

FIRST USE 7-12-2011; IN COMMERCE 1-19-2012.

PRINCIPAL REGISTER

THE MARK CONSISTS OF THE STYLIZED TEXT "JOPHIEL".

SN 85-411,880, FILED 8-31-2011.

WENDY JUN, EXAMINING ATTORNEY



David J. Kybas

Director of the United States Patent and Trademark Office

United States of America

United States Patent and Trademark Office

RELAXATION STATION

Reg. No. 4,207,583

SOUTHERN MOTION, INC. (MISSISSIPPI CORPORATION)

Registered Sep. 11, 2012

PO BOX 1064
PONTOTOC, MS 38863

Int. Cl.: 20

FOR: UPHOLSTERED FURNITURE, IN CLASS 20 (U.S. CLS. 2, 13, 22, 25, 32 AND 50).

TRADEMARK

FIRST USE 7-15-2011; IN COMMERCE 7-15-2011.

PRINCIPAL REGISTER

THE MARK CONSISTS OF STANDARD CHARACTERS WITHOUT CLAIM TO ANY PARTICULAR FONT, STYLE, SIZE, OR COLOR.

SN 85-412,099, FILED 8-31-2011.

MARK SPARACINO, EXAMINING ATTORNEY



David J. Kyffers

Director of the United States Patent and Trademark Office

United States of America

United States Patent and Trademark Office

MiY etSu

Reg. No. 4,207,584

SAPERSTEIN, GEORGE JEFFREY (UNITED STATES INDIVIDUAL)
PO BOX 100112
FORT WORTH, TX 76185

Registered Sep. 11, 2012

Int. Cl.: 14

FOR: BRACELETS; BROOCHES; DIAMOND JEWELRY; GEMSTONE JEWELRY; JEWELRY;
JEWELRY BROOCHES; JEWELRY, NAMELY, CROSSES; PINS BEING JEWELRY; RINGS;
RINGS BEING JEWELRY; WOMEN'S JEWELRY, IN CLASS 14 (U.S. CLS. 2, 27, 28 AND 50).

TRADEMARK

FIRST USE 7-12-2011; IN COMMERCE 7-12-2011.

PRINCIPAL REGISTER

THE MARK CONSISTS OF STANDARD CHARACTERS WITHOUT CLAIM TO ANY PARTICULAR FONT, STYLE, SIZE, OR COLOR.

SN 85-412,569, FILED 9-1-2011.

CHARLES L. JENKINS, EXAMINING ATTORNEY



David J. Kybas

Director of the United States Patent and Trademark Office

United States of America

United States Patent and Trademark Office

SNACK CRAFTERS

Reg. No. 4,207,585

Registered Sep. 11, 2012

Int. Cl.: 30

TRADEMARK

PRINCIPAL REGISTER

SOLUTIONEERING INC. (CANADA CORPORATION), DBA SNACK CRAFTERS,
20 KERSEY CRESCENT
RICHMOND HILL, ONTARIO, CANADA L4C3W3

FOR: BAKERY DESSERTS; BAKERY GOODS; BAKERY PRODUCTS, NAMELY, SWEET BAKERY GOODS; BISCOTTI; BISCUITS, TARTS, CAKES MADE WITH CEREALS; BROWNIES; CAKES; CEREAL BASED ENERGY BARS; CEREAL-BASED SNACK FOODS; CHEESECAKE; CHOCOLATE COVERED FRUIT; COOKIES; CUP CAKES; DANISH PASTRIES; DESSERT MOUSSE; DIVINITY; GRAIN-BASED CHIPS; GRAIN-BASED FOOD BARS ALSO CONTAINING FRUIT, AND/OR NUTS, AND/OR SEEDS, AND/OR CHOCOLATE, AND/OR CANDY; GRANOLA-BASED SNACK BARS; MARSHMALLOW SQUARES; MUESLI; MUESLI BARS; MUFFINS; MULTIGRAIN-BASED SNACK FOODS; PASTRIES; PASTRIES WITH FRUIT; PICKLE RELISH; PIES; PROCESSED CEREAL-BASED FOOD TO BE USED AS A BREAKFAST FOOD, SNACK FOOD OR INGREDIENT FOR MAKING OTHER FOODS; SCONES; SNACK CAKES; TARTS; TOASTER PASTRIES, IN CLASS 30 (U.S. CL. 46).

FIRST USE 1-1-1999; IN COMMERCE 4-26-2012.

THE MARK CONSISTS OF STANDARD CHARACTERS WITHOUT CLAIM TO ANY PARTICULAR FONT, STYLE, SIZE, OR COLOR.

SEC. 2(F).

NO CLAIM IS MADE TO THE EXCLUSIVE RIGHT TO USE "SNACK", APART FROM THE MARK AS SHOWN.

SN 85-412,939, FILED 9-1-2011.

ARETHA SOMERVILLE, EXAMINING ATTORNEY



David J. Kyros

Director of the United States Patent and Trademark Office

United States of America
United States Patent and Trademark Office

HOTBUDGET

Reg. No. 4,207,586

TAKES, TROY (UNITED STATES INDIVIDUAL)
14435 TIARA ST., #6
VAN NUYS, CA 91401

Registered Sep. 11, 2012

Int. Cl.: 9

FOR: COMPUTER SOFTWARE FOR BUDGETING, IN CLASS 9 (U.S. CLS. 21, 23, 26, 36 AND 38).

TRADEMARK

FIRST USE 8-1-2011; IN COMMERCE 8-21-2011.

PRINCIPAL REGISTER

THE MARK CONSISTS OF STANDARD CHARACTERS WITHOUT CLAIM TO ANY PARTICULAR FONT, STYLE, SIZE, OR COLOR.

SN 85-413,584, FILED 9-1-2011.

KATHERINE STOIDES, EXAMINING ATTORNEY



David J. Kybas

Director of the United States Patent and Trademark Office

United States of America

United States Patent and Trademark Office

SPYGLASS PUBLISHING

Reg. No. 4,207,587

SPYGLASS PUBLISHING GROUP, INC. (CALIFORNIA CORPORATION)
100 SHORELINE HIGHWAY
MILL VALLEY, CA 94941

Registered Sep. 11, 2012

Int. Cls.: 41 and 42

FOR: PUBLISHING SERVICES, NAMELY, BOOK PUBLISHING, PUBLISHING ELECTRONIC PUBLICATIONS, IN CLASS 41 (U.S. CLS. 100, 101 AND 107).

SERVICE MARK

FIRST USE 6-13-2012; IN COMMERCE 6-13-2012.

PRINCIPAL REGISTER

FOR: WEB PUBLISHING, NAMELY, CREATING A WEBSITE AND UPLOADING IT ONTO AN INTERNET SERVER, IN CLASS 42 (U.S. CLS. 100 AND 101).

FIRST USE 6-13-2012; IN COMMERCE 6-13-2012.

THE MARK CONSISTS OF STANDARD CHARACTERS WITHOUT CLAIM TO ANY PARTICULAR FONT, STYLE, SIZE, OR COLOR.

NO CLAIM IS MADE TO THE EXCLUSIVE RIGHT TO USE "PUBLISHING", APART FROM THE MARK AS SHOWN.

SN 85-414,017, FILED 9-2-2011.

ANGELA DUONG, EXAMINING ATTORNEY



David J. Kyros

Director of the United States Patent and Trademark Office

United States of America

United States Patent and Trademark Office

TALK ABOUT HEALTHY

Reg. No. 4,207,588

Registered Sep. 11, 2012

Int. Cls.: 16 and 41

TRADEMARK

SERVICE MARK

PRINCIPAL REGISTER

OPUS ONE COMMUNICATIONS, INC. (NEW YORK CORPORATION)
8 RIDGEVIEW COURT
PITTSFORD, NY 14534

FOR: PUBLICATIONS, NAMELY, MAGAZINES IN THE FIELDS OF HEALTH, NUTRITION AND FITNESS, IN CLASS 16 (U.S. CLS. 2, 5, 22, 23, 29, 37, 38 AND 50).

FIRST USE 6-0-2012; IN COMMERCE 6-0-2012.

FOR: ON-LINE PUBLICATION OF MAGAZINES IN THE FIELDS OF HEALTH, NUTRITION AND FITNESS, IN CLASS 41 (U.S. CLS. 100, 101 AND 107).

FIRST USE 6-0-2012; IN COMMERCE 6-0-2012.

THE MARK CONSISTS OF STANDARD CHARACTERS WITHOUT CLAIM TO ANY PARTICULAR FONT, STYLE, SIZE, OR COLOR.

NO CLAIM IS MADE TO THE EXCLUSIVE RIGHT TO USE "HEALTHY", APART FROM THE MARK AS SHOWN.

SN 85-414,444, FILED 9-2-2011.

ROBERT C. CLARK JR., EXAMINING ATTORNEY



David J. Kyros

Director of the United States Patent and Trademark Office

United States of America

United States Patent and Trademark Office

REACHOUT

Reg. No. 4,207,589

Registered Sep. 11, 2012

Int. Cl.: 38

SERVICE MARK

PRINCIPAL REGISTER

BRANCHOUT, INC. (DELAWARE CORPORATION), DBA BRANCHOUT MEDIA, INC. IN CALIFORNIA,
651 BRANNAN ST., SUITE 400
SAN FRANCISCO, CA 94107

FOR: ON-LINE SERVICES, NAMELY, MESSAGE SENDING IN THE FIELDS OF EMPLOYMENT LISTINGS SERVICES AND BUSINESS DEVELOPMENT FOR THE PURPOSE OF CAREER NETWORKING AND DEVELOPMENT; TELECOMMUNICATION SERVICES, NAMELY, PROVIDING ELECTRONIC MESSAGE ALERTS VIA THE INTERNET NOTIFYING INDIVIDUALS OF THE RECEIPT OF MESSAGES IN FIELDS OF EMPLOYMENT LISTINGS SERVICES AND BUSINESS DEVELOPMENT FOR THE PURPOSE OF CAREER NETWORKING AND DEVELOPMENT, IN CLASS 38 (U.S. CLS. 100, 101 AND 104).

FIRST USE 8-8-2011; IN COMMERCE 8-8-2011.

THE MARK CONSISTS OF STANDARD CHARACTERS WITHOUT CLAIM TO ANY PARTICULAR FONT, STYLE, SIZE, OR COLOR.

OWNER OF U.S. REG. NO. 3,973,432.

SN 85-414,905, FILED 9-4-2011.

TARAH HARDY, EXAMINING ATTORNEY



David J. Kyffers

Director of the United States Patent and Trademark Office

United States of America

United States Patent and Trademark Office

Potensa

Reg. No. 4,207,590

LUNADA BIOMEDICAL (CALIFORNIA CORPORATION)
6733 S. SEPULVEDA BLVD. SUITE 108
LOS ANGELES, CA 90045

Registered Sep. 11, 2012

Int. Cl.: 5

FOR: DIETARY AND NUTRITIONAL SUPPLEMENTS, IN CLASS 5 (U.S. CLS. 6, 18, 44, 46, 51 AND 52).

TRADEMARK

FIRST USE 3-1-2012; IN COMMERCE 3-1-2012.

PRINCIPAL REGISTER

THE MARK CONSISTS OF STANDARD CHARACTERS WITHOUT CLAIM TO ANY PARTICULAR FONT, STYLE, SIZE, OR COLOR.

SN 85-414,960, FILED 9-5-2011.

MICHAEL ENGEL, EXAMINING ATTORNEY



David J. Kybas

Director of the United States Patent and Trademark Office

United States of America

United States Patent and Trademark Office



Reg. No. 4,207,591

Registered Sep. 11, 2012

Int. Cl.: 33

TRADEMARK

PRINCIPAL REGISTER

SHERLOCK, MICHAEL T. (UNITED STATES INDIVIDUAL)
4509 INTERLAKE AVE N BOX#247
SEATTLE, WA 98103

FOR: BLENDED SPIRITS; DISTILLED SPIRITS, IN CLASS 33 (U.S. CLS. 47 AND 49).

FIRST USE 8-20-2011; IN COMMERCE 4-15-2012.

THE MARK CONSISTS THE INTERLOCKING LETTERS "JJ" INSIDE A WREATH OF WHEAT.

SN 85-415,247, FILED 9-6-2011.

ANNE FARRELL, EXAMINING ATTORNEY



David J. Kyffers

Director of the United States Patent and Trademark Office

United States of America

United States Patent and Trademark Office

POTTER'S GOLD

Reg. No. 4,207,592

Registered Sep. 11, 2012

Int. Cl.: 1

TRADEMARK

PRINCIPAL REGISTER

HORT SERVICES, LLC (MICHIGAN LIMITED LIABILITY COMPANY)
324 WASHINGTON AVE #1 PO BOX 921
GRAND HAVEN, MI 49417

FOR: POTTING SOIL, IN CLASS 1 (U.S. CLS. 1, 5, 6, 10, 26 AND 46).

FIRST USE 3-1-2012; IN COMMERCE 3-1-2012.

THE MARK CONSISTS OF STANDARD CHARACTERS WITHOUT CLAIM TO ANY PARTICULAR FONT, STYLE, SIZE, OR COLOR.

NO CLAIM IS MADE TO THE EXCLUSIVE RIGHT TO USE "POTTER'S", APART FROM THE MARK AS SHOWN.

SN 85-415,252, FILED 9-6-2011.

BARNEY CHARLON, EXAMINING ATTORNEY



David J. Kyffers

Director of the United States Patent and Trademark Office

United States of America

United States Patent and Trademark Office

REFLECT YOUR BRILLIANCE

Reg. No. 4,207,593

MAUI JIM, INC. (ILLINOIS CORPORATION)
ONE ALOHA LANE
PEORIA, IL 61615

Registered Sep. 11, 2012

Int. Cl.: 9

FOR: SUNGLASSES AND SUNGLASS LENSES, IN CLASS 9 (U.S. CLS. 21, 23, 26, 36 AND 38).

TRADEMARK

FIRST USE 1-1-2012; IN COMMERCE 1-1-2012.

PRINCIPAL REGISTER

THE MARK CONSISTS OF STANDARD CHARACTERS WITHOUT CLAIM TO ANY PARTICULAR FONT, STYLE, SIZE, OR COLOR.

SN 85-415,965, FILED 9-6-2011.

CAROLINE WOOD, EXAMINING ATTORNEY



David J. Kyffers

Director of the United States Patent and Trademark Office

United States of America

United States Patent and Trademark Office

NEARBY

Reg. No. 4,207,594

NEARBY REGISTRY, LLC (NEW HAMPSHIRE LIMITED LIABILITY COMPANY)
2 STERLING PLACE
BOW, NH 03304

Registered Sep. 11, 2012

Int. Cl.: 35

FOR: GIFT REGISTRY SERVICES, IN CLASS 35 (U.S. CLS. 100, 101 AND 102).

SERVICE MARK

FIRST USE 4-27-2012; IN COMMERCE 4-27-2012.

PRINCIPAL REGISTER

THE MARK CONSISTS OF STANDARD CHARACTERS WITHOUT CLAIM TO ANY PARTICULAR FONT, STYLE, SIZE, OR COLOR.

SN 85-416,272, FILED 9-7-2011.

ELI HELLMAN, EXAMINING ATTORNEY



David J. Kybas

Director of the United States Patent and Trademark Office

United States of America

United States Patent and Trademark Office

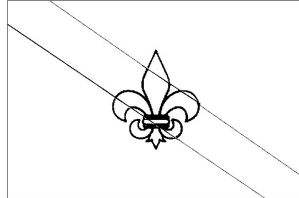

Reg. No. 4,207,595

Registered Sep. 11, 2012

Int. Cl.: 41

SERVICE MARK

PRINCIPAL REGISTER

SMITH, DAVID (UNITED STATES INDIVIDUAL)
8355 STATION VILLAGE LANE
UNIT 4312
SAN DIEGO, CA 92108

FOR: PROVIDING A WEB SITE FEATURING A SEARCHABLE DATABASE OF EDUCATION AND RECREATIONAL INFORMATION FOR SCUBA DIVERS IN THE FIELDS OF SCUBA DIVING , IN CLASS 41 (U.S. CLS. 100, 101 AND 107).

FIRST USE 3-8-2012; IN COMMERCE 3-8-2012.

THE MARK CONSISTS OF A RECTANGLE WITH ITS DIMENSIONS ONE UNIT HIGH AND TWO UNITS WIDE, A FLEUR-DE-LIS SUPERIMPOSED AND CENTERED BOTH HORIZONTALLY AND VERTICALLY. IT IS 1/2 UNIT TALL, AND PROPORTIONATELY APPROPRIATE WIDE. THE RECTANGLE IS IN THE PATTERN OF A "DIVER DOWN FLAG", WITH A DIAGONAL STRIPE FROM UPPER LEFT DOWN TO LOWER RIGHT. PROPORTIONS FOLLOW STANDARD DIVER DOWN FLAG PROPORTIONS. FLEUR-DE-LIS IS AN OUTLINE ONLY, SUPERIMPOSED ON THE BACKGROUND.

SN 85-416,436, FILED 9-7-2011.

SOPHIA S. KIM, EXAMINING ATTORNEY



David J. Kybas

Director of the United States Patent and Trademark Office

United States of America

United States Patent and Trademark Office

EMS HEROES

Reg. No. 4,207,596

BRADM TECHNOLOGIES, LLC. (NEW JERSEY LIMITED LIABILITY COMPANY)
107 GILBRETH PARKWAY SUITE 103-D
MULLICA HILL, NJ 08062

Registered Sep. 11, 2012

Int. Cl.: 9

FOR: COMPUTER SOFTWARE FOR CONTROLLING AND MANAGING PATIENT MEDICAL INFORMATION, IN CLASS 9 (U.S. CLS. 21, 23, 26, 36 AND 38).

TRADEMARK

FIRST USE 5-15-2012; IN COMMERCE 5-15-2012.

PRINCIPAL REGISTER

THE MARK CONSISTS OF STANDARD CHARACTERS WITHOUT CLAIM TO ANY PARTICULAR FONT, STYLE, SIZE, OR COLOR.

NO CLAIM IS MADE TO THE EXCLUSIVE RIGHT TO USE "EMS", APART FROM THE MARK AS SHOWN.

SN 85-416,441, FILED 9-7-2011.

SOPHIA S. KIM, EXAMINING ATTORNEY



David J. Kybas

Director of the United States Patent and Trademark Office

United States of America

United States Patent and Trademark Office

EM3RSN UNLTD

Reg. No. 4,207,597

Registered Sep. 11, 2012

Int. Cl.: 25

TRADEMARK

PRINCIPAL REGISTER

BONAFINI ENTERPRISES, INC. (CALIFORNIA CORPORATION)
SUITE 105
14100 GARFIELD AVE.
PARAMOUNT, CA 90723

FOR: MEN'S AND CHILDREN'S FOOTWEAR, NAMELY, SNEAKERS, LOAFERS, SANDALS, CASUAL BOOTS, CASUAL DRESS SHOES, DRESS BOOTS, MOCCASINS, IN CLASS 25 (U.S. CLS. 22 AND 39).

FIRST USE 6-28-2012; IN COMMERCE 6-28-2012.

THE MARK CONSISTS OF STANDARD CHARACTERS WITHOUT CLAIM TO ANY PARTICULAR FONT, STYLE, SIZE, OR COLOR.

NO CLAIM IS MADE TO THE EXCLUSIVE RIGHT TO USE "UNLTD", APART FROM THE MARK AS SHOWN.

SN 85-417,050, FILED 9-7-2011.

KEVIN CORWIN, EXAMINING ATTORNEY



David J. Kybas

Director of the United States Patent and Trademark Office

United States of America

United States Patent and Trademark Office

MINIBANDA

Reg. No. 4,207,598

Registered Sep. 11, 2012

Int. Cl.: 25

TRADEMARK

PRINCIPAL REGISTER

MINICONF S.R.L. (ITALY LIMITED LIABILITY COMPANY)
VIA PROVINCIALE 1/A
ORTIGNANO RAGGIOLO-AR, ITALY 52010

FOR: CLOTHING, NAMELY, SHIRTS, BLOUSES, T-SHIRTS, SWEATERS, JUMPERS, JACKETS, PADDED JACKETS, COATS, OVERCOATS, JEANS, SHORTS, TROUSERS, SKIRTS, SCARVES, PINAFORE DRESSES, DRESSES, SOCKS, PYJAMAS, ROMPERS, BATHING SUITS, UNDERSHIRTS, UNDERPANTS, HATS, AND FOOTWEAR, IN CLASS 25 (U.S. CLS. 22 AND 39).

FIRST USE 12-13-2011; IN COMMERCE 12-13-2011.

THE MARK CONSISTS OF STANDARD CHARACTERS WITHOUT CLAIM TO ANY PARTICULAR FONT, STYLE, SIZE, OR COLOR.

THE WORDING "MINIBANDA" HAS NO MEANING IN A FOREIGN LANGUAGE.

SN 85-417,064, FILED 9-7-2011.

JENNY PARK, EXAMINING ATTORNEY



David J. Kybas

Director of the United States Patent and Trademark Office

United States of America

United States Patent and Trademark Office

CRANKY DOGS

Reg. No. 4,207,599

MASON, GENE (UNITED STATES INDIVIDUAL)
14098 E. COYOTE RD.
SCOTTSDALE, AZ 852593795 AND

Registered Sep. 11, 2012

Int. Cl.: 6

MASON, JOYCE (UNITED STATES INDIVIDUAL)
14098 E. COYOTE RD.
SCOTTSDALE, AZ 852593795

TRADEMARK

PRINCIPAL REGISTER

FOR: SCULPTURAL CREATIONS, NAMELY, ANIMALS SCULPTURES MADE OF NON-PRECIOUS METALS INCLUDING MILD STEEL AND METALLIC AUTOMOTIVE PARTS; SCULPTURAL CREATIONS, NAMELY, ARTISTIC DESIGNS IN THE NATURE OF WORKS OF ART OF COMMON METAL, INCLUDING MILD STEEL AND METALLIC AUTOMOTIVE PARTS, IN CLASS 6 (U.S. CLS. 2, 12, 13, 14, 23, 25 AND 50).

FIRST USE 8-31-2011; IN COMMERCE 7-3-2012.

THE MARK CONSISTS OF STANDARD CHARACTERS WITHOUT CLAIM TO ANY PARTICULAR FONT, STYLE, SIZE, OR COLOR.

NO CLAIM IS MADE TO THE EXCLUSIVE RIGHT TO USE "DOGS" , APART FROM THE MARK AS SHOWN.

SN 85-418,122, FILED 9-8-2011.

JOHN KELLY, EXAMINING ATTORNEY



David J. Kybas

Director of the United States Patent and Trademark Office

United States of America

United States Patent and Trademark Office



Reg. No. 4,207,600

Registered Sep. 11, 2012

Int. Cl.: 35

SERVICE MARK

PRINCIPAL REGISTER

PARTS FOR A CAUSE, INC. (GEORGIA CORPORATION)
460 HORIZON DRIVE, SUITE 100
SUWANEE, GA 300243114

FOR: ONLINE RETAIL AND WHOLESALE DISTRIBUTORSHIP SERVICES IN THE FIELD OF AUTOMOBILE AND LIGHT TRUCK REPLACEMENT PARTS AND ACCESSORIES; ELECTRONIC, MAIL ORDER, AND WEB-BASED CATALOG SERVICES IN THE FIELD OF AUTOMOBILE AND LIGHT TRUCK REPLACEMENT PARTS AND ACCESSORIES, IN CLASS 35 (U.S. CLS. 100, 101 AND 102).

FIRST USE 6-0-2011; IN COMMERCE 6-0-2011.

NO CLAIM IS MADE TO THE EXCLUSIVE RIGHT TO USE "PARTS", APART FROM THE MARK AS SHOWN.

THE MARK CONSISTS OF A CIRCULAR WHEEL DESIGN IN THE CENTER OF WHICH APPEARS TWO HANDS SHAKING. ARCHED OVER THE TOP OF THE WHEEL APPEARS THE WORDS "PARTS FOR A CAUSE".

SN 85-418,666, FILED 9-9-2011.

TEJBIR SINGH, EXAMINING ATTORNEY



David J. Kyffers

Director of the United States Patent and Trademark Office

United States of America

United States Patent and Trademark Office

MASS TORT MATRIX

Reg. No. 4,207,601

MED QUEST, LTD (NEW YORK CORPORATION)
116 EAST 30TH STREET
NEW YORK, NY 10016

Registered Sep. 11, 2012

Int. Cl.: 45

FOR: PROVIDING INFORMATION IN THE FIELD OF MEDICAL RELATED LEGAL RESEARCH, IN CLASS 45 (U.S. CLS. 100 AND 101).

SERVICE MARK

FIRST USE 10-0-2011; IN COMMERCE 10-0-2011.

PRINCIPAL REGISTER

THE MARK CONSISTS OF STANDARD CHARACTERS WITHOUT CLAIM TO ANY PARTICULAR FONT, STYLE, SIZE, OR COLOR.

NO CLAIM IS MADE TO THE EXCLUSIVE RIGHT TO USE "MASS TORT", APART FROM THE MARK AS SHOWN.

SN 85-418,700, FILED 9-9-2011.

KYLE PEETE, EXAMINING ATTORNEY



David J. Kybas

Director of the United States Patent and Trademark Office

United States of America

United States Patent and Trademark Office

SYNERGY

Reg. No. 4,207,602

Registered Sep. 11, 2012

Int. Cls.: 9 and 42

TRADEMARK

SERVICE MARK

PRINCIPAL REGISTER

EDUPOINT EDUCATIONAL SYSTEMS, LLC (CALIFORNIA LIMITED LIABILITY COMPANY)
101 PACIFICA - SUITE 240
IRVINE, CA 92618

FOR: DOWNLOADABLE COMPUTER SOFTWARE FOR MANAGEMENT AND REPORTING OF STUDENT RECORDS, STAFF RECORDS, AND SCHOOL COURSE RECORDS, IN CLASS 9 (U.S. CLS. 21, 23, 26, 36 AND 38).

FIRST USE 11-14-2011; IN COMMERCE 11-14-2011.

FOR: PROVIDING TEMPORARY USE OF ON-LINE NON-DOWNLOADABLE SOFTWARE FOR MANAGEMENT AND REPORTING OF STUDENT RECORDS, STAFF RECORDS, AND SCHOOL COURSE RECORDS, IN CLASS 42 (U.S. CLS. 100 AND 101).

FIRST USE 11-14-2011; IN COMMERCE 11-14-2011.

THE MARK CONSISTS OF STANDARD CHARACTERS WITHOUT CLAIM TO ANY PARTICULAR FONT, STYLE, SIZE, OR COLOR.

SN 85-418,927, FILED 9-9-2011.

BRENDAN MCCAULEY, EXAMINING ATTORNEY



David J. Kyros

Director of the United States Patent and Trademark Office

United States of America

United States Patent and Trademark Office

CROOKED LABYRINTH

Reg. No. 4,207,603

Registered Sep. 11, 2012

Int. Cl.: 32

TRADEMARK

PRINCIPAL REGISTER

UINTA BREWING COMPANY (UTAH CORPORATION)
1722 SOUTH FREMONT STREET
SALT LAKE CITY, UT 84104

FOR: BEER, IN CLASS 32 (U.S. CLS. 45, 46 AND 48).

FIRST USE 3-1-2010; IN COMMERCE 5-10-2010.

THE MARK CONSISTS OF STANDARD CHARACTERS WITHOUT CLAIM TO ANY PARTICULAR FONT, STYLE, SIZE, OR COLOR.

SN 85-419,145, FILED 9-9-2011.

DOMINICK J. SALEMI, EXAMINING ATTORNEY



David J. Kyffers

Director of the United States Patent and Trademark Office

United States of America

United States Patent and Trademark Office

LET THE FUN BEGIN!

Reg. No. 4,207,604

Registered Sep. 11, 2012

Int. Cl.: 30

TRADEMARK

PRINCIPAL REGISTER

RICH PRODUCTS CORPORATION (DELAWARE CORPORATION)
ONE ROBERT RICH WAY
BUFFALO, NY 14213

FOR: ICE CREAM CUPCAKES, IN CLASS 30 (U.S. CL. 46).

FIRST USE 4-1-2012; IN COMMERCE 4-1-2012.

THE MARK CONSISTS OF STANDARD CHARACTERS WITHOUT CLAIM TO ANY PARTICULAR FONT, STYLE, SIZE, OR COLOR.

SN 85-419,152, FILED 9-9-2011.

DEIRDRE ROBERTSON, EXAMINING ATTORNEY



David J. Kyffers

Director of the United States Patent and Trademark Office

United States of America

United States Patent and Trademark Office

MAKERS vs TAKERS

Reg. No. 4,207,605

Registered Sep. 11, 2012

Int. Cl.: 25

TRADEMARK

PRINCIPAL REGISTER

DIERICKS, ROBERT D. (UNITED STATES INDIVIDUAL)
6501 RED HOOK PLAZA, SUITE 201
ST. THOMAS, USVI, US VIRGIN ISLANDS 00802 AND

WILSON, TODD W. (UNITED STATES INDIVIDUAL)
6501 RED HOOK PLAZA, SUITE 201
ST. THOMAS, USVI, US VIRGIN ISLANDS 00802

FOR: T-SHIRTS , IN CLASS 25 (U.S. CLS. 22 AND 39).

FIRST USE 6-20-2012; IN COMMERCE 6-20-2012.

THE MARK CONSISTS OF STANDARD CHARACTERS WITHOUT CLAIM TO ANY PARTICULAR FONT, STYLE, SIZE, OR COLOR.

SN 85-419,736, FILED 9-11-2011.

GISELLE AGOSTO, EXAMINING ATTORNEY



David J. Kyffers

Director of the United States Patent and Trademark Office

United States of America
United States Patent and Trademark Office

BETATECH

Reg. No. 4,207,606

DOW CHEMICAL COMPANY, THE (DELAWARE CORPORATION)
2030 DOW CENTER
MIDLAND, MI 48674

Registered Sep. 11, 2012

Int. Cl.: 1

FOR: BONDING AGENTS AND ADHESIVES FOR USE IN THE MANUFACTURE AND REPAIR OF MOTORIZED VEHICLES, IN CLASS 1 (U.S. CLS. 1, 5, 6, 10, 26 AND 46).

TRADEMARK

FIRST USE 9-21-2011; IN COMMERCE 9-21-2011.

PRINCIPAL REGISTER

THE MARK CONSISTS OF STANDARD CHARACTERS WITHOUT CLAIM TO ANY PARTICULAR FONT, STYLE, SIZE, OR COLOR.

OWNER OF U.S. REG. NOS. 1,279,402, 1,774,814, AND 2,500,537.

SN 85-419,893, FILED 9-12-2011.

AISHA CLARKE, EXAMINING ATTORNEY



David J. Kybas

Director of the United States Patent and Trademark Office

United States of America

United States Patent and Trademark Office

Ambrozia

Reg. No. 4,207,607

FELDA IFFCO, LLC (DELAWARE LIMITED LIABILITY COMPANY)
4700 ESTE AVENUE
CINCINNATI, OH 45232

Registered Sep. 11, 2012

Int. Cl.: 29

FOR: EDIBLE OILS AND FATS, IN CLASS 29 (U.S. CL. 46).

TRADEMARK

FIRST USE 1-29-2012; IN COMMERCE 1-29-2012.

PRINCIPAL REGISTER

THE MARK CONSISTS OF STANDARD CHARACTERS WITHOUT CLAIM TO ANY PARTICULAR FONT, STYLE, SIZE, OR COLOR.

SN 85-420,209, FILED 9-12-2011.

HANNO RITTNER, EXAMINING ATTORNEY



David J. Kyffers

Director of the United States Patent and Trademark Office

United States of America

United States Patent and Trademark Office



Reg. No. 4,207,608

LA ALOE, LLC (CALIFORNIA LIMITED LIABILITY COMPANY)
1985 VISTA AVE.

Registered Sep. 11, 2012

SIERRA MADRE, CA 91024

Int. Cl.: 32

FOR: DRINKING WATER CONTAINING CERTIFIED ORGANIC ALOE VERA, IN CLASS 32 (U.S. CLS. 45, 46 AND 48).

TRADEMARK

FIRST USE 9-30-2011; IN COMMERCE 12-31-2011.

PRINCIPAL REGISTER

THE MARK CONSISTS OF ALOE VERA LEAVES IN VARIOUS SHADES OF GREEN, WITH THE INTERIOR LEAVES FORMING THE OUTLINE OF A RAINDROP. THE COLOR WHITE REPRESENTS BACKGROUND AND IS NOT PART OF THE MARK.

THE COLOR(S) GREEN IS/ARE CLAIMED AS A FEATURE OF THE MARK.

SN 85-420,348, FILED 9-12-2011.

AHSEN KHAN, EXAMINING ATTORNEY



David J. Kybas

Director of the United States Patent and Trademark Office

United States of America

United States Patent and Trademark Office



Reg. No. 4,207,609

Registered Sep. 11, 2012

Int. Cl.: 9

TRADEMARK

PRINCIPAL REGISTER

PPT VISION, INC. (MINNESOTA CORPORATION)
6301 OLD SHAKOPEE ROAD, SUITE A
BLOOMINGTON, MN 55438

FOR: COMPUTERIZED SYSTEM COMPRISING COMPUTER SOFTWARE AND COMPUTER HARDWARE, NAMELY, PROCESSORS, MONITORS, KEYBOARDS AND CAMERAS, FOR USE TO AUTOMATE AND CONTROL MANUFACTURING PROCESSES AND TO AUTOMATE AND CONTROL INSPECTION OF MANUFACTURED ITEMS, IN CLASS 9 (U.S. CLS. 21, 23, 26, 36 AND 38).

FIRST USE 11-30-2011; IN COMMERCE 11-30-2011.

OWNER OF U.S. REG. NO. 1,959,661.

THE MARK CONSISTS OF STYLIZED DRAWING OF AN APERTURE TO THE LEFT OF LETTERS "PPT".

SN 85-420,356, FILED 9-12-2011.

SANI KHOURI, EXAMINING ATTORNEY



David J. Kybas

Director of the United States Patent and Trademark Office

United States of America

United States Patent and Trademark Office

SAFE MACHINE

Reg. No. 4,207,610

APRIL SOFTWARE, LLC (DELAWARE LIMITED LIABILITY COMPANY)
616 CORPORATE WAY, SUITE 2 #4000
VALLEY COTTAGE, NY 10989

Registered Sep. 11, 2012

Int. Cl.: 39

FOR: ELECTRONIC STORAGE OF COMPUTER DATA AND FILES, IN CLASS 39 (U.S. CLS. 100 AND 105).

SERVICE MARK

FIRST USE 3-0-2012; IN COMMERCE 3-0-2012.

PRINCIPAL REGISTER

THE MARK CONSISTS OF STANDARD CHARACTERS WITHOUT CLAIM TO ANY PARTICULAR FONT, STYLE, SIZE, OR COLOR.

SN 85-420,509, FILED 9-12-2011.

RICHARD WHITE, EXAMINING ATTORNEY



David J. Kybas

Director of the United States Patent and Trademark Office

United States of America

United States Patent and Trademark Office

FIFTH THIRD CASH ACCESS

Reg. No. 4,207,611

FIFTH THIRD BANCORP (OHIO CORPORATION)
38 FOUNTAIN SQUARE PLAZA
CINCINNATI, OH 45263

Registered Sep. 11, 2012

Int. Cl.: 36

FOR: BANKING SERVICES, NAMELY, CHECK CASHING SERVICES, IN CLASS 36 (U.S. CLS. 100, 101 AND 102).

SERVICE MARK

FIRST USE 10-24-2011; IN COMMERCE 10-24-2011.

PRINCIPAL REGISTER

THE MARK CONSISTS OF STANDARD CHARACTERS WITHOUT CLAIM TO ANY PARTICULAR FONT, STYLE, SIZE, OR COLOR.

OWNER OF U.S. REG. NOS. 1,645,502, 3,857,726, AND OTHERS.

NO CLAIM IS MADE TO THE EXCLUSIVE RIGHT TO USE "CASH ACCESS", APART FROM THE MARK AS SHOWN.

SN 85-420,650, FILED 9-12-2011.

KELLEY WELLS, EXAMINING ATTORNEY



David J. Kybas

Director of the United States Patent and Trademark Office

United States of America

United States Patent and Trademark Office

PLS DNT STP

Reg. No. 4,207,612

FREEMAN, FREDRIC VIVIAN VAN (UNITED STATES INDIVIDUAL)
706 PIERCE ST.

Registered Sep. 11, 2012

PHILADELPHIA, PA 19148 AND

Int. Cl.: 9

THOMAS BRYAN KEE (UNITED STATES INDIVIDUAL)
242 NORTH PENN AVE
HATBORO, PA 19040

TRADEMARK

PRINCIPAL REGISTER

FOR: AUDIO AND VIDEO RECORDINGS FEATURING MUSIC AND ARTISTIC PERFORMANCES; AUDIO RECORDINGS FEATURING MUSIC; AUDIO TAPES FEATURING MUSIC; COMPACT DISCS FEATURING MUSIC; DIGITAL MUSIC DOWNLOADABLE FROM THE INTERNET; DOWNLOADABLE MP3 FILES AND MP3 RECORDINGS FEATURING MUSIC; DOWNLOADABLE MUSICAL SOUND RECORDINGS; DOWNLOADABLE RING TONES, GRAPHICS AND MUSIC VIA A GLOBAL COMPUTER NETWORK AND WIRELESS DEVICES; DOWNLOADABLE VIDEO RECORDINGS FEATURING MUSIC; DOWNLOADABLE MUSIC VIA THE INTERNET AND WIRELESS DEVICES; MUSICAL RECORDINGS; MUSICAL SOUND RECORDINGS; MUSICAL VIDEO RECORDINGS; PHONOGRAPH RECORDS FEATURING MUSIC; SERIES OF MUSICAL SOUND RECORDINGS; SOUND RECORDINGS FEATURING MUSIC; VIDEO RECORDINGS FEATURING MUSIC, IN CLASS 9 (U.S. CLS. 21, 23, 26, 36 AND 38).

FIRST USE 1-1-2011; IN COMMERCE 11-16-2011.

THE MARK CONSISTS OF STANDARD CHARACTERS WITHOUT CLAIM TO ANY PARTICULAR FONT, STYLE, SIZE, OR COLOR.

SN 85-421,130, FILED 9-13-2011.

KYLE PEETE, EXAMINING ATTORNEY



David J. Kypos

Director of the United States Patent and Trademark Office

United States of America
United States Patent and Trademark Office

ArgoMT 

Reg. No. 4,207,613

ARGO TRANSLATION, INC. (ILLINOIS CORPORATION)
2420 RAVINE WAY, SUITE 200
GLENVIEW, IL 60025

Registered Sep. 11, 2012

Int. Cl.: 41

FOR: TRANSLATION SERVICES, IN CLASS 41 (U.S. CLS. 100, 101 AND 107).

SERVICE MARK

FIRST USE 12-15-2011; IN COMMERCE 12-15-2011.

PRINCIPAL REGISTER

OWNER OF U.S. REG. NO. 3,536,726.

THE MARK CONSISTS OF THE WORD "ARGOMT" WITH A DEPICTION OF A GEAR.

SN 85-421,437, FILED 9-13-2011.

KYLE PEETE, EXAMINING ATTORNEY



David J. Kyffers

Director of the United States Patent and Trademark Office

United States of America

United States Patent and Trademark Office

GO TREXX

Reg. No. 4,207,614

Registered Sep. 11, 2012

Int. Cl.: 9

TRADEMARK

PRINCIPAL REGISTER

GO TREXX, INC. (CALIFORNIA CORPORATION)
620 NEWPORT CENTER DR., SUITE 1100
NEWPORT BEACH, CA 92660

FOR: DOWNLOADABLE SOFTWARE IN THE NATURE OF A MOBILE APPLICATION FOR EDUCATION AND ENTERTAINMENT, NAMELY, PROVIDING INFORMATION ABOUT LOCATIONS, EVENTS, AND POINTS OF INTEREST; PROVIDING GUIDES, MAPS, ROUTES BETWEEN LOCATIONS, AND TOURS; AND UPLOADING, POSTING, AND DISPLAYING ONLINE VIDEOS, PICTURES, RECOMMENDATIONS, AND NOTES FOR SHARING WITH OTHERS IN THE FIELD OF TRAVEL AND TOURISM, IN CLASS 9 (U.S. CLS. 21, 23, 26, 36 AND 38).

FIRST USE 5-23-2012; IN COMMERCE 5-23-2012.

THE MARK CONSISTS OF STANDARD CHARACTERS WITHOUT CLAIM TO ANY PARTICULAR FONT, STYLE, SIZE, OR COLOR.

SN 85-421,477, FILED 9-13-2011.

SUNG IN, EXAMINING ATTORNEY



David J. Kyfos

Director of the United States Patent and Trademark Office

United States of America

United States Patent and Trademark Office

ROLLING RIVER
café gallery inn

Reg. No. 4,207,615

Registered Sep. 11, 2012

Int. Cls.: 35 and 43

SERVICE MARK

PRINCIPAL REGISTER

ROLLING RIVER CORP (NEW YORK CORPORATION), DBA ROLLING RIVER CAFE BAR GALLERY,
25 COOLEY ROAD
PARKEVILLE, NY 12768

FOR: ART GALLERIES, IN CLASS 35 (U.S. CLS. 100, 101 AND 102).

FIRST USE 8-15-2008; IN COMMERCE 8-15-2008.

FOR: RESTAURANT SERVICES, INCLUDING SIT-DOWN SERVICE OF FOOD AND TAKE-OUT RESTAURANT SERVICES; PROVIDING TEMPORARY ACCOMMODATION, NAMELY, HOTEL BED AND BREAKFAST INN SERVICES; HEALTH RESORT SERVICES, NAMELY, PROVIDING FOOD AND LODGING THAT SPECIALIZE IN PROMOTING PATRONS' GENERAL HEALTH AND WELL-BEING; RESORT LODGING SERVICES, IN CLASS 43 (U.S. CLS. 100 AND 101).

FIRST USE 8-15-2008; IN COMMERCE 8-15-2008.

NO CLAIM IS MADE TO THE EXCLUSIVE RIGHT TO USE "CAFÉ GALLERY INN", APART FROM THE MARK AS SHOWN.

THE COLOR(S) GREEN, BLUE, TURQUOISE, MAGENTA, AND BLACK IS/ARE CLAIMED AS A FEATURE OF THE MARK.

THE MARK CONSISTS OF THE STAGGERED WORDING "ROLLING RIVER CAFÉ GALLERY INN" WITH "ROLLING RIVER" CAPITALIZED IN BLACK WITH TURQUOISE OUTLINE AND SPECKLES ABOVE THE WORD "CAFÉ" IN LOWER CASE IN GREEN WITH BLACK OUTLINE AND SPECKLES NEXT TO THE WORD "GALLERY" IN BLUE WITH BLACK OUTLINE AND SPECKLES NEXT TO "INN" IN MAGENTA WITH BLACK OUTLINE AND SPECKLES.

SN 85-421,647, FILED 9-13-2011.

SANDRA BUJA, EXAMINING ATTORNEY



David J. Kyffers

Director of the United States Patent and Trademark Office

United States of America

United States Patent and Trademark Office

Robotics Today

Reg. No. 4,207,616

ROBOTICS TODAY, BV (NETHERLANDS CORPORATION)
KONINGINNEWEG 5

Registered Sep. 11, 2012

HAARLEM, NETHERLANDS 2012

Int. Cls.: 35, 41, and 42

FOR: ADVERTISING AND MARKETING; PROVIDING INFORMATION IN THE FIELD OF THE ROBOTICS INDUSTRY, IN CLASS 35 (U.S. CLS. 100, 101 AND 102).

SERVICE MARK

FIRST USE 1-1-2012; IN COMMERCE 1-1-2012.

PRINCIPAL REGISTER

FOR: PROVIDING A WEB SITE THAT FEATURES INFORMAL INSTRUCTION ON ROBOTICS; PROVIDING EDUCATIONAL INFORMATION IN THE ACADEMIC FIELD OF ROBOTICS FOR THE PURPOSE OF ACADEMIC STUDY; PROVIDING INFORMATION, NEWS AND COMMENTARY IN THE FIELD OF CURRENT EVENTS RELATING TO ROBOTICS, IN CLASS 41 (U.S. CLS. 100, 101 AND 107).

FIRST USE 1-1-2012; IN COMMERCE 1-1-2012.

FOR: PROVIDING SCIENTIFIC INFORMATION IN THE FIELD OF ROBOTICS, IN CLASS 42 (U.S. CLS. 100 AND 101).

FIRST USE 1-1-2012; IN COMMERCE 1-1-2012.

THE MARK CONSISTS OF STANDARD CHARACTERS WITHOUT CLAIM TO ANY PARTICULAR FONT, STYLE, SIZE, OR COLOR.

NO CLAIM IS MADE TO THE EXCLUSIVE RIGHT TO USE "ROBOTICS", APART FROM THE MARK AS SHOWN.

SN 85-422,000, FILED 9-14-2011.

SKYE YOUNG, EXAMINING ATTORNEY



David J. Kyros

Director of the United States Patent and Trademark Office

United States of America

United States Patent and Trademark Office

FLY WITH ME

Reg. No. 4,207,617

Registered Sep. 11, 2012

Int. Cl.: 9

TRADEMARK

PRINCIPAL REGISTER

ELECTRONIC ARTS INC. (DELAWARE CORPORATION)
LEGAL DEPARTMENT
209 REDWOOD SHORES PARKWAY
REDWOOD CITY, CA 94065

FOR: COMPUTER GAME SOFTWARE; DOWNLOADABLE COMPUTER GAME SOFTWARE
VIA A GLOBAL COMPUTER NETWORK AND WIRELESS DEVICES, IN CLASS 9 (U.S.
CLS. 21, 23, 26, 36 AND 38).

FIRST USE 2-0-2012; IN COMMERCE 2-0-2012.

THE MARK CONSISTS OF STANDARD CHARACTERS WITHOUT CLAIM TO ANY PAR-
TICULAR FONT, STYLE, SIZE, OR COLOR.

SN 85-422,630, FILED 9-14-2011.

CHRISTINA SOBRAL, EXAMINING ATTORNEY



David J. Kybas

Director of the United States Patent and Trademark Office

United States of America

United States Patent and Trademark Office

FLY WITH ME

Reg. No. 4,207,618

ELECTRONIC ARTS INC. (DELAWARE CORPORATION)
209 REDWOOD SHORES PARKWAY
REDWOOD CITY, CA 94065

Registered Sep. 11, 2012

Int. Cl.: 41

FOR: ENTERTAINMENT SERVICES, NAMELY, PROVIDING AN ON-LINE COMPUTER GAME; PROVISION OF INFORMATION RELATING TO ELECTRONIC COMPUTER GAMES PROVIDED VIA THE INTERNET, IN CLASS 41 (U.S. CLS. 100, 101 AND 107).

SERVICE MARK

FIRST USE 2-0-2012; IN COMMERCE 2-0-2012.

PRINCIPAL REGISTER

THE MARK CONSISTS OF STANDARD CHARACTERS WITHOUT CLAIM TO ANY PARTICULAR FONT, STYLE, SIZE, OR COLOR.

SN 85-422,635, FILED 9-14-2011.

CHRISTINA SOBRAL, EXAMINING ATTORNEY



David J. Kyjars

Director of the United States Patent and Trademark Office

United States of America

United States Patent and Trademark Office

NIQUE BRISTLE

Reg. No. 4,207,619

Registered Sep. 11, 2012

Int. Cl.: 44

SERVICE MARK

PRINCIPAL REGISTER

NIQUE DENTAL PLLC (TEXAS PROFESSIONAL LIMITED LIABILITY COMPANY)
STE. 100
4724 SWEETWATER BLVD.
SUGAR LAND, TX 77479

FOR: DENTISTRY, IN CLASS 44 (U.S. CLS. 100 AND 101).

FIRST USE 9-2-2011; IN COMMERCE 9-28-2011.

THE MARK CONSISTS OF STANDARD CHARACTERS WITHOUT CLAIM TO ANY PARTICULAR FONT, STYLE, SIZE, OR COLOR.

SN 85-424,298, FILED 9-16-2011.

LINDA POWELL, EXAMINING ATTORNEY



David J. Kybas

Director of the United States Patent and Trademark Office

United States of America

United States Patent and Trademark Office

Coupon Possible

Reg. No. 4,207,620

FAITH OF THREE, LLP (OKLAHOMA PARTNERSHIP)
RT. 5, BOX 860
STILWELL, OK 74960

Registered Sep. 11, 2012

Int. Cl.: 16

FOR: BINDERS, IN CLASS 16 (U.S. CLS. 2, 5, 22, 23, 29, 37, 38 AND 50).

TRADEMARK

FIRST USE 12-1-2011; IN COMMERCE 12-1-2011.

PRINCIPAL REGISTER

THE MARK CONSISTS OF STANDARD CHARACTERS WITHOUT CLAIM TO ANY PARTICULAR FONT, STYLE, SIZE, OR COLOR.

NO CLAIM IS MADE TO THE EXCLUSIVE RIGHT TO USE "COUPON", APART FROM THE MARK AS SHOWN.

SN 85-424,331, FILED 9-16-2011.

DAVID I, EXAMINING ATTORNEY



David J. Kyffers

Director of the United States Patent and Trademark Office

United States of America

United States Patent and Trademark Office

SUGARTRIM

Reg. No. 4,207,621

GLANBIA PLC (IRELAND PUBLIC LIMITED COMPANY (PLC))
GLANBIA HOUSE
KILKENNY, IRELAND

Registered Sep. 11, 2012

Int. Cl.: 29

FOR: MILK PROTEIN CONCENTRATE USED AS AN INGREDIENT TO REDUCE SUGAR
IN FINISHED FOOD AND NUTRITIONAL PRODUCTS, IN CLASS 29 (U.S. CL. 46).

TRADEMARK

FIRST USE 9-0-2011; IN COMMERCE 9-0-2011.

PRINCIPAL REGISTER

THE MARK CONSISTS OF STANDARD CHARACTERS WITHOUT CLAIM TO ANY PAR-
TICULAR FONT, STYLE, SIZE, OR COLOR.

SN 85-424,565, FILED 9-16-2011.

KATHLEEN LORENZO, EXAMINING ATTORNEY



David J. Kybas

Director of the United States Patent and Trademark Office

United States of America

United States Patent and Trademark Office

SIMPLY SLICED

Reg. No. 4,207,622

TROPICAL FOODS, LLC (FLORIDA LIMITED LIABILITY COMPANY)
10900 NW 25TH ST. SUITE 202
MIAMI, FL 33172

Registered Sep. 11, 2012

Int. Cl.: 29

FOR: CHEESE, IN CLASS 29 (U.S. CL. 46).

TRADEMARK

FIRST USE 4-1-2012; IN COMMERCE 4-1-2012.

PRINCIPAL REGISTER

THE MARK CONSISTS OF STANDARD CHARACTERS WITHOUT CLAIM TO ANY PARTICULAR FONT, STYLE, SIZE, OR COLOR.

NO CLAIM IS MADE TO THE EXCLUSIVE RIGHT TO USE "SLICED", APART FROM THE MARK AS SHOWN.

SN 85-424,733, FILED 9-16-2011.

SUNG IN, EXAMINING ATTORNEY



David J. Kyfos

Director of the United States Patent and Trademark Office

United States of America

United States Patent and Trademark Office

770 BURGER

Reg. No. 4,207,623

770BURGER CORP (NEW YORK CORPORATION)
6185 STRICKLAND AVE.
BROOKLYN, NY 11234

Registered Sep. 11, 2012

Int. Cl.: 30

FOR: HAMBURGER SANDWICHES, IN CLASS 30 (U.S. CL. 46).

TRADEMARK

FIRST USE 9-1-2008; IN COMMERCE 9-1-2008.

PRINCIPAL REGISTER

THE MARK CONSISTS OF STANDARD CHARACTERS WITHOUT CLAIM TO ANY PARTICULAR FONT, STYLE, SIZE, OR COLOR.

NO CLAIM IS MADE TO THE EXCLUSIVE RIGHT TO USE "BURGER", APART FROM THE MARK AS SHOWN.

SN 85-425,729, FILED 9-19-2011.

JANICE KIM, EXAMINING ATTORNEY



David J. Kyffers

Director of the United States Patent and Trademark Office

United States of America

United States Patent and Trademark Office

GOOD WINE, NATURALLY

Reg. No. 4,207,624

Registered Sep. 11, 2012

Int. Cl.: 33

TRADEMARK

PRINCIPAL REGISTER

E. & J. GALLO WINERY (CALIFORNIA CORPORATION)
600 YOSEMITE BOULEVARD
MODESTO, CA 95354

FOR: ALCOHOLIC BEVERAGES EXCEPT BEERS, IN CLASS 33 (U.S. CLS. 47 AND 49).

FIRST USE 5-31-2012; IN COMMERCE 5-31-2012.

THE MARK CONSISTS OF STANDARD CHARACTERS WITHOUT CLAIM TO ANY PARTICULAR FONT, STYLE, SIZE, OR COLOR.

SN 85-426,078, FILED 9-19-2011.

KARANENDRA S. CHHINA, EXAMINING ATTORNEY



David J. Kybas

Director of the United States Patent and Trademark Office

United States of America

United States Patent and Trademark Office



Reg. No. 4,207,625

PUERTO RICO SUPPLIES GROUP, INC. (PUERTO RICO CORPORATION)
PO BOX 11908

Registered Sep. 11, 2012

SAN JUAN, PUERTO RICO 009221908

Int. Cl.: 3

FOR: BABY WIPES, IN CLASS 3 (U.S. CLS. 1, 4, 6, 50, 51 AND 52).

TRADEMARK

FIRST USE 4-1-2012; IN COMMERCE 4-1-2012.

PRINCIPAL REGISTER

THE MARK CONSISTS OF THE STYLIZED WORDING "FRESHIES" IN WHITE LETTERING WITH A BROWN OUTLINE. THE WORDING APPEARS WITHIN AN ORANGE IRREGULAR SHAPED OVAL WITH A WHITE AND BROWN BORDER.

THE COLOR(S) WHITE, BROWN AND ORANGE IS/ARE CLAIMED AS A FEATURE OF THE MARK.

SN 85-426,167, FILED 9-19-2011.

COURTNEY ALVAREZ, EXAMINING ATTORNEY



David J. Kybas

Director of the United States Patent and Trademark Office

United States of America

United States Patent and Trademark Office

LINCOLN WHISKEY KITCHEN

Reg. No. 4,207,626

WHISKEY RESTAURANTS INC. (ILLINOIS CORPORATION)
15849 N 71ST STREET SUITE 100
SCOTTSDALE, AZ 85254

Registered Sep. 11, 2012

Int. Cl.: 43

FOR: RESTAURANT AND BAR SERVICES, IN CLASS 43 (U.S. CLS. 100 AND 101).

SERVICE MARK

FIRST USE 5-7-2012; IN COMMERCE 5-7-2012.

PRINCIPAL REGISTER

THE MARK CONSISTS OF STANDARD CHARACTERS WITHOUT CLAIM TO ANY PARTICULAR FONT, STYLE, SIZE, OR COLOR.

NO CLAIM IS MADE TO THE EXCLUSIVE RIGHT TO USE "WHISKEY KITCHEN", APART FROM THE MARK AS SHOWN.

SN 85-426,209, FILED 9-19-2011.

CHRIS WELLS, EXAMINING ATTORNEY



David J. Kyffers

Director of the United States Patent and Trademark Office

United States of America

United States Patent and Trademark Office

um yeah press

Reg. No. 4,207,627

THOMAS CAMPBELL (UNITED STATES INDIVIDUAL)
401 GRAND AVENUE, SUITE 300
OAKLAND, CA 94610

Registered Sep. 11, 2012

Int. Cl.: 41

FOR: BOOK PUBLISHING, IN CLASS 41 (U.S. CLS. 100, 101 AND 107).

SERVICE MARK

FIRST USE 6-20-2012; IN COMMERCE 6-21-2012.

PRINCIPAL REGISTER

THE MARK CONSISTS OF STANDARD CHARACTERS WITHOUT CLAIM TO ANY PARTICULAR FONT, STYLE, SIZE, OR COLOR.

NO CLAIM IS MADE TO THE EXCLUSIVE RIGHT TO USE "PRESS", APART FROM THE MARK AS SHOWN.

SN 85-426,360, FILED 9-19-2011.

JEAN IM, EXAMINING ATTORNEY



David J. Kybas

Director of the United States Patent and Trademark Office

United States of America

United States Patent and Trademark Office

F.O.R.T.

Reg. No. 4,207,628

Registered Sep. 11, 2012

Int. Cl.: 36

SERVICE MARK

PRINCIPAL REGISTER

JHL CAPITAL GROUP LLC (DELAWARE LIMITED LIABILITY COMPANY)
900 N. MICHIGAN AVE., SUITE 1340
CHICAGO, IL 60611

FOR: FINANCIAL SERVICES, NAMELY, OPERATION AND MANAGEMENT OF HEDGE FUNDS, COMMODITY POOLS AND OTHER COLLECTIVE INVESTMENT VEHICLES NOT IN THE FIELD OF REAL ESTATE, AND TRADING FOR OTHERS OF SECURITIES, OPTIONS, FUTURES, DERIVATIVES, DEBT INSTRUMENTS AND COMMODITIES NOT IN THE FIELD OF REAL ESTATE, IN CLASS 36 (U.S. CLS. 100, 101 AND 102).

FIRST USE 6-1-2012; IN COMMERCE 6-1-2012.

THE MARK CONSISTS OF STANDARD CHARACTERS WITHOUT CLAIM TO ANY PARTICULAR FONT, STYLE, SIZE, OR COLOR.

SN 85-426,398, FILED 9-19-2011.

TOBY BULLOFF, EXAMINING ATTORNEY



David J. Kyffers

Director of the United States Patent and Trademark Office

United States of America

United States Patent and Trademark Office

MALIBU RADIANCE

Reg. No. 4,207,629

Registered Sep. 11, 2012

Int. Cl.: 3

TRADEMARK

PRINCIPAL REGISTER

BATH & BODY WORKS BRAND MANAGEMENT, INC. (DELAWARE CORPORATION)
SEVEN LIMITED PARKWAY
REYNOLDSBURG, OH 43068

FOR: PERSONAL CARE PRODUCTS, NAMELY, ANTIBACTERIAL SKIN SOAPS AND GELS, BATH GELS, BATH LOTION, BATH OILS FOR COSMETIC PURPOSES, BATH SALTS, BATH SOAPS IN LIQUID, SOLID OR GEL FORM, BODY BALM, NAMELY, BODY BUTTERS, BODY CREAM SOAP, BODY CREAMS, BODY LOTIONS, BODY OILS, BODY POWDER, BODY SCRUB, WHIPPED BODY CREAM, BODY SPRAY USED AS A PERSONAL DEODORANT AND AS FRAGRANCE, BODY SPRAYS, NAMELY, WATER IN ATOMIZED CONTAINERS USED TO PRODUCE A COOLING EFFECT, BODY WASHES FOR HUMANS, BUBBLE BATH, COLOGNE, CREAM SOAPS, EAU DE PARFUM, EAU DE TOILETTE, ESSENTIAL OILS FOR PERSONAL USE, EXFOLIANT CREAMS, EXFOLIANTS FOR SKIN, FACE AND BODY CREAMS, FACE AND BODY GLITTER, FACE AND BODY LOTIONS, FACE POWDER, FACIAL BEAUTY MASKS, FACIAL CLEANSERS, FACIAL SCRUBS, FOAM BATH, FOOT SCRUB, HAIR CARE CREAMS, HAIR CONDITIONERS, HAIR GELS, HAIR POMADES, HAIR SHAMPOO, HAIR STYLING MISTS, HAND CLEANSERS, HAND CREAMS, HAND LOTIONS, HAND SCRUBS, HAND SOAPS, LIP BALM, LIP CREAM, LIP GLOSS, LIP GLOSS PALETTE, LIP POLISHER, LIQUID SOAPS FOR HANDS, FACE AND BODY, MAKE-UP KITS COMPRISED OF LIP BALMS, LIP CREAMS, AND LIP GLOSSES, MASSAGE OILS, MEDICATED SOAPS, MOISTURIZING CREAMS, MOUSSE FOR HAIR, NON-MEDICATED BODY SOAKS, NON-MEDICATED FOOT CREAM AND LOTION, PERFUME, PERFUME OILS, PERFUMED SOAPS, SCENTED BODY SPRAY, SHAVING PREPARATIONS, NAMELY, SHAVING CREAMS, SHAVING FOAMS, SHAVING GELS, AND SHAVING LOTIONS, SHOWER AND BATH FOAM, SHOWER CREAMS, SHOWER GELS, SKIN CLEANSERS, SKIN LOTIONS, SKIN MASKS, SKIN MOISTURIZER, SKIN SOAP, SKIN TONERS, IN CLASS 3 (U.S. CLS. 1, 4, 6, 50, 51 AND 52).

FIRST USE 3-5-2012; IN COMMERCE 3-5-2012.

THE MARK CONSISTS OF STANDARD CHARACTERS WITHOUT CLAIM TO ANY PARTICULAR FONT, STYLE, SIZE, OR COLOR.

SN 85-427,158, FILED 9-20-2011.

ANDREA BUTLER, EXAMINING ATTORNEY



David J. Kyros

Director of the United States Patent and Trademark Office

United States of America

United States Patent and Trademark Office

TOOL VAULT

Reg. No. 4,207,630

STRICTLY E-COMMERCE (FLORIDA CORPORATION)

Registered Sep. 11, 2012

4705 NW 41ST ST
GAINESVILLE, FL 32606

Int. Cl.: 6

FOR: TOOL BOXES OF METAL, IN CLASS 6 (U.S. CLS. 2, 12, 13, 14, 23, 25 AND 50).

TRADEMARK

FIRST USE 7-2-2012; IN COMMERCE 7-2-2012.

PRINCIPAL REGISTER

THE MARK CONSISTS OF STANDARD CHARACTERS WITHOUT CLAIM TO ANY PARTICULAR FONT, STYLE, SIZE, OR COLOR.

NO CLAIM IS MADE TO THE EXCLUSIVE RIGHT TO USE "TOOL", APART FROM THE MARK AS SHOWN.

SN 85-427,264, FILED 9-20-2011.

CHRISIE B. KING, EXAMINING ATTORNEY



David J. Kyffers

Director of the United States Patent and Trademark Office

United States of America

United States Patent and Trademark Office

addycase

Reg. No. 4,207,631

LAMERO, INC (MICHIGAN CORPORATION)
3422 HANFORD LN
KALAMAZOO, MI 49009

Registered Sep. 11, 2012

Int. Cl.: 9

FOR: CASES FOR TABLET COMPUTERS, IN CLASS 9 (U.S. CLS. 21, 23, 26, 36 AND 38).

TRADEMARK

FIRST USE 8-1-2011; IN COMMERCE 11-16-2011.

PRINCIPAL REGISTER

THE MARK CONSISTS OF STANDARD CHARACTERS WITHOUT CLAIM TO ANY PARTICULAR FONT, STYLE, SIZE, OR COLOR.

SN 85-427,613, FILED 9-20-2011.

KATHRYN COWARD, EXAMINING ATTORNEY



David J. Kybas

Director of the United States Patent and Trademark Office

United States of America

United States Patent and Trademark Office

MODAMILY

Reg. No. 4,207,632

MODAMILY, INC. (DELAWARE CORPORATION)
455 SYLVAN AVENUE
ENGLEWOOD CLIFFS, NJ 07632

Registered Sep. 11, 2012

Int. Cl.: 45

FOR: PROVIDING ON-LINE PERSONAL INTRODUCTIONS THROUGH A WEBSITE, ACCESSED VIA INTERCONNECTED GLOBAL COMPUTER NETWORKS, FOR INDIVIDUALS SEEKING TO PARTNER WITH ANOTHER FOR THE SHARED PARENTING OF A CHILD, IN CLASS 45 (U.S. CLS. 100 AND 101).

SERVICE MARK

PRINCIPAL REGISTER

FIRST USE 2-1-2012; IN COMMERCE 2-1-2012.

THE MARK CONSISTS OF STANDARD CHARACTERS WITHOUT CLAIM TO ANY PARTICULAR FONT, STYLE, SIZE, OR COLOR.

SN 85-427,659, FILED 9-20-2011.

JENNIFER MARTIN, EXAMINING ATTORNEY



David J. Kybas

Director of the United States Patent and Trademark Office

United States of America
United States Patent and Trademark Office

Navidea 
BIOPHARMACEUTICALS

Reg. No. 4,207,633

Registered Sep. 11, 2012

Int. Cl.: 42

SERVICE MARK

PRINCIPAL REGISTER

NAVIDEA BIOPHARMACEUTICALS, INC. (DELAWARE CORPORATION)
425 METRO PLACE NORTH
SUITE 300
DUBLIN, OH 43017

FOR: PHARMACEUTICAL RESEARCH AND DEVELOPMENT SERVICES, IN CLASS 42
(U.S. CLS. 100 AND 101).

FIRST USE 1-5-2012; IN COMMERCE 1-5-2012.

NO CLAIM IS MADE TO THE EXCLUSIVE RIGHT TO USE "BIOPHARMACEUTICALS",
APART FROM THE MARK AS SHOWN.

THE MARK CONSISTS OF THE WORD "NAVIDEA" OVER THE WORD "BIOPHARMACEUTICALS"
WITH A SPLIT ARROWHEAD DESIGN TO THE RIGHT OF "NAVIDEA".

SN 85-428,328, FILED 9-21-2011.

JOHN WILKE, EXAMINING ATTORNEY



David J. Kyros

Director of the United States Patent and Trademark Office

United States of America

United States Patent and Trademark Office

HEALTHREV

Reg. No. 4,207,634

MCMAHON, RICHARD (AUSTRALIA INDIVIDUAL)
35 BONNIE BRAE ROAD
HOBART, AUSTRALIA 7053

Registered Sep. 11, 2012

Int. Cls.: 5 and 44

FOR: NUTRACEUTICALS FOR USE AS A DIETARY SUPPLEMENT, IN CLASS 5 (U.S. CLS. 6, 18, 44, 46, 51 AND 52).

TRADEMARK

FIRST USE 6-10-2011; IN COMMERCE 6-10-2011.

SERVICE MARK

FOR: PROVIDING ASSISTANCE, FITNESS EVALUATION AND CONSULTATION TO INDIVIDUALS TO HELP THEM MAKE HEALTH, WELLNESS AND NUTRITIONAL CHANGES IN THEIR DAILY LIVING TO IMPROVE HEALTH, IN CLASS 44 (U.S. CLS. 100 AND 101).

PRINCIPAL REGISTER

FIRST USE 6-10-2011; IN COMMERCE 3-29-2012.

THE MARK CONSISTS OF STANDARD CHARACTERS WITHOUT CLAIM TO ANY PARTICULAR FONT, STYLE, SIZE, OR COLOR.

SN 85-428,538, FILED 9-21-2011.

DAVID COLLIER, EXAMINING ATTORNEY



David J. Kyros

Director of the United States Patent and Trademark Office

United States of America

United States Patent and Trademark Office

CITYKIX CAPITAL

Reg. No. 4,207,635

Registered Sep. 11, 2012

Int. Cl.: 36

SERVICE MARK

PRINCIPAL REGISTER

COULSON, MIGUEL (UNITED STATES INDIVIDUAL)
SUITE 470
4000 PONCE DE LEON BLVD.
CORAL GABLES, FL 33146

FOR: REAL ESTATE INVESTMENT SERVICES, IN CLASS 36 (U.S. CLS. 100, 101 AND 102).

FIRST USE 12-14-2010; IN COMMERCE 12-16-2010.

THE MARK CONSISTS OF STANDARD CHARACTERS WITHOUT CLAIM TO ANY PARTICULAR FONT, STYLE, SIZE, OR COLOR.

NO CLAIM IS MADE TO THE EXCLUSIVE RIGHT TO USE "CAPITAL", APART FROM THE MARK AS SHOWN.

SN 85-429,158, FILED 9-22-2011.

KATHERINE E. HALMEN, EXAMINING ATTORNEY



David J. Kybas

Director of the United States Patent and Trademark Office

United States of America

United States Patent and Trademark Office

Soar On The Wings Of Eagles

Reg. No. 4,207,636

TIPTON, MELANIE (UNITED STATES INDIVIDUAL)
P.O. BOX 1302

Registered Sep. 11, 2012

COLLEGEDALE, TN 37315

Int. Cl.: 41

FOR: PRODUCTION OF TELEVISION PROGRAMS, IN CLASS 41 (U.S. CLS. 100, 101 AND 107).

SERVICE MARK

FIRST USE 1-11-2012; IN COMMERCE 1-11-2012.

PRINCIPAL REGISTER

THE MARK CONSISTS OF STANDARD CHARACTERS WITHOUT CLAIM TO ANY PARTICULAR FONT, STYLE, SIZE, OR COLOR.

SN 85-429,166, FILED 9-22-2011.

KATHERINE E. HALMEN, EXAMINING ATTORNEY



David J. Kybas

Director of the United States Patent and Trademark Office

United States of America
United States Patent and Trademark Office

NAVA

Reg. No. 4,207,637

Registered Sep. 11, 2012

Int. Cl.: 9

TRADEMARK

PRINCIPAL REGISTER

BHC NAVIGATION CO., LTD. (CHINA CORPORATION)
18 ZHONGGUANCUN EAST ROAD, C-7
INTELLI-CENTER, HAIDIAN
BEIJING, CHINA 100083

FOR: GPS NAVIGATION DEVICE, IN CLASS 9 (U.S. CLS. 21, 23, 26, 36 AND 38).

FIRST USE 7-1-2010; IN COMMERCE 7-1-2011.

THE MARK CONSISTS OF THE WORDING "NAVA" IN STYLIZED FONT.

SN 85-429,321, FILED 9-22-2011.

REBECCA GILBERT, EXAMINING ATTORNEY



David J. Kybas

Director of the United States Patent and Trademark Office

United States of America
United States Patent and Trademark Office

TESSERA

Reg. No. 4,207,638

ELECTRONIC THEATRE CONTROLS, INC. (WISCONSIN CORPORATION)
3031 PLEASANT VIEW ROAD
MIDDLETON, WI 53562

Registered Sep. 11, 2012

Int. Cl.: 9

FOR: LIGHTING CONTROLLERS FOR ENTERTAINMENT AND ARCHITECTURAL LIGHTING, IN CLASS 9 (U.S. CLS. 21, 23, 26, 36 AND 38).

TRADEMARK

FIRST USE 8-31-2011; IN COMMERCE 11-17-2011.

PRINCIPAL REGISTER

THE MARK CONSISTS OF STANDARD CHARACTERS WITHOUT CLAIM TO ANY PARTICULAR FONT, STYLE, SIZE, OR COLOR.

SN 85-429,525, FILED 9-22-2011.

TINA MAI, EXAMINING ATTORNEY



David J. Kybas

Director of the United States Patent and Trademark Office

United States of America

United States Patent and Trademark Office

AMERICAN BOLER

Reg. No. 4,207,639

JOHANS, ROBERT (UNITED STATES INDIVIDUAL), DBA AMERICAN BOLER CAMPERS,
64955 COLLINS ROAD
BEND, OR 97701

Registered Sep. 11, 2012

Int. Cl.: 12

FOR: CAMPING TRAILERS; RECREATIONAL VEHICLES, NAMELY, TRAVEL TRAILERS,
IN CLASS 12 (U.S. CLS. 19, 21, 23, 31, 35 AND 44).

TRADEMARK

FIRST USE 1-1-2012; IN COMMERCE 6-1-2012.

PRINCIPAL REGISTER

THE MARK CONSISTS OF STANDARD CHARACTERS WITHOUT CLAIM TO ANY PAR-
TICULAR FONT, STYLE, SIZE, OR COLOR.

NO CLAIM IS MADE TO THE EXCLUSIVE RIGHT TO USE "AMERICAN", APART FROM
THE MARK AS SHOWN.

SN 85-429,846, FILED 9-22-2011.

STEVEN R. FINE, EXAMINING ATTORNEY



David J. Kybas

Director of the United States Patent and Trademark Office

United States of America

United States Patent and Trademark Office

Intentions

Reg. No. 4,207,640

WITHANET LLC (CALIFORNIA LIMITED LIABILITY COMPANY)
13078 MINDANAO WAY #315
MARINA DEL REY, CA 90292

Registered Sep. 11, 2012

Int. Cl.: 24

FOR: TEXTILES WITH INSPIRATIONAL MESSAGES AND WORDS IMPRINTED OR WOVEN INTO TEXTILES, IN CLASS 24 (U.S. CLS. 42 AND 50).

TRADEMARK

FIRST USE 10-1-2011; IN COMMERCE 3-31-2012.

PRINCIPAL REGISTER

THE MARK CONSISTS OF STANDARD CHARACTERS WITHOUT CLAIM TO ANY PARTICULAR FONT, STYLE, SIZE, OR COLOR.

SN 85-429,906, FILED 9-22-2011.

MELISSA VALLILLO, EXAMINING ATTORNEY



David J. Kyffers

Director of the United States Patent and Trademark Office

United States of America

United States Patent and Trademark Office

ITC360

Reg. No. 4,207,641

Registered Sep. 11, 2012

Int. Cl.: 42

SERVICE MARK

PRINCIPAL REGISTER

SILICON TURNKEY SOLUTIONS, INC. (CALIFORNIA CORPORATION)
801 BUCKEYE COURT
MILPITAS, CA 95035

FOR: SCIENTIFIC AND TECHNOLOGICAL SERVICES, NAMELY, RELIANCE TESTING OF COMPONENTS IN THE FIELD OF SEMICONDUCTORS, PROCESSORS, LEDS, LED MODULES, AND PRECISION THERMAL CONTROLLERS; TESTING, ANALYSIS, AND EVALUATION OF COMPONENTS, NAMELY, SEMICONDUCTORS, PROCESSORS, LEDS, LED MODULES, AND PRECISION THERMAL CONTROLLERS TO ASSURE COMPLIANCE WITH INDUSTRY STANDARDS, IN CLASS 42 (U.S. CLS. 100 AND 101).

FIRST USE 12-1-2011; IN COMMERCE 12-1-2011.

THE MARK CONSISTS OF STANDARD CHARACTERS WITHOUT CLAIM TO ANY PARTICULAR FONT, STYLE, SIZE, OR COLOR.

SN 85-429,916, FILED 9-22-2011.

ALLISON HOLTZ, EXAMINING ATTORNEY



David J. Kyffers

Director of the United States Patent and Trademark Office

United States of America

United States Patent and Trademark Office

WOOHOO FALLS

Reg. No. 4,207,642

Registered Sep. 11, 2012

Int. Cl.: 41

SERVICE MARK

PRINCIPAL REGISTER

SEA WORLD LLC (DELAWARE LIMITED LIABILITY COMPANY)
SUITE 400
9205 SOUTH PARK CENTER LOOP
ORLANDO, FL 32819

FOR: ENTERTAINMENT SERVICES IN THE NATURE OF AN AMUSEMENT PARK ATTRACTION, NAMELY, AN AMUSEMENT PARK RIDE, IN CLASS 41 (U.S. CLS. 100, 101 AND 107).

FIRST USE 5-19-2012; IN COMMERCE 5-19-2012.

THE MARK CONSISTS OF STANDARD CHARACTERS WITHOUT CLAIM TO ANY PARTICULAR FONT, STYLE, SIZE, OR COLOR.

SN 85-430,075, FILED 9-23-2011.

STEVEN PEREZ, EXAMINING ATTORNEY



David J. Kybas

Director of the United States Patent and Trademark Office

United States of America

United States Patent and Trademark Office

YOUR LIFE STORY LIVES HERE

Reg. No. 4,207,643

LEAVES, INC. (WASHINGTON CORPORATION)
4580 KLAHANIE DRIVE SE NUMBER 475
ISSAQUAH, WA 98029

Registered Sep. 11, 2012

Int. Cl.: 41

FOR: INTERACTIVE ONLINE WEB JOURNALS FEATURING LIFE STORIES AND LEGACIES,
IN CLASS 41 (U.S. CLS. 100, 101 AND 107).

SERVICE MARK

FIRST USE 11-11-2011; IN COMMERCE 11-11-2011.

PRINCIPAL REGISTER

THE MARK CONSISTS OF STANDARD CHARACTERS WITHOUT CLAIM TO ANY PAR-
TICULAR FONT, STYLE, SIZE, OR COLOR.

SN 85-430,728, FILED 9-23-2011.

EMILY CARLSEN, EXAMINING ATTORNEY



David J. Kyffers

Director of the United States Patent and Trademark Office

United States of America

United States Patent and Trademark Office

HandAble

Reg. No. 4,207,644

BLOCK, AARON (UNITED STATES INDIVIDUAL)
14491 GUAMA AVENUE
IRVINE, CA 92606

Registered Sep. 11, 2012

Int. Cl.: 9

FOR: CELL PHONE STRAPS, IN CLASS 9 (U.S. CLS. 21, 23, 26, 36 AND 38).

TRADEMARK

FIRST USE 8-15-2011; IN COMMERCE 8-15-2011.

PRINCIPAL REGISTER

THE MARK CONSISTS OF STANDARD CHARACTERS WITHOUT CLAIM TO ANY PARTICULAR FONT, STYLE, SIZE, OR COLOR.

SN 85-430,837, FILED 9-23-2011.

DAVID MURRAY, EXAMINING ATTORNEY



David J. Kyfos

Director of the United States Patent and Trademark Office

United States of America

United States Patent and Trademark Office

SENDERO

Reg. No. 4,207,645

DOW AGROSCIENCES LLC (DELAWARE LIMITED LIABILITY COMPANY)
9330 ZIONSVILLE ROAD
INDIANAPOLIS, IN 46268

Registered Sep. 11, 2012

Int. Cl.: 5

FOR: PESTICIDES AND PREPARATIONS FOR DESTROYING VERMIN, NAMELY, HERBICIDES, FOR AGRICULTURE, HORTICULTURE, FORESTRY, TURF AND ORNAMENTAL, COMMERCIAL, INDUSTRIAL AND DOMESTIC USE, IN CLASS 5 (U.S. CLS. 6, 18, 44, 46, 51 AND 52).

TRADEMARK

PRINCIPAL REGISTER

FIRST USE 4-11-2012; IN COMMERCE 4-11-2012.

THE MARK CONSISTS OF STANDARD CHARACTERS WITHOUT CLAIM TO ANY PARTICULAR FONT, STYLE, SIZE, OR COLOR.

THE ENGLISH TRANSLATION OF "SENDERO" IN THE MARK IS "PATH".

SN 85-431,985, FILED 9-26-2011.

VIVIAN MICZNIK FIRST, EXAMINING ATTORNEY



David J. Kyffers

Director of the United States Patent and Trademark Office

United States of America

United States Patent and Trademark Office



Reg. No. 4,207,646

BOLD RED ENTERTAINMENT GROUP LLC (TEXAS LIMITED LIABILITY COMPANY)
14711 AEGEAN WAY
SAN ANTONIO, TX 78154

Registered Sep. 11, 2012

Int. Cl.: 25

FOR: WEARABLE GARMENTS AND CLOTHING, NAMELY, SHIRTS; WOMEN'S CLOTHING, NAMELY, SHIRTS, DRESSES, SKIRTS, BLOUSES, IN CLASS 25 (U.S. CLS. 22 AND 39).

TRADEMARK

FIRST USE 11-11-2011; IN COMMERCE 11-11-2011.

PRINCIPAL REGISTER

THE MARK CONSISTS OF THE WORDING "BOLD RED" IN THE COLOR BLACK WHERE THE WORD "RED" APPEARS INSIDE THE "L" AND "D" OF THE WORD "BOLD". THE WORDING IS POSITIONED OVER A STAR WITH A BORDER IN THE COLOR RED.

THE COLOR(S) RED AND BLACK IS/ARE CLAIMED AS A FEATURE OF THE MARK.

SN 85-432,631, FILED 9-27-2011.

EMILY CHUO, EXAMINING ATTORNEY



David J. Kybas

Director of the United States Patent and Trademark Office

United States of America

United States Patent and Trademark Office

B.A. futuretees Corporation

Reg. No. 4,207,647

Registered Sep. 11, 2012

Int. Cl.: 25

TRADEMARK

PRINCIPAL REGISTER

ANGOY, BRIAN (UNITED STATES INDIVIDUAL)
#D3
991 CARROLL STREET
BROOKLYN, NY 11225

FOR: JACKETS; SWEAT SHIRTS; SWEATPANTS; T-SHIRTS, IN CLASS 25 (U.S. CLS. 22 AND 39).

FIRST USE 1-25-2012; IN COMMERCE 3-6-2012.

THE MARK CONSISTS OF STANDARD CHARACTERS WITHOUT CLAIM TO ANY PARTICULAR FONT, STYLE, SIZE, OR COLOR.

NO CLAIM IS MADE TO THE EXCLUSIVE RIGHT TO USE "CORPORATION", APART FROM THE MARK AS SHOWN.

SN 85-432,642, FILED 9-27-2011.

EMILY CHUO, EXAMINING ATTORNEY



David J. Kybas

Director of the United States Patent and Trademark Office

United States of America

United States Patent and Trademark Office

TOSWRISTBANDS

Reg. No. 4,207,648

TAKEN OR SINGLE WRISTBANDS, LLC (FLORIDA LIMITED LIABILITY COMPANY)
5675 STRAND CT.
NAPLES, FL 34110

Registered Sep. 11, 2012

Int. Cl.: 14

FOR: RUBBER OR SILICON WRISTBANDS IN THE NATURE OF A BRACELET, IN CLASS 14 (U.S. CLS. 2, 27, 28 AND 50).

TRADEMARK

FIRST USE 1-0-2012; IN COMMERCE 1-0-2012.

PRINCIPAL REGISTER

THE MARK CONSISTS OF STANDARD CHARACTERS WITHOUT CLAIM TO ANY PARTICULAR FONT, STYLE, SIZE, OR COLOR.

SN 85-432,690, FILED 9-27-2011.

SETH A. RAPPAPORT, EXAMINING ATTORNEY



David J. Kybas

Director of the United States Patent and Trademark Office

United States of America

United States Patent and Trademark Office

NCA: MAKING LIFE SWEETER SINCE 1884

Reg. No. 4,207,649

Registered Sep. 11, 2012

Int. Cl.: 35

SERVICE MARK

PRINCIPAL REGISTER

NATIONAL CONFECTIONERS ASSOCIATION (DELAWARE CORPORATION)
SUITE 200
1101 30TH STREET, N.W.
WASHINGTON, DC 20007

FOR: TRADE ASSOCIATION SERVICES, NAMELY, PROMOTING THE INTERESTS OF
THE CONFECTIONERY INDUSTRY, IN CLASS 35 (U.S. CLS. 100, 101 AND 102).

FIRST USE 5-29-2012; IN COMMERCE 5-29-2012.

THE MARK CONSISTS OF STANDARD CHARACTERS WITHOUT CLAIM TO ANY PAR-
TICULAR FONT, STYLE, SIZE, OR COLOR.

OWNER OF U.S. REG. NO. 3,835,949.

SN 85-432,743, FILED 9-27-2011.

TEJBIR SINGH, EXAMINING ATTORNEY



David J. Kybas

Director of the United States Patent and Trademark Office

United States of America

United States Patent and Trademark Office

VIVI LEDISH

Reg. No. 4,207,650

FIFI DELISH LLC (ILLINOIS LIMITED LIABILITY COMPANY)
209 W MADISON
DIVERNON, IL 62530

Registered Sep. 11, 2012

Int. Cl.: 44

FOR: PROVIDING A WEBSITE FEATURING INFORMATION ABOUT CHILDREN'S HEALTH, WELLNESS AND NUTRITION, IN CLASS 44 (U.S. CLS. 100 AND 101).

SERVICE MARK

FIRST USE 12-24-2011; IN COMMERCE 12-24-2011.

PRINCIPAL REGISTER

THE MARK CONSISTS OF STANDARD CHARACTERS WITHOUT CLAIM TO ANY PARTICULAR FONT, STYLE, SIZE, OR COLOR.

THE WORD(S) "VIVI LEDISH" HAS NO MEANING IN A FOREIGN LANGUAGE.

SN 85-433,662, FILED 9-28-2011.

DEIRDRE ROBERTSON, EXAMINING ATTORNEY



David J. Kybas

Director of the United States Patent and Trademark Office

United States of America

United States Patent and Trademark Office

Uncover the Unexpected

Reg. No. 4,207,651

Registered Sep. 11, 2012

Int. Cl.: 42

SERVICE MARK

PRINCIPAL REGISTER

GENOMIC HEALTH, INC. (DELAWARE CORPORATION)
IP/DOCKETING DEPARTMENT
301 PENOBSCOT DRIVE
REDWOOD CITY, CA 94063

FOR: PROVIDING LABORATORY RESEARCH SERVICES IN THE FIELD OF GENE EXPRESSION, NAMELY, CANCER BIOLOGY; PROVIDING MEDICAL TESTING SERVICES AND INFORMATION IN THE FIELD OF CANCER RESEARCH AND DISEASE CLASSIFICATION, IN CLASS 42 (U.S. CLS. 100 AND 101).

FIRST USE 12-6-2011; IN COMMERCE 12-6-2011.

THE MARK CONSISTS OF STANDARD CHARACTERS WITHOUT CLAIM TO ANY PARTICULAR FONT, STYLE, SIZE, OR COLOR.

SN 85-434,460, FILED 9-28-2011.

KATHLEEN KOLACZ, EXAMINING ATTORNEY



David J. Kyjars

Director of the United States Patent and Trademark Office

United States of America
United States Patent and Trademark Office

INGENIOS

Reg. No. 4,207,652

ZIMMER DENTAL INC. (DELAWARE CORPORATION)
1900 ASTON AVENUE
CARLSBAD, CA 92008

Registered Sep. 11, 2012

Int. Cl.: 10

FOR: SYNTHETIC BONE GRAFT, NAMELY, FOR IMPLANTATION AND TO FILL UP AND RECONSTRUCT BONE DEFECTS, IN CLASS 10 (U.S. CLS. 26, 39 AND 44).

TRADEMARK

FIRST USE 3-31-2012; IN COMMERCE 3-31-2012.

PRINCIPAL REGISTER

THE MARK CONSISTS OF STANDARD CHARACTERS WITHOUT CLAIM TO ANY PARTICULAR FONT, STYLE, SIZE, OR COLOR.

PRIORITY CLAIMED UNDER SEC. 44(D) ON SWITZERLAND APPLICATION NO. 60213/2011, FILED 9-9-2011.

SN 85-434,509, FILED 9-28-2011.

REGINA DRUMMOND, EXAMINING ATTORNEY



David J. Kybas

Director of the United States Patent and Trademark Office

United States of America

United States Patent and Trademark Office

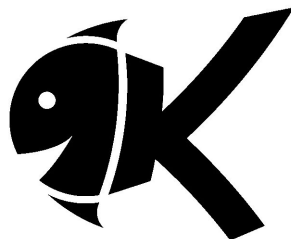

knibbler

Reg. No. 4,207,653

THEY CREATIVE, LP (TEXAS PARTNERSHIP)
5161 SAN FELIPE, STE 320
HOUSTON, TX 77056

Registered Sep. 11, 2012

Int. Cl.: 9

FOR: COMPUTER APPLICATION SOFTWARE FOR MOBILE PHONES. SMARTPHONES, TABLET COMPUTERS, NAMELY, SOFTWARE FOR PROVIDING A LEAD GENERATION TOOL FOR SMALL BUSINESSES, IN CLASS 9 (U.S. CLS. 21, 23, 26, 36 AND 38).

TRADEMARK

FIRST USE 1-10-2012; IN COMMERCE 1-10-2012.

PRINCIPAL REGISTER

THE MARK CONSISTS OF A FISH FACING LEFT WITH A SMILE AND FINS. THE TAIL FIN IS THE SHAPE OF THE LETTER "K". THE STYLIZED TEXT "KNIBBLER" APPEARS BELOW.

SN 85-435,194, FILED 9-29-2011.

DOUGLAS LEE, EXAMINING ATTORNEY



David J. Kyffers

Director of the United States Patent and Trademark Office

United States of America

United States Patent and Trademark Office

UGLYBUDDIES

Reg. No. 4,207,654

Registered Sep. 11, 2012

Int. Cl.: 28

TRADEMARK

PRINCIPAL REGISTER

PRETTY UGLY, LLC (DELAWARE LIMITED LIABILITY COMPANY)
45 FERNWOOD AVENUE
EDISON, NJ 08837 AND

HORVATH, DAVID (UNITED STATES INDIVIDUAL)
45 FERNWOOD AVENUE
EDISON, NJ 08837 AND

KIM, SUN-MIN (REPUBLIC OF KOREA INDIVIDUAL)
45 FERNWOOD AVENUE
EDISON, NJ 08837

FOR: STUFFED AND PLUSH TOYS, IN CLASS 28 (U.S. CLS. 22, 23, 38 AND 50).

FIRST USE 6-26-2012; IN COMMERCE 6-26-2012.

THE MARK CONSISTS OF STANDARD CHARACTERS WITHOUT CLAIM TO ANY PARTICULAR FONT, STYLE, SIZE, OR COLOR.

OWNER OF U.S. REG. NOS. 3,539,565, 3,974,740, AND OTHERS.

SN 85-435,313, FILED 9-29-2011.

JOHN KELLY, EXAMINING ATTORNEY



David J. Kybas

Director of the United States Patent and Trademark Office

United States of America

United States Patent and Trademark Office

ASTRO-QUILT

Reg. No. 4,207,655

GRAND DESIGNS, INC. (CALIFORNIA CORPORATION)
8333 DEMETRE AVE.

Registered Sep. 11, 2012

SACRAMENTO, CA 95828

Int. Cl.: 17

FOR: PACKING AND INSULATING MATERIAL FOR USE IN SHIPPING, IN CLASS 17 (U.S. CLS. 1, 5, 12, 13, 35 AND 50).

TRADEMARK

FIRST USE 3-20-2012; IN COMMERCE 3-20-2012.

PRINCIPAL REGISTER

THE MARK CONSISTS OF STANDARD CHARACTERS WITHOUT CLAIM TO ANY PARTICULAR FONT, STYLE, SIZE, OR COLOR.

SN 85-435,419, FILED 9-29-2011.

SAMUEL E. SHARPER JR., EXAMINING ATTORNEY



David J. Kybas

Director of the United States Patent and Trademark Office

United States of America

United States Patent and Trademark Office

DESIGN CHOCOLATES.COM YOUR LOCAL CHOCOLATE SHOPPE

Reg. No. 4,207,656

SILVIA, CARL (UNITED STATES INDIVIDUAL)
P.O. BOX 693
BRISTOL, RI 02809

Registered Sep. 11, 2012

Int. Cl.: 35

FOR: ON-LINE ORDERING SERVICES FEATURING CHOCOLATES; RETAIL STORE SERVICES FEATURING CHOCOLATES, COFFEE, CANDLES, NUTRITIONAL AND GOURMET FOOD PRODUCTS, IN CLASS 35 (U.S. CLS. 100, 101 AND 102).

SERVICE MARK

FIRST USE 10-1-2011; IN COMMERCE 10-1-2011.

PRINCIPAL REGISTER

THE MARK CONSISTS OF STANDARD CHARACTERS WITHOUT CLAIM TO ANY PARTICULAR FONT, STYLE, SIZE, OR COLOR.

NO CLAIM IS MADE TO THE EXCLUSIVE RIGHT TO USE "CHOCOLATES.COM YOUR LOCAL CHOCOLATE SHOPPE", APART FROM THE MARK AS SHOWN.

SN 85-436,054, FILED 9-30-2011.

KHANH LE, EXAMINING ATTORNEY



David J. Kybas

Director of the United States Patent and Trademark Office

United States of America

United States Patent and Trademark Office



Reg. No. 4,207,657

VANDEBERG-HOLLAND, LINDA (UNITED STATES INDIVIDUAL)
13640 DERBY DOWNS COURT
SAN DIEGO, CA 92130

Registered Sep. 11, 2012

Int. Cl.: 35

FOR: CONSULTATION SERVICES, NAMELY, CREATIVE AND STRATEGIC CONSULTATION REGARDING DEVELOPMENT AND PRODUCTION OF MARKETING CAMPAIGNS FOR OTHERS, IN CLASS 35 (U.S. CLS. 100, 101 AND 102).

SERVICE MARK

FIRST USE 6-1-2011; IN COMMERCE 6-1-2011.

PRINCIPAL REGISTER

THE MARK CONSISTS OF A STYLIZED HEART IN RED WITH BANDS IN THE COLORS ORANGE, YELLOW, GREEN, BLUE, AND PURPLE. THE WORDING "MAKE THE HOPE HAPPEN" APPEARS IN STACKED FORMATION TO THE RIGHT OF THE HEART IN THE COLORS PINK, ORANGE, PURPLE, AND BLUE.

THE COLOR(S) RED, ORANGE, YELLOW, GREEN, BLUE, PURPLE, AND PINK IS/ARE CLAIMED AS A FEATURE OF THE MARK.

SN 85-436,162, FILED 9-30-2011.

KATHLEEN M. VANSTON, EXAMINING ATTORNEY



David J. Kyjars

Director of the United States Patent and Trademark Office

United States of America

United States Patent and Trademark Office

1 *night*
HIGHLIGHTS

Reg. No. 4,207,658

Registered Sep. 11, 2012

Int. Cl.: 3

TRADEMARK

PRINCIPAL REGISTER

ALTERNA HOLDINGS CORP (DELAWARE CORPORATION)
SUITE 1300
2029 CENTURY PARK EAST
CENTURY CITY, CA 90067

FOR: HAIR COLOR, IN CLASS 3 (U.S. CLS. 1, 4, 6, 50, 51 AND 52).

FIRST USE 12-20-2011; IN COMMERCE 12-20-2011.

NO CLAIM IS MADE TO THE EXCLUSIVE RIGHT TO USE "HIGHLIGHTS", APART FROM THE MARK AS SHOWN.

THE MARK CONSISTS OF THE TERM "1 NIGHT HIGHLIGHTS".

SN 85-436,487, FILED 9-30-2011.

RENEE MCCRAY, EXAMINING ATTORNEY



David J. Kyffers

Director of the United States Patent and Trademark Office

United States of America

United States Patent and Trademark Office

PRO BAR

Reg. No. 4,207,659

Registered Sep. 11, 2012

Int. Cl.: 41

SERVICE MARK

PRINCIPAL REGISTER

DGMB CASINO, LLC (NEW JERSEY LIMITED LIABILITY COMPANY), DBA RESORTS
CASINO HOTEL,
1133 BOARDWALK
ATLANTIC CITY, NJ 08401

FOR: NIGHT CLUBS, IN CLASS 41 (U.S. CLS. 100, 101 AND 107).

FIRST USE 10-20-2011; IN COMMERCE 10-20-2011.

THE MARK CONSISTS OF STANDARD CHARACTERS WITHOUT CLAIM TO ANY PARTICULAR FONT, STYLE, SIZE, OR COLOR.

NO CLAIM IS MADE TO THE EXCLUSIVE RIGHT TO USE "BAR", APART FROM THE MARK AS SHOWN.

SN 85-436,833, FILED 9-30-2011.

FRED CARL, EXAMINING ATTORNEY



David J. Kybas

Director of the United States Patent and Trademark Office

United States of America

United States Patent and Trademark Office

JET MEDICAL CENTER

Reg. No. 4,207,660

CHOKSI, SAMER R. (UNITED STATES INDIVIDUAL)
2002 SE 25TH LOOP
OCALA, FL 34471

Registered Sep. 11, 2012

Int. Cl.: 44

FOR: MEDICAL CLINICS, IN CLASS 44 (U.S. CLS. 100 AND 101).

SERVICE MARK

FIRST USE 3-0-2012; IN COMMERCE 3-0-2012.

PRINCIPAL REGISTER

THE MARK CONSISTS OF STANDARD CHARACTERS WITHOUT CLAIM TO ANY PARTICULAR FONT, STYLE, SIZE, OR COLOR.

NO CLAIM IS MADE TO THE EXCLUSIVE RIGHT TO USE "MEDICAL CENTER", APART FROM THE MARK AS SHOWN.

SN 85-436,882, FILED 9-30-2011.

MARILYN IZZI, EXAMINING ATTORNEY



David J. Kyffers

Director of the United States Patent and Trademark Office

United States of America

United States Patent and Trademark Office

FIRST CLASS HEALTHCARE, FAST!

Reg. No. 4,207,661

CHOKSI, SAMER R. (UNITED STATES INDIVIDUAL)
2002 SE 25TH LOOP
OCALA, FL 34471

Registered Sep. 11, 2012

Int. Cl.: 44

FOR: MEDICAL CLINICS, IN CLASS 44 (U.S. CLS. 100 AND 101).

SERVICE MARK

FIRST USE 3-0-2012; IN COMMERCE 3-0-2012.

PRINCIPAL REGISTER

THE MARK CONSISTS OF STANDARD CHARACTERS WITHOUT CLAIM TO ANY PARTICULAR FONT, STYLE, SIZE, OR COLOR.

NO CLAIM IS MADE TO THE EXCLUSIVE RIGHT TO USE "HEALTHCARE", APART FROM THE MARK AS SHOWN.

SN 85-436,921, FILED 9-30-2011.

MARILYN IZZI, EXAMINING ATTORNEY



David J. Kyffers

Director of the United States Patent and Trademark Office

United States of America

United States Patent and Trademark Office



Reg. No. 4,207,662

DRAKE POWDERWORKS, LLC (COLORADO LIMITED LIABILITY COMPANY)
385 SW RUSS COURT
MCMINNVILLE, OR 97128

Registered Sep. 11, 2012

Int. Cls.: 25 and 28

FOR: CLOTHING, NAMELY, T-SHIRTS, SWEATSHIRTS, BEANIES, BASEBALL CAPS, HATS AND SKI BOOTS, IN CLASS 25 (U.S. CLS. 22 AND 39).

TRADEMARK

FIRST USE 9-0-2005; IN COMMERCE 9-0-2005.

PRINCIPAL REGISTER

FOR: SKIS; SKI EQUIPMENT, NAMELY, SKI POLES, IN CLASS 28 (U.S. CLS. 22, 23, 38 AND 50).

FIRST USE 9-0-2005; IN COMMERCE 9-0-2005.

THE MARK CONSISTS OF A PARTIAL SNOWFLAKE INTEGRATED INTO A SET OF PARALLEL LINES WHERE THE UPPER LINE IS SOLID AND THE LOWER LINE IS BROKEN ON THE RIGHT HALF OF THE LINE.

SN 85-437,675, FILED 10-3-2011.

BENJAMIN OKEKE, EXAMINING ATTORNEY



David J. Kybas

Director of the United States Patent and Trademark Office

United States of America

United States Patent and Trademark Office

ShirtWhiz

Reg. No. 4,207,663

CALANCA, PATRICIA D. (UNITED STATES INDIVIDUAL)
40 CONRAD ROAD

Registered Sep. 11, 2012

NEW CANAAN, CT 06840

Int. Cl.: 20

FOR: CLOTHES HANGERS HAVING SLIDING ARMS FOR USE WITH SHIRTS, SWEATERS OR TURTLENECKS BY PLACEMENT THROUGH THE NECK HOLE, IN CLASS 20 (U.S. CLS. 2, 13, 22, 25, 32 AND 50).

TRADEMARK

FIRST USE 10-3-2011; IN COMMERCE 3-1-2012.

PRINCIPAL REGISTER

THE MARK CONSISTS OF STANDARD CHARACTERS WITHOUT CLAIM TO ANY PARTICULAR FONT, STYLE, SIZE, OR COLOR.

SN 85-437,706, FILED 10-3-2011.

PAUL E. FAHRENKOPF, EXAMINING ATTORNEY



David J. Kyffers

Director of the United States Patent and Trademark Office

United States of America

United States Patent and Trademark Office

ACVREP

Reg. No. 4,207,664

Registered Sep. 11, 2012

Int. Cl.: 35

SERVICE MARK

PRINCIPAL REGISTER

ACADEMY FOR CERTIFICATION OF VISION REHABILITATION AND EDUCATION
PROFESSIONALS (VIRGINIA CORPORATION)
4732 N. ORACLE ROAD, SUITE #217
TUCSON, AZ 85705

FOR: TESTING SERVICES TO DETERMINE PROFESSIONAL COMPETENCY, NAMELY, ADMINISTERING, SCORING AND REPORTING THE RESULTS OF ASSESSMENT EXAMINATIONS IN THE FIELD OF LOW VISION THERAPY, ORIENTATION AND MOBILITY, AND VISION REHABILITATION THERAPY; MAINTAINING A REGISTRY OF CERTIFIED PROFESSIONALS IN THE FIELD OF LOW VISION THERAPY, ORIENTATION AND MOBILITY, AND VISION REHABILITATION THERAPY; PROMOTING PUBLIC AWARENESS OF PROFESSIONALS PROVIDING QUALITY SERVICE TO PEOPLE WITH VISION LOSS, IN CLASS 35 (U.S. CLS. 100, 101 AND 102).

FIRST USE 1-1-2000; IN COMMERCE 1-1-2000.

THE MARK CONSISTS OF STANDARD CHARACTERS WITHOUT CLAIM TO ANY PARTICULAR FONT, STYLE, SIZE, OR COLOR.

SN 85-437,708, FILED 10-3-2011.

PAUL E. FAHRENKOPF, EXAMINING ATTORNEY



David J. Kyffers

Director of the United States Patent and Trademark Office

United States of America

United States Patent and Trademark Office



Reg. No. 4,207,665

LAMPLIGHT FARMS INCORPORATED (WISCONSIN CORPORATION)
4900 N. LILLY ROAD
MENOMONEE FALLS, WI 53051

Registered Sep. 11, 2012

Int. Cl.: 4

FOR: OUTDOOR DECORATIVE TABLETOP FUELED TORCHES, IN CLASS 4 (U.S. CLS. 1, 6 AND 15).

TRADEMARK

FIRST USE 12-27-2011; IN COMMERCE 12-27-2011.

PRINCIPAL REGISTER

NO CLAIM IS MADE TO THE EXCLUSIVE RIGHT TO USE "MULTIPLE FUEL OPTIONS", APART FROM THE MARK AS SHOWN.

THE MARK CONSISTS OF AN IMAGE OF AN OVAL SHAPED DESIGN IN THE BACKGROUND, THE STYLIZED WORDS "FLEXFUEL" INSIDE A BANNER, AN IMAGE OF THREE FLAMES ABOVE THE BANNER, AND THE WORDS "MULTIPLE FUEL OPTIONS" BELOW THE BANNER.

SN 85-437,912, FILED 10-3-2011.

MARK SPARACINO, EXAMINING ATTORNEY



David J. Kybas

Director of the United States Patent and Trademark Office

United States of America

United States Patent and Trademark Office

WHAT'S RIGHT WITH AMERICA IS RIGHT NEXT DOOR

Reg. No. 4,207,666

BEANSTALK FOUNDATION (COLORADO NON-PROFIT CORPORATION)
952 LOGAN STREET
DENVER, CO 80203

Registered Sep. 11, 2012

Int. Cl.: 36

FOR: CHARITABLE FUND RAISING SERVICES AND ADMINISTERING MONETARY CHARITABLE CONTRIBUTIONS, IN CLASS 36 (U.S. CLS. 100, 101 AND 102).

SERVICE MARK

FIRST USE 10-20-2011; IN COMMERCE 10-20-2011.

PRINCIPAL REGISTER

THE MARK CONSISTS OF STANDARD CHARACTERS WITHOUT CLAIM TO ANY PARTICULAR FONT, STYLE, SIZE, OR COLOR.

SN 85-438,618, FILED 10-4-2011.

KYLE PEETE, EXAMINING ATTORNEY



David J. Kyffers

Director of the United States Patent and Trademark Office

United States of America

United States Patent and Trademark Office

Roomscaper

Reg. No. 4,207,667

ANNA PIZARRO (UNITED STATES INDIVIDUAL)
85-101 NORTH 3RD STREET APT 212
BROOKLYN, NY 11211

Registered Sep. 11, 2012

Int. Cl.: 42

FOR: PROVIDING A WEB SITE FEATURING TECHNOLOGY THAT ENABLES USERS TO COLLECT, ANALYZE, SHARE AND ANNOTATE PERSONAL AND PUBLIC CONSUMER PRODUCT DATA, IN CLASS 42 (U.S. CLS. 100 AND 101).

SERVICE MARK

FIRST USE 10-1-2011; IN COMMERCE 2-1-2012.

PRINCIPAL REGISTER

THE MARK CONSISTS OF STANDARD CHARACTERS WITHOUT CLAIM TO ANY PARTICULAR FONT, STYLE, SIZE, OR COLOR.

SN 85-438,636, FILED 10-4-2011.

SHANNON TWOHIG, EXAMINING ATTORNEY



David J. Kyffers

Director of the United States Patent and Trademark Office

United States of America

United States Patent and Trademark Office

PostureZone

Reg. No. 4,207,668

Registered Sep. 11, 2012

Int. Cl.: 44

SERVICE MARK

PRINCIPAL REGISTER

BODYZONE, LLC (GEORGIA LIMITED LIABILITY COMPANY)
3000 OLD ALABAMA ROAD, SUITE 119-352
ALPHARETTA, GA 30022

FOR: CHIROPRACTIC SERVICES; CHIROPRACTICS; MASSAGE THERAPY SERVICES; PHYSICAL REHABILITATION; PHYSICAL THERAPY; PROVIDING ON-LINE INFORMATION, NEWS AND COMMENTARY IN THE FIELD OF HEALTH AND WELLNESS RELATING TO CHIROPRACTIC TREATMENT, PHYSICAL REHABILITATION, POSTURE EXERCISE, MASSAGE THERAPY, THERAPEUTIC MASSAGE AND MANUAL MASSAGE, IN CLASS 44 (U.S. CLS. 100 AND 101).

FIRST USE 1-1-2012; IN COMMERCE 1-1-2012.

THE MARK CONSISTS OF STANDARD CHARACTERS WITHOUT CLAIM TO ANY PARTICULAR FONT, STYLE, SIZE, OR COLOR.

SN 85-439,317, FILED 10-5-2011.

JOHN DWYER, EXAMINING ATTORNEY



David J. Kyros

Director of the United States Patent and Trademark Office

United States of America

United States Patent and Trademark Office

BOMBA NEGRA

Reg. No. 4,207,669

Registered Sep. 11, 2012

Int. Cl.: 30

TRADEMARK

PRINCIPAL REGISTER

GRUPO BIMBO, S.A. B. DE C.V. (MEXICO CORPORATION)
PROLONGACION PASEO DE 01210
NO. 1000, COL. PENA BLANCA SANTA FE
MEXICO CITY, MEXICO 01210

FOR: CANDY, NAMELY, LOLLIPOPS AND SUCKERS FROM CRYSTALLIZED SUGAR AND/OR CHOCOLATE, IN CLASS 30 (U.S. CL. 46).

FIRST USE 6-30-2000; IN COMMERCE 6-30-2000.

THE MARK CONSISTS OF STANDARD CHARACTERS WITHOUT CLAIM TO ANY PARTICULAR FONT, STYLE, SIZE, OR COLOR.

NO CLAIM IS MADE TO THE EXCLUSIVE RIGHT TO USE "NEGRA", APART FROM THE MARK AS SHOWN.

THE ENGLISH TRANSLATION OF "BOMBA NEGRA" IN THE MARK IS "BLACK BOMB".

SN 85-439,613, FILED 10-5-2011.

MARGERY A. TIERNEY, EXAMINING ATTORNEY



David J. Kyffers

Director of the United States Patent and Trademark Office

United States of America

United States Patent and Trademark Office

FLASH PAIRING

Reg. No. 4,207,670

CARDO SYSTEMS, INC. (CAYMAN ISLANDS CORPORATION)
100 HIGH TOWER BLVD.
PITTSBURGH, PA 15205

Registered Sep. 11, 2012

Int. Cl.: 9

FOR: WIRELESS NON-STATIONARY COMMUNICATION DEVICES, NAMELY, WIRELESS HEADSETS FOR HELMETS USED FOR COMMUNICATING VIA MOBILE PHONES AND INTERCOMS, AND LISTENING TO MUSIC VIA MP3 PLAYERS, AND LISTENING TO INFORMATION PROVIDED BY GPS DEVICES, IN CLASS 9 (U.S. CLS. 21, 23, 26, 36 AND 38).

TRADEMARK

PRINCIPAL REGISTER

FIRST USE 4-0-2012; IN COMMERCE 4-0-2012.

THE MARK CONSISTS OF STANDARD CHARACTERS WITHOUT CLAIM TO ANY PARTICULAR FONT, STYLE, SIZE, OR COLOR.

SN 85-439,800, FILED 10-5-2011.

JOHN WILKE, EXAMINING ATTORNEY



David J. Kyffers

Director of the United States Patent and Trademark Office

United States of America

United States Patent and Trademark Office

BRAKE

Reg. No. 4,207,671

Registered Sep. 11, 2012

Int. Cl.: 5

TRADEMARK

PRINCIPAL REGISTER

SEPRO CORPORATION (INDIANA CORPORATION)
STE. 600
11550 N. MERIDIAN STREET
CARMEL, IN 46032

FOR: COTTON HERBICIDE, IN CLASS 5 (U.S. CLS. 6, 18, 44, 46, 51 AND 52).

FIRST USE 4-16-2012; IN COMMERCE 4-16-2012.

THE MARK CONSISTS OF STANDARD CHARACTERS WITHOUT CLAIM TO ANY PARTICULAR FONT, STYLE, SIZE, OR COLOR.

SN 85-439,988, FILED 10-5-2011.

WILLIAM ROSSMAN, EXAMINING ATTORNEY



David J. Kyffers

Director of the United States Patent and Trademark Office

United States of America

United States Patent and Trademark Office



Reg. No. 4,207,672

CAMPBELL, TERRY ALVIN (CANADA INDIVIDUAL)
1695 PEARSON AVENUE
PRINCE GEORGE, BC, CANADA V2L4K7

Registered Sep. 11, 2012

Int. Cl.: 5

FOR: AIR FRESHENERS, IN CLASS 5 (U.S. CLS. 6, 18, 44, 46, 51 AND 52).

TRADEMARK

FIRST USE 2-0-2012; IN COMMERCE 2-0-2012.

PRINCIPAL REGISTER

THE MARK CONSISTS OF THE STYLIZED WORD "BUCKLE" TO THE RIGHT OF THE STYLIZED WORD "UP" APPEARING ABOVE THE STYLIZED WORD "ANGEL". THE LETTER "E" IN THE WORD "BUCKLE" AND THE LETTER "U" IN THE WORD "UP" BOTH HAVE SEAT BUCKLES MERGING OFF OF THEM THAT ARE ALMOST CONNECTING. ALL OF THE FOREGOING APPEAR WITHIN THE DESIGN OF AN ANGEL WHERE THE ANGEL WINGS ARE SURROUNDING THE WORDING "BUCKLE UP ANGEL" AND THE ANGEL'S HEAD APPEARS ABOVE THE LETTERS "LE" IN THE WORD "BUCKLE".

SN 85-440,647, FILED 10-6-2011.

JOHN WILKE, EXAMINING ATTORNEY



David J. Kyros

Director of the United States Patent and Trademark Office

United States of America

United States Patent and Trademark Office

OSNA WORKS

Reg. No. 4,207,673

Registered Sep. 11, 2012

Int. Cl.: 42

ORTHOPEDIC SPECIALISTS OF NORTH AMERICA, PLLC (ARIZONA LIMITED LIABILITY COMPANY)
SUITE 325
2355 EAST CAMELBACK ROAD
PHOENIX, AZ 85016

SERVICE MARK

PRINCIPAL REGISTER

FOR: PROVIDING A WEB-BASED SYSTEM AND ONLINE PORTAL FEATURING ON-LINE NON-DOWNLOADABLE SOFTWARE THAT ENABLES USERS TO ACCESS, STORE, MANAGE AND DELIVER CONTENT AND MATERIALS IN THE FIELD OF WORKERS COMPENSATION; COMPUTER SERVICES, NAMELY, PROVIDING A WEB-BASED SYSTEM AND ONLINE PORTAL FOR PROVIDERS TO REMOTELY MANAGE WORKERS COMPENSATION FILES, IN CLASS 42 (U.S. CLS. 100 AND 101).

FIRST USE 8-5-2010; IN COMMERCE 8-5-2010.

THE MARK CONSISTS OF STANDARD CHARACTERS WITHOUT CLAIM TO ANY PARTICULAR FONT, STYLE, SIZE, OR COLOR.

OWNER OF U.S. REG. NO. 2,506,430.

SN 85-440,777, FILED 10-6-2011.

KAPIL BHANOT, EXAMINING ATTORNEY



David J. Kyffers

Director of the United States Patent and Trademark Office

United States of America

United States Patent and Trademark Office



Reg. No. 4,207,674

TURNER, ZUBERI (UNITED STATES INDIVIDUAL)
70 PARKVIEW DRIVE
AMERICAN CANYON, CA 94503

Registered Sep. 11, 2012

Int. Cl.: 41

FOR: ENTERTAINMENT SERVICES, NAMELY, PRE-RECORDED MUSIC, AND GRAPHICS PRESENTED TO MOBILE COMMUNICATIONS DEVICES VIA A GLOBAL COMPUTER NETWORK AND WIRELESS NETWORKS, IN CLASS 41 (U.S. CLS. 100, 101 AND 107).

SERVICE MARK

FIRST USE 12-7-2011; IN COMMERCE 12-7-2011.

PRINCIPAL REGISTER

THE MARK CONSISTS OF THE WORD "BAYTL". THE WORD "BAYTL" IS PRESENTED IN A STYLIZED FONT. THE LETTERS "B" AND "T" IN THE WORD "BAYTL" ARE PRESENTED IN CAPITAL LETTERS. THE "Y" IN "BAYTL" IS ELONGATED OVER THE LETTERS "B" AND "A". THE WORD "BAYTL" IS ENCLOSED IN A RECTANGLE.

SN 85-440,998, FILED 10-6-2011.

ANNE MADDEN, EXAMINING ATTORNEY



David J. Kybas

Director of the United States Patent and Trademark Office

United States of America

United States Patent and Trademark Office

POSTURE

Reg. No. 4,207,675

CELGENE CORPORATION (DELAWARE CORPORATION)
86 MORRIS AVENUE
SUMMIT, NJ 07901

Registered Sep. 11, 2012

Int. Cl.: 42

FOR: MEDICAL AND SCIENTIFIC RESEARCH, NAMELY, CONDUCTING CLINICAL TRIALS FOR OTHERS; PROVIDING MEDICAL AND SCIENTIFIC RESEARCH INFORMATION IN THE FIELD OF PHARMACEUTICALS AND CLINICAL TRIALS, IN CLASS 42 (U.S. CLS. 100 AND 101).

SERVICE MARK

PRINCIPAL REGISTER

FIRST USE 4-20-2012; IN COMMERCE 4-20-2012.

THE MARK CONSISTS OF STANDARD CHARACTERS WITHOUT CLAIM TO ANY PARTICULAR FONT, STYLE, SIZE, OR COLOR.

SN 85-441,205, FILED 10-6-2011.

KATHERINE STOIDES, EXAMINING ATTORNEY



David J. Kyffers

Director of the United States Patent and Trademark Office

United States of America

United States Patent and Trademark Office

DREAM CAPSULE

Reg. No. 4,207,676

FLY AND DREAM INTERNATIONAL, INC. (ILLINOIS CORPORATION)
229 REGENCY DRIVE
BARTLETT, IL 60103

Registered Sep. 11, 2012

Int. Cls.: 20 and 35

FOR: WOODEN CHEST MADE OF DIFFERENT TYPES OF WOOD SUCH AS CHESTNUT, CHERRY WOOD OR RUBBER WOOD WITH A KEY HOLE PROTECTOR FOR CONCEALING A KEY OPERATED LOCKING MECHANISM AND A HANDBOOK MADE OF PAPER AND CONTAINING INSPIRATIONAL MESSAGES, IN CLASS 20 (U.S. CLS. 2, 13, 22, 25, 32 AND 50).

TRADEMARK

SERVICE MARK

FIRST USE 7-1-2011; IN COMMERCE 7-1-2011.

PRINCIPAL REGISTER

FOR: COMPUTERIZED ON-LINE ORDERING SERVICES IN THE FIELD OF WOOD CHESTS WITH A KEY HOLE PROTECTOR FOR CONCEALING THE KEY OPERATED LOCKING MECHANISM AND A HANDBOOK MADE OF PAPER, IN CLASS 35 (U.S. CLS. 100, 101 AND 102).

FIRST USE 7-1-2011; IN COMMERCE 7-1-2011.

THE MARK CONSISTS OF STANDARD CHARACTERS WITHOUT CLAIM TO ANY PARTICULAR FONT, STYLE, SIZE, OR COLOR.

SN 85-442,090, FILED 10-7-2011.

BILL DAWE, EXAMINING ATTORNEY



David J. Kyfos

Director of the United States Patent and Trademark Office

United States of America

United States Patent and Trademark Office

OAKI DOAKI Biscuit Co.

Reg. No. 4,207,677

SLAYTON, MICHAEL (UNITED STATES INDIVIDUAL), DBA OAKI DOAKI BISUIT CO.,
8304 EAST OAK ISLAND DRIVE
OAK ISLAND, NC 28465 AND

Registered Sep. 11, 2012

Int. Cl.: 30

SLAYTON, YVONNE (UNITED STATES INDIVIDUAL), DBA OAKI DOAKI BISCUIT CO.,
8304 EAST OAK ISLAND DRIVE
OAK ISLAND, NC 28465

TRADEMARK

FOR: BISCUITS , IN CLASS 30 (U.S. CL. 46).

PRINCIPAL REGISTER

FIRST USE 11-19-2011; IN COMMERCE 11-19-2011.

THE MARK CONSISTS OF STANDARD CHARACTERS WITHOUT CLAIM TO ANY PARTICULAR FONT, STYLE, SIZE, OR COLOR.

NO CLAIM IS MADE TO THE EXCLUSIVE RIGHT TO USE "BISCUIT CO.", APART FROM THE MARK AS SHOWN.

SN 85-442,767, FILED 10-8-2011.

INGRID C. EULIN, EXAMINING ATTORNEY



David J. Kyfos

Director of the United States Patent and Trademark Office

United States of America

United States Patent and Trademark Office

WANNA SPOON?

Reg. No. 4,207,678

Registered Sep. 11, 2012

Int. Cl.: 30

TRADEMARK

PRINCIPAL REGISTER

P.G.I. OF SAUGATUCK INC (MICHIGAN CORPORATION)
413 3RD STREET
FENNVILLE, MI 49408

FOR: GELATO; SORBETTO; ITALIAN ICE, IN CLASS 30 (U.S. CL. 46).

FIRST USE 1-1-2012; IN COMMERCE 1-4-2012.

THE MARK CONSISTS OF STANDARD CHARACTERS WITHOUT CLAIM TO ANY PARTICULAR FONT, STYLE, SIZE, OR COLOR.

SN 85-443,055, FILED 10-10-2011.

ANNE MADDEN, EXAMINING ATTORNEY



David J. Kyffers

Director of the United States Patent and Trademark Office

United States of America

United States Patent and Trademark Office

ALENZA

Reg. No. 4,207,679

TEVA ANIMAL HEALTH, INC. (DELAWARE CORPORATION)
3915 SOUTH 48TH STREET TERRACE
ST. JOSEPH, MO 64503

Registered Sep. 11, 2012

Int. Cl.: 5

FOR: VETERINARY PREPARATIONS, NAMELY, DIETARY ANTIOXIDANT SUPPLEMENTS FOR COMPANION ANIMALS, IN CLASS 5 (U.S. CLS. 6, 18, 44, 46, 51 AND 52).

TRADEMARK

FIRST USE 6-29-2012; IN COMMERCE 6-29-2012.

PRINCIPAL REGISTER

THE MARK CONSISTS OF STANDARD CHARACTERS WITHOUT CLAIM TO ANY PARTICULAR FONT, STYLE, SIZE, OR COLOR.

SN 85-443,203, FILED 10-10-2011.

ELLEN PERKINS, EXAMINING ATTORNEY



David J. Kybas

Director of the United States Patent and Trademark Office

United States of America

United States Patent and Trademark Office

THE RITCHIE FAMILY

Reg. No. 4,207,680

Registered Sep. 11, 2012

Int. Cl.: 41

SERVICE MARK

PRINCIPAL REGISTER

WOOTEN, CASSANDRA (UNITED STATES INDIVIDUAL)
SECOND FLOOR
8300 PICKERING AVENUE
PHILADELPHIA, PA 19150 AND

MASON-DORMAN, CHERYL (UNITED STATES INDIVIDUAL)
6400 NORTH 8TH STREET
PHILADELPHIA, PA 19126

FOR: ENTERTAINMENT SERVICES IN THE NATURE OF LIVE MUSICAL PERFORMANCES,
IN CLASS 41 (U.S. CLS. 100, 101 AND 107).

FIRST USE 5-13-2012; IN COMMERCE 5-13-2012.

THE MARK CONSISTS OF STANDARD CHARACTERS WITHOUT CLAIM TO ANY PAR-
TICULAR FONT, STYLE, SIZE, OR COLOR.

SN 85-443,366, FILED 10-10-2011.

AISHA SALEM, EXAMINING ATTORNEY



David J. Kybas

Director of the United States Patent and Trademark Office

United States of America

United States Patent and Trademark Office

BLOOD RELATIVES

Reg. No. 4,207,681

Registered Sep. 11, 2012

Int. Cl.: 41

SERVICE MARK

PRINCIPAL REGISTER

DISCOVERY COMMUNICATIONS, LLC (DELAWARE LIMITED LIABILITY COMPANY)
ONE DISCOVERY PLACE
SILVER SPRING, MD 20910

FOR: ENTERTAINMENT AND EDUCATIONAL SERVICES IN THE NATURE OF TELEVISION AND MULTIMEDIA PROGRAM SERIES FEATURING SUBJECTS OF GENERAL HUMAN INTEREST DISTRIBUTED VIA VARIOUS PLATFORMS ACROSS MULTIPLE FORMS OF TRANSMISSION MEDIA; PROVIDING ENTERTAINMENT INFORMATION TO OTHERS VIA A GLOBAL COMPUTER NETWORK, IN CLASS 41 (U.S. CLS. 100, 101 AND 107).

FIRST USE 6-7-2012; IN COMMERCE 6-7-2012.

THE MARK CONSISTS OF STANDARD CHARACTERS WITHOUT CLAIM TO ANY PARTICULAR FONT, STYLE, SIZE, OR COLOR.

SN 85-443,507, FILED 10-10-2011.

KATHY DE JONGE, EXAMINING ATTORNEY



David J. Kyjars

Director of the United States Patent and Trademark Office

United States of America

United States Patent and Trademark Office

KILLER TRIALS: JUDGMENT DAY

Reg. No. 4,207,682

Registered Sep. 11, 2012

Int. Cl.: 41

SERVICE MARK

PRINCIPAL REGISTER

DISCOVERY COMMUNICATIONS, LLC (DELAWARE LIMITED LIABILITY COMPANY)
ONE DISCOVERY PLACE
SILVER SPRING, MD 20910

FOR: ENTERTAINMENT AND EDUCATIONAL SERVICES IN THE NATURE OF TELEVISION AND MULTIMEDIA PROGRAM SERIES FEATURING SUBJECTS OF GENERAL HUMAN INTEREST DISTRIBUTED VIA VARIOUS PLATFORMS ACROSS MULTIPLE FORMS OF TRANSMISSION MEDIA; PROVIDING ENTERTAINMENT INFORMATION TO OTHERS VIA A GLOBAL COMPUTER NETWORK, IN CLASS 41 (U.S. CLS. 100, 101 AND 107).

FIRST USE 2-3-2012; IN COMMERCE 2-3-2012.

THE MARK CONSISTS OF STANDARD CHARACTERS WITHOUT CLAIM TO ANY PARTICULAR FONT, STYLE, SIZE, OR COLOR.

SN 85-443,515, FILED 10-10-2011.

KATHY DE JONGE, EXAMINING ATTORNEY



David J. Kyjars

Director of the United States Patent and Trademark Office

United States of America

United States Patent and Trademark Office

MOMMYLEGS

Reg. No. 4,207,683

LEGS 4 LIFE, LLC (NORTH CAROLINA LIMITED LIABILITY COMPANY)
300 INDUSTRIAL PARK AVENUE
ASHEBORO, NC 27204

Registered Sep. 11, 2012

Int. Cl.: 10

FOR: MEDICAL COMPRESSION HOSIERY, IN CLASS 10 (U.S. CLS. 26, 39 AND 44).

TRADEMARK

FIRST USE 11-1-2011; IN COMMERCE 12-15-2011.

PRINCIPAL REGISTER

THE MARK CONSISTS OF STANDARD CHARACTERS WITHOUT CLAIM TO ANY PARTICULAR FONT, STYLE, SIZE, OR COLOR.

SN 85-443,591, FILED 10-10-2011.

WILLIAM P. SHANAHAN, EXAMINING ATTORNEY



David J. Kyffers

Director of the United States Patent and Trademark Office

United States of America

United States Patent and Trademark Office



Reg. No. 4,207,684

Registered Sep. 11, 2012

Int. Cl.: 3

TRADEMARK

PRINCIPAL REGISTER

THE VILLAGE COMPANY, LLC (MINNESOTA LIMITED LIABILITY COMPANY)
124 COLUMBIA COURT
CHASKA, MN 55318

FOR: PERSONAL CARE PRODUCTS, NAMELY, BUBBLE BATH, BODY WASH, SOAP, HAIR CARE PRODUCTS IN THE NATURE OF SHAMPOO, IN CLASS 3 (U.S. CLS. 1, 4, 6, 50, 51 AND 52).

FIRST USE 9-10-2010; IN COMMERCE 1-1-2011.

THE MARK CONSISTS OF THE DEPICTION OF A PERSON IN THE FORM OF A BUBBLE, SURROUNDED BY SMALLER BUBBLES.

SN 85-443,653, FILED 10-10-2011.

MICHAEL WIENER, EXAMINING ATTORNEY



David J. Kyffers

Director of the United States Patent and Trademark Office

United States of America

United States Patent and Trademark Office

VASTNUTRITION.COM

Reg. No. 4,207,685

Registered Sep. 11, 2012

Int. Cl.: 35

SERVICE MARK

PRINCIPAL REGISTER

VAST NUTRITION CORP. (FLORIDA CORPORATION)
8306 MILLS DRIVE SUITE 395
MIAMI, FL 33183

FOR: ON-LINE RETAIL STORE SERVICES FEATURING SPORTS NUTRITION PRODUCTS, HEALTH FOODS, DIETARY SUPPLEMENTS, SPORTS SUPPLEMENTS, WEIGHT GAIN PRODUCTS, MUSCLE ENHANCERS POWDERS, WEIGHT LOSS PRODUCTS, MEAL REPLACEMENT SNACKS AND VITAMINS, FITNESS PRODUCTS AND APPAREL, IN CLASS 35 (U.S. CLS. 100, 101 AND 102).

FIRST USE 0-0-2011; IN COMMERCE 0-0-2011.

THE MARK CONSISTS OF STANDARD CHARACTERS WITHOUT CLAIM TO ANY PARTICULAR FONT, STYLE, SIZE, OR COLOR.

SN 85-443,686, FILED 10-10-2011.

KELLY TRUSILO, EXAMINING ATTORNEY



David J. Kybas

Director of the United States Patent and Trademark Office

United States of America

United States Patent and Trademark Office

RELLENITOS

Reg. No. 4,207,686

Registered Sep. 11, 2012

Int. Cl.: 30

TRADEMARK

PRINCIPAL REGISTER

GRUPO BIMBO, S.A. B. DE C.V. (MEXICO CORPORATION)
PROLONGACION PASEO DE LA REFORMA
NO. 1000, COL. PENA BLANCA SANTA FE
MEXICO CITY, MEXICO 01210

FOR: CANDY, NAMELY, LOLLIPOPS AND SUCKERS FROM CRYSTALLIZED SUGAR
AND/OR CHOCOLATE, IN CLASS 30 (U.S. CL. 46).

FIRST USE 9-26-2006; IN COMMERCE 9-26-2006.

THE MARK CONSISTS OF STANDARD CHARACTERS WITHOUT CLAIM TO ANY PAR-
TICULAR FONT, STYLE, SIZE, OR COLOR.

THE ENGLISH TRANSLATION OF "RELLENITOS" IN THE MARK IS "LITTLE FILLINGS".

SN 85-444,076, FILED 10-11-2011.

MARGERY A. TIERNEY, EXAMINING ATTORNEY



David J. Kybas

Director of the United States Patent and Trademark Office

United States of America

United States Patent and Trademark Office

PICA FRESA

Reg. No. 4,207,687

Registered Sep. 11, 2012

Int. Cl.: 30

TRADEMARK

PRINCIPAL REGISTER

GRUPO BIMBO, S.A. B. DE C.V. (MEXICO CORPORATION)
PROLONGACION PASEO DE LA REFORMA
NO. 1000, COL. PENA BLANCA SANTA FE
MEXICO CITY, MEXICO 01210

FOR: CANDY, NAMELY, LOLLIPOPS AND SUCKERS FROM CRYSTALLIZED SUGAR AND/OR CHOCOLATE AND GUMMIES, IN CLASS 30 (U.S. CL. 46).

FIRST USE 3-7-2000; IN COMMERCE 3-7-2000.

THE MARK CONSISTS OF STANDARD CHARACTERS WITHOUT CLAIM TO ANY PARTICULAR FONT, STYLE, SIZE, OR COLOR.

NO CLAIM IS MADE TO THE EXCLUSIVE RIGHT TO USE "FRESA", APART FROM THE MARK AS SHOWN.

THE ENGLISH TRANSLATION OF "FRESA" IN THE MARK IS STRAWBERRY.

SN 85-444,081, FILED 10-11-2011.

MARGERY A. TIERNEY, EXAMINING ATTORNEY



David J. Kybas

Director of the United States Patent and Trademark Office

United States of America

United States Patent and Trademark Office

Chemi-Cade

Reg. No. 4,207,688

LORI A. BRIDGES (UNITED STATES INDIVIDUAL)
4745 PACIFIC
EUGENE, OR 97402

Registered Sep. 11, 2012

Int. Cl.: 17

FOR: PLASTIC TAPE FOR USE IN CREATING A VISUAL BARRIER FOR SAFETY PURPOSES, IN CLASS 17 (U.S. CLS. 1, 5, 12, 13, 35 AND 50).

TRADEMARK

FIRST USE 5-15-2012; IN COMMERCE 5-15-2012.

PRINCIPAL REGISTER

THE MARK CONSISTS OF STANDARD CHARACTERS WITHOUT CLAIM TO ANY PARTICULAR FONT, STYLE, SIZE, OR COLOR.

SN 85-444,371, FILED 10-11-2011.

KIM MONINGHOFF, EXAMINING ATTORNEY



David J. Kyffers

Director of the United States Patent and Trademark Office

United States of America

United States Patent and Trademark Office



Readmor

eBooks

Reg. No. 4,207,689

HASTINGS ENTERTAINMENT, INC. (TEXAS CORPORATION)
3601 PLAINS BLVD.

Registered Sep. 11, 2012

AMARILLO, TX 79102

Int. Cl.: 9

FOR: COMPUTER SOFTWARE FOR USE IN DISPLAYING, RECEIVING, READING, PURCHASING AND ACCESSING DOWNLOADABLE ELECTRONIC PUBLICATIONS, SYNCING ELECTRONIC PUBLICATIONS WITH PORTABLE ELECTRONIC APPARATUS, LOANING AND SHARING ELECTRONIC PUBLICATIONS WITH THIRD PARTIES, AND SAMPLING ELECTRONIC PUBLICATIONS; DOWNLOADABLE COMPUTER SOFTWARE FOR USE IN DISPLAYING, RECEIVING, READING, PURCHASING AND ACCESSING DOWNLOADABLE ELECTRONIC PUBLICATIONS, SYNCING ELECTRONIC PUBLICATIONS WITH PORTABLE ELECTRONIC APPARATUS, LOANING AND SHARING ELECTRONIC PUBLICATIONS WITH THIRD PARTIES, AND SAMPLING ELECTRONIC PUBLICATIONS, IN CLASS 9 (U.S. CLS. 21, 23, 26, 36 AND 38).

TRADEMARK

PRINCIPAL REGISTER

FIRST USE 11-10-2011; IN COMMERCE 11-10-2011.

NO CLAIM IS MADE TO THE EXCLUSIVE RIGHT TO USE "EBOOKS", APART FROM THE MARK AS SHOWN.

THE MARK CONSISTS OF A BOOK DESIGN ABOVE THE WORDS "READMOR AND EBOOKS".

SN 85-444,618, FILED 10-11-2011.

ESTHER A. BORSUK, EXAMINING ATTORNEY



David J. Kyffers

Director of the United States Patent and Trademark Office

United States of America

United States Patent and Trademark Office

READMOR

Reg. No. 4,207,690

HASTINGS ENTERTAINMENT, INC. (TEXAS CORPORATION)
3601 PLAINS BLVD.

Registered Sep. 11, 2012

AMARILLO, TX 79102

Int. Cl.: 9

FOR: COMPUTER SOFTWARE FOR USE IN DISPLAYING, RECEIVING, READING, PURCHASING AND ACCESSING DOWNLOADABLE ELECTRONIC PUBLICATIONS, SYNCING ELECTRONIC PUBLICATIONS WITH PORTABLE ELECTRONIC APPARATUS, LOANING AND SHARING ELECTRONIC PUBLICATIONS WITH THIRD PARTIES, AND SAMPLING ELECTRONIC PUBLICATIONS; DOWNLOADABLE COMPUTER SOFTWARE FOR USE IN DISPLAYING, RECEIVING, READING, PURCHASING AND ACCESSING DOWNLOADABLE ELECTRONIC PUBLICATIONS, SYNCING ELECTRONIC PUBLICATIONS WITH PORTABLE ELECTRONIC APPARATUS, LOANING AND SHARING ELECTRONIC PUBLICATIONS WITH THIRD PARTIES, AND SAMPLING ELECTRONIC PUBLICATIONS, IN CLASS 9 (U.S. CLS. 21, 23, 26, 36 AND 38).

TRADEMARK

PRINCIPAL REGISTER

FIRST USE 11-10-2011; IN COMMERCE 11-10-2011.

THE MARK CONSISTS OF STANDARD CHARACTERS WITHOUT CLAIM TO ANY PARTICULAR FONT, STYLE, SIZE, OR COLOR.

SN 85-444,625, FILED 10-11-2011.

ESTHER A. BORSUK, EXAMINING ATTORNEY



David J. Kyros

Director of the United States Patent and Trademark Office

United States of America

United States Patent and Trademark Office

U-ARP

Reg. No. 4,207,691

WAKABAYASHI, AKIO (UNITED STATES INDIVIDUAL)
38558 LOCHINVAR CIRCLE
MURRIETA, CA 92562

Registered Sep. 11, 2012

Int. Cl.: 20

FOR: NON-METAL VALVES FOR CONTAINERS, NAMELY, UNIVERSAL AIR REMOVAL VALVES THAT CAN BE INSTALLED ON ANY BRAND OR SIZE OF COMMERCIALY AVAILABLE, CONSUMER, HOUSEHOLD PLASTIC FOOD PACKAGES FOR USE IN FACILITATING INDUCTION OF VACUUM OF THE FOOD PACKAGES, IN CLASS 20 (U.S. CLS. 2, 13, 22, 25, 32 AND 50).

TRADEMARK

PRINCIPAL REGISTER

FIRST USE 10-11-2011; IN COMMERCE 7-11-2012.

THE MARK CONSISTS OF STANDARD CHARACTERS WITHOUT CLAIM TO ANY PARTICULAR FONT, STYLE, SIZE, OR COLOR.

SN 85-444,912, FILED 10-11-2011.

LINDA LAVACHE, EXAMINING ATTORNEY



David J. Kyjars

Director of the United States Patent and Trademark Office

United States of America

United States Patent and Trademark Office

PALERINDAS

Reg. No. 4,207,692

Registered Sep. 11, 2012

Int. Cl.: 30

TRADEMARK

PRINCIPAL REGISTER

GRUPO BIMBO, S.A. B. DE C.V. (MEXICO CORPORATION)
PROLONGACION PASEO DE LA REFORMA
NO. 1000, COL. PENA BLANCA SANTA FE
MEXICO CITY, MEXICO 01210

FOR: LOLLIPOPS AND SUCKERS FROM CRYSTALLIZED SUGAR AND/OR CHOCOLATE,
IN CLASS 30 (U.S. CL. 46).

FIRST USE 2-9-2000; IN COMMERCE 2-9-2000.

THE MARK CONSISTS OF STANDARD CHARACTERS WITHOUT CLAIM TO ANY PAR-
TICULAR FONT, STYLE, SIZE, OR COLOR.

THE WORDING "PALERINDAS" HAS NO MEANING IN A FOREIGN LANGUAGE.

SN 85-445,263, FILED 10-12-2011.

MARGERY A. TIERNEY, EXAMINING ATTORNEY



David J. Kyffers

Director of the United States Patent and Trademark Office

United States of America

United States Patent and Trademark Office

VZ SUNFLOWER

Reg. No. 4,207,693

VISUALZEN, INC. (DELAWARE CORPORATION)
125 ST. PAUL'S BOULEVARD, SUITE 302
NORFOLK, VA 23510

Registered Sep. 11, 2012

Int. Cl.: 42

FOR: COMPUTER SERVICES, NAMELY, HOSTING AND MAINTAINING AN ONLINE EDUCATIONAL PORTAL WEBSITE FOR OTHERS THAT ALLOWS USERS TO UPLOAD, EXCHANGE AND SHARE PERSONAL AND EDUCATIONAL INFORMATION, IN CLASS 42 (U.S. CLS. 100 AND 101).

SERVICE MARK

PRINCIPAL REGISTER

FIRST USE 9-3-2008; IN COMMERCE 9-3-2008.

THE MARK CONSISTS OF STANDARD CHARACTERS WITHOUT CLAIM TO ANY PARTICULAR FONT, STYLE, SIZE, OR COLOR.

THE LETTERS "VZ" HAS NO MEANING OTHER THAN TRADEMARK SIGNIFICANCE.

SN 85-445,664, FILED 10-12-2011.

STEVEN JACKSON, EXAMINING ATTORNEY



David J. Kyffers

Director of the United States Patent and Trademark Office

United States of America

United States Patent and Trademark Office

Rubber Arm

Reg. No. 4,207,694

RUBBER ARM INC. (VIRGINIA CORPORATION)
145 FOREST CANOPY DR.
AMHERST, VA 24521

Registered Sep. 11, 2012

Int. Cl.: 5

FOR: PREPARATION FOR THE RELIEF OF PAIN, IN CLASS 5 (U.S. CLS. 6, 18, 44, 46, 51 AND 52).

TRADEMARK

FIRST USE 1-12-2012; IN COMMERCE 1-12-2012.

PRINCIPAL REGISTER

THE MARK CONSISTS OF STANDARD CHARACTERS WITHOUT CLAIM TO ANY PARTICULAR FONT, STYLE, SIZE, OR COLOR.

SN 85-446,257, FILED 10-13-2011.

LESLEY LAMOTHE, EXAMINING ATTORNEY



David J. Kyffers

Director of the United States Patent and Trademark Office

United States of America

United States Patent and Trademark Office

PENVEU

Reg. No. 4,207,695

Registered Sep. 11, 2012

Int. Cl.: 9

TRADEMARK

PRINCIPAL REGISTER

INTERPHASE CORPORATION (TEXAS CORPORATION)
ATTN: YORAM SOLOMON
2901 NORTH DALLAS PARKWAY, SUITE #200
PLANO, TX 75093

FOR: COMPUTER CURSOR CONTROL DEVICES, NAMELY, COMPUTER MOUSE; COMPUTER WHITEBOARDS; REMOTE CONTROLS FOR COMPUTERS, TELEVISIONS, DISPLAYS, PROJECTORS; VIDEO GAME INTERACTIVE HAND HELD REMOTE CONTROLS FOR PLAYING ELECTRONIC GAMES; VIDEO GAME INTERACTIVE REMOTE CONTROL UNITS; WIRELESS PRESENTER IN THE NATURE OF A WIRELESS REMOTE POINTER, IN CLASS 9 (U.S. CLS. 21, 23, 26, 36 AND 38).

FIRST USE 4-17-2012; IN COMMERCE 4-17-2012.

THE MARK CONSISTS OF THE STYLIZED WORD "PENVEU".

SN 85-446,855, FILED 10-13-2011.

CHRISTOPHER SIDOTI, EXAMINING ATTORNEY



David J. Kyffers

Director of the United States Patent and Trademark Office

United States of America

United States Patent and Trademark Office

SIP IT

Reg. No. 4,207,696

SARGSYAN, HENRIK (UNITED STATES INDIVIDUAL)
4062 VERDUGO ROAD
LOS ANGELES, CA 90065

Registered Sep. 11, 2012

Int. Cl.: 33

FOR: ALCOHOLIC APERITIF BITTERS; ALCOHOLIC BEVERAGE PRODUCED FROM A BREWED MALT BASE WITH NATURAL FLAVORS; ALCOHOLIC BEVERAGES OF FRUIT; ALCOHOLIC BITTERS; ALCOHOLIC COCKTAIL MIXES; ALCOHOLIC COCKTAILS CONTAINING MILK; ALCOHOLIC EGG NOG; ALCOHOLIC ESSENCES; ALCOHOLIC EXTRACTS; ALCOHOLIC FRUIT COCKTAIL DRINKS; ALCOHOLIC MALT COOLERS; ALCOHOLIC PUNCH; ALCOHOLIC TEA-BASED BEVERAGE; APERITIFS WITH A DISTILLED ALCOHOLIC LIQUOR BASE; COGNAC; DISTILLED SPIRITS; PREPARED ALCOHOLIC COCKTAIL; RUM; TEQUILA; VODKA; WHISKEY; WINE, IN CLASS 33 (U.S. CLS. 47 AND 49).

TRADEMARK

PRINCIPAL REGISTER

FIRST USE 2-20-2012; IN COMMERCE 2-20-2012.

THE MARK CONSISTS OF STANDARD CHARACTERS WITHOUT CLAIM TO ANY PARTICULAR FONT, STYLE, SIZE, OR COLOR.

SN 85-446,963, FILED 10-13-2011.

JOHN WILKE, EXAMINING ATTORNEY



David J. Kybas

Director of the United States Patent and Trademark Office

United States of America

United States Patent and Trademark Office

Fab Foundations

Reg. No. 4,207,697

FAB FOUNDATIONS, LLC (MARYLAND LIMITED LIABILITY COMPANY)
6508 75TH ST.

Registered Sep. 11, 2012

CABIN JOHN, MD 20818

**Int. Cls.: 9, 16, 35, and
41**

FOR: DIGITAL MATERIALS, NAMELY, DOWNLOADABLE E-BOOKS FEATURING WOMEN'S SELF IMPROVEMENT, IN CLASS 9 (U.S. CLS. 21, 23, 26, 36 AND 38).

FIRST USE 1-5-2012; IN COMMERCE 1-5-2012.

TRADEMARK

FOR: A SERIES OF BOOKS AND WRITTEN ARTICLES IN THE FIELD OF WOMEN'S SELF IMPROVEMENT, IN CLASS 16 (U.S. CLS. 2, 5, 22, 23, 29, 37, 38 AND 50).

SERVICE MARK

PRINCIPAL REGISTER

FIRST USE 1-17-2011; IN COMMERCE 2-3-2011.

FOR: MARKETING CONSULTING, IN CLASS 35 (U.S. CLS. 100, 101 AND 102).

FIRST USE 1-17-2011; IN COMMERCE 2-3-2011.

FOR: EDUCATION SERVICES, NAMELY, PROVIDING SEMINARS IN THE FIELD OF WOMEN'S SELF IMPROVEMENT; ON-LINE JOURNALS, NAMELY, BLOGS FEATURING WOMEN'S SELF IMPROVEMENT, IN CLASS 41 (U.S. CLS. 100, 101 AND 107).

FIRST USE 1-17-2011; IN COMMERCE 2-3-2011.

THE MARK CONSISTS OF STANDARD CHARACTERS WITHOUT CLAIM TO ANY PARTICULAR FONT, STYLE, SIZE, OR COLOR.

SN 85-447,131, FILED 10-13-2011.

NAPOLEON SHARMA, EXAMINING ATTORNEY



David J. Kyros

Director of the United States Patent and Trademark Office

United States of America

United States Patent and Trademark Office

DOWN PORE

Reg. No. 4,207,698

WEYERHAEUER NR COMPANY (WASHINGTON CORPORATION)
33663 WEYERHAEUSER WAY SOUTH
FEDERAL WAY, WA 98003

Registered Sep. 11, 2012

Int. Cl.: 19

FOR: NON-METALLIC BUILDING MATERIALS, NAMELY, ORIENTED STRAND BOARD PANELS, IN CLASS 19 (U.S. CLS. 1, 12, 33 AND 50).

TRADEMARK

FIRST USE 10-31-2011; IN COMMERCE 11-30-2011.

PRINCIPAL REGISTER

THE MARK CONSISTS OF STANDARD CHARACTERS WITHOUT CLAIM TO ANY PARTICULAR FONT, STYLE, SIZE, OR COLOR.

SN 85-447,490, FILED 10-14-2011.

KATHERINE STOIDES, EXAMINING ATTORNEY



David J. Kybas

Director of the United States Patent and Trademark Office

United States of America

United States Patent and Trademark Office



Reg. No. 4,207,699

Registered Sep. 11, 2012

Int. Cl.: 42

SERVICE MARK

PRINCIPAL REGISTER

VISUAL ADVERTISING SALES TECHNOLOGY (CALIFORNIA CORPORATION)
11019 LOVAS COURT
GRASS VALLEY, CA 95945

FOR: PROVIDING ONLINE NON-DOWNLOADABLE SOFTWARE FOR USE IN TELEVISED MEDIA SCHEDULING THAT ALLOWS USERS TO ACCESS UPCOMING TELEVISED MEDIA SCHEDULES TO DETERMINE WHERE AND WHEN THEY WOULD LIKE THEIR ADVERTISEMENTS TO APPEAR, AND HELPS MEDIA OUTLETS CREATE AND SEND PROPOSALS TO THOSE USERS TO EXPEDITE THE ADVERTISING SALES PROCESS, IN CLASS 42 (U.S. CLS. 100 AND 101).

FIRST USE 5-18-2012; IN COMMERCE 5-18-2012.

OWNER OF U.S. REG. NO. 3,650,196.

THE MARK CONSISTS OF A TAPERING BOX SHAPE WITH AN INVERTED-V ANTENNA EXTENDING UPWARDLY FROM THE TAPERING BOX WITH THE WORD "SHOWSEEKER" IN STYLIZED LETTERING EXTENDING FROM AN OPEN RIGHT SIDE OF THE TAPERING BOX.

SN 85-447,495, FILED 10-14-2011.

KATHERINE STOIDES, EXAMINING ATTORNEY



David J. Kybas

Director of the United States Patent and Trademark Office

United States of America

United States Patent and Trademark Office

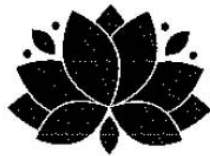

facesthetics

Reg. No. 4,207,700

JONES EYE CENTER, P.C. (SOUTH DAKOTA CORPORATION)
4405 HAMILTON BLVD.
SIOUX CITY, IA 51104

Registered Sep. 11, 2012

Int. Cl.: 44

FOR: EYE CARE AND FACIAL SURGERY, IN CLASS 44 (U.S. CLS. 100 AND 101).

SERVICE MARK

FIRST USE 9-21-2011; IN COMMERCE 9-21-2011.

PRINCIPAL REGISTER

THE MARK CONSISTS OF THE WORD "FACESTHETICS" WITH THE FIRST LETTER "T" UPWARDLY ELONGATED SO AS TO SUGGEST A STEM OF A FLOWER, AND THE DESIGN OF A FLOWER ABOVE THE LETTER.

SN 85-447,724, FILED 10-14-2011.

GENE MACIOL, EXAMINING ATTORNEY



David J. Kyffers

Director of the United States Patent and Trademark Office

United States of America

United States Patent and Trademark Office

Energize Your World

Reg. No. 4,207,701

Registered Sep. 11, 2012

Int. Cl.: 35

SERVICE MARK

PRINCIPAL REGISTER

NATIONAL PEANUT BOARD (UNITED STATES NON-CORPORATE BOARD CREATED PURSUANT TO THE PEANUT PROMOTION, RESEARCH, AND INFORMATION ORDER (7 CFR PART 1216), AUTHORIZED UNDER THE COMMODITY PROMOTION, RESEARCH, AND INFORMATION ACT OF 1996 (7 USC 7401, 7411-7425))

SUITE 210
2839 PACES FERRY ROAD
ATLANTA, GA 30339

FOR: PROMOTING PUBLIC AWARENESS OF THE NUTRITIONAL BENEFITS AND MULTIPLE USES OF PEANUTS; PROMOTING THE INTERESTS OF PEANUT PRODUCERS, IN CLASS 35 (U.S. CLS. 100, 101 AND 102).

FIRST USE 3-8-2012; IN COMMERCE 3-8-2012.

THE MARK CONSISTS OF STANDARD CHARACTERS WITHOUT CLAIM TO ANY PARTICULAR FONT, STYLE, SIZE, OR COLOR.

SN 85-448,014, FILED 10-14-2011.

STEPHANIE ALI, EXAMINING ATTORNEY



David J. Kyros

Director of the United States Patent and Trademark Office

United States of America

United States Patent and Trademark Office



Reg. No. 4,207,702

ASHDON FARMS, LLC (WISCONSIN LIMITED LIABILITY COMPANY)
N21 W23560 RIDGEVIEW PARKWAY WEST
WAUKESHA, WI 53188

Registered Sep. 11, 2012

Int. Cl.: 35

FOR: ON-LINE RETAIL STORE SERVICES FEATURING PROCESSED NUTS AND NUT MIXES, CARAMEL POPCORN, TRAIL MIXES, CHOCOLATE COVERED NUTS, AND CHOCOLATE AND CARAMEL COVERED NUTS, IN CLASS 35 (U.S. CLS. 100, 101 AND 102).

SERVICE MARK

PRINCIPAL REGISTER

FIRST USE 9-7-2011; IN COMMERCE 9-7-2011.

THE MARK CONSISTS OF THE WORDS "HOPE", "SHARE", "GIVE", LOCATED FROM LEFT TO RIGHT RESPECTIVELY, WITHIN OPENINGS CREATED BY A STYLIZED DESIGN ELEMENT THAT CONSISTS OF STYLIZED PEOPLE WITH ARMS LINKED TO FORM DESIGNS OF BRIDGES AND HOUSES.

SN 85-448,079, FILED 10-14-2011.

NAPOLEON SHARMA, EXAMINING ATTORNEY



David J. Kybas

Director of the United States Patent and Trademark Office

United States of America

United States Patent and Trademark Office



Reg. No. 4,207,703

Registered Sep. 11, 2012

Int. Cl.: 13

TRADEMARK

PRINCIPAL REGISTER

TURNBULL MAUNUFACTURING CO. INC. (NEW YORK CORPORATION)
6680 ROUTES 5 & 20
BLOOMFIELD, NY 14469

FOR: FIREARMS, IN CLASS 13 (U.S. CLS. 2 AND 9).

FIRST USE 10-5-2011; IN COMMERCE 3-23-2012.

THE MARK CONSISTS OF A PICTURE OF A TURNING BULL, STANDING ON HIS HIND LEGS, STANDING ON THE EARTH, INSIDE OF A CIRCLE. THE BULL IS TURNING TOWARD HIS RIGHT.

SN 85-448,674, FILED 10-17-2011.

WILLIAM JACKSON, EXAMINING ATTORNEY



David J. Kybas

Director of the United States Patent and Trademark Office

United States of America

United States Patent and Trademark Office

LENOX WOODMASTER C-SHARP

Reg. No. 4,207,704

IRWIN INDUSTRIAL TOOL COMPANY (DELAWARE CORPORATION)
3 GLENLAKE PARKWAY
ATLANTA, GA 30328

Registered Sep. 11, 2012

Int. Cl.: 7

FOR: BLADES FOR POWER TOOLS, NAMELY, BLADES FOR BAND SAWS, IN CLASS 7
(U.S. CLS. 13, 19, 21, 23, 31, 34 AND 35).

TRADEMARK

FIRST USE 1-16-2012; IN COMMERCE 1-16-2012.

PRINCIPAL REGISTER

THE MARK CONSISTS OF STANDARD CHARACTERS WITHOUT CLAIM TO ANY PARTICULAR FONT, STYLE, SIZE, OR COLOR.

OWNER OF U.S. REG. NOS. 1,340,125 AND 2,435,902.

SN 85-449,013, FILED 10-17-2011.

RONALD AIKENS, EXAMINING ATTORNEY



David J. Kyffers

Director of the United States Patent and Trademark Office

United States of America

United States Patent and Trademark Office

WOODMASTER C-SHARP

Reg. No. 4,207,705

IRWIN INDUSTRIAL TOOL COMPANY (DELAWARE CORPORATION)
3 GLENLAKE PARKWAY
ATLANTA, GA 30328

Registered Sep. 11, 2012

Int. Cl.: 7

FOR: BLADES FOR POWER TOOLS, NAMELY, BLADES FOR BAND SAWS, IN CLASS 7
(U.S. CLS. 13, 19, 21, 23, 31, 34 AND 35).

TRADEMARK

FIRST USE 1-16-2012; IN COMMERCE 1-16-2012.

PRINCIPAL REGISTER

THE MARK CONSISTS OF STANDARD CHARACTERS WITHOUT CLAIM TO ANY PARTICULAR FONT, STYLE, SIZE, OR COLOR.

OWNER OF U.S. REG. NO. 2,435,902.

SN 85-449,028, FILED 10-17-2011.

RONALD AIKENS, EXAMINING ATTORNEY



David J. Kyffers

Director of the United States Patent and Trademark Office

United States of America

United States Patent and Trademark Office



Reg. No. 4,207,706

Registered Sep. 11, 2012

Int. Cls.: 5 and 10

TRADEMARK

PRINCIPAL REGISTER

ASTUTE MEDICAL, INC. (DELAWARE CORPORATION)
BLDG. 2, R. 645
3550 GENERAL ATOMICS COURT
SAN DIEGO, CA 92121

FOR: MEDICAL DIAGNOSTIC TESTING APPARATUSES, NAMELY, IMMUNOASSAY KITS CONTAINING IMMUNOLOGICAL REAGENTS FOR THE DETECTION OF MARKERS RELATED TO A WIDE VARIETY OF ILLNESSES AND DISEASES, IN CLASS 5 (U.S. CLS. 6, 18, 44, 46, 51 AND 52).

FIRST USE 6-3-2008; IN COMMERCE 1-5-2012.

FOR: METERS FOR MEDICAL USE, NAMELY, FOR ANALYSIS OF IMMUNOASSAY DEVICES, IN CLASS 10 (U.S. CLS. 26, 39 AND 44).

FIRST USE 6-3-2008; IN COMMERCE 1-5-2012.

THE MARK CONSISTS OF STYLIZED LETTERS "A" AND "M". THE "A" IS ABOVE THE "M" AND INCORPORATES A SHADED DIAMOND IN PLACE OF THE CENTER HORIZONTAL LINE. THE LETTERS "A" AND "M" TOGETHER CREATE A DIAMOND SHAPED DESIGN ELEMENT CONSISTING OF TWO CONCENTRIC DIAMONDS.

SN 85-449,129, FILED 10-17-2011.

WENDY JUN, EXAMINING ATTORNEY



David J. Kybas

Director of the United States Patent and Trademark Office

United States of America

United States Patent and Trademark Office



AUTHENTIC HANDCRAFTED COFFEE

Reg. No. 4,207,707

M2H INVESTMENTS, INC. (WASHINGTON CORPORATION), DBA DILLANO'S COFFEE,
1607 45TH STREET EAST
SUMNER, WA 98390

Registered Sep. 11, 2012

Int. Cl.: 30

FOR: GROUND AND WHOLE BEAN COFFEE, BEVERAGES WITH A COFFEE BASE, AND
READY-TO-DRINK COFFEE-BASED BEVERAGES, IN CLASS 30 (U.S. CL. 46).

TRADEMARK

FIRST USE 6-1-2000; IN COMMERCE 6-1-2000.

PRINCIPAL REGISTER

OWNER OF U.S. REG. NOS. 2,668,793 AND 2,683,103.

NO CLAIM IS MADE TO THE EXCLUSIVE RIGHT TO USE "COFFEE ROASTERS" AND
"AUTHENTIC HANDCRAFTED COFFEE", APART FROM THE MARK AS SHOWN.

THE MARK CONSISTS OF THE WORDING "DILLANOS COFFEE ROASTERS" WITH THE
TERM "COFFEE" ABOVE "DILLANOS", AND THE TERM "ROASTERS" BELOW
"DILLANOS". THE TERM "DILLANOS" IS ENCASED WITHIN ITS OWN OUTLINE AND
SUPERIMPOSED ACROSS A SHADED CONCENTRIC OVAL FEATURING THE WORDING
"COFFEE ROASTERS". THE UNDERLINED WORDING "AUTHENTIC HANDCRAFTED
COFFEE" APPEARS BELOW THE OVAL DESIGN.

SN 85-449,304, FILED 10-17-2011.

ZHALEH DELANEY, EXAMINING ATTORNEY



David J. Kyros

Director of the United States Patent and Trademark Office

United States of America

United States Patent and Trademark Office



Reg. No. 4,207,708

Registered Sep. 11, 2012

Int. Cl.: 2

TRADEMARK

PRINCIPAL REGISTER

EASYDIYMAKEOVERS.COM LLC (ARIZONA LIMITED LIABILITY COMPANY)
6873 W. LINDA LANE
CHANDLER, AZ 85226

FOR: COATINGS COMPRISED OF CEMENT; COATINGS, NAMELY, STAINS AND CLEAR FINISHES FOR EXTERIOR AND INTERIOR USE ON A VARIETY OF SUBSTRATES; DECORATIVE COATING FOR MASONRY BLOCKS AND MONOLITHIC WALLS, NAMELY, COATINGS COMPRISED OF CEMENT SYNTHETIC PLASTERS, IN CLASS 2 (U.S. CLS. 6, 11 AND 16).

FIRST USE 1-1-2012; IN COMMERCE 1-1-2012.

NO CLAIM IS MADE TO THE EXCLUSIVE RIGHT TO USE "MAKEOVERS.COM", APART FROM THE MARK AS SHOWN.

THE MARK CONSISTS OF A ROOF TOP WITH A CHIMNEY WITH THE STYLIZED TEXT "EASY DIY MAKEOVERS .COM" AS THE STRUCTURE OF A HOUSE, WITH "DIY" IN ALL CAPS AND UNDERLINED, AND ".COM" PRINTED VERTICALLY, IN LOWER CASE LETTERS.

SN 85-449,617, FILED 10-18-2011.

ODESSA BIBBINS, EXAMINING ATTORNEY



David J. Kyffers

Director of the United States Patent and Trademark Office

United States of America

United States Patent and Trademark Office

Hometown Heroes Boxing

Reg. No. 4,207,709

Registered Sep. 11, 2012

Int. Cl.: 41

SERVICE MARK

PRINCIPAL REGISTER

HOMETOWN HEROES BOXING (WEST VIRGINIA NON-PROFIT CORPORATION)
809 WISTERIA DRIVE
SOUTH CHARLESTON, WV 25309

FOR: EDUCATION SERVICES, NAMELY, MENTORING IN THE FIELD OF BOXING;
EDUCATION SERVICES, NAMELY, PROVIDING CLASSES IN THE FIELD OF BOXING;
ENTERTAINMENT IN THE NATURE OF BOXING CONTESTS; ORGANIZATION OF BOXING
MATCHES; TEACHING IN THE FIELD OF BOXING, IN CLASS 41 (U.S. CLS. 100, 101 AND
107).

FIRST USE 10-15-2011; IN COMMERCE 1-28-2012.

THE MARK CONSISTS OF STANDARD CHARACTERS WITHOUT CLAIM TO ANY PAR-
TICULAR FONT, STYLE, SIZE, OR COLOR.

NO CLAIM IS MADE TO THE EXCLUSIVE RIGHT TO USE "BOXING", APART FROM THE
MARK AS SHOWN.

SN 85-450,356, FILED 10-18-2011.

ALEXANDER L. POWERS, EXAMINING ATTORNEY



David J. Kypos

Director of the United States Patent and Trademark Office

United States of America

United States Patent and Trademark Office

GRANDPA BECK'S COVER YOUR ASSETS

Reg. No. 4,207,710

FUNTIME GAMES LLC (WASHINGTON LIMITED LIABILITY COMPANY)
10048 FIRST AVENUE SW
SEATTLE, WA 98146

Registered Sep. 11, 2012

Int. Cl.: 28

FOR: BOARD GAMES; CARD GAMES, IN CLASS 28 (U.S. CLS. 22, 23, 38 AND 50).

TRADEMARK

FIRST USE 2-15-2012; IN COMMERCE 2-15-2012.

PRINCIPAL REGISTER

THE NAME(S), PORTRAIT(S), AND/OR SIGNATURE(S) SHOWN IN THE MARK DOES NOT IDENTIFY A PARTICULAR LIVING INDIVIDUAL.

THE MARK CONSISTS OF THE WORDS "GRANDPA BECK'S COVER YOUR ASSETS" IN STYLIZED FONT WITH THE LETTERS "S" IN "ASSETS" REPRESENTED BY DOLLAR SIGNS.

SN 85-450,382, FILED 10-18-2011.

ROBERT C. CLARK JR., EXAMINING ATTORNEY



David J. Kyffers

Director of the United States Patent and Trademark Office

United States of America

United States Patent and Trademark Office

Glass Apps

Reg. No. 4,207,711

LEE, THOMAS (UNITED STATES INDIVIDUAL)
8659 HAYDEN PLACE
CULVER CITY, CA 90232

Registered Sep. 11, 2012

Int. Cl.: 17

FOR: LIQUID CRYSTAL POLYMER FILMS FOR USE ON GLASS TO MAKE THE FILM GO FROM OPAQUE TO CLEAR FOR USE AS A PRIVACY SCREEN, LIGHT CONTROL AND FOR USE IN CONNECTION WITH DISPLAYING IMAGES, IN CLASS 17 (U.S. CLS. 1, 5, 12, 13, 35 AND 50).

TRADEMARK

PRINCIPAL REGISTER

FIRST USE 5-1-2011; IN COMMERCE 5-1-2011.

THE MARK CONSISTS OF STANDARD CHARACTERS WITHOUT CLAIM TO ANY PARTICULAR FONT, STYLE, SIZE, OR COLOR.

NO CLAIM IS MADE TO THE EXCLUSIVE RIGHT TO USE "GLASS", APART FROM THE MARK AS SHOWN.

SN 85-450,665, FILED 10-19-2011.

BRENDAN MCCAULEY, EXAMINING ATTORNEY



David J. Kyros

Director of the United States Patent and Trademark Office

United States of America

United States Patent and Trademark Office

AMERISENT INSURANCE

Reg. No. 4,207,712

MARTIAL INC. (NEVADA CORPORATION)
6070 S. EASTERN AVENUE, SUITE 400
LAS VEGAS, NV 89119

Registered Sep. 11, 2012

Int. Cl.: 36

FOR: INSURANCE AGENCIES, IN CLASS 36 (U.S. CLS. 100, 101 AND 102).

SERVICE MARK

FIRST USE 2-0-2012; IN COMMERCE 2-0-2012.

PRINCIPAL REGISTER

THE MARK CONSISTS OF STANDARD CHARACTERS WITHOUT CLAIM TO ANY PARTICULAR FONT, STYLE, SIZE, OR COLOR.

NO CLAIM IS MADE TO THE EXCLUSIVE RIGHT TO USE "INSURANCE", APART FROM THE MARK AS SHOWN.

SN 85-450,701, FILED 10-19-2011.

CHRISTINA SOBRAL, EXAMINING ATTORNEY



David J. Kyffers

Director of the United States Patent and Trademark Office

United States of America

United States Patent and Trademark Office

DADI

Reg. No. 4,207,713

Registered Sep. 11, 2012

Int. Cl.: 3

TRADEMARK

PRINCIPAL REGISTER

FAMOUS NAMES LLC (NEVADA LIMITED LIABILITY COMPANY)
1050 WIEGAND STREET
OLIVENHAIN, CA 92024

FOR: CUTICLE CONDITIONERS; NAIL CARE PREPARATIONS, IN CLASS 3 (U.S. CLS. 1, 4, 6, 50, 51 AND 52).

FIRST USE 1-31-2012; IN COMMERCE 1-31-2012.

THE MARK CONSISTS OF STANDARD CHARACTERS WITHOUT CLAIM TO ANY PARTICULAR FONT, STYLE, SIZE, OR COLOR.

THE WORD "DADI" HAS NO MEANING IN A FOREIGN LANGUAGE.

SN 85-450,989, FILED 10-19-2011.

THEODORE MCBRIDE, EXAMINING ATTORNEY



David J. Kyffers

Director of the United States Patent and Trademark Office

United States of America

United States Patent and Trademark Office

EXG

Reg. No. 4,207,714

AGILENT TECHNOLOGIES, INC. (DELAWARE CORPORATION)
5301 STEVENS CREEK BOULEVARD
SANTA CLARA, CO 95051

Registered Sep. 11, 2012

Int. Cl.: 9

FOR: ANALOG AND VECTOR SIGNAL GENERATORS, IN CLASS 9 (U.S. CLS. 21, 23, 26, 36 AND 38).

TRADEMARK

FIRST USE 4-27-2012; IN COMMERCE 4-27-2012.

PRINCIPAL REGISTER

THE MARK CONSISTS OF STANDARD CHARACTERS WITHOUT CLAIM TO ANY PARTICULAR FONT, STYLE, SIZE, OR COLOR.

SN 85-451,568, FILED 10-19-2011.

SANJEEV VOHRA, EXAMINING ATTORNEY



David J. Kyffers

Director of the United States Patent and Trademark Office

United States of America

United States Patent and Trademark Office

COWBOY UP MEN'S SALON

Reg. No. 4,207,715

FIXIN' TO CUT LLC (TEXAS LIMITED LIABILITY COMPANY)
6961 RAINIER STREET
FRISCO, TX 75034

Registered Sep. 11, 2012

Int. Cl.: 44

FOR: HAIR CUTTING SERVICES, IN CLASS 44 (U.S. CLS. 100 AND 101).

SERVICE MARK

FIRST USE 3-5-2012; IN COMMERCE 3-5-2012.

PRINCIPAL REGISTER

THE MARK CONSISTS OF STANDARD CHARACTERS WITHOUT CLAIM TO ANY PARTICULAR FONT, STYLE, SIZE, OR COLOR.

NO CLAIM IS MADE TO THE EXCLUSIVE RIGHT TO USE "MEN'S SALON", APART FROM THE MARK AS SHOWN.

SN 85-451,678, FILED 10-20-2011.

AHSEN KHAN, EXAMINING ATTORNEY



David J. Kybas

Director of the United States Patent and Trademark Office

United States of America

United States Patent and Trademark Office

INTEGRA 830 P

Reg. No. 4,207,716

SOUTHERN LITHOPLATE, INC. (NORTH CAROLINA CORPORATION)

Registered Sep. 11, 2012

105 JEFFREY WAY
YOUNGSVILLE, NC 27596

Int. Cl.: 7

FOR: LITHOGRAPHIC PRINTING PLATES, NAMELY, NON PRE-HEAT, AND PRE-HEAT THERMAL, DIGITAL LASER EXPOSED, ALUMINUM SUBSTRATE LITHOGRAPHIC PRINTING PLATES, IN CLASS 7 (U.S. CLS. 13, 19, 21, 23, 31, 34 AND 35).

TRADEMARK

FIRST USE 7-0-2011; IN COMMERCE 10-0-2011.

PRINCIPAL REGISTER

THE MARK CONSISTS OF STANDARD CHARACTERS WITHOUT CLAIM TO ANY PARTICULAR FONT, STYLE, SIZE, OR COLOR.

OWNER OF U.S. REG. NO. 2,971,305.

NO CLAIM IS MADE TO THE EXCLUSIVE RIGHT TO USE "830", APART FROM THE MARK AS SHOWN.

SN 85-452,093, FILED 10-20-2011.

MICHELE SWAIN, EXAMINING ATTORNEY



David J. Kyffers

Director of the United States Patent and Trademark Office

United States of America

United States Patent and Trademark Office

HELI REPLAY

Reg. No. 4,207,717

SPIN MASTER LTD. (CANADA CORPORATION)
450 FRONT STREET WEST
TORONTO, ONTARIO, CANADA M5V1B6

Registered Sep. 11, 2012

Int. Cl.: 28

FOR: TOYS, NAMELY, TOY AIRCRAFT, IN CLASS 28 (U.S. CLS. 22, 23, 38 AND 50).

TRADEMARK

FIRST USE 6-14-2012; IN COMMERCE 6-14-2012.

PRINCIPAL REGISTER

THE MARK CONSISTS OF STANDARD CHARACTERS WITHOUT CLAIM TO ANY PARTICULAR FONT, STYLE, SIZE, OR COLOR.

NO CLAIM IS MADE TO THE EXCLUSIVE RIGHT TO USE "HELI", APART FROM THE MARK AS SHOWN.

SN 85-452,103, FILED 10-20-2011.

DOMINIC FATHY, EXAMINING ATTORNEY



David J. Kyffers

Director of the United States Patent and Trademark Office

United States of America

United States Patent and Trademark Office

Cumulus9

Reg. No. 4,207,718

SUBLIME MARKETING GROUP LLC (ARIZONA LIMITED LIABILITY COMPANY)
7440 E. PINNACLE PEAK RD., SUITE 4
SCOTTSDALE, AZ 85255

Registered Sep. 11, 2012

Int. Cl.: 27

FOR: ANTI-FATIGUE FLOOR MAT, IN CLASS 27 (U.S. CLS. 19, 20, 37, 42 AND 50).

TRADEMARK

FIRST USE 3-10-2012; IN COMMERCE 3-12-2012.

PRINCIPAL REGISTER

THE MARK CONSISTS OF STANDARD CHARACTERS WITHOUT CLAIM TO ANY PARTICULAR FONT, STYLE, SIZE, OR COLOR.

SN 85-452,401, FILED 10-20-2011.

MYRIAH HABEEB, EXAMINING ATTORNEY



David J. Kybas

Director of the United States Patent and Trademark Office

United States of America

United States Patent and Trademark Office

CumulusPro

Reg. No. 4,207,719

SUBLIME MARKETING GROUP LLC (ARIZONA LIMITED LIABILITY COMPANY)
7440 E. PINNACLE PEAK RD., SUITE 4
SCOTTSDALE, AZ 85255

Registered Sep. 11, 2012

Int. Cl.: 27

FOR: ANTI-FATIGUE FLOOR MAT, IN CLASS 27 (U.S. CLS. 19, 20, 37, 42 AND 50).

TRADEMARK

FIRST USE 3-10-2012; IN COMMERCE 3-15-2012.

PRINCIPAL REGISTER

THE MARK CONSISTS OF STANDARD CHARACTERS WITHOUT CLAIM TO ANY PARTICULAR FONT, STYLE, SIZE, OR COLOR.

SN 85-452,405, FILED 10-20-2011.

MYRIAH HABEEB, EXAMINING ATTORNEY



David J. Kyffers

Director of the United States Patent and Trademark Office

United States of America

United States Patent and Trademark Office

EndoMAXX

Reg. No. 4,207,720

Registered Sep. 11, 2012

Int. Cl.: 10

TRADEMARK

PRINCIPAL REGISTER

MERIT MEDICAL SYSTEMS, INC. (UTAH CORPORATION)
LEGAL DEPARTMENT
1600 WEST MERIT PARKWAY
SOUTH JORDAN, UT 84095

FOR: MEDICAL DEVICES, NAMELY, ESOPHAGEAL STENTS, IN CLASS 10 (U.S. CLS. 26, 39 AND 44).

FIRST USE 2-28-2012; IN COMMERCE 2-28-2012.

THE MARK CONSISTS OF STANDARD CHARACTERS WITHOUT CLAIM TO ANY PARTICULAR FONT, STYLE, SIZE, OR COLOR.

SN 85-452,418, FILED 10-20-2011.

ANTHONY RINKER, EXAMINING ATTORNEY



David J. Kybas

Director of the United States Patent and Trademark Office

United States of America

United States Patent and Trademark Office

RED ELEPHANT CAFÉ

Reg. No. 4,207,721

Registered Sep. 11, 2012

Int. Cl.: 43

SERVICE MARK

PRINCIPAL REGISTER

THE RED ELEPHANT, LLC (FLORIDA LIMITED LIABILITY COMPANY)
401 EAST VIRGINIA ST.
TALLAHASSEE, FL 32301

FOR: RESTAURANT AND CATERING SERVICES, IN CLASS 43 (U.S. CLS. 100 AND 101).

FIRST USE 5-1-2012; IN COMMERCE 5-1-2012.

THE MARK CONSISTS OF STANDARD CHARACTERS WITHOUT CLAIM TO ANY PARTICULAR FONT, STYLE, SIZE, OR COLOR.

OWNER OF U.S. REG. NOS. 3,310,396 AND 3,438,772.

NO CLAIM IS MADE TO THE EXCLUSIVE RIGHT TO USE "CAFÉ", APART FROM THE MARK AS SHOWN.

SN 85-452,527, FILED 10-20-2011.

MATTHEW PAPPAS, EXAMINING ATTORNEY



David J. Kyffers

Director of the United States Patent and Trademark Office

United States of America

United States Patent and Trademark Office

HOME STATE HEALTH PLAN

Reg. No. 4,207,722

CENTENE CORPORATION (DELAWARE CORPORATION)
7700 FORSYTH BOULEVARD
ST. LOUIS, MO 63105

Registered Sep. 11, 2012

Int. Cl.: 44

FOR: MANAGED HEALTH CARE SERVICES, IN CLASS 44 (U.S. CLS. 100 AND 101).

SERVICE MARK

FIRST USE 7-2-2012; IN COMMERCE 7-2-2012.

PRINCIPAL REGISTER

THE MARK CONSISTS OF STANDARD CHARACTERS WITHOUT CLAIM TO ANY PARTICULAR FONT, STYLE, SIZE, OR COLOR.

NO CLAIM IS MADE TO THE EXCLUSIVE RIGHT TO USE "HEALTH PLAN", APART FROM THE MARK AS SHOWN.

SN 85-453,442, FILED 10-21-2011.

MARLENE BELL, EXAMINING ATTORNEY



David J. Kyffers

Director of the United States Patent and Trademark Office

United States of America

United States Patent and Trademark Office

BIRDERS LIFE

Reg. No. 4,207,723

ARNOLD, RICHARD L. (UNITED STATES INDIVIDUAL)
125 TRIBBLE GAP ROAD #402
CUMMING, GA 30040 AND

Registered Sep. 11, 2012

Int. Cl.: 25

ARNOLD, SHARON G. (UNITED STATES INDIVIDUAL)
125 TRIBBLE GAP ROAD #402
CUMMING, GA 30040

TRADEMARK

PRINCIPAL REGISTER

FOR: HATS; JACKETS; JERSEYS; SPORTS CAPS AND HATS; TOPS; WEARABLE GARMENTS AND CLOTHING, NAMELY, SHIRTS, IN CLASS 25 (U.S. CLS. 22 AND 39).

FIRST USE 3-12-2012; IN COMMERCE 4-27-2012.

THE MARK CONSISTS OF STANDARD CHARACTERS WITHOUT CLAIM TO ANY PARTICULAR FONT, STYLE, SIZE, OR COLOR.

SN 85-455,384, FILED 10-25-2011.

NICHOLAS ALTREE, EXAMINING ATTORNEY



David J. Kybas

Director of the United States Patent and Trademark Office

United States of America

United States Patent and Trademark Office



BIRDERS
LIFE

Reg. No. 4,207,724

ARNOLD, RICHARD L. (UNITED STATES INDIVIDUAL)
125 TRIBBLE GAP ROAD #402
CUMMING, GA 30040 AND

Registered Sep. 11, 2012

Int. Cl.: 25

ARNOLD, SHARON G. (UNITED STATES INDIVIDUAL)
125 TRIBBLE GAP ROAD #402
CUMMING, GA 30040

TRADEMARK

PRINCIPAL REGISTER

FOR: HATS; JACKETS; JERSEYS; SPORTS CAPS AND HATS; TOPS; WEARABLE GARMENTS AND CLOTHING, NAMELY, SHIRTS, IN CLASS 25 (U.S. CLS. 22 AND 39).

FIRST USE 3-12-2012; IN COMMERCE 4-27-2012.

THE MARK CONSISTS OF THE WORDS "BIRDERS LIFE" IN BLACK, ALL CAPITAL LETTERS SUPERIMPOSED OVER A GREY AND WHITE FEATHER.

SN 85-455,560, FILED 10-25-2011.

NICHOLAS ALTREE, EXAMINING ATTORNEY



David J. Kyros

Director of the United States Patent and Trademark Office

United States of America

United States Patent and Trademark Office



Reg. No. 4,207,725

ZOE MARKETING, INC. (NEVADA CORPORATION)
12375 WORLD TRADE DRIVE
SAN DIEGO, CA 92128

Registered Sep. 11, 2012

Int. Cls.: 18, 26, and 28

FOR: GYM BAGS, IN CLASS 18 (U.S. CLS. 1, 2, 3, 22 AND 41).

FIRST USE 10-30-2011; IN COMMERCE 10-30-2011.

TRADEMARK

FOR: HAIR BOWS , IN CLASS 26 (U.S. CLS. 37, 39, 40, 42 AND 50).

PRINCIPAL REGISTER

FIRST USE 10-30-2011; IN COMMERCE 10-30-2011.

FOR: CHEERLEADING POM-POMS, IN CLASS 28 (U.S. CLS. 22, 23, 38 AND 50).

FIRST USE 10-30-2011; IN COMMERCE 10-30-2011.

OWNER OF U.S. REG. NO. 2,775,620.

THE MARK CONSISTS OF THE WORD "CHASSÉ" PARTIALLY ENCIRCLED IN A STYLIZED LETTER "C".

THE ENGLISH TRANSLATION OF "CHASSE" IS "THE CHASE".

SN 85-455,954, FILED 10-25-2011.

ALICE BENMAMAN, EXAMINING ATTORNEY



David J. Kybas

Director of the United States Patent and Trademark Office

United States of America

United States Patent and Trademark Office

ROC THE DAY

Reg. No. 4,207,726

UNITED WAY OF GREATER ROCHESTER, INC. (NEW YORK NON-PROFIT CORPORATION)
75 COLLEGE AVENUE
ROCHESTER, NY 14607

Registered Sep. 11, 2012

Int. Cl.: 36

FOR: CHARITABLE FUNDRAISING, IN CLASS 36 (U.S. CLS. 100, 101 AND 102).

SERVICE MARK

FIRST USE 10-11-2011; IN COMMERCE 12-8-2011.

PRINCIPAL REGISTER

THE MARK CONSISTS OF STANDARD CHARACTERS WITHOUT CLAIM TO ANY PARTICULAR FONT, STYLE, SIZE, OR COLOR.

SN 85-457,654, FILED 10-27-2011.

JORDAN BAKER, EXAMINING ATTORNEY



David J. Kyffers

Director of the United States Patent and Trademark Office

United States of America

United States Patent and Trademark Office

MAPLERIDGE BAKERY

Reg. No. 4,207,727

Registered Sep. 11, 2012

Int. Cl.: 30

TRADEMARK

PRINCIPAL REGISTER

DIVERSIFIED MARKETING SOLUTIONS, LLC (OKLAHOMA LIMITED LIABILITY COMPANY)
POST OFFICE BOX 1673
OWASSO, OK 74055

FOR: COOKIES AND CRACKERS, IN CLASS 30 (U.S. CL. 46).

FIRST USE 9-28-2011; IN COMMERCE 9-28-2011.

THE MARK CONSISTS OF STANDARD CHARACTERS WITHOUT CLAIM TO ANY PARTICULAR FONT, STYLE, SIZE, OR COLOR.

NO CLAIM IS MADE TO THE EXCLUSIVE RIGHT TO USE "BAKERY", APART FROM THE MARK AS SHOWN.

SN 85-457,889, FILED 10-27-2011.

ALYSSA STEEL, EXAMINING ATTORNEY



David J. Kyffers

Director of the United States Patent and Trademark Office

United States of America

United States Patent and Trademark Office

PET-ENZYMES PLUS

Reg. No. 4,207,728

NWC NATURALS PET PRODUCTS LLC (CALIFORNIA LIMITED LIABILITY COMPANY)
27071 CABOT ROAD, SUITE 117

Registered Sep. 11, 2012

LAGUNA HILLS, CA 92653

Int. Cl.: 5

FOR: DIETARY SUPPLEMENTS FOR PETS COMPRISED PRIMARILY OF ENZYMES; NUTRITIONAL SUPPLEMENTS COMPRISED PRIMARILY OF ENZYMES, IN CLASS 5 (U.S. CLS. 6, 18, 44, 46, 51 AND 52).

TRADEMARK

FIRST USE 1-12-2012; IN COMMERCE 1-12-2012.

PRINCIPAL REGISTER

THE MARK CONSISTS OF STANDARD CHARACTERS WITHOUT CLAIM TO ANY PARTICULAR FONT, STYLE, SIZE, OR COLOR.

OWNER OF U.S. REG. NO. 3,982,932.

NO CLAIM IS MADE TO THE EXCLUSIVE RIGHT TO USE "PET ENZYMES", APART FROM THE MARK AS SHOWN.

SN 85-458,364, FILED 10-27-2011.

SEAN CROWLEY, EXAMINING ATTORNEY



David J. Kyffers

Director of the United States Patent and Trademark Office

United States of America

United States Patent and Trademark Office

DESTROYER

Reg. No. 4,207,729

BLUEWATER CHEMGROUP, INC. (FLORIDA CORPORATION)
501 GULF DRIVE NORTH
BRADENTON BEACH, FL 34217

Registered Sep. 11, 2012

Int. Cl.: 1

FOR: CHEMICALS FOR REMOVING ROOTS AND INHIBITING ROOT GROWTH IN SEWER LINES AND SEPTIC TANKS, PIPES AND LATERALS, IN CLASS 1 (U.S. CLS. 1, 5, 6, 10, 26 AND 46).

TRADEMARK

FIRST USE 11-9-2011; IN COMMERCE 11-9-2011.

PRINCIPAL REGISTER

THE MARK CONSISTS OF STANDARD CHARACTERS WITHOUT CLAIM TO ANY PARTICULAR FONT, STYLE, SIZE, OR COLOR.

SN 85-458,777, FILED 10-28-2011.

WILLIAM VERHOSEK, EXAMINING ATTORNEY



David J. Kyfos

Director of the United States Patent and Trademark Office

United States of America

United States Patent and Trademark Office

BLUE RIBBON

Reg. No. 4,207,730

BLUEWATER CHEMGROUP, INC. (FLORIDA CORPORATION)
501 GULF DRIVE NORTH
BRADENTON BEACH, FL 34217

Registered Sep. 11, 2012

Int. Cl.: 1

FOR: FERTILIZERS, IN CLASS 1 (U.S. CLS. 1, 5, 6, 10, 26 AND 46).

TRADEMARK

FIRST USE 2-20-2012; IN COMMERCE 2-20-2012.

PRINCIPAL REGISTER

THE MARK CONSISTS OF STANDARD CHARACTERS WITHOUT CLAIM TO ANY PARTICULAR FONT, STYLE, SIZE, OR COLOR.

SN 85-458,816, FILED 10-28-2011.

WILLIAM VERHOSEK, EXAMINING ATTORNEY



David J. Kyffers

Director of the United States Patent and Trademark Office

United States of America

United States Patent and Trademark Office

YOUTHQUAKE

Reg. No. 4,207,731

L & L MANUFACTURING CO., INC. (CALIFORNIA CORPORATION)
815 N. NASH STREET
EL SEGUNDO, CA 90245

Registered Sep. 11, 2012

Int. Cl.: 25

FOR: COATS; HOODED SWEATSHIRTS; JACKETS; KNIT SHIRTS; PANTS; SHIRTS AND SHORT-SLEEVED SHIRTS; SHORTS; SKIRTS AND DRESSES; SWEATERS; SWEATSHIRTS; T-SHIRTS; TANK TOPS; TOPS , IN CLASS 25 (U.S. CLS. 22 AND 39).

TRADEMARK

FIRST USE 5-15-2012; IN COMMERCE 5-15-2012.

PRINCIPAL REGISTER

THE MARK CONSISTS OF STANDARD CHARACTERS WITHOUT CLAIM TO ANY PARTICULAR FONT, STYLE, SIZE, OR COLOR.

SN 85-459,097, FILED 10-28-2011.

TINA BROWN, EXAMINING ATTORNEY



David J. Kyffers

Director of the United States Patent and Trademark Office

United States of America

United States Patent and Trademark Office



Reg. No. 4,207,732

UNION CORRUGATING COMPANY (NORTH CAROLINA CORPORATION)
701 SOUTH KING STREET
FAYETTEVILLE, NC 28302

Registered Sep. 11, 2012

Int. Cl.: 6

FOR: STONE-COATED METAL ROOFING SHINGLES, IN CLASS 6 (U.S. CLS. 2, 12, 13, 14, 23, 25 AND 50).

TRADEMARK

FIRST USE 2-1-2012; IN COMMERCE 2-1-2012.

PRINCIPAL REGISTER

THE STIPLING IS A FEATURE OF THE MARK.

THE MARK CONSISTS OF THE STYLIZED WORDING "STONESHIELD" HOUSED IN A RECTANGLE WITH A SHIELD BEHIND IT.

SN 85-459,355, FILED 10-28-2011.

ADA HAN, EXAMINING ATTORNEY



David J. Kybas

Director of the United States Patent and Trademark Office

United States of America

United States Patent and Trademark Office

Schwing

Reg. No. 4,207,733

Registered Sep. 11, 2012

Int. Cl.: 3

TRADEMARK

PRINCIPAL REGISTER

SHIPMAN ASSOCIATES, INC. (DELAWARE CORPORATION), DBA THEBALM,
2130 FILLMORE STREET, #303
SAN FRANCISCO, CA 94115

FOR: BLUSH; BLUSH PENCILS; COLOGNES, PERFUMES AND COSMETICS; COSMETIC PENCILS; COSMETIC ROUGES; COSMETICS; COSMETICS AND COSMETIC PREPARATIONS; COSMETICS AND MAKE-UP; COSMETICS IN GENERAL, INCLUDING PERFUMES; CREAMY FACE POWDER; EYE LINER; EYE MAKE-UP; EYE PENCILS; EYE SHADOW; EYE SHADOWS; EYE-SHADOW; EYEBROW COSMETICS; EYES MAKE-UP; EYES PENCILS; FACIAL CONCEALER; FOUNDATION; FOUNDATION MAKE-UP; LIP GLOSS; LIPSTICK; LIPSTICKS; MAKE UP FOUNDATIONS; MAKE-UP FOUNDATIONS; MASCARA; MASCARAS, IN CLASS 3 (U.S. CLS. 1, 4, 6, 50, 51 AND 52).

FIRST USE 6-1-2012; IN COMMERCE 6-1-2012.

THE MARK CONSISTS OF STANDARD CHARACTERS WITHOUT CLAIM TO ANY PARTICULAR FONT, STYLE, SIZE, OR COLOR.

SN 85-459,578, FILED 10-28-2011.

BENJAMIN OKEKE, EXAMINING ATTORNEY



David J. Kyffers

Director of the United States Patent and Trademark Office

United States of America

United States Patent and Trademark Office



Reg. No. 4,207,734

URBANECARDS.COM, LLC (ILLINOIS LIMITED LIABILITY COMPANY)
11931 ELISE BLVD.

Registered Sep. 11, 2012

FRANKFORT, IL 60423

Int. Cl.: 38

SERVICE MARK

PRINCIPAL REGISTER

FOR: AUDIO AND VIDEO BROADCASTING SERVICES OVER THE INTERNET; AUDIO AND VIDEO BROADCASTING SERVICES OVER THE INTERNET IN THE FIELD OF GREETING CARDS INFORMATION, CREATION AND SENDING OF ELECTRONIC GREETING CARDS; AUDIO BROADCASTING; DELIVERY OF PERSONALIZED GREETING CARDS TO OTHERS VIA ELECTRONIC MAIL; PROVIDING AN ON-LINE FORUM FOR GREETING CARDS INFORMATION, CREATION AND SENDING OF ELECTRONIC GREETING CARDS; PROVIDING ON-LINE CHAT ROOMS FOR TRANSMISSION OF MESSAGES AMONG COMPUTER USERS CONCERNING GREETING CARDS INFORMATION, CREATION AND SENDING OF ELECTRONIC GREETING CARDS; PROVIDING ON-LINE FORUMS FOR TRANSMISSION OF MESSAGES AMONG COMPUTER USERS CONCERNING GREETING CARDS INFORMATION, CREATION AND SENDING OF ELECTRONIC GREETING CARDS; TRANSMISSION OF GREETING CARDS ONLINE, IN CLASS 38 (U.S. CLS. 100, 101 AND 104).

FIRST USE 6-1-2012; IN COMMERCE 6-1-2012.

NO CLAIM IS MADE TO THE EXCLUSIVE RIGHT TO USE "ECARDS.COM", APART FROM THE MARK AS SHOWN.

THE MARK CONSISTS OF THE WORDS "URBAN ECARDS.COM" BELOW THE IMAGE OF A SKYLINE OF A CITY.

SN 85-459,966, FILED 10-31-2011.

KATHLEEN LORENZO, EXAMINING ATTORNEY



David J. Kybas

Director of the United States Patent and Trademark Office

United States of America

United States Patent and Trademark Office

INFOR XTREME

Reg. No. 4,207,735

INFOR GLOBAL SOLUTIONS (MICHIGAN), INC. (MICHIGAN CORPORATION)
30600 TELEGRAPH ROAD
BINGHAM FARMS, MI 48025

Registered Sep. 11, 2012

Int. Cl.: 42

FOR: COMPUTER SOFTWARE SUPPORT SERVICES, NAMELY, TROUBLESHOOTING OF SOFTWARE PROBLEMS, PROVIDING ASSISTANCE WITH UPGRADES, RELEASES AND SUPPORT QUESTIONS; COMPUTER SOFTWARE CONSULTING, IN CLASS 42 (U.S. CLS. 100 AND 101).

SERVICE MARK

PRINCIPAL REGISTER

FIRST USE 1-31-2012; IN COMMERCE 1-31-2012.

THE MARK CONSISTS OF STANDARD CHARACTERS WITHOUT CLAIM TO ANY PARTICULAR FONT, STYLE, SIZE, OR COLOR.

OWNER OF U.S. REG. NOS. 3,261,853, 3,408,051, AND 3,986,817.

SN 85-460,110, FILED 10-31-2011.

B. PARADEWELAI, EXAMINING ATTORNEY



David J. Kyros

Director of the United States Patent and Trademark Office

United States of America

United States Patent and Trademark Office

SizeSnap

Reg. No. 4,207,736

HEAPSYLON (NEVADA LIMITED LIABILITY COMPANY)
PO BOX 3324

Registered Sep. 11, 2012

REDMOND, WA 980733324

Int. Cl.: 9

FOR: COMPUTER APPLICATION SOFTWARE FOR MOBILE PHONES, HANDHELD COMPUTERS AND ELECTRONIC DEVICES THEREOF, NAMELY, SOFTWARE FOR PROVIDING A VIRTUAL DRESSING ROOM EXPERIENCE, IN CLASS 9 (U.S. CLS. 21, 23, 26, 36 AND 38).

TRADEMARK

PRINCIPAL REGISTER

FIRST USE 9-8-2011; IN COMMERCE 10-31-2011.

THE MARK CONSISTS OF STANDARD CHARACTERS WITHOUT CLAIM TO ANY PARTICULAR FONT, STYLE, SIZE, OR COLOR.

SN 85-460,172, FILED 10-31-2011.

LINDA E. BLOHM, EXAMINING ATTORNEY



David J. Kyros

Director of the United States Patent and Trademark Office

United States of America

United States Patent and Trademark Office



Reg. No. 4,207,737

AGRALYTICA INC. (DELAWARE CORPORATION)
333 N. FAIRFAX STREET, SUITE 202
ALEXANDRIA, VA 22314

Registered Sep. 11, 2012

Int. Cl.: 35

FOR: BUSINESS CONSULTATION SERVICES IN THE FIELDS OF FOOD AND AGRICULTURE, IN CLASS 35 (U.S. CLS. 100, 101 AND 102).

SERVICE MARK

FIRST USE 11-1-2011; IN COMMERCE 11-1-2011.

PRINCIPAL REGISTER

THE MARK CONSISTS OF THE STYLIZED REPRESENTATION OF A PLANT WITH TWO LEAVES IN A CIRCULAR DESIGN.

SN 85-460,377, FILED 10-31-2011.

NAPOLEON SHARMA, EXAMINING ATTORNEY



David J. Kyffers

Director of the United States Patent and Trademark Office

United States of America

United States Patent and Trademark Office

Frankly Speaking

Reg. No. 4,207,738

HOJEIJ BRANDED FOODS, INC. (GEORGIA CORPORATION)
1750 THE EXCHANGE, SUITE 200
ATLANTA, GA 30339

Registered Sep. 11, 2012

Int. Cl.: 43

FOR: RESTAURANT SERVICES, IN CLASS 43 (U.S. CLS. 100 AND 101).

SERVICE MARK

FIRST USE 12-26-2011; IN COMMERCE 12-26-2011.

PRINCIPAL REGISTER

THE MARK CONSISTS OF THE STYLIZED WORDS "FRANKLY SPEAKING" ON A GREY SQUARE BACKGROUND WITH THE LETTERS OF "FRANKLY SPEAKING" IN BLUE, EXCEPT FOR THE "LY" PORTION OF THE WORD "FRANKLY" WHICH IS YELLOW.

THE COLOR(S) GREY, BLUE, AND YELLOW IS/ARE CLAIMED AS A FEATURE OF THE MARK.

SN 85-460,666, FILED 10-31-2011.

TOBY BULLOFF, EXAMINING ATTORNEY



David J. Kyffers

Director of the United States Patent and Trademark Office

United States of America

United States Patent and Trademark Office



Reg. No. 4,207,739

Registered Sep. 11, 2012

Int. Cl.: 45

SERVICE MARK

PRINCIPAL REGISTER

NORTHCENTRAL MALTESE RESCUE, INC. (WISCONSIN CORPORATION)
3601 WRIGHT AVENUE
RACINE, WI 53405

FOR: ANIMAL ADOPTION SERVICES, NAMELY, LOCATING AND ARRANGING FOR MALTESE DOGS TO BE PLACED WITH FAMILIES THAT WANT THEM, IN CLASS 45 (U.S. CLS. 100 AND 101).

FIRST USE 1-0-2008; IN COMMERCE 1-0-2008.

NO CLAIM IS MADE TO THE EXCLUSIVE RIGHT TO USE "NORTH CENTRAL MALTESE RESCUE INC.", APART FROM THE MARK AS SHOWN.

THE STIPPLING IS FOR SHADING PURPOSES.

THE MARK CONSISTS OF THE STYLIZED WORDS "NORTHCENTRAL MALTESE RESCUE INC." DISPLAYED INSIDE A CIRCLE WITH AN IMAGE OF A MALTESE DOG WITH A HALO AND WINGS IN THE CENTER.

SN 85-460,721, FILED 10-31-2011.

COURTNEY ALVAREZ, EXAMINING ATTORNEY



David J. Kybas

Director of the United States Patent and Trademark Office

United States of America

United States Patent and Trademark Office

Stealth Tunes

Reg. No. 4,207,740

SHAWN ALSTAD (UNITED STATES INDIVIDUAL)
7931 W. ASTER DRIVE
PEORIA, AZ 85381

Registered Sep. 11, 2012

Int. Cl.: 9

FOR: AUDIO SPEAKERS, IN CLASS 9 (U.S. CLS. 21, 23, 26, 36 AND 38).

TRADEMARK

FIRST USE 1-15-2012; IN COMMERCE 4-1-2012.

PRINCIPAL REGISTER

THE MARK CONSISTS OF STANDARD CHARACTERS WITHOUT CLAIM TO ANY PARTICULAR FONT, STYLE, SIZE, OR COLOR.

NO CLAIM IS MADE TO THE EXCLUSIVE RIGHT TO USE "TUNES", APART FROM THE MARK AS SHOWN.

SN 85-460,752, FILED 10-31-2011.

HOWARD SMIGA, EXAMINING ATTORNEY



David J. Kyffers

Director of the United States Patent and Trademark Office

United States of America

United States Patent and Trademark Office

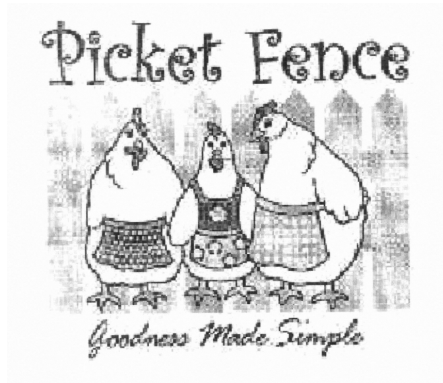

Reg. No. 4,207,741

SHIMABUKURO, LOIS (UNITED STATES INDIVIDUAL)
1214 PUEO STREET
HONOLULU, HI 96816

Registered Sep. 11, 2012

Int. Cl.: 35

FOR: WHOLESALE AND RETAIL STORE SERVICES FEATURING EGGS AND EGG PRODUCTS, IN CLASS 35 (U.S. CLS. 100, 101 AND 102).

SERVICE MARK

FIRST USE 9-19-2011; IN COMMERCE 11-22-2011.

PRINCIPAL REGISTER

THE MARK CONSISTS OF THE PHRASE "PICKET FENCE" IN PRINTED TEXT ABOVE A PICKET FENCE WITH THREE CHICKENS WEARING APRONS STANDING IN FRONT OF THE PICKET FENCE AND THE PHRASE "GOODNESS MADE SIMPLE" BELOW THE PICKET FENCE.

SN 85-460,976, FILED 10-31-2011.

AHSEN KHAN, EXAMINING ATTORNEY



David J. Kyffers

Director of the United States Patent and Trademark Office

United States of America

United States Patent and Trademark Office



Reg. No. 4,207,742

Registered Sep. 11, 2012

Int. Cls.: 37 and 39

SERVICE MARK

PRINCIPAL REGISTER

VALET WASTE LLC (FLORIDA LIMITED LIABILITY COMPANY)
SUITE 700
601 N. ASHLEY DRIVE
TAMPA, FL 33602

FOR: TRASH AND RECYCLING COLLECTION IN THE NATURE OF REFUSE CLEAN-UP FOR MULTI-FAMILY LIVING FACILITIES; COLLECTION OF GLASS, CARDBOARD, NEWSPAPERS, CATALOGS, MAGAZINES, JUNK MAIL, PAPER, SODA CARTONS, CEREAL BOXES, ALUMINUM AND STEEL FOOD AND BEVERAGE CONTAINERS, AND MILK AND JUICE CONTAINERS FOR RECYCLING, IN CLASS 37 (U.S. CLS. 100, 103 AND 106).

FIRST USE 12-12-2011; IN COMMERCE 12-12-2011.

FOR: TRASH AND RECYCLING PICK-UP AND TRANSPORT FROM MULTI-FAMILY LIVING FACILITIES, IN CLASS 39 (U.S. CLS. 100 AND 105).

FIRST USE 12-12-2011; IN COMMERCE 12-12-2011.

THE MARK CONSISTS OF A TRIANGULAR SHAPE MADE UP OF A BLUE CRESCENT SHAPED LINE, A GREEN CRESCENT SHAPED LINE, AND A BROWN CRESCENT SHAPED LINE.

THE COLOR(S) BLUE, GREEN AND BROWN IS/ARE CLAIMED AS A FEATURE OF THE MARK.

SN 85-461,088, FILED 11-1-2011.

JORDAN BAKER, EXAMINING ATTORNEY



David J. Kybas

Director of the United States Patent and Trademark Office

United States of America

United States Patent and Trademark Office



Reg. No. 4,207,743

Registered Sep. 11, 2012

Int. Cls.: 37 and 39

SERVICE MARK

PRINCIPAL REGISTER

VALET WASTE LLC (FLORIDA LIMITED LIABILITY COMPANY)
SUITE 700
601 N. ASHLEY DRIVE
TAMPA, FL 33602

FOR: TRASH AND RECYCLING COLLECTION IN THE NATURE OF REFUSE CLEAN-UP FOR MULTI-FAMILY LIVING FACILITIES; COLLECTION OF GLASS, CARDBOARD, NEWSPAPERS, CATALOGS, MAGAZINES, JUNK MAIL, PAPER, SODA CARTONS, CEREAL BOXES, ALUMINUM AND STEEL FOOD AND BEVERAGE CONTAINERS, AND MILK AND JUICE CONTAINERS FOR RECYCLING, IN CLASS 37 (U.S. CLS. 100, 103 AND 106).

FIRST USE 12-12-2011; IN COMMERCE 12-12-2011.

FOR: TRASH AND RECYCLING PICK-UP AND TRANSPORT FROM MULTI-FAMILY LIVING FACILITIES, IN CLASS 39 (U.S. CLS. 100 AND 105).

FIRST USE 12-12-2011; IN COMMERCE 12-12-2011.

OWNER OF U.S. REG. NOS. 2,402,809 AND 3,507,900.

THE COLOR(S) BLUE, GREEN AND BROWN IS/ARE CLAIMED AS A FEATURE OF THE MARK.

NO CLAIM IS MADE TO THE EXCLUSIVE RIGHT TO USE "DOORSTEP COLLECTION EXPERTS", APART FROM THE MARK AS SHOWN.

THE MARK CONSISTS OF A TRIANGULAR SHAPE MADE UP OF A BLUE CRESCENT SHAPED LINE, A GREEN CRESCENT SHAPED LINE AND A BROWN CRESCENT SHAPED LINE TO THE LEFT OF THE WORDS "VALETWASTE" IN GREEN ABOVE THE WORDS "DOORSTEP COLLECTION EXPERTS" IN BROWN.

SN 85-461,090, FILED 11-1-2011.

JORDAN BAKER, EXAMINING ATTORNEY



David J. Kyffers

Director of the United States Patent and Trademark Office

United States of America

United States Patent and Trademark Office

THE FRIENDLY ZOMBIES

Reg. No. 4,207,744

TRALY (USA) INC. (FLORIDA CORPORATION)
899 APPLEBY STREET
BOCA RATON, FL 33487

Registered Sep. 11, 2012

Int. Cl.: 28

FOR: COLLECTIBLE TOYS, NAMELY, PLUSH TOYS, COLLECTIBLE TOY FIGURES; ART TOYS, NAMELY, UNASSEMBLED MODEL TOYS FOR ASSEMBLY AND PAINTING, IN CLASS 28 (U.S. CLS. 22, 23, 38 AND 50).

TRADEMARK

FIRST USE 10-11-2011; IN COMMERCE 10-11-2011.

PRINCIPAL REGISTER

THE MARK CONSISTS OF STANDARD CHARACTERS WITHOUT CLAIM TO ANY PARTICULAR FONT, STYLE, SIZE, OR COLOR.

SN 85-461,248, FILED 11-1-2011.

ALICIA COLLINS, EXAMINING ATTORNEY



David J. Kybas

Director of the United States Patent and Trademark Office

United States of America

United States Patent and Trademark Office

THE FRIENDLY ZOMBIES

Reg. No. 4,207,745

TRALY (USA) INC. (FLORIDA CORPORATION)
899 APPLEBY STREET
BOCA RATON, FL 33487

Registered Sep. 11, 2012

Int. Cl.: 16

FOR: ART PRINTS; PRINTED MATERIALS, NAMELY, POSTERS, COMIC BOOKS, IN CLASS 16 (U.S. CLS. 2, 5, 22, 23, 29, 37, 38 AND 50).

TRADEMARK

FIRST USE 10-11-2011; IN COMMERCE 10-11-2011.

PRINCIPAL REGISTER

THE MARK CONSISTS OF STANDARD CHARACTERS WITHOUT CLAIM TO ANY PARTICULAR FONT, STYLE, SIZE, OR COLOR.

SN 85-461,259, FILED 11-1-2011.

ALICIA COLLINS, EXAMINING ATTORNEY



David J. Kyffers

Director of the United States Patent and Trademark Office

United States of America

United States Patent and Trademark Office

FRIENDLY ZOMBIES

Reg. No. 4,207,746

TRALY (USA) INC. (FLORIDA CORPORATION)
899 APPLEBY STREET
BOCA RATON, FL 33487

Registered Sep. 11, 2012

Int. Cl.: 28

FOR: COLLECTIBLE TOYS, NAMELY, PLUSH TOYS, COLLECTIBLE TOY FIGURES; ART TOYS, NAMELY, UNASSEMBLED MODEL TOYS FOR ASSEMBLY AND PAINTING, IN CLASS 28 (U.S. CLS. 22, 23, 38 AND 50).

TRADEMARK

FIRST USE 10-11-2011; IN COMMERCE 10-11-2011.

PRINCIPAL REGISTER

THE MARK CONSISTS OF STANDARD CHARACTERS WITHOUT CLAIM TO ANY PARTICULAR FONT, STYLE, SIZE, OR COLOR.

SN 85-461,292, FILED 11-1-2011.

ALICIA COLLINS, EXAMINING ATTORNEY



David J. Kyffers

Director of the United States Patent and Trademark Office

United States of America

United States Patent and Trademark Office



Reg. No. 4,207,747

Registered Sep. 11, 2012

Int. Cl.: 14

TRADEMARK

PRINCIPAL REGISTER

REDDIT, INC. (DELAWARE CORPORATION)
520 THIRD STREET
SAN FRANCISCO, CA 94107

FOR: WATCHES, IN CLASS 14 (U.S. CLS. 2, 27, 28 AND 50).

FIRST USE 3-31-2012; IN COMMERCE 3-31-2012.

OWNER OF U.S. REG. NO. 3,474,493.

THE COLOR(S) BLACK AND ORANGE IS/ARE CLAIMED AS A FEATURE OF THE MARK.

THE MARK CONSISTS OF A STYLIZED ALIEN WITH BLACK OUTLINE AND ORANGE EYES.

SN 85-461,389, FILED 11-1-2011.

JULIE VEPPUMTHARA, EXAMINING ATTORNEY



David J. Kyffers

Director of the United States Patent and Trademark Office

United States of America

United States Patent and Trademark Office



Reg. No. 4,207,748

Registered Sep. 11, 2012

Int. Cl.: 38

SERVICE MARK

PRINCIPAL REGISTER

MGM NETWORKS LATIN AMERICA LLC (DELAWARE LIMITED LIABILITY COMPANY)
NORTH TOWER- 10TH FLOOR
800 DOUGLAS ROAD
CORAL GABLES, FL 33134

FOR: COMMUNICATION SERVICES, NAMELY, BROADCAST OF EDUCATIONAL AND ENTERTAINMENT PROGRAMS, IN THE NATURE OF TELEVISION PROGRAMS, VIA SATELLITE, CABLE, FIBER OPTICS, AND GLOBAL COMPUTER NETWORK, IN CLASS 38 (U.S. CLS. 100, 101 AND 104).

FIRST USE 2-14-2012; IN COMMERCE 2-14-2012.

NO CLAIM IS MADE TO THE EXCLUSIVE RIGHT TO USE "CANAL", APART FROM THE MARK AS SHOWN.

THE MARK CONSISTS OF THE DESIGN OF A BUTTERFLY WITH WINGS SPREAD; THE WORD "ELLA" IN LOWER CASE LETTERS APPEARS BELOW THE BUTTERFLY; THE WORD "CANAL" APPEARS BENEATH THE BUTTERFLY AND ABOVE THE "E" IN "ELLA".

SN 85-462,633, FILED 11-2-2011.

TINA L. SNAPP, EXAMINING ATTORNEY



David J. Kyffers

Director of the United States Patent and Trademark Office

United States of America

United States Patent and Trademark Office



Reg. No. 4,207,749

Registered Sep. 11, 2012

Int. Cl.: 26

TRADEMARK

PRINCIPAL REGISTER

SAVE YOUR DO, LLC (CALIFORNIA LIMITED LIABILITY COMPANY)
1475 N. BROADWAY, SUITE 400
WALNUT CREEK, CA 94596

FOR: HAIR WRAPS FOR USE IN WORKING OUT, FOR THE PURPOSE OF KEEPING ONE'S HAIR FLAT AND FOR MINIMIZING SWEAT ABSORPTION, IN CLASS 26 (U.S. CLS. 37, 39, 40, 42 AND 50).

FIRST USE 4-5-2011; IN COMMERCE 12-1-2011.

THE MARK CONSISTS OF A SWEAT DROP WITH A SILHOUETTE FACE INSIDE THE SWEAT DROP. BELOW THERE IS THE STYLIZED TEXT "SAVE YOUR DO".

SN 85-462,801, FILED 11-2-2011.

TINA MAI, EXAMINING ATTORNEY



David J. Kyffers

Director of the United States Patent and Trademark Office

United States of America

United States Patent and Trademark Office

Exhale Skin Care

Reg. No. 4,207,750

SKIN CARE LABS LLC (MASSACHUSETTS LIMITED LIABILITY COMPANY)
725 HAMMOND ST.

Registered Sep. 11, 2012

CHESTNUT HILL, MA 02467

Int. Cl.: 3

FOR: ANTI-AGING MOISTURIZER; BEAUTY GELS; BODY SCRUB; FACIAL MOISTURIZER WITH SPF; FACIAL SCRUBS; FOOT SCRUBS; HAND SCRUBS; SHAVING CREAMS; SKIN MOISTURIZER; SUNSCREEN CREAM, IN CLASS 3 (U.S. CLS. 1, 4, 6, 50, 51 AND 52).

TRADEMARK

FIRST USE 5-12-2012; IN COMMERCE 5-12-2012.

PRINCIPAL REGISTER

THE MARK CONSISTS OF STANDARD CHARACTERS WITHOUT CLAIM TO ANY PARTICULAR FONT, STYLE, SIZE, OR COLOR.

NO CLAIM IS MADE TO THE EXCLUSIVE RIGHT TO USE "SKIN CARE", APART FROM THE MARK AS SHOWN.

SN 85-463,765, FILED 11-3-2011.

STEPHANIE ALI, EXAMINING ATTORNEY



David J. Kyros

Director of the United States Patent and Trademark Office

United States of America

United States Patent and Trademark Office

RAIN ENERGY WATER

Reg. No. 4,207,751

DYBNIS, MICHAEL ZEV (UNITED STATES INDIVIDUAL)
356 N. SKYEWIAY ROAD.
LOS ANGELES, CA 90049

Registered Sep. 11, 2012

Int. Cl.: 5

FOR: AROMATIZED BEVERAGES BASED ON FRUIT, PROTEIN, CORDIAL, SUGAR AND OTHER FLUID NUTRIENTS, NAMELY, MEAL REPLACEMENT DRINKS FOR USE AS A FOOD FILLERS; DIETARY SUPPLEMENTAL DRINKS; ELECTROLYTE DRINKS FOR MEDICAL PURPOSES, IN CLASS 5 (U.S. CLS. 6, 18, 44, 46, 51 AND 52).

TRADEMARK

PRINCIPAL REGISTER

FIRST USE 6-29-2012; IN COMMERCE 6-29-2012.

THE MARK CONSISTS OF STANDARD CHARACTERS WITHOUT CLAIM TO ANY PARTICULAR FONT, STYLE, SIZE, OR COLOR.

NO CLAIM IS MADE TO THE EXCLUSIVE RIGHT TO USE "ENERGY WATER", APART FROM THE MARK AS SHOWN.

SN 85-463,926, FILED 11-3-2011.

MARGERY A. TIERNEY, EXAMINING ATTORNEY



David J. Kyros

Director of the United States Patent and Trademark Office

United States of America

United States Patent and Trademark Office

RELYANT

Reg. No. 4,207,752

NORDENT MANUFACTURING, INC. (ILLINOIS CORPORATION)
610 BONNIE LANE

Registered Sep. 11, 2012

ELK GROVE VILLAGE, IL 60007

Int. Cl.: 10

FOR: DENTAL INSTRUMENTS, NAMELY, CURETTES AND SCALERS, IN CLASS 10 (U.S. CLS. 26, 39 AND 44).

TRADEMARK

FIRST USE 12-19-2011; IN COMMERCE 12-19-2011.

PRINCIPAL REGISTER

THE MARK CONSISTS OF STANDARD CHARACTERS WITHOUT CLAIM TO ANY PARTICULAR FONT, STYLE, SIZE, OR COLOR.

SN 85-464,120, FILED 11-3-2011.

WILLIAM VERHOSEK, EXAMINING ATTORNEY



David J. Kybas

Director of the United States Patent and Trademark Office

United States of America
United States Patent and Trademark Office

Relyant

Reg. No. 4,207,753

NORDENT MANUFACTURING, INC. (ILLINOIS CORPORATION)
610 BONNIE LANE

Registered Sep. 11, 2012

ELK GROVE VILLAGE, IL 60007

Int. Cl.: 10

FOR: DENTAL INSTRUMENTS, NAMELY, CURETTES AND SCALERS, IN CLASS 10 (U.S. CLS. 26, 39 AND 44).

TRADEMARK

FIRST USE 12-19-2011; IN COMMERCE 12-19-2011.

PRINCIPAL REGISTER

THE MARK CONSISTS OF THE WORD "RELYANT" WITH A HORIZONTAL CURVED LINE EXTENDING THE LENGTH OF THE BOTTOM OF THE WORD AND TOUCHING THE "Y".

SN 85-464,126, FILED 11-3-2011.

WILLIAM VERHOSEK, EXAMINING ATTORNEY



David J. Kybas

Director of the United States Patent and Trademark Office

United States of America

United States Patent and Trademark Office

Nutty Cow

Reg. No. 4,207,754

NUTTY COW INC. (TEXAS CORPORATION)
36 HAYNES RD
WEST HARTFORD, CT 06117

Registered Sep. 11, 2012

Int. Cls.: 5 and 29

FOR: FOODS AND SNACKS WHICH ARE FREE OF MILK TO ACCOMMODATE SPECIAL MEDICAL AND HEALTH CONDITIONS, IN CLASS 5 (U.S. CLS. 6, 18, 44, 46, 51 AND 52).

TRADEMARK

FIRST USE 11-4-2011; IN COMMERCE 11-9-2011.

PRINCIPAL REGISTER

FOR: CHEESE SUBSTITUTES; CHEESE, NAMELY, RICOTTA; NUT CHEESE, NAMELY, CHEESE-TYPE PRODUCT MADE FROM NUTS, IN CLASS 29 (U.S. CL. 46).

FIRST USE 11-4-2011; IN COMMERCE 11-9-2011.

THE MARK CONSISTS OF STANDARD CHARACTERS WITHOUT CLAIM TO ANY PARTICULAR FONT, STYLE, SIZE, OR COLOR.

NO CLAIM IS MADE TO THE EXCLUSIVE RIGHT TO USE "NUTTY", APART FROM THE MARK AS SHOWN.

SN 85-464,567, FILED 11-4-2011.

ELLEN BURNS, EXAMINING ATTORNEY



David J. Kyros

Director of the United States Patent and Trademark Office

United States of America

United States Patent and Trademark Office

My After

Reg. No. 4,207,755

Registered Sep. 11, 2012

Int. Cl.: 35

SERVICE MARK

PRINCIPAL REGISTER

NATIONAL FLUID MILK PROCESSOR PROMOTION BOARD (UNITED STATES
NON-CORPORATE BOARD CREATED PURSUANT TO THE FLUID MILK PROMOTION
ACT OF 1990 (7 USC 6401-6417))
1250 H STREET, NW
WASHINGTON, DC 20005

FOR: PROMOTING PUBLIC AWARENESS OF THE BENEFITS OF FLUID MILK AND
FLUID MILK PRODUCTS THROUGH ADVERTISING VIA THE INTERNET AND ALL
PUBLIC COMMUNICATION MEANS; PROMOTING THE INTERESTS OF FLUID MILK
PROCESSORS, IN CLASS 35 (U.S. CLS. 100, 101 AND 102).

FIRST USE 3-10-2012; IN COMMERCE 3-10-2012.

THE MARK CONSISTS OF STANDARD CHARACTERS WITHOUT CLAIM TO ANY PAR-
TICULAR FONT, STYLE, SIZE, OR COLOR.

SN 85-464,769, FILED 11-4-2011.

ANDREW LEASER, EXAMINING ATTORNEY



David J. Kyros

Director of the United States Patent and Trademark Office

United States of America

United States Patent and Trademark Office

Our After

Reg. No. 4,207,756

Registered Sep. 11, 2012

Int. Cl.: 35

SERVICE MARK

PRINCIPAL REGISTER

NATIONAL FLUID MILK PROCESSOR PROMOTION BOARD (UNITED STATES
NON-CORPORATE BOARD CREATED PURSUANT TO THE FLUID MILK PROMOTION
ACT OF 1990 (7 USC 6401-6417))
1250 H STREET, NW
WASHINGTON, DC 20005

FOR: PROMOTING PUBLIC AWARENESS OF THE BENEFITS OF FLUID MILK AND
FLUID MILK PRODUCTS THROUGH ADVERTISING VIA THE INTERNET AND ALL
PUBLIC COMMUNICATION MEANS; PROMOTING THE INTERESTS OF FLUID MILK
PROCESSORS, IN CLASS 35 (U.S. CLS. 100, 101 AND 102).

FIRST USE 3-10-2012; IN COMMERCE 3-10-2012.

THE MARK CONSISTS OF STANDARD CHARACTERS WITHOUT CLAIM TO ANY PAR-
TICULAR FONT, STYLE, SIZE, OR COLOR.

SN 85-464,816, FILED 11-4-2011.

ANDREW LEASER, EXAMINING ATTORNEY



David J. Kyros

Director of the United States Patent and Trademark Office

United States of America

United States Patent and Trademark Office

UNIQFORM

Reg. No. 4,207,757

CARTE BLANCHE, LLC (CALIFORNIA LIMITED LIABILITY COMPANY)
4930 SAINT ANDREWS AVENUE
BUENA PARK, CA 90621

Registered Sep. 11, 2012

Int. Cl.: 10

FOR: MEN'S AND WOMEN'S MEDICAL SCRUB PANTS, SCRUB TOPS, AND SURGICAL SCRUB SUITS, IN CLASS 10 (U.S. CLS. 26, 39 AND 44).

TRADEMARK

FIRST USE 6-15-2012; IN COMMERCE 6-15-2012.

PRINCIPAL REGISTER

THE MARK CONSISTS OF STANDARD CHARACTERS WITHOUT CLAIM TO ANY PARTICULAR FONT, STYLE, SIZE, OR COLOR.

SN 85-464,977, FILED 11-4-2011.

MARCIE MILONE, EXAMINING ATTORNEY



David J. Kyffers

Director of the United States Patent and Trademark Office

United States of America

United States Patent and Trademark Office

AQUASOL

Reg. No. 4,207,758

PAREX USA, INC. (CALIFORNIA CORPORATION)
4125 E. LA PALMA AVE SUITE 250
ANAHEIM, CA 92807

Registered Sep. 11, 2012

Int. Cl.: 2

FOR: COATINGS FOR EIFS (EXTERNAL INSULATION FINISHING SYSTEMS); COATINGS IN THE NATURE OF AN ACRYLIC FINISH TO BE APPLIED OVER CEMENT, STUCCO OR EIFS (EXTERIOR INSULATION FINISHING SYSTEM); PAINTS; PRESERVATIVE COATINGS FOR INSULATION, DRYWALL, AND MASONRY, IN CLASS 2 (U.S. CLS. 6, 11 AND 16).

TRADEMARK

PRINCIPAL REGISTER

FIRST USE 11-1-2011; IN COMMERCE 11-1-2011.

THE MARK CONSISTS OF STANDARD CHARACTERS WITHOUT CLAIM TO ANY PARTICULAR FONT, STYLE, SIZE, OR COLOR.

SN 85-464,983, FILED 11-4-2011.

MARK SHINER, EXAMINING ATTORNEY



David J. Kyffers

Director of the United States Patent and Trademark Office

United States of America

United States Patent and Trademark Office

ADEYEMI

Reg. No. 4,207,759

BENNETT, ADEYEMI (UNITED STATES INDIVIDUAL)
5763 CAZAUX DRIVE
LOS ANGELES, CA 90068

Registered Sep. 11, 2012

Int. Cl.: 25

FOR: MENS AND WOMENS APPAREL, NAMELY, SHIRTS, PANTS, JACKETS, FOOTWEAR, HATS AND CAPS, GLOVES, SOCKS, BEANIES, SCARFS, IN CLASS 25 (U.S. CLS. 22 AND 39).

TRADEMARK

FIRST USE 6-1-2012; IN COMMERCE 6-1-2012.

PRINCIPAL REGISTER

THE MARK CONSISTS OF STANDARD CHARACTERS WITHOUT CLAIM TO ANY PARTICULAR FONT, STYLE, SIZE, OR COLOR.

THE NAME "ADEYEMI" IDENTIFIES A LIVING INDIVIDUAL WHOSE CONSENT IS OF RECORD.

SN 85-464,996, FILED 11-4-2011.

MICHAEL ENGEL, EXAMINING ATTORNEY



David J. Kyffers

Director of the United States Patent and Trademark Office

United States of America

United States Patent and Trademark Office

what's your type

Reg. No. 4,207,760

SHIPMAN ASSOCIATES, INC. (DELAWARE CORPORATION), DBA THEBALM,
2130 FILLMORE #303

Registered Sep. 11, 2012

SAN FRANCISCO, CA 94108

Int. Cl.: 3

FOR: BLUSH; BODY AND BEAUTY CARE COSMETICS; COLOGNES, PERFUMES AND COSMETICS; CONCEALERS; COSMETIC CREAMS; COSMETIC PENCILS; COSMETIC PREPARATIONS; COSMETIC ROUGES; COSMETICS; COSMETICS AND COSMETIC PREPARATIONS; COSMETICS AND MAKE-UP; COSMETICS IN GENERAL, INCLUDING PERFUMES; COSMETICS, NAMELY, COMPACTS; COSMETICS, NAMELY, LIP PRIMER; CREAMY ROUGES; EYEBROW COSMETICS; EYESHADOWS; FACIAL MAKE-UP; GLITTER FOR COSMETIC PURPOSES; LOTIONS FOR COSMETIC PURPOSES; MAKE UP FOUNDATIONS; MAKE-UP FOR THE FACE AND BODY; MAKE-UP PENCILS; MAKE-UP POWDER; MAKE-UP PREPARATIONS; NAIL VARNISH FOR COSMETIC PURPOSES; PENCILS FOR COSMETIC PURPOSES; PETROLEUM JELLY FOR COSMETIC PURPOSES; SKIN CONDITIONING CREAMS FOR COSMETIC PURPOSES, IN CLASS 3 (U.S. CLS. 1, 4, 6, 50, 51 AND 52).

TRADEMARK

PRINCIPAL REGISTER

FIRST USE 6-1-2012; IN COMMERCE 6-1-2012.

THE MARK CONSISTS OF STANDARD CHARACTERS WITHOUT CLAIM TO ANY PARTICULAR FONT, STYLE, SIZE, OR COLOR.

SN 85-465,239, FILED 11-4-2011.

BENJAMIN OKEKE, EXAMINING ATTORNEY



David J. Kyffers

Director of the United States Patent and Trademark Office

United States of America

United States Patent and Trademark Office

Myst Applied

Reg. No. 4,207,761

Registered Sep. 11, 2012

Int. Cl.: 41

SERVICE MARK

PRINCIPAL REGISTER

DI TOMASSO, DON N. (UNITED STATES INDIVIDUAL)
218
4727 W. 147TH ST.
LAWNDALE, CA 90260

FOR: MUSIC COMPOSITION SERVICES; MUSIC PRODUCTION SERVICES; MUSIC PUBLISHING SERVICES, IN CLASS 41 (U.S. CLS. 100, 101 AND 107).

FIRST USE 1-1-2003; IN COMMERCE 11-6-2011.

THE MARK CONSISTS OF STANDARD CHARACTERS WITHOUT CLAIM TO ANY PARTICULAR FONT, STYLE, SIZE, OR COLOR.

SN 85-465,564, FILED 11-6-2011.

CHRISTOPHER LAW, EXAMINING ATTORNEY



David J. Kyffers

Director of the United States Patent and Trademark Office

United States of America

United States Patent and Trademark Office

OD HOUSEHOLD SERVICES

Reg. No. 4,207,762

Registered Sep. 11, 2012

Int. Cl.: 39

SERVICE MARK

PRINCIPAL REGISTER

OLD DOMINION FREIGHT LINE, INC. (VIRGINIA CORPORATION)
500 OLD DOMINION WAY
THOMASVILLE, NC 27360

FOR: TRANSPORTATION SERVICES, NAMELY, THE TRANSPORTATION OF FREIGHT FOR OTHERS BY TRUCK, TRAIN AND AIR; MOVING SERVICES, NAMELY, TRANSPORTATION OF HOUSEHOLD GOODS OF OTHERS, IN CLASS 39 (U.S. CLS. 100 AND 105).

FIRST USE 5-0-2012; IN COMMERCE 5-0-2012.

THE MARK CONSISTS OF STANDARD CHARACTERS WITHOUT CLAIM TO ANY PARTICULAR FONT, STYLE, SIZE, OR COLOR.

OWNER OF U.S. REG. NOS. 2,732,250, 2,911,225, AND OTHERS.

NO CLAIM IS MADE TO THE EXCLUSIVE RIGHT TO USE "HOUSEHOLD SERVICES", APART FROM THE MARK AS SHOWN.

SN 85-465,979, FILED 11-7-2011.

MICHAEL TANNER, EXAMINING ATTORNEY



David J. Kyffers

Director of the United States Patent and Trademark Office

United States of America

United States Patent and Trademark Office

MICHELLE'S FARMS

Reg. No. 4,207,763

PANE D'ORO FOOD COMPANY LLC (NEW YORK LIMITED LIABILITY COMPANY)
ONE OLYMPIC DRIVE
ORANGEBURG, NY 10962

Registered Sep. 11, 2012

Int. Cl.: 29

FOR: CHEESE; CHEESE, NAMELY, GRATED CHEESE; PROCESSED CHEESE, IN CLASS 29 (U.S. CL. 46).

TRADEMARK

FIRST USE 6-11-2011; IN COMMERCE 6-11-2011.

PRINCIPAL REGISTER

THE MARK CONSISTS OF STANDARD CHARACTERS WITHOUT CLAIM TO ANY PARTICULAR FONT, STYLE, SIZE, OR COLOR.

NO CLAIM IS MADE TO THE EXCLUSIVE RIGHT TO USE "FARMS", APART FROM THE MARK AS SHOWN.

THE NAME(S), PORTRAIT(S), AND/OR SIGNATURE(S) SHOWN IN THE MARK DOES NOT IDENTIFY A PARTICULAR LIVING INDIVIDUAL.

SN 85-465,996, FILED 11-7-2011.

SUSAN RICHARDS, EXAMINING ATTORNEY



David J. Kyffers

Director of the United States Patent and Trademark Office

United States of America

United States Patent and Trademark Office



Reg. No. 4,207,764

Registered Sep. 11, 2012

Int. Cl.: 44

SERVICE MARK

PRINCIPAL REGISTER

STAR ABA NETWORK, INC (CALIFORNIA CORPORATION)
205 SYCAMORE GROVE ST
SIMI VALLEY, CA 93065

FOR: BEHAVIORAL HEALTH SERVICES, NAMELY, APPLIED BEHAVIOR ANALYSIS TREATMENT FOR CHILDREN WITH AUTISM SPECTRUM DISORDERS AND RELATED DISORDERS, IN CLASS 44 (U.S. CLS. 100 AND 101).

FIRST USE 11-2-2011; IN COMMERCE 11-2-2011.

NO CLAIM IS MADE TO THE EXCLUSIVE RIGHT TO USE "THE ABA NETWORK", APART FROM THE MARK AS SHOWN.

THE STIPPLING IS FOR SHADING PURPOSES ONLY.

THE MARK CONSISTS OF A CIRCULAR PUZZLE PIECES. IN THE MIDDLE THERE IS THE STYLIZED TEXT "THE ABA NETWORK".

SN 85-466,872, FILED 11-8-2011.

MARY CRAWFORD, EXAMINING ATTORNEY



David J. Kyffers

Director of the United States Patent and Trademark Office

United States of America

United States Patent and Trademark Office

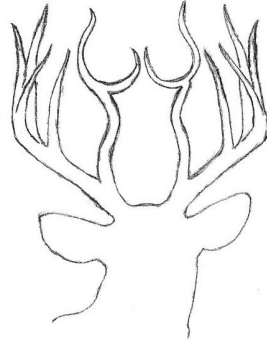

Reg. No. 4,207,765

JASON ADAMS (UNITED STATES INDIVIDUAL)
29009 SHANNON CT.
MECHANICSVILLE, MD 20659

Registered Sep. 11, 2012

Int. Cls.: 16 and 25

FOR: DECALS; DECORATIVE DECALS FOR VEHICLE WINDOWS; STICKERS AND TRANSFERS, IN CLASS 16 (U.S. CLS. 2, 5, 22, 23, 29, 37, 38 AND 50).

TRADEMARK

FIRST USE 11-9-2011; IN COMMERCE 12-10-2011.

PRINCIPAL REGISTER

FOR: HATS; SHIRTS, IN CLASS 25 (U.S. CLS. 22 AND 39).

FIRST USE 10-26-2011; IN COMMERCE 10-26-2011.

THE MARK CONSISTS OF AN OUTLINE OF A DEER'S HEAD WITH ANTLERS.

SN 85-468,017, FILED 11-9-2011.

DAVID MURRAY, EXAMINING ATTORNEY



David J. Kybas

Director of the United States Patent and Trademark Office

United States of America

United States Patent and Trademark Office

FRANKEN MAMA

Reg. No. 4,207,766

Registered Sep. 11, 2012

Int. Cl.: 9

TRADEMARK

PRINCIPAL REGISTER

UNIVERSAL ENTERTAINMENT CORPORATION (JAPAN CORPORATION)
ARIAKE FRONTIER BUILDING, TOWER A
3-7-26 ARIAKE
KOTO-KU, TOKYO, JAPAN 135-0063

FOR: SLOT MACHINES AND REPLACEMENT PARTS THEREFOR; VIDEO SLOT MACHINES AND REPLACEMENT PARTS THEREFOR; GAMING MACHINES AND REPLACEMENT PARTS THEREFOR; GAMING MACHINES WITH A LIQUID CRYSTAL DISPLAY AND REPLACEMENT PARTS THEREFOR; MECHANICAL REEL TYPE SLOT MACHINES WITH A LIQUID CRYSTAL DISPLAY AND REPLACEMENT PARTS THEREFOR; SLOT MACHINES AND GAMING MACHINES AND COMPUTER GAME SOFTWARE FOR SLOT MACHINES AND GAMING MACHINES INCLUDED THEREIN, IN CLASS 9 (U.S. CLS. 21, 23, 26, 36 AND 38).

FIRST USE 10-4-2011; IN COMMERCE 10-4-2011.

THE MARK CONSISTS OF STANDARD CHARACTERS WITHOUT CLAIM TO ANY PARTICULAR FONT, STYLE, SIZE, OR COLOR.

SN 85-468,774, FILED 11-9-2011.

TEJBIR SINGH, EXAMINING ATTORNEY



David J. Kyffers

Director of the United States Patent and Trademark Office

United States of America

United States Patent and Trademark Office

netduino go!

Reg. No. 4,207,767

SECRET LABS LLC (DELAWARE LIMITED LIABILITY COMPANY)
174 W 4TH ST # 207

Registered Sep. 11, 2012

NEW YORK, NY 10014

Int. Cl.: 9

FOR: COMPUTER HARDWARE; COMPUTER HARDWARE FOR ASSEMBLING CUSTOM ELECTRICAL AND ELECTRONIC DEVICES; ELECTRONIC CIRCUIT BOARD, IN CLASS 9 (U.S. CLS. 21, 23, 26, 36 AND 38).

TRADEMARK

FIRST USE 4-30-2012; IN COMMERCE 4-30-2012.

PRINCIPAL REGISTER

THE MARK CONSISTS OF STANDARD CHARACTERS WITHOUT CLAIM TO ANY PARTICULAR FONT, STYLE, SIZE, OR COLOR.

OWNER OF U.S. REG. NO. 3,971,461.

SN 85-469,131, FILED 11-10-2011.

TARAH HARDY, EXAMINING ATTORNEY



David J. Kyffers

Director of the United States Patent and Trademark Office

United States of America

United States Patent and Trademark Office

HUNTING ADVENTURES

Reg. No. 4,207,768

ROCKY TRAIL PRODUCTIONS, LLC (WISCONSIN LIMITED LIABILITY COMPANY)
15730 W. NATIONAL AVE., 3RD FLOOR
NEW BERLIN, WI 53151

Registered Sep. 11, 2012

Int. Cl.: 41

FOR: ENTERTAINMENT SERVICES, NAMELY, A CONTINUING TELEVISION HUNTING PROGRAM BROADCAST ON CABLE NETWORKS, IN CLASS 41 (U.S. CLS. 100, 101 AND 107).

SERVICE MARK

FIRST USE 6-0-1995; IN COMMERCE 6-0-1995.

PRINCIPAL REGISTER

THE MARK CONSISTS OF STANDARD CHARACTERS WITHOUT CLAIM TO ANY PARTICULAR FONT, STYLE, SIZE, OR COLOR.

OWNER OF U.S. REG. NO. 3,145,278.

NO CLAIM IS MADE TO THE EXCLUSIVE RIGHT TO USE "HUNTING", APART FROM THE MARK AS SHOWN.

SN 85-469,527, FILED 11-10-2011.

REBECCA POVARCHUK, EXAMINING ATTORNEY



David J. Kyffers

Director of the United States Patent and Trademark Office

United States of America

United States Patent and Trademark Office

Alueur

Reg. No. 4,207,769

SCENTIMENTALS (TEXAS LIMITED LIABILITY COMPANY)
3917 INWOOD RD.

Registered Sep. 11, 2012

FT. WORTH, TX 76109

Int. Cl.: 4

FOR: AROMATHERAPY FRAGRANCE CANDLES; CANDLES; CANDLES AND WICKS FOR CANDLES FOR LIGHTING; CANDLES FOR LIGHTING; PERFUMED CANDLES; SCENTED CANDLES; TEA LIGHT CANDLES; WICKS FOR CANDLES , IN CLASS 4 (U.S. CLS. 1, 6 AND 15).

TRADEMARK

PRINCIPAL REGISTER

FIRST USE 7-12-2010; IN COMMERCE 3-21-2012.

THE WORDING "ALUEUR" HAS NO MEANING IN A FOREIGN LANGUAGE.

SN 85-469,548, FILED 11-10-2011.

DANNEAN HETZEL, EXAMINING ATTORNEY



David J. Kyffers

Director of the United States Patent and Trademark Office

United States of America

United States Patent and Trademark Office

CLEAR DAYS AHEAD

Reg. No. 4,207,770

PHILOSOPHY, INC. (ARIZONA CORPORATION)
3809 EAST WATKINS STREET
PHOENIX, AZ 85034

Registered Sep. 11, 2012

Int. Cls.: 3 and 5

FOR: NON-MEDICATED SKIN CARE PREPARATIONS, NAMELY, CLEANSING GEL, SPOT BLEMISH TREATMENT, ACNE TREATMENT AND MOISTURIZER, OVERNIGHT REPAIRING PADS, AND CONCEALING TREATMENT, WITH THE EXCEPTION OF BODY CREAMS, IN CLASS 3 (U.S. CLS. 1, 4, 6, 50, 51 AND 52).

TRADEMARK

PRINCIPAL REGISTER

FIRST USE 3-30-2012; IN COMMERCE 3-30-2012.

FOR: MEDICATED SKIN CARE PREPARATIONS, NAMELY, CLEANSING GEL, SPOT BLEMISH TREATMENT, ACNE TREATMENT AND MOISTURIZER, OVERNIGHT REPAIRING PADS, AND CONCEALING TREATMENT, IN CLASS 5 (U.S. CLS. 6, 18, 44, 46, 51 AND 52).

FIRST USE 3-30-2012; IN COMMERCE 3-30-2012.

THE MARK CONSISTS OF STANDARD CHARACTERS WITHOUT CLAIM TO ANY PARTICULAR FONT, STYLE, SIZE, OR COLOR.

SN 85-469,549, FILED 11-10-2011.

JULIE WATSON, EXAMINING ATTORNEY



David J. Kyffers

Director of the United States Patent and Trademark Office

United States of America

United States Patent and Trademark Office

GEOSAVVY

Reg. No. 4,207,771

ONTERRA SYSTEMS LLC (COLORADO LIMITED LIABILITY COMPANY)
P.O. BOX 630692

Registered Sep. 11, 2012

HIGHLANDS RANCH, CO 80163

Int. Cls.: 9 and 42

FOR: COMPUTER PROGRAMS FOR ENABLING INDIVIDUALS AND ORGANIZATIONS TO MAP GEOGRAPHICALLY-RELATED DATA, IN CLASS 9 (U.S. CLS. 21, 23, 26, 36 AND 38).

TRADEMARK

FIRST USE 5-1-2012; IN COMMERCE 5-1-2012.

SERVICE MARK

FOR: COMPUTER SOFTWARE DESIGN; COMPUTER SOFTWARE CONSULTANCY IN THE FIELD OF MAPPING GEOGRAPHICALLY-RELATED DATA; DESIGN AND DEVELOPMENT OF COMPUTER SOFTWARE FOR MAPPING GEOGRAPHICALLY-RELATED DATA, IN CLASS 42 (U.S. CLS. 100 AND 101).

PRINCIPAL REGISTER

FIRST USE 5-1-2012; IN COMMERCE 5-1-2012.

THE MARK CONSISTS OF STANDARD CHARACTERS WITHOUT CLAIM TO ANY PARTICULAR FONT, STYLE, SIZE, OR COLOR.

SN 85-470,052, FILED 11-11-2011.

JAY FLOWERS, EXAMINING ATTORNEY



David J. Kypos

Director of the United States Patent and Trademark Office

United States of America

United States Patent and Trademark Office

SLIP

Reg. No. 4,207,772

CHIP SLIP, LLC (NEW YORK LIMITED LIABILITY COMPANY)
726 LORIMER STREET, SUITE 2R
BROOKLYN, NY 11211

Registered Sep. 11, 2012

Int. Cl.: 16

FOR: VINYL SLEEVES FOR ORGANIZING, ARCHIVING, AND DISPLAYING COLOR MATCHING CHIPS, IN CLASS 16 (U.S. CLS. 2, 5, 22, 23, 29, 37, 38 AND 50).

TRADEMARK

FIRST USE 2-27-2012; IN COMMERCE 2-27-2012.

PRINCIPAL REGISTER

THE MARK CONSISTS OF STANDARD CHARACTERS WITHOUT CLAIM TO ANY PARTICULAR FONT, STYLE, SIZE, OR COLOR.

SN 85-470,125, FILED 11-11-2011.

LEIGH CAROLINE CASE, EXAMINING ATTORNEY



David J. Kyffers

Director of the United States Patent and Trademark Office

United States of America

United States Patent and Trademark Office



TRUSTED COMPANIONS DURING MEDICAL CARE

Reg. No. 4,207,773

Registered Sep. 11, 2012

Int. Cl.: 44

SERVICE MARK

PRINCIPAL REGISTER

THERE4U, LLC (PENNSYLVANIA LIMITED LIABILITY COMPANY)
1150 FIRST AVE. STE 511
KING OF PRUSSIA, PA 19406

FOR: MEDICAL ASSISTANCE SERVICES, IN CLASS 44 (U.S. CLS. 100 AND 101).

FIRST USE 9-1-2011; IN COMMERCE 12-8-2011.

NO CLAIM IS MADE TO THE EXCLUSIVE RIGHT TO USE "MEDICAL CARE", APART FROM THE MARK AS SHOWN.

THE COLOR(S) BLUE AND GREEN IS/ARE CLAIMED AS A FEATURE OF THE MARK.

THE MARK CONSISTS OF A DESIGN THAT DEPICTS A SHAPE OF A SQUARE IN THE COLOR OF BLUE JOINED TO A DIAMOND SHAPE IN THE COLOR OF GREEN, DIRECTLY BELOW IS A REFLECTION OF THE SQUARE DESIGN. DIRECTLY BELOW IS THE WORDING "THERE4U" IN STYLIZED FONT IN THE COLOR OF BLUE WITH THE NUMBER "4" IN THE COLOR OF GREEN. DIRECTLY BELOW IS THE REFLECTION OF THE WORDING "THERE4U". DIRECTLY BELOW IS THE WORDING "TRUSTED COMPANIONS DURING MEDICAL CARE" IN STYLIZED FONT IN THE COLOR OF BLUE.

SN 85-470,275, FILED 11-11-2011.

NICHOLAS COLEMAN, EXAMINING ATTORNEY



David J. Kybas

Director of the United States Patent and Trademark Office

United States of America

United States Patent and Trademark Office

MURDER

MURDER^{and}
ANARCHYTM.com

Reg. No. 4,207,774

BLAUW, CHRISTOPHER (UNITED STATES INDIVIDUAL)
4075 MISSISSIPPI ST #8
SAN DIEGO, CA 92104

Registered Sep. 11, 2012

Int. Cl.: 25

FOR: CLOTHING, NAMELY, TOPS, BOTTOMS, SHIRTS, T-SHIRTS, JACKETS, SWEAT-SHIRTS, PANTS, SHOES, HATS, IN CLASS 25 (U.S. CLS. 22 AND 39).

TRADEMARK

FIRST USE 3-1-2011; IN COMMERCE 5-1-2011.

PRINCIPAL REGISTER

SN 85-470,431, FILED 11-11-2011.

KIMBERLY FRYE, EXAMINING ATTORNEY



David J. Kybas

Director of the United States Patent and Trademark Office

United States of America

United States Patent and Trademark Office



Reg. No. 4,207,775

ROBERT S. BRODER, PLLC (NEW YORK PROFESSIONAL LIMITED LIABILITY COMPANY)
2903 PRESTON LANE
MERRICK, NY 11566

Registered Sep. 11, 2012

Int. Cl.: 45

FOR: LEGAL SERVICES, IN CLASS 45 (U.S. CLS. 100 AND 101).

SERVICE MARK

FIRST USE 5-4-2012; IN COMMERCE 5-4-2012.

PRINCIPAL REGISTER

THE MARK CONSISTS OF A VERTICAL HAND WITH INDEX AND THUMB OUTSTRETCHED AND THREE INVERTED TRIANGLES ABOVE AND BETWEEN THOSE FINGERS, THE OTHER THREE FINGERS ARE FOLDED INTO THE PALM OF THE HAND. THE HORIZONTAL TEXT "TRADEMARKSNAP" IS TO THE RIGHT OF THE HAND AND THE HORIZONTAL TEXT "IT'S AS EASY AS THAT!" APPEARS BELOW.

SN 85-471,239, FILED 11-13-2011.

MIDGE BUTLER, EXAMINING ATTORNEY



David J. Kybas

Director of the United States Patent and Trademark Office

United States of America

United States Patent and Trademark Office



Verebon

Reg. No. 4,207,776

VEREBON, LLC (NEW YORK LIMITED LIABILITY COMPANY)
641 88TH STREET # 2B
BROOKLYN, NY 11228

Registered Sep. 11, 2012

Int. Cl.: 31

FOR: PET FOOD; PET TREATS, IN CLASS 31 (U.S. CLS. 1 AND 46).

FIRST USE 2-15-2012; IN COMMERCE 2-15-2012.

TRADEMARK

THE MARK CONSISTS OF THE STYLIZED WORD "VEREBON" IN WHITE ON A PURPLE RECTANGULAR BACKGROUND.

PRINCIPAL REGISTER

THE COLOR(S) PURPLE AND WHITE IS/ARE CLAIMED AS A FEATURE OF THE MARK.

SN 85-471,698, FILED 11-14-2011.

CHRISTINE MARTIN, EXAMINING ATTORNEY



David J. Kyffers

Director of the United States Patent and Trademark Office

United States of America

United States Patent and Trademark Office

LEGALRADIUS

Reg. No. 4,207,777

TRIALGRAPHIX, INC. (FLORIDA CORPORATION)
3300 CORPORATE WAY
MIRAMAR, FL 33025

Registered Sep. 11, 2012

Int. Cl.: 42

FOR: WEB-BASED NON-DOWNLOADABLE SOFTWARE FOR USE BY LAW FIRMS AND CORPORATIONS THAT ENABLES USERS TO JOINTLY ACCESS DOCUMENTS AND TRANSCRIPTS, ASSEMBLE AND COLLABORATE WITH WORKING GROUPS, AND MANAGE CASE MATERIALS FOR INVESTIGATIONS, MERGERS, TRIALS, HEARINGS, MEDIATIONS OR OTHER MATTERS, IN CLASS 42 (U.S. CLS. 100 AND 101).

SERVICE MARK

PRINCIPAL REGISTER

FIRST USE 1-24-2012; IN COMMERCE 1-24-2012.

THE MARK CONSISTS OF STANDARD CHARACTERS WITHOUT CLAIM TO ANY PARTICULAR FONT, STYLE, SIZE, OR COLOR.

SN 85-472,131, FILED 11-14-2011.

JOHN HWANG, EXAMINING ATTORNEY



David J. Kyffers

Director of the United States Patent and Trademark Office

United States of America
United States Patent and Trademark Office

TEQUIRITA

Reg. No. 4,207,778

GONSALEZ, FRANCISCO F. (UNITED STATES INDIVIDUAL)
30221 ROMERO CANYON ROAD
CASTIAC, CA 91384

Registered Sep. 11, 2012

Int. Cl.: 33

FOR: PREPARED ALCOHOLIC COCKTAIL, IN CLASS 33 (U.S. CLS. 47 AND 49).

TRADEMARK

FIRST USE 11-14-2011; IN COMMERCE 11-14-2011.

PRINCIPAL REGISTER

THE MARK CONSISTS OF STANDARD CHARACTERS WITHOUT CLAIM TO ANY PARTICULAR FONT, STYLE, SIZE, OR COLOR.

SN 85-472,251, FILED 11-14-2011.

AMY C. KEAN, EXAMINING ATTORNEY



David J. Kybas

Director of the United States Patent and Trademark Office

United States of America

United States Patent and Trademark Office



Reg. No. 4,207,779

Registered Sep. 11, 2012

Int. Cl.: 25

TRADEMARK

PRINCIPAL REGISTER

RINGA LLC (NEW YORK LIMITED LIABILITY COMPANY)
232 KNOLLWOOD AVE
MAMARONECK, NY 10543

FOR: BOTTOMS; T-SHIRTS; TOPS, IN CLASS 25 (U.S. CLS. 22 AND 39).

FIRST USE 10-1-2011; IN COMMERCE 5-20-2012.

THE MARK CONSISTS OF TWO UPRIGHT BOXING GLOVES ATTACHED AT THE BASE WITH LACES HANGING DOWN AND JOINED TOGETHER AT THE BOTTOM OF THE DESIGN. THE TWO GLOVES AND LACES FORM A HEART SHAPE. INSIDE A RECTANGLE ON THE WRIST OF THE RIGHT GLOVE IS THE TERM "RINGA" IN STYLIZED LETTERING.

SN 85-472,363, FILED 11-14-2011.

ANDREA K. NADELMAN, EXAMINING ATTORNEY



David J. Kybas

Director of the United States Patent and Trademark Office

United States of America

United States Patent and Trademark Office



Reg. No. 4,207,780

Registered Sep. 11, 2012

Int. Cl.: 35

SERVICE MARK

PRINCIPAL REGISTER

TEAM TAKEOVER MARKETING, LLC (FLORIDA LIMITED LIABILITY COMPANY)
6012 NATIVE WOOD DR.
TAMPA, FL 33625

FOR: MARKETING SERVICES, IN CLASS 35 (U.S. CLS. 100, 101 AND 102).

FIRST USE 5-24-2007; IN COMMERCE 6-1-2007.

NO CLAIM IS MADE TO THE EXCLUSIVE RIGHT TO USE "MARKETING", APART FROM THE MARK AS SHOWN.

THE COLOR(S) GREEN, GOLD AND BLACK IS/ARE CLAIMED AS A FEATURE OF THE MARK.

THE MARK CONSISTS OF THE WORDING "TTO TEAM TAKEOVER MARKETING". THE LETTERS "T", "T", AND "O" ARE WRITTEN VERTICALLY, WITH THE LETTERS "T" AND "T" IN GREEN, THE LETTER "O" IN GOLD, ALL OVER A GOLD SHADOW. THE WORDING "TEAM TAKEOVER MARKETING" IS TO THE RIGHT OF THE LETTERS "T" AND "T" IN BLACK, STACKED IN THREE LINES.

SN 85-472,457, FILED 11-15-2011.

JANET LEE, EXAMINING ATTORNEY



David J. Kybas

Director of the United States Patent and Trademark Office

United States of America
United States Patent and Trademark Office

NURADYNE

Reg. No. 4,207,781

WESTERN HOLDINGS, LLC (NEVADA LIMITED LIABILITY COMPANY)
1000 EAST WILLIAM STREET, SUITE 204
CARSON CITY, NV 89701

Registered Sep. 11, 2012

Int. Cl.: 5

FOR: DIETARY SUPPLEMENTS, IN CLASS 5 (U.S. CLS. 6, 18, 44, 46, 51 AND 52).

TRADEMARK

FIRST USE 5-21-2012; IN COMMERCE 5-21-2012.

PRINCIPAL REGISTER

THE MARK CONSISTS OF STANDARD CHARACTERS WITHOUT CLAIM TO ANY PARTICULAR FONT, STYLE, SIZE, OR COLOR.

SN 85-472,909, FILED 11-15-2011.

RONALD AIKENS, EXAMINING ATTORNEY



David J. Kyfos

Director of the United States Patent and Trademark Office

United States of America

United States Patent and Trademark Office

go!bus

Reg. No. 4,207,782

Registered Sep. 11, 2012

Int. Cl.: 9

TRADEMARK

PRINCIPAL REGISTER

SECRET LABS LLC (DELAWARE LIMITED LIABILITY COMPANY)
315 BLEECKER ST #308
NEW YORK, NY 10014

FOR: COMPUTER HARDWARE; COMPUTER HARDWARE SUBASSEMBLIES FOR ASSEMBLING CUSTOM ELECTRICAL AND ELECTRONIC DEVICES, IN CLASS 9 (U.S. CLS. 21, 23, 26, 36 AND 38).

FIRST USE 4-30-2012; IN COMMERCE 4-30-2012.

THE MARK CONSISTS OF STANDARD CHARACTERS WITHOUT CLAIM TO ANY PARTICULAR FONT, STYLE, SIZE, OR COLOR.

SN 85-473,682, FILED 11-16-2011.

TARAH HARDY, EXAMINING ATTORNEY



David J. Kyffers

Director of the United States Patent and Trademark Office

United States of America

United States Patent and Trademark Office



Reg. No. 4,207,783

Registered Sep. 11, 2012

Int. Cl.: 25

TRADEMARK

PRINCIPAL REGISTER

GO INTERNATIONAL LOGISTICS, CORP. (FLORIDA CORPORATION)
6095 NW 167 STREET
D3
MIAMI, FL 33015

FOR: HATS; SHIRTS, IN CLASS 25 (U.S. CLS. 22 AND 39).

FIRST USE 4-10-2012; IN COMMERCE 4-10-2012.

THE MARK CONSISTS OF THE FOLLOWING: A CIRCLE CONTAINING AN OUTLINE OF AN AIRPLANE AND NEXT TO THE CIRCLE THE WORDS "FLIGHT LEVEL 220".

SN 85-474,116, FILED 11-16-2011.

ALEXANDER L. POWERS, EXAMINING ATTORNEY



David J. Kyffers

Director of the United States Patent and Trademark Office

United States of America
United States Patent and Trademark Office

Kravings

Reg. No. 4,207,784

LATITUDES INC. (MISSOURI CORPORATION)
338 RAMSEY STREET
SULLIVAN, MO 63080

Registered Sep. 11, 2012

Int. Cl.: 25

FOR: FOOTWEAR, IN CLASS 25 (U.S. CLS. 22 AND 39).

TRADEMARK

FIRST USE 2-7-2012; IN COMMERCE 2-7-2012.

PRINCIPAL REGISTER

THE MARK CONSISTS OF WORD "KRAVINGS" IN STYLIZED LETTERING.

SN 85-474,278, FILED 11-16-2011.

KATHERINE M. DUBRAY, EXAMINING ATTORNEY



David J. Kybas

Director of the United States Patent and Trademark Office

United States of America

United States Patent and Trademark Office

trusted advice. peace of
mind

Reg. No. 4,207,785

Registered Sep. 11, 2012

Int. Cls.: 35 and 36

SERVICE MARK

PRINCIPAL REGISTER

BARHORST INSURANCE GROUP LTD (TEXAS LIMITED PARTNERSHIP)
SUITE 100
8220 JONES ROAD
HOUSTON, TX 77065

FOR: MANAGING THE OPERATIONS OF INSURANCE AGENCIES AND BROKERS ON AN OUTSOURCING BASIS; PROMOTION OF FINANCIAL AND INSURANCE SERVICES, ON BEHALF OF THIRD PARTIES, IN CLASS 35 (U.S. CLS. 100, 101 AND 102).

FIRST USE 2-15-2012; IN COMMERCE 2-15-2012.

FOR: CONSULTING AND INFORMATION CONCERNING INSURANCE; FINANCIAL CONSULTANCY AND INSURANCE CONSULTANCY; FINANCIAL EVALUATION FOR INSURANCE PURPOSES; INSURANCE AGENCIES; INSURANCE AGENCY AND BROKERAGE; INSURANCE AND FINANCIAL INFORMATION AND CONSULTANCY SERVICES; INSURANCE BROKERAGE; INSURANCE CONSULTANCY; INSURANCE CONSULTANCY SERVICES, NAMELY, PROVIDING ADVICE IN THE FIELD OF PROPERTY AND CASUALTY INSURANCE; INSURANCE CONSULTATION; INSURANCE INFORMATION; INSURANCE INFORMATION AND CONSULTANCY; INSURANCE PREMIUM RATE COMPUTING; INSURANCE SERVICES, NAMELY, WRITING PROPERTY AND CASUALTY INSURANCE; LIFE INSURANCE BROKERAGE; PROVIDING DETAILED INFORMATION REGARDING AVAILABLE INSURANCE PRODUCTS FOR COMMERCIAL PROPERTY AND CASUALTY, PROFESSIONAL AND PERSONAL LINES; PROVIDING INFORMATION IN INSURANCE MATTERS; PROVIDING VEHICLE INSURANCE RATE QUOTES, IN CLASS 36 (U.S. CLS. 100, 101 AND 102).

FIRST USE 2-15-2012; IN COMMERCE 2-15-2012.

THE MARK CONSISTS OF STANDARD CHARACTERS WITHOUT CLAIM TO ANY PARTICULAR FONT, STYLE, SIZE, OR COLOR.

SN 85-475,141, FILED 11-17-2011.

Laurie Kaufman, Examining Attorney



David J. Kyffers

Director of the United States Patent and Trademark Office

United States of America

United States Patent and Trademark Office

DuoFLEX

Reg. No. 4,207,786

MR INSTRUMENTS, INC. (DELAWARE CORPORATION)
5610 ROWLAND RD. STE. 145
MINNETONKA, MN 55343

Registered Sep. 11, 2012

Int. Cl.: 10

FOR: MRI DIAGNOSTIC APPARATUS, IN CLASS 10 (U.S. CLS. 26, 39 AND 44).

TRADEMARK

FIRST USE 5-15-2011; IN COMMERCE 4-15-2012.

PRINCIPAL REGISTER

THE MARK CONSISTS OF STANDARD CHARACTERS WITHOUT CLAIM TO ANY PARTICULAR FONT, STYLE, SIZE, OR COLOR.

SN 85-475,210, FILED 11-17-2011.

DEBORAH LOBO, EXAMINING ATTORNEY



David J. Kybas

Director of the United States Patent and Trademark Office

United States of America

United States Patent and Trademark Office

ACDONE

Reg. No. 4,207,787

Registered Sep. 11, 2012

Int. Cl.: 9

TRADEMARK

PRINCIPAL REGISTER

ACD SYSTEMS INTERNATIONAL INC. (CANADA CORPORATION)
2412 MARLENE DR.
VICTORIA, B.C., CANADA V9B4L5

FOR: COMPUTER SOFTWARE FOR PROVIDING NETWORK, INTERNET, AND COMPUTER SECURITY; COMPUTER ANTI-VIRUS AND VIRUS CONTROL SOFTWARE; COMPUTER ANTI-SPAM AND ANTI-PHISHING SOFTWARE; COMPUTER SOFTWARE FOR USE IN THE ENCRYPTION OF DIGITAL FILES AND ONLINE COMMUNICATIONS; COMPUTER SOFTWARE FOR PROVIDING ONLINE IDENTITY PROTECTION AND PARENTAL CONTROL; COMPUTER SOFTWARE FOR SCANNING, DETECTING, AND REMOVING VIRUSES, WORMS, TROJAN HORSES, ADWARE, SPYWARE, AND OTHER MALWARE; INTERNET SECURITY SOFTWARE, NAMELY, COMPUTER SOFTWARE FOR USE IN THE MONITORING AND CONTROL OF COMPUTER AND ONLINE ACTIVITY; COMPUTER OPTIMIZATION SOFTWARE; COMPUTER SOFTWARE TO PREVENT, DIAGNOSE, AND REPAIR COMPUTER PROBLEMS; CONTENT FILTERING SOFTWARE; COMPUTER SOFTWARE THAT PROVIDES FIREWALL, CONTENT FILTERING, INTRUSION ALERT, VIRUS PROTECTION, VIRTUAL PRIVATE NETWORKING AND OTHER SECURITY FUNCTIONS, NAMELY, ENSURING THE SECURITY OF ELECTRONIC MAIL, COMPUTER CONNECTIVITY, COMPUTER DATA AND COMPUTER SYSTEMS; COMPUTER SOFTWARE FOR MONITORING, IDENTIFYING, AND RECTIFYING FILE, DISK, SYSTEM, AND COMPUTER NETWORK PROBLEMS AND ERRORS; EMBEDDED SOFTWARE FOR NETWORK MONITORING AND SECURITY; COMPUTER SOFTWARE FOR PROVIDING ONLINE TRANSACTION SECURITY; PRIVACY AND IDENTITY CONTROL SOFTWARE, IN CLASS 9 (U.S. CLS. 21, 23, 26, 36 AND 38).

FIRST USE 12-23-2011; IN COMMERCE 12-23-2011.

THE MARK CONSISTS OF STANDARD CHARACTERS WITHOUT CLAIM TO ANY PARTICULAR FONT, STYLE, SIZE, OR COLOR.

SN 85-475,826, FILED 11-17-2011.

DAVID MURRAY, EXAMINING ATTORNEY



David J. Kyros

Director of the United States Patent and Trademark Office

United States of America

United States Patent and Trademark Office

UNITED BROKERAGE PACKAGING

Reg. No. 4,207,788

UNITED BROKERAGE CO., INC. (GEORGIA CORPORATION)

Registered Sep. 11, 2012

PO BOX 1866
AUGUSTA, GA 309031866

Int. Cl.: 35

FOR: ON-LINE RETAIL STORE SERVICES FEATURING PACKING, PACKAGING AND SHIPPING MATERIALS; ON-LINE WHOLESALE STORE SERVICES FEATURING PACKING, PACKAGING AND SHIPPING MATERIALS; RETAIL STORE SERVICES FEATURING GREEN AND ECO-FRIENDLY PRODUCTS IN THE NATURE OF PACKING, PACKAGING AND SHIPPING MATERIALS; RETAIL STORE SERVICES FEATURING PACKING, PACKAGING AND SHIPPING MATERIALS; WHOLESALE DISTRIBUTORSHIPS FEATURING PACKING, PACKAGING AND SHIPPING MATERIALS, IN CLASS 35 (U.S. CLS. 100, 101 AND 102).

SERVICE MARK

PRINCIPAL REGISTER

FIRST USE 2-6-2012; IN COMMERCE 2-6-2012.

THE MARK CONSISTS OF STANDARD CHARACTERS WITHOUT CLAIM TO ANY PARTICULAR FONT, STYLE, SIZE, OR COLOR.

NO CLAIM IS MADE TO THE EXCLUSIVE RIGHT TO USE "BROKERAGE PACKAGING", APART FROM THE MARK AS SHOWN.

SN 85-476,051, FILED 11-18-2011.

ODESSA BIBBINS, EXAMINING ATTORNEY



David J. Kyffers

Director of the United States Patent and Trademark Office

United States of America

United States Patent and Trademark Office

MACK WELDON

Reg. No. 4,207,789

MACK WELDON, INC. (DELAWARE CORPORATION)
111 EIGHTH AVENUE
NEW YORK, NY 10011

Registered Sep. 11, 2012

Int. Cl.: 25

FOR: CLOTHING, NAMELY, UNDERGARMENTS, T-SHIRTS, TANK TOPS, UNDERSHIRTS, SOCKS, LOUNGE WEAR, PAJAMAS, ROBES, BELTS, TIES, BOWTIES, COLLAR PROTECTORS, SCARVES, EAR MUFFS, GLOVES AND MITTENS, IN CLASS 25 (U.S. CLS. 22 AND 39).

TRADEMARK

PRINCIPAL REGISTER

FIRST USE 4-15-2012; IN COMMERCE 4-15-2012.

THE MARK CONSISTS OF STANDARD CHARACTERS WITHOUT CLAIM TO ANY PARTICULAR FONT, STYLE, SIZE, OR COLOR.

THE NAME(S), PORTRAIT(S), AND/OR SIGNATURE(S) SHOWN IN THE MARK DOES NOT IDENTIFY A PARTICULAR LIVING INDIVIDUAL.

SN 85-476,639, FILED 11-18-2011.

BILL DAWE, EXAMINING ATTORNEY



David J. Kyros

Director of the United States Patent and Trademark Office

United States of America

United States Patent and Trademark Office

LLLITE CENTER FOR HAIR ADVANCEMENT

Reg. No. 4,207,790

Registered Sep. 11, 2012

Int. Cl.: 3

TRADEMARK

PRINCIPAL REGISTER

LLLITE CENTER FOR HAIR ADVANCEMENT FRANCHISING, LLC (MICHIGAN LIMITED LIABILITY COMPANY)
30150 TELEGRAPH, SUITE 173
BINGHAM FARMS, MI 48025

FOR: HAIR CONDITIONERS; NON-MEDICATED SERUMS FOR USE ON HAIR AND SCALP; SHAMPOOS, IN CLASS 3 (U.S. CLS. 1, 4, 6, 50, 51 AND 52).

FIRST USE 6-27-2012; IN COMMERCE 6-27-2012.

THE MARK CONSISTS OF STANDARD CHARACTERS WITHOUT CLAIM TO ANY PARTICULAR FONT, STYLE, SIZE, OR COLOR.

NO CLAIM IS MADE TO THE EXCLUSIVE RIGHT TO USE "CENTER FOR HAIR ADVANCEMENT", APART FROM THE MARK AS SHOWN.

SN 85-476,704, FILED 11-18-2011.

DAWN FELDMAN, EXAMINING ATTORNEY



David J. Kyffers

Director of the United States Patent and Trademark Office

United States of America

United States Patent and Trademark Office

Farm to Foam

Reg. No. 4,207,791

Registered Sep. 11, 2012

Int. Cls.: 21 and 32

TRADEMARK

PRINCIPAL REGISTER

TIMBERLINE BREWING COMPANY (COLORADO CORPORATION), DBA TWISTED PINE BREWING COMPANY,
3201 WALNUT ST. STE A
BOULDER, CO 80301

FOR: BEER JUGS; BEER MUGS, IN CLASS 21 (U.S. CLS. 2, 13, 23, 29, 30, 33, 40 AND 50).

FIRST USE 5-1-2012; IN COMMERCE 5-1-2012.

FOR: ALCOHOL-FREE BEERS; BEER; BEER MAKING KIT; BEER WORT; BEER, ALE AND LAGER; BEER, ALE AND PORTER; BEER, ALE, LAGER, STOUT AND PORTER; BEER, ALE, LAGER, STOUT, PORTER, SHANDY; BEERS; BLACK BEER; BREWED MALT-BASED ALCOHOLIC BEVERAGE IN THE NATURE OF A BEER; COFFEE-FLAVORED BEER; EXTRACTS OF HOPS FOR MAKING BEER; FLAVORED BEERS; GINGER BEER; HOP EXTRACTS FOR MANUFACTURING BEER; IMITATION BEER; MALT BEER; MALT EXTRACTS FOR MAKING BEER; MALT LIQUOR, IN CLASS 32 (U.S. CLS. 45, 46 AND 48).

FIRST USE 5-1-2012; IN COMMERCE 5-1-2012.

THE MARK CONSISTS OF STANDARD CHARACTERS WITHOUT CLAIM TO ANY PARTICULAR FONT, STYLE, SIZE, OR COLOR.

SN 85-476,742, FILED 11-18-2011.

GEORGE LORENZO, EXAMINING ATTORNEY



David J. Kyfos

Director of the United States Patent and Trademark Office

United States of America

United States Patent and Trademark Office

FRANKIE & SAM

Reg. No. 4,207,792

SUPPLIER DIRECT LLC (CALIFORNIA LIMITED LIABILITY COMPANY)
10 WILDER ST

Registered Sep. 11, 2012

SAN FRANCISCO, CA 94131

Int. Cl.: 25

FOR: CLOTHING, NAMELY, TOPS, BOTTOMS, DRESSES, SHIRTS, SKIRTS, JACKETS, PANTS, HATS, SOCKS, COATS, SHOES, IN CLASS 25 (U.S. CLS. 22 AND 39).

TRADEMARK

FIRST USE 1-5-2012; IN COMMERCE 1-5-2012.

PRINCIPAL REGISTER

THE MARK CONSISTS OF STANDARD CHARACTERS WITHOUT CLAIM TO ANY PARTICULAR FONT, STYLE, SIZE, OR COLOR.

SN 85-477,095, FILED 11-19-2011.

DOUGLAS LEE, EXAMINING ATTORNEY



David J. Kyffers

Director of the United States Patent and Trademark Office

United States of America

United States Patent and Trademark Office



Reg. No. 4,207,793

SECRET LABS LLC (DELAWARE LIMITED LIABILITY COMPANY)
174 W 4TH ST #207
NEW YORK, NY 10014

Registered Sep. 11, 2012

Int. Cl.: 9

FOR: COMPUTER HARDWARE; COMPUTER HARDWARE FOR ASSEMBLY OF CUSTOM ELECTRICAL AND ELECTRONIC DEVICES; ELECTRONIC CIRCUIT BOARD, IN CLASS 9 (U.S. CLS. 21, 23, 26, 36 AND 38).

TRADEMARK

FIRST USE 4-30-2012; IN COMMERCE 4-30-2012.

PRINCIPAL REGISTER

THE MARK CONSISTS OF A STYLIZED CAPITAL LETTER "G" INSIDE A SERIES OF THREE CONCENTRIC CIRCLES.

SN 85-477,165, FILED 11-19-2011.

TARAH HARDY, EXAMINING ATTORNEY



David J. Kybas

Director of the United States Patent and Trademark Office

United States of America

United States Patent and Trademark Office

Total Source

Reg. No. 4,207,794

GULF SOUTH MEDICAL SUPPLY, INC. (DELAWARE CORPORATION)
4345 SOUTHPOINT BOULEVARD
JACKSONVILLE, FL 32216 AND

Registered Sep. 11, 2012

Int. Cl.: 35

NATIONAL REHAB EQUIPMENT, INC. (PENNSYLVANIA CORPORATION)
540 LINDBERGH DR.
MOON TOWNSHIP, PA 151082750

SERVICE MARK

PRINCIPAL REGISTER

FOR: WHOLESALE DISTRIBUTORSHIPS FEATURING MEDICAL SUPPLIES AND MEDICAL EQUIPMENT FOR THE HOME HEALTHCARE MARKET, IN CLASS 35 (U.S. CLS. 100, 101 AND 102).

FIRST USE 12-0-2011; IN COMMERCE 12-0-2011.

THE MARK CONSISTS OF THE WORDS "TOTAL SOURCE" WITH A CIRCLE COMPRISED OF ARROWS BETWEEN "TOTAL" AND "SOURCE".

SN 85-477,455, FILED 11-21-2011.

KATHERINE STOIDES, EXAMINING ATTORNEY



David J. Kyffers

Director of the United States Patent and Trademark Office

United States of America

United States Patent and Trademark Office

PLYFE

Reg. No. 4,207,795

Registered Sep. 11, 2012

Int. Cl.: 35

SERVICE MARK

PRINCIPAL REGISTER

ARBOUR, JEFF (UNITED STATES INDIVIDUAL)
8 SPRUCE STREET APT 14G
NEW YORK, NY 10038

FOR: PROVIDING A WEB SITE FOR MARKET RESEARCH; RENTAL OF ADVERTISING SPACE ON WEB SITES; PROVIDING A WEB SITE FOR USERS WITH SPECIFIC INFORMED RECOMMENDATIONS OF SPECIFIC CONSUMER PRODUCTS AND SERVICES VALIDATED BY THE USERS' INPUTTED PREFERENCES AND SOCIAL NETWORK; ONLINE SERVICE FOR CONNECTING SOCIAL NETWORK USERS WITH RETAILERS FOR THE PURPOSE OF FACILITATING DISCOUNTED PURCHASES, IN CLASS 35 (U.S. CLS. 100, 101 AND 102).

FIRST USE 11-11-2011; IN COMMERCE 3-15-2012.

THE MARK CONSISTS OF STANDARD CHARACTERS WITHOUT CLAIM TO ANY PARTICULAR FONT, STYLE, SIZE, OR COLOR.

SN 85-478,990, FILED 11-22-2011.

JAY FLOWERS, EXAMINING ATTORNEY



David J. Kyffers

Director of the United States Patent and Trademark Office

United States of America

United States Patent and Trademark Office

PRODUCTIVITY POWERED BY P.E.O.P.L.E

Reg. No. 4,207,796

Registered Sep. 11, 2012

Int. Cl.: 35

SERVICE MARK

PRINCIPAL REGISTER

DB LATIMORE PROFESSIONAL SERVICES GROUP, LLC. (VIRGINIA LIMITED LIABILITY COMPANY)
10568 JAMES MADISON HIGHWAY
BEALETON, VA 22712

FOR: BUSINESS CONSULTING AND INFORMATION SERVICES; BUSINESS MANAGEMENT CONSULTING AND ADVISORY SERVICES; BUSINESS DEVELOPMENT CONSULTING SERVICES; BUSINESS ORGANIZATION AND HUMAN RESOURCES CONSULTING, IN CLASS 35 (U.S. CLS. 100, 101 AND 102).

FIRST USE 12-1-2011; IN COMMERCE 12-1-2011.

THE MARK CONSISTS OF STANDARD CHARACTERS WITHOUT CLAIM TO ANY PARTICULAR FONT, STYLE, SIZE, OR COLOR.

SN 85-479,653, FILED 11-23-2011.

CHRISTINA SOBRAL, EXAMINING ATTORNEY



David J. Kyffers

Director of the United States Patent and Trademark Office

United States of America

United States Patent and Trademark Office

PACIFIC STANDARD

Reg. No. 4,207,797

Registered Sep. 11, 2012

Int. Cl.: 16

TRADEMARK

PRINCIPAL REGISTER

MILLER-MCCUNE CENTER FOR RESEARCH, MEDIA AND PUBLIC POLICY (CALIFORNIA
NON-PROFIT CORPORATION)
804 ANACAPA STREET
SANTA BARBARA, CA 93101

FOR: MAGAZINE COVERING RESEARCH IN THE AREAS OF HEALTH, ENVIRONMENT,
EDUCATION, PUBLIC POLICY, SCIENCE AND TECHNOLOGY, IN CLASS 16 (U.S. CLS.
2, 5, 22, 23, 29, 37, 38 AND 50).

FIRST USE 4-30-2012; IN COMMERCE 4-30-2012.

THE MARK CONSISTS OF STANDARD CHARACTERS WITHOUT CLAIM TO ANY PAR-
TICULAR FONT, STYLE, SIZE, OR COLOR.

SN 85-479,941, FILED 11-23-2011.

JACLYN KIDWELL WALKER, EXAMINING ATTORNEY



David J. Kyffers

Director of the United States Patent and Trademark Office

United States of America

United States Patent and Trademark Office

VIVALDI CAPITAL MANAGEMENT

Reg. No. 4,207,798

Registered Sep. 11, 2012

Int. Cl.: 36

SERVICE MARK

PRINCIPAL REGISTER

VIVALDI CAPITAL PARTNERS, LLC (ILLINOIS LIMITED LIABILITY COMPANY)
1622 WILLOW ROAD
SUITE 101
NORTHFIELD, IL 60093

FOR: FINANCIAL MANAGEMENT, FINANCIAL ASSET MANAGEMENT, AND FINANCIAL PORTFOLIO MANAGEMENT; FINANCIAL SERVICES, NAMELY, INVESTMENT ADVICE, FINANCIAL PLANNING ADVICE, INVESTMENT MANAGEMENT, INVESTMENT CONSULTATION, RESEARCH RELATING TO FINANCE AND INVESTMENTS, AND INVESTMENT OF FUNDS FOR OTHERS, INCLUDING PRIVATE AND PUBLIC EQUITY AND DEBT INVESTMENT SERVICES; FINANCIAL SERVICES, NAMELY, COORDINATION, WITHIN A SINGLE ACCOUNT, OF AN INVESTMENT PORTFOLIO'S MAINTENANCE, TRADING, RE-BALANCING, AND TAX MANAGEMENT NEEDS; PROVIDING FINANCIAL SERVICES WITH RESPECT TO SECURITIES AND OTHER FINANCIAL INSTRUMENTS AND PRODUCTS, NAMELY, TRADING OF AND INVESTMENTS IN SECURITIES AND FINANCIAL INSTRUMENTS AND PRODUCTS FOR OTHERS, IN CLASS 36 (U.S. CLS. 100, 101 AND 102).

FIRST USE 2-12-2012; IN COMMERCE 2-12-2012.

THE MARK CONSISTS OF STANDARD CHARACTERS WITHOUT CLAIM TO ANY PARTICULAR FONT, STYLE, SIZE, OR COLOR.

NO CLAIM IS MADE TO THE EXCLUSIVE RIGHT TO USE "CAPITAL MANAGEMENT", APART FROM THE MARK AS SHOWN.

SN 85-481,510, FILED 11-28-2011.

MEGHAN REINHART, EXAMINING ATTORNEY



David J. Kybas

Director of the United States Patent and Trademark Office

United States of America

United States Patent and Trademark Office

RINTH ISLAND

Reg. No. 4,207,799

Registered Sep. 11, 2012

Int. Cls.: 9 and 41

TRADEMARK

SERVICE MARK

PRINCIPAL REGISTER

BUZZ MONKEY SOFTWARE, LLC (OREGON LIMITED LIABILITY COMPANY)
576 OLIVE STREET, SUITE 205
EUGENE, OR 97401

FOR: VIDEO GAME SOFTWARE FOR MOBILE DEVICES, PC TABLETS, PERSONAL COMPUTERS, AND HOME VIDEO GAME CONSOLES; GAME SOFTWARE FOR USE ON ANY COMPUTERIZED PLATFORM, INCLUDING HAND-HELD ELECTRONIC DEVICES, ELECTRONIC ENTERTAINMENT DEVICES, TELECOMMUNICATION DEVICES, MOBILE PHONES, ELECTRONIC COMMUNICATION DEVICES OR PERSONAL DIGITAL ASSISTANT DEVICES; ELECTRONIC GAME PROGRAMS; DOWNLOADABLE ELECTRONIC GAME PROGRAMS; ELECTRONIC GAME SOFTWARE; COMPUTER GAME PROGRAMS; DOWNLOADABLE COMPUTER GAME PROGRAMS; INTERACTIVE GAME PROGRAMS; INTERACTIVE GAME SOFTWARE, IN CLASS 9 (U.S. CLS. 21, 23, 26, 36 AND 38).

FIRST USE 10-17-2011; IN COMMERCE 3-29-2012.

FOR: (BASED ON USE IN COMMERCE) ENTERTAINMENT SERVICES, NAMELY, PROVIDING ON-LINE, NONDOWNLOADABLE INTERACTIVE COMPUTER GAMES, VIDEO GAMES OR ELECTRONIC GAME PROGRAMS; PROVIDING NONDOWNLOADABLE INTERACTIVE COMPUTER, VIDEO OR ELECTRONIC GAMES THROUGH COMPUTER NETWORKS OR TELEVISION, OR OTHER TELECOMMUNICATIONS NETWORKS; PROVIDING WEBSITES FEATURING CONTENT AND INFORMATION IN THE FIELD OF COMPUTER GAMES AND ELECTRONIC GAME PROGRAMS; PROVIDING TEMPORARY USE OF ON-LINE, NON-DOWNLOADABLE INTERACTIVE COMPUTER GAMES, VIDEO GAMES OR ELECTRONIC GAME PROGRAMS, IN CLASS 41 (U.S. CLS. 100, 101 AND 107).

FIRST USE 10-17-2011; IN COMMERCE 10-17-2011.

THE MARK CONSISTS OF STANDARD CHARACTERS WITHOUT CLAIM TO ANY PARTICULAR FONT, STYLE, SIZE, OR COLOR.

SN 85-481,581, FILED 11-28-2011.

ZHALEH DELANEY, EXAMINING ATTORNEY



David J. Kyros

Director of the United States Patent and Trademark Office

United States of America

United States Patent and Trademark Office

FIX

Reg. No. 4,207,800

ETERNAL BEVERAGES, INC. (CALIFORNIA CORPORATION)
2950 BUSKIRK AVENUE, SUITE 312
WALNUT CREEK, CA 94597

Registered Sep. 11, 2012

Int. Cl.: 5

FOR: LIQUID NUTRITIONAL SUPPLEMENTS, IN CLASS 5 (U.S. CLS. 6, 18, 44, 46, 51 AND 52).

TRADEMARK

FIRST USE 5-21-2012; IN COMMERCE 5-21-2012.

PRINCIPAL REGISTER

THE MARK CONSISTS OF STANDARD CHARACTERS WITHOUT CLAIM TO ANY PARTICULAR FONT, STYLE, SIZE, OR COLOR.

SN 85-482,033, FILED 11-28-2011.

MICHAEL WEBSTER, EXAMINING ATTORNEY



David J. Kyffers

Director of the United States Patent and Trademark Office

United States of America

United States Patent and Trademark Office

SIN FIRMAR NADA, OBTENLO TODO

Reg. No. 4,207,801

T-MOBILE USA, INC. (DELAWARE CORPORATION)
12920 S.E. 38TH STREET
BELLEVUE, WA 98006

Registered Sep. 11, 2012

Int. Cl.: 38

FOR: TELECOMMUNICATIONS SERVICES, NAMELY, TRANSMISSION OF VOICE AND DATA BY MEANS OF WIRELESS COMMUNICATION NETWORK; ELECTRONIC TRANSMISSION OF MAIL AND MESSAGES AND TEXT AND NUMERIC WIRELESS DIGITAL MESSAGING SERVICES BY MEANS OF WIRELESS COMMUNICATIONS NETWORKS; AND PROVIDING MULTIPLE-USER ACCESS TO A GLOBAL COMPUTER INFORMATION NETWORK, IN CLASS 38 (U.S. CLS. 100, 101 AND 104).

SERVICE MARK

PRINCIPAL REGISTER

FIRST USE 6-27-2011; IN COMMERCE 6-27-2011.

THE MARK CONSISTS OF STANDARD CHARACTERS WITHOUT CLAIM TO ANY PARTICULAR FONT, STYLE, SIZE, OR COLOR.

THE ENGLISH TRANSLATION OF "SIN FIRMAR NADA, OBTENLO TODO" IN THE MARK IS "SIGN NOTHING. GET EVERYTHING".

SN 85-482,037, FILED 11-28-2011.

BILL DAWE, EXAMINING ATTORNEY



David J. Kyros

Director of the United States Patent and Trademark Office

United States of America

United States Patent and Trademark Office

ANSWERS BIBLE CURRICULUM

Reg. No. 4,207,802

ANSWERS IN GENESIS, INC. (KENTUCKY CORPORATION)
2800 BULLITTSBURG CHURCH ROAD
PETERSBURG, KY 41080

Registered Sep. 11, 2012

Int. Cl.: 16

FOR: PRINTED MATTER, NAMELY, CURRICULUM IN THE FIELD OF CHRISTIANITY,
IN CLASS 16 (U.S. CLS. 2, 5, 22, 23, 29, 37, 38 AND 50).

TRADEMARK

FIRST USE 1-1-2012; IN COMMERCE 1-1-2012.

PRINCIPAL REGISTER

THE MARK CONSISTS OF STANDARD CHARACTERS WITHOUT CLAIM TO ANY PAR-
TICULAR FONT, STYLE, SIZE, OR COLOR.

OWNER OF U.S. REG. NOS. 2,918,926, 3,306,416, AND OTHERS.

NO CLAIM IS MADE TO THE EXCLUSIVE RIGHT TO USE "BIBLE CURRICULUM", APART
FROM THE MARK AS SHOWN.

SN 85-482,260, FILED 11-29-2011.

JANICE L. MCMORROW, EXAMINING ATTORNEY



David J. Kybas

Director of the United States Patent and Trademark Office

United States of America

United States Patent and Trademark Office

SPEEDY-SIZED STORES

Reg. No. 4,207,803

ACE HARDWARE CORPORATION (DELAWARE CORPORATION)
2200 KENSINGTON COURT
OAK BROOK, IL 60523

Registered Sep. 11, 2012

Int. Cl.: 35

FOR: RETAIL STORE SERVICES IN THE FIELD OF HARDWARE AND RELATED GOODS,
IN CLASS 35 (U.S. CLS. 100, 101 AND 102).

SERVICE MARK

FIRST USE 2-0-2012; IN COMMERCE 2-0-2012.

PRINCIPAL REGISTER

THE MARK CONSISTS OF STANDARD CHARACTERS WITHOUT CLAIM TO ANY PAR-
TICULAR FONT, STYLE, SIZE, OR COLOR.

NO CLAIM IS MADE TO THE EXCLUSIVE RIGHT TO USE "STORES", APART FROM THE
MARK AS SHOWN.

SN 85-482,552, FILED 11-29-2011.

KATHLEEN LORENZO, EXAMINING ATTORNEY



David J. Kybas

Director of the United States Patent and Trademark Office

United States of America

United States Patent and Trademark Office

STRONGVOLT SOLAR

Reg. No. 4,207,804

SUNKEN STONE, INC. (CALIFORNIA CORPORATION)

Registered Sep. 11, 2012

1041 MARKET STREET, STE 397
SAN DIEGO, CA 92101

Int. Cl.: 9

FOR: APPARATUS FOR CONVERTING ELECTRONIC RADIATION TO ELECTRICAL ENERGY, NAMELY, PHOTOVOLTAIC SOLAR MODULES; PHOTOVOLTAIC SOLAR MODULES FOR PRODUCTION OF ELECTRICITY; SOLAR PANELS FOR PRODUCTION OF ELECTRICITY, IN CLASS 9 (U.S. CLS. 21, 23, 26, 36 AND 38).

TRADEMARK

PRINCIPAL REGISTER

FIRST USE 2-20-2012; IN COMMERCE 2-20-2012.

THE MARK CONSISTS OF STANDARD CHARACTERS WITHOUT CLAIM TO ANY PARTICULAR FONT, STYLE, SIZE, OR COLOR.

NO CLAIM IS MADE TO THE EXCLUSIVE RIGHT TO USE "SOLAR", APART FROM THE MARK AS SHOWN.

SN 85-482,989, FILED 11-29-2011.

REBECCA GILBERT, EXAMINING ATTORNEY



David J. Kyjars

Director of the United States Patent and Trademark Office

United States of America

United States Patent and Trademark Office

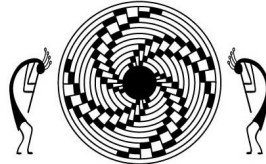

Reg. No. 4,207,805

RAMONA'S AMERICAN INDIAN FOODS LLC (ARIZONA LIMITED LIABILITY COMPANY)
PO BOX 2195
SACATON, AZ 85247

Registered Sep. 11, 2012

Int. Cls.: 21, 25, 29, and 31

FOR: MUGS, IN CLASS 21 (U.S. CLS. 2, 13, 23, 29, 30, 33, 40 AND 50).

FIRST USE 1-24-2012; IN COMMERCE 1-24-2012.

TRADEMARK

FOR: CAPS; T-SHIRTS, IN CLASS 25 (U.S. CLS. 22 AND 39).

PRINCIPAL REGISTER

FIRST USE 1-24-2012; IN COMMERCE 1-24-2012.

FOR: DRIED BEANS, IN CLASS 29 (U.S. CL. 46).

FIRST USE 12-31-2000; IN COMMERCE 12-31-2000.

FOR: UNPROCESSED GRAINS FOR EATING, IN CLASS 31 (U.S. CLS. 1 AND 46).

FIRST USE 1-12-2012; IN COMMERCE 1-12-2012.

THE MARK CONSISTS OF A CIRCULAR INDIAN BASKET CENTERED BETWEEN TWO FLUTE PLAYER STICK FIGURES FACING THE BASKET. THE BASKET HAS CONCENTRIC CIRCLES WITH A DARK CIRCLE AT ITS CENTER AND FOUR SPIRAL ARMS EXTENDING FROM THE DARK CIRCLE OVERLAYING THE CONCENTRIC CIRCLES. EACH SPIRAL ARM HAS A LIGHT COLORED CENTER WITH DARK EDGES.

SN 85-483,047, FILED 11-29-2011.

KATHY DE JONGE, EXAMINING ATTORNEY



David J. Kybas

Director of the United States Patent and Trademark Office

United States of America

United States Patent and Trademark Office

REMIND

Reg. No. 4,207,806

NBTV MEDIA (MICHIGAN CORPORATION)
209 PARK STREET
TROY, MI 48083

Registered Sep. 11, 2012

Int. Cl.: 16

FOR: MAGAZINES FEATURING PUZZLES AND COMICS, IN CLASS 16 (U.S. CLS. 2, 5, 22, 23, 29, 37, 38 AND 50).

TRADEMARK

FIRST USE 12-16-2011; IN COMMERCE 12-16-2011.

PRINCIPAL REGISTER

THE MARK CONSISTS OF STANDARD CHARACTERS WITHOUT CLAIM TO ANY PARTICULAR FONT, STYLE, SIZE, OR COLOR.

SN 85-484,238, FILED 11-30-2011.

LIEF MARTIN, EXAMINING ATTORNEY



David J. Kybas

Director of the United States Patent and Trademark Office

United States of America

United States Patent and Trademark Office

FIREAMP

Reg. No. 4,207,807

Registered Sep. 11, 2012

Int. Cl.: 9

TRADEMARK

PRINCIPAL REGISTER

SOURCEFIRE, INC. (DELAWARE CORPORATION)
9770 PATUXENT WOODS DRIVE
COLUMBIA, MD 21046

FOR: COMPUTER SOFTWARE FOR USE IN THE DETECTION AND REMEDIATION OF MALWARE THAT TARGETS COMPUTING DEVICES, IN CLASS 9 (U.S. CLS. 21, 23, 26, 36 AND 38).

FIRST USE 11-0-2011; IN COMMERCE 1-0-2012.

THE MARK CONSISTS OF STANDARD CHARACTERS WITHOUT CLAIM TO ANY PARTICULAR FONT, STYLE, SIZE, OR COLOR.

SN 85-484,779, FILED 12-1-2011.

CAROLINE WOOD, EXAMINING ATTORNEY



David J. Kyros

Director of the United States Patent and Trademark Office

United States of America

United States Patent and Trademark Office

WILDS OF AFRICA

Reg. No. 4,207,808

Registered Sep. 11, 2012

Int. Cl.: 9

TRADEMARK

PRINCIPAL REGISTER

ARISTOCRAT TECHNOLOGIES AUSTRALIA PTY LTD. (AUSTRALIA CORPORATION)
BUILDING A PINNACLE OFFICE PARK
85 EPPING ROAD
NORTH RYDE, NSW, AUSTRALIA 2113

FOR: ELECTRONIC GAMING MACHINES, NAMELY, DEVICES WHICH ACCEPT A WAGER,
IN CLASS 9 (U.S. CLS. 21, 23, 26, 36 AND 38).

FIRST USE 3-1-2012; IN COMMERCE 3-1-2012.

THE MARK CONSISTS OF STANDARD CHARACTERS WITHOUT CLAIM TO ANY PAR-
TICULAR FONT, STYLE, SIZE, OR COLOR.

OWNER OF U.S. REG. NO. 2,355,559.

SN 85-484,852, FILED 12-1-2011.

JIM RINGLE, EXAMINING ATTORNEY



David J. Kyffers

Director of the United States Patent and Trademark Office

United States of America

United States Patent and Trademark Office

HOMECAST

Reg. No. 4,207,809

Registered Sep. 11, 2012

Int. Cl.: 9

TRADEMARK

PRINCIPAL REGISTER

CELESTRON ACQUISITION, LLC (DELAWARE LIMITED LIABILITY COMPANY), AKA
CELESTRON,
2835 COLUMBIA STREET
TORRANCE, CA 90503

FOR: METEOROLOGICAL MONITORING STATIONS COMPRISED PRIMARILY OF A WIRELESS RECEIVER OR A WIRELESS PROCESSOR WITH SOLAR AND LUNAR CALENDARS AND ALARM FUNCTIONS AND A WIRELESS TRANSMITTER OR A WIRELESS SENSOR TO MEASURE TEMPERATURE, BAROMETRIC PRESSURE, AND HUMIDITY, IN CLASS 9 (U.S. CLS. 21, 23, 26, 36 AND 38).

FIRST USE 1-31-2012; IN COMMERCE 1-31-2012.

THE MARK CONSISTS OF STANDARD CHARACTERS WITHOUT CLAIM TO ANY PARTICULAR FONT, STYLE, SIZE, OR COLOR.

SN 85-486,385, FILED 12-2-2011.

JUDITH HELFMAN, EXAMINING ATTORNEY



David J. Kybas

Director of the United States Patent and Trademark Office

United States of America

United States Patent and Trademark Office



Reg. No. 4,207,810

UTAH JAZZ RETAIL, INC. (UTAH CORPORATION)
301 W. SOUTH TEMPLE
SALT LAKE CITY, UT 84101

Registered Sep. 11, 2012

Int. Cl.: 35

FOR: RETAIL STORE FEATURING APPAREL AND SPORTS MEMORABILIA, IN CLASS 35 (U.S. CLS. 100, 101 AND 102).

SERVICE MARK

FIRST USE 11-1-2011; IN COMMERCE 11-1-2011.

PRINCIPAL REGISTER

THE MARK CONSISTS OF A STAR INCORPORATING THE LETTER "F" IN THE MIDDLE OF IT.

SN 85-487,078, FILED 12-5-2011.

TASNEEM HUSSAIN, EXAMINING ATTORNEY



David J. Kybas

Director of the United States Patent and Trademark Office

United States of America

United States Patent and Trademark Office

ALLEGIS PARTNERS

Reg. No. 4,207,811

Registered Sep. 11, 2012

Int. Cl.: 35

SERVICE MARK

PRINCIPAL REGISTER

ALLEGIS GROUP, INC. (MARYLAND CORPORATION)
7301 PARKWAY DRIVE
HANOVER, MD 21076

FOR: EMPLOYMENT HIRING, RECRUITING, PLACEMENT, STAFFING AND CAREER NETWORKING SERVICES; EMPLOYMENT RECRUITING CONSULTATION; PERSONNEL PLACEMENT AND RECRUITMENT; PROFESSIONAL STAFFING AND RECRUITING SERVICES; PROVIDING ON-LINE INTERACTIVE EMPLOYMENT COUNSELING AND RECRUITMENT SERVICES, IN CLASS 35 (U.S. CLS. 100, 101 AND 102).

FIRST USE 3-15-2012; IN COMMERCE 3-15-2012.

THE MARK CONSISTS OF STANDARD CHARACTERS WITHOUT CLAIM TO ANY PARTICULAR FONT, STYLE, SIZE, OR COLOR.

OWNER OF U.S. REG. NOS. 2,516,311, 2,888,615, AND 3,350,905.

NO CLAIM IS MADE TO THE EXCLUSIVE RIGHT TO USE "PARTNERS", APART FROM THE MARK AS SHOWN.

SN 85-487,095, FILED 12-5-2011.

GINA HAYES, EXAMINING ATTORNEY



David J. Kybas

Director of the United States Patent and Trademark Office

United States of America

United States Patent and Trademark Office

BRILLIANT LOVE

Reg. No. 4,207,812

VICTORIA'S SECRET STORES BRAND MANAGEMENT, INC. (DELAWARE CORPORATION)
FOUR LIMITED PARKWAY
REYNOLDSBURG, OH 43068

Registered Sep. 11, 2012

Int. Cl.: 3

FOR: BODY CREAMS; BODY LOTIONS; BODY WASH; NON-MEDICATED SKIN CARE PREPARATION, NAMELY, BODY MIST, IN CLASS 3 (U.S. CLS. 1, 4, 6, 50, 51 AND 52).

TRADEMARK

FIRST USE 4-20-2012; IN COMMERCE 4-20-2012.

PRINCIPAL REGISTER

THE MARK CONSISTS OF STANDARD CHARACTERS WITHOUT CLAIM TO ANY PARTICULAR FONT, STYLE, SIZE, OR COLOR.

SN 85-489,332, FILED 12-7-2011.

LOURDES AYALA, EXAMINING ATTORNEY



David J. Kyffers

Director of the United States Patent and Trademark Office

United States of America

United States Patent and Trademark Office

JOHN PAUL ATAKER

Reg. No. 4,207,813

ATAKER, KERIME (UNITED STATES INDIVIDUAL)
530 SEVENTH AVENUE MEZZANINE UNIT #12
NEW YORK, NY 10018

Registered Sep. 11, 2012

Int. Cl.: 25

FOR: GOWNS; WOMEN'S CLOTHING, NAMELY, SHIRTS, DRESSES, SKIRTS, BLOUSES,
IN CLASS 25 (U.S. CLS. 22 AND 39).

TRADEMARK

FIRST USE 4-19-2012; IN COMMERCE 4-19-2012.

PRINCIPAL REGISTER

THE MARK CONSISTS OF STANDARD CHARACTERS WITHOUT CLAIM TO ANY PAR-
TICULAR FONT, STYLE, SIZE, OR COLOR.

THE NAME(S), PORTRAIT(S), AND/OR SIGNATURE(S) SHOWN IN THE MARK IDENTIFIES
"JOHN PAUL ATAKER", WHOSE CONSENT(S) TO REGISTER IS MADE OF RECORD.

SN 85-490,246, FILED 12-8-2011.

DEIRDRE ROBERTSON, EXAMINING ATTORNEY



David J. Kybas

Director of the United States Patent and Trademark Office

United States of America

United States Patent and Trademark Office



Reg. No. 4,207,814

Registered Sep. 11, 2012

Int. Cl.: 37

SERVICE MARK

PRINCIPAL REGISTER

MBK REAL ESTATE, LLC (CALIFORNIA LIMITED LIABILITY COMPANY)
4 PARK PLAZA
SUITE 850
IRVINE, CA 92614

FOR: REAL ESTATE DEVELOPMENT, IN CLASS 37 (U.S. CLS. 100, 103 AND 106).

FIRST USE 1-15-2012; IN COMMERCE 1-15-2012.

THE MARK CONSISTS OF AN ABSTRACT DESIGN OF THE LETTER "M" CONSISTING OF THREE RIBBON-LIKE STROKES.

SN 85-490,651, FILED 12-8-2011.

BENJAMIN OKEKE, EXAMINING ATTORNEY



David J. Kyffers

Director of the United States Patent and Trademark Office

United States of America

United States Patent and Trademark Office

Gramma Amber's Salad Dressing

Reg. No. 4,207,815

LLJD (IOWA LIMITED LIABILITY COMPANY)
7596 350TH ST.

Registered Sep. 11, 2012

FOREST CITY, IA 50436

Int. Cl.: 30

FOR: SALAD DRESSING, IN CLASS 30 (U.S. CL. 46).

TRADEMARK

FIRST USE 1-27-2012; IN COMMERCE 2-1-2012.

PRINCIPAL REGISTER

THE MARK CONSISTS OF STANDARD CHARACTERS WITHOUT CLAIM TO ANY PARTICULAR FONT, STYLE, SIZE, OR COLOR.

NO CLAIM IS MADE TO THE EXCLUSIVE RIGHT TO USE "SALAD DRESSING", APART FROM THE MARK AS SHOWN.

SN 85-491,014, FILED 12-8-2011.

WILLIAM VERHOSEK, EXAMINING ATTORNEY



David J. Kybas

Director of the United States Patent and Trademark Office

United States of America

United States Patent and Trademark Office

GLAM ENERGY

Reg. No. 4,207,816

PAUL FERRARA (UNITED STATES INDIVIDUAL)
2 TURTLE HOLLOW DRIVE
MANALAPAN, NJ 07726

Registered Sep. 11, 2012

Int. Cl.: 32

FOR: NON-ALCOHOLIC BEVERAGES, NAMELY, SPORTS DRINKS, ENERGY DRINKS
AND SOFT DRINKS, IN CLASS 32 (U.S. CLS. 45, 46 AND 48).

TRADEMARK

FIRST USE 3-1-2012; IN COMMERCE 3-1-2012.

PRINCIPAL REGISTER

THE MARK CONSISTS OF STANDARD CHARACTERS WITHOUT CLAIM TO ANY PAR-
TICULAR FONT, STYLE, SIZE, OR COLOR.

NO CLAIM IS MADE TO THE EXCLUSIVE RIGHT TO USE "ENERGY", APART FROM THE
MARK AS SHOWN.

SN 85-491,133, FILED 12-8-2011.

DAVID MURRAY, EXAMINING ATTORNEY



David J. Kybas

Director of the United States Patent and Trademark Office

United States of America

United States Patent and Trademark Office

INVICTA DNA

Reg. No. 4,207,817

Registered Sep. 11, 2012

Int. Cl.: 14

TRADEMARK

PRINCIPAL REGISTER

INVICTA WATCH COMPANY OF AMERICA, INC. (FLORIDA CORPORATION)
3069 TAFT STREET
HOLLYWOOD, FL 33021

FOR: WATCHES, IN CLASS 14 (U.S. CLS. 2, 27, 28 AND 50).

FIRST USE 1-0-2012; IN COMMERCE 1-0-2012.

THE MARK CONSISTS OF STANDARD CHARACTERS WITHOUT CLAIM TO ANY PARTICULAR FONT, STYLE, SIZE, OR COLOR.

THE ENGLISH TRANSLATION OF THE WORD "INVICTA" IN THE MARK IS "UNCONQUERED".

SN 85-491,422, FILED 12-9-2011.

JANICE KIM, EXAMINING ATTORNEY



David J. Kyffers

Director of the United States Patent and Trademark Office

United States of America

United States Patent and Trademark Office

lapdance

Reg. No. 4,207,818

Registered Sep. 11, 2012

Int. Cl.: 25

TRADEMARK

PRINCIPAL REGISTER

XGEN, LLC (DELAWARE LIMITED LIABILITY COMPANY), DBA LAPDANCE,
1 PEARL BUCK COURT
BRISTOL, PA 19007

FOR: LINGERIE, IN CLASS 25 (U.S. CLS. 22 AND 39).

FIRST USE 12-1-2011; IN COMMERCE 1-1-2011.

THE MARK CONSISTS OF THE WORD "LAPDANCE" IN CERTAIN FONT.

SN 85-491,518, FILED 12-9-2011.

JASON TURNER, EXAMINING ATTORNEY



David J. Kyffers

Director of the United States Patent and Trademark Office

United States of America

United States Patent and Trademark Office



Reg. No. 4,207,819

Registered Sep. 11, 2012

Int. Cl.: 25

TRADEMARK

PRINCIPAL REGISTER

XGEN, LLC (DELAWARE LIMITED LIABILITY COMPANY), DBA LAPDANCE,
1 PEARL BUCK COURT
BRISTOL, PA 19007

FOR: LINGERIE, IN CLASS 25 (U.S. CLS. 22 AND 39).

FIRST USE 12-1-2011; IN COMMERCE 1-1-2011.

THE MARK CONSISTS OF THE WORD "LAPDANCE" WITH A SILHOUETTE OF A LADY
RESTING ON THE WORD AND A HEART.

SN 85-491,523, FILED 12-9-2011.

JASON TURNER, EXAMINING ATTORNEY



David J. Kyffers

Director of the United States Patent and Trademark Office

United States of America

United States Patent and Trademark Office

Heel Lock

Reg. No. 4,207,820

YOE ENTERPRISES OF NEVADA, INC. (NEVADA CORPORATION)
7823 STONEHENGE DRIVE
CHATTANOOGA, TN 37421

Registered Sep. 11, 2012

Int. Cl.: 25

FOR: A DEEP HEEL MADE OUT OF CUSHIONING FABRIC SOLD AS AN INTEGRAL COMPONENT OF SOCKS, IN CLASS 25 (U.S. CLS. 22 AND 39).

TRADEMARK

FIRST USE 5-21-2012; IN COMMERCE 5-21-2012.

PRINCIPAL REGISTER

THE MARK CONSISTS OF STANDARD CHARACTERS WITHOUT CLAIM TO ANY PARTICULAR FONT, STYLE, SIZE, OR COLOR.

NO CLAIM IS MADE TO THE EXCLUSIVE RIGHT TO USE "HEEL", APART FROM THE MARK AS SHOWN.

SN 85-493,682, FILED 12-13-2011.

ELIZABETH HUGHITT, EXAMINING ATTORNEY



David J. Kyffers

Director of the United States Patent and Trademark Office

United States of America

United States Patent and Trademark Office

MALIBU SUNSHINE

Reg. No. 4,207,821

ABSOLUT HOLDING INC. C/O ABSOLUT HOLDING FILIAL (DELAWARE CORPORATION)
BOX 47170, 100 74

Registered Sep. 11, 2012

STOCKHOLM, SWEDEN

Int. Cl.: 33

FOR: ALCOHOLIC BEVERAGES EXCEPT BEERS, IN CLASS 33 (U.S. CLS. 47 AND 49).

TRADEMARK

FIRST USE 4-0-2012; IN COMMERCE 4-0-2012.

PRINCIPAL REGISTER

THE MARK CONSISTS OF STANDARD CHARACTERS WITHOUT CLAIM TO ANY PARTICULAR FONT, STYLE, SIZE, OR COLOR.

OWNER OF U.S. REG. NOS. 1,374,134, 3,816,881, AND OTHERS.

SN 85-496,028, FILED 12-15-2011.

KATINA MISTER, EXAMINING ATTORNEY



David J. Kyffers

Director of the United States Patent and Trademark Office

United States of America

United States Patent and Trademark Office



Reg. No. 4,207,822

WHISKEY RESTAURANTS INC. (ILLINOIS CORPORATION)
15849 N 71ST STREET SUITE 100
SCOTTSDALE, AZ 85254

Registered Sep. 11, 2012

Int. Cl.: 43

FOR: BAR SERVICES; RESTAURANT SERVICES, IN CLASS 43 (U.S. CLS. 100 AND 101).

SERVICE MARK

FIRST USE 5-7-2012; IN COMMERCE 5-7-2012.

PRINCIPAL REGISTER

NO CLAIM IS MADE TO THE EXCLUSIVE RIGHT TO USE "WHISKEY KITCHEN", APART FROM THE MARK AS SHOWN.

THE COLOR(S) BLACK AND GOLD IS/ARE CLAIMED AS A FEATURE OF THE MARK.

THE MARK CONSISTS OF THE WORD "LINCOLN" IN GOLD LETTERING ABOVE THE WORDS "WHISKEY" AND "KITCHEN" IN GOLD LETTERING SEPARATED BY A GOLD STAR ABOVE A GOLD LINE. THE WORDS ARE IN A BLACK RECTANGLE FRAMED IN BLACK AND GOLD LINES.

SN 85-496,361, FILED 12-15-2011.

CHRIS WELLS, EXAMINING ATTORNEY



David J. Kyffers

Director of the United States Patent and Trademark Office

United States of America

United States Patent and Trademark Office

FFN

Reg. No. 4,207,823

VARIOUS, INC. (CALIFORNIA CORPORATION)
220 HUMBOLDT COURT
SUNNYVALE, CA 94089

Registered Sep. 11, 2012

**Int. Cls.: 38, 41, 42, and
45**

FOR: PROVIDING ON-LINE CHAT ROOMS FOR TRANSMISSION OF MESSAGES AMONG COMPUTER USERS CONCERNING SOCIAL NETWORKING, VIRTUAL COMMUNITIES, DATING AND RELATIONSHIPS, AND TOPICS OF GENERAL INTEREST; PROVIDING ON-LINE ELECTRONIC BULLETIN BOARDS FOR TRANSMISSION OF MESSAGES AMONG COMPUTER USERS CONCERNING SOCIAL NETWORKING, VIRTUAL COMMUNITIES, DATING AND RELATIONSHIPS, AND TOPICS OF GENERAL INTEREST, IN CLASS 38 (U.S. CLS. 100, 101 AND 104).

SERVICE MARK

PRINCIPAL REGISTER

FIRST USE 6-26-2012; IN COMMERCE 6-26-2012.

FOR: ENTERTAINMENT AND EDUCATIONAL SERVICES, NAMELY, PROVIDING WEBSITES FEATURING BLOGS AND ON-LINE NON-DOWNLOADABLE MAGAZINES APPEALING TO INDIVIDUALS INTERESTED IN SOCIAL NETWORKING, VIRTUAL COMMUNITIES, DATING AND RELATIONSHIPS, IN CLASS 41 (U.S. CLS. 100, 101 AND 107).

FIRST USE 6-26-2012; IN COMMERCE 6-26-2012.

FOR: COMPUTER SERVICES, NAMELY, INTERACTIVE HOSTING SERVICES WHICH ALLOW THE USER TO UPLOAD, DOWNLOAD, STREAM, TAG, PUBLISH, SEARCH, SORT, ACCESS, SHARE AND EXCHANGE THEIR OWN CONTENT, TEXT, IMAGES, PERSONAL INFORMATION AND MESSAGES; COMPUTER SERVICES, NAMELY, CREATING AND MAINTAINING ON-LINE COMMUNITIES FOR USERS TO PARTICIPATE IN DISCUSSIONS, GET FEEDBACK FROM THEIR PEERS, FORM VIRTUAL COMMUNITIES, AND ENGAGE IN SOCIAL NETWORKING, IN CLASS 42 (U.S. CLS. 100 AND 101).

FIRST USE 6-26-2012; IN COMMERCE 6-26-2012.

FOR: ON-LINE SOCIAL NETWORKING SERVICES AND DATING SERVICES; PROVIDING AN ON-LINE COMPUTER DATABASE IN THE FIELDS OF SOCIAL NETWORKING, DATING AND RELATIONSHIPS, IN CLASS 45 (U.S. CLS. 100 AND 101).

FIRST USE 6-26-2012; IN COMMERCE 6-26-2012.



David J. Kyjars

Director of the United States Patent and Trademark Office

Reg. No. 4,207,823 THE MARK CONSISTS OF STANDARD CHARACTERS WITHOUT CLAIM TO ANY PARTICULAR FONT, STYLE, SIZE, OR COLOR.

SN 85-497,568, FILED 12-16-2011.

REBECCA POVARCHUK, EXAMINING ATTORNEY

United States of America

United States Patent and Trademark Office

JACKPOT CATCHER

Reg. No. 4,207,824

Registered Sep. 11, 2012

Int. Cl.: 9

TRADEMARK

PRINCIPAL REGISTER

ARISTOCRAT TECHNOLOGIES AUSTRALIA PTY LTD. (AUSTRALIA CORPORATION)
BUILDING A, PINNACLE OFFICE PARK
85 EPPING ROAD
NORTH RYDE, NSW, AUSTRALIA 2113

FOR: ELECTRONIC GAMING MACHINES, NAMELY, DEVICES WHICH ACCEPT A WAGER,
IN CLASS 9 (U.S. CLS. 21, 23, 26, 36 AND 38).

FIRST USE 1-1-2012; IN COMMERCE 1-1-2012.

THE MARK CONSISTS OF STANDARD CHARACTERS WITHOUT CLAIM TO ANY PAR-
TICULAR FONT, STYLE, SIZE, OR COLOR.

OWNER OF U.S. REG. NOS. 2,947,176, 3,849,491, AND OTHERS.

NO CLAIM IS MADE TO THE EXCLUSIVE RIGHT TO USE "JACKPOT", APART FROM
THE MARK AS SHOWN.

SN 85-498,757, FILED 12-19-2011.

JIM RINGLE, EXAMINING ATTORNEY



David J. Kyffers

Director of the United States Patent and Trademark Office

United States of America

United States Patent and Trademark Office

THUNDER PUNCH

Reg. No. 4,207,825

Registered Sep. 11, 2012

Int. Cl.: 28

TRADEMARK

PRINCIPAL REGISTER

MATTEL, INC. (DELAWARE CORPORATION)
M1-1518
333 CONTINENTAL BOULEVARD
EL SEGUNDO, CA 90245

FOR: TOY ACTION FIGURES AND ACCESSORIES THEREFOR, IN CLASS 28 (U.S. CLS. 22, 23, 38 AND 50).

FIRST USE 4-16-2012; IN COMMERCE 4-16-2012.

THE MARK CONSISTS OF STANDARD CHARACTERS WITHOUT CLAIM TO ANY PARTICULAR FONT, STYLE, SIZE, OR COLOR.

SN 85-499,214, FILED 12-19-2011.

CAROLINE WOOD, EXAMINING ATTORNEY



David J. Kyffers

Director of the United States Patent and Trademark Office

United States of America

United States Patent and Trademark Office

COCO BREVÉ

Reg. No. 4,207,826

MILLERCOORS LLC (DELAWARE LIMITED LIABILITY COMPANY)
250 SOUTH WACKER DRIVE, SUITE 800
CHICAGO, IL 606065888

Registered Sep. 11, 2012

Int. Cl.: 33

FOR: ALCOHOLIC BEVERAGE PRODUCED FROM A BREWED MALT BASE WITH NATURAL FLAVORS, IN CLASS 33 (U.S. CLS. 47 AND 49).

TRADEMARK

FIRST USE 6-1-2012; IN COMMERCE 6-1-2012.

PRINCIPAL REGISTER

THE MARK CONSISTS OF STANDARD CHARACTERS WITHOUT CLAIM TO ANY PARTICULAR FONT, STYLE, SIZE, OR COLOR.

NO CLAIM IS MADE TO THE EXCLUSIVE RIGHT TO USE "COCO", APART FROM THE MARK AS SHOWN.

THE ENGLISH TRANSLATION OF "BREVE" IN THE MARK IS "BRIEF".

SN 85-507,719, FILED 1-3-2012.

ERIN FALK, EXAMINING ATTORNEY



David J. Kybas

Director of the United States Patent and Trademark Office

United States of America

United States Patent and Trademark Office

Astute 140

Reg. No. 4,207,827

Registered Sep. 11, 2012

Int. Cl.: 10

TRADEMARK

PRINCIPAL REGISTER

ASTUTE MEDICAL, INC. (DELAWARE CORPORATION)
BLDG 2, R.645
3550 GENERAL ATOMICS COURT
SAN DIEGO, CA 92121

FOR: METERS FOR MEDICAL USE, NAMELY, FOR ANALYSIS OF IMMUNOASSAY DEVICES, IN CLASS 10 (U.S. CLS. 26, 39 AND 44).

FIRST USE 6-3-2008; IN COMMERCE 1-5-2012.

THE MARK CONSISTS OF STANDARD CHARACTERS WITHOUT CLAIM TO ANY PARTICULAR FONT, STYLE, SIZE, OR COLOR.

SN 85-510,732, FILED 1-6-2012.

WENDY JUN, EXAMINING ATTORNEY



David J. Kybas

Director of the United States Patent and Trademark Office

United States of America

United States Patent and Trademark Office



Reg. No. 4,207,828

FLEET WHOLESALE SUPPLY CO., INC. (WISCONSIN CORPORATION)
1300 SOUTH LYNNDALE DRIVE
APPLETON, WI 54914

Registered Sep. 11, 2012

Int. Cl.: 20

FOR: CAMPING CHAIRS, IN CLASS 20 (U.S. CLS. 2, 13, 22, 25, 32 AND 50).

TRADEMARK

FIRST USE 3-1-2012; IN COMMERCE 3-1-2012.

PRINCIPAL REGISTER

OWNER OF U.S. REG. NOS. 2,121,688, 4,015,022, AND OTHERS.

THE MARK CONSISTS OF A STYLIZED REPRESENTATION OF THE LETTERS "F", "F" BACK-TO-BACK AND A HALF CIRCLE ABOVE THE LEFT LETTER "F".

SN 85-511,681, FILED 1-9-2012.

MARY ROSSMAN, EXAMINING ATTORNEY



David J. Kyffers

Director of the United States Patent and Trademark Office

United States of America

United States Patent and Trademark Office



Dr. Maas
COLLECTION

Reg. No. 4,207,829

PARAMOUNT INDUSTRIAL COMPANIES, INC. (VIRGINIA CORPORATION)
1112 KINGWOOD AVENUE
NORFOLK, VA 23502

Registered Sep. 11, 2012

Int. Cl.: 20

FOR: MATTRESSES; MATTRESS FOUNDATIONS; BOX SPRINGS, IN CLASS 20 (U.S. CLS. 2, 13, 22, 25, 32 AND 50).

TRADEMARK

FIRST USE 6-7-2012; IN COMMERCE 6-7-2012.

PRINCIPAL REGISTER

NO CLAIM IS MADE TO THE EXCLUSIVE RIGHT TO USE "COLLECTION", APART FROM THE MARK AS SHOWN.

THE NAME SHOWN IN THE MARK IDENTIFIES "DR." JAMES B. "MAAS", WHOSE CONSENT TO REGISTER IS MADE OF RECORD.

THE MARK CONSISTS OF A SHIELD DESIGN ENCOMPASSING A HUMAN FIGURE WITHIN THE SHIELD AND THE WORDS "DR. MAAS" IN INITIAL CAPS TO THE RIGHT OF THE SHIELD AND THE WORD "COLLECTION" IN ALL CAPS BELOW THE WORDS "DR. MAAS".

SN 85-514,031, FILED 1-11-2012.

CHRISTOPHER BUONGIORNO, EXAMINING ATTORNEY



David J. Kybas

Director of the United States Patent and Trademark Office

United States of America

United States Patent and Trademark Office



Connect. Select. Enable.

Reg. No. 4,207,830

Registered Sep. 11, 2012

Int. Cl.: 38

SERVICE MARK

PRINCIPAL REGISTER

VALLEY TELEPHONE COOPERATIVE, INC. (TEXAS CORPORATION)
480 SOUTH 6TH STREET
RAYMONDVILLE, TX 78580

FOR: AUDIO AND VIDEO BROADCASTING SERVICES OVER THE INTERNET; BROADCASTING OF VIDEO AND AUDIO PROGRAMMING OVER THE INTERNET; BROADCASTING SERVICES AND PROVISION OF TELECOMMUNICATION ACCESS TO FILMS AND TELEVISION PROGRAMMES PROVIDED VIA A VIDEO-ON-DEMAND SERVICE; CABLE TELEVISION BROADCASTING; CALL SCREENING SERVICES; COMMUNICATION SERVICES, NAMELY, TRANSMISSION OF VOICE, AUDIO, VISUAL IMAGES AND DATA BY TELECOMMUNICATIONS NETWORKS, WIRELESS COMMUNICATION NETWORKS, THE INTERNET, INFORMATION SERVICES NETWORKS AND DATA NETWORKS; COMMUNICATIONS BY TELEPHONE; COMMUNICATIONS VIA FIBER-OPTIC NETWORKS; COMPUTERISED TELEPHONY SERVICES; DIGITAL NETWORK TELECOMMUNICATIONS SERVICES; INTERNET TELEPHONY SERVICES; LOCAL AND LONG DISTANCE TELEPHONE SERVICES; PROVIDING ACCESS TO TELECOMMUNICATION NETWORKS; PROVIDING ACCESS TO THE INTERNET; PROVIDING TELECOMMUNICATION CONNECTIONS TO THE INTERNET OR DATABASES; PROVIDING VOICE COMMUNICATION SERVICES VIA THE INTERNET; PROVISION OF ACCESS TO THE INTERNET; SUBSCRIPTION TELEVISION BROADCASTING; TELECOMMUNICATION ACCESS SERVICES; TELECOMMUNICATION SERVICES, NAMELY, LOCAL AND LONG DISTANCE TRANSMISSION OF VOICE, DATA, GRAPHICS AND VIDEO BY MEANS OF BROADBAND OPTICAL OR WIRELESS NETWORKS; TELECOMMUNICATIONS SERVICES, NAMELY, PROVIDING FIBER OPTIC NETWORK SERVICES; TELEPHONE COMMUNICATION SERVICES; TELEVISION BROADCASTING; VIDEO ON DEMAND TRANSMISSIONS; VOICE OVER IP SERVICES, IN CLASS 38 (U.S. CLS. 100, 101 AND 104).

FIRST USE 2-13-2012; IN COMMERCE 2-13-2012.

THE MARK CONSISTS OF THREE CIRCLES ABOVE THE WORDS "CONNECT. SELECT. ENABLE." WITH THE FIRST CIRCLE CONTAINING THE IMAGE OF A COMPUTER MOUSE, THE SECOND CIRCLE CONTAINING THE IMAGE OF A TELEVISION SCREEN OR COMPUTER MONITOR, AND THE THIRD CIRCLE CONTAINING THE IMAGE OF A TELEPHONE.



David J. Kyffers

SN 85-517,536, FILED 1-16-2012.

MICHELE SWAIN, EXAMINING ATTORNEY

United States of America

United States Patent and Trademark Office

CARBONITE

Reg. No. 4,207,831

CARBONITE, INC. (DELAWARE CORPORATION)
177 HUNTINGTON AVENUE
BOSTON, MA 02115

Registered Sep. 11, 2012

Int. Cls.: 9 and 42

FOR: DOWNLOADABLE COMPUTER SOFTWARE FOR ONLINE BACKUP OF COMPUTER CONTENT, IN CLASS 9 (U.S. CLS. 21, 23, 26, 36 AND 38).

TRADEMARK

FIRST USE 2-15-2012; IN COMMERCE 2-15-2012.

SERVICE MARK

FOR: SOFTWARE AS A SERVICE (SAAS) SERVICES FEATURING SOFTWARE FOR BACKING UP AND ARCHIVING ELECTRONIC DATA; REMOTE COMPUTER BACKUP SERVICES; REMOTE ONLINE BACKUP OF ELECTRONIC COMPUTER DATA; BACK-UP SERVICES FOR COMPUTER HARD DRIVE DATA, IN CLASS 42 (U.S. CLS. 100 AND 101).

PRINCIPAL REGISTER

FIRST USE 2-15-2012; IN COMMERCE 2-15-2012.

OWNER OF U.S. REG. NOS. 3,583,942 AND 3,583,943.

THE COLOR(S) PURPLE, GREEN, AND SILVER IS/ARE CLAIMED AS A FEATURE OF THE MARK.

THE MARK CONSISTS OF THE WORD "CARBONITE" IN PURPLE, WITH A GREEN CIRCLE WITH A SILVER BORDER AT THE END OF THE "E" IN "CARBONITE".

SN 85-517,706, FILED 1-17-2012.

BRIDGETT SMITH, EXAMINING ATTORNEY



David J. Kyffers

Director of the United States Patent and Trademark Office

United States of America

United States Patent and Trademark Office



Reg. No. 4,207,832

Registered Sep. 11, 2012

Int. Cl.: 30

TRADEMARK

PRINCIPAL REGISTER

POST FOODS, LLC (DELAWARE LIMITED LIABILITY COMPANY)
1 UPPER POND ROAD
PARSIPPANY, NJ 07054

FOR: READY-TO-EAT CEREALS, IN CLASS 30 (U.S. CL. 46).

FIRST USE 4-4-2012; IN COMMERCE 4-4-2012.

OWNER OF U.S. REG. NOS. 655,328, 2,347,686, AND OTHERS.

THE COLOR(S) RED, GOLD AND WHITE IS/ARE CLAIMED AS A FEATURE OF THE MARK.

THE MARK CONSISTS OF THE WORD "POST" IN WHITE INSIDE A RED OVAL DESIGN. A GOLD BORDER SURROUNDS THE RED OVAL, AND GOLD COLORED ARCUATE ELEMENTS EXTEND ABOUT THE PERIMETER OF THE RED OVAL, JUST INSIDE THE BORDER. BELOW THE WORD "POST" IS A DEPICTION OF A GOLD SUN AND GOLD WHEAT FIELDS.

SN 85-521,553, FILED 1-20-2012.

MARY ROSSMAN, EXAMINING ATTORNEY



David J. Kyjars

Director of the United States Patent and Trademark Office

United States of America

United States Patent and Trademark Office

QRemembrance.com 3D QR Codes

Reg. No. 4,207,833

PAYNE, TIMOTHY J. (UNITED STATES INDIVIDUAL)
2821 TURNBULL STREET
OCEANSIDE, CA 92054

Registered Sep. 11, 2012

Int. Cl.: 38

FOR: COMPUTER TRANSMISSION OF INFORMATION ACCESSED VIA A CODE OR A
TERMINAL, IN CLASS 38 (U.S. CLS. 100, 101 AND 104).

SERVICE MARK

FIRST USE 4-1-2012; IN COMMERCE 4-1-2012.

PRINCIPAL REGISTER

THE MARK CONSISTS OF STANDARD CHARACTERS WITHOUT CLAIM TO ANY PAR-
TICULAR FONT, STYLE, SIZE, OR COLOR.

NO CLAIM IS MADE TO THE EXCLUSIVE RIGHT TO USE "3D QR CODES", APART FROM
THE MARK AS SHOWN.

SN 85-523,224, FILED 1-23-2012.

COLLEEN KEARNEY, EXAMINING ATTORNEY



David J. Kybas

Director of the United States Patent and Trademark Office

United States of America

United States Patent and Trademark Office

IncludED

Reg. No. 4,207,834

FOLLETT CORPORATION (ILLINOIS CORPORATION)
2233 WEST STREET
RIVER GROVE, IL 60171

Registered Sep. 11, 2012

Int. Cl.: 41

FOR: PROVIDING AND ADMINISTERING A TEXTBOOK AND COURSE MATERIALS RENTAL PROGRAM, IN CLASS 41 (U.S. CLS. 100, 101 AND 107).

SERVICE MARK

FIRST USE 4-5-2012; IN COMMERCE 4-5-2012.

PRINCIPAL REGISTER

THE MARK CONSISTS OF STANDARD CHARACTERS WITHOUT CLAIM TO ANY PARTICULAR FONT, STYLE, SIZE, OR COLOR.

SN 85-525,177, FILED 1-25-2012.

MARILYN IZZI, EXAMINING ATTORNEY



David J. Kybas

Director of the United States Patent and Trademark Office

United States of America

United States Patent and Trademark Office



Reg. No. 4,207,835

Registered Sep. 11, 2012

Int. Cl.: 36

SERVICE MARK

PRINCIPAL REGISTER

COMMERCE CONSULTING CORPORATION (CALIFORNIA CORPORATION), DBA WORLD
TELECOM GROUP,
22761 PACIFIC COAST HIGHWAY, SUITE 101
MALIBU, CA 90265

FOR: ENERGY BROKERAGE SERVICES; AND, TELECOMMUNICATIONS VOICE AND
DATA BROKERAGE SERVICES , IN CLASS 36 (U.S. CLS. 100, 101 AND 102).

FIRST USE 3-27-2012; IN COMMERCE 3-27-2012.

THE MARK CONSISTS OF THREE CIRCULAR ARCS, TWO OF WHICH ARE IN A SINGLE
PLANE, TILTED FROM LEFT TO RIGHT, INTERSECTED BY A THIRD ARC, TILTED FROM
LEFT TO RIGHT, STARTING AT THE OUTSIDE OF THE FAR ARC AND MOVING THROUGH
THE PLANE OF THE CENTER OF THE TWO OTHER ARCS.

SN 85-530,660, FILED 2-1-2012.

MATTHEW KLINE, EXAMINING ATTORNEY



David J. Kyros

Director of the United States Patent and Trademark Office

United States of America

United States Patent and Trademark Office

SHORTBOWELSUPPORT

Reg. No. 4,207,836

NPS PHARMACEUTICALS, INC. (DELAWARE CORPORATION)
550 HILLS DRIVE, 3RD FLOOR
BEDMINSTER, NJ 07921

Registered Sep. 11, 2012

Int. Cl.: 44

FOR: PROVIDING A WEBSITE FEATURING MEDICAL AND HEALTHCARE RELATED INFORMATION, IN CLASS 44 (U.S. CLS. 100 AND 101).

SERVICE MARK

FIRST USE 2-25-2011; IN COMMERCE 2-25-2011.

PRINCIPAL REGISTER

THE MARK CONSISTS OF STANDARD CHARACTERS WITHOUT CLAIM TO ANY PARTICULAR FONT, STYLE, SIZE, OR COLOR.

SN 85-976,200, FILED 1-24-2011.

CHRISTOPHER BUONGIORNO, EXAMINING ATTORNEY



David J. Kyffers

Director of the United States Patent and Trademark Office

United States of America

United States Patent and Trademark Office

VALLEY OF THE DOLLS

Reg. No. 4,207,837

TIGER LLC (NEW YORK LIMITED LIABILITY COMPANY)
4018 BALLINA DRIVE
ENCINO, CA 91436

Registered Sep. 11, 2012

Int. Cls.: 18 and 25

FOR: CARRY-ALL BAGS; SPORT BAGS; TOTE BAGS, IN CLASS 18 (U.S. CLS. 1, 2, 3, 22 AND 41).

TRADEMARK

FIRST USE 4-29-2011; IN COMMERCE 4-29-2011.

PRINCIPAL REGISTER

FOR: HEADWEAR; HOODED SWEATSHIRTS; PANTIES; SHIRTS; SLEEPWEAR; SWEAT-PANTS; SWEATSHIRTS; T-SHIRTS; TANK TOPS; UNDERWEAR, IN CLASS 25 (U.S. CLS. 22 AND 39).

FIRST USE 11-30-1995; IN COMMERCE 1-31-1996.

THE MARK CONSISTS OF STANDARD CHARACTERS WITHOUT CLAIM TO ANY PARTICULAR FONT, STYLE, SIZE, OR COLOR.

SEC. 2(F).

SN 85-976,600, FILED 4-1-2011.

TIMOTHY FINNEGAN, EXAMINING ATTORNEY



David J. Kybas

Director of the United States Patent and Trademark Office

United States of America
United States Patent and Trademark Office

ONE2TEN

Reg. No. 4,207,838

JEEZLE PETE'S! LLC (INDIANA LIMITED LIABILITY COMPANY)
4950 E. MORRIS CHURCH RD.
BATESVILLE, IN 47006

Registered Sep. 11, 2012

Int. Cl.: 28

FOR: BOARD GAMES AND CARD GAMES, IN CLASS 28 (U.S. CLS. 22, 23, 38 AND 50).

TRADEMARK

FIRST USE 10-10-2011; IN COMMERCE 10-10-2011.

PRINCIPAL REGISTER

THE MARK CONSISTS OF STANDARD CHARACTERS WITHOUT CLAIM TO ANY PARTICULAR FONT, STYLE, SIZE, OR COLOR.

SN 85-976,758, FILED 3-31-2011.

STEVEN PEREZ, EXAMINING ATTORNEY



David J. Kyffers

Director of the United States Patent and Trademark Office

United States of America

United States Patent and Trademark Office



Reg. No. 4,207,839

Registered Sep. 11, 2012

Int. Cl.: 44

SERVICE MARK

PRINCIPAL REGISTER

UHS OF DELAWARE, INC. (DELAWARE CORPORATION)
367 SOUTH GULPH ROAD
KING OF PRUSSIA, PA 194060958

FOR: MEDICAL AND HEALTHCARE SERVICES, IN CLASS 44 (U.S. CLS. 100 AND 101).

FIRST USE 5-0-2010; IN COMMERCE 5-0-2010.

THE MARK CONSISTS OF A STYLIZED HEART DESIGN SURROUNDING A DEPICTION OF THE U.S. CAPITOL DOME.

SN 85-977,004, FILED 3-21-2011.

CHRISTINA SOBRAL, EXAMINING ATTORNEY



David J. Kyffers

Director of the United States Patent and Trademark Office

United States of America

United States Patent and Trademark Office

VONAGE

Reg. No. 4,207,840

Registered Sep. 11, 2012

Int. Cls.: 9 and 38

TRADEMARK

SERVICE MARK

PRINCIPAL REGISTER

VONAGE MARKETING LLC (DELAWARE LIMITED LIABILITY COMPANY)
23 MAIN STREET
HOLMDEL, NJ 07733

FOR: COMPUTER TELEPHONY SOFTWARE, NAMELY, SOFTWARE APPLICATIONS FOR ESTABLISHING AND PERFORMING PHONE CALLS, OVER A VARIETY OF NETWORKS IN THE NATURE OF THE INTERNET; DOWNLOADABLE SOFTWARE FOR USE WITH WIRELESS TELECOMMUNICATIONS DEVICES TO PROVIDE WIRELESS TRANSMISSION OF E-MAIL, TEXT, VOICE, STILL IMAGES, INFORMATION, DATA AND OTHER CONTENT VIA THE INTERNET AND VIA WIRELESS LOCAL AREA NETWORK DEVICES; COMPUTER AND TELECOMMUNICATIONS NETWORK HUBS, SWITCHES AND ROUTERS; COMPUTER HARDWARE AND COMMUNICATIONS SOFTWARE FOR USE IN CONNECTING TELECOMMUNICATIONS EQUIPMENT, TELEPHONES, COMPUTERS, WIRED AND WIRELESS COMPUTER NETWORKS; COMPUTER SOFTWARE AND HARDWARE FOR PROVIDING TRANSMISSION AND EXCHANGE OF VOICE, DATA, IMAGES AND GRAPHICS IN THE FIELDS OF TELECOMMUNICATIONS; HARDWARE FOR TELECOMMUNICATIONS FOR CONNECTING DEVICES VIA IN-HOME PHONE AND ELECTRICAL WIRING, NAMELY, COMPUTER NETWORK HUBS, COMPUTER SWITCHES AND COMPUTER ROUTERS DESIGNED TO PROVIDE IN-HOME VOICE OVER INTERNET PROTOCOL (VOIP) COMMUNICATIONS, IN CLASS 9 (U.S. CLS. 21, 23, 26, 36 AND 38).

FIRST USE 3-20-2002; IN COMMERCE 3-20-2002.

FOR: TELEPHONY COMMUNICATIONS SERVICES, IN CLASS 38 (U.S. CLS. 100, 101 AND 104).

FIRST USE 4-0-2001; IN COMMERCE 4-0-2001.

THE MARK CONSISTS OF STANDARD CHARACTERS WITHOUT CLAIM TO ANY PARTICULAR FONT, STYLE, SIZE, OR COLOR.

OWNER OF U.S. REG. NOS. 2,614,773, 3,829,340, AND OTHERS.

SN 85-977,024, FILED 11-19-2010.

LESLEY LAMOTHE, EXAMINING ATTORNEY



David J. Kyffers

Director of the United States Patent and Trademark Office

United States of America

United States Patent and Trademark Office

The logo for Vonage, featuring a stylized orange 'V' with a blue dot above it, followed by the word 'onage' in orange lowercase letters.

Reg. No. 4,207,841

Registered Sep. 11, 2012

Int. Cls.: 9 and 38

TRADEMARK

SERVICE MARK

PRINCIPAL REGISTER

VONAGE MARKETING LLC (DELAWARE LIMITED LIABILITY COMPANY)
23 MAIN STREET
HOLMDEL, NJ 07733

FOR: COMPUTER TELEPHONY SOFTWARE, NAMELY, SOFTWARE APPLICATIONS FOR ESTABLISHING AND PERFORMING PHONE CALLS, OVER A VARIETY OF NETWORKS IN THE NATURE OF THE INTERNET; DOWNLOADABLE SOFTWARE FOR USE WITH WIRELESS TELECOMMUNICATIONS DEVICES TO PROVIDE WIRELESS TRANSMISSION OF E-MAIL, TEXT, VOICE, STILL IMAGES, INFORMATION, DATA AND OTHER CONTENT VIA THE INTERNET AND VIA WIRELESS LOCAL AREA NETWORK DEVICES; COMPUTER AND TELECOMMUNICATIONS NETWORK HUBS, SWITCHES AND ROUTERS; COMPUTER HARDWARE AND COMMUNICATIONS SOFTWARE FOR USE IN CONNECTING TELECOMMUNICATIONS EQUIPMENT, TELEPHONES, COMPUTERS, WIRED AND WIRELESS COMPUTER NETWORKS; COMPUTER SOFTWARE AND HARDWARE FOR PROVIDING TRANSMISSION AND EXCHANGE OF VOICE, DATA, IMAGES AND GRAPHICS IN THE FIELDS OF TELECOMMUNICATIONS; HARDWARE FOR TELECOMMUNICATIONS FOR CONNECTING DEVICES VIA IN-HOME PHONE AND ELECTRICAL WIRING, NAMELY, COMPUTER NETWORK HUBS, COMPUTER SWITCHES AND COMPUTER ROUTERS DESIGNED TO PROVIDE IN-HOME VOICE OVER INTERNET PROTOCOL (VOIP) COMMUNICATIONS, IN CLASS 9 (U.S. CLS. 21, 23, 26, 36 AND 38).

FIRST USE 3-15-2006; IN COMMERCE 3-15-2006.

FOR: TELEPHONY COMMUNICATIONS SERVICES, IN CLASS 38 (U.S. CLS. 100, 101 AND 104).

FIRST USE 3-15-2006; IN COMMERCE 3-15-2006.

OWNER OF U.S. REG. NOS. 2,614,773, 3,740,428, AND OTHERS.

THE COLOR(S) ORANGE AND BLUE IS/ARE CLAIMED AS A FEATURE OF THE MARK.

THE MARK CONSISTS OF THE WORD "VONAGE" IN ORANGE WITH A STYLIZED "V" WITH A BLUE DOT.

SN 85-977,028, FILED 7-22-2011.



David J. Kyros

Director of the United States Patent and Trademark Office

Reg. No. 4,207,841 MARK SHINER, EXAMINING ATTORNEY

United States of America

United States Patent and Trademark Office



Reg. No. 4,207,842

IDEA GIRLS ENTERTAINMENT, LLC (FLORIDA LIMITED LIABILITY COMPANY)
16434 N.E. 33RD AVENUE
NORTH MIAMI BEACH, FL 33160

Registered Sep. 11, 2012

Int. Cls.: 21 and 25

FOR: CUPS, DRINKING GLASSES, DRINKING STEINS, MUGS, THERMAL INSULATED CONTAINERS FOR BEVERAGES, IN CLASS 21 (U.S. CLS. 2, 13, 23, 29, 30, 33, 40 AND 50).

TRADEMARK

FIRST USE 6-27-2012; IN COMMERCE 6-27-2012.

PRINCIPAL REGISTER

FOR: CLOTHING, NAMELY, SHIRTS, T-SHIRTS, HATS, HEADWEAR, UNDERGARMENTS, IN CLASS 25 (U.S. CLS. 22 AND 39).

FIRST USE 6-25-2012; IN COMMERCE 6-25-2012.

NO CLAIM IS MADE TO THE EXCLUSIVE RIGHT TO USE "DIVORCE", APART FROM THE MARK AS SHOWN.

THE MARK CONSISTS OF THE WORDS "DIVORCE" ABOVE THE LETTERS "S.O.S" WITH THE DESIGN OF A BROKEN HEART AS THE LETTER "V".

SN 85-977,088, FILED 1-7-2011.

THEODORE MCBRIDE, EXAMINING ATTORNEY



David J. Kybas

Director of the United States Patent and Trademark Office

United States of America

United States Patent and Trademark Office

SOFTSATIONS

Reg. No. 4,207,843

Registered Sep. 11, 2012

Int. Cl.: 3

TRADEMARK

PRINCIPAL REGISTER

KING ZAK INDUSTRIES, INC. (NEW YORK CORPORATION)
3 POLICE DRIVE
GOSHEN, NY 10924

FOR: BABY WIPES; DISPOSABLE WIPES IMPREGNATED WITH CLEANSING CHEMICALS OR COMPOUNDS FOR HOUSEHOLD USE OR PERSONAL HYGIENE; WIPES IMPREGNATED WITH A SKIN CLEANSER, IN CLASS 3 (U.S. CLS. 1, 4, 6, 50, 51 AND 52).

FIRST USE 1-12-2012; IN COMMERCE 1-12-2012.

THE MARK CONSISTS OF STANDARD CHARACTERS WITHOUT CLAIM TO ANY PARTICULAR FONT, STYLE, SIZE, OR COLOR.

SN 85-977,105, FILED 5-23-2011.

HOWARD SMIGA, EXAMINING ATTORNEY



David J. Kybas

Director of the United States Patent and Trademark Office

United States of America

United States Patent and Trademark Office



Reg. No. 4,207,844

UNITED STATES POLO ASSOCIATION, INC. (ILLINOIS CORPORATION)
771 CORPORATE DRIVE, SUITE 430
LEXINGTON, KY 40503

Registered Sep. 11, 2012

Int. Cl.: 41

FOR: ENTERTAINMENT SERVICES, NAMELY, ORGANIZING AND CONDUCTING POLO TOURNAMENTS, IN CLASS 41 (U.S. CLS. 100, 101 AND 107).

SERVICE MARK

FIRST USE 12-1-2011; IN COMMERCE 12-1-2011.

PRINCIPAL REGISTER

OWNER OF U.S. REG. NOS. 3,370,932, 3,729,640, AND OTHERS.

THE MARK CONSISTS OF A SHIELD AND LAUREL DESIGN, WITH THE SHIELD INCLUDING THE WORDS "TEAM USPA" AND A DESIGN OF TWO POLO PLAYERS AND HORSES AND A FLAG DESIGN DISPOSED BELOW THE WORDS.

SN 85-977,137, FILED 11-9-2010.

RUSS HERMAN, EXAMINING ATTORNEY



David J. Kybas

Director of the United States Patent and Trademark Office

United States of America
United States Patent and Trademark Office

BOOKBABY

Reg. No. 4,207,845

AUDIO & VIDEO LABS, INC. (NEW JERSEY CORPORATION)
7905 N. RT. 130

Registered Sep. 11, 2012

PENNSAUKEN, NJ 08110

Int. Cl.: 42

FOR: DIGITAL FORMATTING OF ELECTRONIC BOOKS (EBOOKS) INTO DOWNLOADABLE PRODUCTS; GRAPHIC DESIGN SERVICES, NAMELY, COVER DESIGN FOR ELECTRONIC BOOKS, IN CLASS 42 (U.S. CLS. 100 AND 101).

SERVICE MARK

FIRST USE 5-1-2010; IN COMMERCE 5-1-2010.

PRINCIPAL REGISTER

THE MARK CONSISTS OF STANDARD CHARACTERS WITHOUT CLAIM TO ANY PARTICULAR FONT, STYLE, SIZE, OR COLOR.

OWNER OF U.S. REG. NOS. 3,467,602, 3,551,953, AND OTHERS.

SN 85-977,144, FILED 5-28-2010.

LIEF MARTIN, EXAMINING ATTORNEY



David J. Kyffers

Director of the United States Patent and Trademark Office

United States of America

United States Patent and Trademark Office

TOUCHFIRE

Reg. No. 4,207,846

Registered Sep. 11, 2012

Int. Cl.: 9

TRADEMARK

PRINCIPAL REGISTER

TOUCHFIRE, INC. (DELAWARE CORPORATION)
4008 W. LAKE SAMMAMISH PKWY NE
REDMOND, WA 98052

FOR: ELECTRICAL, MECHANICAL AND ELECTROMECHANICAL ERGONOMIC INPUT DEVICES SPECIALLY ADAPTED FOR USE WITH COMPUTER HARDWARE, MOBILE COMPUTER HARDWARE, AND TELECOMMUNICATIONS HARDWARE IN THE NATURE OF PORTABLE DIGITAL ELECTRONIC DEVICES FOR ORGANIZING, TRANSMITTING, MANIPULATING, AND REVIEWING TEXT, DATA, AUDIO AND VIDEO FILES, IN CLASS 9 (U.S. CLS. 21, 23, 26, 36 AND 38).

FIRST USE 6-28-2012; IN COMMERCE 6-28-2012.

THE MARK CONSISTS OF STANDARD CHARACTERS WITHOUT CLAIM TO ANY PARTICULAR FONT, STYLE, SIZE, OR COLOR.

SN 85-977,158, FILED 12-16-2010.

JAMES MACFARLANE, EXAMINING ATTORNEY



David J. Kyffers

Director of the United States Patent and Trademark Office

United States of America

United States Patent and Trademark Office

BLACK BY VERA WANG

Reg. No. 4,207,847

VE.W. LTD (DELAWARE CORPORATION)
15 EAST 26TH STREET, 4TH AND 5TH FLOORS
NEW YORK, NY 10010

Registered Sep. 11, 2012

Int. Cl.: 25

FOR: MEN'S CLOTHING, NAMELY, TUXEDOES, IN CLASS 25 (U.S. CLS. 22 AND 39).

FIRST USE 3-1-2012; IN COMMERCE 3-1-2012.

TRADEMARK

THE MARK CONSISTS OF STANDARD CHARACTERS WITHOUT CLAIM TO ANY PARTICULAR FONT, STYLE, SIZE, OR COLOR.

PRINCIPAL REGISTER

OWNER OF U.S. REG. NOS. 1,797,058, 4,006,513, AND OTHERS.

NO CLAIM IS MADE TO THE EXCLUSIVE RIGHT TO USE "BLACK", APART FROM THE MARK AS SHOWN.

THE NAME "VERA WANG" IDENTIFIES A LIVING INDIVIDUAL WHOSE CONSENT IS OF RECORD.

SN 85-977,162, FILED 6-23-2011.

JUDITH HELFMAN, EXAMINING ATTORNEY



David J. Kyffers

Director of the United States Patent and Trademark Office

United States of America

United States Patent and Trademark Office

GREENGOURMET

Reg. No. 4,207,848

Registered Sep. 11, 2012

Int. Cl.: 21

TRADEMARK

PRINCIPAL REGISTER

CONAIR CORPORATION (DELAWARE CORPORATION)
ONE CUMMINGS POINT ROAD
STAMFORD, CT 06902

FOR: HOUSEHOLD UTENSILS, NAMELY, SERVINGS SPOONS, SLOTTED SPOONS, COOKING SPATULAS, TURNER, LADLE, POTATO MASHER; MIXING SPOONS; REAMERS FOR FRUIT JUICE; SPOON RESTS, IN CLASS 21 (U.S. CLS. 2, 13, 23, 29, 30, 33, 40 AND 50).

FIRST USE 1-31-2012; IN COMMERCE 1-31-2012.

THE MARK CONSISTS OF STANDARD CHARACTERS WITHOUT CLAIM TO ANY PARTICULAR FONT, STYLE, SIZE, OR COLOR.

OWNER OF U.S. REG. NOS. 3,577,467 AND 3,857,982.

SN 85-977,172, FILED 6-30-2011.

LINDA ORNDORFF, EXAMINING ATTORNEY



David J. Kybas

Director of the United States Patent and Trademark Office

United States of America

United States Patent and Trademark Office

Ready Time Pals

Reg. No. 4,207,849

Registered Sep. 11, 2012

Int. Cl.: 41

SERVICE MARK

PRINCIPAL REGISTER

SLEEPY TIME PALS PRODUCTIONS (CALIFORNIA LIMITED LIABILITY COMPANY)
16723 BERMUDA STREET
GRANADA HILLS, CA 91344

FOR: ENTERTAINMENT SERVICES, NAMELY, AN ON-GOING SERIES FEATURING CHILDREN'S ENTERTAINMENT PROVIDED THROUGH TELEVISION AND WEBCASTS , IN CLASS 41 (U.S. CLS. 100, 101 AND 107).

FIRST USE 11-27-2011; IN COMMERCE 11-27-2011.

THE MARK CONSISTS OF STANDARD CHARACTERS WITHOUT CLAIM TO ANY PARTICULAR FONT, STYLE, SIZE, OR COLOR.

SN 85-977,173, FILED 6-9-2011.

KELLEY WELLS, EXAMINING ATTORNEY



David J. Kyffers

Director of the United States Patent and Trademark Office

United States of America

United States Patent and Trademark Office

IT'S WHAT'S UP FRONT THAT MATTERS

Reg. No. 4,207,850

Registered Sep. 11, 2012

Int. Cl.: 30

TRADEMARK

PRINCIPAL REGISTER

UPFRONT FOODS, LLC (FLORIDA LIMITED LIABILITY COMPANY)
SUITE 1240
301 YAMATO ROAD
BOCA RATON, FL 33431

FOR: GRANOLA CEREALS; BREAKFAST CEREALS; GRANOLA SNACKS, IN CLASS 30
(U.S. CL. 46).

FIRST USE 10-22-2011; IN COMMERCE 10-22-2011.

THE MARK CONSISTS OF STANDARD CHARACTERS WITHOUT CLAIM TO ANY PARTICULAR FONT, STYLE, SIZE, OR COLOR.

OWNER OF U.S. REG. NO. 4,017,269.

SN 85-977,189, FILED 8-10-2011.

JIM RINGLE, EXAMINING ATTORNEY



David J. Kyffers

Director of the United States Patent and Trademark Office

United States of America

United States Patent and Trademark Office

WINEBOOK

Reg. No. 4,207,851

MAISONS MARQUES & DOMAINES USA INC. (DELAWARE CORPORATION)
383 FOURTH STREET SUITE 400
OAKLAND, CA 94607

Registered Sep. 11, 2012

Int. Cls.: 35 and 39

FOR: WHOLESALE AND RETAIL DISTRIBUTORSHIPS IN THE FIELD OF WINES, IN CLASS 35 (U.S. CLS. 100, 101 AND 102).

SERVICE MARK

FIRST USE 9-1-2011; IN COMMERCE 9-14-2011.

PRINCIPAL REGISTER

FOR: DISTRIBUTION SERVICES, NAMELY, DELIVERY OF WINES, IN CLASS 39 (U.S. CLS. 100 AND 105).

FIRST USE 9-1-2011; IN COMMERCE 9-14-2011.

THE MARK CONSISTS OF STANDARD CHARACTERS WITHOUT CLAIM TO ANY PARTICULAR FONT, STYLE, SIZE, OR COLOR.

SN 85-977,213, FILED 5-3-2011.

TEJBIR SINGH, EXAMINING ATTORNEY



David J. Kyros

Director of the United States Patent and Trademark Office

United States of America

United States Patent and Trademark Office

Surviving
Beautifully

Reg. No. 4,207,852

SURVIVING BEAUTIFULLY, LLC (NEW YORK LIMITED LIABILITY COMPANY)
27 CARUSO PLACE
ARMONK, NY 10504

Registered Sep. 11, 2012

Int. Cl.: 44

FOR: PROVIDING A WEBSITE FEATURING CONTENT REGARDING HEALTHY LIVING AND LIFESTYLE WELLNESS; PROVIDING A WEBSITE VIA A GLOBAL COMPUTER NETWORK FEATURING INFORMATION AND COMPREHENSIVE CONTENT IN THE FIELDS OF HEALTH, CANCER, CANCER RECOVERY AND SURVIVAL, IN CLASS 44 (U.S. CLS. 100 AND 101).

SERVICE MARK

PRINCIPAL REGISTER

FIRST USE 10-1-2011; IN COMMERCE 2-1-2012.

NO CLAIM IS MADE TO THE EXCLUSIVE RIGHT TO USE "SURVIVING", APART FROM THE MARK AS SHOWN.

THE COLOR(S) PINK, LIGHT PINK AND BROWN IS/ARE CLAIMED AS A FEATURE OF THE MARK.

THE MARK CONSISTS OF THE PINK AND LIGHT PINK STYLIZED WORD "SURVIVING" STACKED ABOVE THE BROWN STYLIZED WORD "BEAUTIFULLY"; THE LETTER "S" DEPICTS A RIBBON.

SN 85-977,215, FILED 11-4-2011.

MATTHEW PAPPAS, EXAMINING ATTORNEY



David J. Kyppas

Director of the United States Patent and Trademark Office

United States of America

United States Patent and Trademark Office



Reg. No. 4,207,853

LIGHTHOUSE INTERNATIONAL (NEW YORK NOT-FOR-PROFIT CORPORATION)
111 EAST 59TH STREET
NEW YORK, NY 100221202

Registered Sep. 11, 2012

Int. Cls.: 35, 36, and 41

FOR: PROMOTING PUBLIC AWARENESS OF ISSUES RELATED TO VISION HEALTH, IN CLASS 35 (U.S. CLS. 100, 101 AND 102).

SERVICE MARK

FIRST USE 8-0-2010; IN COMMERCE 8-0-2010.

PRINCIPAL REGISTER

FOR: CHARITABLE FUNDRAISING SERVICES, NAMELY, RAISING FUNDS FOR VISION HEALTH; CHARITABLE FUNDRAISING SERVICES BY MEANS OF BICYCLE RIDING AND WALKING EVENTS, IN CLASS 36 (U.S. CLS. 100, 101 AND 102).

FIRST USE 9-0-2010; IN COMMERCE 9-0-2010.

FOR: ENTERTAINMENT SERVICES IN THE NATURE OF ORGANIZING, ARRANGING, AND CONDUCTING BICYCLE RIDING AND WALKING EVENTS, IN CLASS 41 (U.S. CLS. 100, 101 AND 107).

FIRST USE 10-23-2010; IN COMMERCE 10-23-2010.

THE MARK CONSISTS OF THE STYLIZED WORDING "DOUBLE UP 4 VISION" APPEARING OVER A DESIGN ELEMENT. THE DESIGN ELEMENT IS DESIGNED TO LOOK LIKE STYLIZED EYEGLASSES AND A STYLIZED TANDEM BICYCLE WITH TWO RIDERS.

SN 85-977,260, FILED 12-1-2010.

CIMMERIAN COLEMAN, EXAMINING ATTORNEY



David J. Kybas

Director of the United States Patent and Trademark Office

United States of America

United States Patent and Trademark Office

TOM FORD VIOLET BLONDE

Reg. No. 4,207,854

Registered Sep. 11, 2012

Int. Cl.: 3

TRADEMARK

PRINCIPAL REGISTER

THOMAS C. FORD (UNITED STATES INDIVIDUAL)
C/O SHAPIRO & COMPANY, C.P.A
9229 SUNSET BOULEVARD, SUITE 607
LOS ANGELES, CA 90069

FOR: FRAGRANCES FOR PERSONAL USE, IN CLASS 3 (U.S. CLS. 1, 4, 6, 50, 51 AND 52).

FIRST USE 7-31-2011; IN COMMERCE 7-31-2011.

THE MARK CONSISTS OF STANDARD CHARACTERS WITHOUT CLAIM TO ANY PARTICULAR FONT, STYLE, SIZE, OR COLOR.

OWNER OF U.S. REG. NOS. 3,076,975, 3,544,448, AND OTHERS.

NO CLAIM IS MADE TO THE EXCLUSIVE RIGHT TO USE "VIOLET", APART FROM THE MARK AS SHOWN.

THE NAME "TOM FORD" IN THE MARK IDENTIFIES THOMAS C. FORD, A LIVING INDIVIDUAL WHOSE CONSENT IS OF RECORD.

SN 85-977,281, FILED 11-19-2010.

DAVID H. STINE, EXAMINING ATTORNEY



David J. Kybas

Director of the United States Patent and Trademark Office

United States of America

United States Patent and Trademark Office



Reg. No. 4,207,855

Registered Sep. 11, 2012

Int. Cls.: 29, 30, and 32

TRADEMARK

PRINCIPAL REGISTER

CAMPERO INTERNATIONAL LIMITED (BARBADOS CORPORATION)
2ND FLOOR, HASTINGS, CHRIST CHURCH
HASTINGS FINANCIAL CENTRE
BARBADOS, BARBADOS BB15154

FOR: COOKED POULTRY, COLE SLAW, PROCESSED POTATOES, SALADS, NAMELY, VEGETABLE SALADS, GARDEN SALADS, PROCESSED BEANS, COOKED VEGETABLES, FRENCH FRIED POTATOES, AND PREPARED ENTREES CONSISTING OF POULTRY OR VEGETABLES, IN CLASS 29 (U.S. CL. 46).

FIRST USE 10-4-2011; IN COMMERCE 10-4-2011.

FOR: BREADS, PASTRIES, SALSA, GRAIN-BASED BEVERAGES, AND BAKERY DESSERTS, IN CLASS 30 (U.S. CL. 46).

FIRST USE 10-4-2011; IN COMMERCE 10-4-2011.

FOR: BEVERAGES, NAMELY, FRUIT DRINKS, FRUIT PUNCH, LEMONADE AND DRINKING WATER, IN CLASS 32 (U.S. CLS. 45, 46 AND 48).

FIRST USE 10-4-2011; IN COMMERCE 10-4-2011.

OWNER OF U.S. REG. NOS. 1,783,043, 3,508,553, AND OTHERS.

NO CLAIM IS MADE TO THE EXCLUSIVE RIGHT TO USE "POLLO" FOR INTERNATIONAL CLASS 29, APART FROM THE MARK AS SHOWN.

THE MARK CONSISTS OF A RECTANGLE WITH LINES INSIDE OF IT FORMING THE LETTERS "PC" AND A CHICKEN, WITH OTHER LINES FORMING ABSTRACT DESIGNS WITHIN THE RECTANGLE. TO THE LEFT AND BELOW THE RECTANGLE DESIGN ARE THE WORDS "POLLO CAMPERO".

THE ENGLISH TRANSLATION OF "POLLO CAMPERO" IN THE MARK IS "COUNTRY CHICKEN".

SN 85-977,334, FILED 12-13-2010.



David J. Kybas

Director of the United States Patent and Trademark Office

Reg. No. 4,207,855 SARA BENJAMIN, EXAMINING ATTORNEY

United States of America

United States Patent and Trademark Office

HEALTH HISPANICA

Reg. No. 4,207,856

GREEN WEALTH, INC. (CALIFORNIA CORPORATION)
6952 BUCKEYE STREET
CHINO, CA 917108248

Registered Sep. 11, 2012

Int. Cl.: 35

FOR: ONLINE RETAIL STORE SERVICES FEATURING NUTRITIONAL SUPPLEMENTS,
IN CLASS 35 (U.S. CLS. 100, 101 AND 102).

SERVICE MARK

FIRST USE 8-0-2009; IN COMMERCE 8-0-2009.

SUPPLEMENTAL REGISTER

THE MARK CONSISTS OF STANDARD CHARACTERS WITHOUT CLAIM TO ANY PARTICULAR FONT, STYLE, SIZE, OR COLOR.

THE ENGLISH TRANSLATION OF "HISPANICA" IS "HISPANIC".

SER. NO. 76-706,709, FILED P.R. 3-9-2011; AM. S.R. 8-7-2012.

STEVEN PEREZ, EXAMINING ATTORNEY



David J. Kyros

Director of the United States Patent and Trademark Office

United States of America

United States Patent and Trademark Office

JOINT CBRN CONFERENCE & EXHIBITION

Reg. No. 4,207,857

Registered Sep. 11, 2012

Int. Cl.: 35

SERVICE MARK

SUPPLEMENTAL REGISTER

NATIONAL DEFENSE INDUSTRIAL ASSOCIATION (D.C. CORPORATION)
2111 WILSON BOULEVARD
SUITE 400
ARLINGTON, VA 22201

FOR: PROMOTIONAL SPONSORSHIP OF ANNUAL CONFERENCES BETWEEN GOVERNMENT AND THE DEFENSE INDUSTRY ON THE SUBJECT OF CHEMICAL, BIOLOGICAL, RADIOLOGICAL, AND NUCLEAR WARFARE, IN CLASS 35 (U.S. CLS. 100, 101 AND 102).

FIRST USE 10-27-2005; IN COMMERCE 6-26-2006.

THE MARK CONSISTS OF STANDARD CHARACTERS WITHOUT CLAIM TO ANY PARTICULAR FONT, STYLE, SIZE, OR COLOR.

NO CLAIM IS MADE TO THE EXCLUSIVE RIGHT TO USE "JOINT" AND "CONFERENCE & EXHIBITION", APART FROM THE MARK AS SHOWN.

SER. NO. 76-707,326, FILED P.R. 4-18-2011; AM. S.R. 6-26-2012.

LESLEY LAMOTHE, EXAMINING ATTORNEY



David J. Kyffers

Director of the United States Patent and Trademark Office

United States of America

United States Patent and Trademark Office

NATIONAL RUNNING SAFETY MONTH

Reg. No. 4,207,858

FORMULA4MANAGEMENT, LLC. (NEW YORK LIMITED LIABILITY COMPANY)
P.O. BOX 231322
GREAT NECK, NY 11023

Registered Sep. 11, 2012

Int. Cl.: 35

FOR: PROMOTING RUNNING SAFETY INCLUDING HIGH VISIBILITY REFLECTIVE AP-
PAREL, FOOTWEAR AND OTHER RELATED EQUIPMENT AND THE POTENTIAL
DANGERS OF A SHARED ROAD ENVIRONMENT, IN CLASS 35 (U.S. CLS. 100, 101 AND
102).

SERVICE MARK

SUPPLEMENTAL REGISTER FIRST USE 6-0-2012; IN COMMERCE 6-0-2012.

THE MARK CONSISTS OF STANDARD CHARACTERS WITHOUT CLAIM TO ANY PAR-
TICULAR FONT, STYLE, SIZE, OR COLOR.

SER. NO. 76-709,164, FILED P.R. 9-21-2011; AM. S.R. 7-13-2012.

PATRICIA EVANKO, EXAMINING ATTORNEY



David J. Kyffers

Director of the United States Patent and Trademark Office

United States of America

United States Patent and Trademark Office

THE AUTHENTIC DENIM & RIVETS CLOTHING COMPANY

Reg. No. 4,207,859

Registered Sep. 11, 2012

Int. Cl.: 25

TRADEMARK

SUPPLEMENTAL REGISTER

BOBENS TRADING CO., INC. (NEW YORK CORPORATION)
1140 MOTOR PARKWAY
SUITE B
HAUPPAUGE, NY 11788

FOR: MENS, WOMENS AND CHILDRENS DENIM CLOTHING, NAMELY, SUITS, TROUSERS, JACKETS, BLOUSES, PANTS, DRESSES, SHIRTS, AND SHORTS, IN CLASS 25 (U.S. CLS. 22 AND 39).

FIRST USE 9-2-2003; IN COMMERCE 9-2-2003.

THE MARK CONSISTS OF STANDARD CHARACTERS WITHOUT CLAIM TO ANY PARTICULAR FONT, STYLE, SIZE, OR COLOR.

NO CLAIM IS MADE TO THE EXCLUSIVE RIGHT TO USE "DENIM" AND "CLOTHING COMPANY", APART FROM THE MARK AS SHOWN.

SER. NO. 76-709,207, FILED P.R. 9-26-2011; AM. S.R. 1-18-2012.

FONG HSU, EXAMINING ATTORNEY



David J. Kypos

Director of the United States Patent and Trademark Office

United States of America

United States Patent and Trademark Office

GREEN MACHINE

Reg. No. 4,207,860

JIG IP HOLDING, LLC. (NEW HAMPSHIRE LIMITED LIABILITY COMPANY)
5 GIGANTE DRIVE
HAMPSTEAD, NH 03841

Registered Sep. 11, 2012

Int. Cl.: 7

FOR: SORTING MACHINES FOR SOLID WASTE, SINGLE STREAM WASTE, CONSTRUCTION AND DEMOLITION WASTE, ELECTRONICS WASTE, FIBER AND CONTAINER WASTE, AND FERROUS AND NON-FERROUS MATERIAL; CONVEYORS, IN CLASS 7 (U.S. CLS. 13, 19, 21, 23, 31, 34 AND 35).

TRADEMARK

SUPPLEMENTAL REGISTER FIRST USE 1-1-2006; IN COMMERCE 1-1-2006.

THE MARK CONSISTS OF STANDARD CHARACTERS WITHOUT CLAIM TO ANY PARTICULAR FONT, STYLE, SIZE, OR COLOR.

NO CLAIM IS MADE TO THE EXCLUSIVE RIGHT TO USE "MACHINE", APART FROM THE MARK AS SHOWN.

SER. NO. 77-670,520, FILED P.R. 2-13-2009; AM. S.R. 11-4-2009.

KATHLEEN M. VANSTON, EXAMINING ATTORNEY



David J. Kyffers

Director of the United States Patent and Trademark Office

United States of America

United States Patent and Trademark Office

BOARDBUNGEE

Reg. No. 4,207,861

BIG RIVER INNOVATIONS, INC. (IDAHO CORPORATION)
5465 E. TERRA LINDA
NAMPA, ID 83687

Registered Sep. 11, 2012

Int. Cl.: 28

FOR: BRAIDED ELASTIC ROPE OR CORD WITH HANDLES THAT CAN BE STRETCHED TO PROPEL A RIDER ON A RIVERBOARD, SKIMBOARD, SKATEBOARD, SNOWBOARD OR BIKE, IN CLASS 28 (U.S. CLS. 22, 23, 38 AND 50).

TRADEMARK

FIRST USE 4-21-2009; IN COMMERCE 4-21-2009.

SUPPLEMENTAL REGISTER

THE MARK CONSISTS OF STANDARD CHARACTERS WITHOUT CLAIM TO ANY PARTICULAR FONT, STYLE, SIZE, OR COLOR.

SER. NO. 77-719,447, FILED P.R. 4-22-2009; AM. S.R. 12-21-2009.

MATTHEW MCDOWELL, EXAMINING ATTORNEY



David J. Kyfos

Director of the United States Patent and Trademark Office

United States of America

United States Patent and Trademark Office

CHIACORP

Reg. No. 4,207,862

HORACIO-GENNI, ROBERTO (ARGENTINA INDIVIDUAL)
AZUCENA VILLAFLORES 669

Registered Sep. 11, 2012

BUENOS AIRES, ARGENTINA AND

Int. Cl.: 30

RODOLFO-ELGUER, MIGUEL (ARGENTINA INDIVIDUAL)
SÁNCHEZ DE BUSTAMANTE 2275
BUENOS AIRES, ARGENTINA

TRADEMARK

SUPPLEMENTAL REGISTER

FOR: (BASED ON 44(E) PURSUANT TO ARGENTINA FOREIGN REGISTRATION NUMBER 2372653) BAKERY PRODUCTS; BAKING POWDERS; BREAD; CANDY; COCOA; COFFEE; COFFEE AND COFFEE SUBSTITUTES; FLOUR; HONEY; ICE; ICE CREAMS; MOLASSES SYRUP; MUSTARD; PROCESSED CEREAL-BASED FOOD TO BE USED AS A BREAKFAST FOOD, SNACK FOOD OR INGREDIENT FOR MAKING OTHER FOODS; RICE; SAGE; SALT; SAUCES; SPICES; SUGAR; TAPIOCA; TEA; VINEGAR; YEAST; ALL OF THE PRECEDING GOODS MADE IN WHOLE OR SIGNIFICANT PART FROM CHIA PLANTS OR CHIA SEEDS, IN CLASS 30 (U.S. CL. 46).

THE MARK CONSISTS OF STANDARD CHARACTERS WITHOUT CLAIM TO ANY PARTICULAR FONT, STYLE, SIZE, OR COLOR.

PRIORITY CLAIMED UNDER SEC. 44(D) ON ARGENTINA APPLICATION NO. 2939600, FILED 8-28-2009, REG. NO. 2372653, DATED 5-28-2010, EXPIRES 5-28-2020.

SER. NO. 77-824,327, FILED P.R. 9-10-2009; AM. S.R. 7-10-2012.

JERI J. FICKES, EXAMINING ATTORNEY



David J. Kyffers

Director of the United States Patent and Trademark Office

United States of America

United States Patent and Trademark Office

PREFERRED APARTMENT COMMUNITIES

Reg. No. 4,207,863

Registered Sep. 11, 2012

Int. Cl.: 36

SERVICE MARK

SUPPLEMENTAL REGISTER

PREFERRED APARTMENT COMMUNITIES, INC. (MARYLAND CORPORATION)
3625 CUMBERLAND BOULEVARD
SUITE 400
ATLANTA, GA 30339

FOR: APARTMENT HOUSE MANAGEMENT; LEASING OF APARTMENTS; MANAGEMENT OF APARTMENTS; REAL ESTATE SERVICES, NAMELY, RENTAL OF SHORT-TERM FURNISHED APARTMENTS; RENTAL OF APARTMENTS; RENTAL OF APARTMENTS IN AN APARTMENT COMMUNITY; RENTING OF APARTMENTS, IN CLASS 36 (U.S. CLS. 100, 101 AND 102).

FIRST USE 4-1-2011; IN COMMERCE 4-1-2011.

THE MARK CONSISTS OF STANDARD CHARACTERS WITHOUT CLAIM TO ANY PARTICULAR FONT, STYLE, SIZE, OR COLOR.

NO CLAIM IS MADE TO THE EXCLUSIVE RIGHT TO USE "APARTMENT COMMUNITIES", APART FROM THE MARK AS SHOWN.

SER. NO. 77-894,742, FILED P.R. 12-16-2009; AM. S.R. 7-13-2012.

JOHN SCHUYLER YARD, EXAMINING ATTORNEY



David J. Kyffers

Director of the United States Patent and Trademark Office

United States of America

United States Patent and Trademark Office

A PREFERRED APARTMENT COMMUNITY

Reg. No. 4,207,864

PREFERRED APARTMENT COMMUNITIES, INC. (MARYLAND CORPORATION)
3625 CUMBERLAND BOULEVARD, SUITE 400
ATLANTA, GA 30339

Registered Sep. 11, 2012

Int. Cl.: 36

FOR: APARTMENT HOUSE MANAGEMENT; LEASING OF APARTMENTS; MANAGEMENT OF APARTMENTS; REAL ESTATE SERVICES, NAMELY, RENTAL OF SHORT-TERM FURNISHED APARTMENTS; RENTAL OF APARTMENTS; RENTAL OF APARTMENTS IN AN APARTMENT COMMUNITY; RENTING OF APARTMENTS, IN CLASS 36 (U.S. CLS. 100, 101 AND 102).

SERVICE MARK

SUPPLEMENTAL REGISTER

FIRST USE 4-1-2011; IN COMMERCE 4-1-2011.

THE MARK CONSISTS OF STANDARD CHARACTERS WITHOUT CLAIM TO ANY PARTICULAR FONT, STYLE, SIZE, OR COLOR.

NO CLAIM IS MADE TO THE EXCLUSIVE RIGHT TO USE "APARTMENT COMMUNITY", APART FROM THE MARK AS SHOWN.

SER. NO. 77-894,777, FILED P.R. 12-16-2009; AM. S.R. 7-13-2012.

JOHN SCHUYLER YARD, EXAMINING ATTORNEY



David J. Kypos

Director of the United States Patent and Trademark Office

United States of America

United States Patent and Trademark Office

AIR INFUSION

Reg. No. 4,207,865

BUNN-O-MATIC CORPORATION (DELAWARE CORPORATION)
1400 STEVENSON DRIVE
SPRINGFIELD, IL 62703

Registered Sep. 11, 2012

Int. Cl.: 11

FOR: BEVERAGE MAKING MACHINES, NAMELY, COFFEE AND TEA BREWING MACHINES PROVIDING A BREWING PROCESS FOR MIXING A BEVERAGE MAKING SUBSTANCE WITH WATER AND CONTROLLABLY AGITATING THE MIXTURE WITH AIR, IN CLASS 11 (U.S. CLS. 13, 21, 23, 31 AND 34).

TRADEMARK

SUPPLEMENTAL REGISTER FIRST USE 6-1-2010; IN COMMERCE 3-1-2012.

THE MARK CONSISTS OF STANDARD CHARACTERS WITHOUT CLAIM TO ANY PARTICULAR FONT, STYLE, SIZE, OR COLOR.

OWNER OF U.S. REG. NO. 3,058,304.

SER. NO. 77-963,584, FILED P.R. 3-19-2010; AM. S.R. 7-19-2012.

NICHOLAS COLEMAN, EXAMINING ATTORNEY



David J. Kyffers

Director of the United States Patent and Trademark Office

United States of America

United States Patent and Trademark Office

B HAPPY

Reg. No. 4,207,866

Registered Sep. 11, 2012

Int. Cl.: 25

TRADEMARK

SUPPLEMENTAL REGISTER

B HOTEL GROUP, LLC (FLORIDA LIMITED LIABILITY COMPANY)
1825 MAIN STREET, SUITE 229
WESTON, FL 33326

FOR: CLOTHING, NAMELY, BLOUSES, SHIRTS, TOPS, T-SHIRTS, SWEAT SHIRTS, BOXER SHORTS, SHORTS, SKIRTS, SWEAT PANTS, PANTS, CAPS, HATS, HEADBANDS, HEADWEAR, DRESSES, DRESSING GOWNS, COATS, JACKETS, SWEATERS, OVERALLS, JOGGING OUTFITS, ROBES, NIGHT SHIRTS, NIGHTWEAR, SLEEPWEAR, PAJAMAS, PARKAS, RAINWEAR, NECKTIES, SARONGS, SASHES, SCARVES, SHAWLS, BELTS, APRONS, BANDANAS, BATHING SUITS, BEACH COVERUPS, BEACH WEAR, SWIMWEAR, FOOTWEAR AND SOCKS, IN CLASS 25 (U.S. CLS. 22 AND 39).

FIRST USE 11-10-2011; IN COMMERCE 11-10-2011.

THE MARK CONSISTS OF STANDARD CHARACTERS WITHOUT CLAIM TO ANY PARTICULAR FONT, STYLE, SIZE, OR COLOR.

SER. NO. 85-082,390, FILED P.R. 7-12-2010; AM. S.R. 6-12-2012.

LEIGH LOWRY, EXAMINING ATTORNEY



David J. Kyffers

Director of the United States Patent and Trademark Office

United States of America

United States Patent and Trademark Office

PROTEIN PASTRY

Reg. No. 4,207,867

PROMEDIS GROUP INC. (CANADA CORPORATION)
30 CORPORAL PATTERSON LANE
NEWCASTLE, ONTARIO, CANADA L1B0A7

Registered Sep. 11, 2012

Int. Cl.: 5

FOR: FOODS FOR DIETETIC USE, NAMELY, NUTRIENT-DENSE, PROTEIN-BASED FOOD BARS, IN CLASS 5 (U.S. CLS. 6, 18, 44, 46, 51 AND 52).

TRADEMARK

FIRST USE 9-0-2010; IN COMMERCE 9-0-2010.

SUPPLEMENTAL REGISTER

THE MARK CONSISTS OF STANDARD CHARACTERS WITHOUT CLAIM TO ANY PARTICULAR FONT, STYLE, SIZE, OR COLOR.

NO CLAIM IS MADE TO THE EXCLUSIVE RIGHT TO USE "PROTEIN", APART FROM THE MARK AS SHOWN.

SER. NO. 85-097,292, FILED P.R. 7-30-2010; AM. S.R. 7-5-2012.

GRETCHEN ULRICH, EXAMINING ATTORNEY



David J. Kybas

Director of the United States Patent and Trademark Office

United States of America

United States Patent and Trademark Office

PURO COROJO

Reg. No. 4,207,868

Registered Sep. 11, 2012

Int. Cl.: 34

SMOKE INN, LLC (FLORIDA LIMITED LIABILITY COMPANY)
SUITE 305
801 VILLAGE BLVD.
WEST PALM BEACH, FL 33409

FOR: CIGARS, IN CLASS 34 (U.S. CLS. 2, 8, 9 AND 17).

TRADEMARK

FIRST USE 6-0-2011; IN COMMERCE 6-0-2011.

SUPPLEMENTAL REGISTER

THE MARK CONSISTS OF STANDARD CHARACTERS WITHOUT CLAIM TO ANY PARTICULAR FONT, STYLE, SIZE, OR COLOR.

NO CLAIM IS MADE TO THE EXCLUSIVE RIGHT TO USE "COROJO", APART FROM THE MARK AS SHOWN.

THE ENGLISH TRANSLATION OF "PURO" IN THE MARK IS "PURE" OR "CIGAR". THE TERM "COROJO" HAS NO MEANING IN A FOREIGN LANGUAGE.

SER. NO. 85-103,939, FILED P.R. 8-10-2010; AM. S.R. 12-5-2011.

JESSICA A. POWERS, EXAMINING ATTORNEY



David J. Kyros

Director of the United States Patent and Trademark Office

United States of America
United States Patent and Trademark Office

ZNCOAT

Reg. No. 4,207,869

Registered Sep. 11, 2012

Int. Cl.: 6

TRADEMARK

SUPPLEMENTAL REGISTER

NOF METAL COATINGS NORTH AMERICA INC. (DELAWARE CORPORATION)
LEGAL DEPARTMENT
275 INDUSTRIAL PARKWAY
CHARDON, OH 440241083

FOR: METAL FASTENERS, NAMELY, NAILS, BOLTS, SCREWS, RIVETS, ANCHOR BOLTS, WASHERS, NUTS, SPRINGS, CLIPS AND CLAMPS, NAMELY, SPRING STEEL SPEED CLIPS, WIRE LOOP AND BAND-TYPE CLAMPS, ATTACHMENT CLAMPS, AND ADJUSTABLE CLAMPS PINS, COTTER PINS, COILED SPRING PINS, SLOTTED SPRING PINS, THREADED STUDS, PIPES, AND PIPE FITTINGS, ALL TREATED WITH CORROSION-RESISTANT COATINGS, IN CLASS 6 (U.S. CLS. 2, 12, 13, 14, 23, 25 AND 50).

FIRST USE 11-1-2010; IN COMMERCE 11-1-2010.

THE MARK CONSISTS OF STANDARD CHARACTERS WITHOUT CLAIM TO ANY PARTICULAR FONT, STYLE, SIZE, OR COLOR.

SER. NO. 85-131,270, FILED P.R. 9-16-2010; AM. S.R. 10-27-2011.

ANTHONY RINKER, EXAMINING ATTORNEY



David J. Kybas

Director of the United States Patent and Trademark Office

United States of America

United States Patent and Trademark Office

FIJI THERAPY

Reg. No. 4,207,870

REGIS INC. (MINNESOTA CORPORATION)
7201 METRO BOULEVARD
MINNEAPOLIS, MN 55439

Registered Sep. 11, 2012

Int. Cl.: 3

FOR: HAIR STYLING OIL, IN CLASS 3 (U.S. CLS. 1, 4, 6, 50, 51 AND 52).

TRADEMARK

FIRST USE 3-0-2010; IN COMMERCE 3-0-2010.

SUPPLEMENTAL REGISTER

THE MARK CONSISTS OF STANDARD CHARACTERS WITHOUT CLAIM TO ANY PARTICULAR FONT, STYLE, SIZE, OR COLOR.

SER. NO. 85-152,376, FILED P.R. 10-14-2010; AM. S.R. 1-26-2011.

MATTHEW KLINE, EXAMINING ATTORNEY



David J. Kappas

Director of the United States Patent and Trademark Office

United States of America

United States Patent and Trademark Office

HOLMZ

Reg. No. 4,207,871

HOLMES VENTURES, LLC (TENNESSEE LIMITED LIABILITY COMPANY)
2216 SOUTHERN SHADE BLVD.
KNOXVILLE, TN 37932

Registered Sep. 11, 2012

Int. Cl.: 41

FOR: ENTERTAINMENT SERVICES, NAMELY, PROVIDING NON-DOWNLOADABLE
PLAYBACK OF MUSIC VIA GLOBAL COMMUNICATIONS NETWORKS, IN CLASS 41
(U.S. CLS. 100, 101 AND 107).

SERVICE MARK

FIRST USE 7-19-2009; IN COMMERCE 7-19-2009.

SUPPLEMENTAL REGISTER

THE MARK CONSISTS OF STANDARD CHARACTERS WITHOUT CLAIM TO ANY PAR-
TICULAR FONT, STYLE, SIZE, OR COLOR.

SER. NO. 85-166,978, FILED P.R. 11-2-2010; AM. S.R. 8-19-2011.

C. DIONNE CLYBURN, EXAMINING ATTORNEY



David J. Kyfos

Director of the United States Patent and Trademark Office

United States of America

United States Patent and Trademark Office



Reg. No. 4,207,872

EMB DESIGNS, LLC (KENTUCKY LIMITED LIABILITY COMPANY)
2973 MONTAVESTA ROAD
LEXINGTON, KY 40502

Registered Sep. 11, 2012

Int. Cl.: 18

FOR: BACK PACKS; BOOK BAGS; FANNY PACKS; TOTE BAGS, IN CLASS 18 (U.S. CLS. 1, 2, 3, 22 AND 41).

TRADEMARK

FIRST USE 11-5-2011; IN COMMERCE 11-5-2011.

SUPPLEMENTAL REGISTER

THE MARK CONSISTS OF A CARTOON-STYLE HAND DEPICTING THE SIGN LANGUAGE SIGN FOR I LOVE YOU, WITH A FACE FORMED BY THE FINGERNAILS ON THE THIRD AND FOURTH FINGERS AND THE CREASE IN THE PALM OF THE HAND.

SER. NO. 85-173,622, FILED P.R. 11-10-2010; AM. S.R. 7-19-2012.

TRACY FLETCHER, EXAMINING ATTORNEY



David J. Kybas

Director of the United States Patent and Trademark Office

United States of America

United States Patent and Trademark Office



Reg. No. 4,207,873

EMB DESIGNS, LLC (KENTUCKY LIMITED LIABILITY COMPANY)
2973 MONTAVESTA ROAD
LEXINGTON, KY 40502

Registered Sep. 11, 2012

Int. Cl.: 18

FOR: BACK PACKS; BOOK BAGS; FANNY PACKS; TOTE BAGS, IN CLASS 18 (U.S. CLS. 1, 2, 3, 22 AND 41).

TRADEMARK

FIRST USE 11-5-2011; IN COMMERCE 11-5-2011.

SUPPLEMENTAL REGISTER

THE MARK CONSISTS OF A CARTOON-STYLE HAND DEPICTING THE SIGN LANGUAGE SIGN FOR I LOVE YOU, WITH A FACE FORMED BY THE FINGERNAILS ON THE THIRD AND FOURTH FINGERS AND THE CREASE IN THE PALM OF THE HAND, WITH A PALM TREE CURVING AROUND THE HAND AND A SETTING SUN AND AN OCEAN BEHIND THE HAND.

SER. NO. 85-173,644, FILED P.R. 11-10-2010; AM. S.R. 7-19-2012.

TRACY FLETCHER, EXAMINING ATTORNEY



David J. Kyffers

Director of the United States Patent and Trademark Office

United States of America

United States Patent and Trademark Office

EFFORT IS SEXY

Reg. No. 4,207,874

LONGVIEW ENTERPRISES, LLC (VIRGINIA LIMITED LIABILITY COMPANY)
4590 LYNN FOREST DRIVE
GAINESVILLE, VA 20155

Registered Sep. 11, 2012

Int. Cl.: 25

FOR: ATHLETIC APPAREL, NAMELY, SHIRTS, PANTS, JACKETS, FOOTWEAR, HATS AND CAPS, ATHLETIC UNIFORMS; FOOTWEAR; GLOVES; HEADWEAR; JERSEYS; PULLOVERS; RAINWEAR; RUNNING SUITS; SHIRTS; SHORTS; SPORTS PANTS; SPORTS SHIRTS; SWIM WEAR, IN CLASS 25 (U.S. CLS. 22 AND 39).

TRADEMARK

SUPPLEMENTAL REGISTER FIRST USE 2-20-2012; IN COMMERCE 2-20-2012.

THE MARK CONSISTS OF STANDARD CHARACTERS WITHOUT CLAIM TO ANY PARTICULAR FONT, STYLE, SIZE, OR COLOR.

SER. NO. 85-185,284, FILED P.R. 11-25-2010; AM. S.R. 6-29-2012.

JAMES MACFARLANE, EXAMINING ATTORNEY



David J. Kybas

Director of the United States Patent and Trademark Office

United States of America

United States Patent and Trademark Office

Global Metal Powders, LLC

Reg. No. 4,207,875

GLOBAL METAL POWDERS, LLC (PENNSYLVANIA LIMITED LIABILITY COMPANY)
325 EAST WASHINGTON STREET
NEW CASTLE, PA 16101

Registered Sep. 11, 2012

Int. Cl.: 40

FOR: PROCESSING OF METAL MATERIALS, NAMELY, TREATMENT OF METAL MATERIALS FOR THE MANUFACTURE OF METAL POWDERS BY USE OF IN-HOUSE PROPRIETARY TECHNOLOGIES INCLUDING HYDRIDE-DEHYDRIDE (HDH) AND CRYOGENIC CAPABILITIES, IN CLASS 40 (U.S. CLS. 100, 103 AND 106).

SERVICE MARK

SUPPLEMENTAL REGISTER FIRST USE 2-27-2011; IN COMMERCE 2-27-2011.

THE MARK CONSISTS OF STANDARD CHARACTERS WITHOUT CLAIM TO ANY PARTICULAR FONT, STYLE, SIZE, OR COLOR.

NO CLAIM IS MADE TO THE EXCLUSIVE RIGHT TO USE "LLC", APART FROM THE MARK AS SHOWN.

SER. NO. 85-203,562, FILED P.R. 12-22-2010; AM. S.R. 12-27-2011.

BARBARA RUTLAND, EXAMINING ATTORNEY



David J. Kyffers

Director of the United States Patent and Trademark Office

United States of America

United States Patent and Trademark Office

HYBRID TILE FINISHING SYSTEM

Reg. No. 4,207,876

YOUNG IDEAS, LLC (ILLINOIS LIMITED LIABILITY COMPANY)
1350-C WEST SOUTHPORT ROAD, SUITE 157
INDIANAPOLIS, IN 46217

Registered Sep. 11, 2012

Int. Cl.: 37

FOR: TILE INSTALLATION SERVICES, IN CLASS 37 (U.S. CLS. 100, 103 AND 106).

SERVICE MARK

FIRST USE 4-1-2009; IN COMMERCE 4-1-2009.

SUPPLEMENTAL REGISTER

THE MARK CONSISTS OF STANDARD CHARACTERS WITHOUT CLAIM TO ANY PARTICULAR FONT, STYLE, SIZE, OR COLOR.

SER. NO. 85-207,852, FILED P.R. 12-30-2010; AM. S.R. 7-12-2012.

MARK SPARACINO, EXAMINING ATTORNEY



David J. Kyffers

Director of the United States Patent and Trademark Office

United States of America

United States Patent and Trademark Office

PANIC STRICKEN GEEZER

Reg. No. 4,207,877

ENVIRONMENTAL LOGIC, INC. (NORTH CAROLINA CORPORATION)
1215 LOW GAP ROAD
HAYESVILLE, NC 28904

Registered Sep. 11, 2012

Int. Cl.: 25

FOR: WEARABLE GARMENTS AND CLOTHING, NAMELY, SHIRTS, IN CLASS 25 (U.S. CLS. 22 AND 39).

TRADEMARK

FIRST USE 3-5-2011; IN COMMERCE 7-3-2011.

SUPPLEMENTAL REGISTER

THE MARK CONSISTS OF STANDARD CHARACTERS WITHOUT CLAIM TO ANY PARTICULAR FONT, STYLE, SIZE, OR COLOR.

SER. NO. 85-238,113, FILED P.R. 2-9-2011; AM. S.R. 7-23-2012.

MICHAEL WEBSTER, EXAMINING ATTORNEY



David J. Kybas

Director of the United States Patent and Trademark Office

United States of America

United States Patent and Trademark Office

PARTICLE DRILLING TECHNOLOGIES

Reg. No. 4,207,878

PDTI HOLDINGS, LLC (DELAWARE LIMITED LIABILITY COMPANY)

Registered Sep. 11, 2012

5611 BAIRD COURT
HOUSTON, TX 77041

Int. Cls.: 7 and 37

FOR: OIL AND GAS DRILLING EQUIPMENT, NAMELY, DOWNHOLE DRILL BITS AND DRILLING RIG MECHANIZATION MACHINES AND DEVICES, IN CLASS 7 (U.S. CLS. 13, 19, 21, 23, 31, 34 AND 35).

TRADEMARK

FIRST USE 11-0-2009; IN COMMERCE 3-0-2012.

SERVICE MARK

FOR: RENTAL OF OIL AND GAS DRILLING EQUIPMENT AND CONSULTING SERVICES RELATING TO OIL AND GAS DRILLING, IN CLASS 37 (U.S. CLS. 100, 103 AND 106).

SUPPLEMENTAL REGISTER

FIRST USE 11-0-2009; IN COMMERCE 11-0-2009.

THE MARK CONSISTS OF STANDARD CHARACTERS WITHOUT CLAIM TO ANY PARTICULAR FONT, STYLE, SIZE, OR COLOR.

NO CLAIM IS MADE TO THE EXCLUSIVE RIGHT TO USE "DRILLING TECHNOLOGIES", APART FROM THE MARK AS SHOWN.

SER. NO. 85-239,216, FILED P.R. 2-10-2011; AM. S.R. 8-1-2012.

MICHELE SWAIN, EXAMINING ATTORNEY



David J. Kyffers

Director of the United States Patent and Trademark Office

United States of America

United States Patent and Trademark Office

POINTS & MONEY REWARDS

Reg. No. 4,207,879

HILTON HHONORS WORLDWIDE LLC (DELAWARE LIMITED LIABILITY COMPANY)
7930 JONES BRANCH DRIVE
MCLEAN, VA 22102

Registered Sep. 11, 2012

Int. Cls.: 35 and 43

FOR: PROVIDING INCENTIVE AWARD PROGRAMS FOR HOTEL CUSTOMERS THROUGH ISSUANCE OF POINTS TO BE REDEEMED FOR FREE OR DISCOUNTED LODGING, AIR FARES, CAR RENTALS, CRUISES, GIFTS AND MERCHANDISE FOR FREQUENT USE OF THE HOTEL, IN CLASS 35 (U.S. CLS. 100, 101 AND 102).

SERVICE MARK

SUPPLEMENTAL REGISTER FIRST USE 4-4-2011; IN COMMERCE 4-4-2011.

FOR: HOTEL SERVICES FEATURING A BONUS INCENTIVE PROGRAM FOR CUSTOMERS WHICH ALLOW PARTICIPANTS TO EARN POINTS TO BE REDEEMED FOR FREE OR DISCOUNTED LODGING, AIR FARES, CAR RENTALS, CRUISES, GIFTS AND MERCHANDISE, IN CLASS 43 (U.S. CLS. 100 AND 101).

FIRST USE 4-4-2011; IN COMMERCE 4-4-2011.

THE MARK CONSISTS OF STANDARD CHARACTERS WITHOUT CLAIM TO ANY PARTICULAR FONT, STYLE, SIZE, OR COLOR.

NO CLAIM IS MADE TO THE EXCLUSIVE RIGHT TO USE "REWARDS", APART FROM THE MARK AS SHOWN.

SER. NO. 85-241,575, FILED P.R. 2-14-2011; AM. S.R. 7-11-2012.

LINDA M. KING, EXAMINING ATTORNEY



David J. Kybas

Director of the United States Patent and Trademark Office

United States of America

United States Patent and Trademark Office

MONDAY NIGHT FASHION

Reg. No. 4,207,880

MIDWEST FASHION WEEK LLC (INDIANA LIMITED LIABILITY COMPANY)
6057 LAKESIDE MANOR AVENUE
INDIANAPOLIS, IN 46254

Registered Sep. 11, 2012

Int. Cl.: 41

FOR: ENTERTAINMENT IN THE NATURE OF FASHION SHOWS, IN CLASS 41 (U.S. CLS. 100, 101 AND 107).

SERVICE MARK

FIRST USE 3-14-2011; IN COMMERCE 3-14-2011.

SUPPLEMENTAL REGISTER

THE MARK CONSISTS OF STANDARD CHARACTERS WITHOUT CLAIM TO ANY PARTICULAR FONT, STYLE, SIZE, OR COLOR.

NO CLAIM IS MADE TO THE EXCLUSIVE RIGHT TO USE "FASHION", APART FROM THE MARK AS SHOWN.

SER. NO. 85-242,885, FILED P.R. 2-15-2011; AM. S.R. 6-19-2012.

CHARLES L. JENKINS, EXAMINING ATTORNEY



David J. Kyros

Director of the United States Patent and Trademark Office

United States of America

United States Patent and Trademark Office

ULTIMATEGRASS

Reg. No. 4,207,881

EASYTURF, INC. (CALIFORNIA CORPORATION)
2750 LA MIRADA
VISTA, CA 92081

Registered Sep. 11, 2012

Int. Cl.: 27

FOR: ARTIFICIAL TURF, IN CLASS 27 (U.S. CLS. 19, 20, 37, 42 AND 50).

FIRST USE 8-4-2010; IN COMMERCE 8-4-2010.

TRADEMARK

THE MARK CONSISTS OF STANDARD CHARACTERS WITHOUT CLAIM TO ANY PARTICULAR FONT, STYLE, SIZE, OR COLOR.

SUPPLEMENTAL REGISTER

SER. NO. 85-248,672, FILED P.R. 2-22-2011; AM. S.R. 8-7-2012.

NAAKWAMA ANKRAH, EXAMINING ATTORNEY



David J. Kyffers

Director of the United States Patent and Trademark Office

United States of America

United States Patent and Trademark Office

AMERICAN SERIES

Reg. No. 4,207,882

DELAIR LLC (NEW JERSEY LIMITED LIABILITY COMPANY)
8600 RIVER ROAD
DELAIR, NJ 08110

Registered Sep. 11, 2012

Int. Cl.: 6

FOR: FENCES AND GATES MADE OF METAL, IN CLASS 6 (U.S. CLS. 2, 12, 13, 14, 23, 25 AND 50).

TRADEMARK

FIRST USE 8-31-2011; IN COMMERCE 8-31-2011.

SUPPLEMENTAL REGISTER

THE MARK CONSISTS OF STANDARD CHARACTERS WITHOUT CLAIM TO ANY PARTICULAR FONT, STYLE, SIZE, OR COLOR.

SER. NO. 85-249,285, FILED P.R. 2-23-2011; AM. S.R. 6-25-2012.

JASON BLAIR, EXAMINING ATTORNEY



David J. Kyffers

Director of the United States Patent and Trademark Office

United States of America

United States Patent and Trademark Office

Duffin

Reg. No. 4,207,883

Registered Sep. 11, 2012

Int. Cl.: 30

TRADEMARK

SUPPLEMENTAL REGISTER

PONTIAC COFFEE HOUSE, LLC (ARKANSAS LIMITED LIABILITY COMPANY)
515 SOUTH THOMPSON STREET
SPRINGDALE, AR 72764

FOR: DONUTS; DOUGHNUTS; MUFFIN MIXES; MUFFINS, IN CLASS 30 (U.S. CL. 46).

FIRST USE 1-3-2011; IN COMMERCE 2-15-2011.

THE MARK CONSISTS OF STANDARD CHARACTERS WITHOUT CLAIM TO ANY PARTICULAR FONT, STYLE, SIZE, OR COLOR.

SER. NO. 85-250,697, FILED 2-24-2011.

NAKIA HENRY, EXAMINING ATTORNEY



David J. Kybas

Director of the United States Patent and Trademark Office

United States of America

United States Patent and Trademark Office

FIVE IN ONE

Reg. No. 4,207,884

ADM21 CO., LTD. (REPUBLIC OF KOREA CORPORATION)
742-6, WONSI-DONG, DANWON-GU, ANSAN-SI
GYEONGGI-DO, REPUBLIC OF KOREA

Registered Sep. 11, 2012

Int. Cl.: 12

FOR: WINDSHIELD WIPER BLADES FOR AUTOMOBILES; WINDSHIELD WIPERS FOR AUTOMOBILES; WINDSHIELD WIPERS FOR FRONT-GLASS OF AUTOMOBILES , IN CLASS 12 (U.S. CLS. 19, 21, 23, 31, 35 AND 44).

TRADEMARK

THE MARK CONSISTS OF STANDARD CHARACTERS WITHOUT CLAIM TO ANY PARTICULAR FONT, STYLE, SIZE, OR COLOR.

SUPPLEMENTAL REGISTER

PRIORITY CLAIMED UNDER SEC. 44(D) ON REPUBLIC OF KOREA APPLICATION NO. 2010-0064476, FILED 12-15-2010, REG. NO. 0904416, DATED 2-14-2012, EXPIRES 2-14-2022.

SER. NO. 85-253,724, FILED P.R. 2-28-2011; AM. S.R. 7-10-2012.

MARCIE MILONE, EXAMINING ATTORNEY



David J. Kyffers

Director of the United States Patent and Trademark Office

United States of America

United States Patent and Trademark Office

BEDANDBREAKFAST.COM

Reg. No. 4,207,885

Registered Sep. 11, 2012

Int. Cl.: 41

SERVICE MARK

SUPPLEMENTAL REGISTER

HOMEAWAY.COM, INC. (DELAWARE CORPORATION)
SUITE 300
1011 W. FIFTH STREET
AUSTIN, TX 78703

FOR: PROVIDING AN ONLINE BLOG FEATURING LODGING, TRAVEL INFORMATION, FEATURED DESTINATIONS, REVIEWS, AND OTHER INFORMATION RELATED TO LODGING AND TRAVEL PROVIDERS , IN CLASS 41 (U.S. CLS. 100, 101 AND 107).

FIRST USE 5-1-1999; IN COMMERCE 5-1-1999.

THE MARK CONSISTS OF STANDARD CHARACTERS WITHOUT CLAIM TO ANY PARTICULAR FONT, STYLE, SIZE, OR COLOR.

SER. NO. 85-253,958, FILED P.R. 2-28-2011; AM. S.R. 6-12-2012.

RON FAIRBANKS, EXAMINING ATTORNEY



David J. Kybas

Director of the United States Patent and Trademark Office

United States of America

United States Patent and Trademark Office

BEDANDBREAKFAST.COM

Reg. No. 4,207,886

Registered Sep. 11, 2012

Int. Cl.: 42

SERVICE MARK

SUPPLEMENTAL REGISTER

HOMEAWAY.COM, INC. (DELAWARE CORPORATION)
SUITE 300
1011 W. FIFTH STREET
AUSTIN, TX 78703

FOR: COMPUTER SERVICES FOR PROVIDING A REAL ESTATE SEARCH PLATFORM CONFIGURED TO ALLOW USERS TO REQUEST AND RECEIVE CONTENT FROM A WEBSITE; APPLICATION SERVICE PROVIDER (ASP) FEATURING SOFTWARE IN THE FIELD OF RENTALS AND SALES RELATED TO REAL ESTATE; ASP FEATURING SOFTWARE FOR USE BY REAL ESTATE AND TRAVEL BASED COMPANIES TO ADVERTISE SPECIALS, MAKE RESERVATIONS, OFFER COUPONS, SPECIALS, DISCOUNTS, AND DIRECTIONS AND FOR USE IN INTERACTIVE CUSTOMER SERVICES RELATED TO THE RENTAL OR PURCHASE OF REAL ESTATE; PROVIDING INFORMATION SERVICES IN THE FIELD OF ASP FEATURING SOFTWARE FOR REAL ESTATE RENTAL OR SALES; ASP FEATURING SOFTWARE FOR USE BY COMPANIES AND INDIVIDUALS TO ADVERTISE SPECIALS, MAKE RESERVATIONS, OFFER COUPONS, OFFER SPECIALS, OFFER DISCOUNTS, SELL REAL ESTATE, PROVIDE DIRECTIONS, AND FOR USE IN ACCESSING INTERACTIVE CUSTOMER SERVICES OF OTHERS; DESIGN AND DEVELOPMENT OF VISUALIZATION TECHNOLOGIES FOR ADVERTISEMENT OF REAL-ESTATE AND BUSINESS OF OTHERS; APPLICATION SERVICE PROVIDER, NAMELY, HOSTING, MANAGING, DEVELOPING, ANALYZING, AND MAINTAINING APPLICATIONS, SOFTWARE, AND WEB SITES, OF OTHERS IN THE FIELDS OF ADVERTISING AND MARKETING; COMPUTER SERVICE, NAMELY, ACTING AS AN APPLICATION SERVICE PROVIDER IN THE FIELD OF KNOWLEDGE MANAGEMENT TO HOST COMPUTER APPLICATION SOFTWARE FOR CREATING SEARCHABLE DATABASES OF INFORMATION AND DATA; COMPUTER SERVICE, NAMELY, ACTING AS AN APPLICATION SERVICE PROVIDER IN THE FIELD OF KNOWLEDGE MANAGEMENT TO HOST COMPUTER APPLICATION SOFTWARE FOR SEARCHING AND RETRIEVING INFORMATION FROM DATABASES AND COMPUTER NETWORKS; COMPUTER SERVICES IN THE NATURE OF CUSTOMIZED WEB PAGES FEATURING USER-DEFINED INFORMATION AND PERSONAL PROFILES; COMPUTER SERVICES, NAMELY, PROVIDING SEARCH ENGINES FOR OBTAINING DATA ON A GLOBAL COMPUTER NETWORK; PROVIDING A WEBSITE THAT GIVES USERS THE ABILITY TO CREATE CUSTOMIZED WEB PAGES FEATURING USER-DEFINED INFORMATION, IN CLASS 42 (U.S. CLS. 100 AND 101).



David J. Kybas

FIRST USE 5-1-1999; IN COMMERCE 5-1-1999.

Reg. No. 4,207,886 THE MARK CONSISTS OF STANDARD CHARACTERS WITHOUT CLAIM TO ANY PARTICULAR FONT, STYLE, SIZE, OR COLOR.

SER. NO. 85-253,963, FILED P.R. 2-28-2011; AM. S.R. 6-12-2012.

RON FAIRBANKS, EXAMINING ATTORNEY

United States of America

United States Patent and Trademark Office

IDWEEK

Reg. No. 4,207,887

INFECTIOUS DISEASES SOCIETY OF AMERICA (D.C. NON-PROFIT CORPORATION)
1300 WILSON BOULEVARD, SUITE 300
ARLINGTON, VA 22209

Registered Sep. 11, 2012

Int. Cl.: 41

FOR: EDUCATIONAL SERVICES, NAMELY, CONDUCTING CONFERENCES IN THE FIELD OF HEALTH AND DISEASES AND DISTRIBUTION OF COURSE MATERIAL IN CONNECTION THEREWITH, IN CLASS 41 (U.S. CLS. 100, 101 AND 107).

SERVICE MARK

FIRST USE 4-0-2011; IN COMMERCE 3-0-2012.

SUPPLEMENTAL REGISTER

THE MARK CONSISTS OF STANDARD CHARACTERS WITHOUT CLAIM TO ANY PARTICULAR FONT, STYLE, SIZE, OR COLOR.

SER. NO. 85-256,533, FILED P.R. 3-3-2011; AM. S.R. 7-16-2012.

ASMAT KHAN, EXAMINING ATTORNEY



David J. Kyjars

Director of the United States Patent and Trademark Office

United States of America

United States Patent and Trademark Office

The Leading Digital Receipt Platform

Reg. No. 4,207,888

Registered Sep. 11, 2012

Int. Cl.: 9

TRADEMARK

SUPPLEMENTAL REGISTER

THIRD SOLUTIONS, INC. (FLORIDA CORPORATION)
SUITE 505
119 WASHINGTON AVENUE
MIAMI BEACH, FL 33139

FOR: COMPUTER SOFTWARE FOR PROVIDING AN ON-LINE DATABASE IN THE FIELD OF TRANSACTION PROCESSING TO UPLOAD TRANSACTIONAL DATA, PROVIDE STATISTICAL ANALYSIS, AND PRODUCE NOTIFICATIONS AND REPORTS, IN CLASS 9 (U.S. CLS. 21, 23, 26, 36 AND 38).

FIRST USE 9-24-2010; IN COMMERCE 12-7-2010.

THE MARK CONSISTS OF STANDARD CHARACTERS WITHOUT CLAIM TO ANY PARTICULAR FONT, STYLE, SIZE, OR COLOR.

NO CLAIM IS MADE TO THE EXCLUSIVE RIGHT TO USE "DIGITAL RECEIPT PLATFORM", APART FROM THE MARK AS SHOWN.

SER. NO. 85-256,671, FILED P.R. 3-3-2011; AM. S.R. 6-22-2012.

SUSAN RICHARDS, EXAMINING ATTORNEY



David J. Kyffers

Director of the United States Patent and Trademark Office

United States of America

United States Patent and Trademark Office

MOLD SEAL

Reg. No. 4,207,889

FORMBY, GEARY (UNITED STATES INDIVIDUAL)
2511 N. HAYDEN ISLAND DR.
PORTLAND, OR 97217 AND

Registered Sep. 11, 2012

Int. Cls.: 1, 2, and 19

FORMBY, MARTHA PIGG (UNITED STATES INDIVIDUAL)
7711 NE 58TH ST.
VANCOUVER, WA 98662

TRADEMARK

SUPPLEMENTAL REGISTER

FOR: CHEMICALS USED IN INDUSTRY, NAMELY, SEALANTS USED FOR BUILDINGS WHICH PENETRATE THROUGH WALLS, FLOORS AND CEILINGS FOR MOLD PREVENTION, IN CLASS 1 (U.S. CLS. 1, 5, 6, 10, 26 AND 46).

FIRST USE 3-1-2011; IN COMMERCE 3-1-2011.

FOR: PAINT COATINGS USED IN INDUSTRY, NAMELY, COATINGS IN THE NATURE OF PRIMER FOR USE ON SURFACES, SUCH AS WALLS, FLOORS, CEILINGS, AND VARIOUS STRUCTURAL BUILDING COMPONENTS, BOTH INTERIOR AND EXTERIOR, IN CLASS 2 (U.S. CLS. 6, 11 AND 16).

FIRST USE 3-1-2011; IN COMMERCE 3-1-2011.

FOR: BUILDING MATERIALS USED IN INDUSTRY, NAMELY, VINYL WINDOWS, NON-METAL SKYLIGHTS, IN CLASS 19 (U.S. CLS. 1, 12, 33 AND 50).

FIRST USE 3-1-2011; IN COMMERCE 3-1-2011.

THE MARK CONSISTS OF STANDARD CHARACTERS WITHOUT CLAIM TO ANY PARTICULAR FONT, STYLE, SIZE, OR COLOR.

NO CLAIM IS MADE TO THE EXCLUSIVE RIGHT TO USE "SEAL", APART FROM THE MARK AS SHOWN.

SER. NO. 85-262,916, FILED P.R. 3-10-2011; AM. S.R. 12-9-2011.

KATHERINE E. HALMEN, EXAMINING ATTORNEY



David J. Kyros

Director of the United States Patent and Trademark Office

United States of America

United States Patent and Trademark Office

RISKECON

Reg. No. 4,207,890

RISK ECONOMICS INC. (NEW YORK CORPORATION)
P.O. BOX 76

Registered Sep. 11, 2012

MOHEGAN LAKE, NY 10547

Int. Cls.: 35, 36, and 45

FOR: ECONOMIC FORECASTING AND ANALYSIS; ECONOMIC CONSULTING SERVICES; CONSULTING SERVICES, NAMELY, EXPERT ANALYSIS AND MANAGEMENT CONSULTING IN THE FIELDS OF ECONOMICS, STATISTICS AND ACCOUNTING; ECONOMIC ANALYSIS IN CONNECTION WITH ACQUISITIONS, MERGERS AND BUSINESS STRATEGY, IN CLASS 35 (U.S. CLS. 100, 101 AND 102).

SERVICE MARK

SUPPLEMENTAL REGISTER

FIRST USE 0-0-2008; IN COMMERCE 0-0-2008.

FOR: COMPUTATIONAL FINANCE AND FINANCIAL ENGINEERING ADVISORY SERVICES, NAMELY, ADVISORY SERVICES IN THE FIELD OF FINANCIAL INSTRUMENTS AND VALUATION, MARKET AND INDUSTRY STANDARDS AND PRACTICES RELATED TO FINANCING, RISK MANAGEMENT, TRADING OF SECURITIES, DERIVATIVES AND STRUCTURED FINANCIAL PRODUCTS; MANAGEMENT, RESEARCH AND DEVELOPMENT RELATED TO ASSETS AND LIABILITIES, NAMELY, MANAGEMENT, RESEARCH AND DEVELOPMENT IN THE NATURE OF FINANCIAL ECONOMICS; COMPUTATIONAL ECONOMIC TECHNIQUES AND METHODS RELATED TO DEVELOPMENT AND IMPLEMENTATION OF ROBUST MODELING AND DATA ANALYTIC FRAMEWORKS, NAMELY, FINANCIAL ECONOMIC ANALYSIS AND CONSULTING; CONSULTING SERVICES, NAMELY, EXPERT ANALYSIS AND MANAGEMENT CONSULTING IN THE FIELD OF FINANCIAL ECONOMICS; ECONOMIC ANALYTICS AND CONSULTATION; BUSINESS AND SECURITIES VALUATIONS, IN CLASS 36 (U.S. CLS. 100, 101 AND 102).

FIRST USE 0-0-2008; IN COMMERCE 0-0-2008.

FOR: LITIGATION CONSULTING AND TESTIMONY ON ISSUES RELATED TO ECONOMIC VALUATION, DAMAGES, LIABILITY AND CAUSATION, NAMELY, LITIGATION CONSULTANCY; LEGAL SERVICES, NAMELY, LITIGATION SUPPORT, PROVIDING PUBLIC POLICY STUDIES AND PROVIDING EXPERT WITNESS TESTIMONY IN BUSINESS AND COMMERCIAL AREAS; ADVISORY SERVICES AND ANALYTICS RELATED TO REGULATORY PRACTICES AND ECONOMICS IN THE FIELD OF INDUSTRIAL ORGANIZATION, NAMELY, REGULATORY ANALYTIC CONSULTING AND ADVISORY SERVICES IN THE ECONOMIC FIELD OF INDUSTRIAL ORGANIZATION, IN CLASS 45 (U.S. CLS. 100 AND 101).



David J. Kyjars

Director of the United States Patent and Trademark Office

Reg. No. 4,207,890 FIRST USE 0-0-2008; IN COMMERCE 0-0-2008.

THE MARK CONSISTS OF STANDARD CHARACTERS WITHOUT CLAIM TO ANY PARTICULAR FONT, STYLE, SIZE, OR COLOR.

SER. NO. 85-264,715, FILED P.R. 3-11-2011; AM. S.R. 6-25-2012.

MATTHEW MCDOWELL, EXAMINING ATTORNEY

United States of America

United States Patent and Trademark Office

PISTON CUSHION

Reg. No. 4,207,891

NUCAP INDUSTRIES INC. (CANADA CORPORATION)
3370 PHARMACY AVENUE
SCARBOROUGH, ONTARIO, CANADA M1W3K4

Registered Sep. 11, 2012

Int. Cl.: 12

FOR: AUTOMOTIVE PARTS, NAMELY, NOISE, VIBRATION AND HARSHNESS (NVH) SHIMS FOR ATTACHMENT ON BRAKE PISTONS, IN CLASS 12 (U.S. CLS. 19, 21, 23, 31, 35 AND 44).

TRADEMARK

THE MARK CONSISTS OF STANDARD CHARACTERS WITHOUT CLAIM TO ANY PARTICULAR FONT, STYLE, SIZE, OR COLOR.

SUPPLEMENTAL REGISTER

PRIORITY CLAIMED UNDER SEC. 44(D) ON CANADA APPLICATION NO. 1496892, FILED 9-22-2010, REG. NO. TMA805701, DATED 8-31-2011, EXPIRES 8-31-2026.

NO CLAIM IS MADE TO THE EXCLUSIVE RIGHT TO USE "PISTON", APART FROM THE MARK AS SHOWN.

SER. NO. 85-265,850, FILED P.R. 3-14-2011; AM. S.R. 6-19-2012.

FLORENTINA BLANDU, EXAMINING ATTORNEY



David J. Kyffers

Director of the United States Patent and Trademark Office

United States of America

United States Patent and Trademark Office

CYBER INSPECTORS

Reg. No. 4,207,892

CYBER INSPECTORS LLC (MASSACHUSETTS LIMITED LIABILITY COMPANY)
15 NEW ENGLAND EXECUTIVE PARK
BURLINGTON, MA 01803

Registered Sep. 11, 2012

Int. Cl.: 42

FOR: COMPUTER SECURITY CONSULTANCY ABOUT COMPUTER SECURITY IN THE FIELDS OF CORPORATE GOVERNANCE, SECURITY RISK, AND COMPUTER SECURITY THREAT MANAGEMENT; COMPUTER SECURITY CONSULTANCY IN THE NATURE OF TECHNICAL ASSESSMENTS THROUGH SCANNING, EVIDENCE COLLECTION AND PENETRATION TESTING OF APPLICATIONS, COMPUTERS, INFRASTRUCTURE AND NETWORKS TO ASSESS INFORMATION SECURITY VULNERABILITIES AND DETECTION OF ADVANCED CYBER THREATS, IN CLASS 42 (U.S. CLS. 100 AND 101).

SERVICE MARK

SUPPLEMENTAL REGISTER

FIRST USE 1-1-2012; IN COMMERCE 1-1-2012.

THE MARK CONSISTS OF STANDARD CHARACTERS WITHOUT CLAIM TO ANY PARTICULAR FONT, STYLE, SIZE, OR COLOR.

SER. NO. 85-268,123, FILED P.R. 3-16-2011; AM. S.R. 7-19-2012.

BRENDAN MCCAULEY, EXAMINING ATTORNEY



David J. Kyffers

Director of the United States Patent and Trademark Office

United States of America

United States Patent and Trademark Office

ALTERNATIVE SMOKING

Reg. No. 4,207,893

893958 ONTARIO LIMITED (CANADA LIMITED LIABILITY COMPANY)
35 CEDAR SPRINGS DR.

Registered Sep. 11, 2012

RICHMOND HILL, CANADA L4S2B1

Int. Cl.: 5

FOR: IMITATION CIGARETTES FOR QUITTING SMOKING; TOBACCO-FREE CIGARETTES FOR MEDICAL PURPOSES, IN CLASS 5 (U.S. CLS. 6, 18, 44, 46, 51 AND 52).

TRADEMARK

FIRST USE 6-1-2008; IN COMMERCE 6-1-2008.

SUPPLEMENTAL REGISTER

THE MARK CONSISTS OF STANDARD CHARACTERS WITHOUT CLAIM TO ANY PARTICULAR FONT, STYLE, SIZE, OR COLOR.

NO CLAIM IS MADE TO THE EXCLUSIVE RIGHT TO USE "SMOKING", APART FROM THE MARK AS SHOWN.

SER. NO. 85-274,988, FILED P.R. 3-23-2011; AM. S.R. 7-20-2012.

TINA BROWN, EXAMINING ATTORNEY



David J. Kybas

Director of the United States Patent and Trademark Office

United States of America
United States Patent and Trademark Office

BLINGBOX

Reg. No. 4,207,894

Registered Sep. 11, 2012

Int. Cl.: 14

INK GENE (COLORADO LIMITED LIABILITY COMPANY)
190 E. 9TH AVENUE
SUITE 500
DENVER, CO 80203

FOR: JEWELRY BOXES, IN CLASS 14 (U.S. CLS. 2, 27, 28 AND 50).

TRADEMARK

FIRST USE 3-26-2011; IN COMMERCE 3-26-2011.

SUPPLEMENTAL REGISTER

THE MARK CONSISTS OF STANDARD CHARACTERS WITHOUT CLAIM TO ANY PARTICULAR FONT, STYLE, SIZE, OR COLOR.

SER. NO. 85-277,715, FILED P.R. 3-26-2011; AM. S.R. 7-17-2012.

JIM RINGLE, EXAMINING ATTORNEY



David J. Kyffers

Director of the United States Patent and Trademark Office

United States of America

United States Patent and Trademark Office

NURSING VENTURES

Reg. No. 4,207,895

NURSING VENTURES, INC. (UTAH CORPORATION)
2825 EAST COTTONWOOD PARKWAY SUITE 500
SALT LAKE CITY, UT 841217055

Registered Sep. 11, 2012

Int. Cl.: 35

FOR: EMPLOYMENT STAFFING IN THE FIELD OF NURSING; PROFESSIONAL STAFFING AND RECRUITING SERVICES, IN CLASS 35 (U.S. CLS. 100, 101 AND 102).

SERVICE MARK

FIRST USE 4-1-2004; IN COMMERCE 4-5-2004.

SUPPLEMENTAL REGISTER

THE MARK CONSISTS OF STANDARD CHARACTERS WITHOUT CLAIM TO ANY PARTICULAR FONT, STYLE, SIZE, OR COLOR.

NO CLAIM IS MADE TO THE EXCLUSIVE RIGHT TO USE "NURSING", APART FROM THE MARK AS SHOWN.

SER. NO. 85-279,260, FILED P.R. 3-28-2011; AM. S.R. 12-27-2011.

JOHN DWYER, EXAMINING ATTORNEY



David J. Kybas

Director of the United States Patent and Trademark Office

United States of America

United States Patent and Trademark Office

INSPECT.ERADICATE.TREAT.PREVENT.

Reg. No. 4,207,896

CYBER INSPECTORS LLC (MASSACHUSETTS LIMITED LIABILITY COMPANY)
15 NEW ENGLAND EXECUTIVE PARK
BURLINGTON, MA 01803

Registered Sep. 11, 2012

Int. Cl.: 42

FOR: COMPUTER SECURITY CONSULTANCY ABOUT COMPUTER SECURITY IN THE FIELDS OF CORPORATE GOVERNANCE, SECURITY RISK, AND COMPUTER SECURITY THREAT MANAGEMENT; COMPUTER SECURITY CONSULTANCY IN THE NATURE OF TECHNICAL ASSESSMENTS THROUGH SCANNING, EVIDENCE COLLECTION AND PENETRATION TESTING OF APPLICATIONS, COMPUTERS, INFRASTRUCTURE AND NETWORKS TO ASSESS INFORMATION SECURITY VULNERABILITIES AND DETECTION OF ADVANCED CYBER THREATS, IN CLASS 42 (U.S. CLS. 100 AND 101).

SERVICE MARK

SUPPLEMENTAL REGISTER

FIRST USE 1-1-2012; IN COMMERCE 1-1-2012.

THE MARK CONSISTS OF STANDARD CHARACTERS WITHOUT CLAIM TO ANY PARTICULAR FONT, STYLE, SIZE, OR COLOR.

SER. NO. 85-279,803, FILED P.R. 3-29-2011; AM. S.R. 7-19-2012.

BRENDAN MCCAULEY, EXAMINING ATTORNEY



David J. Kybas

Director of the United States Patent and Trademark Office

United States of America

United States Patent and Trademark Office

The Buying Coach

Reg. No. 4,207,897

THE BUYING COACH (FLORIDA LIMITED LIABILITY COMPANY)
1005 GULF BLVD #401

Registered Sep. 11, 2012

INDIAN ROCKS BEACH, FL 33785

Int. Cl.: 9

FOR: PRE-RECORDED EDUCATIONAL DVDS IN THE FIELDS OF RETAIL PURCHASING OF AUTOMOBILES, IN CLASS 9 (U.S. CLS. 21, 23, 26, 36 AND 38).

TRADEMARK

FIRST USE 3-1-2011; IN COMMERCE 3-1-2011.

SUPPLEMENTAL REGISTER

THE MARK CONSISTS OF STANDARD CHARACTERS WITHOUT CLAIM TO ANY PARTICULAR FONT, STYLE, SIZE, OR COLOR.

SER. NO. 85-280,472, FILED P.R. 3-29-2011; AM. S.R. 12-21-2011.

HOWARD B. LEVINE, EXAMINING ATTORNEY



David J. Kybas

Director of the United States Patent and Trademark Office

United States of America

United States Patent and Trademark Office

It's a DRY mix

Reg. No. 4,207,898

Registered Sep. 11, 2012

Int. Cl.: 30

TRADEMARK

SUPPLEMENTAL REGISTER

SOUTHWEST BEVERAGES, LLC (ARIZONA LIMITED LIABILITY COMPANY), DBA
SOUTHWEST BEVERAGES,
PO BOX 37272
TUCSON, AZ 85740

FOR: BEVERAGES MADE OF COFFEE; BEVERAGES WITH A COFFEE BASE; COCOA;
COCOA; COCOA BEVERAGES WITH MILK; COCOA MIXES; COCOA POWDER; COCOA-
BASED BEVERAGES; COCOA-BASED CONDIMENTS AND SEASONINGS FOR FOOD AND
DRINK; COFFEE; COFFEE; COFFEE AND COFFEE SUBSTITUTES; COFFEE BASED
BEVERAGES; COFFEE BEVERAGES WITH MILK; COFFEE-BASED BEVERAGE CONTAIN-
ING MILK; COFFEE-BASED BEVERAGES; PREPARED COCOA AND COCOA-BASED
BEVERAGES, IN CLASS 30 (U.S. CL. 46).

FIRST USE 8-12-2011; IN COMMERCE 8-28-2011.

THE MARK CONSISTS OF STANDARD CHARACTERS WITHOUT CLAIM TO ANY PAR-
TICULAR FONT, STYLE, SIZE, OR COLOR.

NO CLAIM IS MADE TO THE EXCLUSIVE RIGHT TO USE "DRY MIX" , APART FROM
THE MARK AS SHOWN.

SER. NO. 85-281,378, FILED P.R. 3-30-2011; AM. S.R. 7-9-2012.

TRACY CROSS, EXAMINING ATTORNEY



David J. Kypos

Director of the United States Patent and Trademark Office

United States of America

United States Patent and Trademark Office

EAST ROSWELL FORUM

Reg. No. 4,207,899

SARAH WINNER (UNITED STATES INDIVIDUAL), AKA EAST ROSWELL FORUM,
8475 HAVEN WOOD TRAIL
ROSWELL, GA 30076

Registered Sep. 11, 2012

Int. Cl.: 42

FOR: PROVIDING A WEB SITE FEATURING TECHNOLOGY THAT ENABLES USERS TO CONNECT WITH OTHER PEOPLE IN THEIR NEIGHBORHOOD OR CITY FOR ANY NUMBER OF USER-SPECIFIED REASONS, INCLUDING PROVIDING A SERVICE OR ORGANIZING AN EVENT, IN CLASS 42 (U.S. CLS. 100 AND 101).

SERVICE MARK

SUPPLEMENTAL REGISTER FIRST USE 2-1-2006; IN COMMERCE 2-1-2006.

THE MARK CONSISTS OF STANDARD CHARACTERS WITHOUT CLAIM TO ANY PARTICULAR FONT, STYLE, SIZE, OR COLOR.

NO CLAIM IS MADE TO THE EXCLUSIVE RIGHT TO USE "FORUM", APART FROM THE MARK AS SHOWN.

SER. NO. 85-281,888, FILED P.R. 3-30-2011; AM. S.R. 6-26-2012.

LINDA ESTRADA, EXAMINING ATTORNEY



David J. Kybas

Director of the United States Patent and Trademark Office

United States of America

United States Patent and Trademark Office



Reg. No. 4,207,900

Registered Sep. 11, 2012

Int. Cl.: 41

SERVICE MARK

SUPPLEMENTAL REGISTER

WHITE HEAT ENTERTAINMENT, LLC (ARIZONA LIMITED LIABILITY COMPANY)
SUITE 120, BOX 439
7000 NORTH 16TH STREET
PHOENIX, AZ 85020

FOR: ENTERTAINMENT SERVICES, NAMELY, SERVICES IN THE NATURE OF LIVE MUSICAL PERFORMANCES; COMPOSITION OF MUSIC FOR OTHERS; PRODUCTION OF MUSIC RECORDINGS AND MUSIC PRODUCTION SERVICES, IN CLASS 41 (U.S. CLS. 100, 101 AND 107).

FIRST USE 1-1-2008; IN COMMERCE 1-1-2008.

THE MARK CONSISTS OF A THREE-DIMENSIONAL CONFIGURATION A PAINTED HUMAN FACE, AS IN A MASK OR MAKEUP, WITH DARK SHADING AROUND THE NOSE AND EYES, AND LIGHTER COLORING AROUND THE REMAINDER OF THE FACE. THE EYES, NOSE, MOUTH, EARS AND OUTLINE OF THE FACE ARE SHOWN IN DOTTED LINES AND ARE NOT CLAIMED AS FEATURES OF THE MARK BUT ONLY SERVE TO SHOW THE POSITION OF THE MARK ON THE FACE

SER. NO. 85-286,025, FILED 4-5-2011.

MARK SPARACINO, EXAMINING ATTORNEY



David J. Kyffers

Director of the United States Patent and Trademark Office

United States of America

United States Patent and Trademark Office



Reg. No. 4,207,901

Registered Sep. 11, 2012

Int. Cls.: 35, 41, 42, and 44

SERVICE MARK

SUPPLEMENTAL REGISTER

UPMC (PENNSYLVANIA CORPORATION)
U.S. STEEL TOWER, SUITE 6082
600 GRANT STREET
PITTSBURGH, PA 15219

FOR: PROMOTING THE EXCHANGE OF INFORMATION AND RESOURCES WITHIN THE SCIENTIFIC AND MEDICAL COMMUNITIES TO ACHIEVE ADVANCES IN THE FIELD OF HEALTHCARE; BUSINESS CONSULTATION SERVICES IN THE FIELD OF HEALTHCARE BUSINESS INFORMATION TECHNOLOGY, IN CLASS 35 (U.S. CLS. 100, 101 AND 102).

FIRST USE 4-12-2011; IN COMMERCE 4-12-2011.

FOR: MEDICAL TRAINING AND TEACHING, IN CLASS 41 (U.S. CLS. 100, 101 AND 107).

FIRST USE 4-12-2011; IN COMMERCE 4-12-2011.

FOR: COMPUTER CONSULTING SERVICES IN THE FIELD OF HEALTHCARE INFORMATION TECHNOLOGY, IN CLASS 42 (U.S. CLS. 100 AND 101).

FIRST USE 4-12-2011; IN COMMERCE 4-12-2011.

FOR: PROVIDING MEDICAL INFORMATION, IN CLASS 44 (U.S. CLS. 100 AND 101).

FIRST USE 4-12-2011; IN COMMERCE 4-12-2011.

THE MARK CONSISTS OF THE WORDS "CENTER FOR" IN WHITE, ON THE FIRST LINE, THE WORD "CONNECTED" IN YELLOW (IN A LARGER FONT) WITH THE TWO "NS" CONNECTED TOGETHER ON THE SECOND LINE, AND THE WORD "MEDICINE" IN WHITE, ON THE THIRD LINE, ALL WITHIN A SOLID GREEN BOX WITH ROUNDED EDGES.

THE COLOR(S) GREEN, YELLOW AND WHITE IS/ARE CLAIMED AS A FEATURE OF THE MARK.

SER. NO. 85-286,106, FILED P.R. 4-5-2011; AM. S.R. 7-23-2012.



David J. Kybas

Director of the United States Patent and Trademark Office

Reg. No. 4,207,901 ELISSA GARBER KON, EXAMINING ATTORNEY

United States of America

United States Patent and Trademark Office

THE HOME DME

Reg. No. 4,207,902

U.S. MEDICAL MANAGEMENT LLC (DELAWARE LIMITED LIABILITY COMPANY)
500 KIRTS BLVD.
TROY, MI 48084

Registered Sep. 11, 2012

Int. Cls.: 37 and 39

FOR: INSTALLATION OF MEDICAL EQUIPMENT; PROVIDING ON-LINE INSTALLATION INFORMATION ABOUT MEDICAL EQUIPMENT, IN CLASS 37 (U.S. CLS. 100, 103 AND 106).

SERVICE MARK

FIRST USE 0-0-2011; IN COMMERCE 0-0-2011.

SUPPLEMENTAL REGISTER

FOR: DELIVERY OF MEDICAL EQUIPMENT; PROVIDING ON-LINE DELIVERY INFORMATION ABOUT MEDICAL EQUIPMENT BEING DELIVERED, IN CLASS 39 (U.S. CLS. 100 AND 105).

FIRST USE 0-0-2011; IN COMMERCE 0-0-2011.

THE MARK CONSISTS OF STANDARD CHARACTERS WITHOUT CLAIM TO ANY PARTICULAR FONT, STYLE, SIZE, OR COLOR.

SER. NO. 85-286,854, FILED P.R. 4-5-2011; AM. S.R. 7-18-2012.

MAYUR VAGHANI, EXAMINING ATTORNEY



David J. Kybas

Director of the United States Patent and Trademark Office

United States of America

United States Patent and Trademark Office



Reg. No. 4,207,903

U.S. MEDICAL MANAGEMENT LLC (DELAWARE LIMITED LIABILITY COMPANY)
500 KIRTS BLVD.
TROY, MI 48084

Registered Sep. 11, 2012

Int. Cls.: 37 and 39

FOR: INSTALLATION OF MEDICAL EQUIPMENT; PROVIDING ON-LINE INSTALLATION INFORMATION ABOUT MEDICAL EQUIPMENT, IN CLASS 37 (U.S. CLS. 100, 103 AND 106).

SERVICE MARK

FIRST USE 0-0-2011; IN COMMERCE 0-0-2011.

SUPPLEMENTAL REGISTER

FOR: DELIVERY OF MEDICAL EQUIPMENT; PROVIDING ON-LINE DELIVERY INFORMATION ABOUT MEDICAL EQUIPMENT BEING DELIVERED, IN CLASS 39 (U.S. CLS. 100 AND 105).

FIRST USE 0-0-2011; IN COMMERCE 0-0-2011.

NO CLAIM IS MADE TO THE EXCLUSIVE RIGHT TO USE "COMPANY", APART FROM THE MARK AS SHOWN.

THE MARK CONSISTS OF THE WORDS "THE HOME DME" WITH THE WORDS "THE HOME DURABLE MEDICAL EQUIPMENT COMPANY" UNDERNEATH ON A SECOND LINE OF TEXT. AN ARCHED LINE RUNS ACROSS THE TOP OF THE MARK, BEGINNING AT THE FRONT OF THE MARK ABOVE THE "T" IN THE AND EXTENDS AND GROWS FATTER, ENDING IN THE MIDDLE OF THE "M" IN "DME".

SER. NO. 85-286,866, FILED P.R. 4-5-2011; AM. S.R. 7-18-2012.

MAYUR VAGHANI, EXAMINING ATTORNEY



David J. Kybas

Director of the United States Patent and Trademark Office

United States of America

United States Patent and Trademark Office

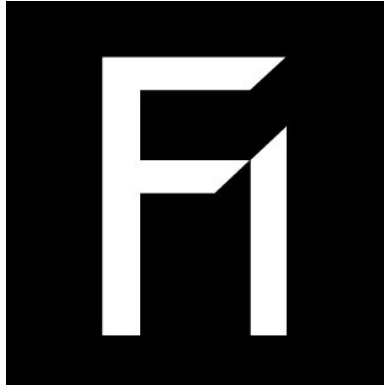

Reg. No. 4,207,904

Registered Sep. 11, 2012

Int. Cls.: 9, 35, 38, and 42

TRADEMARK

SERVICE MARK

SUPPLEMENTAL REGISTER

FIDESSA GROUP, PLC (UNITED KINGDOM PUBLIC LIMITED COMPANY (PLC))
DUKE'S COURT, DUKE STREET
WOKING, SURREY, UNITED KINGDOM GU215BH

FOR: COMPUTER SOFTWARE FOR FINANCIAL TRADING, INVESTMENT MANAGEMENT AND DATA DISPLAY AND ANALYSIS IN THE FIELD OF FINANCIAL SERVICES, IN CLASS 9 (U.S. CLS. 21, 23, 26, 36 AND 38).

FIRST USE 4-11-2011; IN COMMERCE 4-11-2011.

FOR: ANALYZING AND COMPILING DATA FOR MEASURING THE PERFORMANCE OF FINANCIAL MARKETS, IN CLASS 35 (U.S. CLS. 100, 101 AND 102).

FIRST USE 4-11-2011; IN COMMERCE 4-11-2011.

FOR: ELECTRONIC TRANSMISSION FOR OTHERS OF SECURITIES AND FINANCIAL INFORMATION VIA COMPUTER LINKING SERVICES, NAMELY, COMMUNICATING AND ROUTING TRADE INFORMATION INVOLVING ORDERS, ENTRY AND EXECUTION SERVICES, TO OTHERS VIA A GLOBAL COMPUTER NETWORK, IN CLASS 38 (U.S. CLS. 100, 101 AND 104).

FIRST USE 4-11-2011; IN COMMERCE 4-11-2011.

FOR: SOFTWARE AS A SERVICE (SAAS) SERVICES FEATURING SOFTWARE FOR FINANCIAL TRADING, INVESTMENT MANAGEMENT AND DATA DISPLAY AND ANALYSIS IN THE FIELD OF FINANCIAL SERVICES; COMPUTER PROGRAMMING SERVICES; DESIGN, DEVELOPMENT AND IMPLEMENTATION OF SOFTWARE; MAINTENANCE AND UPGRADING OF COMPUTER SOFTWARE; TECHNICAL SUPPORT SERVICES, NAMELY, TROUBLESHOOTING OF COMPUTER SOFTWARE PROBLEMS; CONSULTING SERVICES IN THE FIELD OF DESIGN, SELECTION, IMPLEMENTATION AND USE OF COMPUTER HARDWARE AND SOFTWARE SYSTEMS FOR OTHERS, IN CLASS 42 (U.S. CLS. 100 AND 101).

FIRST USE 4-11-2011; IN COMMERCE 4-11-2011.

THE MARK CONSISTS OF A SQUARE CARRYING THE STYLIZED LETTERS "FI".



David J. Kybas

Director of the United States Patent and Trademark Office

Reg. No. 4,207,904 SER. NO. 85-287,377, FILED P.R. 4-6-2011; AM. S.R. 7-17-2012.

MARK RADEMACHER, EXAMINING ATTORNEY

United States of America

United States Patent and Trademark Office

GREEN WORLD CARGO

Reg. No. 4,207,905

GREEN WORLD CARGO, LLC (NEW YORK LIMITED LIABILITY COMPANY)
150-30 132ND AVENUE
JAMAICA, NY 11434

Registered Sep. 11, 2012

Int. Cl.: 39

FOR: FREIGHT FORWARDING SERVICES, IN CLASS 39 (U.S. CLS. 100 AND 105).

SERVICE MARK

FIRST USE 1-3-2011; IN COMMERCE 1-3-2011.

SUPPLEMENTAL REGISTER

THE MARK CONSISTS OF STANDARD CHARACTERS WITHOUT CLAIM TO ANY PARTICULAR FONT, STYLE, SIZE, OR COLOR.

SER. NO. 85-289,706, FILED 4-8-2011.

ROBIN MITTLER, EXAMINING ATTORNEY



David J. Kyffers

Director of the United States Patent and Trademark Office

United States of America

United States Patent and Trademark Office

Bookstream

Reg. No. 4,207,906

DON JOHNSTON INCORPORATED (ILLINOIS CORPORATION)
26799 W. COMMERCE DRIVE
VOLO, IL 60073

Registered Sep. 11, 2012

Int. Cls.: 9 and 42

FOR: COMPUTER APPLICATION SOFTWARE FOR MOBILE PHONES AND COMPUTERS, NAMELY, SOFTWARE FOR USE IN UPLOADING, DOWNLOADING, STORING AND MANAGING THE TRANSMISSION OF ELECTRONIC BOOKS, IN CLASS 9 (U.S. CLS. 21, 23, 26, 36 AND 38).

TRADEMARK

SERVICE MARK

FIRST USE 9-16-2011; IN COMMERCE 9-16-2011.

SUPPLEMENTAL REGISTER

FOR: SOFTWARE AS A SERVICE (SAAS) SERVICES FEATURING SOFTWARE IN THE FIELD OF UPLOADING, DOWNLOADING, STORING, AND MANAGING THE TRANSMISSION OF ELECTRONIC BOOKS IN THE FIELD OF EDUCATION, IN CLASS 42 (U.S. CLS. 100 AND 101).

FIRST USE 9-16-2011; IN COMMERCE 9-16-2011.

THE MARK CONSISTS OF STANDARD CHARACTERS WITHOUT CLAIM TO ANY PARTICULAR FONT, STYLE, SIZE, OR COLOR.

SER. NO. 85-292,953, FILED P.R. 4-12-2011; AM. S.R. 6-6-2012.

LESLIE RICHARDS, EXAMINING ATTORNEY



David J. Kyros

Director of the United States Patent and Trademark Office

United States of America

United States Patent and Trademark Office

TRANSACTION EXPRESS

Reg. No. 4,207,907

TRANSFIRST, LLC (DELAWARE LIMITED LIABILITY COMPANY)
5400 LBJ FREEWAY, SUITE 900
DALLAS, TX 75240

Registered Sep. 11, 2012

Int. Cl.: 36

FOR: PAYMENT AND TRANSACTION PROCESSING, NAMELY, CREDIT CARD AND DEBIT CARD PROCESSING SERVICES FEATURING AN ONLINE AND BATCH PROCESSING SOFTWARE ENGINE FOR AUTHORIZING, PROCESSING, MAINTAINING, CLEARING, AND ONLINE REAL-TIME REPORTING, 24/7, INTERNET BASED, WIRELESS, OR POS TERMINAL BASED, INCLUDING CREDIT, DEBIT, PROPRIETARY, GIFT, STORED VALUE, E-CHECK, ELECTRONIC CHECKS AND ACH, IN CLASS 36 (U.S. CLS. 100, 101 AND 102).

SERVICE MARK

SUPPLEMENTAL REGISTER

FIRST USE 3-0-2011; IN COMMERCE 3-0-2011.

THE MARK CONSISTS OF STANDARD CHARACTERS WITHOUT CLAIM TO ANY PARTICULAR FONT, STYLE, SIZE, OR COLOR.

SER. NO. 85-294,517, FILED P.R. 4-13-2011; AM. S.R. 7-25-2012.

TRICIA SONNEBORN, EXAMINING ATTORNEY



David J. Kyffers

Director of the United States Patent and Trademark Office

United States of America

United States Patent and Trademark Office

CALLAHAN

Reg. No. 4,207,908

AS IP HOLDCO, LLC (DELAWARE LIMITED LIABILITY COMPANY)
1 CENTENNIAL AVENUE
PISCATAWAY, NJ 08855

Registered Sep. 11, 2012

Int. Cl.: 11

FOR: FAUCETS, IN CLASS 11 (U.S. CLS. 13, 21, 23, 31 AND 34).

TRADEMARK

FIRST USE 7-1-2011; IN COMMERCE 7-1-2011.

SUPPLEMENTAL REGISTER

THE MARK CONSISTS OF STANDARD CHARACTERS WITHOUT CLAIM TO ANY PARTICULAR FONT, STYLE, SIZE, OR COLOR.

SER. NO. 85-301,997, FILED P.R. 4-22-2011; AM. S.R. 7-16-2012.

SAIMA MAKHDOOM, EXAMINING ATTORNEY



David J. Kyffers

Director of the United States Patent and Trademark Office

United States of America
United States Patent and Trademark Office

SHOOTER

Reg. No. 4,207,909

FIELD LOGIC, INC. (MINNESOTA CORPORATION)
101 MAIN STREET
SUPERIOR, WI 54880

Registered Sep. 11, 2012

Int. Cl.: 28

FOR: TARGETS AND REPLACEMENT PARTS THEREFOR; AND TARGET EQUIPMENT,
NAMELY, STANDS FOR TARGETS, IN CLASS 28 (U.S. CLS. 22, 23, 38 AND 50).

TRADEMARK

FIRST USE 1-9-2010; IN COMMERCE 1-9-2010.

SUPPLEMENTAL REGISTER

THE MARK CONSISTS OF STANDARD CHARACTERS WITHOUT CLAIM TO ANY PARTICULAR FONT, STYLE, SIZE, OR COLOR.

SER. NO. 85-305,350, FILED P.R. 4-26-2011; AM. S.R. 8-1-2012.

LINDA E. BLOHM, EXAMINING ATTORNEY



David J. Kyros

Director of the United States Patent and Trademark Office

United States of America

United States Patent and Trademark Office

SKI MARDI GRAS

Reg. No. 4,207,910

Registered Sep. 11, 2012

Int. Cls.: 25 and 41

DICKSON, JOHN (UNITED STATES INDIVIDUAL)
10,000 RR 967
JOHN DICKSON
BUDA, TX 78610

FOR: FOOTWEAR; HEADGEAR, NAMELY, HATS, BEANIES, AND CAPS; JACKETS; T-SHIRTS, IN CLASS 25 (U.S. CLS. 22 AND 39).

FIRST USE 4-26-2011; IN COMMERCE 4-26-2011.

TRADEMARK

SERVICE MARK

FOR: ENTERTAINMENT IN THE NATURE OF SKI MUSIC FESTIVAL, IN CLASS 41 (U.S. CLS. 100, 101 AND 107).

SUPPLEMENTAL REGISTER

FIRST USE 4-26-2011; IN COMMERCE 4-26-2011.

THE MARK CONSISTS OF STANDARD CHARACTERS WITHOUT CLAIM TO ANY PARTICULAR FONT, STYLE, SIZE, OR COLOR.

NO CLAIM IS MADE TO THE EXCLUSIVE RIGHT TO USE "SKI", APART FROM THE MARK AS SHOWN.

SER. NO. 85-305,423, FILED P.R. 4-26-2011; AM. S.R. 8-7-2012.

GIANCARLO CASTRO, EXAMINING ATTORNEY



David J. Kyffers

Director of the United States Patent and Trademark Office

United States of America

United States Patent and Trademark Office

EQUITABLE

Reg. No. 4,207,911

BESILU, LLC (FLORIDA LIMITED LIABILITY COMPANY)
11501 SW 40TH STREET
MIAMI, FL 33165

Registered Sep. 11, 2012

Int. Cl.: 41

FOR: ENTERTAINMENT SERVICES, NAMELY, CONDUCTING EQUESTRIAN EXHIBITIONS,
IN CLASS 41 (U.S. CLS. 100, 101 AND 107).

SERVICE MARK

FIRST USE 5-0-2012; IN COMMERCE 5-0-2012.

SUPPLEMENTAL REGISTER

THE MARK CONSISTS OF STANDARD CHARACTERS WITHOUT CLAIM TO ANY PARTICULAR FONT, STYLE, SIZE, OR COLOR.

SER. NO. 85-308,141, FILED P.R. 4-29-2011; AM. S.R. 7-18-2012.

EVELYN BRADLEY, EXAMINING ATTORNEY



David J. Kyffers

Director of the United States Patent and Trademark Office

United States of America

United States Patent and Trademark Office

Light cube

Reg. No. 4,207,912

ALEXIOU, K.A. STACIE (UNITED STATES INDIVIDUAL)
94 GAIL DRIVE

Registered Sep. 11, 2012

NEW ROCHELLE, NY 10805

Int. Cl.: 11

FOR: CUBED SHAPE RENEWABLE LED LIGHT FIXTURE CONTAINING A THIN-FILM SOLAR, VERTICAL AXIS WIND TURBINE AND OFF-GRID POWER AND DEEP CYCLE BATTERY STORAGE SYSTEMS COMPRISED OF BATTERIES, CHARGE CONTROLLERS AND INVERTERS WITH INTEGRATED LED BULBS, IN CLASS 11 (U.S. CLS. 13, 21, 23, 31 AND 34).

TRADEMARK

SUPPLEMENTAL REGISTER

FIRST USE 1-29-2010; IN COMMERCE 3-22-2010.

THE MARK CONSISTS OF STANDARD CHARACTERS WITHOUT CLAIM TO ANY PARTICULAR FONT, STYLE, SIZE, OR COLOR.

NO CLAIM IS MADE TO THE EXCLUSIVE RIGHT TO USE "LIGHT", APART FROM THE MARK AS SHOWN.

SER. NO. 85-309,912, FILED P.R. 5-2-2011; AM. S.R. 7-17-2012.

WILLIAM ROSSMAN, EXAMINING ATTORNEY



David J. Kyros

Director of the United States Patent and Trademark Office

United States of America

United States Patent and Trademark Office

SPECIALTY SERVICING SOLUTIONS

Reg. No. 4,207,913

Registered Sep. 11, 2012

Int. Cl.: 36

SERVICE MARK

SUPPLEMENTAL REGISTER

REVERSE MORTGAGE SOLUTIONS, INC. (DELAWARE CORPORATION)
2727 SPRING CREEK DRIVE
SPRING, TX 77373

FOR: FINANCING AND LOAN SERVICES, NAMELY, LOAN SERVICING AND ADMINISTRATION; LOAN ESCROW SERVICES, NAMELY, MAINTAINING MORTGAGE ESCROW ACCOUNTS; FINANCIAL SERVICES, NAMELY, LOAN DEFAULT MITIGATION SERVICES; DEFAULT MITIGATION AND LOSS CONTROL SERVICES FOR PERFORMING AND NON-PERFORMING REAL ESTATE LOANS AND DISTRESSED REAL ESTATE ASSETS; FINANCIAL SERVICES, NAMELY, ARRANGING OF MODIFIED MORTGAGE LOAN TERMS DESIGNED TO PREVENT REAL ESTATE FORECLOSURE OR DEFAULT; FINANCIAL ASSET MANAGEMENT SERVICES, NAMELY, MANAGEMENT OF ASSETS AND DISTRESSED ASSETS IN THE FIELD OF REAL ESTATE, MORTGAGES, AND REVERSE MORTGAGES; FINANCIAL RISK MANAGEMENT AND FISCAL ASSESSMENT SERVICES IN THE FIELD OF REAL ESTATE, MORTGAGES, AND REVERSE MORTGAGES; FINANCIAL ASSET MANAGEMENT; FINANCIAL PORTFOLIO ANALYSIS, FINANCIAL TRACKING, AND FINANCIAL REPORTING SERVICES, ALL IN THE FIELD OF REAL ESTATE, MORTGAGES, AND REVERSE MORTGAGES; FINANCIAL DUE DILIGENCE SERVICES IN THE FIELD OF REAL ESTATE, MORTGAGES, AND REVERSE MORTGAGES; FINANCIAL AND ASSET LOSS CONTROL MANAGEMENT FOR OTHERS IN THE FIELD OF REAL ESTATE, MORTGAGES, AND REVERSE MORTGAGES; FINANCIAL SERVICES, NAMELY, LOSS MITIGATION SERVICES FOR UNDER OR NON-PERFORMING MORTGAGE LOANS AND DISTRESSED ASSETS; MORTGAGE FORECLOSURE SERVICES; MORTGAGE FORECLOSURE AND DISTRESSED ASSET MITIGATION AND LOAN DEFAULT MITIGATION SERVICES, NAMELY, ACQUISITION AND LEASE-BACK OF REAL ESTATE, PRE-FORECLOSURE SHORT SALES, DEEDS-IN-LIEU FORECLOSURE, INSTALLMENT SALE, LEASE OPTION, AND REAL ESTATE AGENCY, LEASING, AND BROKERAGE SERVICES IN CONNECTION WITH REAL ESTATE SALES, LEASE OPTIONS, AND INSTALLMENT SALES; REAL ESTATE SERVICES, NAMELY, REAL ESTATE INVESTMENT SERVICES INVOLVING DISTRESSED REAL ESTATE AND REAL PROPERTY MANAGEMENT SERVICES; REAL ESTATE CONSULTANCY; REAL ESTATE AND DISTRESSED REAL ESTATE ASSET ASSESSMENT AND APPRAISAL; REAL ESTATE AGENCY SERVICES, LEASING OF REAL ESTATE, REAL ESTATE BROKERAGE SERVICES; MANAGEMENT OF LISTED AND UNLISTED PROPERTY TRUSTS OR SPECIALIZED FUNDS, NAMELY, REAL ESTATE TRUSTEE SERVICES, IN CLASS 36 (U.S. CLS. 100, 101 AND 102).



David J. Kybas

Director of the United States Patent and Trademark Office

FIRST USE 8-1-2010; IN COMMERCE 8-1-2010.

Reg. No. 4,207,913 THE MARK CONSISTS OF STANDARD CHARACTERS WITHOUT CLAIM TO ANY PARTICULAR FONT, STYLE, SIZE, OR COLOR.

NO CLAIM IS MADE TO THE EXCLUSIVE RIGHT TO USE "SPECIALTY SERVICING", APART FROM THE MARK AS SHOWN.

SER. NO. 85-321,964, FILED P.R. 5-16-2011; AM. S.R. 6-27-2012.

SHAILA SETTLES, EXAMINING ATTORNEY

United States of America

United States Patent and Trademark Office

CHILD HEALTH PATIENT SAFETY ORGANIZATION

Reg. No. 4,207,914

CHILD HEALTH CORPORATION OF AMERICA (DELAWARE CORPORATION)
6803 W. 64TH ST., SUITE 208
SHAWNEE MISSION, KS 66202

Registered Sep. 11, 2012

Int. Cl.: 35

FOR: PROVIDING PATIENT SAFETY ORGANIZATION SERVICES TO HOSPITALS AND OTHER HEALTHCARE PROVIDERS, NAMELY, PROVIDING INFORMATION, DATA AND STATISTICS ABOUT ERRORS AND EVENTS OF BREACH IN MEDICAL SAFETY DURING MEDICAL PROCEDURES AND TREATMENT IN ORDER TO IMPROVE MEDICAL CARE; CONSULTATION IN THE FIELD OF MEDICAL PRACTICE AND TREATMENT SAFETY BY TRACKING ERRORS AND EVENTS OF BREACH IN MEDICAL SAFETY DURING MEDICAL PROCEDURES AND TREATMENT AND PROVIDING AND SHARING MEDICAL PROCEDURE AND TREATMENT SAFETY PROTOCOLS AND BEST PRACTICE, IN CLASS 35 (U.S. CLS. 100, 101 AND 102).

SERVICE MARK

SUPPLEMENTAL REGISTER

FIRST USE 6-14-2012; IN COMMERCE 6-14-2012.

THE MARK CONSISTS OF STANDARD CHARACTERS WITHOUT CLAIM TO ANY PARTICULAR FONT, STYLE, SIZE, OR COLOR.

NO CLAIM IS MADE TO THE EXCLUSIVE RIGHT TO USE "PATIENT SAFETY ORGANIZATION", APART FROM THE MARK AS SHOWN.

SER. NO. 85-324,096, FILED P.R. 5-18-2011; AM. S.R. 7-23-2012.

KELLEY WELLS, EXAMINING ATTORNEY



David J. Kybas

Director of the United States Patent and Trademark Office

United States of America

United States Patent and Trademark Office

CHILD HEALTH PSO

Reg. No. 4,207,915

CHILD HEALTH CORPORATION OF AMERICA (DELAWARE CORPORATION)
6803 W. 64TH ST., SUITE 208
SHAWNEE MISSION, KS 66202

Registered Sep. 11, 2012

Int. Cl.: 35

FOR: PROVIDING PATIENT SAFETY ORGANIZATION SERVICES TO HOSPITALS AND OTHER HEALTHCARE PROVIDERS, NAMELY, PROVIDING INFORMATION, DATA AND STATISTICS ABOUT ERRORS AND EVENTS OF BREACH IN MEDICAL SAFETY DURING MEDICAL PROCEDURES AND TREATMENT IN ORDER TO IMPROVE MEDICAL CARE; CONSULTATION IN THE FIELD OF MEDICAL PRACTICE AND TREATMENT SAFETY BY TRACKING ERRORS AND EVENTS OF BREACH IN MEDICAL SAFETY DURING MEDICAL PROCEDURES AND TREATMENT AND PROVIDING AND SHARING MEDICAL PROCEDURE AND TREATMENT SAFETY PROTOCOLS AND BEST PRACTICES, IN CLASS 35 (U.S. CLS. 100, 101 AND 102).

SERVICE MARK

SUPPLEMENTAL REGISTER

FIRST USE 6-14-2012; IN COMMERCE 6-12-2012.

THE MARK CONSISTS OF STANDARD CHARACTERS WITHOUT CLAIM TO ANY PARTICULAR FONT, STYLE, SIZE, OR COLOR.

NO CLAIM IS MADE TO THE EXCLUSIVE RIGHT TO USE "PSO", APART FROM THE MARK AS SHOWN.

SER. NO. 85-324,138, FILED P.R. 5-18-2011; AM. S.R. 7-23-2012.

KELLEY WELLS, EXAMINING ATTORNEY



David J. Kyjars

Director of the United States Patent and Trademark Office

United States of America

United States Patent and Trademark Office

CHILDPSO

Reg. No. 4,207,916

CHILD HEALTH CORPORATION OF AMERICA (DELAWARE CORPORATION)
6803 W. 64TH ST., SUITE 208
SHAWNEE MISSION, KS 66202

Registered Sep. 11, 2012

Int. Cl.: 35

FOR: PROVIDING PATIENT SAFETY ORGANIZATION SERVICES TO HOSPITALS AND OTHER HEALTHCARE PROVIDERS, NAMELY, PROVIDING INFORMATION, DATA AND STATISTICS ABOUT ERRORS AND EVENTS OF BREACH IN MEDICAL SAFETY DURING MEDICAL PROCEDURES AND TREATMENT IN ORDER TO IMPROVE MEDICAL CARE; CONSULTATION IN THE FIELD OF MEDICAL PRACTICE AND TREATMENT SAFETY BY TRACKING ERRORS AND EVENTS OF BREACH IN MEDICAL SAFETY DURING MEDICAL PROCEDURES AND TREATMENT AND PROVIDING AND SHARING MEDICAL PROCEDURE AND TREATMENT SAFETY PROTOCOLS AND BEST PRACTICES, IN CLASS 35 (U.S. CLS. 100, 101 AND 102).

SERVICE MARK

SUPPLEMENTAL REGISTER

FIRST USE 6-14-2012; IN COMMERCE 6-14-2012.

THE MARK CONSISTS OF STANDARD CHARACTERS WITHOUT CLAIM TO ANY PARTICULAR FONT, STYLE, SIZE, OR COLOR.

SER. NO. 85-324,314, FILED P.R. 5-18-2011; AM. S.R. 7-23-2012.

KELLEY WELLS, EXAMINING ATTORNEY



David J. Kyfos

Director of the United States Patent and Trademark Office

United States of America

United States Patent and Trademark Office

TRI-OLIGOPEPTIDE LIPOATE

Reg. No. 4,207,917

Registered Sep. 11, 2012

Int. Cl.: 5

TRADEMARK

SUPPLEMENTAL REGISTER

GLS SCIENCES LLC (NEVADA LIMITED LIABILITY COMPANY)
SUITE 200
4535 W. SAHARA AVE.
LAS VEGAS, NV 89102

FOR: DIETARY SUPPLEMENTS, VITAMIN, MINERAL AND BOTANICAL SUPPLEMENTS,
AND MEDICAL FOOD SUPPLEMENTS, IN CLASS 5 (U.S. CLS. 6, 18, 44, 46, 51 AND 52).

FIRST USE 6-1-2010; IN COMMERCE 12-3-2010.

THE MARK CONSISTS OF STANDARD CHARACTERS WITHOUT CLAIM TO ANY PAR-
TICULAR FONT, STYLE, SIZE, OR COLOR.

SER. NO. 85-331,514, FILED P.R. 5-26-2011; AM. S.R. 7-17-2012.

KATHY DE JONGE, EXAMINING ATTORNEY



David J. Kyjars

Director of the United States Patent and Trademark Office

United States of America

United States Patent and Trademark Office

NoseComfort

Reg. No. 4,207,918

FRANK, JAMES (UNITED STATES INDIVIDUAL)
P.O. BOX 1573

Registered Sep. 11, 2012

SPRING VALLEY, CA 91979

Int. Cl.: 9

FOR: ACCESSORY FOR EYEGLASSES, NAMELY, A UTILITY APPLIANCE DESIGNED TO PROVIDE COMFORT TO THE NOSE BY SUPPORTING AND PREVENTING THE NOSE PIECE OF THE EYEGLASSES FROM COMING INTO CONTACT WITH THE BRIDGE OF THE NOSE, IN CLASS 9 (U.S. CLS. 21, 23, 26, 36 AND 38).

TRADEMARK

SUPPLEMENTAL REGISTER FIRST USE 1-28-2010; IN COMMERCE 1-28-2010.

THE MARK CONSISTS OF STANDARD CHARACTERS WITHOUT CLAIM TO ANY PARTICULAR FONT, STYLE, SIZE, OR COLOR.

SER. NO. 85-333,601, FILED P.R. 5-31-2011; AM. S.R. 2-2-2012.

TINA BROWN, EXAMINING ATTORNEY



David J. Kyffers

Director of the United States Patent and Trademark Office

United States of America

United States Patent and Trademark Office

ECONOMIC PLANNING GROUP

Reg. No. 4,207,919

ECONOMIC PLANNING GROUP, INC. (NEW YORK CORPORATION)
60 EAST 42ND STREET
NEW YORK, NY 10165

Registered Sep. 11, 2012

Int. Cl.: 36

FOR: FINANCIAL SERVICES, NAMELY, INSURANCE BROKERAGE, INSURANCE AGENCY SERVICES, FINANCIAL PLANNING AND CONSULTING SERVICES, IN CLASS 36 (U.S. CLS. 100, 101 AND 102).

SERVICE MARK

FIRST USE 0-0-1986; IN COMMERCE 0-0-1986.

SUPPLEMENTAL REGISTER

THE MARK CONSISTS OF STANDARD CHARACTERS WITHOUT CLAIM TO ANY PARTICULAR FONT, STYLE, SIZE, OR COLOR.

NO CLAIM IS MADE TO THE EXCLUSIVE RIGHT TO USE "GROUP", APART FROM THE MARK AS SHOWN.

SER. NO. 85-338,480, FILED P.R. 6-6-2011; AM. S.R. 6-19-2012.

CAROLINE WOOD, EXAMINING ATTORNEY



David J. Kybas

Director of the United States Patent and Trademark Office

United States of America

United States Patent and Trademark Office

XAMPLES

Reg. No. 4,207,920

Registered Sep. 11, 2012

Int. Cl.: 35

SERVICE MARK

SUPPLEMENTAL REGISTER

VU, HOA (VIETNAM INDIVIDUAL)
501 EAST 38TH STREET
BOX HP687
ERIE, PA 16546

FOR: DISTRIBUTION OF SAMPLES FOR PUBLICITY PURPOSES, IN CLASS 35 (U.S. CLS. 100, 101 AND 102).

FIRST USE 6-25-2011; IN COMMERCE 6-25-2011.

THE MARK CONSISTS OF STANDARD CHARACTERS WITHOUT CLAIM TO ANY PARTICULAR FONT, STYLE, SIZE, OR COLOR.

SER. NO. 85-338,628, FILED P.R. 6-6-2011; AM. S.R. 7-13-2012.

ESTHER BELENKER, EXAMINING ATTORNEY



David J. Kyffers

Director of the United States Patent and Trademark Office

United States of America

United States Patent and Trademark Office

Performance Cabletray

Reg. No. 4,207,921

WBT (ILLINOIS LIMITED LIABILITY COMPANY)
115 HARTING DRIVE
CENTRALIA, IL 62801

Registered Sep. 11, 2012

Int. Cl.: 6

FOR: METAL CABLE TRAYS USED IN BUILDING CONSTRUCTION, IN CLASS 6 (U.S. CLS. 2, 12, 13, 14, 23, 25 AND 50).

TRADEMARK

FIRST USE 6-1-2011; IN COMMERCE 6-1-2011.

SUPPLEMENTAL REGISTER

THE MARK CONSISTS OF STANDARD CHARACTERS WITHOUT CLAIM TO ANY PARTICULAR FONT, STYLE, SIZE, OR COLOR.

NO CLAIM IS MADE TO THE EXCLUSIVE RIGHT TO USE "CABLETRAY", APART FROM THE MARK AS SHOWN.

SER. NO. 85-344,480, FILED P.R. 6-13-2011; AM. S.R. 9-30-2011.

NICHOLAS ALTREE, EXAMINING ATTORNEY



David J. Kyffers

Director of the United States Patent and Trademark Office

United States of America

United States Patent and Trademark Office

HISTORIC COIN MINT

Reg. No. 4,207,922

JUSTICE IS DONE, LLC (NEVADA LIMITED LIABILITY COMPANY)
318 N. CARSON, STE. 208
CARSON CITY, NV 89701

Registered Sep. 11, 2012

Int. Cl.: 35

SERVICE MARK

SUPPLEMENTAL REGISTER

FOR: RETAIL STORE AND ON-LINE RETAIL STORE SERVICES FEATURING COMMEMORATIVE MEMORABILIA AND COLLECTABLES, COMMEMORATIVE COINS, COINS, JEWELRY, KEY RINGS, WALL PLAQUES, WATCHES, CLOCKS, MEDALLIONS, CLOTHING; MAIL ORDER CATALOG AND ELECTRONIC CATALOG SERVICES FEATURING COMMEMORATIVE MEMORABILIA AND COLLECTABLES, COMMEMORATIVE COINS, COINS, JEWELRY, KEY RINGS, WALL PLAQUES, WATCHES, CLOCKS, MEDALLIONS, CLOTHING; RETAIL STORE SERVICES, AVAILABLE THROUGH COMPUTER COMMUNICATIONS AND INTERACTIVE TELEVISION, FEATURING COMMEMORATIVE MEMORABILIA AND COLLECTABLES, COMMEMORATIVE COINS, COINS, JEWELRY, KEY RINGS, WALL PLAQUES, WATCHES, CLOCKS, MEDALLIONS, CLOTHING, IN CLASS 35 (U.S. CLS. 100, 101 AND 102).

FIRST USE 6-13-2011; IN COMMERCE 6-13-2011.

THE MARK CONSISTS OF STANDARD CHARACTERS WITHOUT CLAIM TO ANY PARTICULAR FONT, STYLE, SIZE, OR COLOR.

NO CLAIM IS MADE TO THE EXCLUSIVE RIGHT TO USE "HISTORIC COIN", APART FROM THE MARK AS SHOWN.

SER. NO. 85-345,976, FILED P.R. 6-14-2011; AM. S.R. 7-25-2012.

MARLENE BELL, EXAMINING ATTORNEY



David J. Kyffers

Director of the United States Patent and Trademark Office

United States of America

United States Patent and Trademark Office

LUXURY EDUCATION

Reg. No. 4,207,923

Registered Sep. 11, 2012

Int. Cl.: 41

SERVICE MARK

SUPPLEMENTAL REGISTER

SECURITIES AND COMMERCE INSTITUTE, LLC (FLORIDA LIMITED LIABILITY COMPANY)
SUITE 1100-1111 BRICKELL AVENUE
MIAMI, FL 331313120

FOR: EDUCATION AND ENTERTAINMENT SERVICES, NAMELY, ARRANGING AND CONDUCTING COURSES, ONLINE COURSES, SEMINARS, WEBINARS, AND WORKSHOPS FEATURING BUSINESS, INFORMATION TECHNOLOGY, AND HOSPITALITY; PROVIDING COURSES OF INSTRUCTION AND TRAINING AT THE COLLEGE AND UNIVERSITY LEVEL IN THE FIELD OF BUSINESS AND SUBJECTS RELATING TO BUSINESS, INFORMATION TECHNOLOGY, AND HOSPITALITY, IN CLASS 41 (U.S. CLS. 100, 101 AND 107).

FIRST USE 3-12-2011; IN COMMERCE 5-15-2011.

THE MARK CONSISTS OF STANDARD CHARACTERS WITHOUT CLAIM TO ANY PARTICULAR FONT, STYLE, SIZE, OR COLOR.

NO CLAIM IS MADE TO THE EXCLUSIVE RIGHT TO USE "EDUCATION", APART FROM THE MARK AS SHOWN.

SER. NO. 85-348,684, FILED P.R. 6-17-2011; AM. S.R. 2-1-2012.

LINDA M. KING, EXAMINING ATTORNEY



David J. Kyros

Director of the United States Patent and Trademark Office

United States of America

United States Patent and Trademark Office

GOODALE

Reg. No. 4,207,924

THRILLIST ACQUISITION, LLC (DELAWARE LIMITED LIABILITY COMPANY)
568 BROADWAY, SUITE 605

Registered Sep. 11, 2012

NEW YORK, NY 10012

Int. Cls.: 18 and 25

FOR: BAGS, NAMELY, ATHLETIC BAGS; CASES, NAMELY, COSMETIC CASES SOLD EMPTY, IN CLASS 18 (U.S. CLS. 1, 2, 3, 22 AND 41).

TRADEMARK

FIRST USE 4-26-2012; IN COMMERCE 4-26-2012.

SUPPLEMENTAL REGISTER

FOR: CLOTHING, NAMELY, SHIRTS, SHORTS, PANTS AND JACKETS, SHOES, HATS AND BELTS, IN CLASS 25 (U.S. CLS. 22 AND 39).

FIRST USE 4-26-2012; IN COMMERCE 4-26-2012.

THE MARK CONSISTS OF STANDARD CHARACTERS WITHOUT CLAIM TO ANY PARTICULAR FONT, STYLE, SIZE, OR COLOR.

SER. NO. 85-349,448, FILED P.R. 6-17-2011; AM. S.R. 7-17-2012.

SUE LAWRENCE, EXAMINING ATTORNEY



David J. Kybas

Director of the United States Patent and Trademark Office

United States of America

United States Patent and Trademark Office

Professionals Realty Group

Reg. No. 4,207,925

Registered Sep. 11, 2012

Int. Cls.: 35 and 36

SERVICE MARK

SUPPLEMENTAL REGISTER

PROFESSIONALS GLOBAL LIMITED (AUSTRALIA CORPORATION)
C/O WEISS BROWN, PLLC, SUITE 143
6263 NORTH SCOTTSDALE ROAD
SCOTTSDALE, AZ 85250

FOR: ORGANIZATION OF HOUSING AND REAL ESTATE DISPLAYS AND EXHIBITIONS FOR PROMOTION OR ADVERTISING PURPOSES; REAL ESTATE AUCTIONEERING; ADVERTISING, MARKETING, MARKETING RESEARCH, MARKETING STUDIES, PUBLICITY, PUBLIC RELATIONS AND PROMOTIONAL SERVICES RELATING TO REAL ESTATE AND BUSINESSES AND PROPERTY; PROMOTING THE REAL ESTATE OF OTHERS, NAMELY, RESIDENTIAL PROPERTIES, COMMERCIAL PROPERTIES, RESIDENCES, HOUSES, FLATS, APARTMENTS, TOWN HOUSES, HOLIDAY PROPERTIES, LAND, FARMS, OFFICES, OFFICE SPACE, CAR PARKS, STORAGE SPACES, FACTORIES, WAREHOUSES, PROPERTIES FOR SALE, LEASE OR RENT BY PREPARING, PLACING AND DISSEMINATING ADVERTISING VIA ON-LINE AND PRINTED FORMATS; DISSEMINATION OF ADVERTISING MATERIAL; RENTAL OF ADVERTISING SPACE; COMPILATION OF ADVERTISEMENTS; ON-LINE ADVERTISING ON A COMPUTER NETWORK; ADVERTISING SERVICES PROMOTING THE GOODS AND SERVICES OF OTHERS; ADVERTISING AND MARKETING THE PROPERTY DEVELOPMENTS OF OTHERS; ORGANIZING OF HOUSING AND REAL ESTATE DISPLAYS, VIEWINGS AND EXHIBITIONS FOR PROMOTION OR ADVERTISING PURPOSES; BUSINESS MANAGEMENT SERVICES, NAMELY, BUSINESS MANAGEMENT OF REAL ESTATE FOR INVESTORS AND OTHERS; FRANCHISING AND FRANCHISOR SERVICES, NAMELY, PROVIDING BUSINESS ADVICE AND ASSISTANCE IN THE ESTABLISHMENT, OPERATION AND MANAGEMENT OF REAL ESTATE BUSINESSES; BUSINESS ADVICE, ASSISTANCE AND DEVELOPMENT; BUSINESS ADMINISTRATION SERVICES; BUSINESS CONSULTANCY AND ADVISORY SERVICES, NAMELY, CONSULTANCY SERVICES RELATING TO MANAGEMENT OF A REAL ESTATE BUSINESS, THE SUPPLY OF QUALITY MANAGEMENT SYSTEMS, BUSINESS RISK MANAGEMENT CONSULTANCY, BUSINESS EFFICIENCY CONSULTANCY, PROCUREMENT SERVICES FOR OTHERS, PERTAINING TO THE PURCHASING OF GOODS AND SERVICES AND PROCUREMENT OF CONTRACTS ON BEHALF OF FRANCHISEES, LANDLORDS OR TENANTS, IN THE FIELDS OF GROUP PURCHASING, SELECTION AND PROCUREMENT OF GOODS AND SERVICES BASED ON ENERGY EFFICIENCY, WATER EFFICIENCY, CARBON OFFSETTING, WASTE REDUCTION AND OTHER SUSTAINABILITY AND ENVIRONMENTAL CONSIDERATIONS AND CRITERIA; PROCUREMENT OF ENERGY, WATER, WASTE MANAGEMENT AND CLEANING SERVICES AND PRODUCTS FOR OTHERS; EFFICIENCY EXPERTS; BUSINESS EFFICIENCY ADVISORY SERVICES,



David J. Kybas

Director of the United States Patent and Trademark Office

Reg. No. 4,207,925 NAMELY, EFFICIENCY AND PROCESS AUDITING; ENERGY, WATER, RESOURCE USE MANAGEMENT FOR RESIDENTIAL AND COMMERCIAL BUILDINGS, COMPLEXES AND OTHER PROPERTIES; ORGANIZATION OF EXHIBITIONS AND TRADE FAIRS FOR COMMERCIAL OR ADVERTISING PURPOSES; DIRECTORY INFORMATION SERVICES, INCLUDING PROVISION OF ONLINE DIRECTORIES IN THE FIELDS OF REAL ESTATE AND PROPERTY MANAGEMENT; PROVISION OF ON-LINE BUSINESS LISTINGS AND CLASSIFIED ADS FOR THE GOODS/SERVICES OF OTHERS; COLLECTION, PREPARATION, COMPILATION, STORAGE, PROCESSING, RETRIEVAL AND PROVISION OF BUSINESS INFORMATION AND BUSINESS LISTINGS, INCLUDING COMPILATION OF BUSINESS LISTINGS FOR PUBLISHING ON THE INTERNET; PROVISION OF ADVERTISING SPACE ON A WEBSITE RELATING TO PROPERTY, ELECTRONIC PUBLICATIONS RELATING TO PROPERTY, DOWNLOADABLE PUBLICATIONS RELATING TO PROPERTY OR PRINTED PUBLICATIONS RELATING TO PROPERTY; RENTAL OF ADVERTISING SPACE ON THE INTERNET; COMPILATION OF INFORMATION INTO COMPUTER DATABASES; PROVISION OF COMPUTER ASSISTED BUSINESS INFORMATION; COMPUTERIZED DATABASE MANAGEMENT; SYSTEMIZATION OF INFORMATION INTO COMPUTER DATABASES; CONDUCT OF BUSINESS STUDIES AND PREPARATION OF BUSINESS REPORTS; ECONOMIC FORECASTING AND ANALYSIS FOR BUSINESS PURPOSES; MARKET ANALYSIS, RESEARCH AND MONITORING SERVICES FOR BUSINESS PURPOSES; BUSINESS ADVISORY SERVICES; BUSINESS PLANNING AND ANALYSIS SERVICES; BUSINESS MANAGEMENT AND BUSINESS ADMINISTRATION SERVICES; BUSINESS SURVEYS, APPRAISALS AND RESEARCH; BUSINESS REFERRALS SERVICES; BUSINESS NETWORKING SERVICES; FRANCHISING CONSULTANCY AND BUSINESS SUPPORT SERVICES; FRANCHISING SERVICES, NAMELY, GROUP PURCHASING AND GROUP ADVERTISING; PROVIDING STATISTICAL INFORMATION RELATING TO REAL ESTATE FOR BUSINESS OR COMMERCIAL PURPOSES; RETAIL STORE SERVICES AND WHOLESALE DISTRIBUTORSHIP SERVICES IN THE FIELD OF PRODUCTS AND SYSTEMS TO MONITOR AND IMPROVE ENERGY AND RESOURCE EFFICIENCY AND REDUCE WASTE AND EMISSIONS; BUSINESS APPRAISALS; ENERGY USE AND ENVIRONMENTAL IMPACT MANAGEMENT SERVICES FOR THE REAL PROPERTY HOLDINGS OF OTHERS, COMPRISING A REVIEW OF ENERGY USE PERFORMANCE AND ENERGY EFFICIENCY IMPROVEMENTS OF PROPERTIES, SETTING ENVIRONMENTAL GOALS FOR PROPERTIES, MONITORING PROGRESS TOWARDS THOSE GOALS, RECOMMENDING IMPROVEMENTS IN THE PERFORMANCE OF SYSTEMS WITHIN PROPERTIES, PROVIDING GUIDELINES AND PLANS TO TENANTS, SUPPLIERS, MANAGERS AND OWNERS, PROVIDING DATA ON EFFICIENCIES AND INEFFICIENCIES AND USE OF ENERGY, WATER AND OTHER RESOURCES AND CREATION OF WASTE TO TENANTS, SUPPLIERS, MANAGERS AND OWNERS; BUSINESS SERVICES RELATING TO THE ACQUISITION/DISPOSAL OF BUSINESSES NOT INVOLVING REAL ESTATE, IN CLASS 35 (U.S. CLS. 100, 101 AND 102).

FIRST USE 4-16-2012; IN COMMERCE 4-16-2012.

FOR: REAL ESTATE AGENCY SERVICES AND REAL ESTATE BROKERAGE SERVICES; LEASING AND RENTAL OF REAL ESTATE, HOUSES, APARTMENTS, FARMS, OFFICE SPACE, SHOPPING PREMISES, AND INDUSTRIAL PREMISES; FINANCIAL APPRAISALS, EVALUATIONS AND ESTIMATES FOR FINANCIAL OR INSURANCE PURPOSES, IN THE FIELDS OF REAL ESTATE, PROPERTY AND LAND; REAL ESTATE MANAGEMENT; REAL ESTATE SELECTION AND/OR ACQUISITION FOR OTHERS; REAL ESTATE INVESTMENT SERVICES; REAL ESTATE INVESTMENT MANAGEMENT SERVICES; REAL ESTATE MANAGEMENT SERVICES INCLUDING COLLECTION OF RENT AND USAGE FEES; BROKERAGE OF CARBON DIOXIDE AND OTHER GREENHOUSE GAS EMISSION CREDITS, ALLOWANCES OR OFFSETS ON BEHALF OF PROPERTY OWNERS OR USERS; PROPERTY MANAGEMENT SERVICES; INSURANCE RISK MANAGEMENT, ENVIRONMENTAL INSURANCE RISK MANAGEMENT; INSURANCE BROKERAGE SERVICES IN THE FIELD OF ENVIRONMENTAL INSURANCE SERVICES; MANAGING THE FINANCIAL RISK RESULTING FROM EXPOSURE TO ENVIRONMENTAL LIABILITIES, SPECIFICALLY IN RELATION TO THE SALE, PURCHASE AND MANAGEMENT OF REAL ESTATE; REAL

Reg. No. 4,207,925 ESTATE BROKERAGE SERVICES IN THE FIELD OF ACQUISITION AND DISPOSAL OF COMMERCIAL, INDUSTRIAL AND DOMESTIC PROPERTIES; MORTGAGE BROKERAGE AND REAL PROPERTY INSURANCE BROKERAGE; PROVIDING INFORMATION, CONSULTATION SERVICES AND ADVISORY SERVICES, ALL REGARDING REAL ESTATE, CREDIT, LOANS, MORTGAGES AND/OR REAL PROPERTY INSURANCE; FINANCIAL SPONSORSHIP SERVICES, NAMELY, FINANCIAL SPONSORSHIP OF EDUCATIONAL, ENTERTAINMENT, SPORTING AND CULTURAL ACTIVITIES; REAL ESTATE BROKERAGE LISTING SERVICES; AND PROVIDING INFORMATION IN ANY FORMAT IN THE FIELDS OF REAL ESTATE, IN CLASS 36 (U.S. CLS. 100, 101 AND 102).

FIRST USE 4-16-2012; IN COMMERCE 4-16-2012.

THE MARK CONSISTS OF STANDARD CHARACTERS WITHOUT CLAIM TO ANY PARTICULAR FONT, STYLE, SIZE, OR COLOR.

NO CLAIM IS MADE TO THE EXCLUSIVE RIGHT TO USE "REALTY GROUP", APART FROM THE MARK AS SHOWN.

SER. NO. 85-349,737, FILED P.R. 6-17-2011; AM. S.R. 6-30-2012.

JENNIFER MARTIN, EXAMINING ATTORNEY

United States of America

United States Patent and Trademark Office

Pro Builders List

Reg. No. 4,207,926

HAXTON, JAMES RANDOLPH (UNITED STATES INDIVIDUAL)
10342 MIRA VISTA DRIVE
COWAN HEIGHTS, CA 92705

Registered Sep. 11, 2012

Int. Cl.: 35

FOR: PROVIDING A WEB SITE FEATURING PRODUCTS AND SERVICES RATINGS AND COMMENTARY OF CONSUMERS IN THE FIELD OF HOME PRODUCTS AND CONTRACT SERVICES , IN CLASS 35 (U.S. CLS. 100, 101 AND 102).

SERVICE MARK

FIRST USE 9-20-2008; IN COMMERCE 9-1-2010.

SUPPLEMENTAL REGISTER

THE MARK CONSISTS OF STANDARD CHARACTERS WITHOUT CLAIM TO ANY PARTICULAR FONT, STYLE, SIZE, OR COLOR.

SER. NO. 85-356,823, FILED P.R. 6-27-2011; AM. S.R. 7-10-2012.

BRENDAN MCCAULEY, EXAMINING ATTORNEY



David J. Kyros

Director of the United States Patent and Trademark Office

United States of America
United States Patent and Trademark Office

RUBY RD.

Reg. No. 4,207,927

HEARTS OF PALM LLC (NEW YORK LIMITED LIABILITY COMPANY)
1411 BROADWAY
NEW YORK, NY 10018

Registered Sep. 11, 2012

Int. Cl.: 14

FOR: COSTUME JEWELRY, IN CLASS 14 (U.S. CLS. 2, 27, 28 AND 50).

FIRST USE 2-0-2011; IN COMMERCE 2-0-2011.

TRADEMARK

THE MARK CONSISTS OF STANDARD CHARACTERS WITHOUT CLAIM TO ANY PARTICULAR FONT, STYLE, SIZE, OR COLOR.

SUPPLEMENTAL REGISTER

OWNER OF U.S. REG. NOS. 2,848,630, 3,598,980, AND 3,800,630.

SER. NO. 85-374,003, FILED P.R. 7-18-2011; AM. S.R. 7-19-2012.

DOUGLAS LEE, EXAMINING ATTORNEY



David J. Kyffers

Director of the United States Patent and Trademark Office

United States of America

United States Patent and Trademark Office

hCG zero

Reg. No. 4,207,928

Registered Sep. 11, 2012

Int. Cl.: 5

TRADEMARK

SUPPLEMENTAL REGISTER

CREATIVE BIOSCIENCE, LLC (UTAH LIMITED LIABILITY COMPANY)
JONF@CREATIVEBIOSCIENCE.COM
5239 GREENPINE DRIVE, MURRAY, UT 84123
MURRAY, UT 84123

FOR: DIET CAPSULES; DIETARY AND NUTRITIONAL SUPPLEMENTS; DIETARY AND NUTRITIONAL SUPPLEMENTS CONTAINING VITAMIN C, VITAMIN B6, VITAMIN B12, CHROMIUM, LYCHEE FRUIT, AFRICAN MANGO, RASPBERRY KETONES, CAFFEINE, GREEN TEA, CITRUS AURANTIUM; DIETARY AND NUTRITIONAL SUPPLEMENTS USED FOR WEIGHT LOSS; NONE OF THE AFOREMENTIONED GOODS CONTAINING HUMAN CHORIONIC GONADOTROPIN (HCG), IN CLASS 5 (U.S. CLS. 6, 18, 44, 46, 51 AND 52).

FIRST USE 1-1-2011; IN COMMERCE 2-1-2011.

THE MARK CONSISTS OF STANDARD CHARACTERS WITHOUT CLAIM TO ANY PARTICULAR FONT, STYLE, SIZE, OR COLOR.

SER. NO. 85-378,828, FILED P.R. 7-22-2011; AM. S.R. 7-31-2012.

AMY KERTGATE, EXAMINING ATTORNEY



David J. Kyffers

Director of the United States Patent and Trademark Office

United States of America

United States Patent and Trademark Office

NeuroMovement

Reg. No. 4,207,929

Registered Sep. 11, 2012

Int. Cl.: 41

SERVICE MARK

SUPPLEMENTAL REGISTER

MOVEMENT COORDINATION LEARNING INC (CALIFORNIA CORPORATION), DBA
ANAT BANIEL METHOD,
4330 REDWOOD HWY, SUITE 350
SAN RAFAEL, CA 94903

FOR: EDUCATIONAL SERVICES, NAMELY, PROVIDING LIVE CLASSES, SEMINARS,
AND MENTORING IN THE FIELD OF MOVEMENT EXERCISES ACCOMPANIED WITH
ATTENTION AND AWARENESS THAT PROMOTE THE CREATION OF NEW NEURAL
PATTERNS IN THE BRAIN RESULTING IN INCREASED FLEXIBILITY AND STRENGTH
IN BODY MOVEMENT, REDUCED ACHES AND PAINS, AND ENHANCED PHYSICAL
AND COGNITIVE PERFORMANCE; PROVIDING ON-LINE CLASSES AND SEMINARS IN
THE FIELD OF MOVEMENT EXERCISES THAT PROMOTE THE CREATION OF NEW
NEURAL PATTERNS IN THE BRAIN RESULTING IN INCREASED FLEXIBILITY AND
STRENGTH IN BODY MOVEMENT, REDUCED ACHES AND PAINS, AND ENHANCED
PHYSICAL AND COGNITIVE PERFORMANCE, IN CLASS 41 (U.S. CLS. 100, 101 AND 107).

FIRST USE 9-6-2010; IN COMMERCE 1-4-2011.

THE MARK CONSISTS OF STANDARD CHARACTERS WITHOUT CLAIM TO ANY PAR-
TICULAR FONT, STYLE, SIZE, OR COLOR.

SER. NO. 85-380,439, FILED P.R. 7-25-2011; AM. S.R. 5-29-2012.

MARGARET POWER, EXAMINING ATTORNEY



David J. Kyjars

Director of the United States Patent and Trademark Office

United States of America

United States Patent and Trademark Office

i Rewards

Reg. No. 4,207,930

CENTURY GAMING, INC. (MONTANA CORPORATION)
P.O. BOX 21138
BILLINGS, MT 59104

Registered Sep. 11, 2012

Int. Cl.: 35

FOR: ARRANGING AND CONDUCTING INCENTIVE REWARD PROGRAMS FOR PROMOTING THE SALE OF CASINO SERVICES BY PROVIDING A SYSTEM IN WHICH INDIVIDUALS CAN EARN PRIZES BY PLAY OF MULTIPLE GAMING MACHINES IN CASINOS AT VARIOUS TIMES BY USING A REGISTERED PLAYER MACHINE-READABLE IDENTIFICATION CARD, IN CLASS 35 (U.S. CLS. 100, 101 AND 102).

SERVICE MARK

SUPPLEMENTAL REGISTER

FIRST USE 10-27-2008; IN COMMERCE 10-1-2009.

THE MARK CONSISTS OF STANDARD CHARACTERS WITHOUT CLAIM TO ANY PARTICULAR FONT, STYLE, SIZE, OR COLOR.

NO CLAIM IS MADE TO THE EXCLUSIVE RIGHT TO USE "REWARDS", APART FROM THE MARK AS SHOWN.

SER. NO. 85-381,403, FILED P.R. 7-26-2011; AM. S.R. 7-18-2012.

SETH A. RAPPAPORT, EXAMINING ATTORNEY



David J. Kypos

Director of the United States Patent and Trademark Office

United States of America

United States Patent and Trademark Office

Aramite

Reg. No. 4,207,931

EXCELAG CORP (DELAWARE CORPORATION)
7300 N KENDALL DR SUITE 521
MIAMI, FL 33156

Registered Sep. 11, 2012

Int. Cl.: 5

FOR: AGRICULTURAL PESTICIDES; ALGAEICIDES; ANTI-INSECT SPRAY; CHEMICAL PREPARATIONS FOR SANITARY PURPOSES; CHEMICAL PREPARATIONS FOR SANITARY USE; CHEMICAL PREPARATIONS FOR TREATING MILDEW; CHEMICAL PREPARATIONS FOR TREATING PHYLLOXERA; CHEMICAL PREPARATIONS TO TREAT MILDEW; CHEMICAL PREPARATIONS TO TREAT WHEAT SMUT; CHEMICAL REAGENTS FOR MEDICAL OR VETERINARY PURPOSES; FUNGICIDES FOR AGRICULTURAL USE; INSECT EXTERMINATING AGENTS; INSECTICIDE FOR AGRICULTURAL USE; INSECTICIDES FOR AGRICULTURAL USE; MITICIDES FOR AGRICULTURAL USE; NEMATODE PESTICIDE; PESTICIDES FOR AGRICULTURAL USE; SOIL DISINFECTANTS FOR THE CONTROL OF NEMATODES, SOIL INSECTS AND SOIL FUNGI; TOPICAL DERMATOLOGICAL PREPARATIONS THAT TREAT INSECT BITES AND STINGS, IN CLASS 5 (U.S. CLS. 6, 18, 44, 46, 51 AND 52).

TRADEMARK

SUPPLEMENTAL REGISTER

FIRST USE 3-1-2010; IN COMMERCE 3-1-2010.

THE MARK CONSISTS OF STANDARD CHARACTERS WITHOUT CLAIM TO ANY PARTICULAR FONT, STYLE, SIZE, OR COLOR.

SER. NO. 85-383,234, FILED 7-28-2011.

WILLIAM ROSSMAN, EXAMINING ATTORNEY



David J. Kyros

Director of the United States Patent and Trademark Office

United States of America

United States Patent and Trademark Office

COLLECTCLOUD

Reg. No. 4,207,932

Registered Sep. 11, 2012

Int. Cl.: 42

SERVICE MARK

SUPPLEMENTAL REGISTER

COLLECTRONICS, INC. (TEXAS CORPORATION)
3710 RAWLINS STREET, SUITE 1400
DALLAS, TX 752194217

FOR: CLOUD COMPUTING FEATURING SOFTWARE FOR ASSESSMENT COLLECTION IN THE FIELDS OF LAW, REAL ESTATE, AND COMMUNITY ASSOCIATION; MANAGING ASSESSMENT COLLECTIONS FOR CLIENTS FOR USE BY LAW FIRMS AND LEGAL COUNSEL, COVENANT ENFORCEMENT IN THE FIELDS OF LAW, REAL ESTATE AND COMMUNITY ASSOCIATION, PROJECT TRACKING AND CASE MANAGEMENT, ELECTRONIC POSTAL SERVICES, NAMELY, PREPARATION OF SHIPPING LABELS AND ENVELOPES WITH USPS TRACKING NUMBERS, ELECTRONIC RETURN RECEIPTS FOR CERTIFIED MAIL AND REGULAR MAIL, ONLINE TRACKING OF DELIVERY STATUS, DOCUMENT BACKUP AND RETRIEVAL SERVICES AND COMPUTER DISASTER RECOVERY SERVICES, IN CLASS 42 (U.S. CLS. 100 AND 101).

FIRST USE 1-20-2012; IN COMMERCE 1-20-2012.

THE MARK CONSISTS OF STANDARD CHARACTERS WITHOUT CLAIM TO ANY PARTICULAR FONT, STYLE, SIZE, OR COLOR.

SER. NO. 85-383,919, FILED P.R. 7-28-2011; AM. S.R. 7-13-2012.

LINDA ORNDORFF, EXAMINING ATTORNEY



David J. Kyros

Director of the United States Patent and Trademark Office

United States of America

United States Patent and Trademark Office

Drill-n-Ream

Reg. No. 4,207,933

ISENHOUR, JAMES D. (UNITED STATES INDIVIDUAL)
4817 COUNTRY FARMS DRIVE
WINDSOR, CO 80528

Registered Sep. 11, 2012

Int. Cl.: 7

FOR: POWER-OPERATED ECCENTRIC REAMER, IN CLASS 7 (U.S. CLS. 13, 19, 21, 23, 31, 34 AND 35).

TRADEMARK

FIRST USE 8-1-2010; IN COMMERCE 2-7-2011.

SUPPLEMENTAL REGISTER

THE MARK CONSISTS OF STANDARD CHARACTERS WITHOUT CLAIM TO ANY PARTICULAR FONT, STYLE, SIZE, OR COLOR.

SER. NO. 85-386,210, FILED P.R. 8-1-2011; AM. S.R. 7-17-2012.

MICHAEL WEBSTER, EXAMINING ATTORNEY



David J. Kyffers

Director of the United States Patent and Trademark Office

United States of America

United States Patent and Trademark Office

The Ramp

Reg. No. 4,207,934

Registered Sep. 11, 2012

Int. Cl.: 10

TRADEMARK

SUPPLEMENTAL REGISTER

RAMP UP, LLC (FLORIDA LIMITED LIABILITY COMPANY), DBA RAMP UP,
#1004
ALDTON ROAD
MIAMI BEACH, FL 33139

FOR: ATHLETIC TRAINING ORTHOTIC FOR THE JAW, IN CLASS 10 (U.S. CLS. 26, 39
AND 44).

FIRST USE 1-1-2011; IN COMMERCE 8-9-2011.

THE MARK CONSISTS OF STANDARD CHARACTERS WITHOUT CLAIM TO ANY PAR-
TICULAR FONT, STYLE, SIZE, OR COLOR.

SER. NO. 85-394,250, FILED P.R. 8-10-2011; AM. S.R. 6-12-2012.

BARBARA RUTLAND, EXAMINING ATTORNEY



David J. Kyffers

Director of the United States Patent and Trademark Office

United States of America

United States Patent and Trademark Office

KISSCAM.COM

Reg. No. 4,207,935

VEITCH, DANA (UNITED STATES INDIVIDUAL)

Registered Sep. 11, 2012

P.O. BOX 741
MORRISON, CO 80465

Int. Cl.: 38

FOR: AUDIO AND VIDEO BROADCASTING SERVICES OVER THE INTERNET OR OTHER COMMUNICATIONS NETWORK, NAMELY, UPLOADING, POSTING, SHOWING, DISPLAYING, TAGGING AND ELECTRONICALLY TRANSMITTING INFORMATION, PHOTOGRAPHS, AUDIO, AND VIDEO CLIPS; PROVIDING ACCESS TO INFORMATION, AUDIO, AND VIDEO VIA WEBSITES, IN CLASS 38 (U.S. CLS. 100, 101 AND 104).

SERVICE MARK

SUPPLEMENTAL REGISTER

FIRST USE 6-15-2011; IN COMMERCE 6-15-2011.

THE MARK CONSISTS OF STANDARD CHARACTERS WITHOUT CLAIM TO ANY PARTICULAR FONT, STYLE, SIZE, OR COLOR.

SER. NO. 85-394,263, FILED P.R. 8-10-2011; AM. S.R. 6-4-2012.

KATHLEEN LORENZO, EXAMINING ATTORNEY



David J. Kyjars

Director of the United States Patent and Trademark Office

United States of America

United States Patent and Trademark Office

KISSCAM.COM

Reg. No. 4,207,936

VEITCH, DANA (UNITED STATES INDIVIDUAL)

Registered Sep. 11, 2012

P.O. BOX 741
MORRISON, CO 80465

Int. Cl.: 41

FOR: ENTERTAINMENT SERVICES, NAMELY, PROVIDING A WEBSITE FEATURING FILM CLIPS, PHOTOGRAPHS, AND OTHER MULTIMEDIA MATERIALS FEATURING COMEDY, ACTION, ADVENTURE, LOVE AND ROMANCE, IN CLASS 41 (U.S. CLS. 100, 101 AND 107).

SERVICE MARK

SUPPLEMENTAL REGISTER FIRST USE 6-15-2011; IN COMMERCE 6-15-2011.

THE MARK CONSISTS OF STANDARD CHARACTERS WITHOUT CLAIM TO ANY PARTICULAR FONT, STYLE, SIZE, OR COLOR.

SER. NO. 85-394,264, FILED P.R. 8-10-2011; AM. S.R. 6-4-2012.

KATHLEEN LORENZO, EXAMINING ATTORNEY



David J. Kyffers

Director of the United States Patent and Trademark Office

United States of America

United States Patent and Trademark Office

FINANCIAL SERVICES ASSOCIATION

Reg. No. 4,207,937

AFFINION PUBLISHING LLC (DELAWARE LIMITED LIABILITY COMPANY)
10750 WEST CHARLESTON BOULEVARD, STE 130
LAS VEGAS, NV 89135

Registered Sep. 11, 2012

**Int. Cls.: 35, 36, 39, and
45**

FOR: PROMOTING THE BANKING, FINANCIAL, CHECKING ACCOUNT, AND CREDIT CARD SERVICES OF THE BANKS AND FINANCIAL INSTITUTIONS OF OTHERS BY OFFERING DISCOUNT AND SAVINGS INFORMATION AND COUPONS IN THE FIELDS OF TRAVEL, CAR RENTAL, LODGING, DINING, THEATER, SPORTING EVENTS, LEISURE ACTIVITIES AND ON CONSUMER MERCHANDISE; PROMOTING THE GOODS AND SERVICES OF OTHERS IN THE FIELDS OF TRAVEL, CAR RENTAL, LODGING, DINING, THEATER, SPORTING EVENTS, LEISURE ACTIVITIES AND ON CONSUMER MERCHANDISE THROUGH THE PROVISION OF DISCOUNT AND SAVINGS INFORMATION AND COUPONS; KEY RETURN REGISTRATION, IN CLASS 35 (U.S. CLS. 100, 101 AND 102).

SERVICE MARK

SUPPLEMENTAL REGISTER

FIRST USE 5-30-1989; IN COMMERCE 5-30-1989.

FOR: ACCIDENTAL DEATH AND DISMEMBERMENT INSURANCE UNDERWRITING, IN CLASS 36 (U.S. CLS. 100, 101 AND 102).

FIRST USE 5-30-1989; IN COMMERCE 5-30-1989.

FOR: TRAVEL AGENCY SERVICES, NAMELY, BOOKING RESERVATIONS FOR TRANSPORTATION, IN CLASS 39 (U.S. CLS. 100 AND 105).

FIRST USE 5-30-1989; IN COMMERCE 5-30-1989.

FOR: FRAUD DETECTION SERVICES IN THE FIELD OF CREDIT CARDS FOR PURCHASING OF GOODS AND SERVICES, IN CLASS 45 (U.S. CLS. 100 AND 101).

FIRST USE 5-30-1989; IN COMMERCE 5-30-1989.

THE MARK CONSISTS OF STANDARD CHARACTERS WITHOUT CLAIM TO ANY PARTICULAR FONT, STYLE, SIZE, OR COLOR.

NO CLAIM IS MADE TO THE EXCLUSIVE RIGHT TO USE "ASSOCIATION", APART FROM THE MARK AS SHOWN.



David J. Kyffers

Director of the United States Patent and Trademark Office

Reg. No. 4,207,937 SER. NO. 85-394,563, FILED P.R. 8-10-2011; AM. S.R. 7-12-2012.

HOWARD B. LEVINE, EXAMINING ATTORNEY

United States of America

United States Patent and Trademark Office

HELIARC

Reg. No. 4,207,938

KERRICK ENTERPRISES, INC. (CALIFORNIA CORPORATION)
1715 SOUTH BOYD STREET
SANTA ANA, CA 927055105

Registered Sep. 11, 2012

Int. Cl.: 15

FOR: GUITARS, IN CLASS 15 (U.S. CLS. 2, 21 AND 36).

TRADEMARK

FIRST USE 2-17-2011; IN COMMERCE 2-17-2011.

SUPPLEMENTAL REGISTER

THE MARK CONSISTS OF STANDARD CHARACTERS WITHOUT CLAIM TO ANY PARTICULAR FONT, STYLE, SIZE, OR COLOR.

SER. NO. 85-404,780, FILED P.R. 8-23-2011; AM. S.R. 7-16-2012.

COLLEEN KEARNEY, EXAMINING ATTORNEY



David J. Kybas

Director of the United States Patent and Trademark Office

United States of America

United States Patent and Trademark Office

HeliArc

Reg. No. 4,207,939

KERRICK ENTERPRISES, INC. (CALIFORNIA CORPORATION)
1715 SOUTH BOYD STREET
SANTA ANA, CA 927055105

Registered Sep. 11, 2012

Int. Cl.: 15

FOR: GUITARS, IN CLASS 15 (U.S. CLS. 2, 21 AND 36).

TRADEMARK

FIRST USE 3-17-2011; IN COMMERCE 3-17-2011.

SUPPLEMENTAL REGISTER

THE MARK CONSISTS OF THE WORD "HELIARC" IN A STYLIZED FONT.

SER. NO. 85-404,835, FILED P.R. 8-23-2011; AM. S.R. 7-16-2012.

COLLEEN KEARNEY, EXAMINING ATTORNEY



David J. Kyros

Director of the United States Patent and Trademark Office

United States of America

United States Patent and Trademark Office

Fiber Sticks +K

Reg. No. 4,207,940

4 LIFE TM HOLDINGS, LLC (ARIZONA LIMITED LIABILITY COMPANY)
P.O. BOX 28278

Registered Sep. 11, 2012

SCOTTSDALE, AZ 85255

Int. Cl.: 5

FOR: DIETARY AND NUTRITIONAL SUPPLEMENTS, IN CLASS 5 (U.S. CLS. 6, 18, 44, 46, 51 AND 52).

TRADEMARK

FIRST USE 10-28-2011; IN COMMERCE 10-28-2011.

SUPPLEMENTAL REGISTER

THE MARK CONSISTS OF STANDARD CHARACTERS WITHOUT CLAIM TO ANY PARTICULAR FONT, STYLE, SIZE, OR COLOR.

SER. NO. 85-405,339, FILED P.R. 8-23-2011; AM. S.R. 7-24-2012.

MIDGE BUTLER, EXAMINING ATTORNEY



David J. Kyffers

Director of the United States Patent and Trademark Office

United States of America

United States Patent and Trademark Office

DERMAL MICA

Reg. No. 4,207,941

KIM, SUK YOUNG (UNITED STATES INDIVIDUAL)
1 OYSTER BAY DR
RUMSON, NJ 07760

Registered Sep. 11, 2012

Int. Cl.: 1

FOR: CHEMICAL ADDITIVES FOR USE IN THE MANUFACTURE OF COSMETICS MADE IN PART OF ALUMINUM SILICATE OR MICA; CHEMICAL PRODUCTS USED AS INGREDIENTS IN THE MANUFACTURE OF COSMETICS, NAMELY, POTASSIUM ALUMINUM SILICATE COATED BY LIPID COMPLEX, IN CLASS 1 (U.S. CLS. 1, 5, 6, 10, 26 AND 46).

TRADEMARK

SUPPLEMENTAL REGISTER FIRST USE 9-1-2008; IN COMMERCE 8-1-2011.

THE MARK CONSISTS OF STANDARD CHARACTERS WITHOUT CLAIM TO ANY PARTICULAR FONT, STYLE, SIZE, OR COLOR.

SER. NO. 85-406,030, FILED P.R. 8-24-2011; AM. S.R. 6-14-2012.

THOMAS MANOR, EXAMINING ATTORNEY



David J. Kyffers

Director of the United States Patent and Trademark Office

United States of America

United States Patent and Trademark Office

CodeRED Weather Warning

Reg. No. 4,207,942

Registered Sep. 11, 2012

Int. Cl.: 38

SERVICE MARK

SUPPLEMENTAL REGISTER

EMERGENCY COMMUNICATIONS NETWORK LLC (DELAWARE LIMITED LIABILITY COMPANY)
9 SUNSHINE BLVD
ORMOND BEACH, FL 32174

FOR: COMMUNICATION SERVICES, NAMELY, TRANSMISSION OF VOICE, AUDIO, VISUAL IMAGES AND DATA BY TELECOMMUNICATIONS NETWORKS, WIRELESS COMMUNICATION NETWORKS, THE INTERNET, INFORMATION SERVICES NETWORKS AND DATA NETWORKS; PROVIDING THIRD PARTY USERS WITH ACCESS TO TELECOMMUNICATION INFRASTRUCTURE; TELECOMMUNICATION SERVICES, NAMELY, PROVIDING E-MAIL NOTIFICATION ALERTS VIA THE INTERNET; TELECOMMUNICATION SERVICES, NAMELY, PROVIDING ELECTRONIC MESSAGE ALERTS VIA THE INTERNET, IN CLASS 38 (U.S. CLS. 100, 101 AND 104).

FIRST USE 9-11-2007; IN COMMERCE 9-11-2007.

THE MARK CONSISTS OF STANDARD CHARACTERS WITHOUT CLAIM TO ANY PARTICULAR FONT, STYLE, SIZE, OR COLOR.

OWNER OF U.S. REG. NOS. 2,885,436, 2,906,346, AND 3,222,362.

SER. NO. 85-407,183, FILED P.R. 8-25-2011; AM. S.R. 5-23-2012.

TIMOTHY FINNEGAN, EXAMINING ATTORNEY



David J. Kybas

Director of the United States Patent and Trademark Office

United States of America

United States Patent and Trademark Office

THE ASCENT

Reg. No. 4,207,943

YEHUDA DUENYAS (UNITED STATES INDIVIDUAL)
155 EAST 2ND STREET, APT. 2D
NEW YORK, NY 10009

Registered Sep. 11, 2012

Int. Cl.: 41

FOR: ENTERTAINMENT IN THE NATURE OF PROVIDING AN INSTALLATION THAT ALLOWS THE USER TO VIRTUALLY DEFY GRAVITY, NAMELY, ENABLING USERS TO CONTROL AN AUTOMATED RIGGING SYSTEM USING AN EEG-BASED CONTROL INTERFACE; ENTERTAINMENT SERVICES IN THE NATURE OF LIVE THEATRE AND STAGE PERFORMANCES, IN CLASS 41 (U.S. CLS. 100, 101 AND 107).

SERVICE MARK

SUPPLEMENTAL REGISTER

FIRST USE 5-11-2011; IN COMMERCE 5-11-2011.

THE MARK CONSISTS OF STANDARD CHARACTERS WITHOUT CLAIM TO ANY PARTICULAR FONT, STYLE, SIZE, OR COLOR.

SER. NO. 85-407,765, FILED P.R. 8-25-2011; AM. S.R. 4-17-2012.

KATHLEEN M. VANSTON, EXAMINING ATTORNEY



David J. Kyros

Director of the United States Patent and Trademark Office

United States of America
United States Patent and Trademark Office

CLOUDQR

Reg. No. 4,207,944

Registered Sep. 11, 2012

Int. Cl.: 35

SERVICE MARK

SUPPLEMENTAL REGISTER

MADE HOLDINGS, LLC (FLORIDA LIMITED LIABILITY COMPANY)
1011 LAKE COUNTY DRIVE
GREENSBORO, GA 30642

FOR: ADVERTISING, MARKETING AND PROMOTIONAL SERVICES PROVIDED BY MEANS OF DIRECT OR INDIRECT METHODS OF MARKETING COMMUNICATIONS, NAMELY, MOBILE MARKETING, MOBILE ACTION CODES, QUICK RESPONSE CODES, SOCIAL MEDIA, SEARCH ENGINE MARKETING, INQUIRY MARKETING, INTERNET MARKETING, BLOGGING AND OTHER FORMS OF PASSIVE, SHARABLE OR VIRAL COMMUNICATIONS CHANNELS, IN CLASS 35 (U.S. CLS. 100, 101 AND 102).

FIRST USE 7-1-2011; IN COMMERCE 7-31-2011.

THE MARK CONSISTS OF STANDARD CHARACTERS WITHOUT CLAIM TO ANY PARTICULAR FONT, STYLE, SIZE, OR COLOR.

SER. NO. 85-409,876, FILED P.R. 8-29-2011; AM. S.R. 7-3-2012.

COLLEEN KEARNEY, EXAMINING ATTORNEY



David J. Kyffers

Director of the United States Patent and Trademark Office

United States of America

United States Patent and Trademark Office

DualPath

Reg. No. 4,207,945

LIGHTPOINTE CORPORATION (CALIFORNIA CORPORATION)
10140 BARNES CANYON RD. SUITE B
SAN DIEGO, CA 92121

Registered Sep. 11, 2012

Int. Cl.: 9

FOR: WIRELESS COMMUNICATION DEVICES FOR VOICE, DATA OR IMAGE TRANSMISSION, IN CLASS 9 (U.S. CLS. 21, 23, 26, 36 AND 38).

TRADEMARK

FIRST USE 5-2-2005; IN COMMERCE 5-2-2005.

SUPPLEMENTAL REGISTER

THE MARK CONSISTS OF STANDARD CHARACTERS WITHOUT CLAIM TO ANY PARTICULAR FONT, STYLE, SIZE, OR COLOR.

SER. NO. 85-411,331, FILED P.R. 8-31-2011; AM. S.R. 6-21-2012.

CHRISTOPHER SIDOTI, EXAMINING ATTORNEY



David J. Kybas

Director of the United States Patent and Trademark Office

United States of America

United States Patent and Trademark Office

CORAL & REEF USA

Reg. No. 4,207,946

BOWTIE, INC. (CALIFORNIA CORPORATION)
3 BURROUGHS
IRVINE, CA 926182804

Registered Sep. 11, 2012

Int. Cls.: 16 and 44

FOR: MAGAZINES IN THE FIELD OF BODIES OF WATER, BOTANICAL REGIONS, AQUATIC ENVIRONMENTS, AQUATIC SPECIES, AND TOPICS OF GENERAL INTEREST TO OWNERS OF AQUATIC SPECIES, IN CLASS 16 (U.S. CLS. 2, 5, 22, 23, 29, 37, 38 AND 50).

TRADEMARK

SERVICE MARK

FIRST USE 4-0-2011; IN COMMERCE 4-0-2011.

SUPPLEMENTAL REGISTER

FOR: PROVIDING ONLINE INFORMATION IN THE FIELD OF SETTING UP AND MAINTAINING AQUARIUMS, AND CREATING AND MAINTAINING AQUATIC ENVIRONMENTS FOR PURPOSES OF MAINTAINING FISH; PROVIDING ONLINE INFORMATION IN THE FIELD OF ANIMALS RELATING TO BREEDING, SELECTION, HEALTH, CARE AND NUTRITION, IN CLASS 44 (U.S. CLS. 100 AND 101).

FIRST USE 5-0-2011; IN COMMERCE 5-0-2011.

THE MARK CONSISTS OF STANDARD CHARACTERS WITHOUT CLAIM TO ANY PARTICULAR FONT, STYLE, SIZE, OR COLOR.

SER. NO. 85-412,335, FILED P.R. 8-31-2011; AM. S.R. 6-27-2012.

KATHERINE STOIDES, EXAMINING ATTORNEY



David J. Kybas

Director of the United States Patent and Trademark Office

United States of America

United States Patent and Trademark Office

AFTER-SUN REPLENISHING MASQUE

Reg. No. 4,207,947

JOHN PAUL MITCHELL SYSTEMS (CALIFORNIA CORPORATION)
20705 CENTRE POINTE PARKWAY
SANTA CLARITA, CA 91350

Registered Sep. 11, 2012

Int. Cl.: 3

FOR: HAIR CONDITIONER, IN CLASS 3 (U.S. CLS. 1, 4, 6, 50, 51 AND 52).

TRADEMARK

FIRST USE 1-31-2012; IN COMMERCE 1-31-2012.

SUPPLEMENTAL REGISTER

THE MARK CONSISTS OF STANDARD CHARACTERS WITHOUT CLAIM TO ANY PARTICULAR FONT, STYLE, SIZE, OR COLOR.

SER. NO. 85-413,554, FILED P.R. 9-1-2011; AM. S.R. 4-10-2012.

AHSEN KHAN, EXAMINING ATTORNEY



David J. Kyffers

Director of the United States Patent and Trademark Office

United States of America

United States Patent and Trademark Office

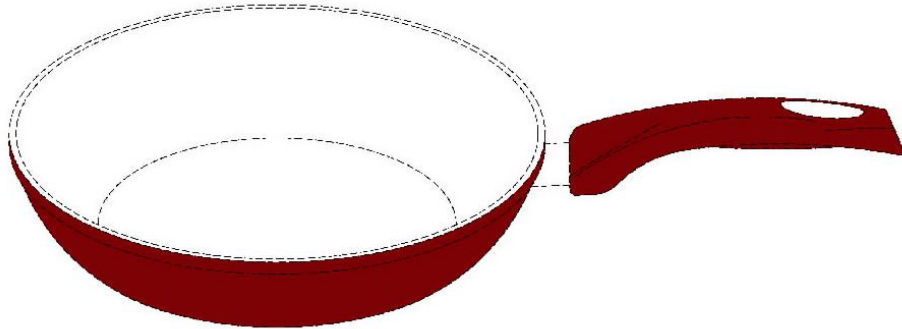

Reg. No. 4,207,948

BRADSHAW INTERNATIONAL, INC. (CALIFORNIA CORPORATION)
9409 BUFFALO AVE.

Registered Sep. 11, 2012

RANCHO CUCAMONGA, CA 91730

Int. Cl.: 21

FOR: COOKWARE, NAMELY, POTS AND PANS, IN CLASS 21 (U.S. CLS. 2, 13, 23, 29, 30, 33, 40 AND 50).

TRADEMARK

FIRST USE 9-0-2009; IN COMMERCE 8-0-2010.

SUPPLEMENTAL REGISTER

THE MARK CONSISTS OF SOLELY THE COLORS RED AND WHITE. THE COLOR RED APPEARS ON THE OUTER SURFACE OF THE COOKWARE. THE COLOR WHITE APPEARS ON THE ENTIRE INNER SURFACE OF THE COOKWARE. THE STEM CONNECTING THE HANDLE TO THE PAN AND THE HANDLE ARE NOT PART OF THE MARK. THE DOTTED LINES ARE INTENDED TO SHOW THE POSITION OF THE MARK AND ARE NOT PART OF THE MARK AS SHOWN.

THE COLOR(S) RED AND WHITE IS/ARE CLAIMED AS A FEATURE OF THE MARK.

SER. NO. 85-414,493, FILED P.R. 9-2-2011; AM. S.R. 7-5-2012.

MARK RADEMACHER, EXAMINING ATTORNEY



David J. Kyffers

Director of the United States Patent and Trademark Office

United States of America

United States Patent and Trademark Office

PELICAS

Reg. No. 4,207,949

Registered Sep. 11, 2012

**Int. Cls.: 11, 20, 37, 40,
and 42**

TRADEMARK

SERVICE MARK

SUPPLEMENTAL REGISTER

MONTECO CORPORATION (DELAWARE CORPORATION)
C/O CAPITAL CORPORATE SERVICES, INC.
1111B SOUTH GOVERNORS AVENUE
DOVER, DE 19904

FOR: SEPARATOR UNIT INSTALLED UNDER SINKS FOR REMOVAL AND STORAGE OF OIL, GREASE AND SEDIMENT FROM LIQUID POURED INTO THE SINK AND THEREAFTER DISCHARGED TO THE SANITARY SEWER; WASTE WATER TREATMENT EQUIPMENT, NAMELY, PH NEUTRALIZATION SYSTEM FOR WASTE WATER TREATMENT, COMPRISED OF A VERTICAL PUMP, STEEL FRAME, AND ELECTRONIC MEASURING DEVICE AND MAGNESIUM OXIDE FOR NEUTRALIZING WASTE WATER; POINT-SOURCE WASTEWATER TREATMENT EQUIPMENT AND RAINWATER HARVESTING EQUIPMENT, NAMELY, SEPARATOR UNITS FOR REMOVAL AND STORAGE OF OIL, GREASE AND SEDIMENT FROM EFFLUENCE AND NEUTRALIZATION OF WASTE WATER DISCHARGED TO THE SANITARY SEWER AND RAINWATER HARVESTING EQUIPMENT, NAMELY, FILTER UNITS FOR SEDIMENT SEPARATION, AND STORAGE AND DISTRIBUTION OF TREATED WATER; SEPARATOR UNITS FOR REMOVAL AND STORAGE OF OIL AND SEDIMENT FROM STORM WATER DRAINAGE; ENGINEERED OXIDE-COATED SUBSTRATE FOR REMOVING OR FILTERING POLLUTANTS FROM STORM WATER WITH GLASS REINFORCED PLASTIC COMPONENTS AND PRODUCTS, NAMELY, PIPES, MANHOLES AND TANKS FOR USE IN THE BUILDING AND CONSTRUCTION INDUSTRY; ENGINEERED OXIDE COATED FILTRATION SUBSTRATE IN THE FORM OF GRANULES, STONE SIZED PIECES, BLOCKS OR PAVEMENTS FOR REMOVING OR FILTERING POLLUTANTS BY ABSORPTION AND ADSORPTION FROM STORM WATER RUNOFF, IN CLASS 11 (U.S. CLS. 13, 21, 23, 31 AND 34).

FIRST USE 10-1-2011; IN COMMERCE 7-1-2012.

FOR: HORIZONTAL, VERTICAL, ABOVE, AND BELOW GROUND, ATMOSPHERIC, PRESSURIZED AND DOUBLE CONTAINMENT FIBREGLASS TANKS FOR CONTAINING FLUIDS, IN CLASS 20 (U.S. CLS. 2, 13, 22, 25, 32 AND 50).

FIRST USE 10-1-2011; IN COMMERCE 7-1-2012.

FOR: PROVIDING MAINTENANCE SERVICES FOR SEPARATOR UNITS, IN CLASS 37 (U.S. CLS. 100, 103 AND 106).



David J. Kypos

Director of the United States Patent and Trademark Office

Reg. No. 4,207,949 FIRST USE 10-1-2011; IN COMMERCE 10-1-2011.

FOR: MANUFACTURE OF GLASS REINFORCED PLASTIC COMPONENTS AND PRODUCTS TO THE ORDER AND SPECIFICATION OF OTHERS; CUSTOM MANUFACTURE TO THE ORDER AND SPECIFICATION OF OTHERS OF FIBERGLASS COMPONENTS AND PRODUCTS, NAMELY, FILTER VESSELS, TANKS, PIPES, MANHOLES AND COVERS, AND FIBERGLASS ARCHITECTURAL COMPONENTS, NAMELY, BUILDING ITEMS REQUIRED BY ARCHITECTURAL SPECIFICATIONS FOR THE APPEARANCE OF STONE, BRICKED AND WOOD, NAMELY, FIBERGLASS THAT IS FORMED TO SIMULATE STONE, BRICK AND WOOD, IN CLASS 40 (U.S. CLS. 100, 103 AND 106).

FIRST USE 10-1-2011; IN COMMERCE 10-1-2011.

FOR: DISSEMINATION OF INFORMATION RELATING TO STORMWATER MANAGEMENT AND TREATMENT, IN CLASS 42 (U.S. CLS. 100 AND 101).

FIRST USE 10-1-2011; IN COMMERCE 10-1-2011.

THE MARK CONSISTS OF STANDARD CHARACTERS WITHOUT CLAIM TO ANY PARTICULAR FONT, STYLE, SIZE, OR COLOR.

SER. NO. 85-415,436, FILED P.R. 9-6-2011; AM. S.R. 7-30-2012.

KELLY TRUSILO, EXAMINING ATTORNEY

United States of America

United States Patent and Trademark Office

IPERMIT

Reg. No. 4,207,950

TWO TECHNOLOGIES, INC. (PENNSYLVANIA CORPORATION)
419 SARGON WAY
HORSHAM, PA 19044

Registered Sep. 11, 2012

Int. Cl.: 9

FOR: COMPUTER SOFTWARE FOR USE BY PARKING LOTS, PARKING AUTHORITIES, POLICE, AND UNIVERSITY AND MUNICIPAL PARKING ENFORCEMENT OFFICERS, FOR THE ISSUANCE OF PARKING PERMITS AND FOR THE ISSUANCE OF PARKING CITATIONS FOR PARKING VIOLATIONS, SOLD AS A COMPONENT OF HAND-HELD OPERATOR INTERFACES WITH BUILT-IN CAMERAS AND HAND-HELD DATA PROCESSORS WITH BUILT-IN CAMERAS, IN CLASS 9 (U.S. CLS. 21, 23, 26, 36 AND 38).

TRADEMARK

SUPPLEMENTAL REGISTER

FIRST USE 3-0-2012; IN COMMERCE 3-0-2012.

THE MARK CONSISTS OF STANDARD CHARACTERS WITHOUT CLAIM TO ANY PARTICULAR FONT, STYLE, SIZE, OR COLOR.

SER. NO. 85-416,707, FILED P.R. 9-7-2011; AM. S.R. 8-8-2012.

DAVID ELTON, EXAMINING ATTORNEY



David J. Kyffers

Director of the United States Patent and Trademark Office

United States of America

United States Patent and Trademark Office

MODERNWORKWEAR

Reg. No. 4,207,951

MAGICALIFE GROUP, LLC (CALIFORNIA LIMITED LIABILITY COMPANY)
1129 E 5TH STREET

Registered Sep. 11, 2012

LOS ANGELES, CA 90013

Int. Cl.: 25

FOR: BOTTOMS; TOPS, IN CLASS 25 (U.S. CLS. 22 AND 39).

TRADEMARK

FIRST USE 8-0-2011; IN COMMERCE 8-0-2011.

SUPPLEMENTAL REGISTER

THE MARK CONSISTS OF STANDARD CHARACTERS WITHOUT CLAIM TO ANY PARTICULAR FONT, STYLE, SIZE, OR COLOR.

SER. NO. 85-418,189, FILED P.R. 9-8-2011; AM. S.R. 7-16-2012.

RONALD MCMORROW, EXAMINING ATTORNEY



David J. Kybas

Director of the United States Patent and Trademark Office

United States of America

United States Patent and Trademark Office

Incomparable Nonpareils

Reg. No. 4,207,952

DAVID SHALOWAY (UNITED STATES INDIVIDUAL)
497 MALLORY ROAD
KENTS STORE, VA 23084

Registered Sep. 11, 2012

Int. Cl.: 30

FOR: CANDY, IN CLASS 30 (U.S. CL. 46).

TRADEMARK

FIRST USE 4-18-2009; IN COMMERCE 10-14-2009.

SUPPLEMENTAL REGISTER

THE MARK CONSISTS OF STANDARD CHARACTERS WITHOUT CLAIM TO ANY PARTICULAR FONT, STYLE, SIZE, OR COLOR.

NO CLAIM IS MADE TO THE EXCLUSIVE RIGHT TO USE "NONPAREILS", APART FROM THE MARK AS SHOWN.

SER. NO. 85-422,098, FILED P.R. 9-14-2011; AM. S.R. 6-26-2012.

MATTHEW MCDOWELL, EXAMINING ATTORNEY



David J. Kyffers

Director of the United States Patent and Trademark Office

United States of America

United States Patent and Trademark Office

CLOSED LOOP

Reg. No. 4,207,953

WORLDWISE, INC. (CALIFORNIA CORPORATION)

Registered Sep. 11, 2012

160 MITCHELL BOULEVARD
SAN RAFAEL, CA 94903

Int. Cls.: 20 and 21

FOR: PET BEDS MADE FROM RECYCLED MATERIALS; STORAGE CABINETS FOR HOUSING PET MANAGEMENT PRODUCTS MADE FROM RECYCLED MATERIALS; CAT SCRATCHING PADS AND REPLACEMENT PADS THEREFOR, IN CLASS 20 (U.S. CLS. 2, 13, 22, 25, 32 AND 50).

TRADEMARK

SUPPLEMENTAL REGISTER

FIRST USE 5-21-2012; IN COMMERCE 5-21-2012.

FOR: LITTER SCOOPS FOR THE DISPOSAL OF PET WASTE, PET LITTER PAN LINERS AND PET LITTER PANS, ALL MADE FROM RECYCLED MATERIALS, IN CLASS 21 (U.S. CLS. 2, 13, 23, 29, 30, 33, 40 AND 50).

FIRST USE 4-26-2012; IN COMMERCE 4-26-2012.

THE MARK CONSISTS OF STANDARD CHARACTERS WITHOUT CLAIM TO ANY PARTICULAR FONT, STYLE, SIZE, OR COLOR.

SER. NO. 85-422,958, FILED P.R. 9-14-2011; AM. S.R. 7-12-2012.

BARNEY CHARLON, EXAMINING ATTORNEY



David J. Kyros

Director of the United States Patent and Trademark Office

United States of America

United States Patent and Trademark Office

WOMEN'S FINANCIAL ACADEMY

Reg. No. 4,207,954

Registered Sep. 11, 2012

Int. Cl.: 41

SERVICE MARK

SUPPLEMENTAL REGISTER

NORMAN, BARBARA (UNITED STATES INDIVIDUAL), DBA WOMEN'S FINANCIAL ACADEMY,
4927 MARLBOROUGH DRIVE
SAN DIEGO, CA 92116

FOR: PROVIDING EDUCATIONAL SERVICES, NAMELY, ORGANIZING AND HOSTING PEER-TO-PEER DISCUSSIONS AND COACHING ON FINANCIAL LITERACY AND INDEPENDENCE; ORGANIZING AND HOSTING PEER-TO-PEER DISCUSSIONS AND COACHING IN THE FIELDS OF INVESTMENT, RETIREMENT, COLLEGE FUNDING AND WEALTH PLANNING; ORGANIZING AND HOSTING PEER-TO-PEER DISCUSSIONS ON INVESTMENT AND ECONOMIC TRENDS FOR THE BUSINESS OWNER; ARRANGING AND CONDUCTING LECTURES, SEMINARS AND WORKSHOPS IN THE FIELDS OF FINANCIAL LITERACY AND INDEPENDENCE, INVESTMENT, RETIREMENT, COLLEGE FUNDING AND WEALTH PLANNING; AND OFFERING COURSES OF INSTRUCTION ON FINANCIAL LITERACY, INVESTMENT, RETIREMENT, COLLEGE FUNDING AND WEALTH PLANNING, IN CLASS 41 (U.S. CLS. 100, 101 AND 107).

FIRST USE 6-20-2010; IN COMMERCE 6-20-2010.

THE MARK CONSISTS OF STANDARD CHARACTERS WITHOUT CLAIM TO ANY PARTICULAR FONT, STYLE, SIZE, OR COLOR.

NO CLAIM IS MADE TO THE EXCLUSIVE RIGHT TO USE "FINANCIAL ACADEMY", APART FROM THE MARK AS SHOWN.

SER. NO. 85-424,079, FILED P.R. 9-15-2011; AM. S.R. 7-10-2012.

ARETHA SOMERVILLE, EXAMINING ATTORNEY



David J. Kyffers

Director of the United States Patent and Trademark Office

United States of America

United States Patent and Trademark Office

USAMEDCARD

Reg. No. 4,207,955

USAMEDCARD LLC (FLORIDA LIMITED LIABILITY COMPANY)
18181 NE 31ST CT 2404
AVENTURA, FL 33160

Registered Sep. 11, 2012

Int. Cl.: 35

FOR: ADMINISTERING DISCOUNT MEDICAL, COSMETIC AND AESTHETIC SERVICE PROGRAMS, NAMELY, NEGOTIATING CONTRACTS WITH PROVIDERS OF MEDICAL, COSMETIC AND AESTHETIC SERVICES, TO ENABLE PARTICIPANT MEMBERS TO OBTAIN DISCOUNTS ON THE PURCHASE OF MEDICAL, COSMETIC AND AESTHETIC PRODUCTS AND SERVICES THROUGH THE USE OF DISCOUNT MEMBERSHIP CARDS; ADMINISTRATION OF A DISCOUNT PROGRAM FOR ENABLING PARTICIPANTS TO OBTAIN DISCOUNTS ON GOODS AND SERVICES THROUGH USE OF A DISCOUNT MEMBERSHIP CARD; ADMINISTRATION OF A DISCOUNT PROGRAM FOR ENABLING PARTICIPANTS TO OBTAIN DISCOUNTS ON THE COST OF SERVICES OR RECEIVE IMPROVED SERVICES THROUGH USE OF A MEMBERSHIP CARD; PROMOTING THE GOODS AND SERVICES OF OTHERS THROUGH THE DISTRIBUTION OF DISCOUNT CARDS; PROMOTING THE SALE OF GOODS AND SERVICES OF OTHERS BY USE OF A DISCOUNT CARD FOR HEALTHCARE SERVICES, IN CLASS 35 (U.S. CLS. 100, 101 AND 102).

SERVICE MARK

SUPPLEMENTAL REGISTER

FIRST USE 7-22-2011; IN COMMERCE 7-22-2011.

THE MARK CONSISTS OF STANDARD CHARACTERS WITHOUT CLAIM TO ANY PARTICULAR FONT, STYLE, SIZE, OR COLOR.

SER. NO. 85-425,248, FILED P.R. 9-16-2011; AM. S.R. 7-10-2012.

JENNIFER MARTIN, EXAMINING ATTORNEY



David J. Kypos

Director of the United States Patent and Trademark Office

United States of America

United States Patent and Trademark Office

CHRISTIANPEOPLEMEET

Reg. No. 4,207,956

Registered Sep. 11, 2012

Int. Cl.: 45

SERVICE MARK

SUPPLEMENTAL REGISTER

PEOPLE MEDIA, INC. (DELAWARE CORPORATION)
3RD FLOOR
8800 SUNSET BOULEVARD
WEST HOLLYWOOD, CA 90069

FOR: DATING SERVICES; INTERNET BASED SOCIAL NETWORKING, INTRODUCTION,
AND DATING SERVICES, IN CLASS 45 (U.S. CLS. 100 AND 101).

FIRST USE 9-10-2010; IN COMMERCE 9-10-2010.

THE MARK CONSISTS OF STANDARD CHARACTERS WITHOUT CLAIM TO ANY PAR-
TICULAR FONT, STYLE, SIZE, OR COLOR.

SER. NO. 85-426,961, FILED P.R. 9-20-2011; AM. S.R. 7-17-2012.

ASMAT KHAN, EXAMINING ATTORNEY



David J. Kybas

Director of the United States Patent and Trademark Office

United States of America

United States Patent and Trademark Office

MENG

Reg. No. 4,207,957

Registered Sep. 11, 2012

Int. Cl.: 28

TRADEMARK

SUPPLEMENTAL REGISTER

MENG YI (CHINA INDIVIDUAL)
NO. 1602, BUILDING 4
GUANGXIJIAYUAN, CHAOYANG DISTRICT
BEIJING, CHINA

FOR: DOLL CLOTHING; DOLLS; ELECTRIC ACTION TOYS; JIGSAW PUZZLES; NOVELTY ITEMS, NAMELY, FAKE TEETH; PLUSH TOYS; SCALE MODEL AIRCRAFT; TOY BUILDING BLOCKS; TOY CARS; TOY MOBILES; TOY PISTOLS; TOY SCOOTERS; TOY VEHICLES; WATER PISTOLS, IN CLASS 28 (U.S. CLS. 22, 23, 38 AND 50).

FIRST USE 5-11-2010; IN COMMERCE 5-11-2010.

THE MARK CONSISTS OF STYLIZED WORD "MENG".

SER. NO. 85-427,757, FILED P.R. 9-21-2011; AM. S.R. 7-9-2012.

PAUL MORENO, EXAMINING ATTORNEY



David J. Kyfos

Director of the United States Patent and Trademark Office

United States of America

United States Patent and Trademark Office

njgenerators

Reg. No. 4,207,958

PLV ELECTRIC LLC (NEW JERSEY LIMITED LIABILITY COMPANY)
1 JOEL RD
OCEAN, NJ 07712

Registered Sep. 11, 2012

Int. Cl.: 37

FOR: INSTALLATION OF GENERATORS; INSTALLATION, MAINTENANCE AND REPAIR OF GENERATORS, IN CLASS 37 (U.S. CLS. 100, 103 AND 106).

SERVICE MARK

FIRST USE 2-24-2011; IN COMMERCE 2-24-2011.

SUPPLEMENTAL REGISTER

THE MARK CONSISTS OF STANDARD CHARACTERS WITHOUT CLAIM TO ANY PARTICULAR FONT, STYLE, SIZE, OR COLOR.

SER. NO. 85-428,202, FILED P.R. 9-21-2011; AM. S.R. 7-13-2012.

MARK T. MULLEN, EXAMINING ATTORNEY



David J. Kyffers

Director of the United States Patent and Trademark Office

United States of America

United States Patent and Trademark Office

VIRTUAL XCHANGE

Reg. No. 4,207,959

Registered Sep. 11, 2012

Int. Cl.: 38

SERVICE MARK

SUPPLEMENTAL REGISTER

AMERICAN MARKETING ASSOCIATION (ILLINOIS NON-PROFIT CORPORATION)
311 S. WACKER DRIVE
SUITE 5800
CHICAGO, IL 60606

FOR: PROVIDING AN ON-LINE FORUM FOR MARKETING PROFESSIONALS; PROVIDING ON-LINE CHAT ROOMS FOR TRANSMISSION OF MESSAGES AMONG COMPUTER USERS CONCERNING MARKETING, IN CLASS 38 (U.S. CLS. 100, 101 AND 104).

FIRST USE 1-28-2011; IN COMMERCE 1-28-2011.

THE MARK CONSISTS OF STANDARD CHARACTERS WITHOUT CLAIM TO ANY PARTICULAR FONT, STYLE, SIZE, OR COLOR.

SER. NO. 85-430,343, FILED P.R. 9-23-2011; AM. S.R. 7-19-2012.

ESTHER BELENKER, EXAMINING ATTORNEY



David J. Kybas

Director of the United States Patent and Trademark Office

United States of America

United States Patent and Trademark Office

VIRTUAL XCHANGE

Reg. No. 4,207,960

Registered Sep. 11, 2012

Int. Cl.: 42

SERVICE MARK

SUPPLEMENTAL REGISTER

AMERICAN MARKETING ASSOCIATION (ILLINOIS NON-PROFIT CORPORATION)
311 S. WACKER DRIVE
SUITE 5800
CHICAGO, IL 60606

FOR: COMPUTER SERVICES, NAMELY, CREATING AN ON-LINE COMMUNITY FOR REGISTERED USERS TO PARTICIPATE IN DISCUSSIONS, FORM VIRTUAL COMMUNITIES, AND ENGAGE IN MARKETING NETWORKING, IN CLASS 42 (U.S. CLS. 100 AND 101).

FIRST USE 1-28-2011; IN COMMERCE 1-28-2011.

THE MARK CONSISTS OF STANDARD CHARACTERS WITHOUT CLAIM TO ANY PARTICULAR FONT, STYLE, SIZE, OR COLOR.

SER. NO. 85-430,420, FILED P.R. 9-23-2011; AM. S.R. 7-19-2012.

ESTHER BELENKER, EXAMINING ATTORNEY



David J. Kyffers

Director of the United States Patent and Trademark Office

United States of America

United States Patent and Trademark Office

ASN.1 STUDIO

Reg. No. 4,207,961

Registered Sep. 11, 2012

Int. Cl.: 9

TRADEMARK

SUPPLEMENTAL REGISTER

OSS NOKALVA, INC. (NEW JERSEY CORPORATION)
SUITE 450
ONE EXECUTIVE DRIVE
SOMERSET, NJ 08873

FOR: COMPUTER SOFTWARE TOOLS FOR PROGRAMMERS TO CREATE APPLICATIONS
FOR EXCHANGING DATA, IN CLASS 9 (U.S. CLS. 21, 23, 26, 36 AND 38).

FIRST USE 9-19-2011; IN COMMERCE 9-19-2011.

THE MARK CONSISTS OF STANDARD CHARACTERS WITHOUT CLAIM TO ANY PAR-
TICULAR FONT, STYLE, SIZE, OR COLOR.

OWNER OF U.S. REG. NO. 4,006,136.

NO CLAIM IS MADE TO THE EXCLUSIVE RIGHT TO USE "ASN.1", APART FROM THE
MARK AS SHOWN.

SER. NO. 85-430,673, FILED P.R. 9-23-2011; AM. S.R. 7-30-2012.

ELISSA GARBER KON, EXAMINING ATTORNEY



David J. Kyjars

Director of the United States Patent and Trademark Office

United States of America

United States Patent and Trademark Office

PATENTFILER

Reg. No. 4,207,962

CISLO & THOMAS LLP (CALIFORNIA LIMITED LIABILITY PARTNERSHIP)
1333 2ND STREET, SUITE 500
SANTA MONICA, CA 90401

Registered Sep. 11, 2012

Int. Cl.: 45

FOR: PROVIDING A WEBSITE FEATURING INFORMATION ABOUT INTELLECTUAL PROPERTY RIGHTS AND PROVIDING INTELLECTUAL PROPERTY CONSULTATION WITH RESPECT TO UNDERSTANDING AND PURSUING INTELLECTUAL PROPERTY MATTERS, IN CLASS 45 (U.S. CLS. 100 AND 101).

SERVICE MARK

SUPPLEMENTAL REGISTER FIRST USE 2-1-2012; IN COMMERCE 2-1-2012.

THE MARK CONSISTS OF STANDARD CHARACTERS WITHOUT CLAIM TO ANY PARTICULAR FONT, STYLE, SIZE, OR COLOR.

SER. NO. 85-431,082, FILED P.R. 9-23-2011; AM. S.R. 7-18-2012.

RENEE MCCRAY, EXAMINING ATTORNEY



David J. Kyffers

Director of the United States Patent and Trademark Office

United States of America

United States Patent and Trademark Office

Bankruptcy Minnesota

Reg. No. 4,207,963

Registered Sep. 11, 2012

Int. Cl.: 45

SERVICE MARK

SUPPLEMENTAL REGISTER

HOGLUND, CHWIALKOWSKI & MROZIK, PLLC (MINNESOTA LIMITED LIABILITY COMPANY)
1781 W. COUNTY ROAD B
ROSEVILLE, MN 55113

FOR: LEGAL SERVICES, IN CLASS 45 (U.S. CLS. 100 AND 101).

FIRST USE 0-0-2010; IN COMMERCE 0-0-2010.

THE MARK CONSISTS OF STANDARD CHARACTERS WITHOUT CLAIM TO ANY PARTICULAR FONT, STYLE, SIZE, OR COLOR.

NO CLAIM IS MADE TO THE EXCLUSIVE RIGHT TO USE "BANKRUPTCY", APART FROM THE MARK AS SHOWN.

SER. NO. 85-432,349, FILED P.R. 9-26-2011; AM. S.R. 7-17-2012.

EMILY CARLSEN, EXAMINING ATTORNEY



David J. Kybas

Director of the United States Patent and Trademark Office

United States of America

United States Patent and Trademark Office

\$0 Down Bankruptcy

Reg. No. 4,207,964

Registered Sep. 11, 2012

Int. Cl.: 45

SERVICE MARK

SUPPLEMENTAL REGISTER

HOGLUND, CHWIALKOWSKI & MROZIK, PLLC (MINNESOTA LIMITED LIABILITY COMPANY)
1781 W. COUNTY ROAD B
ROSEVILLE, MN 55113

FOR: LEGAL SERVICES, IN CLASS 45 (U.S. CLS. 100 AND 101).

FIRST USE 0-0-2005; IN COMMERCE 0-0-2005.

THE MARK CONSISTS OF STANDARD CHARACTERS WITHOUT CLAIM TO ANY PARTICULAR FONT, STYLE, SIZE, OR COLOR.

NO CLAIM IS MADE TO THE EXCLUSIVE RIGHT TO USE "BANKRUPTCY", APART FROM THE MARK AS SHOWN.

SER. NO. 85-432,351, FILED P.R. 9-26-2011; AM. S.R. 7-17-2012.

EMILY CARLSEN, EXAMINING ATTORNEY



David J. Kyffers

Director of the United States Patent and Trademark Office

United States of America

United States Patent and Trademark Office

GEN Y THE MUSICAL

Reg. No. 4,207,965

BROUWER, XAVIER (AUSTRALIA INDIVIDUAL)

Registered Sep. 11, 2012

41 KEON ST
THORNBURY, AUSTRALIA 3071

Int. Cl.: 41

FOR: ENTERTAINMENT SERVICES BY A MUSICAL ARTIST AND PRODUCER, NAMELY, MUSICAL COMPOSITION FOR OTHERS AND PRODUCTION OF MUSICAL SOUND RECORDINGS; ENTERTAINMENT SERVICES IN THE NATURE OF COMEDY SHOWS; ENTERTAINMENT SERVICES IN THE NATURE OF LIVE MUSICAL PERFORMANCES; ENTERTAINMENT SERVICES IN THE NATURE OF PRESENTING LIVE MUSICAL PERFORMANCES; FILM AND VIDEO FILM PRODUCTION; MULTIMEDIA ENTERTAINMENT SERVICES IN THE NATURE OF RECORDING, PRODUCTION AND POST-PRODUCTION SERVICES IN THE FIELDS OF MUSIC, VIDEO, AND FILMS; PRODUCTION OF FILMS; PRODUCTION OF VIDEO DISCS AND TAPES; PROVIDING A WEBSITE FEATURING NON-DOWNLOADABLE VIDEOS, NAMELY, VIDEO PRESENTATIONS OF A COMEDIC NATURE, IN CLASS 41 (U.S. CLS. 100, 101 AND 107).

SERVICE MARK

SUPPLEMENTAL REGISTER

THE MARK CONSISTS OF STANDARD CHARACTERS WITHOUT CLAIM TO ANY PARTICULAR FONT, STYLE, SIZE, OR COLOR.

PRIORITY CLAIMED UNDER SEC. 44(D) ON AUSTRALIA APPLICATION NO. 15354700, FILED 9-26-2011, REG. NO. 1450761, DATED 11-27-2011, EXPIRES 11-27-2021.

NO CLAIM IS MADE TO THE EXCLUSIVE RIGHT TO USE "THE MUSICAL", APART FROM THE MARK AS SHOWN.

SER. NO. 85-432,434, FILED P.R. 9-26-2011; AM. S.R. 7-11-2012.

TINA MAI, EXAMINING ATTORNEY



David J. Kybas

Director of the United States Patent and Trademark Office

United States of America

United States Patent and Trademark Office

Park West Porter

Reg. No. 4,207,966

GREEN FLASH BREWING CO. (CALIFORNIA CORPORATION)
6550 MIRA MESA BLVD.
SAN DIEGO, CA 92121

Registered Sep. 11, 2012

Int. Cl.: 32

FOR: BEER, IN CLASS 32 (U.S. CLS. 45, 46 AND 48).

FIRST USE 6-27-2012; IN COMMERCE 7-13-2012.

TRADEMARK

THE MARK CONSISTS OF STANDARD CHARACTERS WITHOUT CLAIM TO ANY PARTICULAR FONT, STYLE, SIZE, OR COLOR.

SUPPLEMENTAL REGISTER

NO CLAIM IS MADE TO THE EXCLUSIVE RIGHT TO USE "PORTER", APART FROM THE MARK AS SHOWN.

SER. NO. 85-432,840, FILED P.R. 9-27-2011; AM. S.R. 7-16-2012.

BARBARA BROWN, EXAMINING ATTORNEY



David J. Kyffers

Director of the United States Patent and Trademark Office

United States of America

United States Patent and Trademark Office

CUELIGHT

Reg. No. 4,207,967

OBSCURA DIGITAL (CALIFORNIA CORPORATION)
729 TENNESSEE AVE

Registered Sep. 11, 2012

SAN FRANCISCO, CA 94107

Int. Cl.: 11

FOR: LIGHTING SYSTEM COMPRISED OF SPOT LIGHTS FOR USE IN PROVIDING CUES ON POOL TABLES, IN CLASS 11 (U.S. CLS. 13, 21, 23, 31 AND 34).

TRADEMARK

FIRST USE 6-1-2009; IN COMMERCE 8-18-2009.

SUPPLEMENTAL REGISTER

THE MARK CONSISTS OF STANDARD CHARACTERS WITHOUT CLAIM TO ANY PARTICULAR FONT, STYLE, SIZE, OR COLOR.

SER. NO. 85-433,657, FILED P.R. 9-28-2011; AM. S.R. 7-17-2012.

INGRID C. EULIN, EXAMINING ATTORNEY



David J. Kybas

Director of the United States Patent and Trademark Office

United States of America

United States Patent and Trademark Office

SNAPSHOT PHOTOBOOTHS

Reg. No. 4,207,968

JANI, JASON (UNITED STATES INDIVIDUAL)
58 JOHN MCGUCKIN DRIVE
BRICK, NJ 08724

Registered Sep. 11, 2012

Int. Cl.: 41

FOR: RENTAL OF PORTABLE PHOTOGRAPHY AND/OR VIDEOGRAPHY BOOTHS FOR TAKING OF PICTURES AND VIDEOS, IN CLASS 41 (U.S. CLS. 100, 101 AND 107).

SERVICE MARK

FIRST USE 10-10-2008; IN COMMERCE 1-9-2009.

SUPPLEMENTAL REGISTER

THE MARK CONSISTS OF STANDARD CHARACTERS WITHOUT CLAIM TO ANY PARTICULAR FONT, STYLE, SIZE, OR COLOR.

NO CLAIM IS MADE TO THE EXCLUSIVE RIGHT TO USE "PHOTO BOOTHS", APART FROM THE MARK AS SHOWN.

SER. NO. 85-434,693, FILED P.R. 9-28-2011; AM. S.R. 6-27-2012.

MARK RADEMACHER, EXAMINING ATTORNEY



David J. Kybas

Director of the United States Patent and Trademark Office

United States of America

United States Patent and Trademark Office

ASH CACHE

Reg. No. 4,207,969

RONALD C. LOVE (UNITED STATES INDIVIDUAL), DBA HERBAL INNOVATIONS,
1069 GROVE STREET
HEALDSBURG, CA 95448

Registered Sep. 11, 2012

Int. Cl.: 34

FOR: CIGARETTE ASH RECEPTACLES, IN CLASS 34 (U.S. CLS. 2, 8, 9 AND 17).

TRADEMARK

FIRST USE 10-2-2011; IN COMMERCE 3-1-2012.

SUPPLEMENTAL REGISTER

THE MARK CONSISTS OF STANDARD CHARACTERS WITHOUT CLAIM TO ANY PARTICULAR FONT, STYLE, SIZE, OR COLOR.

SER. NO. 85-435,397, FILED P.R. 9-29-2011; AM. S.R. 7-20-2012.

BRENDAN MCCAULEY, EXAMINING ATTORNEY



David J. Kyffers

Director of the United States Patent and Trademark Office

United States of America

United States Patent and Trademark Office

EV500

Reg. No. 4,207,970

CONTOUR HARDENING, INC. (INDIANA CORPORATION)
8401 NORTHWEST BLVD.
INDIANAPOLIS, IN 46278

Registered Sep. 11, 2012

Int. Cl.: 35

FOR: ORGANIZING, PROMOTING, AND CONDUCTING EXHIBITIONS FOR BUSINESS PURPOSES RELATING TO ELECTRIC VEHICLES, IN CLASS 35 (U.S. CLS. 100, 101 AND 102).

SERVICE MARK

FIRST USE 10-13-2011; IN COMMERCE 10-13-2011.

SUPPLEMENTAL REGISTER

THE MARK CONSISTS OF STANDARD CHARACTERS WITHOUT CLAIM TO ANY PARTICULAR FONT, STYLE, SIZE, OR COLOR.

SER. NO. 85-435,441, FILED P.R. 9-29-2011; AM. S.R. 7-16-2012.

SETH A. RAPPAPORT, EXAMINING ATTORNEY



David J. Kyffers

Director of the United States Patent and Trademark Office

United States of America
United States Patent and Trademark Office

ROEDA

Reg. No. 4,207,971

CAROL ROEDA STUDIO, INC. (MICHIGAN CORPORATION)
1615 MONROE N.W.

Registered Sep. 11, 2012

GRAND RAPIDS, MI 49505

Int. Cls.: 9 and 20

FOR: DECORATIVE MAGNETS; REFRIGERATOR MAGNETS, IN CLASS 9 (U.S. CLS. 21, 23, 26, 36 AND 38).

TRADEMARK

FIRST USE 3-31-2010; IN COMMERCE 3-31-2010.

SUPPLEMENTAL REGISTER

FOR: MAGNETIZED PHOTO FRAMES; MAGNETIZED MEMO BOARDS, IN CLASS 20 (U.S. CLS. 2, 13, 22, 25, 32 AND 50).

FIRST USE 3-31-2010; IN COMMERCE 3-31-2010.

THE MARK CONSISTS OF STANDARD CHARACTERS WITHOUT CLAIM TO ANY PARTICULAR FONT, STYLE, SIZE, OR COLOR.

SER. NO. 85-435,442, FILED P.R. 9-29-2011; AM. S.R. 7-18-2012.

LINDSEY RUBIN, EXAMINING ATTORNEY



David J. Kyffers

Director of the United States Patent and Trademark Office

United States of America

United States Patent and Trademark Office

HCP Maturity Model

Reg. No. 4,207,972

EFF CONSULTING, INC. (PENNSYLVANIA CORPORATION)
P.O. BOX 1100
LIONVILLE, PA 19353

Registered Sep. 11, 2012

Int. Cl.: 35

FOR: BUSINESS CONSULTING SERVICES FOR THE PHARMACEUTICAL INDUSTRY, MEDICAL DEVICE INDUSTRY, AND OTHER LIFE SCIENCE COMPANIES, IN CLASS 35 (U.S. CLS. 100, 101 AND 102).

SERVICE MARK

FIRST USE 7-19-2012; IN COMMERCE 7-19-2012.

SUPPLEMENTAL REGISTER

THE MARK CONSISTS OF STANDARD CHARACTERS WITHOUT CLAIM TO ANY PARTICULAR FONT, STYLE, SIZE, OR COLOR.

SER. NO. 85-437,264, FILED P.R. 10-2-2011; AM. S.R. 7-20-2012.

JIM RINGLE, EXAMINING ATTORNEY



David J. Kyffers

Director of the United States Patent and Trademark Office

United States of America

United States Patent and Trademark Office

AMERICAN WOMAN MAGAZINE

Reg. No. 4,207,973

SANDRA L ALLISON (UNITED STATES INDIVIDUAL)
419 NEW STREET

Registered Sep. 11, 2012

FAIRPORT HARBOR, OH 44077

Int. Cl.: 41

FOR: PROVIDING ON-LINE MAGAZINES IN THE FIELD OF WOMEN'S ISSUES, IN CLASS 41 (U.S. CLS. 100, 101 AND 107).

SERVICE MARK

FIRST USE 2-10-2012; IN COMMERCE 6-6-2012.

SUPPLEMENTAL REGISTER

THE MARK CONSISTS OF STANDARD CHARACTERS WITHOUT CLAIM TO ANY PARTICULAR FONT, STYLE, SIZE, OR COLOR.

NO CLAIM IS MADE TO THE EXCLUSIVE RIGHT TO USE "MAGAZINE", APART FROM THE MARK AS SHOWN.

SER. NO. 85-437,270, FILED P.R. 10-2-2011; AM. S.R. 6-13-2012.

JAMES STEIN, EXAMINING ATTORNEY



David J. Kybas

Director of the United States Patent and Trademark Office

United States of America

United States Patent and Trademark Office

Silver Coin of the Month Club

Reg. No. 4,207,974

NUMIS NETWORK, LLC (FLORIDA LIMITED LIABILITY COMPANY)
615 CHANELSIDE DRIVE, SUITE 201
TAMPA, FL 33602

Registered Sep. 11, 2012

Int. Cl.: 14

FOR: MONETARY COIN SETS FOR COLLECTING PURPOSES, IN CLASS 14 (U.S. CLS. 2, 27, 28 AND 50).

TRADEMARK

FIRST USE 5-15-2009; IN COMMERCE 1-5-2011.

SUPPLEMENTAL REGISTER

THE MARK CONSISTS OF STANDARD CHARACTERS WITHOUT CLAIM TO ANY PARTICULAR FONT, STYLE, SIZE, OR COLOR.

NO CLAIM IS MADE TO THE EXCLUSIVE RIGHT TO USE "SILVER COIN", APART FROM THE MARK AS SHOWN.

SER. NO. 85-437,786, FILED P.R. 10-3-2011; AM. S.R. 7-23-2012.

NAAKWAMA ANKRAH, EXAMINING ATTORNEY



David J. Kyffers

Director of the United States Patent and Trademark Office

United States of America

United States Patent and Trademark Office

FULL CONTACT FIT

Reg. No. 4,207,975

Registered Sep. 11, 2012

Int. Cl.: 25

TRADEMARK

SUPPLEMENTAL REGISTER

YOE ENTERPRISES OF NEVADA, INC. (NEVADA CORPORATION)
7823 STONEHENGE DRIVE
CHATTANOOGA, TN 37421

FOR: SOCKS, IN CLASS 25 (U.S. CLS. 22 AND 39).

FIRST USE 5-21-2012; IN COMMERCE 5-21-2012.

THE MARK CONSISTS OF STANDARD CHARACTERS WITHOUT CLAIM TO ANY PARTICULAR FONT, STYLE, SIZE, OR COLOR.

OWNER OF U.S. REG. NOS. 3,819,670 AND 3,871,286.

SER. NO. 85-438,399, FILED P.R. 10-4-2011; AM. S.R. 6-25-2012.

ELIZABETH HUGHITT, EXAMINING ATTORNEY



David J. Kyffers

Director of the United States Patent and Trademark Office

United States of America

United States Patent and Trademark Office

Coupon Caddy

Reg. No. 4,207,976

ROBERT J. LARSON (UNITED STATES INDIVIDUAL)
12085 SILVEROD ST. NW
COON RAPIDS, MN 55433

Registered Sep. 11, 2012

Int. Cl.: 16

FOR: CLIP BOARDS, IN CLASS 16 (U.S. CLS. 2, 5, 22, 23, 29, 37, 38 AND 50).

TRADEMARK

FIRST USE 4-11-2012; IN COMMERCE 4-11-2012.

SUPPLEMENTAL REGISTER

THE MARK CONSISTS OF STANDARD CHARACTERS WITHOUT CLAIM TO ANY PARTICULAR FONT, STYLE, SIZE, OR COLOR.

SER. NO. 85-438,518, FILED P.R. 10-4-2011; AM. S.R. 7-12-2012.

EDWARD FENNESSY, EXAMINING ATTORNEY



David J. Kyffers

Director of the United States Patent and Trademark Office

United States of America

United States Patent and Trademark Office

National Slot League

Reg. No. 4,207,977

CAESARS LICENSE COMPANY, LLC (NEVADA LIMITED LIABILITY COMPANY)
ONE CAESARS PALACE DRIVE
LAS VEGAS, NV 89109

Registered Sep. 11, 2012

Int. Cl.: 41

FOR: ENTERTAINMENT SERVICES, NAMELY, CONDUCTING SPECIAL EVENTS FEATURING CASINO AND GAMING CONTESTS AND TOURNAMENTS, IN CLASS 41 (U.S. CLS. 100, 101 AND 107).

SERVICE MARK

FIRST USE 12-20-2011; IN COMMERCE 1-5-2012.

SUPPLEMENTAL REGISTER

THE MARK CONSISTS OF STANDARD CHARACTERS WITHOUT CLAIM TO ANY PARTICULAR FONT, STYLE, SIZE, OR COLOR.

NO CLAIM IS MADE TO THE EXCLUSIVE RIGHT TO USE "LEAGUE", APART FROM THE MARK AS SHOWN.

SER. NO. 85-438,610, FILED P.R. 10-4-2011; AM. S.R. 7-12-2012.

DAVID I, EXAMINING ATTORNEY



David J. Kyfos

Director of the United States Patent and Trademark Office

United States of America

United States Patent and Trademark Office

UNION OF LIBERIAN ASSOCIATIONS IN THE AMERICAS (ULAA)

Reg. No. 4,207,978

FRANICS, NELLIE S. (UNITED STATES INDIVIDUAL)
16 MILLER AVENUE
PROVIDENCE, RI 02905

Registered Sep. 11, 2012

Int. Cl.: 41

FOR: EDUCATION SERVICES, NAMELY, PROVIDING CLASSES, SEMINARS, AND WORKSHOPS IN THE FIELD OF READJUSTMENT, POLITICAL, AND CULTURAL ISSUES AFFECTING LIBERIANS AT HOME AND ABROAD, IN CLASS 41 (U.S. CLS. 100, 101 AND 107).

SERVICE MARK

SUPPLEMENTAL REGISTER FIRST USE 10-2-2011; IN COMMERCE 10-2-2011.

THE MARK CONSISTS OF STANDARD CHARACTERS WITHOUT CLAIM TO ANY PARTICULAR FONT, STYLE, SIZE, OR COLOR.

SER. NO. 85-438,880, FILED P.R. 10-4-2011; AM. S.R. 6-10-2012.

SIMON TENG, EXAMINING ATTORNEY



David J. Kyffers

Director of the United States Patent and Trademark Office

United States of America

United States Patent and Trademark Office

MCCLESKEY CELLARS

Reg. No. 4,207,979

Registered Sep. 11, 2012

Int. Cl.: 33

TRADEMARK

SUPPLEMENTAL REGISTER

MCCLESKEY CELLARS LLC (OREGON LIMITED LIABILITY COMPANY)
15590 SW APRIL LANE
TIGARD, OR 97224

FOR: WINE, IN CLASS 33 (U.S. CLS. 47 AND 49).

FIRST USE 7-15-2012; IN COMMERCE 7-15-2012.

THE MARK CONSISTS OF STANDARD CHARACTERS WITHOUT CLAIM TO ANY PARTICULAR FONT, STYLE, SIZE, OR COLOR.

NO CLAIM IS MADE TO THE EXCLUSIVE RIGHT TO USE "CELLARS", APART FROM THE MARK AS SHOWN.

SER. NO. 85-439,759, FILED P.R. 10-5-2011; AM. S.R. 7-20-2012.

DAVID H. STINE, EXAMINING ATTORNEY



David J. Kyffers

Director of the United States Patent and Trademark Office

United States of America

United States Patent and Trademark Office

BEGIN PILATES

Reg. No. 4,207,980

BEGIN PILATES LLC (CALIFORNIA LIMITED LIABILITY COMPANY)
65 3RD STREET

Registered Sep. 11, 2012

POINT REYES STATION, CA 94956

Int. Cl.: 41

FOR: PROVIDING FITNESS AND EXERCISE STUDIO SERVICES, NAMELY, PILATES INSTRUCTION AND TRAINING, IN CLASS 41 (U.S. CLS. 100, 101 AND 107).

SERVICE MARK

FIRST USE 9-1-2011; IN COMMERCE 10-1-2011.

SUPPLEMENTAL REGISTER

THE MARK CONSISTS OF STANDARD CHARACTERS WITHOUT CLAIM TO ANY PARTICULAR FONT, STYLE, SIZE, OR COLOR.

NO CLAIM IS MADE TO THE EXCLUSIVE RIGHT TO USE "PILATES", APART FROM THE MARK AS SHOWN.

SER. NO. 85-440,425, FILED P.R. 10-6-2011; AM. S.R. 6-25-2012.

ELIZABETH HUGHITT, EXAMINING ATTORNEY



David J. Kybas

Director of the United States Patent and Trademark Office

United States of America

United States Patent and Trademark Office

INTERNATIONAL PROFESSIONAL PRACTICES FRAMEWORK

Reg. No. 4,207,981

THE INSTITUTE OF INTERNAL AUDITORS, INC. (NEW YORK CORPORATION)
247 MAITLAND AVENUE

Registered Sep. 11, 2012

ALTAMONTE SPRINGS, FL 327014201

Int. Cl.: 16

FOR: PRINTED PUBLICATIONS, NAMELY, STANDARDS AND CODES OF ETHICS DOCUMENTS, POSITION PAPERS, PRACTICE ADVISORIES AND PRACTICE GUIDES IN THE FIELD OF INTERNAL AUDITING, IN CLASS 16 (U.S. CLS. 2, 5, 22, 23, 29, 37, 38 AND 50).

TRADEMARK

FIRST USE 1-1-2009; IN COMMERCE 1-1-2009.

SUPPLEMENTAL REGISTER

THE MARK CONSISTS OF STANDARD CHARACTERS WITHOUT CLAIM TO ANY PARTICULAR FONT, STYLE, SIZE, OR COLOR.

SER. NO. 85-441,300, FILED P.R. 10-6-2011; AM. S.R. 7-17-2012.

ALLISON SCHRODY, EXAMINING ATTORNEY



David J. Kyjars

Director of the United States Patent and Trademark Office

United States of America

United States Patent and Trademark Office

INTERNATIONAL INTERNAL AUDIT STANDARDS BOARD

Reg. No. 4,207,982

THE INSTITUTE OF INTERNAL AUDITORS, INC. (NEW YORK CORPORATION)
247 MAITLAND AVENUE

Registered Sep. 11, 2012

ALTAMONTE SPRINGS, FL 327014201

Int. Cl.: 42

FOR: DEVELOPMENT OF VOLUNTARY STANDARDS FOR INTERNAL AUDITING, IN CLASS 42 (U.S. CLS. 100 AND 101).

SERVICE MARK

FIRST USE 7-18-2011; IN COMMERCE 7-18-2011.

SUPPLEMENTAL REGISTER

THE MARK CONSISTS OF STANDARD CHARACTERS WITHOUT CLAIM TO ANY PARTICULAR FONT, STYLE, SIZE, OR COLOR.

NO CLAIM IS MADE TO THE EXCLUSIVE RIGHT TO USE "INTERNAL AUDIT STANDARDS", APART FROM THE MARK AS SHOWN.

SER. NO. 85-441,345, FILED P.R. 10-6-2011; AM. S.R. 7-17-2012.

ALLISON SCHRODY, EXAMINING ATTORNEY



David J. Kyros

Director of the United States Patent and Trademark Office

United States of America

United States Patent and Trademark Office



Reg. No. 4,207,983

Registered Sep. 11, 2012

Int. Cl.: 42

SERVICE MARK

SUPPLEMENTAL REGISTER

HOLSER, BARBARA (UNITED STATES INDIVIDUAL)
57 PINEY BRANCH WAY, #C
MELBOURNE, FL 32904

FOR: PROVIDING A WEBSITE FEATURING TECHNOLOGY THAT ALLOWS USERS TO CREATE A SCANNABLE PROFILE TO BE USED IN CONNECTION WITH SOCIAL NETWORKING SOFTWARE, IN CLASS 42 (U.S. CLS. 100 AND 101).

FIRST USE 8-16-2011; IN COMMERCE 8-16-2011.

NO CLAIM IS MADE TO THE EXCLUSIVE RIGHT TO USE THE DESIGN OF THE QUICK RESPONSE CODE, APART FROM THE MARK AS SHOWN.

THE MARK CONSISTS OF A SQUARE-SHAPED BOX WITH A QUICK RESPONSE DESIGN CODE IN THE BACKGROUND AND THE WORDING "SUPER QR" SUPERIMPOSED THEREON .

SER. NO. 85-441,650, FILED P.R. 10-7-2011; AM. S.R. 7-9-2012.

COLLEEN KEARNEY, EXAMINING ATTORNEY



David J. Kybas

Director of the United States Patent and Trademark Office

United States of America

United States Patent and Trademark Office

STAYS BRIGHTER LONGER

Reg. No. 4,207,984

Registered Sep. 11, 2012

Int. Cl.: 11

TRADEMARK

SUPPLEMENTAL REGISTER

SHENZHEN JIAWEI PHOTOVOLTAIC LIGHTING CO. LTD. (CHINA LIMITED COMPANY
(LTD.))
XINFA INDUSTRIAL AREA FUPING ROAD
LONGGANG SHENZHEN, CHINA

FOR: LED LIGHT BULBS; LED LIGHTING FIXTURES FOR INDOOR AND OUTDOOR
LIGHTING APPLICATIONS; LED SECURITY LIGHTING; LED TRACK LIGHTING; LED
LANDSCAPE LIGHTS; LED LIGHTING SYSTEMS, NAMELY, LED MODULES, POWER
SUPPLIES, AND WIRING, IN CLASS 11 (U.S. CLS. 13, 21, 23, 31 AND 34).

FIRST USE 11-0-2011; IN COMMERCE 11-0-2011.

THE MARK CONSISTS OF STANDARD CHARACTERS WITHOUT CLAIM TO ANY PAR-
TICULAR FONT, STYLE, SIZE, OR COLOR.

OWNER OF U.S. REG. NO. 3,607,846.

SER. NO. 85-442,172, FILED P.R. 10-7-2011; AM. S.R. 7-19-2012.

SALLY SHIH, EXAMINING ATTORNEY



David J. Kybas

Director of the United States Patent and Trademark Office

United States of America

United States Patent and Trademark Office

BESTSELLING EXPERTS

Reg. No. 4,207,985

Registered Sep. 11, 2012

Int. Cl.: 41

SERVICE MARK

SUPPLEMENTAL REGISTER

SEGR ENTERPRISES, LLC (TEXAS LIMITED LIABILITY COMPANY)
SUITE 610
1431 GREENWAY DRIVE
IRVING, TX 75038

FOR: BOOK PUBLISHING; DESKTOP PUBLISHING FOR OTHERS; DIGITAL VIDEO, AUDIO, AND MULTIMEDIA PUBLISHING SERVICES; PUBLISHING OF BOOKS, E-BOOKS, AUDIO BOOKS, MUSIC AND ILLUSTRATIONS; PUBLISHING OF ELECTRONIC PUBLICATIONS, IN CLASS 41 (U.S. CLS. 100, 101 AND 107).

FIRST USE 10-15-2011; IN COMMERCE 10-15-2011.

THE MARK CONSISTS OF STANDARD CHARACTERS WITHOUT CLAIM TO ANY PARTICULAR FONT, STYLE, SIZE, OR COLOR.

SER. NO. 85-442,236, FILED P.R. 10-7-2011; AM. S.R. 7-16-2012.

ESTHER A. BORSUK, EXAMINING ATTORNEY



David J. Kybas

Director of the United States Patent and Trademark Office

United States of America

United States Patent and Trademark Office

WASHINGTON SCHOOL OF PROFESSIONAL PSYCHOLOGY

Reg. No. 4,207,986

EDUCATION MANAGEMENT LLC (DELAWARE LIMITED LIABILITY COMPANY)
210 SIXTH AVENUE
PITTSBURGH, PA 15222

Registered Sep. 11, 2012

Int. Cl.: 41

FOR: EDUCATION SERVICES, NAMELY, OFFERING COURSES OF INSTRUCTION AT THE POST-SECONDARY LEVEL, IN CLASS 41 (U.S. CLS. 100, 101 AND 107).

SERVICE MARK

FIRST USE 4-15-2012; IN COMMERCE 4-15-2012.

SUPPLEMENTAL REGISTER

THE MARK CONSISTS OF STANDARD CHARACTERS WITHOUT CLAIM TO ANY PARTICULAR FONT, STYLE, SIZE, OR COLOR.

NO CLAIM IS MADE TO THE EXCLUSIVE RIGHT TO USE "SCHOOL OF PROFESSIONAL PSYCHOLOGY", APART FROM THE MARK AS SHOWN.

SER. NO. 85-442,277, FILED P.R. 10-7-2011; AM. S.R. 6-19-2012.

ANDREW LEASER, EXAMINING ATTORNEY



David J. Kyffers

Director of the United States Patent and Trademark Office

United States of America

United States Patent and Trademark Office

HAWAII SCHOOL OF PROFESSIONAL PSYCHOLOGY

Reg. No. 4,207,987

EDUCATION MANAGEMENT LLC (DELAWARE LIMITED LIABILITY COMPANY)
210 SIXTH AVENUE
PITTSBURGH, PA 15222

Registered Sep. 11, 2012

Int. Cl.: 41

FOR: EDUCATION SERVICES, NAMELY, OFFERING COURSES OF INSTRUCTION AT THE POST-SECONDARY LEVEL, IN CLASS 41 (U.S. CLS. 100, 101 AND 107).

SERVICE MARK

FIRST USE 4-15-2012; IN COMMERCE 4-15-2012.

SUPPLEMENTAL REGISTER

THE MARK CONSISTS OF STANDARD CHARACTERS WITHOUT CLAIM TO ANY PARTICULAR FONT, STYLE, SIZE, OR COLOR.

NO CLAIM IS MADE TO THE EXCLUSIVE RIGHT TO USE "SCHOOL OF PROFESSIONAL PSYCHOLOGY", APART FROM THE MARK AS SHOWN.

SER. NO. 85-442,299, FILED P.R. 10-7-2011; AM. S.R. 6-19-2012.

ANDREW LEASER, EXAMINING ATTORNEY



David J. Kyffers

Director of the United States Patent and Trademark Office

United States of America

United States Patent and Trademark Office

DIAMONDS FOR COST

Reg. No. 4,207,988

DIAMONDS FOR COST, LLC (ALABAMA LIMITED LIABILITY COMPANY)
708 CHEROKEE PLAZA
CENTRE, AL 35960

Registered Sep. 11, 2012

Int. Cl.: 14

FOR: DIAMONDS, IN CLASS 14 (U.S. CLS. 2, 27, 28 AND 50).

TRADEMARK

FIRST USE 5-1-2012; IN COMMERCE 5-1-2012.

SUPPLEMENTAL REGISTER

THE MARK CONSISTS OF STANDARD CHARACTERS WITHOUT CLAIM TO ANY PARTICULAR FONT, STYLE, SIZE, OR COLOR.

NO CLAIM IS MADE TO THE EXCLUSIVE RIGHT TO USE "DIAMONDS", APART FROM THE MARK AS SHOWN.

SER. NO. 85-442,490, FILED P.R. 10-7-2011; AM. S.R. 6-25-2012.

DOMINIC J. FERRAIUOLO, EXAMINING ATTORNEY



David J. Kyffers

Director of the United States Patent and Trademark Office

United States of America

United States Patent and Trademark Office

tupanela

Reg. No. 4,207,989

Registered Sep. 11, 2012

Int. Cl.: 30

TRADEMARK

SUPPLEMENTAL REGISTER

RODAS, RAFAEL E (NEW JERSEY LIMITED LIABILITY COMPANY), DBA THE ROCI GROUP, LLC,
UNIT 2
200 S NEWMAN ST
HACKENSACK, NJ 07601 AND

LUISA F MONTAÑO (COLOMBIA INDIVIDUAL)
APT 802
CALLE 6A OESTE NO. 6-89
CALI, COLOMBIA

FOR: UNREFINED SUGAR, NAMELY, EVAPORATED SUGAR CANE JUICE, IN CLASS 30 (U.S. CL. 46).

FIRST USE 10-10-2011; IN COMMERCE 10-10-2011.

THE MARK CONSISTS OF STYLIZED WORD "TUPANELA" IN LOWERCASE LETTERS.

THE FOREIGN WORDING IN THE MARK TRANSLATES INTO ENGLISH AS "YOUR CANE JUICE".

SER. NO. 85-443,861, FILED P.R. 10-10-2011; AM. S.R. 7-23-2012.

ANTHONY RINKER, EXAMINING ATTORNEY



David J. Kybas

Director of the United States Patent and Trademark Office

United States of America

United States Patent and Trademark Office

Tradic3n Latina!

Reg. No. 4,207,990

Registered Sep. 11, 2012

Int. Cls.: 21 and 30

RODAS, RAFAEL E (NEW JERSEY LIMITED LIABILITY COMPANY), DBA THE ROCI GROUP, LLC,
UNIT 2
200 S NEWMAN ST
HACKENSACK, NJ 07601

TRADEMARK

FOR: COOKWARE, NAMELY, POTS AND PANS, IN CLASS 21 (U.S. CLS. 2, 13, 23, 29, 30, 33, 40 AND 50).

SUPPLEMENTAL REGISTER

FIRST USE 4-1-2011; IN COMMERCE 4-1-2011.

FOR: UNREFINED SUGAR, NAMELY, EVAPORATED SUGAR CANE JUICE, IN CLASS 30 (U.S. CL. 46).

FIRST USE 10-10-2011; IN COMMERCE 10-10-2011.

THE MARK CONSISTS OF STYLIZED WORDS "TRADICION LATINA" IN LUCIDA HANDWRITING FONT.

THE FOREIGN WORDING IN THE MARK TRANSLATES INTO ENGLISH AS "LATIN TRADITION"

SER. NO. 85-443,892, FILED P.R. 10-11-2011; AM. S.R. 7-23-2012.

ANTHONY RINKER, EXAMINING ATTORNEY



David J. Kybas

Director of the United States Patent and Trademark Office

United States of America

United States Patent and Trademark Office

PSYCHICSISTERS

Reg. No. 4,207,991

BRAND TRADING COMPANY S.A. (LUXEMBOURG SOCIÉTÉ ANONYME (SA))
38, AVENUE DU X SEPTEMBRE

Registered Sep. 11, 2012

LUXEMBOURG, LUXEMBOURG L-2550

Int. Cl.: 45

FOR: PERSONAL AND SOCIAL SERVICES RENDERED BY OTHERS TO MEET THE NEEDS OF INDIVIDUALS, NAMELY, ONLINE SOCIAL NETWORKING SERVICES; HOROSCOPE CASTING; CLAIRVOYANT SERVICES, NAMELY, PSYCHIC READING SERVICES; CLAIRVOYANT SERVICES AT DISTANCE, NAMELY, PSYCHIC READING SERVICES, IN CLASS 45 (U.S. CLS. 100 AND 101).

SERVICE MARK

SUPPLEMENTAL REGISTER

THE MARK CONSISTS OF STANDARD CHARACTERS WITHOUT CLAIM TO ANY PARTICULAR FONT, STYLE, SIZE, OR COLOR.

PRIORITY CLAIMED UNDER SEC. 44(D) ON ERPN CMNTY TM OFC APPLICATION NO. 010316446, FILED 10-5-2011, REG. NO. 010316446, DATED 2-15-2012, EXPIRES 10-5-2021.

SER. NO. 85-444,173, FILED P.R. 10-11-2011; AM. S.R. 6-21-2012.

MELISSA VALLILLO, EXAMINING ATTORNEY



David J. Kybas

Director of the United States Patent and Trademark Office

United States of America

United States Patent and Trademark Office

BOURBON
Classic

Reg. No. 4,207,992

BOURBON CLASSIC, LLC (KENTUCKY LIMITED LIABILITY COMPANY)
455 S. 4TH STREET, SUITE 650
LOUISVILLE, KY 40202

Registered Sep. 11, 2012

Int. Cl.: 41

FOR: EDUCATIONAL AND ENTERTAINMENT SERVICES, NAMELY, FOOD AND BEVERAGE RELATED COMPETITIONS IN THE NATURE OF COOKING CONTESTS FOR EDUCATIONAL AND ENTERTAINMENT PURPOSES; ARRANGING AND CONDUCTING TOURS OF RESTAURANTS FOR EDUCATIONAL PURPOSES; EDUCATIONAL SERVICES, NAMELY, CONDUCTING EDUCATIONAL PRESENTATIONS AND CLASSES IN THE FIELD OF FOODS AND BEVERAGES AND PREPARATION OF THE SAME; ENTERTAINMENT SERVICES, NAMELY, FOOD AND BEVERAGE TASTINGS; EDUCATIONAL SERVICES, NAMELY, PROVIDING EXHIBITS IN THE FIELD OF FOODS AND BEVERAGES AND PREPARATION OF THE SAME, IN CLASS 41 (U.S. CLS. 100, 101 AND 107).

SERVICE MARK

SUPPLEMENTAL REGISTER

FIRST USE 7-2-2012; IN COMMERCE 7-2-2012.

NO CLAIM IS MADE TO THE EXCLUSIVE RIGHT TO USE "BOURBON", APART FROM THE MARK AS SHOWN.

THE MARK CONSISTS OF THE STYLIZED WORD "BOURBON", WITH A FLEUR-DE-LIS SET IN THE STYLIZED LETTER "U", AND THE STYLIZED WORD "CLASSIC".

SER. NO. 85-444,613, FILED P.R. 10-11-2011; AM. S.R. 7-13-2012.

ZHALEH DELANEY, EXAMINING ATTORNEY



David J. Kybas

Director of the United States Patent and Trademark Office

United States of America

United States Patent and Trademark Office

HEAT ALERT

Reg. No. 4,207,993

FOX 40 INTERNATIONAL INC. (CANADA CORPORATION)
560 ARVIN AVENUE

Registered Sep. 11, 2012

STONEY CREEK, ONTARIO, CANADA L8E5P1

Int. Cl.: 28

FOR: ATHLETIC EQUIPMENT, NAMELY, MOUTH GUARDS; MOUTH GUARDS FOR ATHLETIC USE, IN CLASS 28 (U.S. CLS. 22, 23, 38 AND 50).

TRADEMARK

FIRST USE 1-2-2012; IN COMMERCE 1-2-2012.

SUPPLEMENTAL REGISTER

THE MARK CONSISTS OF STANDARD CHARACTERS WITHOUT CLAIM TO ANY PARTICULAR FONT, STYLE, SIZE, OR COLOR.

SER. NO. 85-445,611, FILED P.R. 10-12-2011; AM. S.R. 7-18-2012.

KAREN SEVERSON, EXAMINING ATTORNEY



David J. Kyffers

Director of the United States Patent and Trademark Office

United States of America

United States Patent and Trademark Office

PROGRAM FOR MULTIPLES

Reg. No. 4,207,994

TEXAS CHILDREN'S HOSPITAL (TEXAS NON-PROFIT ORGANIZATION)

Registered Sep. 11, 2012

6621 FANNIN STREET
HOUSTON, TX 77030

Int. Cl.: 44

FOR: COUNSELING IN THE FIELD OF HEALTH CARE SERVICES, MEDICAL SERVICES, NUTRITIONAL COUNSELING, PHYSICAL THERAPY SERVICES, PHYSICIAN SERVICES, IN CLASS 44 (U.S. CLS. 100 AND 101).

SERVICE MARK

FIRST USE 2-28-2010; IN COMMERCE 2-28-2010.

SUPPLEMENTAL REGISTER

THE MARK CONSISTS OF STANDARD CHARACTERS WITHOUT CLAIM TO ANY PARTICULAR FONT, STYLE, SIZE, OR COLOR.

SER. NO. 85-445,770, FILED P.R. 10-12-2011; AM. S.R. 6-27-2012.

THOMAS MANOR, EXAMINING ATTORNEY



David J. Kyffers

Director of the United States Patent and Trademark Office

United States of America

United States Patent and Trademark Office

SOFA SNAP

Reg. No. 4,207,995

HOMEPLACE GROUP, INC. (NORTH CAROLINA CORPORATION)
380H KNOLLWOOD ST. SUITE 303
WINSTON-SALEM, NC 27103

Registered Sep. 11, 2012

Int. Cl.: 6

FOR: UPHOLSTERY GANGING DEVICE CONNECTOR, NAMELY, PREDOMINATELY METAL BRACKETS FOR USE IN CONNECTING MODULAR FURNITURE, IN CLASS 6 (U.S. CLS. 2, 12, 13, 14, 23, 25 AND 50).

TRADEMARK

FIRST USE 9-7-2006; IN COMMERCE 9-7-2006.

SUPPLEMENTAL REGISTER

THE MARK CONSISTS OF STANDARD CHARACTERS WITHOUT CLAIM TO ANY PARTICULAR FONT, STYLE, SIZE, OR COLOR.

NO CLAIM IS MADE TO THE EXCLUSIVE RIGHT TO USE "SNAP", APART FROM THE MARK AS SHOWN.

SER. NO. 85-446,043, FILED P.R. 10-12-2011; AM. S.R. 7-23-2012.

COLLEEN DOMBROW, EXAMINING ATTORNEY



David J. Kyffers

Director of the United States Patent and Trademark Office

United States of America

United States Patent and Trademark Office

Mr. Know It All

Reg. No. 4,207,996

MICHLIN, SCOTT (UNITED STATES INDIVIDUAL)
PO BOX 5366

Registered Sep. 11, 2012

FARMINGTON, NM 87499

Int. Cl.: 16

FOR: SYNDICATED NEWSPAPER COLUMNS DEALING WITH LOCAL INFORMATION,
IN CLASS 16 (U.S. CLS. 2, 5, 22, 23, 29, 37, 38 AND 50).

TRADEMARK

FIRST USE 10-1-2010; IN COMMERCE 10-1-2010.

SUPPLEMENTAL REGISTER

THE MARK CONSISTS OF STANDARD CHARACTERS WITHOUT CLAIM TO ANY PARTICULAR FONT, STYLE, SIZE, OR COLOR.

SER. NO. 85-446,244, FILED P.R. 10-13-2011; AM. S.R. 7-1-2012.

BERNICE MIDDLETON, EXAMINING ATTORNEY



David J. Kybas

Director of the United States Patent and Trademark Office

United States of America

United States Patent and Trademark Office

TRAVELOG

Reg. No. 4,207,997

CULTSTORY CO., LTD. (REPUBLIC OF KOREA CORPORATION)
134 SHINCHONDONG

Registered Sep. 11, 2012

130, SEOUL, REPUBLIC OF KOREA

Int. Cl.: 42

FOR: MAINTENANCE OF WEB SITES FOR OTHERS, HOSTING COMPUTER SITES FOR OTHERS, CREATING AND MAINTAINING WEB SITES FOR OTHERS, WEB SITE DESIGN, WEB PAGE DESIGN , IN CLASS 42 (U.S. CLS. 100 AND 101).

SERVICE MARK

FIRST USE 8-29-2011; IN COMMERCE 8-29-2011.

SUPPLEMENTAL REGISTER

THE MARK CONSISTS OF STANDARD CHARACTERS WITHOUT CLAIM TO ANY PARTICULAR FONT, STYLE, SIZE, OR COLOR.

PRIORITY CLAIMED UNDER SEC. 44(D) ON REPUBLIC OF KOREA APPLICATION NO. 41-2011-0025, FILED 8-23-2011.

SER. NO. 85-446,474, FILED P.R. 10-13-2011; AM. S.R. 7-11-2012.

COURTNEY ALVAREZ, EXAMINING ATTORNEY



David J. Kyros

Director of the United States Patent and Trademark Office

United States of America

United States Patent and Trademark Office

VETERAN STAFFING

Reg. No. 4,207,998

WALCHLE, JONATHAN (UNITED STATES INDIVIDUAL)
P.O. 3298 WEBB BRIDGE STATION
ALPHARETTA, GA 30005

Registered Sep. 11, 2012

Int. Cl.: 35

FOR: EMPLOYMENT AGENCY SERVICES, NAMELY, FILLING THE TEMPORARY AND PERMANENT STAFFING NEEDS OF BUSINESSES; EMPLOYMENT AGENCY SERVICES, NAMELY, TEMPORARY AND PERMANENT PLACEMENT OF HEALTH CARE PROFESSIONALS; EMPLOYMENT AGENCY SERVICES, NAMELY, TEMPORARY PLACEMENT OF CHILD CARE PROVIDERS; EMPLOYMENT HIRING, RECRUITING, PLACEMENT, STAFFING AND CAREER NETWORKING SERVICES; EMPLOYMENT RECRUITING AND STAFFING SERVICES PROVIDED VIA TEXT MESSAGING; EMPLOYMENT STAFFING CONSULTATION SERVICES; EMPLOYMENT STAFFING IN THE FIELD OF HOSPITALITY, WAREHOUSING, GENERAL LABOR, JANITORIAL CLEANING, HOSPITAL WORKERS AND ALL LIGHT INDUSTRIAL WORKERS; PROFESSIONAL STAFFING AND RECRUITING SERVICES; PROVIDING AN EMPLOYER WITH CANDIDATES OR POTENTIAL EMPLOYEES TO FILL TEMPORARY, CONTRACT AND PERMANENT POSITIONS; STRATEGIC SOURCING, NAMELY, STAFFING IN THE FIELD OF ENGINEERING; TEMPORARY EMPLOYMENT AGENCIES; TEMPORARY PERSONNEL SERVICES, IN CLASS 35 (U.S. CLS. 100, 101 AND 102).

SERVICE MARK

SUPPLEMENTAL REGISTER

FIRST USE 6-1-2012; IN COMMERCE 6-1-2012.

THE MARK CONSISTS OF STANDARD CHARACTERS WITHOUT CLAIM TO ANY PARTICULAR FONT, STYLE, SIZE, OR COLOR.

NO CLAIM IS MADE TO THE EXCLUSIVE RIGHT TO USE "STAFFING", APART FROM THE MARK AS SHOWN.

SER. NO. 85-447,512, FILED P.R. 10-14-2011; AM. S.R. 6-27-2012.

AMY ALFIERI, EXAMINING ATTORNEY



David J. Kyffers

Director of the United States Patent and Trademark Office

United States of America

United States Patent and Trademark Office

FLIXTRACKER

Reg. No. 4,207,999

Registered Sep. 11, 2012

Int. Cls.: 35 and 41

SERVICE MARK

SUPPLEMENTAL REGISTER

REED ELSEVIER INC. (MASSACHUSETTS CORPORATION)
2 NEWTON PLACE
SUITE 350
NEWTON, MA 02458

FOR: ENTERTAINMENT BUSINESS RESEARCH AND BUSINESS DATA ANALYSIS SERVICES IN THE ENTERTAINMENT AND MEDIA BUSINESS INCLUDING TELEVISION, FEATURE FILM AND DIGITAL ENTERTAINMENT; PROVIDING ON LINE NEWS AND INFORMATION ABOUT THE BUSINESS OF THE ENTERTAINMENT INDUSTRY, IN CLASS 35 (U.S. CLS. 100, 101 AND 102).

FIRST USE 12-19-2011; IN COMMERCE 12-19-2011.

FOR: PROVIDING ON LINE NEWS AND INFORMATION RELATING TO THE ENTERTAINMENT INDUSTRY; ELECTRONIC PUBLICATIONS IN THE NATURE OF NEWSLETTERS AND MARKET INTELLIGENCE REPORTS RELATING TO THE ENTERTAINMENT INDUSTRY; NEWSLETTER DELIVERED BY EMAIL RELATING TO THE ENTERTAINMENT INDUSTRY, IN CLASS 41 (U.S. CLS. 100, 101 AND 107).

FIRST USE 12-19-2011; IN COMMERCE 12-19-2011.

THE MARK CONSISTS OF STANDARD CHARACTERS WITHOUT CLAIM TO ANY PARTICULAR FONT, STYLE, SIZE, OR COLOR.

SER. NO. 85-447,911, FILED P.R. 10-14-2011; AM. S.R. 6-6-2012.

SANI KHOURI, EXAMINING ATTORNEY



David J. Kyffers

Director of the United States Patent and Trademark Office

United States of America

United States Patent and Trademark Office

ILLINOIS SCHOOL OF PROFESSIONAL PSYCHOLOGY

Reg. No. 4,208,000

EDUCATION MANAGEMENT LLC (DELAWARE LIMITED LIABILITY COMPANY)
210 SIXTH AVENUE

Registered Sep. 11, 2012 PITTSBURGH, PA 15222

Int. Cl.: 41

FOR: EDUCATION SERVICES, NAMELY, OFFERING COURSES OF INSTRUCTION AT THE POST-SECONDARY LEVEL, IN CLASS 41 (U.S. CLS. 100, 101 AND 107).

SERVICE MARK

FIRST USE 4-15-2012; IN COMMERCE 4-15-2012.

SUPPLEMENTAL REGISTER THE MARK CONSISTS OF STANDARD CHARACTERS WITHOUT CLAIM TO ANY PARTICULAR FONT, STYLE, SIZE, OR COLOR.

NO CLAIM IS MADE TO THE EXCLUSIVE RIGHT TO USE "SCHOOL OF PROFESSIONAL PSYCHOLOGY", APART FROM THE MARK AS SHOWN.

SER. NO. 85-448,949, FILED P.R. 10-17-2011; AM. S.R. 6-19-2012.

ANDREW LEASER, EXAMINING ATTORNEY



David J. Kyffers

Director of the United States Patent and Trademark Office

United States of America

United States Patent and Trademark Office

ARIZONA SCHOOL OF PROFESSIONAL PSYCHOLOGY

Reg. No. 4,208,001

EDUCATION MANAGEMENT LLC (DELAWARE LIMITED LIABILITY COMPANY)
210 SIXTH AVENUE

Registered Sep. 11, 2012

PITTSBURGH, PA 15222

Int. Cl.: 41

FOR: EDUCATION SERVICES, NAMELY, OFFERING COURSES OF INSTRUCTION AT THE POST-SECONDARY LEVEL, IN CLASS 41 (U.S. CLS. 100, 101 AND 107).

SERVICE MARK

FIRST USE 4-15-2012; IN COMMERCE 4-15-2012.

SUPPLEMENTAL REGISTER

THE MARK CONSISTS OF STANDARD CHARACTERS WITHOUT CLAIM TO ANY PARTICULAR FONT, STYLE, SIZE, OR COLOR.

NO CLAIM IS MADE TO THE EXCLUSIVE RIGHT TO USE "SCHOOL OF PROFESSIONAL PSYCHOLOGY", APART FROM THE MARK AS SHOWN.

SER. NO. 85-448,980, FILED P.R. 10-17-2011; AM. S.R. 6-19-2012.

ANDREW LEASER, EXAMINING ATTORNEY



David J. Kyros

Director of the United States Patent and Trademark Office

United States of America

United States Patent and Trademark Office

FLORIDA SCHOOL OF PROFESSIONAL PSYCHOLOGY

Reg. No. 4,208,002

EDUCATION MANAGEMENT LLC (DELAWARE LIMITED LIABILITY COMPANY)
210 SIXTH AVENUE
PITTSBURGH, PA 15222

Registered Sep. 11, 2012

Int. Cl.: 41

FOR: EDUCATION SERVICES, NAMELY, OFFERING COURSES OF INSTRUCTION AT THE POST-SECONDARY LEVEL, IN CLASS 41 (U.S. CLS. 100, 101 AND 107).

SERVICE MARK

FIRST USE 4-15-2012; IN COMMERCE 4-15-2012.

SUPPLEMENTAL REGISTER

THE MARK CONSISTS OF STANDARD CHARACTERS WITHOUT CLAIM TO ANY PARTICULAR FONT, STYLE, SIZE, OR COLOR.

NO CLAIM IS MADE TO THE EXCLUSIVE RIGHT TO USE "SCHOOL OF PROFESSIONAL PSYCHOLOGY", APART FROM THE MARK AS SHOWN.

SER. NO. 85-449,007, FILED P.R. 10-17-2011; AM. S.R. 6-19-2012.

ANDREW LEASER, EXAMINING ATTORNEY



David J. Kyfos

Director of the United States Patent and Trademark Office

United States of America

United States Patent and Trademark Office

SUPERTRUFFLES

Reg. No. 4,208,003

Registered Sep. 11, 2012

Int. Cl.: 30

WINGS OF NARRATIVE, INC. (CALIFORNIA CORPORATION)
C/O FULWIDER PATTON LLP
6060 CENTER DRIVE, TENTH FLOOR
LOS ANGELES, CA 90045

FOR: CHOCOLATES, CANDIES, IN CLASS 30 (U.S. CL. 46).

TRADEMARK

FIRST USE 5-24-2011; IN COMMERCE 5-24-2011.

SUPPLEMENTAL REGISTER

THE MARK CONSISTS OF STANDARD CHARACTERS WITHOUT CLAIM TO ANY PARTICULAR FONT, STYLE, SIZE, OR COLOR.

SER. NO. 85-449,364, FILED P.R. 10-17-2011; AM. S.R. 6-25-2012.

MATTHEW MCDOWELL, EXAMINING ATTORNEY



David J. Kybas

Director of the United States Patent and Trademark Office

United States of America

United States Patent and Trademark Office

REVENUE CYCLE MATURITY MODEL

Reg. No. 4,208,004

GUNAWARDENA, MEL (UNITED STATES INDIVIDUAL)
6772 PATRICK CIRCLE
DALLAS, TX 74214

Registered Sep. 11, 2012

Int. Cl.: 35

FOR: PROVIDING BUSINESS MANAGEMENT INFORMATION IN CONNECTION WITH CONSULTING AND ADVISORY SERVICES IN THE FIELD OF STRATEGIC PLANNING FOR THE HEALTH CARE INDUSTRY; BUSINESS ASSISTANCE, ADVISORY AND CONSULTING SERVICES IN THE FIELD OF REVENUE CYCLE MANAGEMENT SERVICES; STRATEGIC BUSINESS CONSULTING SERVICES, NAMELY, PROVIDING A METHOD TO CATEGORIZE THE MATURITY AND EFFICIENCY OF THE OVERALL REVENUE CYCLE PROCESS OF A HEALTHCARE PROVIDER'S ORGANIZATION, IN CLASS 35 (U.S. CLS. 100, 101 AND 102).

SERVICE MARK

SUPPLEMENTAL REGISTER

FIRST USE 8-1-2011; IN COMMERCE 8-1-2011.

THE MARK CONSISTS OF STANDARD CHARACTERS WITHOUT CLAIM TO ANY PARTICULAR FONT, STYLE, SIZE, OR COLOR.

SER. NO. 85-451,627, FILED P.R. 10-20-2011; AM. S.R. 7-17-2012.

MICHAEL SOUDERS, EXAMINING ATTORNEY



David J. Kyffers

Director of the United States Patent and Trademark Office

United States of America

United States Patent and Trademark Office

Top it off every time.
More pumps, more
locations, more savings.

Reg. No. 4,208,005

PILOT TRAVEL CENTERS LLC (DELAWARE LIMITED LIABILITY COMPANY)
5508 LONAS DRIVE

Registered Sep. 11, 2012

KNOXVILLE, TN 37909

Int. Cl.: 1

FOR: DIESEL EXHAUST FLUID , IN CLASS 1 (U.S. CLS. 1, 5, 6, 10, 26 AND 46).

TRADEMARK

FIRST USE 9-1-2011; IN COMMERCE 9-1-2011.

SUPPLEMENTAL REGISTER

THE MARK CONSISTS OF STANDARD CHARACTERS WITHOUT CLAIM TO ANY PARTICULAR FONT, STYLE, SIZE, OR COLOR.

SER. NO. 85-452,357, FILED 10-20-2011.

CORY BOONE, EXAMINING ATTORNEY



David J. Kyffers

Director of the United States Patent and Trademark Office

United States of America
United States Patent and Trademark Office

AXTON

Reg. No. 4,208,006

ANVS, INC. (UTAH CORPORATION)
801 W. ROBINSON DR., SUITE 500
NORTH SALT LAKE, UT 84054

Registered Sep. 11, 2012

Int. Cls.: 9 and 11

FOR: SURVEILLANCE SYSTEMS COMPRISED OF CAMERAS AND INFRARED ILLUMINATORS, IN CLASS 9 (U.S. CLS. 21, 23, 26, 36 AND 38).

TRADEMARK

FIRST USE 9-1-2010; IN COMMERCE 9-1-2010.

SUPPLEMENTAL REGISTER

FOR: INFRARED ILLUMINATORS, IN CLASS 11 (U.S. CLS. 13, 21, 23, 31 AND 34).

FIRST USE 9-1-2010; IN COMMERCE 9-1-2010.

THE MARK CONSISTS OF STANDARD CHARACTERS WITHOUT CLAIM TO ANY PARTICULAR FONT, STYLE, SIZE, OR COLOR.

SER. NO. 85-454,415, FILED P.R. 10-24-2011; AM. S.R. 7-31-2012.

TASNEEM HUSSAIN, EXAMINING ATTORNEY



David J. Kybas

Director of the United States Patent and Trademark Office

United States of America

United States Patent and Trademark Office

ADVANCEDPRACTICE.COM

Reg. No. 4,208,007

ADVANCEDPRACTICE.COM, LLC (GEORGIA LIMITED LIABILITY COMPANY)
2655 NORTHWINDS PARKWAY
ALPHARETTA, GA 30009

Registered Sep. 11, 2012

Int. Cl.: 35

FOR: EMPLOYMENT AGENCY SERVICES, NAMELY, TEMPORARY PLACEMENT OF HEALTH CARE PROFESSIONALS AND HEALTH CARE PROVIDERS, IN CLASS 35 (U.S. CLS. 100, 101 AND 102).

SERVICE MARK

FIRST USE 5-21-2009; IN COMMERCE 7-12-2009.

SUPPLEMENTAL REGISTER

THE MARK CONSISTS OF STANDARD CHARACTERS WITHOUT CLAIM TO ANY PARTICULAR FONT, STYLE, SIZE, OR COLOR.

SER. NO. 85-456,605, FILED P.R. 10-26-2011; AM. S.R. 7-25-2012.

DEBORAH LOBO, EXAMINING ATTORNEY



David J. Kyros

Director of the United States Patent and Trademark Office

United States of America

United States Patent and Trademark Office

SOCIAL SWITCHBOARD

Reg. No. 4,208,008

SHOUTLET, INC. (WISCONSIN CORPORATION)
1 ERDMAN PLACE, SUITE 102
MADISON, WI 53717

Registered Sep. 11, 2012

Int. Cl.: 9

FOR: COMPUTER SOFTWARE USED TO AUTOMATE SCHEDULING TASKS AND EVENTS FOR MARKETING CAMPAIGNS, IN CLASS 9 (U.S. CLS. 21, 23, 26, 36 AND 38).

TRADEMARK

FIRST USE 12-9-2011; IN COMMERCE 12-9-2011.

SUPPLEMENTAL REGISTER

THE MARK CONSISTS OF STANDARD CHARACTERS WITHOUT CLAIM TO ANY PARTICULAR FONT, STYLE, SIZE, OR COLOR.

SER. NO. 85-456,718, FILED P.R. 10-26-2011; AM. S.R. 7-18-2012.

DAVID C. REIHNER, EXAMINING ATTORNEY



David J. Kyfos

Director of the United States Patent and Trademark Office

United States of America

United States Patent and Trademark Office

My Maine Blankie

Reg. No. 4,208,009

SHEARIN, MARTA (UNITED STATES INDIVIDUAL)
129 FORREST SCHOOL ROAD
CORINTH, MS 38834

Registered Sep. 11, 2012

Int. Cl.: 24

FOR: BABY BLANKETS; BED BLANKETS; CHILDREN'S BLANKETS; LAP BLANKETS;
TRAVELLING BLANKETS; WOOLLEN BLANKETS, IN CLASS 24 (U.S. CLS. 42 AND 50).

TRADEMARK

FIRST USE 5-0-2012; IN COMMERCE 5-0-2012.

SUPPLEMENTAL REGISTER

THE MARK CONSISTS OF STANDARD CHARACTERS WITHOUT CLAIM TO ANY PARTICULAR FONT, STYLE, SIZE, OR COLOR.

SER. NO. 85-457,515, FILED P.R. 10-27-2011; AM. S.R. 7-10-2012.

KIM MONINGHOFF, EXAMINING ATTORNEY



David J. Kyffers

Director of the United States Patent and Trademark Office

United States of America

United States Patent and Trademark Office

STICK IT IN

Reg. No. 4,208,010

BOOKHOLDERS (DELAWARE LIMITED PARTNERSHIP)
2137 HALLMARK DR.
GAMBRILLS, MD 21054

Registered Sep. 11, 2012

Int. Cl.: 25

FOR: ATHLETIC APPAREL, NAMELY, SHIRTS, PANTS, JACKETS, FOOTWEAR, HATS AND CAPS, ATHLETIC UNIFORMS, IN CLASS 25 (U.S. CLS. 22 AND 39).

TRADEMARK

FIRST USE 5-1-2011; IN COMMERCE 5-1-2011.

SUPPLEMENTAL REGISTER

THE MARK CONSISTS OF STANDARD CHARACTERS WITHOUT CLAIM TO ANY PARTICULAR FONT, STYLE, SIZE, OR COLOR.

SER. NO. 85-459,724, FILED P.R. 10-29-2011; AM. S.R. 7-26-2012.

TARAH HARDY, EXAMINING ATTORNEY



David J. Kybas

Director of the United States Patent and Trademark Office

United States of America

United States Patent and Trademark Office

East Village Pilsner

Reg. No. 4,208,011

GREEN FLASH BREWING CO. (CALIFORNIA CORPORATION)
6550 MIRA MESA BLVD.
SAN DIEGO, CA 92102

Registered Sep. 11, 2012

Int. Cl.: 32

FOR: BEER, IN CLASS 32 (U.S. CLS. 45, 46 AND 48).

TRADEMARK

FIRST USE 6-27-2012; IN COMMERCE 6-29-2012.

SUPPLEMENTAL REGISTER

THE MARK CONSISTS OF STANDARD CHARACTERS WITHOUT CLAIM TO ANY PARTICULAR FONT, STYLE, SIZE, OR COLOR.

NO CLAIM IS MADE TO THE EXCLUSIVE RIGHT TO USE "PILSNER", APART FROM THE MARK AS SHOWN.

SER. NO. 85-460,167, FILED P.R. 10-31-2011; AM. S.R. 7-16-2012.

BARBARA BROWN, EXAMINING ATTORNEY



David J. Kyffers

Director of the United States Patent and Trademark Office

United States of America

United States Patent and Trademark Office

STORAGE REVIEW

Reg. No. 4,208,012

FLYING PIG VENTURES, LLC (OHIO LIMITED LIABILITY COMPANY)
7420 JAGER COURT
CINCINNATI, OH 45230

Registered Sep. 11, 2012

Int. Cl.: 41

FOR: PROVIDING A WEBSITE FEATURING BLOGS AND NON-DOWNLOADABLE PUBLICATIONS IN THE NATURE OF NEWS ARTICLES AND PRODUCT REVIEWS IN THE FIELD(S) OF ELECTRONIC DATA STORAGE DEVICES, NAMELY, HARD DRIVES, SOLID-STATE DRIVES, SOLID-STATE DISKS, ELECTRONIC DISKS, NETWORK-ATTACHED STORAGE UNITS, AND SOFTWARE FOR THE ELECTRONIC STORAGE OF DATA, IN CLASS 41 (U.S. CLS. 100, 101 AND 107).

SERVICE MARK

SUPPLEMENTAL REGISTER

FIRST USE 12-31-1998; IN COMMERCE 12-31-1998.

THE MARK CONSISTS OF STANDARD CHARACTERS WITHOUT CLAIM TO ANY PARTICULAR FONT, STYLE, SIZE, OR COLOR.

SER. NO. 85-460,402, FILED P.R. 10-31-2011; AM. S.R. 6-26-2012.

JENNIFER DIXON, EXAMINING ATTORNEY



David J. Kyfos

Director of the United States Patent and Trademark Office

United States of America

United States Patent and Trademark Office

STORAGEREVIEW.COM

Reg. No. 4,208,013

Registered Sep. 11, 2012

Int. Cl.: 41

SERVICE MARK

SUPPLEMENTAL REGISTER

FLYING PIG VENTURES, LLC (OHIO LIMITED LIABILITY COMPANY)
7420 JAGER COURT
CINCINNATI, OH 45230

FOR: PROVIDING A WEBSITE FEATURING BLOGS AND NON-DOWNLOADABLE PUBLICATIONS IN THE NATURE OF NEWS ARTICLES AND PRODUCT REVIEWS IN THE FIELD(S) OF ELECTRONIC DATA STORAGE DEVICES, NAMELY, HARD DRIVES, SOLID-STATE DRIVES, SOLID-STATE DISKS, ELECTRONIC DISKS, NETWORK-ATTACHED STORAGE UNITS, AND SOFTWARE FOR THE ELECTRONIC STORAGE OF DATA, IN CLASS 41 (U.S. CLS. 100, 101 AND 107).

FIRST USE 12-31-1998; IN COMMERCE 12-31-1998.

THE MARK CONSISTS OF STANDARD CHARACTERS WITHOUT CLAIM TO ANY PARTICULAR FONT, STYLE, SIZE, OR COLOR.

SER. NO. 85-460,417, FILED P.R. 10-31-2011; AM. S.R. 6-26-2012.

JENNIFER DIXON, EXAMINING ATTORNEY



David J. Kyffers

Director of the United States Patent and Trademark Office

United States of America

United States Patent and Trademark Office

Flotation Pile

Reg. No. 4,208,014

Registered Sep. 11, 2012

Int. Cl.: 7

TRADEMARK

SUPPLEMENTAL REGISTER

GLOBAL WASTEWATER SOLUTIONS (TEXAS CORPORATION), DBA ENERGY SPECIALTIES INTERNATIONAL,
22955 SH-249 SUITE 10
TOMBALL, TX 77375

FOR: OIL-WATER SEPARATORS FOR PNEUMATIC CONTROLS BEING PART OF MACHINES, IN CLASS 7 (U.S. CLS. 13, 19, 21, 23, 31, 34 AND 35).

FIRST USE 2-12-1998; IN COMMERCE 3-21-2001.

THE MARK CONSISTS OF STANDARD CHARACTERS WITHOUT CLAIM TO ANY PARTICULAR FONT, STYLE, SIZE, OR COLOR.

NO CLAIM IS MADE TO THE EXCLUSIVE RIGHT TO USE "PILE", APART FROM THE MARK AS SHOWN.

SER. NO. 85-460,668, FILED P.R. 10-31-2011; AM. S.R. 2-21-2012.

MICHELE SWAIN, EXAMINING ATTORNEY



David J. Kyfos

Director of the United States Patent and Trademark Office

United States of America

United States Patent and Trademark Office

Good Hearted Leadership

Reg. No. 4,208,015

ANDERSON, RAY (UNITED STATES INDIVIDUAL)
31333 MESA DR.

Registered Sep. 11, 2012

REDLANDS, CA 92373

Int. Cl.: 41

FOR: BUSINESS TRAINING IN THE FIELD OF LEADERSHIP AND MANAGEMENT, IN CLASS 41 (U.S. CLS. 100, 101 AND 107).

SERVICE MARK

FIRST USE 8-13-1997; IN COMMERCE 8-13-1997.

SUPPLEMENTAL REGISTER

THE MARK CONSISTS OF STANDARD CHARACTERS WITHOUT CLAIM TO ANY PARTICULAR FONT, STYLE, SIZE, OR COLOR.

SER. NO. 85-465,156, FILED 11-4-2011.

MARGERY A. TIERNEY, EXAMINING ATTORNEY



David J. Kyffers

Director of the United States Patent and Trademark Office

United States of America

United States Patent and Trademark Office

BASKETBALL SHOTS 3D

Reg. No. 4,208,016

CREATIVE MOBILE OÜ (ESTONIA CORPORATION)

Registered Sep. 11, 2012

PÄRNU MNT 130 46
TALLINN, ESTONIA

Int. Cl.: 9

FOR: COMPUTER GAME SOFTWARE FOR USE ON MOBILE PHONES, PORTABLE MEDIA PLAYERS, AND HANDHELD COMPUTERS, IN CLASS 9 (U.S. CLS. 21, 23, 26, 36 AND 38).

TRADEMARK

FIRST USE 9-30-2010; IN COMMERCE 9-30-2010.

SUPPLEMENTAL REGISTER

THE MARK CONSISTS OF STANDARD CHARACTERS WITHOUT CLAIM TO ANY PARTICULAR FONT, STYLE, SIZE, OR COLOR.

SER. NO. 85-465,248, FILED P.R. 11-4-2011; AM. S.R. 7-18-2012.

TEJBIR SINGH, EXAMINING ATTORNEY



David J. Kyffers

Director of the United States Patent and Trademark Office

United States of America

United States Patent and Trademark Office

DME TRACK

Reg. No. 4,208,017

INVASOFT, LLC (ARIZONA LIMITED LIABILITY COMPANY)
2130 E UNIVERSITY DR.
TEMPE, AZ 85281

Registered Sep. 11, 2012

Int. Cl.: 42

FOR: APPLICATION SERVICE PROVIDER (ASP) FEATURING SOFTWARE FOR USE BY HEALTHCARE PROVIDERS TO PLACE ORDERS FOR MEDICAL EQUIPMENT AND RELATED SUPPLIES, TRACK THE STATUS OF ORDERS, AND REPORT ON EQUIPMENT UTILIZATION AND COSTS, IN CLASS 42 (U.S. CLS. 100 AND 101).

SERVICE MARK

SUPPLEMENTAL REGISTER FIRST USE 1-1-2010; IN COMMERCE 1-1-2010.

THE MARK CONSISTS OF STANDARD CHARACTERS WITHOUT CLAIM TO ANY PARTICULAR FONT, STYLE, SIZE, OR COLOR.

SER. NO. 85-466,453, FILED P.R. 11-7-2011; AM. S.R. 7-10-2012.

SALLY SHIH, EXAMINING ATTORNEY

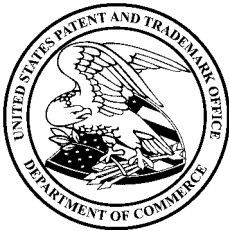

David J. Kyffers

Director of the United States Patent and Trademark Office

United States of America

United States Patent and Trademark Office

STATEWIDE CDC

Reg. No. 4,208,018

BOONE, JEFF (UNITED STATES INDIVIDUAL)
426 D STREET
DAVIS, CA 95616

Registered Sep. 11, 2012

Int. Cl.: 36

FOR: INSURANCE AND FINANCIAL SERVICES, NAMELY, SMALL BUSINESS FINANCING,
IN CLASS 36 (U.S. CLS. 100, 101 AND 102).

SERVICE MARK

FIRST USE 10-1-2011; IN COMMERCE 10-21-2011.

SUPPLEMENTAL REGISTER

THE MARK CONSISTS OF STANDARD CHARACTERS WITHOUT CLAIM TO ANY PARTICULAR FONT, STYLE, SIZE, OR COLOR.

SER. NO. 85-467,650, FILED P.R. 11-8-2011; AM. S.R. 7-24-2012.

JORDAN BAKER, EXAMINING ATTORNEY



David J. Kyffers

Director of the United States Patent and Trademark Office

United States of America

United States Patent and Trademark Office

CDC ADVISORS

Reg. No. 4,208,019

BOONE, JEFF (UNITED STATES INDIVIDUAL)
426 D STREET
DAVIS, CA 95616

Registered Sep. 11, 2012

Int. Cl.: 36

FOR: INSURANCE AND FINANCIAL SERVICES, NAMELY, SMALL BUSINESS FINANCING,
IN CLASS 36 (U.S. CLS. 100, 101 AND 102).

SERVICE MARK

FIRST USE 4-18-2011; IN COMMERCE 4-18-2011.

SUPPLEMENTAL REGISTER

THE MARK CONSISTS OF STANDARD CHARACTERS WITHOUT CLAIM TO ANY PARTICULAR FONT, STYLE, SIZE, OR COLOR.

SER. NO. 85-467,655, FILED P.R. 11-8-2011; AM. S.R. 7-24-2012.

JORDAN BAKER, EXAMINING ATTORNEY



David J. Kybas

Director of the United States Patent and Trademark Office

United States of America

United States Patent and Trademark Office

WELL-GUIDE RSS

Reg. No. 4,208,020

GYRODATA INCORPORATED (TEXAS CORPORATION)
23000 NORTHWEST LAKE DRIVE
HOUSTON, TX 77095

Registered Sep. 11, 2012

Int. Cl.: 42

SERVICE MARK

SUPPLEMENTAL REGISTER

FOR: CONDUCTING WELLBORE SURVEY SERVICES FOR THE OIL AND GAS, ENERGY, MINING, ENVIRONMENTAL AND CONSTRUCTION INDUSTRIES, PROVIDING WELLBORE MAPPING SERVICES; PROVIDING ELECTRONIC WELLBORE DATA COLLECTION SERVICES, NAMELY, PROVIDING SERVICES OF COLLECTING OF WELLBORE DIRECTION AND ORIENTATION DATA FROM WELLBORE MEASUREMENT DEVICES OF OTHERS IN THE OIL AND GAS, ENERGY, MINING, ENVIRONMENTAL AND CONSTRUCTION INDUSTRIES; PROVIDING WELLBORE DATA COLLECTION SERVICES FOR USE IN DIRECTIONAL DRILLING CONTROL IN THE OIL AND GAS, ENERGY, MINING, ENVIRONMENTAL AND CONSTRUCTION INDUSTRIES; PROVIDING WELLBORE DIRECTIONAL DRILLING CONTROL DATA COLLECTION SERVICES IN THE OIL AND GAS WELL DRILLING INDUSTRY, NAMELY, GYROSCOPIC MEASUREMENT OF DIRECTIONAL DRILLING CONTROL DATA, AND COMMUNICATION OF DIRECTIONAL DRILLING CONTROL DATA TO WELLBORE DRILLING OPERATORS; PROVIDING OIL AND GAS WELL RESERVOIR MEASUREMENT SERVICES IN THE OIL AND GAS WELL INDUSTRY, NAMELY, GYROSCOPIC MEASUREMENT OF DIRECTION AND ORIENTATION OF WELLBORES IN RELATION TO OIL AND GAS WELL RESERVOIR FORMATIONS; AND OIL FIELD SURVEY SERVICES, IN CLASS 42 (U.S. CLS. 100 AND 101).

FIRST USE 4-22-2003; IN COMMERCE 4-22-2003.

THE MARK CONSISTS OF STANDARD CHARACTERS WITHOUT CLAIM TO ANY PARTICULAR FONT, STYLE, SIZE, OR COLOR.

SER. NO. 85-467,930, FILED P.R. 11-9-2011; AM. S.R. 7-27-2012.

RUSS HERMAN, EXAMINING ATTORNEY



David J. Kypos

Director of the United States Patent and Trademark Office

United States of America

United States Patent and Trademark Office

RESPONSIBLE SEX EDUCATION INSTITUTE

Reg. No. 4,208,021

Registered Sep. 11, 2012

Int. Cl.: 41

SERVICE MARK

SUPPLEMENTAL REGISTER

ROCKY MOUNTAIN PLANNED PARENTHOOD, INC. (COLORADO CORPORATION), DBA
PLANNED PARENTHOOD OF THE ROCKY MOUNTAINS, INC.,
7155 E. 38TH AVE.
DENVER, CO 80207

FOR: EDUCATIONAL SERVICES, NAMELY, DEVELOPING AND PROVIDING EDUCATIONAL PROGRAMS AND COURSES OF INSTRUCTION IN THE FIELD OF SEXUAL HEALTH EDUCATION; EDUCATIONAL SERVICES, NAMELY, CONDUCTING CLASSES AND SEMINARS IN THE FIELD OF SEXUAL HEALTH EDUCATION; EDUCATION SERVICES, NAMELY, TRAINING EDUCATORS TO TEACH COURSES IN SEXUAL HEALTH EDUCATION; ARRANGING AND CONDUCTING PROFESSIONAL TRAINING COURSES IN THE FIELD OF SEXUAL HEALTH EDUCATION; EDUCATIONAL SERVICES, NAMELY, PROVIDING EDUCATIONAL SPEAKERS IN THE FIELD OF SEXUAL HEALTH AND EDUCATION, IN CLASS 41 (U.S. CLS. 100, 101 AND 107).

FIRST USE 5-31-2012; IN COMMERCE 5-31-2012.

THE MARK CONSISTS OF STANDARD CHARACTERS WITHOUT CLAIM TO ANY PARTICULAR FONT, STYLE, SIZE, OR COLOR.

NO CLAIM IS MADE TO THE EXCLUSIVE RIGHT TO USE "SEX EDUCATION" AND "INSTITUTE", APART FROM THE MARK AS SHOWN.

SER. NO. 85-468,485, FILED P.R. 11-9-2011; AM. S.R. 6-5-2012.

KIM MONINGHOFF, EXAMINING ATTORNEY



David J. Kyffers

Director of the United States Patent and Trademark Office

United States of America

United States Patent and Trademark Office

Charleston Beer Garden

Reg. No. 4,208,022

Registered Sep. 11, 2012

Int. Cl.: 41

SERVICE MARK

SUPPLEMENTAL REGISTER

GUSTO GROUP LLC (SOUTH CAROLINA LIMITED LIABILITY COMPANY)
617 NORTH SHORE DRIVE
CHARLESTON, SC 29412

FOR: ENTERTAINMENT, NAMELY, CONDUCTING ENTERTAINMENT EXHIBITIONS IN THE NATURE OF BEER FESTIVALS, FOOD AND LIVE MUSIC, IN CLASS 41 (U.S. CLS. 100, 101 AND 107).

FIRST USE 0-0-2011; IN COMMERCE 6-23-2012.

THE MARK CONSISTS OF STANDARD CHARACTERS WITHOUT CLAIM TO ANY PARTICULAR FONT, STYLE, SIZE, OR COLOR.

NO CLAIM IS MADE TO THE EXCLUSIVE RIGHT TO USE "BEER GARDEN", APART FROM THE MARK AS SHOWN.

SER. NO. 85-468,699, FILED P.R. 11-9-2011; AM. S.R. 7-16-2012.

PRISCILLA MILTON, EXAMINING ATTORNEY



David J. Kyffers

Director of the United States Patent and Trademark Office

United States of America

United States Patent and Trademark Office

ULCER HEALING ORTHOSIS

Reg. No. 4,208,023

DUPAGE PROSTHETIC-ORTHOTIC SCVS., INC. (ILLINOIS CORPORATION)
121 E. ROOSEVELT ROAD
LOMBARD, IL 60148

Registered Sep. 11, 2012

Int. Cl.: 10

FOR: ORTHOTIC DEVICE FOR AIDING IN HEALING PLANTAR ULCERS, NAMELY, A CUSTOM BRACE SUPPORT FOR THE LOWER LEG AND FOOT, IN CLASS 10 (U.S. CLS. 26, 39 AND 44).

TRADEMARK

FIRST USE 1-31-2001; IN COMMERCE 1-31-2001.

SUPPLEMENTAL REGISTER

THE MARK CONSISTS OF STANDARD CHARACTERS WITHOUT CLAIM TO ANY PARTICULAR FONT, STYLE, SIZE, OR COLOR.

OWNER OF U.S. REG. NO. 2,597,971.

NO CLAIM IS MADE TO THE EXCLUSIVE RIGHT TO USE "ORTHOISIS", APART FROM THE MARK AS SHOWN.

SER. NO. 85-469,099, FILED P.R. 11-10-2011; AM. S.R. 7-10-2012.

KATHERINE CHANG, EXAMINING ATTORNEY



David J. Kyros

Director of the United States Patent and Trademark Office

United States of America

United States Patent and Trademark Office

BROOKLYN SLIDERS

Reg. No. 4,208,024

ALOTTA, DANIEL (UNITED STATES INDIVIDUAL)
35-53 77 STREET

Registered Sep. 11, 2012

JACKSON HEIGHTS, NY 11372 AND

Int. Cl.: 43

ALOTTA, PHILIP (UNITED STATES INDIVIDUAL)
128 AUSTIN AVENUE
TAPPAN, NY 11372

SERVICE MARK

SUPPLEMENTAL REGISTER

FOR: FAST-FOOD RESTAURANT SERVICES; ICE CREAM SHOP SERVICES IN THE NATURE OF A RESTAURANT; PROVIDING PROGRESSIVE DINNER EVENTS WHERE PARTICIPANTS SAMPLE MEALS AND DRINKS AT A SERIES OF RESTAURANTS; RESTAURANT AND CAFE SERVICES; RESTAURANT AND CATERING SERVICES; RESTAURANT SERVICES; RESTAURANT SERVICES FEATURING THE PREPARATION AND CONSUMPTION OF NUMEROUS CATEGORIES OF FOOD AND BEVERAGES; RESTAURANT SERVICES, INCLUDING SIT-DOWN SERVICE OF FOOD AND TAKE-OUT RESTAURANT SERVICES; RESTAURANT SERVICES, NAMELY, PROVIDING OF FOOD AND BEVERAGES FOR CONSUMPTION ON AND OFF THE PREMISES; RESTAURANTS FEATURING HOME DELIVERY; SELF-SERVICE RESTAURANTS; TAKE-OUT RESTAURANT SERVICES, IN CLASS 43 (U.S. CLS. 100 AND 101).

FIRST USE 10-31-2009; IN COMMERCE 10-31-2009.

THE MARK CONSISTS OF STANDARD CHARACTERS WITHOUT CLAIM TO ANY PARTICULAR FONT, STYLE, SIZE, OR COLOR.

NO CLAIM IS MADE TO THE EXCLUSIVE RIGHT TO USE "SLIDERS", APART FROM THE MARK AS SHOWN.

SER. NO. 85-472,723, FILED P.R. 11-15-2011; AM. S.R. 7-20-2012.

COURTNEY ALVAREZ, EXAMINING ATTORNEY



David J. Kyffers

Director of the United States Patent and Trademark Office

United States of America

United States Patent and Trademark Office

LATIMER

Reg. No. 4,208,025

Registered Sep. 11, 2012

Int. Cl.: 11

TRADEMARK

SUPPLEMENTAL REGISTER

LATIMER LIGHTING CORPORATION (GEORGIA CORPORATION), AKA LATIMER LIGHTING,
PO BOX 7682
ATLANTA, GA 30357

FOR: ACCENT LIGHTS FOR INDOOR USE; ARC LAMPS; CEILING LIGHTS; ELECTRIC LIGHT BULBS; ELECTRIC LIGHTING FIXTURES; ELECTRIC LIGHTING FIXTURES, NAMELY, POWER FAILURE BACKUP SAFETY LIGHTING; ELECTRIC LIGHTING FIXTURES, NAMELY, SCONCES; ELECTRIC NIGHT LIGHTS; FIXTURES FOR INCANDESCENT LIGHT BULBS; FLOODLIGHTS; FLUORESCENT ELECTRIC LIGHT BULBS; FLUORESCENT LIGHTING TUBES; HALOGEN LIGHT BULBS; HIGH INTENSITY SEARCH LIGHTS; HYDROPONICS GROW BOX IN THE NATURE OF A CLOSED ENVIRONMENT EQUIPPED WITH LIGHTS, EXHAUST SYSTEM, HYDROPONICS GROWING CONTAINER AND ODOR CONTROL SYSTEM; INCANDESCENT LIGHT BULBS; INDUSTRIAL ELECTRIC OSCILLATING FANS FOR AUTOMATIC CLEANING OF CEILINGS, LIGHT FIXTURES, DUCTS AND OTHER OVERHEAD STRUCTURES EXPOSED TO FIBROUS AIRBORNE CONTAMINANTS; INFRARED LIGHTING FIXTURES; Klieg LIGHTS; LAMP WHOSE LIGHT CAN BE TURNED IN ALL DIRECTIONS; LED (LIGHT EMITTING DIODE) LIGHTING FIXTURES; LED (LIGHT EMITTING DIODES) LIGHTING FIXTURES FOR USE IN DISPLAY, COMMERCIAL, INDUSTRIAL, RESIDENTIAL, AND ARCHITECTURAL ACCENT LIGHTING APPLICATIONS; LED AND HID LIGHT FIXTURES; LED LIGHT ASSEMBLIES FOR STREET LIGHTS, SIGNS, COMMERCIAL LIGHTING, AUTOMOBILES, BUILDINGS, AND OTHER ARCHITECTURAL USES; LED LIGHT BULBS; LED LIGHT MACHINES; LED LIGHTING FIXTURES FOR INDOOR AND OUTDOOR LIGHTING APPLICATIONS; LED LIGHTING SYSTEMS, NAMELY, LED MODULES, POWER SUPPLIES, AND WIRING; LED LIGHTS FOR LIGHTING PURPOSES INCORPORATED INTO KEY CHAINS, SMALL TOYS OR OTHER SIMILAR PERSONAL ITEMS; LED LIGHTS FOR STRINGS, FLOWERS, BRANCHES AND OTHER ORNAMENTAL DECORATIONS; LED UNDERWATER LIGHTS; LIGHT BULBS; LIGHT DIFFUSERS; LIGHT EMITTING DIODE (LED) PLANT GROW LIGHT; LIGHT POST LUMINAIRES; LIGHT REFLECTORS; LIGHTING APPARATUS FOR SPORTS ARENAS; LIGHTING APPARATUS FOR THEATRES, CLUBS AND DISCOTHEQUES; LIGHTING DEVICES FOR SHOWCASES; LIGHTING FIXTURES; LIGHTING FIXTURES FOR USE IN PARKING DECKS AND GARAGES; LIGHTING FIXTURES FOR USE IN PARKING LOTS AND WALKWAYS; LIGHTING FIXTURES THAT INTEGRATE NATURAL DAYLIGHT AND FLUORESCENT LIGHTING INTO THE FIXTURE; LIGHTING FIXTURES WITH MOTION DETECTION; LIGHTING TRACKS; LIGHTING TUBES; LIGHTS FOR ILLUMINATING STAIRS, DOORS AND OTHER PORTIONS OF BUILDINGS; LIGHTS FOR USE IN ILLUMINATING SIGNS



David J. Kyros

Director of the United States Patent and Trademark Office

Reg. No. 4,208,025 AND DISPLAYS; LUMINAIRES, USING LIGHT EMITTING DIODES (LEDS) AS A LIGHT SOURCE, FOR STREET OR ROADWAY LIGHTING; MINIATURE ACCENT LIGHTS FOR ATTACHMENT TO THE BODY AND/OR SPORTS EQUIPMENT TO PROVIDE ACCENT LIGHTING TO PARTS OF THE BODY AND/OR THE SPORTS EQUIPMENT TO WHICH IT IS ATTACHED; MINIATURE LIGHT BULBS; OPTICAL LENS COVERS THAT IMPROVE LIGHT OUTPUT AND UNIFORMITY AND PROTECT THE LED, SOLD AS A FEATURE OF AN LED LIGHTING SYSTEM; OUTDOOR LIGHTING, NAMELY, PAVER LIGHTS; SCONCE LIGHTING FIXTURES; SOCKETS FOR ELECTRIC LIGHTS; SOLAR LIGHT FIXTURES, NAMELY, INDOOR AND OUTDOOR SOLAR POWERED LIGHTING UNITS AND FIXTURES; SOLAR-POWERED ALL-WEATHER LIGHTS; STRIP LIGHTING FOR INDOOR USE; THEATRICAL STAGE LIGHTING APPARATUS; TOOLS, COMPONENTS AND SUPPLIES FOR USE IN MAKING SIGNS, NAMELY, FLUORESCENT, HID, LED AND INCANDESCENT BULBS, LAMPS AND FIXTURES; WALL LIGHTS, IN CLASS 11 (U.S. CLS. 13, 21, 23, 31 AND 34).

FIRST USE 5-15-2011; IN COMMERCE 8-1-2011.

THE MARK CONSISTS OF STANDARD CHARACTERS WITHOUT CLAIM TO ANY PARTICULAR FONT, STYLE, SIZE, OR COLOR.

SER. NO. 85-473,625, FILED P.R. 11-16-2011; AM. S.R. 7-24-2012.

PATRICIA EVANKO, EXAMINING ATTORNEY

United States of America

United States Patent and Trademark Office

CORPORATE FIGHT NIGHT

Reg. No. 4,208,026

BIG BOSS ENTERPRISES LLC (GEORGIA LIMITED LIABILITY COMPANY)
235 ASHBROOK DRIVE
ATHENS, GA 30605

Registered Sep. 11, 2012

Int. Cl.: 41

FOR: ENTERTAINMENT IN THE NATURE OF BOXING CONTESTS; ENTERTAINMENT SERVICES IN THE NATURE OF LIVE MIXED MARTIAL ARTS (MMA) EVENTS; ORGANIZATION OF BOXING MATCHES; PRESENTATION OF MIXED MARTIAL ARTS EVENTS, IN CLASS 41 (U.S. CLS. 100, 101 AND 107).

SERVICE MARK

SUPPLEMENTAL REGISTER FIRST USE 5-1-2010; IN COMMERCE 5-1-2010.

THE MARK CONSISTS OF STANDARD CHARACTERS WITHOUT CLAIM TO ANY PARTICULAR FONT, STYLE, SIZE, OR COLOR.

NO CLAIM IS MADE TO THE EXCLUSIVE RIGHT TO USE "FIGHT NIGHT", APART FROM THE MARK AS SHOWN.

SER. NO. 85-475,670, FILED P.R. 11-17-2011; AM. S.R. 7-11-2012.

MICHELE SWAIN, EXAMINING ATTORNEY



David J. Kybas

Director of the United States Patent and Trademark Office

United States of America

United States Patent and Trademark Office

SCRAPE-N-BURR

Reg. No. 4,208,027

INNOVATIVE PRODUCT IDEAS LLC (WISCONSIN LIMITED LIABILITY COMPANY)
1500 MEADOWBREEZE CIRCLE
NEENAH, WI 54956

Registered Sep. 11, 2012

Int. Cl.: 8

FOR: HAND OPERATED TOOL FOR METAL CLEANING INCLUDING WELDING SPATTER
REMOVAL AND EDGE DE-BURRING, IN CLASS 8 (U.S. CLS. 23, 28 AND 44).

TRADEMARK

FIRST USE 11-21-2002; IN COMMERCE 8-30-2011.

SUPPLEMENTAL REGISTER

THE MARK CONSISTS OF STANDARD CHARACTERS WITHOUT CLAIM TO ANY PAR-
TICULAR FONT, STYLE, SIZE, OR COLOR.

SER. NO. 85-476,592, FILED P.R. 11-18-2011; AM. S.R. 7-10-2012.

KATHRYN COWARD, EXAMINING ATTORNEY



David J. Kyffers

Director of the United States Patent and Trademark Office

United States of America

United States Patent and Trademark Office

INTERNATIONAL CIGAR EXPERTS

Reg. No. 4,208,028

Registered Sep. 11, 2012

Int. Cl.: 35

SERVICE MARK

SUPPLEMENTAL REGISTER

INTERNATIONAL CIGAR KING, INC. (NEW YORK CORPORATION)
UNIT F
261 SOUTH RIVERSIDE ROAD
HIGHLAND, NY 12528

FOR: ON-LINE RETAIL STORE SERVICES FEATURING CIGARS, TOBACCO, AND SMOKING ACCESSORIES, IN CLASS 35 (U.S. CLS. 100, 101 AND 102).

FIRST USE 7-15-2010; IN COMMERCE 7-15-2010.

NO CLAIM IS MADE TO THE EXCLUSIVE RIGHT TO USE "CIGAR", APART FROM THE MARK AS SHOWN.

THE COLOR(S) GRAY, BROWN, AND BLACK IS/ARE CLAIMED AS A FEATURE OF THE MARK.

THE MARK CONSISTS OF THE STYLIZED TEXT "INTERNATIONAL CIGAR EXPERTS". THE WORD "INTERNATIONAL" APPEARS IN THE COLOR GRAY. THE WORD "CIGAR" APPEARS IN THE COLOR BROWN. THE WORD "EXPERTS" APPEARS IN THE COLOR BLACK WITH THE "X" BEING BROWN.

SER. NO. 85-477,770, FILED P.R. 11-21-2011; AM. S.R. 7-11-2012.

ADA HAN, EXAMINING ATTORNEY



David J. Kybas

Director of the United States Patent and Trademark Office

United States of America

United States Patent and Trademark Office

ACCREDITED HEART FAILURE INSTITUTE

Reg. No. 4,208,029

Registered Sep. 11, 2012

Int. Cl.: 42

SERVICE MARK

SUPPLEMENTAL REGISTER

THE HEALTHCARE ACCREDITATION COLLOQUIUM, INC. (OHIO CORPORATION)
SUITE 219
3040 RIVERSIDE DRIVE
COLUMBUS, OH 43221

FOR: ACCREDITATION SERVICES, NAMELY, DEVELOPING, EVALUATING, TESTING AND ADMINISTERING STANDARDS AND PROCEDURES FOR THE ACCREDITATION OF HEALTHCARE ORGANIZATIONS SUCH AS HOSPITALS, CLINICS, PRACTICES IN THE FIELD OF HEART FAILURE, IN CLASS 42 (U.S. CLS. 100 AND 101).

FIRST USE 8-0-2008; IN COMMERCE 8-0-2008.

THE MARK CONSISTS OF STANDARD CHARACTERS WITHOUT CLAIM TO ANY PARTICULAR FONT, STYLE, SIZE, OR COLOR.

NO CLAIM IS MADE TO THE EXCLUSIVE RIGHT TO USE "ACCREDITED" AND "INSTITUTE", APART FROM THE MARK AS SHOWN.

SER. NO. 85-478,683, FILED P.R. 11-22-2011; AM. S.R. 6-28-2012.

CARYN GLASSER, EXAMINING ATTORNEY



David J. Kyffers

Director of the United States Patent and Trademark Office

United States of America

United States Patent and Trademark Office

TOP AGENT MAGAZINE

Reg. No. 4,208,030

FEATURE PUBLICATIONS GA, INC. (GEORGIA CORPORATION)
STE 1000

Registered Sep. 11, 2012

5256 VININGS SPRINGS COURT
MABLETON, GA 30126

Int. Cl.: 16

FOR: MAGAZINES IN THE FIELD OF REAL ESTATE AGENTS FEATURING ARTICLES AND INFORMATION ABOUT AND FOR REAL ESTATE AGENTS AND PROFESSIONALS, IN CLASS 16 (U.S. CLS. 2, 5, 22, 23, 29, 37, 38 AND 50).

TRADEMARK

SUPPLEMENTAL REGISTER FIRST USE 6-30-2008; IN COMMERCE 6-30-2008.

THE MARK CONSISTS OF STANDARD CHARACTERS WITHOUT CLAIM TO ANY PARTICULAR FONT, STYLE, SIZE, OR COLOR.

NO CLAIM IS MADE TO THE EXCLUSIVE RIGHT TO USE "MAGAZINE", APART FROM THE MARK AS SHOWN.

SER. NO. 85-483,875, FILED P.R. 11-30-2011; AM. S.R. 7-20-2012.

KATHERINE CHANG, EXAMINING ATTORNEY



David J. Kyffers

Director of the United States Patent and Trademark Office

United States of America

United States Patent and Trademark Office



Reg. No. 4,208,031

Registered Sep. 11, 2012

Int. Cl.: 16

TRADEMARK

SUPPLEMENTAL REGISTER

SYDA FOUNDATION (NEW YORK NON-PROFIT CORPORATION)
INTELLECTUAL PROPERTY DEPARTMENT
371 BRICKMAN ROAD
SOUTH FALLSBURG, NY 12779

FOR: PRINTED MATTER, NAMELY, POSTERS, GREETING CARDS, AND REFLECTION CARDS, NAMELY MOTIVATIONAL CARDS, IN CLASS 16 (U.S. CLS. 2, 5, 22, 23, 29, 37, 38 AND 50).

FIRST USE 10-18-2008; IN COMMERCE 10-18-2008.

THE MARK CONSISTS OF A STYLIZED GATE DESIGN WITH A LOTUS FLOWER AND PEARL AT THE CENTER.

SER. NO. 85-485,507, FILED P.R. 12-2-2011; AM. S.R. 7-26-2012.

JAMES GRIFFIN, EXAMINING ATTORNEY



David J. Kyffers

Director of the United States Patent and Trademark Office

United States of America

United States Patent and Trademark Office

TRIBAL

Reg. No. 4,208,032

CYNTHIA TAM (CALIFORNIA CORPORATION)
3530 CAMINO DE LAS LOMAS
VISTA, CA 92084

Registered Sep. 11, 2012

Int. Cl.: 36

FOR: FINANCIAL ADMINISTRATION OF DEFERRED COMPENSATION AND NON-QUALIFIED RETIREMENT PLANS, IN CLASS 36 (U.S. CLS. 100, 101 AND 102).

SERVICE MARK

FIRST USE 4-25-2010; IN COMMERCE 4-25-2010.

SUPPLEMENTAL REGISTER

THE MARK CONSISTS OF STANDARD CHARACTERS WITHOUT CLAIM TO ANY PARTICULAR FONT, STYLE, SIZE, OR COLOR.

SER. NO. 85-492,848, FILED P.R. 12-12-2011; AM. S.R. 7-16-2012.

JENNIFER WILLISTON, EXAMINING ATTORNEY



David J. Kybas

Director of the United States Patent and Trademark Office

United States of America

United States Patent and Trademark Office

FAMILY OWNED PHARMACIES

Reg. No. 4,208,033

ULTIMA BSC (CALIFORNIA LIMITED LIABILITY COMPANY)
369 VIA PALO LINDA
FAIRFIELD, CA 94534

Registered Sep. 11, 2012

Int. Cl.: 35

FOR: PHARMACY ADVOCACY, NAMELY, PUBLIC ADVOCACY TO PROMOTE AWARENESS OF INDEPENDENT PHARMACIES AND MERCHANDISING, NAMELY, PRODUCT MERCHANDISING, IN CLASS 35 (U.S. CLS. 100, 101 AND 102).

SERVICE MARK

FIRST USE 12-1-2011; IN COMMERCE 12-1-2011.

SUPPLEMENTAL REGISTER

THE MARK CONSISTS OF STANDARD CHARACTERS WITHOUT CLAIM TO ANY PARTICULAR FONT, STYLE, SIZE, OR COLOR.

NO CLAIM IS MADE TO THE EXCLUSIVE RIGHT TO USE "PHARMACIES", APART FROM THE MARK AS SHOWN.

SER. NO. 85-493,334, FILED P.R. 12-12-2011; AM. S.R. 4-20-2012.

SCOTT BIBB, EXAMINING ATTORNEY



David J. Kyffers

Director of the United States Patent and Trademark Office

United States of America

United States Patent and Trademark Office

Big Game Butter

Reg. No. 4,208,034

SHIVER, ALTON L. (UNITED STATES INDIVIDUAL)
7730 LOWER BLUE SPRINGS ROAD
HAMILTON, GA 31811

Registered Sep. 11, 2012

Int. Cl.: 28

FOR: ANIMAL ATTRACTANTS, IN CLASS 28 (U.S. CLS. 22, 23, 38 AND 50).

TRADEMARK

FIRST USE 7-31-2010; IN COMMERCE 7-31-2010.

SUPPLEMENTAL REGISTER

THE MARK CONSISTS OF STANDARD CHARACTERS WITHOUT CLAIM TO ANY PARTICULAR FONT, STYLE, SIZE, OR COLOR.

SER. NO. 85-497,717, FILED P.R. 12-16-2011; AM. S.R. 7-16-2012.

TRACY CROSS, EXAMINING ATTORNEY



David J. Kyffers

Director of the United States Patent and Trademark Office

United States of America

United States Patent and Trademark Office

INDUSTRIAL INJURY CLAIMS

Reg. No. 4,208,035

CSM CORP. (MONTANA CORPORATION)

Registered Sep. 11, 2012

1304 16TH STREET W
BILLINGS, MT 59104

Int. Cls.: 36 and 45

FOR: INSURANCE AND SELF-INSURED CLAIMS ADMINISTRATION, IN CLASS 36 (U.S. CLS. 100, 101 AND 102).

SERVICE MARK

FIRST USE 12-15-2011; IN COMMERCE 12-15-2011.

SUPPLEMENTAL REGISTER

FOR: LITIGATION CONSULTANCY; INVESTIGATION SERVICES RELATED TO INSURANCE AND SELF-INSURED CLAIMS, IN CLASS 45 (U.S. CLS. 100 AND 101).

FIRST USE 12-15-2011; IN COMMERCE 12-15-2011.

THE MARK CONSISTS OF STANDARD CHARACTERS WITHOUT CLAIM TO ANY PARTICULAR FONT, STYLE, SIZE, OR COLOR.

NO CLAIM IS MADE TO THE EXCLUSIVE RIGHT TO USE "CLAIMS", APART FROM THE MARK AS SHOWN.

SER. NO. 85-497,987, FILED 12-16-2011.

PAM WILLIS, EXAMINING ATTORNEY



David J. Kyffers

Director of the United States Patent and Trademark Office

United States of America

United States Patent and Trademark Office

Chi-City

Reg. No. 4,208,036

JAKUBCO NICHOLAS J (UNITED STATES INDIVIDUAL)
2224 W. IRVING PARK
CHICAGO, IL 60618

Registered Sep. 11, 2012

Int. Cl.: 25

FOR: ATHLETIC APPAREL, NAMELY, SHIRTS, PANTS, JACKETS, FOOTWEAR, HATS AND CAPS, ATHLETIC UNIFORMS, IN CLASS 25 (U.S. CLS. 22 AND 39).

TRADEMARK

FIRST USE 12-30-2011; IN COMMERCE 12-30-2011.

SUPPLEMENTAL REGISTER

THE MARK CONSISTS OF STANDARD CHARACTERS WITHOUT CLAIM TO ANY PARTICULAR FONT, STYLE, SIZE, OR COLOR.

SER. NO. 85-498,373, FILED P.R. 12-19-2011; AM. S.R. 7-30-2012.

GILBERT SWIFT, EXAMINING ATTORNEY



David J. Kybas

Director of the United States Patent and Trademark Office

United States of America

United States Patent and Trademark Office

South Shore Nutrition

Reg. No. 4,208,037

MIRZA, TENLEY (UNITED STATES INDIVIDUAL)
182 CENTRAL STREET
NORWELL, MA 02061

Registered Sep. 11, 2012

Int. Cl.: 44

FOR: CONSULTING SERVICES IN THE FIELDS OF HEALTH AND NUTRITION, IN CLASS 44 (U.S. CLS. 100 AND 101).

SERVICE MARK

FIRST USE 7-1-2012; IN COMMERCE 7-1-2012.

SUPPLEMENTAL REGISTER

THE MARK CONSISTS OF STANDARD CHARACTERS WITHOUT CLAIM TO ANY PARTICULAR FONT, STYLE, SIZE, OR COLOR.

SER. NO. 85-498,432, FILED P.R. 12-19-2011; AM. S.R. 7-20-2012.

SUSAN STIGLITZ, EXAMINING ATTORNEY



David J. Kybas

Director of the United States Patent and Trademark Office

United States of America

United States Patent and Trademark Office

Continuous Competency in Certification

Reg. No. 4,208,038

Registered Sep. 11, 2012

Int. Cl.: 42

SERVICE MARK

SUPPLEMENTAL REGISTER

AMERICAN ASSOCIATION OF PHYSICIAN SPECIALISTS, INC. (FLORIDA CORPORATION)
SUITE 400
5550 WEST EXECUTIVE DRIVE
TAMPA, FL 33609

FOR: TESTING, ANALYSIS, AND EVALUATION OF THE KNOWLEDGE, SKILLS AND ABILITIES OF OTHERS FOR THE PURPOSE OF CERTIFICATION AND RE-CERTIFICATION IN THE FIELD OF MEDICAL SPECIALTIES, IN CLASS 42 (U.S. CLS. 100 AND 101).

FIRST USE 6-21-2012; IN COMMERCE 6-21-2012.

THE MARK CONSISTS OF STANDARD CHARACTERS WITHOUT CLAIM TO ANY PARTICULAR FONT, STYLE, SIZE, OR COLOR.

SER. NO. 85-500,621, FILED P.R. 12-21-2011; AM. S.R. 7-13-2012.

AMY ALFIERI, EXAMINING ATTORNEY



David J. Kyffers

Director of the United States Patent and Trademark Office

United States of America

United States Patent and Trademark Office

LitigationManagement

Reg. No. 4,208,039

Registered Sep. 11, 2012

Int. Cl.: 16

TRADEMARK

SUPPLEMENTAL REGISTER

CLM GROUP, INC. (FLORIDA CORPORATION)
4310 W. BROWARD BLVD.
PLANTATION, FL 33317

FOR: PRINTED MATTER, NAMELY, MAGAZINES IN THE FIELD OF MANAGING LEGAL DISPUTES AND CLAIMS SUBJECT TO LITIGATION OR ALTERNATIVE DISPUTE RESOLUTION, IN CLASS 16 (U.S. CLS. 2, 5, 22, 23, 29, 37, 38 AND 50).

FIRST USE 6-1-2011; IN COMMERCE 6-1-2011.

OWNER OF U.S. REG. NO. 3,823,669.

THE COLOR(S) BLUE AND BLACK IS/ARE CLAIMED AS A FEATURE OF THE MARK.

THE MARK CONSISTS OF THE WORD "LITIGATION" DISPLAYED IN BLUE FOLLOWED BY AND IMMEDIATELY ADJACENT TO THE WORD "MANAGEMENT" DISPLAYED IN BLACK.

SER. NO. 85-505,072, FILED P.R. 12-28-2011; AM. S.R. 7-20-2012.

GINA FINK, EXAMINING ATTORNEY



David J. Kybas

Director of the United States Patent and Trademark Office

United States of America

United States Patent and Trademark Office

ONCOLOGY TREATMENT PATHWAYS

Reg. No. 4,208,040

Registered Sep. 11, 2012

Int. Cl.: 35

SERVICE MARK

SUPPLEMENTAL REGISTER

INTELLISPHERE, LLC (DELAWARE LIMITED LIABILITY COMPANY)
BUILDING 300
666 PLAINSBORO ROAD
PLAINSBORO, NJ 08536

FOR: ADVERTISING SERVICES, NAMELY, PROVIDING ADVERTISING SPACE IN MAGAZINES, NEWSLETTERS, SUPPLEMENTS AND WEB SITES THAT CONCERN INFORMATION IN THE FIELDS OF MEDICINE AND HEALTHCARE, IN CLASS 35 (U.S. CLS. 100, 101 AND 102).

FIRST USE 7-27-2012; IN COMMERCE 7-27-2012.

THE MARK CONSISTS OF STANDARD CHARACTERS WITHOUT CLAIM TO ANY PARTICULAR FONT, STYLE, SIZE, OR COLOR.

OWNER OF U.S. REG. NOS. 4,123,323 AND 4,123,326.

SER. NO. 85-505,242, FILED P.R. 12-28-2011; AM. S.R. 7-27-2012.

BRIAN CALLAGHAN, EXAMINING ATTORNEY



David J. Kyffers

Director of the United States Patent and Trademark Office

United States of America

United States Patent and Trademark Office

Disaster Aid USA

Reg. No. 4,208,041

DISASTER AID USA, INC. (D.C. CORPORATION)
9817 LANHAM SEVERN ROAD

Registered Sep. 11, 2012

LANHAM, MD 20706

Int. Cl.: 36

FOR: CHARITABLE FUNDRAISING, IN CLASS 36 (U.S. CLS. 100, 101 AND 102).

SERVICE MARK

FIRST USE 6-0-2010; IN COMMERCE 6-0-2010.

SUPPLEMENTAL REGISTER

THE MARK CONSISTS OF STANDARD CHARACTERS WITHOUT CLAIM TO ANY PARTICULAR FONT, STYLE, SIZE, OR COLOR.

SER. NO. 85-506,309, FILED P.R. 12-30-2011; AM. S.R. 7-23-2012.

TOBY BULLOFF, EXAMINING ATTORNEY



David J. Kyffers

Director of the United States Patent and Trademark Office

United States of America

United States Patent and Trademark Office

Biomarkers, Pathways, and Targeted Therapies

Reg. No. 4,208,042

Registered Sep. 11, 2012

Int. Cl.: 35

SERVICE MARK

SUPPLEMENTAL REGISTER

INTELLISPHERE, LLC (DELAWARE LIMITED LIABILITY COMPANY)
BUILDING 300
666 PLAINSBORO ROAD
PLAINSBORO, NJ 08536

FOR: ADVERTISING SERVICES, NAMELY, PROVIDING ADVERTISING SPACE IN MAGAZINES, JOURNALS, NEWSLETTERS, ARTICLES, AND WEB SITES THAT CONCERN INFORMATION IN THE FIELDS OF MEDICINE AND HEALTHCARE, IN CLASS 35 (U.S. CLS. 100, 101 AND 102).

FIRST USE 7-27-2012; IN COMMERCE 7-27-2012.

THE MARK CONSISTS OF STANDARD CHARACTERS WITHOUT CLAIM TO ANY PARTICULAR FONT, STYLE, SIZE, OR COLOR.

OWNER OF U.S. REG. NO. 4,156,060.

SER. NO. 85-507,070, FILED P.R. 1-1-2012; AM. S.R. 7-27-2012.

BRIAN CALLAGHAN, EXAMINING ATTORNEY



David J. Kyros

Director of the United States Patent and Trademark Office

United States of America

United States Patent and Trademark Office

START PINLESS

Reg. No. 4,208,043

QUADRANT DISTRIBUTION, LLC (CALIFORNIA LIMITED LIABILITY COMPANY)
2151 EAST CONVENTION CENTER WAY, STE 122
ONTARIO, CA 91764

Registered Sep. 11, 2012

Int. Cl.: 16

FOR: TELEPHONE CALLING CARDS, NAMELY, PREPAID TELEPHONE CALLING CARDS,
NOT MAGNETICALLY ENCODED, IN CLASS 16 (U.S. CLS. 2, 5, 22, 23, 29, 37, 38 AND 50).

TRADEMARK

FIRST USE 2-29-2012; IN COMMERCE 2-29-2012.

SUPPLEMENTAL REGISTER

THE MARK CONSISTS OF STANDARD CHARACTERS WITHOUT CLAIM TO ANY PARTICULAR FONT, STYLE, SIZE, OR COLOR.

SER. NO. 85-508,733, FILED P.R. 1-4-2012; AM. S.R. 7-22-2012.

LOURDES AYALA, EXAMINING ATTORNEY



David J. Kyffers

Director of the United States Patent and Trademark Office

United States of America

United States Patent and Trademark Office

LA MEXICO PINLESS

Reg. No. 4,208,044

QUADRANT DISTRIBUTION, LLC (CALIFORNIA LIMITED LIABILITY COMPANY)
2151 EAST CONVENTION CENTER WAY, STE 122
ONTARIO, CA 91764

Registered Sep. 11, 2012

Int. Cl.: 16

FOR: TELEPHONE CALLING CARDS, NAMELY, PREPAID TELEPHONE CALLING CARDS,
NOT MAGNETICALLY ENCODED, IN CLASS 16 (U.S. CLS. 2, 5, 22, 23, 29, 37, 38 AND 50).

TRADEMARK

FIRST USE 4-2-2012; IN COMMERCE 4-2-2012.

SUPPLEMENTAL REGISTER

THE MARK CONSISTS OF STANDARD CHARACTERS WITHOUT CLAIM TO ANY PARTICULAR FONT, STYLE, SIZE, OR COLOR.

SER. NO. 85-508,867, FILED P.R. 1-4-2012; AM. S.R. 7-22-2012.

LOURDES AYALA, EXAMINING ATTORNEY



David J. Kybas

Director of the United States Patent and Trademark Office

United States of America

United States Patent and Trademark Office

MORTGAGE-LINKED AMORTIZING NOTES

Reg. No. 4,208,045

Registered Sep. 11, 2012

Int. Cl.: 36

SERVICE MARK

SUPPLEMENTAL REGISTER

FEDERAL HOME LOAN MORTGAGE CORPORATION (UNITED STATES FEDERALLY
CHARTERED CORPORATION)
8200 JONES BRANCH DRIVE, MS #204
MCLEAN, VA 22102

FOR: FINANCIAL AND REAL ESTATE SERVICES IN THE FIELD OF MORTGAGE LOANS
AND MORTGAGE-BACKED OR MORTGAGE RELATED SECURITIES, IN CLASS 36 (U.S.
CLS. 100, 101 AND 102).

FIRST USE 1-17-2012; IN COMMERCE 1-17-2012.

THE MARK CONSISTS OF STANDARD CHARACTERS WITHOUT CLAIM TO ANY PAR-
TICULAR FONT, STYLE, SIZE, OR COLOR.

NO CLAIM IS MADE TO THE EXCLUSIVE RIGHT TO USE "NOTES", APART FROM THE
MARK AS SHOWN.

SER. NO. 85-510,564, FILED P.R. 1-6-2012; AM. S.R. 6-29-2012.

AMY KELLY, EXAMINING ATTORNEY



David J. Kyffers

Director of the United States Patent and Trademark Office

United States of America

United States Patent and Trademark Office

COOL SYSTEMS TECHNOLOGY

Reg. No. 4,208,046

JACQUES MORET, INC. (NEW YORK CORPORATION)
1411 BROADWAY
NEW YORK, NY 10018

Registered Sep. 11, 2012

Int. Cl.: 25

FOR: FABRIC SOLD AS AN INTEGRAL COMPONENT OF FINISHED CLOTHING ITEMS,
NAMELY, T-SHIRTS, IN CLASS 25 (U.S. CLS. 22 AND 39).

TRADEMARK

FIRST USE 1-31-2012; IN COMMERCE 1-31-2012.

SUPPLEMENTAL REGISTER

THE MARK CONSISTS OF STANDARD CHARACTERS WITHOUT CLAIM TO ANY PAR-
TICULAR FONT, STYLE, SIZE, OR COLOR.

SER. NO. 85-512,061, FILED P.R. 1-9-2012; AM. S.R. 7-16-2012.

TINA BROWN, EXAMINING ATTORNEY



David J. Kybas

Director of the United States Patent and Trademark Office

United States of America

United States Patent and Trademark Office

BostonGarage

Reg. No. 4,208,047

Registered Sep. 11, 2012

Int. Cl.: 37

PREMIER GARAGE OF BOSTON, LLC (MASSACHUSETTS CORPORATION), DBA BOSTON GARAGE,
UNIT 10
35 POND PARK ROAD
HINGHAM, MA 02043

SERVICE MARK

FOR: CONSTRUCTION AND INSTALLATION OF GARAGE CABINETS AND ORGANIZERS AND APPLYING GARAGE FLOOR COATINGS AND COVERINGS, IN CLASS 37 (U.S. CLS. 100, 103 AND 106).

SUPPLEMENTAL REGISTER

FIRST USE 1-11-2012; IN COMMERCE 1-11-2012.

THE MARK CONSISTS OF STANDARD CHARACTERS WITHOUT CLAIM TO ANY PARTICULAR FONT, STYLE, SIZE, OR COLOR.

SER. NO. 85-517,137, FILED P.R. 1-16-2012; AM. S.R. 7-23-2012.

CAROLYN CATALDO, EXAMINING ATTORNEY



David J. Kyros

Director of the United States Patent and Trademark Office

United States of America

United States Patent and Trademark Office

Boston Home Spaces

Reg. No. 4,208,048

Registered Sep. 11, 2012

Int. Cl.: 20

PREMIER GARAGE OF BOSTON, LLC (MASSACHUSETTS CORPORATION), DBA BOSTON HOME SPACES,
UNIT 10
35 POND PARK ROAD
HINGHAM, MA 02043

TRADEMARK

SUPPLEMENTAL REGISTER

FOR: CLOSET ACCESSORIES, NAMELY, BELT RACKS; CLOSET ACCESSORIES, NAMELY, CLOTHES BARS; CLOSET ACCESSORIES, NAMELY, SHOE RACKS; CLOSET ACCESSORIES, NAMELY, SLIDING CLOTHES RAILS; PREFABRICATED CLOSET ORGANIZATION SYSTEMS MADE OF METAL; PREFABRICATED CLOSET ORGANIZATION SYSTEMS MADE OF WOOD; TOWEL CLOSETS, IN CLASS 20 (U.S. CLS. 2, 13, 22, 25, 32 AND 50).

FIRST USE 1-11-2012; IN COMMERCE 1-11-2012.

THE MARK CONSISTS OF STANDARD CHARACTERS WITHOUT CLAIM TO ANY PARTICULAR FONT, STYLE, SIZE, OR COLOR.

SER. NO. 85-517,165, FILED P.R. 1-16-2012; AM. S.R. 7-23-2012.

CAROLYN CATALDO, EXAMINING ATTORNEY



David J. Kyffers

Director of the United States Patent and Trademark Office

United States of America

United States Patent and Trademark Office

MINDFUL LIVING TV

Reg. No. 4,208,049

HALL, KATHLEEN A. (UNITED STATES INDIVIDUAL)
495 OWLS NEST LANE
CLARKESVILLE, GA 30523

Registered Sep. 11, 2012

Int. Cl.: 41

FOR: ENTERTAINMENT SERVICES, NAMELY, AN ONGOING SERIES FEATURING PHYSICAL, MENTAL AND SPIRITUAL HEALTH, HEALING AND WELLNESS, LIFESTYLE MANAGEMENT, DISEASE PREVENTION, AND IDENTIFYING, OVERCOMING AND AVOIDING STRESS AND DESTRUCTIVE BEHAVIOR PROVIDED THROUGH THE INTERNET, IN CLASS 41 (U.S. CLS. 100, 101 AND 107).

SERVICE MARK

SUPPLEMENTAL REGISTER

FIRST USE 8-8-2008; IN COMMERCE 8-8-2008.

THE MARK CONSISTS OF STANDARD CHARACTERS WITHOUT CLAIM TO ANY PARTICULAR FONT, STYLE, SIZE, OR COLOR.

OWNER OF U.S. REG. NOS. 3,674,694, 3,674,695, AND 3,674,696.

SER. NO. 85-519,812, FILED P.R. 1-19-2012; AM. S.R. 7-9-2012.

SALLY SHIH, EXAMINING ATTORNEY



David J. Kyffers

Director of the United States Patent and Trademark Office

United States of America

United States Patent and Trademark Office

The Foundation for Healing

Reg. No. 4,208,050

SMITH, DANIELLE (UNITED STATES INDIVIDUAL)

Registered Sep. 11, 2012

POST OFFICE BOX 533438
ORLANDO, FL 32853

Int. Cl.: 45

SERVICE MARK

SUPPLEMENTAL REGISTER

FOR: EDUCATIONAL SERVICES, NAMELY, CONDUCTING CLASSES, PROGRAMS, SEMINARS, CONFERENCES, ONLINE WORKSHOPS, TUTORING, MENTORING AND WORKSHOPS IN THE FIELD OF PARENTING, NAMELY, HOW TO EDUCATE YOUR CHILDREN, HOW TO PROVIDE HIGHER EDUCATION FOR YOUR CHILDREN; HOW TO FIND POST HIGH SCHOOL EDUCATION FOR YOUR CHILDREN; HOW TO FIND SCHOLARSHIPS, GRANTS, FINANCIAL AID, INTERNSHIPS, FELLOWSHIPS, EXTERNSHIPS, JOB OPPORTUNITIES AND/OR APPRENTICESHIPS FOR YOUR CHILDREN; HOW TO PREPARE YOUR CHILDREN FOR STANDARDIZED TESTS; EDUCATIONAL SERVICES, NAMELY, CONDUCTING CLASSES, PROGRAMS, SEMINARS, CONFERENCES, ONLINE WORKSHOPS, TUTORING, MENTORING AND WORKSHOPS IN THE FIELD OF PET CARE, NAMELY, HOW TO ADOPT RESCUED ANIMALS; HOW TO FIND BOARDING FOR ANIMALS; HOW TO REMOVE ANIMALS FROM HARM AND TRANSPORT THEM TO SHELTERS; HOW TO TRAIN ANIMALS; EDUCATIONAL SERVICES, NAMELY, CONDUCTING CLASSES, PROGRAMS, SEMINARS, CONFERENCES, ONLINE WORKSHOPS, TUTORING, MENTORING AND WORKSHOPS IN THE FIELDS OF HEALTH, NUTRITION AND LIFESTYLE WELLNESS, NAMELY, HOW TO LIVE A NUTRITIOUS LIFESTYLE; HOW TO FIND LOCAL FOOD BANKS, HOW TO FIND FOOD PANTRIES, HOW TO IMPROVE HEALTHCARE IN IMPOVERISHED COUNTRIES; EDUCATIONAL SERVICES, NAMELY, CONDUCTING CLASSES, PROGRAMS, SEMINARS, CONFERENCES, ONLINE WORKSHOPS, TUTORING, MENTORING AND WORKSHOPS IN THE FIELD OF REHABILITATION, NAMELY, HOW TO FIND MENTAL HEALTH RESOURCES; HOW TO FIND TEMPORARY HOUSING; HOW TO FIND CHARITABLE TRANSPORTATION; HOW TO FIND RESOURCES FOR ABUSED WOMEN AND CHILDREN; HOW TO FIND TREATMENT PROGRAMS FOR ADDICTIONS; HOW TO FIND ADDICTION RECOVERY PROGRAMS; EDUCATIONAL SERVICES, NAMELY, CONDUCTING CLASSES, PROGRAMS, SEMINARS, CONFERENCES, ONLINE WORKSHOPS, TUTORING, MENTORING AND WORKSHOPS IN THE FIELD OF NATURAL DISASTER RECOVERY, NAMELY, HOW TO RECOVER FROM NATURAL AND MAN-MADE DISASTERS OR ACTS OF TERRORISM AND HOW TO RESPOND TO SUCH DISASTERS OR ACTS OF TERRORISM, IN CLASS 45 (U.S. CLS. 100 AND 101).



David J. Kyjars

FIRST USE 8-19-2011; IN COMMERCE 12-9-2011.

Reg. No. 4,208,050 THE MARK CONSISTS OF STANDARD CHARACTERS WITHOUT CLAIM TO ANY PARTICULAR FONT, STYLE, SIZE, OR COLOR.

NO CLAIM IS MADE TO THE EXCLUSIVE RIGHT TO USE "FOUNDATION" , APART FROM THE MARK AS SHOWN.

SER. NO. 85-520,511, FILED P.R. 1-19-2012; AM. S.R. 7-3-2012.

LOURDES AYALA, EXAMINING ATTORNEY

United States of America

United States Patent and Trademark Office

HARNESS ENERGY

Reg. No. 4,208,051

Registered Sep. 11, 2012

Int. Cl.: 35

SERVICE MARK

SUPPLEMENTAL REGISTER

HARNESS ENERGY, LLC (COLORADO LIMITED LIABILITY COMPANY)
SUITE 103
3025 UMATILLA STREET
DENVER, CO 80211

FOR: ASSESSMENT SERVICES FOR THE PURPOSE OF PROJECTING AND DETERMINING ENERGY PRODUCTION, EFFICIENCY AND USAGE MANAGEMENT FOR RENEWABLE ENERGY SYSTEMS, IN CLASS 35 (U.S. CLS. 100, 101 AND 102).

FIRST USE 1-15-2009; IN COMMERCE 1-15-2009.

THE MARK CONSISTS OF STANDARD CHARACTERS WITHOUT CLAIM TO ANY PARTICULAR FONT, STYLE, SIZE, OR COLOR.

NO CLAIM IS MADE TO THE EXCLUSIVE RIGHT TO USE "ENERGY", APART FROM THE MARK AS SHOWN.

SER. NO. 85-524,702, FILED P.R. 1-25-2012; AM. S.R. 7-19-2012.

JULIE WATSON, EXAMINING ATTORNEY



David J. Kyffers

Director of the United States Patent and Trademark Office

United States of America

United States Patent and Trademark Office

SETBACK ON DEMAND

Reg. No. 4,208,052

TPI CORPORATION (TENNESSEE CORPORATION)
114 ROSCOE FITZ ROAD
GRAY, TN 37615

Registered Sep. 11, 2012

Int. Cl.: 9

FOR: THERMOSTATS, IN CLASS 9 (U.S. CLS. 21, 23, 26, 36 AND 38).

TRADEMARK

FIRST USE 1-23-2012; IN COMMERCE 1-23-2012.

SUPPLEMENTAL REGISTER

THE MARK CONSISTS OF STANDARD CHARACTERS WITHOUT CLAIM TO ANY PARTICULAR FONT, STYLE, SIZE, OR COLOR.

SER. NO. 85-526,862, FILED P.R. 1-27-2012; AM. S.R. 7-20-2012.

WILLIAM BRECKENFELD, EXAMINING ATTORNEY



David J. Kyfos

Director of the United States Patent and Trademark Office

United States of America

United States Patent and Trademark Office

AD ZONE

Reg. No. 4,208,053

Registered Sep. 11, 2012

Int. Cl.: 35

SERVICE MARK

SUPPLEMENTAL REGISTER

GALLATIN PUBLISHING COMPANY (MISSOURI CORPORATION)
609B SOUTH MAIN STREET
GALLATIN, MO 64640

FOR: PROMOTING THE GOODS AND SERVICES OF OTHERS BY DISTRIBUTING PRINTED PUBLICATIONS FEATURING ADVERTISEMENTS, COMMERCIAL ADVERTISING ANNOUNCEMENTS, ADVERTISING PROMOTIONS AND COUPONS; PROMOTING THE GOODS AND SERVICES OF OTHERS BY DISTRIBUTING COUPONS, PRINTED PROMOTIONAL INSERTS AND PRINTED ADVERTISING MATERIALS; PROMOTING THE GOODS AND SERVICES OF OTHERS BY PROVIDING ONLINE BANNER ADVERTISING SERVICES AND HYPERLINKS TO THE WEBPAGES OF OTHERS, IN CLASS 35 (U.S. CLS. 100, 101 AND 102).

FIRST USE 1-27-2012; IN COMMERCE 1-27-2012.

THE MARK CONSISTS OF STANDARD CHARACTERS WITHOUT CLAIM TO ANY PARTICULAR FONT, STYLE, SIZE, OR COLOR.

NO CLAIM IS MADE TO THE EXCLUSIVE RIGHT TO USE "AD", APART FROM THE MARK AS SHOWN.

SER. NO. 85-528,766, FILED P.R. 1-30-2012; AM. S.R. 5-30-2012.

KIMBERLY PARKS, EXAMINING ATTORNEY



David J. Kyros

Director of the United States Patent and Trademark Office

United States of America

United States Patent and Trademark Office

EDGE2EDGE ADHESIVE

Reg. No. 4,208,054

THE PROCTER & GAMBLE COMPANY (OHIO CORPORATION)
ONE PROCTER & GAMBLE PLAZA
CINCINNATI, OH 45202

Registered Sep. 11, 2012

Int. Cl.: 5

FOR: CATAMENIAL PRODUCTS, NAMELY, PANTILINERS, IN CLASS 5 (U.S. CLS. 6, 18, 44, 46, 51 AND 52).

TRADEMARK

FIRST USE 2-29-2012; IN COMMERCE 2-29-2012.

SUPPLEMENTAL REGISTER

THE MARK CONSISTS OF STANDARD CHARACTERS WITHOUT CLAIM TO ANY PARTICULAR FONT, STYLE, SIZE, OR COLOR.

SER. NO. 85-528,807, FILED P.R. 1-30-2012; AM. S.R. 7-31-2012.

ELI HELLMAN, EXAMINING ATTORNEY



David J. Kybas

Director of the United States Patent and Trademark Office

United States of America

United States Patent and Trademark Office

CAMPUS STORAGE

Reg. No. 4,208,055

CAMPUS STORAGE, LLC (CALIFORNIA LIMITED LIABILITY COMPANY)
1590-D ROSECRANS AVENUE, #224
MANHATTAN BEACH, CA 90266

Registered Sep. 11, 2012

Int. Cl.: 39

FOR: MOVING AND STORAGE OF PERSONAL BELONGINGS FOR COLLEGE STUDENTS,
IN CLASS 39 (U.S. CLS. 100 AND 105).

SERVICE MARK

FIRST USE 12-18-2008; IN COMMERCE 12-18-2008.

SUPPLEMENTAL REGISTER

THE MARK CONSISTS OF STANDARD CHARACTERS WITHOUT CLAIM TO ANY PARTICULAR FONT, STYLE, SIZE, OR COLOR.

NO CLAIM IS MADE TO THE EXCLUSIVE RIGHT TO USE "STORAGE", APART FROM THE MARK AS SHOWN.

SER. NO. 85-529,167, FILED P.R. 1-30-2012; AM. S.R. 6-27-2012.

KHANH LE, EXAMINING ATTORNEY



David J. Kybas

Director of the United States Patent and Trademark Office

United States of America

United States Patent and Trademark Office

USA Pain Professionals

Reg. No. 4,208,056 NEW MEXICO PAIN SPECIALISTS, LLC (NEW MEXICO LIMITED LIABILITY COMPANY)
4619 GREENE ST, NW
Registered Sep. 11, 2012 ALBUQUERQUE, NM 87114

Int. Cl.: 44 FOR: MEDICAL SERVICES, NAMELY, PAIN MEDICINE AND PAIN MANAGEMENT, IN CLASS 44 (U.S. CLS. 100 AND 101).

SERVICE MARK FIRST USE 11-1-2011; IN COMMERCE 1-1-2012.

SUPPLEMENTAL REGISTER THE MARK CONSISTS OF STANDARD CHARACTERS WITHOUT CLAIM TO ANY PARTICULAR FONT, STYLE, SIZE, OR COLOR.

NO CLAIM IS MADE TO THE EXCLUSIVE RIGHT TO USE "PAIN", APART FROM THE MARK AS SHOWN.

SER. NO. 85-529,256, FILED P.R. 1-31-2012; AM. S.R. 7-16-2012.

MARK RADEMACHER, EXAMINING ATTORNEY



David J. Kyffers

Director of the United States Patent and Trademark Office

United States of America

United States Patent and Trademark Office



Reg. No. 4,208,057

FLOYD-WICKS, AYANNA, NICOLE (UNITED STATES INDIVIDUAL), DBA TWIRL POWER,
17469 HATTERAS STREET
ENCINO, CA 91316

Registered Sep. 11, 2012

Int. Cl.: 25

FOR: APPAREL FOR DANCERS, NAMELY, TEE SHIRTS, SWEATSHIRTS, PANTS, LEG-
GINGS, SHORTS AND JACKETS, IN CLASS 25 (U.S. CLS. 22 AND 39).

TRADEMARK

FIRST USE 4-26-2008; IN COMMERCE 2-1-2009.

SUPPLEMENTAL REGISTER

THE MARK CONSISTS OF A FEMALE POLE FITNESS DANCER SILHOUETTE ON A POLE THAT EXTENDS FROM A STYLIZED HEART SHAPED LOTUS FLOWER "O" CONTAINED IN THE WORD "POWER". THE WORDS "TWIRL POWER ONE REVOLUTION AT A TIME" ARE STAGGERED AND SPACED ON THREE SEPARATE LINES. THE WORD "TWIRL" IS TYPED IN STUYVESANT BT REGULAR FONT AND IS POSITIONED ON THE FIRST LINE, "POWER" IS TYPED IN MYRIAD FONT AND IS POSITIONED ON THE SECOND LINE, AND "ONE REVOLUTION AT A TIME" IS TYPED IN HELVETICA FONT AND IS ON THE THIRD LINE.

SER. NO. 85-530,509, FILED P.R. 2-1-2012; AM. S.R. 8-1-2012.

TASNEEM HUSSAIN, EXAMINING ATTORNEY



David J. Kyros

Director of the United States Patent and Trademark Office

United States of America

United States Patent and Trademark Office

PINK FROSTED ANIMAL CRACKER

Reg. No. 4,208,058

PHILOSOPHY, INC. (ARIZONA CORPORATION)
3809 EAST WATKINS STREET
PHOENIX, AZ 85034

Registered Sep. 11, 2012

Int. Cl.: 3

FOR: LIP GLOSS; NON-MEDICATED BATH PREPARATIONS, IN CLASS 3 (U.S. CLS. 1, 4, 6, 50, 51 AND 52).

TRADEMARK

FIRST USE 4-9-2012; IN COMMERCE 4-9-2012.

SUPPLEMENTAL REGISTER

THE MARK CONSISTS OF STANDARD CHARACTERS WITHOUT CLAIM TO ANY PARTICULAR FONT, STYLE, SIZE, OR COLOR.

SER. NO. 85-531,987, FILED P.R. 2-2-2012; AM. S.R. 6-25-2012.

ERIN FALK, EXAMINING ATTORNEY



David J. Kyffers

Director of the United States Patent and Trademark Office

United States of America

United States Patent and Trademark Office

RADIAL 240 R4

Reg. No. 4,208,059

WEBB, DAVID (UNITED STATES INDIVIDUAL), DBA HILL TOP TIRE,
402 ST HWY 163

Registered Sep. 11, 2012

FORT PLAIN, NY 13339

Int. Cl.: 12

FOR: TIRES; TIRES FOR LAND VEHICLES; TIRES FOR VEHICLES, IN CLASS 12 (U.S. CLS. 19, 21, 23, 31, 35 AND 44).

TRADEMARK

FIRST USE 12-1-2011; IN COMMERCE 12-1-2011.

SUPPLEMENTAL REGISTER

THE MARK CONSISTS OF STANDARD CHARACTERS WITHOUT CLAIM TO ANY PARTICULAR FONT, STYLE, SIZE, OR COLOR.

NO CLAIM IS MADE TO THE EXCLUSIVE RIGHT TO USE "RADIAL" AND "R4", APART FROM THE MARK AS SHOWN.

SER. NO. 85-535,970, FILED P.R. 2-7-2012; AM. S.R. 7-10-2012.

DANIEL CAPSHAW, EXAMINING ATTORNEY



David J. Kyros

Director of the United States Patent and Trademark Office

United States of America

United States Patent and Trademark Office

Kalita

Reg. No. 4,208,060

KALITA CO., LTD. (JAPAN CORPORATION)

Registered Sep. 11, 2012

1-111-1 KOYASUDORI, KANAGAWA-KU,
YOKOHAMA-SHI, KANAGAWA, JAPAN 221-0021

Int. Cls.: 11, 16, and 21

FOR: ELECTRIC COFFEE MAKERS FOR BUSINESS PURPOSES, ELECTRIC COFFEE WARMERS FOR BUSINESS PURPOSES, INSULATED REFRIGERATED AND/OR HEATED CABINETS AND CONTAINERS FOR KEEPING DISHES OR HAND TOWELS KNOWN AS OSHIBORI COOL OR WARM, ELECTRIC COFFEE DISPENSERS FOR BUSINESS PURPOSES, ELECTRIC WARMTH-KEEPING RESERVOIRS USED WITH COFFEE MAKERS AND COFFEE WARMERS FOR BUSINESS PURPOSES, ELECTRIC CUP WARMERS FOR BUSINESS PURPOSES, WATER FILTERS FOR THE EXCLUSIVE USE OF COFFEE MAKERS FOR BUSINESS PURPOSES, WATER FILTERS FOR TAPS, ELECTRIC COFFEE MAKERS FOR HOUSEHOLD PURPOSES; COFFEE FILTERS MADE OF FLANNEL FOR USE WITH ELECTRIC COFFEE MAKERS; ELECTRIC WATER DRIP COFFEE MAKERS, IN CLASS 11 (U.S. CLS. 13, 21, 23, 31 AND 34).

TRADEMARK

SUPPLEMENTAL REGISTER

FOR: COFFEE FILTERS MADE OF PAPER, IN CLASS 16 (U.S. CLS. 2, 5, 22, 23, 29, 37, 38 AND 50).

FOR: COFFEE FILTERS MADE OF FLANNEL FOR USE WITH NON-ELECTRIC COFFEE MAKERS, NON-ELECTRIC COFFEE PERCOLATORS, CUPS WITH COFFEE STRAINERS, NON-ELECTRIC VACUUM COFFEE MAKERS, COFFEE CUPS, HAND-OPERATED COFFEE GRINDERS, DECANTERS FOR COFFEE, NON-ELECTRIC COFFEE STRAINERS, NON-PRECIOUS METAL SERVERS FOR COFFEE AND TEA THAT ARE NON-ELECTRIC, NON-PRECIOUS METAL COFFEE POTS THAT ARE NON-ELECTRIC, NON-ELECTRIC COOLERS FOR COFFEE DRIPPERS, NON-PRECIOUS METAL TEA POTS AND SUGAR POTS AND MILK POTS, NON-PRECIOUS METAL TRAYS, NON-PRECIOUS METAL POTS FOR CAFE AU LAIT THAT ARE NON-ELECTRIC, COFFEE PRESERVING JARS OF GLASS, NON-ELECTRIC COFFEE OR TEA CUP OR POT STANDS EQUIPPED WITH CANDLE HOLDER FOR WARMING BEVERAGES, NON-ELECTRIC WATER DRIP COFFEE MAKERS, NON-ELECTRIC COFFEE DRIPPER FOR BREWING COFFEE, COFFEE STRAINER STANDS FOR BREWING COFFEE BY NON-ELECTRIC MEANS, WIRE MESH HOLDERS FOR COFFEE FILTERS FOR BREWING COFFEE BY NON-ELECTRIC MEANS, FRAMES FOR COFFEE FILTERS FOR BREWING COFFEE BY NON-ELECTRIC MEANS, IN CLASS 21 (U.S. CLS. 2, 13, 23, 29, 30, 33, 40 AND 50).



David J. Kyjars

Director of the United States Patent and Trademark Office

OWNER OF JAPAN REG. NO. 4380035, DATED 4-28-2000, EXPIRES 4-28-2020.

Reg. No. 4,208,060 OWNER OF JAPAN REG. NO. 2107355, DATED 1-23-1989, EXPIRES 1-23-2019.

OWNER OF JAPAN REG. NO. 4330983, DATED 10-29-1999, EXPIRES 10-29-2019.

THE MARK CONSISTS OF THE WORDING "KALITA" IN STYLIZED LETTERS.

SER. NO. 85-537,595, FILED P.R. 2-8-2012; AM. S.R. 7-11-2012.

BARBARA BROWN, EXAMINING ATTORNEY

United States of America

United States Patent and Trademark Office

MS. VETERAN AMERICA

Reg. No. 4,208,061

FINAL SALUTE INC. (VIRGINIA CORPORATION)

Registered Sep. 11, 2012

P.O. BOX 156
HAYMARKET, VA 20168

Int. Cl.: 41

FOR: ENTERTAINMENT IN THE NATURE OF BEAUTY PAGEANTS, IN CLASS 41 (U.S. CLS. 100, 101 AND 107).

SERVICE MARK

FIRST USE 1-16-2012; IN COMMERCE 3-13-2012.

SUPPLEMENTAL REGISTER

THE MARK CONSISTS OF STANDARD CHARACTERS WITHOUT CLAIM TO ANY PARTICULAR FONT, STYLE, SIZE, OR COLOR.

SER. NO. 85-540,018, FILED P.R. 2-10-2012; AM. S.R. 7-3-2012.

CORY BOONE, EXAMINING ATTORNEY



David J. Kyffers

Director of the United States Patent and Trademark Office

United States of America
United States Patent and Trademark Office

**SPORTS
GUARD**

Reg. No. 4,208,062

SPORTSGUARD, LLC (NEW JERSEY LIMITED LIABILITY COMPANY)
522 ROUTE 18

Registered Sep. 11, 2012

EAST BRUNSWICK, NJ 08816

Int. Cl.: 28

FOR: PROTECTIVE PADDING FOR PLAYING BASEBALL AND SOFTBALL, IN CLASS 28
(U.S. CLS. 22, 23, 38 AND 50).

TRADEMARK

FIRST USE 3-3-2010; IN COMMERCE 3-3-2010.

SUPPLEMENTAL REGISTER

OWNER OF U.S. REG. NO. 4,033,739.

THE MARK CONSISTS OF THE WORD "SPORTS" IS ABOVE THE WORD "GUARD" SUCH
THAT THE BOTTOM OF THE INITIAL LETTER "S" IN "SPORTS" AND THE TOP OF THE
LETTER "G" IN "GUARD" ARE FORMED BY A COMMON LINE.

SER. NO. 85-544,329, FILED 2-16-2012.

NELSON SNYDER, EXAMINING ATTORNEY



David J. Kyros

Director of the United States Patent and Trademark Office

United States of America

United States Patent and Trademark Office

OXYGEN ELEMENTS

Reg. No. 4,208,063

GLOBAL HEALTH TRAX INC. (NEVADA CORPORATION)
2465 ASH STREET
VISTA, CA 92081

Registered Sep. 11, 2012

Int. Cl.: 5

FOR: DIETARY SUPPLEMENTS MADE IN SIGNIFICANT PART OF THE CHEMICAL ELEMENT OXYGEN, IN CLASS 5 (U.S. CLS. 6, 18, 44, 46, 51 AND 52).

TRADEMARK

FIRST USE 6-1-2003; IN COMMERCE 6-1-2003.

SUPPLEMENTAL REGISTER

THE MARK CONSISTS OF STANDARD CHARACTERS WITHOUT CLAIM TO ANY PARTICULAR FONT, STYLE, SIZE, OR COLOR.

SER. NO. 85-548,654, FILED 2-21-2012.

MATTHEW GALAN, EXAMINING ATTORNEY



David J. Kyros

Director of the United States Patent and Trademark Office

United States of America

United States Patent and Trademark Office

SPA Trust

Reg. No. 4,208,064

LEE S. MCCULLOUGH, III, P.C. (UTAH CORPORATION)
5255 N. EDGEWOOD DR. STE 100
PROVO, UT 84604

Registered Sep. 11, 2012

Int. Cl.: 36

FOR: FINANCIAL AND ESTATE PLANNING SERVICES, IN CLASS 36 (U.S. CLS. 100, 101 AND 102).

SERVICE MARK

FIRST USE 2-28-2010; IN COMMERCE 2-28-2010.

SUPPLEMENTAL REGISTER

THE MARK CONSISTS OF STANDARD CHARACTERS WITHOUT CLAIM TO ANY PARTICULAR FONT, STYLE, SIZE, OR COLOR.

NO CLAIM IS MADE TO THE EXCLUSIVE RIGHT TO USE "TRUST", APART FROM THE MARK AS SHOWN.

SER. NO. 85-548,968, FILED P.R. 2-21-2012; AM. S.R. 6-14-2012.

FLORENTINA BLANDU, EXAMINING ATTORNEY



David J. Kyffers

Director of the United States Patent and Trademark Office

United States of America

United States Patent and Trademark Office

ALARM PAD

Reg. No. 4,208,065

Registered Sep. 11, 2012

Int. Cl.: 28

TRADEMARK

SUPPLEMENTAL REGISTER

WILD PLANET ENTERTAINMENT, INC. (CALIFORNIA CORPORATION)
13TH FLOOR
225 BUSH STREET
SAN FRANCISCO, CA 94104

FOR: TOYS, GAMES, AND PLAYTHINGS, NAMELY, A MOTION SENSOR ALARM USING INFRARED TECHNOLOGY, IN CLASS 28 (U.S. CLS. 22, 23, 38 AND 50).

FIRST USE 7-15-2012; IN COMMERCE 7-15-2012.

THE MARK CONSISTS OF STANDARD CHARACTERS WITHOUT CLAIM TO ANY PARTICULAR FONT, STYLE, SIZE, OR COLOR.

SER. NO. 85-549,949, FILED P.R. 2-22-2012; AM. S.R. 7-18-2012.

BARBARA GAYNOR, EXAMINING ATTORNEY



David J. Kybas

Director of the United States Patent and Trademark Office

United States of America

United States Patent and Trademark Office

HOME & DESIGN

Reg. No. 4,208,066

Registered Sep. 11, 2012

Int. Cl.: 41

SERVICE MARK

SUPPLEMENTAL REGISTER

SPANO, ANTHONY (UNITED STATES INDIVIDUAL)
#105
975 IMPERIAL GOLF COURSE BLVD.
NAPLES, FL 34110

FOR: ENTERTAINMENT SERVICES, NAMELY, PRODUCTION OF A SHOW FEATURING HOME CONSTRUCTION, HOME REMODELING, ARCHITECTURE, INTERIOR DESIGN, FURNISHINGS, HOME ACQUISITION AND SALES AND HOMEOWNER RESOURCES BROADCAST OVER THE INTERNET, IN CLASS 41 (U.S. CLS. 100, 101 AND 107).

FIRST USE 12-21-2010; IN COMMERCE 12-21-2010.

THE MARK CONSISTS OF STANDARD CHARACTERS WITHOUT CLAIM TO ANY PARTICULAR FONT, STYLE, SIZE, OR COLOR.

OWNER OF U.S. REG. NO. 3,312,581.

SER. NO. 85-550,571, FILED P.R. 2-23-2012; AM. S.R. 7-9-2012.

KATHLEEN M. VANSTON, EXAMINING ATTORNEY



David J. Kyffers

Director of the United States Patent and Trademark Office

United States of America

United States Patent and Trademark Office

ORLANDO HEALTH

Reg. No. 4,208,067

ORLANDO HEALTH, INC. (FLORIDA CORPORATION)

Registered Sep. 11, 2012

1414 KUHL AVENUE
ORLANDO, FL 32806

Int. Cls.: 41 and 44

FOR: EDUCATIONAL SERVICES, NAMELY, DEVELOPING, ARRANGING AND CONDUCTING CLASSES, SEMINARS, CONFERENCES, AND WORKSHOPS FOR HEALTH CARE PROFESSIONALS AND PATIENTS REGARDING THE TREATMENT AND PREVENTION OF ALL DISEASES AND INJURIES, REGARDING THE UNDERSTANDING AND IMPLEMENTATION OF HUMAN LIFESTYLE ACTIVITIES THAT PROMOTE GOOD HEALTH, AND REGARDING DISEASE MANAGEMENT PRACTICES AND TREATMENT TECHNIQUES FOR ALL FORMS OF DISEASE AND ILLNESS, AND DISTRIBUTION OF TRAINING MATERIAL IN CONNECTION THEREWITH, IN CLASS 41 (U.S. CLS. 100, 101 AND 107).

SERVICE MARK

SUPPLEMENTAL REGISTER

FIRST USE 10-1-2008; IN COMMERCE 10-1-2008.

FOR: PROVISION OF HEALTH CARE AND MEDICAL SERVICES BY HEALTH CARE PROFESSIONALS THROUGH A NETWORK OF HOSPITALS AND PHYSICIANS, IN CLASS 44 (U.S. CLS. 100 AND 101).

FIRST USE 10-1-2008; IN COMMERCE 10-1-2008.

THE MARK CONSISTS OF STANDARD CHARACTERS WITHOUT CLAIM TO ANY PARTICULAR FONT, STYLE, SIZE, OR COLOR.

NO CLAIM IS MADE TO THE EXCLUSIVE RIGHT TO USE "HEALTH", APART FROM THE MARK AS SHOWN.

SER. NO. 85-551,145, FILED P.R. 2-23-2012; AM. S.R. 7-11-2012.

DEBORAH LOBO, EXAMINING ATTORNEY



David J. Kyjars

Director of the United States Patent and Trademark Office

United States of America

United States Patent and Trademark Office

The Good Contractors List

Reg. No. 4,208,068

THE GOOD CONTRACTORS LIST, INC. (TEXAS CORPORATION)
706 PRAIRIEVIEW DR.
MANSFIELD, TX 76063

Registered Sep. 11, 2012

Int. Cl.: 35

FOR: ON-LINE BUSINESS DIRECTORIES FEATURING HOME SERVICE CONTRACTORS,
IN CLASS 35 (U.S. CLS. 100, 101 AND 102).

SERVICE MARK

FIRST USE 10-1-2011; IN COMMERCE 11-11-2011.

SUPPLEMENTAL REGISTER

THE MARK CONSISTS OF STANDARD CHARACTERS WITHOUT CLAIM TO ANY PARTICULAR FONT, STYLE, SIZE, OR COLOR.

NO CLAIM IS MADE TO THE EXCLUSIVE RIGHT TO USE "LIST", APART FROM THE MARK AS SHOWN.

SER. NO. 85-553,234, FILED P.R. 2-27-2012; AM. S.R. 7-25-2012.

CHRISTINA SOBRAL, EXAMINING ATTORNEY



David J. Kybas

Director of the United States Patent and Trademark Office

United States of America

United States Patent and Trademark Office

STEMdaily

Reg. No. 4,208,069

Registered Sep. 11, 2012

Int. Cl.: 9

TRADEMARK

SUPPLEMENTAL REGISTER

DIVERSIFIED SEARCH (DELAWARE CORPORATION)
SUITE 570, 1 COMMERCE SQUARE
2005 MARKET STREET
PHILADELPHIA, PA 19103

FOR: DOWNLOADABLE ELECTRONIC NEWSLETTERS IN THE FIELD OF STEM EDUCATION, IN CLASS 9 (U.S. CLS. 21, 23, 26, 36 AND 38).

FIRST USE 9-16-2011; IN COMMERCE 1-18-2012.

THE MARK CONSISTS OF STANDARD CHARACTERS WITHOUT CLAIM TO ANY PARTICULAR FONT, STYLE, SIZE, OR COLOR.

SER. NO. 85-556,820, FILED P.R. 2-29-2012; AM. S.R. 7-18-2012.

RON FAIRBANKS, EXAMINING ATTORNEY



David J. Kyffers

Director of the United States Patent and Trademark Office

United States of America

United States Patent and Trademark Office

Tasty

BRAND

Reg. No. 4,208,070

Registered Sep. 11, 2012

Int. Cls.: 29 and 30

TRADEMARK

SUPPLEMENTAL REGISTER

TASTY BRAND, INC. (CALIFORNIA CORPORATION)
24003 VENTURA BLVD. BLDG. A, SUITE 218
CALABASAS, CA 91302

FOR: FRUIT-BASED SNACK FOOD, IN CLASS 29 (U.S. CL. 46).

FIRST USE 9-30-2009; IN COMMERCE 9-30-2009.

FOR: READY TO EAT, CEREAL DERIVED FOOD BARS; COOKIES, IN CLASS 30 (U.S. CL. 46).

FIRST USE 9-30-2009; IN COMMERCE 9-30-2009.

OWNER OF U.S. REG. NOS. 3,743,442 AND 4,085,352.

NO CLAIM IS MADE TO THE EXCLUSIVE RIGHT TO USE "BRAND", APART FROM THE MARK AS SHOWN.

THE MARK CONSISTS OF THE WORD "TASTY" WRITTEN IN BUBBLE LETTERS WITH THE WORD "BRAND" UNDERNEATH.

SER. NO. 85-559,024, FILED P.R. 3-2-2012; AM. S.R. 7-16-2012.

IRA J. GOODSaid, EXAMINING ATTORNEY



David J. Kyffers

Director of the United States Patent and Trademark Office

United States of America

United States Patent and Trademark Office

NonDefensive Communication

Reg. No. 4,208,071

REID PH.D., KENNETH (UNITED STATES INDIVIDUAL)
658 CUMBRE VISTA
SANTA FE, NM 87501

Registered Sep. 11, 2012

Int. Cl.: 41

FOR: PROFESSIONAL COACHING SERVICES IN THE FIELD OF COMMUNICATION, IN CLASS 41 (U.S. CLS. 100, 101 AND 107).

SERVICE MARK

FIRST USE 6-1-2011; IN COMMERCE 7-1-2011.

SUPPLEMENTAL REGISTER

THE MARK CONSISTS OF STANDARD CHARACTERS WITHOUT CLAIM TO ANY PARTICULAR FONT, STYLE, SIZE, OR COLOR.

NO CLAIM IS MADE TO THE EXCLUSIVE RIGHT TO USE "COMMUNICATION", APART FROM THE MARK AS SHOWN.

SER. NO. 85-559,141, FILED P.R. 3-2-2012; AM. S.R. 8-2-2012.

IRA J. GOODSaid, EXAMINING ATTORNEY



David J. Kyffers

Director of the United States Patent and Trademark Office

United States of America

United States Patent and Trademark Office

EAST COAST MMA FIGHT SHOP

Reg. No. 4,208,072

LIPARI, ZACHARY (UNITED STATES INDIVIDUAL)
172 BEACH 142 STREET
NEPONSI, NY 11694

Registered Sep. 11, 2012

Int. Cl.: 25

FOR: CLOTHING, NAMELY, FOOTWEAR, HEADWEAR, HATS, TOPS, BOTTOMS, SHIRTS, T-SHIRTS, PANTS, SHORTS, SWEAT SHIRTS, LONG SLEEVE SHIRTS, TANK TOPS, AND THERMALS, IN CLASS 25 (U.S. CLS. 22 AND 39).

TRADEMARK

FIRST USE 10-30-2010; IN COMMERCE 3-14-2011.

SUPPLEMENTAL REGISTER

THE MARK CONSISTS OF STANDARD CHARACTERS WITHOUT CLAIM TO ANY PARTICULAR FONT, STYLE, SIZE, OR COLOR.

SER. NO. 85-561,070, FILED P.R. 3-6-2012; AM. S.R. 6-29-2012.

CHERYL CLAYTON, EXAMINING ATTORNEY



David J. Kyjars

Director of the United States Patent and Trademark Office

United States of America
United States Patent and Trademark Office

BOCCHI

Reg. No. 4,208,073

SANIKEY USA INC (GEORGIA CORPORATION)
5260 NASSER AVENUE
ALPHARETTA, GA 30005

Registered Sep. 11, 2012

Int. Cl.: 11

FOR: KITCHEN SINKS; LAVATORY BOWLS; SINK PEDESTALS; SINKS; TOILETS, IN CLASS 11 (U.S. CLS. 13, 21, 23, 31 AND 34).

TRADEMARK

FIRST USE 5-22-2008; IN COMMERCE 5-22-2008.

SUPPLEMENTAL REGISTER

THE MARK CONSISTS OF THE STYLIZED WORDING "BOCCHI".

SER. NO. 85-561,465, FILED P.R. 3-6-2012; AM. S.R. 7-12-2012.

ELLEN BURNS, EXAMINING ATTORNEY



David J. Kyros

Director of the United States Patent and Trademark Office

United States of America

United States Patent and Trademark Office

ALLIANCE FOR CONTINUING EDUCATION IN THE HEALTH PROFESSIONS

Reg. No. 4,208,074

Registered Sep. 11, 2012

Int. Cl.: 41

SERVICE MARK

SUPPLEMENTAL REGISTER

ALLIANCE FOR CONTINUING EDUCATION IN THE HEALTH PROFESSIONS
(CONNECTICUT CORPORATION)
1025 MONTGOMERY HIGHWAY; SUITE 105
BIRMINGHAM, AL 35216

FOR: EDUCATION SERVICES, NAMELY, PROVIDING CONTINUING PROFESSIONAL
EDUCATION COURSES IN THE FIELD OF MEDICINE , IN CLASS 41 (U.S. CLS. 100, 101
AND 107).

FIRST USE 1-22-2012; IN COMMERCE 1-22-2012.

THE MARK CONSISTS OF STANDARD CHARACTERS WITHOUT CLAIM TO ANY PAR-
TICULAR FONT, STYLE, SIZE, OR COLOR.

NO CLAIM IS MADE TO THE EXCLUSIVE RIGHT TO USE "CONTINUING EDUCATION",
APART FROM THE MARK AS SHOWN.

SER. NO. 85-562,680, FILED P.R. 3-7-2012; AM. S.R. 7-24-2012.

ELIZABETH KAJUBI, EXAMINING ATTORNEY



David J. Kyffers

Director of the United States Patent and Trademark Office

United States of America

United States Patent and Trademark Office

GRANDE PATISSERIE

Reg. No. 4,208,075

CLOVERHILL PASTRY-VEND, LLC (DELAWARE LIMITED LIABILITY COMPANY)
2035 N. NARAGANSETT AVE.
CHICAGO, IL 60609

Registered Sep. 11, 2012

Int. Cl.: 30

FOR: DANISH PASTRIES, IN CLASS 30 (U.S. CL. 46).

FIRST USE 4-19-2012; IN COMMERCE 4-19-2012.

TRADEMARK

THE MARK CONSISTS OF STANDARD CHARACTERS WITHOUT CLAIM TO ANY PARTICULAR FONT, STYLE, SIZE, OR COLOR.

SUPPLEMENTAL REGISTER

NO CLAIM IS MADE TO THE EXCLUSIVE RIGHT TO USE "PATISSERIE", APART FROM THE MARK AS SHOWN.

THE ENGLISH TRANSLATION OF THE FRENCH WORD "GRANDE" IN THE MARK IS BIG, OR GREAT/IMPORTANT.

THE ENGLISH TRANSLATION OF THE FRENCH WORD "PATISSERIE" IN THE MARK IS PASTRY, OR PASTRY SHOP.

SER. NO. 85-563,507, FILED P.R. 3-7-2012; AM. S.R. 7-23-2012.

CAITLIN WATTS-FITZGERALD, EXAMINING ATTORNEY



David J. Kybas

Director of the United States Patent and Trademark Office

United States of America

United States Patent and Trademark Office

Pet Pyramid

Reg. No. 4,208,076

DAVES INTERNATIONAL IMPORTS INC (NEW JERSEY CORPORATION)
132 FAIRFIELD ROAD
FAIRFIELD, NJ 07004

Registered Sep. 11, 2012

Int. Cl.: 20

FOR: PLAYHOUSES FOR PETS, IN CLASS 20 (U.S. CLS. 2, 13, 22, 25, 32 AND 50).

FIRST USE 6-22-2012; IN COMMERCE 6-22-2012.

TRADEMARK

THE MARK CONSISTS OF STANDARD CHARACTERS WITHOUT CLAIM TO ANY PARTICULAR FONT, STYLE, SIZE, OR COLOR.

SUPPLEMENTAL REGISTER

NO CLAIM IS MADE TO THE EXCLUSIVE RIGHT TO USE "PET", APART FROM THE MARK AS SHOWN.

SER. NO. 85-564,547, FILED P.R. 3-8-2012; AM. S.R. 6-26-2012.

PAM WILLIS, EXAMINING ATTORNEY



David J. Kyffers

Director of the United States Patent and Trademark Office

United States of America

United States Patent and Trademark Office

VOLITATION

Reg. No. 4,208,077

EMIRIMAGE CORPORATION (FLORIDA CORPORATION)

Registered Sep. 11, 2012

5269 N.W. 161 STREET
HIALEAH, FL 33014

Int. Cl.: 28

FOR: ELECTRONIC TOY VEHICLES; ELECTRONICALLY OPERATED TOY MOTOR VEHICLES; RADIO CONTROLLED TOY VEHICLES; REMOTE CONTROL TOYS, NAMELY, HELICOPTERS AND PLANES; TOY AIRPLANES, IN CLASS 28 (U.S. CLS. 22, 23, 38 AND 50).

TRADEMARK

SUPPLEMENTAL REGISTER FIRST USE 10-20-2009; IN COMMERCE 10-20-2009.

THE MARK CONSISTS OF STANDARD CHARACTERS WITHOUT CLAIM TO ANY PARTICULAR FONT, STYLE, SIZE, OR COLOR.

SER. NO. 85-565,492, FILED P.R. 3-9-2012; AM. S.R. 7-18-2012.

AMY C. KEAN, EXAMINING ATTORNEY



David J. Kyffers

Director of the United States Patent and Trademark Office

United States of America

United States Patent and Trademark Office

Five Hole Cornhole

Reg. No. 4,208,078

ERIC HARRIS PAVONY (UNITED STATES INDIVIDUAL)
132 HAVEMEYER STREET SUITE 3A
BROOKLYN, NY 11211

Registered Sep. 11, 2012

Int. Cl.: 28

FOR: TARGET GAMES, IN CLASS 28 (U.S. CLS. 22, 23, 38 AND 50).

FIRST USE 1-30-2012; IN COMMERCE 1-30-2012.

TRADEMARK

THE MARK CONSISTS OF STANDARD CHARACTERS WITHOUT CLAIM TO ANY PARTICULAR FONT, STYLE, SIZE, OR COLOR.

SUPPLEMENTAL REGISTER

NO CLAIM IS MADE TO THE EXCLUSIVE RIGHT TO USE "CORNHOLE", APART FROM THE MARK AS SHOWN.

SER. NO. 85-566,198, FILED P.R. 3-10-2012; AM. S.R. 7-18-2012.

JENNY PARK, EXAMINING ATTORNEY



David J. Kyffers

Director of the United States Patent and Trademark Office

United States of America

United States Patent and Trademark Office

POLICY INSPECTOR

Reg. No. 4,208,079

POLICY INSPECTOR, INC. (VERMONT CORPORATION)

Registered Sep. 11, 2012

PO BOX 304
STOWE, VT 05672

Int. Cl.: 36

FOR: INSURANCE CONSULTING AND INFORMATION CONCERNING INSURANCE PROVIDED TO BENEFICIARIES OF INSURANCE POLICIES, IN CLASS 36 (U.S. CLS. 100, 101 AND 102).

SERVICE MARK

FIRST USE 7-17-2012; IN COMMERCE 7-17-2012.

SUPPLEMENTAL REGISTER

THE MARK CONSISTS OF STANDARD CHARACTERS WITHOUT CLAIM TO ANY PARTICULAR FONT, STYLE, SIZE, OR COLOR.

SER. NO. 85-566,778, FILED P.R. 3-12-2012; AM. S.R. 7-19-2012.

KATHERINE M. DUBRAY, EXAMINING ATTORNEY



David J. Kybas

Director of the United States Patent and Trademark Office

United States of America

United States Patent and Trademark Office

Visual Diagnosis Series

Reg. No. 4,208,080

SHLAMOVITZ, GIL Z (ISRAEL INDIVIDUAL)
6255 SAN FELIPE ST
HOUSTON, TX 77057

Registered Sep. 11, 2012

Int. Cl.: 41

FOR: PUBLISHING OF BOOKS, E-BOOKS, AUDIO BOOKS, MUSIC AND ILLUSTRATIONS,
IN CLASS 41 (U.S. CLS. 100, 101 AND 107).

SERVICE MARK

FIRST USE 3-12-2012; IN COMMERCE 3-12-2012.

SUPPLEMENTAL REGISTER

THE MARK CONSISTS OF STANDARD CHARACTERS WITHOUT CLAIM TO ANY PARTICULAR FONT, STYLE, SIZE, OR COLOR.

NO CLAIM IS MADE TO THE EXCLUSIVE RIGHT TO USE "SERIES", APART FROM THE MARK AS SHOWN.

SER. NO. 85-567,028, FILED P.R. 3-12-2012; AM. S.R. 6-27-2012.

CIMMERIAN COLEMAN, EXAMINING ATTORNEY



David J. Kybas

Director of the United States Patent and Trademark Office

United States of America

United States Patent and Trademark Office

Rx Wire

Reg. No. 4,208,081

PHARMACEUTICAL STRATEGIES GROUP, LLC (TEXAS LIMITED LIABILITY COMPANY)
5360 LEGACY DRIVE, BLDG 4, SUITE 110
PLANO, TX 75024

Registered Sep. 11, 2012

Int. Cl.: 41

FOR: PROVIDING ON-LINE NEWSLETTERS IN THE FIELD OF PHARMACY INDUSTRY NEWS AND INFORMATION; PROVIDING ONLINE NEWSLETTERS IN THE FIELD OF PHARMACY INDUSTRY NEWS AND INFORMATION VIA E-MAIL, IN CLASS 41 (U.S. CLS. 100, 101 AND 107).

SERVICE MARK

SUPPLEMENTAL REGISTER FIRST USE 0-0-2010; IN COMMERCE 0-0-2010.

THE MARK CONSISTS OF STANDARD CHARACTERS WITHOUT CLAIM TO ANY PARTICULAR FONT, STYLE, SIZE, OR COLOR.

SER. NO. 85-567,817, FILED P.R. 3-13-2012; AM. S.R. 7-4-2012.

CURTIS FRENCH, EXAMINING ATTORNEY



David J. Kyffers

Director of the United States Patent and Trademark Office

United States of America

United States Patent and Trademark Office

DRAFT TRACKER

Reg. No. 4,208,082

SAM NELSON (UNITED STATES INDIVIDUAL)

Registered Sep. 11, 2012

153 TERRACE DRIVE
SAN FRANCISCO, CA 94127

Int. Cl.: 9

FOR: COMPUTER APPLICATION SOFTWARE FOR COMPUTERS AND MOBILE DEVICES, INCLUDING SMART PHONES, AND TABLET AND HANDHELD COMPUTERS, NAMELY, SOFTWARE FOR FOLLOWING SPORTING ACTIVITIES AND ALLOWING USERS TO INTERACT WITH AND FOLLOW THE SELECTION PROCESS OF VARIOUS SPORTING ACTIVITIES; COMPUTER GAME SOFTWARE, IN CLASS 9 (U.S. CLS. 21, 23, 26, 36 AND 38).

TRADEMARK

SUPPLEMENTAL REGISTER

FIRST USE 4-27-2011; IN COMMERCE 4-27-2011.

THE MARK CONSISTS OF STANDARD CHARACTERS WITHOUT CLAIM TO ANY PARTICULAR FONT, STYLE, SIZE, OR COLOR.

NO CLAIM IS MADE TO THE EXCLUSIVE RIGHT TO USE "TRACKER", APART FROM THE MARK AS SHOWN.

SER. NO. 85-568,031, FILED 3-13-2012.

JENNIFER RICHARDSON, EXAMINING ATTORNEY



David J. Kybas

Director of the United States Patent and Trademark Office

United States of America

United States Patent and Trademark Office

WALTERS WEDDING ESTATES

Reg. No. 4,208,083

WALTERS WEDDING ESTATES IP, LLC (TEXAS LIMITED LIABILITY COMPANY)
5804 SOUTHERN HILLS DRIVE
FLOWER MOUND, TX 75022

Registered Sep. 11, 2012

Int. Cl.: 45

FOR: PROVIDING FACILITIES FOR WEDDING CEREMONIES, IN CLASS 45 (U.S. CLS. 100 AND 101).

SERVICE MARK

FIRST USE 9-19-2011; IN COMMERCE 9-19-2011.

SUPPLEMENTAL REGISTER

THE MARK CONSISTS OF STANDARD CHARACTERS WITHOUT CLAIM TO ANY PARTICULAR FONT, STYLE, SIZE, OR COLOR.

NO CLAIM IS MADE TO THE EXCLUSIVE RIGHT TO USE "WEDDING ESTATES", APART FROM THE MARK AS SHOWN.

SER. NO. 85-568,917, FILED P.R. 3-14-2012; AM. S.R. 7-19-2012.

DORITT L. CARROLL, EXAMINING ATTORNEY



David J. Kybas

Director of the United States Patent and Trademark Office

United States of America

United States Patent and Trademark Office

IWINERY HONG KONG COMPANY LIMITED

Reg. No. 4,208,084

CHOI, JOHNSON (HONG KONG INDIVIDUAL)
1188 BISHOP ST STE 3403
HONOLULU, HI 96813

Registered Sep. 11, 2012

Int. Cl.: 33

FOR: WINES; ALCOHOLIC BEVERAGES EXCEPT BEERS; SPIRITS, IN CLASS 33 (U.S. CLS. 47 AND 49).

TRADEMARK

FIRST USE 6-18-2012; IN COMMERCE 6-18-2012.

SUPPLEMENTAL REGISTER

THE MARK CONSISTS OF STANDARD CHARACTERS WITHOUT CLAIM TO ANY PARTICULAR FONT, STYLE, SIZE, OR COLOR.

NO CLAIM IS MADE TO THE EXCLUSIVE RIGHT TO USE "HONG KONG COMPANY LIMITED", APART FROM THE MARK AS SHOWN.

SER. NO. 85-569,551, FILED P.R. 3-14-2012; AM. S.R. 7-24-2012.

NAAKWAMA ANKRAH, EXAMINING ATTORNEY



David J. Kybas

Director of the United States Patent and Trademark Office

United States of America

United States Patent and Trademark Office



Reg. No. 4,208,085

FARREN RACING LLC (DELAWARE LIMITED LIABILITY COMPANY)

Registered Sep. 11, 2012

711 PHILLIPS AVE
WILMINGTON, DE 19809

Int. Cl.: 41

FOR: ENTERTAINMENT SERVICES, NAMELY, PARTICIPATION IN MOTOCROSS RACES,
IN CLASS 41 (U.S. CLS. 100, 101 AND 107).

SERVICE MARK

FIRST USE 11-20-2010; IN COMMERCE 11-20-2010.

SUPPLEMENTAL REGISTER

NO CLAIM IS MADE TO THE EXCLUSIVE RIGHT TO USE "RACING", APART FROM THE
MARK AS SHOWN.

THE MARK CONSISTS OF THE STYLIZED TEXT "FARREN" ABOVE THE STYLIZED TEXT
"RACING". THERE IS A HORIZONTAL LINE BETWEEN THE TWO WORDS AND THE
LETTER "F" EXTENDS DOWN TO THE SECOND LINE OF TEXT.

SER. NO. 85-572,312, FILED 3-16-2012.

LIEF MARTIN, EXAMINING ATTORNEY



David J. Kybas

Director of the United States Patent and Trademark Office

United States of America

United States Patent and Trademark Office

Certified Social Marketer

Reg. No. 4,208,086

SOUZA, JOHN (UNITED STATES INDIVIDUAL)
4575 WEBB BRIDGE ROAD BOX 5394
ALPHARETTA, GA 30005

Registered Sep. 11, 2012

Int. Cl.: 41

FOR: EDUCATION SERVICES, NAMELY, PROVIDING WEB BASED TRAINING IN THE FIELD OF SOCIAL MEDIA MANAGEMENT, IN CLASS 41 (U.S. CLS. 100, 101 AND 107).

SERVICE MARK

FIRST USE 3-17-2012; IN COMMERCE 3-17-2012.

SUPPLEMENTAL REGISTER

THE MARK CONSISTS OF STANDARD CHARACTERS WITHOUT CLAIM TO ANY PARTICULAR FONT, STYLE, SIZE, OR COLOR.

OWNER OF U.S. REG. NOS. 3,899,818, 3,900,172, AND OTHERS.

SER. NO. 85-572,421, FILED P.R. 3-17-2012; AM. S.R. 7-4-2012.

CHERYL CLAYTON, EXAMINING ATTORNEY



David J. Kybas

Director of the United States Patent and Trademark Office

United States of America

United States Patent and Trademark Office

Certified Social Media Consultant

Reg. No. 4,208,087

SOUZA, JOHN (UNITED STATES INDIVIDUAL)
4575 WEBB BRIDGE ROAD BOX 5394
ALPHARETTA, GA 30005

Registered Sep. 11, 2012

Int. Cl.: 41

FOR: EDUCATION SERVICES, NAMELY, PROVIDING WEB BASED TRAINING IN THE FIELD OF SOCIAL MEDIA MANAGEMENT, IN CLASS 41 (U.S. CLS. 100, 101 AND 107).

SERVICE MARK

FIRST USE 3-17-2012; IN COMMERCE 3-17-2012.

SUPPLEMENTAL REGISTER

THE MARK CONSISTS OF STANDARD CHARACTERS WITHOUT CLAIM TO ANY PARTICULAR FONT, STYLE, SIZE, OR COLOR.

OWNER OF U.S. REG. NOS. 3,899,818, 3,900,172, AND OTHERS.

SER. NO. 85-572,423, FILED P.R. 3-17-2012; AM. S.R. 7-4-2012.

CHERYL CLAYTON, EXAMINING ATTORNEY



David J. Kybas

Director of the United States Patent and Trademark Office

United States of America

United States Patent and Trademark Office

Certified Social Media Marketer

Reg. No. 4,208,088

SOUZA, JOHN (UNITED STATES INDIVIDUAL)
4575 WEBB BRIDGE ROAD BOX 5394
ALPHARETTA, GA 30005

Registered Sep. 11, 2012

Int. Cl.: 41

FOR: EDUCATION SERVICES, NAMELY, PROVIDING WEB BASED TRAINING IN THE FIELD OF SOCIAL MEDIA MANAGEMENT, IN CLASS 41 (U.S. CLS. 100, 101 AND 107).

SERVICE MARK

FIRST USE 3-17-2012; IN COMMERCE 3-17-2012.

SUPPLEMENTAL REGISTER

THE MARK CONSISTS OF STANDARD CHARACTERS WITHOUT CLAIM TO ANY PARTICULAR FONT, STYLE, SIZE, OR COLOR.

OWNER OF U.S. REG. NOS. 3,899,818, 3,900,172, AND OTHERS.

SER. NO. 85-572,424, FILED P.R. 3-17-2012; AM. S.R. 7-4-2012.

CHERYL CLAYTON, EXAMINING ATTORNEY



David J. Kyffers

Director of the United States Patent and Trademark Office

United States of America

United States Patent and Trademark Office

Certified Social Media Strategist

Reg. No. 4,208,089

SOUZA, JOHN (UNITED STATES INDIVIDUAL)
4575 WEBB BRIDGE RD. BOX 5394
ALPHARETTA, GA 30005

Registered Sep. 11, 2012

Int. Cl.: 41

FOR: EDUCATION SERVICES, NAMELY, PROVIDING WEB BASED TRAINING IN THE FIELD OF SOCIAL MEDIA MANAGEMENT, IN CLASS 41 (U.S. CLS. 100, 101 AND 107).

SERVICE MARK

FIRST USE 3-17-2012; IN COMMERCE 3-17-2012.

SUPPLEMENTAL REGISTER

THE MARK CONSISTS OF STANDARD CHARACTERS WITHOUT CLAIM TO ANY PARTICULAR FONT, STYLE, SIZE, OR COLOR.

OWNER OF U.S. REG. NOS. 3,899,818, 3,900,172, AND OTHERS.

SER. NO. 85-572,427, FILED P.R. 3-17-2012; AM. S.R. 7-4-2012.

CHERYL CLAYTON, EXAMINING ATTORNEY



David J. Kybas

Director of the United States Patent and Trademark Office

United States of America

United States Patent and Trademark Office

CONVENIENT CLEANERS

Reg. No. 4,208,090

Registered Sep. 11, 2012

Int. Cl.: 37

SERVICE MARK

SUPPLEMENTAL REGISTER

CONVENIENT CLEANERS, LLC (FLORIDA LIMITED LIABILITY COMPANY)
SUITE 103
410 EAST JACKSON STREET
TAMPA, FL 33602

FOR: DRY CLEANING, IN CLASS 37 (U.S. CLS. 100, 103 AND 106).

FIRST USE 3-31-2010; IN COMMERCE 3-31-2010.

THE MARK CONSISTS OF STANDARD CHARACTERS WITHOUT CLAIM TO ANY PARTICULAR FONT, STYLE, SIZE, OR COLOR.

NO CLAIM IS MADE TO THE EXCLUSIVE RIGHT TO USE "CLEANERS", APART FROM THE MARK AS SHOWN.

SER. NO. 85-572,897, FILED P.R. 3-19-2012; AM. S.R. 7-9-2012.

MYRIAH HABEEB, EXAMINING ATTORNEY



David J. Kyffers

Director of the United States Patent and Trademark Office

United States of America

United States Patent and Trademark Office



Reg. No. 4,208,091

Registered Sep. 11, 2012

Int. Cl.: 26

TRADEMARK

SUPPLEMENTAL REGISTER

ARIZONA DEPARTMENT OF PUBLIC SAFETY (ARIZONA STATE AGENCY)
MAILDROP 1200
2102 W ENCANTO BLVD
PHOENIX, AZ 85009

FOR: CLOTH PATCHES FOR CLOTHING; EMBROIDERED PATCHES FOR CLOTHING, IN CLASS 26 (U.S. CLS. 37, 39, 40, 42 AND 50).

FIRST USE 7-1-2011; IN COMMERCE 7-1-2011.

OWNER OF U.S. REG. NO. 3,618,715.

THE COLOR(S) BLUE, RED, YELLOW, BLACK, COPPER IS/ARE CLAIMED AS A FEATURE OF THE MARK.

NO CLAIM IS MADE TO THE EXCLUSIVE RIGHT TO USE "DEPARTMENT OF PUBLIC SAFETY" AND "ARIZONA HIGHWAY PATROL" AND THE DESIGN OF THE MAP OF ARIZONA, APART FROM THE MARK AS SHOWN.

THE MARK CONSISTS OF SHAPE OF THE STATE OF ARIZONA. BLUE BACKGROUND ON THE TOP AND BOTTOM UNDER THE WORDING. RED IS FOR THE 1ST, 3RD, 5TH, 7TH, 9TH, 11TH, AND 13TH RAYS COMING OUT OF THE STAR. YELLOW IS FOR THE LETTERING "DEPARTMENT OF PUBLIC SAFETY" AND "ARIZONA HIGHWAY PATROL", BORDER INSIDE OF BLACK BORDER AND THE 2ND, 4TH, 6TH, 8TH, 10TH AND 12TH RAYS FROM THE STAR. BLACK IS IN THE BORDER. COPPER IS THE STAR IN THE CENTER.

SER. NO. 85-573,567, FILED P.R. 3-19-2012; AM. S.R. 7-24-2012.

ASMAT KHAN, EXAMINING ATTORNEY



David J. Kyffers

Director of the United States Patent and Trademark Office

United States of America

United States Patent and Trademark Office



Reg. No. 4,208,092

Registered Sep. 11, 2012

Int. Cl.: 26

TRADEMARK

SUPPLEMENTAL REGISTER

ARIZONA DEPARTMENT OF PUBLIC SAFETY (ARIZONA STATE AGENCY)
MAILDROP 1200
2102 W ENCANTO BLVD
PHOENIX, AZ 85009

FOR: CLOTH PATCHES FOR CLOTHING; EMBROIDERED PATCHES FOR CLOTHING, IN CLASS 26 (U.S. CLS. 37, 39, 40, 42 AND 50).

FIRST USE 7-1-2011; IN COMMERCE 7-1-2011.

OWNER OF U.S. REG. NO. 3,618,715.

THE COLOR(S) BLUE, RED, YELLOW, BLACK, COPPER IS/ARE CLAIMED AS A FEATURE OF THE MARK.

NO CLAIM IS MADE TO THE EXCLUSIVE RIGHT TO USE "DEPARTMENT OF PUBLIC SAFETY" AND "ARIZONA CAPITOL POLICE" AND THE DESIGN OF THE MAP OF ARIZONA, APART FROM THE MARK AS SHOWN.

THE MARK CONSISTS OF SHAPE OF THE STATE OF ARIZONA, BLUE BACKGROUND ON THE TOP AND BOTTOM UNDER THE WORDING. RED IS FOR THE 1ST, 3RD, 5TH, 7TH, 9TH, 11TH, AND 13TH RAYS COMING OUT OF THE STAR. YELLOW IS FOR THE LETTERING "DEPARTMENT OF PUBLIC SAFETY" AND "ARIZONA CAPITOL POLICE", BORDER INSIDE OF BLACK BORDER AND THE 2ND, 4TH, 6TH, 8TH, 10TH AND 12TH RAYS FROM THE STAR. BLACK IS IN THE BORDER. COPPER IS THE STAR IN THE CENTER.

SER. NO. 85-573,670, FILED P.R. 3-19-2012; AM. S.R. 7-24-2012.

ASMAT KHAN, EXAMINING ATTORNEY



David J. Kyffers

Director of the United States Patent and Trademark Office

United States of America
United States Patent and Trademark Office

Homiletix

Reg. No. 4,208,093

KURUVILLA, ABRAHAM (UNITED STATES INDIVIDUAL)
3411 BRYAN ST.
DALLAS, TX 75204

Registered Sep. 11, 2012

Int. Cl.: 45

FOR: PROVIDING A WEB SITE FEATURING INFORMATION ABOUT RELIGION, IN CLASS 45 (U.S. CLS. 100 AND 101).

SERVICE MARK

FIRST USE 9-5-2005; IN COMMERCE 9-5-2005.

SUPPLEMENTAL REGISTER

THE MARK CONSISTS OF STANDARD CHARACTERS WITHOUT CLAIM TO ANY PARTICULAR FONT, STYLE, SIZE, OR COLOR.

SER. NO. 85-574,970, FILED P.R. 3-20-2012; AM. S.R. 7-19-2012.

KELLY TRUSILO, EXAMINING ATTORNEY



David J. Kybas

Director of the United States Patent and Trademark Office

United States of America

United States Patent and Trademark Office

AMERICAN AKAUSHI ASSOCIATION

Reg. No. 4,208,094

AMERICAN AKAUSHI ASSOCIATION, INC. (TEXAS CORPORATION)

Registered Sep. 11, 2012

P.O. BOX 309
FLATONIA, TX 78941

Int. Cl.: 44

FOR: CATTLE THAT ARE OF THE LINEAGE AND HERITAGE OF THE AKAUSHI BREED,
IN CLASS A (U.S. CL. A).

CERTIFICATION MARK

FIRST USE 5-3-2010; IN COMMERCE 5-3-2010.

GOODS

THE MARK CONSISTS OF STANDARD CHARACTERS WITHOUT CLAIM TO ANY PAR-
TICULAR FONT, STYLE, SIZE, OR COLOR.

SUPPLEMENTAL REGISTER

NO CLAIM IS MADE TO THE EXCLUSIVE RIGHT TO USE "AKAUSHI ASSOCIATION",
APART FROM THE MARK AS SHOWN.

THE CERTIFICATION MARK, AS USED BY PERSONS AUTHORIZED BY THE CERTIFIER,
CERTIFIES THAT THE GOODS PROVIDED ARE OF THE LINEAGE AND HERITAGE OF
THE AKAUSHI BREED.

SER. NO. 85-576,508, FILED P.R. 3-22-2012; AM. S.R. 7-12-2012.

TASNEEM HUSSAIN, EXAMINING ATTORNEY



David J. Kyros

Director of the United States Patent and Trademark Office

United States of America
United States Patent and Trademark Office

QWIKVID

Reg. No. 4,208,095

QWIKVID, INC. (CALIFORNIA CORPORATION)
12397 MEADOWVALE ST
MIRA LOMA, CA 91752

Registered Sep. 11, 2012

Int. Cl.: 42

FOR: PROVIDING ONLINE, NON-DOWNLOADABLE SOFTWARE THAT ENABLES USERS OF GLOBAL COMPUTER NETWORKS TO CREATE SLIDESHOWS AND VIDEOS USING DIGITAL MEDIA SUCH AS PHOTOGRAPHS, MUSIC AND VIDEO , IN CLASS 42 (U.S. CLS. 100 AND 101).

SERVICE MARK

SUPPLEMENTAL REGISTER FIRST USE 1-18-2012; IN COMMERCE 1-18-2012.

THE MARK CONSISTS OF STANDARD CHARACTERS WITHOUT CLAIM TO ANY PARTICULAR FONT, STYLE, SIZE, OR COLOR.

SER. NO. 85-576,888, FILED P.R. 3-22-2012; AM. S.R. 7-2-2012.

DEZMONA MIZELLE, EXAMINING ATTORNEY



David J. Kyffers

Director of the United States Patent and Trademark Office

United States of America

United States Patent and Trademark Office

Reverse Logistics - Optimized

Reg. No. 4,208,096

PRODUCT SUPPORT SERVICES, INC. (DELAWARE CORPORATION)
511 S. ROYAL LANE
COPPELL, TX 75019

Registered Sep. 11, 2012

Int. Cl.: 35

FOR: BUSINESS MANAGEMENT SERVICES IN THE FIELD OF REVERSE LOGISTICS, NAMELY, BUSINESS MANAGEMENT SERVICES RELATING TO PRODUCT RETURNS MANAGEMENT, AUDIT, DISPOSITIONING, DEPOT REPAIR, REFURBISHMENT, RE-KITTING, REMARKETING AND SALVAGE, IN CLASS 35 (U.S. CLS. 100, 101 AND 102).

SERVICE MARK

SUPPLEMENTAL REGISTER FIRST USE 1-23-2012; IN COMMERCE 2-20-2012.

THE MARK CONSISTS OF STANDARD CHARACTERS WITHOUT CLAIM TO ANY PARTICULAR FONT, STYLE, SIZE, OR COLOR.

NO CLAIM IS MADE TO THE EXCLUSIVE RIGHT TO USE "REVERSE LOGISTICS", APART FROM THE MARK AS SHOWN.

SER. NO. 85-579,066, FILED P.R. 3-24-2012; AM. S.R. 7-18-2012.

NICHOLAS ALTREE, EXAMINING ATTORNEY



David J. Kyffers

Director of the United States Patent and Trademark Office

United States of America

United States Patent and Trademark Office

SHOFAR

Reg. No. 4,208,097

ELAG S.A.S. (ITALY CORPORATION)
CANNAREGIO 2904/A
VENEZIA, ITALY

Registered Sep. 11, 2012

Int. Cl.: 21

FOR: DECORATIVE GLASS, IN CLASS 21 (U.S. CLS. 2, 13, 23, 29, 30, 33, 40 AND 50).

FIRST USE 3-20-2012; IN COMMERCE 3-20-2012.

TRADEMARK

THE MARK CONSISTS OF STANDARD CHARACTERS WITHOUT CLAIM TO ANY PARTICULAR FONT, STYLE, SIZE, OR COLOR.

SUPPLEMENTAL REGISTER

THE NAME(S), PORTRAIT(S), AND/OR SIGNATURE(S) SHOWN IN THE MARK DOES NOT IDENTIFY A PARTICULAR LIVING INDIVIDUAL.

THE ENGLISH TRANSLATION OF "SHOFAR" IN THE MARK IS "HORN".

SER. NO. 85-580,741, FILED P.R. 3-27-2012; AM. S.R. 7-29-2012.

TRACY WHITTAKER-BROWN, EXAMINING ATTORNEY



David J. Kybas

Director of the United States Patent and Trademark Office

United States of America

United States Patent and Trademark Office

DEAFREVIEW

Reg. No. 4,208,098

Registered Sep. 11, 2012

Int. Cl.: 35

SERVICE MARK

SUPPLEMENTAL REGISTER

DEAF REVIEW, LLC (WASHINGTON LIMITED LIABILITY COMPANY)
3724 W. COMMODORE WAY
SEATTLE, WA 98199

FOR: PROVIDING AN INTERACTIVE WEBSITE FEATURING USER-SUBMITTED COMMENTS, REVIEWS, RATINGS, AND RECOMMENDATIONS CONCERNING BUSINESSES, ORGANIZATIONS, SERVICE PROVIDERS, AND THE PRODUCTS AND SERVICES OF OTHERS ALL FOR COMMERCIAL PURPOSES; ADVERTISING AND DIRECTORY SERVICES, NAMELY, PROVIDING AN ONLINE DIRECTORY OF BUSINESSES, ORGANIZATIONS, AND SERVICE PROVIDERS; PROMOTING THE GOODS AND SERVICES OF OTHERS BY PROVIDING AN INTERACTIVE WEBSITE FEATURING USER-SUBMITTED COMMENTS, REVIEWS, RATINGS, AND RECOMMENDATIONS; DISSEMINATION OF ADVERTISING FOR OTHERS VIA THE INTERNET, IN CLASS 35 (U.S. CLS. 100, 101 AND 102).

FIRST USE 3-19-2012; IN COMMERCE 3-19-2012.

THE MARK CONSISTS OF STANDARD CHARACTERS WITHOUT CLAIM TO ANY PARTICULAR FONT, STYLE, SIZE, OR COLOR.

SER. NO. 85-582,949, FILED P.R. 3-28-2012; AM. S.R. 7-16-2012.

DANIEL CAPSHAW, EXAMINING ATTORNEY



David J. Kyffers

Director of the United States Patent and Trademark Office

United States of America

United States Patent and Trademark Office

Universal Senior Care

Reg. No. 4,208,099

MATURE AMERICAN HEALTHCARE, LLC (FLORIDA LIMITED LIABILITY COMPANY)
4566 ORANGE BLVD, SUITE 1006
SANFORD, FL 32771

Registered Sep. 11, 2012

Int. Cl.: 36

FOR: INSURANCE BROKERAGE, IN CLASS 36 (U.S. CLS. 100, 101 AND 102).

SERVICE MARK

FIRST USE 2-16-2012; IN COMMERCE 2-16-2012.

SUPPLEMENTAL REGISTER

THE MARK CONSISTS OF STANDARD CHARACTERS WITHOUT CLAIM TO ANY PARTICULAR FONT, STYLE, SIZE, OR COLOR.

SER. NO. 85-584,639, FILED P.R. 3-30-2012; AM. S.R. 7-18-2012.

MEGHAN REINHART, EXAMINING ATTORNEY



David J. Kybas

Director of the United States Patent and Trademark Office

United States of America

United States Patent and Trademark Office

Primary Care Practice Advances in Chronic OA Management

Reg. No. 4,208,100

THE WYANOKE GROUP, INC. (NEW JERSEY CORPORATION)
6900 GROVE ROAD
THOROFARE, NJ 08086

Registered Sep. 11, 2012

Int. Cl.: 16

FOR: JOURNAL TO EDUCATE HEALTH CARE PROFESSIONALS IN DEVELOPMENTS IN OSTEOARTHRITIS, IN CLASS 16 (U.S. CLS. 2, 5, 22, 23, 29, 37, 38 AND 50).

TRADEMARK

FIRST USE 1-9-2012; IN COMMERCE 1-9-2012.

SUPPLEMENTAL REGISTER

THE MARK CONSISTS OF STANDARD CHARACTERS WITHOUT CLAIM TO ANY PARTICULAR FONT, STYLE, SIZE, OR COLOR.

OWNER OF U.S. REG. NO. 4,148,128.

SER. NO. 85-584,847, FILED P.R. 3-30-2012; AM. S.R. 7-24-2012.

DANIEL CAPSHAW, EXAMINING ATTORNEY



David J. Kyffers

Director of the United States Patent and Trademark Office

United States of America

United States Patent and Trademark Office

TOPPRODEALS

Reg. No. 4,208,101

VELPLEX, LLC (CALIFORNIA LIMITED LIABILITY COMPANY)
21515 HAWTHORNE BLVD. #1085
HAWTHORNE, CA 90503

Registered Sep. 11, 2012

Int. Cl.: 35

FOR: ON-LINE RETAIL STORE SERVICES FEATURING VETERINARY, MEDICAL, AND DENTAL PRODUCTS, IN CLASS 35 (U.S. CLS. 100, 101 AND 102).

SERVICE MARK

FIRST USE 5-30-2012; IN COMMERCE 5-30-2012.

SUPPLEMENTAL REGISTER

THE MARK CONSISTS OF STANDARD CHARACTERS WITHOUT CLAIM TO ANY PARTICULAR FONT, STYLE, SIZE, OR COLOR.

SER. NO. 85-586,006, FILED P.R. 4-1-2012; AM. S.R. 7-23-2012.

ALYSSA STEEL, EXAMINING ATTORNEY



David J. Kybas

Director of the United States Patent and Trademark Office

United States of America

United States Patent and Trademark Office

POINT-OF-USE GENERATION

Reg. No. 4,208,102

THE PERFECTLY GREEN CORP. (TEXAS CORPORATION)
2040 REDBUD BLVD STE 110
MCKINNEY, TX 75069

Registered Sep. 11, 2012

Int. Cl.: 40

FOR: ELECTRICITY GENERATION, IN CLASS 40 (U.S. CLS. 100, 103 AND 106).

SERVICE MARK

FIRST USE 3-1-2012; IN COMMERCE 3-1-2012.

SUPPLEMENTAL REGISTER

THE MARK CONSISTS OF STANDARD CHARACTERS WITHOUT CLAIM TO ANY PARTICULAR FONT, STYLE, SIZE, OR COLOR.

NO CLAIM IS MADE TO THE EXCLUSIVE RIGHT TO USE "GENERATION", APART FROM THE MARK AS SHOWN.

SER. NO. 85-586,933, FILED P.R. 4-2-2012; AM. S.R. 7-19-2012.

CHRISIE B. KING, EXAMINING ATTORNEY



David J. Kybas

Director of the United States Patent and Trademark Office

United States of America

United States Patent and Trademark Office

COLOR SPACE

Reg. No. 4,208,103

Registered Sep. 11, 2012

Int. Cl.: 2

TRADEMARK

SUPPLEMENTAL REGISTER

MERCK KGAA (FED REP GERMANY KOMMANDITGESELLSCHAFT AUF AKTIEN (KGAA))
FRANKFURTER STRASSE 250
D-64293 DARMSTADT, FED REP GERMANY

FOR: PAINTS, VARNISHES, LACQUERS; PRESERVATIVES AGAINST RUST IN THE NATURE OF A COATING AND PRESERVATIVES AGAINST THE DETERIORATION OF WOOD; COLORANTS; MORDANTS FOR USE IN THE WOOD-PROCESSING INDUSTRY; RAW NATURAL RESINS; METALS IN FOIL AND POWDER FORM FOR PAINTERS, DECORATORS, PRINTERS AND ARTISTS; PIGMENTS, IN CLASS 2 (U.S. CLS. 6, 11 AND 16).

THE MARK CONSISTS OF STANDARD CHARACTERS WITHOUT CLAIM TO ANY PARTICULAR FONT, STYLE, SIZE, OR COLOR.

PRIORITY CLAIMED UNDER SEC. 44(D) ON ERPN CMNTY TM OFC APPLICATION NO. 010407823, FILED 11-10-2011, REG. NO. 010407823, DATED 3-21-2012, EXPIRES 11-10-2021.

SER. NO. 85-589,930, FILED P.R. 4-5-2012; AM. S.R. 7-6-2012.

DOUGLAS LEE, EXAMINING ATTORNEY



David J. Kyffers

Director of the United States Patent and Trademark Office

United States of America

United States Patent and Trademark Office

ONCOLOGY CONSULTATIONS

Reg. No. 4,208,104

Registered Sep. 11, 2012

Int. Cl.: 41

SERVICE MARK

SUPPLEMENTAL REGISTER

PHYSICIANS' EDUCATION RESOURCE, LLC (NEW JERSEY LIMITED LIABILITY COMPANY)
666 PLAINSBORO ROAD
PLAINSBORO, NJ 08356

FOR: EDUCATIONAL SERVICES, NAMELY, PROVIDING LECTURES, INTERACTIVE DISCUSSIONS, HANDS-ON WORKSHOPS, AND BROADCAST SYMPOSIA IN THE FIELD OF ONCOLOGY AND DISTRIBUTING PRINTED COURSE MATERIALS IN CONNECTION THEREWITH; EDUCATIONAL SERVICES, NAMELY, PROVIDING ON-LINE ACTIVITIES IN THE NATURE OF COURSES, LECTURES, WORKSHOPS AND INTERACTIVE DISCUSSIONS IN THE FIELD OF ONCOLOGY, IN CLASS 41 (U.S. CLS. 100, 101 AND 107).

FIRST USE 10-0-2007; IN COMMERCE 10-0-2007.

THE MARK CONSISTS OF STANDARD CHARACTERS WITHOUT CLAIM TO ANY PARTICULAR FONT, STYLE, SIZE, OR COLOR.

SER. NO. 85-590,201, FILED 4-5-2012.

JAY FLOWERS, EXAMINING ATTORNEY



David J. Kyffers

Director of the United States Patent and Trademark Office

United States of America

United States Patent and Trademark Office

Libya-Analysis

Reg. No. 4,208,105

PACK, JASON I. (UNITED STATES INDIVIDUAL)
206 CHRISTOL ST
METUCHEN, NJ 08840

Registered Sep. 11, 2012

Int. Cl.: 35

FOR: BUSINESS CONSULTATION IN THE FIELD OF LIBYA; BUSINESS CONSULTING AND INFORMATION SERVICES; BUSINESS CONSULTING, INQUIRIES OR INFORMATION; INTERNATIONAL BUSINESS CONSULTING SERVICES RELATING TO CONDUCTING BUSINESS IN LIBYA, IN CLASS 35 (U.S. CLS. 100, 101 AND 102).

SERVICE MARK

SUPPLEMENTAL REGISTER FIRST USE 8-23-2011; IN COMMERCE 8-23-2011.

THE MARK CONSISTS OF STANDARD CHARACTERS WITHOUT CLAIM TO ANY PARTICULAR FONT, STYLE, SIZE, OR COLOR.

SER. NO. 85-591,264, FILED P.R. 4-6-2012; AM. S.R. 7-30-2012.

TASNEEM HUSSAIN, EXAMINING ATTORNEY

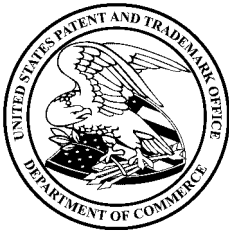

David J. Kybas

Director of the United States Patent and Trademark Office

United States of America

United States Patent and Trademark Office

DIRECT CREMATIONS ONLY

Reg. No. 4,208,106

DUNAWAY, JEFFREY (UNITED STATES INDIVIDUAL)
PO BOX 2996

Registered Sep. 11, 2012

ANNAPOLIS, MD 21404

Int. Cl.: 40

FOR: CREMATION SERVICES, IN CLASS 40 (U.S. CLS. 100, 103 AND 106).

SERVICE MARK

FIRST USE 10-14-2011; IN COMMERCE 10-23-2011.

SUPPLEMENTAL REGISTER

THE MARK CONSISTS OF STANDARD CHARACTERS WITHOUT CLAIM TO ANY PARTICULAR FONT, STYLE, SIZE, OR COLOR.

NO CLAIM IS MADE TO THE EXCLUSIVE RIGHT TO USE "CREMATIONS", APART FROM THE MARK AS SHOWN.

SER. NO. 85-592,138, FILED P.R. 4-9-2012; AM. S.R. 7-24-2012.

JENNIFER VASQUEZ, EXAMINING ATTORNEY



David J. Kyffers

Director of the United States Patent and Trademark Office

United States of America

United States Patent and Trademark Office

SHIRTS ON SITE

Reg. No. 4,208,107

SHIRTS ON SITE INC. (FLORIDA CORPORATION)
257 NE ARDSLEY DRIVE
PORT SAINT LUCIE, FL 34983

Registered Sep. 11, 2012

Int. Cl.: 40

FOR: APPAREL PRINTING SERVICES AND SCREEN PRINTING; IMPRINTING MESSAGES ON WEARING APPAREL, ACCESSORIES AND MUGS, IN CLASS 40 (U.S. CLS. 100, 103 AND 106).

SERVICE MARK

FIRST USE 10-15-2011; IN COMMERCE 10-17-2011.

SUPPLEMENTAL REGISTER

THE MARK CONSISTS OF STANDARD CHARACTERS WITHOUT CLAIM TO ANY PARTICULAR FONT, STYLE, SIZE, OR COLOR.

NO CLAIM IS MADE TO THE EXCLUSIVE RIGHT TO USE "SHIRTS", APART FROM THE MARK AS SHOWN.

SER. NO. 85-594,023, FILED P.R. 4-10-2012; AM. S.R. 7-24-2012.

ELISSA GARBER KON, EXAMINING ATTORNEY



David J. Kybas

Director of the United States Patent and Trademark Office

United States of America

United States Patent and Trademark Office

LAARTS
online.com

Reg. No. 4,208,108

Registered Sep. 11, 2012

Int. Cls.: 35 and 41

SERVICE MARK

SUPPLEMENTAL REGISTER

PAIGE PETRONE (UNITED STATES INDIVIDUAL)
12 24TH AVENUE, APARTMENT 3
VENICE, CA 90291

FOR: ADVERTISING AND BUSINESS SERVICES, NAMELY, SECURING AIRTIME ON ALL FORMS OF MEDIA COMMUNICATIONS STATIONS, SYSTEMS, NETWORKS, AND SERVICES FOR THE PURPOSE OF PROMOTING THE GOODS AND SERVICES OF OTHERS; ADVERTISING AND MARKETING SERVICES PROVIDED BY MEANS OF INDIRECT METHODS OF MARKETING COMMUNICATIONS, NAMELY, SOCIAL MEDIA, SEARCH ENGINE MARKETING, INQUIRY MARKETING, INTERNET MARKETING, MOBILE MARKETING, BLOGGING AND OTHER FORMS OF PASSIVE, SHARABLE OR VIRAL COMMUNICATIONS CHANNELS; PREPARATION AND REALIZATION OF MEDIA AND ADVERTISING PLANS AND CONCEPTS; PROMOTIONAL MARKETING SERVICES USING AUDIOVISUAL MEDIA; PROVIDING CONSULTING SERVICES IN THE FIELD OF FACILITATING THE PLANNING, BUYING, AND SELLING OF MEDIA; SOCIAL MEDIA STRATEGY AND MARKETING CONSULTANCY FOCUSING ON HELPING CLIENTS CREATE AND EXTEND THEIR PRODUCT AND BRAND STRATEGIES BY BUILDING VIRALLY ENGAGING MARKETING SOLUTIONS, IN CLASS 35 (U.S. CLS. 100, 101 AND 102).

FIRST USE 1-1-2012; IN COMMERCE 2-1-2012.



David J. Kyros

Director of the United States Patent and Trademark Office

FOR: CONTINUING PUBLIC SERVICE PROGRAMS IN THE FIELD OF ART, THEATRE, AND MUSIC EVENTS AND CELEBRITY NEWS PRODUCED AND DISTRIBUTED OVER TELEVISION, SATELLITE, FILM, AUDIO, VIDEO, INTERNET, AND 3-D VIRTUAL REALITY MEDIA; ENTERTAINMENT IN THE NATURE OF AN ON-GOING SPECIAL VARIETY, NEWS, MUSIC OR COMEDY SHOW FEATURING ART, THEATRE, AND MUSIC EVENTS AND CELEBRITY NEWS BROADCAST OVER TELEVISION, SATELLITE, AUDIO, AND VIDEO MEDIA; ENTERTAINMENT MEDIA PRODUCTION SERVICES FOR MOTION PICTURES, TELEVISION AND INTERNET; ENTERTAINMENT SERVICES, NAMELY, A MULTIMEDIA PROGRAM SERIES FEATURING COMEDY, ACTION AND ADVENTURE DISTRIBUTED VIA VARIOUS PLATFORMS ACROSS MULTIPLE FORMS OF TRANSMISSION MEDIA; ENTERTAINMENT SERVICES, NAMELY, PROVIDING A WEB SITE FEATURING NON-DOWNLOADABLE MUSICAL PERFORMANCES, MUSICAL VIDEOS, RELATED FILM CLIPS, PHOTOGRAPHS, AND OTHER MULTIMEDIA MATERIALS FEATURING ART, THEATRE, AND MUSIC EVENTS AND CELEBRITY NEWS; ENTERTAINMENT SERVICES, NAMELY, PROVIDING A WEB SITE FEATURING PHOTOGRAPHIC AND

Reg. No. 4,208,108 PROSE PRESENTATIONS FEATURING ART, THEATRE, AND MUSIC EVENTS AND CELEBRITY NEWS; ENTERTAINMENT SERVICES, NAMELY, PROVIDING A WEB SITE FEATURING PHOTOGRAPHIC, AUDIO, VIDEO AND PROSE PRESENTATIONS FEATURING ART EVENTS AND CELEBRITY NEWS; MEDIA PRODUCTION LOCATION SCOUTING SERVICES FOR ENTERTAINMENT PURPOSES; MEDIA PRODUCTION SERVICES, NAMELY, VIDEO AND FILM PRODUCTION, IN CLASS 41 (U.S. CLS. 100, 101 AND 107).

FIRST USE 1-1-2012; IN COMMERCE 2-1-2012.

NO CLAIM IS MADE TO THE EXCLUSIVE RIGHT TO USE "ONLINE.COM", APART FROM THE MARK AS SHOWN.

THE COLOR(S) RED, BLACK AND WHITE IS/ARE CLAIMED AS A FEATURE OF THE MARK.

THE MARK CONSISTS OF THE WORDS "LA ARTS ONLINE.COM". "LA" IS FILLED IN WITH THE COLOR RED AND IS OUTLINED IN BLACK AND DROP-SHADOW; "ARTS" IS FILLED IN WITH THE COLOR WHITE AND IS OUTLINED IN BLACK AND DROP-SHADOW; "ONLINE.COM" APPEARS IN BLACK.

SER. NO. 85-594,535, FILED P.R. 4-11-2012; AM. S.R. 8-1-2012.

CHRISIE B. KING, EXAMINING ATTORNEY

United States of America

United States Patent and Trademark Office

CENTER FOR ECOMMERCE EXCELLENCE

Reg. No. 4,208,109

D.L. RYAN COMPANIES, LLC (DELAWARE LIMITED LIABILITY COMPANY)
50 DANBURY ROAD
WILTON, CT 06897

Registered Sep. 11, 2012

Int. Cl.: 35

FOR: ADVERTISING, MARKETING AND PROMOTION SERVICES, IN CLASS 35 (U.S. CLS. 100, 101 AND 102).

SERVICE MARK

FIRST USE 6-11-2012; IN COMMERCE 6-11-2012.

SUPPLEMENTAL REGISTER

THE MARK CONSISTS OF STANDARD CHARACTERS WITHOUT CLAIM TO ANY PARTICULAR FONT, STYLE, SIZE, OR COLOR.

NO CLAIM IS MADE TO THE EXCLUSIVE RIGHT TO USE "CENTER", APART FROM THE MARK AS SHOWN.

SER. NO. 85-595,814, FILED P.R. 4-12-2012; AM. S.R. 8-1-2012.

IRA J. GOODSaid, EXAMINING ATTORNEY



David J. Kyffers

Director of the United States Patent and Trademark Office

United States of America

United States Patent and Trademark Office

Fundraising Firs

Reg. No. 4,208,110

FUNDRAISING FIRS, LLC (NORTH CAROLINA LIMITED LIABILITY COMPANY)
601 FEES BRANCH ROAD
LANSING, NC 28643 AND

Registered Sep. 11, 2012

Int. Cl.: 36

EYMER, MICHAEL STEPHEN (UNITED STATES INDIVIDUAL)
117 S TAFT HILL ROAD
FORT COLLINS, CO 80521

SERVICE MARK

SUPPLEMENTAL REGISTER

FOR: FUNDRAISING SERVICES, NAMELY, ORGANIZING, ARRANGING AND CONDUCTING FUNDRAISING PROGRAMS FOR THE BENEFIT OF SCHOOLS AND NON-PROFIT ORGANIZATIONS, IN CLASS 36 (U.S. CLS. 100, 101 AND 102).

FIRST USE 6-1-2008; IN COMMERCE 11-25-2008.

THE MARK CONSISTS OF STANDARD CHARACTERS WITHOUT CLAIM TO ANY PARTICULAR FONT, STYLE, SIZE, OR COLOR.

NO CLAIM IS MADE TO THE EXCLUSIVE RIGHT TO USE "FUNDRAISING", APART FROM THE MARK AS SHOWN.

SER. NO. 85-602,023, FILED P.R. 4-18-2012; AM. S.R. 8-2-2012.

JOHN HWANG, EXAMINING ATTORNEY



David J. Kyffers

Director of the United States Patent and Trademark Office

United States of America

United States Patent and Trademark Office

MALLOY

Reg. No. 4,208,111

LIM, TIFFANY (UNITED STATES INDIVIDUAL)
103 W. MARTIN LUTHER KING JR. BLVD.
LOS ANGELES, CA 90037

Registered Sep. 11, 2012

Int. Cl.: 25

FOR: CLOTHING, NAMELY, FOOTWEAR, HEADWEAR, TOPS, BOTTOMS, SHIRTS, PANTS, DRESSES; WOMEN'S CLOTHING, NAMELY, SHIRTS, DRESSES, SKIRTS, BLOUSES, IN CLASS 25 (U.S. CLS. 22 AND 39).

TRADEMARK

FIRST USE 2-1-2012; IN COMMERCE 2-29-2012.

SUPPLEMENTAL REGISTER

THE MARK CONSISTS OF STANDARD CHARACTERS WITHOUT CLAIM TO ANY PARTICULAR FONT, STYLE, SIZE, OR COLOR.

SER. NO. 85-609,970, FILED P.R. 4-27-2012; AM. S.R. 7-19-2012.

DAWN FELDMAN, EXAMINING ATTORNEY



David J. Kyffers

Director of the United States Patent and Trademark Office

United States of America

United States Patent and Trademark Office

DIAMOND COLLECTIBLES

Reg. No. 4,208,112

SUBERI BROTHERS LLC (NEW YORK LIMITED LIABILITY COMPANY)
902 BROADWAY, 14TH FLOOR
NEW YORK, NY 10010

Registered Sep. 11, 2012

Int. Cl.: 14

FOR: DIAMOND JEWELRY; DIAMONDS, IN CLASS 14 (U.S. CLS. 2, 27, 28 AND 50).

FIRST USE 7-22-2012; IN COMMERCE 7-22-2012.

TRADEMARK

THE MARK CONSISTS OF STANDARD CHARACTERS WITHOUT CLAIM TO ANY PARTICULAR FONT, STYLE, SIZE, OR COLOR.

SUPPLEMENTAL REGISTER

NO CLAIM IS MADE TO THE EXCLUSIVE RIGHT TO USE "DIAMOND", APART FROM THE MARK AS SHOWN.

SER. NO. 85-620,483, FILED P.R. 5-9-2012; AM. S.R. 7-30-2012.

THEODORE MCBRIDE, EXAMINING ATTORNEY



David J. Kyffers

Director of the United States Patent and Trademark Office

United States of America

United States Patent and Trademark Office

PUNCH TOP

Reg. No. 4,208,113

MILLERCOORS LLC (DELAWARE LIMITED LIABILITY COMPANY)
250 SOUTH WACKER DRIVE, SUITE 800
CHICAGO, IL 606065888

Registered Sep. 11, 2012

Int. Cl.: 32

FOR: BEER, IN CLASS 32 (U.S. CLS. 45, 46 AND 48).

TRADEMARK

FIRST USE 5-7-2012; IN COMMERCE 5-7-2012.

SUPPLEMENTAL REGISTER

THE MARK CONSISTS OF STANDARD CHARACTERS WITHOUT CLAIM TO ANY PARTICULAR FONT, STYLE, SIZE, OR COLOR.

SER. NO. 85-621,379, FILED 5-10-2012.

EVELYN BRADLEY, EXAMINING ATTORNEY



David J. Kyffers

Director of the United States Patent and Trademark Office

United States of America

United States Patent and Trademark Office

Cataract Refractive Surgical Practice Highlights

Reg. No. 4,208,114

THE WYANOKE GROUP, INC. (NEW JERSEY CORPORATION)
6900 GROVE ROAD
THOROFARE, NJ 08086

Registered Sep. 11, 2012

Int. Cl.: 9

FOR: DOWNLOADABLE ELECTRONIC PUBLICATIONS IN THE NATURE OF MEDICAL JOURNALS AND MAGAZINES IN THE FIELD OF OPHTHALMOLOGY, IN CLASS 9 (U.S. CLS. 21, 23, 26, 36 AND 38).

TRADEMARK

FIRST USE 5-10-2012; IN COMMERCE 5-10-2012.

SUPPLEMENTAL REGISTER

THE MARK CONSISTS OF STANDARD CHARACTERS WITHOUT CLAIM TO ANY PARTICULAR FONT, STYLE, SIZE, OR COLOR.

SER. NO. 85-622,486, FILED P.R. 5-11-2012; AM. S.R. 7-24-2012.

DANIEL CAPSHAW, EXAMINING ATTORNEY



David J. Kyffers

Director of the United States Patent and Trademark Office

United States of America

United States Patent and Trademark Office

REMOTE CHECKOUT

Reg. No. 4,208,115

Registered Sep. 11, 2012

Int. Cl.: 9

TRADEMARK

SUPPLEMENTAL REGISTER

J M SMITH CORPORATION (SOUTH CAROLINA CORPORATION)
POST OFFICE BOX 6052
SPARTANBURG, SC 29304

FOR: COMPUTER SOFTWARE FOR ACCOMMODATING MULTIPLE TYPES OF PAYMENT AND DEBIT TRANSACTIONS ON A MOBILE WIRELESS DEVICE, IN CLASS 9 (U.S. CLS. 21, 23, 26, 36 AND 38).

FIRST USE 4-3-2012; IN COMMERCE 4-3-2012.

THE MARK CONSISTS OF STANDARD CHARACTERS WITHOUT CLAIM TO ANY PARTICULAR FONT, STYLE, SIZE, OR COLOR.

NO CLAIM IS MADE TO THE EXCLUSIVE RIGHT TO USE "CHECKOUT", APART FROM THE MARK AS SHOWN.

SER. NO. 85-628,361, FILED P.R. 5-17-2012; AM. S.R. 6-8-2012.

DOMINIC J. FERRAIUOLO, EXAMINING ATTORNEY



David J. Kyffers

Director of the United States Patent and Trademark Office

United States of America

United States Patent and Trademark Office

KANSAS LAND & CATTLE COMPANY

Reg. No. 4,208,116

KANSAS CITY STEAK COMPANY, LLC (MISSOURI LIMITED LIABILITY COMPANY)
100 OSAGE AVENUE

Registered Sep. 11, 2012

KANSAS CITY, KS 66105

Int. Cl.: 29

FOR: BEEF, IN CLASS 29 (U.S. CL. 46).

TRADEMARK

FIRST USE 5-25-2012; IN COMMERCE 5-25-2012.

SUPPLEMENTAL REGISTER

THE MARK CONSISTS OF STANDARD CHARACTERS WITHOUT CLAIM TO ANY PARTICULAR FONT, STYLE, SIZE, OR COLOR.

NO CLAIM IS MADE TO THE EXCLUSIVE RIGHT TO USE "CATTLE COMPANY", APART FROM THE MARK AS SHOWN.

SER. NO. 85-636,193, FILED P.R. 5-25-2012; AM. S.R. 7-6-2012.

BRIDGETT SMITH, EXAMINING ATTORNEY



David J. Kybas

Director of the United States Patent and Trademark Office

United States of America

United States Patent and Trademark Office

SUN LIFE

Reg. No. 4,208,117

MECCA, DANIEL W III (UNITED STATES INDIVIDUAL)
9721 CYPRESS POND AVE
TAMPA, FL 33647 AND

Registered Sep. 11, 2012

Int. Cl.: 25

MENDOZA, JULIE (UNITED STATES INDIVIDUAL)
9721 CYPRESS POND AVE
TAMPA, FL 33647

TRADEMARK

SUPPLEMENTAL REGISTER

FOR: BASEBALL CAPS; BASEBALL CAPS AND HATS; CAP VISORS; CAPS; SHORT-SLEEVED OR LONG-SLEEVED T-SHIRTS; T-SHIRTS, IN CLASS 25 (U.S. CLS. 22 AND 39).

FIRST USE 5-19-2012; IN COMMERCE 5-21-2012.

THE MARK CONSISTS OF THE WORDS "SUN LIFE" IN A STYLIZED SCRIPT FONT WITH A CIRCLE AND FOUR DASH MARKS OVER THE LETTER "I" AND RESEMBLING A SUN WITH RAYS EMANATING FROM THE TOP.

SER. NO. 85-641,715, FILED P.R. 6-3-2012; AM. S.R. 8-9-2012.

BRENDAN REGAN, EXAMINING ATTORNEY



David J. Kybas

Director of the United States Patent and Trademark Office

United States of America

United States Patent and Trademark Office

PRESCRIBER CENTRIC TARGETING

Reg. No. 4,208,118

CATALINA MARKETING CORPORATION (DELAWARE CORPORATION)
200 CARILLON PARKWAY
ST. PETERSBURG, FL 33716

Registered Sep. 11, 2012

Int. Cl.: 35

FOR: ADVERTISING AND MARKETING SERVICES, NAMELY, PROMOTING THE GOODS AND SERVICES OF OTHERS; ADVERTISING SERVICES, NAMELY, PROMOTING AND MARKETING THE GOODS AND SERVICES OF OTHERS IN THE FIELD OF HEALTH VIA PRINT AND ELECTRONIC MEDIA, IN CLASS 35 (U.S. CLS. 100, 101 AND 102).

SERVICE MARK

SUPPLEMENTAL REGISTER FIRST USE 6-13-2012; IN COMMERCE 6-13-2012.

THE MARK CONSISTS OF STANDARD CHARACTERS WITHOUT CLAIM TO ANY PARTICULAR FONT, STYLE, SIZE, OR COLOR.

SER. NO. 85-642,360, FILED P.R. 6-4-2012; AM. S.R. 8-6-2012.

REBECCA GILBERT, EXAMINING ATTORNEY



David J. Kyffers

Director of the United States Patent and Trademark Office

United States of America

United States Patent and Trademark Office

self blended

Reg. No. 4,208,119

TGM DESIGN, LTD. (CALIFORNIA CORPORATION)

Registered Sep. 11, 2012

7510 W. SUNSET BLVD. #1408
LOS ANGELES, CA 90046

Int. Cl.: 3

FOR: COSMETIC PREPARATIONS FOR SKIN CARE; COSMETICS IN GENERAL, INCLUDING PERFUMES, IN CLASS 3 (U.S. CLS. 1, 4, 6, 50, 51 AND 52).

TRADEMARK

FIRST USE 5-1-2012; IN COMMERCE 5-1-2012.

SUPPLEMENTAL REGISTER

THE MARK CONSISTS OF STANDARD CHARACTERS WITHOUT CLAIM TO ANY PARTICULAR FONT, STYLE, SIZE, OR COLOR.

SER. NO. 85-653,925, FILED 6-17-2012.

HANNO RITTNER, EXAMINING ATTORNEY



David J. Kypos

Director of the United States Patent and Trademark Office