

NIST Measurement Services:

## The Calibration of Thermocouples and Thermocouple Materials

NIST  
Special  
Publication  
250-35

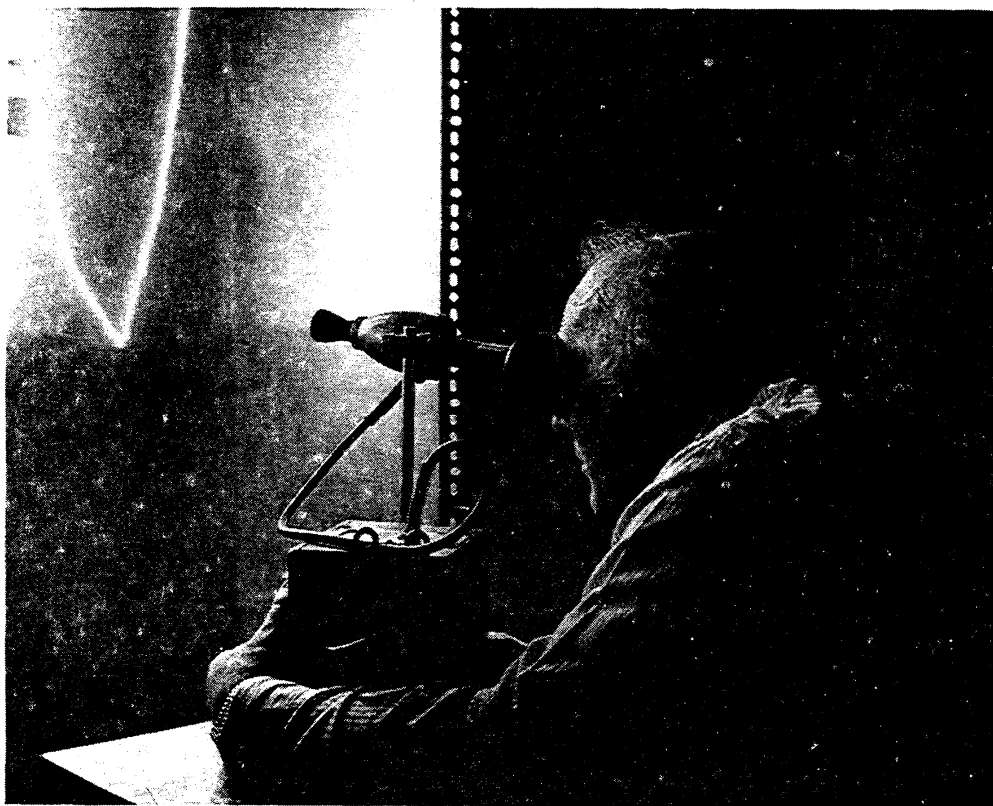

G. W. Burns and M. G. Scroger

U.S. Department of Commerce  
National Institute of Standards and Technology

---

# **NIST MEASUREMENT SERVICES: The Calibration of Thermocouples and Thermocouple Materials**

---

G. W. Burns and M. G. Scroger

Temperature and Pressure Division  
Center for Basic Standards  
National Measurement Laboratory  
National Institute of Standards and Technology  
Gaithersburg, MD 20899

April 1989



**NOTE:** As of 23 August 1988, the National Bureau of Standards (NBS) became the National Institute of Standards and Technology (NIST) when President Reagan signed into law the Omnibus Trade and Competitiveness Act.

---

**U.S. DEPARTMENT OF COMMERCE, Robert A. Mosbacher, Secretary  
NATIONAL INSTITUTE OF STANDARDS AND TECHNOLOGY,  
Raymond G. Kammer, Acting Director**

**Library of Congress Catalog Card Number: 89-600732**

**National Institute of Standards and Technology Special Publication 250-35  
Natl. Inst. Stand. Technol. Spec. Publ. 250-35, 201 pages (Apr. 1989)  
CODEN: NSPUE2**

**Certain commercial equipment, instruments, or materials are identified in this paper in order to adequately specify the experimental procedure. Such identification does not imply recommendation or endorsement by the National Institute of Standards and Technology, nor does it imply that the materials or equipment identified are necessarily the best available for the purpose.**

**U.S. GOVERNMENT PRINTING OFFICE  
WASHINGTON: 1989**

---

**For sale by the Superintendent of Documents, U.S. Government Printing Office, Washington, DC 20402-9325**

## PREFACE

Calibrations and related measurement services of the National Institute of Standards and Technology provide the means for makers and users of measuring tools to achieve levels of measurement accuracy that are necessary to attain quality, productivity and competitiveness. These requirements include the highest levels of accuracy that are possible on the basis of the most modern advances in science and technology as well as the levels of accuracy that are necessary in the routine production of goods and services. More than 300 different calibrations, measurement assurance services and special tests are available from NIST to support the activities of public and private organizations. These services enable users to link their measurements to the reference standards maintained by NIST and, thereby, to the measurement systems of other countries throughout the world. NIST Special Publication 250, NIST Calibration Services Users Guide, describes the calibrations and related services that are offered, provides essential information for placing orders for these services and identifies expert persons to be contacted for technical assistance.

NIST Special Publication 250 has recently been expanded by the addition of supplementary publications that provide detailed technical descriptions of specific NIST calibration services and, together with the NIST Calibration Services Users Guide, they constitute a topical series. Each technical supplement (NIST SP 250- ) on a particular calibration service includes:

- o specifications for the service
- o design philosophy and theory
- o description of the NIST measurement system
- o NIST operational procedures
- o measurement uncertainty assessment
  - error budget
  - systematic errors
  - random errors
- o NIST internal quality control procedures

The new publications will present more technical detail than the information that can be included in NIST Reports of Calibration. In general they will also provide more detail than past publications in the scientific and technical literature; such publications, when they exist, tend to focus upon a particular element of the topic and other elements may have been published in different places at different times. The new series will integrate the description of NIST calibration technologies in a form that is more readily accessible and more useful to the technical user.

The present publication, SP 250-35, NIST Measurement Services: The Calibration of Thermocouples and Thermocouple Materials, by G. W. Burns and M. G. Scroger,

is one of approximately 20 documents in the new series published or in preparation by the Center for Basic Standards. It describes calibration technology and procedures utilized in connection with NIST Service Identification Numbers from 32010C to 32150S listed in the NIST Calibration Services Users Guide 1989, pages 54 to 55. Inquiries concerning the contents of these documents may be directed to the author(s) or to one of the technical contact persons identified in the Users Guide.

Suggestions for improving the effectiveness and usefulness of the new series would be very much appreciated at NIST. Likewise, suggestions concerning the need for new calibration services, special tests, and measurement assurance programs are always welcome.

Joe D. Simmons, Acting Chief  
Office of Physical Measurement Services

Katherine Gebbie, Acting Director  
Center for Basic Standards

## CONTENTS

	Page
1. DESCRIPTION OF SERVICES . . . . .	1
2. PRINCIPLES OF THERMOELECTRIC THERMOMETRY. . . . .	4
2.1 Thermoelectric Phenomena . . . . .	4
2.2 Choice of the Thermocouple Materials . . . . .	6
2.2.1 Temperatures from 0 K to 450 °C. . . . .	8
2.2.2 Temperatures from 450 °C to 1100 °C. . . . .	10
2.2.3 Temperatures above 1100 °C . . . . .	11
2.3 Inhomogeneity. . . . .	13
2.4 Calibration. . . . .	14
2.5 Installation . . . . .	15
2.6 Summary of the Laws of Thermoelectric Circuits . . . . .	16
2.6.1 Law of Homogeneous Metals. . . . .	16
2.6.2 Law of Intermediate Metals . . . . .	16
2.6.3 Law of Successive or Intermediate Temperatures . . . . .	17
2.7 References . . . . .	18
3. CALIBRATION METHODS AND PROCEDURES FOR THERMOCOUPLES AND THERMOCOUPLE MATERIALS. . . . .	25
3.1 Calibration by Comparison with a Reference Thermocouple . . . . .	25
3.1.1 Type S, Type R, and Type B Thermocouples . . . . .	25
3.1.1.1 Preliminary Examination. . . . .	25
3.1.1.2 Electrical Anneal. . . . .	25
3.1.1.3 Mounting for Calibration . . . . .	26
3.1.1.4 Furnace Anneal . . . . .	26
3.1.1.5 Calibration Data . . . . .	27
3.1.1.6 Packing and Shipping . . . . .	27
3.1.1.7 Calibration Report . . . . .	28
3.1.1.8 Apparatus. . . . .	31
3.1.2 Base Metal Thermocouples . . . . .	33
3.1.3 Thermoelements versus Platinum Thermoelectric Reference Standard, Pt-67 . . . . .	35
3.1.4 Metal-Sheathed Thermocouples . . . . .	35
3.2 Calibration by Comparison with a Standard Platinum Resistance Thermometer. . . . .	36
3.2.1 Calibration Baths. . . . .	36
3.2.1.1 Water and Oil Baths. . . . .	36
3.2.1.2 Tin Bath . . . . .	37
3.2.1.3 Cryostat . . . . .	38
3.2.1.4 Liquid Oxygen and Liquid Nitrogen Points. . . . .	38

	Page	
3.2.2	Equipment. . . . .	39
3.2.2.1	Standard Platinum Resistance Thermometer. . . . .	39
3.2.2.2	AC Bridge. . . . .	40
3.2.2.3	Potentiometer. . . . .	40
3.2.3	Calibration Procedure. . . . .	40
3.2.4	Computation of Bath Temperature. . . . .	41
3.2.5	Calibration Report . . . . .	44
3.3	Primary Calibration of Type S Thermocouples in Metal Freezing-Point Cells. . . . .	44
3.3.1	Preliminary Examination. . . . .	46
3.3.2	Electrical Anneal. . . . .	46
3.3.3	Mounting for Calibration . . . . .	46
3.3.4	Furnace Anneal . . . . .	46
3.3.5	Preliminary Tests. . . . .	47
3.3.6	Emf Measurements at Freezing Points. . . . .	47
3.3.6.1	Gold and Silver Freezing Points. . . . .	49
3.3.6.2	Antimony Freezing Point. . . . .	50
3.3.6.3	Zinc Freezing Point . . . . .	50
3.3.7	Packing and Shipping . . . . .	51
3.3.8	Calibration Report . . . . .	51
3.3.9	Apparatus. . . . .	53
3.3.9.1	Electrical Annealing System. . . . .	53
3.3.9.2	Welding Station. . . . .	53
3.3.9.3	Annealing Furnace. . . . .	53
3.3.9.4	Furnace For Preliminary Tests. . . . .	53
3.3.9.5	Freezing-Point Cells . . . . .	53
3.3.9.6	Furnace for Gold and Silver Freezing-Point Cells . . . . .	54
3.3.9.7	Furnace for Antimony and Zinc Freezing-Point Cells . . . . .	55
3.3.9.8	Ice Baths. . . . .	55
3.3.9.9	Measuring Instrument . . . . .	55
3.4	References . . . . .	56
4.	INTERNAL QUALITY CONTROL. . . . .	69
4.1	Voltage Standards. . . . .	69
4.2	Voltage Measuring Instruments. . . . .	70
4.2.1	Potentiometers . . . . .	70
4.2.2	Digital Voltmeters . . . . .	70
4.2.3	Thermocouple Measuring Circuitry . . . . .	70
4.3	Resistance Measuring Instrument. . . . .	71
4.4	Temperature Measuring Instruments. . . . .	71
4.4.1	Working-Standard Reference Thermocouples . . . . .	71
4.4.2	Standard Platinum Resistance Thermometers. . . . .	72
4.5	Platinum Thermolectric Reference Standard . . . . .	72
4.6	Thermocouple Fixed-Point Check Standards . . . . .	72

	Page
4.7 Thermometric Fixed Points . . . . .	73
4.7.1 Metal Freezing-Point Cells . . . . .	73
4.7.2 Water Triple-Point Cells . . . . .	75
4.7.3 Ice Baths . . . . .	75
4.8 References . . . . .	76
5. ASSESSMENT OF UNCERTAINTIES . . . . .	103
5.1 Uncertainties in Primary Calibrations of Type S Thermocouples . . . . .	103
5.2 Uncertainties in Comparison Calibrations of Type S Thermocouples . . . . .	110
5.3 References . . . . .	117
6. FUTURE DIRECTIONS . . . . .	122
7. BIBLIOGRAPHY . . . . .	123
7.1 National Bureau of Standards Publications . . . . .	123
7.2 American Society for Testing and Materials Publications . . . . .	123
7.3 Instrument Society of America Publications . . . . .	124
7.4 International Electrotechnical Commission Publications . . . . .	124
7.5 Other Publications . . . . .	124
8. APPENDICES . . . . .	126
8.1 Calibration Reports . . . . .	126
8.1.1 Type S Thermocouple - Fixed-Point Calibration . . . . .	126
8.1.1.1 Covering Letter and Bound Calibration Report for Customer . . . . .	126
8.1.1.2 Summary of Calibration Results for NIST Record . . . . .	136
8.1.2 Type S Thermocouple - Comparison Calibration . . . . .	148
8.1.2.1 Covering Letter and Bound Calibration Report for Customer . . . . .	148
8.1.2.2 Summary of Calibration Results for NIST Record . . . . .	157
8.1.3 Type R Thermocouple - Comparison Calibration . . . . .	164
8.1.3.1 Covering Letter and Bound Calibration Report for Customer . . . . .	164
8.1.3.2 Summary of Calibration Results for NIST Record . . . . .	173
8.1.4 Type T Thermocouple - Comparison with SPRT . . . . .	180
8.1.5 Base Metal Thermocouple - Comparison Calibration . . . . .	186



## LIST OF FIGURES

Figure		Page
2.1.	Schematic diagram of thermocouples with a junction box . . .	21
2.2.	Thermoelectric power of some low-temperature thermocouples. . . . .	21
2.3.	Calibration emf's of three standard thermocouples at the zinc point and at the gold point. Time at high temperature is about 5 h for each set . . . . .	22
2.4.	Temperature-emf relationships of some high-temperature thermocouples . . . . .	22
2.5.	Thermoelectric power of some high-temperature thermocouples . . . . .	23
2.6.	Emf (E) unaffected by third material, C. . . . .	23
2.7.	Emfs are additive for materials. . . . .	24
2.8.	Emfs are additive for temperature intervals. . . . .	24
3.1.	Schematic of automatic thermocouple calibration system for comparison calibrations . . . . .	57
3.2.	Chromel tube furnace (50 to 1100 °C) . . . . .	58
3.3.	Silicon carbide tube furnace (50 to 1600 °C) . . . . .	59
3.4.	Oil bath . . . . .	60
3.5.	Oil bath and water bath. . . . .	61
3.6.	Tin bath . . . . .	62
3.7.	Tin bath . . . . .	63
3.8.	Cryostat . . . . .	64
3.9.	Cryostat . . . . .	65
3.10.	Metal freezing-point cell. . . . .	66
3.11.	Freezing-point furnace for gold and silver . . . . .	67
3.12.	Freezing-point furnace for antimony and zinc . . . . .	68
4.1.	Calibration history of saturated standard cells. . . . .	77

Figure		Page
4.2.	Calibration corrections for Guildline potentiometer. . . . .	78
4.3.	Calibration history of type S standard thermocouple SC-68-2 at the gold point (1064.43 °C) . . . . .	79
4.4.	Calibration history of type S standard thermocouple SC-68-2 at the silver point (961.93 °C). . . . .	80
4.5.	Calibration history of type S standard thermocouple SC-68-2 at 630.74 °C . . . . .	81
4.6.	Calibration history of type S standard thermocouple SC-68-2 at the zinc point (419.58 °C). . . . .	82
4.7.	Calibration history of type S standard thermocouple SC-68-7 at the gold point (1064.43 °C) . . . . .	83
4.8.	Calibration history of type S standard thermocouple SC-68-7 at the silver point (961.93 °C). . . . .	84
4.9.	Calibration history of type S standard thermocouple SC-68-7 at 630.74 °C . . . . .	85
4.10.	Calibration history of type S standard thermocouple SC-68-7 at the zinc point (419.58 °C). . . . .	86
4.11.	Calibration history of type S standard thermocouple SC-71-5 at the gold point (1064.43 °C) . . . . .	87
4.12.	Calibration history of type S standard thermocouple SC-71-5 at the silver point (961.93 °C). . . . .	88
4.13.	Calibration history of type S standard thermocouple SC-71-5 at 630.74 °C . . . . .	89
4.14.	Calibration history of type S standard thermocouple SC-71-5 at the zinc point (419.58 °C). . . . .	90
4.15.	Calibration history of type S standard thermocouple SC-71-6 at the gold point (1064.43 °C) . . . . .	91
4.16.	Calibration history of type S standard thermocouple SC-71-6 at the silver point (961.93 °C). . . . .	92
4.17.	Calibration history of type S standard thermocouple SC-71-6 at 630.74 °C . . . . .	93
4.18.	Calibration history of type S standard thermocouple SC-71-6 at the zinc point (419.58 °C). . . . .	94

Figure	Page
4.19. Calibration history of type S standard thermocouple SC-72-1 at the gold point (1064.43 °C) . . . . .	95
4.20. Calibration history of type S standard thermocouple SC-72-1 at the silver point (961.93 °C). . . . .	96
4.21. Calibration history of type S standard thermocouple SC-72-1 at 630.74 °C . . . . .	97
4.22. Calibration history of type S standard thermocouple SC-72-1 at the zinc point (419.58 °C) . . . . .	98
4.23. Calibration history of type S standard thermocouple SC-72-2 at the gold point (1064.43 °C) . . . . .	99
4.24. Calibration history of type S standard thermocouple SC-72-2 at the silver point (961.93 °C). . . . .	100
4.25. Calibration history of type S standard thermocouple SC-72-2 at 630.74 °C . . . . .	101
4.26. Calibration history of type S standard thermocouple SC-72-2 at the zinc point (419.58 °C). . . . .	102
5.1. Error per unit emf error at the fixed points in thermocouple emfs calculated from the Sb-Ag-Au calibration quadratic . . . . .	118
5.2. Error per unit emf error at the fixed points calculated from the 0 °C-Zn-Sb quadratic used to represent the emf difference between the calibration values and the NBS Monograph 125 reference table values at the fixed-points . . . . .	119
5.3. Emf difference between values of emf determined in a comparison calibration using type S reference thermocouple SC-83-7 and emf values obtained in a primary calibration at the fixed points for 23 type S test thermocouples. (Emf difference = primary - comparison) . . . . .	120
5.4. Emf difference between values of emf determined in a comparison calibration using type S reference thermocouple SC-83-8 and emf values obtained in a primary calibration at the fixed points for 16 type S test thermocouples. (Emf difference = primary - comparison) . . . . .	121

LIST OF TABLES

Table	Page
1.1. NIST thermocouple calibration capability . . . . .	3
2.1. Compositions, trade names and letter designations for standardized thermocouples . . . . .	7
2.2. Suggested upper temperature limits for protected thermocouples and various wire sizes . . . . .	9
4.1. Freezing-point differences for gold and silver cells . . . . .	74
4.2. Antimony cell freezing points. . . . .	74
5.1. Standard deviations associated with fixed-point cell calibrations. . . . .	104
5.2. Uncertainty in the temperature of the liquidus points. . . . .	108
5.3. Summary of systematic errors in primary calibrations of type S thermocouples at the fixed points. . . . .	109
5.4. Propagated uncertainties from total uncertainties at the four fixed points. . . . .	111
5.5. Means and standard deviations for differences between primary and comparison calibrations. . . . .	113
5.6. Standard deviations for comparison calibrations. . . . .	114
5.7. Total uncertainties in comparison calibrations of type S thermocouples. . . . .	116

## 1. DESCRIPTION OF SERVICES

Calibration services for all commonly used types of thermocouples and thermocouple materials are provided by NIST from -196 to +2100 °C. The temperature range for a particular calibration depends on the type of wire or thermocouple submitted. The thermocouples are calibrated by one or more of three general methods, depending on the type of thermocouple, the temperature range, and the accuracy required. All three methods provide traceability to the IPTS-68. In the first method, thermocouples are calibrated by comparison with a standard thermocouple maintained at NIST. In the second method, thermocouples are calibrated against a standard platinum resistance thermometer (SPRT). In the third method, thermocouples are calibrated at 630.74 °C and at three defining temperatures on the International Practical Temperature Scale (IPTS): the freezing points of Zn, Ag, and Au. Single-leg thermoelements are tested against the NIST maintained platinum thermoelectric reference standard, Pt-67, by the first or second method.

Thermocouple and thermoelement calibrations below 0 °C are made in a cryostat; those above 0 °C are made in stirred liquid baths, metal freezing-point cells, or electric tube-type furnaces. Vacuum or inert-gas furnaces are also available if needed.

Test data are processed on a laboratory computer and calibration tables giving values of the thermocouple emf at 1 degree intervals are provided for B, S, R, and T types of thermocouples. An automatic data acquisition system is used to record the test data for calibrations performed by the comparison method.

The temperature ranges and calibration uncertainties for standard letter-designated thermocouples calibrated by the three methods described above are given in table 1.1. While over 90% of the thermocouples calibrated at NIST are letter-designated types, calibration services are also provided to temperatures as high as 2100 °C for non-standard types of thermocouples formed from various W-Re, Ir-Rh, and Pt-Rh alloys. Calibrations for the non-standard types are performed as special tests on an actual cost basis, and the temperature ranges and calibration uncertainties depend on the thermocouple type.

Only bare wires are needed for NIST thermocouple calibrations. We would prefer customers not to send ceramic insulating and protecting tubes since they may get broken during shipment. If the thermocouple is shipped in a mount such as a protection tube assembly, a special dismantling fee may be charged and the parts will be returned unassembled. Leads and extension wires need not be sent to NIST with the thermocouples.

All thermocouple calibration data furnished in reports are based on a reference junction temperature of 0 °C (32 °F). The customer may request that calibration results be given either in degrees Celsius or Fahrenheit.

For base-metal thermocouples (types E, J, K, N, and T) and thermocouple materials, only those that are unused will be accepted for test. A calibration will be undertaken only if the thermocouple is likely to yield the specified accuracy.

Information about the NIST thermocouple calibration services and the requirements for thermocouples to be submitted for special tests may be obtained by contacting:

Margaret G. Scroger or George W. Burns  
National Institute of Standards and Technology  
Temperature and Pressure Division  
Bldg. 221, Rm. B128  
Route 270 and Quince Orchard Road  
Gaithersburg, MD 20899  
Telephone (301) 975-4818 or 975-4817

Inquiries about thermocouple calibrations performed by comparison with a standard platinum resistance thermometer should be directed to:

Jacquelyn A. Wise  
National Institute of Standards and Technology  
Temperature and Pressure Division  
Bldg. 221, Rm. A242  
Route 270 and Quince Orchard Road  
Gaithersburg, MD 20899  
Telephone (301) 975-4822

Shipment of thermocouples for calibration should be made to one of the above addresses. Shipping costs are paid by the customer. NIST assumes no responsibility for damage in shipment. A formal purchase order for the calibration or test should be sent to NIST at or before the time the thermocouple material is shipped. The purchase order should provide:

1. Clear identification of the types of thermocouple materials submitted;
2. The calibration procedure to be followed;
3. The name and telephone number of the person responsible for the procurement;
4. The name and telephone number of a technical contact familiar with the calibration request; and
5. Instructions for return shipment including the shipping and billing addresses and the customer's choice of carrier.

Table 1.1. NIST thermocouple calibration capability

Thermocouples tested		Temperature Range (°C)	Calibration	
Type	Material		Method*	Uncertainties*** (°C)
<b>NOBLE-METAL</b>				
S	Pt - 10% Rh vs Pt	0 to 1450	3	0.2 at fixed pts. 0.3 (0 to 1100 °C) 2 at 1450 °C
			1	0.5 (0 to 1100 °C) 2 at 1450 °C
R	Pt - 13% Rh vs Pt	0 to 1450	1	0.5 (0 to 1100 °C) 2 at 1450 °C
B	Pt - 30% Rh vs Pt - 6% Rh	0 to 1750	1	0.5 (600 to 1100 °C) 2 at 1450 °C 3 at 1750 °C
<b>BASE-METAL</b>				
E	Ni - 10% Cr vs Constantan	-196 to 538 0 to 1000	2	0.1 to 0.2
			1	1
J	Fe vs Constantan	-196 to 538 0 to 760	2	0.1 to 0.2
			1	1
K	Ni - 10% Cr vs Ni - 5% (Al,Si)**	-196 to 538 0 to 1100	2	0.1 to 0.2
			1	1
N	Ni - 14% Cr - 1½% Si vs Ni - 4½% Si - 1/10% Mg	-196 to 538 0 to 1100	2	0.1 to 0.2
			1	1
T	Cu vs Constantan	-196 to 300 0 to 400	2	0.1 to 0.2
			1	1

\*1 Comparison with a reference thermocouple

2 Comparison with a SPRT

3 Comparison with metal fixed points

\*\*Silicon or aluminum and silicon may be present in combination with other elements.

\*\*\*The uncertainties quoted here are those presently stated in NIST reports of calibration

## 2. PRINCIPLES OF THERMOELECTRIC THERMOMETRY

### 2.1 Thermoelectric Phenomena

A thermocouple consists of two dissimilar conductors or "thermoelements" joined to form a circuit. T. J. Seebeck [1]<sup>1</sup> first discovered that a thermocouple would produce a current in a closed circuit when one junction is at a different temperature from the other. The electromotive force (emf) that produced the current is referred to as the thermocouple emf or as the Seebeck voltage,  $E$ ; its temperature derivative,  $dE/dT$ , is known as the thermoelectric power or the Seebeck coefficient,  $S$ . One of the conductors, A, is said to be positive with respect to the other, B, if current would flow from A to B at the cooler of the two junctions (fig. 2.1).

Peltier [2] discovered the reversible phenomenon, now known as the Peltier effect. He found that a flow of electricity introduced into a thermocouple circuit causes an exchange of heat between a junction and its surroundings that can be reversed by reversing the direction of the current. The effect at one junction is independent of the temperature of the other junction or of the size of the wire, and is directly proportional to the current,  $I$ , i.e.,  $\dot{q} = \Pi_{AB} I$ , where  $\Pi_{AB}$  is the Peltier coefficient. The mathematical relationships between these phenomena and thermodynamic temperature were developed by W. Thomson (Lord Kelvin) by the application of the principles of thermodynamics that were being established at that time [3]. His first efforts clearly failed to describe the actual behavior of the Seebeck coefficient with temperature, so that Thomson was led to postulate, and was subsequently able to demonstrate, a third effect, also reversible, that became known as the Thomson heat. Thomson heat is evolved or absorbed reversibly when a current flows in a single homogeneous conductor in a temperature gradient, in proportion to the size and direction of both the current and the gradient, i.e.,  $\dot{q} = \pm \sigma I dT$ , where  $\sigma$  is the Thomson coefficient. Thomson could then show from the first and second laws of thermodynamics that  $\Pi_{AB} = TS_{AB}$ , where  $T$  is thermodynamic temperature and  $S_{AB}$  is the Seebeck coefficient, and that  $\sigma_A - \sigma_B = -T(d^2 E_{AB})/dT^2$ , where  $E_{AB}$  is the Seebeck voltage.

The absolute thermoelectric power of a single thermoelement is defined as

$$S = \int_0^T \frac{\sigma}{T} dT.$$

Of course, the emf of the thermocouple can only be measured as a combination of a pair of thermoelements. Thus the thermoelectric power of a thermocouple is

---

<sup>1</sup>Figures in brackets indicate the literature references given at the end of each section.



$$\left. \frac{dE}{dT} \right|_0^T = \int_0^T \frac{\sigma_B - \sigma_A}{T} dT.$$

The thermoelectric power of every thermocouple is zero at 0 K; therefore

$$\frac{dE_{AB}(T)}{dT} = S_B - S_A.$$

The net thermocouple emf is a line integral around the path of the thermoelements from the positive to the negative terminal, i.e.,

$$E_{AB} = \int_q (S_B - S_A) \vec{\nabla}T \cdot \vec{dx}.$$

If the thermoelements are physically and chemically homogeneous, so that the values of  $S$  are unique as a function of temperature, the emf of the thermocouple is independent of the path and is unique. Otherwise, if the thermoelements are inhomogeneous, as is always the case to some extent, the emf observed depends upon the location and form of the temperature gradient, ie upon the path.

The laws of thermoelectric circuits [4] are rules summarizing idealized thermocouple behavior. (See sec. 2.6 for summary of laws.) The "second law" of thermocouple circuits is a consequence of the impossibility of perpetual motion of the second kind, i.e., that work cannot be derived from a heat engine operating in a system all at one temperature (and is the sine qua non for thermocouple measurement), namely that the Seebeck voltage of a circuit comprising any number of materials at uniform temperature is zero. The "first law" of thermocouple circuits is a special case derivable from the line integral for  $E_{AB}$ , namely that heat applied to a circuit consisting of a single homogeneous conductor will not produce a thermal emf. The "third law" of thermocouple circuits is a consequence of the first law of thermodynamics, namely that the thermal emf developed by a homogeneous thermocouple with its junctions at temperatures  $T_1$  and  $T_3$  is equal to the sum of the emf's developed by the same thermocouple with its junctions at  $T_1$  and  $T_2$  and subsequently at  $T_2$  and  $T_3$ . The first and third "laws" assume homogeneity with emphasis on the junctions, when in fact a real thermocouple is never completely homogeneous and the thermocouple emf is developed only in those portions of the thermoelements that pass through a temperature gradient.

It is an important application of the "second law" that the exact manner of making thermocouple junctions is not critical. For reliable measurements, some portions of the thermocouple near and including the junctions should be isothermal. Consequently, when the thermocouple is correctly installed, there is no contribution to the Seebeck voltage from the junction region.

## 2.2 Choice of the Thermocouple Materials

Of the approximately 300 different types of temperature measuring thermocouples that have been identified and studied [5], only a few types, having the more favorable characteristics, are in general use. There are eight types of thermocouples that have been standardized, because they are the ones most commonly used industrially. In the United States each type is identified by a letter. This practice was originated by the Instrument Society of America (ISA) and adopted in 1964 as an American Standard to eliminate the use of proprietary names. The standards of the American National Standards Institute (ANSI-MC96.1, 1982) and the American Society for Testing and Materials (ASTM 230-87) utilize the reference tables from National Bureau of Standards Monograph 125 [6] as the basis for standardization. As noted in the ANSI and ASTM standards, the letter designations actually identify the tables and may be applied to any thermocouple that has a temperature-emf relationship agreeing within the tolerances specified in the standards with that of the table, regardless of the composition of the thermocouple. Substantial variations in composition for a given letter type do occur, particularly for types J, K, and E [6,7,8]. Nevertheless, the reference tables were determined for actual thermoelements, which, so far, are representative of the type capable of conforming to the requirements of the standards. The nominal compositions, representative trade names and corresponding letter designations of the standardized thermocouple materials are given in table 2.1.

Table 2.1. Compositions, trade names and letter designations for standardized thermocouples

Type designation	Materials
<b>Thermocouple combinations</b>	
B	<u>platinum</u> -30% rhodium/ <u>platinum</u> -6% rhodium
E	<u>nickel</u> -chromium alloy/a <u>copper</u> -nickel alloy
J	iron/another slightly different <u>copper</u> -nickel alloy
K	<u>nickel</u> -chromium alloy/ <u>nickel</u> -aluminum alloy
N	<u>nickel</u> -chromium-silicon alloy/ <u>nickel</u> -silicon alloy
R	<u>platinum</u> -13% rhodium/platinum
S	<u>platinum</u> -10% rhodium/platinum
T	copper/a <u>copper</u> -nickel alloy
<b>Single-leg thermoelements</b>	
...N	Denotes the negative thermoelement of a given thermocouple type
...P	Denotes the positive thermoelement of a given thermocouple type
BN	<u>platinum</u> -nominal 6% rhodium
BP	<u>platinum</u> -nominal 30% rhodium
EN or TN	a <u>copper</u> -nickel alloy, constantan: Cupron <sup>a</sup> , Advance <sup>c</sup> ; ThermoKanthal JN <sup>b</sup> , nominally 55% Cu, 45% Ni
EP or KP	a <u>nickel</u> -chromium alloy: Chromel <sup>d</sup> , Tophel <sup>a</sup> , T-1 <sup>c</sup> , ThermoKanthal KP <sup>b</sup> ; nominally 90% Ni, 10% Cr
JN	a <u>copper</u> -nickel alloy similar to but usually not interchangeable with EN and TN
JP	iron: ThermoKanthal JP <sup>b</sup> ; nominally 99.5% Fe
KN	a <u>nickel</u> -aluminum alloy: Alumel <sup>d</sup> , Nial <sup>a</sup> , T-2 <sup>c</sup> , ThermoKanthal KN <sup>b</sup> ; nominally 95% Ni, 2% Al, 2% Mn, 1% Si
NN	a <u>nickel</u> -silicon alloy; nominally 95% Ni, 4-1/2% Si, 1/10% Mg
NP	a <u>nickel</u> -chromium-silicon alloy; nominally 84% Ni, 14% Cr, 1-1/2% Si
RN, SN	high-purity platinum
RP	<u>platinum</u> -13% rhodium
SP	<u>platinum</u> -10% rhodium
TP	copper, usually Electrolytic Tough Pitch

Registered trade marks: <sup>a</sup>Carpenter Technology Co.; <sup>b</sup>Kanthal Corp.; <sup>c</sup>Driver-Harris Co.; <sup>d</sup>Hoskins Manufacturing Co.

Note: An underlined word indicates the primary constituent of an alloy and all compositions are expressed in percentages by weight. All materials manufactured in compliance with the established thermoelectric voltage standards are equally acceptable.

The standardized thermocouples are available commercially with thermoelectric properties that agree with the reference tables of temperature versus emf within specified tolerances. Tolerances differ in different countries. Those of the United States can be found in the standards of the ANSI and the ASTM previously cited. The same tables for thermocouples have been published by the International Electrotechnical Commission as Publication 584-1 [9]. In addition, international tolerances for the standardized thermocouples have been formulated by the IEC Subcommittee 65B/WG5, and they appear as Part 2 of the IEC Publication 584 [10].

The choice of thermocouple is strongly influenced by the temperature range of the measurement. We shall consider the best possibilities for three temperature ranges, viz. from 0 K to 450 °C, from 450 °C to 1100 °C, and above 1100 °C.

### 2.2.1 Temperatures from 0 K to 450 °C

All of the base-metal types (E, J, K, and T) have been used at cryogenic temperatures, but, as shown in figure 2.2, their Seebeck coefficients become too small below 20 K for accurate measurement.

It can be shown on theoretical grounds that the thermoelectric power of any thermocouple must approach zero as absolute zero is approached. Adequate sensitivity in the very low range of temperatures has been attained by the decrease to zero to be compressed to a very narrow range of temperature near absolute zero. Over almost all the range below 40 K, the KP versus Au-0.07 at % Fe thermocouple has the highest sensitivity, and is the best choice of currently available thermocouples for very low temperatures. The thermal conductivity of the KP element is the lowest of any of the more frequently used materials; unfortunately, that of the Au-0.07 at % Fe element is high enough to be potentially troublesome. The Au-0.07 at % Fe thermoelement was developed to replace the Au-2.1 at % Co element, which proved to be unstable because of phase changes upon cycling between room temperature and low temperatures.

Above 30 K the Seebeck coefficient of the type E thermocouple is large enough for accurate results. It has been recommended by Hust et al. [11] as the most suitable of the standardized types for general low-temperature use, since it offers the best combination of desirable properties: high thermoelectric power, low thermal conductivity, and good thermoelectric homogeneity and stability. The Seebeck coefficient of type E reaches larger than usual values ( $>60 \mu\text{V K}^{-1}$  for  $t > 15 \text{ }^\circ\text{C}$ ). Hust et al. point out that it is superior to type K in having a lower response to magnetic fields, and is superior to type T because of the undesirably high thermal conductivity of the TP element. They found every thermoelement to have significant inhomogeneity, but by carefully selecting materials, inhomogeneity voltages of the type E over the range from 0 K to 300 K can be kept within 1-2  $\mu\text{V}$  under most conditions. Typical data for the thermoelectric inhomogeneity of commercial type E thermocouple materials at cryogenic temperatures, as well as of other standard base-metal types, are given by Sparks et al. [7].

The upper temperature limits of base-metal thermocouples for extended use in air are given in table 2.2. These are determined by the oxidation resistance of the thermoelements and, therefore, the limits depend upon the composition and the wire size. The limits are set to allow 'satisfactory' thermocouple life for industrial use, when the thermocouples are operated continuously at the limits of the indicated temperatures.

Table 2.2. Suggested upper temperature limits for protected thermocouples and various wire sizes (Values and notes extracted from ASTM Standard E230-87.)

Upper temperature limit (°C) for various wire sizes			
Thermocouple type	AWG 14 (1.63 mm diameter)	AWG 24 (0.51 mm diameter)	AWG 30 (0.25 mm diameter)
T	370	200	150
J	590	370	320
E	650	430	370
K and N	1090	870	760
R and S		1480	
B		1700	

Note 1: This table gives the recommended upper temperature limits for the various thermocouples and wire sizes. These limits apply to protected thermocouples, that is, thermocouples in conventional closed-end protecting tubes. They do not apply to sheathed thermocouples having compacted mineral oxide insulation.

Note 2: The temperature limits given here are intended only as a guide to the user and should not be taken as absolute values nor as guarantees of satisfactory life or performance. These types and sizes are sometimes used at temperatures above the given limits, but usually at the expense of stability or life or both. In other instances, it may be necessary to reduce the above limits in order to achieve adequate service. ASTM STP-470 and other literature sources should be consulted for additional applications information.

Reversible thermoelectric effects that occur in the KP or EP thermoelement on heating in the 250 to 550 °C range impose an upper bound of temperature for the use of the type K or type E thermocouple for precision measurement. Burley [12], Fenton [13], and Kollie et al. [14] have attributed this instability to short-range ordering in the Ni-Cr atomic lattice. Fenton showed that annealing at temperatures of 200 to 450 °C will increase the effect of short-range ordering with a larger maximum effect at increasingly lower temperatures as annealing progresses. The effect is reversible if the wire is heated subsequently to higher temperatures. As an added difficulty with the type K thermocouple, the KN thermoelement has a magnetic transformation at about 170 °C which causes the curve of the Seebeck coefficient versus T for the type K thermocouple to be somewhat tortuous [6].

All base-metal thermoelements of the standardized thermocouples are affected by oxidation. Dahl [15] investigated the change in emf of 18 gauge (1.24 mm diameter) wire for KP, KN, JP and JN elements when they were heated in air at 427 °C for times totaling 1000 h. The drifts of the KP and JN thermoelements (which are equivalent to the thermoelements of the type E thermocouple) compensate well enough that in combination the net emf is nearly constant. Thus, when its properties are compared with other thermocouples, the type E thermocouple is the most suitable for general use from 20 or 30 K to 450 °C, if the EP thermoelement has been stabilized by annealing at 400 °C for 30 days. Alternatively, the type T thermocouple is stable and reproducible up to a lower limit of temperature. It has a lower Seebeck coefficient and a much higher thermal conductivity of the positive leg than the type E thermocouple. Under vacuum or reducing conditions, the type T thermocouple is suitable for use up to a temperature of 500 °C, except in the presence of hydrogen, for which the range has to be restricted to 370 °C because of the tendency to embrittlement.

### 2.2.2 Temperatures from 450 °C to 1100 °C

In this temperature range, the noble metal types B, R, and S, or non-standard thermocouples should be used. Thermocouples employing platinum and platinum-rhodium alloys for their thermoelements are more resistant to oxidation, have higher melting points and at elevated temperatures in air have generally been found to be more reproducible than base-metal types. The type S thermocouple is the oldest [16] and has served as a standard instrument of the International Temperature Scale since the adoption of the Scale in 1927 [17]. In the IPTS-68 Amended Edition of 1975 [18], type S thermocouples must meet strict requirements for purity and thermocouple emf to qualify as standard instruments for interpolation in the range from 630.74 °C to the gold point (1064.43 °C).

The emf of standard type S thermocouples depends upon their thermal histories and, therefore, upon the annealing procedures for the thermoelements. Both the original and amended editions of the IPTS-68 [18, 19] recommend that the platinum thermoelement be annealed at 1100 °C and that the platinum-10% rhodium thermoelement be annealed at 1450 °C, with a final anneal at 1100 °C until stable after assembly. Following these recommendations, Jones [20] reported a measurement uncertainty of a single determination to be  $\pm 0.2$  °C at the 99% confidence level in the IPTS-68 defining range. McLaren and Murdock [21] showed that the type S thermocouple is precise for a given depth of immersion, but that such thermocouples as ordinarily prepared are inhomogeneous. At the copper point (1084.5 °C) McLaren and Murdock [21] found that the thermal emf versus temperature profiles of standard type S thermocouples might vary by amounts approaching 1 °C, and that the shape of the temperature profile as well as the value of the Seebeck voltages depended upon the previous heat treatment of the thermocouple. They investigated the effects of different high-temperature anneals, followed by 16 h "sheathed anneals" at 450 °C. At the NIST, it has been observed that type S thermocouples prepared in this way are subject to rapid change at high temperatures, with a substantial change of thermocouple emf.

The stability of type S thermocouples calibrated at the NIST is demonstrated in figure 2.3. They were calibrated in gold-point, silver-point, antimony-point, and zinc-point cells with nearly the same immersion and temperature gradient each time. Each data point is part of a complete set, where the mean value of 10 measurements of the emf for two different freezes was determined at each temperature. The total time at the temperatures of the silver point and the gold point is about 5 h for each calibration.

The NIST annealing procedure is to heat the thermocouple by electric heating to about 1450 °C for 45 minutes and then allow it to cool quickly in air to ~750 °C. It is held at that temperature for 30 minutes. Then the couple is allowed to cool to room temperature in air, in a time of ~2 minutes. After assembly, all the thermocouple that will be at high temperature or in the gradient is annealed at 1100 °C in a furnace. It is cooled slowly, taking about 2 h to fall to 300 °C. The Seebeck emf of the type S thermocouple annealed in this way is more nearly constant at the gold point than found by McLaren and Murdock for thermocouples annealed by one of their best procedures. If the thermocouple is subsequently annealed at 450 °C, the readings at the fixed point for a given immersion are higher than before. The effects of quenched-in point defects and of composition change of the SP thermoelement (because of preferential oxidation of the rhodium) have been cited as causes for the diverse results obtained.

A possible alternative to the type K or type S thermocouple is the type N (Nicrosil/Nisil) thermocouple. It was developed for use in an oxidizing atmosphere to improve on the type K thermocouple [22]. Its composition has been chosen to minimize the effect of short-range ordering on the Seebeck coefficient. Also, the silicon content of the thermoelements was increased so that an adherent, protective oxide coating could form on the surface to minimize further oxidation. Until the protective oxide coating is formed, the composition and the thermal emf of the wire continue to change at high temperatures. The inhomogeneities in sheathed type N thermocouples for which the oxygen supply is restricted may be attributed to incomplete oxidation. When stabilized by heating in air at 1000 °C for 100 h, the thermocouple has shown a drift rate at the same high temperatures of only about  $0.1 \mu\text{V h}^{-1}$  (where  $S = 36 \mu\text{V K}^{-1}$ ), which is higher than the equivalent temperature drift rate for a type S thermocouple but much lower than that for a type K.

The Platinel couple, a proprietary thermocouple with thermoelements containing gold, palladium and platinum, was developed for this range and up to 1300 °C [23]. It has a sensitivity of  $40 \mu\text{V K}^{-1}$  and is relatively stable in an oxidizing atmosphere. Good performance was reported for this thermocouple in early investigations, but further testing is needed to determine its optimum use.

### 2.2.3 Temperatures above 1100 °C

Even though the temperature for the upper limit of use of the types R and S thermocouples is quoted as high as 1480 °C in an oxidizing atmosphere (for 0.5 mm diameter wires), there are better platinum-rhodium alloy combinations for thermometry under oxidizing conditions above 1100 °C. Bedford [24, 25] investigated the emf-temperature characteristics of Pt-20% Rh/Pt-5% Rh (20/5)

and Pt-40% Rh/Pt-20% Rh (40/20) thermocouples and also observed their emf's at the palladium point (1552 °C) as a function of heating time at 1700 °C. After 200 h at 1700 °C in air, the emf of the 20/5 thermocouple had decreased the equivalent of about 5 °C at the palladium point; after 500 h at 1700 °C in air, the 40/20 thermocouples exhibited changes equivalent to 4 °C at the palladium point. It is expected that the behavior of the type B (30/6) thermocouple will be at least as good as the 20/5 thermocouple. The type B thermocouple has better tensile properties at high temperatures than the 20/5 thermocouple and it also has the additional characteristic that from 0 to 50 °C its Seebeck emf varies only between -2.5 and 2.5  $\mu\text{V}$ , so that the temperature of the reference junction can often be neglected.

Because the melting point of platinum-rhodium thermoelements increases with increasing rhodium content, thermocouples comprised of platinum-rhodium elements of higher rhodium content are relatively stable to higher limits of temperature. The 40/20 thermocouple was first proposed and evaluated by Jewell et al. [26]. Its Pt-20% Rh thermoelement melts at about 1887 °C and it is useful for accurate measurement up to 1850 °C. Its thermoelectric power in the range from 1700 to 1850 °C is about 4.5  $\mu\text{V K}^{-1}$ , which is less than half that of the type B thermocouple. On the basis of the currently available but somewhat limited information, the 40/20 thermocouple is superior to the type B in stability at 1700 °C. A choice of one over the other for measurements from 1500 to 1700 °C would have to be based on the total temperature range and duration of the measurement, the availability of the thermoelements, and the importance of the size of the Seebeck coefficient in terms of the user's measuring equipment. Detailed reference tables for the 40/20 thermocouple have been prepared by Bedford [25] and limited quantities of both thermoelements are available commercially.

For measurements in an oxidizing atmosphere up to temperatures of 2150 to 2250 °C, iridium-rhodium alloy thermocouples have been used. Such thermocouples are expensive and have rather poor mechanical properties, relatively low thermoelectric power, poor stability and short life [27, 28, 29] are unsatisfactory for precise thermometry. Such resistance to oxidation as iridium and iridium-rhodium alloys possess might better be used for a protecting sheath for a W-3% Re/W-25% Re thermocouple.

Three thermocouples with thermoelements of tungsten or tungsten-rhenium alloys are commercially available for measuring very high temperatures. Positive thermoelements of tungsten, W-3% Re, or W-5% Re are used in combination with a negative tungsten-rhenium alloy thermoelement that nominally contains between 25% and 26% Re. The temperature-emf relationship of the W-3% Re/W-25% Re thermocouple is shown in figure 2.4 and the Seebeck coefficients in figure 2.5. These figures also include the relationships for the other non-standardized thermocouples discussed in this section.

The tungsten and tungsten-rhenium alloys have melting points in excess of 3000 °C [30]. The positive thermoelements currently sold in this country contain residual impurity dopants to control their grain growth characteristics. Even after full recrystallization, this control results in a marked improvement in the room-temperature ductility of the dilute alloys [31]. The ductility of the negative thermoelement is satisfactory



after recrystallization, so doping is neither needed nor effective [32]. The tungsten-rhenium alloy thermocouples are suitable for use in hydrogen and in pure inert atmospheres. They may also be used in high vacuum; but, when they are exposed for long periods above 1950 °C, substantial changes in their thermal emf can occur as a result of preferential evaporation of rhenium [31]. Environments containing hydrocarbons, oxygen, and oxygen-containing gases such as H<sub>2</sub>O, CO and CO<sub>2</sub> will seriously degrade the thermocouples at elevated temperatures. Burns and Hurst [31] have shown that suitably annealed bare thermoelements exhibit no significant change in their thermoelectric properties with exposure for 1000 h to temperatures as high as 2125 °C in high-purity argon, helium, hydrogen and nitrogen.

For precise measurements with the tungsten-rhenium alloy thermocouples, the thermoelements must be annealed to stabilize their thermoelectric properties. Burns and Hurst [31] reported that W-3% Re thermoelements should be annealed at 2400 K for 1 h in argon, and W-25% Re for 2 minutes under the same conditions. Later studies by Burns and Hurst [33] indicate that in the commercially annealed W-25% Re thermoelement, precipitates of the sigma phase significantly increase the emf after long-term exposure in the 800 to 1300 °C range.

The formation of the sigma phase can be retarded, however, by employing the recommended annealing procedures of Burns and Hurst. For differential measurements at high temperatures it is good practice to use the W-25% Re element as the leg remaining totally in the high-temperature region.

The W-3% Re/W-25% Re thermocouple is suitable for use only in a reducing or neutral environment, or in a vacuum. When measurements must be made in an oxidizing environment, the tungsten-rhenium pair can be used if it can be protected by a suitable sheath.

### 2.3 Inhomogeneity

Inhomogeneity is a variation in chemical composition or the physical state of a substance. Hust et al. [11] discuss variations in emf due to variation of composition of several thermoelements from several manufacturers. Their investigations show that the variation in composition of the thermoelements tends to increase as the source diverges: between locations on a spool, between spools, between lots, and even more, between manufacturers. For industrial purposes, it is probably necessary to consider this total range of variation (amounting to 50 or 60 μV between room temperature and 4 K), but for precise measurements exactly the opposite approach should be taken. A thermocouple should be derived from materials of as high quality as is available, as closely related in position on the spool as possible, and the supply of thermocouple materials should be from one tested lot in a quantity adequate for the entire job.

Thermocouple emfs are also affected by strain produced from the drawing of the wire and from handling. Pollock and Finch [34] showed that the change of emf produced by drawing can be large. Even though thermocouple wire is ordinarily given a heat treatment in the final stage of its production, it must be carefully annealed under conditions appropriate for the particular

materials and then tested for homogeneity. This can be done separately for each element by observing any thermal emfs developed in a loop when short lengths of the loop are subjected to a steep temperature gradient. More elaborate tests of the complete thermocouple are discussed by Hust et al. [11], who observed the variation of emf as the wires were immersed in cryogenic fluids, by Kollie et al. [14], who recorded the emf while lowering the thermocouple into a hot-liquid thermostat at a programmed rate, and by Fenton [13], who instrumented a device that measured the emf while generating a traveling gradient along a loop of wire. A method using a very short winding in a furnace is discussed by Ergardt [35].

The effect of work-hardening from the installation and handling of thermocouples depends upon the material, the initial condition of the wire and the severity of the deformation. Rosenbaum [36] studied the effects of cold working on Au-0.07 at % Fe thermoelements used for very low temperatures. For normal handling (defined as gently winding the wire on 1.27 cm diameter spools and then carefully unwinding it) no change in emf was observed in the temperature range from 1 to 20 K. Fenton [13] pointed out that cold working can change the Seebeck coefficient of the KP thermoelement by several percent at temperatures below 400 °C, and that the effect of the cold-working, and other, often larger, effects are removed by annealing at 450 °C. Corruccini [37] showed that forming a platinum coil of large radius (12.5 mm) followed by straightening produced very little effect, but that forming a coil of smaller radius (2.5 mm) followed by straightening changed the emf by 3  $\mu$ V at 400 °C and by 2.5  $\mu$ V at 1200 °C. (The emf at the latter temperature should be affected by annealing except for the colder parts of the wire.)

Burns and Hurst [38] investigated the effects of cold-working on the W-3% Re and W-25% Re thermoelements. The entire wire was coiled about a 20 mm mandrel, straightened, then coiled in the reverse direction and again straightened. Their tests demonstrated that annealed tungsten-rhenium thermoelements are sufficiently ductile to be handled, but not without a significant effect on the Seebeck voltage. All tungsten-rhenium thermocouples should be annealed after danger of deformation from handling is past.

#### 2.4 Calibration

For accurate temperature measurements by thermocouple thermometry, the thermocouples must be calibrated. Calibration consists of measuring the thermocouple emf at a series of approximately uniformly spaced temperatures, as established by standard instruments of the IPTS-68 or fixed points. In order to interpolate between calibration points, the coefficients of a polynomial equation are determined to express the difference of the emfs from an accepted temperature versus emf table (e.g., from NBS Monograph 125 [6], or IEC publication 584-1 [9,10]) if they are standardized thermocouples. Over the temperature range from 13.81 K to 630.74 °C this requires comparisons with the values derived from platinum resistance thermometers. The best procedure for calibration depends on the application. Most inhomogeneities are relatively stable so that the calibration is relatively stable over reasonable periods of time. If an inhomogeneous thermocouple can be calibrated in place, its peculiarities are accounted for, to the extent that the temperature gradient and the inhomogeneity remain constant. When a recalibration can be

made in situ to account for "homogeneity changes", the difference in emf can then be interpolated for prior measurements.

Between 630.74 and 1064.43 °C, the Pt-10% Rh/Pt thermocouple (type S) is the standard instrument of the IPTS-68 and must be calibrated at the temperatures of 630.74 °C (as determined by a platinum resistance thermometer), and the silver and gold fixed points. As there is no more accurate instrument in general use to calibrate the thermocouple against, the usual practice is to reserve one or more of the calibrated Pt-10% Rh/Pt thermocouples as standards for checking the working instruments. High-temperature platinum resistance thermometers, now achieving increased acceptance, are, in fact, much more precise and stable, and are very effective for improved calibration in this range.

Above the temperature of the gold point, international practical temperatures are defined by Planck's law, and usually realized with spectral pyrometers. Accurate thermocouple calibrations are much more difficult to achieve in this temperature region, so that the errors of temperature measurement grow as the temperature increases. Calibration equipment for this region of temperature requires the construction of one or more blackbodies.

## 2.5 Installation

Thermocouples must be installed in the apparatus so that they are physically (and if need be, chemically) protected, with adequate immersion, and with the reference junctions at a uniform and known temperature. Immersion is adequate when the heat transfer to the thermocouple is such that the measuring junction is brought within a chosen limit of the temperature it is desired to measure. On the other hand, adequate immersion must be achieved by means that do not invalidate the measurement sought. It is common that the design of the experiment is substantially affected by balancing the effects of these requirements.

In many installations, thermocouples do not need to be sheathed, and for calibration purposes some portions or all of the thermocouple may need to be removable. They may either be inserted into wells open from the outside, or installed in an enclosed system with insulators. The choice of insulators, which must provide electrical isolation but should not contaminate the thermocouples or the system, is an important consideration if reliable performance is to be obtained. Factors affecting the choice of insulators include types of thermoelements, and the temperature range and environment of use. Suitable choices of insulators, as well as protection tubes, are discussed by Zysk and Robertson [29] and in ASTM Special Publication 470B. To avoid any chemical action, thermocouples must not be contaminated from handling during installation, nor from the system. For instance, if the junction is made by soldering or welding, any flux must be thoroughly eliminated.

The problem of inadequate immersion is discussed by Ginnings and West [39]. They distinguish between "continuous tempering", and "step tempering". Continuous tempering is the process of bringing the thermocouple wires to the temperature of the object to be measured by utilizing the heat flow between

the thermocouple and its surroundings, whether through solid or gas or vacuum. Step tempering is accomplished by "thermal tiedowns", i.e., thermal shunts to an object of relatively large heat capacity.

## 2.6 Summary of the Laws of Thermoelectric Circuits<sup>2</sup>

### 2.6.1 Law of Homogeneous Metals

A thermoelectric current cannot be sustained in a circuit of a single homogeneous material, however varying in cross section, by the application of heat alone.

A consequence of this law is that two different materials are required for any thermocouple circuit. Experiments have been reported suggesting that a nonsymmetrical temperature gradient in a homogenous wire gives rise to a measurable thermoelectric emf. A preponderance of evidence indicates, however, that any emf observed in such a circuit arises from the effects of local inhomogeneities. Furthermore, any current detected in such a circuit when the wire is heated in any way whatever is taken as evidence that the wire is inhomogeneous.

### 2.6.2 Law of Intermediate Metals

The algebraic sum of the thermoelectromotive forces in a circuit composed of any number of dissimilar materials is zero if all of the circuit is at a uniform temperature.

A consequence of this law is that a third homogeneous material always can be added in a circuit with no effect on the net emf of the circuit so long as its extremities are at the same temperature. Therefore, it is evident that a device for measuring the thermoelectromotive force may be introduced into a circuit at any point without affecting the resultant emf, provided all of the junctions which are added to the circuit by introducing the device are all at the same temperature. It also follows that any junction whose temperature is uniform and which makes a good electrical contact does not affect the emf of the thermoelectric circuit regardless of the method employed in forming the junction. (See fig. 2.6.)

Another consequence of this law may be stated as follows. If the thermal emfs of any two metals with respect to a reference metal (such as C) are known, then the emf of the combination of the two metals is the algebraic sum of their emfs against the reference metal. (See fig. 2.7.)

---

<sup>2</sup>The information in this section is extracted from ASTM Special Publication 470B Manual on the Use of Thermocouples in Temperature Measurements. American Society for Testing and Materials, 1916 Race Street, Philadelphia, PA 19103 (1981). This ASTM publication gives a comprehensive discussion of the use of thermocouples for industrial thermometry.

### 2.6.3 Law of Successive or Intermediate Temperatures

If two dissimilar homogeneous metals produce a thermal emf of  $E_1$ , when the junctions are at temperatures  $T_1$  and  $T_2$ , and a thermal emf of  $E_2$ , when the junctions are at  $T_2$  and  $T_3$ , the emf generated when the junctions are at  $T_1$  and  $T_3$ , will be  $E_1 + E_2$ .

One consequence of this law permits a thermocouple, calibrated for a given reference temperature, to be used with any other reference temperature through the use of a suitable correction. (See fig. 2.8 for a schematic example.)

Another consequence of this law is that extension wires, having the same thermoelectric characteristics as those of the thermocouple wires, can be introduced in the thermocouple circuit (say from region  $T_2$  to  $T_3$  in fig. 2.8) without affecting the net emf of the thermocouple.

## 2.7 References

- [1] Seebeck, T. J., Abh. Akad. Wiss., Berlin 265 (1822).
- [2] Peltier, J. C. A., Ann. Chim. Phys. 56 (2nd series) 371 (1834).
- [3] Thomson, W., Trans. R. Soc., Edinburgh 21, 123-171, (1854).
- [4] Roeser, W. F., in Temperature: Its Measurement and Control in Science and Industry, pp. 180-205, Volume 1 (New York: American Institute of Physics) (1941).
- [5] Kinzie, P. A., Thermocouple Temperature Measurement (New York: John Wiley) (1973).
- [6] Powell, R. L., Hall, W. J., Hyink, C. H. Jr., Sparks, L. L., Burns, G. W., Scroger, M. G., Plumb, H. H., Natl. Bur. Stand. (U.S.) Monogr. 125, (1974).
- [7] Sparks, L. L., Powell, R. L., Hall, W. J., Natl. Bur. Stand. (U.S.), Monogr. 124 (1972).
- [8] Burley, N. A., in Plumb, H. H. (Ed.), Temperature: Its Measurement and Control in Science and Industry, pp. 1677-1695, Volume 4 (Pittsburgh: Instrument Society of America) (1972).
- [9] IEC, Thermocouples Part 1, International Electrotechnical Commission, Publication 584-1 (1977).
- [10] IEC, Thermocouples Part 2, International Electrotechnical Commission, Publication 584-2 (1982).
- [11] Hust, J. G., Powell, R. J., Sparks, L. L., in Plumb, H. H. (Ed.), Temperature: Its Measurement and Control in Science and Industry, pp. 1525-1535, Volume 4 (Pittsburgh: Instrument Society of America) (1972).
- [12] Burley, N. A., Australian Defense Scientific Service, Defense Standards Laboratories, Report 353 (1970).
- [13] Fenton, A. W., in Plumb, H. H., Temperature: Its Measurement and Control in Science and Industry, pp. 1973-1990, Volume 4 (Pittsburgh: Instrument Society of America) (1972).
- [14] Kollie, T. G. Horton, J. L. Garr, K. R. Herskovitz, M. B., Mossman, C. S., Rev. Sci. Instrum. 46, 1447-1461 (1975).
- [15] Dahl, A. I., in Temperature: Its Measurement and Control in Science and Industry, pp. 1238-1266, Volume 1 (New York: American Institute of Physics) (1941).
- [16] Le Chatelier, C. R., Acad. Sci. 102, 819 (1886).

- [17] Burgess, G. K., J. Res. Natl. Bur. Stand. 11, 635-640 (1928).
- [18] The International Practical Temperature Scale of 1968 Amended Edition of 1975, Metrologia 12, No. 1, 7-17 (1976).
- [19] Barber, C. R., Metrologia 5, 35-44 (1969).
- [20] Jones, T. P., Metrologia 4, 80-83 (1968).
- [21] McLaren, E. H., Murdock, E. G., in Plumb, H. H. (Ed.), Temperature: Its Measurement and Control in Science and Industry, pp. 1543-1560, Volume 4 (Pittsburgh: Instrument Society of America) (1972).
- [22] Burley, N. A., Powell, R. L., Burns, G. W., Scroger, M. G., Natl. Bur. Stand. (U.S.) Monogr. 161 (1978).
- [23] Accinno, D. J., Schneider, J. F., in Herzfeld, C. M. (Ed.), Temperature: Its Measurement and Control in Science and Industry, Part 1, pp. 195-200, Volume 3 (New York: Reinhold) (1962).
- [24] Bedford, R. E., Rev. Sci. Instrum. 35, 1177 (1964).
- [25] Bedford, R. E., Rev. Sci. Instrum. 36, 1571-1580 (1965).
- [26] Jewell, R. C., Knowles, E. G., Land, T., Met. Ind. (London) 87, 217 (1955).
- [27] Freeze, P. D., Thomas, D. B., NASA CR-135055 or Natl. Bur. Stand. (U.S.) IR 76-1026, 55 pp. (1976).
- [28] Aleksaklin, I. A., Lepin, I. R., Bregin, B. K., Issledovaniya Splavov dlya Termopar 22 143-158, Weight Technology Div., Wright-Patterson Air Force Base, Ohio AD-663573 (translation) (1967).
- [29] Zysk, E. D., Robertson, A. R., in Plumb, H. H. (Ed.), Temperature: Its Measurement and Control in Science and Industry, pp. 697-1734, Volume 4 (Pittsburgh: Instrument Society of America) (1972).
- [30] Caldwell, F. R., in Herzfeld, C. M. (Ed.), Temperature: Its Measurement and Control in Science and Industry, Part 1, pp. 81-134, Volume 3 (New York: Reinhold) (1962).
- [31] Burns, G. W., Hurst, W. S., in Plumb, H. H. (Ed.), Temperature: Its Measurement and Control in Science and Industry, pp. 1751-1766, Volume 4 (Pittsburgh: Instrument Society of America) (1972).
- [32] Pugh, J. W., Amra, L. H., Hurd, D. T., Trans. Am. Soc. Met. 55, 451-461 (1962).

- [33] Burns, G. W., Hurst, W. S., in Billing, B. F., Quinn, T. J. (Eds.), Temperature Measurement 1975 Institute of Physics Conference Series, pp. 144-159 Volume 26 (London and Bristol: Institute of Physics) (1975).
- [34] Pollock, D. D., Finch, D. I., in Herzfield, C. M. (Ed.), Temperature: Its Measurement and Control in Science and Industry, Part 2, pp. 237-241, Volume 3 (New York: Reinhold) (1962).
- [35] Ergardt, N. N., Tr. Vses. Nauchno-Issled. Inst. Metrol. 51(111) 89-96 (1961).
- [36] Rosenbaum, R. L., Rev. Sci. Instrum. 39, 890-899 (1968).
- [37] Corruccini, R. J., J. Res. Natl. Bur. Stand. 47, 94-103 (1951).
- [38] Burns, G. W., Hurst, W. S., NASA Contract, C-61545-B, Report No. 3, (1970).
- [39] Ginnings, D. C., West, E. D., Experimental Thermodynamics, Volume 1, (New York: Plenum Press) pp. 113-115 (1968).



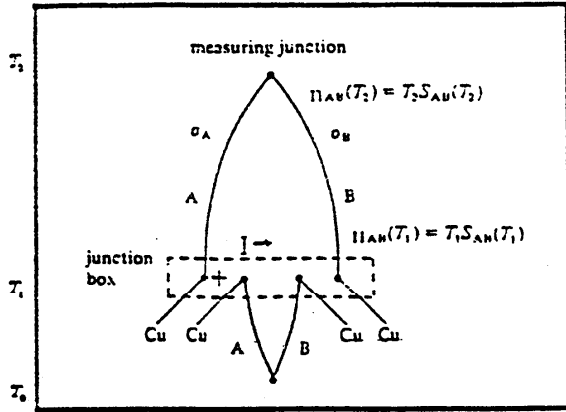

Figure 2.1. Schematic diagram of thermocouples with a junction box.

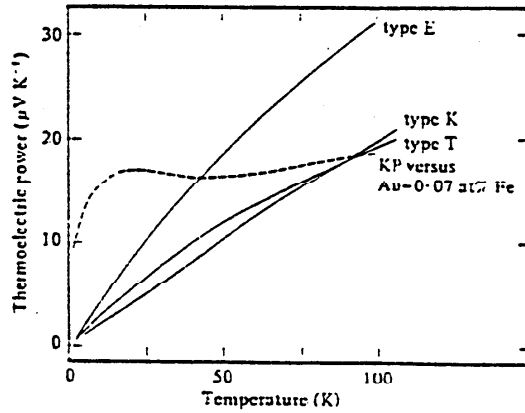

Figure 2.2. Thermoelectric power of some low-temperature Thermocouples.

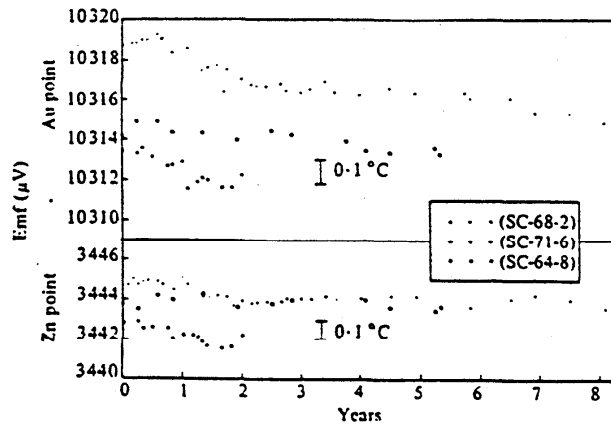

Figure 2.3. Calibration emf's of three standard thermocouples at the zinc point and at the gold point. Time at high temperature is about 5 h for each set.

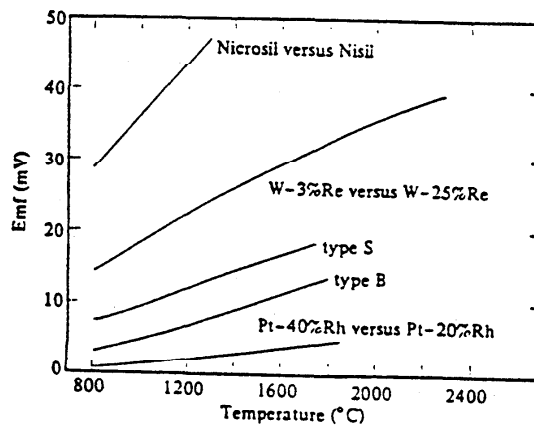

Figure 2.4. Temperature-emf relationships of some high-temperature thermocouples

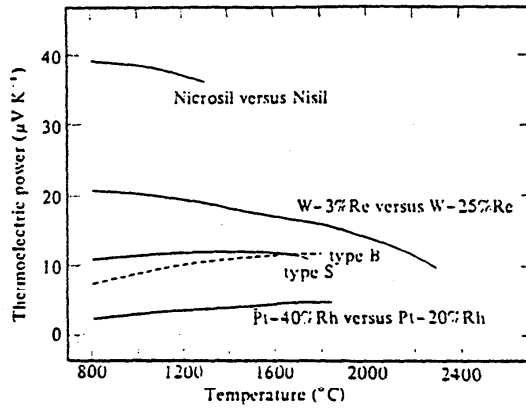

Figure 2.5. Thermoelectric power of some high-temperature thermocouples.

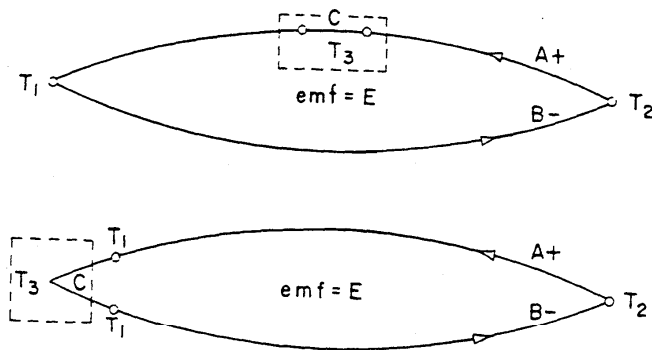

Figure 2.6. Emf(E) unaffected by third material, C.

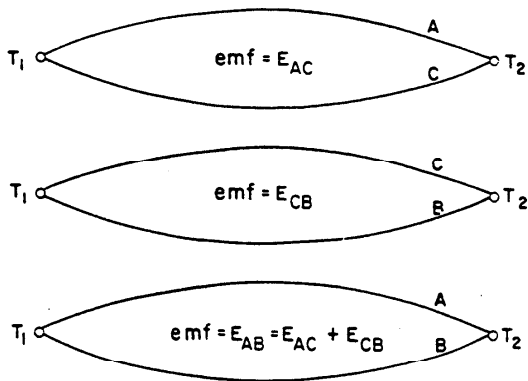

Figure 2.7. Emfs are additive for materials.

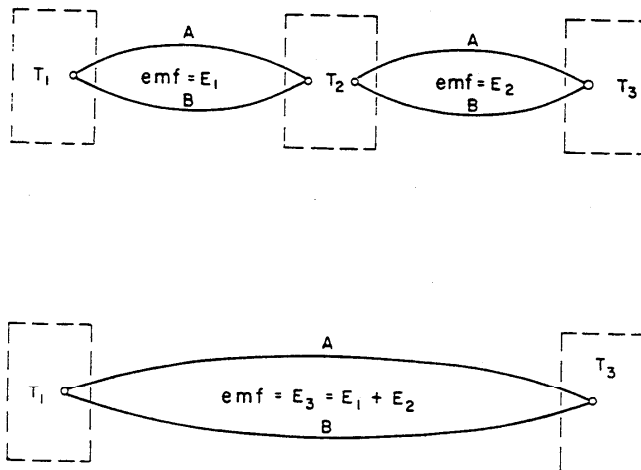

Figure 2.8. Emfs are additive for temperature intervals.

### 3. CALIBRATION METHODS AND PROCEDURES FOR THERMOCOUPLES AND THERMOCOUPLE MATERIALS

As indicated in section 1.0, the calibrations of thermocouples and of single-leg thermoelements versus the platinum thermoelectric standard, Pt-67, are conducted by one or more of the following general methods:

- a) by comparison with a calibrated reference thermocouple in an electric tube-type furnace;
- b) by comparison with a standard platinum resistance thermometer in a cryostat or in a stirred liquid bath; or
- c) at certain thermometric fixed points of the IPTS-68 as realized in metal freezing-point cells.

The equipment and procedures employed for each of the above three calibration methods are described in this section.

#### 3.1 Calibration by Comparison with a Reference Thermocouple

##### 3.1.1 Type S, Type R, and Type B Thermocouples

Type S, type R, and type B thermocouples may be calibrated by comparison with reference thermocouples. The reference thermocouples used consist of a set of type S thermocouples and a set of type B thermocouples. The type S reference thermocouples are calibrated at fixed points and are then checked periodically for changes in calibration by comparison with other type S thermocouples that have been calibrated by fixed points. These type S reference thermocouples are not used above 1100 °C. The type B reference thermocouples are calibrated by comparison with type S reference thermocouples to 1100 °C and by comparison with type B thermocouples whose calibration was determined by comparison with an optical pyrometer using a high temperature furnace, containing a black body enclosure, to heat the thermocouples. The type B reference thermocouples are used in the range 800 to 1600 °C.

##### 3.1.1.1 Preliminary Examination

A thermocouple submitted for calibration is carefully removed from the package in which it was shipped. The packing material and shipping container are saved and used to return the instrument to the customer. The thermocouple is examined visually and its length, diameter, and condition (new, used, etc.) are recorded in the laboratory notebook.

##### 3.1.1.2 Electrical Anneal

Before undertaking a calibration of a type S, type R, or type B thermocouple, the thermocouple wire is annealed electrically in air. The thermocouple is suspended from two spring-loaded copper clips in the electrical annealing system (see sec. 3.1.1.8) and cleaned by wiping with an ethanol-saturated tissue. The wire is then heated by passing a 60 Hz alternating current through it. The annealing current is regulated with an adjustable

transformer. The annealing procedure is to heat the wire at about 1450 °C for 45 minutes and then allow it to cool quickly to about 750 °C. It is held at 750 °C for 30 minutes and then cooled to room temperature in a time of a few minutes. The temperature of the wire is determined with an optical pyrometer (Leeds and Northrup Co. Model 8622-0). It is necessary to add a correction to the observed apparent temperature to obtain the true temperature. For a true temperature of 1450 °C, the correction (based on an emissivity of 0.33) amounts to about 140 °C; hence, the optical pyrometer scale is set to 1310 °C. The electrical current required to bring the wire to 1450 °C depends upon the diameter of the wire and the type of wire. For 0.51 mm diameter thermoelements of type B, S, and R thermocouples, a current of roughly 12 to 12.5 amps is required for annealing at 1450 °C. Type S, type R, and type B thermocouples are all electrically annealed in the same manner.

### 3.1.1.3 Mounting for Calibration

The annealed thermocouples are inserted carefully into high purity alumina insulating tubes (2 or 4 bore). The insulating tubes used for type B thermocouples are kept separate from those used for type S and type R. A common junction is formed by welding together the measuring junctions of the test thermocouples and a calibrated reference thermocouple. A type S reference thermocouple is used in the range 0 to 1100 °C, and a type B reference thermocouple is used when testing type B thermocouples in the range 800 to 1600 °C. The number of thermocouples in a run is limited primarily by the inner diameter of the alumina protection tube used in the calibration furnace. Usually four to six thermocouples are tested in each calibration run. Copper connecting wires (0.4 mm diameter) are joined electrically to the thermocouple wires to form the reference junctions, and the reference junctions are maintained at 0 °C in an ice bath (see sec. 3.1.1.8). In this manner, the test thermocouples are connected, through a switch scanner, to one measuring instrument, and the reference thermocouple to another measuring instrument so that measurements of the test and reference thermocouples may be made simultaneously.

### 3.1.1.4 Furnace Anneal

TYPE S, TYPE R, AND LOW TEMPERATURE RANGE FOR TYPE B. Before the calibration is begun, the test thermocouple assembly is annealed in the calibration furnace. The assembly is inserted into the Chromel tube furnace (see fig. 3.2 and sec. 3.1.1.8) so that the common measuring junction is located about 30 cm from the end of the Chromel heating tube. The thermocouple assembly is protected by a closed-end alumina tube during the anneal. The furnace is heated in two steps to a temperature between 1060 and 1100 °C and held at that temperature for 30 minutes. This anneal is used to remove small mechanical strains that may have been introduced into the wire during the mounting operation.

HIGH TEMPERATURE RANGE FOR TYPE B. Type B thermocouples in the high temperature range (800 to 1600 °C) are calibrated in the silicon carbide horizontal tube furnace (see fig. 3.3 and sec. 3.1.1.8). Before the calibration is begun, the test thermocouple assembly is inserted in the furnace to an immersion of 30 cm from the end of the silicon carbide heating tube and then

annealed. The thermocouple assembly is protected by a closed-end alumina tube during the anneal. The test thermocouple assembly is heated slowly (over a period of 2 to 4 h) to about 1100 °C and held at that temperature for 30 minutes. The temperature is then reduced to about 800 °C to begin the calibration run.

#### 3.1.1.5 Calibration Data

Data for a particular test thermocouple are obtained by measuring the emf of the reference thermocouple and the emf of the test thermocouple simultaneously. From these data, values for the temperature of the common measuring junction and the emf of the test thermocouple are determined. Calibration data are obtained starting at about 1100 °C and decreasing to about 100 °C, except for the high temperature range of a type B thermocouple, which is calibrated starting at 800 °C and increasing to 1550 or 1600 °C. Data for automatic and semi-automatic calibrations are taken at approximately 30 °C intervals. The values of emf are measured and recorded with an automatic digital data acquisition system. This system includes a microcomputer (IBM enhanced AT), two precision digital voltmeters (Hewlett Packard 3456A), two switch scanners (Fluke 2205A), a printer (IBM Proprinter XL24), and a color monitor). A block schematic of the automatic calibration system is shown in figure 3.1, and the individual components are described in section 3.1.1.8. Automatic calibrations are performed with type S and type R thermocouples, and with type B thermocouples in the low temperature range. Data for the high temperature range for type B thermocouples are normally obtained in a semi-automatic mode, in that, readings are taken at the operator's command.

Before beginning the calibration, a qualitative check of the thermoelectric homogeneity of all type S and type R thermocouples is carried out by comparing them with the reference thermocouple at different immersions in the calibration furnace. The common measuring junction is held at about 1100 °C and the thermocouple assembly is moved to produce different temperature gradients along the thermocouples. Test data are taken with the measuring junction at normal immersion into the furnace (30 cm) and then at +5.1, -3.8, and -7.6 cm from normal immersion. This qualitative check will indicate an inhomogeneous thermocouple only if the inhomogeneity in it happens to be located in the temperature gradient zone of our calibration furnace. If gross differences (5 microvolts or more) are found in the emf readings over the 12.7 cm change in immersion, the test thermocouple is checked again for inhomogeneity. The second check is usually made against a different reference thermocouple, and the test thermocouple is annealed in the furnace and may also be reannealed electrically. If the thermocouple still exhibits gross inhomogeneities, it is rejected for calibration and the results of the test are reported to the customer.

#### 3.1.1.6 Packing and Shipping

After the calibration is completed and the furnace has cooled to ambient temperature, the test thermocouple assembly is removed from the furnace and its common junction is cut off. A new measuring junction is then formed on each thermocouple by welding with the oxygen-gas torch. The thermocouples are then packed for shipment. Each of the thermocouples is coiled on a glass

beaker (5 cm in diameter), placed in a small envelope, and packed in the container in which it was received. A thermocouple received on a plastic spool or in plastic tubing is returned to the customer on the same spool or in the same tubing. If the container was damaged in shipment or came with insufficient packing material, the NIST Shipping and Receiving Unit provides a suitable shipping container.

### 3.1.1.7 Calibration Report

The calibration data are processed on a laboratory computer (see sec. 3.1.1.8.) to obtain temperature versus emf tables at 1 degree intervals, with the emf given in millivolts to the nearest microvolt. The tables may have temperature in either °C or °F and on either the IPTS-68 or IPTS-48. The computer programs used for processing the calibration data and for calculating and printing the tables for the type S, type R, and type B thermocouples are discussed in this section.

TEMPERATURE VERSUS EMF TABLES, TYPE S. The data from an automatic calibration of a type S thermocouple are processed using a laboratory computer to obtain a temperature versus emf table for the test thermocouple. The computer program requires that the coefficients giving the temperature-emf relationship of the type S reference thermocouple used in the calibration be on file. The processing is divided into three temperature ranges: 0 to 630.74 °C, 630.74 to 1064.43 °C, and 1064.43 to 1450 °C.

The computer calculates the temperature,  $t_{68}$ , for each data point from the measured emf of the type S reference thermocouple and also calculates the difference,  $D_e$ , between the emf readings of the test thermocouple and the reference thermocouple at that temperature. In the 0 to 630.74 °C range the corresponding values of  $D_e$  and  $t_{68}$  are fitted with a fourth degree polynomial by the method of least squares. The polynomial is constrained to give 0 emf at 0 °C.

In the 630.74 to 1064.43 °C range, the polynomial from the lower temperature range is used to calculate the emf difference,  $D_{sb}$ , at 630.74 °C. This value is then subtracted from the values of  $D_e$ , and 630.74 is subtracted from the corresponding values of calculated temperature,  $t_{68}$ . These data are then fitted with a second degree polynomial by the method of least squares, symbolically  $D_e - D_{sb} = f(t_{68} - 630.74)$ . The polynomial is constrained so that the value of  $D_e - D_{sb}$  equals 0 at 630.74 °C. This polynomial is then rearranged algebraically to yield  $D_e$  as a function of  $t_{68}$ .

The polynomial for the 630.64 to 1064.43 °C range is then extrapolated linearly above 1064.43 °C to obtain the functional relationship between  $D_e$  and  $t_{68}$ . The slope-intercept form of a straight line is used to represent  $D_e$  as a linear function of  $t_{68}$ . The slope is determined by calculating the first derivative with respect to  $t_{68}$  at 1064.43 °C of the polynomial obtained for the 630.74 to 1064.43 °C range.

The polynomials representing  $D_e = f(t)$  in the above three temperature ranges are then combined algebraically with the functions that give the temperature-emf relationship of the type S reference thermocouple to obtain the



polynomials representing the temperature-emf relationship for the test thermocouple.

TEMPERATURE VERSUS EMF TABLES, TYPE R. The data from an automatic calibration of a type R thermocouple are processed using a laboratory computer to obtain a temperature versus emf table for the test thermocouple. The computer program requires that the coefficients giving the temperature-emf relationship of the type S reference thermocouple used in the calibration be on file. The processing is divided into three temperature ranges: 0 to 630.74 °C, 630.74 to 1064.43 °C, and 1064.43 to 1450 °C.

The computer first calculates the temperature,  $t_{68}$ , for each data point from the measured emf of the type S reference thermocouple. The coefficients for the type R emf-temperature table given in NBS Monograph 125 [1] are used to calculate the corresponding value of the emf at each temperature. The difference,  $D_e$ , between the measured emf value of the test thermocouple and the emf value from the reference table is then computed. In the 0 to 630.74 °C range the corresponding values of  $D_e$  and  $t_{68}$  are fitted with a fourth degree polynomial by the method of least squares. The polynomial is constrained to give 0 emf at 0 °C.

In the 630.74 to 1064.43 °C range, the polynomial from the lower temperature range is used to calculate the emf difference,  $D_{sb}$ , at 630.74 °C. This value is then subtracted from the values of  $D_e$ , and 630.74 is subtracted from the corresponding values of calculated temperature,  $t_{68}$ . These data are then fitted with a second degree polynomial by the method of least squares, symbolically  $D_e - D_{sb} = f(t_{68} - 630.74)$ . The polynomial is constrained so that the value of  $D_e - D_{sb}$  equals 0 at 630.74 °C. This polynomial is then rearranged algebraically to yield  $D_e$  as a function of  $t_{68}$ .

The polynomial for the 630.74 to 1064.43 °C range is then extrapolated linearly above 1064.43 °C to obtain the functional relationship between  $D_e$  and  $t_{68}$ . The slope-intercept form of a straight line is used to represent  $D_e$  as a linear function of  $t_{68}$ . The slope is determined by calculating the first derivative with respect to  $t_{68}$  at 1064.43 °C of the polynomial obtained for the 630.74 to 1064.43 °C range.

The polynomials representing  $D_e = f(t)$  in the above three temperature ranges are then combined algebraically with the functions that give the temperature-emf relationship of the type R thermocouple reference table given in Monograph 125 to obtain polynomials representing the temperature-emf relationship for the test thermocouple.

TEMPERATURE VERSUS EMF TABLES, TYPE B. The data from an automatic calibration of a type B thermocouple are processed using a laboratory computer to obtain a temperature-emf table for the test thermocouple. Three computer programs are used for this purpose depending on the temperature range: 1) 800 to 1750 °C, 2) 0 to 1100 °C, or 3) 0 to 1750 °C. Each of the programs requires that the coefficients giving the temperature-emf relationship of the reference thermocouples (type S, or Type B, or both) used in the calibration be on file.

For a calibration in the range 800 to 1750 °C, where the temperature is measured with a type B reference thermocouple, the computer calculates the temperature,  $t_{68}$ , from the measured emf of the reference thermocouple and also calculates the difference,  $De$ , between the emf readings of the test thermocouple and the reference thermocouple at that temperature. The corresponding values of  $De$  and  $t_{68}$  are fitted with a quadratic equation by the method of least squares. This quadratic equation is then combined algebraically with the functions that give the temperature-emf relationship of the type B reference thermocouple to obtain the polynomials representing the temperature-emf relationship of the test thermocouple.

For a calibration in the range 0 to 1100 °C, where the temperature is measured with a type S reference thermocouple, the computer calculates the temperature,  $t_{68}$ , for each data point from the emf of the type S reference thermocouple. The coefficients for the type B emf-temperature table given in NBS Monograph 125 are used to calculate a corresponding value of the emf at each temperature. The difference,  $De$ , between the measured emf value of the test thermocouple and the emf value from the reference table is then computed. The corresponding values of  $De$  and  $t_{68}$  are fitted with a third degree polynomial by the method of least squares. The polynomial is constrained to give 0 emf at 0 °C. The third degree polynomial is then combined algebraically with the function that gives the temperature-emf relationship of the type B thermocouple reference table given in NBS Monograph 125 to obtain a polynomial representing the emf-temperature relationship of the test thermocouple.

For a calibration over the whole range 0 to 1750 °C, the data are processed in two steps. First the calibration data obtained in the 0 to 1100 °C range, where the temperature is measured with a type S reference thermocouple, are processed in the manner described above to obtain a polynomial representing the emf-temperature relationship of the test thermocouple in the range 0 to 1064.43 °C. In the 1064.43 °C to 1750 °C range, the polynomial from the lower temperature range is used to calculate the emf of the test thermocouple at 1064.43 °C and the difference,  $Dau$ , between the calculated emf of the test thermocouple and the emf of the type B reference thermocouple at 1064.43 °C is determined. This value,  $Dau$ , is then subtracted from the values of  $De$ , and 1064.43 °C is subtracted from the corresponding values of calculated temperature,  $t_{68}$ . These data are fitted with a second degree polynomial by the method of least squares, symbolically  $De - Dau = f(t_{68} - 1064.43 \text{ °C})$ . The polynomial is constrained so that the value of  $De - Dau$  equals 0 at 1064.43 °C. This polynomial is then rearranged algebraically to yield  $De$  as a function of  $t_{68}$ . It is then combined algebraically with the function that gives the temperature-emf relationship of the type B reference thermocouple to obtain the polynomial representing the temperature-emf relationship of the test thermocouple in the 1064.43 °C to 1750 °C range.

COMPUTER OPERATIONS USED TO CALCULATE AND PRINT TABLES. Tables for types S, R, and B thermocouples are calculated and printed using the laboratory computer. The computer programs operate as outlined above, using a least-squares fitting routine to fit the data in predetermined temperature ranges. The data file is generated from the automatic calibration programs. The coefficients of the equations giving the temperature-emf relationships of the

reference thermocouple and the appropriate thermocouple reference table from NBS Monograph 125 must be in files.

The printed output will include the temperature versus emf table, a listing of the measured calibration data, results of the least squares fitting of the calibration data, and a summary of the temperature versus emf table and coefficients. The temperature versus emf table and the list of coefficients for the equations that were used to compute the table are bound with a typed report of calibration which gives the customer's name and location, the customer's designation of the thermocouple, the estimated calibration uncertainty, the purchase order number, the test number, and the date. The bound calibration report, along with a typed covering letter, is sent to the customer. Samples of the above information for a comparison calibration of a type S and a type R thermocouple are given in the appendix, section 8.1.2 and 8.1.3, respectively. The calibrated thermocouple is returned under separate cover.

#### 3.1.1.8 Apparatus

WELDING STATION. In order to minimize contamination of the platinum and platinum-rhodium thermocouple wires, a laboratory work bench and special tools are reserved for preparation and assembly of the test thermocouples. The bench top is covered with clean paper. The thermocouple measuring junctions are prepared by welding using a small oxygen-gas torch. Although plastic gloves are not used when handling the wires, care is taken to insure that hands are washed prior to handling the wires.

ELECTRICAL ANNEALING SYSTEM. The purpose of the annealing system is to hold the thermocouple wires during the electrical anneal and protect them from drafts which can cause temperature variation along the wires. The annealing system used in this laboratory is a three sided enclosure (57 cm wide by 57 cm deep and 215 cm high) and has electrical leads coming through the top to two spring-loaded copper clips that hold the thermocouple wire. The front of the system is left open for easy access and to permit the temperature of the thermocouple wire to be determined with the optical pyrometer during the anneal. The longest thermocouple that may be annealed is about 180 cm. Longer thermocouples (up to 360 cm) can be accommodated by annealing each leg separately.

FURNACES. A horizontal tube-type furnace having a tubular heating element of Chromel (a nickel-chromium alloy) is used to heat the thermocouples during a calibration in the 0 to 1100 °C range. A simplified sectional view of the furnace is shown in figure 3.2. The heating element (22 mm i.d. and 610 mm long) is clamped between two water-cooled copper terminals that are bolted to a laminated copper bus that consists of 14 strips of copper, each 1.2 mm thick and 100 mm wide. The copper bus supports the heating element and forms a single-turn secondary winding of an electrical transformer that has a turns ratio of 40 to 1. A radiation shield and a water-cooled furnace shell (190 mm in diameter and 540 mm long) are mounted around the heating element. To minimize the time required for heating and cooling of the furnace, no thermal insulation is used between the heating tube, the radiation shield, and the furnace shell. The middle part of this furnace, for about 450 mm, is at

practically a uniform temperature and the water-cooled terminals produce a very sharp temperature gradient at each end. This furnace can be heated to about 1100 °C in about 10 minutes with about 12 kW and, if all the power is shut off, will cool from that temperature to about 300 °C in about the same time. A large motor-driven adjustable transformer is used to supply power to the primary winding of the transformer and a smaller manually-operated adjustable transformer is used to trim about 10% of the electrical power.

During calibrations of noble metal thermocouples, a high purity alumina tube (11 mm i.d., 16 mm o.d., and 450 mm long) is used in the furnace to protect the test thermocouples from contamination by the Chromel heating element. The temperature of the furnace is changed during an automatic calibration by the computer, which actuates relays to control the motor-driven adjustable transformer.

For the calibration of type B thermocouples in the 800 to 1600 °C range, a horizontal tube-type furnace with a tubular silicon carbide heating element is used. A sectional view of the furnace is shown in figure 3.3. The heating element (29 mm i.d. and 710 mm long) is held between two water cooled terminal assemblies that are spring loaded against the brass end plates of the furnace shell to allow for the thermal expansion and contraction of the heating element during heating and cooling. The outer brass shell (450 mm in diameter and 670 mm long) is also water cooled. A refractory insulating liner formed from ring shaped bricks and contained within an Inconel tube surrounds the heating element. The furnace may be heated to about 1100 °C in about 2 hours and then to 1600 °C in an about four more hours. The power required to hold the furnace at a temperature of 1600 °C is about 4.5 kW. The temperature of this furnace is controlled manually during a calibration and the electrical power is supplied using the large motor-driven adjustable transformer and the smaller adjustable transformer that are used with the Chromel tube furnace. A high purity alumina tube (15 mm i.d., 20 mm o.d., and 610 mm long), closed at one end, is used in the furnace to protect the thermocouples from contamination by the heating element. It is held at the outer end and cantilevered into the furnace so that it is not in contact with the heater.

ICE BATHS. Thermocouple reference junctions are maintained at 0 °C in ice baths during the calibration. The ice bath consists of a mixture of finely divided pure ice and water contained in a Dewar flask (70 mm i.d. and 340 mm high). The reference junctions are formed by inserting the thermocouple wires and 0.4 mm copper connecting wires into closed end glass tubes containing a drop of mercury at the bottom. The glass tubes (4 mm i.d., 6 mm o.d., and 165 mm long) are immersed 135 mm into the ice bath through holes in the cover of the Dewar vessel. The glass tubes must be clean and free from water, or a spurious emf may be introduced into the measurements. They are examined visually each time they are used and replaced with clean tubes as needed. The dirty mercury is removed from the used tubes and saved. The tubes are cleaned with dilute hydrochloric acid, then rinsed with water and with ethanol. After the tubes have dried, they are reused.

MEASURING INSTRUMENTS. During automatic calibrations, the values of emf of the test and reference thermocouples are read simultaneously with two Hewlett Packard 3456A Precision Digital Voltmeters (PDVM's). The computer is

programed to read these instruments simultaneously. The PDVM's are instructed to take 16 readings, calculate the mean and the variance of the readings, and return these values to the computer. During a calibration, the PDVM's are checked against a 10 millivolt constant voltage source at the beginning of the test and after each six sets of readings. The 10 millivolt standard is, in turn, checked against a calibrated six-dial Guildline potentiometer (see sec. 3.3.9.9). The PDVM's are also checked periodically against the six-dial Guildline potentiometer. The zero of each PDVM is determined each time the 10 millivolt constant voltage source is read by measuring an electrical short at the terminal board and the value of emf found is applied to subsequent PDVM readings.

COMPUTER. The computer used in the thermocouple calibration laboratory is an IBM enhanced AT computer operating under PC DOS 3.20, with 640 K memory, using the National IEEE-488 bus interface and TransEra TBASIC. The printer is an IBM Proprinter XL24 and a color monitor is used.

### 3.1.2 Base Metal Thermocouples

Base-metal thermocouples are calibrated manually by comparison with a type S reference thermocouple using procedures and apparatus similar to or identical with those used for noble metal thermocouple calibrations. After removing the thermocouple from the package in which it was shipped, it is examined visually. Only new base-metal thermocouple wires are accepted for calibration, since experience indicates that base-metal thermocouples exhibit various degrees of inhomogeneity after they have been heated to elevated temperatures for relatively short periods. If a thermocouple appears to have been previously heated, the customer is contacted and requested to supply unused thermocouple wire for the calibration.

The base-metal thermocouples are not given an electrical anneal before calibration. The wires are insulated in ceramic tubing. Normally, high purity alumina is used, although mullite is used occasionally. The size (o.d. and i.d.) and configuration of the tubing differ widely and depend on the diameter of the thermocouple wire. Usually, twin-bore tubing in a single continuous length is used, but at times short lengths or single-bore insulators are employed. If the thermocouple was received with the measuring junction already formed, the ceramic tubing is slid over the wires starting at the reference junction end of the thermocouple, and the measuring junction is left intact. When necessary, the measuring junction is formed by welding with an oxygen-natural gas torch, using borax flux to protect the wires from oxidation. The flux is removed after the weld is made by mechanical means or by boiling in water or both.

The type S reference thermocouple that is used to measure the temperature during the calibration is mounted and protected in the following manner to minimize the contamination of the thermocouple wires. First the type S reference thermocouple is assembled in a twin-bore, high-purity alumina insulator. The insulator is then inserted into a high-purity silica glass tube that is open at both ends. The tube is positioned so that the end of the alumina tube is flush with the end of the glass tube, and the measuring junction extends about one centimeter beyond. The ends of the glass and

alumina tubes are then sealed to the thermocouple wire with a small amount of borosilicate glass to prevent metal vapors from the base metal thermocouple and from the furnace heating element from contaminating the type S reference thermocouple during a calibration. The measuring junction of the reference thermocouple is attached to the measuring junction of the base metal test thermocouple by one of the following methods:

- a) It is spot welded to the junction of the base-metal test thermocouple.
- b) It is tied to the junction of the base-metal test thermocouple by wrapping with a short length of platinum wire.
- c) A small diameter hole is drilled in the junction of the base-metal thermocouple and the junction of the type S reference thermocouple is driven into this hole with a steel punch.

The first method is the one that is used most frequently. The third method is sometimes used when the base-metal thermocouple wire is very large in diameter.

For the calibration of base metal thermocouples, the furnace with the Chromel heating tube is used without a closed end alumina protection tube. The thermocouple assembly is inserted into the furnace to an immersion of about 30 cm. Calibration data are taken in order of increasing furnace temperature at temperatures specified by the customer. The highest temperature at which a particular letter-designated type thermocouple is calibrated is determined by the recommended upper temperature limits specified in ASTM Standard E230. These temperature limits are given below.

Thermocouple Type	Temperature Limit (°C)
E	1000
J	760
K	1100
N	1100
T	400

The calibration data are taken in order of increasing temperature since the thermocouples may change even during the calibration process. The magnitude of the change depends upon the type of thermocouple, the temperature to which it is heated, and the time at temperature. The emf of the test thermocouple and the emf of the type S reference thermocouple are measured simultaneously while the furnace temperature is changing slowly, using the two precision digital voltmeters, the switch scanners, and the automatic data acquisition system described in section 3.1.1.5.

The data for the calibration of a base-metal thermocouple are reported at the actual measured temperatures. While a calibration is in progress, the difference between the measured emf of the test thermocouple and the emf given by

the thermocouple reference table found in NBS Monograph 125 is calculated; measurements may be repeated if a particular calibration point appears out of line with the preceding points. After the calibration is completed, a report listing temperature and emf of the test thermocouple is typed and sent to the customer along with a covering letter. An example of a calibration report for a type K thermocouple and a covering letter is shown in section 8.1.5.

### 3.1.3 Thermoelements versus Platinum Thermoelectric Reference Standard, Pt-67

When requested by our customers, thermoelements are tested against the platinum thermoelectric reference standard, Pt-67, that is maintained by the NIST Temperature and Pressure Division. This standard is a selected portion of NIST Standard Reference Material (SRM) 1967; its development and properties are described in NBS Monograph 125. Both noble-metal and base-metal wires are tested against Pt-67. Platinum reference wires whose values of emf are known relative to Pt-67 are used to form a thermocouple with the wire submitted by the customer. This thermocouple is then calibrated using the same test procedures, calibration furnace, and measuring instruments as those described for the comparison calibration of base-metal thermocouples in section 3.1.2. A different set of platinum reference wires is used when testing noble-metal wires than when testing base-metal wires. The platinum reference wires used for testing base-metal wires are insulated in a high purity alumina tube and protected from contamination in the same manner as the type S reference thermocouples used for base-metal thermocouple calibrations. There must be electrical contact, of course, between the platinum reference wire and the test wires. For base-metal wires the measuring junctions of the platinum thermoelectric reference wire and type S thermocouple are spot welded to the test wire, but for noble-metal wires the measuring junctions of the test and reference wires and of the type S reference thermocouple are welded together with an oxygen-gas torch. Calibration points are taken in order of increasing temperature for the base-metal wires and in order of decreasing temperature for the noble-metal wires. Measurements are made at up to 15 different temperatures of the customers' choice. The maximum calibration temperature will depend on the type of wire. In general, base-metal wires are tested to the same upper temperature limits as the corresponding thermocouple type. (See sec. 3.1.2.)

### 3.1.4 Metal-Sheathed Thermocouples

Metal-sheathed thermocouples are accepted for calibration by the comparison method if they can be accommodated in our test apparatus. The customer must supply suitable thermocouple connectors and extension wires for making electrical connections between the thermocouple and the copper connecting wires going to the measuring instrument. Before a metal-sheathed thermocouple is tested at temperatures above room temperature, it is immersed in an ice bath and the emf of the thermocouple is measured with the thermocouple connectors maintained at room temperature.

The method used above room temperature to calibrate metal-sheathed thermocouples is similar to that employed with thermocouples that are not sheathed. The reference thermocouples used for testing such thermocouples are

the same as those used in the calibrations described in sections 3.1.1 and 3.1.2. The choice of the reference standard to be employed depends on the composition of the sheath, the temperature range, and the type of test thermocouple. The measuring junction of the reference thermocouple is attached to the outside of the metal sheath near the tip either by spot welding or by wrapping with platinum wire. The calibration data are obtained in the same manner and with the same apparatus as used for the calibration of a thermocouple that is not sheathed. (See sec. 3.1.1 and 3.1.2.) For sheathed type S, R, and B thermocouples, the calibration data are measured with the automatic data acquisition system and then processed using the computer programs described in section 3.1.1.7. A few minor changes in the programs are required so that the temperature-emf table for the test thermocouple gives the value of emf of the test thermocouple assembly that was measured at 0 °C.

### 3.2 Calibration by Comparison with a Standard Platinum Resistance Thermometer

#### 3.2.1 Calibration Baths

Thermocouples are calibrated by comparison with a standard platinum resistance thermometer (SPRT) in the range -110 to 540 °C and at about -183 °C (boiling point of oxygen) and about -196 °C (boiling point of nitrogen). Such comparisons are carried out by placing an SPRT and the thermocouples under test in a series of stirred liquid baths, in a cryostat, or in a copper block immersed in liquid nitrogen or liquid oxygen.

All electrically heated constant temperature comparison baths used to calibrate thermocouples at NIST have the heating coils isolated from the volume where the thermocouples will be placed. There is an unrestricted path of flow for the bath medium which is stirred at a sufficient rate to maintain a uniform temperature throughout the medium. Surrounding the baths is a 5 to 7 cm thickness of insulation and an insulated cover is provided to help minimize heat loss. Fitted into the top cover is a holder containing the test thermocouples and SPRT.

The comparison baths used to calibrate thermocouples above 0 °C are manually controlled by adjusting the current to the heating coils through a rheostat. For calibration below 0 °C, the temperature is automatically controlled.

All baths at NIST were evaluated to determine the temperature gradient throughout the medium. This was done by placing three SPRT's at various locations and depths in the medium. The thermometers were read simultaneously and the maximum difference between the three readings at each temperature was considered to be caused by the thermal gradient.

##### 3.2.1.1 Water and Oil Baths

An oil bath used at NIST is shown in figure 3.4 and a drawing of both the water and oil baths is shown in figure 3.5. They consist of two cylindrical wells of different diameters with connecting passages at the top and bottom. The heating coil and stirrer are located in the smaller well, leaving the larger well unobstructed for the insertion of the thermocouples and SPRT. The fluid is forced past the heating coils, through the bottom opening into the



larger well, around the thermocouples and SPRT, and back into the smaller well through the connecting passage at the top.

For calibration in the range +1 to +95 °C, distilled water is used as the bath medium. Distilled water is preferable to tap water since no chemical deposits will form at the top of the bath. Water is plentiful, clean, and does not produce harmful vapors. Additional distilled water is added each day the bath is used, since some of the water will leave through the overflow tube due to the expansion of the water when heated. The level should be no more than 10 mm from the top of the thermocouple and SPRT holder. Measured temperature gradients in the water bath are such that the temperature of the thermocouple measuring junctions and SPRT resistor do not exceed 0.01 °C.

Two oil baths are maintained at NIST. One, called the low-temperature oil bath, is used to calibrate thermocouples in the range +95 to +200 °C. An oil purchased from EXXON, known as Zerice 46, is used as the medium. The oil level must be raised to within 25 mm of the top of the bath by hand pumping oil from a pan under the bath. (Heat from the bath will cause the oil to expand and leave the bath through the overflow tube. It is collected in the pan below the bath.) The temperature gradients in the low-temperature oil bath are such that the difference in temperature between the thermocouple measuring junction and the SPRT resistor does not exceed 0.015 °C.

For calibration in the range +200 to +300 °C, the high-temperature oil bath is used. The medium is an oil called Extra Hecla from Mobil Oil Corporation. Oil coming from the overflow tube is collected in a bucket. Before the bath is used, oil from the bucket must be poured into the bath to within 70 mm of the top of the bath. Temperature gradients in this oil bath are such that the difference in temperature between the thermocouple measuring junction and the SPRT are no greater than 0.05 °C.

The calibration baths that use oil as the medium are operated under a fume hood which is not connected to the ventilation system of the building but is exhausted directly outside.

#### 3.2.1.2 Tin Bath

The tin bath is used to calibrate thermocouples in the temperature range +300 to +540 °C. The medium is 99.9% pure tin, conforming to Federal Specification QQ-T-371C, Grade A, and can be purchased commercially, e.g., from Nathan Trotter in Philadelphia, Pennsylvania.

A picture and drawing of the tin bath are shown in figures 3.6 and 3.7. It consists of two coaxial cylinders arranged in such a way as to permit the molten tin to circulate between the walls of the two cylinders and through the inner cylinder by means of openings at the top and bottom. The stirring propeller is situated near the bottom of the inner cylinder, leaving the majority of the space for the reentrant tubes (not shown in the drawing) into which the test thermocouples and SPRT are inserted. The heater coils are wound on the outside of the outer cylinder. The temperature gradients in the tin bath are such that the difference between the temperature of the

thermocouple measuring junctions and the SPRT resistor does not exceed 0.05 °C at 300 °C and 0.1 °C at 500 °C.

In the evening before the tin bath is to be used, a clock is set to turn the power on to the bath in the early morning hours. This is necessary, since it takes approximately 4 h to reach a temperature of 350 °C. If a temperature of over 500 °C is to be realized, the clock should be set to turn the bath on at 0300 hours.

Before the tin bath can be used, oxidized tin, which formed when the bath was last used, must be removed. This is facilitated by removing the reentrant tube holder. The tin oxide is at the top of the bath and can be removed easily with special implements stored near the bath. Some residue, which clings to the reentrant tubes, must be removed also and this must be done quickly before the tubes cool. Fresh tin must be added to bring the level of the molten tin within 1 or 2 cm from the top of the inner cylinder. When all this has been done, the tubes are placed back into the bath. The stirrer is turned on and the adjustment of current to the heating coils is set to control the bath at the desired temperature.

#### 3.2.1.3 Cryostat

Calibrations from -1 to -110 °C are made in the cryostat shown in figure 3.8. A vertical section is shown in figure 3.9. The cryostat consists of an inner Dewar flask which contains the bath liquid. This flask is surrounded by liquid nitrogen contained in the outer Dewar flask. The rate of heat transfer between the bath liquid and the liquid nitrogen is controlled by the presence or absence of gas or air in the space between the walls of the inner Dewar flask. When the lowest temperature desired for the day is reached, the rate of heat transfer is retarded by evacuating the gas or air through the side tube which is connected to a vacuum system. Vigorous stirring of the bath liquid is maintained by the propeller which circulates the liquid around the walls of the stirrer tube similar to the flow of the molten tin in the tin bath. The temperature of the bath is thermostatically controlled by heater coils wound on the outside of the stirrer tube. The test thermocouples and SPRT are immersed inside the stirrer tube, thus shielding them from the heated coils.

The bath liquid is a five-component mixture containing by weight 14.5% chloroform, 25.3% methylene chloride, 33.4% ethyl bromide, 10.4% transdichloroethylene, and 16.4% trichloroethylene. This mixture freezes at approximately -150 °C, but readily absorbs moisture and becomes cloudy at somewhat higher temperatures. For this reason, calibrations are not performed in this bath below -110 °C. Another liquid that has been used as the medium is 2-Methylpentane. Measured gradients in the cryostat do not exceed 0.01 °C.

#### 3.2.1.4 Liquid Oxygen and Liquid Nitrogen Points

A comparison measurement can be made at approximately -196 °C (boiling point of nitrogen) or approximately -183 °C (boiling point of oxygen). A taped Dewar flask is used as a container for the liquid nitrogen or oxygen. A copper block is immersed in the liquid which is agitated by bubbling nitrogen

or oxygen gas in the corresponding liquid through a glass tube with an outlet placed in one of the holes of the copper block.

### 3.2.2 Equipment

#### 3.2.2.1 Standard Platinum Resistance Thermometer

An SPRT has a resistor made of platinum of sufficient purity that the finished thermometer will have a value of the resistance at 100 °C divided by the resistance at 0 °C not less than 1.3925 or alpha, defined as  $(R_{100} - R_0)/100R_0$ , not less than 0.003925. The typical SPRT has an ice-point resistance of about 25.5 ohms and is called a 25 ohm thermometer; its resistor is wound from about 61 cm of 0.075 mm diameter wire.

The insulation material that supports the resistor and leads must not contaminate the platinum during the annealing of the assembled thermometer nor when subjected for extended periods of time to temperatures to which the thermometer is normally exposed. The insulation resistance between the leads must be greater than  $5 \times 10^9$  ohms at 500 °C if the error introduced by insulation leakage in the leads of a 25 ohm thermometer is to be less than the equivalent of 1 microhm. For SPRT's the most commonly used insulation is mica.

The configuration of the resistor is inevitably the result of compromise between conflicting requirements. The resistor must be free to expand and contract without constraint from its support. This characteristic is the so called "strain-free" construction. If the platinum were not free to expand, the resistance of the platinum would not only be a function of the temperature but would also relate to the strain that results from the differential expansion of the platinum and its support.

The sensing elements of all SPRT's have four leads. The four leads define the resistor precisely by permitting measurements that eliminate the effect of the resistance of the leads. The resistor winding is usually "noninductive," often bifilar.

Because the junction of the leads is electrically a part of the measured resistor, the leads extending immediately from the resistor must also be of high purity platinum; the lengths of these leads are often as short as 8 mm. Either gold or platinum wire is employed in continuing these leads within the thermometer. Gold does not seem to contaminate the resistor and is easily worked. Measurement of the resistor may be facilitated if the four leads are made of the same material with the length and diameter the same so that the leads have about equal resistance at any temperature. This statement is also applicable to leads that are external to the protecting envelope.

The hermetic seal through the soft glass envelope at the thermometer head is frequently made using short lengths of tungsten wire, to the ends of which platinum lead wires are welded. The external platinum leads are soft soldered to copper leads that are mechanically secured to the head. Coaxial leads are required when an ac bridge is used to determine the resistance of the SPRT.

### 3.2.2.2 AC Bridge

Bridges operating at 400 hertz have been built at the NIST based on a design by Cutkosky [2]. These bridges were designed for use with SPRT's. The bridge utilizes an inductive ratio divider that eliminates the necessity of calibrating the bridge because the initial uncertainty of the divider is about 2 parts in  $10^8$  and appears to be stable. Additionally, the bridge requires only one manual resistance balance, the phase angle balance being automatic, and incorporates a built-in phase-sensitive null detector with which 1 microhm in 25 ohms can be easily resolved. A small (usually less than 10 microhms) error may be introduced in measuring a 25 ohm SPRT unless coaxial leads are used between the bridge and the thermometer head. (The heads of SPRT's have been modified to contain two BNC coaxial connectors. The two leads from one end of the SPRT coil were connected to the center "female" contacts of the BNC receptacles and the two leads from the other end of the SPRT were connected to the outer shells or the shield contacts.) For precision measurements the length of the pair of coaxial leads should not be greater than 15 meters to limit the dielectric losses of the shunt capacitance. Preliminary measurements on 25 ohm SPRT's indicate that, if the leads do not affect the measurements, the accuracy of the measured value in ohms of a thermometer element is limited by the accuracy to which the reference standard resistor is known. However, in the accurate determination of the resistance ratio,  $R_t/R_0$ , the stability, rather than the accuracy of the reference standard is the important requirement.

### 3.2.2.3 Potentiometer

A Rubicon six-dial potentiometer, Cat. No. 2768, is used to measure the emf of the thermocouples during the calibration. This instrument is calibrated in accordance with the procedure outlined in appendix I of NBS Monograph 126 [3].

### 3.2.3 Calibration Procedure

In calibrating thermocouples by comparison with an SPRT, several steps are followed routinely. These include a preliminary examination, thermocouple preparation, check of SPRT, and acquisition of data. Thermocouples are unpacked and examined. If the measuring junction is not made, this is done by silver soldering the wires together. Fiberglass sleeving is used to insulate the wires if it is a bare wire thermocouple. The test thermocouple is placed in a glass tube before inserting it in the calibration baths. If the instrument is a sheathed thermocouple, it may be placed directly in the baths. The normal depth of immersion is 12 inches below the surface of the stirred liquid bath. When calibrating below 0 °C, trichloroethylene is used in the glass tube containing the test thermocouple to increase the thermal conductivity. The measuring junction of the test thermocouple is placed adjacent to the SPRT coil in the bath.

The thermocouple wire is connected to copper extension wire and this connection is maintained at 0 °C in an ice bath. Measurements are made using a Rubicon six-dial potentiometer and an automatic bridge. The reading

sequence is as follows:

SPRT, TC, SPRT, TC, SPRT.

The bath temperature is determined from the three SPRT readings. The two thermocouple readings are averaged, the potentiometer correction is applied, and the data are normalized to the desired temperature. If the bath temperature changes by more than 0.05 °C during the reading sequence, then the measurement at this temperature is repeated.

Every day the SPRT is going to be used, it is necessary to check its resistance at the triple point of water to see that it is still in calibration and to obtain the resistance at the 0 °C point for the purpose of calculating the temperature of the bath medium. This is done by placing the SPRT in a properly prepared triple point of water cell [3]. Before inserting the thermometer in the cell, it should be checked to see that the ice mantle is moving freely around the reentrant well. A small piece of foam is placed at the bottom of the reentrant well, enabling the SPRT to have something soft on which to rest. An aluminum bushing, which is approximately 50 mm long is placed inside the reentrant well on the foam, and is made to fit snugly around the portion of the SPRT containing the platinum coil.

The SPRT is placed in the triple point of water cell and water is poured into the reentrant well until it is full. The SPRT is covered with a black cloth to eliminate any error in the resistance reading caused by ambient room radiation, especially from ceiling lights. After the SPRT has been allowed to remain in the triple point of water cell for a minimum of 15 minutes, the ac bridge is balanced and the resistance at the triple point of water is recorded.

The resistance value on that particular SPRT is compared with previous resistance values at the triple point of water. If the value has changed by an amount equivalent to or exceeding 0.001 °C, then the SPRT is sent to the Platinum Resistance Thermometer Calibration Laboratory for recalibration.

If the SPRT is going to be used below 150 °C, the triple point of water is taken at the beginning of the day. If the SPRT is going to be used above 150 °C, the triple point of water is taken at the end of the day, after being out of the bath medium for at least 15 minutes.

#### 3.2.4 Computation of Bath Temperature

The first step in calculating the temperature of a stirred liquid bath is to average the two resistance values determined for the SPRT at the triple point of water taken on the day the calibrations were performed. This average resistance value at the triple point of water,  $R_{TP}$ , is converted to the resistance value at the ice point,  $R_0$ , by multiplying it by a factor of 0.99996101, which was derived from information given in NBS Monograph 126, Platinum Resistance Thermometry [3] and in the Metrologia article, The International Practical Temperature Scale of 1968 (Amended Edition of 1975) [4].

Since the derivation of this factor is not explicitly outlined in either of the above publications, it is explained below.

The triple point of water cell has an axial well for the thermometers and the triple point temperature is obtained whenever the ice is in equilibrium with a liquid-vapor surface. The equilibrium temperature  $t_{68}$  between the ice and liquid water at a depth  $h$  below the liquid-vapor surface is given by:

$$t_{68} = A + Bh$$

where

$$A = 0.01 \text{ } ^\circ\text{C}$$

$$B = -.0007 \text{ } ^\circ\text{C/m}$$

$h$  = height of the water column in the triple-point cell from the middle of the SPRT coil to the water surface.

The value  $h$  varies from cell to cell. For this case, the hydrostatic head of water from the middle of the SPRT coil to the water surface of the cell used for the calibration was 0.315 m; hence, the value  $t_{68}$  of the triple point of water is calculated to be:

$$t_{68} = 0.01 \text{ } ^\circ\text{C} + (-0.0007 \text{ } ^\circ\text{C/m})(0.315 \text{ m})$$

$$t_{68} = 0.0097795 \text{ } ^\circ\text{C}.$$

This value for  $t_{68}$  must then be converted to  $t'$ . The conversion is done by using the  $M(t')$  relation given by equation 10 in reference [4]. Near 0  $^\circ\text{C}$ ,  $dM(t')/dt'$  is equal to -0.000450. Therefore,

$$t' = (0.0097795)(1.000450) \text{ } ^\circ\text{C}$$

$$t' = 0.0097839 \text{ } ^\circ\text{C}.$$

The value for the resistance at 0  $^\circ\text{C}$ ,  $R_0$ , is calculated from the resistance at the triple point of water according to the following formula:

$$R_t/R_0 = 1 + At' + Bt'^2$$

Since  $t'^2$  is very small, the last term is dropped, the value  $A$  is determined from the formula:

$$A = \alpha(1 + \delta/100 \text{ } ^\circ\text{C})$$

The  $\alpha$  and  $\delta$  values are given with the report of calibration for each SPRT. For the resistance thermometer used in this example, the value of  $\alpha$  was 0.003926378  $^\circ\text{C}^{-1}$  and  $\delta$  was 1.496448  $^\circ\text{C}$ . The value  $A$  is calculated to be:

$$A = 0.003926378[1 + (1.496448/100 \text{ } ^\circ\text{C})]$$

$$A = 0.0039851342 \text{ } ^\circ\text{C}^{-1}$$

Knowing the value for  $A$  and the value  $t'$  at the triple point of water, the

factor used to convert the  $R_{TP}$  value to the  $R_0$  value can be determined as shown below:

$$\begin{aligned}R_{TP}/R_0 &= 1 + At' \\R_0 &= R_{TP}/(1 + At') \text{ ohms} \\R_0 &= R_{TP}/[1 + (0.0039851342)(0.0097839)] \text{ ohms} \\R_0 &= (25.46480)(0.99996101) \text{ ohms} \\R_0 &= 25.46381 \text{ ohms}\end{aligned}$$

After the value  $R_0$  is determined, the calculation of the bath temperatures can be made. The first step is to find the average of the three resistance readings at each temperature. This value is called  $R_t$ . Since the tables computed for the SPRT's are based on a ratio of the resistance at a stated temperature to the resistance at the ice point (the ratio of  $R_t/R_0$ ), the value  $R_t$  at each calibration point must be divided by  $R_0$ . The computation of the value  $R_t/R_0$  for a trial temperature is given below:

$$\begin{aligned}R_t &= 27.48510 \text{ ohms} \\R_0 &= 25.46381 \text{ ohms} \\R_t/R_0 &= 1.079379\end{aligned}$$

It is then determined where in the platinum resistance thermometer table this ratio falls. For the SPRT used in this example the computed value for  $R_t/R_0$  of 1.079379 falls between 19 and 20 °C. The temperature of the calibration bath medium is, therefore, 19 and some decimal value. To obtain the decimal portion of the temperature, the  $R_t/R_0$  value at 19 °C is subtracted from the  $R_t/R_0$  value in the example and the difference is multiplied by the inverse difference, which is the inverse (reciprocal) of the difference between successive values of  $R_t/R_0$ , given on the line at 20 °C. This procedure is shown below:

table value for  $R_t/R_0$  at 19 °C for SPRT 445 is 1.075531  
table value for  $R_t/R_0$  at 20 °C for SPRT 445 is 1.079494  
the value 1.079379 falls between these two ratios  
the temperature of the calibration bath will be 19.XX.

From  $R_t/R_0$  subtract  $R_t/R_0$  at 19 °C and multiply by the inverse difference given for the nominal temperature of 20 °C.

$$\begin{aligned}R_t/R_0 &= 1.079379 \\R_t/R_0 \text{ at } 19 \text{ °C} &= 1.075531 \\ \text{Difference} &= 0.003848 \\ \text{Decimal value} &= \text{Difference} \times \text{inverse difference} \\ \text{Decimal value} &= 0.003848 \times 252.33 \\ \text{Decimal value} &= 0.97\end{aligned}$$

The calculated temperature of the calibration bath at this calibration point is 19.97 °C.

This procedure is repeated at each calibration point to determine the temperature of the calibration bath medium.

### 3.2.5 Calibration Report

The emf values determined during the calibration of a base-metal thermocouple are reported at the measured temperatures, except for type T thermocouples. Type T thermocouples may be calibrated at specified temperatures and a table of temperature versus emf at 1° intervals prepared. The computer program used for processing the calibration data and for calculating and printing the table for a type T thermocouple is covered in this section.

TEMPERATURE VERSUS EMF TABLE, TYPE T. Values of emf are measured at specified temperatures (-183, -110, -50, +50, +100, +200, +300 °C) and a table of temperature versus emf at 1° intervals is calculated for any of seven temperature ranges within the overall range -190 to 300 °C. The data are processed using the NIST Cyber computer and the data are transmitted between the laboratory and the computer using the NIST net. After the calculations are completed, the table is printed in the laboratory on an Okidata Model  $\mu$ 83A printer.

The computer first calculates the emf difference,  $D_e$ , between the emf readings of the test thermocouple and the emf value from the type T reference table in NBS Monograph 125 at each of the specified calibration temperatures. The calculations are divided into two temperature ranges: -183 or -110 °C to 0 °C and 0 °C to 100, or 200, or 300 °C. A cubic or quadratic equation, which is constrained to give 0 emf at 0 °C, is used to represent  $D_e$  as a function of the temperature in each range. The polynomials representing  $D_e = f(t)$  in the two ranges are then combined algebraically with the functions that give the temperature-emf relationship of the type T thermocouple reference table given in Monograph 125 to obtain polynomials representing the temperature-emf relationship of the test thermocouple.

The printed output includes the temperature versus emf table and the coefficients of the equations that were used to compute the table. One set of output is kept as the NIST record for the calibration. The second set of output is bound with a typed report of calibration which gives the customer's name and location, the customer's designation of the thermocouple, the estimated calibration uncertainty, the purchase order number, the test number, and the date. The calibration report, along with a typed covering letter, is sent to the customer. A sample of the report and covering letter is given in the appendix, section 8.1.4.

### 3.3 Primary Calibration of Type S Thermocouples in Metal Freezing-Point Cells

The type S thermocouple is the specified standard interpolating instrument on the International Practical Temperature Scale of 1968 (IPTS-68) in the range 630.74 to 1064.43 °C [4]. The primary calibration of such thermocouples at NIST as IPTS standards involves determining their values of emf at four thermometric fixed points while their reference junctions are maintained at 0 °C. It is the most accurate calibration the NIST offers for type S thermocouples. The fixed points used are the liquidus points of gold, silver,



antimony<sup>3</sup>, and zinc. The liquidus point calibrating temperatures are realized in metal freezing-point cells whose liquidus temperatures have been established from measurements made with platinum resistance thermometers as described in section 4.7.1. Our procedure follows the instructions given in the text of the IPTS-68 (Amended Edition of 1975) [4] to establish the temperature-emf relationship of the thermocouple over the range 630.74 to 1064.43 °C (gold point). Corresponding values of emf and temperature for the thermocouple above and below this range are obtained by extrapolation and interpolation.

For a type S thermocouple to be a standard interpolating instrument for realizing the IPTS-68, it must meet certain requirements. The purity of the platinum wire shall be such that the ratio of its electrical resistance at 100 °C to its electrical resistance at 0 °C ( $R_{100}/R_0$ ) is not less than 1.3920. The platinum-rhodium wire shall contain nominally 10% rhodium and 90% platinum by mass. In addition, the values of emf of the thermocouple at 630.74 °C ( $E_{630.74}$ ), the silver point ( $E_{Ag}$ ), and the gold point ( $E_{Au}$ ) must satisfy the following relations:

$$E_{Au} = 10334 \mu V \pm 30 \mu V,$$

$$E_{Au} - E_{Ag} = 1186 \mu V + 0.17(E_{Au} - 10334 \mu V) \pm 3 \mu V,$$

$$E_{Au} - E_{630.74} = 4782 \mu V + 0.63(E_{Au} - 10334 \mu V) \pm 5 \mu V.$$

Not all type S thermocouples will meet the above requirements, but suitable thermocouples may be obtained commercially. Reference or "premium" grade type S thermocouple wire that meets the above requirements should be specified when procuring thermocouples for primary calibration at NIST. Type S thermocouples that meet the above requirements are referred to as standard thermocouples in the text of the IPTS-68.

Primary calibrations are generally performed on a batch of six or more thermocouples at one time. A large batch is more economical of our time and helps to lower the costs for maintaining and providing this calibration service. We attempt to balance the need to run a large batch of thermocouples to hold down the calibration fee with the need to keep the calibration turn-around time to our customers reasonably short.

A special group of six thermocouples from three different lots of type S thermocouple wire have been assembled for use as NIST check standards. During the calibration of each batch of test thermocouples, at least two thermocouples from this special group are included. The calibration history compiled on this set of thermocouples gives an indication of the performance of a type S thermocouple under carefully controlled conditions. Any gross change in emf measured for a particular thermocouple (or measurements during an immersion check) at a particular freezing point from values found in previous calibrations is cause for examination of the system. The discrepancy

---

<sup>3</sup>The freezing point of antimony is not a defining fixed point of the IPTS-68.

may be caused by the measuring instrument, contamination of the metal freezing-point cell, lack of temperature uniformity in the furnace, change in the thermocouple itself or in some other part of the measuring system. This procedure can not detect small, gradual changes in the freezing point temperatures of the various cells, since the temperature-emf relationships of the thermocouples themselves change slowly with use.

### 3.3.1 Preliminary Examination

A type S thermocouple submitted for a primary calibration is removed from its shipping container and examined visually. Its length, diameter, and condition (new, used, good condition, poor condition, etc.) are recorded in the laboratory notebook. A thermocouple to be calibrated by this method must be at least 100 cm long, and the diameter of the thermocouple wire must not be less than 0.4 mm. If the thermocouple does not meet these dimensional requirements, the customer is requested to submit another thermocouple or have the thermocouple calibrated by the comparison method (see sec. 3.1), which has a minimum length requirement of 70 cm and no minimum diameter requirement.

### 3.3.2 Electrical Anneal

The type S thermocouple wire is annealed electrically in air before calibration. The electrical anneal is carried out in the same manner as for type S, R, and B thermocouples for comparison calibrations described in section 3.1.1.2.

### 3.3.3 Mounting for Calibration

The annealed thermocouple wires are inserted carefully into alumina insulating tubes. The tubes are made of sintered (99.8+% purity) alumina and they are 60 cm long, 4 mm in diameter and have four 1 mm bores. These tubes are reserved for use only with thermocouples to be given primary calibrations and the bores to be used with the pure platinum wires are notched at the cold end of the tube. The thermocouple wires emerging from the alumina tube are insulated with flexible fiberglass tubing to within about 2 cm of their ends. The flexible fiberglass tubing is joined to the alumina tube with heat shrinkable tubing.

### 3.3.4 Furnace Anneal

After the type S test thermocouples are mounted in the alumina insulating tubes, they are annealed in a horizontal tube furnace to remove small mechanical strains that may have been introduced during the mounting operation. The silicon carbide tube furnace shown in figure 3.3 is used for this anneal. The thermocouples are immersed approximately 55 cm into the furnace and protected by a closed-end alumina tube during the anneal. They are heated slowly over a period of 2 to 4 h to about 1100 °C and held at that temperature for 1 h. Then the furnace is cooled slowly to near room temperature over a period of about 3 h, and the thermocouples are removed.

### 3.3.5 Preliminary Tests

Prior to calibration of the test thermocouples in the metal freezing-point cells, they are given preliminary tests to assess their thermoelectric homogeneity and to determine if they satisfy the purity and emf requirements for a standard thermocouple discussed in section 3.0. For these tests, the measuring junction of a calibrated type S reference thermocouple (one of those used for comparison calibrations, see sec. 3.1.1) and the measuring junctions of several (2 to 6) test thermocouples are welded together to form a common junction. The test thermocouple assembly is then placed in the Chromel tube furnace shown in figure 3.2 in the same manner as for a comparison calibration (see sec. 3.1.1). The furnace is heated to 1100 °C and held at that temperature for 30 minutes. Then a qualitative check of the thermoelectric homogeneity of each test thermocouple is made in the manner described in section 3.1.1.5. In addition, the emf of the platinum thermoelement of each thermocouple versus the platinum thermoelement of the reference thermocouple is measured at 1100 °C. Values of emf for the test thermoelements versus Pt-67 may be obtained from the latter measurements, since the emf of the platinum thermoelement of the reference thermocouple is known relative to Pt-67. The test thermocouples are also calibrated by comparison with the reference thermocouple in the range 1100 to 0 °C, as described in section 3.1.1.5. After the comparison calibration is completed, the test thermocouple assembly is removed from the furnace, its common junction is cut off, and the measuring junctions of the individual thermocouples are reformed.

The experimental data obtained in the above tests are evaluated before proceeding with a primary calibration of the test thermocouple. A positive value for the emf of the platinum thermoelement of a test thermocouple versus Pt-67 indicates that the purity of the thermoelement is less than that of Pt-67. An emf for a platinum thermoelement versus Pt-67 at 1100 °C greater than 14 microvolts indicates [5,6] that its resistance ratio ( $R_{100}/R_0$ ) is less than 1.3920; hence, the test thermocouple is rejected for a primary calibration. Furthermore, if the value of emf at 1064.43 °C (gold point) determined during the comparison calibration does not satisfy the IPTS-68 requirement listed in section 3.0, or if an emf variation of more than 5 microvolts is observed during the homogeneity test at 1100 °C, the test thermocouple is also rejected for a primary calibration. When a test thermocouple is rejected for a primary calibration, the results of the preliminary tests are discussed with the customer to determine the action to be taken.

### 3.3.6 EMF Measurements at Freezing Points

The values of emf of type S test thermocouples are determined at the liquidus point of each of the following metals: gold, silver, antimony, and zinc. The liquidus temperatures of the four metals are realized in metal freezing-point cells of the design shown in figure 3.10 (see also sec. 3.3.9.5 for a description of the cell). The freezing-point cells are heated in vertical tube furnaces (see sec. 3.3.9.6 and 3.3.9.7). Before heating, the cells are pumped down to about  $10^{-2}$  Torr with a rotary, oil-sealed vacuum pump and back filled with argon three times to remove the air and then filled with argon to a pressure slightly above ambient. This argon pressure is also maintained when the cells are heated.

The method used for nucleating freezes depends on the particular metal and on the extent to which the metal supercools. The special techniques employed to initiate freezes with each of the four metals are discussed in the following subsections. However, the initial procedures followed for preparing the freezing-point cells for a freeze are similar with all four metals. The cells are heated in the appropriate furnace which is set to control at a temperature 5 to 7 °C above the freezing point. When the metal is completely melted, as indicated by a monitoring thermocouple placed in the cell well, the furnace temperature is reduced and then stabilized about 2 °C above the freezing point. The furnace is held at this temperature until the temperature of the liquid metal is nearly equal to the furnace temperature, and then the furnace temperature is again lowered to initiate the process of nucleating solid metal on the walls of the graphite crucible.

A thermocouple assembly to be tested is inserted slowly into the heated freezing-point cell, and the thermocouple wires are joined electrically to polyvinyl insulated copper connecting wires (0.4 mm diameter). The electrical connections form the thermocouple reference junctions and they are maintained at 0 °C in an ice bath (see sec. 3.3.9.8) when emf measurements are made. The copper connecting wires go to a rotary, thermocouple selector switch that is connected to a six-dial precision potentiometer (see sec. 3.3.9.9). The potentiometer, which is interfaced with the laboratory computer, is balanced manually, and then the dial settings are read and recorded by the computer at the operators command.

The thermocouple measuring junctions are kept a few millimeters above the bottom of the glass protecting tube when measurements are made in freezing-point cells. This is accomplished by fastening an alligator clip to the thermocouple insulating tube and letting it rest on the top end of the protecting tube to hold the thermocouple assembly at the proper immersion. Experience has shown that allowing the measuring junction to touch the silica glass can alter the thermocouple emf by a microvolt or more in the gold cell. The thermocouple emf tends to be low and shows poor repeatability from freeze to freeze. The magnitude of this effect is smaller in the silver, antimony, and zinc cells.

Measurements are made first at the gold point, and then at the silver point, antimony point, and zinc point. After a freeze is initiated and the metal is either in or very nearly in the temperature plateau region of its freezing curve, measurements of the thermocouple emf are taken at 30 second intervals. Five readings are taken on the first test thermocouple, then five readings are taken on the other test thermocouple mounted in the same assembly. Such sets of measurements are then repeated until 10 successive readings are obtained for each thermocouple that agree within 0.15 microvolts. A mean of the 10 readings is computed and is corrected by applying potentiometer dial corrections. In the cases when a cold thermocouple assembly is inserted into a cell while a freeze is in progress, the measurements are started after a delay of about 15 minutes to allow the assembly to attain temperature equilibrium with its surroundings. Each thermocouple is tested in at least two freezes in each of the metal freezing-point cells. If the emf values determined in the two freezes do not agree within 0.3 microvolts, the thermocouple is tested in a

third freeze. If there is still lack of agreement, the test thermocouple is re-annealed and tested again at each of the fixed points.

A single value of emf for each test thermocouple at each calibration temperature is determined by computing the mean of the emf values from the two or more freezes. These mean values are corrected by applying small corrections to account for the departure of the liquidus points of the gold, silver, antimony, and zinc freezing-point cells from the IPTS-68 defining values of temperature of 1064.43, 961.93, 630.74, and 419.58 °C, respectively. As discussed in section 4.0, the liquidus points of the gold-point and silver-point cells used for thermocouple calibrations have been determined by comparing them with gold-point and silver-point reference cells using high temperature platinum resistance thermometers, while the liquidus points of the antimony and zinc cells used have been determined with standard platinum resistance thermometers calibrated at the IPTS-68 defining fixed points (freezing points of tin and zinc, and the triple point of water).

#### 3.3.6.1 Gold and Silver Freezing Points

The gold and silver freezing-point cells are used in the electrically heated vertical tube furnace shown in figure 3.11. The furnace must be heated to above 600 °C before the gold or silver freezing point cell is introduced to allow the Inconel well to expand sufficiently to accommodate the silica glass cell.

The same techniques are used for nucleating freezes with gold and silver. After the metal is melted and stabilized at about 2 °C above its freezing point, the furnace temperature is lowered to about 5 °C below the freezing point. Since gold and silver supercool at most a few degrees, this decrease in the furnace temperature is sufficient to cause nucleation. After recalescence is detected by observing a rapid increase in the emf of the test thermocouple, the furnace temperature is increased and set to control at about 2 °C below the freezing point. Then, after about 15 minutes, measurements of the thermocouple emf are begun, as described above in section 3.3.6. Only one thermocouple assembly is tested during a freeze, and once sufficient data have been obtained, the metal is remelted. Remelting is accomplished in a fairly short time, since only a portion of the metal is frozen. It takes about 1 h from the beginning of one freeze to the beginning of the next freeze.

When the thermocouples are removed from the gold and silver freezing-point cells, the rapid cooling of the wires to room temperature produces small thermoelectric inhomogeneities in them. These inhomogeneities are thought to result primarily from a complex nonequilibrium concentration of vacancies that are quenched into the wires [7]. If the thermocouples are placed in the gold or silver point cells again, this quenching effect has very little influence on the measured thermocouple emf since annealing for a short time at these temperatures will quickly restore an equilibrium concentration of vacancies. However, in the antimony freezing-point cell a much longer annealing time would be required to obtain an equilibrium concentration of vacancies at this temperature for a thermocouple quenched from the silver point. A thermocouple quenched in this manner will typically yield an emf value at the antimony

point that is 0.5 to 0.7 microvolts lower than that of the same thermocouple after it has annealed in the antimony cell for a long period. This condition is alleviated by giving the test thermocouples a furnace anneal after they are tested at the silver point. The thermocouples are placed in the annealing furnace (see sec. 3.3.9.3.), heated slowly to about 900 °C, and held at that temperature for 1 h. They are then cooled slowly in the furnace to room temperature.

#### 3.3.6.2 Antimony Freezing Point

The antimony freezing point cell is heated in the vertical tube furnace shown in figure 3.12. The furnace must be heated to about 400 °C before the cell is inserted to allow the Inconel guide tube to expand sufficiently to accommodate the silica glass cell.

The supercooling of antimony before freezing is excessive (usually amounting to roughly 20 to 25 °C), and special treatment is needed, therefore, to initiate the freeze to avoid the necessity of cooling the furnace considerably and shortening the freeze significantly. After the antimony is melted and stabilized at about 2 °C above its freezing point, the furnace is set to control at about 2 °C below the freezing point. The emf of the monitoring thermocouple (whose emf at the freezing point of antimony is known) is observed closely as the antimony cools. When the freezing-point temperature is reached, the freezing-point cell is completely withdrawn from the furnace and then replaced in the furnace after about 30 seconds. Experience has shown that this cell withdrawal procedure is sufficient to cause recalescence to occur in the supercooled antimony. After nucleation of the freeze, the monitoring thermocouple is removed from the cell well, and immediately a cold test thermocouple assembly is inserted, inducing a thin layer of antimony to freeze onto the walls of the well. After the thermocouple assembly is in the cell for approximately 15 minutes, measurements of the thermocouple emf are begun, as described in section 3.3.6. With the furnace temperature controlled about 2 °C below the temperature of the freezing antimony, the freeze is prolonged for a few hours, allowing three or four thermocouple assemblies to be tested during each freeze.

#### 3.3.6.3 Zinc Freezing Point

The zinc freezing-point cell is used in a vertical tube furnace of the same design as the one used with the antimony freezing-point cell. (See fig. 3.12 and sec. 3.3.9.7.) Zinc, which supercools less than 0.2 °C, requires no special treatment to nucleate a freeze. After the zinc is melted and stabilized at about 2 °C above its freezing point, the furnace is set to control at about 2 °C below the freezing point to begin cooling the liquid zinc. When the monitoring thermocouple indicates the zinc has reached the freezing point, it is removed from the cell well, and immediately a cold test thermocouple assembly is inserted, inducing a thin layer of zinc to freeze onto the walls of the well. Measurements of the thermocouple emf are begun after approximately 15 minutes, as described in section 3.3.6. As with antimony, the zinc freeze is prolonged for several hours, and four to six thermocouple assemblies may be tested during the freeze.

### 3.3.7 Packing and Shipping

After the calibration is completed, the thermocouples are packaged for shipment back to customers. The measuring junctions are cut off and the thermocouple wires are pulled gently from the alumina insulating tube. The measuring junction is reformed by welding with the oxygen-gas torch. A tag is prepared from plastic embossed tape with the NIST test number and attached to the thermocouple. The thermocouple is inserted into a polyethylene tube (9.5 mm o.d. and 6.5 mm i.d.) that has been cleaned with alcohol. Plastic caps are used to seal the ends of the tube. The tube is then coiled and packed in the same container in which the thermocouple was received. If the container is inadequate or damaged, the NIST Shipping and Receiving Unit is requested to provide a suitable shipping container.

### 3.3.8 Calibration Report

The calibration data (mean emf value determined at each of the four fixed points) are processed on the laboratory computer to obtain a temperature versus emf table at one degree intervals for the type S test thermocouple. This table gives values of the emf in millivolts to the nearest microvolt and may have temperature in either °F or °C, and on either the IPTS-68 or the IPTS-48. Computer processing of the calibration data involves deriving equations to represent the emf-temperature relationship of the test thermocouple. The processing is broken into three temperature ranges: 0 to 630.74 °C, 630.74 to 1064.43 °C, and 1064.43 to 1450 °C.

From 630.74 to 1064.43 °C the temperature,  $t_{68}$ , is defined [4] by the equation:

$$E = a + bt_{68} + ct_{68}^2,$$

where E is the emf of a type S standard thermocouple when its measuring junction is at  $t_{68}$  and its reference junction is at 0 °C.

The coefficients a, b, and c in the equation are determined by the solution of three simultaneous equations using the values of emf determined at 1064.43 °C (gold point), 961.93 °C (silver point), and 630.74 °C for each test thermocouple. The emf-temperature relationship of the type S reference table in NBS Monograph 125 [1] is also represented by a quadratic equation in this temperature range; hence, the difference between the temperature-emf relationship of the test thermocouple and that of the reference table is given by a quadratic equation. This equation representing the difference is extrapolated to obtain values at higher temperatures, and its value at 630.74 °C is used when determining an equation giving the difference at lower temperatures. The difference equations, above 1064.43 °C and below 630.74 °C, are then combined algebraically with the polynomials representing the temperature-emf relationship of the type S reference table in Monograph 125 to obtain polynomials giving the emf-temperature relationship of the test thermocouple in the 0 to 630.74 °C and 1064.43 to 1450 °C ranges.

An illustration of the method used to obtain the emf-temperature equations for the thermocouple below 630.74 °C and above 1064.43 °C follows. In the 0 to

630.74 °C range, the emf deviation (De) of the thermocouple from the reference table is represented by:

$$De = b_0 + b_1 t + b_2 t^2,$$

where  $b_0$ ,  $b_1$ , and  $b_2$  are computed from the values of De at 0, 419.58 (zinc point), and 630.74 °C ( $b_0 = 0$  since  $De = 0$  at  $t = 0$  °C). The emf of the reference table ( $E_{R.T.}$ ) is given by:

$$E_{R.T.} = a_1 t + a_2 t^2 + a_3 t^3 + a_4 t^4 + a_5 t^5 + a_6 t^6,$$

where  $a_1$ ,  $a_2$  .....  $a_6$  are from table 2.3.1 in NBS Monograph 125. The emf of the thermocouple ( $E_{T/C}$ ) is given by:

$$E_{T/C} = E_{R.T.} + De;$$

therefore,

$$E_{T/C} = (a_1 + b_1)t + (a_2 + b_2)t^2 + a_3 t^3 + a_4 t^4 + a_5 t^5 + a_6 t^6.$$

In the range 1064.43 to 1450 °C, the emf-temperature equation is determined in the following manner. The emf deviation (De) of the thermocouple from the reference table is represented by:

$$De = b_0 + b_1 t,$$

where  $b_0$  and  $b_1$  are computed from values of De and  $dDe/dt$  at 1064.43 °C, as given by the quadratic De function for the range 630.74 to 1064.43 °C:

$$b_1 = dDe/dt \quad \text{and}$$

$$b_0 = De - 1064.43 \times b_1.$$

The emf of the reference table ( $E_{R.T.}$ ) is given by:

$$E_{R.T.} = a_0 + a_1 t + a_2 t^2 + a_3 t^3,$$

where  $a_0$ ,  $a_1$ ,  $a_2$ , and  $a_3$  are from table 2.3.1 in NBS Monograph 125. The emf of the test thermocouple ( $E_{T/C}$ ) is given by:

$$E_{T/C} = (a_0 + b_0) + (a_1 + b_1)t + a_2 t^2 + a_3 t^3.$$

From the above set of three equations, the temperature versus emf table for the test thermocouple is calculated. The printed computer output includes the temperature versus emf table, a listing of the measured calibration data, and the coefficients of the equations that are used to calculate the table. This information is bound with a typed report of calibration which gives the customer's name and location, the customer's designation for the thermocouple, the test number, the date, and the estimated calibration uncertainty. The information to be kept in the NIST records includes the coefficients of the equations used to calculate the temperature versus emf table, the calibration data, and a summary of the calculated table. The bound calibration report,



along with a covering letter, is sent to the customer. Samples of the above information are given in the appendix in sections 8.1.1.1 and 8.1.1.2.

### 3.3.9 Apparatus

#### 3.3.9.1 Electrical Annealing System

The thermocouples are electrically annealed for primary calibrations using the same equipment outlined in section 3.1.1.8.

#### 3.3.9.2 Welding Station

The measuring junctions of the test thermocouples are formed by welding with a small oxygen-gas torch. This is performed at the welding station described in section 3.1.1.8.

#### 3.3.9.3 Annealing Furnace (SiC Heating Element)

The horizontal tube furnace with the tubular silicon carbide heating element is used to anneal the thermocouples after they are mounted in alumina 4-bore insulators. The salient features of the furnace are described in section 3.1.1.8 and figure 3.3 gives a sectional view of the furnace.

#### 3.3.9.4 Furnace for Preliminary Tests

The horizontal tube-type furnace having a tubular heating element of Chromel is used to heat the thermocouples during preliminary tests. This furnace is discussed in section 3.1.1.8 and a sectional view of the furnace is shown in figure 3.2.

#### 3.3.9.5 Freezing-Point Cells

The fixed-point calibrating temperatures are realized in metal freezing-point cells. The longitudinal section of a typical cell is shown in figure 3.10. The freezing-point metal is contained in a high purity graphite crucible that is 190 mm long and has a 42.5 mm o.d. and 30 mm i.d. A graphite thermometer well (170 mm long, 12 mm o.d., and 8.5 mm i.d.) extends through the lid and into the metal. All graphite parts are obtained from a commercial supplier who purified the graphite after machining. The crucible contains about 100 cm<sup>3</sup> of metal, and when the metal is melted, the liquid surface is about 14.5 cm above the bottom of the graphite well. The freezing-point metals of gold, silver, antimony, and zinc used in the preparation of the cells are of very high purity (typically 99.999+% to 99.9999+%).

The glass parts for the gold, silver, and antimony cells are made from high purity silica glass. For the zinc cell, a borosilicate type glass is used. The gold and silver cells are 570 mm long, the antimony cell 500 mm long, and the zinc cell 475 mm long. The outer diameter of all the cells is 48 mm and the inner diameter is 44 mm.

The stainless steel cap at the top of the glass cell provides a means of operating the cell in an inert atmosphere to protect the freezing-point metal and graphite parts from air oxidation. The cap is sealed to the cell with a rubber O-ring. A thermocouple protecting tube (not shown in fig. 3.10), made of glass and closed at one end, is inserted into each cell through the thermometer port. The protecting tube (6 mm i.d. and 8 mm o.d.) is sealed in the thermometer port with a rubber O-ring and a compression nut, and it is held a few millimeters off the bottom of the graphite well. When the freezing-point cell is at an elevated temperature, it is filled with argon to a pressure slightly above ambient.

The thermocouple protecting tube used in the zinc cell is made of a borosilicate type glass, while high purity silica glass tubes are used in the gold, silver, and antimony cells. The latter tubes are roughened on the outside with an air propelled abrasive to lessen heat losses by radiation piping up the walls of the tubing. The loss of heat by radiation piping, if not effectively minimized, can prevent the thermocouple measuring junction from reaching the temperature of the surroundings, thus causing significant calibration errors.

#### 3.3.9.6 Furnace for Gold and Silver Freezing-Point Cells

The gold and silver freezing-point cells are used in an electrically heated vertical tube furnace of the design shown in figure 3.11. The furnace, which is 35 cm in diameter and 66 cm high, has independently heated end zones to promote temperature uniformity near the furnace center. Each of the three cylindrical heater sections is 20 cm long and is made from commercially available resistance heaters that have helical shaped Ni-Cr alloy elements supported in grooves on the inner walls of semi-cylindrical ceramic forms. Two of the semi-cylindrical forms are used for each heater section and their heater elements are connected in parallel. The heater sections are contained within an Inconel tube that has a 10 cm i.d., and the space between this Inconel tube and the brass shell is filled with Fiberfrax insulation. A rather widely spaced helical coil of 9.5 mm copper tubing (not shown in fig. 3.11) is soldered to the outside of the brass shell to permit water cooling; a comparable provision is used on the top and bottom end plates.

An axial Inconel well for the freezing-point cell is centered inside the heaters. A 6-mm diameter Inconel rod welded to the bottom of the well is used to support the well. Three smaller diameter Inconel tubes (not shown in fig. 3.11) are equally spaced around the outside of the Inconel well for control thermocouples. Some Fiberfrax insulation is placed in the bottom of the Inconel well to support the freezing-point cell and the level of the insulation is adjusted to locate the bottom of the cell about 5 mm above the top of the bottom heater. The Inconel well and tubes attached to it are connected to an electrical earth ground and serve to shield the test and control thermocouples from the heaters.

Automatic temperature control of the furnace is achieved with type S thermocouples connected to conventional control components. The center-zone control thermocouple, with reference junctions kept at about 22 °C in a water bath, is connected to a K-3 potentiometer that is set to the desired control

point. The unbalance voltage from the potentiometer is amplified with a dc null detector, and the detector output is fed to a 3-mode electronic controller that operates a solid-state current regulator connected to the center heater. The top- and bottom-zone control thermocouples are of the differential type - their reference junctions are located near the midpoint of the center heater and their control junctions are located several centimeters inside the end zones. They are connected directly to a dc null detector. Similarly, the outputs of the two detectors go to 3-mode electronic controllers that operate solid-state current regulators connected to the top and bottom heaters. Short-time (1 h) control stability of about 0.1 °C is realized with these control components.

#### 3.3.9.7 Furnace for Antimony and Zinc Freezing-Point Cells

The antimony and zinc freezing-point cells are heated in furnaces of the design shown in figure 3.12. Each of the furnaces is 35 cm in diameter and 66 cm high. They use a commercially available heater that has a single heating element made of Ni-Cr wire and embedded within a ceramic muffle. The heater is positioned in the center of the brass shell by transite collars secured to the top and bottom end-plates. The space between the heater and the brass shell is filled with Fiberfrax insulation. Copper tubing (not shown in fig. 3.12) is soldered to the outside of the brass shell and end plates to permit water cooling. A cylindrical liner (not shown in fig. 3.12) formed from 1 mm thick Inconel sheet is fitted snugly inside the ceramic muffle. A cylindrical copper block (10 cm in diameter and 28 cm long) is used to promote temperature uniformity near the center of the furnace. The block is nickel plated to lessen deterioration of the copper by air oxidation. Inconel tubes (about 5 mm o.d.) used to hold a control or monitoring thermocouple are placed in two holes drilled through the copper block. The temperature of the furnace is controlled automatically. An electronic controller is used in conjunction with a type N control thermocouple to operate a solid state current regulator connected to the heater.

#### 3.3.9.8 Ice Baths

Thermocouple reference junctions are maintained at 0 °C in ice baths during the calibration. The ice baths are described in section 3.1.1.8.

#### 3.3.9.9 Measuring Instrument

A six-dial precision potentiometer (Guildline model 9160D) is used to measure the emf of the thermocouples during the freezes. Each dial of the potentiometer is equipped with an auxiliary switch that is interfaced with the laboratory computer so that the dial settings may be recorded by the computer. This instrument is calibrated in accordance with the procedure outlined in Appendix I of NBS Monograph 126 [3]. The calibration history and accuracy of this instrument are discussed in section 4.0.

### 3.4 References

- [1] Powell, R. L., Hall, W. J., Hyink, Jr., C. H., Sparks, L. L., Burns, G. W., Scroger, M. G., Plumb, H. H., Thermocouple Reference Tables Based on the IPTS-68, Natl. Bur. Stand. (U.S.) Monogr. 125, 410 pages (1974).
- [2] Cutkosky, R. D., An ac resistance thermometer bridge, J. Res. Natl. Bur. Stand. (U.S.) 74C (Engr. & Instr.), Nos. 1 & 2, pp. 15-18 (Jan.-June 1970).
- [3] Riddle, John L., Furukawa, George T., Plumb, Harmon H., Platinum Resistance Thermometry, Natl. Bur. Stand. (U.S.), Monogr. 126, 126 pages (1973).
- [4] The International Practical Temperature Scale of 1968, Amended Edition of 1975, Metrologia 12, No. 1, pp. 7-17 (1976).
- [5] Corruccini, R. J., Annealing of Platinum for Thermometry, J. Research, NBS, 47, No. 2, 1951.
- [6] Cochrane, J., Relationship of Chemical Composition to the Electric Properties of Platinum, Temperature, Vol. 4, p. 1619 (Instrument Society of America, Pittsburgh, PA, 1972).
- [7] McLaren, E. H., Murdock, E. G., Properties of Some Noble and Base Metal Thermocouples at Fixed Points in the Range 0-1100 °C, Temperature, Vol. 5, Pt. 2, p. 953 (American Institute of Physics, New York, NY, 1982).

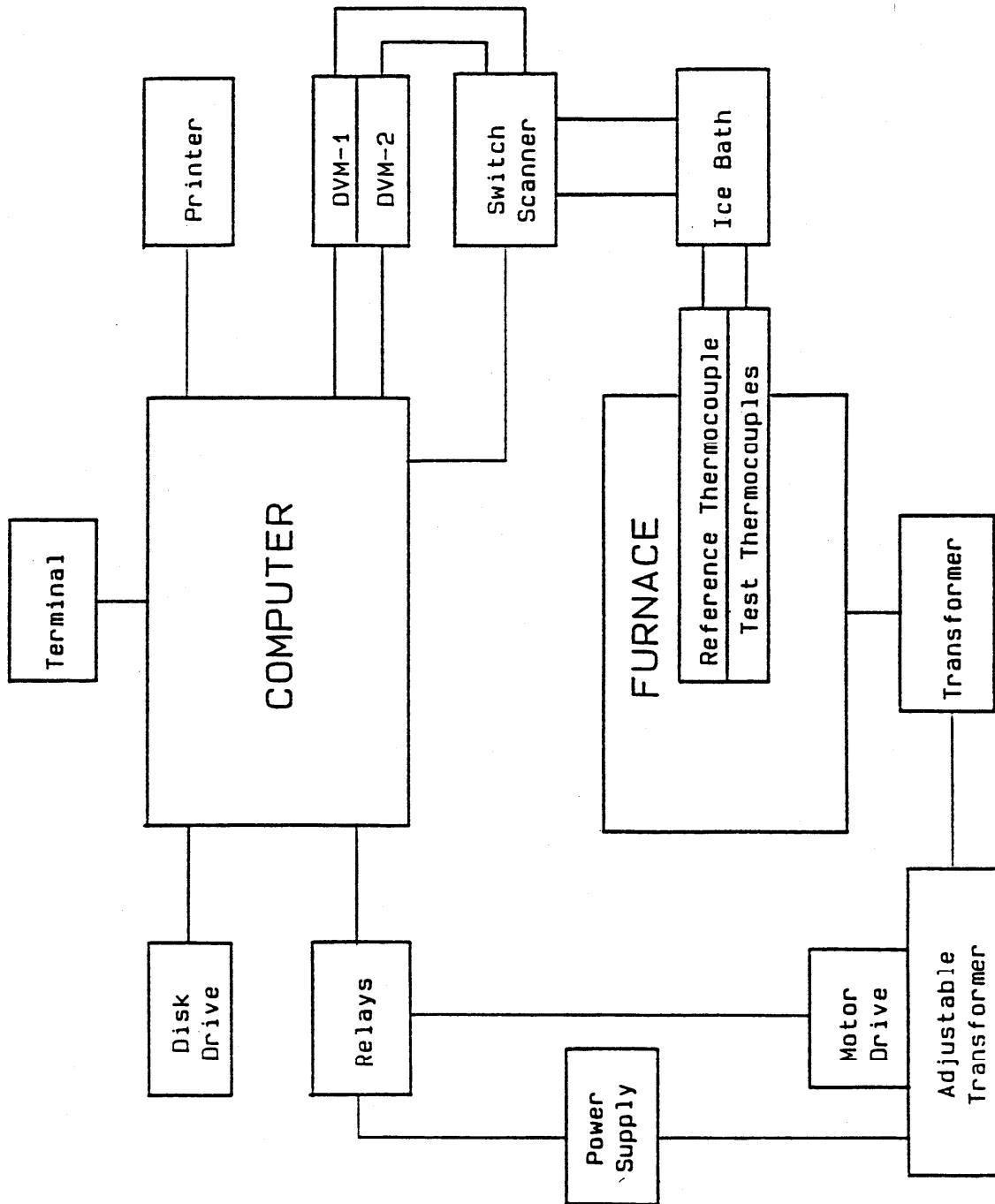

Figure 3.1. Schematic of automatic thermocouple calibration system for comparison calibrations.

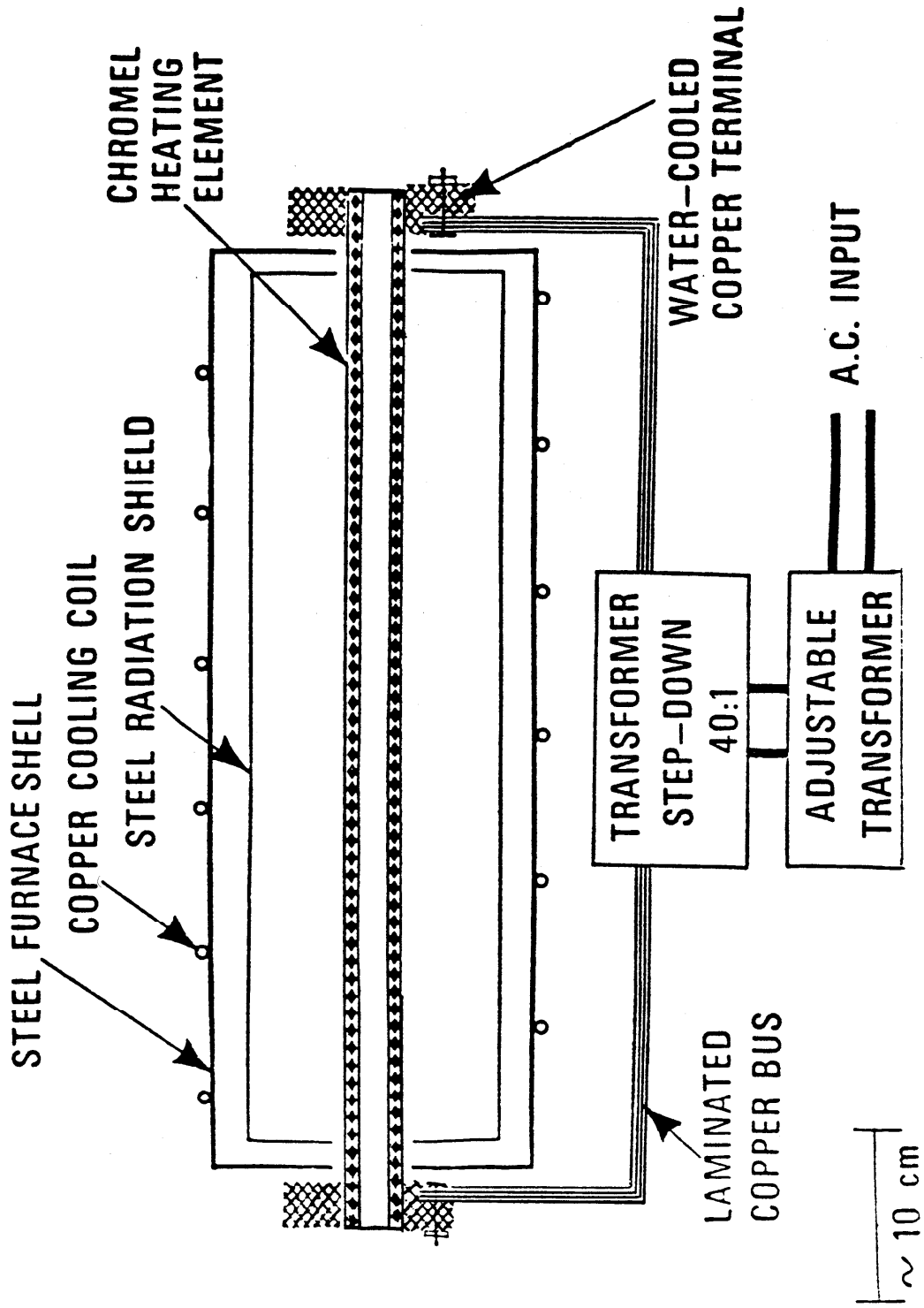

Figure 3.2. Chromel tube furnace (50 to 1100 °C).

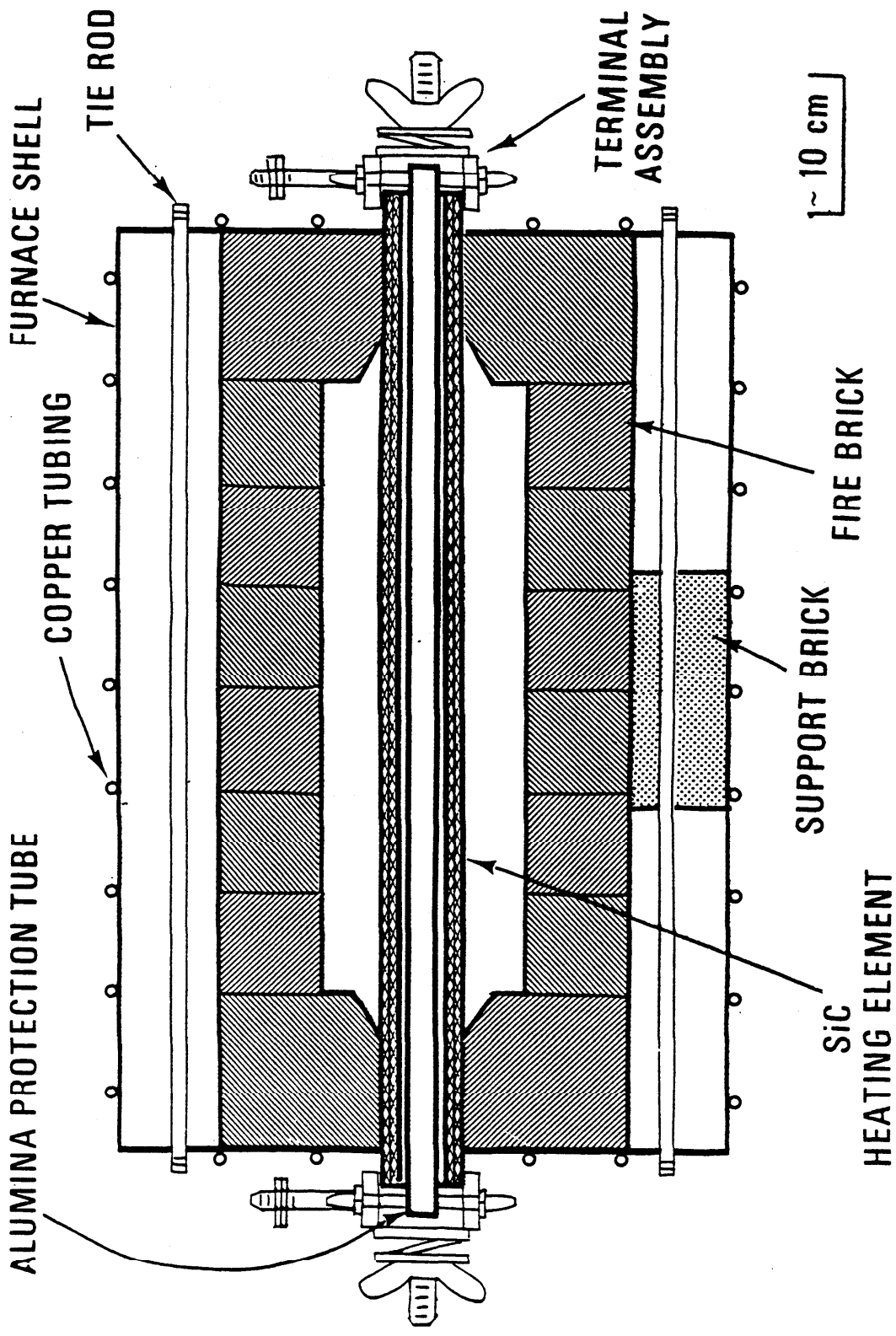

Figure 3.3. Silicon carbide tube furnace (50 to 1600 °C).

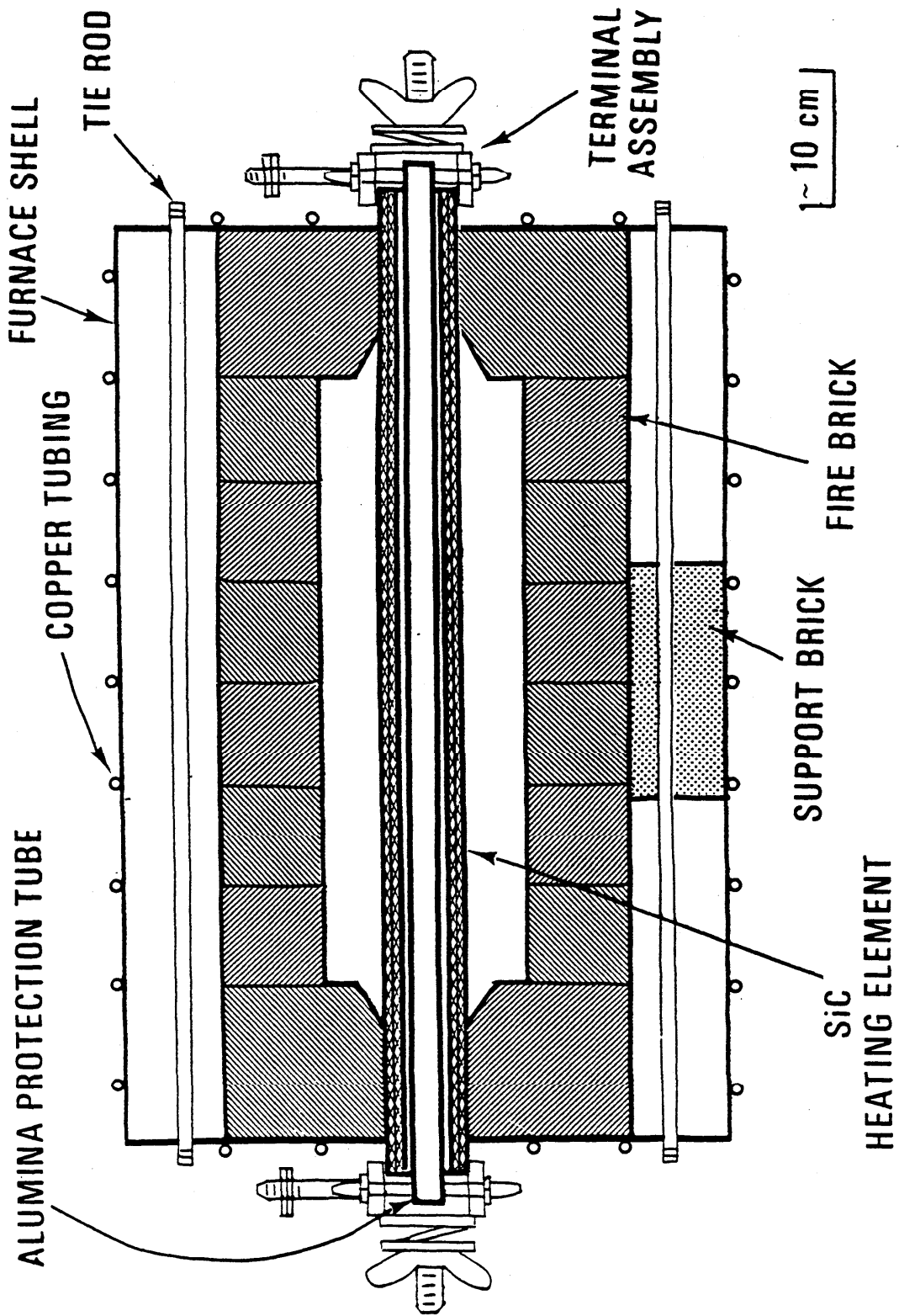

Figure 3.3. Silicon carbide tube furnace (50 to 1600 °C).



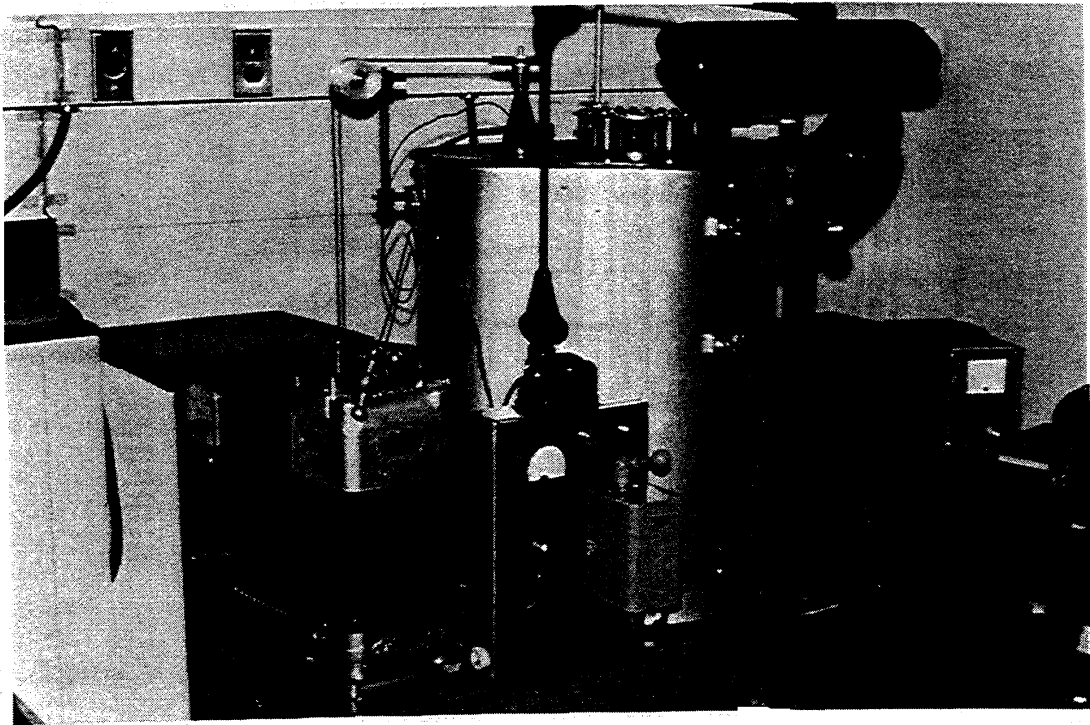

Figure 3.4. Oil bath.

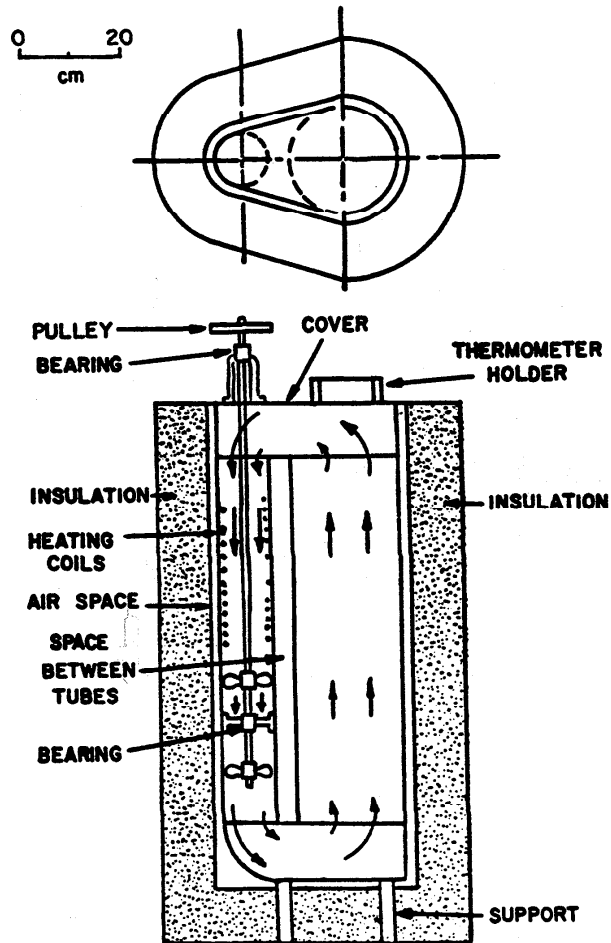

Figure 3.5. Oil bath and water bath.

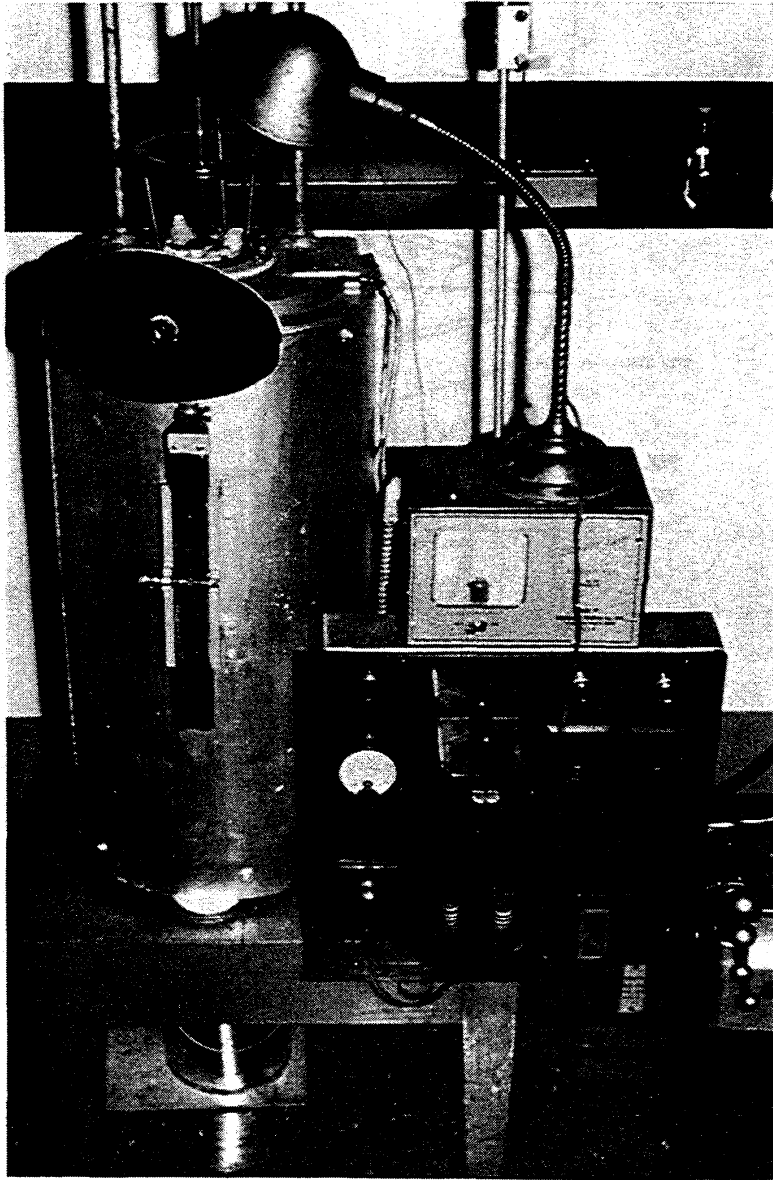

Figure 3.6. Tin bath.

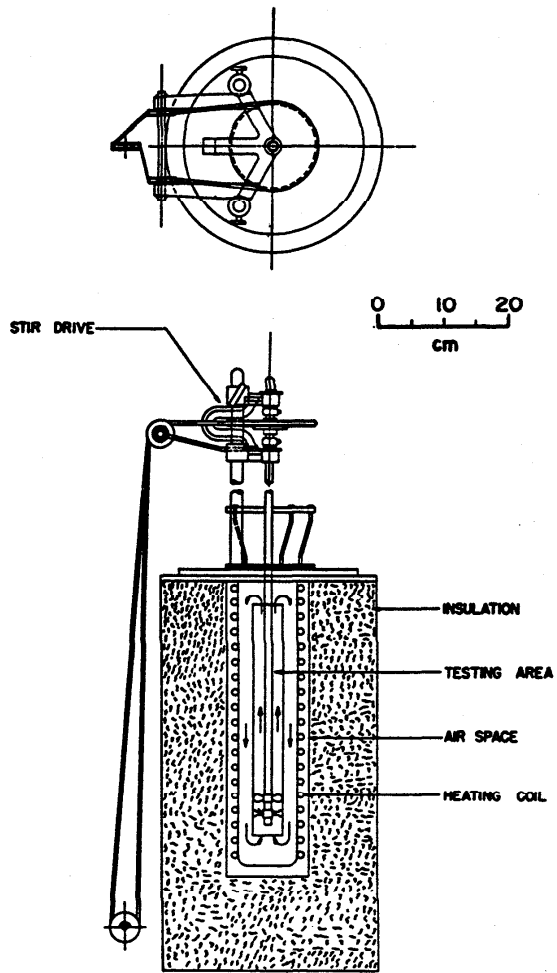

Figure 3.7. Tin bath.

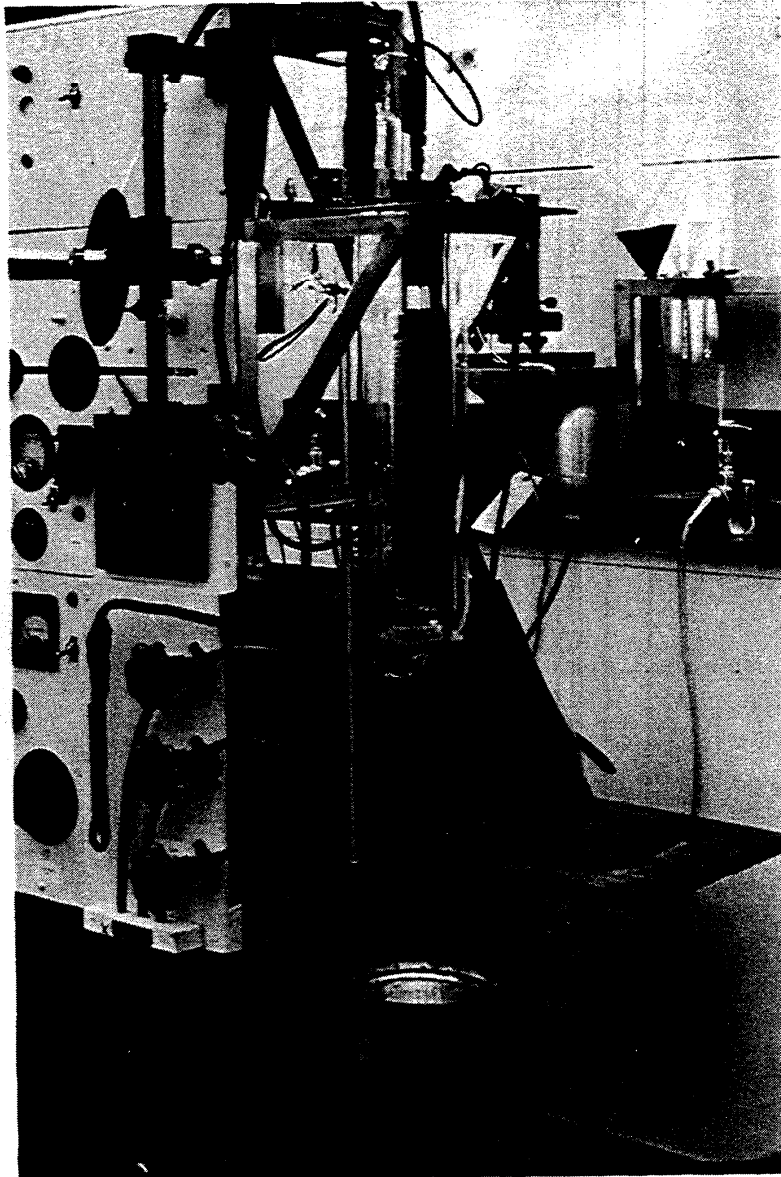

Figure 3.8. Cryostat.

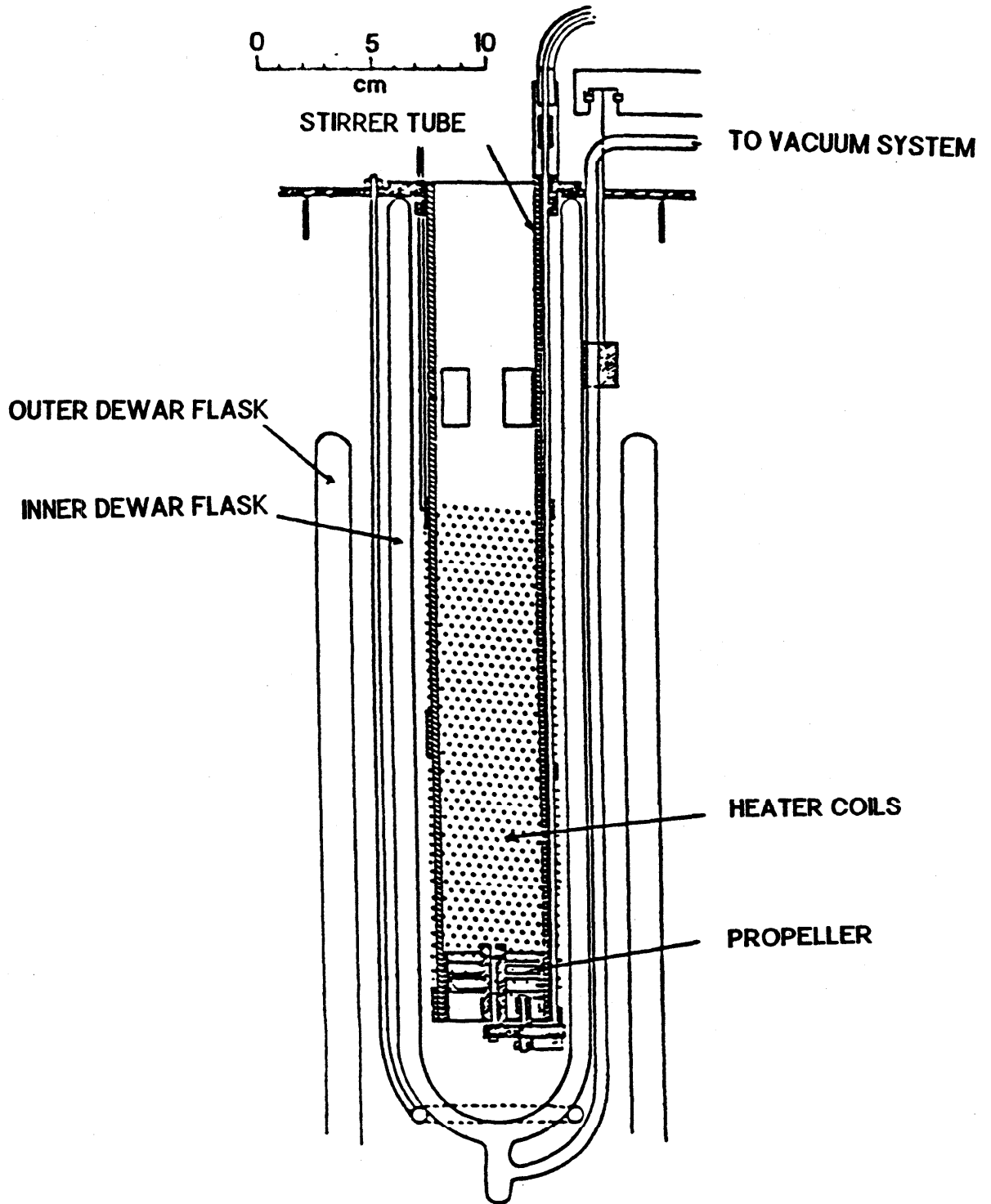

Figure 3.9. Cryostat.

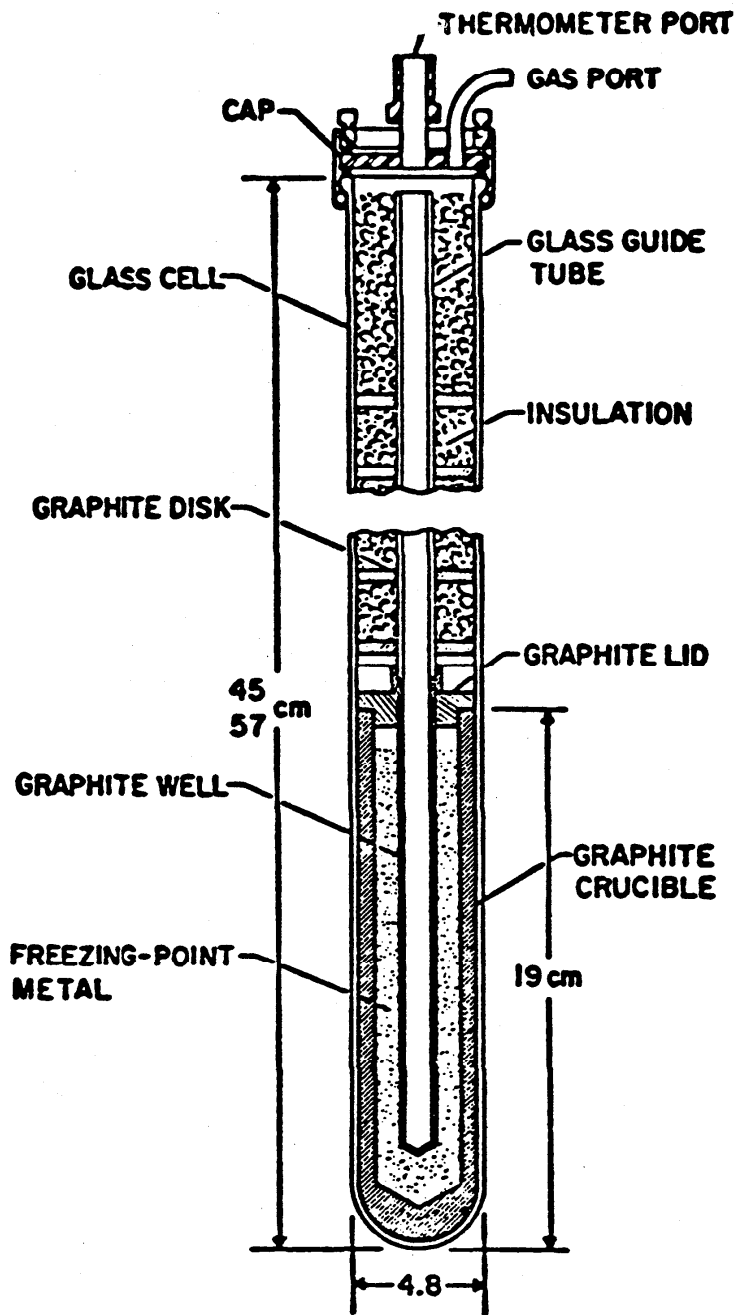

Figure 3.10. Metal freezing-point cell.

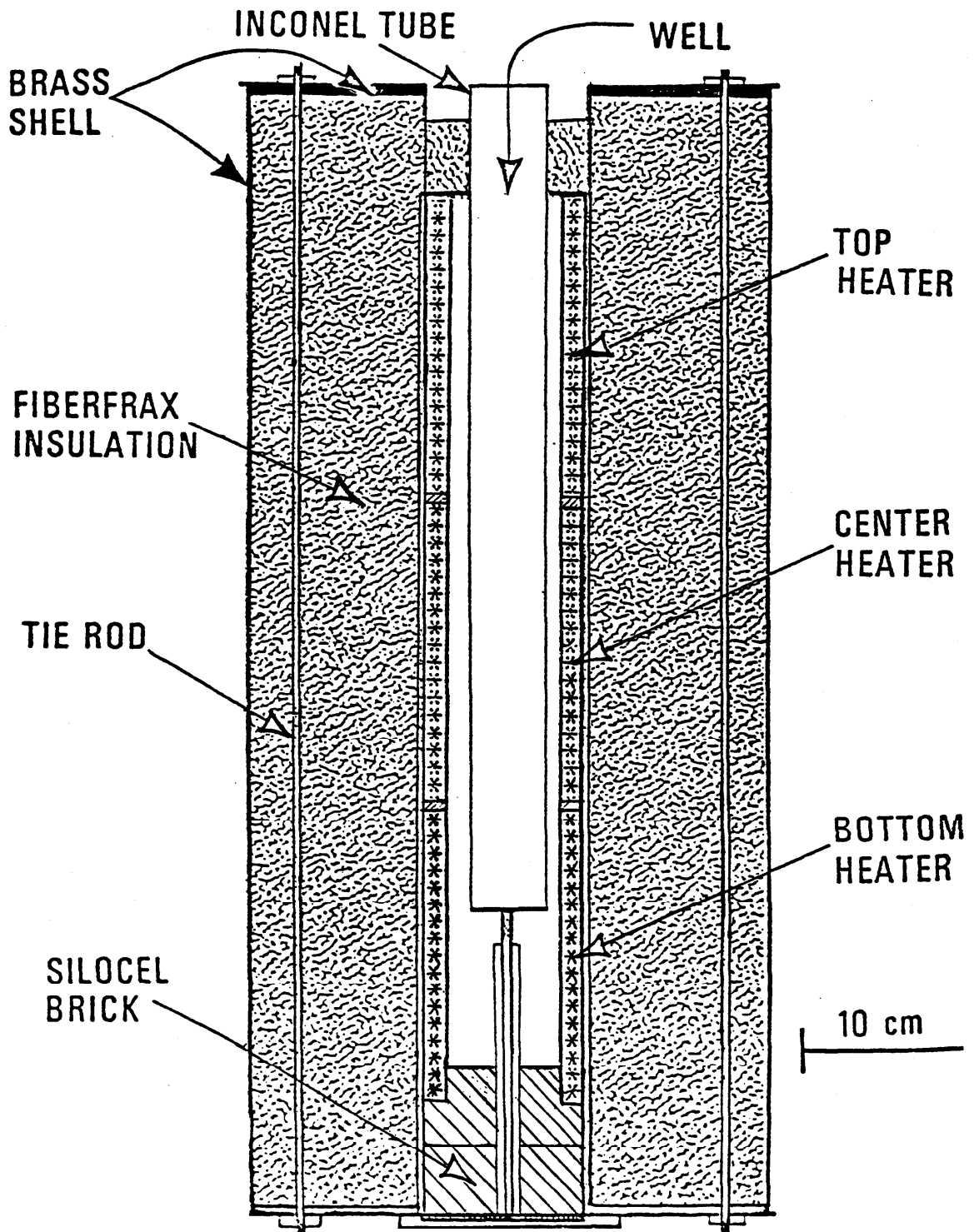

Figure 3.11. Freezing point furnace for gold and silver.



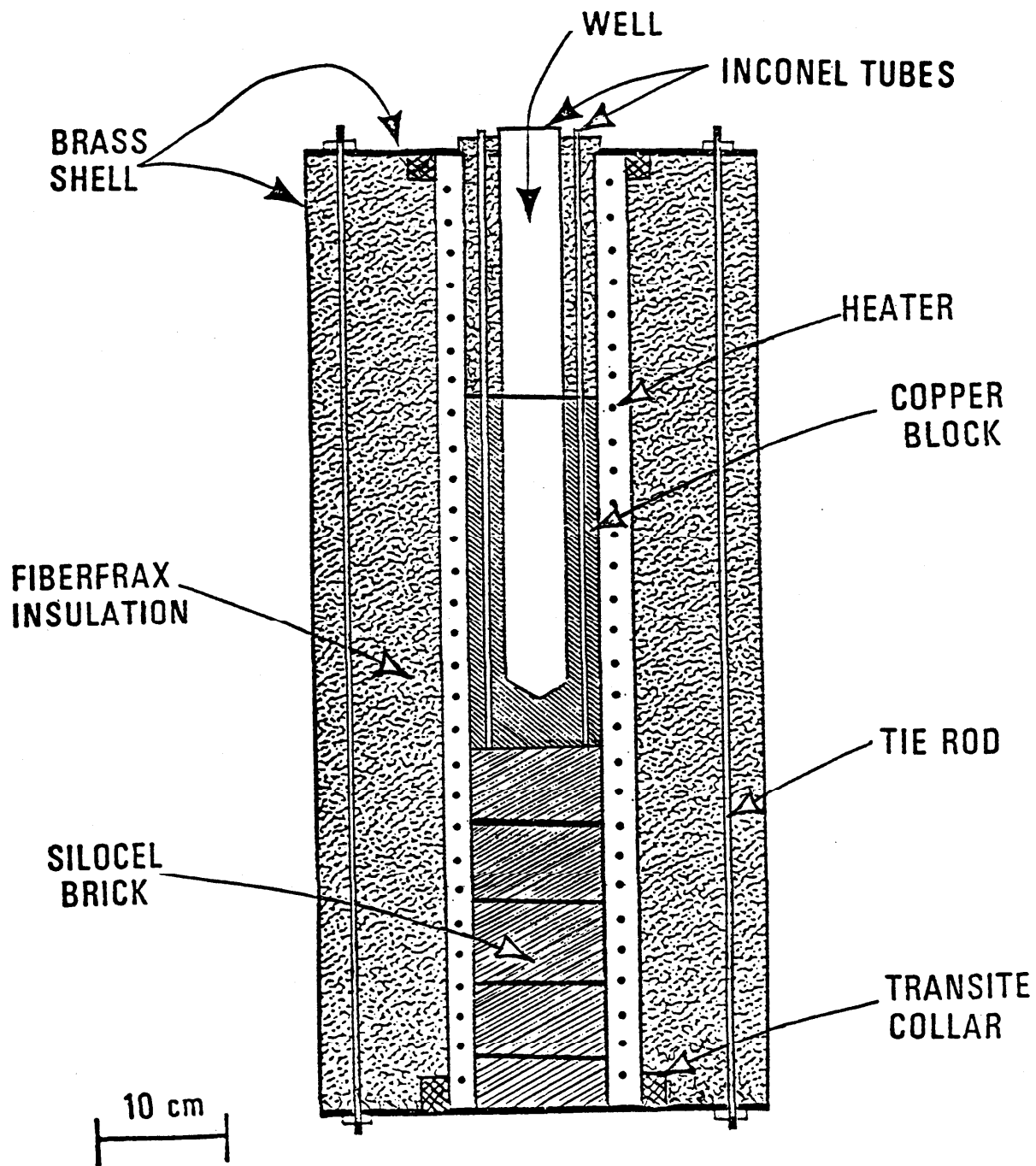

Figure 3.12. Freezing point furnace for antimony and zinc.

#### 4. INTERNAL QUALITY CONTROL

To obtain reliable calibration results, it is necessary to maintain internal standards in the laboratory and to follow routine procedures to check equipment and standards as well as to have some equipment calibrated in other laboratories on a regular basis.

The apparatus involved in our internal quality control system include voltage standards, voltage measuring instruments, resistance measuring instruments, standard platinum resistance thermometers, calibrated reference thermocouples, thermocouple check standards, and various thermometric fixed-points. The maintenance and calibrations of these apparatus are discussed in the following subsections.

##### 4.1 Voltage Standards

In the NIST thermocouple calibration laboratories since electromotive force is measured, it is essential to maintain dc voltage standards calibrated in terms of the U.S. legal unit of emf.<sup>4</sup> A primary set of four saturated standard cells housed in a thermostatically controlled enclosure is used for this purpose in the high-temperature thermocouple calibration laboratory. They are calibrated by the NIST Electricity Division at about 4-year intervals, and their calibration history over the past 28 years is shown in figure 4.1. The emf increase of each cell from mid-1969 to mid-1986 is about 10 microvolts (10 ppm), while the change in each cell during the past 8 years is about 2 microvolts (2 ppm).

Two additional sets of saturated standard cells are also maintained in separate temperature controlled enclosures and each set consists of two cells. One set, which is used in the low-temperature thermocouple calibration laboratory where thermocouples are calibrated by comparison with an SPRT, is calibrated periodically by the NIST Electricity Division. The other set of cells is used in the high-temperature thermocouple calibration laboratory as a back-up. Since mid-1969, they have been compared with the primary set of four cells just before and just after the primary set of cells is calibrated by the NIST Electricity Division.

The reported calibration uncertainties for the standard cells in the primary set are 0.78 microvolts and are determined by adding all estimated systematic errors to the computed random error at the three sigma level. As stated in the report of calibration issued by the NIST Electricity Division, no allowances are made for long-term drift in the cells or for possible effects of transporting the cells between laboratories. Considering the stability of the cells during the past 8 years, together with the results of the comparisons made in our laboratory before and after transport, we estimate that reasonable allowances for the calibration drift during the 4-year interval between calibrations and for the effect of transporting the cells are +2 or -1 microvolts and  $\pm 1$  microvolt, respectively. The linear sum of these

---

<sup>4</sup>The U.S. legal unit of voltage is known to be consistent with the SI unit within  $\pm 10$  ppm at the three sigma level.

allowances and the calibration uncertainty gives an overall uncertainty of +3.78 to -2.78 microvolts in our laboratory voltage standard.

## 4.2 Voltage Measuring Instruments

### 4.2.1 Potentiometers

The various potentiometers used in thermocouple calibrations are calibrated periodically in terms of the U.S. legal unit of emf. In the high-temperature thermocouple calibration laboratory the six-dial Guildline potentiometer used during the primary calibration of type S thermocouples (see sec. 3.3) and for calibrating other emf-measuring instruments is calibrated in our laboratory at approximately 1-year intervals in accordance with the procedure given in appendix I of NBS Monograph 126. This instrument has a resolution of 0.01 microvolts and is standardized with respect to one of the saturated standard cells in the primary set. The potentiometer dial corrections for emf measurements of 10.33, 9.14, 5.55, and 3.44 millivolts (which correspond to the emf of a type S thermocouple at the gold, silver, antimony, and zinc points) obtained in calibrations of the instrument over the past 18 years are shown in figure 4.2. The drift in the potentiometer correction between 1978 and 1986 corresponds to about 7 ppm per year of the measured voltage. The random uncertainty in determining the potentiometer correction with respect to the laboratory voltage standard at each of the above four voltages was estimated from the residual standard deviation of a straight line fitted by the method of least squares to the values obtained between 1978 and 1986. The estimated uncertainty, computed at the three sigma level, is 29 ppm of the measured voltage.

The six-dial Rubicon potentiometer presently used when calibrating thermocouples by comparison with an SPRT was obtained recently from another laboratory and no long calibration history exists. An initial calibration of the instrument was performed using apparatus obtained from the NIST Electricity Division. Subsequent calibrations will be made in our laboratory in the same manner used for calibrating the Guildline potentiometer.

### 4.2.2 Digital Voltmeters

The two Hewlett Packard 3456A digital voltmeters used in the automatic calibration system are calibrated by comparison with the Guildline six-dial potentiometer at 2 to 3 week intervals. This calibration is made at one millivolt intervals between 0 and 12 millivolts to check the linearity of the instruments. These digital voltmeters are also compared with a 10-millivolt constant voltage source during each thermocouple calibration run. The 10-millivolt constant voltage source, calibrated by comparison with the Guildline potentiometer, has been found to have a short-time stability (2 months) of 30 ppm computed at the three sigma level.

### 4.2.3 Thermocouple Measuring Circuitry

The circuitry connecting the thermocouples to the measuring instruments must be as free as possible from parasitic thermal emfs. In the thermocouple calibration laboratory, circuit junction pairs are located physically close

together to promote temperature equality and almost the entire length of the copper connecting wires is thermally and electrically shielded. However, experience shows that the portions of the copper connecting wires located within reference-junction ice baths, as well as the electrical contacts and connections within switch scanners can be troublesome sources of residual emf in the measuring circuits. Physical inhomogeneities are introduced in the copper connecting wire with extended use and handling due to work hardening of the copper wire, and small unwanted emfs in the circuits result when the inhomogeneous wires are within the temperature gradient zone of the ice bath. Consequently, all thermocouple measuring circuits are checked frequently for residual emfs by electrically shorting the pairs of copper connecting wires from each selector switch position and from each channel of the switch scanners in an ice bath and then measuring the circuit voltages with the measuring instrument. By replacing inhomogeneous copper connecting wires, the residual emfs in circuits used in the primary calibration system are kept to less than 0.1 microvolt. In the comparison calibration system, by similar maintenance of the connecting wire circuits and the proper selection of switch scanner positions, residual emfs are kept to less than 0.3 microvolts.

#### 4.3 Resistance Measuring Instrument

During the calibration of thermocouples by comparison with an SPRT, measurements of the thermometer resistance are made with an ac bridge (see sec. 3.2.2.2) operating at 400 hertz. The bridge utilizes an inductive ratio divider that eliminates the necessity of calibrating the bridge because the initial uncertainty of the divider is about 2 parts in  $10^8$  and has been found to be stable. The proper operation of the resistance measuring system is monitored from measurements made with a set of three SPRT's at the triple point of water. (See sec. 4.4.2.)

#### 4.4 Temperature Measuring Instruments

##### 4.4.1 Working Standard Reference Thermocouples

As mentioned in section 3.1.1, the type S reference thermocouples used as working standards in the comparison calibration system are calibrated initially at fixed points and then checked periodically for changes in calibration by comparison with other type S thermocouples. Such checks of each working standard are made at 2 to 3 month intervals against customer's type S standard thermocouples during preliminary tests for fixed-point calibrations. (See sec. 3.3.5.) In addition, during these preliminary tests, as well as each time the working standards are used in a comparison calibration run, they are compared with customer's thermocouples at various immersions in the furnace. While the latter comparisons are performed to assess the thermoelectric homogeneity of the customer's thermocouple, they also provide a continual monitor of the thermoelectric quality of the working standards since many of the customer's thermocouples are made from new, previously unused wire.

The above type S thermocouples are used to check the type B reference thermocouples for changes in calibration. These checks with the type B

reference thermocouples are made in the 800 to 1100 °C range and are performed after about every five times the type B reference thermocouples are used.

The specially mounted type S reference thermocouples used in the comparison calibration of base-metal thermocouples are monitored for calibration changes by comparing them with other similarly mounted type S reference thermocouples that have been calibrated at the fixed points but have not yet been used to calibrate base-metal thermocouples.

#### 4.4.2 Standard Platinum Resistance Thermometers

A set of three standard platinum resistance thermometers are maintained in the low-temperature thermocouple calibration laboratory. A history is kept of the values of their resistances that are measured at the triple point of water each day the thermometer is used. If this measured value deviates by more than the equivalent of 1 mK from the value determined in the initial calibration, the particular SPRT, along with the ac bridge, is sent to the NIST Platinum Resistance Thermometry Calibration Laboratory where it is re-calibrated. Experience has shown that the thermometers require calibration every 2 to 4 years.

The uncertainty in the calibration of the standard platinum resistance thermometer is given in NIST Monograph 126 as  $\pm 0.0001$  °C at the triple point of water,  $\pm 0.001$  °C at the freezing point of tin, and  $\pm 0.001$  °C at the freezing point of zinc. From the documentation of the NIST resistance thermometer calibration service, the uncertainty of the interpolated values between the fixed points is  $\pm 0.001$  °C in the range 0 to 420 °C, increasing to  $\pm 0.003$  °C at 500 °C.

#### 4.5 Platinum Thermoelectric Reference Standard

The platinum thermoelectric reference standard, Pt-67, is maintained with a selected portion of NIST SRM 1967. The standard is in the form of 0.51 mm diameter wire and has received extensive characterization under the direction of the NIST Office of Standard Reference Materials. Three samples, each 1 meter long, taken from our reserve supply of SRM 1967 are used in the laboratory to check the platinum thermoelectric working standards that are used in thermoelectric tests of customer's thermoelements.

#### 4.6 Thermocouple Fixed-Point Check Standards

A group of six type S thermocouples are used as check standards to monitor the operation of the primary calibration system, as described in section 3.3. Two of the thermocouples are included with every set of customer's thermocouples that are given a primary calibration. Each check standard is calibrated about twice yearly, and data on the oldest of these thermocouples goes back to the year 1969. The calibration histories obtained with each of these check standards in the gold-point, silver-point, antimony-point, and zinc-point cells are shown in figures 4.3 to 4.26. Statistical analyses of these data were performed to establish limits to random error for the primary thermocouple calibration process and are discussed in section 5.0.

## 4.7 Thermometric Fixed Points

### 4.7.1 Metal Freezing-Point Cells

Freezing-point cells containing zinc, antimony, silver, and gold are used in the primary calibration of type S thermocouples described in section 3.3. The values assigned to the liquidus temperatures of these cells are determined from measurements made with platinum resistance thermometers. The most recent tests of the gold-point, silver-point, and antimony-point cells maintained in the high-temperature thermocouple calibration (HTTC) laboratory were carried out in mid-1985, using NIST-made, high-temperature platinum resistance thermometers (RT's No. 8202, 8204, and 8205). These thermometers have toroidal resistors of nominal resistance at 0 °C of about 0.37 ohm. The design and construction of the thermometers are described in references [1] and [2] and performance of the thermometers is discussed in reference [3]. The gold- and silver-point cells were compared with similar reference cells of the highest available quality maintained in the High Temperature Resistance Thermometry (HTRT) laboratory. For the antimony cells, the values of the freezing points on the IPTS-68 were determined by calibrating the thermometers at the defining fixed points (freezing points of tin and zinc, and the triple point of water) in the HTRT laboratory.

The thermometric fixed points in the HTRT laboratory include the triple point of water, and the freezing points of gold, silver, zinc, and tin. The metal freezing points are contained in sealed glass cells. A description of the cells, furnaces, and control systems may be found in reference [3]. The reference gold and silver cells used in the HTRT laboratory are designated AU83-1 and AG79-1, respectively. It should be noted that cell AU83-1 is not the same gold cell reported in reference [3]. Cell AU83-1 has a total depth of immersion of about 17 cm, and it was found to have a freezing point about 15 mK higher than the cell reported in reference [3]. Because of the demonstrated exceptional purity of the original metal samples, and because the sealed cell construction has ensured continued purity with use, it is believed that the freezing points of the reference cells are as close to the ideal gold and silver points as it is possible to achieve at the present time and that the departure in the freezing points from perfection probably does not exceed 2 mK.

The differences found between the freezing points of two gold-point cells (AU67-11 and AU85-1) maintained in the HTTC laboratory and the freezing point of reference cell AU83-1 are given in table 4.1. Table 4.1 also gives the differences found between the freezing points of two HTTC laboratory silver-point cells (AG67-4 and AG65-2) and the freezing point of reference cell AG79-1. In each case, the freezing point of the HTTC laboratory cell is lower than the freezing point of the reference cell.

The freezing points of the two antimony cells (SB69-1 and SB67-1) used in the thermocouple calibration laboratory were calculated on the IPTS-68. All three platinum resistance thermometers met the requirements for standard thermometers according to the definition of the IPTS-68. The results are presented in table 4.2. It should be noted that above 630.74 °C the IPTS-68 is not defined in terms of platinum resistance thermometry. However, the departures of the values in table 4.2 from IPTS-68 are negligible.

Table 4.1. Freezing point differences for gold and silver cells

(Test cell) - (Reference cell)					
(Values in degrees Celsius)					
RT No.	Test Cell: Ref. Cell:	AU67-11 AU83-1	AU85-1 AU83-1	AG67-4 AG79-1	AG65-2 AG79-1
8202		-0.0551	-0.0266	-0.0442	-0.0361
8204		-0.0544	-0.0210	-0.0405	-0.0307
8205		-0.0497	-0.0189	-0.0426	-0.0290
-----					
Mean		-0.0531	-0.0222	-0.0424	-0.0319
Std. Dev.		0.0029	0.0040	0.0019	0.0037
Std. Dev. of Mean		0.0017	0.0023	0.0011	0.0021

Table 4.2. Antimony cell freezing points

(Values in degrees Celsius, IPTS-68)

RT No.	SB69-1	SB67-1
8202	630.7297	630.7474
8204	630.7281	630.7472
8205	630.7202	630.7405
-----		
Mean	630.7260	630.7450
Std. Dev.	0.0051	0.0039
Std. Dev. of Mean	0.0029	0.0023

The zinc freezing-point cell presently used in the HTTC laboratory was constructed in 1986 using zinc of very high purity (less than 1 ppm total impurity content). The freezing point of the cell was determined from measurements made in the NIST platinum resistance thermometry calibration laboratory with a 25 ohm SPRT and was found to be within 1 mK of the freezing point of the zinc cell maintained and used in that laboratory for SPRT calibrations.

#### 4.7.2 Water Triple Point Cells

As described in section 3.2.3, a triple point of water cell is used during the calibration of thermocouples by comparison with an SPRT. The triple point is realized in a sealed glass cell containing water, ice, and water vapor. The techniques described in section 7.1 of NBS Monograph 126 are followed in the preparation, maintenance, and use of the cell.

#### 4.7.3 Ice Baths

During the calibration of thermocouples at NIST, the reference junctions are maintained at 0 °C in an ice bath. The ice bath is made from distilled water and finely divided ice that is prepared from distilled water. The ice-water mixture is contained in a large-mouth Dewar flask with an inside depth of 30 cm. It has been found that by following careful preparation techniques to minimize contamination, the ice point temperature of 0 °C can be repeatedly realized to within 2 mK.

Proper maintenance of the ice bath is essential during use. Care is taken to ensure that the reference junction tubes are located properly within the ice-water portion of the bath at all times. Junction tubes are used that are of sufficient length to ensure that the electrical connection between the thermoelement and the copper connecting wire very closely approaches the temperature of its surroundings. An experimental investigation [4] of thermocouple reference junction temperatures in ice baths was conducted at NIST to assess the errors caused by insufficient depth of immersion. The results of this investigation indicate that the immersion errors due to conductive heat flow into the bath along the wires and junction tube can be kept to less than 10 mK by using an immersion depth of 12.5 cm with 0.4 mm diameter copper wire and 0.51 mm diameter platinum wire and an immersion depth of 15 cm with 0.4 mm diameter copper wire and type K thermoelements as large as 3.3 mm in diameter. In addition, the precautions for keeping the tubes clean, described in section 3.1.1.8, are followed.



#### 4.8 References

- [1] Bass, N., NBS Technical Note 1183, part 1 (January 1984).
- [2] Evans, J.P., Tillett, S. B., NBS Technical Note 1183, part 2 (January 1984).
- [3] Evans, J. P., Evaluation of Some High-Temperature Platinum Resistance Thermometers, J. Res. Natl. Bur. Stand. (U.S.) Vol. 89, No. 5, p. 349 (September-October 1984).
- [4] Caldwell, F. R., Temperature of Thermocouple Reference Junctions in an Ice Bath, J. Res. Natl. Bur. Stand. (U.S.) 69C (Engr. & Instr.) 95-101 (1965).

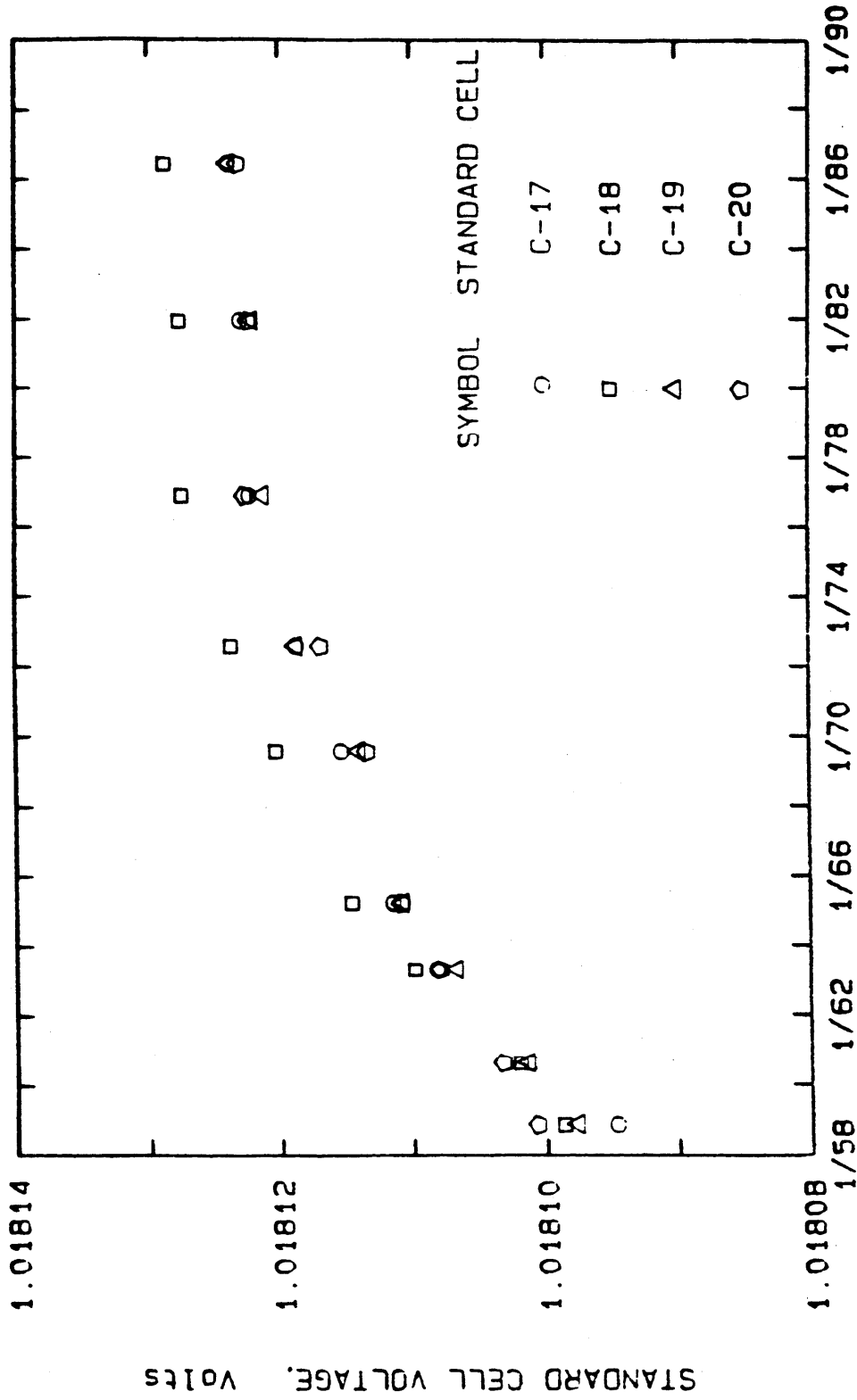

Figure 4.1. Calibration history of saturated standard cells.

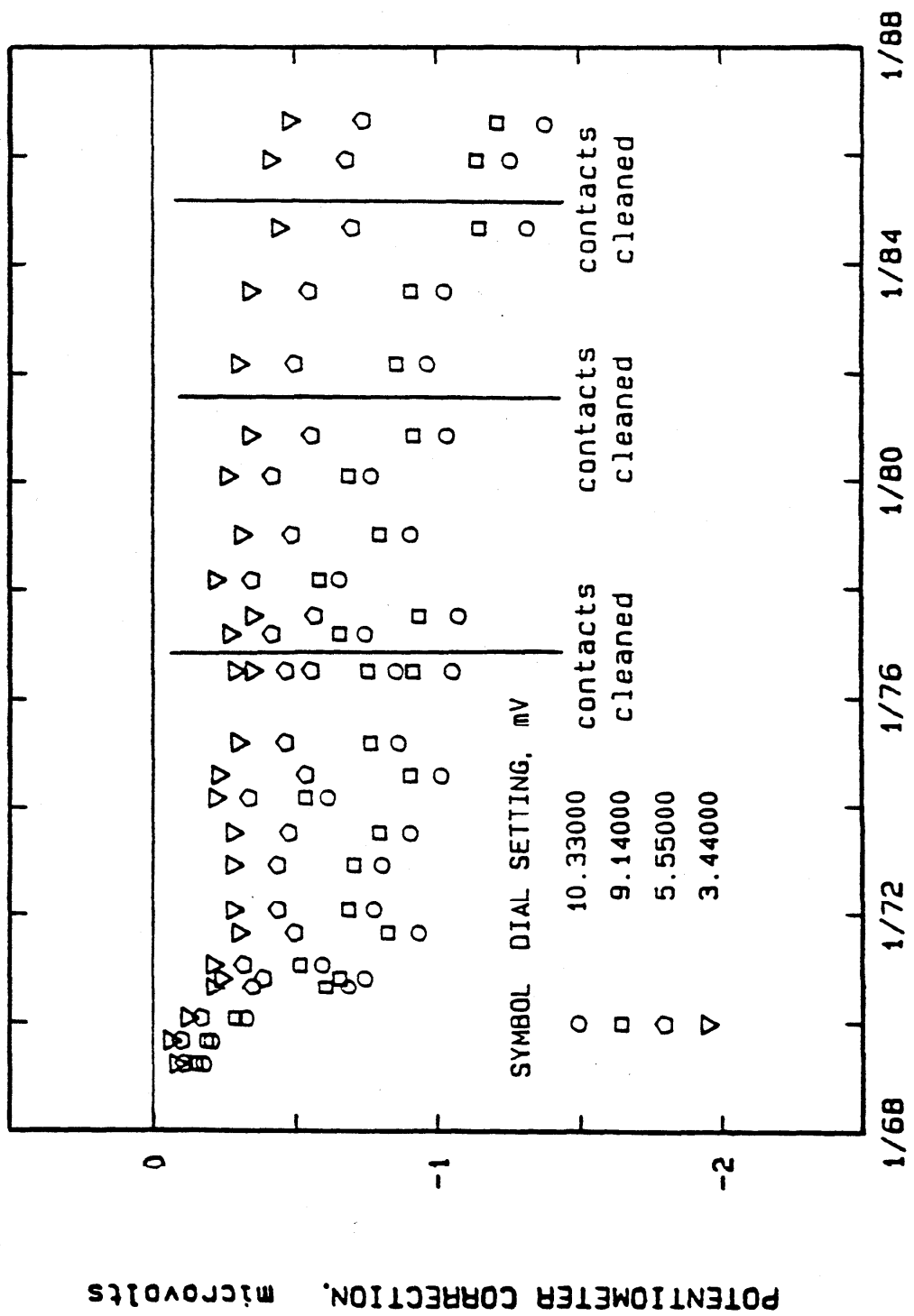

Figure 4.2. Calibration corrections for Guildline potentiometer.

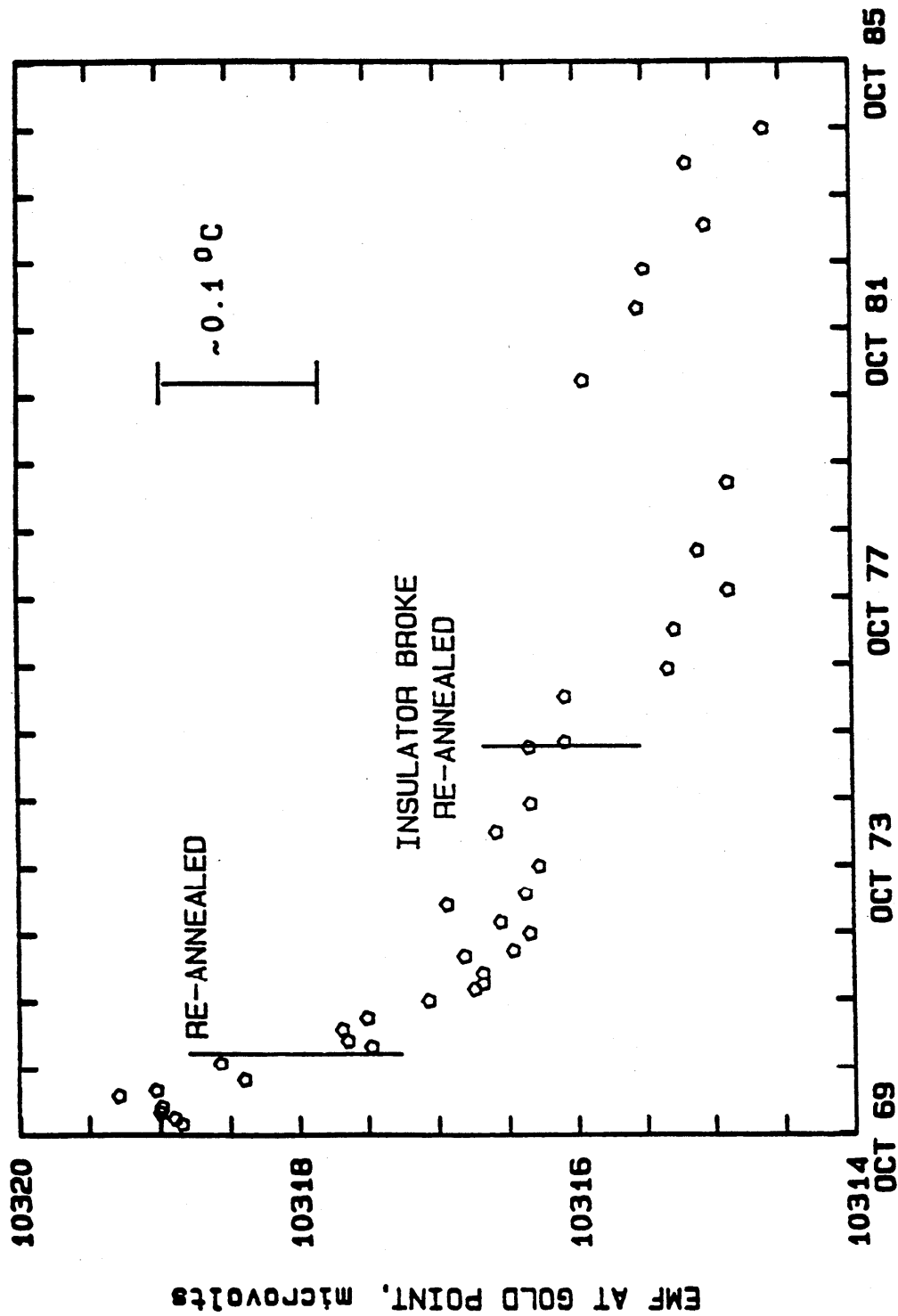
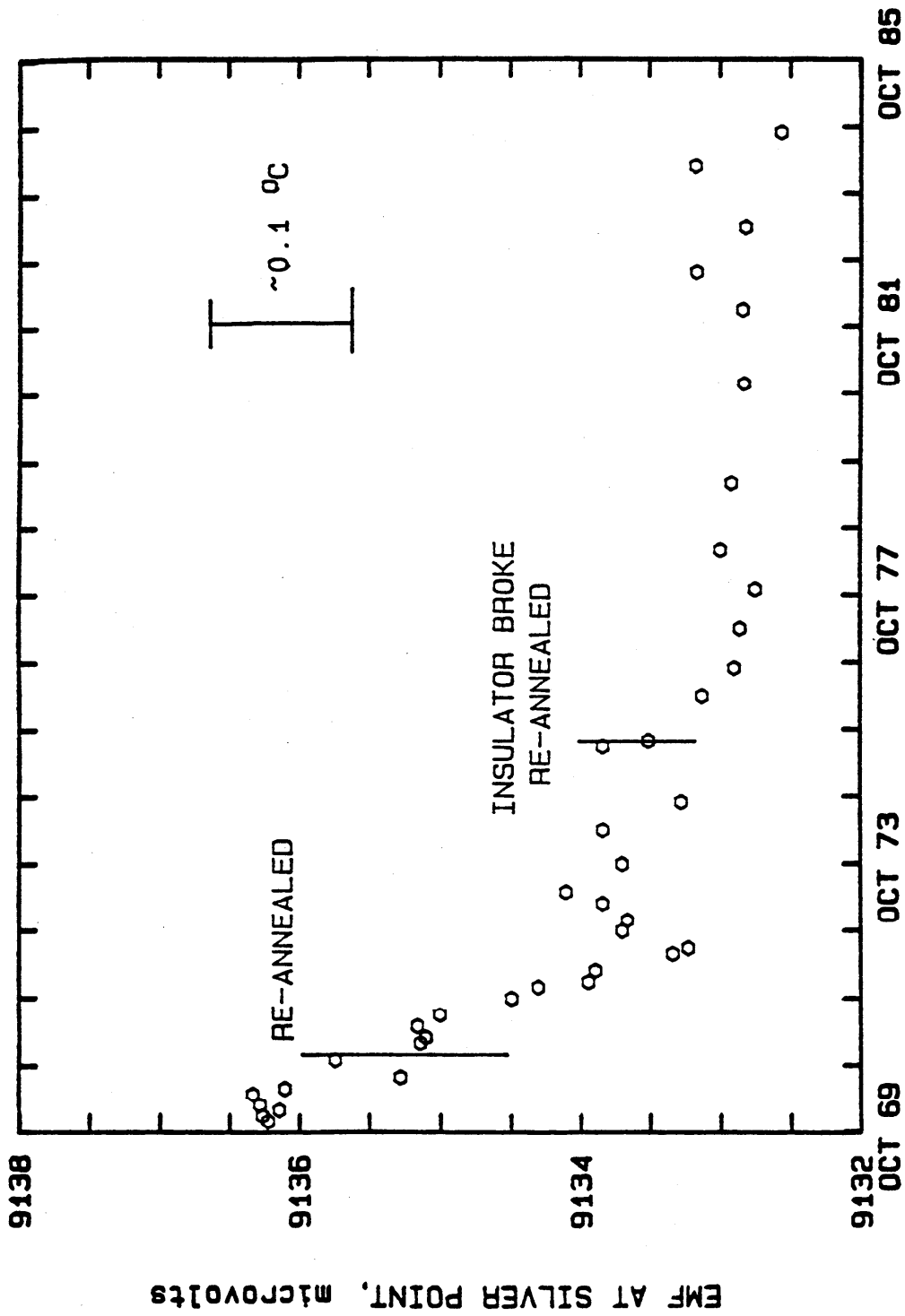

Figure 4.3. Calibration history of type S standard thermocouple SC-68-2 at the gold point (1064.43 °C).



**DATE OF CALIBRATION**

Figure 4.4. Calibration history of type S standard thermocouple SC-68-2 at the silver point (961.93 °C).

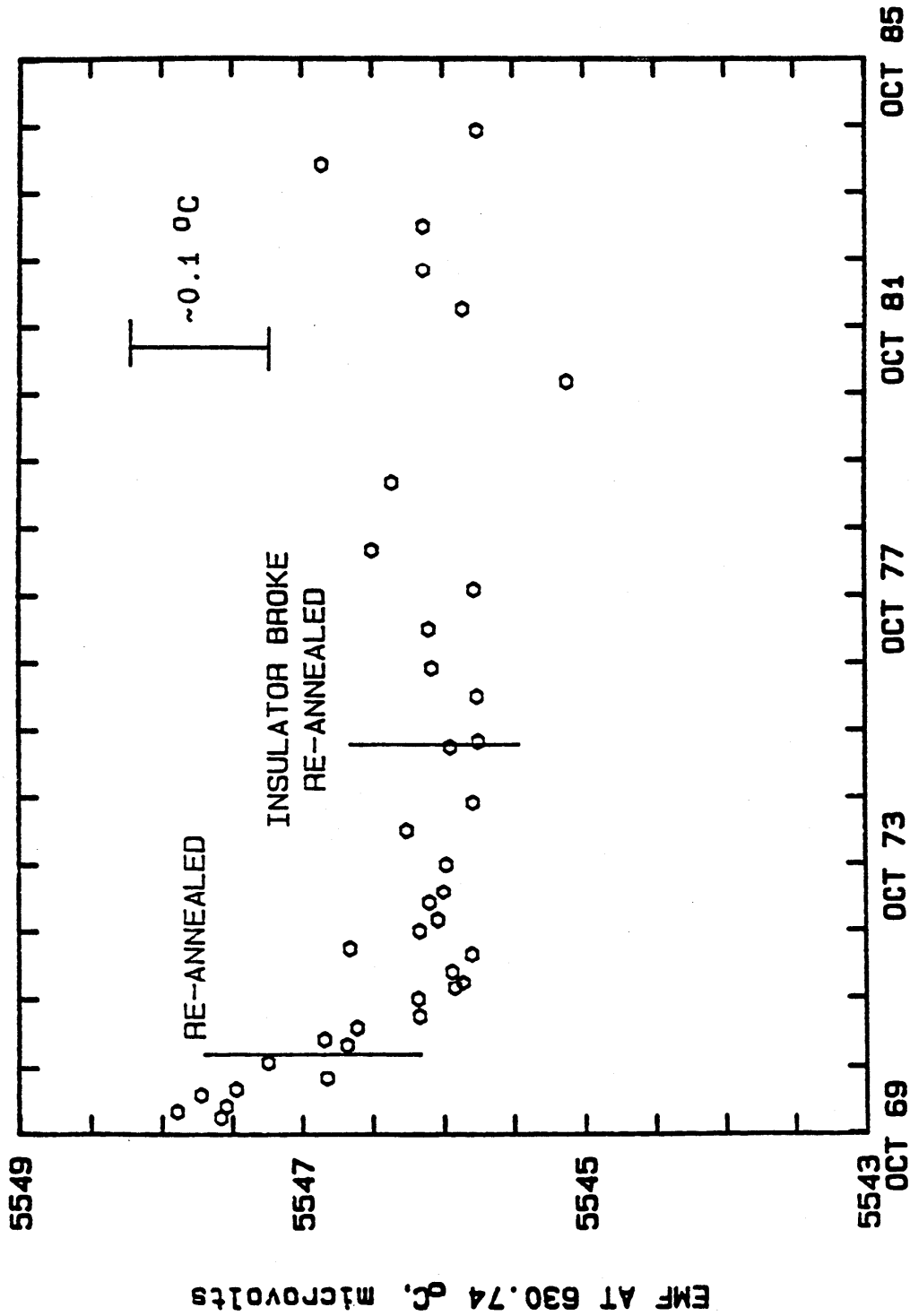

Figure 4.5. Calibration history of type S standard thermocouple SC-68-2 at 630.74 °C.

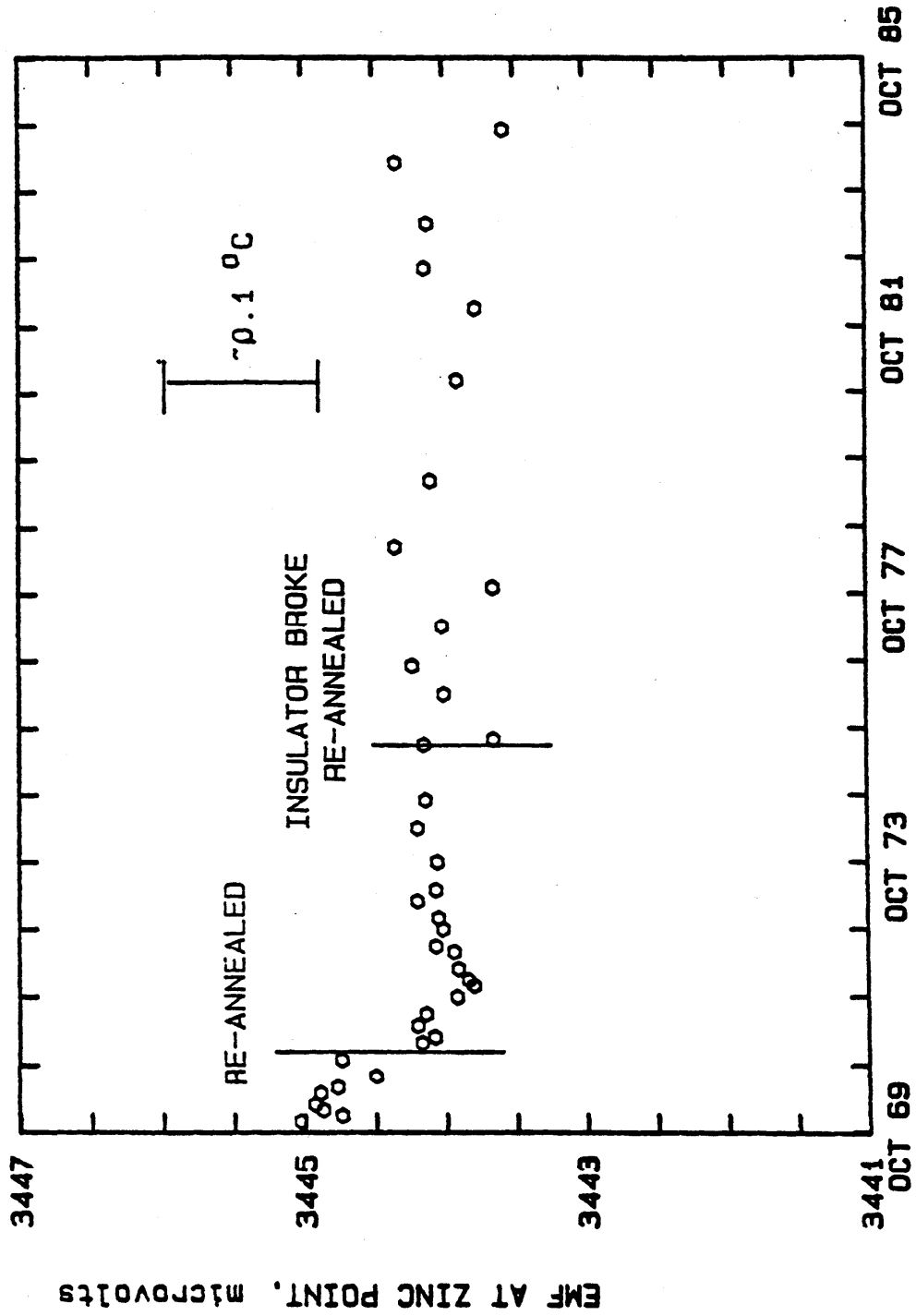

Figure 4.6. Calibration history of type S standard thermocouple SC-68-2 at the zinc point (419.58 °C).

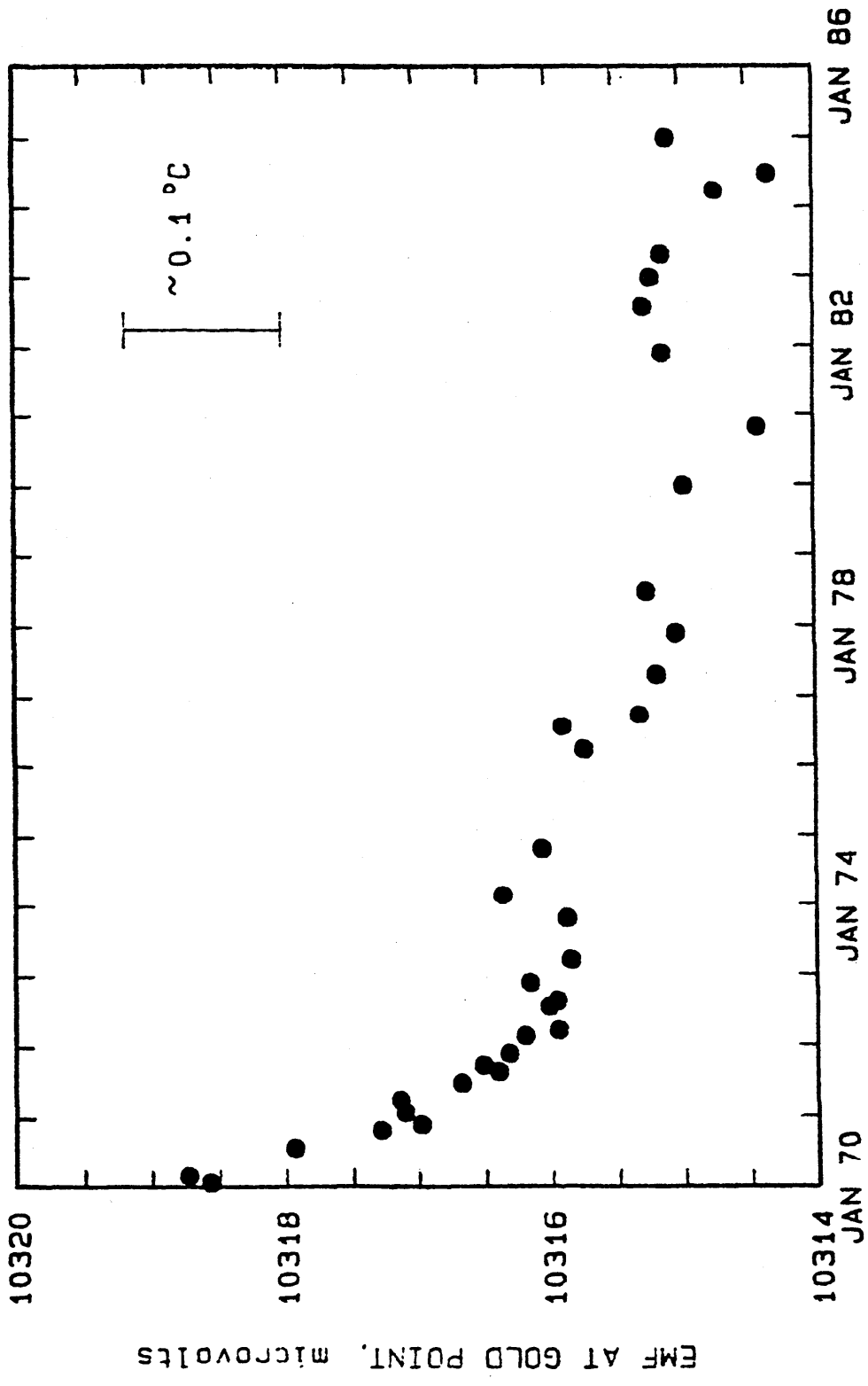
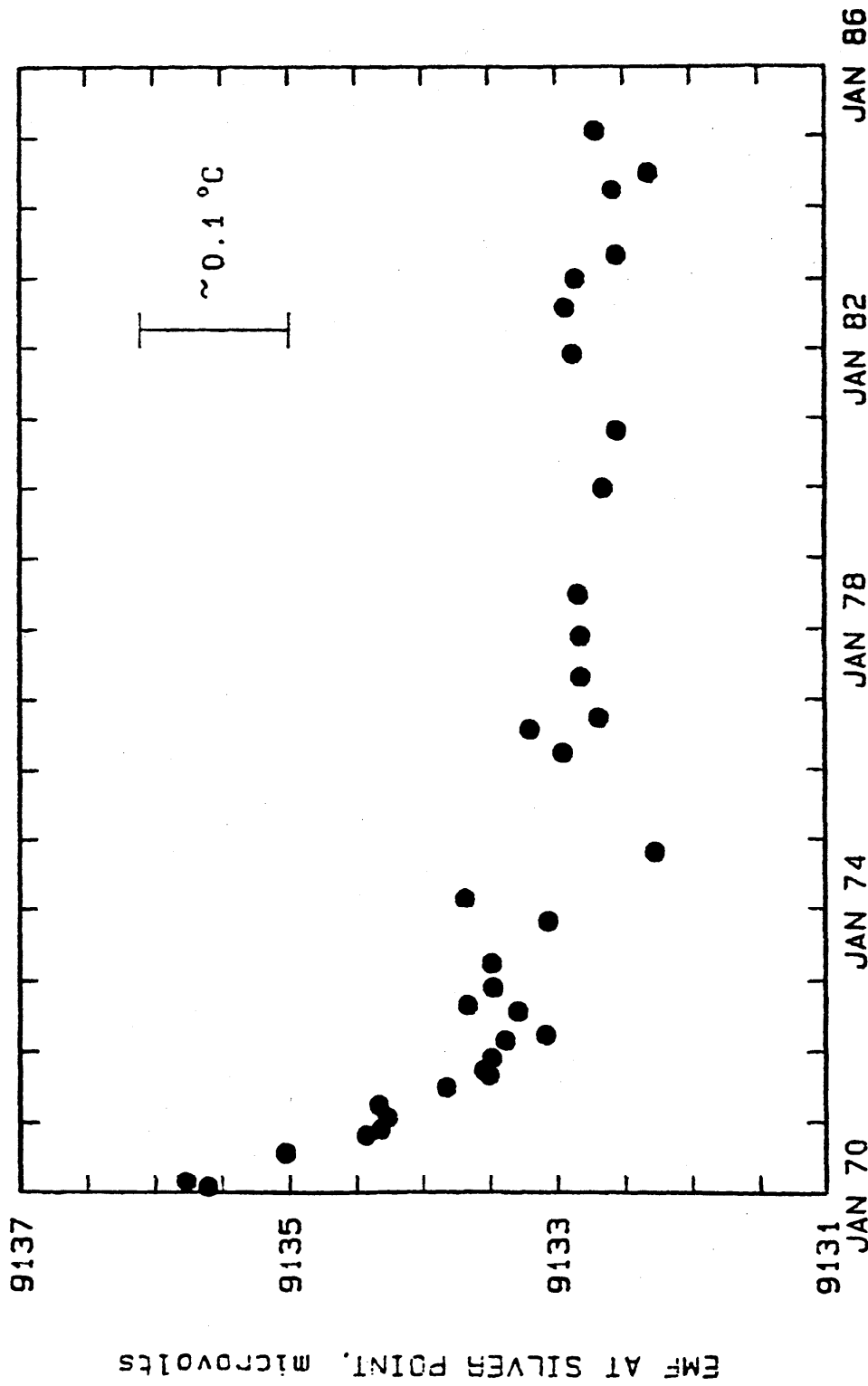

Figure 4.7. Calibration history of type S standard thermocouple SC-68-7 at the gold point (1064.43 °C).





DATE OF CALIBRATION

Figure 4.8. Calibration history of type S standard thermocouple SC-68-7 at the silver point (961.93 °C).

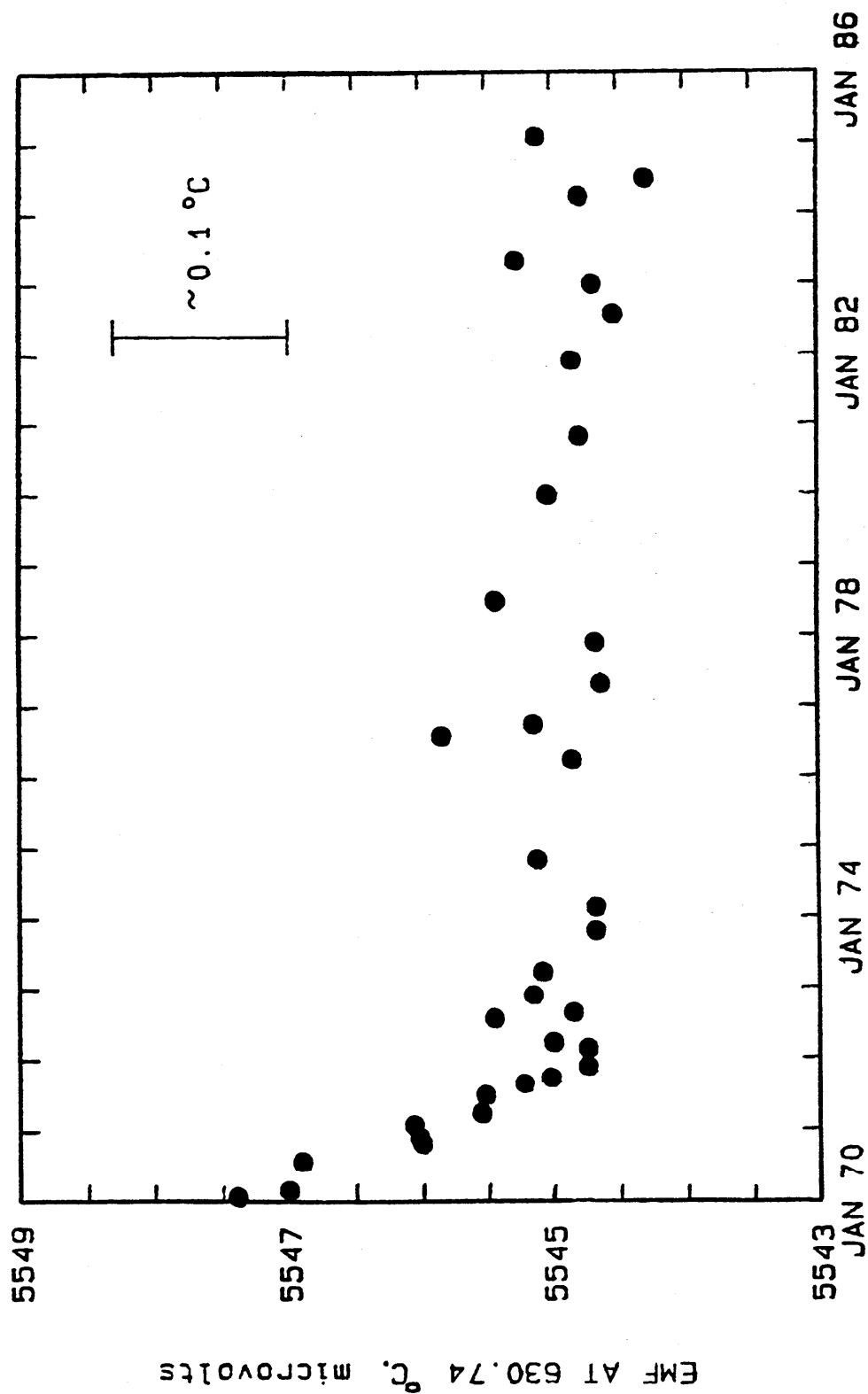

DATE OF CALIBRATION

Figure 4.9. Calibration history of type S standard thermocouple SC-68-7 at 630.74 °C.

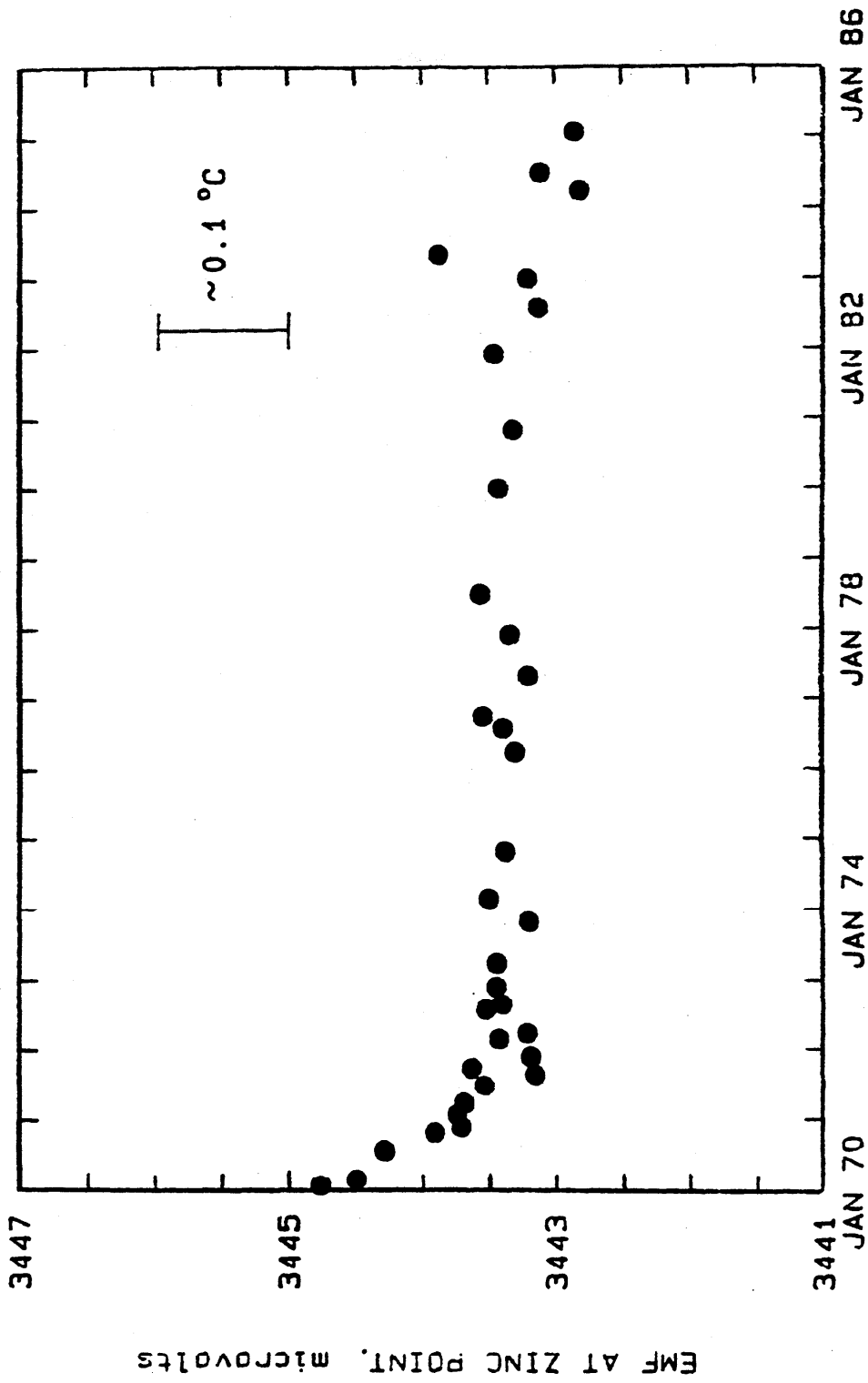

DATE OF CALIBRATION

Figure 4.10. Calibration history of type S standard thermocouple SC-68-7 at the zinc point (419.58 °C).

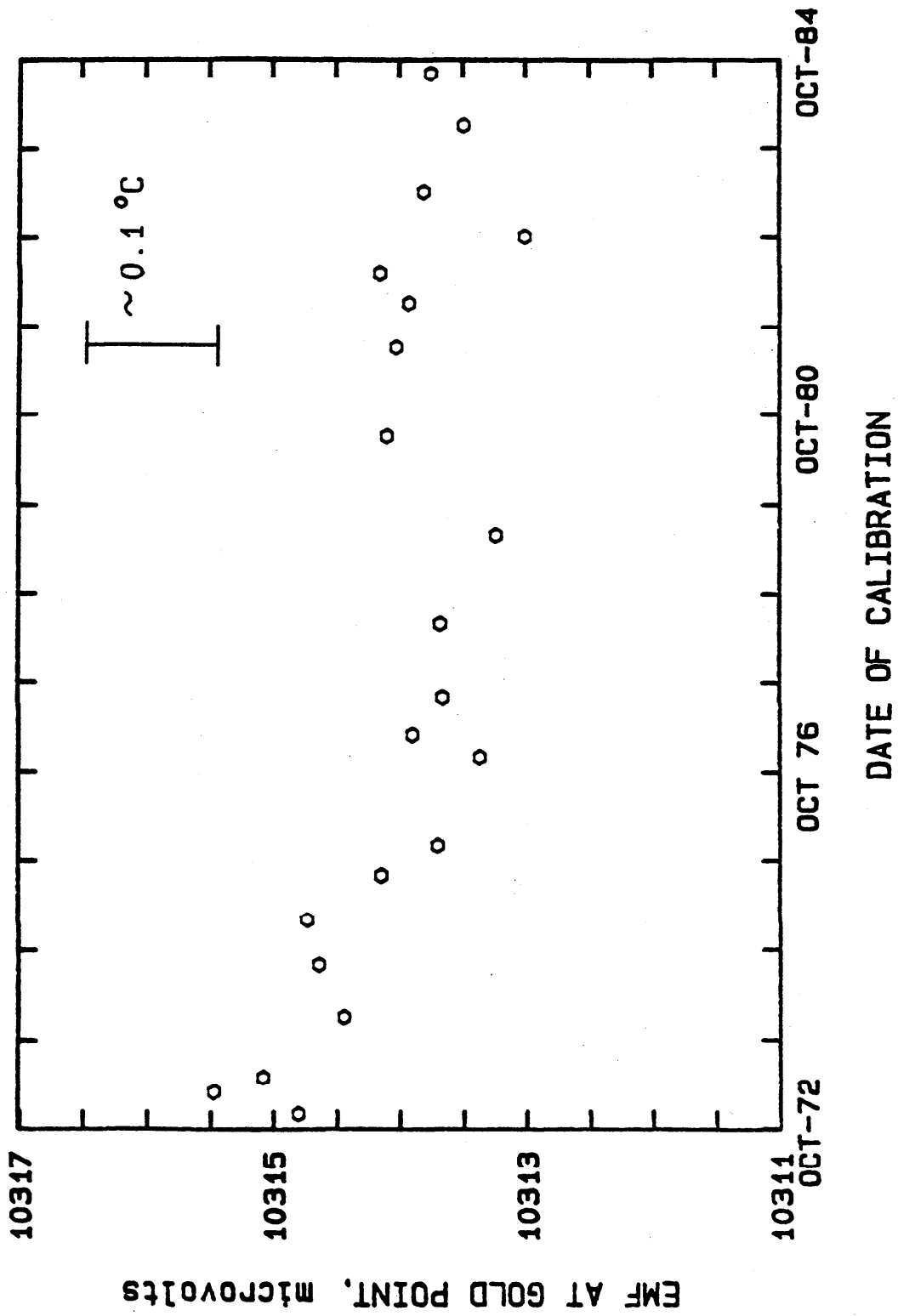
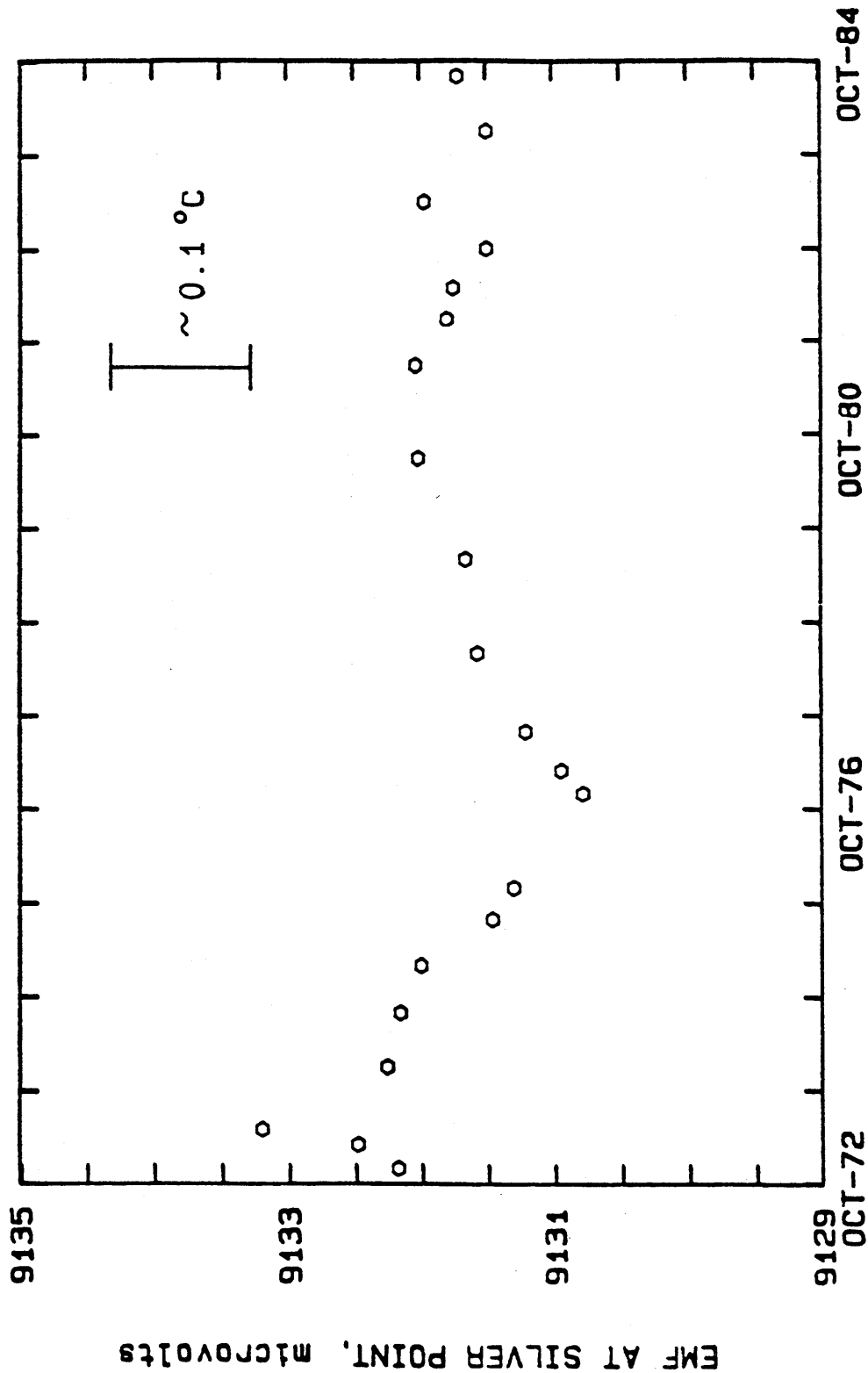

Figure 4.11. Calibration history of type S standard thermocouple SC-71-5 at the gold point (1064.43 °C).



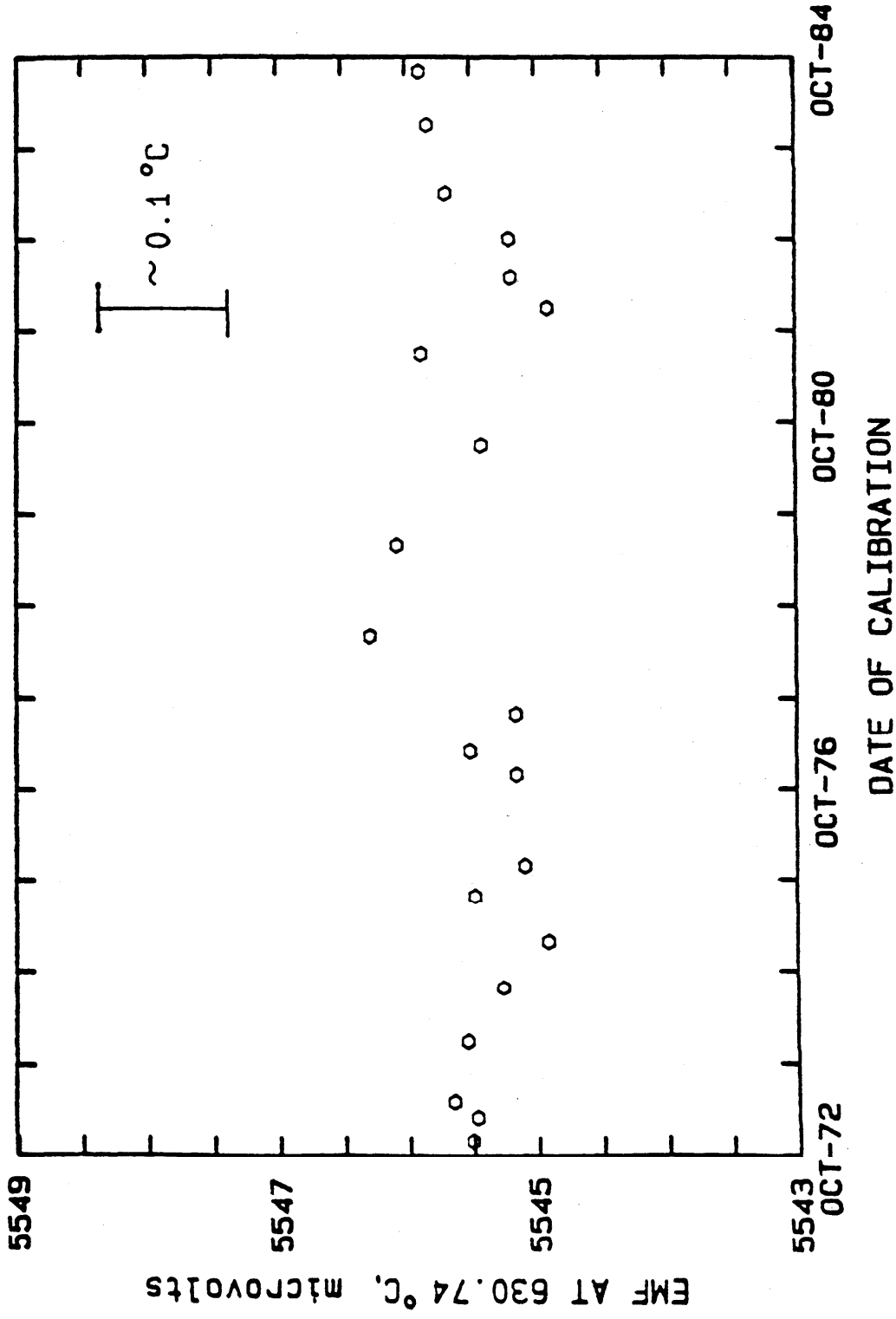

Figure 4.13. Calibration history of type S standard thermocouple SC-71-5 at 630.74 °C.

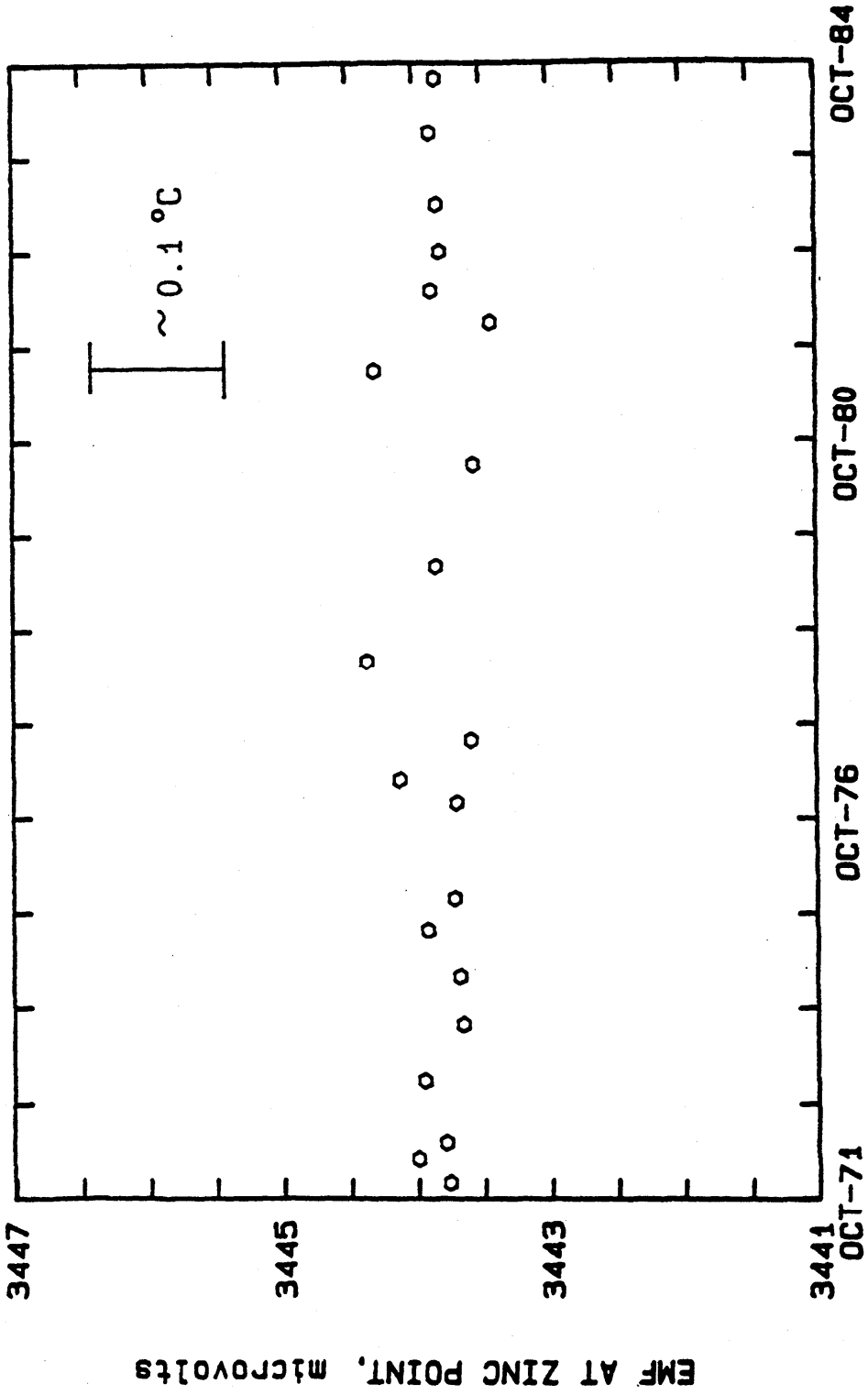
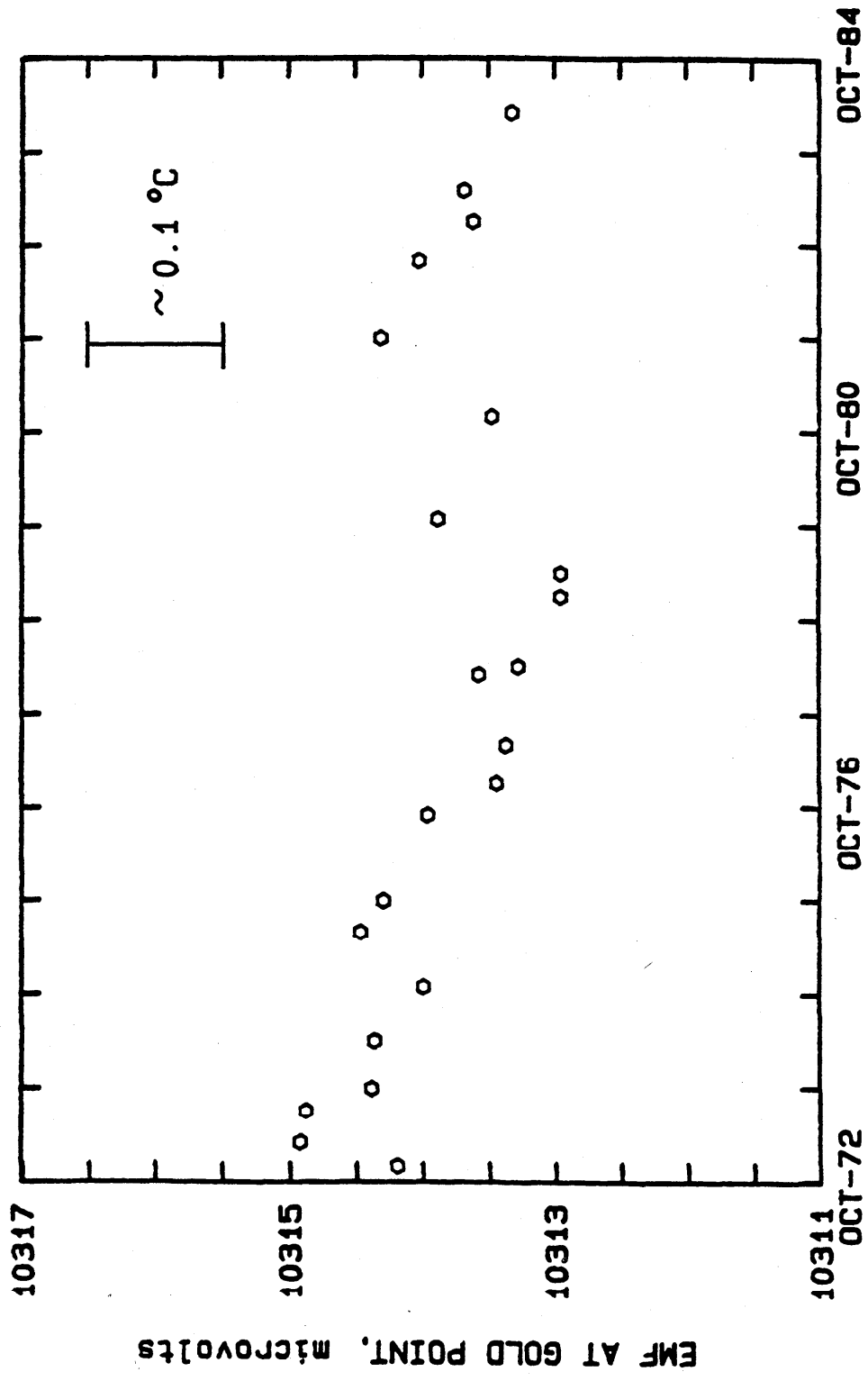

Figure 4.14. Calibration history of type S standard thermocouple SC-71-5 at the zinc point (419.58 °C).



DATE OF CALIBRATION

Figure 4.15. Calibration history of type S standard thermocouple SC-71-6 at the gold point (1064.43 °C).



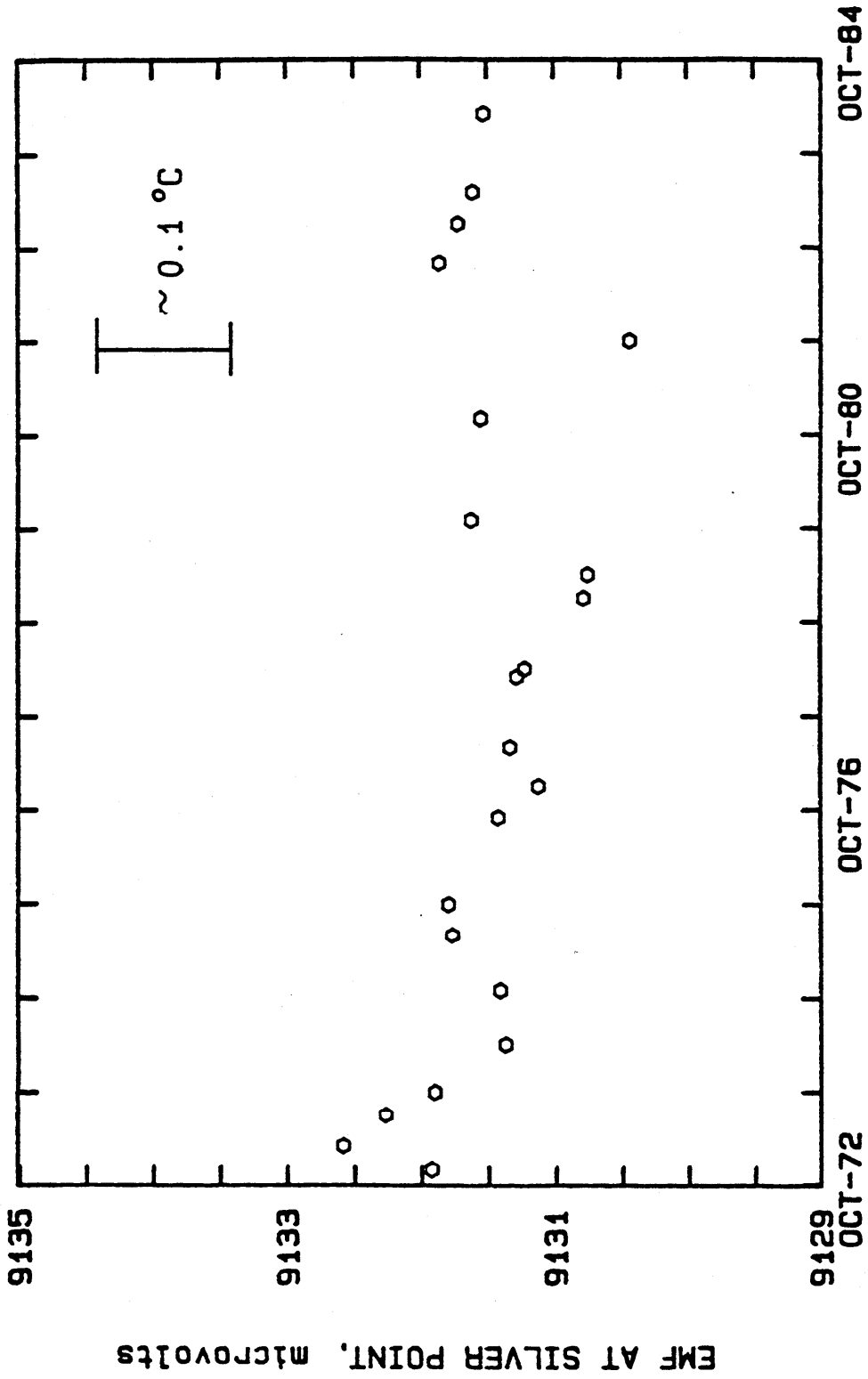

DATE OF CALIBRATION

Figure 4.16. Calibration history of type S standard thermocouple SC-71-6 at the silver point (961.93 °C).

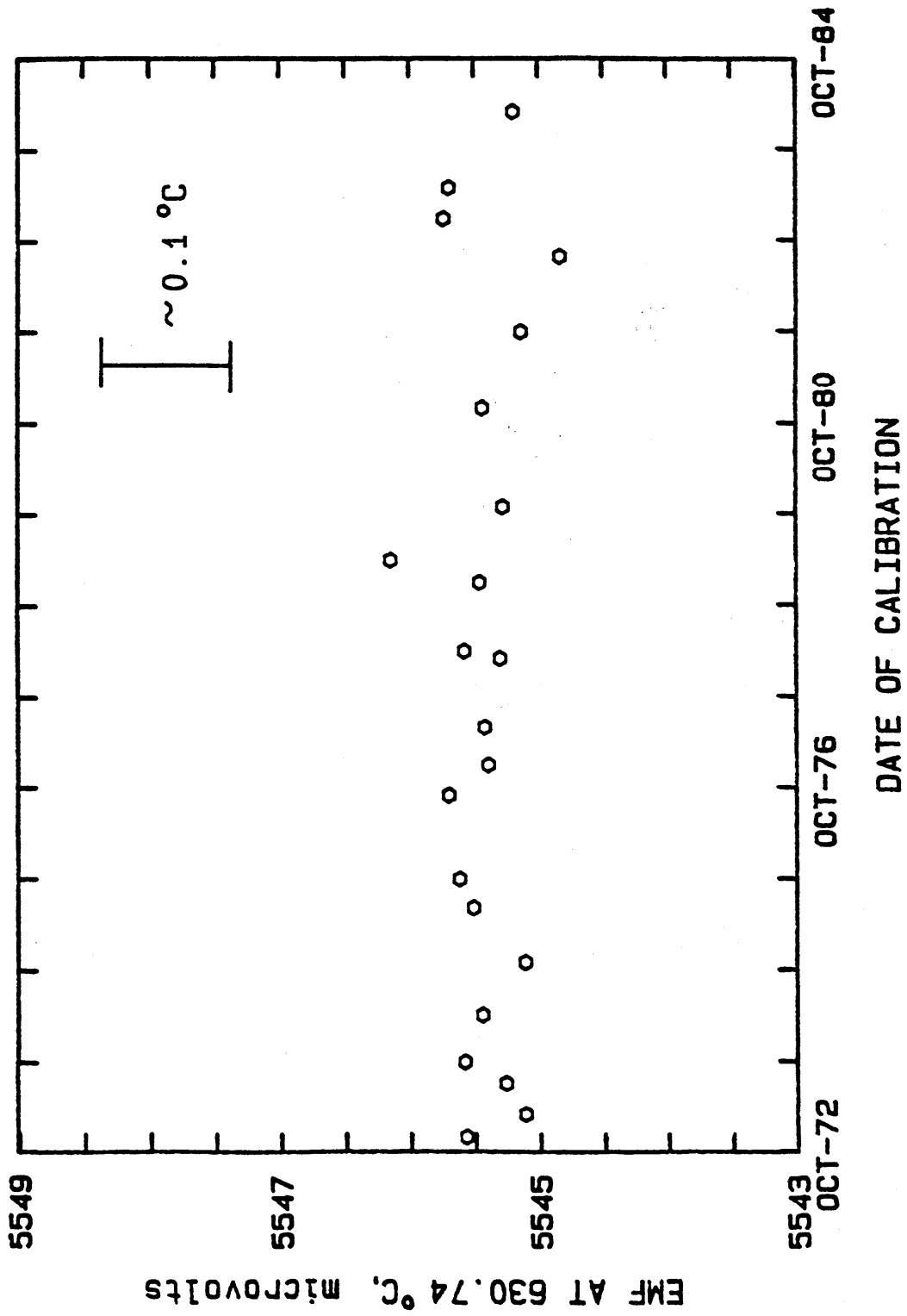
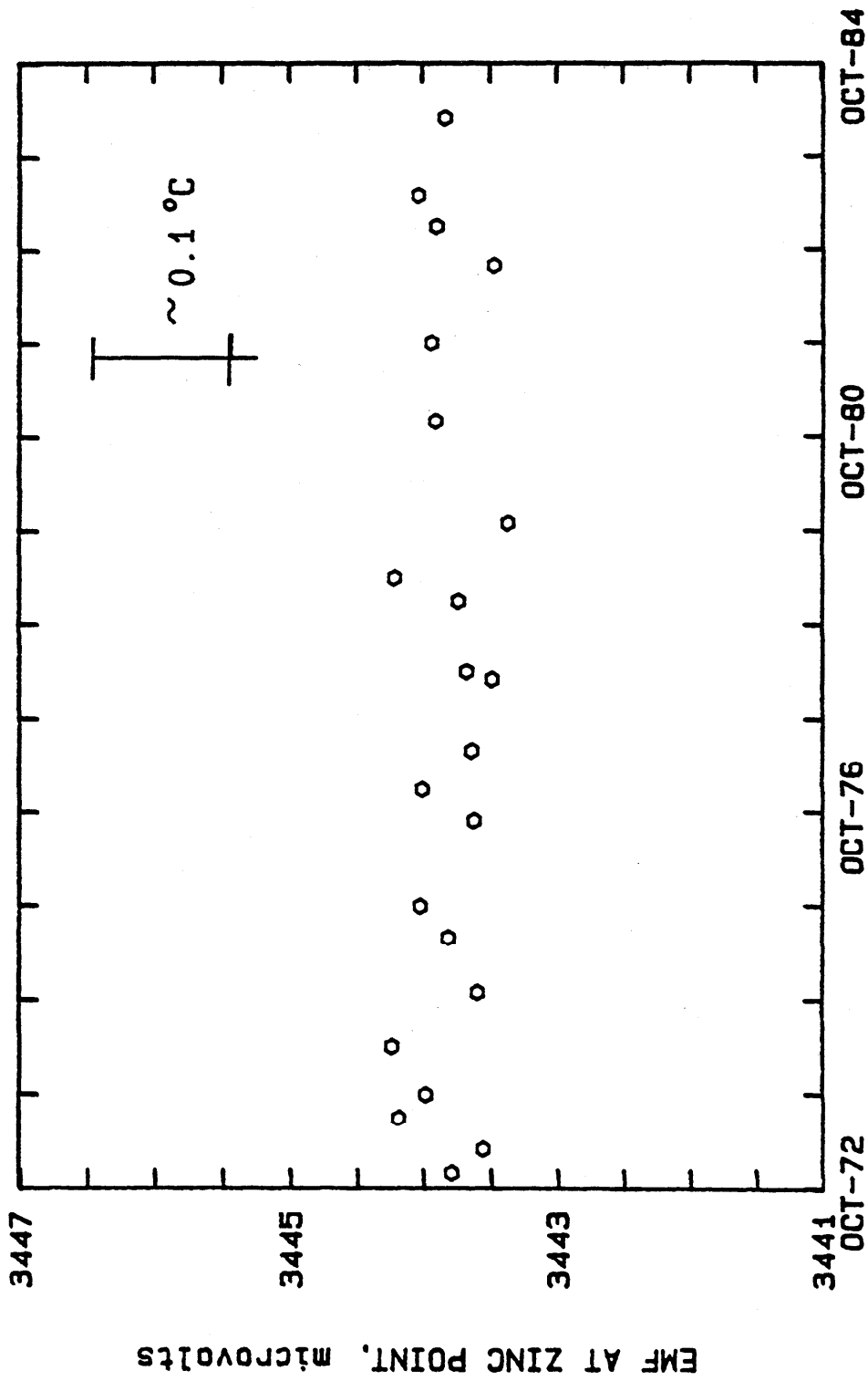

Figure 4.17. Calibration history of type S standard thermocouple SC-71-6 at 630.74 °C.



DATE OF CALIBRATION

Figure 4.18. Calibration history of type S standard thermocouple SC-71-6 at the zinc point (419.58 °C).

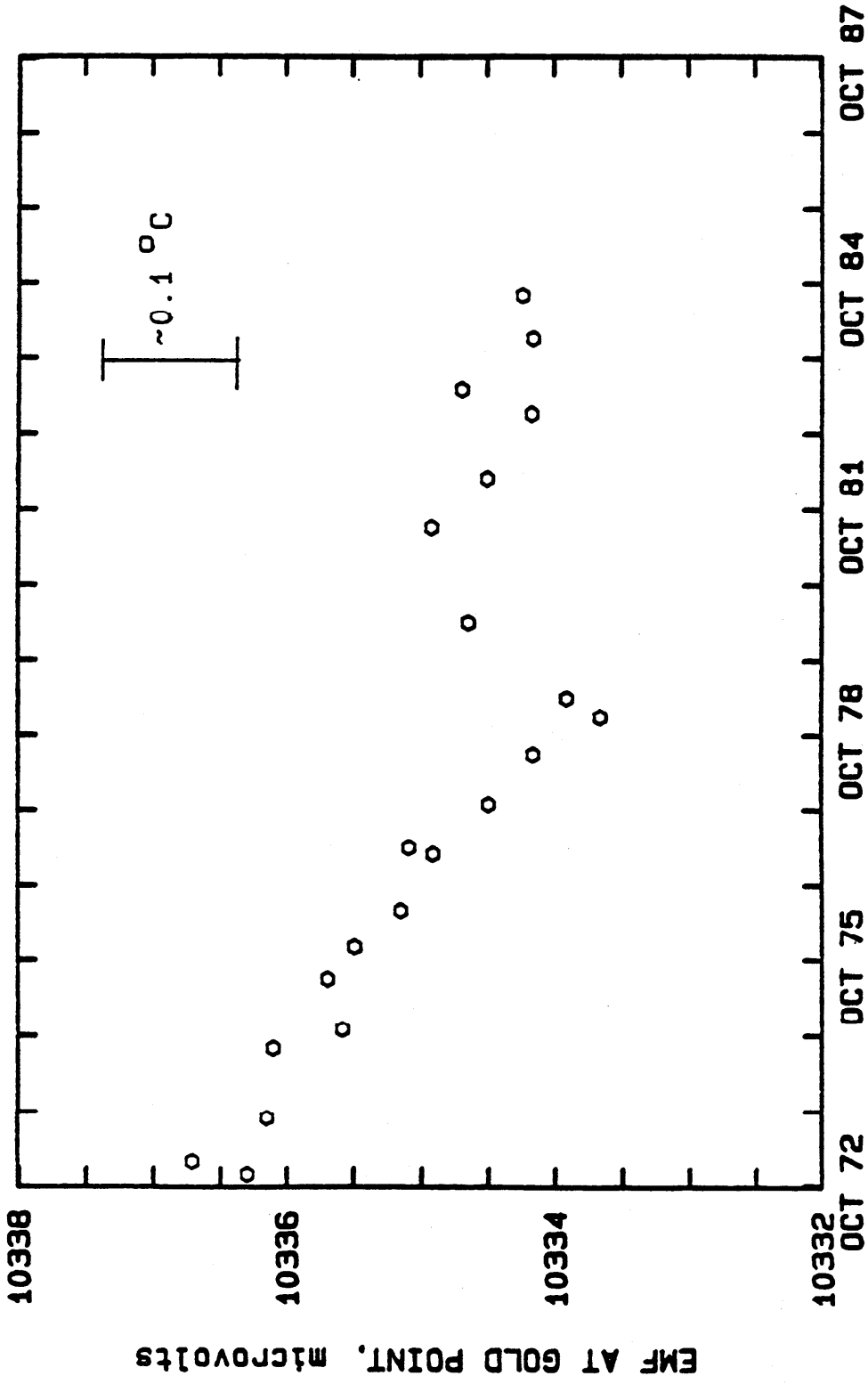
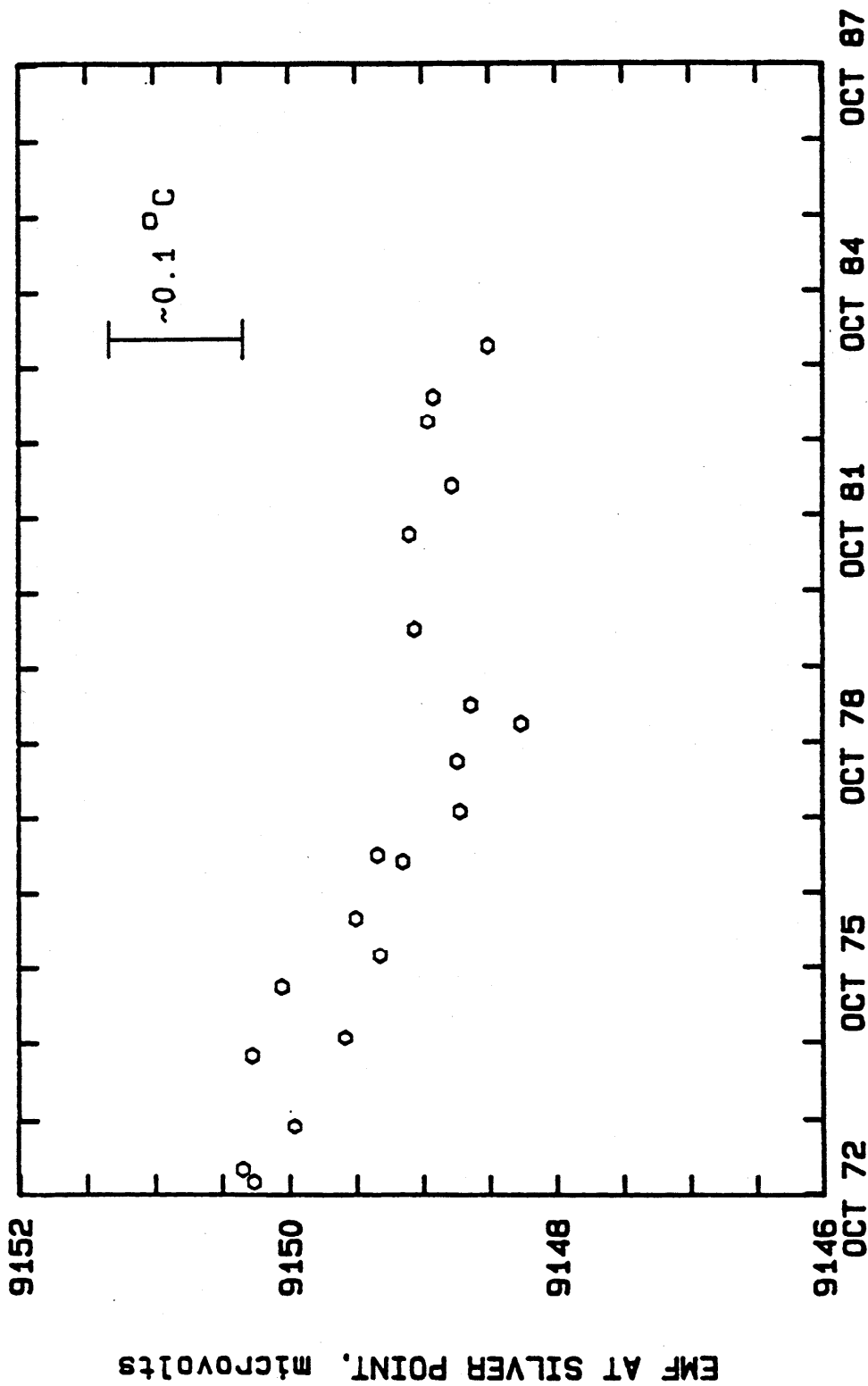

Figure 4.19. Calibration history of type S standard thermocouple SC-72-1 at the gold point (1064.43 °C).



DATE OF CALIBRATION

Figure 4.20. Calibration history of type S standard thermocouple SC-72-1 at the silver point (961.93 °C).

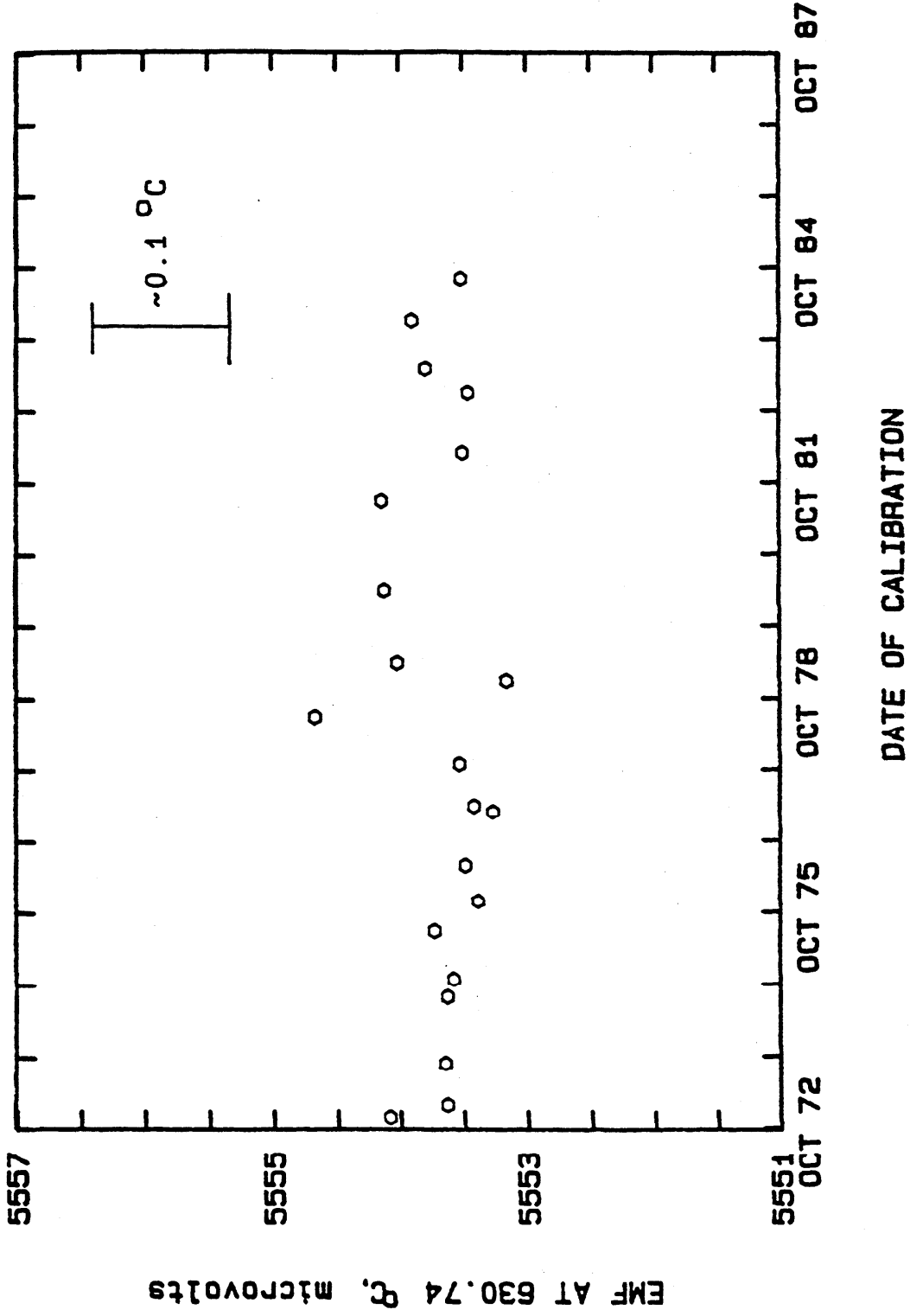

Figure 4.21. Calibration history of type S standard thermocouple SC-72-1 at 630.74 °C.

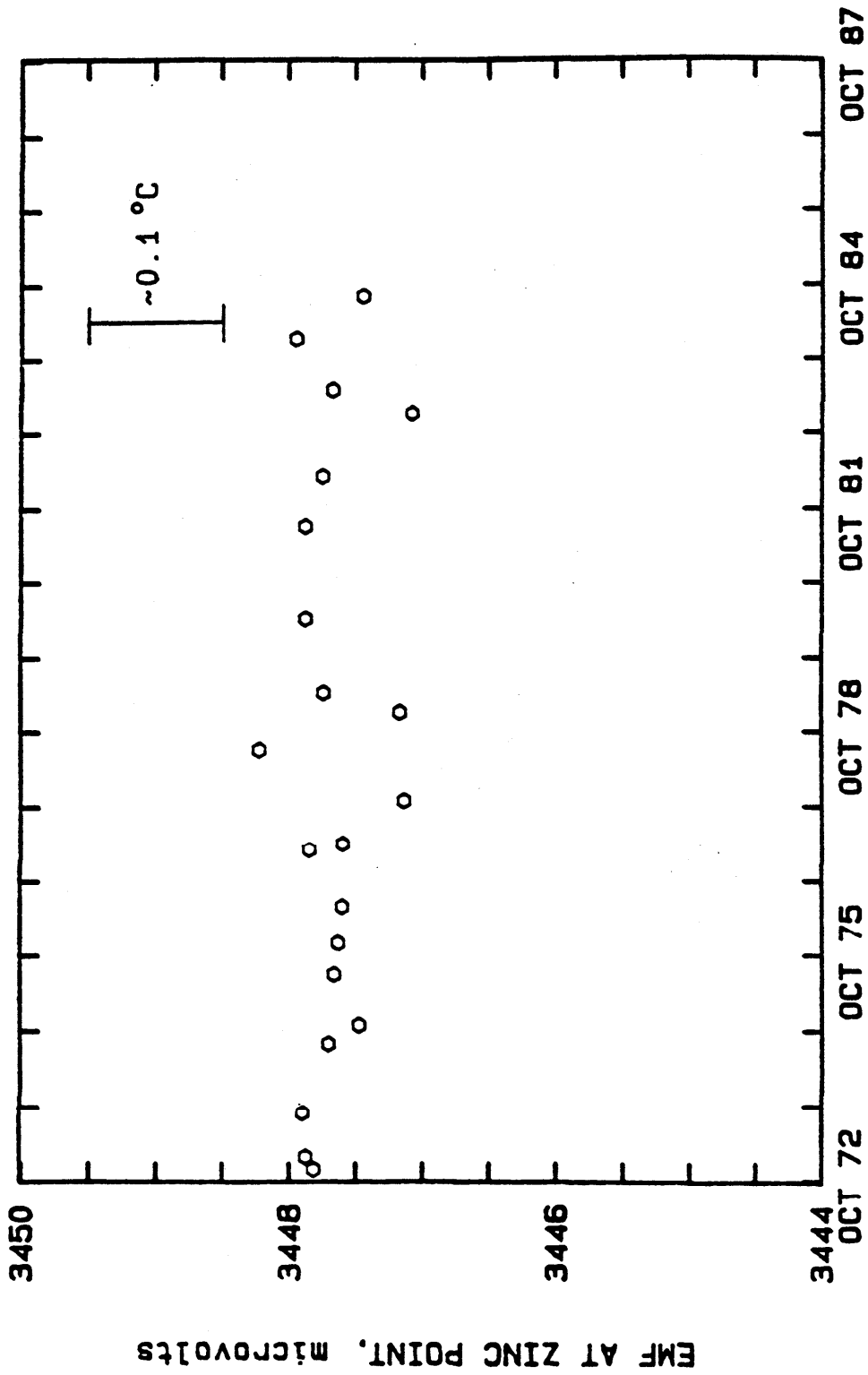

Figure 4.22. Calibration history of type S standard thermocouple SC-72-1 at the zinc point (419.58 °C).

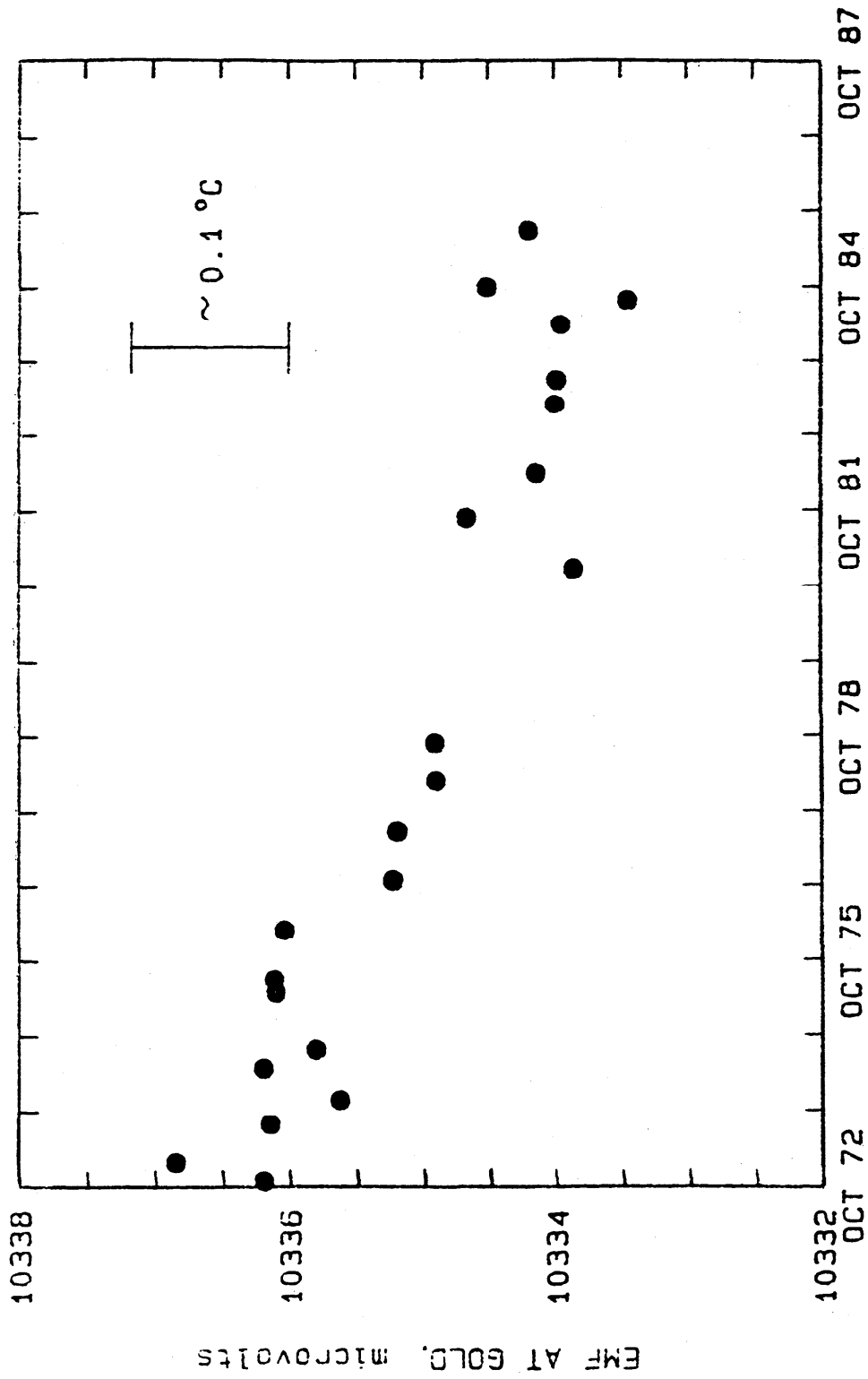

Figure 4.23. Calibration history of type S standard thermocouple SC-72-2 at the gold point (1064.43 °C).



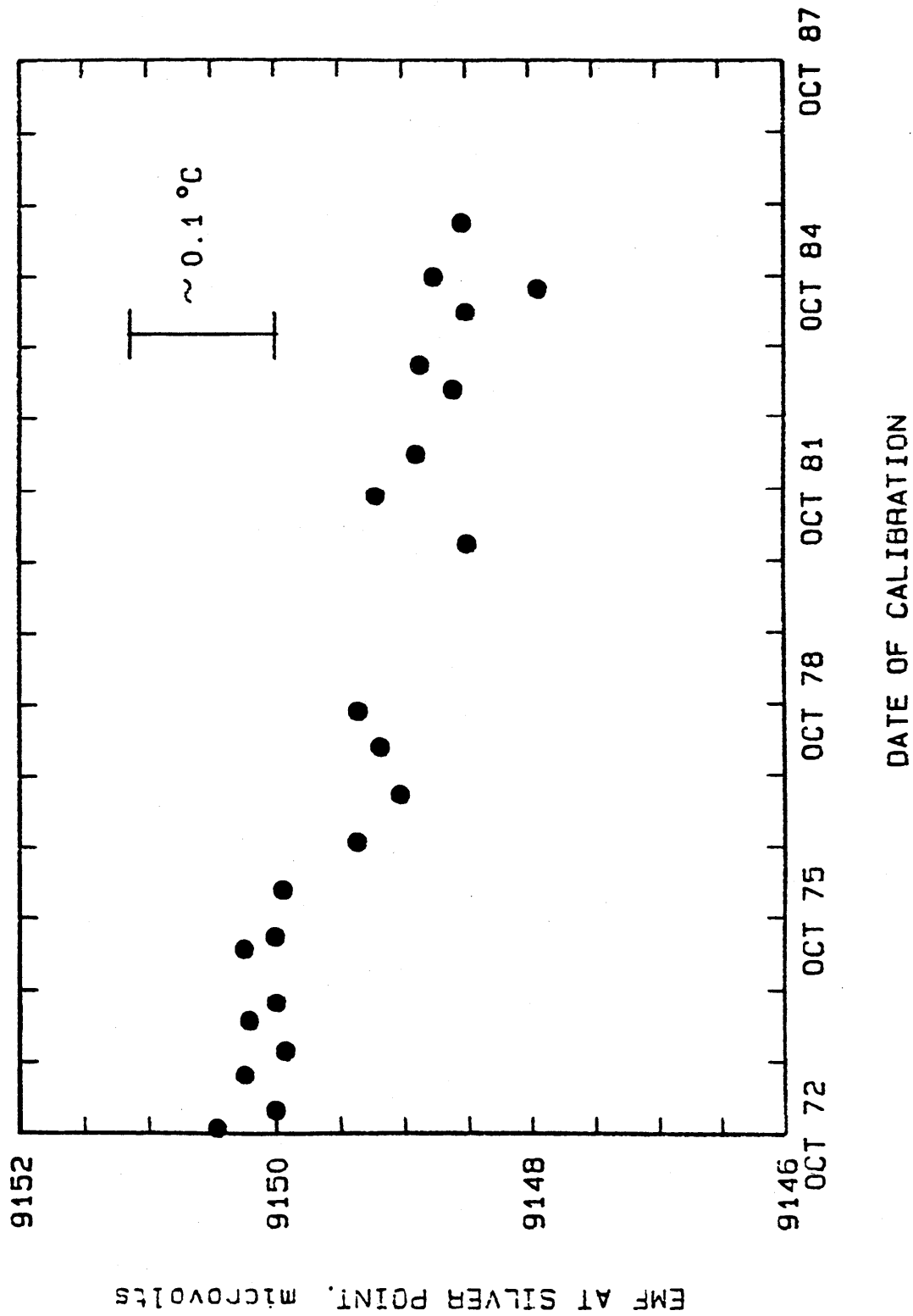

Figure 4.24. Calibration history of type S standard thermocouple SC-72-2 at the silver point (961.93 °C).

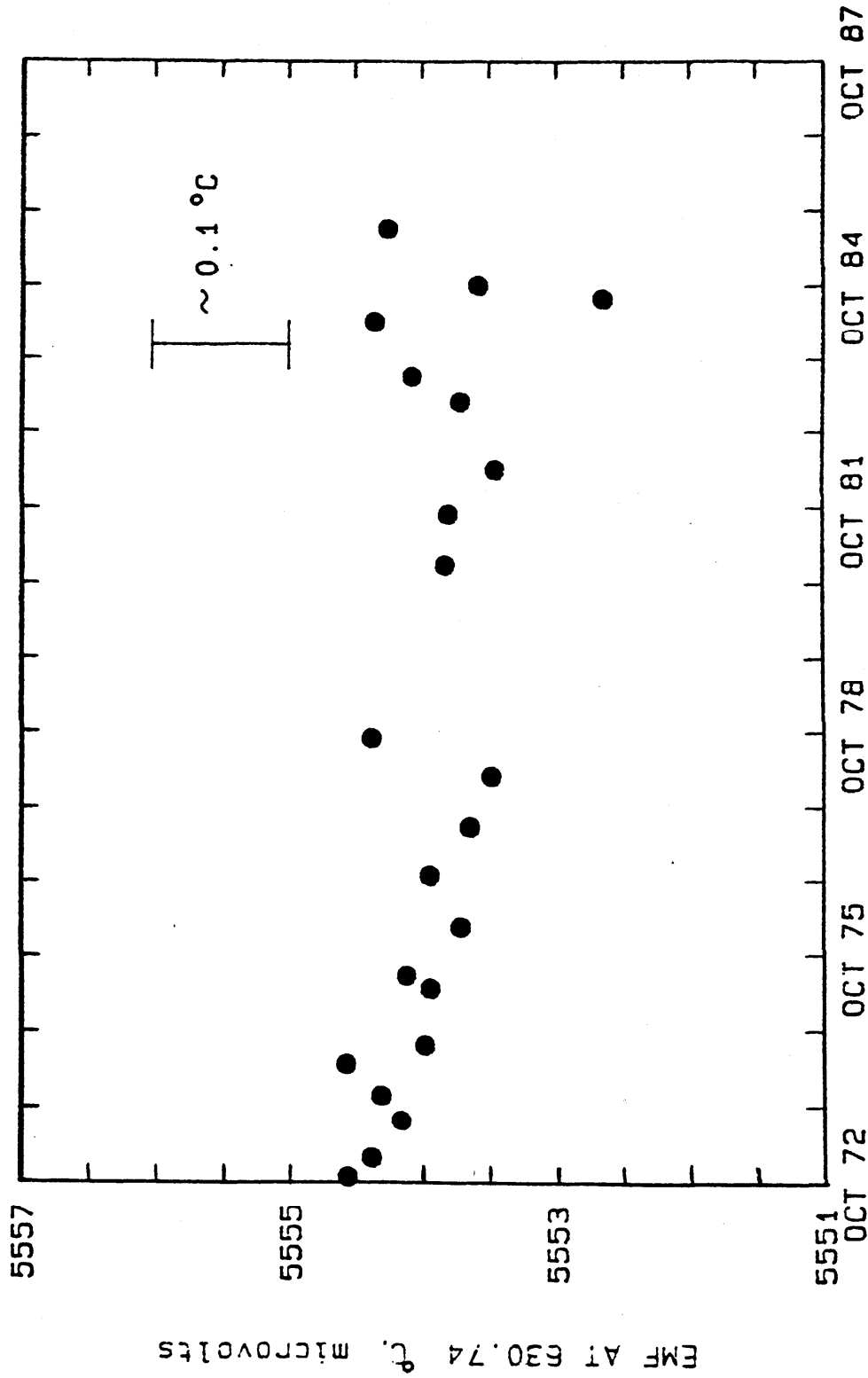

Figure 4.25. Calibration history of type S standard thermocouple SC-72-2 at 630.74 °C.



## 5. ASSESSMENT OF UNCERTAINTIES

In assessing the uncertainties involved in calibrating thermocouples and thermoelements, it is necessary to take note of two features of the program. First, a substantial variety of tests and calibrations are performed, some of which are not routine or repeated and thus defy precise analysis. Second, the recent introduction of a microcomputer into the calibration process has resulted in marked changes in the way in which calibration data are obtained and analyzed.

Despite these cautions, we can evaluate reasonably well uncertainties associated with our primary services -- the calibration of type S (Pt-10Rh vs Pt) standard thermocouples by the fixed-point method and by the comparison method. We wish to acknowledge the very capable and enthusiastic assistance of M. C. Croarkin of the NIST Statistical Engineering Division in this portion of the project.

### 5.1 Uncertainties in Primary Calibrations of Type S Thermocouples

The random component of uncertainties associated with primary calibrations at the fixed points of gold, silver, antimony and zinc are determined from data on the six thermocouples that serve as check standards in the NIST primary calibration process. Two of these thermocouples are included with every set of customer's thermocouples that are given a primary calibration. Each check standard is calibrated about twice yearly, and data on the oldest of these thermocouples, SC-68-2, goes back to the year 1969.

The emfs as measured on each check standard in each fixed-point cell are plotted as a function of the time of measurement in figures 4.3 to 4.26. The apparent drift for some thermocouples, as measured in the gold and silver freezing-point cells, is attributed to a slight drift in the liquidus temperature of the cells, as well as to change in the emf of the thermocouples themselves. Cell drift is related to the age of the cell but is not necessarily linear, and changes in the thermocouples are probably related to time spent in the furnace. From the available data, it would be difficult to build a model that is sufficiently descriptive of these phenomena to allow estimates of the model parameters and the residual standard deviation. Therefore, we follow a model-free approach based on first differences.

Let  $Y_i (i=1, \dots, n)$  be the measured emf of the thermocouple which has value  $\mu_i (i=1, \dots, n)$  at the  $i$ th time period. Thus,

$$Y_i = \mu_i + \epsilon_i \quad i=1, \dots, n \quad (1)$$

where the  $\epsilon_i$  are assumed to be independent random errors which come from a distribution with mean zero and standard deviation.

We construct the  $(n-1)$  first differences

$$Z_i = Y_i - Y_{i+1} \quad i=1, \dots, n-1 \quad (2)$$

and compute the standard deviation of these differences by the usual formula

$$s^2 = \frac{1}{n-2} \sum_{i=1}^{n-1} (Z_i - Z.)^2 \quad (3)$$

where

$$Z. = \frac{1}{n-1} \sum_{i=1}^{n-1} Z_i. \quad (4)$$

The expected value for  $s^2$  is given by the formula

$$E(s^2) = 2\sigma^2 + \frac{2}{n-2} \left\{ \mu_1 \mu_n + \sum_{i=2}^{n-1} \mu_i^2 - \sum_{i=1}^{n-1} \mu_i \mu_{i+1} \right\} \quad (5)$$

Thus, we can estimate the standard deviation  $\sigma$  which is associated with the primary calibration process by substituting estimates from the data for the quantities  $E(s^2)$  and  $\mu_i$ ;  $E(s^2)$  is estimated by  $s^2$  and  $\mu_i$  is estimated by  $Y_i$ . Then

$$\hat{\sigma}^2 = \frac{s^2}{2} - \frac{1}{n-2} \left\{ Y_1 Y_n + \sum_{i=2}^{n-1} Y_i^2 - \sum_{i=1}^{n-1} Y_i Y_{i+1} \right\} \quad (6)$$

Estimates of  $\hat{\sigma}$  for the gold, silver, antimony, and zinc cells are shown in table 5.1.

Table 5.1. Standard deviations associated with fixed-point cell calibrations

Thermocouple ID	(values in microvolts)							
	Au		Ag		Sb		Zn	
	$\hat{\sigma}$	DF	$\hat{\sigma}$	DF	$\hat{\sigma}$	DF	$\hat{\sigma}$	DF
SC-68-2*	0.385	11	0.266	11	0.681	11	0.383	11
SC-68-7	-	-	(0.099)	(31)	(0.247)	(30)	(0.206)	(30)
SC-71-5	0.484	19	0.443	19	0.495	19	0.428	19
SC-71-6	0.419	21	0.526	21	0.386	20	0.409	20
SC-72-1	0.231	20	0.307	20	0.540	19	0.470	19
SC-72-2	(0.141)	(20)	-	-	(0.476)	(19)	(0.221)	(19)
Pooled	0.391	71	0.415	71	0.514	69	0.430	69

Pooled (all cells)  $\hat{\sigma} = 0.439$  with 280 degrees of freedom.

\*Data prior to last anneal deleted.

The blanks in table 5.1 represent negative values for the estimate of  $\hat{\sigma}^2$  and are explained by the fact that eq (5) and (6) depend upon the assumption that

$$\text{Cov}(\epsilon_i, \epsilon_j) = 0$$

If there are covariances between adjacent measurements, then the statistics in table 5.1 approximately estimate

$$\sigma^2 - \sigma_{i,j}^2 \quad \text{instead of} \quad \sigma^2$$

where  $\sigma_{i,j}^2$  is the covariance between  $\epsilon_i$  and  $\epsilon_{i+1}$ .

Positive covariances and underestimation of  $\hat{\sigma}$  in table 5.1 may be explained by emf drift exhibited by some of the thermocouples early in their life. Inhomogeneous behavior is expected to affect gold and silver cell determinations to a greater extent than antimony and zinc cell determinations. Thus, we conclude that thermocouples SC-68-7 and SC-72-2, which have negative or small estimates of  $\hat{\sigma}^2$  for gold and silver fixed points, should not be used for characterizing the measurement process. Their data are excluded from the pooled estimates.

Limits to random error for the primary calibration process are taken to be three times the pooled value over the four fixed point cells or 1.32 microvolts. Note in the analysis that the pooled random uncertainties for the Fixed-Point Check Standard thermocouples show very similar standard deviations at all four fixed points (0.4 - 0.5 microvolt, corresponding to 0.04 - 0.05 °C). Total uncertainties are taken as a linear combination of limits to random error plus systematic errors.

In the primary calibration system every effort is made to minimize systematic errors. Systematic errors cannot be eliminated completely however, and the following attempts to assess known sources of error. These known sources include: the emf measuring instrument and circuitry, the temperature assigned to the freezing points, the thermocouple stem losses in freezing point cells, and temperature of the reference junction. As discussed in section 4.2.1, the estimated random uncertainty in determining the potentiometer correction with respect to the laboratory voltage standard is 29 ppm of the measured voltage. This random uncertainty is considered to be accounted for in the random error obtained from the above analysis of the check standards. However, we have decided to make allowances to the overall systematic error of +7 ppm of the measured voltage to account for the drift in the potentiometer calibration between calibrations and +3.8 or -2.8 ppm of the measured voltage to account for the uncertainty in our laboratory voltage standard. We consider the sum of these errors, which amounts to +10.8 or -2.8 ppm of the measured voltage, to be adequate allowance for systematic error caused by the emf measuring system. As mentioned in section 4.2.3, the measuring circuitry is checked frequently for parasitic emfs and inhomogeneous connecting wires are replaced when needed to keep these emfs to less than 0.1 microvolt. The parasitic emfs

tend to be random from calibration to calibration and are also considered to be part of the random error of the check standard measurements.

The values of temperature assigned to the liquidus points of the freezing-point cells are derived from measurements made with platinum resistance thermometers, as described in section 4.7.1. The uncertainties in determining these values arise from random variations in the measurements, systematic biases in the measurements, and departure of the reference cell temperature from perfection. These uncertainties are considered to be systematic errors in the primary calibration of type S thermocouples. For the gold and silver freezing-point cells, which were compared with reference cells of the highest quality, the largest contribution to uncertainty in that comparison was believed to be the random error in the measurements. Because of the electrical isolation of the bridge from ground, systematic biases due to leakage through ground were expected to be negligible. Systematic immersion losses were known to be small in the reference cells and in the test cells; any immersion losses seen by the resistance thermometer could be expected to represent losses also seen by the thermocouple undergoing calibration. For these reasons the uncertainties in the values assigned to the freezing points of the gold and silver cells are based on the random variations in the comparison data given in section 4.7.1. together with an additional allowance of 2 mK for the departure of the temperature of the reference gold and silver cells from perfection, and no additional allowance is made for systematic biases in the measurements.

From table 4.1, the pooled standard deviations of the mean for the measured differences between the gold and silver cells used in the HTTC laboratory and the reference cells are  $\pm 2.0$  mK and  $\pm 1.7$  mK, respectively. We believe that three standard deviations of the mean plus 2 mK to allow for reference cell imperfection are adequate allowances for systematic error in the assigned temperatures of the gold and silver freezing-point cells.

In the case of the antimony freezing-point cells we make allowances for the uncertainty in the resistance thermometer calibrations at 630.74 °C and the random variation in the antimony freezing-point temperature measurements listed in table 4.2 to obtain an estimate of the total systematic error in the antimony freezing-point temperature. The error in the calibration of the resistance thermometer is estimated to be  $\pm 1$  mK at the freezing points of tin and zinc (see sec. 4.4.2). If these errors in thermometer calibration are propagated according to figure 17 in NBS Monograph 126, they give an estimated error of  $\pm 7$  mK in the calibration of the thermometer at 630.74 °C. The pooled standard deviation of the mean of the antimony freezing-point temperatures given in table 4.2 is 2.6 mK. We believe that three standard deviations of the measured temperatures (7.8 mK) plus the thermometer calibration error (7 mK) is adequate allowance for the total systematic error.

In the case of the zinc-point cell, measurements made (see sec. 4.7.1.) with a 25 ohm standard platinum resistance thermometer indicated that the IPTS-68 [1] assigned value of temperature could be used for the liquidus point of this cell. The uncertainty of this measurement is estimated to be not more than  $\pm 1$  mK or  $-2$  mK. The uncertainties in the values of temperature assigned

to the liquidus points of the freezing-point cells are summarized in table 5.2.

In addition to systematic errors associated with determining the liquidus points of the freezing-point cells, we have decided to include some allowance for possible changes in the liquidus points with use even though it is recognized that such predictions are prone to considerable uncertainty. One of the gold-point cells, both of the silver-point cells, and both of the antimony-point cells have been in use for over 15 years, and we make use of their past performance to predict future drift. Considering the manner in which these cells are used, together with their past history, we estimate that changes in the cells during the next 6 to 8 years probably will not exceed 15 mK for the gold and silver cells and 10 mK for the antimony and zinc cells.

The loss of heat up the stem of the thermocouple assembly by radiation, conduction, or convection can prevent the measuring junction of the thermocouple from reaching the temperature of its surroundings; thus, errors can be introduced during calibration. This source of error can be minimized by providing adequate depth of immersion and by suitable thermocouple design. It has been found [2] from measurements made with fully immersed high temperature resistance thermometers in freezing-point cells and furnaces nearly identical to those used in the primary calibration of thermocouples described in section 3.3, that the thermometer resistors were probably within 2 mK of the liquidus point. These measurements were made with thermometers in silica glass tubes roughened on the outer surface to lessen loss of heat by radiation piping. The depth of immersion characteristics of thermocouples in the freezing-point cells are measured routinely during primary calibrations, but small inhomogeneities in the thermocouple wires make it difficult to access the magnitude of the stem loss errors in the gold and silver freezing-point cells. However, since the silica glass tubes used with the resistance thermometers and with thermocouples are of similar size and have had their outer surfaces similarly treated, the stem losses for the two instruments are thought to be roughly the same. We have decided, therefore, to allow -10 mK for the contribution of stem losses to the estimated uncertainties.

We also have decided, based on information given in section 4.2., to make a small allowance of -10 mK to account for the thermocouple reference junctions not attaining the temperature of the surroundings due to heat flow into the ice bath. Any small variations in the ice-point temperature resulting from slight differences in preparation are considered to be reflected in the random error.

To obtain the total uncertainties in microvolts associated with this type of measurement, we must add to the limits to random error our estimates of the related systematic uncertainties. The above allowances for systematic error that are expressed in millidegrees are converted to microvolts by multiplying them by the Seebeck coefficient of the type S thermocouple (as taken from NBS Monograph 125) at the indicated temperature. Table 5.3 gives the estimated systematic uncertainties and the overall uncertainties obtained by simple addition at the four fixed-point temperatures.



The total uncertainties include no allowances for systematic error due to inhomogeneities in the thermocouples or for changes in the emf during subsequent use. Such uncertainties are applicable when the thermocouples are used in a systematic manner in the same apparatus and with nearly the same depth of immersion and temperature gradients along the thermocouple wires. However, in general use such accuracy may not be obtainable because of continually changing chemical and physical inhomogeneities in the thermocouple wires in the region of temperature gradients. The effects of quenched-in point defects and of composition change of the type SP thermoelement (because of preferential oxidation of rhodium) have been cited [3, 4, and 5] as the primary limitations in the use of the standard thermocouple. The emf of the thermocouple depends on its thermal history and in the next section we discuss allowances for inhomogeneities and drift when the standard thermocouples are used in the comparison calibration furnace which has a much different temperature profile than the fixed-point calibrating furnaces.

Table 5.2. Uncertainty in the temperature of the liquidus points

---

Gold Freezing-Point Cell

Random (three sigma)	$\pm 6.0$ mK
Reference cell imperfection	$+0.0, -2.0$ mK
	<hr/>
Uncertainty	$+6.0, -8.0$ mK

Silver Freezing-Point Cell

Random (three sigma)	$\pm 5.1$ mK
Reference cell imperfection	$+0.0, -2.0$ mK
	<hr/>
Uncertainty	$+5.1, -7.1$ mK

Antimony Freezing-Point Cell

Random (three sigma)	$\pm 7.8$ mK
SPRT calibration	$\pm 7.0$ mK
	<hr/>
Uncertainty	$\pm 14.8$ mK

Zinc Freezing-Point Cell

Uncertainty	$+1.0, -2.0$ mK
-------------	-----------------

---

Table 5.3. Summary of systematic errors in primary calibrations of type S thermocouples at the fixed points

	(Values in microvolts)			
	Au	Ag	Sb	Zn
emf	+0.13	+0.12	+0.11	+0.10
Measuring System	-0.03	-0.03	-0.03	-0.03
Temperature of Liquidus Point	+0.07	+0.05	+0.15	+0.01
	-0.09	-0.07	-0.15	-0.02
Change in Liquidus Point With Use	+0.00	+0.00	+0.00	+0.00
	-0.18	-0.17	-0.10	-0.10
Stem Losses in Thermocouple	+0.00	+0.00	+0.00	+0.00
	-0.12	-0.12	-0.10	-0.10
Reference Junction Temperature	+0.00	+0.00	+0.00	+0.00
	-0.05	-0.05	-0.05	-0.05
Total Systematic Error	+0.20	+0.17	+0.26	+0.11
	-0.47	-0.43	-0.43	-0.30
Limits to Random Error	±1.32	±1.32	±1.32	±1.32
Total Uncertainty	+1.52	+1.49	+1.58	+1.43
	-1.79	-1.75	-1.75	-1.62

The total uncertainties of interpolated values in the IPTS-68 defining range 630.74 to 1064.43 °C may be obtained by multiplying the total uncertainties at the fixed points given in table 5.3 by the appropriate values taken from the curves in figure 5.1 and summing the contributions from the Sb, Ag, and Au points. By trial we determined the maximum error caused by this propagation and the values are listed in table 5.4.

Similarly, in the temperature range 0 to 630.74 °C, where the interpolation is accomplished with a quadratic equation fit to the difference between the emf of the test thermocouple and that from the emf-temperature reference table in NBS Monograph 125, the uncertainties in the interpolated values may be estimated from the curves shown in figure 5.2. The maximum errors caused by propagation of the uncertainties at the zinc and antimony points are also listed in table 5.4. It should be noted that the propagated errors in this temperature range do not include an allowance for possible irregularities in the reference table.

## 5.2 Uncertainties in Comparison Calibrations of Type S Thermocouples

Whenever a primary calibration at the four fixed points is performed on a customer's thermocouple, that same thermocouple is submitted to a comparison calibration using a NIST type S reference thermocouple to measure temperature over the same temperature range covered by the fixed points. A table of emfs (in millivolts) versus temperature results from each type of calibration. The emf differences between results for the same thermocouple calibrated by both methods constitute a data base for estimating systematic differences between the primary and comparison calibration processes and for quantifying the random error in the comparison calibration process.

Calibration data obtained with two reference thermocouples (SC-83-7 and SC-83-8) that were used during the past few years in the automatic calibration system were examined for this purpose. During a period of about 20 months, SC-83-7 was used in about 46 calibration runs in the 1100 to 0 °C range. SC-83-8 was used in about 35 calibration runs during a period of about 17 months. Some of these calibration runs included type S test thermocouples that were also given a primary calibration. There were 23 such thermocouples compared with SC-83-7 and 16 such thermocouples compared with SC-83-8. The emf differences between the primary and comparison calibration values obtained for the 23 thermocouples compared with SC-83-7 are shown in figure 5.3, and those for the 16 thermocouples compared with SC-83-8 are shown in figure 5.4.

Let  $Y_i$  and  $X_i$  ( $i=1, \dots, n$ ) represent the emf values obtained with the  $i$ th test thermocouple at a given temperature from primary and comparison calibrations, respectively, using the same reference thermocouple.

Let

$$D_i = Y_i - X_i \quad i = 1, \dots, n$$

Table 5.4. Propagated uncertainties from total uncertainties at the four fixed points

Temperature degrees Celsius	Uncertainty microvolts	Temperature degrees Celsius	Uncertainty microvolts
50	+0.71 -0.75	630.74	+1.58 -1.75
100	+1.28 -1.35	650	+2.01 -2.19
150	+1.70 -1.80	700	+2.89 -3.09
200	+1.97 -2.10	750	+3.40 -3.61
250	+2.09 -2.24	800	+3.54 -3.77
300	+2.07 -2.24	850	+3.32 -3.56
350	+1.91 -2.09	900	+2.73 -2.98
400	+1.59 -1.78	950	+1.77 -2.03
419.58	+1.43 -1.62	961.93	+1.49 -1.75
450	+1.48 -1.67	1000	+1.56 -1.82
500	+1.53 -1.72	1000	+1.55 -1.81
550	+1.57 -1.75	1064.43	+1.52 -1.79
600	+1.58 -1.76	1100	+3.10 -3.40
630.74	+1.58 -1.75		

At each temperature, we compute an average

$$D. = \frac{1}{n} \sum_{1}^n D_i \quad (7)$$

and a standard deviation

$$s = \left\{ \frac{1}{n-1} \sum_{1}^n (D_i - D.)^2 \right\}^{1/2} \quad (8)$$

The computed means and standard deviations are given in table 5.5. A pooled standard deviation at each temperature is computed as

$$s_p = \left\{ \frac{(n_1-1)s_1^2 + (n_2-1)s_2^2}{n_1 + n_2 - 2} \right\}^{1/2} \quad (9)$$

with  $n_1 + n_2 - 2$  degrees of freedom

where

- $n_1$  = sample size for standard SC-83-7
- $n_2$  = sample size for standard SC-83-8
- $s_1$  = standard deviation for standard SC-83-7
- $s_2$  = standard deviation for standard SC-83-8.

Functionally, the pooled standard deviation  $s_p$  is of the form

$$s_p^2 = s_{\text{prim}}^2 + s_{\text{comp}}^2 \quad (10)$$

where  $s_{\text{prim}}$  is the standard deviation associated with the primary calibration process and  $s_{\text{comp}}$  is the standard deviation associated with the comparison calibration process. Thus, based on table 5.1 we can compute the standard deviation for the comparison process.

In order to make the best use of all comparison data, we note that the standard deviations increase with temperature, and we fit the pooled standard deviations as a linear function of temperature by the method of least-squares. The predicted values at the fixed point temperatures are used in the computation discussed above.

Again, in order to evaluate uncertainties over the temperature range 100 to 1100 °C, we fit the comparison standard deviations as computed at the four fixed points to a linear function of temperature and predict comparison values for all temperatures. Computations are shown in table 5.6.

Limits to random error for the comparison calibration process are taken to be three times these standard deviations. Uncertainties assigned to values for the working standards by the primary calibration process propagate into systematic errors for the comparison process. Total uncertainties for the comparison process are taken to be the limits to random error plus systematic error.

Table 5.5. Means and standard deviations for differences between primary and comparison calibrations

(values in microvolts)				
Temperature °C	Reference Thermocouple	No. of Test Thermocouples	Mean	Standard Deviation
100	SC-83-7	23	-0.220	0.351
200	SC-83-7	23	-0.373	0.395
300	SC-83-7	23	-0.566	0.428
400	SC-83-7	23	-0.837	0.511
419.58	SC-83-7	23	-0.894	0.528
500	SC-83-7	23	-1.179	0.585
600	SC-83-7	23	-1.522	0.628
630.74	SC-83-7	23	-1.609	0.670
700	SC-83-7	23	-1.371	0.646
800	SC-83-7	23	-1.208	0.679
900	SC-83-7	23	-1.267	0.708
961.93	SC-83-7	23	-1.406	0.740
1000	SC-83-7	23	-1.542	0.783
1064.43	SC-83-7	23	-1.832	0.923
1100	SC-83-7	23	-2.023	1.041
100	SC-83-8	16	+0.178	0.533
200	SC-83-8	16	+0.129	0.803
300	SC-83-8	16	-0.111	0.874
400	SC-83-8	16	-0.491	0.770
419.58	SC-83-8	16	-0.568	0.735
500	SC-83-8	16	-0.926	0.575
600	SC-83-8	16	-1.324	0.485
630.74	SC-83-8	16	-1.415	0.534
700	SC-83-8	16	-0.954	0.378
800	SC-83-8	16	-0.514	0.426
900	SC-83-8	16	-0.357	0.609
961.93	SC-83-8	16	-0.395	0.739
1000	SC-83-8	16	-0.481	0.826
1064.43	SC-83-8	16	-0.704	1.002
1100	SC-83-8	16	-0.865	1.116

Table 5.6. Standard deviations for comparison calibrations

(values in microvolts)

Temperature °C	Pooled Std Dev	DF	Predicted Std Dev	Comp. Std Dev	Pred Comp Std Dev
100	0.434	37	0.461	---	0.23
200	0.595	37	0.500	---	0.28
300	0.647	37	0.538	---	0.33
400	0.629	37	0.577	---	0.38
419.58 (Zn)	0.620	37	0.585	0.387	0.39
500	0.581	37	0.616	---	0.43
600	0.575	37	0.655	---	0.48
630.74	0.618	37	0.666	0.501	0.50
700	0.553	37	0.693	---	0.53
800	0.590	37	0.732	---	0.58
900	0.670	37	0.771	---	0.63
961.93 (Ag)	0.740	37	0.795	0.663	0.66
1000	0.801	37	0.809	---	0.68
1064.43 (Au)	0.956	37	0.834	0.709	0.71
1100	1.072	37	0.848	---	0.73

The only known source of systematic error in the comparison calibration system for which we make allowance is the uncertainty in the calibration of the reference thermocouple and how well its calibration transfers from the fixed-point calibration system to the comparison calibration system. No allowance is made for systematic error in the emf measurements. As discussed in section 3.1, the values of emf of each type S test thermocouple and of the type S reference thermocouple are read simultaneously. The emf of each thermocouple is measured with both digital voltmeters at each calibration temperature. When the emf difference between a test thermocouple and the reference thermocouple is analyzed during the data processing, small systematic differences that may exist between the calibrations of the digital voltmeters will average out. As mentioned in section 4.2.3, the measuring circuits are checked frequently for parasitic emf and by replacing inhomogeneous copper connecting wires and by proper selection of switch scanner positions the parasitic emfs are kept to less than 0.3 microvolt. They tend to be random from calibration to calibration and are considered to be reflected in the random error associated with the automatic calibration system. Similarly, variations in the ice-point reference junction temperature resulting from slight differences in preparation will tend to be random from calibration to calibration and are also considered part of the random error. In addition, any small departure of the temperature of the thermocouple reference junctions from the ice point caused by heat conduction into the ice bath would be very nearly the same for

the test thermocouples as for the reference thermocouple and thus produce negligible systematic error in the measurements.

We make a small allowance to account for systematic difference found between calibrations of type S thermocouples performed by the fixed-point calibration method and the comparison calibration method. Since 1968, we have been calibrating all thermocouples submitted for calibration by the fixed-point method by the comparison method as well. Experience has shown that calibrations by the comparison method usually yield slightly higher values of emf than those obtained by the fixed-point method. The systematic differences shown in table 5.5 for the two reference thermocouples analyzed are typical for thermocouples annealed by the present procedures. These differences are believed to be largely the result of inhomogeneities in the alloy arms of the thermocouples combined with the different temperature profiles that exist in the comparison and fixed-point calibration furnaces. For a new reference thermocouple calibrated by the fixed-point method and then used at fixed immersion in the comparison calibration furnace we believe an allowance of approximately 0.5 microvolt at 100 °C increasing to approximately 2 microvolts over the range 400 to 1100 °C is adequate to account for inhomogeneity as well as change in the emf-temperature relationship of the reference thermocouple during the first 100 hours (equivalent to approximately 20 calibration runs) of use in the comparison calibration apparatus. Values for this allowance over the range from 100 to 1100 °C were obtained by fitting allowances of +0.5, +1.8, and +2.0 microvolts at 100, 419.58, and 1064.43 °C respectively with a quadratic function of temperature (constrained to give 0 microvolts at 22 °C) by the method of least-squares. The total uncertainties in the comparison calibration process are taken as a linear combination of the limits to random error plus the allowances for systematic error and are given in table 5.7.



Table 5.7. Total uncertainties in comparison calibrations of type S thermocouples

Temperature degrees C	(values in microvolts)			
	Limits to Random Error	Systematic Errors Due to Reference Thermocouple Fixed Point Calibration	Drift and Inhomogeneity	Total Uncertainty
100	+0.69 -0.69	+1.28 -1.35	+0.46 -0.00	+2.43 -2.04
200	+0.84 -0.84	+1.97 -2.10	+0.97 -0.00	+3.78 -2.94
300	+0.99 -0.99	+2.07 -2.24	+1.40 -0.00	+4.46 -3.23
400	+1.14 -1.14	+1.59 -1.78	+1.75 -0.00	+4.48 -2.92
419.58 (Zn)	+1.17 -1.17	+1.43 -1.62	+1.81 -0.00	+4.41 -2.79
500	+1.29 -1.29	+1.53 -1.72	+2.02 -0.00	+4.84 -3.01
600	+1.44 -1.44	+1.58 -1.76	+2.21 -0.00	+5.23 -3.20
630.74	+1.50 -1.50	+1.58 -1.75	+2.25 -0.00	+5.33 -3.25
700	+1.59 -1.59	+2.89 -3.09	+2.31 -0.00	+6.79 -4.68
800	+1.74 -1.74	+3.54 -3.77	+2.33 -0.00	+7.61 -5.51
900	+1.89 -1.89	+2.73 -2.98	+2.27 -0.00	+6.89 -4.87
961.93 (Ag)	+1.98 -1.98	+1.49 -1.75	+2.20 -0.00	+5.67 -3.73
1000	+2.04 -2.04	+1.56 -1.82	+2.13 -0.00	+5.73 -3.86
1064.43 (Au)	+2.13 -2.13	+1.52 -1.79	+2.00 -0.00	+5.65 -3.92
1100	+2.19 -2.19	+3.10 -3.40	+1.99 -0.00	+7.28 -5.59

### 5.3 References

- [1] The International Practical Temperature Scale of 1968, Amended Edition of 1975, Metrologia 12, No. 1, 7-17 (1976).
- [2] Evans, J. P., Wood, S. D., An Intercomparison of High Temperature Platinum Resistance Thermometers and Standard Thermocouples, Metrologia Vol. 7, No. 3, 108-130 (1971).
- [3] McLaren, E. H., Murdock, E. G., New Considerations on the Preparations, Properties, and Limitations of the Standard Thermocouple for Thermometry, in Temperature: Its Measurement and Control in Science and Industry, Vol. 4, Part 3, pp. 1543-1560 (Instrument Society of America, Pittsburgh, PA., 1972).
- [4] McLaren, E. H., Murdock, E. G., Properties of Some Noble and Base Metal Thermocouples at Fixed Points in the Range 0 - 1100 °C, Temperature, Vol. 5, Part 2, pp. 953-975 (American Institute of Physics, New York, NY, 1982).
- [5] Bentley, R. E., Jones, T. P., Inhomogeneities in Type S Thermocouples When Used to 1064 °C, High Temperatures - High Pressures, Vol. 12, pp. 33-45 (1980).

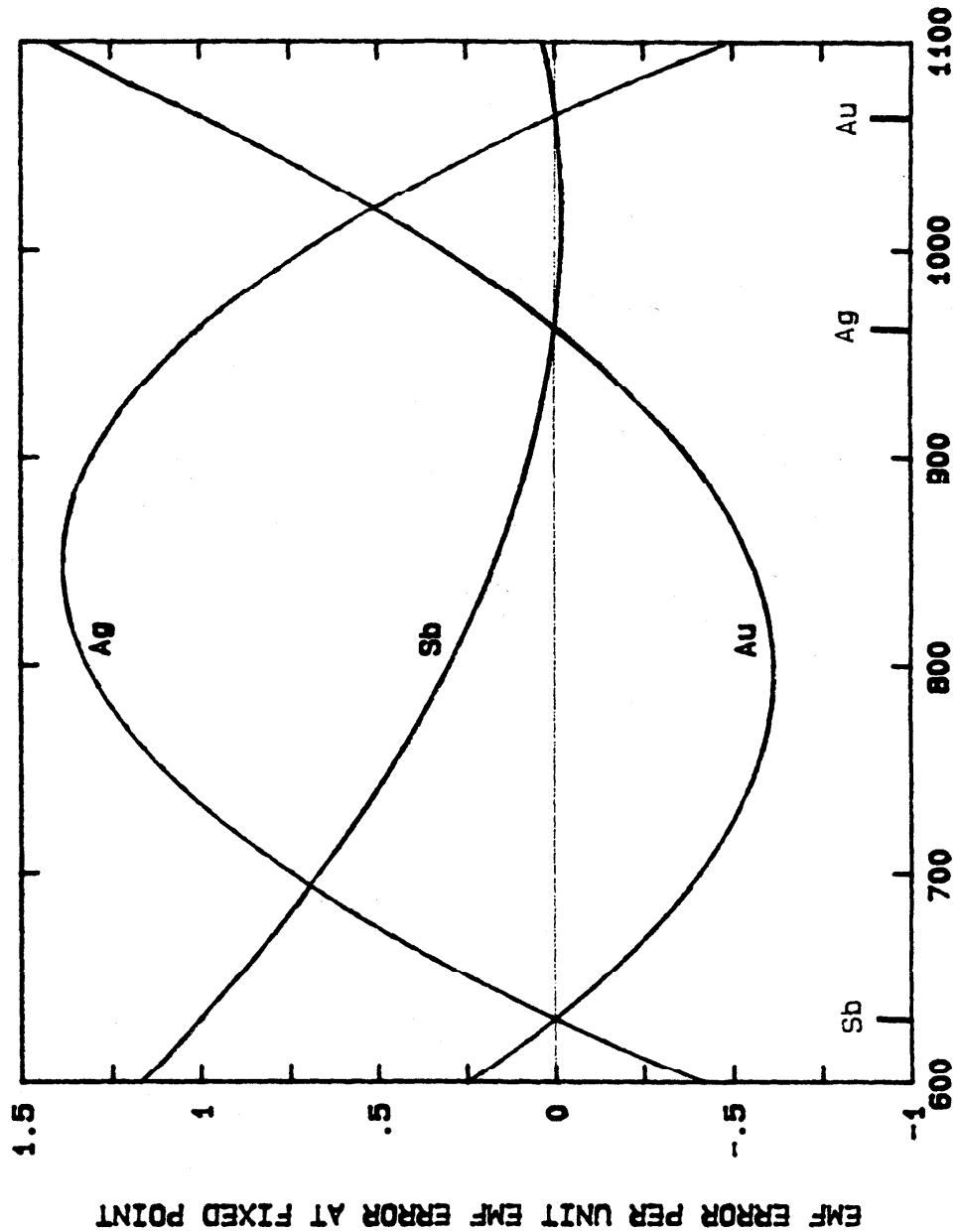
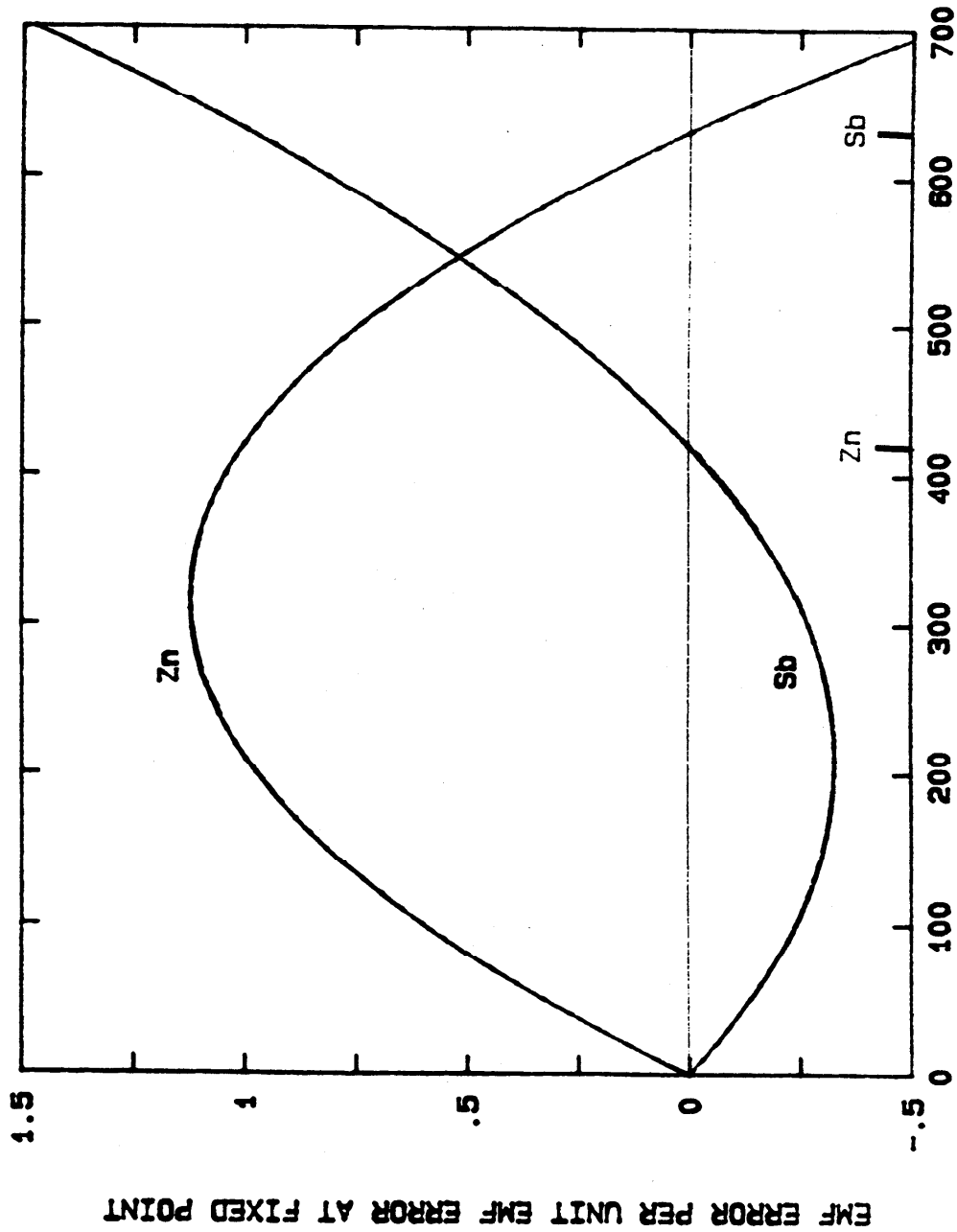

Figure 5.1. Error per unit emf error at the fixed points in thermocouple emfs calculated from the Sb-Ag-Au calibration quadratic.



**TEMPERATURE, degrees Celsius**

Figure 5.2. Error per unit emf error at the fixed points calculated from the 0 °C-Zn-Sb quadratic used to represent the emf difference between the calibration values and the NBS Monograph 125 reference table values at the fixed-points.

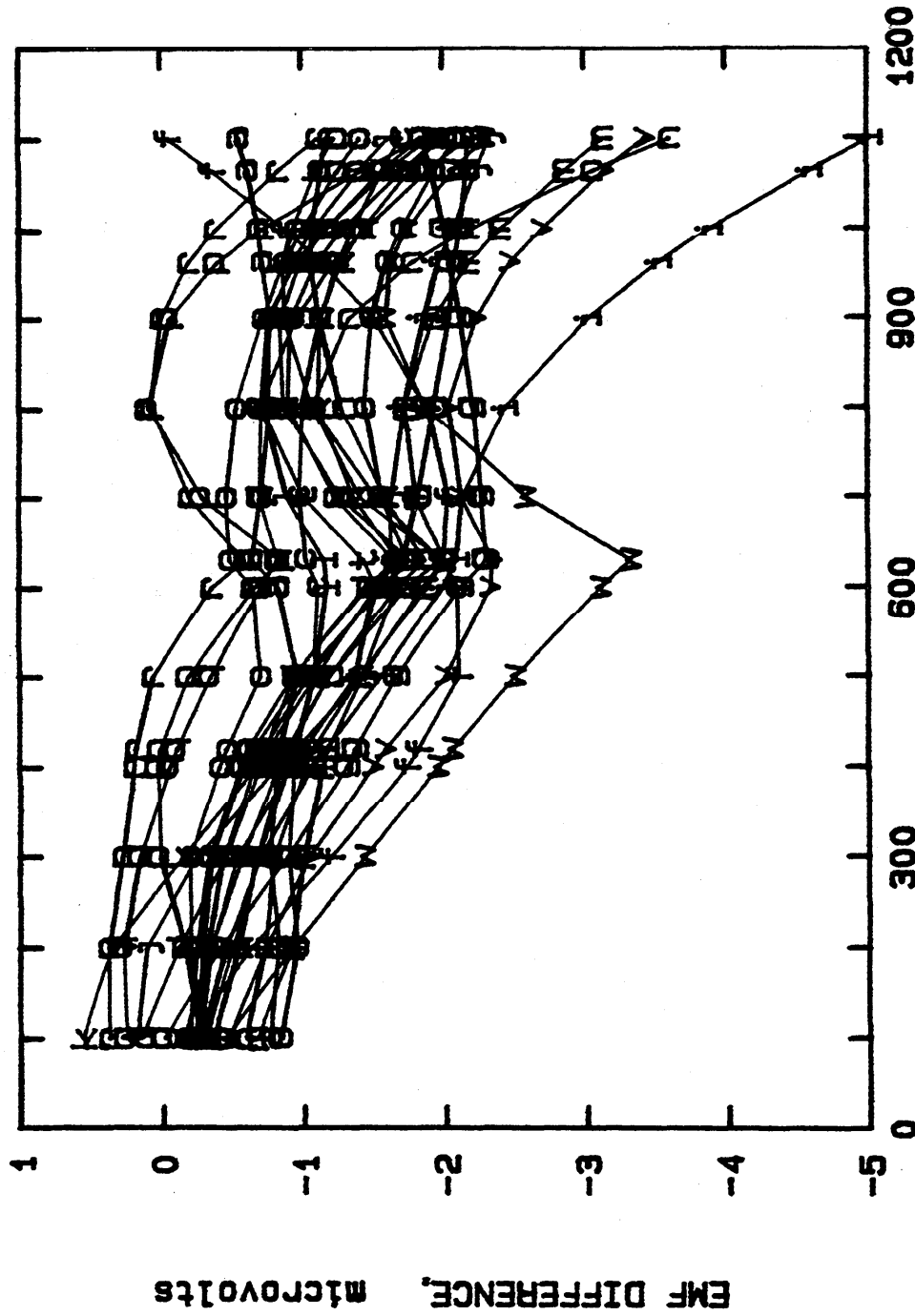
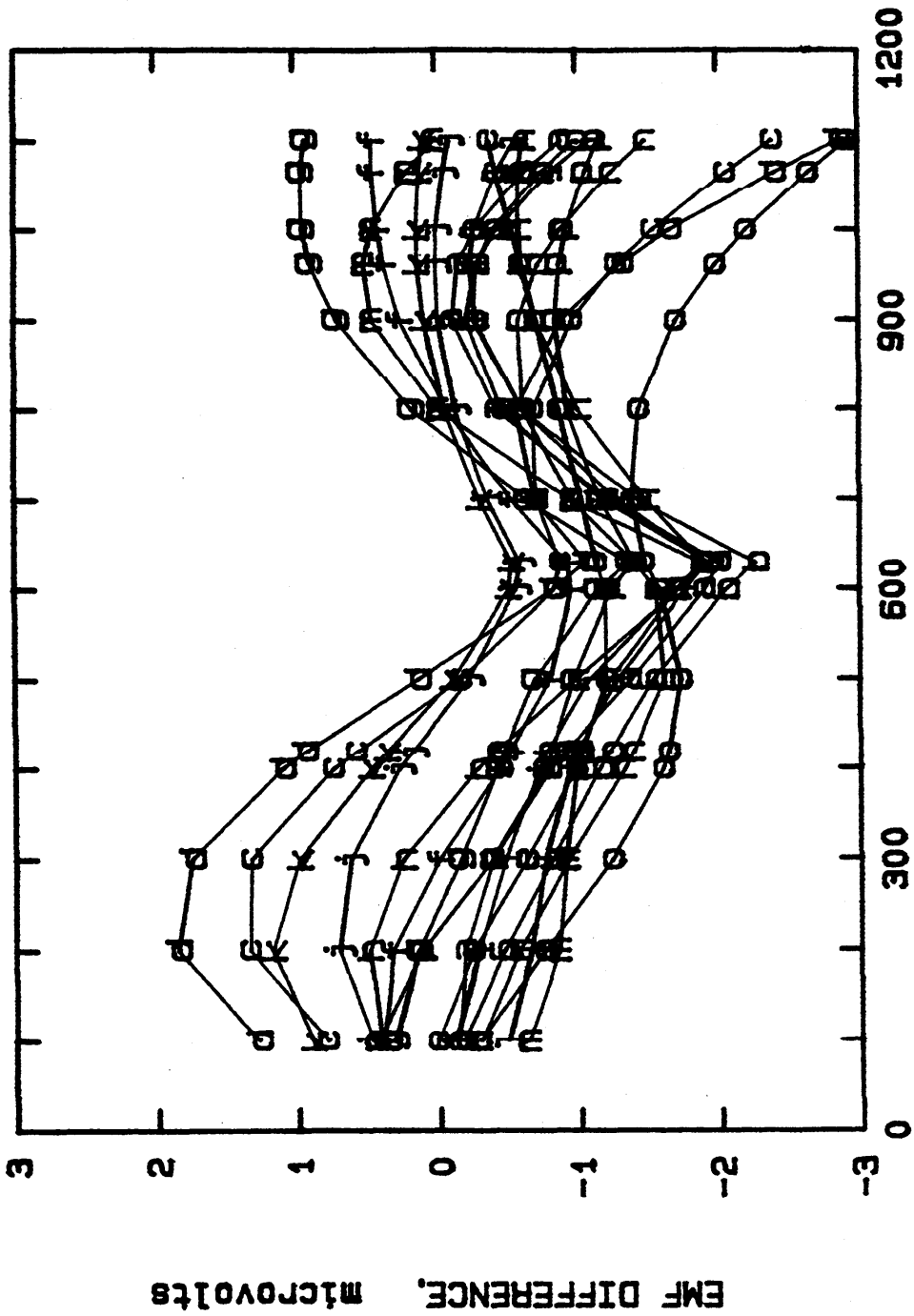

Figure 5.3. Emf difference between values of emf determined in a comparison calibration using type S reference thermocouple SC-83-7 and emf values obtained in a primary calibration at the fixed points for 23 type S test thermocouples. (Emf difference = primary - comparison)



**TEMPERATURE, degrees Celsius**

Figure 5.4. Emf difference between values of emf determined in a comparison calibration using type S reference thermocouple SC-83-8 and emf values obtained in a primary calibration at the fixed points for 16 type S test thermocouples. (Emf difference = primary - comparison)

## 6. FUTURE DIRECTIONS

We foresee marked changes in the international standard in temperature as the IPTS-68 is replaced by a new scale sometime during the next 5 years.

Despite this scale modification, we expect that thermocouple thermometers will continue to be used as working standards in a great variety of applications; therefore, it will be necessary for NIST to continue to offer a range of thermocouple calibration services. We will continue, therefore, to update and expand the present calibration services to meet the needs of our customers. We note that special, non-routine requests for special thermocouple tests, such as emf stability testing of thermocouples and thermocouple devices, have grown during the past 2 years. We intend to modify existing equipment when practical and develop new techniques as needed in order to satisfy as many future requests of this nature as possible.

The future of the NIST thermocouple calibration laboratory thus can be outlined as follows:

- o Any new temperature scale definition must be realized in this laboratory over the whole calibration range;
- o A new radiation thermometer reference standard should be installed to bring the quality of calibrations above 1000 °C into line with the user community's needs;
- o A more comprehensive check-standard program should be implemented to take advantage of our recently developed computer-based data acquisition system.

New programmable controllers have been acquired to control the furnaces used for calibrating thermocouples by fixed-point and comparison methods. They will be put into service as soon as the final hardware is installed and testing is completed.

## 7. BIBLIOGRAPHY

### 7.1 National Bureau of Standards Publications

1. Powell, R. L., Hall, W. J., Hyink, Jr., C. H., Sparks, L. L., Burns, G. W., Scroger, M. G., and Plumb, H. H., Thermocouple Reference Tables Based on the IPTS-68, Natl. Bur. Stand. (U.S.) Monogr. 125, 410 pages (1974).
2. "Accurate Thermocouple Thermometry", Guildner, L. A., and Burns, G. W., High Temperatures - High Pressures, Vol. 11, p. 173 (1979).
3. "Methods of Testing Thermocouples and Thermocouple Materials", Roeser, W. R., and Lonberger, S. T., Natl. Bur. Stand. (U.S.) Circular 590, 13 pages (1958).
4. Burley, N. A., Powell, R. L., Burns, G. W., and Scroger, M. G., "The Nicrosil versus Nisil Thermocouple: Properties and Thermoelectric Reference Data", Natl. Bur. Stand. (U.S.) Monogr. 161, 167 pages (1978).
5. Dahl, A. J., "The Stability of Base-metal Thermocouples in Air from 800 to 2200 °F", in Temperature, Its Measurement and Control in Science and Industry, Vol. 2 (Reinhold Publishing Corp., New York, NY 1941).
6. Burns, G. W. and Hurst, W. S., "Studies of the Performance of W-Re Type Thermocouples", in Temperature, Its Measurement and Control in Science and Industry, Vol. 4, Part 3 (Instrument Society of America, Pittsburgh, PA, 1972), p. 1751.
7. Burns, G. W., Hurst, W. S., and Scroger, M. G., "High Reliability Sheathed, Beryllia Insulated, Tungsten-Rhenium Alloy Thermocouple Assemblies - Their Fabrication and emf Stability", Report No. NASA CR-134549, NBSIR 74-447 (1974).

### 7.2 American Society for Testing and Materials Publications

1. ASTM Standard E230-87, Temperature-Electromotive Force (EMF) tables for Thermocouples, 1988 Annual Book of ASTM Standards, Vol. 14.03, p. 101 (American Society for Testing and Materials, Philadelphia, PA, 1988).
2. ASTM E220-86, Standard Method for Calibration of Thermocouples by Comparison Techniques, 1988 Annual Book of ASTM Standards Vol. 14.03, p. 90, (American Society for Testing and Materials, Philadelphia, PA, 1988).
3. Manual on the Use of Thermocouples in Temperature Measurement, ASTM STP 470B, (American Society for Testing and Materials, Philadelphia, PA, 1981).



7.2 American Society for Testing and Materials Publications (cont'd)

4. Pollock, D. D., The Theory and Properties of Thermocouple Elements, ASTM STP 492, (Omega Press, Ithaca, NY, 1979).
5. Pollock, D. D., Thermoelectricity: Theory Thermometry Tool, ASTM STP 852, (American Society for Testing and Materials, Philadelphia, PA, 1985).
6. ASTM Standard E452-83, Standard Method for Calibration of Refractory Metal Thermocouples Using an Optical Pyrometer, 1988 Annual Book of ASTM Standard, Vol. 14.03, p. 241 (American Society for Testing and Materials, Philadelphia, PA, 1988).

7.3 Instrument Society of America Publications

1. American National Standard, Temperature Measurement Thermocouples, ANSI-MC96.1-1982 (Instrument Society of America, Research Triangle Park, NC, 1982).
2. Kerlin, T. W., and Shepard, R. L., Industrial Temperature Measurement, ISBN 0-87664-622-4 (Instrument Society of America, Research Triangle Park, NC, 1982).

7.4 International Electrotechnical Commission Publications

1. International Electrotechnical Commission Standard, Thermocouples, Part 1: Reference tables, IEC Publication 584-1 (Bureau Central de la Commission Electrotechnique Internationale, Geneva, 1977).
2. International Electrotechnical Commission Standard, Thermocouples, Part 2: Tolerances, IEC Publication 584-2 (Bureau Central de la Commission Electrotechnique Internationale, Geneva, 1982).

7.5 Other Publications

1. Thermocouple Temperature Measurement, Kinzie, P. A., John Wiley and Sons, Inc., New York, NY (1973).
2. Barnard, R. D., Thermoelectricity in Metals and Alloys, (Halsted Press, John Wiley and Sons, Inc., New York, NY, 1972).
3. MacDonald, D. K. C., Thermoelectricity: An Introduction to the Principles, (John Wiley and Sons, Inc., New York, NY, 1962).
4. Walker, B. E., Ewing, C. T., and Miller, R. P., "Thermoelectric Instability of Some Noble Metal Thermocouples at High Temperatures, Rev. Sci. Instrum. 33, 1029-1040 (1962).

7.5 Other Publications (Cont'd)

5. Burley, N. A., and Acklund, R. G., "The Stability of Thermo-emf/Temperature Characteristics of Nickel-base Thermocouples", J. of Australian Inst. of Metals, 12 (1967).
6. Burley, N. A., "Solute Depletion and Thermo-emf Drift in Nickel-base Thermocouple Alloys", J. Inst. Metals 97, 252-254 (1969).
7. Potts, Jr., J. F., and McElroy, D. L., "The Effects of Cold Working, Heat Treatment, and Oxidation on the Thermal emf of Nickel-base Thermoelements", in Temperature, Its Measurement and Control in Science and Industry, Vol. 3, Part 2, p. 243, (Reinhold Publishing Corp., New York, NY 1962).
8. Darling, A. S., and Selman, G. L., "Some Effects of Environment on the Performance of Noble Metal Thermocouples", in Temperature, Its Measurement and Control in Science and Industry, Vol. 4, Part 3, p. 1633, (Instrument Society of America, Pittsburgh, PA, 1972).
9. Glawe, G. E., and Szaniszlo, A. J., "Long-Term Drift of Some Noble- and Refractory-Metal Thermocouples at 1600 K in Air, Argon and Vacuum", in Temperature, Its Measurement and Control in Science and Industry, Vol. 4, Part 3, p. 1645, (Instrument Society of America, Pittsburgh, PA, 1972).
10. McLaren, E. H., and Murdock, E. O., "Properties of Some Noble and Base Metal Thermocouples at Fixed Points in the Range 0 - 1100 °C", in Temperature, Its Measurement and Control in Sciences and Industry, Vol. 5, p. 953, (American Institute of Physics, New York, NY, 1982).
11. Anderson, R. L., Lyons, J. D., Kollie, T. G., Christie, W. H., and Eby, R., "Decalibration of Sheathed Thermocouples", in Temperature, Its Measurement and Control in Science and Industry, Vol. 5, p. 977, (American Institute of Physics, New York, NY 1982).
12. Wang, T. P., and Starr, C. D., "Oxidation Resistance and Stability of Nicrosil-Nisil in Air and in Reducing Atmosphere", in Temperature, Its Measurement and Control in Science and Industry, Vol. 5, p. 1147, (American Institute of Physics, New York, NY, 1982).
13. Burley, N. A., Cocking, J. L., Burns, G. W., and Scroger, M. G., "The Nicrosil versus Nisil Thermocouple: The Influence of Magnesium on the Thermoelectric Stability and Oxidation Resistance of the Alloys", in Temperature, Its Measurement and Control in Science and Industry, Vol. 5, p. 1129, (American Institute of Physics, New York, NY, 1982).

## 8. APPENDICES

### 8.1 Calibration Reports

A variety of reports are issued for thermocouple calibrations depending upon the type of thermocouple or thermoelement, the type of calibration, the temperature range, and the temperature scale (IPTS-68 or IPTS-48, °C or °F). The five calibration reports listed in the following subsections are samples of the reports issued most frequently by the thermocouple calibration laboratory.

#### 8.1.1 Type S Thermocouple - Fixed-Point Calibration

##### 8.1.1.1 Covering Letter and Bound Calibration Report for Customer



**UNITED STATES DEPARTMENT OF COMMERCE**  
**National Institute of Standards and Technology**  
**(formerly National Bureau of Standards)**  
Gaithersburg, Maryland 20899

January 10, 1989

In reply refer to:  
586/888765

WWXX  
Hometown, U. S. A.

Attn: Jane Doe / purchasing agent

Subject : Thermometric Test  
Order No: XX5556

Enclosed are results of the test which you requested in the above reference. Please refer to the above file number in any later communication, and if you have any questions concerning this test, contact Margaret G. Scroger, telephone number (301) 975-4818.

Sincerely.

B. W. Mangum, Group Leader  
Thermometry Research & Calibration Group  
Temperature and Pressure Division

Material tested:  
1 Thermocouple

Enclosure:  
1 Report of Calibration

UNITED STATES DEPARTMENT OF COMMERCE  
NATIONAL INSTITUTE OF STANDARDS AND TECHNOLOGY  
GAITHERSBURG, MARYLAND

REPORT OF CALIBRATION  
TYPE S THERMOCOUPLE

Submitted by

WVXX Corporation  
Hometown, U. S. A.

The emf of the thermocouple was determined at 1064.43 °C (gold point), 961.93 °C (silver point), 630.74 °C, and 419.58 °C (zinc point) with the reference junctions at 0 °C. The values of emf found are given in Table 1. The uncertainties in these values are estimated not to exceed 2 microvolts.

Table 2 gives values of emf from 0 °C to 1450 °C. The uncertainties in the values given are estimated not to exceed 3 microvolts in the range 0 °C to 1100 °C and then increase to not more than 20 microvolts at 1450 °C. These uncertainties are discussed in National Bureau of Standards Circular 590, Methods of Testing Thermocouples and Thermocouple Materials. Table 3 gives the coefficients of the equations that were used to compute the values given in Table 2. Each equation is valid only within the specified temperature range.

All temperatures in this report are given in degrees Celsius (ITS-68). The International Practical Temperature Scale of 1968, ITS-68, was adopted by the International Committee of Weights and Measures at its meeting in October 1968, and is described in "The International Practical Temperature Scale of 1968, Amended Edition of 1975", Metrologia 12, No. 1, 7-17 (1976).

The calibration of a thermocouple is subject to change during use. The magnitude of the change depends upon such factors as the temperature, the length of time, and the conditions under which it is used. Factors affecting the stability of platinum-rhodium versus platinum thermocouples are discussed in Thermocouple and Radiation Thermometry Above 900 °K, Proceedings of Symposium on Measurement of Thermal Radiation Properties of Solids (1963). (Reprints are available from NBS, Temperature and Pressure Division, Gaithersburg, MD 20899).

The thermocouple was electrically annealed in air before testing.

For the Director  
National Institute of Standards and Technology

B. W. Mangum, Group Leader  
Thermometry Research & Calibration Group  
Temperature and Pressure Division

P.O. No. XX5556  
Test No. 888765  
Date : January 10, 1989

JANUARY 10, 1989

NIST TEST NO. 888765

TABLE 1

TEMPERATURE IN DEGREES CELSIUS (IPTS-68)  
EMF IN MICROVOLTS  
REFERENCE JUNCTIONS AT 0 DEGREES CELSIUS

TEMPERATURE	EMF
1064.43 (Gold Point)	10316.7
961.93 (Silver Point)	9134.4
630.74	5544.9
419.58 (Zinc Point)	3443.2

JANUARY 10, 1989  
 TEMP. IN DEGREES CELSIUS (PTS-68),  
 TYPE S THERMOCOUPLE  
 REF. JCTS. AT 0 DEGREES CELSIUS  
 NIST TEST NO. 888765

TEMP	0	1	2	3	4	5	6	7	8	9
0	0.000	0.005	0.011	0.016	0.022	0.027	0.033	0.038	0.044	0.050
10	0.055	0.061	0.066	0.072	0.078	0.084	0.089	0.095	0.101	0.107
20	0.113	0.118	0.124	0.130	0.136	0.142	0.148	0.154	0.160	0.166
30	0.172	0.178	0.185	0.191	0.197	0.203	0.209	0.215	0.222	0.228
40	0.234	0.241	0.247	0.253	0.260	0.266	0.272	0.279	0.285	0.292
50	0.298	0.305	0.311	0.318	0.324	0.331	0.337	0.344	0.351	0.357
60	0.364	0.371	0.377	0.384	0.391	0.398	0.404	0.411	0.418	0.425
70	0.432	0.438	0.445	0.452	0.459	0.466	0.473	0.480	0.487	0.494
80	0.501	0.508	0.515	0.522	0.529	0.536	0.543	0.550	0.557	0.565
90	0.572	0.579	0.586	0.593	0.601	0.608	0.615	0.622	0.630	0.637
100	0.644	0.652	0.659	0.666	0.674	0.681	0.688	0.696	0.703	0.711
110	0.718	0.726	0.733	0.741	0.748	0.756	0.763	0.771	0.778	0.786
120	0.794	0.801	0.809	0.816	0.824	0.832	0.839	0.847	0.855	0.862
130	0.870	0.878	0.886	0.893	0.901	0.909	0.917	0.925	0.932	0.940
140	0.948	0.956	0.964	0.972	0.980	0.987	0.995	1.003	1.011	1.019
150	1.027	1.035	1.043	1.051	1.059	1.067	1.075	1.083	1.091	1.099
160	1.107	1.115	1.123	1.131	1.140	1.148	1.156	1.164	1.172	1.180
170	1.188	1.197	1.205	1.213	1.221	1.229	1.238	1.246	1.254	1.262
180	1.271	1.279	1.287	1.295	1.304	1.312	1.320	1.329	1.337	1.345
190	1.354	1.362	1.371	1.379	1.387	1.396	1.404	1.413	1.421	1.429
200	1.438	1.446	1.455	1.463	1.472	1.480	1.489	1.497	1.506	1.514
210	1.523	1.531	1.540	1.548	1.557	1.566	1.574	1.583	1.591	1.600
220	1.609	1.617	1.626	1.634	1.643	1.652	1.660	1.669	1.678	1.686
230	1.695	1.704	1.712	1.721	1.730	1.739	1.747	1.756	1.765	1.774
240	1.782	1.791	1.800	1.809	1.817	1.826	1.835	1.844	1.853	1.861
250	1.870	1.879	1.888	1.897	1.906	1.914	1.923	1.932	1.941	1.950
260	1.959	1.968	1.977	1.986	1.994	2.003	2.012	2.021	2.030	2.039
270	2.048	2.057	2.066	2.075	2.084	2.093	2.102	2.111	2.120	2.129
280	2.138	2.147	2.156	2.165	2.174	2.183	2.192	2.201	2.210	2.219
290	2.228	2.237	2.247	2.256	2.265	2.274	2.283	2.292	2.301	2.310

JANUARY 10, 1989  
 TEMP. IN DEGREES CELSIUS(IPTS-68),  
 TABLE 2  
 EMF IN MILLIVOLTS  
 TYPE S THERMOCOUPLE  
 REF. JCTS. AT 0 DEGREES CELSIUS  
 NIST TEST NO. 888765

TEMP	0	1	2	3	4	5	6	7	8	9
300	2.319	2.329	2.338	2.347	2.356	2.365	2.374	2.383	2.393	2.402
310	2.411	2.420	2.429	2.439	2.448	2.457	2.466	2.475	2.485	2.494
320	2.503	2.512	2.521	2.531	2.540	2.549	2.558	2.568	2.577	2.586
330	2.596	2.605	2.614	2.623	2.633	2.642	2.651	2.661	2.670	2.679
340	2.689	2.698	2.707	2.716	2.726	2.735	2.745	2.754	2.763	2.773
350	2.782	2.791	2.801	2.810	2.819	2.829	2.838	2.848	2.857	2.866
360	2.876	2.885	2.895	2.904	2.913	2.923	2.932	2.942	2.951	2.961
370	2.970	2.980	2.989	2.998	3.008	3.017	3.027	3.036	3.046	3.055
380	3.065	3.074	3.084	3.093	3.103	3.112	3.122	3.131	3.141	3.150
390	3.160	3.169	3.179	3.188	3.198	3.208	3.217	3.227	3.236	3.246
400	3.255	3.265	3.274	3.284	3.294	3.303	3.313	3.322	3.332	3.342
410	3.351	3.361	3.370	3.380	3.390	3.399	3.409	3.418	3.428	3.438
420	3.447	3.457	3.467	3.476	3.486	3.495	3.505	3.515	3.524	3.534
430	3.544	3.553	3.563	3.573	3.582	3.592	3.602	3.611	3.621	3.631
440	3.641	3.650	3.660	3.670	3.679	3.689	3.699	3.709	3.718	3.728
450	3.738	3.747	3.757	3.767	3.777	3.786	3.796	3.806	3.816	3.825
460	3.835	3.845	3.855	3.864	3.874	3.884	3.894	3.904	3.913	3.923
470	3.933	3.943	3.953	3.962	3.972	3.982	3.992	4.002	4.011	4.021
480	4.031	4.041	4.051	4.060	4.070	4.080	4.090	4.100	4.110	4.119
490	4.129	4.139	4.149	4.159	4.169	4.179	4.188	4.198	4.208	4.218
500	4.228	4.238	4.248	4.258	4.268	4.277	4.287	4.297	4.307	4.317
510	4.327	4.337	4.347	4.357	4.367	4.377	4.386	4.396	4.406	4.416
520	4.426	4.436	4.446	4.456	4.466	4.476	4.486	4.496	4.506	4.516
530	4.526	4.536	4.546	4.556	4.566	4.576	4.586	4.595	4.605	4.615
540	4.625	4.635	4.645	4.655	4.665	4.675	4.685	4.695	4.706	4.716
550	4.726	4.736	4.746	4.756	4.766	4.776	4.786	4.796	4.806	4.816
560	4.826	4.836	4.846	4.856	4.866	4.876	4.886	4.896	4.906	4.917
570	4.927	4.937	4.947	4.957	4.967	4.977	4.987	4.997	5.007	5.017
580	5.028	5.038	5.048	5.058	5.068	5.078	5.088	5.098	5.109	5.119
590	5.129	5.139	5.149	5.159	5.169	5.180	5.190	5.200	5.210	5.220



JANUARY 10, 1989  
 TEMP. IN DEGREES CELSIUS (IPTS-68),  
 TYPE S THERMOCOUPLE  
 REF. JCTS. AT 0 DEGREES CELSIUS  
 NIST TEST NO. 888765

TEMP	0	1	2	3	4	5	6	7	8	9
600	5.230	5.241	5.251	5.261	5.271	5.281	5.292	5.302	5.312	5.322
610	5.332	5.343	5.353	5.363	5.373	5.383	5.394	5.404	5.414	5.424
620	5.435	5.445	5.455	5.465	5.476	5.486	5.496	5.506	5.517	5.527
630	5.537	5.548	5.558	5.568	5.579	5.589	5.599	5.609	5.620	5.630
640	5.640	5.651	5.661	5.671	5.682	5.692	5.703	5.713	5.723	5.734
650	5.744	5.754	5.765	5.775	5.785	5.796	5.806	5.817	5.827	5.837
660	5.848	5.858	5.869	5.879	5.889	5.900	5.910	5.921	5.931	5.942
670	5.952	5.962	5.973	5.983	5.994	6.004	6.015	6.025	6.036	6.046
680	6.056	6.067	6.077	6.088	6.098	6.109	6.119	6.130	6.140	6.151
690	6.161	6.172	6.182	6.193	6.203	6.214	6.224	6.235	6.245	6.256
700	6.266	6.277	6.287	6.298	6.309	6.319	6.330	6.340	6.351	6.361
710	6.372	6.382	6.393	6.404	6.414	6.425	6.435	6.446	6.456	6.467
720	6.478	6.488	6.499	6.509	6.520	6.531	6.541	6.552	6.563	6.573
730	6.584	6.594	6.605	6.616	6.626	6.637	6.648	6.658	6.669	6.680
740	6.690	6.701	6.711	6.722	6.733	6.743	6.754	6.765	6.776	6.786
750	6.797	6.808	6.818	6.829	6.840	6.850	6.861	6.872	6.883	6.893
760	6.904	6.915	6.925	6.936	6.947	6.958	6.968	6.979	6.990	7.001
770	7.011	7.022	7.033	7.044	7.054	7.065	7.076	7.087	7.097	7.108
780	7.119	7.130	7.141	7.151	7.162	7.173	7.184	7.195	7.205	7.216
790	7.227	7.238	7.249	7.260	7.270	7.281	7.292	7.303	7.314	7.325
800	7.335	7.346	7.357	7.368	7.379	7.390	7.401	7.411	7.422	7.433
810	7.444	7.455	7.466	7.477	7.488	7.498	7.509	7.520	7.531	7.542
820	7.553	7.564	7.575	7.586	7.597	7.608	7.619	7.630	7.640	7.651
830	7.662	7.673	7.684	7.695	7.706	7.717	7.728	7.739	7.750	7.761
840	7.772	7.783	7.794	7.805	7.816	7.827	7.838	7.849	7.860	7.871
850	7.882	7.893	7.904	7.915	7.926	7.937	7.948	7.959	7.970	7.981
860	7.992	8.003	8.014	8.025	8.036	8.047	8.058	8.070	8.081	8.092
870	8.103	8.114	8.125	8.136	8.147	8.158	8.169	8.180	8.191	8.203
880	8.214	8.225	8.236	8.247	8.258	8.269	8.280	8.291	8.303	8.314
890	8.325	8.336	8.347	8.358	8.369	8.381	8.392	8.403	8.414	8.425

JANUARY 10, 1989  
 TEMP. IN DEGREES CELSIUS (PTS-68),  
 TYPE S THERMOCOUPLE  
 REF. JCTS. AT 0 DEGREES CELSIUS  
 NIST TEST NO. 888765

TEMP	0	1	2	3	4	5	6	7	8	9
900	8.436	8.448	8.459	8.470	8.481	8.492	8.504	8.515	8.526	8.537
910	8.548	8.560	8.571	8.582	8.593	8.604	8.616	8.627	8.638	8.649
920	8.661	8.672	8.683	8.694	8.705	8.717	8.728	8.739	8.751	8.762
930	8.773	8.784	8.796	8.807	8.818	8.829	8.841	8.852	8.863	8.875
940	8.886	8.897	8.908	8.920	8.931	8.942	8.954	8.965	8.976	8.988
950	8.999	9.010	9.022	9.033	9.044	9.056	9.067	9.078	9.090	9.101
960	9.113	9.124	9.135	9.147	9.158	9.169	9.181	9.192	9.204	9.215
970	9.226	9.238	9.249	9.261	9.272	9.283	9.295	9.306	9.318	9.329
980	9.340	9.352	9.363	9.375	9.386	9.398	9.409	9.420	9.432	9.443
990	9.455	9.466	9.478	9.489	9.501	9.512	9.524	9.535	9.547	9.558
1000	9.570	9.581	9.593	9.604	9.616	9.627	9.639	9.650	9.662	9.673
1010	9.685	9.696	9.708	9.719	9.731	9.742	9.754	9.765	9.777	9.789
1020	9.800	9.812	9.823	9.835	9.846	9.858	9.870	9.881	9.893	9.904
1030	9.916	9.927	9.939	9.951	9.962	9.974	9.985	9.997	10.009	10.020
1040	10.032	10.044	10.055	10.067	10.078	10.090	10.102	10.113	10.125	10.137
1050	10.148	10.160	10.172	10.183	10.195	10.207	10.218	10.230	10.242	10.253
1060	10.265	10.277	10.288	10.300	10.312	10.323	10.335	10.347	10.359	10.370
1070	10.382	10.394	10.405	10.417	10.429	10.441	10.452	10.464	10.476	10.487
1080	10.499	10.511	10.523	10.534	10.546	10.558	10.570	10.581	10.593	10.605
1090	10.617	10.629	10.640	10.652	10.664	10.676	10.687	10.699	10.711	10.723
1100	10.735	10.746	10.758	10.770	10.782	10.794	10.805	10.817	10.829	10.841
1110	10.853	10.864	10.876	10.888	10.900	10.912	10.923	10.935	10.947	10.959
1120	10.971	10.983	10.994	11.006	11.018	11.030	11.042	11.054	11.066	11.077
1130	11.089	11.101	11.113	11.125	11.137	11.149	11.160	11.172	11.184	11.196
1140	11.208	11.220	11.232	11.244	11.255	11.267	11.279	11.291	11.303	11.315
1150	11.327	11.339	11.351	11.363	11.374	11.386	11.398	11.410	11.422	11.434
1160	11.446	11.458	11.470	11.482	11.494	11.506	11.517	11.529	11.541	11.553
1170	11.565	11.577	11.589	11.601	11.613	11.625	11.637	11.649	11.661	11.673
1180	11.685	11.697	11.708	11.720	11.732	11.744	11.756	11.768	11.780	11.792
1190	11.804	11.816	11.828	11.840	11.852	11.864	11.876	11.888	11.900	11.912

JANUARY 10, 1989  
 TEMP. IN DEGREES CELSIUS (IPTS-68), TYPE S THERMOCOUPLE NIST TEST NO. 888765  
 REF. JCTS. AT 0 DEGREES CELSIUS

TEMP	0	1	2	3	4	5	6	7	8	9
1200	11.924	11.936	11.948	11.960	11.972	11.984	11.996	12.008	12.020	12.032
1210	12.044	12.056	12.068	12.080	12.092	12.104	12.116	12.128	12.140	12.152
1220	12.164	12.176	12.188	12.200	12.212	12.224	12.236	12.248	12.260	12.272
1230	12.284	12.296	12.308	12.320	12.332	12.344	12.356	12.368	12.380	12.392
1240	12.404	12.416	12.428	12.440	12.452	12.464	12.476	12.488	12.501	12.513
1250	12.525	12.537	12.549	12.561	12.573	12.585	12.597	12.609	12.621	12.633
1260	12.645	12.657	12.669	12.681	12.693	12.705	12.717	12.729	12.742	12.754
1270	12.766	12.778	12.790	12.802	12.814	12.826	12.838	12.850	12.862	12.874
1280	12.886	12.898	12.910	12.922	12.935	12.947	12.959	12.971	12.983	12.995
1290	13.007	13.019	13.031	13.043	13.055	13.067	13.079	13.092	13.104	13.116
1300	13.128	13.140	13.152	13.164	13.176	13.188	13.200	13.212	13.224	13.236
1310	13.249	13.261	13.273	13.285	13.297	13.309	13.321	13.333	13.345	13.357
1320	13.369	13.381	13.394	13.406	13.418	13.430	13.442	13.454	13.466	13.478
1330	13.490	13.502	13.514	13.527	13.539	13.551	13.563	13.575	13.587	13.599
1340	13.611	13.623	13.635	13.647	13.660	13.672	13.684	13.696	13.708	13.720
1350	13.732	13.744	13.756	13.768	13.780	13.793	13.805	13.817	13.829	13.841
1360	13.853	13.865	13.877	13.889	13.901	13.914	13.926	13.938	13.950	13.962
1370	13.974	13.986	13.998	14.010	14.022	14.034	14.047	14.059	14.071	14.083
1380	14.095	14.107	14.119	14.131	14.143	14.155	14.167	14.179	14.192	14.204
1390	14.216	14.228	14.240	14.252	14.264	14.276	14.288	14.300	14.312	14.325
1400	14.337	14.349	14.361	14.373	14.385	14.397	14.409	14.421	14.433	14.445
1410	14.457	14.469	14.482	14.494	14.506	14.518	14.530	14.542	14.554	14.566
1420	14.578	14.590	14.602	14.614	14.626	14.638	14.651	14.663	14.675	14.687
1430	14.699	14.711	14.723	14.735	14.747	14.759	14.771	14.783	14.795	14.807
1440	14.819	14.831	14.844	14.856	14.868	14.880	14.892	14.904	14.916	14.928
1450	14.940									

TABLE 3

COEFFICIENTS OF EQUATIONS USED TO CALCULATE TABLE 2

FOR DEGREES CELSIUS TABLE

Temperature Range---	0.0 to 630.74	630.74 to 1064.43	1064.43 to 1450.0
A =	0.0	-3.1710621E-01	+1.3028746E+00
E =	+5.3891567E-03	+8.2811519E-03	+3.4559370E-03
C =	+1.2518195E-05	+1.6055796E-06	+6.3824649E-06
D =	-2.2448218E-08		-1.5722425E-09
F =	+2.8452165E-11		
F =	-2.2440580E-14		
G =	+8.5054170E-18		

The equations are of the form:

$$EE = A + BT + CT^{**2} + DT^{**3} + ET^{**4} + FT^{**5} + GT^{**6}$$

where EE is the emf in millivolts and  
T is the temperature in degrees Celsius(IPTS-68)

#### 8.1.1.2 Summary of Calibration Results for NIST Record

DECEMBER 28, 1988

FREEZING POINT CALIBRATION AT GOLD

	888765	TIME
1	10317.65	10:10:29.9
2	10317.65	10:11:01.2
3	10317.66	10:11:30.6
4	10317.66	10:11:59.8
5	10317.66	10:12:29.6
6	10317.68	10:15:30.1
7	10317.69	10:16:00.7
8	10317.68	10:16:31.2
9	10317.68	10:17:00.2
10	10317.68	10:17:30.1

VALUES	1 to 10
AVERAGE	10317.669
POT CORRECTION	-1.150
CELL CORRECTION	0.260
	-----
CORR AVERAGE	10316.78

DECEMBER 28, 1988

FREEZING POINT CALIBRATION AT AU

	888765	TIME
1	10317.54	11:20:30.2
2	10317.55	11:21:00.1
3	10317.55	11:21:29.9
4	10317.57	11:22:00.3
5	10317.57	11:22:30.1
6	10317.59	11:25:31.6
7	10317.60	11:26:00.1
8	10317.60	11:26:30.5
9	10317.61	11:27:00.5
10	10317.61	11:27:30.2

VALUES	1 to 10
AVERAGE	10317.579
POT CORRECTION	-1.150
CELL CORRECTION	0.260
	-----
CORR AVERAGE	10316.69

IMMERSION CHECK

CM ABOVE BOTTOM	242301	EMF, Microvolts	TIME	DELTA
1	10317.68	11:30:02	0.10	
2	10317.71	11:32:31	0.13	
4	10317.63	11:35:01	0.05	
6	10317.45	11:37:32	-0.13	

JANUARY 3, 1989

FREEZING POINT CALIBRATION AT SILVER

	888765	TIME
1	9135.07	13:51:00.5
2	9135.07	13:51:29.7
3	9135.07	13:52:00.0
4	9135.07	13:52:29.8
5	9135.08	13:52:59.7
6	9135.08	13:56:00.1
7	9135.08	13:56:30.0
8	9135.08	13:57:00.0
9	9135.08	13:57:29.9
10	9135.08	13:58:00.1

VALUES	1 to 10
AVERAGE	9135.076
POT CORRECTION	-1.020
CELL CORRECTION	0.360
	-----
CORR AVERAGE	9134.42



JANUARY 3, 1989

FREEZING POINT CALIBRATION AT AG

	888765	TIME
1	9135.12	14:53:00.4
2	9135.12	14:53:30.1
3	9135.12	14:53:59.9
4	9135.12	14:54:29.8
5	9135.12	14:54:59.5
6	9135.12	14:57:59.7
7	9135.12	14:58:29.7
8	9135.12	14:58:59.8
9	9135.12	14:59:30.2
10	9135.12	15:00:00.0

VALUES	1 to 10
AVERAGE	9135.120
POT CORRECTION	-1.020
CELL CORRECTION	0.360
	-----
CORR AVERAGE	9134.46

IMMERSION CHECK

CM ABOVE BOTTOM	EMF, Microvolts	TIME	DELTA
242301			
1	9135.15	15:02:57	0.03
2	9134.98	15:05:31	-0.14
4	9134.74	15:08:01	-0.38
6	9134.71	15:10:38	-0.41

JANUARY 5, 1989

FREEZING POINT CALIBRATION AT ANTIMONY

	888765	TIME
1	5545.57	9:04:30.6
2	5545.57	9:05:00.3
3	5545.57	9:05:30.0
4	5545.57	9:06:00.3
5	5545.57	9:06:30.0
6	5545.57	9:09:29.9
7	5545.57	9:10:01.2
8	5545.57	9:10:29.8
9	5545.57	9:10:59.8
10	5545.57	9:11:29.1

VALUES	1 to 10
AVERAGE	5545.570
POT CORRECTION	-0.590
CELL CORRECTION	-0.050
	-----
CORR AVERAGE	5544.93

JANUARY 5, 1989

FREEZING POINT CALIBRATION AT SB

	888765	TIME
1	5545.51	15:34:59.6
2	5545.51	15:35:30.1
3	5545.51	15:36:00.1
4	5545.51	15:36:30.0
5	5545.52	15:37:00.2
6	5545.50	15:39:59.4
7	5545.50	15:40:31.1
8	5545.50	15:41:00.4
9	5545.50	15:41:30.2
10	5545.51	15:42:00.0

VALUES	1 to 10
AVERAGE	5545.507
POT CORRECTION	-0.590
CELL CORRECTION	-0.050
	-----
CORR AVERAGE	5544.87

JANUARY 9, 1989

FREEZING POINT CALIBRATION AT ZN4

	888765	TIME
1	3443.54	12:26:30.3
2	3443.54	12:27:00.4
3	3443.54	12:27:30.4
4	3443.54	12:28:00.0
5	3443.54	12:28:30.0
6	3443.56	12:34:36.8
7	3443.56	12:34:59.8
8	3443.56	12:35:29.7
9	3443.56	12:36:00.3
10	3443.56	12:36:31.4

VALUES	1 to 10
AVERAGE	3443.550
POT CORRECTION	-0.350
CELL CORRECTION	0.000
	-----
CORR AVERAGE	3443.20

JANUARY 9, 1989

FREEZING POINT CALIBRATION AT ZN5

	888765	TIME
1	3443.59	17:00:00.3
2	3443.59	17:00:30.1
3	3443.59	17:00:59.6
4	3443.59	17:01:30.5
5	3443.59	17:01:59.5
6	3443.60	17:05:00.2
7	3443.60	17:05:29.8
8	3443.60	17:06:00.3
9	3443.60	17:06:30.5
10	3443.59	17:07:00.7

VALUES	1 to 10
AVERAGE	3443.594
POT CORRECTION	-0.350
CELL CORRECTION	0.000
	-----
CORR AVERAGE	3443.24

JANUARY 10, 1989

NIST TEST NO. 888765

FOR TEST FOLDER

('AT COMPUTER')

TABLE 1

TEMPERATURE IN DEGREES CELSIUS(IPTS-68)  
EMF IN MICROVOLTS  
REFERENCE JUNCTIONS AT 0 DEGREES CELSIUS

TEMPERATURE	EMF	Table - Test
1064.43 (Gold Point)	10316.7	+17.6
961.93 (Silver Point)	9134.4	+13.8
630.74	5544.9	+7.2
419.58 (Zinc Point)	3443.2	+4.7

Data book PTC-29  
Page 150  
DEGREES C TABLE GIVEN

('AT COMPUTER')

THERMOCOUPLE CALIBRATION JANUARY 10, 1989

NIST TEST NUMBER 888765

IPTS-;68

FIXED POINT EMF VALUES IN MICROVOLTS

		EMF(table) - EMF(TC) microvolts
1064.43 (gold point)	- 10316.74	+17.6
961.93 (silver point)	- 9134.44	+13.8
630.74	- 5544.90	+7.2
419.58 (zinc point)	- 3443.22	+4.7

COEFFICIENTS FOR EMF EQUATIONS

Temperature Range---	0 TO 630.74	630.74 TO 1064.43	1064.43 TO 1450.0
A =	0.0	-3.1710621E+02	+1.3028746E+03
B =	+5.3891567E+00	+8.2811519E+00	+3.4559370E+00
C =	+1.2518195E-02	+1.6055796E-03	+6.3824649E-03
D =	-2.2448218E-05		-1.5722425E-06
E =	+2.8452165E-08		
F =	-2.2440580E-11		
G =	+8.5054170E-15		

IPTS CRITERIA

- 1)  $E(\text{Au})-10334.0 = -17.26$
- 2)  $E(\text{Au})-E(\text{Ag})-1186-.17(E(\text{Au})-10334) = -0.765800000001$
- 3)  $E(\text{Au})-E(630.74)-4782-.63(E(\text{Au})-10334) = 0.7138$

EMF of the platinum wire vs Pt-67 at 1100 C in microvolts was 1.9

THIS THERMOCOUPLE DOES NOT MEET THE CONDITIONS FOR A STANDARD THERMOCOUPLE IF  
CRITERIA 1) IS GREATER THAN 30  
CRITERIA 2) IS GREATER THAN 3  
CRITERIA 3) IS GREATER THAN 5

0	0.0	+0.0
100	644.3	+1.1
200	1437.9	+2.1
300	2319.4	+3.3
400	3255.3	+4.4
500	4228.0	+5.6
600	5230.5	+6.8
700	6266.4	+7.8
800	7335.4	+9.5
900	8436.4	+11.9
1000	9569.6	+15.1
1100	10734.5	+19.0
1200	11923.9	+23.1
1300	13127.7	+27.3
1400	14336.6	+31.4
1450	14939.9	+33.4

DEGREES C TABLE GIVEN

JANUARY 10, 1989

TYPE S THERMOCOUPLE

NIST TEST NO. 888765

TABLE 3

FOR TEST FOLDER ('AT COMPUTER')

COEFFICIENTS OF EQUATIONS USED TO CALCULATE TABLE 2

FOR DEGREES CELSIUS TABLE

Temperature Range---	0.0 to 630.74	630.74 to 1064.43	1064.43 to 1450.0
A =	0.0	-3.1710621E-01	+1.3028746E+00
B =	+5.3891567E-03	+8.2811519E-03	+3.4559370E-03
C =	+1.2518195E-05	+1.6055796E-06	+6.3824649E-06
D =	-2.2448218E-08		-1.5722425E-09
E =	+2.8452165E-11		
F =	-2.2440580E-14		
G =	+8.5054170E-18		

The equations are of the form:

$$EE = A + BT + CT^{**2} + DT^{**3} + ET^{**4} + FT^{**5} + GT^{**6}$$

where EE is the emf in millivolts and

T is the temperature in degrees Celsius (IPTS-68)



**8.1.2 Type S Thermocouple - Comparison Calibration**

**8.1.2.1 Covering Letter and Bound Calibration Report for Customer**



**UNITED STATES DEPARTMENT OF COMMERCE**  
**National Institute of Standards and Technology**  
**[formerly National Bureau of Standards]**  
Gaithersburg, Maryland 20899

January 10, 1989

In reply refer to:  
586/999888A

XYZ Corporation  
Hometown, U. S. A.

Attn: Jane Doe / purchasing agent

Subject : Thermometric Test  
Order No: 12345

Enclosed are results of the test which you requested in the above reference. Please refer to the above file number in any later communication, and if you have any questions concerning this test, contact Margaret G. Scroger, telephone number (301) 975-4818.

Sincerely,

B. W. Mangum, Group Leader  
Thermometry Research & Calibration Group  
Temperature and Pressure Division

Material tested:  
1 Thermocouple

Enclosure:  
1 Report of Calibration

UNITED STATES DEPARTMENT OF COMMERCE  
NATIONAL INSTITUTE OF STANDARDS AND TECHNOLOGY  
GAITHERSBURG, MARYLAND

## REPORT OF CALIBRATION

TYPE S THERMOCOUPLE

(Tagged: ZZZ999)

Submitted by

XYZ Corporation  
Hometown, U.S.A.

The thermocouple was calibrated by comparison with a standard type S thermocouple in the range 0° to 1100 °C. Values above 1100 °C were obtained by extrapolation. The calibration procedure is described in Section 4.1 of NBS Circular 590, Methods of Testing Thermocouples and Thermocouple Materials. The thermocouple was electrically annealed in air before testing.

Table 1 gives corresponding values of the emf of the thermocouple in millivolts and the temperature of its measuring junction in °C(IPTS-68) when the reference junctions are at 0 °C. The uncertainties in the values given in the table are estimated not to exceed the equivalent of 0.5 degree in the range 0° to 1100 °C and then increase to not more than the equivalent of 2 degrees at 1450 °C. These uncertainties are discussed in National Bureau of Standards Circular 590. Table 2 gives the coefficients of the equations that were used to compute the values given in table 1. Each equation is valid only within the specified temperature range.

All temperatures in this report are given in degrees Celsius (IPTS-68). The International Practical Temperature Scale of 1968, IPTS-68, was adopted by the International Committee of Weights and Measures at its meeting in October 1968, and is described in "The International Practical Temperature Scale of 1968 Amended Edition of 1975", Metrologia 12, No. 1, 7-17 (1976).

The calibration of a thermocouple may change during use. The magnitude of the change depends upon such factors as the temperature, the length of time, and the conditions under which it is used. Factors affecting the stability of platinum-rhodium vs. platinum thermocouples are discussed in Thermocouple and Radiation Thermometry Above 900 °K, Proceedings of Symposium on Measurement of Thermal Radiation Properties of Solids (1963). Reprints are available from NBS, Temperature and Pressure Division, Gaithersburg, MD 20899.

For the Director  
National Institute of Standards and Technology

B. W. Mangum, Group Leader  
Thermometry Research & Calibration Group  
Temperature and Pressure Division

P.O. No. 12345  
Test No. 999888A  
Date : January 10, 1989

JANUARY 10, 1989  
 TEMP. IN DEGREES CELSIUS (IPTS-68)      TABLE 1      TYPE S THERMOCOUPLE      NIST TEST NO. 999888A  
 REF. JCTS. AT 0 DEGREES CELSIUS.

TEMP	0	1	2	3	4	5	6	7	8	9
0	0.000	0.005	0.011	0.016	0.022	0.027	0.033	0.038	0.044	0.050
10	0.055	0.061	0.067	0.072	0.078	0.084	0.089	0.095	0.101	0.107
20	0.113	0.119	0.125	0.130	0.136	0.142	0.148	0.154	0.160	0.166
30	0.173	0.179	0.185	0.191	0.197	0.203	0.209	0.216	0.222	0.228
40	0.234	0.241	0.247	0.253	0.260	0.266	0.273	0.279	0.285	0.292
50	0.298	0.305	0.311	0.318	0.324	0.331	0.338	0.344	0.351	0.358
60	0.364	0.371	0.378	0.384	0.391	0.398	0.405	0.411	0.418	0.425
70	0.432	0.439	0.446	0.452	0.459	0.466	0.473	0.480	0.487	0.494
80	0.501	0.508	0.515	0.522	0.529	0.536	0.544	0.551	0.558	0.565
90	0.572	0.579	0.587	0.594	0.601	0.608	0.616	0.623	0.630	0.637
100	0.645	0.652	0.659	0.667	0.674	0.681	0.689	0.696	0.704	0.711
110	0.719	0.726	0.734	0.741	0.749	0.756	0.764	0.771	0.779	0.786
120	0.794	0.802	0.809	0.817	0.824	0.832	0.840	0.848	0.855	0.863
130	0.871	0.878	0.886	0.894	0.902	0.909	0.917	0.925	0.933	0.941
140	0.949	0.956	0.964	0.972	0.980	0.988	0.996	1.004	1.012	1.020
150	1.028	1.036	1.044	1.052	1.060	1.068	1.076	1.084	1.092	1.100
160	1.108	1.116	1.124	1.132	1.140	1.148	1.156	1.164	1.173	1.181
170	1.189	1.197	1.205	1.214	1.222	1.230	1.238	1.246	1.255	1.263
180	1.271	1.279	1.288	1.296	1.304	1.313	1.321	1.329	1.338	1.346
190	1.354	1.363	1.371	1.380	1.388	1.396	1.405	1.413	1.422	1.430
200	1.438	1.447	1.455	1.464	1.472	1.481	1.489	1.498	1.506	1.515
210	1.523	1.532	1.541	1.549	1.558	1.566	1.575	1.583	1.592	1.601
220	1.609	1.618	1.626	1.635	1.644	1.652	1.661	1.670	1.678	1.687
230	1.696	1.704	1.713	1.722	1.731	1.739	1.748	1.757	1.766	1.774
240	1.783	1.792	1.801	1.809	1.818	1.827	1.836	1.845	1.853	1.862
250	1.871	1.880	1.889	1.898	1.906	1.915	1.924	1.933	1.942	1.951
260	1.960	1.969	1.978	1.986	1.995	2.004	2.013	2.022	2.031	2.040
270	2.049	2.058	2.067	2.076	2.085	2.094	2.103	2.112	2.121	2.130
280	2.139	2.148	2.157	2.166	2.175	2.184	2.193	2.202	2.211	2.220
290	2.229	2.239	2.248	2.257	2.266	2.275	2.284	2.293	2.302	2.311

JANUARY 10, 1989  
 TEMP. IN DEGREES CELSIUS(IPTS-68)      TABLE 1      TYPE S THERMOCOUPLE      NIST TEST NO. 999888A  
 REF. JCTS. AT 0 DEGREES CELSIUS.

TEMP	0	1	2	3	4	5	6	7	8	9
300	2.321	2.330	2.339	2.348	2.357	2.366	2.375	2.385	2.394	2.403
310	2.412	2.421	2.431	2.440	2.449	2.458	2.467	2.477	2.486	2.495
320	2.504	2.513	2.523	2.532	2.541	2.550	2.560	2.569	2.578	2.588
330	2.597	2.606	2.615	2.625	2.634	2.643	2.653	2.662	2.671	2.681
340	2.690	2.699	2.709	2.718	2.727	2.737	2.746	2.755	2.765	2.774
350	2.783	2.793	2.802	2.812	2.821	2.830	2.840	2.849	2.859	2.868
360	2.877	2.887	2.896	2.906	2.915	2.925	2.934	2.943	2.953	2.962
370	2.972	2.981	2.991	3.000	3.010	3.019	3.029	3.038	3.048	3.057
380	3.067	3.076	3.086	3.095	3.105	3.114	3.124	3.133	3.143	3.152
390	3.162	3.171	3.181	3.190	3.200	3.210	3.219	3.229	3.238	3.248
400	3.257	3.267	3.276	3.286	3.296	3.305	3.315	3.324	3.334	3.344
410	3.353	3.363	3.372	3.382	3.392	3.401	3.411	3.421	3.430	3.440
420	3.450	3.459	3.469	3.478	3.488	3.498	3.507	3.517	3.527	3.536
430	3.546	3.556	3.566	3.575	3.585	3.595	3.604	3.614	3.624	3.633
440	3.643	3.653	3.663	3.672	3.682	3.692	3.701	3.711	3.721	3.731
450	3.740	3.750	3.760	3.770	3.779	3.789	3.799	3.809	3.818	3.828
460	3.838	3.848	3.857	3.867	3.877	3.887	3.897	3.906	3.916	3.926
470	3.936	3.946	3.955	3.965	3.975	3.985	3.995	4.005	4.014	4.024
480	4.034	4.044	4.054	4.064	4.073	4.083	4.093	4.103	4.113	4.123
490	4.133	4.142	4.152	4.162	4.172	4.182	4.192	4.202	4.212	4.221
500	4.231	4.241	4.251	4.261	4.271	4.281	4.291	4.301	4.311	4.320
510	4.330	4.340	4.350	4.360	4.370	4.380	4.390	4.400	4.410	4.420
520	4.430	4.440	4.450	4.460	4.470	4.480	4.490	4.499	4.509	4.519
530	4.529	4.539	4.549	4.559	4.569	4.579	4.589	4.599	4.609	4.619
540	4.629	4.639	4.649	4.659	4.669	4.679	4.689	4.699	4.710	4.720
550	4.730	4.740	4.750	4.760	4.770	4.780	4.790	4.800	4.810	4.820
560	4.830	4.840	4.850	4.860	4.870	4.880	4.891	4.901	4.911	4.921
570	4.931	4.941	4.951	4.961	4.971	4.981	4.992	5.002	5.012	5.022
580	5.032	5.042	5.052	5.062	5.073	5.083	5.093	5.103	5.113	5.123
590	5.133	5.144	5.154	5.164	5.174	5.184	5.194	5.205	5.215	5.225

JANUARY 10, 1989  
 TEMP. IN DEGREES CELSIUS (IPTS-68)

TABLE 1  
 TYPE S THERMOCOUPLE

NIST TEST NO. 999888A  
 REF. JCTS. AT 0 DEGREES CELSIUS.

TEMP	0	1	2	3	4	5	6	7	8	9
600	5.235	5.245	5.256	5.266	5.276	5.286	5.296	5.307	5.317	5.327
610	5.337	5.347	5.358	5.368	5.378	5.388	5.399	5.409	5.419	5.429
620	5.440	5.450	5.460	5.470	5.481	5.491	5.501	5.511	5.522	5.532
630	5.542	5.553	5.563	5.573	5.584	5.594	5.604	5.615	5.625	5.635
640	5.646	5.656	5.666	5.677	5.687	5.697	5.708	5.718	5.729	5.739
650	5.749	5.760	5.770	5.780	5.791	5.801	5.812	5.822	5.832	5.843
660	5.853	5.864	5.874	5.885	5.895	5.905	5.916	5.926	5.937	5.947
670	5.958	5.968	5.979	5.989	5.999	6.010	6.020	6.031	6.041	6.052
680	6.062	6.073	6.083	6.094	6.104	6.115	6.125	6.136	6.146	6.157
690	6.167	6.178	6.188	6.199	6.209	6.220	6.230	6.241	6.251	6.262
700	6.273	6.283	6.294	6.304	6.315	6.325	6.336	6.346	6.357	6.368
710	6.378	6.389	6.399	6.410	6.421	6.431	6.442	6.452	6.463	6.474
720	6.484	6.495	6.505	6.516	6.527	6.537	6.548	6.558	6.569	6.580
730	6.590	6.601	6.612	6.622	6.633	6.644	6.654	6.665	6.676	6.686
740	6.697	6.708	6.718	6.729	6.740	6.750	6.761	6.772	6.783	6.793
750	6.804	6.815	6.825	6.836	6.847	6.858	6.868	6.879	6.890	6.900
760	6.911	6.922	6.933	6.943	6.954	6.965	6.976	6.986	6.997	7.008
770	7.019	7.030	7.040	7.051	7.062	7.073	7.083	7.094	7.105	7.116
780	7.127	7.137	7.148	7.159	7.170	7.181	7.192	7.202	7.213	7.224
790	7.235	7.246	7.257	7.267	7.278	7.289	7.300	7.311	7.322	7.333
800	7.343	7.354	7.365	7.376	7.387	7.398	7.409	7.420	7.430	7.441
810	7.452	7.463	7.474	7.485	7.496	7.507	7.518	7.529	7.540	7.550
820	7.561	7.572	7.583	7.594	7.605	7.616	7.627	7.638	7.649	7.660
830	7.671	7.682	7.693	7.704	7.715	7.726	7.737	7.748	7.759	7.770
840	7.781	7.792	7.803	7.814	7.825	7.836	7.847	7.858	7.869	7.880
850	7.891	7.902	7.913	7.924	7.935	7.946	7.957	7.968	7.979	7.990
860	8.001	8.012	8.024	8.035	8.046	8.057	8.068	8.079	8.090	8.101
870	8.112	8.123	8.134	8.146	8.157	8.168	8.179	8.190	8.201	8.212
880	8.223	8.234	8.246	8.257	8.268	8.279	8.290	8.301	8.312	8.324
890	8.335	8.346	8.357	8.368	8.379	8.391	8.402	8.413	8.424	8.435

JANUARY 10, 1989  
 TEMP. IN DEGREES CELSIUS (IPPTS-68)      TABLE 1      TYPE S THERMOCOUPLE      NIST TEST NO. 999888A  
 REF. JCTS. AT 0 DEGREES CELSIUS.

TEMP	0	1	2	3	4	5	6	7	8	9
900	8.447	8.458	8.469	8.480	8.491	8.503	8.514	8.525	8.536	8.547
910	8.559	8.570	8.581	8.592	8.604	8.615	8.626	8.637	8.649	8.660
920	8.671	8.682	8.694	8.705	8.716	8.727	8.739	8.750	8.761	8.773
930	8.784	8.795	8.806	8.818	8.829	8.840	8.852	8.863	8.874	8.886
940	8.897	8.908	8.920	8.931	8.942	8.954	8.965	8.976	8.988	8.999
950	9.010	9.022	9.033	9.044	9.056	9.067	9.078	9.090	9.101	9.113
960	9.124	9.135	9.147	9.158	9.170	9.181	9.192	9.204	9.215	9.227
970	9.238	9.249	9.261	9.272	9.284	9.295	9.307	9.318	9.329	9.341
980	9.352	9.364	9.375	9.387	9.398	9.410	9.421	9.433	9.444	9.456
990	9.467	9.479	9.490	9.502	9.513	9.525	9.536	9.548	9.559	9.571
1000	9.582	9.594	9.605	9.617	9.628	9.640	9.651	9.663	9.674	9.686
1010	9.697	9.709	9.721	9.732	9.744	9.755	9.767	9.778	9.790	9.801
1020	9.813	9.825	9.836	9.848	9.859	9.871	9.883	9.894	9.906	9.917
1030	9.929	9.941	9.952	9.964	9.976	9.987	9.999	10.010	10.022	10.034
1040	10.045	10.057	10.069	10.080	10.092	10.104	10.115	10.127	10.139	10.150
1050	10.162	10.174	10.185	10.197	10.209	10.220	10.232	10.244	10.256	10.267
1060	10.279	10.291	10.302	10.314	10.326	10.338	10.349	10.361	10.373	10.384
1070	10.396	10.408	10.420	10.431	10.443	10.455	10.467	10.478	10.490	10.502
1080	10.514	10.525	10.537	10.549	10.561	10.573	10.584	10.596	10.608	10.620
1090	10.632	10.643	10.655	10.667	10.679	10.691	10.702	10.714	10.726	10.738
1100	10.750	10.761	10.773	10.785	10.797	10.809	10.820	10.832	10.844	10.856
1110	10.868	10.880	10.892	10.903	10.915	10.927	10.939	10.951	10.963	10.974
1120	10.986	10.998	11.010	11.022	11.034	11.046	11.058	11.069	11.081	11.093
1130	11.105	11.117	11.129	11.141	11.153	11.165	11.176	11.188	11.200	11.212
1140	11.224	11.236	11.248	11.260	11.272	11.284	11.295	11.307	11.319	11.331
1150	11.343	11.355	11.367	11.379	11.391	11.403	11.415	11.427	11.439	11.451
1160	11.462	11.474	11.486	11.498	11.510	11.522	11.534	11.546	11.558	11.570
1170	11.582	11.594	11.606	11.618	11.630	11.642	11.654	11.666	11.678	11.690
1180	11.702	11.714	11.726	11.738	11.750	11.762	11.774	11.786	11.798	11.810
1190	11.822	11.834	11.846	11.858	11.870	11.882	11.894	11.906	11.918	11.930

JANUARY 10, 1989  
 TEMP. IN DEGREES CELSIUS (IPTS-68)

TABLE 1  
 TYPE S THERMOCOUPLE  
 EMF IN MILLIVOLTS, REF. JCTS. AT 0 DEGREES CELSIUS.

NIST TEST NO. 999888A  
 REF. JCTS. AT 0 DEGREES CELSIUS.

TEMP	0	1	2	3	4	5	6	7	8	9
1200	11.942	11.954	11.966	11.978	11.990	12.002	12.014	12.026	12.038	12.050
1210	12.062	12.074	12.086	12.098	12.110	12.122	12.134	12.146	12.158	12.170
1220	12.182	12.194	12.206	12.218	12.230	12.242	12.254	12.266	12.278	12.290
1230	12.302	12.314	12.327	12.339	12.351	12.363	12.375	12.387	12.399	12.411
1240	12.423	12.435	12.447	12.459	12.471	12.483	12.495	12.507	12.519	12.531
1250	12.544	12.556	12.568	12.580	12.592	12.604	12.616	12.628	12.640	12.652
1260	12.664	12.676	12.688	12.701	12.713	12.725	12.737	12.749	12.761	12.773
1270	12.785	12.797	12.809	12.821	12.833	12.846	12.858	12.870	12.882	12.894
1280	12.906	12.918	12.930	12.942	12.954	12.966	12.979	12.991	13.003	13.015
1290	13.027	13.039	13.051	13.063	13.075	13.087	13.100	13.112	13.124	13.136
1300	13.148	13.160	13.172	13.184	13.196	13.209	13.221	13.233	13.245	13.257
1310	13.269	13.281	13.293	13.305	13.318	13.330	13.342	13.354	13.366	13.378
1320	13.390	13.402	13.414	13.427	13.439	13.451	13.463	13.475	13.487	13.499
1330	13.511	13.523	13.536	13.548	13.560	13.572	13.584	13.596	13.608	13.620
1340	13.633	13.645	13.657	13.669	13.681	13.693	13.705	13.717	13.729	13.742
1350	13.754	13.766	13.778	13.790	13.802	13.814	13.826	13.839	13.851	13.863
1360	13.875	13.887	13.899	13.911	13.923	13.935	13.948	13.960	13.972	13.984
1370	13.996	14.008	14.020	14.032	14.045	14.057	14.069	14.081	14.093	14.105
1380	14.117	14.129	14.141	14.154	14.166	14.178	14.190	14.202	14.214	14.226
1390	14.238	14.250	14.263	14.275	14.287	14.299	14.311	14.323	14.335	14.347
1400	14.359	14.372	14.384	14.396	14.408	14.420	14.432	14.444	14.456	14.468
1410	14.481	14.493	14.505	14.517	14.529	14.541	14.553	14.565	14.577	14.589
1420	14.602	14.614	14.626	14.638	14.650	14.662	14.674	14.686	14.698	14.710
1430	14.722	14.735	14.747	14.759	14.771	14.783	14.795	14.807	14.819	14.831
1440	14.843	14.855	14.868	14.880	14.892	14.904	14.916	14.928	14.940	14.952
1450	14.964									



TABLE 2

COEFFICIENTS OF EQUATIONS USED TO CALCULATE TABLE 1

FOR DEGREES CELSIUS TABLE

Temperature Range---	0.0 to 630.74	630.74 to 1064.43	1064.43 to 1450.0
A =	+0.000000E+00	-3.1737366E-01	+1.2890636E+00
B =	+5.3964199E-03	+8.2819167E-03	+3.4821494E-03
C =	+1.2473157E-05	+1.6175332E-06	+6.3824649E-06
D =	-2.2304367E-08		-1.5722425E-09
E =	+2.8339764E-11		
F =	-2.2440585E-14		
G =	+8.5054170E-18		

The equations are of the form:

$$EE = A + BT + CT^{**2} + DT^{**3} + ET^{**4} + FT^{**5} + GT^{**6}$$

Where EE is the emf in millivolts and  
T is the temperature in degrees Celsius (IPITS-68)

#### 8.1.2.2 Summary of Calibration Results for NIST Record

TEST THERMOCOUPLE NUMBER 999888A

COEFFICIENTS FOR EMF EQUATIONS FOR STANDARD THERMOCOUPLE SC-83-13

Temperature range ...	0 to 630.74	630.74 to 1064.43	1064.43 to 1450
A =	+0.0000000E+00	-3.1875966E+02	+1.2839709E+03
B =	+5.3893631E+00	+8.2906905E+00	+3.4978878E+00
C =	+1.2544059E-02	+1.6208047E-03	+6.3824649E-03
D =	-2.2448218E-05		-1.5722425E-06
E =	+2.8452165E-08		
F =	-2.2440585E-11		
G =	+8.5054170E-15		

JANUARY 10, 1989      TYPE S THERMOCOUPLE      NIST TEST NO.      999888A

TEMPERATURE DEG C	S		DELTA (TEST - STD)
	STANDARD SC-83-13	TEST 999888A	
76.612	477.343	478.631	1.288
77.020	480.187	479.731	-0.456
91.034	579.456	579.669	0.213
91.341	581.663	582.100	0.437
110.937	725.562	725.294	-0.268
111.243	727.850	728.087	0.237
136.647	922.300	922.256	-0.044
137.047	925.425	924.994	-0.431
166.836	1163.325	1163.119	-0.206
167.311	1167.194	1166.756	-0.438
200.677	1444.656	1444.188	-0.468
201.098	1448.225	1447.662	-0.563
236.645	1754.425	1754.056	-0.369
237.159	1758.919	1757.950	-0.969
274.869	2093.790	2092.516	-1.274
275.340	2098.026	2096.950	-1.076
312.280	2434.460	2433.416	-1.044
312.739	2438.686	2437.560	-1.126
349.301	2778.610	2776.506	-2.104
349.724	2782.586	2781.340	-1.246

385.818	3123.980	3121.746	-2.234
386.300	3128.566	3126.240	-2.326
421.330	3464.750	3462.376	-2.374
421.755	3468.846	3466.040	-2.806
458.144	3822.570	3819.976	-2.594
458.593	3826.966	3824.680	-2.286
495.478	4189.796	4186.674	-3.123
495.867	4193.644	4190.256	-3.387
531.272	4545.756	4542.024	-3.733
531.682	4549.854	4546.166	-3.688
566.522	4899.976	4895.744	-4.233
566.923	4904.034	4899.806	-4.227
599.061	5230.326	5225.424	-4.903
599.434	5234.134	5229.596	-4.538
631.947	5567.796	5562.604	-5.193
632.256	5570.984	5565.636	-5.348
663.576	5896.426	5891.094	-5.333
663.936	5900.194	5893.886	-6.308
697.641	6254.010	6247.540	-6.470
697.963	6257.410	6251.360	-6.050
731.594	6614.160	6607.360	-6.800
731.887	6617.280	6610.760	-6.520
764.647	6968.350	6960.710	-7.640
764.907	6971.150	6963.940	-7.210
797.511	7324.030	7316.190	-7.840
797.752	7326.650	7319.360	-7.290
828.179	7659.090	7651.130	-7.960
828.403	7661.550	7653.960	-7.590
859.778	8007.520	7998.400	-9.120
859.999	8009.960	8001.490	-8.470
893.134	8378.824	8369.424	-9.400
893.345	8381.184	8371.654	-9.530
922.780	8711.854	8702.444	-9.410
922.942	8713.684	8704.544	-9.140
952.887	9052.984	9043.354	-9.630
953.157	9056.054	9045.874	-10.180
986.397	9436.124	9425.444	-10.680
986.569	9438.094	9427.434	-10.660
1011.841	9729.474	9719.024	-10.450
1012.005	9731.374	9720.444	-10.930
1035.874	10008.504	9997.254	-11.250
1035.999	10009.954	9998.704	-11.250
1062.721	10322.410	10311.251	-11.159
1062.846	10323.881	10311.760	-12.121
1078.479	10507.750	10496.041	-11.709
1078.702	10510.381	10498.450	-11.931

TEMPERATURE	DELTA EMF	CALC DELTA	DEVIATION	WEIGHTS
76.6118	+1.2878	+0.1853	+1.1025	1
77.0200	-0.4558	+0.1847	-0.6405	1
91.0343	+0.2127	+0.1556	+0.0571	1
91.3410	+0.4373	+0.1548	+0.2825	1
110.9373	-0.2683	+0.0896	-0.3579	1
111.2430	+0.2373	+0.0884	+0.1489	1
136.6473	-0.0443	-0.0318	-0.0125	1
137.0471	-0.4307	-0.0339	-0.3968	1
166.8361	-0.2063	-0.2153	+0.0090	1
167.3106	-0.4377	-0.2184	-0.2193	1
200.6770	-0.4682	-0.4589	-0.0093	1
201.0984	-0.5627	-0.4622	-0.1005	1
236.6454	-0.3693	-0.7468	+0.3775	1
237.1589	-0.9687	-0.7510	-0.2177	1
274.8693	-1.2737	-1.0714	-0.2023	1
275.3399	-1.0763	-1.0755	-0.0008	1
312.2800	-1.0437	-1.3988	+0.3551	1
312.7389	-1.1263	-1.4028	+0.2765	1
349.3006	-2.1037	-1.7284	-0.3753	1
349.7244	-1.2463	-1.7322	+0.4859	1
385.8184	-2.2337	-2.0606	-0.1731	1
386.2996	-2.3263	-2.0650	-0.2613	1
421.3305	-2.3737	-2.3961	+0.0224	1
421.7545	-2.8063	-2.4002	-0.4061	1
458.1438	-2.5937	-2.7679	+0.1742	1
458.5933	-2.2863	-2.7726	+0.4863	1
495.4782	-3.1225	-3.1863	+0.0638	1
495.8671	-3.3875	-3.1909	-0.1966	1
531.2723	-3.7325	-3.6468	-0.0857	1
531.6821	-3.6875	-3.6525	-0.0350	1
566.5216	-4.2325	-4.1805	-0.0520	1
566.9232	-4.2274	-4.1872	-0.0402	1
599.0609	-4.9025	-4.7674	-0.1351	1
599.4340	-4.5376	-4.7748	+0.2372	1

COEFFICIENTS FOR DELTA EQUATION  
0 TO 630.74 deg C

	COEFFICIENT	STD. DEV
A =	+7.0567866E-03	+3.1108755E-03
B =	-7.0901970E-05	+2.8337852E-05
C =	+1.4385087E-07	+7.9296834E-08
D =	-1.1240066E-10	+6.8894828E-11

STANDARD DEVIATION = 0.343

JANUARY 10, 1989 TYPE S THERMOCOUPLE NIST TEST NO. 999888A

TEMPERATURE	DELTA EMF -DELTA(630.74)	CALC (DELTA - DELTA(630.74))	DEVIATION	MEASURED DELTA	WEIGHTS	CALC DELTA
631.9474	+0.2570	-0.0156	+0.2726	-5.1925	1	-5.4651
632.2557	+0.1019	-0.0196	+0.1215	-5.3476	1	-5.4691
663.5755	+0.1170	-0.4271	+0.5442	-5.3325	1	-5.8767
663.9363	-0.8581	-0.4319	-0.4262	-6.3076	1	-5.8814
697.6410	-1.0205	-0.8777	-0.1427	-6.4700	1	-6.3273
697.9632	-0.6005	-0.8820	+0.2816	-6.0500	1	-6.3316
731.5942	-1.3505	-1.3344	-0.0161	-6.8000	1	-6.7839
731.8868	-1.0705	-1.3383	+0.2679	-6.5200	1	-6.7879
764.6470	-2.1905	-1.7862	-0.4043	-7.6400	1	-7.2357
764.9070	-1.7605	-1.7898	+0.0293	-7.2100	1	-7.2393
797.5112	-2.3905	-2.2425	-0.1480	-7.8400	1	-7.6920
797.7521	-1.8405	-2.2458	+0.4054	-7.2900	1	-7.6954
828.1787	-2.5105	-2.6746	+0.1642	-7.9600	1	-8.1242
828.4028	-2.1405	-2.6778	+0.5374	-7.5900	1	-8.1274
859.7782	-3.6705	-3.1264	-0.5441	-9.1200	1	-8.5759
859.9985	-3.0205	-3.1296	+0.1091	-8.4700	1	-8.5791
893.1342	-3.9505	-3.6103	-0.3401	-9.4000	1	-9.0599
893.3452	-4.0805	-3.6134	-0.4670	-9.5300	1	-9.0630
922.7801	-3.9605	-4.0466	+0.0861	-9.4100	1	-9.4961
922.9423	-3.6905	-4.0490	+0.3585	-9.1400	1	-9.4985
952.8875	-4.1805	-4.4955	+0.3150	-9.6300	1	-9.9450
953.1572	-4.7304	-4.4995	-0.2308	-10.1799	1	-9.9491
986.3972	-5.2305	-5.0021	-0.2284	-10.6800	1	-10.4516
986.5687	-5.2105	-5.0047	-0.2058	-10.6600	1	-10.4542
1011.8407	-5.0004	-5.3917	+0.3913	-10.4499	1	-10.8412
1012.0049	-5.4805	-5.3942	-0.0863	-10.9300	1	-10.8437
1035.8744	-5.8005	-5.7635	-0.0369	-11.2500	1	-11.2131
1035.9988	-5.8005	-5.7655	-0.0350	-11.2500	1	-11.2150
1062.7208	-5.7092	-6.1834	+0.4742	-11.1587	1	-11.6329
1062.8461	-6.6718	-6.1854	-0.4864	-12.1213	1	-11.6349
1078.4786	-6.2592	-6.4320	+0.1729	-11.7087	1	-11.8816
1078.7019	-6.4818	-6.4356	-0.0462	-11.9313	1	-11.8851

COEFFICIENTS FOR DELTA EQUATION  
630.74 TO 1064.43 deg C

DE - DE(630.74) = FUNCTION (T-630.74)	DEV	DE=FUNCTION(T)
A =		1.3859960E+00
B =	+4.0501558E-07	-8.7738436E-03
C =	+5.4448175E-11	-3.2715191E-06

STANDARD DEVIATION = 0.3200

CALCULATED DELTA AT 630.74 = -5.4495 MICROVOLTS

CALCULATED DELTA AT 1064.43 = -11.6598 MICROVOLTS

SLOPE OF DELTA AT 1064.43 = -0.0157 MICROVOLTS / deg C

( 'AT' COMPUTER)

CALCULATED FIXED POINT EMF VALUES IN MICROVOLTS      EMF(TABLE) - EMF(TC)  
MICROVOLTS

1064.43	(GOLD POINT)	- 10330.83	+3.5
961.93	(SILVER POINT)	- 9145.97	+2.2
630.74		- 5549.87	+2.2
419.58	(ZINC POINT)	- 3445.48	+2.4

COEFFICIENTS FOR EMF EQUATIONS

TEMPERATURE RANGE---	0.0 TO 630.74	630.74 TO 1064.43	1064.43 TO 1450.0
A =	+0.0000000E+00	-3.1737366E+02	+1.2890636E+03
B =	+5.3964199E+00	+8.2819167E+00	+3.4821494E+00
C =	+1.2473157E-02	+1.6175332E-03	+6.3824649E-03
D =	-2.2304367E-05		-1.5722425E-06
E =	+2.8339764E-08		
F =	-2.2440585E-11		
G =	+8.5054170E-15		

IPTS CRITERIA

- 1) E(Au)-10334. = -3.46986678822
- 2) E(Au)-E(Ag)-1186-.17(E(Au)-10334) = -0.548950378131
- 3) E(Au)-E(630.74)-4782-.63(E(Au)-10334) = 1.14583423497

THIS THERMOCOUPLE DOES NOT MEET THE CONDITIONS FOR A STANDARD THERMOCOUPLE IF:

- CRITERIA 1) IS GREATER THAN 30
- CRITERIA 2) IS GREATER THAN 3
- CRITERIA 3) IS GREATER THAN 5

Pt leg vs. Pt-67 = -2.2uV AT 1105.80 deg C

0	0.0	+0.0
100	644.7	+0.7
200	1438.5	+1.5
300	2320.5	+2.2
400	3257.3	+2.4
500	4231.3	+2.3
600	5235.1	+2.2
700	6272.6	+1.7
800	7343.4	+1.5
900	8446.6	+1.8
1000	9582.1	+2.6
1100	10749.6	+4.0
1200	11941.6	+5.5
1300	13148.0	+7.0
1400	14359.5	+8.5
1450	14964.1	+9.2

DEGREES C TABLE GIVEN

TABLE 2  
FOR TEST FOLDER ('AT' COMPUTER)

COEFFICIENTS OF EQUATIONS USED TO CALCULATE TABLE 1

FOR DEGREES CELSIUS TABLE

Temperature Range---	0.0 to 630.74	630.74 to 1064.43	1064.43 to 1450.0
A =	+0.000000E+00	-3.1737366E-01	+1.2890636E+00
B =	+5.3964199E-03	+8.2819167E-03	+3.4821494E-03
C =	+1.2473157E-05	+1.6175332E-06	+6.3824649E-06
D =	-2.2304367E-08		-1.5722425E-09
E =	+2.8339764E-11		
F =	-2.2440585E-14		
G =	+8.5054170E-18		

The equations are of the form:

$$EE = A + BT + CT^{**2} + DT^{**3} + ET^{**4} + FT^{**5} + GT^{**6}$$

Where EE is the emf in millivolts and  
T is the temperature in degrees Celsius (IPTS-68)



**8.1.3 Type R Thermocouple - Comparison Calibration**

**8.1.3.1 Covering Letter and Bound Calibration Report for Customer**



**UNITED STATES DEPARTMENT OF COMMERCE**  
**National Institute of Standards and Technology**  
**[formerly National Bureau of Standards]**  
Gaithersburg, Maryland 20899

January 10, 1989

In reply refer to:  
586/999999

AAA Company  
Any Town, Any State

Attn: John Doe / purchasing agent

Subject : Thermometric Test  
Order No: AB123

Enclosed are results of the test which you requested in the above reference. Please refer to the above file number in any later communication, and if you have any questions concerning this test, contact Margaret G. Scroger, telephone number (301) 975-4818.

Sincerely,

B. W. Mangum, Group Leader  
Thermometry Research & Calibration Group  
Temperature and Pressure Division

Material tested:  
1 Thermocouple

Enclosure:  
1 Report of Calibration

UNITED STATES DEPARTMENT OF COMMERCE  
NATIONAL INSTITUTE OF STANDARDS AND TECHNOLOGY  
GAITHERSBURG, MARYLAND

## REPORT OF CALIBRATION

TYPE R THERMOCOUPLE

(Tagged: AAA111)

Submitted by

AAA Company  
Any Town, Any State

The thermocouple was calibrated by comparison with a standard type S thermocouple in the range 0° to 1100 °C. Values above 1100 °C were obtained by extrapolation. The calibration procedure is described in Section 4.1 of NBS Circular 590, Methods of Testing Thermocouples and Thermocouple Materials. The thermocouple was electrically annealed in air before testing.

Table 1 gives corresponding values of the emf of the thermocouple in millivolts and the temperature of its measuring junction in °C (IPTS-68) when the reference junctions are at 0 °C. The uncertainties in the values given in the table are estimated not to exceed the equivalent of 0.5 degree in the range 0° to 1100 °C and then increase to not more than the equivalent of 2 degrees at 1450 °C. These uncertainties are discussed in National Bureau of Standards Circular 590. Table 2 gives the coefficients of the equations that were used to compute the values given in table 1. Each equation is valid only within the specified temperature range.

All temperatures in this report are given in degrees Celsius (IPTS-68). The International Practical Temperature Scale of 1968, IPTS-68, was adopted by the International Committee of Weights and Measures at its meeting in October, 1968, and is described in "The International Practical Temperature Scale of 1968 Amended Edition of 1975," Metrologia 12, No. 1, 7-17 (1976).

The calibration of a thermocouple may change during use. The magnitude of the change depends upon such factors as the temperature, the length of time, and the conditions under which it is used. Factors affecting the stability of platinum-rhodium thermocouples are discussed in Thermocouple and Radiation Thermometry Above 900°K, Proceedings of Symposium on Measurement of Thermal Radiation Properties of Solids (1963). Reprints are available from NBS, Temperature and Pressure Division, Gaithersburg, Maryland 20899.

For the Director  
National Institute of Standards and Technology

B. W. Mangum, Group Leader  
Thermometry Research & Calibration Group  
Temperature and Pressure Division

P.O. No. AB123  
Test No. 999999  
Date : January 10, 1989

JANUARY 10, 1989  
 TEMP. IN DEGREES CELSIUS(IPTS-68),  
 TYPE R THERMOCOUPLE  
 EMF IN MILLIVOLTS,  
 REF. JCTS. AT 0 DEGREES CELSIUS.  
 NIST TEST NO. 999999

TEMP	0	1	2	3	4	5	6	7	8	9
0	0.000	0.005	0.011	0.016	0.021	0.027	0.032	0.038	0.043	0.048
10	0.054	0.060	0.065	0.071	0.076	0.082	0.088	0.093	0.099	0.105
20	0.111	0.116	0.122	0.128	0.134	0.140	0.146	0.152	0.158	0.164
30	0.170	0.176	0.182	0.188	0.194	0.200	0.206	0.213	0.219	0.225
40	0.231	0.238	0.244	0.250	0.257	0.263	0.269	0.276	0.282	0.289
50	0.295	0.302	0.308	0.315	0.321	0.328	0.335	0.341	0.348	0.355
60	0.361	0.368	0.375	0.381	0.388	0.395	0.402	0.409	0.416	0.422
70	0.429	0.436	0.443	0.450	0.457	0.464	0.471	0.478	0.485	0.492
80	0.499	0.506	0.514	0.521	0.528	0.535	0.542	0.549	0.557	0.564
90	0.571	0.579	0.586	0.593	0.601	0.608	0.615	0.623	0.630	0.637
100	0.645	0.652	0.660	0.667	0.675	0.682	0.690	0.698	0.705	0.713
110	0.720	0.728	0.736	0.743	0.751	0.759	0.766	0.774	0.782	0.790
120	0.797	0.805	0.813	0.821	0.829	0.836	0.844	0.852	0.860	0.868
130	0.876	0.884	0.892	0.900	0.908	0.916	0.924	0.932	0.940	0.948
140	0.956	0.964	0.972	0.980	0.988	0.997	1.005	1.013	1.021	1.029
150	1.038	1.046	1.054	1.062	1.071	1.079	1.087	1.095	1.104	1.112
160	1.120	1.129	1.137	1.146	1.154	1.162	1.171	1.179	1.188	1.196
170	1.205	1.213	1.222	1.230	1.239	1.247	1.256	1.264	1.273	1.281
180	1.290	1.299	1.307	1.316	1.325	1.333	1.342	1.351	1.359	1.368
190	1.377	1.385	1.394	1.403	1.412	1.420	1.429	1.438	1.447	1.456
200	1.464	1.473	1.482	1.491	1.500	1.509	1.518	1.526	1.535	1.544
210	1.553	1.562	1.571	1.580	1.589	1.598	1.607	1.616	1.625	1.634
220	1.643	1.652	1.661	1.670	1.679	1.689	1.698	1.707	1.716	1.725
230	1.734	1.743	1.752	1.762	1.771	1.780	1.789	1.798	1.808	1.817
240	1.826	1.835	1.845	1.854	1.863	1.872	1.882	1.891	1.900	1.910
250	1.919	1.928	1.938	1.947	1.956	1.966	1.975	1.984	1.994	2.003
260	2.013	2.022	2.031	2.041	2.050	2.060	2.069	2.079	2.088	2.098
270	2.107	2.117	2.126	2.136	2.145	2.155	2.164	2.174	2.184	2.193
280	2.203	2.212	2.222	2.231	2.241	2.251	2.260	2.270	2.280	2.289
290	2.299	2.309	2.318	2.328	2.338	2.347	2.357	2.367	2.376	2.386

JANUARY 10, 1989  
 TEMP. IN DEGREES CELSIUS(IPTS-68), TYPE R THERMOCOUPLE REF. JCTS. AT 0 DEGREES CELSIUS.  
 NIST TEST NO. 999999

TABLE 1  
 EMF IN MILLIVOLTS, EMF

TEMP	0	1	2	3	4	5	6	7	8	9
300	2.396	2.406	2.415	2.425	2.435	2.445	2.455	2.464	2.474	2.484
310	2.494	2.504	2.513	2.523	2.533	2.543	2.553	2.563	2.572	2.582
320	2.592	2.602	2.612	2.622	2.632	2.642	2.652	2.662	2.671	2.681
330	2.691	2.701	2.711	2.721	2.731	2.741	2.751	2.761	2.771	2.781
340	2.791	2.801	2.811	2.821	2.831	2.841	2.851	2.862	2.872	2.882
350	2.892	2.902	2.912	2.922	2.932	2.942	2.952	2.963	2.973	2.983
360	2.993	3.003	3.013	3.023	3.034	3.044	3.054	3.064	3.074	3.084
370	3.095	3.105	3.115	3.125	3.136	3.146	3.156	3.166	3.177	3.187
380	3.197	3.207	3.218	3.228	3.238	3.248	3.259	3.269	3.279	3.290
390	3.300	3.310	3.321	3.331	3.341	3.352	3.362	3.372	3.383	3.393
400	3.404	3.414	3.424	3.435	3.445	3.456	3.466	3.476	3.487	3.497
410	3.508	3.518	3.529	3.539	3.549	3.560	3.570	3.581	3.591	3.602
420	3.612	3.623	3.633	3.644	3.654	3.665	3.675	3.686	3.696	3.707
430	3.717	3.728	3.738	3.749	3.760	3.770	3.781	3.791	3.802	3.812
440	3.823	3.834	3.844	3.855	3.865	3.876	3.887	3.897	3.908	3.919
450	3.929	3.940	3.951	3.961	3.972	3.983	3.993	4.004	4.015	4.025
460	4.036	4.047	4.057	4.068	4.079	4.089	4.100	4.111	4.122	4.132
470	4.143	4.154	4.165	4.175	4.186	4.197	4.208	4.218	4.229	4.240
480	4.251	4.262	4.272	4.283	4.294	4.305	4.316	4.326	4.337	4.348
490	4.359	4.370	4.381	4.391	4.402	4.413	4.424	4.435	4.446	4.457
500	4.468	4.478	4.489	4.500	4.511	4.522	4.533	4.544	4.555	4.566
510	4.577	4.588	4.599	4.609	4.620	4.631	4.642	4.653	4.664	4.675
520	4.686	4.697	4.708	4.719	4.730	4.741	4.752	4.763	4.774	4.785
530	4.796	4.807	4.818	4.829	4.840	4.851	4.862	4.874	4.885	4.896
540	4.907	4.918	4.929	4.940	4.951	4.962	4.973	4.984	4.995	5.007
550	5.018	5.029	5.040	5.051	5.062	5.073	5.084	5.096	5.107	5.118
560	5.129	5.140	5.151	5.163	5.174	5.185	5.196	5.207	5.219	5.230
570	5.241	5.252	5.263	5.275	5.286	5.297	5.308	5.319	5.331	5.342
580	5.353	5.364	5.376	5.387	5.398	5.409	5.421	5.432	5.443	5.455
590	5.466	5.477	5.488	5.500	5.511	5.522	5.534	5.545	5.556	5.568

JANUARY 10, 1989  
 TEMP. IN DEGREES CELSIUS (IPTS-68),  
 TYPE R THERMOCOUPLE  
 EMF IN MILLIVOLTS,  
 REF. JCTS. AT 0 DEGREES CELSIUS,  
 NIST TEST NO. 999999

TEMP	0	1	2	3	4	5	6	7	8	9
600	5.579	5.590	5.602	5.613	5.624	5.636	5.647	5.658	5.670	5.681
610	5.693	5.704	5.715	5.727	5.738	5.749	5.761	5.772	5.784	5.795
620	5.807	5.818	5.829	5.841	5.852	5.864	5.875	5.887	5.898	5.909
630	5.921	5.932	5.944	5.955	5.967	5.978	5.990	6.002	6.013	6.025
640	6.036	6.048	6.059	6.071	6.083	6.094	6.106	6.117	6.129	6.141
650	6.152	6.164	6.176	6.187	6.199	6.210	6.222	6.234	6.245	6.257
660	6.269	6.280	6.292	6.304	6.315	6.327	6.339	6.351	6.362	6.374
670	6.386	6.397	6.409	6.421	6.433	6.444	6.456	6.468	6.480	6.491
680	6.503	6.515	6.527	6.538	6.550	6.562	6.574	6.586	6.597	6.609
690	6.621	6.633	6.645	6.656	6.668	6.680	6.692	6.704	6.716	6.728
700	6.739	6.751	6.763	6.775	6.787	6.799	6.811	6.823	6.834	6.846
710	6.858	6.870	6.882	6.894	6.906	6.918	6.930	6.942	6.954	6.966
720	6.978	6.989	7.001	7.013	7.025	7.037	7.049	7.061	7.073	7.085
730	7.097	7.109	7.121	7.133	7.145	7.157	7.169	7.181	7.193	7.206
740	7.218	7.230	7.242	7.254	7.266	7.278	7.290	7.302	7.314	7.326
750	7.338	7.350	7.362	7.375	7.387	7.399	7.411	7.423	7.435	7.447
760	7.459	7.472	7.484	7.496	7.508	7.520	7.532	7.545	7.557	7.569
770	7.581	7.593	7.605	7.618	7.630	7.642	7.654	7.667	7.679	7.691
780	7.703	7.715	7.728	7.740	7.752	7.764	7.777	7.789	7.801	7.813
790	7.826	7.838	7.850	7.863	7.875	7.887	7.900	7.912	7.924	7.936
800	7.949	7.961	7.973	7.986	7.998	8.010	8.023	8.035	8.048	8.060
810	8.072	8.085	8.097	8.109	8.122	8.134	8.147	8.159	8.171	8.184
820	8.196	8.209	8.221	8.233	8.246	8.258	8.271	8.283	8.296	8.308
830	8.321	8.333	8.346	8.358	8.370	8.383	8.395	8.408	8.420	8.433
840	8.445	8.458	8.470	8.483	8.496	8.508	8.521	8.533	8.546	8.558
850	8.571	8.583	8.596	8.608	8.621	8.634	8.646	8.659	8.671	8.684
860	8.696	8.709	8.722	8.734	8.747	8.760	8.772	8.785	8.797	8.810
870	8.823	8.835	8.848	8.861	8.873	8.886	8.899	8.911	8.924	8.937
880	8.949	8.962	8.975	8.987	9.000	9.013	9.025	9.038	9.051	9.064
890	9.076	9.089	9.102	9.115	9.127	9.140	9.153	9.166	9.178	9.191

JANUARY 10, 1989  
 TEMP. IN DEGREES CELSIUS(IPTS-68),  
 TYPE R THERMOCOUPLE  
 EMF IN MILLIVOLTS, REF. JCTS. AT 0 DEGREES CELSIUS.  
 NIST TEST NO. 999999

TEMP	0	1	2	3	4	5	6	7	8	9
900	9.204	9.217	9.229	9.242	9.255	9.268	9.281	9.293	9.306	9.319
910	9.332	9.345	9.357	9.370	9.383	9.396	9.409	9.422	9.435	9.447
920	9.460	9.473	9.486	9.499	9.512	9.525	9.537	9.550	9.563	9.576
930	9.589	9.602	9.615	9.628	9.641	9.654	9.667	9.680	9.692	9.705
940	9.718	9.731	9.744	9.757	9.770	9.783	9.796	9.809	9.822	9.835
950	9.848	9.861	9.874	9.887	9.900	9.913	9.926	9.939	9.952	9.965
960	9.978	9.991	10.004	10.017	10.030	10.043	10.056	10.070	10.083	10.096
970	10.109	10.122	10.135	10.148	10.161	10.174	10.187	10.200	10.213	10.227
980	10.240	10.253	10.266	10.279	10.292	10.305	10.319	10.332	10.345	10.358
990	10.371	10.384	10.397	10.411	10.424	10.437	10.450	10.463	10.477	10.490
1000	10.503	10.516	10.529	10.543	10.556	10.569	10.582	10.596	10.609	10.622
1010	10.635	10.649	10.662	10.675	10.688	10.702	10.715	10.728	10.741	10.755
1020	10.768	10.781	10.795	10.808	10.821	10.834	10.848	10.861	10.874	10.888
1030	10.901	10.914	10.928	10.941	10.954	10.968	10.981	10.995	11.008	11.021
1040	11.035	11.048	11.061	11.075	11.088	11.102	11.115	11.128	11.142	11.155
1050	11.169	11.182	11.195	11.209	11.222	11.236	11.249	11.263	11.276	11.289
1060	11.303	11.316	11.330	11.343	11.357	11.370	11.384	11.397	11.411	11.424
1070	11.438	11.451	11.465	11.478	11.492	11.505	11.519	11.532	11.546	11.559
1080	11.573	11.586	11.600	11.614	11.627	11.641	11.654	11.668	11.681	11.695
1090	11.708	11.722	11.736	11.749	11.763	11.776	11.790	11.803	11.817	11.831
1100	11.844	11.858	11.871	11.885	11.899	11.912	11.926	11.940	11.953	11.967
1110	11.980	11.994	12.008	12.021	12.035	12.049	12.062	12.076	12.090	12.103
1120	12.117	12.131	12.144	12.158	12.172	12.185	12.199	12.213	12.226	12.240
1130	12.254	12.268	12.281	12.295	12.309	12.322	12.336	12.350	12.364	12.377
1140	12.391	12.405	12.419	12.432	12.446	12.460	12.473	12.487	12.501	12.515
1150	12.529	12.542	12.556	12.570	12.584	12.597	12.611	12.625	12.639	12.652
1160	12.666	12.680	12.694	12.708	12.721	12.735	12.749	12.763	12.777	12.790
1170	12.804	12.818	12.832	12.846	12.860	12.873	12.887	12.901	12.915	12.929
1180	12.943	12.956	12.970	12.984	12.998	13.012	13.026	13.039	13.053	13.067
1190	13.081	13.095	13.109	13.123	13.137	13.150	13.164	13.178	13.192	13.206

JANUARY 10, 1989  
 TEMP. IN DEGREES CELSIUS(IPTS-68),  
 TYPE R THERMOCOUPLE  
 EMF IN MILLIVOLTS, REF. JCTS. AT 0 DEGREES CELSIUS.  
 NIST TEST NO. 999999

TEMP	0	1	2	3	4	5	6	7	8	9
1200	13.220	13.234	13.248	13.261	13.275	13.289	13.303	13.317	13.331	13.345
1210	13.359	13.373	13.387	13.401	13.414	13.428	13.442	13.456	13.470	13.484
1220	13.498	13.512	13.526	13.540	13.554	13.568	13.582	13.596	13.609	13.623
1230	13.637	13.651	13.665	13.679	13.693	13.707	13.721	13.735	13.749	13.763
1240	13.777	13.791	13.805	13.819	13.833	13.847	13.861	13.875	13.889	13.903
1250	13.917	13.931	13.945	13.959	13.973	13.987	14.001	14.015	14.029	14.043
1260	14.057	14.071	14.085	14.099	14.113	14.127	14.141	14.155	14.169	14.183
1270	14.197	14.211	14.225	14.239	14.253	14.267	14.281	14.295	14.309	14.323
1280	14.337	14.351	14.365	14.379	14.393	14.407	14.421	14.435	14.449	14.463
1290	14.477	14.491	14.505	14.519	14.533	14.547	14.562	14.576	14.590	14.604
1300	14.618	14.632	14.646	14.660	14.674	14.688	14.702	14.716	14.730	14.744
1310	14.758	14.772	14.786	14.801	14.815	14.829	14.843	14.857	14.871	14.885
1320	14.899	14.913	14.927	14.941	14.955	14.969	14.983	14.998	15.012	15.026
1330	15.040	15.054	15.068	15.082	15.096	15.110	15.124	15.138	15.152	15.166
1340	15.181	15.195	15.209	15.223	15.237	15.251	15.265	15.279	15.293	15.307
1350	15.321	15.336	15.350	15.364	15.378	15.392	15.406	15.420	15.434	15.448
1360	15.462	15.477	15.491	15.505	15.519	15.533	15.547	15.561	15.575	15.589
1370	15.603	15.618	15.632	15.646	15.660	15.674	15.688	15.702	15.716	15.730
1380	15.744	15.759	15.773	15.787	15.801	15.815	15.829	15.843	15.857	15.871
1390	15.885	15.900	15.914	15.928	15.942	15.956	15.970	15.984	15.998	16.012
1400	16.026	16.041	16.055	16.069	16.083	16.097	16.111	16.125	16.139	16.153
1410	16.167	16.182	16.196	16.210	16.224	16.238	16.252	16.266	16.280	16.294
1420	16.308	16.323	16.337	16.351	16.365	16.379	16.393	16.407	16.421	16.435
1430	16.449	16.464	16.478	16.492	16.506	16.520	16.534	16.548	16.562	16.576
1440	16.590	16.604	16.619	16.633	16.647	16.661	16.675	16.689	16.703	16.717
1450	16.731									



TABLE 2  
 COEFFICIENTS USED TO GENERATE TABLE 1

TEMP RANGE--	0 TO 630.74	630.74 TO 1064.43	1064.43 TO 1450.0
A =	0.000000E+00	-3.1270229E-01	+1.5111096E+00
B =	+5.2637228E-03	+8.1565406E-03	+2.8431452E-03
C =	+1.3923327E-05	+2.9279224E-06	+8.0823631E-06
D =	-2.3861528E-08	-2.6876059E-10	-1.9338478E-09
E =	+3.6020533E-11		
F =	-4.4645019E-14		
G =	+3.8497692E-17		
H =	-1.5372642E-20		

The equations are of the form:

$$EE = A + BT + CT^{**2} + DT^{**3} + ET^{**4} + FT^{**5} + GT^{**6} + HT^{**7}$$

where EE is in millivolts and T is in degrees Celsius (IPTS-68).

### 8.1.3.2 Summary of Calibration Results for NIST Record

JANUARY 10, 1989

999999

('AT' COMPUTER)

TEMPERATURE deg C	S STANDARD SC-83-13	TEST 999999	M-125 TABLE VALUE	DELTA (TEST - M125)
60.374	366.52	363.96	365.20	-1.24
60.811	369.44	367.14	368.14	-1.00
79.679	498.78	496.89	498.94	-2.04
80.235	502.68	501.38	502.89	-1.51
105.426	684.53	685.26	688.04	-2.79
106.078	689.36	691.02	692.98	-1.96
137.484	928.84	935.45	938.72	-3.27
138.297	935.21	942.26	945.28	-3.02
176.112	1239.36	1256.61	1260.14	-3.53
177.034	1246.96	1263.98	1268.05	-4.08
216.155	1576.71	1609.01	1612.36	-3.35
217.162	1585.37	1617.40	1621.44	-4.04
255.891	1924.10	1974.41	1978.06	-3.65
256.896	1933.02	1982.73	1987.49	-4.77
297.001	2294.40	2367.14	2370.87	-3.73
298.035	2303.84	2376.34	2380.93	-4.59
339.130	2683.43	2783.17	2786.54	-3.37
340.272	2694.09	2793.61	2797.98	-4.37
381.744	3085.19	3215.47	3218.76	-3.29
382.749	3094.74	3225.00	3229.07	-4.08
423.229	3483.10	3646.27	3649.61	-3.35
424.176	3492.25	3656.03	3659.55	-3.53
462.006	3860.37	4057.38	4060.60	-3.22
463.025	3870.35	4068.57	4071.50	-2.93
500.219	4236.73	4470.25	4472.94	-2.69
501.112	4245.58	4479.61	4482.66	-3.05
535.634	4589.39	4858.04	4861.36	-3.32
536.539	4598.45	4868.03	4871.36	-3.33
567.491	4909.77	5212.97	5215.79	-2.82
568.136	4916.29	5219.71	5223.01	-3.31
600.517	5245.19	5585.13	5588.13	-3.01
601.378	5253.98	5594.79	5597.90	-3.12
640.480	5656.14	6043.35	6045.29	-1.94
641.487	5666.57	6054.17	6056.92	-2.75
679.079	6058.70	6493.32	6494.59	-1.27
679.812	6066.39	6501.75	6503.20	-1.45
716.167	6450.06	6933.53	6933.16	+0.37
716.918	6458.03	6941.19	6942.12	-0.93
750.053	6811.53	7340.48	7339.67	+0.81
750.654	6817.97	7346.11	7346.93	-0.82

782.881	7165.26	7739.13	7738.70	+0.43
784.278	7180.39	7755.76	7755.80	-0.05
814.239	7506.42	8125.39	8124.63	+0.77
814.680	7511.23	8129.65	8130.08	-0.44
852.245	7924.17	8598.87	8598.50	+0.37
852.747	7929.71	8605.37	8604.81	+0.56
886.623	8306.07	9032.98	9032.88	+0.11
887.081	8311.17	9038.99	9038.69	+0.29
917.943	8657.33	9432.90	9433.29	-0.39
918.283	8661.15	9437.68	9437.66	+0.01
943.968	8951.62	9769.61	9769.37	+0.25
944.342	8955.86	9774.55	9774.22	+0.32
969.988	9248.06	10107.69	10108.41	-0.71
970.238	9250.91	10111.05	10111.68	-0.63
1009.205	9698.99	10624.47	10625.02	-0.55
1009.635	9703.96	10629.36	10630.73	-1.37
1035.249	10001.22	10971.48	10971.81	-0.33
1035.490	10004.03	10973.36	10975.04	-1.68
1059.217	10281.31	11293.28	11293.55	-0.27
1059.516	10284.81	11295.89	11297.57	-1.68
1077.050	10490.87	11534.26	11534.48	-0.22
1077.202	10492.66	11534.08	11536.54	-2.46
1086.955	10607.63	11668.38	11668.81	-0.43
1087.116	10609.53	11668.24	11671.00	-2.76
1088.284	10623.32	11687.38	11686.87	+0.51
1088.477	10625.59	11686.97	11689.48	-2.52
1099.369	10754.31	11836.10	11837.66	-1.56
1099.289	10753.36	11834.41	11836.57	-2.17

JANUARY 10, 1989

TYPE R THERMOCOUPLE

NIST TEST NO. 999999

('AT' COMPUTER)

TEMPERATURE	DELTA EMF	CALC DELTA	DEVIATION	WEIGHTS
60.374	-1.239	-1.461	+0.222	1
60.811	-1.000	-1.471	+0.471	1
79.679	-2.043	-1.882	-0.161	1
80.234	-1.510	-1.894	+0.384	1
105.425	-2.786	-2.398	-0.388	1
106.077	-1.960	-2.410	+0.450	1
137.484	-3.274	-2.955	-0.319	1
138.297	-3.018	-2.967	-0.051	1
176.111	-3.532	-3.486	-0.046	1
177.033	-4.076	-3.497	-0.579	1
216.155	-3.346	-3.867	+0.521	1
217.162	-4.036	-3.874	-0.162	1
255.891	-3.650	-4.071	+0.421	1
256.895	-4.769	-4.074	-0.695	1
297.000	-3.730	-4.114	+0.384	1
298.035	-4.594	-4.113	-0.481	1
339.129	-3.370	-4.002	+0.632	1
340.272	-4.373	-3.997	-0.376	1
381.744	-3.287	-3.769	+0.482	1
382.748	-4.079	-3.762	-0.317	1
423.229	-3.350	-3.477	+0.127	1
424.175	-3.526	-3.471	-0.055	1
462.006	-3.221	-3.204	-0.017	1
463.025	-2.932	-3.197	+0.265	1
500.219	-2.690	-2.994	+0.304	1
501.112	-3.051	-2.990	-0.061	1
535.633	-3.323	-2.913	-0.410	1
536.538	-3.334	-2.913	-0.421	1
567.490	-2.825	-2.984	+0.159	1
568.135	-3.309	-2.988	-0.321	1
600.516	-3.010	-3.258	+0.248	1
601.377	-3.118	-3.269	+0.151	1

COEFFICIENTS FOR DELTA EQUATION  
0 TO 630.74 Deg C

	COEFFICIENT	STD. DEV.
B =	-2.5416699E-02	+2.3264567E-07
C =	+1.2217191E-05	+1.6263324E-11
D =	+1.4371083E-07	+8.1748810E-16
E =	-1.8087732E-10	+3.9510814E-20

STANDARD DEVIATION = 0.386

JANUARY 10, 1989      TYPE R THERMOCOUPLE      NIST TEST NO. 999999  
 ('AT' COMPUTER)

TEMPERATURE	DELTA EMF -DELTA(630.74)	CALC (DELTA - DELTA(630.74))	DEVIATION	MEASURED DELTA	WEIGHTS	CALC DELTA
640.480	+1.7963	+0.3091	+1.4872	-1.9410	1	-3.4282
641.486	+0.9863	+0.3404	+0.6459	-2.7510	1	-3.3969
679.078	+2.4693	+1.0000	+1.0496	-1.2680	1	-2.3176
679.812	+2.2843	+1.4391	+0.8452	-1.4530	1	-2.2982
716.166	+4.1083	+2.3149	+1.7935	+0.3710	1	-1.4225
716.918	+2.8063	+2.3313	+0.4751	-0.9310	1	-1.4061
750.052	+4.5503	+2.9852	+1.5651	+0.8130	1	-0.7521
750.654	+2.9123	+2.9959	-0.0835	-0.8250	1	-0.7415
782.880	+4.1653	+3.5004	+0.6649	+0.4280	1	-0.2369
784.278	+3.6883	+3.5194	+0.1689	-0.0490	1	-0.2179
814.239	+4.5023	+3.8691	+0.6332	+0.7650	1	0.1318
814.679	+3.3003	+3.8734	-0.5731	-0.4370	1	0.1361
852.245	+4.1053	+4.1544	-0.0490	+0.3680	1	0.4170
852.747	+4.2953	+4.1569	+0.1384	+0.5580	1	0.4196
886.623	+3.8423	+4.2598	-0.4175	+0.1050	1	0.5225
887.080	+4.0283	+4.2602	-0.2319	+0.2910	1	0.5229
917.943	+3.3463	+4.2298	-0.8834	-0.3910	1	0.4924
918.283	+3.7513	+4.2288	-0.4774	+0.0140	1	0.4914
943.967	+3.9823	+4.1133	-0.1309	+0.2450	1	0.3759
944.342	+4.0603	+4.1110	-0.0507	+0.3230	1	0.3737
969.988	+3.0233	+3.9138	-0.8905	-0.7140	1	0.1765
970.238	+3.1053	+3.9115	-0.8061	-0.6320	1	0.1741
1009.204	+3.1903	+3.4563	-0.2660	-0.5470	1	-0.2810
1009.635	+2.3643	+3.4502	-1.0859	-1.3730	1	-0.2871
1035.248	+3.4033	+3.0483	+0.3550	-0.3340	1	-0.6890
1035.490	+2.0523	+3.0441	-0.9918	-1.6850	1	-0.6932
1059.216	+3.4703	+2.5993	+0.8710	-0.2670	1	-1.1380
1059.515	+2.0523	+2.5933	-0.5409	-1.6850	1	-1.1441
1077.049	+3.5193	+2.2195	+1.2998	-0.2180	1	-1.5178
1077.201	+1.2743	+2.2161	-0.9418	-2.4630	1	-1.5212
1086.954	+3.3053	+1.9918	+1.3136	-0.4320	1	-1.7456
1087.116	+0.9733	+1.9879	-1.0146	-2.7640	1	-1.7494
1088.284	+4.2483	+1.9603	+2.2881	+0.5110	1	-1.7771
1088.476	+1.2203	+1.9557	-0.7354	-2.5170	1	-1.7816
1099.368	+2.1723	+1.6893	+0.4830	-1.5650	1	-2.0480
1099.288	+1.5713	+1.6913	-0.1200	-2.1660	1	-2.0460

COEFFICIENTS FOR DELTA EQUATION  
630.74 TO 1064.43 deg C

	DE-DE(630.74) = FUNCTION (T-630.74)	STD DEV	DE = FUNCTION (T)
A =			-4.8522222E+01
B =	+3.2334952E-02	+2.7482624E-07	+1.0967249E-01
C =	-6.1306990E-05	+3.7740216E-11	-6.1306990E-05

STANDARD DEVIATION = 0.924

CALACULATE4D DELTA AT 630.74 = -3.73733378834 Microvolts

CALCULATED DELTA AT 1064.43 = -1.24503740324 Microvolts

SLOPE OF DELTA AT 1064.43 = -0.0208415053908 Microvolts / deg C

JANUARY 10, 1989

TYPE R THERMOCOUPLE

NIST TEST NO. 999999

('AT' COMPUTER)

Degrees C table given

TABLE 2

COEFFICIENTS USED TO GENERATE TABLE 1

TEMP RANGE--	0 TO 630.74	630.74 TO 1064.43	1064.43 TO 1450.0
A =	0.0000000E+00	-3.1270229E-01	+1.5111096E+00
B =	+5.2637228E-03	+8.1565406E-03	+2.8431452E-03
C =	+1.3923327E-05	+2.9279224E-06	+8.0823631E-06
D =	-2.3861528E-08	-2.6876059E-10	-1.9338478E-09
E =	+3.6020533E-11		
F =	-4.4645019E-14		
G =	+3.8497692E-17		
H =	-1.5372642E-20		

The equations are of the form:

$$EE = A + BT + CT^{**2} + DT^{**3} + ET^{**4} + FT^{**5} + GT^{**6} + HT^{**7}$$

Where EE is in millivolts and T is in degrees Celsius (IPTS-68).

TEMP. deg C	CALC. DELTA (test - table)	TEMP. deg C	CALC. DELTA (test - table)
0.0	+0.00	750.0	-0.75
50.0	-1.22	800.0	-0.02
100.0	-2.29	850.0	+0.41
150.0	-3.14	900.0	+0.52
200.0	-3.73	950.0	+0.34
250.0	-4.05	1000.0	-0.16
300.0	-4.11	1050.0	-0.96
350.0	-3.95	1100.0	-1.99
400.0	-3.64	1150.0	-3.03
450.0	-3.28	1200.0	-4.07
500.0	-3.00	1250.0	-5.11
550.0	-2.92	1300.0	-6.15
600.0	-3.25	1350.0	-7.20
650.0	-3.14	1400.0	-8.24
700.0	-1.79	1450.0	-9.28

Platinum leg versus Pt-67 = 15.6 microvolts at 1099.3 degrees Celsius.



#### 8.1.4 Type T Thermocouple - Comparison with SPRT



**UNITED STATES DEPARTMENT OF COMMERCE**  
**National Institute of Standards and Technology**  
**[formerly National Bureau of Standards]**  
Gaithersburg, Maryland 20899

Date: January 10, 1989

In reply refer to: 586/999999

National Institute of Standards and Technology  
Gaithersburg, Maryland 20899

Attn: Mr. John Smith

Subject: Thermometric Test  
P.O. No: 99999

Gentlemen:

Enclosed are results of the test which you requested in the above reference. Please refer to the above file number in any later communication, and if you have any questions concerning this test, contact Jacquelyn A. Wise, telephone number (301) 975-4822. For questions relating to shipping please call Robert J. Lewis, telephone number (301) 975-6353.

Sincerely yours,

B. W. Mangum, Physicist  
Temperature and Pressure Division

Material tested:  
1 Thermocouple

Enclosure:  
1 Report of Calibration  
2 Tables

UNITED STATES DEPARTMENT OF COMMERCE  
NATIONAL INSTITUTE OF STANDARDS AND TECHNOLOGY  
GAITHERSBURG, MARYLAND

## REPORT OF CALIBRATION

**THERMOCOUPLE**  
Type T

Submitted by

National Institute of Standards and Technology  
Gaithersburg, Maryland

Electromotive Force as a Function of Temperature of  
Measuring Junction (reference junctions at 0 °C)

<u>Degrees Celsius</u> <u>(IPTS-68)</u>	<u>Microvolts</u>	<u>Degrees Celsius</u> <u>(IPTS-68)</u>	<u>Microvolts</u>
-110	-3620	100	4266
-50	-1802	200	9257
0	0	300	14816

The uncertainty in the above values is estimated not to exceed the equivalent of  $\pm 0.1$  °C. A discussion of uncertainties inherent in thermocouple calibrations is given in National Bureau of Standards Circular 590, Methods of Testing Thermocouples and Thermocouple Materials.

All temperatures in this report are given in degrees Celsius (IPTS-68). The International Practical Temperature Scale of 1968, IPTS-68 was adopted by the International Committee of Weights and Measures at its meeting in October, 1968, and is described in "The International Practical Temperature Scale of 1968, Amended Edition of 1975", Metrologia 12, No. 1, 7-17 (1976).

For the Director  
National Institute of Standards and Technology

B. W. Mangum, Physicist  
Temperature and Pressure Division

Test No.: 999999  
Completed: January 10, 1989  
P. O. No.: 99999

JANUARY 10, 1989      TABLE 1      TYPE T THERMOCOUPLE      NIST TEST NO. 999999  
 TEMP. IN DEGREES C (1PTS-68)      EMF IN MICROVOLTS      REF. JUNCTIONS AT 0 DEGREES C

TEMP	0	1	2	3	4	5	6	7	8	9
-110	-3620.	-3373.	-3401.	-3429.	-3456.	-3484.	-3511.	-3539.	-3566.	-3593.
-100	-3345.									
-90	-3059.	-3088.	-3117.	-3146.	-3175.	-3203.	-3232.	-3260.	-3289.	-3317.
-80	-2761.	-2791.	-2821.	-2851.	-2881.	-2911.	-2941.	-2971.	-3000.	-3029.
-70	-2452.	-2483.	-2515.	-2546.	-2577.	-2608.	-2639.	-2669.	-2700.	-2731.
-60	-2132.	-2165.	-2197.	-2229.	-2262.	-2294.	-2325.	-2357.	-2389.	-2421.
-50	-1802.	-1836.	-1869.	-1902.	-1935.	-1968.	-2001.	-2034.	-2067.	-2100.
-40	-1461.	-1496.	-1530.	-1565.	-1599.	-1633.	-1667.	-1701.	-1735.	-1769.
-30	-1111.	-1146.	-1182.	-1217.	-1252.	-1287.	-1322.	-1357.	-1392.	-1427.
-20	-750.	-786.	-823.	-859.	-895.	-931.	-968.	-1003.	-1039.	-1075.
-10	-380.	-417.	-454.	-492.	-529.	-566.	-603.	-640.	-677.	-713.
0	0.	-38.	-77.	-115.	-153.	-191.	-229.	-267.	-304.	-342.
0	0.	39.	78.	116.	155.	194.	233.	272.	312.	351.
10	390.	430.	469.	509.	549.	588.	628.	668.	708.	748.
20	780.	828.	869.	909.	949.	990.	1031.	1071.	1112.	1153.
30	1194.	1235.	1276.	1317.	1359.	1400.	1442.	1483.	1525.	1566.
40	1608.	1650.	1692.	1734.	1776.	1819.	1861.	1903.	1946.	1988.
50	2031.	2074.	2116.	2159.	2202.	2245.	2289.	2332.	2375.	2418.
60	2462.	2505.	2549.	2593.	2637.	2681.	2725.	2769.	2813.	2857.
70	2901.	2946.	2990.	3035.	3079.	3124.	3169.	3214.	3258.	3303.
80	3349.	3394.	3439.	3484.	3530.	3575.	3621.	3666.	3712.	3758.
90	3804.	3849.	3895.	3942.	3988.	4034.	4080.	4126.	4173.	4219.
100	4266.	4313.	4359.	4406.	4453.	4500.	4547.	4594.	4641.	4688.
110	4736.	4783.	4830.	4078.	4926.	4973.	5021.	5069.	5116.	5164.
120	5212.	5260.	5309.	5357.	5405.	5453.	5502.	5550.	5599.	5647.
130	5696.	5745.	5793.	5842.	5891.	5940.	5989.	6038.	6087.	6137.
140	6186.	6235.	6285.	6334.	6384.	6433.	6483.	6533.	6583.	6632.

JANUARY 10, 1989  
 TEMP. IN DEGREES C (IPIS-68)

TABLE 1  
 EMF IN MICROVOLTS

TYPE T THERMOCOUPLE  
 REF. JUNCTIONS AT 0 DEGREES C

NIST TEST NO. 999999

TEMP	0	1	2	3	4	5	6	7	8	9
150	5682.	6732.	6782.	6833.	6883.	6933.	6983.	7034.	7084.	7135.
160	7185.	7236.	7286.	7337.	7388.	7439.	7490.	7541.	7592.	7643.
170	7694.	7745.	7797.	7848.	7899.	7951.	8002.	8054.	8106.	8157.
180	8209.	8261.	8313.	8365.	8417.	8469.	8521.	8573.	8626.	8678.
190	8730.	8783.	8835.	8888.	8940.	8993.	9046.	9098.	9151.	9204.
200	9257.	9310.	9363.	9416.	9469.	9523.	9576.	9629.	9683.	9736.
210	9790.	9843.	9897.	9950.	10004.	10058.	10112.	10166.	10220.	10274.
220	10328.	10382.	10436.	10490.	10544.	10599.	10653.	10708.	10762.	10817.
230	10871.	10926.	10980.	11035.	11090.	11145.	11200.	11255.	11310.	11365.
240	11420.	11475.	11530.	11586.	11641.	11696.	11752.	11807.	11863.	11918.
250	11974.	12030.	12085.	12141.	12197.	12253.	12309.	12365.	12421.	12477.
260	12533.	12589.	12645.	12702.	12758.	12814.	12871.	12927.	12984.	13040.
270	13097.	13153.	13210.	13267.	13324.	13380.	13437.	13494.	13551.	13608.
280	13665.	13722.	13779.	13837.	13894.	13951.	14009.	14066.	14123.	14181.
290	14238.	14296.	14354.	14411.	14469.	14527.	14584.	14642.	14700.	14758.
300	14816.									

COEFFICIENTS OF EQUATIONS USED TO CALCULATE TABLE 1

TEMPERATURE RANGE	-110 TO 0	0 TO 300
A =	.384023921E+02	.385905045E+02
B =	.440523165E-01	.324023057E-01
C =	.114052303E-03	.226704250E-03
D =	.199744066E-04	-.219458348E-05
E =	.904454012E-06	.110319006E-07
F =	.227660103E-07	-.309275819E-10
G =	.362474094E-09	.456553372E-13
H =	.386409242E-11	-.276166700E-16
I =	.582906785E-13	
J =	.142813833E-15	
K =	.468332544E-18	
L =	.106054747E-20	
M =	.139492910E-23	
N =	.797958932E-27	

THE EQUATIONS ARE OF THE FORM-

$$EE = A*T + B*T**2 + C*T**3 + D*T**4 + E*T**5 + F*T**6 + G*T**7 + H*T**8 + I*T**9 + J*T**10 + K*T**11 + L*T**12 + M*T**13 + N*T**14$$

WHERE EE IS THE EMF IN MICROVOLTS AND T IS THE TEMPERATURE IN DEGREES CELSIUS (IPTS-68).

8.1.5 Base Metal Thermocouple - Comparison Calibration

Date : January 10, 1989