

Change #1 Hosted 20 Sep 10

**ARMY FM 10-541
AIR FORCE TO 13C7-11-21**

AIRDROP OF SUPPLIES AND EQUIPMENT:

**RIGGING
MILITARY BRIDGES**

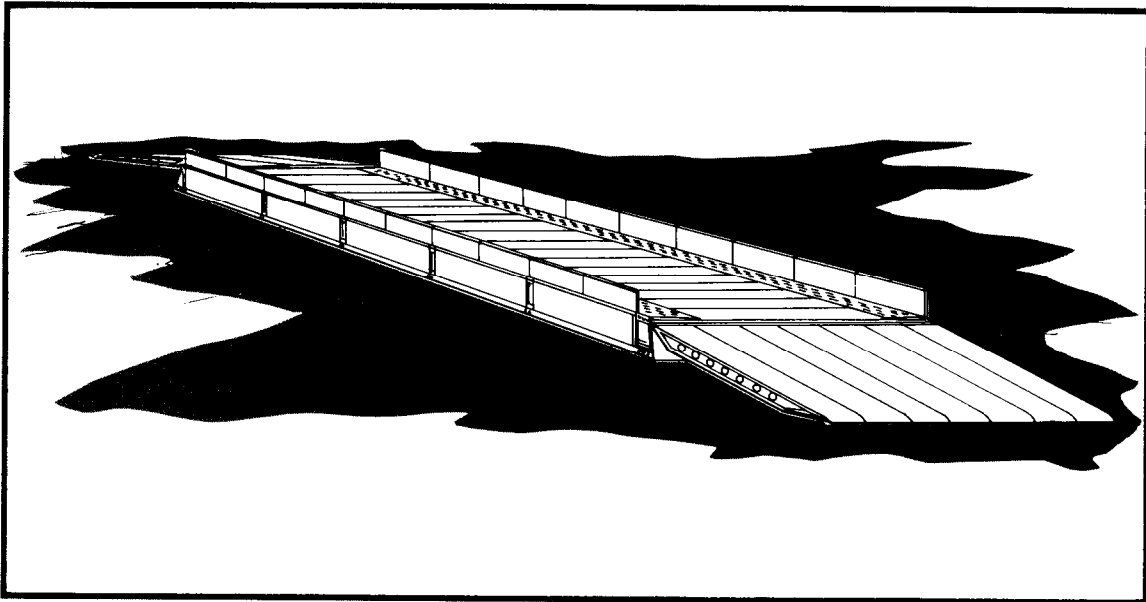

DISTRIBUTION RESTRICTION: Distribution authorized to US government agencies only to protect technical or operational information from automatic dissemination under the International Exchange Program or by other means. This determination was made on 30 April 1991. Other requests for this document will be referred to Commander, US Army Quartermaster Center and School, ATTN: ATSM-DTL, Fort Lee, VA 23801-5036.

DESTRUCTION NOTICE: Destroy by any method that will prevent disclosure of contents or reconstruction of the document.

DEPARTMENTS OF THE ARMY AND THE AIR FORCE



REPLY TO
ATTENTION OF

DEPARTMENT OF THE ARMY
AERIAL DELIVERY AND FIELD SERVICES DEPARTMENT
U.S. ARMY QUARTERMASTER CENTER AND SCHOOL
1010 SHOP ROAD
FORT LEE, VIRGINIA 23801-1502

ATSM-ADFSD

7 October 1998

MEMORANDUM FOR Commander, US Army Training Support Center, ATTN: ATIC-TIST (Mr. Baston), Fort Eustis, VA 23604

SUBJECT: Distribution Restriction Notice on Airdrop Rigging Manuals

1. As proponent for development of all 10-500 series airdrop rigging field manuals and the 10-450 sling load manuals, it has been determined that the distribution restriction on these field manuals should be changed to read: Approved for public release, distribution unlimited.
2. It is requested that unrestricted release of these field manuals be made via the Army Training Digital Library.
3. The new distribution notice will be added to the cover pages as future changes/revisions are made to the manuals.
4. Enclosed you will find a numerical list and the number of changes of the manuals that have unlimited distribution.
5. The point of contact for this action is Mr. Roger Hale, DSN 687-4769.

Encl

THEODORE J. DLUGOS
Director, Aerial Delivery and
Field Services Department

Distribution restrictions for the following Airdrop field manuals should read "**Approved for public release; distribution is unlimited.**"

10-450-3	10-524, c2	10-552, c2
10-450-4	10-526, c3	10-554
10-500-2, c2	10-527, c3	10-555, c2
10-500-3, c1	10-528, c6	10-556
10-500-7, c1	10-529, c1	10-557
10-500-45	10-530	10-558, c1
10-500-53	10-531, c2	10-562
10-500-66, c1	10-532, c4	10-564, c6
10-500-71	10-533	10-567, c1
10-508, c1	10-534, c2	10-569, c1
10-510, c3	10-535	10-571
10-512, c4	10-537, c4	10-572
10-513, c3	10-539, c3	10-573, c1
10-515, c1	10-540, c2	10-574, c4
10-516	10-541, c1	10-575, c2
10-517, c5	10-542, c2	10-576, c1
10-518	10-543, c2	10-577
10-519, c3	10-546	10-579, c2
10-520, c3	10-547, c1	10-584
10-521, c2	10-548, c1	10-586
10-522, c1	10-549	10-588
10-523, c2	10-550, c3	10-591, c1



DEPARTMENT OF THE ARMY

HEADQUARTERS UNITED STATES ARMY TRAINING AND DOCTRINE COMMAND
FORT MONROE, VIRGINIA 23651-5000

REPLY TO
ATTENTION OF

ATCD-SL (70-1f)

21 Oct 96

MEMORANDUM FOR DEPUTY CHIEF OF STAFF OPERATIONS AND PLANS,
400 ARMY PENTAGON, ATTN: DAMO-FDL, WASHINGTON
DC 20310-0400

SUBJECT: Quartermaster (QM) Functional Area Assessment (FAA)
Response

1. References:

a. Message, HQDA, DAMO-FDL, 231825Z Apr 96, subject: QM FAA Results.

b. Memorandum, HQ TRADOC, ATCG, 29 Jul 96, Army Airdrop Capabilities Assessment.

2. At the 29 Mar 96 QM FAA briefing to the Director of Army Staff, the decision was reached to revisit the Army's decision to "shelf" Low Altitude Parachute Extraction System (LAPES) (reference 1a).

a. Reference 1b, solicited CINCs input for their positions on LAPES and assessments of airdrop capabilities. The CINCs responses will be used to chart the direction and role for airdrop in the 21st century.

b. Based on the responses received (enclosure), there is no strong support for LAPES airdrop capability at this time. The consensus for the airdrop capabilities is to continue support for current Low Velocity Airdrop System (LVAD), develop a 500-foot LVAD and further explore Advanced Precision Aerial Delivery System (APADS).

3. Further, we will continue to maintain a range of airdrop capabilities to support all contingencies throughout the Army. The results of the Army Airdrop Capabilities Assessment also will be incorporated into the Operational Concept for Aerial Delivery Operations and Improved Cargo Aerial Delivery Capability Mission Needs Statement being developed by the Quartermaster Directorate of Combat Developments, U.S. Army Combined Arms Support Command (CASCOM).

4. The HQ TRADOC POC is MAJ Higgins, Airborne Airlift Action Office, ATCD-SL, E-mail: higginsn@emh10.monroe.army.mil, DSN 680-2469/3921, datafax DSN 680-2520.

ATCD-SL

SUBJECT: Quartermaster (QM) Functional Area Assessment (FAA)
Response

FOR THE DEPUTY CHIEF OF STAFF FOR COMBAT DEVELOPMENTS:

Encl

JOHN A. MANDEVILLE
Colonel, GS
Director, Combat Service Support

CF:

USACASCOM (ATCL-CG/ATCL-QC/ATCL-MES)

USAQMC&S (ATSM-CG/ATSM-ABN/FS)

USANRDEC (SSCNC-UT/AMSSC-PM)

ORGANIZATION	LAPES	LVAD	500' LVAD	APADS	SPTS/ NOT SPEC
USSOCOM		X	X	X	
EUCCOM					X
CENTCOM		X	X		
FORSCOM		X	X	X	
TRANSCOM					X
SOUTHCOM	X			X	
VIII ARMY					X
ACOM					X

USSOCOM: Memorandum specifically states that the command does not support LAPES airdrop capability, but supports LVAD as well as APADS.

EUCCOM: Draft memorandum specifically states that the command support the need for a low level airdrop capability. However, memorandum summarizes that the specific capability is not important as to have a capability to meet the required mission/threat profile.

CENTCOM: Memorandum specifically states that the command does not support LAPES airdrop capability, but support both current LVAD and 500-foot LVAD airdrop capabilities.

FORSCOM: 1st Endorsement specifically states that the command does not support LAPES airdrop capability, however supports LVAD, 500-foot LVAD and APADS.

TRANSCOM: Memorandum does not specifically address any airdrop capability as it talks to the 21st century requiring the full spectrum of tactical delivery methods.

SOUTHCOM: Memorandum specifically supports LAPES and APADS airdrop capabilities for their command.

VIII ARMY: E-Mail note for VIII Army states that the command has no input to the assessment as their plans call for a limited employment of airdrop.

ACOM: Sent request for input on 30 Sep 96. Received verbal response on 16 Oct 96 stating command is indifferent on the specific capability received.



DEPARTMENT OF THE ARMY
HEADQUARTERS UNITED STATES ARMY TRAINING AND DOCTRINE COMMAND
FORT MONROE, VIRGINIA 23651-3000

REPLY TO
ATTENTION OF

6 SEP 1995

ATCD-SL (70-1f)

MEMORANDUM FOR

Major General Thomas W. Robison, Commander, U.S. Army Combined
Arms Support Command and Fort Lee, Fort Lee, VA 23801-6000
Major General Robert K. Guest, Commander, U.S. Army Quartermaster
Center and School, Fort Lee, VA 23801-5030

SUBJECT: Low Altitude Parachute Extraction System (LAPES)
Disassembly.

1. References:

a. Message, HQ TRADOC, ATCD-SL, 100930Z Jan 95, subject:
LAPES.

b. OVVM Note, HQ USACASCOM, 30 March 95, subject: TRADOC
Disassembly of LAPES.

2. The U.S. Army and other services recently have concurred that
LAPES will be terminated, as this capability is no longer required
as a viable wartime contingency airdrop option. However,
Headquarters, Department of the Army (DA), Deputy Chief of Staff
for Operations and Plans, has agreed that LAPES technology will be
shelved, and all specialized equipment preserved for possible
future use.

3. Take the necessary steps to terminate training and leader
development concerning LAPES operations. Major General Guest's
questions regarding the disassembly of LAPES (enclosed) with
following guidance will be utilized:

a. "Does the U.S. Army Quartermaster Center and School
(USAQMC&S) continue to publish LAPES procedures in their joint
field manual (FMs)/technical order manuals?" "Do we publish the
LAPES procedures that have been written but not been printed yet?"
Publishing LAPES procedures in all joint publications, Army FMs,
regulations, etc., will be discontinued and addressed in the next
revision of the aforementioned documents. Concurrently, all LAPES
procedures that have been written and not printed will not be
published.

6 SEP 1995

ATCD-SL
SUBJECT: Low Altitude Parachute Extraction System (LAPES)
Disassembly

b. "Do we keep LAPES in our programs of instruction (POIs)?" "Do we teach LAPES to other services and our allies?" The USAQMC&S will remove LAPES procedures from PCI and cease teaching LAPES to other services and/or allies.

c. "What do we teach to folks that have LAPES equipment in their war reserves?" All instruction concerning LAPES procedures will be discontinued whether LAPES equipment is located in units or in war reserves.

d. "What is the DA/TRADOC guidance on disposition of unit, depot, and war reserves LAPES equipment?" All LAPES equipment in war reserves and depot should be preserved with the exception of a few items that can be utilized in other existing airdrop capabilities. Specifically, the Type V airdrop platforms and attitude control bars of the LAPES system are being utilized to augment current Low Velocity Airdrop Systems (LVADS) loads.

e. "What is the guidance to U.S. Army Test and Experimentation Command on force development test and experimentation certification of LAPES loads?" The certification of all LAPES loads at the Airborne Special Operations Test Directorate will be redirected toward testing and certification of LVADS loads.

4. HQ TRADOC POC is CPT Higgins or CPT Phillips, ATCD-SL, DSN 680-2469/3921, datafax DSN 680-2520.

FOR THE COMMANDER:

Encl

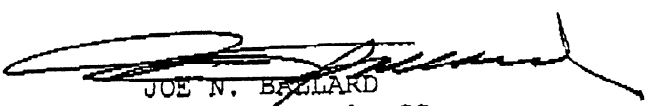

JOE N. BALLARD
Major General, GS
Chief of Staff

CF:
HQDA (DAMO-FDL)
CDR, NRDEC (SAFNC-UA)
CDR, FORSCOM (FCJ3-FC)
CDR, OPTEC (CSTE-CS, CSTE-OPM)
CDR, ATCOM (AMSAT-W-TD)
DIR, ABNSOTD (ATCT-AB)
HQ TRADOC (ATCD-L, ATCD-RM, ATDO-A, ATTG-IT)

Date and time 07/18/95 10:28:11

From: HIGGINSN--MON1
To: HIGGINSN--MON1

From: OPT NEIL HIGGINS, (AAACO), 680-2469
Subject: TRADOC "DISASSEMBLY" OF LAPES

* AIRBORNE AIRLIFT ACTION OFFICE *
* (AAACO) *

** Forwarding note from BRUNEAUN--OMSNAMES 07/18/95 10:27 ***
Received: from LEE-EMH2.ARMY.MIL by MONROE-EMH2.ARMY.MIL (IBM VM SMTP V2R2)
with TOP; Tue, 18 Jul 95 10:27:22 EDT
Received: from LEE1 by LEE-EMH2.ARMY.MIL (IBM VM SMTP V2R2) with SMTP id 3547;
Tue, 18 Jul 95 10:29:34 EDT
Comments: Converted from PROFS to RFC822 format by PUMP V2.2X
Date: Tue, 18 Jul 95 10:29:26 EDT
From: NORMAN BRUNEAU <BRUNEAUN@LEE-EMH2.ARMY.MIL>
Subject: TRADOC "DISASSEMBLY" OF LAPES
To: "NEIL HIGGINS- AAACO " <HIGGIN@MONROE-EMH1.ARMY.MIL>

** Resending note of 06/30/95 09:23

From: LARRY MC MILLIAN AAA <MCMILLI@MONROE-EMH1.ARMY.MIL>
To: NORMAN BRUNEAU
Subject: TRADOC "DISASSEMBLY" OF LAPES

NEIL- HERE ARE THE QUESTIONS THAT MG GUEST WANTS DA/ TRADOC TO ANSWER RE LAPES, AS I UNDERSTAND HIS GUIDANCE. I HAVE DISCUSSED THESE W/ OUR ABN DPT. IF THESE QUESTIONS MAKE SENSE, GIVE ME AN "UP" BEFORE I FORMALLY SEND ANYTHING OUT. MG GUEST WANTS SPECIFIC GUIDANCE FM TRADOC ON LAPES, RESPONSE NEEDS TO BE CLEAR AND TO THE POINT. A LOT OF THIS WILL HINGE ON WHAT ACC PLANS TO DO W/ LAPES NOW THAT THE AIR STAFF HAS GIVEN THEM THE GREEN LIGHT TO KILL IT. IF THEY PLAN TO PLACE IT ON THE SHELF OR KEEP A LIMITED OR CONTINGENCY CAPABILITY, THAT WILL DRIVE YOUR ANSWER TO US, AT THIS POINT I THINK ACC WILL DO WHATEVER THE ARMY WANTS, AS THEIR PRIMARY CUSTOMER. I WILL NOT REHASH HOW THE ARMY DECIDED THEY DIDNT NEED LAPES. QUESTIONS FOLLOW:

- DOES THE GMS CONTINUE TO PUBLISH LAPES PROCEDURES IN THEIR JOINT FM/TO MANUALS?
- DO WE PUBLISH THE LAPES PROCEDURES THAT HAVE BEEN WRITTEN BUT HAVE NOT BEEN PRINTED YET?
- DO WE REMOVE ALL LAPES PROCEDURES FROM ALREADY PUBLISHED MANUALS?
- DO WE KEEP LAPES IN OUR POI?
- DO WE TEACH LAPES TO OTHER SERVICES AND OUR ALLIES?
- WHAT DO WE TEACH TO FOLKS THAT HAVE LAPES EQUIPMENT IN THEIR WAR RESERVES?
- WHAT IS THE DA/TRADOC GUIDANCE ON DISPOSITION OF UNIT, DEPOT, AND WAR RESERVE LAPES EQUIPMENT?
- WHAT IS THE GUIDANCE TO TEXCOM ON THE FUTE CERTIFICATION OF LAPES LOADS?

I KNOW THESE ARE TOUGH QUESTIONS, BUT THEY HAVE TO BE ASKED. HQ STAFFS CANNOT SIMPLY SAY "KILL IT" AND MOVE ON TO THE NEXT ISSUE. I DONT THINK WE ARE DOING OUR JOB IF WE LEAVE IT UP TO THE SCHOOLHOUSE TO INTERPRET SKETCHY GUIDANCE. THAT PLACES US IN THE POSSIBLE POSITION OF BEING ACCUSED OF NOT FOLLOWING ORDERS.

LETS TALK.....NORM

TRK 2/47

SEP 11 11 08:30AM CSSRD FT MONROE VA 66 11

DEPARTMENT OF THE ARMY
QUARTERMASTER CENTER AND SCHOOL
1201 22D STREET
FORT LEE, VIRGINIA 23801-1601

ATSM-ABN-FS

15 Dec 96

MEMORANDUM FOR RECORD

SUBJECT: Airdrop Equipment Update

Reference:

- a. Phone conversation between CW4 Mahon, CASCOM and Dick Harper, Weapons System Management Office, Army Aviation Troop Command. Subject : sab
- b. Phone conversation between CW4 Mahon, CASCOM and Don Stump, Logistics Management Specialist, Office, Deputy Chief of Staff for Logistics. Subject. sab
- c. Phone conversation between CW4 Mahon, CASCOM and Chief Msgt Okraneck, Hqrs Air Combat Command. Subject sab
- d. msg dtg R 181348Z Feb 94. subject: FCIF item: Type II platforms, PEFTC and SL/CS for Air Force unilateral training

1. Based on information received from the references a-c above, the following update is provided per request ref c, above.
 - a. The type II modular platform no longer exists within any contingency stocks. Therefore, maintaining Joint Inspection training program is no longer required for this equipment.
 - b. The Parachute Extraction Transfer Force Coupling (PEFTC) no longer exists within any contingency stocks. Therefore, maintaining Joint Inspection training program is no longer required for this equipment.
 - c. The metric platform interim rigging procedures are no longer valid as they apply to metric platforms. Those rigging procedures which have dual application with the type V platform are still valid for the type V platform.
 - d. The static line connector strap (SL/CS) currently has limited application. Only those loads that specifically require this system are authorized use of this system. The SL/CS is not an across the board substitute for the Extraction Force Transfer Coupling (EFTC). These authorized loads are specific in nature and will normally be found in the special operations arena of airdrop loads. This system is not authorized for use IAW ref d, above.
2. For additional questions/information contact the undersigned at DSN 687-4733, Fax 3084.

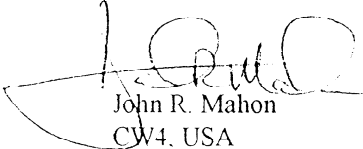
John R. Mahon
CW4, USA
Senior Airdrop Systems
Technician

CHANGE
NO 1

HEADQUARTERS
DEPARTMENTS OF THE ARMY
AND THE AIR FORCE
Washington, DC, 13 July 1992

AIRDROP OF SUPPLIES AND EQUIPMENT RIGGING MILITARY BRIDGES

This change adds the procedures for rigging the five-bay and the seven-bay, single-story, medium girder (fixed) bridges on a type V platform for low-velocity and LAPE airdrops.

FM 10-541/TO 13C7-11-21, 5 March 1984, is changed as follows:

1. New or changed material is identified by a vertical bar in the margin opposite the changed material.
2. Remove old pages and insert new pages as indicated below:

<u>Remove old pages</u>	<u>Insert new pages</u>
Cover page	Cover page
i through iii	i through vi
1-1	1-1
	4-1 through 4-144
	5-1 through 5-45
Glossary-1	Glossary-1
Reference-1	References-1

3. File this transmittal sheet in front of the publication for reference purposes.

DISTRIBUTION RESTRICTION. Distribution authorized to US government agencies only to protect technical or operational information from automatic dissemination under the International Exchange Program or by other means. This determination was made on 30 April 1991. Other requests for this document will be referred to Commander, US Army Quartermaster Center and School, ATTN: ATSM-DTL, Fort Lee, VA 23801-5036.

DESTRUCTION NOTICE: Destroy by any method that will prevent disclosure of contents or reconstruction of the document.

C1, FM 10-541/TO 13C7-11-21

By order of the Secretaries of the Army and the Air Force:

GORDON R. SULLIVAN
General, United States Army
Chief of Staff

Official:

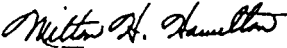
MILTON H. HAMILTON
Administrative Assistant to the
Secretary of the Army

01745

DISTRIBUTION:

Active Army, USAR, and ARNG : To be distributed in accordance with DA Form 12-11-E, requirements for FM 10-541, Airdrop of Supplies and Equipment: Rigging Military Bridges (Qty rqr block no 0923) .

FIELD MANUAL
NO 10-541
TECHNICAL ORDER
NO 13C7-11-21

HEADQUARTERS
DEPARTMENTS OF THE ARMY
AND THE AIR FORCE
Washington, DC, 5 March 1984

AIRDROP OF SUPPLIES AND EQUIPMENT RIGGING MILITARY BRIDGES

TABLE OF CONTENTS

		Paragraph	Page
PREFACE			vi
CHAPTER 1	INTRODUCTION		
	Description of Items	1-1	1-1
	Special Considerations	1-2	1-1
CHAPTER 2	RIGGING ALUMINUM FLOATING BRIDGE, RAFT SECTION		
Section I	Rigging Deck Sections With Auxiliary Components		
	Description of Load	2-1	2-1
	Preparing Platform, Installing Suspension Slings, Installing Platform Extraction Attaching Points, and Attaching Tiedown Clevises	2-2	2-1
	Positioning and Securing Load	2-3	2-3
	Installing Lashings	2-4	2-10
	Stowing Cargo Parachutes	2-5	2-13
	Installing Extraction System	2-6	2-13
	Installing Load Cover	2-7	2-14
	Installing Release System	2-8	2-14

DISTRIBUTION RESTRICTION. Distribution authorized to US government agencies only to protect technical or operational information from automatic dissemination under the International Exchange Program or by other means. This determination was made on 30 April 1991. Other requests for this document will be referred to Commander, US Army Quartermaster Center and School, ATTN: ATSM-DTL, Fort Lee, VA 23801-5036.

DESTRUCTION NOTICE: Destroy by any method that will prevent disclosure of contents or reconstruction of the document.

*This manual supersedes TM 10-500-41/TO 13C7-11-21, 17 March 1966.

	Paragraph	Page
Positioning Extraction Parachute	2-9	2-14
Special Considerations	2-10	2-14
Marking Rigged Load	2-11	2-14
Equipment Required	2-12	2-14
Section II		
Rigging Pontoon Boats		
Description of Load	2-13	2-17
Preparing Platform	2-14	2-17
Preparing and Positioning Honeycomb	2-15	2-17
Preparing Pontoon Boats	2-16	2-18
Installing Suspension Slings	2-17	2-19
Positioning Load	2-18	2-20
Installing Lashings	2-19	2-20
Installing Extraction Attaching Point	2-20	2-21
Installing Cargo Parachutes	2-21	2-22
Installing Extraction System	2-22	2-24
Installing Release System	2-23	2-24
Positioning Extraction Parachute	2-24	2-24
Marking Rigged Load	2-25	2-25
Equipment Required	2-26	2-26
CHAPTER 3		
RIGGING 38-FOOT ALUMINUM FIXED BRIDGE		
Section I		
Rigging Bridge Deck Balk With Transverse Stiffeners		
Description of Load	3-1	3-1
Preparing Platform	3-2	3-1
Installing Suspension Slings	3-3	3-2
Positioning and Lashing Load	3-4	3-3
Stowing Cargo Parachutes	3-5	3-14
Installing Extraction System	3-6	3-15
Installing Release System	3-7	3-16
Positioning Extraction Parachute	3-8	3-16
Marking Rigged Load	3-9	3-16
Equipment Required	3-10	3-17
Section II		
Rigging Bridge Plates and Accessories		
Description of Load	3-11	3-18
Preparing Platform	3-12	3-18
Installing Suspension Slings	3-13	3-18
Installing Platform Extraction Attaching Point	3-14	3-18
Positioning Honeycomb and Plywood	3-15	3-18
Positioning Load	3-16	3-20
Installing Lashings	3-17	3-21
Stowing Cargo Parachute	3-18	3-22
Installing Extraction System	3-19	3-22

	Paragraph	Page
Installing Release System	3-20	3-22
Positioning Extraction Parachute	3-21	3-22
Marking Rigged Load	3-22	3-22
Equipment Required	3-23	3-23
CHAPTER 4	RIGGING FIVE-BAY, SINGLE-STORY, MEDIUM GIRDER (FIXED) BRIDGE ON A TYPE V PLATFORM	
Section I	Low-Velocity Airdrop	
Description of Load	4-1	4-1
Preparing Platform	4-2	4-1
Preparing and Positioning Honeycomb Stacks	4-3	4-3
Preparing Pallet 1	4-4	4-6
Preparing Pallet 2	4-5	4-30
Positioning Pallets 1 and 2 on Platform	4-6	4-44
Building and Positioning Restraint Boards 2, 3, 4, and 5	4-7	4-46
Preparing Pallets 1 and 2 After Positioning on Platform	4-8	4-57
Lashing Pallets 1 and 2	4-9	4-60
Positioning Honeycomb Filler Between Pallets 1 and 2	4-10	4-73
Installing Suspension Slings	4-11	4-74
Preparing and Positioning Load Covers	4-12	4-77
Safelying Suspension Slings	4-13	4-78
Building, Positioning, and Securing Parachute Stowage Platform	4-14	4-79
Stowing Cargo Parachutes	4-15	4-84
Installing Release System	4-16	4-86
Installing Extraction System	4-17	4-87
Installing Provisions for Emergency Restraints	4-18	4-89
Placing Extraction Parachute	4-19	4-89
Marking Rigged Load	4-20	4-89
Equipment Required	4-21	4-90
Section II	LAPE Airdrop	
Description of Load	4-22	4-93
Preparing Platform	4-23	4-93
Preparing and Positioning Honeycomb Stacks	4-24	4-94
Preparing Pallet 1	4-25	4-96
Preparing Pallet 2	4-26	4-96
Positioning Pallets 1 and 2 on Platform	4-27	4-96
Building and Positioning Restraint Boards 1, 2, 3, 4, and 5	4-28	4-98
Preparing Pallets 1 and 2 After Positioning on Platform	4-29	4-113
Lashing Pallets 1 and 2	4-30	4-113

	Paragraph	Page
Building, Positioning, and Securing LAPES Parts Box	4-31	4-128
Positioning Honeycomb Filler Between Pallets 1 and 2	4-32	4-134
Preparing and Positioning Load Cover	4-33	4-135
Installing Attitude Control Bar	4-34	4-136
Installing Extraction System	4-35	4-139
Placing Extraction Parachutes	4-36	4-141
Marking Rigged Load	4-37	4-141
Equipment Required	4-38	4-142
CHAPTER 5		
		RIGGING SEVEN-BAY, SINGLE-STORY, MEDIUM GIRDER (FIXED) BRIDGE ON A TYPE V PLATFORM
Section I		Low-Velocity Airdrop
Description of Load	5-1	5-1
Preparing Platform	5-2	5-1
Preparing and Positioning Honeycomb Stacks	5-3	5-3
Preparing Pallet	5-4	5-6
Building and Positioning Restraint Boards	5-5	5-14
Positioning Pallet on Platform	5-6	5-17
Lashing Pallet	5-7	5-18
Preparing and Positioning Load Cover	5-8	5-21
Installing Suspension Slings	5-9	5-22
Stowing Cargo Parachutes	5-10	5-23
Installing Release System	5-11	5-24
Installing Extraction System	5-12	5-25
Installing Provisions for Emergency Restraints	5-13	5-26
Placing Extraction Parachute	5-14	5-26
Marking Rigged Load	5-15	5-26
Equipment Required	5-16	5-27
Section II		LAPE Airdrop
Description of Load	5-17	5-28
Preparing Platform	5-18	5-29
Preparing and Positioning Honeycomb Stacks	5-19	5-30
Preparing Pallet	5-20	5-30
Building and Positioning Restraint Boards 1 and 2	5-21	5-30
Positioning Pallet on Platform	5-22	5-35
Lashing Pallet	5-23	5-35
Installing Attitude Control Bar	5-24	5-38
Installing Extraction System	5-25	5-41
Placing Extraction Parachutes	5-26	5-43
Marking Rigged Load	5-27	5-43
Equipment Required	5-28	5-44

GLOSSARY
REFERENCES

Paragraph **Page**
Glossary-1
References-1

PREFACE

SCOPE

This manual tells and shows how to rig aluminum deck sections with auxiliary components for a low-velocity airdrop. Eight pontoon boats also are rigged for low-velocity airdrop. This manual tells and shows how to rig the aluminum bridge deck balk with transverse stiffeners and bridge plates and accessories for low-velocity airdrop. Only the C-130 aircraft can be used for the airdrop of these loads. This manual also shows and tells how to rig the five- and seven-bay, single-story, medium girder (fixed) bridges for low-velocity and LAPE airdrops from the C-130 aircraft. These bridges may also be rigged for low-velocity airdrop from the C-141 aircraft. This manual is designed to be used by all parachute riggers.

USER INFORMATION

The proponent of this publication is HQ TRADOC. You are encouraged to report any errors or omissions and to suggest ways for making this a better manual. Army personnel, send your comments on DA Form 2028 directly to:

Commander
US Army Quartermaster Center and School
ATTN: ATSM-DTL
Fort Lee, Virginia 23801-5036

Air Force personnel, send your reports on AFTO Form 22 through:

Headquarters
Air Mobility Command
(AMC/XOTT)
Scott AFB, Illinois 62225-5001

to:

Commander
US Army Quartermaster Center and School
ATTN: ATSM-DTL
Fort Lee, Virginia 23801-5036

Also send information copies of AFTO Form 22 to:

San Antonio ALC/LDILT
Kelly AFB, Texas 78241-5000

CHAPTER 1

INTRODUCTION

1-1. Description of Items

The description of the items covered in this manual is as follows:

- a.* The aluminum deck sections with auxiliary components weigh 5,771 pounds.
- b.* Eight pontoon boats with cradle weigh 5,660 pounds.
- c.* The deck balk with stiffeners weighs 19,596 pounds.
- d.* The bridge plates and accessories weigh 2,528 pounds.

e. The five-bay bridge weighs 11,522 pounds.

f. The seven-bay bridge weighs 15,135 pounds.

1-2. Special Considerations

A copy of this manual must be available to the joint airdrop inspectors during before- and after-loading inspections.

CHAPTER 4

RIGGING FIVE-BAY, SINGLE-STORY, MEDIUM GIRDER (FIXED) BRIDGE ON A TYPE V PLATFORM

Section I

LOW-VELOCITY AIRDROP

4-1. Description of Load

The five-bay, single-story, medium girder (fixed) bridge (Figure 4-1) is rigged on a 32-foot, type V platform with five G-11B parachutes. The unrigged bridge weighs 11,522 pounds. When the bridge is rigged for airdrop, it is 407 inches long, 108 inches wide, and 97 inches high.

NOTES: 1. The curbs and guide markers are not included in this manual.

2. There must be at least eight bridge crew personnel to assist in the rigging of this load.

3. The nose bumper may or may not be installed.

4. Measurements given in this section are from the front edge of the platform. NOT from the front edge of the nose bumper.

4-2. Preparing Platform

Prepare a 32-foot, type V airdrop platform as given below.

a. Inspecting Platform. Inspect, or assemble and inspect, the platform according to TM 10-1670-268-20&P/TO 13C7-52-22.

NOTE: If the platform must be assembled, install the suspension links when assembling the platform. See Figure 4-2 for the location of the suspension links.

b. Installing Suspension Links. Install eight suspension links on the assembled platform according to FM 10-500-2/TO 13C7-1-5 and as shown in Figure 4-2.

c. Installing Tandem Links. Install two tandem links as shown in Figure 4-2.

d. Attaching and Numbering Clevises. Attach and number 68 clevis assemblies as shown in Figure 4-2.

Note: This drawing is not drawn to scale.

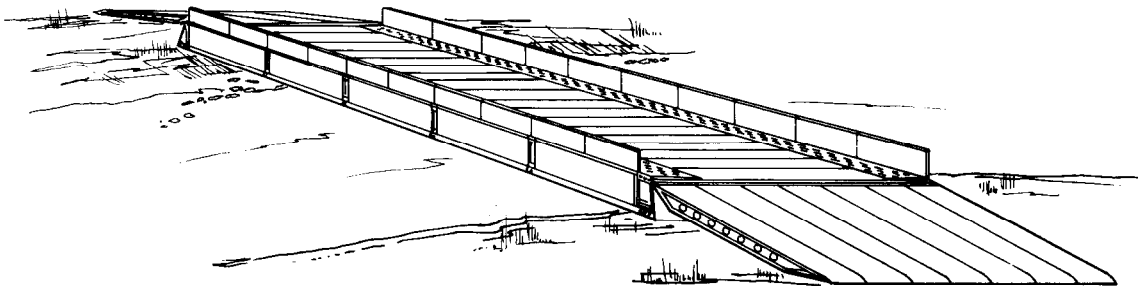
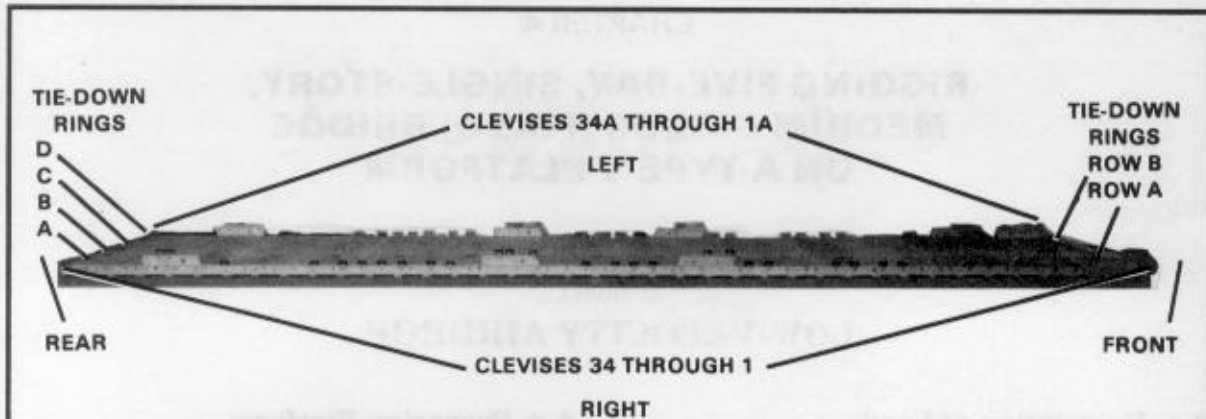

Figure 4-1. Five-bay, single-story, medium girder (fixed) bridge assembled



Step:

1. Install a suspension link in holes 26, 27, and 28 on each platform side rail. Face the flat part of the suspension link to the front of the platform side rail.
2. Install a suspension link in holes 6, 7, and 8 on each platform side rail. Face the flat part of the suspension link to the front of the platform side rail.
3. Install a suspension link in holes 37, 38, and 39 on each platform side rail. Face the flat part of the suspension link to the rear of the platform side rail.
4. Install a suspension link in holes 57, 58, and 59 on each platform side rail. Face the flat part of the suspension link to the rear of the platform side rail.
5. Install a tandem link on the front of each platform side rail using holes 1, 2, and 3.
6. Install clevises on bushings 1, 2, and 4 on each front tandem link.
7. Install a clevis on bushings 2 and 3 on the first suspension link on each side.
8. Install clevises on bushings 1 and 3 on the second suspension link on each side.
9. Install a clevis on bushings 1, 2, and 3 on the third suspension link on each side.
10. Install a clevis on bushings 2 and 3 on the fourth suspension link on each side.
11. Starting at the front of each platform side rail, install clevises on the bushings bolted on holes 5, 10, 11, 15, 16, 18, 19, 23, 24, 30, 31, 32, 34, 42, 43, 45, 46, 47, 48, 50, 55, and 64.
12. Starting at the front of the platform, number the clevises bolted to the right side from 1 through 34 and those bolted to the left side from 1A through 34A.
13. Starting at the front of the platform, label the two tie-down rings in the first 15 panels A and B from right to left. Label the four tie-down rings in the last panel A, B, C, and D from right to left. Starting with the first panel, number the tie-down rings 1 through 16.

Figure 4-2. Platform prepared

4-3. Preparing and Positioning Honeycomb Stacks

Prepare the honeycomb stacks as shown in Figures 4-3, 4-4, and 4-5. Position the honeycomb stacks on the platform as shown in Figure 4-6.

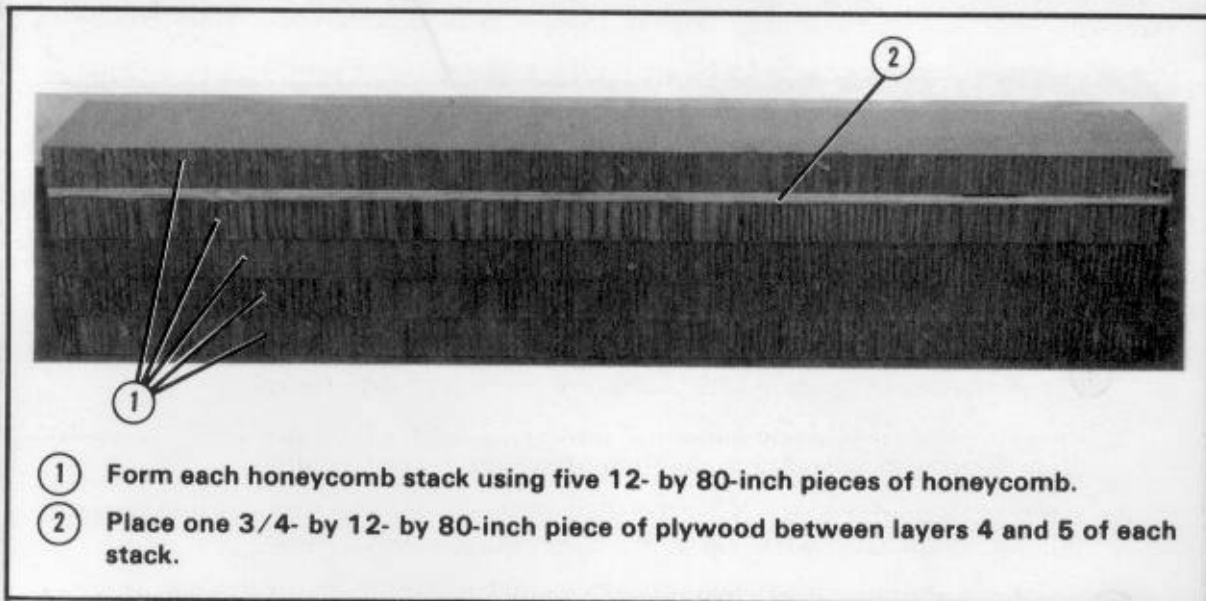

Figure 4-3. Honeycomb stacks 1, 4, 5, 8, 9, 12, 13, and 16 prepared

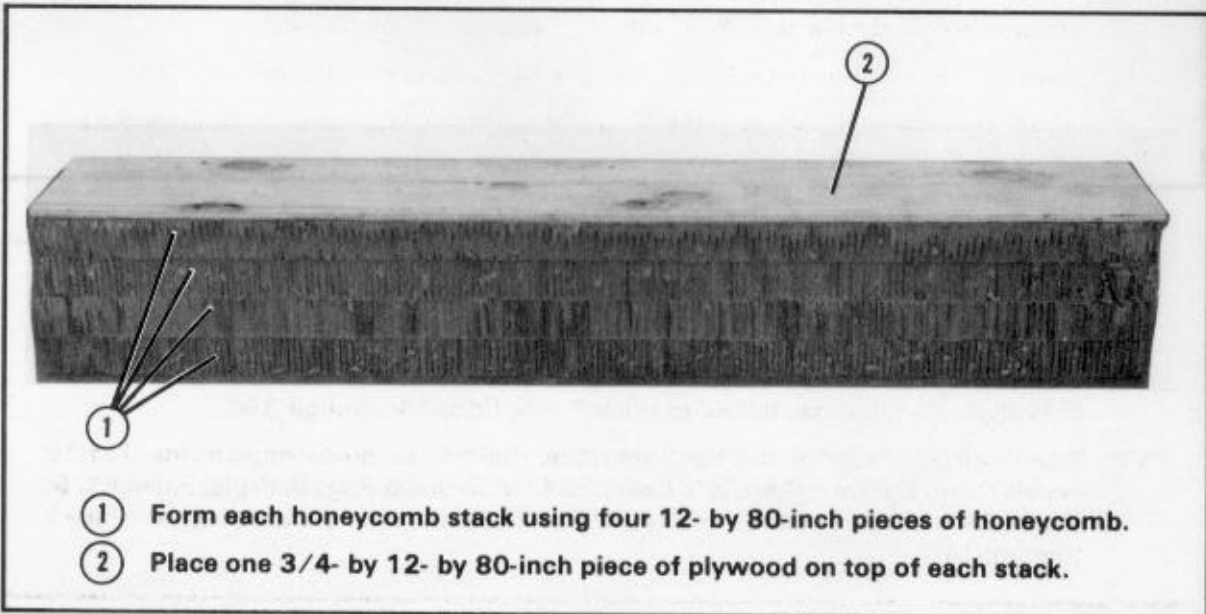
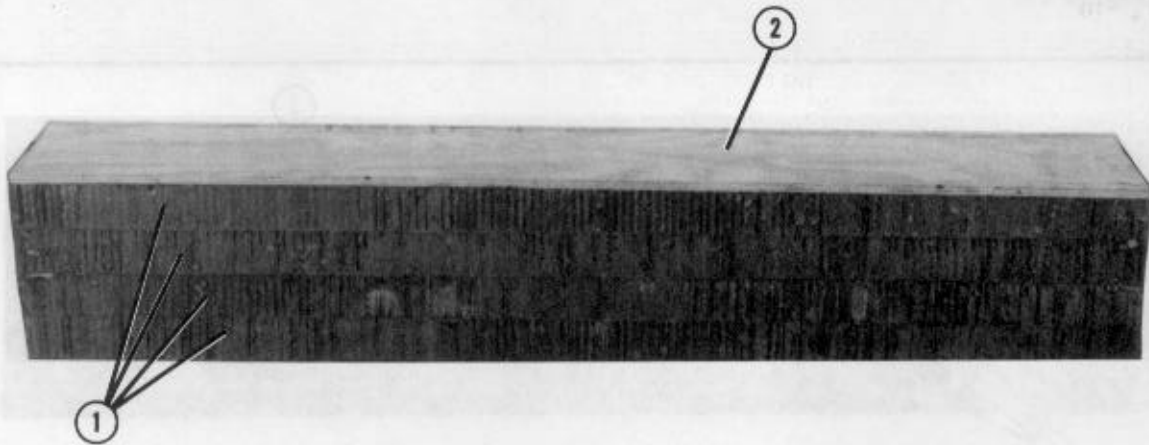
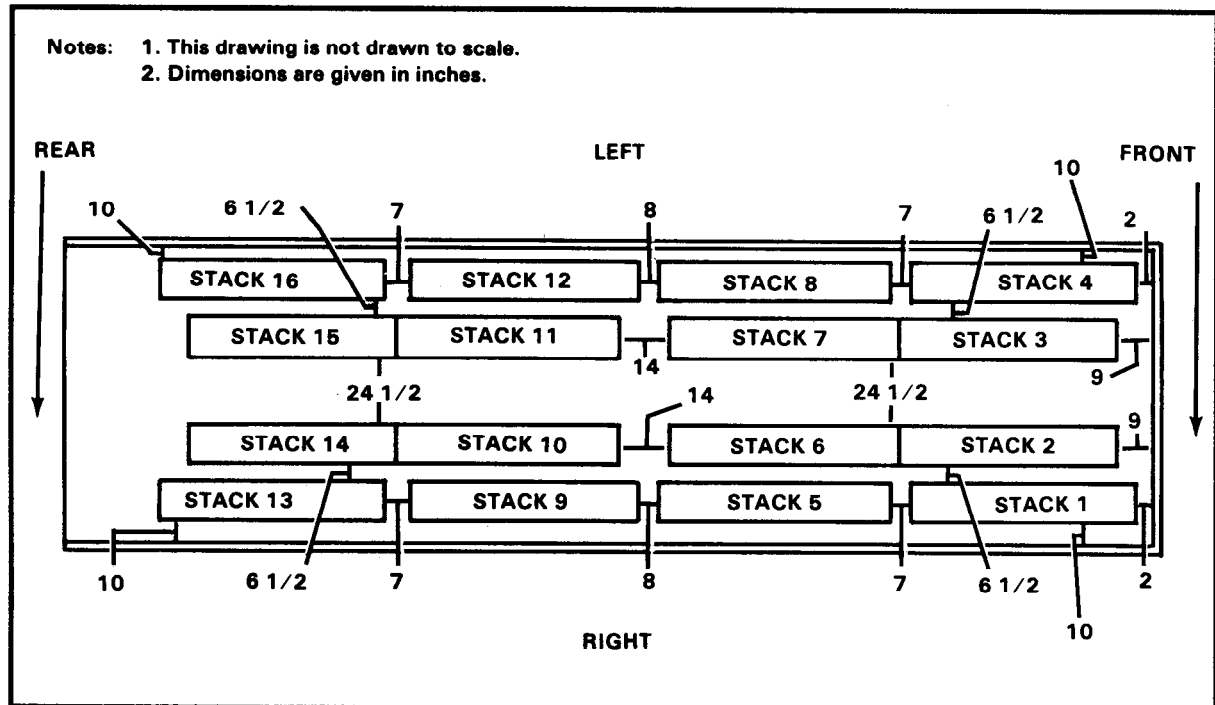

Figure 4-4. Honeycomb stacks 2, 3, 6, 7, 10, and 11 prepared



- ① Form each honeycomb stack using four 12- by 73-inch pieces of honeycomb.
- ② Place one 3/4- by 12- by 73-inch piece of plywood on top of each stack.

Figure 4-5. Honeycomb stacks 14 and 15 prepared



Stack Number	Position of Stack on Platform
1	Place stack: 2 inches from the front edge of the platform and 10 inches from the right side rail.
2	9 inches from the front edge of the platform and 6 1/2 inches from the left edge of stack 1.
3	9 inches from the front edge of the platform and 24 1/2 inches from the left edge of stack 2.
4	2 inches from the front edge of the platform and 10 inches from the left side rail.
5	7 inches from the rear edge of stack 1 and 10 inches from the right side rail.
6	Flush against stack 2 and 6 1/2 inches from the left edge of stack 5.
7	Flush against stack 3 and 24 1/2 inches from the left edge of stack 6.
8	7 inches from the rear edge of stack 4 and 10 inches from the left side rail.
9	8 inches from the rear edge of stack 5 and 10 inches from the right side rail.
10	14 inches from the rear edge of stack 6 and 6 1/2 inches from the left edge of stack 9.
11	14 inches from the rear edge of stack 7 and 24 1/2 inches from the left edge of stack 10.
12	8 inches from the rear edge of stack 8 and 10 inches from the left side rail.
13	7 inches from the rear edge of stack 9 and 10 inches from the right side rail.
14	Flush against stack 10 and 6 1/2 inches from the left edge of stack 13.
15	Flush against stack 11 and 24 1/2 inches from the left edge of stack 14.
16	7 inches from the rear edge of stack 12 and 10 inches from the left side rail.

Figure 4-6. Honeycomb stacks positioned on the platform

4-4. Preparing Pallet 1

Prepare pallet 1 as shown in Figures 4-7 through 4-23.

- Notes:**
1. Front, rear, right, and left refer to the pallet.
 2. Pad all sharp edges that lashings may touch.

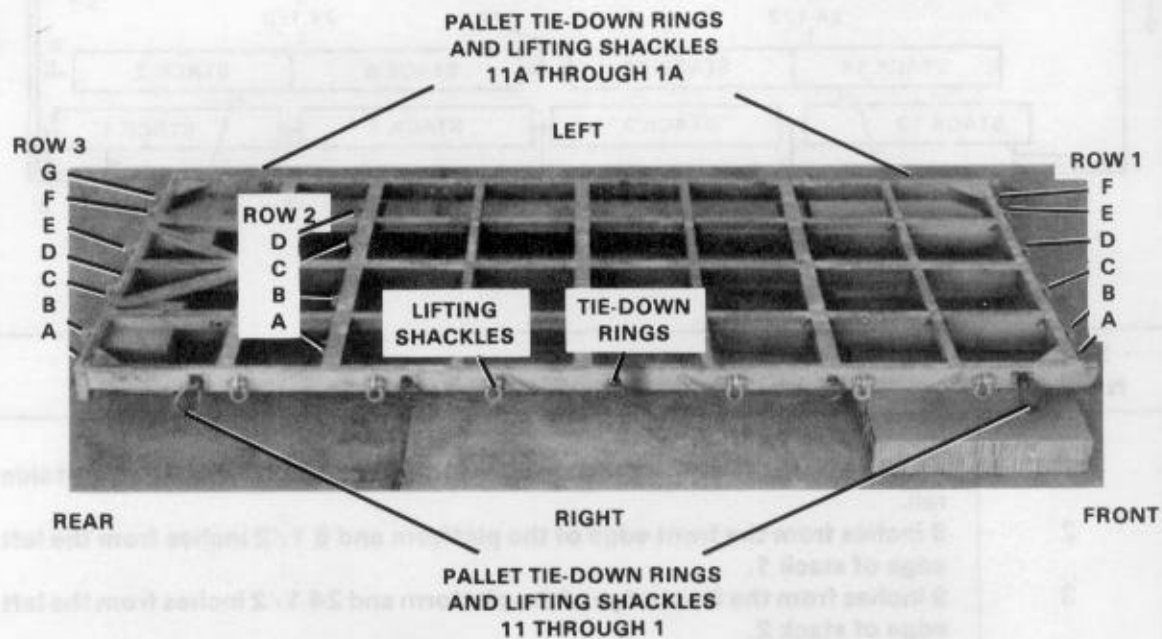

Step:

1. Starting at the front of the pallet, number the tie-down rings and lifting shackles bolted to the right side from 1 through 11 and those bolted to the left side from 1A through 11A.
2. Starting at the front of the pallet, label row 1 of tie-down rings and lifting shackles from right to left A1 through F1. Label row 2 from right to left A2 through D2. Label row 3 from right to left A3 through G3.
3. Place two 96- by 36-inch pieces of honeycomb under the front of the pallet to keep the pallet level.

Figure 4-7. Pallet 1 labeled

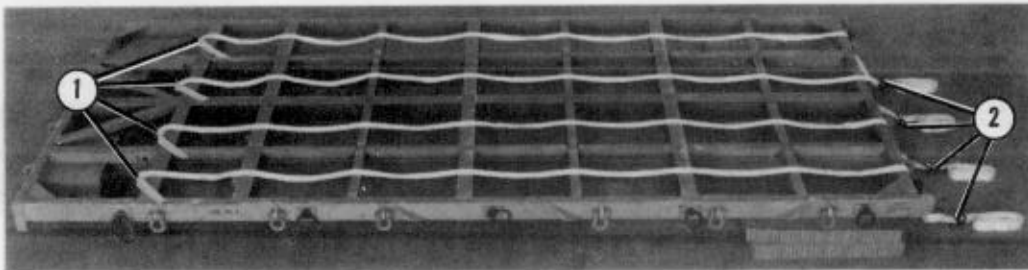

- ① Form four 30-foot lashings according to FM 10-500-2/TO 13C7-1-5. Evenly space the lashings on top of the pallet from front to rear between the pallet rails.
- ② Make sure each lashing D-rings are 20 inches from the front edge of the pallet.

Figure 4-8. Front-to-rear lashings pre-positioned

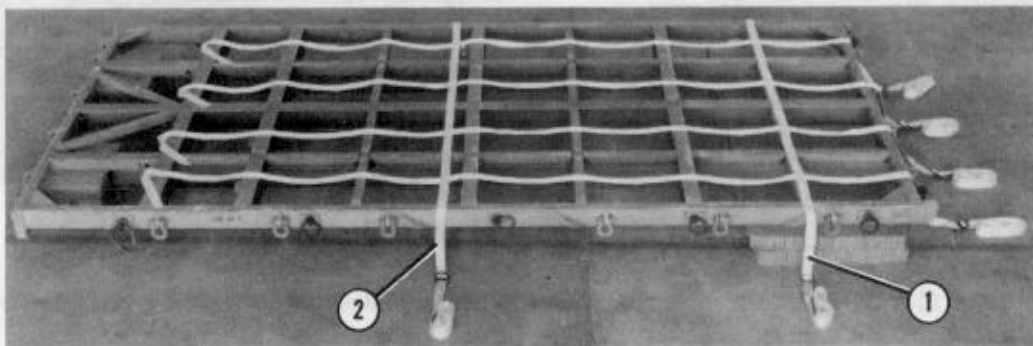

- ① Form two 30-foot lashings according to FM 10-500-2/TO 13C7-1-5. Place one 30-foot lashing on top of the pallet 21 inches from the front edge of the pallet in a side-to-side direction. Make sure the D-rings are 15 inches from the right side of the pallet.
- ② Place one 30-foot lashing on top of the pallet 90 inches from the front edge of the pallet in a side-to-side direction. Make sure the D-rings are 15 inches from the right side of the pallet.

Figure 4-9. Side-to-side lashings pre-positioned



ONE DECK

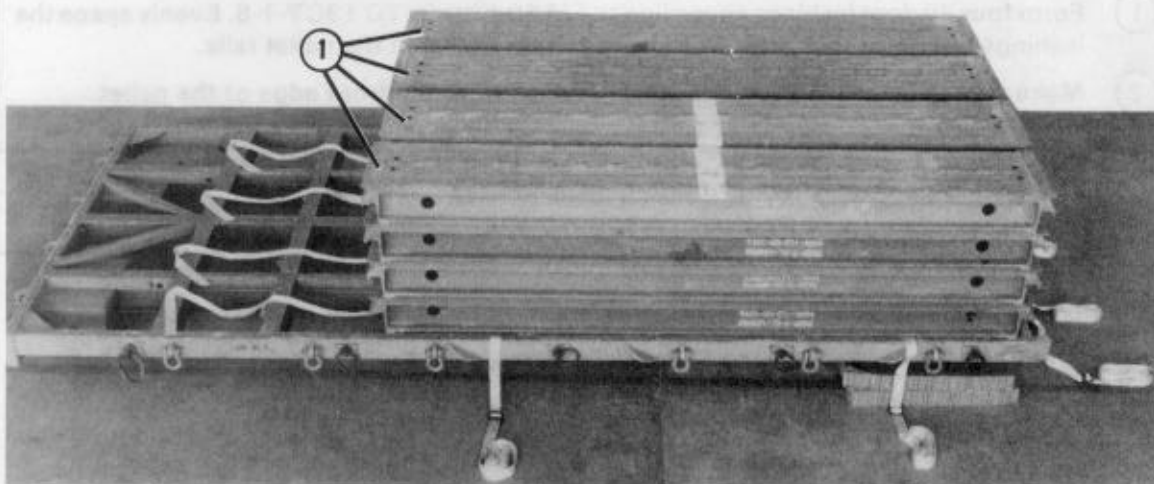

- ① Place four rows of four decks each on top of the pallet flush with the front edge of the pallet.

Figure 4-10. Sixteen decks positioned on pallet

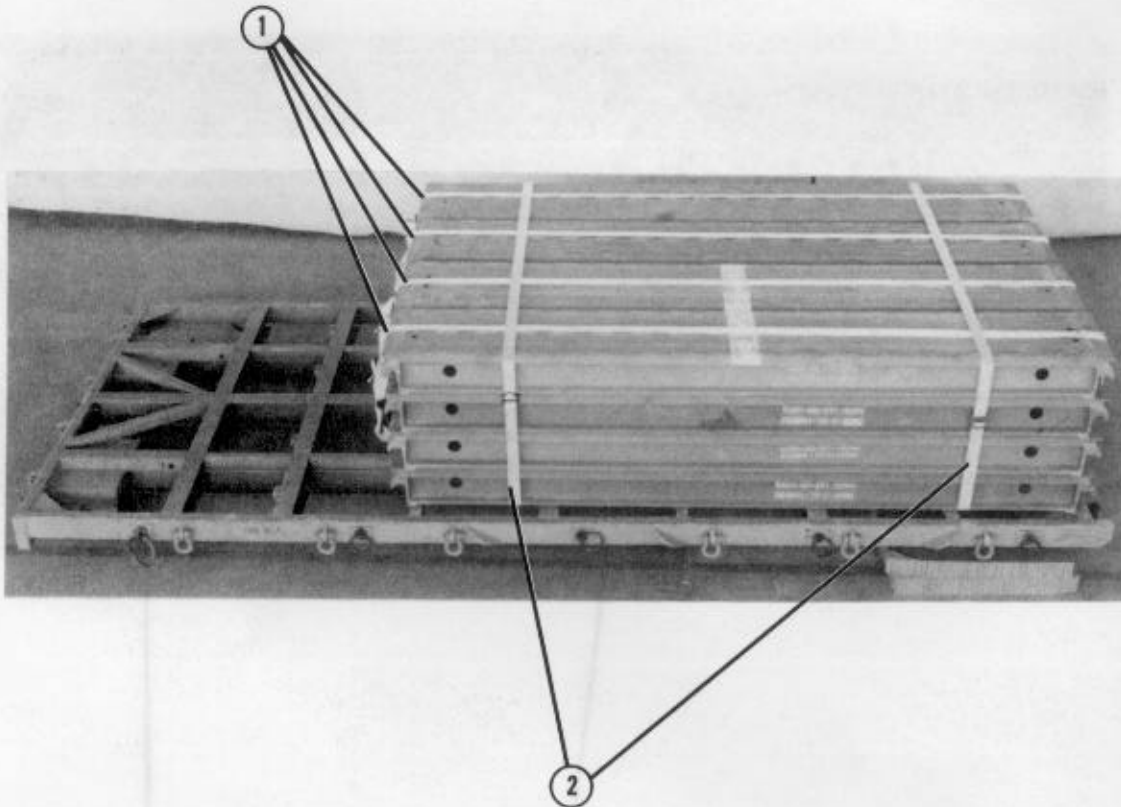

- ① Run the four front-to-rear pre-positioned lashings over the top of the decks. Secure the lashings according to FM 10-500-2/TO 13C7-1-5 on the rear of the decks.
- ② Run the two side-to-side pre-positioned lashings over the top of the decks. Secure the lashings according to FM 10-500-2/TO 13C7-1-5 on the left side of the decks.

Figure 4-11. Sixteen decks secured

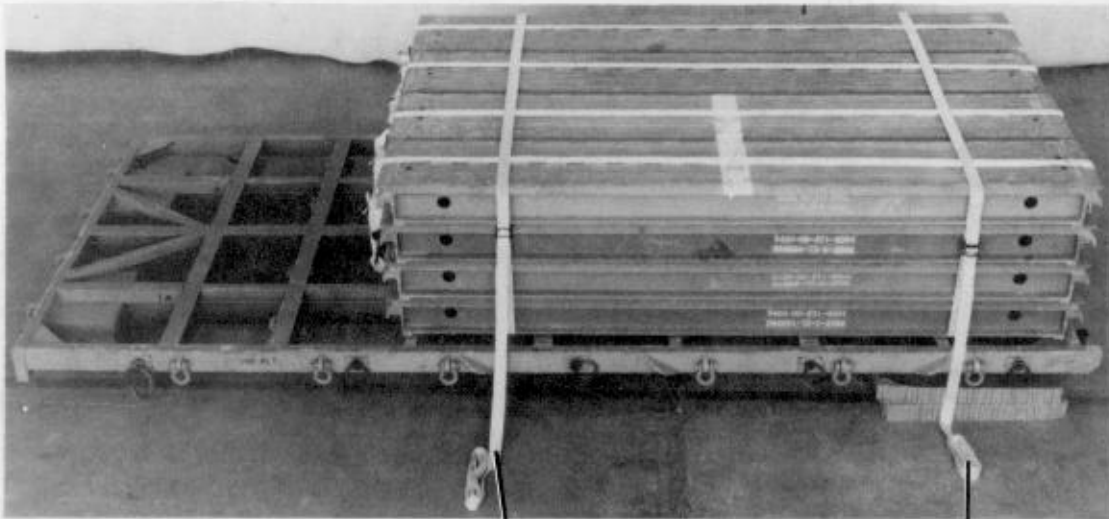

- ① Form two 30-foot lashings according to FM 10-500-2/TO 13C7-1-5. Place one 30-foot lashing on top of the secured decks 21 inches from the front edge of the pallet in a side-to-side direction. Make sure the D-rings are placed on the right side of the decks.
- ② Place one 30-foot lashing on top of the secured decks 90 inches from the front edge of the pallet in a side-to-side direction. Make sure the D-rings are placed on the right side of the decks.

Figure 4-12. Short ramps positioned and secured

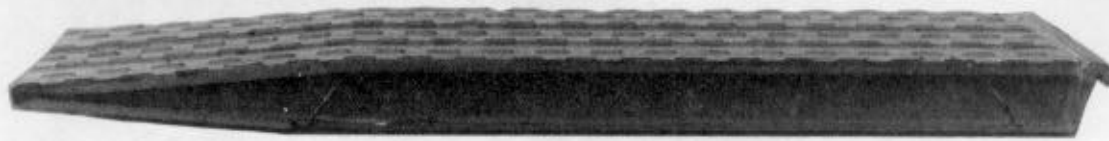

ONE RAMP

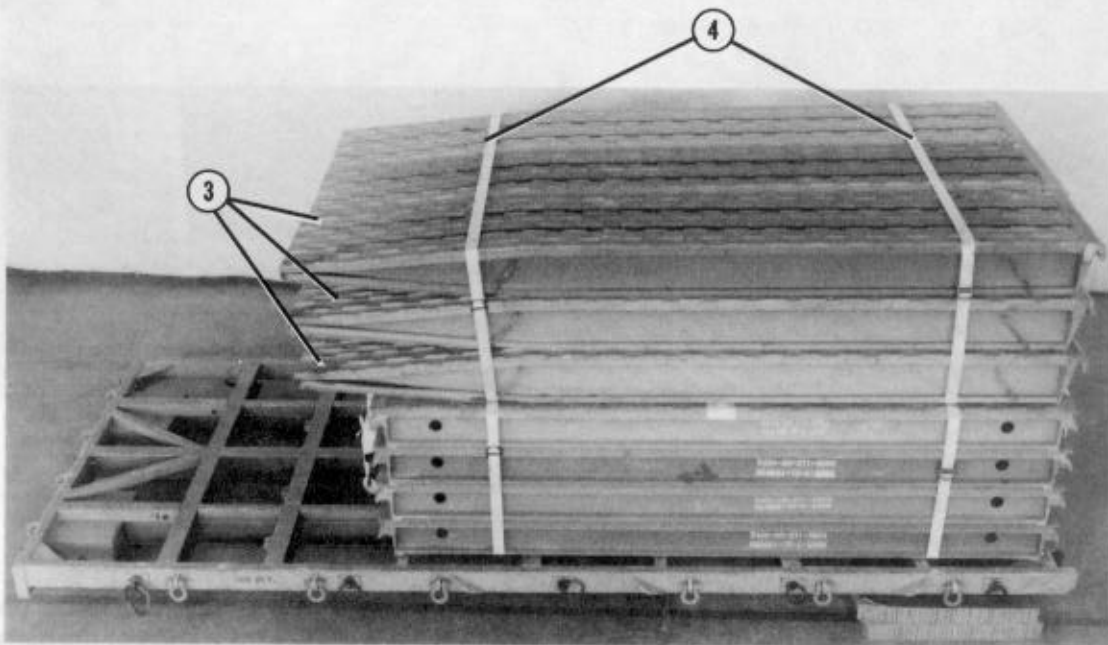

- ③ Position three rows of three short ramps on top of and flush with the front edge of the secured decks.
- ④ Run the two pre-positioned lashings over the top of the short ramps. Secure the lashings according to FM 10-500-2/TO 13C7-1-5 on the left side of the ramps.

Figure 4-12. Short ramps positioned and secured (continued)

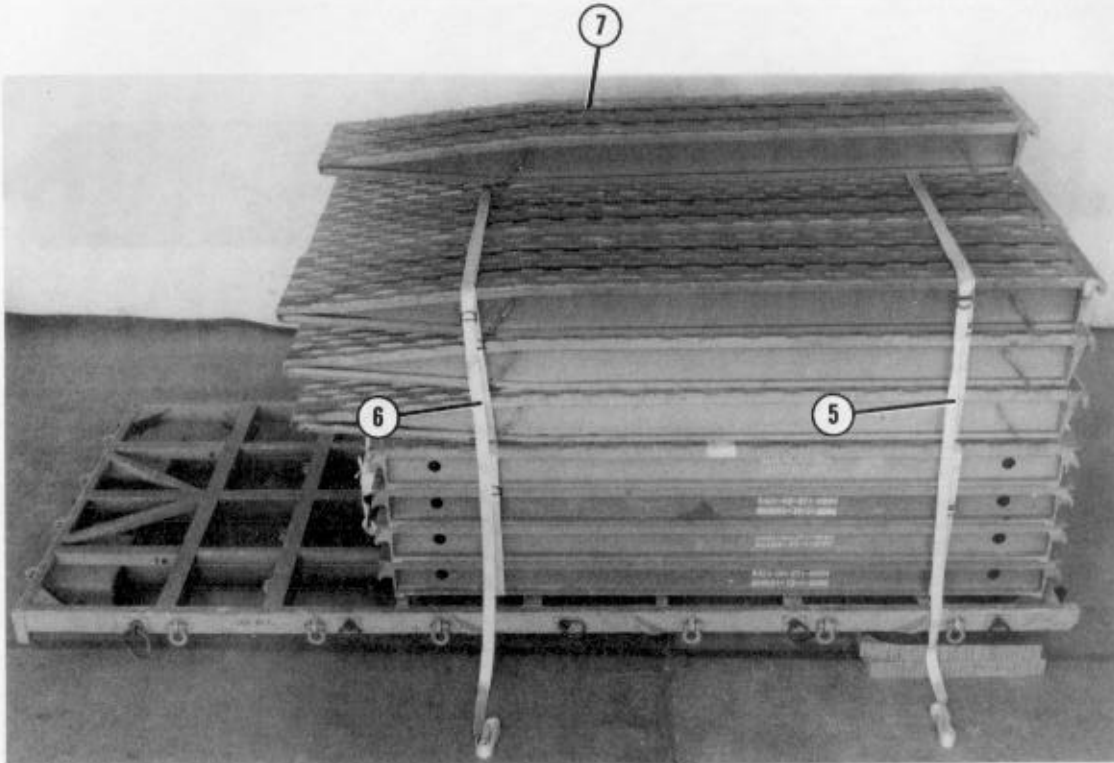

- ⑤ Form two 30-foot lashings according to FM 10-500-2/TO 13C7-1-5. Place one 30-foot lashing on top of the secured ramps 21 inches from the front edge of the pallet in a side-to-side direction. Make sure the D-rings are placed on the right side of the short ramps.
- ⑥ Place one 30-foot lashing on top of the secured ramps 90 inches from the front edge of the pallet in a side-to-side direction. Make sure the D-rings are placed on the right side of the short ramps.
- ⑦ Place one short ramp on top of the left side of the secured ramps flush with the front edge of the secured ramps.

Figure 4-12. Short ramps positioned and secured (continued)

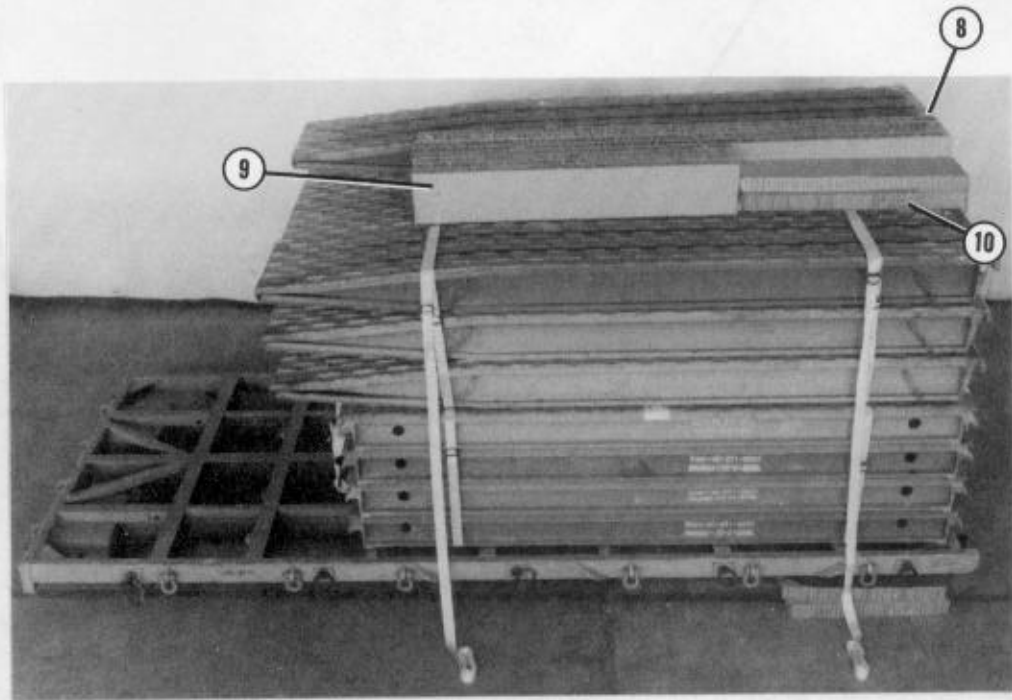

- ⑧ Place four 9- by 96-inch pieces of honeycomb on edge. Place them next to the short ramp flush with the front edge of the load.
- ⑨ Place four 9- by 56-inch pieces of honeycomb on edge. Place them flush with the rear edge of the 9- by 96-inch pieces of honeycomb.
- ⑩ Place two 11- by 40-inch pieces of honeycomb next to the 9- by 96-inch pieces of honeycomb flush with the front edge of the load.

Figure 4-12. Short ramps positioned and secured (continued)

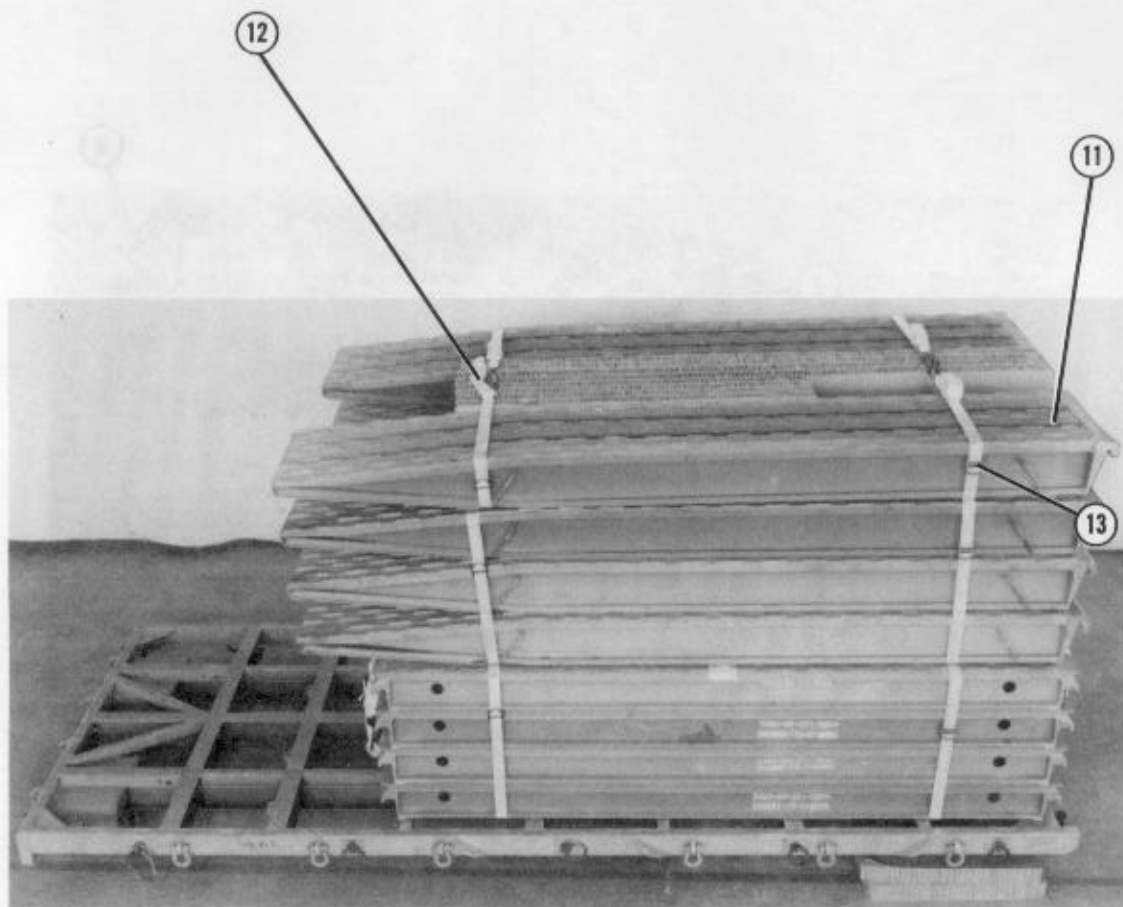

- ⑪ Place a short ramp next to the 9- by 56-inch pieces of honeycomb flush with the front edge of the load.
- ⑫ Run the rear pre-positioned lashing on top of the load. Secure the lashing according to FM 10-500-2/TO 13C7-1-3.
- ⑬ Run the front pre-positioned lashing on top of the load, and hook the lashing together using two D-rings and a load binder. Do NOT secure the lashing at this time.

Figure 4-12. Short ramps positioned and secured (continued)

Note: Dimensions are given in inches.

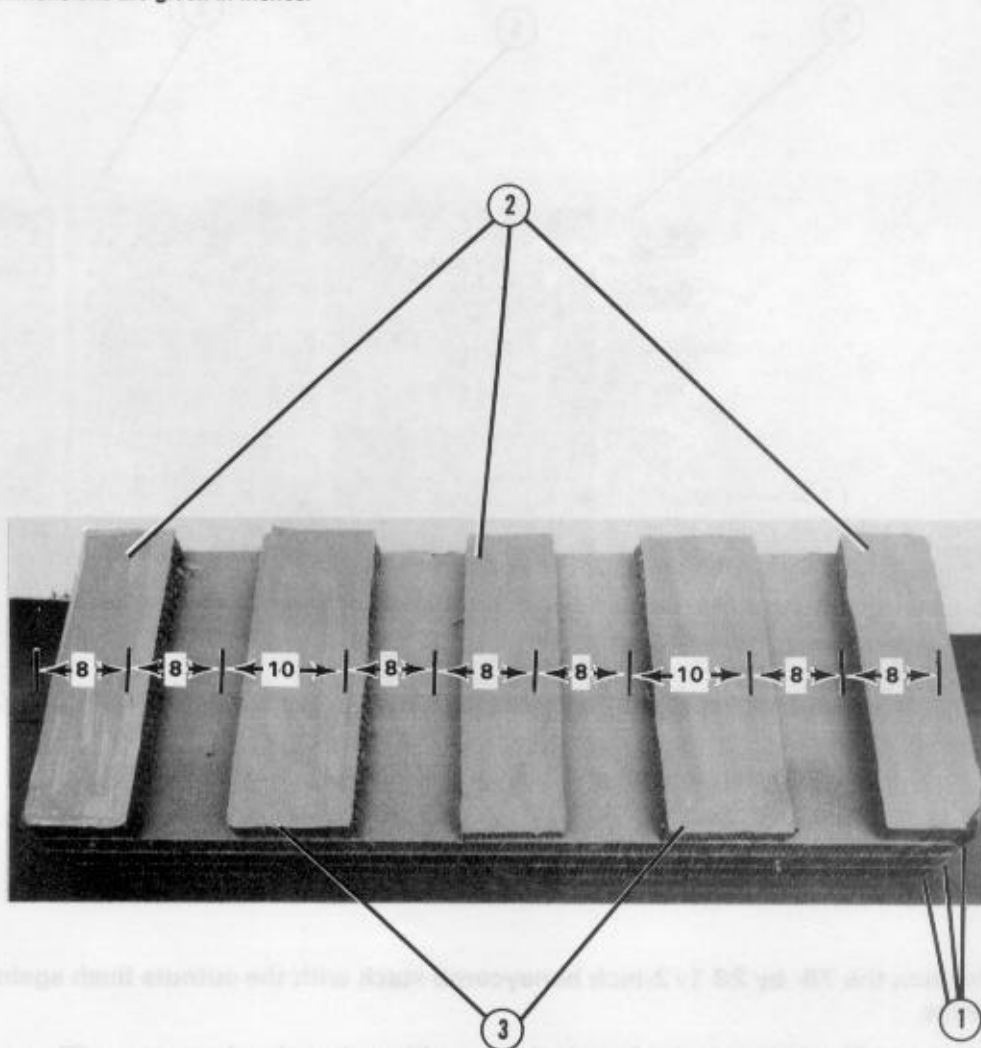

- ① Glue three 76- by 28 1/2-inch pieces of honeycomb together.
- ② Glue three 8- by 28 1/2-inch pieces of honeycomb as shown.
- ③ Glue two 10- by 28 1/2-inch pieces of honeycomb as shown.

Figure 4-13. Honeycomb stack prepared

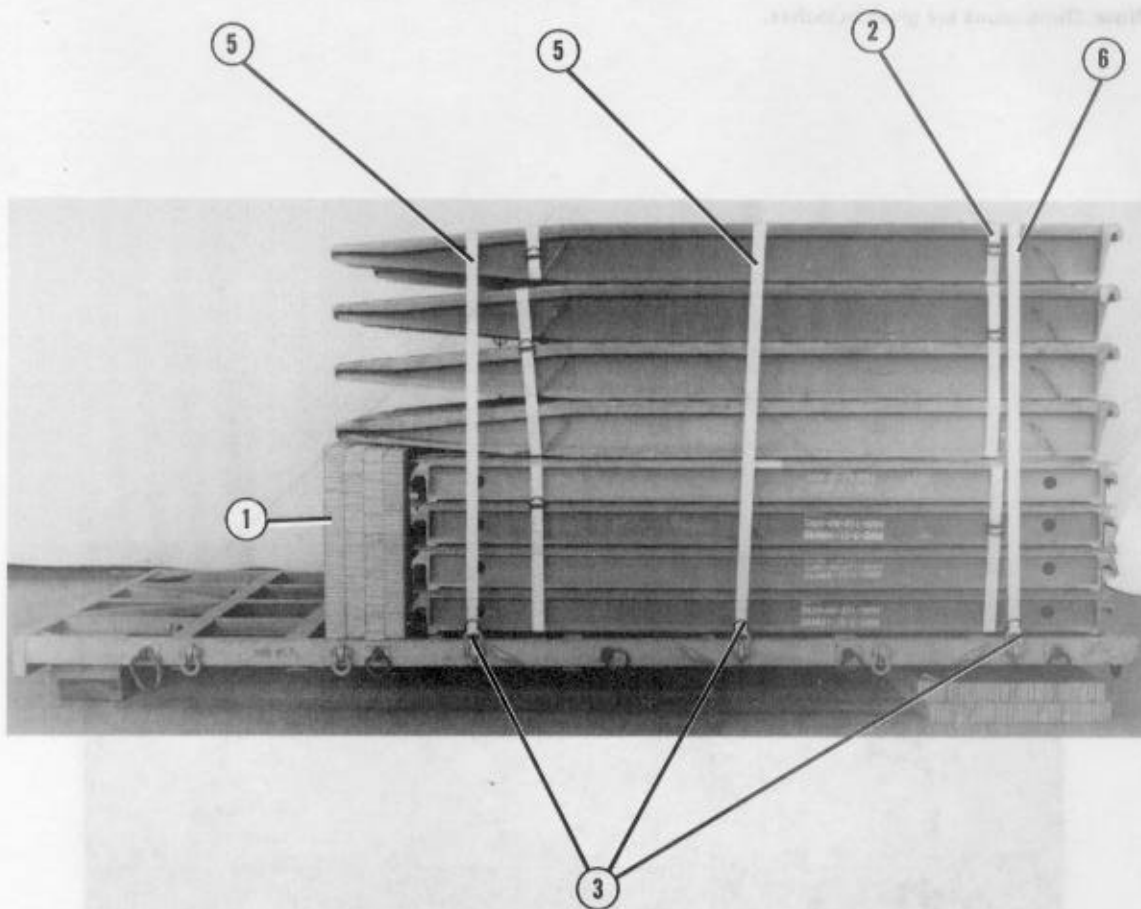

- ① Position the 76- by 28 1/2-inch honeycomb stack with the cutouts flush against the decks.
- ② Close but do not secure the front lashing positioned on the short ramps (Figure 4-12, step 13).
- ③ Pass a 15-foot lashing through pallet lifting shackles 2, 5, and 7 and back through their own D-rings.
- ④ Repeat step 3 for the left side of the pallet (not shown) using pallet lifting shackles 2A, 5A, and 7A.
- ⑤ Run the lashings, placed in pallet lifting shackles 5 and 5A and 7 and 7A, over the top of the load from right to left. Secure the lashings according to FM 10-500-2/TO 13C7-1-5 on the left side.
- ⑥ Run the lashings, placed in pallet lifting shackles 2 and 2A, over the top of the load from right to left. Close but do not secure the lashings at this time.

Figure 4-14. Honeycomb stack positioned and lashings secured

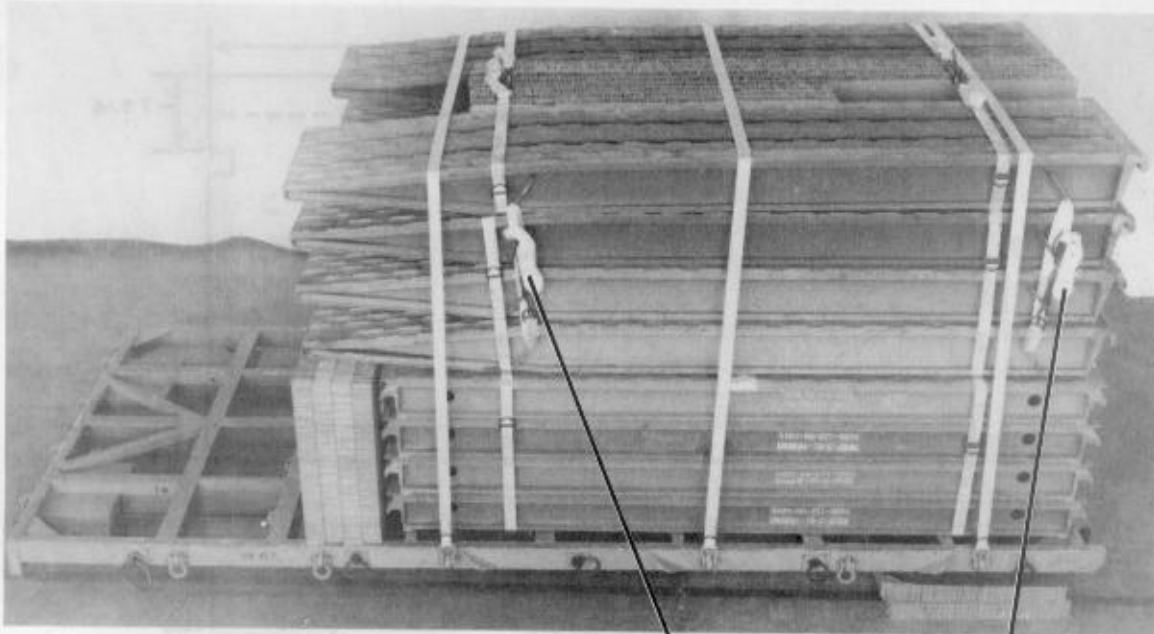

- ① Pass a 15-foot lashing through the front outside carrying handles of the short ramps. Secure the lashing according to FM 10-500-2/TO 13C7-1-5.
- ② Pass a 15-foot lashing through the rear outside carrying handles of the short ramps. Secure the lashing according to FM 10-500-2/TO 13C7-1-5.
- ③ Repeat steps 1 and 2 for the left side of the load (not shown).

Material	Length (inches)	Width (inches)	Quantity	Notes
3/4-inch plywood	32	28	1	1
2-by-4-inch lumber	4	28	2	2
3/4-inch plywood	32	28	1	3
2-by-4-inch lumber	4	28	2	4

Figure 4-15. Short ramps secured

- Notes: 1. These drawings are not drawn to scale.
 2. Dimensions are given in inches.

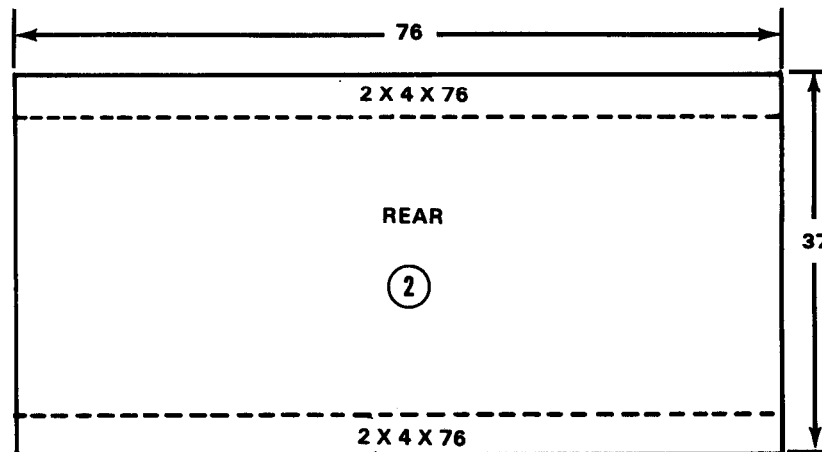
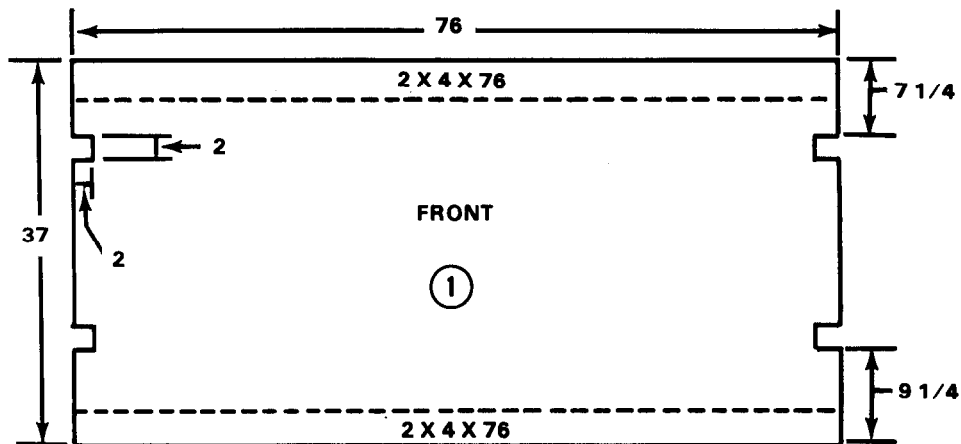

Item Number	Pieces	Width (Inches)	Length (Inches)	Material
1	1	76	37	3/4-inch plywood
	2	76	4	2- by 4-inch lumber
2	1	76	37	3/4-inch plywood
	2	76	4	2- by 4-inch lumber

Figure 4-16. Materials required to build parts box

- Notes: 1. These drawings are not drawn to scale.
 2. Dimensions are given in inches.

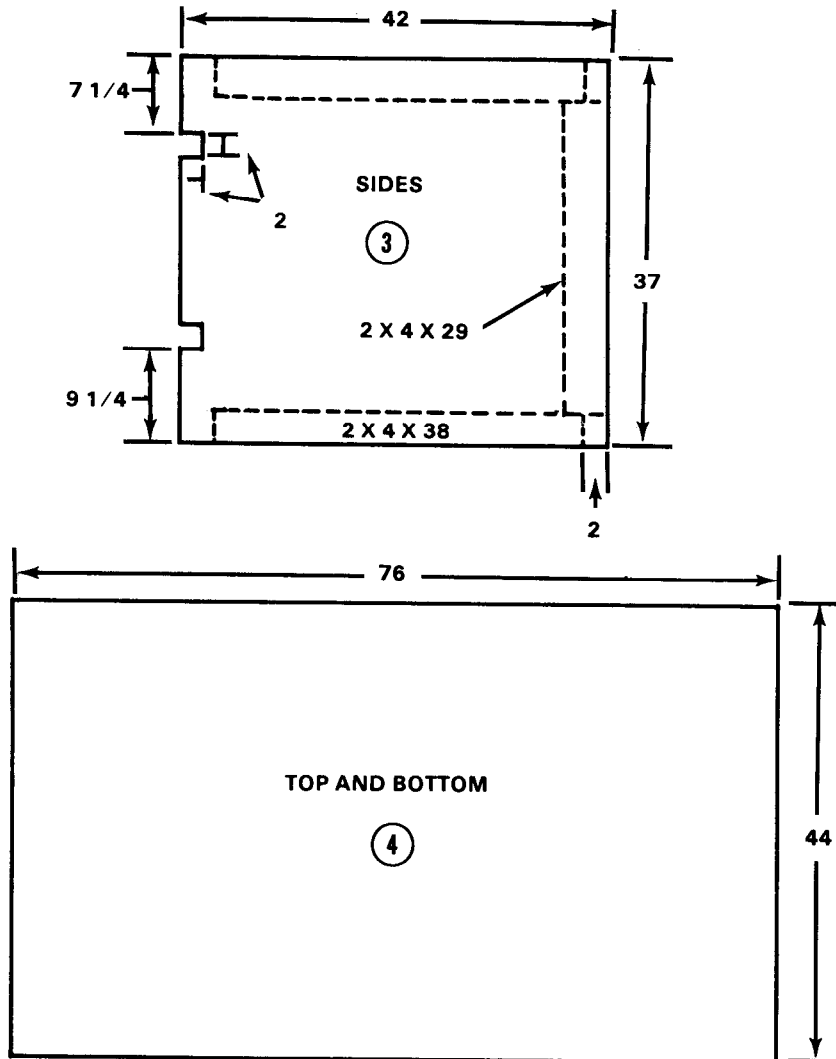

Item Number	Pieces	Width (Inches)	Length (Inches)	Material
3	2	42	37	3/4-inch plywood 2- by 4-inch lumber 2- by 4-inch lumber 3/4-inch plywood
	4	38	4	
	2	29	4	
4	2	76	44	

Figure 4-16. Materials required to build parts box (continued)

Note: This drawing is not drawn to scale.

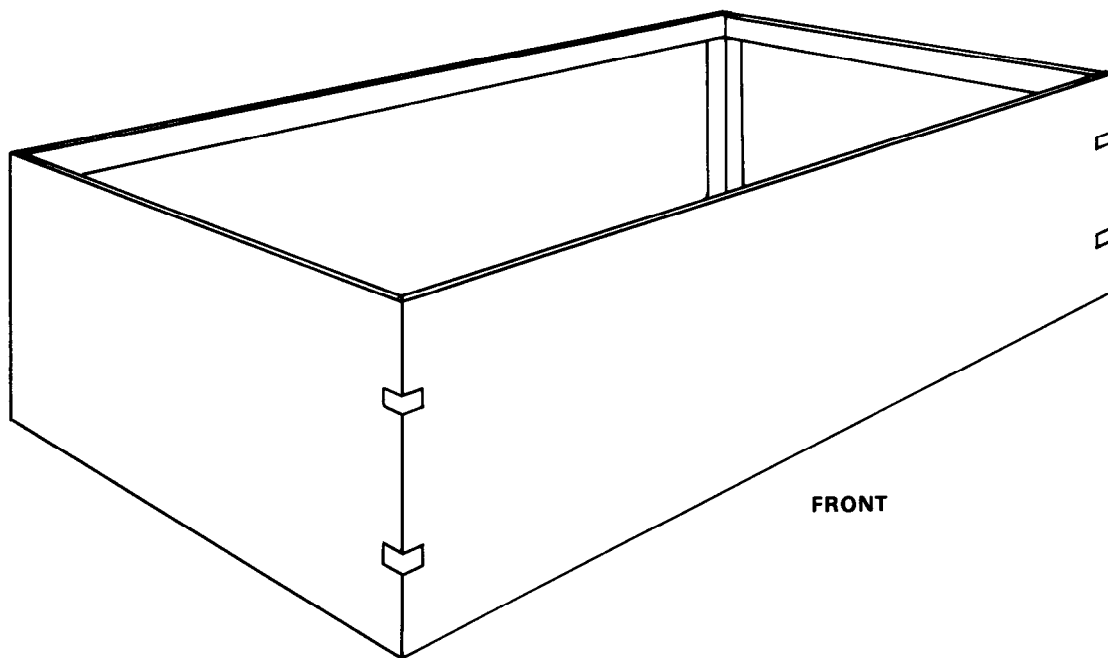

Step:

1. Build the parts box using the materials given in Figure 4-16.
2. Use eightpenny nails to secure the parts box.

Figure 4-17. Parts box built

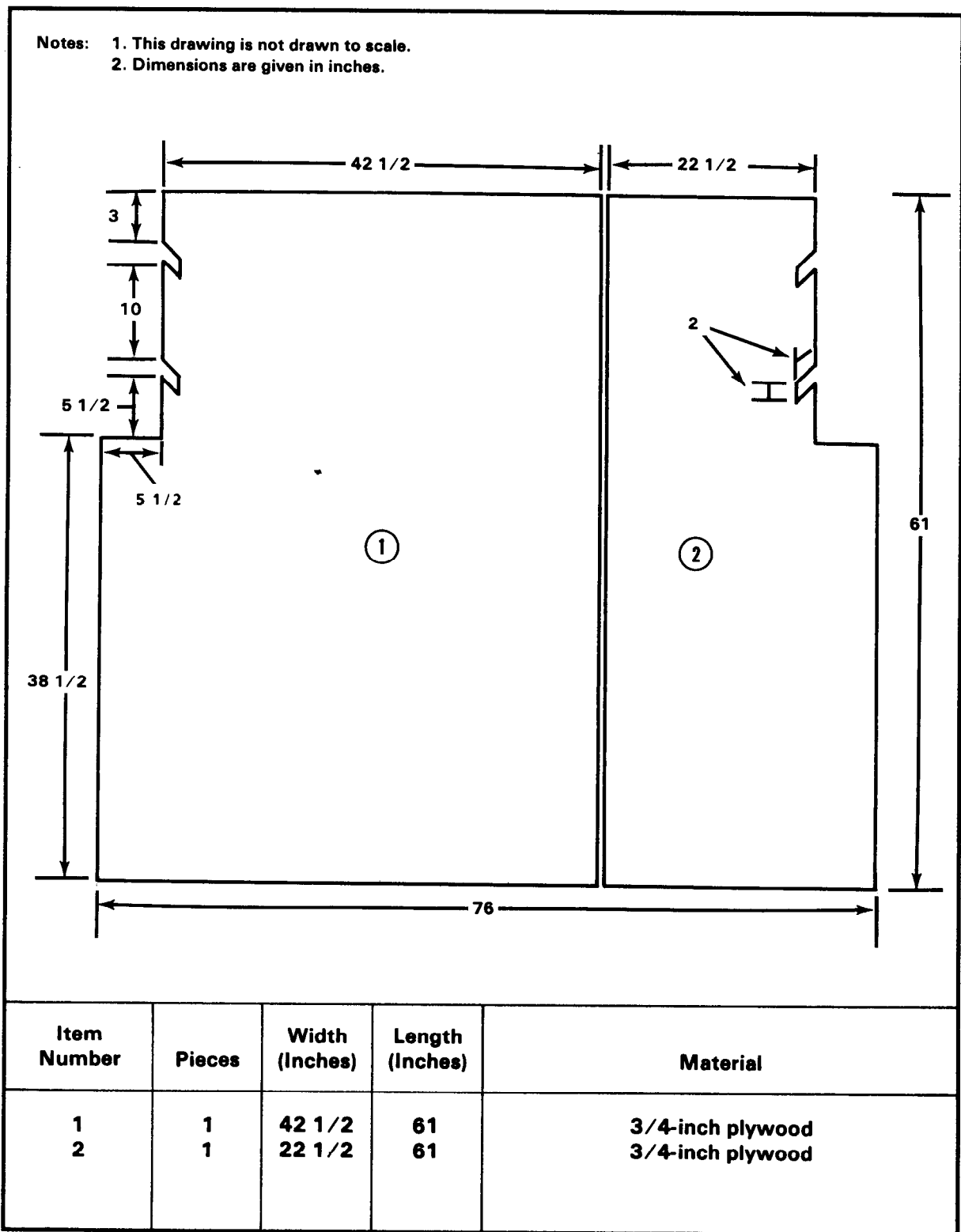
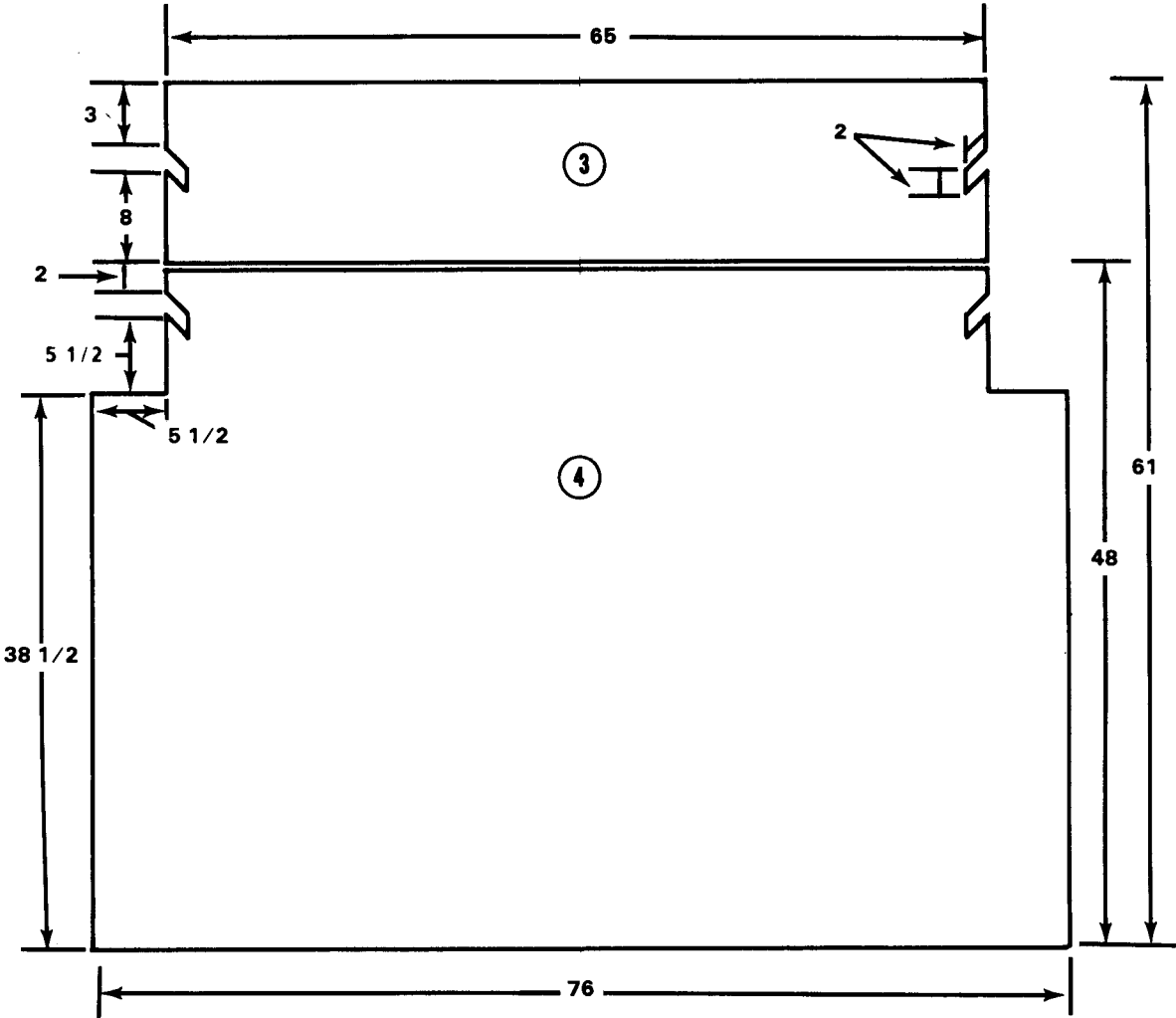

Figure 4-18. Materials required to build restraint board 1

Notes: 1. This drawing is not drawn to scale.
 2. Dimensions are given in inches.



Item Number	Pieces	Width (Inches)	Length (Inches)	Material
3	1	65	13	3/4-inch plywood
4	1	76	48	3/4-inch plywood

Figure 4-18. Materials required to build restraint board 1 (continued)

Note: This drawing is not drawn to scale.

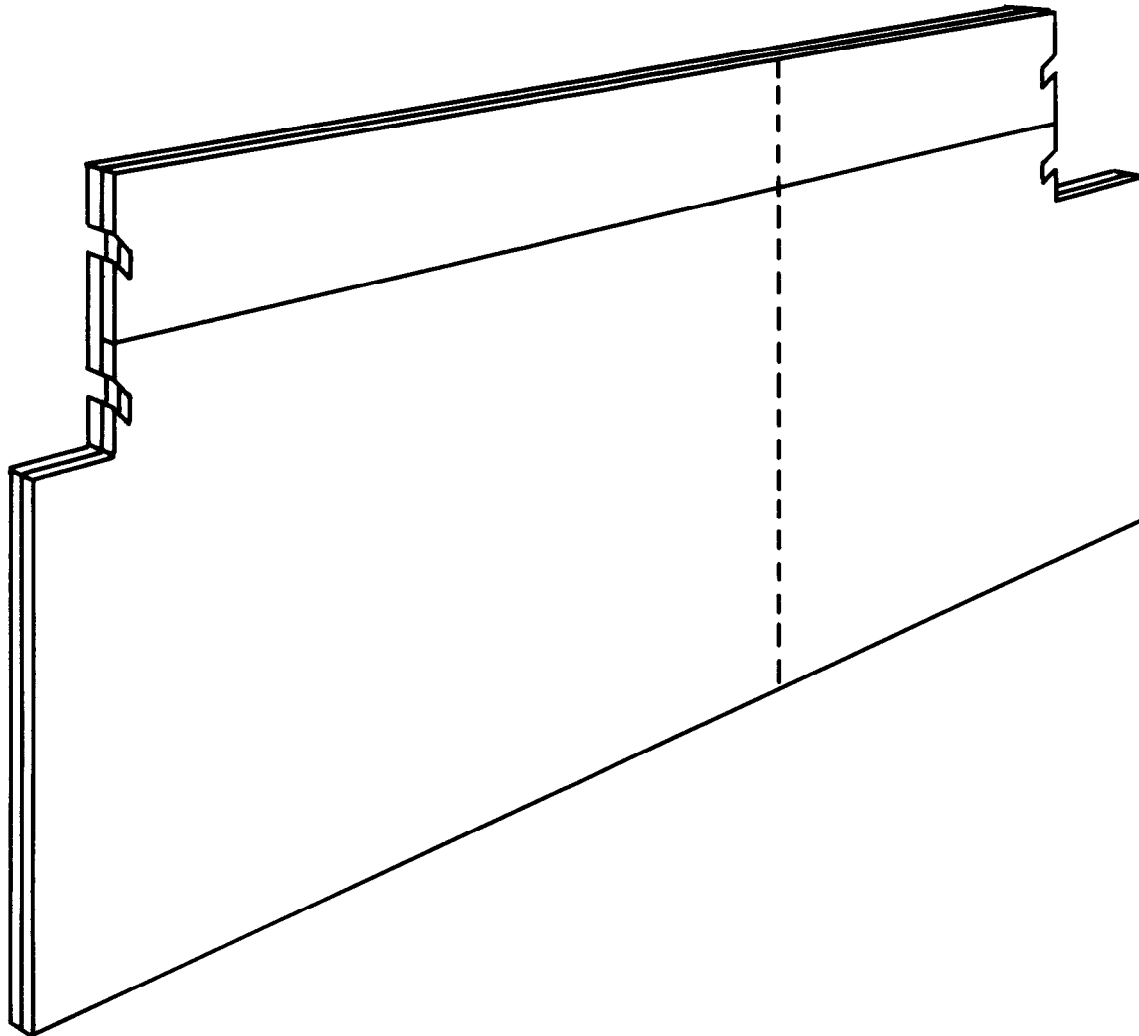

Step:

- 1. Build the restraint board 1 using the materials given in Figure 4-18.**
- 2. Use eightpenny nails to secure restraint board 1.**

Figure 4-19. Restraint board 1 built

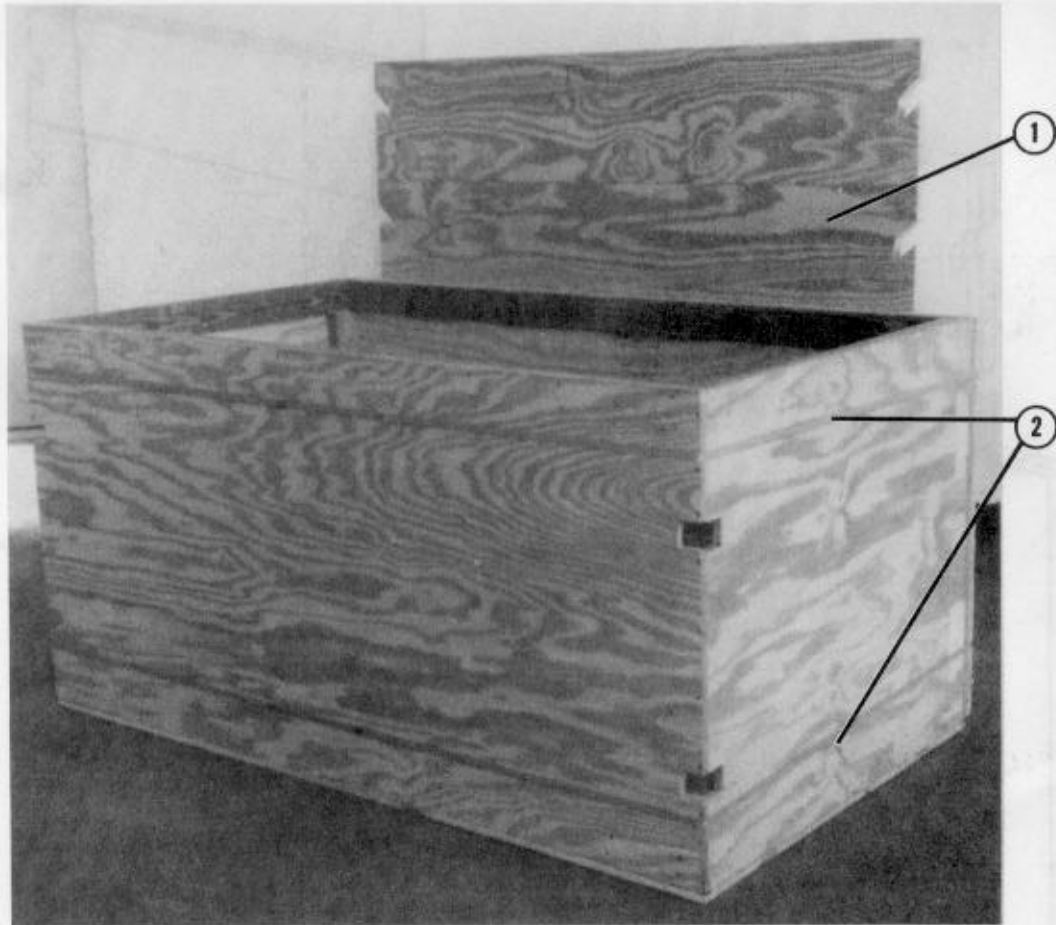

- ① Nail restraint board 1 to the rear of the parts box using eightpenny nails.
- ② Secure the parts box and restraint board 1 together using steel strapping material or two 30-foot lashings (formed according to FM 10-500-2/TO 13C7-1-5). These photographs show steel strapping being used.

Figure 4-20. Parts box and restraint board 1 secured together

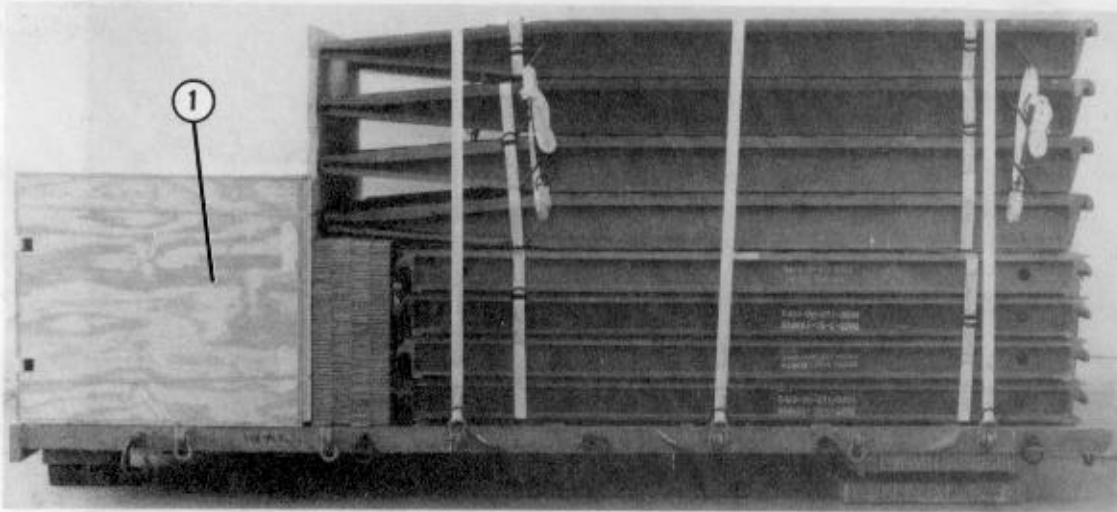

- ① Position the parts box and restraint board 1 on the rear of pallet 1 with restraint board 1 flush against the load.

Figure 4-21. Parts box and restraint board 1 positioned on pallet 1

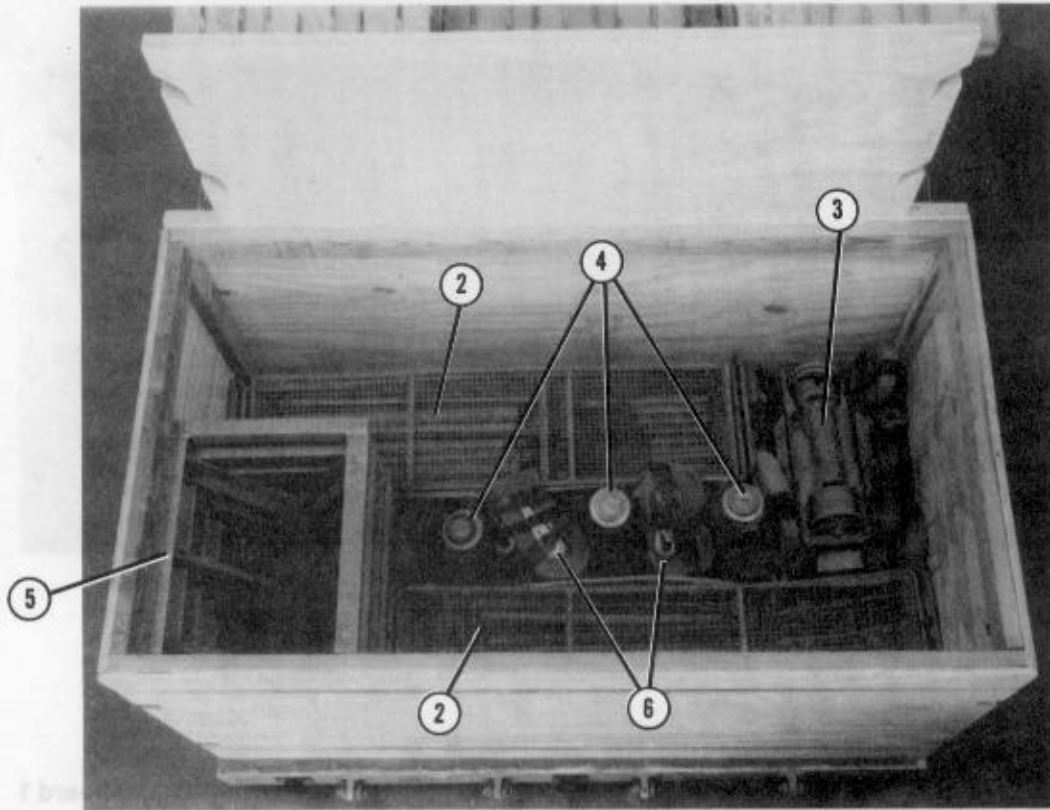

- ① Place a 71 1/2- by 36-inch piece of honeycomb (not shown) in the bottom of the parts box.
- ② Place the two baskets in the parts box. Make sure the basket with the pins is to the front and rear corner of the parts box.
- ③ Place a landing roller in the parts box (as shown). Wedge a 4- by 7 1/2-inch piece of honeycomb at either end of the landing roller to prevent tilting (not shown).
- ④ Place three hydraulic jacks in the parts box.
- ⑤ Place four building pedestals in the parts box.
- ⑥ Fill open spaces with 10,000-pound straps.

Figure 4-22. Parts placed in parts box

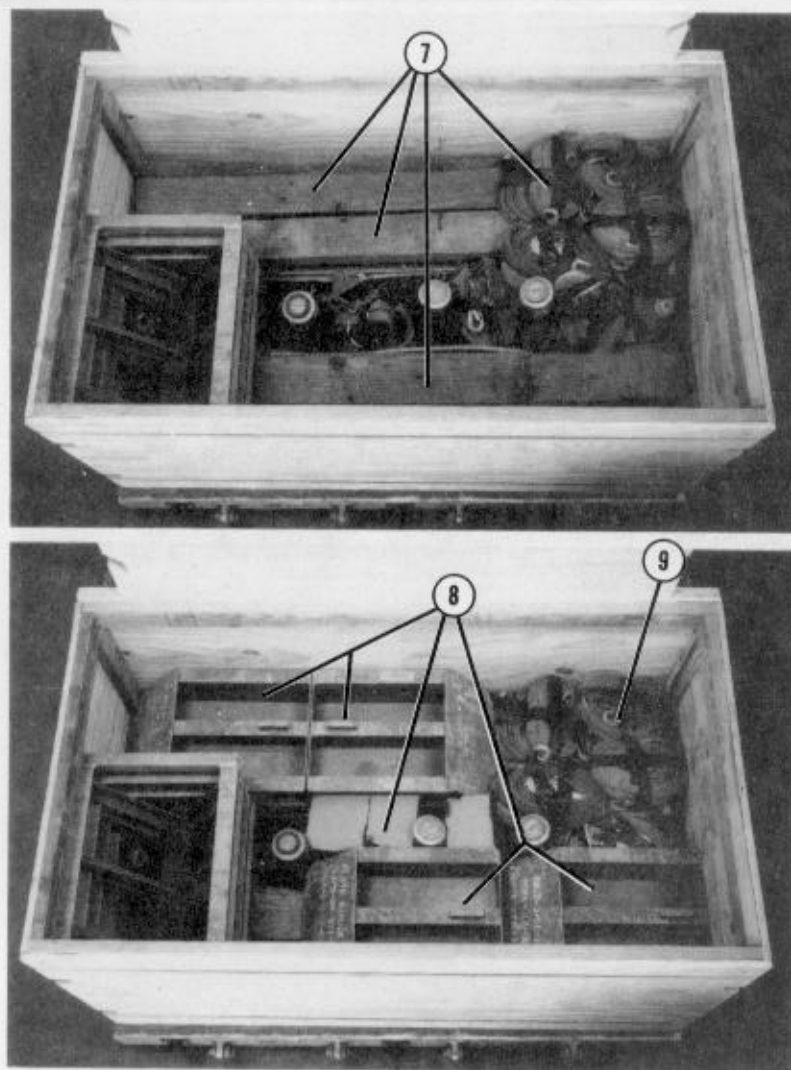

- ⑦ Place three pieces of dunnage and additional 10,000-pound straps in the parts box.
- ⑧ Place four single store baseplates in the parts box with honeycomb fillers between the baseplates.
- ⑨ Place additional 10,000-pound straps in the parts box.

Figure 4-22. Parts placed in parts box (continued)

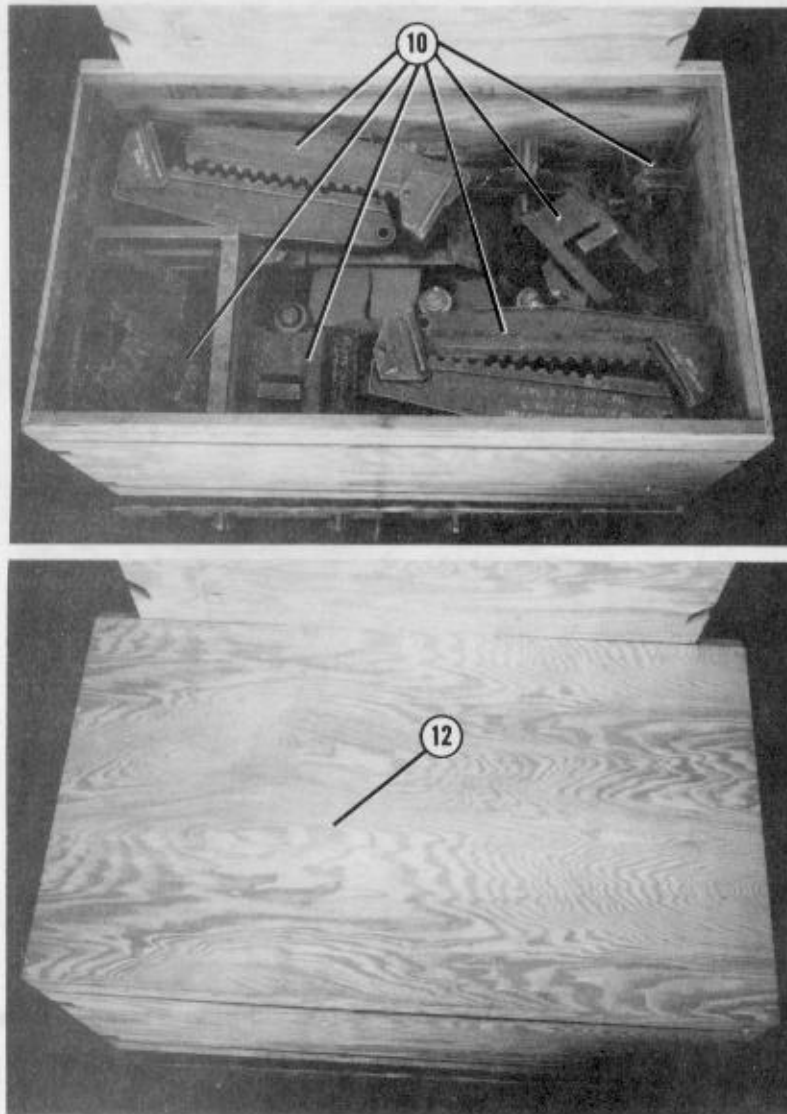

- ⑩ Place four jack posts, four jack supports, and two fixed supports in the parts box.
- ⑪ Fill the remainder of the parts box with pieces of honeycomb (not shown).
- ⑫ Place the top on the box, and secure it using eightpenny nails.

Figure 4-22. Parts placed in parts box (continued)

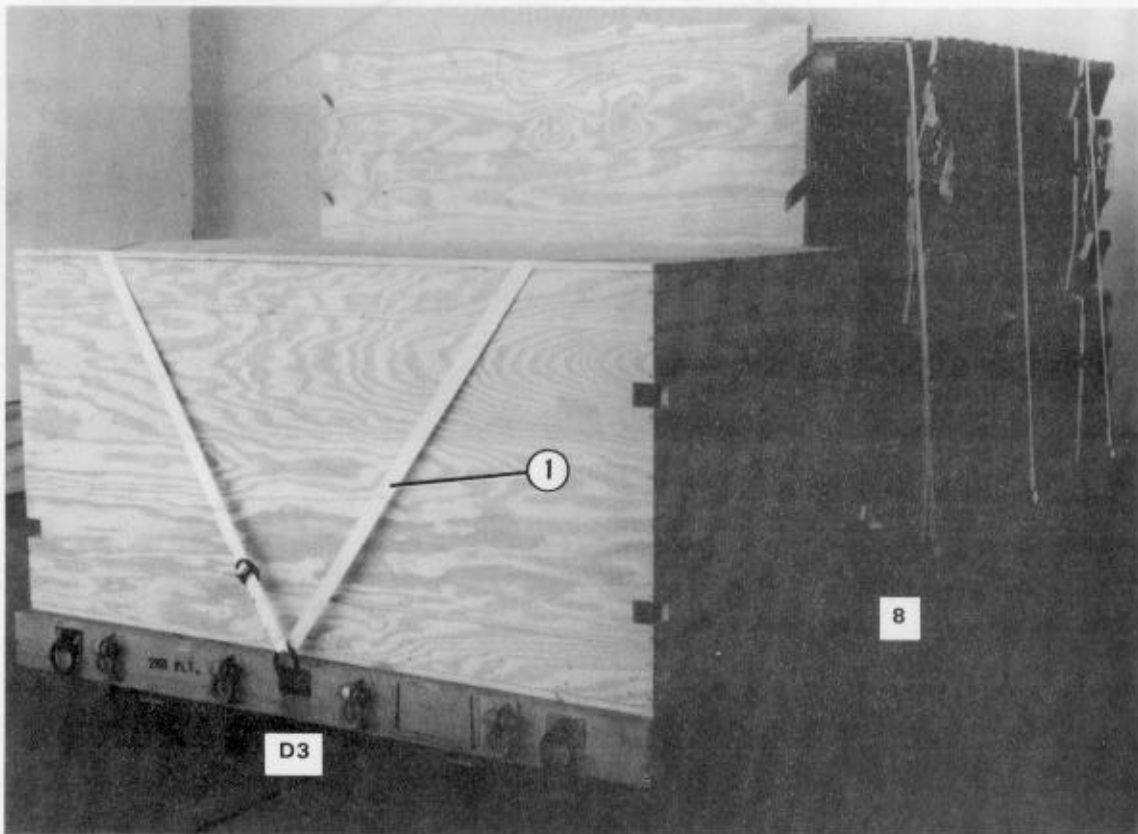

- ① Form a 30-foot lashing according to FM 10-500-2/TO 13C7-1-5. Pass the lashing through tie-down ring D3. Bring the free ends over the top rear corners of the parts box. Secure the lashing to tie-down rings 8 and 8A with a load binder and D-ring on each side.

Figure 4-23. Parts box secured to pallet 1

4-5. Preparing Pallet 2

Prepare pallet 2 as shown in Figures 4-24 through 4-35.

- Notes:
1. Front, rear, right, and left refer to the pallet.
 2. Pad all sharp edges that lashings may touch.

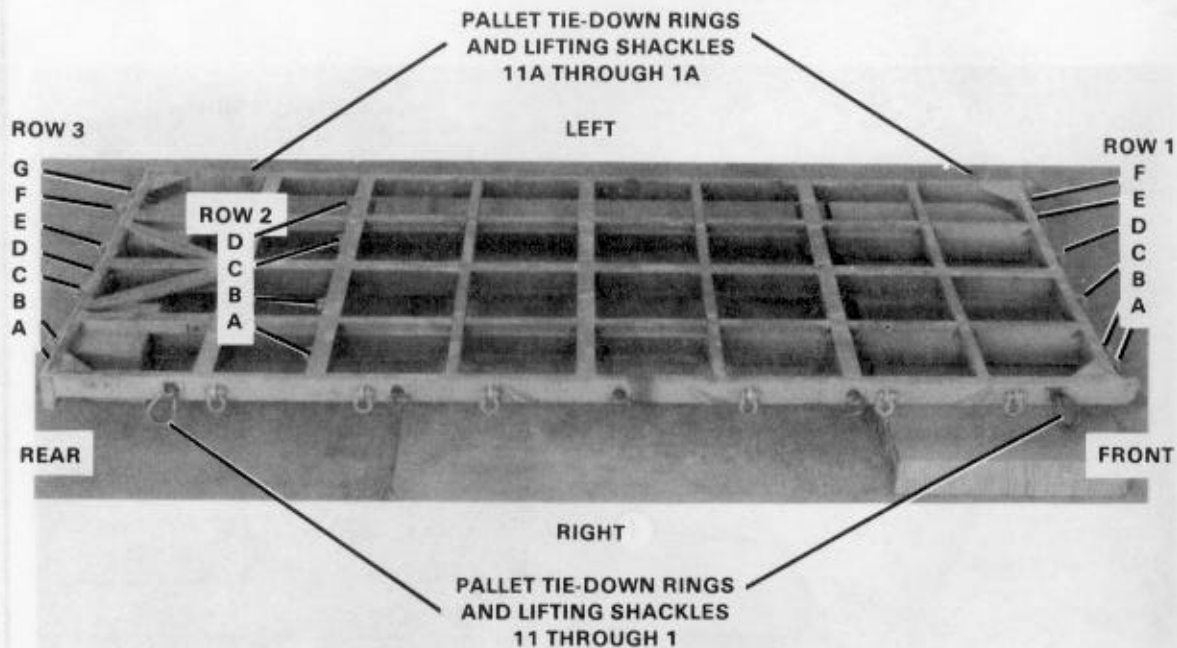

Step:

1. Starting at the front of the pallet, number the tie-down rings and lifting shackles bolted to the right side from 1 through 11 and those bolted to the left side from 1A through 11A.
2. Starting at the front of the pallet, label row 1 of tie-down rings and lifting shackles from right to left A1 through F1. Label row 2 from right to left A2 through D2. Label row 3 from right to left A3 through G3.
3. Place two 96- by 36-inch pieces of honeycomb under the front of the pallet to keep the pallet level.

Figure 4-24. Pallet 2 labeled

Note: Dimensions are given in inches.

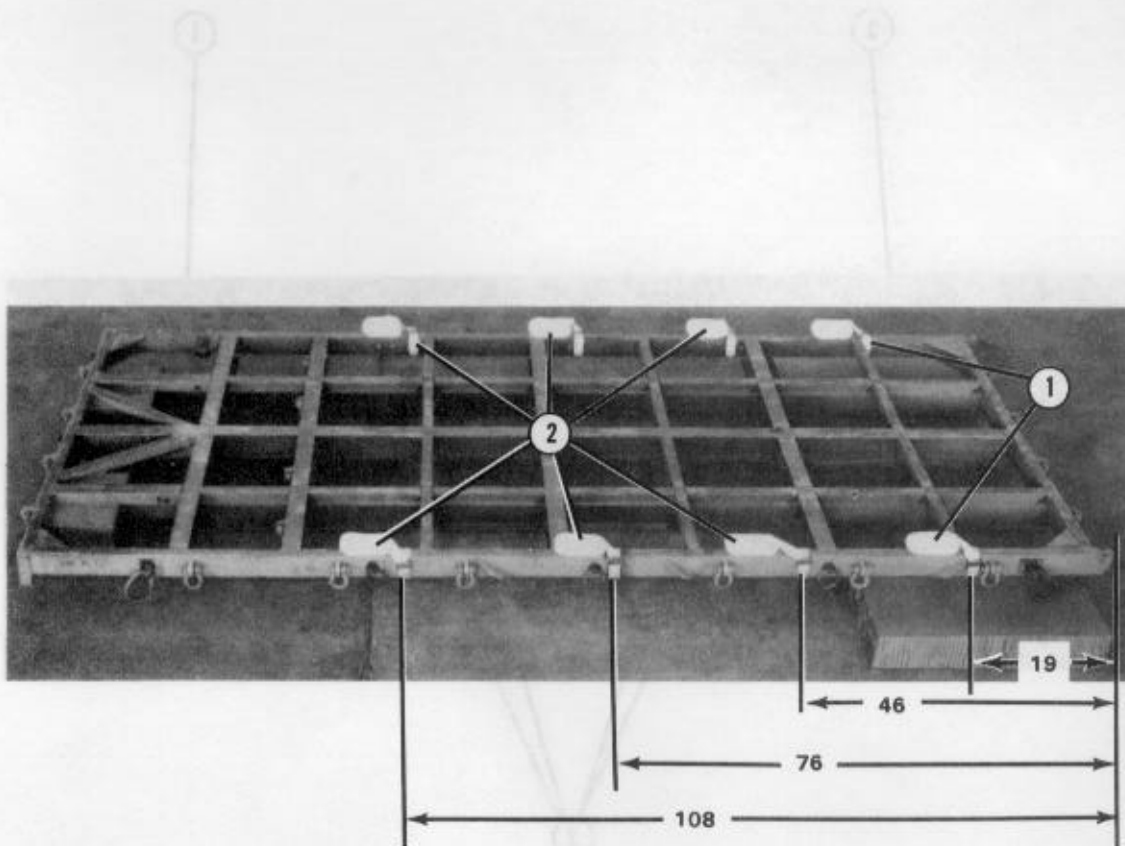

① Pass a 15-foot lashing around the right front side rail and through its own D-ring 19 inches from the front edge of the pallet. Repeat this step for the left side rail.

② Repeat step 1 at intervals of 46, 76, and 108 inches.

Note: Make sure the D-rings are facing to the outside of the side rails.

Figure 4-25. Eight lashings pre-positioned

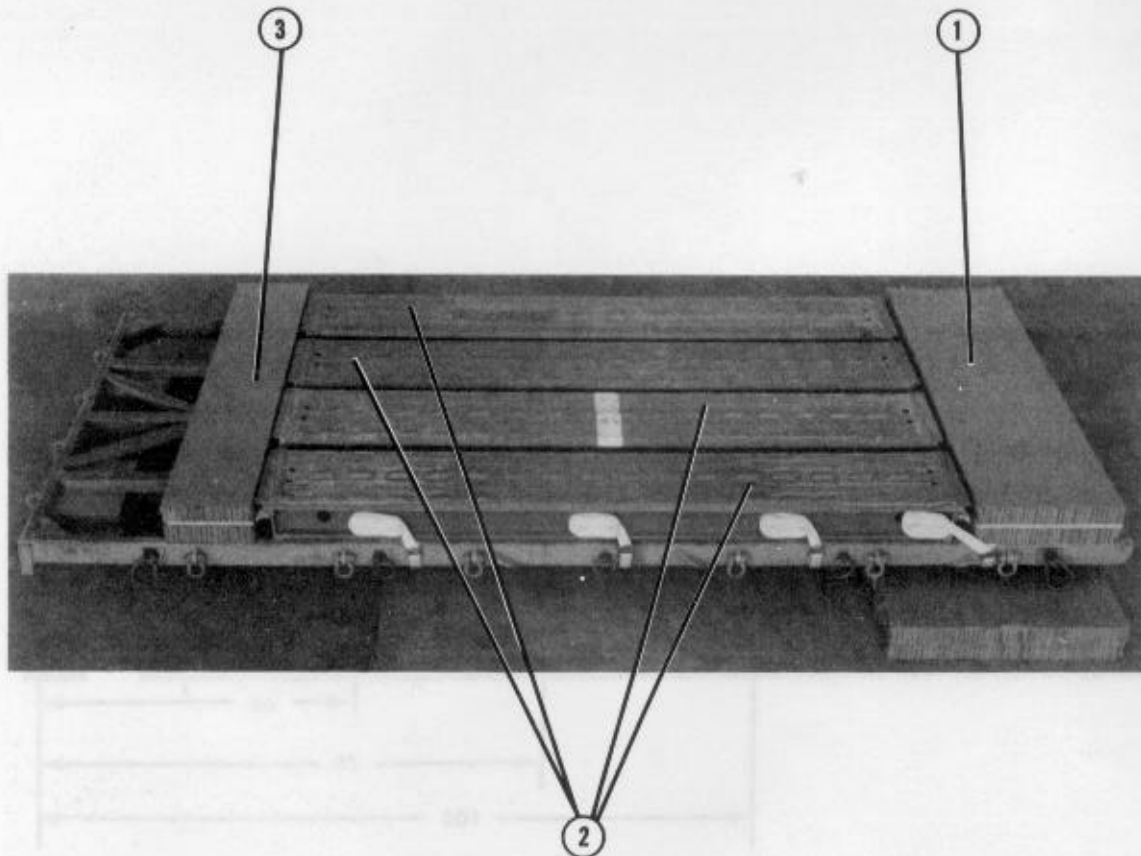

- ① Place one 3/4- by 76- by 22-inch piece of plywood between two 76- by 22-inch pieces of honeycomb to form a stack. Place the stack flush with the front edge of the pallet.
- ② Place four decks side by side on top of the pallet flush against the 76- by 22-inch stack.
- ③ Place one 3/4- by 76- by 13 1/2-inch piece of plywood between two 76- by 13 1/2-inch pieces of honeycomb to form a stack. Place the stack flush against the rear of the decks.

Figure 4-26. Honeycomb, plywood, and decks positioned

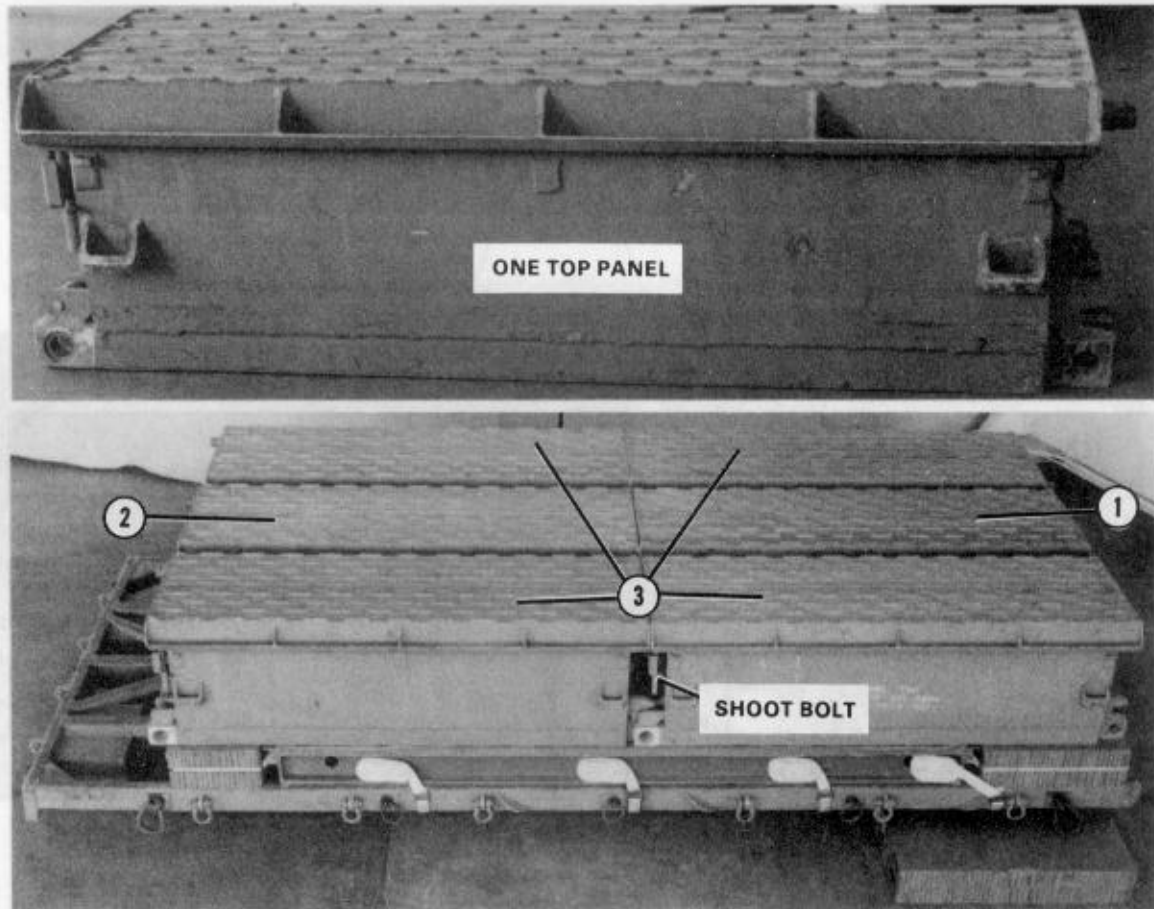

- ① Center a top panel with the end of the panel flush with the front edge of the pallet.
Note: Make sure the shoot bolt is in the unlocked position.
- ② Center another top panel against the rear edge of the top panel positioned in step 1. Interlock the two panels with the shoot bolt.
- ③ Position two top panels to each side of the panels positioned in steps 1 and 2. Interlock all the top panels with the shoot bolts.

Figure 4-27. Top panels positioned

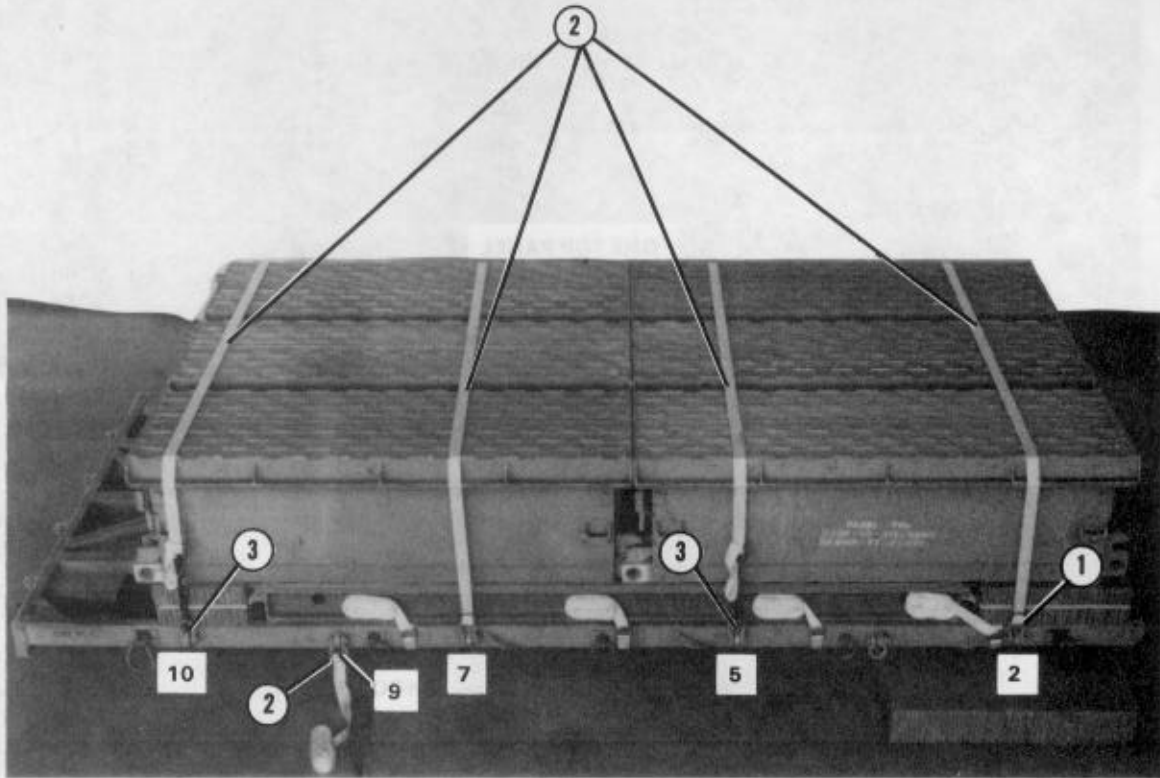

- ① Pass a 15-foot lashing through lifting shackles 2, 5A, 7, 9, and 10A, and back through its own D-rings.
- ② Run the lashings attached to lifting shackles 2, 5A, 7, and 10A over the top panels.
Note: The lashing attached to lifting shackle 9 is NOT secured at this time.
- ③ Secure the lashings to tie-down rings 2A, 5, 7A, and 10 according to FM 10-500-2/TO 13C7-11-21.

Figure 4-28. Six top panels secured

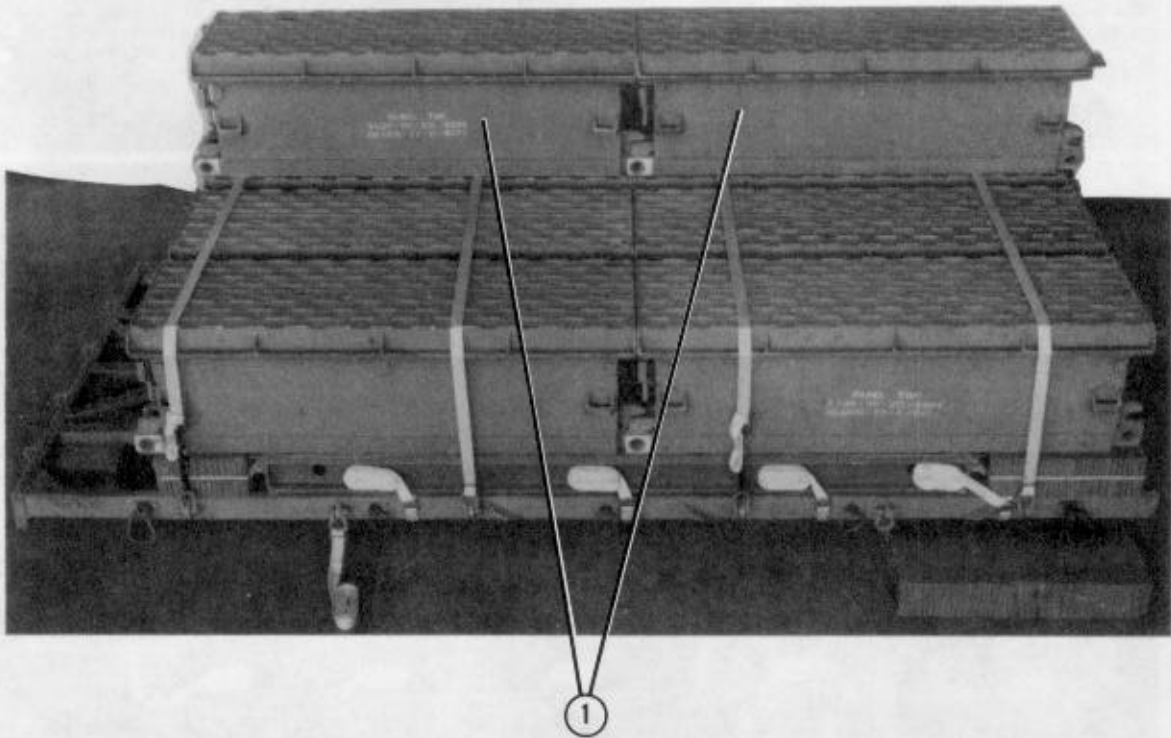

- ① Position two top panels even with the left side of the load. Interlock the top panels with the shoot bolt.

Position the top panels against the front edge of the load. Make sure the front edge of the top panels is flush with the front edge of the load. Position the top panels against the front edge of the load. Make sure the front edge of the top panels is flush with the front edge of the load.

Figure 4-29. Two top panels positioned

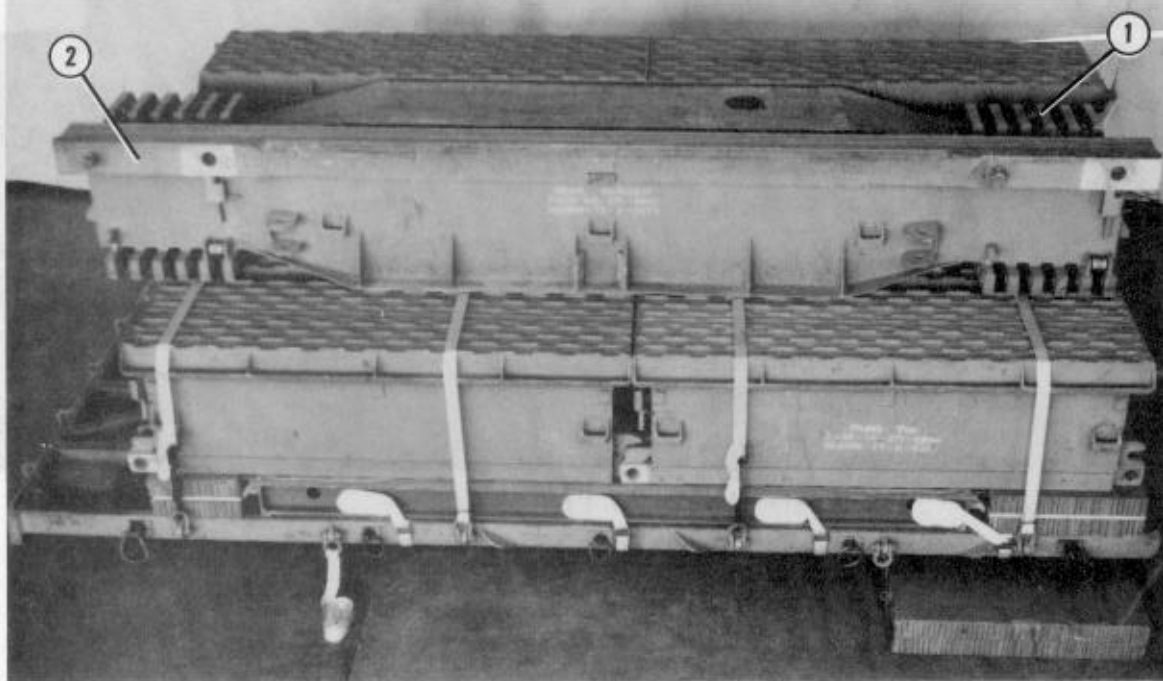

- ① Position a BSB facing down against the two top panels. Make sure the front edge of the BSB is flush with the front edge of the pallet.
- ② Position another BSB facing up against the first BSB. Make sure the front edge of the BSB is flush with the front edge of the pallet.

Figure 4-30. BSBs positioned and prepared

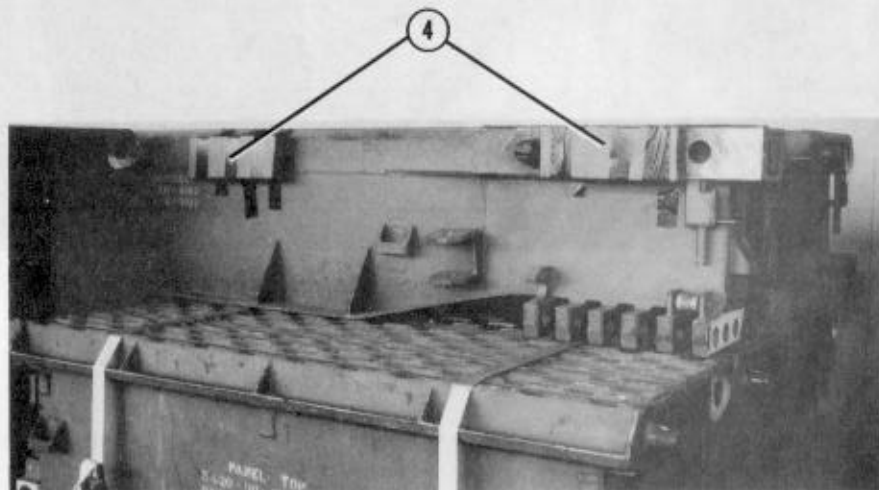
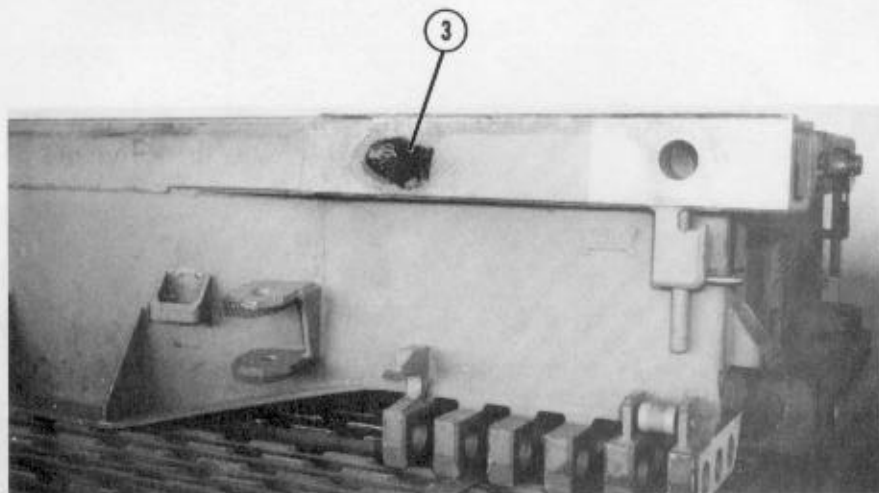

Position two top panels on the right side of the BSB flush with the front edge of the
 pallet. Make sure the top panels are interlocked.
 Secure the top panels and BSB in place using the pre-positioned lashings at the 15-
 45 and 105-degree intervals.

- ③ Cover the BSB tits with cellulose wadding. Tape the wadding in place.
- ④ Evenly space four 5- by 7-inch pieces of honeycomb across the right side of the BSB. Tape the honeycomb in place.

Figure 4-30. BSBs positioned and prepared (continued)

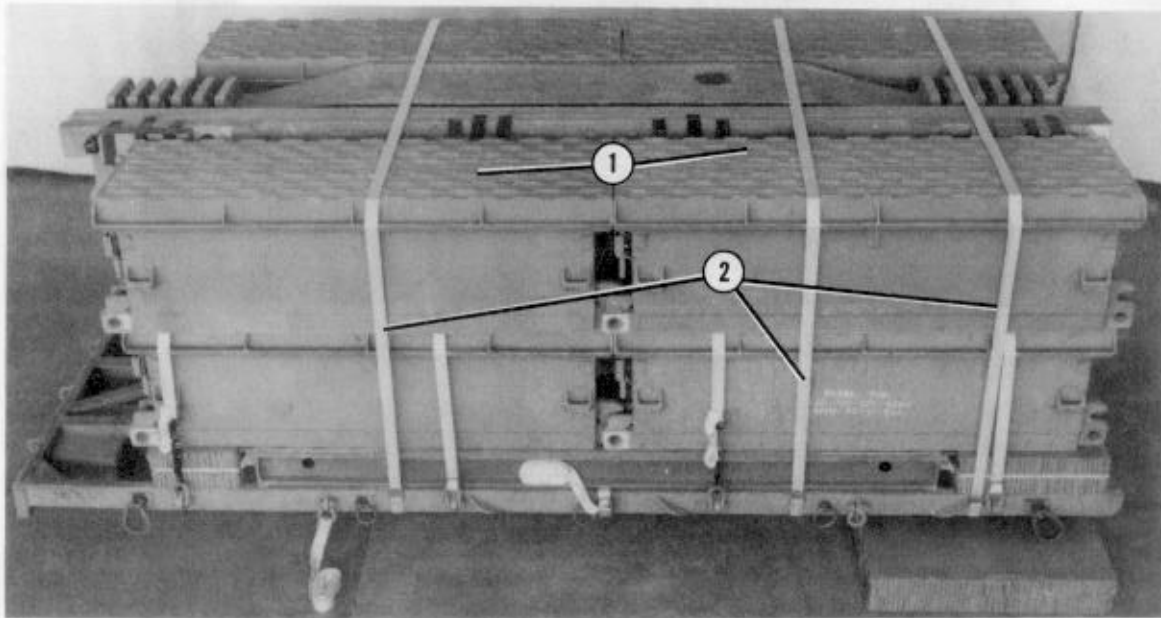

- ① Position two top panels on the right side of the BSBs flush with the front edge of the pallet. Make sure the tops panels are interlocked.
- ② Secure the top panels and BSBs in place using the pre-positioned lashings at the 19-, 46-, and 108-inch intervals.

Note: Make sure the lashings are secured to the left side of the load.

Figure 4-31. Top panels and BSBs secured

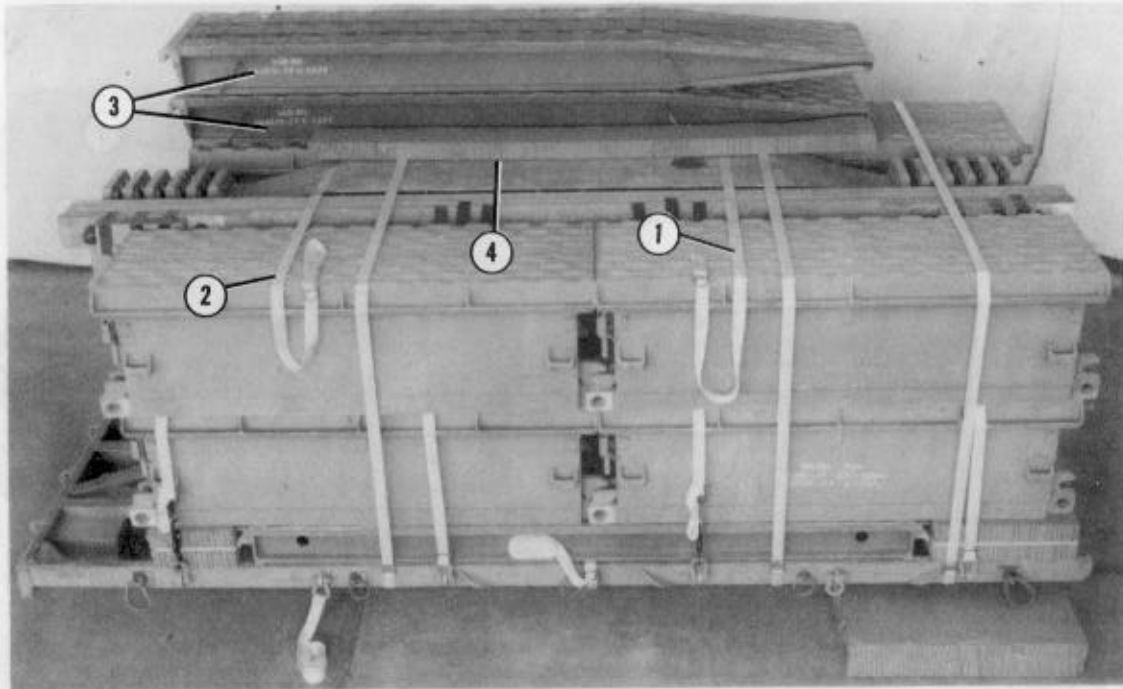

- ① Place a 15-foot lashing over the top panels and BSBs in a side-to-side direction 51 1/2 inches from the front edge of the pallet.
- ② Place a 15-foot lashing over the top panels and BSBs in a side-to-side direction 117 inches from the front edge of the pallet.
- ③ Position two ramps on top of the left side of the load flush with the rear edge of the top panels.
- ④ Place a 7- by 96-inch piece of honeycomb against the bottom ramp. Align the honeycomb with the front edge of the bottom ramp.

Figure 4-32. Two ramps positioned on pallet

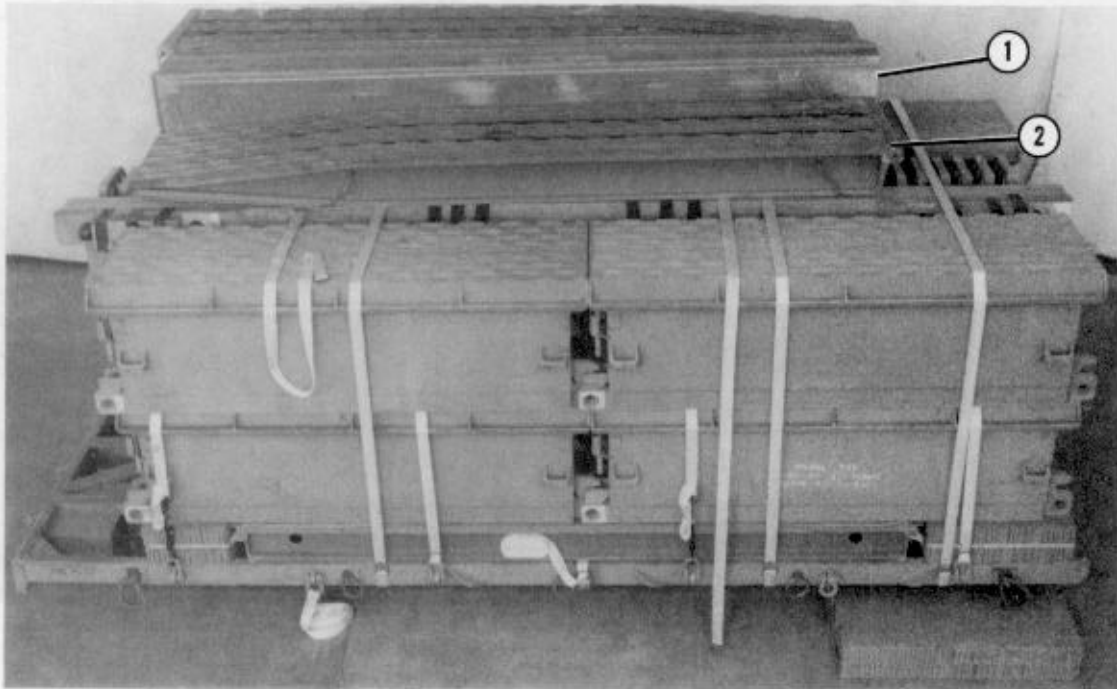

- ① Place the front light launching nose to the right of the ramp on the 7- by 96-inch piece of honeycomb. Turn the launching nose on its side with the larger end flush with the rear edge of the top panel.
- ② Place a ramp to the right of the front light launching nose. Make sure the declining end of the ramp is flush with the rear edge of the top panel.

Figure 4-33. Front light launching nose and ramp positioned

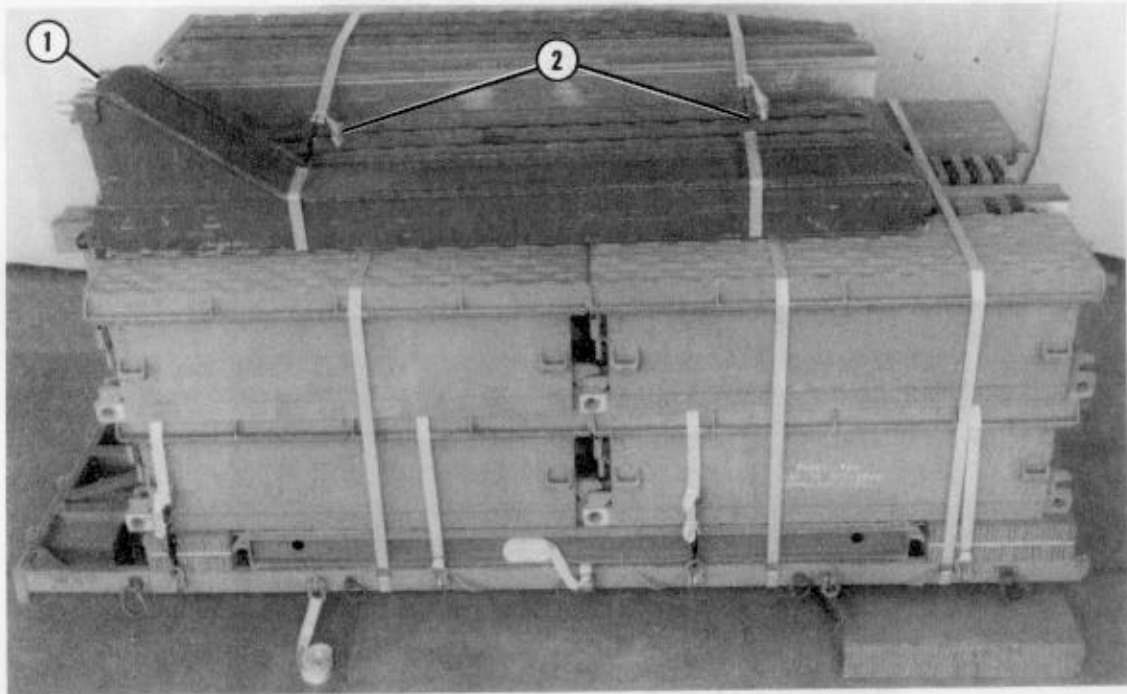

- ① Position the rear light launching nose against the right side of the ramp. Make sure the taller end of the rear light launching nose is facing toward the rear of the pallet and flush with the rear edge of the top panel.
- ② Pass the pre-positioned lashings (Figure 4-32, steps 1 and 2) around the launching noses and ramps. Hook the ends of the lashings using D-rings and load binders. Do NOT tighten the lashings at this time.

Figure 4-34. Rear light launching nose positioned and pre-positioned lashings secured

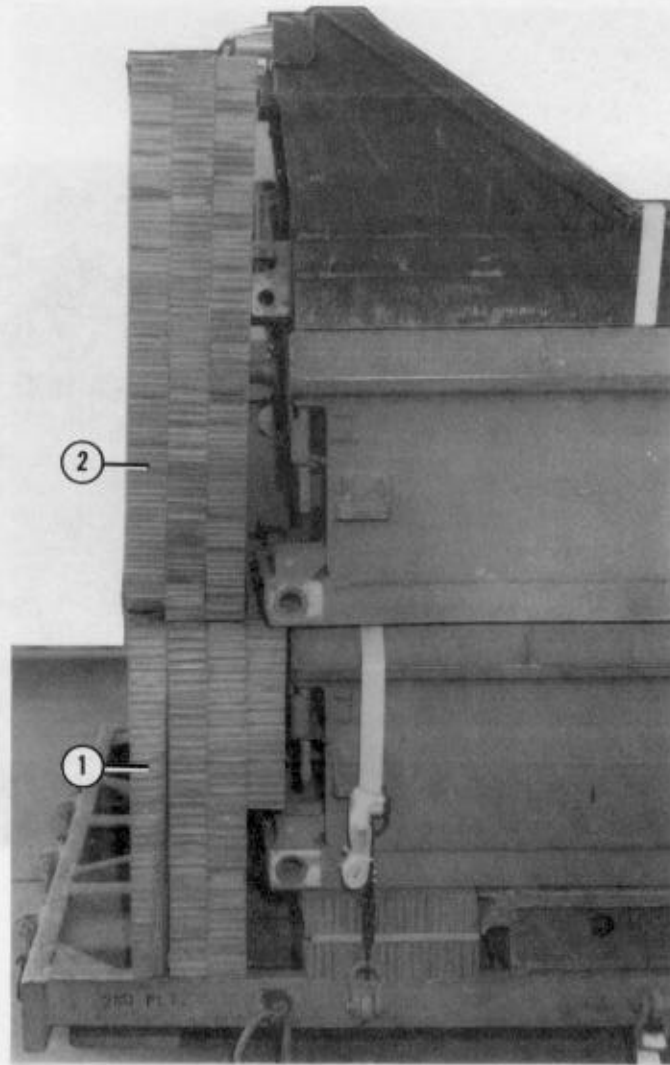

- ① Place one 76- by 14-inch piece of honeycomb and three 76- by 28-inch pieces of honeycomb on top of the pallet against the right rear of the load.
- ② Place three 22- by 41-inch pieces of honeycomb on top of the honeycomb positioned in step 1 and against the right rear of the load.

Figure 4-35. Honeycomb positioned against load

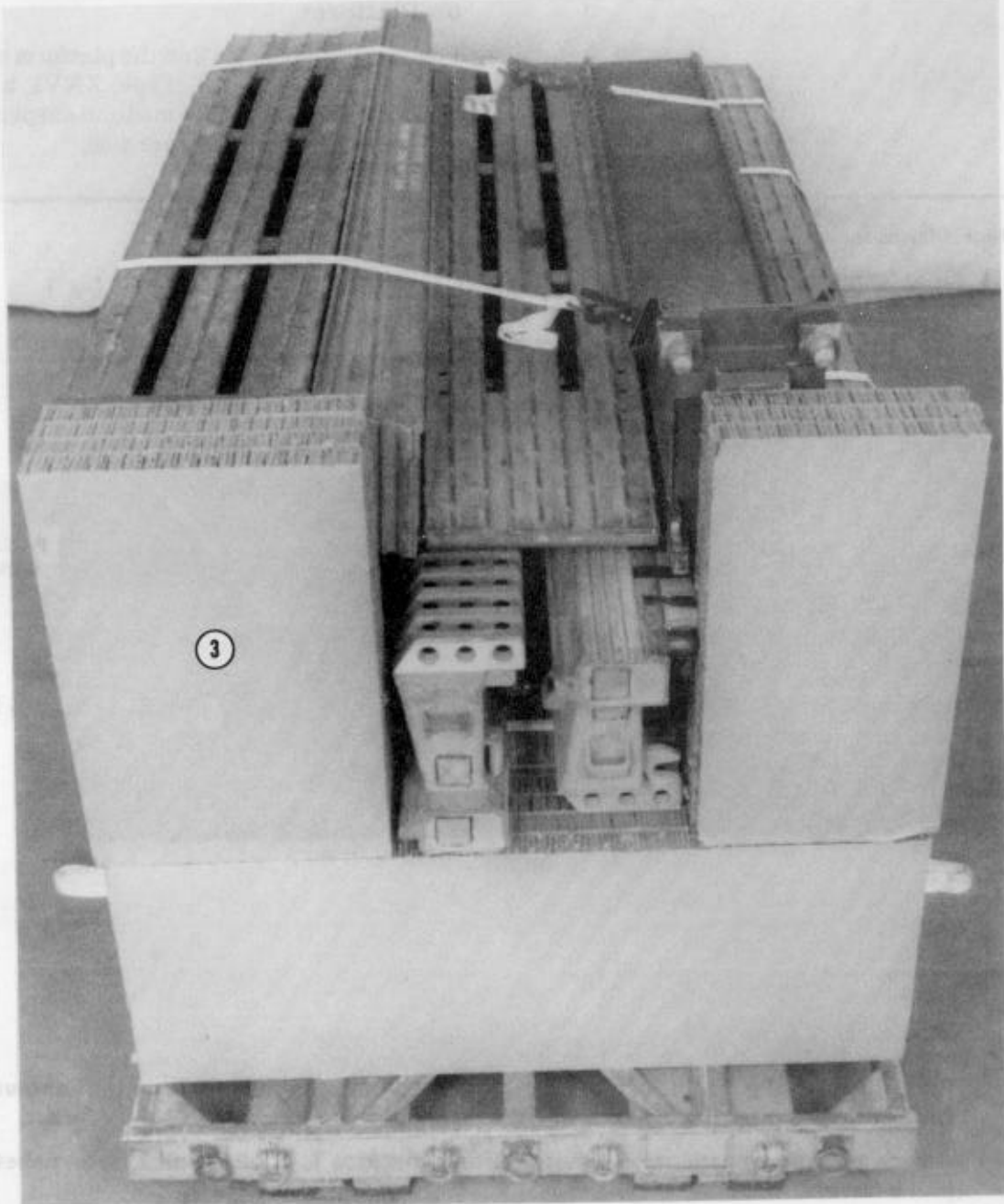

- ③ Place four 27- by 41-inch pieces of honeycomb on the top left of and flush with the honeycomb positioned in step 1.

Figure 4-35. Honeycomb positioned against load (continued)

4-6. Positioning Pallets 1 and 2 on Platform

Position pallets 1 and 2 on the platform using four 16-foot (2-loop), type XXVI nylon webbing slings and four medium suspension clevises as shown in Figure 4-36.

Note: Dimensions are given in inches.

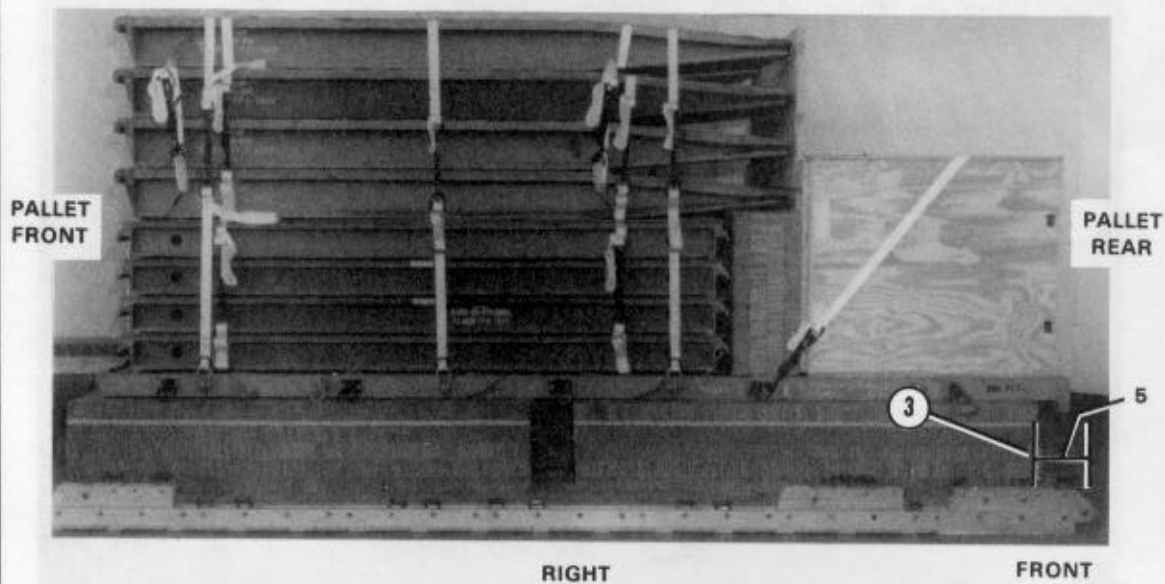

- ① Pass the end of a 16-foot sling through a medium suspension clevis (not shown). Repeat this step for the other three 16-foot slings.
- ② Attach a medium suspension clevis to lifting shackles 1, 1A, 11, and 11A on pallet 1 (not shown).
- ③ Position pallet 1 on the platform so that the rear of the pallet overhangs the front of the platform 5 inches.
- ④ Remove the lifting slings and the medium suspension clevises from the pallet (not shown).

Figure 4-36. Pallets 1 and 2 positioned on platform

Note: Dimensions are given in inches.

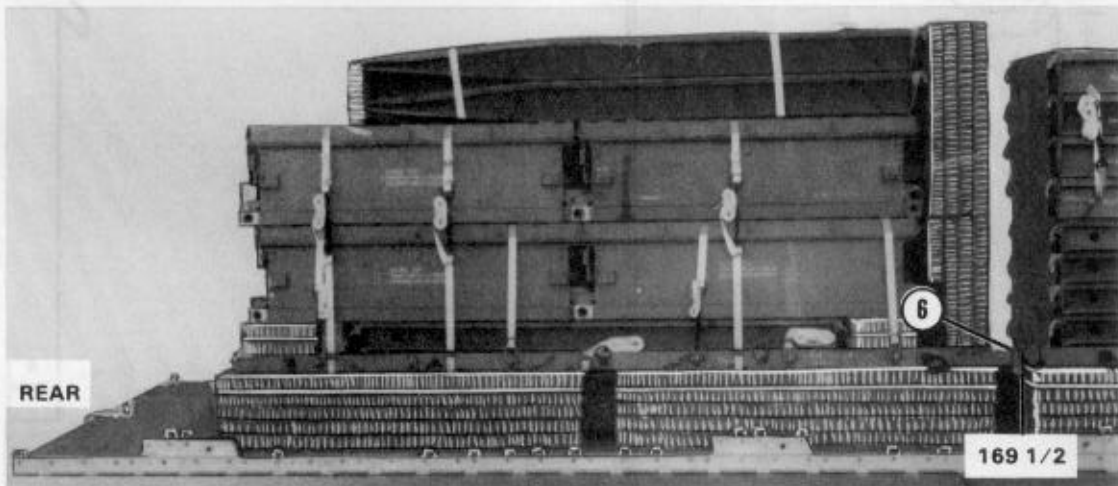

- 5 Repeat steps 1 and 2 for pallet 2 (not shown).
- 6 Position pallet 2 on the platform so that the rear edge of the pallet is 169 1/2 inches from the front edge of the platform.
- 7 Remove the suspension slings and the medium suspension clevises from the pallet (not shown).

Figure 4-36. Pallets 1 and 2 positioned on platform (continued)

4-7. Building and Positioning Restraint Boards 2, 3, 4, and 5

Build restraint boards 2, 3, 4, and 5 as shown in Figures 4-37 through 4-44. Position restraint boards 2, 3, 4, and 5 as shown in Figure 4-45.

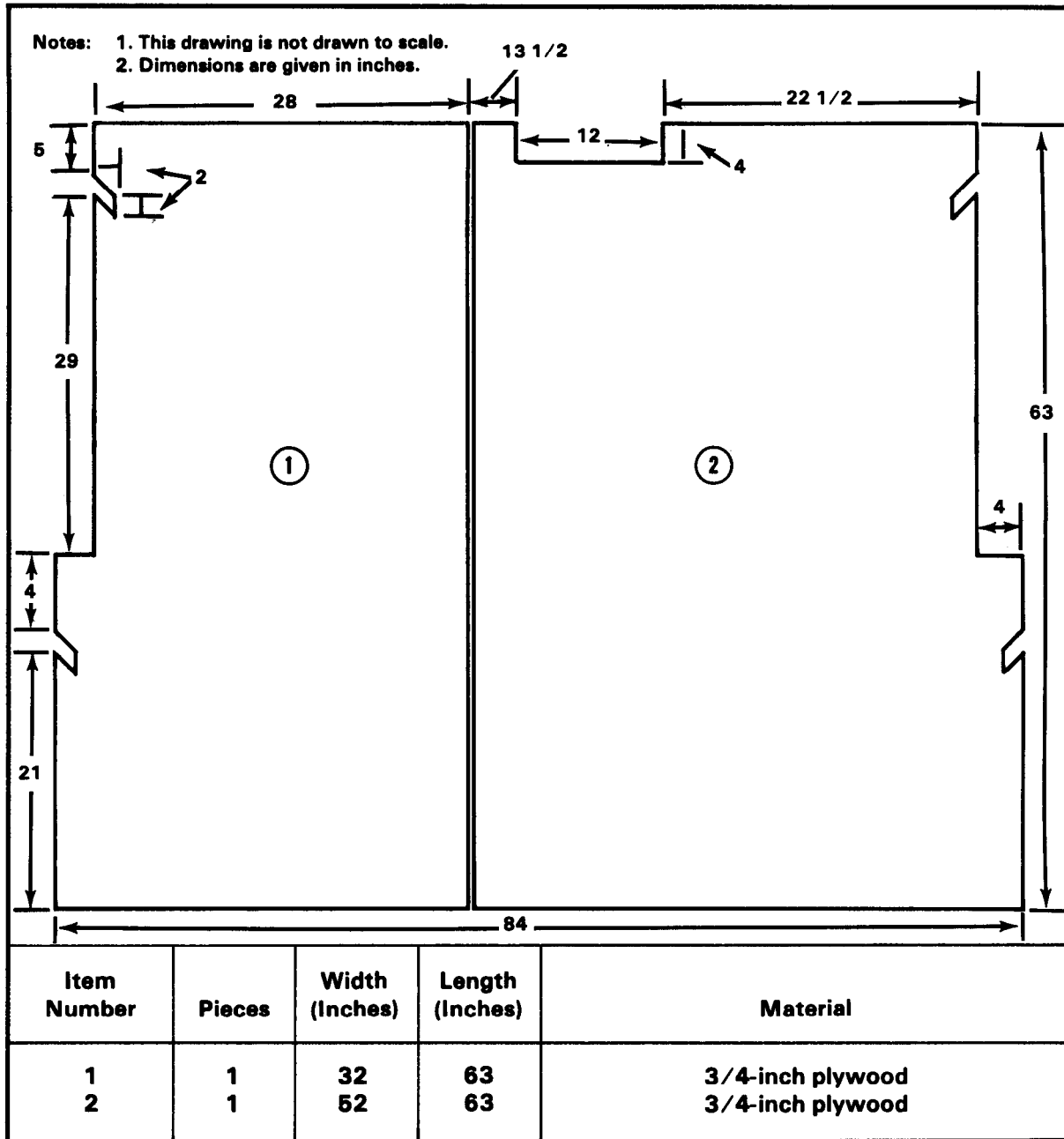
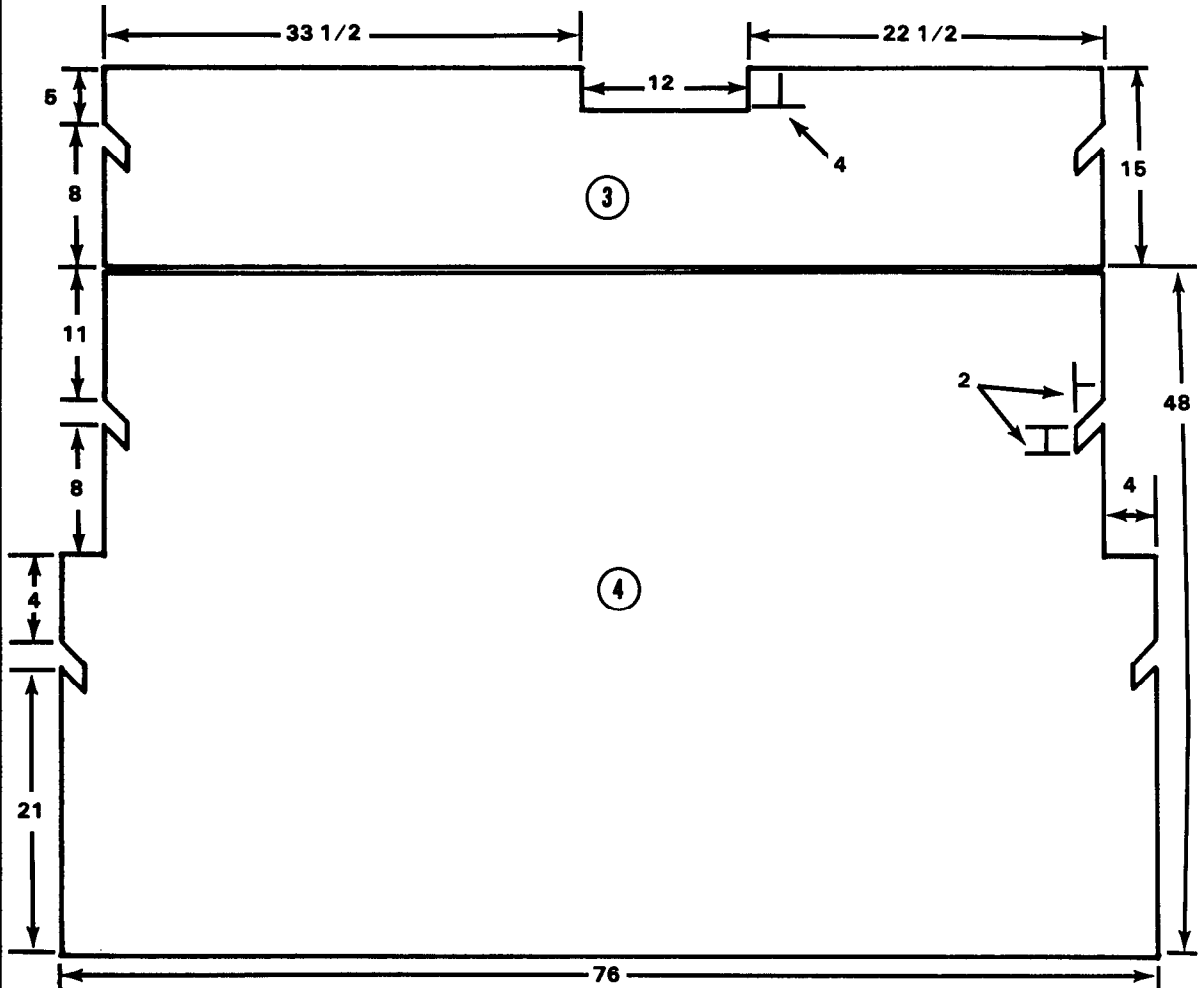

Figure 4-37. Materials required to build restraint board 2

- Notes: 1. This drawing is not drawn to scale.
 2. Dimensions are given in inches.



Item Number	Pieces	Width (Inches)	Length (Inches)	Material
3	1	68	15	3/4-inch plywood
4	1	76	48	3/4-inch plywood

Figure 4-37. Materials required to build restraint board 2 (continued)

Note: This drawing is not drawn to scale.

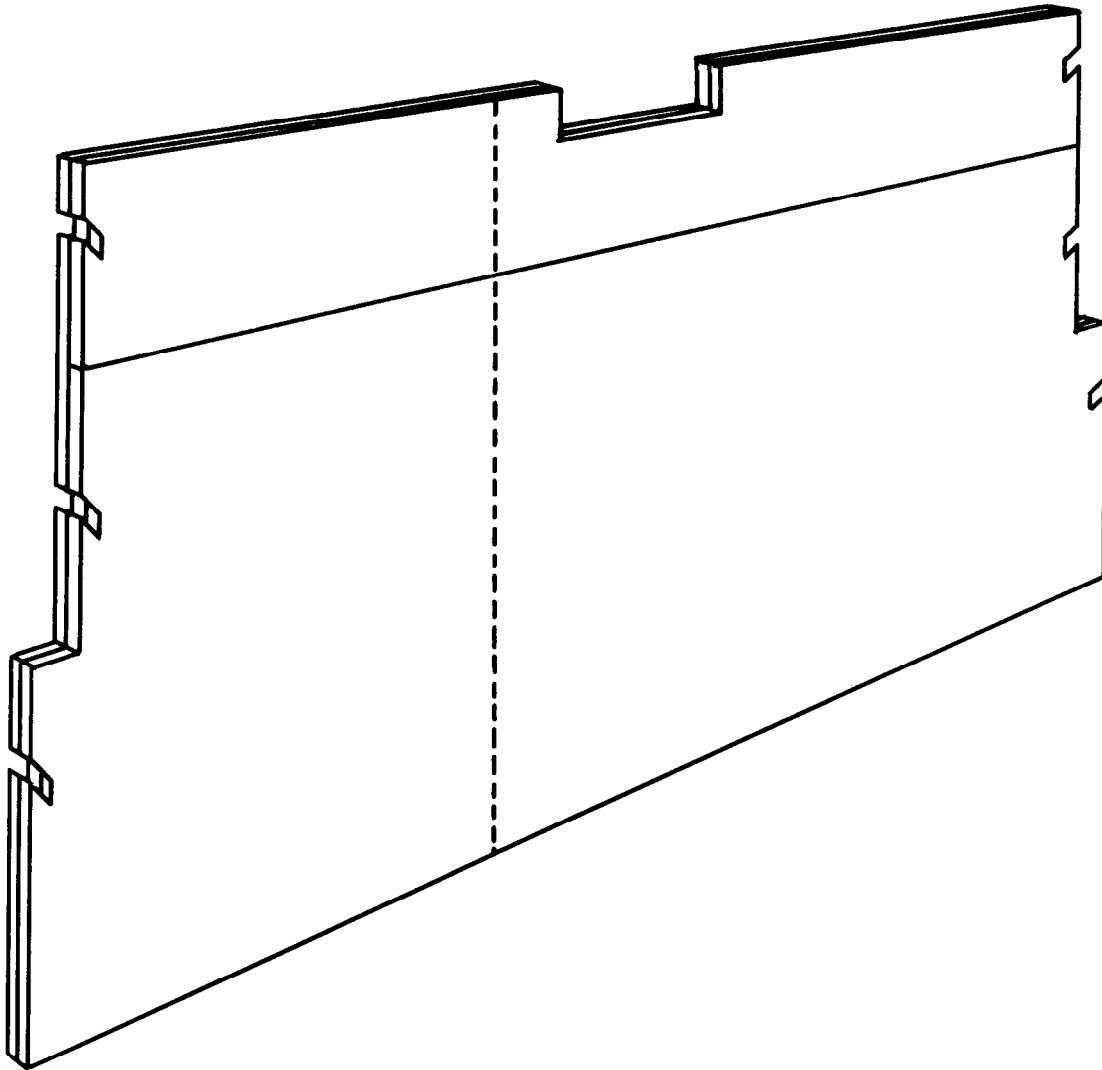

Step:

1. Build restraint board 2 using the materials given in Figure 4-37.
2. Use eightpenny nails to secure restraint board 2.

Figure 4-38. Restraint board 2 built

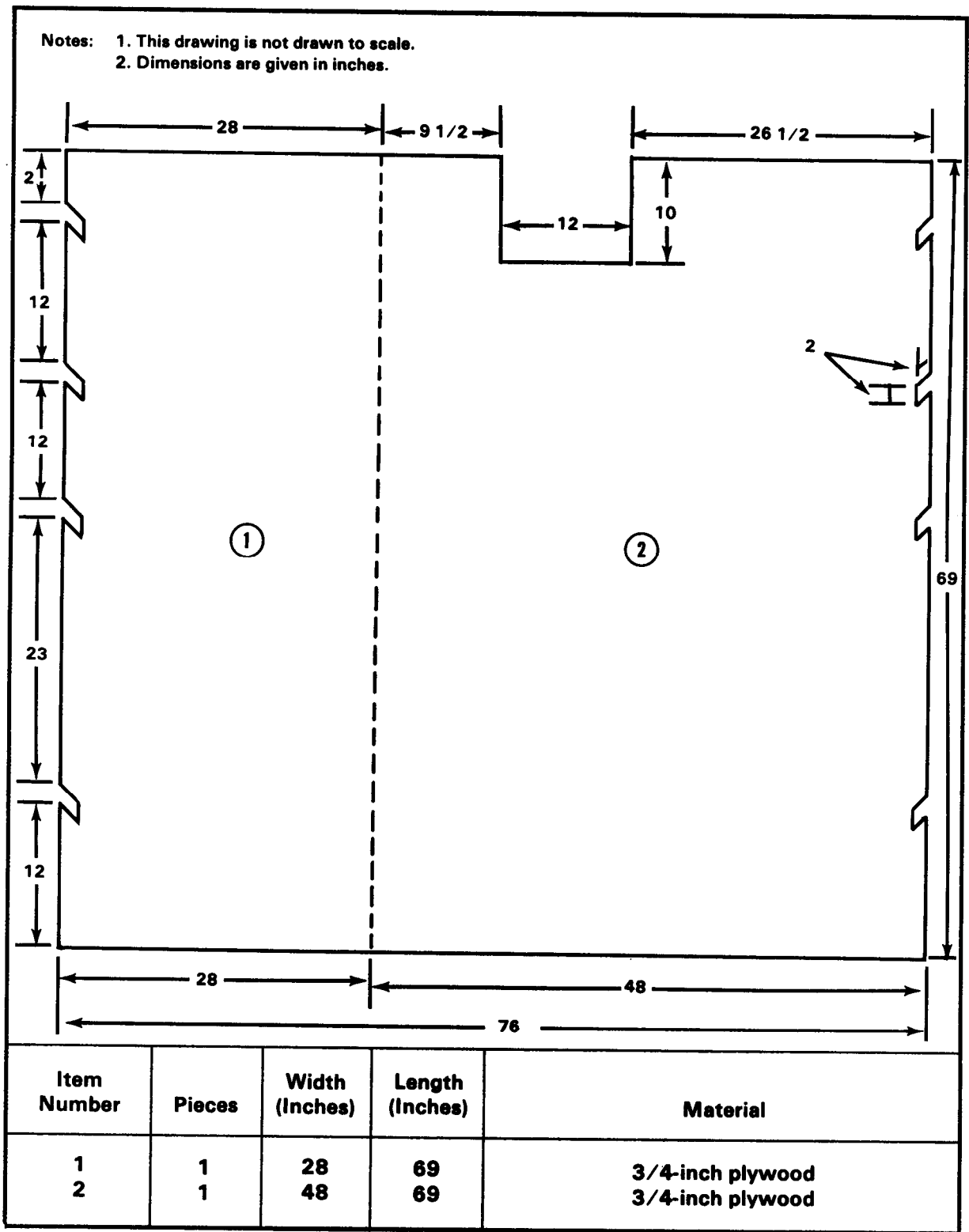
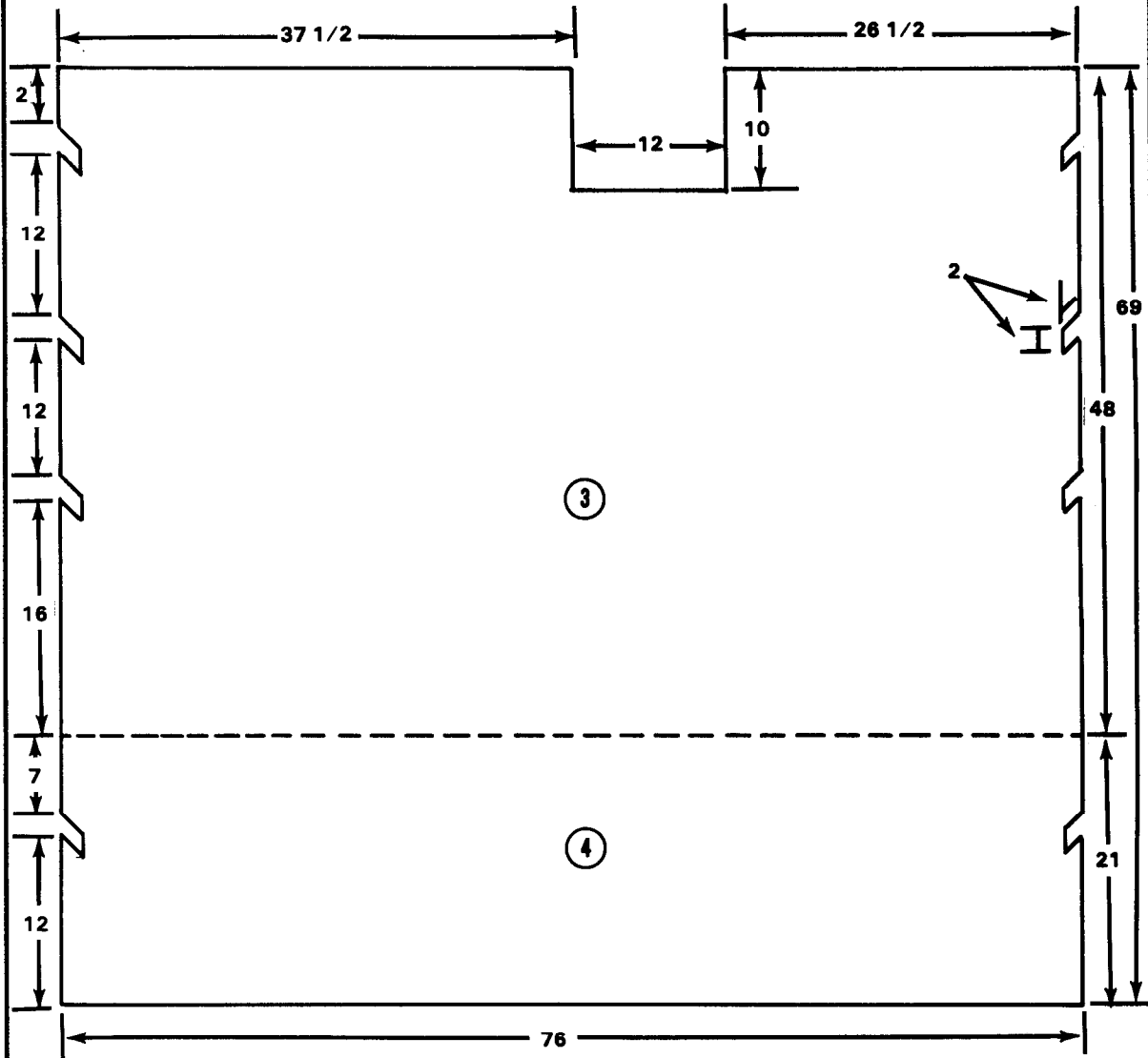

Figure 4-39. Materials required to build restraint board 3

Notes: 1. This drawing is not drawn to scale.
 2. Dimensions are given in inches.



Item Number	Pieces	Width (Inches)	Length (Inches)	Material
3	1	76	48	3/4-inch plywood
4	1	76	21	3/4-inch plywood

Figure 4-39. Materials required to build restraint board 3 (continued)

Note: This drawing is not drawn to scale.

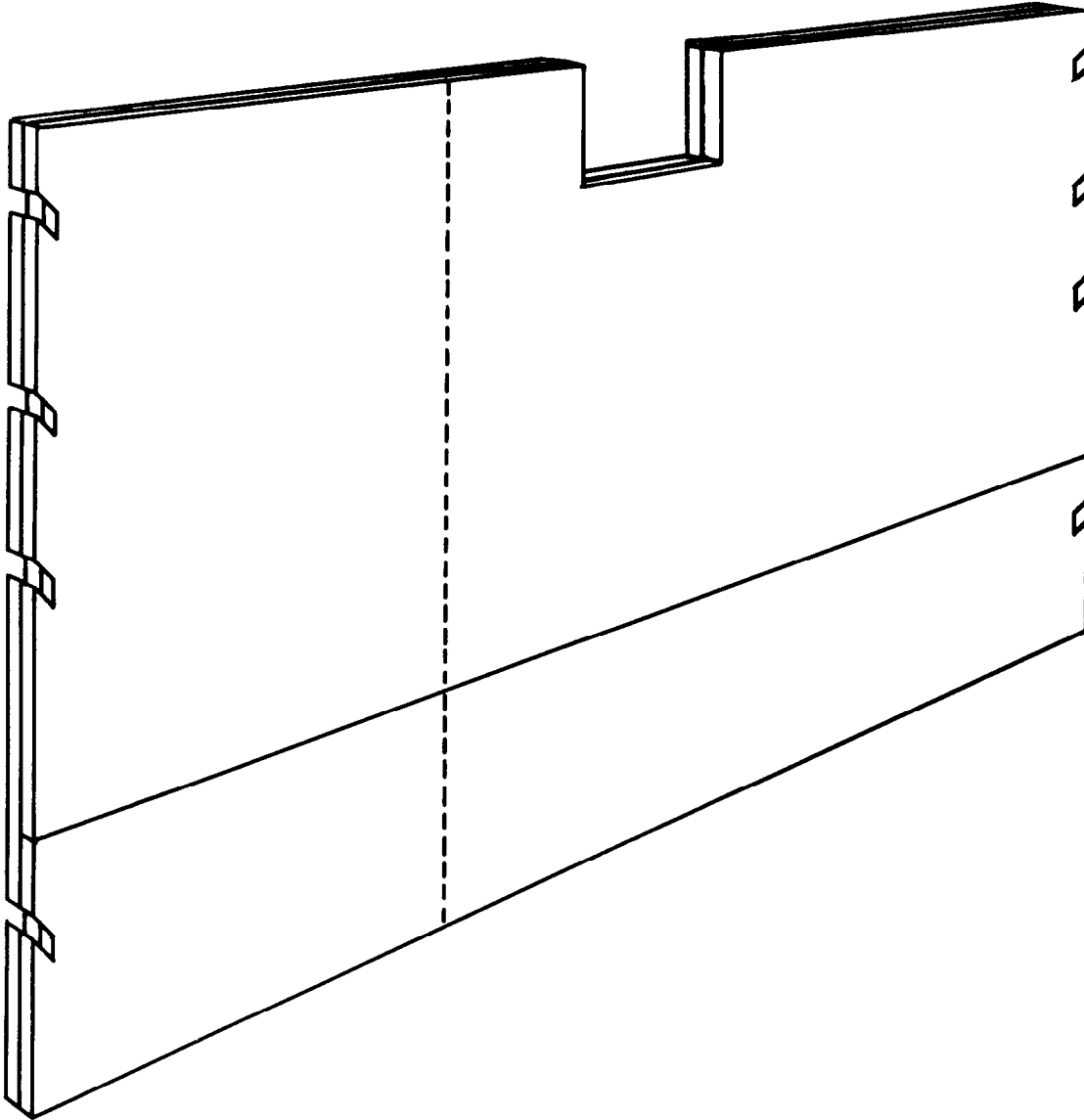

Step:

1. Build restraint board 3 using the materials given in Figure 4-39.
2. Use eightpenny nails to secure restraint board 3.

Figure 4-40. Restraint board 3 built

- Notes: 1. This drawing is not drawn to scale.
 2. Dimensions are given in inches.

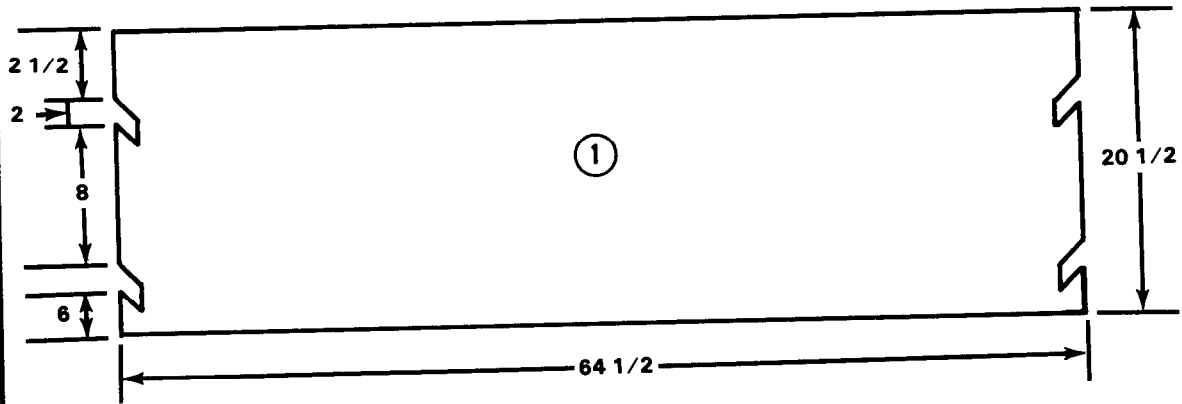

Item Number	Pieces	Width (Inches)	Length (Inches)	Material
1	2	64 1/2	20 1/2	3/4-inch plywood

Figure 4-41. Materials required to build restraint board 4

Note: This drawing is not drawn to scale.

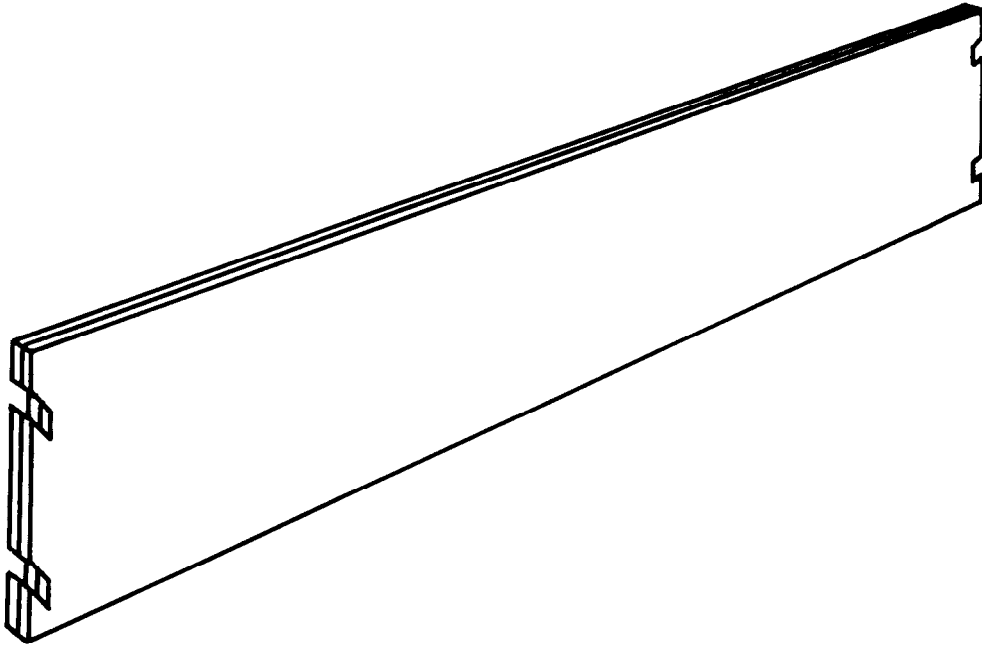

Step:

1. **Build restraint board 4 using the materials given in Figure 4-41.**
2. **Use eightpenny nails to secure restraint board 4.**

Figure 4-42. Restraint board 4 built

Notes: 1. This drawing is not drawn to scale.
 2. Dimensions are given in inches.

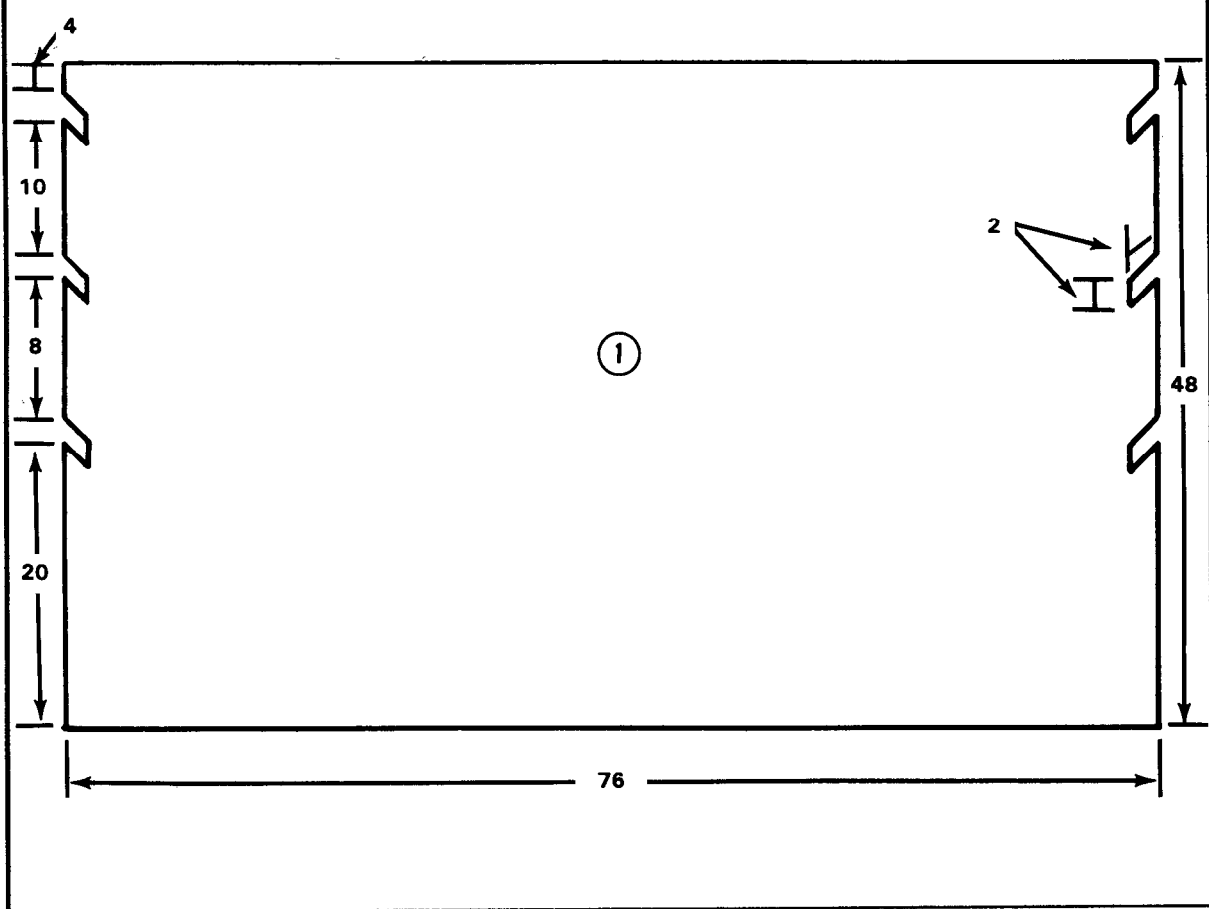

Item Number	Pieces	Width (Inches)	Length (Inches)	Material
1	2	76	48	3/4-inch plywood

Figure 4-43. Materials required to build restraint board 5

Note: This drawing is not drawn to scale.

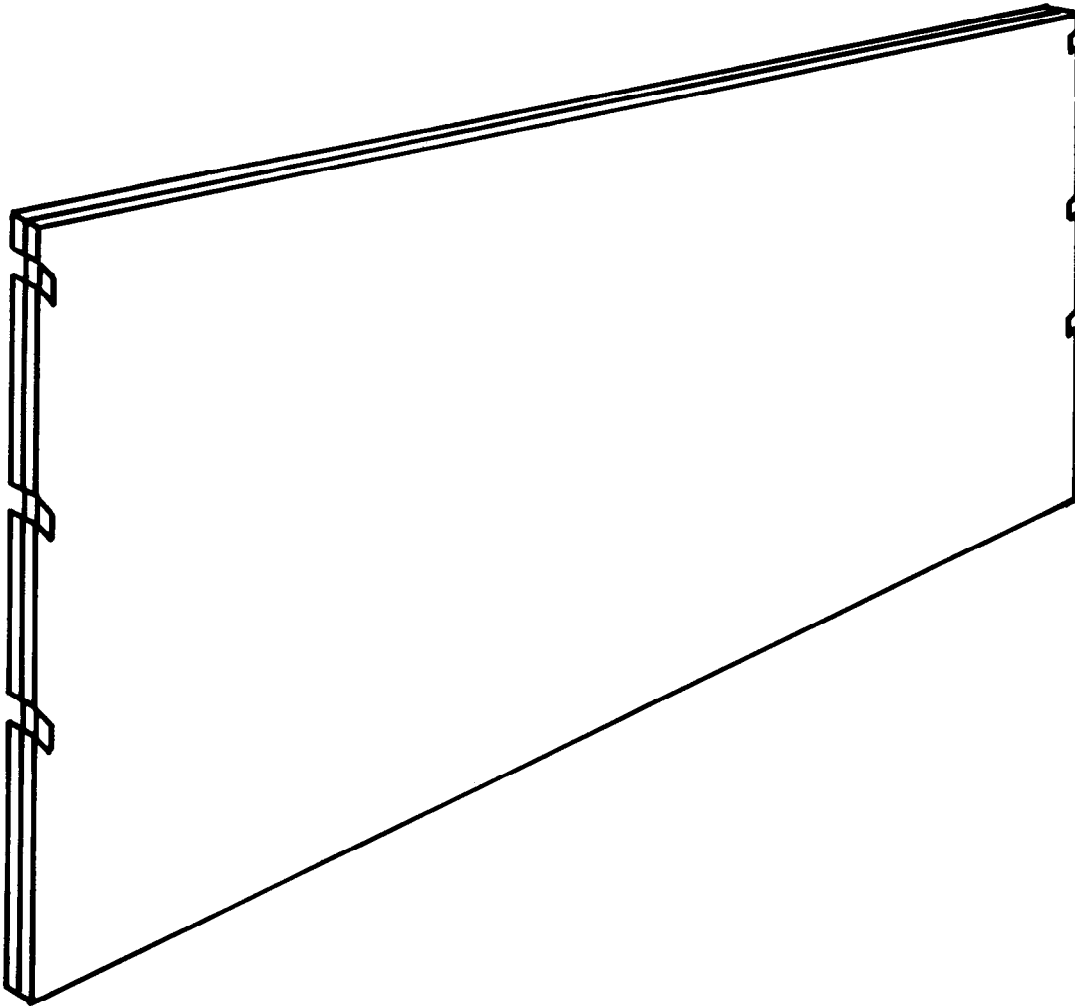

Step:

1. Build restraint board 5 using the materials given in Figure 4-43.
2. Use eightpenny nails to secure restraint board 5.

Figure 4-44. Restraint board 5 built

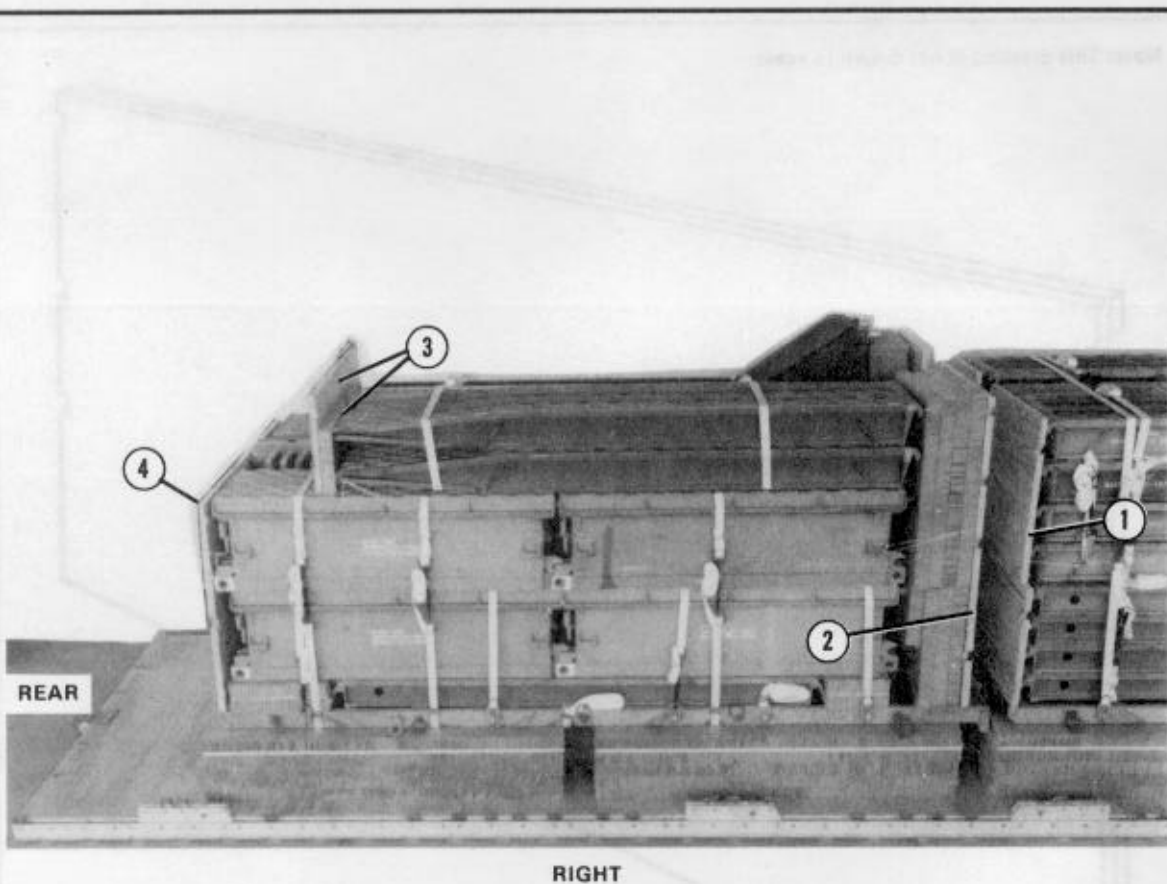

- ① Position restraint board 2 against the front of pallet 1. Make sure the 22 1/2-inch top edge of the restraint board is on the left side of the platform. Secure restraint board 2 in place with type III nylon cord.
- ② Position restraint board 3 against the rear of pallet 2. Make sure the 26 1/2-inch top edge of the restraint board is on the left side of the platform. Secure restraint board 3 in place with type III nylon cord.
- ③ Place a 53- by 15-inch piece of honeycomb against the declining end of the ramps on pallet 2. Position restraint board 4 against the piece of honeycomb. Secure restraint board 4 in place with type III nylon cord.
- ④ Position restraint board 5 against the front of pallet 2. Secure restraint board 5 in place with type III nylon cord.

Figure 4-45. Restraint boards 2, 3, 4, and 5 positioned and secured

4-8. Preparing Pallets 1 and 2 After Positioning on Platform

Prepare pallets 1 and 2 after they have been positioned on the platform as shown in Figures 4-46, 4-47, and 4-48.



- ① Position the roller beam on the load with the roller portion of the beam facing up. Make sure the roller beam is flush against restraint board 4 and is through the cutout of restraint boards 2 and 3.

Figure 4-46. Roller beam positioned



- ① Wedge two 9- by 96-inch pieces of honeycomb and one 6-by 96-inch piece of honeycomb between the roller beam and the front light launching nose.

Figure 4-47. Honeycomb wedged on pallet 2

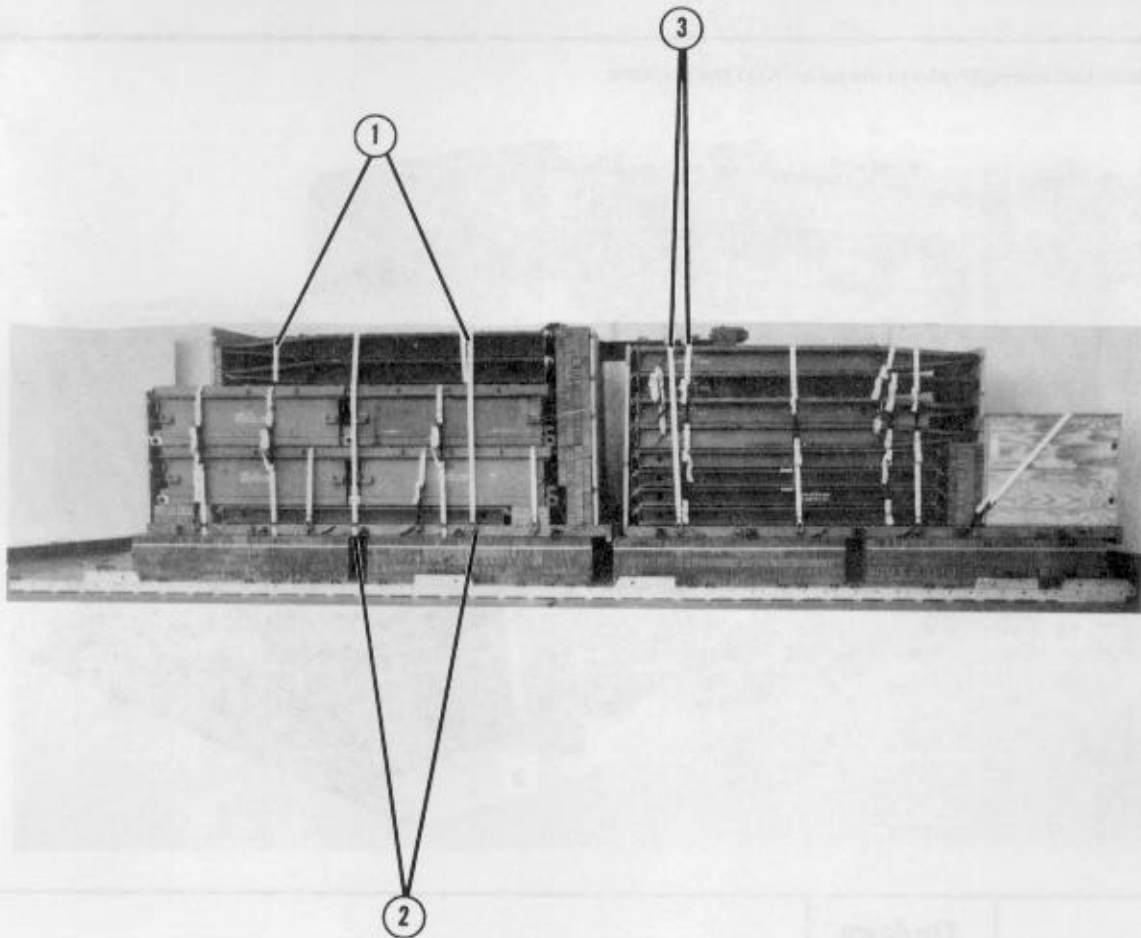

- ① Pass the pre-positioned lashings (Figure 4-32, steps 1 and 2) on top of the top panels of pallet 2 around the ramps and roller beam. Secure the lashings on top of the load according to FM 10-500-2/TO 13C7-1-5.
- ② Pass the lashings attached to tie-down rings 9 and 9A and the pre-positioned lashing 76 inches from the front of pallet 2 around the load. Secure the lashings on top of the load according to FM 10-500-2/TO 13C7-1-5.
- ③ Secure the load, to include the roller beam on pallet 1, using the lashings attached to tie-down rings 2 and 2A and the pre-positioned lashing 21 inches from the front of pallet 1. Secure the lashings according to FM 10-500-2/TO 13C7-1-5.

Figure 4-48. Pallets 1 and 2 secured

4-9. Lashing Pallets 1 and 2

Lash pallets 1 and 2 to the platform with seventy-one 15-foot tie-down assemblies as shown in Figures 4-49 through 4-61. If the 15-foot lashings DO NOT reach, additional

lashings may be added. Use the procedures in FM 10-500-2/TO 13C7-1-5 to form the additional lengths. Secure the lashings according to FM 10-500-2/TO 13C7-1-5.

Note: Left and right refer to the pallet, NOT the platform.

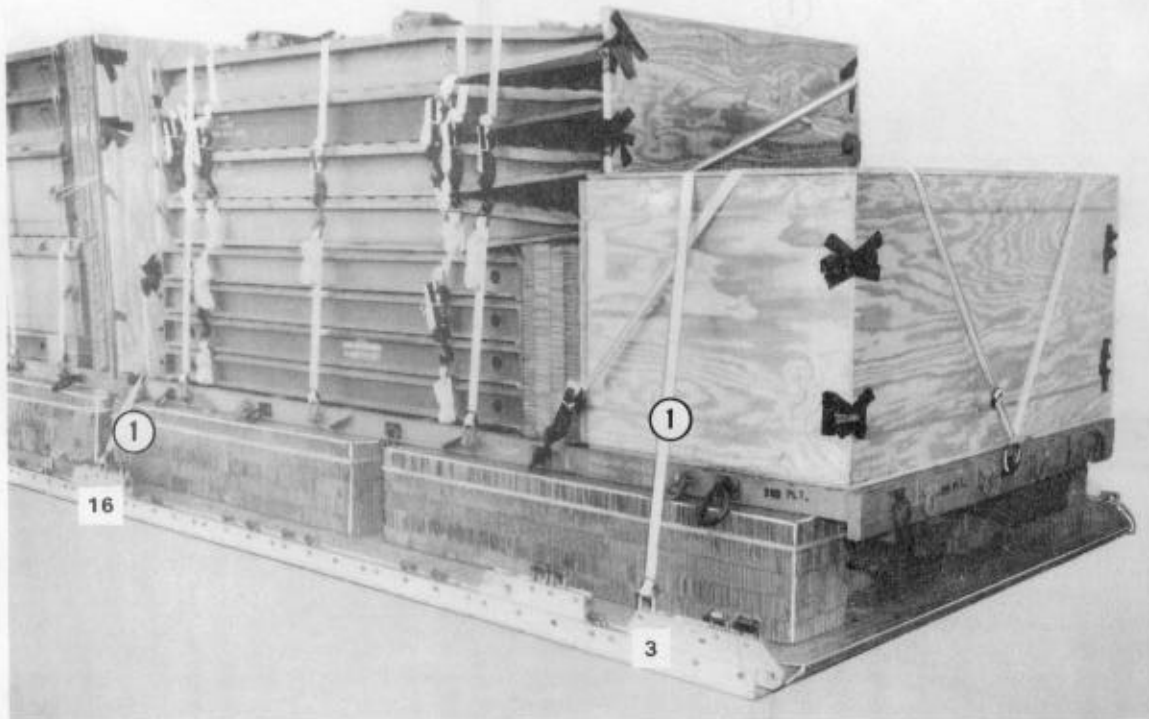

Lashing Number	Tie-down Clevis Number	Instructions
*1	3 16	<p>Pass lashing: Through its own D-ring, over top of parts box, through right top cutout of restraint board 1, around right side of pallet 1. Through its own D-ring, through right top cutout of restraint board 2, around the right side of pallet 1. Connect and secure these two lashings with a third 15-foot lashing.</p> <p>*Use three 15-foot lashings. Use the procedures in FM 10-500-2/TO 13C7-1-5 to form the additional lengths.</p>

Figure 4-49. Lashing 1 installed

Note: Left and right refer to the pallet, NOT the platform.

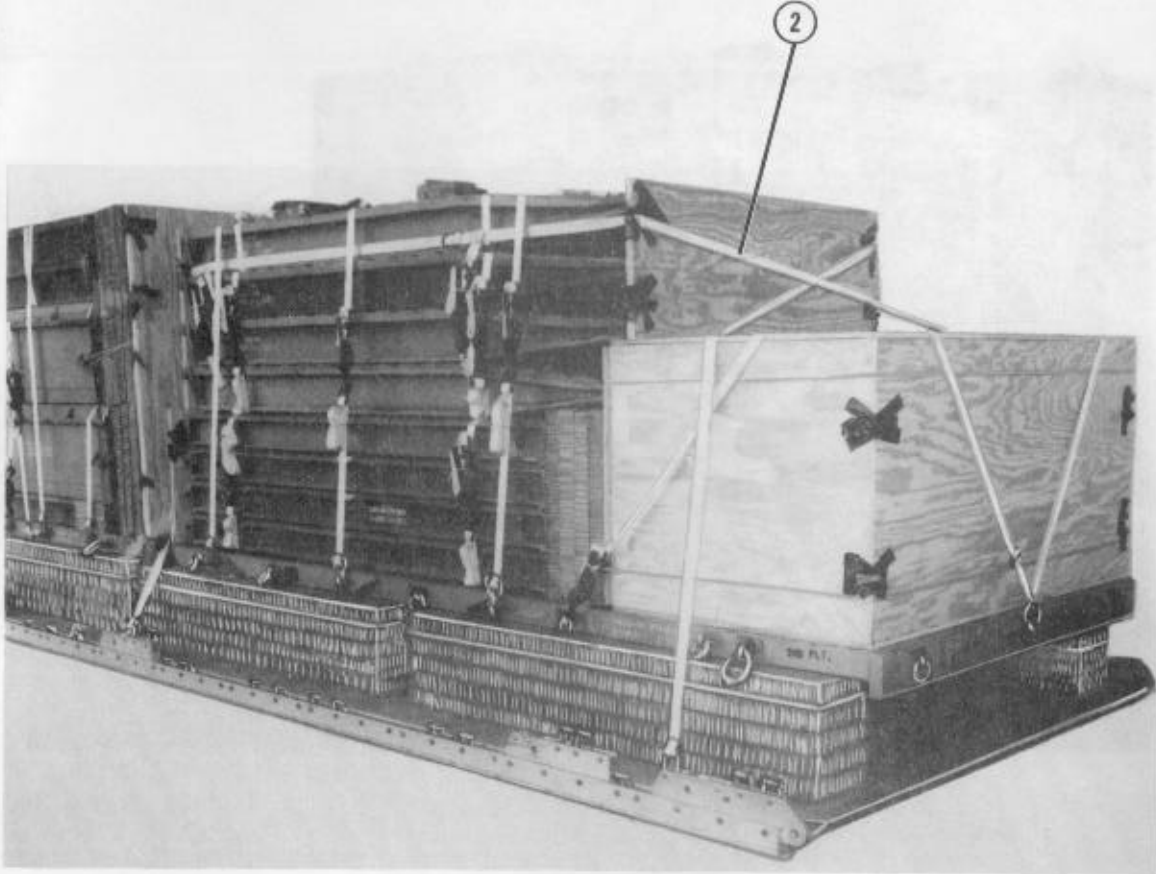

Lashing Number	Tie-down Clevis Number	Instructions
*2	3A 16A	<p>Pass lashing: Through its own D-ring, over top of parts box, through left top cutout of restraint board 1, around left side of pallet 1. Through its own D-ring, through left top cutout of restraint board 2, around the left side of pallet 1. Connect and secure these two lashings with a third 15-foot lashing.</p> <p>*Use three 15-foot lashings. Use the procedures in FM 10-500-2/TO 13C7-1-5 to form the additional lengths.</p>

Figure 4-50. Lashing 2 installed

Note: Left and right refer to the pallet, NOT the platform.

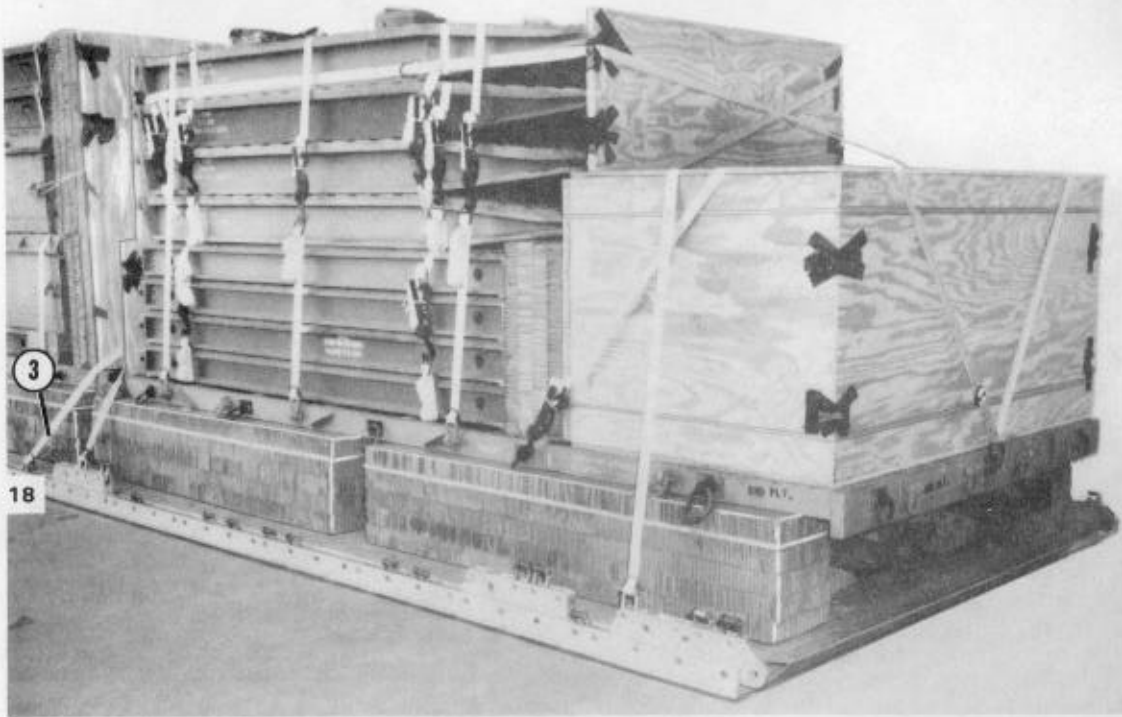

Lashing Number	Tie-down Clevis Number	Instructions
*3	18 32	<p>Pass lashing: Through its own D-ring, around the second cutout from top on right side of restraint board 3, around right side of pallet 2. Through its own D-ring, through top cutout on right side of restraint board 5, around right side of pallet 2. Connect and secure these two lashings with a third 15-foot lashing.</p> <p>*Use three 15-foot lashings. Use the procedures in FM 10-500-2/TO 13C7-1-5 to form the additional lengths.</p>

Figure 4-51. Lashing 3 installed

Note: Left and right refer to the pallet, NOT the platform.

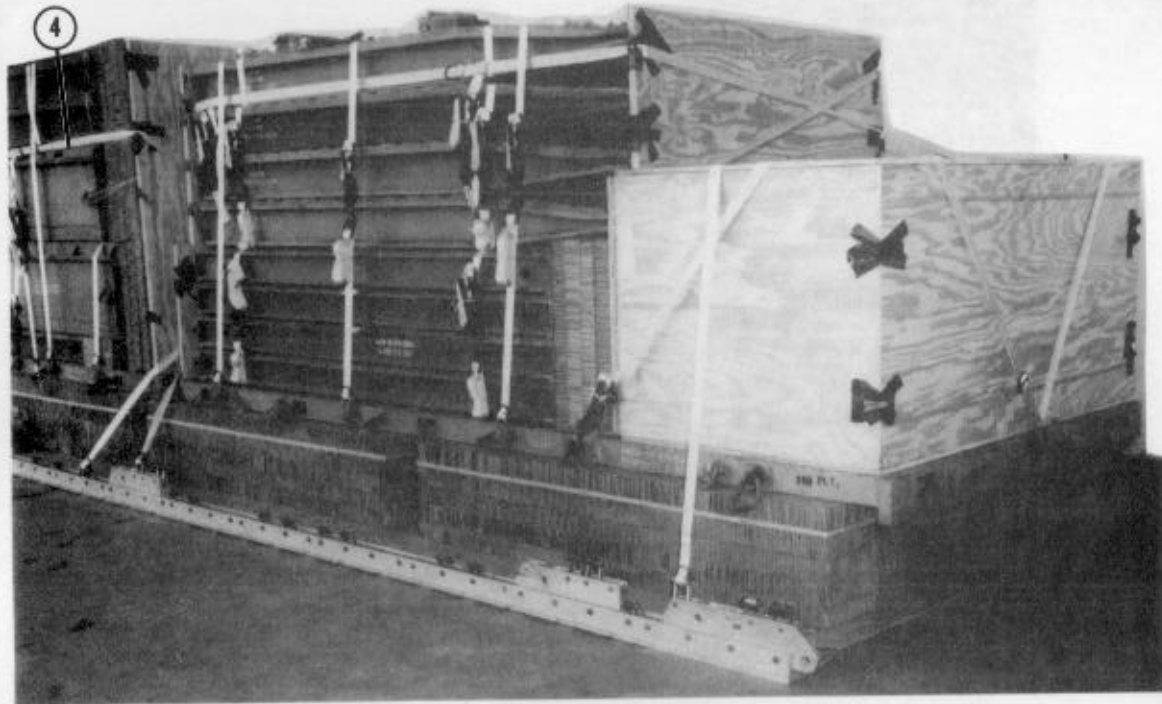

Lashing Number	Tie-down Clevis Number	Instructions
*4	18A 32A	<p>Pass lashing: Through its own D-ring, around the second cutout from top on left side of restraint board 3, around left side of pallet 2. Through its own D-ring, through top cutout on left side of restraint board 5, around left side of pallet 2. Connect and secure these two lashings with a third 15-foot lashing.</p> <p>*Use three 15-foot lashings. Use the procedures in FM 10-500-2/TO 13C7-1-5 to form the additional lengths.</p>

Figure 4-52. Lashing 4 installed

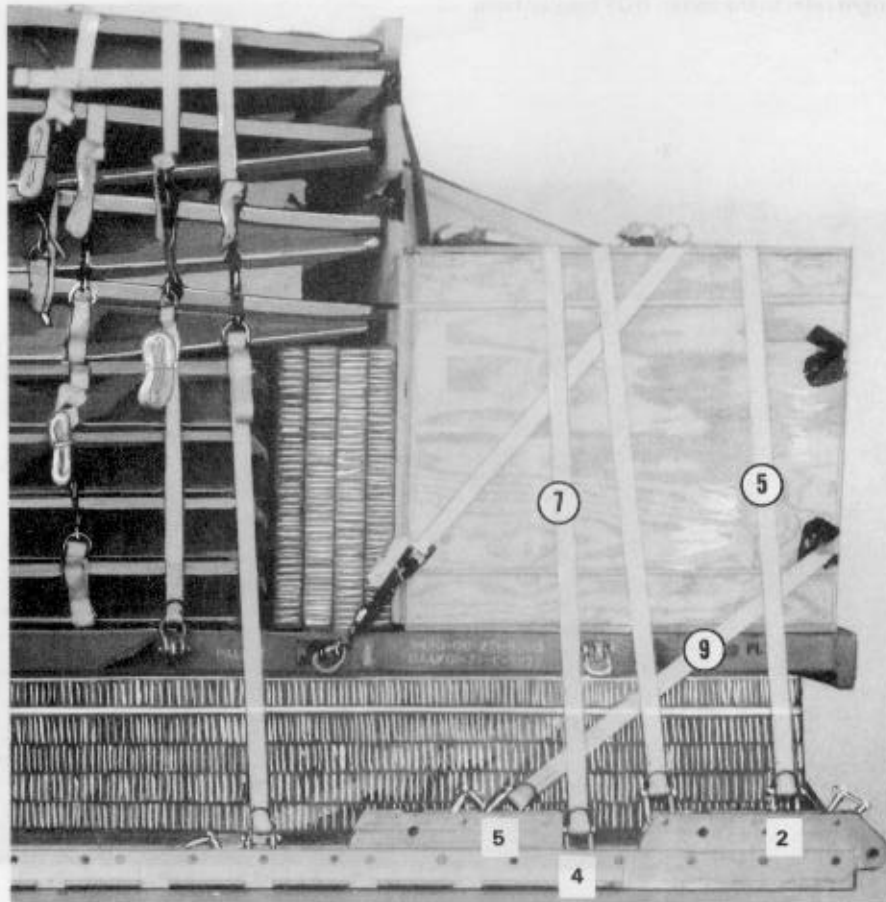

Lashing Number	Tie-down Clevis Number	Instructions
5	2	Pass lashing: Through its own D-ring and to top of parts box.
6	2A	Through its own D-ring and to top of parts box. Secure it to lashing 5.
7	4	Through its own D-ring and to top of parts box.
8	4A	Through its own D-ring and to top of parts box. Secure it to lashing 7.
9	5	Through its own D-ring and through bottom cutout of parts box.
10	5A	Through its own D-ring and through bottom cutout of parts box. Secure it to lashing 9.

Figure 4-53. Lashings 5 through 10 installed

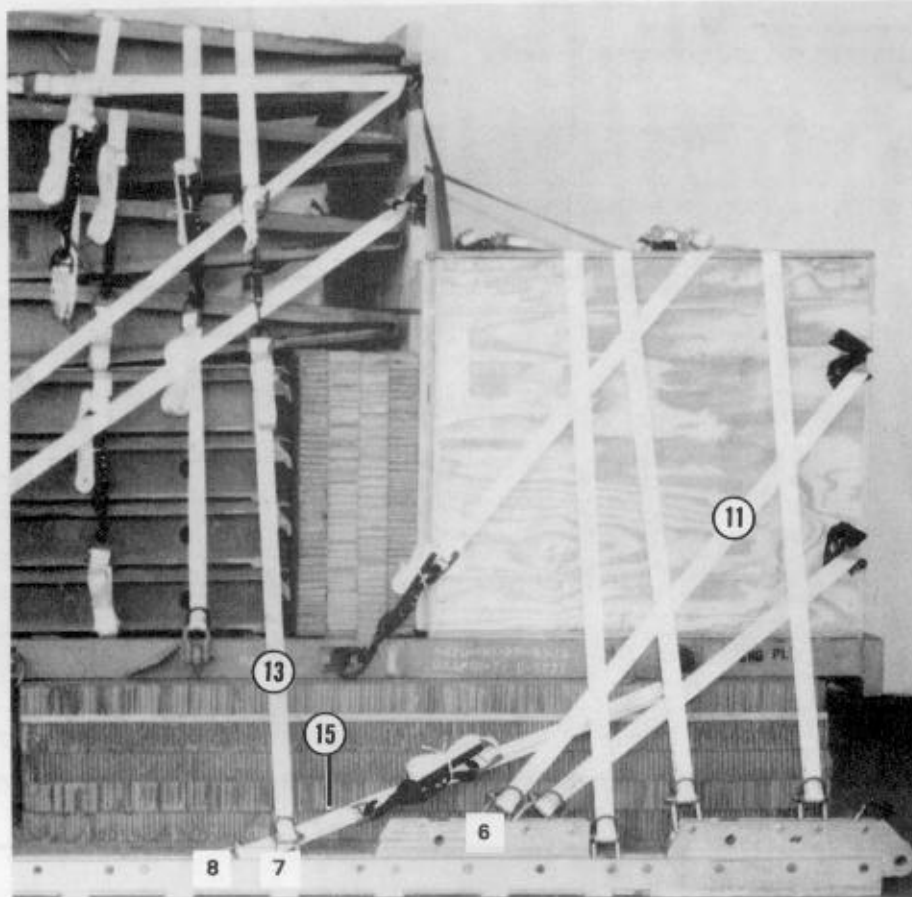

Lashing Number	Tie-down Clevis Number	Instructions
11	6	Pass lashing: Through its own D-ring and through top cutout of parts box.
12	6A	
13	7	Through its own D-ring and to top of pallet 1.
14	7A	Through its own D-ring and to top of pallet 1. Secure it to lashing 13.
15	8	Through lifting shackle 11A of pallet 1.
16	8A	Through lifting shackle 11 of pallet 1.

Figure 4-54. Lashings 11 through 16 installed

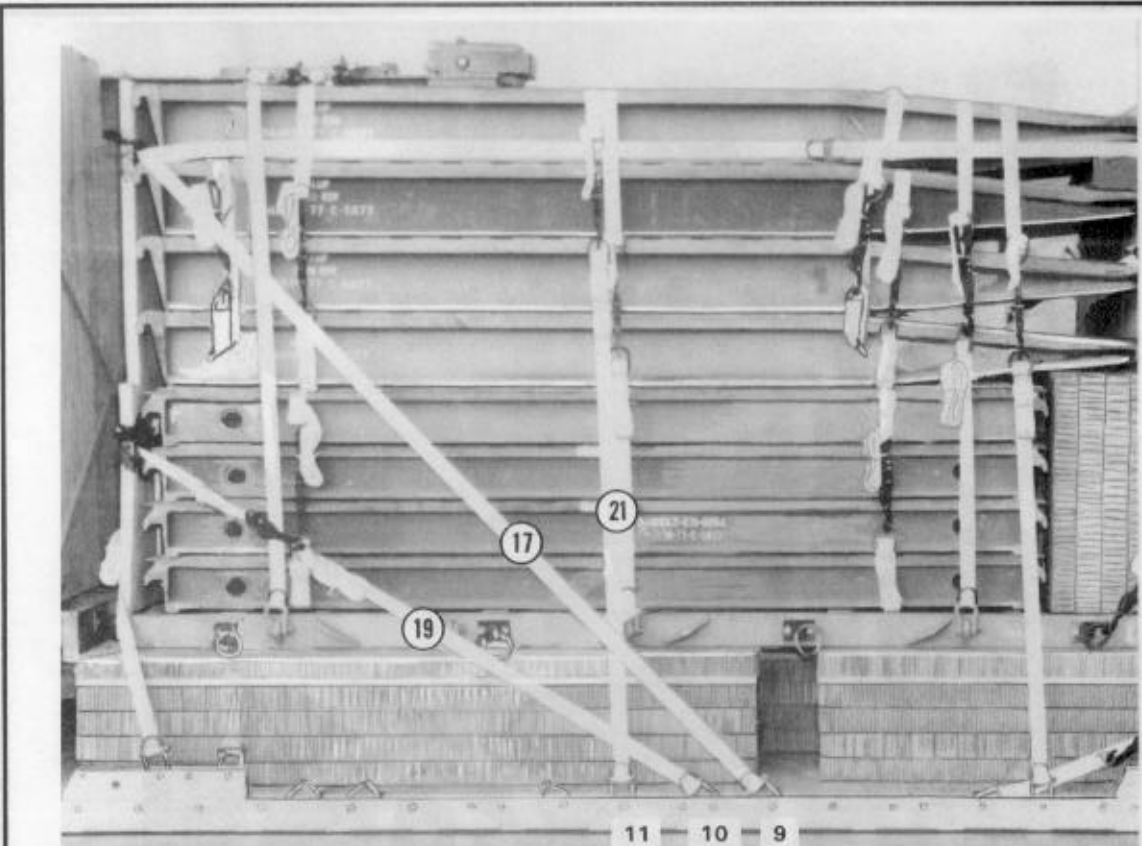

Lashing Number	Tie-down Clevis Number	Instructions
17	9	Pass lashing: Through its own D-ring and through top cutout of restraint board 2.
18	9A	Through its own D-ring and through top cutout of restraint board 2. Secure it to lashing 17.
19	10	Through its own D-ring and through bottom cutout of restraint board 2.
20	10A	Through its own D-ring and through bottom cutout of restraint board 2. Secure it to lashing 19.
21	11	Through its own D-ring and over top of pallet 1.
22	11A	Through its own D-ring and over top of pallet 1. Secure it to lashing 21.

Figure 4-55. Lashings 17 through 22 installed

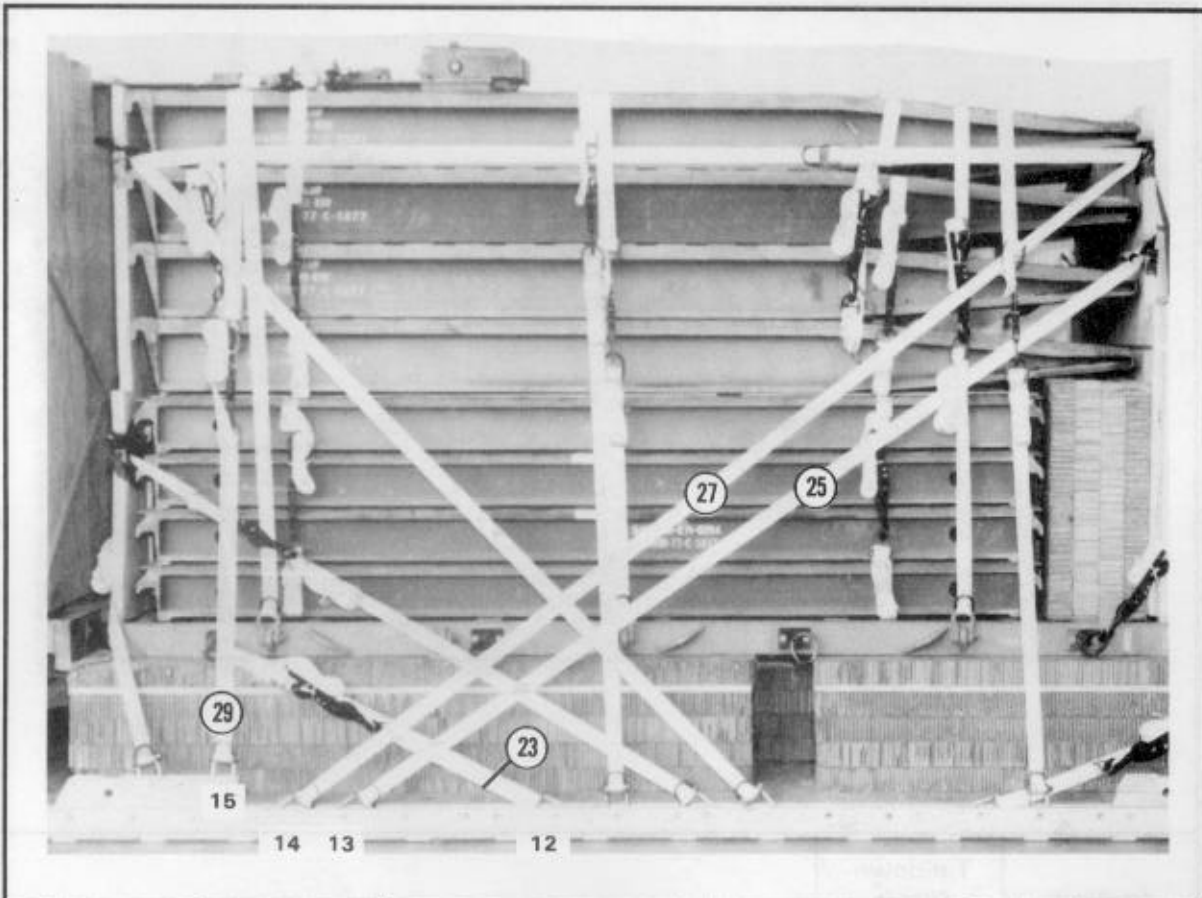

Lashing Number	Tie-down Clevis Number	Instructions
23	12	Pass lashing: Through lifting shackle 1A of pallet 1.
24	12A	Through lifting shackle 1 of pallet 1.
25	13	Through its own D-ring and through bottom cutout of restraint board 1.
26	13A	Through its own D-ring and through bottom cutout of restraint board 1. Secure it to lashing 25.
27	14	Through its own D-ring and through top cutout of restraint board 1.
28	14A	Through its own D-ring and through top cutout of restraint board 1. Secure it to lashing 27.
29	15	Through its own D-ring and over top of pallet 1.
30	15A	Through its own D-ring and over top of pallet 1. Secure it to lashing 29.

Figure 4-56. Lashings 23 through 30 installed

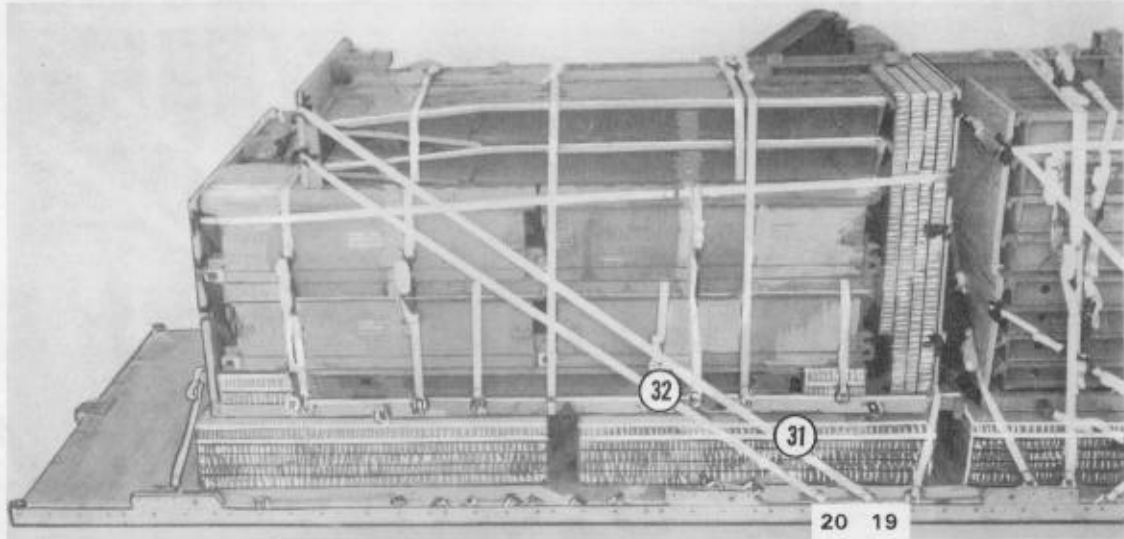

Lashing Number	Tie-down Clevis Number	Instructions
*31	19 19A	<p>Pass lashing: Through its own D-ring and through top cutout of restraint board 4.</p> <p>Through its own D-ring and through top cutout of restraint board 4. Connect and secure these two lashings with a third 15-foot lashing.</p>
*32	20 20A	<p>Through its own D-ring and through bottom cutout of restraint board 4.</p> <p>Through its own D-ring and through bottom cutout of restraint board 4. Connect and secure these two lashings with a third 15-foot lashing.</p> <p>*Use three 15-foot lashings. Use the procedures in FM 10-500-2/TO 13C7-1-5 to form the additional lengths.</p>

Figure 4-57. Lashings 31 and 32 installed

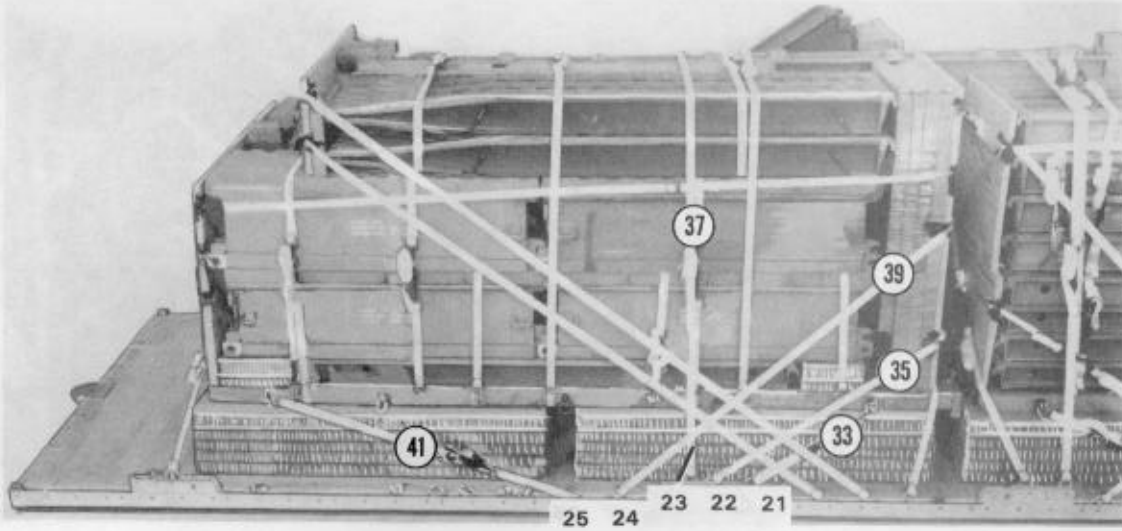

Lashing Number	Tie-down Clevis Number	Instructions
33	21	Pass lashing: To lifting shackle 11A of pallet 2.
34	21A	To lifting shackle 11 of pallet 2.
35	22	Through its own D-ring and through bottom cutout of restraint board 3.
36	22A	Through its own D-ring and through bottom cutout of restraint board 3. Secure it to lashing 35.
37	23	Through its own D-ring and over top of pallet 2.
38	23A	Through its own D-ring and over top of pallet 2. Secure it to lashing 37.
39	24	Through its own D-ring and through third cutout from the top of restraint board 3.
40	24A	Through its own D-ring and through third cutout from the top of restraint board 3. Secure it to lashing 39.
41	25	Through lifting shackle 1A of pallet 2.
42	25A	Through lifting shackle 1 of pallet 2.

Figure 4-58. Lashings 33 through 42 installed

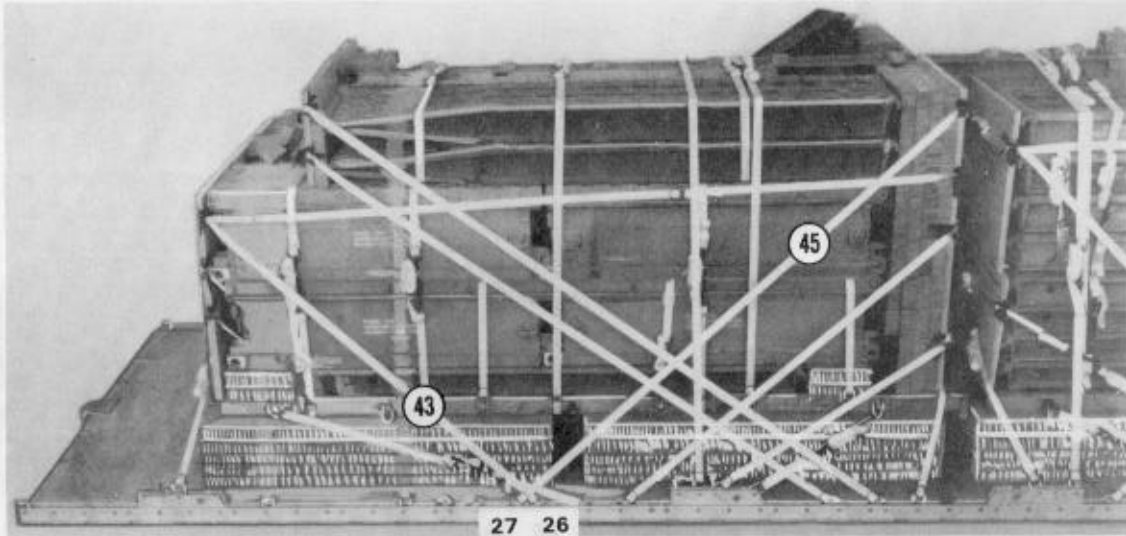

Lashing Number	Tie-down Clevis Number	Instructions
43	26	Pass lashing: Through its own D-ring and through top cutout of restraint board 5.
44	26A	Through its own D-ring and through top cutout of restraint board 5. Secure it to lashing 43.
*45	27	Through its own D-ring and through top cutout of restraint board 3.
	27A	Through its own D-ring and through top cutout of restraint board 3. Connect and secure these two lashings with a third 15-foot lashing.
*Use three 15-foot lashings. Use the procedures in FM 10-500-2/TO 13C7-1-5 to form the additional lengths.		

Figure 4-59. Lashings 43, 44, and 45 installed

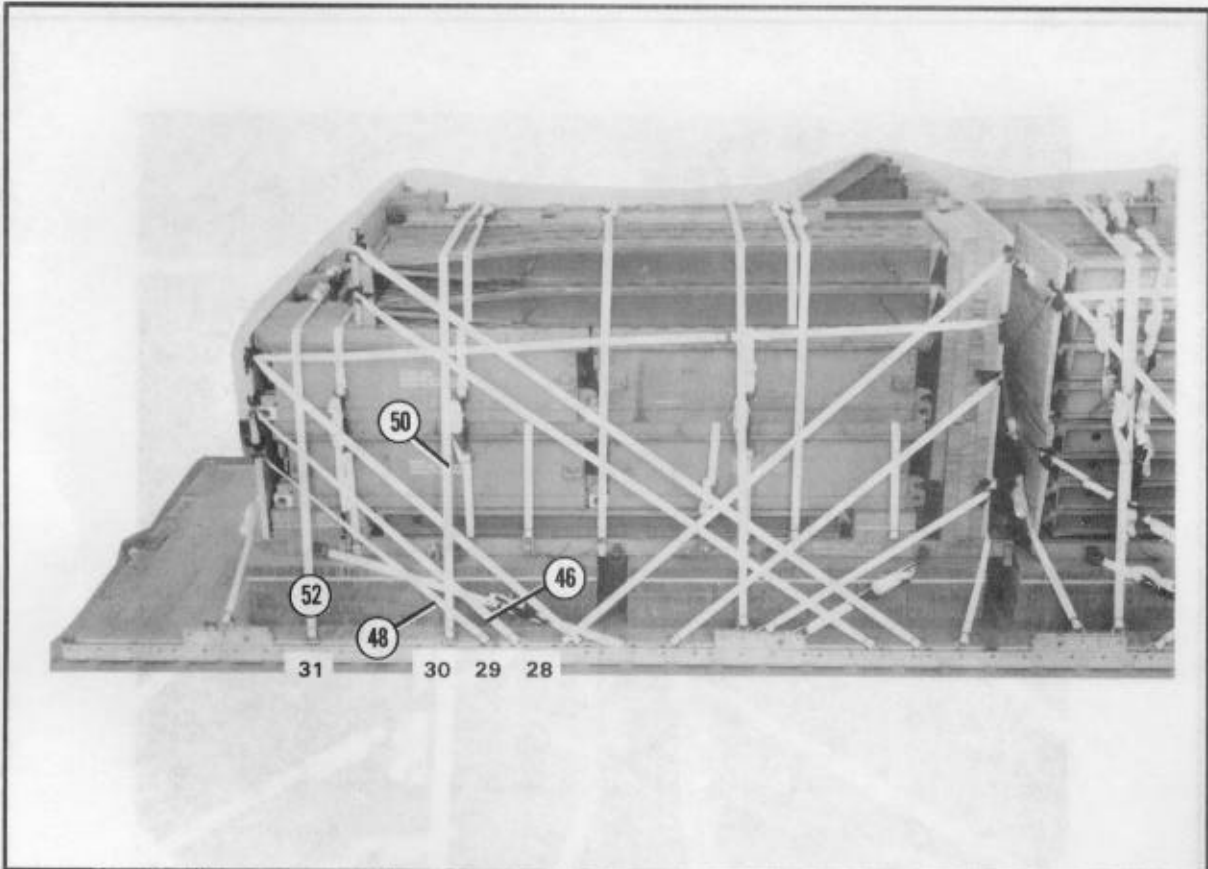

Lashing Number	Tie-down Clevis Number	Instructions
46	28	Pass lashing: Through its own D-ring and through middle cutout of restraint board 5.
47	28A	Through its own D-ring and through middle cutout of restraint board 5. Secure it to lashing 46.
48	29	Through its own D-ring and through bottom cutout of restraint board 5.
49	29A	Through its own D-ring and through bottom cutout of restraint board 5. Secure it to lashing 48.
50	30	Through its own D-ring and over top of pallet 2.
51	30A	Through its own D-ring and over top of pallet 2. Secure it to lashing 50.
52	31	Through its own D-ring and over top of pallet 2.
53	31A	Through its own D-ring and over top of pallet 2. Secure it to lashing 52.

Figure 4-60. Lashings 46 through 53 installed

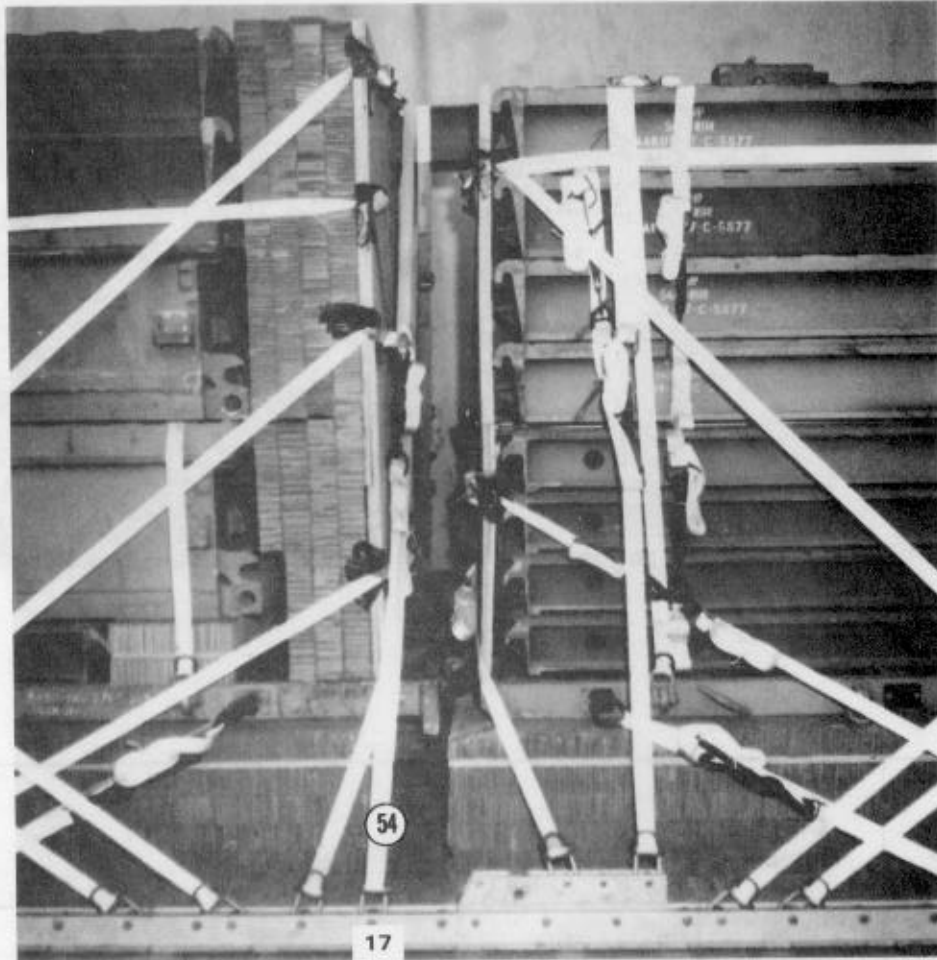

Lashing Number	Tie-down Clevis Number	Instructions
*54	17	Pass lashing: Around roller beam.
*55	17A	
*30-foot lashing		

Figure 4-61. Lashings 54 and 55 installed

4-11. Installing Suspension Slings

Install the suspension slings as shown in Figure 4-63.

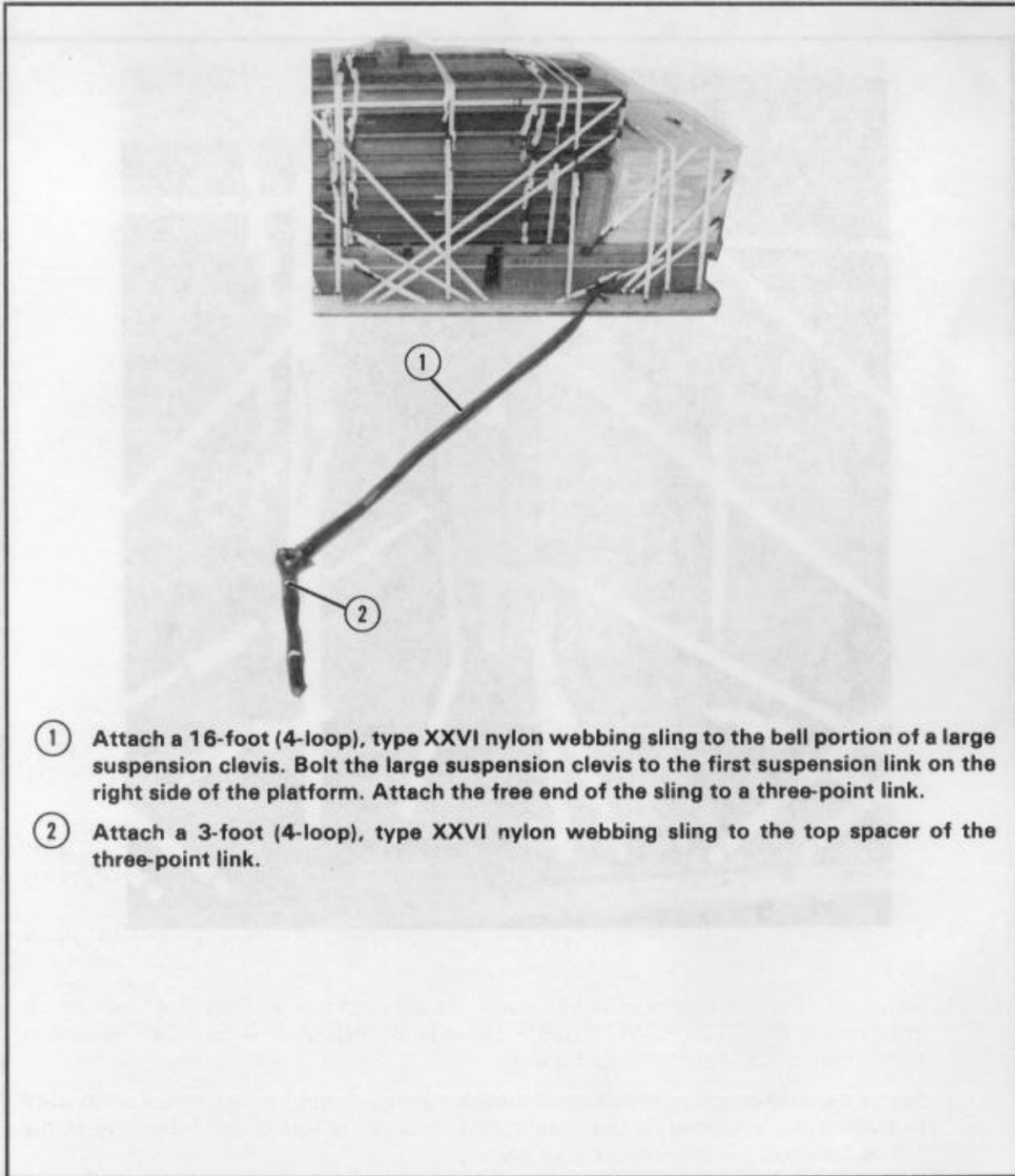
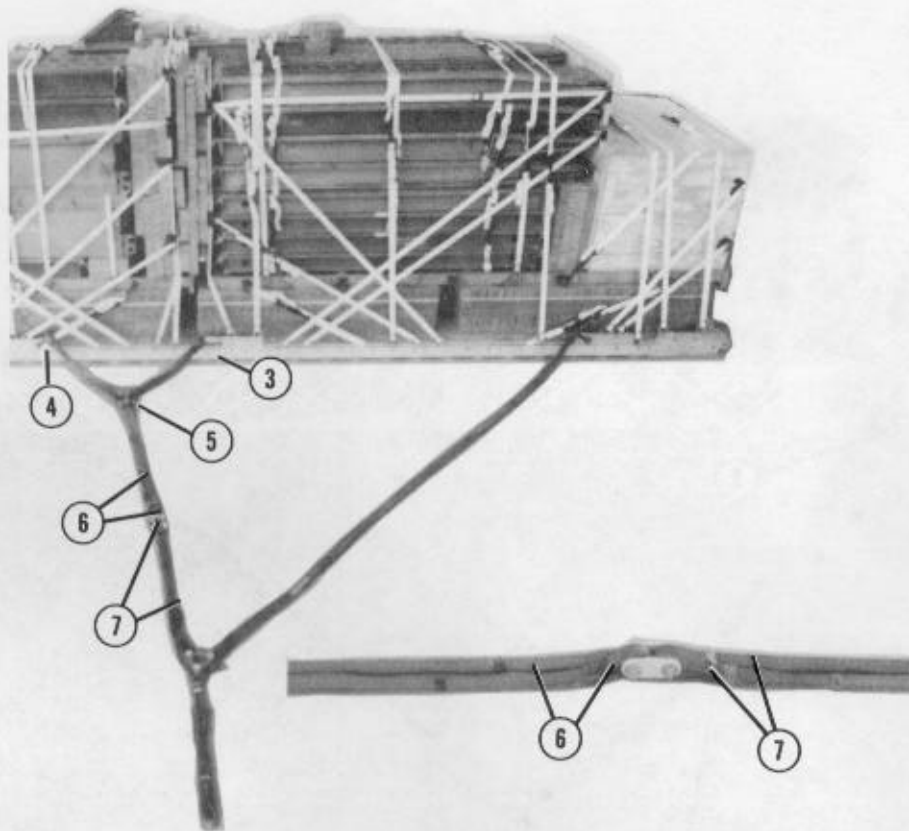

Figure 4-63. Suspension slings installed

Note: Tape the folded slings at three connections.



- ③ Attach a 3-foot (4-loop), type XXVI nylon webbing sling to the bell portion of a large suspension clevis. Bolt the large suspension clevis to the second suspension link on the right side of the platform.
- ④ Attach a 3-foot (4-loop), type XXVI nylon webbing sling to the bell portion of a large suspension clevis. Bolt the large suspension clevis to the third suspension link on the right side of the platform.
- ⑤ Attach the free ends of both 3-foot slings to the bell portion of a large suspension clevis on the right side of the platform.
- ⑥ Pass a 11-foot (2-loop), type XXVI nylon webbing sling around the bolt portion of the large suspension clevis used in step 5 by folding the sling in half. Attach the free ends of the sling to a 3 3/4-inch two-point link.
- ⑦ Pass a 9-foot (2-loop), type XXVI nylon webbing sling through the three-point link used in steps 1 and 2 by folding the sling in half. Attach the free ends of the sling to the 3 3/4-inch two-point link used in step 6.

Figure 4-63. Suspension slings installed (continued)

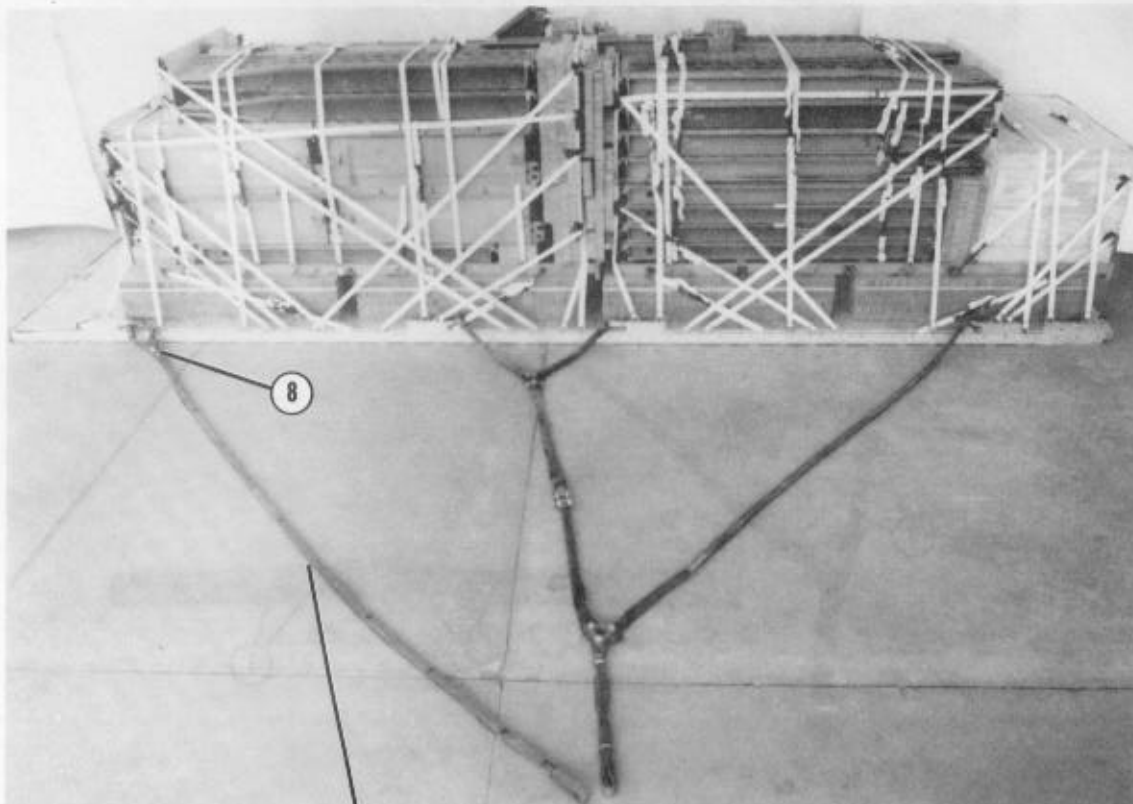

- ⑧ Route a 3-foot (4-loop), type XXVI nylon webbing sling through a 5 1/2-inch two-point link. Attach the free ends of the sling to the bell portion of a large suspension clevis. Bolt the suspension clevis to the fourth suspension link on the right side of the platform.
- ⑨ Attach a 20-foot (4-loop), type XXVI nylon webbing sling to the other end of the two-point link used in step 8.
- ⑩ Repeat steps 1 through 9 for the left side of the platform (not shown).

Figure 4-63. Suspension slings installed (continued)

4-12. Preparing and Positioning Load Covers

Prepare and position the load covers as shown in Figure 4-64.

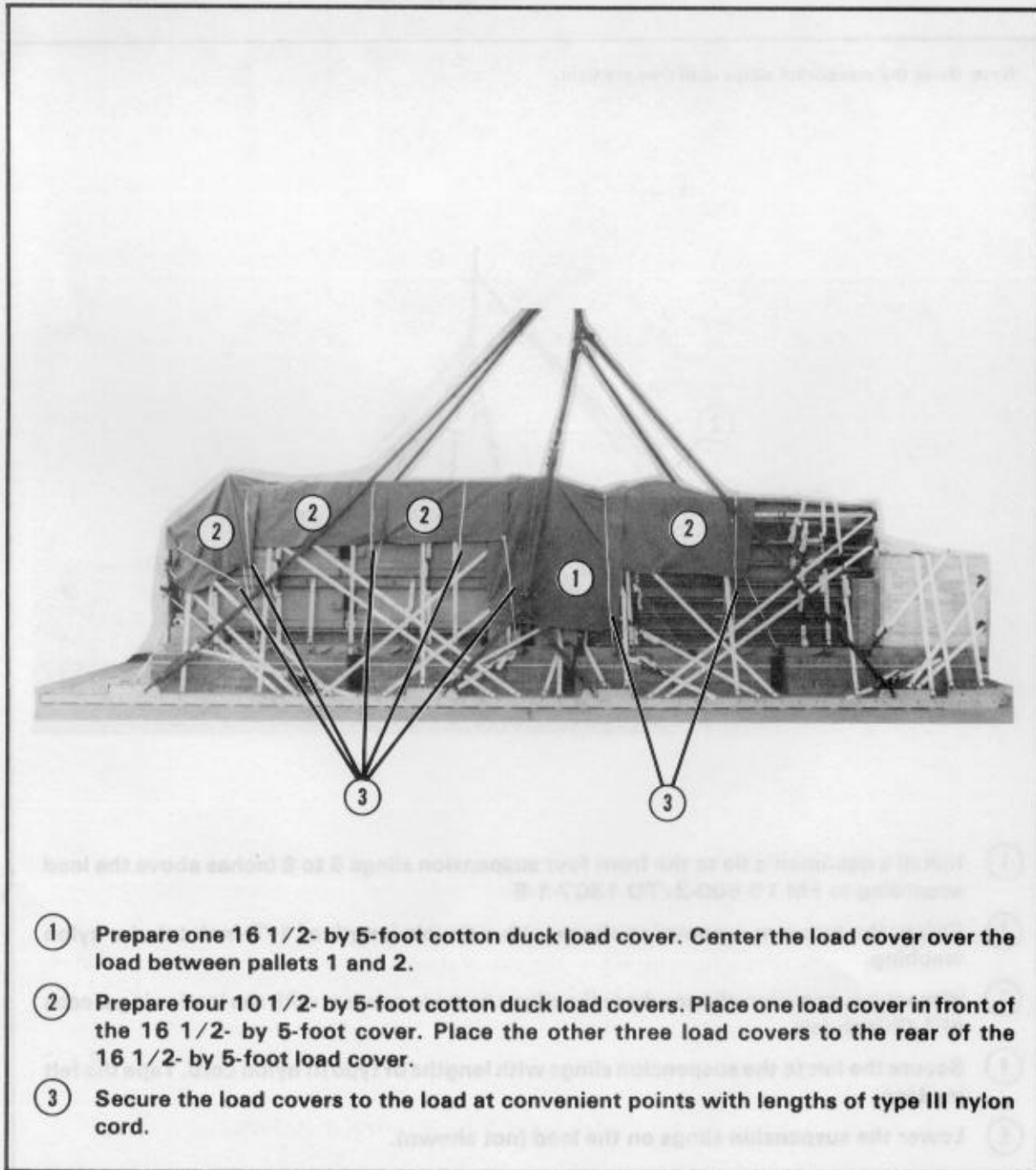
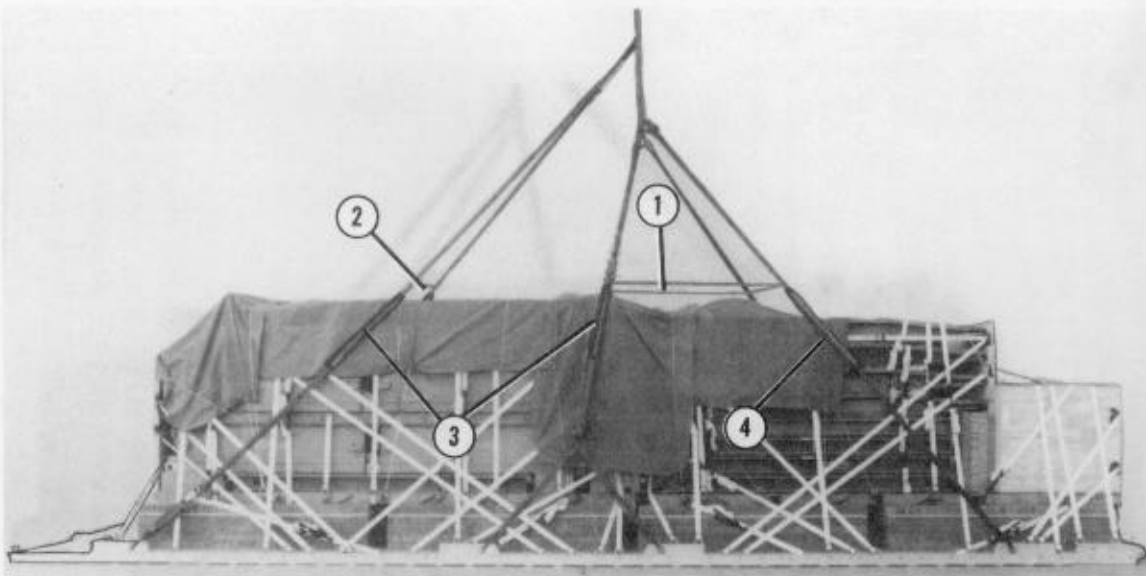

Figure 4-64. Load covered

4-13. Safeying Suspension Slings

Safety the suspension slings according to FM 10-500-2/TO 13C7-1-5 and as shown in Figure 4-65.

Note: Raise the suspension slings until they are tight.



- ① Install a deadman's tie to the front four suspension slings 6 to 8 inches above the load according to FM 10-500-2/TO 13C7-1-5.
- ② Safety the two rear suspension slings with a double length of 1/2-inch tubular nylon webbing.
- ③ Wrap the suspension slings where the slings come in contact with the load using pieces of 1/2-inch felt.
- ④ Secure the felt to the suspension slings with lengths of type III nylon cord. Tape the felt in place.
- ⑤ Lower the suspension slings on the load (not shown).

Figure 4-65. Suspension slings safetied

4-14. Building, Positioning, and Securing Parachute Stowage Platform

Build and position four honeycomb supports for the parachute stowage platform as shown in Figure 4-66. Build the parachute stowage platform as shown in Figures 4-67 and 4-68. Lash the parachute stowage platform as shown in Figure 4-69 using four 15-foot tie-down assemblies.

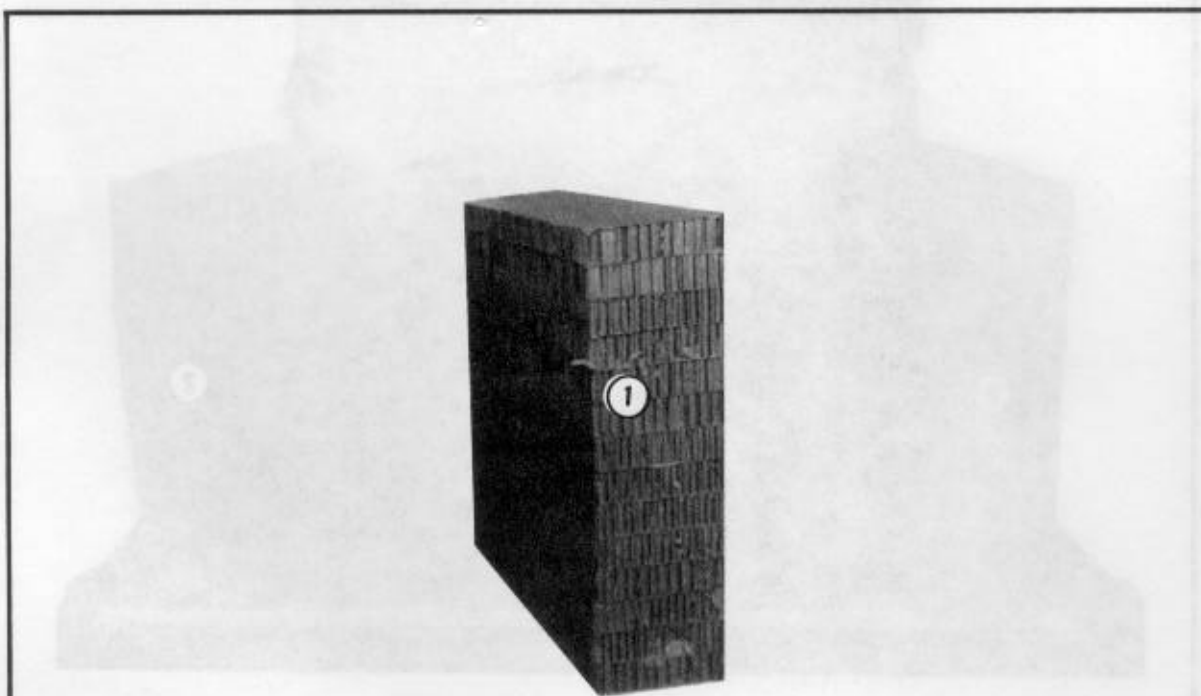

- ① Form four honeycomb supports using fifty-six 12- by 40-inch pieces of honeycomb, 14 pieces in each honeycomb support.

Figure 4-66. Honeycomb supports built and positioned

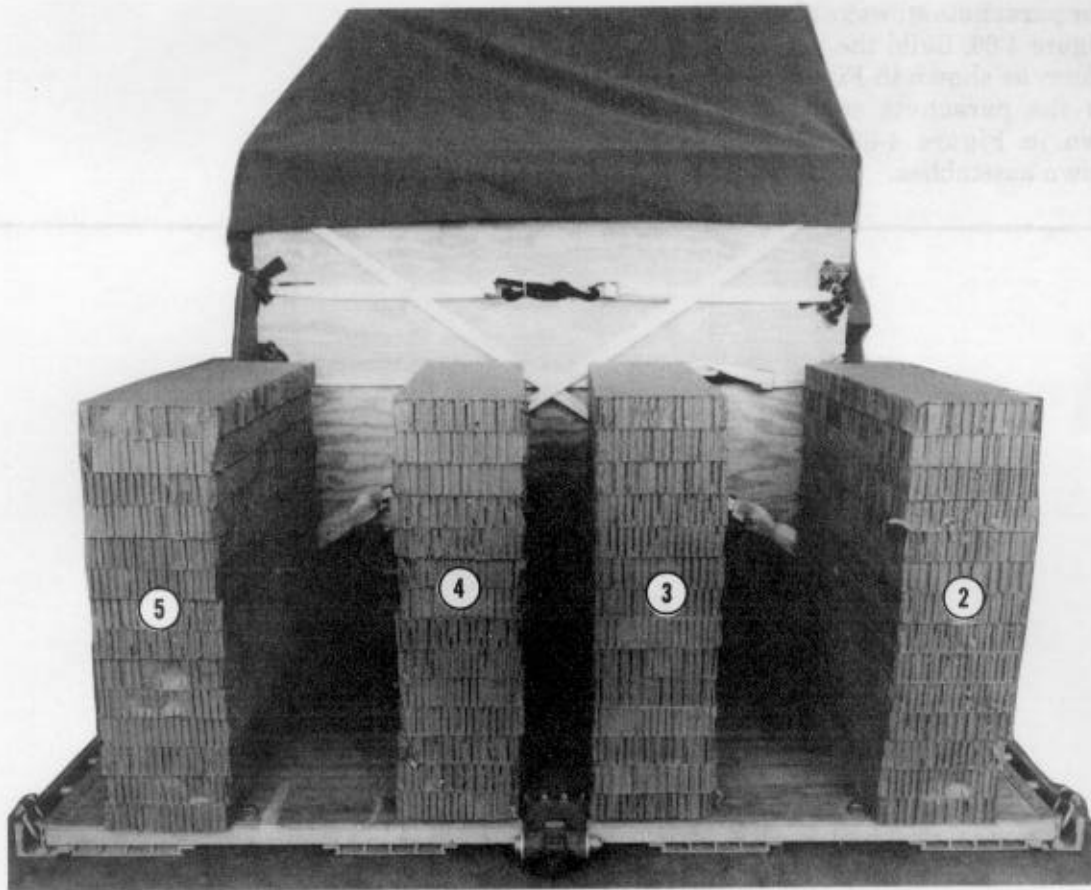

- ② Position honeycomb support 1 flush with the rear edge of the platform and 9 1/4 inches from the right rail of the platform.
- ③ Position honeycomb support 2 flush with the rear edge of the platform and 16 inches from the left edge of honeycomb support 1.
- ④ Position honeycomb support 3 flush with the rear edge of the platform and 7 inches from the left edge of honeycomb support 2.
- ⑤ Position honeycomb support 4 flush with the rear edge of the platform and 9 1/4 inches from the left rail of the platform.

Figure 4-66. Honeycomb supports built and positioned (continued)

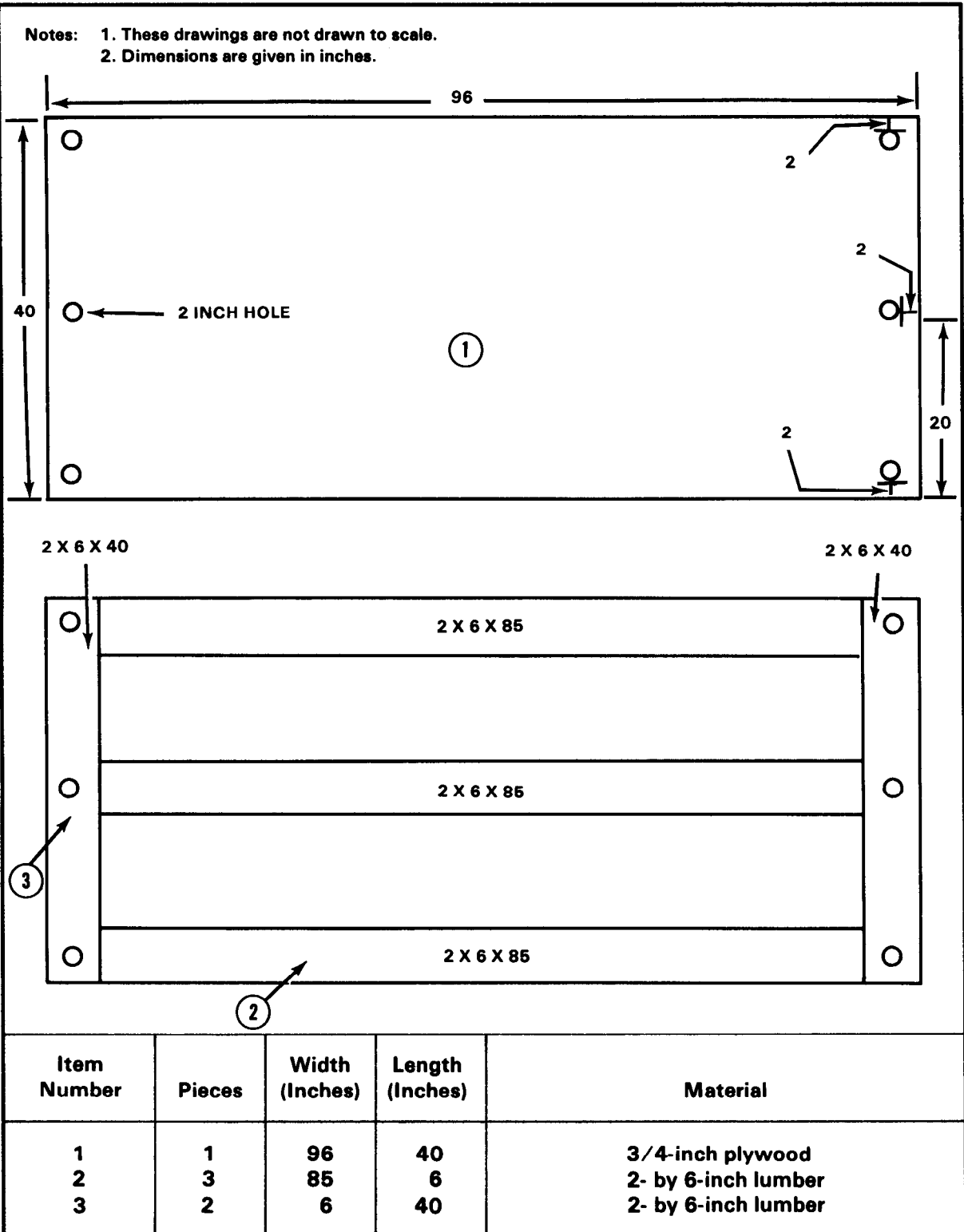
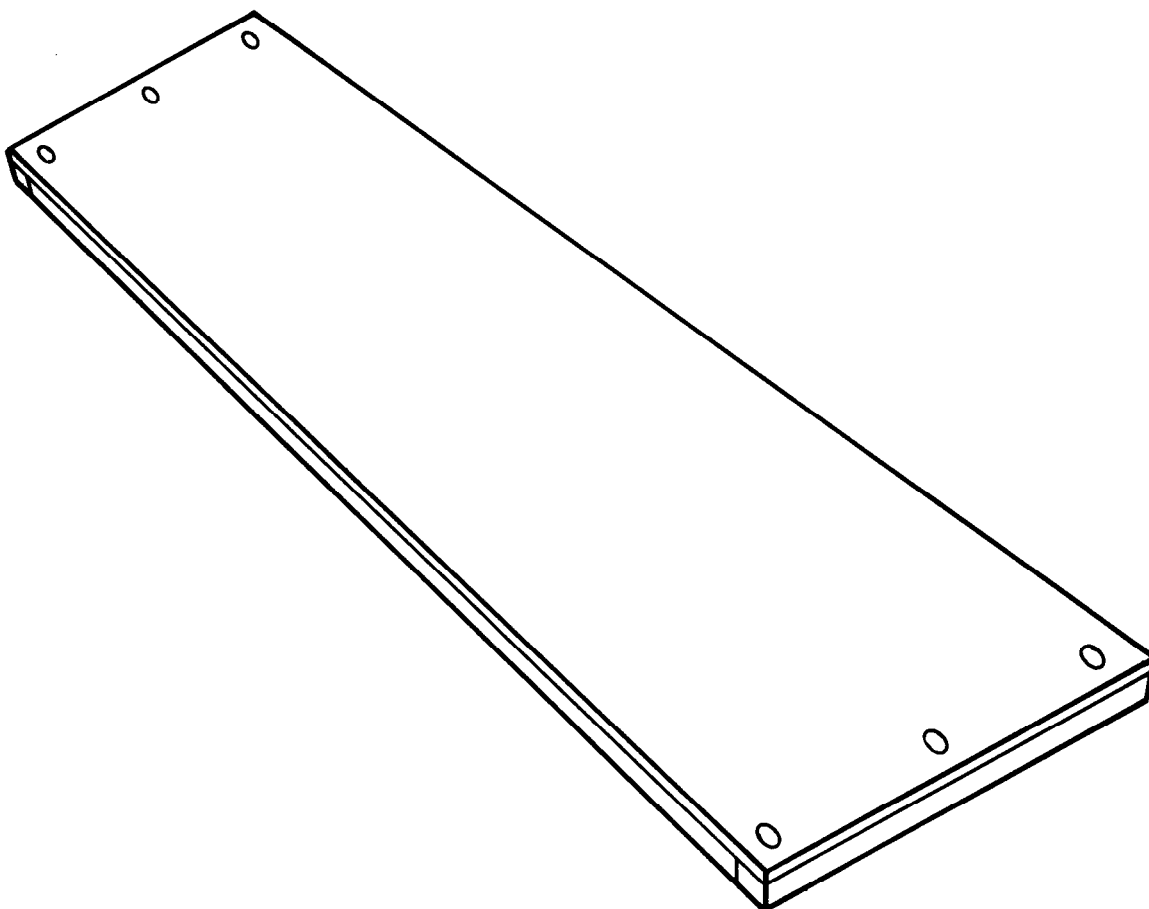

Figure 4-67. Materials required to build parachute stowage platform

Note: This drawing is not drawn to scale.



Step:

1. Build the parachute stowage platform using the materials given in Figure 4-67.
2. Use eightpenny nails to secure the parachute stowage platform.

Figure 4-68. Parachute stowage platform built

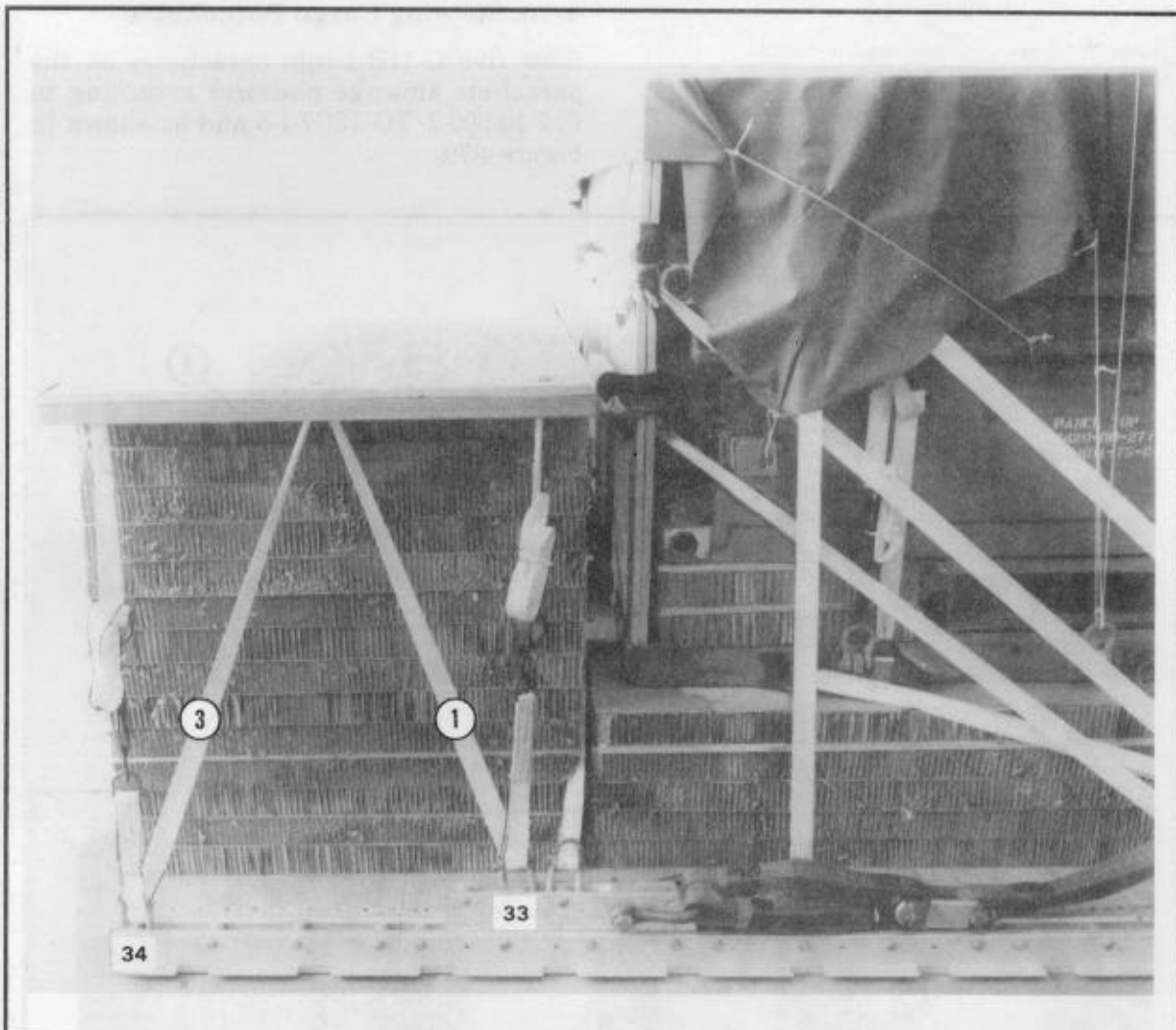

Lashing Number	Tie-down Clevis Number	Instructions
1	33	Pass lashing: Through center hole and then through front hole of parachute stowage platform, right side.
2	33A	Through center hole and then through front hole of parachute stowage platform, left side.
3	34	Through center hole and then through rear hole of parachute stowage platform, right side.
4	34A	Through center hole and then through rear hole of parachute stowage platform, left side.

Figure 4-69. Parachute stowage platform secured

4-15. Stowing Cargo Parachutes

Stow five G-11B cargo parachutes on the parachute stowage platform according to FM 10-500-2/TO 13C7-1-5 and as shown in Figure 4-70.

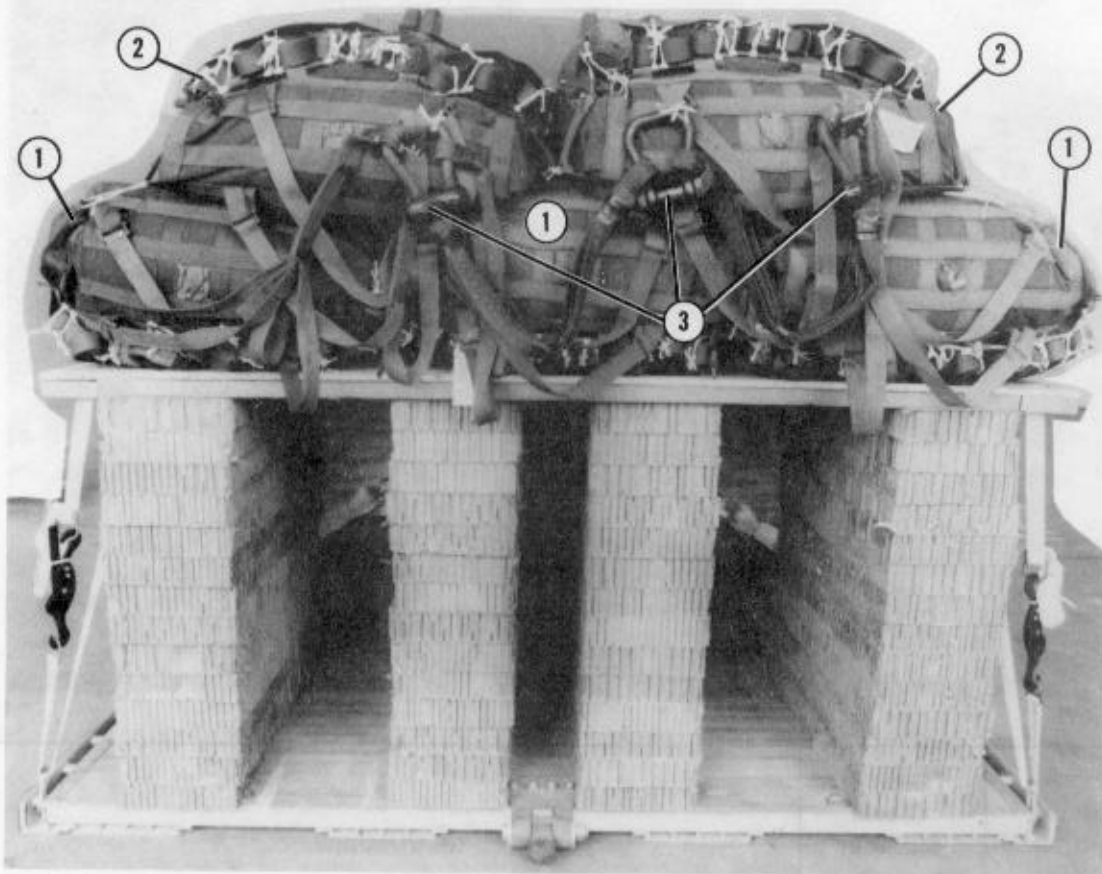

- ① Set three G-11B cargo parachutes with the riser extension compartments facing down on the parachute stowage platform.
- ② Set two G-11B cargo parachutes with the riser extension compartments facing up on top of the parachutes placed in step 1.
- ③ Group the bridle assemblies as shown in FM 10-500-2/TO 13C7-1-5.

Figure 4-70. Parachutes stowed

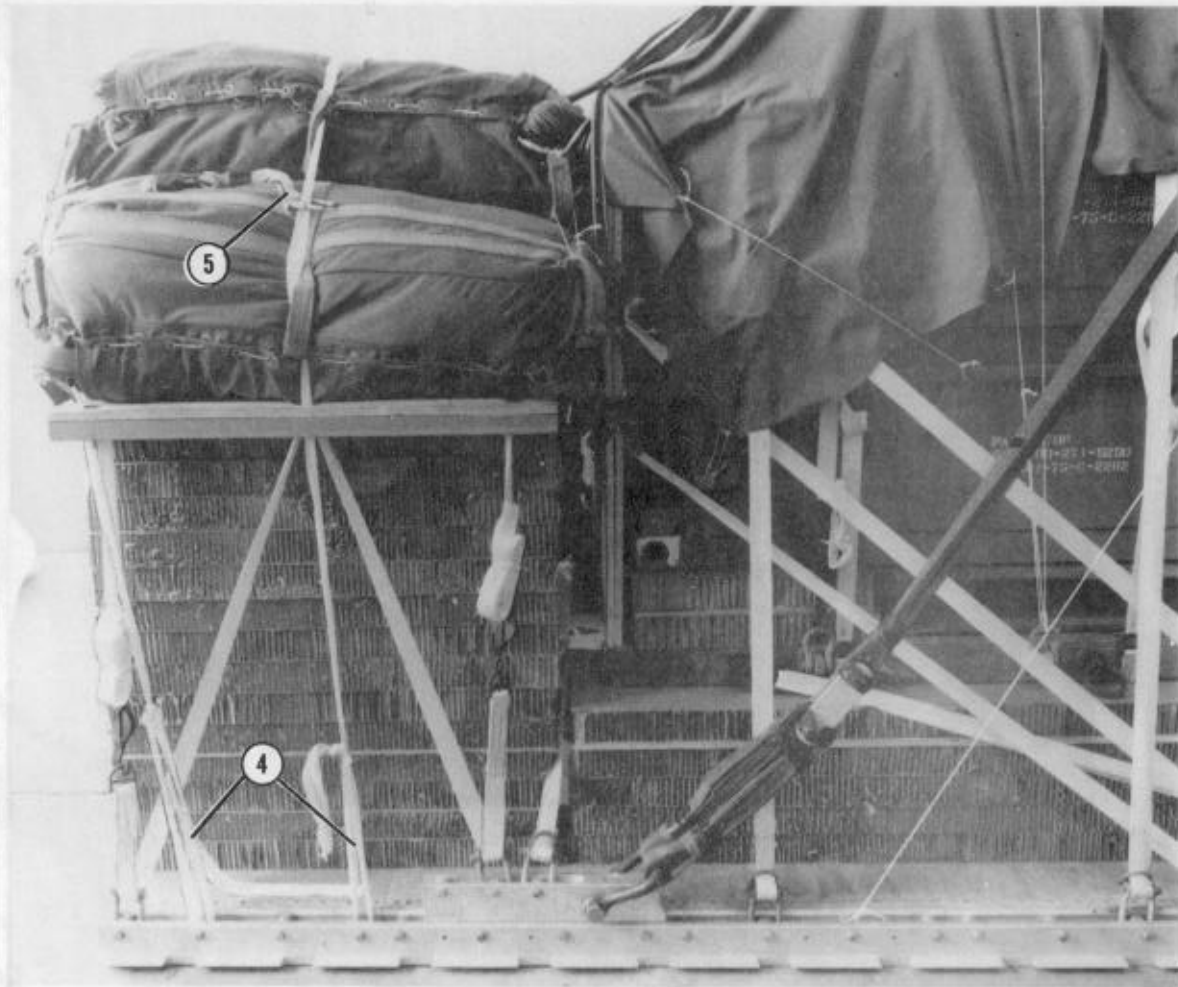

- ④ Restrain the cargo parachutes to the platform using two lengths of type VIII nylon webbing according to FM 10-500-2/TO 13C7-1-5. Tie the ends of the webbing to the platform bushings between clevises 33 and 34.
- ⑤ Install two multicut parachute release straps according to FM 10-500-2/TO 13C7-1-5.

Figure 4-70. Parachutes stowed (continued)

4-16. Installing Release System

Prepare and install the M-2 release system according to FM 10-500-2/TO 13C7-1-5 and as shown in Figure 4-71.

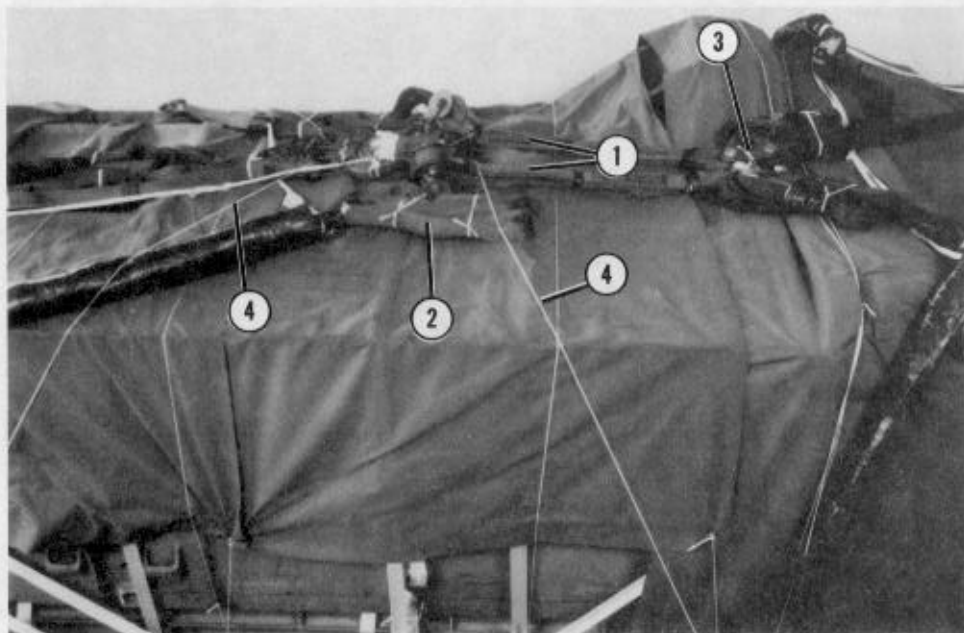

- ① Prepare an M-2 cargo release assembly according to FM 10-500-2/TO 13C7-1-5. Attach the M-2 cargo release assembly to the suspension slings and the cargo parachutes according to FM 10-500-2/TO 13C7-1-5.
- ② Fold the suspension slings. Secure the folds with lengths of type I, 1/4-inch cotton webbing.
- ③ Safety the three-point links together with a length of type I, 1/4-inch cotton webbing.
- ④ Secure the top and bottom of the M-2 cargo parachute release according to FM 10-500-2/TO 13C7-1-5.

Figure 4-71. Release system installed

4-17. Installing Extraction System

Install the EFTC extraction system as shown in Figures 4-72 and 4-73.

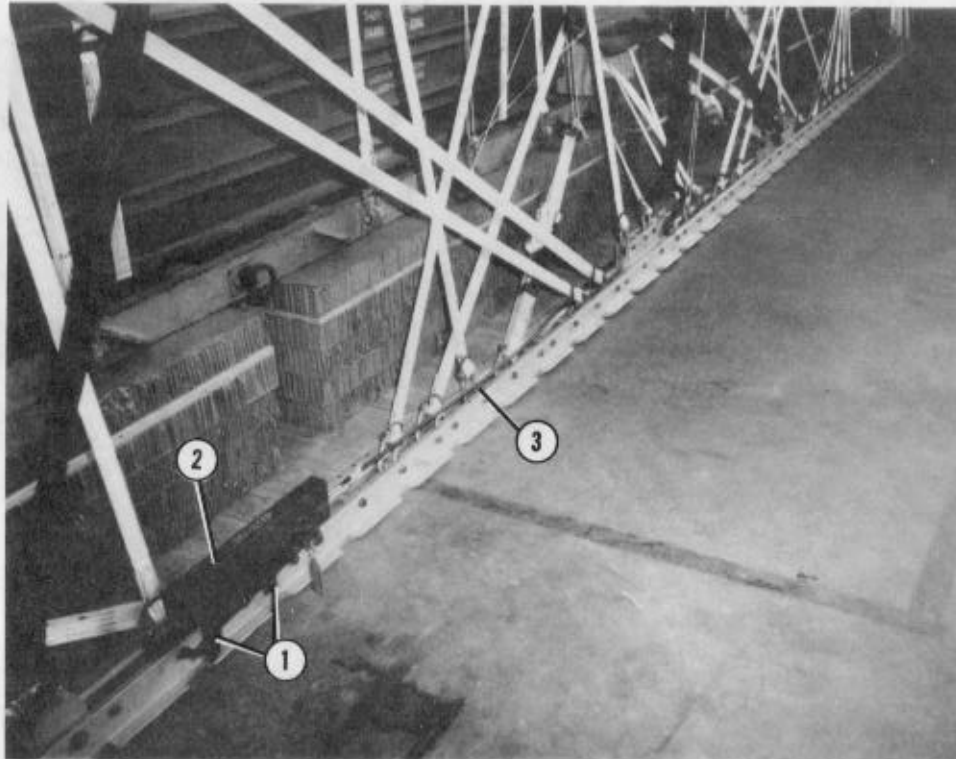

- ① Attach the EFTA mounting brackets to the rear mounting holes on the left platform side rail.
- ② Install the actuator to the EFTA mounting brackets with a 28-foot cable according to FM 10-500-2/TO 13C7-1-5.
- ③ Safety the 28-foot cable to the lashings along the left platform side rail using lengths of type I, 1/4-inch cotton webbing.

Figure 4-72. Actuator and cable installed

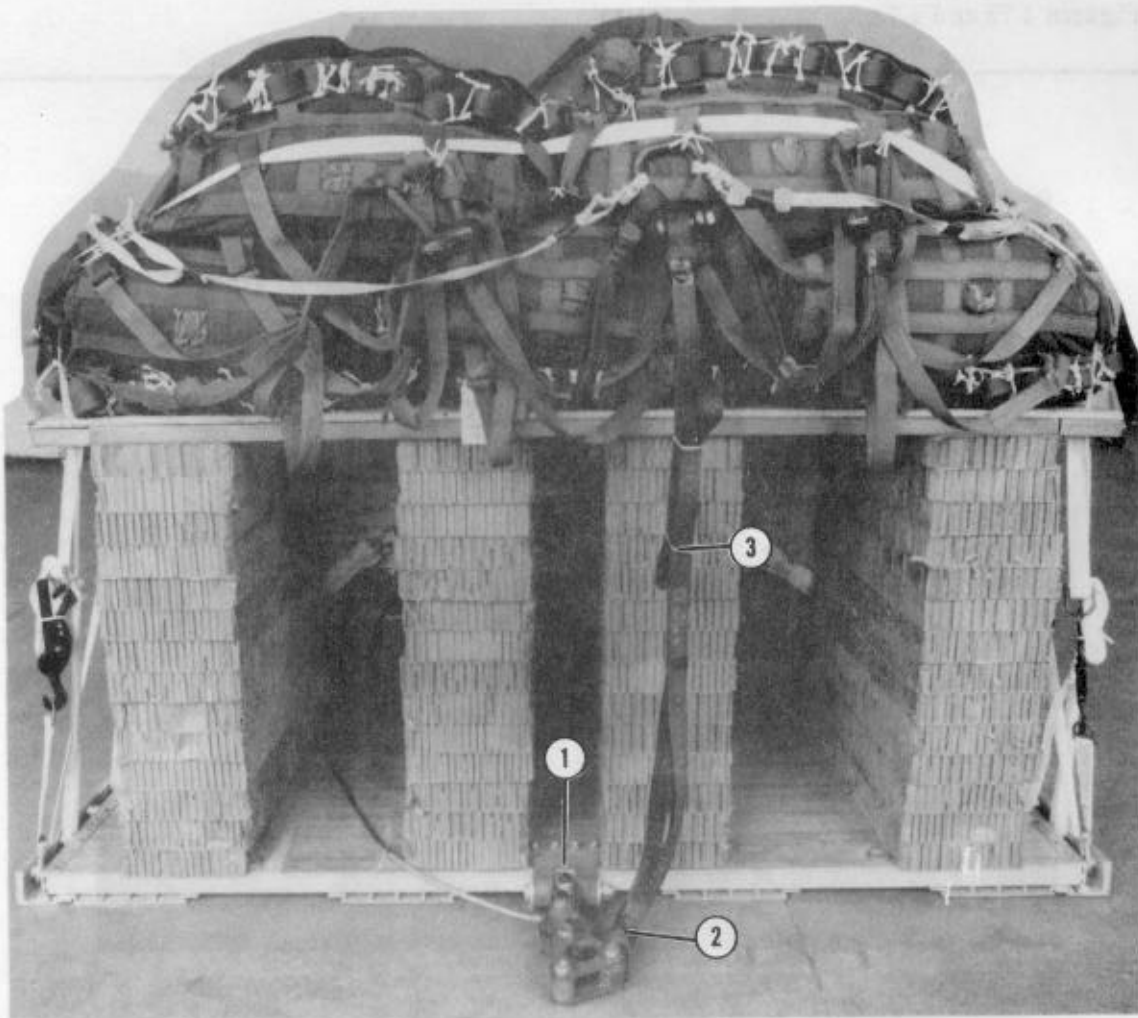

- ① Attach the latch assembly to the extraction bracket with the locking nut hole facing toward the left side of the platform according to FM 10-500-2/TO 13C7-1-5.
- ② Connect one end of a 9-foot (2-loop), type XXVI nylon webbing sling as a deployment line to the right spacer of the link assembly. Connect the free end of the deployment line to the center large clevis on the 3-foot clustering slings.
- ③ Fold the excess deployment line. Secure the folds with type I, 1/4-inch cotton webbing.

Figure 4-73. Extraction system installed

4-18. Installing Provisions for Emergency Restraints

Install provisions for emergency restraints according to FM 10-500-2/TO 13C7-1-5.

4-19. Placing Extraction Parachute

Place the extraction parachute as described below.

a. *C-130 Aircraft.* Place one 28-foot cargo extraction parachute; a 60-foot (3-loop), type XXVI nylon webbing extraction line; and a 5 1/2-inch, two-point link assembly on the load for installation in the aircraft.

b. *C-141 Aircraft.* Place one 28-foot heavy-duty cargo extraction parachute and a continuous 140-foot (3-loop), type XXVI nylon webbing extraction line on the load for installation in the aircraft.

4-20. Marking Rigged Load

Mark the rigged load according to FM 10-500-2/TO 13C7-1-5 and as shown in Figure 4-74. If the load varies from the one shown, the weight, height, CB, and parachute requirements must be recomputed.

CAUTION: Make the final rigger inspection required by FM 10-500-2/TO 13C7-1-5 before the load leaves the rigging site.

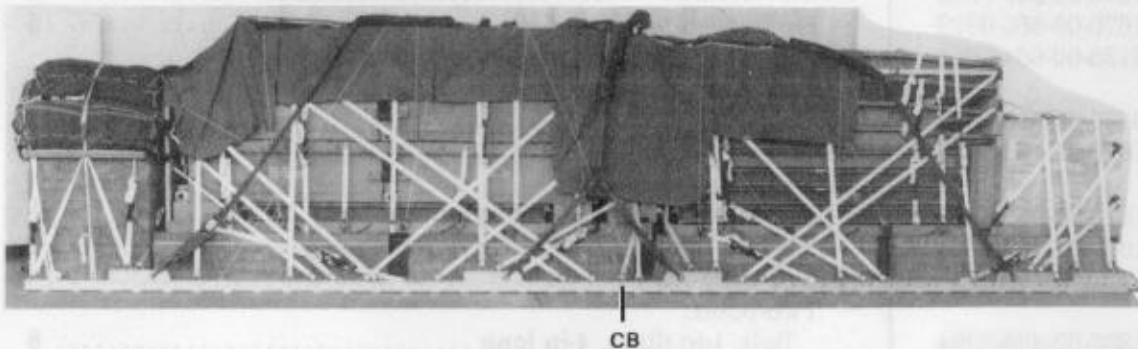

RIGGED LOAD DATA

Weight:	Load shown	22,480 pounds
	Maximum load allowed	23,500 pounds
Height		97 inches
Width		108 inches
Length		407 inches
Overhang:	Front	5 inches
	Rear	18 inches
CB (from front edge of platform)		186 inches
Extraction system		EFTC

Figure 4-74. Five-bay, single-story, medium girder (fixed) bridge rigged for low-velocity airdrop on a type V platform

4-21. Equipment Required

Use the equipment listed in Table 4-1 to rig this load.

Table 4-1. Equipment required for rigging the five-bay, single-story, medium girder (fixed) bridge for low-velocity airdrop on a type V platform

National Stock Number	Item	Quantity
8040-00-273-8713	Adhesive, paste, 1-gal	As required
	Clevis, suspension:	
4030-00-678-8562	3/4-in (medium)	4
4030-00-090-5354	1-in (large)	10
8305-00-242-3593	Cloth, cotton duck, 60-in	As required
4020-00-240-2146	Cord, nylon, type III, 550-lb	As required
1670-00-157-6527	Coupling, airdrop, extraction force transfer w 28-ft cable	1
	Cover:	
1670-00-360-0328	Clevis, large	5
1670-00-360-0329	Link assembly (type IV)	15
8135-00-664-6958	Cushioning material, packaging, cellulose wadding	As required
8305-00-958-3685	Felt, 1/2-in thick	As required
1670-01-183-2678	Leaf, extraction line	2
	Line, extraction:	
1670-01-062-6313	60-ft (3-loop), type XXVI nylon webbing	1
1670-01-107-7615	140-ft (3-loop), type XXVI nylon webbing	1
	Link assembly:	
	Two-point:	
5306-00-435-8994	Bolt, 1-in diam, 4-in long	8
5310-00-232-5165	Nut, 1-in, hexagonal	8
1670-00-003-1953	Plate, side, 3 3/4-in	4
1670-00-003-1954	Plate, side, 5 1/2-in	4
5365-00-007-3414	Spacer, large	8
1670-01-307-0155	Three-point	2
1670-00-783-5988	Type IV	15
	Lumber:	
	2- by 4-in:	
5510-00-220-6146	29	2
	38	4
	76	4
	2- by 6-in:	
5510-00-220-6148	40	2
	85	3
5315-00-010-4659	Nail, steel wire, common, 8d	As required
1670-00-753-3928	Pad, energy-dissipating, honeycomb, 3- by 36- by 96-in	48 sheets

4-21. Equipment Required

Use the equipment listed in Table 4-1 to rig this load.

Table 4-1. Equipment required for rigging the five-bay, single-story, medium girder (fixed) bridge for low-velocity airdrop on a type V platform

National Stock Number	Item	Quantity
8040-00-273-8713	Adhesive, paste, 1-gal	As required
	Clevis, suspension:	
4030-00-678-8562	3/4-in (medium)	4
4030-00-090-5354	1-in (large)	10
8305-00-242-3593	Cloth, cotton duck, 60-in	As required
4020-00-240-2146	Cord, nylon, type III, 550-lb	As required
1670-00-157-6527	Coupling, airdrop, extraction force transfer w 28-ft cable	1
	Cover:	
1670-00-360-0328	Clevis, large	5
1670-00-360-0329	Link assembly (type IV)	15
8135-00-664-6958	Cushioning material, packaging, cellulose wadding	As required
8305-00-958-3685	Felt, 1/2-in thick	As required
1670-01-183-2678	Leaf, extraction line	2
	Line, extraction:	
1670-01-062-6313	60-ft (3-loop), type XXVI nylon webbing	1
1670-01-107-7615	140-ft (3-loop), type XXVI nylon webbing	1
	Link assembly:	
	Two-point:	
5306-00-435-8994	Bolt, 1-in diam, 4-in long	8
5310-00-232-5165	Nut, 1-in, hexagonal	8
1670-00-003-1953	Plate, side, 3 3/4-in	4
1670-00-003-1954	Plate, side, 5 1/2-in	4
5365-00-007-3414	Spacer, large	8
1670-01-307-0155	Three-point	2
1670-00-783-5988	Type IV	15
	Lumber:	
	2- by 4-in:	
5510-00-220-6146	29	2
	38	4
	76	4
	2- by 6-in:	
5510-00-220-6148	40	2
	85	3
	Nail, steel wire, common, 8d	As required
5315-00-010-4659	Pad, energy-dissipating, honeycomb,	
1670-00-753-3928	3- by 36- by 96-in	48 sheets

Table 4-1. Equipment required for rigging the five-bay, single-story, medium girder (fixed) bridge for low-velocity airdrop on a type V platform (continued)

National Stock Number	Item	Quantity
	4- by 7 1/2-in	(1)
	5- by 7-in	(4)
	6- by 96-in	(1)
	7- by 96-in	(1)
	8- by 28 1/2-in	(3)
	9- by 56-in	(4)
	9- by 96-in	(6)
	10- by 28 1/2-in	(2)
	11- by 40-in	(2)
	12- by 40-in	(56)
	12- by 73-in	(8)
	12- by 80-in	(64)
	22- by 41-in	(3)
	27- by 41-in	(4)
	53- by 15-in	(1)
	71 1/2- by 36-in	(1)
	76- by 13 1/2-in	(2)
	76- by 14-in	(1)
	76- by 22-in	(2)
	76- by 28-in	(3)
	76- by 28 1/2-in	(3)
	96- by 36-in	(4)
	Parachute:	
1670-01-016-7841	Cargo, G-11B	5
	Cargo extraction:	
1670-00-262-1797	28-ft or	1
1670-00-040-8135	28-ft, heavy-duty	1
	Platform, AD, type V, 32-ft:	1
	Bracket:	
1670-01-162-2375	Inside EFTA	(1)
1670-01-162-2374	Outside EFTA	(1)
1670-01-162-2372	Clevis assembly	(70)
1670-01-162-2376	Extraction bracket assembly	(1)
1670-01-247-2389	Suspension link	(8)
1670-01-162-2381	Tandem link	(2)
5530-00-128-4981	Plywood, 3/4-in:	25 sheets
	12- by 73-in	(2)
	12- by 80-in	(14)
	22 1/2- by 61-in	(1)
	24- by 63-in	(1)
	28- by 69-in	(1)
	32- by 63-in	(1)
	42- by 37-in	(2)

Table 4-1. Equipment required for rigging the five-bay, single-story, medium girder (fixed) bridge for low-velocity airdrop on a type V platform (continued)

National Stock Number	Item	Quantity
	42 1/2- by 61-in	(1)
	44- by 63-in	(1)
	48- by 69-in	(1)
	52- by 63-in	(1)
	64 1/2- by 20 1/2-in	(2)
	65- by 13-in	(1)
	68- by 15-in	(1)
	76- by 13 1/2-in	(1)
	76- by 21-in	(1)
	76- by 22-in	(1)
	76- by 37-in	(2)
	76- by 44-in	(2)
	76- by 48-in	(5)
	96- by 40-in	(1)
1670-01-097-8817	Release, cargo parachute, M-2	1
8135-00-290-1086	Seal, steel strapping, 5/8-in	As required
	Sling, cargo airdrop:	
	For deployment line:	
1670-01-062-6304	9-ft (2-loop), type XXVI nylon webbing	1
	For lifting:	
1670-01-063-7761	16-ft (2-loop), type XXVI nylon webbing	4
	For riser extensions:	
1670-01-062-6302	20-ft (2-loop), type XXVI nylon webbing	20
	For suspension slings:	
1670-01-062-6306	3-ft (4-loop), type XXVI nylon webbing	10
1670-01-062-6304	9-ft (2-loop), type XXVI nylon webbing	2
1670-01-063-7760	11-ft (2-loop), type XXVI nylon webbing	2
1670-01-062-6308	16-ft (4-loop), type XXVI nylon webbing	2
1670-00-432-2511	20-ft (4-loop), type XXVI nylon webbing or	2
1670-01-064-4453	20-ft (4-loop), type XXVI nylon webbing	2
1670-00-040-8219	Strap, parachute release, multicut comes w 3 knives	2
8135-00-283-0667	Strapping, steel, 5/8-in	As required
8305-00-074-5124	Tape, adhesive, 2-in	As required
1670-00-937-0271	Tie-down assembly, 15-ft	144
	Webbing:	
8305-00-268-2411	Cotton, 1/4-in, type I	As required
	Nylon:	
	Tubular:	
8305-00-082-5752	1/2-in or	As required
8305-00-268-2453	1/2-in	As required
8305-00-263-3591	Type VIII	As required

CHAPTER 5

RIGGING SEVEN-BAY, SINGLE-STORY, MEDIUM GIRDER (FIXED) BRIDGE ON A TYPE V PLATFORM

Section I

LOW-VELOCITY AIRDROP

5-1. Description of Load

The seven-bay, single-story, medium girder (fixed) bridge consists of a five-bay, single-story, medium girder (fixed) bridge with additional component parts that, when combined, make up the seven-bay bridge. Chapter 4, Section I gives the procedures for rigging the five-bay bridge. The additional component parts are rigged on a 16-foot, type V platform and use two G-11B cargo parachutes. When the load is rigged for airdrop, it is 215 inches long, 108 inches wide, and 67 1/2 inches high. When rigged, the components weigh 6,310 pounds.

NOTES: 1. The additional components platform must be dropped with the five-bay, single-story, medium girder (fixed) bridge. See Chapter 4 for the rigging procedures for the five-bay bridge.

2. All small components will be placed in the parts box on the five-bay bridge.

3. The curbs and guide markers are not included in this manual.

4. There must be at least eight bridge crew personnel to assist in the rigging of this load.

5. The nose bumper may or may not be installed.

6. Measurements given in this section are from the front edge of the platform, NOT from the front edge of the nose bumper.

5-2. Preparing Platform

Prepare a 16-foot, type V airdrop platform using four tandem links and 22 clevis assemblies as shown in Figure 5-1.

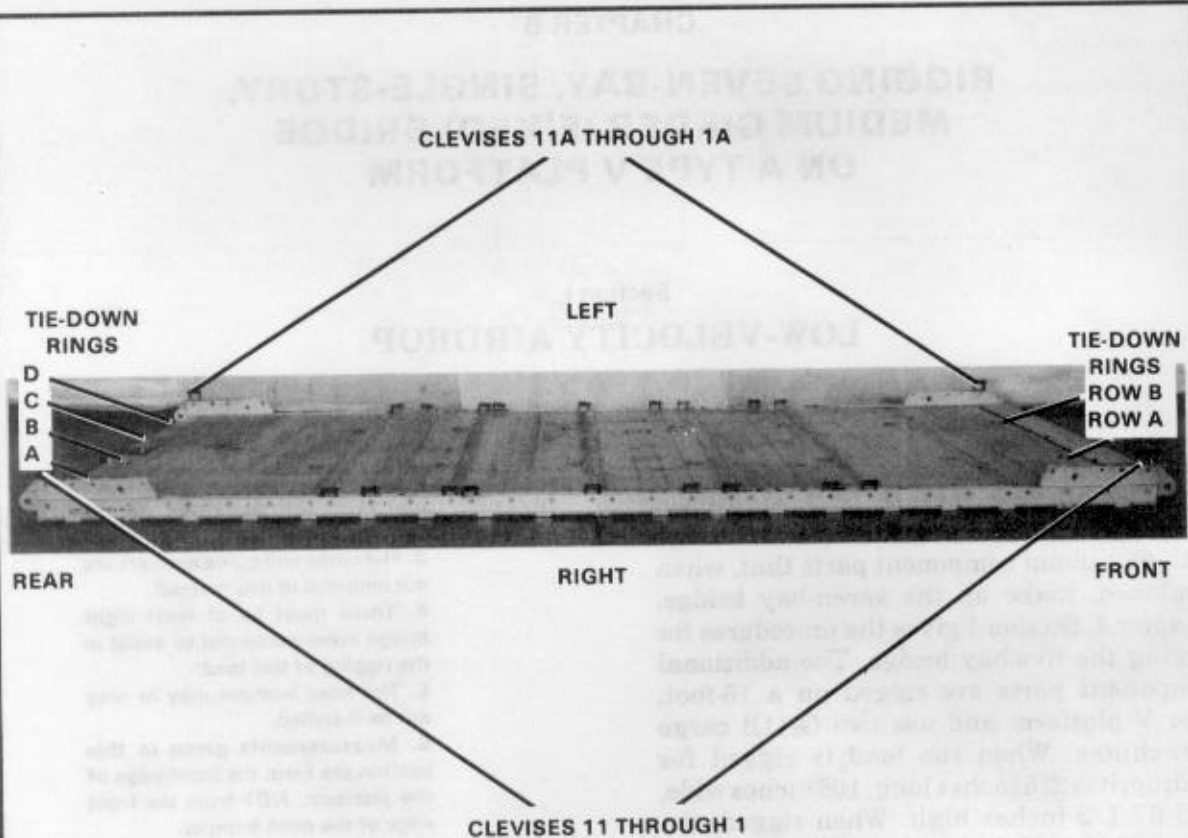

Step:

1. Inspect, or assemble and inspect, the platform according to TM 10-1670-268-20&P/TO 13C7-52-22.
2. Install a tandem link on the front of each platform side rail using holes 1, 2, and 3.
3. Install a tandem link on the rear of each platform side rail using holes 30, 31, and 32.
4. Install a clevis on bushing 1 on each front tandem link.
5. Install a clevis on bushing 4 on each rear tandem link.
6. Starting at the front of each platform side rail, install clevises on each platform side rail using the bushings bolted on holes 9, 10, 13, 14, 17, 20, 21, 23, and 24.
7. Starting at the front of the platform, number the clevises bolted to the right side from 1 through 11 and those bolted to the left side from 1A through 11A.
8. Starting at the front of the platform, label the two tie-down rings in the first seven panels A and B from right to left. Label the four tie-down rings in the last panel A, B, C, and D from right to left. Starting with the first panel, number the tie-down rings 1 through 8.

Figure 5-1. Platform prepared

5-3. Preparing and Positioning Honeycomb Stacks

Prepare the honeycomb stacks as shown in Figures 5-2 and 5-3. Position the honeycomb stacks on the platform as shown in Figure 5-4.

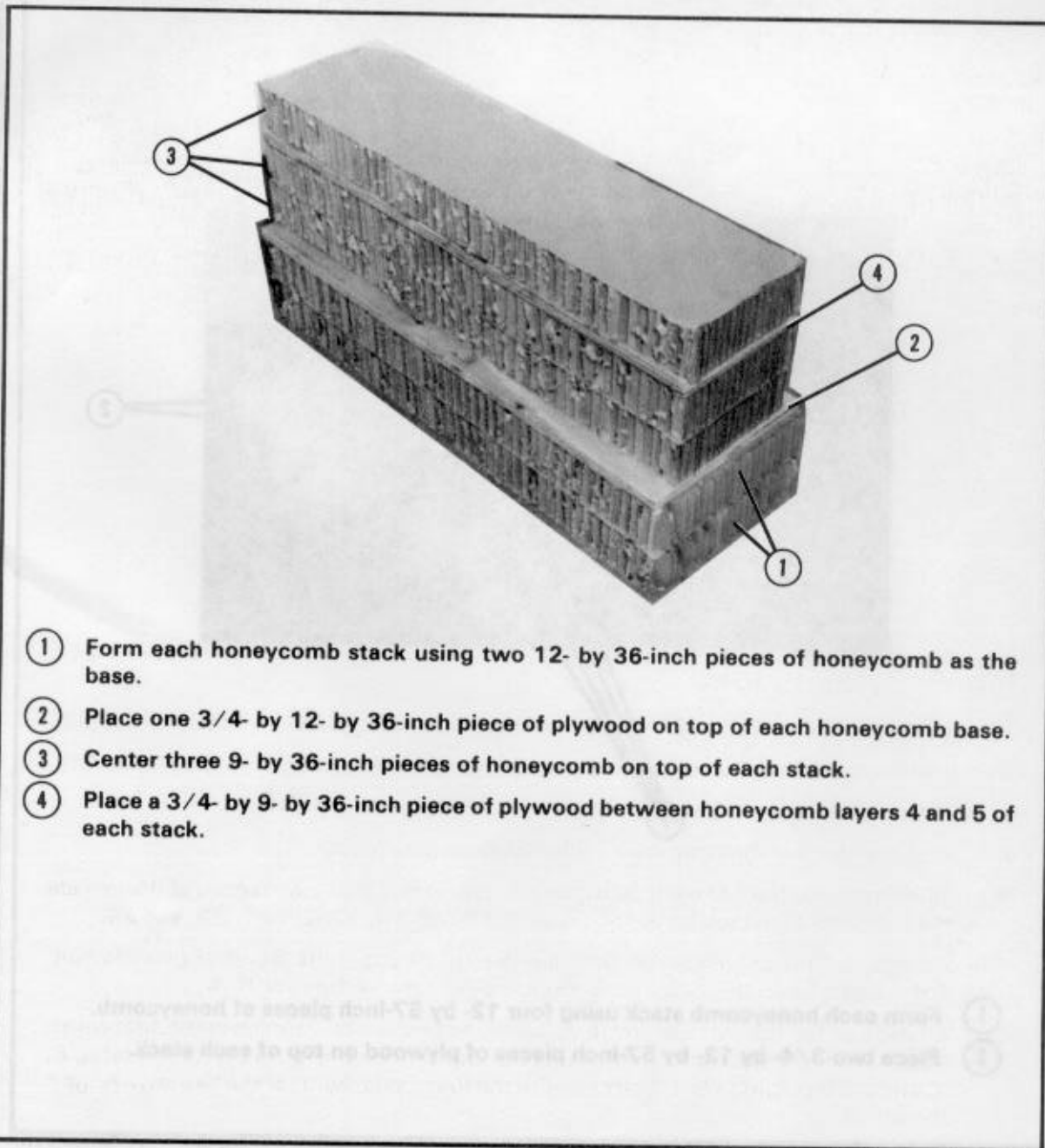

- ① Form each honeycomb stack using two 12- by 36-inch pieces of honeycomb as the base.
- ② Place one 3/4- by 12- by 36-inch piece of plywood on top of each honeycomb base.
- ③ Center three 9- by 36-inch pieces of honeycomb on top of each stack.
- ④ Place a 3/4- by 9- by 36-inch piece of plywood between honeycomb layers 4 and 5 of each stack.

Figure 5-2. Honeycomb stacks 1, 4, 5, and 8 prepared

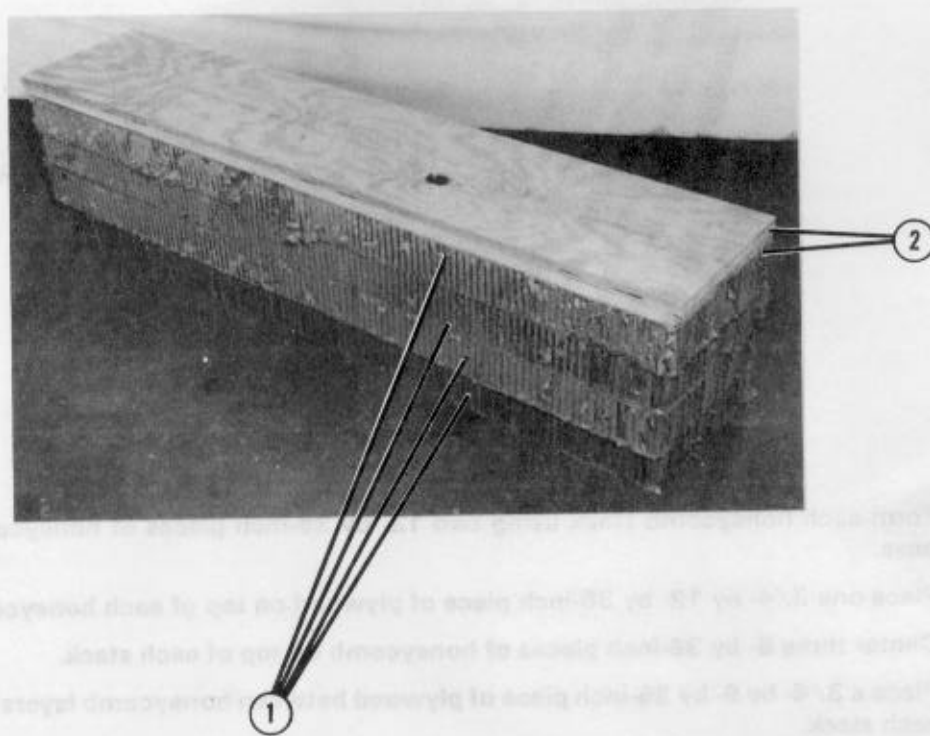

- ① Form each honeycomb stack using four 12- by 57-inch pieces of honeycomb.
- ② Place two 3/4- by 12- by 57-inch pieces of plywood on top of each stack.

Figure 5-3. Honeycomb stacks 2, 3, 6, and 7 prepared

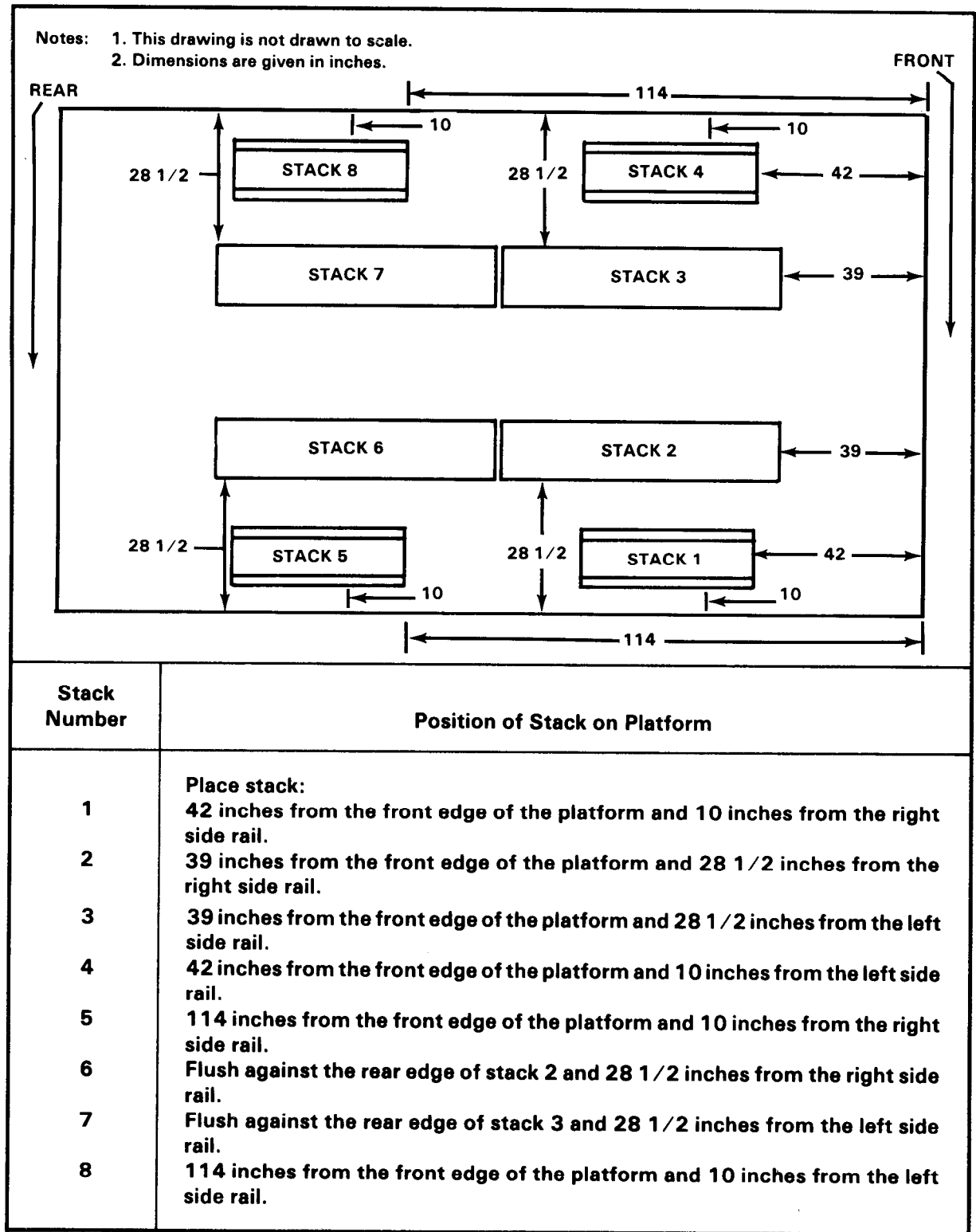
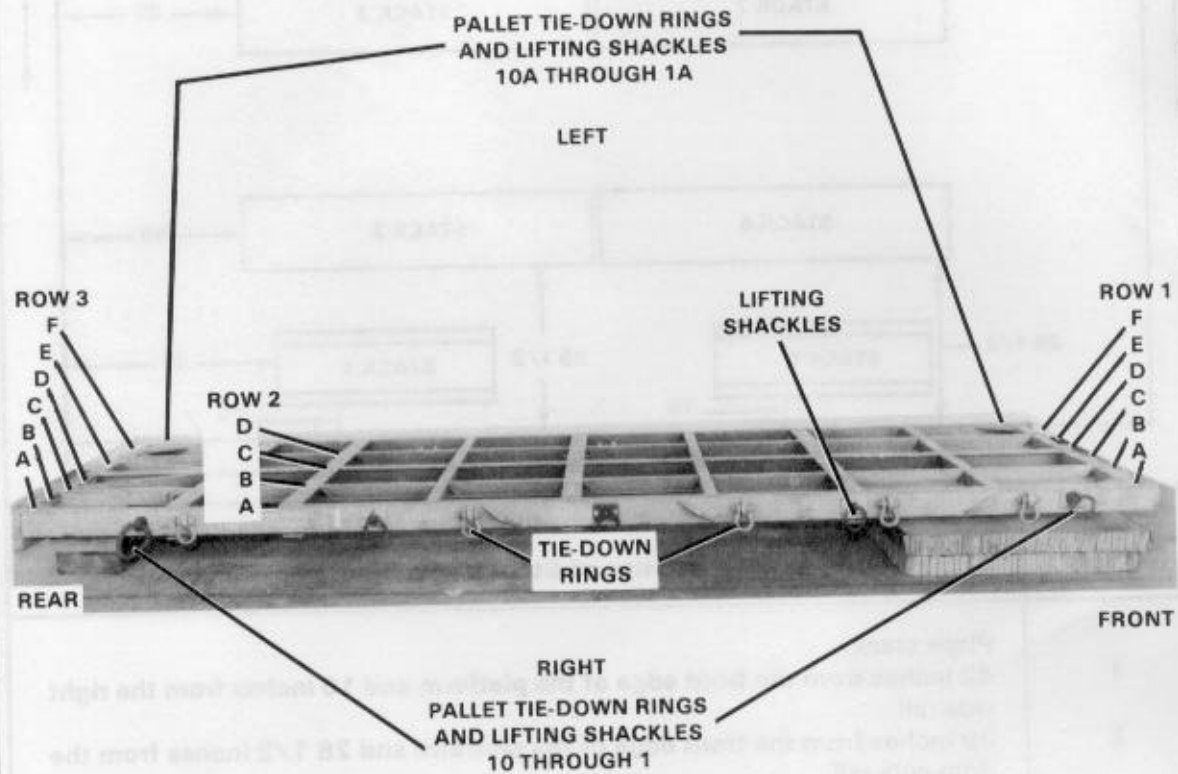

Figure 5-4. Honeycomb stacks positioned on the platform

5-4. Preparing Pallet

Prepare the pallet as shown in Figures 5-5 through 5-12.

Note: All pallet tie-down rings and lifting shackles must be present.



Step:

1. Starting at the front of the pallet, number the tie-down rings and lifting shackles bolted to the right side from 1 through 10 and those bolted to the left side from 1A through 10A.
2. Starting at the front of the pallet, label row 1 of tie-down rings and lifting shackles from right to left A1 through F1. Label row 2 from right to left A2 through D2. Label row 3 from right to left A3 through F3.
3. Place two 96- by 36-inch pieces of honeycomb under the front of the pallet to keep the pallet level.

Figure 5-5. Pallet labeled

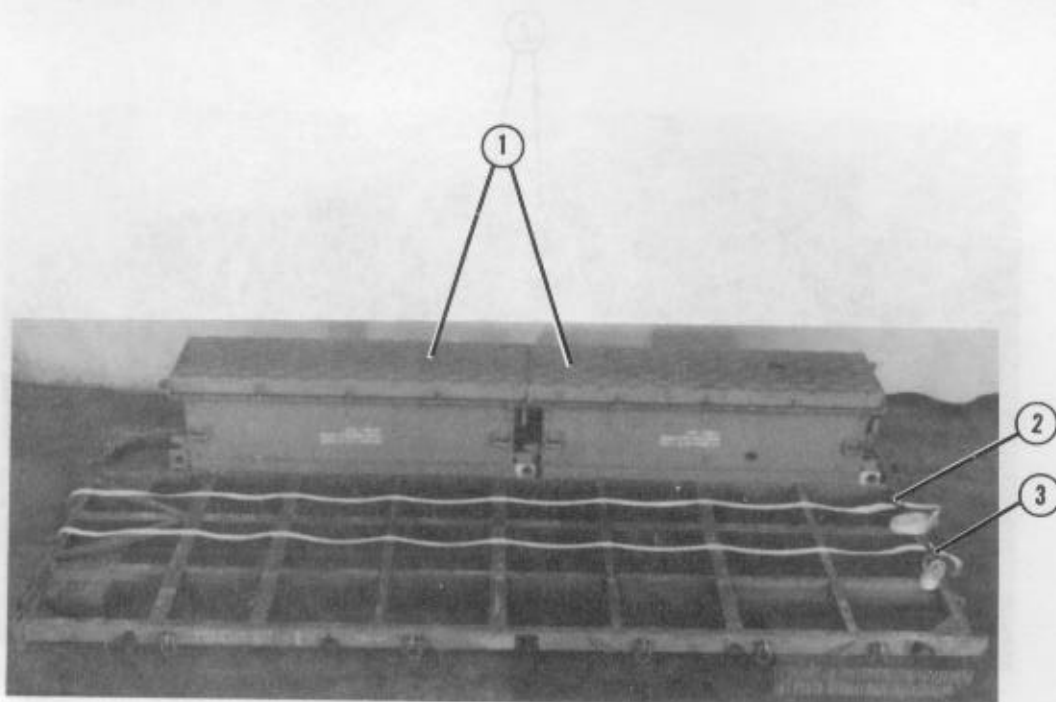

- ① Position two top panels on the pallet 4 1/2 inches from the front edge of the pallet and 2 1/2 inches overhanging the left side of the pallet. Make sure the shoot bolt is in the locked position.
- ② Form two 30-foot lashings according to FM 10-500-2/TO 13C7-1-5. Place one 30-foot lashing on top of the pallet 8 3/4 inches from the right edge of the top panels in a front-to-rear direction.
- ③ Place one 30-foot lashing on top of the pallet 26 1/4 inches from the right edge of the top panels in a front-to-rear direction.

Figure 5-6. Two top panels positioned on left side of pallet

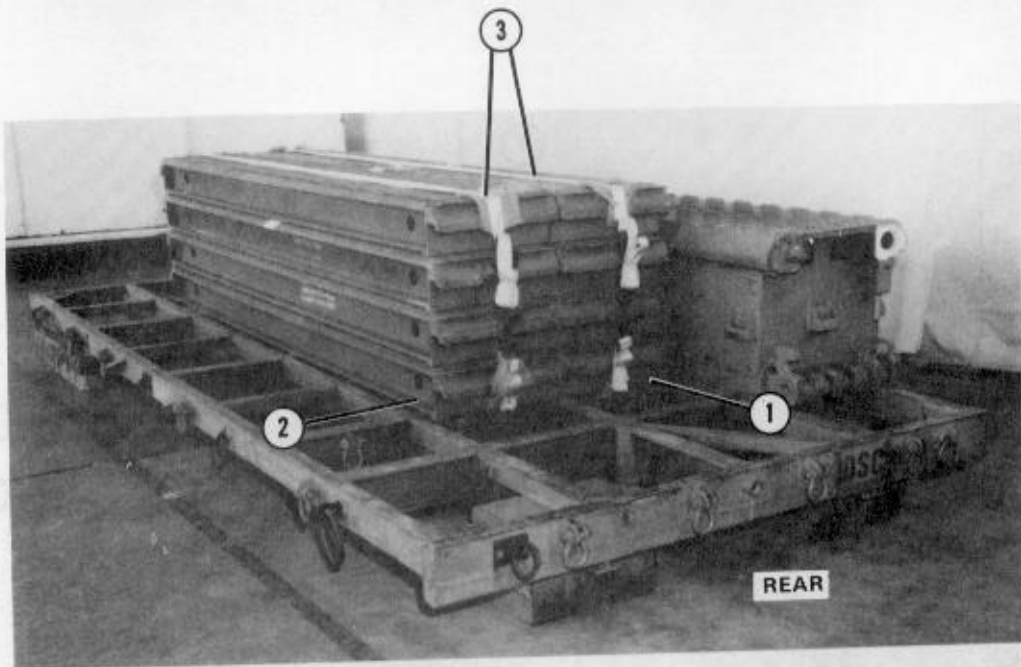

- ① Center four decks on the pallet against the top panels.
- ② Center four decks on the pallet against the first four decks.
- ③ Secure each stack of decks using the pre-positioned lashings. Secure the lashings according to FM 10-500-2/TO 13C7-1-5 on the rear of the decks.

Note: Pad the lashings where they touch the ends of the decks.

Figure 5-7. Eight decks positioned and secured

Note: Dimensions are given in inches.

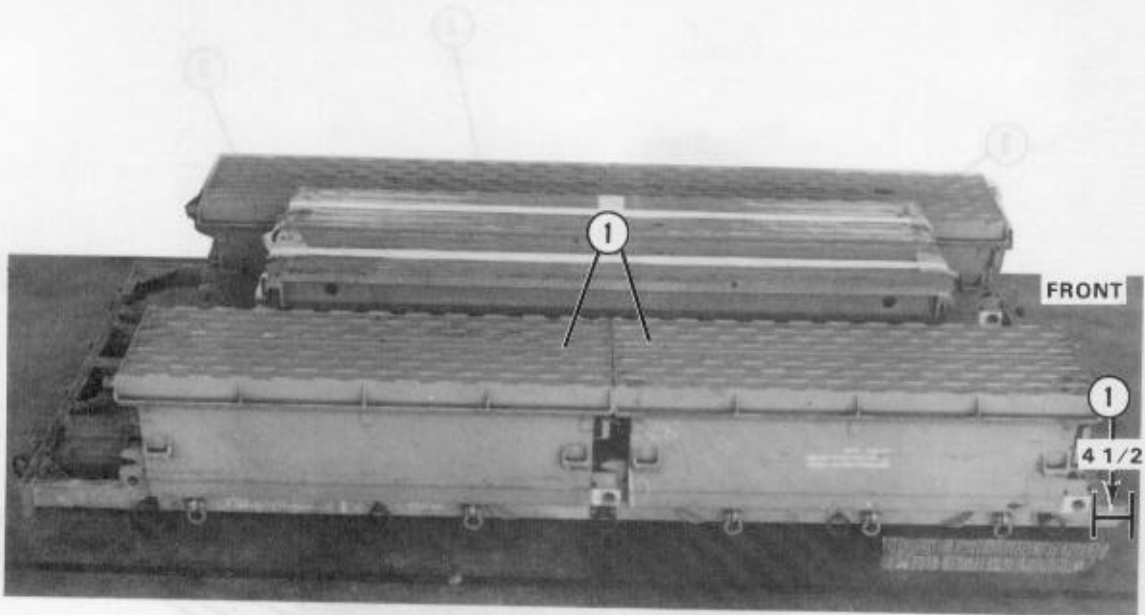

- ① Position two top panels on the pallet 4 1/2 inches from the front edge of the pallet and 2 1/2 inches overhanging the right side of the pallet. Make sure the shoot bolt is in the locked position.

Figure 5-8. Two top panels positioned on right side of pallet

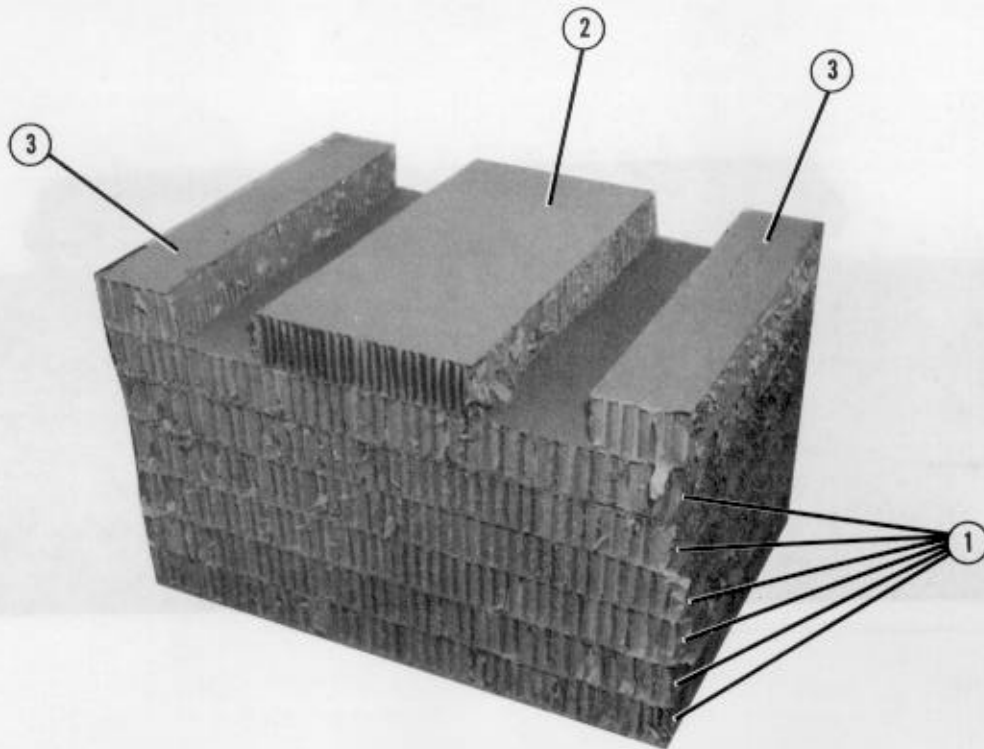

- ① Form the base of the honeycomb support using six 35-by 26-inch pieces of honeycomb.
- ② Center a 13- by 26-inch piece of honeycomb on the base.
- ③ Place a 5- by 26-inch piece of honeycomb on each side flush with the edges of the base.
- ④ Repeat steps 1 through 3 to build another honeycomb support.

Figure 5-9. Honeycomb supports built



- ① Place a honeycomb support on edge. Position the honeycomb support so that the small pieces of honeycomb are against the front end of the secured decks.
- ② Place the other honeycomb support on edge. Position the honeycomb support so that the small pieces of honeycomb are against the rear end of the secured decks (not shown).

Figure 5-10. Honeycomb supports positioned

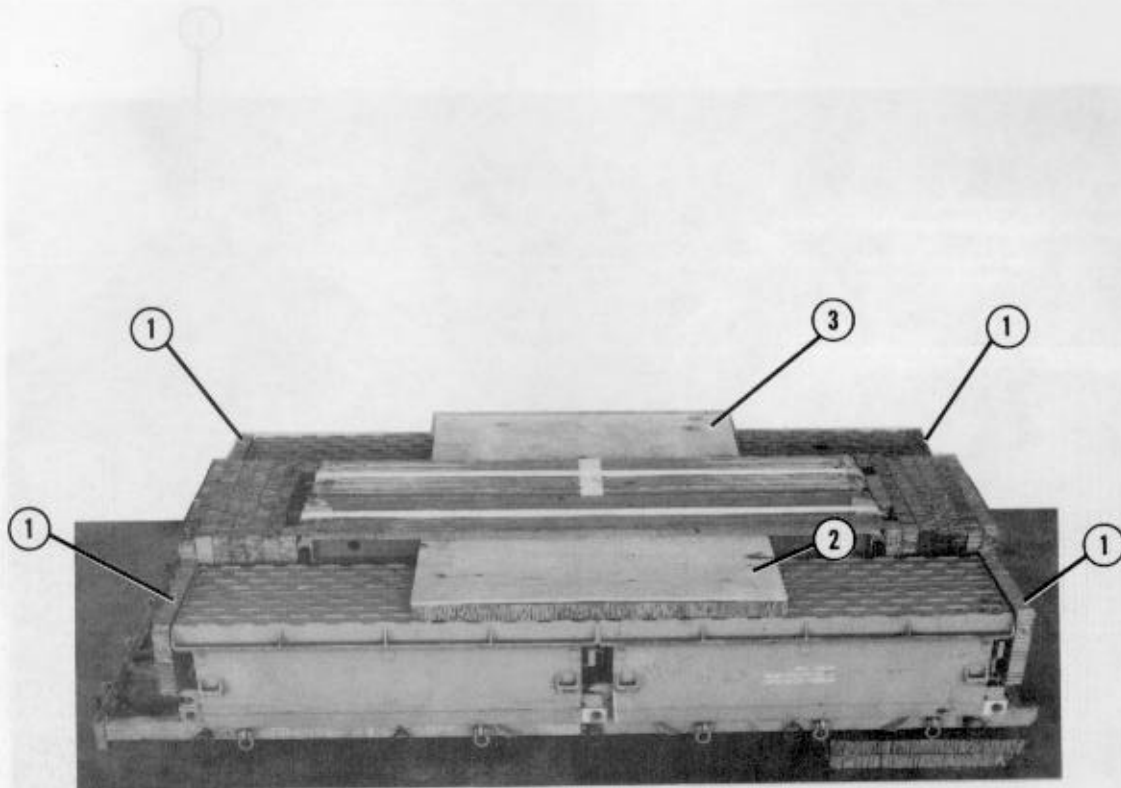

- ① Place a 24- by 14-inch piece of honeycomb on each end of the positioned top panels. Make sure the honeycomb pieces are flush with the top edge of the panels.
- ② Center a 25- by 64-inch piece of honeycomb on top of the right two top panels. Place a 3/4- by 25- by 64-inch piece of plywood on top of the honeycomb.
- ③ Center a 25- by 64-inch piece of honeycomb on top of the left two top panels. Place a 3/4- by 25- by 64-inch piece of plywood on top of the honeycomb.

Figure 5-11. Honeycomb and plywood placed on top panels

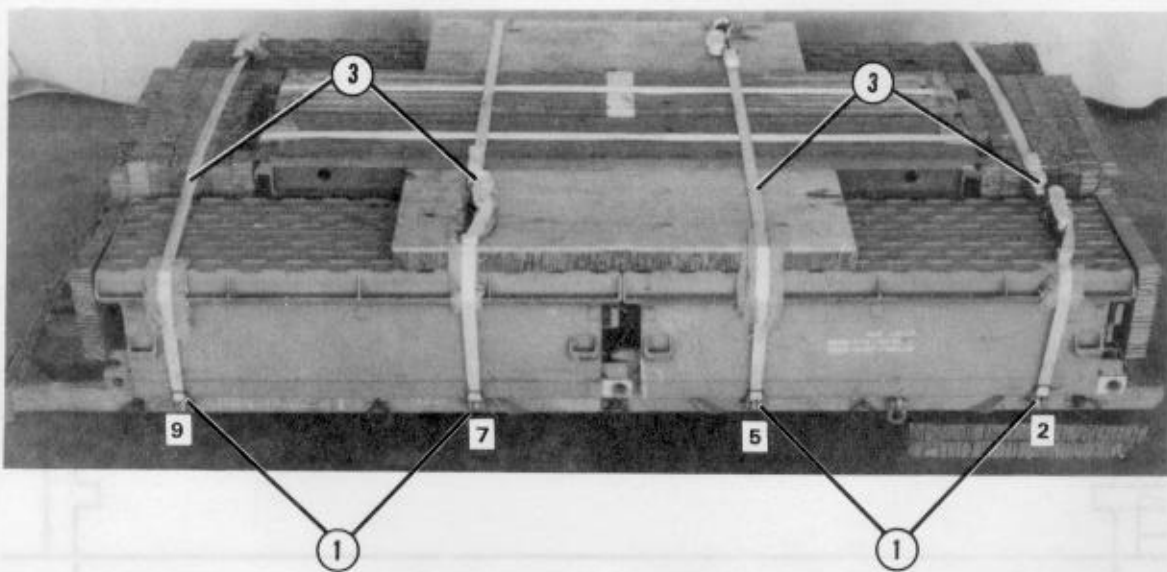

- ① Pass a 15-foot lashing through pallet tie-down rings 2, 5, 7, and 9 and back through their own D-rings.
- ② Repeat step 1 for the left side of the pallet (not shown) using pallet tie-down rings 2A, 5A, 7A, and 9A.
- ③ Run the lashings over the top of the load. Secure the lashings according to FM 10-500-2/TO 13C7-1-5. Pad the lashings where they come in contact with the top panels and honeycomb.

Figure 5-12. Pallet lashings installed and secured

5-5. Building and Positioning Restraint Boards

Build the restraint boards as shown in Figures 5-13 and 5-14. Position the restraint boards as shown in Figure 5-15.

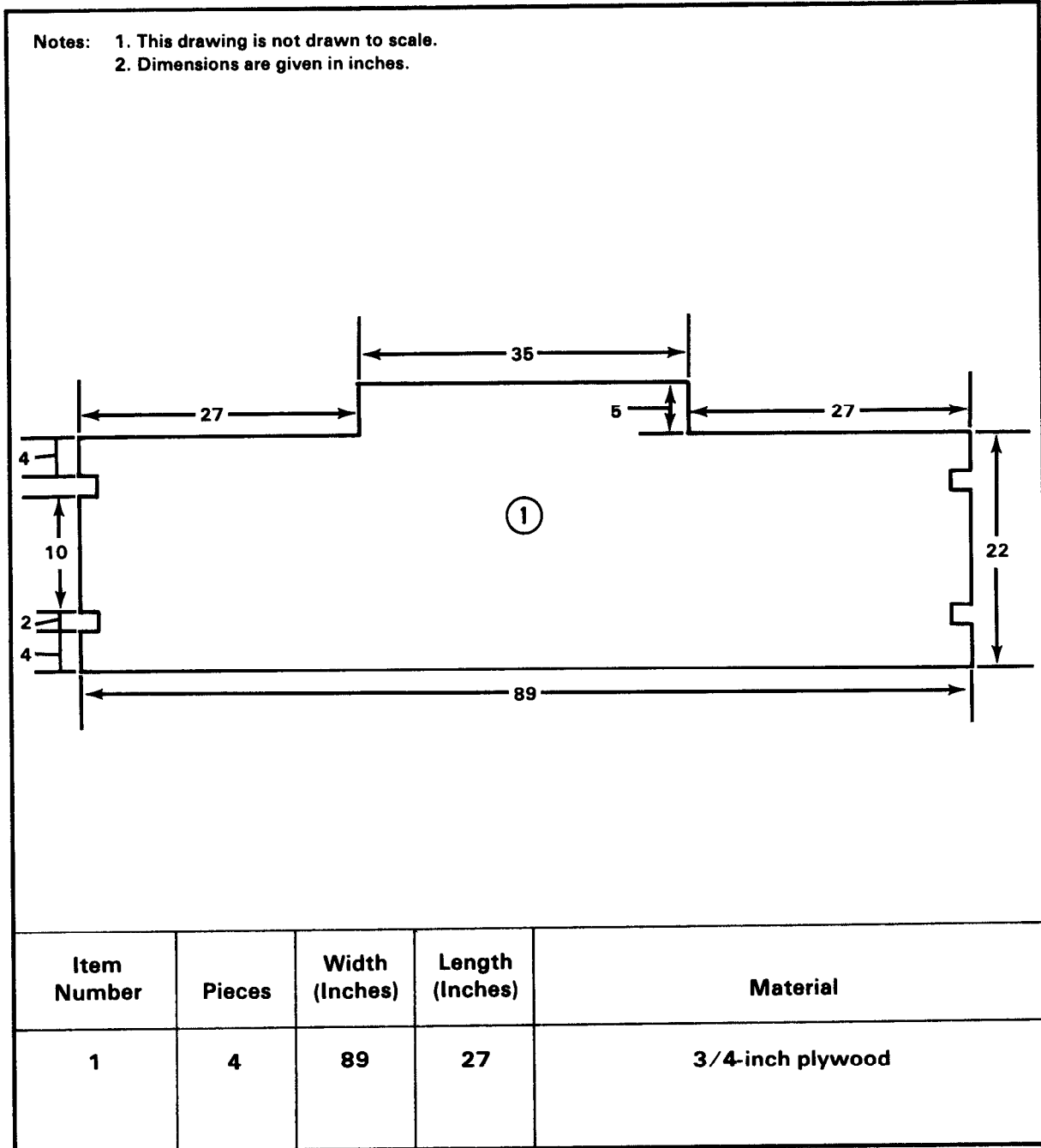
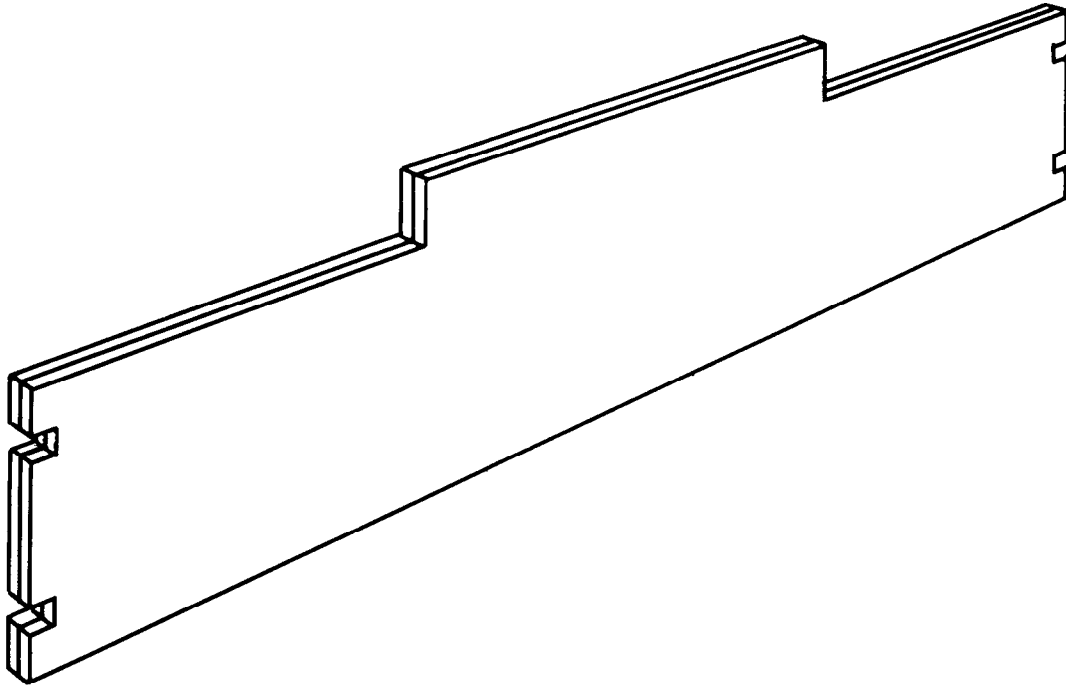

Figure 5-13. Materials required to build restraint boards

Note: This drawing is not drawn to scale.



Step:

1. Build each restraint board using two pieces of plywood as given in Figure 5-13.
2. Use eightpenny nails to secure each restraint board.

Figure 5-14. Restraint boards built

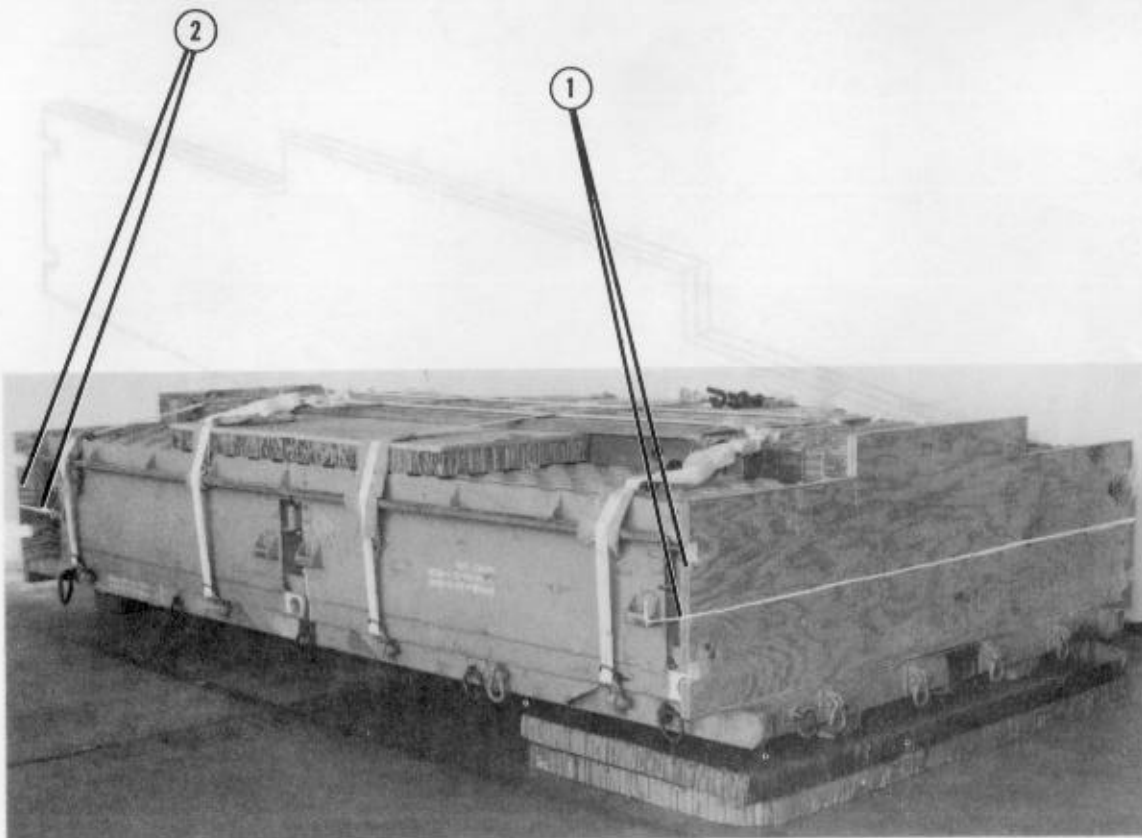

- ① Position one restraint board against the front of the load. Secure the board in place using a length of type III nylon cord.
- ② Position one restraint board against the rear of the load. Secure the board in place using a length of type III nylon cord.

Figure 5-15. Restraint boards positioned

5-6. Positioning Pallet on Platform

Position the pallet on the platform using four 12-foot (2-loop), type XXVI nylon webbing slings and four medium suspension clevises as shown in Figure 5-16.

- Notes:**
1. Dimensions are given in inches.
 2. Tape the unused pallet tie-down rings and lifting shackles in the UP position while positioning the pallet (not shown).

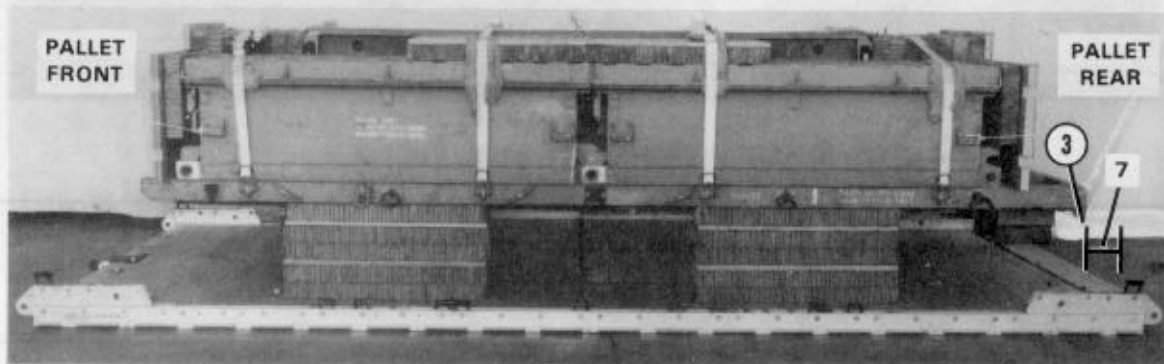

- ① Pass the end of a 12-foot sling through a medium suspension clevis (not shown). Repeat this step for the other three lifting slings.
- ② Attach the medium suspension clevises to lifting shackles 1, 1A, 10, and 10A (not shown).
- ③ Position the pallet on the platform so that the rear of the pallet is 7 inches from the front edge of the platform.

Figure 5-16. Pallet positioned on platform

5-7. Lashing Pallet

Lash the pallet to the platform with twenty-two 15-foot tie-down assemblies as shown in Figures 5-17, 5-18, and 5-19. Secure the lashings according to FM 10-500-2/TO 13C7-1-5.

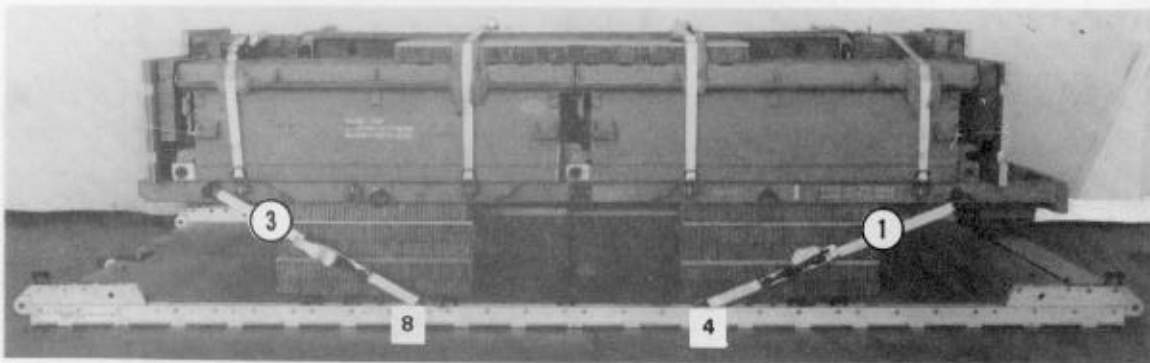

Lashing Number	Tie-down Clevis Number	Instructions
<p>1 2 3 4</p>	<p>4 4A 8 8A</p>	<p>Pass lashing: To lifting shackle 10A. To lifting shackle 10. To lifting shackle 1A. To lifting shackle 1.</p>

Figure 5-17. Lashings 1 through 4 installed

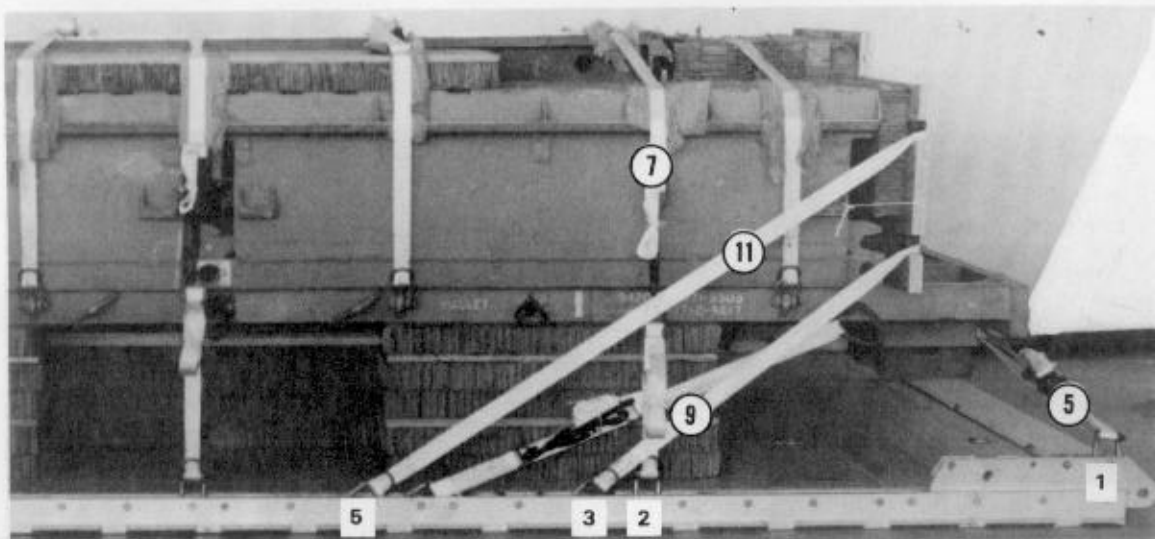

Lashing Number	Tie-down Clevis Number	Instructions
5	1	Pass lashing: To lifting shackle A3.
6	1A	To lifting shackle F3.
7	2	Through own D-ring and over top of load.
8	2A	Through own D-ring and over top of load. Secure it to lashing 7.
9	3	Through own D-ring and through bottom cutout of restraint board.
10	3A	Through own D-ring and through bottom cutout of restraint board. Secure it to lashing 9.
11	5	Through own D-ring and through top cutout of restraint board.
12	5A	Through own D-ring and through top cutout of restraint board. Secure it to lashing 11.

Figure 5-18. Lashings 5 through 12 installed

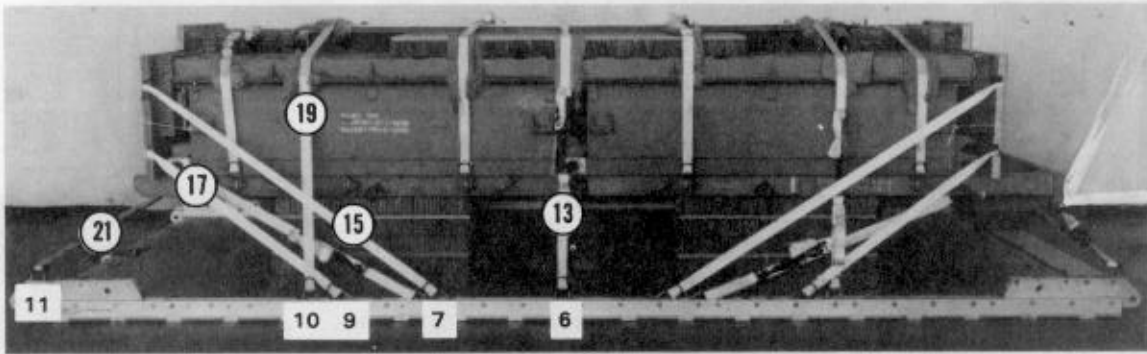

Lashing Number	Tie-down Clevis Number	Instructions
13	6	Pass lashing: Through own D-ring and over top of load.
14	6A	Through own D-ring and over top of load. Secure it to lashing 13.
15	7	Through own D-ring and through top cutout of restraint board.
16	7A	Through own D-ring and through top cutout of restraint board. Secure it to lashing 15.
17	9	Through own D-ring and through bottom cutout of restraint board.
18	9A	Through own D-ring and through bottom cutout of restraint board. Secure it to lashing 17.
19	10	Through own D-ring and over top of load.
20	10A	Through own D-ring and over top of load. Secure it to lashing 19.
21	11	To lifting shackle A1.
22	11A	To lifting shackle F1.

Figure 5-19. Lashings 13 through 22 installed

5-8. Preparing and Positioning Load Cover

Prepare and position the load cover as shown in Figure 5-20.

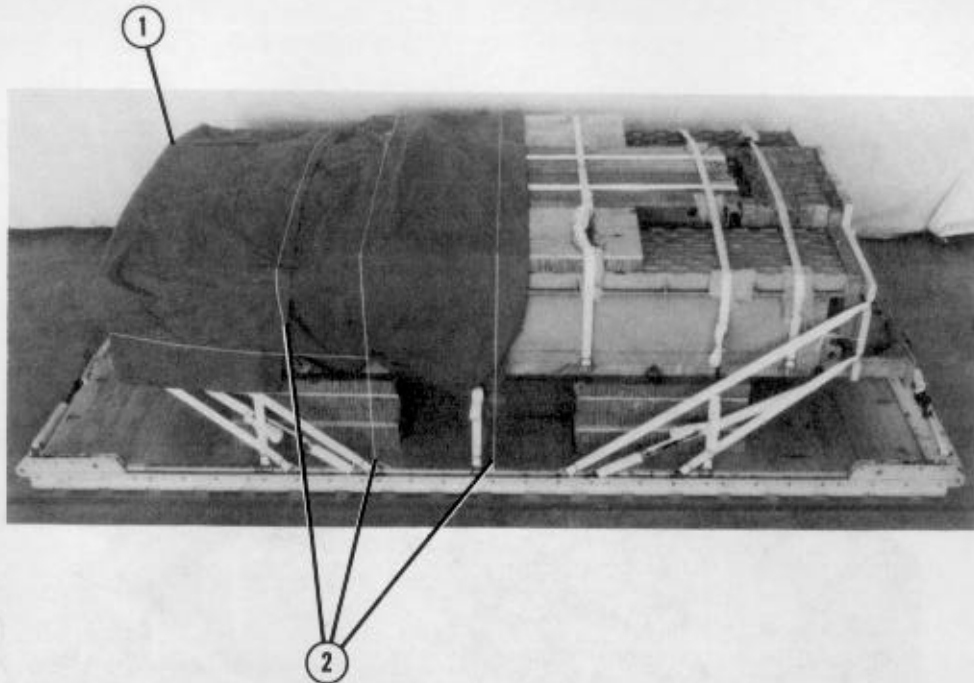

- ① Prepare a 8- by 12-foot cotton duck load cover. Place the load cover on the front end of the pallet toward the rear of the platform.
- ② Secure the load cover in place to convenient points on the load and platform with lengths of type III nylon cord.

Figure 5-20. Load covered

5-9. Installing Suspension Slings

Install the suspension slings as shown in Figure 5-21.

Note: Raise the suspension slings until they are tight.

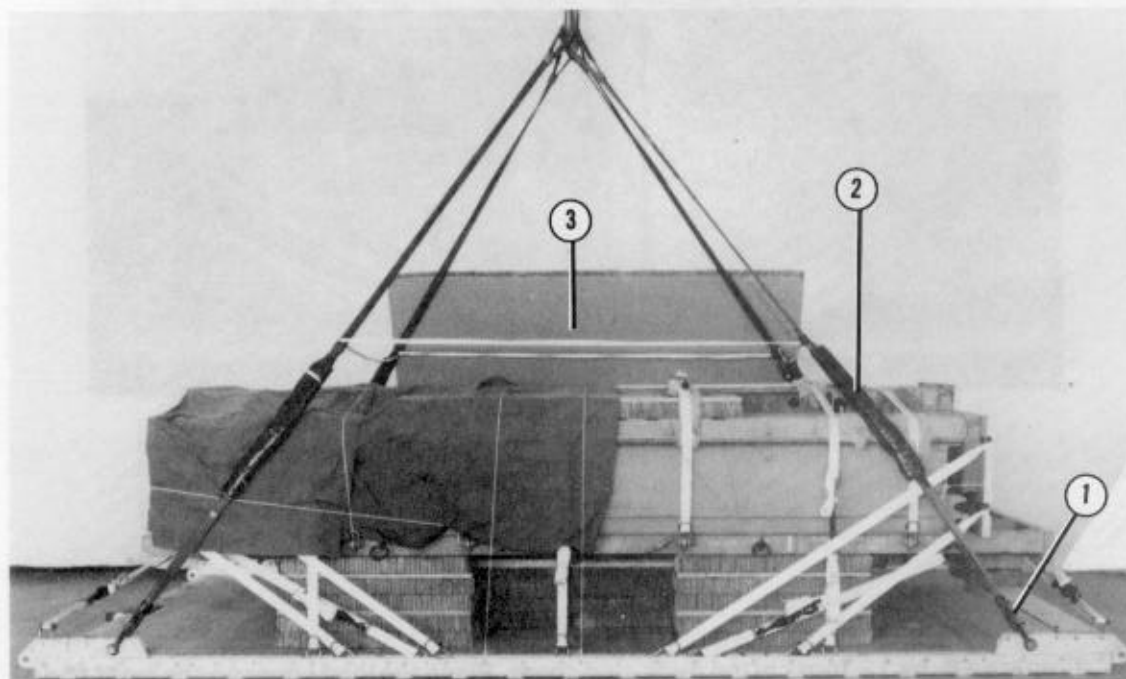

- ① Fit a 12-foot (2-loop), type XXVI nylon webbing sling to the bell portion of a large suspension clevis. Bolt the large suspension clevis to the right front tandem link. Adapt this step for the other three suspension slings.
- ② Pad the suspension slings by wrapping an 8- by 36-inch piece of felt 30 inches from the top of the large suspension clevis of each sling. Secure the padding with three lengths of type III nylon cord and pressure-sensitive tape.
- ③ Safety the suspension slings by installing a deadman's tie according to FM 10-500-2/TO 13C7-1-5.
- ④ Lower the suspension slings on the load (not shown).

Figure 5-21. Suspension slings installed and safetied

5-10. Stowing Cargo Parachutes

Stow two G-11B cargo parachutes on the front of the pallet according to FM 10-500-2/TO 13C7-1-5 and as shown in Figure 5-22.

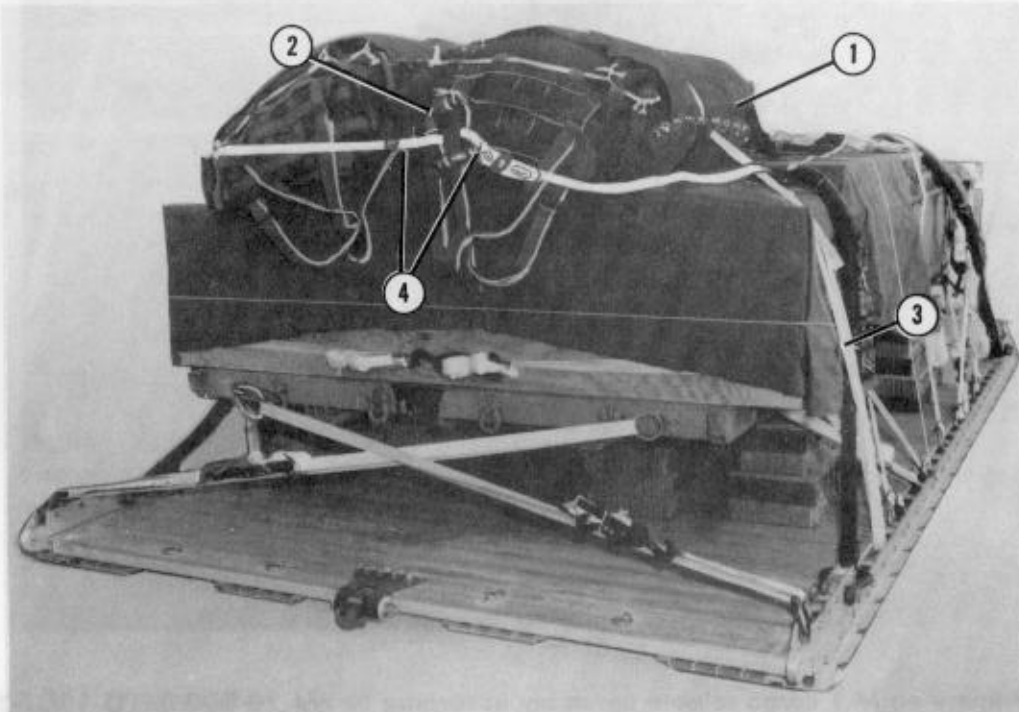

- ① Set two G-11B cargo parachutes side by side on the front of the pallet to the rear of the platform.
- ② Group the two bridle assemblies on the right side with a large suspension clevis.
- ③ Restrain the cargo parachutes to convenient points on the platform with lengths of type VIII nylon webbing according to FM 10-500-2/TO 13C7-1-5.
- ④ Install two multicut parachute release straps according to FM 10-500-2/TO 13C7-1-5.

Figure 5-22. Cargo parachutes stowed

5-11. Installing Release System

Prepare and install the M-1 release system according to FM 10-500-2/TO 13C7-1-5 and as shown in Figure 5-23.

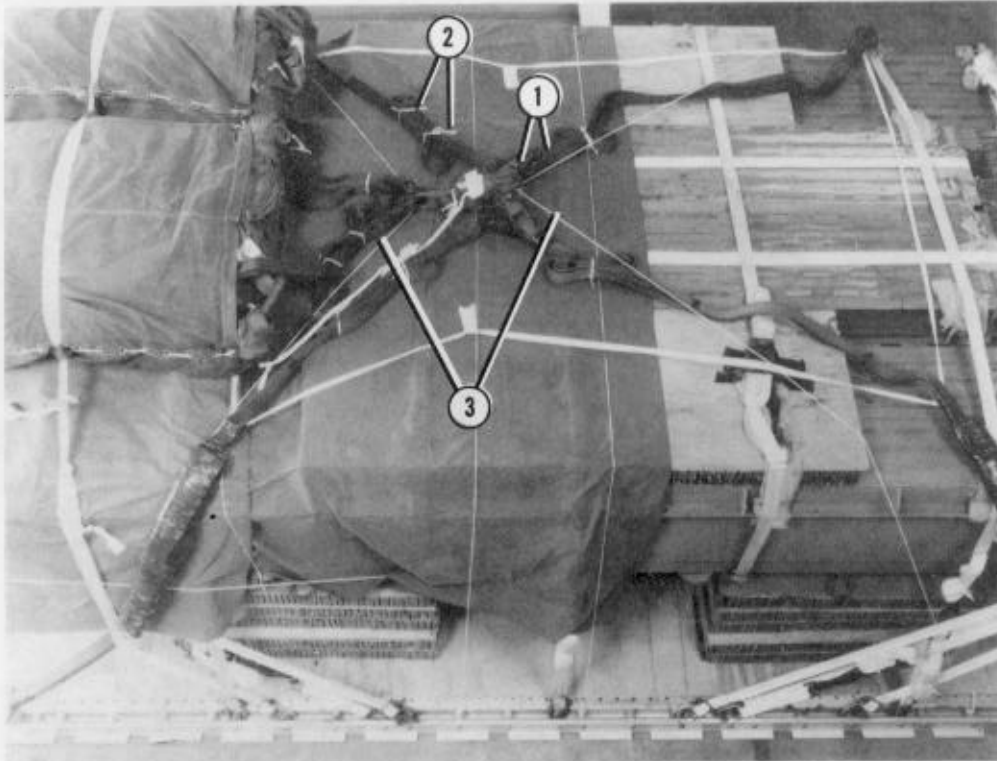

- ① Prepare an M-1 cargo release assembly according to FM 10-500-2/TO 13C7-1-5. Attach the M-1 cargo release assembly to the suspension slings and G-11B cargo parachutes according to FM 10-500-2/TO 13C7-1-5.
- ② Fold the suspension slings. Secure the folds with lengths of type I, 1/4-inch cotton webbing.
- ③ Secure the top and bottom of the M-1 cargo parachute release according to FM 10-500-2/TO 13C7-1-5.

Figure 5-23. Release system installed

5-12. Installing Extraction System

Install the EFTC extraction system according to FM 10-500-2/TO 13C7-1-5 and as shown in Figure 5-24.

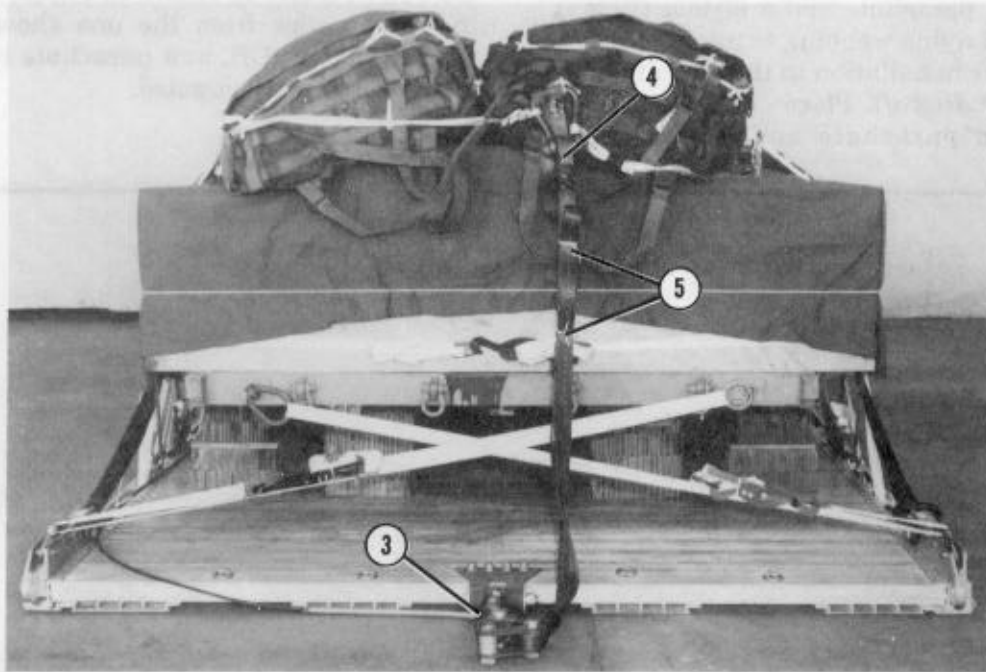

- ① Bolt the type V EFTA mounting brackets to the front mounting holes on the left platform side rail (not shown).
- ② Install the actuator to the EFTA mounting brackets with a 16-foot cable according to FM 10-500-2/TO 13C7-1-5 (not shown).
- ③ Attach the latch assembly to the extraction bracket with the locking nut hole facing toward the left side of the platform according to FM 10-500-2/TO 13C7-1-5.
- ④ Connect one end of a 9-foot (2-loop), type XXVI nylon webbing sling as a deployment line to the right spacer of the link assembly. Connect the free end of the deployment line to the large clevis clustering the bridle assemblies.
- ⑤ Fold the excess deployment line. Secure the folds with type I, 1/4-inch cotton webbing.
- ⑥ Safety the 16-foot cable to the lashings along the left platform side rail using lengths of type I, 1/4-inch cotton webbing (not shown).

Figure 5-24. Extraction system installed

5-13. Installing Provisions for Emergency Restraints

Install provisions for emergency restraints according to FM 10-500-2/TO 13C7-1-5.

5-14. Placing Extraction Parachute

Place the extraction parachute as described below.

a. C-130 Aircraft. Place one 15-foot cargo extraction parachute and a 60-foot (1-loop), type XXVI nylon webbing extraction line on the load for installation in the aircraft.

b. C-141 Aircraft. Place one 15-foot cargo extraction parachute and a continuous

160-foot (1-loop), type XXVI nylon webbing extraction line on the load for installation in the aircraft.

5-15. Marking Rigged Load

Mark the rigged load according to FM 10-500-2/TO 13C7-1-5 and as shown in Figure 5-25. If the load varies from the one shown, the weight, height, CB, and parachute requirements must be recomputed.

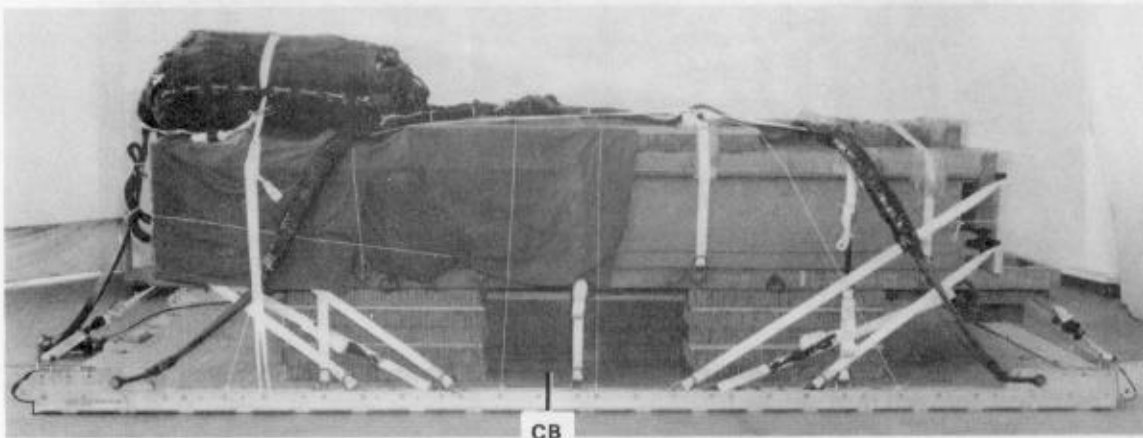

RIGGED LOAD DATA

Weight:	Load shown	6,310 pounds
	Maximum load allowed	6,800 pounds
Height		67 1/2 inches
Width		108 inches
Length		215 inches
Overhang:	Front	5 inches
	Rear	18 inches
CB (from front edge of platform)		101 inches
Extraction system		EFTC

Figure 5-25. Two-bay components for the seven-bay, single-story, medium girder (fixed) bridge rigged for low-velocity airdrop on a type V platform

5-16. Equipment Required

Use the equipment listed in Table 5-1 to rig this load.

Table 5-1. Equipment required for rigging two-bay components for the seven-bay, single-story, medium girder (fixed) bridge for low-velocity airdrop on a type V platform

National Stock Number	Item	Quantity
8040-00-273-8713	Adhesive, paste, 1-gal	As required
	Clevis, suspension:	
4030-00-678-8562	3/4-in (medium)	4
4030-00-090-5354	1-in (large)	5
8305-00-242-3593	Cloth, cotton duck, 60-in	As required
4020-00-240-2146	Cord, nylon, type III, 550-lb	As required
1670-00-434-5785	Coupling, airdrop, extraction force transfer w 16-ft cable	1
8135-00-664-6958	Cushioning material, packaging, cellulose wadding	As required
8305-00-958-3685	Felt, 1/2-in thick	As required
1670-01-183-2678	Leaf, extraction line	2
	Line, extraction:	
1670-01-064-4452	60-ft (1-loop), type XXVI nylon webbing	1
1670-01-107-7652	160-ft (1-loop), type XXVI nylon webbing	1
5315-00-010-4659	Nail, steel wire, common, 8d	As required
1670-00-753-3928	Pad, energy-dissipating, honeycomb, 3- by 36- by 96-in	14 sheets
	5- by 26-in	(4)
	9- by 36-in	(12)
	12- by 36-in	(8)
	12- by 57-in	(16)
	13- by 26-in	(2)
	24- by 14-in	(4)
	25- by 64-in	(2)
	35- by 26-in	(12)
	96- by 36-in	(2)
	Parachute:	
1670-01-016-7841	Cargo, G-11B	2
	Cargo extraction:	
1670-00-052-1548	15-ft <u>or</u>	1
1670-01-063-3715	15-ft	1
	Platform, AD, type V, 16-ft:	1
	Bracket:	
1670-01-162-2375	Inside EFTA	(1)
1670-01-162-2374	Outside EFTA	(1)
1670-01-162-2372	Clevis assembly	(22)

Table 5-1. Equipment required for rigging two-bay components for the seven-bay, single-story, medium girder (fixed) bridge for low-velocity airdrop on a type V platform (continued)

National Stock Number	Item	Quantity
1670-01-162-2376	Extraction bracket assembly	(1)
1670-01-162-2381	Tandem link	(4)
5530-00-128-4981	Plywood, 3/4-in:	6 sheets
	9- by 36-in	(4)
	12- by 36-in	(4)
	12- by 57-in	(8)
	25- by 64-in	(2)
	89- by 27-in	(4)
1670-01-097-8816	Release, cargo parachute, M-1	1
	Sling, cargo airdrop:	
	For deployment line:	
1670-01-062-6304	9-ft (2-loop), type XXVI nylon webbing	1
	For lifting:	
1670-01-062-6303	12-ft (2-loop), type XXVI nylon webbing or	4
	For riser extensions:	
1670-01-062-6302	20-ft (2-loop), type XXVI nylon webbing	2
	For suspension slings:	
1670-01-062-6303	12-ft (2-loop), type XXVI nylon webbing	4
1670-00-040-8219	Strap, parachute release, multicut comes	
	w 3 knives	2
8305-00-074-5124	Tape, adhesive, 2-in	As required
1670-00-937-0271	Tie-down assembly, 15-ft	34
	Webbing:	
8305-00-268-2411	Cotton, 1/4-in, type I	As required
	Nylon:	
	Tubular:	
8305-00-082-5752	1/2-in or	As required
8305-00-268-2453	1/2-in	As required
8305-00-263-3591	Type VIII	As required

Section II

LAPE AIRDROP

5-17. Description of Load

The seven-bay, single-story, medium girder (fixed) bridge consists of a five-bay,

single-story, medium girder (fixed) bridge with additional components that, when

GLOSSARY

ACB attitude control bar	in inch
AD airdrop	LAPE low-altitude parachute-extraction
AFB Air Force base	LAPES low-altitude parachute-extraction system
AFTO Air Force technical order	lb pound
ALC Air Logistics Center	MAC Military Airlift Command
ARNG Army National Guard	MGB medium girder bridge
attn attention	no number
BSB bank seat beam	qty quantity
C change	rel release
CB center of balance	rqr requirement
d penny	sec second
DA Department of the Army	SL/CS static line/connector strap
DC District of Columbia	TM technical manual
DD Department of Defense	TO technical order
diam diameter	TRADOC United States Army Training and Doctrine Command
EFTA extraction force transfer actuator	US United States
EFTC extraction force transfer coupling	USAR United States Army Reserve
FM field manual	VA Virginia
ft foot/feet	w with
gal gallon	yd yard
HQ headquarters	

REFERENCES

These documents must be available to the intended users of this publication.

FM 10-500-2/TO 13C7-1-5. Airdrop of Supplies and Equipment: Rigging Airdrop Platforms. 1 November 1990.

TM 5-5420-212-12. Operator and Organizational Maintenance Manual for Medium Girder Bridge (MGB). 18 April 1985.

TM 10-1670-208-20&P/TO 13C3-4-12. Organizational Maintenance Manual Including Repair Parts and Special Tools List for Platforms, Types II Modular and LAPES/Airdrop Modular. 10 August 1978.

TM 10-1670-268-20&P/TO 13C7-52-22. Organizational Maintenance Manual With Repair Parts and Special Tools List: Type V Airdrop Platform. 1 June 1986.

TM 10-1670-286-20/TO 13C5-2-41. Unit Maintenance Manual for Sling/Extraction Line Panel (Including Stowing Procedures). 1 April 1986.

AFTO Form 22. Technical Order Publication Improvement Report. April 1973.

DA Form 2028. Recommended Changes to Publications and Blank Forms. February 1974.

DD Form 1387-2. Special Handling Data/Certification. June 1986.

PIN: 054849-001