

**ARMY FM 10-576  
AIR FORCE TO 13C7-27-151**

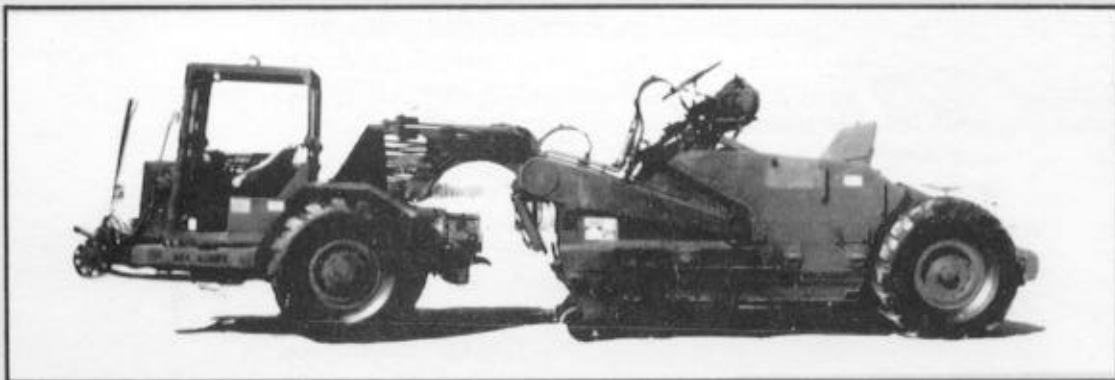

**AIRDROP OF SUPPLIES AND EQUIPMENT:  
RIGGING THE  
613S SCRAPERS**



**DISTRIBUTION RESTRICTION.** Distribution authorized to US government agencies only to protect technical or operational information from automatic dissemination under the International Exchange Program or by other means. This determination was made on 18 May 1987. Other requests for this document will be referred to Commandant, US Army Quartermaster School, ATTN: ATSM-DTP, Fort Lee, Virginia 23801-5036.

**DESTRUCTION NOTICE.** Destroy by any method that will prevent disclosure of contents or reconstruction of the document.

**DEPARTMENTS OF THE ARMY AND THE AIR FORCE**

CHANGE  
NO.1

HEADQUARTERS  
DEPARTMENT OF THE ARMY  
AND THE AIR FORCE  
Washington, DC, 12 December 1991

## AIRDROP OF SUPPLIES AND EQUIPMENT RIGGING THE 613S SCRAPERS

This change adds the procedure for rigging the 613S scrapers for low-velocity and LAPE airdrop on the type V platform.

FM 10-576/TO 13C7-27-151, 21 August 1987, is changed as follows:

1. New or changed material is identified by a vertical bar in the margin opposite the changed material.
2. Remove old pages and insert new pages as identified below:

**Remove Old Pages**

i and ii  
1-1  
  
Glossary -1  
References-1

**Insert New Pages**

i through iii  
1-1  
3-1 through 3-87  
Glossary-1  
References-1

3. File this transmittal sheet in front of the publication.

**DISTRIBUTION RESTRICTION: Approved for public release; distribution is unlimited.**

By Order of the Secretaries of the Army and the Air Force:

**GORDON R. SULLIVAN**  
*General, United States Army*  
*Chief of Staff*

Official:

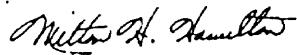

MILTON H. HAMILTON  
*Administrative Assistant to the*  
*Secretary of the Army*  
00278

**DISTRIBUTION:**

**Active Army, USAR, and ARNG:** To be distributed in accordance with DA Form 12-11E, requirements for FM 10-576, Airdrop of Supplies and Equipment: Rigging the 613S Scrapers (Qty rqr block no. 3884).



REPLY TO  
ATTENTION OF

DEPARTMENT OF THE ARMY  
AERIAL DELIVERY AND FIELD SERVICES DEPARTMENT  
U.S. ARMY QUARTERMASTER CENTER AND SCHOOL  
1010 SHOP ROAD  
FORT LEE, VIRGINIA 23801-1502

ATSM-ADFSD

7 October 1998

MEMORANDUM FOR Commander, US Army Training Support Center, ATTN: ATIC-TIST (Mr. Baston), Fort Eustis, VA 23604

SUBJECT: Distribution Restriction Notice on Airdrop Rigging Manuals

1. As proponent for development of all 10-500 series airdrop rigging field manuals and the 10-450 sling load manuals, it has been determined that the distribution restriction on these field manuals should be changed to read: Approved for public release, distribution unlimited.
2. It is requested that unrestricted release of these field manuals be made via the Army Training Digital Library.
3. The new distribution notice will be added to the cover pages as future changes/revisions are made to the manuals.
4. Enclosed you will find a numerical list and the number of changes of the manuals that have unlimited distribution.
5. The point of contact for this action is Mr. Roger Hale, DSN 687-4769.

Encl

  
THEODORE J. DLUGOS  
Director, Aerial Delivery and  
Field Services Department

Distribution restrictions for the following Airdrop field manuals should read "**Approved for public release; distribution is unlimited.**"

10-450-3	10-524, c2	10-552, c2
10-450-4	10-526, c3	10-554
10-500-2, c2	10-527, c3	10-555, c2
10-500-3, c1	10-528, c6	10-556
10-500-7, c1	10-529, c1	10-557
10-500-45	10-530	10-558, c1
10-500-53	10-531, c2	10-562
10-500-66, c1	10-532, c4	10-564, c6
10-500-71	10-533	10-567, c1
10-508, c1	10-534, c2	10-569, c1
10-510, c3	10-535	10-571
10-512, c4	10-537, c4	10-572
10-513, c3	10-539, c3	10-573, c1
10-515, c1	10-540, c2	10-574, c4
10-516	10-541, c1	10-575, c2
10-517, c5	10-542, c2	10-576, c1
10-518	10-543, c2	10-577
10-519, c3	10-546	10-579, c2
10-520, c3	10-547, c1	10-584
10-521, c2	10-548, c1	10-586
10-522, c1	10-549	10-588
10-523, c2	10-550, c3	10-591, c1



## DEPARTMENT OF THE ARMY

HEADQUARTERS UNITED STATES ARMY TRAINING AND DOCTRINE COMMAND  
FORT MONROE, VIRGINIA 23651-5000

REPLY TO  
ATTENTION OF

ATCD-SL (70-1f)

21 Oct 96

MEMORANDUM FOR DEPUTY CHIEF OF STAFF OPERATIONS AND PLANS,  
400 ARMY PENTAGON, ATTN: DAMO-FDL, WASHINGTON  
DC 20310-0400

SUBJECT: Quartermaster (QM) Functional Area Assessment (FAA)  
Response

1. References:

a. Message, HQDA, DAMO-FDL, 231825Z Apr 96, subject: QM FAA Results.

b. Memorandum, HQ TRADOC, ATCG, 29 Jul 96, Army Airdrop Capabilities Assessment.

2. At the 29 Mar 96 QM FAA briefing to the Director of Army Staff, the decision was reached to revisit the Army's decision to "shelf" Low Altitude Parachute Extraction System (LAPES) (reference 1a).

a. Reference 1b, solicited CINCs input for their positions on LAPES and assessments of airdrop capabilities. The CINCs responses will be used to chart the direction and role for airdrop in the 21st century.

b. Based on the responses received (enclosure), there is no strong support for LAPES airdrop capability at this time. The consensus for the airdrop capabilities is to continue support for current Low Velocity Airdrop System (LVAD), develop a 500-foot LVAD and further explore Advanced Precision Aerial Delivery System (APADS).

3. Further, we will continue to maintain a range of airdrop capabilities to support all contingencies throughout the Army. The results of the Army Airdrop Capabilities Assessment also will be incorporated into the Operational Concept for Aerial Delivery Operations and Improved Cargo Aerial Delivery Capability Mission Needs Statement being developed by the Quartermaster Directorate of Combat Developments, U.S. Army Combined Arms Support Command (CASCOM).

4. The HQ TRADOC POC is MAJ Higgins, Airborne Airlift Action Office, ATCD-SL, E-mail: higginsn@emh10.monroe.army.mil, DSN 680-2469/3921, datafax DSN 680-2520.

ATCD-SL

SUBJECT: Quartermaster (QM) Functional Area Assessment (FAA)  
Response

FOR THE DEPUTY CHIEF OF STAFF FOR COMBAT DEVELOPMENTS:

Encl

JOHN A. MANDEVILLE  
Colonel, GS  
Director, Combat Service Support

CF:

USACASCOM (ATCL-CG/ATCL-QC/ATCL-MES)

USAQMC&S (ATSM-CG/ATSM-ABN/FS)

USANRDEC (SSCNC-UT/AMSSC-PM)

<b>ORGANIZATION</b>	<b>LAPES</b>	<b>LVAD</b>	<b>500' LVAD</b>	<b>APADS</b>	<b>SPTS/ NOT SPEC</b>
<b>USSOCOM</b>		X	X	X	
<b>EUCCOM</b>					X
<b>CENTCOM</b>		X	X		
<b>FORSCOM</b>		X	X	X	
<b>TRANSCOM</b>					X
<b>SOUTHCOM</b>	X			X	
<b>VIII ARMY</b>					X
<b>ACOM</b>					X

**USSOCOM:** Memorandum specifically states that the command does not support LAPES airdrop capability, but supports LVAD as well as APADS.

**EUCCOM:** Draft memorandum specifically states that the command support the need for a low level airdrop capability. However, memorandum summarizes that the specific capability is not important as to have a capability to meet the required mission/threat profile.

**CENTCOM:** Memorandum specifically states that the command does not support LAPES airdrop capability, but support both current LVAD and 500-foot LVAD airdrop capabilities.

**FORSCOM:** 1st Endorsement specifically states that the command does not support LAPES airdrop capability, however supports LVAD, 500-foot LVAD and APADS.

**TRANSCOM:** Memorandum does not specifically address any airdrop capability as it talks to the 21st century requiring the full spectrum of tactical delivery methods.

**SOUTHCOM:** Memorandum specifically supports LAPES and APADS airdrop capabilities for their command.

**VIII ARMY:** E-Mail note for VIII Army states that the command has no input to the assessment as their plans call for a limited employment of airdrop.

**ACOM:** Sent request for input on 30 Sep 96. Received verbal response on 16 Oct 96 stating command is indifferent on the specific capability received.





DEPARTMENT OF THE ARMY  
HEADQUARTERS UNITED STATES ARMY TRAINING AND DOCTRINE COMMAND  
FORT MONROE, VIRGINIA 23651-3000

REPLY TO  
ATTENTION OF

6 SEP 1995

ATCD-SL (70-1f)

MEMORANDUM FOR

Major General Thomas W. Robison, Commander, U.S. Army Combined  
Arms Support Command and Fort Lee, Fort Lee, VA 23801-6000  
Major General Robert K. Guest, Commander, U.S. Army Quartermaster  
Center and School, Fort Lee, VA 23801-5030

SUBJECT: Low Altitude Parachute Extraction System (LAPES)  
Disassembly.

1. References:

a. Message, HQ TRADOC, ATCD-SL, 100930Z Jan 95, subject:  
LAPES.

b. OVVM Note, HQ USACASCOM, 30 March 95, subject: TRADOC  
Disassembly of LAPES.

2. The U.S. Army and other services recently have concurred that  
LAPES will be terminated, as this capability is no longer required  
as a viable wartime contingency airdrop option. However,  
Headquarters, Department of the Army (DA), Deputy Chief of Staff  
for Operations and Plans, has agreed that LAPES technology will be  
shelved, and all specialized equipment preserved for possible  
future use.

3. Take the necessary steps to terminate training and leader  
development concerning LAPES operations. Major General Guest's  
questions regarding the disassembly of LAPES (enclosed) with  
following guidance will be utilized:

a. "Does the U.S. Army Quartermaster Center and School  
(USAQMC&S) continue to publish LAPES procedures in their joint  
field manual (FMs)/technical order manuals?" "Do we publish the  
LAPES procedures that have been written but not been printed yet?"  
Publishing LAPES procedures in all joint publications, Army FMs,  
regulations, etc., will be discontinued and addressed in the next  
revision of the aforementioned documents. Concurrently, all LAPES  
procedures that have been written and not printed will not be  
published.

6 SEP 1995

ATCD-SL  
SUBJECT: Low Altitude Parachute Extraction System (LAPES)  
Disassembly

b. "Do we keep LAPES in our programs of instruction (POIs)?" "Do we teach LAPES to other services and our allies?" The USAQMC&S will remove LAPES procedures from PCI and cease teaching LAPES to other services and/or allies.

c. "What do we teach to folks that have LAPES equipment in their war reserves?" All instruction concerning LAPES procedures will be discontinued whether LAPES equipment is located in units or in war reserves.

d. "What is the DA/TRADOC guidance on disposition of unit, depot, and war reserves LAPES equipment?" All LAPES equipment in war reserves and depot should be preserved with the exception of a few items that can be utilized in other existing airdrop capabilities. Specifically, the Type V airdrop platforms and attitude control bars of the LAPES system are being utilized to augment current Low Velocity Airdrop Systems (LVADS) loads.

e. "What is the guidance to U.S. Army Test and Experimentation Command on force development test and experimentation certification of LAPES loads?" The certification of all LAPES loads at the Airborne Special Operations Test Directorate will be redirected toward testing and certification of LVADS loads.

4. HQ TRADOC POC is CPT Higgins or CPT Phillips, ATCD-SL, DSN 680-2469/3921, datafax DSN 680-2520.

FOR THE COMMANDER:

Encl



JOE N. BALLARD  
Major General, GS  
Chief of Staff

CF:  
HQDA (DAMO-FDL)  
CDR, NRDEC (SAFNC-UA)  
CDR, FORSCOM (FCJ3-FC)  
CDR, OPTEC (CSTE-CS, CSTE-OPM)  
CDR, ATCOM (AMSAT-W-TD)  
DIR, ABNSOTD (ATCT-AB)  
HQ TRADOC (ATCD-L, ATCD-RM, ATDO-A, ATTG-IT)

Date and time 07/18/95 10:28:11

From: HIGGINSN--MON1  
To: HIGGINSN--MON1

From: OPT NEIL HIGGINS, (AAACO), 680-2464  
Subject: TRADOC "DISASSEMBLY" OF LAPES

\*\*\*\*\*  
\* AIRBORNE AIRLIFT ACTION OFFICE \*  
\* (AAACO) \*  
\*\*\*\*\*

\*\* Forwarding note from BRUNEAUN--OMSNAMES 07/18/95 10:27 \*\*\*  
Received: from LEE-EMH2.ARMY.MIL by MONROE-EMH2.ARMY.MIL (IBM VM SMTP V2R2)  
with TOP; Tue, 18 Jul 95 10:27:22 EDT  
Received: from LEE1 by LEE-EMH2.ARMY.MIL (IBM VM SMTP V2R2) with SMTP id 3547;  
Tue, 18 Jul 95 10:29:34 EDT  
Comments: Converted from PROFS to RFC822 format by PUMP V2.2X  
Date: Tue, 18 Jul 95 10:29:26 EDT  
From: NORMAN BRUNEAU <BRUNEAUN@LEE-EMH2.ARMY.MIL>  
Subject: TRADOC "DISASSEMBLY" OF LAPES  
To: "NEIL HIGGINS- AAACO " <HIGGIN@MONROE-EMH1.ARMY.MIL>

\*\* Resending note of 06/30/95 09:23

From: LARRY MC MILLIAN AAA <MCMILLI@MONROE-EMH1.ARMY.MIL>  
To: NORMAN BRUNEAU  
Subject: TRADOC "DISASSEMBLY" OF LAPES

NEIL- HERE ARE THE QUESTIONS THAT MG GUEST WANTS DA/ TRADOC TO ANSWER RE LAPES, AS I UNDERSTAND HIS GUIDANCE. I HAVE DISCUSSED THESE W/ OUR ABN DPT. IF THESE QUESTIONS MAKE SENSE, GIVE ME AN "UP" BEFORE I FORMALLY SEND ANYTHING OUT. MG GUEST WANTS SPECIFIC GUIDANCE FM TRADOC ON LAPES, RESPONSE NEEDS TO BE CLEAR AND TO THE POINT. A LOT OF THIS WILL HINGE ON WHAT ACC PLANS TO DO W/ LAPES NOW THAT THE AIR STAFF HAS GIVEN THEM THE GREEN LIGHT TO KILL IT. IF THEY PLAN TO PLACE IT ON THE SHELF OR KEEP A LIMITED OR CONTINGENCY CAPABILITY, THAT WILL DRIVE YOUR ANSWER TO US, AT THIS POINT I THINK ACC WILL DO WHATEVER THE ARMY WANTS, AS THEIR PRIMARY CUSTOMER. I WILL NOT REHASH HOW THE ARMY DECIDED THEY DIDNT NEED LAPES. QUESTIONS FOLLOW:

- DOES THE GMS CONTINUE TO PUBLISH LAPES PROCEDURES IN THEIR JOINT FM/TO MANUALS?
- DO WE PUBLISH THE LAPES PROCEDURES THAT HAVE BEEN WRITTEN BUT HAVE NOT BEEN PRINTED YET?
- DO WE REMOVE ALL LAPES PROCEDURES FROM ALREADY PUBLISHED MANUALS?
- DO WE KEEP LAPES IN OUR POIT?
- DO WE TEACH LAPES TO OTHER SERVICES AND OUR ALLIES?
- WHAT DO WE TEACH TO FOLKS THAT HAVE LAPES EQUIPMENT IN THEIR WAR RESERVES?
- WHAT IS THE DA/TRADOC GUIDANCE ON DISPOSITION OF UNIT, DEPOT, AND WAR RESERVE LAPES EQUIPMENT?
- WHAT IS THE GUIDANCE TO TEXCOM ON THE FUTE CERTIFICATION OF LAPES LOADS?

I KNOW THESE ARE TOUGH QUESTIONS, BUT THEY HAVE TO BE ASKED. HQ STAFFS CANNOT SIMPLY SAY "KILL IT" AND MOVE ON TO THE NEXT ISSUE. I DONT THINK WE ARE DOING OUR JOB IF WE LEAVE IT UP TO THE SCHOOLHOUSE TO INTERPRET SKETCHY GUIDANCE. THAT PLACES US IN THE POSSIBLE POSITION OF BEING ACCUSED OF NOT FOLLOWING ORDERS.

LETS TALK.....NORM

TRK 2/47

SEP 11 11 08:30AM CSSRD FT MONROE VA 66 11

**DEPARTMENT OF THE ARMY**  
QUARTERMASTER CENTER AND SCHOOL  
1201 22D STREET  
FORT LEE, VIRGINIA 23801-1601

ATSM-ABN-FS

15 Dec 96

MEMORANDUM FOR RECORD

SUBJECT: Airdrop Equipment Update

Reference:

- a. Phone conversation between CW4 Mahon, CASCOM and Dick Harper, Weapons System Management Office, Army Aviation Troop Command. Subject : sab
- b. Phone conversation between CW4 Mahon, CASCOM and Don Stump, Logistics Management Specialist, Office, Deputy Chief of Staff for Logistics. Subject. sab
- c. Phone conversation between CW4 Mahon, CASCOM and Chief Msgt Okraneck, Hqrs Air Combat Command. Subject sab
- d. msg dtg R 181348Z Feb 94. subject: FCIF item: Type II platforms, PEFTC and SL/CS for Air Force unilateral training

1. Based on information received from the references a-c above, the following update is provided per request ref c, above.
  - a. The type II modular platform no longer exists within any contingency stocks. Therefore, maintaining Joint Inspection training program is no longer required for this equipment.
  - b. The Parachute Extraction Transfer Force Coupling (PEFTC) no longer exists within any contingency stocks. Therefore, maintaining Joint Inspection training program is no longer required for this equipment.
  - c. The metric platform interim rigging procedures are no longer valid as they apply to metric platforms. Those rigging procedures which have dual application with the type V platform are still valid for the type V platform.
  - d. The static line connector strap (SL/CS) currently has limited application. Only those loads that specifically require this system are authorized use of this system. The SL/CS is not an across the board substitute for the Extraction Force Transfer Coupling (EFTC). These authorized loads are specific in nature and will normally be found in the special operations arena of airdrop loads. This system is not authorized for use IAW ref d, above.
2. For additional questions/information contact the undersigned at DSN 687-4733, Fax 3084.

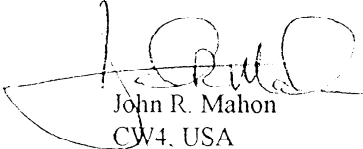
  
John R. Mahon  
CW4, USA  
Senior Airdrop Systems  
Technician

FIELD MANUAL  
NO 10-576  
TECHNICAL ORDER  
NO 13C7-27-151

HEADQUARTERS  
DEPARTMENTS OF THE ARMY  
AND THE AIR FORCE  
Washington, DC, 21 August 1987

## AIRDROP OF SUPPLIES AND EQUIPMENT: RIGGING THE 613S SCRAPERS

### TABLE OF CONTENTS

	Paragraph	Page
<b>PREFACE</b> .....		iii
<b>CHAPTER 1 INTRODUCTION</b>		
Description of Items .....	1-1	1-1
Special Considerations .....	1-2	1-1
<b>CHAPTER 2 RIGGING 613S, TYPE I AND II SCRAPERS FOR LOW-VELOCITY AIRDROP</b>		
Description of Load .....	2-1	2-1
Preparing Platform .....	2-2	2-1
Preparing Honeycomb Stacks .....	2-3	2-5
Building Supports .....	2-4	2-8
Positioning Stacks, Load Spreader, and Nylon Webbing on Platform .....	2-5	2-14
Preparing Scraper .....	2-6	2-17
Installing Lifting Slings and Positioning Scraper .....	2-7	2-36
Lashing Scraper .....	2-8	2-40
Installing and Safetying Suspension Slings .....	2-9	2-46
Installing Parachute Release Platform and Load Cover .....	2-10	2-50
Building and Installing Parachute Stowage Platform .....	2-11	2-52
Stowing Cargo Parachutes .....	2-12	2-59
Installing Extraction System .....	2-13	2-60
Installing Release Assembly .....	2-14	2-62
Positioning Extraction Parachutes .....	2-15	2-62

**DISTRIBUTION RESTRICTION:** Distribution authorized to US government agencies only to protect technical or operational information from automatic dissemination under the International Exchange Program or by other means. This determination was made on 30 April 1991. Other requests for this document will be referred to Commander, US Army Quartermaster Center and School, ATTN: ATSM-DTL, Fort Lee, VA 23801-5036.

**DESTRUCTION NOTICE:** Destroy by any method that will prevent disclosure of contents or reconstruction of the document.

	<b>Paragraph</b>	<b>Page</b>
Marking Rigged Load .....	2-16	2-63
Equipment Required .....	2-17	2-64
<b>CHAPTER 3</b>	<b>RIGGING 613S, TYPE I AND II SCRAPERS ON A</b>	
	<b>TYPE V PLATFORM</b>	
<b>Section I</b>	<b>LOW-VELOCITY AIRDROP</b>	
Description of Load .....	3-1	3-1
Preparing Platform .....	3-2	3-2
Preparing Honeycomb Stacks .....	3-3	3-4
Building Load Spreaders and Supports .....	3-4	3-7
Positioning Honeycomb Stacks, Belly Pan Load Spreader, and Nylon Webbing .....	3-5	3-13
Preparing Scraper .....	3-6	3-16
Installing Lifting Slings and Positioning Scraper .....	3-7	3-35
Lashing Scraper .....	3-8	3-39
Installing and Safetying Suspension Slings .....	3-9	3-44
Installing Parachute Release Platform and Load Cover .....	3-10	3-48
Building and Installing Parachute Stowage Platform .....	3-11	3-51
Stowing Cargo Parachutes .....	3-12	3-54
Installing Extraction System .....	3-13	3-55
Installing Release Assembly .....	3-14	3-57
Placing Extraction Parachutes .....	3-15	3-58
Installing Provisions for Emergency Restraints .....	3-16	3-58
Marking Rigged Load .....	3-17	3-59
Equipment Required .....	3-18	3-60
<b>Section II</b>	<b>LAPE AIRDROP</b>	
Description of Load .....	3-19	3-62
Preparing Platform .....	3-20	3-62
Preparing Honeycomb Stacks and Building Load Spreaders and Supports .....	3-21	3-64
Positioning Honeycomb Stacks, Belly Pan Load Spreader, and Nylon Webbing .....	3-22	3-64
Preparing Scraper .....	3-23	3-67
Installing Lifting Slings and Positioning Scraper .....	3-24	3-68
Lashing Scraper .....	3-25	3-69
Installing Extraction System .....	3-26	3-74
Placing Extraction Parachutes .....	3-27	3-84
Marking Rigged Load .....	3-28	3-84
Equipment Required .....	3-29	3-85
<b>GLOSSARY</b> .....		Glossary-1
<b>REFERENCES</b> .....		References-1

## **PREFACE**

---

### **SCOPE**

This manual tells and shows how to rig the 613SNS, type I (nonsectionalized) scraper and the 613S, type II (sectionalized) scraper for low-velocity airdrop from the C-130 and C-141 aircraft and for LAPE airdrop from a C-130 aircraft. This manual is designed for use by all parachute riggers.

### **USER INFORMATION**

The proponent of this publication is HQ TRADOC. You are encouraged to report any errors or omissions and to suggest ways for making this a better manual. Army personnel, send your comments on DA Form 2028 to:

Commander  
US Army Quartermaster Center and School  
ATTN: ATSM-DTL  
Fort Lee, Virginia 23801-5036

Air Force personnel, send your reports on AFTO Form 22 through:

Headquarters  
Military Airlift Command  
(MAC/OXTT)  
Scott AFB, Illinois 62225-5001

to:

Commander  
US Army Quartermaster Center and School  
ATTN: ATSM-DTL  
Fort Lee, Virginia 23801-5036

Also send information copies of AFTO Form 22 to:

San Antonio ALC/MMILRA  
Kelly AFB, Texas 78241-5000

## CHAPTER 1

**INTRODUCTION****1-1. Description of Items**

The description of the items rigged in this manual are given below.

**a. The 613SNS, Type I Scraper.** The unrigged 613SNS, type I scraper (NSN 3805-01-144-2992) (Figure 1-1) or rebuy (NSN 3805-01-267-4178) with the fuel tank full weighs 33,000 pounds. The fuel tank must be at least 1/2 full. The length of the scraper is 405 inches, reducible to 393 inches. Its height is 121 inches, reducible to 91 inches. The width of the scraper is 104 3/4 inches.

**b. The 613SS, Type II Scraper.** The unrigged 613SS, type II scraper (NSN 3805-01-144-8837) or rebuy (NSN 3805-01-267-4177) with the fuel tank full weighs 34,645 pounds. The fuel tank must be at least 1/2 full. The length of the scraper is 436 inches, reducible to 393 inches. Its height is 121 inches, reducible to 91 inches. The width of the scraper is 104 3/4 inches.

**1-2. Special Considerations**

Special considerations for this manual are given below.

**CAUTION: Rigging of the 613S scrapers for airdrop is critical. Deviation from the rigging procedures and materials covered by this manual may result in Air Force rejection of the load.**

**a.** The loads covered in this manual may include hazardous materials as defined in AFR 71-4/TM 38-250. If included, the hazardous material must be packaged, marked, and labeled as required by AFR 71-4/TM 38-250.

**b.** A copy of this manual must be available to the joint airdrop inspectors during the before- and after-loading inspections.

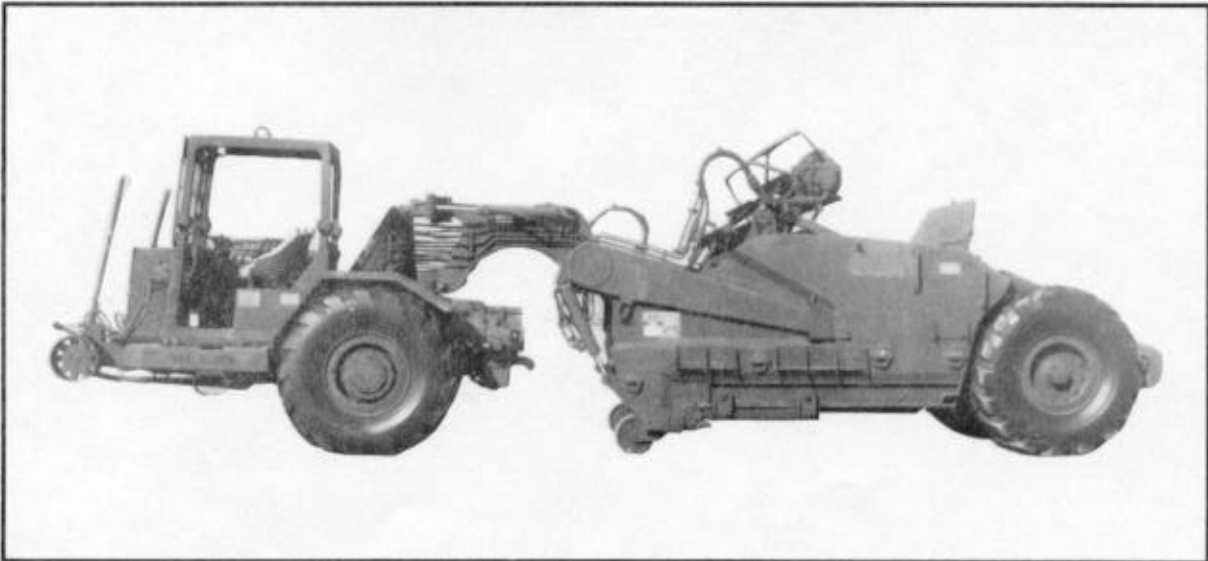

*Figure 1-1. The unrigged 613S, type I scraper with IAT kit installed*



CHAPTER 3

**RIGGING 613S, TYPE I AND II SCRAPERS  
ON A TYPE V PLATFORM**

**Section I. LOW-VELOCITY AIRDROP**

---

**3-1. Description of Load**

The 613S, type I and II scrapers are rigged on a 32-foot, type V airdrop platform for low-velocity airdrop from C-130 and C-141 aircraft. The scraper is rigged with eight G-11B cargo parachutes and other items of airdrop equipment, to include a modified M-2 release.

The type I and II scrapers are rigged the same, except where noted.

**CAUTION: These loads may be airdropped from C-141 aircraft only if the rigged weight is 38,500 pounds or less.**

### 3-2. Preparing Platform

Prepare a 32-foot, type V airdrop platform as shown in Figure 3-1.

**CAUTION:** The 32-foot, type V airdrop platform must be modified as shown in Figure 3-1.

#### Notes:

1. The nose bumper may or may not be installed.
2. Measurements given in this section are from the front edge of the platform, NOT from the front edge of the nose bumper.

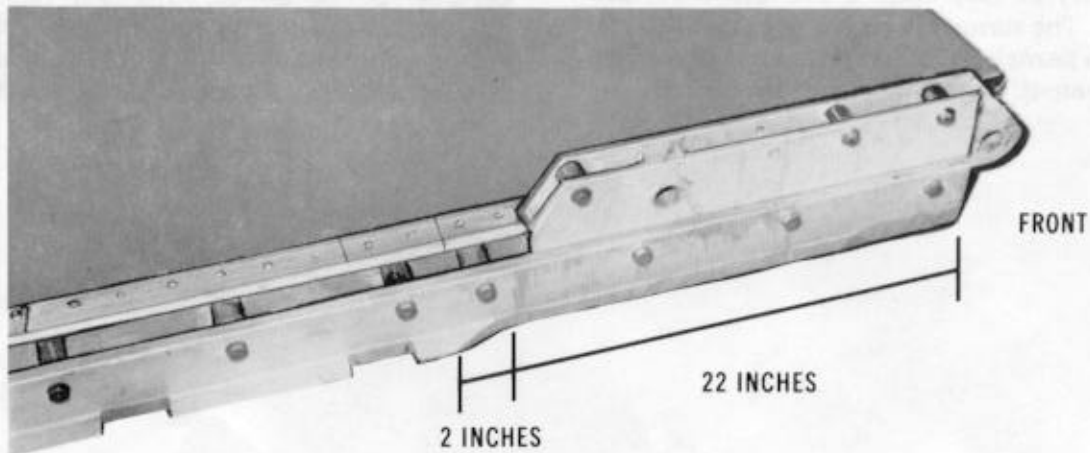

#### Step:

1. Inspect, or assemble and inspect, the platform according to TM 10-1670-268-20&P/TO 13C7-52-22.

**Note:** If the rail has not been modified, use the following modification procedures in steps 2 and 3:

2. Cut off the indent locks 22 inches from the front of the platform, even with the platform side rails. Taper the cut 2 inches to the edge of the third indent block.
3. Drill a set of EFTC bracket holes in the left rail. Drill the first .406-inch-diameter hole 120 inches on center from the front edge of the rail and 1 1/8 inches on center from the top of the rail. Drill the second hole 7 1/4 inches on center from the first hole and 1 1/8 inches from the top of the rail.

Figure 3-1. Platform prepared

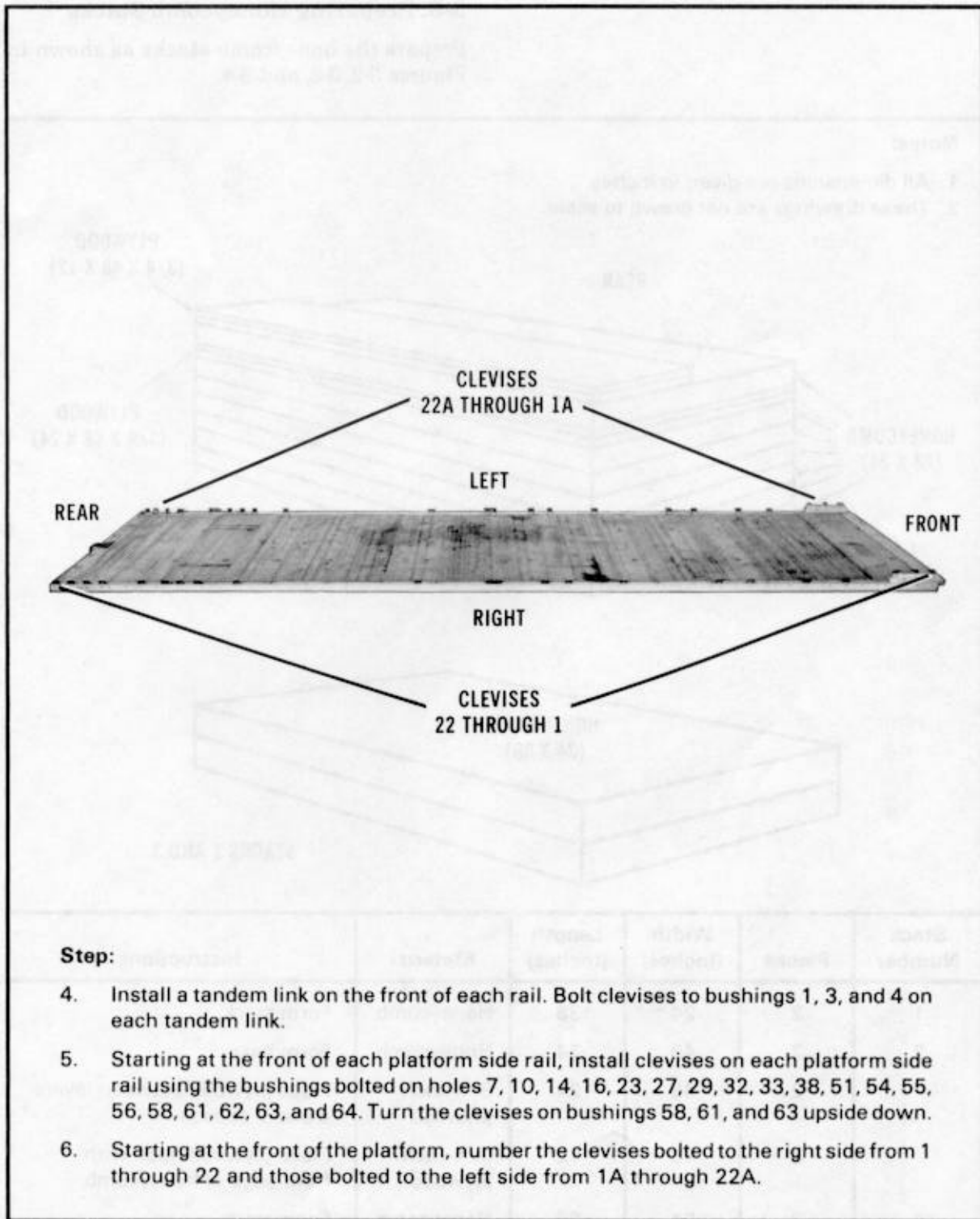
**Step:**

4. Install a tandem link on the front of each rail. Bolt clevises to bushings 1, 3, and 4 on each tandem link.
5. Starting at the front of each platform side rail, install clevises on each platform side rail using the bushings bolted on holes 7, 10, 14, 16, 23, 27, 29, 32, 33, 38, 51, 54, 55, 56, 58, 61, 62, 63, and 64. Turn the clevises on bushings 58, 61, and 63 upside down.
6. Starting at the front of the platform, number the clevises bolted to the right side from 1 through 22 and those bolted to the left side from 1A through 22A.

*Figure 3-1. Platform prepared (continued)*

### 3-3. Preparing Honeycomb Stacks

Prepare the honeycomb stacks as shown in Figures 3-2, 3-3, and 3-4.

**Notes:**

1. All dimensions are given in inches.
2. These drawings are not drawn to scale.

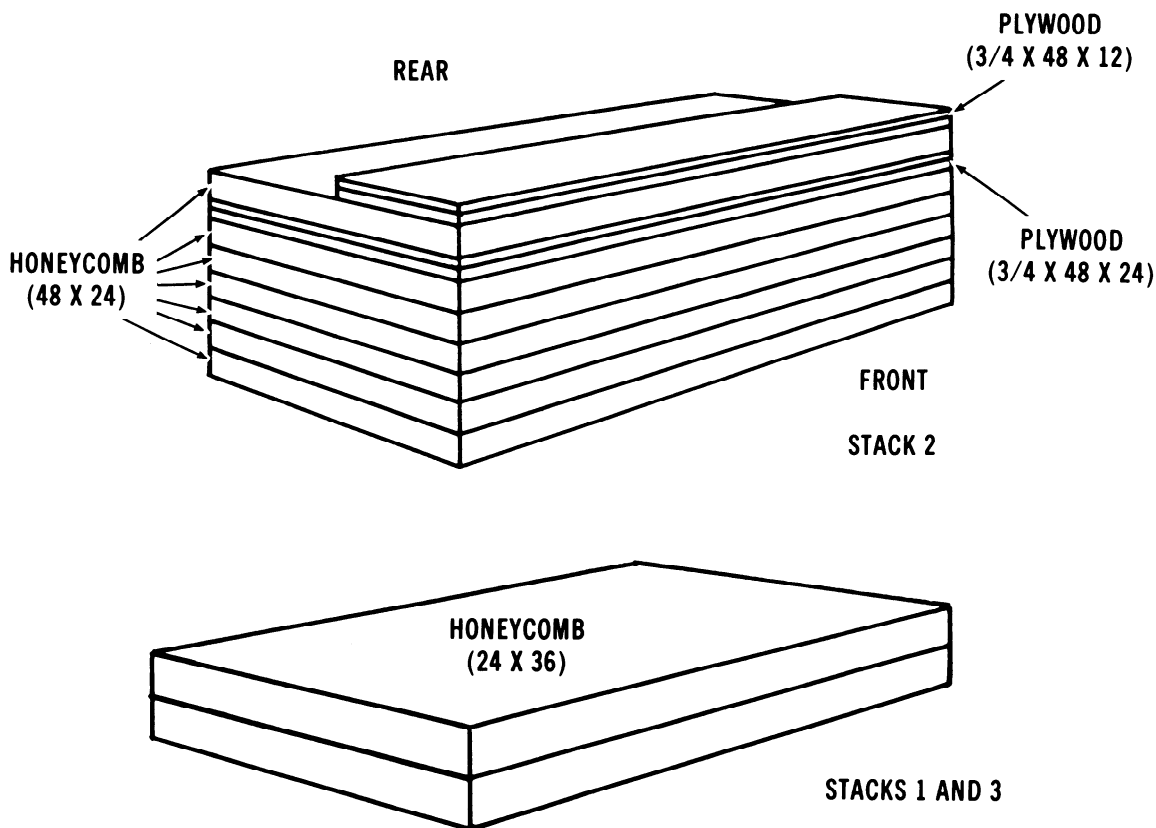

Stack Number	Pieces	Width (Inches)	Length (Inches)	Material	Instructions
1	2	24	36	Honeycomb	Form stack.
2	7	48	24	Honeycomb	Form base.
	2	48	24	3/4-inch plywood	Place plywood between layers 6 and 7 of base.
	2	48	12	3/4-inch plywood	Place plywood flush with front edge of honeycomb.
3	2	24	36	Honeycomb	Form stack.

Figure 3-2. Honeycomb stacks 1, 2, and 3 prepared

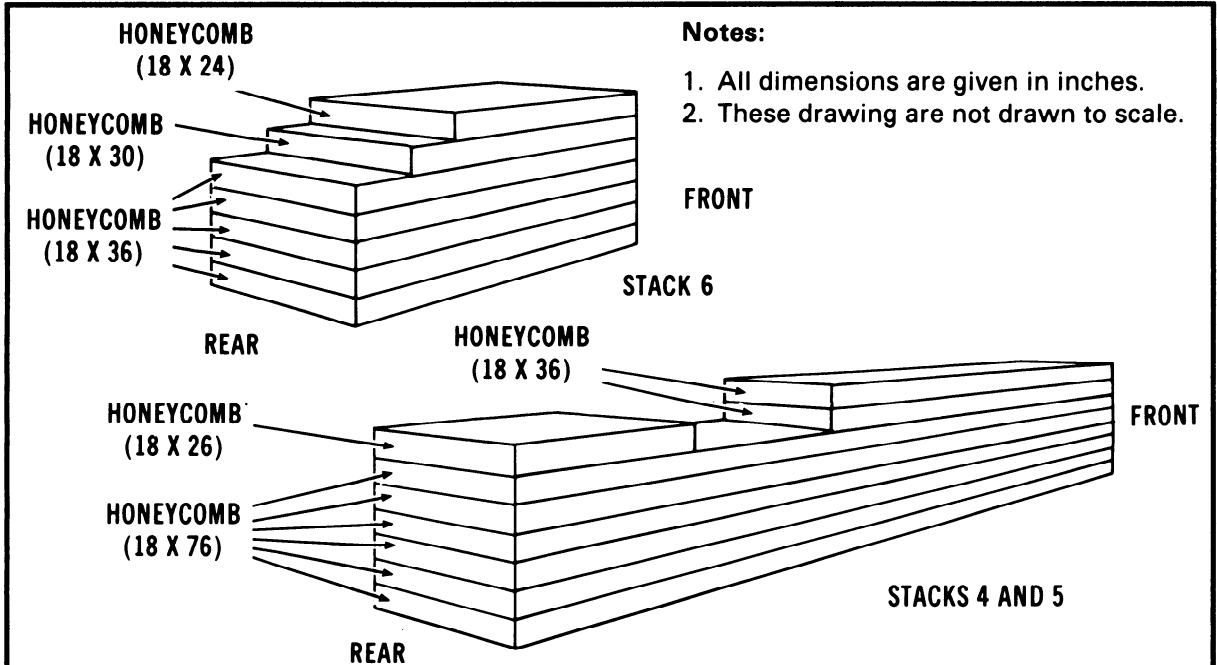

**Notes:**  
 1. All dimensions are given in inches.  
 2. These drawing are not drawn to scale.

Stack Number	Pieces	Width (Inches)	Length (Inches)	Material	Instructions
4	6	18	76	Honeycomb	Form base.
	2	18	36	Honeycomb	Place honeycomb on base flush with front edge of stack.
	1	18	26	Honeycomb	Place honeycomb on base flush with rear edge of stack.
5	6	18	76	Honeycomb	Form base.
	2	18	36	Honeycomb	Place honeycomb on base flush with front edge of stack.
	1	18	26	Honeycomb	Place honeycomb on base flush with rear edge of stack.
6	5	18	36	Honeycomb	Form base.
	1	18	30	Honeycomb	Place honeycomb on base flush with front edge of stack.
	1	18	24	Honeycomb	Place honeycomb on top of the 18- by 30-inch piece of honeycomb flush with the front edge of the stack.

Figure 3-3. Honeycomb stacks 4, 5, and 6 prepared

**C1, FM 10-576/TO 13C7-27-151**

**Notes:**

1. All dimensions are given in inches.
2. These drawings are not drawn to scale.

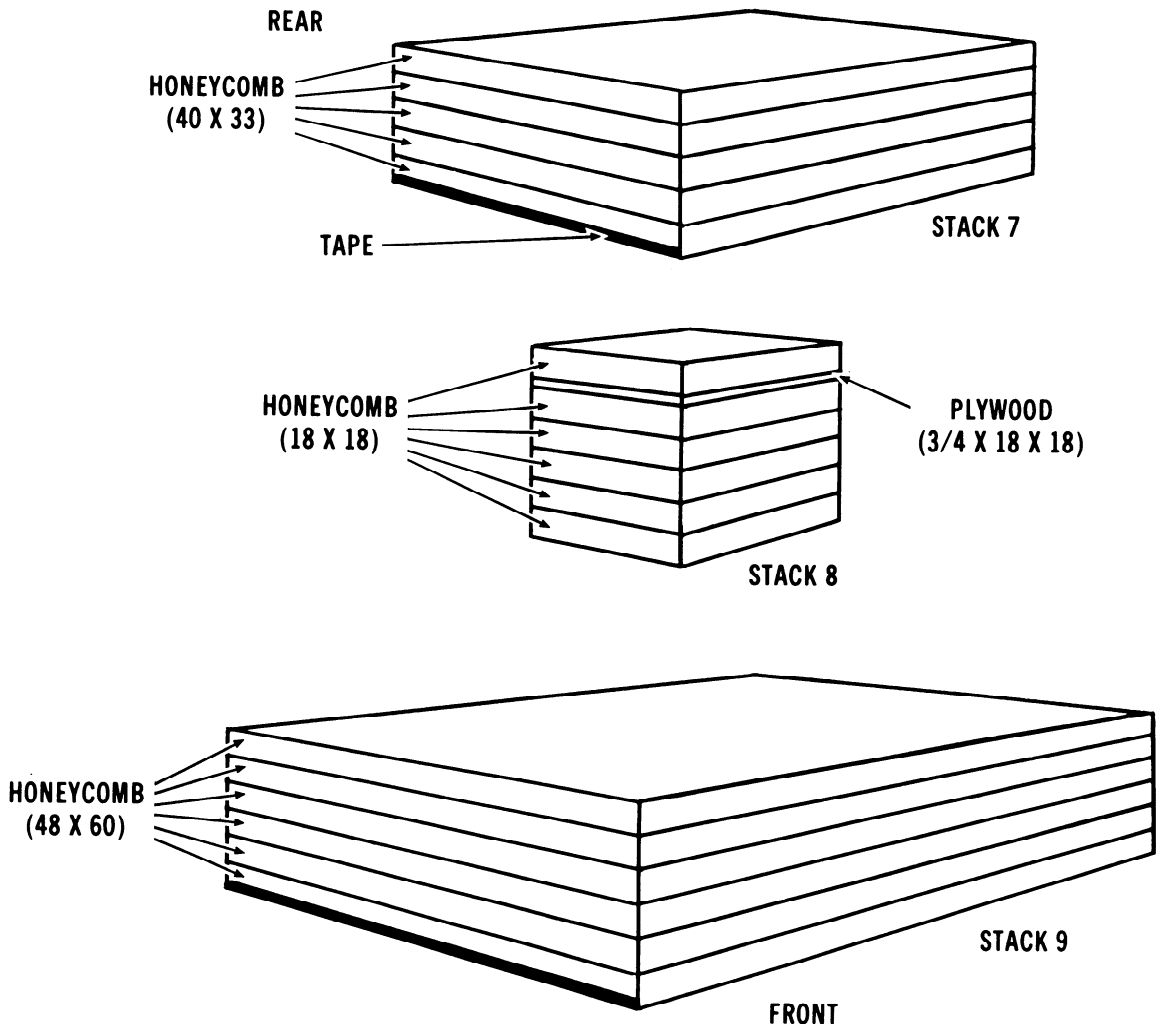

Stack Number	Pieces	Width (Inches)	Length (Inches)	Material	Instructions
7	5	40	33	Honeycomb	Form stack. Tape the left and right bottom edges of this stack.
8	6	18	18	Honeycomb	Form stack.
	1	18	18	3/4-inch plywood	Place plywood between layers 5 and 6 of stack.
9	6	48	60	Honeycomb	Form stack.

*Figure 3-4. Honeycomb stacks 7, 8, and 9 prepared*

**3-4. Building Load Spreaders and Supports**

Build the load spreaders and supports as shown in Figures 3-5 through 3-8.

**a. Building the Belly Pan Load Spreader.** Build the belly pan load spreader as shown in Figure 3-5.

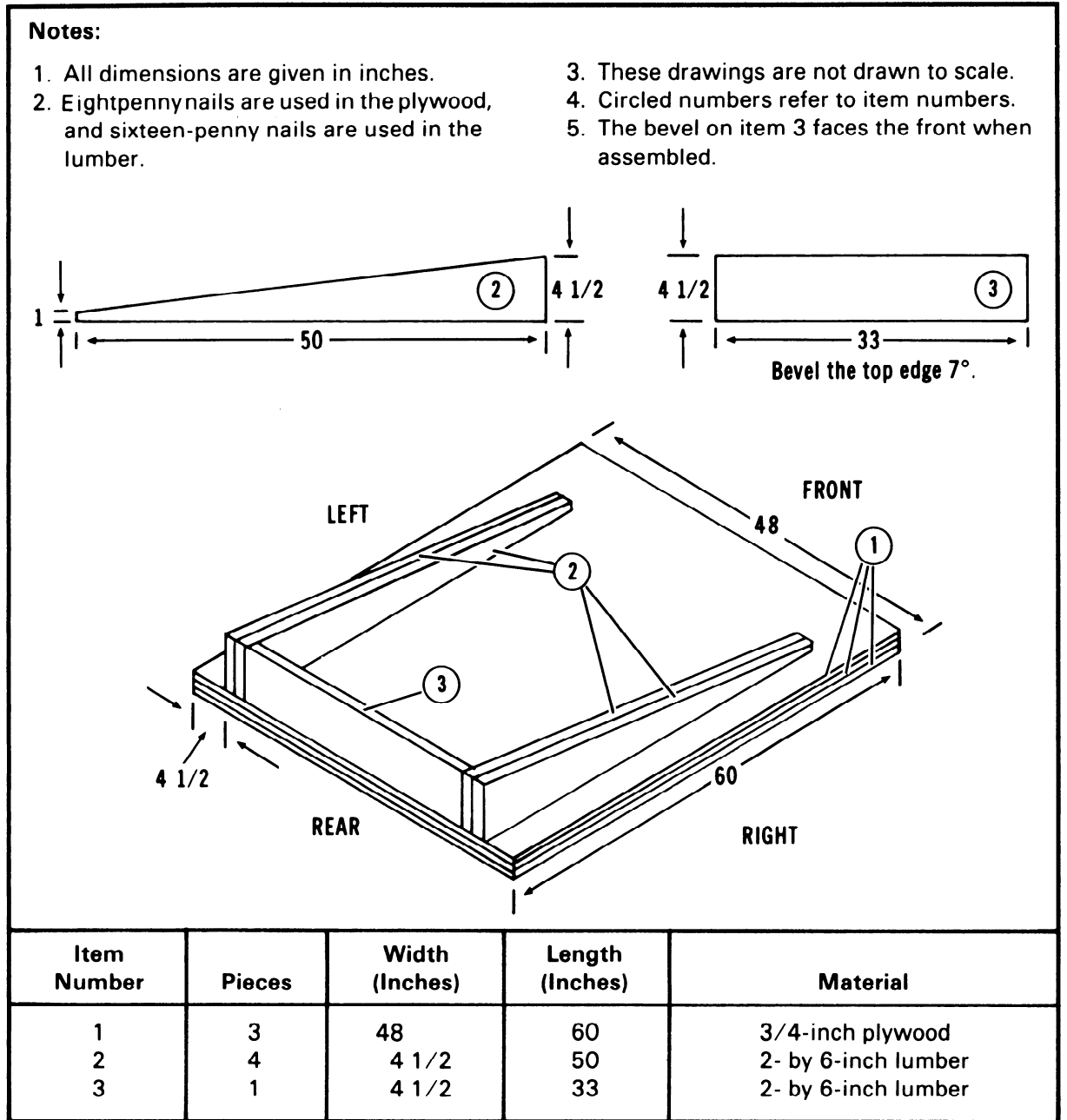

Figure 3-5. Belly pan load spreader built

**b. Building the Transmission Housing Load Spreader.** Build the transmission housing load spreader as shown in Figure 3-6.

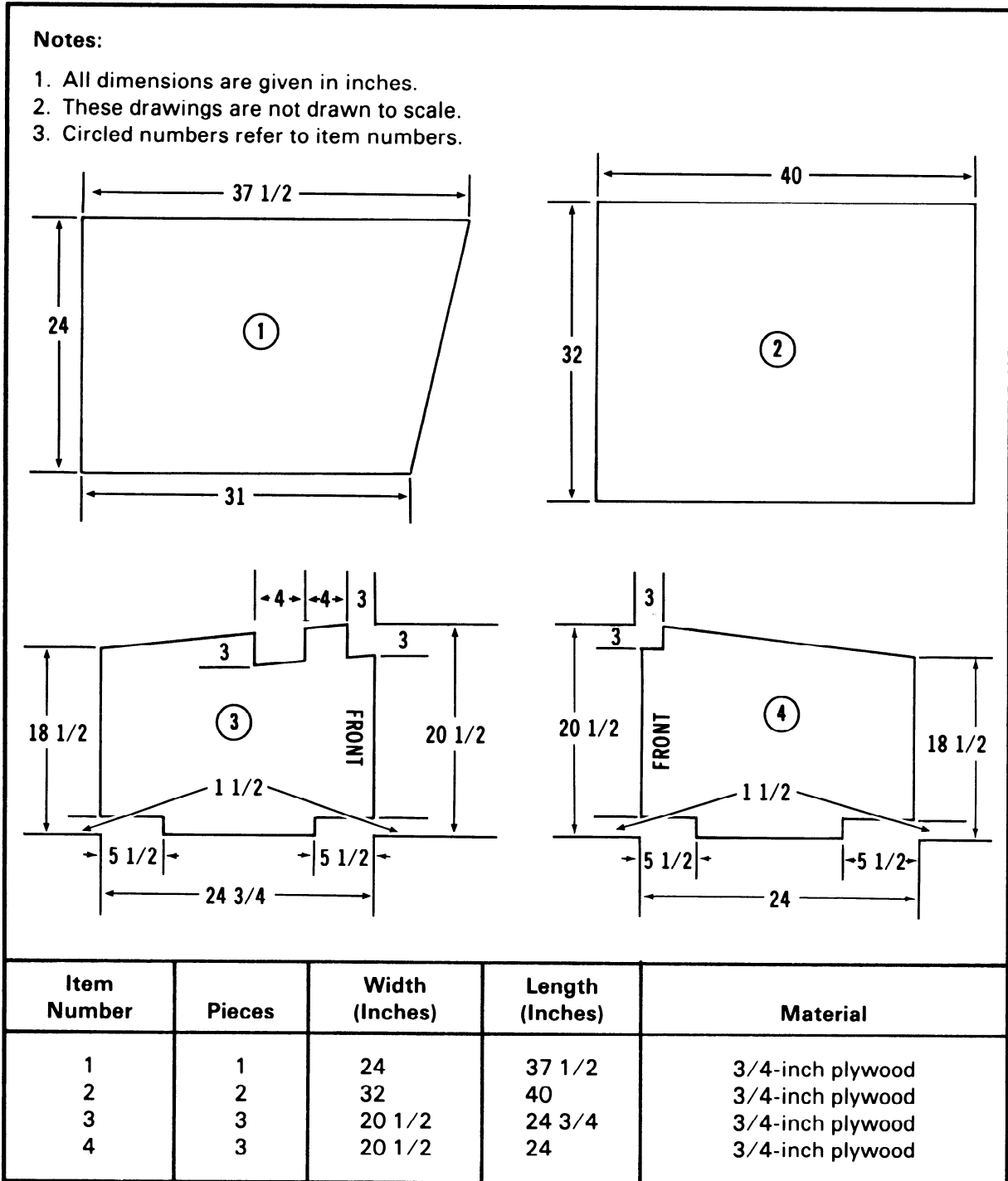
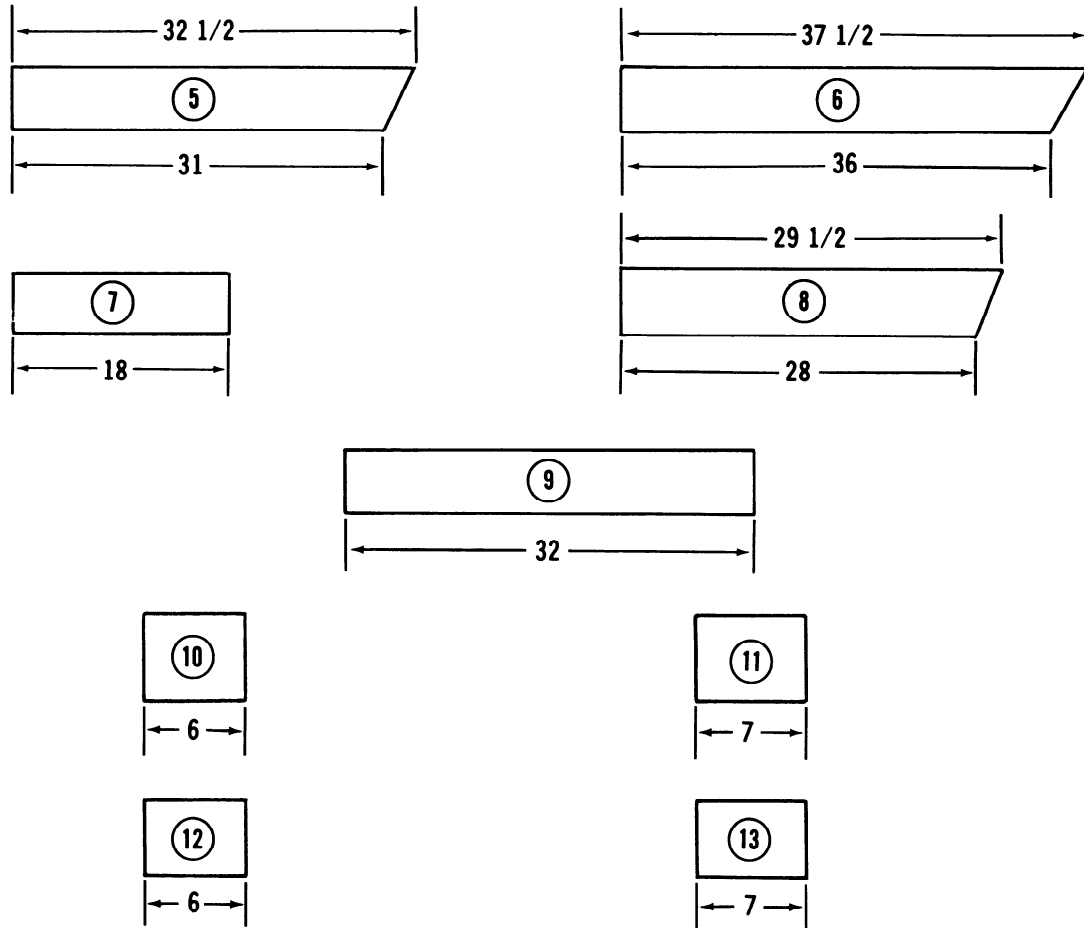

Figure 3-6. Transmission housing load spreader built



**Notes:**

1. All dimensions are given in inches.
2. These drawings are not drawn to scale.
3. Circled numbers refer to item numbers.



Item Number	Pieces	Width (Inches)	Length (Inches)	Material
5	1	5 1/2 (actual)	32 1/2	2- by 6-inch lumber
6	1	5 1/2 (actual)	37 1/2	2- by 6-inch lumber
7	1	5 1/2 (actual)	18	2- by 6-inch lumber
8	1	5 1/2 (actual)	29 1/2	2- by 6-inch lumber
9	2	3 1/2 (actual)	32	2- by 4-inch lumber
10	1	5 1/2 (actual)	6	2- by 6-inch lumber
11	1	5 1/2 (actual)	7	2- by 6-inch lumber
12	1	5 1/2	6	1/4-inch plywood
13	1	5 1/2	7	1/4-inch plywood

Figure 3-6. Transmission housing load spreader built (continued)

**Notes:**

1. All dimensions are given in inches.
2. These drawings are not drawn to scale.
3. Circled numbers refer to item numbers.
4. A generous amount of nails must be used.

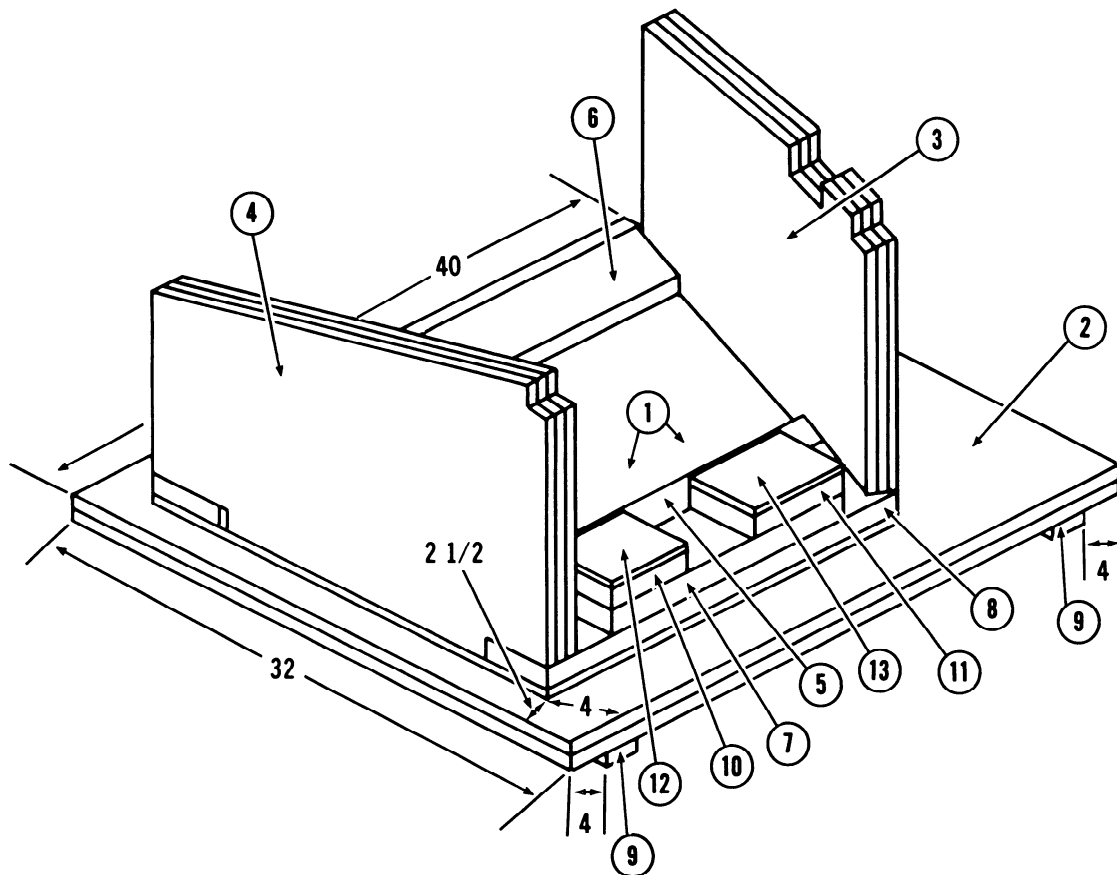
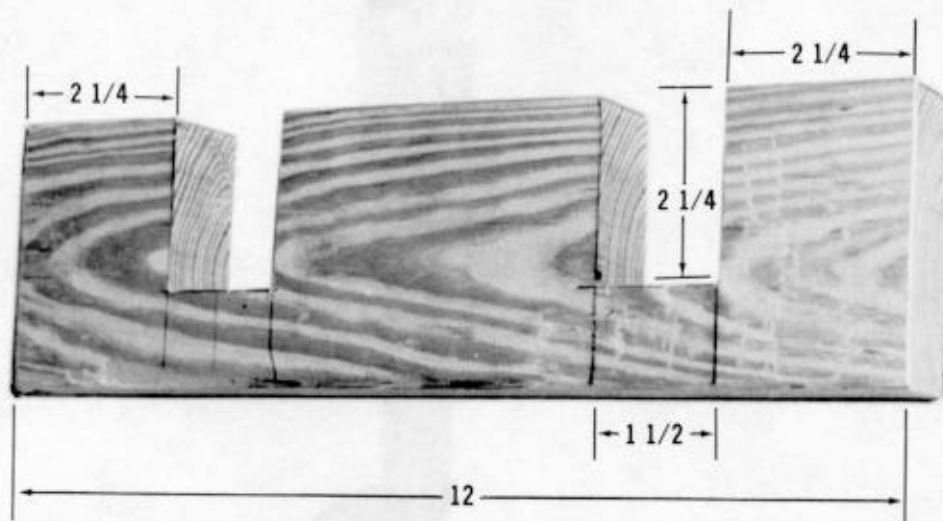

Figure 3-6. Transmission housing load spreader built (continued)

**c. Building the Engine Mount Support.**  
Build the engine mount support as shown in Figure 3-7.

**Note:** All dimensions are given in inches.



**Step:**

1. Use a 2- by 4- by 12-inch piece of lumber.
2. Make both cutouts 1 1/2 inches wide and 2 1/4 inches deep.

*Figure 3-7. Engine mount support built*

**d. Building the Elevator Supports.**  
 Build two elevator supports as shown in Figure 3-8.

**Notes:**

1. All dimensions are given in inches.
2. Sixteen-penny nails must be used.

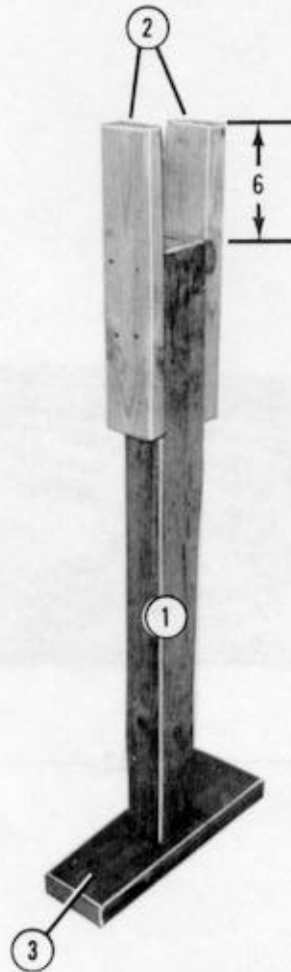

Item Number	Pieces	Width (Inches)	Length (Inches)	Material
1	2	3 1/2 (actual)	41	4- by 4-inch lumber
2	4	3 1/2 (actual)	18	2- by 4-inch lumber
3	2	5 1/2 (actual)	18	2- by 6-inch lumber

Figure 3-8. Elevator support built

### 3-5. Positioning Honeycomb Stacks, Belly Pan Load Spreader, and Nylon Webbing

Position the honeycomb stacks, load spreader, and nylon webbing on the platform as shown in Figures 3-9, 3-10, and 3-11.

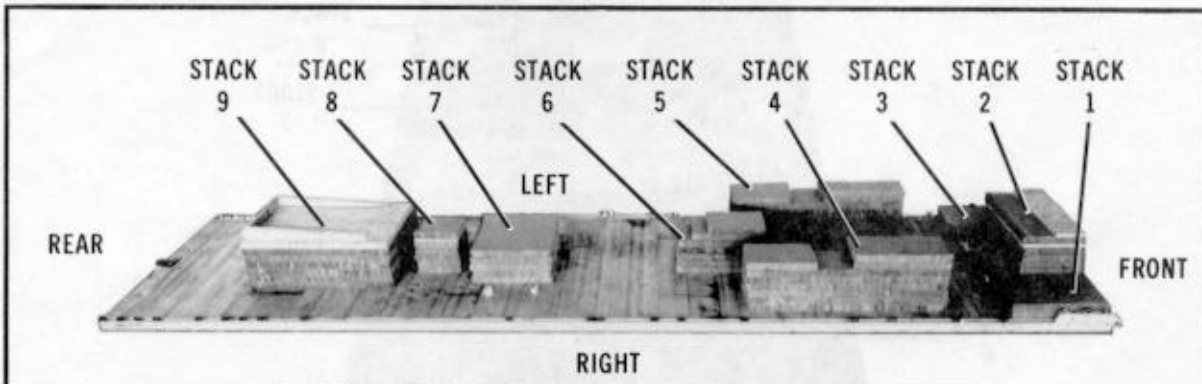

Stack Number	Position of Stack on Platform
1	Place stack: Flush with the front edge of the platform and the inside edge of the right rail.
2	Centered flush with the front edge of the platform. Pass two 15-foot lengths of 1/2-inch tubular nylon webbing under stack 2 in a front-to-rear direction.
3	Flush with the front edge of the platform and 2 1/2 inches from the left side of stack 2.
4	10 inches from the outside edge of the right rail and 22 inches from stack 1.
5	10 inches from the outside edge of the left rail and 22 inches from stack 3.
6	Centered and 101 inches from stack 2.
7	Centered and 52 inches from stack 6. Pass two 15-foot lengths of 1/2-inch tubular nylon webbing under stack 7 in a side-to-side direction.
8	Centered and 6 inches from stack 7.
9	Centered and 48 inches from the rear edge of the platform. Place the belly pan load spreader flush on stack 9 with the tapered ends toward the front of the platform.

Figure 3-9. Honeycomb stacks, belly pan load spreader, and nylon webbing positioned on platform

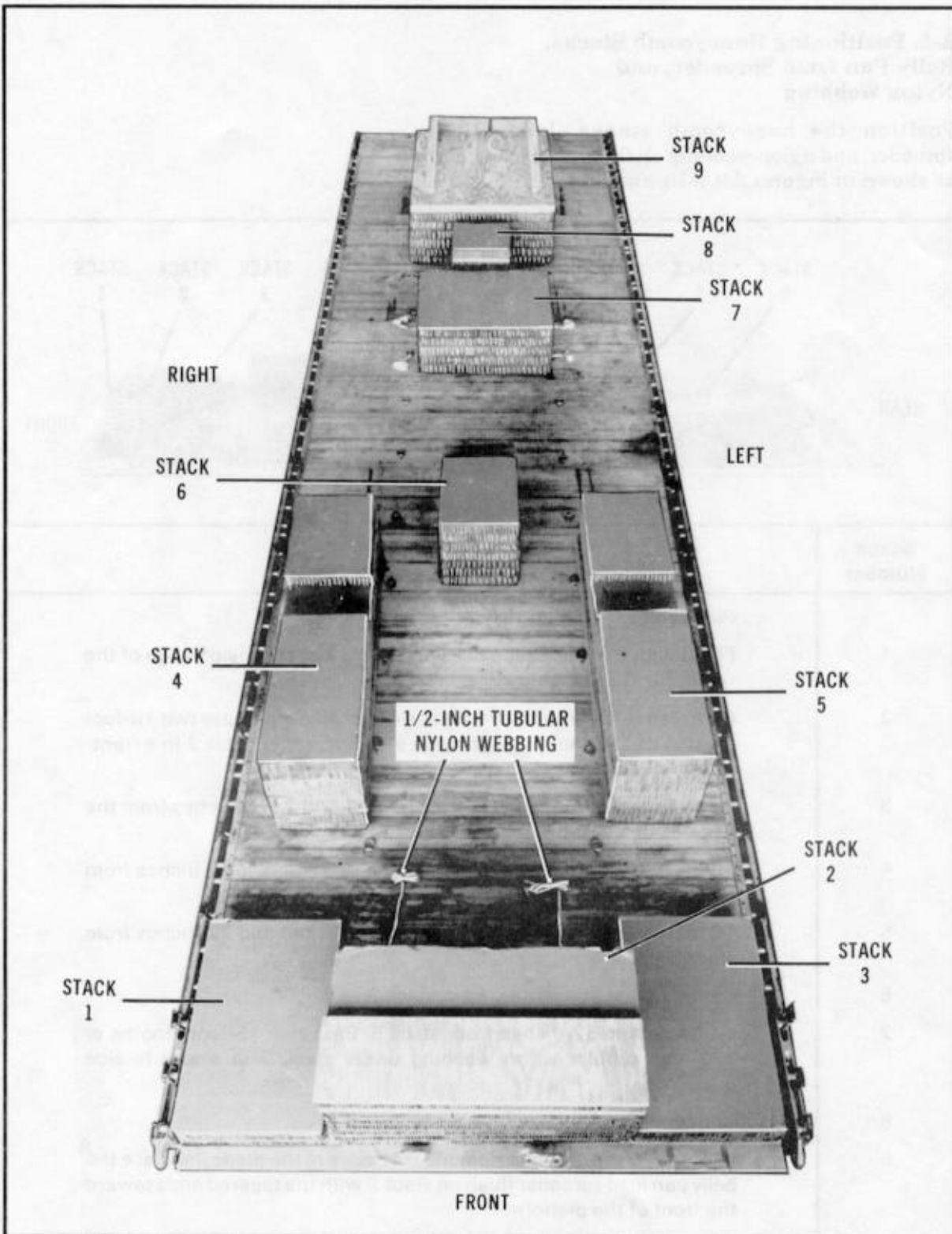

Figure 3-10. Front view of honeycomb stacks positioned on platform

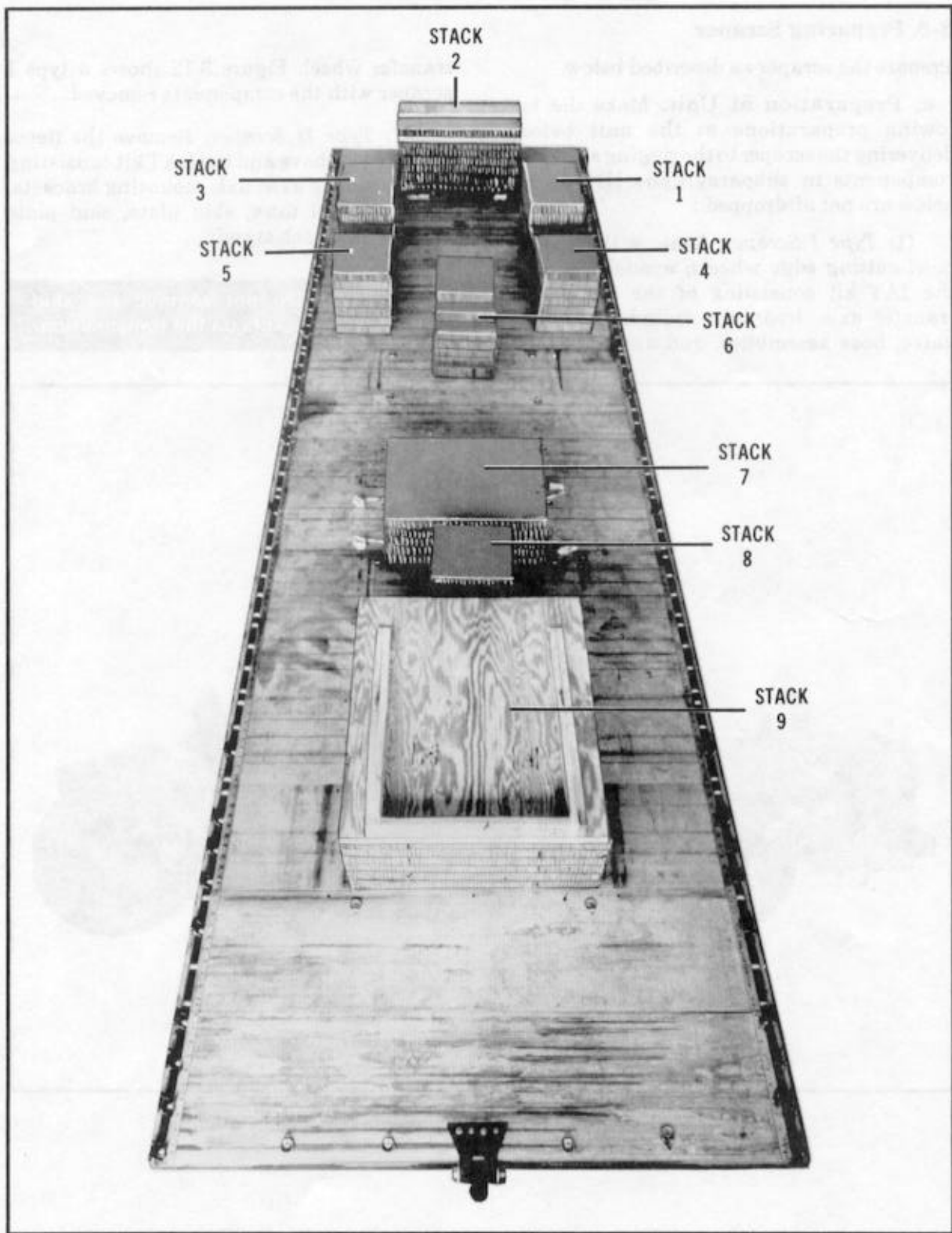

Figure 3-11. Rear view of honeycomb stacks positioned on platform

### 3-6. Preparing Scraper

Prepare the scraper as described below.

**a. Preparation at Unit.** Make the following preparations at the unit before delivering the scraper to the rigging site. (The components in subparagraphs (1) and (2) below are not airdropped.)

(1) *Type I Scraper.* Remove the ROPS; bowl cutting edge wheels; windshield; and the IAT kit consisting of the front load transfer axle, hydraulic cylinders, control valve, hose assemblies, and auxiliary load

transfer wheel. Figure 3-12 shows a type I scraper with the components removed.

(2) *Type II Scraper.* Remove the items listed in (1) above and the EAT kit consisting of the steering axle, axle mounting brackets, auxiliary fuel tank, skid plate, skid plate mounts, and jack stands.

**CAUTION:** Do not remove the skid mounting brackets on the transmission.

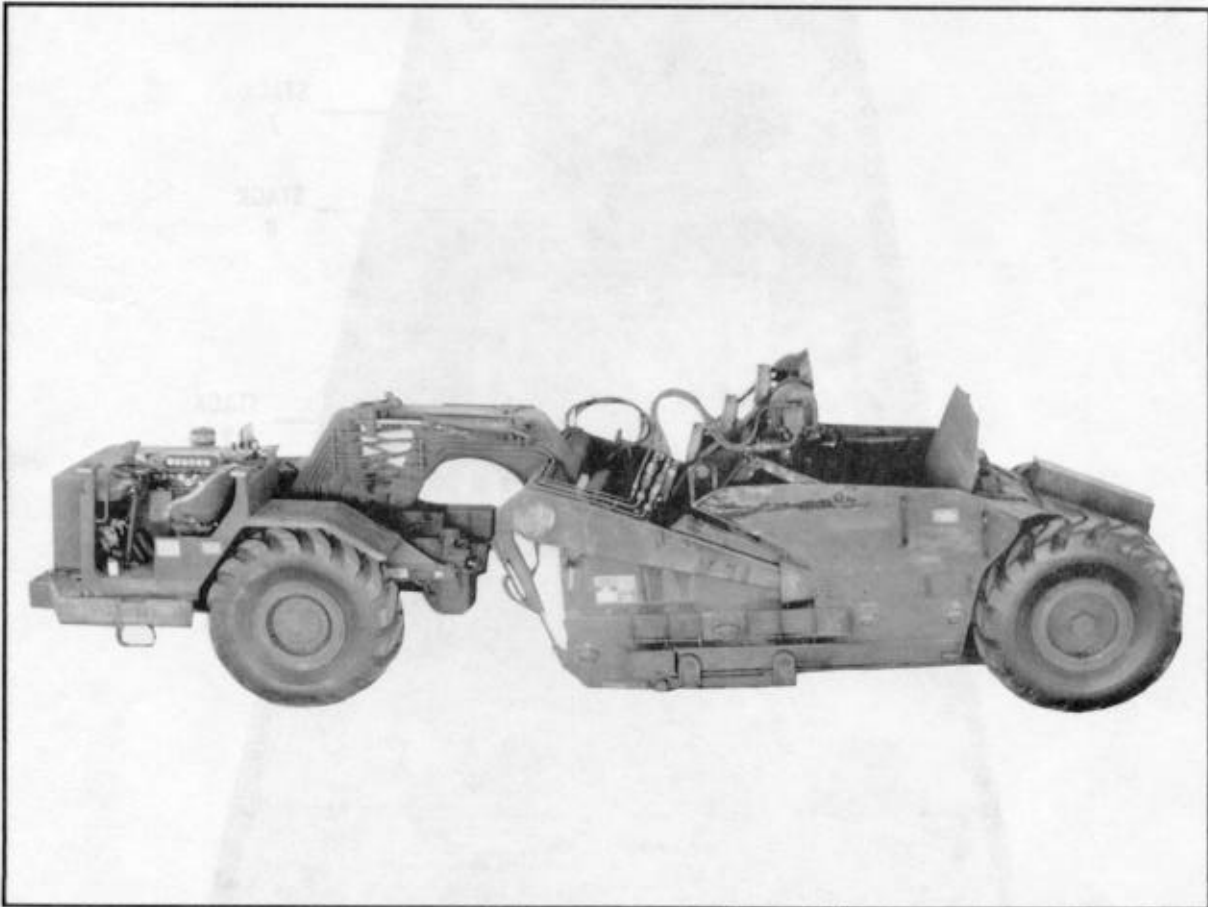

Figure 3-12. Type I scraper with components removed by the unit



(3) *Type I and II Scrapers.* Make these additional preparations for both scrapers before delivering them to the rigging site.

(a) Remove the cutting edge teeth, and stow them in the toolbox on the rear deck.

(b) Pad the wiper controls with cellulose wadding, and secure them to the air vent control arm with type III nylon cord.

(c) Adjust the fuel in the fuel tank so that the tank is 1/2 full.

(d) Adjust the tire pressure to 17 psi in the front tires and 24 psi in the rear tires. This is very important for meeting height requirements.

(e) Safety the towing pintle on the front of the scraper as shown in Figure 3-13. If you cannot secure the towing pintle as shown, remove it and stow in the toolbox.



- ① Safety the pintle with a large cotter pin on the bottom (not shown).
- ② Safety the top latch with type III nylon cord doubled.

Figure 3-13. Towing pintle safetied

**b. Preparation at Rigging Site.** Prepare the vehicle at the rigging site as described below.

**CAUTION:** Steps (1) through (4) must be performed **ONLY** by qualified operators or maintenance personnel.

(1) Raise the scraper bowl to its maximum height. Make sure the power and scraper sections of the vehicle are aligned in a straight-line position.

(2) Have the operator install the steering cylinder rod travel lock sleeves as shown in Figure 3-14.

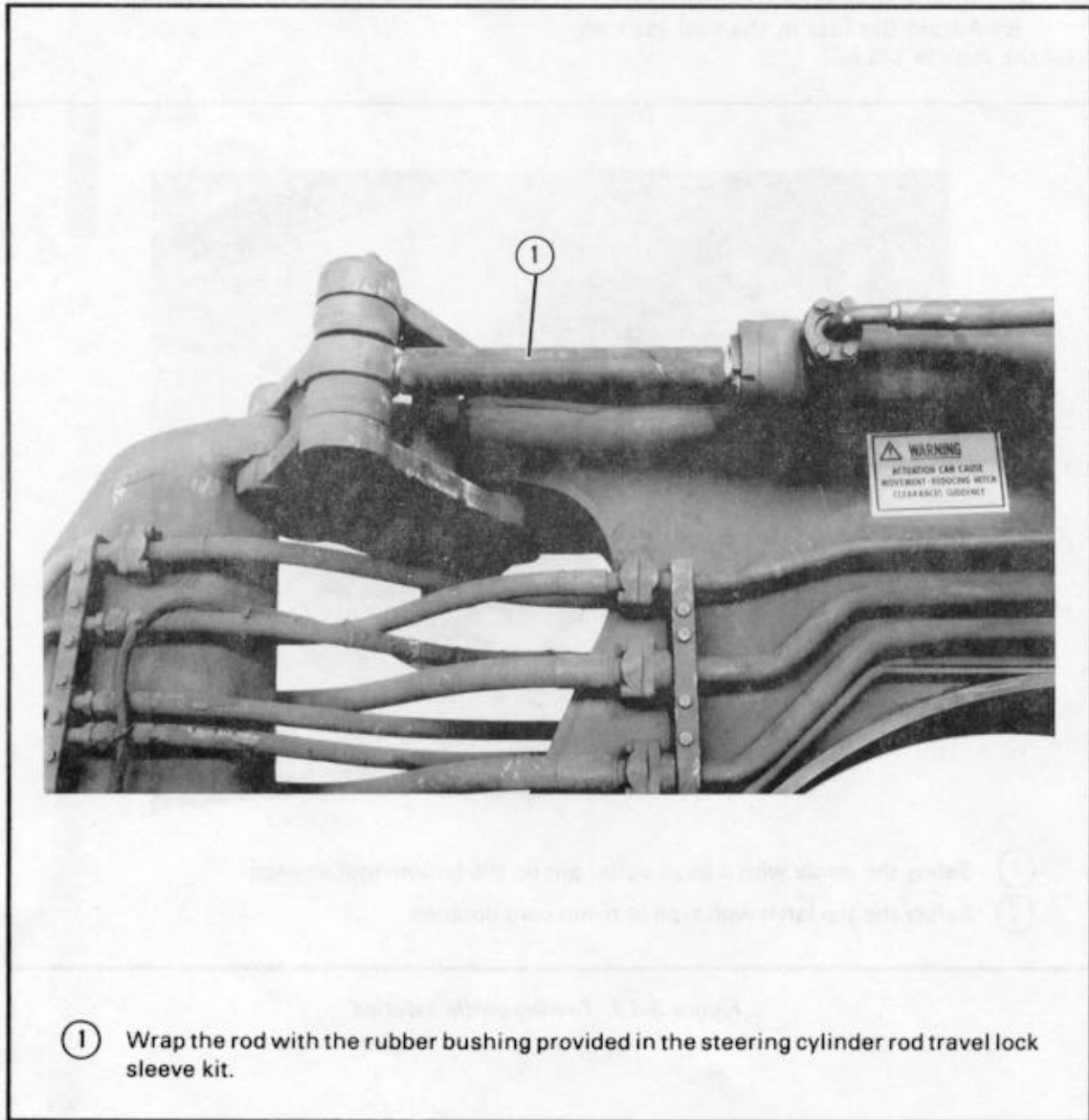
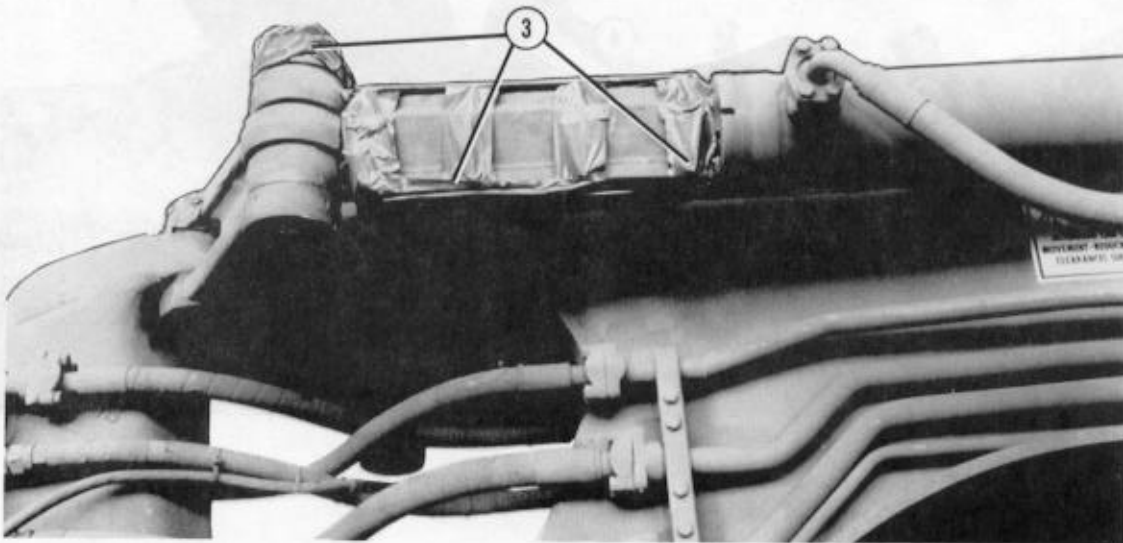
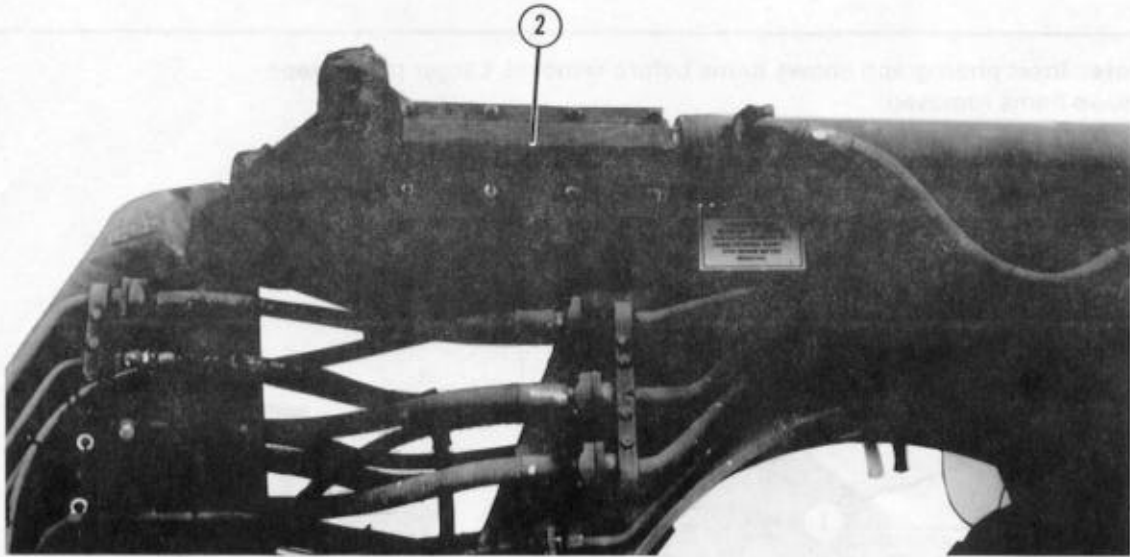

Figure 3-14. Steering cylinder rod travel lock sleeves installed



- ② Bolt on the lock sleeves. Be sure that the sleeve flanges are vertical and that the nuts face the outside.
- ③ Tape nuts, bolts, edges of sleeves, and tops of steering arm joints.

Figure 3-14. Steering cylinder rod travel lock sleeves installed (continued)

(3) Prepare the elevator motor assembly as shown in Figure 3-15.

**Note:** Inset photograph shows items before removal. Larger photograph shows items removed.

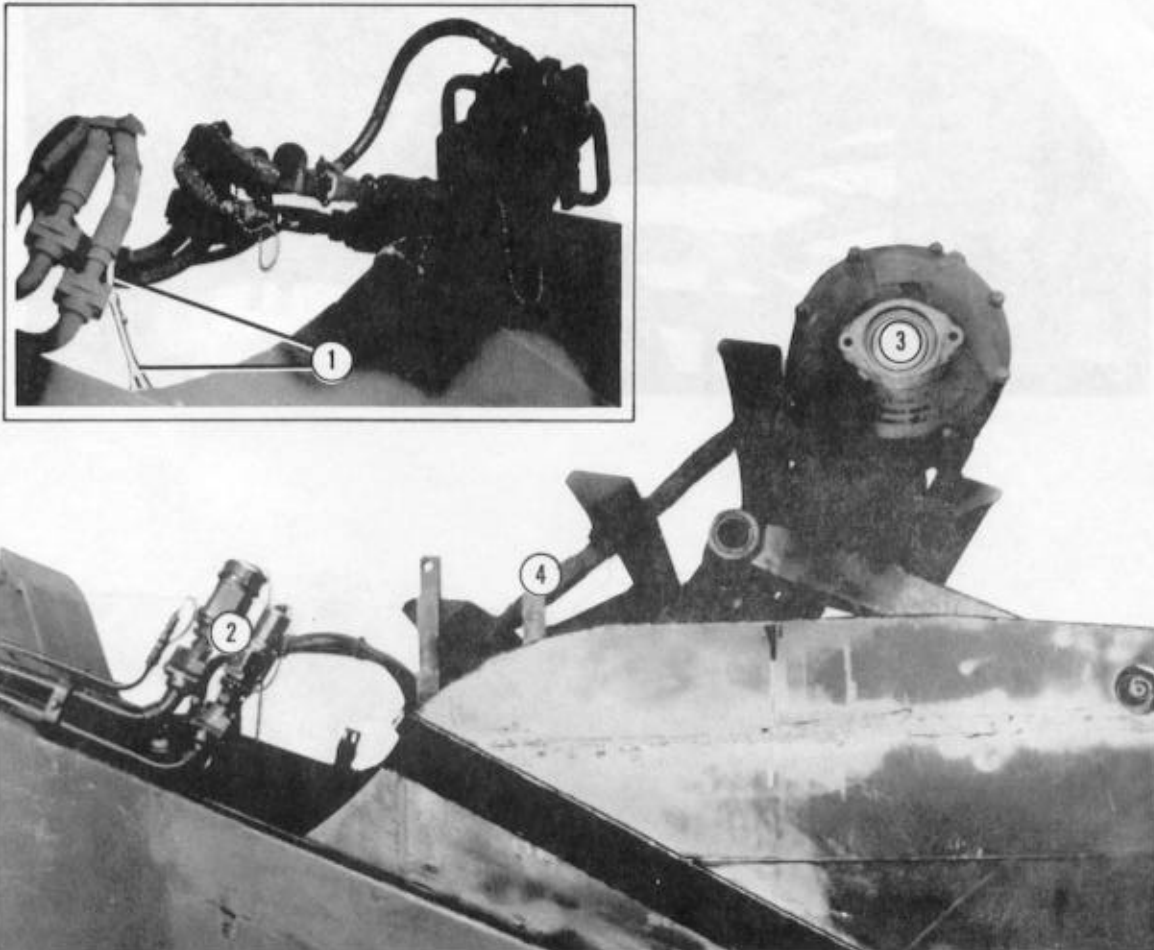

① Tie the elevator motor hose assembly to a convenient point on the load with 1/2-inch tubular nylon webbing.

OR

② Remove the elevator motor hose assembly for stowage later.

③ Remove the elevator motor from the speed reducer.

④ Remove the cap and gasket assembly from the motor stowage brackets.

Figure 3-15. Elevator motor assembly prepared

**Note:** View shown is from inside the scraper bowl.

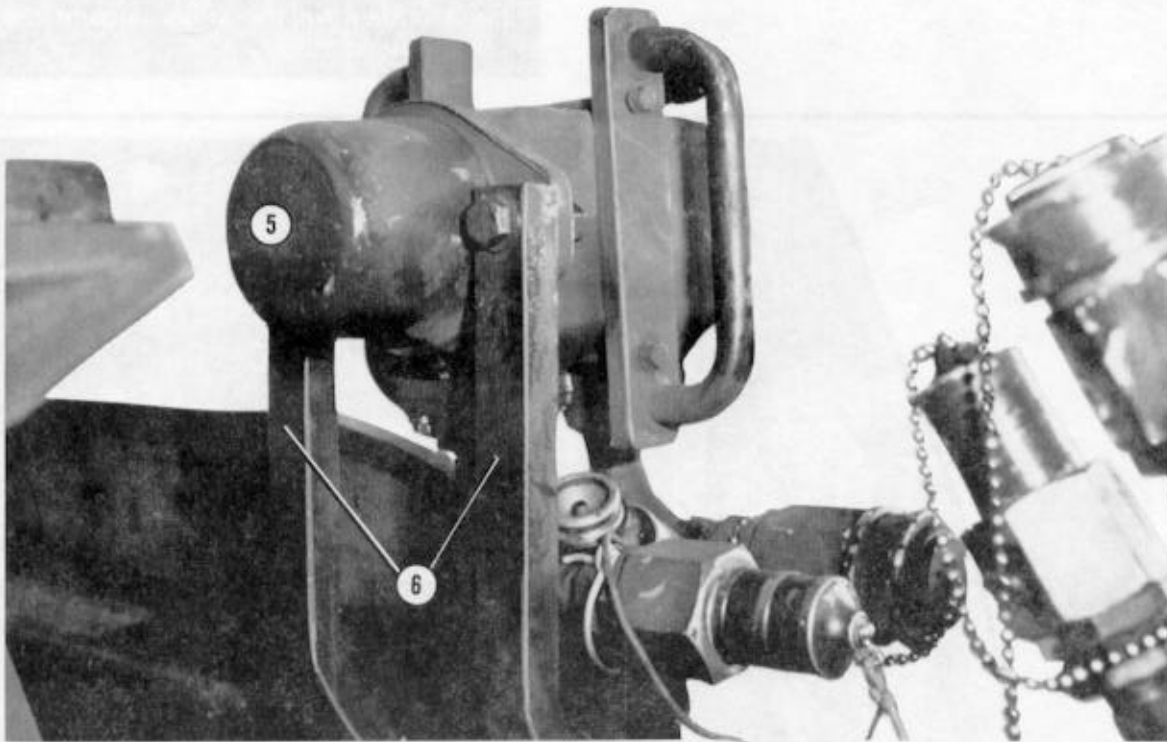

- ⑤ Place the cap and gasket over the exposed motor shaft.
- ⑥ Bolt the elevator motor assembly to the motor stowage brackets.

*Figure 3-15. Elevator motor assembly prepared (continued)*

(4) Install the elevator supports as shown in Figure 3-16.

**CAUTION:** The steps shown in Figures 3-16 and 3-17 are a three-person operation. The driver maintains hydraulic pressure on the ejector while two assistants perform these tasks. The assistants must remain on the steps outside the scraper bowl.



- ① Position the two elevator supports (Figure 3-8) inside the bowl between the elevator hanger arm support brackets and the hanger arm pivot points.
- ② Have the operator retract the ejector and lower the elevator into the bowl and onto the supports. Adjust the supports, if necessary, so that they are vertical.

*Figure 3-16. Elevator assembly prepared*

**CAUTION:** Wait until the elevator supports are placed and the elevator slats are in the reduced height position before beginning this procedure.

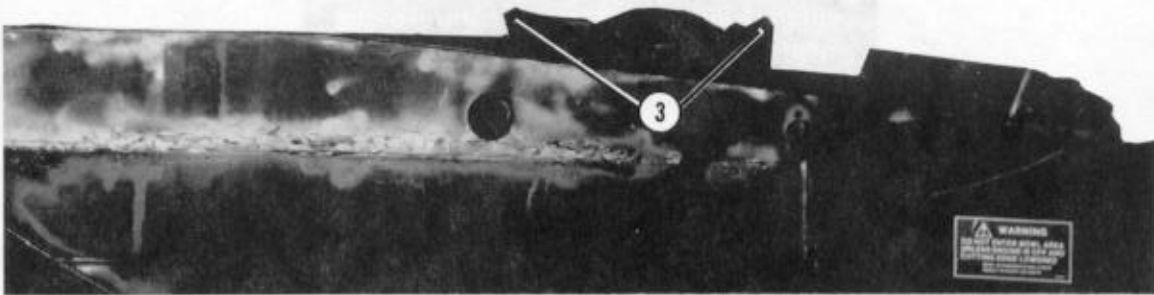

- ③ Manually position the elevator slats as shown to reduce height. (Pry bar may be required.)

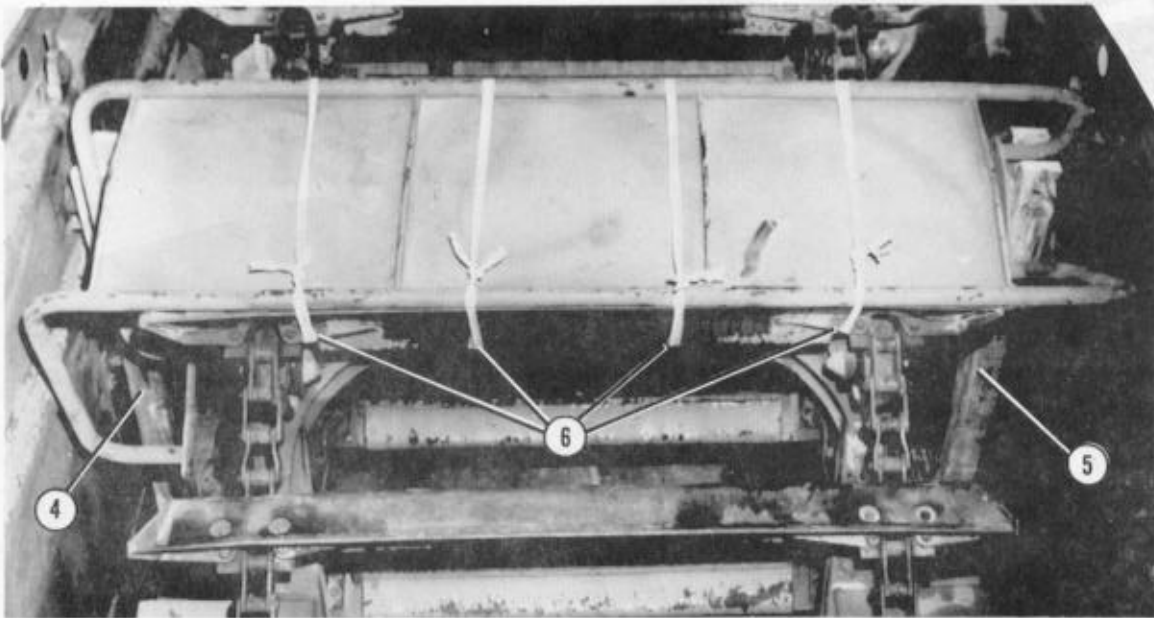

- ④ Place the straight portion of the guard supports in the left side of the scraper bowl just behind the left elevator support.
- ⑤ Place the right front curved portion of the guard support into the right elevator support.
- ⑥ Tie the elevator rack guard to the two uppermost elevator slats with four lengths of 1/2-inch tubular nylon webbing.

*Figure 3-16. Elevator assembly prepared (continued)*

(5) Secure the ejector and remove the hanger arms as shown in Figure 3-17.

**CAUTION:** Operator must keep the engine running to maintain control of the ejector during this operation.

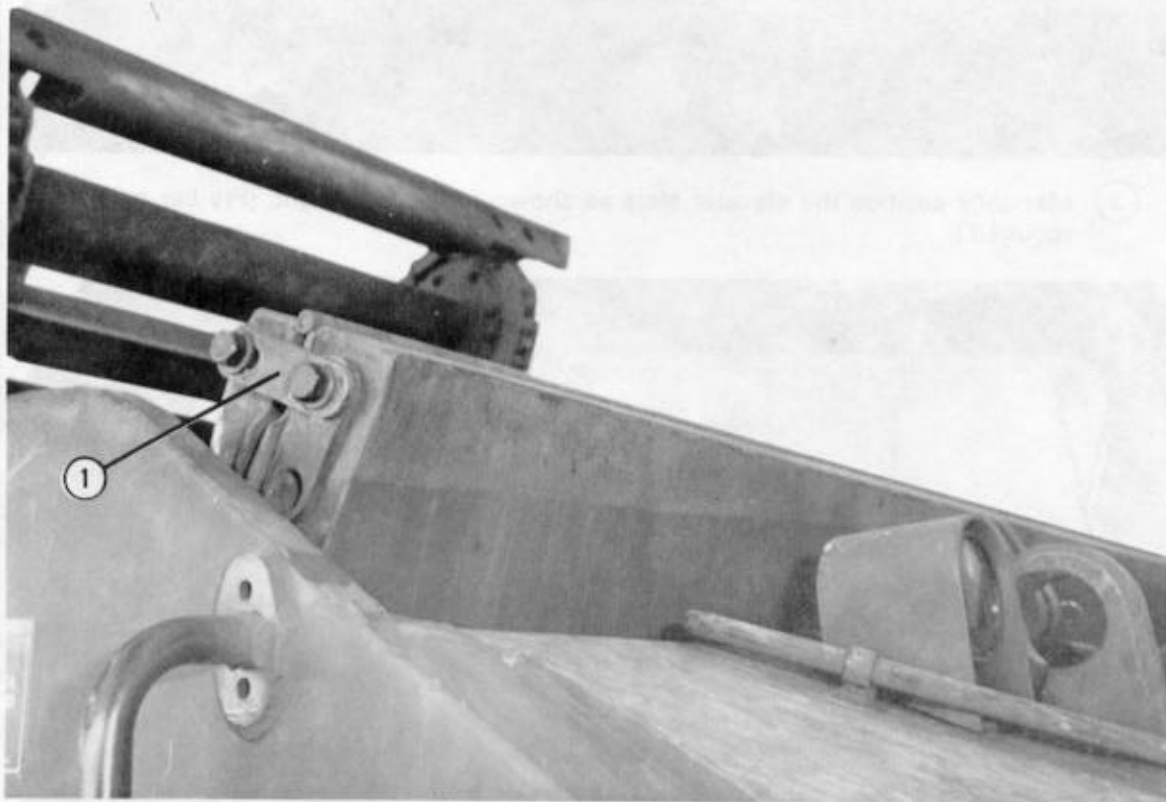

- ① Remove the bolts. Fold the top section of the ejector, and secure it with the metal straps provided. Replace the bolts.

*Figure 3-17. Ejector secured, and hanger arms removed*



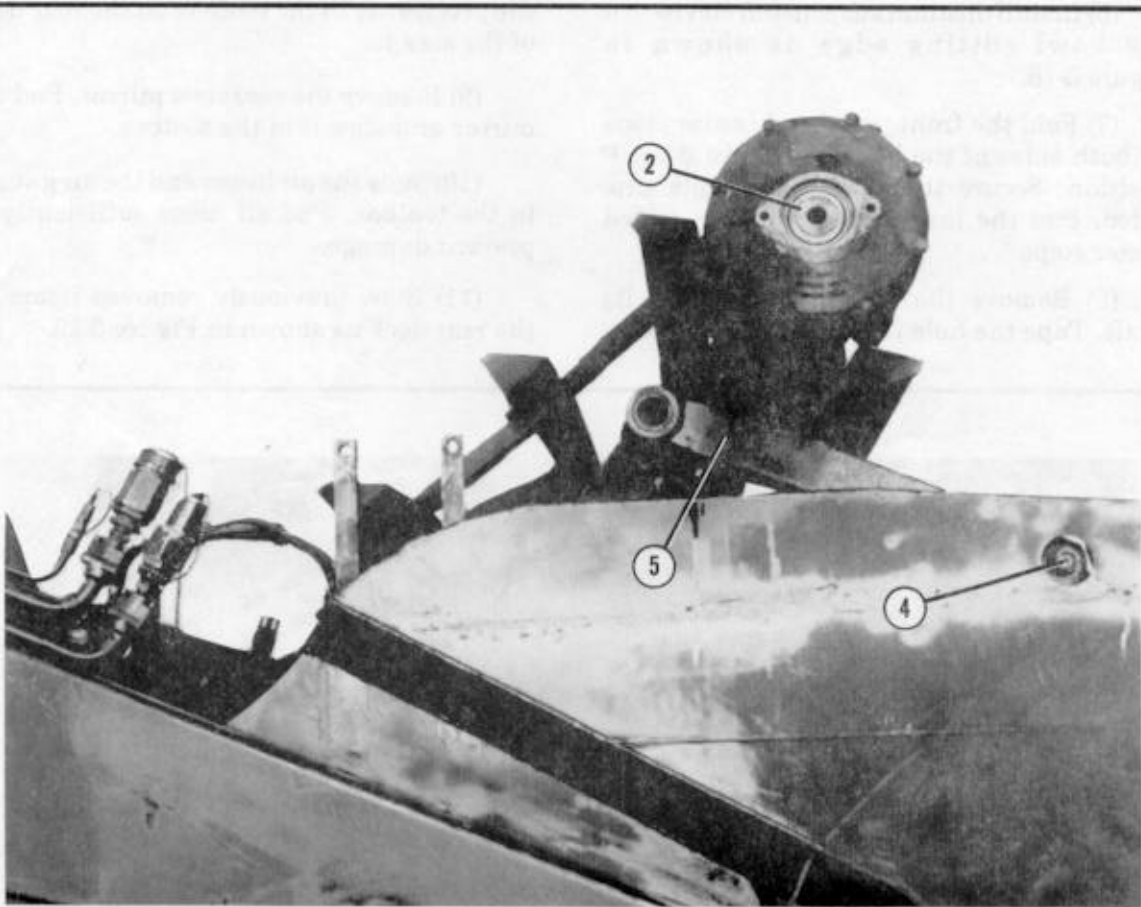

- ② Bolt the plate from the cap and gasket assembly (removed in Figure 3-15, step 4) over the speed reducer opening.
- ③ Have the operator move the ejector forward. Attach the retractor links to the ejector (not shown) with the pins and eyes provided.
- ④ Remove the hanger arm pin retaining nuts and bolts.
- ⑤ Remove the elevator hanger arms and pins. Replace the pins in the hanger arm holes for stowage later.

*Figure 3-17. Ejector secured, and hanger arms removed (continued)*

(6) Install medium suspension clevises in the bowl cutting edge as shown in Figure 3-18.

(7) Fold the front, rear, and center steps on both sides of the bowl section in the UP position. Secure them with the bolts provided. Pad the lower corners of the folded center steps.

(8) Remove the air precleaner and its shaft. Tape the hole in the air cleaner. Stow

the precleaner in the toolbox on the rear deck of the scraper.

(9) Remove the rearview mirror. Pad the mirror and stow it in the toolbox.

(10) Stow the air hoses and the air gauges in the toolbox. Pad all items sufficiently to prevent damage.

(11) Stow previously removed items on the rear deck as shown in Figure 3-19.

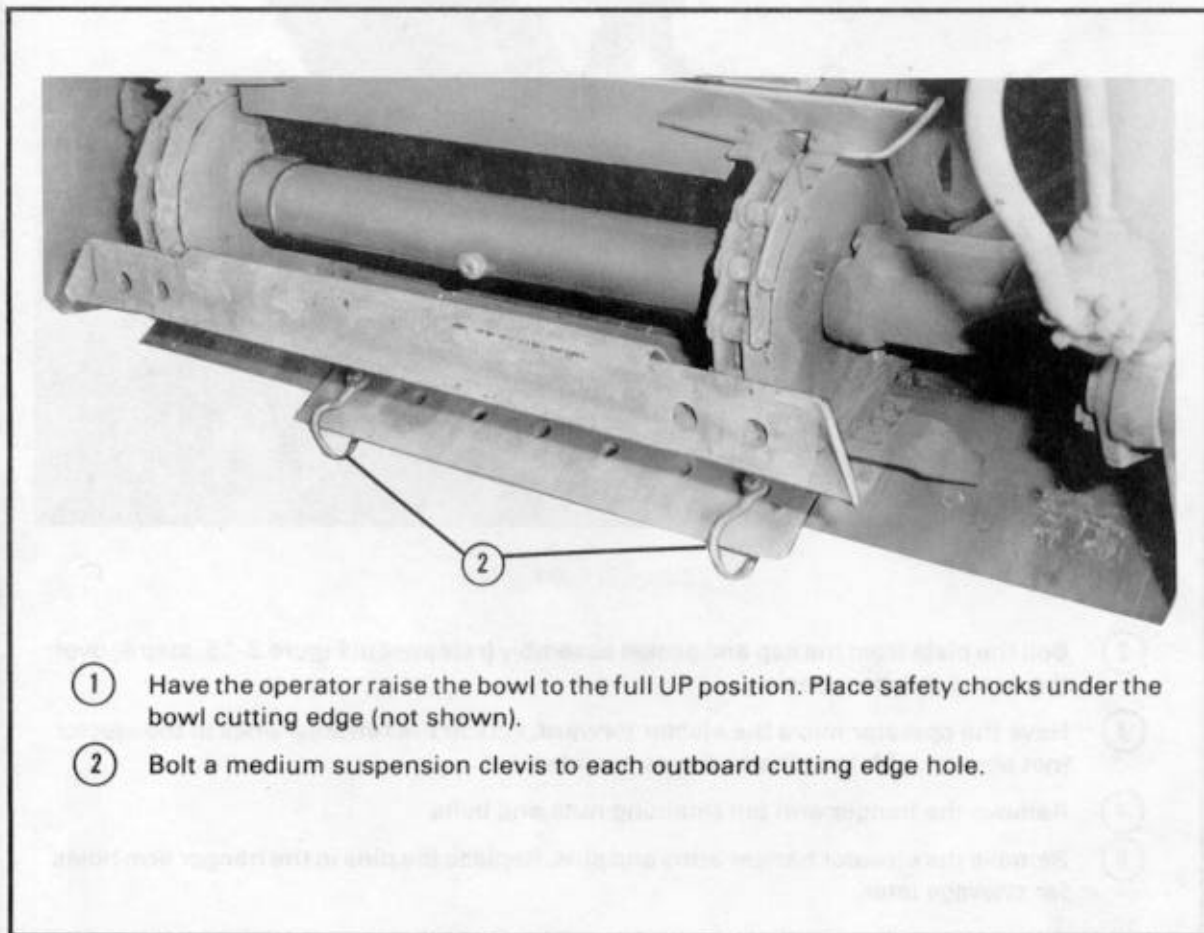
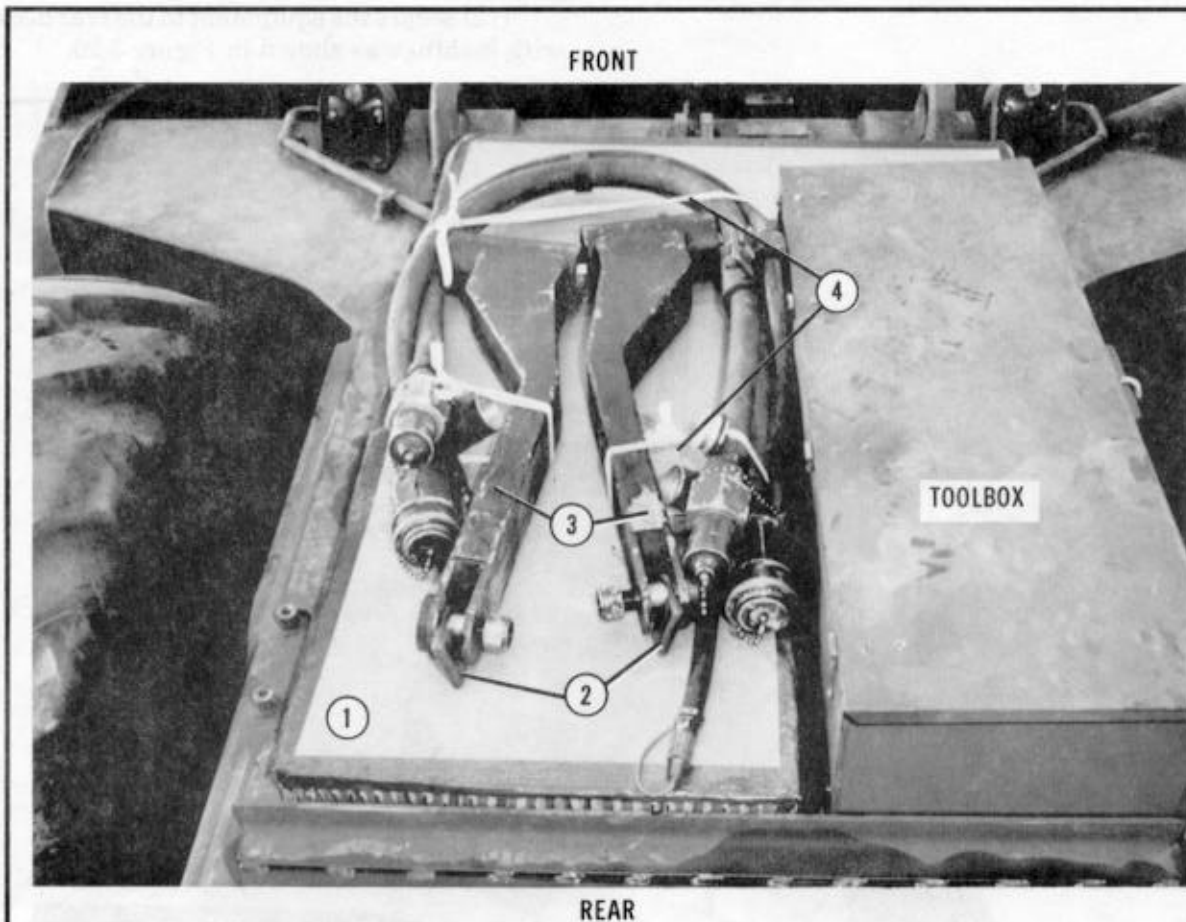

Figure 3-18. Medium suspension clevises installed in bowl cutting edge



- ① Place a 36- by 51-inch piece of honeycomb on the rear deck. Make a 15- by 41-inch cutout in the honeycomb so that the honeycomb covers the part of the deck to the left of and in front of the toolbox.
- ② Attach a D-ring to the bolt end of each hanger arm. Secure the D-rings with the hanger arm bolts.
- ③ Position the hanger arms on the honeycomb with the D-rings facing the rear of the scraper.
- ④ Position the elevator motor hoses in a U-shape around the hanger arms. Safety the hoses to the hanger arms with 1/2-inch tubular nylon webbing.

*Figure 3-19. Elevator motor hoses and hanger arms positioned on the rear deck*

(12) Secure the equipment to the rear deck with lashings as shown in Figure 3-20.

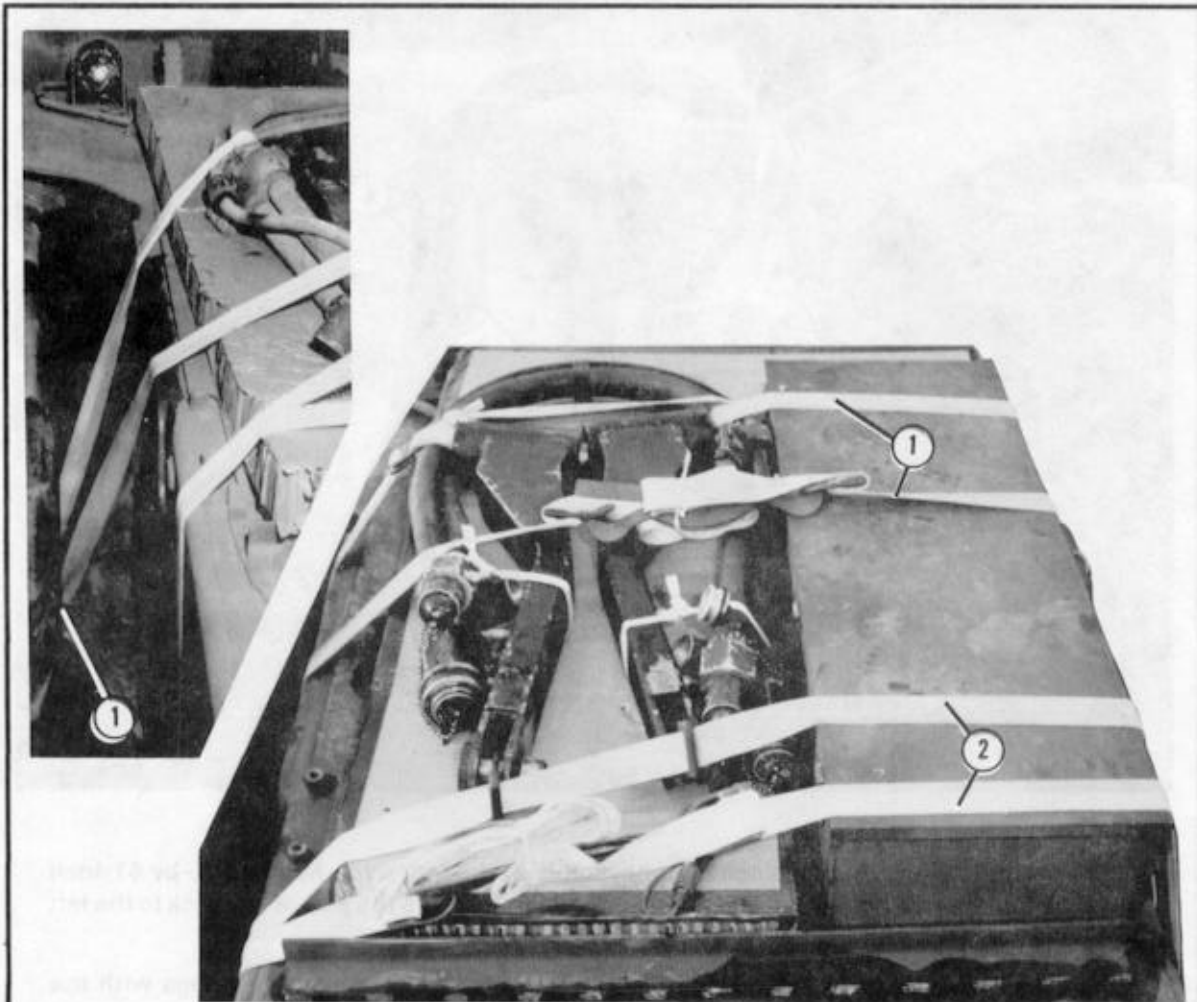

- ① Run a 30-foot lashing around the left axle between the axle and the brake line, up over the hoses, through the hanger arm holes, over the toolbox, and under the right axle. Fasten the lashing with a load binder and a D-ring on top of the deck.
- ② Run a 30-foot lashing around the push bar frame on either side, through the D-rings in the hanger arms, and over the toolbox. Fasten the lashing with a load binder and a D-ring on top of the deck.

Figure 3-20. Equipment secured to rear deck

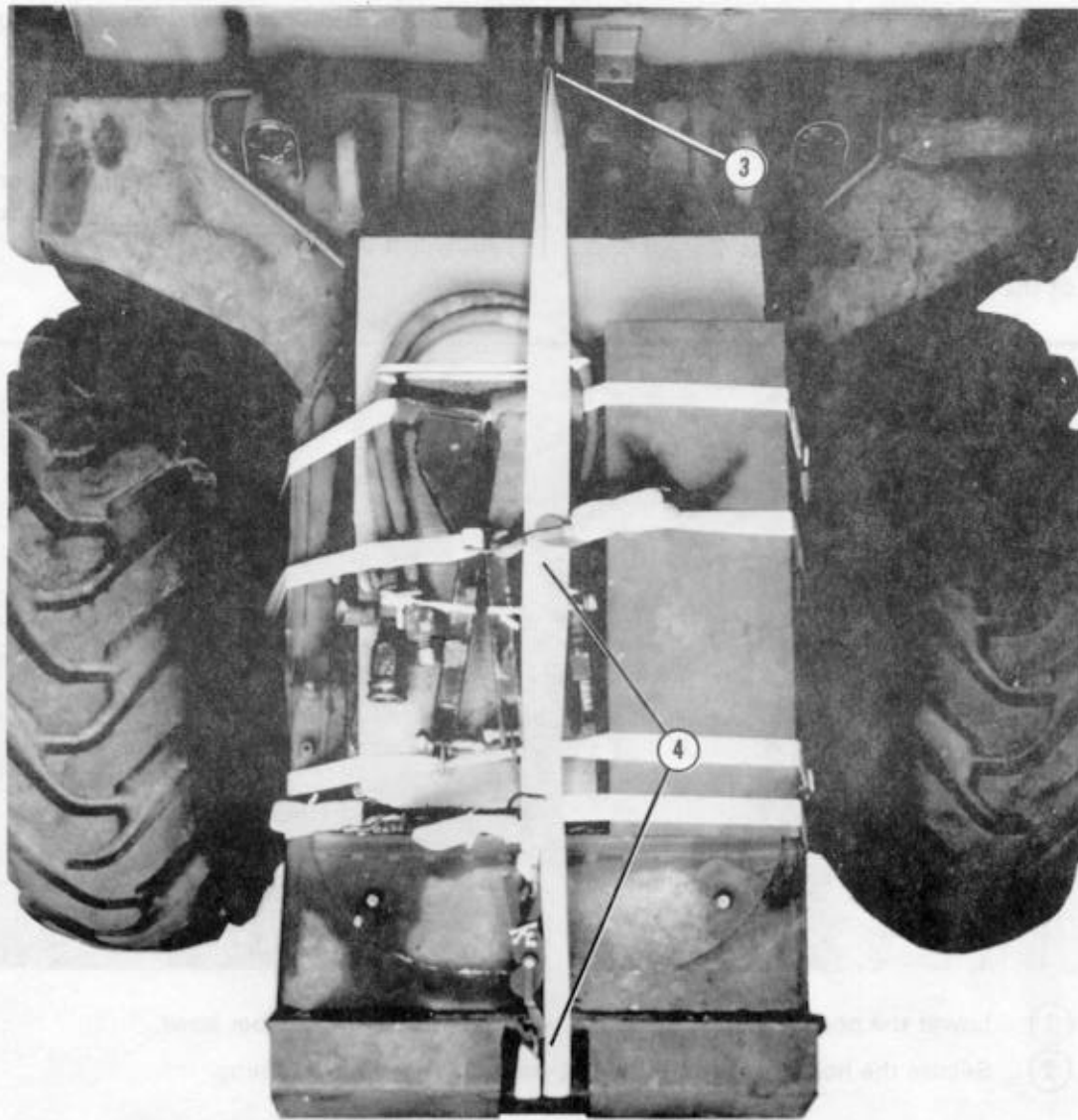

- ③ Attach a D-ring to the fitting on the rear of the ejector using the pin provided.
- ④ Run a 15-foot lashing through the D-ring on the ejector, down to the towing pintle, and back, passing it under the load binder portions of the side-to-side lashings. Fasten the lashing with a load binder and a D-ring on top of the deck.

*Figure 3-20. Equipment secured to rear deck (continued)*

(13) Prepare the cab as described below.

(a) Lower the seat, and move it all the way to the rear.

(b) Tape the ignition key in the OFF position. Safety it to the transmission lock lever with type III nylon cord.

(c) Tape all lights and gauges.

(d) Remove the control arm handles. Place them in the storage box on the right side of the operator compartment.

(e) Pad the mirror bracket above the air cleaner with cellulose wadding, and tape the cellulose wadding in place.

(14) Lower and secure the hose assembly on the scraper bowl as shown in Figure 3-21.

(15) If the scraper has quick-disconnect couplers at the front of the bowl, tape them as shown in Figure 3-22.

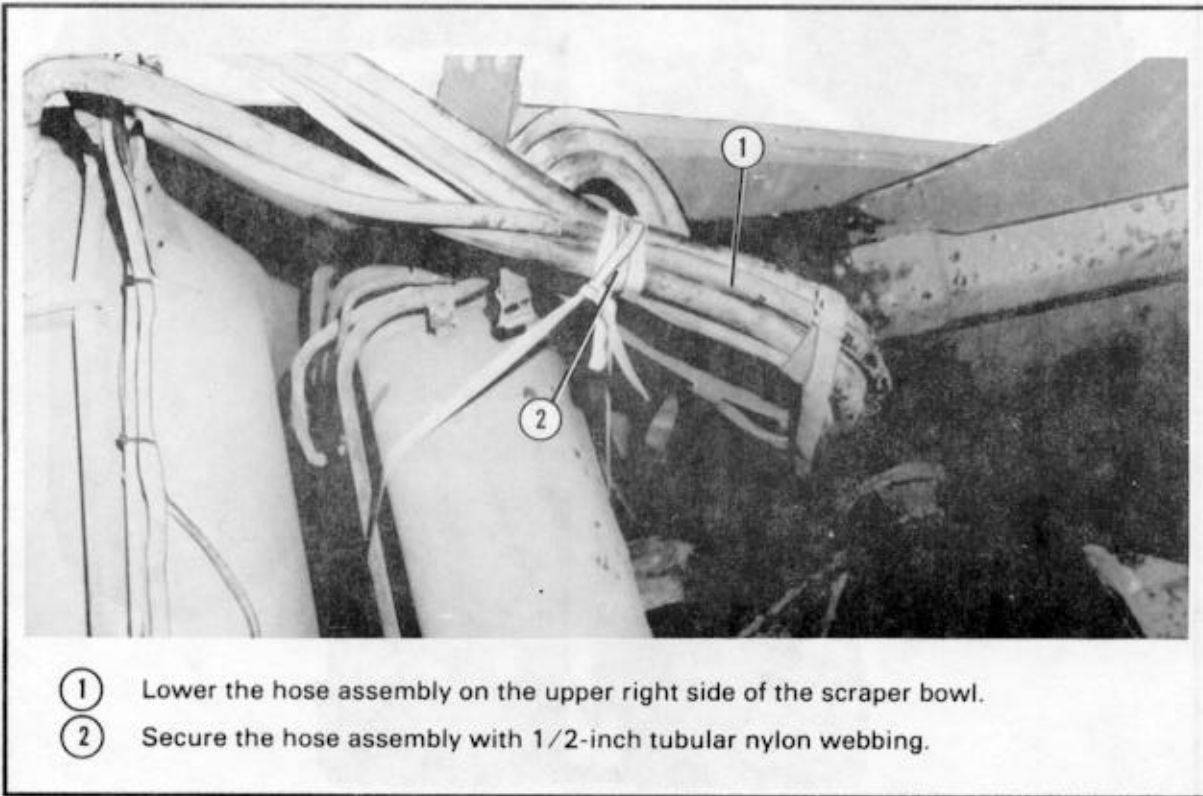
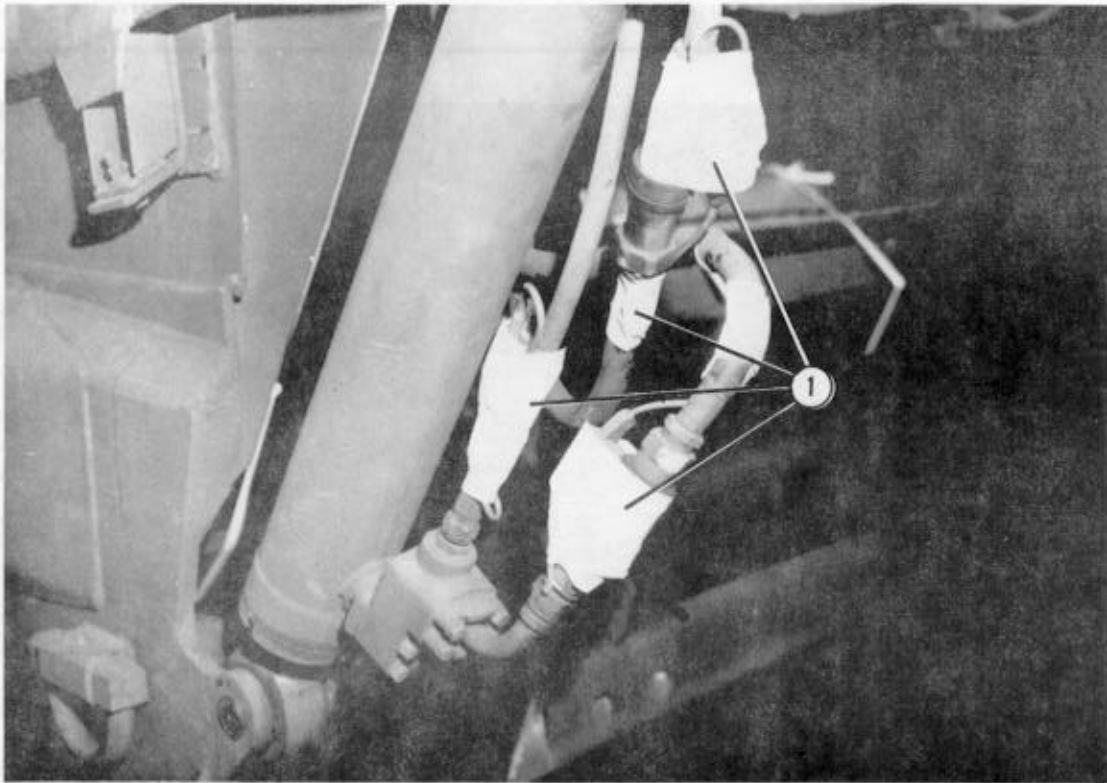

Figure 3-21. Hose assembly secured



- ① Tape the quick-disconnect couplers as shown above.

*Figure 3-22. Quick-disconnect couplers taped*

(16) Remove the muffler, and stow it on the elevator slats as shown in Figure 3-23.

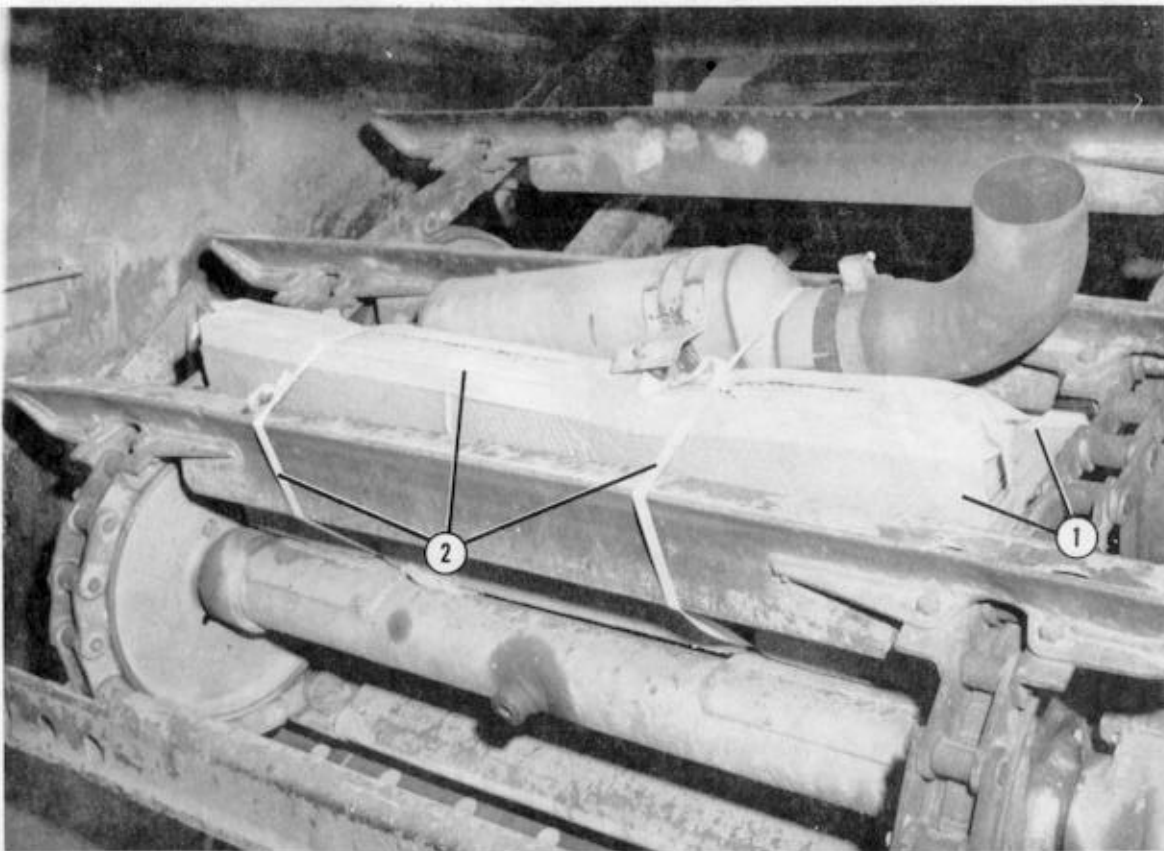

- ① Cradle the muffler between two pieces of 12- by 43-inch honeycomb placed lengthwise between the elevator chains.
- ② Tape the outer edges of the honeycomb. Tie the muffler in place with 1/2-inch tubular nylon webbing.

Figure 3-23. Muffler stowed



(17) Install the engine mount support as shown in Figure 3-24.

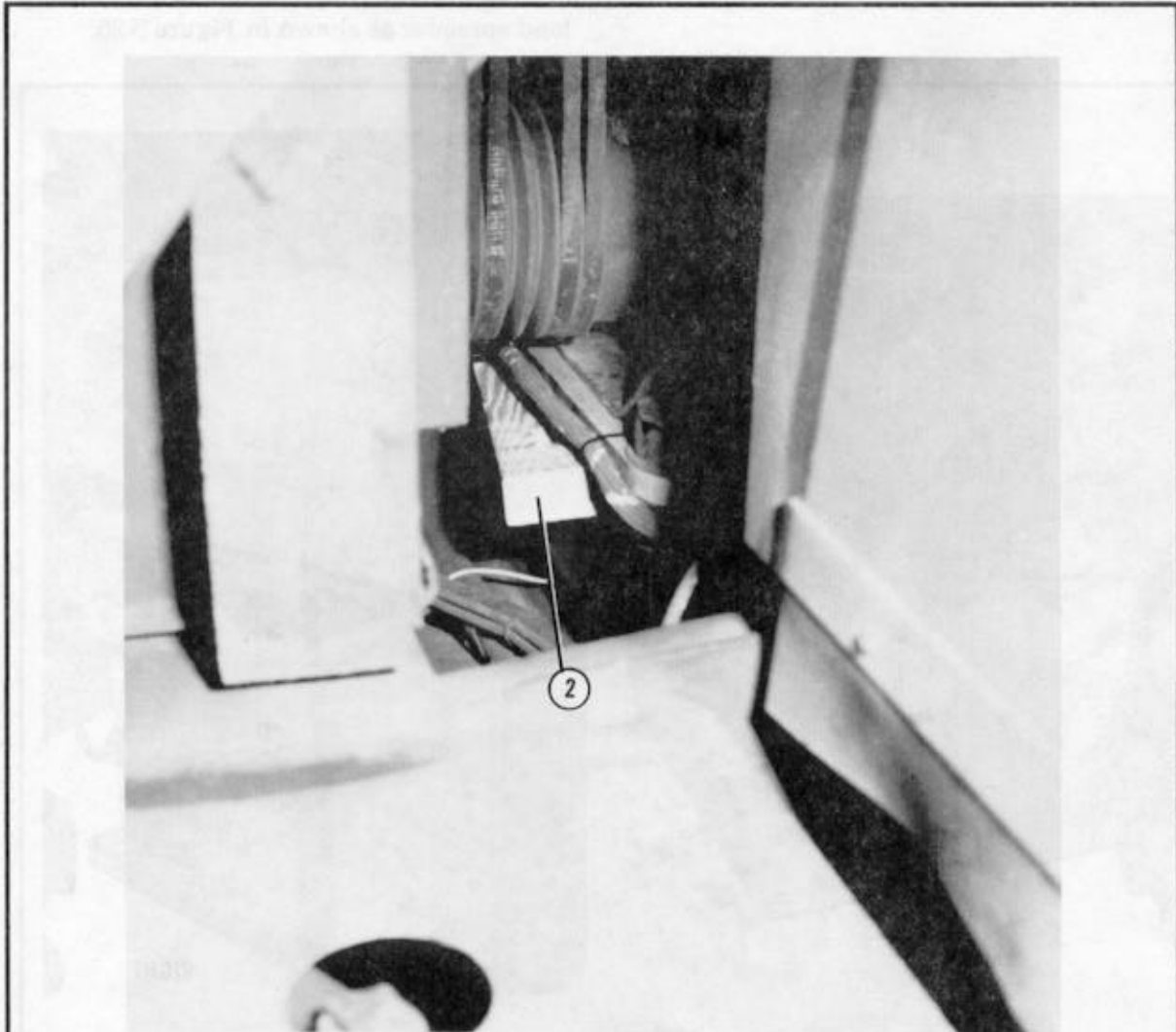

- ① Center the engine mount support (Figure 3-7) under the crankshaft pulley between the motor support and frame.
- ② Seat the engine mount support as far as possible toward the rear. Secure it around the cross member on both sides of the pulley with type III nylon cord (support shown partly installed).

*Figure 3-24. Engine mount support installed*

(18) Install the transmission housing load spreader as shown in Figure 3-25.

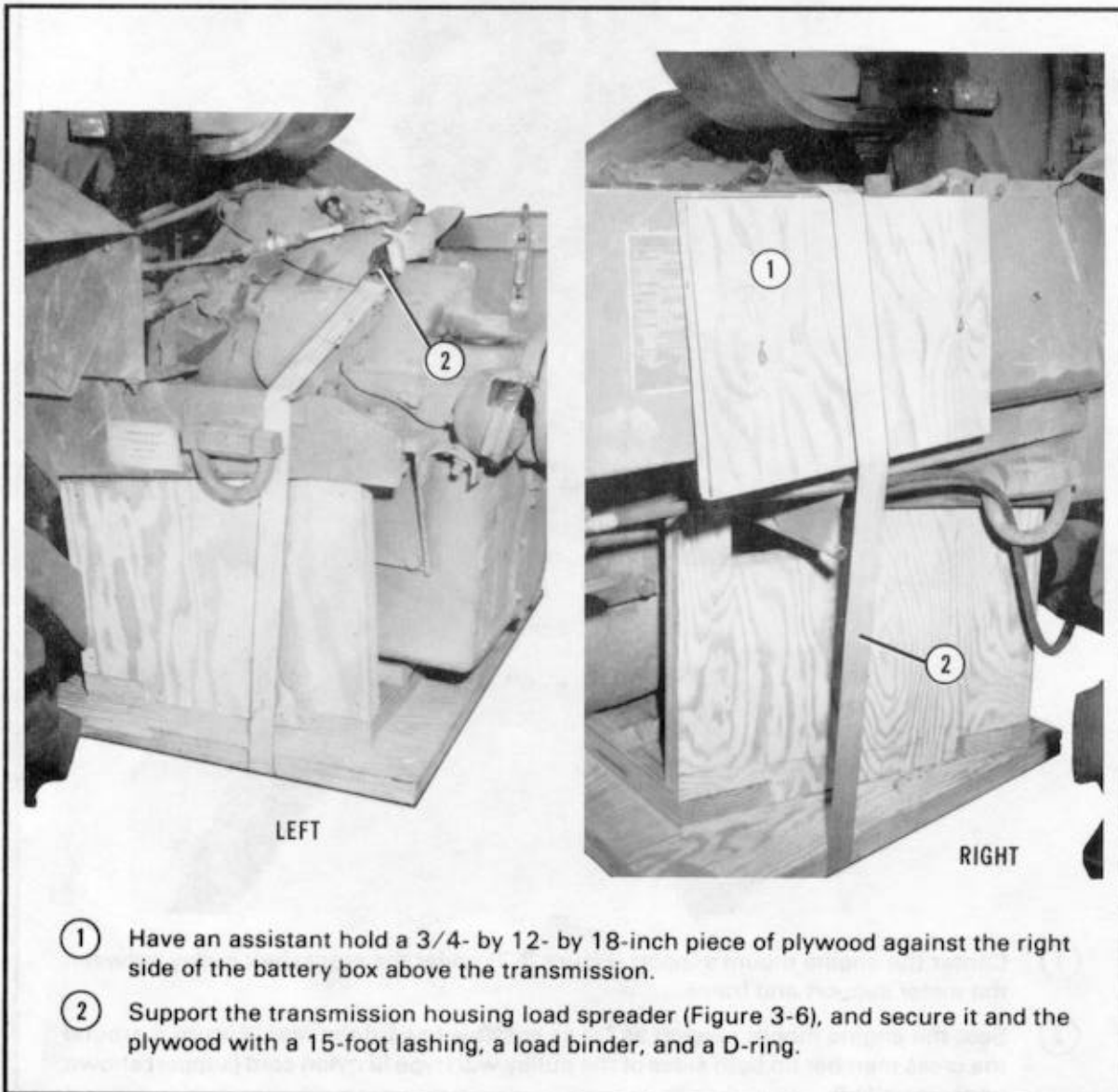
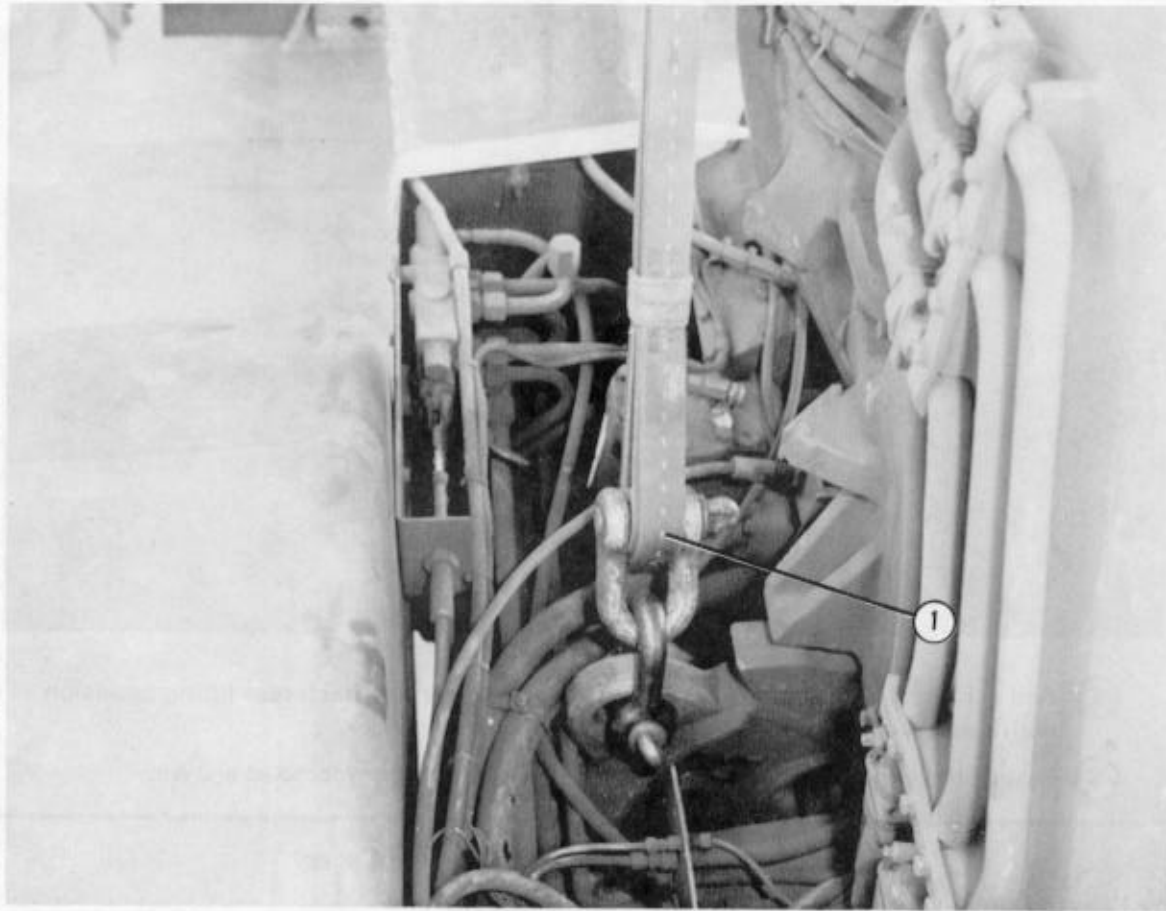

Figure 3-25. Transmission housing load spreader installed

### 3-7. Installing Lifting Slings and Positioning Scraper

Install the lifting slings as shown in Figure 3-26. Position the scraper on the honeycomb stacks as shown in Figure 3-27.



- ① Bolt a 9-foot (4-loop), type XXVI nylon webbing sling to each front lifting provision using a screw-pin suspension clevis. Pass the slings up between the steering cylinders and the frame.

*Figure 3-26. Lifting slings installed*

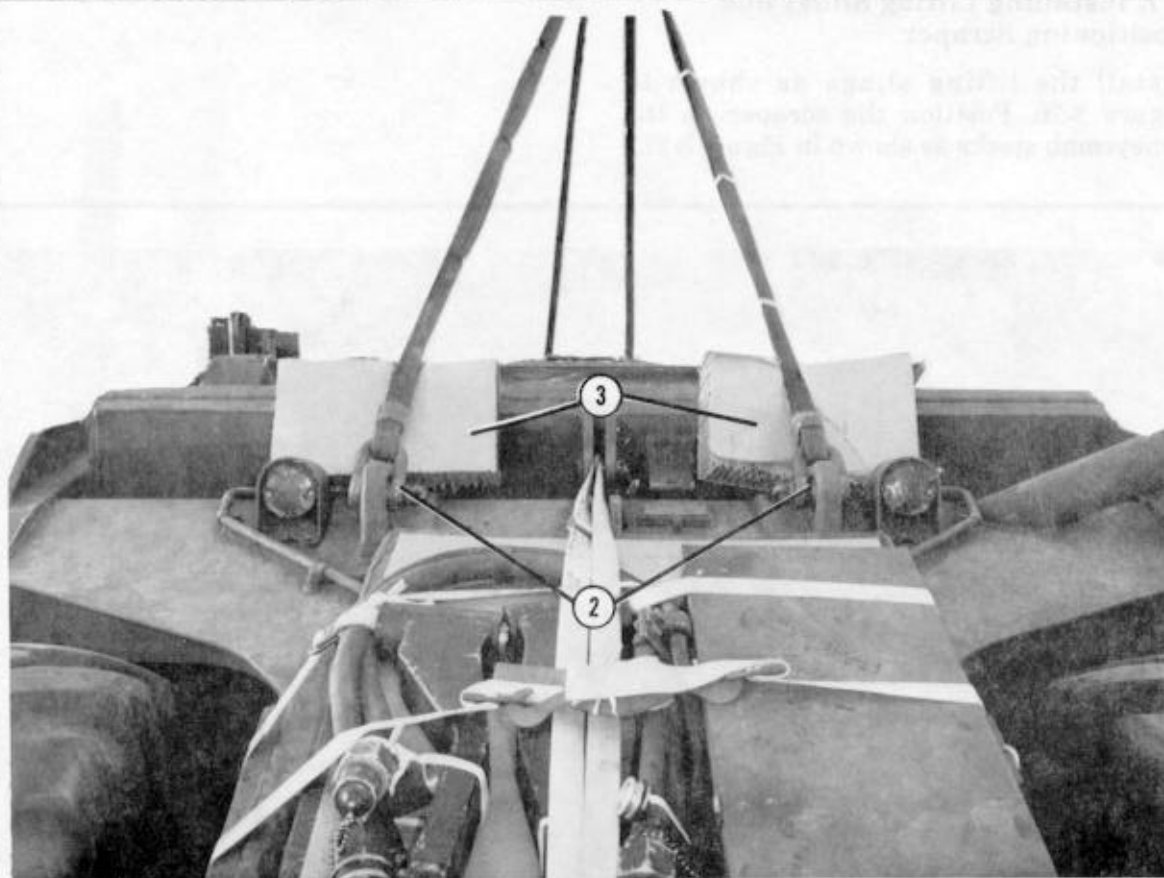

- ② Bolt a 12-foot (4-loop), type XXVI nylon webbing sling to each rear lifting provision with a screw-pin suspension clevis.
- ③ Protect the slings with two pieces of 12- by 18-inch honeycomb as shown.

*Figure 3-26. Lifting slings installed (continued)*

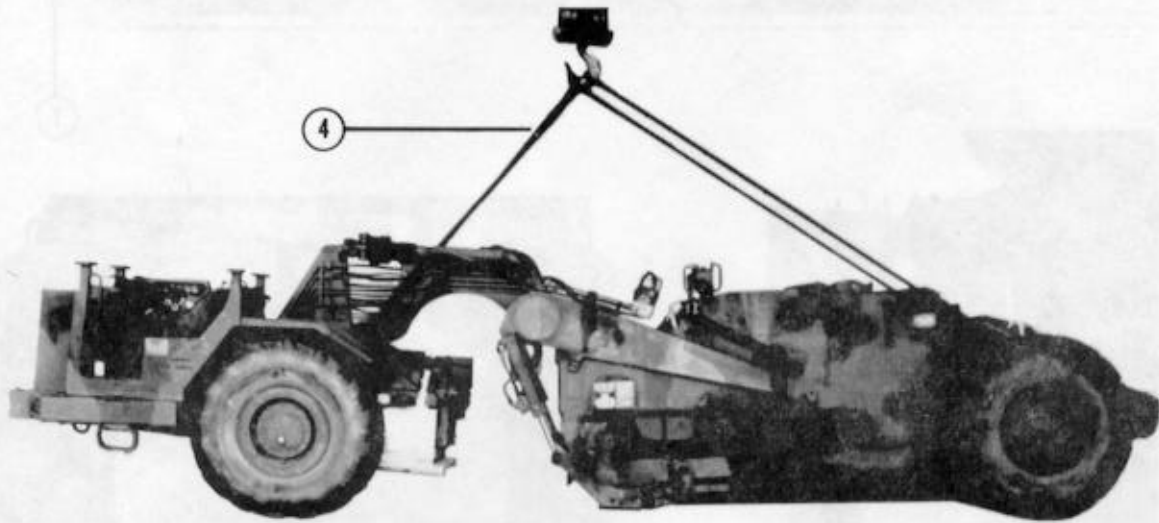

- ④ Pass a 3-foot (4-loop), type XXVI nylon webbing sling through the end loop of each of the 9-foot slings. Secure each 3-foot sling with a type IV link to form two loops. Place the slings on the crane hook in the following order: left front sling, rear slings, right front sling.

*Figure 3-26. Lifting slings installed (continued)*

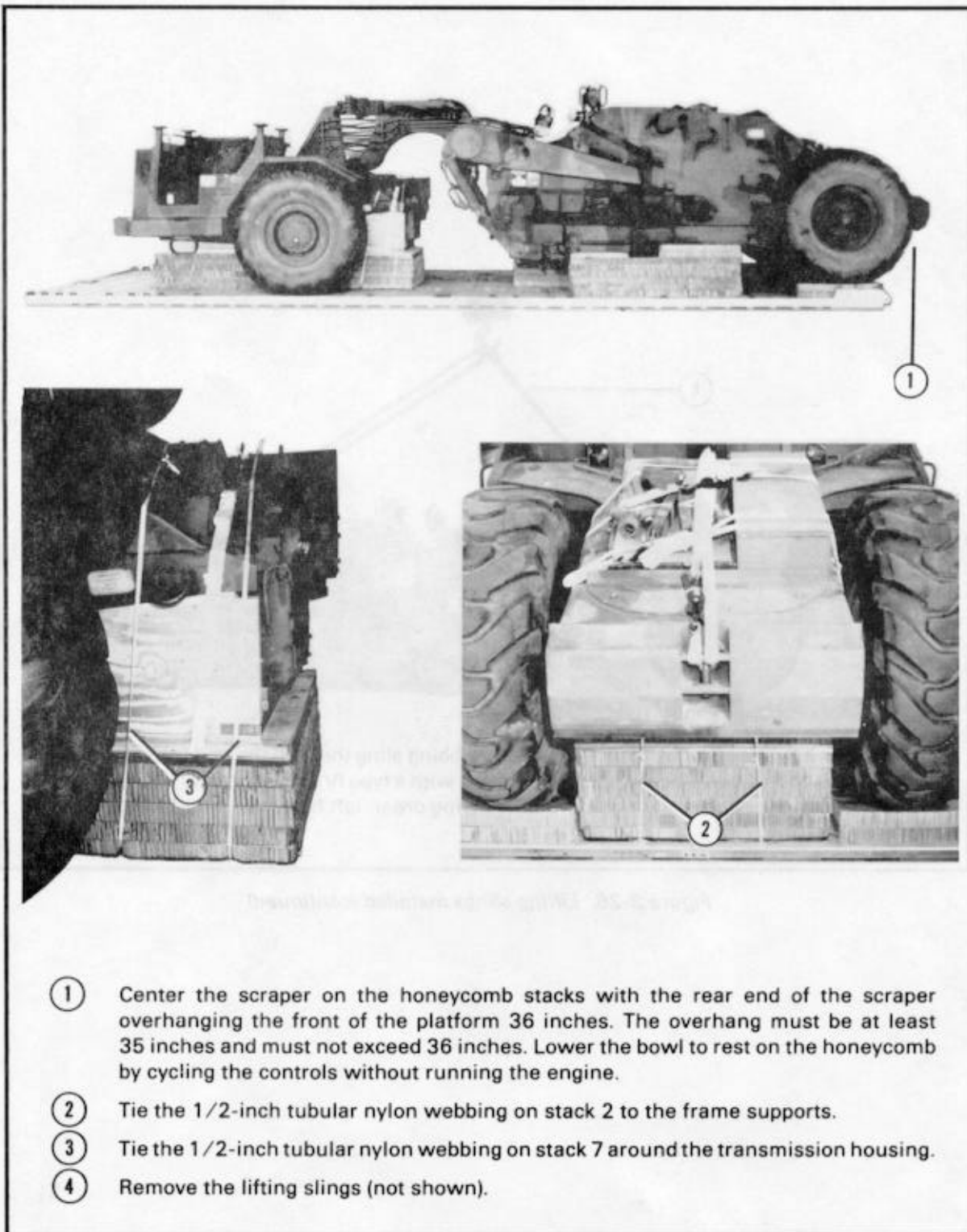

Figure 3-27. Scrapper positioned

### 3-8. Lashing Scraper

Lash the scraper to the platform using fifty-four 15-foot tie-down assemblies. Figure 3-28 shows the tie-down provisions on the scraper. Install the tie-down assemblies according to FM 10-500-2/TO 13C7-1-5 and as shown in Figures 3-29 through 3-32.

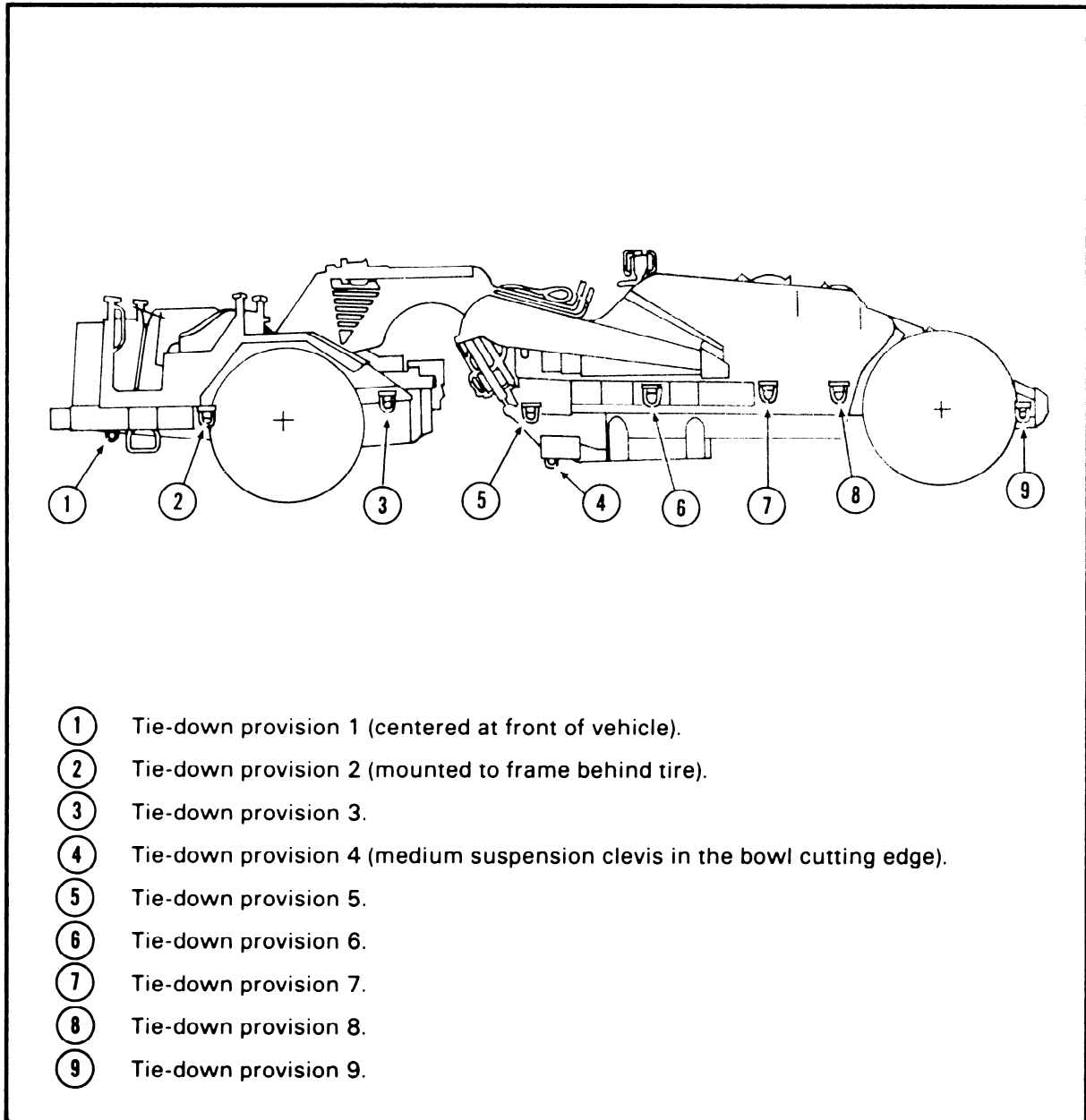
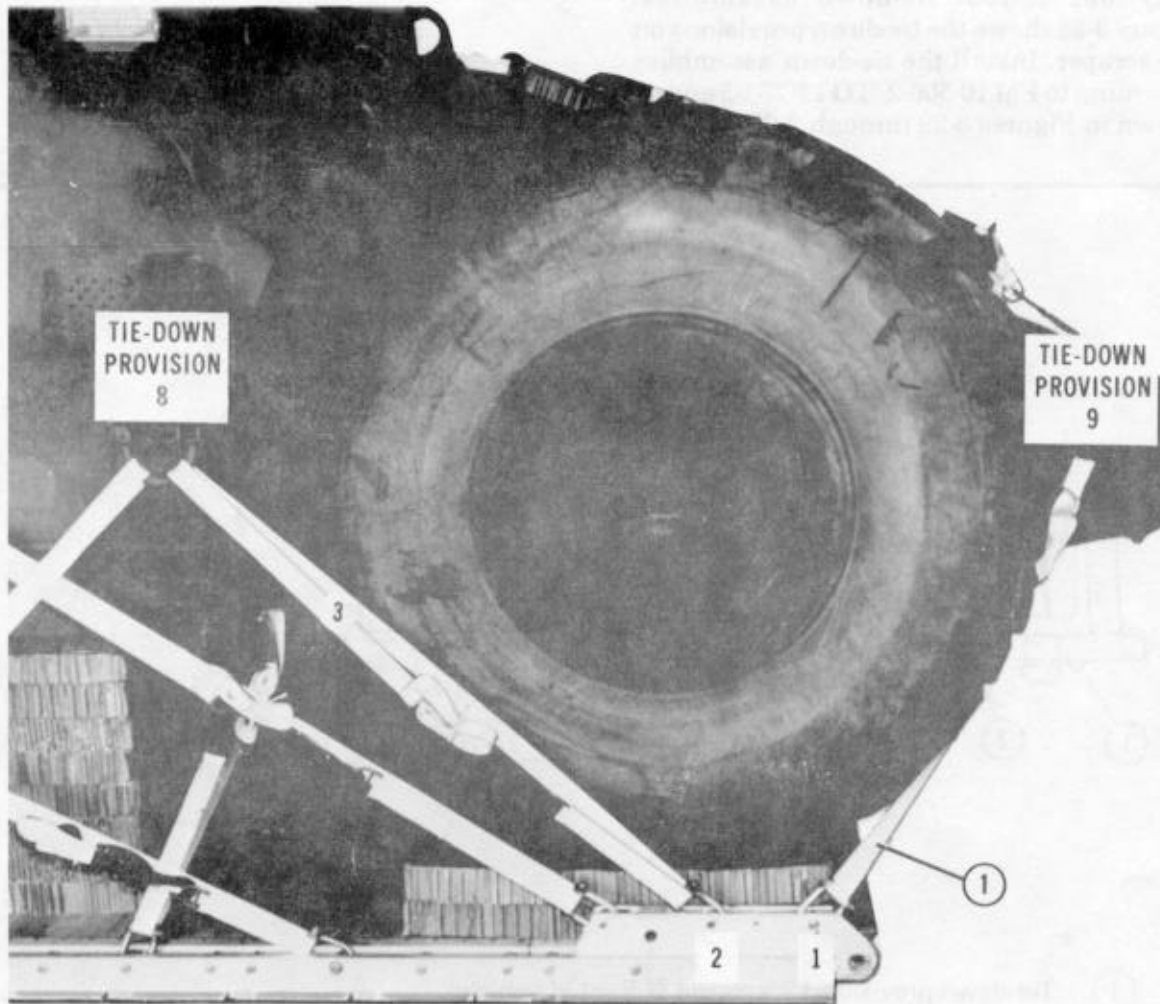

Figure 3-28. Tie-down provisions on the 613S, type I and II scrapers



Lashing Number	Tie-down Clevis Number	Instructions
1	1	Pass lashing: Through tie-down provision 9. Through tie-down provision 9. Through tie-down provision 8. Through tie-down provision 8.
2	1A	
3	2	
4	2A	

Figure 3-29. Lashings 1 through 4 installed



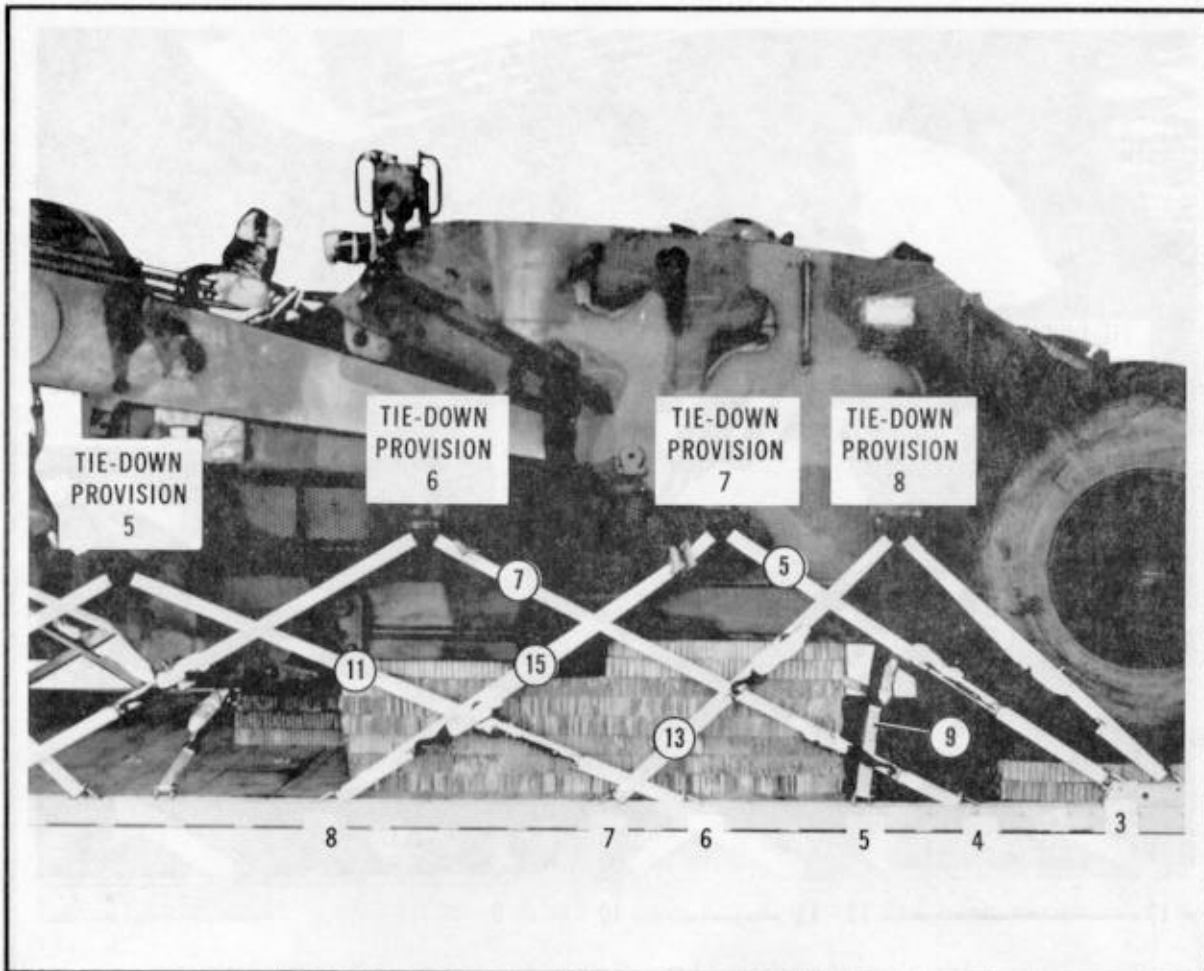

Lashing Number	Tie-down Clevis Number	Instructions
5	3	Pass lashing:
6	3A	Through tie-down provision 7.
7	4	Through tie-down provision 7.
8	4A	Through tie-down provision 6.
9	5	Through tie-down provision 6.
10	5A	Around rear frame member of vehicle.
11	6	Around rear frame member of vehicle.
12	6A	Through tie-down provision 5.
13	7	Through tie-down provision 5.
14	7A	Through tie-down provision 8.
15	8	Through tie-down provision 8.
16	8A	Through tie-down provision 7.
		Through tie-down provision 7.

Figure 3-30. Lashings 5 through 16 installed

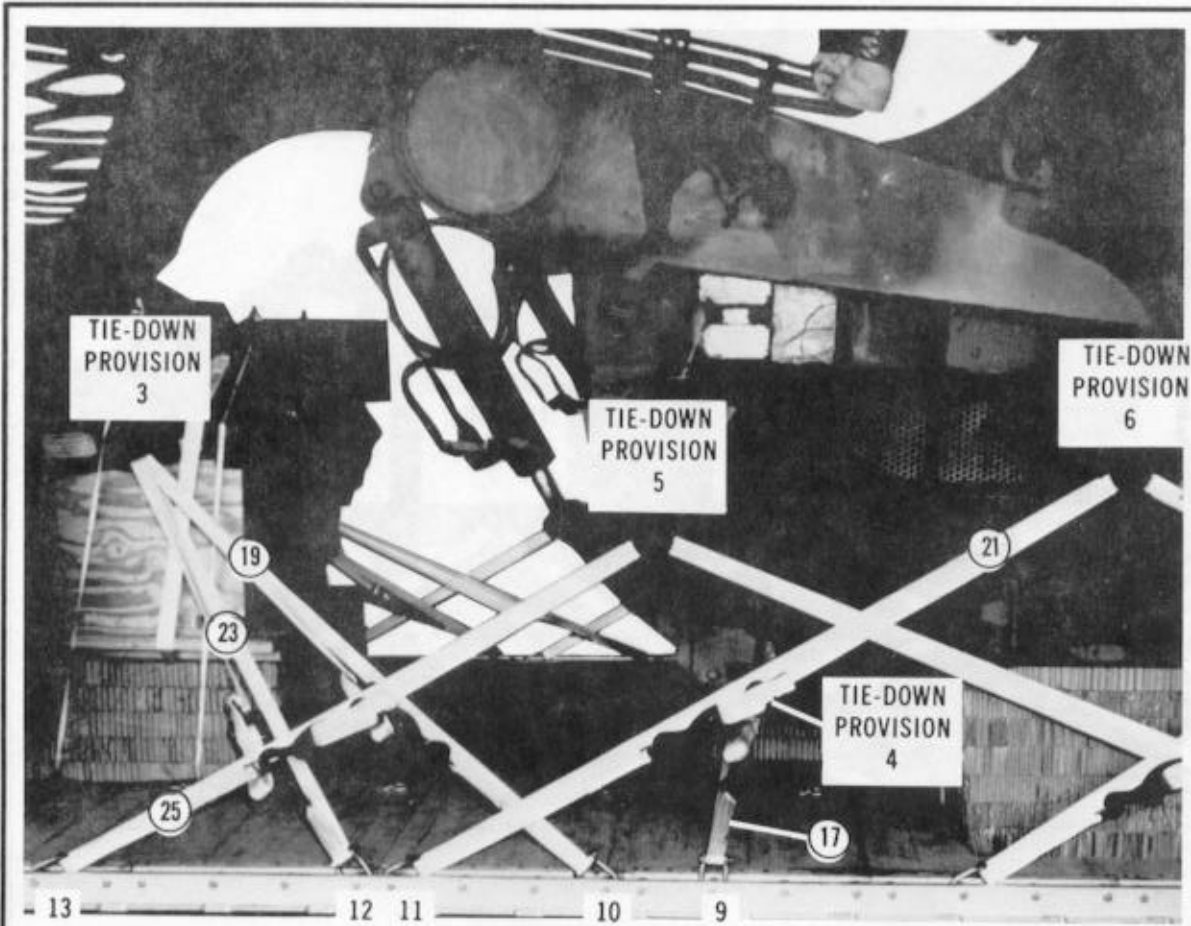

Lashing Number	Tie-down Clevis Number	Instructions
17	9	Pass lashing:
18	9A	Through tie-down provision 4.
19	10	Through tie-down provision 4.
20	10A	Through tie-down provision 3.
21	11	Through tie-down provision 3.
22	11A	Through tie-down provision 6.
23	12	Through tie-down provision 6.
24	12A	Through tie-down provision 3.
25	13	Through tie-down provision 3.
26	13A	Through tie-down provision 5.
		Through tie-down provision 5.

Figure 3-31. Lashings 17 through 26 installed

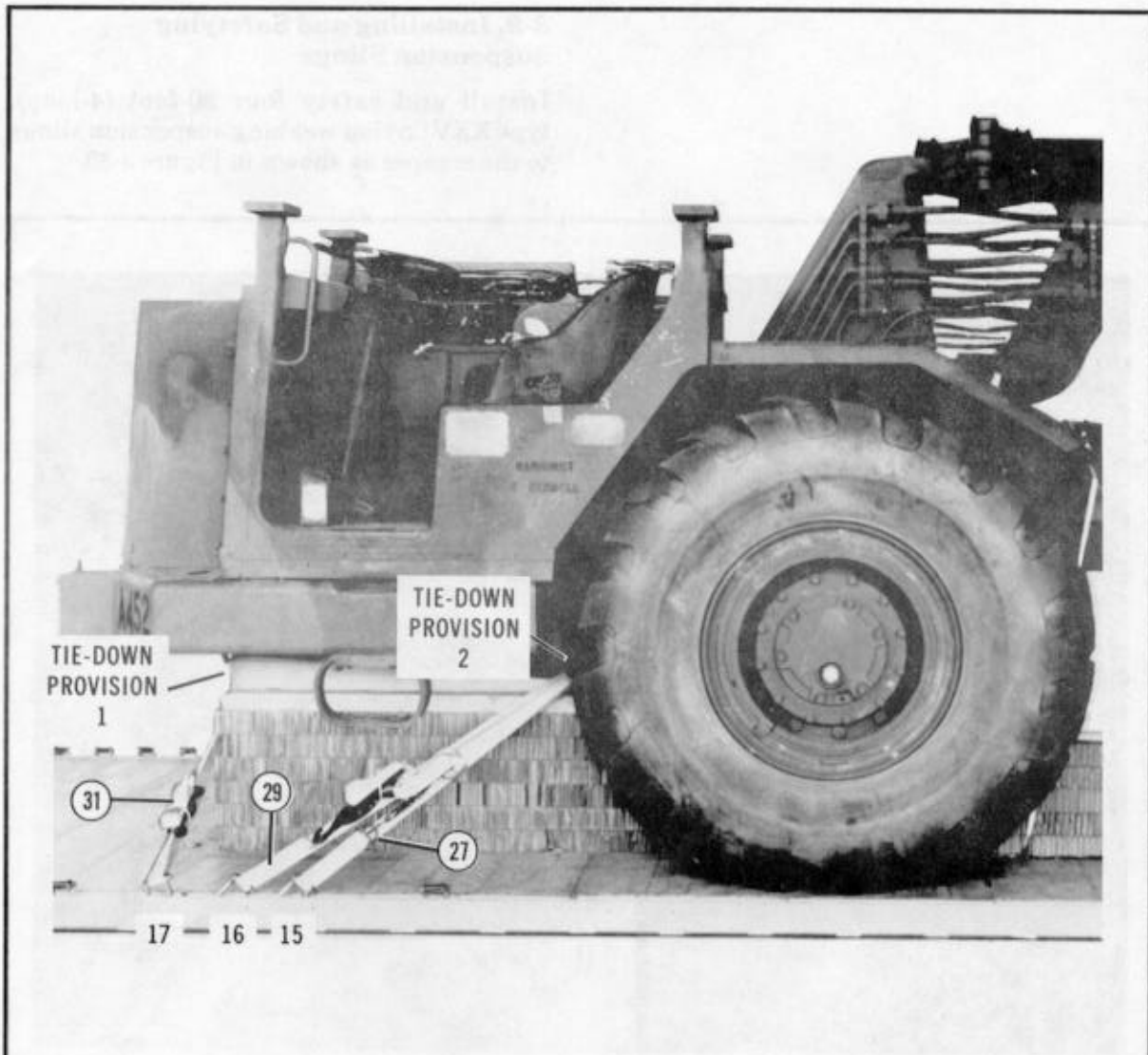

Lashing Number	Tie-down Clevis Number	Instructions
27	15	Pass lashing: Through tie-down provision 2. Through tie-down provision 2. Through tie-down provision 2. Through tie-down provision 2. Through tie-down provision 1. Through tie-down provision 1.
28	15A	
29	16	
30	16A	
31	17	
32	17A	

Figure 3-32. Lashings 27 through 32 installed

### 3-9. Installing and Safetying Suspension Slings

Install and safety four 20-foot (4-loop), type XXVI nylon webbing suspension slings to the scraper as shown in Figure 3-33.

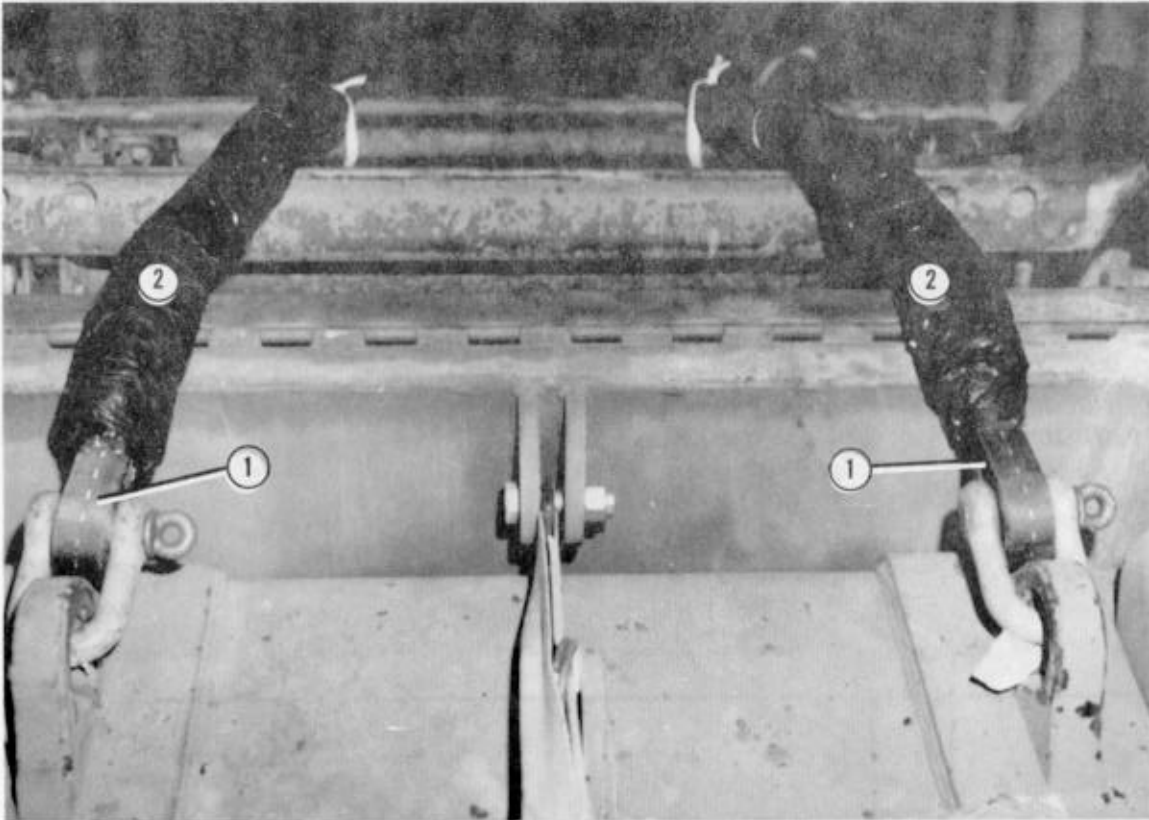

- ① Bolt a 20-foot sling to each of the lifting provisions at the rear of the scraper with a screw-pin suspension clevis. Install a 2 3/8-inch steel spacer on each clevis pin. These will be the front slings.
- ② Wrap each front sling with an 8- by 36-inch piece of felt. Tape the felt in place with pressure-sensitive tape beginning 1 inch from the end loop of the sling.

Figure 3-33. Suspension slings installed and safetyed

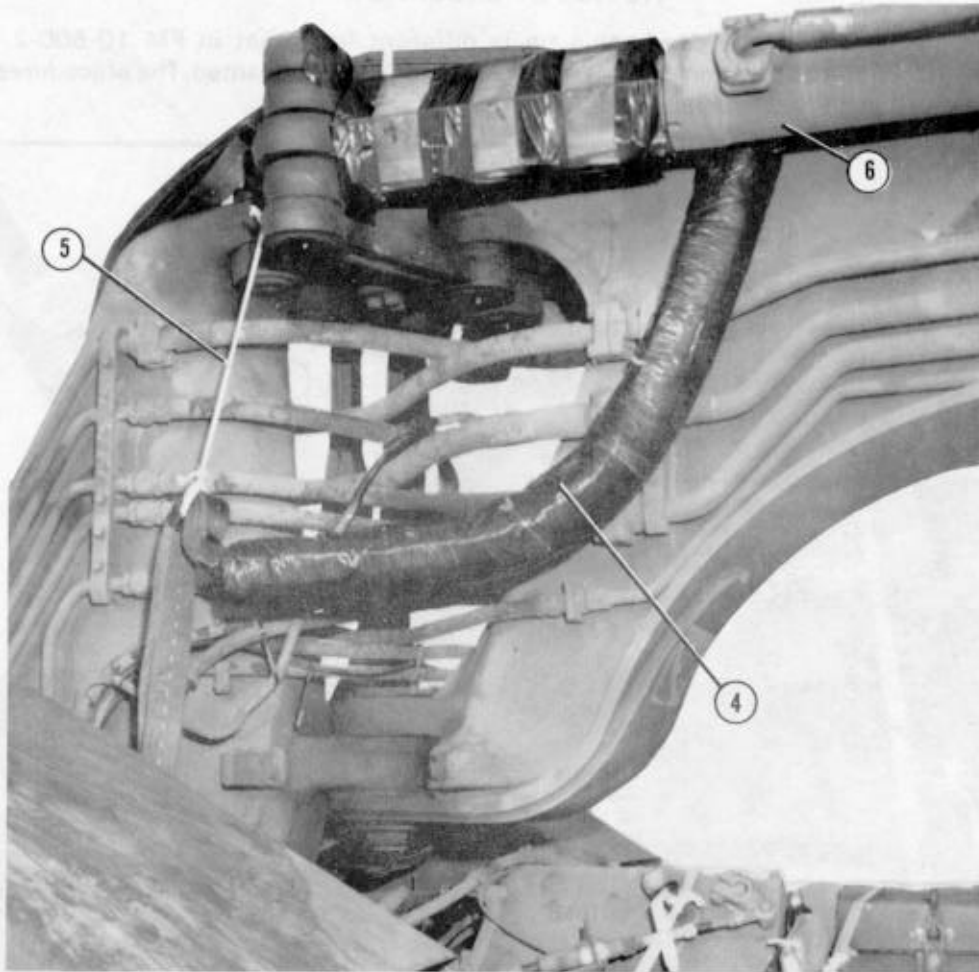

- ③ Bolt a 20-foot sling to each of the lifting provisions at the front of the scraper with a screw-pin suspension clevis (not shown). Install a 2 3/8-inch steel spacer on each clevis pin. These will be the rear slings.
- ④ Wrap each rear sling with an 8- by 36-inch piece of felt. Tape the felt in place with pressure-sensitive tape beginning 30 inches from the end loop of the sling.
- ⑤ Safety the rear slings to the steering assembly arms with two lengths of type I, 1/4-inch cotton webbing. Tie the webbing 22 inches from the clevis.
- ⑥ Pass the slings between the steering cylinders and the frame.

Figure 3-33. Suspension slings installed and safetied (continued)

### NOTICE OF EXCEPTION

The positioning of the deadman's tie is different from that in FM 10-500-2/TO 13C7-1-5. An exception to FM 10-500-2/TO 13C7-1-5 is granted. The procedures in steps 7 and 8 below must be followed.

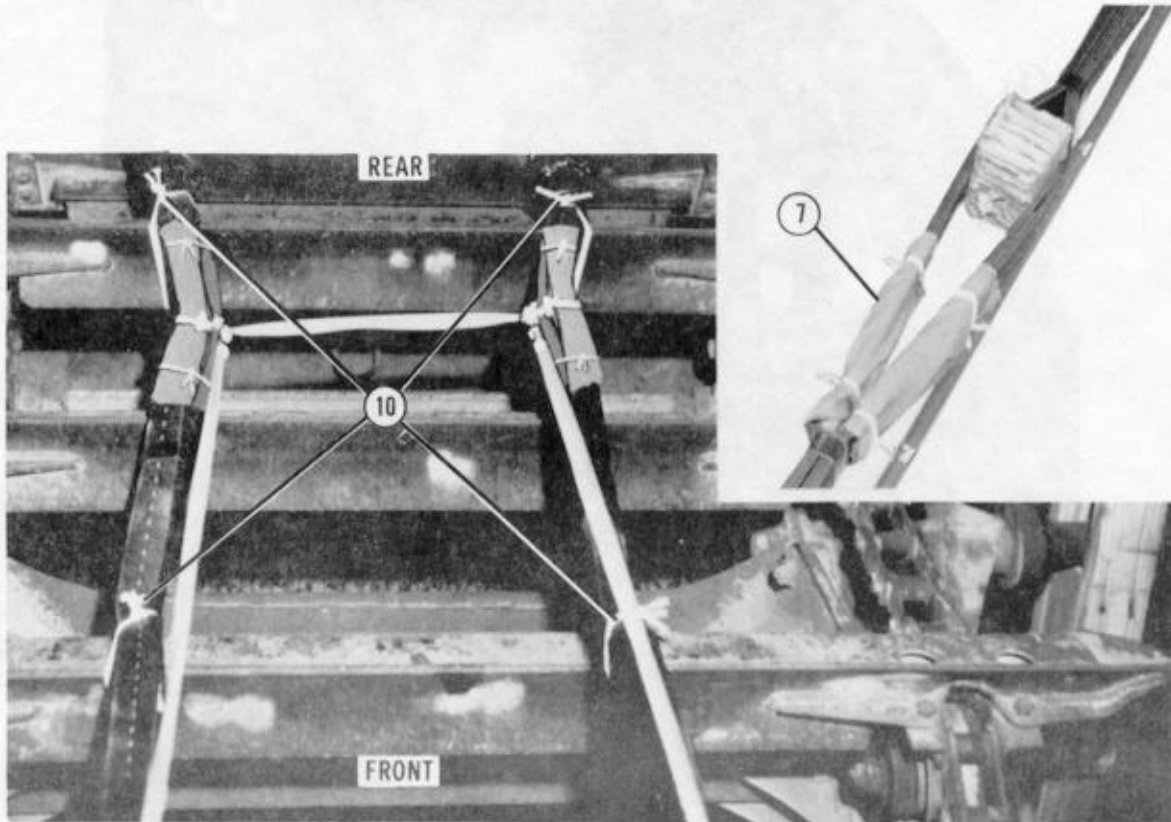

- ⑦ Center a 12- by 12-inch piece of cotton muslin cloth on one of the suspension slings 13 inches above the highest point of the load. Wrap the cloth around four of the eight plies of the sling, and tie it at the top and bottom with type I, 1/4-inch cotton webbing. Wrap the other four plies of the sling in the same way. Prepare the other three slings using the same procedure.
- ⑧ Raise the slings, and install the deadman's tie (not shown) 13 inches above the highest point on the load.
- ⑨ Lower the slings (not shown), passing them from the front of the load toward the rear.
- ⑩ Safety the lower part of the front slings to the elevator slats. Safety the upper portion of the slings to the 1/2-inch tubular nylon ties. Secure the elevator guard with two lengths of type I, 1/4-inch cotton webbing.

Figure 3-33. Suspension slings installed and safetied (continued)

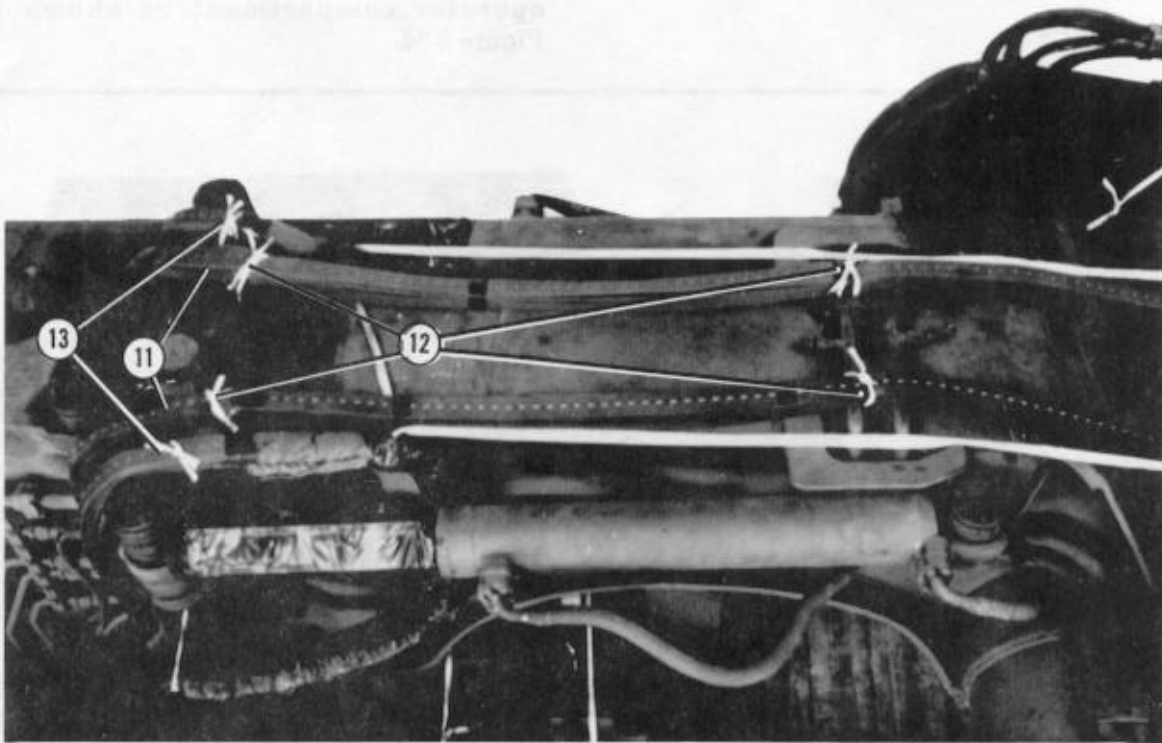

- ⑪ Pass the front slings over the steering arms. Be sure that the slings do not extend above the top of the steering assembly.
- ⑫ Safety the front slings to the frame plate assembly and the steering arms with two lengths of type I, 1/4-inch cotton webbing.
- ⑬ Safety the rear slings to the steering arms with two lengths of type I, 1/4-inch cotton webbing. Be sure that the rear slings pass to the outside of the front slings.

Figure 3-33. Suspension slings installed and safetied (continued)

### 3-10. Installing Parachute Release Platform and Load Cover

Install the honeycomb for the parachute release platform beside the operator compartment as shown in Figure 3-34. Position and secure the canvas cover over the engine and operator compartment as shown in Figure 3-34.

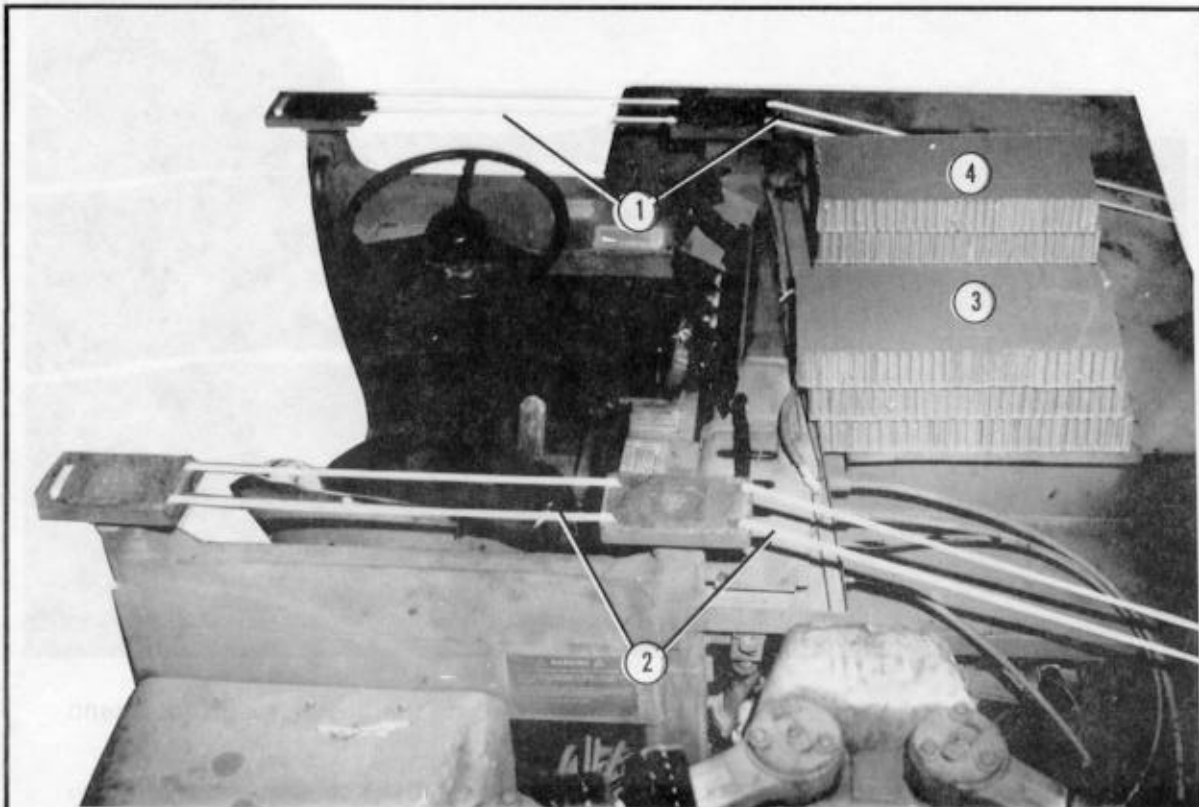

- ① Pass a length of 1/2-inch tubular nylon webbing through the front ROPS mounting holes and over the vehicle. Tie the webbing to clevis 26A.
- ② Pass a length of 1/2-inch tubular nylon webbing through the rear ROPS mounting holes and over the vehicle. Tie the webbing to clevis 24A.
- ③ Place three 10- by 21-inch pieces of honeycomb beside the operator compartment and even with the edge of the engine cover.
- ④ Place three 10- by 21-inch pieces of honeycomb against the webbing placed in step 1 above.

Figure 3-34. Parachute release platform and load cover installed



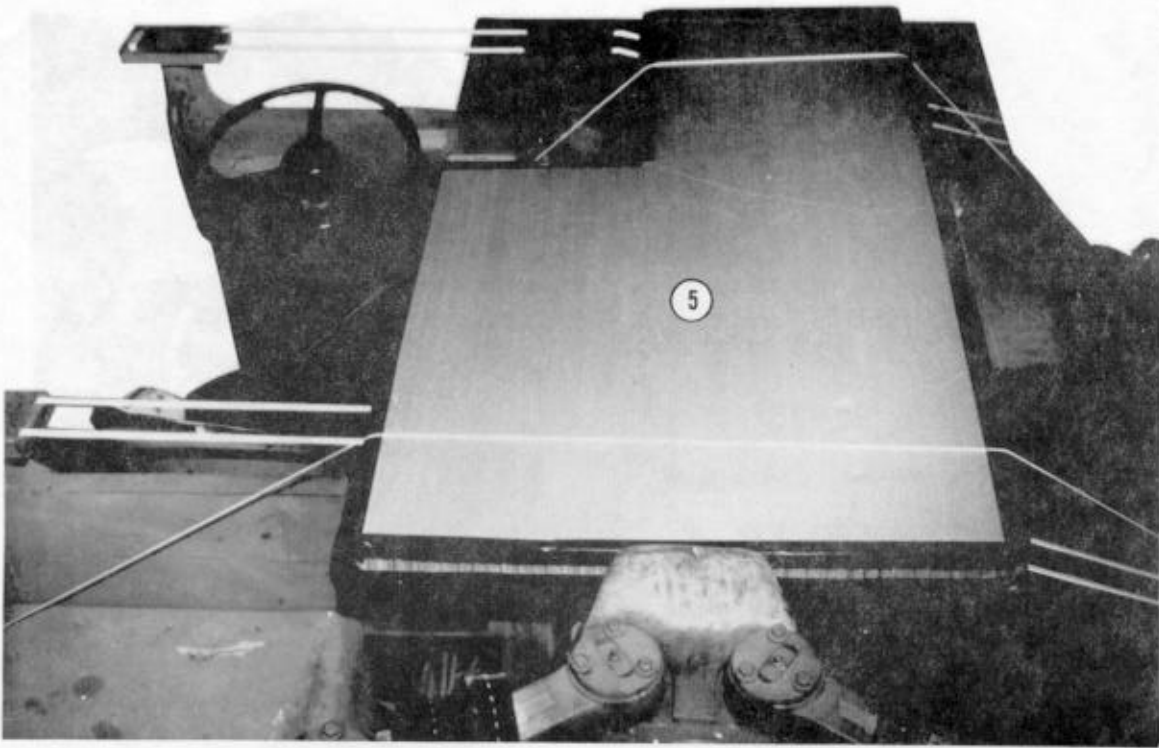

- 5 Position a 36- by 62-inch piece of honeycomb with a 15- by 24-inch cutout as the parachute release platform over the engine housing as shown. Tape the upper edges of the honeycomb. Safety the honeycomb with type III nylon cord to convenient points on the platform.

*Figure 3-34. Parachute release platform and load cover installed (continued)*



- ⑥ Secure a 10- by 10-foot canvas cover with type III nylon cord to convenient points on the platform. Secure the corners of the cover to the bumper.

*Figure 3-34. Parachute release platform and load cover installed (continued)*

### 3-11. Building and Installing Parachute Stowage Platform

Build the parachute stowage platform support stack as shown in Figure 3-35. Build the parachute stowage platform as shown in Figure 3-36. Lash the parachute stowage platform to the platform as shown in Figure 3-37.

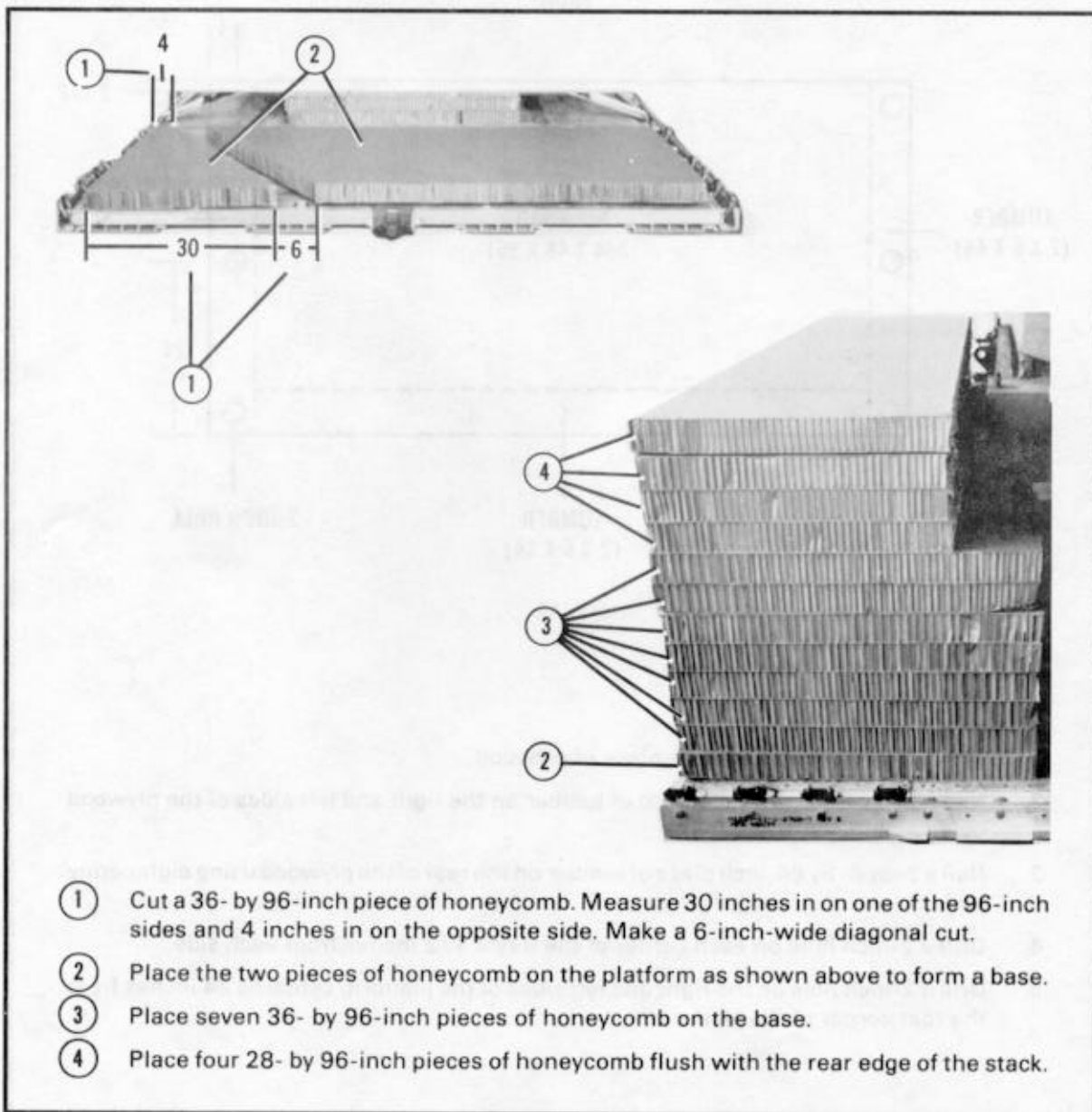
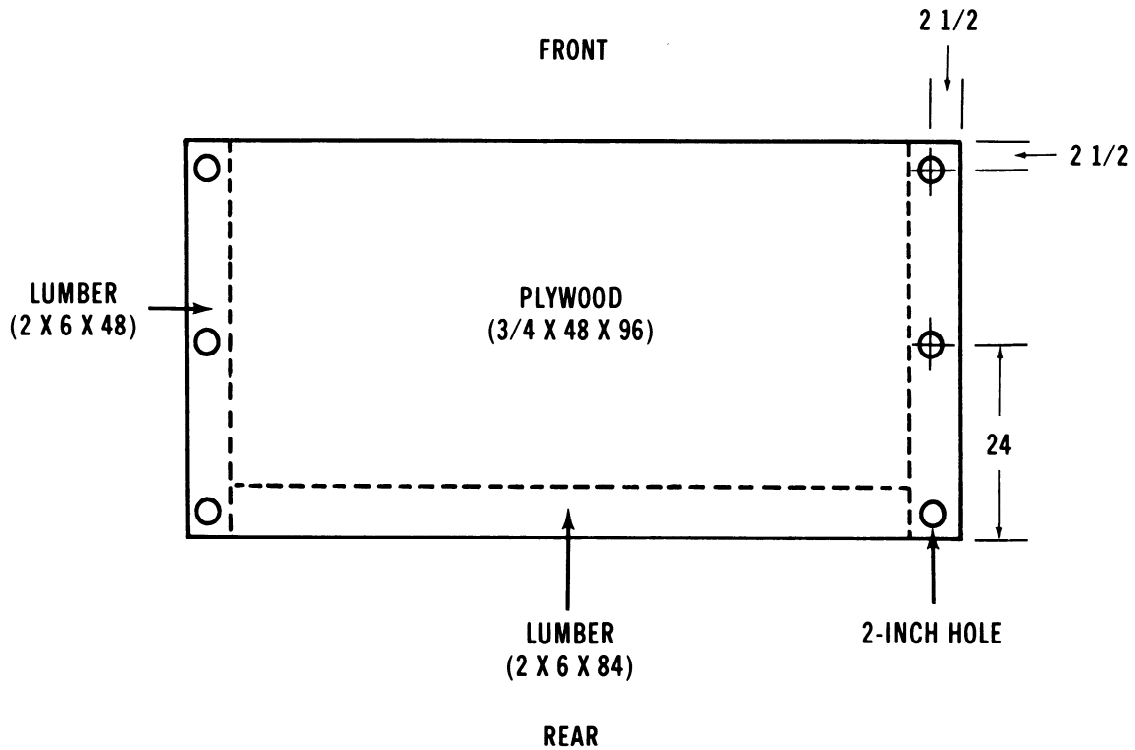

Figure 3-35. Parachute stowage platform support stack built

**Notes:**

1. All dimensions are given in inches.
2. This drawing is not drawn to scale.



**Step:**

1. Cut a 3/4- by 48- by 96-inch piece of plywood.
2. Nail a 2- by 6- by 48-inch piece of lumber on the right and left sides of the plywood using eightpenny nails.
3. Nail a 2- by 6- by 84-inch piece of lumber on the rear of the plywood using eightpenny nails.
4. Drill a 2-inch hole on each corner of the tray 2 1/2 inches from each side.
5. Drill a 2-inch hole on the right and left sides of the platform centered 24 inches from the rear corner of the platform.

Figure 3-36. Parachute stowage platform built

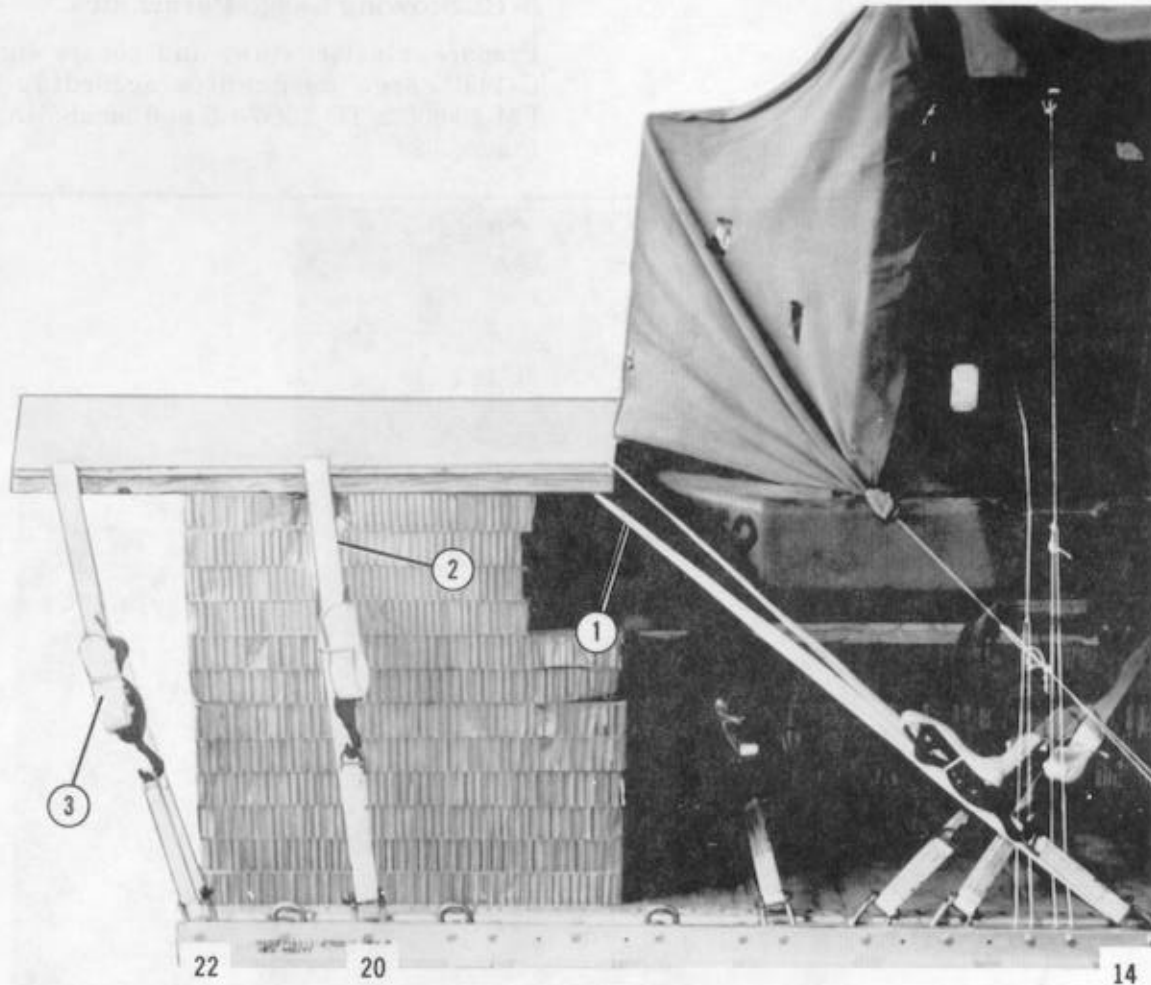

- ① Run a 15-foot tie-down strap from clevis 14 through the front hole in the right side of the parachute stowage platform. Run a 15-foot tie-down strap from clevis 14A through the front hole on the left side of the parachute stowage platform. Secure each strap with a D-ring and a load binder.
- ② Run a 15-foot tie-down strap from clevis 20 through the center hole on the right side of the tray. Run a 15-foot tie-down strap from clevis 20A through the center hole on the left side of the parachute stowage platform. Secure each strap with a D-ring and a load binder.
- ③ Run a 15-foot tie-down strap from clevis 22 through the rear hole in the right side of the parachute stowage platform. Run a 15-foot tie-down strap from clevis 22A through the rear hole on the left side of the parachute stowage platform. Secure each strap with a D-ring and a load binder.

Figure 3-37. Parachute stowage platform lashed to platform

### 3-12. Stowing Cargo Parachutes

Prepare, cluster, stow, and secure eight G-11B cargo parachutes according to FM 10-500-2/TO 13C7-1-5 and as shown in Figure 3-38.

**CAUTION:**

1. The front clustering ties must not interfere with the deployment of the parachutes.
2. Make certain the parachutes are not higher than the load.



- ① Secure the parachutes with three lengths of type X nylon webbing. Attach the first restraint strap to clevises 19 and 19A.
- ② Attach the second restraint strap to clevises 21 and 21A.
- ③ Attach the third restraint strap to clevises 18 and 18A.

Figure 3-38. Cargo parachutes stowed and secured

### 3-13. Installing Extraction System

Install the EFTC extraction system according to FM 10-500-2/TO 13C7-1-5 and as shown in Figure 3-39.

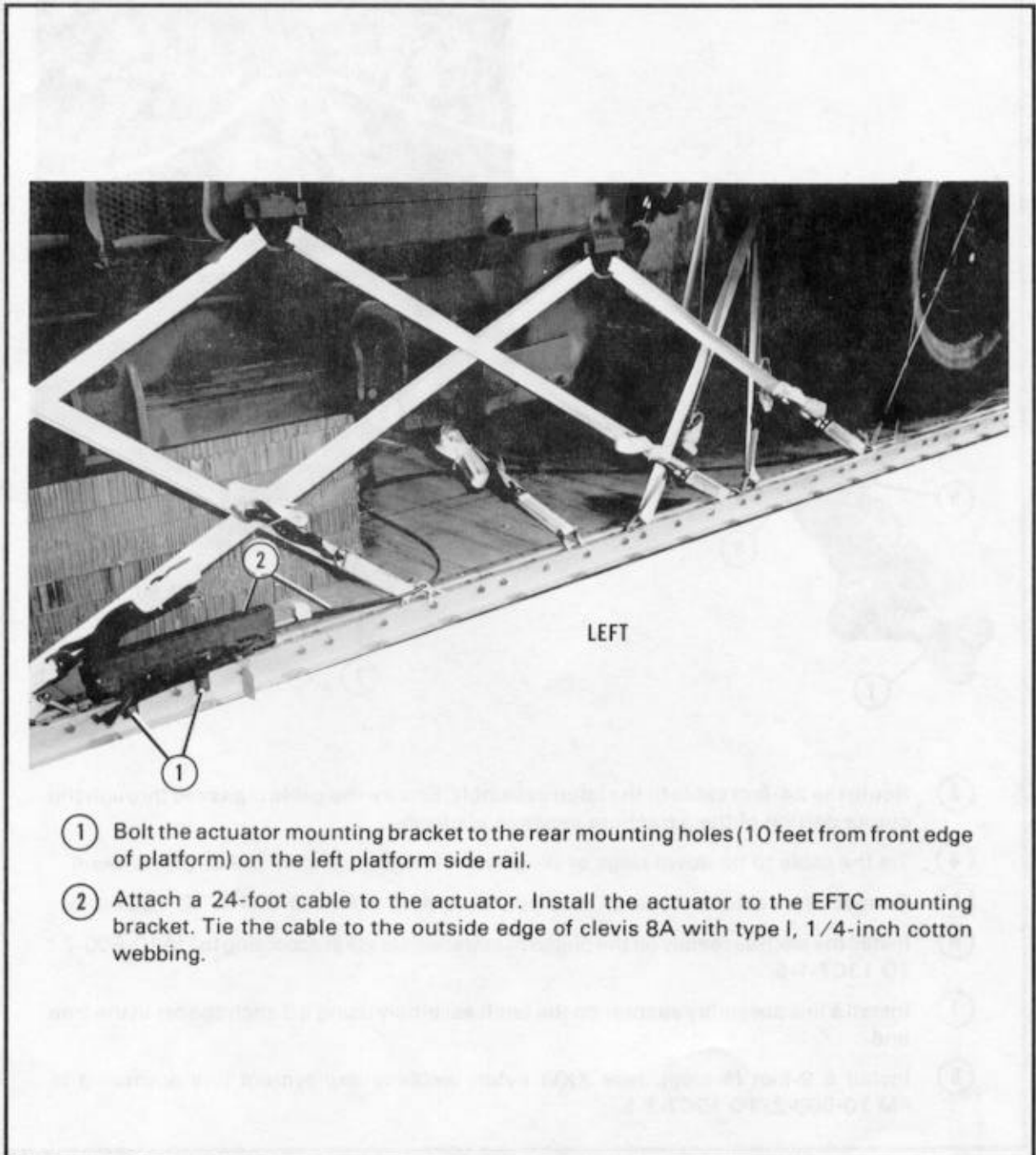
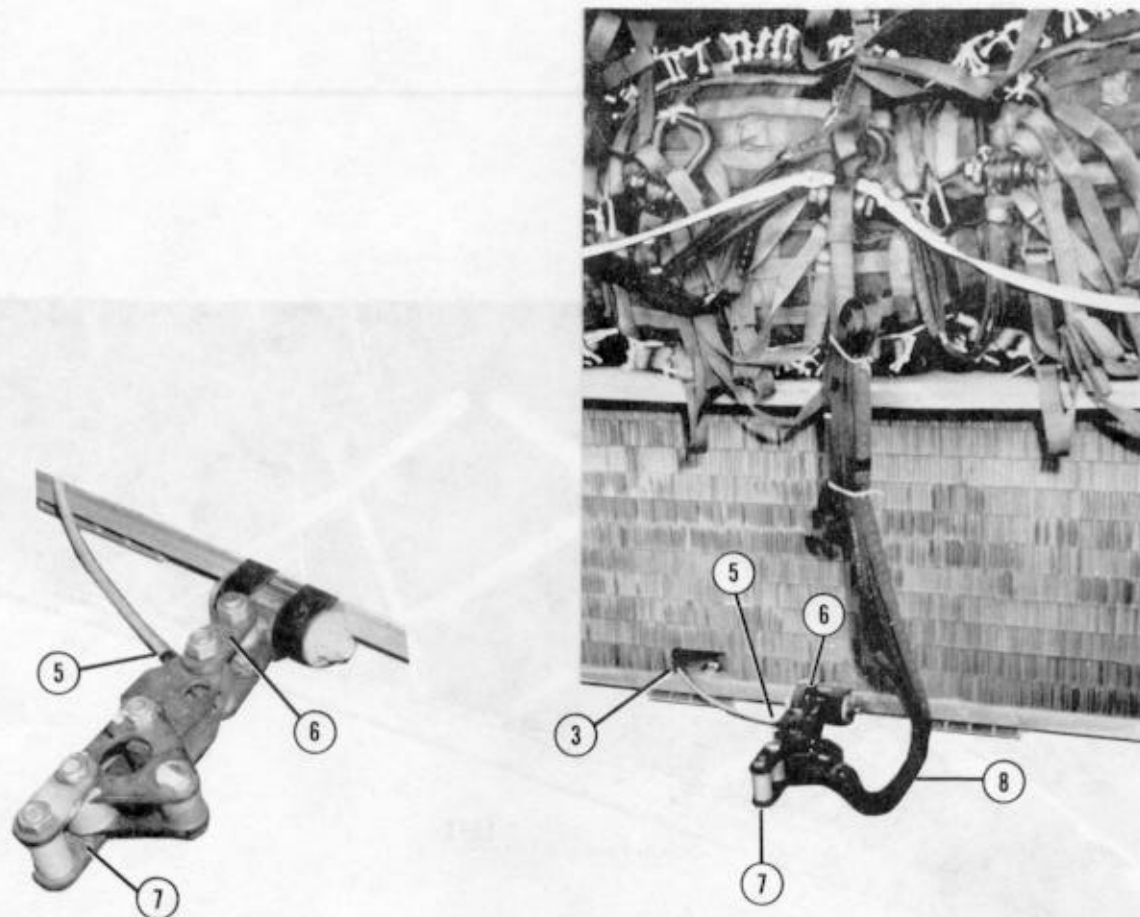

Figure 3-39. Extraction system installed



- ③ Route the 24-foot cable to the latch assembly. Ensure the cable is passed through the cutout portion of the parachute stowage platform.
- ④ Tie the cable to tie-down rings or tie-down clevises at random points (not shown).
- ⑤ Connect the cable to the latch assembly according to FM 10-500-2/TO 13C7-1-5.
- ⑥ Install the latch assembly on the platform extraction bracket according to FM 10-500-2/TO 13C7-1-5.
- ⑦ Install a link assembly adapter on the latch assembly using a 3-inch spacer in the free end.
- ⑧ Install a 9-foot (4-loop), type XXVI nylon webbing deployment line according to FM 10-500-2/TO 13C7-1-5.

Figure 3-39. Extraction system installed (continued)



### 3-14. Installing Release Assembly

Prepare a modified M-2 cargo parachute release assembly according to FM 10-500-2/TO 13C7-1-5. Safety the suspension sling keepers as shown in Figure 3-40. Install the release assembly on the load as shown in Figure 3-41.

**CAUTION:** Be sure to use a modified M-2 cargo parachute release assembly as shown in FM 10-500-2/TO 13C7-1-5.

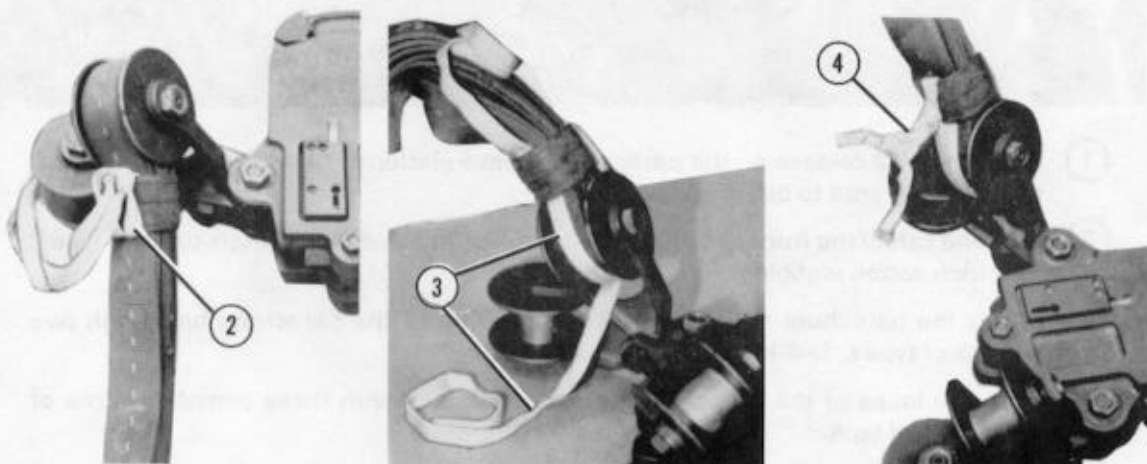

- ① Lay the M-2 release assembly face up on the load (not shown). Bolt the rear suspension slings to the lower links. Bolt the front suspension slings to the upper links.
- ② Form a girth hitch around one side of a sling keeper with a 60-inch length of 1/2-inch tubular nylon webbing so that the running ends are of equal length.
- ③ Bring both running ends around the loop of the sling and through the suspension link. Bring one running end through the sling keeper.
- ④ Tie the two running ends together with two half hitches and a locking knot. Pull the sling keeper as tightly as possible toward the sling loop.
- ⑤ Secure the other three suspension sling keepers in the same manner.

Figure 3-40. Suspension sling keepers safetied

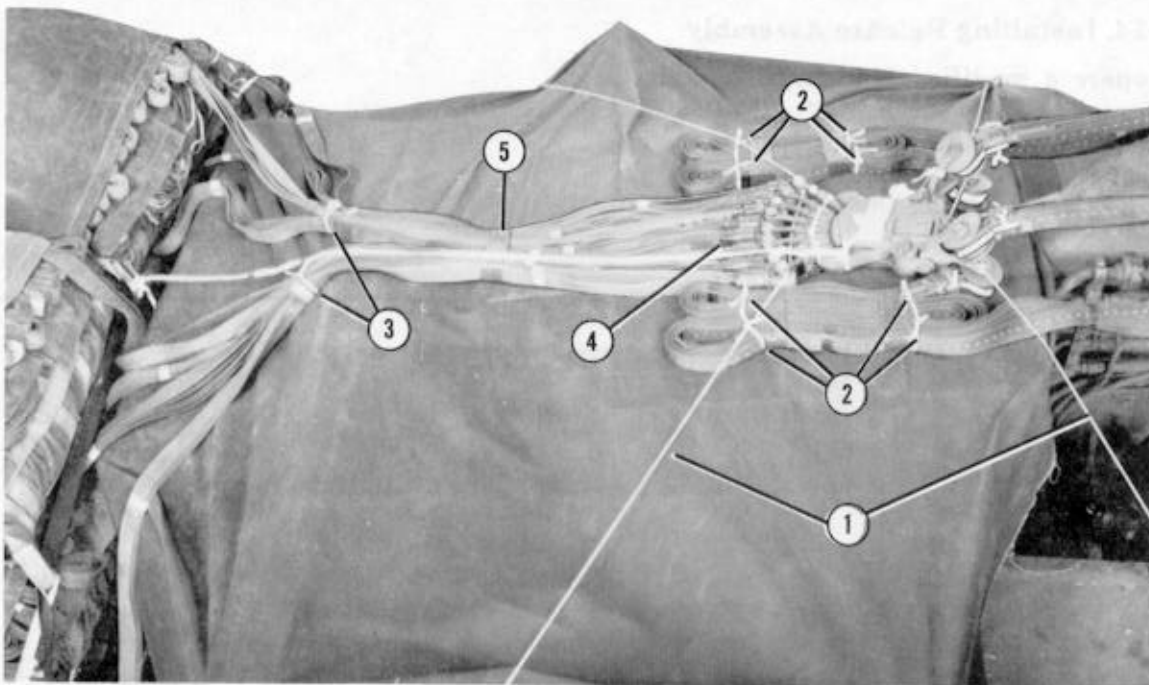

- ① Place the M-2 release on the parachute release platform. Tie it down securely with type III nylon cord to bushings 39 and 57.
- ② Fold and safety the front suspension slings in eight places with single turns of type I, 1/4-inch cotton webbing.
- ③ Safety the parachute risers about 3 feet in front of the parachute bags with two lengths of type I, 1/4-inch cotton webbing.
- ④ Tape the loops of the parachute risers individually with three complete turns of cloth-backed tape.
- ⑤ Tape all the parachute risers together about 18 inches from the taped loops with three complete turns of cloth-backed tape.

Figure 3-41. Release assembly installed

### 3-15. Placing Extraction Parachutes

Place extraction parachutes as given below.

**a. C-130 Aircraft.** Place two 28-foot, heavy-duty cargo extraction parachutes and a 60-foot (6-loop), type XXVI nylon webbing extraction line on the load for installation in the aircraft.

**b. C-141 Aircraft.** Place two 28-foot, heavy-duty cargo extraction parachutes and a 120-foot (6-loop), type XXVI nylon webbing

extraction line on the load for installation in the aircraft.

### 3-16. Installing Provisions for Emergency Restraints

Install provisions for the emergency restraints when the scraper is to be air-dropped from a C-141 aircraft. Install the provisions for the emergency restraints according to FM 10-500-2/TO 13C7-1-5.

### 3-17. Marking Rigged Load

Mark the rigged load according to FM 10-500-2/TO 13C7-1-5 and as shown in Figure 3-42. Complete DD Form 1387-2, and securely attach it to the load. Indicate on DD Form 1387-2 that the vehicle fuel tank and the batteries have been prepared according to AFR 71-4/TM 38-250. If the load varies, the weight, height, CB, and parachute requirements must be recomputed.

**CAUTION:** Make the final rigger inspection required by FM 10-500-2/TO 13C7-1-5 before the load leaves the rigging site.

**Note:** Disconnect the suspension slings, lay them aside, and install the lifting slings to lift this load onto the transport vehicle. Reconnect the suspension slings after the load is on the transport vehicle.

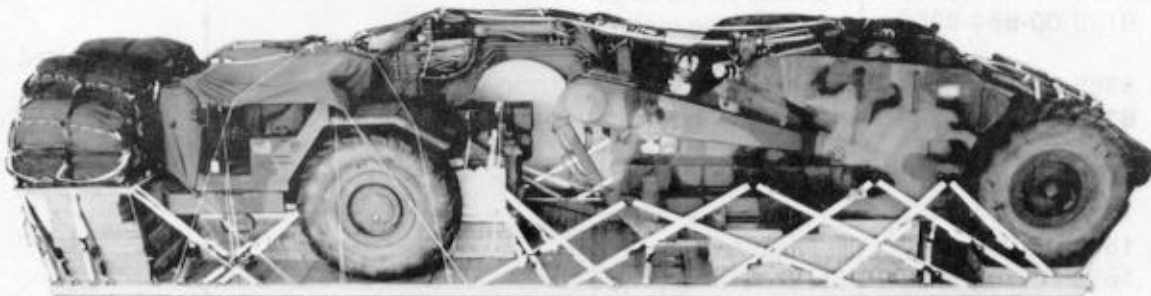

#### RIGGED LOAD DATA

		REBUY	TYPE I	TYPE II
Weight:	Load shown	37,880 lb	38,270 lb	38,670 lb
	Maximum load allowed	39,500 lb	39,500 lb	39,500 lb
Height		98 1/2 in	98 1/2 in	98 1/2 in
Width		108 in	108 in	108 in
Length		440 in	440 in	440 in
Overhang:	Front	35 to 36 in	35 to 36 in	35 to 36 in
	Rear	20 to 21 in	20 to 21 in	20 to 21 in
CB (from front edge of platform)		181 in	180 in	178 in
Extraction System		EFTC	EFTC	EFTC

Figure 3-42. The 613S, type I scraper rigged on a type V platform for low-velocity airdrop

**3-18. Equipment Required**

Use the equipment listed in Table 3-1 to rig this load.

*Table 3-1. Equipment required for rigging the 613S, type I and II scrapers on a type V platform for low-velocity airdrop*

NSN	Item	Quantity
8040-00-273-8713	Adhesive, paste, 1-gal	As required
4030-00-432-2516	Clevis, screw-pin	6
4030-00-678-8562	Clevis, suspension: 3/4-in (medium)	2
4030-00-090-5354	1-in (large)	8
8305-00-242-3593	Cloth, cotton duck, 60-in	As required
4020-00-240-2146	Cord, nylon, type III, 550-lb	As required
1670-00-434-5782	Coupling, airdrop, extraction force transfer w 24-ft cable	1
1670-00-360-0328	Cover, clevis, large	1
8135-00-664-6958	Cushioning material, packaging, cellulose wadding	As required
5365-00-937-0147	D-ring, heavy-duty, 10,000-lb	3
8305-00-958-3685	Felt, 1/2-in thick	As required
1670-00-003-1957	Line, extraction, type XXVI nylon webbing: 60-ft (6-loop) <i>or</i>	1
1670-01-064-4454	60-ft (6-loop)	1
1670-01-062-6312	120-ft (6-loop)	1
1670-00-783-5988	Link assembly, type IV	2
1670-00-006-2752	Link, four-point	1
5510-00-220-6146	Lumber, 2- by 4-in: 12-in	1
	18-in	4
	32-in	2
5510-00-220-6148	Lumber, 2- by 6-in: 6-in	1
	7-in	1
	18-in	3
	29 1/2-in	1
	32 1/2-in	1
	33-in	1
	37 1/2-in	1
	48-in	2
	50-in	4
	84-in	1
5510-00-220-6274	Lumber, 4- by 4- by 41-in	2
5315-00-010-4659	Nail, steel wire, common: 8d	As required
5315-00-010-4663	16d	As required

Table 3-1. Equipment required for rigging the 613S, type I and II scrapers on a type V platform for low-velocity airdrop (continued)

NSN	Item	Quantity
1670-00-753-3928	Pad, energy-dissipating, honeycomb, 3- by 36- by 96-in:	28 sheets
	5- by 21-in	(2)
	10- by 21-in	(6)
	12- by 18-in	(2)
	12- by 30-in	(2)
	12- by 43-in	(2)
	12- by 48-in	(1)
	18- by 18-in	(6)
	18- by 24-in	(1)
	18- by 26-in	(2)
	18- by 30-in	(1)
	18- by 36-in	(9)
	18- by 76-in	(12)
	24- by 36-in	(4)
	36- by 51-in	(1)
	36- by 62-in	(1)
	36- by 96-in	(8)
	40- by 33-in	(5)
	48- by 24-in	(7)
	48- by 60-in	(6)
	Parachute:	
1670-01-016-7841	Cargo, G-11B	8
1670-00-040-8135	Cargo extraction, 28-ft, heavy-duty	2
	Platform, AD, type V, 32-ft:	1
	Bracket:	
1670-01-162-2375	Inside EFTA	(1)
1670-01-162-2374	Outside EFTA	(1)
1670-01-162-2372	Clevis assembly	(44)
1670-01-162-2376	Extraction bracket assembly	(1)
1670-01-162-2381	Tandem link	(2)
	Plywood:	
5530-00-129-7721	1/4-in:	
	5 1/2- by 6-in	1
	5 1/2- by 7-in	1
5530-00-128-4981	3/4-in:	
	12- by 18-in	1
	18- by 18-in	1
	20 1/2- by 24-in	3
	20 1/2- by 24 3/4-in	3
	24- by 37 1/2-in	1
	32- by 40-in	2
	48- by 12-in	2
	48- by 24-in	2

**C1, FM 10-576/TO 13C7-27-151**

*Table 3-1. Equipment required for rigging the 613S, type I and II scrapers on a type V platform for low-velocity airdrop (continued)*

NSN	Item	Quantity
	48- by 60-in	3
	48- by 96-in	1
1670-01-097-8817	Release, cargo parachute, M-2 (modified)	1
	Sling, cargo, airdrop:	
	For deployment line:	
1670-01-062-6305	9-ft (4-loop), type XXVI nylon	1
	For lifting:	
1670-00-432-2499	3-ft (4-loop), type XXVI nylon webbing <i>or</i>	2
1670-01-062-6306	3-ft (4-loop), type XXVI nylon webbing	2
1670-00-432-2501	9-ft (4-loop), type XXVI nylon webbing <i>or</i>	2
1670-01-062-6305	9-ft (4-loop), type XXVI nylon webbing	2
1670-01-062-6307	12-ft (4-loop), type XXVI nylon webbing	2
	For riser extension:	
1670-01-062-6311	120-ft (2-loop), type XXVI nylon webbing	8
	For suspension:	
1670-01-064-4453	20-ft (4-loop), type XXVI nylon webbing <i>or</i>	4
1670-00-432-2511	20-ft (4-loop), type XXVI nylon webbing	4
1670-00-040-8219	Strap, parachute release, multicut	
	comes w 3 knives	2
7510-00-266-6710	Tape, adhesive, 2-in	As required
1670-00-937-0271	Tie-down assembly, 15-ft	84
	Webbing:	
8305-00-268-2411	Cotton, 1/4-in, type I	As required
	Nylon:	
8305-00-082-5752	Tubular, 1/2-in	As required
8305-00-261-8584	Type X	As required

## GLOSSARY

---

<b>AD</b> airdrop	<b>hex</b> hexagon
<b>AFB</b> Air Force base	<b>HQ</b> headquarters
<b>AFR</b> Air Force regulation	<b>IAT</b> internal air transport
<b>AFTO</b> Air Force technical order	<b>in</b> inch
<b>ALC</b> Air Logistics Center	<b>LAPE</b> low-altitude parachute extraction
<b>attn</b> attention	<b>lb</b> pound
<b>C</b> change	<b>MAC</b> Military Airlift Command
<b>CB</b> center of balance	<b>no</b> number
<b>d</b> penny	<b>NSN</b> national stock number
<b>DA</b> Department of the Army	<b>psi</b> pounds per square inch
<b>DC</b> District of Columbia	<b>ROPS</b> roll-over protection structure
<b>diam</b> diameter	<b>TM</b> technical manual
<b>EAT</b> external air transport	<b>TO</b> technical order
<b>EFTA</b> extraction force transfer actuator	<b>TRADOC</b> United States Army Training and Doctrine Command
<b>EFTC</b> extraction force transfer coupling	<b>US</b> United States
<b>FM</b> field manual	<b>w</b> with
<b>ft</b> foot/feet	<b>yd</b> yard
<b>gal</b> gallon	

## REFERENCES

---

These documents must be available to the intended users of this publication.

**AFR 71-4/TM 38-250.** *Packaging and Materials Handling: Preparing Hazardous Materials for Military Air Shipments.* 15 January 1988.

**FM 10-500-2/TO 13C7-1-5.** *Airdrop of Supplies and Equipment: Rigging Airdrop Platforms.* 1 November 1990.

**TM 10-1670-208-20&P/TO 13C3-4-12.** *Organizational Maintenance Manual Including Repair Parts and Special Tools List for Platforms, Types II Modular and LAPES/Airdrop Modular.* 10 August 1978.

**TM 10-1670-268-20&P/TO 13C7-52-22.** *Organizational Maintenance Manual With Repair Parts and Special Tools List: Type V Airdrop Platform.* 1 June 1986.

**AFTO Form 22.** *Technical Order Publication Improvement Report.* April 1973.

**DA Form 2028.** *Recommended Changes to Publications and Blank Forms.* February 1974.

**DD Form 1387-2.** *Special Handling Data/Certification.* June 1986.



**FM 10-576  
TO 13C7-27-151  
21 AUGUST 1987**

By Order of the Secretary of the Army:

**CARL E. VUONO**  
*General, United States Army*  
*Chief of Staff*

Official:

**R. L. DILWORTH**  
*Brigadier General, United States Army*  
*The Adjutant General*

**DISTRIBUTION:**

**Active Army, USAR, and ARNG: To be distributed in accordance with DA Form 12-11A, requirements for Airdrop—Rigging 612B Tractor Scraper (Qty rqr block no. 3884) and Airdrop—Rigging D-5B Tractor Dozer Separator (Qty rqr block no. 3836).**

**PIN: 062508-001**