

GRAPHIC TRAINING AID

Supersedes GTA 5-10-19, July 1961

03-04-009

CHARTS 1-11

FILTER UNIT, GAS PARTICULATE, TANK, 4 MAN 12 CFM M8A3, 5 MAN, 20 CFM M13 SERIES

DISTRIBUTION: U.S. Army Training Aids Centers.

Charts are printed on both sides of page. Turn GTA after
Chart 5 for continuation of sequence.

HEADQUARTERS, DEPARTMENT OF THE ARMY
SEPTEMBER 1975

FILTER UNIT, GAS PARTICULATE, TANK, 4 MAN 12 CFM M8A3, 5 MAN, 20 CFM M13 SERIES

Department of the Army Graphic Training Aid 3-4-9 (1)
HEADQUARTERS, DEPARTMENT OF THE ARMY SEPTEMBER 1975

CHART 1

M48

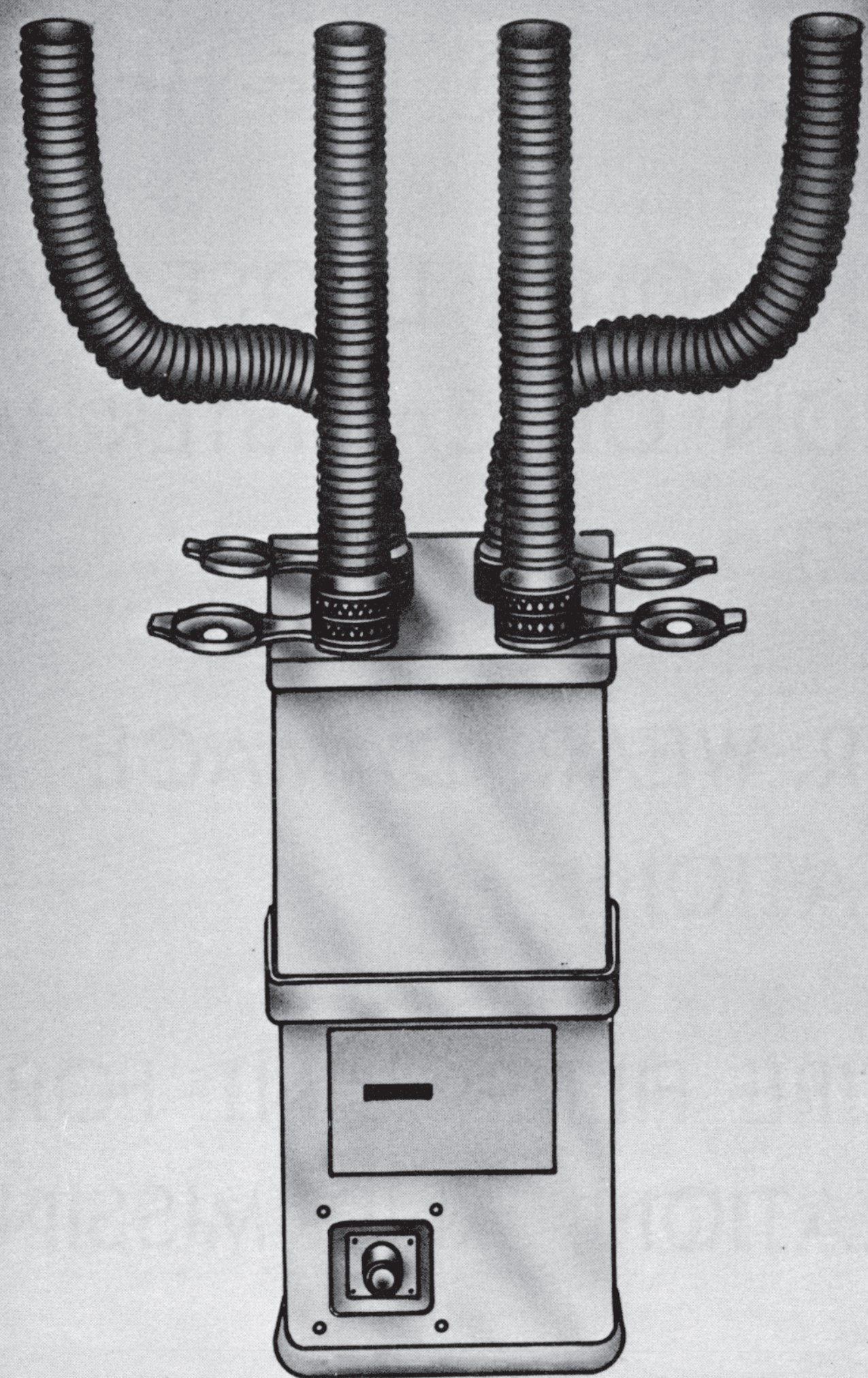
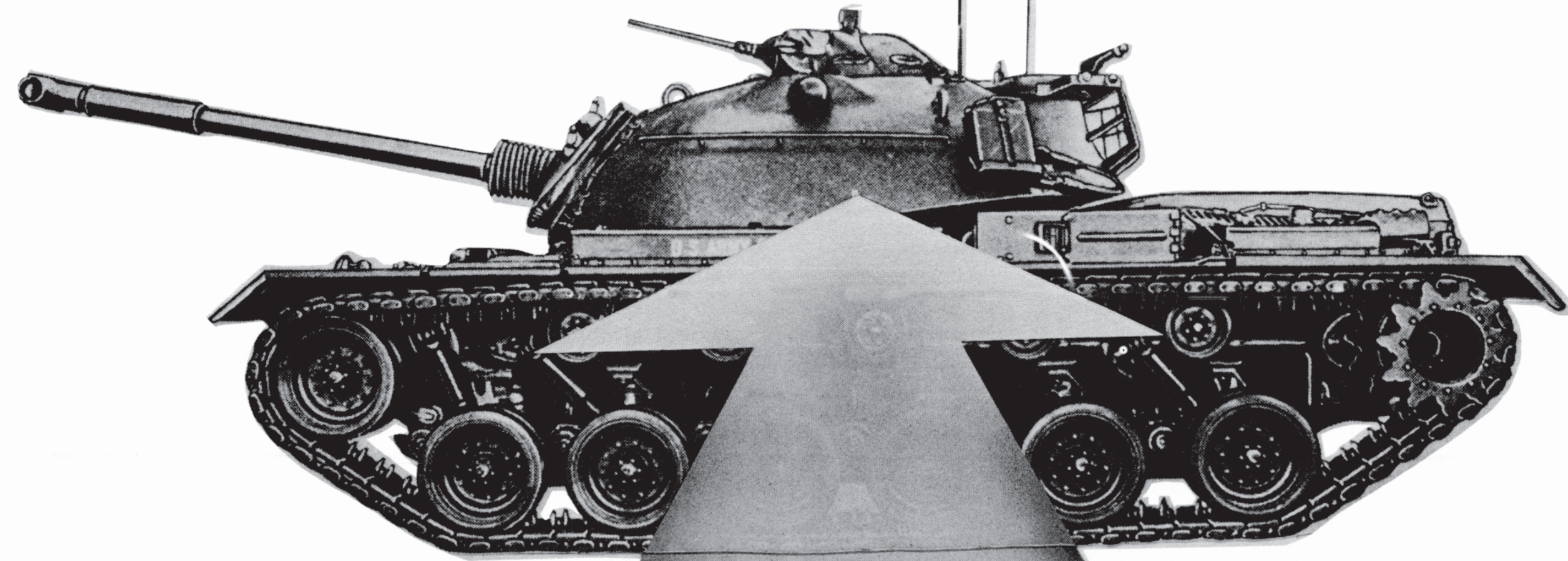

FILTER UNIT

FOUR - MAN 12 CFM, M8A3

M60

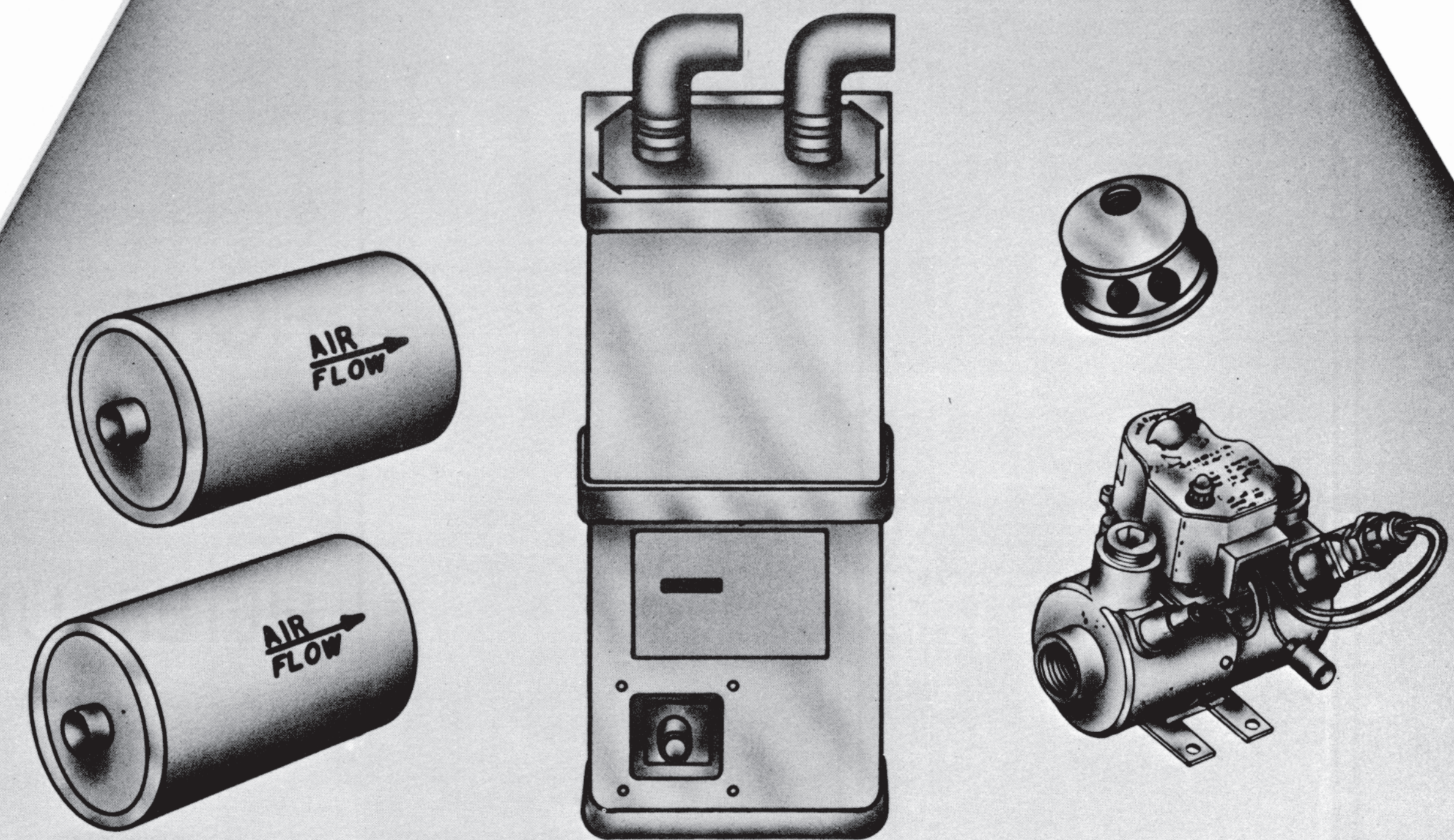
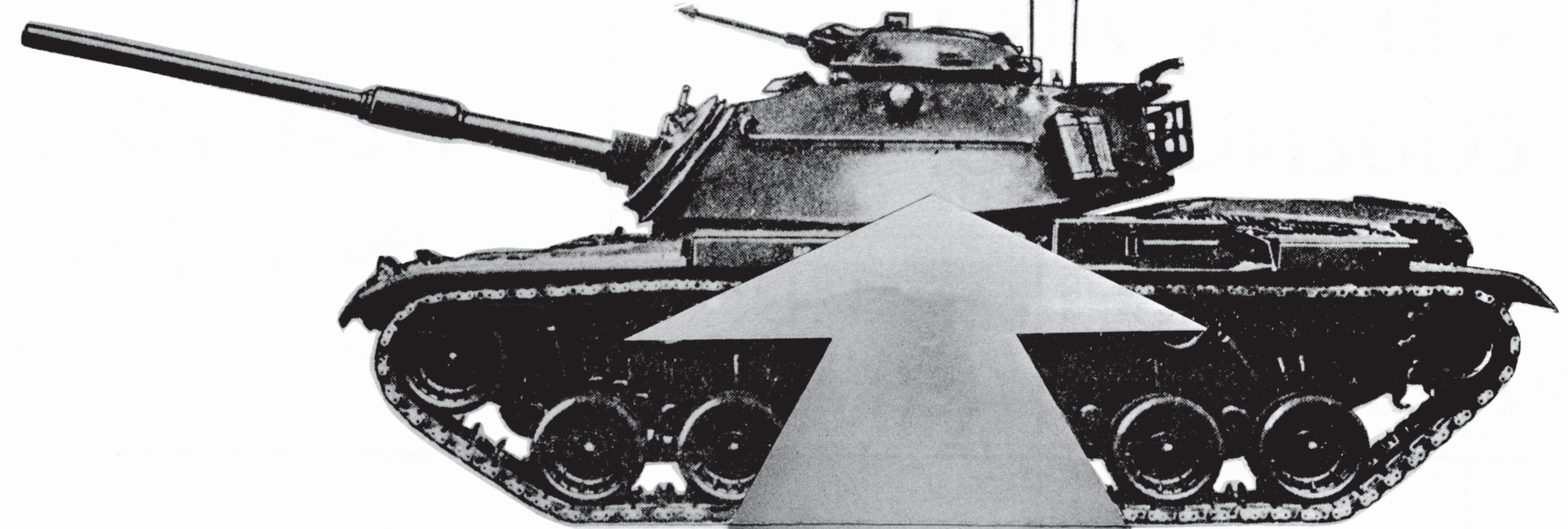

FILTER UNIT

FIVE - MAN 20 CFM, M13 SERIES

FILTER UNIT, GAS-PARTICULATE TANK

FILTER UNIT, GAS PARTICULATE, TANK, 4 MAN 12 CFM M8A3, 5 MAN, 20 CFM M13 SERIES

Department of the Army Graphic Training Aid 3-4-9 (2)
HEADQUARTERS, DEPARTMENT OF THE ARMY SEPTEMBER 1975

CHART 2

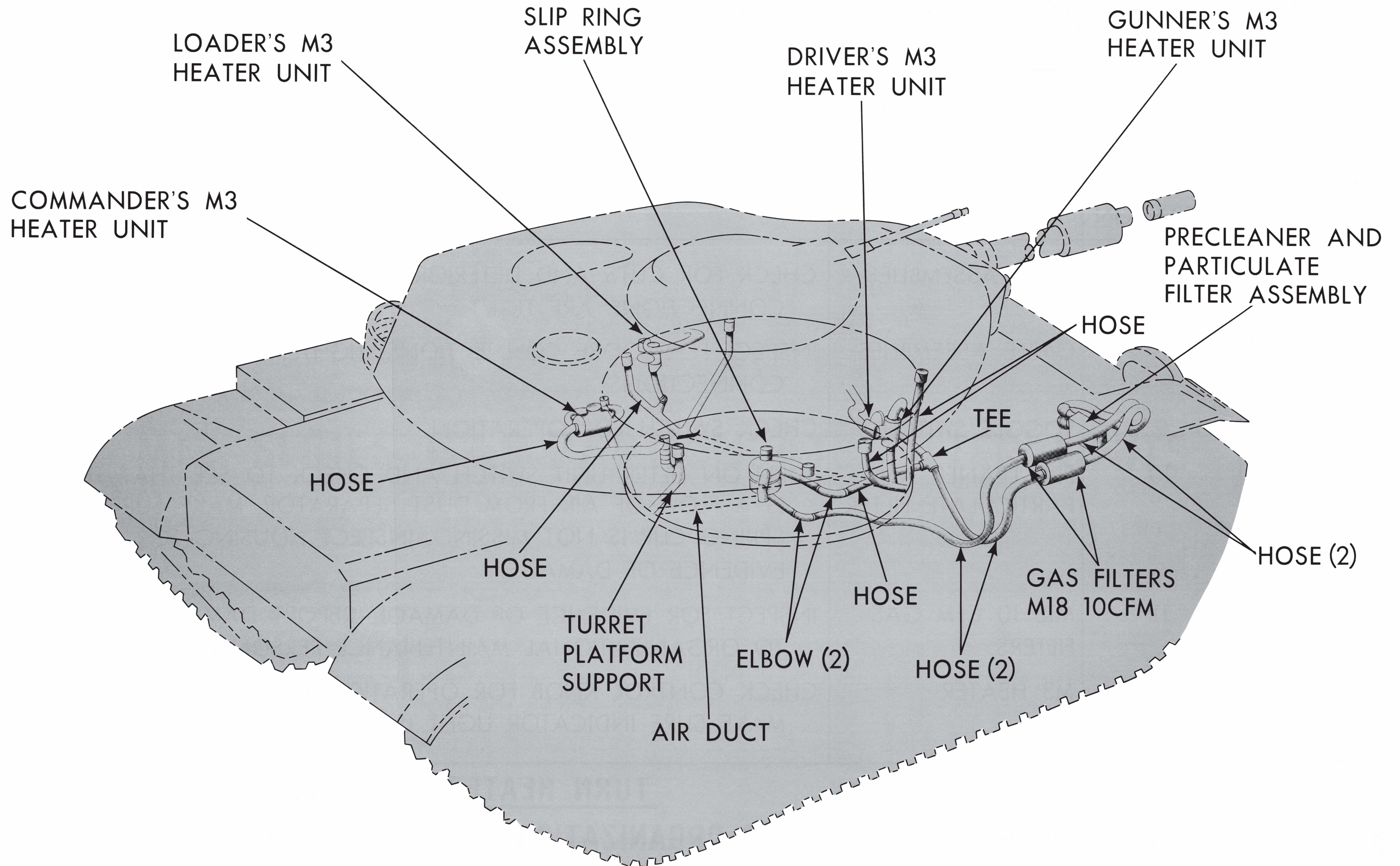

M13 SERIES GAS-PARTICULATE FILTER UNITS

FILTER UNIT, GAS PARTICULATE, TANK, 4 MAN 12 CFM M8A3, 5 MAN, 20 CFM M13 SERIES

Department of the Army Graphic Training Aid 3-4-9 (3)
HEADQUARTERS, DEPARTMENT OF THE ARMY SEPTEMBER 1975

CHART 3

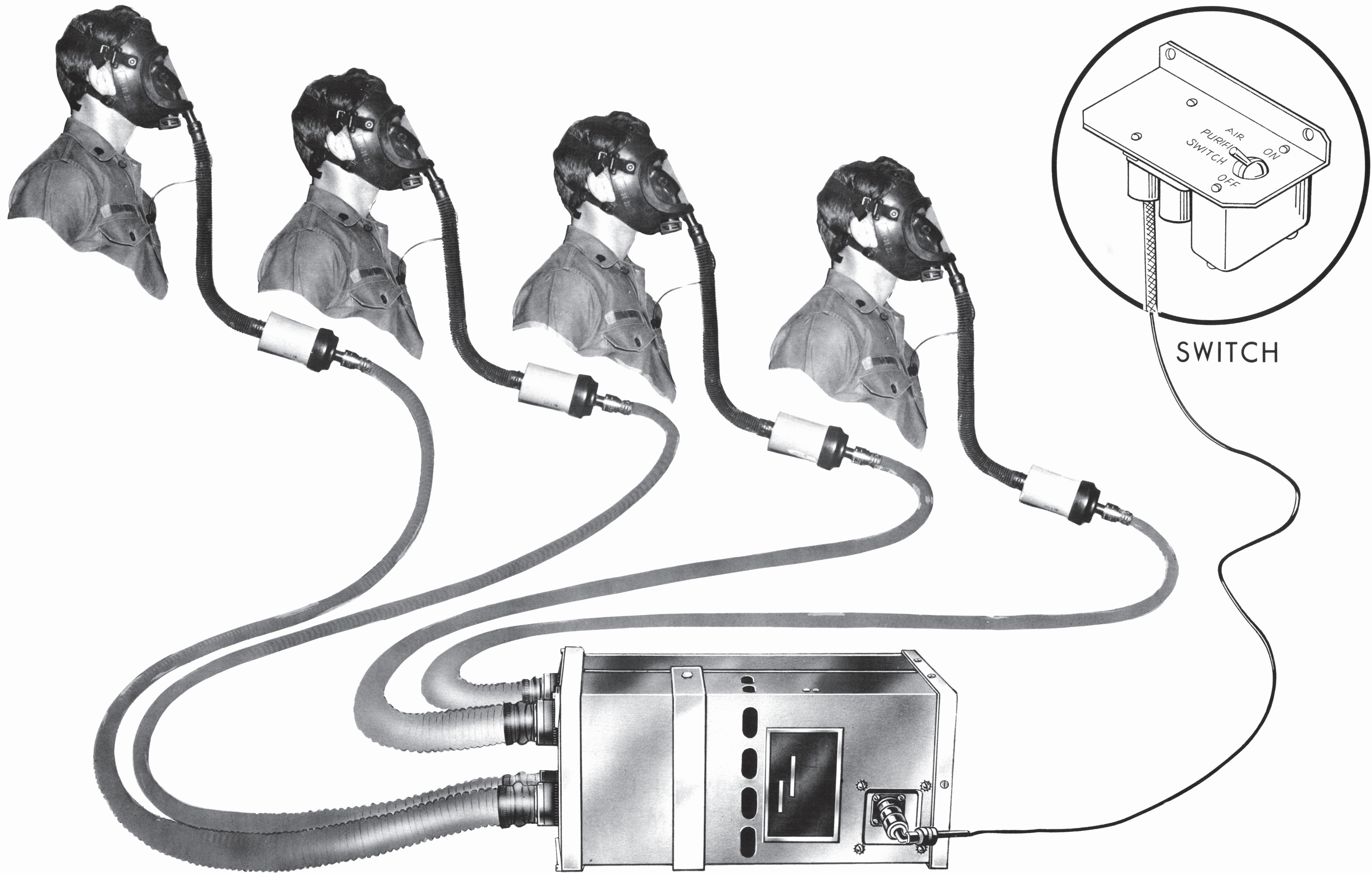

M8A3 GAS-PARTICULATE FILTER UNITS

FILTER UNIT, GAS PARTICULATE, TANK, 4 MAN 12 CFM M8A3, 5 MAN, 20 CFM M13 SERIES

Department of the Army Graphic Training Aid 3-4-9 (4)
HEADQUARTERS, DEPARTMENT OF THE ARMY SEPTEMBER 1975

CHART 4

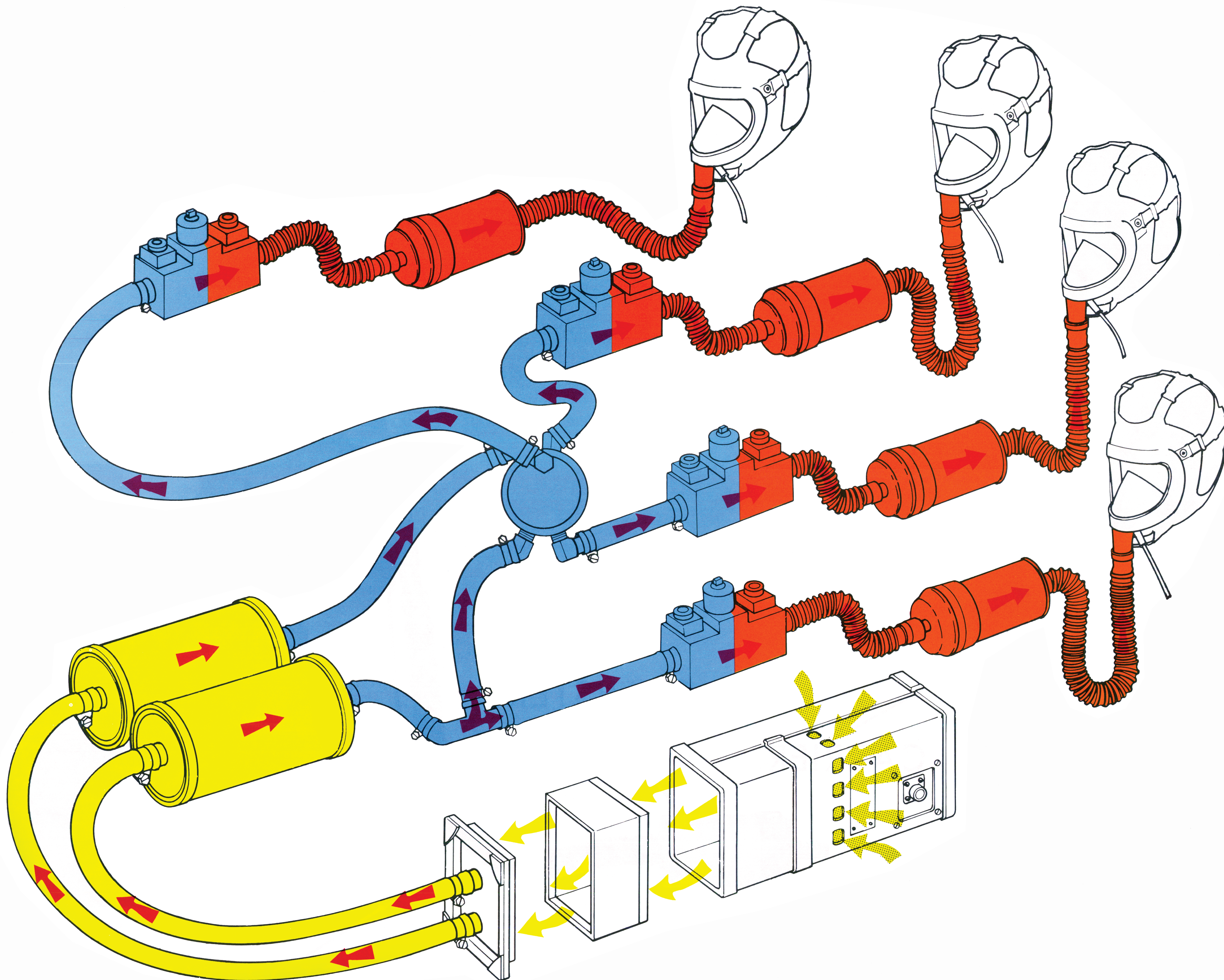

AIR FILTRATION M13A1

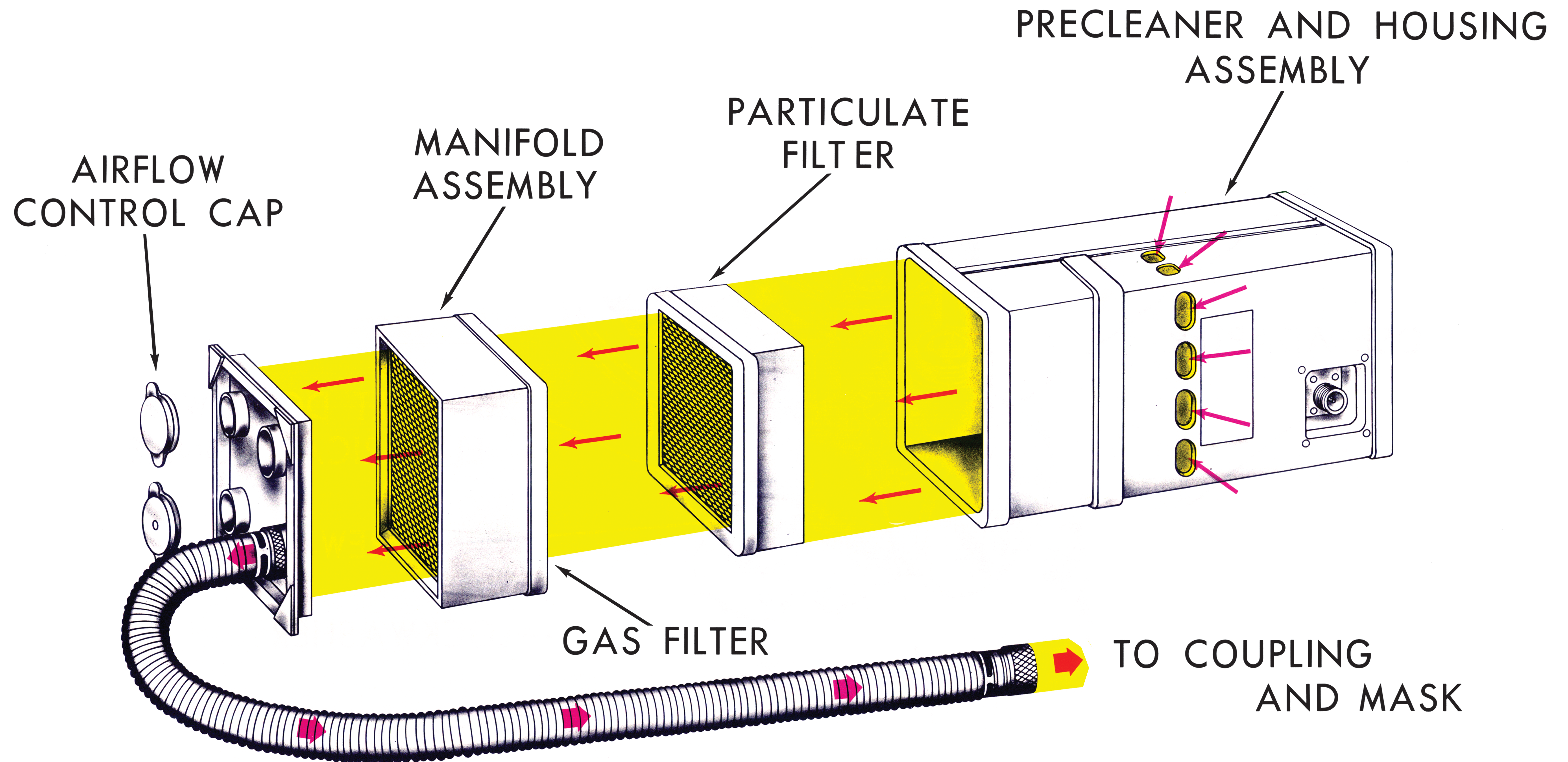

AIR FILTRATION M8A3

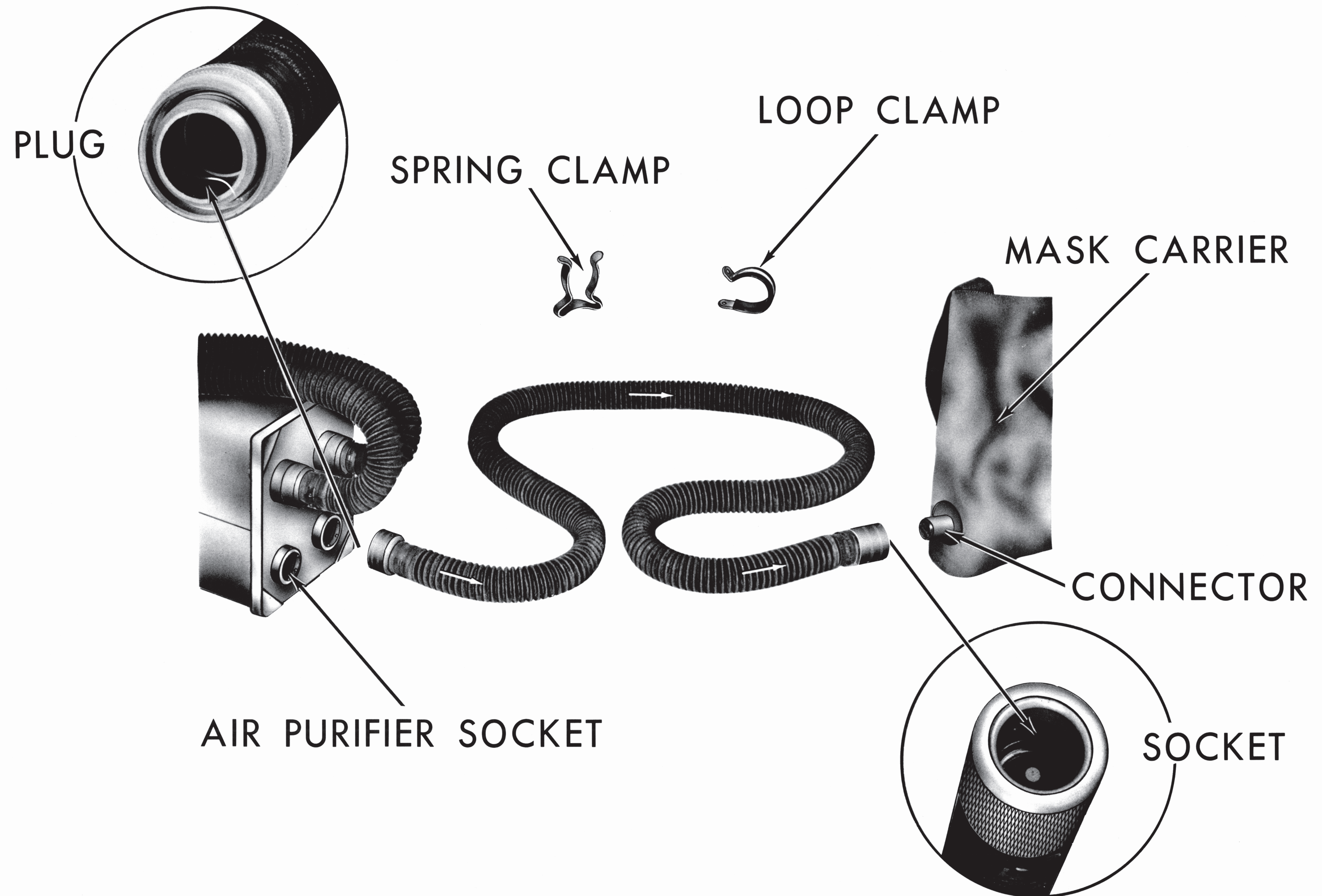

↳ CARRIES AIR FROM PURIFIER TO MASK.

HOSE ASSEMBLY

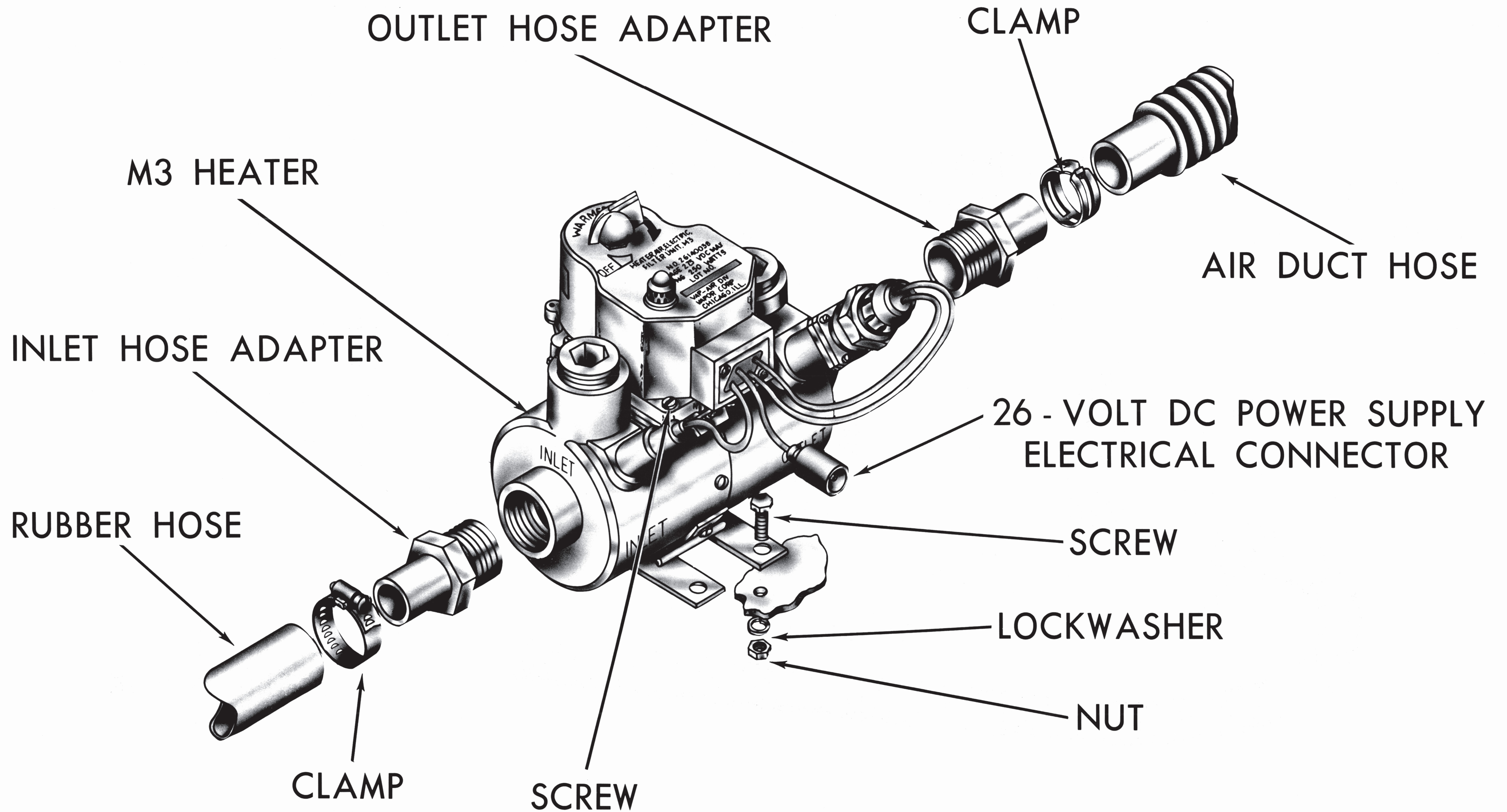

⚡ THE M8A3 FILTER UNIT DOES NOT USE THE AIR HEATER

M3 HEATER - EXPLODED VIEW

FILTER UNIT, GAS PARTICULATE, TANK, 4 MAN 12 CFM M8A3, 5 MAN, 20 CFM M13 SERIES

Department of the Army Graphic Training Aid 3-4-9 (8)
HEADQUARTERS, DEPARTMENT OF THE ARMY SEPTEMBER 1975

CHART 8

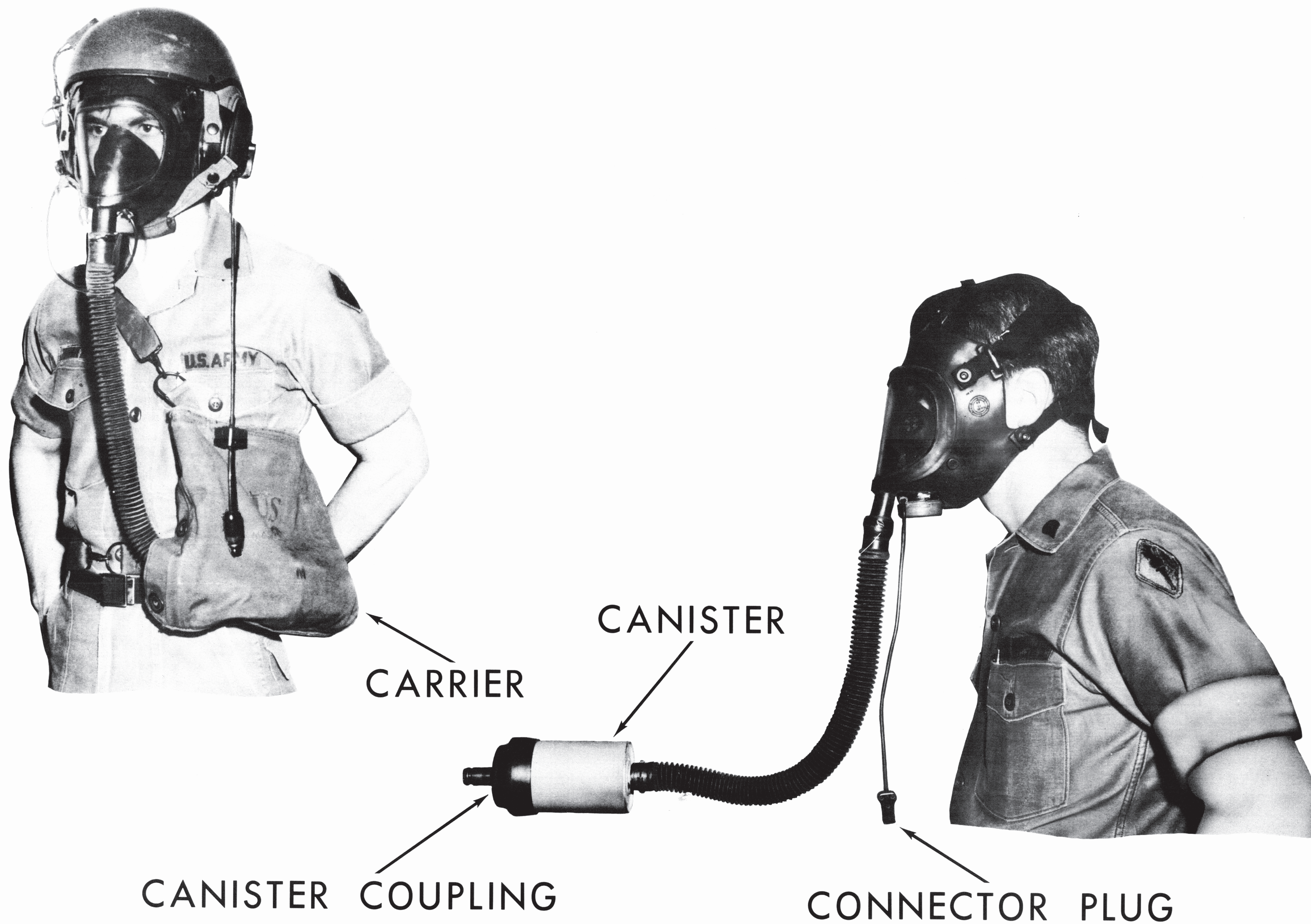

M25A1 TANK PROTECTIVE MASK

FILTER UNIT, GAS PARTICULATE, TANK, 4 MAN 12 CFM M8A3, 5 MAN, 20 CFM M13 SERIES

Department of the Army Graphic Training Aid 3-4-9 (9)
HEADQUARTERS, DEPARTMENT OF THE ARMY SEPTEMBER 1975

CHART 9



1. DON AND ADJUST MASK

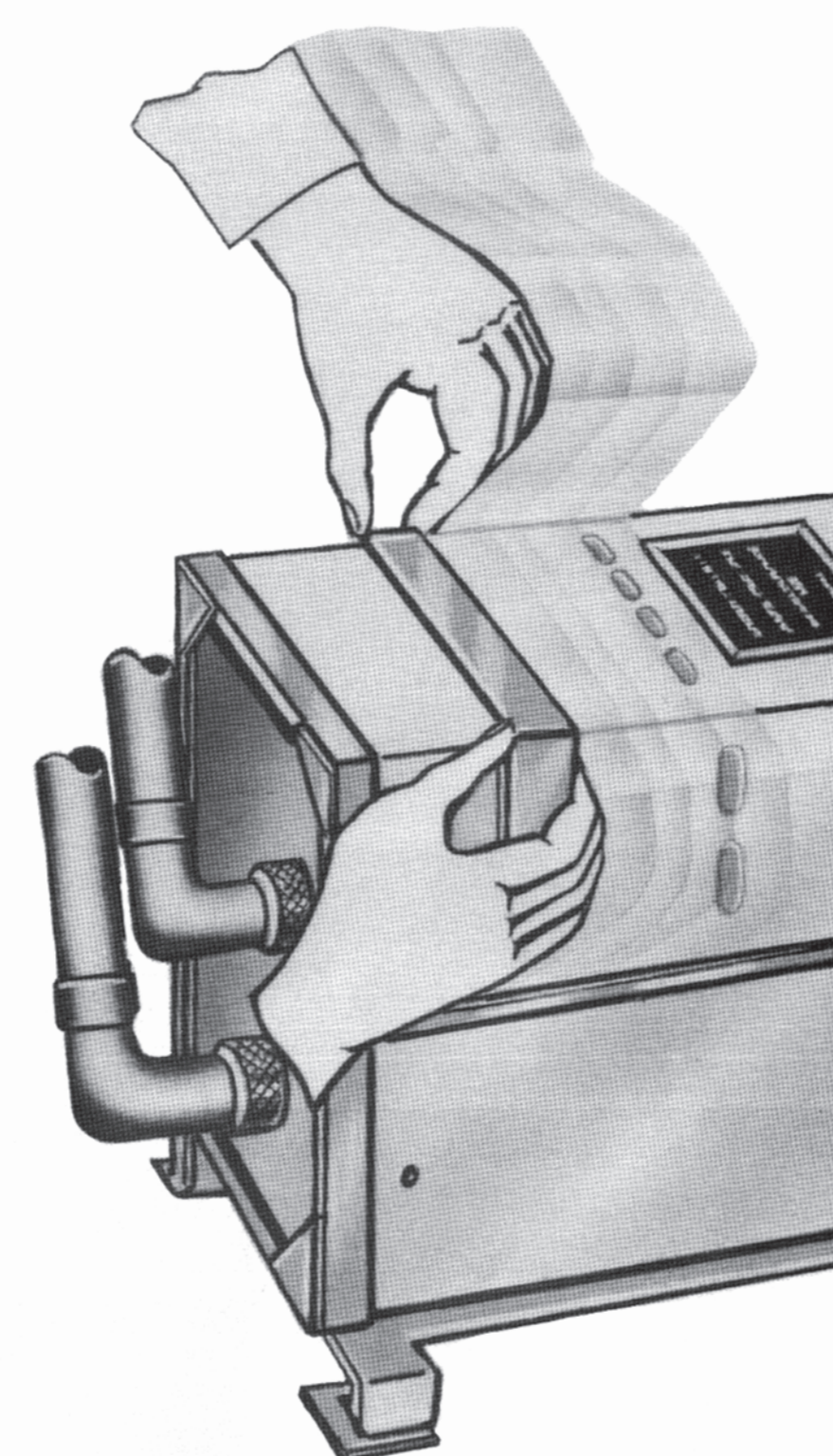

2. MOVE SPRING CLIP TO HOSE END

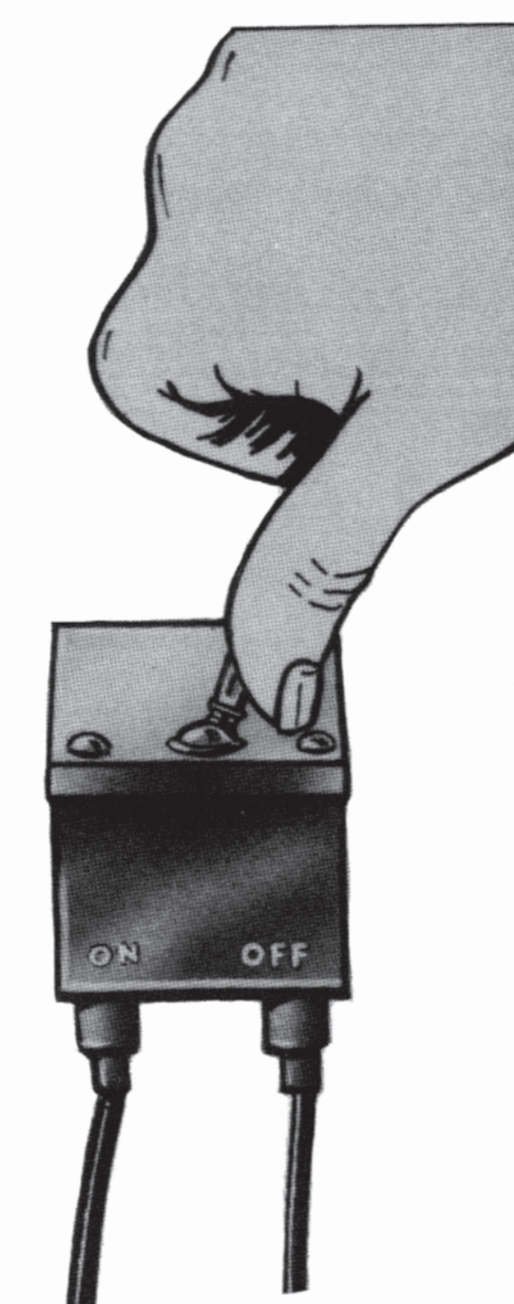

3. TURN SWITCH TO "ON"



4. COUPLE HOSE TO CANISTER



5. PLUG MICROPHONE CABLE INTO INTERCOMM SYSTEM

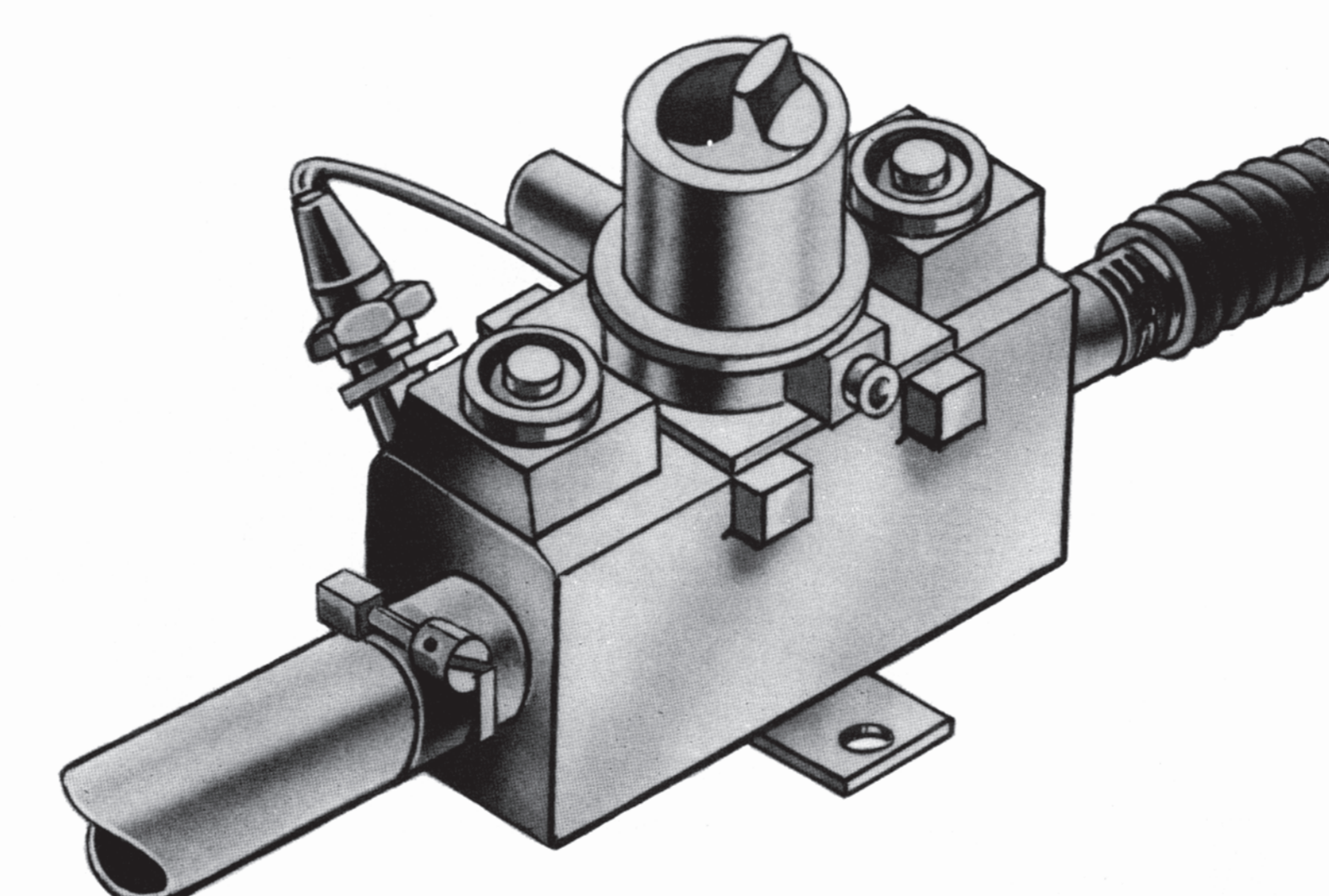

6. ADJUST HEATER AS NEEDED
(M13A1 ONLY)
TURN HEATER OFF AFTER USE

FILTER UNIT OPERATION

PREVENTIVE MAINTENANCE CHECKS AND SERVICES

INTERVAL AND SEQUENCE NO.		ITEM TO BE INSPECTED	PROCEDURE
BEFORE OPERATION	AFTER OPERATION		
1	7	HOSE ASSEMBLIES	CHECK FOR CUTS AND DETERIORATION. MAKE SURE CONNECTIONS ARE TIGHT.
2	8	CABLE ASSEMBLIES	INSPECT FOR LOOSE CONNECTIONS. TIGHTEN LOOSE CONNECTIONS.
3	9	TOGGLE SWITCH	CHECK SWITCH FOR OPERATION.
4	10	PRECLEANER AND PARTICULATE FILTER.	TURN ON FILTER UNIT SWITCH AND CHECK TO SEE THAT THERE IS A FLOW OF AIR FROM DUST SEPARATOR. MAKE SURE SPRING CLIP IS NOT MISSING. INSPECT HOUSING FOR EVIDENCE OF DAMAGE.
5	11	M18 10 CFM GAS FILTERS.	INSPECT FOR EVIDENCE OF DAMAGE. REPORT DAMAGED FILTERS TO ORGANIZATIONAL MAINTENANCE PERSONNEL.
6	12	M3 HEATER	CHECK CONTROL KNOB FOR OPERATION. INSPECT FOR DAMAGE. MAKE SURE INDICATOR LIGHT IS FUNCTIONING.

TURN HEATER OFF AFTER USE!

▶ REPORT DEFECTS AND MALFUNCTIONS TO ORGANIZATIONAL MAINTENANCE

M13 SERIES GAS-PARTICULATE FILTER UNIT

PREVENTIVE MAINTENANCE CHECKS AND SERVICES

INTERVAL AND SEQUENCE NO.			ITEM TO BE INSPECTED	PROCEDURE
BEFORE OPERATION	DURING OPERATION	AFTER OPERATION		
1	4		SWITCH AND PRECLEANER ASSEMBLY	TURN SWITCH TO ON; CHECK TO SEE THAT THE MOTOR IN THE PRECLEANER OPERATES PROPERLY AND THAT A NOTICEABLE AMOUNT OF AIR FLOWS TO THE HEADPIECE.
2		5	HEADPIECE	INSPECT FOR HOLES, LOOSE EYEPIECES, AND FOR SEPARATION OF CANISTER MOUNTING FROM HEADPIECE.
3		6	HOSE	INSPECT FOR WEAR, DAMAGE, AND DETERIORATION.
		7	FILTER UNIT	CHECK ENTIRE FILTER UNIT FOR DAMAGE, DETERIORATION, AND MISSING PARTS.

▶ REPORT DEFECTS AND MALFUNCTIONS TO ORGANIZATIONAL MAINTENANCE

M8A3 GAS-PARTICULATE FILTER UNIT