

FM 34-81/AFM 105-4

**WEATHER SUPPORT FOR
ARMY TACTICAL OPERATIONS**

AUGUST 1989

**DEPARTMENTS OF THE ARMY AND
THE AIR FORCE**

DISTRIBUTION RESTRICTION: Approved for public
release; distribution is unlimited.

FIELD MANUAL
NO 34-81

AIR FORCE MANUAL
NO 105-4

*FM 34-81/AFM 105-4
DEPARTMENTS OF THE ARMY AND
THE AIR FORCE
Washington, DC, 31 August 1989

WEATHER SUPPORT FOR ARMY TACTICAL OPERATIONS

Table of Contents

| | Page |
|---|--------------|
| Preface | i i |
| CHAPTER 1 - Weather Support for the AirLand Battle | 1-1 |
| AirLand Battle | 1-2 |
| Battlefield Area | 1-4 |
| Echelon Responsibilities | 1-6 |
| CHAPTER 2 - Weather Resources | 2-1 |
| Weather Support | 2-2 |
| Functions and Responsibilities | 2-2 |
| Weather Information Sources | 2-4 |
| Integrated Weather Support | 2-8 |
| CHAPTER 3 - Air Weather Service Support to Army Units | 3-1 |
| Air Weather Service Centralized Support Structure | 3-1 |
| Weather Support Force | 3-4 |
| CHAPTER 4 - Weather Support by Army Elements | 4-1 |
| Intelligence Preparation of the Battlefield | 4-1 |
| Weather Data Sources | 4-6 |
| Forward Area Limited Observing Program | 4-9 |
| CHAPTER 5 - Weather Support Communications | 5-1 |
| Communications Factors | 5-2 |
| Communications Responsibilities | 5-2 |
| CHAPTER 6 - Combat Service Support | 6-1 |
| Army Support | 6-1 |
| Air Force Support | 6-5 |
| APPENDIX A - Forward Area Limited Observing Program | A-1 |
| APPENDIX B - Weather Effects on Army Operations | B-1 |
| APPENDIX C - Meteorological Critical Values | C-1 |
| GLOSSARY | Glossary-1 |
| REFERENCES | References-1 |
| INDEX | Index-1 |

*This publication supersedes FM 34-81/AFM 105-4, 31 August 1984.

DISTRIBUTION RESTRICTION: Approved for public release; distribution is unlimited.

Preface

The AirLand Battle is an extended, integrated battle involving all air and land forces. Conventional, nuclear, chemical, and electronic weapons are integrated to attack enemy forces throughout the depth of their formations. Basic to the AirLand Battle is the fact that modern battles will be fought by air and land forces working together. Interaction and cooperation must extend into almost every function of combat.

The potential AirLand battlefield exists wherever United States forces face relatively modern, well-equipped forces using Soviet tactics and operational concepts. These forces are typified by the Warsaw Pact in Central Europe and the mechanized forces in the Middle East and Korea. The Army and Air Force must be prepared to fight and win by using all available combat power throughout every dimension of the battlefield.

Combat power depends on more than troops and weapon systems. It requires the integration of communications, intelligence, and other types of combat support (CS) and combat service support (CSS). These factors may be decisive, since commanders can manipulate and control them to achieve a tactical advantage.

Weather is the single decisive factor over which commanders have little or no control. Weather may be the most significant factor considered in all combat operations.

Many battles were won or lost due to the impact of weather. Some examples are the Spanish Armada, Operation Overlord, Battle of Trenton, Battle of Stalingrad, and the Battle of the Bulge, as well as Napoleon's and Hitler's attempts to take Moscow.

Although commanders have no control over weather, they can take advantage of it or minimize its effects through planning. To do so, they need support from meteorological elements operating from the tactical to the national and international levels.

This manual provides weather support doctrine for combat operations. FM 100-5 describes operations and FM 34-1 describes intelligence and electronic warfare operations. The target audience includes Army and Air Force commanders and staffs. It also includes those US Air Force (USAF) weather teams (WETMs) deployed in support of Army tactical commands and echelons above corps (EAC) which provide weather data to lower echelon WETMs. Publications in the references support this manual and should be consulted for more details.

Use of special operations forces (SOF) in this manual refers to both special forces groups (SFGs) and the ranger regiment.

The proponent of this publication is HQ, TRADOC. Submit changes for improving this publication on DA Form 2028 (Recommended Changes to Publications and Blank Forms) and forward it to Commander, US Army Intelligence Center and School, ATTN: ATSI-TD-PAL, Fort Huachuca, AZ 85613-7000.

CHAPTER 1

WEATHER SUPPORT FOR THE AIRLAND BATTLE

Weather is critical to Army tactical operations and operational level planning. History is filled with examples of the weather's effects on combat operations on a variety of battlefields. The AirLand battlefield of today may provide additional examples of victories and defeats attributable to skillful integration of weather in military planning and execution of combat operations. Weather, enemy, and terrain are often referred to as the wet trilogy, as shown in Figure 1-1.

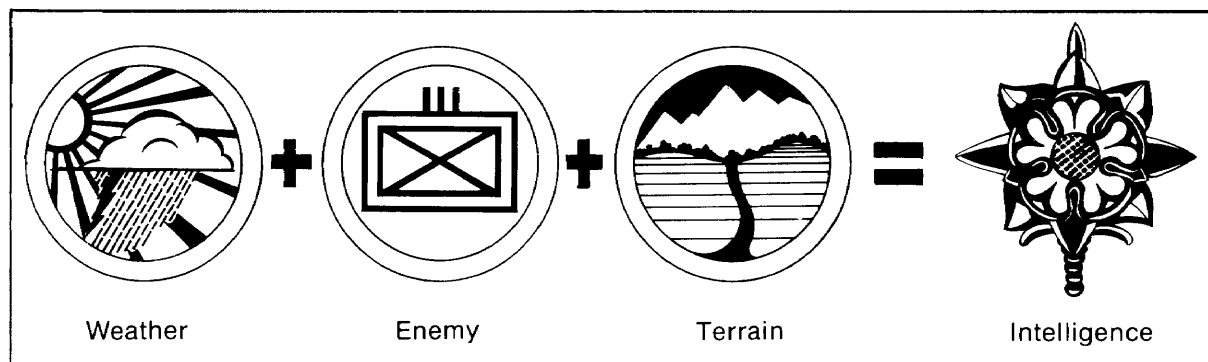

Figure 1-1. The wet trilogy.

Weather information is as much a part of combat intelligence as enemy and terrain data. It is often as significant as enemy intentions and trafficability. It affects enemy actions and the decisions of both forces. Adverse weather conditions--

- Affect mobility.
- Decrease the ability to see and attack deep.
- Degrade electro-optical (E-O) systems.
- Increase the requirement for thoroughly integrated air and ground operations.
- Slow the movement of supplies and reinforcements.

Weather is one dynamic factor on the battlefield which commanders cannot control but which has the potential to affect every combatant, piece of equipment, and operation. Weather becomes more significant to

success on the Air Land battlefield as advanced E-O weapon systems are fielded because of their vulnerability to adverse weather.

Commanders must be aware of and prepare for general and specific effects of weather on enemy and friendly major weapons systems and operations. This includes evaluating plans to minimize the adverse weather effects on friendly forces and to maximize the effects on the enemy.

Potential adversaries do not place as much emphasis on numerical weather prediction as the United States and its North Atlantic Treaty Organization (NATO) Allies. Warsaw Pact doctrine minimizes the effects of changing weather conditions by seizing and holding the initiative through speed, mass, and disruption. Timely and accurate weather forecasts help our commanders exploit this Warsaw Pact vulnerability. In a low-intensity conflict (LIC), the enemy will most likely have very primitive weather support. Sophisticated support to US forces allows commanders to employ their forces to maximum effectiveness according to the major tenets of the AirLand Battle.

- Initiative. Adverse weather normally favors the attacker. However, changing conditions provide both sides with windows of opportunity and vulnerability. Defenders use these windows to set the terms of battle, defeat the enemy attack, and seize the initiative. Attackers use these windows to enhance the attack and carry the battle to conclusion.
- Depth. As the battlefield is extended in space and time it becomes more likely that weather conditions will vary, opening windows of opportunity and vulnerability.
- Agility. If commanders are knowledgeable of weather effects on the enemy and friendly forces, then timely and accurate weather support will enable them to respond to changing conditions more rapidly than the enemy.
- Synchronization. The combat power of AirLand Battle forces is made up of many components, each with its own unique weather sensitivities. In order to employ these component forces for maximum effect on the battlefield, commanders must know of weather conditions and weather effects on the components.

AIRLAND BATTLE

The AirLand Battle is an extended, integrated battle involving the use of all available air and land forces. It is extended because the battle is fought from the rear boundary out to the range of available weapons as a single, continuous battle. It is integrated in that nuclear and

chemical weapons are merged with electronic and conventional weapons in all operations and plans. The use of nuclear and chemical weapons depends on the tactical situation and requires a release from the national command authority.

Inherent in the AirLand Battle is the simultaneous fighting of deep, close-in, and rear operations. The need for deep attack emerges from the nature of our potential enemy's doctrine and numerical superiority. Our objectives are to--

- Gain a degree of manipulative control over enemy follow-on forces.
- Destroy enemy combat power before they can join in the close-in operations in the defense.
- Carry the battle to the enemy's depth through bold but calculated offensive operations.

Whether the enemy is doctrinally echeloned is not critical. What is important is that superiority in numbers permits the enemy to keep a significant portion of its force out of the fight, with freedom to either overwhelm or to bypass the friendly force. The existence of these follow-on echelons gives the enemy an advantage which must be overcome. Friendly forces must seize and retain the initiative in order to fight successfully and win. To gain the initiative, friendly forces must--

- See deep and begin early to disrupt, delay, and destroy enemy follow-on or reinforcing echelons.
- Move quickly against enemy assault echelons to prevent them from achieving their objectives.
- Finish the opening fight against assault echelons rapidly and go on the attack before follow-on echelons can join the battle.
- Prevent enemy forces from reinforcing the assault forces and achieving their objectives through mass and continuous combat.
- Find the opportunity to seize the initiative--to attack and destroy the integrity of the enemy operations plan, forcing the enemy to stop the attack or risk defeat.

Vulnerabilities are inherently created as the enemy organizes forces into echelons that are needed for success. These same vulnerabilities give us the opportunity to put enemy second-echelon forces at great risk. Intelligence preparation of the battlefield (IPB) and target value analysis (TVA) help us identify high-value targets (HVTs). These targets include bridges and choke points that cause enemy follow-on echelons to

bunch up and present lucrative targets. Effective deep attack provides the friendly force commander the opportunity to seize the initiative and dictate battle terms.

Limited strike and acquisition means are applied in a well-organized and coordinated scheme to support this plan. The commander decides when to use deep attack and which targets to destroy to create opportunities for offensive action. The decision is based on a single scheme of maneuver and a fire plan for deep operations. The opportunities for decisive action must be created in areas where sufficient logistic support, fire support, and maneuver forces are available.

Careful coordination of present and future action throughout the depth of the battlefield requires the plan come from one commander's concept. Separation of close and deep operations invites the risk that opportunities will not be generated or, if generated, that forces will be unprepared to identify and exploit them.

Unity of command is essential to the extended battlefield. The commander is fighting one battle, composed of several parts, that are interrelated. The depth of this battlefield extends beyond the forward line of own troops (FLOT) and is a function of the commander's planning horizon. Each level of command has a dual responsibility. Each commander must attack the enemy's assault echelons and delay and disrupt follow-on echelons to seize the initiative and destroy their operational plan. Commanders must also see and determine the intentions of enemy forces that can affect future operations.

BATTLEFIELD AREA

Commanders consider the battlefield in terms of the time and space necessary to defeat the enemy force or to complete the assigned mission. Time is the first consideration and must be related to a battlefield area so commanders can direct their reconnaissance, surveillance, and target acquisition resources to identify targets and threats. To convert time into space, commanders must consider the unit's mission and capabilities and the maneuverability, terrain, and capabilities of the enemy. Commanders view the battlefield as having two distinct areas which can be expressed in terms of time. These are the area of operations (AO) and the area of interest (AI). Weather products, like any other intelligence information, must be keyed to those two areas.

The AO is a geographical area assigned to commanders for which they have responsibility and in which they have authority to conduct military operations. Commanders are assigned an AO based on the mission, enemy, terrain, troops, and time available (METT-T). The AO is of sufficient size to allow maneuver for successful completion of the mission, as shown in Figure 1-2.

| LEVEL OF COMMAND | TIME BEYOND FLOT OR ATTACK OBJECTIVE |
|-------------------------|---|
| Battalion | Up to 3 hours |
| Brigade | Up to 12 hours |
| Division | Up to 24 hours |
| Corps | Up to 72 hours |
| EAC | Up to 96 hours |

Figure 1-2. Area of operations.

The AI is an area of concern to the commander. It encompasses adjacent areas and areas occupied by enemy forces that could jeopardize the mission. The time span, as shown in Figure 1-3, is increased to allow planning for future operations.

| LEVEL OF COMMAND | TIME BEYOND FLOT OR ATTACK OBJECTIVE |
|-------------------------|---|
| Battalion | Up to 12 hours |
| Brigade | Up to 24 hours |
| Division | Up to 72 hours |
| Corps | Up to 96 hours |
| EAC | Beyond 96 hours |

Figure 1-3. Area of interest.

Whether attacking or defending, each echelon of command must create the time and space needed for subordinate echelons to defeat enemy forces in contact before it becomes necessary to engage those not yet in contact. This is done by attacking deeper enemy echelons to delay, disrupt, and destroy them before they can affect the operations of friendly subordinates. For example, the division may interdict deeper enemy regiments while its brigades fight assaulting enemy regiments or defending enemy battalions; corps may interdict deeper enemy divisions while the division fights assaulting enemy divisions or defending enemy regiments.

Subordinate commanders may request that superior commanders take specific measures against deeper enemy forces, normally in the subordinate's AI. When this is the case, subordinate commanders should also specify what they want done to the enemy formation; for example, delayed for a specific time, canalized along a specific avenue of approach, or defeated in a specific area.

ECHELON RESPONSIBILITIES

Each echelon of command has a range of responsibilities while fighting a rear, close-in, and deep operation at its own level. Weather support requirements are different at each level and must be tailored to meet the scale and time for the AO and AI.

ECHELONS ABOVE CORPS

An Army headquarters normally exists between the theater and the corps echelon. This may occur when--

- ° Several corps are employed.
- ° There is a dispersion of forces.
- ° Political or geographical conditions dictate wide variations in the nature of operations.

The EAC commander directs the operational level of warfare. Overcoming the enemy's initial numerical advantage must begin at the highest level. EAC is responsible for skillful employment of long-range assets, including--

- ° Air power.
- ° The movement of reinforcing forces into the battle area.
- ° Much of the CSS activities required to support the operations of deployed corps.

Enemy forces and their nuclear delivery systems must be located and destroyed before they can affect close-in operations. EAC commanders must see the enemy forces that will affect friendly operations up to 96 hours and beyond. To see the battlefield enables commanders to make timely decisions to effectively employ friendly forces and long-range weapon systems.

Several operational work centers may exist to support EAC responsibilities. The EAC structure depends on the theater and level of conflict. Geographically separated command and control (C²) centers may exist at EAC main, rear, alternate, and echelon above corps intelligence centers (EACICs). The EACIC is the hub of theater intelligence and normally is part of the EAC MI brigade. Several components in the EACIC include--

- An all-source analysis center (ASAC).
- Ten intelligence support elements.
- A center support element to direct collection efforts, analyze information, and integrate data into operational planning.

EAC commanders need to know--

- Current and forecast weather condition effects and impacts in their AO and AI and logistical points of embarkation and debarkation.
- A general overview of weather effects on subordinate commands and the weather impacts on tactical air support and tactical and strategic airlift.
- Seasonal conditions and climatology which affects their campaigns across the theater.
- The plan for the next season and how the combination of terrain and weather will limit or enhance their capabilities.
- Historical climatological studies for the theater of operations to ensure operations plans include general weather effects on weapon systems, maneuver, logistics, personnel, and the use of aviation and close air support (CAS) assets.

CORPS

The corps is the highest tactical echelon. The corps directs, coordinates, and allocates resources for operations in its AO up to 72 hours in the future. Corps generally conducts offensive operations by--

- Massing fires or forces against enemy flanks, gaps, or rear.
- Seeking to avoid enemy strength.
- Going against enemy weak areas.
- Using economy of force in areas from which forces have been drawn.

While divisions normally attack first- and second-echelon defenses, corps plan and conduct operations against deeper defensive echelons, reserves, and reinforcing forces. Corps interdict second-echelon enemy divisions of first-echelon armies to delay and disrupt those forces before they can join the battle. Corps direct the AirLand Battle and provide security for the rear area.

Weather information requirements differ for EAC and subordinate commanders in the time period and the level of detail. Weather effects interpretation efforts key on the engagement of forces during the next 72 hours. However, corps commanders need to know current observed weather conditions and forecasts for their AI out to 96 hours in order to--

- Judge the weather effects on the enemy plans and movement.
- Assess the affects on their systems and tactics.
- Adjust their planning.

Commanders need forecasts of conditions limiting ground and air movement from aerial and sea points of debarkation to support logistical efforts. The same type forecasts provided to divisions but expanded in time and space are needed to support corps combat operations such as artillery and aviation assets.

DIVISIONS

Divisions are the basic units of maneuver at the tactical level. They possess great flexibility and tailor their brigades for specific missions. Infantry, armored, mechanized infantry, airborne, and air assault divisions are presently in the force. Designed to be largely self-sustaining, portions of their CS and CSS battalions and separate companies may be attached to or placed in support of brigades for the performance of a particular mission. At the direction of the corps, divisions perform major tactical operations and conduct sustained battles and engagements.

Significant planning activities take place at the division level to direct subordinate brigades against first-echelon regiments; this is done

while interdicting enemy second-echelon regiments and follow-on divisions with long-range artillery, maneuver, and organic aviation assets. Normally, there are three separate battle planning centers at each division:

- The current close-in operation is supervised at the forward tactical command post (CP) under the supervision of the assistant division commander for maneuver.
- Rear operations are supervised at the division rear CP under the supervision of the assistant division commander for support.
- Deep operations and planning for sustained division operations are conducted at the division main CP.

The division planning staff needs tailored weather forecasts and current observations for synchronizing the combat power components into a comprehensive plan for battle. Detailed, accurate weather information and the effects of the environment on weapon systems, tactics, and logistics are required to conduct and direct operations and to plan for future operations.

Division artillery requires observations and forecasts for the tactical fire (TACFIRE) direction computer system. Chemical teams need data for chemical and nuclear support planning. All divisions need illumination forecasts for night vision devices.

Many divisions require more tailored weather information. Heavy divisions require more tailored weather information. Heavy divisions are especially concerned with weather affecting trafficability, thermal sights, laser range finders, and aviation. Air assault divisions are mostly concerned with weather affecting aircraft operations. Light infantry divisions are more concerned with visibility and illumination as well as weather conditions affecting the individual soldier and mobility on foot. Some divisions have areas of specialization such as cold weather, desert, and mountain operations which require tailored support.

DIVISION MANEUVER BRIGADES

Maneuver brigades are the major combat units of all types of divisions. They control two or more battalions. Capabilities for self-support and independent action vary with the type of brigade. It is in the brigade AO where friendly forces must gain the initiative and destroy enemy forces. Brigades direct, coordinate, and support operations against enemy first-echelon regiments and interdict second-echelon battalions of first-echelon regiments.

Brigades are concerned primarily with current weather conditions and weather which would affect operations during the next 12 hours. Current and near-term conditions are more important to today's battle; the outcome will play a major role in future planning. Division WETMs ensure brigade commanders are updated on current weather observations and provided timely weather forecasts.

SEPARATE BRIGADES AND ARMORED CAVALRY REGIMENTS

Separate brigades and armored cavalry regiments (ACRs) can be used to reinforce corps or divisions and can be shifted to tailor forces for combat. They are employed as units when attached to corps or divisions. Separate brigades provide corps commanders with the assets to execute several missions, especially deep operations. ACRs engage in the battle early in the covering force area (CFA) and are very mobile. ACRs have organic air cavalry assets.

ACRs and separate brigades require dedicated weather support similar to divisions because they operate as corps assets. Their AO and AI vary with their missions but normally coincide with that of a division or brigade, depending on how they are employed.

SPECIAL OPERATIONS FORCES

SOF are normally employed at the direction of EAC. They may deploy before announced hostilities and often operate in a stand-alone mode. Large distances may exist between the group headquarters and subordinate battalions at forward operating bases (FOBs). Battalions may deploy teams over continent-sized operational areas for special missions deep in enemy territory.

Independent, direct weather support is needed for long-range planning, mission execution, and resupply operations. Support must be tailored to--

- ° The unique weapon systems.
- ° Particular mission objectives.
- ° Aviation requirements.
- ° Infiltration, exfiltration, and resupply operations. Time and space considerations are often similar to the EAC AO and AI with particular attention to specific geographical points and routes.

AVIATION BRIGADES

Aviation brigades are organic to each corps and division. Operations are similar for corps and division aviation brigades, except the

division's AO planning timeframe is shorter. Deep, close, and rear operational missions include--

- Direct attack.
- Air insertion or extraction.
- Resupply.
- Reconnaissance.

Aviation brigades receive mission taskings from their respective corps or division to employ support or attack aircraft. However, they independently plan and execute their missions. Single and multiple aircraft missions will also be flown in conjunction with ground and joint operations. Each brigade will have a tactical operations center (TOC) which will be geographically separated from the corps or division TOC.

Aviation brigades are especially susceptible to weather factors. Direct, dedicated weather support is required to ensure the optimum employment of these highly technical, weather-sensitive systems. Weather support for aviation brigades should coincide with the corps or division AO and AI versus that of a brigade.

ARMY AIRSPACE COMMAND AND CONTROL (A²C²)

Air traffic control (ATC) facilities control supporting rotary wing resupply efforts moving from the corps rear to the forward areas. The main corps WETM provides forecasts and observations to the corps airfield, which then relays them to mobile ATC facilities. Careful coordination between ATC and the staff weather officer (SWO) is required to ensure latest forecasts are provided. Weather forecasts made at lower echelons (for example, divisions, ACRs, and separate brigades) are transmitted to the corps WETM. The corps WETM passes them to the corps airfield and into the A²C² system. The SWO coordinates to ensure the communications for this linkage are included in communications annexes and all aviation support annexes to the war plans.

BATTALIONS

Battalions fight what they can see and shoot. The AO normally covers out to about 5 kilometers (km) from the FLOT to meet objectives over the next 3 hours. Battalion commanders need weather information--near real time-- for their AO and for planning operations for their AI.

CHAPTER 2

WEATHER RESOURCES

Weather significantly impacts on the feasibility of using military force and on ensuing operations. It impacts differently on various types of forces and, in some cases, dictates the types of forces that can be employed effectively. Weather data is part of the intelligence information required by commanders and staffs to plan and conduct combat operations. The answers achieved by analyzing weather data, identifying weather effects, and assessing the impact of weather on systems, tactics, and operations provide vital information for commanders to optimally employ their forces.

The global mission of the United States Armed Forces requires an extensive network of weather observers, analysts, and forecasters. The network consists of the national weather services of each friendly country, our own National Oceanographic and Atmospheric Administration (NOAA), and weather or environmental units within the US Army, Navy, Air Force, and Marine Corps.

Meteorological services of each country provide the basic observation network and related weather facilities in the country. Current and future global weather conditions can be forecast by exchanging data among nations. Peacetime cooperation among nations for weather services provides global and hemispheric analyses in support of military operations anywhere in the world. During wartime, meteorological control and other security restrictions may drastically limit the availability of other national and indigenous weather information.

US military weather services and units are specialized organizations with worldwide capabilities structured to satisfy unique military requirements. They exchange weather data with national weather services and have access to national and international weather data bases. Characteristics of the military weather services are--

- ° Mobility.
- ° Responsiveness to command.
- ° Combat readiness.

Weather support is most effective when weather personnel know the mission, organization, capabilities, plans, and procedures of the Army units they support. The demands placed on weather support organizations are more realistic when Army personnel understand the basic principles of weather forecasting and recognize the capabilities, limitations, and support requirements of the WETM.

WEATHER SUPPORT

Weather support for Army tactical operations is based on the following principles. Each of these principles as they apply to Army operations is described in chapters and appendixes as shown.

- Weather effects must be considered by all tactical units during all planning and operational phases, including deployment, employment, CS, and CSS (Chapter 3).
- Commanders must consider favorable and unfavorable weather conditions to determine the best course of action to accomplish the mission (Appendixes B and C).
- Accuracy of weather forecasts is dependent on the density and timeliness of weather observations. All weather observations, particularly those taken by Army personnel forward of the division TOC, must have high priority and be rapidly transmitted to an Air Force WETM (Appendix A).
- Timely, reliable primary and alternate communications must be provided (Chapter 5).
- Because of continually changing atmospheric conditions, weather information is highly perishable. Weather observations and forecasts must be monitored and updated continually.

FUNCTIONS AND RESPONSIBILITIES

The Air Force provides the bulk of weather support required by the Army. AR 115-10/AFR 105-3 specifies each service's functions and responsibilities associated with that support.

AIR FORCE

The USAF Chief of Staff, through the Military Airlift Commander (MAC) Air Weather Service (AWS), provides--

- Weather personnel with the technical training and skills necessary to support their Army customer.
- Direct weather support for EAC, corps, divisions, separate brigades, aviation brigades, regiments, and groups according to jointly agreed upon tactical doctrine and operational support concepts.

- Weather training for Army personnel assigned to take limited surface weather observations in support of Air Force forecasting operations, or in support of Army ATC operations.
- The general effect of weather on systems, tactics, and operations based on critical threshold values identified by the Army.
- Weather observations, forecasts, staff support, and timely warnings of expected weather that may adversely affect operations or that could be a hazard to personnel or materiel.
- Weather support products for use in soil trafficability and hydrographical prediction.
- Unique and specialized meteorological observations and forecasts of data elements not include in standard surface weather observations or critical values on request.
- Climatological support for tactical missions, IPB, and tactical decision aids.

ARMY

The US Army provides--

- Surface observations forward of division command elements and all upper-air observations. This does not preclude the Air Force from placing personnel in forward areas to collect and relay weather information and to take weather observations.
- Critical or threshold values for determining the weather effects on systems, tactics, or operations.
- The assessment of the impact of weather effects on systems, tactics, or operations.
- Trafficability and hydrographic forecasts.
- Weather communications circuits from the Defense Communications System (DCS) interface point to tactical locations.

JOINT SERVICES

Joint responsibilities of the individual services are determined in contingencies and wartime by--

- AR 115-10/AFR 105-3.

- Joint agreements governing US major Army commands (MACOMs) to include USAF WETMs early in their war plans.
- The type of operation.
- The service that provides the majority of forces.
- Directives of the unified or specified commands, subordinate unified commands, or other joint force commanders.

Wartime support required by individual combat arm units is described in the field manuals and doctrinal publications of those units. Peacetime support required by US Army garrisons, other fixed installations, and combat elements for peacetime training is determined in accordance with Army and joint regulations listed in the references. This peacetime training support may exceed the level of wartime support. US Army commanders should be well informed of the differences between peacetime and wartime support.

WEATHER INFORMATION SOURCES

There are several other sources of weather information besides national and international sources. These sources--Air Force, Army, and Navy--acquire weather data from locations throughout the AI. This information ranges from intermittent measurements of a few weather elements to detailed observations of many environmental elements taken on a regular schedule by trained weather observers. The detailed observations contribute most significantly to the data base from which tactical weather products are derived. The primary sources of tactical surface weather observations and upper-air data are the--

- AWS WETMs.
- Army artillery meteorological (ARTYMET) sections.
- Forward Area Limited Observing Program (FALOP).

AIR WEATHER SERVICE

The AWS obtains, evaluates, and disseminates weather information for the Army. The AWS operates on a global scale. Its mission is to provide weather support for Army, Air Force, and certain joint operations. Support includes--

- Weather observations.
- Forecasts.

- Climatological data.
- Light and tide data.
- Atmospheric and astronomical information affecting radar, wireless communications, and E-O weapon systems.

This global support requires the input of both surface and upper-air data from AWS, National Weather Service (NWS), Federal Aviation Administration (FAA), Navy, and allied meteorological services, as well as data furnished by Army sources.

A reliable forecast depends on an accurate description of the atmosphere over a large geographical area. In parts of the world where surface observation sites are sparse or nonexistent, data are partially obtained by aerial reconnaissance flights and weather satellites. Aircraft weather observations are available from several sources. Data derived and extracted from these sources are relayed to the forecast unit (FU) for distribution to both Army and Air Force WETMs. Other weather observations are available from--

- Civilian and military aircraft that provide information along their routes.
- Military aircraft performing tactical missions.

The Defense Meteorological Satellite Program (DMSP) is a joint service program whose mission is to provide--

- Timely, high-quality stored data for support of special strategic missions and EAC operations.
- Real-time direct readout data for support of tactical air and ground operations to EAC or other locations. This satellite imagery then can be interpreted, and forecasts based on it will be relayed to corps and division.
- Research and development in advancing meteorological satellite technology.

DMSP satellites are in near polar orbit and can provide coverage of a theater of operations. Visible, infrared, and high resolution data can be obtained. The AWS has transportable receivers that can receive imagery as a satellite passes over or near the area. These receivers can be airlifted by C-130, C-141, or C-5 aircraft, or transported over improved roads.

DMSP imagery can be obtained from these receivers and relayed to EAC, corps, and division WETMs where the appropriate receivers are installed. Satellite imagery may be the single available source to fill in data-sparse areas.

The Naval Oceanographic Command (NOC) provides the AWS the necessary charts and tidal data for Army tactical operations. Ships at sea also provide data.

WETMs support the tactical Army by providing SWO support and forecasting and observing services. Weather observations are taken and disseminated to weather units throughout the theater. They are interpreted by a forecaster and incorporated into tailored weather products for the Army. These observations are included in the worldwide data base for national use. The SWO provides tailored support to the Army for effective integration into all facets of tactical operations. A detailed description of the AWS support system is in Chapter 3.

ARTILLERY METEOROLOGICAL SECTIONS

Within an Army command, ARTYMET sections acquire upper-air data and surface weather observations. They disseminate current meteorological data to their assigned field artillery unit and for the USAF WETM.

The mission of ARTYMET sections is to support the needs of the Army by providing--

- Ballistic meteorological messages.
- Meteorological data for fallout prediction.
- Computer meteorological messages.
- Upper-air weather observations to the AWS WETM.
- Limited surface weather observations to the AWS WETM.
- Target acquisition meteorological messages.

The data obtained by an ARTYMET section can be vital in developing tactical weather forecasts. Similarly, data collected by the AWS can help the ARTYMET section perform its other missions. Therefore, corps and division WETMs, fire support elements (FSEs), and ARTYMET sections must develop a harmonious working relationship. To ensure the expeditious exchange of data, standing operating procedures (SOPs) should specify the support requirements, including frequency of contact, scheduling, and mode of communication. A complete description of the ARTYMET section is in Chapter 4.

FORWARD AREA LIMITED OBSERVING PROGRAM

The FALOP is a G2 directed program designed to obtain timely weather observations in the forward areas of the battlefield. A complete description of FALOP is in Chapter 4 and Appendix A.

OTHER SOURCES

Other Army organizations obtain limited weather data in support of their missions and weapons systems. These organizations include maneuver, chemical, aviation, and engineer units.

Availability of these sources varies. Therefore, the SWOs must identify them within their supported Army units, have the requirement to transmit the observations published in tactical SOPs, and ensure that reliable communications links are established in appropriate signal annexes to operation plans (OPLANs) or operation orders (OPORDs). The G2 provides command emphasis in stressing the importance of these observations to major subordinate commands (MSCs).

Collectively, the above organizations can provide a variety of surface and low-level observations on an unscheduled basis, such as--

⁰ Onsite observations of--

- Surface temperature.
- Dewpoint temperature.
- Wind direction and speed.
- Surface pressure.
- Visibility and obstructions to visibility.
- Special phenomena.
- Cloud cover and height.
- Type and amount of precipitation.
- Snow depth.

⁰ Observation from ground observers, aircraft, and ground radars of--

- Cloud cover.

- Visibility and obstructions to visibility.
- Type and amount of precipitation.
- Special phenomena over both friendly and enemy-held territories.

These observations must be provided quickly to AWS WETMs if they are to be of value.

INTEGRATED WEATHER SUPPORT

Weather information provided by each of the sources in the preceding paragraphs must be integrated with operational data to determine its impact on tactical operations. Intelligence staffs of EAC, corps, divisions, ACRs, separate brigades, aviation brigades, and SOFs convert correlated data into information that is useful to the commander.

Weather information is the staff responsibility of the intelligence officer at each echelon. At EAC, corps, divisions, ACRs, separate brigades, aviation brigades, and SOF the intelligence officer is supported by a USAF WETM commanded by the SWO. Additionally, the terrain team supporting corps and divisions assists the intelligence officer at those echelons in assessing the environment's effect on the terrain.

The intelligence section, the USAF WETM, and the terrain analysis detachment provide integrated environmental support at EAC, corps, and divisions. This close relationship ensures that the best possible weather and environmental effects information is available to planners and decision makers when needed.

TACTICAL DECISION AIDS

At the tactical level, requirements for forecasts are of shorter range. Shorter lead times enable more accurate forecasts and, subsequently, better determination of weather effects information. Weather effects apply to specific weapons systems, vehicles, tactics, personnel, and equipment; they also impact on resupply and reinforcement because they affect rates of movement.

Weather effects information is becoming more important as smart, sophisticated weapon systems and faster more maneuverable vehicles are entering our inventory. Adverse weather conditions can--

- Reduce speed.
- Eliminate avenues of approach.
- Thwart a well thought-out concept of operations.

- Limit some smart munitions.
- Cause thermal devices to become blind to the target.

Because of this, a system of tactical decision aids can be used to determine effects. Tactical decision aids can be as simple as a look-up table giving simple results; or a complex software package on a tactical computer terminal which produces graphics of weapons limited by weather conditions. Results of the tactical decision aids can be--

- Acquisition and lock-on ranges for thermal sights or smart munitions.
- Cross-country movement rates of specific vehicles.
- Air or ground avenues of approach.
- Effects on ammunition requirements.
- Needs of individual soldiers to remain effective in combat.

Threshold weather effect values are established by testing equipment or by actual experience. When weather passes below that value, a flag is triggered to identify an impact on a specific mission. Thus, through the use of tactical decision aids, users are warned of the specific impacts of weather on operations.

At lower echelons weather effects determinations may be based on observations instead of forecasts; they provide information of what the weather is actually doing to the troops and equipment engaged on the battlefield.

INTELLIGENCE OFFICER

The G2 at EAC, corps, and division and the S2 at brigade, ACR, separate brigade, aviation brigade, SOF, ranger regiment, and battalion operations have primary staff responsibility for weather analysis at their respective echelons. Each ensures that critical weather data required for current and projected operations are reviewed on a timely basis and integrated into the planning cycle. The intelligence officer--

- Knows where to obtain weather data and the types of weather products available.
- Coordinates support and consolidates the commander's requirements for weather support.

- Coordinates with the SWO to ensure that weather information affecting intelligence is interpreted correctly.
- Interprets the effects of weather on tactical operations.
- Coordinates with the SWO and artillery commander to arrange for the timely exchange of meteorological information.
- Informs subordinate Army units of FALOP requirements. The SWO coordinates the FALOP requirements with the G2 or S2. The G2 or S2 informs subordinate units at brigade and battalion levels what information is required, the priority of requirements, and how the information is forwarded. Tasking as shown below is included in the intelligence annex provided by the G2 or S2.
- Transmits weather forecasts and warnings down the chain of command to lower echelons.
- Ensures Army weather observations are transmitted up the chain of command to the G2 or S2.
- Integrates weather analysis into advanced planning.
- Ensures all AWS elements are provided with communications, logistic, and administrative support from Army resources in accordance with AR 115-10/AFR 105-3.
- Coordinates weather observation training requirements of Army personnel with the G3 or S3, ensuring that Army personnel are trained to take FALOP observations.

STAFF WEATHER OFFICER

The SWO is an Air Force officer supporting Army echelons by providing direct weather service support to the Army unit to which assigned. The SWO is a member of the commander's special staff, under the staff supervision of the G2. The SWO and the WETM are under the operational control of the Army commander. The SWO's primary duty is to advise the tactical commander and staff on all matters pertaining to weather and climate. A complete description of SWO duties is in Chapter 3.

TERRAIN ANALYSIS DETACHMENT

Terrain analysis detachments support corps and division terrain intelligence requirements. Terrain analysis detachments--

- Interpret the effects of weather in terms of trafficability and mobility.

- ° Produce terrain studies and terrain-related intelligence data.
- ° Collect and compile graphic and textual data required by supported units.

When necessary, terrain analysis detachments update maps by using all available information including weather and environmental data.

CHAPTER 3

AIR WEATHER SERVICE SUPPORT TO ARMY UNITS

AWS is a numbered Air Force command within MAC. It exists to fulfill special worldwide environmental needs of the Air Force, Army, and other Department of Defense (DOD) agencies as directed by the Chief of Staff of the Air Force. AWS personnel and meteorological observing equipment are dedicated to support the unique requirements of the Army while it is in garrison or in a tactical environment. Such AWS units are trained and oriented by the Army on applicable Army organizations, concepts of operations, and weather sensitivities. This chapter describes how AWS is structured and how it supports the Army in the tactical environment.

AIR WEATHER SERVICE CENTRALIZE SUPPORT STRUCTURE

AWS provides weather support using a centralized weather support structure encompassing large computer processing capabilities and personal tailoring of data for specific users. Air Force Global Weather Central (AFGWC) is at the hub of this structure. Its products are disseminated to theater weather centers which add weather products tailored to the needs of the theater.

WETMs supporting tactical Army units further tailor the products they receive to the near term, smaller AI needs of their supported Army command. The role of centralized products is to provide predominant features of displayed analyses for a given area and time which must be essentially the same for all WETMs. There are advantages to centralizing support for tactical operations. Centralizing support--

- Limits the size of the weather communications facilities.
- Concentrates highly skilled forecasting capabilities.
- Makes the use of large computers feasible.
- Assists and guides the forecasters.
- Saves time and makes products more timely.
- Makes processed information available.
- Significantly enhances the accuracy of forecasts.

Being communications-dependent is one serious disadvantage. When critical communications are disrupted or denied, WETMs must have a backup, stand-alone capability to produce weather products required to support Army units. Another disadvantage of automated weather products is that

they are normally developed using a global data base, and mesoscale effects may be lost during the process. Figure 3-1 is an example of a weather information flow.

AIR FORCE GLOBAL WEATHER CENTRAL (AFGWC)

AFGWC at Offutt Air Force Base (AFB), Nebraska, is the largest meteorological center in the world and is the focal point for worldwide weather analysis and forecasting. Weather observations from all over the world are received there via high-speed communications networks along with other data such as satellite imagery.

This timely weather data base is processed on large, modern computers and by specialized weather technicians to analyze the earth's atmosphere in three dimensions twice each day. Sophisticated computer programs manipulate the complex interactions of data elements to develop forecast weather products for immediate dissemination to weather personnel worldwide. These products consist of standard analysis and prognosis charts as well as specialized products requested by SWOs at all support levels.

UNITED STATES AIR FORCE ENVIRONMENTAL TECHNICAL APPLICATIONS CENTER (USAFETAC)

USAFETAC is a part of the AFGWC although geographically separated. USAFETAC stores and processes worldwide climatological data. This data is vital for long-range planning, IPB, and near-term contingency requirements.

FORECAST UNITS (FUs)

Complementing AFGWC are permanent weather centers in other parts of the world which, in addition to AFGWC products, provide tailored products for their respective theaters. These FUs are dedicated to providing weather support to joint US forces or Combined Forces operating in wartime. Currently, FUs are located in Europe, Alaska, Korea, and Central America.

WEATHER SUPPORT FORCE

The tactical arm of the AWS support structure is aligned with the vertical command structure of the supported forces. The structure of supported forces often varies depending on the level of conflict, theater of operations, and duration of the conflict. To accommodate these differences, the weather support force adapts to the supported force

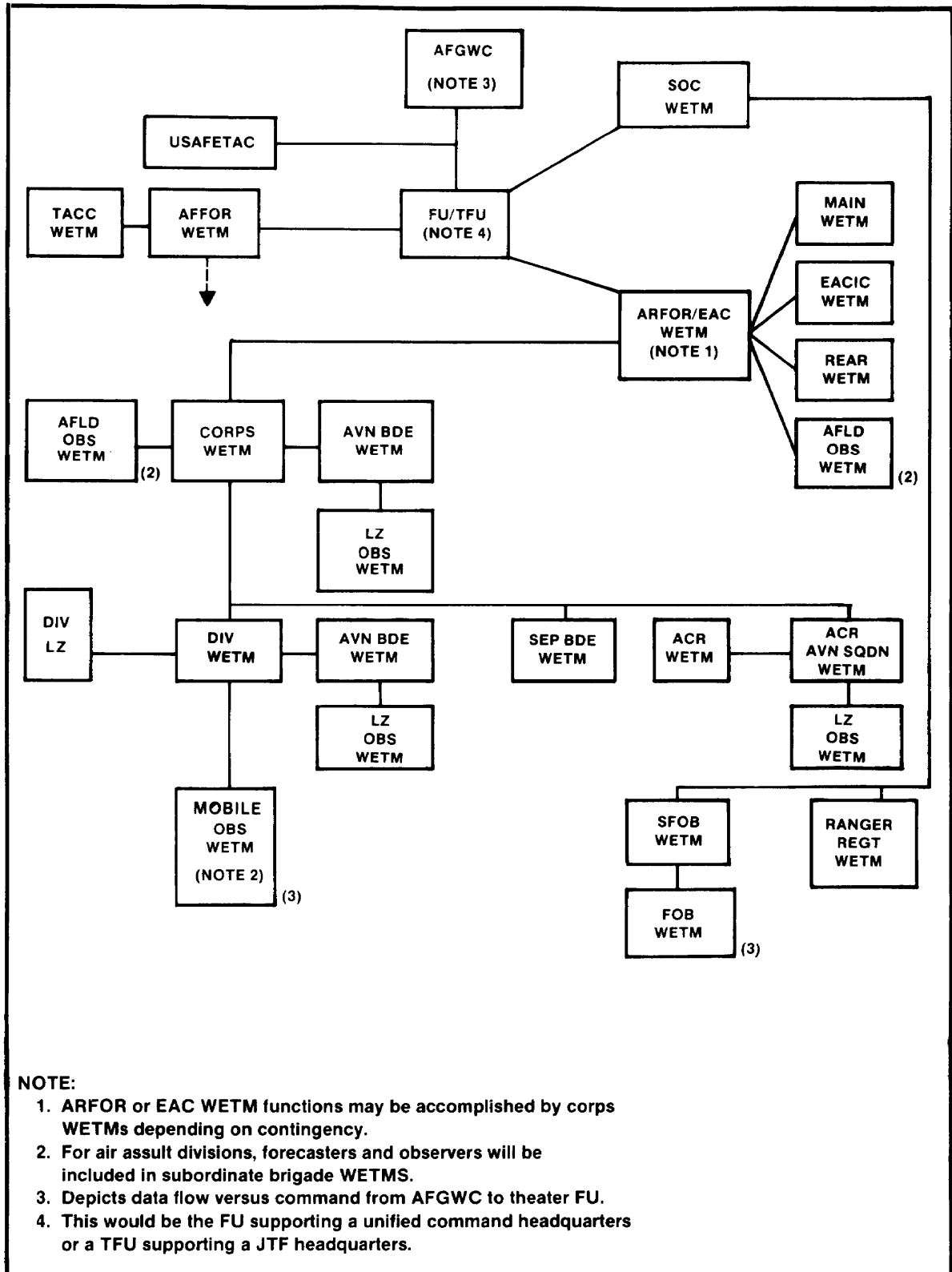

Figure 3-1. AWS weather information flow.

structure by assigning tactical WETMs to key elements of the command structure during peacetime. These teams deploy with their supported units during a war or contingency.

TACTICAL FORECAST UNITS (TFU)

A TFU would be established at the joint task force (JTF) level to provide support for a specific geographical area or combat operation. It would be activated and deployed to support a wartime mission or contingency. It is either redeployed or deactivated upon completion of the mission. The TFU supports lower echelon WETMs through--

- Direct relay of products from AFGWC, USAFETAC, and the theater FU.
- Limited editing and tailoring of products.
- Local generation of new products.

The TFU may provide all centralized products, using various data sources, during periods when other AWS system support is not available.

USAF TACTICAL WETM

The WETM prepares operational forecasts and user interface. It is the WETM forecaster or SWO who tells the user what the weather is going to be. The WETM tailors and refines the forecast guidance received from FUs to the specific operational needs of the user in terms of time, space, and form of presentation. Remote support is provided to subordinate commands of each echelon through the G2 or S2 section, which is responsible for transmitting forecasts and weather information to those users in the field. Call-up capability from the subordinate commands to the WETM for special requests or unscheduled forecasts is through area communication networks. Army support WETMs--

- Make maximum use of weather observations from Army sources.
- Use support from other US and Allied weather services.
- Use weather data from all sources both friendly and enemy.
- Use information from weather radar and satellites when available.
- Request specialized forecast products from centralized forecast facilities.

WETM Composition

The following describes various weather support teams, their functions, and responsibilities.

- EAC.
 - Main CP.
 - Rear CP.
 - EACIC.
 - EAC airfields.
 - SOF includes SFGs and ranger regiment.
- Corps.
 - Main CP.
 - Corps airfield.
 - Corps aviation brigade.
 - ACRs.
- Division.
 - Main CP.
 - Division landing zone (LZ).
 - Division aviation brigade.
 - Mobile observing teams.

When weather support force structure changes are required, the SWO requiring the change will coordinate the change with the supported command and request approval from the SWO at the next higher echelon. For example, if an ACR or separate brigade were to be under operational control to a division, to fight as a division brigade, the division SWO may request that the observer, forecaster, or SWO function be removed from the ACR or brigade WETM and be reallocated. This would be coordinated with the division commander, and the corps SWO would approve or disapprove the decision after consulting with the corps staff.

WETMs will be composed of one or a combination of--

- SWO.
- Officer and noncommissioned officer (NCO) forecasters.
- Weather observers.
- Administrative specialists (at division and higher echelons).

Each element of a WETM has specific responsibilities stated below. They are provided as guidelines for WETM members to provide insight on the WETM's mission, capabilities, and functions. Some responsibilities may not apply or must be tailored to the supported mission, and in some cases, team members share responsibilities. For example, it is common for the SWO to delegate many SWO responsibilities to the NCO forecasters and for NCO forecasters to take, record, and transmit weather observations.

Staff Weather Officer. The SWO, the senior officer of an echelon WETM, is a member of the Army commander's special staff, under the commander's operational control and under the general staff supervision of the G2 or S2. The SWO coordinates directly with the commander and staff on weather service matters and on weather and climate. While tactically deployed, WETM members are under the command of the WETM SWO. Each SWO falls under the command of the SWO to the next higher echelon of command in the weather support force structure; this normally parallels the supported Army force structure. The senior theater SWO has command authority of all weather support force theater personnel. The SWO--

- Commands the WETM and coordinates Air Force weather support activities.
- Advises the supported Army commander on weather support matters to include advice on the use of weather support to enhance the efficiency of combat operations.
- Coordinates with the G2 where subordinate SWO, forecasting, and observing WETM elements are employed.
- Provides daily weather briefings to commanders and their staffs to support current and future operations.
- Provides weather effects information with particular attention to critical weather threshold values which limit systems, operations, or tactics.
- Coordinates with staff officers in determining optimum systems, operations, and tactics to meet mission objectives.

- Prepares weather annexes to plans of the supported command, reviews weather annexes of subordinate commands, and ensures the stated responsibilities are met.
- Advises the Army commander of Air Force weather support capabilities and limitations; coordinates effective methods of providing support to plan and carry out Army operations.
- Requests and/or prepares climatological studies and analyses in support of planned exercises, operations, and commitments.
- Develops weather support procedures and trains Army personnel to use and understand weather information.
- Assists in arranging remote weather support for subordinate units of the command.
- Advises the Air Force of new or unfilled operational weather support requirements for the supported Army command.
- Assists in determining weather support data requirements.
- Monitors weather support provided to lower echelons of the supported Army command.
- Advises the G2 on the need for Army provided weather observations from forward areas.
- Coordinates communication requirements for weather support.
- Monitors meteorological conditions in the AI.
- Evaluates weather data received from the Army or collected by the Air Force.
- Provides weather products for IPB.
- Works closely with engineers, fire support officers (FSOs), G3's, air defense artillery, signal, and other special staff officers.
- Works closely with the chemical officer in discussing the overall synoptic situation; ensuring low-level inversions, wind shifts, diurnal changes, and microscale terrain effects on weather are discussed in detail.
- Coordinates with field artillery to receive upper-air and surface observations taken by the ARTYMET section.

- Provides the ARTYMET section with data when needed.
- Ensures operator maintenance of Army supplied equipment.

Weather Forecaster. The weather forecaster, either an officer or an NCO, is the specialist who applies the weather analysis and forecasting tools to the weather data base. Weather analysis, the intervening step between weather observing and forecasting, is based on observations over a synoptic area. Synoptic observations require that all observations be taken on a predetermined schedule. These observations include surface and upper air, taken from all sites, inside and outside the operational area.

The unscheduled observation data acquired by many Army units in support of their own operations are also important to the forecaster. Weather forecasting capabilities are the greatest at the higher echelons where specialized personnel and computerized equipment can be used. At lower echelons, weather forecasters tailor forecasting products to the particular requirements of supported Army units. Weather forecasters--

- Monitor and analyze weather observations, forecasts, satellite imagery, radar information, and other data received.
- Ensure data critical for accurate analysis is requested.
- Keep the SWO informed of current and expected weather, particularly conditions adverse to the supported mission.
- Tailor forecast information received from higher echelons to the supported mission.
- Provide services normally provided by higher echelon WETMs if these units are not available.
- Collect and forward to higher echelons the forecasts and observations from lower echelons.
- Assist the SWO and perform delegated SWO responsibilities.
- Perform the meteorological watch for specific routes, target locations, and AIs.
- Disseminate products to the G2 or S2.
- Coordinate forecasts with other WETMs.
- Operate all meteorological equipment including satellite receivers, radar, or other available weather data display equipment used as the basis for weather forecasting.

- Prepare and disseminate forecasts. Forecast services include providing--
 - Forecasts focused on specific missions, locations, and weather parameters critical to current operations and for future planning.
 - Forecasts of upper-air winds.
 - Forecasts of precipitation and temperature amounts to support terrain team hydrographic and trafficability predictions.
 - Forecasts and mission briefings to aircrews which may be operating from the division LZ.
 - Data for chemical downwind messages.
 - Nuclear fallout bulletins from the theater-level WETMs.
 - Tailored forecasts for transmission to lower echelons.
 - Forecasts and observations, as required, to ATC.
 - Astronomic, climatic, oceanographic, and illumination data.
 - Weather products for IPB.
 - Weather warnings for mission areas and deployed locations.
 - Forecasts tailored for other MSCs. For example, road condition forecasts for logistic support; precipitation forecasts for maintenance facilities; the most usable radio frequencies for signal elements; and the height of inversion, stability, and low-level wind forecasts for deliberate smoke operations.

Weather Observer. Enlisted weather observers provide part of the basic observation input for weather support to the tactical Army. The continuous monitoring of atmospheric conditions, recording of surface weather observations, and transmitting data to higher echelons provide the basis for forecasts and are essential to satisfy Army requirements for current weather information. Weather observers--

- Take, record, and disseminate weather observations.
- Assist the forecaster in weather station operations.
- Plot standard weather maps and charts.

- Receive and forward FALOPs and aircraft observations pilot reports (PIREPs) or target weather indicators (TARWIs) from lower to higher echelons.
- Update or transmit weather displays to the TOC.
- Operate all meteorological equipment including satellite receivers, radars, weather data display, and applicable data transmission and receiving equipment.
- Assemble and operate modification table of organization and equipment (MTOE) and tables of distribution and allowance (TDA) items.
- Train Army personnel to take limited observations.
- Relay observations and forecasts to aircrews, ATC personnel, and other agencies on request.

Administrative Specialist. Administrative specialists are an integral part of the WETMs they are assigned to support. While they are not weather specialists, their assistance in managing administrative details is essential to the WETM's success.

WETM Support

WETMs assigned to different echelon levels are tailored to meet the customer's mission and requirements described in Chapter 1. The following provides details of the WETM structure and the support provided to each level of command.

EAC. EAC is supported by an EAC WETM that generally is derived from the headquarters of the weather squadron that supports the MACOM during peacetime. The commander of that weather squadron is the MACOM SWO and, when deployed, becomes the EAC SWO. The WETM may split into cells to support--

- EAC main, rear, and alternate CPs.
- EACIC operations.
- Airfields.

Weather support requests beyond those cells that are unique to a theater of war will be identified by the MACOM to the appropriate Department of the Army (DA) and Air Force staff element. Figure 3-2 shows the locations of the EAC WETM cells and support provided, but depend highly on the theater of operations, contingency, or command structure supported.

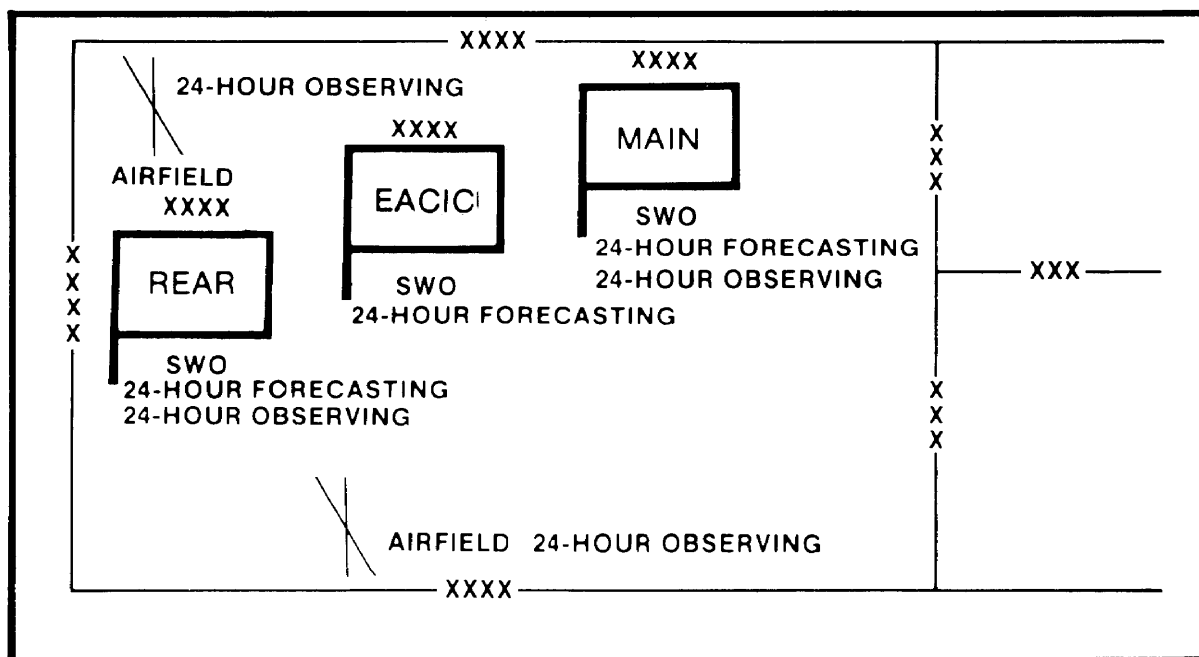

Figure 3-2. USAF weather support at echelons above corps.

In general terms, the EAC WETM functions as the center for weather support to a multicorps operation. Using centralized products from the AWS system, the WETM prepares and tailors products to meet the needs of the EAC commander staff, and subordinate commanders. In addition, finished weather products are prepared to support independent operations. These operations include those of corps, divisions, separate brigades, SOF, aviation brigades, and ACRs whenever the products are not immediately available from the AWS system.

The EAC WETMs--

- Provide weather support to the EAC commander by monitoring meteorological conditions in the lines of communication (LOC), aerial ports of debarkation (APODs), and seaports of debarkation (SPODs).
- Monitor all WETMs that are providing weather support to Army units in the theater.

- Provide a briefing or forecast cell at EAC headquarters. This may be a combined meteorological cell (CMC) with Allied weather services in some theaters.
- Receive, edit, and reformat AFGWC and FU or TFU products into tailored packages for routine distribution to WETMs at corps and below.
- Disseminate all products at EAC to corps and below WETMs.
- Incorporate indigenous products with AFGWC products when developing the weather support plans and annexes.
- Ensure lower echelon WETMs write weather support plans and annexes at their levels and provide general guidance and monitoring of the Army weather support procedures across the theater.

The EACIC WETM--

- Provides climatic and meteorological services in support of the EACIC's intelligence and electronic warfare (IEW) functions.
- Prepares weather analysis products for weather analysis functions of IPB.
- Prepares tailored weather forecasts for the EACIC's target development electronic warfare (EW), counter intelligence, and indications and warning functions.

In addition, weather forecasts are used to help determine which of the MI brigade's collection assets should be employed. Other tailored forecasts and weather observations are provided to support the theater intelligence imagery gathering systems. The EACIC SWO is under the command of the EAC SWO and functions as the weather advisor within the EACIC.

The EAC WETM will provide two 24-hour observing cells to support air traffic at two EAC airfields. For joint and/or combined operations in a theater where a corps does not exist, the theater aviation group or brigade is also a theater aviation unit equal to that of the corps aviation brigade. These requirements include direct, tactical SWO, and 24-hour forecasting and observing support.

Special Operations Forces. Army special operations forces (ARSOF), which include SFGs and ranger regiments, are likely to be employed on politically sensitive, high-risk missions. Employment methods are often

highly sensitive to environmental conditions since sophisticated weapons and delivery systems require specific environmental conditions for successful operation.

ARSOF missions include--

- Deep reconnaissance.
- Direct action.
- Terrorism counteraction.
- Unconventional warfare.
- Foreign internal defense.
- Psychological operations (PSYOP).
- Civil affairs.

These ARSOF missions are often joint and/or combined and conducted worldwide, through all types of conflict. A special operations weather team (SOWT) supports the SFG or ranger regiment.

Special Forces Groups. When deployed, the C² element of the group headquarters is located at the special forces operational base (SFOB). The SFOB receives direct SWO and 24-hour forecasting and limited observing support. Each SFOB can control up to three battalions located at FOBs. FOBs are normally composed of C² elements from the special forces battalion. Each battalion receives 24-hour forecasting and limited observing support because of the great distances between the SFOBs and FOBs. These isolated locations require special communications or satellite links to relay required basic weather data for forecasts and IPB planning. Figure 3-3 shows the USAF support to SFGs.

Ranger Regiments. Direct weather support is provided by a WETM to support ranger regiments. Figure 3-4 shows SWO, 24-hour forecasting, and limited observing support provided to the ranger regiments.

Corps. The corps WETM--

- Provides dedicated, 24-hour weather support to the corps headquarters.

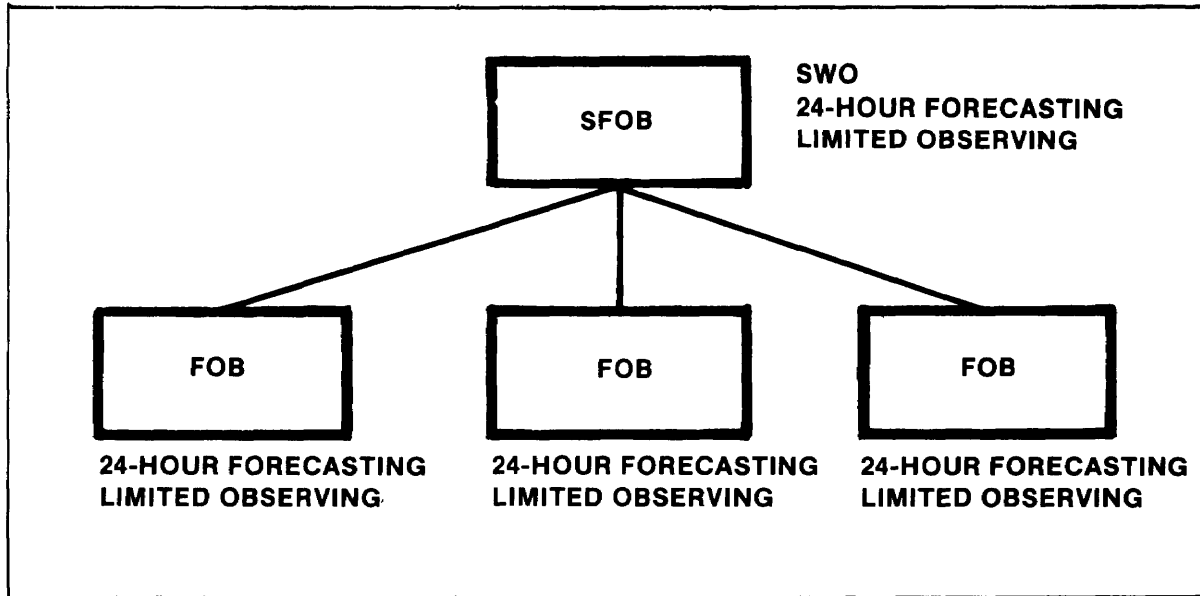

Figure 3-3. USAF weather support to special forces groups.

Figure 3-3. (21)

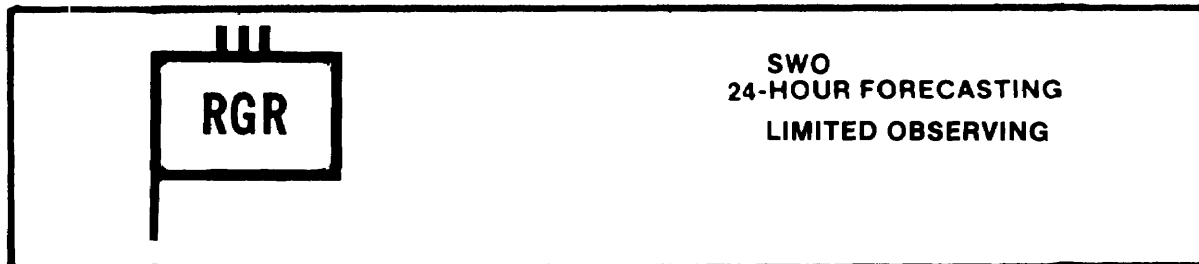

Figure 3-4. USAF weather support to ranger regiments.

Figure 3-4. (12)

- Operates in the corps TOC area and is supported by the corps headquarters and headquarters company (HHC).
- Functions as the Army Forces (ARFOR) TFU when no higher echelon is employed.
- Provides guidance to subordinate WETMs at the divisions, separate brigades, and ACRs. This guidance includes tailored weather products of sufficient detail to support their different operations.

- Functions as a hub for collecting weather observations, ARTYMET upper-air soundings, and FALOP data from lower echelons.
- Passes observations from adjacent divisions and corps to its division WETMs so they have a complete picture of the battlefield.
- Operates and maintains weather-dedicated Army equipment including vehicles, generators, and communications equipment (except high frequency (HF) radio teletypewriter (RATT) equipment).
- Maintains other common table of allowances (CTA) equipment such as tents and heaters.
- Functions 24 hours a day and is capable of observing weather and providing forecasting support to a tactical CP for limited periods.

This information is incorporated into the AFGWC data base to make the next forecast and is passed to the theater FU, TFU, or EAC WETMs for their immediate interests. The theater FU, TFU, or EAC WETM ensures that the Air Force forces (AFFOR) WETM gets the lower echelon observations and forecasts so planners for both Army units and tactical air (TACAIR) sorties have coordinated forecasts.

Twenty-four hour observing support is provided for two corps airfields. The location of each WETM is determined by the SWO in coordination with the corps G2.

Corps aviation brigade. The corps aviation brigade receives direct weather support from its separate WETM. This WETM relies on the corps aviation brigade HHC for its field equipment and support. The WETM provides SWO and 24-hour forecasting and observing services to the corps aviation brigade commander and staff. The observing team provides observations from a field aircraft landing zone (LZ). The aviation brigade SWO will coordinate with the aviation brigade S2 to ensure communication and support to the weather observers. The purpose of the WETM is to--

- Help preserve the integrity of the brigade by minimizing aircraft damage and dispersal caused by adverse weather and environmental effects.
- Provide the commander with forecasts on the best opportunity to use aviation to exploit enemy vulnerabilities.
- Maximize the advantage of sophisticated weapon systems, then rapidly determine effects of weather, and turn inside the enemy's decision cycle.

- Plan deep operations in favorable weather conditions.
- Sequence aviation brigade attacks to support the corps commander's plan.

Tailored forecasts and observations help determine--

- Target acquisition ranges.
- Night operations limitations.
- Cargo lift capabilities.
- Flight paths.
- Nuclear, biological, chemical (NBC) prediction. The aviation brigade WETM is capable of providing limited weather support to the corps main CP if needed.

Corps weather support is organized to provide direct support to corps operations as shown in Figure 3-5.

Armored cavalry regiment. An ACR is designed to function as a separate entity under a corps, thus it has its own separate WETM for direct weather support. The ACR WETM acquires its field equipment and support from the ACR headquarters and headquarters troop (HHT). Its highly mobile battle plan, with heavy use of weather sensitive aviation assets, requires the unique tailoring of the WETM.

The current WETM structure is designed for the early stages of battle and may require restructuring as the ACR mission evolves. SWO support is provided at the ACR CP to support the current battle planning strategy and command of the forces. Direct SWO and 24-hour forecasting and observing support are provided at the aviation squadron; 24-hour observing is dedicated for the ACR (LZ) to support organic aviation squadron air traffic. Figure 3-6 shows USAF weather support to ACRs.

Separate brigades. Direct weather support is provided by a WETM to support separate brigades since these units are designed to function as separate entities under the corps. Field equipment and support to this brigade WETM are provided by the HHC. SWO and 24-hour forecasting and observing are provided at the separate brigade CP as shown in Figure 3-7.

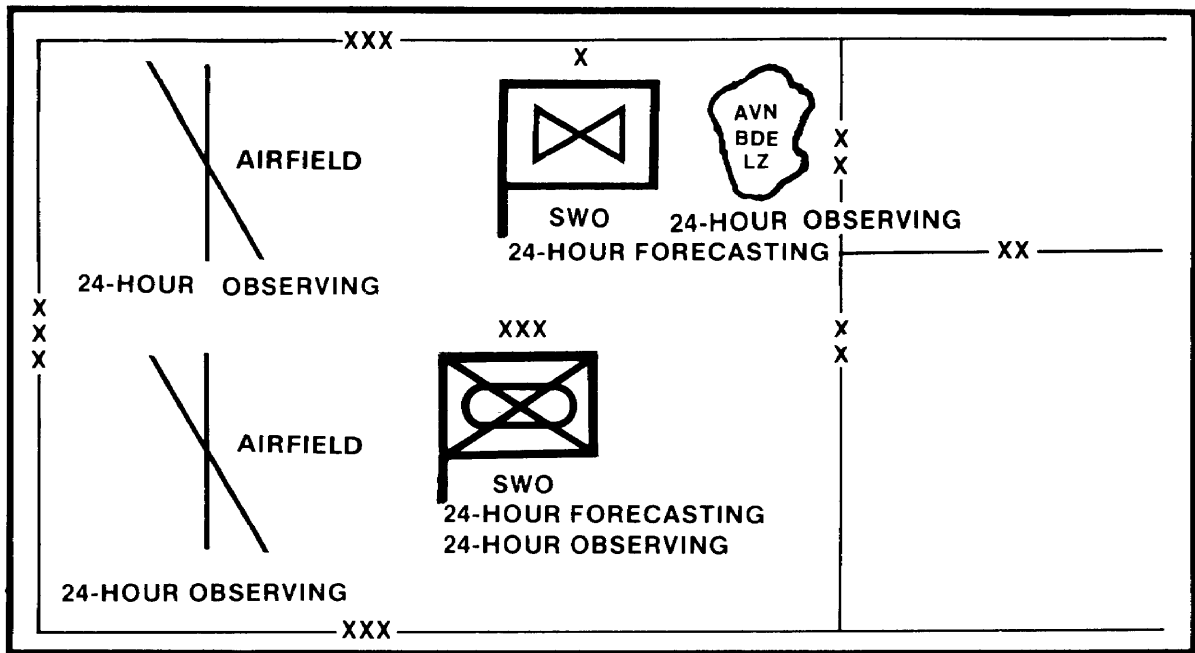

Figure 3-5. USAF weather support to corps.

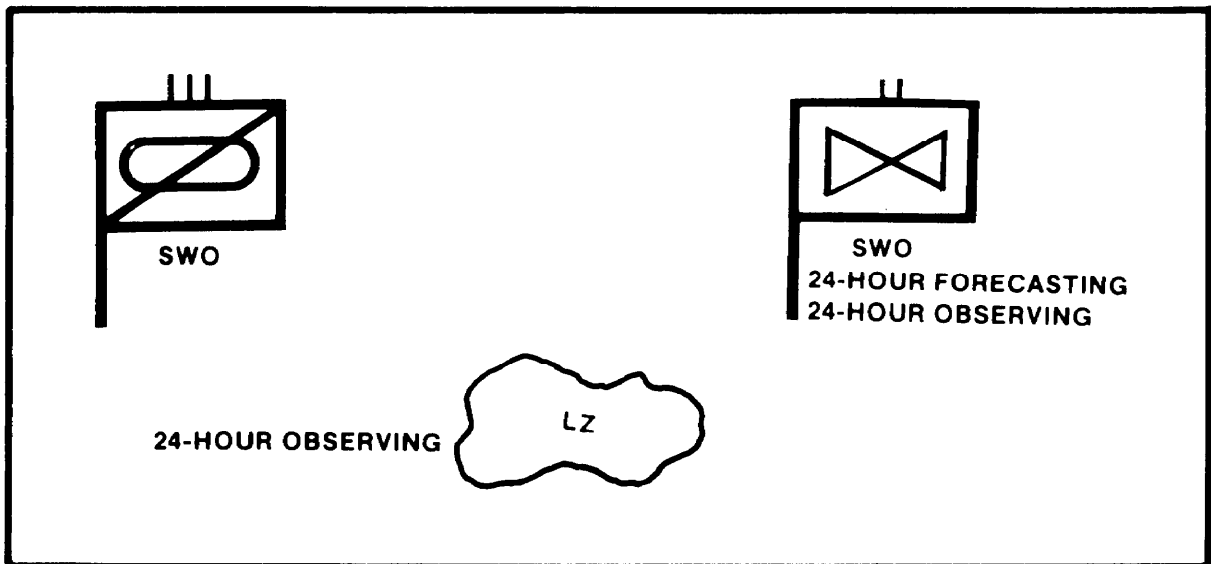

Figure 3-6. USAF weather support to armored cavalry regiments.

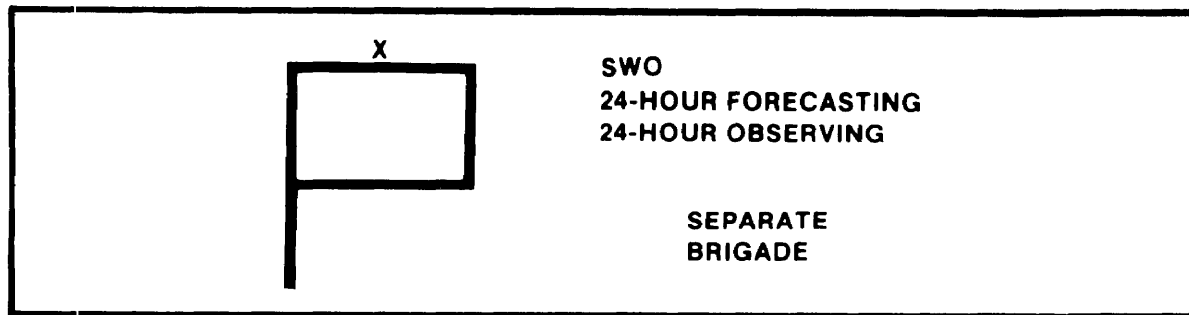

Figure 3-7. USAF weather support to separate brigades.

The differences in capabilities, mission, and tactics of these units require that weather support be tailored to each unit just as it is for divisions. Weather support in the separate brigade closely parallels weather support in the division.

The difference between the support is that in the separate brigade heavy emphasis is placed on the close-in operations. Close-in operations narrow the scope of the AO and focus of weather support. Normally, current observations and 12-hour forecasts are provided for close-in operations.

The WETMs place emphasis on current observations from Army field elements to support the commander's immediate battle plan and as the basis for forecasting support. Adverse weather limits surveillance and air operations. Precipitation may limit maneuver since these units depend on speed and maneuverability for survival. The AI of these units also depends heavily on how they are employed and their capability. As a corps asset, this could coincide with the distance and time requirements of the corps for planning deep operations.

Division. The division WETM operates in the division main CP area and receives support from the division HHC. The division SWO is the commander of the WETM attached to the division. The WETM--

- Provides direct SWO and 24-hour forecasting and observing support to division commanders and their staffs at the division main CP.
- Provides 24-hour direct support at the tactical CP for limited periods.

An observing team supports the division LZ. Remote forecasting support is provided from the division CP.

Mobile observing teams. Three mobile observing WETMs are organic to the division WETM. They will be deployed within the division area at the direction of the SWO after coordination with the G2. These teams provide--

- Special weather observations from locations which are critical to operations, such as along air corridors.
- Information for joint weather sensitive missions.
- Support forecasts for specific areas.

Division aviation brigade. Support to the division aviation brigade is provided by a separate WETM. This WETM receives its support and field equipment from the aviation brigade HHC. Mission and support requirements for the division aviation brigade are similar to those of the aviation brigade discussed previously. Figure 3-8 shows USAF weather support to a division.

Division types. Division support will vary with the type of division. Each type of division must be capable of continuous operations. Thus some support, such as illumination requirements for night vision devices, is important to all divisions.

Heavy divisions are concerned with cross-country movement of armored vehicles and rely on accurate and timely precipitation data and forecasts to plan tactical movements. Heavy divisions are equipped with a wide range of E-O guided weapons. The effectiveness of their weapon systems may be degraded by precipitation, fog, or snow-covered targets.

Air assault divisions rely on rotary-wing aircraft for their mobility. Consequently, direct forecasting and observing support is provided at each maneuver brigade TOC. Of prime importance are forecasts and observations of low-level cloudiness, gusty surface winds causing turbulence in LZs, aircraft icing conditions, and reduced visibility caused by fog or precipitation. A forecaster's attention is more focused on aircraft briefings in an air assault division than in any other division. Temperature, humidity, and LZ elevation are key factors in determining aircraft lift capability, especially in areas with large daily variations in temperature.

The light infantry division fights best in reduced visibility and darkness. It is concerned with the individual soldier and the performance of the weapons in adverse weather conditions. Heat and glare from the sun, cold and windchill, precipitation, and the trafficability conditions are of increased importance to the light forces that move on foot. Restrictions to visibility from dust or falling precipitation that affect the performance of night vision goggles and night sights are very important.

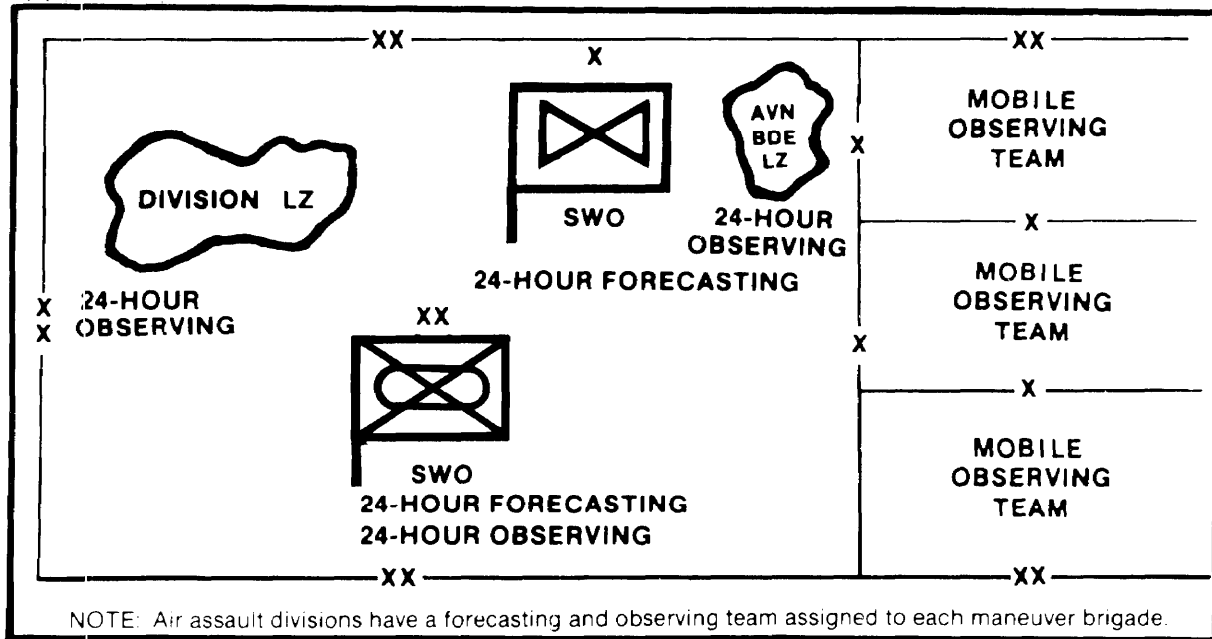

Figure 3-8. USAF weather support to a division.

Some divisions have areas of specialization because of their assigned missions; for example, cold weather operations, desert operations, or jungle warfare. For these environments the SWO will provide special climatic studies and evaluations as required. Division operations manuals in all of these areas explain the concept of operations to which the SWO and the WETM tailor their forecasts.

CHAPTER 4

WEATHER SUPPORT BY ARMY ELEMENTS

The Army organization which provides weather and environmental support directly to Army users has a decentralized structure. It is composed of individual elements which are assigned support missions at various Army operational and tactical echelons. This decentralization permits immediate response to diverse requirements. Army meteorological services are specialized to satisfy unique military requirements and are under the direct control of the supported unit. Mobility and responsiveness to command and combat readiness requirements are characteristic of these organizations.

This chapter provides information on the Army weather collection and analysis process and identifies the types of data and sources available within the Army tactical structure.

INTELLIGENCE PREPARATION OF THE BATTLEFIELD

The IPB process directs the collection and analysis effort of the SWO at all echelons. IPB requires the dedicated efforts of the entire IEW staff, as well as the support of numerous other elements of the command. IPB is routinely performed at all echelons in combat, CS, and CSS units.

As the intelligence coordinator, the G2 is responsible for coordinating the IPB effort. The G2 is assisted by the integrated efforts of order of battle (OB) technicians and intelligence analysts of the all-source production section (ASPS), the engineer detachment (terrain), and the Air Force WETM. The G2 ensures that IPB focuses on the intelligence, terrain, and weather needs of the commander.

The ASPS assembles the threat data base, converts it to graphics where possible, and integrates it with weather and terrain information. The ASPS develops the IPB products that are used to support combat operations. The engineer detachment analyzes terrain and weather data to determine their integrated impact on friendly and enemy tactical and logistic operations. The engineer detachment, supported by its EAC engineer topographic battalion, provides special terrain and map products. The WETM provides climate and weather products to support the IPB effort.

IPB orients on the AI and the enemy forces that are expected to be operating in that vicinity. Figure 4-1 shows the five-function cycle of the IPB process. These functions are discussed below.

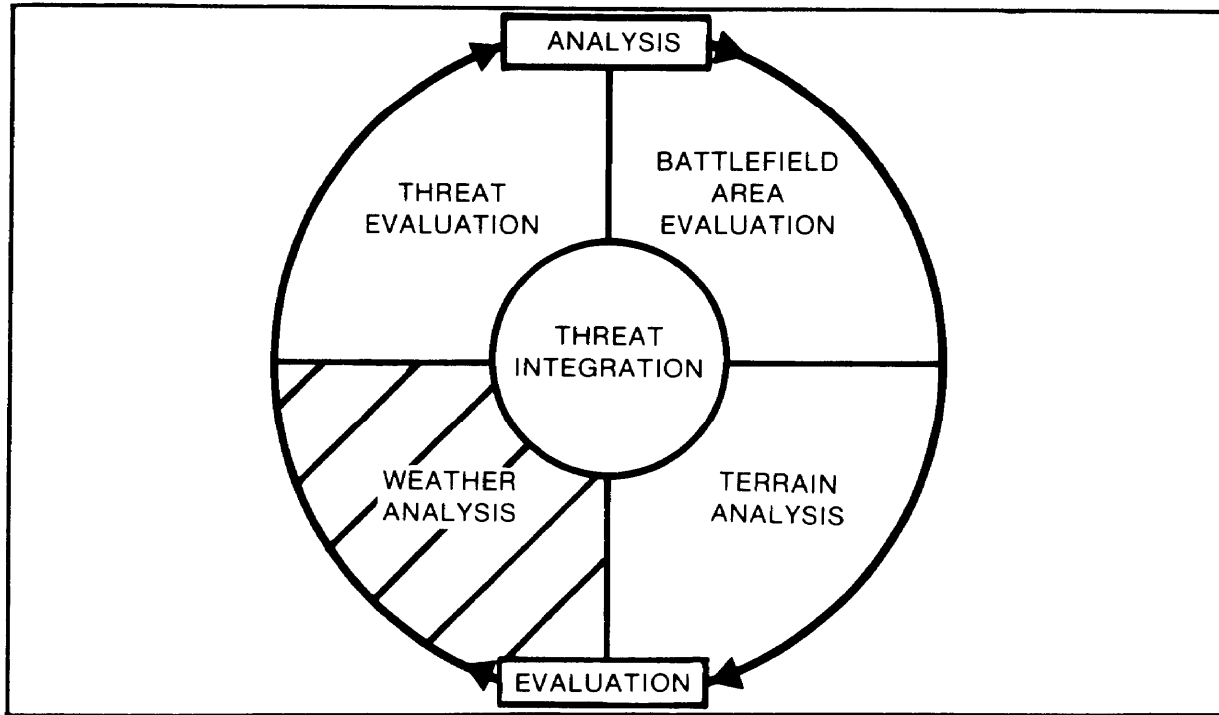

Figure 4-1. IPB process.

BATTLEFIELD AREA EVALUATION

The first function of the IPB process is battlefield area evaluation. When the AO and AI are identified and applied to the battlefield, the staff's and SWO's attention are focused on a specific geographical area for enemy, terrain, and weather effects analysis.

TERRAIN ANALYSIS

The second function of the IPB process is terrain analysis. This function is focused on the military aspects of the terrain and its effects on friendly and enemy capabilities to move, shoot, and communicate. This includes the five military aspects of the terrain:

- ° Observation and fields of fire.
- ° Concealment and cover.
- ° Obstacles.

- Key terrain.
- Avenues of approach and mobility corridors.

The terrain analysis process emphasizes the use of graphics to portray the effects of trafficability and visibility on operations. A series of overlays are prepared to develop a terrain graphic data base.

Terrain analysis guides the selection of terrain and weather factor overlays needed to analyze the battlefield.

Terrain factor overlays graphically portray the military aspects of terrain (types and spacing of vegetation, soil, and climate conditions and variations) in the AO and AI.

The final step of the terrain analysis process is the identification of the avenues of approach that support friendly and enemy capabilities to move, shoot, and communicate.

WEATHER ANALYSIS

The third function of the IPB process is weather analysis. Weather has a significant impact on both friendly and enemy capabilities. Analyzing the weather in detail to determine how it affects friendly and enemy capabilities to move, shoot, and communicate is critical to this function of IPB. Because weather has a tremendous effect on terrain, terrain and weather analyses are inseparable factors of intelligence.

Weather and engineer terrain teams work together during much of the analysis process. The WETM analyzes climatic or forecast data to determine the characteristics of weather in the battlefield area. The terrain team analyzes the effects of weather on terrain and integrates climatic, forecast, and current weather data with terrain analysis. This information is integrated into a four-step operation known as the weather analysis process. This process is shown in Figure 4-2.

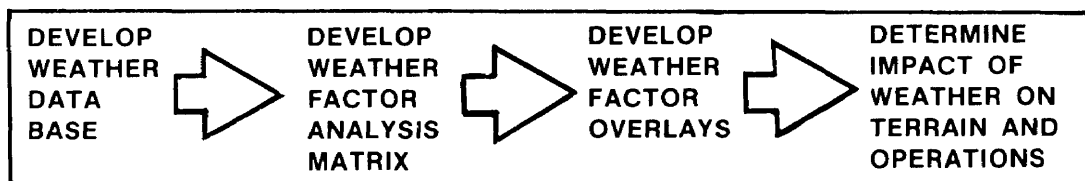

Figure 4-2. Weather analysis process.

Weather input to the IPB process is in two forms: climatological information and current forecasts. Climatological information is used for general planning purposes. It is combined with terrain data to produce synthesized products. Current operational forecasts up to 96 hours are used in actual planning for weapons and tactics.

During peacetime, climatic averages are used to determine significant weather parameters in the battlefield area. The weather data base is updated periodically and is used as the foundation for analyzing the effects of weather on tactical operations. Alternate sources should be considered to fill gaps in the data base.

To attempt a logical approach to IPB, the SWO must determine the needs of the commander in reference to the mission--combat arms, CS, and CSS. The SWO must have knowledge of the mission, weapons, and personnel of the unit. This information must be updated as new weapons or IEW systems are fielded. Critical values must be determined to see what the threshold weather values are that affect Army weapons, equipment, tactics, mission, and logistics. From this process a matrix of weather factors can be built.

The weather factor matrix identifies the specific operations the unit performs. Then critical values can be overlaid to show the weather effects on these operations. The matrix is tailored to the unit. Different matrixes can be developed for different scenarios. Color codes are used to show the impact for each use and parameter. Figure 4-3 is an example of a weather factor analysis matrix. Appendix B contains detailed data on the effects of weather on friendly and enemy forces. Appendix C discusses meteorological critical values which reduce the effectiveness of tactical operations and weapon systems.

THREAT EVALUATION

The fourth function of the IPB process is threat evaluation. It consists of a detailed study of enemy forces, their composition and organization, tactical doctrine, weapons and equipment, and supporting battlefield functional systems. The thrust of this function is to determine enemy capabilities and how they operate as prescribed by their doctrine and training.

THREAT INTEGRATION

The nucleus of the IPB process is the integration of enemy doctrine with weather and terrain data. The objective of threat integration is to determine how the enemy will fight as influenced by weather and terrain. Threat integration, a sequential process, is accomplished through the development of situation, event, and decision support templates. More information on IPB can be found in FM 34-130.

| MISSION AREA OR USE | FAVORABLE | MARGINAL | UNFAVORABLE |
|---|---|--|---|
| Airborne/(Drop Zone) Static Line | CIG/VIS > 2500 and 3 SFC Wind ≤ 13 knots Wind at Alt ≤ 30 knots | CIG/VIS ≤ 1000 and 2 but ≥ 500 and 1 | CIG/VIS < 500 and 1 SFC Wind > 13 knots Wind at Alt > 30 knots |
| Airmobile (Landing Zone) | CIG/VIS ≥ 300 and 1-1/2 miles No icing or turbulence SFC winds at ≤ 20 knots | CIG/VIS ≤ 300 and 1-1/2 miles but ≥ 200 and 1/2 mile Light icing and turbulence SFC Wind > 20 knots but < 30 knots | CIG/VIS < 200 and 1/2 mile Moderate icing and turbulence SFC Wind > 30 knots |
| Night Vision Goggles (PVS-5) and starlight scope | Sky clear moon > one quarter Elevation > 30° | SCT clouds New moon to one quarter | Overcast clouds or new moon |
| C-130 Operations to penetration landing | CIG/VIS > 1000 and 2 miles | CIG/VIS < 1000 and 2 miles but > 500 and 1 mile | CIG/VIS < 500 and 1 mile |
| MOPP IV wear | Temp ≤ 70°F RH ≤ 50% | Temp 70° to 85°F RH 50% to 70% | Temp > 85°F or RH > 70% |
| PSYOP Leaflet drop Loudspeaker NBC | SFC wind < 10 knots SFC wind < 20 knots Temp Inversion aloft Winds toward threat force SFC wind 3 to 7 miles | SFC Wind 10 to 20 knots SFC Wind 20 to 35 knots No inversion Wind light/variable Neutral lapse rate Wind 3 to 7 knots | SFC Wind > 20 knots SFC Wind > 35 knots Inversion aloft with wind toward friendly force SFC winds > 10 knots |
| Weapon sighting | VIS > 1000 meters | VIS < 1000 but > 500 meters | VIS < 500 meters |
| Ground Reconnaissance | VIS > 3200 meters | VIS < 3200 but > 1000 meters | VIS < 1000 meters |
| <p>Key:</p> <p>≥ Greater than or equal to.</p> <p>> Greater than.</p> <p>≤ Less than or equal to.</p> <p>< Less than.</p> <p>CIG - Ceiling or height above ground level to base of clouds.</p> <p>RH - Relative Humidity</p> <p>VIS - Optical visibility in miles or meters.</p> <p>SFC wind - Wind speed at the surface from any direction.</p> <p>Temp - Temperature in degrees Fahrenheit or Celcius.</p> <p>Inversion - A layer of air above the ground where temperature rises rather than continuing to cool as height increases.</p> | | | |

Figure 4-3.. Weather factor analysis matrix.

WEATHER DATA SOURCES

The following represents the most significant sources of weather data within the Army tactical structure:

- ° ARTYMET sections.
- ° ATC units.
- ° Engineer units.
- ° Ground reconnaissance and surveillance elements.
- ° Imagery interpretation elements.
- ° Brigade and battalion intelligence personnel (FALOP).

Each element possesses a limited measuring capability designed to meet its own immediate needs. Consequently, their weather observing capabilities are supplemental to their primary mission. They should not be viewed as a replacement or substitute for USAF WETM support. USAF weather observation responsibility ends at the division CP. Army responsibility to take weather observations is from the division CP across the FLOT except at locations such as ACRs or separate brigades which have a USAF WETM assigned. If USAF weather support elements are destroyed or support is disrupted, Army elements can provide temporary support. Generally, temporary support is limited to observing and reporting current local conditions.

ARTILLERY METEOROLOGICAL SECTIONS

ARTYMET sections provide meteorological data for artillery firing units. They also provide upper-air observations and artillery limited surface observations (ALSOs) to Air Force WETMs.

ARTYMET sections are organized to support the ballistic meteorological requirements of artillery units. Each division artillery (DIVARTY) meteorological section and separate brigade meteorological section accompanies its own artillery. Each field artillery brigade has a meteorological team assigned and deployed where it can best support overall meteorological requirements. Other meteorological sections are deployed where they can best acquire the data needed. For instance, the need for fallout meteorological messages requires that one meteorological section is usually designated to produce fallout data.

Meteorological sections are located where they can best sound the atmosphere through which weapon trajectories will pass. The section should be well forward and within the general proximity of a compatible

communications facility. Considerations in selecting the position for a meteorological section are--

- ° Prevailing winds.
- ° Location of artillery units.
- ° Communications facilities and capabilities.
- ° Administrative support.
- ° Local security.

ARTYMET sections are equipped to perform electronic and visual upper-air observations employing a balloon-sounding method. If this is not available to provide upper-air density and pressure. It may be extracted from surface data climatological tables available to the ARTYMET section. Normally, they are equipped with FM radio and HF RATT communications.

ARTYMET sections in a corps area communicate with each other and exchange data on the corps ARTYMET net. Artillery units obtain meteorological data by monitoring this net at specified times. DIVARTY units may also obtain meteorological data over the DIVARTY command or fire direction RATT net and through tactical fire direction computer system (TACFIRE) automatic data processing (ADP) systems.

ARTYMET sections sound the atmosphere to heights of 98,424 feet (30,000 meters), day or night, and in all types of weather except during severe surface winds.

A limiting factor is the time required for a sounding balloon to reach a required height. Where high altitude soundings and several types of messages are required, meteorological sections are capable of sounding the atmosphere every 4 hours. A meteorological section in position is capable of producing a ballistic message for light artillery 30 minutes after releasing the balloon. The minimum time required to produce a maximum height fallout message is about 2 hours.

If electronic equipment fails, sections have an alternate, but limited, method of measuring upper-air winds by observing pilot balloons (PIBALs). Upper-air densities and temperature are computed by using climatological tables with the current surface values of each element (assuming there is no low cloud cover).

All ARTYMET sections are trained to produce--

- ° Ballistic meteorological messages.

- Computer meteorological messages.
- Fallout messages.
- Upper-air data for transmission to AWS.
- Target acquisition meteorological messages.

The meteorological sections are also capable of reporting limited surface weather observations.

Normally, the ARTYMET staff officer at division is a warrant officer assigned to the DIVARTY meteorological section. At corps, usually a commissioned officer from the corps artillery S3 section fills the position.

The ARTYMET staff officer--

- Supervises the operation of the meteorological section in the publication of ballistic and fallout meteorological messages, meteorological data for artillery computers, and meteorological data for the Air Force WETM.
- Provides liaison on meteorological matters with higher headquarters, adjacent DIVARTY units, and AWS detachments.

AIR TRAFFIC CONTROL UNITS

ATC units may have weather observing instruments to include measurement of surface pressure, temperature, and surface wind velocity. In addition, aircrews, flight operations personnel, and control tower operators visually estimate horizontal visibility and obstructions to visibility; they observe such special phenomena as lightning, thunderstorms, and tornadoes. Control tower operators assigned to ATC units are trained by the AWS to make limited weather observations.

ENGINEER UNITS

Engineer elements can measure surface pressure, temperature, humidity, and precipitation to determine the effects of weather on the terrain. The engineers can provide stream flow measurements and predictions of river stages and floods. The Engineer Flood Prediction Service (EFPS) relies on the WETM for precipitation forecasts in support of river crossings, airheads, and defensive positions.

GROUND RECONNAISSANCE AND SURVEILLANCE ELEMENTS

Cavalry units provide the corps and division principle ground reconnaissance capability. Cavalry and maneuver battalions have organic ground reconnaissance capability that may be used to obtain information related to weather, terrain, and overall environmental conditions requested by the G2 or S2.

In addition, long-range surveillance units (LFSUs) at division and corps may be required to take weather observations deep across the FLOT based on specific weather requirements meeting the given situation.

IMAGERY INTERPRETATION ELEMENTS

These units can provide information on visibility, cloud cover, trafficability, and flooding.

ACR, BRIGADE, BATTALION, AND SQUADRON INTELLIGENCE PERSONNEL

ACR, brigade, battalion, and squadron intelligence officers are tasked by the G2 to provide weather observations as part of the FALOP. The frequency of observations depends on the IPB process which identifies critical areas where adverse weather may have a major impact on Army weapons, personnel, and tactics. High priority must be placed on these messages to transmit them immediately to the SWO at the division main CP.

FORWARD AREA LIMITED OBSERVING PROGRAM

Doctrinally, the Army is responsible for collecting weather and environmental data forward of the division main CP in support of Army operations. For this reason, a FALOP is required. FALOP is a weather data collection program. The S2 at brigade transmits the FALOP observations promptly to the division. These observations require a high priority to ensure transmission within 15 minutes of the time they are taken.

The G2 specifies the FALOP observations that are required and ensures that these observations are passed directly to the USAF WETM, which handles further distribution. The G2, FSE, chemical officer, A³C² element, aviation brigade, terrain team, and higher echelons all require observations in the forward areas. In particular, the terrain team needs them to evaluate trafficability and avenues of approach for the IPB process; the G3 and fire support coordinator (FSCOORD) need them to help direct smart munitions and deep operations. The FALOP observations serve as the basis for the G2 and SWO to determine the effects of adverse weather on Army systems, operation, and tactics.

The WETM incorporates FALOP with all other sources of information, when they are available, to make a complete weather picture of the battlefield at the time of the observation. In some cases the FALOP may be the only source of observations in forward areas and is the key to forecasts tailored to the user's needs.

The collected data in a FALOP weather observation include--

- ° Measurement of temperature.
- ° Wind direction and speed.
- ° Cloud information.
- ° Visibility estimate.
- ° Type of precipitation and intensity.
- ° Atmospheric pressure.
- ° Road, ground, and water conditions.

FALOP observations are taken using an expendable belt weather kit identified by a national stock number (NSN 666-001-0242638, Belt Weather Kit). The G2 obtains and maintains the belt weather kit. The FALOP observation is disseminated through intelligence reporting channels or other communications links. The approximate time needed to take, record, encode, and transmit a single observation is 15 minutes.

Figure 4-4 shows the FALOP reporting channels and the Army units and echelons responsible for FALOP observation and reporting. Appendix A gives a detailed description of encoding and decoding a FALOP observation and a list of belt weather kit component parts.

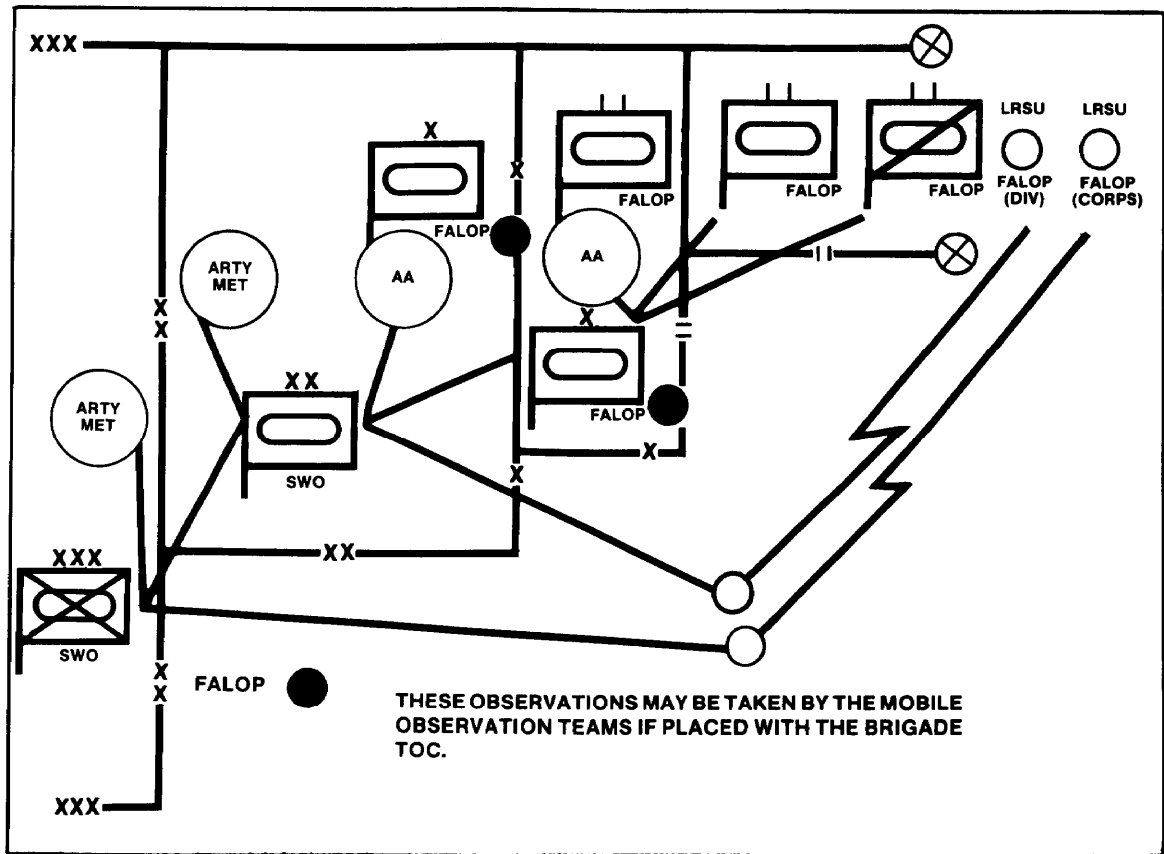

Figure 4-4. Army FALOP reporting channels.

CHAPTER 5

WEATHER SUPPORT COMMUNICATIONS

The ability to provide accurate weather support depends directly on a specialized and highly responsive communications system. The responsiveness of support to the Army is directly related to the quality of communications support provided. The vital link between weather support and communications is shown in the following examples:

- The extreme perishability of weather data requires responsive communications, especially during periods of approaching weather disturbances.
- Round-the-clock weather observations and forecasting requirements continue regardless of the nature of tactical operations or force configurations.
- Numerous elements and activities at various echelons require specialized weather forecasts, summaries, and climatological reports.

For support, WETM's rely on--

- Centralized weather forecasts and products.
- Other WETMs.
- ARTYMET section observations.
- FALOP observations.
- Indigenous weather data.

Because of this requirement for substantial communications support, they must have the availability of communication circuits to receive all necessary information to provide necessary weather products and services. WETMs also--

- Intercept military and World Meteorological Organization (WMO) weather broadcasts and meteorological satellite imagery.
- Communicate with other weather units within the theater of operations.

COMMUNICATIONS FACTORS

The following factors must be considered when planning or providing communications support for tactical weather elements:

- Rapid transmission of a high volume of data.
- Interfacing between the Army and other service communication circuits and ADP systems.
- Compatibility with supported unit's communication equipment.
- Signal security (SIGSEC).
- Redundant communications to reduce impact of radio electronic combat (REC) operations.
- Automatic exchange of data base information between critical elements such as the AFGWC, FUs, and TFUs.

COMMUNICATIONS RESPONSIBILITIES

Communications for weather support is a joint Army and Air Force responsibility requiring continuous cooperation to ensure compatibility of communications systems. The Air Force Communication Command (AFCC) provides long-line communications facilities for inter-theater exchange of weather data. In addition, AFCC installs, operates, and maintains complete communication systems down to the designated DCS interface point.

The interface between DCS and Army tactical systems is designated by the commander of the unified or specified command or JTF for oversea operations. The Army is responsible for communications below this interface point.

AIR FORCE COMMUNICATIONS

The capability of AWS to provide effective support to tactical Army commands depends on a specialized, complex, and responsive communications system. Normally, AWS uses automated communication displays and machine processing systems to collect, assemble, analyze, display, and disseminate weather information to commanders and their supporting staffs. Because of the amount of data processed, automated systems are required for accurate forecasts, timely observations, and climatic studies.

AFGWC is the focal point for worldwide weather analysis and forecasting. AFGWC prepares global and regional weather analyses and forecasts continuously. In addition, AFGWC forms contingency response

teams to provide tailored products for individual theaters. USAFETAC provides climatological data and studies. Products produced are transmitted by the Air Force to the designated DCS interface point.

Normally, the tactical Air Force headquarters and the highest Army echelon will be designated the AFFOR and ARFOR headquarters, respectively. The ARFOR headquarters also is known as the EAC. For large-scale and theaterwide conflicts, the communications structure within the theater down to the TACC and the highest ARFOR headquarters will be tailored to meet requirements.

The TACC normally is collocated with the AFFOR headquarters. When combined commands are created, the standard JTF organization may not apply and additional LOC are required. Because requirements will differ with the type and scope of each operation, and the forces involved, weather communications for all operations are not addressed in this manual. WETMs will be located and tailored to support the command structure regardless of the theater or operation. The command structure and WETM requirements will drive communication requirements.

Disruption of communications during combat operations must be considered and plans formulated to provide mission-essential products. When the FU or TFU cannot perform its mission, the next lower AFFOR WETM will produce weather data for lower echelons and ensure products are relayed, as necessary, to the ARFOR headquarters WETM (EAC WETM).

The regional broadcast system (RBS) is a series of HF broadcast stations presently being developed by AFCC to provide limited support for AWS weather data requirements. These HF transmission sites will broadcast AFGWC-generated products and data continuously. For many world contingency areas, this broadcast initially will be the only source of AFGWC information to the deployed WETMs. When the theater communications system is established, the RBS becomes a critical backup source of weather information in the event that communication links cannot be maintained with higher echelon weather units.

ARMY COMMUNICATIONS

The SWOs at corps and EACs must specify weather communication requirements in an appropriate annex of the supported Army plan. This is to ensure adequate communications are provided to all tactical WETMs. SWOs at all subordinate units also must ensure communication requirements are in their supported unit's plan. The Army's communications responsibilities start at the DCS theater communications interface point.

The Army --

- Provides installation, operation, and maintenance of Army standard communications systems required by Air Force weather units below the DCS interface point.
- Is responsible for tactical or transportable interface equipment that can meet the DCS circuit factors and interface point criteria.

If communications at the DCS interface point become inoperable, the next lower Air Force echelon (or Army echelon if necessary) will become the new DCS interface point.

The ARFOR headquarters WETM located at the EAC, or possibly at the corps (in a small contingency), receives information from the TFU or JTF TFU and refines it to meet the tactical needs of the subordinate commands. The information (as received from the TFU and refined by the EAC WETM) is transmitted to all corps, divisions, separate brigades, aviation brigades, ACRs, and SOF WETMs for their use in supporting tactical operations.

Within each supported Army command, weather information products are disseminated to Army users through a number of Army communication channels. The primary means of dissemination is through common users' communication nets.

Army ATC requires real-time weather information from the WETM. The ATC operates a network of flight operations centers (FOCs) to control aircraft operating within the corps airspace and to provide weather information to Army, aircrews on request. FOC communications with the WETM are installed by aviation units and coordinated with the SWO. A flight coordination center (FCC) extends the communications capability of each FOC. This serves as the link between the SWO, the FOC, and the terminal traffic control facilities at tactical airfields.

While weather data is being processed and disseminated down the tactical chain, new data is being collected, processed, and disseminated up the communication chain to higher elements for inclusion in analysis and forecast preparation. Weather products prepared by the TFU and at lower WETMs depend on a reliable and steady upward and downward exchange of weather data from both Air Force and Army tactical units.

The essential element for tactical weather support is a high speed, timely communications system. The system must--

- Be reliable, secure, and easy to maintain.
- Support highly mobile operations.

- Interface with the AFCC, Joint Communications Service Element (JCSE), and the Army Tactical Command and Control Systems (ATCCS).

Currently, two systems provide this capability: HF RATT and the Army tactical area communications system (ATACS) network.

HF RATT

The HF RATT--

- Establishes initial communications and is the primary means of communication in a fluid tactical situation.
- Provides initial communications between the main CP and the jump or tactical CP.
- Is used for initial communications between the corps and the division until multichannel ATACS links can be established.
- Can be used to receive meteorological data from the RBS.

Figure 5-1 shows WETM communication requirements.

ATACS (Multichannel)

Once operational, ATACS (or multichannel) becomes the primary means for exchanging weather information and for interfacing with the AFCC weather communications system. The ATACS carries alphanumerical products (teletype), graphic products (facsimile), and voice.

For division operations HF radio, very high frequency (VHF) and FM radio, and HF RATT maintain continuity of operations during CP moves. Additionally, FM radio provides service to airborne forward air controllers. FM radio is the primary communications link between the division CP WETM and their subordinate WETMs, and serves as the pilot to the forecaster communications link.

The critical echelon for Army weather communications is the echelon where the DCS interfaces with Army tactical communications. At this level, intra-Army ATACS communications must interface with AFCC weather communications systems from the FU and JTF TFU. The ARFOR headquarter (EAC) WETM uses HF RATT and facsimile to interface with the FU and TFU, AFFOR headquarters WETM, and supporting WETMs with subordinate Army commands. The ATACS teletype must be multipointed to permit adequate, rapid transmission of environmental information to and from the tactical AO.

| ECHELON COMMUNICATION CAPABILITY | JTF/EAC WETM | CORPS WETM | DIVISION WETM | ACR/SEP BDE WETM | CORPS DIV/ AVN BDE WETM | SFOB WETM | RANGER REGIMENT WETM |
|---|---|---|---|---|---|---|----------------------|
| FACSIMILE TERMINAL (THROUGH MULTICHANNEL SYSTEMS) | FU/TFU SEND/RECEIVE CORPS SEND/RECEIVE | EAC SEND/RECEIVE DIVISION SEND AVN BDE/ACR SEP BDE SEND | CORPS RECEIVE | CORPS RECEIVE | CORPS OR DIVISION RECEIVE | EAC RECEIVE | EAC RECEIVE |
| AREA MULTI-CHANNEL TELECOMMUNICATIONS NETWORK | FU/TFU SEND/RECEIVE CORPS SEND/RECEIVE | EAC SEND/RECEIVE DIVISION SEND/RECEIVE AVN BDE/ACR SEP BDE SEND/RECEIVE | CORPS SEND/RECEIVE | CORPS SEND/RECEIVE | CORPS OR DIVISION SEND/RECEIVE | EAC SEND/RECEIVE | EAC SEND/RECEIVE |
| HF RATT | FU/TFU SEND/RECEIVE CORPS SEND/RECEIVE | EAC SEND/RECEIVE DIVISION SEND/RECEIVE AVN BDE/ACR SEP BDE SEND/RECEIVE | CORPS SEND/RECEIVE | CORPS SEND/RECEIVE | CORPS OR DIVISION SEND/RECEIVE | EAC SEND/RECEIVE | EAC SEND/RECEIVE |
| FM RADIO (VOICE) | AIRFIELD OBSERVING TEAMS SEND/RECEIVE | AIRFIELD OBSERVING TEAMS AVN BDE SEND/RECEIVE | LANDING ZONE OBSERVING TEAMS AVN BDE SEND/RECEIVE | LANDING ZONE OBSERVING TEAMS SEND/RECEIVE | LANDING ZONE OBSERVING TEAMS SEND/RECEIVE | | |
| METEORO-LOGICAL SATELLITE RECEIVER | RECEIVE | RECEIVE | RECEIVE | RECEIVE | RECEIVE | RECEIVE | RECEIVE |
| HF RADIO VOICE | | | | | | EAC SEND/RECEIVE FOB WETM SEND/RECEIVE | EAC SEND/RECEIVE |

Figure 5-1. WETM communication requirements.

Environmental messages are transmitted on a recurring basis or upon request. These messages are composed of raw data, analyzed data, forecasts, and special products. Because most environmental messages are perishable, rapid transmission is essential. During periods of unstable weather conditions, the normal data load can be expected to increase tremendously. Rapid receipt of weather data is most critical during these periods. Army communications circuits must be capable of handling the data load and should provide backup circuits in case of loss of primary circuits.

On a rapidly changing battlefield with multiple jumps of the TOC, communications provided for WETM support must be operative as soon as the TOC relocates to receive the large volume of data required to make reliable forecasts, and to update the battle staff.

Should contact be lost with the EAC WETM or it is destroyed, the next lower Air Force echelon will be required to interface with the FU or JTF TFU and Air Force communications circuits. Figure 5-2 shows weather support communications.

US Message Text Format

The messages identified below are considered viable instruments for transmitting data using JCS Publication 25 (formerly JINTACCS) and Army Command and Control System (ACCS) formats. Further description of these messages may be obtained from the tactical IEW Character-Oriented Message Catalog (which can be found in the G2 or S2 office) or JCS Publication 25.

The message format contains two messages that are designed to facilitate passing weather information in a tactical environment. The first message is for severe weather warnings (SVWXWARNs). This message is used to warn commanders of severe weather that could affect an AO. It is transmitted as required until the normal weather conditions prevail. The second message is for a weather forecast (WXFCST). This message provides the commander with a WXFCST for a point or area. Forecasts are updated at least every 6 hours.

There is a free text format which can be used for any bulletins (such as a corps SWO bulletin or a group of observations) that do not fit the two standard weather formats.

A FALOP weather observation message format is in Appendix A. This FALOP message is in the USMTF format as a voice message template.

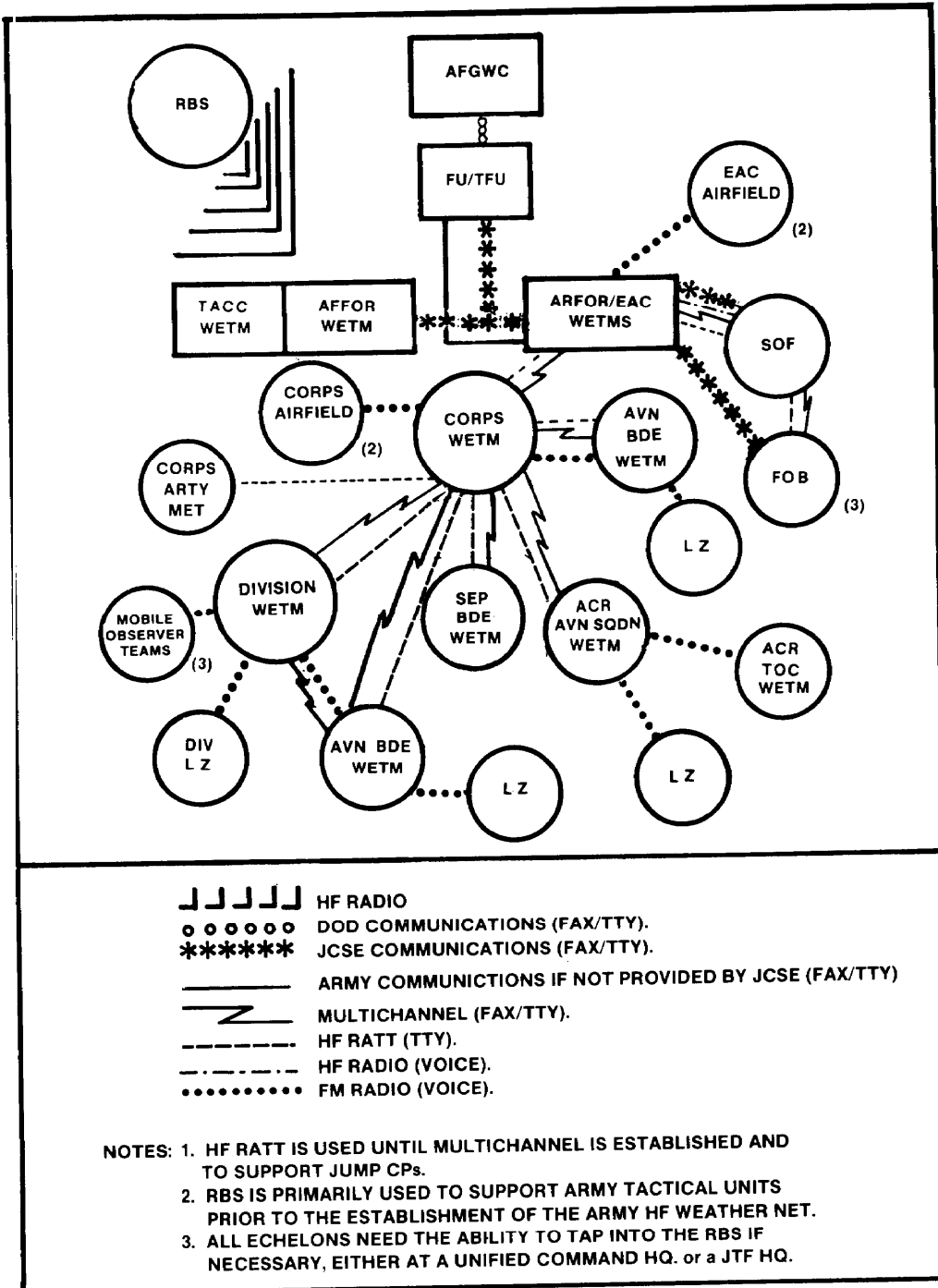

Figure 5-2. Weather support communications.

CHAPTER 6

COMBAT SERVICE SUPPORT

While in the field, WETMs supporting Army tactical organizations depend totally on the supported Army unit for CSS. This includes food service, maintenance, supply, and other CSS functions required to sustain WETMs. Support responsibilities are established in AR 115-10/AFR 105-3. In the field, all tactical equipment is supplied on an Army tables of organization and equipment (TOE) or TDA and maintained beyond operation levels by Army CSS units. The Air Force provides specialized meteorological equipment, and the maintenance and supplies required to support it. No AFCC personnel accompany WETMs to the field.

ARMY SUPPORT

At each echelon, Army units provide the tactical equipment required by WETMs. This is the HHC unit. This equipment includes--

- Communications.
- Electrical power generation.
- Illumination.
- NBC.
- Camouflage.
- Weapons.
- Tactical vehicles.

Additionally, they provide the unit maintenance of Army equipment supplied to WETMs. Other CSS provided include supply, food service, and administrative support.

TOE AND MTOE

At each tactical level supported by a WETM, the Army provides the common equipment required for that WETM. The quantity of equipment is based on the TOE of the Army unit providing support.

The MTOE authorizes personnel and equipment for each particular unit. It is tailored to meet specific conditions required to carry out the wartime mission. The WETM equipment is authorized in the MTOE of the HHC at each supported echelon. The remarks sections of the TOE and MTOE identify weapons, mission-oriented protection posture (MOPP) gear, or other items in sufficient quantity for the WETM. Definitions for the remarks are in the last section of the TOE and MTOE.

The SWOs actively participate in MTOE modifications to ensure the MTOE provides adequate support for their WETM. WETM requirements are determined by the SWO based on the missions of the WETM and the supported command. The SWO ensures that all necessary modifications are included in the request submitted by the supported command to DA.

MTOE modifications requested by the SWO and approved by the supported Army command must be coordinated with the SWO assigned to each level of coordination. Coordination is required to ensure that Air Force WETM resources and the requested changes are compatible. The MTOE is not provide all the equipment needed by tactical units. The CTA augments the MTOE and authorized items such as tents, safes, and heaters which are common to most tactical users. The G4 or S4 of the supported command is responsible for the CTA and issues equipment authorized by it. CTA equipment required by the WETM is requested from the G4 or S4 by the SWO through the G2 or S2. AR 310-49 describes the CTA process.

MAINTENANCE

At corps and division, the WETMs are supported by the HHC. Communications equipment authorized for the WETM is in the corps and division HHC's MTOE. Maintenance is provided through normal CSS channels.

WETM elements operating away from the corps and division main CP areas may receive unit and intermediate direct support (DS) from nearby units. This support is coordinated by the SWO through logistic channels prior to deployment. The SWO ensures these requirements are stated in the appropriate logistic annexes to OPLANs or OPORDs. The WETM is responsible for normal operator maintenance.

WETMs supporting separate brigades, aviation brigades, ACRs, and SOF are supported logistically by headquarters elements from which they have drawn their TOE equipment. Elements of these echelons provide the common equipment required by the WETMs' unit maintenance and evacuate equipment requiring higher levels of maintenance.

Corps

The corps signal brigade provides intermediate DS maintenance for corps WETM communication equipment. Organizational maintenance for communication security (COMSEC) equipment is also included in the support.

Intermediate DS and general support (GS) maintenance for all power generators, vehicles, and other Army common equipment is provided through normal CSS channels.

COMSEC equipment requiring intermediate DS maintenance is evacuated by the corps HHC to the corps signal brigade. Equipment requiring

intermediate GS maintenance is further evacuated by the corps signal brigade to the theater Army COMSEC logistic support unit.

Division

Intermediate DS and GS maintenance of equipment (except COMSEC) is provided by the division support command. HHC is responsible for Evacuation of WETM equipment requiring intermediate DS or GS maintenance. COMSEC equipment requiring intermediate DS maintenance is evacuated by the division HHC to the division signal battalion. Equipment requiring intermediate GS maintenance is further evacuated by the division signal battalion to the theater Army COMSEC logistic support unit.

SUPPLY

Supply support for WETMs parallels maintenance support. Each supporting Army unit at EAC, corps, division, ACR, aviation brigade separate brigade, and SOF provides the common supplies needed by the teams. This includes normal expendable such as paper, pens, and special paper for tactical communication equipment. Supplies needed by the WETMs are provided for and issued through the supply section of the unit supporting that WETM and include the following Class I through Class VIII items:

- Class I - Rations.
- Class II - Clothing.
- Class III - Petroleum, oils, and lubricants (POL).
- Class IV - Construction.
- Class V - Ammunition.
- Class VI - Personal demand items.
- Class VII - Major end items.
- Class VIII - Medical.

On occasion, minor Class IX--Repair Parts--may be issued to the WETM. These repair parts are usually limited to operator-replaceable items such as light bulbs and cables.

Most supplies are issued directly to the WETM by the responsible company's supply section. Other materials such as bulk POL or major end items are usually delivered to the WETMs. Mobile equipment is refueled at

fuel distribution points. Refueling of WETM generators and vehicles in relatively fixed positions is performed by fuel tankers of the HHC.

WETM elements deployed to divisional brigades, corps, and division landing sites may receive some supply support such as fuel, food, and ammunition from other units. The Army unit supporting the WETM coordinates for such support.

FOOD SERVICE

Food service support will be provided to WETMs at the same facilities as the supported unit. When possible, tactical units establish field dining facilities to provide hot meals. When such facilities cannot be established, the WETMs are provided combat rations through supply channels.

WETM personnel deployed to corps or division airfields and LZs are provided food service by the supported aviation unit. Prior coordination with the HHC S4 is required to ensure availability of support at the airfield.

WETMs deployed with divisional brigades are supported by the brigade. ACRs, separate brigades, aviation brigades, and SOF WETMs receive food service support from the HHC field dining facilities established near their respective TOCs. The SWO should coordinate with the HHC S4 to ensure meals are available at the TOC and for their WETMs located at locations other than at the TOC.

PERSONNEL SUPPORT

Air Force WETM personnel do not appear on the Army TOE or MTOE. Army radio operators are the only personnel included in the TOE or MTOE and their numbers are specified on the MTOE of the supported Army unit. The number of radio operators are in the TOE or MTOE.

AIR FORCE SUPPORT

AWS provides and supplies all tactical meteorological observing equipment used by WETMs supporting Army tactical commands. Equipment provided to WETMs is designed to meet Army criteria for--

- Mobility.
- Physical signature.
- Electronic signature.
- Cross-service maintainability.

Accountability of Air Force meteorological equipment is the responsibility of the issuing AWS unit.

Maintenance of Air Force meteorological equipment is an AFCC responsibility. The parent AWS unit, through coordination with AFCC, arranges for onsite maintenance or evacuation of equipment for each WETM.

AWS issues to each WETM all specialized supplies required for tactical meteorological observing and forecasting functions. Such supplies include replacement of tactical meteorological equipment, weather expendable supplies (such as weather charts and graphs), and repair parts. When necessary, AWS ensures that each WETM maintains sufficient quantities of expendable supplies to meet tactical requirements.

APPENDIX A

FORWARD AREA LIMITED OBSERVING PROGRAM

The wide dispersion of units on the modern battlefield and the complexity of current and projected weapon systems have increased the requirements for weather information. Weather varies with both time and location-- one valley is fogged in while an adjacent one is completely clear; 6 hours later, the situation can be reversed. Weather data must be constantly reappraised and updated to retain its usefulness. The FALOP is designed to obtain timely weather observations from the forward areas of the battlefield.

The FALOP is a G2-directed program under which maneuver brigade and ACR and battalion and squadron S2 personnel collect forward area weather information and transmit this data to the USAF WETM.

The Army uses these observations to support Army weapon systems, NBC planning and operations, terrain analysis, and IPB.

The WETM uses this information in preparing tailored tactical weather support products. Collected data include--

- Measurements of temperature.
- Wind direction and speed.
- Cloud information.
- Visibility estimate.
- Type of precipitation and intensity.
- Road, ground, and water conditions.

A FALOP observation is taken using a belt weather kit. It is then encoded into a 13-digit message. Each digit is represented in the final message by a letter or number representing the observed weather element. The FALOP voice message template is transmitted as a series of numbers and letters to higher echelons. The G2 specifies the frequency that FALOP observations must be taken based on METT-T. Normally, the G2 requires observations three times per day at sunrise, noon, and sunset. Additional observations may be required, based on mission needs or a fast-changing weather situation.

The FALOP voice message template consists of three parts:

- Universal transverse mercator (UTM) grid location represented by 8 digits, 2 letters, and 6 numbers.
- A date-time group (DTG) including day of the month and time of observation in Greenwich Mean Time (GMT) (Zulu). This is represented by 6 numbers.
- An encoded weather observation. This consists of 13 encoded weather elements represented by numbers and letters.

The following tables and figures are used to prepare a FALOP report.

- Example of a FALOP report: FALOP NB 131825 051200 83455165012212////CEN (Figure A-1).
- FALOP codes (Tables A-1 through A-13).
- Voice message template (Figure A-2).
- Example of a completed voice message template (Figure A-3).
- Example of a voice message transmission (Figure A-4).
- Belt weather kit description and component parts list (Figure A-5).

Tables A-1 through A-13 describe the FALOP codes and the 13 weather elements in the report. The encircled code digits correspond to the example in Figure A-1. The free text to support the FALOP report in Figure A-1 would read:

FALOP weather observation at grid location NB131825, taken at time 051200. It is overcast with hills seen through the clouds. The wind is from the southeast at 10 to 19 miles per hour (mph). Visibility is 2 to 4 km. Currently there is a light drizzle. The height of the observation is 500 m. The roads are wet with the ground having pools of water on the surface. Current river level is high, but not overflowing. The temperature is 12° C. No surface pressure was taken. Visibility is lowest in the SW. Higher terrain is obscured. Thunderstorms moving toward NE quadrant.

| UTM LOCATION | | | | | | | | DTG | | | | | | FALOP WEATHER OBSERVATION | | | | | | | | | | | | | | | | | | | |
|----------------------|---|---|---|---|---|---|---|--------------------|---|---|---|---|---|---|---|---|---|---|---|---|---|---|----|----|----|----|---|---|---|-----|---|---|---|
| 1 | 2 | 3 | 4 | 5 | 6 | 7 | 8 | 1 | 2 | 3 | 4 | 5 | 6 | 1 | 2 | 3 | 4 | 5 | 6 | 7 | 8 | 9 | 10 | 11 | 12 | 13 | | | | | | | |
| N | B | 1 | 3 | 1 | 8 | 2 | 5 | X | 0 | 5 | 1 | 2 | 0 | 0 | X | 8 | 3 | 4 | 5 | 5 | 1 | 0 | 5 | 0 | 1 | 2 | 2 | 1 | 2 | /// | C | E | N |
| UTM grid coordinates | | | | | | | | Time in GMT (ZULU) | | | | | | Cloud cover Wind direction Wind speed Visibility Current weather Amplification to current weather Height of observation State of the road State of the terrain State of the water Temperature Barometric pressure Remarks | | | | | | | | | | | | | | | | | | | |
| N | B | 1 | 3 | 1 | 8 | 2 | 5 | X | 0 | 5 | 1 | 2 | 0 | 0 | X | 8 | 3 | 4 | 5 | 5 | 1 | 0 | 5 | 0 | 1 | 2 | 2 | 1 | 2 | /// | C | E | N |

- Cloud cover (See Table A-1)
- Wind direction (See Table A-2)
- Wind speed (See Table A-3)
- Visibility (See Table A-4)
- Current weather (See Table A-5)
- Amplification to current weather (See Table A-6)
- Height of observation (See Table A-7)
- State of the road (See Table A-8)
- State of the terrain (See Table A-9)
- State of water (See Table A-10)
- Temperature (See Table A-11)
- Barometric pressure (See Table A-12)
- Remarks (See Table A-13)

Figure A-1. Example of a FALOP Report.

Table A-1. Total amount of cloud cover.

| CODE DIGIT | EXPLANATION |
|------------|-----------------------------|
| 0 | Clear |
| 1 | None |
| 2 | Scattered |
| 3 | Scattered (hills in clouds) |
| 4 | None |
| 5 | Broken |
| 6 | Broken (hills in clouds) |
| 7 | Overcast |
| 8 | Overcast (hills in clouds) |
| 9 | None |

Table A-2. Direction of surface winds.

| CODE DIGIT | EXPLANATION | DEGREES |
|------------|----------------|------------|
| 0 | Calm | None |
| 1 | Northeast (NE) | 023 to 067 |
| 2 | East (E) | 068 to 112 |
| 3 | Southeast (SE) | 113 to 157 |
| 4 | South (S) | 158 to 202 |
| 5 | Southeast (SW) | 203 to 247 |
| 6 | West (W) | 248 to 292 |
| 7 | Northwest (NW) | 293 to 337 |
| 8 | North (N) | 338 to 022 |
| 9 | Variable | None |

Table A-3. Force of surface winds.

| CODE DIGIT | EXPLANATION | MILES PER HOUR |
|------------|-----------------|----------------|
| 0 | Calm | Less than 3 |
| 1 | - | - |
| 2 | Light breeze | 4 to 9 |
| 3 | - | - |
| 4 | Moderate breeze | 10 to 19 |
| 5 | - | - |
| 6 | Strong breeze | 20 to 29 |
| 7 | - | - |
| 8 | Gale | 30 |

Table A-4. Visibility at the surface.

| CODE DIGIT | EXPLANATION |
|------------|--------------------------------------|
| 0 | <164 ft (<50 m) |
| 1 | 164 to <656 ft (50 to <200 m) |
| 2 | 656 to <1,640 ft (200 to <500 m) |
| 3 | 1,640 to <3,280 ft (500 to <1,000 m) |
| 4 | 3,280 ft to <1.2 miles (1 to <2 km) |
| 5 | 1.2 to <2.48 miles (2 to <4 km) |
| 6 | 2.48 to <6.21 miles (4 to <10 km) |
| 7 | 6.21 to <12.42 miles (10 to <20 km) |
| 8 | 12.42 to <31.06 miles (20 to <50 km) |
| 9 | >31.06 miles (>50 km or more) |

Table A-5. Present weather and obstruction to vision.

| CODE DIGIT | EXPLANATION |
|------------|---|
| 0 | No significant weather |
| 1 | Smoke or haze |
| 2 | Fog in valley |
| 3 | Sandstorm, duststorm, or blowing snow |
| 4 | Fog |
| 5 | Drizzle |
| 6 | Rain |
| 7 | Snow or rain and snow mixed |
| 8 | Showers |
| 9 | Thunderstorms with or without precipitation |

Table A-6. Amplification of phenomenon reported in Table A-5.

| CODE DIGIT | EXPLANATION |
|------------|--|
| 0 | No specification |
| 1 | Light |
| 2 | Heavy |
| 3 | In the past hour, but not at the time of observation |
| 4 | Within sight |
| 5 | Freezing precipitation |
| 6 | None |
| 7 | None |
| 8 | None |
| 9 | Hail or ice pellets |

Table A-7. Height of observation.

The height of the observation is stated in decameters above mean sea level (500 m would be encoded as 050).

Table A-8. State of the road in the vicinity of observation point or station.

| CODE DIGIT | EXPLANATION |
|------------|--|
| 0 | Dry |
| ① | Wet |
| 2 | Flooded |
| 3 | Slush |
| 4 | Ice patches |
| 5 | Glazed ice |
| 6 | Snow depth 0 to 7.48 inches (0 to 19 cm) |
| 7 | Snow depth 7.87 inches or more (20 cm or more) |
| 8 | Snow drift |
| 9 | - |

Table A-9. State of the terrain in vicinity of observation point or station.

| CODE DIGIT | EXPLANATION |
|-------------------------|---|
| 0 | Dry |
| 1 | Wet |
| ② | Pools of water on surface |
| 3 | Flooded |
| 4 | Ground frozen 0 to 1.5 inches (0 to 4 cm)* |
| 5 | Ground frozen 1.97 inches (5 cm or more) |
| 6 | Snow depth 0 to 1.5 inches (0 to 4 cm) |
| 7 | Snow depth 1.97 to 9.45 inches (5 to 24 cm) |
| 8 | Snow depth 9.45 to 17.32 inches (25 to 44 cm) |
| 9 | Snow depth >17.32 inches (45 cm or more) |
| *Use of spade possible. | |

Table A-10. State of the water surface in vicinity of observation point or station.

| CODE DIGIT | EXPLANATION |
|------------|--|
| 0 | Water level normal |
| 1 | Water level much below normal |
| 2 | Water level high, but not overflowing |
| 3 | Banks overflowing |
| 4 | Floating ice (more than half) |
| 5 | Thin ice 0 to 1.5 inches (0 to 4 cm) thick, complete cover, impassable for persons |
| 6 | Ice depth unknown, complete cover, passable for persons |
| 7 | Ice depth 1.97 to 3.54 inches (5 to 9 cm) complete cover |
| 8 | Ice depth 3.93 to 9.44 inches (10 to 24 cm) complete cover |
| 9 | Ice depth >9.84 inches (25 cm or more) complete cover |

Table A-11. Temperature.

Temperature at observation point or station in whole degrees Celsius (C). Negative temperatures are encoded by adding 50 to the absolute value of the temperature (-20°C would be encoded as 70).

Table A-12. Barometric pressure.

Surface pressure at observation point or station.

NOTE: This group is used only if a barometer is available to measure pressure. Observers without a barometer will use four slashes (////) to encode that the pressure is missing. See Figure A-1.

Table A-13. Remarks.

| CODE | EXPLANATION |
|------|---|
| A | Visibility lowest in the NE quadrant. |
| B | Visibility lowest in the SE quadrant. |
| (C) | Visibility lowest in the SW quadrant. |
| D | Visibility lowest in the NW quadrant. |
| (E) | Higher terrain obscured. |
| F | Sky totally obscured, sun or moon not visible. |
| G | Sky obscured, sun or moon dimly visible. |
| H | Rainfall 0.2 inches (5 mm) or less since last observation. |
| I | Rainfall between 0.2 inches (5 mm) and 1 inch (25 mm) since last observation. |
| J | Rainfall 1 inch (25 mm) or greater since last observation. |
| K | Ground thawing. |
| L | Ice forming on vehicles, trees, exposed surfaces. |
| M | Thunderstorms over mountains. |
| (N) | Thunderstorms moving toward NE quadrant. |
| O | Thunderstorms moving toward SE quadrant. |
| P | Thunderstorms moving toward SW quadrant. |

Table A-13. Remarks (Continued).

| CODE | EXPLANATION |
|------|--|
| Q | Thunderstorms moving toward NW quadrant. |
| R | Rainfall (in hundredths of inches) since last observation. |
| S | Snowfall (in inches) since last observation. |
| T | Precipitation not occurring at time of observation but has occurred in the last 2 hours. |
| U | Gusty surface winds. |
| V | Weather conditions fluctuating in vicinity of observation point during past 2 hours. |
| W | WBGW in degrees Celsius. Encoded as WXX where XX is the WBGW. if the WBGW is negative, no remark is necessary. |
| X | PIREP follows in plain language. |
| Z | Free text narrative. |

| | | |
|---|------------|---|
| VOICE MESSAGE TEMPLATE | | Page 1 of 2 |
| TITLE: Forward Area Limited Observing Program (FALOP) Weather Observation | | |
| THIS IS | originator | FALOP OVER weather observation |
| addressee | originator | FALOP OVER weather observation |
| THIS IS | SEND | FALOP OVER |
| originator | addressee | weather observation |
| THIS IS | originator | |
| FLASH IMMEDIATE PRIORITY ROUTINE | | (Underline and transmit the precedence of this message.) |
| TOP SECRET SECRET CONFIDENTIAL UNCLASSIFIED | | (Underline and transmit the security classification of this message.) |
| <u>FALOP WEATHER OBSERVATION</u> | | |
| <u>LOCATION</u> | | (The center of observed weather expressed in UTM coordinates, accurate to within 100 meters.) |
| <u>TIME</u> | | (Day-Time Zulu observation is taken.) |
| 1 | | Cloud cover (See Table A-1). |
| 2 | | Direction of surface winds (See Table A-2). |
| 3 | | Force of surface winds (See Table A-3). |

Figure A-2. Voice message template.

TITLE: Forward Area Limited Observing Program (FALOP) Weather Observation

- 4 _____ Visibility at the surface (See Table A-4).
- 5 _____ Present weather (See Table A-5).
- 6 _____ Amplification of present weather (See Table A-6).
- 7 _____ Height of observation (See Table A-7).
- 8 _____ State of the road (See Table A-8).
- 9 _____ State of the terrain (See Table A-9).
- 10 _____ State of the water surface (See Table A-10).
- 11 _____ Temperature (See Table A-11).
- 12 _____ Barometric pressure (See Table A-12).
- 13 **REMARKS/NARRATIVE** (See Table A-13).
- _____
- _____
- _____
- 14 **TIME** _____ Hour-Minute-Zone. (See NOTE.)
- 15 **AUTHENTICATION IS** _____ Message Authentication. (See NOTE.)
- OVER**

NOTE: The message time group is used when required to identify message time of origin. Authentication will be in accordance with current CEOI or JTF procedures.

Figure A-2. Voice message template (Continued).

| | | | | |
|---|---------------------------|---------------------|---|--|
| COMPLETED VOICE MESSAGE TEMPLATE | | | | Page 1 of 2 |
| TITLE: Forward Area Limited Observing Program (FALOP) Weather Observation | | | | |
| HORNET addressee | THIS IS | RADAR originator | FALOP OVER weather observation | |
| RADAR originator | THIS IS | HORNET addressee | SEND | FALOP OVER weather observation |
| HORNET addressee | THIS IS | RADAR originator | | |
| FLASH | IMMEDIATE | PRIORITY | <u>ROUTINE</u> | (Underline and transmit the precedence of this message.) (Underline and transmit the security classification of this message.) |
| TOP SECRET | SECRET | CONFIDENTIAL | <u>UNCLASSIFIED</u> | |
| <u>FALOP WEATHER OBSERVATION</u> | | | | |
| | <u>LOCATION NB 131825</u> | | (The center of observed weather expressed in UTM coordinates, accurate to within 100 meters.) | |
| | <u>TIME 051200Z</u> | | (Day-Time Zulu observation is taken.) | |
| 1 | <u>8</u> | | Cloud cover (See Table A-1). | |
| 2 | <u>3</u> | | Direction of surface winds (See Table A-2). | |
| 3 | <u>4</u> | | Force of surface winds (See Table A-3). | |

Figure A-3. Example of a completed voice message template.

TITLE: Forward Area Limited Observing Program (FALOP) Weather Observation

| | | |
|----|-------------------|---|
| 4 | 5 | Visibility at the surface (See Table A-4). |
| 5 | 5 | Present weather (See Table A-5). |
| 6 | 1 | Amplification of present weather (See Table A-6). |
| 7 | 050 | Height of observation (See Table A-7). |
| 8 | 1 | State of the road (See Table A-8). |
| 9 | 2 | State of the terrain (See Table A-9). |
| 10 | 2 | State of the water surface (See Table A-10). |
| 11 | 12 | Temperature (See Table A-11). |
| 12 | MISSING | Barometric pressure (See Table A-12). |
| 13 | REMARKS/NARRATIVE | (See Table A-13). |

| | | |
|----|-------------|-------------------------------|
| 14 | <u>TIME</u> | Hour-Minute-Zone. (See NOTE.) |
|----|-------------|-------------------------------|

| | | |
|----|--------------------------|-------------------------------------|
| 15 | <u>AUTHENTICATION IS</u> | Message Authentication. (See NOTE.) |
|----|--------------------------|-------------------------------------|

OVER

NOTE: The message time group is used when required to identify message time of origin. Authentication will be in accordance with current CEOI or JTF procedures.

Figure A-3. Example of a completed voice message template (Continued).

VOICE MESSAGE TRANSMISSION

TITLE: Forward Area Limited Observing Program (FALOP) Weather Observation

HOPNET THIS IS RADAR FALOP WEATHER OBSERVATION OVER

RADAR THIS IS HORNET SEND FALOP WEATHER OBSERVATION OVER

HOPNET THIS IS RADAR

PRIORITY

UNCLASSIFIED

FALOP WEATHER OBSERVATION

LOCATION NOVEMBER BRAVO ONE THREE ONE EIGHT TWO FIVE

TIME ZERO FIVE ONE TWO HUNDRED ZULU

LINE ONE EIGHT

LINE TWO THREE

LINE THREE FOUR

LINE FOUR FIVE

LINE FIVE FIVE

LINE SIX ONE

LINE SEVEN ZERO FIVE ZERO

LINE EIGHT ONE

LINE NINER TWO

LINE TEN TWO

LINE ELEVEN ONE TWO

LINE TWELVE MISSING

LINE THIRTEEN CHARLIE ECHO NOVEMBER

OVER

Figure A-4. Example of a voice message transmission.

BELT WEATHER KIT DESCRIPTION AND COMPONENT PARTS LIST

- A. Bag, Belt weather kit, PN 92402. Heavy olive drab case with fitted pockets for wind meter, compass, psychrometer, water bottle, psychrometric computer, pressure reduction computer, rain gauge, weather forms, pencil, and map. Dimensions: 8-1/2 by 11-1/2 by 2 inches. Weight: 2 pounds. Contents identified above will be marked on the inside case. The outside flap will be marked: "BELT WEATHER KIT."
- B. Psychrometer, Sling Type, PN 92021, with reinforced leather case and instructions for use. Measurement ranges and accuracies: Wet and Dry Bulb -40°C to $+66^{\circ}\text{C} \pm 25^{\circ}\text{C}$.
- C. Wind Meter, PN 92175, with cleaners, case, and instructions for use. Measurement ranges and accuracies: Low Scale: 2 - 8.5 knots $\pm 10\%$; High Scale: 6 knots - 56 knots $\pm 10\%$.
- D. Compass, PN 11012. Liquid filled, fast needle, oscillation stops in 4 seconds, and instructions for use.
- E. Psychrometric Computer, Miniature, CO-164/UM-Small, PN 92405. Measurement ranges and accuracies: Dewpoint: -50°C to $+29.4^{\circ}\text{C}$; Relative Humidity: 1% to 100%; Wet-Bulb Thermometer: -50°C to $+29.4^{\circ}\text{C}$; Barometric Pressure: 23 to 30 inches; Size: 5-3/4 inches in diameter. Instructions for use are printed on the computer and FMH-1B.
- F. Pressure Reduction Computer, Miniature, CO-875/UM-Small, PN 92406. Measurement ranges and accuracies: Pressure Reduced to Sea Level: 875 to 1,075 millibars (Mb) with 0.5 Mb graduation; 25.80 to 31.75 inches with 0.01 inch graduation. Station Pressure: 711 to 1,075 Mb with 0.5 mb graduation; 21.00 to 31.75 inches with 0.01 inch graduation. Altimeter: -1,400 to +9,500 feet with 10 feet graduations. Size: 5 inches in diameter. Instructions for use are printed on the computer and FMH-1B.
- G. Gauge, Precipitation (Rain) with 5-inch Rod, PN 92201. Measurement ranges and accuracies: Capacity: 2 inches or 50 millimeters; Graduations: 0.02 inch or 1.0 mm; Scale: Millimeters and inches.

Figure A-5. Belt weather kit description and component parts list.

H. Water Bottle, Psychrometer, with Cap, PN 92026. Plastic - nonbreakable.

I. Pencil No. 2 lead, mechanical, with refill capability.

NOTE: An altimeter barometer has an NSN and has to be ordered separately: NSN 6660-00-551-3998. Order through normal supply channels. The Sims anemometer is a substitute item for the Dwyer wind meter found in the belt weather kit. The anemometer part number is Model BTC Anemometer.

Figure A-5. Belt weather kit description and component parts list (Continued).

APPENDIX B

WEATHER EFFECTS ON ARMY OPERATIONS

This appendix describes common weather and general weather effects on operations as they affect specific types of units and selected operations.

COMMON EFFECTS

Although environmental elements tend to have different effects on different types of units and operations, many can be identified as having similar effects on a majority of combat elements and operations.

Many of the common effects can be derived for planning purposes from the climate of the theater of operations. Special attention must be given to those elements of weather which may limit operations or preclude them altogether. For instance, operations in the tropics must be planned to consider the recurring cycle of the monsoon season. In continental Europe, strategy must be considered with severe winters and with the annual autumn and spring thaws affecting trafficability and cross-country movement.

Very early in the planning process, planners must relate the possible courses of action to weather expectancies derived from climatological studies. There must be an acceptable likelihood that the weather conditions required for any proposed course of action will occur. It is imperative that an operation be feasible meteorologically at the operational level of warfare, and that planning for seasonal weather changes be considered early in the campaign process.

When considering the effects of environmental conditions, the impact weather and terrain have on each other must be considered. Weather and terrain are so interrelated they must be considered together when planning ground and air operations. Weather elements can drastically alter terrain features and trafficability. Conversely, terrain features may exert considerable influence on local weather. The relationship between weather and terrain must be carefully correlated in terrain studies to produce accurate terrain intelligence. This planning is an integral part of the IPB process.

WEATHER ELEMENTS

Terrain features affect weather, climate, and weather elements such as--

- Visibility.
- Temperature.

- Humidity.
- Precipitation.
- Winds.
- Clouds.

These specific elements vary with the geographical area, time, and season. A description of the climate of a large area considers terrain influences only in general terms; whereas a description of a small area such as a single valley can be specific. FM 30-10 contains further information on terrain.

It is important that commanders and staffs understand and consider weather in their tactical planning. They must recognize the tactical significance of weather effects on intended operations and the risks or opportunities they present. The effects of weather are integrated with enemy and terrain analysis through IPB. Factors that must be considered include--

- Visibility.
- Wind.
- Clouds.
- Temperature and humidity.
- Severe weather.
- Illumination and obstructions to vision.

VISIBILITY

Low visibility is beneficial to offensive and retrograde operations and detrimental to defensive operations. In the offense, it conceals the concentration of maneuver or friendly forces, thus enhancing the possibility of achieving the element of surprise. Low visibility hinders the defense because cohesion and control become difficult to maintain, reconnaissance and surveillance are impeded, and target acquisition is less accurate.

These disadvantages may be offset partially by extensive use of illuminatives, radar, sound detection, thermal, and infrared devices; however, infrared devices are degraded in range by any moisture source, precipitation, or moisture-absorbing smoke. Smoke and obscurant aerosols can be expected on medium-intensity to high-intensity battlefields and may be used locally to reduce visibility. In all operations, obscurants limit the use of aircraft and aerial optical and infrared surveillance devices.

WIND

Wind speed and direction, both on the surface and aloft, usually favor the upwind force in the use of NBC weapons. Winds of sufficient speed can reduce the combat effectiveness of a force downwind as the result of blowing dust, smoke, sand, rain, or snow on personnel and equipment. The force located upwind has better visibility and can, therefore, advance and maneuver faster. Strong winds limit airborne, air assault, and aviation operations.

Strong surface winds and gusts can--

- Injure personnel.
- Damage material and structures.
- Give false radar returns.
- Restrict visibility due to blowing sand, dust, and other material.

Generally, winds above 20 nautical mph create such effects. Smoke operations are usually ineffective at wind speeds greater than 7 nautical mph. As surface wind speed (SFC) increases, either naturally or enhanced by vehicle movement, the windchill becomes a critical factor. The windchill factor adversely affects improperly clothed personnel and impedes activity in unsheltered areas. Wind speed also affects the distance that sound will travel. Wind may prove beneficial by aiding in drying soil. A windchill index chart developed by US Army Research Institute of Environmental Medicine is shown at Figure B-1.

| Estimated Wind Speed (In mph) | Actual Temperature Reading (°F) | | | | | | | | | | | |
|--|---|----|----|---|-----|-----|-----|--|------|------|------|------|
| | 50 | 40 | 30 | 20 | 10 | 0 | -10 | -20 | -30 | -40 | -50 | -60 |
| | Equivalent Chill Temperature (°F) | | | | | | | | | | | |
| Calm | 50 | 40 | 30 | 20 | 10 | 0 | -10 | -20 | -30 | -40 | -50 | -60 |
| 5 | 48 | 37 | 27 | 16 | 6 | -5 | -15 | -26 | -36 | -47 | -57 | -68 |
| 10 | 40 | 28 | 16 | 4 | -9 | -24 | -33 | -46 | -58 | -70 | -83 | -95 |
| 15 | 36 | 22 | 9 | -5 | -18 | -32 | -45 | -58 | -72 | -85 | -99 | -112 |
| 20 | 32 | 18 | 4 | -10 | -25 | -39 | -53 | -67 | -82 | -96 | -110 | -121 |
| 25 | 30 | 16 | 0 | -15 | -29 | -44 | -59 | -74 | -88 | -104 | -118 | -133 |
| 30 | 28 | 13 | -2 | -18 | -33 | -48 | -63 | -79 | -94 | -109 | -125 | -140 |
| 35 | 27 | 11 | -4 | -20 | -35 | -51 | -67 | -82 | -98 | -113 | -129 | -145 |
| 40 | 26 | 10 | -6 | -21 | -37 | -53 | -69 | -85 | -100 | -116 | -132 | -148 |
| (Wind speeds greater than 40 mph have little additional effect.) | LITTLE DANGER Is < hr with dry skin. Maximum danger of false sense of security. | | | INCREASING DANGER Danger from freezing of exposed flesh within one minute. | | | | GREAT DANGER Flesh may freeze within 30 seconds | | | | |
| | Trenchfoot and immersion foot may occur at any point on this chart. | | | | | | | | | | | |
| Developed by U.S. Army Research Institute of Environmental Medicine, Natick, MA. | | | | | | | | | | | | |

Figure B-1. Windchill factor chart.

PRECIPITATION

The primary significance of precipitation is its effect on soils, visibility, personnel effectiveness, and the functioning of ground maneuver systems, aviation, and E-O and infrared systems. State-of-the-ground affects trafficability; heavy rain can make some unsurfaced roads and off-road areas impassable. Rain and snow can greatly reduce--

- o Personnel effectiveness by limiting visibility, increasing fatigue, and causing discomfort and other physical and psychological problems.
- o The persistence of chemical agents or create NBC hot spots.
- o The range of lasers, night vision devices, and thermal tank sights.
- o The effectiveness of aircraft.

Precipitation also adversely degrades the quality of supplies in storage. Snow accumulation of greater than 1 inch degrades trafficability and reduces the impact of mines and the blast effects of point munitions. Generally, precipitation in excess of .10 inches per hour or 2 inches in a 12-hour period is considered critical for tactical operations. Snowfall exceeding 18 inches reduces tracked vehicle speed; movement on foot is very difficult without snowshoes or skis.

CLOUDS

The type and amount of cloud cover, as well as the height of cloud bases and tops, influence friendly and enemy aviation operations. Extensive cloud cover reduces the effectiveness of air support. This effect becomes more pronounced as cloud cover increases, as cloud bases lower, and as conditions associated with clouds (such as icing, turbulence, and poor visibility aloft) increase. In a relatively unstable airmass, clouds are associated with strong vertical currents, turbulence, and restricted visibility aloft. Generally, TACAIR CAS missions and MAC aerial resupply missions require a ceiling of at least 1,000 feet.

Clouds affect ground operations by limiting illumination and the solar heating of targets for infrared systems. Clouds limit the use of infrared-guided artillery by decreasing the envelope in which it can seek and lock on to laser-designated targets. Cloud-free line of sight (LOS) is required for delivery of precision-guided munitions from aircraft.

TEMPERATURE AND HUMIDITY

Temperature and humidity affect air density. Air density decreases as the temperature or humidity increases; thus, the efficiency of aircraft propulsion is reduced in areas of high temperature or high humidity. Although temperature and humidity may not directly affect a particular tactical operation, extremes will reduce personnel and equipment capabilities and may necessitate a reduction of aircraft payloads (for example, fuel, weapons, and personnel).

Tactics effective in one climate may be ineffective when applied in another. The high temperatures and humidity in the tropics are conducive to the growth of dense foliage which greatly affects tactical operations. Desert climates can range from extremely hot in the daytime to very cold at night, requiring added protective measures. In arctic climates, cold weather periods--

^oCreate an almost constant need for heated shelters.

^oCause difficulty in constructing fortifications.

- Increase the dependence on logistical support.
- Necessitate special clothing, equipment, and survival training.

Windchill factors are produced by a combination of temperature and wind speed. A windchill factor of -26°F (-32°C) is considered the critical value for equipment and personnel operating in cold weather. The opposite extreme, 120°F (49°C), is the critical value for personnel operating in hot weather. The critical wet-bulb-globe- temperature (WBGT) value for personnel operating in hot weather is 90°F . Similar restrictions occur in desert terrain, where the difference in temperature from day to night may vary as much as 100°F (37°C).

Temperatures of targets and objects on the battlefield at night are important for the use of thermal sights and forward looking infrared (FLIR) devices. A difference in temperature or thermal contrast is required for these devices to “see” a target. Normally, heating and cooling are at a different rate for the target and background. Twice a day, in the morning and evening, targets without internal heating come to relatively the same temperature as the background.

At this point thermal crossover occurs and the thermal device does not have the capability to “see” the target. Time of thermal crossover may be only a few seconds when the morning sun strikes a target, or for several minutes on cloudy adverse weather days; this depends on the threshold temperature’s contrast required by the thermal device. Tactical decision aids can be used to predict these temperature differences for planners and estimate length of thermal crossover periods.

SEVERE WEATHER

Severe weather affects most operations by presenting a threat of injury to personnel, damaging equipment and structures, limiting ground and air mobility and air operations, and threatening troop morale. Electrical storms often accompany severe weather conditions and add the hazard of lightning strikes at munitions storage areas and fueling points. Lightning also may interrupt landline communications and both communication and noncommunication use of the electromagnetic spectrum.

ILLUMINATION AND OBSTRUCTIONS TO VISION

Illumination and obstructions to visions impact on the visibility required for various operations. They affect the overall planning for--

- Security.
- Concealment.

- ° Target acquisition by visual, electronic, or E-O means.

METEOROLOGICAL PRODUCTS

Meteorological products are categorized as either primary products or tactical weather products.

Primary products are used by the SWO in preparing tactical weather products. They are usually received in the form of weather observations, forecasts, and climatological studies. Primary products are received from AWS, indigenous sources, other WETMs, the Navy, Army, and in-flight aircraft in wartime, and from NWS and FAA in peacetime. While some primary weather products are passed directly to the Army user, many need to be modified or updated to reflect local observation, local terrain, and mission requirements.

Weather observations contain information on existing weather conditions and specific weather elements at specific locations and times. The basic types of observations are surface and upper air.

SURFACE OBSERVATIONS

Surface observations are taken hourly or as required by the WETMs, ARTYMET sections, and selected Army units using the FALOP. Observations include--

- ° Surface winds.
- ° Prevailing visibility.
- ° Precipitation type and intensity.
- ° Obstructions to vision.
- ° Clouds.
- ° Temperature.
- ° Dewpoint temperature.
- ° Surface atmospheric pressure.
- ° Altimeter setting.
- ° Remarks.

Additional elements may include--

- ° Snow depth.

- Precipitation amounts.
- State-of-the-ground.
- Maximum and minimum temperatures.

Other products such as windchill, pressure altitude, and density altitude can be derived from the surface observation. The WBGT is obtained from medical units and provides information on heat casualty potential. Freeze-thaw depth, ice thickness, current water depth, river stages, and trafficability are obtained from engineer and cavalry units.

UPPER-AIR OBSERVATIONS

Upper-air observations are taken by ARTYMET sections at established time intervals. They measure temperature, pressure, relative humidity, and wind speed and direction. From these observations, fallout winds, ballistic, and computer meteorological messages are prepared.

WEATHER PLANNING FACTORS

This paragraph describes weather planning factors peculiar to specific units or selected operations.

EFFECTS OF WEATHER ON AIR DEFENSE OPERATIONS

Air defense operations require environmental information for both deployment and employment. Deployment requires climatological data, trafficability, and severe weather forecasts. Environmental elements affecting employment vary according to the type of weapon systems used. When missile systems require radar surveillance, elements such as refractive index and precipitation must be known. Other systems require visual target acquisition. Figure B-2 shows the effects of weather on air defense operations.

| | |
|-------------------------|--|
| REFRACTIVE INDEX | Degrades target acquisition and tracking radar performance especially during superfraction. |
| FOG | Degrades visual acquisition and tracking. |
| CLOUD COVER AND CEILING | May degrade visual acquisition and tracking. |
| PRECIPITATION | Degrades or prevents visual acquisition and tracking. May attenuate radar signal. Degrades or prevents infrared homing. |
| SURFACE PRESSURE | Affects calibration of equipment. |
| ELECTRICAL STORMS | Degrades effectiveness of electronic systems. |
| LIGHT DATA | Affects visual acquisition and tracking. |
| TEMPERATURE | High temperatures degrade effectiveness of electronic systems. Very low temperatures may affect mechanical devices. Extreme cold can produce detectable ice-fog exhaust trails from certain weapon systems and vehicles. |
| HUMIDITY | Affects refractive index and may degrade radar effectiveness. |

Figure B-2. Effects of weather on air defense operations.

EFFECTS OF WEATHER ON AMPHIBIOUS OPERATIONS

Weather effects on amphibious operations may be beneficial and detrimental. Certain weather condition may help conceal landing operations. Other conditions may hinder beaching and unloading, task force movement, and essential air support operations. Figure B-3 shows effects of weather on amphibious operations.

| |
|--|
| <p>CEILING--CLOUD AND SKY COVER Hampers air support operations. Offers concealment from air reconnaissance. May hamper landing craft navigation.</p> <p>FOG Reduces visibility. Increases landing craft navigation problems. Increases water and terrain hazards. May provide concealment.</p> <p>SEVERE WEATHER Hampers debarkation. Hampers landing craft operations. Creates unacceptable surf conditions. May preclude landing. Interferes with construction support.</p> <p>ILLUMINATION May dictate time of landing and support operations.</p> <p>LUNAR PHASE Affects tidal conditions.</p> <p>FREEZE OR THAW DEPTH May hamper movement over the beach. May hamper construction support.</p> <p>STATE-OF-THE-SEA May preclude landing or resupply of landing forces. Debarkation may be canceled. May endanger use of landing craft. Severe conditions can degrade naval gunfire support.</p> <p>TEMPERATURE (WATER) Cold temperatures decrease survivability of personnel in the water.</p> <p>TIDE May cause postponement of landing. May conceal beach obstacles.</p> |
|--|

Figure B-3. Effects of weather on amphibious operations.

| |
|---|
| <p>WIND (SURFACE) May cause postponement of landing. Affects state-of-the-sea. Affects landing craft handling.</p> <p>WINDCHILL May require special equipment and rigging for landing. May require special supplies and equipment to support operations afloat and ashore.</p> <p>TEMPERATURE (SURFACE) May require special equipment and rigging for landing. May require special supplies and equipment to support operations afloat and ashore.</p> |
|---|

Figure B-3. Effects of weather on amphibious operations (Continued).

EFFECTS OF WEATHER ON ARMOR AND INFANTRY OPERATIONS

Armor and infantry operations are influenced primarily by those weather elements which degrade trafficability and visibility. Figure B-4 shows the effects of weather on armor or infantry operations.

EFFECTS OF WEATHER ON ARTILLERY OPERATIONS

Artillery operations are heavily weather-dependent. Not only must artillery contend with those weather effects common to all units but also must compensate for a number of special effects pertinent to their operations. Figure 6-15 provides a complete description of artillery requirements. Figure B-5 shows the effects of weather on artillery operations.

| |
|---|
| <p>VISIBILITY May affect visual acquisition. May degrade laser range-finding and target designation. Poor visibility increases survivability of light Infantry</p> <p>FRECPITATION Degrades trafficability. Limits visibility. Degrades the effectiveness of target acquisition and weapon control system.</p> <p>WIND (SURFACE) Trajectory data and first-round hit capability degraded by high crosswinds. Smoke disperses quickly.</p> <p>WINDCHILL Influences type lubricants to be used. Determines engine warm-up periods. Affects sustained rate of fire for weapons. Affects soldier effectiveness and safety.</p> <p>TEMPERATURE (SURFACE) Decreases habitability of vehicles. Low temperatures degrade ballistics of main guns. Low temperatures require frequent starting of vehicles. Extreme temperatures reduce personnel effectiveness.</p> <p>HUMIDITY When coupled with high temperatures, decreases effectiveness of crews in closed vehicles. Decreases stamina of foot soldiers.</p> <p>BAROMETRIC PRESSURE Affects M1 gunnery computations.</p> |
|---|

Figure B-4. Effects of weather on armor and infantry operations.

| |
|---|
| <p>CEILING--CLOUD AND SKY COVER Affects target acquisition. Affects terminally guided munitions.</p> <p>VISIBILITY Affects target acquisition and fire adjustment. Affects E-0 target designation.</p> <p>ELECTRICAL STORMS AND THUNDER Restrict munitions handling.</p> <p>REFRACTIVE INDEX Affects radar, laser, and infrared distance measuring techniques.</p> <p>WIND (SURFACE) Affects accuracy of rocket fires.</p> <p>WIND (ALOFT) Wind profiles are used to calculate ballistic wind correction.</p> <p>ALTIMETER SETTING AND ATMOSPHERIC PRESSURE Required for altitude accuracy. Used in barofuzing. Used for fire control calculations.</p> <p>DENSITY PROFILE Affects fire control computations.</p> <p>PRESSURE PROFILE Used for baroarming and barofuzing techniques. Used to calculate densities.</p> <p>TEMPERATURE (SURFACE) Used in fire control surface density determinations. Used in estimating ballistic atmosphere pressure and densities aloft.</p> <p>TEMPERATURE PROFILE Used to calculate ballistic temperature and air density.</p> <p>MOISTURE PROFILE Used to determine virtual temperature. Used to determine atmosphere ducting conditions. Affects E-0 target designation.</p> |
|---|

Figure B-5. Effects of weather on artillery operations.

EFFECTS OF WEATHER ON AVIATION AND AIR ASSAULT OPERATIONS

Army aviation is involved in multifaceted operations over the length and breadth of the battlefield. These operations include aerial weapons, reconnaissance and surveillance, and routine logistic support. Missions are varied and require the operation of aviation, both fixed-wing and rotary-wing assets in a variety of flight modes and altitudes. Figure B-6 shows the effects of weather on aviation operations.

EFFECTS OF WEATHER ON C-E OPERATIONS

Communications-Electronics (C-E) operations are affected by a number of weather elements. Virtually all of the special weather conditions that apply to C-E operations affect electromagnetic propagation. Figure B-7 shows the effects of weather on C-E operations.

CEILING--CLOUD AND SKY COVER

Limits operations requiring aircraft clear of clouds.
May preclude landings or increase danger in takeoffs.
May preclude CAS missions.

VISIBILITY

Affects landing and takeoff capabilities.
Affects reconnaissance and target acquisition.
Low visibility increases flight hazards.
Affects E-O target designation and terminally guided munitions.

ELECTRICAL STORMS AND THUNDER

Hazardous to inflight operations.
Hazardous to refueling operations.
Hazardous to rearming operations.

PRECIPITATION

Affects visibility and safety of flight.
Affects density altitude.

SNOW DEPTH

Affects ground handling.
Powdery snow may preclude hover operations.

REFRACTIVE INDEX

Affects optical, radar, laser, and infrared range-finding techniques.

ICE AND THICKNESS

Used in evaluating landing sites.

ICING

Affects aerodynamics of aircraft.
Any intensity of icing can preclude aviation operations.

STATE-OF-THE-GROUND

Impacts on effectiveness of aerially delivered munitions.

TURBULENCE

Affects reconnaissance and surveillance--shear affects systems performance.
May cause aircraft structural damage.
May affect aircraft control.
Severe turbulence may cancel operations.

Figure B-6. Effects of weather on aviation and air assault operations.

WIND (SURFACE)

Affects aircraft control near the ground.
Affects landing and takeoff.
Affects ground speed for low-level flights.

BLOWING DUST AND SAND

Affects hydraulic systems and windscreens.

WIND (ALOFT)

Affects navigation.
Affects ground speed at higher flight altitudes.

DENSITY ALTITUDE

Affects lift capabilities.
Affects reciprocating engine performance.
Limits fuel and weapons load.

PRESSURE ALTITUDE

Affects reciprocating engine performance.

PRESSURE PROFILE

Affects terrain avoidance.

TEMPERATURE (SURFACE)

High temperatures reduce lift capabilities.
Cold temperatures increase maintenance requirements and time to perform.
Reduces personnel carried due to weight and bulk of protection gear.

DEWPOINT

Affects engine efficiency calculations.
Serves as warning of possible fog formation or icing conditions.

ILLUMINATION

Affects operations using night vision devices.

Figure B-6. Effects of weather on aviation and air assault operations (Continued).

| | |
|-------------------------------|--|
| DUST | Affects electromagnetic propagation. |
| ELECTRICAL STORMS AND THUNDER | Interfere with radio and wire communications. May disrupt synchronization for data communications. |
| FOG | Affects electromagnetic propagation. |
| PRECIPITATION | Affects electromagnetic propagation. |
| BLOWING SNOW | Builds static discharge which may affect electromagnetic propagation. |
| IONOSPHERIC DISTURBANCES | Affect reliability of radio communications systems. |
| REFRACTIVE INDEX | Affects electromagnetic propagation characteristics of the atmosphere. |
| ICING | May damage cable lines and antennas. Decreases efficiency of microwave systems. |
| WIND (SURFACE) | May damage antennas and transmission lines. May cause cable blow-down. Interferes with antenna installation. |
| TEMPERATURE (SURFACE) | High temperatures adversely affect electronic circuits and may increase maintenance. Extreme cold may snap cable lines. Cold decreases life of battery-operated equipment. |
| HUMIDITY | May cause fungus growth within circuits resulting in premature system failure. |

Figure B-7. Effects of weather on C-E operations.

EFFECTS OF WEATHER ON ENGINEER OPERATIONS

Engineer operations are influenced by current environmental conditions, forecasted conditions, and climatology. Figure B-8 shows the effects of weather on engineer operations.

| |
|--|
| VISIBILITY Impacts survey operations. |
| PRECIPITATION Influences river current, water depth, and bridge construction. Complicates construction and maintenance operations. Effects flooding and river-crossing operations and soil-bearing strength. |
| SNOW DEPTH Impacts site selection and construction. Impacts flood prediction. |
| FREEZE OR THAW DEPTH Impacts site selection and construction. Complicates excavation. |
| TEMPERATURE (WATER) Affects survivability of troops in the water during port construction, river crossings, and beach operations. |
| TIDE Affects site selection, port, and beach operations. Affects timing of beach operations. |
| WIND (SURFACE) Affects river crossings and port and watercraft operations. Impacts smoke operations. Impacts required structural strength. Hinders certain construction operations. |
| HUMIDITY Affects handling, storage, and use of building materials. |
| TEMPERATURE (SURFACE) Impacts trafficability. Influences flood potential. May affect use of certain construction materials. Influences ice thickness and river-crossing capabilities. |

Figure B-8. Effects of weather on engineer operations.

EFFECTS OF WEATHER ON INTELLIGENCE OPERATIONS

Many intelligence operations are dependent on weather. Collection and dissemination may be hindered by certain weather conditions. All-source processing requires evaluation of all weather conditions, current and forecast, as they impact on enemy and friendly operations. Figure B-9 shows the effects of weather on intelligence operations.

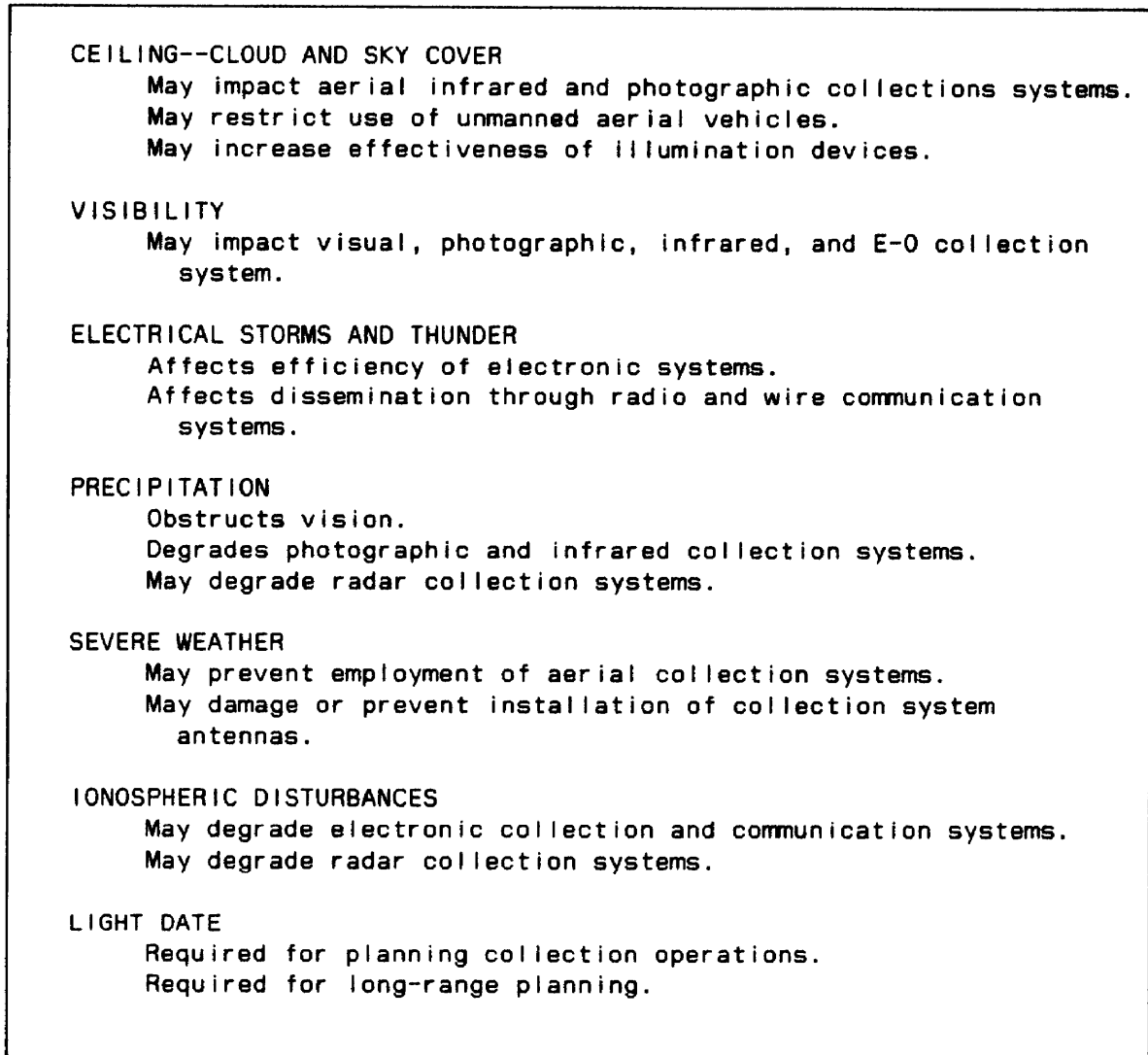

Figure B-9. Effects of weather on intelligence operations.

ICING

May degrade performance of aerial collection systems if permitted to coat antennas.

WIND (SURFACE)

May affect employment of aerial collection systems.

May damage or prevent installation of electronic collection system antennas.

TEMPERATURE (SURFACE)

May affect collection system reliability.

INVERSION

May provide false indications to certain electronic collection systems.

EFFECTS OF WEATHER ON LOGISTIC OPERATIONS

Logistical operations include supply, maintenance, and transportation required to support the combat force. Numerous weather factors affect the planning and the activities required for each operation. Those weather factors which influence logistic operations subsequently affect the supported combat force. If logistic units are prevented from supporting forward combat elements, the success of the combat mission may be jeopardized. Figure B-10 shows the effects of weather on logistical operations.

VISIBILITY

May slow ground movement of munitions and supplies forward.
May preclude aerial resupply operations.
May conceal ground transport operations.

ELECTRICAL STORMS AND THUNDER

Endanger storage, handling, and transportation of munitions and fuels.
May interrupt computerized inventory operations.
Can damage storage facilities and stored material.

PRECIPITATION

May affect storage of munitions and supplies.
May preclude ground transport over unpaved surfaces.

SNOW DEPTH

Affects ability to move supplies forward.
Affects forward deployment of maintenance teams.

FREEZING PRECIPITATION

Has a severe impact on logistical and maintenance support (air and surface).

SURF AND TIDE CONDITIONS

Impact movement of supplies ashore and amphibious operations.

TEMPERATURE (SURFACE)

Cold may affect transport vehicle starting and warm-up periods.
May increase maintenance requirements (temperature induced failures).
Creates ice which may preclude use of waterways for transportation.
Affects storage of perishable supplies.
Affects snow melting which can cause flooding, poor trafficability, and hindering ground transportation.
Affects freeze or thaw depth which may determine use of supply routes.
Required for calibration of artillery systems.

HUMIDITY

Affects storage of munitions and other supplies.
May increase equipment failure rate and impact maintenance operations.

Figure B-10. Effects of weather on logistic operations.

EFFECTS OF WEATHER ON MEDICAL SUPPORT OPERATIONS

The extensive use of air ambulances requires the same weather support as other aviation elements. Besides aviation operations, weather influences are considered in establishing field hospitals and anticipating prestockage and workloads. The requirements for weather support for ground evacuation of casualties are the same as land transportation, including considering patient comfort under extreme weather conditions. Figure B-11 shows the effects of weather on medical support operations.

| |
|---|
| <p>PRECIPITATION Impacts available water supply. Impacts hospital site selection. May damage unprotected supplies.</p> <p>SEVERE WEATHER May produce increased nonbattle casualty load.</p> <p>TEMPERATURE (SURFACE) May require special protection of medical supplies. May increase patient load because of heat and cold injuries. May impact seasonal diseases.</p> <p>HUMIDITY May affect storage of medical supplies.</p> |
|---|

Figure B-11. Effects of weather on medical support operations.

EFFECTS OF WEATHER ON MILITARY POLICE OPERATIONS

Military police are involved in weather-sensitive operations such as--

- Route and area reconnaissance.
- Security.
- Traffic and movement control.
- Rear area protection.
- Refugee control.
- Enemy prisoner of war (EPW) control.
- Civil disturbance control operations.

Acoustical propagation can affect significantly the use of loudspeakers in civil disturbance control operations. Acoustical propagation is a function of attenuation and refraction, which in turn is influenced by temperature gradient, density, wind, and sky cover. Figure B-12 shows the effects of weather on military police operations.

| |
|---|
| <p>PRECIPITATION May require additional protection for EPW.</p> <p>SEVERE WEATHER May affect security operations and refugee control.</p> <p>WIND (SURFACE) Affects use of riot control agents.</p> <p>INVERSION Base of inversion may affect use of riot control agents.</p> |
|---|

Figure B-12. Effects of weather on military police operations.

EFFECTS OF WEATHER ON NBC OPERATIONS

NBC operations are extremely sensitive to environmental conditions that affect the transport and diffusion of chemical or biological (CB) fallout. Figure B-13 shows the effects of weather on NBC operations. A few of the critical elements to consider when planning NBC operations are--

- Humidity.
- Air temperature.
- Ground temperature.
- Wind speed and direction.
- Low-level temperature gradient.
- Precipitation.
- Cloud cover.
- Sunlight.

CEILING--CLOUD AND SKY COVER

Cloud and ground albedo, sky cover, and visibility are required to estimate thermal levels resulting from nuclear bursts.

PRECIPITATION

Affects persistence of chemical agents.
Snow may cover and render ineffective certain liquid agents.
May produce radioactive rainout and hot spots.

SUNLIGHT

Shortens lifespan of biological agents.

STATE-OF-THE-GROUND

Impacts effectiveness of chemical agents.
Wet soil degrades effectiveness of smoke munitions.
Affects fallout concentration levels.

TURBULENCE

Affects time in which chemical agents and smoke will remain in target area.

WIND (SURFACE)

From surface to 98,424 feet (50,000 m) or higher are needed for fallout pattern prediction (nuclear weapons).
Affects CB agent dispersion.
May decrease chemical agent persistence.

WIND (ALOFT)

Affects aerial delivery of CB agents.
May degrade effectiveness of smoke operations.

HUMIDITY

High level increases effectiveness of smoke and some chemical agents.
Combined with high temperature, reduces time in which troops in protective gear are effective.
High levels destroy some chemical agents.
Affects biological agents; varies depending on humidity level and type of agent.

INVERSION

Affects aerosol dispersion.
Affect persistence of agents.

Figure B-13. Effects of weather on NBC operations.

EFFECTS OF WEATHER ON PSYCHOLOGICAL OPERATIONS

Tactical PSYOP are influenced primarily by those weather elements which degrade audibility of loudspeaker broadcasts and affect the distribution of leaflets. Figure B-14 shows the effects of weather on PSYOP.

| |
|---|
| <p>CEILING--CLOUD AND SKY COVER May affect aerial loudspeakers and leaflet delivery by restricting visibility and access to the target. High winds will reduce audibility of loudspeakers.</p> <p>VISIBILITY May hamper delivery of leaflets by aircraft when pilot cannot see target.</p> <p>ELECTRICAL STORMS AND THUNDER Reduces audibility of loudspeakers. Interferes with radio broadcasts.</p> <p>PRECIPITATION May force target audience under cover where they are not receptive to leaflet drops or loudspeaker broadcasts. Reduces audibility of loudspeakers. Destroys leaflets.</p> <p>SNOW Reduces effectiveness of leaflet dissemination and durability.</p> <p>WIND (SURFACE) Wind speed and direction will affect the distribution of leaflets by air or artillery.</p> <p>HUMIDITY Affects distance sound will travel.</p> |
|---|

Figure B-14. Effects of weather on psychological operations.

APPENDIX C

METEOROLOGICAL CRITICAL VALUES

Meteorological critical values are those values which reduce significantly the effectiveness of tactical operations and/or weapon systems. Significant variations above or below critical values can prevent the successful completion of a mission. Therefore, the SWO must be aware of critical values and must consider them in all forecasts.

This appendix provides a table of critical values for specific and branch operations. It does not, however, provide absolute values for every operation or weapon system on the battlefield. Critical values must be weighed against the tactical situation and the mission. Although weather personnel forecast and call attention to critical factors, only commanders decide which values are critical for each operation. Additional input from terrain analysis teams and other sources and the criticality of the mission are weighed by the commander in reaching a decision. Figure C-1 shows some meteorological critical values for specific and branch operations.

Weather information frequently is color coded to help the decision maker quickly assess the impact of weather on impending operations and decisions. This person normally is the tactical unit commander whom the WETM supports. The following color code is suggested for consistency within the operational commands:

- ^oGREEN (Favorable): weather has no restrictions.
- ^oAMBER (Marginal): weather degrades or limits.
- ^oRED (Unfavorable) : weather prohibits.

| AIRBORNE OPERATIONS | | |
|--|---|--|
| ELEMENTS | CRITICAL VALUES | IMPACTS |
| Ceiling-- cloud and sky cover | <= 300 ft (90 m) flat terrain | Mission planning - day, jump altitude; aircraft penetration. |
| | <= 500 ft (150 m) flat terrain | Mission planning - night, jump altitude; aircraft penetration. |
| | <= 500 ft (150 m) mountain terrain | Target acquisition - day. |
| | <= 1,000 ft (300 m) mountain terrain | Target acquisition - night. |
| | <= 10,000 ft mountain terrain | Mission planning for LZ or DZ. |
| Surface visibility at the following visible wave lengths: 3.47 ft (1.06 m) 10 to 16.4 ft (3 to 5 m), 26.2 to 39.6 ft (8 to 12 m) | <= 1/4 mile (400 m) | Mission planning - infrared sensors. Navigation and target acquisition - rotary wing. |
| | <= 1 mile (1,600 m) | Day mission planning - minimum takeoff or landing, minimum fixed wing. |
| | <= 3 miles (4,800 m) | Night mission planning - minimum takeoff or landing, minimum fixed wing. |
| Wind (Surface) | <= 13 knots | Troop safety for paradrop operations; limiting value for operations during training. |
| | <= 15 knots (<= 21 knots for C-12 and U-21) | Mission planning and aircraft; safety on recovery. |

Figure C-1. Meteorological critical values.

| ELEMENTS | CRITICAL VALUES | IMPACTS |
|---|--|--|
| | 25 knots (OV-1) <= 30 knots and/or gust speeds | Mission planning and aircraft; safety on recovery. |
| Winds (Aloft) | <= 40 knots | Jump point; planning for flight route and duration. |
| Precipitation | Any intensity or type | Rate of troop fall and target acquisition. |
| Thunderstorms and Lightning | Any occurrence | Restricts aircraft performance; limits aircraft refueling; reliability or communications systems; predetonation of certain munitions. |
| Temperature (Surface) | 32.0°F (0°C) | Ground conditions. |
| Pressure altitude | 100 ft | Parachute opening altitude. |
| Density altitude: Variable with aircraft, weight, power, and temperature. | 6,900 ft >4,000 ft >2,000 ft | Planning; cargo limits. Weight limits for attack and OH-58. OH-58 limit troop configuration. |
| Effective illumination | <= 10-3 frequency | Planning of night missions; navigation safety. |
| AVIATION AND AIR ASSAULT OPERATIONS | | |
| Ceiling--cloud and sky cover | <= 300 ft (90 m) | Nap-of-the-earth planning and acquisition - rotary wing. |
| | <= 300 ft (90 m) flat terrain | Daylight target acquisition - fixed wing. |
| | <= 500 ft (150 m) mountain terrain | Daylight target acquisition - fixed wing. |
| | <= 500 ft (150 m) flat terrain | Night target acquisition - fixed wing. |

Figure C-1. Meteorological critical values (Continued).

| ELEMENTS | CRITICAL VALUES | IMPACTS |
|-----------------------------|---|--|
| | <= 1,000 ft mountain terrain | Night target acquisition - fixed wing. |
| Visibility (Surface) | <= 1/4 mile (400 m) | Navigation and target acquisition - rotary wing. |
| | <= 1 mile (1,600 m) | Landing and takeoff minimums for mission planning. |
| | <= 3 miles (4,800 m) | Landing and takeoff minimums for mission planning. |
| Visibility (Slant range) | <= 1/4 mile (400 m) | Navigation and target acquisition - rotary wing. |
| | 3 miles (4,800 m) mountain terrain | Navigation and target acquisition - rotary wing. |
| Wind (Surface) | >30 knots 15-knot gust spread (21 knots C-21 and U-21) (25 knots OV-1) | Mission planning, aircraft safety. |
| Winds (Aloft) | >30 knots | Mission planning - duration. |
| Precipitation | Any freezing | Rotorblade icing, aircraft survivability and damage. |
| | >0.5 inch per hour - liquid | Target acquisition. |
| Hail | >= 1/4 inch in diameter | Aircraft damage. |
| Snow depth and cover | >1 inch (2.54 cm) powder | Location of LZ and DZ; vertigo. |
| Icing | >= Light (clear/rime) | Mission planning and safety; ordnance delivery restrictions - rotary wing. |
| Turbulence | Moderate | Mission planning, aircraft survivability. |

Figure C-1. Meteorological critical values (Continued).

| ELEMENTS | CRITICAL VALUES | IMPACTS |
|--|---|--|
| Thunderstorms and lightning | Any occurrence within 3 miles (4,800 m) of site | Safety and fuel operations. |
| Density altitude variable with aircraft, weight allowable, power, and temperature. | 6,900 ft (2,103 m) | Flight control, runway limits, takeoff, and landing; compute maximum gross weight. |
| Effective illumination | <= 10-3 footcandles | Mission planning for night operations. |
| AIR DEFENSE OPERATIONS | | |
| ELEMENTS | CRITICAL VALUES | IMPACTS |
| Ceiling--cloud and sky cover | <= 500 ft | Selection of weapon systems and positioning for convoy. |
| | <= 5,000 ft | Aircraft detection and identification. |
| Visibility (Surface) | 2 miles | Aircraft detection and identification for short-range air defense systems--ROLANDS, Vulcan, and Chaparrel. |
| | <3 miles | Weapon systems selection and placement for the Stinger and Redeye. |
| Wind (Surface) | >30 knots | Communications and radar antenna affected. |
| | >50 knots 57 knot gusts | Weapon systems selection and planning reconnaissance figure and inspect Hawk, Patriot, and Hercules. |
| Winds (Aloft) | >50 knots | Aiming and tracking. |
| Precipitation | >0.5 inch (1.27 cm) per hour liquid | All radar >10 GHz degraded; all infrared sensors affected. |

Figure C-1. Meteorological critical values (Continued).

| ELEMENTS | CRITICAL VALUES | IMPACTS |
|------------------------------|--|---|
| Thunderstorms and lightning | Any occurrence within 1.2 miles (2 km) of site | Affects communications, radar, and storage and protection of missile systems. |
| Temperature (Surface) | >120.2°F (49°C) <-45.5°F (-43°C) | Mission planning for use of Chaparrel, Redeye, and Stinger. |
| | <-65.2°F (-54°C) | Mission planning for use of Vulcan. |
| Windchill | <= -25.6°F (-32°C) 1-minute exposure | Personnel protection; plan gear and equipment needs. |
| | <= -74.2°F (-59°C) 1-second exposure | Personnel protection; plan gear and equipment needs. |
| Effective illumination | <= 10-3 foot candles | Target acquisition or aircraft. |
| Movement of systems | SEE GROUND MANEUVER OPERATIONS. | |
| AMPHIBIOUS OPERATIONS | | |
| Ceiling--cloud and sky cover | <= 1,000 ft (300 m) | Concealment; planning CAS. |
| Visibility (Surface) | <= 1 mile (1,600 m) (1.6 km) | Target acquisition. |
| Wind (Surface) | >= 7 knots | Personnel landing and smoke operations. |
| | >= 35 knots | Affects wave and surf limits. |
| Temperature (Surface) | >89.6°F (32°C) | Affects personnel and equipment support. |
| | <32.0°F (0°C) | Affects planning for logistic support, fuels, and expendable supplies. |

Figure C-1. Meteorological critical values (Continued).

| ELEMENTS | CRITICAL VALUES | IMPACTS |
|------------------------------|---|---|
| Windchill | <= -25.6°F (-32°C) 1-minute exposure | Troop safety. |
| | <= -74.2°F (-59°C) 1-second exposure | Troop safety. |
| Precipitation | >0.1 inch (2.54 cm) per hour liquid | Affects shore trafficability. |
| Effective illumination | <= 10-3 footcandles | Planning night landing operations and concealment. |
| Littoral current | Any underlying current or riptide >3 knots | Mission planning. |
| Tides (provided by the Navy) | Variable threshold of watercraft | Type of watercraft required; timing of mission. |
| Temperature (water) | >86°F (30°C) | Personnel safety. |
| Shore trafficability | Variable with equipment | Planning shore vehicle operations. |
| State-of-the-sea | >3.0 ft (1 meter) waves | Dictates airborne versus water operation. |
| Surf breaker description | Surging surf > 4 ft (1.2 m) breakers | Mission planning. |
| Surf zone | Area covered by surf | Mission planning. |
| Ground mobility | SEE GROUND MANEUVER OPERATIONS. | |
| ENGINEER OPERATIONS | | |
| Ceiling--cloud and sky cover | <= 500 ft | A0 and location of facilities; personnel safety; aerial reconnaissance; camouflage needs. |

Figure C-1. Meteorological critical values (Continued).

| ELEMENTS | CRITICAL VALUES | IMPACTS |
|------------------------------|--|---|
| Visibility (Surface) | <= 1/4 mile | Mission planning; concealment and cover. |
| Wind (Surface) | >= 13 knots | Construction and stability of bridges and structures. |
| Precipitation | >0.5 inch per hour liquid | Need for mines reduced; loading and offloading operations. |
| Snow depth and cover | >2 inch in a 12-hour period | Some AO and locations of locations of facilities; stability of bridge structures; types of demolitions to be used, size and charge; blast from trigger mechanisms may render mines ineffective. |
| Freeze and thaw depth | 6 inches | Trafficability determination. |
| Thunderstorms and lightning | Any occurrence within 0.6 miles (1 km) of site | Equipment and personnel safety; munitions protection. |
| Temperature (ground) | -< 32°F (0°C) | Freeze or thaw depth determination, construction material; precipitation at or below 32°F (0°C) poses a threat for personnel and may cause structural damage; may curtail some operations. |
| Humidity | >35% | Comfort, equipment operations, and site selection planning. |
| FIELD ARTILLERY OPERATIONS | | |
| Ceiling--cloud and sky cover | <= 600 m (2,120 m) | Target acquisition. Affects copperhead performance. |

Figure C-1. Meteorological critical values (Continued).

| ELEMENTS | CRITICAL VALUES | IMPACTS |
|--|--|---|
| Visibility-- slant range at the following wave lengths: 3.47 ft (1.06 m), 10 to 16.4 ft (3 to 5 m), 26.2 to 39.36 ft (8 - 12 m) wavelengths. | <= 1 mile (1.5 km) | Target acquisition. |
| Wind vertical profile | >5 knot change per 3,280.8 ft (1.1 km) | Affects UAV operations; nuclear fallout prediction; TACFIRE requirement-artillery fire. |
| Thunderstorms and lightning | Any occurrence within within 3 miles (4,800 m) | Safety and storage of munitions; erection of missile hampered. |
| Effective illumination | <= 10-3 footcandles | Mission planning for night artillery operations. |
| INTELLIGENCE AND ELECTRONIC WARFARE OPERATIONS | | |
| Ceiling--cloud and sky cover | =200 ft (60 m) <= 1,000 ft (300 m) | Degrades engagement range. Degrades aerial observation. |
| Surface visibility at the following wave lengths: visible, 3.47 ft (1.06m), 10 to 16.4 ft (3 to 5 m), 26.2 to 39.6 ft (8 to 12 m) | <1 mile (1,600 m) | Essential to determine enemy's ability to conceal actions; locating and identifying targets. |
| Wind (Surface) | >60 knots | Equipment damage. |
| Precipitation | >0.1 inch (.254 cm) per hour liquid | Audio sensors and radar effectiveness reduced. |

Figure C-1. Meteorological critical values (Continued).

| ELEMENTS | CRITICAL VALUES | IMPACTS |
|--|--|---|
| | >0.5 inch (1.27 cm) per hour liquid | Reduces speed of personnel and equipment movement. |
| | >2.0 inch (5.08 cm) in a 12-hour period | Reduces speed of personnel and equipment movement. |
| Snow depth and cover | >6 inch (15 cm) >24 inch (60 cm) | Reduces trafficability. |
| Thunderstorms and lightning | Any occurrence within 3 miles (4,800 m) | Troop and equipment safety; false alarms and false reading. |
| Temperature (Surface) | >122.0°F (50°C) <-58.0°F (-50°C) | Emplacement site selection. |
| Temperature (Ground) | <32°F (0°C) | Trafficability assessment. |
| WBGT | >85°F (29.4°C) | Troop safety. |
| Electromagnetic propagation | Subrefraction or superrefraction | Ducting of radar transmission and return. |
| Effect illumination | <= 10-3 footcandles | Target acquisition. |
| River stage and current strength | >6 ft (2 meters) depth | Affects enemy's ability to cross rivers or streams. |
| Precipitation | >2.0 inch (5 cm) in a 12-hour period | Trafficability; storage of equipment. |
| SEE AVIATION AND AIR ASSAULT FOR ADDITIONAL WEATHER EFFECTS ON FIXED-WING OR ROTARY-WING AIRCRAFT. | | |
| LOGISTICS | | |
| Snow depth and cover | >2.0 inch (5 cm) | Trafficability. |
| Freeze and thaw depth | 6 inches (15 cm) | Site and equipment selection, mobility. |

Figure C-1. Meteorological critical values (Continued).

| ELEMENTS | CRITICAL VALUES | IMPACTS |
|--|---|--|
| Thunderstorms and lightning | Any occurrence within 3 miles (4,800 m) | Equipment, personnel, and munitions safety. |
| Temperature (Surface) | >122.0°F (50°C) <-25.6°F (-32°C) | Affects storage and required temperature control for movement of medicines; munitions storage. |
| Humidity | >70% | Affects storage of selected supplies and munitions. |
| Coastal operations | SEE AMPHIBIOUS OPERATIONS. | |
| GROUND MANEUVER OPERATIONS | | |
| Ceiling--cloud and sky cover | <= 1,000 ft (300 m) | Concealment and cover from threat surveillance; TACAIR and aerial supply support; affects background contract for target acquisition or using thermal devices. |
| Surface visibility at the following wave lengths: visible, 3.47 ft (1.06 m), 10 to 16.4 ft (3 to 5 m), 26.2 to 39.6 ft (8 to 12 m) | Dragon and Viper <2,624.57 ft (800 m) Tow < 5,249.3 ft (1,600 m) | Target acquisition; system selection. |
| Wind (Surface) | >7 knots | Affects smoke operations; background radar noise. |
| | >20 knots | Creates visibility restriction in blowing sand and snow; soil drying aerial resupply; windchill effect on equipment and personnel. |

Figure C-1. Meteorological critical values (Continued).

| ELEMENTS | CRITICAL VALUES | IMPAIRMENTS |
|-----------------------------|---|---|
| | >30 knots | Accuracy of antitank missiles. |
| | >75 knots | Antenna failure. |
| | >125 knots | Equipment (van) failure. |
| Precipitation | >0.1 inch (.254 cm) per hour liquid >2.0 inch (5 cm) in a 12-hour period | Soil type affected by temperature and moisture; vehicle movement; site location, river levels, runoff, flooding, delays resupply, demolitions, river crossing, visibility, target acquisition, and radar effectiveness. |
| Snow depth and cover | >2.0 inch (5 cm) in a 12-hour period >6 inch (15 cm) >24 inch (60 cm) | Effectiveness of mines reduced; choice of construction materials; trafficability. |
| Freeze and thaw depth | 6 inches (15 cm) | Off-road employment of wheeled and tracked vehicles. |
| Thunderstorms and lightning | Any occurrence within 3 miles (5 km) (4,800 m) | Munition safety; personnel communications equipment safety. |
| Temperature (Surface) | >= 122°F (50°C) | Affects thermal sights. |
| | >89.6°F (32°C) | Affects lubricants, personnel, and infrared sensors. |
| | >32°F (0°C) | Melting snow and ice affects river crossing sites and offroad movements. |
| | <32°F (0°C) | Drying of soil; affects freeze or thaw depth. |
| | Any change of 50°F (10°C) | Affects munitions trajectories. |

Figure C-1. Meteorological critical values (Continued).

| ELEMENTS | CRITICAL VALUES | IMPACTS |
|--|---|---|
| Windchill | <= -25.6°F (-32°C) 1-minute exposure <= -74.2°F (-59°C) 1-second exposure | Reduces time before exposed flesh will suffer frostbite. |
| Effective illumination | <= 10-3 footcandles | Affects use of night vision devices. |
| Seashore conditions-- provided by the Navy | Current and Tide >6.22 mph (10 km) Waves >3 ft (1 m) Swell >3 ft (1 m) Surf 5 to 6 ft (1.52 to 1.82 m) | Affects beach and port sea-to-shore loading and offloading operations. Impedes landing operations. |
| MILITARY POLICE OPERATIONS | | |
| SEE GROUND MANEUVER OPERATIONS FOR THOSE ELEMENTS IMPACTING ON MILITARY POLICE OPERATIONS. | | |
| NUCLEAR, BIOLOGICAL, CHEMICAL OPERATIONS | | |
| Ceiling--cloud and sky cover | <= 5,000 ft (1.5 km) | Impacts on aerial deployment agents; enhances thermal effects if burst is below clouds; reduces thermal and EMP effects if burst is above clouds. |
| Visibility (Surface) | <1,312 ft (400 m) <3,280 ft (1 km) <9,842.5 ft (3 km) | Determines smoke generator necessary to maintain desired smoke screen. |
| Visibility (Slant range) | <3,280 ft (1 km) | Needed if agents are delivered by TAC. |
| Wind (Surface) | >3 knots but <7 knots >10 knots | Favorable for NBC operations. Unfavorable for NBC operations. |

Figure C-1. Meteorological critical values (Continued).

| ELEMENTS | CRITICAL VALUES | IMPACTS |
|--|--|---|
| | >15 knots | With winds above this speed, munition accuracy--first round is especially important for chemical dispersion since the enemy masks in 9 seconds. |
| Precipitation | Any intensity or type | Washes agents and smoke out of the atmosphere; causes nuclear hot spots. |
| Thunderstorms and lightning | Any occurrence within 3.1 miles (5 km) of site | Troop and munition storage safety. |
| Temperature (Surface) | >95°F (35°C) | Affects rate of evaporation of liquid chemical agents; dispersion of aerosols, high risk of injury in MOPP IV. |
| | >68°F (29°C) | Moderate risk of heat illness in persons in MOPP IV. |
| | <32°F (0°C) | Climate extremes determine the type of shelter; indirectly affecting troop vulnerability to nuclear radiation; indirect thermal radiation effect due to type of troop clothing. |
| Temperature (Vertical gradient or profile) | Reversal from stable to unstable | Reduces the time agents or smoke will remain in an area. |
| | or Reversal from unstable to stable | Increases time agents or smoke will remain in an area. |
| Humidity | >60% | Affects agent effectiveness dispersion of snow blister agents; very effective in hot, humid weather. |
| Effective illumination | <= 10-3 footcandles | Needed for night operations of NBC equipment. |

Figure C-1. Meteorological critical values (Continued).

| ELEMENTS | CRITICAL VALUES | IMPACTS |
|-----------------------------|---|---|
| | SIGNAL COMMUNICATION OPERATIONS | |
| Wind (Surface) | >7 knots | Creates radar background noise. |
| | >25 knots | Safety and stability for installing LOS and troposcattering antennas; once up, the antennas can withstand a constant wind of 65 knots with gusts up to 85 knots. |
| | >69 knots | Wind damage to main communications antenna-linear pole. |
| | >78 knots | Safety and stability of single-channel radio and short-range, wide-band radio antennas. |
| Precipitation | Any occurrence of freezing | Damage to equipment and antennas; affects wind tolerances of antennas; affects troop safety. |
| | >0.5 inch (1.27 cm) per hour liquid | Blocks troposcatter transmission and decreases radar range; any precipitation attenuates the signal for single-channel radio (AM or FM), short-range wide-band radio, and LOS communications. |
| Snow depth and cover | >6 inch (15 cm) | Site and equipment location; install and maintain cable, wire, and systems. |
| | >24 inch (60 cm) | |
| Thunderstorms and lightning | Any occurrence within 3 miles (4,800 m) | Damage to equipment; interferes with radio signals, especially HF signals. |
| Temperature (Surface) | <-13°F (-25°C) | Batteries of PRC-77 and VRC-12 series radios will not operate. |
| | <-40°F (-40°C) | Degrades humes and linear pole antennas. |

Figure C-1. Meteorological critical values (Continued).

| ELEMENTS | CRITICAL VALUES | IMPACTS |
|---|-------------------------------|---|
| Temperature (vertical gradient or profile) | All significant inversions | Cause fading of tropospheric during use of troposcatter equipment. |
| Ionospheric disturbances | NA | Dictates most usable frequencies for communications. |
| SEE GROUND MANEUVER OPERATIONS FOR ADDITIONAL WEATHER EFFECTS ON PERSONNEL AND EQUIPMENT MOBILITY. | | |
| SPECIAL FORCES OPERATIONS | | |
| Ceiling--cloud and sky cover | <= 300 ft (90 m) | Necessary for acquisition of target area while maintaining confidentiality of UW. |
| | <= 1,000 ft (300 m) | Planning TACAIR support and for cover and concealment. |
| Visibility (Surface) | 1/4 mile (400 m) | Acquisition of target area while maintaining confidentiality of UW. |
| Visibility (Slant range) | <= 1/2 mile (800 m) | Target acquisition, concealment and cover. |
| Wind (Surface) | >5 knots | Dictates area covered, drop point and altitude, and bundle size for leaflet drops. |
| | >7 knots | Mission planning for waterborne operations; affects wave and surf conditions and safety of landing operations. |
| | >15 knots | Troop safety and navigation of steerable parachute. |
| | >25 knots | Affects installation of antennas during setup operations. |

Figure C-1. Meteorological critical values (Continued).

| ELEMENTS | CRITICAL VALUES | IMPACTS |
|---|---|--|
| | >69 knots | Wind damage on main communication antenna. |
| Winds (Aloft) | >20 knots surface to 1,000 ft 1,000 to 5,000 ft | Troop safety and navigation of steerable parachute. |
| Precipitation | >0.1 inch (.254 cm) per hour liquid | Rate of fall; acquisition of target area; affects leaflet dispersion. |
| Snow depth and cover | >1 inch (2.54 cm) per hour | Degrades transmission effectiveness. |
| Thunderstorms and lightning | Any occurrence within 3.1 miles (5 km) of site | Degrades communications; safety personnel and equipment. |
| Temperature (Surface) | >95°F (35°C) <-40°F (-40°C) | Troop safety; planning equipment support requirement. Communications can be degraded; cables become brittle and break. |
| Ionospheric disturbance | NA | Dictates most usable frequencies for communications. |
| Effective illumination | <= 10-3 footcandles | Concealment and cover; minimum light needed for operations. |
| Tides | >6 ft (2 m) | Affects safety of landing operations. |
| State-of-the-sea (provided by the Navy) | Swell and surf >3 ft (1 m) Chop > 3 ft (1 m) | Troop safety; mission accomplishment; dictates airborne entry. |
| Littoral current | Any current > 3 knots | Safety of personnel; mission accomplishment. |
| Surf | >4 ft (1.2 m) breakers | Mission accomplishment. |

Figure C-1. Meteorological critical values (Continued).

GLOSSARY

| | |
|-------------------------------|--|
| AA | assembly area |
| A ² C ² | Army airspace command and control |
| ACCS | Army Command and Control systems |
| ACR | armored cavalry regiment |
| ADP | automatic data processing |
| AFB | Air Force Base |
| AFCC | Air Force Communication Command |
| AFFOR | Air Force forces |
| AFGWC | Air Force Global Weather Central |
| AFLD | airfield |
| AI | area of interest |
| ALSO | artillery limited surface observation |
| alt | altitude |
| AM | amplitude modulation |
| AO | area of operations |
| APOD | aerial port of debarkation |
| ARFOR | Army Forces |
| ARSOF | Army special operations forces |
| ARTYMET | artillery meteorological |
| ASAC | all-source analysis center |
| ASPS | all-source production section |
| ATACS | Army tactical area communications system |
| ATC | air traffic control |
| ATCCS | Army Tactical Command and Control System |
| ATS | air traffic service |
| avn | aviation |
| AWS | Air Weather Service |
| | |
| bde | brigade |
| | |
| C | Celcius |
| C ² | command and control |
| C-5 | USAF aircraft |
| C-130 | USAF aircraft |
| C-141 | USAF aircraft |
| CAS | close air support |
| CB | chemical or biological |
| CBT | combat |
| C-E | Communications-Electronics |
| CEOI | Communications-Electronic Operation Instruction |
| CFA | covering force area |
| CIG | ceiling or height above ground level to base of clouds |

| | |
|---------|---|
| cm | centimeter |
| CMC | combined meteorological cell |
| COMSEC | communications security |
| CP | command post |
| CS | combat support |
| CSS | combat service support |
| CTA | common table of allowances |
| | |
| DA | Department of the Army |
| DCS | Defense Communications System |
| DCSINT | Deputy Chief of Staff for Intelligence |
| div | division |
| DIVARTY | division artillery |
| DMSF | Defense Meteorological Satellite Program |
| DOD | Department of Defense |
| DS | direct support |
| DTG | date-time group |
| DZ | drop zone |
| | |
| E | east |
| EAC | echelons above corps |
| EACIC | echelons above corps intelligence center |
| EFPS | Engineer Flood Prediction Service |
| E-O | electro-optical |
| EPW | enemy prisoner of war |
| EW | electronic warfare |
| | |
| F | Fahrenheit |
| FAA | Federal Aviation Administration |
| FALOP | Forward Area Limited Observing Program |
| FAX | facsimile |
| FCC | flight coordination center |
| FLIR | forward-looking infrared |
| FLOT | forward line of own troops |
| FM | frequency modulated |
| FOB | forward operating base |
| FOC | flight operations center |
| FSCORD | fire support coordinator |
| FSE | fire support element |
| FSO | fire support officer |
| ft | feet |
| FU | forecast unit |
| | |
| G2 | Assistant Chief of Staff, G2 (Intelligence) |
| G3 | Assistant Chief of Staff, G3 (Operations and Plans) |
| GHz | gigahertz |

| | |
|--------|---|
| GMT | Greenwich Mean Time |
| GS | general support |
| HALO | high altitude low opening |
| HF | high frequency |
| HHC | headquarters and headquarters company |
| HHT | headquarters and headquarters troop |
| HQ | headquarters |
| hr | hour |
| HVT | high-value target |
| IEW | intelligence and electronic warfare |
| IPB | intelligence preparation of the battlefield |
| JCSE | Joint Communications Service Element |
| JTF | joint task force |
| km | kilometer |
| LIC | low-intensity conflict |
| LOC | lines of communications |
| LOS | line of sight |
| LRSU | long-range surveillance unit |
| LZ | landing zone |
| m | meter |
| MAC | Military Airlift Command |
| MACOM | major Army command |
| Mb | millibar |
| METT-T | mission, enemy, terrain, troops, and time available |
| MI | military intelligence |
| mm | millimeter |
| MOPP | mission-oriented protection posture |
| mph | miles per hour |
| MSC | major subordinate command |
| MSL | mean sea level |
| MTOE | modification table of organization and equipment |
| N | north |
| NA | not applicable |
| NAI | named areas of interest |
| NATO | North Atlantic Treaty Organization |
| NBC | nuclear, biological, chemical |
| NCO | noncommissioned officer |
| NE | northeast |
| No | number |
| NOAA | National Oceanographic and Atmospheric Administration |
| NOC | Naval Oceanographic Command |
| NSN | national stock number |
| NW | northwest |
| NWS | National Weather Service |

| | |
|-----------|--|
| OB | order of battle |
| OBS | observers |
| OPLAN | operation plan |
| OPORD | operation order |
| PIBAL | pilot balloon |
| PIREP | pilot report |
| PN | part number |
| POL | petroleum, oils, and lubricants |
| PSYOP | psychological operations |
| PVS-5 | night vision goggles |
| RAM | reliability, availability, and maintainability |
| RATT | radio teletypewriter |
| RBS | regional broadcast system |
| REC | radio electronic combat |
| regt | regiment |
| RH | relative humidity |
| S | south |
| S2 | Intelligence Officer (US Army) |
| S3 | Operations and Training Officer (US Army) |
| SCT | scattered |
| SE | southeast |
| sep | separate |
| SFC | surface wind speed |
| SFG | special forces group |
| SFOB | special forces operational base |
| SIGSEC | signal security |
| SOC | special operations command |
| SOF | special operations forces |
| SOP | standing operating procedure |
| SOWT | special operations weather team |
| SPOD | seaport of debarkation |
| sqdn | squadron |
| SVWX/WARN | severe weather warning |
| SW | southwest |
| SWO | staff weather officer |
| TAC | Tactical Army Command |
| TACAIR | tactical air |
| TACC | Tactical Air Control Center |
| TACFIRE | tactical fire direction computer system |
| TARWI | target weather indicator |
| TDA | tables of distribution and allowances |
| temp | temperature |
| TFU | tactical forecast unit |
| TOC | tactical operations center |
| TOE | tables of organization and equipment |
| TRADOC | United States Army Training and Doctrine Command |

| | |
|----------|--|
| TTY | teletypewriter |
| TVA | target value analysis |
| UAV | unmanned aerial vehicle |
| USAF | United States Air Force |
| USAFETAC | United States Air Force Environmental Technical Applications Center |
| USAICS | United States Army Intelligence Center and School |
| USMTF | US message test format (formerly JINTACCS) |
| UTM | universal transverse mercator (grid) |
| UW | unconventional warfare |
| VHF | very high frequency |
| vis | visibility |
| W | west |
| WBGT | wet-bulb-globe-temperature |
| WETM | weather team |
| WMO | World Meteorological Organization |
| WSF | weather support force |
| WXFCST | weather forecast |

References

REQUIRED PUBLICATIONS

Required publications are sources that users must read in order to understand or to comply with this publication.

Army/Air Force Regulation (AR/AFR)

115-10/AFR 105-3 Meteorological Support for the US Army

Army Regulation (AR)

310-49 The Army Authorization Documents System (TAADS)

Field Manuals (FMs)

5-105 Topographic Operations

6-15 Field Artillery Meteorology

30-10 Military Geographic Intelligence (Terrain)

34-1 Intelligence and Electronic Warfare Operations

34-130 Intelligence Preparation of the Battlefield

100-5 Operations

RELATED PUBLICATIONS

Related publications are sources of additional information. They are not required in order to understand this publication.

TRADOC Pamphlet

525-21/MAC Pam 105-3 Joint Operational Concept for Weather and Environmental Support to Army Operations

Air Force Regulations

AFR 23-31 Air Weather Service

AWSR 55-2 AWS Tactical Weather Support

AWSR 105-18 AWS Support System

JCS Publication

25 US Message Text Format

INDEX

- ACR, brigade, battalion, and squadron intelligence personnel
as weather data sources, 4-9
- AI. See area of interest.
- Air Force Global Weather Central (AFGWC)
 - as the hub of AWS centralized support structure, 3-1
 - description of, 3-2
 - factor in planning communications for weather support, 5-2
- Air Force support
 - as part of combat service support, 6-4
- AirLand Battle
 - as directed by the corps, 1-7
 - description of, ii, 1-2
 - E-O weapon systems in, 1-2
 - extended and integrated forces of, 1-2
 - major tenets of, 1-2
 - weather as a dynamic factor in, 1-1
- Air Traffic Control (ATC)
 - facilities support rotary wing resupply efforts, 1-11
 - operates flight operations centers, 5-4
- Air Weather Service (AWS)
 - centralized support structure, 3-1, 3-2
 - meteorological products furnished by, B-6
 - primary source of tactical surface weather observations, 2-4
 - tidal data support from NOC, 2-6
 - use of transportable receivers, 2-5
- ALSO. See artillery limited surface observations.
- AO. See area of operations.
- AR 115-10/AFR 105-3
 - specifies Air Force, Army, and joint responsibilities, 2-2, 2-3, 2-10
- area of interest (AI)
 - as an area expressed in terms of time and space, 1-4
 - corps support in the, 1-8

- echelon responsibilities in the, 1-6 through 1-11
- in the battlefield area, 1-4
- weather condition effects in, 1-7, 1-8
- weather information sources, 2-4

area of operations (AO)

- as a geographical area in the battlefield, 1-4
- as an area expressed in terms of time and space, 1-4
- echelon responsibilities in the, 1-6 through 1-11
- weather condition effects in, 1-7, 1-8

armored cavalry regiments

- as a part of WETM composition, 3-5
- description of, 3-16
- used to reinforce corps or divisions in combat, 1-10

Army Airspace Command and Control (A²C²)

- description of, 1-11

Army communications

- responsibilities of, 5-3

Army tactical area communications system (ATACS)

- a means for exchanging weather information, 5-5
- as a communications system for tactical weather support, 5-5

ARSOF. See special operations forces.

Artillery limited surface observations (ALSO)

- also known as multichannel, 5-5
- as a responsibility of ARTYMET, 4-6

artillery meteorological (ARTYMET) sections

- as a weather data source, 4-6
- description of, 2-6
- duties of ARTYMET staff officer, 4-8
- primary source of tactical surface weather observations, 2-4
- products of, 4-7
- responsibilities of, 4-6, 4-7, B-7

ARTYMET. See artillery meteorological sections.

ATACS. See Army tactical area communications system.

ATC. See Air Traffic Control.

ATC units

as a weather data source, 4-8

aviation brigades

as part of WETM composition, 3-5, 3-19
description of, 1-10
integrated weather support of, 2-8, 5-4

battalions

deployment of, 1-10
echelon responsibilities, 1-11

battlefield area evaluation

function of the IPB process, 4-2

belt weather kit

used for FALOP observations, 4-10, A-1, A-2
description and component parts list, A-17

clouds

amount of cloud cover (FALOP codes), A-4
as part of surface observations, B-7
effect on terrain features, B-1 through B-24
factor in tactical planning, B-2
FALOP observation includes data on, 4-10, A-1
their influence on aviation operations, B-4
their influence on ground operations, B-5

combat service support (CSS)

activities required to support operations of deployed corps, 1-6
as a combat power, ii
description of, 6-1

command post (CP)

as part of WETM composition, 3-5

common effects

of weather on operations, B-1

corps

as part of WETM composition, 3-5, 3-14, 3-15, 5-4
combat operations of, 1-7
description of, 1-7
integrated weather support of, 2-8
interdicting enemy divisions, 1-9
maintenance of communications equipment, 6-2

FM 34-81/AFM 105-4

CP. See command post.

CSS. See combat service support.

Defense Meteorological Satellite Program (DMSP)
description of, 2-5

division maneuver brigades
description of, 1-9

divisions
as part of the WETM composition, 3-5, 5-4
description of, 1-8
integrated weather support of, 2-8, 3-13
in the battlefield area, 1-6 through 1-8
perform major tactical operations, 1-8
three separate battle planning centers at, 1-8
types of, 3-19 through 3-20

DMSF. See Defense Meteorological Satellite Program.

EAC. See echelon above corps.

echelon above corps (EAC)
as part of the WETM composition, 3-5, 3-10 through 3-12
responsibilities, 1-6

effects of weather on--
air defense operations, B-8
amphibious operations, B-9
armor and infantry operations, B-11
Army operations, B-1
artillery operations, B-11
aviation and air assault operations, B-14
C-E operations, B-14
combat operations, 1-1
enemy and friendly major weapons systems, 1-2
enemy and friendly forces, 4-4
engineer operations, B-18
intelligence operations, B-19
logistic operations, B-20
medical support operations, B-22
military police operations, B-22
NEC operations, B-23
psychological operations, B-25
tactical operations, 2-9, 4-4
terrain, 4-3, 4-8

engineer units

- as a source for obtaining limited weather data, 2-7, 4-6
- as a weather data source, 4-8

FAA. See Federal Aviation Administration.

FALOP. See Forward Area Limited Observing Program.

Federal Aviation Administration (FAA)

- support for AWS, 2-5

food service

- as part of combat service support, 6-4

forecast units (FUs)

- description of, 3-2
- factor in planning communications support, 5-2
- weather information and observation relayed to, 2-5

Forward Area Limited Observing Program (FALOP)

- example of a completed voice message template, A-14
- material needed to prepare a report, A-2
- primary source of tactical surface weather observations, 2-4, 2-7, 4-9, A-1, B-6
- requirements of, 2-9, 4-9
- voice message transmission, 5-7, A-16
- voice message template, 5-7, A-1, A-12

FU. See forecast unit.

ground reconnaissance and surveillance elements

- as a weather data source, 4-9

HF RATT

- as a communications system for tactical weather support, 5-5
- communications for ARTYMET, 4-7
- description of, 5-5

high value target (HVT)

- identification of, 1-3

HVT. See high value target.

imagery interpretation elements

- as a weather data source, 4-9

FM 34-81/AFM 105-4

intelligence center (EACIC)

- as part of WETM composition, 3-5
- as the hub of theater intelligence, 1-7
- responsibilities of, 3-12

intelligence officer

- responsibilities of, 2-7 through 2-9, 4-9

intelligence preparation of the battlefield

- description of, 4-1
- functions of IPB process, 4-2 through 4-4

JINTACCS. See US message text.

maintenance

- affect of increased maintenance through weather, B-15 through B-20
- as part of CSS, 6-2
- as part of SWO duties, 3-8
- provided by the Army for standard communications systems, 5-4

meteorological critical values

- color codes, C-1
- description of, C-1

meteorological critical values of--

- airborne operations, C-2
- air defense operations, C-5
- aviation and air assault operations, C-3
- amphibious operations, C-6
- engineer operations, C-7
- field artillery operations, C-8
- ground maneuver operations, C-11
- intelligence and electronic warfare operations, C-9
- logistic operations, C-10
- military police operations, C-13
- N3C operations, C-13
- signal communication operations, C-15
- special forces operations, C-16

meteorological products

- definition of, B-7

National Oceanographic and Atmospheric Administration (NOAA)

- as a weather resource, 2-1

National Weather Service (NWS)

- support for AWS, 2-5

NOAA. See National Oceanographic and Atmospheric Administration.

operations

- corps conduct of offensive operations, 1-7
- effects of clouds on, B-4
- environmental data in support of Army, 4-9
- nuclear and chemical weapons in AirLand Battle, 1-3
- need for climatological studies in the theater of, 1-7
- support for AWS joint operations, 2-4
- weather critical to Army tactical operations, 1-1

personnel support

- as part of CSS, 6-4

precipitation

- as part of FALOP weather observation, 4-10, A-1
- effects of, 3-18, 3-19, B-1 through B-24
- factor in tactical planning, B-2
- forecasts of, 4-9

ranger regiments

- as part of ARSOF missions, 3-13
- as part of WETM composition, 3-5
- responsibilities of, 3-13, 3-14

separate brigades

- as part of WETM composition, 3-5
- direct weather support for, 3-16, 3-17
- integrated weather support of, 2-8, 5-4
- responsibilities of, 3-16, 3-18
- used to reinforce corps or division in combat, 1-10

severe weather

- effects of, B-6, B-9, B-18, B-21, B-22
- factor in tactical planning, B-2

severe weather warnings (SVWXWARNs)

- US message text format, 5-7

special forces groups (SFG)

- as part of WETM composition, 3-5
- responsibilities of, 3-13

special operations forces (ARSOF)

- as employed in high-risk missions, 1-10,
- as part of WETM composition, 3-5
- responsibilities, 3-13

FM 34-81/AFM 105-4

staff weather officer (SWO)

- as part of integrated weather support, 2-10
- as part of the WETM composition, 3-5 through 3-6
- coordination with ATC, 1-11
- definition and responsibilities of, 2-7 through 2-10, 4-4, 5-3, 5-4, C-1

supply

- as part of Army support, 6-3, B-19

surface observations

- as a type of meteorological observation, B-7
- as provided by the Army, 2-3

SWO. See staff weather officer.

tactical decision aids

- as part of integrated weather support, 2-8
- used to predict temperature differences and thermal crossovers, B-6

tactical forecast units (TFU)

- description of, 3-4
- factor in planning communications support, 5-2

target value analysis (TVA)

- identification of, 1-3

temperature and humidity

- critical values and impacts of, A-9, 2-7, C-3 through C-17
- effects of, B-1 through B-24
- factors in tactical planning, B-2
- key factors in aircraft lift capability, 3-20
- key factors in upper-air densities, 4-8
- measurement of, 4-8 through 4-10, A-1

terrain analysis

- as part of integrated weather support, 2-8
- function of IPB process, 4-2, A-1

terrain analysis detachment

- responsibilities of, 2-10

TFU. See tactical forecast unit.

threat evaluation

- function of IPB process, 4-4

threat integration

nucleus of IPB process, 4-4

TVA. See target value analysis.

United States Air Force Environmental Technical Applications Center
(USAFETAC)

as part of AFGWC, 3-2

provides climatological data and studies for Air Force, 5-3

upper-air observations

as provided by ARTYMET, 4-6, 4-7

description of, B-8

US message text format

description of, 5-7

visibility

as part of data in a FALOP, 2-7, 4-10, A-1

critical values and impacts of, C-2 through C-16

effects of, B-1 through B-24

factor in tactical planning, B-2

table of visibility at the surface, A-5

weather analysis

AFGWC as focal point for, 3-2

as based on observations, 3-8

function of IPB process, 4-3

G2 responsibilities for, 2-9

weather data sources

within the Army tactical structure, 4-6

weather factor analysis matrix

example of, 4-5

weather forecast (WXFCST)

description of, 5-7

principles of, 2-2

weather forecaster

as part of the WETM composition, 3-8

responsibilities of, 3-8

weather observer

as part of the WETM composition, 3-6

responsibility of, 3-9

support to, 3-15

wind

- as part of surface and low-level observations, 2-7
- ATC unit measurements of, 4-8
- critical values and impacts of, C-2 through C-17
- description of wind meter in belt weather kit, A-17
- effects of, B-1 through B-24
- factor in tactical planning, B-2
- FALOP observation includes data on, 4-10, A-1
- part of forecast services, 3-9
- table on direction of surface, A-4
- table on force of surface, A-5

wincchill factors, B-4, B-6

FM 34-81/AFM 105-4
31 AUGUST 1989

By Order of the Secretaries of the Army and Air Force:

CARL E. VUONO
General, United States Army
Chief of Staff

Official:

WILLIAM J. MEEHAN II
Brigadier General, United States Army
The Adjutant General

LARRY D. WELCH
General, United States Air Force
Chief of Staff

WILLIAM O. NATIONS
Director of Information Management
and Administration

DISTRIBUTION:

Active Army, USAR, and ARNG: To be distributed in accordance with DA Form 12-11E, requirements for FM 34-81, Weather Support for Army Tactical Operations (Qty rqr block no. 484).

USAF: F

PIN: 056522-000