

ARMY, MARINE CORPS, NAVY, AIR FORCE



**AIR LAND SEA
APPLICATION
CENTER**

TMD IPB

**MULTISERVICE TACTICS,
TECHNIQUES, AND PROCEDURES
FOR THEATER MISSILE DEFENSE
INTELLIGENCE PREPARATION
OF THE BATTLESPACE**

**FM 3-01.16
MCWP 2-12.1A
NTTP 2-01.2
AFTTP(I) 3-2.36**

MARCH 2002

**DISTRIBUTION RESTRICTION: Approved for
public release; distribution is unlimited.**

MULTISERVICE TACTICS, TECHNIQUES, AND PROCEDURES

FOREWORD

This publication has been prepared under our direction for use by our respective commands and other commands as appropriate.

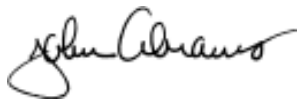

JOHN N. ABRAMS
General, USA
Commander
Training and Doctrine Command



BRUCE B. KNUTSON, JR.
Lieutenant General, USMC
Commanding General
Marine Corps Combat
Development Command



R. G. SPRIGG
Rear Admiral, USN
Commander
Navy Warfare Development Command



LANCE L. SMITH
Major General, USAF
Commander
Headquarters Air Force Doctrine Center

**This publication is available on the
General Dennis J. Reimer Training
and Doctrine Digital Library at
www.adtdl.army.mil**

PREFACE

1. Scope

In support of theater missile defense (TMD) operations, this multiservice publication provides detailed tactics, techniques, and procedures (TTP) for conducting intelligence preparation of the battlespace (IPB). TMD IPB reduces uncertainties regarding terrain, weather, and adversary capabilities to develop potential adversary courses of action. The 4-step IPB methodology detailed in this publication is based on Joint Publication 2-01.3, *Joint Tactics, Techniques, and Procedures for Joint Intelligence Preparation of the Battlespace*.

2. Purpose

This publication provides the intelligence analyst the tools to support commander and staff planning and decision making at the joint, combined, and service levels by providing a systematic, continuous, and common methodology for analyzing the adversary theater missile force.

3. Application

The target audience for this publication is the intelligence analyst responsible for IPB development. It will also aid the joint force commander in planning and executing cohesive joint operations against theater missiles throughout the battlespace and be beneficial for sensor employment, collection management, target development, and force application.

4. Implementation Plan

Participating service command offices of primary responsibility (OPRs) will review this publication, validate the information and, where appropriate, reference and incorporate it in service and command manuals, regulations, and curricula as follows:

Army. The Army will incorporate the tactics, techniques, and procedures (TTP) in this publication in United States (US) Army training and doctrinal publications as directed by the Commander, US Army Training and Doctrine Command (TRADOC). Distribution is in accordance with Department of the Army Form 12-99-R.

Marine Corps. The Marine Corps will incorporate the TTP in this publication in US Marine Corps training and doctrinal publications as directed by the Commanding General, US Marine Corps Combat Development Command (MCCDC). Distribution is in accordance with Marine Corps Publication Distribution System.

Navy. The Navy will incorporate these procedures in US Navy training and doctrinal publications as directed by the Commander, Navy Warfare Development Command (NWDC). Distribution is in accordance with Military Standard requisitioning and Issue Procedure Desk Guide and Navy Standing Operating Procedure Publication 409.

Air Force. Air Force units will validate and incorporate appropriate procedures in accordance with applicable governing directives. Distribution is in accordance with Air Force Instruction 33-360.

5. User Information

a. TRADOC, MCCDC, NWDC, Headquarters Air Force Doctrine Center (HQ AFDC) Air Land Sea Application (ALSA) Center developed this publication with the joint participation of the approving service commands. ALSA Center will review and update this publication as necessary.

b. This publication reflects current joint and service doctrine, command and control organizations, facilities, personnel, responsibilities, and procedures. Changes in service protocol, appropriately reflected in joint and service publications, will likewise be incorporated in revisions of this document.

c. We encourage recommended changes for improving this publication. Key your comments to the specific page and paragraph and provide a rationale for each recommendation. Send comments and recommendations directly to—

Army

Commander
US Army Training and Doctrine Command
ATTN: ATDO-A
Fort Monroe VA 23651-5000
DSN 680-3454 COMM (757) 727-3454
E-mail Address: doctrine@monroe.army.mil

Marine Corps

Commanding General
US Marine Corps Combat Development Command
ATTN: C42
3300 Russell Road Suite 318A
Quantico, VA 22134-5021
DSN 278-6234 COMM (703) 784-6234

Navy

Navy Warfare Development Command
Doctrine Development Division (Code N5)
686 Cushing Road
Newport, RI 02841-1207
DSN 948-4201 COMM (401) 841-4201

Air Force

Headquarters Air Force Doctrine Center
ATTN: DJ
216 Sweeney Boulevard, Suite 109
Langley AFB, VA 23665-2722
DSN 574-8091 COMM (757) 764-8091
E-mail Address: afdc.dj@langley.af.mil

ALSA

ALSA Center
ATTN: Director
114 Andrews Street
Langley AFB, VA 23665-2785
DSN 575-0902 COMM (757) 225-0902
E-mail Address: alsa.director@langley.af.mil

FM 3-01.16
MCWP 2-12.1A
NTTP 2-01.2
AFTTP(I) 3-2.36

FM 3-01.16 US Army Training and Doctrine Command
Fort Monroe, Virginia

MCWP 2-12.1A Marine Corps Combat Development Command
Quantico, Virginia

NTTP 2-01.2 Navy Warfare Development Command
Newport, Rhode Island

AFTTP(I) 3-2.36 Air Force Doctrine Center
Maxwell Air Force Base, Alabama

04 March 2002

TMD IPB

Multiservice Tactics, Techniques, and Procedures for Theater Missile Defense Intelligence Preparation of the Battlespace

TABLE OF CONTENTS

	Page
EXECUTIVE SUMMARY	ix
CHAPTER I OVERVIEW	
Scope	I-1
TMD Mission Areas	I-1
TMD IPB Overview	I-4
TM Threat Forces	I-5
Phases of TMD Operations	I-8
Who Conducts IPB	I-8
CHAPTER II STEP-1: DEFINE THE BATTLESPACE ENVIRONMENT	
What Is It?	II-1
How To Do It For TMD	II-1
CHAPTER III STEP-2: DEFINE THE BATTLESPACE EFFECTS	
What Is It?	III-1
How To Do It For TMD	III-1

CHAPTER IV	STEP-3: EVALUATE THE TM FORCE	
	What Is It?	IV-1
	How to Create TM Models	IV-1
	Doctrinal Template	IV-2
CHAPTER V	STEP-4: DETERMINE TM COURSES OF ACTION	
	What Is It?	V-1
	How To Do It.....	V-1
APPENDIX A	COMMON TMD IPB PROCESSES	A-1
APPENDIX B	SUGGESTED TMD IPB TEMPLATES	B-1
APPENDIX C	AUTOMATED TOOLS AND EXAMPLE ARCHITECTURES	C-1
APPENDIX D	TMD IPB CHECKLIST AND DEVELOPMENT PLAN	D-1
APPENDIX E	TMD IPB INTERNET LINKS	E-1
REFERENCES	References-1
GLOSSARY	Glossary-1
INDEX	Index-1
FIGURES		
	1 Continuous 4-Step TMD Process	ix
I-1	TMD IPB and TMD Operations	I-4
I-2	Multiple Dimensions of the TM Threat	I-6
II-1	Step 1 - Define the Battlespace Environment.....	II-1
II-2	AO and AOI Assessment Process for TMD IPB	II-6
II-3	Composite AOI Assessment Process	II-6
II-4	Potential TM Force Coverage Template	II-7
II-5	Potential TM Force Deployment Area Assessment Template	II-8
II-6	AO and AOI Assessment for TMD Active Defense Operations Template	II-9
II-7	AO and AOI Assessment for TMD Passive Defense Operations Template	II-10
II-8	AO and AOI Assessment for TMD Attack Operations Template	II-11
II-9	Composite AO and AOI Assessment Template.....	II-12
II-10	TMD Battlespace Assessment Template (1 of 2)	II-13
II-10	TMD Battlespace Assessment Template (2 of 2)	II-14
II-11	Geopolitical and Regional Threat Assessment Template....	II-17
II-12	Adversary TM Force Capabilities Assessment Template (1 of 2)	II-18
II-12	Adversary TM Force Capabilities Assessment Template (2 of 2)	II-19
II-13	Major Terrain and LOC Overview Template	II-20
III-1	Step 2 - Define the Battlespace Effects	III-1
III-2	Adversary TM Force Infrastructure Assessment Process ...	III-16

III-3	Infrastructure Functional Decomposition Assessment Template (1 of 2)	III-21
III-3	Infrastructure Functional Decomposition Assessment Template (2 of 2)	III-22
IV-1	Step 3 - Evaluate the TM Force	IV-1
IV-2	TM National Level Organization and C2 Template	IV-4
IV-3	TM Unit Level Organization and C2 Template	IV-5
V-1	Step 4 - Determine TM COAs	V-1
V-2	Adversary TM COA Development Flow Process	V-2
V-3	Situation Template Concept	V-6
V-4	Event Template Concept	V-9
B-1	TMD IPB Template Cover Sheet - Example	B-2
B-2	TMD IPB Template Cover Sheet	B-3
B-3	Command Mission(s) Objective(s) Summary Template	B-4
B-4	Command Mission(s) Objective(s) Worksheet Template	B-5
B-5	Command Mission(s) Guidance Worksheet Template	B-6
B-6	AO/AOI/ Battlespace Assessment Template	B-7
B-7	Geopolitical and Regional Threat Assessment Template	B-8
B-8	TM Force General Capabilities Assessment Template (1 of 2)	B-9
B-8	TM Force General Capabilities Assessment Template (2 of 2)	B-10
B-9	Major Terrain and LOC Overview Template	B-11
B-10	TMD IPB Holdings, Database, Sources, and Links Assessment Template (1 of 3)	B-12
B-10	TMD IPB Holdings, Database, Sources, and Links Assessment Template (2 of 3)	B-13
B-10	TMD IPB Holdings, Database, Sources, and Links Assessment Template (3 of 3)	B-14
B-11	TMD IPB Information Sources Evaluation Template (1 of 2)	B-15
B-11	TMD IPB Information Sources Evaluation Template (2 of 2)	B-16
B-12	TMD IPB POC Template	B-17
B-13	Recommended PIR/EEI/RFI/Other Requirement Request Worksheet Template (1 of 2)	B-18
B-13	Recommended PIR/EEI/RFI/Other Requirement Request Worksheet Template (2 of 2)	B-19
B-14	TMD IPB Key Word Search Template (1 of 4)	B-20
B-14	TMD IPB Key Word Search Template (2 of 4)	B-21
B-14	TMD IPB Key Word Search Template (3 of 4)	B-22
B-14	TMD IPB Key Word Search Template (4 of 4)	B-23
B-15	DIA Standardized Functional Category Code Information Search Template (1 of 2)	B-24
B-15	DIA Standardized Functional Category Code Information Search Template (2 of 2)	B-25
B-16	DIA Standardized Equipment Code Information Search Template (1 of 4)	B-26

B-16	DIA Standardized Equipment Code Information Search Template (2 of 4)	B-27
B-16	DIA Standardized Equipment Code Information Search Template (3 of 4)	B-28
B-16	DIA Standardized Equipment Code Information Search Template (4 of 4)	B-29
B-17	Feature Class Data to Terrain Analysis Template Cross Reference Template (1 of 5)	B-33
B-17	Feature Class Data to Terrain Analysis Template Cross Reference Template (2 of 5)	B-34
B-17	Feature Class Data to Terrain Analysis Template Cross Reference Template (3 of 5)	B-35
B-17	Feature Class Data to Terrain Analysis Template Cross Reference Template (4 of 5)	B-36
B-17	Feature Class Data to Terrain Analysis Template Cross Reference Template (5 of 5)	B-37
B-18	Terrain Assessment Checklist and Status Template	B-38
B-19	TMD IPB Slope Categories Template	B-39
B-20	Transportation and LOC Legend Symbols	B-45
B-21	CCM Overlay(s) Worksheet Template (1 of 2)	B-46
B-21	CCM Overlay(s) Worksheet Template (2 of 2)	B-47
B-22	Climatology Assessment Template.....	B-48
B-23	Weather Effects on Adversary TM Force Operations Template	B-49
B-24	Current/Forecasted Weather Effects on TM Force Operations Template	B-50
B-25	TM Force Required Infrastructure Assessment Template..	B-51
B-26	Integrated TM Force Infrastructure List Template (1 of 2)	B-52
B-26	Integrated TM Force Infrastructure List Template (2 of 2)	B-53
B-27	General Facility/Area Assessment Template (1 of 4)	B-54
B-27	General Facility/Area Assessment Template (2 of 4)	B-55
B-27	General Facility/Area Assessment Template (3 of 4)	B-56
B-27	General Facility/Area Assessment Template (4 of 4)	B-57
B-28	Field Operating Area Assessment Template	B-58
B-29	Area Limitation Worksheet Template	B-59
B-30	Doctrinal Template Requirements Template	B-60
B-31	TM Equipment Template	B-61
B-32	TM Equipment List Template	B-62
B-33	TM System Ground Vehicle Equipment Template.....	B-63
B-34	TM Force Attack Objectives Worksheet Template	B-64
B-35	TM Unit Functional Doctrinal Template	B-65
B-36	TM Force Employment Worksheet Template (1 of 2)	B-66
B-36	TM Force Employment Worksheet Template (2 of 2)	B-67
B-37	Time-Pattern Analysis Template	B-68
B-38	Date-Pattern Analysis Template	B-69
B-39	TM Operational State Doctrinal Template	B-70
B-40	TM HVT Relative Value Matrix Template	B-71
B-41	TM COA Assessment Template	B-72
B-42	TM COA Situation Matrix Template	B-73

B-43	NAI and HVT Assessment Template (1 of 2)	B-74
B-43	NAI and HVT Assessment Template (2 of 2)	B-75
B-44	TM COA Situation/Event Template (1 of 2)	B-76
B-44	TM COA Situation/Event Template (2 of 2)	B-77
B-45	TM Event Matrix Template.....	B-78
B-46	Recommended Target Nominations and TAIs Worksheet Template	B-79
C-1	32d AAMDC Brigade G-2 TOC	C-2
C-2	32d AAMDC External Information Sources.....	C-3
C-3	TMD Flight Simplified Organizational Relationships.....	C-3
C-4	Physical Layout of the 7th Air Force TMD Intelligence Team	C-4
D-1	TMD IPB Checklist (1 of 2).....	D-2
D-1	TMD IPB Checklist (2 of 2).....	D-3
D-2	TMD IPB Development Plan (1 of 2)	D-4
D-2	TMD IPB Development Plan (2 of 2)	D-5
 TABLES		
I-1	TMD Mission Areas, Objectives, and Associated TMD IPB Requirements	I-2
I-2	Some Organizations and Intelligence Roles and Responsibilities in Support of TMD.....	I-9
A-1	Matrix of General Sensor Types to Intelligence Advantages and Disadvantages	A-5-6
A-2	Typical Intelligence Reports.....	A-7
A-3	Commonly Used Digital/Hardcopy GGI&S Products	A-11
A-4	Other Vector-Based/Digital GGI&S Products	A-11
A-5	Other Raster-Based/Hardcopy GGI&S Products	A-11
A-6	Geospatial Precision and Accuracy Comparisons	A-14
B-1	Overlays, Doctrinal Templates, and GGI&S Products Supporting Terrain Analysis.....	B-30-32
B-2	Vegetation Type Codes.....	B-40
B-3	Unified Soils Classification System and Associated Rating Cone Index Values.....	B-41
B-4	Landforms and Commonly Associated Soils	B-42-44
B-5	Lane Widths Typical of Current Military Maps	B-44
B-6	Urban Area Building Type Codes and Descriptions	B-44
C-1	Selected Automated Tools.....	C-1
C-2	Specific 7th Air Force TMD Intelligence Team Functions	C-5

EXECUTIVE SUMMARY

TMD IPB

Multiservice Tactics, Techniques, and Procedures for Theater Missile Defense Intelligence Preparation of the Battlespace

Theater missile defense intelligence preparation of the battlespace (TMD IPB) is a systematic, continuous process of analyzing the adversary theater missile (TM) force and environment in a specific geographic area and the battlespace around it. By determining the likely adversary TM force courses of action (COAs) and their associated branches and sequels and by describing the environment where TM forces are operating, this TMD IPB process helps the commander and staff selectively apply and maximize combat power at critical points in time and space in the battlespace. Applied properly, TMD IPB provides for the timely and effective suppression and/or destruction of a TM force, while minimizing the use of friendly assets for the TMD mission. This provides the commander and staff with a cost-effective method for providing force protection from an adversary's TM force. A large number of adversary countries possess or are trying to acquire TMs for prestige and/or military purposes. TMs have the potential to give adversaries military advantages against the United States (US) and allied forces. The TM threat these adversaries present is a complex multi-dimensional intelligence problem. To develop potential adversary TM COAs, the TMD IPB procedures concept decomposes and correlates the *“who and what (equipment and units); where (infrastructure); when, why, and how (operations).”* Typically TM forces are equipped, organized, trained, and employed differently. Many of these differences are relatively minor, while some are more dramatic. TMD IPB uses templating to standardize the process of analyzing adversary TM forces. Templates can be in the form of text, tables, forms, or graphics. Templates in this publication provide a starting framework for analysis and development. They are not meant to be all encompassing, and they should be adapted for a particular geographic area or situation. TMD IPB is a continuous process consisting of four major iterative and parallel steps (Figure 1).

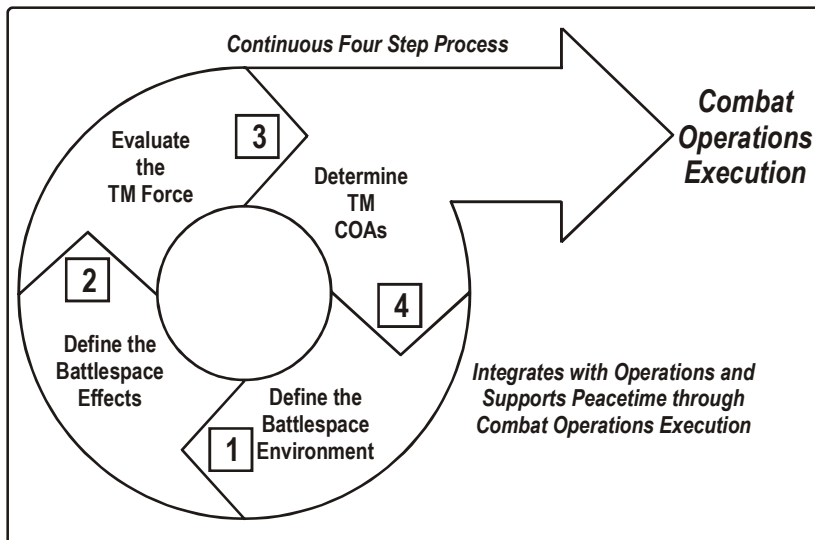

Figure-1. Continuous 4-Step TMD IPB Process

STEP-1 — Define the Battlespace Environment (Focus). This step focuses the initial intelligence collection efforts and the remaining steps of the TMD IPB process. It identifies battlespace characteristics requiring in-depth evaluation of their effects on adversary TM force operations, such as terrain, weather, logistical infrastructure, and demographics. The initial effort is oriented on defining the limits of the area of operations (the geographic region where TM forces operate and/or where TMD operations will be conducted) and area of interest (the area from which information and intelligence are required). Defining the significant characteristics of the battlespace environment aids in identifying and filling current intelligence data gaps.

STEP-2 — Define the Battlespace Effects (Influences). This step evaluates the environment's effect on adversary TM force operations. This assessment examines terrain, weather, and other battlespace characteristics (that is, adversary TM force infrastructure) to determine how these characteristics may limit or provide opportunities for TM force operations. The objective is to integrate these effects into a terrain analysis designating the most probable adversary TM force operations areas.

STEP-3 — Evaluate the TM Force (Operational Model). This step examines in detail how the adversary TM force normally organizes for combat and conducts operations under ideal conditions. The evaluation is portrayed in a threat model of the TM force that includes doctrinal templates depicting how the TM force operates when unconstrained by the effects of the battlespace environment. TM force threat models are depicted graphically (doctrinal templates) supplemented by high-value target matrices and simple narratives.

STEP-4 — Determine TM COAs (Integrate). This step integrates the results of the previous steps into a meaningful conclusion. Given what the adversary TM force normally prefers to do, and the effects of the environment it is currently operating in, this step attempts to define the likely objectives and COAs available to the TM force. This is accomplished by creating event templates and matrices focusing on intelligence collection aimed at identifying the COA the TM force will most likely execute.

TMD IPB is a complicated and time-consuming process. Automated intelligence and terrain analysis tools greatly assist this process. Currently, several core intelligence systems are being developed and fielded that will greatly enhance the TMD IPB process. To more efficiently solve the threat TM problem, continued emphasis on these current and future automated TMD IPB techniques is essential. However, equally important is the emphasis placed on development of the intelligence data needed for the TMD IPB. It is critical to begin the TMD IPB process during the prehostilities phase, with well-developed intelligence databases, in order to successfully impact US and allied TMD operations.

PROGRAM PARTICIPANTS

The following commands and agencies participated in the development of this publication:

Joint

Ballistic Missile Defense Organization, Pentagon, Washington, D.C.
Joint Theater Attack Analysis Center, Kirtland AFB, Albuquerque, NM
Joint Theater Air and Missile Defense Office, Pentagon, Washington, D.C.

Unified

USSTRATCOM, Joint Intelligence Center, Offutt AFB, NE

Army

32d Army Air and Missile Defense Command, Fort Bliss, TX
United States Army Intelligence and Security Command, Fort Belvoir, VA
United States Army Intelligence Center, Fort Huachuca, AZ

Marine Corps

Marine Corps Combat Development Command, Quantico, VA

Navy

Naval Surface Warfare Center, Dahlgren, VA
Naval Strike and Air Warfare Center, Fallon, NV
Navy Warfare Development Command (Norfolk Detachment), Norfolk, VA
PEO-Surface Warfare Combatants, McLean, VA

Air Force

7th Air Force, Osan Air Base, Korea
612 Air Intelligence Squadron, Davis-Monthan AFB, Tucson, AZ
Air Combat Command/XOIP, Langley AFB, Hampton, VA
Air Combat Command/XOFR, Langley AFB, Hampton, VA
Headquarters, Air Intelligence Agency/DOOQ, Kelly AFB, San Antonio, TX

Other

Anteon Corporation, Arlington, VA
Pacific-Sierra Research, Arlington, VA
SPARTA Corporation, Huntsville, AL

Chapter I

OVERVIEW

1. Scope

This publication gives multiservice tactics, techniques, and procedures (MTTP) for conducting intelligence preparation of the battlespace (IPB) analysis in support of theater missile defense (TMD) operations. *"Joint theater missile defense is an integral part of counterair operations. . . . which integrates both offensive and defensive operations from all components to counter the air and missile threat."* (This quote can be found in Joint Publication (JP) 3-01, *Joint Doctrine for Countering Air and Missile Threats*, Chapter I, page I-2.) TMD IPB is a systematic and continuous process for analyzing adversary theater missile (TM) capabilities, weather, terrain, and related infrastructure in a specific geographic region to support friendly TMD operations. Although this MTTP focuses specifically on the manual method of performing IPB, Appendix C lists some supporting automated tools. This basic TMD IPB methodology is derived from the steps, functions, and the structure established by the United States Army (USA) Field Manual (FM) 2-01.3 (FM 34-130), *Intelligence Preparation of The Battlefield*, JP 2-01.3, *Joint Tactics, Techniques, and Procedures for Joint Intelligence Preparation of The Battlespace*, and JP 3-01.5, *Doctrine for Joint Theater Missile Defense*. This document is derived from authoritative and field-tested concepts. It addresses unique aspects of the TM threat such as—

- a. Encompass the strategic, operational, and tactical levels of war.
- b. Operate theater-wide and significantly impact on a wide array of friendly operations.
- c. Operate noncontinuous, nonlinear, and asymmetric in time and space and over large nonlinear geographic areas.
- d. Do not require direct contact with friendly forces.
- e. Are a highly diversified target system including infrastructure, movement, and highly mobile tactical target elements.
- f. Move and launch using TM specific unit patterns.
- g. Conceal and camouflage easily.
- h. Are capable of employing weapons of mass destruction (WMD).
- i. Have geopolitical implications.

2. TMD Mission Areas

Joint TMD is the integration of joint force capabilities to destroy enemy TMs in-flight or before launch or otherwise disrupt the enemy's TM operations. This is accomplished through an appropriate mix of mutually supportive command, control, communications, computers, and intelligence (C4I) activities; active attack operations; active missile defense operations; and passive missile defense operations. TMD incorporates several missions requiring IPB. Table I-1 shows the correlation between TMD missions and their required TMD IPB.

Table I-1. TMD Mission Areas, Objectives, and Associated TMD IPB Requirements

Mission Area	Include	Associated TMD IPB Requirements	
TMD C4I	<ul style="list-style-type: none"> • Timely and accurate data and systems to plan, monitor, direct, control, and report TMD operations. • Integrated systems of doctrine, organizational structures, facilities, communications, computers, supporting intelligence, and missile warning and cueing by sensors and ground stations. • OPSEC. 	TM probable operating areas. TM countermeasures. TM WMD capabilities. TM warhead types. Threat employment COAs. TM OB. TM system signatures.	Adversary TM targeting process. TM probable targets and target areas. TM attack timing and numbers. TM TTPs. Meteorological effects on TM operations. Adversary knowledge of TMD deployment. Defense suppression threat capabilities.
Attack Operations	<ul style="list-style-type: none"> • Destruction, disruption, or neutralization of TM launch platforms; supporting C3; logistics; and platforms. 	TM RDT&E infrastructure. TM field operating areas. Probable hide sites/launch sites. TM equipment. Threat employment COAs. TM system signatures. Air defenses supporting TMs. TM system C2 nodes.	TM production infrastructure. TM Fixed operational infrastructure. TM TTPs. Meteorological effects on TM operations. TM OB. TM WMD infrastructure.
Active Defense	<ul style="list-style-type: none"> • Multi-tiered defense in-depth via multiple engagements using land, sea, air, space, and special operations forces. • Active EW to disrupt remote or on-board guidance systems. • Information Operations. 	TM probable operating areas. Probable TM targets. TM flight characteristics. TM WMD capabilities. Threat employment COAs. TM OB. Defense suppression threat capabilities.	Adversary TM targeting process. TM attack timing and numbers. TM countermeasures. TM warhead types. Meteorological effects on TM operations. Adversary knowledge of TMD deployment.
Passive Defense	<ul style="list-style-type: none"> • Deception. • NBC protection. • TM early warning. • EW. • OPSEC. • Countersurveillance. • Recovery and reconstitution. • Camouflage and concealment. • Mobility, dispersal, and hardening. 	TM time of flight. TM accuracy. TM OB. TM WMD capabilities. TM warhead types and effects. Meteorological effects.	Adversary TM targeting process. TM probable targets and target areas. TM attack timing and numbers. Threat employment COAs.

a. TMD C4I. Command and control (C2) for joint TMD operations is a commander's exercise of authority and direction over forces assigned joint TMD missions. Use existing joint and service C4I systems and resources to efficiently accomplish C4I for joint TMD missions. This integrates other operational functions and optimizes the use of scarce resources. The C4I system links passive defense, active defense, and attack operations to provide timely assessment of the threat (to include IPB); rapid dissemination of tactical warning; and mission assignment, targeting data, and poststrike assessment to the appropriate joint TMD element. For each operational element, the C4I system must provide rapid communications among intelligence assets, the fusion and decision-making facilities, and the warning and weapon systems, to include a capability for rapid coordination with supporting combatant commanders. Space assets and information operations are critical to attack operations, active

defense, and passive defense because they provide launch warning, launch point prediction, launch point detection, threat type determination, impact point prediction, weapon systems cueing, communications, and related intelligence. Joint TMD C4I capabilities must support the principles of centralized planning, decentralized execution, and coordinated efforts by forces assigned joint TMD tasks.

b. Attack Operations. Attack operations are characterized by offensive actions intended to destroy and disrupt adversary TM capabilities before, during, and after launch. Attack operations prevent TM launch or additional TM launches by attacking critical elements (that is, launch platforms, reconnaissance, surveillance, and target acquisition [RSTA] platforms, C2 nodes, missile stocks, and infrastructure) of the overall system. The preferred method of countering adversary TM operations is to attack and destroy or disrupt TMs before their launch. Attack operations can be preemptive or reactive as part of counterair, strategic attack, interdiction, fire support, maneuver, antisubmarine warfare, antisurface warfare, strike warfare, amphibious, or special operations. Attack operations are challenging because TM systems are generally hard to detect and are normally dispersed, mobile, electronically quiet, and redundant. Thus, the detection, acquisition, identification, tracking, and attack tasks are highly dependent on a near-real-time C4I process and rapid targeting capability.

c. Active Defense. The role of active defense operations is to protect selected assets and forces from attack by destroying TM airborne launch platforms and/or TMs in-flight. Active defense must consist of defense in-depth against all classes of TMs. When destruction of the TM launch platform before launch is not possible or successful, TMs should be engaged by all means available throughout their entire flight profile. Defense in-depth provides multiple opportunities to negate the TMs with differing capabilities, increases probability of kill, and prohibits the enemy from being able to counter the defensive system with a single technique. Active defense also includes those actions that mitigate the effectiveness of targeting and delivery systems through electronic warfare (EW) against remote or on-board guidance systems.

d. Passive Defense. Passive defense is necessary to provide essential individual and collective protection for friendly forces, population centers, and critical assets. Passive defense measures should be planned whenever United States (US) forces might face a TM threat. By examining various combinations of TM warhead accuracy and effects, numbers of available missiles, and the adversary targeting process, the likelihood and timing of an attack may be predicted and passive measures selected for employment before, during, and after a TM attack.

e. Mission Focus. The different mission areas of TMD require different types of IPB products. For instance, the C4I mission requires a focus that addresses the adversary's use of ISR assets and how to counter them. Attack operations need IPB products that highlight vulnerable nodes in the adversary's TM infrastructure and launch complexes. Active defense missions require IPB products that highlight the adversary's targeting process and probable targets. Passive defense missions require IPB data on the accuracy of adversary TMs and probable warhead selection. The intelligence analyst should focus the friendly IPB process to best support the commander's specific TMD mission.

A good IPB is essential if the operators are to understand how the threat is likely to operate, to get sensors in the most effective configuration and to react to subtle TM activity indicators. The IPB information helps sort out real TM information from the distracting background traffic.

Joint Theater Missile Defense - Attack Operations Test Force, 1997

3. TMD IPB Overview

a. What is TMD IPB? TMD IPB is a systematic, continuous process of analyzing the adversary TM force and environment in a specific geographic area. The process is designed to support planning and decision making by commanders and staffs. It allows them to selectively apply and maximize combat power at critical points in the battlespace.

b. What are the objectives of TMD IPB? TMD IPB identifies facts and assumptions about the battlespace environment and the TM threat. TMD IPB determines likely TM courses of action (COAs), their associated branches and sequels, and describes the operating environment for TM operations. This supports commander and staff planning and the development of friendly COAs. TMD IPB provides the basis for intelligence collection, synchronization, and target development to support the commander's chosen COA. (Figure I-1).

c. TMD IPB contains the following 4 major iterative and parallel steps:

(1) *Step-1 - Define the Battlespace Environment.* Step-1 focuses the command's initial intelligence collection efforts and the remaining TMD IPB steps. To focus the remaining steps, the analyst should identify the battlespace characteristics affecting TM force operations. Generally these characteristics include terrain, weather, lines of communications (LOCs), infrastructure, and demographics. To limit the analytical and intelligence collection efforts to the geographic areas significant to the command's mission, the joint force commander (JFC) will establish the limits of the area of operations (AO) and the

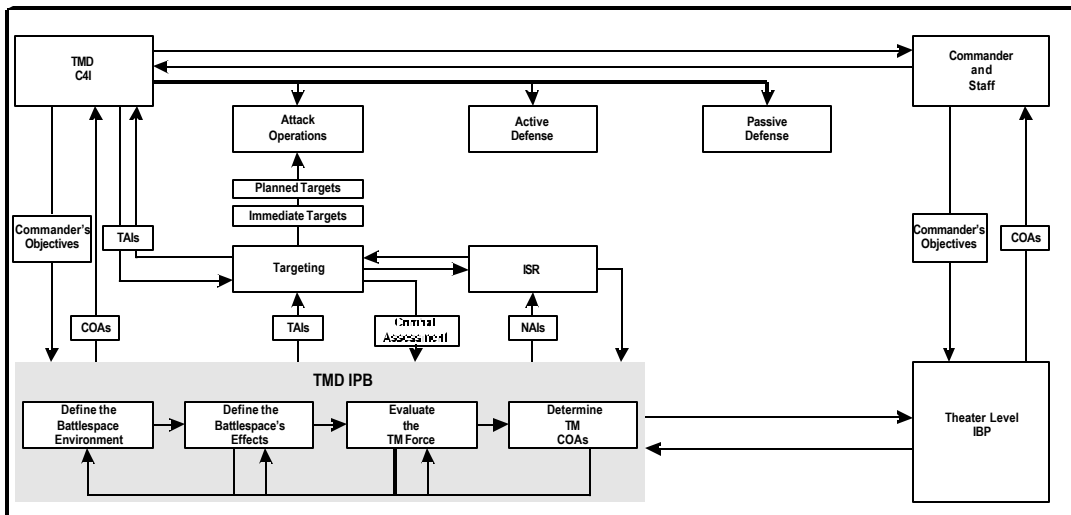

Figure I-1. TMD IPB and TMD Operations

area of interest (AOI) for the TMD IPB process. The AO and AOI limits are dynamic and based on the location and characteristics of the battlespace influencing the operation. Defining the significant characteristics of the battlespace environment aids in identifying gaps in current intelligence holdings and the specific intelligence required to fill them. Similarly, the TMD IPB identifies gaps in the analyst's knowledge of the TM force and its current situation. Once approved by the commander, the specific intelligence required to fill gaps in information regarding the battlespace environment and adversary TM force disposition becomes the commander's TMD priority intelligence requirements.

(2) *Step-2 - Define the Battlespaces Effects.* Step-2 evaluates environmental effects impacting adversary TM forces. The analysis performed in this step examines terrain, weather, and other battlespace characteristics (that is, the adversary's use of the electromagnetic spectrum and their TM force infrastructure) to determine how these characteristics may limit or provide opportunities for TM force operations. The objective is to integrate these effects into an analysis that designates the most probable adversary TM force operating areas. This integrated analysis provides key pieces of information for evaluating COAs by focusing on how the environment impacts on TM capabilities.

(3) *Step-3 - Evaluate the TM Force.* In Step-3, TMD IPB focuses in detail on how the TM force normally organizes for combat and conducts operations under ideal conditions. When facing a well-known adversary, the TMD IPB process can rely on historical databases and well-developed threat models. When operating against a new, changing, or less well-known adversary, the analyst may need to develop intelligence databases and threat models concurrently. The TM force evaluation is portrayed in a threat model that includes doctrinal templates depicting how the TM force operates when unconstrained by battlespace environmental effects. Threat models are depicted graphically (doctrinal templates) supplemented by high-value target matrices and simple narratives.

(4) *Step-4 - Determine TM COAs.* Step-4 integrates the results of the previous steps into a meaningful conclusion. Given what the TM force normally prefers to do and the effects of the specific environment in which it is now operating, this step assesses adversary objectives and available TM COAs. In addition, Step-4 includes preparation of event templates and matrices that focus intelligence collection on identifying which COA the TM force will execute for each phase of operations. The TM COA models developed in Step-4 are the products that the command staff will use to portray the TM force in their decision-making and force management processes. These models can only be produced effectively if a good foundation has been established during the first 3 steps of the TMD IPB process.

4. TM Threat Forces

a. *The TM Threat.* The TM threat is a complex multidimensional intelligence problem, as illustrated in Figure I-2. TMD IPB aims to decompose and correlate the "*who, what (equipment and units), where (infrastructure), when, why, and how (operations)*" in order to develop potential TM COAs for the operational planning process. Each TM force is equipped, organized, trained,

and employed with various degrees of difference. Many of these differences are relatively minor, while some are more dramatic. TMD IPB encompasses all dimensions of the threat. Because of the gravity of the TM threat, TMD IPB focuses on developing this information to allow for the best possible choice of friendly COAs.

b. TM Systems. There is a wide range of TMs currently deployed and available to adversary countries. JP 3-01, *Joint Doctrine for Countering Air and Missile Threats*, defines the following major categories as—

(1) Theater ballistic missiles (TBMs) with range capabilities of less than or equal to 3500 kilometers (km).

(a) Short range ballistic missiles (SRBMs) with range capabilities of less than or equal to 1000 km.

(b) Medium range ballistic missiles (MRBMs) with range capabilities between 1000 and 3000 km.

(c) Intermediate range ballistic missiles (IRBMs) with range capabilities between 3000 and 3500 km.

(d) Sea-launched ballistic missiles (SLBMs) with range capabilities of less than or equal to 3500 km.

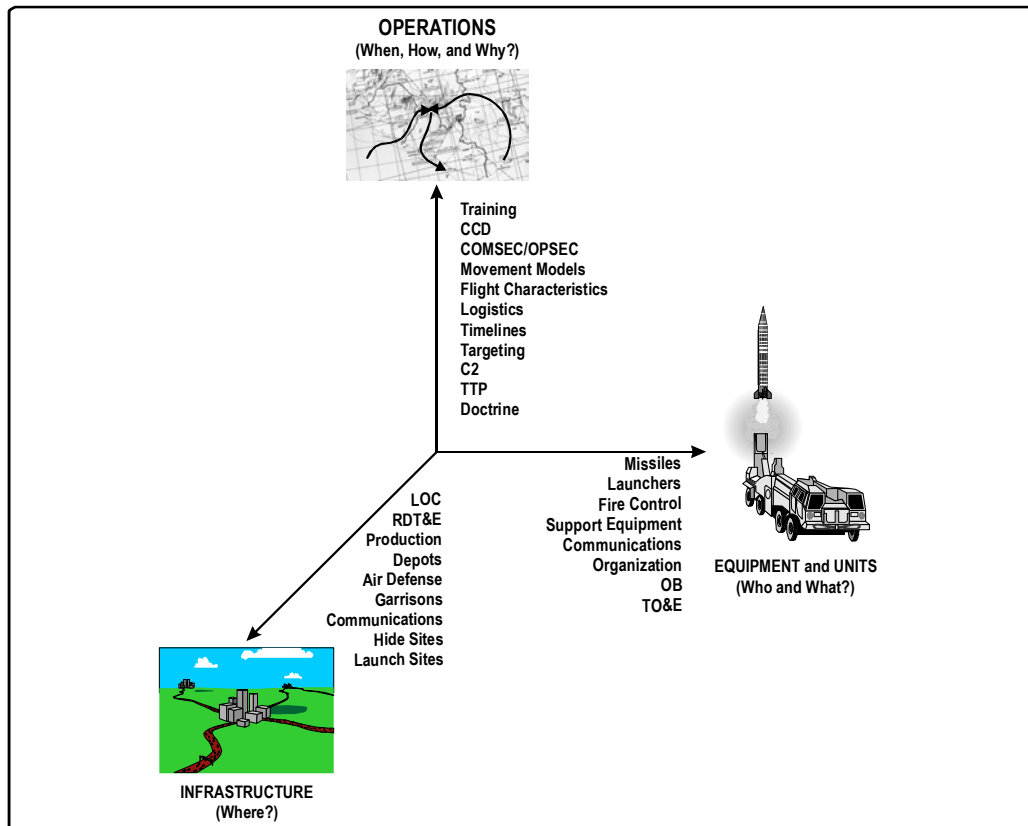

Figure I-2. Multiple Dimensions of the TM Threat

(2) Cruise Missiles (CMs).

(a) Land attack cruise missiles (LACMs) including sea, underwater, air, and land launched types.

(b) Antiship cruise missiles (ASCMs) including sea, underwater, air, and land launched types.

(3) Air-to-surface missiles (ASMs) or tactical air-to-surface missiles (TASM). ASM as defined in JP 3-01 excludes short-range, nonnuclear, direct fire missiles, bombs, and rockets such as Maverick or wire-guided missiles. This definition does not adequately define the boundaries of what should be or should not be considered when addressing ASMs. To provide boundaries, this publication will exclude ASMs with less than a 30-km range capability.

c. TMD IPB Focus. The examples used in this publication focus on the TBM threat. This focus is based on the inherent complexities involved in TBM operations. In short, there are more steps involved in launching a TBM vice launching a CM or ASM. By using the TBM threat as an example, this publication attempts to provide a more complete TMD IPB methodology. This focus does not imply a lesser importance to the CM or ASM threat. These systems are, and will continue to be, a credible threat to friendly operations. However, the methodology for conducting IPB against a ground-launched CM threat is sufficiently similar to the IPB against a TBM threat that the procedures described are applicable for either system. The IPB against a sea-launched cruise missile (SLCM), an air-launched cruise missile, or an ASM is sufficiently different in that it is much more platform-centric. In these cases, the focus of the IPB is more on the launch platform and the different environments in which they operate. With these systems, the IPB process must focus on the physical maritime and air battlespace environments. These system specific differences are discussed further in Chapter III.

d. Deployed TM Systems. Technologically, TM systems span a spectrum of sophistication that has direct implications for the IPB process.

(1) The most widely deployed TMs today are systems with technologies (guidance and control (G&C), liquid-propellant propulsion, and airframe) dating from the 1940s through the 1960s. Operationally, the surface-to-surface missile system (SCUD) TBMs and SILKWORM ASCMs representative of this class are the most widely deployed and continue to be improved and proliferated. They are manpower and equipment intensive when compared to modern systems.

(2) Advanced TM systems are currently deployed in fewer numbers and include solid-propellant propulsion, improved G&C with digital flight computers and global positioning systems (GPSs), improved airframe, and modern ground support equipment (GSE) technologies. These more modern technologies result in improved quick reaction times, accuracy, lethality, and a need for less support vehicles and operational support. Operationally these systems require significantly less manpower and integrate automation in erector-launchers and other GSE. Although limited in number, these systems pose a growing threat to TMD operations.

5. Phases of TMD Operations

US military operations can be broken into 5 major phases: prehostilities, lodgment, decisive combat and stabilization, follow-through, and posthostilities and redeployment.

a. Prehostilities Phase. The prehostilities phase encompasses normal day-to-day peacetime operations and offers the highest leverage for TMD IPB preparation. During this phase, TMD IPB development can draw upon the distributed production assets of the intelligence community (national, theater, and service organizations), which have the responsibility for providing the key data needed for TMD IPB development. To optimize the value of these sources, the analyst should begin TMD IPB development as early as possible and continually refine to provide as much depth as possible given available intelligence data.

b. Lodgment Phase. The lodgment phase involves the movement and buildup of a decisive combat force in the operational area. It may include initial strikes from outside the theater as well as holding or defensive actions from units already in-theater. During this phase, TMD IPB plays an important role in TMD deployments, initial planning for TMD attack operations, options for passive defense, and overall command COA development to mitigate the effects of an adversary's TMs. Joint or component level units assigned TMD IPB responsibilities should acquire as much TMD IPB data as possible before deployment. Links should be established with appropriate national intelligence organizations to provide support to TMD intelligence operations as required.

c. Decisive Combat and Stabilization Phase. This phase initially focuses on the continuing rapid buildup of joint force capabilities. The goal is to deter hostilities, but if deterrence fails, to conduct decisive combat operations. In this phase, the TMD IPB should be updated and refined based on observed and anticipated adversary combat operations and used to plan and execute active defense operations, attack operations, and passive defense measures.

d. Follow-Through Phase. The follow-through phase aims to bring the conflict to a successful conclusion. In this phase, TMD IPB will be updated based on observed adversary combat operations. TMD IPB will be used to optimize active defense deployments, attack operations, passive defense, and the command's COAs.

e. Posthostilities and Redeployment Phase. This phase includes closing the campaign with a coordinated withdrawal while maintaining theater integrity. TMD IPB will again be updated based on observed adversary combat operations and used to establish posthostility defensive COAs.

6. Who Conducts IPB

Organizational Roles and Responsibilities. Many organizations have the role and responsibility to support the integrated TMD IPB effort; Table I-2 lists some of these through the execution level. One important aspect not depicted in the table is the essential relationship between the intelligence and operations staffs. That relationship must be 2-way for the TMD IPB process to work properly. It is

properly. It is essential that the intelligence staff understands the current operations situation and plan in order to facilitate a smooth and efficient TMD IPB. It is also essential that the intelligence staff performing the TMD IPB function adequately convey the TMD IPB information to the operations staff in a timely manner. In essence, neither operations nor intelligence can function properly without each other. Teamwork is essential for TMD IPB and TMD to succeed.

Table I-2. Some Organizations and Intelligence Roles and Responsibilities in Support of TMD

Some Organizations and Intelligence Roles and Responsibilities in Support of TMD		
Organization	Subordinated To	Roles and Responsibilities in Support of TMD
National Level		
DIA	Secretary of Defense	General Military Intelligence
NSA	Secretary of Defense	SIGINT and ELINT
CIA	President	General Military Intelligence
Central MASINT Office	DIA	MASINT
USAF Director ISR	USAF/Deputy Chief of Staff Air and Space Operations	General Military Intelligence on Threat TM Forces
USA Deputy Chief of Staff for Intelligence	Chief of Staff USA	General Military Intelligence
USN Chief of Naval Intelligence	Chief of Naval Operations	General Military Intelligence
USMC Assistant Chief of Staff C4I	Commandant of the USMC	General Military Intelligence
Joint Information Operations Center	US Space Command	Information Operations
US Strategic Command JIC	CINC Strategic Command	General Military Intelligence on Ballistic Missiles
US Space Command CINC NORAD J-2	US Space Command CINC NORAD	TBM Indications and Warnings
MSIC	DIA	DIA executive agent for TMD IPB, S&TI on SRBMs and Air Defense Systems
NAIC	USAF	S&TI on M/IRBMs, Aircraft, and Cruise Missiles
NGIC	USA Deputy Chief of Staff for Intelligence	S&TI on Ground Systems, ELs, and GSE
Armed Forces Medical Intelligence Center	DIA	S&TI on CBW
Office of Naval Intelligence	Chief of Naval Operations	S&TI on SLBMs, Ships, and ASCMs
NIMA	Secretary of Defense	Overhead Intelligence Collection & MC&G Support
Defense Special Missile and Astronautics Center	DIA	Foreign Missile/Space Activity Indications & Warning
Department of State Intelligence	Secretary of State	Arms Control and Political Considerations
Theater Level		
National Military JIC	Secretary of Defense	National Level Intelligence Point of Entry for JTF
J-2 & JISE	Combatant Command CINC	The CINC's Immediate Intelligence Staff
JTF J-2 and JISE	JFC	The JFC's Immediate Intelligence Staff
NIST	JFC and NMJIC	National Level Augmentation to JTF J-2 & JISE
USAF Theater Intelligence Elements	JFC and Air Force Forces	USAF Theater Intelligence Elements
USA Theater Intelligence Elements	JFC and Army Forces	USA Theater Intelligence Elements
USN Theater Intelligence Elements	JFC and Navy Forces	USN Theater Intelligence Elements
USMC Theater Intelligence Elements	JFC and Marine Forces	USMC Theater Intelligence Elements

Chapter II

STEP-1: DEFINE THE BATTLESPACE ENVIRONMENT

1. What Is It?

a. Definition. *Step-1* of the TMD IPB process identifies for further analysis specific features of the environment or activities within it that affect the battlespace for both adversary and friendly operations.

b. Desired End Effect.

(1) Focus the IPB effort on the battlespace areas and characteristics that influence the command's mission.

(2) Acquire the intelligence needed to complete the TMD IPB process to the degree of detail required to support the decision-making process.

(3) Save time and effort by focusing only on those areas and features that influence TMD operations. Information must be to a level of detail required to support the command's decision-making process.

2. How To Do It For TMD

The primary sub-steps are shown in Figure II-1. The products are a series of templates used to direct, focus, and feed the analytical efforts of *Steps-2, -3, and -4* with intelligence data/information.

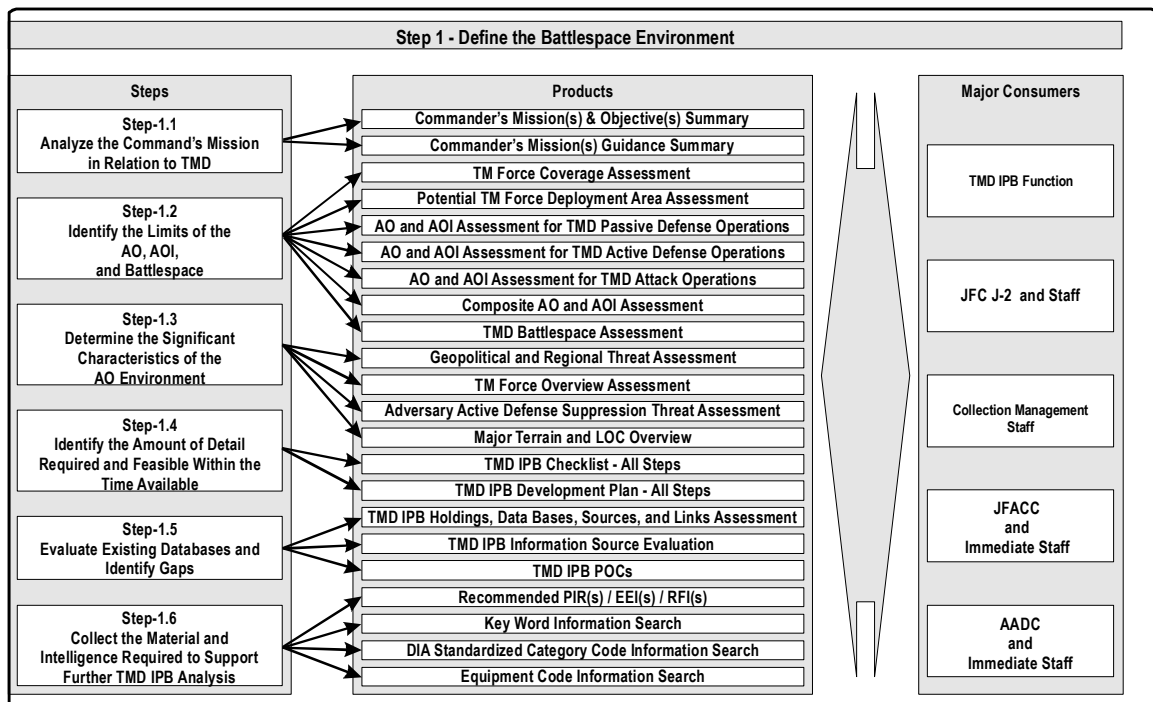

Figure II-1. Step 1 - Define the Battlespace Environment

a. Step-1.1 - Analyze the Command's Mission in Relation to TMD. The TM mission is determined by understanding provided objectives and guidance. Objectives and guidance identify what is to be achieved and under what conditions and parameters. This is an important stage in the TMD IPB process. Without a clear understanding of what is to be achieved, it is impossible to achieve efficient TMD IPB development. Objectives and guidance begin at the national level as broad concepts and should end as short-term, well-defined mission objectives at the appropriate command level.

(1) Objectives. An objective must be understandable, attainable, measurable, and allow room for a solution. It defines the specific TMD IPB problems to be solved. When possible, identify the specific starting and ending times for the objective as knowledge of the timing is critical to providing TMD IPB support. If possible, estimate latest time information is of value (LTIOV). This is the time by which information about the objective must be delivered in order to provide decision makers with timely intelligence. Another significant part of an objective is identifying the area in which to affect the adversary activity. This information narrows the geographical scope and simplifies the TMD IPB analyst's job.

(a) Relationship of Objectives. The 3 broad levels of objectives are national, theater, and component. The objective levels are intertwined and each successive level down becomes more detailed and specific. The component commander's objectives are based on the objectives set by the theater commander, the assigned mission(s), the resources available, adversary characteristics, and the military characteristics of the AO. Components normally supplement operation and contingency plans. The theater commander sets objectives for the theater of operations, which are contingent upon the national objectives. Operation/contingency plans normally specify the command objectives, commander's concept of operations, the threat, and forces available. The President and Secretary of Defense are responsible for setting the very broad national objectives, which generally outline the overall desired outcome of the campaign. There should be no conflicting objectives among the levels and the TMD IPB developers must be cognizant of all objectives.

(b) Objectives Template. A simple questionnaire worksheet can provide a template for evaluating and recording mission objectives. Once a complete set of objectives is defined, summarize them in a list form. First develop the objectives for the command's overall mission if not already obtained from higher headquarters. Next evaluate TMD specific mission objectives. See Appendix B, Figure B-3 for suggested template examples of an objectives summary template and Figure B-4 for an objectives worksheet template. The objectives worksheet template should be completed for each identified objective.

(2) Guidance. Guidance provides the framework to achieve the objectives and establishes the force employment scope and restrictions.

(a) Types. The law of armed conflict (LOAC) (also referred to as *law of armed war*) is that portion of international law that regulates the conduct of armed hostilities. The LOAC includes treaties, conventions, international agreements and customary international law. Ratified treaties, conventions, and

international agreements, as well as applicable customary international law legally bind the US. Rules of engagement (ROE) are directives issued by competent military authority that delineate the circumstances and limitations under which US forces will initiate and/or continue combat engagement with other forces encountered. The ROE can change within each conflict, based on directives issued by competent military authority.

(b) Command Guidance. Command guidance comes in many forms and can entail a broad range of subjects, from approved tactics for active TMD to proper behavior in local establishments. A template for recording the command's mission and TMD mission guidance is at Appendix B, Figure B-5. List each of the identified command guidance, ROE, and applicable LOAC on the worksheet and describe each in as much detail as needed.

Note: Objectives and guidance are the cornerstones of the TMD IPB process. They guide the 4 major steps of the TMD IPB process and should be clear and well defined. Once developed, theater and command objectives are constantly reviewed to assure they accurately reflect the current command TMD mission. Everyone involved in the TMD IPB process should fully understand the commander's objectives and guidance or request further clarification. A starting point for receiving and assessing the commander's objectives and guidance follow:

- ◆ Operations Plan (OPLAN).
- ◆ Operations Order (OPORD).
- ◆ Warning Order.
- ◆ Alert Order/Deploy Order.
- ◆ Planning Order.
- ◆ Air Tasking Order/Integrated Tasking Order.
- ◆ Fragmentary Order.
- ◆ Operation Plan in Concept Format (CONPLAN).
- ◆ Concept of Operations (CONOPS).
- ◆ Time-Phased Force and Deployment List.
- ◆ Defended Asset List (DAL).
- ◆ Standing ROEs.

b. Step-1.2 - Identify the Limits of the AO, AOI, and Battlespace for the TMD IPB Process. To assist in the coordination and deconfliction of joint action, JFCs may define operational or joint areas. For operations limited in scope (such as TMD) geographic combatant commanders can designate operational areas such as joint operation areas, joint special operations areas (JSOAs), joint rear areas

(JRAs), amphibious objective areas, or AOs. An AO is the geographical area where a commander is assigned the responsibility and authority to conduct military operations. An AOI is based on operational factors and the command's concept of operations, as defined by higher headquarters. The intelligence cell recommends the AOI to the commander based on IPB.

(1) AO for TMD IPB. To save time and focus the IPB effort on the areas and characteristics of the battlespace that most directly affect the command's mission, the intelligence analyst will limit the analysis to the geographical areas supporting troops and capabilities that can influence TMD operations. This publication refers to that geographical area as the AO. AOs for TMD IPB are those geographical regions analysts use to define missile threat envelopes, the locations where TM forces operate, and/or where TMD operations will be conducted. *Note: The Army and Marine Corps use the term area of operations (AO) in their IPB manual [FM 2-01.3/MCRP 2-12A] whereas the Air Force uses operational area (OA) in their IPB pamphlet.* For the purpose of TMD IPB, these terms are analogous. Both references define these terms as “*that portion of an area of conflict necessary for military operations.*” This publication uses the term AO; however, the definition differs from that in JP 1-02. The use of AO in this publication does not infer that a specified AO commander, as defined in JP 1-02, has responsibility and authority for TMD operations, nor does it limit the size of the geographical area or limit it to only naval or land commanders. This term only defines a geographical area necessary to focus the IPB process for the intelligence analyst. The maximum attack depth of the commander's available TMD attack operations assets usually limits the AO for TMD IPB. The evaluation of the battlespace's effects in the AO is generally more thorough and detailed than it is within the AOI. The AO for TMD IPB is derived from the DAL, OPLAN, OPORD, CONPLAN, and/or CONOPS. Remember that the DAL requires an analysis, which includes several IPB products, of the adversary's targeting strategy. Generally the DAL is established based upon what the friendly commander wants to protect that may leave possible targets unprotected.

(2) AOI for TMD IPB. The TM operations battlespace defines the AOI for TMD IPB. To plan and successfully conduct the TMD mission, AOI information and intelligence are required. The limits of the TMD composite AOI are based on the ability of the adversary to project power or move TM forces into the AO. Geographical locations of other activities (for example, terrorists) or characteristics of the environment that might influence COAs or the commander's decisions, are also considered. Because the limits of the TMD composite, AOIs are based on threats to mission accomplishment rather than strictly terrain considerations; they might cross into other countries. For example, if political developments in a neutral country might influence the accomplishment of the command's mission, that country should be included in the TMD composite AOI. Likewise, if another country provides a base of support for the adversary country's TM force, it should be included within the TMD composite AOI. The following templates should be created for defining the AOs and AOIs for TMD IPB:

- ◆ Potential TM Force Coverage.
- ◆ Potential TM Force Deployment Area(s).
- ◆ TMD Active Defense AO and AOI Template.
- ◆ TMD Passive Defense AO and AOI Template.
- ◆ TMD Attack Operations AO and AOI Template.
- ◆ Composite AO and AOI Template.

Two basic considerations the TMD IPB analyst should keep in mind are division of AO and AOI templates into multiple sets and knowledge of TM force infrastructure data. Depending upon the situation, it may be beneficial to divide the AO templates into multiple areas based upon TM force weapon system category. For example, there are significant differences between TBMs and ASCMs. In most cases, it is better to build a set of AO templates for TBMs and another set of AO templates for ASCMs. Some countries have many more SRBMs than MRBMs. Because of the differences between missiles, this is a case when separate AO templates may again be better. Each situation is different, and the TMD IPB analyst will have to use the best judgement in determining how to divide the AO templates. One final consideration is the extent of knowledge of the adversary TM force infrastructure data. If the TM force operating areas are unknown, then assume that the TM force (air, land, or sea-based) can operate from any part of the adversary's battlespace. This can include occupied portions of neighboring countries such as Kuwait for Iraq during the Gulf War of 1991.

(3) TMD Battlespace. The AO and AOI are geographic areas that can be defined not only in three-dimensions (height, width, and depth) but in other dimensions as well. In determining other dimensions of the TMD battlespace, the TMD intelligence function must move beyond addressing only the concrete, physical aspects of the geographic environment. The TMD battlespace includes all elements of the environment that are relevant to the command's TMD mission. The TMD forces use of the electromagnetic spectrum (for example, radios and radars); the capabilities of the TMD force to use satellites for communications and intelligence gathering; and TMD force information systems capabilities and vulnerabilities, both inside and outside the TMD IPB AO, are examples of other environment elements that must be considered when determining the dimensions of the command's TMD battlespace. Figure II-2 and Figure II-3 provide the basic processes for assessing the AO/AOI for TMD IPB. Using these processes, Figures II-4 through II-10 provide illustrative examples of assessing the AO, AOI, and battlespace for TMD IPB. See Appendix B, Figures B-6 through B-9 for correlating blank templates.

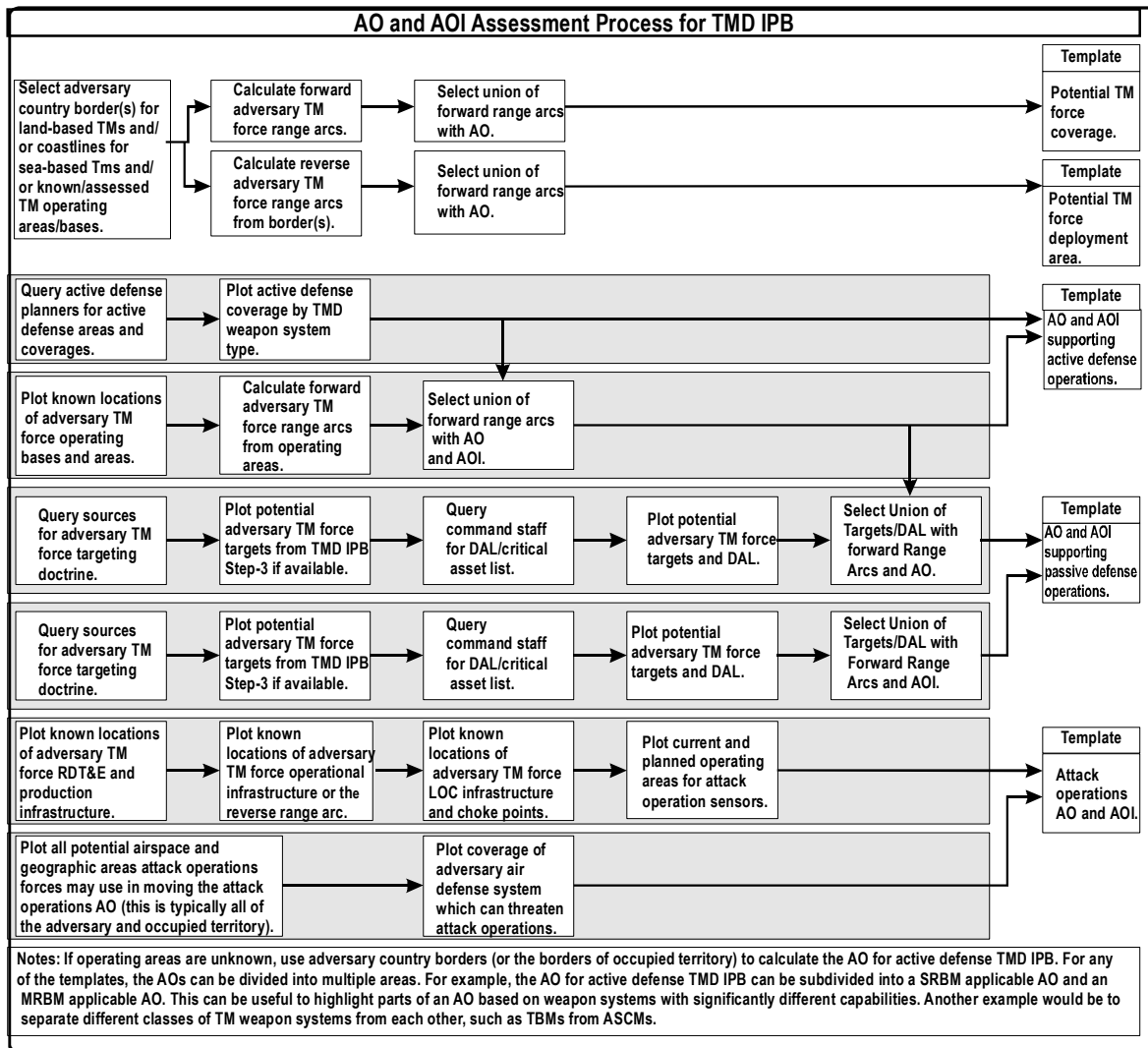

Figure II-2. AO and AOI Assessment Process for TMD IPB

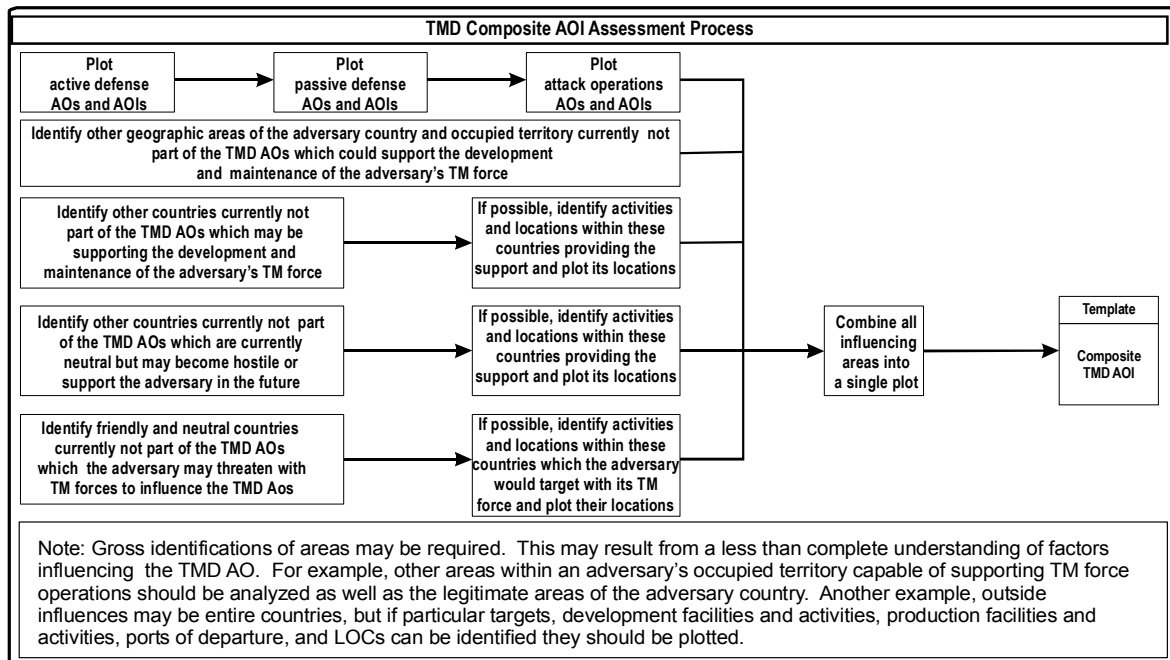
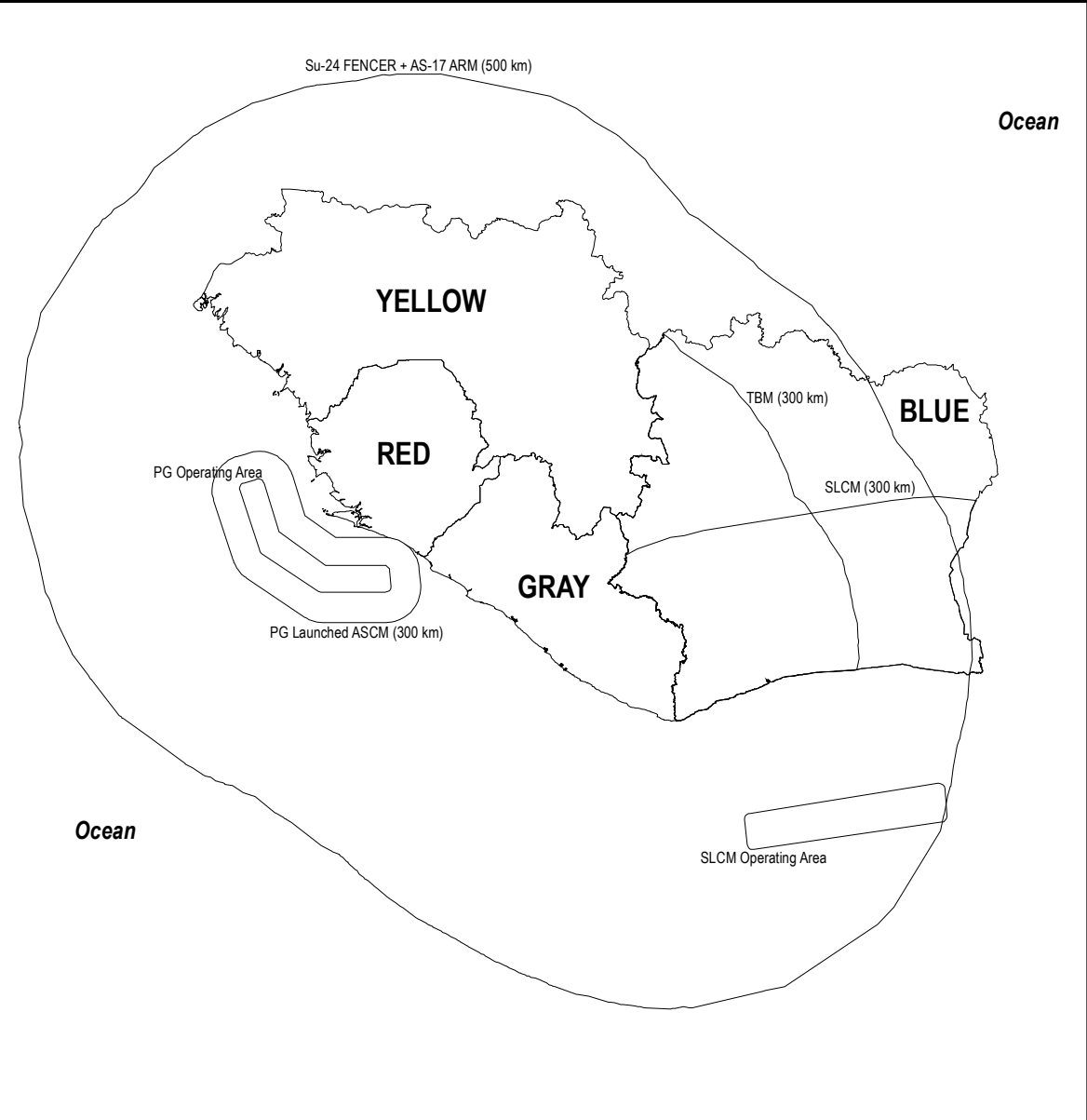

Figure II-3. Composite AOI Assessment Process

Potential TM Force Coverage



Notes:

1. Patrol combatant (PG) operating area is known.
2. SLCM operating area is known.
3. TBM and ARM operating areas are unknown.
4. TBM and ARM range arcs are based on forward range arcs from the borders of the combined territory of RED and GRAY.
5. ARM coverage is based on a maximum launch range of 400 km for the Su-24 FENCER and an additional 100 km for the AS-17 after launch. The combined range coverage is 500 km.

Figure II-4. Potential TM Force Coverage Template

Potential TM Force Deployment Area Assessment

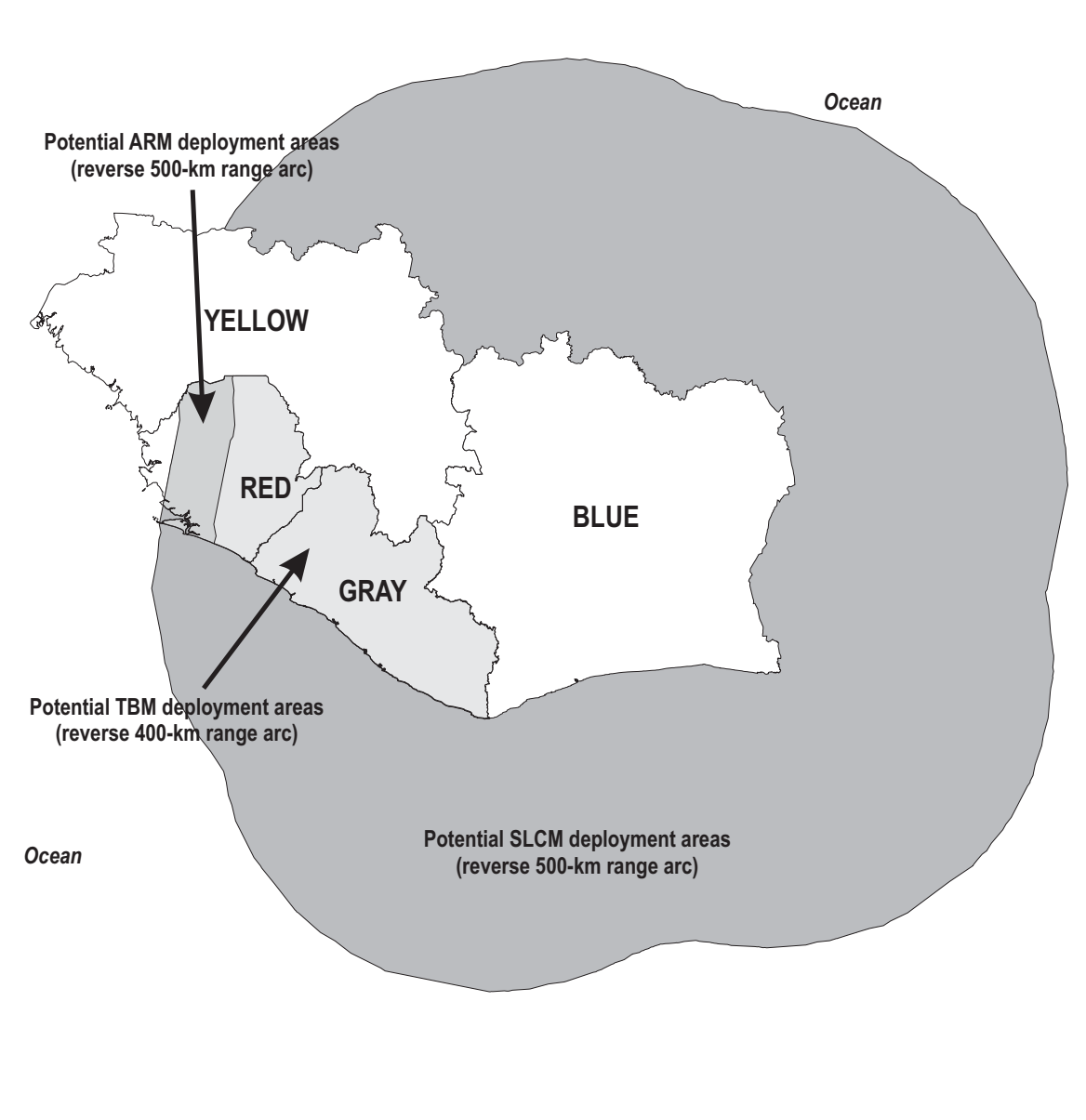

Notes:

1. Reverse range arcs are from the BLUE country border and represent the maximum potential deployment areas.
2. GRAY is currently occupied by RED forces and has to be considered as a potential area for deployment of RED forces.
3. The potential ARM deployment area includes all airfields capable of supporting Su-24 FENCER operations within the shaded area.
4. RED PGs under continuous patrol have a maximum range of 2,000 km at 25 kph. This range covers the entire command AO and more. Since the PGs are not blue water capable, they have not been plotted. Refer to the TM Force Coverage Assessment Template for their deployment area.

Figure II-5. Potential TM Force Deployment Area Assessment Template

AO and AOI Assessment for TMD Active Defense Operations

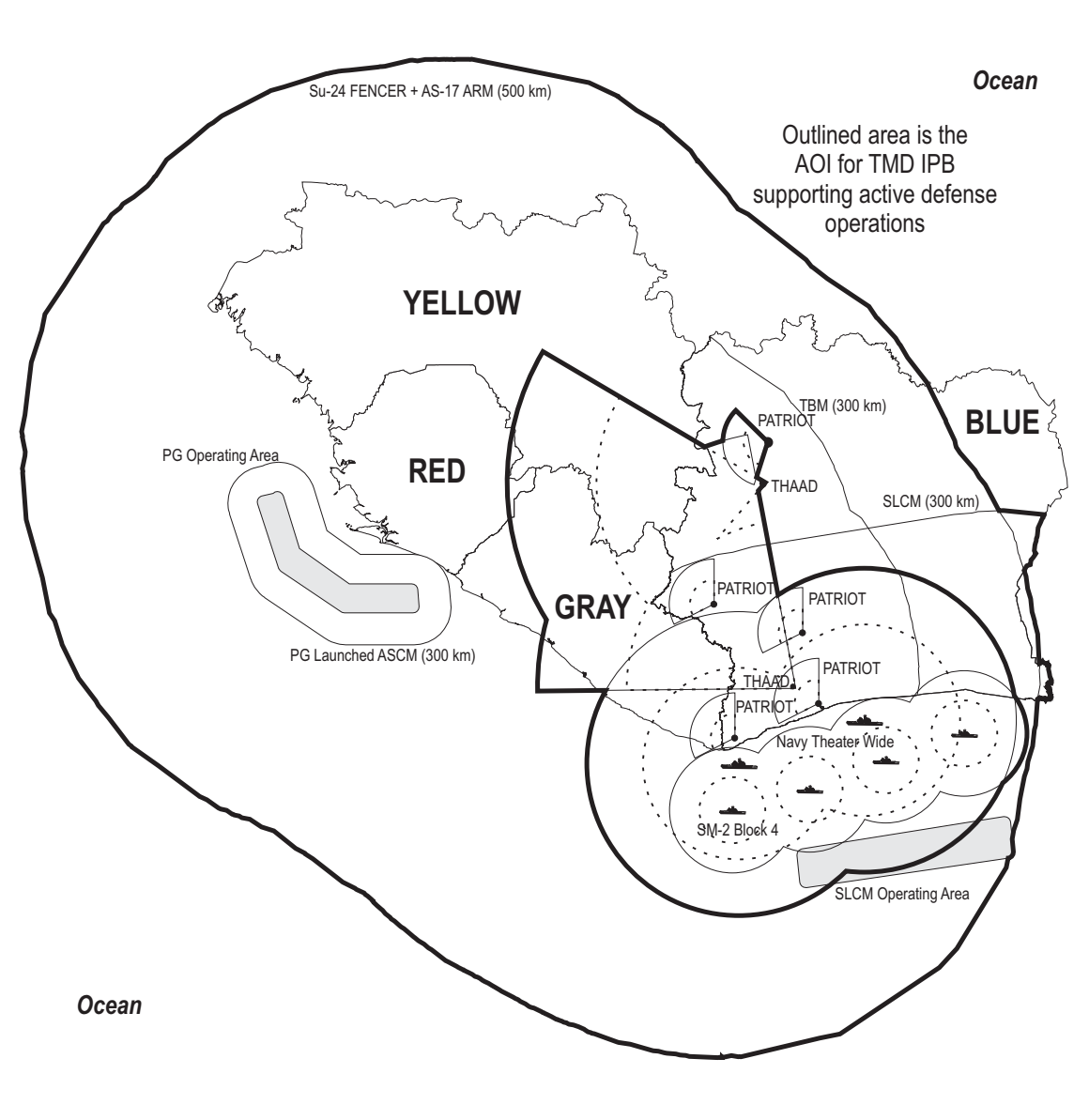

Notes:

- 1. Dashed lines represent nominal interceptor coverages.
- 2. Solid lines represent nominal radar coverage.

Figure II-6. AO and AOI Assessment for TMD Active Defense Operations Template

AO and AOI Assessment for TMD Passive Defense Operations

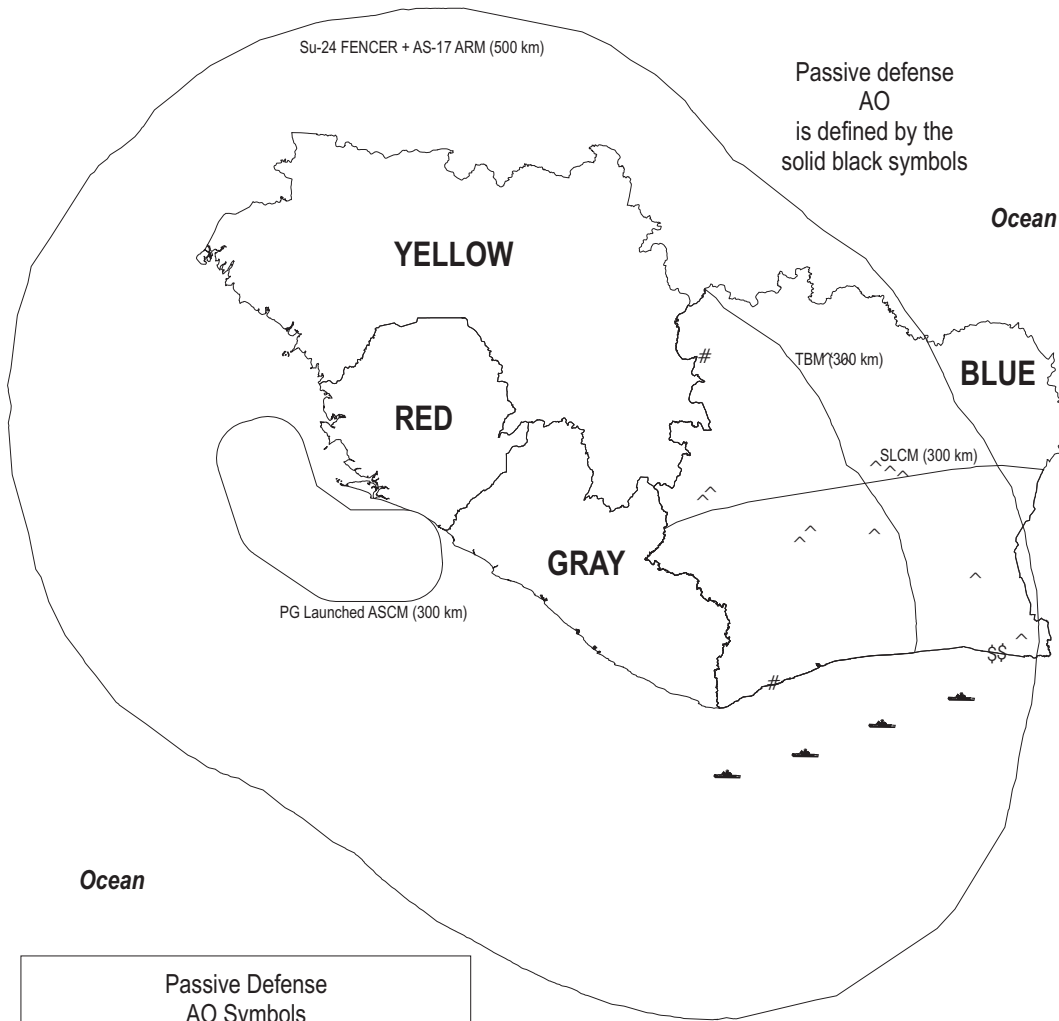

Passive Defense AO Symbols	
#	Both DAL and Potential RED Target List
^	DAL Only
\$	Potential RED Target List Only
	Potential Mobile Naval Targets

Notes:

1. Passive defense AOs are points or small areas represented by the passive defense AO symbology.
2. There are no passive defense AOIs. An example of a passive defense AOI is potential adversary targets or DAL targets outside of the current command AO. A specific DESERT STORM example is potential Iraqi targets within Israel prior to Iraq launching its first TBMs at Israel, which then became part of the passive defense AO.

Figure II-7. AO and AOI Assessment for TMD Passive Defense Operations Template

AO and AOI Assessment for TMD Attack Operations

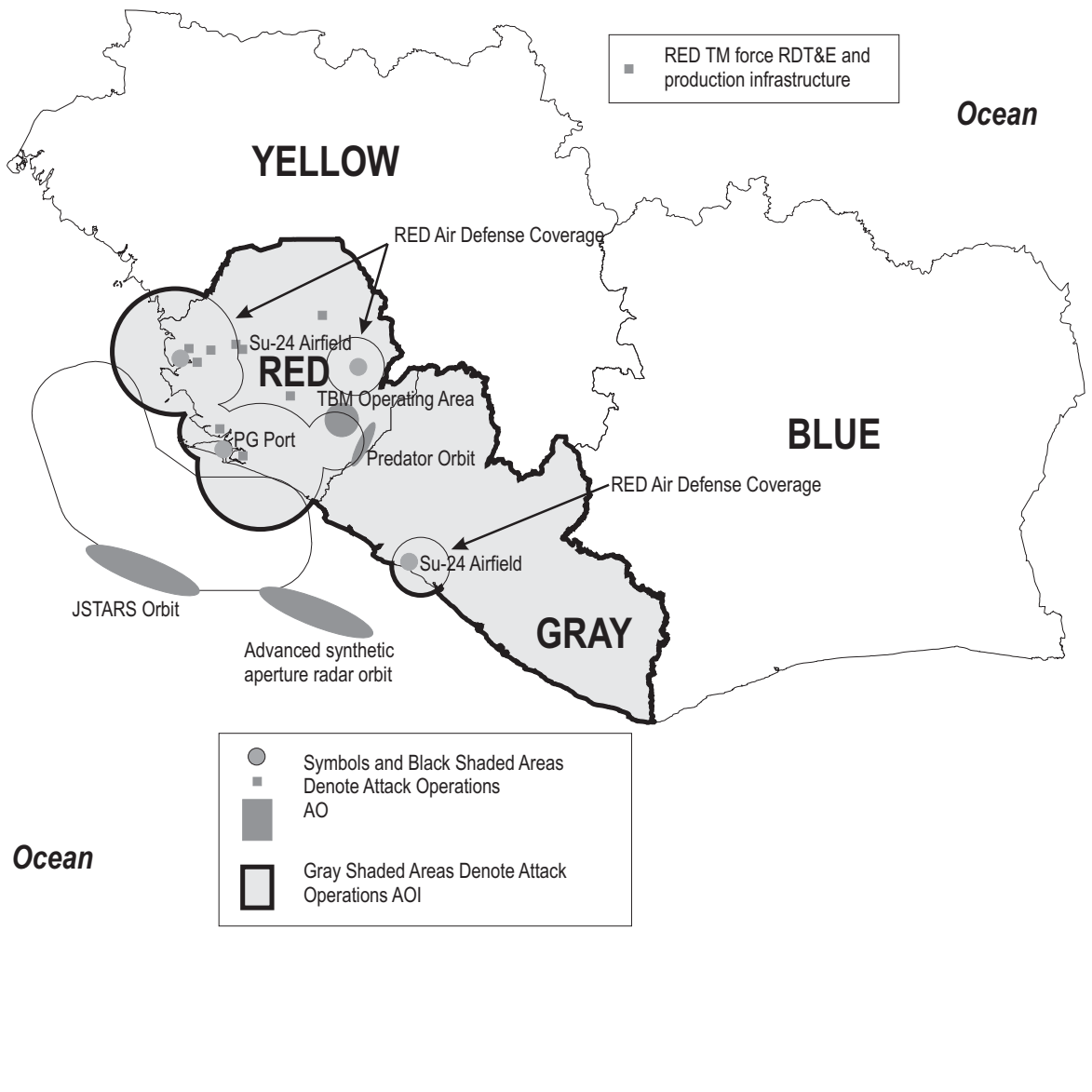

Notes:

1. Given the capabilities of US aircraft to approach targets from all aspects and at any range, the entire countries of RED and GRAY are considered an AOI for attack operations.
2. Only the targets and RED TM force operating areas are considered as the attack operations AO.
3. Given the capabilities of US aircraft to approach targets from all aspects and at any range, ingress and egress routes/areas are not considered as part of the attack operations AO.

Figure II-8. AO and AOI Assessment for TMD Attack Operations Template

Composite AO and AOI Assessment

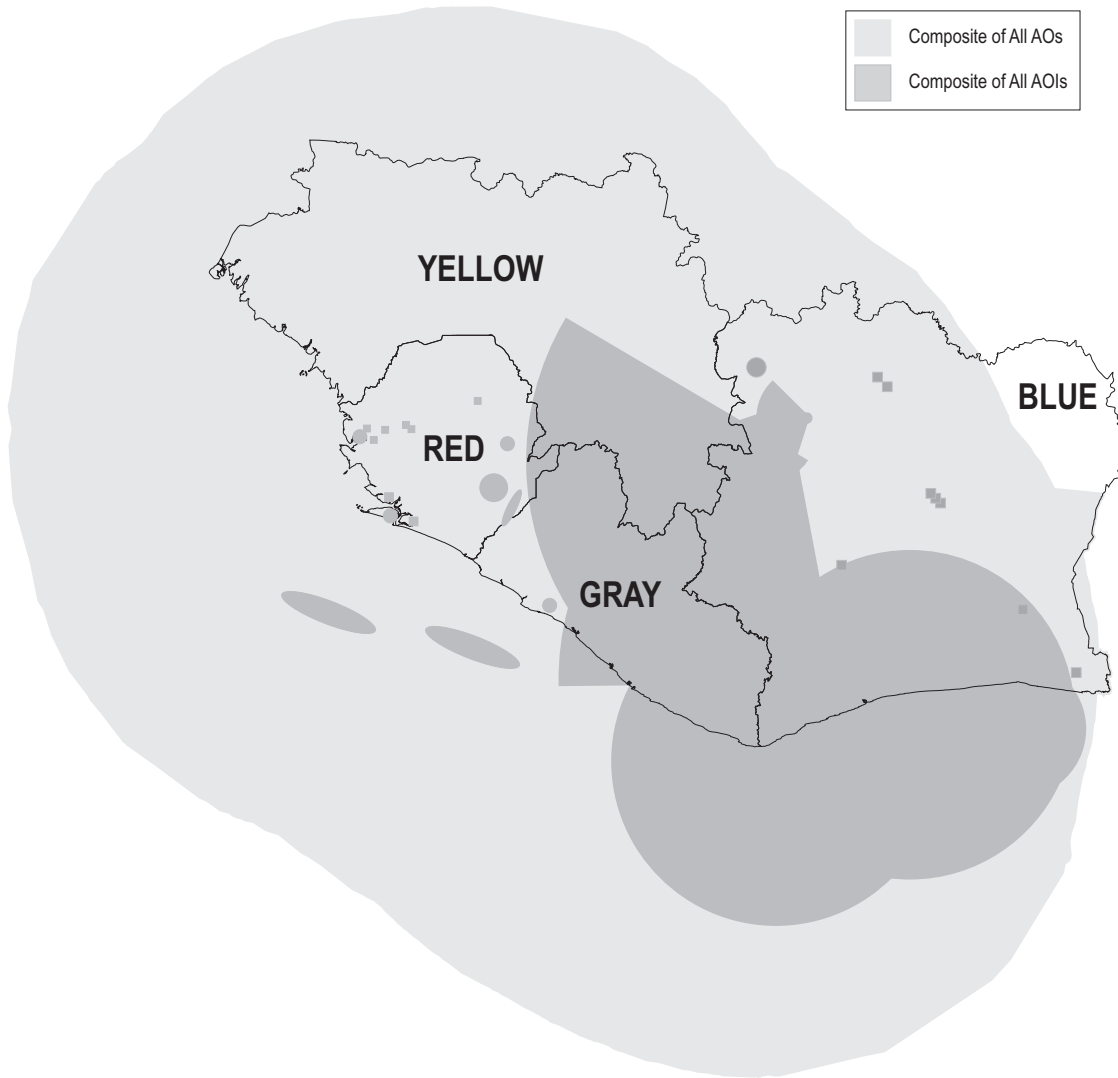

Note:

The country YELLOW is contained in the composite AOI because YELLOW is supplying RED with complete TM systems and production capabilities. The whole country represents an AOI while the small circles denote identified facilities within YELLOW known to be supporting RED.

Figure II-9. Composite AO and AOI Assessment Template

TMD Battlespace Assessment

TMD Related Radio Frequency Battlespace

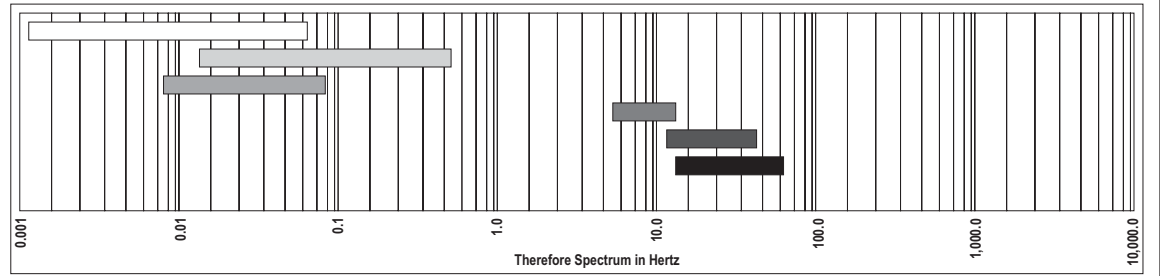
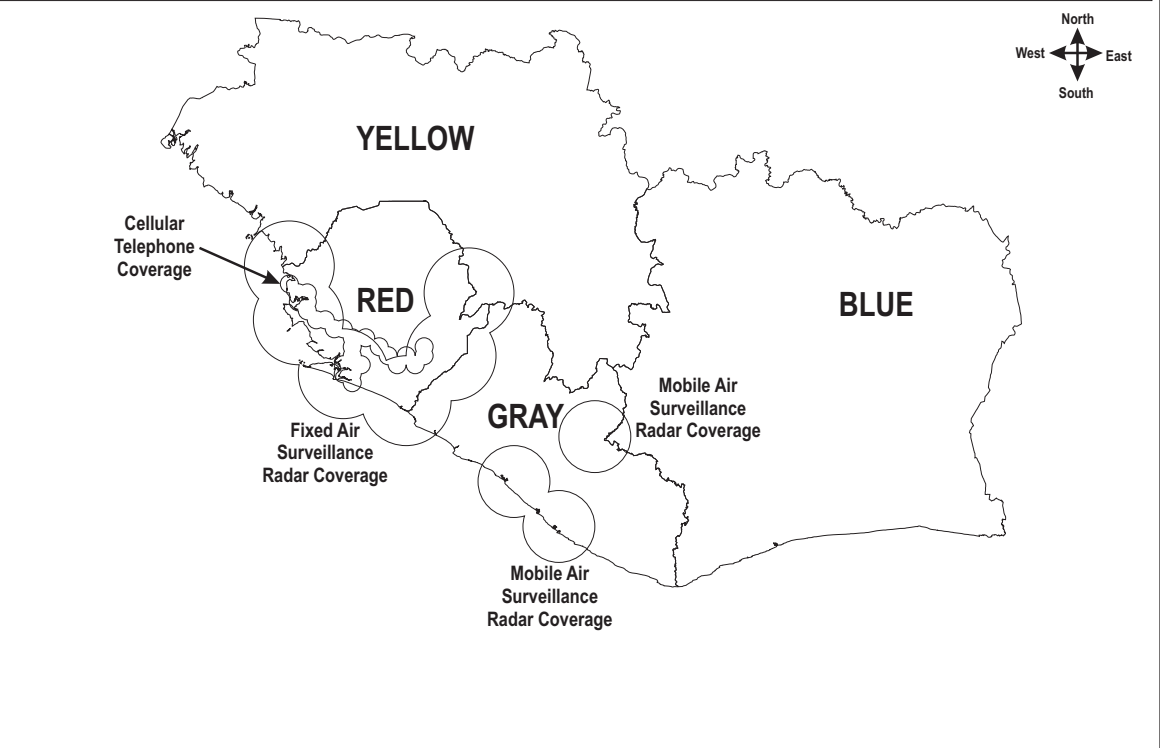

Map Sheet Name	Map Sheet Series	Map Sheet Number	Map Sheet Edition	Map Sheet Scale	Horizontal/Vertical Datum	0 5 10 15 20 Km 0 5 10 Nm
NA	NA	NA	NA	NA	NA	Scale

Legend / Key / Symbols / Scale

- Fixed Air Surveillance Radar
- Mobile Air Surveillance Radar
- ARM Passive Radar Seeker
- Cellular Telephone Communications
- Voice / Data RED Imagery Satellite
- Data RED Imagery Satellite

Notes:

Figure II-10. TMD Battlespace Assessment Template (1 of 2)

TMD Battlespace Assessment

TM Force Related Satellite Battlespace

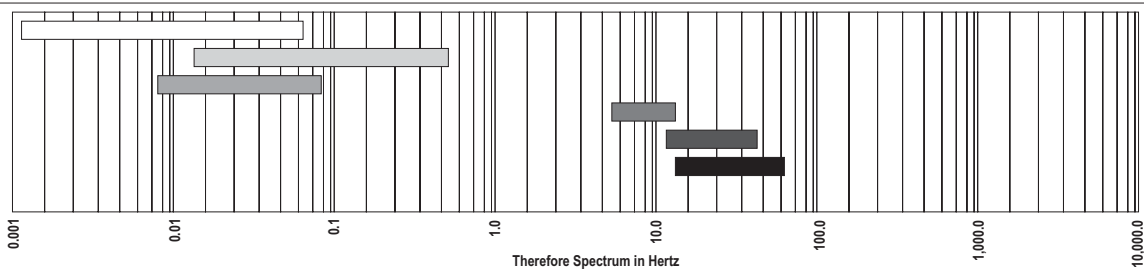
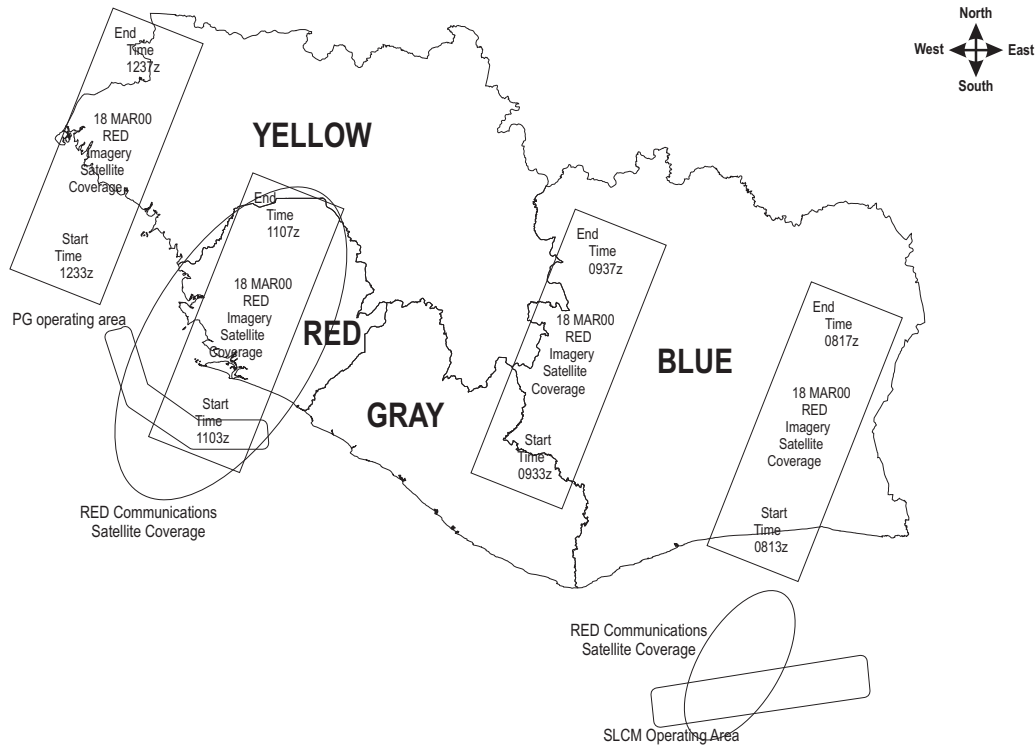

Map Sheet Name	Map Sheet Series	Map Sheet Number	Map Sheet Edition	Map Sheet Scale	Horizontal/Vertical Datum	0 5 10 15 20 Km Scale 0 5 10 Nm
NA	NA	NA	NA	NA	NA	

Legend/Key/Symbols/Scale

- Fixed Air Surveillance Radar
- Mobile Air Surveillance Radar
- ARM Passive Radar Seeker
- Cellular Telephone Communications
- Voice / Data RED Imagery Satellite
- Data RED Imagery Satellite

Notes: The RED communications satellite is capable of supporting 2 simultaneous footprints with 20 2.6 to 3.2 GHz bent pipe transponders per footprint for both uplink and downlink. Each transponder can support 50 multiplexed voice channels or ten 500 kilobits per second data channels. The RED communications satellite has no store-dump or EP capabilities. The RED imagery satellite makes 4 passes over the AO every five days with a west to east ground track walk. The RED imagery satellite has a best ground resolution of 15 m and has no off-axis imaging capability (i.e. vertical imaging only). Downlink is through a 2 megabits per second link at 2.8 GHz and only downlinks within LOS of the RED downlink site which requires 2 to 5 minutes for acquisition and 15 to 25 minutes for image transfer. The RED imagery satellite has no store-dump capability.

Figure II-10 (Continued). TMD Battlespace Assessment Template (2 of 2)

c. Step-1.3 - Determine the Significant Environmental Characteristics of the AO. Battlespace characteristics that affect the commander's decisions or the available command or adversary COAs are of special significance in the TMD IPB process. For TM operations include—

(1) Geopolitical and Regional Threat Assessment. An assessment of the geopolitical and regional situation (Figure II-11) is useful in developing a framework in which TMs will likely be employed. This definition should address national security goals, regional factors, and relations with the US and allies, and be condensed into short bulletized statements. Use the theater level IPB, military capabilities study (MCS), and Defense Intelligence Agency (DIA) as sources and supplement as appropriate where gaps exist.

(2) General TM Force Capabilities. A general understanding of the TM force's capabilities helps orient the TMD IPB process. To develop an understanding, determine, at a minimum, the following TM force parameters:

- (a) TM role/missions/targeting.
- (b) Historical use.
- (c) Order of battle (OB) data.
 - Missile and launcher types and numbers.
 - WMD capabilities and numbers.
 - Known or potential mobile (that is, field operating areas) and fixed TM infrastructures, (that is, research, development, test and evaluation [RDT&E], production and operational garrisons/storage).
 - Performance data (that is, basic flight trajectory and accuracy and lethality data). Examine each characteristic in general terms to identify those of significance to the command and mission. Further evaluation of characteristic effects occurs later in the process. Figure II-12 provides an example template.

(3) TM Force Active Defense Suppression Capabilities Assessment. Assessing the adversary's intent and capability to suppress active TMD operations provides valuable inputs to active TMD operations and security planning. Consider the following information when doing this assessment (template at Figure II-12):

- (a) Historical use of suppression against theater air and missile defenses.
- (b) Distinction between theater air defense and TMD.
- (c) Motivation and intent to suppress active TMD operations.
- (d) Capability to suppress TMD operations.
 - TMs to suppress TMD operations.
 - TM tactics to penetrate active TMD operations.
 - TMs configured with penetration aids (signature reduction, decoys, jammers, etc.).

- Aircraft to suppress active TMD operations.
- ASCMs to suppress ship-based TMD elements.
- Antiradiation missiles and/or electronic combat to suppress TMD radar and C4I elements.
- WMD, special operations forces, terrorist and insurgent forces, combined arms tactics, and/or conventional ground and naval forces (artillery, armor, infantry, naval surface warfare, underwater warfare, etc.) to suppress TMD operations.
- Capabilities to locate TMD assets for suppression.

(4) Major Terrain and Environment. An understanding of the general terrain environment is gained by completing TMD IPB Step-1. For TMD IPB Steps-1 and -2, review and update the current hard copy, digital global geospatial information and services (GGI&S) databases, and imagery. The National Imagery and Mapping Agency (NIMA), a primary source for this data, can provide terrain maps depicting surface configuration (plains, hills, and mountains) and vegetation (forested area, scrub, swamps, desert and open grassland). Figure II-13 is an example of a Central Intelligence Agency (CIA) produced map showing an analysis of terrain. Digital chart of the world (DCW) II can provide an alternative view. TMD IPB Step-2 addresses terrain and environmental effects on TM operations in detail.

(5) Major LOCs. Defining the LOCs (road, rail, and telecommunication networks) is important for the detailed area limitation analysis in TMD IPB Step-2. TMD IPB Step-1 defines and uses the primary road/rail network as an overlay when determining the AO and AOI. Rail networks will typically be less significant for TM operations in most countries. An overlay is not needed if its TM force does not use a particular adversary country's rail network. Also, an overlay for telecommunication networks should be developed. The military telecommunications network is more important than the civilian network, though in many countries the military uses the civilian network. Landlines are of particular importance to TM operations. Use MCS, country studies, or digital intelligence databases to obtain information. Available data within DCW-II and commercial GGI&S systems generated the example (Figure II-13) of a kind of graphic needed for this step.

d. Step-1.4 - Identify the Amount of Detail Required and Feasible Within the Time Available. Understanding the TMD IPB development process is essential in order to collect the required information and to deliver that information in a timely manner. Failing to get the right information to the right place at the right time can result from trying to do too much. Yet, doing too little results in getting the wrong information to the right place at the right time. To avoid this, develop a TMD IPB checklist to gauge the amount and detail of work that needs be accomplished, then build a TMD IPB development plan to schedule the work identified in the TMD IPB checklist (Appendix D). This helps in focusing the development effort to get the right information to the right place at the right time.

Geopolitical and Regional Threat Assessment

Adversary National Security Goals and Desired End State

- Ensure survival of current political regime
- Limit foreign, primarily US and Allies, influence in the region



Adversary Regional Strategic Vulnerabilities

- RED has a weak, but stable economy
- RED has a long-standing dispute with GRAY over border, claims GRAY is their fourth province
- RED has engaged in armed conflict with GRAY twice and BLUE once within the last 50 years
- YELLOW has sold 250 TBMs to RED over the last five years
- YELLOW is assisting RED in establishing a TBM production capability
- YELLOW has sold 150 ASCMs to RED over the last two years
- YELLOW has sold an additional 100 ASCMs to RED for delivery over the next three years

Principal Strategic and Operational Objectives

- Absorb GRAY into RED
- Dominate BLUE
- Deter perceived GRAY and BLUE aggressions

Intent and Strategic Concept of Operations

- RED views US economic and military aid to GRAY and BLUE as a direct threat to RED's national security
- RED views strong US and Blue economic ties as a threat to RED economic security
- Annex GRAY through military invasion
- Force the removal of US and allied forces in the region through the annexation of GRAY and military intimidation of BLUE
- Dominate BLUE through the continued intimidation of BLUE

Notes:

Figure II-11. Geopolitical and Regional Threat Assessment Template

Adversary TM Force Capabilities Assessment

General Capabilities

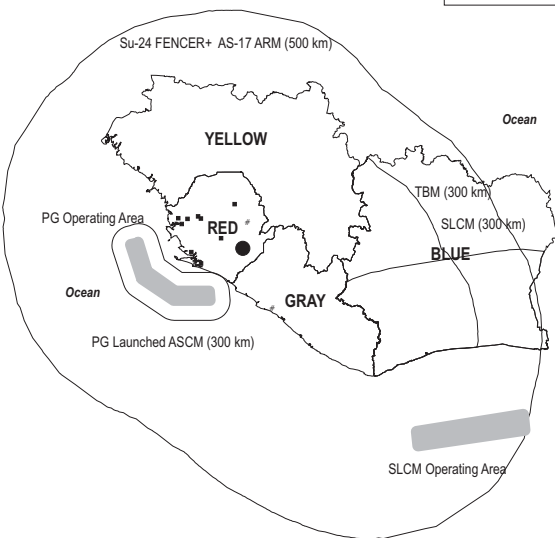

Types and OB of TMs

- ASMs
 - None
- ARMs
 - 72 x Russian AS-17a
 - 12 x Launch Platform - Russian Su-24D FENCER
- ASCMS
 - 96 x YELLOW SSY-N-4
 - 8 x Launch Platforms - Russian OSA II PG
- LACMs - SLCMs
 - 120 x YELLOW SSY-N-2
 - 2 x Launch Platform - French Agosta SS
- TBM s- SRBMs
 - 400 x YELLOW SSY-6
 - 18 x Launch Platform - MAZ-543

Role/Mission/Targeting of TM

- TBMs, LACMs, and SLCMs
 - Strategic weapons - foundation for regional military influence
 - Primary deep strike weapons
 - Key military airfields, key C4I nodes, air defense/TMD sites, and large fixed military logistics/materials sites
 - Possible nuclear and CW dimension, no biological weapon capability
- ASCMS
 - Coastal defense
 - Large surface group formations, aircraft carriers and other major capital and amphibious ships
- ARMs
 - Defense suppression of air and TMD
 - PATRIOT radars, THAAD radars, and possibly AEGIS radars

Historical Use

Known Flight Tests/Training Launches (successes/failures)
 AS-17a ARMs (15/5), SSY-N-4 (35/6), SSY-N-2 SLCMs (6/0), and SSY-6 TBMs (22/3).
 1980 RED-GRAY War
 6 SSY-6s - used against GRAY airfields.
 1988 RED-BLUE War
 2 BLUE frigates attacked with 8 RED SSY-N-4 ASCMs.
 1 frigate sunk and one severely damaged.
 1992 RED-GRAY War
 12 AS-17a ARMs used in three separate attacks.
 AS-17a targeted Russian-supplied GRAY SA-2 radars.
 46 SSY-6 TBMs used against key GRAY airfields.
 12 SSY-6 TBMs used against key GRAY C4I nodes.
 4 SSY-N-4 ASCMs used against a GRAY PG.
 SSY-N-2 SLCM never used in combat.
 RED never used WMD in combat.

Employment Concepts

- TBMs
 - Deploy before conflict initiation to conduct mobile field operations.
 - Launchers move into hide sites, then to launch sites and launch.
 - After launch, launchers move to different hide site, then to transload site.
 - Missiles/fuel/warheads move from field storage sites to transload sites.
 - Transload site prepares and reloads missile/reload launchers upon arrival.
 - After reload, launchers move to new hide site. Cycle repeats.
- SLCMs
 - Deploy to operating area off BLUE coast prior to conflict initiation.
- ASCMS
 - Deploy to operating area off RED coast/capital port prior to conflict initiation.
 - Conduct defensive operations against hostile navy attacking capital.
- ARMs
 - Operate from home airfields.
 - Su-24D FENCERs fly to BLUE border and launch ARMs.
 - Primary target: THAAD and then PATRIOT radars.

TM Characteristics and Performance

Parameters	AS-17a	SSY-N-4 ASCM	SSY-N-2 SLCM	SSY-6 TBM
Propulsion Type	Turbojet	Turbojet	Turbojet	Single Stage Liquid
Length (m)	5	5	4.5	12
Diameter (m)	0.35	1	0.75	1
Wing Span (m)	1.2	2	1.75	1.8 (tail-fin span)
Maximum Range (km)	100	50	500	300
Minimum Range (km)	5	2	50	30
Accuracy (circular error probable) (m)	2	5	200	500
Maximum Range Apogee (m)	120,000 (lofted profile)	NA	NA	100
Nominal Launch Altitude (m)	500 - 25,000	Sea-level	Sea-level to -90	Ground-level
Nominal Cruise Altitude (m)	Loft-dive or direct descent	25	100	32,000 (burnout altitude)
Nominal Cruise Speed (mach)	2.5 - 3.2	0.75	0.80	1,700 m/s (burnout velocity)
Maximum Time of Flight (minutes)	5.5	25	270	16
Payload Mass	100	500	500	1,000
Warhead Mass	90	400	425	850
Payload Options	Semi-Armor Piercing	Semi-Armor Piercing	Unitary HE, CW, & Nuclear	Unitary HE, CW, & Nuclear HE & CW Submunitions

Figure II-12. Adversary TM Force Capabilities Assessment Template (1 of 2)

Adversary TM Force Capabilities Assessment

Active Defense Suppression Capabilities

Motivation and Intent

Motivation - US and allied TMD and TAD forces can destroy or at a minimum neutralize RED theater air and missile forces, effectively rendering them useless.

Intent - Given RED priority for TM forces and historical use of SEAD, RED is assessed to be highly motivated to conduct active defense suppression of US and allied TMD forces. Therefore, it is assessed that RED intent is to suppress active defenses with available military forces when operationally feasible.

Historical Use of Suppression of Active Air or TMD

During the 1992 RED-GRAY war, RED conducted 3 separate SEAD attacks against GRAY SA-2 radars. In each attack, RED used 2 Su-24 FENCER Ds, with each launching 2 AS-17a ARMs.

TAD Versus TMD

RED places a higher strategic value on its TBM and SLCM force and is therefore assessed to place at least the same priority on countering US and allied TMD as on countering US and allied TAD forces. However, defense against air attack by the US and allied air forces is first priority for the RED air force.

Capability to Locate TMD Assets for Suppression

The primary intelligence asset available to RED will be indigenous personnel sympathetic to RED and inserted intelligence covert operations. These in-place agents will likely blend in with the local populace to avoid detection. They may carry still or video cameras, as well as small hand-held GPS receivers for recce in support of targeting US and allied TMD assets by other RED forces. They are not expected to carry laser ranging equipment, laser designators for PGMs, or weapons.

The use of SOF teams is possible, but will likely have difficulty in being inserted in a timely fashion. If inserted, they are not expected to present a physical threat unless RED perceives that hostilities are a direct threat to the current political regime. The SOF teams will likely conduct recce to support targeting by other RED forces. SOF teams may include laser designators for directing PGMs onto US and allied TMD assets.

RED has 6-8 French built Mirage III fighters configured for recce and could use them against US and allied TMD assets. However, their survival against US and allied TAD is questionable. See doctrinal templates for these recce configured Mirage IIIs and details on deployment, performance, characteristics, and tactics.

RED operates a handful of mobile ELINT vehicles; however, their range is limited to less than 50 km, placing them out of range of the current deployment for US and allied TMD assets.

Suppression Capabilities

Suppression Capability	Applicable To:
TMs in Suppression Role - Probable against land-based TMD assets and very probable against sea-based TMD assets using ASCMs.	PATRIOT, THAAD, and TMD equipped AEGIS CGs and DDGs.
TM Penetration Tactics - Only salvo launch is expected with 6-12 TBMs or SLCMs against a single target within a 1-minute time span.	PATRIOT, THAAD, and TMD equipped AEGIS CGs and DDGs.
TM TMD Countermeasures - Only simple RCS reduction expected.	PATRIOT, THAAD, and TMD equipped AEGIS CGs and DDGs.
Aircraft - Very probable if aircraft can survive to weapon release points.	PATRIOT, THAAD, and TMD equipped AEGIS CGs and DDGs.
ASCMs to Suppress TMD Capable Ships - Very probable.	TMD equipped AEGIS CGs and DDGs.
ARMs - Very probable if aircraft can survive to weapon release points.	PATRIOT, THAAD, and TMD equipped AEGIS CGs and DDGs.
Information Warfare (Including EC) - Very unlikely, no known capability.	PATRIOT, THAAD, and TMD equipped AEGIS CGs and DDGs.
WMD - Not expected in a active defense suppression role.	PATRIOT, THAAD, and TMD equipped AEGIS CGs and DDGs.
SOF - Medium probability in an intelligence collection role and very low probability for physical attack role.	PATRIOT and THAAD.
Terrorist and Insurgent Forces - Very probable for intelligence collection role and very low probability for physical attack role.	PATRIOT and THAAD.
Conventional Ground Forces - Very unlikely.	PATRIOT and THAAD.
Conventional Naval Forces - Unlikely.	TMD equipped AEGIS CGs and DDGs.
Combined Arms Tactics - Unlikely.	PATRIOT, THAAD, and TMD equipped AEGIS CGs and DDGs.

Figure II-12 (Continued). Adversary TM Force Capabilities Assessment Template (2 of 2)

Major Terrain and LOC Overview

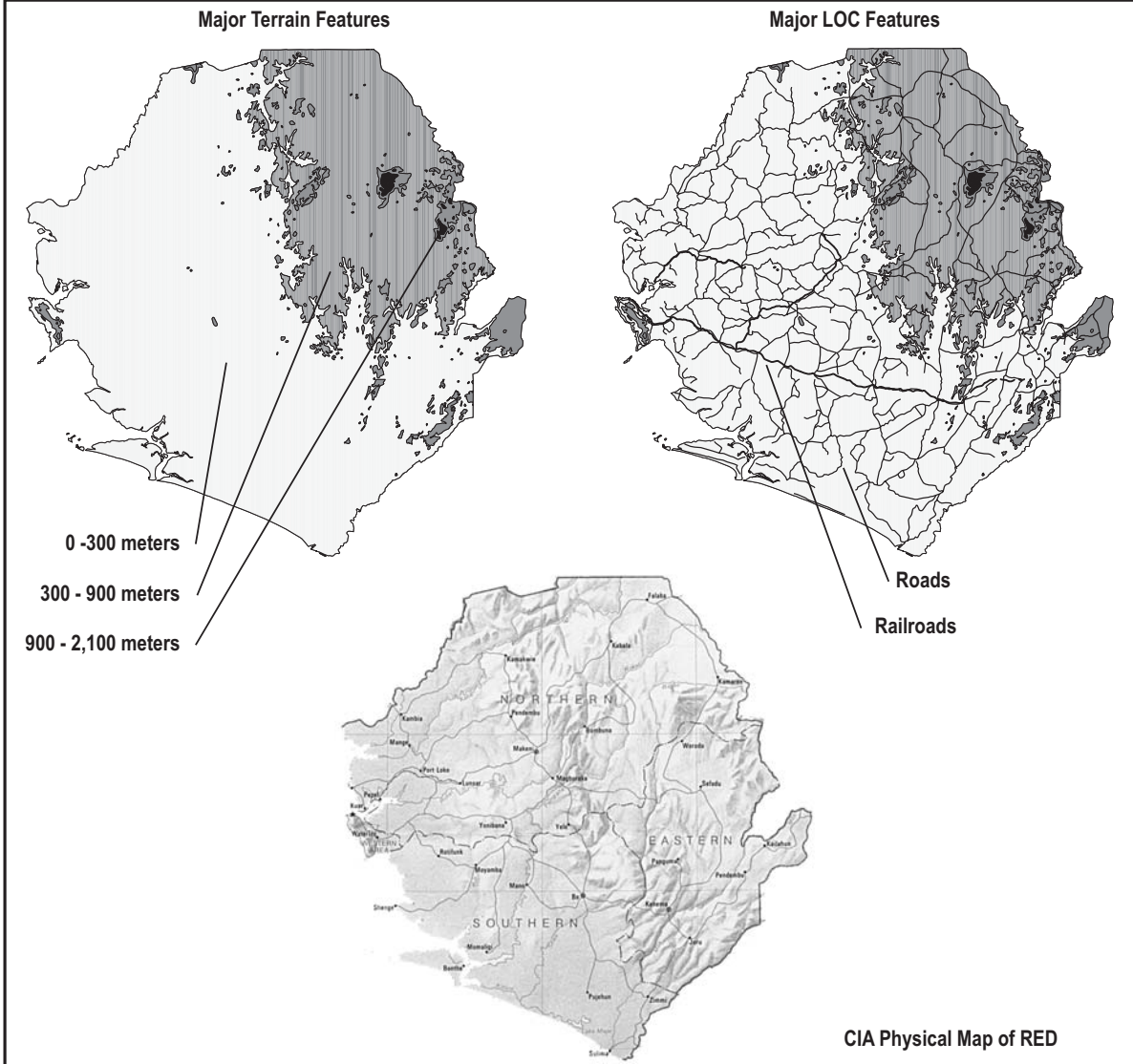

Area:	Total: 71,740 km ² Land Only: 71,620 km ² Water Only: 120 km ²
Area-Comparitive:	Slightly smaller than South Carolina
Land Boundaries:	Total: 958 km Border with GRAY: 306 km Border with YELLOW: 652 km Coastline: 402 km
Maritime Claims:	Territorial Sea: 200 km Continental Shelf: 200-m depth or to the depth of exploration

Terrain:	Coastal belt of mangrove swamps, wooded hill country, upland plateau, and mountains in the east	
Elevation Extremes:	Lowest Point:	0 meters (Ocean)
	Highest Point:	1,948 meters (Loma Mansa)
Land Use:	Arable Land:	7%
	Permanent Crops:	1%
	Permanent Pastures:	31%
	Forests and Woodland:	28%
	Other:	33% (1993 estimate)
Irrigated Land:	290 km ² (1993 estimate)	

Figure II-13. Major Terrain and LOC Overview Template

e. Step-1.5 - Evaluate Existing Databases and Identify Gaps. The TMD IPB database will not have all the intelligence and information required to evaluate the effects of each battlespace characteristic and each TM force. Databases only contain a fraction of the information required to support TMD IPB development. Hardcopy reports are still very valuable sources of information. Maps are essential and digital maps are required. Valuable on-line sources include intelligence link (INTELINK) and near real time links (that is, tactical related applications [TRAP] data dissemination service [TDDS], tactical information broadcast service [TIBS], Joint Tactical Information Distribution System, and moving target indicator feeds). Open source resources include books, periodicals, academia and industry. Identifying intelligence gaps early allows for data collection operations before the start of combat operations. In many cases, support from other intelligence organizations is needed to obtain and analyze data to fill gaps. Identifying gaps that cannot be filled within the time allowed is equally important in developing the TMD IPB. Maintain communication with the command staff regarding the gaps not expected to be filled and formulate reasonable assumptions. Identify gaps by identifying organizational sources and points of contact (POCs); identifying current, on-order, and desired information holdings and connectivity to sources (Appendix B, Figure B-10); evaluating the identified sources; and assess the critical gaps in the information relative to the TMD IPB steps (Appendix B, Figure B-11).

(1) IPB Holdings and Database Assessment. It is good practice to maintain a log of the information holdings. Each organization handles this function differently. Some organizations use a library function to keep a log of information holdings and others find it more efficient to develop and maintain ones own log. Appendix B, Figure B-10 shows one way to catalog the information holdings. Ideally, maintain the catalog within a computerized database accessible over a network.

(2) POCs. No single organization can accomplish the TMD IPB process alone and support is needed from outside organizations. To develop a complete and accurate TMD IPB, it is important to identify and establish national through theater level POCs early. Establish a POC for each of the organizations identified in the organizational sources template (Appendix B, Figure B-10). A general purpose computerized personal information manager or contact manager is very useful in managing POCs. See Appendix B, Figure B-12, to build a list of POCs manually.

f. Step-1.6. Collect the Material and Intelligence Required to Support Further TMD IPB Analysis. Collecting intelligence and incorporating it into the TMD IPB process is a continuous effort. The TMD intelligence team fills intelligence gaps by initiating collection operations through priority intelligence requirements (PIRs), essential elements of information (EEIs), and requests for information (RFIs). Additional intelligence data is applied to the appropriate steps to allow updating of all TMD IPB products.

(1) PIRs, EEIs, and RFIs. PIRs represent the commander's most important intelligence requirements that are prioritized according to relative value. PIRs are single requirements, typically in the form of a single question

and oriented towards identifying the COA an adversary is executing. Recommended PIRs are typically submitted to the command's intelligence collection manager who submits them and other command PIRs to the commander for approval. The collection manager is then responsible for submitting the PIRs to the appropriate intelligence functions for collection. EEIs identify information needed to support a wide variety of standing information requirements and may duplicate PIRs. The TMD IPB team typically submits EEIs to the command's intelligence collection management that then racks and stacks them with other command EEIs to form the command's collection requirements. RFIs are used to request any needed information that does not fall into the PIR or EEI categories and range from simple to very complex requests. See Appendix B, Figure B-13 for a PIR, EEI, and RFI worksheet.

(2) Information Searches. Appendix B, Figures B-14 through B-16 assist in developing initial information search profiles for documents, text message retrieval, digital databases (INTELINK, modernized integrated database [MIDB], National Exploitation System), and other digital information sources. Conduct information searches early, as they are useful for performing parts of TMD IPB Step-1. After the initial search is complete, review the data for relevancy and accuracy. This review refines the search profiles that is critical to retrieving the appropriate information. A narrow search profile results in missed information, while a wide search profile results in information overload. The search profile is relatively static during peacetime. During crisis, it needs to be dynamic to keep up with changing adversary and friendly situations. The information retrieval specialists are essential to getting the search criteria correct for the current situation, because each search system is different and requires different filtering criteria to achieve the desired results. The *key* is to interact frequently with the information retrieval specialists.

Chapter III

STEP-2: DEFINE THE BATTLESPACE EFFECTS

1. What Is It?

a. Definition. Step-2 determines how the battlespace environment affects adversary TM and friendly TMD operations.

b. Desired End Effect. The desired end effect is the identification of how the battlespace environment influences adversary TM and friendly TMD operations. Terrain plays an important role because TM systems are so mobile. By focusing on terrain suitability for TM and TMD operations based on geography, weather, and the technical characteristics of the TM equipment and forces, the terrain assessment process analyzes the military aspects of the terrain. Two primary objectives of the TMD IPB terrain assessment are— identification of potential mobility areas within TM force operating areas and identification of exploited terrain for countering mobile TM operations. Terrain analysis is not the end product of the TMD IPB process. It is the means to determine which friendly COAs best exploit the terrain and how the terrain affects the adversary's available TM COAs and friendly forces ability to defend against them.

2. How To Do It For TMD

Step-2 is concerned with the evaluation and integration of the various environmental and infrastructure factors affecting adversary TM force operations. The primary steps in Step-2 are shown in Figure III.

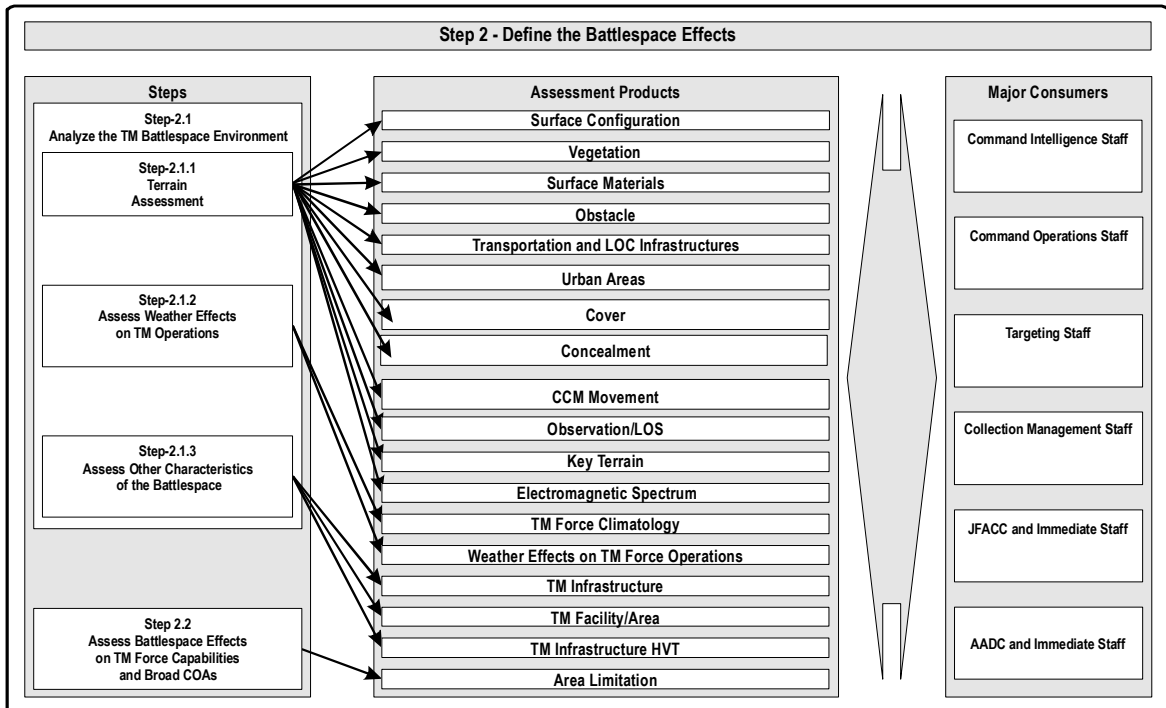

Figure III-1. Step 2 - Define the Battlespace Effects

Generally, the AO is evaluated in more detail than the AOI. The focus also varies for different TMD mission areas. For example, an active defense only IPB analysis would reduce the urgency for a detailed missile infrastructure analysis. The battlespace is not homogeneous because certain areas or sub-sectors will affect various types of operations in varying degrees. During the evaluation, identify those areas that favor each type of operation and consider traditional operations (defense and offense) as well as operations associated with any specific operational factors (launch, transload, etc.). The following discussion focuses on adversary capabilities and effects, but the processes are also required for analysis of friendly TMD operations.

a. Step-2.1 - Analyze the TM Battlespace Environment. The detail in which the battlespace environment is analyzed varies depending on the command's mission, the general TM forces' capabilities, and each battlespace dimension's relative significance or importance to the specific command operation being planned. Military planning requirements generally require a more detailed evaluation of the AO than the AOI. Since the battlespace is not homogeneous, various air, land, and maritime areas may require greater or lesser analysis depending on the relative geographical complexity of the region. Each battlespace dimension's environment is analyzed for its military aspects and evaluated for its effects on military operations. In the case of SLCM, air-launched cruise missiles (ALCMs), and ASMs, give special consideration to analyzing the maritime and air dimensions and their effects on TM operations. Weather is considered in terms of its ability to modify each dimension's environment and as a separate factor capable of directly affecting military operations. For example, heavy rainfall modifies the land environment by swelling streams and degrading/reducing soil trafficability, but it can also directly impact military operations across the spectrum of all battlespace dimensions by reducing visibility.

(1) It is important to focus the analysis, because performing a detailed terrain analysis is generally unrealistic for very large areas. TMs normally operate over much more constrained geographic areas. An assessment is made to define a TM force's field operating areas and to focus terrain and weather analysis to only those areas from which the TM force is likely to operate. If time allows, expand the analysis areas to where TM operations could take place.

(2) Maritime Dimension Considerations. The maritime dimension of the battlespace is the environment in which all naval operations take place to include SLCM operations. The maritime dimension is influenced both by the sea and the littorals. When conducting IPB against SLCMs, examine the effects of maritime geography on the battlespace for both the AO and AOI. Key military aspects of the maritime dimension include maneuver space and chokepoints, natural harbors, anchorages, ports, naval bases, sea LOCs, and the hydrographic and topographic characteristics of the ocean floor and littoral land mass. Base the evaluation of these key aspects on the degree to which they control or dominate SLCM operations. Evaluate the location of adversary naval bases in relation to how well they support SLCM operations. Identify adversary axes and avenues of approach, high-risk areas, low-risk areas, and potential naval engagement areas. The end result is an evaluation of how the maritime environment helps or hinders SLCM operations. Identifying potential SLCM launch locations is the ultimate goal. Identifying these areas is problematic and

depends largely on factors such as friendly target locations, SLCM ranges, and the specific launch platform (that is, surface combatant vice submarine). For example, analyze bottom composition and fathom curves to determine the possible locations of subsurface threats (particularly quieted diesel submarines) within SCLM range of potential targets.

(3) Air Dimension Considerations. The air dimension of the battlespace is the environment in which ALCM and ASM operations are conducted. IPB against these threats is also focused on the launch platforms more so than the missile itself. Give special consideration during the IPB process in analyzing how the air dimension affects these platforms. When conducting TMD IPB against ALCMs and ASMs, analyze air avenues of approach. Likely approaches are those that protect the launch platforms from detection and engagement (masking terrain) while still allowing maneuver and providing adequate line-of-sight (LOS) to the target. Other factors that affect ALCM/ASM platforms include attack profiles, ordnance, point of origin, and ground control radar positions. Ordnance or payload may affect range and altitude and will probably influence the avenues of approach. Adverse weather may also affect the enemy's ability to employ these air-breathing launch platforms. The air dimension is analyzed in a 2-step process that analyzes the various military aspects of the environment and then evaluates how the environment affects military operations. The first step is to identify and locate friendly assets that are potential adversary targets. This is followed by identifying adversary airfields from which air attacks might be launched and that are within range of the previously identified target areas. The surface and air environment located between these adversary airfields and friendly targets are then analyzed to determine likely air avenues of approach and to determine any other characteristics of the air dimension that may influence ALCM/ASM launch operations. The ultimate purpose of this type of analysis is to determine the optimal air attack heading and profile in effect, the ALCM/ASM forward operating locations.

b. Step-2.1.1 - Terrain Assessment. The best TMD IPB terrain analysis technique is a combined approach using automated terrain analysis tools supplemented by reconnaissance and manual techniques using high-resolution maps and imagery. A comprehensive TMD IPB terrain analysis integrates data developed during TMD IPB Steps 1, 2, and 3 and is iterative throughout the effort.

(1) Analysis of Military Terrain Aspects. To conduct this analysis, break down the elements of the battlespace terrain and analyze each aspect. Key aspects are—

- (a) Surface configuration (includes land, sea and littoral).
- (b) Vegetation.
- (c) Surface materials.
- (d) Obstacles.
- (e) Transportation and LOC infrastructures.

- (f) Urban areas.
- (g) Cover.
- (h) Concealment.
- (i) Cross-country movement (CCM).
- (j) Observation/ LOS.
- (k) Key terrain.
- (l) Electromagnetic (EM) spectrum.

Consider all of these factors when analyzing terrain but focus on the ones most relevant to the specific situation and the commander's needs. Evaluate the factors in the order that best supports the analysis. Each terrain analysis template has its own requirements for either digital data and/or hard copy maps/charts (Appendix B, Table B-1). In most cases, only limited types of digital data and hard copy maps/charts will be available.

(2) Terrain Feature Data. Terrain feature data is used throughout the terrain analysis process. NIMA's foundation feature data (FFD) classifies terrain features data across multiple GGI&S products. Appendix B, Figure B-17 provides a suggested template for identifying terrain FFD codes, attributes, and values.

(3) Terrain Reconnaissance. Identify the terrain knowledge gaps that analysis cannot satisfy. Use these gaps as a guide for reconnaissance planning and focus the reconnaissance on the areas most important to the mission. When feasible, supplement the predeployment terrain analyses with actual reconnaissance.

(4) Terrain Analysis and Weather. Terrain analysis must always consider weather effects. The terrain analysts should work closely with the weather detachment or staff weather officer to ensure that the analysis incorporates the effects of current and projected weather. Terrain analysis is a continuous process and changes in the battlespace environment may alter the evaluations of its terrain-derived effects. For example, if built-up areas are reduced to rubble or LOCs are destroyed in battle, reevaluate the mobility characteristics of the AO. Similarly, if weather conditions change, reevaluate the terrain's impact on military operations. Finally, TM unit operations use organic engineering capabilities to develop hide and launch locations in areas previously judged unsuitable.

(5) Terrain Analysis and TM Force COAs. Evaluating terrain effects identifies the battlespace areas that affect each TM force's COA. For example, terrain effect evaluation helps identify areas best suited for launch sites/areas, airfields, ports, fire control sites, hide sites, transloading areas, forward operating locations (FOLs), and forward storage areas.

(6) Terrain Analysis Templates. There are 12 basic types of terrain analysis templates applicable to TMD IPB development. See Appendix B, Figure B-18 for a suggested checklist to determine which ones apply to a particular

TMD IPB development. Templates provide a good method for tracking the status of the terrain analysis. Use USA FM 3-34.33 (FM 5-33), *Terrain Analysis*, as the primary source for terrain analysis techniques and analytical procedures. The following sections provide the primary terrain analysis steps and resultant templates. Step-1 is identical for each section.

(a) Surface Configuration. A surface configuration template depicts the terrain's slope by using degrees or percent of slope. Terrain slope affects area suitability for TM force operations (launch, missile handling, field storage, and radar siting). The surface configuration template helps determine cross-country mobility. Use the following terrain analysis steps to produce the land surface configuration and bathymetric surface configuration templates.

- Step-1. Retrieve available data. Depending on the type of FFD available (see Appendix B, Figure B-17), use automated terrain analysis tools or manual terrain analysis techniques (see USA FM 3-34.33 [FM 5-33] for the remaining steps).

- Step-2 (Optional for land surface configuration). Plot elevation/depth contours. Select an appropriate contour interval for the current TMD IPB development. Five, 10, and 20 meters (m) are typical values for contour intervals.

- Step-3 (Optional). Plot identified (see Appendix B, Figure B-17) surface drainage features. Label the outlined areas with a W.

- Step-4 (Optional). Plot dissected terrain (pits, quarries, dumps, piles, landfills, ravines, gorges, etc.). Most of these features are easily recognized on topographic maps.

- Step-5. Define, plot, and code label the desired slope categories (see Appendix B, Figure B-19).

(b) Vegetation. A vegetation overlay shows the natural and cultivated vegetated areas. It helps determine LOS, cover, concealment, and the capability of the TM force's equipment to move cross-country. Use the following terrain analysis steps and USA FM 3-34.33 (FM 5-33) to produce the vegetation template:

- Step-1. Retrieve available data. Depending on the type of FFD available (see Appendix B, Figure B-17) use automated terrain analysis tools or manual terrain analysis techniques (see USA FM 3-34.33 [FM 5-33] for the remaining steps).

- Step-2 (Optional). Plot identified surface drainage features (see Appendix B, Figure B-17). Label the outlined areas with a W.

- Step-3 (Optional). Use available imagery or human intelligence (HUMINT) resources to identify vegetation areas by type that are not in the vegetation FFD. Use the dominant (60 percent or greater) vegetation in the area to type an area with mixed vegetation. Digitize previously unavailable data and add it to the available local vegetation FFD.

- Step-4. Plot the boundaries and areas of all identified vegetation types using the vegetation FFD and overhead or HUMINT from Step-3. Label and code each type of vegetation (see Appendix B, Table B-2). Use additional user defined codes as required.

Note: After completing each of the following steps through Step-7, apply step results to Step-8. Digitize the previously unavailable data and add it to the available local vegetation FFD.

- Step-5 (Optional). Determine the canopy closure and mean height to the canopy top for each forested area using the coding standard in Appendix B, Table B-2. Add the canopy closure and height results to Step-4.

- Step-6 (Optional). Determine the tree crown diameter for each forested area. Tree crown diameter is the distance across the spread of a tree crown and is measured in meters.

- Step-7 (Optional). Determine the mean stem diameter and the stem spacing for each forested area. Tree stem diameter is the diameter of a tree at 1.4 m above the ground. Stem spacing is the distance from the center of one tree to the center of the nearest adjacent tree.

- Step-8 (Optional). Estimate the vegetation roughness factor (VRF) for each vegetation area. The VRF is a numerical estimation of vehicular speed degradation when moving over flat terrain and through a particular type of vegetation. The factor decreases from 1.0 (no speed degradation) to 0.00 (vegetation roughness does not permit off-road mobility). For example, grassland with little slowdown effect has a VRF of 1.0 to 0.9 but virtually impassable swamp with dense ground vegetation, fallen branches and trees, and exposed stumps has a VRF of 0.1. The VRF designated to a vegetation category is subjective and designated by the terrain analyst.

(c) Surface Materials. A surface materials' template shows the natural and cultivated vegetated areas. It helps determine LOS, cover, concealment, and the capability of the TM force's equipment to move cross-country. Use the following terrain analysis steps and USA FM 3-34.33 (FM 5-33) to produce the surface materials' template.

- Step-1. Retrieve available data. Depending on the type of FFD available (see Appendix B, Figure B-17) use automated terrain analysis tools or manual terrain analysis techniques (see USA FM 3-34.33 [FM 5-33]) for the remaining steps.

- Step-2 (Optional). Plot identified surface drainage features (use Figure B-17). Label the outlined areas with a W.

- Step-3 (Optional). Plot built-up area features using completed Figure B-17. Label the outlined areas with an X.

- Step-4 (Optional). Plot permanent snowfield features using completed Appendix B, Figure B-17. Label the outlined areas with a PS.

- Step-5 (Optional). Plot salt evaporators and salt encrustation features using completed Appendix B, Figure B-17. Label the outlined areas with an EV.

- Step-6 (Optional). Use available imagery or HUMINT resources to identify any surface material areas by type that are not contained in the available surface material FFD. Use the dominant (60 percent or greater) surface material in the area to type an area with mixed types. Digitize previously unavailable data and add it to the available local surface materials FFD.

- Step-7 (Optional). Plot exposed bedrock features or those void of surface materials using completed Appendix B, Figure B-17. Label the outlined areas with a RK.

- Step-8. Plot the boundaries and areas of all identified surface material types using surface materials FFD and overhead or HUMINT from Step-6. Label each surface material type using the codes in Appendix B, Figure B-17. A 3d digit is used with the Unified Soils Classification System (USCS) (see Appendix B, Table B-3). The 3d through 6th digit indicates the surface roughness factor from the next step. Do not assign a surface roughness factor to the USCS codes RK, PS, EV, X, and W. Use additional user defined codes as required. See Appendix B, Table B-4 for landforms and commonly associated soils to assist in identifying surface materials.

- Step-9. Estimate surface roughness factors and compute the degree to which a vehicle's speed is degraded by surface characteristics (boulder fields, gullies, and rugged bedrock). Factors can be any number from 0.00 to 1.00 in 0.05 increments. The surface roughness factor of 1.00 indicates no vehicle speed degradation while a 0.80 factor indicates a degradation by 20 percent. In estimating the factor, consider all physical characteristics of the feature as well as vehicle characteristics (ground clearance, wheel size, etc.). Estimate surface roughness factors for the primary TM force vehicle or create a surface materials template for each important TM vehicle type.

(d) Obstacles. An obstacle template depicts the location and type of man-made or natural movement obstacles. It is used with the other terrain analysis templates to produce cross-country movement overlays. Use the following terrain analysis steps to produce the land obstacles and nautical obstacles templates:

- Step-1. Retrieve available data. Depending on the type of FFD available (see Appendix B, Figure B-17) use automated terrain analysis tools or manual terrain analysis techniques (see USA FM 3-34.33 [FM 5-33]) for the remaining steps.

- Step-2 (Optional). Use available imagery or HUMINT resources to identify any obstacles by type that are not contained in available surface material FFD. Start with the LOC infrastructure and search along its infrastructure. Digitize previously unavailable data and add it to the available local obstacle FFD.

- Step-3. Plot existing obstacle features (see Appendix B, Figure B-17) using the appropriate military symbology.

(e) Transportation and LOC Infrastructures. Transportation and LOC infrastructure templates show the 2 infrastructures. Transportation is all the routes (land, sea, and air) within the operating area of a TM force. Air transportation includes all of the routes for air delivered TMs from the operating base to the targets. LOCs are all the supply and equipment routes (land, sea, and air) that connect an operating military force with a base of operations. Use the following terrain analysis steps to produce the road transportation and LOC template; railroad transportation and LOC template; air lanes and LOC template; and port transportation, inland waterways and LOC template:

Note: To perform the labeling and coding in the following steps, use the symbology and coding in USA FM 3-25.31 (FM 21-31), Topographic Symbols, USA FM 3-34.33 (FM 5-33) and Appendix B, Figure B-20. After completing each of the steps, digitize the previously unavailable data and add it to the available local transportation and LOC FFD.

- Step-1. Retrieve available data. Depending on the type of FFD available (see Appendix B, Figure B-17) use automated terrain analysis tools or manual terrain analysis techniques (see USA FM 3-34.33 [FM 5-33]) for the remaining steps.

- Step-2. Use available imagery or HUMINT resources to perform an analysis of the terrain to locate all appropriate transportation and LOC features. Restrict the transportation and LOC analysis to the transportation infrastructure operating areas and the LOC infrastructure routes connecting the field operating areas and fixed locations. This step is necessary since most NIMA GGI&S products are either incomplete, out-of-date, or lack the resolution to support TMD IPB transportation and LOC analysis.

Note: For each unique segment of the transportation and LOC infrastructures, do the following steps:

- Step-3 (Optional). Identify and label the surface material of the roads.

- Step-4 (Optional). Determine the minimum road width and number of lanes. Each segment is assigned a minimum width value (see Appendix B, Table B-5 for military map lane widths). Always use a decimal point to record the segment width (5 m = 5.0 m) and place that number parallel to the segment. Note and label every point at which a change in width occurs and place a segment symbol at each.

- Step-5 (Optional). Determine the gradient, degree, or percent of slope when it exceeds a predefined value (less than or equal to 17 or 25 degrees) based on the equipment templates from TMD IPB Step-3. Place an arrowhead symbol at each end of the gradient with the flat end of the arrowhead at the bottom of the grade and the point of the arrowhead at the top.

- Step-6 (Optional). Depict constrictions when the segment narrows to less than a predefined value (default of 3 m) based on the TMD IPB Step-3 equipment templates. Indicate the width measurement adjacent to the arrowhead symbol.
- Step-7 (Optional). Depict all sharp curves with a radius in meters of a predefined value (default of 30 m) based on TMD IPB Step-3 equipment templates. Indicate the width measurement adjacent to the arrowhead symbol.
- Step-8 (Optional). Depict all features that are currently under construction with the circled symbol "UC."
- Step-9 (Optional). Determine and label each bridge segment's length and width and height clearances in meters and its military load classification in tons.
- Step-10. Determine each bridge segment's bypass potential within a 2 km distance from the bridge. Rate and label the bypass potential as either easy, difficult, or impossible.
- Step-11. Determine and label each segment's under-bridge width and height clearance in meters.
- Step-12. Determine and label each tunnel segment's length, width and height clearances, and overburden depth in meters.
- Step-13. Determine each tunnel segment's bypass potential within a 2 km distance from the tunnel. Rate and label the bypass potential as either easy, difficult, or impossible
- Step-14 (Optional). Estimate and label each fording location's length and width and each ferry location's length and capacity.
- Step-15. Plot each runway outline to show which way it is oriented. Determine its length, width, and surface material. Label the facility as either airfield, heliport, or both.
- Step-16 (Optional). Determine and label all railroad segment track gages and any point a change occurs.

(f) Urban Areas. An urban areas template depicts built-up areas that could conceal TM equipment and forces. Use the following terrain analysis steps to produce the urban areas template:

Note: To perform the labeling and coding in the following steps, use the symbology and coding in USA FM 3-25.31 (FM 21-31), USA FM 3-34.33 (FM 5-33) and Appendix B, Table B-6. After completing each of the steps, digitize the previously unavailable data and add it to the local obstacle or transportation FFD.

- Step-1. Retrieve available data. Depending on the type of FFD available (see Appendix B, Figure B-17) use automated terrain analysis tools or manual terrain analysis techniques (see USA FM 3-34.33 [FM 5-33]) for the remaining steps.

- Step-2 (Optional). Use available imagery to identify any built-up areas which are not contained in available surface material FFD. Start with the LOC infrastructure and search along it.

- Step-3. Plot and label all built-up area boundaries.

- Step-4 (Optional). Divide and label the urban areas by dominant (60 percent or greater) building type into smaller areas.

(g) Cover. A cover template depicts locations and terrain features which can provide the TM force cover from friendly attack operations. Use the following terrain analysis steps to produce the land cover and nautical cover templates.

- Step-1. Retrieve available data. Depending on the type of FFD available (see Appendix B, Figure B-17) use automated terrain analysis tools or manual terrain analysis techniques (see USA FM 3-34.33 [FM 5-33]) for the remaining steps.

- Step-2. Determine the potential friendly attack assets and their capabilities from the commander's guidance and command OPLANs. Information on the general types of weapon systems and capabilities that penetrate and destroy hardened targets is needed. Information from higher should suffice for this step.

- Step-3. Using Step-2 information, examine each terrain feature found in all previous templates and determine which terrain features provide potential cover from the command's TMD attack assets. Plot and label features. If the command has a fully deployed air capability with significant assets allocated to TMD attack operations, very few terrain features may provide cover. For example, current precision-guided munitions can penetrate significantly hardened targets and only deep tunnels may be capable of providing cover. Consider all factors when determining a terrain feature's potential for providing cover.

(h) Concealment. A concealment template depicts potential TM force hide locations. Concealment is protection from friendly observation. Use the following terrain analysis steps to produce the friendly air defense and TMD radar masking template; friendly airborne radar masking template; and friendly surface radar masking template.

- Step-1. Retrieve available data. Depending on the type of FFD available (see Appendix B, Figure B-17) use automated terrain analysis tools or manual terrain analysis techniques (see USA FM 3-34.33 [FM 5-33]) for the remaining steps.

- Step-2. Determine the potential friendly intelligence, surveillance, reconnaissance (ISR) assets and their capabilities from the commander's guidance and command OPLANs. Information on the general types of ISR systems and capabilities used to observe TM forces is needed.

- Step-3. Using information from Step-2, examine each terrain feature found in all previous templates and determine which terrain features provide potential concealment from the command's TMD ISR assets. Plot and label using USA FM 3-25.31 (FM 21-31) and FM 3-34.33 (FM 5-33). Consider all relevant factors when determining a terrain feature's potential for providing concealment.

(i) CCM. A CCM template depicts the mobility of a TM force. Also referred to as an avenue of approach overlay, the CCM template depicts the mobility corridors and best off-road routes TM vehicles can use to get to an objective. It also shows the terrain that these vehicles cannot cross. It relies on many of the previously produced templates, such as surface configuration and obstacle templates and vegetation and surface materials templates. CCM analysis is a very manually intensive process; when possible, use automated terrain analysis tools. Use the following terrain analysis steps to produce the CCM template:

- Step-1. Retrieve available data. Depending on the type of FFD available (see Appendix B, Figure B-17) use automated terrain analysis tools or manual terrain analysis techniques (see USA FM 3-34.33 [FM 5-33]) for the remaining steps.

- Step-2. Determine the types of vehicles and conditions (dry, wet or both) for which CCM templates will be developed. Several templates may be required to support a TMD IPB development. The following is typical for a TBM case in an environment with both a dry and wet season:

- TBM transporter erector launcher (TEL) dry season CCM template.
- TBM TEL wet season CCM template.
- TBM GSE vehicles dry season CCM template.
- TBM GSE vehicles wet season CCM template.

- Step-3. Retrieve and consider the below factors for each overlay. Estimate the ones that can not be calculated (see USA FM 3-34.33 [FM 5-33] to calculate) and ignore those with insufficient data. Most of the factors are on the previously constructed templates (surface configuration and vegetation). If required, consider and use additional factors. Use Appendix B, Figure B-21 to gather all the factors and start the CCM template production. The standard terrain analysis factors are—

- Road slope versus maximum vehicle speed. Express in kilometers per hour (kph).
- Off-road slope versus maximum vehicle speed (express in kph).

- Slope-intercept-frequency. This is the number of times the ground surface changes between positive and negative slopes over a 1 km distance. Express as a factor between 0.00 and 1.00.

- Dry soils. Express as a factor between 0.00 and 1.00 for each soil type.

- Wet soils. Express as a factor between 0.00 and 1.00 for each soil type.

- Surface roughness. Express as a factor between 0.00 and 1.00.

- VRF. Express as a factor between 0.00 and 1.00 for each vegetation type.

- Vegetation. This is the combination of VRF, vehicle factor, vehicle clearance factor, and vehicle override. Express as a factor between 0.00 and 1.00.

- Step-4. Establish vehicle speed categories (go, no go, restricted, severely restricted, and not evaluated) using Appendix B, Figure B-21.

Note: After completing Steps 5 and 6, digitize previously unavailable data and add it to the available local transportation FFD.

- Step-5. Determine each unique area's slope. Multiply all of the factors together and then remultiply using the road or off-road slope speed.

- Step-6. Assign a speed category to each unique area's terrain as established in Step 4 and Appendix B, Figure B-21.

- Step-7. Plot all unique areas, mark their speed categorization, and code each area with shading, color, or alphanumerically.

(j) Observation/LOS. An observation/LOS template depicts the ability to see the adversary or for the adversary to see friendly TMD operations visually or with surveillance devices. Factors that limit or deny observation include concealment and cover. Use the following terrain analysis steps to produce the friendly overhead ISR and TMD radar template; friendly standoff ISR and TMD radar template; friendly surface ISR and TMD radar template (includes special forces [SF]); adversary air defense and TMD radar coverage template; adversary overhead ISR template; adversary standoff ISR template; adversary surface ISR template (includes SF).

- Step-1. Retrieve available data. Depending on the type of FFD available (see Appendix B, Figure B-17) use automated terrain analysis tools or manual terrain analysis techniques (see USA FM 3-34.33 [FM 5-33]) for the remaining steps.

- Step-2. Retrieve and plot the locations and sensor coverage capabilities for all friendly ISR and TMD radar assets assigned to the command. Take into account the effects of terrain masking. If an ISR or radar asset is

mobile (that is, Airborne Warning and Control System or Joint Surveillance Target Attack Radar System [JSTARS]), plot the areas of coverage for which 100 percent coverage will be available. Mark other visible areas as less than 100 percent coverage. If feasible, develop a variable scale areas with 100, 75-100, 50-75, 25-50, and 0-25 percent coverage.

- Step-3. Retrieve and plot the known locations and sensor coverage capabilities for all adversary ISR, air defense radar, and TMD radar assets. Take into account the effects of terrain masking. If an ISR or radar asset is mobile (that is, overhead imagery satellite and aerial surveillance radar), plot the areas of coverage for which 100 percent coverage will be available. Mark other visible areas as less than 100 percent coverage. If feasible, develop a variable scale for areas with 100, 75-100, 50-75, 25-50, and 0-25 percent coverage.

(k) Key Terrain. A key terrain overlay depicts terrain features that afford a marked advantage to either combatant if seized, retained, or controlled. Use the following terrain analysis steps to produce the key terrain template;

- Step-1. Retrieve available data. Depending on the type of FFD available (see Appendix B, Figure B-17) use automated terrain analysis tools or manual terrain analysis techniques (see USA FM 3-34.33 [FM 5-33]) for the remaining steps.

- Step-2. Examine each terrain feature found in all previous templates and determine which terrain features are key terrain to either the adversary TM force or friendly TMD operations.

- Step-3. Plot and outline each key terrain feature's location. Label each as key terrain for the adversary TM force and/or friendly TMD operations.

(l) EM spectrum. A TM force EM spectrum template depicts the potential EM emissions from a TM force. It keys friendly signals intelligence (SIGINT) operations to locate and/or directly target TM force assets. New measurement and signature intelligence (MASINT) technologies may permit the detection of generator (and other similar equipment) EM energy; therefore, the generator becomes the transmitter. The TMD analyst needs to carefully check the sensor technologies available and adjust the intelligence targets accordingly. Use the following analysis steps to produce the EM spectrum template.

- Step-1. Retrieve available data. Depending on the type of FFD available (see Appendix B, Figure B-17) use automated terrain analysis tools or manual terrain analysis techniques (see USA FM 3-34.33 [FM 5-33]) for the remaining steps.

- Step-2. List all of the TM force types of equipment that transmit in the EM spectrum (retain this information for further analysis in TMD IPB Step 3). Include the equipment's basic transmitter type, frequency limits, antenna pattern characteristics, and antenna pointing capabilities.

- Step-3. Plot the frequency limits of each transmitter type using a logarithmic scale.

- Step-4. Plot and code label all the known transmitter locations.

- Step-5. Plot the coverage of each transmitter not included in an observation/LOS overlay template.

c. Step-2.1.2 - Assess Weather Effects on TM Operations. Weather analysis evaluates the weather's direct effects on TM force operations. Terrain and weather analyses are inseparable. The weather assessments needed to support TMD IPB are climatology, current weather, and forecast weather.

(1) Climatology Assessment. Climatology assessment is statistical weather data collected or calculated for an area. It focuses on mean weather conditions likely to affect peacetime readiness planning phases and/or future TM force operations. Favorable TM climatology factors obscure observation of TM force operations (that is, cloud cover) and detrimental factors impede TM force operations (that is, precipitation, thunderstorms, temperature extremes, high winds [surface and at flight altitudes], inversion, and humidity). Climate/weather can have the following effects on TM force operations:

(a) Impacts the tempo of operations by reducing missile crew efficiency.

(b) Adversely affects technical performance of the missile system and associated support equipment, particularly if the adversary is denied access to current meteorological data.

(c) Enables the adversary to tactically exploit its effects on friendly TMD.

(d) Impacts the effectiveness and likely use of chemical and biological weapons, both negatively and positively. Climatology data is assessed for each TM operating area. Appendix B, Figure B-22 depicts sample climatology data for a given TM operating area. The first source for this data is the local weather unit and if unavailable, the Air Force Combat Climatology Center at 151 Patton Avenue, Room 120, Asheville, North Carolina.

(2) Current and Forecast Weather. Current and forecast weather are used during combat operations. Current assessment is used to support active missions and operations. Forecast assessment is used for mission planning and TMD IPB development out to 5 to 7 days. To focus weather analysis, begin with available weather trend information or climatology-based overlays for specific TM operational locations within the AO, and analyze each military weather aspect. Evaluate the aspects that have the most bearing on TM missile operations (that is, visibility, precipitation, and winds). Weather has both direct and indirect effects on missile operations. Integrate the effects of the different weather aspects into a single template to provide current and forecast effects on missile operations (see Appendix B, Figures B-23 and B-24). Use it in conjunction with other terrain analysis products to further refine estimates of CCM and when operations may occur. Use local climatology data and then fine-tune with more current information. Military weather aspects significantly impacting TM operations are—

(a) Visibility. Low visibility benefits TM operations because it conceals TM unit movement and field deployed activities and enhances the

possibility of surprise. Consider all aspects when evaluating visibility. Precipitation and other obscurants have varying effects. For example, cloud cover can negate friendly overhead reconnaissance of TM. A major factor in evaluating visibility is the amount of available light. Consider phases of the moon, times associated with sunrise, sunset, moonrise, and moonset. Night or low visibility operations can screen launches and limit TEL and GSE visual signatures (during DESERT STORM, the majority of Iraqi missile launches occurred at night). In future conflicts, TM forces are likely to conduct missile launch operations at night or during periods of reduced visibility and cloud cover. During periods of poor flying weather, missile operations degrade the ability of TMD attack operations to visually search for missile equipment. Extreme darkness can cause crew disorientation and slow TM unit movement. Movement would probably be in closed column formation, transit speeds reduced, and vehicle spacing less than 100m.

(b) Winds. Winds can affect TM operations by reducing crew efficiency in performing transloading operations, reducing crew efficiency in performing prelaunch missile operations (that is, launch site setup and missile erection and alignment), and degrading missile accuracy if the wind's effects are not accounted for during the prelaunch operations (particularly for certain types of warheads). Wind-generated blowing sand, dust, rain, or snow reduces the effectiveness of friendly TMD systems (that is, radar and communication systems). Strong winds hamper the efficiency of directional antenna systems by inducing antenna wobble and can detrimentally impact friendly attack operations.

(c) Precipitation. Precipitation affects visibility and soil trafficability and can hamper TM crew performance at the launch, transloading, and fueling sites. Combined with lightning, it would likely stop launch activity. It can degrade the functioning of electro-optical systems. Heavy snow cover can reduce mobility, affect communication systems, and degrade the effects of many munitions and air operations.

(d) Temperature and Humidity. Temperature and humidity extremes reduce personnel and equipment capabilities and may require the use of special personnel shelters or equipment. Missile range performance is slightly sensitive to temperature conditions. Temperature extremes can reduce the maximum range performance of liquid propellant systems by 5 percent under severe conditions (<-30° Celsius (C) and >50° C). Nominal operational conditions (0°-30° C) generally do not impact the performance. Solid propellant missiles are more sensitive to temperature and humidity constraints. The missiles are stored at nominal temperature ranges of 5-25° C. Environmental covers on the TEL or heating cloths placed on the missile maintain missile temperature. Maintaining solid propellant motors within nominal temperature bounds decreases the variation in propellant burn rate and corresponding variation in delivered thrust. High temperatures will increase burn rate (and delivered thrust), while cold temperatures will significantly degrade missile delivered thrust. Unexpected thermal variations may adversely impact accuracy.

d. Step-2.1.3 - Assess Other Characteristics of the Battlespace. This includes other TMD related terrain aspects. Normally, fixed TM force facilities have a specific assessment area while mobile TM force operations have a wider

geographical area assessment. An important limitation in countering mobile TM force operations is the lack of TM infrastructure information. This can be partially overcome by using broad area imagery of National Imagery Interpretability Rating Scale 4.0 quality or better to classify a TM force infrastructure and related terrain features; prioritizing the manpower and time intensive identification and cataloging of a confirmed or potential TM force infrastructure and related terrain features; and using the detailed imagery-based cataloging technique to enhance TMD IPB.

To analyze a TM force's infrastructure, see Figure III-2 for the general process and Appendix B, Figures B-25 and B-26 for example templates used during the process. Known TM force infrastructure typically consists of RDT&E and production facilities, fixed operational facilities, and assessed field operating areas.

(1) RDT&E and Production. A country's TM RDT&E and production infrastructure represents a long-term investment in specialized manufacturing, test equipment, and facilities. TMD IPB analysis against this infrastructure provides specialized support to potential strike missions intended to disrupt, degrade or destroy a country's capability to produce ballistic missile systems. To support this objective, elements of the infrastructure that are unique and difficult to reconstitute are identified and a detailed IPB of the infrastructure

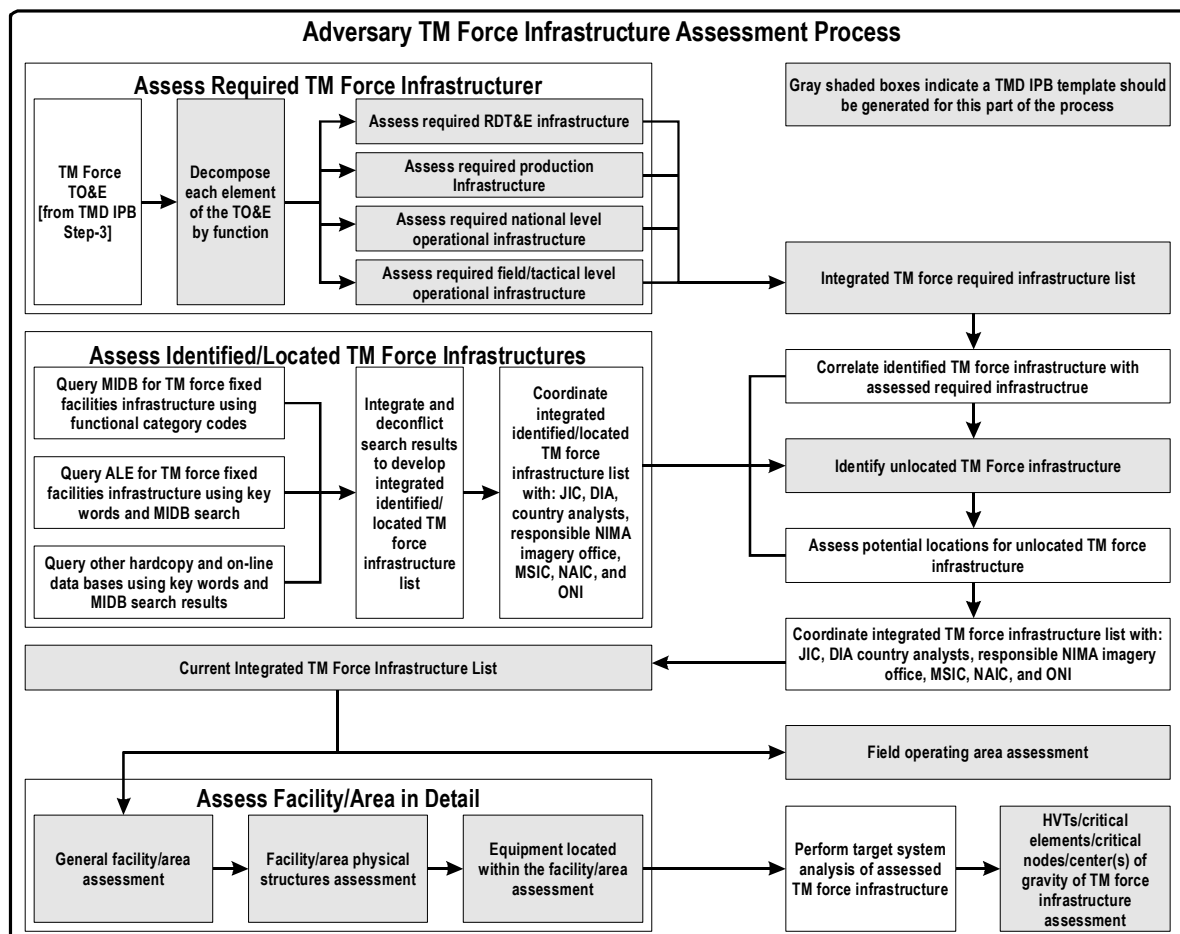

Figure III-2. Adversary TM Force Infrastructure Assessment Process

during the readiness phase is performed. This analysis is a primary function of DIA, Missile and Space Intelligence Center (MSIC) and National Air Intelligence Center (NAIC) and requires specialized engineering expertise and databases.

(a) When developing a detailed IPB of missile-associated RDT&E and production infrastructure—

- Use all available intelligence resources to determine system component stockage, associated manufacturing processes and subsystems that impact on missile operations.

- Identify the critical nodes within the RDT&E and production complexes such as difficult to replace manufacturing facilities requiring long lead development time, controlled manufacturing equipment and technology, one-of-a-kind or high value production or test equipment, and component and system integration/test points.

- Correlate specific RDT&E and production functions with specific buildings in a complex. Use MSIC and NAIC assessments of system components, production flow, manufacturing techniques/processes to develop candidate facility signatures to support correlations.

- Identify potential RDT&E and production elements that would most directly impact the conduct of the war. For example, identify facilities that might support a production surge to increase operational inventories or high priority weapons modification/development efforts in response to the TMD battle. See Figure III-3 for a sample infrastructure and production decomposition assessment template.

(b) The level of RDT&E and production infrastructure within a country depends upon the degree to which indigenous production of TMs is underway. The 5 levels of missile production capability are—

- Complete dependence on import of assembled ballistic missile systems; the RDT&E and production infrastructure is minimal with few facilities. Focus on missile logistics and off-the-shelf modifications (that is, extended range Al Hussein).

- Assembly of missile systems from semi-knock down kits (major components preassembled); the RDT&E and production infrastructure is minimal with few final integration and flight test range facilities.

- Assembly of missile systems from complete-knock down kits (missile shipped in parts with all major components disassembled); the RDT&E and production infrastructure is significant with multiple component assembly and test facilities for specialized and critical assembly and test equipment.

- Indigenous production (missile entirely manufactured in-country from country's raw materials and general products); the RDT&E and production infrastructure is extensive with multiple component assembly and test facilities for specialized and critical manufacturing equipment.

- Indigenous development (missile designed and manufactured in-country from country's raw materials and general products); the RDT&E and production infrastructure is comprehensive with complete design and test capability and multiple component assembly and test facilities for specialized and critical manufacturing equipment.

(c) Production is characterized by manufacturing functions and processes. A facility's specific usage varies from country to country. The following factors will influence a country's actual facility layout and organization:

- Missile system hardware decomposition.
- Production functions such as metal forming and working (rolling, extruding, stamping/pressing, casting, cutting, milling, machining, etc.), metal treating and finishing (heat treating, chemical treating, painting, coating/preparation for storage, etc.), and electronics fabrication (board manufacture, soldering, component manufacture, cable/harness manufacture, etc.).
- Production labor craft skills (that is, technicians and engineers of various types, administration and support personnel, etc.).
- Production environments and fit-to-process including but not limited to general industrial (rolling, welding, etc.), toxic (chemical treatment, etc.), explosive hazard (explosive loading, etc.), clean (precision fabrication, manufacturing, etc.).
- Overall production flow (time and motion efficiency and common sense).
- Test areas.

The desired production rate dictates the degree of parallelism in facilities. For example, a single machine shop could manufacture all the machined parts in the TM system; however, actual production is likely grouped by manufacturing function (part type, size, materials) system component or assembly, etc.

(2) Fixed Operational Infrastructure. During the employment/sustainment phase, TMD IPB operational infrastructure analysis confirms operational status, identifies structures, equipment, and functions, tracks and analyzes deployment patterns, and tracks unit and equipment movements. A complete analysis of the operational infrastructure involves TMD IPB Steps-2 and -3. Operational infrastructures of interest to the TMD IPB process at all levels (national, strategic, operational, tactical) are C4I, TM garrisons and ports, storage areas/maintenance/logistics/depots, training garrisons, and training areas. At the national/strategic level, flight test areas/sites are of interest. At the operational/ tactical levels, field operating areas or deployment areas, field launch areas/sites, field support areas/sites (functions such as—warhead mating, fueling, and transloading) and field hide areas/sites are of interest. Infrastructure analysis develops a functional evaluation of facilities and/or areas (see Appendix B, Figure B-27 for a suggested template.) This functional evaluation and the mapping of its results for the entire operational infrastructure helps to develop the critical node analysis of the fixed operational infrastructure.

(3) Assessed Field Operating Areas. The operational deployment of units and missile equipment begins from missile garrison and storage areas/depots. The missile garrison houses the missile force (typically a brigade level unit) with its associated GSE. It may also have missile and warhead storage areas that primarily maintain the original missile condition and reliability by controlling the missile's environment and performing scheduled maintenance and operational checks. Peacetime deployment areas maintain alert force operations, hence reveal characteristic terrain and doctrinal practices, which

probably apply to wartime models. Training areas are good readiness phase TMD IPB targets to understand enemy practices regarding the use of terrain and overall threat capabilities. See Appendix B, Figure B-28 for a suggested field operating area assessment template.

(a) WMD Infrastructure Analysis. In the context of TMD IPB, WMD infrastructure analysis is limited to those facilities that support production, test, and storage of chemical, biological, and nuclear warheads for TMs. This infrastructure is a subset of the overall WMD infrastructure and may include basic resource and development (R&D), agent production, weapons development, testing, storage and disposal for delivery systems other than ballistic missiles. TMD IPB must draw information from the national level agencies (DIA, CIA, Armed Forces Medical Intelligence Center, etc.) that have the primary responsibility for this area. Analyze the WMD infrastructure to—

- Locate and monitor operational status of potential warhead storage facilities and correlate with TMD IPB.
- Locate missile assembly and fueling facilities.
- Determine primary LOCs and establish named areas of interest (NAIs).
- Determine specific chemical and biological warfare agents available for TMs and specific warhead types (unitary or sublimation).
- Identify unique TMD indicators (for example, unique canisters) associated with WMD.

(b) TM Command, Control and Communications (C3) Infrastructure. A primary function of joint and service (National Security Agency, Joint Warfare Analysis Center, Air Force Information Warfare Center ["Links and Nodes" analysis under the CONSTANT WEB program], DIA [MIDB], published intelligence studies, and TIBS/TRAP broadcasts) information warfare analysis efforts is detailed analysis of the C3 infrastructure. TMD IPB must use these intelligence sources and focus on identifying the communications infrastructure supporting TM operations and correlating the C3 infrastructure location with other battlespace factors (for example, terrain, fixed infrastructure). C3 data vital to the TMD IPB are—

- National command centers.
- Locations where the adversary TM target list is developed and maintained.
- Brigade command posts.
- Landline communications and radio or microwave relay networks.
- Satellite communications (SATCOM) nodes.
- Intercepted mobile high frequency/very high frequency (HF/VHF) radio communications.

These targets are normally high priority information warfare targets, and it is vital to receive updates about their status throughout a conflict. A C3 overlay needs to be built for use in Step-2.2's area limitation analysis.

(4) Conclusion. As with terrain and weather, express other battlespace characteristics in terms of their effects on adversary missile and friendly TMD COAs. The graphic depictions of the other battlespace characteristics developed during TMD IPB Step-2 provide a template to annotate broad COA text assessments. Some examples are—

(a) On the operational TM infrastructure graphic, show COA indications such as—

- The adversary missile force requires prepositioned equipment or depends on long logistics LOCs to maintain deployed operations.
- The adversary has 3 primary deployment routes from this missile garrison.

(b) On the probable adversary target set graphic, show implied missile operations areas to highlight the closest target sets.

e. Step-2.2. - Assess Battlespace Effects on TM Force Capabilities and Broad COAs. Once the effects of terrain, weather, and the other battlespace characteristics have been evaluated and defined, combine them into an integrated product. For TMD IPB this critical integration step is referred to as area limitation analysis.

(1) Area Limitation Analysis. The area limitation analysis produces a detailed area limitation product providing a graphic overlay of likely missile operations areas delineating C4I, TM garrisons and ports, storage areas/logistics/maintenance/depots, operating areas or deployment areas, field launch areas/sites, field support areas/sites (functions such as—warhead mating, fueling, and transloading and terms such as FOL, forward support element, forward operating base, and transload site), and field hide areas/sites. Also desirable are graphical overlays that correlate key infrastructures (fixed missile infrastructure, probable TM target sets, communication networks (landlines, SATCOM, etc.), road networks, and air defense coverage areas. Automated terrain analysis tools assist in performing area limitation. See Appendix B, Figure B-29 for example area limitation assessment inputs.

(2) Automated Terrain Analysis Tools. Automated terrain analysis tools assist in rapidly evaluating terrain for TMD IPB by integrating features and general military information that facilitate movement modeling and locational assessment of mobile targets (see Appendix C). This process combines analytic assumptions regarding the movement of a target (that is, speed, direction, destination, and hold times) with the inherent terrain suitability analysis (that is, road accessibility, elevation, slope, distance from support sites, etc.). Automated TM terrain analysis is affected by 3 primary factors:

(a) Limited potential TM related operational infrastructure (hide sites, potential launch sites, etc.) databases.

(b) Limited available digital terrain materials (that is, terrain elevation data, digital mapping products, digital road network, and features data, etc.).

(c) Difficulty in correlating operational restrictions with existing terrain databases and determining COAs since TM operations favor use of diverse terrain.

Even with automated terrain analysis, some factors may have to be evaluated through map analysis supplemented by reconnaissance and imagery. NIMA and DIA produce specialized maps, overlays, and databases to aid in map based evaluations.

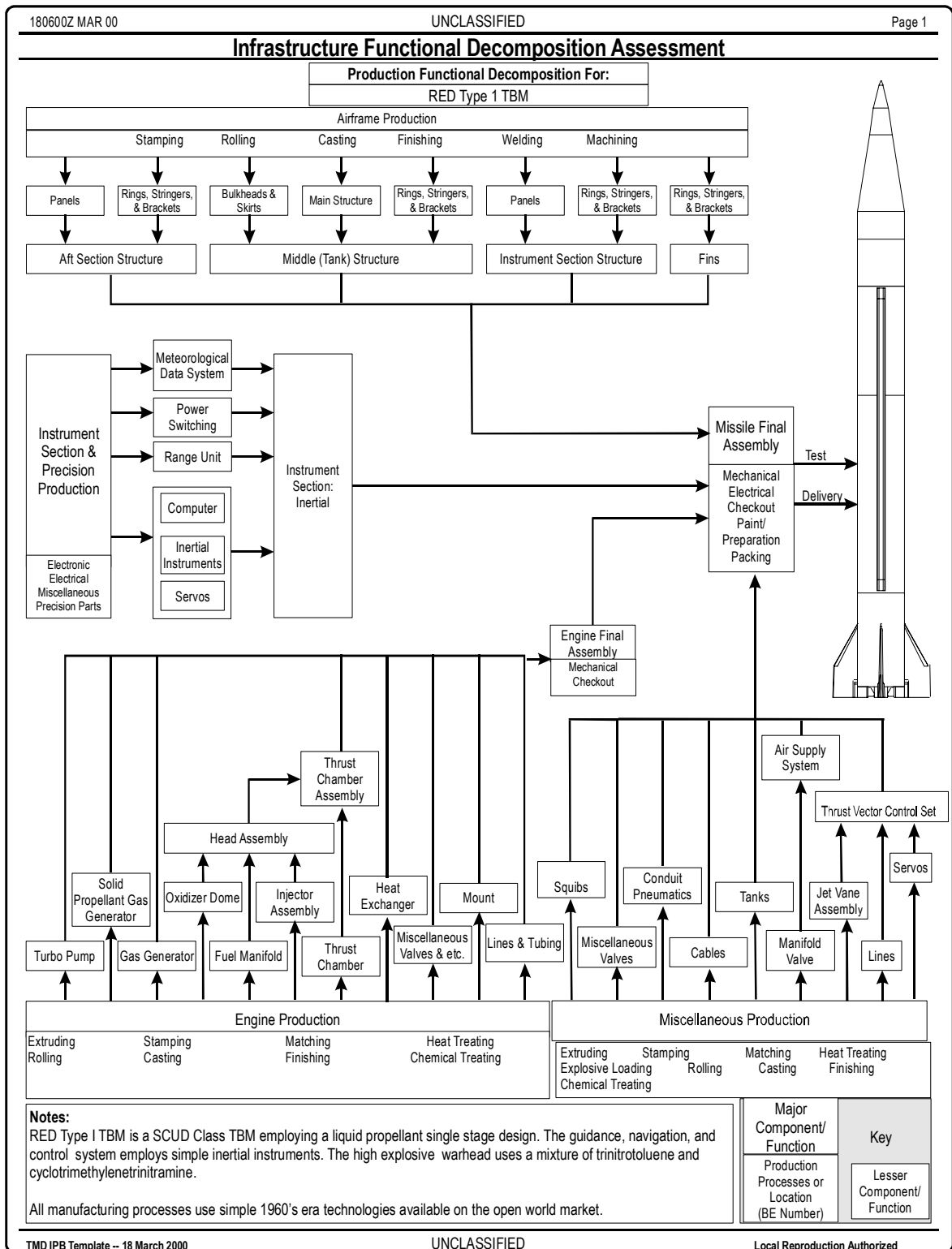
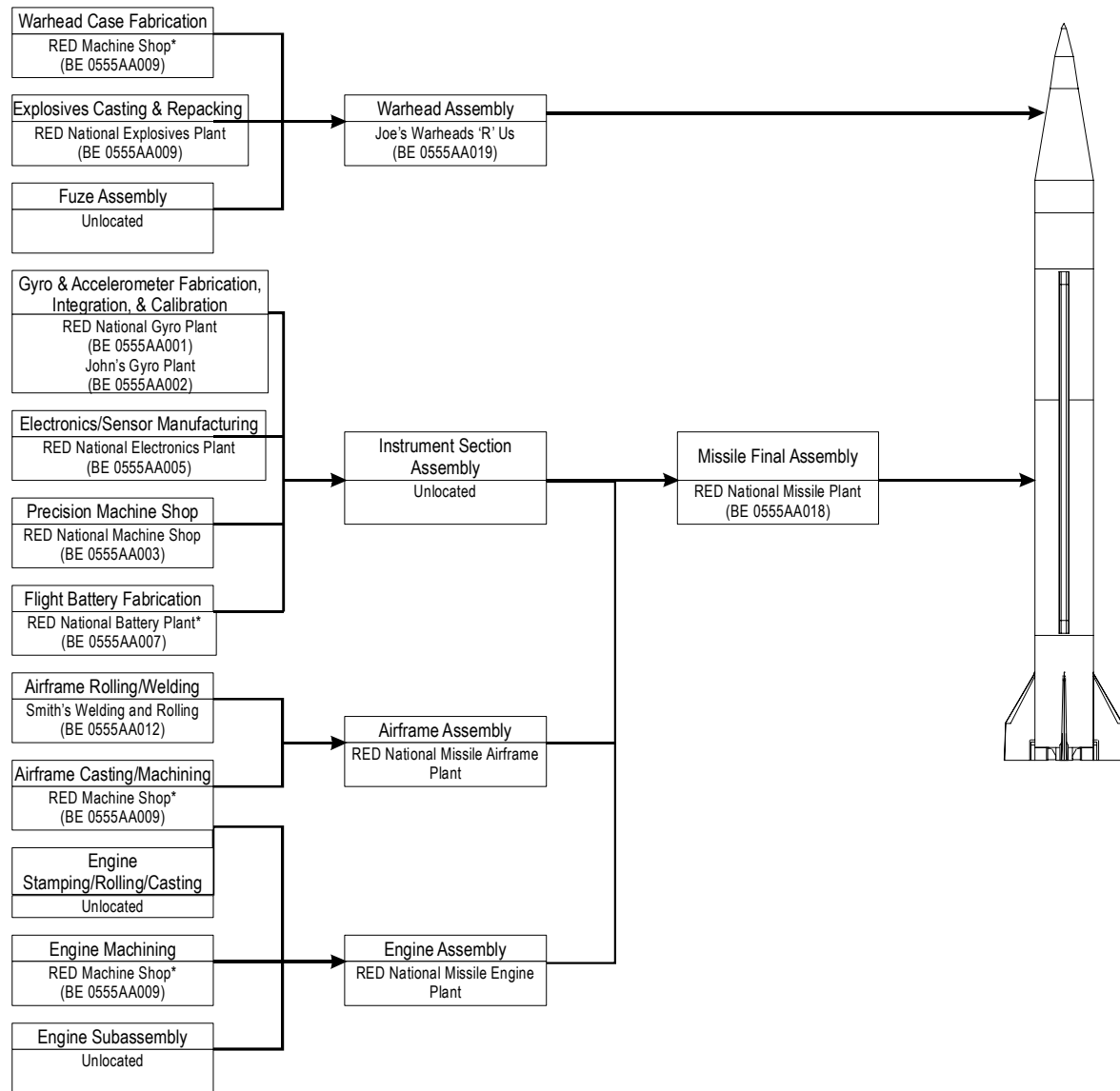

Figure III-3. Infrastructure Functional Decomposition Assessment Template (1 of 2)

Infrastructure Functional Decomposition Assessment

Production Functional Decomposition For:
RED Type 1 TBM



Notes: Facilities with an asterisk are assessed and not confirmed to be performing the assessed production function.

Major Component/ Function	Key
Production Processes Or Location	
	Lesser Component/ function

Figure III-3 (Continued). Infrastructure Functional Decomposition Assessment Template (2 of 2)

Chapter IV

STEP-3: EVALUATE THE TM FORCE

1. What Is It?

a. Definition. Step-3 determines TM force capabilities and the doctrinal principles and tactics, techniques, and procedures (TTP) TM forces prefer to employ.

b. Desired End Effect. The desired end effect of Step-3 is to know the TM force capability given the current situation. This is achieved by developing models that accurately portray how TM forces normally execute operations and how they have previously reacted in similar situations.

2. How To Create TM Models

Evaluating an adversary involves creating models and identifying capabilities and uses the common understanding of the battlespace established in TMD IPB Step-2. TM models depict how TM forces prefer to conduct operations under ideal conditions and are based on the TM force's normal or "doctrinal" organization, equipment, doctrine, and TTP. They result from a detailed study of the TM force and address both its temporal and spatial factors. The model construction can involve in-depth analysis requiring data and expertise from national and theater intelligence organizations. Construct models before deployment and include both graphical depictions and text descriptions of the TM tactics and employment options. Continue to evaluate the TM force after deployment and update the TM models as required. TM models consist of doctrinal templates, description of preferred TTP and options, and high value target (HVT) identification (Figure IV-1).

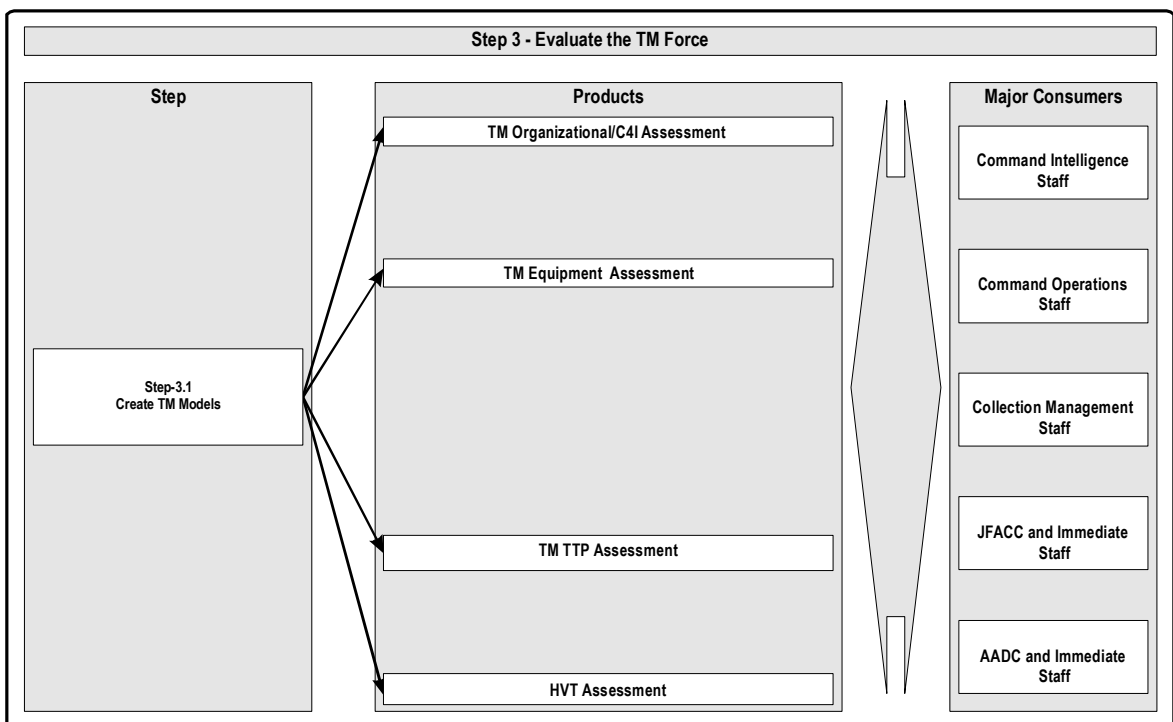

Figure IV-1. Step 3 - Evaluate the TM Force

3. Doctrinal Templates

Doctrinal templates illustrate the TM force's deployment pattern and disposition when not constrained by battlespace environmental effects. They are scaled graphic depictions of TM force dispositions for a particular type of standard operation and are constructed through an analysis of the intelligence database and an evaluation of the TM force's past operations. To develop doctrinal templates, determine how the TM force organizes for combat and how it deploys and employs its units and various TM assets. Observe patterns in task force organization, timing, distances, relative locations, groupings, and use of the terrain or weather. Focus on major elements as well as individual HVTs. Conduct a comprehensive analysis/OB of TM force capabilities (organization, equipment, TTP, and the temporal and spatial factors) by breaking the capabilities down into the following components:

- ◆ Composition - Identification and organization of TM units.
- ◆ Disposition - Physical location of TM units.
- ◆ Strength - Unit description in terms of personnel, weapons and equipment.
- ◆ Tactics - Force and unit level tactical doctrine.
- ◆ Training - Individual and unit level.
- ◆ Logistics - Supplies and LOCs.
- ◆ Combat Effectiveness - Abilities and fighting quality of a unit.
- ◆ C4I OB - Unit network, equipment, and personnel makeup and array.
- ◆ Miscellaneous Data - Additional intelligence needed to "know your enemy."

Use the MIDB to begin the analysis but thoroughly evaluate all available databases and published defense intelligence reference documents (DIRDs), and directly interface with national intelligence organizations throughout the process. Doctrinal templates integrate a mixture of graphic adversary representations for both the force and unit level combined with descriptive text (that is a force level coordinated attack plan is expanded by a template subset of individual TEL units deployed throughout the battlespace). Tailor doctrinal templates to the type of friendly TMD mission being pursued. Templates for an active defense mission focus on potential and likely TM launch areas, likely TM targets, raid size, maximum and minimum number of missiles per target, types of warheads, and so forth. Templates for an attack operation mission focus on an adversary's TM marshalling areas, likely launch areas, TELs, and C2 facilities supporting TM operations.

To develop the set of TMD IPB templates, start at the TM force level and work down to the individual TM firing battery. Modify generic template sets to fit the particular TM force and the available intelligence data by adding new unique templates and omitting or adding data fields as required. If a crisis

occurs and templates are not available before deployment, develop a minimum subset of the most critical templates for the deploying or deployed TMD unit. See Figure B-30 to determine which templates are the most critical for each specific TMD mission.

Once deployed, continually update templates with the latest intelligence. The following describes example doctrinal templates, including attributes, contents, and instructions. These templates provide a graphic overview of the TM organizational structure and force level OB. This helps visualize both the organizational structure and the national through lowest TM unit C2 structure. There are no prescribed steps for doing these templates. Use intelligence databases and expertise from responsible organizations (DIA, MSIC, NAIC, and National Ground Intelligence Center [NGIC]).

a. TM Organizational/C4I Templates. These templates define the composition and strength of the TM force and define the C4I system used to control those units.

(1) The first template in this series is a national level TM organizational structure (Figure IV-2). The organizational structure delineates the flow of control for peacetime and crisis/wartime. Since most countries control TMs as strategic assets, the line of control begins at the highest level of execution authority in the country and extends to the lowest TM unit level. If known, write key individuals' names, unit designators, skip echelon communication, unit composition, etc., on the graphic.

(2) The second organizational template graphically depicts the brigade level table of organization and equipment (TO&E) by providing a functional representation of the TM force, annotating strength in terms of personnel and equipment, and providing detail on specific units assigned at the brigade, battalion, and battery levels (Figure IV-3 for a battalion level example). Include known specific unit designators and locational data, if available. TM units worldwide use a high level of operations security (OPSEC) and communications security (COMSEC) that limits available intelligence and hinders construction of this template. Initiate and maintain the database for this template using the "facilities, units, and equipment views" in the MIDB and supplement with all-source analysis. One of the most important techniques in constructing the template is a detailed imagery review of the TM unit's home garrisons and supporting depots. The garrison worksheet (TMD IPB Step-2) provides a guide for confirming the functional and equipment status of TM units. Identify the status of those functions and equipment as confirmed, probable, likely, possible, or doubtful as defined in Section-3 of Appendix A. In addition, consider potential modifications, such as a special weapons storage function being accomplished by a TM force. Compile results into a new template representing the current assessment of the particular TM force under analysis.

(3) The final template provides a graphical C4I breakout of the operational communications structure from the national level down to the battery execution level. It is important to graphically depict the communications connectivity throughout the brigade equivalent structure. As with the other 2 templates, write as much detail as possible on the template.

TM National Level Organization and C2 Template

Descriptive Title: National Level Organization and C2

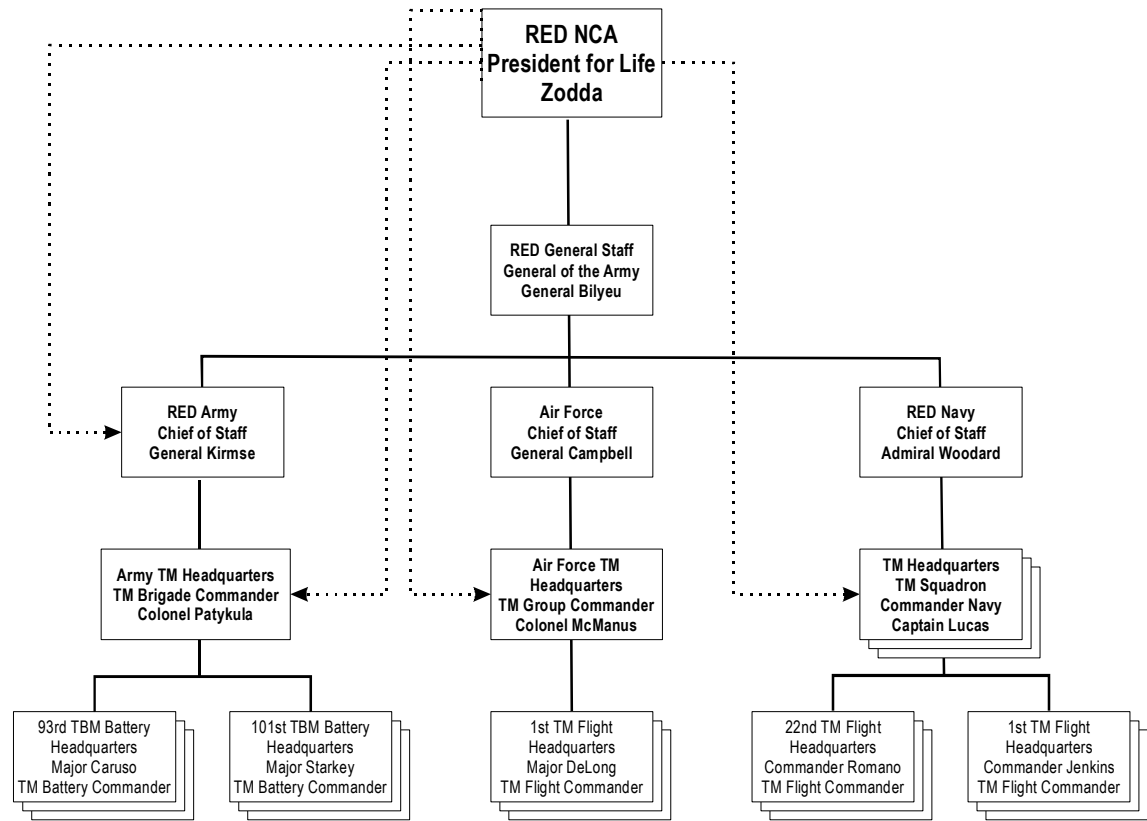

Normal C2 Path

Skip Echelon C2 Path

Notes:

1. President for Life Zodda can use skip echelon communications to bypass national and service level headquarters in the event those elements become inoperable.
2. All target selections require RED Presidential written signature
3. Targets are typically preassigned during peacetime and require 24 to 48 hours from decision to execution during wartime.
4. Targets not preassigned during peacetime require additional national level staff and field targeting staff work and take an additional 12 to 24 hours over the standard targeting cycle of 24 to 48 hours.

Figure IV-2. TM National Level Organization and C2 Template

TM Unit Level Organization and C2 Template

Descriptive Title: 1st RED TM Battery TO&E

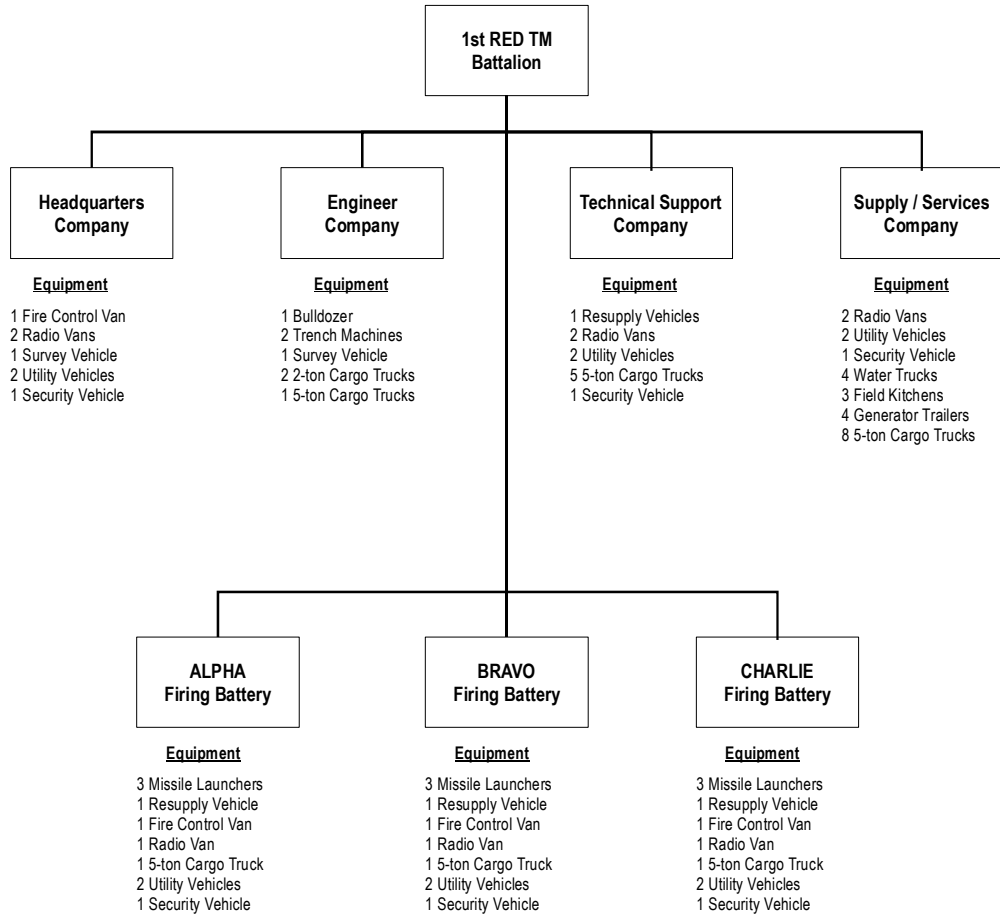

Notes:

1. Field medical services are provided by the brigade
2. The headquarters company is capable of assuming control of any of the firing batteries if required.

Figure IV-3. TM Unit Level Organization and C2 Template

b. TM Equipment Templates. In terms of equipment, a TM force has a missile system, launcher, fire control, and GSE. Equipment template detail varies significantly depending on mission requirements and the time and depth of the TMD IPB analysis. They address composition, strength, logistics, and force effectiveness factors from the OB analysis. To meet this requirement, develop a set of quick reference templates for the most critical data. More detailed templates may be developed later for all other equipment areas.

(1) Missile Data System. This template provides a quick reference format for key TMD mission parameters and addresses critical information requirements for the TMD IPB. Required missile system data varies between TMD mission areas (see Appendix B, Figure B-31). Typical data is photograph, external line drawing with dimensions, internal line drawing annotated with propellant type and number of stages, key performance, parameters/ characteristics, warhead data including mass and type, flight trajectories (maximum, 2/3 maximum, and minimum ranges), nominal reaction times, and median in-flight signature data. Tailor the data template to the specific country of interest (for example, available warhead types), and augment with textual data such as missile descriptions and operational status. MSIC, NAIC, and Office of Naval Intelligence (ONI) are responsible for developing detailed missile engineering data. This data is distributed in missile handbooks, detailed systems reports, engineering reference documents, and spot reports. Data and missile expertise is also accessible through on-line sources such as INTELINK. Published DIRDs or direct interface with the appropriate intelligence center provide the highly detailed missile design information (see missile R&D infrastructure discussion in TMD IPB Step-2) needed for detailed peacetime IPB.

There are 2 TMD IPB critical analysis areas that go beyond the general information requirements covered by the quick-reference missile equipment template. The first area is evidence of modified or improved missile system capabilities discovered during the TMD IPB. It is unlikely that an adversary could develop and deploy a new missile system for which there is no intelligence data. However, it is possible that an adversary may be able to integrate modifications or improvements to an operational missile for use during a crisis or conflict that have gone undetected by intelligence systems. The primary modification concerns are performance (changes to an existing missile's range/ payload capability), lethality (change or development of new warhead options), and defense penetration (changes to the missile's nominal operation, signature, or tactical employment). Defense penetration operations are likely to include TM tactics and missile equipment changes, thus will become critical TMD IPB issues. Integrate MSIC, NAIC, and ONI technical expertise into the TMD IPB process to address missile technical issues.

The second important missile consideration for TMD IPB, particularly for the active and passive defense missions, is the specific warhead options available to a country. Specific warhead options are defined within the intelligence databases and reference sources supporting the TMD IPB. However, because of the particular importance of this area for the TMD IPB, consider the following questions:

(a) Has the adversary weaponized nuclear, biological, or chemical (NBC) warheads for TMs?

(b) Does the adversary have multiple warhead options? Which ones are better suited for specific targets?

(c) Does the adversary have advanced warhead options (that is terminal or anti-radiation homing)?

(d) Do a specific country's warhead systems have any unique employment constraints?

(2) Launchers and GSE. It is vital to analyze certain TM vehicles for function, value, mobility characteristics, signatures, imagery keys, and other purposes. This aids in determining HVTs and identifying TM force activity in imagery searches. In some cases, such characteristics provide visual, infrared, and radar recognition guides for attack operations assets. Begin template development (time and resources dictate scope) by identifying the TM force vehicle complement (see Appendix B, Figure B-32). Vehicle types to consider in the analysis are missile launcher, missile handling equipment, missile checkout equipment, missile support equipment, missile fueling equipment, and site survey equipment. Collect data from applicable DIA reference documents, the MIDB "equipment view" and the responsible analysts at DIA, NGIC, MSIC, NAIC, and ONI. A suggested vehicle template is provided at Appendix B, Figure B-33. Insert data and applicable graphics as needed.

The most important vehicle for TM operations is the missile launcher. There are three primary types of TM launchers:

(a) TEL - Self-powered vehicle with integrated launcher erector mechanism and on-board equipment compartments and possible internal launch control capability

(b) Mobile Erector Launchers - Separate towing vehicle required; typical configuration is missile erector-launcher on flatbed trailer; mobility is generally more restrictive than a TEL.

(c) Launch Platforms - Aircraft (cruise missiles and TASM)s and naval vessels (cruise missiles) are the primary launch platforms available for launching TMs.

A critical missile launcher issue is the possibility of the adversary employing launcher systems not previously included in intelligence estimates. This employment could take the form of a country having a larger number of launchers of a known type—either indigenously developed or purchased—than previously estimated or indigenously developing a previously unidentified launcher system. Such systems could span the spectrum from a simple fixed launcher or a simple TEL system to more sophisticated TELs. Analysts should also consider the potential use of vehicles modified to support missile operations such as one that integrates missile checkout equipment into a single vehicle specifically to reduce the number of support vehicles used in missile operations. Communications between these support vehicles and TM launchers are usually via tactical wire. TM forces may also use radio frequency communications that increases the possibility of detection by intelligence sources. Some TM missiles

(ASCMs and TASMs) use radar systems and require at least a search/surveillance radar; others require a tracking and fire control radar. Radars are detectable when they emit, which allows them to be geographically located for attack operations assets. Their locations also imply operating areas for the launchers and other supporting functions. The destruction or disruption of these radars will severely impede a TM unit's operations.

Some TM units employ organic or local air defense equipment in support of TM operations. Depending on the situation, the inclusion of air defense equipment templates is important to identify these assets for attack operations. Use standard air defense equipment data (available in the MIDB or within standard references) as a data source.

c. TM TTP. TM TTP templates show the deployment pattern, disposition, tactics, training, and logistics OB factors in graphic, matrix, and text form. They describe the major operations, associated timelines, and options should an operation fail (branches), or subsequent operations should it succeed (sequels). Doctrinal TTP template development for TM operations is vital in the IPB process. Depict a TM force's preferred TTP graphically and include text descriptions. This aids in mentally wargaming the operation's duration during TM COA and situation template development. Displaying the functions of an operation in time-event charts to show how the TM force normally conducts an operation is another technique. For example, while it is difficult to depict a large scale TMD operation graphically, the time relationships between the various elements and their normal composition can easily be described in a time-event chart, narrative, or matrix format. The description addresses characteristic signatures, timelines and phases of the operation (operations, movement, and support), points where units transition from one formation to another, and how the different types of TM equipment contribute to the operation's success. Describe equipment in enough detail to allow later identification of HVTs and high priority targets (HPTs). Since the target's value usually varies with its role in each phase of the operation, ensure that each phase is separately examined.

The description of the TM force's TTP is developed from an evaluation of its doctrine and past or current operations. Include a description of the branches and sequels normally available to or preferred by the TM force should the depicted operation succeed or fail. Examine the basic scheme of operations and for each, check how each type of equipment 'fits in' or provides support. Tag key events or positions on the template (that is, describe the TM force's normal reaction to a friendly attack operation).

(1) TM Attack Objectives. Consider political and military factors, TM weapons system and warhead capabilities, and intelligence available to the TM force to guide target selection when analyzing TM attack objectives. TMD IPB Step-2 summarized the important factors impacting the analysis of TM attack objectives. The suggested attack objective worksheet (see Appendix B, Figure B-34) assists in systematically addressing the important issues impacting TBM employment. Available intelligence rarely supports stating TM objectives as facts, so qualify assumptions with standard confidence levels (confirmed, probable, etc.).

(2) TM Tactics. Developing a detailed assessment of the TM force's tactical operations concept is a critical factor in separating the individual activities within the battlespace. The aspects of the TM tactics model are—

(a) Functions Doctrinal Template. It provides a graphic representation of TM operations (see Appendix B, Figure B-35) and begins with the missile garrison and the missile/warhead storage depot (fixed infrastructure). It illustrates the multi-axes movement to the deployment area where operations are geographically dispersed. Dispersing versus centralizing operations enhances TM survivability at the force, brigade, and battalion level. The generic operation template implies the following functions:

- C2
- Storage
- Missiles, warheads, propellants.
- Missile transporter loading and fueling at the FOL.
- TEL loading, TEL hide, launch site setup, launch operations, fire control.
- Support and services, security/defense.
- Movement and transportation and engineering support (optional).

Breaking down TM operations helps in understanding TM dispositions. A deployed TM force is typically brigade-sized and spread out into battalion-sized deployment areas. Functions are normally redundant within the battalion-sized deployment areas in order to minimize concentration of units, scatter the vehicle movement pattern and increase the effectiveness of camouflage, cover and concealment measures.

The functions template is based on the TM force, in line with operational doctrine, dispersing throughout the battlespace to enhance survivability and effectiveness. The variation in the model shows functions centralized in one location. For example, some countries will centralize some missile support functions (storage, transloading, refueling, etc.) in large underground facilities (UGFs). This tactic significantly reduces the number of vehicles deployed in the battlespace, but gives attack forces a greater opportunity to significantly disrupt operations if the centralized location is successfully identified and attacked. Examine existing historical exercise data and focus on the employment of support assets as well as the launcher. Support asset exercise and training indicate a TM force's preference toward either field-dispersed or centralized operations. Terrain and infrastructure analysis (TMD IPB Step-2) also indicate battlespace suitability for 1 model or the other. The basic model can serve as a starting point for other missile systems, such as solid propellant systems, that eliminates the need for propellant storage and fueling functions.

(b) Dispersed Deployment Estimate. Develop this estimate for the operational brigade level. Determining the distances between units/functions requires all source analysis, terrain delimitation and tactical judgement. Focus all-source analysis on doctrinal information, typically contained in human or communications intelligence data, combined with exercise/training pattern analysis. Draw terrain factors supporting dispersed deployment doctrine from the integrated terrain analysis (TMD IPB Step-2).

(c) Time-phased Factors. Analyze the time-phased factors of the TM operation. Develop timelines for all TM operational phases in order to correlate the time and distance factors for TM functions being executed on the battlespace. The TM force's objectives impact the TM time-phased factors. The worksheet at Appendix B, Figure B-36 includes time-phased factors and target/weapon/warhead correlation. Important TM time-phased factors are—

- Time-of-day considerations.
- Missile launch and arrival timelines.
- Execution timelines for specific operations.

Definition of these 3 elements requires detailed analysis of the adversary's doctrinal and technical capabilities. To examine time-phased execution, time-event charts and time-pattern analysis charts are useful techniques. Time-event charts, depict the sequential flow of the steps needed to execute a specific operation and are constructed for any level of execution. For instance, a time-event chart shows the broad sequential steps a TM force takes to deploy from garrison. For a much more specific operation, such as a missile setup and launch, the sequential steps would be much more detailed. The purpose of defining steps to this level of detail is to have a technical understanding of the operational requirements, that drive the timelines. This understanding will support estimating minimum timelines, pacing events, and potential areas where changes to or omission of specific steps could impact timelines and/or performance. Examples of detailed time-event charts are provided at Appendix B, Figures B-37 and B-38. The second technique, a time-pattern analysis chart, supports specific operation scheduling and timing analysis, such as the pattern associated with missile launch history. It is an analysis tool to estimate when specific operations need to occur in order to meet the pattern of observed launch activity.

(3) Operation Doctrinal Templates. These templates show the relationships between the TM types of operations. Begin template development with comprehensive operation branches and sequels diagram (see Appendix B, Figure B-39). This diagram forms the basis for doctrinal template development of specific operations. An alternative to the branches and sequels technique is to detail the conditions for possible variations to the basic operation doctrinal template. Use the TM functions doctrinal template and identify a series of possible TM operations. Next, graphically and in text form depict the specific operations required to perform the function onto doctrinal templates.

These templates represent the entire TM deployment sequence. Develop operation templates at the lowest individual unit level required to perform the particular function. Breakdown to this level is required in order to identify specific signatures associated with the TM operations and the HVTs required for the operations. Integration of these operation templates into a TM battlespace situation template is done in TMD IPB Step-4 for specific COAs. Use all-source intelligence analysis to develop operation doctrinal templates and accurately depict times and relative distances. Notations describe the activity and associated characteristic signature patterns and help to identify HVTs and their locations in time and space. Several combat operations TTP templates may be needed. Begin development of TM operation doctrinal templates with a specific

missile system and perform detailed analysis of the required operations and characterize each basic operation. Integrate terrain and equipment information particular to the specific operation. Missile specific manuals (foreign material exploitation information), the intelligence center responsible for the missile system, and country exercise data (missile system operation and employment requirements-based assessments) are good sources of information.

Tailor generic missile system templates to the country of interest. Integrate terrain factors (TMD IPB Step-2) that dictate changes to the generic template. Overlay country-specific TO&E data to identify specific variations in support equipment and consider different technical capabilities of the equipment. The basic components are a graphical depiction of the operation, a functional description, and characteristic signatures addressing site configuration, surrounding environment, accessibility, equipment, and movement patterns. To illustrate, a series of generic TBM templates follow:

(a) TBM Garrison and Missile/Warhead Storage Depot. Operational employment begins at the TM garrison and storage depot. The TM garrison is normally the peacetime location of the personnel, the brigade's launchers and GSE and can vary significantly in composition. Most TM garrisons include hardened storage bunkers or tunnels to house critical equipment, particularly launchers, and vehicle maintenance and small unit training areas. Normally, missile systems and warheads are not stored at the garrison (except for some training and emergency alert supplies), but maintained in storage depots. A typical storage depot includes hardened bunkers for separate airframe and warhead storage and assembly/checkout areas for routine and major maintenance.

(b) TBM Field Deployed Storage Sites. TM units usually use dispersed storage locations for field operations. Missile systems are normally stored unfueled (liquid propellant only), but in a ready condition with only limited additional checkout required. Missiles are normally stored on missile transporters or triple carry frameworks. Warheads, especially NBC types, are usually stored separately. Propellant is stored in prepositioned storage containers, or storage containers carried on cargo trucks. Liquid-propellant is stored in standard-sized containers or oversized storage tanks.

(c) TBM FOL. Missile preparation in the field is done at the FOL, which is typically a deployed area of operations. The FOL site is normally dispersed for increased security and vehicles use cover, concealment, and camouflage. It can encompass several square km, though consolidating the FOL functions into a single location (a UGF or an above ground building or cleared area), is an alternate possibility. The primary field preparation activities are missile and warhead mating, limited missile checkout/maintenance, missile transporter loading (direct TEL loading at FOL is also possible), and missile fueling operations (liquid-propellant systems only).

(d) TBM Transloading Area. This is the location where fueled, ready missiles are loaded onto the TEL. TEL loading can be done at the FOL, but for OPSEC reasons the doctrinal template depicts this function performed at a separate field location or UGF. Develop a separate timeline template for the transloading operation detailing specific steps.

(e) TBM Hide Site. The TM hide site refers to TEL cover and concealment positions with the most important locations being those that support hiding pre- and post-TEL launches. Based on general operational practices, these sites are located within a few km and several minutes travel time of a launch site. This pattern analysis helps to establish the current position of the TEL after a launch. Use analysis of wartime launch activity to revalidate or modify patterns and distance/time estimate. TM forces also employ long-term hide sites that are at greater distances from the launch areas but usually within tens of km from support areas. Routine TEL maintenance is probably performed at long-term hide sites.

(f) TBM Launch Site. The TM fire position is referred to as the launch site. TMD IPB uses terrain analysis to determine potential launch sites. Characteristic signature guidelines provide constraints for the area limitation analysis of potential launch areas. However, the combination of broad TM flexibility and limited fidelity terrain data make classification of launch sites a difficult and tenuous process.

(g) TBM Launch Operations. An actual missile launch operation takes less than a minute once all prelaunch set activity is complete, though terrain, weather and TTP constraints can impact the launch procedure. Cable and hoses connecting the launcher to the missile are normally replaced after each launch, so it takes minimally several minutes before the launcher can begin travel. Preparing the launcher for travel can be an automated sequence.

(h) TM Support and Services. Combat service support is the total logistical and administrative effort required to maintain the TM capability to fight. Its functions include missile, warhead and propellant (if applicable) storage, vehicle maintenance support, medical, mess, supply, etc. Very little missile maintenance occurs in the field.

(i) TM Security/Defense. Security/defense measures that deployed missile units primarily use are passive defense measures (against visual and electronic detection), physical site security, and air defense (either through organic or non-organic assets). Protection of TM assets against sensors and air and ground attack assets, including SF, is a high priority because of their strategic value. A TM unit's inherent small unit mobility, dispersed operational modes, and passive and active defense measures (camouflage, concealment, and deception (CCD) techniques) help provide missile force survivability. Analysis of terrain cover and concealment factors (TMD IPB Step-2) impact missile operating area selection. Planned movement under conditions of low visibility, equipment siting, and light and noise discipline complicate visual detection. A wide range of camouflage techniques (paints, nets, covers, and obscurants) are integrated into missile operations. The use of decoy launchers, radar corner reflectors, and other techniques vary in fidelity and scale. Integrate analysis of OPSEC CCD practices throughout the doctrinal template development process. TM units, lightly armed, perform physical security against US and allied SF operations with security patrols, defensive perimeters and possibly listening/observation posts.

COMSEC is a demonstrated strength of TM forces worldwide because they use landlines and couriers and avoid radio communications in wartime.

When they do use electronic communications equipment, they employ directional antennas, low power VHF radios, unscheduled transmission patterns of short duration and coded messages.

d. HVT Identification. HVTs are assets that the adversary commander requires for successful completion of the mission. Identify HVTs from database evaluation, doctrinal and TTP templates, supporting narrative, and the use of tactical judgement. Develop the initial list of HVTs by mentally wargaming and thinking through the operation. Consider how the TM force will use each type of equipment to accomplish specific operational functions. Use target relative value matrices to evaluate HVTs. Target value matrices measure a target's relative worth, gives the rationale for attacking each type of target, and the resulting effects on the operation.

First rank order the operational functions the TM force is performing (see Appendix B, Figure B-40). This identifies assets that are key to executing the primary operation or are needed to satisfy decision criteria or initial adoption of branches and sequels. Next, determine how the TM force might react to the loss of each identified HVT and consider its ability to substitute other assets or adopt alternate branches and sequels to the operation. To develop target sets, group important assets into the following categories:

- (1) C3.
- (2) Fire support (includes missiles, TELs, and support).
- (3) Air defense.
- (4) Engineer.
- (5) RSTA.
- (6) NBC (includes support elements and weapons).
- (7) Radio electronic combat or EW assets.
- (8) Bulk fuels (storage and refueling assets).
- (9) Missile and warhead storage/distribution points.
- (10) Maintenance and repair units.
- (11) Transportation.
- (12) LOCs (roads, bridges, railheads, transloading facilities, airfields, choke points).

Finally, rank order the identified HVT set with regard to each HVT's relative worth to the TM force's operation. Record as part of the adversary model. The value of HVTs usually vary over the course of an operation. Identify the changes in value by operational phase and make annotations.

Chapter V

STEP-4: DETERMINE TM COURSES OF ACTION

1. What Is It?

a. Definition. Step-4 identifies and develops likely TM COAs that will influence accomplishment of the TMD mission.

b. Desired End Effect. The desired end effect of Step-4 is to replicate the set of specific COAs that the TM commander and staff are executing and considering. All specific COAs that will influence the friendly TMD mission need to be identified including NAIs, HVTs, and TM COA branches and sequels.

2. How To Do It

The primary steps in Step-4 are shown in Figure V-1. Step-4 is a general process for developing and determining TM force COAs (Figure V-2). One example of a TM COA is for an adversary's TM forces to deploy from their peacetime garrison locations to their wartime forward operating locations to target airfields and port facilities to prevent allied forces from completing their lodgment phase operations. Another TM COA—used unsuccessfully by the Iraqis in the Gulf War—is to target a third party nonbelligerent with the goal of forcing that country to enter into the conflict with resultant political consequences.

a. Identify Objectives and Desired End States. State these in simple, 1-line bullet statements and ensure that confidence levels are clearly identified. Rarely is sufficient intelligence available to state the objectives and desired end state as facts. Even during noncombat operations, the TM force has objectives, such as maintaining combat readiness while remaining in cover.

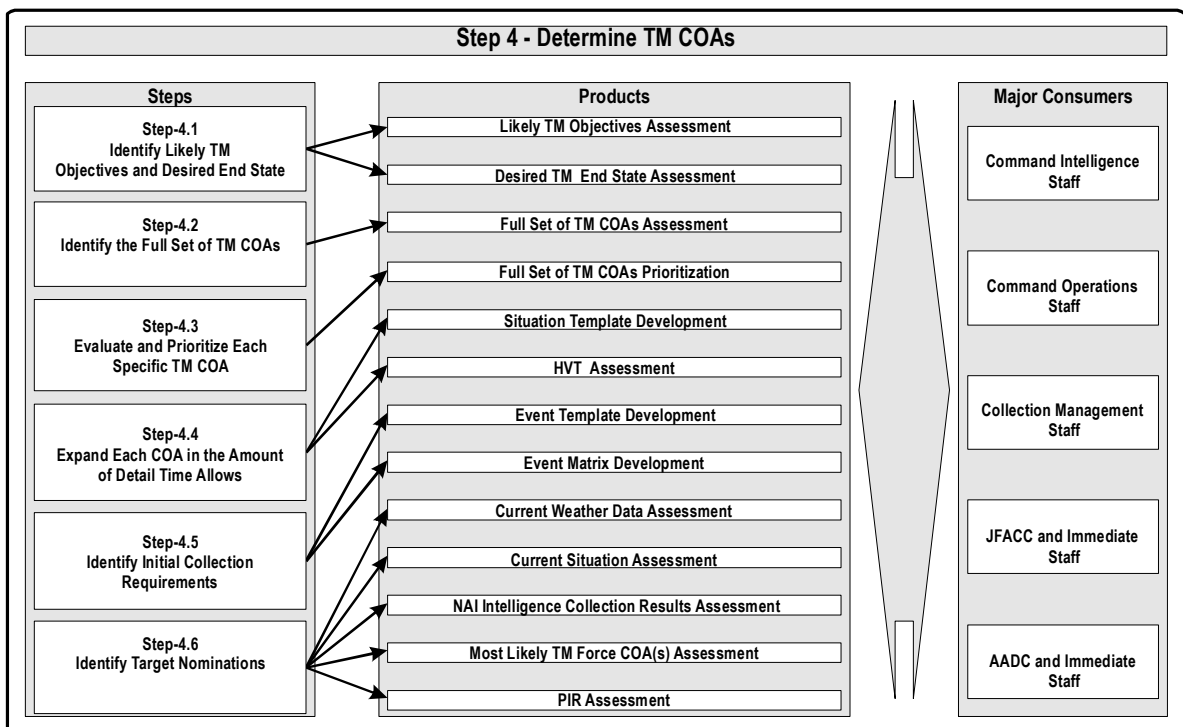

Figure V-1. Step 4 - Determine TM COAs

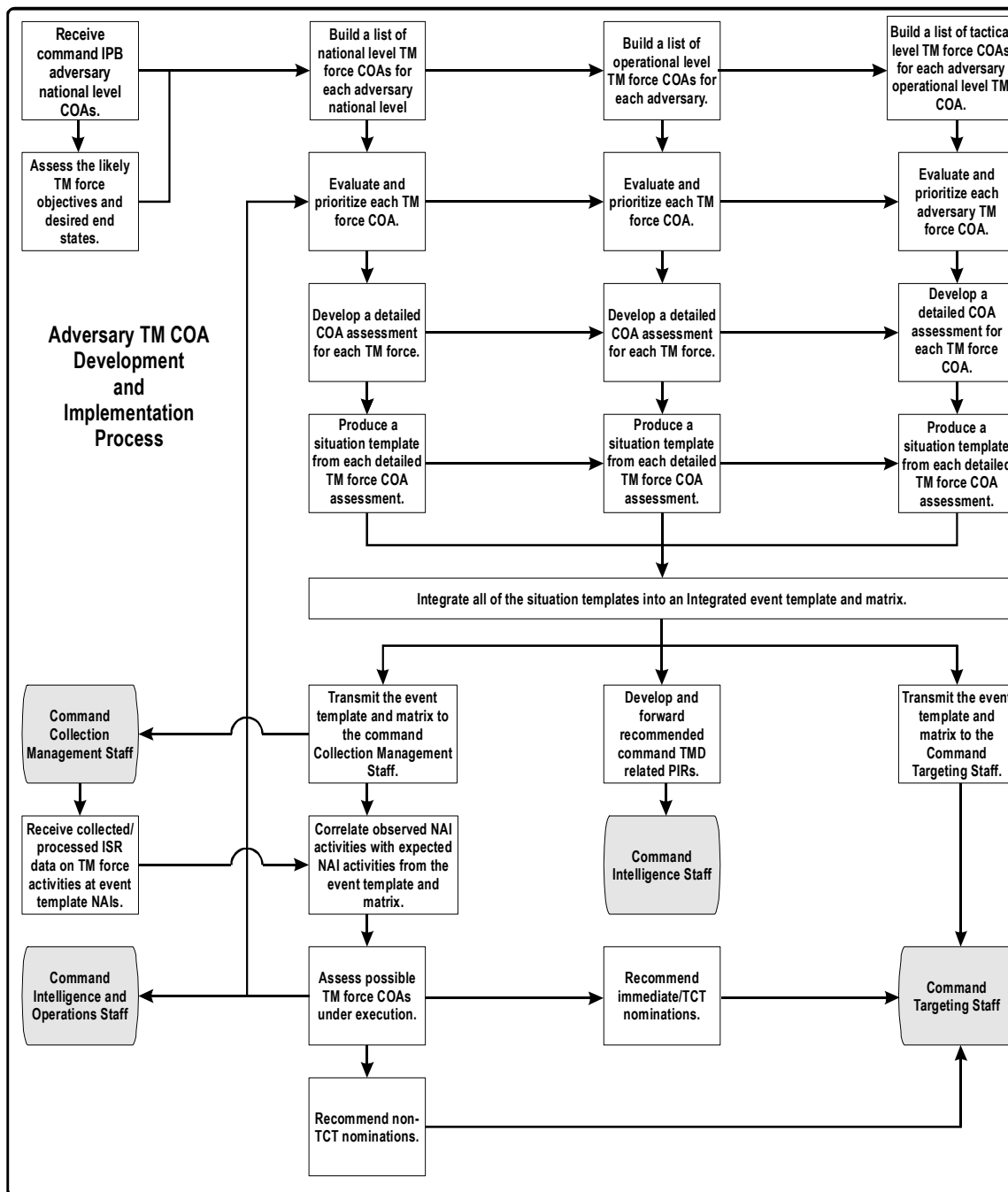

Figure V-2. Adversary TM COA Development Flow Process

b. Identify the Full Set of Available COAs. Consider the following when developing—

(1) The probable doctrinal COAs given the current situation and the likely objectives. This requires understanding the adversary’s decision-making process and perception of the current situation.

(2) The TM COAs that could significantly influence the command’s mission, even if doctrine considers them infeasible or “*suboptimum*” under current conditions. Consider any indirect or “*wildcard*” COAs that the TM force is capable of executing.

(3) The TM COAs indicated by recent activities and events. To avoid surprise from an unanticipated COA, consider all possible explanations for the TM activity in terms of possible COAs.

(4) Asymmetric and asynchronous threats that could impact TMD operations.

Consider each COA subset independently to avoid forming biases that restrict the analysis and evaluation. Once subsets have been evaluated separately, combine them to eliminate redundancy and minor variations. Compare the consolidated list to TM capabilities (TMD IPB Step-3) to eliminate any nonexecutable COAs. Based on the capabilities evaluation, select TM models that will accomplish the likely TM objectives. The effects of the battlespace (TMD IPB Step-2) influence their application as COAs. Typically terrain, weather, and other characteristics of the battlespace environment *“offer”* a limited set of COAs, encouraging some while discouraging others. Start with general COAs open to the adversary, such as *“deploy to field,” “maintain combat readiness in the field,”* and *“multiple missile combat operations.”* Define each general COA further as a set of specific COAs by integrating the TM models from Step-3 with the description of the battlespace’s effects from Step-2. For example, a general COA such as *“single missile combat operations”* might be further defined as a set of specific COAs such as *“with SCUD Bs from a specific geographic area using chemical warfare warheads . . . against the enemy command center.”* TM factors to consider are intent or desired end state and likely attack objectives; effects of the battlespace environment on operations and broad COAs; vulnerabilities or shortages in equipment or personnel and current dispositions; and location of main and supporting efforts and perception of friendly forces and efforts to present an ambiguous situation or achieve surprise. Each identified COA should meet the following criteria:

(a) Suitability. A COA must have the potential for accomplishing the TM force’s likely objective or desired end state. If the COA is successfully executed, will it accomplish the objective?

(b) Feasibility. To determine the feasibility of a COA, consider the time and space, resources, and physical means required to successfully execute the COA. Force compositions or other factors might indicate the lack of means to accomplish likely TM objectives. Consider all actions that could create the conditions needed for success before discounting the COA completely. For example, the adversary might conduct economy of force operations in some sectors in order to generate sufficient combat power for offensive operations in others. A lack of resources might force the TM force to violate its own doctrine in order to accomplish its objective. Avoid surprise, consider any seemingly radical measure that may be taken to create the conditions for success.

(c) Acceptability. Consider the amount of risk a TM force will accept in adopting the COA. Can it afford the resource expenditure for an uncertain chance at success? This is a subjective judgement based on knowledge of the TM force and its doctrine. Sometimes the TM force might undertake otherwise unfavorable COAs, if they are the only means to accomplishing its objective.

(d) Uniqueness. Each COA must be significantly different from the others or else consider it a variation rather than a distinct COA. Consider the following factors to determine if a COA is “significantly” different:

- Its effect on the friendly mission.
- Exposure of force assets and location.
- Employment concept and task organization.

(e) Consistency with Doctrine. Each COA must be consistent with TM doctrine. The evaluation of consistency is based on written doctrine and observations of the TM force's past application of that doctrine. Check the intelligence database and templates from TMD IPB Step-3 for this information. Do not overlook TM efforts to achieve surprise by deviating from known doctrine or using "wildcard" COAs.

(f) Additional Considerations. Consider the following guidelines to identify the full set of available COAs:

- Account for the effect of or the TM force's perception of friendly dispositions, when determining the available TM COAs. Conduct a "reverse IPB" by replicating the process that the TM force is using to discern friendly COAs.
- Focus on those COAs that will affect accomplishment of the friendly command's mission. Include indications that the TM force might adopt a COA that favors accomplishment of the command's mission. This prepares the commander to take advantage of opportunities that might arise.
- Identify the full set of COAs available to the TM force. History repeatedly demonstrates that those who predict only one COA are often surprised by the adversary.

c. Evaluate and Prioritize Specific COA. The resulting set of COAs depicts the full set of options available to the TM force. It is not possible to predict with complete accuracy which of the COAs the TM force will employ because the identified TM force COAs are predictive, not exclusively facts. The templates at Appendix B, Figures B-41 and B-42, assist in listing COAs and prioritizing them. The commander and staff need to develop a plan targeted at one of the COAs, while still allowing for contingency options if the TM force chooses another COA. Therefore, evaluate and prioritize each COA according to its likely adoption by the TM force. An initial priority list allows the staff to plan for friendly COAs. Even after the commander selects a friendly COA, continue to reorder the TM COAs according to the situation and any change in the adversary's perception of friendly forces.

In developing TM COAs for TMD, focus on the types of COAs the TMD command may execute based on the adversary's predicted targeting strategy and the terrain and weapon limitations. For instance, the TMD unit wants to use TMD systems to their best advantage over adversary missile launches. Specific details on TM launch areas, targets, attack structure, flight azimuths, etc., allow adjustment of TMD radar systems. Similarly, the attack operations unit wants to quickly react to TM activity when on SCUD hunting missions. Focus COA development on those data elements that provide the highest leverage for TMD commanders. To prioritize each TM COA—

(1) Analyze each to identify its strengths and weaknesses, centers of gravity, decisive points and risk factor.

(2) Evaluate how well each meets the criteria of suitability, feasibility, acceptability, uniqueness and consistency with doctrine.

(3) Evaluate how well each takes advantage of the battlespace environment.

(4) Consider that the TM force may choose the second or third “best” COA while attempting a deception operation portraying acceptance of the “best” COA.

(5) Analyze recent TM activity to determine if there are indications that a specific COA is being adopted. Do current dispositions favor one COA over others?

d. Expand Each COA in the Amount of Detail Time Allows. Once the complete set of TM COAs has been identified, evaluated, and prioritized, develop each COA with as much detail as the situation requires and time allows. Develop each in the order of its priority and the commander’s guidance. Each COA should answer the following 5 questions:

- ◆ WHAT (the type of operation [that is, deploy, attack, or maintain])?
- ◆ WHEN (the time the action will begin [state this in term of the earliest time that the TM force can adopt the COA under consideration])?
- ◆ WHERE (the COA sectors, zones, direction of attack, and objectives)?
- ◆ HOW (the method [that is, dispositions, location of main effort, the scheme of maneuver, and how it will be supported] the TM force uses to employ its assets)?
- ◆ WHY (the TM objective or end state)?

Time permitting, the final product should consist of a comprehensive, detailed set of TM COAs. Each developed TM COA has the following 4 parts:

(1) Situation Template. Situation templates are graphic depictions of the expected TM dispositions should a particular COA be adopted. Several templates represent different “snapshots in time” and start with the TM force’s initial array of forces. They depict points where the TM force might adopt branches or sequels to its main COA, places where the TM force is especially vulnerable, or other key points in the battlespace (that is, initial contact or TM operations against friendly forces). Use situation templates to support staff wargaming and to develop event templates and event matrices.

Begin construction of a situation template with the TM model from TMD IPB Step-3, representing the operation under consideration. Overlay the doctrinal template on the products that depict the battlespace environment’s effects on operations from TMD IPB Step-2. Use the integrated area limitations product to build the situation template (Figure V-3). This approach combines the TM force’s doctrine for fighting (TMD IPB Step-3) with the environment (integrated area limitation product) from TMD IPB Step-2, and the current intelligence situation. Using judgment and knowledge of TM tactics and doctrine (see TM model), account for battlespace environmental effects and adjust the dispositions portrayed on the doctrinal template. There will be many options, so consider the situation from the TM commander’s point of view when selecting from among them.

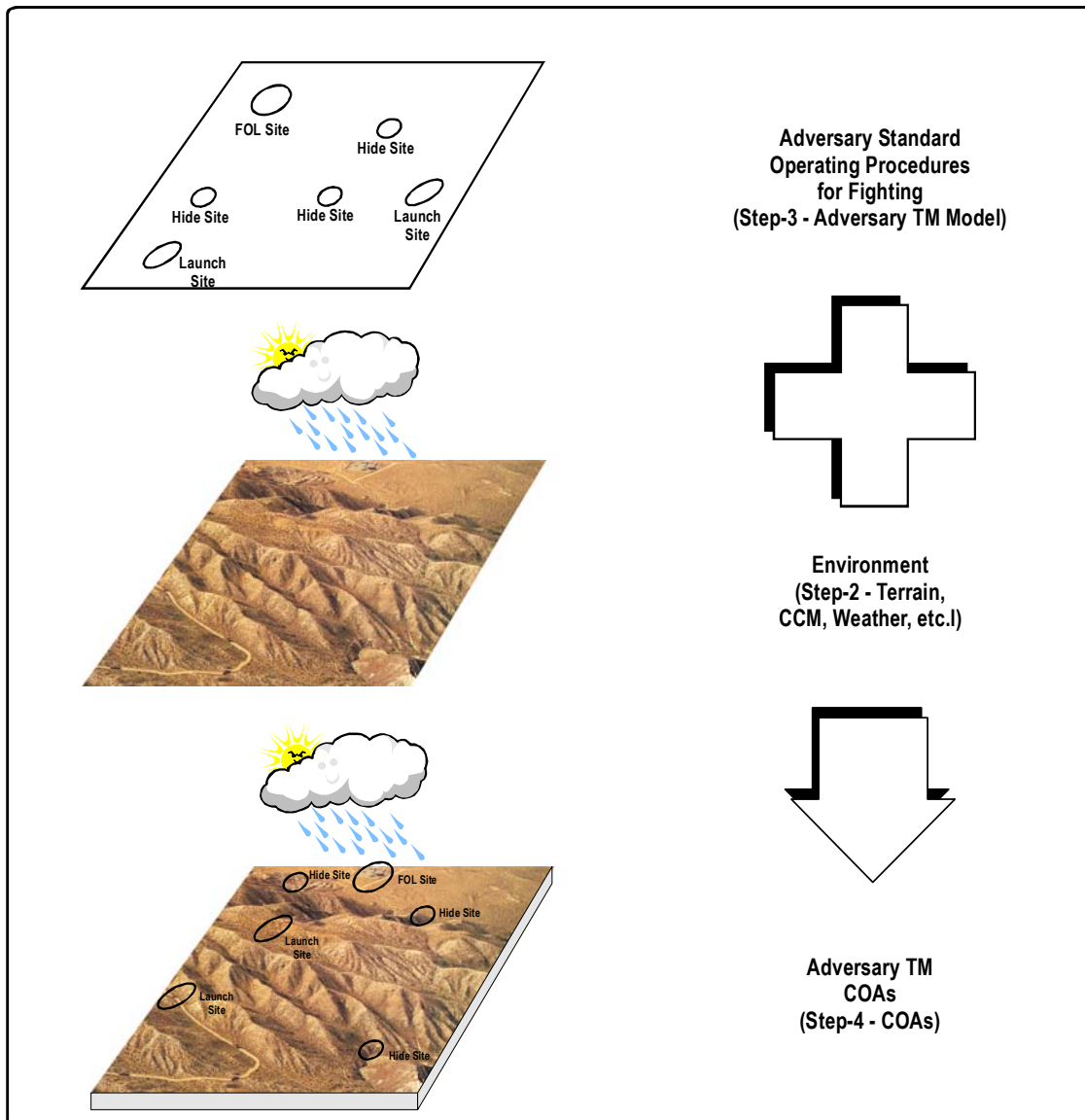

Figure V-3. Situation Template Concept

The situation template is a checkpoint to ensure that all the major assets have been accounted for, and that none have been inadvertently duplicated. This ensures that the template reflects the main effort identified for this COA. Compare the depicted dispositions to the known TM doctrine, checking for consistency. Always consider the TM force's desire to present an ambiguous situation and achieve surprise. Include as much detail as the time and situation warrant in the template. For example, if the TM force is conducting multiple missile combat operations, identify the operations' likely launch and hide sites, FOLs, and transloading areas. Depict the locations and activities of the HVTs listed in the TM model. Next, using preferred TM TTP (accompanies the doctrinal template), evaluate the COA's scheme of maneuver. Visualize how the TM force transitions from its current positions to those depicted on the template and consider its scheme of maneuver through the COA's success or failure. Identify points where forces will transition from one formation to another, potential hide sites, etc. After working through the scheme of maneuver, determine how each of the TM systems "fits in" and supports the operation.

The command level and type of operation have a direct bearing on the detail that goes into each situation template. At strategic levels, situation templates might focus on the shift of TM forces from garrison to field deployment, as well as political and economic developments that may indicate an adversary's intent to use TMs. NAIs highlighting these actions can sometimes encompass large regions. At operational levels, the situation template might focus on groups of TM vehicles, operating areas, and LOCs. Operational NAIs may be large operating areas or logistical support areas. At tactical levels, the focus may be on individual vehicles in TM dispositions. These NAIs are often "pinpoint" locations such as road junctions or small unit battle positions. Tailor the situation templates to the factors that are important to the commander or mission area. For example, if the important factor is TM launchers, focus on them when determining and developing TM COAs and produce a situation template that shows only the location and movement routes TM launchers, their likely employment areas and NAIs.

Depicting TM movement by evaluating time and space factors develops time phase lines (TPLs). TPLs are drawn on the template to depict the expected progress of the operation and are based on the doctrinal TM rates of movement, with some modification. Evaluate and compare actual database movement rates with written doctrine. Consider battlespace environmental effects on mobility by using terrain analysis systems, such as generic area limitation environment (GALE). Some situation templates can be presented in a matrix format. For example, a situation template in matrix form could show one COA for a TM strike against friendly targets. The timeline could indicate spacing between the various elements as well as the time each element is expected within each NAI.

(2) Description of the COA and Options. Describe TM activities and systems depicted on the situation template either in text form or with a detailed "synchronization matrix." Address timelines to include the earliest time the TM force COA can be executed, phases associated with the COA, and probable TM command decisions made during and after COA execution. Use the TM COA depiction and timeline to support staff wargaming and to develop event template and supporting indicators. As the TM force approaches friendly decision points (DP), record each decision and its timeline into the TM COA depiction. DPs are points in space and time where the commander anticipates making a decision concerning the specific friendly COA. These decisions are usually triggered by specific threat force activity and are normally associated with one or more NAIs. This is the basis for developing TM branches or sequels, if they are needed to support friendly planning. Record any decision criterion that is associated with a DP.

(3) HVTs. As the situation template is prepared and mentally wargamed, note how and where each TM force activity and asset provides critical support to the COA. This leads to HVT identification. The list of HVTs in the TM model serves as a guide and may not be all-encompassing. Determine the COA effect of losing each HVT and identify likely TM responses. Each HVT's relative worth varies depending on the specific situation and COA execution. Identify times or phases in the COA when the target is most valuable to the TM commander and make appropriate notations on the HVT list. Transfer the refined and updated HVT list to the situation template. The list supports staff wargaming and the targeting process. Note on the situation template where HVTs must appear or be employed to make the operation successful. Highlight these locations at or just before the times they are most valuable.

(4) HPTs. HPTs are those targets whose loss to the enemy will significantly contribute to the success of the friendly COA. Identify HPTs by correlating the HVT list with the selected friendly COA. In accordance with the commander's intent, the operations and targeting staff may also select HPTs that are not on the TMD IPB HVT list. The end result is a list of HPTs that must be successfully attacked in order to successfully accomplish the friendly commander's mission.

e. Identify Initial Collection Requirements. After identifying the set of potential TM COAs, determine which one will be adopted. Initial collection requirements aid in this identification. To identify these requirements, predict specific areas and activities that when observed will confirm which COA the TM force has chosen. NAIs are the areas, routes, and points where key events are expected to occur. NAIs can be—

- ◆ Large areas, such as brigade or battalion field operating areas; often referred to as “SCUD boxes” or “TM operating areas.”

- ◆ Normal or focused areas, such as terrain, over which TM units are expected to move and suitable field operating areas (that is, launch and hide sites).

- ◆ Linear routes, such as roads or waterways.

- ◆ Point locations, such as road intersections and fixed facilities.

NAIs are typically hierarchical in nature. A large area NAI may include many area, linear and point NAIs. Linear NAIs, such as roads, may contain point NAIs, such as road intersections. Indicators are the activities that identify the selected COA (see Appendix B, Figure B-43, for an aid in documenting NAIs).

(1) The Event Template. The differences between the NAIs, indicators, and COA phases of operations form the basis of the event template (Figure V-4). The event template (see Appendix B, Figure B-44) is a guide for collection, reconnaissance, and surveillance planning. It aids in determining which COA the TM force has adopted by showing where to collect the information. Since single TMD event templates may not be practical, considerable cooperation amongst all the friendly TMD intelligence elements within a multiservice TMD environment is needed. One method is to produce multiple event templates at the strategic, operational, and tactical levels and for the TMD operation they are supporting (that is, active defense, passive defense, and attack operations). Evaluate each COA to identify its associated NAIs. It is important to mentally wargame execution of the COA and note places where activity must occur if that COA is adopted. Pay particular attention to times and places TM HVTs enter or use areas, so that they can be easily acquired and engaged. These areas evolve into NAIs and together with the correct use of DPs and timelines can support targeting. Allow enough time from the verification of an NAI activity and the decision to target to asset identification and strike mission. Consider those places the TM force expects to take certain actions or make certain decisions. An NAI can be a specific point, a route, or an area and can match obvious natural terrain features or arbitrary features, such as engagement areas. Make NAIs large enough to encompass the activity that indicates the TM COA. Compare and contrast COA associated NAIs and indicators with each other and identify any differences. Place emphasis on the differences that most reliably confirm or deny

the adoption of a COA. Mark the selected NAIs on the event template. The initial event template focuses only on identifying which of the predicted COAs the TM force has adopted. Later, it will be updated and refined to support friendly decisions identified during staff wargaming.

(2) The Event Matrix. The event matrix supports the event template by providing details on the type of activity expected in each NAI, the times the NAI is expected to be active, and its relationship to other events in the battlespace. It plans intelligence collection and serves as an aid to situation development (see Appendix B, Figure B-45). Examine the events associated with each NAI on the event template and restate in the form of indicators. Enter the indicators into the event matrix along with the times they are likely to occur. By using the situation template's phases of operations or the COA description, establish the expected times in the event matrix. If there is a latest-time-information-of-value timeline, based on the expected flow of events, record it into the event matrix as a guide for the collection manager (Figure V-4).

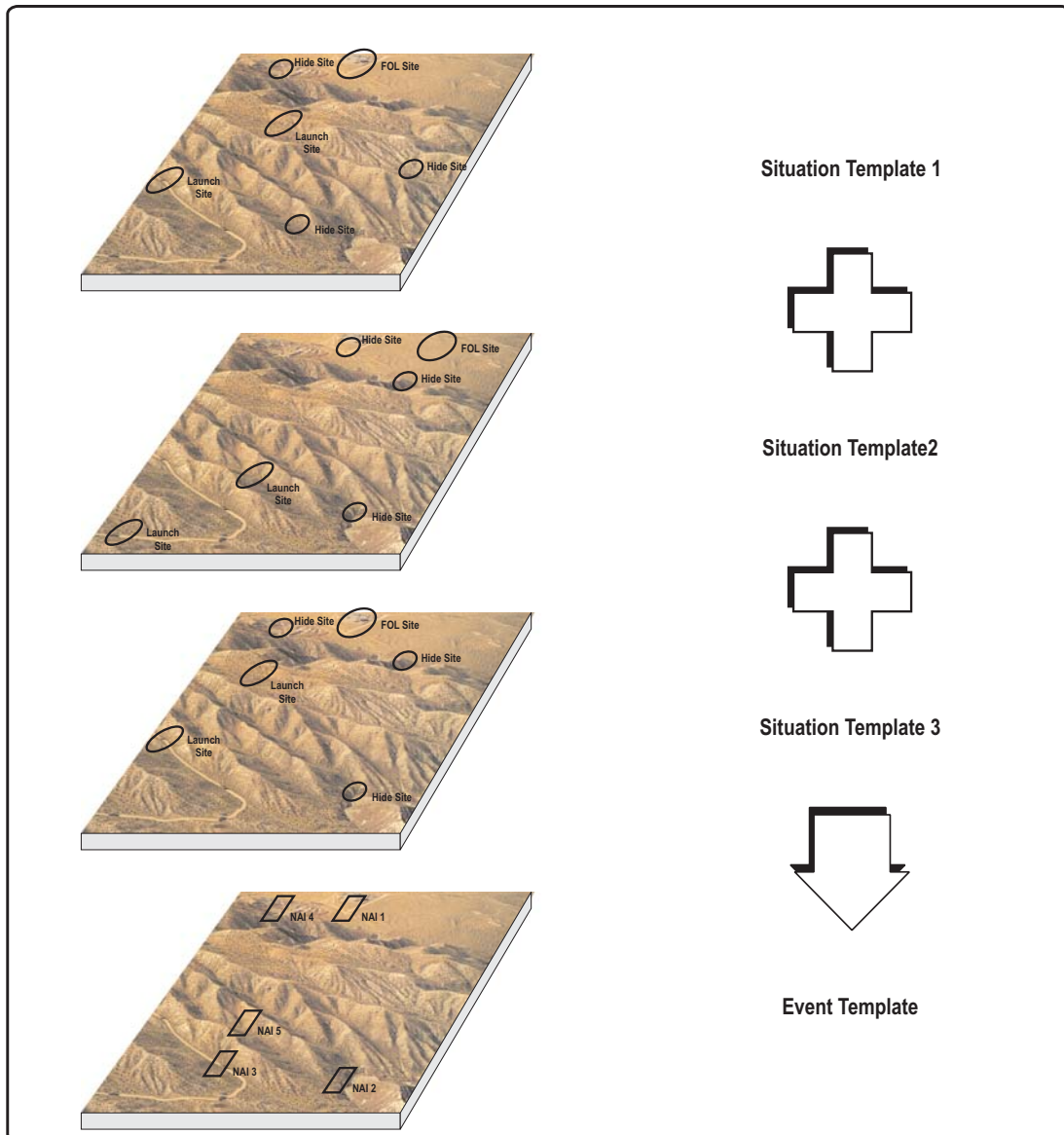

Figure V-4. Event Template Concept

(3) Additional Considerations. To identify initial collection requirements consider the following:

(a) Differences between COAs can consist of different TPLs or indicators associated with a particular NAI but are usually reflected in different NAIs.

(b) TM deception can affect the reliability of each event as an indicator.

(c) During staff wargaming, a decision support template (DST) can incorporate NAIs to support decisions by the commander and track HPTs. Develop additional NAIs from potential NAIs identified on the situation templates and the results of decisions made during friendly COA wargaming. TM COA models drive friendly COA wargaming and aid in the construction of the command's DST and other staff synchronization tools used during mission execution. Disseminate these TM COA models as widely as possible.

The event template and event matrix, once completed, form the basis for planning collection strategies, synchronizing intelligence with friendly operations, and preparing the collection plan. In some cases, the event template might be disseminated in the form of a collection graphic to support intelligence planning and collection by other units. The collection plan, based on the event template and matrix, determines the types, quantity, and quality of future intelligence fed into the TMD IPB process. The ability to improve the TMD IPB process and output depends on the quality of the event template and matrix.

f. Identify Target Nominations. After identifying potential TM COAs and establishing initial collection requirements, identify as many targets as possible for attack operations. To identify HVTs, predict specific points, areas, equipment, and activities which, when observed from established collection requirements, reveal TM targets for attack operations. The result is an HVT nomination list, an event template, and an event matrix. Develop the event template and matrix using the same guidelines as those for identification of initial collection requirements but focus on HVTs. The completed event template and matrix aid in target planning for attack operations. Certain HVTs are nominated during the command staff wargaming process to become HPTs and make their engagement an integral part of the friendly COA under consideration. HVT graphic and targeting materials may also be required (see Appendix B, Figure B-46). The TMD IPB process produced a number of graphics, textual descriptions, and imagery products, some of which are used within target folders. Package and give these and any updated products to the target planners as some targets may not have target folders built or may have only partial target folders.

Appendix A

COMMON TMD IPB PROCESSES

1. Introduction

There are several common processes used throughout the TMD IPB process. It requires a great deal of discipline, but it is essential that the basics are followed in order to complete and maintain an adequate TMD IPB for the command.

2. Graphics and Templates

a. Graphics are basic to TMD IPB analysis and best communicate the intelligence picture. They assist but do not replace battlespace analysis and the intelligence estimate and are the basis for intelligence and operational planning. Currency is maintained through graphic renewal or update. Currently, the majority of IPB analysis is done manually—a time and manpower intensive process. Exploit automated graphical analysis and display of IPB—it is worth the investment of time and resources. Automated tools are particularly useful when dealing with time critical targets (TCT)/time sensitive targets. Use available automation, time, resources, and personnel to produce the graphics that are most beneficial to the command and distribute TMD IPB products to subordinate units when feasible. This maximizes unit efficiency and permits subordinate units to expand on higher level TMD IPB products or produce others unique to their unit mission.

b. Adversary evaluation and integration is achieved by templating. Templates are normally graphical illustrations but can be in a matrix, tabular, textual, or other format. Templates provide a visualization of the intelligence databases and have numerous purposes and functions. Terrain and weather factor overlays; for example, depict the effects of terrain and weather on potential TM COAs. Templates graphically depict TM force capabilities; TM force characteristics (that is, force dispositions, weapons, and equipment) predict probable TM force COAs and confirm or refute predictions. Templates need to be dynamic and continuously updated to maintain a current assessment of the TM force status. The TMD IPB process normally produces 4 types of templates:

(1) General - Provides general information (terrain, weather, etc.) not fitting into the next 3 types of templates and not related to specific TM force operations.

(2) Doctrinal - Provides unconstrained weather and terrain TM force TTP. Depicted information includes depths, composition, formations, TO&E, and HVTs.

(3) Situation - Depicts how the TM force might deploy and operate when constrained by weather and terrain. These templates normally depict TM force COAs.

(4) Event - Depicts where critical events and activities are expected to occur and critical targets expected to appear. Depicted information includes NAIs and HPTs.

Establish a consistent format for all templates. The particular format is not as important as consistency. The format depends greatly on whether the templates will be distributed electronically, hardcopy, or both. Electronic templates look and feel very different than hardcopy templates. They also vary depending on the type of software and computer. For example, commercial off the shelf (COTS) software may impose limitations on a consistent format but have benefits generally not available in non-COTS software.

Note: This TTP illustrates only hardcopy template formats using a 2-part concept. The first part/page is the template cover page and provides valuable overview and classification information (see Appendix B, Figures B-1 and B-2). The second part/follow-on page(s) is the body/analytical content of the template (see Appendix B, Figures B-3 through B-46). The templates and formats are illustrative and can be freely used for actual TMD IPB development but are not the only suitable formats. Tailor formats to the needed product, customer, and unique situation(s). The rest of this TTP shows only the second part/follow-on page(s) of the illustrative and blank example template(s).

3. Knowns Versus Assumptions

TMD IPB development distinguishes between what is known with confidence (based on the situational facts and adversary) and what are untested assumptions. Intelligence can be an observed fact or a conclusion based on facts of such certainty that it is considered to be knowledge. It can also be conclusions and estimates deduced from incomplete sets of facts or deduced from potentially related facts. Make and maintain these distinctions when using intelligence for operations. The commander may decide objectives and operations based on whether the intelligence is “fact” or assumption, its confidence level, and the particular logic used to develop the intelligence estimate.

Adapt an internal methodology for tracking the reliability and credibility of TMD IPB intelligence analysis and conclusions and for presenting consistent and uniform information to decision makers. The intelligence community uses 3 methodologies, which can be used independently or in conjunction with each other, to assess information validity. The 3 methodology scales are *confidence level, source reliability, and information credibility*. The latter 2 are typically used with HUMINT information but are equally applicable to many other types of information.

a. Confidence-Level Scale:

- (1) HIGH PROBABILITY (CONFIRMED) - >95 percent.
- (2) PROBABLE - 75-94 percent.
- (3) LIKELY - 50-74 percent.
- (4) LOW PROBABILITY (UNLIKELY) - 5-49 percent.
- (5) VERY LOW PROBABILITY (VERY UNLIKELY or DOUBTFUL) - <4 percent.

b. Source Reliability Scale:

- (1) A - COMPLETELY RELIABLE.
- (2) B - USUALLY RELIABLE.
- (3) C - FAIRLY RELIABLE.
- (4) D - NOT USUALLY RELIABLE.
- (5) E - UNRELIABLE.
- (6) F - CANNOT BE JUDGED.

c. Information Credibility Scale:

- (1) 1 - SEVERAL CONFIRMATIONS.
- (2) 2 - PROBABLY TRUE.
- (3) 3 - POSSIBLY TRUE.
- (4) 4 - DOUBTFUL.
- (5) 5 - IMPROBABLE.
- (6) 6 - CANNOT BE JUDGED.

4. All Source Approach

Evaluate, correlate, and integrate information and intelligence from all sources into TMD IPB products to present the most complete, accurate, and objective views possible. In particular, joint operations require complete and composite views of the situation and TM forces. Using and having access to all information and intelligence sources is essential to understanding the actual situation, because single-source intelligence analysis may lead to incomplete assessments. Use of the all-source concept and methodology reduces the risks of deception, and all-source collection and analysis help to identify and frustrate an adversary's deception and denial attempts. All-source intelligence fusion begins with collection and production planning. Each source can provide useful information and cues for other source collection and exploitation.

a. Sources. The intelligence community divides sources into several distinct categories; each with a unique contribution to the TMD IPB process. They are imagery intelligence (IMINT), SIGINT, HUMINT, MASINT, open source intelligence, scientific and technical (S&T) intelligence or technical intelligence, and counterintelligence.

A multitude of sensors are available to perform the many intelligence collection missions. They vary in their technical performance (weather plays a limiting role) and capabilities. The same sensor can vary in performance when used in different ways. For example, the range and angle that a sensor is employed greatly affects the resolution of its product. To understand basic advantages, disadvantages, products, and timeliness of different sensor types, see Tables A-1 and A-2 for a basic matrix of general sensor type characteristics.

b. Classification of Sources. The all-source approach stresses using all available intelligence to include sources classified up to and including TOP SECRET (TS) sensitive compartmented information (SCI). Overall, most source reports are classified TS/SCI, but a lot of the information is classified at the collateral level. Valuable information that is not collateral can usually be sanitized to the collateral level. When information has to remain at the TS/SCI classification level, distribute separate TS/SCI TMD IPB products to those with the proper clearances and need to know.

c. Typical Types of Intelligence Reports. Reports are verbal or written explanations of intelligence information and are generally prepared by reconnaissance aircrews or by imagery analysts who glean information from reconnaissance imagery. Each of the various intelligence reports possesses unique characteristics of timeliness and precision, and the intelligence requester needs to know them to tailor requests to actual information needs. See Table A-2, JP 2-01, *Joint Intelligence Support to Military Operations*, and the following paragraphs for descriptions of typical intelligence reports.

(1) In-flight Report (INFLTREP). Aircrews and unmanned aerial vehicle (UAV) operators use the INFLTREP to report mission results or other sighted tactical information of such importance and urgency that the delay (if reported by normal debriefing) would negate the usefulness of the information. The INFLTREP is a voice-only message.

(2) Reconnaissance Exploitation Report. This provides an abbreviated imagery interpretation report for tactical reporting. It is normally transmitted within 45 minutes of reconnaissance platform recovery but may take several hours depending on the sensor, film type, processing, and quality of image sensor reading.

(3) Mission Report. This reports mission results and items of intelligence interest in all tactical roles.

(4) Imagery Interpretation Report. This is a single-message format for sending either the Initial Phase Interpretation Report (IPIR) or the Supplemental Photographic Interpretation Report (SUPIR). The IPIR provides the results of first-phase exploitation of imagery. IPIRs are normally transmitted within 15 minutes of imagery receipt. For a mission, all IPIRs are normally completed within 24 hours of reconnaissance platform recovery. The SUPIR provides results of second-phase exploitation of imagery and may take hours or days to complete based on the detail of the requested information.

(5) RFI . This is the message format used to reply to RFI/production requirement. It is used to advise requesters that a previously transmitted message (reference the message) contained the requested information.

(6) Tactical Reports. Tactical reports are of immediate interest to commanders and operators of tactical units at all levels. The intent of tactical reports is to get perishable, concise information to units in time for it to be acted upon. Tactical reports include the tactical report, the tactical ELINT report, and the operations report.

Table A-1. Matrix of General Sensor Types to Intelligence Advantages and Disadvantages

Sensor/Intelligence Matrix				
SENSOR TYPE	ADVANTAGES	DISADVANTAGES	PRODUCTS	TIMELINESS*
IMINT Other than Visible Spectrum				
Forward looking infrared	Both day and night	Stand off range Weather obscuration Field of view Resolution Dusk/dawn crossover Rain washout	Video report INFLTREP	>1 hour Near real time
Infrared linescanner	Both day and night High resolution	Stand off range Weather obscuration Field of view Resolution Dusk/dawn crossover Rain washout	Hardcopy Video report INFLTREP	>4 hours >4 hours Near real time
Ultraviolet linescanner	High resolution May "see thru" camouflage	Day only Weather obscuration View time Field of view	Hardcopy Video report INFLTREP	>4 hours >4 hours Near real time
Multi-spectral fusion sensors	Both day and night Medium resolution	Weather obscuration Field of view	Video report INFLTREP	>4 hours Near real time
IMINT Visible Spectrum				
Image-intensified video	Night Medium resolution	No day capability Standoff	Video report IINFLTREP	>4 hours Near real time
Framing camera – wet film	Resolution Standoff range	Timeliness View time Weather obscuration Information dissemination Day only	Textual report Photos Oblique Vertical Panoramic	1-2 hours 12-24 hours
Framing camera – digital	Standoff Timeliness	Resolution Viewtime Weather obscuration	Textual report Photos Oblique Vertical Panoramic	>1 hour >1 hour
Framing camera – electro- optical	Standoff Timeliness Resolution	View time Weather obscuration	Textual report Photos Oblique Vertical Panoramic	>1 hour >1 hour
Video	Timeliness	Resolution Weather obscuration Day only Information dissemination	Videotape Textual report INFLTREP	>1 hour >1 hour Near real time
* Measured from moment of collection to availability for analysis				

Table A-1 (Continued). Matrix of General Sensor Types to Intelligence Advantages and Disadvantages

Sensor/Intelligence Matrix				
SENSOR TYPE	ADVANTAGES	DISADVANTAGES	PRODUCTS	TIMELINESS
IMINT – Radar				
Side-looking airborne radar	Area coverage All-weather Day and night	Requires interpretation	Video Textual report Dry film INFLTRP	<1 hour <1 hour <1 hour Near real time
Inverse synthetic aperture radar	High resolution Range independent Standoff range Best for maritime targets	Requires interpretation	Video Textual report INFLTRPT	<1 hour <1 hour Near real time
Synthetic aperture radar	Moving target indicator Best for land targets Range independent Standoff range	Requires interpretation	Video Textual report Dry film INFLTRPT	<1 hour <1 hour <1 hour Near real time
Forward looking airborne radar	Standoff range Small target detection	Resolution Target classification	Video Textual report INFLTRPT	<1 hour <1 hour Near real time
Ground surveillance radar	Timeliness Resolution	Range	Report	Near real time
Visual Intelligence				
Surface-aggressive (cavalry)	Direct observation	Possible loss of reconnaissance asset Limited range Field of view	Report	Near real time
Surface-stealth (cavalry/reconnaissance)	Direct observation	Limited range Field of view	Report	Near real time
SOF	Direct observation	Limited range Field of view Need for clandestine insertion/extraction	Report	Ranges from near real time to considerable delays
Aircrew	Direct observation	Limited view Time Standoff Reference for information	Report	Near real time
SIGINT				
ELINT	Passive detection of non-communications radiation	Target must emit in order to collect intelligence	Report	Near real time
Communications intelligence	Passive detection of communications	Target must emit in order to collect intelligence	Report	Near real time
Foreign instrumentation signals intelligence	Passive detection of telemetry and other data	Target must emit in order to collect intelligence	Report	<1 hour
MASINT				
MASINT	Passive detection Measures specific emitter data	Requires interpretation	Report	<1 hour
Acoustic				
Active acoustic	Timeliness Able to work subsurface	Thermal layer blockage Standoff Possible loss of sensor platform	Report	Near real time
Passive acoustic	Timeliness	Thermal layer blockage range	Report	Near real time

Table A-2. Typical Intelligence Reports

Intelligence Category	Intelligence Products		
Visual	Textual – Written report	Verbal – INFLTREP over the radio	
Imagery	Visual – Imagery prints – Video – Digital imagery	Verbal/Textual – Accompanying reports	
Signal	On-line – TIBS display – Special information systems/voice product net	Textual – ELINT reports – Tactical reports	Verbal – Tactical reports
Weather	Visual – Charts – Imagery	Verbal – INFLTREP reports – Weather briefings	

(a) Tactical Report. This provides the most urgent, perishable information of tactical significance to tactical unit commanders. It alerts them to immediate threats and provides enhanced situational awareness. Though the report can be either a free-flow voice report or a hardcopy computer-formatted message, send it via message precedence commensurate with its content. Examples of the voice format and the hardcopy report are in JP 6-04, *United States Text Formatting Program*.

(b) Tactical ELINT Report. This reports time-critical operational ELINT and parametric information and may be used for indications and warning, database maintenance, orders of battle, and strike planning.

(c) Operations Report. Any unit can use the Operations Report-3 to provide the joint force commander and other appropriate commanders with immediate notification of an incident or event where national interest is not indicated or has not been determined.

(7) Tactical Information Broadcasting System. This is a satellite broadcast of intelligence and combat information. It is used during contingency and exercise operations and provides near-real-time data on adversary force disposition and array and friendly elements. This transportable system can be placed with battle managers or other C2 nodes. It links intelligence producers with consumers and allows selected users to query collectors for data during operations. Data is filtered by software and displayed either graphically or as text.

(8) Special Information System/Voice Product Net. This is a secure ultra high frequency (UHF) KY-58 voice link between intelligence producer and consumer. It is used to pass the tactical report and situational awareness information based on pre-mission tasking or on-scene dynamic tasking.

5. Establishing Collection Requirements

a. Collection Management. Collection management is the process of converting intelligence requirements into collection requirements, establishing, tasking or coordinating with appropriate collection sources or agencies, monitoring results and retasking, as required. It is a staff activity that focuses on decisions and choices that concern collection requests and RFI. There are many ways to task the intelligence community to get needed information for

operational use. A variety of collectors, ranging from humans to airborne collectors (controlled manually or software-driven), are tasked to fulfill intelligence requirements. Intelligence support personnel at the unit level need to determine the direction and flow of intelligence information. Intelligence needs, referred to as requirements, are registered based on time sensitivity. Requirements satisfied by airborne platforms are defined as follows:

(1) Time Critical Requirements - Requester needs the intelligence either in near-real-time or based upon the requester's LTIOV but no later than 24 hours. Typically the timeliness required is "upon recognition." (Example: A location request for a SCUD TEL that recently launched a missile is a time critical requirement.)

(2) Routine Requirements - Requester needs in 24 hours or more. It supports routine combat operations and is addressed through the collections process (for example, creation of collection targets to search for specific adversary units not yet located in the AO).

(3) Standing Requirements - Established before a contingency arises and provides a baseline for the intelligence problem set (that is, request to monitor TM operating areas for operational activity).

b. Collection Requirements. Always state intelligence requests clearly and include precise parameters (desired and minimum required) and a written justification statement. Parameters include suspense dates, frequency of coverage, resolution/level of information, and specific viewing angles/direction (IMINT).

(1) Requirement Identification. Ensure collection managers are aware of TMD IPB objectives, information needs (quality, quantity, frequency, etc.), and the constraints and limitations imposed on the TMD IPB process. Inform the collection manager as soon as possible of tasked targets.

(2) Collection Priorities. A target's value changes. Keep the collection manager informed so collection priorities can be adjusted, if needed. Establish requirements and their associated priorities for peacetime target surveillance, crisis monitoring, and combat support. Prioritize and monitor all targets on a routine basis. Higher priority targets are normally collected with greater expediency and frequency than lower priority targets. Mobile targets present a specific collection problem because their data is extremely perishable and current data is essential to target analysis.

(3) Frequency. Establish collection requirements through the collection management process and for any frequency (daily, twice weekly, weekly, every 2 weeks, monthly, every 2 months, quarterly, semiannually, annually, or until satisfactorily acquired). The specific time of collection may also be requested.

(4) Exploitation Requirements. Targeting must also identify the EEI needed from imagery and all-source analysts. The 2 types of EEI are *generic* and *specific*. If generic EEIs are requested, the imagery and all-source analysts reports all activity and identifies all structures on or in the target area. Generic EEIs are listed as part of the overall command objectives and may vary in

different commands. If information on specific activity/observations is needed, provide specific EEs with the RFI.

c. Collection Operations (Systems). The collection manager is responsible for managing the assets and choosing the most efficient methods and sensors to satisfy requirements. Overall theater sensors are more flexible and can react faster to collection requirements. National collection platforms are not as flexible and have set times and locations where they collect on a target area. National assets collect on targets within their specific collection ground tracks. Dissemination of national system products relies on primary and secondary dissemination methods and equipment in theater. If communication lines cannot handle intelligence dissemination, the product will not be responsive to theater needs.

6. Target System Development

a. The Target System Concept. The target system concept is important because almost all targeting is based on targeting systems. A target is composed of components, and components are composed of elements. A single target may be significant because of its own characteristics, but often its importance lies in its relationship to other targets. Usually the effect of a strike or attack mission upon an adversary can be determined only by analyzing the target in the overall adversary's target system. JP 1-02, *DOD Dictionary of Military and Associated Terms*, states that a "*target system includes all the targets situated in a particular geographic area and functionally related; or a group of targets which are so related that their destruction will produce some particular effect desired by the attacker.*" Targeteers normally focus on functionality. "*Functionally related*" means that all targets in the system have the same activity or that each makes one or more parts of a particular product or type of product. Usually the effect of an attack upon an adversary can be determined only by analyzing the adversary's target systems combined with their relationship(s) with the adversary's warmaking or warfighting capability.

b. Target System Characteristics. All target systems are goal, objective, or purpose oriented and composed of individual parts called components, through which they perform activities to achieve their goals. Survival is fundamental for all systems and they adapt to survive. Systems are complex. System components are interdependent and a change in one component causes change in or to other components. Each system is a component of a larger, more inclusive system.

c. Target System Activity. Do not focus the targeting process on the system or its components but on the activity of the system or its components. Identify and nominate important target systems and target system components for strike by determining which activity is to be modified or affected by friendly forces. On a lesser scale, perform this same analysis for individual targets. Identify key and vulnerable elements of each target for attack. A comprehensive analysis of the system and its component parts is essential to understand the activities of the entire system.

d. Target System Analysis. This is a systematic approach to determine adversary target system vulnerabilities and exploitable weaknesses. It determines what effects will likely be achieved against target systems and their

associated activities. Review the functions and interactions between components and elements of a target system, to determine how the target system works. The analysis helps to determine what effects are likely to be achieved by attacking the system, where the system must be attacked, and how long the attack will disrupt adversary plans or operations. By reviewing probabilities of damage and arrival for a weapon system, targeteers can evaluate the effects of attacks on different components and isolate relevant elements to plan the disruption or neutralization of an entire target system.

7. Recording Information

Recording information makes evaluation and analysis easier and more accurate. It provides a useful source for historical data during and after operations are concluded and is essential for supporting the lessons learned process. Recording means and techniques must permit timely information and intelligence dissemination and the means must adequately handle the volume of information and intelligence received and serve the needs of those who must have access to it. Some common recording techniques are TMD IPB templates, intelligence journals, intelligence community databases, and local TMD IPB databases.

Intelligence community and local TMD IPB databases are typically fully automated and require trained personnel to operate them. The TMD IPB process generates the templates. An intelligence journal is an official, permanent, and chronological record of received and transmitted reports and messages, important events that have occurred, and actions taken in response. Since the journal will be referenced during the TMD IPB process, accuracy and completeness are essential. The journal covers a specified time period, usually 24 hours, and entries should accurately and concisely state the message, report, or event (meeting purposes, subjects, and conclusions, TMD IPB organizational or personnel changes, TM force incidents or movements, etc.); note the sender or individual making the report (include unit and unit duty position); note the receipt or dispatch time and method of transmission; and any actions taken as a result (disseminating reports, other internal TMD IPB recording, actions taken based on TM force activities).

8. Lessons Learned

During development of the TMD IPB, systematically identify, evaluate, and apply intelligence lessons learned. It is important to benefit from significant operations, training, and intelligence experiences. Use the Joint Universal Lessons Learned System to document intelligence lessons learned.

9. Geospatial Information and Products

a. Geospatial Information. Geospatial information is found on maps and charts, and spatial imagery (mapping, charting, and geodesy, imagery, and IMINT). It gives physical and cultural phenomenon characteristics, properties, and locations associated with the earth's natural and man-made environment. NIMA's global geospatial information and services (GGI&S) provide geospatial information in four information classes; *hard copy* (traditional GGI&S products produced as paper products), *digital raster data*, *digital vector*, and *digital composite*. Definitions can be found on the NIMA home page.

b. GGI&S and TMD IPB Development. For TMD development, GGI&S is divided into commonly used digital/hardcopy GGI&S (Table A-3), other vector-based/digital GGI&S (TableA-4), and other raster-based/hard copy GGI&S (Table A-5).

Table A-3. Commonly Used Digital/Hardcopy GGI&S Products

Arc Second Raster Chart Digitized Raster Graphic	Bathymetric Navigation Chart
Compressed Arc Second Raster Chart Digitized Raster Graphic	Controlled Image Base
Digital Bathymetric Database	Digital Chart of the World
Digital Feature Analysis Data	Digital Terrain Elevation Data
Joint Operations Graphic	Nautical Chart or
Hydrographic Chart	
Operational Navigation Chart	Tactical Pilotage Chart
Topographic Line Map	Vector Map Level 0
Vector Map Level 1	Vector Map Level 2
Vector Map Coverages (boundaries, data quality, elevation, hydrography, industry, physiography, population, transportation, utilities, vegetation, political entities, place names)	
World Vector Shoreline	

Table A-4. Other Vector-Based/Digital GGI&S Products

Anaglyph	Arc Second Raster Chart Digital Raster Imagery
Compressed Aeronautical Chart	Compressed Raster Graphic
Digital Cities Data Base	Digital Aeronautical Flight Information File
Digital Elevation Model	Digital Line Graph
Digital Line Graph-Enhanced	Digital Topographic Data
High Speed Digital Chart	Digitized/Digital Point Positioning Database
Interim Terrain Data	Planning Terrain Analysis Database
Relocatable Target Assessment Data	Probabilistic Vertical Obstruction Data
Tactical Terrain Data	Tactical Terrain Analysis Database
Vertical Obstruction Data	Video Point Positioning Database
World Mean Elevation Data	

Table A-5. Other Raster-Based/Hardcopy GGI&S Products

Approach Chart	Antisubmarine Warfare Prediction Area Chart
Bathymetric Navigation Planning Chart	Bathymetric Recovery Area Chart
Bottom Contour Chart	City Graphic
Coastal Chart	Current Chart
Gazetteer	Harbor and Approach Chart
Harbor Chart	Hydrographic Chart or Nautical Chart
Hypsographic or Hypsometric Map (or Chart)	Ice Chart
Instrument Approach Chart	Magnetic Anomaly Detection Planning Chart
Magnetic Anomaly Detection	Operational Effectiveness Chart
Military Installation Map	Modified Cacsimile Chart
Naval Operating Area Chart	Non-Submarine Contact List
Pilot Chart	Precise Bathymetric Navigation Zone Chart
Point Positioning Database	Provisional Map
Sound Surveillance Systems Charts (SOSUS)	

10. Target Materials

Target materials are graphic, textual, tabular, digital, video, or other physical and quantitative presentations of target intelligence. These products locate, identify, and describe potential targets with enough accuracy to attack designated targets by one or more weapon systems. Current target materials suitable for TMD IPB production are basic target graphics, automated tactical target graphics, operational target graphics, quick response graphics, and operational support plans graphics.

11. Locational Information

a. TMD IPB and Locational Information. TMD IPB relies on and generates a large amount of locational information. Locational information is defined by coordinates that are linear or angular quantities that designate the position that a point occupies in a given reference frame or system. The use of cartographic techniques to derive coordinates is suitable for cueing but cannot provide the precise coordinates needed for many of the newer weapon systems. Because it is easy to make locational errors, it is important to have a basic working knowledge of coordinate systems, datums, and other accuracy measures.

b. Errors and Mismatches. Data errors or mismatches can occur when mixing locational data from multiple sources. For example, database locations taken and placed on a map can lead to severe errors unless the locations' coordinates use the same scale and datum as the map. However, if the locations' coordinates use different scales and/or datums, large errors can result ranging from several meters to several kilometers. Another example, 2 objects, such as roads, taken from different databases and placed on a map can result in mismatches (do not intersect on the map where they are suppose to join) if different scales and/or datums are used. In some cases, the intersection can be off as much as several kilometers. When the same road exists in 2 databases and both are plotted on a map, a set of nearly parallel roads may result from the differences in the scale and/or datums. It is important to use identical scales and datums, but when this is not possible, understand and account for the resulting errors in the locational information. It is easy to make errors when using digital terrain data and since most of the data uses the same datum, it is usually a scale error. Remember, if locational data information is incorrect and not accounted for, the terrain analysis results are confusing and useless.

c. Coordinate Reference System. Coordinate reference systems are a shorthand means of communicating earth surface locations. The most familiar coordinate reference system uses latitude, longitude, and elevation, while the Universal Transverse Mercator (UTM) and Universal Polar Stereographic (UPS) grid systems are two-dimensional. They identify a location without the lengthy description of latitude and longitude degrees, minutes, and seconds by placing grids on maps. The Military Grid Reference System is an alphanumeric shorthand for expressing UTM and UPS coordinates with fewer numbers. A coordinate reference system always connects to a datum that defines its reference frame and point of origin; when the datum changes, so do the position coordinates.

d. Datums. A critical consideration often overlooked in using coordinates is the geodetic datum upon which the coordinates and stated accuracy are based. A datum is a regional or global coordinate reference system. It includes a reference ellipsoid (a mathematical representation of the earth's size and shape) and a specific origin point. Coordinates within the same geodetic datum are directly

related to the same origin point. Coordinates within different datums must be converted to a common reference before they can be used. The World Geodetic System (WGS) provides the basic reference frame and geometric figure for the earth, models the earth gravimetrically, and provides the means for relating positions on various local geodetic systems to an earth-centered, earth-fixed (ECEF) coordinate system. World Geodetic System-1984 (WGS 84) is the ECEF system officially authorized for use by the Department of Defense. WGS represents NIMA's modeling of the earth from a geometric, geodetic, and gravitational standpoint. It was developed using new and more extensive data sets and improved computer software and is constantly upgraded.

e. Coordinate Conversion/Transformation. NIMA has a computer-based program to convert and transform coordinates. This program is called GEOTRANS and is very useful for accurately converting coordinates from one datum or coordinate system to another. NIMA maintains an INTELINK page for converting datums and coordinates online.

f. Measures of Accuracy. Geospatial data cannot be more accurate than its original source, and sources vary in accuracy. Furthermore, each step in the production process can introduce position or elevation errors because of production hardware and software limitations, human factors, and inherent product characteristics (that is, chart size and scale or the digital data specification accuracy). If not accounted for, significant accuracy errors will occur from mixing products and data of different scale. Error distribution assumes that systematic errors and blunders have been removed and only random errors are left. Systematic errors need to be detected before they can be removed from positional information and one method is to compare the positional information against given control. If systematic errors are not removed, they will affect, for example, geodetic and photogrammetric measurements and the resulting positional information. Statistical techniques are used to measure and identify errors. The measures express an accuracy confidence level of the NIMA data to the user. Depending on the data's intended use, geospatial accuracy is normally expressed in absolute and/or relative accuracy terms. Absolute accuracy is how close each feature or data point is to the specified higher standard and includes all random and systematic errors. Relative accuracy is how close the measured distance or elevation is between two features or data points over a specified distance within standard and includes only random errors. Geospatial position accuracy is traditionally measured in feet or meters of linear error for heights, and feet or meters of circular error for horizontal position, both at 90 percent probability. Spherical error is the three-dimensional (3-D) combination of horizontal and vertical errors at 90 percent probability and is increasingly used as the geospatial fidelity measure. Target location error is the difference between the target's actual and expected location.

g. Precision and Accuracy. There is an important difference between the terms precision and accuracy. Precision is the closeness with which repeated measurements made under similar conditions are grouped together, and accuracy is the closeness of the best-estimated measured value to the measured quantity's true value. Precision is affected only by random measuring process errors, while accuracy is affected by precision as well as the existence of unknown or systematic errors. Measurements may be both precise and inaccurate, but they cannot be accurate unless they are precise. Developed, transmitted, and used coordinates should support measurements down to a precision equal to DDD MM SS.SSS. At the equator, these coordinates would be

precise within 3 centimeters. State the associated coordinates' accuracy so that the user can determine the usefulness of the coordinate data. Not all coordinates must be to that level of precision or positions to that level of accuracy. For example, an object's measurements may determine the precise location within 6 inches, while the object's positional accuracy may only be within 100 feet. If the objective is to measure the object, this precision may suffice, but if the objective is to verify and bomb the object, this precision is unneeded and the accuracy may or may not be adequate based on the bombing scenario. Table A-6 compares precision with scale and coordinate resolution and lists some products used during the TMD IPB process.

Table A-6. Geospatial Precision and Accuracy Comparisons

Starting Unit, Scale, and/or Precision			Resulting Precision/Resolution			Example Product
Coordinate	Scale	Precision	DDD MM SS.SSS	meters	m/inch	
DDD				111.120		
DDD MM				1.852		
DDD MM.SS				30.87		
DDD MM.SS.S				3.087		
DDD MM.SS.SS				0.3087		
DDD MM.SS.SSS				0.03087		
	1:25,000				635	City Graphic
	1:50,000				1,270	Topographic Line Map Vector Smart Map Level 2
	1:100,000				2,540	Topographic Line Map
	1:250,000				6,350	Joint Operations Graphic Vector Map Level 1
	1:500,000				5,080	Tactical Pilotage Chart
	1:1,000,000				10,160	Operational Navigation Chart Vector Map Level 0 Digital Chart of the World
	1:2,000,000				20,320	Jet Navigation Chart
	1:5,000,000				127,000	Global Navigation Chart
		100 m	000 03 14.384			DTED Level 1
		30 m	000 00 58.315			DTED Level 2
		10 m	000 00 19.438			DTED Level 3 Controlled Image Base Space Imaging's Ikonos Satellite Land satellite and SPOT
		5 m	000 00 09.719			DTED Level 4 Controlled Image Base Space Imaging's Ikonos Satellite
		1 m	000 00 01.944			DTED Level 5 Controlled Image Base Space Imaging's Ikonos Satellite
Scale			Horizontal Circular Error 90%	Vertical Linear Error 90%		Example Product
1:25,000			50 m	± 20 m		City Graphic
1:50,000			50 m	± 20 m		Topographic Line Map Vector Map Level 2
1:100,000			50 m	± 20 m		Topographic Line Map
1:250,000			250 m	± 100 m		Joint Operations Graphic Vector Map Level 1
1:500,000			1,000 m	± 150 m		Tactical Pilotage Chart
1:1,000,000			2,000 m	± 650 m		Operational Navigation Chart Vector Map Level 0 Digital Chart of the World

Note: Approximate for longitude at the equator

h. Precise Geopositioning Capability. Coordinate derivation is the process of generating geodetic coordinates that precisely identify the position of a point or target. Accuracy in describing position or desired mean point of impact within a common reference system is an important element in the TMD IPB function. Point positioning data base (PPDB) are sets of geodetically controlled photographic materials, accompanying data, and computer programs that enable trained personnel to derive accurate coordinates for any identifiable ground feature within the database area. PPDB accuracy is estimated for the entire coverage. To derive PPDB target or point coordinates, use the manual Analytical Photogrammetric Positioning System (APPS) or automated RAINDROP software for mensuration and geopositioning. The operator selects the appropriate stereo pair, locates the target optically, and determines the point's geoposition. NIMA began phasing out hardcopy PPDB production in FY96, so APPS and PPDB use is decreasing. Digital point positioning database (DPPDB) is a classified image product consisting of high-resolution digital stereo image pairs and replaces the hardcopy PPDB. The DPPDB provides warfighters with a deployable product. Digital exploitation workstations with stereo capability quickly and accurately derive latitude, longitude, and elevation. The DPPDB consists of 3 main components: imagery support data, a digital map graphic for reference, and stereo imagery. The nominal DPPDB area coverage is a rectangle, called the product rectangle, measuring 60 nautical miles on each side. At the equator, a product rectangle is a 1-degree x 1-degree geocell and is bounded by 1-degree parallels on the north and south and by 1-degree meridians on the east and west. Smaller DPPDBs unconstrained by geocell boundaries can also be produced. Ground coordinates derived using the DPPDB rational function model are referenced to the WGS ellipsoid. The DPPDB absolute and relative accuracy is consistent with the rigorous triangulation performed by NIMA's Digital Production System. The computed absolute and relative accuracy values, which vary from product to product, are provided as part of the imagery support data. Basic DPPDB imagery viewing and point mensuration can be performed on a suitably equipped workstation using NIMA's RAINDROP software.

12. Required Intelligence Databases for TMD IPB Production

a. Modernized Integrated Database. The MIDB is a standardized intelligence data system providing data exchange between national to tactical level intelligence and operational consumers. The database contains a baseline source of intelligence on installations, military forces, population concentrations, C2 structures, significant events, and equipment.

b. Basic Encyclopedia (BE). This manual of MIDB installation intelligence is the most inclusive of all installation lists. It describes every identified installation with an active function or of valid interest to intelligence agencies, particularly to the unified command operational and planning staffs. The BE contains basic data on the identification, location, and function of each installation. It can be used to select potential fixed targets for ground, sea, or air attack or to identify installations (such as public utilities and hospitals) to be spared from attack. The BE lists installations in Eurasia, Western Europe, Latin America and the Atlantic, Middle East and Africa, and Southeast Asia and the Western Pacific.

c. Military Equipment and Parameters Engineering Database. This is a standardized intelligence data system providing data exchange between national to tactical level intelligence and operational consumers. The database contains a more baseline source of intelligence on military equipment than the MIDB to include engineering level parameters.

d. NIMA Exploitation System (NES). NES is a standardized intelligence data system designed to provide for data exchange between national to tactical level intelligence and operational consumers. The database contains a baseline source of intelligence on overhead imagery and information on available overhead imagery. Imagery reports within NES are textual and contain a brief imagery analysis by NIMA.

e. Standard Coding System Functional Classification Handbook. This handbook contains guidance and procedures for using functional category codes. The classification system uses a 5-digit numeric character code to classify installations by function and indicate the products, capability, or activity associated with the installation.

13. How TMD IPB Relates to Everything Else

IPB and its products are essential elements of the intelligence cycle. The intelligence cycle and its functions (procedures, organizations, and equipment that collect, process, store, and disseminate intelligence) respond to the commander's intelligence needs. IPB products aid the intelligence staff in processing volumes of information and exploiting modern technology. They focus collection systems, so that sufficiently accurate near-real-time information can be used to directly target TCTs. IPB enables a staff to put steel on target and also helps to prioritize and maximize targeting effects; it plays a critical role in the decision-making process. The commander leads the IPB effort and the entire staff executes the IPB process.

Appendix B

SUGGESTED TMD IPB TEMPLATES

The TMD IPB templates and tables in this appendix are initial starting points for building a TMD IPB. They are not meant to represent the entire spectrum of TMD IPB products. Use them as the situation requires (reproduce as is, modified, and/or discarded). Many can be used with current or future intelligence and operational automated systems. Figures B-1 and B-2 are suggested cover pages for completed or in development TMD IPB templates. Figures B-3 through B-46 are suggested templates for developing the TMD IPB and are organized in the TMD IPB 4-step process order.

DTG: 180600Z MAR 00	Classification: UNCLASSIFIED	Page: ___ of: ___
TMD IPB Template (U)		
Title:		
TMD IPB Dummy Template (U)		
TMD IPB Associated Step(s) 1.2, 1.3, and 3.2		
Date / Date Time Group (DTG)	180600Z MAR 00	Number of Pages Cover + 2
Time	0900 Local	Copy Number 5
Date of Information (DOI)	011200Z APR 99	Number of Copies 25
Originator Control Number	ABC-12345	Work Station Gilligan
Holder Control Number	DEF-67890	Network or Hard Disk Skipper
File and Location	D:\TMD\IPB\Templates\Step1\TMD_IPB_Dummy_Template.doc	
Status	Complete as of: 180600Z MAR 00	
Template Description and/or Usage Note(s)		
This TMD IPB template is intended as a dummy template for illustration purposes only.		
Originator		
Agency // Organization // Unit // Office Symbol		
1st TMD IPB Unit, Terrain Analysis Division // 1st TIU/TAD		
Address: <input type="checkbox"/> Unclassified & Classified <input checked="" type="checkbox"/> Unclassified Only <input type="checkbox"/> Classified Only	Name, Last	Name, First Name, Middle
1st TIU/TAD Attn: Sgt John Doe Camp Smith, AL 35777-5555	Doe	John A
	Rank	Service Country
	Sgt	USA US
	Title / Position	
	NCOIC TMD IPB Terrain Analysis Division	
	Non-Secure Phone (DSN)	Secure Phone (DSN)
	DSN 555-5555 x55	DSN 555-5555 x55
Address: <input type="checkbox"/> Unclassified & Classified <input type="checkbox"/> Unclassified Only <input checked="" type="checkbox"/> Classified Only	Non-Secure Phone (Commercial)	Secure Phone (Commercial)
1st TIU/TAD Attn: Document Control Camp Smith, AL 35777-5555	(555) 333-5555 x55	(555) 333-5555 x55
	E-Mail: <input checked="" type="checkbox"/> Unclassified Only <input type="checkbox"/> Collateral <input type="checkbox"/> TS/SCI <input type="checkbox"/> Other:	
	John.doe@campsmith.army.mil	
	E-Mail: <input type="checkbox"/> Unclassified Only <input type="checkbox"/> Collateral <input checked="" type="checkbox"/> TS/SCI <input type="checkbox"/> Other:	
	Jdoe@campsmith.army.mil	
Overall U.S. Classification	UNCLASSIFIED	
Overall Non-U.S. Classification	Not Applicable	
SCI Control Systems and Code Words	Not Applicable	
Foreign Government Information	Not Applicable	
Dissemination Controls	Not Applicable	
Non-Intelligence Community Markings	Not Applicable	
Declassification Date Marking	Not Applicable	
Composite Classification and Control Marking	Not Applicable	
Classification Authority / Classified By (If Applicable)	Not Applicable	
Derived From (If Applicable)	Not Applicable	
Downgrade Instruction(s) (If Applicable)	Not Applicable	
Downgrade Event / Declassify On (If Applicable)	Not Applicable	
Security Control Number	DEF-67890	
<input type="checkbox"/> See Attachment for Warning(s), Destruction Notice, Distribution Restrictions, and Other Notices and Warning <input checked="" type="checkbox"/> Regrade this Cover Sheet to UNCLASSIFIED When Separated from the Document		
TMD IPB Template -- 18 March 2000	Classification: UNCLASSIFIED	Local Reproduction Authorized

Figure B-1. TMD IPB Template Cover Sheet - Example

DTG: _____	Classification: _____	Page: ___ of: ___
Title:		
TMD IPB Associated Step(s)		
Date / Date Time Group (DTG)	Number of Pages	
Time	Copy Number	
Date of Information (DOI)	Number of Copies	
Originator Control Number	Work Station	
Holder Control Number	Network or Hard Disk	
File and Location		
Status		
Template Description and/or Usage Note(s)		
Originator		
Agency // Organization // Unit // Office Symbol		
Address: <input type="checkbox"/> Unclassified & Classified <input type="checkbox"/> Unclassified Only <input type="checkbox"/> Classified Only	Name, Last	Name, First
	Rank	Service
		Country
	Title / Position	
Address: <input type="checkbox"/> Unclassified & Classified <input type="checkbox"/> Unclassified Only <input type="checkbox"/> Classified Only	Non-Secure Phone (DSN) DSN - x	Secure Phone (DSN) DSN - x
	Non-Secure Phone (Commercial) () - x	Secure Phone (Commercial) () - x
	E-Mail: <input type="checkbox"/> Unclassified Only <input type="checkbox"/> Collateral <input type="checkbox"/> TS/SCI <input type="checkbox"/> Other:	
	E-Mail: <input type="checkbox"/> Unclassified Only <input type="checkbox"/> Collateral <input type="checkbox"/> TS/SCI <input type="checkbox"/> Other:	
Overall U.S. Classification		
Overall Non-U.S. Classification		
SCI Control Systems and Code Words		
Foreign Government Information		
Dissemination Controls		
Non-Intelligence Community Markings		
Declassification Date Marking		
Composite Classification and Control Marking		
Classification Authority / Classified By (If Applicable)		
Derived From (If Applicable)		
Downgrade Instruction(s) (If Applicable)		
Downgrade Event / Declassify On (If Applicable)		
Security Control Number		
<input type="checkbox"/> See Attachment for Warning(s), Destruction Notice, Distribution Restrictions, and Other Notices and Warning <input type="checkbox"/> Regrade this Cover Sheet to UNCLASSIFIED When Separated from the Document		
TMD IPB Template -- 18 March 2000	Classification: _____	Local Reproduction Authorized

Figure B-2. TMD IPB Template Cover Sheet

DTG: _____	Classification: _____	Page: ____ of: ____
Command Mission(s) Objective(s) Summary (U)		
Overall Command Mission(s) Objective(s) (U)		
Objective:		
01:		
02:		
03:		
04:		
05:		
Overall Component Mission(s) Objective(s) (U)		
Objective:		
01:		
02:		
03:		
04:		
05:		
Overall TMD Mission(s) Objective(s) (U)		
Objective:		
01:		
02:		
03:		
04:		
05:		
Notes:		
TMD IPB Template -- 18 March 2000	Classification: _____	Local Reproduction Authorized

Figure B-3. Command Mission(s) Objective(s) Summary Template

DTG: _____	Classification: _____	Page: ____ of: ____
Command Mission(s) Objective(s) Worksheet (U)		
Objective:		
WHAT do we want to make the adversary do?		
Against WHOM?		
HOW do we want to reach the objective?		
WHY do we want to reach the objective?		
How much (TO WHAT DEGREE) do we want to affect adversary activity?		
WHEN and for HOW LONG do we want to reach the objective?		
WHERE do we want to affect the adversary activity?		
HOW MUCH will it cost to achieve the objective and is it WORTH the cost?		
How do we know when we have REACHED the objective?		
Notes:		

Figure B-4. Command Mission(s) Objective(s) Worksheet Template

DTG: _____	Classification: _____	Page: ___ of: ___
Command's Mission(s) Guidance Worksheet Template (U)		
TMD and TMD Related Command Guidance		
Command Guidance:		
Details:		
Command Guidance:		
Details:		
Command Guidance:		
Details:		
Command Guidance:		
Details:		
TMD and TMD Related Rules of Engagement (ROE)		
Command Guidance:		
Details:		
Command Guidance:		
Details:		
Command Guidance:		
Details:		
Command Guidance:		
Details:		
TMD and TMD Related Applicable Laws of Armed Conflict (LOAC)		
Command Guidance:		
Details:		
Command Guidance:		
Details:		
Command Guidance:		
Details:		
Command Guidance:		
Details:		
Notes:		
TMD IPB Template -- 18 March 2000 Classification: _____ Local Reproduction Authorized		

Figure B-5. Command Mission(s) Guidance Worksheet Template

DTG: _____	Classification: _____	Page: ___ of: ___				
AO/AOI/Battlespace Assessment Template (U)						
						
						
Map Sheet Name	Map Sheet Series	Map Sheet Number	Map Sheet Edition	Map Sheet Scale	Horizontal/Vertical Datum	Scale
Legend / Key / Symbols / Scale						
Notes:						
TMD IPB Template -- 18 March 2000		Classification: _____		Local Reproduction Authorized		

Figure B-6. AO/AOI/Battlespace Assessment Template

Geopolitical and Regional Threat Assessment Template (U)

Adversary National Security Goals and Desired End State

[Empty box for Adversary National Security Goals and Desired End State]

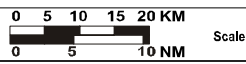
Regional Overview Map:

[Empty box for Regional Overview Map]

Adversary Regional Strategic Vulnerabilities

[Empty box for Adversary Regional Strategic Vulnerabilities]

Adversary Strategic and Operational Objectives

[Empty box for Adversary Strategic and Operational Objectives]

Adversary Intent and Strategic Concept of Operations

[Empty box for Adversary Intent and Strategic Concept of Operations]

Notes:

[Empty box for Notes]

Figure B-7. Geopolitical and Regional Threat Assessment Template

DTG: _____ Classification: _____ Page: ___ of: ___

TM Force General Capabilities Assessment Template (U)

Types and Order of Battle of TMs

Historical Use

Role / Mission / Targeting of TMs

Employment Concepts

TM Characteristics and Performance				
Parameters				
Propulsion Type				
Length (m)				
Diameter (m)				
Wing Span (m)				
Maximum Range (km)				
Minimum Range (km)				
Accuracy (CEP) (m)				
Maximum Range Apogee (m)				
Nominal Launch Altitude (m)				
Nominal Cruise Altitude (m)				
Nominal Cruise Speed (mach)				
Maximum Time of Flight (minutes)				
Payload Mass				
Warhead Mass				
Payload Options				

TMD IPB Template -- 18 March 2000 Classification: _____ Local Reproduction Authorized

Figure B-8. TM Force General Capabilities Assessment Template (1 of 2)

DTG: _____	Classification: _____	Page: ____ of: ____
TM Force General Capabilities Assessment Template (U)		
Motivation and Intent		
Motivation -		
Intent -		
Historical Use of Suppression of Active Air or TMD	Theater Air Defense versus TMD	
Capability to Locate TMD Assets for Suppression		
Suppression Capabilities		
Suppression Capability	Applicable To:	
TMs in Suppression Role -		
TM Penetration Tactics -		
TM TMD Countermeasures -		
Aircraft -		
ASCMs to Suppress TMD Capable Ships -		
ARMs -		
Information Warfare (Including EC) -		
WMD -		
SOF -		
Terrorist and Insurgent Forces -		
Conventional Ground Forces -		
Conventional Naval Forces -		
Combined Arms Tactics -		
TMD IPB Template – 18 March 2000 Classification: _____ Local Reproduction Authorized		

Figure B-8 (Continued). TM Force General Capabilities Assessment Template (2 of 2)

DTG: _____	Classification: _____	Page: ___ of: ___
Major Terrain and Line of Communications Overview Template (U)		
Major Terrain Features Map	Major LOC Features Map	
Physical Map		
<p>Area:</p> <p>Total: Land Only: Water Only:</p> <p>Area-Comparative:</p> <p>Land Boundaries: Total: Coastline:</p> <p>Maritime Claims: Territorial Sea: Continental Shelf:</p>	<p>Terrain:</p> <p>Elevation Extremes: Lowest Point: Highest Point:</p> <p>Land Use:</p> <p>Arable Land: Permanent Crops: Permanent Pastures: Forests and Woodland: Other:</p> <p>Irrigated Land:</p>	
TMD IPB Template -- 18 March 2000		Classification: _____ Local Reproduction Authorized

Figure B-9. Major Terrain and LOC Overview Template

TMD IPB Holdings, Database, Sources, and Links Assessment (U)

Organizational Sources

Organization	POC Established	MOU or Equivalent	Status	Type of Support
Command Intelligence Staff				
Command Operations Staff				
Command Plans Staff				
JIC				
US Army Component				
US Air Force Component				
US Navy Component				
US Marine Corps Component				
NM/JIC				
NMCC				
DIA				
NIMA - Imagery Services				
NIMA - GGI&S				
CIA				
NSA				
USSPACECOM				
MSIC				
NAIC				
ONI				
NGIC				
AFMIC				
DTRA				
Others				

Notes:

Figure B-10. TMD IPB Holdings, Database, Sources, and Links Assessment Template (1 of 3)

DTG: _____	Classification: _____		Page: ____ of: ____
TMD IPB Holdings, Database, Sources, and Links Assessment (U)			
Connectivity			
Connection	Speed	Reliability of Connection	Status (G, Y, R)
Voice - Unclassified			
Voice - Collateral			
Voice - High			
INTELINK			
SIPRNET			
e-Mail - Unclassified			
e-Mail - Collateral			
e-Mail - High			
MIDB - National			
MIDB - Theater			
MIDB - Local			
MEPED			
SAFE			
NES			
Message Traffic			
5D			
IPL			
IPA			
TDDS (TRAP)			
TIBS			
JTIDS			
GCCS			
Others			
Notes:			
TMD IPB Template -- 18 March 2000	Classification: _____		Local Reproduction Authorized

Figure B-10 (Continued). TMD IPB Holdings, Database, Sources, and Links Assessment Template(2 of 3)

DTG: _____	Classification: _____	Page: ____ of: ____	
TMD IPB Holdings, Database, Sources, and Links Assessment (U)			
Current, On-Order, and Desired TMD IPB Information Holdings			
Title:	Originator Control #:		Copies:
	Date or DTG:	DOI:	Received:
	Ordered:	Expected Delivery Date:	
	Type		Format
	Report:	Targeting Material:	Hardcopy:
	Imagery: EO, Radar, MSI, Other	SA Data:	Digital:
Classification of Title:	GGI&S:	Software:	On-line:
Classification:	Message Traffic:	Other:	Other:
Source:			
Assessment (Green/Yellow/Red [G/Y/R]):	Applicable To:		
Checked Out To:			
Notes:			
Title:	Originator Control #:		Copies:
	Date or DTG:	DOI:	Received:
	Ordered:	Expected Delivery Date:	
	Type		Format
	Report:	Targeting Material:	Hardcopy:
	Imagery: EO, Radar, MSI, Other	SA Data:	Digital:
Classification of Title:	GGI&S:	Software:	On-line:
Classification:	Message Traffic:	Other:	Other:
Source:			
Assessment (G, Y, R):	Applicable To:		
Checked Out To:			
Notes:			
Title:	Originator Control #:		Copies:
	Date or DTG:	DOI:	Received:
	Ordered:	Expected Delivery Date:	
	Type		Format
	Report:	Targeting Material:	Hardcopy:
	Imagery: EO, Radar, MSI, Other	SA Data:	Digital:
Classification of Title:	GGI&S:	Software:	On-line:
Classification:	Message Traffic:	Other:	Other:
Source:			
Assessment (G, Y, R):	Applicable To:		
Checked Out To:			
Notes:			
Title:	Originator Control #:		Copies:
	Date or DTG:	DOI:	Received:
	Ordered:	Expected Delivery Date:	
	Type		Format
	Report:	Targeting Material:	Hardcopy:
	Imagery: EO, Radar, MSI, Other	SA Data:	Digital:
Classification of Title:	GGI&S:	Software:	On-line:
Classification:	Message Traffic:	Other:	Other:
Source:			
Assessment (G, Y, R):	Applicable To:		
Checked Out To:			
Notes:			
Title:	Originator Control #:		Copies:
	Date or DTG:	DOI:	Received:
	Ordered:	Expected Delivery Date:	
	Type		Format
	Report:	Targeting Material:	Hardcopy:
	Imagery: EO, Radar, MSI, Other	SA Data:	Digital:
Classification of Title:	GGI&S:	Software:	On-line:
Classification:	Message Traffic:	Other:	Other:
Source:			
Assessment (G, Y, R):	Applicable To:		
Checked Out To:			
Notes:			
TMD IPB Template -- 18 March 2000			
Classification: _____		Local Reproduction Authorized	

Figure B-10 (Continued). TMD IPB Holdings, Database, Sources, and Links Assessment Template(3 of 3)

DTG: _____		Classification: _____		Page: ____ of: ____	
TMD IPB Information Sources Evaluation Template (U)					
#	Checklist item	Status (G,Y,R)	Critical Gaps		
01	Step 1 - Define the Battlespace Environment				
02	1.1 - Analyze the Command's Mission in Relation to TMD				
03	1.1.1 - Summarize the Command's Mission and Objectives				
04	1.1.2 - Summarize the Commander's Guidance				
05	1.2 - Identify the Limits of the AO, AOI, and Battlespace				
06	1.2.1 - Assess TM Force Coverage				
07	1.2.2 - Assess Potential TM Force Deployment Area				
08	1.2.3 - Assess Passive Defense AO and AOI				
09	1.2.4 - Assess Active Defense AO and AOI				
10	1.2.5 - Assess Attack Operations AO and AOI				
11	1.2.6 - Assess Composite AO and AOI				
12	1.2.7 - Assess TMD Battlespace				
13	1.3 - Determine the Significant Environment Characteristics of the AO				
14	1.3.1 - Assess Geopolitical and Regional Threat				
15	1.3.2 - Assess TM Force General Capabilities				
16	1.3.3 - Assess TM Force Active Defense Suppression Capabilities				
17	1.3.4 - Assess Major Terrain Features				
18	1.3.5 - Assess Major Lines of Communication				
19	1.4 - Identify the Amount of Detail Required & Feasible Within the Time Available				
20	1.4.1 - Create or Update IPB Checklist and Development Plan				
21	1.5 - Evaluate Existing Databases and Identify Gaps				
22	1.5.1 - Assess TMD IPB Holdings, Databases, Sources, and Links				
23	1.5.2 - Evaluate TMD IPB Information Sources				
24	1.5.3 - Establish TMD IPB POCs				
25	1.6 - Collect Material & Intelligence Required for Further TMD IPB Analysis				
26	1.6.1 - Collect Recommended PIRs/EELs/RFIs				
27	1.6.2 - Search for Information by Key Word and Equipment & Category Codes				
28	Step 2 - Define the Battlespace Effects				
29	2.1 - Analyze the TM Battlespace Environment				
30	2.1.1 - Assess Terrain				
31	2.1.1.1 - Assess Surface Configuration				
32	2.1.1.2 - Assess Vegetation				
33	2.1.1.3 - Assess Surface Materials				
34	2.1.1.4 - Assess Obstacles				
35	2.1.1.5 - Assess Transportation and LOC Infrastructure				
36	2.1.1.6 - Assess Urban Areas				
37	2.1.1.7 - Assess Cover				
38	2.1.1.8 - Assess Concealment				
39	2.1.1.9 - Assess CCM				
40	2.1.1.10 - Assess Observation/LOS				
41	2.1.1.11 - Assess Key Terrain				
42	2.1.1.12 - Assess Electromagnetic Spectrum				
43	2.1.2 - Assess Weather Effects on TM Operations				
44	2.1.2.1 - Assess TM Force Climatology				
45	2.1.2.2 - Assess Current and Forecast Weather				
46	2.1.3 - Assess Other Characteristics of the Battlespace				
47	2.1.3.1 - Assess TM Infrastructure				
48	2.1.3.2 - Assess TM Facility/Area				
49	2.1.3.3 - Assess TM Infrastructure HVTs				
50	2.2 - Assess Battlespace Effects on TM Force Capabilities and Broad COAs				

TMD IPB Template -- 18 March 2000

Classification: _____

Local Reproduction Authorized

Figure B-11. TMD IPB Information Sources Evaluation Template (1 of 2)

DTG: _____	Classification: _____	Page: ____ of: ____	
TMD IPB Information Sources Evaluation Template (U)			
#	Checklist item	Status (G,Y,R)	Critical Gaps
51	2.2.1 - Assess Area Limitation		
52	Step 3 - Evaluate the TM Force		
53	3.1 - Create TM Models		
54	3.1.1 - Assess TM Organizational/C4I Structure		
55	3.1.2 - Assess TM Equipment		
56	3.1.3 - Assess TM TTPs		
57	3.1.4 - Assess HVTs		
58	Step 4 - Determine TM COAs		
59	4.1 - Identify Likely TM Objectives and Desired End State		
60	4.2 - Identify the Full Set of TM COAs		
61	4.3 - Evaluate and Prioritize Each Specific TM COA		
62	4.4 - Expand Each COA in the Amount of Detail Time Allows		
63	4.4.1 - Develop Situation Template and Assess HVTs		
64	4.5 - Identify Initial Collection Requirements		
65	4.5.1 - Develop Event Template and Matrix		
66	4.6 - Identify Target Nominations		
67	4.6.1 - Assess Current Situation and Weather Data		
68	4.6.2 - Assess NAI Intelligence Collection Results		
69	4.6.3 - Assess Most Likely TM Force COA		
70	4.6.4 - Assess PIRs		
Notes:			

Figure B-11 (Continued). TMD IPB Information Sources Evaluation Template (2 of 2)

DTG: _____ Classification: _____			Page: ___ of: ___		
TMD IPB Points-of-Contact (POC) Template (U)					
Name, Last	Name, First	Name, Middle	Rank	Service	Country
Organization / Office Symbol			Title / Position		
Address: <input type="checkbox"/> Unclassified Only <input type="checkbox"/> Classified Only <input type="checkbox"/> Both <input type="checkbox"/> Collateral <input type="checkbox"/> TS/SCI <input type="checkbox"/> Other <input type="checkbox"/>			Non-Secure Phone		
			() - x		Secure Phone
			() - x		Pager
			() - x		Other:
			() - x		() - x
Address <input type="checkbox"/> Unclassified Only <input type="checkbox"/> Classified Only <input type="checkbox"/> Both <input type="checkbox"/> Collateral <input type="checkbox"/> TS/SCI <input type="checkbox"/> Other <input type="checkbox"/>			E-Mail <input type="checkbox"/> Unclassified Only <input type="checkbox"/> Classified Only <input type="checkbox"/> Both <input type="checkbox"/> Collateral <input type="checkbox"/> TS/SCI <input type="checkbox"/> Other <input type="checkbox"/>		
			E-Mail <input type="checkbox"/> Unclassified Only <input type="checkbox"/> Classified Only <input type="checkbox"/> Both <input type="checkbox"/> Collateral <input type="checkbox"/> TS/SCI <input type="checkbox"/> Other <input type="checkbox"/>		
			E-Mail <input type="checkbox"/> Unclassified Only <input type="checkbox"/> Classified Only <input type="checkbox"/> Both <input type="checkbox"/> Collateral <input type="checkbox"/> TS/SCI <input type="checkbox"/> Other <input type="checkbox"/>		
			E-Mail <input type="checkbox"/> Unclassified Only <input type="checkbox"/> Classified Only <input type="checkbox"/> Both <input type="checkbox"/> Collateral <input type="checkbox"/> TS/SCI <input type="checkbox"/> Other <input type="checkbox"/>		
Notes:					

Name, Last	Name, First	Name, Middle	Rank	Service	Country
Organization / Office Symbol			Title / Position		
Address: <input type="checkbox"/> Unclassified Only <input type="checkbox"/> Classified Only <input type="checkbox"/> Both <input type="checkbox"/> Collateral <input type="checkbox"/> TS/SCI <input type="checkbox"/> Other <input type="checkbox"/>			Non-Secure Phone		
			() - x		Secure Phone
			() - x		Pager
			() - x		Other:
			() - x		() - x
Address <input type="checkbox"/> Unclassified Only <input type="checkbox"/> Classified Only <input type="checkbox"/> Both <input type="checkbox"/> Collateral <input type="checkbox"/> TS/SCI <input type="checkbox"/> Other <input type="checkbox"/>			E-Mail <input type="checkbox"/> Unclassified Only <input type="checkbox"/> Classified Only <input type="checkbox"/> Both <input type="checkbox"/> Collateral <input type="checkbox"/> TS/SCI <input type="checkbox"/> Other <input type="checkbox"/>		
			E-Mail <input type="checkbox"/> Unclassified Only <input type="checkbox"/> Classified Only <input type="checkbox"/> Both <input type="checkbox"/> Collateral <input type="checkbox"/> TS/SCI <input type="checkbox"/> Other <input type="checkbox"/>		
			E-Mail <input type="checkbox"/> Unclassified Only <input type="checkbox"/> Classified Only <input type="checkbox"/> Both <input type="checkbox"/> Collateral <input type="checkbox"/> TS/SCI <input type="checkbox"/> Other <input type="checkbox"/>		
			E-Mail <input type="checkbox"/> Unclassified Only <input type="checkbox"/> Classified Only <input type="checkbox"/> Both <input type="checkbox"/> Collateral <input type="checkbox"/> TS/SCI <input type="checkbox"/> Other <input type="checkbox"/>		
Notes:					

Name, Last	Name, First	Name, Middle	Rank	Service	Country
Organization / Office Symbol			Title / Position		
Address: <input type="checkbox"/> Unclassified Only <input type="checkbox"/> Classified Only <input type="checkbox"/> Both <input type="checkbox"/> Collateral <input type="checkbox"/> TS/SCI <input type="checkbox"/> Other <input type="checkbox"/>			Non-Secure Phone		
			() - x		Secure Phone
			() - x		Pager
			() - x		Other:
			() - x		() - x
Address <input type="checkbox"/> Unclassified Only <input type="checkbox"/> Classified Only <input type="checkbox"/> Both <input type="checkbox"/> Collateral <input type="checkbox"/> TS/SCI <input type="checkbox"/> Other <input type="checkbox"/>			E-Mail <input type="checkbox"/> Unclassified Only <input type="checkbox"/> Classified Only <input type="checkbox"/> Both <input type="checkbox"/> Collateral <input type="checkbox"/> TS/SCI <input type="checkbox"/> Other <input type="checkbox"/>		
			E-Mail <input type="checkbox"/> Unclassified Only <input type="checkbox"/> Classified Only <input type="checkbox"/> Both <input type="checkbox"/> Collateral <input type="checkbox"/> TS/SCI <input type="checkbox"/> Other <input type="checkbox"/>		
			E-Mail <input type="checkbox"/> Unclassified Only <input type="checkbox"/> Classified Only <input type="checkbox"/> Both <input type="checkbox"/> Collateral <input type="checkbox"/> TS/SCI <input type="checkbox"/> Other <input type="checkbox"/>		
			E-Mail <input type="checkbox"/> Unclassified Only <input type="checkbox"/> Classified Only <input type="checkbox"/> Both <input type="checkbox"/> Collateral <input type="checkbox"/> TS/SCI <input type="checkbox"/> Other <input type="checkbox"/>		
Notes:					

Figure B-12. TMD IPB POC Template

DTG: _____	Classification: _____	Page: ___ of: ___																																										
Recommended PIR / EEI / RFI / Other Requirement Request Worksheet (U)																																												
Requesting Organization / Point-of-Contact (POC) for PIR / EEI RFI / Other																																												
Name, Last _____	Name, First _____	Name, Middle _____	Rank _____	Service _____	Country _____																																							
Organization / Office Symbol _____			Title / Position _____																																									
Address: <input type="checkbox"/> Unclassified Only <input type="checkbox"/> Classified Only <input type="checkbox"/> Both <input type="checkbox"/> Collateral <input type="checkbox"/> TS/SCI <input type="checkbox"/> Other <input type="checkbox"/>			Non-Secure Phone () - x																																									
_____			Secure Phone () - x																																									
			Cellular Phone () - x			Pager () - x																																						
			Non-Secure FAX () - x			Secure FAX () - x																																						
			Address <input type="checkbox"/> Unclassified Only <input type="checkbox"/> Classified Only <input type="checkbox"/> Both <input type="checkbox"/> Collateral <input type="checkbox"/> TS/SCI <input type="checkbox"/> Other <input type="checkbox"/>			E-Mail <input type="checkbox"/> Unclassified Only <input type="checkbox"/> Classified Only <input type="checkbox"/> Both <input type="checkbox"/> Collateral <input type="checkbox"/> TS/SCI <input type="checkbox"/> Other <input type="checkbox"/>																																						
_____			E-Mail <input type="checkbox"/> Unclassified Only <input type="checkbox"/> Classified Only <input type="checkbox"/> Both <input type="checkbox"/> Collateral <input type="checkbox"/> TS/SCI <input type="checkbox"/> Other <input type="checkbox"/>																																									
_____			E-Mail <input type="checkbox"/> Unclassified Only <input type="checkbox"/> Classified Only <input type="checkbox"/> Both <input type="checkbox"/> Collateral <input type="checkbox"/> TS/SCI <input type="checkbox"/> Other <input type="checkbox"/>																																									
_____			_____																																									
Recommended / Suggested Supporting Organization / Point-of-Contact (POC) for PIR / EEI RFI / Other if Known																																												
Name, Last _____	Name, First _____	Name, Middle _____	Rank _____	Service _____	Country _____																																							
Organization / Office Symbol _____			Title / Position _____																																									
Address: <input type="checkbox"/> Unclassified Only <input type="checkbox"/> Classified Only <input type="checkbox"/> Both <input type="checkbox"/> Collateral <input type="checkbox"/> TS/SCI <input type="checkbox"/> Other <input type="checkbox"/>			Non-Secure Phone () - x																																									
_____			Secure Phone () - x																																									
			Cellular Phone () - x			Pager () - x																																						
			Non-Secure FAX () - x			Secure FAX () - x																																						
			Address <input type="checkbox"/> Unclassified Only <input type="checkbox"/> Classified Only <input type="checkbox"/> Both <input type="checkbox"/> Collateral <input type="checkbox"/> TS/SCI <input type="checkbox"/> Other <input type="checkbox"/>			e-Mail <input type="checkbox"/> Unclassified Only <input type="checkbox"/> Classified Only <input type="checkbox"/> Both <input type="checkbox"/> Collateral <input type="checkbox"/> TS/SCI <input type="checkbox"/> Other <input type="checkbox"/>																																						
_____			e-Mail <input type="checkbox"/> Unclassified Only <input type="checkbox"/> Classified Only <input type="checkbox"/> Both <input type="checkbox"/> Collateral <input type="checkbox"/> TS/SCI <input type="checkbox"/> Other <input type="checkbox"/>																																									
_____			e-Mail <input type="checkbox"/> Unclassified Only <input type="checkbox"/> Classified Only <input type="checkbox"/> Both <input type="checkbox"/> Collateral <input type="checkbox"/> TS/SCI <input type="checkbox"/> Other <input type="checkbox"/>																																									
_____			_____																																									
Potential Intelligence Sources																																												
<table style="width:100%; border:none;"> <tr> <td style="width:33%; text-align:center;">Yes Possible No Unknown NA</td> <td style="width:33%; text-align:center;">Yes Possible No Unknown NA</td> <td style="width:33%; text-align:center;">Yes Possible No Unknown NA</td> </tr> <tr> <td>IMINT <input type="checkbox"/> <input type="checkbox"/> <input type="checkbox"/> <input type="checkbox"/> <input type="checkbox"/></td> <td>SIGINT - SIGINT <input type="checkbox"/> <input type="checkbox"/> <input type="checkbox"/> <input type="checkbox"/> <input type="checkbox"/></td> <td>HUMINT <input type="checkbox"/> <input type="checkbox"/> <input type="checkbox"/> <input type="checkbox"/> <input type="checkbox"/></td> </tr> <tr> <td>IMINT - Visible <input type="checkbox"/> <input type="checkbox"/> <input type="checkbox"/> <input type="checkbox"/> <input type="checkbox"/></td> <td>SIGINT - COMINT <input type="checkbox"/> <input type="checkbox"/> <input type="checkbox"/> <input type="checkbox"/> <input type="checkbox"/></td> <td>MASINT <input type="checkbox"/> <input type="checkbox"/> <input type="checkbox"/> <input type="checkbox"/> <input type="checkbox"/></td> </tr> <tr> <td>IMINT - Radar <input type="checkbox"/> <input type="checkbox"/> <input type="checkbox"/> <input type="checkbox"/> <input type="checkbox"/></td> <td>SIGINT - ELINT <input type="checkbox"/> <input type="checkbox"/> <input type="checkbox"/> <input type="checkbox"/> <input type="checkbox"/></td> <td>MASINT - ACINT <input type="checkbox"/> <input type="checkbox"/> <input type="checkbox"/> <input type="checkbox"/> <input type="checkbox"/></td> </tr> <tr> <td>IMINT - IR <input type="checkbox"/> <input type="checkbox"/> <input type="checkbox"/> <input type="checkbox"/> <input type="checkbox"/></td> <td>SIGINT - ELINT - FISINT <input type="checkbox"/> <input type="checkbox"/> <input type="checkbox"/> <input type="checkbox"/> <input type="checkbox"/></td> <td>MASINT - Electro-Optical <input type="checkbox"/> <input type="checkbox"/> <input type="checkbox"/> <input type="checkbox"/> <input type="checkbox"/></td> </tr> <tr> <td>IMINT - MSI <input type="checkbox"/> <input type="checkbox"/> <input type="checkbox"/> <input type="checkbox"/> <input type="checkbox"/></td> <td>SIGINT - ELINT - TELINT <input type="checkbox"/> <input type="checkbox"/> <input type="checkbox"/> <input type="checkbox"/> <input type="checkbox"/></td> <td>MASINT - IRINT <input type="checkbox"/> <input type="checkbox"/> <input type="checkbox"/> <input type="checkbox"/> <input type="checkbox"/></td> </tr> <tr> <td>SIGINT <input type="checkbox"/> <input type="checkbox"/> <input type="checkbox"/> <input type="checkbox"/> <input type="checkbox"/></td> <td>SIGINT - ELINT - RADINT <input type="checkbox"/> <input type="checkbox"/> <input type="checkbox"/> <input type="checkbox"/> <input type="checkbox"/></td> <td>MASINT - LASINT <input type="checkbox"/> <input type="checkbox"/> <input type="checkbox"/> <input type="checkbox"/> <input type="checkbox"/></td> </tr> <tr> <td></td> <td></td> <td>MASINT - NUCINT <input type="checkbox"/> <input type="checkbox"/> <input type="checkbox"/> <input type="checkbox"/> <input type="checkbox"/></td> </tr> <tr> <td></td> <td></td> <td>MASINT - RINT <input type="checkbox"/> <input type="checkbox"/> <input type="checkbox"/> <input type="checkbox"/> <input type="checkbox"/></td> </tr> <tr> <td></td> <td></td> <td>OSINT <input type="checkbox"/> <input type="checkbox"/> <input type="checkbox"/> <input type="checkbox"/> <input type="checkbox"/></td> </tr> <tr> <td></td> <td></td> <td>TECHINT <input type="checkbox"/> <input type="checkbox"/> <input type="checkbox"/> <input type="checkbox"/> <input type="checkbox"/></td> </tr> <tr> <td></td> <td></td> <td>Counter Intelligence (CI) <input type="checkbox"/> <input type="checkbox"/> <input type="checkbox"/> <input type="checkbox"/> <input type="checkbox"/></td> </tr> <tr> <td></td> <td></td> <td>Other: _____ <input type="checkbox"/> <input type="checkbox"/> <input type="checkbox"/> <input type="checkbox"/> <input type="checkbox"/></td> </tr> </table>						Yes Possible No Unknown NA	Yes Possible No Unknown NA	Yes Possible No Unknown NA	IMINT <input type="checkbox"/> <input type="checkbox"/> <input type="checkbox"/> <input type="checkbox"/> <input type="checkbox"/>	SIGINT - SIGINT <input type="checkbox"/> <input type="checkbox"/> <input type="checkbox"/> <input type="checkbox"/> <input type="checkbox"/>	HUMINT <input type="checkbox"/> <input type="checkbox"/> <input type="checkbox"/> <input type="checkbox"/> <input type="checkbox"/>	IMINT - Visible <input type="checkbox"/> <input type="checkbox"/> <input type="checkbox"/> <input type="checkbox"/> <input type="checkbox"/>	SIGINT - COMINT <input type="checkbox"/> <input type="checkbox"/> <input type="checkbox"/> <input type="checkbox"/> <input type="checkbox"/>	MASINT <input type="checkbox"/> <input type="checkbox"/> <input type="checkbox"/> <input type="checkbox"/> <input type="checkbox"/>	IMINT - Radar <input type="checkbox"/> <input type="checkbox"/> <input type="checkbox"/> <input type="checkbox"/> <input type="checkbox"/>	SIGINT - ELINT <input type="checkbox"/> <input type="checkbox"/> <input type="checkbox"/> <input type="checkbox"/> <input type="checkbox"/>	MASINT - ACINT <input type="checkbox"/> <input type="checkbox"/> <input type="checkbox"/> <input type="checkbox"/> <input type="checkbox"/>	IMINT - IR <input type="checkbox"/> <input type="checkbox"/> <input type="checkbox"/> <input type="checkbox"/> <input type="checkbox"/>	SIGINT - ELINT - FISINT <input type="checkbox"/> <input type="checkbox"/> <input type="checkbox"/> <input type="checkbox"/> <input type="checkbox"/>	MASINT - Electro-Optical <input type="checkbox"/> <input type="checkbox"/> <input type="checkbox"/> <input type="checkbox"/> <input type="checkbox"/>	IMINT - MSI <input type="checkbox"/> <input type="checkbox"/> <input type="checkbox"/> <input type="checkbox"/> <input type="checkbox"/>	SIGINT - ELINT - TELINT <input type="checkbox"/> <input type="checkbox"/> <input type="checkbox"/> <input type="checkbox"/> <input type="checkbox"/>	MASINT - IRINT <input type="checkbox"/> <input type="checkbox"/> <input type="checkbox"/> <input type="checkbox"/> <input type="checkbox"/>	SIGINT <input type="checkbox"/> <input type="checkbox"/> <input type="checkbox"/> <input type="checkbox"/> <input type="checkbox"/>	SIGINT - ELINT - RADINT <input type="checkbox"/> <input type="checkbox"/> <input type="checkbox"/> <input type="checkbox"/> <input type="checkbox"/>	MASINT - LASINT <input type="checkbox"/> <input type="checkbox"/> <input type="checkbox"/> <input type="checkbox"/> <input type="checkbox"/>			MASINT - NUCINT <input type="checkbox"/> <input type="checkbox"/> <input type="checkbox"/> <input type="checkbox"/> <input type="checkbox"/>			MASINT - RINT <input type="checkbox"/> <input type="checkbox"/> <input type="checkbox"/> <input type="checkbox"/> <input type="checkbox"/>			OSINT <input type="checkbox"/> <input type="checkbox"/> <input type="checkbox"/> <input type="checkbox"/> <input type="checkbox"/>			TECHINT <input type="checkbox"/> <input type="checkbox"/> <input type="checkbox"/> <input type="checkbox"/> <input type="checkbox"/>			Counter Intelligence (CI) <input type="checkbox"/> <input type="checkbox"/> <input type="checkbox"/> <input type="checkbox"/> <input type="checkbox"/>			Other: _____ <input type="checkbox"/> <input type="checkbox"/> <input type="checkbox"/> <input type="checkbox"/> <input type="checkbox"/>
Yes Possible No Unknown NA	Yes Possible No Unknown NA	Yes Possible No Unknown NA																																										
IMINT <input type="checkbox"/> <input type="checkbox"/> <input type="checkbox"/> <input type="checkbox"/> <input type="checkbox"/>	SIGINT - SIGINT <input type="checkbox"/> <input type="checkbox"/> <input type="checkbox"/> <input type="checkbox"/> <input type="checkbox"/>	HUMINT <input type="checkbox"/> <input type="checkbox"/> <input type="checkbox"/> <input type="checkbox"/> <input type="checkbox"/>																																										
IMINT - Visible <input type="checkbox"/> <input type="checkbox"/> <input type="checkbox"/> <input type="checkbox"/> <input type="checkbox"/>	SIGINT - COMINT <input type="checkbox"/> <input type="checkbox"/> <input type="checkbox"/> <input type="checkbox"/> <input type="checkbox"/>	MASINT <input type="checkbox"/> <input type="checkbox"/> <input type="checkbox"/> <input type="checkbox"/> <input type="checkbox"/>																																										
IMINT - Radar <input type="checkbox"/> <input type="checkbox"/> <input type="checkbox"/> <input type="checkbox"/> <input type="checkbox"/>	SIGINT - ELINT <input type="checkbox"/> <input type="checkbox"/> <input type="checkbox"/> <input type="checkbox"/> <input type="checkbox"/>	MASINT - ACINT <input type="checkbox"/> <input type="checkbox"/> <input type="checkbox"/> <input type="checkbox"/> <input type="checkbox"/>																																										
IMINT - IR <input type="checkbox"/> <input type="checkbox"/> <input type="checkbox"/> <input type="checkbox"/> <input type="checkbox"/>	SIGINT - ELINT - FISINT <input type="checkbox"/> <input type="checkbox"/> <input type="checkbox"/> <input type="checkbox"/> <input type="checkbox"/>	MASINT - Electro-Optical <input type="checkbox"/> <input type="checkbox"/> <input type="checkbox"/> <input type="checkbox"/> <input type="checkbox"/>																																										
IMINT - MSI <input type="checkbox"/> <input type="checkbox"/> <input type="checkbox"/> <input type="checkbox"/> <input type="checkbox"/>	SIGINT - ELINT - TELINT <input type="checkbox"/> <input type="checkbox"/> <input type="checkbox"/> <input type="checkbox"/> <input type="checkbox"/>	MASINT - IRINT <input type="checkbox"/> <input type="checkbox"/> <input type="checkbox"/> <input type="checkbox"/> <input type="checkbox"/>																																										
SIGINT <input type="checkbox"/> <input type="checkbox"/> <input type="checkbox"/> <input type="checkbox"/> <input type="checkbox"/>	SIGINT - ELINT - RADINT <input type="checkbox"/> <input type="checkbox"/> <input type="checkbox"/> <input type="checkbox"/> <input type="checkbox"/>	MASINT - LASINT <input type="checkbox"/> <input type="checkbox"/> <input type="checkbox"/> <input type="checkbox"/> <input type="checkbox"/>																																										
		MASINT - NUCINT <input type="checkbox"/> <input type="checkbox"/> <input type="checkbox"/> <input type="checkbox"/> <input type="checkbox"/>																																										
		MASINT - RINT <input type="checkbox"/> <input type="checkbox"/> <input type="checkbox"/> <input type="checkbox"/> <input type="checkbox"/>																																										
		OSINT <input type="checkbox"/> <input type="checkbox"/> <input type="checkbox"/> <input type="checkbox"/> <input type="checkbox"/>																																										
		TECHINT <input type="checkbox"/> <input type="checkbox"/> <input type="checkbox"/> <input type="checkbox"/> <input type="checkbox"/>																																										
		Counter Intelligence (CI) <input type="checkbox"/> <input type="checkbox"/> <input type="checkbox"/> <input type="checkbox"/> <input type="checkbox"/>																																										
		Other: _____ <input type="checkbox"/> <input type="checkbox"/> <input type="checkbox"/> <input type="checkbox"/> <input type="checkbox"/>																																										
Period of Relevance / Frequency of Response																																												
Date (DD / MMM / YY) / DTG		Time of Day (HH:MM:SS) / DTG		Duration (YY / MM / DD / HH:MM:SS)																																								
Start _____	_____	End _____	_____	Duration _____	_____																																							
By Date (DD / MMM / YY) / DTG		By Time of Day (HH:MM:SS) / DTG		Date (DD / MMM / YY) / DTG																																								
Desired Timeliness _____		Latest Time Information of Value (LTIOV) _____		_____																																								
Desired Within:			Desired Within:																																									
≤ 8 Hours <input type="checkbox"/> ≤ 16 Hours <input type="checkbox"/> ≤ 24 Hours <input type="checkbox"/> ≤ 2 Days <input type="checkbox"/> ≤ 3 Days <input type="checkbox"/>			≤ 8 Hours <input type="checkbox"/> ≤ 16 Hours <input type="checkbox"/> ≤ 24 Hours <input type="checkbox"/> ≤ 2 Days <input type="checkbox"/> ≤ 3 Days <input type="checkbox"/>																																									
≤ 1 Week <input type="checkbox"/> ≤ 2 Weeks <input type="checkbox"/> ≤ 3 Weeks <input type="checkbox"/> ≤ 1 Month <input type="checkbox"/> ≤ 2 Months <input type="checkbox"/>			≤ 1 Week <input type="checkbox"/> ≤ 2 Weeks <input type="checkbox"/> ≤ 3 Weeks <input type="checkbox"/> ≤ 1 Month <input type="checkbox"/> ≤ 2 Months <input type="checkbox"/>																																									
≤ 3 Months <input type="checkbox"/> ≤ 6 Months <input type="checkbox"/> ≤ 1 Year <input type="checkbox"/> ≤ 3 Years <input type="checkbox"/> See Notes <input type="checkbox"/>			≤ 3 Months <input type="checkbox"/> ≤ 6 Months <input type="checkbox"/> ≤ 1 Year <input type="checkbox"/> ≤ 3 Years <input type="checkbox"/> See Notes <input type="checkbox"/>																																									
Desired Frequency of Response: _____																																												
Time Standard: Local <input type="checkbox"/> Zulu <input type="checkbox"/> Year: Calendar <input type="checkbox"/> Fiscal <input type="checkbox"/>																																												
Readiness Phase		Crisis / Deployment Phase		Combat Phase																																								
Real Time <input type="checkbox"/> Every Monday <input type="checkbox"/>		Real Time <input type="checkbox"/> Every Monday <input type="checkbox"/>		Real Time <input type="checkbox"/> Every Monday <input type="checkbox"/>																																								
Near Real Time <input type="checkbox"/> Every Tuesday <input type="checkbox"/>		Near Real Time <input type="checkbox"/> Every Tuesday <input type="checkbox"/>		Near Real Time <input type="checkbox"/> Every Tuesday <input type="checkbox"/>																																								
Hourly <input type="checkbox"/> Every Wednesday <input type="checkbox"/>		Hourly <input type="checkbox"/> Every Wednesday <input type="checkbox"/>		Hourly <input type="checkbox"/> Every Wednesday <input type="checkbox"/>																																								
Daily <input type="checkbox"/> Every Thursday <input type="checkbox"/>		Daily <input type="checkbox"/> Every Thursday <input type="checkbox"/>		Daily <input type="checkbox"/> Every Thursday <input type="checkbox"/>																																								
Weekly <input type="checkbox"/> Every Friday <input type="checkbox"/>		Weekly <input type="checkbox"/> Every Friday <input type="checkbox"/>		Weekly <input type="checkbox"/> Every Friday <input type="checkbox"/>																																								
Monthly <input type="checkbox"/> Every Saturday <input type="checkbox"/>		Monthly <input type="checkbox"/> Every Saturday <input type="checkbox"/>		Monthly <input type="checkbox"/> Every Saturday <input type="checkbox"/>																																								
Quarterly <input type="checkbox"/> Every Sunday <input type="checkbox"/>		Quarterly <input type="checkbox"/> Every Sunday <input type="checkbox"/>		Quarterly <input type="checkbox"/> Every Sunday <input type="checkbox"/>																																								
Yearly <input type="checkbox"/> See Notes <input type="checkbox"/>		Yearly <input type="checkbox"/> See Notes <input type="checkbox"/>		Yearly <input type="checkbox"/> See Notes <input type="checkbox"/>																																								
See Notes At: (HH:MM) _____		See Notes At: (HH:MM) _____		See Notes At: (HH:MM) _____																																								
Other Phase:																																												
Real Time <input type="checkbox"/> Every Monday <input type="checkbox"/>		Real Time <input type="checkbox"/> Every Monday <input type="checkbox"/>		Real Time <input type="checkbox"/> Every Monday <input type="checkbox"/>																																								
Near Real Time <input type="checkbox"/> Every Tuesday <input type="checkbox"/>		Near Real Time <input type="checkbox"/> Every Tuesday <input type="checkbox"/>		Near Real Time <input type="checkbox"/> Every Tuesday <input type="checkbox"/>																																								
Hourly <input type="checkbox"/> Every Wednesday <input type="checkbox"/>		Hourly <input type="checkbox"/> Every Wednesday <input type="checkbox"/>		Hourly <input type="checkbox"/> Every Wednesday <input type="checkbox"/>																																								
Daily <input type="checkbox"/> Every Thursday <input type="checkbox"/>		Daily <input type="checkbox"/> Every Thursday <input type="checkbox"/>		Daily <input type="checkbox"/> Every Thursday <input type="checkbox"/>																																								
Weekly <input type="checkbox"/> Every Friday <input type="checkbox"/>		Weekly <input type="checkbox"/> Every Friday <input type="checkbox"/>		Weekly <input type="checkbox"/> Every Friday <input type="checkbox"/>																																								
Monthly <input type="checkbox"/> Every Saturday <input type="checkbox"/>		Monthly <input type="checkbox"/> Every Saturday <input type="checkbox"/>		Monthly <input type="checkbox"/> Every Saturday <input type="checkbox"/>																																								
Quarterly <input type="checkbox"/> Every Sunday <input type="checkbox"/>		Quarterly <input type="checkbox"/> Every Sunday <input type="checkbox"/>		Quarterly <input type="checkbox"/> Every Sunday <input type="checkbox"/>																																								
Yearly <input type="checkbox"/> See Notes <input type="checkbox"/>		Yearly <input type="checkbox"/> See Notes <input type="checkbox"/>		Yearly <input type="checkbox"/> See Notes <input type="checkbox"/>																																								
See Notes At: (HH:MM) _____		See Notes At: (HH:MM) _____		See Notes At: (HH:MM) _____																																								

Figure B-13. Recommended PIR/EEI/RFI/Other Requirement Request Worksheet Template (1 of 2)

DTG:	Classification:	Page: ___ of: ___		
Recommended PIR / EEI / RFI / Other Requirement Request Worksheet (U)				
Desired Format of Response				
All				
Formal Response <input type="checkbox"/>	In-Formal Response <input type="checkbox"/>	Hardcopy <input type="checkbox"/> Softcopy <input type="checkbox"/> Imagery <input type="checkbox"/> GGI&S <input type="checkbox"/>		
Real Time / Near Real Time <input type="checkbox"/>	Voice <input type="checkbox"/>	FAX <input type="checkbox"/> Message (USMTF) <input type="checkbox"/> e-Mail <input type="checkbox"/> Video Teleconference (VTC) <input type="checkbox"/>		
Presentation <input type="checkbox"/>	Briefing <input type="checkbox"/> Meeting / Conference <input type="checkbox"/> Other: _____	Other: _____		
Maximum Level of Classification Desired				
Unclassified <input type="checkbox"/> For Official Use Only (FOUO) <input type="checkbox"/>	Collateral - Confidential <input type="checkbox"/>	Collateral - Secret <input type="checkbox"/> Collateral - Top Secret <input type="checkbox"/> Top Secret SCI <input type="checkbox"/>		
Special Access <input type="checkbox"/> No ORCON <input type="checkbox"/>	No Proprietary <input type="checkbox"/>	No LIMDIS <input type="checkbox"/> No NOFORN <input type="checkbox"/> Contractor Releasable <input type="checkbox"/>		
Releasable To: _____	Other: _____	Other: _____		
Hardcopy				
Report <input type="checkbox"/>	Presentation <input type="checkbox"/> White / Talking / Etc ... Paper <input type="checkbox"/>	Other: _____		
Softcopy				
Type	Data / Data Base	Soft Format	Physical Format	Hosted On
Report <input type="checkbox"/>	MIDB <input type="checkbox"/>	Windows OS: _____ <input type="checkbox"/>	CDROM <input type="checkbox"/>	5D Server <input type="checkbox"/>
Presentation <input type="checkbox"/>	Local MIDB <input type="checkbox"/>	Unix OS: _____ <input type="checkbox"/>	High Density Floppy Disk <input type="checkbox"/>	JPL Server <input type="checkbox"/>
Imagery <input type="checkbox"/>	MEPED <input type="checkbox"/>	System Type: _____ <input type="checkbox"/>	100 MByte Zip Disk <input type="checkbox"/>	IPA Server <input type="checkbox"/>
HTML (i.e. INTELINK) <input type="checkbox"/>	Local TMD IPB Data Base <input type="checkbox"/>	File Type(s): _____ <input type="checkbox"/>	250 MByte Zip Disk <input type="checkbox"/>	LAN <input type="checkbox"/>
Software <input type="checkbox"/>	Local Intelligence Data Base <input type="checkbox"/>	File Type(s): _____ <input type="checkbox"/>	8 mm Tape <input type="checkbox"/>	WAN <input type="checkbox"/>
Video <input type="checkbox"/>	ASCII - Tab delimited <input type="checkbox"/>	File Type(s): _____ <input type="checkbox"/>	4 mm Tape <input type="checkbox"/>	INTELINK Server <input type="checkbox"/>
Audio <input type="checkbox"/>	ASCII - Fixed Length <input type="checkbox"/>	NITF <input type="checkbox"/>	Tape <input type="checkbox"/>	INTELINK-S Server <input type="checkbox"/>
Message (USMTF) <input type="checkbox"/>	Other: _____ <input type="checkbox"/>	Other: _____ <input type="checkbox"/>	Other: _____ <input type="checkbox"/>	Other: _____ <input type="checkbox"/>
Other: _____ <input type="checkbox"/>	Other: _____ <input type="checkbox"/>	Other: _____ <input type="checkbox"/>	Other: _____ <input type="checkbox"/>	Other: _____ <input type="checkbox"/>
Softcopy				
Print Size	Target Area (Mission Planning)	Type of Imagery	Resolution	Other
3 x 5 Print <input type="checkbox"/>	18.5 km (10 nmi) x 18.5 km <input type="checkbox"/>	Optical / Electro-Optical <input type="checkbox"/>	Broad Area Coverage - 30 meters <input type="checkbox"/>	Registered / Georectified <input type="checkbox"/>
5" x 7" Print <input type="checkbox"/>	9.3 km (5 nmi) x 9.3 km <input type="checkbox"/>	IR <input type="checkbox"/>	Broad Area Coverage - 15 meters <input type="checkbox"/>	Annotations <input type="checkbox"/>
8" x 10" Print <input type="checkbox"/>	5.6 km (3 nmi) x 5.6 km <input type="checkbox"/>	Radar <input type="checkbox"/>	Broad Area Coverage - 3 meters <input type="checkbox"/>	No Annotations <input type="checkbox"/>
_____ x _____" Print <input type="checkbox"/>	_____ km (_____ nmi) x _____ km <input type="checkbox"/>	Multi-Spectral Imagery (MSI) <input type="checkbox"/>	Medium Resolution - 1-2 meters <input type="checkbox"/>	Duplicate Positive <input type="checkbox"/>
_____ x _____" Print <input type="checkbox"/>	Target (Attack Parameters)	MSI - Panchromatic <input type="checkbox"/>	High Resolution - ≤ 1 meters <input type="checkbox"/>	VFP Compatible (i.e. CADRG) <input type="checkbox"/>
_____ x _____" Print <input type="checkbox"/>	1.8 km (1 nmi) x 1.8 km <input type="checkbox"/>	MSI - Color <input type="checkbox"/>	Broad Area Coverage ≥ NIIRS 3 <input type="checkbox"/>	Best Available <input type="checkbox"/>
Wide Area (Orientation)	0.9 km (0.5 nmi) x 0.9 km <input type="checkbox"/>	MSI - TERCAT <input type="checkbox"/>	Medium Resolution - NIIRS 4-5 <input type="checkbox"/>	Textual Imagery Report <input type="checkbox"/>
185.2 km (100 nmi) x 185.2 km <input type="checkbox"/>	_____ km (_____ nmi) x _____ km <input type="checkbox"/>	MSI - Change Detection <input type="checkbox"/>	High Resolution - NIIRS 5-6 <input type="checkbox"/>	Vertical / Near-Vertical Shot <input type="checkbox"/>
111.1 km (60 nmi) x 111.1 km <input type="checkbox"/>	Close-Up of Specific Object <input type="checkbox"/>	MSI - Seasonal Imagery <input type="checkbox"/>	Very High Resolution - ≥ NIIRS 6 <input type="checkbox"/>	High Oblique Shot <input type="checkbox"/>
59.3 km (32 nmi) x 59.3 km <input type="checkbox"/>	MSI Mosaic of Area of Operations <input type="checkbox"/>	Other: _____ <input type="checkbox"/>	NIIRS _____ <input type="checkbox"/>	Low Oblique Shot <input type="checkbox"/>
_____ km (_____ nmi) x _____ km <input type="checkbox"/>	Other: _____ <input type="checkbox"/>	Other: _____ <input type="checkbox"/>	Other: _____ meters <input type="checkbox"/>	Other: _____ <input type="checkbox"/>
Global Geospatial Information and Services				
General Type	DFAD Level 2 <input type="checkbox"/>	DTOP <input type="checkbox"/>	Map Type	Scale
Hardcopy (Paper) Map <input type="checkbox"/>	DFAD Level 1C <input type="checkbox"/>	DDPDB <input type="checkbox"/>	GNC (1:5,000,000) <input type="checkbox"/>	1:25,000 <input type="checkbox"/>
Softcopy (Digital or Raster Map) <input type="checkbox"/>	DFAD Level 3C <input type="checkbox"/>	Interim Terrain Data (ITD) <input type="checkbox"/>	JNC (1:2,000,000) <input type="checkbox"/>	1:50,000 <input type="checkbox"/>
On-Line Map <input type="checkbox"/>	VMAP Level 0 <input type="checkbox"/>	Vector Product ITD (VITD) <input type="checkbox"/>	ONC (1:1,000,000) <input type="checkbox"/>	1:100,000 <input type="checkbox"/>
Other: _____ <input type="checkbox"/>	VMAP Level 1 <input type="checkbox"/>	DBDB 5 minute <input type="checkbox"/>	TPC (1:500,000) <input type="checkbox"/>	1:250,000 <input type="checkbox"/>
Text <input type="checkbox"/>	VMAP Level 2 <input type="checkbox"/>	DBDB 0.5 minute <input type="checkbox"/>	JOG-A (Air) (1:250,000) <input type="checkbox"/>	1:500,000 <input type="checkbox"/>
DTED Level 0 (1,000 meters) <input type="checkbox"/>	Urban VMAP (UVMAP) <input type="checkbox"/>	DBDB 0.1 minute <input type="checkbox"/>	JOG-G (Ground) (1:250,000) <input type="checkbox"/>	1:1,000,000 <input type="checkbox"/>
DTED Level 1 (100 meters) <input type="checkbox"/>	CIB 10 meter <input type="checkbox"/>	Digital Chart of the World (DCW) II <input type="checkbox"/>	JOG-R (Radar) (1:250,000) <input type="checkbox"/>	1:2,000,000 <input type="checkbox"/>
DTED Level 2 (30 meters) <input type="checkbox"/>	CIB 5 meter <input type="checkbox"/>	World Vector Shoreline (WVS) <input type="checkbox"/>	TLM (1:100,000) <input type="checkbox"/>	1:5,000,000 <input type="checkbox"/>
DTED Level 3 (10 meters) <input type="checkbox"/>	CIB 1 meter <input type="checkbox"/>	DNC <input type="checkbox"/>	TLM (1:50,000) <input type="checkbox"/>	Other: _____ <input type="checkbox"/>
DTED Level 4 (5 meters) <input type="checkbox"/>	CADRG <input type="checkbox"/>	Other: _____ <input type="checkbox"/>	City Graphics (1:25,000) <input type="checkbox"/>	Other: _____ <input type="checkbox"/>
DTED Level 5 (1 meters) <input type="checkbox"/>	TTADB <input type="checkbox"/>	Other: _____ <input type="checkbox"/>	Other: _____ <input type="checkbox"/>	Other: _____ <input type="checkbox"/>
DFAD Level 1 <input type="checkbox"/>	Digital Gazetteer <input type="checkbox"/>	Other: _____ <input type="checkbox"/>	Other: _____ <input type="checkbox"/>	Other: _____ <input type="checkbox"/>
Real Time / Near Real Time				
INTELINK <input type="checkbox"/>	INTELINK-S (SIPRNET) <input type="checkbox"/>	GCCS <input type="checkbox"/>	TDDS (TRAP) <input type="checkbox"/>	TIBS <input type="checkbox"/>
JWICS <input type="checkbox"/>	JTIDS <input type="checkbox"/>	TADIL-A <input type="checkbox"/>	TADIL-J <input type="checkbox"/>	Voice <input type="checkbox"/>
Other: _____ <input type="checkbox"/>	Other: _____ <input type="checkbox"/>	Other: _____ <input type="checkbox"/>	Other: _____ <input type="checkbox"/>	Other: _____ <input type="checkbox"/>
Other				
Other: _____ <input type="checkbox"/>	Other: _____ <input type="checkbox"/>	Other: _____ <input type="checkbox"/>	Other: _____ <input type="checkbox"/>	Other: _____ <input type="checkbox"/>
Other: _____ <input type="checkbox"/>	Other: _____ <input type="checkbox"/>	Other: _____ <input type="checkbox"/>	Other: _____ <input type="checkbox"/>	Other: _____ <input type="checkbox"/>
Area(s) of Interest				
NAI <input type="checkbox"/> HVT <input type="checkbox"/> TCT <input type="checkbox"/> Fixed - Facility <input type="checkbox"/> Non-Fixed - Moving <input type="checkbox"/> Non-Fixed - Not Moving <input type="checkbox"/> Terrain Analysis <input type="checkbox"/> Other: _____ <input type="checkbox"/>				
BE Number: _____ Point <input type="checkbox"/> Radius (km) _____ Area / Polygon <input type="checkbox"/> Route / Polyline <input type="checkbox"/> Datum: WGS84 <input type="checkbox"/> Other: _____ <input type="checkbox"/>				
Geocoordinate Units: dd.decimal <input type="checkbox"/> ddmms <input type="checkbox"/> dd.msss <input type="checkbox"/> MGRS <input type="checkbox"/> UTM <input type="checkbox"/> Other: _____ <input type="checkbox"/> See Attached for Further Definition <input type="checkbox"/>				
Point or Centroid Coordinates: Latitude _____ Longitude _____ MGRS _____ UTM _____				
Area / Polygon / Route / Polyline Definition:				
Starting Point	Latitude / MGRS / UTM N S	Longitude	E W	Next Point
Next Point	_____	_____	_____	_____
Next Point	_____	_____	_____	_____
Next Point	_____	_____	_____	_____
Next Point	_____	_____	_____	_____
Next Point	_____	_____	_____	_____
Next Point	_____	_____	_____	_____
Next Point	_____	_____	_____	Ending Point
Next Point	_____	_____	_____	_____

Figure B-13 (Continued). Recommended PIR/EEI/RFI Other Requirement Request Worksheet Template (2 of 2)

TMD IPB Key Word Search Template (U)

Adversary / Country Focus Key Words		
<input type="checkbox"/> Country 1 Name: _____	<input type="checkbox"/> Country 2 Name: _____	<input type="checkbox"/> Country 3 Name: _____
<input type="checkbox"/> Country 4 Name: _____	<input type="checkbox"/> Country 5 Name: _____	<input type="checkbox"/> Country 6 Name: _____
<input type="checkbox"/> Country 7 Name: _____	<input type="checkbox"/> Country 8 Name: _____	<input type="checkbox"/> Country 9 Name: _____
<input type="checkbox"/> Country 1 3-Letter Designator: _____	<input type="checkbox"/> Country 2 3-Letter Designator: _____	<input type="checkbox"/> Country 3 3-Letter Designator: _____
<input type="checkbox"/> Country 4 3-Letter Designator: _____	<input type="checkbox"/> Country 5 3-Letter Designator: _____	<input type="checkbox"/> Country 6 3-Letter Designator: _____
<input type="checkbox"/> Country 7 3-Letter Designator: _____	<input type="checkbox"/> Country 8 3-Letter Designator: _____	<input type="checkbox"/> Country 9 3-Letter Designator: _____
<input type="checkbox"/> Country 1 2-Letter Designator: _____	<input type="checkbox"/> Country 2 2-Letter Designator: _____	<input type="checkbox"/> Country 3 2-Letter Designator: _____
<input type="checkbox"/> Country 4 2-Letter Designator: _____	<input type="checkbox"/> Country 5 2-Letter Designator: _____	<input type="checkbox"/> Country 6 2-Letter Designator: _____
<input type="checkbox"/> Country 7 2-Letter Designator: _____	<input type="checkbox"/> Country 8 2-Letter Designator: _____	<input type="checkbox"/> Country 9 2-Letter Designator: _____
<input type="checkbox"/> Country 1 Nick Name: _____	<input type="checkbox"/> Country 2 Nick Name: _____	<input type="checkbox"/> Country 3 Nick Name: _____
<input type="checkbox"/> Country 4 Nick Name: _____	<input type="checkbox"/> Country 5 Nick Name: _____	<input type="checkbox"/> Country 6 Nick Name: _____
<input type="checkbox"/> Country 7 Nick Name: _____	<input type="checkbox"/> Country 8 Nick Name: _____	<input type="checkbox"/> Country 9 Nick Name: _____
<input type="checkbox"/> Russia	<input type="checkbox"/> China	<input type="checkbox"/> North Korea
<input type="checkbox"/> Iran	<input type="checkbox"/> Iraq	<input type="checkbox"/> Syria
<input type="checkbox"/> Libya	<input type="checkbox"/> India	<input type="checkbox"/> Pakistan
<input type="checkbox"/> Area 1 Name: _____	<input type="checkbox"/> Area 2 Name: _____	<input type="checkbox"/> Area 3 Name: _____
<input type="checkbox"/> Area 4 Name: _____	<input type="checkbox"/> Area 5 Name: _____	<input type="checkbox"/> Area 6 Name: _____
<input type="checkbox"/> Area 7 Name: _____	<input type="checkbox"/> Area 8 Name: _____	<input type="checkbox"/> Area 9 Name: _____
<input type="checkbox"/> Other: _____	<input type="checkbox"/> Other: _____	<input type="checkbox"/> Other: _____
<input type="checkbox"/> Other: _____	<input type="checkbox"/> Other: _____	<input type="checkbox"/> Other: _____
General Key Words		
<input type="checkbox"/> Missile	<input type="checkbox"/> Rocket	<input type="checkbox"/> Theater Missile
<input type="checkbox"/> Research	<input type="checkbox"/> Development	<input type="checkbox"/> R&D
<input type="checkbox"/> Testing	<input type="checkbox"/> Evaluation	<input type="checkbox"/> T&E
<input type="checkbox"/> RDT&E	<input type="checkbox"/> Production	<input type="checkbox"/> Flight Test
<input type="checkbox"/> Theater Missile Defense	<input type="checkbox"/> TMD	<input type="checkbox"/> Order of battle
<input type="checkbox"/> OB	<input type="checkbox"/> OOB	<input type="checkbox"/> Missile Order of Battle
<input type="checkbox"/> MOB	<input type="checkbox"/> Defensive Missile Order of Battle	<input type="checkbox"/> DMOB
<input type="checkbox"/> Air Route Closure	<input type="checkbox"/> Area Closure	<input type="checkbox"/> Operational Test
<input type="checkbox"/> Exercise	<input type="checkbox"/> Field Exercise	<input type="checkbox"/> Command
<input type="checkbox"/> Control	<input type="checkbox"/> C2	<input type="checkbox"/> Communications
<input type="checkbox"/> Intelligence	<input type="checkbox"/> Computers	<input type="checkbox"/> C4
<input type="checkbox"/> Suppression of Enemy Air Defense	<input type="checkbox"/> C3I	<input type="checkbox"/> C4I
<input type="checkbox"/> SEMD	<input type="checkbox"/> SEAD	<input type="checkbox"/> Suppression of Enemy Missile Defense
<input type="checkbox"/> DST	<input type="checkbox"/> Defense Suppression	<input type="checkbox"/> Defense Suppression Threat
<input type="checkbox"/> Surface-to-Air Missile	<input type="checkbox"/> Air Defense	<input type="checkbox"/> AD
<input type="checkbox"/> EW	<input type="checkbox"/> SAM	<input type="checkbox"/> Electronic Warfare
<input type="checkbox"/> Information Warfare	<input type="checkbox"/> Electronic Combat	<input type="checkbox"/> EC
<input type="checkbox"/> Electronic Attack	<input type="checkbox"/> IW	<input type="checkbox"/> Information Operations
<input type="checkbox"/> Fire Control	<input type="checkbox"/> Electronic Countermeasures	<input type="checkbox"/> ECM
<input type="checkbox"/> Early Warning	<input type="checkbox"/> EA	<input type="checkbox"/> Fire Control System
<input type="checkbox"/> Target	<input type="checkbox"/> Radar	<input type="checkbox"/> Search
<input type="checkbox"/> Engine Test Stand	<input type="checkbox"/> Acquisition	<input type="checkbox"/> Track
<input type="checkbox"/> Satellite Navigation	<input type="checkbox"/> Point Target	<input type="checkbox"/> Area Target
<input type="checkbox"/> GPS	<input type="checkbox"/> Inertial Navigation System	<input type="checkbox"/> INS
<input type="checkbox"/> Terminal Guidance	<input type="checkbox"/> SATNAV	<input type="checkbox"/> Global Positioning System
<input type="checkbox"/> Guidance and Control	<input type="checkbox"/> GLONASS	<input type="checkbox"/> Seeker
<input type="checkbox"/> GNC	<input type="checkbox"/> Midcourse Guidance	<input type="checkbox"/> Midcourse Update Guidance
<input type="checkbox"/> Rocket Motor	<input type="checkbox"/> G&C	<input type="checkbox"/> Guidance, Navigation, and Control
<input type="checkbox"/> Ramjet	<input type="checkbox"/> Booster	<input type="checkbox"/> Airframe
<input type="checkbox"/> Other: _____	<input type="checkbox"/> Rocket Engine	<input type="checkbox"/> Turbojet
<input type="checkbox"/> Other: _____	<input type="checkbox"/> Turbofan	<input type="checkbox"/> Turboprop
<input type="checkbox"/> Other: _____	<input type="checkbox"/> Other: _____	<input type="checkbox"/> Other: _____
<input type="checkbox"/> Other: _____	<input type="checkbox"/> Other: _____	<input type="checkbox"/> Other: _____
Weapon System Nomenclature		
<input type="checkbox"/> Primary Designator System 1: _____	<input type="checkbox"/> Primary Designator System 2: _____	<input type="checkbox"/> Primary Designator System 3: _____
<input type="checkbox"/> Primary Designator System 4: _____	<input type="checkbox"/> Primary Designator System 5: _____	<input type="checkbox"/> Primary Designator System 6: _____
<input type="checkbox"/> Primary Designator System 7: _____	<input type="checkbox"/> Primary Designator System 7: _____	<input type="checkbox"/> Primary Designator System 9: _____
<input type="checkbox"/> Indigenous Designator System 1: _____	<input type="checkbox"/> Indigenous Designator System 2: _____	<input type="checkbox"/> Indigenous Designator System 3: _____
<input type="checkbox"/> Indigenous Designator System 4: _____	<input type="checkbox"/> Indigenous Designator System 5: _____	<input type="checkbox"/> Indigenous Designator System 6: _____
<input type="checkbox"/> Indigenous Designator System 7: _____	<input type="checkbox"/> Indigenous Designator System 8: _____	<input type="checkbox"/> Indigenous Designator System 9: _____
<input type="checkbox"/> Nick Name System 1: _____	<input type="checkbox"/> Nick Name System 2: _____	<input type="checkbox"/> Nick Name System 3: _____
<input type="checkbox"/> Nick Name System 4: _____	<input type="checkbox"/> Nick Name System 5: _____	<input type="checkbox"/> Nick Name System 6: _____
<input type="checkbox"/> Nick Name System 7: _____	<input type="checkbox"/> Nick Name System 8: _____	<input type="checkbox"/> Nick Name System 9: _____
<input type="checkbox"/> NATO Designator System 1: _____	<input type="checkbox"/> NATO Designator System 2: _____	<input type="checkbox"/> NATO Designator System 3: _____
<input type="checkbox"/> NATO Designator System 4: _____	<input type="checkbox"/> NATO Designator System 5: _____	<input type="checkbox"/> NATO Designator System 6: _____
<input type="checkbox"/> NATO Designator System 7: _____	<input type="checkbox"/> NATO Designator System 8: _____	<input type="checkbox"/> NATO Designator System 9: _____
<input type="checkbox"/> NATO Code Name System 1: _____	<input type="checkbox"/> NATO Code Name System 2: _____	<input type="checkbox"/> NATO Code Name System 3: _____
<input type="checkbox"/> NATO Code Name System 4: _____	<input type="checkbox"/> NATO Code Name System 5: _____	<input type="checkbox"/> NATO Code Name System 6: _____
<input type="checkbox"/> NATO Code Name System 7: _____	<input type="checkbox"/> NATO Code Name System 8: _____	<input type="checkbox"/> NATO Code Name System 9: _____
<input type="checkbox"/> WSSIC Designator System 1: _____	<input type="checkbox"/> WSSIC Designator System 2: _____	<input type="checkbox"/> WSSIC Designator System 3: _____
<input type="checkbox"/> WSSIC Designator System 4: _____	<input type="checkbox"/> WSSIC Designator System 5: _____	<input type="checkbox"/> WSSIC Designator System 6: _____
<input type="checkbox"/> WSSIC Designator System 7: _____	<input type="checkbox"/> WSSIC Designator System 8: _____	<input type="checkbox"/> WSSIC Designator System 9: _____
<input type="checkbox"/> ASSC Designator System 1: _____	<input type="checkbox"/> ASSC Designator System 2: _____	<input type="checkbox"/> ASSC Designator System 3: _____
<input type="checkbox"/> ASSC Designator System 4: _____	<input type="checkbox"/> ASSC Designator System 5: _____	<input type="checkbox"/> ASSC Designator System 6: _____
<input type="checkbox"/> ASSC Designator System 7: _____	<input type="checkbox"/> ASSC Designator System 8: _____	<input type="checkbox"/> ASSC Designator System 9: _____
<input type="checkbox"/> Other: _____	<input type="checkbox"/> Other: _____	<input type="checkbox"/> Other: _____
<input type="checkbox"/> Other: _____	<input type="checkbox"/> Other: _____	<input type="checkbox"/> Other: _____

Figure B-14. TMD IPB Key Word Search Template (1 of 4)

DTG: _____	Classification: _____	Page: ____ of: ____
TMD IPB Key Word Search Template (U)		
Ballistic Missile (not including: launcher, delivery vehicle, or support equipment)		
<input type="checkbox"/> Theater Ballistic Missile <input type="checkbox"/> Ballistic Missile <input type="checkbox"/> Medium range Ballistic Missile <input type="checkbox"/> IRBM <input type="checkbox"/> Ship Launched Ballistic Missile <input type="checkbox"/> System <input type="checkbox"/> Other: _____ <input type="checkbox"/> Other: _____	<input type="checkbox"/> Tactical Ballistic Missile <input type="checkbox"/> Short Range Ballistic Missile <input type="checkbox"/> MRBM <input type="checkbox"/> Sea Launched Ballistic Missile <input type="checkbox"/> SLBM <input type="checkbox"/> Theater Missile <input type="checkbox"/> Other: _____ <input type="checkbox"/> Other: _____	<input type="checkbox"/> TBM <input type="checkbox"/> SRBM <input type="checkbox"/> Intermediate Range Ballistic Missile <input type="checkbox"/> Submarine Launched Ballistic Missile <input type="checkbox"/> Surface-to-Surface Missile <input type="checkbox"/> TM <input type="checkbox"/> Other: _____ <input type="checkbox"/> Other: _____
Cruise Missile (not including: launcher, delivery vehicle, or support equipment)		
<input type="checkbox"/> Cruise Missile <input type="checkbox"/> ASCM <input type="checkbox"/> LACM <input type="checkbox"/> Attack Unmanned Aerial Vehicle <input type="checkbox"/> RPV <input type="checkbox"/> Other: _____ <input type="checkbox"/> Other: _____	<input type="checkbox"/> CM <input type="checkbox"/> Antiship <input type="checkbox"/> Unmanned Aerial Vehicle <input type="checkbox"/> AUAV <input type="checkbox"/> Air-to-Surface Missile <input type="checkbox"/> Other: _____ <input type="checkbox"/> Other: _____	<input type="checkbox"/> Antiship Cruise Missile <input type="checkbox"/> Land Attack Cruise Missile <input type="checkbox"/> UAV <input type="checkbox"/> Remotely Piloted Vehicle <input type="checkbox"/> ASM <input type="checkbox"/> Other: _____ <input type="checkbox"/> Other: _____
Non-Ballistic and Non-Cruise Missile (not including: launcher, delivery vehicle, or support equipment)		
<input type="checkbox"/> Antiradiation Missile <input type="checkbox"/> AR <input type="checkbox"/> Air-to-Surface Missile <input type="checkbox"/> TASM <input type="checkbox"/> Chemical Warfare <input type="checkbox"/> CW <input type="checkbox"/> Biological Warhead <input type="checkbox"/> Nuclear Weapon <input type="checkbox"/> Special Weapon <input type="checkbox"/> Biological Agent <input type="checkbox"/> Chemical Weapons Program <input type="checkbox"/> Weaponization <input type="checkbox"/> Non-Persistent <input type="checkbox"/> VX <input type="checkbox"/> GD <input type="checkbox"/> Tabun <input type="checkbox"/> Anthrax <input type="checkbox"/> Other: _____ <input type="checkbox"/> Other: _____	<input type="checkbox"/> ARM <input type="checkbox"/> Antiradiation Homing <input type="checkbox"/> ASM <input type="checkbox"/> Artillery Rocket <input type="checkbox"/> Chemical Weapon <input type="checkbox"/> Biological Warfare <input type="checkbox"/> BW <input type="checkbox"/> Nuclear Warhead <input type="checkbox"/> Protective Measures <input type="checkbox"/> Bio <input type="checkbox"/> Biological Weapons Program <input type="checkbox"/> Weaponize <input type="checkbox"/> Decontamination <input type="checkbox"/> GF <input type="checkbox"/> Sarin <input type="checkbox"/> GA <input type="checkbox"/> Q-Fever <input type="checkbox"/> Other: _____ <input type="checkbox"/> Other: _____	<input type="checkbox"/> Antiradiation <input type="checkbox"/> ARH <input type="checkbox"/> Tactical Air-to-Surface Missile <input type="checkbox"/> Field Artillery Rocket <input type="checkbox"/> Chemical Warhead <input type="checkbox"/> Biological Weapon <input type="checkbox"/> Nuclear Warfare <input type="checkbox"/> Nuke <input type="checkbox"/> Chemical Agent <input type="checkbox"/> Chem <input type="checkbox"/> Nuclear Weapons Program <input type="checkbox"/> Persistent <input type="checkbox"/> Binary Weapon <input type="checkbox"/> Soman <input type="checkbox"/> GB <input type="checkbox"/> Mustard <input type="checkbox"/> Toxin <input type="checkbox"/> Other: _____ <input type="checkbox"/> Other: _____
Weapons of Mass Destruction (WMD)		
Warhead / Payload		
<input type="checkbox"/> Ramjet <input type="checkbox"/> Payload <input type="checkbox"/> Blast <input type="checkbox"/> Fragmentation <input type="checkbox"/> SAP <input type="checkbox"/> Terminally Guided Submunition <input type="checkbox"/> Biological <input type="checkbox"/> Cluster <input type="checkbox"/> FAE <input type="checkbox"/> EMP <input type="checkbox"/> Electronic Attack <input type="checkbox"/> EW <input type="checkbox"/> GPS Guided <input type="checkbox"/> Other: _____ <input type="checkbox"/> Other: _____	<input type="checkbox"/> Turbofan <input type="checkbox"/> Unitary <input type="checkbox"/> High Explosive <input type="checkbox"/> Blast Fragmentation <input type="checkbox"/> Armor Piercing <input type="checkbox"/> TGSM <input type="checkbox"/> Nuclear <input type="checkbox"/> Bulk Fill <input type="checkbox"/> Bomblet <input type="checkbox"/> Antiradiation Missile <input type="checkbox"/> EA <input type="checkbox"/> Laser Guided <input type="checkbox"/> Circular Error Probable <input type="checkbox"/> Other: _____ <input type="checkbox"/> Other: _____	<input type="checkbox"/> Warhead <input type="checkbox"/> Submunition <input type="checkbox"/> HE <input type="checkbox"/> Semi-Armor Piercing <input type="checkbox"/> Mine <input type="checkbox"/> Chemical <input type="checkbox"/> Conventional <input type="checkbox"/> Fuel Air Explosive <input type="checkbox"/> Electro-Magnetic Pulse <input type="checkbox"/> ARM <input type="checkbox"/> Electronic Warfare <input type="checkbox"/> Laser Designated <input type="checkbox"/> CEP <input type="checkbox"/> Other: _____ <input type="checkbox"/> Other: _____
Countermeasures		
<input type="checkbox"/> Electronic Warfare <input type="checkbox"/> ECM <input type="checkbox"/> Penetration Aid <input type="checkbox"/> Chaff <input type="checkbox"/> Replica <input type="checkbox"/> Signature Reduction <input type="checkbox"/> Radar Cross Section Reduction <input type="checkbox"/> IR Coating <input type="checkbox"/> Denial and Deception <input type="checkbox"/> Camouflage <input type="checkbox"/> Denial <input type="checkbox"/> Simultaneous Arrival <input type="checkbox"/> OPSEC <input type="checkbox"/> Maneuvering <input type="checkbox"/> Multiple Reentry Vehicles <input type="checkbox"/> Balloon <input type="checkbox"/> Terrain Bounce Jammer <input type="checkbox"/> Barrage Jammer <input type="checkbox"/> ERS <input type="checkbox"/> SEAD <input type="checkbox"/> Standoff Jammer <input type="checkbox"/> Other: _____ <input type="checkbox"/> Other: _____	<input type="checkbox"/> EW <input type="checkbox"/> Electronic Counter-Countermeasures <input type="checkbox"/> Penaid <input type="checkbox"/> Flare <input type="checkbox"/> Shroud <input type="checkbox"/> Radar Cross Section <input type="checkbox"/> RCS Reduction <input type="checkbox"/> Camouflage, Concealment, and Deception <input type="checkbox"/> D&D <input type="checkbox"/> Concealment <input type="checkbox"/> Salvo Launch <input type="checkbox"/> Simultaneous Impact <input type="checkbox"/> Communications Security <input type="checkbox"/> Maneuvering Reentry Vehicle <input type="checkbox"/> MRV <input type="checkbox"/> Light replica <input type="checkbox"/> Towed Decoy <input type="checkbox"/> Countermeasures Dispenser <input type="checkbox"/> Defense Suppression <input type="checkbox"/> Air Defense Suppression <input type="checkbox"/> Terrain Following <input type="checkbox"/> Other: _____ <input type="checkbox"/> Other: _____	<input type="checkbox"/> Electronic Countermeasures <input type="checkbox"/> ECCM <input type="checkbox"/> Decoy <input type="checkbox"/> Jammer <input type="checkbox"/> Signature <input type="checkbox"/> RCS <input type="checkbox"/> Coating <input type="checkbox"/> CCD <input type="checkbox"/> DD <input type="checkbox"/> Deception <input type="checkbox"/> Time-on-Target Control <input type="checkbox"/> Operations Security <input type="checkbox"/> COMSEC <input type="checkbox"/> MaRV <input type="checkbox"/> Stealth <input type="checkbox"/> Heavy Replica <input type="checkbox"/> Escort Jammer <input type="checkbox"/> Early Release of Submunitions <input type="checkbox"/> Suppression of Enemy Air Defense <input type="checkbox"/> Simultaneous Launch <input type="checkbox"/> Terrain Masking <input type="checkbox"/> Other: _____ <input type="checkbox"/> Other: _____
TMD IPB Template -- 18 March 2000 Classification: _____ Local Reproduction Authorized		

Figure B-14 (Continued). TMD IPB Key Word Search Template (2 of 4)

TMD IPB Key Word Search Template (U)

<ul style="list-style-type: none"> <input type="checkbox"/> Air Base <input type="checkbox"/> AFLD <input type="checkbox"/> Garrison <input type="checkbox"/> Depot <input type="checkbox"/> Forward Operating Area <input type="checkbox"/> Field Storage Site <input type="checkbox"/> FOB <input type="checkbox"/> Fueling Site <input type="checkbox"/> Transload Site <input type="checkbox"/> Launch Area <input type="checkbox"/> Operating Area <input type="checkbox"/> Operational Test Activity <input type="checkbox"/> Doctrine <input type="checkbox"/> Tactics, Techniques, and Procedures <input type="checkbox"/> Course of Action <input type="checkbox"/> Other: _____ <input type="checkbox"/> Other: _____ 	<p style="text-align: center;">Operations</p> <ul style="list-style-type: none"> <input type="checkbox"/> AB <input type="checkbox"/> Naval Base <input type="checkbox"/> National Level Garrison <input type="checkbox"/> National Level Depot <input type="checkbox"/> FOA <input type="checkbox"/> Field Storage Area <input type="checkbox"/> Field Operating Location <input type="checkbox"/> Fueling Area <input type="checkbox"/> Transload Area <input type="checkbox"/> Hide Site <input type="checkbox"/> Field Operating Area <input type="checkbox"/> Field Training <input type="checkbox"/> Strategy <input type="checkbox"/> TTP <input type="checkbox"/> COA <input type="checkbox"/> Other: _____ <input type="checkbox"/> Other: _____ 	<ul style="list-style-type: none"> <input type="checkbox"/> Airfield <input type="checkbox"/> Port <input type="checkbox"/> National Garrison <input type="checkbox"/> National Level Storage <input type="checkbox"/> Field Storage Location <input type="checkbox"/> Field Operating Base <input type="checkbox"/> FOL <input type="checkbox"/> Warhead Mating <input type="checkbox"/> Launch Site <input type="checkbox"/> Hide Area <input type="checkbox"/> Flight Test Activity <input type="checkbox"/> Field Exercise <input type="checkbox"/> Tactics <input type="checkbox"/> Operating Procedures <input type="checkbox"/> Procedure <input type="checkbox"/> Other: _____ <input type="checkbox"/> Other: _____
<ul style="list-style-type: none"> <input type="checkbox"/> Erector Launcher <input type="checkbox"/> TEL <input type="checkbox"/> Mobile Erector Launcher <input type="checkbox"/> Launcher <input type="checkbox"/> Launch Aircraft Model: _____ <input type="checkbox"/> Launch Ship Model: _____ <input type="checkbox"/> Vehicle Designator: _____ <input type="checkbox"/> Truck Mounted Launcher <input type="checkbox"/> Other: _____ <input type="checkbox"/> Other: _____ 	<p style="text-align: center;">Launchers and Delivery vehicles</p> <ul style="list-style-type: none"> <input type="checkbox"/> EL <input type="checkbox"/> TEL Chassis Manufacturer: _____ <input type="checkbox"/> MEL <input type="checkbox"/> Launch Aircraft Origin: _____ <input type="checkbox"/> Launch Ship Origin: _____ <input type="checkbox"/> Launch Name: _____ <input type="checkbox"/> Launch Ship Type Abbreviation: _____ <input type="checkbox"/> Transporter Erector Launcher and Radar <input type="checkbox"/> Other: _____ <input type="checkbox"/> Other: _____ 	<ul style="list-style-type: none"> <input type="checkbox"/> Transporter Erector Launcher <input type="checkbox"/> TEL Chassis Model: _____ <input type="checkbox"/> Fixed Launcher <input type="checkbox"/> Launch Aircraft Manufacture: _____ <input type="checkbox"/> Launch Ship Manufacture: _____ <input type="checkbox"/> Transportable launcher <input type="checkbox"/> Rail Launcher <input type="checkbox"/> TELAR <input type="checkbox"/> Other: _____ <input type="checkbox"/> Other: _____
<p>Ground Support Equipment (not including: launchers and delivery vehicles)</p>		
<ul style="list-style-type: none"> <input type="checkbox"/> Ground Support Equipment <input type="checkbox"/> Ground Support Vehicle <input type="checkbox"/> Oxidizer Vehicle <input type="checkbox"/> Checkout Truck <input type="checkbox"/> Crane <input type="checkbox"/> Resupply Trailer <input type="checkbox"/> Vehicle Chassis Model: _____ <input type="checkbox"/> Missile Transporter <input type="checkbox"/> Warhead Truck <input type="checkbox"/> Warhead Crate <input type="checkbox"/> Fire Control Van <input type="checkbox"/> Command and Control Vehicle <input type="checkbox"/> C2 Truck <input type="checkbox"/> Horizontal Checkout Vehicle <input type="checkbox"/> Autonomous Checkout Vehicle <input type="checkbox"/> Mobile Power vehicle <input type="checkbox"/> Aiming Truck <input type="checkbox"/> Missile Crate <input type="checkbox"/> Airframe Crate <input type="checkbox"/> Missile Crate Transporter <input type="checkbox"/> Airframe Crate Transporter <input type="checkbox"/> Oxidizer Cannister <input type="checkbox"/> Fuel Container <input type="checkbox"/> Inhibited Red Fuming Nitric Acid <input type="checkbox"/> IRFNA Container <input type="checkbox"/> Air Compressor Vehicle <input type="checkbox"/> Compressed Air Truck <input type="checkbox"/> Water Vehicle <input type="checkbox"/> Wash Down Truck <input type="checkbox"/> Warhead Trolley <input type="checkbox"/> Fin Dolly <input type="checkbox"/> Missile Dolly <input type="checkbox"/> Missile Air frame Trolley <input type="checkbox"/> Meteorological Radar <input type="checkbox"/> Survey truck <input type="checkbox"/> Engineer Vehicle <input type="checkbox"/> Ambulance Van <input type="checkbox"/> Computer Vehicle <input type="checkbox"/> Topographical Vehicle <input type="checkbox"/> Radio Vehicle <input type="checkbox"/> Other: _____ <input type="checkbox"/> Other: _____ 	<ul style="list-style-type: none"> <input type="checkbox"/> GSE <input type="checkbox"/> Fuel Vehicle <input type="checkbox"/> Oxidizer Truck <input type="checkbox"/> Checkout Van <input type="checkbox"/> Resupply Vehicle <input type="checkbox"/> RST <input type="checkbox"/> Vehicle Designator: _____ <input type="checkbox"/> Triple Carry Framework <input type="checkbox"/> Warhead Cannister <input type="checkbox"/> Fire Control Vehicle <input type="checkbox"/> FCV <input type="checkbox"/> C2 Vehicle <input type="checkbox"/> Horizontal Test Vehicle <input type="checkbox"/> Autonomous Test Vehicle <input type="checkbox"/> HCV <input type="checkbox"/> Mobile Power Truck <input type="checkbox"/> Missile Cannister <input type="checkbox"/> Airframe Cannister <input type="checkbox"/> Missile Cannister Transporter <input type="checkbox"/> Airframe Cannister Transporter <input type="checkbox"/> Heavy Equipment Transporter <input type="checkbox"/> Oxidizer Container <input type="checkbox"/> Starter Fuel Cannister <input type="checkbox"/> IRFNA <input type="checkbox"/> Washing and Neutralizing Vehicle <input type="checkbox"/> Air Compressor Truck <input type="checkbox"/> Tanker Vehicle <input type="checkbox"/> Water Truck <input type="checkbox"/> Truck Mounted Crane <input type="checkbox"/> Warhead/Fin Dolly <input type="checkbox"/> Fin Trolley <input type="checkbox"/> Missile Trolley <input type="checkbox"/> Meteorological Vehicle <input type="checkbox"/> Survey equipment <input type="checkbox"/> Spare Parts Vehicle <input type="checkbox"/> Generator Trailer <input type="checkbox"/> POL Vehicle <input type="checkbox"/> Computer Truck <input type="checkbox"/> Topographical Truck <input type="checkbox"/> Radio Truck <input type="checkbox"/> Other: _____ <input type="checkbox"/> Other: _____ 	<ul style="list-style-type: none"> <input type="checkbox"/> Ground Support <input type="checkbox"/> Fuel Truck <input type="checkbox"/> Checkout vehicle <input type="checkbox"/> Box-Bodied Van <input type="checkbox"/> RSV <input type="checkbox"/> Vehicle Chassis manufacture: _____ <input type="checkbox"/> Transporter <input type="checkbox"/> Warhead Vehicle <input type="checkbox"/> Warhead Container <input type="checkbox"/> Fire Control Truck <input type="checkbox"/> Warhead Van <input type="checkbox"/> Command and Control Truck <input type="checkbox"/> Horizontal Test Truck <input type="checkbox"/> Autonomous Test Truck <input type="checkbox"/> Comprehensive Test Equipment <input type="checkbox"/> Aiming Vehicle <input type="checkbox"/> Missile Container <input type="checkbox"/> Airframe Container <input type="checkbox"/> Missile Container Transporter <input type="checkbox"/> Airframe Container Transporter <input type="checkbox"/> HET <input type="checkbox"/> Fuel Cannister <input type="checkbox"/> Starter Fuel Container <input type="checkbox"/> IRFNA Cannister <input type="checkbox"/> Washing and Neutralizing Truck <input type="checkbox"/> Compressed Air Vehicle <input type="checkbox"/> Tanker Truck <input type="checkbox"/> Wash Down Vehicle <input type="checkbox"/> Warhead Dolly <input type="checkbox"/> Warhead/Fin Trolley <input type="checkbox"/> Sustained Handling Skid <input type="checkbox"/> Missile Airframe Dolly <input type="checkbox"/> Meteorological Truck <input type="checkbox"/> Survey Vehicle <input type="checkbox"/> Spare Parts Truck <input type="checkbox"/> Ambulance <input type="checkbox"/> POL Truck <input type="checkbox"/> Computer Van <input type="checkbox"/> Topographical Van <input type="checkbox"/> Radio Van <input type="checkbox"/> Other: _____ <input type="checkbox"/> Other: _____
<p>Other</p>		
<ul style="list-style-type: none"> <input type="checkbox"/> Other: _____ <input type="checkbox"/> Other: _____ <input type="checkbox"/> Other: _____ <input type="checkbox"/> Other: _____ <input type="checkbox"/> Other: _____ 	<ul style="list-style-type: none"> <input type="checkbox"/> Other: _____ <input type="checkbox"/> Other: _____ <input type="checkbox"/> Other: _____ <input type="checkbox"/> Other: _____ <input type="checkbox"/> Other: _____ 	<ul style="list-style-type: none"> <input type="checkbox"/> Other: _____ <input type="checkbox"/> Other: _____ <input type="checkbox"/> Other: _____ <input type="checkbox"/> Other: _____ <input type="checkbox"/> Other: _____

Figure B-14 (Continued). TMD IPB Key Word Search Template (3 of 4)

DTG: _____	Classification: _____	Page: ____ of: ____
TMD IPB Key Word Search Template (U)		
Instructions:		
<p>1 - Check each keyword required to search for the desired information.</p> <p>2 - Provide the data search operator with the logic for relating the key words to each other key word for filtering the data sources. This is usually in the form of boolean logic. Boolean logic uses simple operators to relate key words:</p> <p style="margin-left: 40px;">AND - "key word 1" AND "key word 2" filters such that any returned hit has both "key word 1" and "key word 2" in the returned hit.</p> <p style="margin-left: 40px;">OR - "key word 1" OR "key word 2" filters such that any returned hit has either "key word 1" or "key word 2" in the returned hit, not necessarily both.</p> <p style="margin-left: 40px;">NOT - "key word 1" NOT "key word 2" filters such that any returned hit has "key word 1" and does not have "key word 2" in the returned hit.</p> <p>For Example:</p> <p style="margin-left: 40px;">In most cases, the country name or country 2- or 3-letter designator of the adversary is always associated with any desired information search return to ensure that the search returns only information focused on the AO and AOI, for example:</p> <p style="margin-left: 80px;">[RD OR RED]AND [TBM] will return hits that are focused on the country RED that relate to theater ballistic missiles.</p> <p style="margin-left: 40px;">There is no effective way to provide a template for building the filtering logic for an information search, because of the wide variety of search engines used by the intelligence community. This template provides a way of identifying the key words and then the analyst must work with the data search operator to define the filtering logic based on the search tools available to the data search operator.</p> <p>3 - After receiving the results of the data information search, evaluate the results. If the search returned a much larger number of hits that are not relevant, then tighten the filtering logic to reduce the number to a manageable level. If the search returned a much smaller number of hits than expected and there appears to be missing information, then expand the filtering logic to increase the number of returns. In any case, it will likely take several iterations to get to an efficient and effective set of key words and filtering logic. In some cases the key words and filtering logic will have to be dynamic to keep up with changing situations.</p> <p>4 - When choosing key words and setting up filtering logic, take caution with the use of plurals, abbreviations, compound words, and others. The particular cautions and their fixes will be dependent on the specific search system being used. Work closely with the data search operator to ensure the best possible choices of key words and filtering logic have been chosen. As an example, the use of the key word "Denial & Deception" may yield little or no results on some search systems while "Denial and Deception" retrieves the results that are of interest.</p>		
Notes:		
TMD IPB Template -- 18 March 2000	Classification: _____	Local Reproduction Authorized

Figure B-14 (Continued). TMD IPB Key Word Search Template (4 of 4)

DIA Standardized Functional Category Code Information Search Template (U)

- TM Research, Development, Testing, and Evaluation (RDT&E)
 - o Radar Systems - All Types [40340, 40341, 40343, 40344, 40346, 40347]
 - o TM - All Types [408?? (except 40801, 408??, 4086?)]
- RDT&E and Operational Training Theater Missile Impact Areas
 - o Short Range Ballistic Missiles (SRBM) [7070?, 707?5 (except 7074?), 70710]
 - o Medium Range Ballistic Missiles (MRBMs) [7070?, 707?3 (except 7074?), 70710]
 - o Sea-Launched Ballistic Missiles (SLBM) [7070?, 70740, 70742, 70743, 70745, 70730, 70740]
 - o Intermediate Range Ballistic Missiles (IRBM) [7070?, 707?2 (except 7074?), 70710]
 - o GLCM [7070?, 707?4]
 - o CM [7070?, 707?0]
 - o ASM [7070?, 707?6 70720]
- TM Production
 - o SRBMs [6820?, 6821?, 6871?]
 - o MRBMs [6813?, 6871?, 6872?]
 - o SLBMs [6815?, 6824?, 6831?, 6832?, 6871?, 6872?]
 - o IRBMs [6812?, 6871?, 6872?]
 - o GLCM [6814?, 6823?] Naval Cruise Missiles [6833?]
 - o Tactical Air-to-Surface Missiles (TASM) [6850?, 6852?]
 - o ASMs [6850?, 6851?]
 - o UAVs [616??, 688??]
 - o Radar Systems [5214?, 524??]
 - o TM - All Types [408?? (except 408?? and 4086?), 5253?, 5261?, 5263?, 680??, 6810?]
 - o Warheads - All Types [62213, 6233?, 6235?, 627??, 6294?, 6930?, 6934?, 6935?]
 - o Rocket Motors - All Types [6234?]
 - o Solid Propellants - All Types [68006, 692??]
 - o GSE Chassis [641?? (64131, 6414?, and 6415?), 6442?, 68005, 68125, 68135, 68145, 68215, 68235, 68315, 68325, 68335, 68515, 68525, 68715, 68725, 68805]
 - o D&D Equipment [524??, 652??]
- WMD
 - o Chemical Weapons RDT&E [405??]
 - o Biological Weapons RDT&E [405??]
 - o Nuclear Weapons RDT&E [401??]
 - o Chemical Weapons Production [6600?, 6610?, 66120, 66121, 66129, 6615?, 668??, 6690?, 6695?, 6699?]
 - o Biological Weapons Production [6650?, 6651?, 6652?, 6690?, 6695?, 6699?]
 - o Nuclear Weapons Production [603??]
 - o Chemical Weapons Storage [662??, 6690?, 6691?, 6692?, 6693?, 6694?, 6699?]
 - o Biological Weapons Storage [666??, 6690?, 6691?, 6692?, 6693?, 6694?, 6699?]
 - o Nuclear Weapons Storage [604??, 605??]
 - o Chemical Operational Facilities [6630?, 66310, 66311, 66350, 66351]
 - o Biological Operational Facilities [6630?, 66310, 66311, 66350, 66352]
- LOC
 - o Roads [441??, 442??, 443??, 444??, 447??]
 - o Railroads [451??, 452??, 453??, 454??, 45500, 457??, 4592?, 4593?, 4595?, 4596?]
 - o Naval [473??, 477??]
- Key Terrain
 - o Roads [441??, 442??, 443??, 444??, 445?? (except 44591)]
 - o Railroads [451??, 452??, 454??, 455??]
 - o Naval [479??]
- Operational Storage, Maintenance, Repair, Overhaul, Refit, and Depots
 - o SRBMs [8760?, 87645, 88250, 88251]
 - o MRBMs [8760?, 87635, 88250, 88251]
 - o IRBMs [8760?, 87625, 88250, 88251]
 - o GLCMs [8760?, 87655, 88250, 88251]
 - o Multiple Missile Types [8760?, 87665]
 - o Missile Liquid Propellant Storage [219??]
 - o Aviation and Aviation Delivered Missiles [8600?, 8610?, 8611?, 8612?, 8613?, 862??, 863?? (except 8632?), 864??, 867??, 869?? (except 8693?), 88253]
 - o Naval TMs [9700?, 972??, 88252]
- National or Main Operating Garrisons/Bases/Ports/Facilities/Posts
 - o Missile Complex Centers - Geographic Position Points [70310]
 - o SRBMs [8760?, 87644, 87647, 87648, 88280, 88281]
 - o MRBMs [8760?, 87634, 87637, 87638, 88280, 88281]
 - o IRBMs [8760?, 87624, 87627, 87628, 88280, 88281]
 - o GLCMs [8760?, 87654, 87657, 87658, 88280, 88281]
 - o Aviation and Aviation Delivered Missiles [88283]
 - o Naval TMs [88282]
 - o Multiple Missile Types [8760?, 87664, 87667, 87668]
- Aviation Airfields (including temporary airfields, such as highway strips)
 - o Aircraft [8000?, 8001?, 8002?, 8003?, 8004?, 8005?, 8006?, 80071, 80072, 80073, 80074, 80075, 8010?, 8011?, 8016?]
 - o Helicopter [80060, 80150, 80151, 80153]
- Naval TMs
 - o Major Surface Ships [9500?, 9511?]
 - o Other Surface Ships [9500?, 9512?, 9513?, 9514?]
 - o Submarines [9520?, 9521?, 95212?]
 - o Maritime Ports [47400, 4741?, 47526, 47528, 956??]

All DIA Standardized Functional Category Codes are 5 numerical characters in length. There are a potential 90,000 category codes. In order to provide an efficient method for information searching, most information systems, use wild card characters. Only one wild card character is used within this template. That wild card character is ?. The ? represents 0 through 9 in any combination. For example, the category code 2191? represents the category codes 21910 through 21919; category code 219??? represents the category codes 21900 through 21999; and category code 21?10 represents the category codes 21010, 21110, 21210, 21310, 21410, 21510, 21610, 21710, 21810, & 21910.

Figure B-15. DIA Standardized Functional Category Code Information Search Template (1 of 2)

DTG: _____	Classification: _____	Page: ___ of: ___
DIA Standardized Functional Category Code Information Search Template (U)		
<p>Operational Support Garrisons/Bases/Ports/Facilities/Posts</p> <ul style="list-style-type: none"> ○ SLBMs [8760?, 8762?, 882?, 882?] ○ MRBMs [8760?, 8762?, 882?, 882?] ○ GLCMs [8760?, 8765?, 882?, 882?] Aviation [882?, 882?] ○ Aviation Delivered Missiles [882?, 882?] ○ Naval TMs [8790?, 8791?, 8792?, 8793?, 8794?, 882?, 882?] ○ Coastal Defense Missiles [8790?, 8795?, 882?, 882?] ○ Multiple Missile Types [8760?, 8766?] <p>Operational Field Garrisons/Bases/Facilities/Posts/Areas</p> <ul style="list-style-type: none"> ○ SRBMs [87609, 87649] ○ MRBMs [87609, 87639] ○ IRBMs [87609, 87629] ○ GLCMs [87609, 87659] ○ Multiple Missile Types [87609, 87669] <p>Operational Missile Sites/Areas</p> <p>Fixed</p> <ul style="list-style-type: none"> ○ SRBMs [8700?, 8706?, 8714?] ○ MRBMs [8700?, 8703?, 8714?, 8800?, 88100, 88101, 88130, 88131, 88134, 88135, 88136, 88140, 88141, 88144, 88145, 88146] ○ IRBMs [8700?, 8702?, 8714?, 8800?, 88100, 88101, 88120, 88121, 88124, 88125, 88126, 88140, 88141, 88144, 88145, 88146] ○ GLCMs [8700?, 8705?, 8714?, 8800?, 88103, 88123, 88133, 88143, 88153, 88163, 88150, 88151, 88154, 88155, 88156, 88161] ○ Naval Surface-to-Surface Missiles (SSM) [8700?, 8800?, 88102, 88122, 88132, 88142, 88152, 88162] <p>Mobile Launch Positions</p> <ul style="list-style-type: none"> ○ Road [8718?] ○ Railroad [8717?] ○ Troops in the Field, Tactical Missile Troop Field Position [9024?] ○ Naval Relocation Areas [953?? (except 953?4 and 9534?)] ○ Coastal Defenses [9800?, 981?? (except 9823?)] <p>Operational Training Garrisons/Bases/Facilities/Posts/Areas</p> <ul style="list-style-type: none"> ○ SRBMs [87606, 87646, 88260, 88261] ○ MRBMs [87606, 87636, 87646, 88260, 88261] ○ IRBMs [87606, 87626, 87646, 88260, 88261] ○ GLCMs [87606, 88293, 87646, 87656, 88260, 88261] ○ Naval TMs [88262] ○ Aviation and Aviation Delivered Missiles [88263] ○ Multiple Missile Types [87666] <p>Potential Mobile Ground-Launched TM Hide Sites</p> <ul style="list-style-type: none"> ○ Road Bridges and Viaducts [441??] ○ Railroad Bridges and Viaducts [451??] ○ Road Tunnels and Bunkers [442??] ○ Railroad Tunnels and Bunkers [452??] ○ Other Man-made Tunnels and Bunkers [9820?, 9821?, 9828?, 9829?] ○ Natural and Constructed Caves [9826?] ○ Covered Storage Areas [481?? (except 4814? and 4815?)] ○ Artillery Positions [9823?] ○ Other [443??] <p>C2</p> <ul style="list-style-type: none"> ○ National and National Command Authority (NCA) [8900? (except 89002), 8901?, 8910?, 893?? (except 8932?), 894?? (except 8942?), 895?? (except 8952?)] ○ National Level TM [8740?, 8741?, (except 874?1)] ○ SRBMs [8740?, 8746, 8747, 8747?, (except 874?1), 88300, 88311] ○ MRBMs [8740?, 8743, 8744, 8747?, (except 874?1), 8780?, 8783?, 88300, 88311] ○ IRBMs [8740?, 8742, 8744, 8747?, (except 874?1), 8780?, 8782?, 88300, 88311] ○ GLCMs [8740?, 8745, 8747?, (except 874?1), 8780?, 8784?, 88300, 88311] ○ Aviation and Aviation Delivered Munitions [8100?, 813?? (except 81300), 814??, 88313] ○ Naval TMs [88302, 956??, 96000, 96001, 96002, 96100, 96101, 96102, 962?? (except 96213, 96223, 9623?, 9624?, 96253, 9626?), 96300, 96301, 96302] ○ Multiple Missile Types [8740?, 8747?, 8747?, (except 874?1)] <p>Communications</p> <p>Landlines</p> <ul style="list-style-type: none"> ○ Coaxial Cable [41300, 4132?, 4133?] ○ Submarine Cable [41300, 4131?] ○ Multiconductor [41300, 4133?] ○ Fiber Optic [41300, 4134?] ○ Switching and Control Centers [414??] ○ RF [411?? except 41113] ○ SATCOM [4114?] ○ Fixed Base Mobile Signal Units [8960?, 8966?, 8968?, 8969?] <p>Air Defense</p> <ul style="list-style-type: none"> ○ Early Warning, Surveillance, Detection, Tracking, and Acquisition Radars [851??] ○ GCI Radar Facilities [852??] ○ Missile Control Radars [853??] ○ Surveillance Radar [854??] ○ Anti-aircraft artillery (AAA) Gunfire Control Radar [8550?, 8552?] ○ Complexes [8720?, 8722?, 8725, 8727? (except 8724?), 8730?, 8731?, 8734, 8735, 8736, 8739, 8740?,] <p>Meteorological</p>		
<p>All DIA Standardized Functional Category Codes are 5 numerical characters in length. There are a potential 90,000 category codes. In order to provide an efficient method for information searching most information systems, use wild card characters. Only one wild card character is used within this template. That wild card character is ?. The ? represents 0 through 9 in any combination. For example, the category code 2191? represents the category codes 21910 through 21919; category code 219?? represents the category codes 21900 through 21999; and category code 21?10 represents the category codes 21010, 21110, 21210, 21310, 21410, 21510, 21610, 21710, 21810, & 21910.</p>		
TMD IPB Template -- 18 March 2000	Classification: _____	Local Reproduction Authorized

Figure B-15 (Continued). DIA Standardized Functional Category Code Information Search Template (2 of 2)

DIA Standardized Equipment Code Information Search Template (U)

Character Position	1st	2nd	3rd	4th	5th	Description			
□ □ □ □ □ □ □ □ □ □ □ □ □ □ □ □ □ □ □ □	A	A				Aircraft, Fixed Wing			
		B				Bomber, Long Range			
		C					Bomber, Intermediate Range		
		D					Bomber, Short Range		
		E					Fighter, All-Weather		
		F					Fighter, Day		
		G					Attack		
		I					Fighter-Bomber		
		P					Antisubmarine Warfare		
		Q					Unmanned Aerial Vehicles (UAV), Drones, and Remotely Piloted Vehicles (RPV)		
		U					Multi-Role Combat Aircraft		
				?	?		Mixed / Unknown Types and 'Total' Entries		
						A	Unique Aircraft Type Identifier		
						B	Antiship Capability		
						C	Attack		
						D	Antisubmarine Warfare (ASW)		
						P	Antiradar		
						S	No Modification to Basic Type		
						U	UAV / Drone / RPV Conversion Control		
						V	Other Special Modifications		
				X	Multiple Capability				
				Z	Fighter-Bomber				
					All Weather Fighter				
□ □ □ □ □ □ □ □ □ □ □ □ □ □ □	B	A				Aircraft, Rotary Wing			
		G					Attack Helicopter		
		H					ASW Helicopter		
		U					UAVs / Drones / Remotely Piloted Helicopters (RPH)		
		V					Mixed/Unknown Types and 'Total' Entries		
				?	?		Autogyro		
						A	Unique Aircraft Type Identifier		
						B	ASW		
						J	Attack		
						U	No Modification to Basic Type		
						V	Other Special Modifications		
							Antiship		
		□ □ □ □ □ □ □ □ □ □ □ □ □ □ □	C	A				Vessels, Combatant Ship Category	
				B					Submarine Type
				C					Aircraft Carrier Type
D							Surface Combatant Type, Battleship		
E							Surface Combatant Type, Cruiser		
F							Surface Combatant Type, Destroyer		
G							Surface Combatant Type, Frigate		
W							Patrol Combatant Type		
				?			Coast Guard Cutter		
					A	0	Unique Vessel / Ship Type Identifier		
					A	1	Ship Type Entry (without Ship Class Name Indication)		
					A	2	Not Further Identified		
					A	3	Single Ship Entry		
					A	4	New Ship Class Entry		
					A	5	Hulls Under Construction		
			A	7	Miscellaneous Groupings				
			A	9	Projected				
					Total Count Entry for the Given Ship Type				
□ □ □ □ □ □ □ □ □ □ □ □ □ □ □	D	I				Vessels, Combatant Craft Category			
		J					Patrol Craft Type		
				?			Patrol Craft Type		
					A	0	Unique Vessel / Ship Type Identifier		
					A	1	Ship Type Entry (without Ship Class Name Indication)		
					A	2	Not Further Identified		
					A	3	Single Ship Entry		
					A	4	New Ship Class Entry		
					A	5	Hulls Under Construction		
					A	7	Miscellaneous Groupings		
					A	9	Projected		
							Total Count Entry for the Given Ship Type		

All DIA Standardized Equipment Codes are 5 alphanumeric characters in length. In order to provide an efficient method for information searching most information systems use wild card characters. Only one wild card character is used within this template. That wild card character is ?. The ? represents 0 through 9 in any combination. For example, the equipment code AA??P represents the equipment codes AA00P through AAZZP; and equipment code AA00? represents the equipment codes AA00A, AA00B, AA00C, AA00D, AA00E, AA00F, AA00G, AA00H, AA00I, AA00J, AA00K, AA00L, AA00M, AA00N, AA00O, AA00P, AA00R, AA00S, AA00T, AA00U, AA00V, AA00W, AA00X, AA00Y, AA00Z.

Figure B-16. DIA Standardized Equipment Code Information Search Template (1 of 4)

DTG:		Classification:			Page: ___ of: ___	
DIA Standardized Equipment Code Information Search Template (U)						
Character Position	1st	2nd	3rd	4th	5th	Description
○	J					Engines and Propulsion Systems
○		A				Aircraft Engines (for Fixed Wing Aircraft)
○		B				Aircraft Engines (for Rotary Wing Aircraft)
○		C				Naval/Marine Engines
○		K				Space Launch Vehicle/Spacecraft Engines and Propulsion Systems
○		N				Armored Vehicle/Tank Engines
○		Q				Vehicular Engines
○		R				Rail Locomotive Engines
○		Z				Missile/Rocket Propulsion Systems
○		L				Miscellaneous Engines/Propulsion Systems
○			?	?	?	Unique Equipment Identifier
○	L					Associated / Miscellaneous Equipment
○		A				Aircraft, Fixed Wing Related
○		B				Aircraft, Rotary Wing Related
○		C				Vessels, Combatant Ship Category Related
○		D				Vessels, Combatant Craft Category Related
○		J				Engines and Propulsion Systems Related
○		N				Armored Vehicle Related
○		Q				General Purpose Vehicles Related
○		R				Special Purpose Vehicles Related
○		S				Engineering Equipment Related
○		T				Air Defense Weapons Related
○		U				Field Artillery/Surface Bombardment/Torpedo Systems Related
○		V				Surface-to-Surface Missile (SSM) Launchers/Rocket Launchers Related
○		X				Radar/Electronic Equipment Related
○		Y				Communications/Automated Data Processing (ADP) Related
○		Z				Ammunition Reload Related
○		L				Not Otherwise Categorized Related
○			?	?	?	Unique Equipment Identifier
○	N					Armored Vehicles
○		C				Armored Command Vehicle (ACV)
○		D				Armored Combat Support Vehicles
○		E				Armored Service Support Vehicles
○			A			Amphibious / Tracked
○			B			Amphibious / Wheeled
○			D			Non-Amphibious / Tracked
○			C			Non-Amphibious / Wheeled
○			H			Half-Tracked Vehicles
○			V			Mixed or Variant Types
○			U			Mixed or Variant Types
○				?	?	Unique Equipment Identifier
○	Q					General Purpose Vehicles
○		R				Tractor (Prime Mover)
○		S				Trailer / Semitrailer
○		T				Truck
○		U				Combination / Variant / Unknown
○			A			Less Than or Equal to 1/4 Ton / 5 Personnel
○			B			Less Than or Equal to 1/2 Ton / 10 Personnel
○			C			Less Than or Equal to 3/4 Ton / 15 Personnel
○			D			Less Than or Equal to 1 Ton / 20 Personnel
○			E			Less Than or Equal to 1.5 Ton / 25 Personnel
○			F			Less Than or Equal to 2 Tons / 30 Personnel
○			G			Less Than or Equal to 2.5 Tons / 35 Personnel
○			H			Less Than or Equal to 3 Tons / 40 Personnel
○			I			Less Than or Equal to 4 Tons / 45 Personnel
○			J			Less Than or Equal to 5 Tons / 50 Personnel
○			K			More Than 5 Tons / 50 Personnel
○			V			Mixed or Multiple Weight / Personnel Categories
○			U			Unknown
○				?	?	Unique Equipment Identifier
○	R					Special Purpose Vehicles
○		C				Communications (Exclusive of Specific Communications Gear)
○		H				Chemical / Biological / Radiological (CBR) Defense and Decontamination
○		I				POL / Water / Liquid Carriers and Tankers
○		K				Tank / Heavy Equipment Transporters
○		L				Other Special Purpose
○		P				Missile Transporter-Erector-Launcher (TEL) & Associated Missile Support Vehicles
○			A			Tracked, Self-Propelled
○			B			Tracked, Towed
○			C			Wheeled, Self-Propelled
○			D			Wheeled, Towed
○			N			Not Applicable
○			Q			Rail, Locomotives and Self-Propelled Rail Vehicles

All DIA Standardized Equipment Codes are 5 alphanumeric characters in length. In order to provide an efficient method for information searching most information systems use wild card characters. Only one wild card character is used within this template. That wild card character is ?. The ? represents 0 through 9 in any combination. For example, the equipment code AA??P represents the equipment codes AA00P through AAZZP; and equipment code AA00? represents the equipment codes AA00A, AA00B, AA00C, AA00D, AA00E, AA00F, AA00G, AA00H, AA00I, AA00J, AA00K, AA00L, AA00M, AA00N, AA00O, AA00P, AA00R, AA00S, AA00T, AA00U, AA00V, AA00W, AA00X, AA00Y, AA00Z.

Figure B-16 (Continued). DIA Standardized Equipment Code Information Search Template (2 of 4)

DIA Standardized Equipment Code Information Search Template (U)

Character Position	1st	2nd	3rd	4th	5th	Description
○	S					Engineering Equipment
○		B				Earth-Moving Equipment (Bulldozers, Excavators, etc.)
○		C				Construction (Cranes, Jackhammers, etc.)
○		F				Material Lifting and Handling Equipment
○		M				Mixed or Multi-Purpose Equipment
○			A			Tracked Self-Propelled, Amphibious
○			B			Tracked Self-Propelled, Non-Amphibious
○			C			Wheeled, Self-Propelled, Amphibious
○			D			Wheeled, Self-Propelled, Non-Amphibious
○			E			Wheeled, Towed, Amphibious
○			F			Wheeled, Towed, Non-Amphibious
○			G			Floating Only
○			H			Fixed
○			U			Unknown or Not Applicable
○				?	?	Unique Equipment Identifier
○	T					Air Defense Weapons
○		G				Missile Launcher, Fixed Site
○		H				Missile Launcher, Man-Portable
○		I				Missile Launcher, Self-Propelled
○		J				Missile Launcher, Towed
○		K				Missile Launcher, Shipboard Mounted
○		U				Mixed/Multiple Categories/Unknown
○			1			Optical Tracking/Unguided
○			2			Radar Tracking, Unguided
○			3			Optical Tracking, Homing
○			4			Radar Tracking, Homing
○			5			Command Guided/Wire Guided
○			6			Homing
○			U			Unknown
○			V			Mixed/Variant
○				?	?	Unique Equipment Identifier
○	U					Field Artillery / Surface Bombardment Weapons / Torpedo Tubes
○		O				Multiple Rocket Launcher, Towed
○		R				Rocket Launcher, Single Rail (not mounted)
○		P				Multiple Rocket Launcher, Self-Propelled
○			M			Equal To 122 mm
○			N			Greater Than 122 mm But Less Than 152 mm
○			O			Greater Than Or Equal To 152 mm But Less Than 155 mm
○			P			Equal To 155 mm
○			Q			Greater Than 152 mm But Less Than Or Equal To 175 mm
○			R			Greater Than 175 mm But Less Than Or Equal To 210 mm
○			S			Greater Than 210 mm But Less Than 240 mm
○			T			Equal To Or Greater Than 240 mm
○			U			Unknown
○			V			Mixed/Variant
○				?	?	Unique Equipment Identifier
○	V					SSM Launchers / Rocket Launchers
○		B				Ballistic Missiles With Ranges Greater Than 600 km
○		C				Ballistic Missiles With Ranges Less Than 600 km
○		D				Free Rockets
○		E				Guided Cruise Missiles
○		G				Antiship Surface Missile
○		U				Unknown / Mixed
○			A			Fixed Site
○			B			Ship or Submarine Launcher
○			C			Self-Propelled Launcher
○			D			Towed Launcher
○			E			Semi-Mobile Launcher
○			U			Unknown / Mixed
○				?	?	Unique Equipment Identifier
○		B				Alternative 2nd Character For Intermediate Range Ballistic Missiles (IRBM)
○		C				Alternative 2nd Character For Medium Range Ballistic Missiles (MRBM)
○		S				Alternative 2nd Character For Short Range Ballistic Missiles (SRBM)

All DIA Standardized Equipment Codes are 5 alphanumeric characters in length. In order to provide an efficient method for information searching most information systems use wild card characters. Only one wild card character is used within this template. That wild card character is ?. The ? represents 0 through 9 in any combination. For example, the equipment code AA??P represents the equipment codes AA00P through AA99P; and equipment code AA00? represents the equipment codes AA00A, AA00B, AA00C, AA00D, AA00E, AA00F, AA00G, AA00H, AA00I, AA00J, AA00K, AA00L, AA00M, AA00N, AA00O, AA00P, AA00R, AA00S, AA00T, AA00U, AA00V, AA00W, AA00X, AA00Y, AA00Z.

Figure B-16 (Continued). DIA Standardized Equipment Code Information Search Template (3 of 4)

DIA Standardized Equipment Code Information Search Template (U)

	Character Position				Description
	1st	2nd	3rd	4th	5th
□	X				Radars, Electronic Warfare (EW) Equipment, And Other Remote Detection Devices
□		A			Early Warning / Acquisition Radars, Component Parts, And Overall Systems
□		B			Height Finding Radars, Component Parts, And Overall Systems
□		C			Missile Guidance Radars, Component Parts, And Overall Systems
□		D			Fire Control Radars, Component Parts, And Overall Systems
□		F			Combat Surveillance Radars, Component Parts, And Overall Systems
□		I			Meteorological Radars, Component Parts, And Overall Systems
□		J			Mixed Or Unidentified Radars, Component Parts, And Overall Systems
□		K			Radiosondes And Ionosondes
□		O			EW Equipment (Active)
□		R			Waterway / Seaway Traffic Control And Ship Navigational Radars
□			A		Land Based Or Radiosondes
□			B		Land Based Or Radiosonde Sounders
□			C		Land Based
□			E		Experimental And Developmental Radars
□			F		Radar Entries By Megahertz And Frequency Band
□			H		Harbor Surveillance Radars
□			I		Ionosondes
□			J		Countermeasures / Jammer
□			N		Naval
□			Q		U.S. Produced
□			R		Airborne
□			S		Airborne Intercept Or 3-Dimensional Or Coastal Surveillance Radar
□			T		Tracking Or Direction Finder
□			W		Weather
□			X		Wind Finder
□			Z		General / Mixed / Totals
□			U		Unidentified Electronic Equipment
□				?	Unique Equipment Identifier
□	Y				Communications and ADP Equipment
□		A			Communication Antennas
□		C			ADP Equipment
□		E			Communications Equipment
□		F			Communications Associated Equipment
□			D		Radio Sets and Stations
□			E		Radio Transmitters
□			F		Radio Receivers
□			G		Radio Transceivers
□			H		Radio Relay Systems
□			I		Communications Equipment, Mixed, or Unspecified
□			J		ADP Equipment, General Purpose
□			K		ADP Equipment, Fire Control
□			L		ADP Associated Equipment
□			Q		Communications Antennas, Naval (Shipboard)
□			R		Communications Antennas, Airborne
□				?	Unique Equipment Identifier
□	Z				Ammunition Reload
□		B			Ballistic Missiles with Ranges from 600 km to 5,500 km
□		C			Ballistic Missiles with Ranges Less Than 600 km
□		D			Free Rockets
□		E			Guided Cruise Missiles
□		G			Anti-Air Missiles, Ground or Air Launched
□		H			Air-to-Surface Missiles (ASM)
□		W			Nuclear Devices
□			N		Naval Missile
□			H		Nuclear Warheads (W 2nd Character Only)
□			R		Nuclear Rockets (W 2nd Character Only)
□			W		Nuclear Weapons (W 2nd Character Only)

Notes:

All DIA Standardized Equipment Codes are 5 alphanumeric characters in length. In order to provide an efficient method for information searching most information systems use wild card characters. Only one wild card character is used within this template. That wild card character is ?. The ? represents 0 through 9 in any combination. For example, the equipment code AA??P represents the equipment codes AA00P through AAZZP; and equipment code AA00? represents the equipment codes AA00A, AA00B, AA00C, AA00D, AA00E, AA00F, AA00G, AA00H, AA00I, AA00J, AA00K, AA00L, AA00M, AA00N, AA00O, AA00P, AA00R, AA00S, AA00T, AA00U, AA00V, AA00W, AA00X, AA00Y, AA00Z.

Figure B-16 (Continued). DIA Standardized Equipment Code Information Search Template (4 of 4)

Table B-1. Overlays, Doctrinal Templates, and GGI&S Products Supporting Terrain Analysis

<p align="center">Basic Terrain Analysis Products Potential Overlays, Doctrinal Templates, and GIS Products</p> <p>Grayed boxes indicate overlays, doctrinal templates, and GIS products that typically can contribute to the production of these basic terrain analysis products on the left.</p>	Basic Mapping Functionality	Surface Configuration	Vegetation	Surface Materials	Obstacles	Transportation / LOC Infrastructure	Urban Areas	Cover	Concealment	Cross-Country Movement	Observation / Line-of-Sight	Key Terrain	Electromagnetic Spectrum
Terrain Analysis Overlays													
Surface Configuration Overlay(s)													
Vegetation Overlay(s)													
Surface Materials Overlay(s)													
Obstacles Overlay(s)													
Transportation Infrastructure Overlay(s)													
Urban Areas Overlay(s)													
Cover Overlay(s)													
Concealment Overlay(s)													
Cross-Country Movement Overlay(s)													
Observation / Line-of-Sight Overlay(s)													
Key Terrain Overlay(s)													
Electromagnetic Spectrum Overlay(s)													
Doctrinal Templates from Step 3													
TM Equipment Doctrinal Template(s)													
TM TTP Doctrinal Template(s)													
Weather Effects on TM Operations Assessment													
Climatology Assessment(s)													
Weather Forecast(s)													
Current Weather Observation(s)													
Commonly Available GIS Products													
Global Navigation Chart(s)													
Jet Navigation Chart(s)													
Operational Navigation Chart(s)													
Tactical Pilotage Chart(s)													
Joint Operations Graphic / Ground (Series 1501) Chart(s)													
Joint Operations Graphic / Air (Series 1501 Air) Chart(s)													
Joint Operations Graphic / Radar (Series 1501 Radar) Chart(s)													
Topographic Line Map(s) (1:25,000)													
Topographic Line Map(s) (1:50,000)													
Topographic Line Map(s) (1:100,000)													
Nautical Chart(s) or Hydrographic Chart(s)													
Digital Chart of the World II													
Digital Terrain Elevation Data Level 1													
Digital Terrain Elevation Data Level 2													
ARC Digitized Raster Graphic(s)													
Compressed ARC Digitized Raster Graphic(s)													
Vector Map Level 0													
Vector Map Level 1													
Vector Map Level 2													
Terrain Categorization Data													
Digital Features Analysis Data Level 1													
Digital Features Analysis Data Level 2													
Controlled Image Base 10 meter													
Controlled Image Base 5 meter													
World Vector Shoreline Plus													
Digital Bathymetric Data Base (DBDB)													

Table B-1 (Continued). Overlays, Doctrinal Templates, and GGI&S Products Supporting Terrain Analysis

<p align="center">Basic Terrain Analysis Products Potential Overlays, Doctrinal Templates, and GGIS Products</p> <p>Grayed boxes indicate overlays, doctrinal templates, and GGIS products that typically can contribute to the production of these basic terrain analysis products on the left.</p>	Basic Mapping Functionality	Surface Configuration	Vegetation	Surface Materials	Obstacles	Transportation / LOC Infrastructure	Urban Areas	Cover	Concealment	Cross-Country Movement	Observation / Line-of-Sight	Key Terrain	Electromagnetic Spectrum
	DBDB - Variable Resolution												
DBDB 5'													
DBDB 0.5'													
DBDB 0.1'													
Other Vector, Raster, Data, and Hard Copy GGIS Products													
Aim Point Graphic(s)													
Air Target Chart(s) – Series 200													
Anaglyph(s)													
Approach Chart(s)													
ARC Digitized Raster Image(s)													
ASW Prediction Area Chart(s)													
Automated Tactical Target Graphic(s)													
Basic Target Graphic(s)													
Bathymetric Navigation Planning Chart(s)													
Bathymetric Recovery Area Chart(s)													
Bottom Contour Chart(s)													
City Graphic(s)													
Coastal Chart(s)													
Combat Chart(s)													
Compressed Aeronautical Chart(s)													
Compressed Digital Terrain Elevation Data													
Compressed Raster Graphic(s)													
Current Chart(s)													
DBDB - Variable Resolution													
Digital Aeronautical Flight Information File													
Digital Cities Data Base													
Digital Elevation Model													
Digital Features Analysis Data Level 1C													
Digital Features Analysis Data Level 3C													
Digital Landmass Blanking System													
Digital Line Graph													
Digital Line Graph-Enhanced													
Digital Nautical Chart(s)													
Digital Point Positioning Data Base													
Digital Terrain Elevation Data Level 0													
Digital Terrain Elevation Data Level 3													
Digital Terrain Elevation Data Level 4													
Digital Terrain Elevation Data Level 5													
Digital Topographic Data													
Digital World Port Index													
Foundation Features Data													
Gazetteer													
Gridded Airfield Photograph(s)													
Gridded Installation Photograph(s)													
Harbor Chart(s)													
Harbor, Approach and Coastal Chart(s)													
Harbor, Approach and Coastal 1 Chart(s)													
Harbor, Approach and Coastal 2 Chart(s)													
Harbor, Approach and Coastal 3 Chart(s)													

Table B-1 (Continued). Overlays, Doctrinal Templates, and GGI&S Products Supporting Terrain Analysis

<p align="center">Basic Terrain Analysis Products Potential Overlays, Doctrinal Templates, and GGIS Products</p> <p>Grayed boxes indicate overlays, doctrinal templates, and GGIS products that typically can contribute to the production of these basic terrain analysis products on the left.</p>	Basic Mapping Functionality	Surface Configuration	Vegetation	Surface Materials	Obstacles	Transportation / LOC Infrastructure	Urban Areas	Cover	Concealment	Cross-Country Movement	Observation / Line-of-Sight	Key Terrain	Electromagnetic Spectrum
Harbor, Approach and Coastal 4 Chart(s)													
Harbor, Approach and Coastal 5 Chart(s)													
Harbor, Approach and Coastal 6 Chart(s)													
Harbor, Approach and Coastal 7 Chart(s)													
Harbor, Approach and Coastal 8 Chart(s)													
Harbor, Approach and Coastal 9 Chart(s)													
Harbor, Approach, Coastal & General Nautical Chart(s)													
High Speed Digital Chart(s)													
Ice Chart(s)													
Instrument Approach Chart(s)													
Interim Terrain Data													
Joint Digital Target Material													
Littoral Warfare Data													
Magnetic Anomaly Detection Planning Chart(s)													
Magnetic Anomaly Detection Operational Effectiveness Chart(s)													
Military Installation Map(s)													
Modified Facsimile Chart(s)													
Naval Operating Area Chart(s)													
Non-Submarine Contact List(s)													
Operational Support Plan Graphic(s)													
Operational Target Graphic(s)													
Pilot Chart(s)													
Planning Interim Terrain Data													
Planning Terrain Analysis Data Base													
Point Positioning Data Base													
Precise Bathymetric Navigation Zone Chart(s)													
Probabilistic Vertical Obstruction Data													
Provisional Map(s)													
Quick Response Graphic(s)													
RegridDED Terrain Elevation Data													
Relocatable Targets Data Base													
Sound Surveillance Systems Chart(s)													
Standard Image Map													
Tactical Oceanographic Data - Level 0													
Tactical Oceanographic Data - Level 1													
Tactical Oceanographic Data - Level 2													
Tactical Terrain Analysis Data Base													
Tactical Terrain Data													
Urban Vector Map(s)													
Vector Product Interim Terrain Data													
Vector Relocatable Targets Analysis Data													
Vector Vertical Obstruction Data													
Vertical Obstruction Data													
Video Point Positioning Data Base													
World Data Bank II													
World Magnetic Model													
World Mean Elevation Data													
G = Good Applicability, Y = Marginal Applicability, R = Poor Applicability, and BLANK = No Applicability Some products are available on a limited basis or are planned for future production (in <i>italics</i>) by NIMA													

Feature Class Data to Terrain Analysis Template Cross Reference Template (U)

Feature Foundation Data (FFD) is a set of features defined by NIMA and found in NIMA's hard copy and digital GIS products. The Feature Foundation Data is divided into codes, attributes, and values and is consistent with terrain features used in USA FM 5-33 "Terrain Analysis". For each Terrain Analysis Template check the availability of the Feature Foundation Data within your available GIS products. Next check whether the Feature Foundation Data is required or optional for a particular Terrain Analysis Template. If required place an R in each Terrain Analysis Template block requiring the Feature Foundation Data. If optional place an O in each Terrain Analysis Template block requiring the Feature Foundation Data. As an initial starting point this template has grayed cells for typically required Feature Foundation Data for each Terrain Analysis Template.

Feature Code Feature Attribute Feature Value	Feature Name	Data Type (L=Line A=Area P=Point N=node T=Text)	Available Terrain Data	Terrain Analysis Template
				Land Surface Configuration Template Bathymetric Surface Configuration Template Vegetation Template Surface Materials Template Land Obstacle Template Nautical Obstacle Template Urban Areas Template Road LOC Infrastructure Template Railroad LOC Infrastructure Template Airfield LOC Infrastructure Template Port LOC Infrastructure Template Land Cover Template Nautical Cover Template Friendly AD and TMD Radar Masking Template Friendly Airborne Radar Masking Template Friendly Surface Radar Masking Template Friendly ABL Masking Template Cross Country Movement Template Friendly Overhead ISR and Fire Control (FC) Template Friendly Standoff ISR and Fire Control Template Friendly Surface ISR and Fire Control Template Adversary AD and TMD Radar Coverage Template Adversary Overhead ISR and FC Coverage Template Adversary Standoff ISR and FC Coverage Template Adversary Surface ISR and FC Coverage Template Key Terrain Template Adversary TM Force EM Spectrum Template
Foundation Feature Data – Boundaries Coverage				
X	Coastline / Shoreline	L		
X	Vertical Datum Category	L		
X	Mean Sea Level	L		
X	Mean High Water	L		
X	Mean Low Water	L		
X	Administrative Boundary	L		
X	Administrative Area	A		
X	Armistice Line	L		
X	Maritime Limit Boundary	L		
X	Cease-Fire Line	L		
Foundation Feature Data – Elevation Coverage				
X	Depth Contour	L		
X	Depth Curve or Contour Value (meters)	L		
X	Contour Line (Land)	L		
X	Hydrography Portrayal Category	L		
X	Index	L		
X	Intermediate	L		
X	Depression Index	L		
X	Depression Intermediate	L		
X	Highest Z-value (meters)	L		
X	Spot Elevation	P		
X	Highest Z-value (meters)	P		
Foundation Feature Data – Hydrography Coverage				
X	Settling Basin / Sludge Pond	A		
X	Island	A		
X	Water (Except Inland)	A		
X	Aqueduct	L		
X	Hydrological Category	L		
X	Dry	L		
X	Non-Perennial / Intermittent / Fluctuating	L		
X	Perennial / Permanent	L		
X	Width (meters)	L		
X	Canal	LA		
X	Hydrological Category	LA		
X	Dry	LA		
X	Non-Perennial / Intermittent / Fluctuating	LA		
X	Perennial / Permanent	LA		
X	Width (meters)	LA		
X	Ditch	LA		
X	Hydrological Category	LA		
X	Dry	LA		
X	Non-Perennial / Intermittent / Fluctuating	LA		
X	Perennial / Permanent	LA		
X	Width (meters)	LA		
X	Filtration Beds / Aeration Beds	A		
X	Fish Hatchery / Fish Farm / Marine Farm	A		
X	Lake / Pond	A		
X	Hydrological Category	A		
X	Dry	A		
X	Perennial / Permanent	A		
X	Land Subject to Inundation	A		
X	Reservoir	A		
X	Hydrological Category	A		

Figure B-17. Feature Class Data to Terrain Analysis Template Cross Reference Template (1 of 5)

Feature Class Data to Terrain Analysis Template Cross Reference Template (U)

Feature Foundation Data (FFD) is a set of features defined by NIMA and found in NIMA's hard copy and digital GIS products. The Feature Foundation Data is divided into codes, attributes, and values and is consistent with terrain features used in USA FM 5-33 "Terrain Analysis". For each Terrain Analysis Template check the availability of the Feature Foundation Data within your available GIS products. Next check whether the Feature Foundation Data is required or optional for a particular Terrain Analysis Template. If required place an R in each Terrain Analysis Template block requiring the Feature Foundation Data. If optional place an O in each Terrain Analysis Template block requiring the Feature Foundation Data. As an initial starting point this template has grayed cells for typically required Feature Foundation Data for each Terrain Analysis Template.

Feature Code Feature Attribute Feature Value	Feature Name	Data Type [L=Line A=Area P=Point N=code T=Text]	Terrain Analysis Template
		Available Terrain Data	
			Land Surface Configuration Template Bathymetric Surface Configuration Template Vegetation Template Surface Materials Template Land Obstacle Template Nautical Obstacle Template Urban Areas Template Road LOC Infrastructure Template Railroad LOC Infrastructure Template Port LOC Infrastructure Template Land Cover Template Nautical Cover Template Friendly AD and TMD Radar Masking Template Friendly Airborne Radar Masking Template Friendly Surface Radar Masking Template Friendly ABL Masking Template Cross Country Movement Template Friendly Overhead ISR and Fire Control Template Friendly Standoff ISR and Fire Control Template Friendly Surface ISR and Fire Control Template Adversary AD and TMD Radar Coverage Template Adversary Overhead ISR and FC Coverage Template Adversary Standoff ISR and FC Coverage Template Adversary Surface ISR and FC Coverage Template Key Terrain Template Adversary TM Force EM Spectrum Template
Foundation Feature Data – Hydrography Coverage			
<input type="checkbox"/>	Dry	A	
<input type="checkbox"/>	Perennial / Permanent	A	
<input checked="" type="checkbox"/>	Salt Evaporator	A	
<input checked="" type="checkbox"/>	Dam / Weir	PNLA	
<input checked="" type="checkbox"/>	Lock	P N	
Foundation Feature Data – Population Coverage			
<input checked="" type="checkbox"/>	Built-Up Area	A	
<input checked="" type="checkbox"/>	World Port Index Code	A	
<input checked="" type="checkbox"/>	Settlement	A	
<input checked="" type="checkbox"/>	World Port Index Code	A	
<input checked="" type="checkbox"/>	Native Settlement	A	
<input checked="" type="checkbox"/>	World Port Index Code	A	
Foundation Feature Data – Transportation Coverage			
<input checked="" type="checkbox"/>	Railroad	N	
<input checked="" type="checkbox"/>	Existence Category	N	
<input checked="" type="checkbox"/>	Under Construction	N	
<input checked="" type="checkbox"/>	Abandoned / Disused	N	
<input checked="" type="checkbox"/>	Destroyed	N	
<input checked="" type="checkbox"/>	Dismantled	N	
<input checked="" type="checkbox"/>	Operational	N	
<input checked="" type="checkbox"/>	Location Category	N	
<input checked="" type="checkbox"/>	On Ground Surface	N	
<input checked="" type="checkbox"/>	Suspended / Elevated Above Ground or Water	N	
<input checked="" type="checkbox"/>	Track / Lane Number	N	
<input checked="" type="checkbox"/>	Railroad Gauge Category	N	
<input checked="" type="checkbox"/>	Broad	N	
<input checked="" type="checkbox"/>	Narrow	N	
<input checked="" type="checkbox"/>	Normal	N	
<input checked="" type="checkbox"/>	Railroad Siding / Railroad Spur	N	
<input checked="" type="checkbox"/>	Existence Category	N	
<input checked="" type="checkbox"/>	Under Construction	N	
<input checked="" type="checkbox"/>	Abandoned / Disused	N	
<input checked="" type="checkbox"/>	Destroyed	N	
<input checked="" type="checkbox"/>	Dismantled	N	
<input checked="" type="checkbox"/>	Operational	N	
<input checked="" type="checkbox"/>	Railroad Gauge Category	N	
<input checked="" type="checkbox"/>	Broad	N	
<input checked="" type="checkbox"/>	Narrow	N	
<input checked="" type="checkbox"/>	Normal	N	
<input checked="" type="checkbox"/>	Rail Siding / Spur Attribute	N	
<input checked="" type="checkbox"/>	Spur	N	
<input checked="" type="checkbox"/>	Siding	N	
<input checked="" type="checkbox"/>	Passing Track	N	
<input checked="" type="checkbox"/>	Railroad Yard / Marshalling Yard	N	
<input checked="" type="checkbox"/>	Existence Category	N	
<input checked="" type="checkbox"/>	Under Construction	N	
<input checked="" type="checkbox"/>	Abandoned / Disused	N	
<input checked="" type="checkbox"/>	Operational	N	
<input checked="" type="checkbox"/>	Cart Track	N	
<input checked="" type="checkbox"/>	Weather Type Category	N	
<input checked="" type="checkbox"/>	Fair / Dry Weather	N	
<input checked="" type="checkbox"/>	Winter Only	N	
<input checked="" type="checkbox"/>	Road	N	

Figure B-17 (Continued). Feature Class Data to Terrain Analysis Template Cross Reference Template (2 of 5)

Feature Class Data to Terrain Analysis Template Cross Reference Template (U)

Feature Foundation Data (FFD) is a set of features defined by NIMA and found in NIMA's hard copy and digital GIS products. The Feature Foundation Data is divided into codes, attributes, and values and is consistent with terrain features used in USA FM 5-33 "Terrain Analysis". For each Terrain Analysis Template check the availability of the Feature Foundation Data within your available GIS products. Next check whether the Feature Foundation Data is required or optional for a particular Terrain Analysis Template. If required place an R in each Terrain Analysis Template block requiring the Feature Foundation Data. If optional place an O in each Terrain Analysis Template block requiring the Feature Foundation Data. As an initial starting point this template has grayed cells for typically required Feature Foundation Data for each Terrain Analysis Template.

Feature Code Feature Attribute Feature Value	Feature Name	Data Type [L=Line A=Area P=Point N=node T=Text]	Terrain Analysis Template
		Available Terrain Data	Land Surface Configuration Template Bathymetric Surface Configuration Template Vegetation Template Surface Materials Template Land Obstacle Template Nautical Obstacle Template Urban Areas Template Road LOC Infrastructure Template Railroad LOC Infrastructure Template Airfield LOC Infrastructure Template Port LOC Infrastructure Template Land Cover Template Nautical Cover Template Friendly AD and TMD Radar Masking Template Friendly Airborne Radar Masking Template Friendly Surface Radar Masking Template Friendly ABL Masking Template Cross Country Movement Template Friendly Overhead ISR and Fire Control Template Friendly Standoff ISR and Fire Control Template Friendly Surface ISR and Fire Control Template Adversary AD and TMD Radar Coverage Template Adversary Overhead ISR and FC Coverage Template Adversary Standoff ISR and FC Coverage Template Adversary Surface ISR and FC Coverage Template Key Terrain Template Adversary TM Force EM Spectrum Template
	Foundation Feature Data – Transportation Coverage		
X	Existence Category	N	
	Under Construction	N	
X	Operational	N	
X	Location Category	N	
	On Ground Surface	N	
X	Suspended / Elevated above Ground or Water	N	
X	Median Category	N	
	With Median	N	
X	Without Median	N	
X	Road / Runway Surface Type	N	
	Hard / Paved	N	
X	Loose / Paved	N	
X	Minimum Traveled Way Width (meters)	N	
X	Weather Type Category	N	
	All Weather	N	
X	Fair / Dry Weather	N	
X	Trail	N	
X	Bridge / Overpass / Viaduct	LN	
	Existence Category	LN	
X	Under Construction	LN	
	Destroyed	LN	
X	Operational	LN	
X	Length / Diameter (meters)	LN	
X	Transportation Use Category	LN	
	Both Road and Railroad	LN	
X	Railroad	LN	
X	Road	LN	
X	Minimum Traveled Way Width (decimeters)	LN	
X	Ferry Crossing	LN	
X	Ferry Crossing Length (meters)	LN	
X	Transportation Use Category	LN	
	Both Road and Railroad	LN	
X	Railroad	LN	
X	Road	LN	
X	Tunnel	LN	
X	Existence Category	LN	
	Under Construction	LN	
X	Operational	LN	
X	Length / Diameter (meters)	LN	
X	Transportation Use Category	LN	
	Both Road and Railroad	LN	
X	Railroad	LN	
X	Road	LN	
X	Pier / Wharf / Quay	LN	
X	Length / Diameter (meters)	LN	
X	Width	LN	
X	Ford	LN	
X	Airport / Airfield	PLA	
X	Existence Category	PLA	
	Under Construction	PLA	
X	Abandoned / Disused	PLA	
X	Destroyed	PLA	
X	Operational	PLA	

Figure B-17 (Continued). Feature Class Data to Terrain Analysis Template Cross Reference Template (3 of 5)

Feature Class Data to Terrain Analysis Template Cross Reference Template (U)

Feature Foundation Data (FFD) is a set of features defined by NIMA and found in NIMA's hard copy and digital GIS products. The Feature Foundation Data is divided into codes, attributes, and values and is consistent with terrain features used in USA FM 5-33 "Terrain Analysis". For each Terrain Analysis Template check the availability of the Feature Foundation Data within your available GIS products. Next check whether the Feature Foundation Data is required or optional for a particular Terrain Analysis Template. If required place an R in each Terrain Analysis Template block requiring the Feature Foundation Data. If optional place an O in each Terrain Analysis Template block requiring the Feature Foundation Data. As an initial starting point this template has grayed cells for typically required Feature Foundation Data for each Terrain Analysis Template.

Feature Code Feature Attribute Feature Value	Feature Name	Data Type [L=Line A=Area P=Point N=node T=Text]	Terrain Analysis Template
			Available Terrain Data Land Surface Configuration Template Bathymetric Surface Configuration Template Vegetation Template Surface Materials template Land Obstacle Template Nautical Obstacle Template Urban Areas Template Road LOC Infrastructure Template Railroad LOC Infrastructure Template Airfield LOC Infrastructure Template Port LOC Infrastructure Template Land Cover template Nautical Cover Template Friendly AD and TMD Radar Masking Template Friendly Airborne Radar Masking Template Friendly Surface Radar Masking Template Friendly ABL Masking Template Cross Country Movement Template Friendly Overhead ISR and Fire Control Template Friendly Standoff ISR and Fire Control Template Adversary AD and TMD Radar Coverage Template Adversary Overhead ISR and FC Coverage Template Adversary Standoff ISR and FC Coverage Template Adversary Surface ISR and FC Coverage Template Key Terrain Template Adversary TM Force EM Spectrum Template
Foundation Feature Data - Transportation Coverage			
<input type="checkbox"/>	<input checked="" type="checkbox"/> Damaged		PLA
<input type="checkbox"/>	<input type="checkbox"/> Usage		PLA
<input type="checkbox"/>	<input checked="" type="checkbox"/> Military		PLA
<input type="checkbox"/>	<input checked="" type="checkbox"/> Joint Military / Civilian		PLA
<input type="checkbox"/>	<input checked="" type="checkbox"/> Civilian / Public		PLA
<input checked="" type="checkbox"/>	<input type="checkbox"/> Heliport		PLA
<input checked="" type="checkbox"/>	<input type="checkbox"/> Existence Category		PLA
<input type="checkbox"/>	<input checked="" type="checkbox"/> Under Construction		PLA
<input type="checkbox"/>	<input checked="" type="checkbox"/> Abandoned / Disused		PLA
<input type="checkbox"/>	<input checked="" type="checkbox"/> Destroyed		PLA
<input type="checkbox"/>	<input checked="" type="checkbox"/> Operational		PLA
<input type="checkbox"/>	<input checked="" type="checkbox"/> Damaged		PLA
<input checked="" type="checkbox"/>	<input type="checkbox"/> Usage		PLA
<input type="checkbox"/>	<input checked="" type="checkbox"/> Military		PLA
<input type="checkbox"/>	<input checked="" type="checkbox"/> Joint Military / Civilian		PLA
<input type="checkbox"/>	<input checked="" type="checkbox"/> Civilian / Public		PLA
<input checked="" type="checkbox"/>	<input type="checkbox"/> Runway		A
<input checked="" type="checkbox"/>	<input type="checkbox"/> Existence Category		A
<input type="checkbox"/>	<input checked="" type="checkbox"/> Under Construction		A
<input type="checkbox"/>	<input checked="" type="checkbox"/> Abandoned / Disused		A
<input type="checkbox"/>	<input checked="" type="checkbox"/> Destroyed		A
<input type="checkbox"/>	<input checked="" type="checkbox"/> Operational		A
<input type="checkbox"/>	<input checked="" type="checkbox"/> Damaged		A
<input checked="" type="checkbox"/>	<input type="checkbox"/> Length / Diameter (meters)		A
<input checked="" type="checkbox"/>	<input type="checkbox"/> Road / Runway Surface Type		A
<input type="checkbox"/>	<input checked="" type="checkbox"/> Hard / Paved		A
<input type="checkbox"/>	<input checked="" type="checkbox"/> Loose / Unpaved		A
<input type="checkbox"/>	<input checked="" type="checkbox"/> Width (meters)		A
<input type="checkbox"/>	<input checked="" type="checkbox"/> Highest Z-value (meters)		A
<input checked="" type="checkbox"/>	<input type="checkbox"/> Seaplane Base		PLA
<input checked="" type="checkbox"/>	<input type="checkbox"/> Existence Category		PLA
<input type="checkbox"/>	<input checked="" type="checkbox"/> Under Construction		PLA
<input type="checkbox"/>	<input checked="" type="checkbox"/> Abandoned / Disused		PLA
<input type="checkbox"/>	<input checked="" type="checkbox"/> Destroyed		PLA
<input type="checkbox"/>	<input checked="" type="checkbox"/> Operational		PLA
<input type="checkbox"/>	<input checked="" type="checkbox"/> Damaged		PLA
<input checked="" type="checkbox"/>	<input type="checkbox"/> Usage		PLA
<input type="checkbox"/>	<input checked="" type="checkbox"/> Military		PLA
<input type="checkbox"/>	<input checked="" type="checkbox"/> Joint Military / Civilian		PLA
<input type="checkbox"/>	<input checked="" type="checkbox"/> Civilian / Public		PLA
Foundation Feature Data - Vegetation Coverage			
<input checked="" type="checkbox"/>	<input type="checkbox"/> Marsh / Swamp		A
<input checked="" type="checkbox"/>	<input type="checkbox"/> Surface Material Category		A
<input type="checkbox"/>	<input checked="" type="checkbox"/> Herbaceous / Scrub Vegetation (no trees)		A
<input type="checkbox"/>	<input checked="" type="checkbox"/> Trees [swamp]		A
<input checked="" type="checkbox"/>	<input type="checkbox"/> Tree Type Category		A
<input type="checkbox"/>	<input checked="" type="checkbox"/> Deciduous		A
<input type="checkbox"/>	<input checked="" type="checkbox"/> Evergreen		A
<input type="checkbox"/>	<input checked="" type="checkbox"/> Mixed		A
<input checked="" type="checkbox"/>	<input type="checkbox"/> Vegetation Characteristic		A
<input type="checkbox"/>	<input checked="" type="checkbox"/> Mangrove		A
<input checked="" type="checkbox"/>	<input type="checkbox"/> Rice Field		A
<input checked="" type="checkbox"/>	<input type="checkbox"/> Orchard / Plantation		A

Figure B-17 (Continued). Feature Class Data to Terrain Analysis Template Cross Reference Template (4 of 5)

Terrain Assessment Checklist and Status Template (U)

Field Operating Area ID #

Field Operating Area Name and Description

Required / Commonly Available Terrain Products
 (Grayed Cell = Available Blank Cell = Not Required)

- Use Field Operating Area Assessment Templates Area Definition
- Use Field Operating Area Centroid and a Radius of: Km
- Use Field Operating Area Centroid and a Rectangular Area with Sides of:
 East-West Km North-South Km
- Use Rectangular Area Definition as Follows:

Latitude or MGRS or UTM	N	S	Longitude	E	W
<input type="text"/>	<input type="checkbox"/>	<input type="checkbox"/>	<input type="text"/>	<input type="checkbox"/>	<input type="checkbox"/>
<input type="text"/>	<input type="checkbox"/>	<input type="checkbox"/>	<input type="text"/>	<input type="checkbox"/>	<input type="checkbox"/>
<input type="text"/>	<input type="checkbox"/>	<input type="checkbox"/>	<input type="text"/>	<input type="checkbox"/>	<input type="checkbox"/>

- GNCS [H=Hardcopy C=CADRG B=Both]
- JNCs [H=Hardcopy C=CADRG B=Both]
- ONCS [H=Hardcopy C=CADRG B=Both]
- TPCs [H=Hardcopy C=CADRG B=Both]
- JOGs [H=Hardcopy C=CADRG B=Both]
- JOG/A [H=Hardcopy C=CADRG B=Both]
- JOG/R [H=Hardcopy C=CADRG B=Both]
- TLM 1:25,000 [H=Hardcopy C=CADRG B=Both]
- TLM 1:50,000 [H=Hardcopy C=CADRG B=Both]
- TLM 1:100,000 [H=Hardcopy C=CADRG B=Both]
- DCW II [X=Required]
- DTEG [Indicate Maximum Level Available]
- Vmap-0 [X=Required]
- Vmap-1 [X=Required]
- Vmap-2 [X=Required]
- DFAD [Indicate Maximum Level Available]
- CIB [Indicate 10 or 5 meter Coverage]
- TERCAT [X=Required]
- Nautical Charts [H=Hardcopy C=CADRG B=Both]
- WVSR [X=Required]
- DBDB [B=0.2=0.5' 1=0.1' Variable Coverage]

Required	Optional	Completed	Start Date	Finish Date	Terrain Analysis Product					
Surface Configuration Templates										
<input type="checkbox"/>	<input type="checkbox"/>	<input type="checkbox"/>	<input type="text"/>	<input type="text"/>	Land Surface Configuration Template	<input type="checkbox"/>	<input type="checkbox"/>	<input type="checkbox"/>	<input type="checkbox"/>	<input type="checkbox"/>
<input type="checkbox"/>	<input type="checkbox"/>	<input type="checkbox"/>	<input type="text"/>	<input type="text"/>	Bathymetric Surface Configuration Template	<input type="checkbox"/>	<input type="checkbox"/>	<input type="checkbox"/>	<input type="checkbox"/>	<input type="checkbox"/>
Vegetation Template										
<input type="checkbox"/>	<input type="checkbox"/>	<input type="checkbox"/>	<input type="text"/>	<input type="text"/>	Vegetation Template	<input type="checkbox"/>	<input type="checkbox"/>	<input type="checkbox"/>	<input type="checkbox"/>	<input type="checkbox"/>
Surface Materials Template										
<input type="checkbox"/>	<input type="checkbox"/>	<input type="checkbox"/>	<input type="text"/>	<input type="text"/>	Surface Materials Template	<input type="checkbox"/>	<input type="checkbox"/>	<input type="checkbox"/>	<input type="checkbox"/>	<input type="checkbox"/>
Obstacle Templates										
<input type="checkbox"/>	<input type="checkbox"/>	<input type="checkbox"/>	<input type="text"/>	<input type="text"/>	Land Obstacle Template	<input type="checkbox"/>	<input type="checkbox"/>	<input type="checkbox"/>	<input type="checkbox"/>	<input type="checkbox"/>
<input type="checkbox"/>	<input type="checkbox"/>	<input type="checkbox"/>	<input type="text"/>	<input type="text"/>	Nautical Obstacle Template	<input type="checkbox"/>	<input type="checkbox"/>	<input type="checkbox"/>	<input type="checkbox"/>	<input type="checkbox"/>
Transportation / Line of Communications Infrastructure Templates										
<input type="checkbox"/>	<input type="checkbox"/>	<input type="checkbox"/>	<input type="text"/>	<input type="text"/>	Road LOC Infrastructure Template	<input type="checkbox"/>	<input type="checkbox"/>	<input type="checkbox"/>	<input type="checkbox"/>	<input type="checkbox"/>
<input type="checkbox"/>	<input type="checkbox"/>	<input type="checkbox"/>	<input type="text"/>	<input type="text"/>	Railroad LOC Infrastructure Template	<input type="checkbox"/>	<input type="checkbox"/>	<input type="checkbox"/>	<input type="checkbox"/>	<input type="checkbox"/>
<input type="checkbox"/>	<input type="checkbox"/>	<input type="checkbox"/>	<input type="text"/>	<input type="text"/>	Airfield LOC Infrastructure Template	<input type="checkbox"/>	<input type="checkbox"/>	<input type="checkbox"/>	<input type="checkbox"/>	<input type="checkbox"/>
<input type="checkbox"/>	<input type="checkbox"/>	<input type="checkbox"/>	<input type="text"/>	<input type="text"/>	Port LOC Infrastructure Template	<input type="checkbox"/>	<input type="checkbox"/>	<input type="checkbox"/>	<input type="checkbox"/>	<input type="checkbox"/>
Urban Areas Template										
<input type="checkbox"/>	<input type="checkbox"/>	<input type="checkbox"/>	<input type="text"/>	<input type="text"/>	Urban Areas Template	<input type="checkbox"/>	<input type="checkbox"/>	<input type="checkbox"/>	<input type="checkbox"/>	<input type="checkbox"/>
Cover Templates										
<input type="checkbox"/>	<input type="checkbox"/>	<input type="checkbox"/>	<input type="text"/>	<input type="text"/>	Land Cover Template	<input type="checkbox"/>	<input type="checkbox"/>	<input type="checkbox"/>	<input type="checkbox"/>	<input type="checkbox"/>
<input type="checkbox"/>	<input type="checkbox"/>	<input type="checkbox"/>	<input type="text"/>	<input type="text"/>	Nautical Cover Template	<input type="checkbox"/>	<input type="checkbox"/>	<input type="checkbox"/>	<input type="checkbox"/>	<input type="checkbox"/>
Concealment Templates										
<input type="checkbox"/>	<input type="checkbox"/>	<input type="checkbox"/>	<input type="text"/>	<input type="text"/>	Friendly AD and TMD Radar Masking Template	<input type="checkbox"/>	<input type="checkbox"/>	<input type="checkbox"/>	<input type="checkbox"/>	<input type="checkbox"/>
<input type="checkbox"/>	<input type="checkbox"/>	<input type="checkbox"/>	<input type="text"/>	<input type="text"/>	Friendly Airborne Radar Masking Template	<input type="checkbox"/>	<input type="checkbox"/>	<input type="checkbox"/>	<input type="checkbox"/>	<input type="checkbox"/>
<input type="checkbox"/>	<input type="checkbox"/>	<input type="checkbox"/>	<input type="text"/>	<input type="text"/>	Friendly Surface Radar Masking Template	<input type="checkbox"/>	<input type="checkbox"/>	<input type="checkbox"/>	<input type="checkbox"/>	<input type="checkbox"/>
<input type="checkbox"/>	<input type="checkbox"/>	<input type="checkbox"/>	<input type="text"/>	<input type="text"/>	Friendly ABL Masking Template	<input type="checkbox"/>	<input type="checkbox"/>	<input type="checkbox"/>	<input type="checkbox"/>	<input type="checkbox"/>
Cross Country Movement Template										
<input type="checkbox"/>	<input type="checkbox"/>	<input type="checkbox"/>	<input type="text"/>	<input type="text"/>	Cross Country Movement Template	<input type="checkbox"/>	<input type="checkbox"/>	<input type="checkbox"/>	<input type="checkbox"/>	<input type="checkbox"/>
Observation / Line of Sight Templates										
<input type="checkbox"/>	<input type="checkbox"/>	<input type="checkbox"/>	<input type="text"/>	<input type="text"/>	Friendly Overhead ISR and Radar Template	<input type="checkbox"/>	<input type="checkbox"/>	<input type="checkbox"/>	<input type="checkbox"/>	<input type="checkbox"/>
<input type="checkbox"/>	<input type="checkbox"/>	<input type="checkbox"/>	<input type="text"/>	<input type="text"/>	Friendly Standoff ISR and Radar Template	<input type="checkbox"/>	<input type="checkbox"/>	<input type="checkbox"/>	<input type="checkbox"/>	<input type="checkbox"/>
<input type="checkbox"/>	<input type="checkbox"/>	<input type="checkbox"/>	<input type="text"/>	<input type="text"/>	Friendly Surface ISR and Radar Template	<input type="checkbox"/>	<input type="checkbox"/>	<input type="checkbox"/>	<input type="checkbox"/>	<input type="checkbox"/>
<input type="checkbox"/>	<input type="checkbox"/>	<input type="checkbox"/>	<input type="text"/>	<input type="text"/>	TM Force AD and TMD Radar Coverage Template	<input type="checkbox"/>	<input type="checkbox"/>	<input type="checkbox"/>	<input type="checkbox"/>	<input type="checkbox"/>
<input type="checkbox"/>	<input type="checkbox"/>	<input type="checkbox"/>	<input type="text"/>	<input type="text"/>	TM Force Overhead ISR Template	<input type="checkbox"/>	<input type="checkbox"/>	<input type="checkbox"/>	<input type="checkbox"/>	<input type="checkbox"/>
<input type="checkbox"/>	<input type="checkbox"/>	<input type="checkbox"/>	<input type="text"/>	<input type="text"/>	TM Force Standoff ISR Template	<input type="checkbox"/>	<input type="checkbox"/>	<input type="checkbox"/>	<input type="checkbox"/>	<input type="checkbox"/>
<input type="checkbox"/>	<input type="checkbox"/>	<input type="checkbox"/>	<input type="text"/>	<input type="text"/>	TM Force Surface ISR Template	<input type="checkbox"/>	<input type="checkbox"/>	<input type="checkbox"/>	<input type="checkbox"/>	<input type="checkbox"/>
Key Terrain Template										
<input type="checkbox"/>	<input type="checkbox"/>	<input type="checkbox"/>	<input type="text"/>	<input type="text"/>	Key Terrain Template	<input type="checkbox"/>	<input type="checkbox"/>	<input type="checkbox"/>	<input type="checkbox"/>	<input type="checkbox"/>
Electromagnetic Spectrum Template										
<input type="checkbox"/>	<input type="checkbox"/>	<input type="checkbox"/>	<input type="text"/>	<input type="text"/>	TM Force Electromagnetic Spectrum Template	<input type="checkbox"/>	<input type="checkbox"/>	<input type="checkbox"/>	<input type="checkbox"/>	<input type="checkbox"/>
User Defined Templates										
<input type="checkbox"/>	<input type="checkbox"/>	<input type="checkbox"/>	<input type="text"/>	<input type="text"/>	<input type="text"/>	<input type="checkbox"/>	<input type="checkbox"/>	<input type="checkbox"/>	<input type="checkbox"/>	<input type="checkbox"/>
<input type="checkbox"/>	<input type="checkbox"/>	<input type="checkbox"/>	<input type="text"/>	<input type="text"/>	<input type="text"/>	<input type="checkbox"/>	<input type="checkbox"/>	<input type="checkbox"/>	<input type="checkbox"/>	<input type="checkbox"/>
<input type="checkbox"/>	<input type="checkbox"/>	<input type="checkbox"/>	<input type="text"/>	<input type="text"/>	<input type="text"/>	<input type="checkbox"/>	<input type="checkbox"/>	<input type="checkbox"/>	<input type="checkbox"/>	<input type="checkbox"/>
<input type="checkbox"/>	<input type="checkbox"/>	<input type="checkbox"/>	<input type="text"/>	<input type="text"/>	<input type="text"/>	<input type="checkbox"/>	<input type="checkbox"/>	<input type="checkbox"/>	<input type="checkbox"/>	<input type="checkbox"/>

Notes:

Figure B-18. Terrain Assessment Checklist and Status Template

TMD IPB Slope Categories Template (U)

Slope Category	Cat Codes	Associated Vehicle(s) / Equipment	% Slope Definition	Degree Slope Definition	Slope Associated Speed Definition
Unrestricted On-Road	0		% ≤ SLOPE ≤ [] %	Deg ≤ SLOPE ≤ [] Deg	Kph ≤ SPEED ≤ [] Kph
CCM -- Unrestricted / Go	0		% ≤ SLOPE ≤ [] %	Deg ≤ SLOPE ≤ [] Deg	Kph ≤ SPEED ≤ [] Kph
CCM -- Restricted	0		% ≤ SLOPE ≤ [] %	Deg ≤ SLOPE ≤ [] Deg	Kph ≤ SPEED ≤ [] Kph
CCM -- No Go	0		% ≤ SLOPE ≤ [] %	Deg ≤ SLOPE ≤ [] Deg	Kph ≤ SPEED ≤ [] Kph
TM Launch Operations	0		% ≤ SLOPE ≤ [] %	Deg ≤ SLOPE ≤ [] Deg	Kph ≤ SPEED ≤ [] Kph
TM Fire Control Operations	0		% ≤ SLOPE ≤ [] %	Deg ≤ SLOPE ≤ [] Deg	Kph ≤ SPEED ≤ [] Kph
TM Field Missile Handling Ops	0		% ≤ SLOPE ≤ [] %	Deg ≤ SLOPE ≤ [] Deg	Kph ≤ SPEED ≤ [] Kph
TM Field Storage Operations	0		% ≤ SLOPE ≤ [] %	Deg ≤ SLOPE ≤ [] Deg	Kph ≤ SPEED ≤ [] Kph
User Defined Slope Categories					
	0		% ≤ SLOPE ≤ [] %	Deg ≤ SLOPE ≤ [] Deg	Kph ≤ SPEED ≤ [] Kph
	0		% ≤ SLOPE ≤ [] %	Deg ≤ SLOPE ≤ [] Deg	Kph ≤ SPEED ≤ [] Kph
	0		% ≤ SLOPE ≤ [] %	Deg ≤ SLOPE ≤ [] Deg	Kph ≤ SPEED ≤ [] Kph
	0		% ≤ SLOPE ≤ [] %	Deg ≤ SLOPE ≤ [] Deg	Kph ≤ SPEED ≤ [] Kph
	0		% ≤ SLOPE ≤ [] %	Deg ≤ SLOPE ≤ [] Deg	Kph ≤ SPEED ≤ [] Kph
	0		% ≤ SLOPE ≤ [] %	Deg ≤ SLOPE ≤ [] Deg	Kph ≤ SPEED ≤ [] Kph
	0		% ≤ SLOPE ≤ [] %	Deg ≤ SLOPE ≤ [] Deg	Kph ≤ SPEED ≤ [] Kph
	0		% ≤ SLOPE ≤ [] %	Deg ≤ SLOPE ≤ [] Deg	Kph ≤ SPEED ≤ [] Kph
	0		% ≤ SLOPE ≤ [] %	Deg ≤ SLOPE ≤ [] Deg	Kph ≤ SPEED ≤ [] Kph
	0		% ≤ SLOPE ≤ [] %	Deg ≤ SLOPE ≤ [] Deg	Kph ≤ SPEED ≤ [] Kph
	0		% ≤ SLOPE ≤ [] %	Deg ≤ SLOPE ≤ [] Deg	Kph ≤ SPEED ≤ [] Kph
	0		% ≤ SLOPE ≤ [] %	Deg ≤ SLOPE ≤ [] Deg	Kph ≤ SPEED ≤ [] Kph
	0		% ≤ SLOPE ≤ [] %	Deg ≤ SLOPE ≤ [] Deg	Kph ≤ SPEED ≤ [] Kph
	0		% ≤ SLOPE ≤ [] %	Deg ≤ SLOPE ≤ [] Deg	Kph ≤ SPEED ≤ [] Kph
	0		% ≤ SLOPE ≤ [] %	Deg ≤ SLOPE ≤ [] Deg	Kph ≤ SPEED ≤ [] Kph
	0		% ≤ SLOPE ≤ [] %	Deg ≤ SLOPE ≤ [] Deg	Kph ≤ SPEED ≤ [] Kph
	0		% ≤ SLOPE ≤ [] %	Deg ≤ SLOPE ≤ [] Deg	Kph ≤ SPEED ≤ [] Kph
	0		% ≤ SLOPE ≤ [] %	Deg ≤ SLOPE ≤ [] Deg	Kph ≤ SPEED ≤ [] Kph
	0		% ≤ SLOPE ≤ [] %	Deg ≤ SLOPE ≤ [] Deg	Kph ≤ SPEED ≤ [] Kph
	0		% ≤ SLOPE ≤ [] %	Deg ≤ SLOPE ≤ [] Deg	Kph ≤ SPEED ≤ [] Kph
	0		% ≤ SLOPE ≤ [] %	Deg ≤ SLOPE ≤ [] Deg	Kph ≤ SPEED ≤ [] Kph
	0		% ≤ SLOPE ≤ [] %	Deg ≤ SLOPE ≤ [] Deg	Kph ≤ SPEED ≤ [] Kph
	0		% ≤ SLOPE ≤ [] %	Deg ≤ SLOPE ≤ [] Deg	Kph ≤ SPEED ≤ [] Kph
	0		% ≤ SLOPE ≤ [] %	Deg ≤ SLOPE ≤ [] Deg	Kph ≤ SPEED ≤ [] Kph
	0		% ≤ SLOPE ≤ [] %	Deg ≤ SLOPE ≤ [] Deg	Kph ≤ SPEED ≤ [] Kph
	0		% ≤ SLOPE ≤ [] %	Deg ≤ SLOPE ≤ [] Deg	Kph ≤ SPEED ≤ [] Kph
	0		% ≤ SLOPE ≤ [] %	Deg ≤ SLOPE ≤ [] Deg	Kph ≤ SPEED ≤ [] Kph
	0		% ≤ SLOPE ≤ [] %	Deg ≤ SLOPE ≤ [] Deg	Kph ≤ SPEED ≤ [] Kph
	0		% ≤ SLOPE ≤ [] %	Deg ≤ SLOPE ≤ [] Deg	Kph ≤ SPEED ≤ [] Kph
	0		% ≤ SLOPE ≤ [] %	Deg ≤ SLOPE ≤ [] Deg	Kph ≤ SPEED ≤ [] Kph
	0		% ≤ SLOPE ≤ [] %	Deg ≤ SLOPE ≤ [] Deg	Kph ≤ SPEED ≤ [] Kph
	0		% ≤ SLOPE ≤ [] %	Deg ≤ SLOPE ≤ [] Deg	Kph ≤ SPEED ≤ [] Kph
	0		% ≤ SLOPE ≤ [] %	Deg ≤ SLOPE ≤ [] Deg	Kph ≤ SPEED ≤ [] Kph
	0		% ≤ SLOPE ≤ [] %	Deg ≤ SLOPE ≤ [] Deg	Kph ≤ SPEED ≤ [] Kph
	0		% ≤ SLOPE ≤ [] %	Deg ≤ SLOPE ≤ [] Deg	Kph ≤ SPEED ≤ [] Kph
	0		% ≤ SLOPE ≤ [] %	Deg ≤ SLOPE ≤ [] Deg	Kph ≤ SPEED ≤ [] Kph
	0		% ≤ SLOPE ≤ [] %	Deg ≤ SLOPE ≤ [] Deg	Kph ≤ SPEED ≤ [] Kph
	0		% ≤ SLOPE ≤ [] %	Deg ≤ SLOPE ≤ [] Deg	Kph ≤ SPEED ≤ [] Kph
	0		% ≤ SLOPE ≤ [] %	Deg ≤ SLOPE ≤ [] Deg	Kph ≤ SPEED ≤ [] Kph

Notes:

Figure B-19. TMD IPB Slope Categories Template

Table B-2. Vegetation Type Codes

Vegetation Code	Vegetation Type	Typical Vegetation Roughness Factor (VRF)
A1	Agriculture (dry crops)	0.80
A2	Agriculture (wet crops, rice)	
A3	Agriculture (terraced crops, both wet and dry)	
A4	Agriculture (shifting cultivation)	
B1	Brushland (<5 meters high, open to medium spacing)	
B2	Brushland (<5 meters high, medium to dense spacing)	0.95
C*	Coniferous/Evergreen Forest	
D*	Deciduous Forest	
E*	Mixed Forest (Coniferous/Deciduous)	
EV	Salt Evaporators/Salt Encrustation	
F*	Orchard/Plantation (rubber, palm, fruit, etc.)	
G1	Grassland, Pasture, Meadow	0.90
G2	Grassland with Scattered Trees, some Scrub Growth	0.60
H	Forest Clearing (cutover areas, burns, etc.)	0.50
I**	Swamp (mangrove, cypress, etc.)	0.10
J	Marsh / Bog (treeless bogs, maskegs, etc.)	0.10
K	Wetlands (low-lying wet areas)	
L	Vineyard/Hops	
M	Bamboo	
N	Bare Ground	
PS	Permanent Snowfield	
RK	Exposed Bedrock/Features Void of Surface Materials	
T	Trees Unidentified Types	
W	Open Water	0.00
X	Built-up Area	

* These vegetation types are given a three digit code. In addition to the letter for the type code, a second digit (number) is added as the canopy closure code [1 – 0-25% canopy closure, 2 – 25-50% canopy closure, 3 - 50-75% canopy closure, and 4 – 75-100% canopy closure], and a third digit (number) and possibly fourth digit is added as the height code [Mean or average height to top of canopy for a specific tree type or category rounded to nearest meter or tenth of a meter if less than 10 meters in height].

** A second digit, representing canopy closure, is added to the swamp code [1 – 0-25% canopy closure, 2 – 25-50% canopy closure, 3 - 50-75% canopy closure, and 4 – 75-100% canopy closure].

Table B-3. Unified Soils Classification System and Associated Rating Cone Index Values

Soils Category USCS Symbol ¹	Type	Rating Cone Index Values		
		Dry	Moist	Wet
GW	Gravel or sandy gravel, well graded	163	123	83
GP	Gravel or sandy gravel, poorly graded	160	120	81
GM	Gravel, silty	120	76	32
GC	Gravel or sand gravel, clayed	130	91	52
SW	Sand, well graded	155	116	78
SP	Sand, poorly graded	145	109	73
SM	Sand, Silty	119	72	25
SC	Sand, clayey	126	86	46
ML	Silts	118	69	20
CL	Clays	123	81	40
OL	Organic silts	111	57	3
MH	Inorganic elastic silts	114	61	8
CH	Fat clays	136	99	62
OH	Fat organic clays	107	54	1
PT	High organic soils or peat	106	52	0
R ²	Rock outcrops	165	165	165
NE ²	Not evaluated	–	–	–
W ²	Open water	0	0	0

¹ Unified Soils Classification System
² Not part of the Unified Soils Classification System codes.

For a particular soil type, compare the Rating Cone Index value to the Vehicle Cone Index value found in TMD IPB Step 3 equipment templates to determine cross-country movement impacts. For example, one adversary TM launcher may have a Vehicle Cone Index of 30 and can therefore traverse wet clay (Rating Cone Index=40), but not sandy silt (Rating Cone Index=25). If the Vehicle Cone Index is known for multiple vehicle convoys, the same launcher in a convoy of 5 launchers with a Vehicle Cone Index of 48 could not traverse the same wet clay (Rating Cone Index=40).

Table B-4. Landforms and Commonly Associated Soils

Landform/Bedrock		Climate	Commonly Associated Soils		
			Horizon ¹	USCS Symbol ²	
Sandstone		unspecified	surface (A) parent material (C)	SM, SM-SC, ML, SP, SW SM, SM-SC, GM, SC, GC, ML	
		humid	A	SM	
			B C	SM, GM SM-GM	
Shale		unspecified	surface (A) parent material (C)	CH, CL, CL-CH ML, CL, MH, CH, CL-CH, SC, CL-SC, GC	
		semi arid or humid	A	CL, CH	
			B	CL, SC, CL-SC	
C	CL, SC				
Limestone		unspecified	surface (A) parent material (C)	ML-CL, ML, CL, GM CL, CH, MH, ML, CH-MH, ML-CL	
		tropical	lower horizons (B & C)	CH, MH, GC, GM	
		humid	A	ML-CL	
B	CH				
C	CH				
Interbedded, sandstone, shale, limestone	Flat-lying	unspecified	unspecified	CL, ML, CH, MH, ML-CL, SC, GM, SM	
	Tilted	unspecified	unspecified	ML, MH, ML-CL	
Intrusive	Granitic rock ³	unspecified	surface (A) subsurface (B)	SM, ML, SC, ML-CL SC, CH, CL, CL-CH	
		Granite	humid	A	SM, ML, CL
	B			SC	
C	SC, CL				
Extrusive, Basaltic, and Volcanic		humid tropical or subtropical	A	ML, CL	
			B	CH, MH	
			C	ML-MH, MH, CH	
		arid	A	ML-CL, ML, GM	
B	CH, CL, MH, ML-CL, GC				
Slate		unspecified	unspecified	GM, GC, GM-GC	
		humid	A	SM	
			B	SM, ML-CL	
C	SM, GM				
Schist		humid	A	SM, SC	
			B	MH-CH	
			C	SM, ML-CL, ML	
Gneiss		humid	A	SM, SM-SC, ML-CL, ML	
			B	MH, CH, SC	
			C	SM, ML, CL, MH-CH, ML-CL, MH, CH	
Glacial Tilt / Ground Moraine ⁴		humid/derived from soft sedimentary rock	A	ML, CL, ML-CL, OL	
			B	CL, CH, CL-CH	
			C	CL, CH, ML	
		humid/derived from igneous-metamorphic rock (crystalline)	A	SM, ML, SC	
			B	SM, ML	
			C	SM, ML, GM	
Glacial / Moraines		humid/derived from soft sedimentary rock	A	CL, ML, CL-CH, CH, GM, GC	
			B	GW, GC-GP, SC-SP	
			C	SM-SC, SW, SP, GM, GC, SM, SC	
		humid/derived from igneous-metamorphic rock (crystalline)	A	SM-SP	
			B	GW, GC-GP, SC-SP	
			C	SM-SC, SW, SP, GM, GC, SM, SC	
Drumlins		humid/derived from soft sedimentary rock	surface or surface (A or B) C	ML, ML-CL, GM, GC CL, GM, GC	
			humid/derived from igneous-metamorphic rock (crystalline)	A	GM-GC, SM
				B	GM-GC, SM
C	GM, SM-SC, ML				
Eskers		unspecified	unspecified	GM, GM-GC, GP, SP, GW, SW, SW-SM	

Table B-4 (Continued). Landforms and Commonly Associated Soils

Landform/Bedrock		Climate	Commonly Associated Soils	
			Horizon ¹	USCS Symbol ²
Drumlins		humid / derived from soft sedimentary rock	surface or surface (A or B) C	ML, ML-CL, GM, GC CL, GM, GC
		humid / derived from igneous-metamorphic rock (crystalline)	A B C	GM-GC, SM GM-GC, SM GM, SM-SC, ML
		unspecified	unspecified	GM, GM-GC, GP, SP, GW, SW, SW-SM
Kames		unspecified	unspecified	GP, SP, GP-GM, GM, GM-GC, SM-SC, SP-SM, SM
Glacial Outwash		unspecified	unspecified	GW, SW, GP, SP, GM, SM, CL, GM-GC
Silt / Clay Lakebeds		unspecified	A	ML-CL, CH
			B	CL-CH
			C	CL-CH, ML-CL, MH-CH
Sandy lakebeds		unspecified	unspecified	SM, ML, ML-MH, ML-CL
Sand Dunes	unstabilized	unspecified	no horizons	SP
	stabilized	unspecified	surface (A) parent material (C)	SM, SP SP
Loess deposits		unspecified	unspecified	ML, ML-CL, CL
		semi arid	A B C	ML-CL ML-CL ML-CL
		unspecified	unspecified	ML, ML-CL, CL
Flood Plains	braided channels	unspecified	unspecified	GW, SP
	point bars	unspecified	unspecified	SW, SP, GW
	natural levees	unspecified	unspecified	SM, ML
	slack water	unspecified	unspecified	ML, CL, MH, CH, MH-CH
	swamps depressions	unspecified	unspecified	OL, OH, PT, ML, CL, CH
	terrace	unspecified	surface subsurface	ML SC, GW, GP
Deltas	Arc delta	unspecified	surface (A) subsurface (B)	ML, CL, MH, CH GP, SP, GM, GC, SM, SC, GM-GC
		humid	A B C	ML ABSENT GM-GC
	Bird's-foot delta	unspecified	A B C	OH CH-OH CH
Alluvial fans		unspecified	unspecified	GP, SP, SW, GW, GM, GC, SM, SC, ML, CL
		semi arid	A B C	GM-SM SM, ML GM, SM, ML
		unspecified	unspecified	GP, SP, GW, SW, GM, GC, SM, SC, CL, ML, CL-CH, CH
Valley fills		unspecified	unspecified	GP, SP, GW, SW, GM, GC, SM, SC, CL, ML, CL-CH, CH
		semi arid	A B C	SM SM ML-SM, SM, GM, SM, ML
		unspecified	unspecified	CL, SC, CL-CH, CH
Continental alluvium		unspecified	unspecified	CL, SC, CL-CH, CH
		semi arid	A B C	CL CL CL
		unspecified	unspecified	ML, CL, SM, SC, MH, CH
Playas		unspecified	unspecified	ML, CL, SM, SC, MH, CH
Swamps, Bogs, and Marshes		unspecified	unspecified	PT, OH, CH, MH, OL

Table B-4 (Continued). Landforms and Commonly Associated Soils

Landform/Bedrock	Climate	Commonly Associated Soils	
		Horizon ¹	USCS Symbol ²
Coastal Plain Uplands	unspecified	subsurface (A)	SM, SP-SM
		subsurface (B)	SM, SC, SP-SM
	humid	A B C	SM SC, SM SC, SM
Coastal Plain Depressions	unspecified	unspecified	OL, ML, CL, ML-CL, MH, CH, OH, PT
Beach Ridges	unspecified	surface (A)	SM, GM
		subsurface (B)	SP, GP, GP-GM, SP-SM, SW
	humid	A B C	SM absent SP, SM
Tidal Marsh	unspecified	surface (A)	PT
		subsurface (B)	OL, OH, MH
Mud Flat	unspecified	unspecified	CH, CH-MH, CH-OH
Sand Flat	unspecified	unspecified	SP

¹ Horizons are the distinct layers distinguished by differing types of soil materials.
² Unified Soils Classification System.
³ Granitic rock includes rhyolite porphyry, trachyte porphyry, dacite porphyry, basalt porphyry, augite porphyry, granite, syenite porphyry, syenite, diorite porphyry, diorite, gabbro porphyry, gabbro, pyroxenite porphyry, pyroxenite periodote.
⁴ A much wider range of texture is possible as in the North Central United States.

Table B-5. Lane Widths Typical of Current Military Maps

Table B-6. Urban Area Building Type Codes and Descriptions

Description	Type
Wood and timber frame construction	1
Masonry construction	2
One or two family dwellings	3
Prefabricated one family dwellings	4
Low rise office buildings	5
High rise office buildings	6
Low rise apartment buildings	7
High rise apartment buildings	8
Buildings common to newer industrial and warehouse complexes	9

Add a second digit to the type to designate the cover and concealment potential for each urban built-up area. Use the following codes for the second digit: a – building type interior and entrances large enough for TM equipment, b – exterior sufficient for some concealment of TM equipment, and c – unsuitable as cover or concealment for TM equipment. Example, 1a is a wood and timberframe construction building with an interior and entrances large enough to house TM equipment.

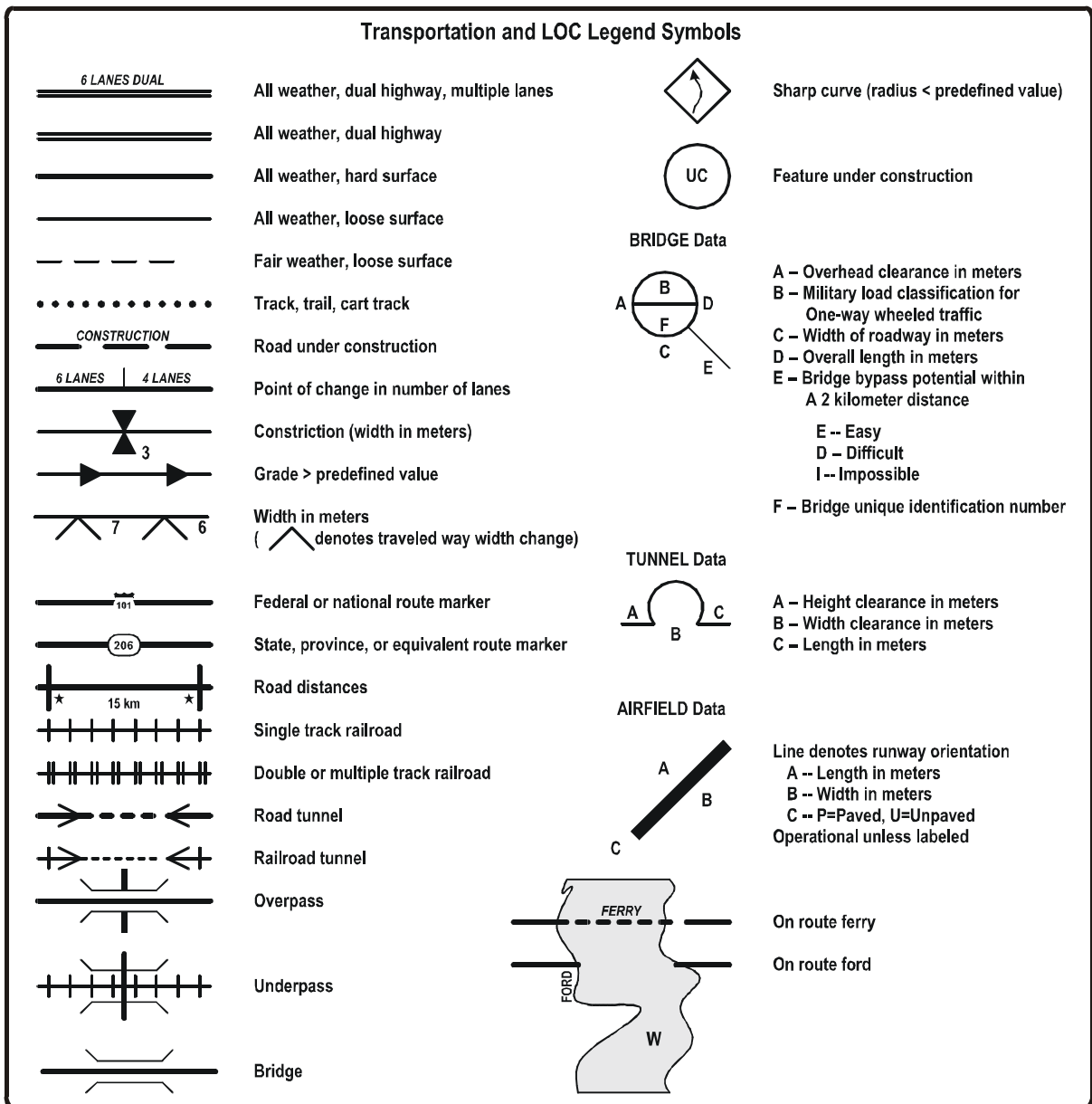

Figure B-20. Transportation and LOC Legend Symbols

CCM Overlay(s) Worksheet Template (U)

Vehicle Characteristics

<input type="checkbox"/> Single Vehicle CCM Overlay (Listed Below) _____ <input type="checkbox"/> Multiple Vehicle CCM Overlay (Listed Below) _____ _____ _____ _____ _____ _____ _____ _____	<p style="text-align: center;">Potential Vehicle Characteristics to be Used for CCM Analysis</p> Maximum On-Road Speed _____ Kph Maximum Off-Road Speed _____ Kph Maximum On-Road Gradability _____ Degrees of slope Maximum Off-Road Gradability _____ Degrees of slope Vehicle Width _____ Meters Vehicle Cone Index 1 Pass (VCI) _____ # Minimum Turning Radius _____ Meters Vehicle Length _____ Meters Military Class Load _____ Tons
---	---

Cross-Country Movement Category Definition

Speed Category	Default Category Descriptor	User Speed Category	User Defined Category Descriptor
_____ kph -- _____ Kph	Go / Unrestricted	_____ Kph -- _____ Kph	_____
_____ Kph -- _____ Kph	Restricted	_____ Kph -- _____ Kph	_____
_____ Kph -- _____ Kph	Severely Restricted	_____ Kph -- _____ Kph	_____
_____ Kph -- _____ Kph	No Go	_____ Kph -- _____ Kph	_____
Notes:			

Vehicle Speed versus Slope and Slope-Intercept-Frequency (SIF) Factor

<input type="checkbox"/> Dry Terrain <input type="checkbox"/> Wet Terrain <input type="checkbox"/> Other: _____											
_____ Deg of slope -- _____ Deg of slope	_____ Kph	_____ SIF Factor	_____ Deg of slope -- _____ Deg of slope	_____ Kph	_____ SIF Factor	_____ Deg of slope -- _____ Deg of slope	_____ Kph	_____ SIF Factor	_____ Deg of slope -- _____ Deg of slope	_____ Kph	_____ SIF Factor
_____ Deg of slope -- _____ Deg of slope	_____ Kph	_____ SIF Factor	_____ Deg of slope -- _____ Deg of slope	_____ Kph	_____ SIF Factor	_____ Deg of slope -- _____ Deg of slope	_____ Kph	_____ SIF Factor	_____ Deg of slope -- _____ Deg of slope	_____ Kph	_____ SIF Factor
_____ Deg of slope -- _____ Deg of slope	_____ Kph	_____ SIF Factor	_____ Deg of slope -- _____ Deg of slope	_____ Kph	_____ SIF Factor	_____ Deg of slope -- _____ Deg of slope	_____ Kph	_____ SIF Factor	_____ Deg of slope -- _____ Deg of slope	_____ Kph	_____ SIF Factor
_____ Deg of slope -- _____ Deg of slope	_____ Kph	_____ SIF Factor	_____ Deg of slope -- _____ Deg of slope	_____ Kph	_____ SIF Factor	_____ Deg of slope -- _____ Deg of slope	_____ Kph	_____ SIF Factor	_____ Deg of slope -- _____ Deg of slope	_____ Kph	_____ SIF Factor
_____ Deg of slope -- _____ Deg of slope	_____ Kph	_____ SIF Factor	_____ Deg of slope -- _____ Deg of slope	_____ Kph	_____ SIF Factor	_____ Deg of slope -- _____ Deg of slope	_____ Kph	_____ SIF Factor	_____ Deg of slope -- _____ Deg of slope	_____ Kph	_____ SIF Factor

Vehicle Speed versus Slope and Slope-Intercept-Frequency (SIF) Factor

<input type="checkbox"/> Dry Terrain <input type="checkbox"/> Wet Terrain <input type="checkbox"/> Other: _____											
_____ Deg of slope -- _____ Deg of slope	_____ Kph	_____ SIF Factor	_____ Deg of slope -- _____ Deg of slope	_____ Kph	_____ SIF Factor	_____ Deg of slope -- _____ Deg of slope	_____ Kph	_____ SIF Factor	_____ Deg of slope -- _____ Deg of slope	_____ Kph	_____ SIF Factor
_____ Deg of slope -- _____ Deg of slope	_____ Kph	_____ SIF Factor	_____ Deg of slope -- _____ Deg of slope	_____ Kph	_____ SIF Factor	_____ Deg of slope -- _____ Deg of slope	_____ Kph	_____ SIF Factor	_____ Deg of slope -- _____ Deg of slope	_____ Kph	_____ SIF Factor
_____ Deg of slope -- _____ Deg of slope	_____ Kph	_____ SIF Factor	_____ Deg of slope -- _____ Deg of slope	_____ Kph	_____ SIF Factor	_____ Deg of slope -- _____ Deg of slope	_____ Kph	_____ SIF Factor	_____ Deg of slope -- _____ Deg of slope	_____ Kph	_____ SIF Factor
_____ Deg of slope -- _____ Deg of slope	_____ Kph	_____ SIF Factor	_____ Deg of slope -- _____ Deg of slope	_____ Kph	_____ SIF Factor	_____ Deg of slope -- _____ Deg of slope	_____ Kph	_____ SIF Factor	_____ Deg of slope -- _____ Deg of slope	_____ Kph	_____ SIF Factor
_____ Deg of slope -- _____ Deg of slope	_____ Kph	_____ SIF Factor	_____ Deg of slope -- _____ Deg of slope	_____ Kph	_____ SIF Factor	_____ Deg of slope -- _____ Deg of slope	_____ Kph	_____ SIF Factor	_____ Deg of slope -- _____ Deg of slope	_____ Kph	_____ SIF Factor

Vehicle Speed versus Slope, Slope-Intercept-Frequency (SIF) Factor, and Surface Roughness Factor

Surface Materials Code and Description	Dry RCI	Moist RCI	Wet RCI	Dry Soil Factor	Wet Soil Factor	Surface Roughness Factor
GW Gravel or Sandy Gravel, Well Graded						
GP Gravel or Sandy Gravel, Poorly Graded						
GM Gravel, Silty						
GC Gravel or Sandy Gravel, Clayed						
SW Sand, Well Graded						
SP Sand, Poorly Graded						
SM Sand, Silty						
SC Sand, Clayey						
ML Silts						
CL Clays						
OL Organic Silts						
MH Inorganic Elastic Silts						
CH Fat Clays						
OH Fat Organic Clays						
PT High Organic Soils or Peat						
R Rock Outcrops						
W Open Water						

Notes: _____

Figure B-21. CCM Overlay(s) Worksheet Template (1 of 2)

CCM Overlay(s) Worksheet Template (U)

Vegetation Factor

Surface Materials Code and Description	Vegetation Factor	Vegetation Roughness Factor
A1 Agriculture (Dry Crops)	<input type="text"/>	<input type="text"/>
A2 Agriculture (Wet Crops, Rice)	<input type="text"/>	<input type="text"/>
A3 Agriculture (Terraced Crops, both Wet and Dry)	<input type="text"/>	<input type="text"/>
A4 Agriculture (Shifting Cultivation)	<input type="text"/>	<input type="text"/>
B1 Brushland (<5-meters High, Open to Medium Spacing)	<input type="text"/>	<input type="text"/>
B2 Brushland (<5-meters High, Medium to Dense Spacing)	<input type="text"/>	<input type="text"/>
C Coniferous / Evergreen Forest	<input type="text"/>	<input type="text"/>
D Deciduous Forest	<input type="text"/>	<input type="text"/>
E Mixed Forest (Coniferous / Deciduous)	<input type="text"/>	<input type="text"/>
F Orchard / Plantation (Rubber, Palm, Fruit, etc.)	<input type="text"/>	<input type="text"/>
G1 Grassland, Pasture, Meadow	<input type="text"/>	<input type="text"/>
G2 Grassland with Scattered Trees, some Scrub Growth	<input type="text"/>	<input type="text"/>
H Forest Clearing (Cutover Areas, Burns, etc.)	<input type="text"/>	<input type="text"/>
I Swamp (Mangrove, Cypress, etc.)	<input type="text"/>	<input type="text"/>
J Marsh / Bog (Treeless Bogs, Muskegs, etc.)	<input type="text"/>	<input type="text"/>
K Wetlands (Low-Lying Wet Areas)	<input type="text"/>	<input type="text"/>
L Vineyards	<input type="text"/>	<input type="text"/>
M Bamboo	<input type="text"/>	<input type="text"/>

Notes:

Notes:

Figure B-21 (Continued). CCM Overlay(s) Worksheet Template (2 of 2)

Climatology Assessment Template (U)

Name of Area _____
 Description of Area _____
 BE Number _____
 Centroid of Area _____
 MGRS _____
 Latitude _____
 Longitude _____
 Radius Climatology Valid For _____
 Kilometers _____
 Climatic Region _____

General Climate Descriptions _____

Natural Climate Hazards Descriptions _____

**Surface
Air
Temperature**
Degrees (F)

140																			
130																			
120																			
110																			
100																			
90																			
80																			
70																			
60																			
50																			
40																			
30																			
20																			
10																			
0																			
-10																			
-20																			
-30																			
-40																			
	Jan	Feb	Mar	Apr	May	Jun	Jul	Aug	Sep	Oct	Nov	Dec							

.....	Extreme High Temperature																		
----	Average High Temperature																		
_____	Mean Temperature																		
----	Average Low Temperature																		
.....	Extreme Low Temperature																		

Mean Precipitation _____
 Average Low Precipitation _____
 Average High Snow Accumulation for a 1 Hour Period _____
 Mean Snow Accumulation for a 1 Hour Period _____
 Average Maximum Snow Accumulation for a 24 Hour Period _____
 Mean Relative Humidity @ 0600 Local Standard Time _____
 Mean Relative Humidity @ 1300 Local Standard Time _____
 Prevailing Surface Wind Direction _____
 Mean Prevailing Direction Surface Wind Speed _____
 Mean Surface Wind Speed All Observations _____
 Average maximum Peak Surface Wind Gust Speed _____
 Mean Cloud Cover _____
 % Frequency of Ceiling / Visibility < 3,000 ft / 3 Statute Miles _____
 % Frequency of Ceiling / Visibility < 300 ft / 1 Statute Miles _____
 % Frequency of Ceiling / Visibility < 200 ft / 0.5 Statute Miles _____
 Mean Cloud Top Altitude _____
 Minimum Cloud Top Altitude _____
 % Frequency of Thunderstorm _____
 Mid Month Sunset¹ _____
 Mid Month End of Evening Nautical Twilight (EENT)¹ _____
 Mid Month Beginning of Morning Nautical Twilight (BMNT)¹ _____
 Mid Month Sunrise¹ _____

Units	Jan	Feb	Mar	Apr	May	Jun	Jul	Aug	Sep	Oct	Nov	Dec	
Inches													
Inches													
Inches													
Inches													
%													
%													
Direction													
Knots													
Knots													
Knots													
%													
%													
%													
%													
Feet													
Feet													
%													
HHMM													
HHMM													
HHMM													
HHMM													

= less than 0.5 day, or 0.05 inch, or 0.5%, as applicable
 * = Data not available
 N = North, NE = Northeast, E = East, SE = Southeast, S = South, SW = Southwest, W = West, NW = Northwest
 1 = Light data calculated using the year _____ and the mid month being the 15th of each month with all times adjusted to local standard time for: _____

Figure B-22. Climatology Assessment Template

Weather Effects on TM Force Operations Template (U)

	Strongly Disfavorable Precludes Operations	Unfavorable to Operations	May Be Favorable or Unfavorable to Operations	Favorable to Operations	Strongly Favorable to Operations	Strongly Disfavorable Precludes Operations	Unfavorable to Operations	May Be Favorable or Unfavorable to Operations	Favorable to Operations	Strongly Favorable to Operations
Effectuated Missile Operation	Upper Bound Temperature (F)					Upper Bound Surface Winds (knots)				
	<input type="text"/>	<input type="text"/>	<input type="text"/>	<input type="text"/>	<input type="text"/>	<input type="text"/>	<input type="text"/>	<input type="text"/>	<input type="text"/>	<input type="text"/>
	<input type="text"/>	<input type="text"/>	<input type="text"/>	<input type="text"/>	<input type="text"/>	<input type="text"/>	<input type="text"/>	<input type="text"/>	<input type="text"/>	<input type="text"/>
	Lower Bound Temperature (F)					Lower Bound Surface Winds (knots)				
<input type="text"/>	<input type="text"/>	<input type="text"/>	<input type="text"/>	<input type="text"/>	<input type="text"/>	<input type="text"/>	<input type="text"/>	<input type="text"/>	<input type="text"/>	<input type="text"/>
<input type="text"/>	<input type="text"/>	<input type="text"/>	<input type="text"/>	<input type="text"/>	<input type="text"/>	<input type="text"/>	<input type="text"/>	<input type="text"/>	<input type="text"/>	<input type="text"/>
	Visibility (statute miles)					Cloud Cover (%)				
<input type="text"/>	<input type="text"/>	<input type="text"/>	<input type="text"/>	<input type="text"/>	<input type="text"/>	<input type="text"/>	<input type="text"/>	<input type="text"/>	<input type="text"/>	<input type="text"/>
<input type="text"/>	<input type="text"/>	<input type="text"/>	<input type="text"/>	<input type="text"/>	<input type="text"/>	<input type="text"/>	<input type="text"/>	<input type="text"/>	<input type="text"/>	<input type="text"/>
	Cloud Ceiling (feet)					Cloud Tops Altitude (feet)				
<input type="text"/>	<input type="text"/>	<input type="text"/>	<input type="text"/>	<input type="text"/>	<input type="text"/>	<input type="text"/>	<input type="text"/>	<input type="text"/>	<input type="text"/>	<input type="text"/>
<input type="text"/>	<input type="text"/>	<input type="text"/>	<input type="text"/>	<input type="text"/>	<input type="text"/>	<input type="text"/>	<input type="text"/>	<input type="text"/>	<input type="text"/>	<input type="text"/>
	Precipitation (inches)					Snow Accumulation (inches)				
<input type="text"/>	<input type="text"/>	<input type="text"/>	<input type="text"/>	<input type="text"/>	<input type="text"/>	<input type="text"/>	<input type="text"/>	<input type="text"/>	<input type="text"/>	<input type="text"/>
<input type="text"/>	<input type="text"/>	<input type="text"/>	<input type="text"/>	<input type="text"/>	<input type="text"/>	<input type="text"/>	<input type="text"/>	<input type="text"/>	<input type="text"/>	<input type="text"/>
	Thunderstorms (Heavy, Moderate, Light)					Lightning (Heavy, Moderate, Light)				
<input type="text"/>	<input type="text"/>	<input type="text"/>	<input type="text"/>	<input type="text"/>	<input type="text"/>	<input type="text"/>	<input type="text"/>	<input type="text"/>	<input type="text"/>	<input type="text"/>
<input type="text"/>	<input type="text"/>	<input type="text"/>	<input type="text"/>	<input type="text"/>	<input type="text"/>	<input type="text"/>	<input type="text"/>	<input type="text"/>	<input type="text"/>	<input type="text"/>
<input type="text"/>	<input type="text"/>	<input type="text"/>	<input type="text"/>	<input type="text"/>	<input type="text"/>	<input type="text"/>	<input type="text"/>	<input type="text"/>	<input type="text"/>	<input type="text"/>
<input type="text"/>	<input type="text"/>	<input type="text"/>	<input type="text"/>	<input type="text"/>	<input type="text"/>	<input type="text"/>	<input type="text"/>	<input type="text"/>	<input type="text"/>	<input type="text"/>

Notes:

Figure B-23. Weather Effects on Adversary TM Force Operations Template

Current / Forecasted Weather Effects on TM Force Operations Template (U)

Name of Area _____ **Current Weather Valid for Date / DTG** _____ **Through** _____

Description of Area _____

Be Number _____ **Forecast Weather Valid for Date / DTG** _____ **Through** _____

Centroid of Area _____

MGRS _____

Latitude _____

Longitude _____

Radius Climatology Valid For _____

Kilometers _____

Light Data

BMNT _____ **EECT** _____ **Sunrise** _____ **Moonrise** _____

BMCT _____ **EENT** _____ **Sunset** _____ **Moonsset** _____

Effected Missile Operation	Temperature (F)		Surface Winds (knots)		Visibility (statute miles)	
	Current Condition		Current Condition		Current Condition	
Effected Missile Operation	Cloud Cover (%)		Cloud Ceiling (feet)		Cloud Tops Altitude (feet)	
	Current Condition		Current Condition		Current Condition	
Effected Missile Operation	Precipitation (inches)		Snow Accumulation (inches)		Thunderstorms & Lightning	
	Current Condition		Current Condition		Current Condition	

Key

1 (Blue) = Strongly Disfavorable / Precludes Operations 4 (Yellow) = Favorable to Operations UA (White) = Currently Unavailable

2 (Green) = Unfavorable to Operations 5 (Red) = Strongly Favorable to Operations

3 (Gray) = May Be Favorable or Unfavorable Depending on the Circumstances NF (Black) = Not a Factor

Notes:

Integrated TM Force Infrastructure List Template (U)

TM Force Overview Description and Notes

ID	Located	Functional Code	MIDB Facility Name	BE Number	Latitude or MGRS	N/S	Longitude	E/W	Primary Function(s)

Figure B-26. Integrated TM Force Infrastructure List Template (1 of 2)

DTG: _____	Classification: _____	Page: ___ of: ___				
Integrated TM Force Infrastructure List Template (U)						
Functional Codes						
Located Codes	First Character Operations Level	Second Character Function	Third Character Subfunction	Fourth Character Sub-subfunction	Fifth Character Type	Fifth Character WMD Relationship
C - Confirmed P - Probable / Possible A - Assessed U - Unknown	N - National Operations O - Operational Operations T - Tactical / Field Operations Z - Other U - Unknown -- None	A - Administration 2 - Command and Control (C2) C - Communications E - Port of Entry X - Research and Development P - Production Y - Testing T - Training G - Garrison D - Depot S - Storage F - Field Operations M - Air Defense Z - Other U - Unknown -- None	H - Headquarters Ops C - C2 Operations G - General Operations M - Missile Operations F - Fire Control Operations W - Meteorological Ops S - Storage V - Vehicle Parking P - Personnel S - Security E - Power Generation Z - Other U - Unknown -- None	M - Missile A - Airframe W - Warhead E - Warhead Mating C - Checkout T - Transload F - Fueling L - Launcher R - Fire Control Z - C2 G - GSE P - Missile Fuel O - Missile Oxidizer D - POL B - Access Control H - Housing S - Support Z - Other U - Unknown -- None	C - Fixed Complex B - Bunker Complex T - Tunnel Complex F - Field / Unprepared G - Field / Prepared A - Airfield P - Port R - Road I - Railroad W - Waterway Z - Other U - Unknown -- None	C - Chemical B - Biological N - Nuclear Z - Other U - Unknown -- None
Use / Instructions: 1 Using the "Adversary TM Force Required Infrastructure Assessment" template and the TO&E assessment fill the IDs, functional category codes, and primary function(s) fields in this template with the required and optional infrastructure in the appropriate quantities. This forms the "Initial Integrated TM Force Infrastructure List." 2 Using the results of the identified / located adversary TM force infrastructure assessment to fill in the remaining fields of the template where possible. This identifies the "Unlocated TM Force Infrastructure List." 3 Where possible assess locations for the unlocated adversary TM force infrastructure. This forms the "Current Integrated TM Force Infrastructure List." 4 Repeat process as often as required.						
Notes:						
TMD IPB Template -- 18 March 2000 Classification: _____ Local Reproduction Authorized						

Figure B-26 (Continued). Integrated TM Force Infrastructure List Template (2 of 2)

DTG: _____ Classification: _____ Page: ___ of: ____

General Facility / Area Assessment Template (U)

Facility / Area MIDB Name

BE Number Latitude UTM MGRS N S Longitude E W

Elevation (m) Datum: WGS-84 Other Geographic Coordinates for Reference Only -- Do Not Use for Precise Targeting

Integrated Infrastructure List ID # Functional Code from Integrated Adversary TM Force Infrastructure List

MIDB Category Code(s) Assessed TMD Category Code(s)

Target Materials Available : Basic Target Graphic (BTG) Target Folder Operational Support Plan Other

Target : Soft Hard PV Character Code:

Hard Targets Consist of:

Data Bases Searched	ICOD: From		To	Related Message Traffic		
	DTG	Originator		Subject		
ALE						
IESS						
SAFE						

See Attached for More Data Bases Searched See Attached for More Related Message Traffic

Facility /Area Event Chronology				
Event / Activity / Item of Interest	Date	Time (zulu)	Start	Finish

TMD IPB Template -- 18 March 2000 Classification: _____ Local Reproduction Authorized

Figure B-27. General Facility/Area Assessment Template (1 of 4)

DTG: _____ Classification: _____ Page: ____ of: ____

General Facility / Area Assessment Template (U)

Facility / Area - Significance / Function

Facility / Area - Physical Description

Facility / Area Status: Active Inactive Under Construction Under Modification Other: _____

Organization Name(s) and/or Unit(s) Designator(s) Military Civilian Other _____

	Subordinate To	Subordinate Unit(s)

Launcher Hide Criteria

Launcher Type	Dimensions (m)	Width	X Height	X Length	Ventilation Required
<input type="checkbox"/>	<input type="text"/>	<input type="text"/>	<input type="text"/>	<input type="text"/>	<input type="checkbox"/>
<input type="checkbox"/>	<input type="text"/>	<input type="text"/>	<input type="text"/>	<input type="text"/>	<input type="checkbox"/>
<input type="checkbox"/>	<input type="text"/>	<input type="text"/>	<input type="text"/>	<input type="text"/>	<input type="checkbox"/>
<input type="checkbox"/>	<input type="text"/>	<input type="text"/>	<input type="text"/>	<input type="text"/>	<input type="checkbox"/>

Communication Link(s)	# Observed	Transportation Interface(s)	# Observed	# Observed
Above Ground Landline <input type="checkbox"/>	<input type="text"/>	Roads CAT 1/2 <input type="checkbox"/>	<input type="text"/>	Air (Runways, HWY Strips, etc.) <input type="checkbox"/>
Buried Landline <input type="checkbox"/>	<input type="text"/>	Roads CAT 3 <input type="checkbox"/>	<input type="text"/>	Sea (Ports, Docks, etc.) <input type="checkbox"/>
HF Radio <input type="checkbox"/>	<input type="text"/>	Roads CAT 4 <input type="checkbox"/>	<input type="text"/>	<input type="text"/>
Microwave <input type="checkbox"/>	<input type="text"/>	Roads CAT 5 <input type="checkbox"/>	<input type="text"/>	<input type="text"/>
Other Radio <input type="checkbox"/>	<input type="text"/>	Roads CAT 6 <input type="checkbox"/>	<input type="text"/>	<input type="text"/>
Satellite Communications <input type="checkbox"/>	<input type="text"/>	Roads CAT 7 <input type="checkbox"/>	<input type="text"/>	<input type="text"/>
<input type="checkbox"/>	<input type="text"/>	Railroads <input type="checkbox"/>	<input type="text"/>	<input type="text"/>
None Observed <input type="checkbox"/>	<input type="text"/>	<input type="text"/>	<input type="text"/>	None Observed <input type="checkbox"/>

Electrical Power Interface(s)

Uses Local Power Grid Above Ground Transmission Lines Power Capacity Other

On-Site Power Generation Below Ground Transmission Lines Back-Up Power Capability None Observed

Associated Security

Terrain Single Fenced Triple Fenced Manned Security On-Site SAMs Other

Vegetation Double Fenced Walled Guard Posts On-Site AAA None Observed

TMD IPB Template -- 18 March 2000 Classification: _____ Local Reproduction Authorized

Figure B-27 (Continued). General Facility/Area Assessment Template (2 of 4)

DTG: _____	Classification: _____	Page: ____ of: ____
General Facility / Area Assessment Template (U)		
Critical Elements (CE) / Critical Nodes (CN) / High Value Targets (HVT) Within The Facility / Area		
CE / CN / HVT <input type="checkbox"/> Mensurated Point (MP) <input type="checkbox"/> Element or MP ID # _____ Elevation _____ M _____ Ft Latitude <input type="checkbox"/> UTM <input type="checkbox"/> MGRS <input type="checkbox"/> _____ N S _____ Longitude _____ E W _____ Datum: WGS84 <input type="checkbox"/> Other _____ PV Char Code _____ JMEM Code _____ Length (m) _____ Width (m) _____ Height (m) _____ Basic Physical Shape _____	Critical Element Rationale	
CE / CN / HVT <input type="checkbox"/> Mensurated Point (MP) <input type="checkbox"/> Element or MP ID # _____ Elevation _____ M _____ Ft Latitude <input type="checkbox"/> UTM <input type="checkbox"/> MGRS <input type="checkbox"/> _____ N S _____ Longitude _____ E W _____ Datum: WGS84 <input type="checkbox"/> Other _____ PV Char Code _____ JMEM Code _____ Length (m) _____ Width (m) _____ Height (m) _____ Basic Physical Shape _____	Critical Element Rationale	
CE / CN / HVT <input type="checkbox"/> Mensurated Point (MP) <input type="checkbox"/> Element or MP ID # _____ Elevation _____ M _____ Ft Latitude <input type="checkbox"/> UTM <input type="checkbox"/> MGRS <input type="checkbox"/> _____ N S _____ Longitude _____ E W _____ Datum: WGS84 <input type="checkbox"/> Other _____ PV Char Code _____ JMEM Code _____ Length (m) _____ Width (m) _____ Height (m) _____ Basic Physical Shape _____	Critical Element Rationale	
CE / CN / HVT <input type="checkbox"/> Mensurated Point (MP) <input type="checkbox"/> Element or MP ID # _____ Elevation _____ M _____ Ft Latitude <input type="checkbox"/> UTM <input type="checkbox"/> MGRS <input type="checkbox"/> _____ N S _____ Longitude _____ E W _____ Datum: WGS84 <input type="checkbox"/> Other _____ PV Char Code _____ JMEM Code _____ Length (m) _____ Width (m) _____ Height (m) _____ Basic Physical Shape _____	Critical Element Rationale	
CE / CN / HVT <input type="checkbox"/> Mensurated Point (MP) <input type="checkbox"/> Element or MP ID # _____ Elevation _____ M _____ Ft Latitude <input type="checkbox"/> UTM <input type="checkbox"/> MGRS <input type="checkbox"/> _____ N S _____ Longitude _____ E W _____ Datum: WGS84 <input type="checkbox"/> Other _____ PV Char Code _____ JMEM Code _____ Length (m) _____ Width (m) _____ Height (m) _____ Basic Physical Shape _____	Critical Element Rationale	
CE / CN / HVT <input type="checkbox"/> Mensurated Point (MP) <input type="checkbox"/> Element or MP ID # _____ Elevation _____ M _____ Ft Latitude <input type="checkbox"/> UTM <input type="checkbox"/> MGRS <input type="checkbox"/> _____ N S _____ Longitude _____ E W _____ Datum: WGS84 <input type="checkbox"/> Other _____ PV Char Code _____ JMEM Code _____ Length (m) _____ Width (m) _____ Height (m) _____ Basic Physical Shape _____	Critical Element Rationale	
CE / CN / HVT <input type="checkbox"/> Mensurated Point (MP) <input type="checkbox"/> Element or MP ID # _____ Elevation _____ M _____ Ft Latitude <input type="checkbox"/> UTM <input type="checkbox"/> MGRS <input type="checkbox"/> _____ N S _____ Longitude _____ E W _____ Datum: WGS84 <input type="checkbox"/> Other _____ PV Char Code _____ JMEM Code _____ Length (m) _____ Width (m) _____ Height (m) _____ Basic Physical Shape _____	Critical Element Rationale	
CE / CN / HVT <input type="checkbox"/> Mensurated Point (MP) <input type="checkbox"/> Element or MP ID # _____ Elevation _____ M _____ Ft Latitude <input type="checkbox"/> UTM <input type="checkbox"/> MGRS <input type="checkbox"/> _____ N S _____ Longitude _____ E W _____ Datum: WGS84 <input type="checkbox"/> Other _____ PV Char Code _____ JMEM Code _____ Length (m) _____ Width (m) _____ Height (m) _____ Basic Physical Shape _____	Critical Element Rationale	
CE / CN / HVT <input type="checkbox"/> Mensurated Point (MP) <input type="checkbox"/> Element or MP ID # _____ Elevation _____ M _____ Ft Latitude <input type="checkbox"/> UTM <input type="checkbox"/> MGRS <input type="checkbox"/> _____ N S _____ Longitude _____ E W _____ Datum: WGS84 <input type="checkbox"/> Other _____ PV Char Code _____ JMEM Code _____ Length (m) _____ Width (m) _____ Height (m) _____ Basic Physical Shape _____	Critical Element Rationale	
TMD IPB Template -- 18 March 2000 Classification: _____ Local Reproduction Authorized		

Figure B-27 (Continued). General Facility/Area Assessment Template (3 of 4)

General Facility / Area Assessment Template (U)

Recommended Imagery Views and Codes

Recommended Imagery Views				
View	EO Resolution	IR Resolution	Radar Resolution	Angle
Map [Wide Area (Orientation)]	≥ NIIRS 3	0.61 m / 2 ft	2.44 m / 8 ft	Vertical
Order of battle (OB) [Wide Area (Orientation)]	≥ NIIRS 3	0.61 m / 2 ft	2.44 m / 8 ft	Near Vertical ¹
5 nm / 9.26 km x 5 nm / 9.26 km [Target Area / Overview (Mission Planning)]	≥ NIIRS 4	0.61 m / 2 ft	2.44 m / 8 ft	Near Vertical ¹
3 nm / 5.56 km x 3 nm / 5.56 km [Target Area / Overview (Mission Planning)]	≥ NIIRS 4	0.61 m / 2 ft	2.44 m / 8 ft	Near Vertical ¹
1 nm / 1.85 km x 1 nm / 1.85 km [Target (Attack Parameters)]	≥ NIIRS 5	0.61 m / 2 ft	2.44 m / 8 ft	Near Vertical ¹
0.67 nm / 1.24 km x 0.67 nm / 1.24 km [Target (Attack Parameters)]	≥ NIIRS 5	0.61 m / 2 ft	2.44 m / 8 ft	Near Vertical ¹
Critical Element / MP [Target (Attack Parameters)]				Near Vertical ¹
Blueprints / Sketches / Drawings				Vertical and/or Cutaway
Equipment				Hand Held

¹ Also Include Oblique Shot - Line of Approach / Look Angle When Possible

Function Codes	1st Character	2nd Character	3rd Character	4th Character	5th Character	6th Character
Character Positions	N - National Operations	A - Administration	H - Headquarters Ops	M - Missile	C - Fixed Complex	C - Chemical
1st - Operations Level	O - Operational Operations	2 - Command and Control (C2)	C - C2 Operations	A - Airframe	B - Bunker Complex	B - Biological
2nd - Function	T - Tactical / Field Operations	C - Communications	G - General Operations	W - Warhead	T - Tunnel Complex	N - Nuclear
3rd - Subfunction	Z - Other	E - Port of Entry	M - Missile Operations	E - Warhead Mating	F - Field / Unprepared	Z - Other
4th - Sub-subfunction	U - Unknown	X - Research and Development	F - Fire Control Operations	C - Checkout	G - Field / Prepared	U - Unknown
5th - Type	-- None	P - Production	W - Meteorological Ops	T - Transload	A - Airfield	-- None
6th - WMD Relationship		Y - Testing	S - Storage	F - Fueling	P - Port	
		T - Training	V - Vehicle Parking	L - Launcher	R - Road	
		G - Garrison	P - Personnel	R - Fire Control	I - Railroad	
		D - Depot	S - Security	2 - C2	W - Waterway	
		S - Storage	E - Power Generation	G - GSE	Z - Other	
		F - Field Operations	Z - Other	P - Missile Fuel	U - Unknown	
		M - Air Defense	U - Unknown	O - Missile Oxidizer	-- None	
		Z - Other	-- None	D - POL		
		U - Unknown		B - Access Control		
		-- None		H - Housing		
				S - Support		
				Z - Other		
				U - Unknown		
				-- None		

TMD Hide Site Codes	
CAT 1	Confirmed TM Launcher Hide / Storage Site, The Site Entrance Is Large Enough To Accommodate The Launcher And Missile Equipment Or TM Activity Has Been Observed
CAT 2	Site Entrance Is Larger Than TM Launcher And Substantial Reporting Or Imagery Indicators Exist Implying The Site Could Be TM Related
CAT 3	Site Entrance Is Larger Than TM Launcher And Has Fair To good Accessibility
CAT 4	Site Entrance Is Larger Than TM Launcher But Has Poor Accessibility Or Is Known To Be Associated With A Non-TM Unit
CAT 5	Site Entrance Is Larger Than TM Launcher But Has No Current Accessibility

Structure Type Codes					
AG - Above Ground	OA - Open Area	HB - High Bay	RV - Revetted	FS - Fence Secured	UG - Under Ground
PUG - Partially Under Ground	C - Culvert	BN - Bunker	T - Tunnel	BA - Bunker Adit	TA - Tunnel Adit
B - Bridge	CP - Choke Point				

PV Codes					
1st and 2nd Characters – Number of Stories in the Structure			Exceptions:		
SS	Single Story		Single-Story Load-Bearing Wall - Log and Timber Walls	LOG 1	
MS	Multiple Story		Multistory Load-Bearing Wall - Log and Timber Walls	LOG 2	
If excluded implies structure is single story					
Following Characters					
AD	Adobe Walls	MON	Monumental Masonry Load-Bearing Walls	HSF	Heavy Steel framed
WB	Masonry Load-Bearing Walls	HCF	Heavy Composite Framed	LSF	Light Steel Framed
WF	Wood Framed	LCF	Light Composite Framed	VLSF	Very Light Steel Framed
VLWF	Very Light Wood Framed	SF	Steel Framed		
RC	Reinforced Concrete				
Additional RC Modifiers (i.e. RCLF = Reinforced Concrete Framed w/Columns and Roof Slab)					
LF	Light Framed (spans < 22.86 m / 75 ft) Columns & Roof Slab or Arch (rigid)			SS	Stressed Skin or Shell
VLF	Very Light Framed or Columns & Trusses or Columns & Beams			TC	T-Columns
Crane Capacity For Buildings with Cranes					
HCF	[10-50 tons]	LCF, SLSLF, & RCLF	<10 tons]	A Space Plus After PV Code:	100 [>100 tons], 90 [60-100 tons], 50 [30-60 tons, or 25 [10-25 tons]
A Space Plus After PV Code: BR Blast-Resistant Design ER Earthquake-Resistant Design					
Use Multiple Story Code For All Structures, Unless The Structure Can Be Positively Identified As Single Story					

Roof Construction Codes	
C	Concrete
M	Metal
S	Shingled
W	Wood
U	Unknown

LOC and LOC Access Codes	
CAT ½	Paved, All Weather, Highway of Two or More Lanes
CAT 3	Paved, All Weather, Undivided Highway, Less Than Two Lanes
CAT 4	Unpaved, Improved, All Weather, Two Lanes Wide
CAT 5	Unpaved, Unimproved, Dry-Weather, Earthen, 1-2 Lanes Wide
CAT 6	Unpaved, Unimproved, Dry-Weather, Earthen, 1 Lane (Track)
CAT 7	Unpaved, Unimproved, Dry-Weather, Earthen, Less Than 1 Lane (Trail)

Figure B-27 (Continued). General Facility/Area Assessment Template (4 of 4)

Area Limitation Worksheet Template (U)

	Slope Less Than or Equal to xx Degrees	Within xx Kilometers of Roads	Identified Potential Hide Site Radius in Meters	Within xx Kilometers of a Potential Hide Site	Within xx Kilometers of a Potential Launch Site	Within xx Kilometers of a Communications Link or Node	All Roads +/- xx Meters	Xxx Meters Into Tree Cover	Within xxx Meters of the Tree Line	Exclude Dry Season Obstacles	Exclude Wet Season Obstacles	Other:	Other:	Other:
Field Launch Operations Capable Areas	<input type="checkbox"/>	<input type="checkbox"/>	<input type="checkbox"/>	<input type="checkbox"/>	<input type="checkbox"/>	<input type="checkbox"/>	<input type="checkbox"/>	<input type="checkbox"/>	<input type="checkbox"/>	<input type="checkbox"/>	<input type="checkbox"/>	<input type="checkbox"/>	<input type="checkbox"/>	<input type="checkbox"/>
Field Hide Site Capable Areas	<input type="checkbox"/>	<input type="checkbox"/>	<input type="checkbox"/>	<input type="checkbox"/>	<input type="checkbox"/>	<input type="checkbox"/>	<input type="checkbox"/>	<input type="checkbox"/>	<input type="checkbox"/>	<input type="checkbox"/>	<input type="checkbox"/>	<input type="checkbox"/>	<input type="checkbox"/>	<input type="checkbox"/>
Field Transload Operations Capable Areas	<input type="checkbox"/>	<input type="checkbox"/>	<input type="checkbox"/>	<input type="checkbox"/>	<input type="checkbox"/>	<input type="checkbox"/>	<input type="checkbox"/>	<input type="checkbox"/>	<input type="checkbox"/>	<input type="checkbox"/>	<input type="checkbox"/>	<input type="checkbox"/>	<input type="checkbox"/>	<input type="checkbox"/>
Field Warhead Mating Operations Capable Areas	<input type="checkbox"/>	<input type="checkbox"/>	<input type="checkbox"/>	<input type="checkbox"/>	<input type="checkbox"/>	<input type="checkbox"/>	<input type="checkbox"/>	<input type="checkbox"/>	<input type="checkbox"/>	<input type="checkbox"/>	<input type="checkbox"/>	<input type="checkbox"/>	<input type="checkbox"/>	<input type="checkbox"/>
Field Fueling Operations Capable Areas	<input type="checkbox"/>	<input type="checkbox"/>	<input type="checkbox"/>	<input type="checkbox"/>	<input type="checkbox"/>	<input type="checkbox"/>	<input type="checkbox"/>	<input type="checkbox"/>	<input type="checkbox"/>	<input type="checkbox"/>	<input type="checkbox"/>	<input type="checkbox"/>	<input type="checkbox"/>	<input type="checkbox"/>
Field Storage Site Capable Areas	<input type="checkbox"/>	<input type="checkbox"/>	<input type="checkbox"/>	<input type="checkbox"/>	<input type="checkbox"/>	<input type="checkbox"/>	<input type="checkbox"/>	<input type="checkbox"/>	<input type="checkbox"/>	<input type="checkbox"/>	<input type="checkbox"/>	<input type="checkbox"/>	<input type="checkbox"/>	<input type="checkbox"/>
Field TM Related Communications Capable Areas	<input type="checkbox"/>	<input type="checkbox"/>	<input type="checkbox"/>	<input type="checkbox"/>	<input type="checkbox"/>	<input type="checkbox"/>	<input type="checkbox"/>	<input type="checkbox"/>	<input type="checkbox"/>	<input type="checkbox"/>	<input type="checkbox"/>	<input type="checkbox"/>	<input type="checkbox"/>	<input type="checkbox"/>
Other:	<input type="checkbox"/>	<input type="checkbox"/>	<input type="checkbox"/>	<input type="checkbox"/>	<input type="checkbox"/>	<input type="checkbox"/>	<input type="checkbox"/>	<input type="checkbox"/>	<input type="checkbox"/>	<input type="checkbox"/>	<input type="checkbox"/>	<input type="checkbox"/>	<input type="checkbox"/>	<input type="checkbox"/>
Other:	<input type="checkbox"/>	<input type="checkbox"/>	<input type="checkbox"/>	<input type="checkbox"/>	<input type="checkbox"/>	<input type="checkbox"/>	<input type="checkbox"/>	<input type="checkbox"/>	<input type="checkbox"/>	<input type="checkbox"/>	<input type="checkbox"/>	<input type="checkbox"/>	<input type="checkbox"/>	<input type="checkbox"/>
Other:	<input type="checkbox"/>	<input type="checkbox"/>	<input type="checkbox"/>	<input type="checkbox"/>	<input type="checkbox"/>	<input type="checkbox"/>	<input type="checkbox"/>	<input type="checkbox"/>	<input type="checkbox"/>	<input type="checkbox"/>	<input type="checkbox"/>	<input type="checkbox"/>	<input type="checkbox"/>	<input type="checkbox"/>
Other:	<input type="checkbox"/>	<input type="checkbox"/>	<input type="checkbox"/>	<input type="checkbox"/>	<input type="checkbox"/>	<input type="checkbox"/>	<input type="checkbox"/>	<input type="checkbox"/>	<input type="checkbox"/>	<input type="checkbox"/>	<input type="checkbox"/>	<input type="checkbox"/>	<input type="checkbox"/>	<input type="checkbox"/>
Other:	<input type="checkbox"/>	<input type="checkbox"/>	<input type="checkbox"/>	<input type="checkbox"/>	<input type="checkbox"/>	<input type="checkbox"/>	<input type="checkbox"/>	<input type="checkbox"/>	<input type="checkbox"/>	<input type="checkbox"/>	<input type="checkbox"/>	<input type="checkbox"/>	<input type="checkbox"/>	<input type="checkbox"/>
Other:	<input type="checkbox"/>	<input type="checkbox"/>	<input type="checkbox"/>	<input type="checkbox"/>	<input type="checkbox"/>	<input type="checkbox"/>	<input type="checkbox"/>	<input type="checkbox"/>	<input type="checkbox"/>	<input type="checkbox"/>	<input type="checkbox"/>	<input type="checkbox"/>	<input type="checkbox"/>	<input type="checkbox"/>
Other:	<input type="checkbox"/>	<input type="checkbox"/>	<input type="checkbox"/>	<input type="checkbox"/>	<input type="checkbox"/>	<input type="checkbox"/>	<input type="checkbox"/>	<input type="checkbox"/>	<input type="checkbox"/>	<input type="checkbox"/>	<input type="checkbox"/>	<input type="checkbox"/>	<input type="checkbox"/>	<input type="checkbox"/>
Other:	<input type="checkbox"/>	<input type="checkbox"/>	<input type="checkbox"/>	<input type="checkbox"/>	<input type="checkbox"/>	<input type="checkbox"/>	<input type="checkbox"/>	<input type="checkbox"/>	<input type="checkbox"/>	<input type="checkbox"/>	<input type="checkbox"/>	<input type="checkbox"/>	<input type="checkbox"/>	<input type="checkbox"/>
Other:	<input type="checkbox"/>	<input type="checkbox"/>	<input type="checkbox"/>	<input type="checkbox"/>	<input type="checkbox"/>	<input type="checkbox"/>	<input type="checkbox"/>	<input type="checkbox"/>	<input type="checkbox"/>	<input type="checkbox"/>	<input type="checkbox"/>	<input type="checkbox"/>	<input type="checkbox"/>	<input type="checkbox"/>

Notes:

Figure B-29. Area Limitation Worksheet Template

**SUGGESTED TEMPLATES FOR STEP THREE OF THE TMD IPB PROCESS
"EVALUATE THE TM FORCE"**

DTG: _____	Classification: _____	Page: ___ of: ___			
Doctrinal Template(s) Requirements Template (U)					
	Required	Optional	Not Required	Status (G, Y, R)	
Organizational / C1 Templates					Doctrinal Template Purpose
National Level Organization and Command & Control	<input type="checkbox"/>	<input type="checkbox"/>	<input type="checkbox"/>	<input type="checkbox"/>	Provide a adversary TM force level braakout of major assigned units, equipment, command, and control
Adversary TM Unit TO&E	<input type="checkbox"/>	<input type="checkbox"/>	<input type="checkbox"/>	<input type="checkbox"/>	Provide the adversary TM force organizational structure and assigned equipment by brigade
Adversary TM Communications Structure	<input type="checkbox"/>	<input type="checkbox"/>	<input type="checkbox"/>	<input type="checkbox"/>	Provide the adversary TM force unit level command and control structure
Other: <input style="width:150px;" type="text"/>	<input type="checkbox"/>	<input type="checkbox"/>	<input type="checkbox"/>	<input type="checkbox"/>	
Other: <input style="width:150px;" type="text"/>	<input type="checkbox"/>	<input type="checkbox"/>	<input type="checkbox"/>	<input type="checkbox"/>	
Other: <input style="width:150px;" type="text"/>	<input type="checkbox"/>	<input type="checkbox"/>	<input type="checkbox"/>	<input type="checkbox"/>	
Equipment Templates					
Missile	<input type="checkbox"/>	<input type="checkbox"/>	<input type="checkbox"/>	<input type="checkbox"/>	Provide detailed equipment information and graphics for adversary theater missiles
Launcher	<input type="checkbox"/>	<input type="checkbox"/>	<input type="checkbox"/>	<input type="checkbox"/>	Provide detailed equipment information and graphics for adversary TM launchers
Radar	<input type="checkbox"/>	<input type="checkbox"/>	<input type="checkbox"/>	<input type="checkbox"/>	Provide detailed equipment information and graphics for adversary TM radars
Ground Support Equipment	<input type="checkbox"/>	<input type="checkbox"/>	<input type="checkbox"/>	<input type="checkbox"/>	Provide detailed equipment information and graphics for adversary TM ground support equipment
Other: <input style="width:150px;" type="text"/>	<input type="checkbox"/>	<input type="checkbox"/>	<input type="checkbox"/>	<input type="checkbox"/>	
Other: <input style="width:150px;" type="text"/>	<input type="checkbox"/>	<input type="checkbox"/>	<input type="checkbox"/>	<input type="checkbox"/>	
Other: <input style="width:150px;" type="text"/>	<input type="checkbox"/>	<input type="checkbox"/>	<input type="checkbox"/>	<input type="checkbox"/>	
TTP Templates					
Adversary TM Force Attack Objectives	<input type="checkbox"/>	<input type="checkbox"/>	<input type="checkbox"/>	<input type="checkbox"/>	Provide the adversary TM force attack objectives
Adversary TM Force Potential Target List	<input type="checkbox"/>	<input type="checkbox"/>	<input type="checkbox"/>	<input type="checkbox"/>	Provide assessment of potential adversary TM force target list
Adversary TM Unit Functional Breakout	<input type="checkbox"/>	<input type="checkbox"/>	<input type="checkbox"/>	<input type="checkbox"/>	Provide a functional breakout of the adversary TM force units
Adversary TM Unit Spatial Deployment TTP	<input type="checkbox"/>	<input type="checkbox"/>	<input type="checkbox"/>	<input type="checkbox"/>	Provide the spatial deployment patterns for adversary TM force units
Adversary TM Employment TTP	<input type="checkbox"/>	<input type="checkbox"/>	<input type="checkbox"/>	<input type="checkbox"/>	Provide the employment TTP for adversary TM force units
Other: <input style="width:150px;" type="text"/>	<input type="checkbox"/>	<input type="checkbox"/>	<input type="checkbox"/>	<input type="checkbox"/>	
Other: <input style="width:150px;" type="text"/>	<input type="checkbox"/>	<input type="checkbox"/>	<input type="checkbox"/>	<input type="checkbox"/>	
Other: <input style="width:150px;" type="text"/>	<input type="checkbox"/>	<input type="checkbox"/>	<input type="checkbox"/>	<input type="checkbox"/>	
Operational State Templates					
National Level Garrison - Peacetime	<input type="checkbox"/>	<input type="checkbox"/>	<input type="checkbox"/>	<input type="checkbox"/>	Provide the operational state diagrams and timelines for the day-to-day peacetime adversary TM force garrison
National Level Training	<input type="checkbox"/>	<input type="checkbox"/>	<input type="checkbox"/>	<input type="checkbox"/>	Provide the operational state diagrams and timelines for national level adversary TM force level training
National Level Operational Testing	<input type="checkbox"/>	<input type="checkbox"/>	<input type="checkbox"/>	<input type="checkbox"/>	Provide the operational state diagrams and timelines for national level adversary TM force operational testing
National Level RDT&E Testing	<input type="checkbox"/>	<input type="checkbox"/>	<input type="checkbox"/>	<input type="checkbox"/>	Provide the operational state diagrams and timelines for national level adversary TM force RDT&E testing
National Level Depot and Storage	<input type="checkbox"/>	<input type="checkbox"/>	<input type="checkbox"/>	<input type="checkbox"/>	Provide the operational state diagrams and timelines for national level adversary TM force depot and storage
Peacetime National Level to Field Garrison Deployment	<input type="checkbox"/>	<input type="checkbox"/>	<input type="checkbox"/>	<input type="checkbox"/>	Provide the operational state diagrams and timelines for peacetime national to field garrison deployments
Crisis National Level to Field Garrison Deployment	<input type="checkbox"/>	<input type="checkbox"/>	<input type="checkbox"/>	<input type="checkbox"/>	Provide the operational state diagrams and timelines for crisis national to field garrison deployments
Field Level Garrison - Peacetime	<input type="checkbox"/>	<input type="checkbox"/>	<input type="checkbox"/>	<input type="checkbox"/>	Provide the operational state diagrams and timelines for the day-to-day peacetime adversary TM force garrison
Field Level Training	<input type="checkbox"/>	<input type="checkbox"/>	<input type="checkbox"/>	<input type="checkbox"/>	Provide the operational state diagrams and timelines for field level adversary TM force level training
Field Level Depot and Storage	<input type="checkbox"/>	<input type="checkbox"/>	<input type="checkbox"/>	<input type="checkbox"/>	Provide the operational state diagrams and timelines for field level adversary TM force depot and storage
Peacetime Field Level to Field Operating Area Deployment	<input type="checkbox"/>	<input type="checkbox"/>	<input type="checkbox"/>	<input type="checkbox"/>	Provide the operational state diagrams and timelines for peacetime garrison to field op area deployments
Crisis Field Level to Field Operating Area Deployment	<input type="checkbox"/>	<input type="checkbox"/>	<input type="checkbox"/>	<input type="checkbox"/>	Provide the operational state diagrams and timelines for crisis garrison to field op area deployments
Field Storage	<input type="checkbox"/>	<input type="checkbox"/>	<input type="checkbox"/>	<input type="checkbox"/>	Provide the operational state diagrams and timelines for field op area field storage
Field Warhead Matng Operations	<input type="checkbox"/>	<input type="checkbox"/>	<input type="checkbox"/>	<input type="checkbox"/>	Provide the operational state diagrams and timelines for field op area warhead-to-missile mating operations
Field Fueling Operations	<input type="checkbox"/>	<input type="checkbox"/>	<input type="checkbox"/>	<input type="checkbox"/>	Provide the operational state diagrams and timelines for field op area missile fueling operations
Field Checkout Operations	<input type="checkbox"/>	<input type="checkbox"/>	<input type="checkbox"/>	<input type="checkbox"/>	Provide the operational state diagrams and timelines for field op area missile checkout operations
Field Transload Operations	<input type="checkbox"/>	<input type="checkbox"/>	<input type="checkbox"/>	<input type="checkbox"/>	Provide the operational state diagrams and timelines for field op area missile transload operations
Field Hide Operations	<input type="checkbox"/>	<input type="checkbox"/>	<input type="checkbox"/>	<input type="checkbox"/>	Provide the operational state diagrams and timelines for field op area TM launcher hide operations
Field Fire Control Operations	<input type="checkbox"/>	<input type="checkbox"/>	<input type="checkbox"/>	<input type="checkbox"/>	Provide the operational state diagrams and timelines for field op area TM fire control operations
Field Launch Operations	<input type="checkbox"/>	<input type="checkbox"/>	<input type="checkbox"/>	<input type="checkbox"/>	Provide the operational state diagrams and timelines for field op area missile launch operations
Field Targeting Operations	<input type="checkbox"/>	<input type="checkbox"/>	<input type="checkbox"/>	<input type="checkbox"/>	Provide the operational state diagrams and timelines for field op area TM targeting operations
Field Communications Operations	<input type="checkbox"/>	<input type="checkbox"/>	<input type="checkbox"/>	<input type="checkbox"/>	Provide the operational state diagrams and timelines for field op area communications operations
Other: <input style="width:150px;" type="text"/>	<input type="checkbox"/>	<input type="checkbox"/>	<input type="checkbox"/>	<input type="checkbox"/>	
Other: <input style="width:150px;" type="text"/>	<input type="checkbox"/>	<input type="checkbox"/>	<input type="checkbox"/>	<input type="checkbox"/>	
Other: <input style="width:150px;" type="text"/>	<input type="checkbox"/>	<input type="checkbox"/>	<input type="checkbox"/>	<input type="checkbox"/>	
TMD IPB Template -- 18 March 2000			Classification: _____		Local Reproduction Authorized

Figure B-30. Doctrinal Templates Requirements Template

TM Equipment Template (U)

<p>System Image</p> <div style="border: 1px solid black; height: 150px;"></div>	<p>System Altitude versus Ground Range Trajectory plot</p> <div style="border: 1px solid black; height: 150px;"></div>
--	---

<p>System Internal and / or External Drawings</p> <div style="border: 1px solid black; height: 150px;"></div>	<p>Typical System Flight Profile with Major System Events</p> <div style="border: 1px solid black; height: 150px;"></div>
--	--

<p align="center">General Data</p> <table style="width:100%; border-collapse: collapse;"> <tr><td>Primary TM System Name</td><td><input type="text"/></td><td></td></tr> <tr><td>TM System Designator</td><td><input type="text"/></td><td></td></tr> <tr><td>Indigenous TM System Designator</td><td><input type="text"/></td><td></td></tr> <tr><td>Number of Stages</td><td><input type="text"/></td><td align="right">#</td></tr> <tr><td>Stage Propulsion Types</td><td><input type="text"/></td><td></td></tr> <tr><td>Total Missile Length</td><td><input type="text"/></td><td align="right">M</td></tr> <tr><td>Payload Length</td><td><input type="text"/></td><td align="right">M</td></tr> <tr><td>Maximum Missile Diameter (less fins or wings)</td><td><input type="text"/></td><td align="right">M</td></tr> <tr><td>Missile Diameter / Wing Span (with fins or wings)</td><td><input type="text"/></td><td align="right">M</td></tr> <tr><td colspan="3" style="text-align: center;">Payload Data</td></tr> <tr><td>Payload Options</td><td><input type="text"/></td><td></td></tr> <tr><td>Type of Guidance, Navigation, and Control</td><td><input type="text"/></td><td></td></tr> <tr><td>Typical Payload Mass</td><td><input type="text"/></td><td align="right">Kg</td></tr> <tr><td>Typical Warhead Mass</td><td><input type="text"/></td><td align="right">Kg</td></tr> </table>	Primary TM System Name	<input type="text"/>		TM System Designator	<input type="text"/>		Indigenous TM System Designator	<input type="text"/>		Number of Stages	<input type="text"/>	#	Stage Propulsion Types	<input type="text"/>		Total Missile Length	<input type="text"/>	M	Payload Length	<input type="text"/>	M	Maximum Missile Diameter (less fins or wings)	<input type="text"/>	M	Missile Diameter / Wing Span (with fins or wings)	<input type="text"/>	M	Payload Data			Payload Options	<input type="text"/>		Type of Guidance, Navigation, and Control	<input type="text"/>		Typical Payload Mass	<input type="text"/>	Kg	Typical Warhead Mass	<input type="text"/>	Kg	<p align="center">Performance Data</p> <table style="width:100%; border-collapse: collapse;"> <tr><td>Maximum Range</td><td><input type="text"/></td><td align="right">Km</td></tr> <tr><td>2/3 Range</td><td><input type="text"/></td><td align="right">Km</td></tr> <tr><td>Minimum Range</td><td><input type="text"/></td><td align="right">Km</td></tr> <tr><td>Maximum Apogee or Altitude</td><td><input type="text"/></td><td align="right">M</td></tr> <tr><td>Cruising Altitude</td><td><input type="text"/></td><td align="right">M</td></tr> <tr><td>Maximum Time of Flight</td><td><input type="text"/></td><td align="right">Seconds</td></tr> <tr><td>Maximum Operation Time for Propulsion System</td><td><input type="text"/></td><td align="right">Seconds</td></tr> <tr><td>CEP or Accuracy</td><td><input type="text"/></td><td align="right">M</td></tr> <tr><td>Total Missile Reliability</td><td><input type="text"/></td><td align="right">%</td></tr> <tr><td colspan="3" style="text-align: center;">Typical Nose-On (+/- degrees) Signature Data</td></tr> <tr><td>10 GHz Median RCS (Circular)</td><td><input type="text"/></td><td align="right">DBsm</td></tr> <tr><td>5.5 GHz Median RCS (Circular)</td><td><input type="text"/></td><td align="right">DBsm</td></tr> <tr><td>3 GHz Median RCS (Circular)</td><td><input type="text"/></td><td align="right">DBsm</td></tr> <tr><td>10 GHz Median RCS (Horizontal)</td><td><input type="text"/></td><td align="right">DBsm</td></tr> <tr><td>5.5 GHz Median RCS (Horizontal)</td><td><input type="text"/></td><td align="right">DBsm</td></tr> <tr><td>3 GHz Median RCS (Horizontal)</td><td><input type="text"/></td><td align="right">DBsm</td></tr> </table>	Maximum Range	<input type="text"/>	Km	2/3 Range	<input type="text"/>	Km	Minimum Range	<input type="text"/>	Km	Maximum Apogee or Altitude	<input type="text"/>	M	Cruising Altitude	<input type="text"/>	M	Maximum Time of Flight	<input type="text"/>	Seconds	Maximum Operation Time for Propulsion System	<input type="text"/>	Seconds	CEP or Accuracy	<input type="text"/>	M	Total Missile Reliability	<input type="text"/>	%	Typical Nose-On (+/- degrees) Signature Data			10 GHz Median RCS (Circular)	<input type="text"/>	DBsm	5.5 GHz Median RCS (Circular)	<input type="text"/>	DBsm	3 GHz Median RCS (Circular)	<input type="text"/>	DBsm	10 GHz Median RCS (Horizontal)	<input type="text"/>	DBsm	5.5 GHz Median RCS (Horizontal)	<input type="text"/>	DBsm	3 GHz Median RCS (Horizontal)	<input type="text"/>	DBsm
Primary TM System Name	<input type="text"/>																																																																																										
TM System Designator	<input type="text"/>																																																																																										
Indigenous TM System Designator	<input type="text"/>																																																																																										
Number of Stages	<input type="text"/>	#																																																																																									
Stage Propulsion Types	<input type="text"/>																																																																																										
Total Missile Length	<input type="text"/>	M																																																																																									
Payload Length	<input type="text"/>	M																																																																																									
Maximum Missile Diameter (less fins or wings)	<input type="text"/>	M																																																																																									
Missile Diameter / Wing Span (with fins or wings)	<input type="text"/>	M																																																																																									
Payload Data																																																																																											
Payload Options	<input type="text"/>																																																																																										
Type of Guidance, Navigation, and Control	<input type="text"/>																																																																																										
Typical Payload Mass	<input type="text"/>	Kg																																																																																									
Typical Warhead Mass	<input type="text"/>	Kg																																																																																									
Maximum Range	<input type="text"/>	Km																																																																																									
2/3 Range	<input type="text"/>	Km																																																																																									
Minimum Range	<input type="text"/>	Km																																																																																									
Maximum Apogee or Altitude	<input type="text"/>	M																																																																																									
Cruising Altitude	<input type="text"/>	M																																																																																									
Maximum Time of Flight	<input type="text"/>	Seconds																																																																																									
Maximum Operation Time for Propulsion System	<input type="text"/>	Seconds																																																																																									
CEP or Accuracy	<input type="text"/>	M																																																																																									
Total Missile Reliability	<input type="text"/>	%																																																																																									
Typical Nose-On (+/- degrees) Signature Data																																																																																											
10 GHz Median RCS (Circular)	<input type="text"/>	DBsm																																																																																									
5.5 GHz Median RCS (Circular)	<input type="text"/>	DBsm																																																																																									
3 GHz Median RCS (Circular)	<input type="text"/>	DBsm																																																																																									
10 GHz Median RCS (Horizontal)	<input type="text"/>	DBsm																																																																																									
5.5 GHz Median RCS (Horizontal)	<input type="text"/>	DBsm																																																																																									
3 GHz Median RCS (Horizontal)	<input type="text"/>	DBsm																																																																																									

Notes:

Figure B-31. TM Equipment Template

TM Equipment List Template (U)

National Level Equipment List
 Unit Level Equipment List
 Facility / Area Level Equipment List

Unit or Facility or Area Identification	Equipment Class		
TM System			
Missile Launcher			
Fire Control			
Missile Handling			
Missile Checkout			
Missile Fueling			
Missile Support			
Site Survey Support			
Meteorological Support			
Engineer			
Security			
General Support			
Other			

Figure B-32. TM Equipment List Template

DTG: _____	Classification: _____	Page: ____ of: ____
TM System Ground Vehicle Equipment Template (U)		
Vehicle Designator / Name	<input style="width: 100%;" type="text"/>	
Vehicle Purpose / Class	<input style="width: 100%;" type="text"/>	
Associated Missile System	<input style="width: 100%;" type="text"/>	
Length	<input style="width: 50%;" type="text"/> Meters	Maximum On-Road Speed
Width	<input style="width: 50%;" type="text"/> Meters	<input style="width: 50%;" type="text"/> Kph
Height	<input style="width: 50%;" type="text"/> Meters	Maximum Off-Road Speed
Gross Vehicle Weight (GVW)	<input style="width: 50%;" type="text"/> Kg	<input style="width: 50%;" type="text"/> Kph
Military Load Class	<input style="width: 50%;" type="text"/> Tons	Restricted Speed Range
Maximum Payload Capacity	<input style="width: 50%;" type="text"/> Kg	<input style="width: 50%;" type="text"/> Km
Drive Configuration	<input style="width: 50%;" type="text"/>	Severely Restricted Speed Range
Engine Power	<input style="width: 50%;" type="text"/> KW	<input style="width: 50%;" type="text"/> Km
Maximum On-Road Range	<input style="width: 50%;" type="text"/> Km	Ground Clearance
Maximum Off-Road Range	<input style="width: 50%;" type="text"/> Km	<input style="width: 50%;" type="text"/> Meters
Fuel Consumption-to-Payload	<input style="width: 50%;" type="text"/> L/100 km x 1,000 kg	Approach Angle
Vehicle Cone Index 1 Pass (VCI)	<input style="width: 50%;" type="text"/> #	<input style="width: 50%;" type="text"/> Degrees
		Departure Angle
		<input style="width: 50%;" type="text"/> Degrees
		Trench Crossing Ability
		<input style="width: 50%;" type="text"/> Meters
		Ford Depth
		<input style="width: 50%;" type="text"/> Meters
		Maximum On-Road Gradability
		<input style="width: 50%;" type="text"/> Deg of slope
		Maximum Off-Road Gradability
		<input style="width: 50%;" type="text"/> Deg of slope
		Minimum Turning Radius
		<input style="width: 50%;" type="text"/> Meters
		Crew Size
		<input style="width: 50%;" type="text"/> #
Left Side View / Image		
Right Side View / Image		
Top View / Image	Front View / Image	Rear View / Image
3D Perspective View / Image		
Image		
Notes:		

Figure B-33. TM System Ground Vehicle Equipment Template

TM Force Attack Objectives Worksheet Template (U)

Specific Missile Event and/or Broad TM Force COA

TM Attack Coordinated with Other Forces

None
 Strategic
 Tactical
 Ground Forces
 Air Forces
 Naval Forces
 Other: _____

TM Attack Decision Factors

Is the attack to be coordinated with other operations? No Yes, Explain: _____
 Is timely ISR required? No Yes, Explain: _____
 Is collateral damage a concern? No Yes, Explain: _____
 Is the attack likely to divert U.S. / Allied air power? No Yes, Explain: _____
 Are U.S. / Allied active TMD assets deployed? No Yes, Explain: _____

Theater Missile Weapon System Factors

Missile System	CEP (m)	Accuracy Class	Warhead Types Available							
		<input type="checkbox"/> Point <input type="checkbox"/> Area	<input type="checkbox"/> Unitary HE	<input type="checkbox"/> Unitary Nuclear	<input type="checkbox"/> Unitary Frag	<input type="checkbox"/> Unitary BW	<input type="checkbox"/> Cluster HE	<input type="checkbox"/> Cluster Frag	<input type="checkbox"/> Unitary CW	<input type="checkbox"/> Cluster CW
			<input type="checkbox"/> Unitary Nuclear	<input type="checkbox"/> Unitary BW	<input type="checkbox"/> Cluster HE	<input type="checkbox"/> Cluster BW	<input type="checkbox"/> ARM	<input type="checkbox"/> FAE	<input type="checkbox"/> EMP	

Missile System	CEP (m)	Accuracy Class	Warhead Types Available							
		<input type="checkbox"/> Point <input type="checkbox"/> Area	<input type="checkbox"/> Unitary HE	<input type="checkbox"/> Unitary Nuclear	<input type="checkbox"/> Unitary Frag	<input type="checkbox"/> Unitary BW	<input type="checkbox"/> Cluster HE	<input type="checkbox"/> Cluster Frag	<input type="checkbox"/> Unitary CW	<input type="checkbox"/> Cluster CW
			<input type="checkbox"/> Unitary Nuclear	<input type="checkbox"/> Unitary BW	<input type="checkbox"/> Cluster HE	<input type="checkbox"/> Cluster BW	<input type="checkbox"/> ARM	<input type="checkbox"/> FAE	<input type="checkbox"/> EMP	

Missile System	CEP (m)	Accuracy Class	Warhead Types Available							
		<input type="checkbox"/> Point <input type="checkbox"/> Area	<input type="checkbox"/> Unitary HE	<input type="checkbox"/> Unitary Nuclear	<input type="checkbox"/> Unitary Frag	<input type="checkbox"/> Unitary BW	<input type="checkbox"/> Cluster HE	<input type="checkbox"/> Cluster Frag	<input type="checkbox"/> Unitary CW	<input type="checkbox"/> Cluster CW
			<input type="checkbox"/> Unitary Nuclear	<input type="checkbox"/> Unitary BW	<input type="checkbox"/> Cluster HE	<input type="checkbox"/> Cluster BW	<input type="checkbox"/> ARM	<input type="checkbox"/> FAE	<input type="checkbox"/> EMP	

Missile System	CEP (m)	Accuracy Class	Warhead Types Available							
		<input type="checkbox"/> Point <input type="checkbox"/> Area	<input type="checkbox"/> Unitary HE	<input type="checkbox"/> Unitary Nuclear	<input type="checkbox"/> Unitary Frag	<input type="checkbox"/> Unitary BW	<input type="checkbox"/> Cluster HE	<input type="checkbox"/> Cluster Frag	<input type="checkbox"/> Unitary CW	<input type="checkbox"/> Cluster CW
			<input type="checkbox"/> Unitary Nuclear	<input type="checkbox"/> Unitary BW	<input type="checkbox"/> Cluster HE	<input type="checkbox"/> Cluster BW	<input type="checkbox"/> ARM	<input type="checkbox"/> FAE	<input type="checkbox"/> EMP	

Targeting Objective(s)	TM Suitable	Priority	Time Urgent	Only Major	Only Selected	All	Unspecified	Do Not Target	Destroy	Degrade	Suppress	Temporary	Permanent	Target Category Code(s) or Selected Target(s)
Military (Counterforce)	<input type="checkbox"/>	<input type="checkbox"/>	<input type="checkbox"/>	<input type="checkbox"/>	<input type="checkbox"/>	<input type="checkbox"/>	<input type="checkbox"/>	<input type="checkbox"/>	<input type="checkbox"/>	<input type="checkbox"/>	<input type="checkbox"/>	<input type="checkbox"/>	<input type="checkbox"/>	
Hardened Targets	<input type="checkbox"/>	<input type="checkbox"/>	<input type="checkbox"/>	<input type="checkbox"/>	<input type="checkbox"/>	<input type="checkbox"/>	<input type="checkbox"/>	<input type="checkbox"/>	<input type="checkbox"/>	<input type="checkbox"/>	<input type="checkbox"/>	<input type="checkbox"/>	<input type="checkbox"/>	
Airfields	<input type="checkbox"/>	<input type="checkbox"/>	<input type="checkbox"/>	<input type="checkbox"/>	<input type="checkbox"/>	<input type="checkbox"/>	<input type="checkbox"/>	<input type="checkbox"/>	<input type="checkbox"/>	<input type="checkbox"/>	<input type="checkbox"/>	<input type="checkbox"/>	<input type="checkbox"/>	
Naval Vessels	<input type="checkbox"/>	<input type="checkbox"/>	<input type="checkbox"/>	<input type="checkbox"/>	<input type="checkbox"/>	<input type="checkbox"/>	<input type="checkbox"/>	<input type="checkbox"/>	<input type="checkbox"/>	<input type="checkbox"/>	<input type="checkbox"/>	<input type="checkbox"/>	<input type="checkbox"/>	
Commercial Ships	<input type="checkbox"/>	<input type="checkbox"/>	<input type="checkbox"/>	<input type="checkbox"/>	<input type="checkbox"/>	<input type="checkbox"/>	<input type="checkbox"/>	<input type="checkbox"/>	<input type="checkbox"/>	<input type="checkbox"/>	<input type="checkbox"/>	<input type="checkbox"/>	<input type="checkbox"/>	
Troop Concentrations	<input type="checkbox"/>	<input type="checkbox"/>	<input type="checkbox"/>	<input type="checkbox"/>	<input type="checkbox"/>	<input type="checkbox"/>	<input type="checkbox"/>	<input type="checkbox"/>	<input type="checkbox"/>	<input type="checkbox"/>	<input type="checkbox"/>	<input type="checkbox"/>	<input type="checkbox"/>	
Armored Vehicles	<input type="checkbox"/>	<input type="checkbox"/>	<input type="checkbox"/>	<input type="checkbox"/>	<input type="checkbox"/>	<input type="checkbox"/>	<input type="checkbox"/>	<input type="checkbox"/>	<input type="checkbox"/>	<input type="checkbox"/>	<input type="checkbox"/>	<input type="checkbox"/>	<input type="checkbox"/>	
Ports / Naval Bases	<input type="checkbox"/>	<input type="checkbox"/>	<input type="checkbox"/>	<input type="checkbox"/>	<input type="checkbox"/>	<input type="checkbox"/>	<input type="checkbox"/>	<input type="checkbox"/>	<input type="checkbox"/>	<input type="checkbox"/>	<input type="checkbox"/>	<input type="checkbox"/>	<input type="checkbox"/>	
LOCs	<input type="checkbox"/>	<input type="checkbox"/>	<input type="checkbox"/>	<input type="checkbox"/>	<input type="checkbox"/>	<input type="checkbox"/>	<input type="checkbox"/>	<input type="checkbox"/>	<input type="checkbox"/>	<input type="checkbox"/>	<input type="checkbox"/>	<input type="checkbox"/>	<input type="checkbox"/>	
Bridges / Dams / Waterways	<input type="checkbox"/>	<input type="checkbox"/>	<input type="checkbox"/>	<input type="checkbox"/>	<input type="checkbox"/>	<input type="checkbox"/>	<input type="checkbox"/>	<input type="checkbox"/>	<input type="checkbox"/>	<input type="checkbox"/>	<input type="checkbox"/>	<input type="checkbox"/>	<input type="checkbox"/>	
Logistics Areas	<input type="checkbox"/>	<input type="checkbox"/>	<input type="checkbox"/>	<input type="checkbox"/>	<input type="checkbox"/>	<input type="checkbox"/>	<input type="checkbox"/>	<input type="checkbox"/>	<input type="checkbox"/>	<input type="checkbox"/>	<input type="checkbox"/>	<input type="checkbox"/>	<input type="checkbox"/>	
Radar / Air Defense / TMD	<input type="checkbox"/>	<input type="checkbox"/>	<input type="checkbox"/>	<input type="checkbox"/>	<input type="checkbox"/>	<input type="checkbox"/>	<input type="checkbox"/>	<input type="checkbox"/>	<input type="checkbox"/>	<input type="checkbox"/>	<input type="checkbox"/>	<input type="checkbox"/>	<input type="checkbox"/>	
Economic (Countervalue)	<input type="checkbox"/>	<input type="checkbox"/>	<input type="checkbox"/>	<input type="checkbox"/>	<input type="checkbox"/>	<input type="checkbox"/>	<input type="checkbox"/>	<input type="checkbox"/>	<input type="checkbox"/>	<input type="checkbox"/>	<input type="checkbox"/>	<input type="checkbox"/>	<input type="checkbox"/>	
Industry	<input type="checkbox"/>	<input type="checkbox"/>	<input type="checkbox"/>	<input type="checkbox"/>	<input type="checkbox"/>	<input type="checkbox"/>	<input type="checkbox"/>	<input type="checkbox"/>	<input type="checkbox"/>	<input type="checkbox"/>	<input type="checkbox"/>	<input type="checkbox"/>	<input type="checkbox"/>	
Power	<input type="checkbox"/>	<input type="checkbox"/>	<input type="checkbox"/>	<input type="checkbox"/>	<input type="checkbox"/>	<input type="checkbox"/>	<input type="checkbox"/>	<input type="checkbox"/>	<input type="checkbox"/>	<input type="checkbox"/>	<input type="checkbox"/>	<input type="checkbox"/>	<input type="checkbox"/>	
POL	<input type="checkbox"/>	<input type="checkbox"/>	<input type="checkbox"/>	<input type="checkbox"/>	<input type="checkbox"/>	<input type="checkbox"/>	<input type="checkbox"/>	<input type="checkbox"/>	<input type="checkbox"/>	<input type="checkbox"/>	<input type="checkbox"/>	<input type="checkbox"/>	<input type="checkbox"/>	
Transportation	<input type="checkbox"/>	<input type="checkbox"/>	<input type="checkbox"/>	<input type="checkbox"/>	<input type="checkbox"/>	<input type="checkbox"/>	<input type="checkbox"/>	<input type="checkbox"/>	<input type="checkbox"/>	<input type="checkbox"/>	<input type="checkbox"/>	<input type="checkbox"/>	<input type="checkbox"/>	
Political (Terror)	<input type="checkbox"/>	<input type="checkbox"/>	<input type="checkbox"/>	<input type="checkbox"/>	<input type="checkbox"/>	<input type="checkbox"/>	<input type="checkbox"/>	<input type="checkbox"/>	<input type="checkbox"/>	<input type="checkbox"/>	<input type="checkbox"/>	<input type="checkbox"/>	<input type="checkbox"/>	
Population Centers	<input type="checkbox"/>	<input type="checkbox"/>	<input type="checkbox"/>	<input type="checkbox"/>	<input type="checkbox"/>	<input type="checkbox"/>	<input type="checkbox"/>	<input type="checkbox"/>	<input type="checkbox"/>	<input type="checkbox"/>	<input type="checkbox"/>	<input type="checkbox"/>	<input type="checkbox"/>	
Government Control	<input type="checkbox"/>	<input type="checkbox"/>	<input type="checkbox"/>	<input type="checkbox"/>	<input type="checkbox"/>	<input type="checkbox"/>	<input type="checkbox"/>	<input type="checkbox"/>	<input type="checkbox"/>	<input type="checkbox"/>	<input type="checkbox"/>	<input type="checkbox"/>	<input type="checkbox"/>	
Cultural Centers	<input type="checkbox"/>	<input type="checkbox"/>	<input type="checkbox"/>	<input type="checkbox"/>	<input type="checkbox"/>	<input type="checkbox"/>	<input type="checkbox"/>	<input type="checkbox"/>	<input type="checkbox"/>	<input type="checkbox"/>	<input type="checkbox"/>	<input type="checkbox"/>	<input type="checkbox"/>	
Other: _____	<input type="checkbox"/>	<input type="checkbox"/>	<input type="checkbox"/>	<input type="checkbox"/>	<input type="checkbox"/>	<input type="checkbox"/>	<input type="checkbox"/>	<input type="checkbox"/>	<input type="checkbox"/>	<input type="checkbox"/>	<input type="checkbox"/>	<input type="checkbox"/>	<input type="checkbox"/>	
Other: _____	<input type="checkbox"/>	<input type="checkbox"/>	<input type="checkbox"/>	<input type="checkbox"/>	<input type="checkbox"/>	<input type="checkbox"/>	<input type="checkbox"/>	<input type="checkbox"/>	<input type="checkbox"/>	<input type="checkbox"/>	<input type="checkbox"/>	<input type="checkbox"/>	<input type="checkbox"/>	

Notes:

Figure B-34. TM Force Attack Objectives Worksheet Template

DTG: _____	Classification: _____	Page: ___ of: ___
TM Unit Functional Doctrinal Template (U)		
TM Unit: _____		
TM Unit Function		
TM Unit Functional Relationships		
Notes:		
TMD IPB Template -- 18 March 2000	Classification: _____	Local Reproduction Authorized

Figure B-35. TM Unit Functional Doctrinal Template

DTG: _____	Classification: _____	Page: ____ of: ____		
TM Force Employment Worksheet Template (U)				
Specific Missile Event and/or Broad TM Force COA				
TM System Type 1	_____			
TM System Type 2	_____			
TM System Type 3	_____			
Employment Conditions				
	Minimum / Start	Nominal	Maximum / Stop	Condition
Time of Day for TM Employment	<input type="checkbox"/>	<input type="checkbox"/>	<input type="checkbox"/>	<input type="checkbox"/>
Visibility Conditions for TM Employment	<input type="checkbox"/>	<input type="checkbox"/>	<input type="checkbox"/>	<input type="checkbox"/>
Weather Conditions for TM Employment	<input type="checkbox"/>	<input type="checkbox"/>	<input type="checkbox"/>	<input type="checkbox"/>
TM System Type 2				
	Minimum / Start	Nominal	Maximum / Stop	Condition
Time of Day for Theater Missile Employment	<input type="checkbox"/>	<input type="checkbox"/>	<input type="checkbox"/>	<input type="checkbox"/>
Visibility Conditions for TM Employment	<input type="checkbox"/>	<input type="checkbox"/>	<input type="checkbox"/>	<input type="checkbox"/>
Weather Conditions for TM Employment	<input type="checkbox"/>	<input type="checkbox"/>	<input type="checkbox"/>	<input type="checkbox"/>
TM System Type 3				
	Minimum / Start	Nominal	Maximum / Stop	Condition
Time of Day for TM Employment	<input type="checkbox"/>	<input type="checkbox"/>	<input type="checkbox"/>	<input type="checkbox"/>
Visibility Conditions for TM Employment	<input type="checkbox"/>	<input type="checkbox"/>	<input type="checkbox"/>	<input type="checkbox"/>
Weather Conditions for TM Employment	<input type="checkbox"/>	<input type="checkbox"/>	<input type="checkbox"/>	<input type="checkbox"/>
Employment Characteristics				
	Minimum / Start	Nominal	Maximum / Stop	Condition
Salvo Size	<input type="checkbox"/>	<input type="checkbox"/>	<input type="checkbox"/>	<input type="checkbox"/>
Salvo Launch Time Span	<input type="checkbox"/>	<input type="checkbox"/>	<input type="checkbox"/>	<input type="checkbox"/>
Salvo Arrival Time Span	<input type="checkbox"/>	<input type="checkbox"/>	<input type="checkbox"/>	<input type="checkbox"/>
Salvo Interval	<input type="checkbox"/>	<input type="checkbox"/>	<input type="checkbox"/>	<input type="checkbox"/>
Other: _____	<input type="checkbox"/>	<input type="checkbox"/>	<input type="checkbox"/>	<input type="checkbox"/>
Other: _____	<input type="checkbox"/>	<input type="checkbox"/>	<input type="checkbox"/>	<input type="checkbox"/>
TM System Type 2				
	Minimum / Start	Nominal	Maximum / Stop	Condition
Salvo Size	<input type="checkbox"/>	<input type="checkbox"/>	<input type="checkbox"/>	<input type="checkbox"/>
Salvo Launch Time Span	<input type="checkbox"/>	<input type="checkbox"/>	<input type="checkbox"/>	<input type="checkbox"/>
Salvo Arrival Time Span	<input type="checkbox"/>	<input type="checkbox"/>	<input type="checkbox"/>	<input type="checkbox"/>
Salvo Interval	<input type="checkbox"/>	<input type="checkbox"/>	<input type="checkbox"/>	<input type="checkbox"/>
Other: _____	<input type="checkbox"/>	<input type="checkbox"/>	<input type="checkbox"/>	<input type="checkbox"/>
Other: _____	<input type="checkbox"/>	<input type="checkbox"/>	<input type="checkbox"/>	<input type="checkbox"/>
TM System Type 3				
	Minimum / Start	Nominal	Maximum / Stop	Condition
Salvo Size	<input type="checkbox"/>	<input type="checkbox"/>	<input type="checkbox"/>	<input type="checkbox"/>
Salvo Launch Time Span	<input type="checkbox"/>	<input type="checkbox"/>	<input type="checkbox"/>	<input type="checkbox"/>
Salvo Arrival Time Span	<input type="checkbox"/>	<input type="checkbox"/>	<input type="checkbox"/>	<input type="checkbox"/>
Salvo Interval	<input type="checkbox"/>	<input type="checkbox"/>	<input type="checkbox"/>	<input type="checkbox"/>
Other: _____	<input type="checkbox"/>	<input type="checkbox"/>	<input type="checkbox"/>	<input type="checkbox"/>
Other: _____	<input type="checkbox"/>	<input type="checkbox"/>	<input type="checkbox"/>	<input type="checkbox"/>
Notes:				

Figure B-36. TM Force Employment Worksheet Template (1 of 2)

DTG: _____	Classification: _____	Page: ___ of: ___	
TM Force Employment Worksheet Template (U)			
TARGET CLASS versus TM FORCE versus TARGET SIZE CLASS versus APPLICABLE WARHEAD TYPES			
Target Class	TM	Target Size Class	Applicable Warhead Types
Hardened Targets	<input type="checkbox"/> System Type 1 <input type="checkbox"/> System Type 2 <input type="checkbox"/> System Type 3	<input type="checkbox"/> Point <input type="checkbox"/> Area	<input type="checkbox"/> Unitary HE <input type="checkbox"/> Unitary Frag <input type="checkbox"/> Cluster HE <input type="checkbox"/> Cluster Frag <input type="checkbox"/> Unitary CW <input type="checkbox"/> Cluster CW <input type="checkbox"/> Unitary Nuclear <input type="checkbox"/> Unitary BW <input type="checkbox"/> Cluster BW <input type="checkbox"/> ARM <input type="checkbox"/> FAE <input type="checkbox"/> EMP
Airfields	<input type="checkbox"/> System Type 1 <input type="checkbox"/> System Type 2 <input type="checkbox"/> System Type 3	<input type="checkbox"/> Point <input type="checkbox"/> Area	<input type="checkbox"/> Unitary HE <input type="checkbox"/> Unitary Frag <input type="checkbox"/> Cluster HE <input type="checkbox"/> Cluster Frag <input type="checkbox"/> Unitary CW <input type="checkbox"/> Cluster CW <input type="checkbox"/> Unitary Nuclear <input type="checkbox"/> Unitary BW <input type="checkbox"/> Cluster BW <input type="checkbox"/> ARM <input type="checkbox"/> FAE <input type="checkbox"/> EMP
Naval Vessels	<input type="checkbox"/> System Type 1 <input type="checkbox"/> System Type 2 <input type="checkbox"/> System Type 3	<input type="checkbox"/> Point <input type="checkbox"/> Area	<input type="checkbox"/> Unitary HE <input type="checkbox"/> Unitary Frag <input type="checkbox"/> Cluster HE <input type="checkbox"/> Cluster Frag <input type="checkbox"/> Unitary CW <input type="checkbox"/> Cluster CW <input type="checkbox"/> Unitary Nuclear <input type="checkbox"/> Unitary BW <input type="checkbox"/> Cluster BW <input type="checkbox"/> ARM <input type="checkbox"/> FAE <input type="checkbox"/> EMP
Commercial Ships	<input type="checkbox"/> System Type 1 <input type="checkbox"/> System Type 2 <input type="checkbox"/> System Type 3	<input type="checkbox"/> Point <input type="checkbox"/> Area	<input type="checkbox"/> Unitary HE <input type="checkbox"/> Unitary Frag <input type="checkbox"/> Cluster HE <input type="checkbox"/> Cluster Frag <input type="checkbox"/> Unitary CW <input type="checkbox"/> Cluster CW <input type="checkbox"/> Unitary Nuclear <input type="checkbox"/> Unitary BW <input type="checkbox"/> Cluster BW <input type="checkbox"/> ARM <input type="checkbox"/> FAE <input type="checkbox"/> EMP
Troop Concentrations	<input type="checkbox"/> System Type 1 <input type="checkbox"/> System Type 2 <input type="checkbox"/> System Type 3	<input type="checkbox"/> Point <input type="checkbox"/> Area	<input type="checkbox"/> Unitary HE <input type="checkbox"/> Unitary Frag <input type="checkbox"/> Cluster HE <input type="checkbox"/> Cluster Frag <input type="checkbox"/> Unitary CW <input type="checkbox"/> Cluster CW <input type="checkbox"/> Unitary Nuclear <input type="checkbox"/> Unitary BW <input type="checkbox"/> Cluster BW <input type="checkbox"/> ARM <input type="checkbox"/> FAE <input type="checkbox"/> EMP
Armored Vehicles	<input type="checkbox"/> System Type 1 <input type="checkbox"/> System Type 2 <input type="checkbox"/> System Type 3	<input type="checkbox"/> Point <input type="checkbox"/> Area	<input type="checkbox"/> Unitary HE <input type="checkbox"/> Unitary Frag <input type="checkbox"/> Cluster HE <input type="checkbox"/> Cluster Frag <input type="checkbox"/> Unitary CW <input type="checkbox"/> Cluster CW <input type="checkbox"/> Unitary Nuclear <input type="checkbox"/> Unitary BW <input type="checkbox"/> Cluster BW <input type="checkbox"/> ARM <input type="checkbox"/> FAE <input type="checkbox"/> EMP
Ports & Naval Bases	<input type="checkbox"/> System Type 1 <input type="checkbox"/> System Type 2 <input type="checkbox"/> System Type 3	<input type="checkbox"/> Point <input type="checkbox"/> Area	<input type="checkbox"/> Unitary HE <input type="checkbox"/> Unitary Frag <input type="checkbox"/> Cluster HE <input type="checkbox"/> Cluster Frag <input type="checkbox"/> Unitary CW <input type="checkbox"/> Cluster CW <input type="checkbox"/> Unitary Nuclear <input type="checkbox"/> Unitary BW <input type="checkbox"/> Cluster BW <input type="checkbox"/> ARM <input type="checkbox"/> FAE <input type="checkbox"/> EMP
LOCs	<input type="checkbox"/> System Type 1 <input type="checkbox"/> System Type 2 <input type="checkbox"/> System Type 3	<input type="checkbox"/> Point <input type="checkbox"/> Area	<input type="checkbox"/> Unitary HE <input type="checkbox"/> Unitary Frag <input type="checkbox"/> Cluster HE <input type="checkbox"/> Cluster Frag <input type="checkbox"/> Unitary CW <input type="checkbox"/> Cluster CW <input type="checkbox"/> Unitary Nuclear <input type="checkbox"/> Unitary BW <input type="checkbox"/> Cluster BW <input type="checkbox"/> ARM <input type="checkbox"/> FAE <input type="checkbox"/> EMP
Bridges / Dams / Waterways	<input type="checkbox"/> System Type 1 <input type="checkbox"/> System Type 2 <input type="checkbox"/> System Type 3	<input type="checkbox"/> Point <input type="checkbox"/> Area	<input type="checkbox"/> Unitary HE <input type="checkbox"/> Unitary Frag <input type="checkbox"/> Cluster HE <input type="checkbox"/> Cluster Frag <input type="checkbox"/> Unitary CW <input type="checkbox"/> Cluster CW <input type="checkbox"/> Unitary Nuclear <input type="checkbox"/> Unitary BW <input type="checkbox"/> Cluster BW <input type="checkbox"/> ARM <input type="checkbox"/> FAE <input type="checkbox"/> EMP
Logistics Areas	<input type="checkbox"/> System Type 1 <input type="checkbox"/> System Type 2 <input type="checkbox"/> System Type 3	<input type="checkbox"/> Point <input type="checkbox"/> Area	<input type="checkbox"/> Unitary HE <input type="checkbox"/> Unitary Frag <input type="checkbox"/> Cluster HE <input type="checkbox"/> Cluster Frag <input type="checkbox"/> Unitary CW <input type="checkbox"/> Cluster CW <input type="checkbox"/> Unitary Nuclear <input type="checkbox"/> Unitary BW <input type="checkbox"/> Cluster BW <input type="checkbox"/> ARM <input type="checkbox"/> FAE <input type="checkbox"/> EMP
Radar / Air Defense / TMD	<input type="checkbox"/> System Type 1 <input type="checkbox"/> System Type 2 <input type="checkbox"/> System Type 3	<input type="checkbox"/> Point <input type="checkbox"/> Area	<input type="checkbox"/> Unitary HE <input type="checkbox"/> Unitary Frag <input type="checkbox"/> Cluster HE <input type="checkbox"/> Cluster Frag <input type="checkbox"/> Unitary CW <input type="checkbox"/> Cluster CW <input type="checkbox"/> Unitary Nuclear <input type="checkbox"/> Unitary BW <input type="checkbox"/> Cluster BW <input type="checkbox"/> ARM <input type="checkbox"/> FAE <input type="checkbox"/> EMP
Industry	<input type="checkbox"/> System Type 1 <input type="checkbox"/> System Type 2 <input type="checkbox"/> System Type 3	<input type="checkbox"/> Point <input type="checkbox"/> Area	<input type="checkbox"/> Unitary HE <input type="checkbox"/> Unitary Frag <input type="checkbox"/> Cluster HE <input type="checkbox"/> Cluster Frag <input type="checkbox"/> Unitary CW <input type="checkbox"/> Cluster CW <input type="checkbox"/> Unitary Nuclear <input type="checkbox"/> Unitary BW <input type="checkbox"/> Cluster BW <input type="checkbox"/> ARM <input type="checkbox"/> FAE <input type="checkbox"/> EMP
Power	<input type="checkbox"/> System Type 1 <input type="checkbox"/> System Type 2 <input type="checkbox"/> System Type 3	<input type="checkbox"/> Point <input type="checkbox"/> Area	<input type="checkbox"/> Unitary HE <input type="checkbox"/> Unitary Frag <input type="checkbox"/> Cluster HE <input type="checkbox"/> Cluster Frag <input type="checkbox"/> Unitary CW <input type="checkbox"/> Cluster CW <input type="checkbox"/> Unitary Nuclear <input type="checkbox"/> Unitary BW <input type="checkbox"/> Cluster BW <input type="checkbox"/> ARM <input type="checkbox"/> FAE <input type="checkbox"/> EMP
POL	<input type="checkbox"/> System Type 1 <input type="checkbox"/> System Type 2 <input type="checkbox"/> System Type 3	<input type="checkbox"/> Point <input type="checkbox"/> Area	<input type="checkbox"/> Unitary HE <input type="checkbox"/> Unitary Frag <input type="checkbox"/> Cluster HE <input type="checkbox"/> Cluster Frag <input type="checkbox"/> Unitary CW <input type="checkbox"/> Cluster CW <input type="checkbox"/> Unitary Nuclear <input type="checkbox"/> Unitary BW <input type="checkbox"/> Cluster BW <input type="checkbox"/> ARM <input type="checkbox"/> FAE <input type="checkbox"/> EMP
Transportation	<input type="checkbox"/> System Type 1 <input type="checkbox"/> System Type 2 <input type="checkbox"/> System Type 3	<input type="checkbox"/> Point <input type="checkbox"/> Area	<input type="checkbox"/> Unitary HE <input type="checkbox"/> Unitary Frag <input type="checkbox"/> Cluster HE <input type="checkbox"/> Cluster Frag <input type="checkbox"/> Unitary CW <input type="checkbox"/> Cluster CW <input type="checkbox"/> Unitary Nuclear <input type="checkbox"/> Unitary BW <input type="checkbox"/> Cluster BW <input type="checkbox"/> ARM <input type="checkbox"/> FAE <input type="checkbox"/> EMP
Population Centers	<input type="checkbox"/> System Type 1 <input type="checkbox"/> System Type 2 <input type="checkbox"/> System Type 3	<input type="checkbox"/> Point <input type="checkbox"/> Area	<input type="checkbox"/> Unitary HE <input type="checkbox"/> Unitary Frag <input type="checkbox"/> Cluster HE <input type="checkbox"/> Cluster Frag <input type="checkbox"/> Unitary CW <input type="checkbox"/> Cluster CW <input type="checkbox"/> Unitary Nuclear <input type="checkbox"/> Unitary BW <input type="checkbox"/> Cluster BW <input type="checkbox"/> ARM <input type="checkbox"/> FAE <input type="checkbox"/> EMP
Government Control	<input type="checkbox"/> System Type 1 <input type="checkbox"/> System Type 2 <input type="checkbox"/> System Type 3	<input type="checkbox"/> Point <input type="checkbox"/> Area	<input type="checkbox"/> Unitary HE <input type="checkbox"/> Unitary Frag <input type="checkbox"/> Cluster HE <input type="checkbox"/> Cluster Frag <input type="checkbox"/> Unitary CW <input type="checkbox"/> Cluster CW <input type="checkbox"/> Unitary Nuclear <input type="checkbox"/> Unitary BW <input type="checkbox"/> Cluster BW <input type="checkbox"/> ARM <input type="checkbox"/> FAE <input type="checkbox"/> EMP
Cultural Centers	<input type="checkbox"/> System Type 1 <input type="checkbox"/> System Type 2 <input type="checkbox"/> System Type 3	<input type="checkbox"/> Point <input type="checkbox"/> Area	<input type="checkbox"/> Unitary HE <input type="checkbox"/> Unitary Frag <input type="checkbox"/> Cluster HE <input type="checkbox"/> Cluster Frag <input type="checkbox"/> Unitary CW <input type="checkbox"/> Cluster CW <input type="checkbox"/> Unitary Nuclear <input type="checkbox"/> Unitary BW <input type="checkbox"/> Cluster BW <input type="checkbox"/> ARM <input type="checkbox"/> FAE <input type="checkbox"/> EMP
Other:	<input type="checkbox"/> System Type 1 <input type="checkbox"/> System Type 2 <input type="checkbox"/> System Type 3	<input type="checkbox"/> Point <input type="checkbox"/> Area	<input type="checkbox"/> Unitary HE <input type="checkbox"/> Unitary Frag <input type="checkbox"/> Cluster HE <input type="checkbox"/> Cluster Frag <input type="checkbox"/> Unitary CW <input type="checkbox"/> Cluster CW <input type="checkbox"/> Unitary Nuclear <input type="checkbox"/> Unitary BW <input type="checkbox"/> Cluster BW <input type="checkbox"/> ARM <input type="checkbox"/> FAE <input type="checkbox"/> EMP
Other:	<input type="checkbox"/> System Type 1 <input type="checkbox"/> System Type 2 <input type="checkbox"/> System Type 3	<input type="checkbox"/> Point <input type="checkbox"/> Area	<input type="checkbox"/> Unitary HE <input type="checkbox"/> Unitary Frag <input type="checkbox"/> Cluster HE <input type="checkbox"/> Cluster Frag <input type="checkbox"/> Unitary CW <input type="checkbox"/> Cluster CW <input type="checkbox"/> Unitary Nuclear <input type="checkbox"/> Unitary BW <input type="checkbox"/> Cluster BW <input type="checkbox"/> ARM <input type="checkbox"/> FAE <input type="checkbox"/> EMP
Notes:			

Figure B-36 (Continued). TM Force Employment Worksheet Template (2 of 2)

Time-Pattern Analysis Template (U)

Analysis Focus:

Day 1 Reference: Day of Month Week of Month Day of Week Day Month Yes DTG

Day 21 Reference: Day of Month Week of Month Day of Week Day Month Yes DTG

Analytical Legend:

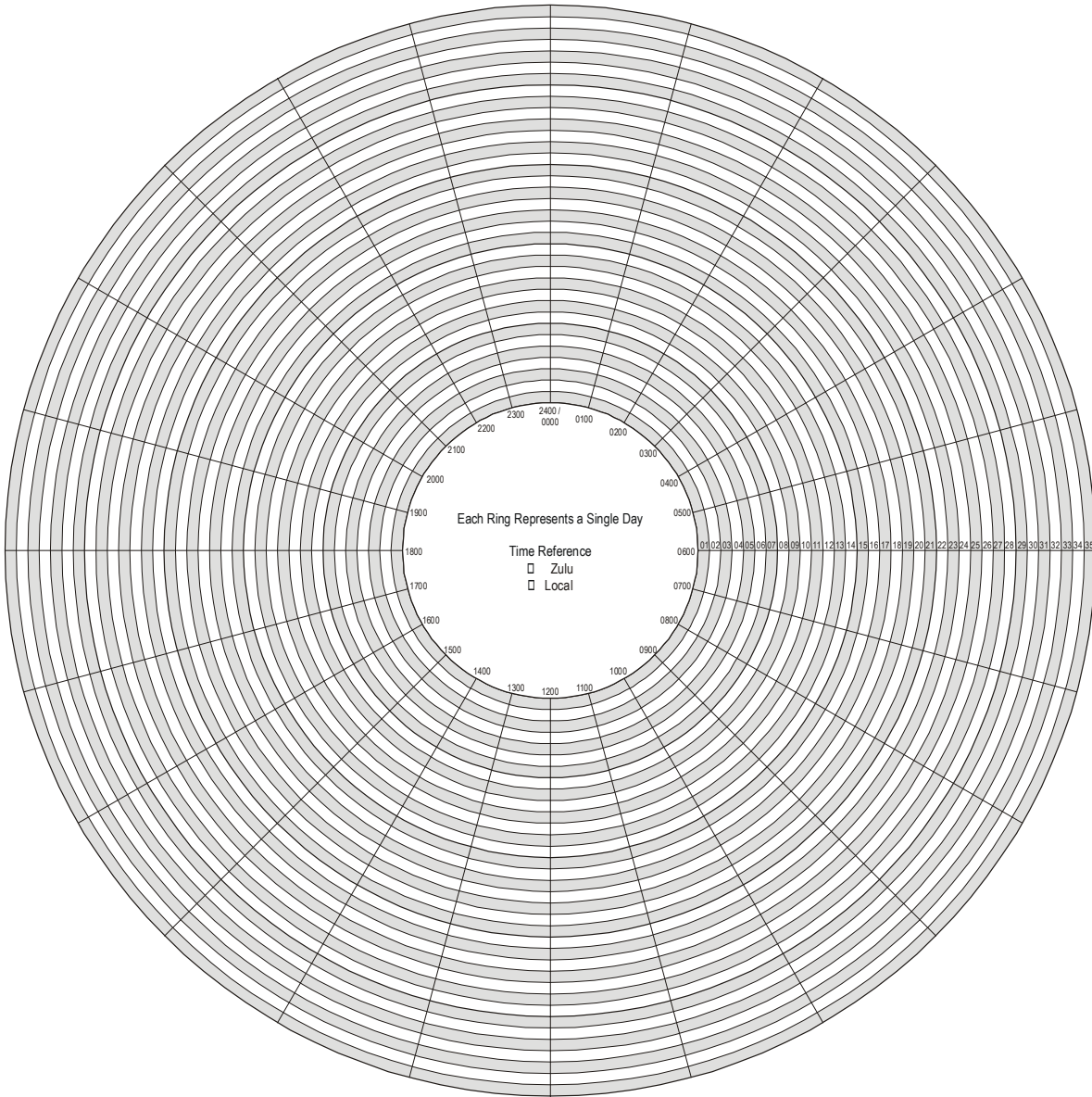

Figure B-37. Time-Pattern Analysis Template

DTG: _____ Classification: _____ Page: ___ of: ___

Date-Pattern Analysis Template (U)

Analysis Focus:

Starting Reference: Month Year DTG

Analytical Legend:

Monday	Tuesday	Wednesday	Thursday	Friday	Saturday	Sunday

Notes:

Day	Week

TMD IPB Template -- 18 March 2000 Classification: _____ Local Reproduction Authorized

Figure B-38. Date-Pattern Analysis Template

DTG: _____	Classification: _____	Page: ____ of: ____
TM Operational State Doctrinal Template (U)		
Analytical Focus:		
Operational State Characteristics:		
Operational State Spatial Relationship:		
TMD IPB Template -- 18 March 2000	Classification: _____	Local Reproduction Authorized

Figure B-39. TM Operational State Doctrinal Template

TM HVT Relative Value Matrix Template (U)

TM Force Broad COA

Applicable Timeframe / Phase

HVT Relative Value Matrix

<input type="checkbox"/> Destroy <input type="checkbox"/> Degrade <input type="checkbox"/> Suppress <input type="checkbox"/> No Action	HVT Set	Applicable Note(s)	Relative Worth (Higher Number = Higher Relative Worth)																				
			1	2	3	4	5	6	7	8	9	10											
<input type="checkbox"/>			<input type="checkbox"/>	<input type="checkbox"/>	<input type="checkbox"/>	<input type="checkbox"/>	<input type="checkbox"/>	<input type="checkbox"/>	<input type="checkbox"/>	<input type="checkbox"/>	<input type="checkbox"/>	<input type="checkbox"/>	<input type="checkbox"/>	<input type="checkbox"/>	<input type="checkbox"/>	<input type="checkbox"/>	<input type="checkbox"/>	<input type="checkbox"/>	<input type="checkbox"/>	<input type="checkbox"/>	<input type="checkbox"/>	<input type="checkbox"/>	<input type="checkbox"/>
<input type="checkbox"/>			<input type="checkbox"/>	<input type="checkbox"/>	<input type="checkbox"/>	<input type="checkbox"/>	<input type="checkbox"/>	<input type="checkbox"/>	<input type="checkbox"/>	<input type="checkbox"/>	<input type="checkbox"/>	<input type="checkbox"/>	<input type="checkbox"/>	<input type="checkbox"/>	<input type="checkbox"/>	<input type="checkbox"/>	<input type="checkbox"/>	<input type="checkbox"/>	<input type="checkbox"/>	<input type="checkbox"/>	<input type="checkbox"/>	<input type="checkbox"/>	<input type="checkbox"/>
<input type="checkbox"/>			<input type="checkbox"/>	<input type="checkbox"/>	<input type="checkbox"/>	<input type="checkbox"/>	<input type="checkbox"/>	<input type="checkbox"/>	<input type="checkbox"/>	<input type="checkbox"/>	<input type="checkbox"/>	<input type="checkbox"/>	<input type="checkbox"/>	<input type="checkbox"/>	<input type="checkbox"/>	<input type="checkbox"/>	<input type="checkbox"/>	<input type="checkbox"/>	<input type="checkbox"/>	<input type="checkbox"/>	<input type="checkbox"/>	<input type="checkbox"/>	<input type="checkbox"/>
<input type="checkbox"/>			<input type="checkbox"/>	<input type="checkbox"/>	<input type="checkbox"/>	<input type="checkbox"/>	<input type="checkbox"/>	<input type="checkbox"/>	<input type="checkbox"/>	<input type="checkbox"/>	<input type="checkbox"/>	<input type="checkbox"/>	<input type="checkbox"/>	<input type="checkbox"/>	<input type="checkbox"/>	<input type="checkbox"/>	<input type="checkbox"/>	<input type="checkbox"/>	<input type="checkbox"/>	<input type="checkbox"/>	<input type="checkbox"/>	<input type="checkbox"/>	<input type="checkbox"/>
<input type="checkbox"/>			<input type="checkbox"/>	<input type="checkbox"/>	<input type="checkbox"/>	<input type="checkbox"/>	<input type="checkbox"/>	<input type="checkbox"/>	<input type="checkbox"/>	<input type="checkbox"/>	<input type="checkbox"/>	<input type="checkbox"/>	<input type="checkbox"/>	<input type="checkbox"/>	<input type="checkbox"/>	<input type="checkbox"/>	<input type="checkbox"/>	<input type="checkbox"/>	<input type="checkbox"/>	<input type="checkbox"/>	<input type="checkbox"/>	<input type="checkbox"/>	<input type="checkbox"/>
<input type="checkbox"/>			<input type="checkbox"/>	<input type="checkbox"/>	<input type="checkbox"/>	<input type="checkbox"/>	<input type="checkbox"/>	<input type="checkbox"/>	<input type="checkbox"/>	<input type="checkbox"/>	<input type="checkbox"/>	<input type="checkbox"/>	<input type="checkbox"/>	<input type="checkbox"/>	<input type="checkbox"/>	<input type="checkbox"/>	<input type="checkbox"/>	<input type="checkbox"/>	<input type="checkbox"/>	<input type="checkbox"/>	<input type="checkbox"/>	<input type="checkbox"/>	<input type="checkbox"/>
<input type="checkbox"/>			<input type="checkbox"/>	<input type="checkbox"/>	<input type="checkbox"/>	<input type="checkbox"/>	<input type="checkbox"/>	<input type="checkbox"/>	<input type="checkbox"/>	<input type="checkbox"/>	<input type="checkbox"/>	<input type="checkbox"/>	<input type="checkbox"/>	<input type="checkbox"/>	<input type="checkbox"/>	<input type="checkbox"/>	<input type="checkbox"/>	<input type="checkbox"/>	<input type="checkbox"/>	<input type="checkbox"/>	<input type="checkbox"/>	<input type="checkbox"/>	<input type="checkbox"/>
<input type="checkbox"/>			<input type="checkbox"/>	<input type="checkbox"/>	<input type="checkbox"/>	<input type="checkbox"/>	<input type="checkbox"/>	<input type="checkbox"/>	<input type="checkbox"/>	<input type="checkbox"/>	<input type="checkbox"/>	<input type="checkbox"/>	<input type="checkbox"/>	<input type="checkbox"/>	<input type="checkbox"/>	<input type="checkbox"/>	<input type="checkbox"/>	<input type="checkbox"/>	<input type="checkbox"/>	<input type="checkbox"/>	<input type="checkbox"/>	<input type="checkbox"/>	<input type="checkbox"/>
<input type="checkbox"/>			<input type="checkbox"/>	<input type="checkbox"/>	<input type="checkbox"/>	<input type="checkbox"/>	<input type="checkbox"/>	<input type="checkbox"/>	<input type="checkbox"/>	<input type="checkbox"/>	<input type="checkbox"/>	<input type="checkbox"/>	<input type="checkbox"/>	<input type="checkbox"/>	<input type="checkbox"/>	<input type="checkbox"/>	<input type="checkbox"/>	<input type="checkbox"/>	<input type="checkbox"/>	<input type="checkbox"/>	<input type="checkbox"/>	<input type="checkbox"/>	<input type="checkbox"/>
<input type="checkbox"/>			<input type="checkbox"/>	<input type="checkbox"/>	<input type="checkbox"/>	<input type="checkbox"/>	<input type="checkbox"/>	<input type="checkbox"/>	<input type="checkbox"/>	<input type="checkbox"/>	<input type="checkbox"/>	<input type="checkbox"/>	<input type="checkbox"/>	<input type="checkbox"/>	<input type="checkbox"/>	<input type="checkbox"/>	<input type="checkbox"/>	<input type="checkbox"/>	<input type="checkbox"/>	<input type="checkbox"/>	<input type="checkbox"/>	<input type="checkbox"/>	<input type="checkbox"/>
<input type="checkbox"/>			<input type="checkbox"/>	<input type="checkbox"/>	<input type="checkbox"/>	<input type="checkbox"/>	<input type="checkbox"/>	<input type="checkbox"/>	<input type="checkbox"/>	<input type="checkbox"/>	<input type="checkbox"/>	<input type="checkbox"/>	<input type="checkbox"/>	<input type="checkbox"/>	<input type="checkbox"/>	<input type="checkbox"/>	<input type="checkbox"/>	<input type="checkbox"/>	<input type="checkbox"/>	<input type="checkbox"/>	<input type="checkbox"/>	<input type="checkbox"/>	<input type="checkbox"/>
<input type="checkbox"/>			<input type="checkbox"/>	<input type="checkbox"/>	<input type="checkbox"/>	<input type="checkbox"/>	<input type="checkbox"/>	<input type="checkbox"/>	<input type="checkbox"/>	<input type="checkbox"/>	<input type="checkbox"/>	<input type="checkbox"/>	<input type="checkbox"/>	<input type="checkbox"/>	<input type="checkbox"/>	<input type="checkbox"/>	<input type="checkbox"/>	<input type="checkbox"/>	<input type="checkbox"/>	<input type="checkbox"/>	<input type="checkbox"/>	<input type="checkbox"/>	<input type="checkbox"/>
<input type="checkbox"/>			<input type="checkbox"/>	<input type="checkbox"/>	<input type="checkbox"/>	<input type="checkbox"/>	<input type="checkbox"/>	<input type="checkbox"/>	<input type="checkbox"/>	<input type="checkbox"/>	<input type="checkbox"/>	<input type="checkbox"/>	<input type="checkbox"/>	<input type="checkbox"/>	<input type="checkbox"/>	<input type="checkbox"/>	<input type="checkbox"/>	<input type="checkbox"/>	<input type="checkbox"/>	<input type="checkbox"/>	<input type="checkbox"/>	<input type="checkbox"/>	<input type="checkbox"/>
<input type="checkbox"/>			<input type="checkbox"/>	<input type="checkbox"/>	<input type="checkbox"/>	<input type="checkbox"/>	<input type="checkbox"/>	<input type="checkbox"/>	<input type="checkbox"/>	<input type="checkbox"/>	<input type="checkbox"/>	<input type="checkbox"/>	<input type="checkbox"/>	<input type="checkbox"/>	<input type="checkbox"/>	<input type="checkbox"/>	<input type="checkbox"/>	<input type="checkbox"/>	<input type="checkbox"/>	<input type="checkbox"/>	<input type="checkbox"/>	<input type="checkbox"/>	<input type="checkbox"/>
<input type="checkbox"/>			<input type="checkbox"/>	<input type="checkbox"/>	<input type="checkbox"/>	<input type="checkbox"/>	<input type="checkbox"/>	<input type="checkbox"/>	<input type="checkbox"/>	<input type="checkbox"/>	<input type="checkbox"/>	<input type="checkbox"/>	<input type="checkbox"/>	<input type="checkbox"/>	<input type="checkbox"/>	<input type="checkbox"/>	<input type="checkbox"/>	<input type="checkbox"/>	<input type="checkbox"/>	<input type="checkbox"/>	<input type="checkbox"/>	<input type="checkbox"/>	<input type="checkbox"/>
<input type="checkbox"/>			<input type="checkbox"/>	<input type="checkbox"/>	<input type="checkbox"/>	<input type="checkbox"/>	<input type="checkbox"/>	<input type="checkbox"/>	<input type="checkbox"/>	<input type="checkbox"/>	<input type="checkbox"/>	<input type="checkbox"/>	<input type="checkbox"/>	<input type="checkbox"/>	<input type="checkbox"/>	<input type="checkbox"/>	<input type="checkbox"/>	<input type="checkbox"/>	<input type="checkbox"/>	<input type="checkbox"/>	<input type="checkbox"/>	<input type="checkbox"/>	<input type="checkbox"/>
<input type="checkbox"/>			<input type="checkbox"/>	<input type="checkbox"/>	<input type="checkbox"/>	<input type="checkbox"/>	<input type="checkbox"/>	<input type="checkbox"/>	<input type="checkbox"/>	<input type="checkbox"/>	<input type="checkbox"/>	<input type="checkbox"/>	<input type="checkbox"/>	<input type="checkbox"/>	<input type="checkbox"/>	<input type="checkbox"/>	<input type="checkbox"/>	<input type="checkbox"/>	<input type="checkbox"/>	<input type="checkbox"/>	<input type="checkbox"/>	<input type="checkbox"/>	<input type="checkbox"/>
<input type="checkbox"/>			<input type="checkbox"/>	<input type="checkbox"/>	<input type="checkbox"/>	<input type="checkbox"/>	<input type="checkbox"/>	<input type="checkbox"/>	<input type="checkbox"/>	<input type="checkbox"/>	<input type="checkbox"/>	<input type="checkbox"/>	<input type="checkbox"/>	<input type="checkbox"/>	<input type="checkbox"/>	<input type="checkbox"/>	<input type="checkbox"/>	<input type="checkbox"/>	<input type="checkbox"/>	<input type="checkbox"/>	<input type="checkbox"/>	<input type="checkbox"/>	<input type="checkbox"/>
<input type="checkbox"/>			<input type="checkbox"/>	<input type="checkbox"/>	<input type="checkbox"/>	<input type="checkbox"/>	<input type="checkbox"/>	<input type="checkbox"/>	<input type="checkbox"/>	<input type="checkbox"/>	<input type="checkbox"/>	<input type="checkbox"/>	<input type="checkbox"/>	<input type="checkbox"/>	<input type="checkbox"/>	<input type="checkbox"/>	<input type="checkbox"/>	<input type="checkbox"/>	<input type="checkbox"/>	<input type="checkbox"/>	<input type="checkbox"/>	<input type="checkbox"/>	<input type="checkbox"/>
<input type="checkbox"/>			<input type="checkbox"/>	<input type="checkbox"/>	<input type="checkbox"/>	<input type="checkbox"/>	<input type="checkbox"/>	<input type="checkbox"/>	<input type="checkbox"/>	<input type="checkbox"/>	<input type="checkbox"/>	<input type="checkbox"/>	<input type="checkbox"/>	<input type="checkbox"/>	<input type="checkbox"/>	<input type="checkbox"/>	<input type="checkbox"/>	<input type="checkbox"/>	<input type="checkbox"/>	<input type="checkbox"/>	<input type="checkbox"/>	<input type="checkbox"/>	<input type="checkbox"/>
<input type="checkbox"/>			<input type="checkbox"/>	<input type="checkbox"/>	<input type="checkbox"/>	<input type="checkbox"/>	<input type="checkbox"/>	<input type="checkbox"/>	<input type="checkbox"/>	<input type="checkbox"/>	<input type="checkbox"/>	<input type="checkbox"/>	<input type="checkbox"/>	<input type="checkbox"/>	<input type="checkbox"/>	<input type="checkbox"/>	<input type="checkbox"/>	<input type="checkbox"/>	<input type="checkbox"/>	<input type="checkbox"/>	<input type="checkbox"/>	<input type="checkbox"/>	<input type="checkbox"/>
<input type="checkbox"/>			<input type="checkbox"/>	<input type="checkbox"/>	<input type="checkbox"/>	<input type="checkbox"/>	<input type="checkbox"/>	<input type="checkbox"/>	<input type="checkbox"/>	<input type="checkbox"/>	<input type="checkbox"/>	<input type="checkbox"/>	<input type="checkbox"/>	<input type="checkbox"/>	<input type="checkbox"/>	<input type="checkbox"/>	<input type="checkbox"/>	<input type="checkbox"/>	<input type="checkbox"/>	<input type="checkbox"/>	<input type="checkbox"/>	<input type="checkbox"/>	<input type="checkbox"/>
<input type="checkbox"/>			<input type="checkbox"/>	<input type="checkbox"/>	<input type="checkbox"/>	<input type="checkbox"/>	<input type="checkbox"/>	<input type="checkbox"/>	<input type="checkbox"/>	<input type="checkbox"/>	<input type="checkbox"/>	<input type="checkbox"/>	<input type="checkbox"/>	<input type="checkbox"/>	<input type="checkbox"/>	<input type="checkbox"/>	<input type="checkbox"/>	<input type="checkbox"/>	<input type="checkbox"/>	<input type="checkbox"/>	<input type="checkbox"/>	<input type="checkbox"/>	<input type="checkbox"/>
<input type="checkbox"/>			<input type="checkbox"/>	<input type="checkbox"/>	<input type="checkbox"/>	<input type="checkbox"/>	<input type="checkbox"/>	<input type="checkbox"/>	<input type="checkbox"/>	<input type="checkbox"/>	<input type="checkbox"/>	<input type="checkbox"/>	<input type="checkbox"/>	<input type="checkbox"/>	<input type="checkbox"/>	<input type="checkbox"/>	<input type="checkbox"/>	<input type="checkbox"/>	<input type="checkbox"/>	<input type="checkbox"/>	<input type="checkbox"/>	<input type="checkbox"/>	<input type="checkbox"/>

Notes:

Figure B-40. TM HVT Relative Value Matrix Template

TM COA Template (U)

COA Title / Name

Unique COA ID Rank Order Likelihood: Very High Probability Medium Probability Low Probability Very Low Probability

COA Objective(s)

COA Desired End State(s)

COA Mission(s)

COA Sequel(s)

COA Branch(es)

Notes:

COA Title / Name

Unique COA ID Rank Order Likelihood: Very High Probability Medium Probability Low Probability Very Low Probability

COA Objective(s)

COA Desired End State(s)

COA Mission(s)

COA Sequel(s)

COA Branch(es)

Notes:

COA Title / Name

Unique COA ID Rank Order Likelihood: Very High Probability Medium Probability Low Probability Very Low Probability

COA Objective(s)

COA Desired End State(s)

COA Mission(s)

COA Sequel(s)

COA Branch(es)

Notes:

Figure B-41. TM COA Assessment Template

DTG: _____	Classification: _____	Page: ____ of: ____																																																						
TM COA Situation Matrix Template (U)																																																								
COA Unique ID # <input type="text"/> COA Title <input type="text"/>																																																								
COA Description <input style="width:100%;" type="text"/>																																																								
Period of Relevance																																																								
Exclusive Period <input type="text"/>	DTG / Date <input type="text"/>	Through <input type="text"/>																																																						
No Earlier Than <input type="text"/>	DTG / Date <input type="text"/>	No Later Than <input type="text"/>																																																						
Duration <input type="text"/>																																																								
All Times Relative To:		Units <input type="checkbox"/> Minutes <input type="checkbox"/> Hours <input type="checkbox"/> Days of <input type="checkbox"/> Weeks <input type="checkbox"/> Months <input type="checkbox"/> Years Time																																																						
Potential NAI(s) or NAI Type	Activity / Event Time	Activity / Event Time																																																						
ID#:	<table border="1" style="width:100%; border-collapse: collapse;"> <tr> <th colspan="3">Start</th> <th colspan="3">Duration</th> <th colspan="3">Stop</th> </tr> <tr> <th>Minimum</th><th>Nominal</th><th>Maximum</th> <th>Minimum</th><th>Nominal</th><th>Maximum</th> <th>Minimum</th><th>Nominal</th><th>Maximum</th> </tr> <tr> <td><input type="text"/></td><td><input type="text"/></td><td><input type="text"/></td> <td><input type="text"/></td><td><input type="text"/></td><td><input type="text"/></td> <td><input type="text"/></td><td><input type="text"/></td><td><input type="text"/></td> </tr> </table>	Start			Duration			Stop			Minimum	Nominal	Maximum	Minimum	Nominal	Maximum	Minimum	Nominal	Maximum	<input type="text"/>	<input type="text"/>	<input type="text"/>	<input type="text"/>	<input type="text"/>	<input type="text"/>	<input type="text"/>	<input type="text"/>	<input type="text"/>	<table border="1" style="width:100%; border-collapse: collapse;"> <tr> <th colspan="3">Start</th> <th colspan="3">Duration</th> <th colspan="3">Stop</th> </tr> <tr> <th>Minimum</th><th>Nominal</th><th>Maximum</th> <th>Minimum</th><th>Nominal</th><th>Maximum</th> <th>Minimum</th><th>Nominal</th><th>Maximum</th> </tr> <tr> <td><input type="text"/></td><td><input type="text"/></td><td><input type="text"/></td> <td><input type="text"/></td><td><input type="text"/></td><td><input type="text"/></td> <td><input type="text"/></td><td><input type="text"/></td><td><input type="text"/></td> </tr> </table>	Start			Duration			Stop			Minimum	Nominal	Maximum	Minimum	Nominal	Maximum	Minimum	Nominal	Maximum	<input type="text"/>	<input type="text"/>	<input type="text"/>	<input type="text"/>	<input type="text"/>	<input type="text"/>	<input type="text"/>	<input type="text"/>	<input type="text"/>
Start			Duration			Stop																																																		
Minimum	Nominal	Maximum	Minimum	Nominal	Maximum	Minimum	Nominal	Maximum																																																
<input type="text"/>	<input type="text"/>	<input type="text"/>	<input type="text"/>	<input type="text"/>	<input type="text"/>	<input type="text"/>	<input type="text"/>	<input type="text"/>																																																
Start			Duration			Stop																																																		
Minimum	Nominal	Maximum	Minimum	Nominal	Maximum	Minimum	Nominal	Maximum																																																
<input type="text"/>	<input type="text"/>	<input type="text"/>	<input type="text"/>	<input type="text"/>	<input type="text"/>	<input type="text"/>	<input type="text"/>	<input type="text"/>																																																
<input style="width:100%;" type="text"/>	Activity / Event Indicator: <input style="width:100%;" type="text"/>	Activity / Event Indicator: <input style="width:100%;" type="text"/>																																																						
Potential NAI(s) or NAI Type	Activity / Event Time	Activity / Event Time																																																						
ID#:	<table border="1" style="width:100%; border-collapse: collapse;"> <tr> <th colspan="3">Start</th> <th colspan="3">Duration</th> <th colspan="3">Stop</th> </tr> <tr> <th>Minimum</th><th>Nominal</th><th>Maximum</th> <th>Minimum</th><th>Nominal</th><th>Maximum</th> <th>Minimum</th><th>Nominal</th><th>Maximum</th> </tr> <tr> <td><input type="text"/></td><td><input type="text"/></td><td><input type="text"/></td> <td><input type="text"/></td><td><input type="text"/></td><td><input type="text"/></td> <td><input type="text"/></td><td><input type="text"/></td><td><input type="text"/></td> </tr> </table>	Start			Duration			Stop			Minimum	Nominal	Maximum	Minimum	Nominal	Maximum	Minimum	Nominal	Maximum	<input type="text"/>	<input type="text"/>	<input type="text"/>	<input type="text"/>	<input type="text"/>	<input type="text"/>	<input type="text"/>	<input type="text"/>	<input type="text"/>	<table border="1" style="width:100%; border-collapse: collapse;"> <tr> <th colspan="3">Start</th> <th colspan="3">Duration</th> <th colspan="3">Stop</th> </tr> <tr> <th>Minimum</th><th>Nominal</th><th>Maximum</th> <th>Minimum</th><th>Nominal</th><th>Maximum</th> <th>Minimum</th><th>Nominal</th><th>Maximum</th> </tr> <tr> <td><input type="text"/></td><td><input type="text"/></td><td><input type="text"/></td> <td><input type="text"/></td><td><input type="text"/></td><td><input type="text"/></td> <td><input type="text"/></td><td><input type="text"/></td><td><input type="text"/></td> </tr> </table>	Start			Duration			Stop			Minimum	Nominal	Maximum	Minimum	Nominal	Maximum	Minimum	Nominal	Maximum	<input type="text"/>	<input type="text"/>	<input type="text"/>	<input type="text"/>	<input type="text"/>	<input type="text"/>	<input type="text"/>	<input type="text"/>	<input type="text"/>
Start			Duration			Stop																																																		
Minimum	Nominal	Maximum	Minimum	Nominal	Maximum	Minimum	Nominal	Maximum																																																
<input type="text"/>	<input type="text"/>	<input type="text"/>	<input type="text"/>	<input type="text"/>	<input type="text"/>	<input type="text"/>	<input type="text"/>	<input type="text"/>																																																
Start			Duration			Stop																																																		
Minimum	Nominal	Maximum	Minimum	Nominal	Maximum	Minimum	Nominal	Maximum																																																
<input type="text"/>	<input type="text"/>	<input type="text"/>	<input type="text"/>	<input type="text"/>	<input type="text"/>	<input type="text"/>	<input type="text"/>	<input type="text"/>																																																
<input style="width:100%;" type="text"/>	Activity / Event Indicator: <input style="width:100%;" type="text"/>	Activity / Event Indicator: <input style="width:100%;" type="text"/>																																																						
Potential NAI(s) or NAI Type	Activity / Event Time	Activity / Event Time																																																						
ID#:	<table border="1" style="width:100%; border-collapse: collapse;"> <tr> <th colspan="3">Start</th> <th colspan="3">Duration</th> <th colspan="3">Stop</th> </tr> <tr> <th>Minimum</th><th>Nominal</th><th>Maximum</th> <th>Minimum</th><th>Nominal</th><th>Maximum</th> <th>Minimum</th><th>Nominal</th><th>Maximum</th> </tr> <tr> <td><input type="text"/></td><td><input type="text"/></td><td><input type="text"/></td> <td><input type="text"/></td><td><input type="text"/></td><td><input type="text"/></td> <td><input type="text"/></td><td><input type="text"/></td><td><input type="text"/></td> </tr> </table>	Start			Duration			Stop			Minimum	Nominal	Maximum	Minimum	Nominal	Maximum	Minimum	Nominal	Maximum	<input type="text"/>	<input type="text"/>	<input type="text"/>	<input type="text"/>	<input type="text"/>	<input type="text"/>	<input type="text"/>	<input type="text"/>	<input type="text"/>	<table border="1" style="width:100%; border-collapse: collapse;"> <tr> <th colspan="3">Start</th> <th colspan="3">Duration</th> <th colspan="3">Stop</th> </tr> <tr> <th>Minimum</th><th>Nominal</th><th>Maximum</th> <th>Minimum</th><th>Nominal</th><th>Maximum</th> <th>Minimum</th><th>Nominal</th><th>Maximum</th> </tr> <tr> <td><input type="text"/></td><td><input type="text"/></td><td><input type="text"/></td> <td><input type="text"/></td><td><input type="text"/></td><td><input type="text"/></td> <td><input type="text"/></td><td><input type="text"/></td><td><input type="text"/></td> </tr> </table>	Start			Duration			Stop			Minimum	Nominal	Maximum	Minimum	Nominal	Maximum	Minimum	Nominal	Maximum	<input type="text"/>	<input type="text"/>	<input type="text"/>	<input type="text"/>	<input type="text"/>	<input type="text"/>	<input type="text"/>	<input type="text"/>	<input type="text"/>
Start			Duration			Stop																																																		
Minimum	Nominal	Maximum	Minimum	Nominal	Maximum	Minimum	Nominal	Maximum																																																
<input type="text"/>	<input type="text"/>	<input type="text"/>	<input type="text"/>	<input type="text"/>	<input type="text"/>	<input type="text"/>	<input type="text"/>	<input type="text"/>																																																
Start			Duration			Stop																																																		
Minimum	Nominal	Maximum	Minimum	Nominal	Maximum	Minimum	Nominal	Maximum																																																
<input type="text"/>	<input type="text"/>	<input type="text"/>	<input type="text"/>	<input type="text"/>	<input type="text"/>	<input type="text"/>	<input type="text"/>	<input type="text"/>																																																
<input style="width:100%;" type="text"/>	Activity / Event Indicator: <input style="width:100%;" type="text"/>	Activity / Event Indicator: <input style="width:100%;" type="text"/>																																																						
Potential NAI(s) or NAI Type	Activity / Event Time	Activity / Event Time																																																						
ID#:	<table border="1" style="width:100%; border-collapse: collapse;"> <tr> <th colspan="3">Start</th> <th colspan="3">Duration</th> <th colspan="3">Stop</th> </tr> <tr> <th>Minimum</th><th>Nominal</th><th>Maximum</th> <th>Minimum</th><th>Nominal</th><th>Maximum</th> <th>Minimum</th><th>Nominal</th><th>Maximum</th> </tr> <tr> <td><input type="text"/></td><td><input type="text"/></td><td><input type="text"/></td> <td><input type="text"/></td><td><input type="text"/></td><td><input type="text"/></td> <td><input type="text"/></td><td><input type="text"/></td><td><input type="text"/></td> </tr> </table>	Start			Duration			Stop			Minimum	Nominal	Maximum	Minimum	Nominal	Maximum	Minimum	Nominal	Maximum	<input type="text"/>	<input type="text"/>	<input type="text"/>	<input type="text"/>	<input type="text"/>	<input type="text"/>	<input type="text"/>	<input type="text"/>	<input type="text"/>	<table border="1" style="width:100%; border-collapse: collapse;"> <tr> <th colspan="3">Start</th> <th colspan="3">Duration</th> <th colspan="3">Stop</th> </tr> <tr> <th>Minimum</th><th>Nominal</th><th>Maximum</th> <th>Minimum</th><th>Nominal</th><th>Maximum</th> <th>Minimum</th><th>Nominal</th><th>Maximum</th> </tr> <tr> <td><input type="text"/></td><td><input type="text"/></td><td><input type="text"/></td> <td><input type="text"/></td><td><input type="text"/></td><td><input type="text"/></td> <td><input type="text"/></td><td><input type="text"/></td><td><input type="text"/></td> </tr> </table>	Start			Duration			Stop			Minimum	Nominal	Maximum	Minimum	Nominal	Maximum	Minimum	Nominal	Maximum	<input type="text"/>	<input type="text"/>	<input type="text"/>	<input type="text"/>	<input type="text"/>	<input type="text"/>	<input type="text"/>	<input type="text"/>	<input type="text"/>
Start			Duration			Stop																																																		
Minimum	Nominal	Maximum	Minimum	Nominal	Maximum	Minimum	Nominal	Maximum																																																
<input type="text"/>	<input type="text"/>	<input type="text"/>	<input type="text"/>	<input type="text"/>	<input type="text"/>	<input type="text"/>	<input type="text"/>	<input type="text"/>																																																
Start			Duration			Stop																																																		
Minimum	Nominal	Maximum	Minimum	Nominal	Maximum	Minimum	Nominal	Maximum																																																
<input type="text"/>	<input type="text"/>	<input type="text"/>	<input type="text"/>	<input type="text"/>	<input type="text"/>	<input type="text"/>	<input type="text"/>	<input type="text"/>																																																
<input style="width:100%;" type="text"/>	Activity / Event Indicator: <input style="width:100%;" type="text"/>	Activity / Event Indicator: <input style="width:100%;" type="text"/>																																																						
Potential NAI(s) or NAI Type	Activity / Event Time	Activity / Event Time																																																						
ID#:	<table border="1" style="width:100%; border-collapse: collapse;"> <tr> <th colspan="3">Start</th> <th colspan="3">Duration</th> <th colspan="3">Stop</th> </tr> <tr> <th>Minimum</th><th>Nominal</th><th>Maximum</th> <th>Minimum</th><th>Nominal</th><th>Maximum</th> <th>Minimum</th><th>Nominal</th><th>Maximum</th> </tr> <tr> <td><input type="text"/></td><td><input type="text"/></td><td><input type="text"/></td> <td><input type="text"/></td><td><input type="text"/></td><td><input type="text"/></td> <td><input type="text"/></td><td><input type="text"/></td><td><input type="text"/></td> </tr> </table>	Start			Duration			Stop			Minimum	Nominal	Maximum	Minimum	Nominal	Maximum	Minimum	Nominal	Maximum	<input type="text"/>	<input type="text"/>	<input type="text"/>	<input type="text"/>	<input type="text"/>	<input type="text"/>	<input type="text"/>	<input type="text"/>	<input type="text"/>	<table border="1" style="width:100%; border-collapse: collapse;"> <tr> <th colspan="3">Start</th> <th colspan="3">Duration</th> <th colspan="3">Stop</th> </tr> <tr> <th>Minimum</th><th>Nominal</th><th>Maximum</th> <th>Minimum</th><th>Nominal</th><th>Maximum</th> <th>Minimum</th><th>Nominal</th><th>Maximum</th> </tr> <tr> <td><input type="text"/></td><td><input type="text"/></td><td><input type="text"/></td> <td><input type="text"/></td><td><input type="text"/></td><td><input type="text"/></td> <td><input type="text"/></td><td><input type="text"/></td><td><input type="text"/></td> </tr> </table>	Start			Duration			Stop			Minimum	Nominal	Maximum	Minimum	Nominal	Maximum	Minimum	Nominal	Maximum	<input type="text"/>	<input type="text"/>	<input type="text"/>	<input type="text"/>	<input type="text"/>	<input type="text"/>	<input type="text"/>	<input type="text"/>	<input type="text"/>
Start			Duration			Stop																																																		
Minimum	Nominal	Maximum	Minimum	Nominal	Maximum	Minimum	Nominal	Maximum																																																
<input type="text"/>	<input type="text"/>	<input type="text"/>	<input type="text"/>	<input type="text"/>	<input type="text"/>	<input type="text"/>	<input type="text"/>	<input type="text"/>																																																
Start			Duration			Stop																																																		
Minimum	Nominal	Maximum	Minimum	Nominal	Maximum	Minimum	Nominal	Maximum																																																
<input type="text"/>	<input type="text"/>	<input type="text"/>	<input type="text"/>	<input type="text"/>	<input type="text"/>	<input type="text"/>	<input type="text"/>	<input type="text"/>																																																
<input style="width:100%;" type="text"/>	Activity / Event Indicator: <input style="width:100%;" type="text"/>	Activity / Event Indicator: <input style="width:100%;" type="text"/>																																																						
Legend: <input style="width:100%;" type="text"/>	Notes: <input style="width:100%;" type="text"/>																																																							
TMD IPB Template -- 18 March 2000 Classification: _____ Local Reproduction Authorized																																																								

Figure B-42. TM COA Situation Matrix Template

DTG:	Classification:	Page: of:
------	-----------------	-----------

NAI and HVT Template (U)

NAI and HVT Unique ID # NAI
 HVT

See Attached Geographical Area Definition Template for Map View of NAI or HVT

Associated COA(s)

Description:

NAI or HVT TM Force Activity / Event Indicators

Indicators Observed
 Observations Confirmed

DTG(s) of Observation(s):

Period of Interest	Probable Signature Sources																		
<p>No Earlier Than DTG: <input style="width:100px;" type="text"/> No Later Than DTG: <input style="width:100px;" type="text"/></p> <p>Activity / Event Time: <input type="checkbox"/> Hours <input type="checkbox"/> Days <input type="checkbox"/> Weeks <input type="checkbox"/> Months <input type="checkbox"/> Years</p> <table style="width:100%; border-collapse: collapse;"> <tr> <th colspan="2" style="text-align:left;">Start</th> <th colspan="2" style="text-align:left;">Duration</th> <th colspan="2" style="text-align:left;">Stop</th> </tr> <tr> <td style="border: 1px solid black;">Minimum</td> <td style="border: 1px solid black;">Nominal</td> <td style="border: 1px solid black;">Minimum</td> <td style="border: 1px solid black;">Nominal</td> <td style="border: 1px solid black;">Maximum</td> <td style="border: 1px solid black;">Nominal</td> </tr> <tr> <td><input style="width:30px;" type="text"/></td> <td><input style="width:30px;" type="text"/></td> <td><input style="width:30px;" type="text"/></td> <td><input style="width:30px;" type="text"/></td> <td><input style="width:30px;" type="text"/></td> <td><input style="width:30px;" type="text"/></td> </tr> </table>	Start		Duration		Stop		Minimum	Nominal	Minimum	Nominal	Maximum	Nominal	<input style="width:30px;" type="text"/>	<input style="width:30px;" type="text"/>	<input style="width:30px;" type="text"/>	<input style="width:30px;" type="text"/>	<input style="width:30px;" type="text"/>	<input style="width:30px;" type="text"/>	<ul style="list-style-type: none"> IMINT <input type="checkbox"/> IMINT - Visible <input type="checkbox"/> IMINT - Radar <input type="checkbox"/> IMINT - IR <input type="checkbox"/> IMINT - MSI <input type="checkbox"/> SIGINT <input type="checkbox"/> SIGINT - SIGINT <input type="checkbox"/> SIGINT - COMINT <input type="checkbox"/> SIGINT - ELINT <input type="checkbox"/> SIGINT - ELINT - FISINT <input type="checkbox"/> SIGINT - ELINT - TELINT <input type="checkbox"/> SIGINT - ELINT - RADINT <input type="checkbox"/> HUMINT <input type="checkbox"/> MASINT <input type="checkbox"/> MASINT - ACINT <input type="checkbox"/> MASINT - Electro-Optical <input type="checkbox"/> MASINT - IRINT <input type="checkbox"/> MASINT - LASINT <input type="checkbox"/> MASINT - NUCINT <input type="checkbox"/> MASINT - RINT <input type="checkbox"/> OSINT <input type="checkbox"/> TECHINT <input type="checkbox"/> Counter Intelligence (CI) <input type="checkbox"/> Other: <input type="checkbox"/>
Start		Duration		Stop															
Minimum	Nominal	Minimum	Nominal	Maximum	Nominal														
<input style="width:30px;" type="text"/>	<input style="width:30px;" type="text"/>	<input style="width:30px;" type="text"/>	<input style="width:30px;" type="text"/>	<input style="width:30px;" type="text"/>	<input style="width:30px;" type="text"/>														

Associated NAIs and HVTs

Unique ID	Distance (km)	Estimated Time Between Next & Previous
Possible Previous NAIs and HVTs		
<input style="width:50px;" type="text"/>	<input style="width:50px;" type="text"/>	<input style="width:50px;" type="text"/>
<input style="width:50px;" type="text"/>	<input style="width:50px;" type="text"/>	<input style="width:50px;" type="text"/>
<input style="width:50px;" type="text"/>	<input style="width:50px;" type="text"/>	<input style="width:50px;" type="text"/>
<input style="width:50px;" type="text"/>	<input style="width:50px;" type="text"/>	<input style="width:50px;" type="text"/>
Possible Next NAIs and HVTs		
<input style="width:50px;" type="text"/>	<input style="width:50px;" type="text"/>	<input style="width:50px;" type="text"/>
<input style="width:50px;" type="text"/>	<input style="width:50px;" type="text"/>	<input style="width:50px;" type="text"/>
<input style="width:50px;" type="text"/>	<input style="width:50px;" type="text"/>	<input style="width:50px;" type="text"/>
<input style="width:50px;" type="text"/>	<input style="width:50px;" type="text"/>	<input style="width:50px;" type="text"/>

Desired Reporting

By Date (DD / MMM / YY) / DTG By Time of Day (HH:MM:SS) / DTG

Desired Timeliness Latest Time Information of Value (LTIOV) Date (DD / MMM / YY) / DTG Time of Day (HH:MM:SS) / DTG

Desired Frequency of Response:

Time Standard: Local Zulu Year: Calendar Fiscal

<p>Readiness Phase</p> <ul style="list-style-type: none"> Real Time <input type="checkbox"/> Every Monday <input type="checkbox"/> Near Real Time <input type="checkbox"/> Every Tuesday <input type="checkbox"/> Hourly <input type="checkbox"/> Every Wednesday <input type="checkbox"/> Daily <input type="checkbox"/> Every Thursday <input type="checkbox"/> Weekly <input type="checkbox"/> Every Friday <input type="checkbox"/> Monthly <input type="checkbox"/> Every Saturday <input type="checkbox"/> Quarterly <input type="checkbox"/> Every Sunday <input type="checkbox"/> Yearly <input type="checkbox"/> See Notes <input type="checkbox"/> See Notes <input type="checkbox"/> At: (HH:MM) <input style="width:50px;" type="text"/> 	<p>Crisis / Deployment Phase</p> <ul style="list-style-type: none"> Real Time <input type="checkbox"/> Every Monday <input type="checkbox"/> Near Real Time <input type="checkbox"/> Every Tuesday <input type="checkbox"/> Hourly <input type="checkbox"/> Every Wednesday <input type="checkbox"/> Daily <input type="checkbox"/> Every Thursday <input type="checkbox"/> Weekly <input type="checkbox"/> Every Friday <input type="checkbox"/> Monthly <input type="checkbox"/> Every Saturday <input type="checkbox"/> Quarterly <input type="checkbox"/> Every Sunday <input type="checkbox"/> Yearly <input type="checkbox"/> See Notes <input type="checkbox"/> See Notes <input type="checkbox"/> At: (HH:MM) <input style="width:50px;" type="text"/> 	<p>Combat Phase</p> <ul style="list-style-type: none"> Real Time <input type="checkbox"/> Every Monday <input type="checkbox"/> Near Real Time <input type="checkbox"/> Every Tuesday <input type="checkbox"/> Hourly <input type="checkbox"/> Every Wednesday <input type="checkbox"/> Daily <input type="checkbox"/> Every Thursday <input type="checkbox"/> Weekly <input type="checkbox"/> Every Friday <input type="checkbox"/> Monthly <input type="checkbox"/> Every Saturday <input type="checkbox"/> Quarterly <input type="checkbox"/> Every Sunday <input type="checkbox"/> Yearly <input type="checkbox"/> See Notes <input type="checkbox"/> See Notes <input type="checkbox"/> At: (HH:MM) <input style="width:50px;" type="text"/> 	<p>Other Phase:</p> <ul style="list-style-type: none"> Real Time <input type="checkbox"/> Every Monday <input type="checkbox"/> Near Real Time <input type="checkbox"/> Every Tuesday <input type="checkbox"/> Hourly <input type="checkbox"/> Every Wednesday <input type="checkbox"/> Daily <input type="checkbox"/> Every Thursday <input type="checkbox"/> Weekly <input type="checkbox"/> Every Friday <input type="checkbox"/> Monthly <input type="checkbox"/> Every Saturday <input type="checkbox"/> Quarterly <input type="checkbox"/> Every Sunday <input type="checkbox"/> Yearly <input type="checkbox"/> See Notes <input type="checkbox"/> See Notes <input type="checkbox"/> At: (HH:MM) <input style="width:50px;" type="text"/>
--	--	---	---

Notes:

TMD IPB Template -- 18 March 2000 Classification: Local Reproduction Authorized

Figure B-43. NAI and HVT Assessment Template (1 of 2)

DTG: _____ Classification: _____ Page: ___ of: ___

NAI and HVT Template (U)

Type
 NAI HVT TCT Fixed - Facility Non-Fixed - Moving Non-Fixed - Not Moving Terrain Analysis Other: _____

Properties
 BE Number _____ Point Radius (km) _____ Area / Polygon Route / Polyline Datum: WGS84 Other: _____
 Geocoordinate Units: Dd.decimal Ddmsss Dd.msss MGRS UTM Other: _____ See Attached for Further Definition
 Point or Centroid Coordinates: Latitude _____ Longitude _____ MGRS _____ UTM _____

Area / Polygon / Route / Polyline Definition: See Attached Page for Map View of This Area / Polygon / Route / Polyline Definition

	Latitude / MGRS / UTM				N	Longitude				E	W	Next Point	Latitude / MGRS / UTM				N	Longitude				E	W	Next Point	Latitude / MGRS / UTM				N	Longitude				E	W	Next Point																								
Starting Point	<input type="checkbox"/>	<input type="checkbox"/>	<input type="checkbox"/>	<input type="checkbox"/>	<input type="checkbox"/>	<input type="checkbox"/>	<input type="checkbox"/>	<input type="checkbox"/>	<input type="checkbox"/>	<input type="checkbox"/>	<input type="checkbox"/>	<input type="checkbox"/>	Next Point	<input type="checkbox"/>	<input type="checkbox"/>	<input type="checkbox"/>	<input type="checkbox"/>	<input type="checkbox"/>	<input type="checkbox"/>	<input type="checkbox"/>	<input type="checkbox"/>	<input type="checkbox"/>	<input type="checkbox"/>	<input type="checkbox"/>	<input type="checkbox"/>	Next Point	<input type="checkbox"/>	<input type="checkbox"/>	<input type="checkbox"/>	<input type="checkbox"/>	<input type="checkbox"/>	<input type="checkbox"/>	<input type="checkbox"/>	<input type="checkbox"/>	<input type="checkbox"/>	<input type="checkbox"/>	<input type="checkbox"/>	<input type="checkbox"/>	Next Point	<input type="checkbox"/>	<input type="checkbox"/>	<input type="checkbox"/>	<input type="checkbox"/>	<input type="checkbox"/>	<input type="checkbox"/>	<input type="checkbox"/>	<input type="checkbox"/>	<input type="checkbox"/>	<input type="checkbox"/>	<input type="checkbox"/>	<input type="checkbox"/>	Next Point	<input type="checkbox"/>	<input type="checkbox"/>	<input type="checkbox"/>	<input type="checkbox"/>				
Ending Point	<input type="checkbox"/>	<input type="checkbox"/>	<input type="checkbox"/>	<input type="checkbox"/>	<input type="checkbox"/>	<input type="checkbox"/>	<input type="checkbox"/>	<input type="checkbox"/>	<input type="checkbox"/>	<input type="checkbox"/>	<input type="checkbox"/>	<input type="checkbox"/>	Ending Point	<input type="checkbox"/>	<input type="checkbox"/>	<input type="checkbox"/>	<input type="checkbox"/>	<input type="checkbox"/>	<input type="checkbox"/>	<input type="checkbox"/>	<input type="checkbox"/>	<input type="checkbox"/>	<input type="checkbox"/>	<input type="checkbox"/>	<input type="checkbox"/>	Ending Point	<input type="checkbox"/>	<input type="checkbox"/>	<input type="checkbox"/>	<input type="checkbox"/>	<input type="checkbox"/>	<input type="checkbox"/>	<input type="checkbox"/>	<input type="checkbox"/>	<input type="checkbox"/>	<input type="checkbox"/>	<input type="checkbox"/>	<input type="checkbox"/>	<input type="checkbox"/>	<input type="checkbox"/>	<input type="checkbox"/>	<input type="checkbox"/>	Ending Point	<input type="checkbox"/>	<input type="checkbox"/>	<input type="checkbox"/>	<input type="checkbox"/>	<input type="checkbox"/>	<input type="checkbox"/>	<input type="checkbox"/>	<input type="checkbox"/>	<input type="checkbox"/>	<input type="checkbox"/>	<input type="checkbox"/>	<input type="checkbox"/>	Ending Point	<input type="checkbox"/>	<input type="checkbox"/>	<input type="checkbox"/>	<input type="checkbox"/>

TMD IPB Template -- 18 March 2000 Classification: _____ Local Reproduction Authorized

Figure B-43 (Continued). NAI and HVT Assessment Template (2 of 2)

DTG: _____	Classification: _____	Page: ____ of: ____				
TM COA Situation / Event Template (U)						
<input type="checkbox"/> Event Template <input type="checkbox"/> Situation Template <input type="checkbox"/> Event Template or COA Title Unique Event Template or COA ID # _____						
Description: _____						
Geocoordinate Units: Dd.decimal <input type="checkbox"/> Ddmmss <input type="checkbox"/> Dd.mmss <input type="checkbox"/> MGRS <input type="checkbox"/> UTM <input type="checkbox"/> Other: _____ <input type="checkbox"/> See Attached for Further Definition <input type="checkbox"/>						
Point or Centroid Coordinates: Latitude _____ Longitude _____ MGRS _____ UTM _____ Datum: WGS84						
Map Sheet Name	Map Sheet Series	Map Sheet Number	Map Sheet Edition	Map Sheet Scale	Horizontal/Vertical Datum	Scale
						0 5 10 15 20 Kilometers 0 5 10 11 111
Legend: _____						
TMD IPB Template -- 18 March 2000 Classification: _____ Local Reproduction Authorized						

Figure B-44. TM COA Situation/Event Template (1 of 2)

DTG: _____	Classification: _____	Page: ____ of: ____
TM COA Situation / Event Template (U)		
Expanded Description:		
Notes:		
TMD IPB Template -- 18 March 2000	Classification: _____	Local Reproduction Authorized

Figure B-44 (Continued). TM COA Situation/Event Template (2 of 2)

TM Event Matrix Template (U)

COA Unique ID # COA Title

COA Description

Period of Relevance

Exclusive Period DTG / Date Through DTG / Date
 No Earlier Than DTG / Date No Later Than DTG / Date
 Duration

All Times Relative To:

Units of Time Minutes Hours Days
 Weeks Months Years

Potential NAI(s) or NAI Type	Activity / Event Time									Activity / Event Time								
	Start			Duration			Stop			Start			Duration			Stop		
	Minimum	Nominal	Maximum	Minimum	Nominal	Maximum	Minimum	Nominal	Maximum	Minimum	Nominal	Maximum	Minimum	Nominal	Maximum	Minimum	Nominal	Maximum
ID#: <input style="width: 100%;" type="text"/>	Activity / Event Indicator: <input style="width: 100%; height: 50px;" type="text"/>									Activity / Event Indicator: <input style="width: 100%; height: 50px;" type="text"/>								
ID#: <input style="width: 100%;" type="text"/>	Activity / Event Indicator: <input style="width: 100%; height: 50px;" type="text"/>									Activity / Event Indicator: <input style="width: 100%; height: 50px;" type="text"/>								
ID#: <input style="width: 100%;" type="text"/>	Activity / Event Indicator: <input style="width: 100%; height: 50px;" type="text"/>									Activity / Event Indicator: <input style="width: 100%; height: 50px;" type="text"/>								
ID#: <input style="width: 100%;" type="text"/>	Activity / Event Indicator: <input style="width: 100%; height: 50px;" type="text"/>									Activity / Event Indicator: <input style="width: 100%; height: 50px;" type="text"/>								
ID#: <input style="width: 100%;" type="text"/>	Activity / Event Indicator: <input style="width: 100%; height: 50px;" type="text"/>									Activity / Event Indicator: <input style="width: 100%; height: 50px;" type="text"/>								

Legend:

Notes:

Figure B-45. TM Event Matrix Template

DTG: _____	Classification: _____	Page: ____ of: ____
Recommended Target Nominations and TAIs Template (U)		
Facility / Area MIDB Name _____		
Recommended Target Priority: <input type="checkbox"/> Time Critical / Sensitive <input type="checkbox"/> Immediate <input type="checkbox"/> Routine <input type="checkbox"/> Other _____		
Target Available No Earlier Than DTG _____		Target Available No Earlier Than DTG _____
Unique ID # _____	Integrated Infrastructure List ID # _____	BE Number _____
Type		
<input type="checkbox"/> HVT <input type="checkbox"/> TCT <input type="checkbox"/> Fixed - Facility <input type="checkbox"/> Non-Fixed - Moving <input type="checkbox"/> Non-Fixed - Not Moving <input type="checkbox"/> Other: _____		
Point <input type="checkbox"/> Radius (km) _____ Area / Polygon <input type="checkbox"/> Route / Polyline <input type="checkbox"/> Datum: WGS84 <input type="checkbox"/> Other: _____		
Geocoordinate Units: Dd.decimal <input type="checkbox"/> Ddmsss <input type="checkbox"/> Dd.mmss <input type="checkbox"/> MGRS <input type="checkbox"/> UTM <input type="checkbox"/> Other: _____ <input type="checkbox"/> See Attached for Further Definition <input type="checkbox"/>		
Point or Centroid Coordinates: Latitude _____ Longitude _____ MGRS _____ UTM _____		
Facility / Area MIDB Name _____		
Recommended Target Priority: <input type="checkbox"/> Time Critical / Sensitive <input type="checkbox"/> Immediate <input type="checkbox"/> Routine <input type="checkbox"/> Other _____		
Target Available No Earlier Than DTG _____		Target Available No Earlier Than DTG _____
Unique ID # _____	Integrated Infrastructure List ID # _____	BE Number _____
Type		
<input type="checkbox"/> HVT <input type="checkbox"/> TCT <input type="checkbox"/> Fixed - Facility <input type="checkbox"/> Non-Fixed - Moving <input type="checkbox"/> Non-Fixed - Not Moving <input type="checkbox"/> Other: _____		
Point <input type="checkbox"/> Radius (km) _____ Area / Polygon <input type="checkbox"/> Route / Polyline <input type="checkbox"/> Datum: WGS84 <input type="checkbox"/> Other: _____		
Geocoordinate Units: Dd.decimal <input type="checkbox"/> Ddmsss <input type="checkbox"/> Dd.mmss <input type="checkbox"/> MGRS <input type="checkbox"/> UTM <input type="checkbox"/> Other: _____ <input type="checkbox"/> See Attached for Further Definition <input type="checkbox"/>		
Point or Centroid Coordinates: Latitude _____ Longitude _____ MGRS _____ UTM _____		
Facility / Area MIDB Name _____		
Recommended Target Priority: <input type="checkbox"/> Time Critical / Sensitive <input type="checkbox"/> Immediate <input type="checkbox"/> Routine <input type="checkbox"/> Other _____		
Target Available No Earlier Than DTG _____		Target Available No Earlier Than DTG _____
Unique ID # _____	Integrated Infrastructure List ID # _____	BE Number _____
Type		
<input type="checkbox"/> HVT <input type="checkbox"/> TCT <input type="checkbox"/> Fixed - Facility <input type="checkbox"/> Non-Fixed - Moving <input type="checkbox"/> Non-Fixed - Not Moving <input type="checkbox"/> Other: _____		
Point <input type="checkbox"/> Radius (km) _____ Area / Polygon <input type="checkbox"/> Route / Polyline <input type="checkbox"/> Datum: WGS84 <input type="checkbox"/> Other: _____		
Geocoordinate Units: Dd.decimal <input type="checkbox"/> Ddmsss <input type="checkbox"/> Dd.mmss <input type="checkbox"/> MGRS <input type="checkbox"/> UTM <input type="checkbox"/> Other: _____ <input type="checkbox"/> See Attached for Further Definition <input type="checkbox"/>		
Point or Centroid Coordinates: Latitude _____ Longitude _____ MGRS _____ UTM _____		
Facility / Area MIDB Name _____		
Recommended Target Priority: <input type="checkbox"/> Time Critical / Sensitive <input type="checkbox"/> Immediate <input type="checkbox"/> Routine <input type="checkbox"/> Other _____		
Target Available No Earlier Than DTG _____		Target Available No Earlier Than DTG _____
Unique ID # _____	Integrated Infrastructure List ID # _____	BE Number _____
Type		
<input type="checkbox"/> HVT <input type="checkbox"/> TCT <input type="checkbox"/> Fixed - Facility <input type="checkbox"/> Non-Fixed - Moving <input type="checkbox"/> Non-Fixed - Not Moving <input type="checkbox"/> Other: _____		
Point <input type="checkbox"/> Radius (km) _____ Area / Polygon <input type="checkbox"/> Route / Polyline <input type="checkbox"/> Datum: WGS84 <input type="checkbox"/> Other: _____		
Geocoordinate Units: Dd.decimal <input type="checkbox"/> Ddmsss <input type="checkbox"/> Dd.mmss <input type="checkbox"/> MGRS <input type="checkbox"/> UTM <input type="checkbox"/> Other: _____ <input type="checkbox"/> See Attached for Further Definition <input type="checkbox"/>		
Point or Centroid Coordinates: Latitude _____ Longitude _____ MGRS _____ UTM _____		
Facility / Area MIDB Name _____		
Recommended Target Priority: <input type="checkbox"/> Time Critical / Sensitive <input type="checkbox"/> Immediate <input type="checkbox"/> Routine <input type="checkbox"/> Other _____		
Target Available No Earlier Than DTG _____		Target Available No Earlier Than DTG _____
Unique ID # _____	Integrated Infrastructure List ID # _____	BE Number _____
Type		
<input type="checkbox"/> HVT <input type="checkbox"/> TCT <input type="checkbox"/> Fixed - Facility <input type="checkbox"/> Non-Fixed - Moving <input type="checkbox"/> Non-Fixed - Not Moving <input type="checkbox"/> Other: _____		
Point <input type="checkbox"/> Radius (km) _____ Area / Polygon <input type="checkbox"/> Route / Polyline <input type="checkbox"/> Datum: WGS84 <input type="checkbox"/> Other: _____		
Geocoordinate Units: Dd.decimal <input type="checkbox"/> Ddmsss <input type="checkbox"/> Dd.mmss <input type="checkbox"/> MGRS <input type="checkbox"/> UTM <input type="checkbox"/> Other: _____ <input type="checkbox"/> See Attached for Further Definition <input type="checkbox"/>		
Point or Centroid Coordinates: Latitude _____ Longitude _____ MGRS _____ UTM _____		
Notes:		
TMD IPB Template – 18 March 2000 Classification: _____ Local Reproduction Authorized		

Figure B-46. Recommended Target Nominations and TAIs Worksheet Template

Appendix C

AUTOMATED TOOLS AND EXAMPLE ARCHITECTURES

1. Selected Automated Tools

Table C-1 lists selected automated tools that assist in TMD IPB development. At a minimum, use the Joint Deployable Intelligence Support System (JDISS), GALE, and joint services workstation (JSWS).

2. Current TMD IPB Automated Tool Architecture Examples

Each organization tasked with conducting TMD IPB is uniquely configured to accomplish that mission. Because of this diversity, there is no one-way to construct a doctrinal TMD IPB architecture. Instead, the following examples serve to illustrate how 2 real-world organizations are configured to perform the TMD IPB mission.

a. 32d Army Air and Missile Defense (AAMDC) Brigade. The 32d AAMDC is the Army Forces and Joint Forces Land Component Commander’s organization that performs critical theater air and missile defense planning, integration, coordination, and execution functions. The 32d AAMDC coordinates and

Table C-1. Selected Automated Tools

ASAS-RWS:	
DESCRIPTION: Provides collateral intelligence processing capabilities to Army, corps, and division J-/G-2s; disseminates a collateral picture of the all-source database to tactical commanders for battlespace situational awareness; produces ground battle situation analysis through adversary integration; rapidly disseminates intelligence information; provides target identification and nominations; and provides intelligence collection management.	
Current Capability	POC: United States Army
ASAS-Light:	
DESCRIPTION: Same as for the ASAS.	
Current Capability	POC: United States Army
JDISS:	
DESCRIPTION: Receives, processes, and displays tactical, theater, and national level intelligence and imagery to support TMD IPB; provides rapid data exchange, primarily IPB products and databases at the joint level for time-sensitive targeting, TMD nodal analysis and collaborative planning; and the means to share critical combat information and intelligence to coordinate courses of action and develop common TTPs.	
Current Capability	POC: Defense Intelligence Agency
GALE:	
DESCRIPTION: Performs suitability modeling and location assessments against the TMD adversary and projects probable adversary mobile and stationary missile launcher operating locations. Assists in terrain analysis by using digital mapping data; provides terrain delimitation features to conduct detailed slope, road/rail, line of sight, and terrain analysis.	
Current Capability	POC: Defense Intelligence Agency
JSWS:	
DESCRIPTION: Provides MTI/SAR information and initiates RSR. Depth of tracking in AOR limited by adversary SAM threat to sensor.	
Current Capability	POC:
MCS:	
DESCRIPTION:	
Current Capability	POC:
ABIS (MSTS):	
DESCRIPTION: Provides real-time high-resolution 3-D imagery, flight following, and adversary displays (TIBS and TRAP broadcast feeds). Allows the commander to “stand on” or “fly over” the terrain in his AO.	
Current Capability	POC:

integrates the 4 operational elements of the TMD mission. Its G-2 section is responsible for all current and future TMD IPB operations. Figure C-1 depicts the internal architecture that supports the G-2 section in the tactical operations center (TOC).

Although an Army organization, the AAMDC plays a critical role in the joint TMD mission arena. The AAMDC commanding general is usually assigned as the deputy, area air defense commander and is responsible for facilitating the overall air and missile defense mission. Supporting this task is a robust ISR coordination function residing in the AAMDC TOC. Figure C-2 depicts some of the external agencies that feed information to the TOC.

b. 7th Air Force TMD Intelligence Team. Another real-world organization performing TMD IPB is the 7th Air Force TMD Intelligence Team. This team is responsible for US Forces, Korea's (USFK) TMD IPB. It supports the execution of attack operations, active defense (PATRIOT), and passive defense. The team directly inputs into the integrated tasking order; dynamically retasks ISR assets; plans active defense; and cues the retasking of attack assets. The 607th Air Intelligence Squadron mans and the 32d AAMDC augments the TMD intelligence team. A simplified relationship diagram is shown in Figure C-3.

The TMD intelligence team is located in a small office space with about 14 workstations and a large plexiglas map display area. Networks available to the team are TDDS, Pacific Command automated data processing server site - Korea (PASS-K) high, Joint Worldwide Intelligence Communication System (JWICS), PASS-K low, SECRET internet protocol router network (SIPRNET), and 7th Air Force SCI wide area network/JWICS. Major available applications are applix e-mail, INTELINK, GALE, automated message handling system, JSWS, direct UAV video, contingency theater automated planning system, and other PASS-K applications (virtually identical to JDISS applications). The team also has secure

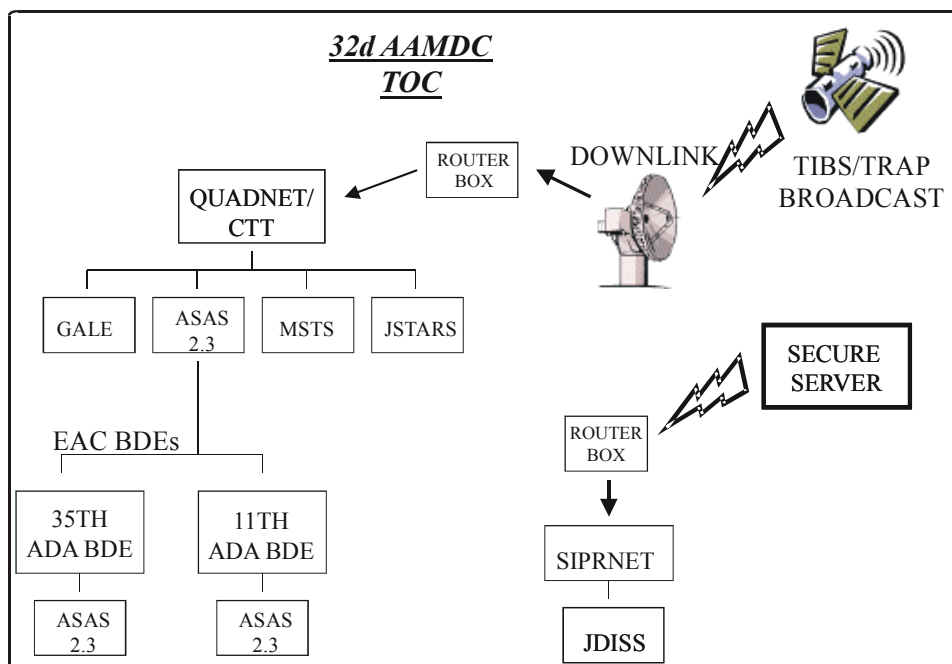

Figure C-1. 32d AAMDC Brigade G-2 TOC

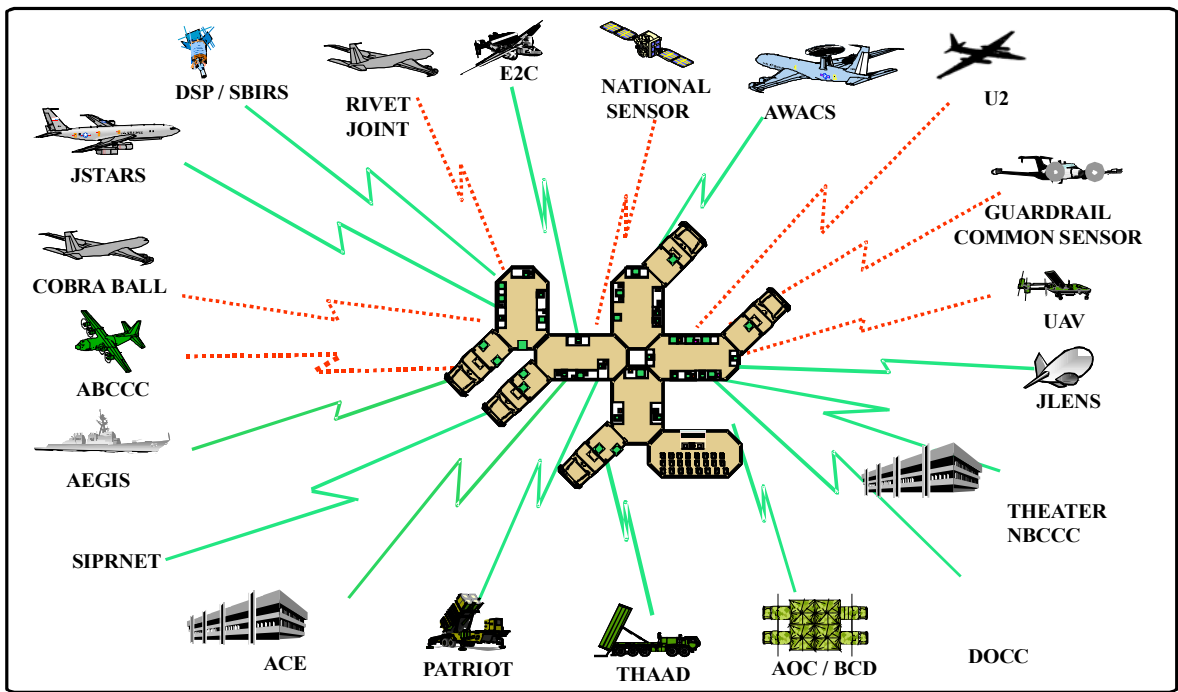

Figure C-2. 32d AAMDC External Information Sources

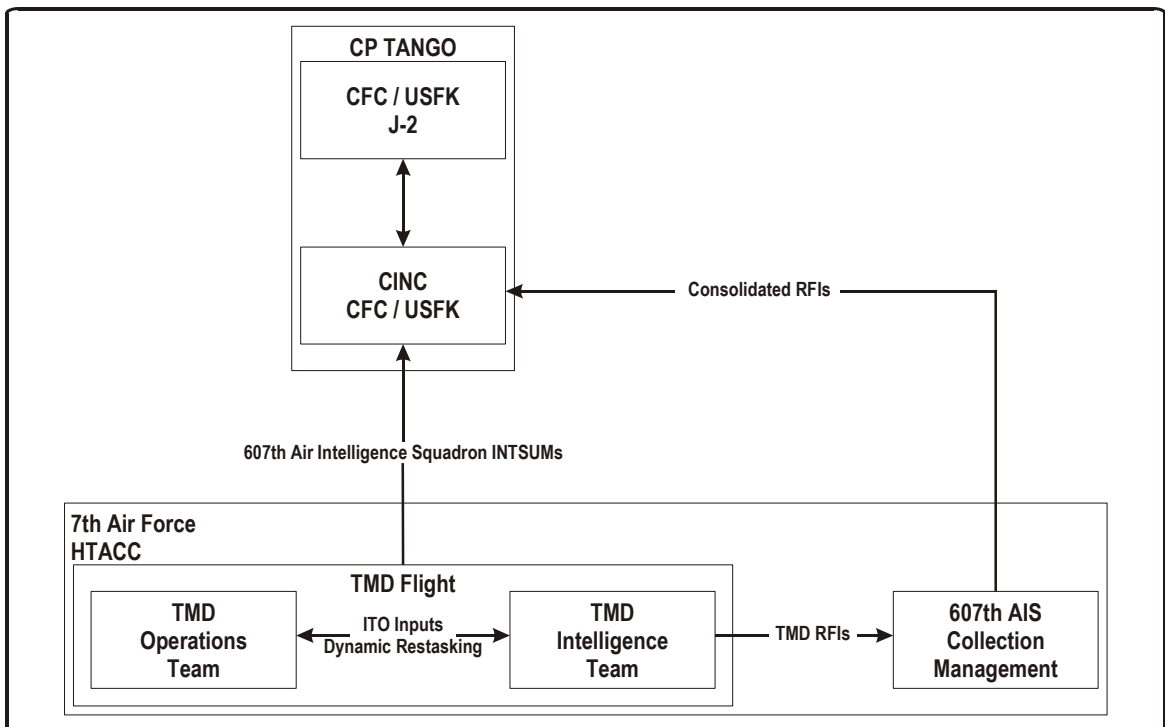

Figure C-3. TMD Flight Simplified Organizational Relationships

telephone unit-III connectivity. Figure C-4 shows the team's physical layout. Minimal manning for the TMD intelligence team is 9 operators/analysts and each has a specific function as shown in Table C-2.

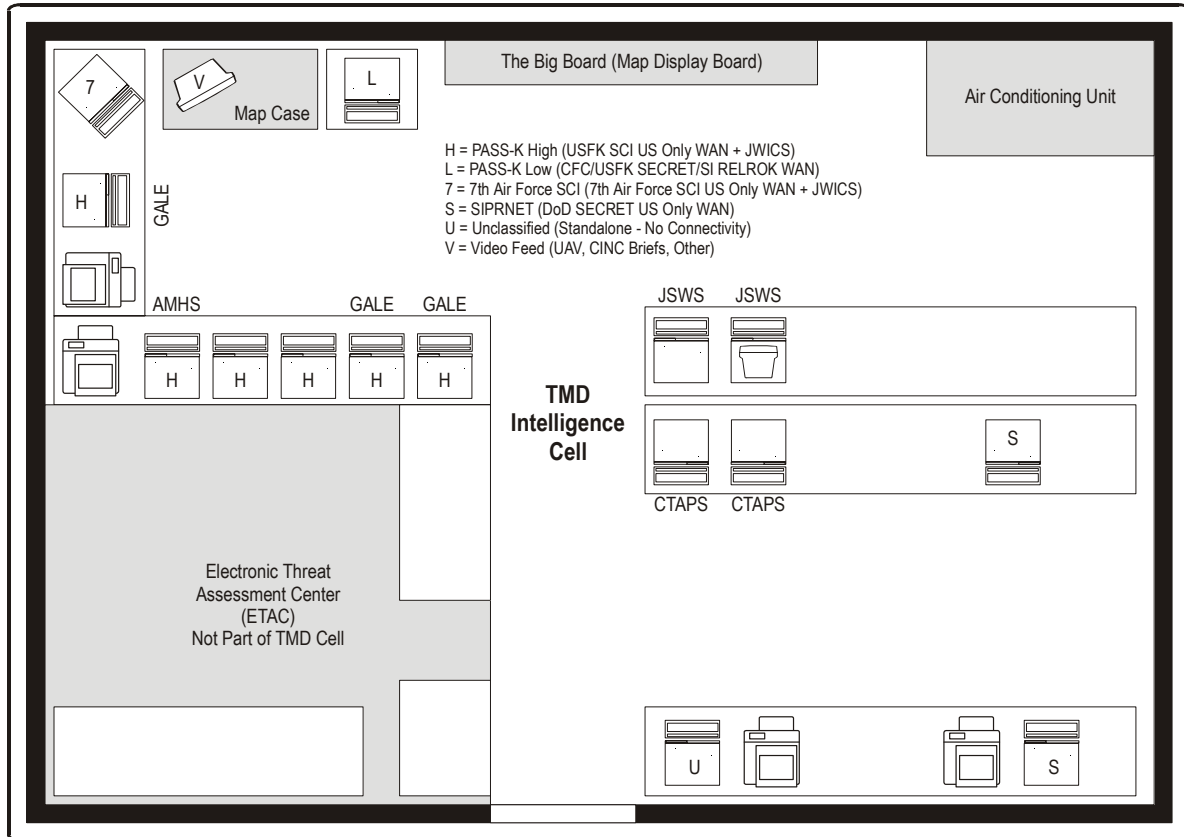

Figure C-4. Physical Layout of the 7th Air Force TMD Intelligence Team

Table C-2. Specific 7th Air Force TMD Intelligence Team Functions

<p align="center">IPB Analyst</p> <p>Fuses all-source intelligence. Predicts adversary courses of action. Recommends potential targets and collection to team chief. Primary ADP system: JSWS (SIPRNET).</p>	<p align="center">JSWS Analyst</p> <p>Analyzes moving target indicator data; exploits “replay” function to track activity. Coordinates with GALE operator/analyst. Provides interpretation to IPB analyst. Primary ADP system: PASS-K high.</p>
<p align="center">Research Analyst</p> <p>Operates message handling system. Builds queries to retrieve information on TBM and NBC activities. Passes collection summaries and battle damage assessment (BDA) reports to team members. Maintains message files. Primary ADP system: PASS-K high.</p>	<p align="center">Collection Analyst</p> <p>Receives and evaluates IPB collection requests. Submits requirements to collection management. Tracks requests and reports results to IPB analyst. Primary ADP system: PASS-K low and SIPRNET.</p>
<p align="center">Target Analyst</p> <p>Receives target nominations from IPB analyst. Builds target submission worksheet for team chief’s approval. Submits coordinated targets to TMD execution cell. Tracks mission status and BDA reporting. Primary ADP system: PASS-K high.</p>	<p align="center">Combined Unconventional Warfare Task Force (CUWTF) Liaison Officer (LNO)</p> <p>Coordinates tasking and reporting of CUWTF operations. Focal point for training on CUWTF assets and their tactics. Point of contact for CUWTF TMD named areas Of interest. Primary ADP system: laptop computer at the SECRET level with no connectivity.</p>
<p align="center">Weapons of Mass Destruction Analyst/Reporter</p> <p>Monitors reporting on TBM activities. Tracks activity at NBC chemical facilities. Drafts TMD intelligence team input to 607th AIS INTSUM. Builds slides for TMD execution cell briefing. Primary ADP system: PASS-K high.</p>	<p align="center">Team Chief and Non-commissioned Officer in Charge (NCOIC)</p> <p>Directs and coordinates activities of team members. Ensures TMD execution cell intelligence requirements. Approves target nominations, collection requests, intelligence summaries (INTSUMS), and pit briefings. Primary ADP system: PASS-K high.</p>
	<p align="center">GALE Operator</p> <p>Receives missile launch data via TDDS. Performs terrain analysis to determine ground movement limitations. Provides interpretations to IPB analyst. Primary ADP system: PASS-K high (GALE).</p>

Appendix D

TMD IPB CHECKLIST AND DEVELOPMENT PLAN

1. TMD IPB Checklist

Figure D-1 is a template for a suggested TMD IPB checklist. Use it to quickly organize the TMD IPB process and determine the detail required. This checklist aids in identifying the depth of coverage needed to support current TMD IPB data requirements and analysis. Break each sub-step out further as required for the situation. Prioritize them using a simple 1-2-3-priority scheme or a more complex one if desired. Use the checklist for recurring requirement, assigned level of detail, and current status and to define the TMD IPB process required for the current command mission. By initially skimming the checklist and then reevaluating the requirements based on available time and resources, the entire TMD IPB process is more effectively balanced. Use the checklist as a guideline for all the steps and as intelligence requirements are filled; use it to monitor and maintain their status. The checklist is not meant to be comprehensive. It is a basis for starting, guiding, and tracking the TMD IPB process and starting the collection process.

2. IPB Development Plan

Develop a plan to help organize, guide, and track the TMD IPB development. A checklist is a good starting point for developing the plan. Give start and expected completion times to checklist items and make links between checklist items to show dependencies and information and product flow. As the checklist items progress, track them on the development plan. The development plan acts as a management tool to show the TMD IPB development's progress and status. Tailor the development plan to a particular situation's requirements. A plan for creating a new TMD IPB looks significantly different than one for a completed, but monitored TMD IPB. In a wartime situation, the TMD IPB development plan will be highly dynamic to keep it synchronized with combat operations. Figure D-2 is a TMD IPB development plan example for a completed TMD IPB that is being maintained. There are many computerized tools to help develop these plans; Microsoft Project is one such program.

DTG: _____		Classification: _____		Page: ____ of: ____			
TMD IPB Checklist -- All Steps Template (U)							
#	Checklist item	Priority (1,2,3)	Time Criticality	Detail (1,2,3)	Status (G,Y,R)	Consumer	Notes
01	Step 1 - Define the Battlespace Environment						
02	1.1 - Analyze the Command's Mission in Relation to TMD						
03	1.1.1 - Summarize the Command's Mission and Objectives						
04	1.1.2 - Summarize the Commander's Guidance						
05	1.2 - Identify the Limits of the TMD AO, AOIs, and Battlespace						
06	1.2.1 - Assess TM Force Coverage						
07	1.2.2 - Assess Potential TM Force Deployment Area						
08	1.2.3 - Assess TMD Passive Defense AO and AOI						
09	1.2.4 - Assess TMD Active Defense AO and AOI						
10	1.2.5 - Assess TMD Attack Operations AO and AOI						
11	1.2.6 - Assess TMD Composite AO and AOI						
12	1.2.7 - Assess TMD Battlespace						
13	1.3 - Determine the Significant Environment Characteristics of the AO						
14	1.3.1 - Assess Geopolitical and Regional Threat						
15	1.3.2 - Assess TM Force General Capabilities						
16	1.3.3 - Assess TM Force Active Defense Suppression Capabilities						
17	1.3.4 - Assess Major Terrain Features						
18	1.3.5 - Assess Major Lines of Communication						
19	1.4 - Identify the Amount of Detail Required & Feasible within the Time Available						
20	1.4.1 - Create or Update IPB Checklist and Development Plan						
21	1.5 - Evaluate Existing Databases and Identify Gaps						
22	1.5.1 - Assess TMD IPB Holdings, Databases, Sources and Links						
23	1.5.2 - Evaluate TMD IPB Information Sources						
24	1.5.3 - Establish TMD IPB POCs						
25	1.6 - Collect Material & Intelligence Required For Further TMD IPB Analysis						
26	1.6.1 - Collect Recommended PIRs/EEIs/RFIs						
27	1.6.2 - Search For Information by Key Word and Equipment & Category Codes						
28	Step 2 - Define the Battlespace Effects						
29	2.1 - Analyze the TM Battlespace Environment						
30	2.1.1 - Assess Terrain						
31	2.1.1.1 - Assess Surface Configuration						
32	2.1.1.2 - Assess Vegetation						
33	2.1.1.3 - Assess Surface Materials						
34	2.1.1.4 - Assess Obstacles						
35	2.1.1.5 - Assess Transportation and LOC Infrastructure						
36	2.1.1.6 - Assess Urban Areas						
37	2.1.1.7 - Assess Cover						
38	2.1.1.8 - Assess Concealment						
39	2.1.1.9 - Assess CCM						
40	2.1.1.10 - Assess Observation/LOS						
41	2.1.1.11 - Assess Key Terrain						
42	2.1.1.12 - Assess Electromagnetic Spectrum						
43	2.1.2 - Assess Weather Effects on TM Operations						
44	2.1.2.1 - Assess TM Force Climatology						
45	2.1.2.2 - Assess Current and Forecast Weather						
46	2.1.3 - Assess Other Characteristics of the Battlespace						
47	2.1.3.1 - Assess TM Infrastructure						
48	2.1.3.2 - Assess TM Facility/Area						
49	2.1.3.3 - Assess TM Infrastructure HVTs						
50	2.2 - Assess Battlespace Effects on TM Force Capabilities and Broad COAs						

Figure D-1. TMD IPB Checklist (1 of 2)

TMD IPB Checklist -- All Steps Template (U)

#	Checklist item	Priority (1,2,3)	Time Criticality	Detail (1,2,3)	Status (G,Y,R)	Consumer	Notes
51	2.2.1- Assess Area Limitation						
52	Step 3 - Evaluate the TM Force						
53	3.1 - Create TM Models						
54	3.1.1 - Assess TM Organizational/C4I Structure						
55	3.1.2 - Assess TM Equipment						
56	3.1.3 - Assess TM TTPs						
57	3.1.4 - Assess HVTs						
58	Step 4 - Determine TM COAs						
59	4.1 - Identify Likely TM Objectives and Desired End State						
60	4.2 - Identify the Full Set of TM COAs						
61	4.3 - Evaluate and Prioritize Each Specific TM COA						
62	4.4 - Expand Each COA in the Amount of Detail Time Allows						
63	4.4.1 - Develop Situation Template and Assess HVTs						
64	4.5 - Identify Initial Collection Requirements						
65	4.5.1 - Develop Event Template and Matrix						
66	4.6 - Identify Target Nominations						
67	4.6.1 - Assess Current Situation and Weather Data						
68	4.6.2 - Assess NAI Intelligence Collection Results						
69	4.6.3 - Assess Most Likely TM Force COA						
70	4.6.4 - Assess PIRs						

Notes:

Abbreviations and Codes

<p>All</p> <p>NA - Not Applicable UNK - Unknown or Unassessed TBD - To Be Determined</p> <p>Priority</p> <p>1 - High (Required, Can Not Do Without) 2 - Medium (Required, but Can Accept Some or Loss of Detail) 3 - Low (Desirable, but Not Required)</p> <p>Time Criticality</p> <p>First Digit - Recurrence</p> <table border="0"> <tr><td>1 - One Time</td><td>S - Semi-Annually</td></tr> <tr><td>D - Daily</td><td>A - Annually</td></tr> <tr><td>W - Weekly</td><td>C - Biannually</td></tr> <tr><td>M - Monthly</td><td>E - On Demand</td></tr> <tr><td>B - Bimonthly</td><td>R - As Required</td></tr> <tr><td>Q - Quarterly</td><td>O - Other</td></tr> </table> <p>Second Digit - Timeliness (from Receipt of Sufficient Data)</p> <table border="0"> <tr><td>1 - Critical, Less Than 8 Hours (1 Shift)</td><td>5 - Weeks</td></tr> <tr><td>2 - Immediate, Less Than 16 Hours (2 Shifts)</td><td>6 - Months</td></tr> <tr><td>3 - High, Less Than 24 Hours (3 Shifts)</td><td>7 - Years</td></tr> <tr><td>4 - Days</td><td>O - Other</td></tr> </table> <p>Detail</p> <p>1 - High, Must Have High Level of Detail to Meet TMD IPB Requirements 2 - Medium, A Medium Level of Detail is Acceptable to Meet TMD IPB Requirements 3 - Low, A Low Level of Detail is Acceptable to Meet TMD IPB Requirements</p> <p>Status</p> <p>G - or GREEN for Complete or Acceptable in Meeting TMD IPB Requirements Y - or YELLOW for Partially Complete, but Meets Some TMD IPB Requirements R - or RED for Incomplete or Unacceptable for Meeting TMD IPB Requirements</p>	1 - One Time	S - Semi-Annually	D - Daily	A - Annually	W - Weekly	C - Biannually	M - Monthly	E - On Demand	B - Bimonthly	R - As Required	Q - Quarterly	O - Other	1 - Critical, Less Than 8 Hours (1 Shift)	5 - Weeks	2 - Immediate, Less Than 16 Hours (2 Shifts)	6 - Months	3 - High, Less Than 24 Hours (3 Shifts)	7 - Years	4 - Days	O - Other	<p>Consumers</p> <p>All - All T - TMD IPB Function</p> <p>L - TMD IPB Function Leadership G - General Analysis T - Terrain Analysis I - Infrastructure Analysis D - Adversary/Threat Modeling Analysis C - COA Analysis S - Situational Analysis</p> <p>E - External to TMD IPB Function, but Within the Command or Units Attached to the Command</p> <p>C - Commander and/or Immediate Staff 2 - J2, C2, G2, A2, N2, or S2 and/or Staff 3 - J3, C3, G3, A3, N3, or S3 and/or Staff 5 - J5, C5, G5, A5, N5, or S5 and/or Staff J - JFACC and/or Immediate Staff A - AOC</p> <p>E - External to TMD IPB Function and the Command or Units Attached to the Command</p> <p>N - NMJIC M - NMCC</p> <p>Other</p> <p>Z - _____ Y - _____ X - _____ W - _____ V - _____ U - _____ R - _____ Q - _____</p>
1 - One Time	S - Semi-Annually																				
D - Daily	A - Annually																				
W - Weekly	C - Biannually																				
M - Monthly	E - On Demand																				
B - Bimonthly	R - As Required																				
Q - Quarterly	O - Other																				
1 - Critical, Less Than 8 Hours (1 Shift)	5 - Weeks																				
2 - Immediate, Less Than 16 Hours (2 Shifts)	6 - Months																				
3 - High, Less Than 24 Hours (3 Shifts)	7 - Years																				
4 - Days	O - Other																				

Figure D-1 (Continued). TMD IPB Checklist (2 of 2)

TMD IPB Development Plan -- All Steps Template (U)

#	Checklist item	Year: _____	Jan	Feb	Mar	Apr	May	Jun	Jul	Aug	Sep	Oct	Nov	Dec
01	Step 1 - Define the Battlespace Environment													
02	1.1 - Analyze the Command's Mission in Relation to TMD													
03	1.1.1 - Summarize the Command's Mission and Objectives													
04	1.1.2 - Summarize the Commander's Guidance													
05	1.2 - Identify the Limits of the TMD AOs, AOIs, and Battlespace													
06	1.2.1 Assess TM Force Coverage													
07	1.2.2 - Assess Potential TM Force Deployment Area													
08	1.2.3 - Assess TMD Passive Defense AO and AOI													
09	1.2.4 - Assess TMD Active Defense AO and AOI													
10	1.2.5 - Assess TMD Attack Operation AO and AOI													
11	1.2.6 - Assess TMD Composite AO and AOI													
12	1.2.7 - Assess TMD Battlespace													
13	1.3 - Determine the Significant Environment Characteristics of the AO													
14	1.3.1 - Assess Geopolitical and Regional Threat													
15	1.3.2 - Assess TM Force General Capabilities													
16	1.3.3 - Assess TM Force Active Defense Suppression Capabilities													
17	1.3.4 - Assess Major Terrain Features													
18	1.3.5 - Assess Major Lines of Communication													
19	1.4 - Identify the Amount of Detail Required & Feasible within the Time Available													
20	1.4.1 - Create or Update IPB Checklist and Development Plan													
21	1.5 - Evaluate Existing Databases and Identify Gaps													
22	1.5.1 - Assess TMD IPB Holdings, Databases, Sources and Links													
23	1.5.2 - Evaluate TMD IPB Information Sources													
24	1.5.3 - Establish TMD IPB POCs													
25	1.6 - Collect Material & Intelligence Required For Further Analysis													
26	1.6.1 - Collect Recommended PIRs/EIs/RFIs													
27	1.6.2 - Search for Information by Key Word and Equipment and Category Codes													
28	Step 2 - Define the TM Battlespace Environment													
29	2.1 - Analyze the TM Battlespace Environment													
30	2.1.1 - Assess Terrain													
31	2.1.1.1 - Assess Surface Configuration													
32	2.1.1.2 - Assess Vegetation													
33	2.1.1.3 - Assess Surface Materials													
34	2.1.1.4 - Assess Obstacles													
35	2.1.1.5 - Assess Transportation and LOC Infrastructure													
36	2.1.1.6 - Assess Urban Areas													
37	2.1.1.7 - Assess Cover													
38	2.1.1.8 - Assess Concealment													
39	2.1.1.9 - Assess CCM													
40	2.1.1.10 - Assess Observation/LOS													
41	2.1.1.11 - Assess Key Terrain													
42	2.1.1.12 - Assess Electromagnetic Spectrum													
43	2.1.2 - Assess Weather Effects on TM Operations													
44	2.1.2.1 - Assess TM Force Climatology													
45	2.1.2.2 - Assess Current and Forecast Weather													
46	2.1.3 - Assess Other Characteristics of the Battlespace													
47	2.1.3.1 - Assess TM Infrastructure													
48	2.1.3.2 - Assess TM Facility/Area													
49	2.1.3.3 - Assess TM Infrastructure HVTs													
50	2.2 - Assess Battlespace Effects on TM Force Capabilities and Broad COAs													

Figure D-2. TMD IPB Development Plan (1 of 2)

TMD IPB Development Plan -- All Steps Template (U)

#	Checklist item	Jan	Feb	Mar	Apr	May	Jun	Jul	Aug	Sep	Oct	Nov	Dec
51	2.2.1 - Assess Area Limitation												
52	Step 3 - Evaluate the TM Force												
53	3.1 - Create TM Models												
54	3.1.1 - Assess TM Organizational/C4I Structure												
55	3.1.2 - Assess TM Equipment												
56	3.1.3 - Assess TM TTPs												
57	3.1.4 - Assess HVTs												
58	Step 4 - Determine TM COAs												
59	4.1 - Identify Likely TM Objectives and Desired End State												
60	4.2 - Identify the Full Set of TM COAs												
61	4.3 - Evaluate and Prioritize Each Specific TM COA												
62	4.4 - Expand Each COA in the Amount of Time and Detail Time Allows												
63	4.4.1 - Develop Situation Template and Assess HVTs												
64	4.5 - Identify Initial Collection Requirements												
65	4.5.1 - Develop Event Template and Matrix												
66	4.6 - Identify Target Nominations												
67	4.6.1 - Assess Current Situation and Weather Data												
68	4.6.2 - Assess NAI Intelligence Collection Results												
69	4.6.3 - Assess Most Likely TM Force COA												
70	4.6.4 - Assess PIRs												

Notes:

Legend



-  Gray bar represents planned start to finish length of step from scratch
-  Black internal bar represents the estimated percentage of completion of the step to meet TMD IPB requirements
-  Event marker, Q is for quarterly review meeting and T is for today or the last date the plan was updated (other codes can be used as required)
-  Indicates flow of data from one step to another, only used for significant data flow or dependency

Figure D-2 (Continued). TMD IPB Development Plan (2 of 2)

Appendix E

TMD IPB INTERNET LINKS

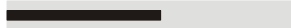
1. Intelligence Organizations

Central Intelligence Agency: <http://www.cia.gov>
Defense Intelligence Agency: <http://www.dia.mil>
Missile and Space Intelligence Center: <http://www.msic.dia.mil>
National Imagery and Mapping Agency: <http://www.nima.mil>
National Security Agency: <http://www.nsa.gov>
Office of Naval Intelligence: <http://www.odci.gov/ic/ni.html>

2. Joint Military Organizations

Air Land Sea Application (ALSA) Center: <http://www.dtic.mil/alsa>
Department of Defense (DOD): <http://www.defenselink.mil/>
DOD Directives and Records: <http://www.dtic.mil/whs/directives>
Joint Doctrine: <http://www.dtic.mil/doctrine>
Joint Electronic Library: <http://www.dtic.mil/doctrine/jel/index.html>
US Space Command: <http://www.spacecom.af.mil/usspace>

3. Air Force

Air Force Space Command: <http://www.peterson.af.mil/hqafspc/index.htm>
Air Intelligence Agency: <http://www.aia.af.mil>

4. Army

Homepage: <http://www.army.mil/>
Doctrine and Training Digital Library: <http://www.adtdl.army.mil>
Space and Missile Defense Command: <http://www.smdc.army.mil/default.html>
US Army Intelligence and Security Command: <http://www.inscom.army.mil>

5. Marines

Marine Link: <http://www.usmc.mil> or <http://www.hqmc.usmc.mil>

6. Navy

NavyOnLine: <http://www.ncts.navy.mil>
Naval Space Command: <http://www.navspace.navy.mil>

7. US Government Agencies

Congress: <http://www.senate.gov/> and <http://www.house.gov/>
Congressional Record: http://www.access.gpo.gov/su_docs
Defense Information Systems Agency: <http://www.disa.mil/disahomejs.html>
Department of Justice: <http://www.usdoj.gov>
Department of State: <http://www.state.gov>
Department of Treasury: <http://www.ustreas.gov>
Embassies: <http://www.embassy.org>
Federal Bureau of Investigation: <http://www.fbi.gov>
Federal Communications Commission: <http://www.fcc.gov>

Federal Emergency Management Agency: <http://www.fema.gov>
Library of Congress: <http://www.loc.gov>
National Archives and Records Administration: <http://www.nara.gov>
US Agency for International Development: <http://www.info.usaid.gov>
US Department of State, Office of International Information Programs (IIP):
<http://usinfo.state.gov>
White House: <http://www.whitehouse.gov/>

8. International Organizations/Databases

European Line: <http://www.europeonline.com>
France Defense: <http://www.ensmp.fr/~scherer/adminet/min/def/>
International Laws and Treaties: <http://www.jura.uni-sb.de> (contains German
and European codes)
North Atlantic Treaty Organization: <http://www.nato.int/>
United Nations: <http://www.un.org>
Office of the High Representative: <http://www.ohr.int/>

9. Think Tanks

Center for Defense Information: <http://www.cdi.org/>
Center for Nonproliferation Studies: <http://cns.miis.edu/>
Center for Strategic and International Studies: <http://www.csis.org/>
Centre for Strategic Studies: <http://www.vuw.ac.nz/css/>
Institute for the Advanced Study of Information Warfare:
<http://www.psychom.net/iwar.1.html>
Jaffe Center for Strategic Studies: <http://www.tau.ac.il/jcss/>
RAND Corporation: <http://www.rand.org/>
Stockholm International Peace Research Institute: <http://www.sipri.se/>
Strategic Studies Institute: <http://carlisle-www.army.mil/>

10. News Organizations

Cable News Network: <http://www.cnn.com/>
China News Digest: <http://www.cnd.org>
CNET: <http://www.cnet.com> (a news and information service)
Early Bird: <http://ebird.dtic.mil/>
New York Times: <http://www.nytimes.com>
US News and World Report: <http://www.usnews.com>
USA Today: <http://www.usatoday.com/>

11. Miscellaneous Links

IntelWeb: <http://intelweb.janes.com/>
Weather Information: <http://www.nws.noaa.gov> or
<http://cirrus.sprl.umich.edu/wxnet>

12. Search Tools

<http://www.lycos.com>
<http://www2.infoseek.com>
<http://www.excite.com>
<http://www.altavista.com>
<http://dogpile.com>
<http://www.yahoo.com>
<http://webcrawler.com>

References

Joint

- DIA NAIC-1061-0789-97, *Theater Missile Defense Intelligence Preparation of the Battlespace Methodology (U)*, Aug 1997, Pub Classification: SECRET.
- JP 1-02, *DOD Dictionary for Military and Associated Terms*, Jan 2000.
- JP 2-0, *Doctrine for Intelligence Support to Joint Military Operations*, Mar 2000.
- JP 2-01, *Joint Intelligence Support to Military Operations*, Nov 1996.
- JP 2-01.3, *Tactics, Techniques, and Procedures for Joint Intelligence Preparation of the Battlespace*, May 2000.
- JP 3-01, *Joint Doctrine for Countering Air and Missile Threats*, Oct 1999.
- JP 3-01.5, *Doctrine for Joint Theater Missile Defense*, Feb 1996.
- JP 6-04, *US Message Text Formatting Program (U)*, Oct 1992, Pub Classification: SECRET.
- DDB-2600-312-88, *Target Intelligence Handbook Annex A, Category Assignment Responsibility List (U)*, Sep 1988, DIA, Pub Classification: Confidential/NOFORN.

Multiservice

- FM 2-01.3 (FM 34-130)/MCRP 2-12A, *Intelligence Preparation of the Battlefield*, Jul 1994.
- FM 90-43/MCRP 3-42.1A/NWP 3-01.13/AFTTP(I) 3-2.24, *JTMTD, Multiservice Procedures for Joint Theater Missile Target Development*, Oct 1999.
- FM 90-36 (FM 3-60.1)/ MCRP 3-16.1F/ NWP 2-01.11/AFJPAM 10-225, *TARGETING The Joint Targeting Process and Procedures for Targeting Time-Critical Targets*, Jul 1997.
- FM 6-99.1 (FM 101-5-1)/MCRP 5-2A, *Operational Terms and Graphics*, May 1997.

Army

- FM 2-33.201 (FM 34-81-1), *Battlefield Weather Effects*, Dec 1992.
- FM 3-0 (FM 100-5), *Operations*, Jun 1993.
- FM 3-09.24 (FM 6-20-10) *Tactics, Techniques, and Procedures for the Targeting Process*, May 1996.
- FM 3-25.31 (FM 21-31), *Topographic Symbols*, Jun 1961.
- FM 3-34.33 (FM 5-33), *Terrain Analysis*, Jul 1990.
- FM 6-99 (FM 101-5), *Staff Organization and Operations*, May 1997.

Air Force

- AFPAM 14-118, *Aerospace Intelligence Preparation of the Battlespace*, 5 Jun 2001.

Glossary

PART I—ABBREVIATIONS AND ACRONYMS

A

AAA	anti-aircraft artillery
AADC	area air defense commander
AAMDC	Army Air Missile Defense Command
AB	airbase
ABCCC	airborne battlefield command and control center
ABL	airborne laser
ACE	all-source collection element (US Army)
ACINT	acoustical intelligence
ACP	army country profile
AD	air defense
ADA	air defense artillery
ADP	automated data processing
AEGIS	Airborne Early Warning Ground Environment Integration Segment
AFGC	Armed Forces General Command
a fld	airfield
AFMIC	Armed Forces Medical Intelligence Center
AIS	air intelligence squadron
Al	aluminum
ALCM	air-launched cruise missile
ALE	area limitation environment
AMEWS	Automatic Mobile Electronic Warfare System
AMHS	automated message handling system
AO	area of operations
AOC	air operations center
AOI	area of interest
AOR	area of responsibility
AP	ammonium percholate
APPS	analytical photogrammetric positioning system
AR	artillery rocket
ARC	arc-second raster chart
ARH	antiradiation homing
ARM	antiradiation missile
ASAS	All Source Analysis System
ASCII	American Standard Code for Information Interchange
ASCM	antiship cruise missile
ASM	air-to-surface missile
ASSC	Air Standardization Coordinating Committee
ASW	antisubmarine warfare
AUAV	attack unmanned aerial vehicle

B

BDA	battle damage assessment
BDE	brigade

BE	basic encyclopedia
BMCT	beginning morning civil twilight
BMNT	beginning morning nautical twilight
BMDO	Ballistic Missile Defense Organization
BTG	basic targeting graphic
BN	battalion
BW	biological warfare
C	
C	Celsius
C2	command and control
C3	command, control, and communications
C3I	command, control, communications, and intelligence
C4	command, control, communications, and computers
C4I	command, control, communications, computers, and intelligence
C4ISR	command, control, communications, computers, intelligence, surveillance, and reconnaissance
CADRG	compressed ARC digitized raster graphics
CAT	category
CBR	chemical/biological/radiological
CBW	chemical and biological warfare
CCD	camouflage, concealment, and deception
CCM	cross-country movement
CD-ROM	compact disc read-only memory
CEP	circular error probable
CFC	Combined Forces Command, Korea
CG	cruiser
CI	counterintelligence
CIA	Central Intelligence Agency
CIB	controlled image base
CINC	commander in chief
CM	cruise missile
COA	course of action
COMINT	communications intelligence
COMSEC	communications security
CONOPS	concept of operations
CONPLAN	operation plan in concept format
COTS	commercial off the shelf
CP	command post
CTAPS	contingency Theater Air Control System automated planning system
CTT	commander's tactical terminal
CUWTF	combined unconventional warfare task force
CW	chemical warfare
D	
D&D	deception and denial
DA	Department of the Army
DAL	defended asset list

DBDB	digital bathymetric data base
dBsm	decibels per square meter
DCW	Digital Chart of the World
DD	destroyer
DDG	guided missile destroyer
DF	direction finding
DFAD	Digital Features Analysis Data
DIA	Defense Intelligence Agency
DIRD	defense intelligence reference document
DMOB	defensive missile order of battle
DNC	digital nautical chart
doc	document
DOCC	deep operations coordination cell
DOI	date of information
DP	decision point
DPPDB	digital point positioning data base
DSN	Defense Switched Network
DSP	Defense Satellite Program
DST	decision support template
DTED	digital terrain elevation data
DTG	date time group
DTM	digital target materials
DTOP	digital topographic data
DTRA	Defense Threat Reduction Agency

E

E	east
EA	electronic attack
EC	electronic combat
ECCM	electronic counter-countermeasures
ECEF	earth-centered, earth fixed
ECM	electronic countermeasures
EECT	end of evening civil twilight
E EI	essential elements of information
EENT	end of evening nautical twilight
EL	erector launcher
ELINT	electronic intelligence
EM	electromagnetic
EMP	electromagnetic pulse
EO	electro-optical
EP	electronic protection
ERS	early release of submunitions
ES	electronic warfare support
EW	electronic warfare
EWCO	Electronic Warfare Company

F

5D	demand driven direct digital dissemination
FAE	fuel air explosive
fax	facsimile

FCV	fire control vehicle
FEBA	forward edge of the battle area
FFD	foundation feature data
FISINT	foreign instrumentation signals intelligence
FM	field manual
FOA	forward operating area
FOB	forward operations base
FOL	forward operating location
FOUO	for official use only
Frag	fragmentation
FSU	Former Soviet Union
FY	fiscal year

G

G-2	Army or Marine Corps component intelligence staff officer
G&C	guidance and control
GA	Tabun, a nerve agent
GALE	generic area limitation environment
GB	group buffer, Sarin, a nerve agent
GCC	Gulf Cooperation Council
GCCS	Global Command and Control System
GCI	ground control intercept
GD	Soman, a nerve agent
GEOTRANS	geographic translator
GF	a nerve agent
GGI&S	global geospatial information and services
GHz	gigahertz
GLCM	ground-launched cruise missile
GLONASS	Global Navigation Satellite System
GNC	global navigation chart
GPS	global positioning system
GSE	ground support equipment

H

HCV	horizontal checkout vehicle
HE	high explosive
HET	heavy equipment transporter
HF	high frequency
HH	hour, hour
HOIS	hostile intelligence service
HPT	high payoff target
HTACC	Hardened Theater Air Control Center
HTML	Hypertext Markup Language
HTPB	Hydroxyl-Terminated PolyButadiene
HUMINT	human intelligence
HVT	high value target

I

i.e.	that is
IBIS	Integrated Battlefield Intelligence System
ICOD	intelligence cutoff data
ICWM	International Committee on Weights and Measures
ID	identity
IESS	Imagery Exploitation Systems
IG	intelligence group
IMINT	imagery intelligence
INFLTREP	in-flight report
INS	inertial navigation system
INTELINK	intelligence link
INTSUM	intelligence summary
IPA	intelligence production agency
IPB	intelligence preparation of the battlespace
IPIR	Initial Phase Interpretation Report
IPL	integrated priority list
IR	infrared
IRBM	intermediate range ballistic missile
IRFNA	inhibited red fuming nitric acid
IRINT	infrared intelligence
ISMD	integrated suppression of missile defense
ISR	intelligence, surveillance, and reconnaissance
ITO	integrated tasking order
IW	information warfare

J

J-2	intelligence directorate of a joint staff
JAADC	joint area air defense commander
JCSP	Joint Chiefs of Staff Publication
JDISS	joint deployable intelligence support system
JFACC	joint force air component commander
JFC	joint force commander
JIC	joint intelligence center
JISE	joint intelligence support element
JLENS	Joint Land Attack Cruise Missile Defense Elevated Netted Sensor System
JMEM	Joint Munitions Effectiveness Manual
JNC	joint navigational chart
JOG	joint operations graphics
JOG-A	joint operations graphics-air
JOG-G	joint operations graphics-ground
JOG-R	joint operations graphics-radar
JP	joint publication
JRA	joint rear area
JSOA	joint special operations area
JSTARS	Joint Surveillance Target Attack Radar System
JSWS	joint services work station

JTF	joint task force
JTIDS	Joint Tactical Information Distribution System
JWICS	joint worldwide intelligence communication system
K	
kg	kilogram
km	kilometer
km²	square kilometer
kph	kilometers per hour
L	
LACM	land attack cruise missile
LAN	local area network
LASINT	laser intelligence
LIMDIS	limited distribution
LNO	liaison officer
LOAC	law of armed conflict
LOC	line of communications
LOS	line-of-sight
LR	long range
LTIOV	latest time information is of value
M	
m	meter
M/IRBM	medium/intermediate range ballistic missile
Mar	March
MARV	maneuvering reentry vehicle
MASINT	measurement and signature intelligence
Mbyte	megabyte
MC&G	mapping, charting, and geodesy
MCOO	modified combined obstacle overlay
MCS	military capabilities study
MEL	mobile erector launcher
MEPED	Military Equipment and Parametrics Engineering Database
METT-T	mission, enemy, terrain and weather , troops and support available, time available
MGRS	Military Grid Reference System
MHz	megahertz
mi	statute mile
MIDB	modernized integrated data-base
MIIDS/IDB	Military Intelligence Integrated Data System/Integrated Database
mm	millimeter
mmm	month, month, month
MOB	missile order of battle
MOU	memorandum of understanding
MP	mission planning
MRBM	medium range ballistic missile

MRL	multiple rocket launcher
MRV	multiple reentry vehicles
m/s	meter(s) per second
MSI	multi-spectral imagery
MSIC	Missile and Space Intelligence Center
MSTS	multi-source tactical system
MTCR	Missile Technology Control Regime
MTI	moving target indicator
MTTP	multiservice tactics, techniques and procedures
N	
N	north
N/A	not applicable
NAI	named area of interest
NAIC	National Air Intelligence Center
NATO	North Atlantic Treaty Organization
NBC	nuclear, biological, and chemical
NBCCC	nuclear, biological, chemical coordination center
NCOIC	noncommissioned officer in charge
NES	NIMA Exploitation System
NGIC	National Ground Intelligence Center
NIIRs	National Imagery Interpretability Rating Scale
NIMA	National Imagery and Mapping Agency
NIST	National Intelligence Support Team
NM	nautical mile
NMCC	National Military Command Center
NMJIC	National Military Joint Intelligence Center
NOFORN	not releasable to foreign nationals
NORAD	North American Aerospace Defense Command
NSA	National Security Agency
NUCINT	nuclear intelligence
O	
OA	operational area
OB	order of battle
ONC	operational navigation chart
ONI	Office of Naval Intelligence
OOB	order of battle
OPLAN	operations plan
OPORD	operation order
OPSEC	operations security
ORCON	dissemination and extraction controlled by originator
OS	operating system
OSINT	open-source intelligence
OTE	operational threat environment
P	
PG	patrol combatant
PGM	precision-guided munitions

PHOTINT	photographic intelligence
PIR	primary intelligence requirements
POC	point of contact
POL	petroleum, oils, and lubricants
PPDB	point positioning database
PS	permanent snowfield
PSYOP	psychological operations
PV	petroleum, oils, and lubricants vehicle
 Q	
Q-fever	an infectious disease caused by rickettsia
QUADNET	quadruple network
 R	
R&D	research and development
RADINT	radar intelligence
RCS	radar cross section
RDA	research, development and acquisition
RDT&E	research, development, test and evaluation
REC	radioelectronic combat
recce	reconnaissance
RF	radio frequency
RFI	request for information
RHAW	radar homing and warning
RINT	unintentional radiation intelligence
RK	bedrock
ROE	rules of engagement
RPH	remotely piloted helicopter
RPV	remotely piloted vehicle
RST	resupply trailer
RSTA	reconnaissance, surveillance and target acquisition
RSV	resupply vehicle
RWS	remote workstation
 S	
S	south
S&O	systems and operations
S&T	scientific and technical
S&TI	scientific and technical intelligence
SA	selective availability (GPS)
SAFE	secure analyst file environment
SAM	surface-to-air missile
SAP	semi-armor piercing
SAR	synthetic aperture radar
SATCOM	satellite communications
SATNAV	satellite navigation
SBIRS	space-based infrared system
SCI	sensitive compartmented information

SCUD	surface-to-surface missile system
SEAD	suppression of enemy air defenses
SEMD	suppression of enemy missile defenses
SF	special forces
SIGINT	signals intelligence
SIPRNET	Secret Internet Protocol Router Network
SLAR	side looking airborne radar
SLBM	sea-launched ballistic missile
SLCM	sea-launched cruise missile
SOF	special operations forces
SOJ	stand-off jammer
SPOT	satellite pour l'observation de la terre
SRBM	short-range ballistic missile
SS	second, second
SSM	surface-to-surface missile
STAR	Systems Threat Assessment Report
SUPIR	Supplemental Photographic Interpretation Report

T

3-D	three-dimensional
T&E	test and evaluation
TAD	theater air defense
TADIL-A	tactical digital information link-A
TADIL-J	tactical digital information link-Joint
TAI	target area of interest
TASM	tactical air-to-surface missile
TBD	to be determined
TBM	theater ballistic missile
TCT	time critical target
TDDS	TRAP data dissemination service
TECHINT	technical intelligence
TEL	transporter erector launcher
TELAR	transporter erector launcher and radar
TELINT	telemetry intelligence
TERCAT	terrain categorization
TGSM	terminally guided submunition
THAAD	theater high altitude area defense
TIBS	tactical information broadcast system
TLM	topographic line map
TM	theater missile
TMD	theater missile defense
TO&E	table of organization and equipment
TOC	tactical operation center
TPC	tactical pilotage chart
TPL	time phase line
TS	top secret
TS/SCI	top secret/sensitive compartmented information
TRAP	tactical related applications
TTADB	Tactical Terrain Analysis Database
TTP	tactics, techniques, and procedures

U

U	unclassified
UAV	unmanned aerial vehicle
UC	under construction
UGF	underground facility
UHF	ultra high frequency
Unk	unknown
UPS	universal polar stereographic
US	United States
USA	United States Army
USAF	United States Air Force
USCENTCOM	United States Central Command
USCS	Unified Soils Classification System
USFK	United States Forces, Korea
USMC	United States Marine Corps
USMTF	United States message text format
USN	United States Navy
USSPACECOM	United States Space Command
UTM	universal transverse mercator
UW	unconventional warfare

V

VHF	very high frequency
VMAP	vector map
VPF	vector product format
VRF	vegetation roughness factor
VTC	video teleconference
VX	a nerve agent

W

W	west
WAN	wide area network
WGS	World Geodetic System
WGS-84	World Geodetic System 1984
WMD	weapons of mass destruction
WSSIC	Weapon and Space Systems Intelligence Committee
WVS	World Vector Shoreline

X

X	built up areas plotted on map (FM 5-33)
---	---

Y

YY	year, year
----	------------

Z

Z	zulu
---	------

PART II - TERMS AND DEFINITIONS

Areas of Interest – The geographical area from which information and intelligence are required to permit planning or successful conduct of the command's operation. The AOI is usually larger than the command's AO and battle space; it includes any threat forces or characteristics of the battlespace environment that will significantly influence accomplishment of the command's mission.

Areas of Operations – As used in this publication, an AO is that portion of an area of conflict necessary for military operations. AOs for TMD IPB are those geographical regions analysts use to define missile threat envelopes, the locations where TM forces operate and/or where TMD operations will be conducted.

(An operational area defined by the joint force commander for land and naval forces. Areas of operations do not typically encompass the entire operational area of the joint force commander, but should be large enough for component commanders to accomplish their missions and protect their forces. [JP 1-02])

(Operational area: that portion of an area of conflict necessary for military operations. OAs are geographical areas assigned to commanders for which they have responsibility and in which they have the authority to conduct military operations. [Air Force IPB pamphlet]).

Assumptions – Information used to replace missing facts necessary for command and staff planning, estimating, and decision making. Assumptions may also be required for facts that change due to the time difference between receipt of the mission and the time of execution, such as threat dispositions. Assumptions should be confirmed or denied by intelligence collection whenever practical.

Battle Damage Assessment – The timely and accurate estimate of damage resulting from the application of military force, either lethal or nonlethal, against an objective or target.

Battle Space – Components determined by the maximum capabilities of an unit to acquire and dominate the enemy; includes areas beyond the AO; it varies over time according to how the commander positions assets. It depends on the command's ability to both acquire and engage targets using its own assets or those of other commands on its behalf.

Beginning Morning Nautical Twilight – Morning nautical twilight begins when the sun is 12 degrees below the eastern horizon. It is the start of that period where, in good conditions and in the absence of other illumination, enough light is available to identify the general outlines of ground objects, conduct limited military operations, and engage in most types of ground movement without difficulty. See end evening nautical twilight.

Branch – A contingency plan (an option built into the basic plan) for changing the disposition, orientation, or direction of movement of the force.

Capability – The ability to successfully perform an operation or accomplish an objective. The evaluation of capabilities includes an assessment of a force's current situation as well as its organization, doctrine, and normal TTPs. Capabilities are stated in terms of broad COAs and supporting operations. Generally, only capabilities that will influence accomplishment of the friendly command's mission are addressed.

Common Understanding of the Battlespace – How the commander and staff perceive the battlespace environment. It includes the sum of all that is known or perceived of friendly and threat forces and the effects of the battlespace environment.

Confirmed Intelligence – Information or intelligence reported by three independent sources. The test for independence is certainty that the information report of one source was not derived from either of the two other sources, usually resulting in reliance on original reporting. Analytical judgement counts as one source. Ensure that no more than one source is based solely on analytical judgement.

Course of Action – A possible plan open to an individual or commander that would accomplish or is related to accomplishment of the mission. A COA is initially stated in broad terms with the details determined during staff wargaming. To develop COAs, the staff must focus on key information and intelligence necessary to make decisions. COAs include five elements: *WHAT* (the type of operation), *WHEN* (the time the action will begin), *WHERE* (boundaries, axis, etc.), *HOW* (the use of assets), *WHY* (the purpose or desired end state).

Decision Point – The point in space and time where the commander or staff anticipates making a decision concerning a specific friendly COA. DPs are usually associated with threat force activity or the battlespace environment and are therefore associated with one or more NAIs. DPs also may be associated with the friendly force and the status of ongoing operations.

Decision Support Template – A graphic record of wargaming. The DST depicts DPs, timelines associated with movement of forces and the flow of the operation, and other key items of information required to execute a specific friendly COA.

Doctrinal Template – A model based on postulated threat doctrine. Doctrinal templates illustrate the disposition and activity of threat forces and assets (HVTs) conducting a particular operation unconstrained by the effects of the battlespace environment. They represent the application of threat doctrine under ideal conditions. Ideally, doctrinal templates depict the threat's normal organization for combat, frontages, depths, boundaries and other control measures, assets available from other commands, objective depths, engagement areas, battle positions, and so forth. Doctrinal templates are usually scaled to allow ready use on a map background. They are one part of a threat model.

End Evening Nautical Twilight – Occurs when the sun has dropped 12 degrees below the western horizon, and is the instant of last available daylight for the visual control of limited ground operations. At EENT there is no further sunlight available. See beginning morning nautical twilight.

Event Matrix – A description of the indicators and activity expected to occur in each NAI. It normally cross-references each NAI and indicator with the ties they are expected to occur and the COAs they will confirm or deny. There is no prescribed format.

Event Template – A guide for collection planning. The event template depicts the NAIs where activity (or its lack) will indicate which COA the threat has adopted.

Facts – Information known to be true. In terms of intelligence, facts include confirmed intelligence. See Assumptions.

High-Payoff Target – Target whose loss to the threat will contribute to the success of the friendly COA.

High-Value Target – Assets that the threat commander requires for the successful completion of a specific COA.

Indicators – Positive or negative evidence of threat activity or any characteristic of the AO which points toward threat vulnerabilities or the adoption or rejection by the threat of a particular capability, or which may influence the commander's selection of a COA. Indicators may result from previous actions or from threat failure to take action.

Information Requirement – An intelligence requirement of lower priority than the PIR of lowest priority.

Intelligence Preparation of the Battlespace – The systematic, continuous process of analyzing the threat and environment in a specific geographic area. IPB is designed to support the staff estimate and military decision making process. Most intelligence requirements are generated as a result of the IPB process and its interrelation with the decision making process.

Intelligence Requirement – A requirement for intelligence to fill a gap in the command's knowledge and understanding of the battlespace or threat forces. Intelligence requirements are designed to reduce the uncertainties associated with successful completion of a specific friendly COA; a change in the COA usually leads to a change in intelligence requirements. Intelligence requirements that support decisions which affect the overall mission accomplishment (such as choice of a COA, branch, or sequel) are designated by the commander as PIR. Less important intelligence requirements are designated as IR.

Latest Time Information of Value – The time by which information must be delivered to the requestor in order to provide decision makers with timely intelligence. Sometimes the LTIOV is the expected time of a decision anticipated during staff wargaming and planning. If someone other than the decision maker must first process the information, the LTIOV is earlier than the time associated with the decision point. The time difference accounts for delays in processing and communicating the final intelligence to the decision maker.

Line of Contact – A general trace delineating the location where two opposing forces are engaged.

Lines of Communication – All the routes (land, water, and air) that connect an operating military force with one or more bases of operations and along which supplies and military forces move. Note that not all roads and rails are LOCs; some are unsuited, others may be suitable but not used. Note also that in this context, a communications center is an area where LOCs converge, such as transshipment points or hub-pattern cities.

Mission, Enemy, Terrain, Troops, and Time Available – Used to describe the factors that must be considered during the planning or execution of a tactical operation. Since these factors vary in any given situation, the term “METT-T dependent” is a common way of denoting that the proper approach to a problem in any situation depends on these factors and their interrelationship in that specific situation.

Modified Combined Obstacle Overlay – A product used to depict the battlespace’s effects on military operations. It is normally based on a product depicting all obstacles to mobility, modified to also depict the following, which are not prescriptive nor inclusive:

- Cross-country mobility classifications (such as RESTRICTED),
- Objectives,
- AAs and mobility corridors,
- Likely locations of counter-mobility obstacle systems,
- Defensible terrain,
- Likely engagement areas, and
- Key terrain.

Named Area of Interest – The geographical area where information that will satisfy a specific information requirement can be collected. NAIs are usually selected to capture indications of threat COAs but also may be related to conditions of the battlespace.

Not Later Than – The time by which something must be accomplished.

OCOKA – A commonly used acronym and mnemonic for the military aspects of terrain. The acronym does not dictate the order in which the factors are evaluated; use the order in which the factors are evaluated; use the order best suited to the situation at hand. The military aspects of terrain are observation and fields of fire, concealment and cover, obstacles, key terrain, and avenues of approach.

Operational Area – That portion of an area of conflict necessary for military operations. OAs are geographical areas *assigned* to commanders for which they have responsibility and in which they have the authority to conduct military operations.

Order of Battle – Intelligence pertaining to identification, strength, command structure, and disposition of personnel, units, and equipment of any military force. The OB factors form the framework for analyzing military forces and their capabilities, building threat models, and hence developing COA models.

Pattern Analysis – Deducing the doctrine and TTP of a force by careful observation and evaluation of patterns in its activities. Pattern analysis leads to the development of threat models and hence to COA models. Identified patterns of threat activity can be used as indicators of threat COAs.

Possible – Information or intelligence reported by only one independent source is classified as possibly true. The test for independence is certainty that the

information report of a source was not derived from some other source, usually resulting in reliance on original reporting. A classification of possibly true cannot be based on analytical judgement alone.

Priority Intelligence Requirement – An intelligence requirement associated with a decision that will affect the overall success of the command’s mission. PIRs are a subset of intelligence requirements of a higher priority than information requirements. PIRs are prioritized among themselves and may change in priority over the course of the operation’s conduct. Only the commander designates PIRs.

Probable – Information or intelligence reported by two independent sources is classified as probably true. The test for independence is certainty that the information report of one source was not derived from the other source, usually resulting in reliance on original reporting. Analytical judgement counts as one source. Ensure that no more than one source is based solely on analytical judgement.

Reconnaissance – A mission undertaken to obtain information by visual observation, or other detection methods, about the activities and resources of an enemy or potential enemy, or about the meteorologic, hydrographic, or geographic characteristics of a particular area. Reconnaissance differs from surveillance primarily in duration of the mission.

Restricted – A classification indicating terrain that hinders movement. Little effort is needed to enhance mobility through restricted terrain but units may have difficulty maintaining preferred speeds, moving in combat formations, or transitioning from one formation to another. A force can generally use administrative or march formations through restricted terrain with only minimal delay.

Sequel – Major operations that follow an initial major operation. Plans for sequels are based on the possible outcome—*victory, stalemate, or defeat*—of the current operation.

Severely Restricted – A classification indicating terrain that severely hinders or slows movement in combat formations unless some effort is made to enhance mobility. Severely restricted terrain includes man-made obstacles, such as minefields and cities, as well as natural barriers. Severely restricted terrain generally slows or impedes administrative and march formations.

Situation Template – Depictions of assumed threat dispositions, based on threat doctrine and the effects of the battlespace, if the threat should adopt a particular COA. In effect, they are the doctrinal templates depicting a particular operation modified to account for the effects of the battlespace environment and the threat’s current situation (training and experience levels, logistic status, losses, dispositions). Normally, the situation template depicts threat units two levels of command below the friendly force as well as the expected locations of HVTs. Situation templates use TPLs to indicate movement of forces and the expected flow of the operation. Usually, the situation template depicts a critical point in the COA. Situation templates are one part of a threat COA model. Models may contain more than one situation template.

Specific Information Requirement – Specific information requirements describe the information required to answer all or part of an intelligence requirement. A complete SIR describes the information required, the location where the required information can be collected, and the time during which it can be collected. Generally, each intelligence requirement generates sets of SIRs.

Specific Order or Request – The order or request that generates planning and execution of a collection mission or analysis of data base information. SORs sent to subordinate commands are orders. SORs sent to other commands are requests. SORs often use system-specific message formats but also induce standard military OPODs and FRAGOs.

Surveillance – The systematic observation of airspace or surface areas by visual, aural, photographic, or other means. Surveillance differs from reconnaissance primarily in duration of the mission.

Target Area of Interest – The geographical area where HVTs can be acquired and engaged by friendly forces. Not all TAIs will form part of the friendly COA; only TAIs associated with HPTs are of interest to the staff. These are identified during staff planning and wargaming. TAIs differ from engagement areas in degree. Engagement areas plan for the use of all available weapons; TAIs might be engaged by a single weapon.

Threat Course of Action Model – A model of one COA available to the threat. It consists of a *graphic depiction* (situation template); a *description* (narrative or matrix); and a *listing of assets* important to the success of the COA (HVTs). The degree of detail in the model depends on available time. Ideally, threat COA models address all target sets. At a minimum, threat COA models address the five standard elements of a COA: WHAT (the type of operation), WHEN (in this case, the earliest time the action can begin), WHERE (boundaries, axis), HOW (the use of assets), and WHY (the purpose or desired end-state). Threat COA models should also meet the tests of suitability, feasibility, acceptability, uniqueness, and consistency with doctrine. Threat COAs are derived from capabilities.

Threat Model – A model of the threat force's doctrine and TTPs for the conduct of a particular operation. Threat models are based on a study of all available information, structured by the OB factors, of the particular threat force under consideration. Ideally, threat models consider all target sets in detail. Threat models are normally prepared prior to deployment.

TM Force – All of the personnel and equipment that directly impact the employment of TMs. This ranges from the field commanders who direct TM operations to the troops who actually deploy, fuel/load, and launch TMs to the vehicles, launchers, transporters, and support equipment that enable TM operations.

Unrestricted – A classification indicating terrain that is free of general restrictions to movement. In fair weather conditions movement off-road can be conducted with minimal reductions in speed.

CONVERSIONS

Parameters and measurements standards used within a joint, service, and/or combined TMD IPB function may vary significantly. The following lists the more common parameters and measurements conversions that a TMD IPB function may encounter.

Use of the International System of Units requires that a distinction be made between force and mass, which customarily have been expressed in pound-force and pound-mass, respectively.

Quantity	To Get – Divide By Conversion Factor	Conversion Factor	To Get – Multiply By Conversion Factor
Velocity	km/hr	0.539 956 8	knot
Velocity	km/hr	0.621 371 2	mph
Velocity	m/s	196.850 4	ft/min
Velocity	m/s	3.280 840	ft/sec
Velocity	m/s	1.943 844	knot
Acceleration	m/s ²	3.280 840	ft/sec ²
Acceleration	m/s ²	0.101 971 6	"g"
Dimension	km	0.539 956 8	NM
Dimension	km	0.621 371 2	mile (statute)
Dimension	m	3.280 840	foot
Dimension	m	1.093 613	yard
Dimension	cm	0.393 700 8	inch
Dimension	mm	0.039 370 08	inch
Dimension	mm	0.00039 370 08	caliber
Area	m ²	10.763 91	ft ²
Area	cm ²	0.155 000 3	in ²
Area	km ²	0.291 553 3	nm ²
Volume	m ³	35.314 66	ft ³
Volume	cm ³	0.061 023 74	in ³
Volume	liter	0.264 172 0	gallon
Mass	kg	2.204 623	pound-mass
Mass	g	0.035 273 96	ounce
Mass	tonne	1.102 311	ton
Force	N	0.224 808 9	pound-force
Force	kN	224.808 9	pound-force
Total Impulse	N • s	0.224 808 9	lbf-second
Specific Impulse	N • s/kg	0.101 971 6	"second"
Thrust-to-Weight	N/kg	0.101 971 6	lbf/lbm, "g"
Power	kW	1.341 022	HP (550 ft ² lbf/s)
Temperature		$T_c ? 1.8 + 32 = ^\circ\text{F}$ $(T_f - 32)/1.8 = ^\circ\text{C}$	
Pressure	kPa	20.885 43	psf
Pressure	kPa	0.145 037 7	psi
Loading	kg/m ²	0.204 816 1	lbm/ft ²
Density	kg/m ³	0.062 427 97	lbm/ft ³
Density	kg/liter	8.345 406	lbm/gal

Index

A

ACINT B-18, Glossary-1
Acoustical intelligence (see ACINT)
Active defense v, I-2, I-3, I-8, II-5, II-9, II-15, II-19, III-2, IV-2, IV-12, V-8, C-2
AFMIC III-19, B-12, B-15, D-2, D-4, Glossary-1
AO v, vi, x, I-4, I-5, II-1, II-2, II-3, II-4, II-5, II-6, II-9, II-10, II-11, II-12, II-15, II-16, III-2, III-4, III-14, IV-11, A-8, B-7, B-15, C-1, D-2, D-4, Glossary-1, Glossary-11, Glossary-13
AOI v, vi, x, I-5, II-1, II-3, II-4, II-5, II-6, II-9, II-10, II-11, II-12, II-16, III-2, B-7, B-15, D-2, D-4, Glossary-1, Glossary-7, Glossary-9, Glossary-11, Glossary-14, Glossary-16
Area of interest (see AOI)
Area of operations (see AO)
Armed forces medical intelligence center (see AFMIC)
Attack operations v, I-1, I-2, I-3, I-4, I-8, II-4, II-5, II-11, III-10, III-15, IV-7, IV-8, V-4, V-8, V-10, B-15, C-2

B

Battlespace effects iv, v, x, III-20
Battlespace environment iv, v, x, I-4, I-5, II-1, III-1, III-2, III-4, V-3, V-5, B-4, Glossary-11, Glossary-12, Glossary-16
Biological warfare (see BW)
BW III-19, B-21, Glossary-2

C

C3I B-20, Glossary-2
C4I I-1, I-2, I-3, I-4, I-9, II-16, II-18, III-18, III-20, IV-2, IV-3, B-16, B-20, B-60, D-3, Glossary-2
CBW III-19, Glossary-2
CCM vii, III-4, III-7, III-11, III-14, B-39, B-46, B-47, Glossary-2
Central Intelligence Agency (see CIA)
Chemical and biological warfare (see CBW)
Chemical warfare (see CW)
CIA I-9, II-16, III-19, B-12, E-1, Glossary-2
COMINT IV-9, B-74, Glossary-2
Command, control, communications, and intelligence (see C3I)
Command, control, communications, computers, and intelligence (see C4I)
Communications intelligence (see COMINT)
Communications security (see COMSEC)
COMSEC I-6, IV-3, IV-12, Glossary-2
Concept of operations (see CONOPS)
CONOPS II-2, II-3, II-4, Glossary-2
CONPLAN II-3, II-4, Glossary-2
Cross-country movement (see CCM)
CW II-18, V-3, B-21, Glossary-2

D

D&D A-3, Glossary-2
DAL II-6, II-3, II-4, Glossary-2
DCW II-16, A-11, Glossary-3
Deception and denial (see D&D)
Decision point (see DP)
Decision support template (see DST)
Defended asset list (see DAL)
Defense Intelligence Agency (see DIA)
DIA vi, vii, I-9, II-15, III-16, III-17, III-19, IV-3, IV-7, B-12, B-24, B-25, B-26, B-27, B-28, B-29, E-1, References-1, Glossary-3
Digital Chart of the World (see DCW)
Digital point positioning data base (see DPPDB)
DP V-7, Glossary-3, Glossary-12, Glossary-13
DPPDB A-15, Glossary-3
DST V-10, B-20, Glossary-3, Glossary-12

E

EA B-20, Glossary-3,
EC II-16, II-19, IV-13, B-10, Glossary-3
ECM B-20, Glossary-3
EEI vi, II-21, II-22, A-8, B-15, B-18, B-19, D-2, D-4, Glossary-3
Electronic attack (see EA)
Electronic combat (see EC)
Electronic countermeasures (see ECM)
Electronic intelligence (see ELINT)
Electronic warfare (see EW)
ELINT I-9, II-19, A-4, A-7, B-18, B-74, Glossary-3
Essential elements of information (see EEI)
Event matrix viii, V-9, V-10, B-78, Glossary-13
Event template vi, viii, V-7, V-8, V-9, V-10, B-76, B-77, Glossary-13
EW I-2, I-3, IV-13, B-20, B-21, B-29, Glossary-3

F

FISINT B-18, B-74, Glossary-4
FOB B-22, Glossary-4
FOL III-20, IV-9, IV-11, V-6, V-9, B-22, Glossary-4
Foreign instrumentation signals intelligence (see FISINT)
Forward operating location (see FOL)
Forward operations base (see FOB)

G

G&C I-7, Glossary-4
GALE V-7, C-1, C-2, Glossary-4
GCCS B-13, Glossary-4
Generic Area Limitation Environment (see GALE)
Global Command and Control System (see GCCS)

Global positioning system (see GPS)
GPS II-19, B-20, Glossary-4, Glossary-8
Ground support equipment (see GSE)
GSE I-7, III-11, III-15, III-18, IV-6, IV-7, IV-11, B-24, B-57, Glossary-4
Guidance and control (see G&C)

H

High value target (see HVT)
Human intelligence (see HUMINT)
HUMINT III-5, III-6, III-7, III-8, A-2, A-3, B-18, B-74, Glossary-4
HVT vii, viii, III-16, IV-1, IV-13, V-1, V-7, V-8, V-10, B-15, B-16, B-56, B-71, B-74,
B-75, D-2, D-3, D-4, D-5, Glossary-4

I

IESS B-54, Glossary-5
Imagery Exploitation Systems (see IESS)
Imagery intelligence (see IMINT)
IMINT A-3, A-5, A-6, A-8, A-10, B-18, B-74, Glossary-5
In-flight report (see INFLTREP)
INFLTREP A-4, A-5, A-6, A-7, Glossary-5
Information warfare (see IW)
Infrared intelligence (see IRINT)
Initial Phase Interpretation Report (see IPIR)
Integrated priority list (see IPL)
INTELINK II-21, II-22, IV-6, A-13, B-13, B-19, C-2, Glossary-5
Intelligence link II-21, Glossary-5
Intelligence, surveillance, and reconnaissance (see ISR)
Intermediate range ballistic missile (see IRBM)
IPIR A-4, Glossary-5
IPL B-13, Glossary-5
IRBM I-9, B-21, B-25, B-28, Glossary-5, Glossary-6
IRINT B-18, Glossary-5
ISR I-3, I-9, III-11, III-12, III-13, V-2, C-2, Glossary-2, Glossary-5
IW III-19, B-20, E-2, Glossary-5

J

JDISS C-1, C-2, Glossary-5
JIC xi, I-9, III-16, B-12, Glossary-5, Glossary-7
JISE I-9, Glossary-5
Joint deployable intelligence support system (see JDISS)
Joint intelligence center (see JIC)
Joint intelligence support element (see JISE)
Joint services work station (see JSWS)
Joint Tactical Information Distribution System (see JTIDS)
Joint worldwide intelligence communication system (see JWICS)
JSWS C-1, C-2, C-4, C-5, Glossary-5
JTIDS II-21, B-13, Glossary-5
JWICS C-2, Glossary-6

L

LACM II-18, B-21, Glossary-5, Glossary-6
Land attack cruise missile (see LACM)
Laser intelligence (see LASINT)
LASINT B-18, Glossary-6
Latest time information is of value (see LTIOV)
LTIOV II-2, A-8, B-18, Glossary-6, Glossary-13

M

MASINT I-9, III-13, A-3, A-6, B-18, b-74, Glossary-6
Measurement and signature intelligence (see MASINT)
MIDB II-22, III-16, III-19, IV-2, IV-3, IV-7, IV-8, A-15, A-16, B-13, B-54, B-58, B-79,
Glossary-6
Missile and Space Intelligence Center (see MSIC)
Modernized integrated data base (see MIDB)
MSIC I-9, III-16, III-17, IV-3, IV-6, IV-7, B-12, E-1, Glossary-7

N

NAI viii, V-1, V-2, V-7, V-8, V-9, V-10, B-73, B-74, B-75, Glossary-7, Glossary-13
Named area of interest (see NAI)
National Ground Intelligence Center (see NGIC)
National Imagery and Mapping Agency (see NIMA)
National Intelligence Support Team (see NIST)
NBC IV-6, IV-11, IV-13, Glossary-7
NGIC I-9, IV-3, IV-7, B-12, Glossary-7
NIMA I-9, II-16, III-4, III-8, III-16, A-10, A-13, A-15, A-16, B-12, B-34, B-35, B-36,
B-37, E-1, Glossary-7
NIST I-9, Glossary-7
Nuclear, biological, and chemical (see NBC)

O

Open-source intelligence (see OSINT)
Operation plan in concept format (see CONPLAN)
Operations security (see OPSEC)
OPSEC I-2, I-6, IV-3, IV-11, IV-12, B-21, Glossary-7
OSINT B-74, Glossary-7

P

Passive defense v, I-2, I-3, I-8, II-5, II-10, IV-6, IV-12, V-8, B-15, C-2, D-2, D-4
PIR vi, II-1, II-22, V-1, B-15, B-16, B-18, B-19, D-2, D-3, D-4, D-5, Glossary-8,
Glossary-13, Glossary-15
Primary intelligence requirements (see PIR)

R

Radar intelligence (see RADINT)

RADINT B-18, B-74, Glossary-8

Reconnaissance, surveillance, and target acquisition (see RSTA)

RSTA I-3, IV-13, Glossary-8

S

SEAD II-19, B-20, B-21, Glossary-9

Sea-launched ballistic missile (see SLBM)

Sea-launched cruise missile (see SLCM)

Secret Internet Protocol Router Network (see SIPRNET)

Short-range ballistic missile (see SRBM)

SIGINT I-9, III-13, A-3, A-6, B-18, B-74, Glossary-4, Glossary-9

Signals intelligence (see SIGINT)

SIPRNET B-13, C-2, C-5, Glossary-9

Situation template vi, IV-8, IV-10, V-5, V-6, V-7, V-9, Glossary-15, Glossary-16

SLBM B-21, B-24, B-25, Glossary-9

SLCM I-7, I-9, II-7, II-8, II-9, II-18, II-19, III-2, III-3, Glossary-9

SRBM I-9, II-18, B-24, B-25, B-28, Glossary-9

SUPIR A-4, Glossary-9

Supplemental Photographic Interpretation Report (see SUPIR)

Suppression of enemy air defenses (see SEAD)

T

Tactical air-to-surface missile (see TASM)

TASM I-7, B-21, Glossary-9

TECHINT A-3, B-18, b-74, Glossary-8, Glossary-9

Technical intelligence (see TECHINT)

TEL III-11, III-15, IV-2, IV-7, IV-9, IV-11, IV-12, A-8, B-22, B-27, Glossary-9

Telemetry intelligence (see TELINT)

TELINT B-18, Glossary-9

Transporter erector launcher (see TEL)

U

UGF IV-11, Glossary-10

Underground facility (see UGF)

**FM 3-01.16
MCWP 2-12.1A
NTTP 2-01.2
AFTTP(I) 3-2.36
4 MARCH 2002**

By Order of the Secretary of the Army:

Official:

ERIC K. SHINSEKI
General, United States Army
Chief of Staff

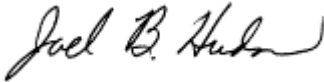

JOEL B. HUDSON
Administrative Assistant to the
Secretary of the Army
0208801

DISTRIBUTION:

Active Army, Army National Guard, and U.S. Army Reserve: Distribute in accordance with Special Distribution for FM 3-01.16.

By Order of the Secretary of the Air Force:

LANCE L. SMITH
Major General, USAF
Commander
Headquarters Air Force Doctrine

Air Force Distribution: F

