



**THE STRYKER BRIGADE COMBAT
TEAM INFANTRY BATTALION
RECONNAISSANCE PLATOON**



APRIL 2003

HEADQUARTERS
DEPARTMENT OF THE ARMY

DISTRIBUTION RESTRICTION: Approved for public release; distribution is unlimited.

THE STRYKER BRIGADE COMBAT TEAM INFANTRY BATTALION RECONNAISSANCE PLATOON

CONTENTS

		Page
PREFACE		vii
CHAPTER 1. OVERVIEW OF THE SBCT INFANTRY BATTALION RECONNAISSANCE PLATOON		
Section	I. Capabilities, Limitations, Organization, and Responsibilities.....	1-1
	1-1. Capabilities	1-2
	1-2. Limitations	1-8
	1-3. Organization.....	1-9
	1-4. Reconnaissance Sections and Teams	1-12
	1-5. Dismounted Organizations	1-12
	1-6. Mounted Organizations.....	1-13
	1-7. Responsibilities.....	1-13
Section	II. Combat Power and Considerations for Employment and Training....	1-16
	1-8. Combat Power.....	1-16
	1-9. Considerations for Employment	1-17
	1-10. Training Considerations.....	1-18
CHAPTER 2. BATTLE COMMAND AND TROOP-LEADING PROCEDURES		
Section	I. Command and Control.....	2-1
	2-1. Leadership.....	2-1
	2-2. Mission-Oriented Command and Control.....	2-2
Section	II. Plans and Orders	2-3
	2-3. Mission Statement	2-4
	2-4. Combat Orders.....	2-4
Section	III Troop-Leading Procedures and Techniques	2-6
	2-5 Receive the Mission.....	2-7
	2-6 Issue a Warning Order	2-7
	2-7 Make a Tentative Plan	2-7
	2-8 Initiate Movement.....	2-20
	2-9 Conduct a Leader's Reconnaissance.....	2-20

DISTRIBUTION RESTRICTION: Approved for public release; distribution is unlimited.

		Page
	2-10	Complete the Plan 2-20
	2-11	Issue the Operations Order 2-21
	2-12	Supervise and Refine 2-21
CHAPTER 3. MOVEMENT		
	3-1.	Navigation and Route Planning 3-1
	3-2.	Movement Formations 3-3
	3-3.	Movement Techniques 3-7
	3-4.	Actions on Contact 3-12
	3-5.	Actions at Danger Areas 3-24
	3-6.	Infiltration 3-26
	3-7.	Exfiltration 3-30
CHAPTER 4. RECONNAISSANCE		
Section	I.	Purpose and Fundamentals 4-1
	4-1.	Orient on the Reconnaissance Objective 4-1
	4-2.	Maintain Tempo and Focus 4-2
	4-3.	Report All Information Rapidly and Accurately 4-2
	4-4.	Retain Freedom to Maneuver 4-2
	4-5.	Establish and Maintain Enemy Contact 4-2
	4-6.	Develop Situation Rapidly 4-2
	4-7.	Acquire All Required Information 4-2
	4-8.	Avoid Detection 4-3
	4-9.	Employ Security Measures 4-4
	4-10.	Utilize Sensory Techniques 4-4
Section	II.	Planning 4-5
	4-11.	Planning, Methods, and Employment of Reconnaissance Forces 4-5
	4-12.	Reconnaissance Methods 4-6
	4-13.	Rehearsals 4-8
	4-14.	Essential Planning Considerations 4-8
Section	III.	Reconnaissance and Surveillance Handover 4-9
	4-15.	Reason for Surveillance Handover 4-9
	4-16.	Additional Missions 4-11
	4-17.	Digital Systems 4-12
Section	IV.	Area Reconnaissance 4-12
	4-18.	Tasks 4-13
	4-19.	Mounted Techniques 4-13
	4-20.	Dismounted Techniques 4-14
	4-21.	Objective Rally Point 4-15
	4-22.	Leader's Reconnaissance 4-16
	4-23.	Actions at the Objective 4-16
	4-24.	Withdrawal and Dissemination of Information 4-19
Section	V.	Zone Reconnaissance 4-19
	4-25.	Tasks 4-19
	4-26.	Mounted Reconnaissance Techniques 4-20

		Page
	4-27.	Dismounted Zone Reconnaissance Techniques..... 4-21
	4-28.	Dismounted Reconnaissance Methods 4-21
Section	VI.	Route Reconnaissance 4-24
	4-29.	Purpose..... 4-24
	4-30.	Organization..... 4-25
	4-31.	Stealth and Speed..... 4-26
	4-32.	Movement near Roads 4-26
	4-33.	Engineer Support 4-26
	4-34.	Route Reconnaissance Overlay 4-26
	4-35.	Employment Considerations..... 4-26
	4-36.	Key Tasks 4-27
	4-37.	Techniques..... 4-28
Section	VII.	Urban Reconnaissance..... 4-29
	4-38.	Employ Dismounted Surveillance Teams..... 4-29
	4-39.	Urban Patrolling..... 4-31
	4-40.	Assessment of the Area of Operations..... 4-33
	4-41.	End State..... 4-33
Section	VIII.	Reconnaissance of Obstacles and Restrictions 4-34
	4-42.	Types of Obstacles and Restrictions..... 4-34
	4-43.	Tasks..... 4-34
	4-44.	Elements of Obstacle Reconnaissance..... 4-34
CHAPTER 5. SECURITY OPERATIONS		
Section	I.	Purpose and Fundamentals 5-1
	5-1.	Purpose 5-1
	5-2.	Fundamentals..... 5-2
	5-3.	Planning Considerations 5-2
Section	II.	Screening Missions..... 5-3
	5-4.	Fundamentals..... 5-3
	5-5.	Sequencing and Prioritization..... 5-4
	5-6.	Surveillance Techniques..... 5-5
	5-7.	Counterreconnaissance Techniques..... 5-13
Section	III.	Area Security Operations..... 5-15
	5-8.	High-Value Targets..... 5-15
	5-9.	Convoy and Route Security 5-16
Section	IV.	Observation Post Employment 5-24
	5-10.	Critical Tasks..... 5-24
	5-11.	Types of Observation Posts 5-26
	5-12.	Observation Post Positions 5-26
	5-13.	Observation Post Site Selection..... 5-27
	5-14.	Occupation of the Observation Post 5-28
	5-15.	Manning the Observation Post..... 5-28
	5-16.	Position Improvement..... 5-29
	5-17.	Communications 5-30
	5-18.	Observation Post Security..... 5-30
	5-19.	Active Patrolling..... 5-31

		Page
	5-20. Extended Observation Posts	5-31
Section	V. Construction Techniques	5-32
	5-21. Dirt Removal.....	5-32
	5-22. Natural Vegetation.....	5-33
	5-23. Sidewall Support.....	5-33
	5-24. Observation Post Kits	5-33
Section	VI. Observation Post Employment in Operational Environments.....	5-34
	5-25. Urban Environment.....	5-34
	5-26. Mountainous Environment	5-35
	5-27. Types of Ground Observation Posts	5-37
	5-28. Checkpoints, Roadblocks, and Observations Posts	5-40
CHAPTER 6. URBAN ENVIRONMENT		
Section	I. Understanding the Urban Environment	6-1
	6-1. Definitions	6-1
	6-2. Characteristics of the Urban Environment.....	6-3
Section	II. Planning.....	6-6
	6-3. Collect and Analyze Existing Intelligence.....	6-6
	6-4. Develop the Plan.....	6-9
Section	III. Execution	6-18
	6-5. Approach the Urban Area of Operations	6-18
	6-6. Employ Dismounted Surveillance Teams.....	6-18
	6-7. Conduct Reconnaissance	6-19
	6-8. Assess the Area of Operations	6-19
	6-9. End State.....	6-19
Section	IV. Combat Multipliers.....	6-20
	6-10. Armored Vehicles.....	6-20
	6-11. Engineers	6-22
	6-12. Attack Helicopters	6-23
	6-13. Antiarmor Weapons.....	6-23
	6-14. Sniper Employment Considerations	6-24
CHAPTER 7. TACTICAL ENABLING OPERATIONS		
	7-1. Linkup Operations	7-1
	7-2. Passage of Lines.....	7-2
	7-3. Relief in Place.....	7-4
	7-4. Stay-Behind Operations.....	7-6
	7-5. Air Assault Operations	7-7
	7-6. Assembly Area Operations	7-8
CHAPTER 8. COMBAT SUPPORT		
Section	I. Fire Support	8-1
	8-1. Fire Planning.....	8-1
	8-2. Linking Fire Support Tasks and Maneuver Purpose	8-2

		Page
Section	II. Indirect Fire Support.....	8-3
	8-3. Fire-Planning Process	8-4
	8-4. Call for Fire.....	8-5
	8-5. Adjust Fire	8-8
	8-6. Mortar Support.....	8-16
	8-7. Field Artillery Support.....	8-17
	8-8. Fire Direction Assets	8-18
	8-9. Fire Request Channels	8-19
	8-10. Close Air Support	8-21
	8-11. Attack Helicopters	8-25
Section	III. Combat Engineer Support.....	8-26
	8-12. Medium Engineer Company	8-26
	8-13. Engineer Missions.....	8-28
	8-14. Mobility	8-28
	8-15. Countermobility	8-29
	8-16. Survivability.....	8-29
	8-17. Reconnaissance Operations	8-29
Section	IV. Air Defense.....	8-29
	8-18. Systems, Organization, and Capabilities	8-30
	8-19. Employment of Air Defense Systems.....	8-33
	8-20. Weapons Control Status	8-33
	8-21. Early Warning Procedures	8-34
	8-22. Reaction Procedures	8-34
Section	V. Nuclear, Biological, and Chemical Support	8-37
	8-23. Reconnaissance Support	8-37
	8-24. Decontamination Support	8-37

CHAPTER 9. COMBAT SERVICE SUPPORT

9-1.	Organization.....	9-1
9-2.	Individual Responsibilities	9-1
9-3.	Planning Considerations	9-2
9-4.	Resupply Operations.....	9-4
9-5.	Aerial Sustainment.....	9-8
9-6.	Soldier's Load.....	9-9
9-7.	Combat Load and Basic Load.....	9-9
9-8.	Maintenance.....	9-9
9-9.	Recovery and Destruction.....	9-10
9-10.	Evacuation Procedures.....	9-10
9-11.	Administration	9-11
9-12.	Medical Support.....	9-14
9-13.	Prisoners of War	9-17

CHAPTER 10. PATROLLING

Section	I. General.....	10-1
	10-1. Organization.....	10-1
	10-2. Initial Planning.....	10-2

		Page
	10-3. Completion of the Plan	10-2
	10-4. Depart from Friendly Lines	10-4
	10-5. Patrol Bases.....	10-5
	10-6. Rally Points.....	10-5
	10-7. Leader’s Reconnaissance.....	10-7
	10-8. Reentry of Friendly Lines.....	10-7
	10-9. Debrief.....	10-8
Section	II. Types of Patrols	10-8
	10-10. Reconnaissance Patrol	10-8
	10-11. Combat Patrol	10-12
	10-12. Presence Patrol.....	10-16
APPENDIX A.	RECONNAISSANCE OVERLAYS, SYMBOLS, AND FORMULAS	A-1
APPENDIX B.	LIMITED VISIBILITY OPERATIONS	B-1
APPENDIX C.	RISK MANAGEMENT	C-1
APPENDIX D.	FRATRICIDE AVOIDANCE	D-1
APPENDIX E.	NUCLEAR, BIOLOGICAL, OR CHEMICAL ENVIRONMENT OPERATIONS	E-1
APPENDIX F.	JAVELIN EMPLOYMENT	F-1
APPENDIX G.	M240B MACHINE GUN AND M249 SAW EMPLOYMENT	G-1
GLOSSARY	Glossary-1
REFERENCES	References-1
INDEX	Index-1

PREFACE

This manual is based on the premise that although the unit organization, weapon systems, and conditions have changed, section and platoon maneuver, movement, reconnaissance, and surveillance have not.

This manual describes the doctrinal and tactical employment principles for the Stryker reconnaissance vehicle (RV)-equipped infantry battalion reconnaissance platoon, which is an element of the Stryker brigade combat team (SBCT). It provides emerging doctrine, tactics, techniques, and procedures (TTP) for the SBCT infantry battalion reconnaissance platoon and its teams and sections.

This manual provides the platoon and team leaders with tactics, techniques, and procedures to exploit reconnaissance platoon capabilities through situational understanding (SU), which will reduce vulnerabilities and enable the parent unit to obtain the required information to defeat the enemy on the battlefield. Although this manual reemphasizes critical information from other manuals, the user must continue to refer to other manuals for in-depth discussions of particular subjects.

Although this manual does not implement any international agreements, the material presented herein is in accordance with related international agreements.

The proponent of this publication is the US Army Infantry School. Send comments and recommendations to doctrine@benning.army.mil or on DA Form 2028 directly to Commandant, US Army Infantry School, ATTN: ATSH-ATD, Fort Benning, Georgia 31905-5593.

Unless this publication states otherwise, masculine nouns and pronouns do not refer exclusively to men.

CHAPTER 1
**OVERVIEW OF THE SBCT INFANTRY BATTALION
RECONNAISSANCE PLATOON**

The Stryker brigade combat team (SBCT) infantry battalion's primary mission is to close with and destroy the enemy during full-spectrum operations through close, violent combat. The SBCT infantry battalion is capable of accomplishing all missions historically identified with the infantry and is organized and equipped to conduct operations in restricted and urban terrain. The battalion, as part of the SBCT, deploys rapidly, executes early-entry operations, and conducts effective combat operations immediately upon arrival to prevent, contain, stabilize, or resolve a conflict

The infantry battalion reconnaissance platoon is comprised of handpicked, highly motivated, expert infantry soldiers and serves as the forward "EYES AND EARS" for the battalion commander. The primary mission of the reconnaissance platoon is to conduct reconnaissance and surveillance in support of the battalion commander's intelligence, surveillance, and reconnaissance (ISR) operation to determine enemy composition and disposition along named areas of interest. The commander and his staff use this information during the planning and execution of combat operations.

**Section I. CAPABILITIES, LIMITATIONS, ORGANIZATION, AND
RESPONSIBILITIES**

The mission of the infantry is to close with the enemy by means of fire and movement to defeat him, capture him, or repel his assault by fire, close combat, or counterattack. The reconnaissance platoon is organized, equipped, and trained to conduct reconnaissance, surveillance, and limited security missions for its parent battalion. The platoon's primary mission is to provide battlefield information and assist in the tactical control, movement, and positioning of the battalion's companies and platoons. Its organization enables the platoon to conduct both mounted and dismounted reconnaissance tasks simultaneously. It provides the battalion commander with the ability to reconnoiter throughout his battalion's battle space. To ensure understanding, the following definitions apply:

- Reconnaissance is a mission undertaken to obtain, by visual observation or other detection methods, information about the activities and resources of an enemy or potential enemy or to secure data concerning the meteorological, hydrographic, or geographic characteristics of a particular area.
- Security operations are designed to provide reaction time, maneuver space, and protection to the main body.

1-1. CAPABILITIES

The reconnaissance platoon's vehicles and design parameters provide it with the ability to maintain "eyes on" four to six named areas of interest (NAIs). The SBCT infantry battalion reconnaissance platoon can also accomplish the following:

- Conduct zone, area, and route reconnaissance.
- Conduct limited screening and area security operations to the battalion's front, flank, or rear.
- Conduct linkup and liaison.
- Guide maneuver forces.
- Conduct terminal guidance for helicopter operation.
- Mark helicopter landing and pickup zones.
- Perform quartering party duties.
- Provide traffic control.
- Conduct limited obstacle construction and reduction.
- Participate in air assault operations.
- Conduct reconnaissance handover between elements of the cavalry squadron (reconnaissance, surveillance, and target acquisition [RSTA]) and itself.

a. **Survivability.** The increased mobility and protection afforded by the reconnaissance vehicle (RV) and the ability of the vehicle to protect the infantrymen from small-arms fire and fragmentation before dismounting increases the platoon's survivability. In addition, the employment of the Force XXI battle command brigade and below (FBCB2) system significantly enhances the platoon's survivability by increasing its ability to communicate and receive tactical information and command and control (C2). (See sub-paragraph c, for more information on FBCB2.)

b. **Command, Control, and Communications.** The RVs for both the reconnaissance platoon leader and platoon sergeant are equipped with FBCB2 systems that tie those vehicles and leaders to the C2 hierarchy of the infantry companies, battalions, and brigade. Features that support command, control, and communications (C3) are command and control software, navigational software, and digital communications capabilities.

c. **Force XXI Battle Command Brigade and Below.** FBCB2 is a network of computers, global positioning equipment, and communication systems that provide on-the-move, real-time command and control information to tactical combat arms, combat support (CS), and combat service support (CSS) soldiers and leaders. FBCB2 is designed for units performing missions at the tactical level (brigade to individual fighting platform). It provides a common database with automated positional information and current tactical battlefield geometry for friendly and known or suspected enemy forces. Collectively, the FBCB2 systems generate the common operational picture (COP). FBCB2 displays relevant information, showing the user his location, the location of other friendly forces, observed or templated enemy locations, and all known obstacles. The system also provides preformatted, standardized reports that allow leaders to rapidly disseminate graphic overlays and written fragmentary orders (FRAGOs). The command receives data "pushed" from all other battlefield systems to maintain real-time battle information. The commander must organize and interpret the information received via FBCB2 to determine its value in relation to the current situation.

NOTE: A COP is an operational picture tailored to the user's requirements, based on common data and information (friendly and enemy) shared by more than one unit.

(1) ***FBCB2 Architecture.*** Figure 1-1, page 1-4, depicts the FBCB2 architecture. Each vehicle in the platoon is equipped with the three basic components of the FBCB2 system.

(a) The global positioning system (GPS) provides precise location and date/time for reporting real-time friendly locations and for generating laser designated map spots for reporting purposes.

(b) The single-channel ground and airborne radio system (SINCGARS) provides a secure means of transmitting (both voice and digital) between vehicles in the platoon. In addition to the SINCGARS, platoon vehicles also are equipped with the enhanced position location and reporting system (EPLRS). The EPLRS provides a secure digital connection and serves as a router, efficiently sending message traffic internally within the platoon and out to the company and fire support nets. This routing capability ensures that information is passed even if the chain of command is disrupted by physical separation on the battlefield, casualties, or mechanical failures.

(c) The FBCB2 terminal provides the monitor, keyboard, mouse, and computing functions that allow the crew to access the system. These systems form the lower tactical Internet (TI).

(d) The upper TI consists of a variety of tactical computer systems and communications equipment located primarily at the battalion level and higher. The most important of these are the maneuver control system (MCS), the all source analysis system (ASAS), the advanced field artillery tactical data system (AFATDS), and the combat service support control system (CSSCS). These systems draw upon the reports and positional data passed on from the lower TI to provide the COP at higher command levels. In turn, these systems can push information such as location of adjacent units, known and templated enemy positions, graphics, and operations orders (OPORDs), down to the FBCB2 users.

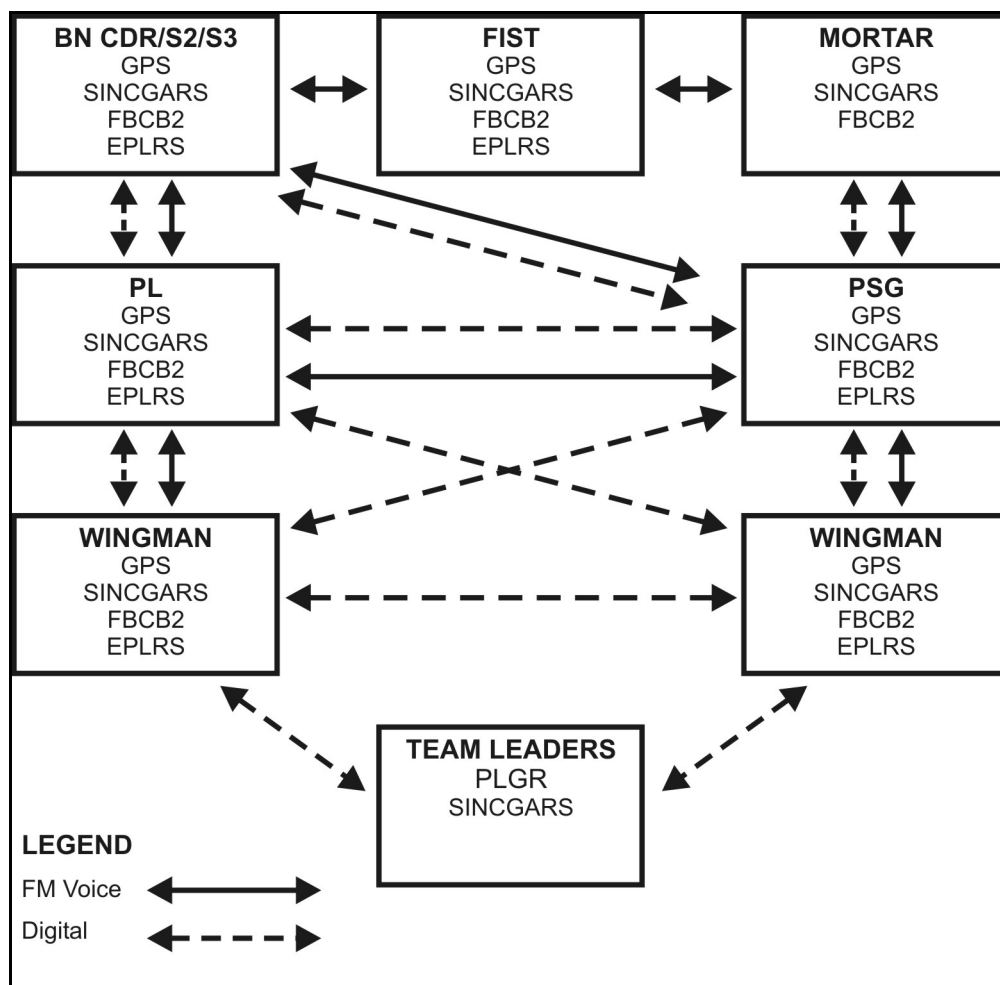


Figure 1-1. FBCB2 architecture.

(2) **FBCB2 Capabilities.** The FBCB2 displays the current information on both friendly and enemy forces, delivering the common operational picture for the platoon. The following are capabilities of FBCB2.

(a) **Friendly Information.** The FBCB2 screen displays an icon for each friendly individual vehicle in the platoon. This provides the vehicle commander (VC) with a clear picture of where he is located in relation to the platoon. It provides the platoon leader with a picture of where he is operating in relation to the rifle companies. While the system functions automatically for vehicles equipped to operate on the TI, it does not provide locations to every friendly element on the battlefield. For example, the system does not automatically track dismounted elements operating at extended ranges from their RVs. In addition, it does not cover non-digitally equipped units or allied and or coalition forces that may be operating adjacent to the platoon. Icons representing these elements may be imported into FBCB2 based on frequency modulated (FM) radio reports, but they are not updated in real time. As a result, FBCB2 cannot be the sole instrument used to clear fires; it does not substitute for a leader's judgment in preventing fratricide.

(b) **Enemy Information.** FBCB2 creates the COP from both top-down and bottom-up feeds. The battalion S2 inputs enemy icons into the system based on spot reports

generated by the cavalry squadron (RSTA) and other information-gathering assets outside the battalion. Based on his intelligence preparation of the battlefield (IPB), the S2 augments these actual locations with templated positions in the form of a situation template (SITEMP).

(c) *Enemy Activity and Obstacles.* As the platoon conducts operations, it adds to the COP by sending spot reports of enemy activity and obstacles via FBCB2. When a VC sends a spot report, he automatically creates an icon representing the enemy on other FBCB2 systems in the platoon. The platoon leader evaluates the validity of the report, ensures its accuracy, and forwards the report to the other section and teams in the platoon and higher to battalion.

(d) *Enemy Location.* To keep the COP current, units must update spot reports concerning enemy locations that are represented by icons on the FBCB2. Updates must be sent whenever the enemy situation changes (enemy element moves or is destroyed). An icon will “fade” and eventually disappear from the FBCB2 screen as the icon’s information ages. The unit standing operating procedure (SOP) governs the icon “fade” rate.

(e) *Unreported Enemy.* Members of the platoon must remember that the COP provided by FBCB2 is only as good as the reports that the system receives. It will never give a 100-percent complete or accurate enemy picture. The platoon leader, section leaders, VCs, and team leaders must ensure that plans are adequate to detect enemy forces not yet reported by digital means.

d. **Standardized Reporting.** FBCB2 streamlines the reporting process by providing the platoon with the capability to send and receive preformatted, standardized reports (Figure 1-2, page 1-6).

(1) Standardized reports afford several tactical advantages:

- They help to ensure that all required information is included in a particular report or request.
- They reduce the chance of errors in transmission.
- They allow for the storage of messages for retrieval and reference.

FREE TEXT MESSAGE	REDCON ALERT
Check Fire	Situation Report (SITREP)
Call for Fire	Field Orders ²
Observer Mission Updates ¹	Operations Plan
On-Call Fire Command	Fragmentary Order (FRAGO)
Message to Observer ¹	Warning Order (WARNO)
Fire SPT COORD Measures	Minefield Laying
End of Mission/Surveillance	Overlay
Sequent Adjust	MOPP Alert
Observer Readiness Report	MEDEVAC Report
Airborne Fire Mission	Logistics Report
Spot Report	Personnel Report
Engagement Report	Supply Point Status
Contact Report	Task Management
Land Route Report	LOG Task Order
Obstacle Report	LOG Call for Support
Bridge Report	LOG Task Status
Position Report	LOG Task Sync
NBC 1 Report	Execution Matrix
NBC 4 Report ¹	

¹ Commander's graphic intent (CGI)

² Receive Only

Figure 1-2. Preformatted, standardized reports.

(2) There continues to be a requirement for FM voice message traffic. For example, platoon leaders must still transmit contact reports to initiate battle drills and to cue VCs to reference their FBCB2 screens for updated information. Additionally, VCs may need to send FM voice descriptions of enemy locations, routes, or obstacles to clarify the situation. This is especially true in urban terrain where the FBCB2 cannot display the terrain in sufficient detail to assist leaders in making effective decisions.

e. **Combat Orders and Graphics.** FBCB2 greatly enhances the speed and precision of the orders process at platoon level. The system allows leaders to add or modify operational graphics during the planning process or during execution. This ensures that every element has the most current information to control movement and fires. In addition, platoon leaders can use free text messages to transmit OPORDs, FRAGOs, and situational updates over extended distances without the loss of time and information typical of FM voice communications. Like the standardized reports, orders and graphics can be stored for retrieval and reference. (For more information on reconnaissance platoon overlays, symbols, and graphics, see Appendix A.)

f. **Sustainability.** The reconnaissance platoon can operate for up to 72 hours on or off the RV. This is accomplished by prestocking the RV with Class I and Class V supplies as well as with potable water. The RV can operate for up to 16 hours daily and travel a minimum of 100 kilometers with Class III resupply. The CSS system in the parent battalion resupplies the RV as necessary.

g. **Mobility.** The driver's vision enhancer (thermal) and the driver's navigation display unit improve the driver's vision, thus allowing upgraded platoon mobility in total darkness, all weather conditions, and degraded visibility conditions. The RV precision navigation system (PNS) consists of an inertial navigation unit (INU), a GPS, and precision lightweight global positioning system receiver (PLGR).

(1) The PLGR provides the user with precise position coordinates with time and navigation capability under all conditions except when obstructions exist between the satellite and antenna. Users can enter map coordinates as waypoints. When the user selects a waypoint as a destination, the receiver can provide steering indications and azimuth and range information to the destination. The user can program a desired course to the waypoint and can indicate an offset distance from this course line. The user can also remove the PLGR from the vehicle and operate it in the handheld mode.

(2) The INU is a ring-laser, gyro-based navigation device. It is the primary navigation system and supplies position, velocity, attitude, angular rate, and acceleration (roll, pitch, and azimuth) to the turret processor unit. The GPS supplies the INU with initial position data.

(3) The components of the precision navigation system can operate in a combination of five modes:

- Integrated GPS/INU/vehicle motion sensor (VMS).
- GPS only (when the INU sensor fails).
- INU/VMS (when the GPS receiver fails to acquire satellite signal or is damaged).
- GPS/INU (when the VMS fails).
- INU only (if both the GPS receiver and the VMS are not available).

h. **Night-Vision Equipment.** Own-the-night (OTN) equipment advancements enhance command and control at night and improve the reconnaissance platoon's ability to conduct surveillance and acquire targets (Table 1-1, page 1-8). SBCT sections and platoons have infrared illuminators, improved nightsights, target acquisition devices, and signaling devices. (Refer to Appendix B for a detailed discussion of limited visibility operations.)

EQUIPMENT	CAPABILITIES
AN/PVS-14	Provides observation out to 300 meters for man-sized targets and 500 meters for vehicle-sized targets.
3X Magnifier	Provides observation out to 600 meters for man-sized targets and 1,000 meters for vehicle-sized targets.
Thermal Weapon Sight, Medium (M16, M249, M240)	Maximum range 1,100 meters.
Ground Commander's Pointer (GCP-1)	Designate target from 0 to 8,000 meters (pinpoint mode); illuminate target 800 meters with 10-degree scan (area mode).
AN/PAQ-4B/C	600 meters maximum.
Aim-1	Zeroed out to the maximum range of 3,000 meters.
Black Light	12-hour duration; range varies with terrain.
Infrared Trip Flare	20-meter radius; emits minimal visible light.
Phoenix	12-hour duration; range varies with terrain.
Javelin CLU Thermal Weapon Sight	Range in excess of 3,000 meters.

Table 1-1. Night vision equipment capabilities.

(1) The reconnaissance teams use infrared light from infrared parachute flares or infrared handheld flares to illuminate targets without the enemy's knowledge. These advancements allow the teams to see more of the battlefield and aid in target acquisition, indirect fire adjustment, and increased survivability.

(2) The key infrared target designator is the ground commander's pointer (GCP-1). Platoon and squad leaders use the GCP-1 to designate targets to cue observers for target acquisition and assist in reconnaissance handover.

(3) The reconnaissance teams are equipped with the infrared laser designators for increased target acquisition.

(4) Individual soldiers are equipped with an AN/PAQ-4B/C laser aiming light that emits a pulsating infrared laser on the desired target at the point of aim. The AN/PAQ-4B/C mounts on the M16, M4, M203, and M249. Soldiers use the laser with night-vision goggles (NVGs) to improve the probability of hitting the target during darkness.

(5) Platoon members also have improved night-vision devices. Each soldier is equipped with AN/PVS-14 night-vision goggles with 3X magnification.

1-2. LIMITATIONS

The reconnaissance platoon is best suited to conducting operations as part of a larger combined-arms force. Reconnaissance elements in general have limitations that must be considered when planning for employment. Limitations of the reconnaissance platoon include the following:

- The reconnaissance platoon is dependent on its parent unit for CS and CSS.
- During screening operations, reconnaissance platoons are limited in their ability to destroy or repel enemy reconnaissance units.

- The platoon can effectively conduct route reconnaissance of only two separate company mobility corridors.
- The small size of the platoon limits its ability to conduct a detailed zone reconnaissance.
- Terrain, enemy situation, and time available also affect the size of the zone the reconnaissance platoon can reconnoiter.
- The reconnaissance platoon's communications equipment limits how far from the main body it can operate. With its organic equipment, the platoon operates on two nets--the battalion operations and intelligence net and the platoon net.
- The reconnaissance platoon has limited obstacle construction abilities and carries only a limited load of demolitions.
- The reconnaissance platoon has very limited obstacle reduction capability; under most conditions, it can breach only point obstacles.
- Platoon RVs are vulnerable to enemy antiarmor fires.

1-3. ORGANIZATION

The reconnaissance platoon is organized into two sections of two RVs each and three 5-man reconnaissance teams (Figure 1-3, page 1-10). One section is "heavy" and transports two reconnaissance teams. The other "light" section transports one reconnaissance team and the platoon leader. The reconnaissance platoon rarely uses a headquarters element during tactical operations; it relies instead on the leaders of its sections or teams as described in the following discussion.

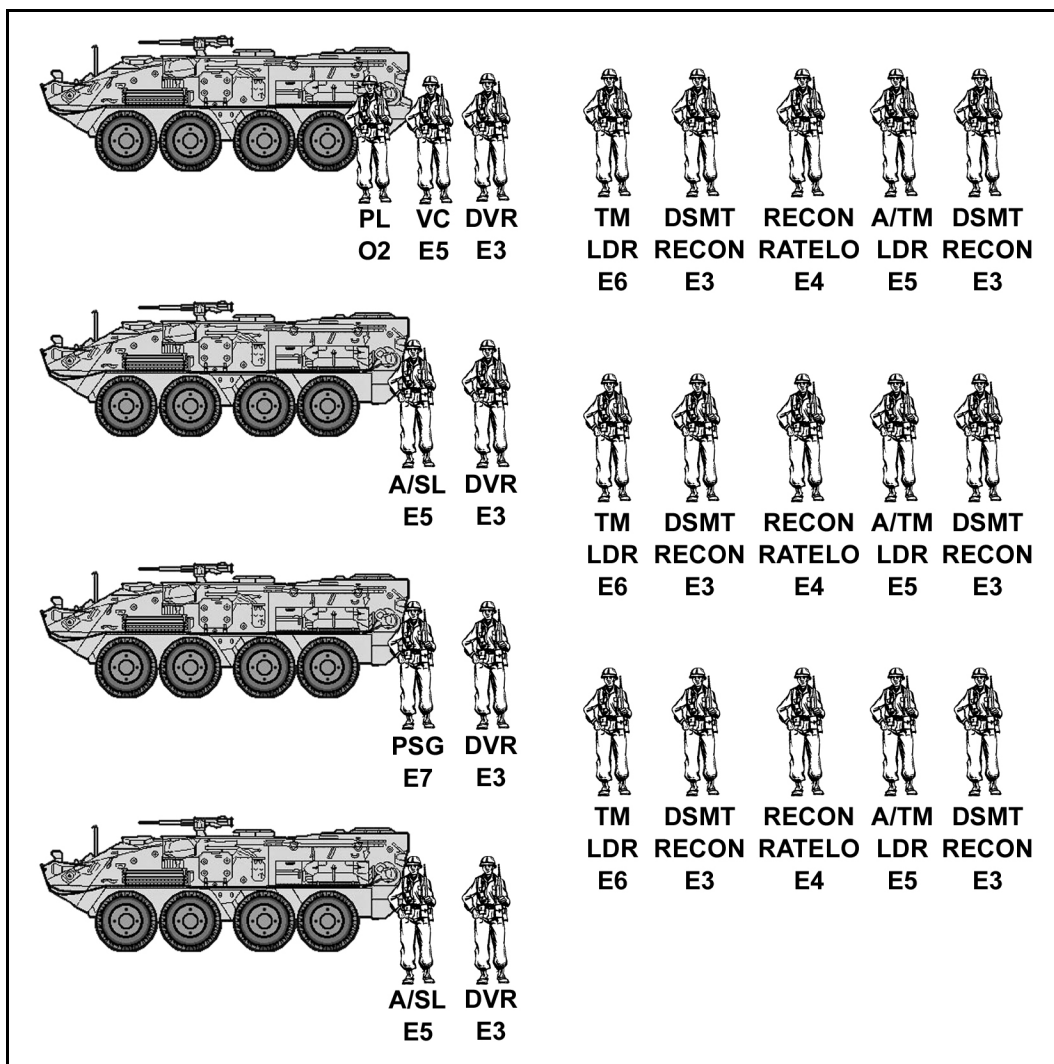


Figure 1-3. Reconnaissance platoon organization.

a. **Platoon Headquarters.** The platoon headquarters element provides C2 to the platoon and consists of the platoon leader (PL), platoon sergeant (PSG), and their respective vehicle crews. The platoon may be augmented with a medic.

b. **Mounted Element.** The reconnaissance platoon is equipped with four RVs that provide the reconnaissance teams with rapid, protected tactical and operational mobility to critical locations on the battlefield. The RV is a fully mobile system capable of operating in conjunction with infantry and other elements of the combined arms team. Each RV has a crew of two (commander and driver) that operates the vehicle. When conducting mounted movement or reconnaissance, the PL and PSG are included in the mounted element and serve as VCs and the reconnaissance section leaders (Figure 1-4). The crew provides critical support to the platoon by operating and maintaining the RVs and properly employing them on the battlefield to ensure protected delivery of the reconnaissance teams to their dismount point. Once the reconnaissance teams have dismounted the carriers, the vehicle crew may employ local self-defense armament to

defeat “thin-skinned” enemy vehicles (trucks or lightly armored vehicles) or dismounted infantry.

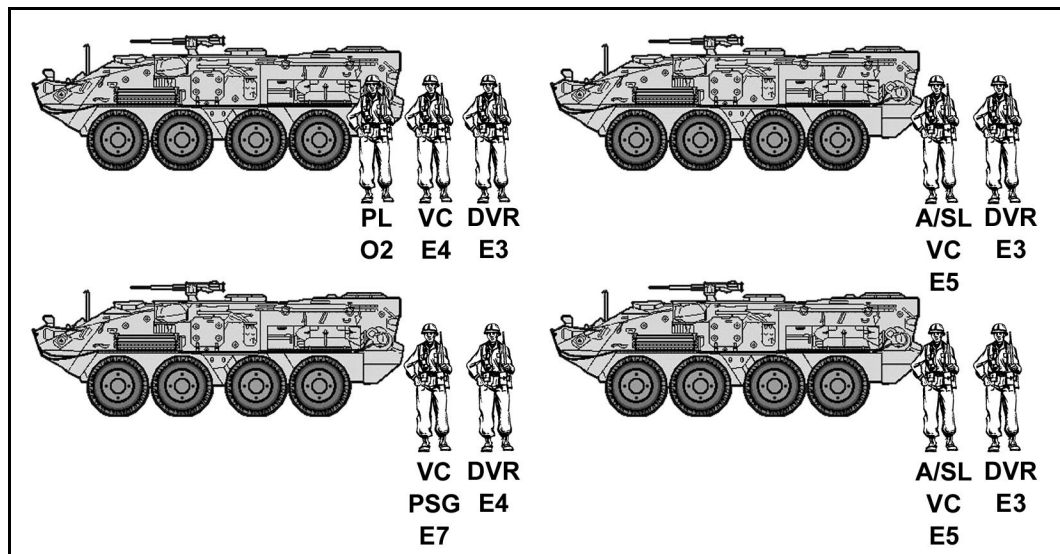


Figure 1-4. Mounted element.

c. **Dismounted Element.** The dismounted element. consists of the platoon headquarters and the three reconnaissance teams. The five-man reconnaissance team (Figure 1-5) is the foundation of the reconnaissance and surveillance forces and is employed to conduct reconnaissance and surveillance missions in support of the battalion commander’s information-gathering effort. The dismounted element may be required to fight as infantrymen. To support the fight, the platoon is equipped with four M240 machine guns which may be task-organized to the dismounted elements. The element must be prepared to defeat enemy forces, secure key or decisive terrain, deprive the enemy of resources, deceive and divert the enemy, hold the enemy in position, or disrupt an enemy attack.

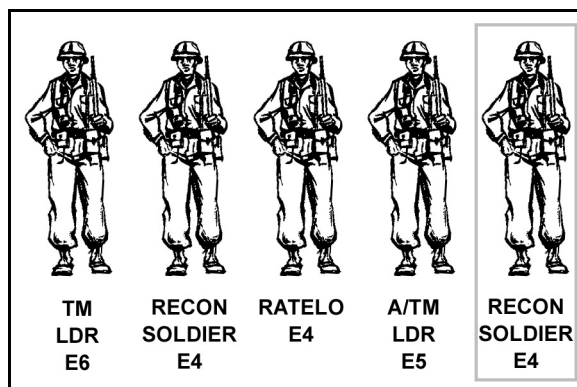


Figure 1-5. Dismounted reconnaissance teams.

1-4. RECONNAISSANCE SECTIONS AND TEAMS

The reconnaissance section is normally employed as the platoon's basic tactical maneuver organization. Each section consists of a section leader (either the PL or the PSG), team leaders, reconnaissance team(s), and two crews, each of which mans a vehicle. The assistant section leader (A/SL) assists with command and control of the section. For maneuver purposes, the platoon may also be task-organized into elements known as reconnaissance teams (a team is normally a single vehicle and its crew). The reconnaissance sections are capable of conducting mounted and dismounted reconnaissance operations at the same time. The section leader reports critical intelligence information obtained by his section to the reconnaissance platoon leader or the battalion tactical operations center (TOC). The mounted element of each section is capable of conducting traditional mounted reconnaissance missions (area, route, and zone). The three dismounted reconnaissance teams are capable of conducting independent, traditional dismounted reconnaissance missions. These include conducting long-range surveillance of key areas of interest, marking landing and pickup zones, providing terminal guidance for helicopter operations, and providing guides for the conduct of dismounted infiltration operations.

1-5. DISMOUNTED ORGANIZATIONS

The basic element within the reconnaissance platoon is the dismounted team. Every dismounted team consists of a reconnaissance element and a control and security element. The purpose of the reconnaissance element is to obtain data for information requirements. The control and security element's primary responsibility is to protect the reconnaissance element. The control and security element may also be a reconnaissance element and have both reconnaissance and security responsibilities, or it may alternate responsibilities with the other element. Regardless of other roles the control and security element plays, its primary objective is to protect the reconnaissance element. A two-man element is the smallest element within the reconnaissance platoon. The following paragraphs describe possible dismounted organizations. Each type of organization can perform reconnaissance tasks, security tasks, observation post (OP) and or surveillance tasks, liaison, or a combination of any of these tasks. Within each team there is always an element designated as control and security. The platoon's vehicle(s) may be the control and security element for the reconnaissance element.

a. **Dismounted Team Organization.** The five-man dismounted team is the optimal dismounted configuration. Each team has a single RV and is led by an experienced noncommissioned officer (staff sergeant or higher).

b. **Dismounted Section Organization.** The dismounted section combines the strength of one or two dismounted teams. A platoon leader, PSG, or staff sergeant leads this section. The section is large enough to have a team capable of reacting to contact as part of its control and security element.

c. **Dismounted Platoon Organization.** The dismounted platoon organization is appropriate when the threat is high or vehicular movement is impossible. Infiltration, for example, may require the platoon to conduct a dismounted tactical movement. The platoon leader or platoon sergeant leads the dismounted platoon.

1-6. MOUNTED ORGANIZATIONS.

When mounted, the reconnaissance platoon normally operates in one of three organizations: as three teams with one vehicle in each team and the platoon leader's vehicle serving as C2; as two sections with two vehicles in each section; or as a four-vehicle platoon with each having an independent mission.

a. **Three-Team Organization.** The three-team organization is used when the anticipated threat is low to medium. The key to this organization rests in ensuring that adjacent vehicles mutually support each other. If mutual support is not possible because of terrain or other mission constraints, vehicles must have the ability to maneuver and support other adjacent platoon elements. This organization also allows the platoon leader to provide C2 for the platoon and direct fire support for any of the other three vehicles in his platoon. This organization does not provide the reconnaissance platoon with overwatch capability, thus leaving elements vulnerable to enemy contact.

b. **Two-Section Organization.** The platoon uses the two-section organization when it needs increased security, when it can cover the area of operations efficiently with only two elements, or when the enemy situation is unknown. This type of organization limits the amount of terrain the platoon can cover and decreases the speed with which the platoon can perform its tasks. On the other hand, it increases internal section security by providing mutually supporting fires. It also gives the platoon leader and the PSG greater flexibility in performing C2 and CSS requirements.

c. **Four-Vehicle Organization.** The four-vehicle organization is the most difficult to control. The platoon leader employs this organization when he must have four separate information sources on-going at the same time requiring each of the reconnaissance platoon's four vehicles and associated crews to be in separate locations or when executing specific surveillance missions directed by battalion. The platoon should use this organization when the likelihood of enemy contact is low or the enemy situation is known. The platoon may also implement this formation during short-duration security missions to allow for depth in the platoon's sector.

1-7. RESPONSIBILITIES

The reconnaissance platoon leader and the platoon's noncommissioned officers (NCOs) must be experts in the use of the platoon's organic crew-served weapons, indirect fires, land navigation, supporting direct and indirect fires, obstacles, communications, reconnaissance, surveillance, information collection, liaison, and security techniques. They must be familiar with infantry, mortar, and combined arms tactics and be able to react to rapidly changing situations. They must also know how to employ CS assets that are attached to the platoon. Because of the many missions the platoon must perform, the reconnaissance platoon leader and PSG must be proficient in all collective and individual infantry tasks and all the tactics, techniques, and procedures (TTP) for reconnaissance and surveillance. They must also be familiar with the capabilities, limitations, and deployment of ground sensors.

a. **Platoon Leader.** The platoon leader is responsible for the tactical employment, collective training, administration, personnel management, and logistics of the platoon. He must know his soldiers and how to employ the platoon and its weapons. He is personally responsible for positioning and employing all assigned or attached weapons. The platoon leader--

- Leads the platoon in supporting the battalion missions. He bases his actions on the missions the battalion commander assigns to him and the battalion commanders' concepts.
- Informs his commander of his actions when operating without orders.
- Plans operations with the help of the platoon sergeant, section leaders, team leaders, and other key personnel.
- Stays abreast of the situation and goes where needed to supervise, issue FRAGOs, and accomplish the mission.
- Requests necessary support from the battalion for his platoon to perform its mission.
- Provides guidance to the platoon sergeant in planning and coordinating the platoon's CSS effort.
- During planning, receives on-hand status reports from the platoon sergeant, section leaders, and team leaders.
- Reviews platoon requirements based on the tactical plan.
- During execution, supervises the platoon sergeant and section leaders.
- Develops the fire support plan with the platoon sergeant, section leaders, and team leaders.
- Coordinates the obstacle plan.
- Analyzes tactical situations, disseminates information, and employs the full capabilities of his platoon's equipment to accomplish the mission.
- Manages the C3 information.
- Ensures subordinates follow database protection procedures to prevent the compromise of digital information.
- Ensures that situation reports (SITREPs) are accurate and are forwarded to the commander and staff as applicable.
- Analyzes and then disseminates pertinent tactical friendly and enemy updates to his subordinates.
- During limited visibility, employs all available OTN assets to designate targets for the direct- and indirect-fire weapons and for situation updates.
- As a section leader, keeps his crew and wingman informed.

b. **Platoon Sergeant.** The platoon sergeant is the senior NCO in the platoon and second in command. He assists and advises the platoon leader and leads the platoon in the platoon leader's absence. He supervises the platoon's administration, logistics, and maintenance. The PSG is responsible for individual training. He advises the platoon leader on appointments, promotions and reductions, assignments, and discipline of NCOs and enlisted soldiers in the platoon. He is a tactical expert in platoon operations to include maneuver of the platoon and employment of all weapons. The platoon sergeant--

- Controls the mounted element when the platoon leader dismounts or dismounts with the platoon when it is conducting ground operations independent of its organic vehicles or when it is necessary to command and control the platoon (mission dependent). The platoon sergeant is a fighter by trade and should be considered in the tactical plan as either dismounted or maneuvering the mounted element.
- Serves as VC and section leader when the platoon is mounted.

- Receives team and section leaders' administrative, logistical, and maintenance reports and requests for rations, water, fuel, and ammunition. Coordinates with the battalion's headquarters and headquarters company's (HHC) first sergeant or executive officer (XO) to request resupply.
 - Directs the platoon medic and platoon aid and litter teams in moving casualties during mounted or dismounted operations.
 - Maintains platoon strength information, consolidates and forwards the platoon's casualty reports, and receives and orients replacements.
 - Monitors the morale, discipline, and health of platoon members.
 - Takes charge of task-organized elements in the platoon during tactical operations. This can include, but is not limited to, quartering parties, support elements in raids, combat patrols, and security patrols.
 - Ensures ammunition and supplies are properly distributed after consolidation on the objective and during reorganization.
 - Controls digital reports while the platoon is in contact to allow the platoon leader to maneuver the teams.
 - Ensures the platoon leader is updated on appropriate reports and forwards those needed by higher headquarters.
 - Collects, prepares, and forwards logistical status updates and requests to the battalion's HHC.
 - As the leader of Section B, keeps his crew and wingman informed and directs fire and maneuver of his section.
 - Ensures maintenance of all equipment.
 - Ensures precombat inspections are conducted.
- c. **Reconnaissance Section Leader and Team Leader.** The section leader and team leader are responsible for all that the section or team does or fails to do. They are tactical leaders and lead by example. The reconnaissance section leader and team leader--
- Are experts in dismounted patrols, employment of assets, reconnaissance, surveillance, and establishment of OPs.
 - Control the maneuver of their section or team.
 - Brief operations orders to the section or team.
 - Train their section or team on individual and collective tasks required to sustain combat effectiveness.
 - Manage the logistical and administrative needs of their section or team and request and issue ammunition, water, rations, and special equipment.
 - Maintain accountability of soldiers and equipment.
 - Complete casualty feeder reports and review casualty reports completed by section or team members.
 - Direct maintenance of section or team weapons and equipment.
 - Inspect the condition of soldiers' weapons, clothing, and equipment.
 - Ensure material and supplies are distributed to the soldiers in the section or team.
 - Keep the platoon leader and platoon sergeant informed of section or team supply status and requirements.

- Ensure supplies and equipment are internally cross-leveled within the section or team.
- Assist the VC and driver in maintaining the RV.
- Are responsible to the platoon leader for the training and discipline of their reconnaissance sections and teams.

d. **Reconnaissance Soldiers.** Soldiers within a reconnaissance platoon must be among the most tactically and technically proficient soldiers in the battalion. The reconnaissance platoon leader and PSG should be actively involved in the selection of these soldiers. Reconnaissance soldiers are physically fit and are experts in land navigation, communications, camouflage, surveillance, reconnaissance, target acquisition, employment of indirect fire and aviation assets, and survival. They understand the importance of the reconnaissance platoon's mission and what is required for successful accomplishment. Like their leaders, these soldiers use initiative and are intelligent, resourceful, dependable, and disciplined.

Section II. COMBAT POWER AND CONSIDERATIONS FOR EMPLOYMENT AND TRAINING

This section discusses the elements of combat power and the considerations for employing and training the reconnaissance platoon.

1-8. COMBAT POWER

The doctrine that guides infantry forces is based on the elements of combat power: maneuver, firepower, protection, leadership, and information.

a. **Maneuver.** Maneuver is the employment of forces on the battlefield through movement in combination with fire, or fire potential, to achieve a position of advantage with respect to the enemy in order to accomplish the mission. Infantry forces move to gain a position of advantage over the enemy and to hold that advantage. They maneuver to attack enemy flanks, rear areas, logistics points, and command posts. In the defense, they maneuver to counterattack a flank of the enemy attack. Maneuver, properly supported by fires, allows the infantry to close with the enemy and gain a decision in combat.

b. **Firepower.** Firepower is the amount of fire a position, unit, or weapons system can deliver. Firepower destroys or suppresses the enemy in his positions, deceives the enemy, and supports maneuver. Without effective supporting fires, the infantry cannot maneuver. Before attempting to maneuver, units must establish a base of fire.

(1) A base of fire is fire that is placed on an enemy force or position to reduce or eliminate the enemy's ability to interfere with friendly maneuver. A single weapon or group of weapon systems may provide a base of fire, but a base of fire generated by the weapons squad for the desired effect for the length of time necessary is most effective.

(2) Leaders must know how to control, mass, and combine fire with maneuver. They must identify the most critical targets quickly, direct fires onto them, and ensure the volume of fires is sufficient to keep the enemy from returning fire effectively and to keep the platoon from expending ammunition needlessly.

c. **Protection.** Protection is the preservation of the fighting potential of a force so it can be applied with maximum combat power at the decisive time and place. Platoons must never permit the enemy to acquire an unexpected advantage. Platoons, sections, and

teams take active and passive measures to protect themselves from surprise, observation, detection, interference, espionage, sabotage, and annoyance. Protection includes two basic considerations: care of the soldier and his equipment and actions to counter enemy combat power.

(1) The first consideration involves sustainment techniques to maintain the platoon, sections, and teams as an effective fighting force. It includes keeping soldiers healthy to maintain morale through personal hygiene, physical conditioning, and rest plans. It also includes keeping equipment in good working condition and providing and protecting supplies.

(2) The second consideration involves security, dispersion, cover, camouflage, deception, and suppression of enemy weapons. Infantry units gain protection by digging fighting positions when stationary for any length of time; by skillful use of terrain while moving mounted; by dismounting the infantry to increase protection; and through overwatch, suppressive fires, and obscurity. The infantry always wants to set the time and place of battle. It must protect itself so it can do so with maximum combat power and with the important element of surprise.

d. **Leadership.** Military leadership is a process by which a soldier influences others to accomplish a mission. Leaders coordinate the other elements of combat power, and their competent and confident leadership results in effective unit action. The right leadership gives purpose, direction, and motivation in combat. Leaders must know their profession, their soldiers, and the tools of war. Only leaders who embody the warrior ethos can inspire and direct soldiers to do difficult tasks under dangerous and stressful conditions. Leadership is the most important element of combat power.

e. **Information.** Information enhances leadership and magnifies the effects of maneuver, firepower, and protection at decisive points. Infantry leaders have access to, and an understanding of, the broader tactical situation. This knowledge allows leaders to develop plans that better incorporate the elements of combat power during a decisive action. It also allows infantry leaders to make crucial decisions while a mission is ongoing to increase the opportunity for success.

1-9. CONSIDERATIONS FOR EMPLOYMENT

The platoon leader must know the tactical strengths and weaknesses of the reconnaissance platoon and must determine the most effective and efficient method of employing the platoon. The reconnaissance platoon leader prepares, plans, and executes its assigned missions with the assistance of the battalion staff. Primary and specialty staff officers provide expertise for a particular battlefield operating system. The platoon leader also understands the brigade concept of the operation and how the battalion fits into the overall brigade concept. He identifies the brigade's task and purpose and his contribution to the battalion's fight. The platoon leader must clearly understand the brigade commander's intent from paragraph 3 of the brigade order. Additionally, the platoon leader identifies the task, purpose, and disposition for all adjacent maneuver elements under brigade control. The reconnaissance platoon leader should understand the specific functions of the battalion staff, ensure he understands the battalion commander's intent, and use the staff's expertise whenever possible. Finally, he must understand why the battalion commander gave his platoon a particular tactical task and how that task fits into the battalion's concept of the operation.

a. The reconnaissance platoon leader task-organizes his platoon to accomplish the mission based on the factors of mission, enemy, terrain and weather, troops and support available, time available, and civil considerations (METT-TC). Unlike most other combat arms platoons that maneuver together in formation, the reconnaissance platoon normally maneuvers as individual reconnaissance sections or teams, either mounted or dismounted, under the direction and control of the platoon leader. A reconnaissance section or team may consist of one or two vehicles plus any combat elements under its operational control (OPCON). Determining which organization best meets his mission requirements is one of the key decisions the platoon leader must make during his planning process.

b. Primary and specialty battalion staff officers provide expertise for particular battlefield operating systems:

(1) The battalion S2 provides information on the enemy and terrain.

(2) The S3 assigns the reconnaissance platoon its mission and then integrates its plan into that of the battalion.

(3) The fire support officer provides artillery and mortar fires to support the reconnaissance platoon's plan.

(4) The S4 maintains the platoon's logistical requirements.

(5) The signal officer maintains the battalion C2 and supplies the platoon's communications requirements.

c. The platoon leader coordinates with the battalion commander and staff when planning the platoon's mission. METT-TC factors determine whether to employ the platoon as an intact unit or in sections under platoon control.

d. Distance and mission duration are critical considerations affecting employment of the reconnaissance platoon away from the main body of its parent unit. Fire support, CSS, and communications requirements are also important factors when the reconnaissance platoon must conduct sustained operations beyond the immediate supporting range of the main body.

1-10. TRAINING CONSIDERATIONS

Training is the cornerstone of success. The reconnaissance platoon must train for combat using appropriate training literature and doctrinal manuals that provide reconnaissance leaders with the TTP and principles required to conduct training properly. The leaders should refer to the applicable infantry collective tasks (contained in the Army training and evaluation program [ARTEP], Mission Training Plan) to find the specific conditions and standards for the techniques and procedures discussed in this manual. Training requires leaders to use their initiative and to make quick decisions. The training environment must be realistic and stressful, and it must challenge soldiers to master all infantry tasks (individual and collective). The training environment must constantly remind soldiers of their mission, of their heritage, and of the physical toughness and mental stress that is required of them. Platoon training also promotes the cohesion and determination of the platoon so that it continues to carry out the mission.

CHAPTER 2
BATTLE COMMAND AND TROOP-LEADING PROCEDURES

This chapter describes techniques and procedures used by reconnaissance platoons, teams, and sections for command, control, and communications. It also describes troop-leading procedures (TLP), communications in combat, and operation orders. Technical enhancements in SBCT platoons provide leaders with several significant improvements in command and control. These improvements aid the platoon leader and team leaders throughout the planning, preparation, and execution of tactical operations. Combined with the technical enhancements, the platoon and team leaders must use proven techniques of mission tactics and leadership.

Section I. COMMAND AND CONTROL

Command and control refers to the process of directing, coordinating, and controlling a unit to accomplish a mission. Command and control implements the commander’s will in pursuit of the unit’s objective. The two components of command and control are the *commander* and the *command and control system*. At platoon level, the *commander* is the platoon leader; the *command and control system* consists of the personnel, information management, procedures, and equipment the platoon leader uses to carry out the operational process (plan, prepare, execute, and assess) within his platoon.

2-1. LEADERSHIP

Leadership means influencing people by providing purpose, direction, and motivation to accomplish a mission (Figure 2-1). Leadership is the most vital component of command and control.

- a. **Purpose.** Purpose gives soldiers a *reason* to accomplish the mission.
- b. **Direction.** Direction gives them the *means* to accomplish the mission.
- c. **Motivation.** Motivation gives them the *will* to accomplish the mission.
- d. **Communications.** To command or control, leaders *must* communicate with their subordinates. Digital radios represent a significant technical improvement over previous systems. Leaders and soldiers at every level must ensure they know digital radio procedures and how to link digital systems. Soldiers quickly lose these skills, so leaders must constantly work to maintain them through sustainment training.

Leadership: Influencing people to accomplish a mission by providing—	PURPOSE	The <i>reason</i> to accomplish the mission.
	DIRECTION	The <i>means</i> to accomplish the mission.
	MOTIVATION	The <i>will</i> to accomplish the mission.

Figure 2-1. Elements of leadership.

2-2. MISSION-ORIENTED COMMAND AND CONTROL

The mission-oriented command and control method of directing military operations encourages and helps subordinates to act within the intent and concept of both the SBCT and battalion commanders. Mission-oriented C2 requires that subordinate elements clearly understand the purpose and commander's intent (two levels up). This understanding allows them the freedom to respond, with disciplined initiative, to the changing situation without further guidance. With mission-oriented C2, the platoon leader must consider the following guidelines.

a. **Expect Uncertainty.** The platoon leader must understand the impact of and the manner in which capability impacts on the environment of combat. Dynamic battle conditions, an (obviously) uncooperative enemy, and the chaos--the noise and confusion of battle--challenge the platoon leader's ability to know what is happening in his immediate area of operations (AO). Through the collection of data and information, he must try to understand and envision the evolving battle beyond his personal knowledge and senses. Using all of his personal, technical, and tactical resources helps him to develop the situation and reduce the "fog of battle." Information alone cannot develop the entire situation. The situation the leader anticipates during the planning phase will invariably change; this fact requires flexible, dynamic leadership during the execution of current operations.

b. **Reduce Leader Intervention.** Control stifles initiative. When soldiers expect the platoon, section, or team leader to make every decision or initiate every action, they may become reluctant to act. To counter this tendency, the platoon leader must plan and direct operations in a manner that requires a minimum of intervention. The platoon leader must operate on the principle that trained subordinates with a clear understanding of the mission will accomplish the task.

c. **Optimize Planning Time for Subordinates.** The platoon leader must ensure that the timelines he develops for mission planning and preparation provide adequate troop-leading time for the subordinate elements.

d. **Allow Maximum Freedom of Action for Subordinates.** Given the expected battlefield conditions, leaders at every level must avoid unnecessary limits on their soldiers' freedom of action. The leader at the decisive point must have the knowledge, training, and freedom to make the correct choice in support of both the battalion and company commanders' intent. This concept must be emphasized at every opportunity and at every level of leadership. Soldiers win battles. Their leaders can only place them in a position where they can seize the opportunity to do so.

e. **Encourage Cross Talk.** Section and team leaders sometimes need no guidance from the platoon leader in order to address a change in the situation. In some instances, because of their position on the battlefield, two or more subordinates working together may have on-site information that enhances the platoon leader's understanding of the situation, thus providing the clearest view of what is happening. This information becomes critical to the platoon leader as he develops the tactical solution. This type of problem solving involving direct coordination between subordinate elements is critical to mission-oriented C2.

f. **Lead Well Forward.** The platoon leader locates where he can best employ his platoon and make critical decisions to influence the outcome of the fight. He normally chooses a position with the main effort in order to control his elements and, at the same

time, support or draw resources from the main effort as needed. From his far forward position, he can use all of the available technology and personal resources to “see” the battlefield. In addition to visual observation, intelligence resources also include radio reports and, if available, information provided via the FBCB2 system. The platoon sergeant positions where he can best accomplish his tasks and assume command of the platoon quickly, if needed.

g. Maintain the Common Operational Picture. The commander structures the battlefield based on his intent and on the factors of METT-TC. How he does this affects the platoon leader’s mission planning and his ability to assess the situation and make tactical decisions. The framework of the battlefield can vary from one extreme to the other and with many variations. At one extreme, the battlefield could have obvious front and rear boundaries and closely tied adjacent units. At the other extreme, it could consist of a dispersed, decentralized structure with few secure areas and unit boundaries and no definable front or rear boundary. Maintaining the COP becomes more difficult as the battlefield loses structure. Modern, highly mobile operations involving small forces lend themselves to a less rigid framework. To “see” the battlefield accurately, the platoon leader must know the friendly situation one level higher. Whenever possible, he shares what he knows with the section and team leaders. The platoon leader also must know the terrain and weather and the enemy situation. He must picture enemy and friendly elements through time as well as picture how the terrain will affect their actions. Analyzing the situation (gaining and understanding the situation)--

- Includes having an understanding of relevant terrain, an understanding of the relationship between friendly and enemy forces, and the ability to correlate battlefield events as they develop.
- Helps leaders form logical conclusions, make decisions that anticipate future events and information, and, if time is short, conduct TLP as fast as possible.
- Provides a basis for platoon sergeants, section leaders, and team leaders to make sound, quick, tactical decisions.
- Reduces fratricide.

NOTE: The platoon leader must understand the situation and commander’s intent two levels higher than his own. However, he must know the real-time battlefield situation in detail for his immediate higher level (battalion).

Section II. PLANS AND ORDERS

Plans are the basis for any mission. To develop his plan (concept of the operation), the platoon leader summarizes how best to accomplish his mission within the scope of the commander’s intent two levels up. The platoon leader uses TLP to turn the concept into a fully developed plan and to prepare a concise, accurate OPORD. He assigns additional tasks (and outlines their purpose) for subordinate elements, allocates available resources, and establishes priorities to make the concept work. The following discussion covers important aspects of orders development and serves as an introduction to the discussion of the troop-leading procedures. This section focuses on the mission statement and the commander’s intent, which provide the foundation for the OPORD. It also includes a basic discussion of the three types of orders (warning orders [WARNOs], OPORDs, and

FRAGOs) used by the platoon leader. The platoon leader and his subordinates must have a thorough understanding of the building blocks for everything else that he does.

2-3. MISSION STATEMENT

The platoon leader uses the mission statement to summarize the upcoming operation. This brief paragraph (sometimes a single sentence) describes the type of operation, the unit's tactical task and purpose, the actions to be taken, and the reasons for these actions. It is written based on the five "Ws:" who (unit), what (tasks), when (date-time group), where (grid location or geographical reference for the area of operations or objective), and why (purpose). The platoon leader must ensure that the mission is thoroughly understood by all leaders and soldiers two echelons down. The following considerations apply in development of the mission statement.

a. **Operations.** Operations are groupings of related activities into four broad categories: offense, defense, stability, and support.

b. **Tasks.** Tactical tasks are specific activities performed by the unit while it is conducting a form of tactical operation or a choice of maneuver. (The title of each task can also be used as an action verb in the unit's mission statement to describe actions during the operation.) Tasks should be definable, attainable, and measurable. Tactical tasks that require specific tactics, techniques, and procedures for the platoon are covered in detail throughout this manual.

c. **Purpose.** A simple, clear statement tells the subordinates why the platoon is conducting the mission and how the platoon will operate with or provide support for other units.

d. **Placement in OPORD.** The platoon leader has several options as to where he outlines his subordinates' tasks and purpose in the OPORD. His main concern is that placement of the mission statement should assist subordinate leaders in understanding the task, purpose, and each of the five W elements exactly. Figure 2-2 shows an example of a mission statement the platoon leader might include in his order:

EXAMPLE:

The reconnaissance platoon (**who**) screens (**task/what**) along PL Anaconda (**Where**) NLT 040600Z FEB 98 (**when**) to provide early warning to the battalion (**purpose/why**).

Or, broken out into the five-W format:

Who	Reconnaissance Platoon.
What	Screen.
When	PL Anaconda (PK59674578 to Pk61544978).
Where	At 040600Z FEB 01.
Why	To provide early warning to the battalion.

Figure 2-2. Example mission statement.

2-4. COMBAT ORDERS

Combat orders are the means by which the platoon leader receives and transmits information, from the earliest notification that an operation will occur through the final

steps of execution. Warning orders, operations orders, and fragmentary orders are absolutely critical to mission success. In a tactical situation, the platoon leader and subordinate leaders work with combat orders on a daily basis. At the same time, they must ensure that every soldier in the platoon understands how to receive and respond to the various types of orders. The skills associated with analyzing orders are highly perishable; therefore, the platoon leader must take every opportunity to train the platoon in the use of combat orders with realistic practice.

a. **Warning Orders.** Platoon leaders alert section and team leaders by using a WARNO during planning for an operation. Warning orders also initiate the parallel planning process, the platoon leader’s most valuable time management tool. The platoon leader may issue a series of warning orders to his subordinate leaders to help them prepare for new missions. The directions and guidelines in the warning order allow subordinates to begin their own planning and preparation activities.

(1) The content of WARNOs is based on two major variables: information available about the upcoming operation and special instructions. The information usually comes from the battalion main command post.

(2) In addition to alerting the unit to the upcoming operation, WARNOs allow the platoon leader to issue tactical information incrementally and, ultimately, to shorten the length of the actual OPORD. Warning orders do not have a specific format, but one technique to follow is the five-paragraph OPORD format. Table 2-1 shows an example of how the platoon leader might use warning orders to alert the platoon and provide initial planning guidance.

PLATOON LEADER’S ACTION	POSSIBLE CONTENT OF WARNING ORDER	PLATOON LEADER’S PURPOSE
Receive battalion WARNO #1	Warning order #1 covers: Security plan. Movement plan. Initial reconnaissance and surveillance guidance. Tentative timeline. Standard drills to be rehearsed.	Prepare squads and vehicles for movement to the tactical assembly area. Obtain map sheets. Initiate generic rehearsals (drill- and task-related).
Receive battalion WARNO #2 or Conduct METT-TC analysis	Warning order #2 covers: Friendly situation. Enemy situation. Terrain analysis. Platoon mission.	Initiate squad-level mission analysis. Prepare for combat.
Receive battalion WARNO #3 or Receive battalion OPORD or Develop a tentative plan	Warning order #3 covers: Concept of the operation. Concept of fires. Subordinate unit tasks and purposes. Updated graphics.	Identify platoon-level reconnaissance requirements. Direct leader’s reconnaissance. Prepare for combat.

Table 2-1. Example of multiple warning orders.

b. **Operations Order.** The OPORD is the five-paragraph directive issued by a leader to subordinates for the purpose of effecting the coordinated execution of an

operation. When time and information are available, the platoon leader will normally issue a complete OPORD as part of his troop-leading procedures; however, after issuing a series of WARNOs, he does not need to repeat information previously covered. He can simply review previously issued information or brief the changes or earlier omissions. He then will have more time to concentrate on visualizing his concept of the fight for his subordinates. As noted in his warning orders, the platoon leader also may issue an execution matrix either to supplement the OPORD or as a tool to aid in the execution of the mission; however, the matrix order technique does not replace a five-paragraph OPORD.

c. **Fragmentary Order.** A FRAGO is a brief oral or written order. The platoon leader uses a FRAGO to--

- Communicate changes in the enemy or friendly situation.
- Task subordinate elements based on changes in the situation.
- Implement timely changes to existing orders.
- Provide pertinent extracts from more detailed orders.
- Provide interim instructions until he can develop a detailed order.
- Specify instructions for subordinates who do not need a complete order.

A written FRAGO can follow the five-paragraph OPORD structure; however, it includes only the information required for subordinates to accomplish their mission. To enhance understanding of oral FRAGOs, digitally equipped units can quickly develop hasty graphics and transmit digital overlays.

Section III. TROOP-LEADING PROCEDURES AND TECHNIQUES

Troop-leading procedures begin when the platoon leader receives the first indication of an upcoming operation and continue throughout the operational process (plan, prepare, execute, and assess). The TLP are a sequence of actions (Figure 2-3) that help platoon leaders to effectively and efficiently use available time to issue orders and execute tactical operations. TLP are not a hard and fast set of rules. They are a guide that must be applied consistent with the situation and the experience of the platoon leader and his subordinate leaders. The tasks involved in some steps (such as initiate movement, issue the warning order, and conduct reconnaissance) may recur several times during the process. The last step, those activities associated with supervising and refining the plan, occur throughout troop-leading. The following TLP information assumes that the platoon leader will plan in a time-constrained environment. As such, the suggested techniques are oriented to help a platoon leader quickly develop and issue a combat order.

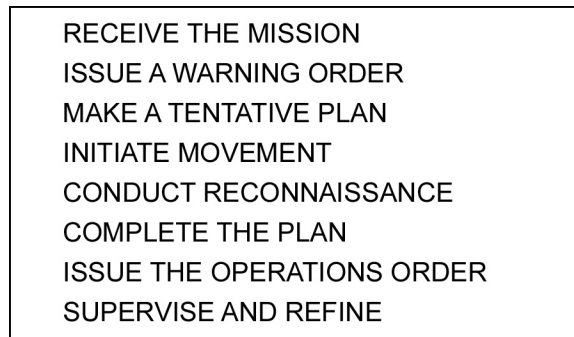


Figure 2-3. Troop-leading procedures.

2-5. RECEIVE THE MISSION

This step begins with the receipt of the initial WARNO or OPOD from the battalion. This step begins the planning and preparation process so that the platoon leader can prepare an initial WARNO as quickly as possible. The platoon leader must not become involved in a detailed METT-TC analysis. During this step, the platoon leader determines the time he has available to prepare and execute the mission. For the platoon leader, mission analysis is essentially the analysis of the factors of METT-TC. At this stage of the TLP, mission analysis should focus on determining the unit's mission and the amount of available time. Detailed mission analysis will occur after the platoon leader issues the initial WARNO.

2-6. ISSUE A WARNING ORDER

After the platoon leader has determined his platoon's mission and gauged the time available for planning and execution, he immediately issues an oral WARNO to his subordinates. In addition to telling his subordinates of the platoon's new mission, the WARNO also gives them the platoon leader's planning timeline. The platoon leader relays all other instructions or information that he thinks will assist the platoon in preparing for the new mission. Such information includes information about the enemy, the nature of the overall plan, and specific instructions for preparation. Most importantly, by issuing the initial WARNO as quickly as possible, the platoon leader enables his subordinates to begin their own planning and preparation while he begins to develop the platoon operation order. This is called parallel planning.

2-7. MAKE A TENTATIVE PLAN

After receiving the battalion WARNO, the platoon leader develops a tentative plan. The process of developing this plan in a time-constrained environment usually has four steps: mission analysis, course of action (COA) development, COA analysis, and COA selection. If more time is available, the platoon leader may develop more than one COA. In this event, he will need to compare these COAs and select the best one.

a. **Mission Analysis.** This is a continuous process during the course of the mission. It requires the platoon leader to analyze all the factors of METT-TC in as much depth as time and quality of information allow. The factors of METT-TC are not always analyzed sequentially. How and when the platoon leader analyzes each factor depends on when information is made available to him. One technique for the analysis is based on the sequence of products that the battalion staff produces: *mission, terrain and weather, enemy, troops and support available, time available, and civil considerations*. The platoon leader can streamline his analysis effort by using his digital capability to access products produced at the battalion or brigade to fill in gaps he identifies. As a result of his analysis, the platoon leader must develop significant conclusions about how each element will affect mission accomplishment.

(1) **Analysis of Mission.** Leaders at every echelon must have a clear understanding of the mission, intent, and concept of the operation of the commanders one and two levels higher. Without this understanding, it would be difficult to exercise disciplined initiative. One technique to quickly understand the operation is to draw a simple sketch of the battalion and brigade's concept of the operations (if not provided by the battalion staff). The platoon leader can then understand how his platoon is nested into the overall plan

and can capture this understanding in his restated mission statement. The platoon leader will write a restated mission statement using his analyses of these areas: the battalion mission, intent, and concept; the company mission, intent, and concept; identification of specified, implied, and essential tasks; identification of risks; and any constraints.

(a) *Battalion Mission, Intent, and Concept.* The platoon leader understands the battalion concept of the operation. He identifies the battalion's task and purpose and how his platoon is contributing to the battalion's fight. The platoon leader must also understand the battalion commander's intent, which is found in the battalion intelligence, surveillance and reconnaissance annex.

(b) *Brigade Mission, Intent, and Concept.* The platoon leader understands the brigade concept of the operation and how the battalion fits into the overall brigade concept. He identifies the brigade's task and purpose and his contribution to the battalion's fight. The platoon leader must clearly understand the brigade commander's intent from the brigade order (paragraph 3). Additionally, the platoon leader identifies the task, purpose, and disposition for all adjacent maneuver elements under brigade control.

(c) *Platoon Mission.* The platoon leader finds his platoon's mission in the battalion's concept of the operation paragraph. The platoon leader must understand how his purpose relates to the other companies in the battalion. He determines the platoon's essential tactical task to successfully accomplish his given purpose. Finally, he must understand why the battalion commander gave his platoon a particular tactical task and how it fits into the battalion's concept of the operation.

(d) *Constraints.* Constraints are restrictions the battalion commander places on the platoon leader to dictate action or inaction. Constraints restrict the freedom of action the platoon leader has for planning by stating the things that must or must not be done. The platoon leader identifies all the constraints the commander places on the unit's ability to execute its mission. There are two types of constraints: requirements for action (for example, "place one reconnaissance team under operational control of Alpha company") and prohibitions of action (for example, "do not cross PL BULL until authorized").

(e) *Identification of Tasks.* The platoon leader must identify and understand the tasks required to accomplish the mission. There are three types of tasks: specified, implied, and essential.

- Specified tasks are tasks specifically assigned to a platoon by a battalion commander. Paragraphs 2 and 3 from the battalion OPORD state specified tasks. Specified tasks may also be found in annexes and overlays.
- Implied tasks are tasks that must be performed to accomplish a specified task but which are not stated in the battalion OPORD. Implied tasks are derived from a detailed analysis of the battalion OPORD, the enemy situation and courses of action, and the terrain. Analysis of the platoon's current location in relation to future areas of operation as well as the doctrinal requirements for each specified task might provide implied tasks. SOP tasks are not considered implied tasks.
- Essential task(s) must be executed to accomplish the mission. These are derived from a review of the specified and implied tasks.

(f) *Identification of Risks.* Risk is the chance of injury or death for individuals and damage to or loss of vehicles and equipment. Risk, or the potential for risk, is always present in every combat and training situation the platoon faces. Risk management must

take place at all levels of the chain of command during every operation; it is an integral part of tactical planning. The platoon leader, his NCOs, and all other platoon soldiers must know how to use risk management, coupled with fratricide avoidance measures, to ensure that the mission is executed in the safest possible environment within mission constraints. (Refer to Appendix C for a detailed discussion of risk management and Appendix D for a discussion of fratricide avoidance.)

(g) *Restated Platoon Mission Statement.* The platoon leader prepares his mission statement expressed with the five Ws: who, what, when, where, and why. The “who” is the platoon. The “what” is the type of operation and the platoon’s essential tactical task. The “when” is given in the battalion OPORD. The “where” is the objective or location taken from the OPORD. The “why” is the purpose for the platoon’s essential tactical task taken from the battalion commander’s concept of the operations paragraph.

(2) *Analysis of Terrain and Weather.* The platoon leader must conduct a detailed analysis of the terrain to determine how it will affect his unit and the enemy he anticipates fighting. The platoon leader must gain an appreciation of the terrain before attempting to develop either enemy or friendly COAs. He must exceed merely making observations (for example, this is high ground, this is an avenue of approach); he must arrive at significant conclusions about how the ground will affect the enemy as well as his unit. Because of limited planning time, the platoon leader normally prioritizes his terrain analysis. For example, in the conduct of an assault his priority may be the area around the objective followed by the platoon’s specific axis leading to the objective.

(a) Terrain mobility is classified in one of three categories.

- Unrestricted. This is terrain free of any movement restrictions; no actions are required to enhance mobility. For mechanized forces, unrestricted terrain is typically flat or moderately sloped, with scattered or widely spaced obstacles such as trees or rocks. Unrestricted terrain generally allows wide maneuver and offers unlimited travel over well-developed road networks. Unrestricted terrain is an advantage in situations requiring rapid movement.
- Restricted. This terrain hinders movement to some degree, and units may need to detour frequently. Restricted terrain may cause difficulty in maintaining optimal speed, moving in some types of combat formations, or transitioning from one formation to another. This terrain typically encompasses moderate to steep slopes or moderate to dense spacing of obstacles such as trees, rocks, or buildings. The terrain may not require additional assets or time to traverse, but it may hinder movement to some degree due to increased security requirements. In instances when security is the paramount concern, both friendly and enemy elements may move in more restricted terrain that may provide more cover and concealment.
- Severely Restricted. This terrain severely hinders or slows movement in combat formations unless some effort is made to enhance mobility. It may require a commitment of engineer forces to improve mobility or a deviation from doctrinal tactics, such as using a column rather than a wedge formation or moving at speeds much slower than otherwise preferred. Severely restricted terrain includes any terrain that requires equipment not organic to the unit to cross (for example, a large body of water and slopes requiring mountaineering equipment).

(b) The military aspects of terrain (OAKOC), Figure 2-4, are used to analyze the ground. The sequence used to analyze the military aspects of terrain can vary. The platoon leader may prefer to determine *Obstacles* first, *Avenues of Approach* second, *Key Terrain* third, *Observation and Fields of Fire* fourth, and *Cover and Concealment* last. For each aspect of terrain, the platoon leader determines its effect on both friendly and enemy forces. These effects translate directly into conclusions that can be applied to either friendly or enemy courses of action.

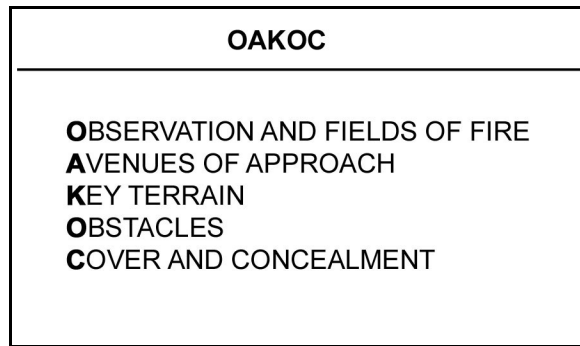


Figure 2-4. Military aspects of terrain.

- **Obstacles.** Within his AO, the platoon leader identifies existing and reinforcing obstacles that limit his mobility with regards to the mission. Existing obstacles are typically natural terrain features present on the battlefield and may include ravines, gaps, or ditches over 3 meters wide; tree stumps and large rocks over 18 inches high; forests with trees 8 inches or greater in diameter and with less than 4 meters between trees; and manmade obstacles such as towns or cities. Reinforcing obstacles are typically manmade obstacles that augment existing obstacles and may include minefields, antitank ditches, road craters, abatis and log cribs, wire obstacles, and infantry strongpoints. Figure 2-5 lists several offensive and defensive considerations the platoon leader can include in his analysis of obstacles and restricted terrain.

OFFENSIVE CONSIDERATIONS

- HOW IS THE ENEMY USING OBSTACLES AND RESTRICTED TERRAIN FEATURES?
- WHAT IS THE COMPOSITION OF THE ENEMY'S REINFORCING OBSTACLES?
- HOW WILL OBSTACLES AND TERRAIN AFFECT MY MOVEMENT AND MANEUVER?
- IF NECESSARY, HOW CAN THE COMPANIES AVOID SUCH FEATURES?
- HOW DO WE DETECT AND, IF DESIRED, BYPASS THE OBSTACLES?
- WHERE HAS THE ENEMY POSITIONED WEAPONS TO COVER THE OBSTACLES, AND WHAT TYPE OF WEAPONS IS HE USING?
- IF I MUST SUPPORT A BREACH, WHERE IS THE EXPECTED BREACH SITE?

DEFENSIVE CONSIDERATIONS

- WHERE DO I WANT TO KILL THE ENEMY? WHERE DO I WANT HIM TO GO?
- HOW WILL EXISTING OBSTACLES AND RESTRICTED TERRAIN AFFECT THE ENEMY?
- HOW CAN I USE THESE FEATURES TO FORCE THE ENEMY INTO MY ENGAGEMENT AREA, DENY HIM AN AVENUE, OR DISRUPT HIS MOVEMENT?

Figure 2-5. Considerations in obstacle and terrain analysis.

- **Avenues of Approach.** An avenue of approach is an air or ground route of an attacking force leading to its objective or key terrain. For each avenue of approach, the platoon leader determines (or receives from the battalion commander) the type (mounted, dismounted, air, or subterranean), size, formation, and speed of the largest unit that can travel along it. Mounted forces may move on avenues along unrestricted or restricted terrain (or both). Dismounted avenues and avenues used by reconnaissance elements normally include restricted terrain and, at times, terrain severely restricted to mounted forces. In addition, the terrain analysis must identify avenues of approach for both friendly and enemy units. Figure 2-6 lists several considerations for avenue of approach analysis.

OFFENSIVE CONSIDERATIONS

- HOW CAN I USE EACH AVENUE OF APPROACH TO SUPPORT MY MOVEMENT AND MANEUVER?
- HOW WILL EACH AVENUE SUPPORT MOVEMENT TECHNIQUES, FORMATIONS, AND (ONCE WE MAKE ENEMY CONTACT) MANEUVER?
- WILL VARIATIONS IN TRAFFICABILITY OR LANE WIDTH FORCE CHANGES IN FORMATIONS OR MOVEMENT TECHNIQUES OR REQUIRE DEFILE DRILLS?
- WHAT ARE THE ADVANTAGES AND DISADVANTAGES OF EACH AVENUE?
- WHAT ARE THE ENEMY'S LIKELY COUNTERATTACK ROUTES?
- DO LATERAL ROUTES EXIST THAT WE CAN USE TO SHIFT TO OTHER AXES OR THAT THE ENEMY CAN USE TO THREATEN OUR FLANKS?

DEFENSIVE CONSIDERATIONS

- WHAT ARE ALL LIKELY ENEMY AVENUES INTO MY SECTOR?
- HOW CAN THE ENEMY USE EACH AVENUE OF APPROACH?
- DO LATERAL ROUTES EXIST THAT THE ENEMY CAN USE TO THREATEN OUR FLANKS?
- WHAT AVENUES WOULD SUPPORT A FRIENDLY COUNTERATTACK?

Figure 2-6. Considerations in avenue of approach analysis.

- Key Terrain. Key terrain affords a marked advantage to the combatant who seizes, retains, or controls it. The platoon leader identifies key terrain not previously identified by the battalion S2. The platoon leader identifies key terrain starting at the objective or main battle area and working backwards to his current position. It is a conclusion rather than an observation. Key terrain may allow the platoon leader to apply direct fire or achieve observation of the objective (or avenue of approach). The platoon leader must assess what terrain is key to his mission accomplishment.
 - ⇒ An example of key terrain for a platoon could be a tree line on a hillside that over looks a high-speed avenue of approach. Controlling this tree line may be critical in passing follow-on forces (the main effort) to their objective. High ground, however, is not necessarily key terrain. For example, a prominent hilltop overlooks an avenue of approach and offers clear observation and fields of fire, but if it is easily bypassed, it is not key terrain. For another example, a bridge may ease or hamper movement by forming a chokepoint. Therefore, whoever controls it has the marked advantage.
 - ⇒ Although unlikely, the platoon leader may identify decisive terrain -- key terrain that holds such importance that the seizure, retention, and control of it will be **necessary** for mission accomplishment and may decide the outcome of the battle. (Decisive terrain will not be present in every situation.) A technique for evaluating key terrain is to analyze the next two military aspects of terrain (observation and fields of fire and cover and concealment) for each piece of key terrain. Figure 2-7 depicts operational considerations when analyzing key terrain.

<p>OPERATIONAL CONSIDERATIONS</p> <ul style="list-style-type: none"> • WHAT TERRAIN IS KEY TO THE COMPANY AND BATTALION AND WHY? • IS THE ENEMY CONTROLLING THIS TERRAIN? • WHAT TERRAIN IS KEY TO THE ENEMY AND WHY? • HOW DO I GAIN OR MAINTAIN CONTROL OF KEY TERRAIN? • WHAT TERRAIN IS KEY FOR FRIENDLY OBSERVATION, BOTH FOR COMMAND AND CONTROL AND FOR CALLING FOR FIRES?

Figure 2-7. Considerations in key terrain analysis.

- Observation and Fields of Fire. The platoon leader analyzes areas surrounding key terrain, objectives, avenues of approach, and obstacles to determine if they provide clear observation and fields of fire for both friendly and enemy forces. He locates inter-visibility (IV) lines (terrain that inhibits observation from one point to another) that have not been identified by the commander and determines where visual contact between the two forces will occur. When analyzing fields of fire, the platoon leader focuses on both friendly and enemy direct fire capabilities. Additionally, he identifies positions that enable artillery observers to call for indirect fires and permit snipers to engage

targets. Figure 2-8 provides considerations for analysis of observation and fields of fire. Whenever possible, the platoon leader conducts a ground reconnaissance from both the friendly and enemy perspectives.

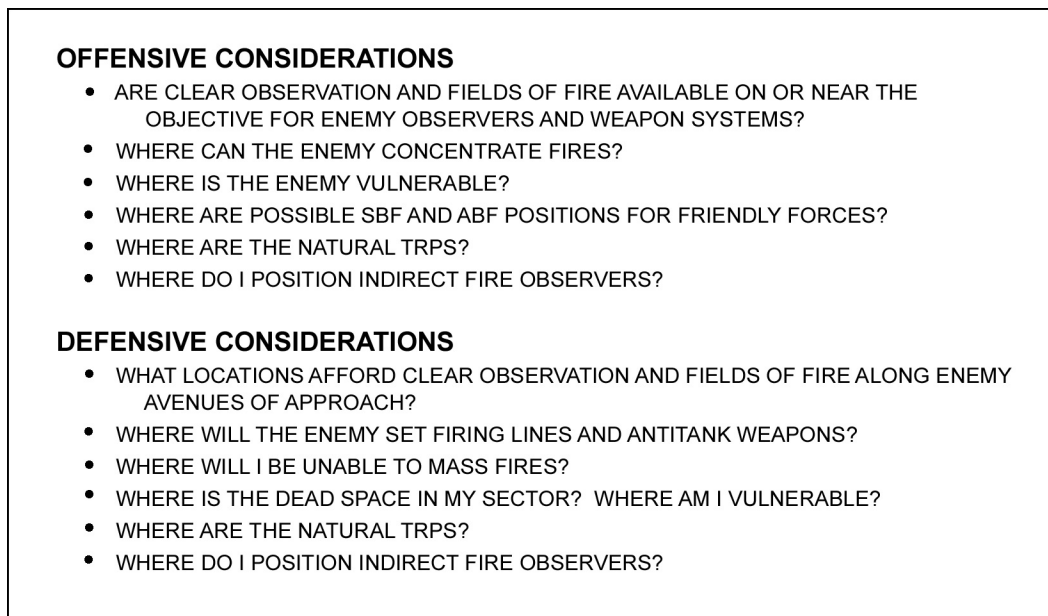


Figure 2-8. Considerations in analysis of observation and fields of fire.

- **Cover and Concealment.** Cover is protection from the effects of fires. Concealment is protection from observation but not direct or indirect fires. Figure 2-9 provides considerations for analysis of cover and concealment. Consideration of these elements leads the platoon leader to identify areas that can, at best, achieve both facets. The platoon leader looks at the terrain, foliage, structures, and other features on the key terrain, the objective, and the avenues of approach to identify sites that offer cover and concealment.

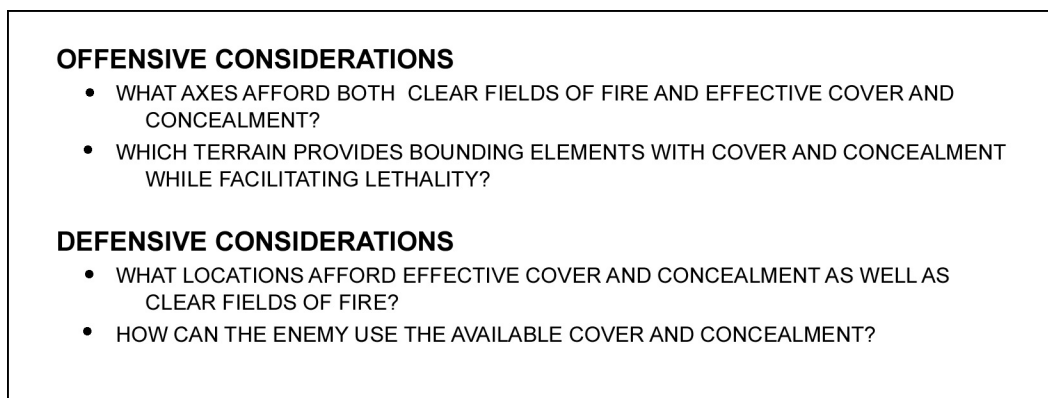


Figure 2-9. Considerations in analysis of cover and concealment.

- (c) There are five military aspects of weather:

- Light data.
- Visibility.
- Temperature
- Precipitation
- Winds.

The platoon leader must go beyond merely making observations; he must arrive at significant conclusions about how the weather will affect his platoon and the enemy. He receives conclusions from the commander and identifies his own critical conclusions about the five military aspects of weather. Most importantly, the platoon leader must apply these conclusions when he develops friendly and enemy COAs.

- **Light Data.** The platoon leader identifies critical conclusions about beginning morning nautical twilight (BMNT), sunrise (SR), sunset (SS), end of evening nautical twilight (EENT), moonrise (MR), moonset (MS), and percentage of illumination. Light data considerations include the following:
 - ⇒ Will the sun rise behind my attack?
 - ⇒ How can I take advantage of the limited illumination?
 - ⇒ How will limited illumination affect friendly and enemy target acquisition?
- **Visibility.** The platoon leader identifies critical conclusions about visibility factors (such as fog, smog, and humidity) and battlefield obscurants (such as smoke and dust). Visibility considerations include the following:
 - ⇒ Will the current weather favor the use of smoke to obscure during breaching?
 - ⇒ Will fog affect friendly and enemy target acquisition?
- **Temperature.** The platoon leader identifies critical conclusions about temperature factors (such as high and low temperatures and infrared crossover times) and battlefield factors (such as use of smoke or chemicals). Temperature considerations include the following:
 - ⇒ How will temperature (hot or cold) affect the dismounted rate of march for the platoon?
 - ⇒ How will temperature (hot or cold) affect the soldiers and equipment?
 - ⇒ Will temperatures favor the use of nonpersistent chemicals?
- **Precipitation.** The platoon leader identifies critical conclusions about precipitation factors (such as type, amount, and duration). Precipitation considerations include the following:
 - ⇒ How will precipitation affect mobility?
 - ⇒ How can precipitation add to the platoon's ability to achieve surprise?
- **Winds.** The platoon leader identifies critical conclusions about wind factors (such as direction and speed). Wind considerations include the following:
 - ⇒ Will wind speed cause smoke to dissipate quickly?
 - ⇒ Will wind speed and direction favor enemy use of smoke?

(3) **Enemy Analysis.** The critical outcome of this step is for the platoon leader to identify the enemy's strengths and potential weaknesses or vulnerabilities so that he can exploit them by generating overwhelming combat power in achieving his mission. To accomplish this, the platoon leader must understand the assumptions the battalion staff

used to portray the enemy's courses of action during their mission analysis. Furthermore, the platoon leader's own assumptions about the enemy must be consistent with those of the battalion commander. To effectively analyze the enemy, the platoon leader must know how the enemy may fight. It is equally important for the platoon leader to understand what is actually known of the enemy through the COP as opposed to what is only assumed or templated (an educated guess). During doctrinal analysis, it is not enough only to know the number and types of vehicles, soldiers, and weapons the enemy has. The platoon leader's analysis must extend down to the squad level. During stability operations and support operations or small-scale contingency (SSC) operations in an underdeveloped area where little is known about the combatants, it may be difficult to portray or template the enemy doctrinally. In this case, the platoon leader must rely on brigade and battalion analyses provided via the COP and on his own knowledge of recent enemy activities. The platoon leader should consider the following areas as he analyzes the enemy.

(a) *Composition (Order of Battle)*. The platoon leader's analysis must determine the number and types of enemy vehicles, soldiers, and equipment that could be used against his platoon. He gets this information from situational understanding or paragraph 1a of the battalion OPORD. His analysis must also examine how the enemy organizes for combat to include the possible use of a reserve.

(b) *Disposition*. From the battalion S2's information, the platoon leader identifies how the enemy is arrayed. Much of the information is gained through the COP and a detailed battalion reconnaissance and surveillance annex.

(c) *Strength*. The platoon leader identifies the strength of the enemy. It is imperative for the platoon leader to determine the actual numbers of equipment and personnel that his platoon is expected to encounter or that may affect his platoon. Again, much of this information is gained through the COP and a detailed battalion reconnaissance and surveillance annex.

(d) *Capabilities*. Based on the commander's assessment and the enemy's doctrine and current location, the platoon leader must determine what the enemy is capable of doing against his platoon during the mission. Such an analysis must include the planning ranges for each enemy weapon system that the platoon may encounter.

(e) *Anticipated Enemy Courses of Action*. To identify potential enemy COAs, the platoon leader weighs the result of his initial analysis of terrain and weather against the enemy's composition, capabilities, and doctrinal objectives (through information provided via FBCB2), then develops an enemy SITEMP for his portion of the company plan. The end product is a platoon SITEMP, a visual or graphic depiction of how he believes the enemy will fight under the specific conditions expected on the battlefield. Much of this information will be gained from the commander's analysis and understanding of the current enemy and friendly situation.

- Included in this SITEMP is the range fan of the enemy's weapons and any tactical and protective obstacles, either identified or merely templated. Once the SITEMP has been developed it should be transferred to a large-scale sketch to enable subordinates to see the details of the anticipated enemy COA. After the platoon leader briefs the enemy analysis to his subordinates, he must ensure they understand what is known, what is suspected, and what is merely

templated. The platoon's SITEMP should depict individual soldier and weapons positions and is a refinement of the commander's SITEMP.

- In conjunction with the SITEMP, the platoon leader considers the factors of METT-TC from the enemy's perspective to develop the details of possible enemy COAs. The following points can assist in this process:
 - ⇒ Understand the enemy's mission. What will the enemy's likely mission be based on enemy doctrine and knowledge of the situation and the enemy's capabilities? This may be difficult to determine if the enemy has no established order of battle. Enemy analysis must consider situational reports of enemy patterns and COP updates. When does the enemy strike, and where? Where does the enemy get logistical support and fire support? What cultural or religious factors are involved?
 - ⇒ Why is the enemy conducting this operation?
 - ⇒ What are the enemy's goals?
 - ⇒ What are the enemy's capabilities?
 - ⇒ What are the enemy's objectives? Based on the SITEMP and the projected enemy mission, what are the enemy's march objectives (offense) or the terrain or force he intends to protect (defense)? The commander normally provides this information.
 - ⇒ Terrain and weather. If the enemy is attacking, which avenues will he use to reach his objectives in executing his COAs and why?
 - ⇒ How will terrain affect his speed and formations?
 - ⇒ How will he use key terrain and locations with clear observation and fields of fire?
 - ⇒ Does the weather aid or hinder the enemy in accomplishing his mission or does the weather degrade the enemy's weapons or equipment effectiveness?
 - ⇒ Enemy obstacles. These locations, provided by the company commander or obtained from the COP, give the platoon leader insights into how the enemy is trying to accomplish his mission.

(4) **Analysis of Troops.** Perhaps the most critical aspect of mission analysis is determining the combat power potential of one's force. The platoon leader must realistically and unemotionally determine what tasks his soldiers are capable of performing. This analysis includes the troops attached to or in direct support of the platoon. The platoon leader must know the status of his soldiers' experience and level of training and the strengths and weaknesses of his subordinate leaders. His assessment includes knowing the status of his soldiers and their equipment, and it includes understanding the full array of assets that are in support of the platoon such as indirect fire support, mobile gun system (MGS), snipers, and engineers. This information is gained from the lower tactical Internet.

(5) **Time Analysis.** As addressed in the first step of the TLP, time analysis is a critical aspect of planning, preparation, and execution. The platoon leader must appreciate not only how much time is available but also the time-space aspects of preparing, moving, fighting, and sustaining. He must be able to see his own tasks and enemy actions in relation to time.

(a) He must be able to assess the impact of limited visibility conditions on the troop-leading procedures.

(b) He must know how long it takes to conduct certain tasks such as order preparation, rehearsals, back-briefs, and other time-sensitive preparations for subordinate elements.

(c) Most importantly, as events occur, the platoon leader must adjust his analysis of time available to him and assess the impact on what he wants to accomplish.

(d) Finally, he must update previous timelines for his subordinates listing all events that affect the platoon.

(6) ***Analysis of Civil Considerations.*** The battalion S2 provides the platoon leader with civil considerations that may affect the platoon missions. The platoon leader must also identify any civil consideration that may affect only his platoon's mission. These may include refugee movement, humanitarian assistance requirements, or specific requirements related to the rules of engagement (ROE) or rules of interaction (ROI).

(7) ***Summary of Mission Analysis.*** The end result of mission analysis, as done during the formulation of a tentative plan, is a number of insights and conclusions regarding how the factors of METT-TC affect accomplishment of the platoon's mission. From these, the platoon leader develops a course of action.

b. **Course of Action Development.** The purpose of COA development is to determine one or more ways to achieve the mission by applying the overwhelming effects of combat power at the decisive place or time with the least cost in friendly casualties. If time permits, the platoon leader should develop several COAs. The platoon leader makes each COA as detailed as possible to describe clearly how he plans to use his forces to achieve the unit's mission essential task(s) and purpose consistent with the commander's intent. He focuses on the actions the unit must take at the decisive point and works backward to his start point. A COA should satisfy the criteria listed in Table 2-2, page 2-18.

NOTE: The platoon leader should consider (METT-TC dependent) incorporating his section and team leaders in COA development. Incorporating the platoon's leadership in the process may add time to the initial COA development process, but it will save time by increasing their understanding of the platoon's plan.

Suitable	If the COA were successfully executed, would the unit accomplish the mission consistent with the battalion commander's concept and intent?
Feasible	The platoon must have the technical and tactical skill and resources to successfully accomplish the COA. In short, given the enemy situation and terrain, the unit must have the training, equipment, leadership, and rehearsal time necessary to successfully execute the mission.
Distinguishable	If more than one COA is developed, each COA must be sufficiently different from the others to justify full development and consideration. At platoon level, this is very difficult to accomplish, particularly if the platoon has limited freedom of action.
Complete	The COA must include the operational factors of who, what, when, where, and how. The COA must address the doctrinal aspects of the operation. For example, in the attack against a defending enemy, the COA must cover movement to, deployment against, assault of, and consolidation upon the objective.

Table 2-2. Course of action criteria.

(1) **Course of Action Development Step 1. Analyze Relative Combat Power.** The purpose of this step is to compare combat power, strengths, and weaknesses of both friendly and enemy forces. At the platoon level, this should not be a complex process. However, if the battalion is attacking or defending against a force in a situation where the enemy has no order of battle but has exhibited guerrilla- or terrorist-type tactics, it could be difficult. For the platoon leader, it starts by returning to the conclusions the commander arrived at during mission analysis, specifically the conclusions about the enemy's strengths, weaknesses, and vulnerabilities. In short, the platoon leader is trying to see where, when, and how the effects of the platoon's combat power (maneuver, protection, leadership, and information) can be superior to the enemy's while achieving the mission. This analysis should lead to techniques and procedures at a potentially decisive point that will focus the COA development. (See FM 101-5-1 for the definition of a decisive point.)

(2) **Course of Action Development Step 2. Generate Options.** The platoon leader must first identify the objectives or times at which the unit will mass overwhelming firepower to achieve a specific result (with respect to terrain, enemy, and or time) that will accomplish the platoon's mission. He should take the following action.

(a) **Determine the Doctrinal Requirements.** As the platoon leader begins to develop a COA he should consider, if he has not done so in mission analysis, what doctrine suggests in terms of accomplishing the mission. For example, in an attack of a strongpoint, doctrine outlines several steps: isolate the objective area and the selected breach site, attack to penetrate and seize a foothold in the strongpoint, exploit the penetration, and clear the objective. In this case, doctrine gives the platoon leader a framework to begin developing a way to accomplish the mission.

(b) **Determine the Decisive Point.** The next and most important action is to identify a decisive point in order to progress with COA development. The decisive point may be given to the platoon leader by the commander or be determined by the platoon leader through his relative combat power analysis.

(c) *Determine the Purpose of Each Element.* Determine the purpose of the subordinate elements starting with the main effort. The main effort's purpose is nested to the platoon's purpose and is achieved at the platoon leader's decisive point. The platoon leader next identifies the purposes of supporting efforts. These purposes are nested to the main effort's purpose by setting the conditions for success of the main effort.

(d) *Determine Tasks of Subordinate Elements.* Starting with the main effort, the platoon leader specifies the essential tactical tasks that will enable the main and supporting efforts to achieve their purpose.

(3) ***Course of Action Development Step 3. Array Initial Forces.*** The platoon leader next must determine the specific number of elements and weapons necessary to accomplish the mission and provide a basis for development of a scheme of maneuver. He will consider the platoon's restated mission statement, the commander's intent, and the enemy's most probable COA. He should allocate resources to the main effort (at the decisive point) and continue with supporting efforts in descending order of importance to accomplish the tasks and purposes he assigned during Step 2.

(4) ***Course of Action Development Step 4. Develop Schemes of Maneuver.*** The scheme of maneuver is a description of how the platoon leader envisions his subordinates will accomplish the mission from the start of the operation until its completion. He does this by determining how the achievement of one task will lead to the execution of the next. He clarifies in his mind the best ways to use the available terrain as well as how best to employ the platoon's strengths against the enemy's weaknesses (gained from his relative combat power analysis). This includes the requirements of indirect fire to support the maneuver. The platoon leader then develops the maneuver control measures necessary to enhance understanding of the scheme of maneuver, ensure fratricide avoidance, and to clarify the task and purpose of the main and supporting efforts. (Refer to Appendix D for a detailed discussion of fratricide avoidance.) He also determines the supply and medical evacuation aspects of the COA.

(5) ***Course of Action Development Step 5. Assign Headquarters or elements.*** The platoon leader assigns specific elements (for example, section and or teams) as the main and supporting efforts. The platoon leader ensures that he has employed every element of the unit and has C2 for each element.

(6) ***Course of Action Development Step 6. Prepare COA Statements and Sketches.*** The platoon leader's ability to prepare COA sketches and statements will depend on the amount of time available and his skill and experience as a platoon leader. Whenever possible, the platoon leader should prepare a sketch showing the COA. The COA statement is based on the scheme of maneuver the commander has already developed and the platoon leader's situational analysis. It focuses on all significant actions from the start of the COA to its finish.

c. **Analysis of Course of Action.** After developing a COA, the platoon leader analyzes it to determine its advantages and disadvantages, to visualize the flow of the battle, and to identify requirements to synchronize actual execution. Typically this is done either mentally or during a rehearsal with the team leaders, platoon sergeant, and other key personnel. This technique is not complicated and facilitates a total understanding of the plan.

d. **Course of Action Comparison and Selection.** If the platoon leader develops more than one COA, he must compare them by weighing the specific advantages,

disadvantages, strengths, and weaknesses of each. These attributes may pertain to the accomplishment of the platoon purpose, the use of terrain, the destruction of the enemy, or any other aspect of the operation that the platoon leader believes is important. The platoon leader uses these factors as his frame of reference in tentatively selecting the best COA. He makes the final selection of a COA based on his own analysis.

2-8. INITIATE MOVEMENT

The platoon leader initiates any movement that is necessary to continue preparations or to posture the unit for the operation. This may include movement to an assembly area, battle position, perimeter defense, or attack position; movement of reconnaissance elements; or movement to compute time-distance factors for the unit's mission.

2-9. CONDUCT A LEADER'S RECONNAISSANCE

NOTE: The following discussion on reconnaissance and the amount or type of reconnaissance conducted must be evaluated by the amount of information needed, the risk to leaders conducting the reconnaissance, and the amount of time available. Reconnaissance must be a coordinated effort with higher command.

During troop-leading procedures, the platoon leader should conduct a reconnaissance after he has developed a plan. The focus of the reconnaissance is to confirm the priority intelligence requirements (PIR) that support the tentative plan.

a. PIR are assumptions or critical facts concerning the enemy's location and strength. The PIR also include assumptions about the terrain (to verify, for example, that a tentative support-by-fire position actually will allow for suppression of the enemy or to verify the utility of an avenue of approach).

b. If possible, the platoon leader includes his subordinate leaders in this reconnaissance (or instructs a team to conduct a reconnaissance patrol with specific objectives). This allows them to see as much of the terrain and enemy as possible. It also helps each leader visualize the plan more clearly.

c. In addition to the information available via the COP, the platoon leader also needs to conduct a leader's reconnaissance. Examples include surveillance of an area by subordinate elements, patrols by reconnaissance teams to determine where the enemy is (and is not) located, and establishment of OPs to gain additional information. The nature of the reconnaissance, including what it covers and how long it lasts, depends on the tactical situation and time available. The platoon leader should use the results from the COA development process to identify information and security requirements for the platoon's reconnaissance operations.

2-10. COMPLETE THE PLAN

Completion of the plan includes several steps that transform the commander's intent and concept and the platoon's concept into a fully developed platoon OPOD. These steps include preparing overlays, refining the indirect fire list, completing CSS and C2 requirements, as well as updating the tentative plan as a result of the reconnaissance or COP updates. As part of completing the plan, the platoon leader prepares the briefing

site, briefing medium, and briefing material he needs to present the OPORD to his subordinates. Completing the plan allows the platoon leader to make final coordination with other units or the commander before issuing the OPORD to his subordinates.

2-11. ISSUE THE OPERATIONS ORDER

The OPORD precisely and concisely explains the platoon leader's intent and concept of how he wants the teams and mounted elements to accomplish the mission. The OPORD must not contain unnecessary information that could obscure what is essential and important. The platoon leader must ensure his teams know exactly what must be done, when it must be done, and how the platoon must work together to accomplish the mission and stay consistent with the intentions of the commander.

a. Whenever possible, the platoon leader issues the order in person to ensure each of his soldiers understands the mission and what his element must achieve. The platoon leader also uses visual aids, such as sand tables and concept sketches, to depict actions on the objective or movement. (FM 7-8, Chapter 2, discusses techniques for sand table construction and use.)

b. The platoon leader may issue the platoon OPORD via FBCB2. FBCB2 allows for quick dissemination of information and graphics; however, the platoon leader lacks the human contact that allows him to feel comfortable that his subordinates clearly understand the plan. Some combination of personal interaction and the tactical Internet is the best solution.

c. The format of the five-paragraph OPORD helps the platoon leader paint a complete picture of all aspects of the operation: terrain, enemy, higher and adjacent friendly units, platoon mission, execution, support, and command. The format also helps him address all relevant details of the operation. Finally, it provides subordinates with a smooth flow of information from beginning to end.

2-12. SUPERVISE AND REFINE

The platoon leader supervises the unit's preparation for combat by conducting confirmation briefs, rehearsals, and inspections.

a. Platoon leaders should conduct a confirmation brief after issuing the oral OPORD to ensure subordinates know the mission, the commander's intent, the concept of the operation, and their assigned tasks. Confirmation briefs can be conducted face to face, by radio, or by FBCB2, depending on the situation. Face to face is the desired method because all section and team leaders are together to resolve questions and ensure that each leader knows what the adjacent team or vehicle is doing.

b. If time permits, the platoon conducts full rehearsals. During the rehearsals, leaders practice sending tactical reports in accordance with the unit's SOP. Reporting before, during, and after contact with the enemy is rehearsed in detail, starting with actions on the objective.

(1) The platoon leader uses well-planned, efficiently run rehearsals to accomplish the following:

- Reinforce training and increase proficiency in critical tasks.
- Reveal weaknesses or problems in the plan.
- Integrate the actions of attached elements.

- Confirm coordination requirements between the platoon and adjacent units.
- Improve each soldier's understanding of the concept of the operation, the direct fire plan, anticipated contingencies, and possible actions and reactions for various situations that may arise during the operation.

NOTE: Time permitting, rehearse mounted and dismounted plans.

(2) Rehearsal techniques include:

(a) *Map Rehearsal*. A map rehearsal is usually conducted as part of a confirmation brief involving subordinate leaders, portions of their elements, or both. The leader uses the map and overlay to guide participants as they brief their role in the operation. If necessary, he can use a sketch map. A sketch map provides the same information as a terrain model and can be used at any time.

(b) *Sand Table or Terrain Model*. This technique employs a small-scale sand table or model that depicts graphic control measures and important terrain features for reference and orientation. Participants walk or move "micro" vehicles around the sand table or model to practice the actions of their own elements or vehicles in relation to other members of the platoon.

(c) *Radio/Tactical Internet Rehearsal*. This rehearsal is conducted when the situation does not allow the platoon to gather at one location. Subordinate elements check their communications systems and rehearse key elements of the platoon plan.

(d) *Reduced-Force Rehearsal*. In this rehearsal, leaders discuss the mission while moving (in vehicles or dismounted) over key terrain or similar terrain.

(e) *Full-Up Mounted and Dismounted Rehearsal*. This is a full-force rehearsal. Rehearsals begin in good visibility over open terrain and become increasingly realistic until conditions approximate those expected in the area of operations.

CHAPTER 3 MOVEMENT

The purpose of tactical movement is to move units on the battlefield either to initiate contact with the enemy or to reach a destination when contact with the enemy along the way is possible. Movement is not maneuver. Maneuver happens once a unit has made contact with the enemy. This chapter focuses on the movement techniques and formations that combine to provide the platoon leader with options for moving his unit. The various techniques and formations have unique advantages and disadvantages. Some are secure yet slow while others are faster but less secure. Some formations work well in certain types of terrain or tactical situations but are less effective in others. The command and control equipment available to the SBCT infantry battalion reconnaissance platoon significantly enhances the platoon's ability to conduct effective tactical movement, both day and night.

Many times the platoon must plan, rehearse, and execute a combination of mounted and dismounted movement. The platoon operates with and without vehicle support, so section and platoon leaders must understand how to move and maneuver in either tactical situation. Movement during dismounted operations is similar to mounted movement but requires more command and control due to the decentralized nature of the task. Compared to mounted operations, dismounted movement techniques and formations require as much--or more--detail during the planning phase.

3-1. NAVIGATION AND ROUTE PLANNING

This paragraph discusses the technological advantages of the mobility systems and C3 subsystems of the reconnaissance platoon as operational aids for planning, navigating, controlling, and executing combat operations.

a. **Navigation.** Position navigation (POSNAV) assists in land navigation but does not replace the need for basic navigational skills. Leaders use POSNAV aids to identify their location and the location of subordinate and adjacent units. These aids also provide directional information for movement and target acquisition, and they augment operational planning graphics such as checkpoints, boundaries, coordination points, and phase lines. Platoon and section leaders and VCs use position updates from their navigation systems and analog information to assist in following their planned routes. Position updates include, as a minimum, the locations of the platoon leader, his section leaders, and vehicles. Before each mission, the leader designates the duration between digital and analog position updates. Each section leader and VC should have, as a minimum, the locations of every element in the platoon on his C3 subsystem. This information allows the platoon leader to disperse his unit during movement.

(1) During dismounted movement, the section leader allows the lead team to move along covered and concealed routes as long as it does not deviate too far from the axis, route, or direction of attack. Technology aids, such as the GPS, can assist the sections in location positioning during movement and allow the sections to move using

predetermined waypoints as guides. The section leader must continue to use route planning, mechanical navigational aids, visual observation of terrain features, and manual techniques to ensure that the sections are in proper position. Leaders may detach small security elements from the main body to provide early warning by acting as an advance guard or as guides along a route.

(2) During mounted movement, leaders use their commander's tactical display (CTD) to monitor the company, platoon, and sections. The POSNAV enables mounted elements to use greater dispersion during movement without losing awareness of vehicle positions. When dismounted, the platoon leader or platoon sergeant should transmit his position location to direct the mounted elements into positions of greater advantage to provide support and maintain digital connectivity with the battalion. Technology can assist in navigational planning and execution, but soldiers, and especially leaders, should be trained and able to navigate and send accurate reports, day or night, using all methods of navigation.

b. **Route Planning.** The leader analyzes the terrain for routes that provide protection from direct and indirect fires and from ground and aerial observation. The routes should facilitate mission accomplishment within the limitations of boundaries and allow freedom of maneuver.

(1) The platoon leader receives the obstacle overlay and the situational template overlay from the commander to identify reported enemy and obstacle locations. He also receives the commander's operations overlay to identify graphic control measures impacting on his route planning. The platoon leader then plans his routes.

(2) The leader identifies adjacent units and creates additional graphic control measures as needed on his operations overlay. The additional graphic control measures may include routes of march, coordination points, passage points, and boundaries for subordinate units.

(3) The leader plots waypoints on easily recognizable terrain and on significant turns on the route for ease in navigation. As he moves along the prescribed route or axis of advance during execution, the leader navigates from waypoint to waypoint and reports locations using the waypoints as checkpoints or phase lines. A good technique is to plot the waypoints to coincide with other graphic control measures such as checkpoints and rally points or significant terrain features. These techniques are applicable either mounted or dismounted. Do not replace operational graphics with an over-reliance on waypoint land navigation techniques.

c. **Maps.** Digital maps and overlays provide the platoon with a common operating picture of the terrain and operational graphics. Leaders must maintain a paper map with an acetate operational graphics overlay in case of system failures. Do not rely totally on technology. Leaders and soldiers must remain proficient in using basic land navigation and terrain orientation skills. They use the POSNAV capabilities of the C3 subsystem as an enhancement to tactical navigation and not as a replacement. A system failure, an inability of the GPS to acquire satellites, or a lag time in position updates could prove disastrous in combat if the leader relies solely on the system.

d. **Control Measures.** The command and control system software on the RV can create most standard graphic control measures used at platoon level. However, the screen may display only a small portion of the platoon's area of operations. The screens are relatively small and easily become cluttered with control measures. This problem

increases with the addition of position updates and friendly and enemy icons during the mission.

(1) If using only the FBCB2 software, the commander must use only the necessary graphic control measures and icons for the mission to ensure clarity. The system features layered overlays that allow leaders to selectively post overlays based on the tactical situation. The vehicle commander can retrieve the operational overlay on one layer, the enemy situation template on another layer, the fire support overlay on another, and so forth.

(2) Technology can enhance movement and route planning for operations, but platoon and section leaders must create concept sketches for briefing to the platoon. The software should not limit the platoon leader's planning and use of control measures and operational graphics.

e. **Limited Visibility Navigation.** Navigation during limited visibility conditions is easier for the digitized platoon with the introduction of POSNAV and limited visibility equipment. This equipment has greater optics resolution, which allows the leader to read his map and terrain association during mounted movement in limited visibility. Additionally, drivers and VCs have night-vision devices to aid in navigation. All leaders within the platoon must ensure that their subordinates continuously wear their night-vision devices when moving dismounted. The platoon should also develop SOPs for limited visibility marking to aid in command and control at night.

3-2. MOVEMENT FORMATIONS

During mounted and dismounted movement, the platoon employs combat formations when the terrain supports their use or when the mission or reconnaissance objective is very focused.

a. **Dismounted Formations.** When the platoon conducts dismounted movement, the factors of METT-TC determine the formation of the dismounted element. Vehicles must be located where enemy elements can not observe them. In addition, digital communications are to be maintained between the dismounted and vehicular elements. The platoon leadership must keep in perspective that during dismounted operations there is always an information-gathering element and a control and security element (Figures 3-1 and 3-2, page 3-4), and they should resource each operation accordingly. Chapter 4 of this manual discusses dismounted movement techniques in detail. FM 3-21.9 provides additional information on infantry platoon dismounted formations.

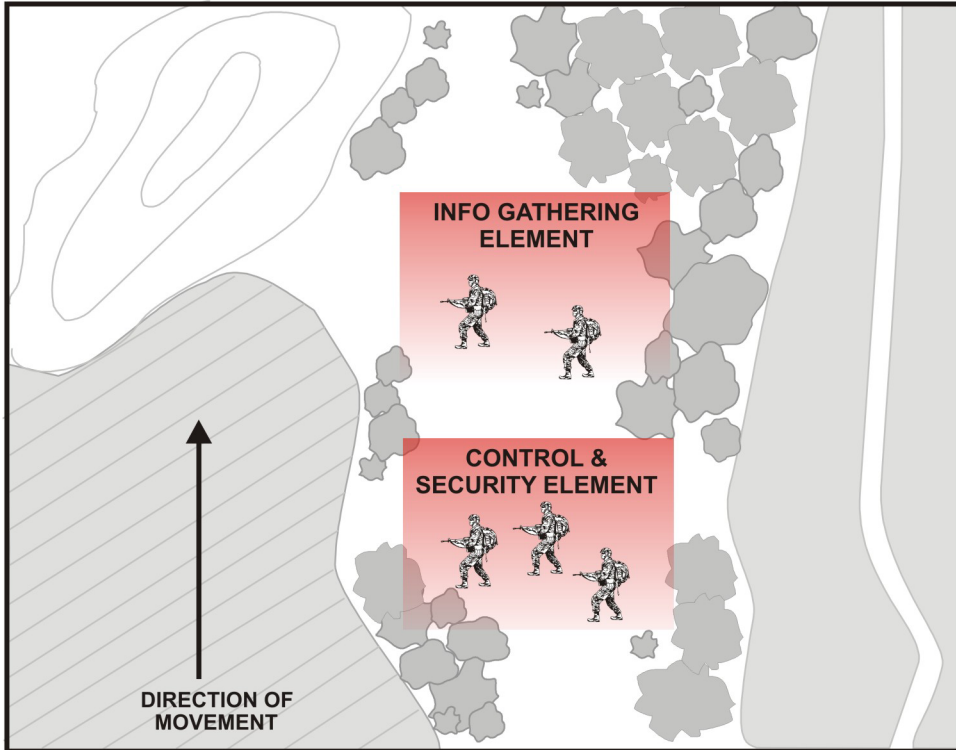


Figure 3-1. Team dismounted formation.

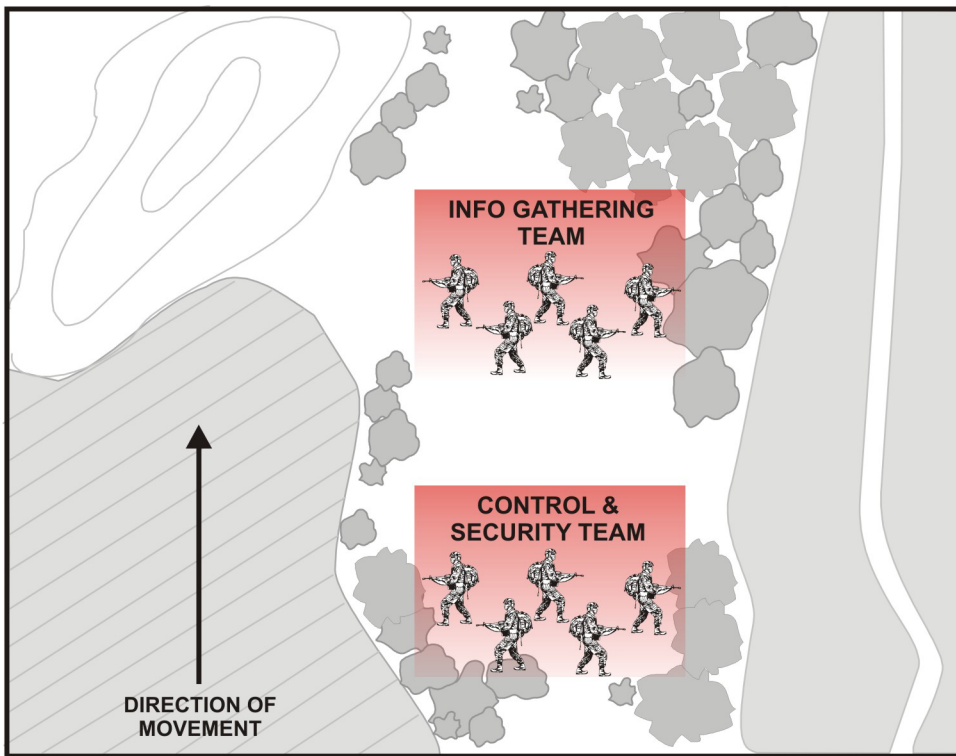


Figure 3-2. Section dismounted formation.

b. **Mounted Formations.** The six mounted reconnaissance platoon formations are line, wedge, column, staggered column, coil, and herringbone. Movement into and out of the various formations must be second nature to each section. Formations are intended to be flexible and easily modified to fit the situation, terrain, and combat losses. They do not have exact geometric dimensions and design.

(1) **Line Formation.** This formation can be used regardless of the platoon organization and is applicable to most reconnaissance platoon missions. It allows the platoon to cover the most ground systematically with maximum reconnaissance forward (Figure 3-3).

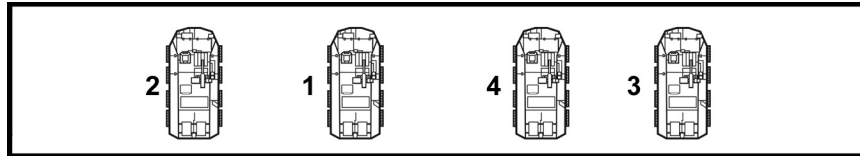


Figure 3-3. Two-section platoon line formation.

(2) **Wedge Formation.** This formation uses the two-section organization. The platoon maintains relative positioning based on terrain and combat losses. The wedge lends itself to immediate mutual support and provides depth; it is very flexible. Using any of the techniques of movement, the two forward vehicles perform all of the information gathering and reporting. The rear vehicles provide overwatch and command and control (Figure 3-4).

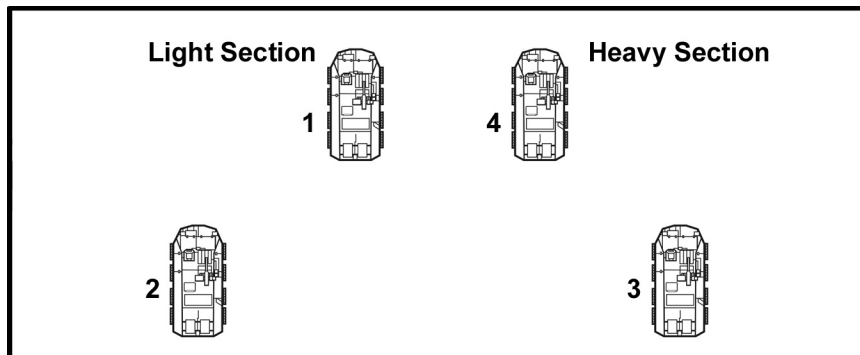


Figure 3-4. Two-section platoon wedge formation.

(3) **Column Formation.** The platoon uses the column formation when speed is essential as it moves on a designated route (Figure 3-5, page 3-6). The column offers protection to the flanks but little to the front and rear. Normally, the platoon leader briefs the section leaders on the route and speed and then allows the lead section to control the column movement. This frees the platoon leader to concentrate on the subsequent mission, thus enhancing command and control. It does not, however, relieve him of the responsibility of tracking the move on his map. The order of march in the column may depend on which organization the platoon will use at the end of the movement; in addition, the lead section may vary based on METT-TC considerations. When conducting movement in a secure area, it is appropriate to specify the order of march by SOP.

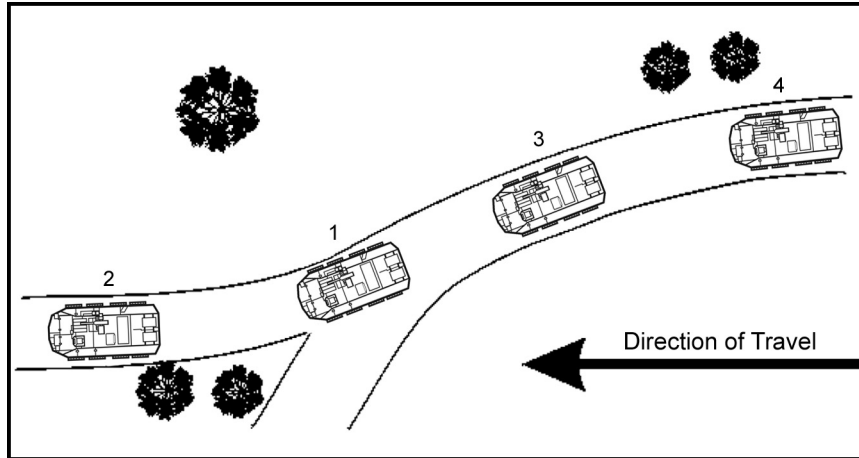


Figure 3-5. Platoon column formation.

(4) **Staggered Column Formation.** The staggered column is used for rapid movement across open terrain. It affords all-round observation and fields of fire. Figure 3-6 shows the platoon in the staggered column in a two-section organization with the heavy section leading.

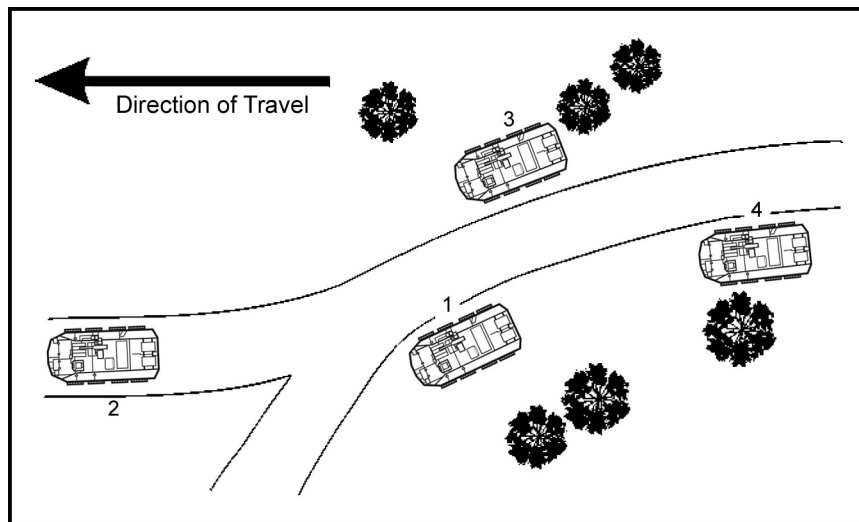


Figure 3-6. Platoon staggered column formation.

(5) **Coil Formation.** The platoon coil provides all-round security during halts. Each vehicle has a particular position to occupy in the coil. The platoon leader designates the orientation of the coil using a cardinal direction. (In the absence of orders, the direction of travel becomes 12 o'clock.) The reconnaissance platoon should develop a coil SOP based on its mission-essential task list (METL), war plans, and most frequently used organizations. The platoon should then practice this SOP as a drill so that correct execution of the coil becomes automatic. The platoon always executes the coil from the column or staggered column, using the four-vehicle organization. The lead vehicle occupies the 12 o'clock position, and the other vehicles occupy the 3, 9, and 6 o'clock

positions in accordance with the order of march. Vehicles are positioned 100 to 150 meters apart (Figure 3-7).

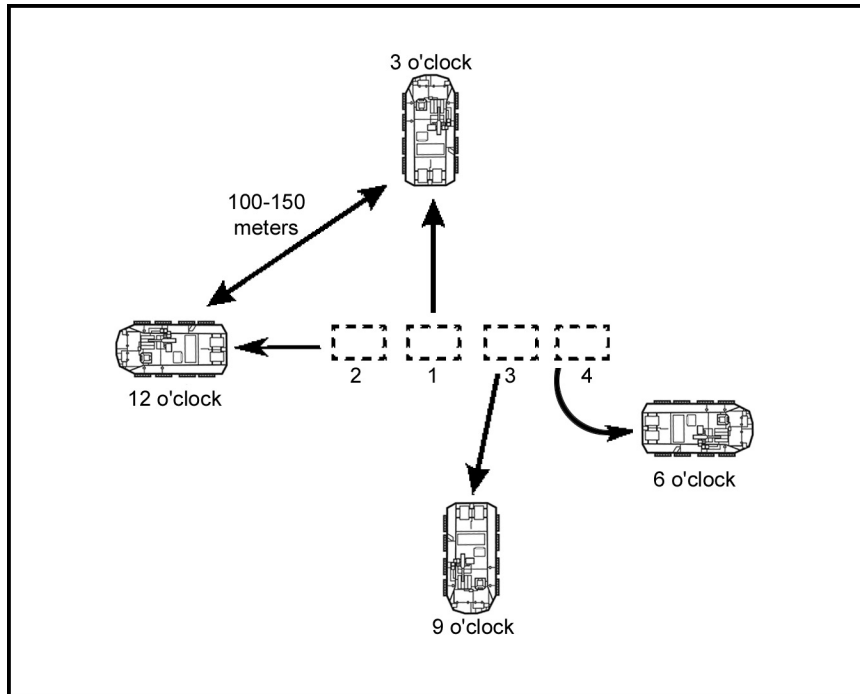


Figure 3-7. Example platoon coil formation.

(6) **Herringbone Formation.** The herringbone provides 360-degree security during a temporary halt from a march column (Figure 3-8). Troops should dismount to provide greater security. The formation may be widened to permit passage of vehicles down the center of the column. All vehicles should move completely off the road if terrain allows.

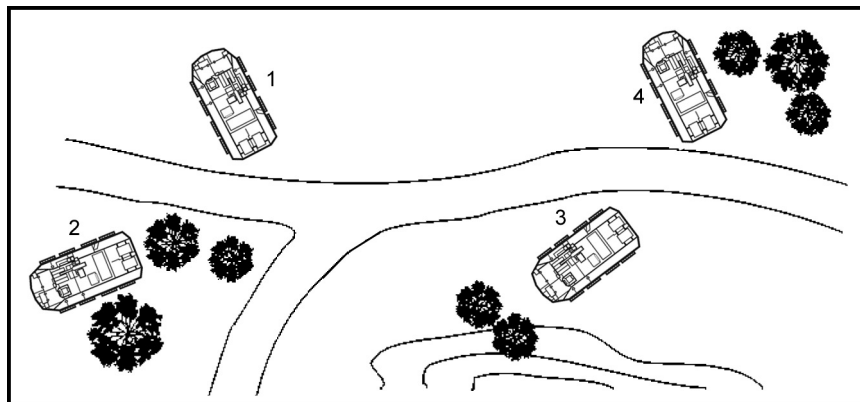


Figure 3-8. Platoon herringbone formation.

3-3. MOVEMENT TECHNIQUES

The reconnaissance platoon employs movement techniques for a number of reasons (to minimize exposure, maintain freedom of movement, maximize available tactical options,

and react effectively to contact). Effectively employed, movement techniques allow the platoon to find and observe threats without being compromised.

a. At the same time, however, movement techniques alone are not enough to guarantee accomplishment of these tactical goals. The platoon must use them in conjunction with other movement- and security-related measures. For example, the platoon must make maximum use of all available natural cover and concealment when moving. In addition, it must avoid becoming vehicle-bound; it must be prepared to dismount to improve observation, prevent enemy detection, and provide security.

b. In conducting both mounted and dismounted movement on the battlefield, the reconnaissance platoon uses three movement techniques: traveling, traveling overwatch, and bounding overwatch. These techniques provide a standard method of movement, but the platoon leader must use common sense in employing them as he performs his missions and encounters different situations. The decision of which technique to use is based in large part on the likelihood of enemy contact; in general, this can be summarized as whether contact is not likely (traveling), possible (traveling overwatch), or expected (bounding overwatch). Terrain considerations may also affect the choice of movement technique.

c. In the conduct of most tactical missions, the reconnaissance platoon may move as separate sections or sections under the command and control of the platoon leader. Traveling overwatch and bounding overwatch are most often executed at the section level. Traveling, which is usually employed in secured areas, is used equally at the section and platoon levels.

d. Regardless of which technique is used, the reconnaissance section leader gives the section an order explaining what each element will do. This becomes more critical as the likelihood of enemy contact increases. If possible, the section leader should provide his section with the following information:

- The enemy situation as he knows or suspects it to be.
- The next overwatch position (the objective for the bounding element).
- The route of the bounding element to that position.
- What he wants the section to do after the bounding element gets to the next position.

e. Execution of the movement techniques is described below.

(1) **Traveling**. In this technique, the lead and trail elements move together as a unit. Traveling is the fastest but least secure movement technique. It is used when speed is important and enemy contact is not likely. Movement is continuous, and interval and dispersion are maintained between sections as terrain and weather permit. The platoon does not intend to engage in combat, but it is dispersed to prevent destruction in case of unexpected air or ground attack. When using this technique, the platoon could be in a column formation or dispersed in its other formations (Figure 3-9).

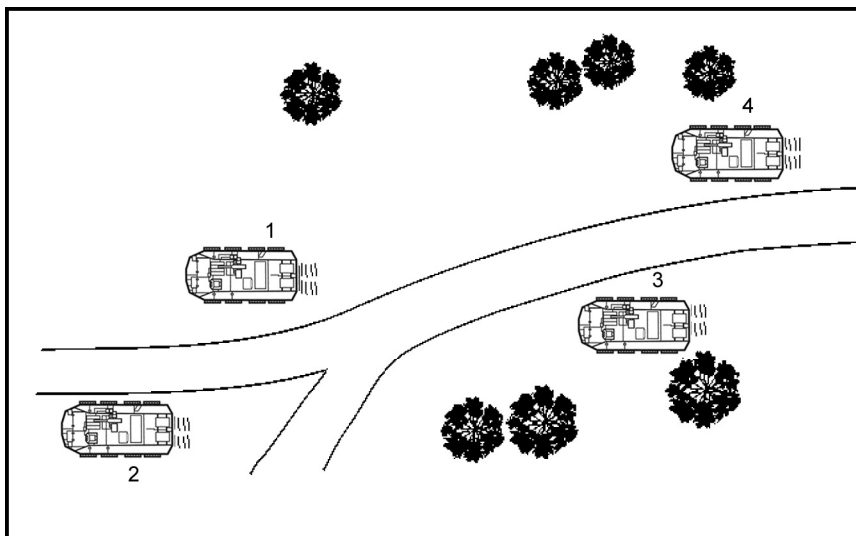


Figure 3-9. Platoon using traveling technique and staggered column formation.

(2) ***Traveling Overwatch.*** Traveling overwatch is used when contact is possible but speed is desirable (Figures 3-10 and 3-11, page 3-10). The lead element moves continuously along covered and concealed routes that afford the best available protection from possible enemy observation and direct fire. The trail element moves at variable speeds, providing continuous overwatch. It normally maintains contact with the lead element and may stop periodically for better observation. The trail element remains close enough to provide immediate suppressive fire and to maneuver for support. It must, however, be far enough to the rear to avoid contact in case an enemy force engages the lead element.

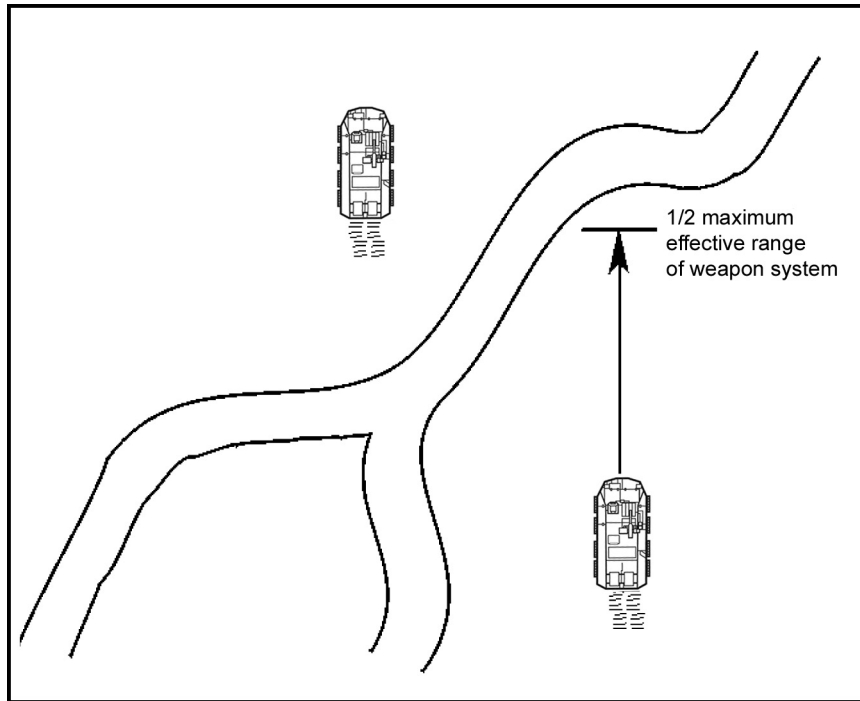


Figure 3-10. Section using traveling overwatch technique and wedge formation.

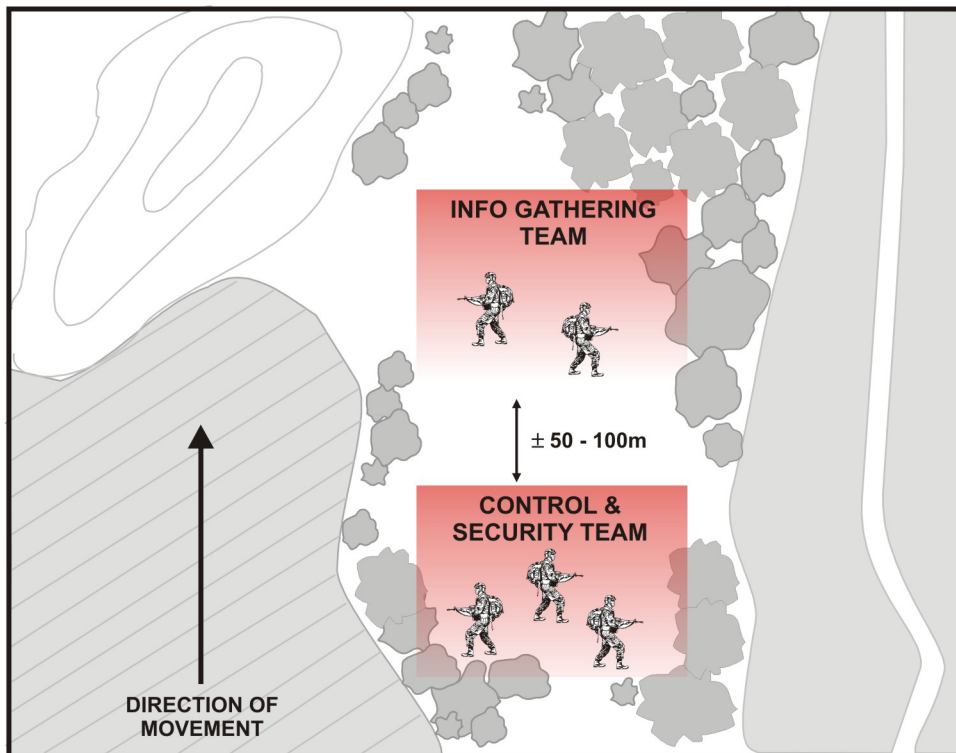


Figure 3-11. Dismounted traveling overwatch.

(3) **Bounding Overwatch.** Bounding overwatch, the slowest but most secure movement technique, is employed when enemy contact is expected. Regardless of the likelihood of enemy contact, the platoon should always use bounding overwatch if time is available and when there is a possibility of enemy contact. It provides for immediate direct fire suppression on an enemy force that engages the bounding element with direct fire. In bounding overwatch, one element is always stopped to provide overwatch. The trail element first occupies a covered and concealed position from which it can overwatch the lead element. Upon completing its movement (bound), the lead element then occupies a similar position and provides overwatch as the trail element bounds forward to its next overwatch position. As an example, a two-vehicle section may use bounding overwatch (Figure 3-12). The lead vehicle advances to a point (first move) where it can support the advance of the overwatch vehicle. On signal, the overwatch vehicle moves forward to a position abreast of the lead vehicle (second move) and halts. During its move, the lead vehicle overwatches it. The lead vehicle then moves forward again, with the overwatch vehicle providing security. Maximum use is made of folds of the earth and concealment to mask movement from likely enemy positions. (See Figure 3-13, page 3-12, for an illustration of dismounted bounding overwatch.) Bounding overwatch can be executed using one of the following bounding methods.

(a) *Alternate Bounds.* In this method, the trail element advances past the lead element to the next overwatch position. This is usually more rapid than successive bounds.

(b) *Successive Bounds.* In successive bounding, the trail element moves to an overwatch position that is approximately abreast of the lead element. This method is easier to control and is more secure than alternate bounding, but it is slower.

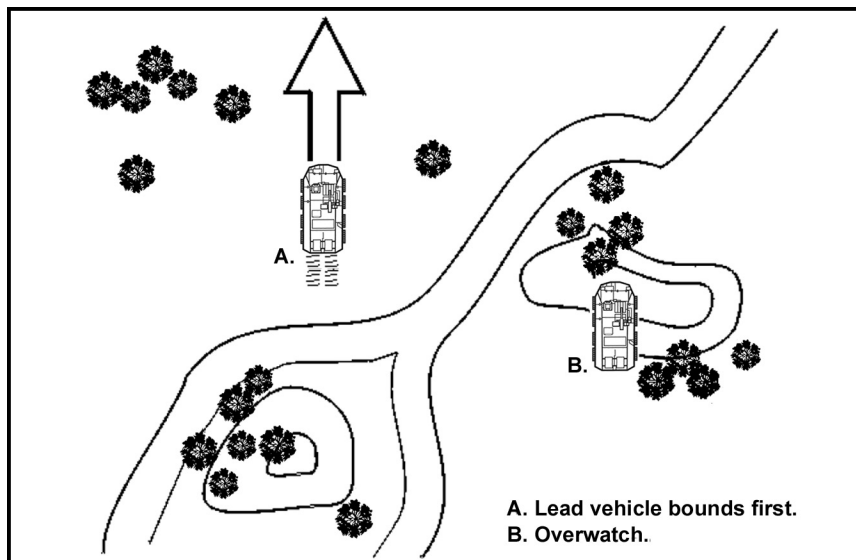


Figure 3-12. Section using bounding overwatch technique.

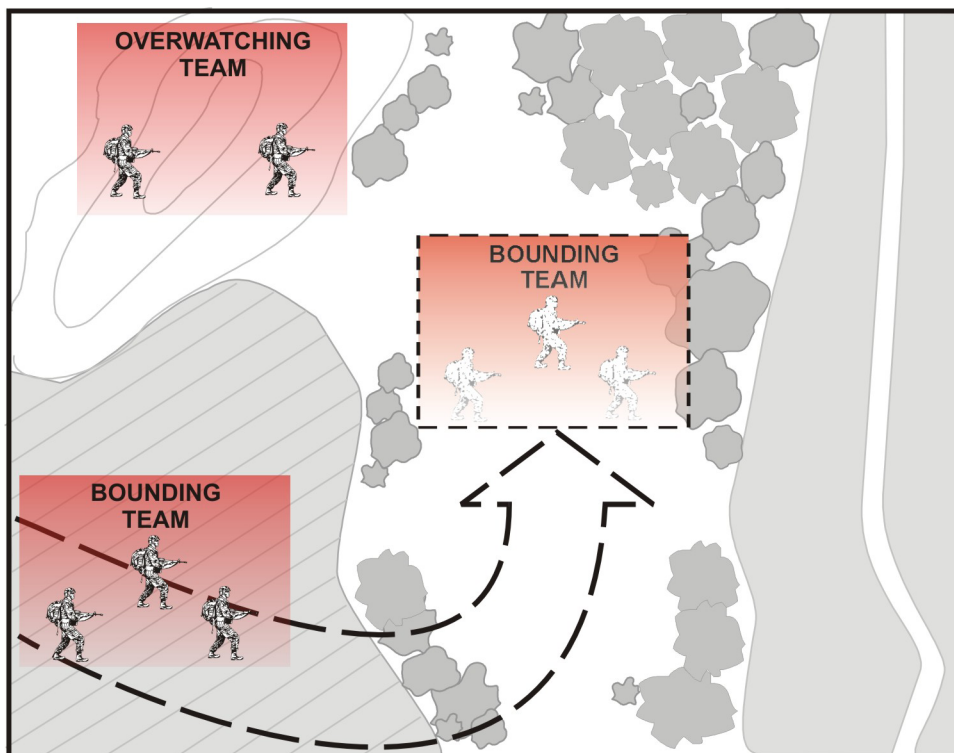


Figure 3-13. Dismounted bounding Overwatch.

(4) **Move-Set Technique.** The move-set technique of movement is simply an organized way of controlling the reconnaissance section when it moves in bounding Overwatch. “Set” means that the element has arrived at its destination and has occupied a position from which it can observe to its front. This technique allows for an absolute minimum of radio transmissions, positive control by the section leader, and maximum security within the section. Preferably, the section leader uses hand-and-arm signals or digital communication within the section for command and control. The move-set method can be used to control bounding Overwatch within the reconnaissance section regardless of the platoon organization. When terrain permits sections to be mutually supporting (such as in desert terrain) and other METT-TC factors are favorable, the platoon leader can use this technique to control bounding by sections.

3-4. ACTIONS ON CONTACT

Leaders at echelons from platoon through company conduct actions on contact when they, or a subordinate element, recognize one of the forms of contact or receive a report of enemy contact.

a. **Planning.** Prior to any mission, the reconnaissance platoon leader must receive a detailed IPB of the area of operations from the battalion S2. This information is part of the mission analysis during troop-leading procedures (discussed in Chapter 2). The leader must determine the probability of contact and where that contact will most likely occur. To do this, they use information from the battalion S2, sensor reports on the FBCB2, and information collected by dismounted patrols. The leader is then able to plan for contact

and determine how to employ TTP, such as the proper movement techniques, to reduce the occurrence of chance contact.

(1) The ideal way for the platoon to make contact is by means of FBCB2 reports from sensor elements (such as tactical unmanned aerial vehicles [TUAVs], ground surveillance radar [GSR], or other intelligence, surveillance, and reconnaissance [ISR] assets). This allows the platoon leader to evaluate and develop the situation while out of contact. Based on this evaluation and further guidance from higher, he can then maneuver the platoon out of contact and make contact either on his own terms or as directed by the commander.

(2) Regardless of how thorough this analysis and planning may be, direct contact with the enemy is still a possibility, usually as a result of chance contact. When contact is made, the platoon executes battle drills, designated by SOP, to maintain freedom of maneuver and avoid becoming decisively engaged. It uses the four steps of actions on contact (covered in detail later in this paragraph) as the foundation for these drills:

- Deploy and report.
- Evaluate and develop the situation.
- Choose and recommend a COA and maneuver the force.
- Execute the COA.

b. **Initial Contact.** The platoon must be prepared to execute actions on contact under any of the following conditions:

- Visual contact (the platoon is undetected by the enemy force).
- Contact with an unknown or superior force.
- Contact with an inferior force.

Whether the platoon remains undetected or is identified by enemy forces, it must first take actions to protect itself, find out what it is up against, and decide on a COA. To properly execute actions on contact, the platoon must take action consistent with the fundamentals of reconnaissance (refer to Chapter 4 of this manual for a detailed discussion):

- Develop the situation rapidly.
- Report quickly and accurately.
- Maintain contact with the enemy in accordance with mission.
- Retain the freedom to maneuver.
- Remain focused on the reconnaissance objective.

c. **The Seven Forms of Contact.** In all types of operations, contact occurs when an individual soldier, team, or section of the reconnaissance platoon encounters any situation that requires an active or passive response to the enemy. These situations may entail one or more of the seven forms of contact:

- Visual contact (friendly elements may or may not be observed by the enemy).
 - Physical contact (direct fire) with an enemy force or civilians.
 - Indirect fire contact.
 - Contact with obstacles of enemy or unknown origin.
 - Contact with enemy or unknown aircraft.
- Situations involving nuclear, biological, or chemical (NBC) conditions (see Appendix E).

- Situations involving electronic warfare tactics.

d. **Summary of Actions on Contact.** When contact occurs, the reconnaissance platoon leader bases the platoon's actions on the commander's intent and guidance that he receives from the OPORD and or FRAGO. These specific instructions must include focus of the reconnaissance, tempo of the operation, engagement criteria, and the desired COA based on the size and activity of the enemy force encountered. By knowing these details ahead of time, the platoon leader can develop the situation more rapidly and arrive at and execute the desired COA. The platoon should strive to make contact with its combat multipliers or with its smallest possible internal element--the dismounted soldier. Digital or visual contact, in which the enemy is observed but the platoon remains undetected, is the goal. This gives the platoon the greatest possible flexibility to maneuver and develop the situation.

(1) When the platoon deploys and reports, it uses fundamental techniques of tactical movement (dismounted or mounted) and action drills using the terrain to ensure effective cover and concealment. As information becomes available, the element in contact sends a contact report, followed by a digital or analog size, activity, location, and time (SALT) report .

(2) Developing the situation is a critical step in choosing the correct COA and providing an accurate, timely report to the commander. Once the platoon leader has enough information to make a decision, he selects a COA that is within the capabilities of the platoon, that allows the platoon to continue the reconnaissance as quickly as possible, and that supports the commander's concept of the operation. He considers various possible COAs, based on well-developed TTP (including battle drills), to meet the types of contact. At a minimum, the platoon must rehearse and be ready to execute these potential COAs:

- Disengage from enemy contact.
- Break contact and bypass.
- Maintain contact and bypass.
- Maintain contact to support an attack on an inferior force.
- Conduct an attack against an inferior force.
- Conduct a hasty defense.
- Conduct target handoff.

e. **The Four Steps of Actions on Contact.** The steps that make up actions on contact must be thoroughly trained and rehearsed so that the platoon can react instinctively, as a team, whenever it encounters enemy forces. Executing the four steps allows the platoon to accomplish its mission in accordance with reconnaissance fundamentals:

(1) **Deploy and Report.** When a reconnaissance platoon member makes contact with the enemy, he reacts according to the circumstances of the contact.

NOTE: Refer to the seven general categories of contact discussed in paragraph 3-4c.

(a) The reconnaissance section or team that makes initial visual contact with the enemy deploys to covered terrain that affords good observation and fields of fire. If the

section or team receives fire from the enemy, it returns fire but only with the intent of breaking direct fire contact.

(b) The element in contact sends a contact report to the platoon leader (refer to the discussion of report procedures and formats earlier in this chapter) and follows as soon as possible with a spot report using the format of size, activity, location, unit identification, time, and equipment (SALUTE). If the element in contact is unable to report or cannot report quickly, another team in the reconnaissance platoon section must report.

(c) Elements not in contact temporarily halt in covered and or concealed positions, monitor the incoming reports, and plot the situation on their maps. Once they determine that the enemy in contact cannot influence them, they continue their mission with the platoon leader's approval. The platoon leader or PSG relays the contact report to the battalion tactical operations center and or the tactical command post (TAC CP), followed as soon as possible by a spot report and updates.

(2) ***Evaluate and Develop the Situation.*** The element in contact next concentrates on defining what enemy it faces. If it has not yet sent a spot report, it initially focuses on getting enough information to send one.

(a) If undetected by the enemy and time is available, the section or team reconnoiters the enemy position, emphasizing stealth, dismounted reconnaissance, and use of assets such as GSR and TUAVs, if available.

(b) If detected by the enemy, the section or team uses a combination of mounted and dismounted reconnaissance. It conducts dismounted reconnaissance to get detailed information on enemy dispositions. It may use mounted reconnaissance to move additional assets into the area to support the reconnaissance element in contact.

(c) When physical contact occurs, the reconnaissance platoon employs indirect and direct fires to suppress the enemy while maneuvering to get information. It attempts to confirm (or to determine in detail) enemy size, composition, activity, orientation, and weapon system locations. It searches for antitank (AT) ditches, minefields, wire, or other obstacles that could force friendly forces into a fire sack. The platoon finds the flanks of the enemy position and looks for other enemy elements that could provide mutual support to the position. Once the platoon determines the nature of the enemy it faces, the platoon leader updates the spot report.

(3) ***Choose and Recommend a COA and Maneuver the Force.*** Once the element in contact has developed the situation and the platoon leader has enough information to make a decision, he selects a COA. He ensures that the COA is within the capabilities of the platoon, allows platoon members to continue the reconnaissance as quickly as possible, and supports the commander's concept of the operation. The platoon leader should consider all available COAs, including those outlined in the following discussion. Once he decides on a COA, he recommends it to the battalion commander and provides information on how the platoon COA will affect the current situation.

(a) ***Disengage from Enemy Contact.*** The reconnaissance platoon can not conduct its mission if the enemy decisively engages it. Should the platoon become decisively engaged, it must have a plan on how to break contact with the enemy. As a general rule, the platoon, section, or team should disengage from the enemy as early in the contact as possible. This allows for continuation of the mission and reduces the chance of any loss of combat power.

- At platoon level, OPs or patrols gain contact with the enemy, then report and prepare to displace to successive positions. These platoon members should report the enemy contact to the overwatching vehicles and to the platoon leader.
- When the enemy force reaches the OP disengagement criteria (the point at which the OPs must displace or risk detection and engagement by the enemy), the OPs pass off responsibility for tracking the enemy to other OPs in depth. The platoon then displaces its OPs to successive positions in depth while maintaining contact with the enemy. Patrols request permission to return to the platoon vehicles. When the leader grants permission, they use covered and concealed routes back to the vehicle positions and remount the vehicles.
- After reporting the initial contact to higher headquarters and receiving the order to break contact, the patrol disengages. One section or team acts as overwatch for the displacing section or team as it moves. The unit that moves first keeps its weapon systems oriented on the enemy. It uses covered and concealed routes to move to a designated rally point that avoids enemy observation and provides cover and concealment. The overwatching section or team provides suppressive fires, both indirect and direct (if necessary), to cover the movement of the displacing unit. The battalion mortars can also provide effective and responsive support when elements must break contact.
- Once the displacing section or team has arrived at the rally point, it takes up defensive positions and reports its arrival to the overwatch section or team. The overwatching element then calls for protective fires and uses an alternate covered and concealed route to move to the rally point. When the entire platoon or section has moved back to the rally point, it consolidates and reorganizes, reports its status to the higher headquarters, and continues the mission.

(b) *Break Contact and Bypass*. The reconnaissance platoon may select this COA when it does not have the resources to leave an element in contact and continue to accomplish its priority reconnaissance tasks. The platoon may also break contact and bypass when it has made contact with an enemy force that cannot adversely affect the mission of the platoon's higher headquarters. Because breaking contact is a violation of reconnaissance fundamentals, the platoon leader must be sure that his higher headquarters is informed of and approves this COA (Figure 3-14).

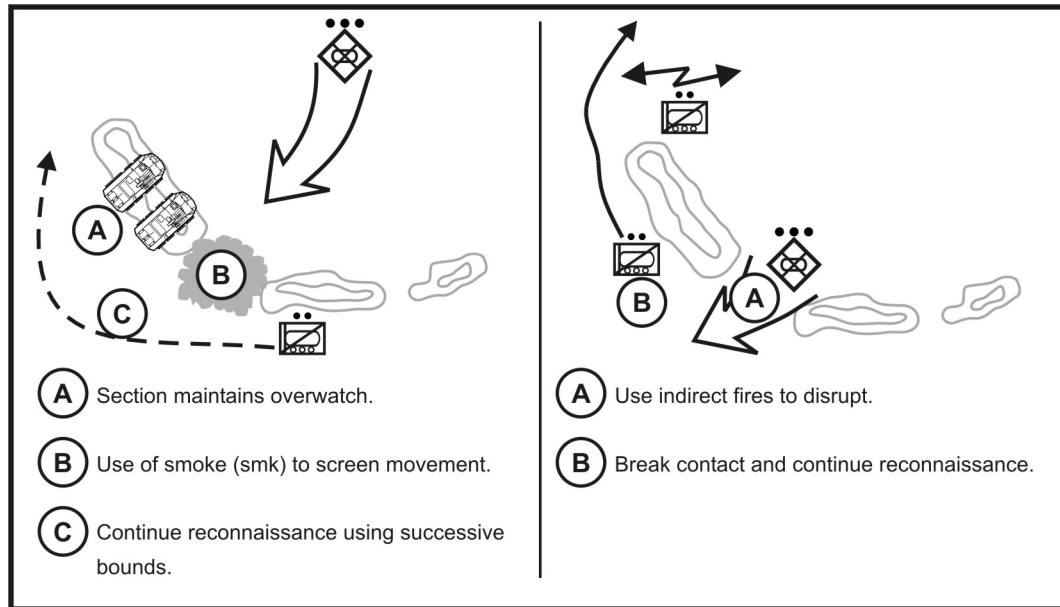


Figure 3-14. Break contact and bypass.

(c) *Maintain Contact and Bypass.* This COA is appropriate when an enemy force, based on its current disposition, is not in a position to influence the platoon's higher commander. An element (normally a section or team) maintains contact while the rest of the reconnaissance platoon continues the reconnaissance mission. The element that remains in contact maintains visual contact with the enemy and reports if the enemy situation changes. The platoon must keep an element in contact with the enemy unless specifically authorized to do otherwise. Based on task organization, the reconnaissance platoon leader must carefully assess METT-TC factors before deciding upon this COA. Due to mission constraints, the platoon leader may have to leave one vehicle in contact. To regain the use of all his assets, the platoon leader continues coordination to hand off contact to a follow-on element (Figure 3-15, page 3-18).

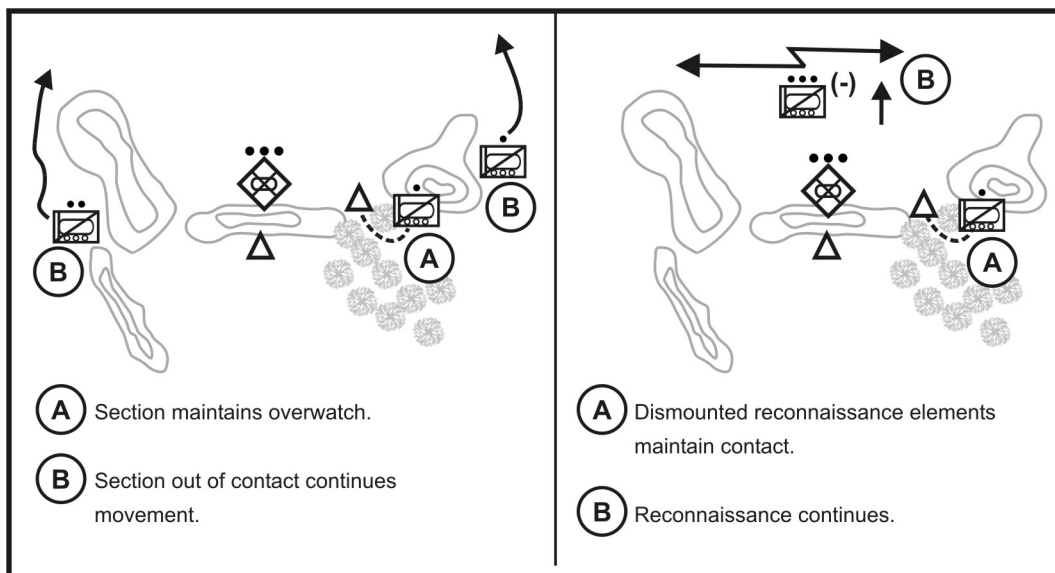


Figure 3-15. Maintain contact and bypass.

(d) *Maintain Contact to Support a Hasty Attack.* This COA is appropriate when the reconnaissance platoon discovers enemy elements his higher commander wants to destroy but which it cannot destroy either because it lacks sufficient combat power or because it has other tasks to perform. In this situation, the platoon maintains contact by leaving a section or team in contact. The rest of the platoon moves on to establish far-side security, monitor any changes in the enemy situation, and support the hasty attack by a friendly unit. The platoon focuses on requirements for a successful friendly attack, to include--

- Locating covered and concealed movement routes for friendly attacking units.
- Locating attack positions.
- Establishing a contact point to link up with, brief, and guide the friendly unit as necessary.
- Designating a line of departure (LD) to use as a handoff line to the attacking unit.
- Preparing and coordinating fire support for the friendly attack.
- Locating and preparing to occupy base of fire positions, if required.

It is essential that the section or team left in contact understands what it needs to accomplish, who will execute the attack, and when the friendly unit anticipates being in position to receive handoff of the enemy. As the unit responsible for the attack moves into position, the reconnaissance element in contact may rejoin the platoon or be placed OPCON to the attacking unit to ease command, control, and coordination (Figure 3-16).

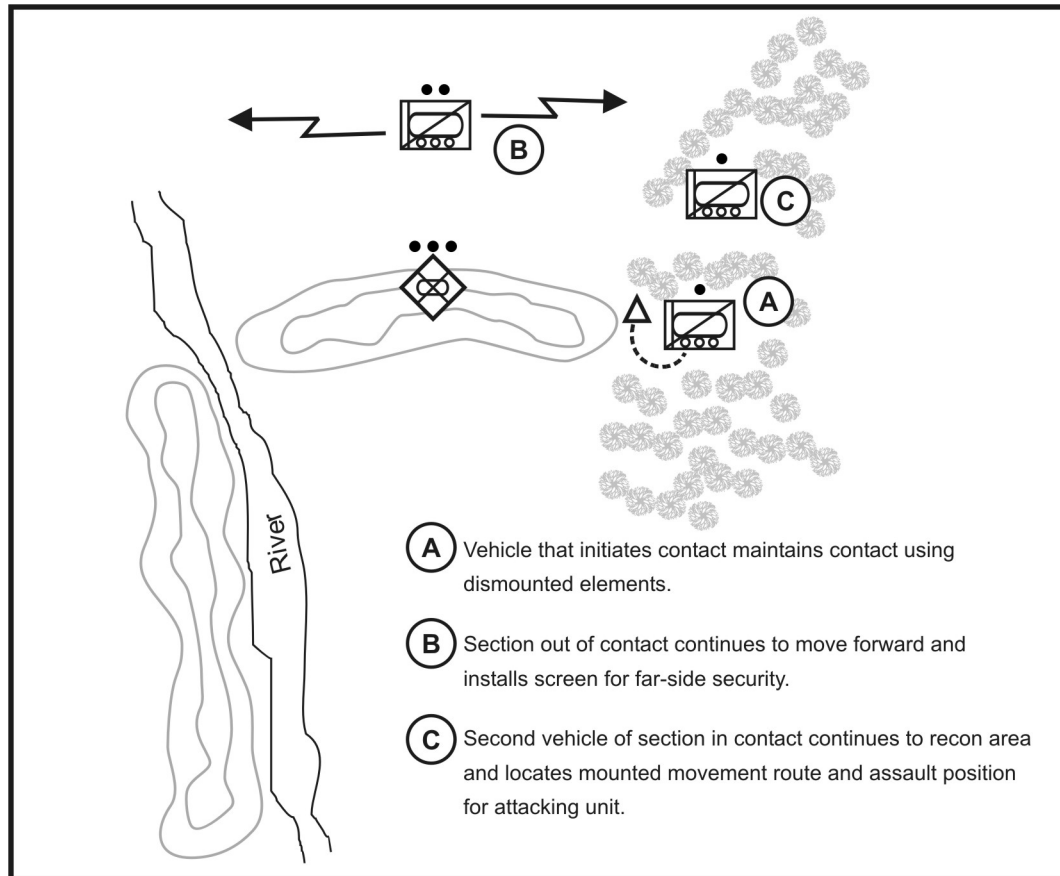


Figure 3-16. Maintain contact to support a hasty attack.

(e) *Conduct a Hasty Attack.* In most cases, the reconnaissance platoon can not or should not mass its combat power to defeat an enemy force. If the platoon concentrates, it risks losing its capability to complete its mission and jeopardizing its ability to conduct subsequent missions. If necessary, the reconnaissance platoon can attack unarmored reconnaissance vehicles, such as motorcycles or Soviet-style wheeled reconnaissance vehicles (BRDMs) (Figure 3-17, page 3-20). They should not attack more heavily armored vehicles except in self-defense.

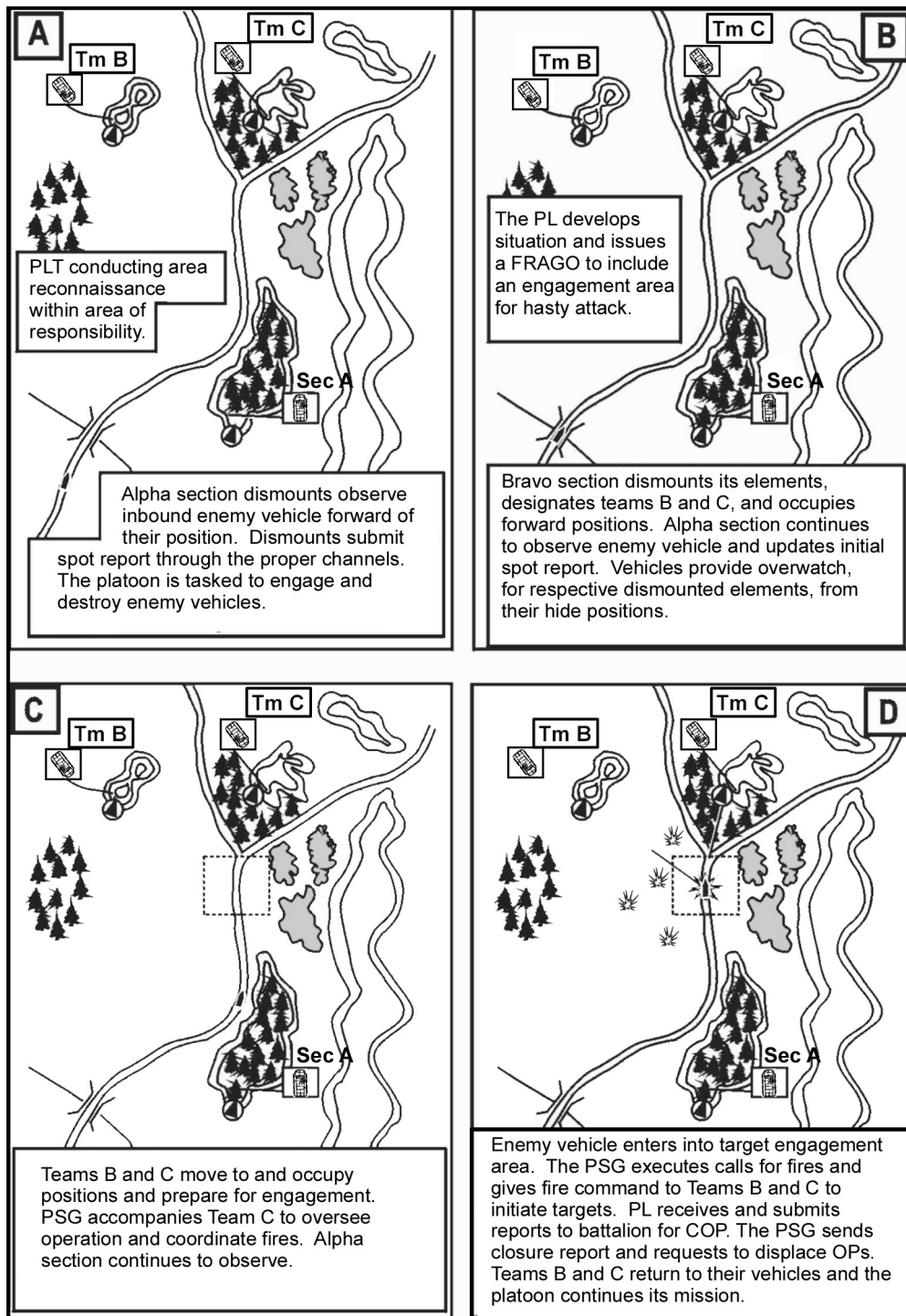


Figure 3-17. Conduct a hasty attack.

(f) *Establish a Hasty Defense.* The platoon establishes a hasty defense if it cannot bypass the enemy, all the sections or teams are fixed or suppressed, and the platoon no longer has the ability to maneuver. The platoon must also establish a hasty defense when the enemy executes a hasty attack. The platoon maintains contact or fixes the enemy in place until additional combat power arrives or the platoon is ordered to move (Figure 3-

18. If the reconnaissance platoon must conduct a hasty defense, the battalion commander assumes responsibility for continuing to develop the situation.

NOTE: Without the use of indirect fires in this situation, the platoon will fail.

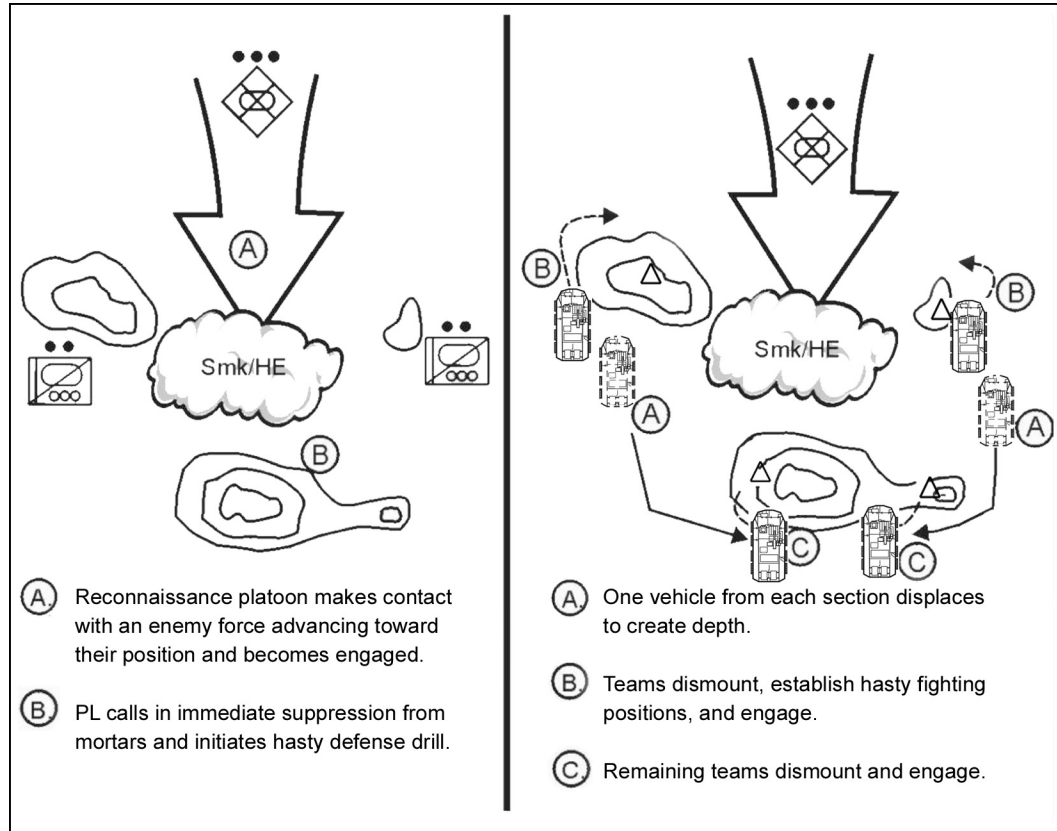


Figure 3-18. Establish a hasty defense.

(g) *Conduct Target Handoff.* The platoon leader attempts to hand off responsibility for the enemy element. He does this for several tactical reasons: to continue operations as directed, to regain use of all his elements, or to give responsibility to a friendly element that can more effectively handle the enemy force.

(4) ***Execute the COA.***

(a) The platoon leader updates his spot report to the commander with any new information and then recommends a COA to the commander. The commander approves or disapproves the recommended COA based on how it will affect the parent unit's mission.

(b) If the commander and the S2 have anticipated the enemy situation the reconnaissance platoon is reporting, they will already have addressed the contingency in the OPORD and given guidance to their subordinates on what COA the platoon should execute. In such a case, the reconnaissance platoon leader can evaluate the situation, choose a COA consistent with his higher commander's intent or concept, and execute it without further guidance. He keeps the commander informed of what he is doing as he executes the COA.

f. **Examples of Actions on Contact.** The following examples illustrate actions on contact in a variety of tactical situations. They are organized using the four-step process.

(1) ***Visual Contact, Undetected by the Enemy.***

(a) *Deploy and Report.* A reconnaissance section or team makes contact when its dismounted element identifies an enemy force. It immediately sends a contact report informing higher headquarters that it has made visual contact with the enemy but is not being engaged. This report is quickly followed by an initial spot report.

(b) *Evaluate and Develop the Situation.* Based on the initial spot report of the reconnaissance section or team in contact, the platoon leader determines that he has located his primary reconnaissance objective. He orders additional sections or teams to maneuver into the area. These reconnaissance elements move to dismount points, set their vehicles in hide positions, and send dismounted patrols to multiple vantage points using dismounted reconnaissance techniques, with the emphasis on avoiding detection. As they develop new information, they send spot reports to the platoon leader. The platoon leader moves his element to a covered and concealed hide position where he can maintain effective communications with both subordinate elements and higher headquarters. From this position, he establishes local security (a hasty OP) and monitors and controls the efforts of his sections or teams.

(c) *Choose and Recommend a COA and Maneuver the Force.* When the platoon leader receives sufficient reports to have a clear picture of the situation, he chooses to prepare to support a hasty attack. This choice is made because the platoon leader determines that the force he has located is the objective of his commander; therefore, this COA is in accordance with his commander's intent. After determining that the commander's intent has not changed, the platoon leader recommends the COA to the commander and requests permission to execute. He ensures that he receives clear guidance from the commander before moving on to the execution step.

(d) *Execute the COA.* The platoon leader issues appropriate orders directing his subordinates to prepare to support the hasty attack. He continues to inform his commander of the enemy situation and the platoon's actions.

(2) ***Contact with an Unknown or Superior Force.***

(a) *Deploy and Report.* The dismounted platoon members make contact as the lead platoon vehicle is engaged. The lead element and the overwatch element see the signature of the enemy weapon system. Since they do not have a clear idea of the size of the enemy, they react as if it is a superior force. Simultaneously, the lead element returns fire, sends a contact report, employs smoke grenades, and moves to the nearest hide position. The overwatch vehicle engages the source of enemy fire by calling for indirect fire support, then monitors to ensure the contact report is sent. As soon as the lead vehicle is in a covered and concealed position, the overwatch vehicle moves to an alternate firing position and occupies a hide position while trying to maintain contact with the smallest possible element. The platoon leader follows up on the contact report with an initial spot report.

(b) *Evaluate and Develop the Situation.* Once the reconnaissance section or team is set in cover and concealment and has submitted its initial reports, it must develop the situation. The objective is to determine exactly what the enemy situation is by dismounted reconnaissance or other reconnaissance assets and systems (ground surveillance radar, tactical unmanned aerial vehicles, and long-range reconnaissance and

surveillance). This can best be done by moving to the enemy's flank or rear. The section or team leader organizes a hasty reconnaissance patrol that attempts to move to the flank or rear of the enemy and observes the enemy position. Simultaneously, the section or team maintains at least one hasty OP in contact with the enemy.

- As the dismounted element maneuvers, it is supported by direct fire from the reconnaissance vehicles, by indirect fire called for by the OP, or by both. These fires serve to suppress the enemy, reducing his ability to observe the reconnaissance platoon; they also fix the enemy's attention on the last known location of the mounted element.
- While attempting to develop the situation, the section or team may find that it cannot determine the exact enemy situation for a number of possible reasons to include obstacles, combat losses, suppressive fires by the enemy, or the size and extent of the enemy position. It sends this information to the platoon leader in the form of updates to the original spot report as soon as possible. If this occurs, the platoon leader must decide whether to commit additional platoon assets to the contact to develop it further or to adopt a COA based on the information he has discovered to that point. If the platoon leader determines he needs more information, he may commit additional assets (reconnaissance sections or teams) to develop the situation further. The earlier in the contact that the platoon leader can make this decision, the better. However, he must not commit unneeded resources to an action that will detract from other reconnaissance tasks.
- If he decides additional assets are required, the platoon leader then orders other sections or teams not in contact to move to specific locations and assist in developing the situation. As more than one section or team becomes involved in the situation, the platoon leader or PSG (whoever is in the best location to do so) takes control of coordinating their efforts.
- The elements conduct mounted movement to designated dismount points where they organize dismounted patrols to develop the situation from a new direction. As these patrols discover the enemy and add additional information to the platoon leader's picture, the platoon leader may determine he has sufficient information to choose and execute a COA or to make a recommendation to his commander.

(c) *Choose and Recommend a COA and Maneuver the Force.* Based on the available information and his commander's intent and guidance, the platoon leader decides to leave one section in contact to support a hasty attack by a supporting MGS platoon. His other sections continue their reconnaissance mission.

(d) *Execute the COA.* In this example, because the commander had specifically addressed the contingency the reconnaissance platoon has developed, the platoon leader neither makes a recommendation to his commander nor asks his permission to execute the COA. Instead, the platoon leader immediately issues orders to his sections and contacts the MGS platoon leader to initiate coordination for handover of the enemy and support of the MGS platoon's hasty attack. He keeps the commander informed of his actions.

(3) *Contact with an Inferior Force.*

(a) *Deploy and Report.* The lead reconnaissance element (section or team) identifies an enemy element consisting of one enemy reconnaissance vehicle. In the commander's order, the engagement criteria tasked the reconnaissance section or team to engage when the enemy force consists of one wheeled vehicle or less (dismounted troops). The section or team leader sends a contact report and quickly engages and destroys the enemy vehicle. After the engagement is complete, he sends an initial spot report.

(b) *Evaluate the Situation.* The lead vehicle and the overwatch element occupy positions that allow them to observe the destroyed vehicle. They look for any other signs of enemy activity or any enemy response to the destruction of the vehicle. The lead vehicle then bounds past the destroyed vehicle and establishes far-side security. Once far-side security is established, a dismounted element moves to the destroyed vehicle and conducts a thorough search for prisoners, items of intelligence value, and any other information that can be gained from a close examination of the enemy. When this reconnaissance is complete, the section or team sends an updated report to higher headquarters.

(c) *Choose and Recommend a COA and Maneuver the Force.* When engagement is complete and the enemy is destroyed, the COA is obvious: the section or team continues its mission.

(d) *Execute the COA.* Since the destruction of the enemy is in accordance with the commander's order, the section or team leader simply informs higher headquarters that he is continuing the mission.

3-5. ACTIONS AT DANGER AREAS

During the execution of reconnaissance and security missions, the reconnaissance platoon will encounter specific types of terrain or features that expose it to enemy fire. Known as danger areas, these are likely points of enemy contact due both to the platoon's vulnerability and to the cover, concealment, and observation these sites afford to the enemy. The platoon leader identifies and highlights danger areas when he performs his map reconnaissance during TLP. Once he identifies these areas, the platoon leader considers where the enemy will focus its reconnaissance assets and determines their fields of observation. He then employs specific reconnaissance methods and movement techniques to either avoid the danger areas or move through them as quickly as possible and with as much security as possible. The factors the reconnaissance platoon leader needs to consider addressing, such as moving more rapidly and employing greater stealth and security in the various terrains, will always be METT-TC dependent.

a. **Open Areas.** Open areas frequently afford the reconnaissance platoon the opportunity to observe the enemy or objectives from long ranges. Conversely, these areas often expose the platoon to possible enemy observation and fire for long periods of movement. Therefore, the platoon must make maximum use of the terrain and employ effective observation techniques to avoid exposing itself to a well-concealed and camouflaged enemy.

(1) Before moving across a large open area, the reconnaissance platoon must make a thorough visual scan of the area. This should be done both dismounted and mounted. The platoon leader must use all available optics and other assets, including GSR, to reconnoiter the open area and find a bypass, if applicable. If he cannot find a bypass, he focuses not only on finding potential enemy positions but also on locating covered and

concealed routes for bounding and a covered and concealed position to which the unit can move. If time and terrain permit, he may send dismounted platoon members to move to the far side of the open area and secure it. In very large open areas, however, use of dismounted troops may not be feasible because of the distances between covered and concealed positions.

(2) Once it has reconnoitered the area using visual, digital, and sensor enablers, the platoon moves across the area. It uses bounding overwatch because of the possibility of enemy contact. If the open area is very large, the overwatch element should only remain stationary until the bounding element has moved a distance equal to half the effective range of the overwatching element's weapon system. When that point is reached, the overwatch element must move out, even if the bounding element has not yet reached a position of cover and concealment.

(3) When enemy contact is likely and the platoon must move across large open areas with limited cover and concealment, the platoon leader should consider using reconnaissance by indirect fire to provide additional security during movement. The platoon leader must decide whether to use this method with the understanding that doing so will sacrifice stealth. Indirect fire can also provide concealment, with smoke used alone or mixed with suppressive fires.

b. **Wooded Areas.** Wooded areas provide a high degree of concealment to forces that occupy them, particularly infantry forces. However, troops must approach and move through them with extreme caution. Visibility within wooded areas is very limited; therefore, reconnaissance is confined primarily to trafficable routes and trails through the forest. In densely wooded areas, mounted elements are extremely vulnerable to dismounted enemy forces that can close on them undetected.

(1) Platoon members should use available terrain to scan the wooded area before entering. They should search for movement, reflections, smoke, and any irregular shapes or colors indicating camouflage. Whenever possible, dismounted members should reconnoiter the entire wood line before mounted movement to the wooded area.

(2) The platoon should move to the wooded area using mounted bounding overwatch. Once the vehicles are inside the wood line (approximately 100 to 200 meters), the platoon shuts off vehicle engines, maintains dismounted security, and conducts a listening/security halt. The halt should last approximately one to two minutes, with 360-degree security maintained and radio speakers minimized throughout. The platoon must conduct these halts at regular intervals (approximately every kilometer) while moving through the wooded area.

(3) During movement through a wooded area, the platoon should move using traveling overwatch. This technique is appropriate because of the extremely short fields of view and the danger of dismounted ambush. Reconnaissance vehicles are most vulnerable in wooded areas when they are stopped, so halts should be kept to a minimum. Exposed sections or teams should maintain minimum silhouette in their vehicles because of the danger from close-in snipers and ambush.

(4) The platoon may encounter small clearings, buildings, or hills while moving through a wooded area. It must treat each as a separate task.

- Small clearings may require crossing in the same manner as a large open area.
- Dismounted troops must check isolated buildings.

- The platoon must approach hills and curves cautiously, and dismounted members must clear any dead space.

(5) Before leaving a wooded area, the platoon must clear the open area to the front. It stops inside the wood line, ensuring it is still within the shadow line of the woods. Drivers turn off vehicle engines, and dismounted elements move to the edge of the wooded area to observe. If they determine the area is clear, the platoon brings vehicles forward to observation positions. As the dismounted elements remount, the vehicles use their optics to visually clear the open area again. Once they finish, the platoon resumes movement using its chosen movement technique.

c. **Urban Areas.** Urban areas, including towns and villages, pose many potential dangers for the reconnaissance platoon. Troops can be garrisoned in villages, snipers can dominate approaches, and buildings and roads can be mined and booby-trapped. Cover and concealment are abundant, and it is easy for the enemy to remain undetected until he is at very close range. Urban areas are ideal for effective ambush by small numbers of infantry. Whenever possible, the reconnaissance platoon should reconnoiter urban areas from a distance, execute hand-off to follow-on elements, and bypass if possible. The reconnaissance platoon is not manned or equipped to conduct detailed reconnaissance of urban areas. (Refer to Chapter 6 of this manual for specific information on the urban environment.)

d. **Lateral or Boundary Routes.** As the reconnaissance platoon executes reconnaissance and security missions, it will encounter routes or mobility corridors that provide access into the area between the platoon and friendly elements to its rear. These lateral corridors pose a security threat to both the platoon and the other friendly elements.

(1) It is critical that the platoon maintains continuous surveillance of these mobility corridors to provide security against enemy forces that move into the sector after the reconnaissance platoon has moved on. This is especially important when the platoon is moving through an enemy security area where enemy forces are likely to move in response to friendly activity or when the platoon expects to encounter a moving enemy force. If necessary, the platoon can use a series of contact points, coordination points, or both, to enhance security during movement through the area.

(2) To maintain surveillance, the platoon can use OPs to maximize the reconnaissance effort forward. This security technique involves the use of short-duration OPs consisting of mounted or dismounted soldiers with necessary observation equipment. A reconnaissance section or team should deploy an OP when it is at risk of losing observation on a possible enemy approach route that no other element can cover. Once deployed, the OP maintains surveillance of the avenue of approach until the rest of the reconnaissance element returns. In doing so, the OP can provide security through early warning of enemy activity that the mounted element would not have detected.

3-6. INFILTRATION

Infiltration is a form of maneuver that entails movement by small groups or individuals, at extended or irregular intervals, through or into an area occupied by an enemy or friendly force, while avoiding contact with the enemy. To avoid the enemy's strength, elements use stealth and move through gaps or around enemy positions to conduct operations to the enemy's rear and out of contact with the enemy. The reconnaissance platoon may use this form of maneuver during reconnaissance and security operations

and may reconnoiter passage lanes and infiltration routes before movement of the battalion. To accomplish a specific task, the reconnaissance platoon itself may need to infiltrate areas occupied by enemy forces. The platoon may infiltrate by sections, by teams, or as a complete platoon.

a. **Tactics.** Ground reconnaissance assets use infiltration most often although aerial platforms may also employ tactics based on infiltration techniques. During infiltration, the platoon uses predesignated routes to reach its objective without being detected and engaged by the enemy. The infiltrating elements employ cover, concealment, and stealth to move through gaps templated by the battalion S2 in the enemy array.

b. **Purposes.** Purposes of infiltration include the following:

- To achieve a positional advantage to conduct reconnaissance and surveillance.
- To emplace remote sensors.
- To establish communications relay capability for a specific period in support of other reconnaissance operations.
- To locate unobserved routes through enemy positions.

c. **Planning.** The amount of intelligence information available to the reconnaissance platoon leader during the planning process determines the risk involved in conducting the infiltration. Due to the complexity of these operations, the battalion staff and the reconnaissance platoon leader conduct detailed planning. Leaders must focus information-gathering assets (GSR, UAVs, human intelligence [HUMINT], and RSTA) to provide detailed enemy locations and intentions. They base decisions about routes and movement techniques on the mission, terrain and weather, likelihood of enemy contact, speed of movement, and depth to which the platoon's elements must penetrate. After considering these factors, the leaders decide to infiltrate either mounted or dismounted. The infiltration plan must provide the platoon with enough time for preparation, rehearsal, and initial movement. The platoon must conduct detailed coordination with any adjacent units or friendly elements through which it will pass to ensure these elements do not compromise the reconnaissance platoon as it conducts the infiltration. Coordination must include CSS activities, integration of communications, fires, passage lanes, C2, and battle handover.

d. **Techniques.** The size of the elements within the reconnaissance platoon depends on several factors: the assigned mission, time available, cover and concealment, target acquisition capabilities of both friendly and enemy forces, available communications assets, and navigation capabilities and limitations. If the reconnaissance platoon is tasked to gather information over a wide area, it may employ several small teams to cover the complete sector. In most situations, smaller elements are better able to take advantage of available cover and concealment. The battalion commander determines if the battalion moves along single or multiple infiltration lanes with forces in the infiltration lanes separated by space and time. The platoon leader decides whether to move as a platoon or as teams. The advantages of moving as a platoon are faster movement and easier control and navigation. When moving as teams, the size of the teams makes detection less likely. However, navigation, consolidation, and command and control are more difficult. If the battalion employs multiple lanes, the platoon leader must task organize to move along all lanes. The overriding factor in determining whether to use single or multiple lanes is the ability to remain undetected.

(1) **Single-Lane Infiltration.** Infiltration on a single lane (Figure 3-19) is the least desirable technique because it requires all infiltrating groups to move at intervals on the same lane. The reconnaissance platoon uses this technique only when an analysis of METT-TC shows that only one lane is feasible.

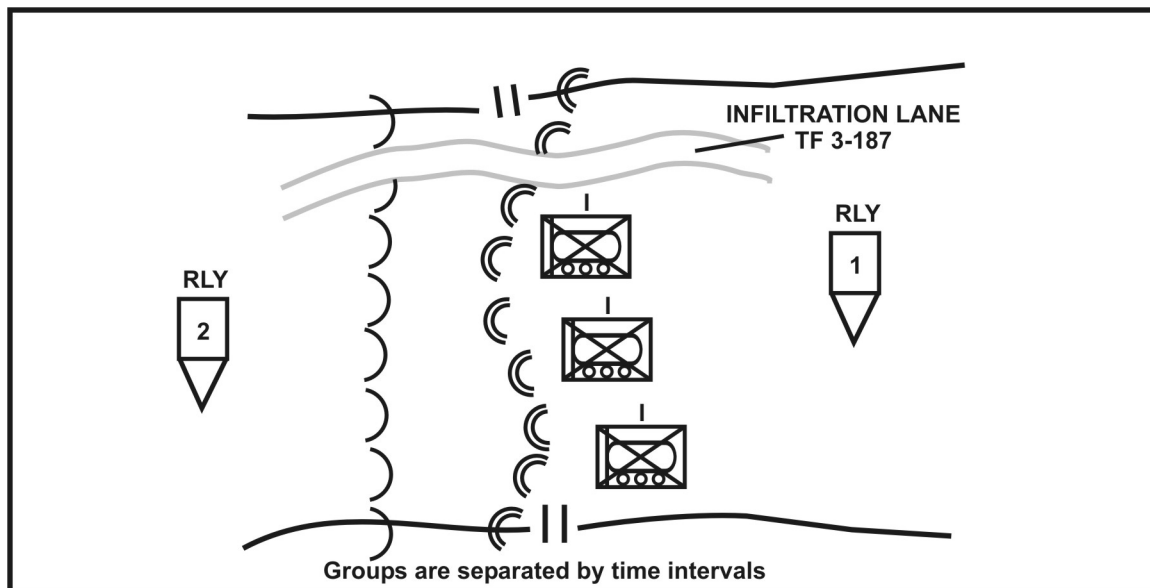


Figure 3-19. Single-lane infiltration.

(2) **Multiple-Lane Infiltration.** Soldiers infiltrate by multiple lanes when two or more infiltration lanes are found through the enemy defense (Figure 3-20). Rally points may be in either enemy or friendly areas, depending on the situation. The platoon leader assigns lanes to the sections and teams. The reconnaissance platoon normally uses no more than two lanes due to its size and limited resources.

(3) **Combination of Methods.** Rarely are there enough lanes for each group to have a separate one. Thus, some groups must share a lane with one or more groups while others do not. Groups on different routes may move using different methods of insertion or extraction (for example, one group moves by RVs, another group moves by helicopter, and another moves dismounted).

(4) **Rally Point.** To aid in the control of movement, the platoon should choose rally points for all infiltrations and exfiltrations.

(a) The first group to reach the rally point establishes security and exchanges recognition signals with subsequent groups. All groups rehearse this procedure since no one knows which group will arrive first.

(b) The leader must allow adequate time for each group to reach the rally point. Delays may result when groups must avoid enemy contact. Contingency plans should address what happens if a force fails to arrive or arrives late at a rally point.

(c) The leader must designate an alternate rally point to use if the primary rally point is occupied by the enemy, is compromised, or is found to be unsuitable. The platoon leader plans signals to direct movement to the alternate rally point. The contingency plan must allow time for groups to reach the new (alternate) rally point.

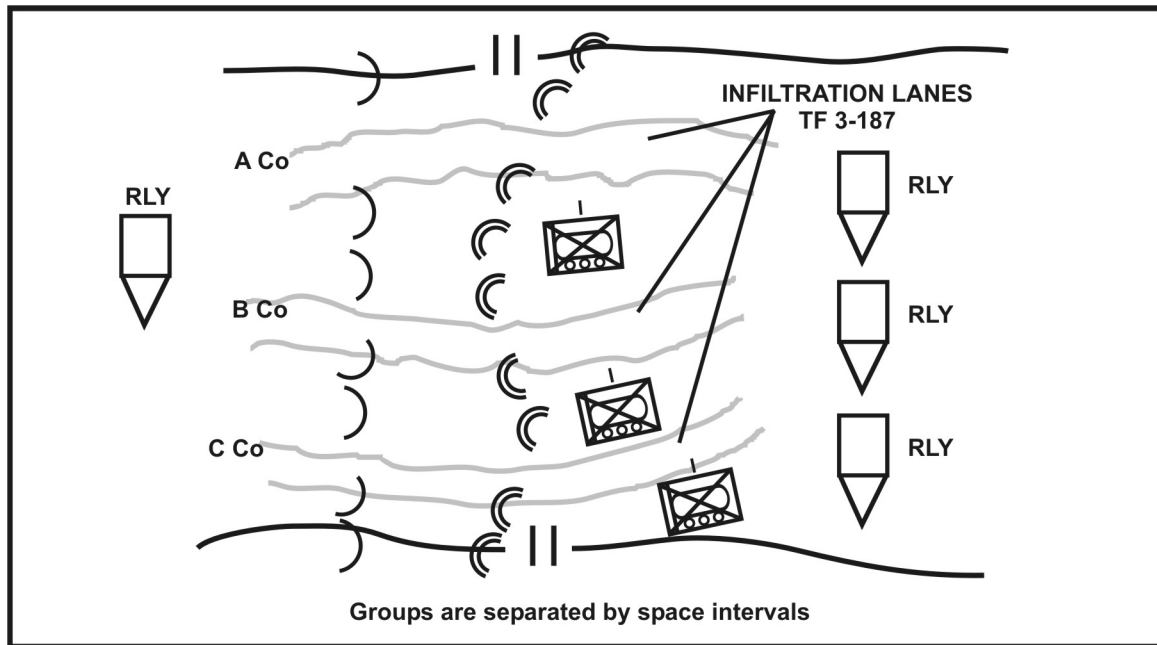


Figure 3-20. Multiple-lane infiltration.

e. **Communications.** In general, infiltrating elements should use digital communications as the primary means of communications. They should use radio listening silence except to report contact with enemy forces or to send critical information that the commander has directed them to report immediately. When operating out of normal communications range, an infiltrating element that must transmit required information should move to high ground or set up a long-range expedient antenna.

f. **Fire Support.** Infiltration plans always cover employment of indirect fires although the platoon uses them only in limited circumstances. The most common use of indirect fires is when the infiltrating unit makes enemy contact, in which case the commander or platoon leader may employ indirect fires in another sector to divert attention from the infiltration lane. The platoon can also use indirect fires to degrade the enemy's acquisition and observation capabilities by forcing him to seek cover.

g. **Actions on Contact.** Each infiltrating element must develop and rehearse a plan that clearly defines its actions in case of contact with enemy security forces. If detected, an infiltrating element typically returns fire, breaks contact, and reports. Fighting through the enemy force is the least preferred COA. Direct fire engagements are normally limited to whatever actions are required to break contact. During infiltration using multiple lanes, the detection of one platoon's elements may alert the enemy and compromise other units in the infiltration zone. The OPORD must clearly state whether the element will continue the mission or return to friendly lines if detected by the enemy. If the element makes visual contact but is not detected, it should continue the mission.

3-7. EXFILTRATION

Exfiltration is removal of personnel or units from areas under enemy control using stealth, deception, surprise, or clandestine means. The reconnaissance platoon and its elements may need to exfiltrate during any tactical operation or situation. For example,

reconnaissance forces that have infiltrated or bypassed the enemy-occupied area may need to exfiltrate as soon as they gather the required information. In another instance, the platoon may deploy in a stay-behind mode during defensive operations, requiring it to plan and execute movement to return to friendly controlled areas.

a. **Planning.** In all situations, leaders must plan exfiltration as carefully as infiltration. An effective exfiltration plan is essential for mission accomplishment and morale. In most cases, planning for an exfiltration operation begins at the same time as planning for the infiltration (or other tactical operation) that precedes it. For example, the reconnaissance platoon leader must anticipate contingency measures in case his elements must conduct an unplanned exfiltration during a reconnaissance operation. His exfiltration plan should factor in additional time that the platoon may need to react to unforeseen circumstances, such as inadvertent contact with enemy forces or unexpected restrictive terrain. Whether the platoon plans to exfiltrate on foot, by RV, or by air, it must conduct detailed planning to establish criteria for a passage of lines to minimize the chances of fratricide.

b. **Contingencies.** The exfiltration plan should also cover other types of contingencies that will not require the platoon to exfiltrate. For example, when a section or team repeatedly misses mandatory radio contact, other elements must assume that the element has a communications problem, is in trouble, or both. The exfiltration plan might address this situation by calling for a resupply drop of new batteries and another means of communication at a predetermined location. The plan would mandate that the resupply location be specially marked for security and identity purposes.

(1) **Movement Considerations.** The principles of route selection, movement formations, and movement security are critical to the success of the exfiltration operation. Leaders must develop plans for extraction by applicable means (ground or air) before the operation, to include procedural contingencies such as the destruction of the RVs, evacuation of sick and wounded personnel, and disruption of communications. These plans should address various contingencies for movement, such as the possibility that the platoon may be able to exfiltrate intact or in smaller groups to avoid detection.

(2) **Terrain Factors.** The reconnaissance platoon uses terrain features to its advantage during the exfiltration. It employs movement routes that put ridgelines, rivers, and other restrictive terrain between the platoon and enemy security forces. The platoon leader ensures that primary and alternate linkup points are not on a single azimuth leading away from the OP or exfiltration route.

(3) **Pickup Points.** Exfiltration pickup points for dismounted personnel should be far enough away from the OP to ensure the enemy does not hear vehicle or helicopter noises. The exfiltrating force should use mountains, dense foliage, and other terrain features to screen these noises. Under normal conditions in flat, open terrain on a clear night, rotary-wing aircraft lose most of their audio signature at a distance of **about** 5 kilometers.

c. **Methods.** The platoon can exfiltrate by air, water, or land. Each method requires specific operational considerations, and each has tactical advantages and disadvantages. The exfiltration plan and OPORD must address these factors. They must also state what actions the reconnaissance platoon must take if it must exfiltrate unexpectedly.

(1) **Extraction by Air or Vehicle.** Extraction by air or RV (ground) is favored when the resources are available and their use will not compromise the mission. The platoon uses these methods when it must cover long distances, time of return is essential, the

exfiltration route lacks adequate cover and concealment, the enemy does not have air superiority, or heavily populated hostile areas obstruct ground exfiltration.

(2) ***Exfiltration by Land.*** Reconnaissance forces normally conduct exfiltration via land routes dismounted when friendly lines are close or no other extraction method is feasible. Dismounted ground exfiltration is preferred when areas along the route are largely uninhabited, when enemy forces are widely dispersed or under such pressure that they cannot conduct counterreconnaissance and security operations, or when terrain is sufficiently restricted to degrade enemy efforts to use mobile forces against the exfiltrating reconnaissance unit.

(3) ***Emergency Exfiltration.*** The reconnaissance platoon may have to conduct an emergency exfiltration if detected or engaged by an enemy force. This type of operation may require the battalion to activate its escape and evasion plan or to deploy a reaction or support force to help extract the friendly elements. The battalion must carefully coordinate and rehearse employment of the reaction force and supporting fires before initiating the infiltration (or other tactical mission, if applicable).

CHAPTER 4

RECONNAISSANCE

Infantry leaders of all ranks are responsible for continuous reconnaissance. The SBCT infantry battalion reconnaissance platoon is the battalion commander's tool to conduct this type of reconnaissance. The reconnaissance platoon conducts reconnaissance and surveillance missions before, during, and after all combat operations to obtain information of tactical value for the SBCT infantry battalion commander. To make valid decisions regarding courses of action, the commander must know in detail what to expect from the enemy, terrain, and weather in the area of operations. Reconnaissance and surveillance reveals the enemy's disposition, composition, strengths, and weaknesses and establishes the effects of weather and terrain on maneuver conditions. This information helps the commander to successfully maneuver against and apply overwhelming combat power to destroy the enemy. The battalion commander, S2, and S3 develop and direct the battalion's reconnaissance and surveillance effort.

The platoon conducts both mounted and dismounted reconnaissance. The platoon conducts dismounted reconnaissance to gather detailed information, to enhance security, or when moving in severely restricted terrain. It conducts mounted reconnaissance when time is critical or the area of operations is large. Mounted reconnaissance maintains the tempo of operations and makes maximum usage of digitized communications systems and optics. The reconnaissance platoon must never lose sight of its reconnaissance objectives or priorities. It should avoid engagements with enemy forces and engage enemy forces with direct-fire weapons only in self-defense.

Section I. PURPOSE AND FUNDAMENTALS

Based on the commander's intent and guidance, the platoon conducts reconnaissance forward of friendly forces to provide current, accurate information about the enemy, terrain, weather, and physical resources within a specified area of operations. This provides follow-on forces with an opportunity to maneuver freely and rapidly to their objective. Reconnaissance keeps follow-on forces from being surprised or interrupted and prevents these forces from losing men and equipment en route to the objective. Reconnaissance platoons perform three types of reconnaissance: area, zone, and route. The following tenets provide a foundation to effectively employ and accomplish the mission of the reconnaissance platoon.

4-1. ORIENT ON THE RECONNAISSANCE OBJECTIVE

The reconnaissance platoon scheme of maneuver must revolve around the specific objective or objectives. The objective may be a terrain feature, a specific area, an enemy force, an NAI, or a checkpoint. The platoon must maintain its orientation toward the objective, regardless of what it encounters, until the mission is complete. For the reconnaissance platoon, the objective(s) are normally discussed in the battalion

reconnaissance and surveillance annex, the commander's critical information requirements (CCIR), or the execution portion of the OPOD. It is critical that the platoon leader understand the mission explicitly before he begins the planning process.

4-2. MAINTAIN TEMPO AND FOCUS

The platoon leader must ensure that the platoon focuses on reconnaissance objectives and keeps up the operational tempo of the mission. Operational tempo is not speed but is more a constant rate of movement over time, focused on the objective. If the platoon does not maintain tempo, it will quickly lose its combat effectiveness.

4-3. REPORT ALL INFORMATION RAPIDLY AND ACCURATELY

Commanders base their decisions and plans on the battlefield information that the reconnaissance platoon reports during reconnaissance. Information loses value over time. Reconnaissance teams must report all information exactly as they see it and as fast as possible using both analog and digital communications. Inaccurate information is dangerous. The teams must never assume, distort, or exaggerate. Information stating where the enemy is located is equally as important as information stating where the enemy is not located.

4-4. RETAIN FREEDOM TO MANEUVER

Reconnaissance teams must be able to maneuver on the battlefield. If the enemy fixes the reconnaissance teams, they must break contact on their own. They must continuously maintain situational understanding (SU), employ effective techniques of tactical movement, and react appropriately to unexpected developments. If the platoon makes contact, the platoon leader should break contact as soon as possible and avoid decisive engagement with the enemy.

4-5. ESTABLISH AND MAINTAIN ENEMY CONTACT

The reconnaissance platoon must establish contact with the enemy without being detected. This allows them the ability to retain the initiative and control the situation.

4-6. DEVELOP THE SITUATION RAPIDLY

When the reconnaissance platoon makes contact with the enemy, it must determine as much as possible about the current situation. It must determine the size, composition, activity, and location of the enemy force. It must do so quickly and with little or no guidance from higher. Time is the reconnaissance platoon's most precious resource; wasting time could cause the platoon to fail to accomplish its mission.

4-7. ACQUIRE ALL REQUIRED INFORMATION

The battalion S2 and S3 are responsible for coordinating and directing the battalion's reconnaissance and surveillance effort. During the intelligence cycle, the commander establishes priority information requirements. This is information critical to the commander since it affects his plan. The PIR form the basis of the battalion's reconnaissance and surveillance plan. The S2 and S3 develop the reconnaissance and surveillance annex, which specifies the information that is needed by the battalion and assigns responsibility for obtaining that information. The battalion commander or S3

briefs the reconnaissance platoon leader on the specifics of the reconnaissance and surveillance annex. During this brief, the platoon leader ensures that he understands the commander's expectations; failure to do so can result in information that is not of any tactical value. The platoon leader then ensures that the reconnaissance platoon understands the specific reconnaissance requirements and the purpose of the reconnaissance. The reconnaissance mission is complete once all information is collected and transmitted to the correct headquarters or when the commander directs the platoon to end the mission and transmit the information collected so far. All information gathered should be disseminated to all members of the platoon.

4-8. AVOID DETECTION

The reconnaissance platoon must not let the enemy detect its presence in the objective area. The key is to see and not be seen.

a. If the enemy suspects that it is being observed, it may move its elements or increase security measures as part of its counterreconnaissance plan. If this occurs, movement in the objective area must be reduced; the patrol moves no closer to the objective than necessary.

b. Adequate time must be allocated for the reconnaissance to answer the battalion commander's PIR.

c. The platoon must exploit the technical advantages of its equipment, such as FBCB2, to gain information.

d. The platoon uses camouflage, discipline, and stealth to help avoid detection. It avoids routes covered by enemy radar, reconnaissance and surveillance, and target acquisition devices.

e. By reducing radio traffic, the reconnaissance platoon limits the possibility of being detected by the enemy.

f. Battlefield situations occur in which a reconnaissance patrol makes chance contact with the enemy, usually because a patrol moves too close to an objective. A technique for addressing these contingencies is to brief soldiers on situations concerning enemy contact and the risks the platoon leader will accept to obtain information.

(1) Although the intent of the reconnaissance platoon is to avoid enemy contact to preserve combat power, every soldier should know what action to take upon enemy contact. The platoon leader ensures the soldiers understand the engagement criteria by asking questions that affect the engagement decision (Figure 4-1, page 4-4).

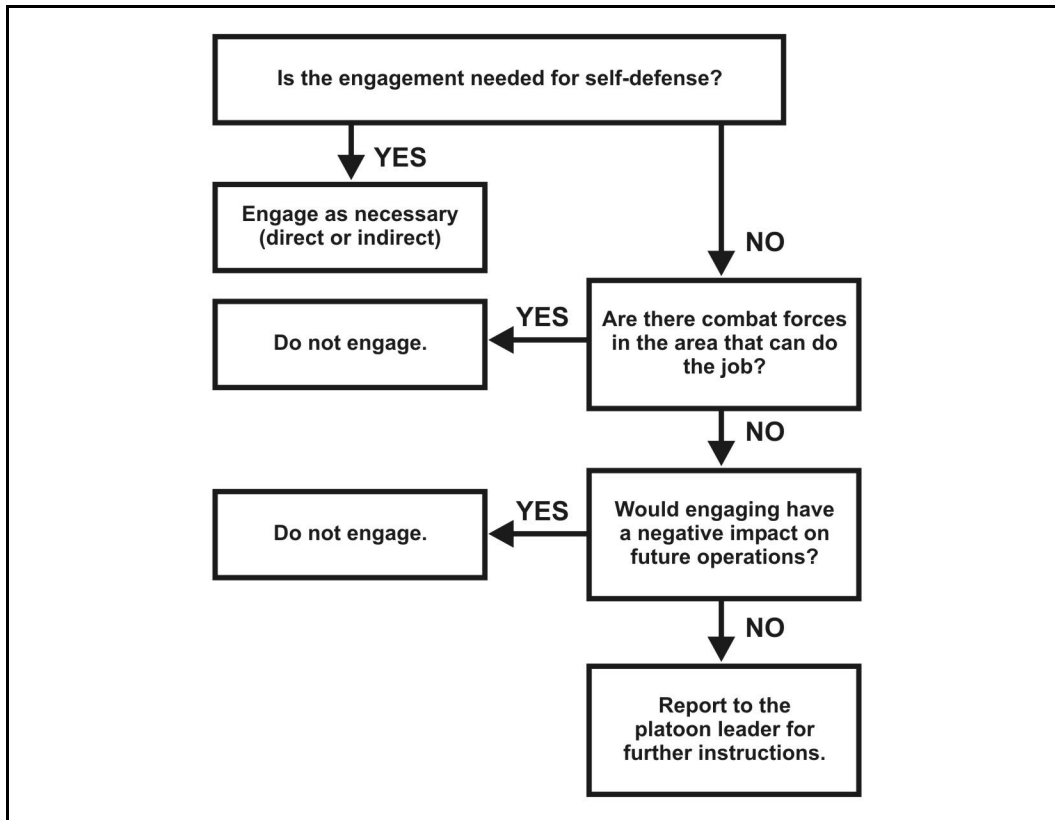


Figure 4-1. Engagement decision questions.

(2) Soldiers also need to know about the criterion of risk acceptance. If the commander wants a detailed sketch of the objective, he accepts the risk that the reconnaissance platoon will have to move close to the objective. If the commander wants general information, such as a location of an objective, then there is less risk. The platoon leader ensures the soldiers understand the risk involved in obtaining information.

4-9. EMPLOY SECURITY MEASURES

If detected, a reconnaissance element breaks contact using SOPs and then either returns to friendly lines or continues the mission. The platoon rehearses plans for breaking contact to include handling casualties. The platoon leader organizes the reconnaissance platoon based on METT-TC factors.

4-10. UTILIZE SENSORY TECHNIQUES

A soldier's ability to effectively use his senses is critical to effective reconnaissance, second only to the ability to move and observe without being detected. Equipment supplements the senses, enabling the observer to accurately portray the combat environment. Senses used in reconnaissance are sight, hearing, touch, and smell.

- a. **Sight.** A soldier looks for--
 - Enemy personnel, vehicles, and aircraft.
 - Sudden or unusual movement.
 - Smoke or dust.
 - Unusual movement of farm or wild animals.

- Activity of local inhabitants.
 - Vehicle and personnel tracks.
 - Signs or evidence of enemy occupation.
 - Recently cut foliage or vegetation.
 - Muzzle flashes, lights, fires, or reflections.
 - Amount and type of trash.
- b. **Hearing.** A soldier listens for--
- Running engines or track sounds.
 - Voices.
 - Metallic sounds.
 - Gunfire (by type of weapon).
 - Unusual calm or silence.
 - Dismounted movement.
 - Aircraft.
- c. **Touch.** A soldier feels for--
- Warmth of coals or materials from fires.
 - Freshness of tracks.
 - Age of food or trash.
- d. **Smell.** A soldier smells for--
- Vehicle exhaust.
 - Burning petroleum products.
 - Cooking food.
 - Age of food or trash.
 - Human waste.
 - Fires.
 - Soap and hygiene products.

Section II. PLANNING

The platoon leader and battalion staff use the TLP and military decision-making process to develop the reconnaissance plan. Section and team leaders develop the plan based on the reconnaissance platoon leader's plan. Every soldier should have an understanding of the reconnaissance platoon's plan and the team's plan.

4-11. PLANNING, METHODS, AND EMPLOYMENT OF RECONNAISSANCE FORCES

Critical to the platoon leader's ability to execute his mission is a clear understanding of the focus and tempo of the reconnaissance mission. This information comes from the battalion commander's initial guidance, which answers the two basic questions the platoon leader needs to know to plan his mission (Figure 4-2, page 4-6). Essential commander's guidance is an extension of the commander's intent and is meant to fully clarify the commander's intent for his reconnaissance platoon. The platoon leader receives the commander's guidance from higher and issues it to subordinates.

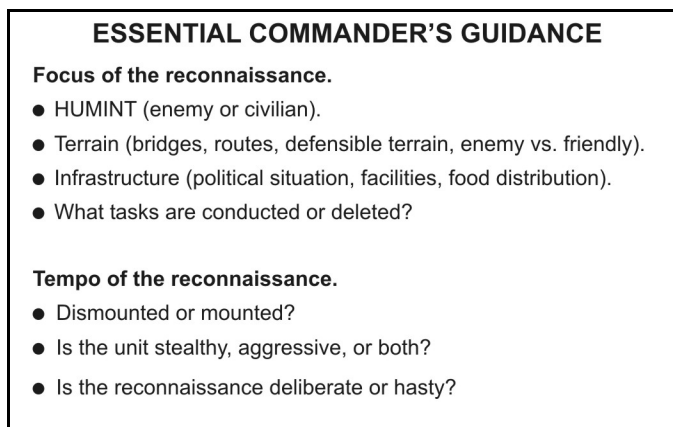


Figure 4-2. Essential commander's guidance.

a. **Focus.** The focus of the reconnaissance allows the platoon leader to determine which critical tasks he wants the platoon to accomplish first. It helps him narrow the platoon's scope of operations to get the information that is most important to the battalion's operations. The platoon focus is either terrain-oriented or enemy-oriented. In stability operations, the platoon might focus on local populace sentiment or on identifying local military leaders.

b. **Tempo.** The tempo of the reconnaissance allows the platoon leader to establish associated time requirements with planning time and movement formations and methods, such as dismounted or mounted. The platoon leader establishes the tempo by answering two questions: Is the platoon conducting stealthy or aggressive reconnaissance and is the reconnaissance deliberate or hasty? The reconnaissance platoon leader must understand the answer to the two questions and articulate them to his platoon.

- Stealthy implies unseen, time-consuming, dismounted operations minimizing chance contact where the platoon might be observed.
- Aggressive implies mounted, fast-paced operations.
- Deliberate reconnaissance operations are slow, detailed, and broad-based.
- Hasty reconnaissance operations focus the platoon on a few key pieces of information required by the commander.

4-12. RECONNAISSANCE METHODS

This paragraph describes the methods of conducting reconnaissance.

a. **Reconnaissance Patrols.** Reconnaissance patrols provide timely and accurate information about the enemy and terrain. The reconnaissance platoon may be tasked to conduct any of the three types of reconnaissance patrols (area, zone, or route). The patrol leader must have specific intelligence collection requirements for each mission. For a detailed discussion of reconnaissance patrols, refer to Chapter 10 of this manual.

b. **Mounted Reconnaissance.** Platoon members can frequently stay in their vehicles while conducting assigned reconnaissance tasks. Remaining mounted allows the reconnaissance platoon to conduct fairly detailed reconnaissance while maintaining the speed and momentum required for the operation. Mounted reconnaissance also allows the platoon to take advantage of the protection afforded by its vehicles.

(1) **Employment Considerations.** Mounted reconnaissance is normally used under these conditions:

- Time is limited.
- Detailed reconnaissance is not required.
- The cavalry squadron (RSTA) is performing coordinated reconnaissance tasks in support of the infantry battalions.
- Ground sensors (such as GSR elements) are conducting reconnaissance activities in support of ground forces.
- IPB provides accurate information on the enemy.
- Terrain is open.

(2) **Advantages.** Speed and momentum are rarely necessary in a reconnaissance operation, but they are often critical to the successful execution of offensive operations that the reconnaissance mission may support. In addition to speed, mounted reconnaissance offers platoon members the advantages of their reconnaissance vehicle. These advantages depend on the specific vehicle employed, but they can include armor protection, enhanced navigation and communications capability, enhanced optics, and limited firepower.

(3) **Disadvantages.** The disadvantages of mounted reconnaissance include the loss of stealth due to the visual, noise, and thermal signatures of the vehicle and the loss of some detail because of restricted vision and impairment of the senses of smell and hearing. These disadvantages increase the risk to the platoon as it conducts reconnaissance.

c. **Dismounted Reconnaissance.** The primary purpose of dismounted reconnaissance is to obtain detailed information about terrain features, obstacles, or enemy forces. In addition, platoon members dismount and reconnoiter forward of their vehicles to provide security before moving through danger areas such as open spaces, hilltops, curves, or other blind spots on the battlefield. They also dismount to set up short- or long-duration OPs. (Refer to the discussion of patrolling [Chapter 10] and observation posts [Chapter 5] for additional information on how the reconnaissance platoon takes part in dismounted reconnaissance.)

(1) **Employment Considerations.** In general, the reconnaissance platoon conducts dismounted reconnaissance when the following conditions apply:

- Detailed reconnaissance is required.
- Stealth is required.
- Enemy contact is expected or visual contact has been achieved.
- Restricted terrain is encountered.
- Time is available.
- Danger areas are encountered.
- Security is the primary concern.
- IPB indicates close proximity to enemy positions.

Dismounted teams provide security for each other as they move. When only an individual soldier dismounts, he should never move beyond effective overwatching fires of the vehicle.

(2) **Advantages.** Dismounted reconnaissance is the preferred method when stealthy movement is desired. Teams on foot benefit from the concealment offered by vegetation and terrain; in addition, they do not emit a significant visual or audio signature. Dismounted reconnaissance techniques allow the reconnaissance platoon to observe

enemy vehicles and soldiers at close range without being detected. Soldiers conducting dismounted reconnaissance can also quickly transition to a stationary OP for a short period of time without suffering any loss of effectiveness.

(3) **Disadvantages.** Disadvantages of dismounted reconnaissance include a relatively slow rate of movement for personnel on foot, extensive requirements for detailed preliminary planning and coordination, and considerable risk to soldiers conducting dismounted operations. Unless they establish a radio relay, teams cannot conduct dismounted reconnaissance in depth because of the relatively short range of FM man-portable communications systems.

(4) **Tools for Dismounted Reconnaissance.** Dismounted platoon members employ a variety of equipment and other tactical tools to enhance their capability to report information accurately and to call for and adjust indirect fires. At a minimum, they carry the following items:

- SOPs.
- Personal weapons.
- Communications equipment.
- Signal operation instruction (SOI) extracts.
- Maps.
- Compass.
- Binoculars (and night-vision devices, if necessary).

4-13. REHEARSALS

To ensure everyone understands the plan, the platoon leader conducts rehearsals. Each has a specific purpose and result. The five types of rehearsals include--

- Confirmation brief.
- Backbrief.
- Combined arms rehearsal.
- Support rehearsal.
- Battle drill or SOP rehearsal.

4-14. ESSENTIAL PLANNING CONSIDERATIONS.

The platoon sergeant assists the platoon leader in the development of the plan and coordinates support requirements. The following items are essential to reconnaissance planning:

- a. Composition and task organization of the platoon and teams.
- b. Information to be obtained by the reconnaissance element.
- c. Movement routes and formations to the reconnaissance site for mounted and dismounted personnel.
- d. Actions at the objective and use of control measures.
- e. Special instructions to members of the mounted and dismounted reconnaissance and security elements.
- f. Special equipment to be used during the reconnaissance.
- g. Contingency plans such as--
 - Actions on contact.
 - Actions if the reconnaissance party does not return.
 - Evacuation of casualties.

- Initial rally point (IRP) for RV extraction.
- Stay-behind surveillance.
- Indirect-fire support for movement and reconnaissance.
- Special communication arrangements.
- Withdrawal plan from the reconnaissance site.
- Plan for dissemination of information acquired during the reconnaissance.
- Deadline for reporting information to higher headquarters.
- Establishment of no-fire areas over OP positions once in position.

Section III. RECONNAISSANCE AND SURVEILLANCE HANDOVER

Reconnaissance and surveillance handover is the transfer of information and or responsibility for observation (surveillance) of an assigned area or enemy force from one unit to another. Battle handover is the transferring of the responsibility for conducting the fight from one commander to another. Battle handover is a coordinated operation executed to sustain continuity of the combined arms fight and to protect the combat potential of both forces involved. While reconnaissance and surveillance handover shares many critical tasks with battle handover, it focuses primarily on passing information and the related responsibility for surveillance of an area or enemy force from one unit to another. Reconnaissance and surveillance handover is normally associated with a designated area or graphic control measure (such as a phase line); it may cover a sector or zone, NAI, target area of interest (TAI), and or enemy contact. Reconnaissance and surveillance handover can be visual, digital (FBCB2), or FM voice.

4-15. REASON FOR SURVEILLANCE HANDOVER

Surveillance handover is designed to provide information connection, overlapping communications, and focus on the common commander's CCIR and reconnaissance objectives.

a. **Surveillance Handover.** The geographical point of reference or time of transfer of surveillance responsibility must be coordinated between the coordinating staff and commanders of the units affected or designated by the SBCT. The controlling higher headquarters provides the graphic control measures that depict the applicable phase lines and contact points, either digitally or on an overlay issued to subordinate units with the OPOD or FRAGO. Reconnaissance and surveillance handover is complete when the unit accepting the handover has established visual contact with the enemy element or has the area (NAI or TAI) under surveillance. The higher headquarters commander prescribes the specific criteria that mark completion of handover and ensures that both subordinate commanders understand these criteria.

b. **Critical Tasks for Unit Transferring Responsibility.** The unit responsible for surveillance must accomplish several critical tasks during change of responsibility. It must--

- Immediately establish FBCB2 linkage and enter appropriate communication nets of adjacent units.
- Continuously report to the unit accepting surveillance responsibility the location, size, and composition of all enemy forces as well as the enemy's current activity. If the enemy is attacking, the unit conducting the surveillance reports the enemy's direction of movement, movement formation, and

estimated rate of advance. If the enemy is defending, the unit conducting the surveillance reports the enemy's locations, orientation, composition, engagement areas (EA), reserves (if known), obstacles, and flanks.

- Coordinates with the unit accepting surveillance responsibility to determine contact points at which subordinate elements (such as reconnaissance sections) will physically coordinate handover with representatives of the unit accepting surveillance responsibility. Once contact points are determined, the surveilling unit leader digitally sends a FRAGO to all sections, specifying where they will physically coordinate the change of responsibility for surveillance of the enemy with the unit accepting surveillance responsibility.
- Ensure that each section or team acknowledges where it must physically coordinate the change.
- Maintain visual contact with all enemy units, while avoiding decisive engagement, until change of responsibility is complete.

c. **Critical Tasks for Unit Accepting Surveillance Responsibility.** The unit accepting surveillance responsibility must accomplish a variety of critical tasks when ordered to conduct surveillance handover. It must--

- Establish communications with the unit conducting the surveillance and coordinate necessary contact points.
- Ensure that contact points are manned and that maneuver elements have established personal communications with their representatives.
- Position security forces (if working with the platoon) where they have the best possible observation of enemy avenues of approach (AA), adjusting as necessary for limited visibility conditions.
- Ensure that routes through the obstacle system (if emplaced in the AO) are clearly marked and physically controlled by guides or that escorts are provided to the unit handing over surveillance responsibility.
- Ensure that all routes of withdrawal obligated to the unit conducting the surveillance are unobstructed and facilitate rapid movement to the release point (RP).
- Ensure that designated routes of advance, attack positions, and routes to the point where responsibility for surveillance is changed are clear and facilitate rapid movement.

d. **An Example of Surveillance Handover.** In this example, the cavalry squadron (RSTA) is conducting a zone reconnaissance forward of the SBCT. The battalion's reconnaissance platoon has been given a mission to conduct area reconnaissance missions behind the cavalry squadron (RSTA) to develop attack positions and then conduct surveillance of TAIs in support of the battalion's attack. This configuration allows the reconnaissance platoon to conduct a thorough reconnaissance while taking advantage of the security the cavalry squadron (RSTA) provides. The reconnaissance platoon has been assigned a movement route to move to its assigned areas. The battalion's reconnaissance platoon conducts physical and FM and or digital linkup with the RSTA reconnaissance element directly to its front and with the lead infantry rifle company that directly follows the platoon.

(1) En route to its OPs, the reconnaissance platoon maneuvers into the cavalry squadron's AO. They report real time information to the battalion and its lead companies.

Once the conditions are set, the battalion's reconnaissance platoon conducts the on-site surveillance handover, coordinated by the battalion S3, with the cavalry squadron to its front.

- The cavalry squadron (RSTA) reports that it bypassed an enemy OP consisting of a light skinned wheeled vehicle and six to eight indigenous personnel armed with automatic weapons and RPG-7s. The cavalry squadron also provides additional information concerning the terrain and enemy on the battalion's objective.
- The cavalry squadron (RSTA) and the battalion's reconnaissance platoon also coordinate passage of lines for the platoon to move into OPs that observe the assigned TAIs.
- The platoon executes the handover from the cavalry squadron (RSTA) and reports the contact to the battalion and the follow-on companies; it also updates the FBCB2 overlay with the OP contact and updates the enemy template on the objective.
- The battalion accepts responsibility for the enemy OP contact and directs the reconnaissance platoon to bypass the OP and continue the mission.

(2) The reconnaissance platoon establishes OPs to observe TAIs and support the battalion's attack.

- The reconnaissance teams provide a visual contact SITREP and then lead the rifle companies to positions of advantage using covered and concealed routes identified en route to their linkup point.
- The reconnaissance platoon leader now has enough information to physically point out enemy and friendly locations and routes to the flank and rear of the enemy and to continue to support the battalion's attack.

4-16. ADDITIONAL MISSIONS

Given the capabilities of the reconnaissance platoon, many commanders require it to assist other units in the passage of lines. Primarily, the reconnaissance platoon enhances the command and control function for the commander. The platoon may be required to conduct one or all of the critical tasks of a stationary or passing unit or may assist its parent unit in the following ways:

- Elements of the reconnaissance platoon may assist in securing contact and passage points where units will meet and pass.
- The reconnaissance platoon may reconnoiter possible passage lanes (primary and alternate), mark their locations, and find bypasses.
- The reconnaissance platoon may guide units from contact points to or through passage lanes. The platoon may also control traffic at the passage point and in the lane.
- Reconnaissance platoon elements may be positioned in the passage area to act as a communications link in case units involved in the passage have trouble communicating with each other.

- The reconnaissance platoon may conduct area reconnaissance of attack positions (forward passage) and assembly area locations (rearward passage). This reconnaissance effort may include a requirement to check for NBC contamination.
- The reconnaissance platoon may assist the commander by occupying OPs or conducting patrols to provide a continuous flow of information about the enemy situation.

4-17. DIGITAL SYSTEMS

Digital systems assist the battalion staff in its coordination and synchronization efforts for the operation. Each unit transmits or delivers a complete copy of its OPORD and overlays either by digital (FBCB2 and MCS) or conventional (hardcopy and acetate overlay) means. Any changes made after initial distribution are updated immediately. The coordination effected between the two commanders includes--

- Establishing digital and FM voice communications.
- Providing updates of both friendly and enemy situations (digital, voice, and graphic).
- Coordinating passage points and routes and ensuring these are displayed on operational overlays (digital and conventional).
- Collocating C2 and exchanging liaison personnel (if required).
- Coordinating fires and fire control measures (direct and indirect) and ensuring these are displayed on operational overlays (digital and conventional).
- Determining the need for and dispatching contact point representatives.
- Establishing and coordinating recognition signals (conventional).
- Providing the location of obstacles and related covering fires.
- Providing route information to include waypoints.
- Determining CS and CSS requirements.

Due to the fluid nature of a battle handover, digital coordination may be too difficult to accomplish. Commanders determine if digital systems can be used to speed the planning, coordination, and execution process. However, FM voice may be the most prudent method of coordinating and executing battle handover.

Section IV. AREA RECONNAISSANCE

Before moving forces into or near a specified area, the commander may call on his reconnaissance platoon to conduct an area reconnaissance to avoid being surprised by unsuitable terrain conditions or unexpected enemy forces. The area could be a town, ridgeline, woods, or another feature that friendly forces intend to occupy, pass through, or avoid. The commander frequently employs area reconnaissance to gain information on objective areas, to confirm the IPB templates, and to provide detailed information regarding enemy dispositions. Within an area of operations, area reconnaissance can focus the reconnaissance on the specific area that is critical to the commander. This technique of focusing the reconnaissance also permits the mission to be accomplished more quickly. Area reconnaissance can thus be a stand-alone mission or a task to a section or the platoon. Like zone reconnaissance, area reconnaissance can be either terrain- or force-oriented. The commander analyzes the mission using METT-TC to

determine whether the platoon will conduct these types of reconnaissance separately or in conjunction with each other.

4-18. TASKS

The reconnaissance platoon must accomplish numerous tasks during the area reconnaissance.

- a. **Primary.** The platoon's primary tasks include the following:
 - Find and report all enemy forces within the area.
 - Reconnoiter specific terrain within the area.
 - Report reconnaissance information.
- b. **Other.** In addition to the primary tasks, the reconnaissance platoon must be prepared to conduct other tasks as directed by the higher commander. Additional tasks for the area reconnaissance include the following:
 - Reconnoiter all terrain within the area.
 - Inspect and classify all bridges within the area.
 - Locate fords or crossing sites near all the bridges in the area.
 - Inspect and classify all overpasses, underpasses, and culverts.
 - Within capability, locate all minefields and other obstacles in the area, reduce or breach them, and clear and mark lanes.
 - Locate bypasses around built-up areas, obstacles, and contaminated areas.

4-19. MOUNTED TECHNIQUES

The order to conduct an area reconnaissance mission identifies the area to be reconnoitered within a continuous boundary. The reconnaissance platoon leader analyzes the mission, enemy, and terrain and completes his troop-leading procedures. He also plans the movement to (and, if necessary, from) the area, following the basic rule of using different routes to and from the area. The battalion reconnaissance and surveillance plan specifies the ingress and egress routes for the platoon.

a. The platoon's primary concern during movement to the area is security rather than reconnaissance. If the platoon leader feels there may be enemy forces along the route to the area to be reconnoitered, the platoon should employ the principles of tactical movement based on METT-TC factors. The platoon leader must also incorporate information from UAVs and ground sensor assets (such as GSR) into the operation. The platoon may be augmented with Javelin AT systems. The Javelin's command launch unit (CLU) thermal sight has a range of more than 3,000 meters and can be used to observe the area. (See Appendix F for information on Javelin employment.) During movement to the area, it may be appropriate (depending on the commander's intent) for the platoon to avoid physical contact with the enemy. The platoon leader may also choose to orient and focus sections or teams on checkpoints as the platoon moves to the area.

b. The platoon leader encloses the given area within a platoon zone; he uses boundaries, an LD, and a limit of advance (LOA). He can divide the area into section zones by placing boundaries on identifiable terrain. By doing this, the platoon leader ensures that each section has responsibility for specific pieces of terrain.

c. The platoon leader places contact points at the intersections of phase lines and boundaries and any other places he wants physical contact and coordination between his reconnaissance (recon) sections. He can use the terrain index reference system (TIRS) as

necessary. He works with the fire support officer (FSO) to plan indirect fires to support the platoon's scheme of maneuver.

d. The platoon can conduct area reconnaissance using either two 2-vehicle sections or four individual vehicle elements. Vehicle formations are often not appropriate to the area reconnaissance mission because of the wide variety of METT-TC considerations the platoon may encounter.

4-20. DISMOUNTED TECHNIQUES

The platoon leader conducts an area reconnaissance to obtain information concerning the terrain or enemy activity within a prescribed area. The major actions required during dismounted area reconnaissance include moving to and occupying an objective rally point (ORP), conducting a leader's reconnaissance, conducting actions at the objective, and withdrawing and disseminating information. The patrol conducting the area reconnaissance reconnoiters and surveils the reconnaissance objective. To obtain the required information, the patrol uses a series of vantage points around the reconnaissance objective to observe it and the surrounding area. The patrol uses long-range and short-range observation and surveillance. The platoon leader may assign the task to the entire platoon or to individual teams. In the latter case, either the platoon leader or platoon sergeant locates at a position, usually the release point, which allows good C2. The platoon leader can use single or multiple teams. Security measures depend on the situation.

a. When the battalion orders the reconnaissance platoon to conduct an area reconnaissance, it identifies the area to be reconnoitered within a continuous boundary. The reconnaissance platoon leader analyzes the mission, enemy, and terrain and completes his troop-leading procedures. He also plans the movement to and, if necessary, from the area following the basic rule of using different routes to and from the area. The routes are specified for the platoon in the battalion reconnaissance and surveillance annex.

b. The platoon's primary concern during movement to the area is security rather than reconnaissance. If the platoon leader feels there may be enemy forces along the route to the area to be reconnoitered, the platoon should employ the principles of tactical movement based on METT-TC factors. The platoon leader must also incorporate information from the cavalry squadron (RSTA) and ground sensor assets (such as GSR) into the operation. During movement to the area, it is imperative for the platoon to avoid physical contact with the enemy. The platoon leader may also choose to orient and focus sections or teams on checkpoints as the platoon moves to the area.

c. The platoon leader uses boundaries, an LD, and an LOA. He can then divide the area into section zones by placing boundaries on identifiable terrain; this ensures that each section has responsibility for specific pieces of terrain.

d. The platoon leader should focus sections or teams on checkpoints as the platoon moves through the area. He uses graphic control measures as necessary. He works with the FSO to plan indirect fires to support the platoon's scheme of maneuver.

e. The platoon can conduct area reconnaissance using any of the platoon organizations. The platoon leader deploys his sections based upon the factors of METT-TC to accomplish their reconnaissance and surveillance tasks. Dispersed movement formations are often not appropriate to the area reconnaissance mission because the area

may be irregular in shape and because of the wide variety of METT-TC considerations the platoon may encounter.

4-21. OBJECTIVE RALLY POINT

During planning, the platoon leader selects a tentative ORP based on a map reconnaissance or, if possible, a physical reconnaissance.

a. From the leader's standpoint, the ORP should offer--

- Cover and concealment.
- Easy short-term defensibility.
- Location that is easy to find.
- Proximity to objective to simplify control.

b. The platoon leader then decides how to occupy the ORP. Every member of the reconnaissance platoon must know how to execute this task. The patrol can use the triangle technique (Figure 4-3), patrol bases, and rally points to occupy an ORP.

c. While in the ORP, the patrol makes final preparations for the leader's reconnaissance and actions at the objective.

d. With a five-man team, the leader can leave two soldiers to secure the ORP. The other three team members conduct the reconnaissance and provide security.

e. The patrol team leader may cache equipment in the ORP and take the entire team on the reconnaissance.

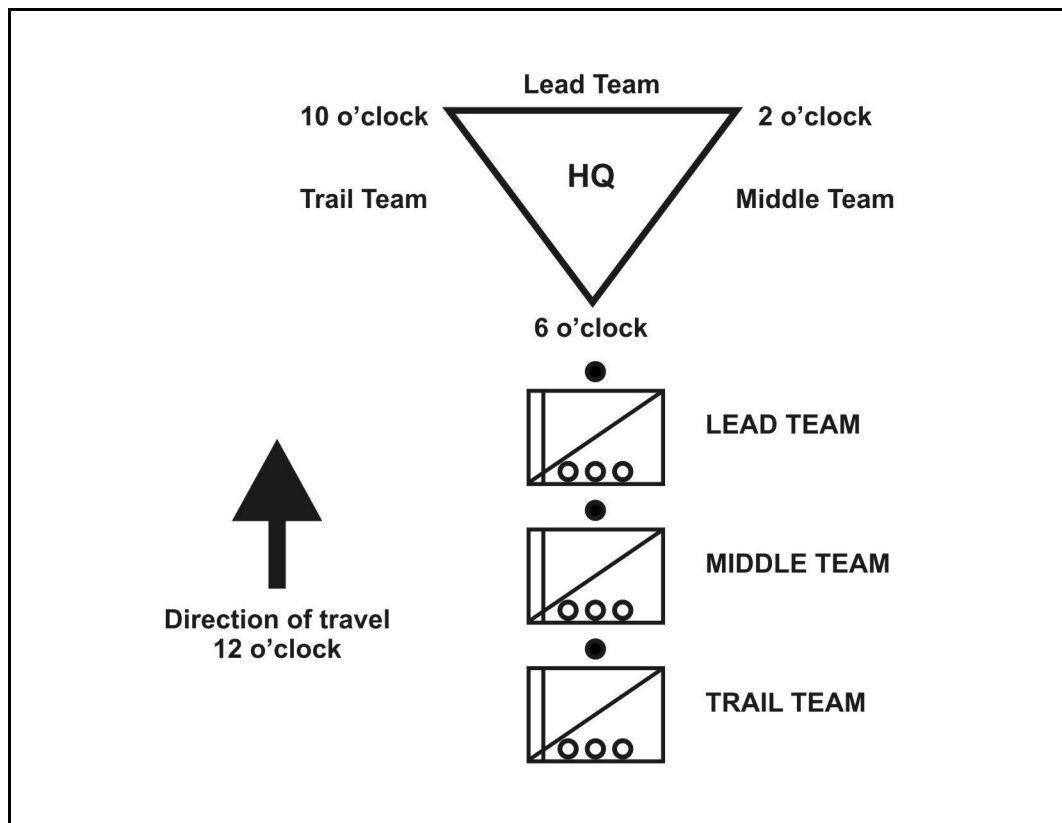


Figure 4-3. Occupation of an ORP using the triangle technique (3 teams).

4-22. LEADER'S RECONNAISSANCE

During the area reconnaissance, the platoon and team leaders conduct their own reconnaissance. This allows them to determine whether to modify the plan for actions at the objective and allows them to ensure smooth execution of the reconnaissance. A leader's reconnaissance of an objective may include the following tasks:

- Pinpoint the objective. If possible, accomplish this by checking terrain features in the area, not by directly approaching the objective.
- Locate observation or surveillance positions, routes, and security positions.
- Determine or confirm the enemy situation in the objective area, locate enemy OPs, determine enemy security status and activity, and adapt the patrol to the local sounds in the area.
- Designate the release point and the positions for the reconnaissance and control and security elements.

4-23. ACTIONS AT THE OBJECTIVE

Once the patrol pinpoints the objective, designated elements conduct the reconnaissance, viewing the objective from as many locations as necessary. Movement in and around the objective must be cautious and slow. If the control and security elements separate from the reconnaissance elements, they occupy a position that will allow them to place direct or indirect fire on the objective, if necessary. The patrol leader decides how detailed a reconnaissance to conduct. Thoroughness counts but so does avoiding detection. Two techniques for conducting reconnaissance include long- and short-range observation and surveillance.

a. **Long-Range Observation or Surveillance.** The ideal way to observe and survey an objective is from a distance--out of sight and out of range. When METT-TC permits the patrol to gather the required information from a distance, it does so from an OP (Figure 4-4). This reduces the chance of detection or vulnerability to enemy small-arms fire and local security measures. When one OP proves insufficient, then team-sized reconnaissance patrols occupy successive or multiple OPs. Using available cover and concealment, each patrol finds the best possible view of the objective.

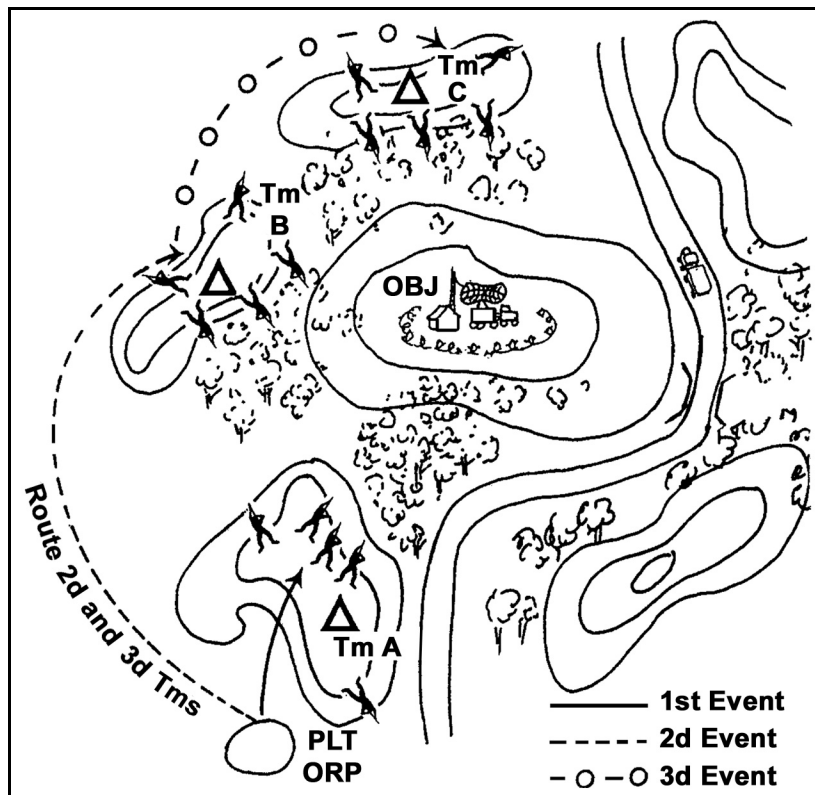


Figure 4-4. Example of long-range observation.

b. **Short-Range Observation or Surveillance.** Sometimes, to get the information needed, the patrol (platoon or team) must observe within range of enemy weapons systems (Figure 4-5, page 4-18). When the platoon as a whole operates at short range, the leader must clearly define the routes and area to be reconnoitered.

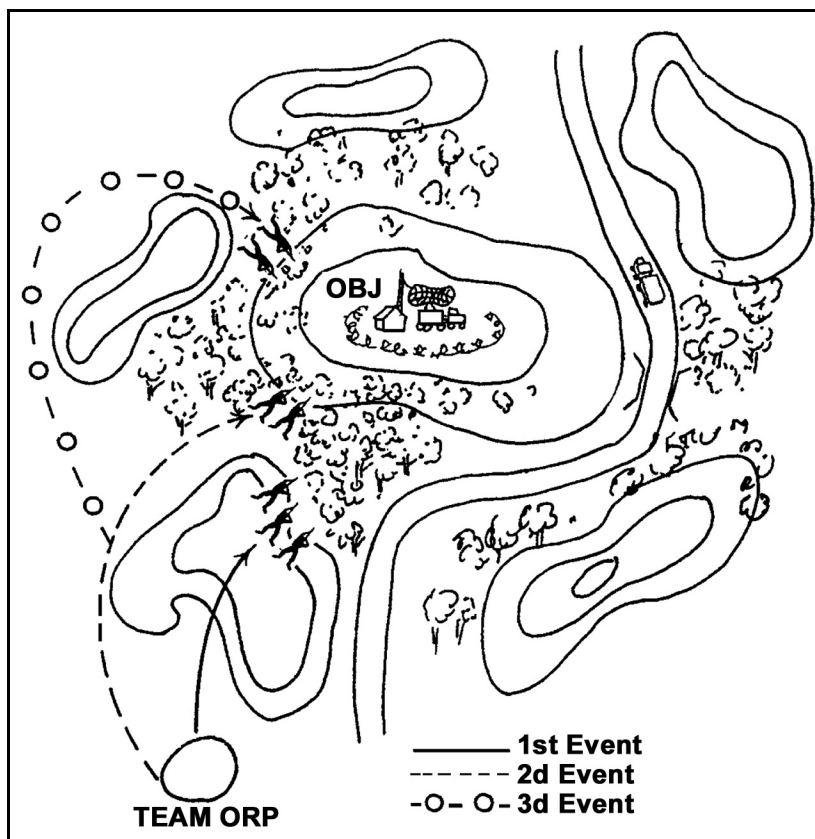


Figure 4-5. Example of short-range observation.

(1) Once the reconnaissance platoon leader has identified the objective, he looks for possible routes and locations from which he can observe the objective. He then briefs the plan to the reconnaissance element. The size of the reconnaissance element should be limited--for a team, two men conduct the reconnaissance while the others provide security. Once the control and security element is in position, the reconnaissance element begins slow and deliberate movement to the objective. This may require the soldier to low-crawl a considerable distance, taking time, energy, and patience. Individuals take only the equipment that is necessary. When moving, one soldier moves while the other observes. They continue using this method until the reconnaissance element reaches its final position.

(2) Once in position, the reconnaissance element observes and listens to acquire the needed information. No eating, no talking, and no unnecessary movement occur at this time; soldiers prone to coughing or sneezing should be in the control and security element. If the reconnaissance element cannot acquire the information needed from its initial position, it retraces the route and repeats the process. This method of reconnaissance is extremely risky. The reconnaissance element must remember that the closer it moves to an objective, the greater the risk of being detected. The reconnaissance element moves only as close to the objective as necessary.

(3) The control and security element has limitations on what it can do. The security element should go where it can observe the objective and, if possible, the reconnaissance element. If it cannot observe the reconnaissance element, it should know the element's

general location. If the enemy compromises the reconnaissance element, the control and security element calls for fire and places direct fire on the objective. This method of reconnaissance is difficult. The reconnaissance elements and the control and security elements should think through and rehearse well their actions at the objective and contingency plans.

4-24. WITHDRAWAL AND DISSEMINATION OF INFORMATION

After reconnoitering, the reconnaissance and control and security elements return to the ORP or to a rally point. Control and security elements remain in position until the reconnaissance elements leave the objective area. Once all elements arrive in the ORP, each element leader debriefs the soldiers. He then moves to the center of the perimeter to give the information to designated recorders. The recorders write the information and make or collect sketches of the objective. Element leaders share the information obtained with the soldiers. This ensures that everyone has the information and, if necessary, can relay it back to battalion. If the platoon leader wants to increase the security of the platoon, he can give the soldiers the information on the move or he can move the platoon away from the ORP to another ORP. If he chooses the latter, he might move one terrain feature away.

Section V. ZONE RECONNAISSANCE

Commanders normally assign a zone reconnaissance to the reconnaissance platoon when they need detailed information before maneuvering their forces through the zone. The reconnaissance provides the commander with a detailed picture of how the enemy has occupied the zone, enabling him to choose the appropriate COA. Zone reconnaissance can be terrain-oriented, force-oriented, or both. The reconnaissance platoon conducts terrain-orientated zone reconnaissance to gain detailed information about routes, terrain, and resources within the assigned zone. This is the most thorough and complete reconnaissance mission and therefore is very time-intensive. The reconnaissance platoon conducts force-oriented zone reconnaissance to gain detailed information about enemy forces within the zone. As the platoon conducts this type of zone reconnaissance, its emphasis is on determining the enemy's locations, strengths, and weaknesses. The techniques and objectives of terrain-oriented and force-oriented reconnaissance are not mutually exclusive. The commander's intent, specifically the focus of the reconnaissance and METT-TC factors, dictates if the platoon conducts these two types of reconnaissance separately or in conjunction with each other.

4-25. TASKS

The reconnaissance platoon must accomplish numerous key tasks during the zone reconnaissance.

- a. **Primary.** Its primary tasks include the following:
 - Find and report all enemy forces within the zone.
 - Reconnoiter specific terrain within the zone.
 - Report information higher.
- b. **Other.** In addition to its primary tasks, the platoon must also conduct other tasks as part of this type of reconnaissance. These tasks may include the following:

- Reconnoiter all terrain within the zone.
- Inspect and classify all bridges within the zone.
- Locate fords or crossing sites near all bridges in the zone.
- Inspect and classify all overpasses, underpasses, and culverts.
- Within capability, locate all minefields and other obstacles in the zone and mark lanes and bypasses.
- Locate bypasses around built-up areas, obstacles, and contaminated areas.

4-26. MOUNTED RECONNAISSANCE TECHNIQUES

Zone reconnaissance is very time-consuming. Unless the orders specify otherwise, all tasks listed in the previous discussion are implied in the zone reconnaissance mission statement. When speed is the primary concern, commanders must modify the mission statement or prioritize the critical tasks for the platoon leader.

a. The width of the zone is determined by the road network, terrain features, anticipated enemy activity, and time available to accomplish the mission.

b. When the reconnaissance platoon leader receives a zone reconnaissance mission, the order defines the zone by lateral boundaries, an LD, and an LOA or objective. The battalion may include additional phase lines or other graphic control measures within the zone to help control the maneuver of the battalion.

c. The platoon leader analyzes the mission to determine what must be accomplished. He analyzes the commander's guidance on focus (the reconnaissance objective: enemy, terrain, or a combination) and tempo (time allowed for mission accomplishment: aggressive, stealthy, deliberate, or rapid). He evaluates any information he has received from the IPB to determine what enemy activity he should expect to encounter. He then analyzes the terrain by conducting a map reconnaissance and by examining any imagery intelligence (IMINT), signal intelligence (SIGINT), HUMINT, or information from other reconnaissance units (for example, RSTA) to determine the types of terrain in which the platoon must operate. This reconnaissance is important in identifying areas the enemy could occupy based on observation capability, fields of fire, and natural obstacles. From these factors, the platoon leader determines the manner in which the reconnaissance platoon will accomplish its mission.

d. The platoon leader completes TLP and develops a COA to accomplish his assigned mission. He may add phase lines on easily identifiable terrain through the zone to help control the maneuver. He places checkpoints in specific areas that must be reconnoitered or where they will aid in controlling the operation. If the terrain is mixed with both extensive dead space and easily identifiable features, he may use boundaries to designate areas of responsibility for each section. He places contact points at critical areas where he wants to ensure that sections maintain contact.

e. The platoon leader works with the battalion FSO to plan indirect fire targets to support the platoon's scheme of maneuver. As a minimum, they should plan targets on known or suspected enemy positions.

f. Depending on applicable METT-TC considerations, the platoon can conduct the zone reconnaissance using a two-section or four-vehicle organization. It must deploy to cover the entire zone. Additionally, the three dismounted teams can operate independently of the vehicles. The platoon usually operates in a zone it knows very little

about, so the COA must allow for flexibility, responsiveness, and security during movement.

g. The platoon leader deploys the reconnaissance sections and teams on line across the LD and assigns each section or team a zone within the zone for which the platoon is responsible. He uses phase lines, checkpoints, or contact points to ensure that the reconnaissance platoon reconnoiters the entire zone. He ensures that the reconnaissance sections remain generally on line to prevent development of significant gaps that a moving enemy could exploit. Platoon members dismount to gather detailed information, reconnoiter danger areas, or move through areas that are not accessible to the vehicles. The reconnaissance platoon continues to reconnoiter the zone until it reaches the LOA or the final reconnaissance objective.

4-27. DISMOUNTED ZONE RECONNAISSANCE TECHNIQUES

Zone reconnaissance focuses on obtaining detailed information concerning routes, obstacles (to include chemical or radiological contamination), terrain, and enemy forces within a zone defined by boundaries. A zone reconnaissance is assigned when the enemy situation is vague or when information concerning cross-country trafficability is desired. A reconnaissance platoon and other reconnaissance elements (infantry platoons or squads) acquire this information by reconnoitering within the zone, by maintaining surveillance over the zone, or by coordinating area reconnaissance of designated locations within a zone. The platoon leader organizes the reconnaissance platoon based on METT-TC. This analysis determines whether the platoon uses single or multiple teams to conduct the reconnaissance. As in an area reconnaissance, the following methods may be used as long as the fundamentals of reconnaissance are applied.

- a. **Single Team.** Single-team reconnaissance is favored when--
 - Specific information requirements can be gathered within the required time by a single reconnaissance element.
 - Control of multiple teams in the objective area is difficult.
 - Terrain is open and visibility is good.
 - Enemy security measures, such as patrols, sensors, and radar, are active in the area.
- b. **Multiple Teams.** Multiple-team reconnaissance is favored when--
 - The area to be reconnoitered is too large for a single team. In this case, the platoon leader uses multiple reconnaissance teams to complete the reconnaissance on time.
 - Several angles of observation are needed.
 - Terrain is difficult and visibility is poor.

4-28. DISMOUNTED RECONNAISSANCE METHODS

The methods used to move multiple reconnaissance elements through a zone are fan, converging routes, and successive sectors. To reduce the possibility of fratricide, effective command and control is important when conducting reconnaissance with multiple elements .

a. **Fan Method.** The element leader selects a series of ORPs throughout the zone. When the element arrives at the first ORP, it halts and establishes security. The element leader selects reconnaissance routes to and from each ORP, with the routes forming a

fan-shaped pattern around the ORP (Figure 4-6). A technique for determining routes is to divide the route into four separate legs. The distance of each leg remains constant with respect to one another. Whatever the initial azimuth is, the leader adds or subtracts 90 degrees. For example, if the initial azimuth is 360 degrees, the corresponding return azimuth is 90 degrees, 180 degrees, and 270 degrees. This ensures that a patrol leaves the ORP in one direction (360 degrees) and returns in another direction (270 degrees). Once the routes are selected and briefed to the team leaders, the teams execute accordingly. The platoon leader may send one or all three teams, or he may send two and keep one team as a reserve. The platoon leader or platoon sergeant can accompany one of the teams or remain at the ORP. The platoon leader also sends the teams out on adjacent routes. This prevents the patrol from making enemy contact in two directions. After the platoon has reconnoitered all the areas (the "fan"), it reports to battalion, moves to the next ORP, and repeats the action.

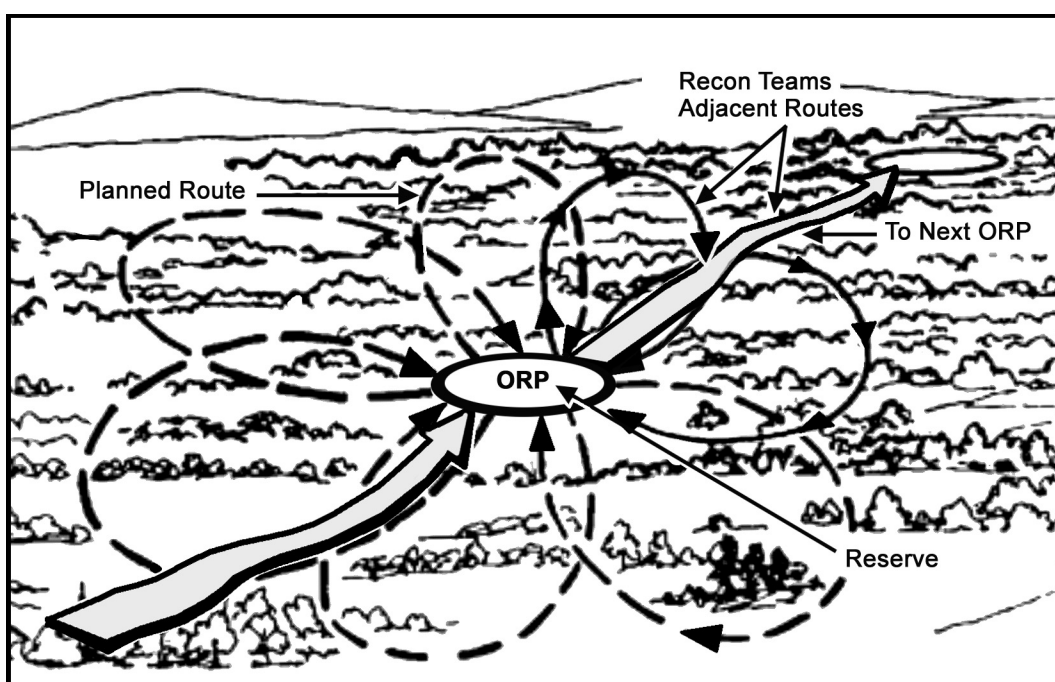


Figure 4-6. Fan method.

b. **Converging-Routes Method.** The platoon leader selects an ORP, reconnaissance routes (through the zone), and a rally point (Figure 4-7). (The rally point is where the platoon links up after the reconnaissance.) Once the platoon arrives at the ORP, it halts and establishes security. The platoon leader confirms the platoon's location and selects a reconnaissance route for each team, a rally point, and a rendezvous time. A team is sent out on each route, which they reconnoiter using the fan method. At a designated time, the entire platoon meets at the rally point, an easily identified terrain feature that is secured the same as the ORP. Once there, the platoon consolidates and disseminates all information obtained. The platoon leader sends the information to higher headquarters and, based on guidance from battalion, returns to friendly lines or continues the mission.

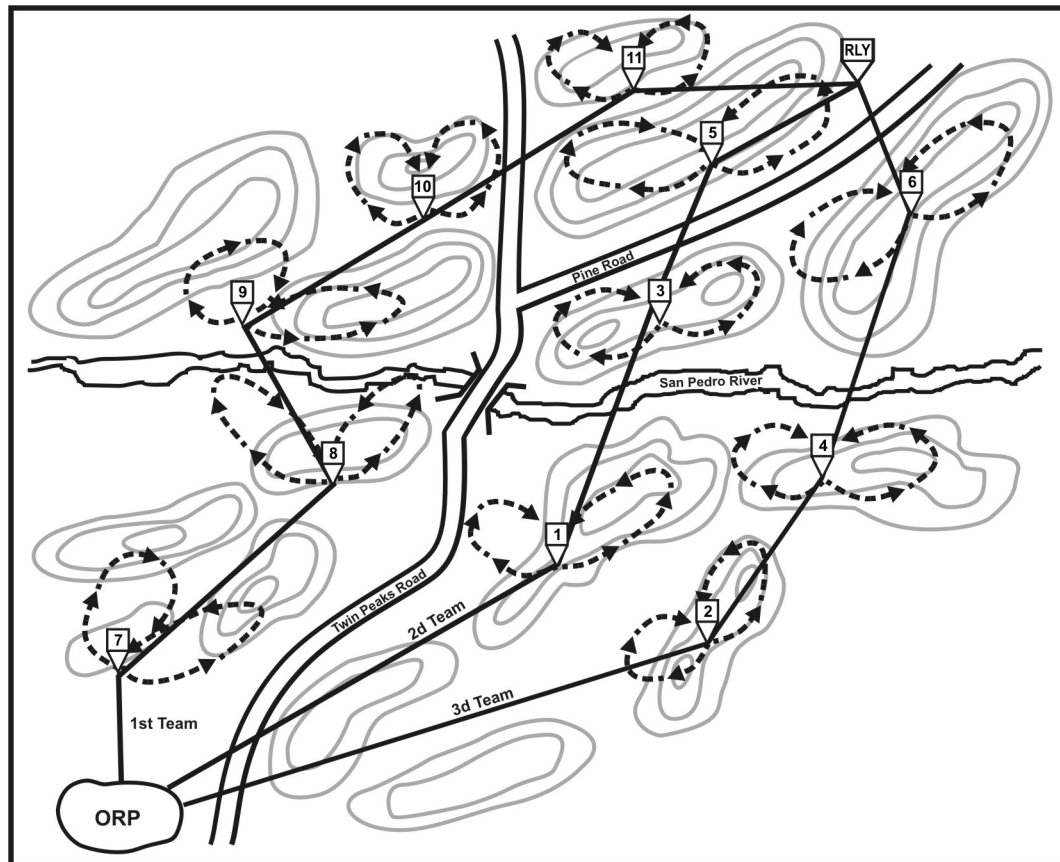


Figure 4-7. Converging-routes method.

c. **Successive-Sectors Method.** The successive-sectors method (Figure 4-8, page 4-24) is a continuation of the converging-routes method. The platoon leader selects an ORP, a series of reconnaissance routes, and rally points. The platoon's actions from each ORP to each rally point are the same as in the converging-routes method. (Each rally point becomes the ORP for the next phase.) When the platoon links up at a rally point, the platoon leader again selects reconnaissance routes, a linkup time, and the next rally point. This action continues until the platoon has reconnoitered the entire zone. The platoon then returns to friendly lines.

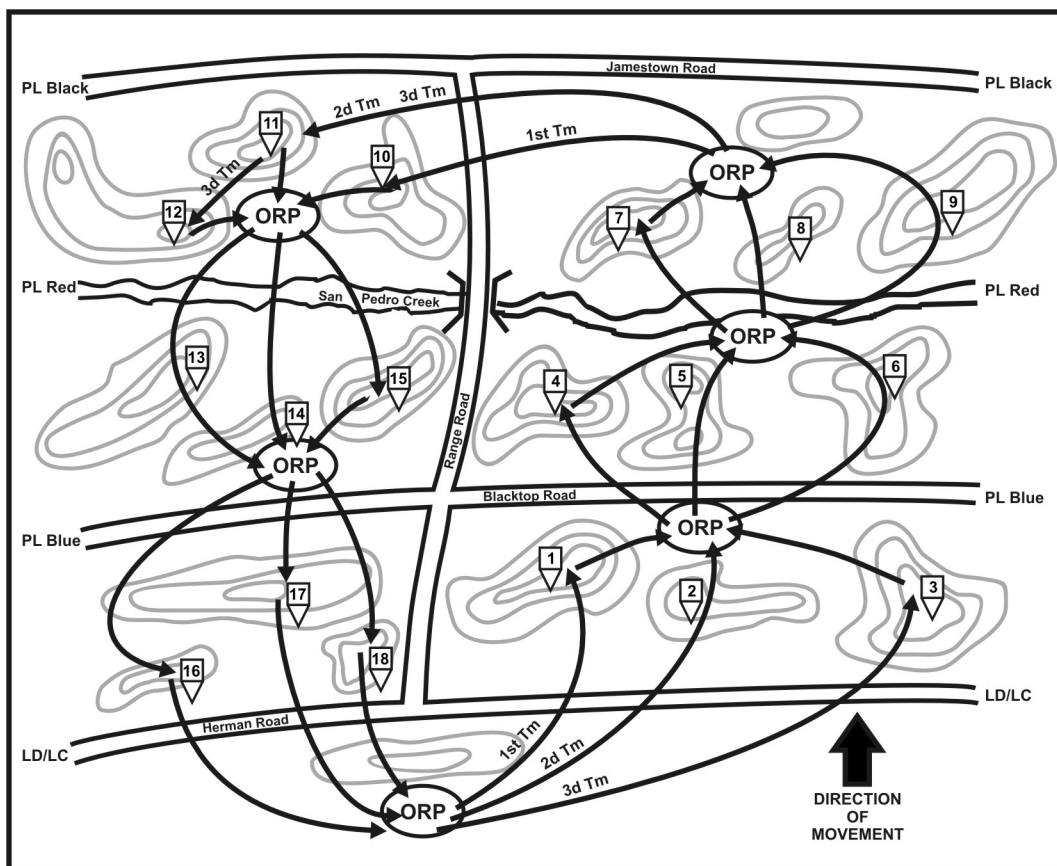


Figure 4-8. Successive-sectors method.

Section VI. ROUTE RECONNAISSANCE

The purpose of route reconnaissance is to provide detailed information on trafficability, enemy activity, NBC contamination, and the adjacent terrain from the viewpoint of both enemy and friendly forces. Route reconnaissance focuses on obtaining information about a specified route and all terrain from which the enemy could influence movement along that route. Route reconnaissance can orient on a road, a railway, a waterway, or a general direction of attack to provide new or updated information on route conditions or activities along the route.

4-29. PURPOSE

The battalion commander orders a route reconnaissance when he needs information on routes to and in his assigned area of operations. Usually, he gives an overlay to the reconnaissance platoon leader along with specific information requirements needed for specific routes. Possible information requirements include the following:

- The available space in which a force can maneuver without being forced to bunch up due to obstacles. This requirement includes the size of trees and the density of forests due to their effects on vehicle movement.
- The location and types of all obstacles and the location of any available bypass. Obstacles can consist of minefields, barriers, steep ravines, marshy areas, or NBC contamination.
- The enemy forces that can influence movement along the route.

- The observation and fields of fire along the route and adjacent terrain. This information assists planners as a supplement to map information.
- The locations along the route that provide good cover and concealment.
- The trafficability for the type of forces using the route.
- The bridges by construction type, dimensions, and classification.
- The landing zones and pickup zones.

4-30. ORGANIZATION

When conducting a route reconnaissance, the platoon leader organizes the reconnaissance platoon based on the factors of METT-TC. Depending on the time available, he conducts a thorough map reconnaissance and plans a series of fans (Figure 4-9) along the route to provide detailed terrain information. (Fans are the preferred reconnaissance method.) The platoon must reconnoiter roads and trails intersecting or traversing the route until they reach terrain where the enemy could influence friendly movement from adjacent terrain.

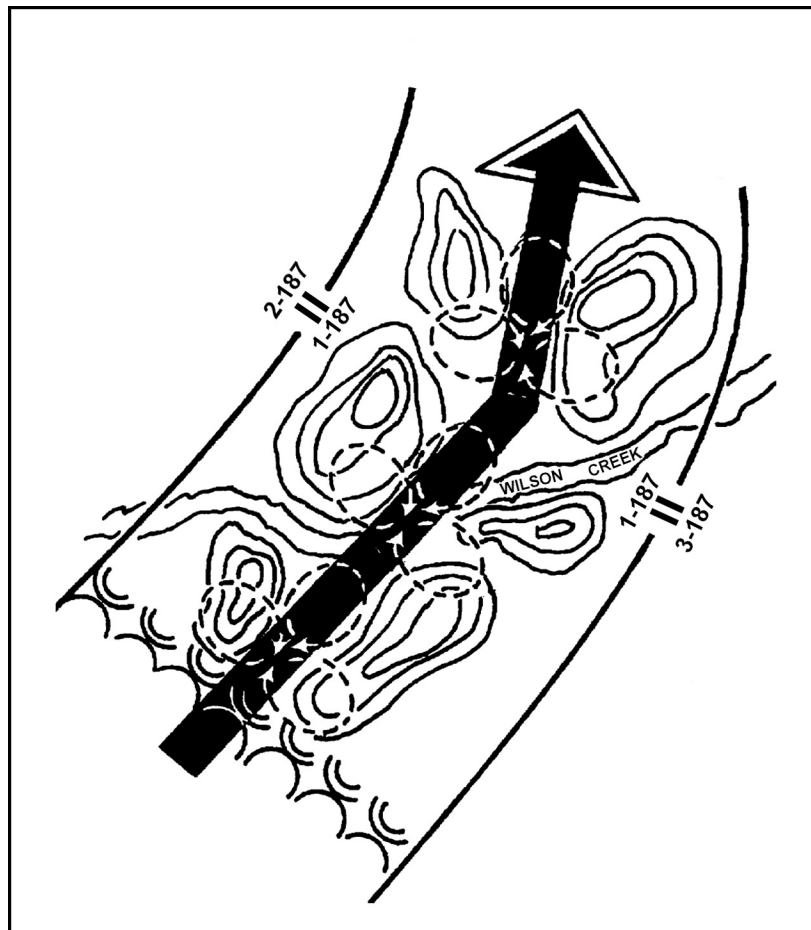


Figure 4-9. Route reconnaissance with fans.

4-31. STEALTH AND SPEED

If the platoon must conduct a route reconnaissance as part of the higher unit's mission, then stealth and speed, in conjunction with detailed intelligence reporting, become key. The reconnaissance platoon must remain far enough ahead of the maneuver force to assist in early warning and to prevent the force from becoming surprised. In this case, the fan method may not be as effective as a modification of the converging-routes method.

4-32. MOVEMENT NEAR ROADS

If all or part of the proposed route is a road, the platoon considers the road a danger area. It moves parallel to the road using a covered and concealed route. When required, reconnaissance and control and security teams move close to the road to reconnoiter key areas.

4-33. ENGINEER SUPPORT

Engineers can support the platoon in collecting technical information. They assist the reconnaissance platoon by clearing obstacles and classifying bridges. (For detailed information on classifying routes and bridges, refer to FM 5-34.)

4-34. ROUTE RECONNAISSANCE OVERLAY

The reconnaissance platoon reports conditions that are likely to affect the friendly movement in accordance with (IAW) the SOP and prepares an overlay of the route. (Figure 4-10 is an example of a route reconnaissance overlay using standard symbols.)

- a. **Required Information.** The overlay must include--
 - Two grid references.
 - Magnetic north arrow.
 - Route drawn to scale.
 - Title block.
 - Route classification formula.
- b. **Additional Information.** The overlay may also include--
 - Road curves having a radius less than 45 meters.
 - Steep grades with their maximum gradients.
 - Road width of constrictions (bridges, tunnels, and so forth) with width and lengths of the traveled ways in meters.
 - Underpass limitations with limiting heights and widths in meters.
 - Bridge bypasses classified as easy, difficult, or impossible.
 - Civil or military road numbers or other designations.
 - Location of fords, ferries, and tunnels, including limiting information.

4-35. EMPLOYMENT CONSIDERATIONS

The following employment considerations apply when planning a route reconnaissance:

- Time.
- Detail of reconnaissance required.
- Accuracy of information on the enemy from the IPB.
- Terrain.

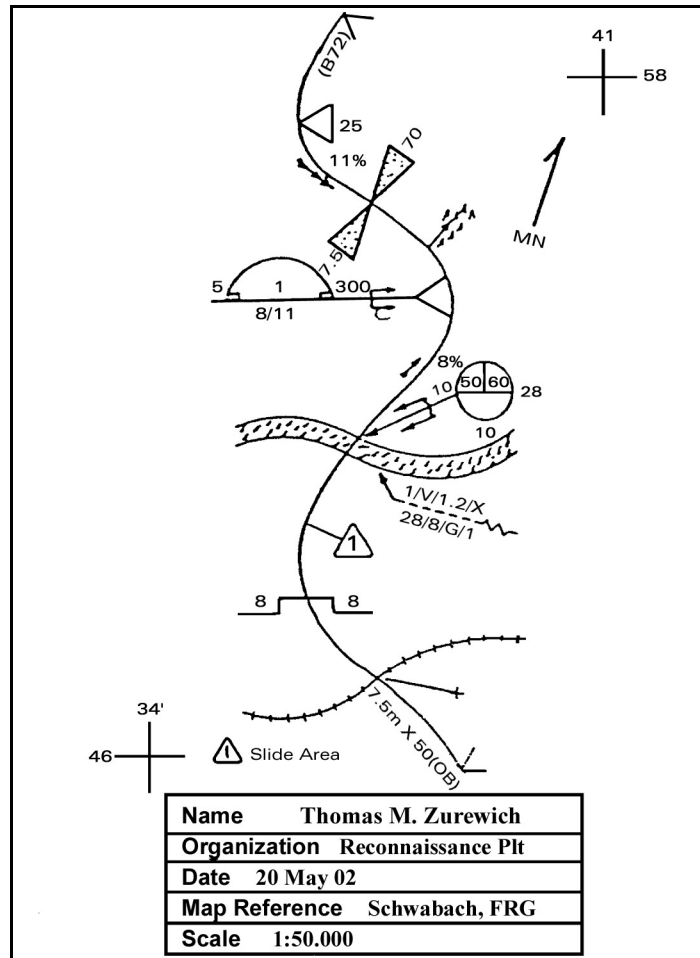


Figure 4-10. Example of a route reconnaissance overlay.

4-36. KEY TASKS

During route reconnaissance, the platoon must be trained for and prepared to accomplish a variety of reconnaissance tasks. Based on factors of METT-TC and the commander's intent, the commander may direct the platoon to conduct reconnaissance for a general purpose or to acquire only specific information. To ensure the platoon is ready for either situation, the platoon leader must be prepared to conduct the following tasks:

- Determine route trafficability.
- Reconnoiter terrain that dominates the route.
- Reconnoiter all lateral routes.
- Reconnoiter all built-up areas along the route.
- Inspect and classify all bridges on the route.
- Locate fords or crossing sites near all bridges on the route.
- Inspect and classify all overpasses, underpasses, and culverts.
- Reconnoiter all defiles along the route.
- Locate minefields and other obstacles along the route.
- Locate a bypass around built-up areas, obstacles, restrictions, and contaminated areas.

- Report route information.
- Find and report all enemy forces that can influence movement along the route.

4-37. TECHNIQUES

The reconnaissance platoon needs to be prepared to conduct two detailed route reconnaissance missions at a time. The following example outlines the aspects of getting all tasks accomplished rapidly and securely:

a. The order the platoon leader receives specifies the route the platoon must reconnoiter and defines the route from start point (SP) to RP. Additionally, the order may specify platoon boundaries, phase lines, LD, and a LOA or reconnaissance objective. These control measures specify how much terrain on both sides of the route the platoon must reconnoiter and where the operation must begin and end.

b. Boundaries are drawn on both sides to include the terrain that dominates the route. This ensures that the platoon reconnoiters all terrain the enemy could use to influence movement along the route. The LD is drawn from one boundary to the other behind the SP. This allows the platoon to cross the LD and be fully deployed before reaching the route. The LOA or objective is placed beyond the RP on the last terrain feature that dominates the route or at a location out to about 3 kilometers. (Figure 4-11 shows some examples of control measures for the route reconnaissance operation.)

c. The platoon leader may add additional phase lines, contact points, and checkpoints to the graphics he receives from the commander. Phase lines help control the maneuver of the platoon. Contact points ensure that the sections or teams maintain contact at particular critical points. Checkpoints along the route or on specific terrain control movement or designate areas that must be reconnoitered.

d. In coordination with the FSO, the platoon leader plans artillery targets on known or suspected enemy positions and on dominant terrain throughout the area of operations. The platoon leader evaluates the factors of METT-TC to select a platoon organization. He ensures that at least one section has responsibility for reconnoitering the route.

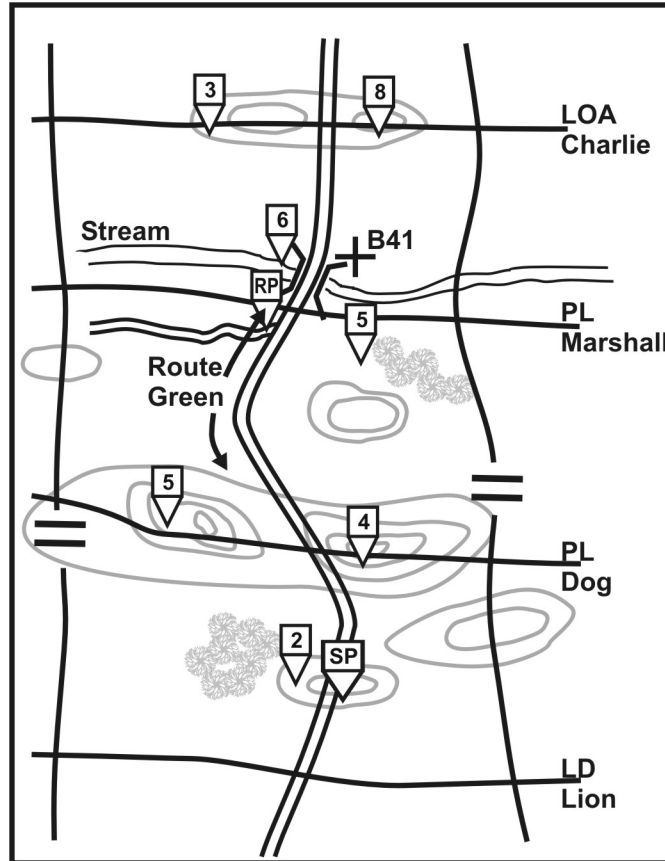


Figure 4-11. Control measures.

Section VII. URBAN RECONNAISSANCE

The platoon collects information from local nationals outside of the urban area to gain information on the objective. Depending on the time available, the platoon develops the urban situation progressively as it moves from the surrounding area toward the city. The platoon leader may refine objectives and routes as he gains and analyzes information. RSTA assets should provide information about the local population to include attitudes and dispositions toward US forces. The reconnaissance platoon then conducts reconnaissance of the urban area. The platoon develops an understanding of the regional, local, and neighborhood-level situation. The platoon members must learn the characteristics of the urban area.

4-38. EMPLOY DISMOUNTED SURVEILLANCE TEAMS

The primary method of employing surveillance teams is in a hide or surveillance site. However, the terrain, mission, and location of the site may dictate that the teams establish a separate surveillance site (or sites) to effectively observe the area.

a. **Personnel Requirements.** Personnel requirements depend on the mission and conditions under which surveillance teams must operate. At least two soldiers are required to conduct surveillance. One observes while the other records the information in the surveillance log. Because observer efficiency decreases rapidly, the observer and the recorder switch duties about every 30 minutes. When using night-vision devices, the observer's initial period of viewing is 10 minutes followed by a 15-minute rest period.

After several periods of viewing, the observation period is extended to 15-20 minutes. Hide site personnel should be rotated every 24 hours.

b. **Surveillance Sites.** During limited visibility, two to three (normally three) members may be required to set up a new surveillance site. The site is near the target area so that information may be collected through close-in observation and sound detection. The remainder of the team stays in the hide site. The surveillance site and the route to and from it are selected during good visibility. Members go in and out of the surveillance site during limited visibility. One member observes, one records, and one maintains security to the rear and flanks. Only passive night-vision devices are used to help prevent detection.

c. **Hide Sites.** The hide site may not be suitable for transmitting reports. When this is the case, a separate communication site is needed. At least two soldiers are required at the communication site; one to send the message and erect an antenna (if necessary) and one to provide security. The communication site is occupied long enough to transmit the message and conceal any signs of the team's presence.

d. **Hasty Sites.** These are sites the team plans to occupy for a short period (generally less than six hours). This occurs most often during target-acquisition missions.

(1) The team makes the best use of natural cover and concealment. It uses manmade camouflage materials as required to improve concealment and keeps movement to a minimum.

(2) Generally, two or three members are positioned forward to observe the target area and record information. The hasty hide site is positioned far enough to the rear so it is out of the direct line of enemy observation. The distance depends on terrain and vegetation. It must be far enough away from the surveillance element so that if an enemy force discovers one of the two elements, the other element has enough standoff to prevent it from being discovered also.

(3) The position allows the elements to fire on the enemy and enables one or both to break contact. Team members in the hasty hide site maintain rear and flank security. Communications are normally conducted after the team moves away from the area.

e. **Urban Surveillance Sites.** Surveillance teams can construct fixed urban hide sites in occupied and abandoned buildings, on water tanks, in shrubbery, on rooftops, or in attics of multistory buildings or other tall structures. If possible, teams should avoid wooden and significantly deteriorated buildings because of the risk of injury from fire and structural failure. Fixed sites should not be in buildings that will attract the enemy's attention but should be in rubble, yards, and gardens. If the site is to be set up in an undamaged part of the urban area, teams select buildings of solid construction with serviceable stairs and basements that can be equipped for the rest and shelter of personnel. Site construction may consist simply of taking a position by a suitable viewing port, or it can be much more elaborate, time being a crucial factor. The team fills windows, doors, and other openings with bricks, fragments of building materials, or sandbags, if available, and removes flammable objects from the premises. If the enemy has previously occupied the building, the team takes precautions against booby traps and mines. When the enemy is near, the team prepares several places in the building for observation and departure.

f. **Hasty Subsurface Sites.** A hasty subsurface site is constructed when there is not enough time to construct a complete subsurface site. The site is especially useful when there is little natural cover and concealment.

(1) Considerations in the employment of hasty subsurface sites include the following:

- Lower profile than surface surveillance sites.
- Better protection against small-arms weapons and indirect fires.
- Excellent camouflage.
- Requirement to conceal soil.
- Time required to construct.
- Construction noise.

(2) Materials that may prove useful in building the position include the following:

- Ponchos or other waterproofing.
- Yetti net or small camouflage net to assist in camouflage.
- Entrenching tool.
- 550 cord or bungee cord.
- Chicken wire (optional).
- Burlap or canvas (optional).
- Sandbags.
- Polyvinyl chloride (PVC) pipe with connectors.
- Fiberglass rod.
- Plywood.

4-39. URBAN PATROLLING

The reconnaissance platoon will not perform building-to-building clearance in urban areas. They may, however, perform urban patrolling to accomplish reconnaissance missions. Urban patrols can be conducted either mounted or dismounted with vehicles in support, depending on the enemy situation. Patrols should never be conducted lower than section level. Detailed planning, as discussed earlier in this chapter, is accomplished before execution of a patrol. Using maps, aerial photography, and any other intelligence, the reconnaissance platoon leader conducts preliminary route reconnaissance to identify the following features:

- Insertion and extraction routes.
- Choke points along the routes.
- Escape and evasion directions or corridors.

a. **Mounted Patrolling.** Mounted patrols capitalize on the mobility of the reconnaissance platoon's vehicles. Mounted patrols never enter an area via the route they will use to exit the area. Vehicles should travel at moderate speeds, with the lead vehicle stopping only to investigate those areas that pose a potential threat or support the essential tasks of the patrol. Use a vehicle speed of 15 to 20 miles per hour to allow for adequate observation and quick reaction. Slower speeds may allow noncombatants or a more aggressive group to impede movement. On the other hand, vehicles should move at high speeds only when responding to an incident. Equipment stored externally on the vehicle should be secured high enough to prevent the problems of locals trying to snatch equipment and weapons. When vehicles must stop the vehicle commander is at the ready, and the driver remains in his seat with the engine running. It is imperative that the

platoon maintains an accurate COP and awareness of the location of other friendly elements during patrols; this includes orientation on other patrols in the urban area. Other mounted urban patrolling principles include the following:

- Ensure mutual support and depth by maintaining constant observation among vehicles.
- Coordinate a supporting fire plan with all units in the area.
- Maintain all-round security.
- Develop a reliable communications plan for mounted and dismounted elements.
- Adjust patrol routes and speed to promote deception and avoid repetitive patterns.

b. **Dismounted Patrolling.** During urban reconnaissance, dismounted patrolling is used to collect information the battalion needs to be successful. Patrols are organized no lower than team level. Leaders of dismounted patrols must maintain communications with vehicles and the patrol headquarters throughout the mission. In the reconnaissance platoon, vehicles must be prepared to react to any situation the dismounted element may encounter. Patrols should avoid areas with large masses of civilians that could quickly turn against the patrol. As with mounted patrols, dismounted patrol leaders must be ready to contact other patrols or supporting elements for support in unfavorable or dangerous situations.

c. **Subterranean Patrolling.** Reconnaissance of subterranean systems can determine enemy use of the passageway, determine subterranean capabilities, or provide support for isolating the urban area. The team leader organizes his patrol with one soldier tasked with security to the front, one point man, and one soldier tasked with rear security. If available, an engineer should assist the team leader in classifying the passageway or eliminating obstacles. The team leader navigates and records data through the passage. Two soldiers remain at the point of entry as a security post. They are responsible for enemy detection and serve as a communications link between the team leader and higher.

(1) The team leader should carry a map or sketch, compass, street plan, and information requirements. A team member should carry the tools needed to open manhole covers. The point man is equipped with night-vision goggles. All soldiers entering the passageway should carry a sketch of the subterranean systems to include magnetic north, azimuths, distances, and manholes. They should also have flashlights, gloves, and chalk for marking features along the route.

(2) In addition to chemical agents, noxious gases from decomposing sewage, especially methane gas, can pose a threat. These gases are not detected by NBC detection systems nor are they completely filtered out by the protective mask. Physical signs (nausea and dizziness) indicate their presence in harmful quantities. Team leaders should be constantly alert to these signs and know the shortest route to the surface for fresh air.

(3) Once the team is organized and equipped, it moves to the entrance of the tunnel. The point man then descends into the tunnel to determine whether the air is safe to breathe and if movement is restricted. The point man should remain in the tunnel for 10 minutes before the rest of the team follows. If he becomes ill or is exposed to danger, the team can use a safety rope to pull him out.

(4) When the patrol is moving through the tunnel, the point man moves about 10 meters in front of the team leader. Other team members maintain five-meter intervals. If

the water in the tunnel is flowing fast or if the subterranean system contains slippery obstacles, the intervals should be increased to prevent all members from falling if one man slips.

(5) The team leader should note the azimuth and pace count of each turn he takes in the tunnel. When the team encounters a manhole to the surface, the point man should open it and determine the location, which the team leader then records. Recognition signals with friendly troops must be coordinated to prevent fratricide as the point man opens the manhole.

(6) Once the patrol has returned and submitted its report, the commander decides how to use the tunnel. Sealing off manhole covers and emplacing obstacles in the tunnel are options for the commander. The patrol's report is converted into an overlay for the urban operations sketch, which is sent to battalion.

4-40. ASSESSMENT OF THE AREA OF OPERATIONS

The platoon leader receives and analyzes the information gathered by the reconnaissance and surveillance teams. He then assesses the area of operations according to the mission and intent of higher headquarters. The assessment includes, but is not limited to, these elements:

- Enemy composition and activity.
- Areas of vulnerability to friendly forces.
- Key terrain.
- Approach routes for mounted and dismounted forces.
- Entry points or points of penetration.
- Support positions for direct and indirect systems.
- Civilian disposition.
- Density and composition of urban area.
- Hazard areas (fuel storage, natural gas lines, chemical production sites).
- Communication facilities.
- Retransmission sites.
- Intent of civilian populace (stay or flee).

4-41. END STATE

The efforts of the reconnaissance platoon can be a critical factor in shaping the urban area of operations and in maximizing the effectiveness of the battalion. A summary of the platoon's tasks in the urban environment includes the following:

- Develop and distribute urban operations sketches.
- Reconnoiter recommended entry points and routes.
- Maintain surveillance on key objectives.
- Conduct target acquisition.
- Assist in isolation of the area of operations by conducting screening operations (or establishing checkpoints) on the perimeter.
- Conduct battle handover with the lead elements of the battalion and pass them into the urban AO.

Section VIII. RECONNAISSANCE OF OBSTACLES AND RESTRICTIONS

One of the common tasks associated with reconnaissance missions is location and reconnaissance of obstacles and restrictions that may affect the trafficability of a particular route or axis.

4-42. TYPES OF OBSTACLES AND RESTRICTIONS

Obstacles can be either existing or reinforcing. These obstacles include--

- Minefields.
- Bridges.
- Log obstacles such as abatis, log cribs, stumps, and posts.
- Destroyed or damaged buildings.
- Antitank ditches.
- Wire entanglements.
- Defiles.
- Persistent agent contamination.

4-43. TASKS

The reconnaissance platoon's ability to deal with an obstacle or restriction is extensive in certain aspects and somewhat limited in others. The reconnaissance platoon has the capability to reduce or breach small obstacles; however, this is generally limited to point obstacles that are not integrated into the enemy defense and are not covered by enemy fire and observation. Such obstacles are usually found along routes and not at enemy strongpoints. When the reconnaissance platoon encounters obstacles that support an enemy defense, it has the capability to assist the infantry with breaching.

a. **Deliberate Obstacles.** Most importantly, the platoon reconnoiters tactical obstacles, including supporting enemy positions, and determines possible breach sites.

b. **Bypasses.** Another important reconnaissance task is to locate bypasses around obstacles and restrictions.

c. **Engineers.** The battalion may task-organize engineer reconnaissance teams to the reconnaissance platoon to aid in obstacle reconnaissance. An engineer squad is often attached to the reconnaissance platoon to aid in reconnoitering obstacles and restrictions. This squad provides expertise in collecting obstacle intelligence (OBSTINTEL) and has limited breaching capability.

4-44. ELEMENTS OF OBSTACLE RECONNAISSANCE

How the reconnaissance platoon approaches obstacle reconnaissance depends on METT-TC factors. In general, however, the following five steps ensure an organized and efficient operation under most METT-TC conditions.

a. **Detection.** During reconnaissance operations, the reconnaissance platoon must locate and evaluate manmade and natural obstacles and restrictions to support the movement of its parent unit. Detection of obstacles and restrictions begins in the planning phase of an operation when the S2 conducts IPB. The reconnaissance platoon combines the S2's work with the reconnaissance conducted during the troop-leading process (normally a map reconnaissance only) to identify all possible obstacles and restrictions within AOs. The platoon leader then plans the reconnaissance based on the orders he receives, the S2's IPB, and the platoon leader's own map reconnaissance.

(1) The reconnaissance platoon uses visual and physical means to detect mines and obstacles while conducting its mission. It visually inspects terrain for signs of mine emplacement and other obstacles. It also must be alert to dangerous battlefield debris such as bomblets from cluster bomb units (CBUs) or dual-purpose improved conventional munitions (DPICMs).

(2) Mines and other types of obstacles can be difficult for mounted elements to detect; therefore, the platoon must also conduct obstacle detection while dismounted. It may need to dismount the vehicles several hundred meters short of a suspected obstacle and approach the obstacle on foot to conduct reconnaissance. The platoon looks for disturbed earth, unusual or out-of-place features, surface-laid mines, tilt rods, and tripwires. It can incorporate vehicle-mounted thermal sights into the search to help detect surface-laid mines.

(3) Physical detection methods include detonating, probing, and using a mine detector. Detection occurs when a vehicle, soldier, or countermine system physically encounters a mine. This method does not indicate the boundaries of the obstacle. The reconnaissance platoon must probe or conduct additional visual inspection to define the extent of the minefield.

b. **Area Security and Reconnaissance.** Enemy forces often cover their obstacles with observation and fire. Whenever platoon members encounter an obstacle, they must proceed with their reconnaissance assuming the enemy can observe and engage them. The reconnaissance element that detects the obstacle establishes overwatch before it proceeds with the reconnaissance. The members in overwatch look out for signs of enemy forces in and around the obstacle or in positions that allow observation of the obstacle. They visually search the dominant terrain on the far side of the obstacle for evidence of enemy positions or ambushes. Once they confirm the enemy situation from the near side, the element not in overwatch moves (mounted or dismounted) to find bypasses around the obstacle. If it finds a bypass, it moves around the obstacle and establish OPs on the far side to provide 360-degree security of the obstacle. If it is unable to find a bypass, it must conduct its reconnaissance from the near side under the security of the overwatch elements.

c. **Obstacle Reconnaissance.** After establishing security, the reconnaissance platoon then moves dismounted to the obstacle. The soldiers take care when reconnoitering it. Trip wires or other signs may indicate enemy usage of booby traps or command-detonated mines to prevent friendly forces from determining pertinent information about the obstacle (OBSTINTEL). The platoon collects all potentially important information, especially information that may help in planning a breach and verifying the enemy template. The reconnaissance element reconnoitering the obstacle prepares an obstacle report with this information and forwards the report through the platoon leader or PSG to the commander. Examples of OBSTINTEL include--

- Obstacle location.
- Obstacle orientation.
- Soil conditions.
- Presence of wire, gaps, and bypasses.
- Composition of complex obstacles.
- Minefield composition, including types of mines.
- Breaching requirements.

- Gaps between successive obstacle belts.
- Location of enemy direct fire weapons.

Before recommending to the battalion commander a possible course of action, the reconnaissance platoon leader analyzes the situation and the factors of METT-TC and considers the following options.

(1) ***Bypass***. A bypass is the preferred technique the reconnaissance platoon uses when it encounters an obstacle. A good bypass must allow the entire force to avoid the primary obstacle without risking further exposure to enemy ambush and without diverting the force from its objective. Bypassing conserves reduction assets and maintains the momentum of the moving unit. If the platoon leader decides to bypass and his commander approves, the unit must mark the bypass and report it to the commander. It may be required to provide guides for the main body if the bypass is difficult to locate or visibility conditions are poor. If the obstacle is part of a prepared defensive position and the only available bypass canalizes friendly forces into an enemy engagement area or ambush, the platoon must find an alternate bypass.

(2) ***Support a Breaching Operation***. When the reconnaissance platoon locates a large obstacle that cannot be easily bypassed, its primary option is to support a breaching operation. The unit performs additional reconnaissance and security tasks as necessary. These may include determining the amount of time and resources required to reduce the obstacle and locating the best available reduction site.

NOTE: If he expects to encounter large obstacles during an operation, the commander may direct engineer reconnaissance teams to move with the unit to determine much of the information needed for breaching.

- (a) The reconnaissance platoon's effort focuses on the following features:
- Fighting positions for support force weapons on the near side of the obstacle.
 - Trafficable routes to the reduction site and routes from the far side leading to the objective.
 - Dispersed covered and concealed areas near the reduction site.
 - Work areas on the near side for reduction assets of the breach force.
 - Fighting positions on the far side once a foothold is established.
 - Positions on both sides of the obstacle that could facilitate enemy observation of the reduction site.
 - Trafficability and soil conditions near the reduction site. (This is especially important for minefield reduction because mine-clearing blades do not work properly in all soil conditions.)
 - Width, depth, bottom condition, bank height, and slope and soil stability of wet and dry gaps.
 - Water velocity of wet gaps.
 - Wind direction for obscuration of the obstacle.

(b) Working closely with engineers makes gathering OBSTINTEL much easier. If he expects to encounter large obstacles during a mission, the reconnaissance platoon leader should request an attached engineer reconnaissance team or, as a minimum, an engineer NCO to serve as a technical advisor.

(c) After the reconnaissance platoon reports the necessary information to the commander, it maintains security of the obstacle and serves as a guide, if necessary, for the breach force. The information it provides is used by the commander and his engineers to prepare the suppression, obscuration, security, reduction, and assault (SOSRA) plans for the breach. The reconnaissance element maintains security during the breaching operation and calls for and adjusts indirect fire, as necessary, in support of the breaching operation. It must be in position to move rapidly through the obstacle once a lane is created so it can continue the mission.

(3) ***Continue the Mission.*** When the reconnaissance platoon encounters a restriction, such as a bridge or defile, it may find that the restriction is not an obstacle to movement and is not covered by enemy fire or observation. The reconnaissance platoon may also discover dummy minefields or obstacles that are incomplete and easily passed through. Under these conditions, the COA may be to report this information and then continue the reconnaissance mission.

CHAPTER 5

SECURITY OPERATIONS

The reconnaissance platoon conducts security operations to protect the main body from observation and surprise attack. These operations provide the main body commander with early warning, allowing him to gain positional dominance and concentrate his combat power at the right place and time to defeat the enemy. There are four types of security missions: screen, guard, cover, and area security. The reconnaissance platoon screens and conducts reconnaissance and surveillance as part of the battalion's counterreconnaissance effort. This chapter discusses the purpose, fundamentals, missions, and TTP of security operations.

Section I. PURPOSE AND FUNDAMENTALS

This section discusses the purpose, fundamentals, and planning considerations of security operations.

5-1. PURPOSE

All security missions serve the same general purpose: they prevent the main body from being observed or attacked unexpectedly by the enemy. This provides the main body with time and space to react and to achieve positional advantage to defeat the enemy. These operations are conducted forward, to the flanks, or to the rear of the main body and may be at extended distances (limited only by communications capabilities and the range of indirect fire support). The reconnaissance platoon can conduct screening and area security operations independently or as part of a larger force.

a. **Screen.** A screening force provides early warning to the main body and impedes and harasses the enemy with direct and indirect fires. Screening missions, which are defensive in nature, provide the protected force with the lowest level of protection of any security mission. Screening missions are conducted to the front, flanks, and rear of a stationary force and to the flanks and rear of a moving force. The reconnaissance platoon generally accomplishes a screening mission by establishing a series of OPs and conducting patrols to ensure adequate reconnaissance and surveillance of the assigned sector. Within its capabilities and based on the commander's guidance, the platoon may suppress enemy reconnaissance units with indirect fires in coordination with other combat elements.

b. **Guard.** A force conducting a guard mission deploys over a narrower front than a screening force. It accomplishes all the tasks of a screening force, with the additional task of preventing enemy ground observation of and direct fire against the main body. A guard force reconnoiters, attacks, defends, and delays as necessary to accomplish its mission. It normally operates within the range of the supporting artillery. Guard operations are not conducted below battalion level. The reconnaissance platoon conducts a screen or conducts reconnaissance for the guard force.

c. **Cover.** A covering force accomplishes all the tasks of screening and guard forces. It also operates apart from the main body to develop the situation early. It deceives, disorganizes, and destroys enemy forces. Unlike screening or guard forces, a covering force is tactically self-contained. It has enough CS and CSS forces to operate

independently of the main body. The reconnaissance platoon conducts reconnaissance and screens in support of a covering force.

d. **Area Security.** Area security missions provide reconnaissance and security in support of designated forces, facilities (including airfields), unit convoys, main supply routes, lines of communications, high value assets, equipment, and critical points. The reconnaissance platoon normally performs an area security operation when conventional security or combat operations would not work. The reconnaissance platoon may perform area security operations as part of a larger force or as an independent platoon mission.

5-2. FUNDAMENTALS

Five fundamentals, described in the following paragraphs, are common to all security missions. The reconnaissance platoon leader's plans must adhere to these fundamentals as the platoon executes its mission.

a. **Orient on the Main Body.** If the main body moves, the platoon must be aware of the move and must reposition its forces accordingly. The platoon must understand the main body commander's scheme of maneuver and where he wants the screening force in relation to his movement. The screen must be positioned where it can provide the needed security.

b. **Perform Continuous Reconnaissance.** The reconnaissance platoon conducts continuous reconnaissance during security operations to gain as much information as possible about the area of operations and the enemy.

c. **Provide Early and Accurate Warnings.** Early and accurate warning of enemy approach is essential to successful operations. The main body commander needs this information to shift and concentrate his forces to meet and defeat the enemy. Reconnaissance elements occupy OPs and conduct patrols to provide long-range observation, to observe enemy movement, and to report the enemy's size, location, and activity to the main body commander.

d. **Provide Reaction Time and Maneuver Space.** The reconnaissance platoon works at sufficient distance from the main body to identify and report on the enemy so the main body commander can react accordingly. The platoon provides additional reaction time and space by employing indirect fires to slow the enemy's rate of advance.

e. **Maintain Enemy Contact.** Reconnaissance elements gain and maintain contact with the enemy to provide the commander with continuous information. If they lose contact, they take steps to regain it. They then maintain contact until ordered to break contact or until they hand over the enemy to another unit.

5-3. PLANNING CONSIDERATIONS

Critical to the reconnaissance platoon leader's ability to execute his mission is a clear understanding of the answers to three basic questions: the focus, tempo, and engagement and or displacement criteria of the security mission. This information comprises the essential commander's guidance, an extension of the commander's intent that is meant to fully clarify the intent for the security mission. The reconnaissance platoon leader receives the essential commander's guidance from higher and then issues it to subordinates within the platoon.

a. **Focus.** The focus of the security mission allows the commander to determine which critical tasks he wants the platoon to accomplish. It helps him narrow the platoon's

scope of operations to get the information that is most important to battalion and brigade operations. In major theater war (MTW) or small-scale contingency operations, for example, the platoon's focus might be on the main body or the enemy force. In stability and support operations, the platoon might focus on determining local populace sentiment or identifying local entity military leaders. While all critical tasks have some degree of applicability in any given operation, certain tasks are more important for specific missions; this must be clearly articulated at each level. Given its focus and a specific amount of time, the reconnaissance platoon accomplishes its specified tasks as instructed by the commander, then moves on to any other tasks within its capabilities.

b. **Operational Tempo.** The tempo of the security mission allows the commander to establish associated time requirements (such as the available planning time) and operational methods (such as dismounted or mounted OPs, reconnaissance patrols, engagement criteria, and triggers for displacement).

c. **Engagement and Displacement Criteria.** The engagement and displacement criteria establish what the platoon is expected to defeat with indirect fires and what it is expected to hand over to the battalion. This is particularly important when the unit conducts counterreconnaissance. At his level, the reconnaissance platoon leader uses his understanding of the commander's intent, coupled with his understanding of the enemy's most likely COA, to determine what he wants the sections or teams to engage. Displacement criteria inform the platoon leader of the events that will trigger the collapse of the mission. He uses these criteria in planning how to occupy the area and in determining when the platoon will execute displacement security drills.

Section II. SCREENING MISSIONS

The infantry battalion uses a screening force in both the offense and defense. Screening forces operate to the front, flanks, and rear of the battalion. The exact size of the screening force depends on the width of its sector in the defense or its zone of attack in the offense. The nature of the terrain and specific tasks to be accomplished also affect the composition of the force. Early warning is always a screening force task. The reconnaissance platoon and designated forces screen as part of the battalion's overall security plan.

5-4. FUNDAMENTALS

Reconnaissance platoons conduct screen missions for the battalion to provide early warning of enemy approach and to provide real-time information, reaction time, and maneuver space for the main body. The battalion commander calls on his reconnaissance platoons to screen for him when he needs advance warning of when and where the enemy is attacking. Operating over an extended area, the platoon fights within its capabilities only to protect itself or to deny enemy elements close-in observation of the main body.

a. **Critical Tasks.** During a screening mission, the reconnaissance platoon must accomplish the following critical tasks:

- Maintain continuous surveillance of all assigned NAIs or high-speed AAs into the sector.
- Provide early warning of enemy approach.

- Within capability and based on commander's guidance, identify enemy reconnaissance units and, in coordination with other combat elements, destroy them.
- Gain and maintain contact with the enemy main body and report its activity.
- Impede and harass the enemy main body by controlled use of indirect fires.

b. **Surveillance.** The reconnaissance platoon maintains surveillance from a series of OPs, either in linear positions or in depth. OPs are positioned where they can best observe designated NAIs and AAs. The screen, normally identified by a phase line or checkpoint on a map, designates the most forward location of the OPs. Commanders must carefully weigh time and distance factors when choosing where to place this line. In executing a screen mission, reconnaissance elements conduct active patrolling to extend their observation range or to cover dead space and the area between OPs. Except for self-defense actions, reconnaissance elements do not fight with their direct fire weapons. (See Section IV for a discussion of observation posts.)

5-5. SEQUENCING AND PRIORITIZATION

When planning a screen mission, the reconnaissance platoon leader uses the critical task requirements covered in the following discussion as a guide to prioritize and sequence the mission. He must address each requirement.

a. **Conduct Surveillance of Assigned Areas.** The first task that must be accomplished is to provide surveillance of the assigned area of operations.

b. **Surveillance Requirements.** Generally, reconnaissance elements are assigned to screen along a lateral line (the screen line). This can be misleading, however. The reconnaissance screen is actually set to observe specific AAs or, more specifically, NAIs. The screen line merely indicates the limit of the forward positioning of the reconnaissance elements. Along with the screen line graphic, the reconnaissance platoon leader must have an event template or matrix; he may also have a decision support template.

(1) Either the reconnaissance and surveillance plan the platoon leader receives or the OPORD from battalion should identify the areas the platoon is tasked to observe. If the platoon does not receive an IPB product, the battalion OPORD must specifically state where to focus and what indicator the platoon is looking for during the screening operation. If it assigns multiple requirements to the platoon, the battalion must prioritize them.

(2) The platoon leader's understanding of the commander's intent and guidance is the most critical aspect of planning the screen mission. The focus of what to look for is more important than the specifics of where to orient the focus. There are three choices for this focus: the enemy main body, the enemy reconnaissance effort, or both. The intent should specify which one the reconnaissance elements will focus on or, if both are required (as is often the case), which has priority.

(3) The commander's intent and guidance then determines where the platoon will orient and how it will allocate resources. If the commander's priority is locating the main body, the platoon may focus most of its assets on the main avenues of approach and accept risk on the enemy reconnaissance route. If the commander's priority is counterreconnaissance, the platoon focuses on the enemy reconnaissance route and accepts some risk on the main avenue. If the commander wants both, with equal priority,

the platoon must plan to transition from the enemy reconnaissance route to the main avenue at a designated point in the battle. The commander usually orders this transition based on the enemy situation.

NOTE: An enemy reconnaissance route may mirror or parallel the intended route of an enemy maneuver force, or it may follow a route that facilitates observation of key terrain or friendly forces but is unrelated to the enemy scheme of maneuver.

c. **Surveillance Assets.** Once the reconnaissance platoon leader has a thorough understanding of what his surveillance requirements are, he must next determine what assets he has available to execute these requirements. Availability of assets depends on how long the screen must remain in place and how the platoon is task-organized. Among the assets that can enhance the platoon's surveillance capability are GSR teams, infantry teams, engineer reconnaissance teams, artillery forward observers, and TUAV assets. If the screen will be of short duration (less than 12 hours), individual reconnaissance teams can emplace and man separate OPs. If the duration of the screen is unknown or longer than 12 hours, the platoon leader must task-organize to facilitate continuous operations.

5-6. SURVEILLANCE TECHNIQUES

To ensure that the critical task of surveillance of assigned reconnaissance objectives is accomplished, the platoon leader and his higher headquarters apply a combination of techniques to make the most efficient use of their assets.

a. **Task Organization.** The platoon leader task-organizes the platoon and any other assigned assets to achieve the most effective surveillance of an NAI or avenue. He may also employ assets not under his direct control but under control of the battalion or brigade. As noted, these assets could be engineer teams, infantry teams, GSR, artillery observers, and TUAV assets.

(1) When the platoon leader does not control the assets directly, he should synchronize all elements on the screen to ensure he best utilizes his assets to accomplish the mission. He must also ensure that all members of the platoon understand where these forces are and what role they are playing.

(2) The platoon leader may use the surveillance assets in a number of ways. These may include adjusting the number of reconnaissance sections or teams into a task-organized surveillance team; mixing reconnaissance elements and other assets such as engineers, artillery, GSR, or infantry into the same team; or maintaining elements in pure teams under the platoon leader's control. The platoon leader must consider the characteristics of the NAI or avenue of approach when task organizing for surveillance. These considerations determine whether the platoon will need to call for fire or conduct dismounted patrols; they also affect the field of view and applicability of GSR and TUAVs. Figure 5-1, page 5-6, illustrates how the reconnaissance platoon might be task-organized for surveillance operations.

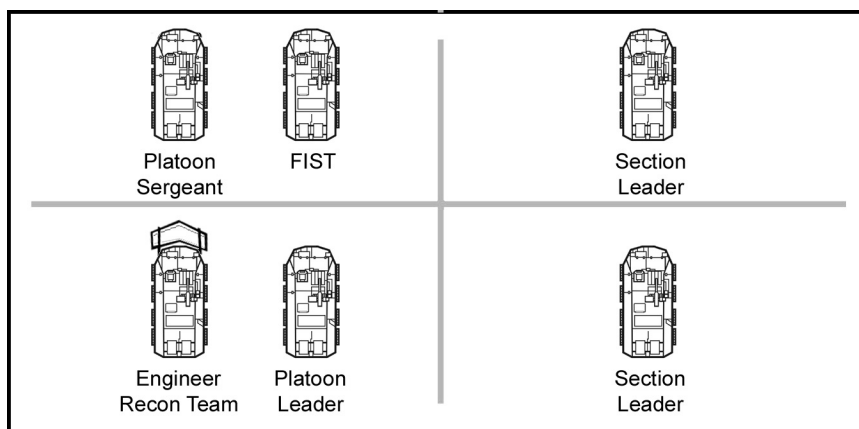


Figure 5-1. Sample reconnaissance platoon task organization.

b. **Redundancy.** The platoon leader may task more than one element to observe a particular assigned NAI or avenue. He does this based on the nature of the NAI or avenue in terms of size, terrain, or importance. For example, a very large avenue of approach may require multiple observation assets to ensure all aspects of the avenue of approach are covered. Terrain that is very broken or mixed with areas of thick vegetation may require more than one asset. Finally, if a particular NAI is assigned significant priority by the commander, the reconnaissance platoon leader may assign multiple elements to cover it. Redundancy not only ensures that an NAI or avenue is adequately observed but also enables the unit to accomplish the mission even if some assets are compromised by enemy forces. Figure 5-2 illustrates redundancy of observation assets.

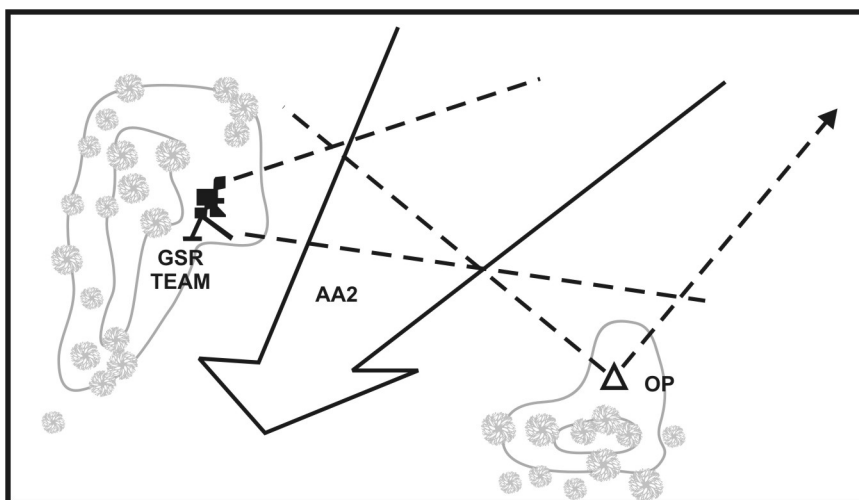


Figure 5-2. Redundant coverage of an avenue of approach.

c. **Cueing.** Cueing is a technique the reconnaissance platoon leader can use to cover an NAI or avenue when assets are limited and he lacks the capability for redundancy. He plans contingency tasks that will increase surveillance on a particular NAI; his surveillance teams execute the tasks when “cued” by activity at that NAI. The NAI or avenue is covered initially either by a single surveillance team or by a remote or electronic signaling device such as a trip flare (Figure 5-3) or the platoon early warning

system (PEWS). When activity is detected, other teams move into preselected positions to add their capabilities to the surveillance of the NAI or avenue.

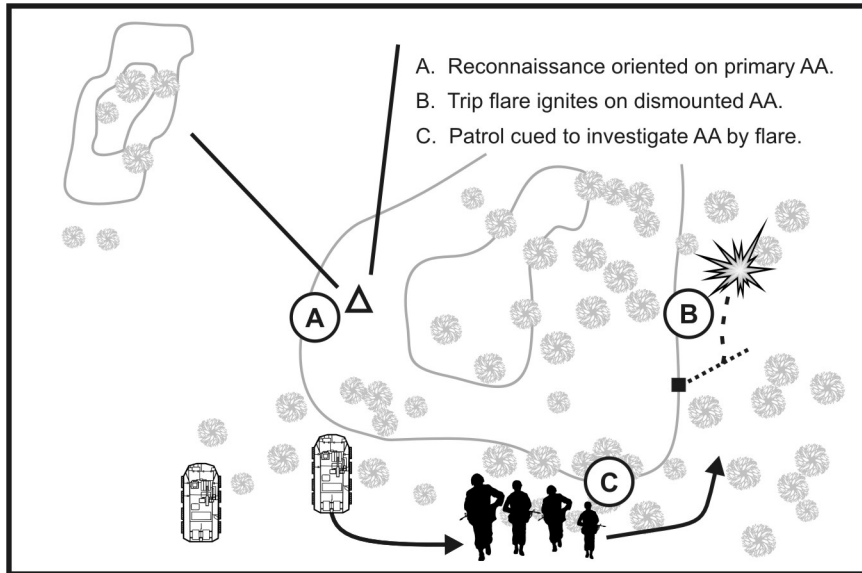


Figure 5-3. Use of trip flare to cue a patrol.

d. **Early Warning.** The reconnaissance platoon provides early warning of an enemy approach. Effective early warning requires detailed communications planning. The platoon leader looks at communications distances and significant terrain features to identify potential communications problems. If he anticipates problems, he can request support from higher in the form of battalion retransmission (retrans), or he can plan for radio relays and directional antennas (Figure 5-4).

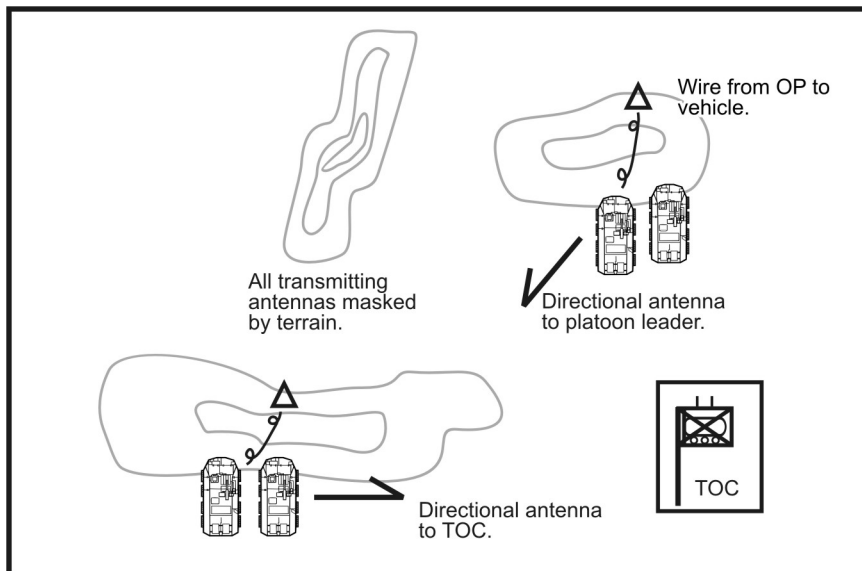


Figure 5-4. Platoon communications setup.

e. **Counterreconnaissance.** After planning surveillance and ensuring he can provide early warning, the platoon leader evaluates the enemy's reconnaissance effort and the platoon's assigned counterreconnaissance role. Counterreconnaissance operations consist of two elements: finders and killers. Normally, the platoon's counterreconnaissance role includes finding enemy reconnaissance assets rather than killing them.

(1) The commander's guidance specifically defines the role of the reconnaissance platoon in counterreconnaissance operations. The reconnaissance platoon leader seeks to thoroughly understand the commander's intent. He considers several factors in acquiring enemy reconnaissance elements:

- Enemy reconnaissance routes.
- Expected time for encountering enemy reconnaissance forces.
- Expected conditions for encountering enemy reconnaissance forces.
- Size of the enemy reconnaissance forces.
- Organization of the enemy reconnaissance forces.
- Equipment of the enemy reconnaissance forces.
- Identity of friendly killing forces.
- Location of friendly killing forces.

(2) Enemy reconnaissance forces seldom use primary AAs to execute their mission. To acquire their assigned reconnaissance objectives, reconnaissance elements must orient on trails, rough terrain, and dead spaces that allow mounted movement, but only for small teams of vehicles. Enemy reconnaissance elements typically move during darkness and periods of limited visibility. Knowing the composition of enemy reconnaissance elements helps the reconnaissance platoon more accurately determine the enemy's likely routes and how best to acquire them.

(3) Other battalion or brigade elements receive the specific mission of killing enemy reconnaissance. Once the reconnaissance platoon locates enemy reconnaissance elements, it must use its thorough knowledge of the terrain and of the location and capabilities of the friendly killing force to coordinate battle handover of the enemy forces.

(4) The counterreconnaissance task is extremely resource-intensive. It is generally most effective when conducted by an element larger than the reconnaissance platoon. The reconnaissance platoon does not have sufficient assets to both acquire and defeat the enemy unless augmented by battalion. In addition, it may not be able to cover all enemy reconnaissance routes and still maintain surveillance on the enemy's main avenues of approach. The commander's intent is critical to resolving this dilemma.

(5) When the reconnaissance platoon must acquire both enemy reconnaissance elements and the main body, the priority in the early stages of the mission will be on the reconnaissance forces, focusing on the reconnaissance routes. The platoon will then track the echeloned arrival of enemy elements on the battlefield and shift priority to the main avenues of approach at the appropriate time. This technique permits the platoon to time-phase its priorities based on battlefield conditions. The platoon leader, however, must recognize when to change priority to the main avenue and then execute the change successfully (Figures 5-5 and 5-6).

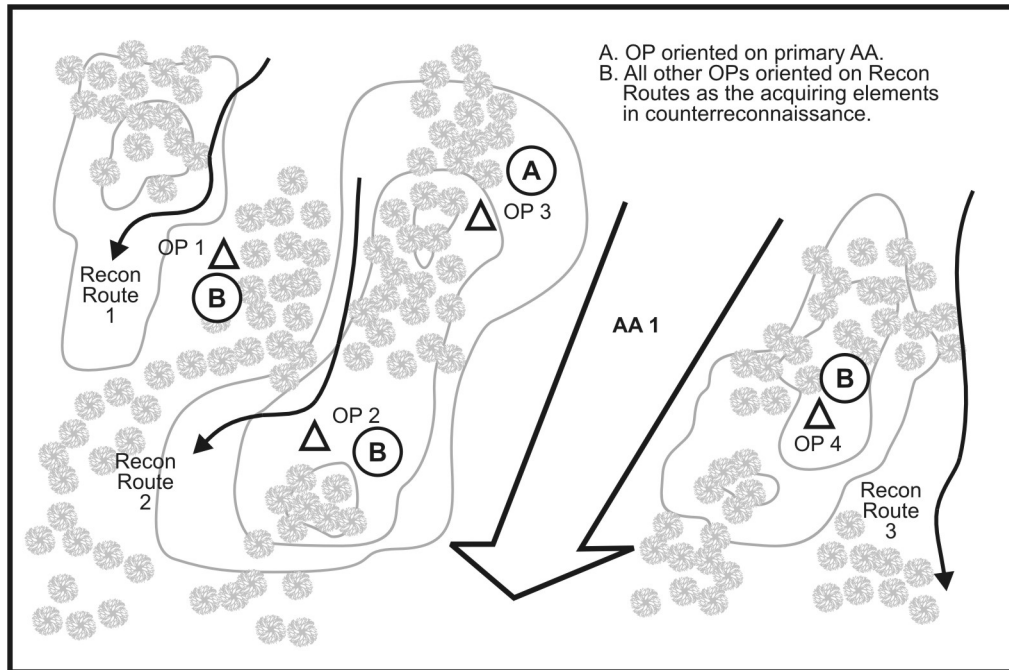


Figure 5-5. Change of screen priority (initial priority to counterreconnaissance).

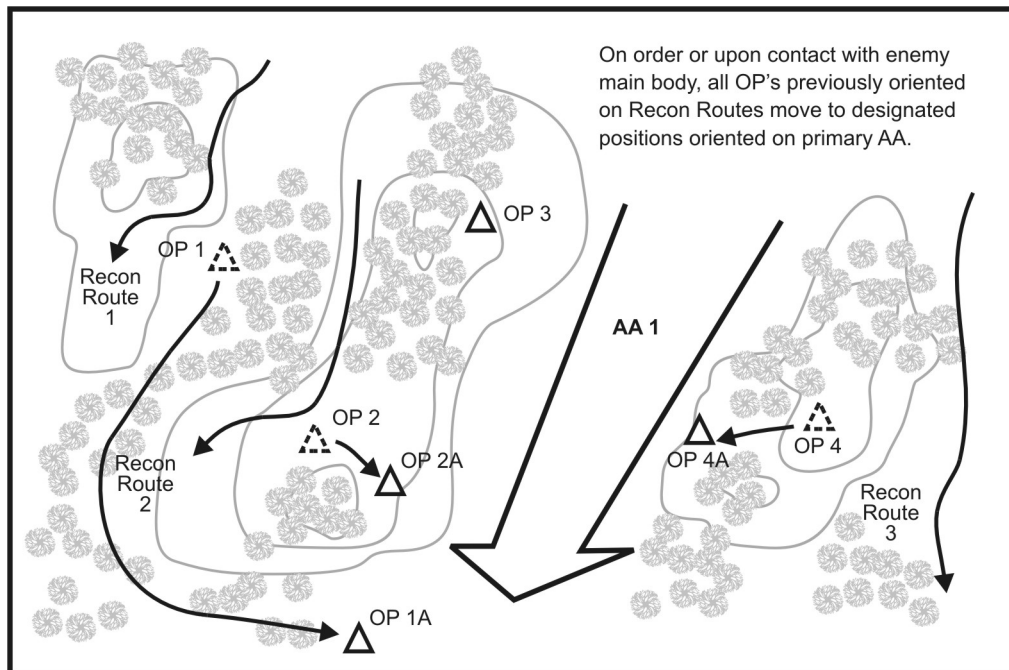


Figure 5-6. Change of screen priority (initial priority to main avenue of approach).

f. **Maintaining Contact.** After locating the enemy's main body, the reconnaissance platoon maintains contact until authorized to hand over contact to another friendly element. Such a handover remains one of the most difficult tasks for the individual

reconnaissance vehicle section or dismounted section to accomplish and is best accomplished through a platoon effort.

(1) The preferred method to maintain contact with a moving enemy main body is to position echeloned OPs in depth along the avenue of approach (Figure 5-7). This allows the OP to hand off contact to another OP without having to physically displace. This technique works only if the reconnaissance platoon has enough assets to pre-position the OPs in depth.

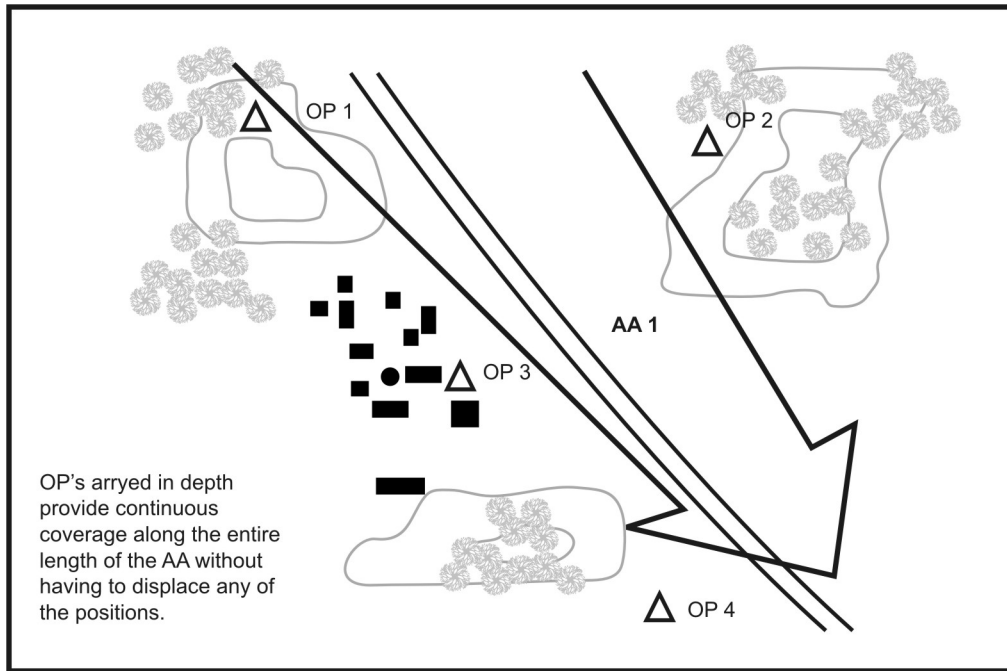


Figure 5-7. Positioning OPs in depth.

(2) Another technique to maintain contact is to displace in front of a moving enemy. This technique is very difficult because the reconnaissance elements must move to the rear faster than the enemy moves forward. This often exposes the reconnaissance forces to enemy fire. Additionally, if reconnaissance elements attempt to use only covered and concealed routes, they risk moving too slowly, being overrun or outrun by the enemy, and losing contact. Figure 5-8 illustrates how reconnaissance elements can conduct displacement while maintaining contact.

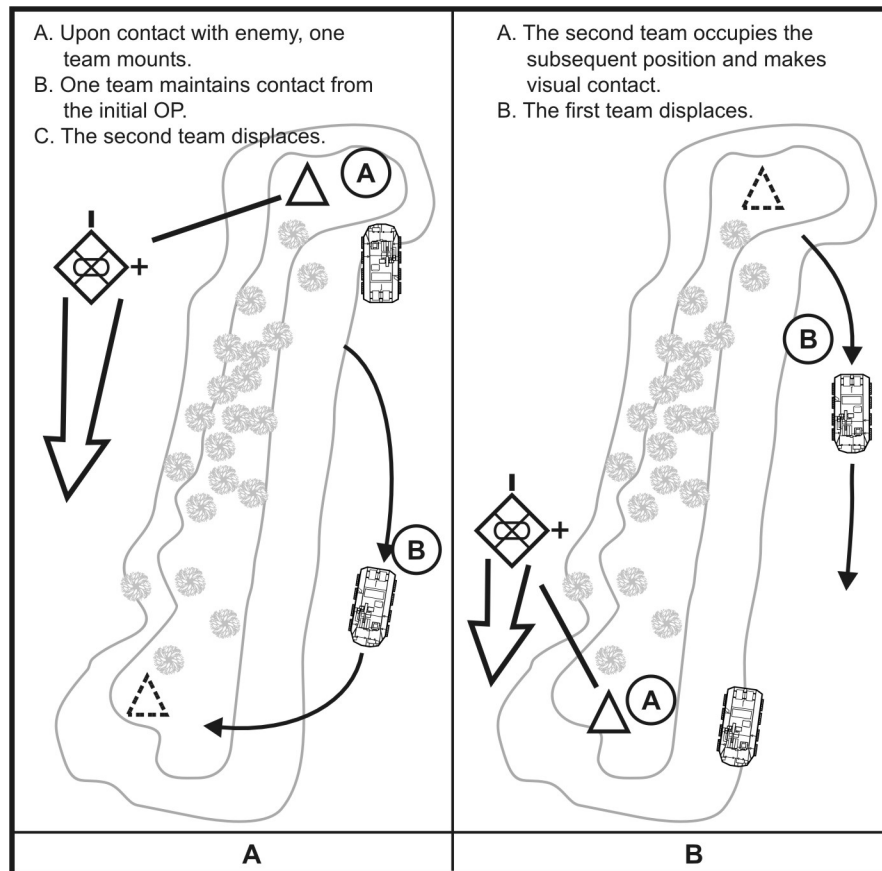


Figure 5-8. Displacement while in contact.

(3) A third technique combines the two previous techniques. Leaving the original dismounted OP in position (with a vehicle in support, if possible), the reconnaissance forces detach a vehicle or vehicle section. They reposition it in depth as either a mounted or dismounted OP. They can establish or reorient this OP to maintain contact until they can hand off the enemy force to a maneuver element. This technique reduces both the time associated with moving OPs and the likelihood of compromising any reconnaissance element (Figure 5-9, page 5-12).

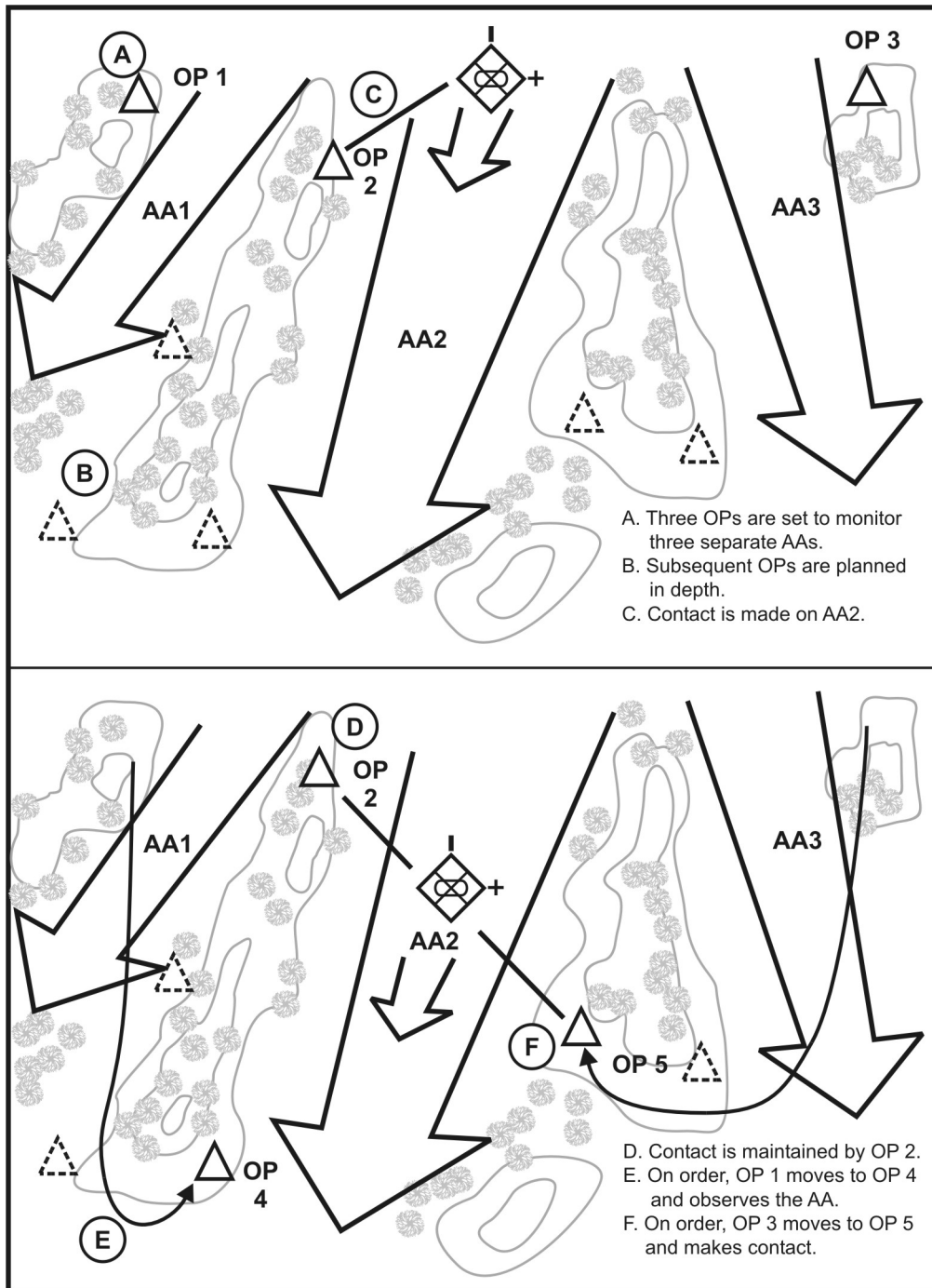


Figure 5-9. Repositioning OPs in depth.

g. **Harassing and Impeding.** The reconnaissance platoon should try to harass and impede the enemy using indirect fire. Engaging a moving armored element with indirect fire is difficult. The reconnaissance platoon leader plans carefully, focusing on expected avenues of approach, choke points, the enemy rate of march, and artillery time of flight. He can then determine trigger lines (or points) for accurate enemy engagement.

h. **Accurate Artillery Fire.** Accurate artillery fire immediately affects the enemy main body. Artillery fire disrupts formations; individual enemy vehicles change speed,

button up, or are destroyed or disabled. Command and control deteriorates as the smoke and dust of battle restrict vision and as antennas stop working. This loss of vision and command and control restricts the enemy's ability to spot displacing friendly forces. Also, if he tries to find the element directing the fire, the enemy may compromise his momentum and combat power.

5-7. COUNTERRECONNAISSANCE TECHNIQUES

Counterreconnaissance is a directed effort to prevent visual observation or infiltration of friendly forces by enemy reconnaissance elements. It is a task of all reconnaissance platoon security missions. Countering the enemy's mounted and dismounted reconnaissance elements is the first and possibly most important step in ensuring the main body can successfully execute its mission. At the same time, it can be extremely difficult to identify enemy reconnaissance forces, especially when they are dismounted. The reconnaissance platoon may lack this capability. As a result, this task is most successfully executed when it is approached as a combined arms effort at battalion level.

a. **Planning Considerations.** The battalion concept of executing counterreconnaissance must address how the unit will accomplish the two aspects of counterreconnaissance: acquiring the enemy and then killing it. The battalion S2 provides key input in this determination. He identifies where enemy reconnaissance routes into the unit sector are located, what type of enemy reconnaissance elements might be used in the sector, and when they are most likely to move into the sector.

(1) The battalion commander should discuss conduct of counterreconnaissance in the OPOD or FRAGO, indicating in tactical terms how elements will organize and conduct the operations throughout the depth of the area of operations. This information should include planning considerations for the operation to include--

- Direct fire planning and coordination.
- Observation planning and coordination.
- Command and control.
- Battle handover.

(2) In all counterreconnaissance operations, the goal is to destroy the enemy reconnaissance forces after they have penetrated the initial screen line. The reconnaissance platoon's role in these operations is usually to conduct a screen mission to acquire and identify enemy reconnaissance forces. This requires that the acquiring elements of the platoon be well hidden to prevent the enemy from detecting the screen line. In most cases, the reconnaissance platoon does not have the capability to acquire, identify, and defeat the enemy reconnaissance by itself. Other combat forces from other battalion or brigade elements must fight and destroy the enemy reconnaissance elements.

b. **Organization.** Several organizational options, which are described in the following paragraphs, are available to the commander to counter the enemy reconnaissance effort.

(1) **Reconnaissance Platoon.** This technique puts the entire burden for counterreconnaissance on the reconnaissance platoon and attached combat and combat support assets. It requires maximum use of the CS assets to acquire the enemy, freeing the reconnaissance platoon to perform the killing function of counterreconnaissance. The reconnaissance platoon leader places acquiring assets along the screen line and positions his designated killing teams in depth. The killing assets of the platoon occupy positions

on likely enemy reconnaissance routes; however, they must be flexible to respond to enemy elements moving on other routes. This technique requires that the platoon's sections or teams reconnoiter alternate positions and routes that permit quick repositioning once the acquiring elements make contact. With this organization, counterreconnaissance tasks must be prioritized in the early stages of the screen mission.

(2) ***Reconnaissance Platoon and MGS or Infantry Platoon or Section***. The team technique requires the close integration of a reconnaissance platoon and an MGS or infantry element to execute counterreconnaissance tasks. The reconnaissance platoon is the acquiring element, and the MGS or infantry element is the killing element. The reconnaissance platoon leader, as leader of the element that makes first contact, commands the counterreconnaissance effort; the killing element is placed OPCON to the reconnaissance platoon. The battalion commander may decide to control and coordinate this effort or may designate one of the infantry companies to execute the operation.

(3) ***Killing***. The reconnaissance platoon acquires the enemy using surveillance techniques. The killing elements occupy a battle position (BP) along likely reconnaissance avenues, but they are prepared to move to alternate positions based on reports coming from the reconnaissance platoon. This organization is most effective when the elements establish a habitual relationship. (Refer to Figure 5-10 for an illustration of this technique.)

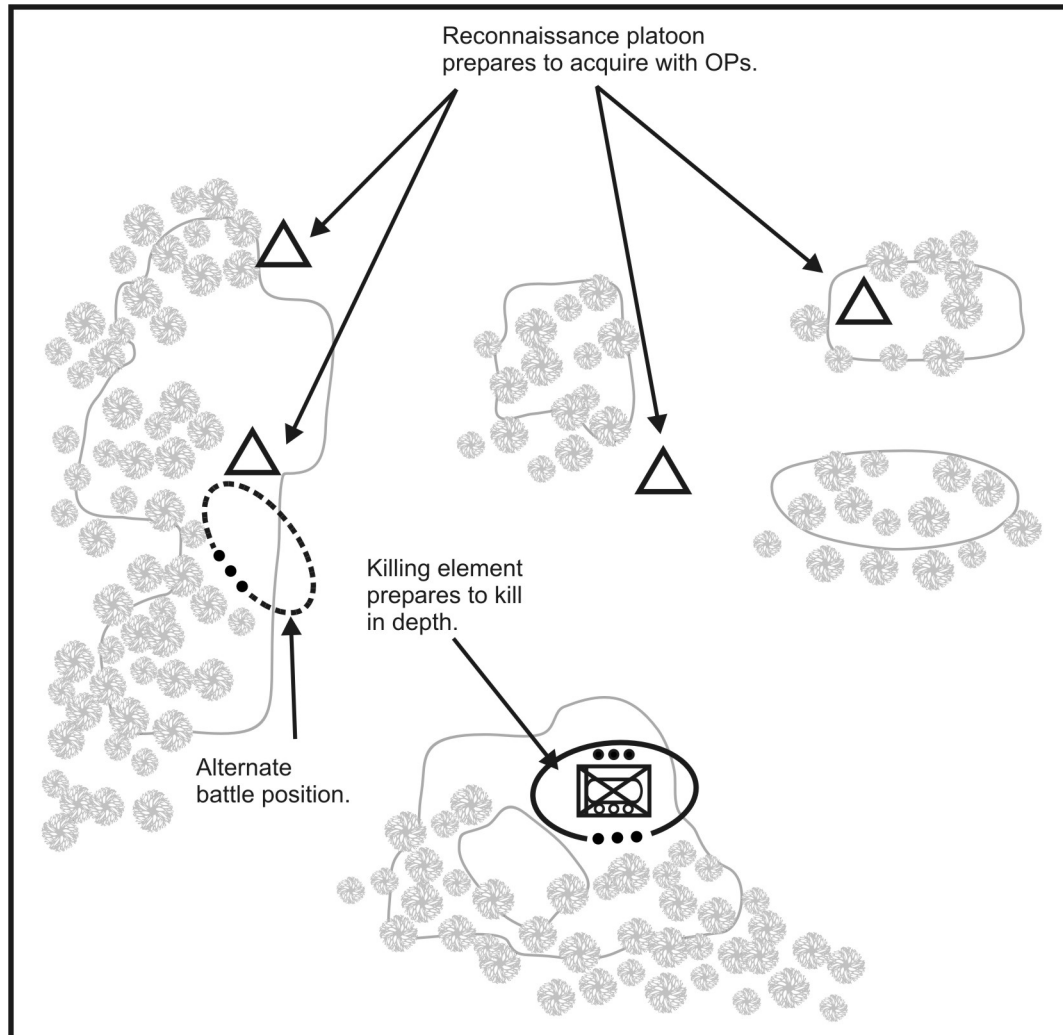


Figure 5-10. Reconnaissance and MGS/infantry team counterreconnaissance array.

Section III. AREA SECURITY OPERATIONS

Area security operations protect specific critical and vulnerable assets or terrain from enemy observation and direct fire. They can consist of escorting friendly convoys; protecting critical points such as bridges, command and control installations, or other key and vulnerable sites; or participating in protection of large areas such as airfields. The platoon normally performs an area security operation when conventional security or combat operations would not work. The reconnaissance platoon may perform area security operations as part of a larger force or as an independent platoon mission.

5-8. HIGH-VALUE TARGETS

Reconnaissance platoons normally conduct area security missions to protect high-value targets. Whether and how much protection the target requires depends on METT-TC. The reconnaissance platoon leader must integrate his elements into the overall security plan for the area he must protect. Area security operations rely on various techniques. They may include reconnaissance, security, defensive tasks, and offensive tasks.

a. When deploying for area security, the platoon generally moves into a coil formation around the point, area, or asset it must secure. It orients vehicle positions on likely enemy avenues of approach. If the platoon has engineer support, the engineers dig in the vehicle positions; if not, the vehicles occupy hasty fighting positions.

b. To further improve the position, the reconnaissance platoon employs hasty protective minefields, wire, and other obstacles, as appropriate and available. It emplaces wire obstacles outside grenade range of friendly positions. Once it sets up vehicle positions and obstacles, the platoon develops a fire plan. This plan includes integrated indirect fires. It submits the plan to higher headquarters.

c. In addition to setting up the reconnaissance platoon position around the asset to be secured, the platoon also employs patrols and OPs to enhance security (Figure 5-11). Reconnaissance patrols and combat patrols learn the AO, gain information on enemy forces, and destroy small dismounted enemy reconnaissance elements. The platoon deploys OPs to observe likely avenues of approach, to provide early warning of enemy activity, and to aid in control of indirect fires.

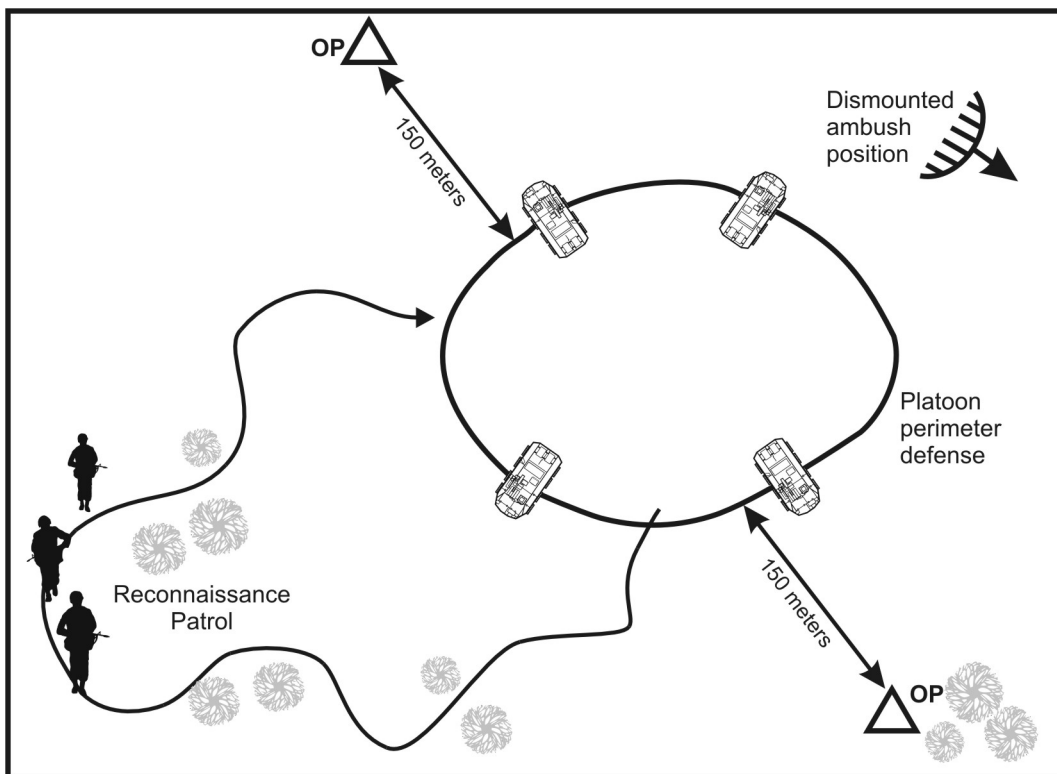


Figure 5-11. Platoon area security dispositions.

5-9. CONVOY AND ROUTE SECURITY

A company or larger organization usually performs convoy or route security missions. Convoy security provides protection for a specific convoy. Route security aims at securing a specific route for a designated period of time, during which multiple convoys may use the route. These missions include numerous tasks (such as escort, reconnaissance, and combat reaction forces) that become missions for subordinate units. The size of the unit performing the convoy or route security operation depends on a

number of factors, including the size of the convoy, the terrain, and the length of the route.

a. **Route Reconnaissance.** When the reconnaissance platoon conducts a route reconnaissance as part of a route security operation, it is done in the same manner as discussed in Chapter 4 of this manual. In this mission, the reconnaissance platoon leader focuses on the route's trafficability and on enemy forces that might influence the route. The reconnaissance platoon must plan to call for engineer assets to aid in breaching point-type obstacles. Command-detonated devices pose a major threat during route reconnaissance.

b. **Echeloning OPs.** Echeloning OPs is a technique used during route security to screen the route after it has been reconnoitered. Its use is similar to the technique for reconnaissance operations covering lateral and boundary routes.

(1) All elements of the platoon OPs are part of route security to help secure the route or convoy. The platoon employs OPs on critical portions of the route or on key avenues of approach to the route. The OPs provide early warning if an enemy element tries to interdict the route or convoy.

(2) Echeloning OPs differs from a conventional screen in that OPs orient on the route rather than on the friendly main body (Figure 5-12). OPs have little ability to destroy small enemy forces that try to influence the route. They acquire the enemy and then direct either reaction forces or indirect fire to destroy the enemy.

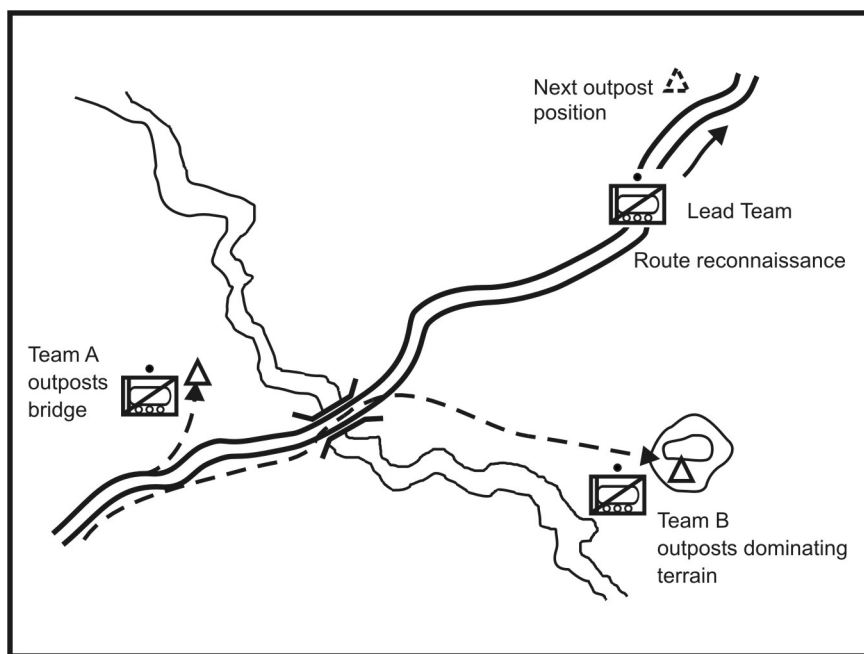


Figure 5-12. Reconnaissance platoon echeloning OPs.

c. **Convoy Escort.** The reconnaissance platoon may perform a convoy escort mission either independently or as part of a larger unit's convoy security mission. The convoy escort mission requires that the platoon provide the convoy with limited close-in protection from direct small arms fire. Platoon vehicles include military CSS and C2 vehicles. Leaders must carefully evaluate the enemy before assigning a convoy escort

mission to reconnaissance platoons. The following considerations apply during convoy escort operations.

(1) **Command and Control.** Command and control is especially critical during convoy escort because of the task organization inherent to the mission. If the battalion commander expects the reconnaissance platoon to engage in combat operations, he places the reconnaissance platoon under the convoy commander's control during the escort mission. The relationship between the convoy commander and the reconnaissance platoon leader must provide for unity of command and effort.

(a) The platoon leader must issue a complete OPORD to all vehicle commanders in the convoy before the mission. This is vital; the commander may have task-organized the convoy from a variety of units, so many of the vehicles may lack tactical radios.

(b) The OPORD should follow the standard five-paragraph OPORD format, with special emphasis on the following subjects:

- Order of march.
- Actions on contact.
- Chain of command.
- Communications and signals.
- Actions on vehicle breakdown.
- Actions at a halt.
- Route of march (this should include a sketch for each vehicle commander).

(2) **Tactical Disposition.** The platoon must post security during convoy escort missions in all directions and throughout the length of the convoy. Thus, reconnaissance platoon elements and any combat or CS attachments must disperse throughout the convoy formation. Engineer assets should locate toward the front to respond to obstacles. The fire support team (FIST) or combat observation lasing team (COLT) team should locate near the platoon leader. The platoon normally uses the column formation because of its inherent speed and ease of movement (Figure 5-13).

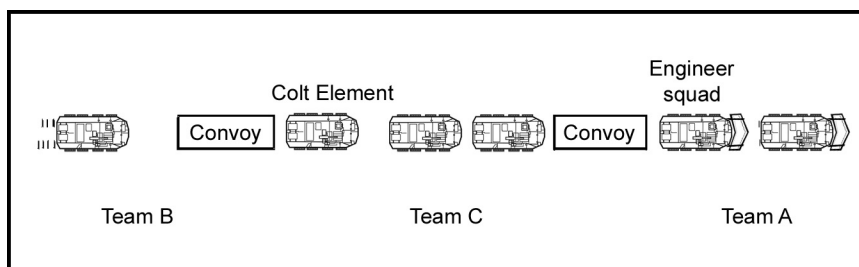


Figure 5-13. Reconnaissance platoon escorting a convoy.

(3) **Actions at an Ambush.** Ambush is one of the most effective ways to interdict a convoy. Therefore, the convoy escort must prepare to counter such a threat. The platoon must react to an ambush quickly, overwhelmingly, and decisively. All escort and convoy elements must execute the ambush as a drill, taking care to avoid fratricide. The convoy escort drill should include the following actions.

(a) As soon as the platoon detects an enemy force, the escort vehicles act. They first seek covered positions between the convoy and the enemy. As quickly as possible, they suppress the enemy with the highest possible volume of fire. They send contact reports to higher headquarters (Figure 5-14).

(b) Elements of the escort force may remain with the convoy main body. They usually do so when the convoy consists mostly of nonmilitary elements such as private organizations or local civilian agencies. Not only do these elements normally have no weapons, but also they usually lack communications capabilities. This makes linking up with the main body difficult.

(c) The convoy commander retains control of the convoy vehicles and maintains radio contact with the security force. At the same time, he moves the convoy along the route as fast as possible.

(d) The convoy abandons and pushes off the route any damaged or disabled vehicles (Figure 5-15, page 5-20).

(e) The escort leader (the reconnaissance platoon leader) submits spot reports. He can request needed reinforcements, and he can also call for and direct indirect fires and air support, if available.

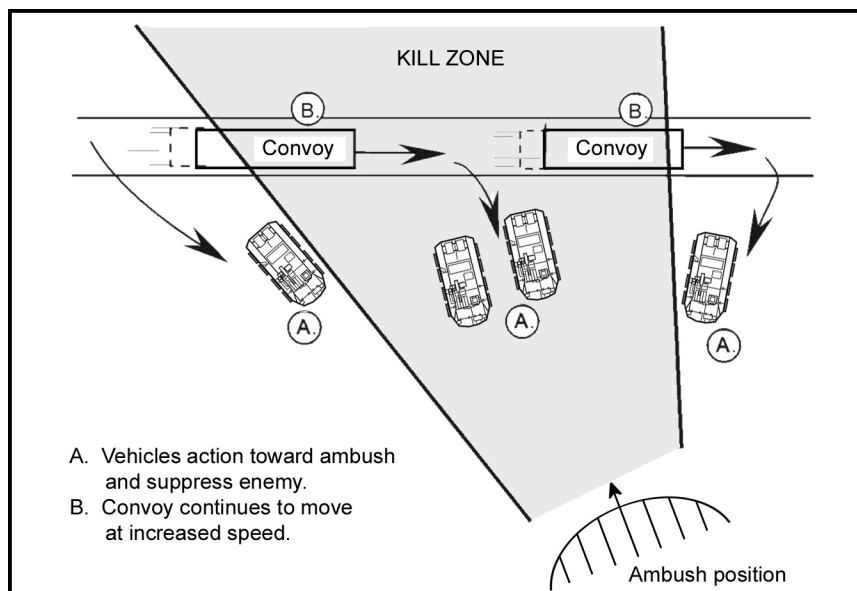


Figure 5-14. Convoy escort actioning toward ambush.

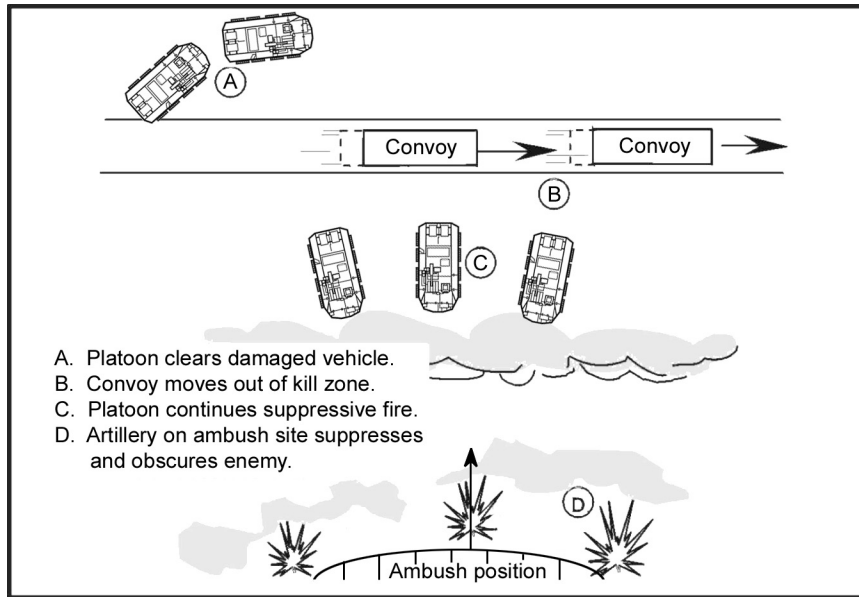


Figure 5-15. Convoy moving out of kill zone.

(4) *Actions after Clearing the Kill Zone.* Once the convoy clears the kill zone, the escort chooses one of the following COAs based on the composition of the escort and the strength of the enemy force:

- Continue to suppress the enemy while combat reaction forces move to support (Figure 5-16).
- Break contact and move out of the kill zone (Figure 5-17). Generally, reconnaissance platoons should move out of the kill zone as soon as the convoy clears it. However, the platoon should break contact only with the approval of its higher commander.

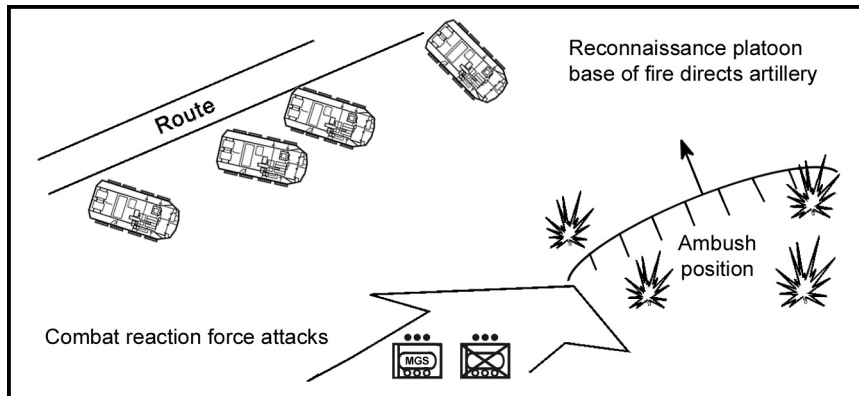


Figure 5-16. Escort suppressing ambush for reaction force.

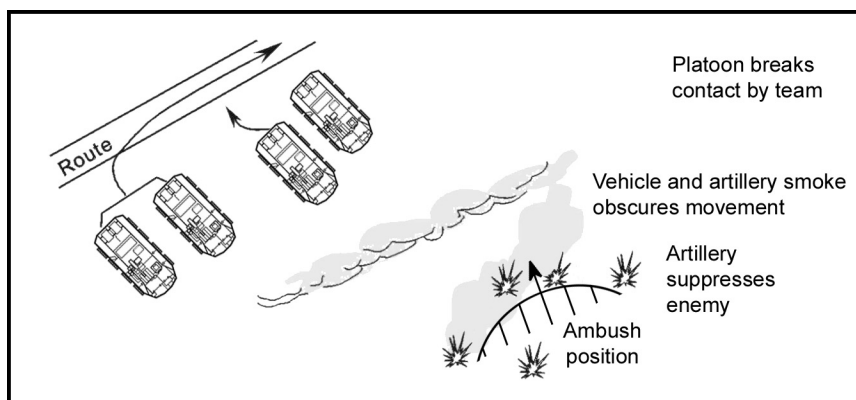


Figure 5-17. Escort breaking contact.

(5) **Actions During a Short Halt.** The convoy may have to make a short halt for a number of reasons. During the short halt, the escorting unit remains on full alert, regardless of what the convoy vehicles do. If the convoy halted for any reason other than for an obstacle, the escort unit takes the following actions.

(a) The convoy commander signals the short halt and transmits the order via tactical radio.

(b) The convoy assumes a herringbone formation.

(c) Escort vehicles take up protective positions forward, to the rear, and to the flanks (up to 100 meters beyond the convoy vehicles) and orient their weapon systems outward. They remain at the highest readiness condition (REDCON), that of REDCON-1. Meanwhile, they establish dismounted local security (Figure 5-18, page 5-22). The vehicles being escorted pull into the protected area in the center of the road, between the escort vehicles.

(d) The convoy receives the order to move out. Convoy vehicles reestablish the column formation, leaving space for the escort vehicles (Figure 5-19, page 5-22). The escort vehicles join the column. Local security continues dismounted (Figure 5-20, page 5-23).

(e) Once all elements have moved into column formation, local security personnel mount. The convoy continues to move.

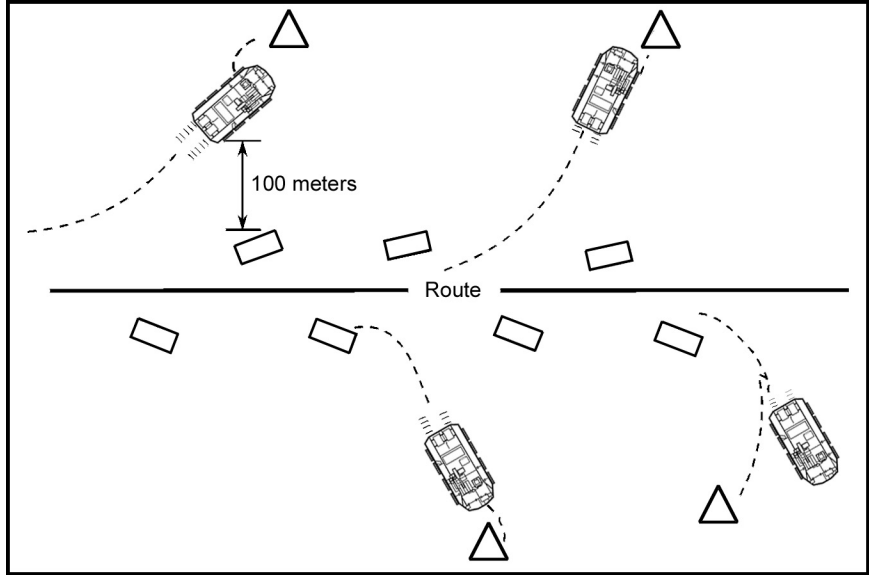


Figure 5-18. Convoy assuming herringbone formation.

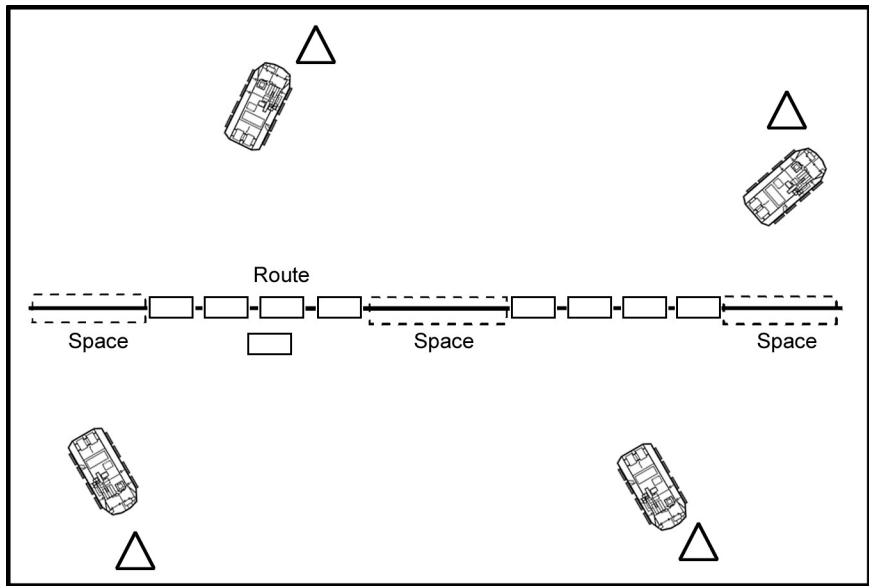


Figure 5-19. Convoy moving back into column formation.

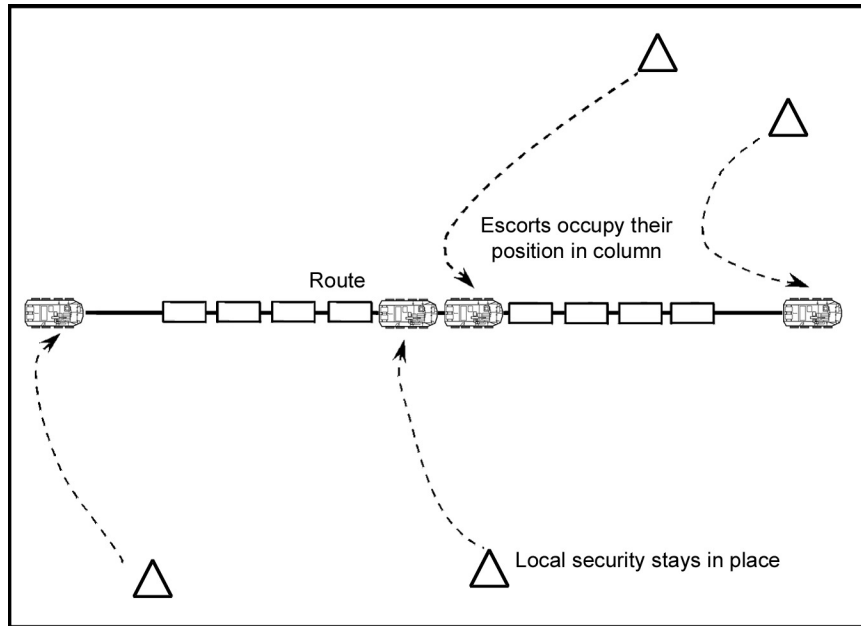


Figure 5-20. Escort vehicles rejoining column.

(6) **Actions at Obstacles.** Obstacles pose a major threat to convoys. The enemy can use obstacles to harass the convoy by delaying it. In some terrain, an obstacle can stop the convoy altogether. In addition, the enemy can use an obstacle or series of obstacles to channel or stop the convoy for an ambush.

(a) The route reconnaissance moves ahead of the convoy to identify obstacles. The reconnaissance element either breaches or locates bypasses around obstacles. Sometimes, the platoon cannot mount a route reconnaissance ahead of the convoy. At other times, the reconnaissance element may fail to detect the enemy or its obstacles. In these cases, the convoy must try to reduce or bypass the obstacle itself.

(b) When a convoy must deal with an obstacle itself, it faces a two-sided problem. First, the convoy's vulnerability increases when it stops. Second, the escort force is unable to provide security while working to overcome or bypass the obstacle. Security becomes critical, so the convoy and escort must act quickly.

(7) **Actions at a Point-Type Obstacle.** When the lead security element identifies a point-type obstacle, the following actions are taken.

(a) The convoy commander directs a short halt. He establishes dismounted local security and overwatch on the obstacle. Convoy vehicles remain on the road; escort elements move to the flanks to provide security.

(b) The convoy commander relays a spot report to higher headquarters. He requests combat reaction, engineer (if he does not already have it), and aerial reconnaissance support. He also alerts artillery units to prepare to provide fire support. With the help of these assets, he can get the convoy moving again sooner, which will reduce its vulnerability. The convoy commander must always assume that the enemy maintains overwatch and cover on the obstacle.

(c) Escort forces form a reconnaissance team. They begin reconnaissance for a bypass while at the same time maintaining all-round security for the convoy (Figure 5-21, page 5-24).

(d) At the same time, an additional reconnaissance team (consisting of escort elements, engineers, or both) moves forward to conduct an obstacle reconnaissance. Because of limited time and assets, the convoy need not establish far-side security before it reconnoiters the obstacle.

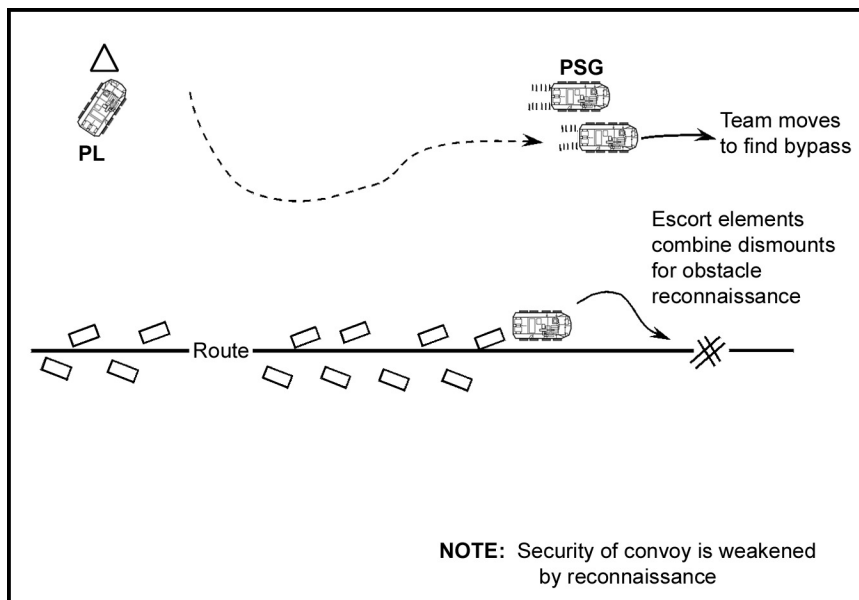


Figure 5-21. Escort teams conducting obstacle reconnaissance and reconnaissance for a bypass.

(e) Once the reconnaissance element has completed all reconnaissance, the convoy commander chooses and executes a COA to continue the mission. Possible COAs include the following:

- Bypass the obstacle.
- Breach the obstacle with the assets on hand.
- Breach the obstacle with reinforcing assets.

(f) The convoy commander executes the best COA and continues the mission.

Section IV. OBSERVATION POST EMPLOYMENT

The reconnaissance platoon can occupy up to three short-duration OPs, one per team, for up to 12 hours if the teams are at full strength. For extended periods (12 hours or longer), the reconnaissance platoon occupies long-duration OPs by sections, which limits long-duration OPs to a maximum of two. In addition, the platoon can array OPs either in linear positions or in depth. Depth is the preferred method for maintaining contact with a moving threat. Linear placement is effective when the threat is not moving; it provides maximum eyes on the threat.

5-10. CRITICAL TASKS

Employment of OPs entails accomplishment of selected critical tasks .

a. **Determine the Type of OP.** Determine the type of OP (mounted, dismounted, or a combination) depending on requirements for either maximum stealth or rapid movement.

b. **Position the OPs.** Position the OPs either in linear positions or in depth to allow for observation of the assigned sector. Several factors affect proper positioning, including the following:

- The need for observation from several OPs to reduce the chance of the enemy entering the sector undetected.
- A requirement for the platoon to observe the entire sector by placing OPs along the enemy's most likely avenues of approach.

c. **Select Positions.** Select a position for each OP that affords the best possible force protection. Selection criteria include the following:

- Covered and concealed routes to and from the OP.
- Unobstructed observation of the assigned area.
- Effective cover and concealment.
- Sites that avoid natural lines of drift and that do not call attention to or skyline observers.

d. **Occupy the OP.** The platoon should employ the most secure method of moving into position; dismounted occupation is the preferred method. Occupation steps include the following:

- Establish overwatch.
- Reconnoiter the position.
- Establish security.
- Clear the site and ensure sector visibility.
- Establish vehicle hide positions.
- Develop sector sketches.

e. **Man the OP.** The reconnaissance platoon leader must ensure that each OP has the necessary personnel and equipment to perform the following tasks:

- Observe the assigned area.
- Provide force protection (including planning and preparation for contact and actions on contact).
- Report information.
- Call for and adjust indirect fire.

f. **Maintain Security.** Conduct local reconnaissance patrols to cover dead space, provide local security, and observe avenues of approach and NAIs from different vantage points.

g. **Employ Active and Passive Protective Measures.** Reconnaissance elements are extremely vulnerable in the OP. Their best self-defense is not to be seen, heard, or otherwise located by the enemy.

h. **Improve the Position.** The reconnaissance platoon can enhance OP protection by--

- Digging in the OP position.
- Camouflaging the position.
- Installing communications equipment.
- Emplacing hasty obstacles.

5-11. TYPES OF OBSERVATION POSTS

The types of OPs are dismounted, mounted, and a combination of mounted and dismounted.

a. **Dismounted OPs.** The dismounted OP provides maximum stealth and thus has the greatest likelihood of remaining undetected by the enemy. The disadvantages of the dismounted OP are the time it takes if the reconnaissance troops must remount and move and the lack of optics capability if a ground-mounted thermal device is not available. If rapid movement or displacement is anticipated, the OP should mount or remain mounted.

b. **Mounted OPs.** These offer the advantages of rapid movement and vehicle optics and protection. Because the enemy can more easily detect them, however, they are potentially less effective than dismounted OPs.

c. **Combination OPs.** The reconnaissance platoon can employ an OP that combines the advantages of both the dismounted and mounted types. For example, the vehicle can monitor a particular NAI while other crewmen dismount to observe an enemy dismounted avenue of approach. The combination OP can offset the limitations and vulnerabilities of the others, but some of these weaknesses may still apply, including lack of mobility and ease of enemy detection.

5-12. OBSERVATION POST POSITIONS

OPs may be placed on the battlefield either in a linear configuration or in depth.

a. **Linear Placement.** Linear placement (Figure 5-22) allows the reconnaissance platoon to observe the assigned sector from several OP sites, reducing the chance of the enemy entering the sector without being observed. This method works well when the reconnaissance platoon has been assigned a large sector with few avenues of approach or is in desert-type terrain.

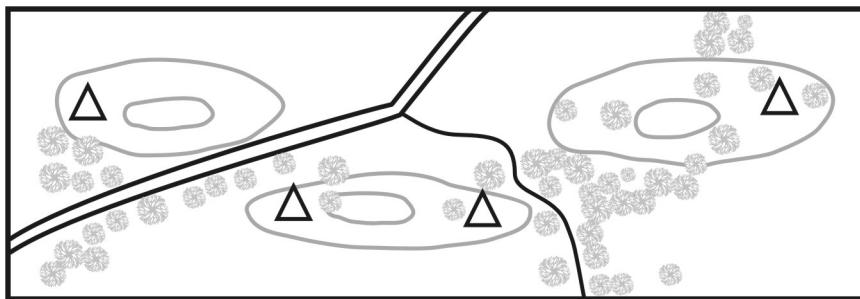


Figure 5-22. Linear positioning of OPs.

b. **In-Depth OP Placement.** In-depth OP placement (Figure 5-23) allows the reconnaissance platoon to observe the entire sector by placing OP sites where the platoon can observe the most likely avenues of approach in the sector as well as along the sector flanks. This method works well when the reconnaissance platoon is assigned a sector with several avenues of approach or is in heavily wooded terrain. In-depth placement allows for redundancy in observation and better coverage of the sector.

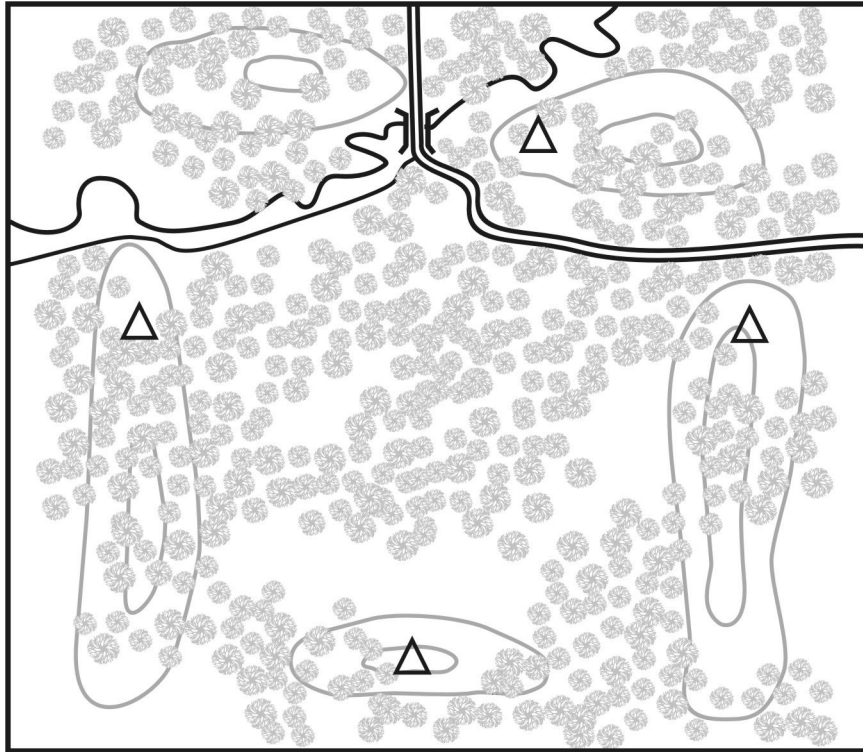


Figure 5-23. In-depth positioning of OPs.

5-13. OBSERVATION POST SITE SELECTION

Based on METT-TC factors, the battalion commander's guidance, and staff input, the reconnaissance platoon leader selects the general location for the platoon's OPs. From his analysis, he determines how many OPs he must establish and where he must position them to allow long-range observation along the avenues of approach assigned by his commander and to provide depth through the sector. Section and team leaders select the exact position for each OP on the ground. OPs should have the following characteristics.

a. **Covered and Concealed Routes to and from the OP.** Soldiers must be able to enter and leave the OP without being seen by the enemy.

b. **Unobstructed Observation of the Assigned Area or Sector.** Ideally, the fields of observation of adjacent OPs overlap to ensure full coverage of the sector.

c. **Effective Cover and Concealment.** Leaders should select positions with cover and concealment to reduce the vulnerability of their elements on the battlefield. They may need to pass up a position with favorable observation capability but with no cover and concealment in favor of a position that affords better survivability.

d. **A Location That Will Not Attract Attention.** OPs should not be sited in locations such as a water tower, an isolated grove of trees, or a lone building or tree. These positions draw enemy attention and may be used as enemy artillery TRPs. The OPs should also be located away from natural lines of drift along which a moving enemy force can be expected to travel. Such locations might include a route on the floor of a valley or a site near a major highway.

e. **A Location That Does Not Skyline the Observers.** Avoid hilltops. Position OPs further down the slope of the hill or on the side, provided there are covered and concealed routes into and out of the position.

5-14. OCCUPATION OF THE OBSERVATION POST

The reconnaissance platoon leader selects a technique to move to the screen line based on his analysis of METT-TC. Unless the area has already been cleared, the platoon should conduct a zone reconnaissance to the screen line. This is the most secure method of moving to the screen line but also the most time-consuming. The following steps provide an example of how the reconnaissance platoon might occupy an OP.

a. A reconnaissance section stops short of its OP site. The section leader directs the drivers into positions to overwatch the general OP site and any terrain the enemy could use to dominate movement into or out of the position (Figure 5-24).

b. The reconnaissance section leader dismounts with four soldiers, two from each vehicle. Drivers and team leaders remain on their vehicles to overwatch the dismounted personnel as they move forward to reconnoiter the OP.

c. The section leader moves the dismounted soldiers to the OP site, establishes security overwatching the far side of the site, and checks the site for mines, booby traps, and enemy personnel. He verifies that he can observe his sector or area of responsibility from this site and determines which exact position is best for the OP.

d. The section leader selects hide positions and fighting positions for his two vehicles. Once the area around the OP is cleared and secure, he signals the vehicles forward to move into their fighting positions.

e. The driver and a soldier from each vehicle mark each vehicle's position using a GPS and appropriate marking device.

f. The section or team leader and the vehicle commander complete and check the sector sketch. Each vehicle then moves back out of its fighting position into a hide position. The section leader checks the sketches to ensure they provide complete coverage of the sector and provides the platoon leader a digital or hard copy of the sketches. Sector sketches or range cards allow the OP to use the vehicle's thermal sights for observation; they are also a valuable reference if the vehicle is ordered to fight.

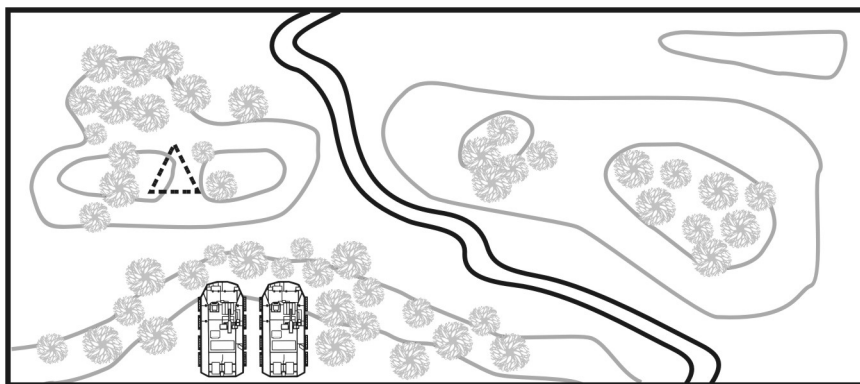


Figure 5-24. Vehicles overwatching a potential OP site.

5-15. MANNING THE OBSERVATION POST

A minimum of two soldiers man each OP. They must be equipped to observe the area, report information, provide their own security, and call for and adjust indirect fire. One observes the area while the other provides local security, records information, and sends reports to the section, team, or platoon leader. The two soldiers should switch jobs every

20 to 30 minutes because the observer's effectiveness decreases quickly after that time. Essential equipment for the OP includes the following:

- Map of the area.
- Compass.
- Communications equipment (wire, radio, or both).
- Observation devices (such as binoculars, observation telescopes, and night-vision devices including Javelin CLU thermal sights for observation.). See Appendix F, Javelin Employment.
- SOI extract.
- Report formats.
- Weapons (personal, crew-served M249 SAW or M240B MG (see Appendix G, M240B Machine Gun and M249 SAW Employment) and or light AT weapons, or Javelin AT weapons if augmented (see Appendix F, Javelin Employment) and mines, if necessary.
- Seasonal uniform and load-carrying equipment (LCE).
- Appropriate NBC equipment to achieve the highest mission-oriented protective posture (MOPP) level prescribed in the OPOD.

5-16. POSITION IMPROVEMENT

Once the section leader has established the OP and assigned the soldiers their sectors of observation, the section improves the position.

a. **Sector Sketch.** The section leader prepares a sector sketch (Figure 5-25, page 5-30). This sketch is similar to a fighting position sketch but with some important differences. As a minimum, the sketch includes--

- A rough sketch of key and significant terrain, including NAIs and avenues of approach.
- Location of the OP.
- Location of the hide position.
- Locations of vehicle fighting and observation positions.
- Alternate positions (hide, fighting, observation).
- Routes to and from the OP and fighting positions.
- Sectors of observation.
- Preplanned artillery targets.
- TRPs for direct fire.
- Prepared spot reports and calls for fire, based on trigger points and projected locations where the enemy will first be seen.

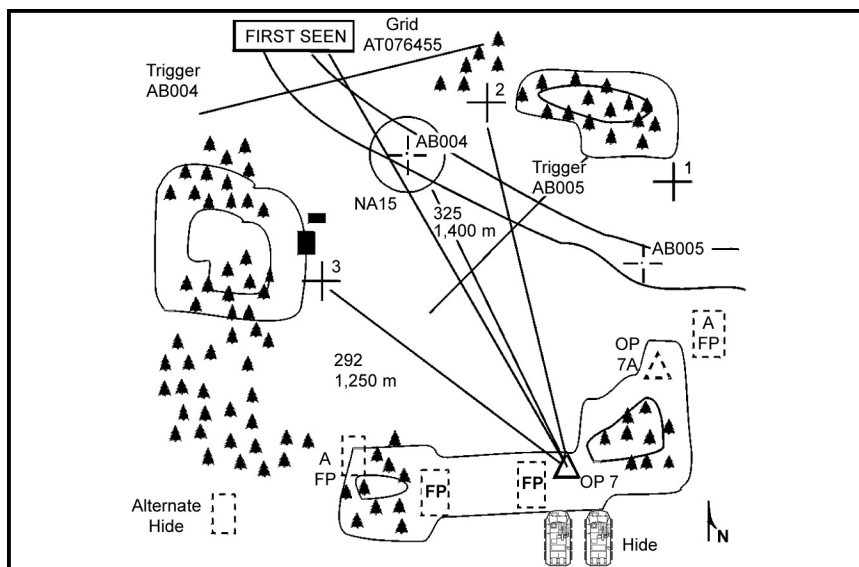


Figure 5-25. Section leader's OP sketch.

b. **Improvements.** Personnel manning the OP site begin digging in to provide protection from indirect and direct fires. They also camouflage the position, install wire communications equipment and directional antennas for FM communications, and emplace hasty obstacles for local protection. Vehicle commanders and drivers reconnoiter the routes to their fighting or observation positions and alternate positions, perform maintenance, and camouflage vehicles and positions.

5-17. COMMUNICATIONS

The soldiers occupying the OP use wire, radio, or land warrior (LW) systems (or a combination) as their primary means of communications. Wire is the most secure means of communication, but it may not be the most practical means based upon the current tactical situation and mission duration.

5-18. OBSERVATION POST SECURITY

As noted, soldiers are extremely vulnerable in an OP; their best self-defense is not to be seen, heard, or otherwise located by the enemy. They employ active and passive measures to protect themselves from enemy detection and direct and indirect fires.

a. **Covered and Concealed Position.** The first step is to locate the OP in a covered and concealed position to reduce the chance of being seen by the enemy. The soldiers add camouflage to the position to enhance natural concealment. If they have enough time, they dig in the position and add overhead cover to increase survivability against enemy fires. The soldiers enforce strict light and noise discipline and reduce activity in and around the OP to essential movement only. All vehicles remain hidden because the enemy can easily identify their large signatures. Soldiers in the OP also must maintain secure communications.

b. **Early Warning.** To provide early warning of enemy movement around the screen line or OP position, the soldiers emplace their PEWS in areas that they cannot observe or in the dead spaces between OPs. Trip flares and M18A1 claymore mines provide additional early warning and protection from enemy personnel.

5-19. ACTIVE PATROLLING

Active patrolling around and between OPs also enhances security. Patrols give the platoon the ability to observe areas that cannot be observed from the OPs and to clear the area around the OP of enemy elements. A patrol can be executed by a minimum of two dismounted crewmen from the vehicles in the hide position.

a. **Security Patrols.** To discover enemy elements that might have observed the occupation, the platoon executes security patrols as soon as possible after occupying the position. The patrols reconnoiter favorable observation positions that might be occupied by the enemy. Route selection is critical when organizing these patrols; the soldiers must assume that the OP position is under observation.

b. **Enemy Compromise.** OPs cannot always avoid enemy detection so they must take actions to limit their vulnerability. Covered positions provide protection from enemy fires, and vehicle dispersion further reduces the effects of these fires. The vehicles in the fighting positions extricate the soldiers from the OP if the position is identified and attacked by the enemy.

5-20. EXTENDED OBSERVATION POSTS

Extended OPs are fixed surveillance positions that require the soldiers to remain at the site for up to 72 hours without relief or rotation of reconnaissance teams. They provide the maximum degree of stealth available to the soldier from a stationary position. Vehicle placement is not in direct support of the OP. Infiltration and exfiltration, accomplished using any method of aerial and dismounted movement, is the primary method of occupying and departing the OP. Once the OP is occupied, movement around the OP ceases until mission is complete, evacuation is required, or exfiltration begins. This paragraph addresses the process of selection, construction, and occupation of extended OPs used in permissive and nonpermissive operational environments.

a. **Site Selection.** In choosing where to position extended OPs, the reconnaissance platoon must ensure that the sites--

- Afford adequate visual and electronic line-of-sight target observation and security for the observers.
- Have as wide a field of view and as little dead space as possible.
- Are not near natural lines of drift or in terrain that would naturally draw the attention of enemy forces, such as on top of a flat rock face on a hill.
- Have covered and concealed exit and entry points.
- Are far enough downwind from the target and inhabited areas to minimize the olfactory detection of the position by dogs or people. (Keep in mind that wind direction often changes at various times of the day.)
- In general, are as close to, or distant from, the target as mission and security considerations dictate.
- Afford effective overhead and side cover and concealment.
- Can support execution of battle drills if the observers must break enemy contact.
- Support reliable communications between the observers and their main body, security element, and communications element.
- Are, above all, in a location that is not obvious to enemy forces.

b. **Multiple Positions.** If the reconnaissance platoon cannot find all these features in a single position (for example, daytime versus nighttime requirements), it may have to select separate positions suited to the types of surveillance needed. Multiple positions must be mutually supporting so that if one position is compromised, observers in the other position can continue the surveillance mission and warn the rest of the platoon. Further, if the positions are not being used during the day, the platoon should keep them under observation. If this is not possible, then the platoon should not reuse that position the following night. This practice prevents the soldiers from walking into an ambush while trying to reoccupy the position. Another consideration in the use of separate positions is that observers must avoid establishing patterns and trails while moving to and from the different positions.

Section V. CONSTRUCTION TECHNIQUES

Several construction techniques are common to all observation positions. These techniques are included in SOPs and practiced during normal training.

5-21. DIRT REMOVAL

The primary task in constructing any position is the removal of excess dirt. Excavated soil expands in volume. In dry climates, the subsurface soil contains the most water, which causes the soil to be a different color. Thus, this soil must be camouflaged. Construct underground positions before the early morning dew develops. Discarding excess soil before the dew sets in aids in the camouflage process. Consider the effect of the sun drying out the excess soil. This dried soil may need to be camouflaged. The main technique for camouflaging soil, using plastic sheeting or a poncho, entails the following steps.

- a. Lay out the sheeting alongside the position.
- b. Place the topsoil to one side of the sheeting. Remember that the topsoil only extends a few centimeters below the surface. Save as much of the vegetation as possible.
- c. Dig out the remaining soil. Do not mix the topsoil with subsoil from the hole.
- d. Fill sandbags with the (loose) soil dug from the hole and use them to reinforce the sides of the position.
- e. Fill surrounding depressions, ruts, or ditches with the remaining excess soil. If this is not possible, spread the soil lightly on the surface in an area away from the position. Avoid putting the excess soil in creeks or streams that may wash the dirt down the waterway and attract unwanted attention.
- f. After the overhead cover is constructed and waterproofed, replace the topsoil. Spread vegetation, leaves, deadfall, or other local materials about the area to complete the camouflage of the position.
- g. The final step in the process is to pick up the sheeting used to contain the soil. Check the vegetation under the sheeting to ensure that it was not matted down under the weight of the soil. If matting has occurred, take the time to brush it with a branch to return it to its natural state.
- h. As time passes, continually check the vegetation and soil around the position to ensure that they appear natural. Loose soil often falls through small holes in the ground and results in strange-looking, funnel-shaped holes. Check vegetation to ensure it blends with the surrounding area. Remove or replace dead vegetation.

5-22. NATURAL VEGETATION

Remember that vegetation is critical to blending the OP with surrounding terrain. Replanting and watering vegetation during initial position construction can eliminate the need to continually replace wilted plants.

a. **Grasses.** When removing topsoil, save the grass. Use an entrenching tool or shovel to remove the grass in clumps by cutting a circle about 5 to 15 centimeters around the section to be saved. Pry the roots and soil up from the bottom. When replacing the grass around the position, pattern the placement after the natural design. Shake the grass slightly to loosen the roots, then replace it at ground level. If water is available, a small amount placed on the grass will lessen the shock of replanting and extend the life of the camouflage.

b. **Plants and Bushes.** Medium-sized plants or bushes will aid the security of the position. Not only will the plants add to the camouflage of the position, but they will also discourage vehicle and foot movement over the top of the position. The main disadvantage to using plants on top of the position is that the plants may die or fall over due to the shallow depth of the overhead cover.

c. **Deadfall.** Deadfall can restrict movement in much the same way as can the plants and bushes discussed above. If used, it must be reinforced with dirt. The use of deadfall as part of the overall camouflage effort presents several disadvantages.

(1) In most regions of the world, deadfall is used for home heating, cooking, and construction. If the position has this fuel near it, the risk of discovery is increased. The only options available to OP personnel if they are discovered by a non-hostile civilian is emergency exfiltration and activation of the evasion and escape (E&E) plan. Either course of action will result in termination of the mission.

(2) Cover from small arms fire is very limited when using deadfall. Most trees decompose quickly on the ground. Modern small arms fire will easily pass through these rotten trees.

5-23. SIDEWALL SUPPORT

Depending on the soil condition in the area of operations, the sidewall of the position may require some type of shoring or support to prevent cave-ins. A variety of material for support of the walls is available, such as local timber, branches, deadfall, plastic sheeting, and ponchos. The primary means for supporting the sides, however, is the use of sandbags. These lightweight bags serve a variety of uses and conform to almost any shape required. The exact number of bags required depends on the size and overall design of the position. When cross-bracing sandbagged walls, use freshly cut green timber or a prefabricated support such as PVC pipe, conduit, or other like items. (Examples of cross-bracing and revetments can be found in FM 5-34.)

5-24. OBSERVATION POST KITS

Whenever possible, the unit should assemble prefabricated kits to aid in the construction of the required positions. These kits need not be taken into the operational area; rather, they are assembled as a stockpile from which elements can draw mission-specific equipment during isolation. Items in these kits include the following:

- Schedule-80 PVC pipe, elbows, straight connectors, three- and four-way connectors, and PVC cement. This strong, lightweight material can be formed into a multitude of shapes and designs. It can be used to build the frame of the overhead cover or to form cross bracing.
- Parachute suspension line. This material serves many uses, such as being interwoven to produce a frame for overhead cover.
- Sandbags.
- Assorted tapes, cords, and ropes.
- Plastic bags with press-together “zippers” for closing. These items can be used for general storage.
- Half-meter square pieces of 1-centimeter plywood. This lightweight material is excellent for constructing overhead cover, platforms for use in trees, and insulation when operating on ice and snow. The squares are painted to match the terrain in which they are used.
- Plastic sheeting. Heavy-gauge plastic sheeting fills many roles. If plastic sheeting is not available, the heavy-duty plastic bags used to cover pallets work well.
- Hand tools, such as D-handle shovels, hacksaws, hammers, and small bow saws.
- Plastic or aluminum tent stakes. These items save time during construction of the position.
- Canvas and camouflage netting.
- Mirrors or periscopes.

Section VI. OBSERVATION POST EMPLOYMENT IN OPERATIONAL ENVIRONMENTS

During tactical operations, the reconnaissance platoon must be prepared to establish OPs in various operational environments. This section discusses OPs in urban and mountainous terrain and during area security missions.

5-25. URBAN ENVIRONMENT

An urban or built-up area forms the economic and cultural focus for the surrounding area. It is characterized by a concentration of people and manmade structures and facilities. Because of the generally limited fields of vision, urban operations normally require more positions than rural operations. (See FM 3-06.11 as well as the discussion of urban operations in Chapter 6 of this manual.)

a. **Position Selection.** As with other observation and surveillance positions, METT-TC factors dictate the selection of urban OPs. Soldiers can construct fixed urban positions in occupied and abandoned buildings, on water tanks, behind shrubbery, on factory chimneys, or in the attics of multistory buildings or other tall structures. If the position is to be set up in an undamaged part of the urban area, they should select buildings of solid construction with serviceable stairs and basements that can be equipped for the rest and shelter of personnel.

(1) Soldiers should avoid wooden and significantly deteriorated buildings because of the risk of injury from fire or structural failure. Fixed positions should not be in buildings

that will attract the enemy's attention; instead, they should be placed in rubble, yards, and gardens.

(2) When occupying the position, soldiers must look for booby traps and mines. If they detect such devices, they must be prepared to take proper precautions, including disabling the devices, if possible or marking the area if the devices cannot be disabled.

b. **Construction.** Position construction may consist simply of being able to look out of a suitable viewing port, or it can be much more elaborate. Considerations and actions should include the following:

- Emphasize operations security (OPSEC) while constructing the position.
- Fill windows, doors, and other openings (such as bullet holes not used for observation) with bricks, fragments of building materials, or sandbags if available.
- Remove flammable objects. These may be used for early warning or defensive devices.
- Establish communications between buildings by hard wire. If available, fiber-optic cables (telephones) offer better security.
- Identify and construct rapid departure routes.

c. **Avoiding Detection.** Because of the higher concentration of people, security forces, lighting, and movement, forces in urban areas must take additional precautions to avoid detection during surveillance activities. Considerations for detection avoidance include the following:

(1) At least two soldiers are required in occupying the OP.

(2) If operating from an occupied dwelling, do not consume more electric power, water, and heat than average for the normal occupants.

(3) Employ OPSEC to negate or evade enemy electronic countermeasures (ECM). For example, technological advances make it possible for mobile units operating from the street to electronically survey a building and detect and identify very small sources of energy. Such capabilities are increasingly widespread and are often found in built-up areas of even marginally developed countries, especially in the "security states" of the Third World.

5-26. MOUNTAINOUS ENVIRONMENT

Rugged, poorly trafficable terrain, steep slopes, and elevations that allow observation of surrounding terrain characterize mountainous areas. The number of observers and positions required may increase in mountainous terrain due to the relatively limited fields of vision compared to flat terrain. On the other hand, in areas above the tree line or where lower elevations lack vegetation, the number of observers needed may decrease. A careful study of the target area will give a good indication of the requirements. For a general discussion of operations in mountainous areas, see FM 3-97.6.

a. **Position Selection.** Mountain terrain provides many places for cover and concealment. Position selection is not guided by the height of a given mountain but by irregular fields of observation, dead space, cover and concealment, and the limits of the observation equipment used by the soldiers.

b. **Systems of Observation.** Soldiers may employ a circular, multi-tiered system of observers. To increase daytime viewing capability, positions are placed not only laterally

but also with vertical dispersion. This layering of positions also reduces the need for movement when changing from daytime to nighttime operations (Figure 5-26).

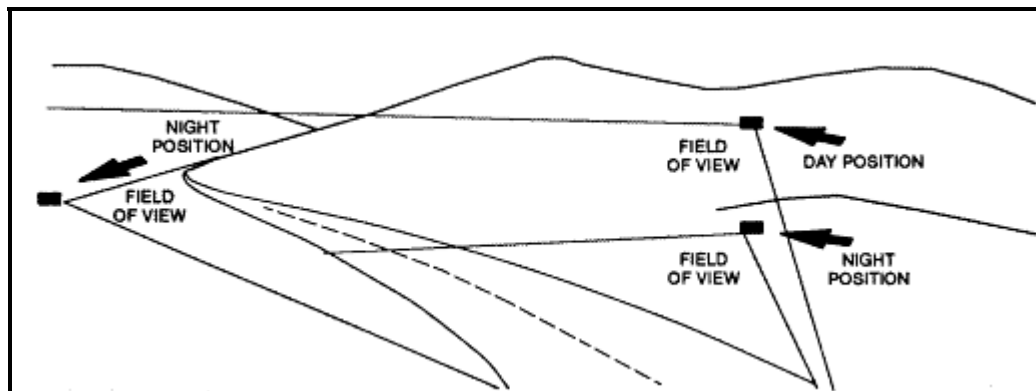


Figure 5-26. Overlapping mountain observation sites.

c. **Construction.** Irregular terrain in mountains often affords natural hiding places for observers. In most mountainous areas, the rocky nature of the ground makes it difficult and often impossible to dig belowground positions. In those cases, boulders and loose rocks can be used to construct aboveground, low-walled positions called "scrapes." When constructing these positions, exercise the same degree of care in camouflage as in the case of all other types of construction. The position must blend in with its surroundings and not be detectable from any angle. Trimming back the lower branches on the undergrowth with a wire saw, shears, or knife often enhances fields of view.

d. **Night Observation.** At night, sending out additional observers into valleys and hollows enhances observation. Observation from below, facing upward against the background of the sky, often gives better results. In addition, the soldiers should supplement night observation by monitoring. Monitoring is more effective in mountainous areas than on flat terrain because sounds are often funneled to the head of valleys and are perceptible at great distances. Sounds in the mountains can be deceptive, however. Various obstructions can reduce their volume and change their direction.

e. **Snow.** In mountainous areas where snow is expected or known to be on the ground, soldiers can use certain tactics to reduce the problems associated with operations in the snow. Some of these tactics are discussed in the following paragraphs.

(1) **Melting Conditions.** Observers should choose positions that are in shaded areas, on slopes facing away from the equator (north in the Northern Hemisphere, south in the Southern Hemisphere). In moderate temperatures, the heat generated from the observers' bodies melts the snow on the cover of the position. The result is an observable muddy area in snow. Such muddy areas are common around trees, where the heat of the day can cause melting snow to fall to the ground and melt the snow on the ground around the tree. (The melting snow falling off the trees often can be used as a water source. Unlike frozen snow, it does not require melting over a heat source.) The shadows found around rock outcroppings and trees can aid in hiding the foot trails leading to the work area and position. The shade aids in an even melt.

(2) **Snow Compression.** Walking compresses snow under each footprint, and the compressed snow melts at a slower rate than the surrounding snow. This effect is like the difference between crushed ice and cubed ice in a drink. The loose, crushed ice melts

faster than the dense cubes. In areas where the snow melts fast, such as a sunny side of a hill, the compressed snow leaves footprints or trails leading to the position.

(3) **Avalanche Danger.** The constant daytime melting and nighttime refreezing of snow on slopes often results in avalanches. Soldiers should use shadowed areas and slopes to reduce the risk of avalanches. Most danger areas are well known and are often plotted on military and civilian maps.

5-27. TYPES OF GROUND OBSERVATION POSTS

Observation posts on the ground are camouflaged to resemble such features as stumps, fallen trees, and bushes. For enhanced surveillance, the soldiers locate the position to overwatch the intersection of fire lanes, roads, and footpaths on the edge of sparsely wooded areas and natural clearings. When available, obstacles such as creeks, ditches, or steep slopes should be located between the position and the probable route of enemy security forces. At night, even a small creek disrupts a force's formations, causes it to make noise, and generally slows its progress. Monitoring of the target area is critical to accomplishing the mission and providing soldiers with operational security. Observers in a well-camouflaged position can monitor the target using several types of ground positions.

a. **Spider Hole.** This type of position is similar to a fighting position with overhead cover. The dimensions are normally about 0.75 meters wide by 1.2 meters long and 1 to 1.5 meters deep. The observer can adjust the dimensions to meet his needs. This one-man position is normally established on a line or ring to provide support and enhance security. If using this type of OP, the platoon must use a minimum of two mutually supporting holes (Figure 5-27).

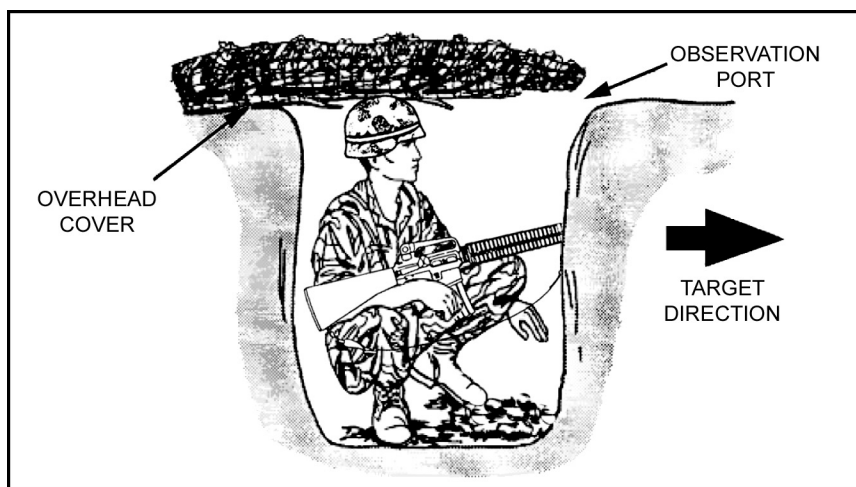


Figure 5-27. Spider hole OP.

b. **Scrape.** A scrape (Figures 5-28 and 5-29, page 5-38) is the enlargement of a depression in the ground to allow one man to occupy a position. Scrapes are hasty in nature and require little preparation. Often used during darkness, scrapes provide the observer with a position where he can better use his optical devices. The observer removes as many of the signs of occupation as possible when he leaves. He obscures the area by brushing matted grasses, displaced dirt, and footprints. Overhead cover such as a

poncho provides limited protection from the elements. If using this type of OP, the reconnaissance platoon must use a minimum of two mutually supporting scrapes.



Figure 5-28. Scrape OP.

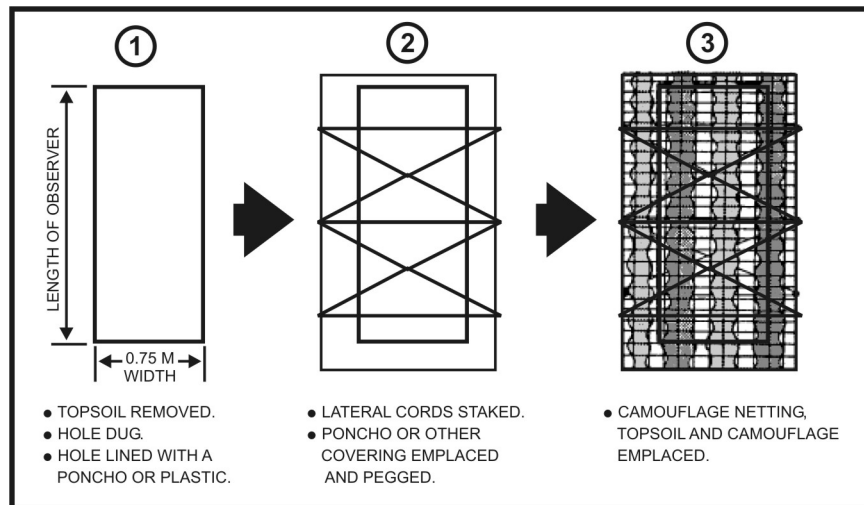


Figure 5-29. Example scrape plan.

c. **Tent-Type Position.** Larger than a spider hole, this position is constructed for more than one observer. Supports for the overhead cover are made from a variety of material. Branches, aluminum conduit, parachute suspension line, or fiberglass rods all work well as a frame for the cover. A slight arch in the cover multiplies the available space on the inside of the position. The observers avoid grossly breaking the ground plane with the apex of the position (Figure 5-30).

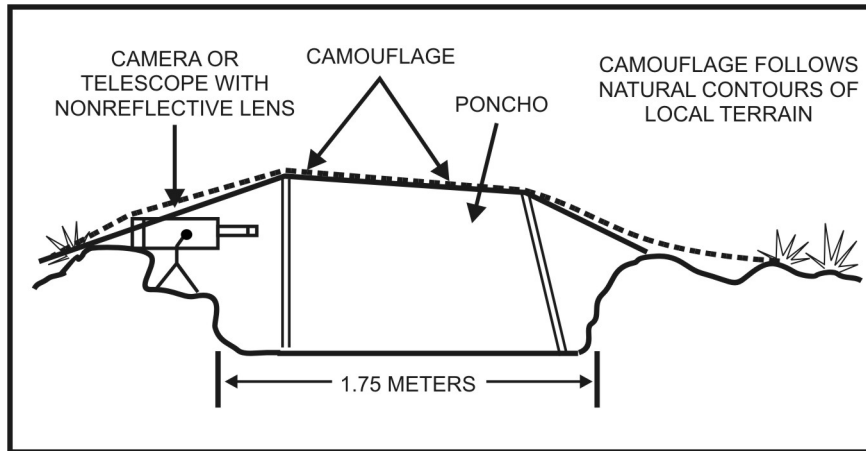


Figure 5-30. Tent-type observation post.

d. **Underground Position.** The safest type of OP for the reconnaissance soldier is the underground position. The complexity of design and the effort required to construct the position are the primary disadvantages. When the section or team plans to use underground positions, soil type is a critical planning consideration that must not be overlooked during mission preparation. For example, when only light equipment (such as shovels and entrenching tools) is available, underground positions can only be constructed in loose soils.

e. **Bunker-Type Position.** This position requires extensive construction time and material to complete. The observer can construct the underground bunker-type position using a prefabricated kit. This kit includes the tools needed to excavate and cut local materials such as trees and logs. The kit also contains plastic sheeting for waterproofing the roof, walls, and floor. The sheeting can also be used to reinforce loose soil in the position. Depending on the soil in the area, however, sandbags are often required to shore up the sides of the position; sandbags also lessen the accumulation of condensation produced when plastic sheeting is used (Figure 5-31).

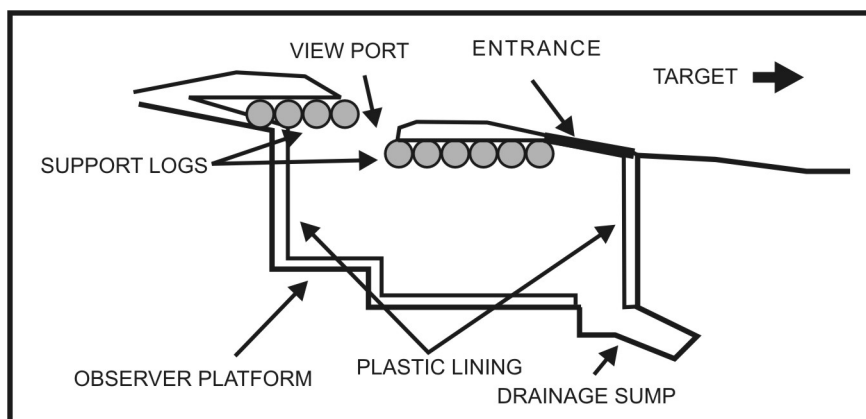


Figure 5-31. Bunker-type underground observation post.

f. **Cave.** A cave can provide the observer with a ready-made observation position; however, it presents special problems. First, caves attract attention. They are often shown

on maps or are known to the local populace. Locals often use caves for shelter and sometimes for storage. Caves also attract animals. Bats, birds, snakes, and larger animals use caves for shelter, and the unsanitary conditions resulting from their presence present medical risks to reconnaissance personnel. Furthermore, early warning devices may be activated and attract the attention of local enemy forces. Use of caves increases the chance of discovery and is avoided in all but emergency situations.

5-28. CHECKPOINTS, ROADBLOCKS, AND OBSERVATION POSTS

Construction and manning of checkpoints, roadblocks, and observation points are high-frequency tasks for infantry units. The reconnaissance platoon may be required to establish area security during stability operations.

- Checkpoints. A checkpoint is a predetermined point used as a means of controlling movement, such as a place where military police check vehicular or pedestrian traffic, to enforce circulation control measures and other laws, orders, and regulations. (Figure 5-32, page 5-42, shows an example of a deliberate checkpoint.)
- Roadblocks. A roadblock is used to limit the movement of vehicles along a route or to close access to certain areas or roads. Checkpoints and roadblocks can be either deliberate or hasty, with the primary difference being the extent of planning and preparation conducted by the establishing force.
- Observation Posts. An OP is a position from which military observations are made or fire directed and adjusted and which has appropriate communications. They are both overt (conspicuously visible, unlike their tactical counterparts) and deliberately constructed. Observation posts are similar in construction to bunkers and are supported by fighting positions, barriers, and patrols.

a. **Purposes.** The reconnaissance platoon may be directed to establish a checkpoint, roadblock, or OP for the following reasons:

- To show a military presence to all parties and to the population in the area.
- To survey all activity in the terrain, along roads, and in inhabited areas.
- To check and or inspect and register all personnel and vehicles in and out of the controlled area.
- To survey airspace, coastal areas, airfields, cease-fire lines, and borders.
- To deter illegal movement.
- To create an instant roadblock.
- To control movement into the area of operations or on a specific route.
- To prevent smuggling of contraband.
- To enforce the terms of peace agreements.
- To ensure proper use of routes by both civilian and military vehicles.

b. **Planning and Establishment.** The layout, construction, and manning of checkpoints, roadblocks, and OPs should reflect the factors of METT-TC, especially the time available for emplacing them. The following procedures and considerations may apply:

- Position the checkpoint or roadblock where it is visible and where traffic cannot turn back, get off the road, or bypass without being observed.
- Position a combat vehicle off the road, but within sight, to deter resistance to soldiers manning the checkpoint. The vehicle should be in a hull-down position and protected by local security. It must be able to engage vehicles attempting to break through or bypass the checkpoint.
- Place obstacles in the road to slow or canalize traffic into the search area.
- Establish a reserve.
- Establish wire communications in the checkpoint area to connect the checkpoint bunker, the combat vehicle, the search area, security forces, the rest area, and any other elements involved in the operation.
- Designate the search area. If possible, it should be below ground to provide protection against incidents such as the explosion of a booby-trapped vehicle. Establish a parking area adjacent to the search area.
- If applicable, checkpoint personnel should include linguists.
- Establish an early warning system around the perimeter of the OP (trip flares, empty cans, dry branches, and so on).
- Prepare shelters and defensive positions.

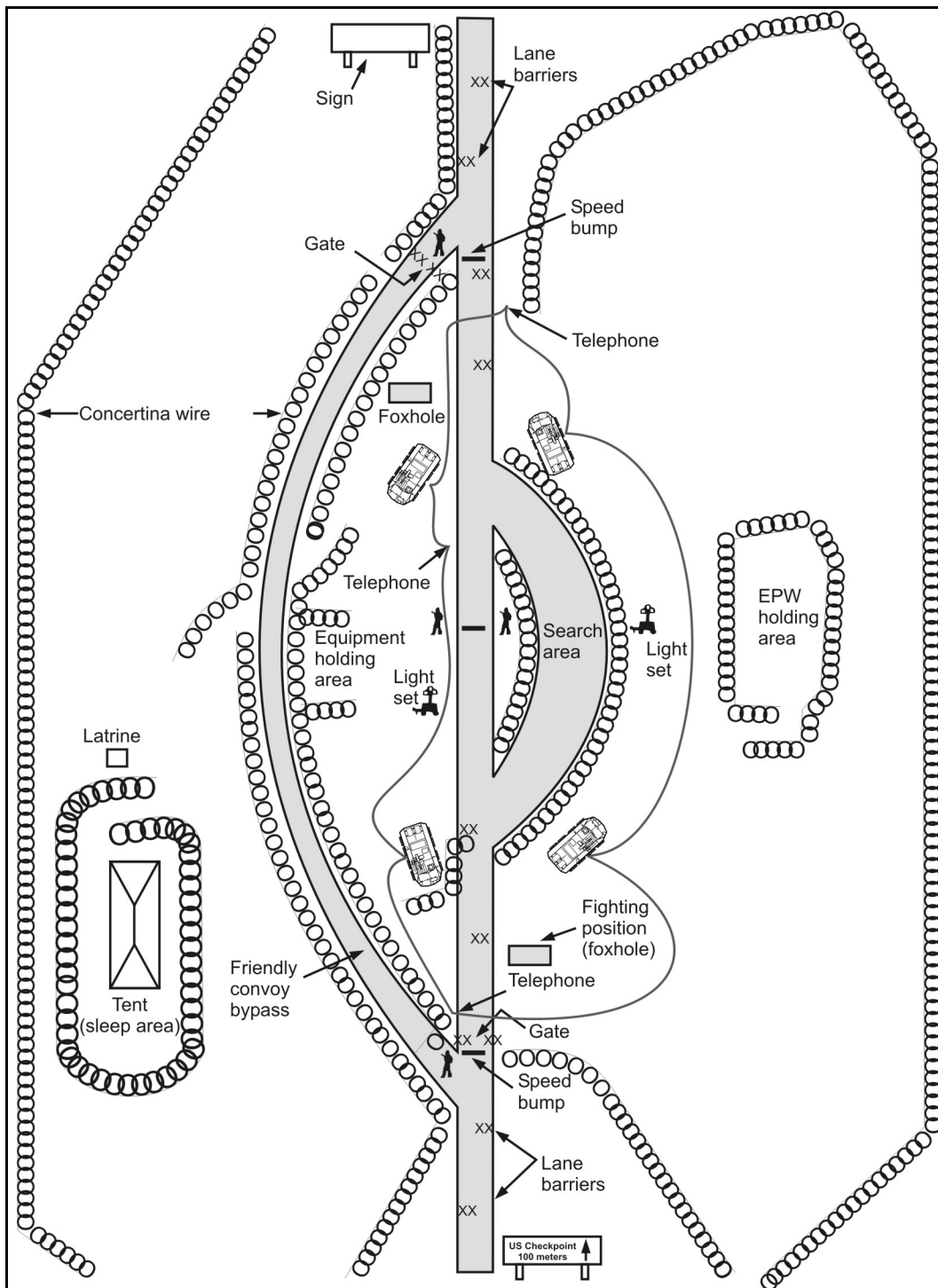


Figure 5-32. Example of a deliberate checkpoint.

c. **Manning Observation Posts and Checkpoints.** When manning OPs and checkpoints, proper order and a systematic approach must be emphasized. Personnel must behave so that no misunderstanding occurs. The personnel manning the checkpoint must be in complete control of the surrounding terrain.

(1) Although the OP is usually manned on a 24-hour basis, it may be manned only by day or night. During darkness, at least two persons must be in the OP position--one observes while the other is resting. In remote areas, or if the situation in the area is tense, more personnel man the OP for security and observation.

(2) A minimum of two soldiers should man the checkpoint, depending on traffic and the general situation. One soldier examines people and vehicles; the other soldier covers the area where people and vehicles are checked. The soldier covering the other area is armed and has easy access to radio and telephone. If more soldiers are manning the checkpoint, one of them should be ready to set up obstacles to stop vehicles trying to force their way through the checkpoint.

d. **Communications.** All OPs and checkpoints are connected to their unit or directly to the battalion operations center by radio and telephone. A spare radio and batteries should be supplied to the OP and checkpoint, especially to remote OPs located in dangerous areas. Radio and telephone checks are carried out at least twice every 24 hours (three times is recommended). Special code words must be prepared for use in certain situations. Conversation must be coded. Reserve frequencies must be available. OPs and checkpoints of great operational value may be connected by direct landline to ensure rapid coordination in urgent situations.

e. **Equipment.** Many items are used to reinforce a roadblock, checkpoint, or OP. Some of the recommended equipment includes--

- Barrels filled with sand, water, or heavy concrete blocks (emplaced to slow and canalize vehicles).
- Concertina wire (emplaced to control movement around the checkpoint).
- Secure facilities for radio and wire communications with the controlling headquarters.
- First aid kit or a medic if available.
- Sandbags for defensive positions.
- Bunker construction material.
- Binoculars, night vision devices, and or flashlights.
- Long-handled mirrors (used to inspect vehicle undercarriages).
- Signs stating the speed limit into and out of the checkpoint. (The text of these signs must be written in English and the local language.)

Elements manning a deliberate checkpoint may require access to specialized equipment such as:

- Floodlights.
- Duty log.
- Flag and unit sign.
- Barrier pole that can be raised and lowered.
- Generators with electric wire.

f. **Control.** During periods in which the civilian administration is not functioning, refugees will be traveling routinely throughout the area. All soldiers participating in these operations must fully understand the procedures for appropriately identifying personnel and for controlling personnel and vehicles moving through their AO.

(1) **Personnel Identification.** People who have permission to enter a sector are regulated by special instructions to the patrol conducting the operation. Often local and civilian employees, mayors, and chiefs of tribes in villages in the AO are given special

identification (ID) cards and may pass without being checked. These special ID cards must be registered. The primary reasons for checking people will be for identification and to prevent illegal items being brought into the AO through the checkpoint. Personnel must identify themselves with an ID card, passport, and so on. Such ID cards are written in the local language. Examples of different ID cards must be kept in the checkpoint.

(2) ***Personnel Control.*** Personnel control is conducted in different ways. Soldiers manning the checkpoint should watch for people acting strangely or with bulging clothing. If there is a danger of car bombs, special attention should be paid to cars containing only one person. When conducting body searches, soldiers should feel along clothes and not just pat them. Special attention must be paid to the lower parts of the back and from the shoes up to the knees. Armpits also must be checked. The wide trousers used by some cultures should be carefully examined. Soldiers also should check boots and hats.

(3) ***Checking Women and Clerical Personnel.*** Making a body search of women and clerical personnel is often difficult in Moslem countries and may lead to strong reactions. The commander must thoroughly discuss this with mayors and other leaders, and the procedure used must be consistent with agreements and treaties. Women usually are only checked with a metal detector. Elderly women often may remain in the vehicle during inspection of a car. If there is a suspicion that the “rules” are being misused, then other and better checks must be made. The battalion commander makes these decisions.

CHAPTER 6

URBAN ENVIRONMENT

American and foreign doctrines reflect that military training must give more attention to urban combat. Urban areas are the power centers, and urban terrain is expected to be the most common type of area of operations for future American forces throughout the world. Recent deployments in Panama, Somalia, Kosovo, and Bosnia, as well as developments in Afghanistan, have shown the need for units to be proficient in warfighting in urban and complex terrain. The increasing focus on urban terrorism and civil disorder emphasizes that combat in built-up areas is unavoidable.

Expanding urban development affects military operations as the terrain is altered. Urban and complex close terrain pose significant problems for all types of military forces, but platoons and squads in the SBCT must be capable of leveraging combat power to achieve decisive results. The increased population and accelerated growth of cities have made the problems of combat in built-up areas an urgent requirement for the US Army. This chapter discusses the tools necessary for understanding the urban environment and for planning and executing missions, including reconnaissance, in the urban area.

Section I. UNDERSTANDING THE URBAN ENVIRONMENT

This section discusses the characteristics and definitions of urban operations. Throughout history, military planners have viewed cities as centers of gravity and sources of national strength. Cities are population centers; transportation and communication hubs; key nodes of industrial, financial, and information systems; seats of government; and repositories of wealth. Because the US has worldwide interests that directly relate to global security, deployments into urban environments are likely to become more frequent. These urban operations will serve a variety of tactical purposes--to neutralize or stabilize extremely volatile political situations, to defeat an enemy force that has sought protection afforded by urban terrain, and to provide assistance to allies in need of support. The reconnaissance platoon is an essential element in providing friendly forces with the real-time information and situational understanding they need to defeat the enemy in the urban environment. The commander must examine two key questions that affect the mission of the reconnaissance platoon and the battalion:

- Is it essential that maneuver forces be employed in the urban environment?
- How can forces apply combat power in the most efficient manner in an urban setting?

6-1. DEFINITIONS

Urban operations (UO) are defined as all military actions, combat and noncombat, conducted on terrain where manmade construction affects the tactical options. These operations may involve noncombatants, so the ROE and use of combat power are normally more restrictive than under other conditions of combat. Because of political change, advances in technology, and the Army's role in maintaining world order, UO

now takes on new dimensions. Infantrymen conduct urban combat operations under many varying conditions across the spectrum of conflict from major theater war through SSC to stability operations and support operations. These conditions range from large-scale, high-intensity combat through isolated actions against armed belligerents mixed with noncombatants to peace operations that resemble dangerous police work more than combat. The following terms and definitions provide clarity and focus for commanders conducting tactical planning for combat in an urban environment. They describe the US force's degree of sensitivity to political considerations during the operation being conducted.

a. **High-Intensity UO Conditions.** Under high-intensity UO conditions, combat actions are conducted against a determined enemy occupying prepared positions or conducting planned attacks. These conditions require the coordinated application of the full combat power of the SBCT. An infantry unit's mission is normally to seize, secure, clear, or defend urban terrain, engaging and defeating the enemy using any force necessary. High-intensity UO represents the high end of the combat spectrum. Units must be trained for it because high-intensity UO conditions can be casualty-intensive for both sides. Even though the full, integrated firepower of the SBCT is brought to bear on the enemy, leaders must still try to limit unnecessary destruction and casualties among noncombatants. A recent example of high-intensity UO conditions is the Russian experience in Grozny.

b. **Precision Small-Scale Contingency Operations in Urban Conditions.** Under precision SSC urban conditions, conventional forces conduct combat operations to defeat an enemy mixed with noncombatants. Units conduct combat operations carefully to limit noncombatant casualties and collateral damage while still achieving the military objectives.

(1) **Noncombatant and Political Considerations.** Under these conditions, either the enemy is mixed with the noncombatants or political considerations require the ROE to be more restrictive than under high-intensity UO conditions. It also requires specific tactics, techniques, and procedures for precise use of combat power (as in Operation Just Cause). Some of this combat can be quite violent for short periods.

(2) **Focus and Restraint.** Forces accepting the need to focus and restrain the combat power mark this type of operation. The platoon or section leader may bring overwhelming force to bear but only on specific portions of the urban area occupied by the enemy. He may choose different TTP to remain within the bounds of the more restrictive ROE. This is complicated by the fact that, due to an asymmetrical threat, a precision operation could occur while a high-intensity operation occurs in another part of the city. UO requires strict accountability of individual and unit actions through strict ROE. This requires soldiers to be disciplined and trained.

c. **Stability and Support Operations in UO Conditions.** Under these conditions, infantry units conduct stability and support operations that can easily turn into combat operations (for example, Somalia). Stability operations and support operations may include humanitarian assistance, evacuation of American nationals, or peacekeeping operations. Recent examples include the operations in Monrovia and Bosnia. (Stability operations and support operations are also covered in FM 7-98, FM 100-23, and FM 90-8. Lesson plans for many of these techniques are in TC 7-98-1.)

6-2. CHARACTERISTICS OF THE URBAN ENVIRONMENT

Although each operational environment encountered by the reconnaissance platoon has its own distinct characteristics, urban areas are the most complex. There are two primary factors that influence the complexity of urban operations. One is the manmade terrain and supporting infrastructure. These are covered later in this discussion. The other factor is the density of noncombatants in close proximity to combat forces. Of these two key urban factors, noncombatants and the human dimension are the most important and, potentially, the most confusing. HUMINT, which focuses on gaining an understanding of how the local populace feels toward friendly and enemy forces, is a major part of the reconnaissance platoon's effort. The following discussion describes characteristics unique to the urban environment and the enemy as well as considerations that the reconnaissance platoon must take into account during preparation and planning.

a. **Urban Considerations.** Urban terrain presents operational challenges in an extraordinary mix of horizontal, vertical, interior, exterior, and subterranean settings. Four aspects of this physical dimension merit special consideration.

(1) ***Airspace over the City.*** Airspace provides a rapid avenue of approach into the urbanized area. While aviation assets are unaffected by obstacles such as rubble, they must consider towers, signs, power lines, and other obstructions to flight. Soldiers can locate these obstructions, determine how they can serve as passive air defense measures, and provide a hazards overlay for unmanned aerial vehicle (UAV) units and other aviation assets. The reconnaissance platoon can also identify and mark potential pickup zones (PZs) and landing zones (LZs).

(2) ***Buildings.*** Buildings provide cover and concealment, limit or enhance fields of fire, and restrict or block movement of ground forces. Soldiers must identify buildings that serve as key terrain (for example, as communications nodes or dominant vantage points) throughout the urban area. They must consider rooftops a separate and unique threat. Whenever possible, UAV or aviation reconnaissance of rooftops can identify threats and help to preempt enemy action.

(3) ***Streets.*** Streets afford avenues of approach and are the primary means for rapid ground movement in an urban area. Forces traveling along streets, however, are often canalized by buildings and have little space for maneuver off the main thoroughfares. The reconnaissance platoon must identify trafficability of streets (lateral and parallel) within the area of operations. This includes determining the width and weight capabilities of streets throughout the urban area to assist follow-on forces in their planning.

(4) ***Subterranean Systems.*** Subterranean systems can easily be employed as avenues of approach and supply routes for dismounted elements. Friendly forces must identify subways, sewers, cellars, and utility systems in the urban area. They can then develop an understanding of how the enemy may use these systems to conduct ambushes, counterattacks, infiltration, and sustainment operations. Entrances and exits to subterranean areas should be mapped as part of an overlay.

b. **Types of Urban Terrain.** The urban area is classified into six types of urban terrain.

(1) ***Dense, Random Construction.*** Dense, random construction is typical of the old inner city pattern with narrow, winding streets radiating from a central area in an irregular manner. Buildings are located close together and frequently close to the edge of a roadway.

(2) ***Closed-Orderly Block Areas***. This type of city block typically has wider streets that form rectangular patterns. The buildings frequently form a continuous front along the blocks. Inner-block courtyards are common.

(3) ***Dispersed Residential Areas***. Normally adjacent to closed-orderly block areas in Europe, this pattern consists of row houses or single-family dwellings with yards, gardens, trees, and fences. Street patterns are normally rectangular or curving.

(4) ***High-Rise Areas***. High-rise areas are typical of modern construction in larger cities and towns. They consist of multistoried apartments, separated open areas, and single-story buildings. Wide streets are laid out in rectangular patterns. These areas are often adjacent to industrial-transportation areas or interspersed with closed-orderly block areas.

(5) ***Industrial-Transportation Areas***. These are generally located on or along major rail and highway routes in urban complexes. Older complexes may be located within dense, random construction or closed-orderly block areas. New construction normally consists of low, flat-roofed factory and warehouse buildings. High-rise areas providing worker housing are normally located adjacent to these areas throughout the Orient. Identification of transportation facilities within these areas is critical. These facilities, especially rail facilities, pose significant obstacles to military movement.

(6) ***Permanent or Fixed Fortifications and Other Military Installations***. Examples of permanent or fixed fortifications include the Hue Citadel and the Siegfried and Maginot Lines. While most of these types of fortifications are found in Western Europe, a number can be found in the Balkans, Middle East, Asia, Africa, and South America. Fortifications in the United States are mostly of the coast-defense type. Permanent-type fortifications can be made of earth, wood, rock, brick, concrete, steel-reinforced concrete, or any combination of these. Some of the latest variants have been built underground and employ heavy tank or warship armor, major caliber and other weapons, internal communications, service facilities, and NBC overpressure systems.

c. **The Enemy in the Urban Area**. Trends indicate increasing availability and integration of sophisticated technology and unorthodox operational approaches by potential opponents in urban operations. To offset their inherent weaknesses, enemy forces seek the advantage in urban and complex terrain by remaining dispersed and decentralized; they adapt their tactics to counter the response of US forces and their allies most effectively.

(1) ***Organizations and Capabilities***.

(a) ***Other Forces***. In addition to conventional forces, the enemy in urban areas may include the following:

- Unconventional forces.
- Paramilitary forces.
- Militia and special police organizations.
- Organized crime organizations.

(b) ***Enemy Force Employment***. Enemy forces employ the full range of military ordnance and organizations from small arms, mortars, machine guns, antiarmor weapons, and mines to very capable mechanized and armored forces equipped with current-generation equipment. The enemy uses these various approaches to counter the technological and numerical advantages of US and allied systems and forces. In addition, enemy forces seek to exploit constraints placed on US forces because of cultural bias,

media presence, ROE, ROI, and distance from the crisis location. Urban environments also provide many passive dangers such as disease from unsanitary conditions and psychological stresses.

(c) *Most Dangerous Opponent*. The most dangerous potential opponents remain those who have the capacity to execute full-scale combat actions escalating to a major theater of war. They employ weapons of mass destruction wherever possible. Such organizations as special operations forces (SOFs), state-controlled terrorist elements, paramilitary units, and guerilla forces are part of a strategy of simultaneous, distributed operations both inside and outside of the area of operations. They use mines and unexploded ordnance to demoralize and hamper US forces.

(2) *Enemy Tactics*. While the nature of active threats vary widely among specific urban areas, many principles and techniques are common to all such elements. This discussion examines several operational and tactical tenets that may be used against US forces in the urban environment.

(a) *Local Populace*. The populace of a given urban area represents an aspect of key terrain: the side that manages it best has a distinct advantage. Enemy forces use the population to provide camouflage, concealment, and deception for their operations. Guerilla and terrorist elements look no different from other members of the community. Even conventional and paramilitary forces often adopt a civilian look to confuse friendly forces. The civilian populace can also actively provide cover for enemy forces, enhancing their mobility in proximity to US positions.

(b) *Moral Responsibility*. Enemy forces take advantage of the moral responsibilities of US and ally units, attempting to make the civilian populace a burden on their logistical and force protection resources. Local residents also serve as a key intelligence source for enemy forces that attempt to use civilians with access to US bases or perimeters to gain information on friendly dispositions, readiness, and intent.

(c) *Information War*. Enemy forces take advantage of the media to turn the sentiments of the civilian populace of other countries against US forces. Print and broadcast reporters and photographers, video cameras, Internet web sites, and cellular telephones are examples of tools the enemy can use to influence popular opinion.

(d) *Key Facilities*. Enemy forces identify key facilities and then use them to shape the area of operations in their favor. Examples of facilities that the enemy may target to gain a position of advantage against US forces include telecommunication sites, water treatment plants, and power generation and transmission sites.

(e) *Physical Environment*. Enemy forces take advantage of every aspect of the urban environment to attack US forces. Rooftops and tall buildings afford vantage points and ambush positions that exceed the maximum elevation capability of many friendly weapon systems. Elevated attack positions allow the enemy to strike vehicles at their most vulnerable points and to use enfilading fire against exposed dismounted soldiers. Basements and other subterranean areas provide covered and concealed positions that allow movement and access throughout the area of operations. Many of these positions are below the minimum depression capability of friendly vehicles and weapons.

d. **Civilian Considerations**. Analyzing the information gained on the civilian populace is an important factor in determining courses of action for higher headquarters. The platoon leader analyzes the information collected and assesses what actions are necessary to control the impact of civilians. Options that the reconnaissance platoon

leader can recommend to higher headquarters include screening civilians, prohibiting unauthorized movement, diverting or controlling refugee movements, and evacuating civilians. Information requirements for the platoon consist of the following:

- Political affiliations and grievances.
- Ethnicity.
- Factions.
- Cultural distinctions.
- Living conditions.
- Religious beliefs.
- Attitude toward US forces (friendly, neutral, or hostile).

Section II. PLANNING

The planning phase for urban operations entails two key actions: collecting and analyzing existing intelligence and developing the plan.

6-3. COLLECT AND ANALYZE EXISTING INTELLIGENCE

During the planning phase, the reconnaissance platoon leader assesses his assigned reconnaissance objectives and conducts his urban IPB. To begin developing the situation, the platoon collects and analyzes existing intelligence, including map and aerial images (IMINT) and HUMINT. The platoon begins mapping the urban area as part of the planning phase.

a. Before entering an urban environment, reconnaissance elements should develop urban operations sketches. These reconnaissance products, usually created as overlays, serve several purposes. The sketches are an important supplement to existing maps which in most cases do not show the level of detail necessary for effective situational understanding. The sketches also allow the reconnaissance platoon leader to track his elements with greater accuracy and to give precise location updates to higher headquarters. The ultimate goal is to hand off the sketch to the battalion for use by leaders and soldiers at all levels of the operation.

b. In developing urban operations sketches and overlays, the reconnaissance platoon should attempt to gain access to city planner or civil engineer maps which provide detailed information on the urban area. The platoon then conducts initial map and aerial photograph reconnaissance to pinpoint key terrain and other important locations in the area of operations. Figure 6-1 shows an example of photoreconnaissance, which focuses on areas such as the following:

- (1) Sites that may serve as potential safe havens for enemy forces, including--
 - Hospitals.
 - Police stations.
 - Embassies.
 - Other facilities that are nominally friendly but that could harbor enemy elements.
- (2) Hazardous areas such as--
 - Construction sites.
 - Dangerous intersections.
 - Bridges.
 - Areas of criminal activity.

(3) Major terrain features, including--

- Bridges.
- Parks.
- Industrial complexes.
- Airports.

(4) Subterranean features such as--

- Sewers/utility systems.
- Subway systems.
- Underground water systems.



Figure 6-1. Initial photoreconnaissance in urban operations.

c. Once this basic reconnaissance is complete, the reconnaissance unit uses the available maps and photographs to refine the information and translate it into a form that can be transferred to the urban operations sketch. This process includes incorporating a reference system to identify buildings and streets. Naming and numbering conventions should be simple (for example, odd number buildings on left side of street, even numbers on right street) to allow for ease of navigation and orientation in the urban environment. Street names should not be used as references as the signs can be removed or changed to confuse friendly forces.

d. The reconnaissance elements add graphic control measures and identify sites of tactical and operational significance (Figure 6-2, page 6-8). The reconnaissance platoon leader can then use the accumulated information to develop a detailed urban operations

sketch (Figure 6-3). He must ensure that the sketches the platoon develops and uses are consistent with those used throughout the battalion.

e. The sketches are distributed both within the unit and to higher and adjacent elements. The platoon leader must ensure that every soldier has an understanding of the sketch and reference system since individual vehicles and sections may have to execute operations on their own. As the reconnaissance platoon conducts operations in the urban area, it confirms the accuracy of the sketch and adds more detail as necessary.



Figure 6-2. Refinement of urban operations photoreconnaissance.

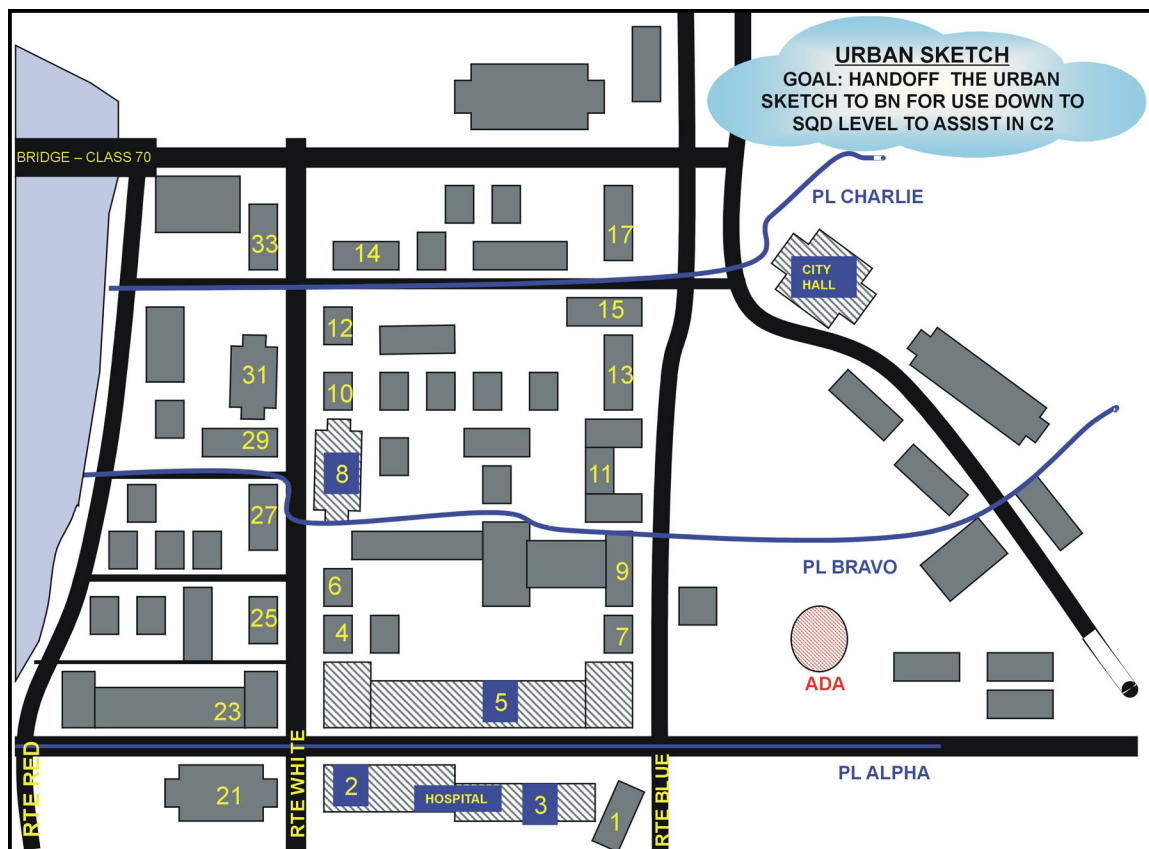


Figure 6-3. Urban operations sketch.

6-4. DEVELOP THE PLAN

Once the reconnaissance platoon leader has collected and analyzed existing intelligence, he and his subordinates then develop the plan for completing the reconnaissance.

a. **Intelligence Collection Plan.** The collection plan begins with the reconnaissance platoon obtaining all available information, including that from internal military forces and SOFs. In particular, the platoon gathers information on locations of reliable sources near the urban area that can be used to gain the most current situation within the area of operations. In diverse multiethnic areas, it is important for platoon soldiers to have an understanding of how the different segments of the local populace will react to them during the course of operations.

(1) **Approach Routes.** Based upon his current information, the platoon leader identifies the best approach route into the urban area, locations or obstacles to be avoided, sources within the urban area, and any other specific areas of interest. The use of tactical questioning is an invaluable skill in validating the information from HUMINT sources. Depending on the mission and the information gained initially, the reconnaissance platoon may have to conduct infiltration using surveillance teams to observe areas of interest or conduct target acquisition. It must develop thorough plans for the surveillance teams, covering security considerations such as exfiltration routes, immediate support (direct or indirect), and evasion corridors. Surveillance positions should be placed in low-activity areas and occupied during limited visibility to reduce the possibility of compromise. Sustainment considerations are also critical; these include the duration of

the surveillance mission and required logistical support (such as food, water, and batteries). The surveillance teams must have redundant communications for successful operations (refer to the following discussion of communications in the urban environment).

(2) **Gaining Information.** After analyzing the mission and the commander's intent, the reconnaissance platoon leader determines how to gain the information required within its AO. The information-gathering process is conducted progressively from outside the urban area to inside the urban area. As the platoon gains information from the outer ring of the area of operations, it updates the focus of the collection plan and refines the reconnaissance and surveillance objectives within the urban area. The urban situation can change quickly, leading to compromise or attack; it is essential that reconnaissance units continuously maintain a current COP. The platoon continues to collect and corroborate information as it approaches the urban area. The platoon leader then determines whether to use reconnaissance or surveillance to gather information on or in the objective areas.

b. **Reconnaissance.** The reconnaissance platoon leader must decide on the stealthy or aggressive method of reconnaissance. Mounted or dismounted patrols are used in conjunction with other surveillance assets to gain information required by the mission.

c. **Surveillance.** The reconnaissance platoon uses surveillance to collect information on or in objectives. Locating surveillance positions within the urban area requires thorough planning to ensure teams are not compromised and that the platoon can assist in extraction, if necessary. Communications are of vital importance to the surveillance team; therefore, redundancy must be incorporated into the collection plan. Security considerations for the team, such as exfiltration routes, immediate support (direct or indirect), and evasion corridors, are essential. Surveillance positions should be placed in low-activity areas and occupied during limited visibility to reduce possibility of compromise. The duration of the surveillance mission must also be considered for sustainment of the team (considering items such as food, water, and batteries). The selection of the hide site and surveillance site(s) depends on METT-TC. The following are considerations for site selection:

- Can the team place the designated surveillance target(s) under continuous and effective observation and within the range of surveillance devices to be used?
- Will the surveillance site have to move if weather and light conditions change?
- Does the area provide concealment and entrance and exit routes?
- Are there dominant or unusual terrain features nearby?
- Is the area wet, is there adequate drainage, or is the area prone to flooding?
- Is the area a place the enemy would want to occupy?
- Is the site silhouetted against the skyline or a contrasting background?
- Are there roads or trails nearby?
- Are there other natural lines of movement nearby (gullies, draws, or any other terrain for easy foot movement)?
- Could the team be easily trapped in the site?
- Are there any obstacles to prevent vehicle movement nearby (roadside ditch, fence, wall, stream, or river)?
- Are there any inhabited areas in the prevailing downwind area?
- Are there any suitable communication sites nearby?

- Is the site in the normal line of vision of enemy personnel in the area?
- Is there a source of water in the area?

d. **Infiltration.** Plans for infiltration are based on the requirement for conducting movement to the AO with the least risk of detection.

(1) Select concealed primary or alternate routes based on detailed map reconnaissance, aerial photographs, ground reconnaissance, and data on the enemy situation from other sources.

(2) Avoid obstacles, populated areas, silhouetting, enemy positions, main avenues of approach, and movement along heavily populated routes and trails.

(3) The time of infiltration should be during reduced visibility and reduced alertness. The time is especially important during critical phases such as moving through populated areas.

(4) Soldiers must know routes, rally points (and alternates), time schedules, danger areas, and the enemy situation. These are critical to speed and stealth.

(5) The team should have centralized coordination to ensure that all crewmen act in accordance with cover and deception plans. Infiltration by land is characterized by centralized planning and decentralized execution.

e. **Exfiltration.** The principles of route selection, movement formations, and movement security are observed during movement to the extraction site.

(1) The time that a team remains in the urban area of operations depends on its mission, composition, and equipment. The exfiltration is critical from a standpoint of morale and mission accomplishment. Plans for extraction are made before the operation, with alternate plans for contingencies such as the evacuation of sick or injured personnel. During the mission, the team leader may encounter an unforeseen situation that may demand the utmost flexibility, discipline, and leadership.

(2) Each team is given code words in the OPORD for use during exfiltration. For example, one code word may mean that the team is at its PZ. Another may mean that both the primary and alternate PZs are compromised and to abort the extraction.

(3) When a team has missed a certain number of required transmissions, the command assumes that the team has a communication problem, is in trouble, or both. At that time, a no-communication resupply and exfiltration plan is used.

(4) Exfiltration of the team may be by means other than linkup with their vehicles. The OPORD may specify dismounted exfiltration or linkup with friendly forces in an offensive operation. Any of these means may also be planned as alternatives in the event the team cannot be extracted by their vehicles or to avoid capture.

(5) Soldiers must be trained in exfiltration techniques so they can walk out either singly or in groups.

f. **Communications.** Communications in the urban environment requires detailed planning. Because of the effects of urban terrain, the reconnaissance platoon leader must plan for redundant communications that will allow the reconnaissance platoon freedom of movement. In simplest terms, to communicate effectively and continuously, he must minimize the limitations imposed by the urban environment and maximize the advantages of existing civil communications. The reconnaissance platoon should follow this general rule: if you cannot communicate where you are, move until you can.

(1) **Terrain.** The first step is to identify terrain along the approach route and in the urban area of operations that supports line of sight (LOS) communications. Manmade

structures can create problems for single-channel radios; they may inhibit LOS radio communications by absorbing or reflecting transmitted signals. One solution is to establish retrans sites on supporting terrain or structures to facilitate C2 during the reconnaissance platoon's initial entry into the urban area. The platoon continues to identify structures within the urban area that can support retrans sites as it moves within the area of operations. If retrans teams are not available, unit vehicles must position themselves to maintain communications with all elements. TUAV retrans capabilities should be requested and coordinated for redundancy. The battalion should also plan to request and coordinate use of aviation assets for C2 and retrans, if available.

(2) **Advantages.** The urban environment may have exploitable advantages such as the availability of electrical power and commercial telecommunications networks. Electrical power generation stations and other emergency power systems are normally found in protected structures and are often usable in UO. Enclosed areas offer excellent concealment and protection of communications and other C2 support equipment. Extensive commercial communications networks composed of miles of protected underground cable connecting central telephone exchanges are likely to be available, as are numerous types of public service radio nets (such as those used for police, fire, civil defense, and taxi radios). These systems have existing antennas and retransmission stations.

g. **Fire Support.** The reconnaissance platoon leader must plan for employment of indirect fires in the urban area of operations.

(1) **Mortar Fires.** Mortars are the most responsive indirect fires available to infantry commanders and leaders. Their mission is to provide close and immediate fire support to the maneuver units. Mortars are well suited for combat in urban areas because of their high rate of fire, steep angle of fall, and short minimum range. The platoon leader must plan mortar support with the fire support element (FSE) as part of the total fire support system. (See FM 7-90 for detailed information on the tactical employment of mortars.)

(a) **Role of Mortar Units.** The role of mortar units is to deliver suppressive fires to support maneuver, especially against dismounted infantry. Mortars can be used to obscure, neutralize, suppress, or illuminate during urban combat. Mortar fires inhibit enemy fires and movement, allowing friendly forces to maneuver to a position of advantage. The most common and valuable use for mortars is often harassment and interdiction fires. One of their greatest contributions is interdicting supplies, evacuation efforts, and reinforcement in the enemy rear just behind his forward defensive positions. During World War II and the recent Middle East conflicts, light mortar high explosive (HE) fires have been used extensively during urban combat to deny the use of streets, parks, and plazas to enemy personnel. Finally, mortars can be used, with some limitations, against light armor and structures. Effectively integrating mortar fires with dismounted maneuver is key to successful combat in an urban area.

(b) **Communications.** Initially, radio is the primary means of communication during urban combat, but an increased use of wire, messenger, and visual signals will be required. However, wire usually is the primary means of communication between the forward observers, fire support team, fire direction center, and mortars since these elements are close to each other. Also, FM radio transmissions in urban areas are likely to be erratic. Structures reduce radio ranges; however, remoting the antennas to upper floors or roofs may improve communications and enhance operator survivability. The use of

radio retransmissions is another technique that may apply. A practical solution is to use existing civilian systems to supplement the unit's capability, understanding that this is an unsecure method of communication.

(c) *Magnetic Interference*. In an urban environment, all magnetic instruments are affected by surrounding structural steel, electrical cables, and automobiles. Minimum distance guidelines for the use of the M2 aiming circle (FM 23-90) are difficult to apply. To overcome this problem, an azimuth is obtained to a distant aiming point. From this azimuth, the back azimuth of the direction of fire is subtracted. The difference is indexed on the red scale and the gun manipulated until the vertical cross hair of the sight is on the aiming point. Features such as the direction of a street may be used instead of a distant aiming point.

(d) *High-Explosive Ammunition*. During urban combat, mortar HE fires are used more than any other type of indirect fire weapon. Although mortar fires often are targeted against roads and other open areas, the natural dispersion of indirect fires will result in many hits on buildings. Leaders must use care when planning mortar fires during urban operations to minimize collateral damage.

- HE ammunition, especially the 120-mm projectile, gives good results when used against lightly built structures within cities. However, it does not perform well against reinforced concrete found in larger urban areas.
- When using HE ammunition in urban fighting, only point-detonating fuzes should be used. The use of proximity fuzes normally should be avoided because the nature of urban areas causes proximity fuzes to function prematurely. Proximity fuzes, however, are useful in attacking some targets such as OPs on tops of buildings.

(e) *Illumination*. In the offense, illuminating rounds are planned to burst above the objective. If the illumination were behind the objective, the enemy troops would be in the shadows rather than in the light. In the defense, illumination is planned to burst behind friendly troops to put them in the shadows and place the enemy troops in the light. Buildings reduce the effectiveness of the illumination by creating shadows. Continuous illumination requires close coordination between the observer and fire direction center (FDC) to produce the proper effect by bringing the illumination over the defensive positions as the enemy troops approach the buildings (Figure 6-4, page 6-14).

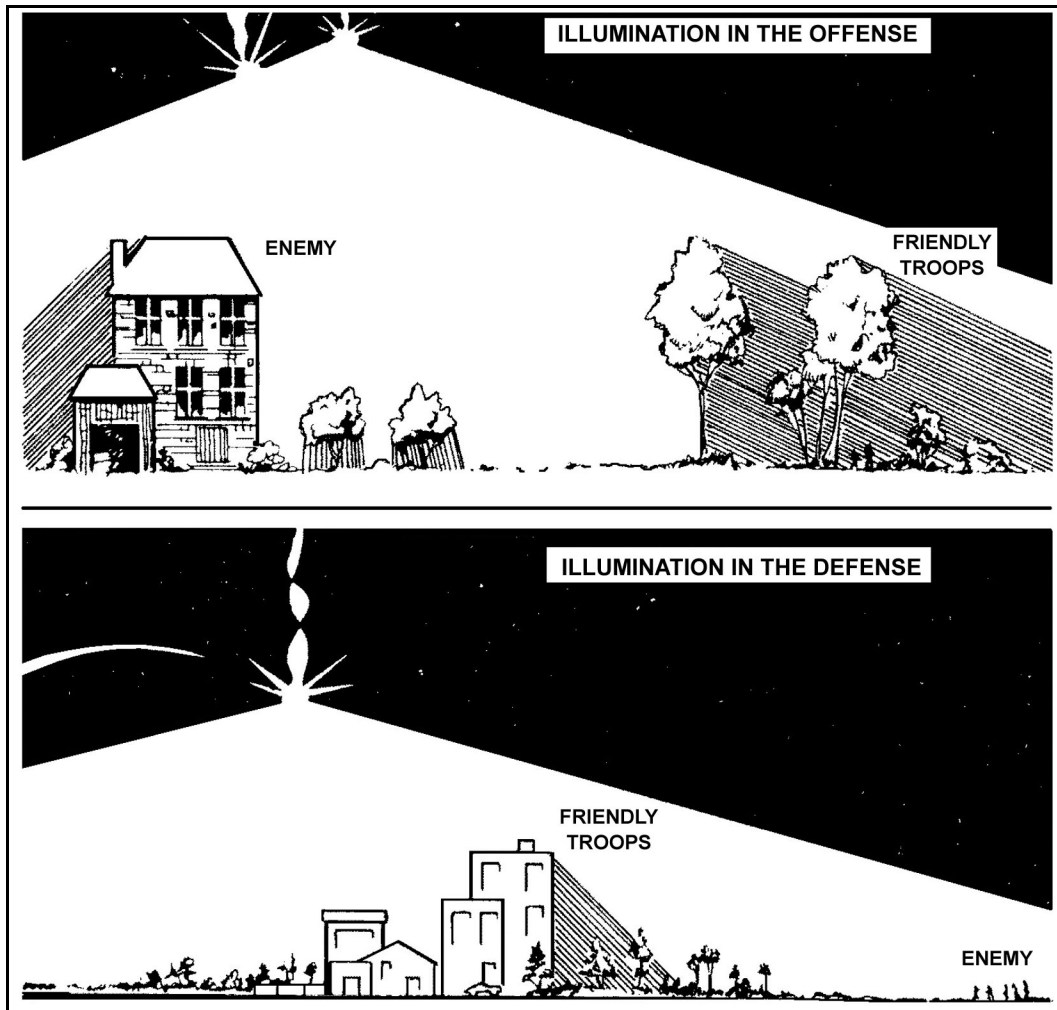


Figure 6-4. Illumination during urban operations.

(f) *Special Considerations.* When planning the use of mortars, the reconnaissance platoon leader must consider the following:

- Forward observers (FOs) should be positioned where they can get the maximum observation so target acquisition and adjustments in fire can be best accomplished. This is not necessarily on tops of buildings.
- The reconnaissance platoon leader must understand ammunition effects to correctly estimate the number of volleys needed for the specific target coverage. Also, the effects of using white phosphorus may create unwanted smoke screens or limited visibility conditions that could interfere with the tactical plan.
- Observers must be able to determine dead space in urban terrain. Dead space is the area in which indirect fires cannot reach the street level because of buildings. This area is a safe haven for the enemy. For mortars, the dead space is about one-half the height of the building.

(2) *Field Artillery.* During urban combat, field artillery (FA) provides direct support (DS), general support (GS), and general support-reinforcing (GS-R) to infantry units.

(For further discussion on the employment of field artillery in urban terrain, see FM 3-06.11.)

(a) When FA supports fighting in urban areas, fire support coordination measures necessary to provide adequate yet safe support must be considered carefully due to the close proximity of friendly forces to the enemy. When planning for fire support, leaders should consider the following:

- The increased cover and concealment afforded by the terrain.
- Ground observation is limited in urban areas.
- Adjusting fires is difficult since buildings block the view of adjusting rounds.
- Acquiring targets is difficult in urban terrain because the enemy has many covered and concealed positions and movement lanes.
- Forward observers must be able to determine where and how large the dead spaces are.
- The use of air burst fires is an effective means of clearing snipers from rooftops.

(b) Employing artillery in the direct-fire mode to destroy fortifications (Figure 6-5, page 6-16) should be considered, especially when assaulting well-prepared enemy positions. Also, restrictive fire support coordination measures, such as a restrictive fire area or no-fire area, may be imposed to protect civilians and critical installations.

- The 155-mm self-propelled howitzer is extremely effective in neutralizing concrete targets with direct fire.
- Concrete-piercing 155-mm rounds can penetrate 36 inches of concrete at ranges up to 2,200 meters.
- When employing artillery in the direct-fire mode and maneuvering the self-propelled howitzers within the urban area, it is important that the infantry secure them because they do not have any significant protection for their crews.

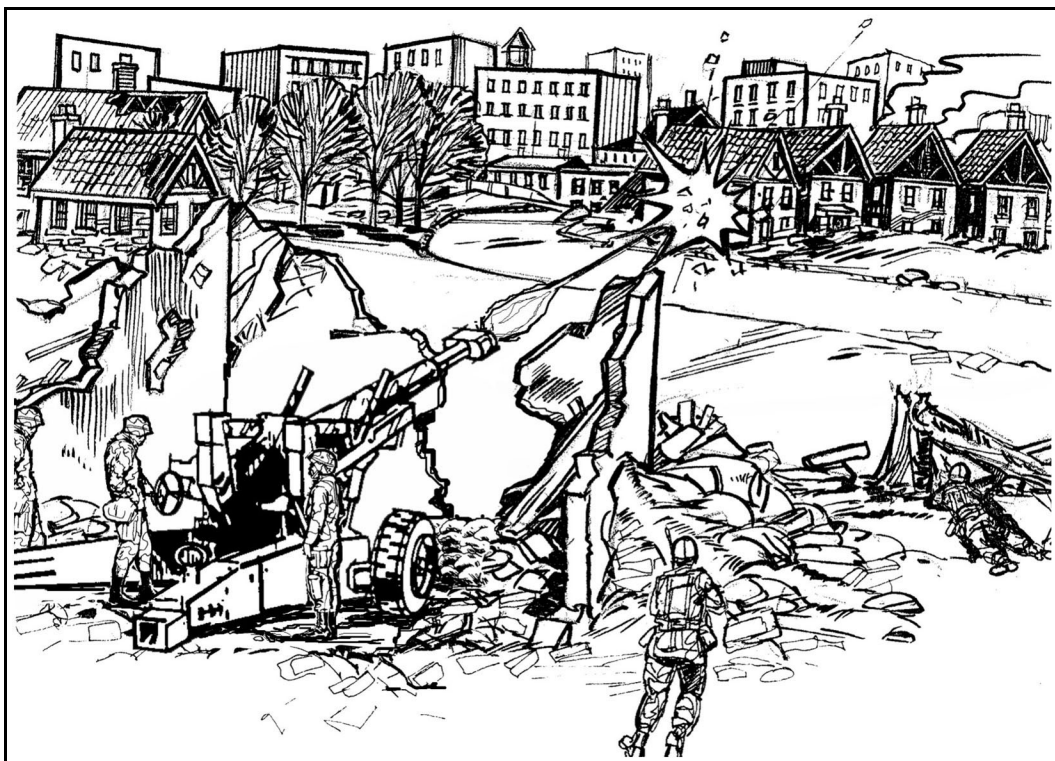


Figure 6-5. Artillery in direct fire role.

NOTE: When employing these weapon systems, leaders must be aware of the explosive effects and fragmentation fallout as well as the blast-over pressure and how these will affect the infantry on the ground. (For more specific information on the effects of weapons, see FM 3-06.11.)

(3) ***Precision-Guided Munitions.*** The reconnaissance platoon must also be prepared to employ precision-guided munitions from other sources, including Army artillery and joint and allied military services. This may entail use of laser or infrared (IR) designator equipment or use of special augmentation. The platoon leader must ensure that no-fire areas (NFAs) are placed on all surveillance positions and that critical friendly zones are coordinated along reconnaissance routes. The following are some fire support considerations for urban operations; they are by no means all-inclusive:

- Identify who controls each fire support asset.
- Exchange fire plans and observer plans with adjacent units.
- Develop observer plans to include OPs in buildings, location of laser designators, and overwatch of trigger points.
- Identify location of hazardous sites (both above and below ground), fuel and industrial storage tanks, gas distribution lines, and any other area where incendiary effects of detonating artillery and mortar rounds will start fires.
- Identify the general construction or composition of the buildings and road surfaces (these may impact the type of munitions used).
- Determine where building masking, overhead power lines, or towers degrade GPS and compass functioning.

- Determine if use of obscurants and illumination will favor friendly units or the enemy.
- Determine whether buildings or structures will require fire support personnel to carry or use equipment not normally carried (for example, field expedient antennas, climbing rope, wire gloves, axes, or sledgehammers).
- Identify the requirements for radar coverage.

h. **Combat Service Support.** To preclude compromise, surveillance teams carry required supplies into the area of operations on their vehicles. They avoid unnecessary movement in their area of operations. Some missions, however, may require additional supplies that cannot be carried on the vehicles. Resupply operations for deployed surveillance teams are planned and coordinated during the planning phase.

(1) **Resupply.** When resupply is required, a drop point is established. It should be well away from the hide site and the surveillance site, but in a position that is available to all teams. Caches should be used in these instances. Units should standardize the contents of caches so all teams understand what is available. Example items to be carried in the cache include the following:

- Emergency Class I items.
- Batteries (radio/night vision devices [NVDs]).
- Class VIII items.
- Nonsensitive mission-specific items.

(2) **Maintenance.** In the urban area of operations, self-recovery within the platoon will be necessary. Vehicles should have towing cables and shackles attached and be configured for immediate recovery. The platoon identifies a secured maintenance collection point outside the urban area during planning and coordinates with battalion for maintenance support. All vehicle crews must know this location.

(3) **Medical.** Organic medical support in the reconnaissance platoon is limited to self aid and buddy aid. Due to the remote deployment of teams, primary medical care is not readily available. All soldiers should receive combat lifesaver and emergency medical technician training.

(4) **Medical Evacuation.** Additional medical support is requested as needed. When possible, medical evacuation of team members is delayed until the whole team is evacuated from the area of operations. Wounded team members are sent directly to the nearest medical facility that can provide definitive care and treatment. Combat stress is another medical aspect with which reconnaissance teams must cope. Due to the nature of reconnaissance missions, the teams are subjected to stress in many ways. Some of these factors are listed below.

(a) **Limited Visibility** (darkness, smoke, fog, rain, snow, ice, and glare). This requires the extended use of night-vision devices.

(b) **Disrupted Sleep Cycles.** Performance suffers from the disruption of the normal sleep schedule.

(c) **Mental Fatigue.** This results from having to make decisions of serious consequences in too little time with too little information while exposed to danger.

(d) **Physical Fatigue.** This results from conducting physical activity excessive to current conditioning or at a strenuous level without rest.

(5) **Combat Stress.** Combat stress is not solely a medical problem. It is also a command problem in terms of reduced performance and personnel lost from duty. It is a

command responsibility to take actions to increase the individual team member's resistance to stress. This can be done through extensive training under simulated combat conditions and a high level of physical fitness. Proper nutrition is also a major factor in coping with stress. Soldiers should have a healthy, balanced diet not only during combat operations but also before the mission begins.

Section III. EXECUTION

The execution phase entails four key actions, which are examined in this section:

- Approach the urban AO .
- Employ dismounted surveillance teams.
- Conduct reconnaissance.
- Conduct assessment of the AO.

6-5. APPROACH THE URBAN AREA OF OPERATIONS

The platoon conducts information-gathering operations outside of the urban area to gain information on the objective. Depending on the time available, the reconnaissance platoon develops the urban situation progressively as it moves from the surrounding area toward the city. The battalion may refine objectives and routes as it gains and analyzes information. If available, UAVs conduct aerial reconnaissance of routes and objective areas. UAVs focus on unit entry points to determine the enemy situation, including obstacles in the urban area, ambush positions on rooftops, or movement of personnel and vehicles as reconnaissance units approach.

6-6. EMPLOY DISMOUNTED SURVEILLANCE TEAMS

The primary method of employing surveillance teams is in a hide or surveillance site. However, the terrain, mission, and location of the site may dictate that the teams establish a separate surveillance site (or sites) to effectively observe the area.

a. **Hasty Sites.** These are sites the team plans to occupy for a short period (generally less than six hours). This occurs most often during target-acquisition missions.

b. **Urban Surveillance Sites.** Surveillance teams can construct fixed urban hide sites in occupied and abandoned buildings, in water tanks, in shrubbery, on warehouse rooftops, or in attics of multistory buildings or other tall structures. If possible, teams should avoid wooden buildings and buildings in a significantly deteriorated condition because of the risk of injury from fire and structural failure.

c. **Hasty Subsurface Sites.** A hasty subsurface site is constructed when there is not enough time to construct a complete subsurface site. The site is especially useful when there is little natural cover and concealment. Considerations in the employment of hasty subsurface sites include the following:

- Lower profile than surface surveillance sites.
- Better protection against small-arms weapons and indirect fires.
- Excellent camouflage.
- Requirement to conceal soil.
- Greater time required to construct.
- Construction noise.

6-7. CONDUCT RECONNAISSANCE

The fundamentals of reconnaissance described in Chapter 4 are applicable in an urban environment, but the type of information and the method by which it is collected takes on a new form. The reconnaissance platoon develops an understanding of the regional, local, and neighborhood-level situation. The soldiers must learn how the urban area operates and who the sources of power or influence are. Examples include the following:

- The formal and informal political power structure.
- Police, secret police, and intelligence agencies.
- Criminal organizations.
- Military and paramilitary structures.
- Key terrain.
- Sensitivities of the populace.

6-8. ASSESS THE AREA OF OPERATIONS

The platoon leader receives and analyzes the information gathered by the reconnaissance and surveillance teams. He then assesses the AO according to the mission and intent of higher. The assessment includes, but is not limited to, these elements:

- Enemy composition and activity.
- Areas of vulnerability to friendly forces.
- Key terrain.
- Approach routes for mounted and dismounted forces.
- Entry points or points of penetration.
- Support positions for direct and indirect systems.
- Civilian disposition.
- Density and composition of urban area.
- Hazard areas (fuel storage, natural gas lines, chemical production sites).
- Communication facilities.
- Retrans sites.
- Intent of civilian populace (stay or flee).

6-9. END STATE

The efforts of the reconnaissance platoon can be a critical factor in shaping the urban area of operations and in maximizing the effectiveness of the battalion (and, therefore, the brigade).

a. **Reconnaissance Platoon Tasks.** A summary of the reconnaissance platoon's tasks in the urban environment includes the following:

- Develop and distribute UO sketches.
- Reconnoiter recommended entry points and routes.
- Maintain surveillance on key objectives.
- Conduct target acquisition.
- Assist in isolation of the AO by conducting screening operations (or establishing checkpoints) on the perimeter.
- Perform continuous information gathering during the operation. Especially vital to the battalion effort is information on personnel attempting to leave or enter the urban area.

b. **Mission Accomplishment.** The reconnaissance platoon achieves the end state of its reconnaissance effort when two critical questions are answered:

- Is it essential to conduct operations in the urban environment?
- If so, how can the battalion employ combat power in the most efficient manner?

Section IV. COMBAT MULTIPLIERS

The nature of urban operations makes it infantry-centric; however, the urban battle should never be exclusively an infantry fight. A powerful combined arms team properly employed in an urban area will enhance mission accomplishment. It is imperative that the leadership of the reconnaissance platoon have a full understanding of the capabilities of other supporting assets in order to successfully accomplish its reconnaissance mission in urban terrain. This section discusses the more common combat multipliers available to infantry units during the execution of UO.

6-10. ARMORED VEHICLES

Based on the considerations of the METT-TC analysis and the operational ROE, a situation may arise that requires the attachment of tanks in direct support of the SBCT infantry battalion mission. This paragraph discusses tactics and techniques used by infantry units when working with armored vehicles.

a. **Task Organization for Mechanized Operations.** Leaders must understand the principles of employing infantry and armor forces to maximize their capabilities and ensure mutual support. Support from the armored vehicles enhances maneuver by the infantry.

(1) The infantry assists the mechanized forces by infiltrating to clear obstacles or key enemy positions and to disrupt the enemy defense. It provides security for the armored vehicles by detecting and suppressing or destroying enemy antitank weapons. It designates targets and spots the impact of fires for tanks and Bradley fighting vehicles (BFVs).

(2) Mechanized forces support the infantry by moving with it along an axis of advance and providing a protected, fast moving assault weapons system. They suppress and destroy enemy weapons, bunkers, and tanks by fire and maneuver (Figure 6-6). They also provide transport when the enemy situation permits.

(3) Armored vehicles should never be maneuvered individually. The smallest maneuver level for armor is a section (two vehicles).

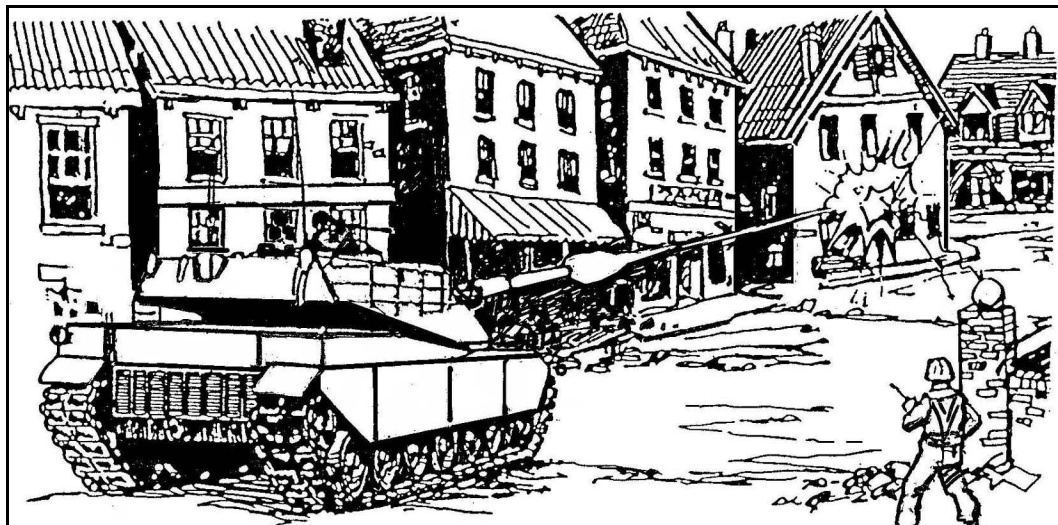


Figure 6-6. Tank in direct support of infantry.

NOTE: For further discussion concerning the strengths, limitations, and employment considerations of armor with the infantry, see FM 3-06.11.

b. **Weapon System Considerations.** While operating in concert with armored forces, the infantry leader must be knowledgeable of the capabilities, limitations, and effects of the armor weapon systems. He must understand the dangers these systems pose to his soldiers when operating together and ensure that his soldiers are briefed about these dangers. Figure 6-7, page 6-22, shows the difference in the capabilities of the BFV and the M1A1/A2 tank with regard to fields of fire on urban terrain. Note that the BFV can engage a target 9 to 10 stories high at 20 meters, whereas an M1A1/A2 tank requires 90 meters.

(1) ***Bradley Fighting Vehicles.***

(a) The primary role of the BFV in an urban environment is to provide suppressive fires and to breach exterior walls. The vehicle's armor-piercing rounds can be very useful in urban terrain. They can penetrate concrete up to 16 inches thick and can easily penetrate brick structures. They are highly effective against earthen- and sandbag-reinforced structures.

(b) The BFV can elevate its 25-mm gun to about +60 degrees and depress the gun to about -10 degrees.

(c) The crew has limited visibility to the sides and rear and no visibility to the top when buttoned up.

(d) The BFV can be outfitted with an external phone hookup for communications with accompanying infantry.

(e) The 25-mm gun, firing antipersonnel (AP), HE, and even target practice-tracer (TP-T) rounds, can be used effectively against enemy-occupied buildings and fortifications.

(2) ***M1-Series Tanks.***

(a) Normally, the primary ammunition for the main gun in the urban environment is the high explosive antitank (HEAT) round. It is the most effective round against masonry and will penetrate all but the thickest reinforced concrete. A HEAT round will create a

hole in masonry or concrete large enough for a man to fit through but will not cut the reinforcing steel bars. A HEAT round is also effective against earthen- and sandbag-reinforced strong points. A 120-mm HEAT round does not become armed until it is about 36 feet from the end of the gun tube.

(b) Multipurpose antitank (MPAT) rounds will penetrate masonry and concrete but are less effective than HEAT rounds against heavier structures.

(c) Sabot ammunition has limited use against non-vehicular targets, and its discarding petals endanger accompanying infantry. Sabot petals create a hazard area extending 70 meters on either side of the gun target line for a distance of one kilometer.

(d) The external M2 HB (cal. 50) machine gun can elevate to +36 degrees; however, to fire the cal. 50 on the M1A2 Abrams, the tank commander must be exposed to enemy fire.

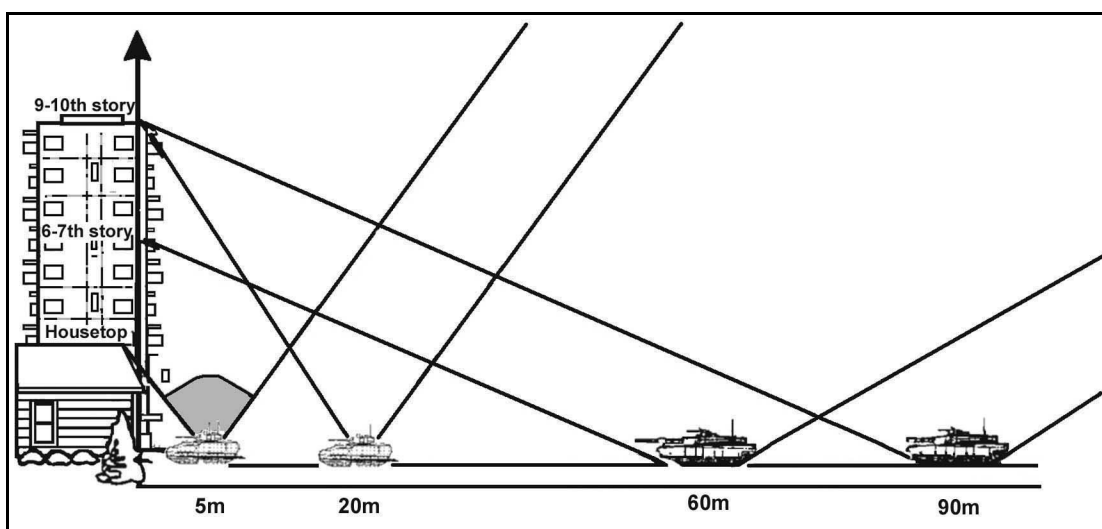


Figure 6-7. Fields of fire on urban terrain.

NOTE: When employing these weapon systems to support the infantry assault, leaders must be aware of the explosive effects and fragmentation fallout as well as the blast-over pressure and how these will affect the infantry on the ground. (For more specific information on the effects of weapons, see FM 3-06.11.)

6-11. ENGINEERS

Normally an engineer squad will be attached to an infantry company. Most engineer manual-labor tasks (for example, preparing fighting positions) will have to be completed by infantry units with reinforcing engineer heavy-equipment support and technical supervision. (For further discussion on the employment of engineers with the infantry, see FM 3-06.11.)

a. **Offensive Missions.** During offensive operations, an engineer sapper team may be attached to the reconnaissance platoon for specific missions. They may be required to conduct the following tasks in support of the platoon:

- Use explosives to destroy fortifications and strong points that cannot be reduced with the maneuver unit's organic assets.
- Locate and remove mines that may hamper the unit's movement.

- Conduct breaching operations.
- b. **Defensive Missions.** Engineers may perform the following tasks in support of the platoon during the defense of an urban area:
 - Construct complex obstacle systems.
 - Assist in the preparation of defensive positions and strong points.

NOTE: When employing demolitions along side the infantry assault, leaders must be aware of the explosive effects and fragmentation fallout as well as the blast-over pressure and how these will affect the infantry on the ground. (For more specific information on the effects of weapons, see FM 3-06.11.)

6-12. ATTACK HELICOPTERS

Infantry units may receive support by a variety of attack helicopters, including (but not limited to) the AH-64A, AH-64D, OH-58D, and MH-6. Attack helicopters can provide area fire to suppress targets and precision fire to destroy specific targets or breach structures. Attack helicopters provide real-time reconnaissance information through direct viewing of the area of operations. This facilitates the platoon leader's ability to effectively coordinate and integrate all aspects of the mission. Attack helicopters can also assist with ISR and close air support (CAS) integration and communications using their advanced suite of sensors and radios. Other supporting helicopters, such as the UH-60, CH-47, and MH-47, may also have weapons systems (7.62-mm machine gun, cal. 50 machine gun, 7.62-mm mini-gun) that aid in the suppression of enemy forces when operating in urban terrain. Operational control of attack helicopter units will remain at battalion level or higher; however, attack helicopters may conduct direct air-to-ground coordination with companies and platoons during combat operations. (For further discussion on the supporting role of the attack helicopter, see FM 1-114 and FM 3-06.11.)

6-13. ANTIARMOR WEAPONS

The tactical use of antiarmor weapons does not change in the urban environment but how they are employed does change. Some employment limitations include--

- Stand-off.
- Displacement after engagements.
- Ability to fire in-depth engagements.
- More obstacles that may interfere with the flight of the AT weapons (such as chicken wire in windows and or door ways, power lines.)
- Increased danger zones.
- All-round security.

For further discussion on the employment of antiarmor weapons in the urban environment, see FM 3-06.11.

a. Although antiarmor weapons are primarily designed to destroy armored vehicles, they also can be used to damage or destroy fortifications. Additionally, they can be used for ballistic breaching of doorways and the walls of lightly constructed buildings to create entry points. They also may be used for creating deceptions just before the assault element enters the actual initial breach (entry) point. The larger systems (tube-launched, optically tracked, wire-guided [TOW] missiles and Javelin) that have highly magnified

day and thermal sights can be used to detect snipers and to disrupt or kill them with long-range missiles.

b. Engaging targets from an enclosure creates unique hazards. Before positioning soldiers in enclosures (combat only), leaders must consider several factors that affect safety. Only in combat, and when no other tactical option exists, should antiarmor weapons be fired from an enclosure. If antiarmor weapons must be employed this way, the enclosure must meet the following minimum requirements:

- Construction of wood or stucco buildings must be sturdy to reduce the damage that will occur.
- All objects and debris must be removed from the rear of the weapon because the backblast will cause loose objects to fly around the enclosure, possibly injuring someone.

NOTE: When employing these weapon systems to support the infantry assault, leaders must be aware of the explosive effects and fragmentation fallout as well as the blast-over pressure and how these will affect the infantry on the ground. (For more specific information on the effects of weapons, see FM 3-06.11.)

6-14. SNIPER EMPLOYMENT CONSIDERATIONS

The characteristics of urban areas and the nature of urban warfare impact on both the effectiveness of the sniper weapons system and how the system may be employed. The sniper must consider the location of the target in relation to his position and whether he or the target is inside or outside the building. The sniper also must consider the structural configuration of the buildings in his area of operation. The basic classes of structures encountered in an urban area are concrete, masonry, and wood. However, any one building may include a combination of these materials. All buildings offer the sniper concealment, though the degree of protection varies with the materials used.

a. **Selecting Positions and Targets.** Leaders will provide the sniper with the general area of operation (building or group of buildings) in which to position, but the sniper selects the best position for his specific engagements. Sniper positions should cover--

- Obstacles.
- Roofs.
- Friendly routes.
- Likely avenues of approach.
- Gaps in the final protective fires.
- Dead space.
- Other areas that may provide the enemy an advantage.

The sniper also selects numerous alternate and supplementary positions to cover his areas of responsibility. The sniper should think three-dimensionally. Because the urban environment poses a three-dimensional battlespace, the sniper should anticipate the threat from any direction at any time.

b. **Offensive Missions.** Offensive operations carry the fight to the enemy to destroy his capability and will to fight. The sniper can prove to be a key combat multiplier by neutralizing enemy targets that threaten the success of the attack. During offensive operations snipers--

- Conduct countersniper operations.
- Overwatch movement of friendly forces and suppress enemy targets that threaten the moving forces.
- Place precision fire on enemy crew-served weapons teams and into exposed apertures of bunkers.
- Place precision fire on enemy leaders, armored vehicle drivers or commanders, FOs, radiotelephone operators (RATELOs), or other designated personnel.
- Place precision fire on small, isolated, bypassed elements.
- Place precision fire on enemy forces that are withdrawing or threatening a counterattack.
- Assist in screening a flank using supplemental fires.
- Dominate key terrain by controlling access with fires.

(1) To increase security and surprise, snipers must move covertly into position in an objective area long before the main attack forces arrive. Once the assault begins, snipers may need to reposition due to masking of fires by friendly forces. A detailed evaluation must be made when determining where and how the snipers would be most beneficial to the mission.

(2) Upon consolidation of forces on the objective area, the snipers may be displaced forward to new positions for security. These positions may not necessarily be on the objective. From these positions the snipers conduct observation and provide early warning to the friendly unit. They also will provide precision fire against bypassed enemy positions, enemy counterattacks, or other enemy positions that could impede the unit's ability to exploit the success of the mission.

c. **Defensive Operations.** When employed properly, snipers can effectively enhance a commander's defensive fire plan. After analyzing the terrain, snipers should provide the commander with recommendations for their employment. Snipers are capable of performing the following tasks during defensive operations:

- Cover obstacles, minefields, roadblocks, and pre-positioned demolitions.
- Perform counterreconnaissance (terminate enemy reconnaissance efforts).
- Engage enemy OPs, exposed armored vehicle commanders, and AT weapons teams.
- Engage enemy vehicles' optics to degrade vision and disrupt movement.
- Engage enemy crew-served weapons.
- Disrupt follow-on units with long-range precision fire.

(1) Snipers should be positioned to cover one or more avenues of approach into the defensive position. They can be used to enhance security, allowing the platoon leader to concentrate his combat power against the most likely enemy avenue of approach. Snipers, with their optics for target acquisition and their long-range engagement capability, will compliment the unit's machine guns. Snipers also may be used in an economy-of-force role to cover a dismounted enemy avenue of approach into positions the unit cannot cover.

(2) Multiple sniper teams can be positioned for surveillance and mutual support. If possible, they should establish positions in depth for continuous support during the fight. The sniper's rate of fire neither increases nor decreases as the enemy approaches.

Specific targets are systematically and deliberately engaged; accuracy is never sacrificed for speed.

(3) When supporting a strongpoint defense, the sniper teams should be positioned outside the defensive position to allow for freedom of movement. Their primary mission is to conduct observation tasks or independent harassing engagements against enemy reconnaissance elements or induce the enemy to move into a predetermined engagement area.

CHAPTER 7

TACTICAL ENABLING OPERATIONS

Tactical enabling operations are specialized missions that are planned and conducted to achieve or sustain a tactical advantage and that are executed as part of an offensive, defensive, stability, or support mission. In addition to reconnaissance, surveillance, and screens, the reconnaissance platoon may assist the battalion in occupying assembly areas and may participate in air assault operations and in conducting passage of lines, linkups, and relief-in-place missions. The complexity of these operations requires special planning and training considerations. In providing this specialized support, the reconnaissance platoon follows standardized procedures. This chapter discusses the role of the reconnaissance platoon and establishes techniques and procedures for these specialized missions.

7-1. LINKUP OPERATIONS

Linkup is an operation that entails the meeting of friendly ground forces (or their leaders or designated representatives). The platoon conducts linkup activities independently or as part of a larger force. Within a larger unit, the reconnaissance platoon may lead the linkup force. Linkup operations may occur during the following situations, among others:

- Advancing forces reaching an objective area previously secured by air assault, airborne, or infiltrating forces.
- Units conducting coordination for a relief in place.
- Cross-attached units moving to join their new organization.
- Units moving forward during a follow and support mission with a fixing force.
- A unit moving to assist an encircled force.
- Units converging on the same objective during the attack.
- Units conducting a passage of lines.
- Units conducting reconnaissance forward of the main body.

a. **Phases of the Linkup Operation.** The linkup consists of three phases.

(1) **Phase 1, Far Recognition Signal.** The units or elements involved in the linkup establish communications before they reach direct-fire range. The lead element of each linkup force monitors the communications channels of the other friendly element.

(2) **Phase 2, Coordination.** Before initiating movement to the linkup point, the elements must coordinate necessary tactical information to include the following:

- Command relationship.
- Known enemy situation.
- Type and number of friendly vehicles.
- Disposition of stationary forces (if either unit is stationary).
- Routes to the linkup point and rally point (if used).
- Fire control measures.
- Near recognition signal(s).
- Communications information.
- CS coverage.

- CSS responsibilities and procedures.
- Finalized location of the linkup point and rally point (if used).
- Any special coordination such as maneuver instructions or requests for medical support.
- Visual linkup signals or alternate locations for linkup due to contact.

(3) **Phase 3. Movement to the Linkup Point and Linkup.** All units or elements involved in the linkup must enforce strict fire control measures to help prevent fratricide. Linkup points and restrictive fire lines must be recognizable by moving and converging forces. Linkup elements take these actions:

- Conduct far recognition using FBCB2 or FM radio.
- Conduct short-range (near) recognition using the designated signal.
- Complete movement to the linkup point.
- Establish local security at the linkup point.
- Conduct additional coordination and linkup activities as necessary.

b. **Planning Considerations.** When planning a linkup, the reconnaissance platoon leader follows standard troop-leading procedures. Digitization assists units in transferring information and using common graphics between the two units conducting the linkup. Both units exchange digital graphics before the actual linkup.

(1) To aid navigation and fratricide prevention, the RV's navigation system allows constant tactical situational updates between elements conducting the linkup operation. For example, the moving element or vehicle can monitor the location of the stationary unit and linkup site using the position updates and digital graphics displayed on the commander's tactical display or land warrior system. Furthermore, the stationary unit can monitor the moving unit's location as it moves along the prescribed route to the linkup point by monitoring position updates on the CTD or LW system. As the moving force closes on the linkup site, the stationary force is more aware of its presence and location, thus reducing the possibility of fratricide. The moving unit does the same type of monitoring to reduce fratricide potential.

(2) In addition to digital equipment, OTN equipment also enhances execution of the linkup operations and reduces the likelihood of fratricide by use of night vision devices.

(3) Once the moving unit arrives close to the linkup location, the stationary unit should challenge it digitally, visually, or with audible sounds. For example, the stationary unit can give the moving unit a series of flashes using an infrared source during limited visibility. The moving force responds with a pre-coordinated number of flashes. The two units may also use a digital or verbal challenge and response.

7-2. PASSAGE OF LINES

A passage of lines is an operation in which one element passes through the position of another. The direction of travel relative to the enemy determines whether a passage is forward or rearward. An example of a rearward passage is a covering force withdrawing through the forward edge of the main battle area (MBA). An example of a forward passage is an exploitation force moving through the element that initially conducted the attack in order to relieve it. As part of a passage of lines, the reconnaissance platoon conducts liaisons, provides guides, reconnoiters routes, and establishes screens. Once the reconnaissance platoon leader knows the commander's requirement, he assigns specific missions to the sections. The platoon leader should locate where he can monitor and

control the actions of the platoon. Each section must know the sequence of events, the times they will occur, and the exact location of the passage. The platoon leader ensures the section knows whether it must link up with the platoon leader or execute the follow-on mission. The controlling headquarters is responsible for planning and coordinating a passage of lines involving the platoon. In some situations, as when the platoon is using multiple passage routes (such as a separate route for each section or team), the platoon leader must take responsibility for planning and coordinating each phase of the operation.

a. **Planning Considerations.** In planning passage of lines, the reconnaissance platoon leader must consider the following tactical factors and procedures:

(1) The passage should facilitate transition to follow-on missions through the use of multiple lanes or lanes wide enough to support doctrinal formations for the passing units.

(2) Deception techniques, such as the use of smoke, may be employed to enhance security during the passage. The controlling commander must clearly define the battle handover criteria and procedures used during the passage. His order should cover the roles of both the passing unit and the stationary unit and the use of direct and indirect fires. If necessary, he also specifies the location of the battle handover line (BHL) as part of the unit's graphic control measures. For a forward passage, the BHL is normally the LD for the passing force. In a rearward passage, it is normally a location in direct fire range of the stationary force. In general, a defensive handover is complete when the passing unit is clear and the stationary unit is ready to engage the enemy. Offensive handover is complete when the passing unit has deployed and crossed the BHL.

(3) The passing and stationary units coordinate obstacle information including the locations of enemy and friendly obstacles, existing lanes and bypasses, and guides for the passage.

(4) Responsibility for CSS actions such as vehicle recovery or casualty evacuation in the passage lane must be clearly defined for both passing and stationary units.

(5) To enhance command and control during the passage, the platoon will collocate a command and control element, normally the platoon leader or platoon sergeant, with a similar element from the stationary or moving unit.

b. **Reconnaissance and Coordination.** Detailed reconnaissance and coordination are critical in a passage of lines, both in dealing with the planning factors outlined previously and in ensuring the passage is conducted quickly and smoothly. The platoon leader normally conducts all necessary reconnaissance and coordination for the passage. At times, he may designate the platoon sergeant or section leader to conduct liaison duties for reconnaissance and coordination. Items of information to coordinate include--

- Unit designation and composition; type and number of passing vehicles and soldiers.
- Passing unit arrival time(s).
- Location of attack positions or assembly areas (should be confirmed by reconnaissance).
- Current enemy situation.
- Obstacles.
- Stationary unit's mission and plan (to include OP, patrol, and obstacle locations).
- Location of movement routes, contact points, passage points, and passage lanes.

- Guide requirements.
- Order of march.
- Anticipated actions on enemy contact.
- Requirements for supporting direct and indirect fires, including the location.
- NBC conditions.
- Available CS and CSS assets and their locations.
- Communications information (to include frequencies, digital data, and near and far recognition signals).
- Criteria for battle handover and location of the BHL.

c. **Forward Passage of Lines.** In a forward passage, the passing unit first moves to an assembly area or an attack position behind the stationary unit. Designated liaison personnel move forward to link up with guides and confirm coordination information with the stationary unit. Guides lead the passing elements through the passage lane.

(1) The platoon conducts a forward passage by employing tactical movement. It moves quickly, uses appropriate dispersal and formations whenever possible, and keeps radio traffic to a minimum.

(2) The platoon holds its fire until it passes the BHL or designated fire control measure unless the commander has coordinated fire control with the stationary unit. Once clear of passage lane restrictions, the unit consolidates at a rally point or attack position and conducts tactical movement in accordance with its orders.

d. **Rearward Passage of Lines.** Because of the increased risk of fratricide during a rearward passage, coordination of recognition signals and fire restrictions is critical. The passing unit contacts the stationary unit while it is still beyond direct fire range and conducts coordination as discussed previously. The platoon emphasizes near recognition signals and location of the BHL and may use additional fire control measures such as NFAs to further minimize the risk of fratricide. After coordination, the passing unit continues tactical movement toward the passage lane. If the stationary unit provides guides, the passing unit may conduct a short halt to link up and coordinate with them. The passing unit moves quickly through the passage lane to a designated location behind the stationary unit.

7-3. RELIEF IN PLACE

A relief in place is an operation in which one force replaces another. A relief-in-place operation is planned, coordinated, and controlled at battalion. The battalion commander or S3 determines the role of the reconnaissance platoon during a relief. The platoon normally provides guides, conducts initial coordination, and relieves the outgoing force's reconnaissance platoon. Before they relieve the outgoing force's reconnaissance platoon, the platoon assists with relief of other elements.

- a. **Planning Considerations.** In planning a relief in place, the platoon leader--
- Issues a FRAGO.
 - Uses an advance party composed of key leaders to conduct detailed reconnaissance and coordination.
 - As the relieving unit, adopts the outgoing unit's normal pattern of activity as much as possible.
 - As the relieving unit, determines when the platoon will assume responsibility for the outgoing unit's position.

- As the relieving unit, collocates platoon headquarters with the relieved unit's headquarters.
- Maximizes OPSEC to prevent the enemy from detecting the relief operation.
- Plans to transfer excess ammunition, wire, petroleum, oil, lubricants, (POL) and other material of tactical value to the incoming unit
- Controls movement by reconnoitering, designating, and marking routes and providing guides.

b. **Coordination.** The incoming and outgoing leaders must meet to exchange tactical information, conduct a joint reconnaissance of the area, and complete other required coordination for the relief. The two leaders must address passage of command and jointly develop contingency actions for enemy contact during the relief. This process will normally include coordination of--

- Location of vehicle and dismounted OPs (to include hide, alternate, and supplementary positions).
- Enemy situation.
- The outgoing unit's tactical plan, to include graphics, platoon and section fire plans, and individual vehicles' sector sketches.
- Fire support coordination, including indirect fire plans and the time of relief for supporting artillery and mortar units.
- Types of weapons systems being replaced.
- Time, sequence, and method of relief.
- Location and disposition of obstacles and what time responsibility will be transferred.
- Supplies and equipment to be transferred.
- Movement control, route priority, and placement of guides.
- Command and signal information.
- Maintenance, logistical support, and evacuation, if necessary, for disabled vehicles.

c. **Conduct of the Relief.** The outgoing leader retains responsibility for the area of operations and the mission. He exercises operational control over all subordinate elements of the incoming unit completing their portion of the relief. Responsibility can pass to the incoming commander when all elements of the outgoing unit are relieved and adequate communications are established. Relief of individual elements can be conducted in one of two ways:

(1) **By Alternate Element Position.** The relieving element occupies a position separate from the relieved element.

(2) **By Alternate Vehicle Position or OP.** The relieving element occupies vehicle positions or OPs in the same zone or sector as the relieved element. There are two relief methods: sequential (elements relieved one at a time) and simultaneous (all elements relieved at one time):

(a) **Sequential.** This is the most time-consuming method. The relieving unit moves to an assembly area to the rear of the unit to be relieved. Subordinate elements are relieved one at a time, in any order, with the relief generally following this sequence:

- The outgoing and incoming units collocate their headquarters to facilitate command and control and transfer of equipment, ammunition, fuel, and water.
- The first element being relieved (such as a team) moves to its alternate vehicle position or OP while the relieving element moves into the outgoing element's primary positions. The incoming element occupies the appropriate positions.
- Incoming and outgoing elements complete the transfer of equipment and supplies.
- The relieved element moves to the designated assembly area behind the position.
- Once each outgoing element clears the release point en route to its assembly area, the next relieving element moves forward.

(b) *Simultaneous*. This is the fastest but least secure method. All outgoing elements are relieved at once, with the incoming unit normally occupying existing positions. The relief takes place in this general sequence:

- Outgoing elements move to their alternate OPs or vehicle positions.
- Incoming elements move along designated routes to the outgoing elements' primary positions.
- Units complete the transfer of equipment and supplies.
- Relieved elements move to the designated unit assembly area.

7-4. STAY-BEHIND OPERATIONS

Stay-behind operations can be used as a part of defend or delay missions. In the defense, once the enemy's combat units have passed, his weakest point (CS and CSS units) can be attacked.

a. **Types**. The two types of stay-behind operations are unplanned and deliberate.

(1) An unplanned stay-behind operation is one in which a unit finds itself cut off from other friendly elements for an indefinite time without specific planning or targets and must rely on its organic assets.

(2) A deliberate stay-behind operation is one in which a unit plans to operate in an enemy-controlled area as a separate and cohesive element for a certain amount of time or until a specified event occurs. This type of operation requires extensive planning. The reconnaissance platoon and sections normally conduct planned stay-behind operations as part of larger units.

b. **Planning**. During troop-leading procedures, the planners must consider the following:

(1) **Task Organization**. The stay-behind unit includes only the soldiers and equipment needed for the mission. It needs minimal logistics support and can provide its own security. It must be able to hide easily and move through restricted terrain. RVs may or may not be a part of the stay-behind forces.

(2) **Reconnaissance**. This is most important in a stay-behind operation. Reporting tasks and information requirements can include suitable sites for patrol bases, hide positions, OPs, caches, water sources, dismounted and mounted avenues of approach, kill zones, engagement areas, and covered and concealed approach routes.

(3) **Combat Service Support**. Because the stay-behind unit will not be in physical contact with its supporting unit, supplies of rations, ammunition, radio batteries, water,

and medical supplies are cached. The controlling headquarters establishes provisions for casualty and enemy prisoner of war (EPW) evacuation.

7-5. AIR ASSAULT OPERATIONS

The battalion's tactical plan may require the reconnaissance platoon to participate in air assault operations. The platoon has the ability to be airlifted as part of a larger operation, but it does not have the resources to plan the overall operation. The battalion is the lowest level with sufficient personnel to plan, coordinate, and control an air assault operation. When company-size or lower operations are conducted, the planning takes place at battalion or higher headquarters. (Refer to FM 90-4 for more information.) Successful air assault execution is based on a careful analysis of METT-TC and detailed, precise reverse planning. The basic plans comprising the reverse planning sequence developed for each air assault operation are the ground tactical plan, landing plan, air movement plan, loading plan, and staging plan. The battalion staff normally coordinates and develops these plans to make the best use of available time. If time is limited, planning steps may be compressed or conducted concurrently; detailed plans and orders may be SOPs or lessons learned in training.

a. **Ground Tactical Plan.** The foundation of a successful air assault operation is the commander's ground tactical plan, around which subsequent planning is based. The ground tactical plan specifies actions in the objective area to accomplish the mission and address subsequent operations. The ground tactical plan contains essentially the same elements as for any other infantry attack but capitalizes on speed and mobility to achieve surprise.

b. **Landing Plan.** The landing plan must support the ground tactical plan. This plan sequences elements into the AO, ensuring platoons arrive at designated locations and times prepared to execute the ground tactical plan.

c. **Air Movement Plan.** The air movement plan is based on the ground tactical and landing plans. It specifies the schedule and provides instructions for air movement of soldiers, equipment, and supplies from PZs and LZs.

d. **Loading Plan.** The loading plan is based on the movement plan. It ensures soldiers, equipment, and supplies are loaded on the correct aircraft. Planners of aircraft loads maintain platoon integrity, if possible. Cross loading may be necessary to ensure command and control assets and the weapons arrive at the LZ intact and ready to fight. The platoon or section leader should always ensure the aircraft is loaded so dismounting soldiers react promptly and contribute to mission accomplishment. The platoon leader must have a bump plan to ensure essential soldiers and equipment are loaded ahead of less critical loads in case of aircraft breakdown or other problems.

e. **Staging Plan.** The staging plan is based on the loading plan and prescribes the arrival time of ground units (soldiers, equipment, and supplies) at the PZ in the order of movement. The staging plan includes the disposition of the vehicles left in the staging area and the platoon's linkup plan on return from the air assault mission.

(1) **Disposition of Vehicles.** The platoon leader must develop a security plan for the vehicles in the staging area to last until the air assault mission is complete and the platoon returns to the LZ. The security plan can be as simple as a coil or herringbone formation for the platoon, or the platoon may be part of a larger unit's modified perimeter defense. The security plan also includes instructions for linkup of the platoon with its vehicles.

(2) **Linkup of Vehicles.** The platoon leader's linkup plan must be just as detailed as the staging and loading plan. To simplify the linkup, the platoon leader must maintain platoon integrity as much as possible. The platoon leader or company commander should designate a linkup point for each unit to link up with its vehicles on landing. As the aircrafts land, the units immediately move to their linkup point to continue the mission.

7-6. ASSEMBLY AREA OPERATIONS

An assembly area is a site where a unit regroups or prepares for future operations. SOPs cover most situations in which a unit occupies an assembly area. Normally, a reconnaissance platoon occupies an assembly area as part of its parent unit, but it may occupy one independently. A battalion occupies an assembly area for security while preparing for future operations. The requirements of the reconnaissance platoon vary according to the SOP, but the platoon normally receives the task to locate, clear, and assist in the orderly occupation of an assembly area. The platoon precedes the battalion's quartering party. It assesses the assembly area's suitability for occupation and, most importantly, determines whether the enemy is in the area. Once in the assembly area, the platoon prepares and issues orders, conducts resupply operations, repairs and maintains vehicles and equipment, and feeds and rests its soldiers.

a. **Characteristics.** The battalion commander often directs the reconnaissance platoon to find, secure, and occupy an assembly area. The reconnaissance platoon looks for certain characteristics when selecting the assembly area:

- Concealment from overhead observation.
- Cover from direct fire.
- Good drainage and ground that will support the platoon's and parent unit's vehicles.
- Adequate entrances, exits, and internal roads.
- Enough space for adequate dispersion of vehicles, personnel, and equipment.
- Adequate defensibility and fields of fire.

b. **Quartering Party Responsibilities.** As part of its parent unit or on its own, the reconnaissance platoon may assume quartering party duties. Understanding these duties makes occupying the assembly area much easier. The quartering party's mission is to reconnoiter the area for enemy presence and booby traps, designate vehicle locations, prepare the area for occupation, and assist units with occupation.

(1) **Reconnoiter the Area.** The battalion quartering party conducts a reconnaissance of the assembly area to find enemy forces, obstacles, and NBC contamination. To prevent enemy infiltration, the quartering party establishes OPs or security patrols to secure the area. If the enemy situation warrants, the PL or PSG may enlarge the quartering party by adding security personnel, which frees more soldiers to organize and mark the assembly area.

(2) **Determine Suitability of Assembly Area.** After the quartering party secures the area, the quartering party officer in charge (OIC) or noncommissioned officer in charge (NCOIC) conducts a reconnaissance to verify its suitability and to position guides and markings. They can do this along with the initial area reconnaissance. When checking the position for suitability, the quartering party analyzes--

- Cover and concealment.
- Drainage.

- Routes into and out of the area.
- Internal routes.
- Defensibility.
- Fields of fire.

(3) ***Search for Alternate***. If the area is unsatisfactory, the reconnaissance element immediately starts looking for an alternate site to recommend to the commander. The OIC or NCOIC should contact the commander at once to report his actions and recommendations and to request further instructions.

(4) ***Organize the Area***. The quartering party designates positions on the ground for the various elements within the assembly area. It chooses sites consistent with the commander's guidance, unit SOP, and follow-on missions. The quartering party also chooses frontages for the various elements. The frontages must allow for terrain considerations and adequate defensive coverage.

(5) ***Improve and Mark Entrances, Exits, and Internal Routes***. Once the quartering party organizes the assembly area, it marks positions. It also reconnoiters and marks routes from the RP to the assembly area. To facilitate easy movement, it marks well the actual entrance and exit for the assembly area. To prevent excessive movement that could create a large unit signature, it designates and marks internal routes. Unit SOP should dictate the marking system used; examples include chemlights, engineer tape, unit tactical signs, flashlights, VS-17 panels, and thermal tape.

(6) ***Mark or Remove Obstacles and Mines***. Ideally, the battalion commander should know whether the enemy is or has been in the proposed area. He may suspect the presence of mines or CBUs in the assembly area and plan for obstacle and mine clearance. Then, before the quartering party departs, the battalion commander sends combat engineers to check the area with mine-detecting equipment, which may include pioneer tools, demolitions, or engineer vehicles. He must allow sufficient time for the quartering party to finish before the main body arrives. If the area selected contains numerous obstacles, the battalion commander should choose another area to reconnoiter.

(7) ***Prepare Assembly Area***. The quartering party prepares the assembly area to make the occupation of the new positions swift and efficient. The guides are positioned between the RP and the assembly area entrance so that they can meet their unit as it crosses the RP. They must know the proper route from the RP to the new positions to quickly move their unit through the RP and into the assembly area. Once in the new area, the guides direct the vehicles to their tentative positions.

(8) ***Accomplish Additional Assigned Tasks***. If the battalion commander assigns other tasks, the quartering party performs them as well. The commander should prioritize these tasks. If he does not, the quartering party leader ranks the tasks from most to least important. Additional tasks might include establishing priorities of work, providing security for the command group, testing firing weapons, and aiding in traffic control.

c. **Occupation of the Assembly Area**. When a unit arrives at an assembly area, all elements move off the route of march and clear the RP without slowing or halting. The platoon leader should keep this in mind as he posts guides, selects routes, and allocates space in the assembly area. After a march serial clears the route, it can adjust vehicle positions without holding up traffic.

d. **Actions in the Assembly Area.** As soon as the reconnaissance platoon occupies its area, it executes the following priority of tasks:

- (1) Positions vehicles.
- (2) Establishes local security.
- (3) Establishes lateral contact with vehicles on the flanks.
- (4) Develops range cards or sector sketches.
- (5) Camouflages positions.
- (6) Performs preventive maintenance checks and services (PMCS).

(7) Enforces security. Assembly areas require constant security, especially noise and light discipline and limiting vehicular access to the assembly area. As soon as it is in position, the platoon replaces initial local security with OPs.

e. **Departure from the Assembly Area.** Departing an assembly area is a critical and often overlooked task. A well-organized departure sets the reconnaissance platoon up for its next mission. A poorly organized departure can cause delays and other problems that may adversely affect the reconnaissance platoon's mission before it begins. The departure requires thorough planning and preparation, including a walk-through rehearsal. As part of the preparation, a thorough police call must be conducted. This ensures that all evidence of the unit's occupation is removed and denies the enemy any equipment, supplies, or other items that might be of tactical or intelligence value. Leaders must carefully supervise execution of the departure to ensure that no delays occur.

CHAPTER 8

COMBAT SUPPORT

The battalion commander is responsible for effective combat support. Mortars, artillery, air defense artillery, combat engineers, and aviation assets provide CS for the platoon. The battalion commander decides how to employ assets based on his estimate of the situation. He attaches supporting elements to the SBCT infantry reconnaissance platoon, or he places CS elements under operational control, in direct support, or in general support of the platoon. The reconnaissance platoon leader must know the employment considerations and abilities of all CS assets.

Section I. FIRE SUPPORT

Fire support is the collective and coordinated use of indirect fire weapons and armed aircraft in support of the battle plan. Fire support assets include mortars, field artillery cannons and rockets, Army aviation, close air support, and naval surface fire support. Support can be lethal or non-lethal (smoke or illumination). Indirect fire support procedures do not change significantly with the infantry carrier vehicle- (ICV) equipped infantry battalion except that fire support should be more responsive. Additionally, the mortars organic to the battalion provide the earliest and most responsive fires to the reconnaissance platoon.

8-1. FIRE PLANNING

Digitization improves the reconnaissance platoon's ability to conduct fire support planning. The platoon leader receives the battalion indirect fire plan on his CTD as soon as the battalion FSO enters it into the database on his hand-held terminal unit (HTU). No longer must the reconnaissance platoon leader wait until the final OPORD is issued to receive the fire support overlay.

a. The platoon leader calls up the operational graphics and the latest enemy situational graphics to aid with his planning, enters the platoon's proposed targets into his CTD, and forwards them to the battalion FSO. The FSO reviews the proposed targets with the battalion S3. The S3 accepts, rejects, or adjusts the platoon leader's proposed targets and forwards to the battalion commander for his approval.

(1) If the battalion commander accepts or adjusts the targets, he incorporates them into the battalion fire support plan and forwards the targets to the *brigade* FSO.

(2) It is the FSO's responsibility to clean up the digital fire support graphics. The FSO ensures only valid targets remain on the digital fire support graphics.

b. Once the battalion and company finalize the targets, the battalion FSO puts out a net call to inform the platoon leader that the fire support graphics are finalized. All leaders must review the digital fire support graphics so they are familiar with any changes and to ensure graphics are updated for subsequent fire missions

c. Fire support planning is conducted concurrently with maneuver planning at all levels. Battalions typically use top-down fire support planning with bottom-up refinement of the plans. The battalion commander develops guidance for fire support in terms of task and purpose. In turn, the fire support planner determines the method to be used in

accomplishing each task. He also specifies an end state that quantifies task accomplishment.

d. Individual fire support assets incorporate assigned tasks into their fire plans. Units tasked to initiate fires must refine and rehearse their assigned task. This means the platoon leader refines the platoon's assigned portion of the fire support plan to ensure the designated targets will achieve the intended purpose. He also conducts rehearsals to prepare for the mission and, as specified in the plan, directs the platoon to execute its assigned targets.

8-2. LINKING FIRE SUPPORT TASKS AND MANEUVER PURPOSE

A clearly defined maneuver purpose enables the maneuver commander to articulate precisely how he wants indirect fire to affect the enemy during different portions of the battle. This in turn allows fire support planners to develop an effective plan to support the intended purpose. They can determine each required task (in terms of effects on target), the best method for accomplishing each task (in terms of a fire support asset and its fire capabilities), and a means of quantifying accomplishment.

A carefully developed method of fire is equally valuable during execution of the fire support mission; it assists not only the firing elements but also the observers responsible for monitoring the effects of the indirect fires. With a clear understanding of the intended effects, fire support assets and observers can work together effectively, planning and adjusting fires as necessary to achieve the desired effects on the enemy. The following paragraphs describe several types of targeting effects associated with fire support tasks.

a. **Final Protective Fire Planning.** Final protective fires (FPFs) are designed to create a final barrier, or "steel curtain," to prevent a dismounted enemy from moving across defensive lines. They are fires of last resort and take priority over all other fires. The employment of FPFs presents several potential problems. They are linear fires, with coverage dependent on the firing sheaf of the fire support asset(s). In addition, while FPFs may create a barrier against penetration by enemy infantry, armored vehicles may simply button up and move through the fires into the friendly defensive position. FPFs are planned targets with a clearly defined purpose. FPF planning is normally delegated to the company that is allocated the support.

b. **Target Refinement.** The platoon leader is responsible for employing indirect fires in his zone or sector. The most critical aspect of this responsibility is target refinement, in which he makes changes to the fire support plan to ensure targets accomplish the battalion commander's intended battlefield purpose. Rather than merely executing targets without regard to the actual enemy situation, the platoon leader must be ready to support the commander's intent by adjusting existing targets or nominating new targets that will allow engagement of specific enemy forces.

c. **Fire Support Preparation.** As noted, although the battalion commander establishes target tasks and purposes and allocates appropriate fire support assets, the platoon leader must ensure execution of assigned targets. Successful execution demands detailed preparation that focuses on areas covered in the following paragraphs.

(1) **Observation Plan.** In developing the observation plan, the platoon leader must ensure both a primary observer and an alternate observer for redundancy to cover all targets. The plan must provide clear, precise guidance for the observers. Positioning is perhaps the most important aspect of the plan.

(a) Observers' positions must allow them to see the trigger for initiating fires as well as the target area and the enemy forces on which the target is oriented. The platoon leader also must consider other aspects of observer capabilities including available equipment, communication, and security of the teams.

(b) In addition to providing the specific guidance outlined in the observation plan, the platoon leader must ensure each observer understands the target task and the purpose. For example, observers must understand that once the first round impacts, the original target location is of no consequence. They must orient on the targeted enemy force to ensure that fires achieve the intended battlefield purpose.

(2) **Rehearsals.** The platoon leader is responsible for involving his observers in platoon- and battalion-level rehearsals. He also should use rehearsals to ensure the platoon's primary and backup communications systems adequately support the plan.

(3) **Target Adjustment.** In the defense, the commander should confirm target location by adjusting fires as part of engagement area development.

Section II. INDIRECT FIRE SUPPORT

The main indirect fire support available to the reconnaissance platoon includes mortars and field artillery (Table 8-1, page 8-4). This section discusses the responsibilities, considerations, and procedures for employing all the indirect-fire assets supporting the platoon. (FM 6-30 discusses in detail how to call for and adjust indirect fires.)

CALIBER:	60-mm	81-mm	81-mm (im- proved)	120-mm	105-mm	155 -mm	155-mm
MODEL:	M224	M29A1	M252	M285	M119	M198	M109A6
MAX RANGE (HE)(m):	3,490	4,595	5,608	7,200	14,000	18,100	18,100
PLANNING RANGE (m):					11,500	14,600	14,600
PROJECTILE:	HE, WP, ILLUM,	HE, WP, ILLUM,	HE, WP, ILLUM, RP	HE, SMK, ILLUM,	HE M760 ILLUM, HEP-T, APICM, CHEM, RAP	HE, WP, ILLUM, SMK, CHEM, NUC, RAP, FASCAM, CPHD, AP/ DPICM	HE, WP, ILLUM, SMK, CHEM, NUC, RAP, FASCAM, CPHD, AP/ DPICM
MAX RATE OF FIRE:	30 RPM for 1 MIN	30 RPM FOR 1 MIN	30 RPM for 2 MIN	15 RPM for 3 MIN	6 RPM for 1 MIN	4 RPM for 1 MIN	4 RPM for 1 MIN
SUSTAINED RATE OF FIRE (rd/min):	20	8	15	5	3	2	2
MINIMUM RANGE (m):	70	70	83	180	DIRECT FIRE		
FUZES:	MO	PD, VT, TIME, DLY	PD, VT, TIME, DLY	MO	PD, VT, MTSQ, CP, MT, DLY	PD, VT, CP, MT, MTSQ, DLY	PD, VT, CP, MT, MTSQ, DLY
<p>LEGEND:</p> <p>AP - Armor Piercing APICM - Antipersonnel Improved Conventional Munitions CHEM - Chemical CP - Concrete Piercing CPHD - Copperhead DLY - Delay DPICM - Dual Purpose Improved Conventional Munitions FASCAM - Family of Scatterable Mines HE - High Explosive HEP-T - High Explosive Plastic Tracer ILLUM - Illumination MIN - Minute</p> <p>MO - Multioption - VT, PD, DLY MT - Mechanical Time MTSQ - Mechanical Time Super Quick NUC - Nuclear PD - Point Detonating RAP - Rocket Assisted Projectile RD - Round RP - Red Phosphorus RPM - Rounds per Minute SMK - Smoke TIME - Adjustable Time Delay VT - Variable Time WP - White Phosphorus</p>							

Table 8-1. Indirect fire weapons capabilities.

8-3. FIRE-PLANNING PROCESS

The fire-planning process begins at higher echelons and continues down through the company FSOs and other key personnel, to include the reconnaissance platoon leader. The effectiveness of this process depends on continuous interaction and feedback from the lower echelons upward. Key functions include refinement and confirmation of target locations and execution of events. Specific responsibilities include those listed on the fire support execution matrix. The matrix shows the leader who bears responsibility for each

target, when the responsible party should execute the target, and what means (artillery, mortars, CAS) he or they should use. Table 8-2 shows an example of a battalion fire support execution matrix. It shows maneuver elements along the left side and the different phases of the mission along the top. It shows the platoon's role throughout the operation. The preparer should always include the platoon as a subunit in the matrix.

EVENT SUPPORT DATA	EVENT I (LD to SBF 01)	EVENT II (Set conditions for breach from SBF 01)	EVENT III (B Company breach)	EVENT IV (C Company assault)
TARGET/ GRID	AE0001 (PK 10184938).	AE0002 (PK 09005031).	O/O shift AE0001 to AE0003 (PK 10204810) and lift AE0002.	O/O lift AE0003.
ASSET	155-mm HE.	Mortar smoke.	155-mm.	155-mm.
OBSERVER/ BACKUP	Recon platoon will initially call for and adjust fires; FSO adjusts upon arrival at SBF; 1st platoon leader is backup.	FSO (primary)/ 1st platoon leader (backup).	AE0003: FSO (primary)/ 2d platoon leader (backup).	FSO (primary)/ 3d platoon leader (backup).
TRIGGER	C Company crosses PL LYNX.	On-call at SBF.	B Company crosses PL LION.	C Company completes consolidation on OBJ BOB.
PURPOSE	Disrupt enemy on OBJ BOB to facilitate maneuver of A Company to SBF position.	Obscure enemy to prevent interference with B Company's breach.	Disrupt MRB reserve to protect the assault force (C Company).	Protect the assault force (C Company).

Table 8-2. Example of a battalion fire support matrix.

8-4. CALL FOR FIRE

The battalion fire support execution matrix may require the platoon to call for and adjust its own indirect fire support. The matrix also might designate platoon targets. The platoon uses these preplanned artillery targets to call for and adjust indirect fire. Either a soldier or an FO can prepare and request a call for fire. However, to receive immediate indirect fire support, the observer must plan targets and follow proper call-for-fire procedures. If available, he should use a GPS and laser range finder. The call for fire must include certain elements and might include others.

a. **Required Elements.** Calls for fire must include--

(1) **Observer Identification and Warning Order.** Observer identification tells the FDC who is calling. It also clears the net for the duration of the call. The warning order tells the FDC the type of mission and the method of locating the target. The types of indirect fire missions are--

- Adjust fire--Use this command when uncertain of target location.
- Fire for effect--Use this command for rounds on target; no adjustment.
- Suppress--Use this command to obtain fire quickly.
- Immediate suppression--Use this command to indicate the platoon is already being engaged by enemy; must give target identification.

(2) **Target Location Methods.** The observer sends the target location as six digits (letters and numbers). Before the first adjusting rounds are fired, the observer gives the direction in mils. The FDC must know the observer's exact location. The observer sends observer-target (OT) direction (to the nearest 10 mils) from his position to the target. He specifies which target location method to use:

- Grid (Figure 8-1).
- Polar (Figure 8-2).
- Shift from a known point (Figure 8-3).
- Range shifts and lateral shifts (Figure 8-4).

INITIAL FIRE REQUEST	
Observer	FDC
Z57, This is 271, Adjust Fire, Over.	This is Z57, Adjust Fire, Out.
Grid NK180513, Over.	Grid NK180513, Out.
Infantry Platoon in the open, ICM in effect, Over.	Infantry Platoon in the open, ICM in effect, Over.
MESSAGE TO OBSERVER	
FDC	Observer
Z, 2 rounds, Target, AF1027, Out.	Z, 2 rounds, Target is AF1027, Over.
Direction 1680, Out.	Direction 1680, Over.
NOTE: <i>Send direction before or with the first subsequent correction.</i>	

Figure 8-1. Example fire mission (grid).

INITIAL FIRE REQUEST	
Observer	FDC
Z56, This is Z31, Fire for effect, Polar. Over.	This is Z56, Fire for effect, Polar, Out.
Direction 4520, Distance 2300, Down 35, Over.	Direction 4520, Distance 2300, Down 35, Over.
Infantry Company in the open, ICM, Over.	Infantry Company in the open, ICM, Over.
MESSAGE TO OBSERVER	
FDC	Observer
Y, VT, 3 rounds, Target, AF2036, Out.	Y, VT, 3 rounds, Target, AF2036, Over.

Figure 8-2. Example fire mission (polar plot).

INITIAL FIRE REQUEST	
Observer	FDC
H66, This is H44, Adjust Fire, Shift AA7733, Over.	This is H66, Adjust Fire, Shift AA7733, Out.
Direction 5210, Left 380, Add 400, Down 35, Over.	Direction 5210, Left 380, Add 400, Down 35, Out.
Combat OP in open, ICM in effect, Over.	Combat OP in open, ICM in effect, Out.
MESSAGE TO OBSERVER	
FDC	Observer
H, 1 round, Target AA7742, Over.	H, 1 round, Target AA7742, Out.
NOTE: Shift from a known point is performed when the observer and FDC have a common known point. The observer sends OT line, then determines the lateral and range shifts.	

Figure 8-3. Example fire mission (shift from a known point).

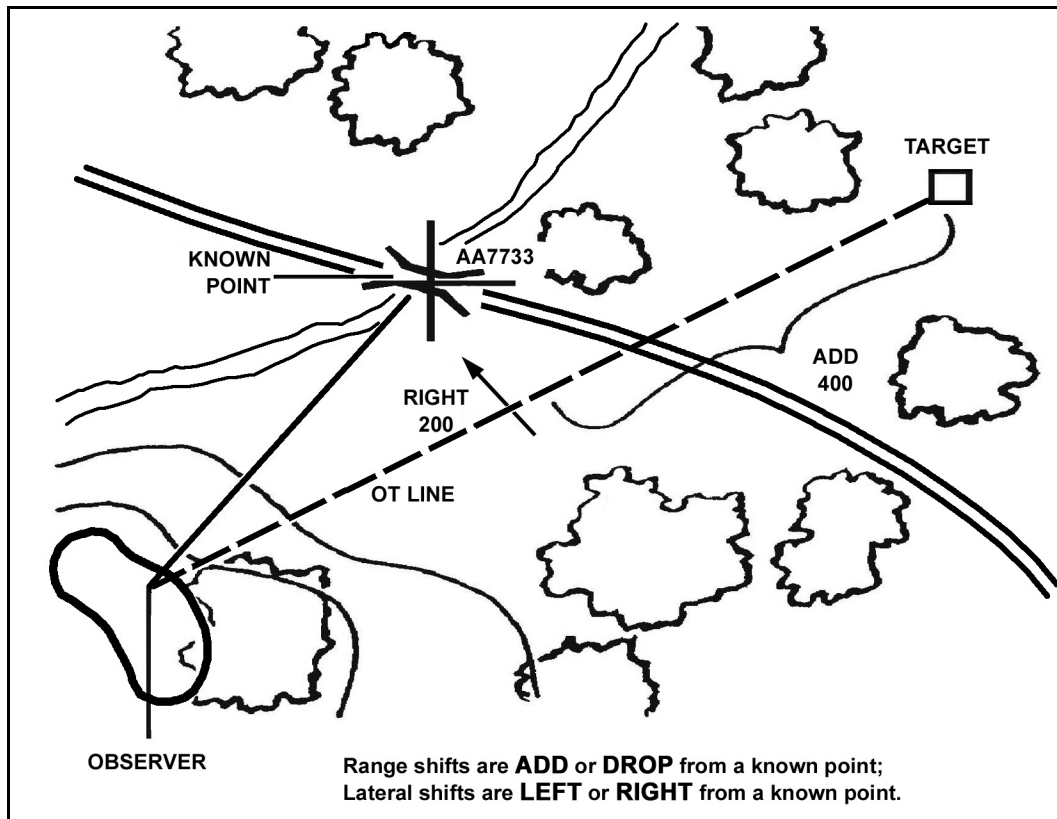


Figure 8-4. Lateral and range shifts.

(3) **Target Description.** Give a brief description of the target using the acronym “SNAP”:

- Size and or Shape.
- Nature and or Nomenclature.
- Activity.
- Protection and or Posture.

b. **Optional Elements.** A call for fire also might include the following information:

(1) **Method of Engagement.** The method of engagement consists of danger-close (if applicable) and distribution, ammunition, and trajectory (DAT).

(2) **Method of Fire and Control.** The method of fire and control indicates the desired manner of attacking the target, whether the observer wants to control the time of delivery of fire and whether he can observe the target. The observer announces methods of fire and control:

- At My Command--fire at observer's command.
- When Ready--standard method of fire control.
- Cannot Observe--fire will not be observed.
- Time on Target--rounds land at specified time.
- Continuous Illumination--FDC determines when to fire.
- Coordinated Illumination--observer determines when to fire.
- Cease Loading--used when two or more rounds are in effect (causes loader to stop loading).
- Check Firing--temporary halt in firing.
- Continuous Fire--will continue to fire unless told to stop.
- Repeat--will repeat last data fired by the firing unit.

(3) **Refinement and End of Mission.** The observer should observe the results of the fire for effect (FFE) and then take whatever action is necessary to complete the mission:

- Correct any adjustments.
- Record as target.
- Report battle damage assessment.

(4) **Danger-Close.** Danger-close information is included when applicable:

- Field artillery and mortars--Danger-close target is within 600 meters of friendly troops.
- Naval gunfire--Danger-close target is within 750 meters when using 5-inch or smaller guns (1,000 meters for larger naval guns).
- Method of adjustment--During danger-close missions, the FO uses only the creeping method of adjustment (corrections of no more than 100 meters).

8-5. ADJUST FIRE

Once he calls for fire, the observer adjusts the fire onto the target. If he has accurately located the target, he requests fire for effect. If the observer cannot locate the target (because of deceptive terrain, lack of identifiable terrain features, poor visibility, or an inaccurate map), he adjusts the impact point of the rounds. One artillery piece or mortar adjusts fire. The observer chooses an adjusting point: for a destruction mission (precision fire), the target is the adjusting point; for an area target (area fire), the observer picks a well-defined adjusting point close to the center. The observer spots the first and each

successive adjusting round, and he sends range and deviation corrections back to the FDC until rounds hit the target. The observer spots by relating the round's point of impact to the adjusting point. (See FM 6-30 for a more detailed discussion of adjusting mortar and artillery fire.)

a. **Deviation Spotting.** Deviation (left or right) spotting involves measuring the horizontal angle (in mils) between the burst and the adjusting point (Figure 8-5). A burst to the right (left) of the target is spotted as "(so many) mils right (left)." The observer uses an angle-measuring device to determine deviation. He might use the mil scale on his binoculars (Figure 8-6) or his fingers and hand (Figure 8-7, page 8-10).

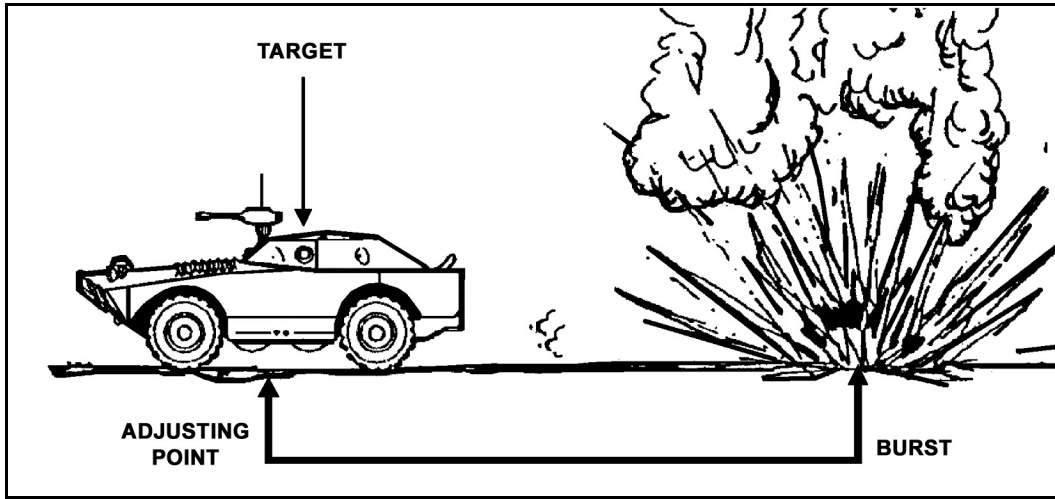


Figure 8-5. Deviation spotting.

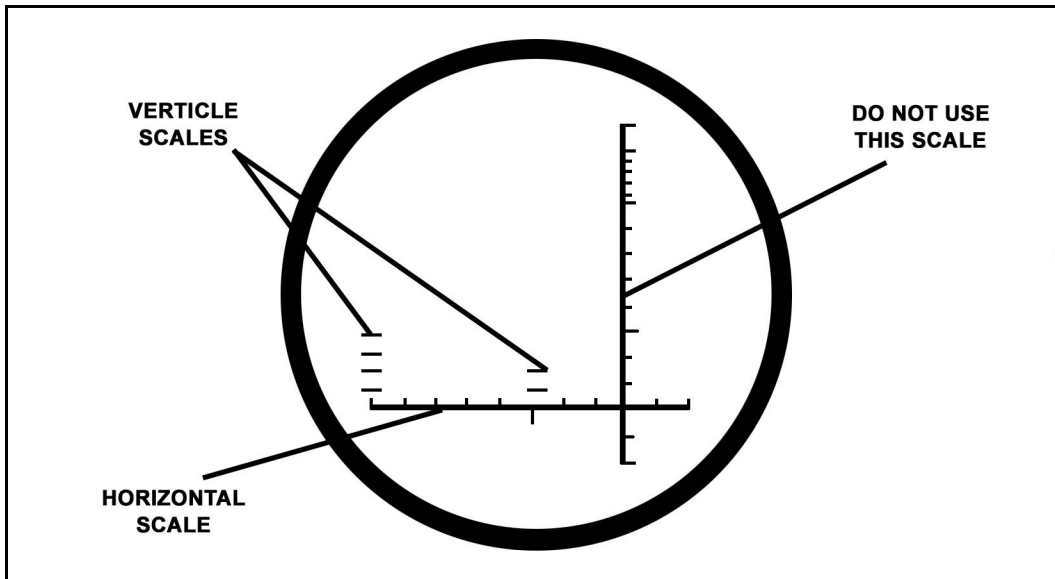


Figure 8-6. Mil scale on M17 binoculars.

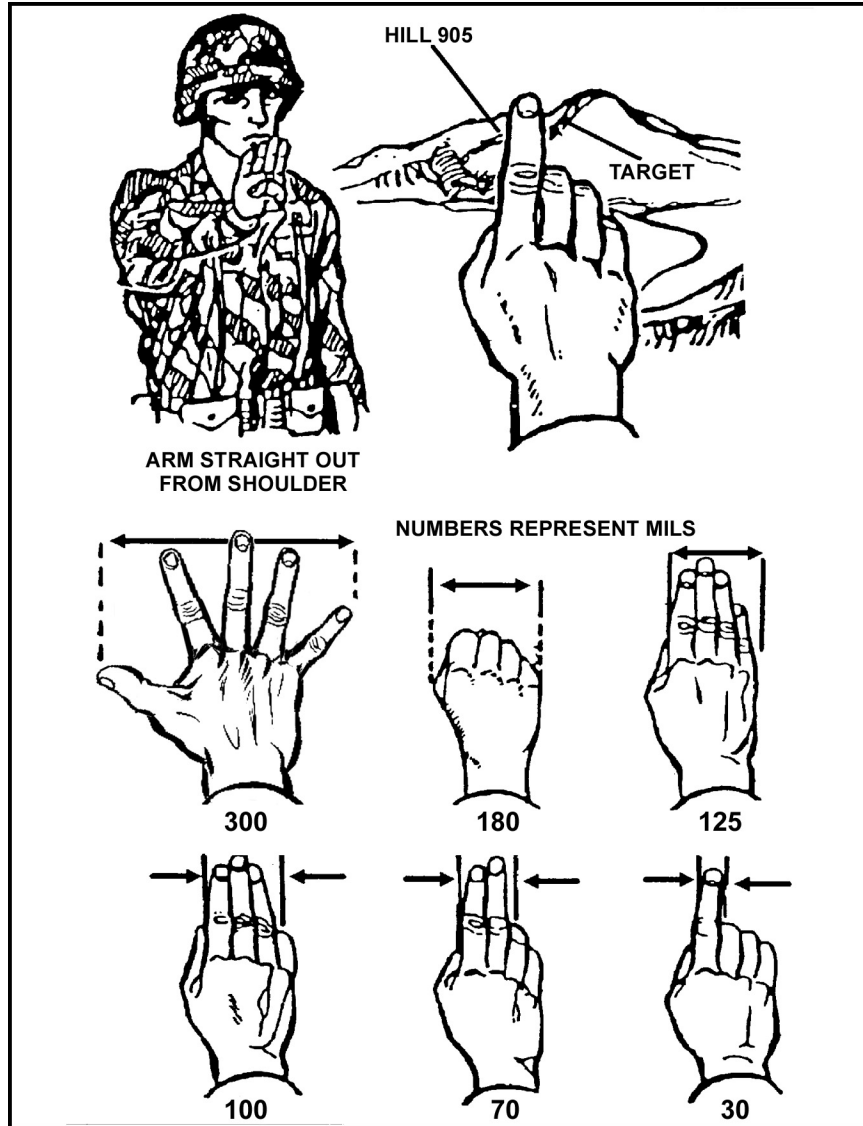


Figure 8-7. Hand and fingers used to determine deviation.

(1) On binoculars, the horizontal scale is divided into 10-mil increments and is used for measuring horizontal angles. The vertical scales in the center and on the left of the reticle are divided into 5-mil increments and are used for measuring vertical angles. The scale on the right, if present, is no longer used.

(2) A burst on the OT line is spotted as “line.” Deviation (left or right) should be measured to the nearest 5 mils for area targets, with measurements taken from the center of the burst. Deviation for a destruction mission (precision fire) is estimated to the nearest mil. (Figure 8-8 shows the adjusting point at the center of the binocular horizontal scale.)

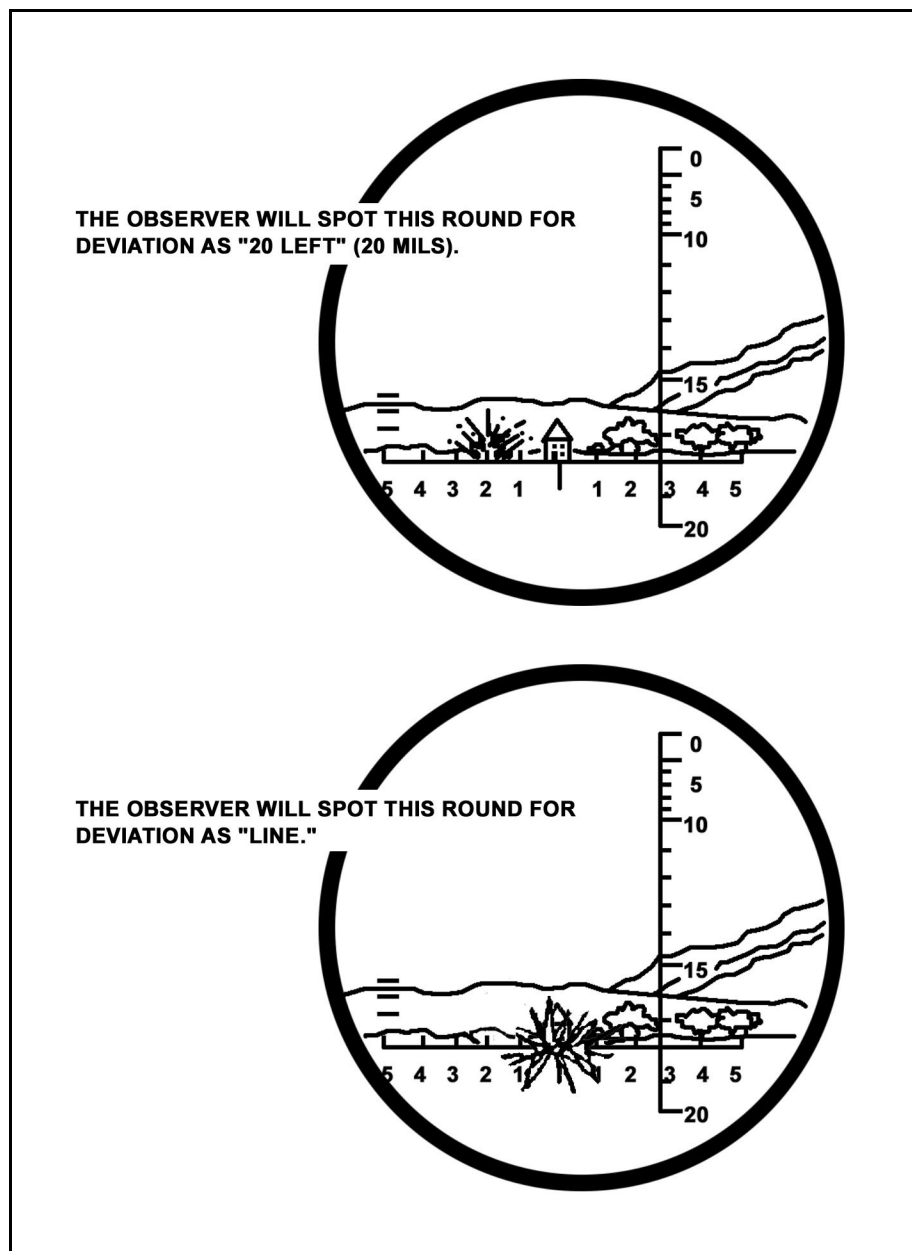


Figure 8-8. Deviation spotting with binoculars.

b. **Deviation Correction.** Deviation correction is the distance (in meters) the burst must be moved left or right to be on line between the observer and the target. Once the mil deviation has been determined, the observer converts it into a deviation correction (in meters). He sends it to the FDC either when sending the range correction for the next adjusting round or when calling for fire for effect.

(1) The deviation correction is determined by multiplying the observed deviation in mils by the distance from the observer to the target in thousands of meters (the OT factor). The result is expressed to the nearest 10 meters (see Example 1 on page 8-12). A minor deviation correction (10 to 20 meters) should be made in adjustment of precision fire.

(2) In adjustment of area fire, small deviation corrections (20 meters or less) can be ignored except when a small change determines a definite range spotting. Throughout the adjustment, the observer moves the adjusting rounds close enough to the OT line so that range spotting is accurate.

(3) If the OT distance is greater than 1,000 meters, round to the nearest thousand and express it in thousands of meters (Example 2). If the OT distance is less than 1,000 meters, round to nearest 100 meters and express it as a decimal in thousands of meters (Example 3).

EXAMPLE 1:

Observer deviation 20 mils
OT distance 2,000 meters
OT factor 2
Observer deviation x OT factor = deviation correction.
 $20 \times 2 = 40$ meters

EXAMPLE 2:

OT distance 4,200 meters—OT factor 4.0
OT distance 2,700 meters—OT factor 3.0

EXAMPLE 3:

OT distance 800 meters—OT factor 0.8

c. **Angle T.** Angle T (Figure 8-9) is the angle formed by the intersection of the gun-target line and the OT line with its vertex at the target. If angle T is 500 mils or greater, the FDC should tell the observer. If this occurs, the observer continues to use the OT factor to make his deviation corrections. If he sees that he is getting more of a correction than he has asked for, the observer should consider cutting the corrections to better adjust rounds onto the target.

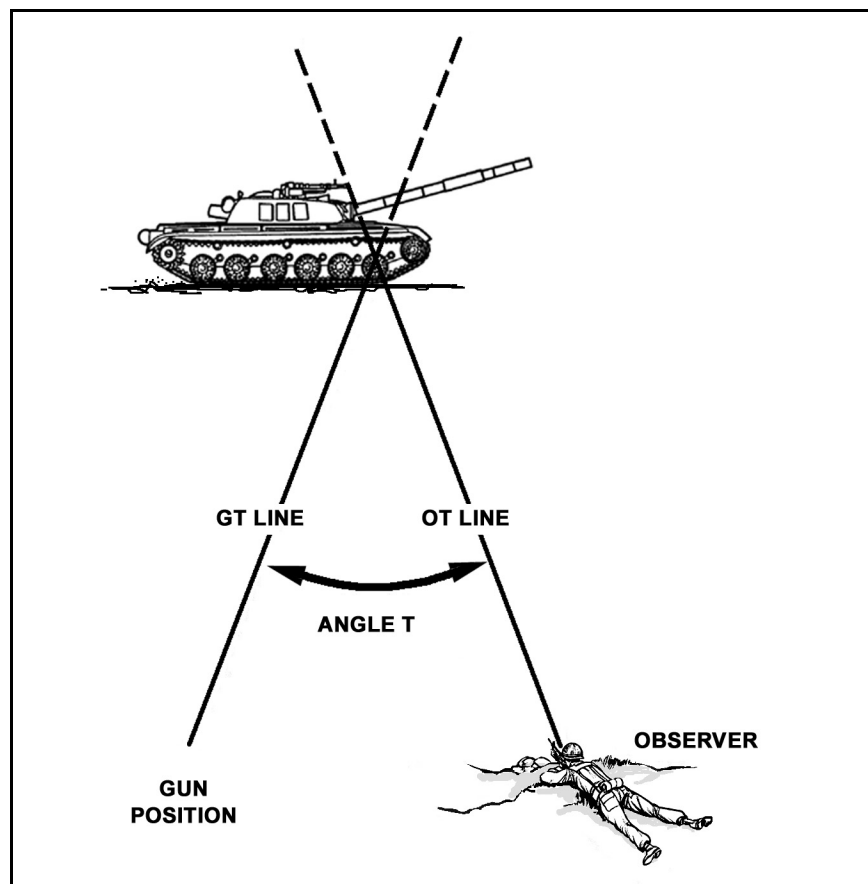


Figure 8-9. Angle T.

d. **Range Spotting.** Range spotting (short or over) requires adjusting the range to obtain fire on the target. An adjusting round's burst on or near the OT line gives a definite range spotting. If he cannot make a definite spotting, the observer announces a "lost" or "doubtful" spotting. In these situations only, he gives the deviation correction to the FDC.

- (1) **"Over."** The observer sees the burst beyond the adjusting point.
- (2) **"Short."** The observer sees the burst between himself and the adjusting point.
- (3) **"Target."** The observer sees the burst hit the target. He uses this spotting only in precision fire (destruction missions).
- (4) **"Range Correct."** The observer believes that the burst occurred at the correct range.
- (5) **"Doubtful."** The observer sees the burst but cannot tell whether it occurred over, short, target, or range correct.
- (6) **"Lost, Over" or "Lost, Short."** The observer cannot see the burst, but he knows that it occurred beyond or short of the adjusting point.

e. **Range Correction.** With each successive correction, the *adjusting round* lands over or short of the *adjusting point*, but closes on the target.

- (1) **Bracketing.** Bracketing brings fire on a target. Time is important, especially while targets move or seek cover from fire. Accuracy of data and speed of adjustments

determine the effectiveness of the fire. To reduce adjustment time, the observer tries to bracket the target with the first two or three adjusting rounds.

(2) **Successive Bracketing.** The observer calls FFE when a range correction brings the round within 50 meters of the adjusting point. He also calls FFE when the firer splits a 100-meter bracket; for example, “Drop 50, fire for effect.” This technique is called successive bracketing (Figure 8-10). When bracketing, the observer uses the following guide to determine his first range correction:

- OT between 1,000 to 2,000 meters--add or drop at least 200 meters.
- OT greater than 2,000 meters--add or drop at least 400 meters.

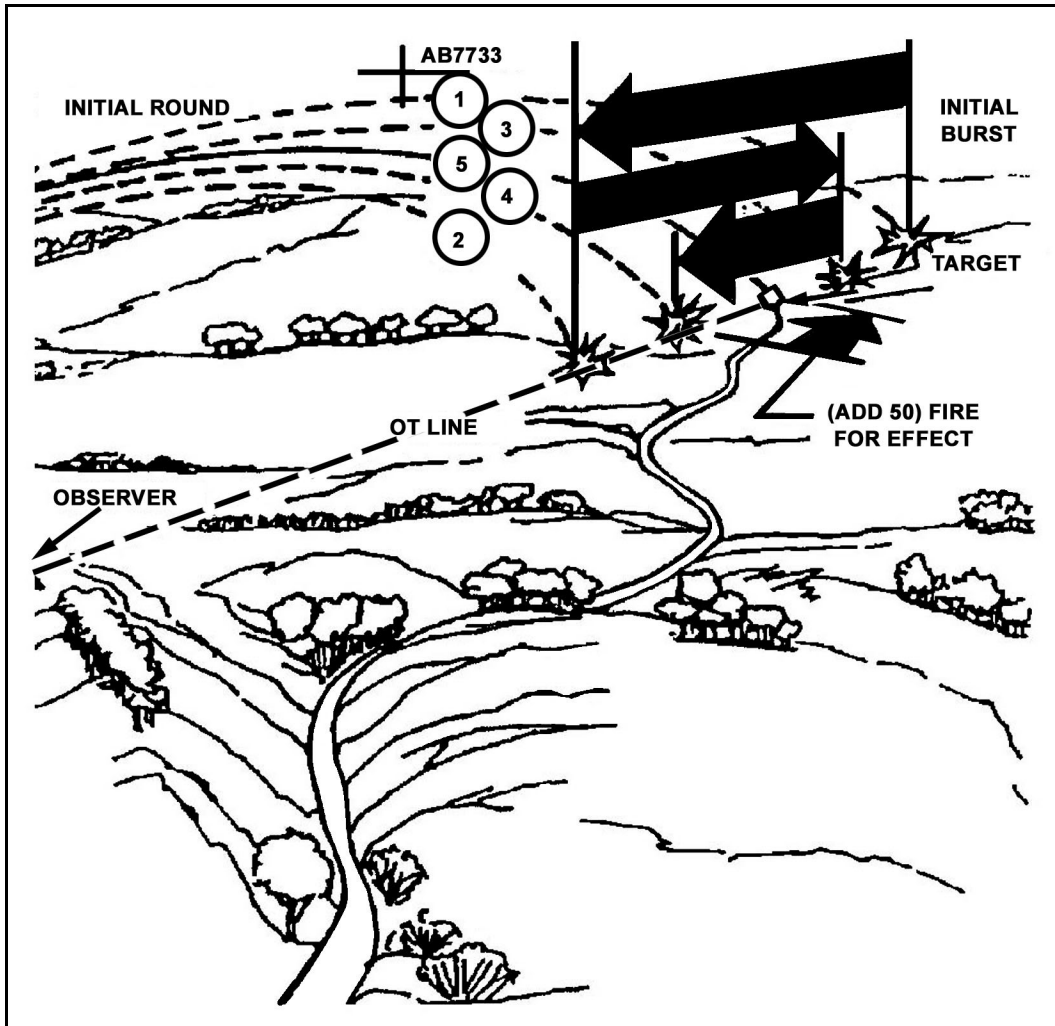


Figure 8-10. Successive bracketing technique.

(3) **Hasty Bracketing.** The effect on the target decreases as the number of rounds used in adjustment increases. Successive bracketing ensures that FFE rounds hit within 50 meters of the adjusting point. Hasty bracketing offers a quicker alternative to successive bracketing. A successful hasty bracket depends on a thorough terrain analysis, which gives the observer an accurate initial target location. For his first correction, the observer receives a bracket similar to that used for successive bracketing. Once the

observer receives the initial bracket, he uses it like a yardstick to determine the subsequent correction. He then sends the FDC the correction to move the rounds to the target and to fire for effect (Figure 8-11). Hasty bracketing improves with observer experience and judgment.

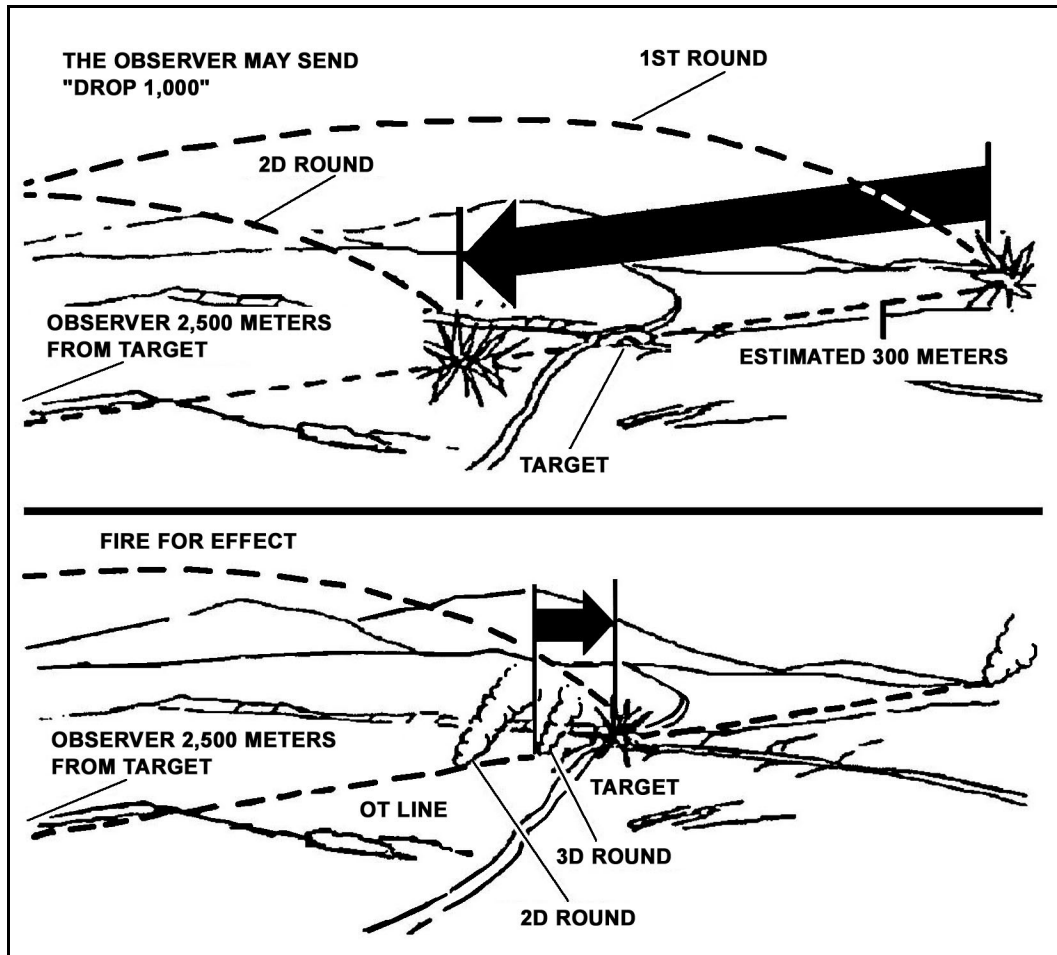


Figure 8-11. Hasty bracketing technique.

(4) *Creeping Method.* In danger-close situations the observer uses the creeping method of adjustment. The observer calls for the first round, deliberately overshooting the target. He adjusts rounds in 100-meter increments or less until the fire hits the target (Figure 8-12, page 8-16). This method requires more time and ammunition than other methods; therefore, the observer uses it only when he must consider safety first.

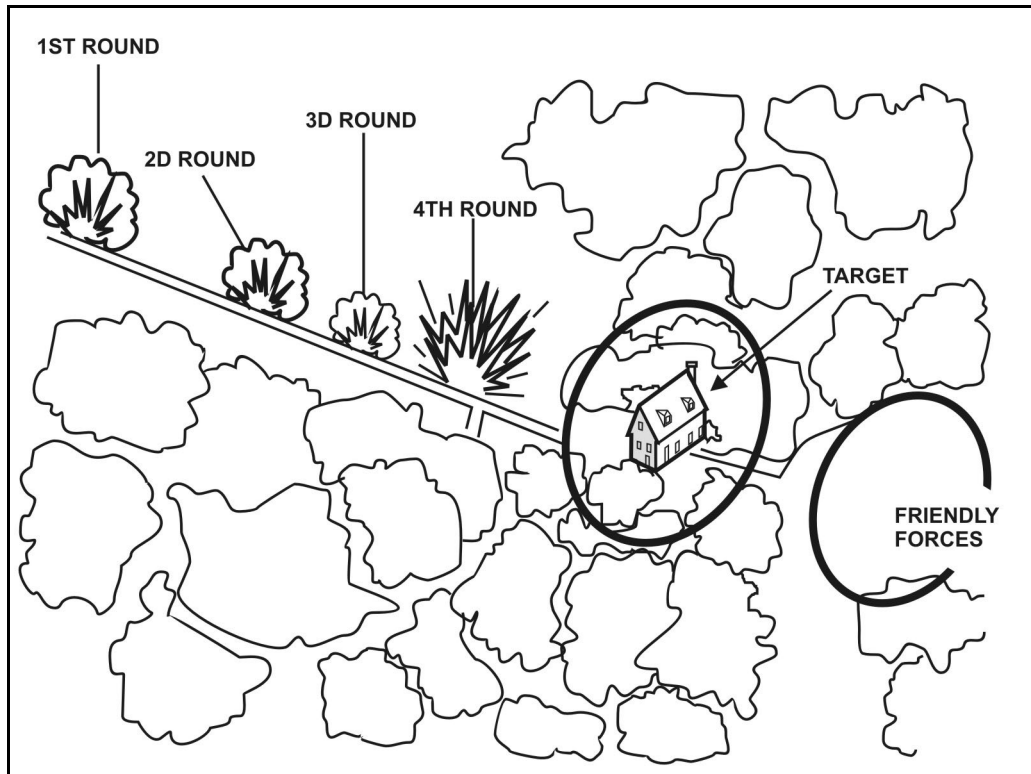


Figure 8-12. Creeping method of adjustment.

8-6. MORTAR SUPPORT

The battalion mortar platoon has both 120-mm and 81-mm mortars. The company has 120-mm and 60-mm mortars. The battalion and company mortars provide immediate indirect fire support. Using mortars, the platoon can quickly place a heavy volume of accurate, sustained fire on the threat. Mortar rounds can strike targets that low-angle fires cannot reach. These include targets on reverse slopes, in narrow ravines or trenches, and in forests or towns, among others. The platoon will receive the preponderance of indirect fire support from mortars.

a. **Types of Mortar Support.** Mortars provide the following types of effective support.

(1) **Suppression.** The platoon can fire HE rounds to force the enemy to button up or move to a less advantageous positions. Only a direct hit, however, will destroy an armored vehicle.

(2) **Smoke.** The platoon uses white phosphorus (WP) rounds for obscuration and screening. Mortar smoke builds up more rapidly than artillery smoke. To obscure the enemy's vision, the platoon places smoke on or just in front of his positions. Placing smoke between the enemy and the platoon's position conceals platoon movement. Mortar smoke marks enemy positions to aid in friendly maneuver and to orient direct fires. Scouts must be careful, however, not to allow smoke to work against them by marking their own positions for enemy gunners.

(3) **Illumination.** The platoon uses illumination rounds to light an area or enemy position during periods of limited visibility. Illumination increases the effectiveness of image-intensification devices, which helps with gathering information, adjusting artillery,

and engaging enemy targets. The platoon also uses ground-burst illumination to mark enemy positions and to provide a thermal target reference point (TRP) for control of fires. The platoon must use illumination carefully so as not to illuminate friendly positions. Because US night-vision devices work better than those of most potential adversaries, the platoon may not need to illuminate the battlefield at all. Doing so could cause more harm than good by revealing friendly positions.

b. **Capabilities and Limitations.** The advantages of using the mortar platoon include its close working relationship with the platoons, fast response time, and availability for low-density targets. The limitations of mortars are--

- Short-range capability only.
- Few types of ammunition available.
- Mortar elements can carry only limited amounts of ammunition.
- FDC and mortar tubes cannot be linked to AFATDS.

8-7. FIELD ARTILLERY SUPPORT

The platoon must know how to use artillery support to its best advantage. Artillery often offers the best way to impede and disrupt enemy formations and suppress enemy positions. It can provide immediate, responsive, and accurate fires with a wide variety of munitions. The platoon may receive FA priority of fire.

a. **Capabilities.** In support of the platoon, FA elements can--

- Provide fires in all weather conditions and on all types of terrain.
- Shift and mass fires rapidly.
- Support the battle in depth with long-range fires.
- Provide a variety of conventional shell and fuze combinations.
- Provide continuous fires by careful positioning and timely displacement.

b. **Limitations.** FA support has the following limitations:

- Limited capability against moving targets.
- May require large amounts of ammunition to destroy point targets.
- Firing signature makes it vulnerable to detection.

c. **Munitions.** FA employs a wide variety of munitions that the platoon can tailor to engage different types of targets.

(1) **High-Explosive.** The best targets for HE rounds include personnel, field fortifications, and vehicles.

(2) **Smoke.** The best uses for smoke include obscuring and screening friendly soldiers.

(3) **Illumination.** Ideally, these illuminate only the threat, not friendly forces.

(4) **White Phosphorus.** This volatile material effectively obscures friendly soldiers or actions, marks locations, and burns obstacles and equipment.

(5) **Cannon-Launched Guided Projectiles.** These projectiles (Copperheads) work best against point targets.

(6) **Improved Conventional Munitions.** Improved conventional munitions (ICM) work best against personnel targets.

(7) **Dual-Purpose Improved Conventional Munitions.** These munitions work best against personnel and light armored vehicles in the open.

(8) **Scatterable Mines.** These include *area denial munitions* for use against personnel and *remote antiarmor mines* for use against armored vehicles. An FA battery cannot mix

other fire missions with scatterable mine missions. Scatterable mines require slightly more lead time than other FA-delivered munitions.

NOTE: The commander or leader must consider the danger to friendly troops in areas where friendly forces fire AP munitions. The potential dud rate of ICM makes maneuver in the area of an ICM field hazardous.

8-8. FIRE DIRECTION ASSETS

The battalion fire support element consists of the fire support officer, an assistant FSO (A/FSO), a senior fire support noncommissioned officer (FSNCO), an assistant FSNCO, and two fire support specialists. The FSE assists the battalion commander and S3 with planning, integrating, coordinating, and executing all types of available supporting fires during tactical operations. The FSE is the commander's primary fire support coordinator and provides a direct link to the battalion's indirect fire support systems and supporting artillery units. The FSE is the primary fire support coordination element for the reconnaissance platoon. During specific missions or when special munitions engagements require on-target designation, the battalion commander may OPCON or attach a fire support team to the platoon. The FIST is organic to the SBCT infantry company. The FIST's command-and-control link with the artillery makes it a valuable resource.

a. The FSE serves as the net control station (NCS) on the battalion fire support net. The FIST relays the call for fire to supporting artillery on a digital net (AFATDS) or sends the fire mission to the mortar platoon or section. The command net allows the FIST to monitor unit operations. It links the FIST to the commander and platoon leaders for planning and coordination. The battalion FSO is the unit fire support coordinator. While the maneuver commander is responsible for integrating fire support and maneuver, the FSO must understand the scheme of maneuver as well as the battalion commander does. Based on the commander's guidance, the FSO devises his fire support plan, which must be presented to the commander for approval. FSO responsibilities include the following:

- Plan, coordinate, and execute fire support.
- Advise the company commander on fire support matters to include capabilities, limitations, and employment of all fire support assets available to support his operation.
- Ensure the battalion fire support plan is developed as an integral part of the battalion OPORD and or operation plan (OPLAN) and that essential fire support tasks (EFSTs) are adequately addressed in the maneuver rehearsals.
- Make recommendations to integrate fire support assets (FA and mortars) into the maneuver commander's battle plan.
- Keep key personnel informed of pertinent information (by spot reports and situation reports).
- Train the FIST and FOs in applicable fire support matters.
- Request, adjust, and direct all types of fire support.
- Ensure the fire support plan and or execution matrix is prepared and disseminated to key personnel.
- Advise the commander on positioning and use of mortars.

- Allocate FOs and other observers to maintain surveillance of target and named areas of interest.
 - Integrate and employ combat observation lasing teams into planned operations.
 - Plan, direct, and manage the employment of observer platforms and laser equipment where they will best support the commander's concept of operation.
 - Provide emergency control of CAS and naval gunfire (NGF) in the absence of qualified personnel.
- b. The FIST is organized, equipped, and trained to provide a fire support advisor and coordinator. It also provides a communications link to all available fire support assets.

8-9. FIRE REQUEST CHANNELS

The reconnaissance platoon can request indirect fire in several ways. The battalion SOP should specify which method it will use. The reconnaissance platoon leader must also coordinate with the battalion FSO, FSE, or both, on which of these methods the platoon will employ.

- a. **Mortar Requests.** The platoon can send requests for mortar fire directly to the mortars on the battalion heavy mortar net. The FSE monitors these requests (Figure 8-13).
- b. **Artillery Requests.** The platoon can send requests for artillery fire directly to the FA battalion on a fire direction net; the FSE monitors the requests (Figure 8-14, page 8-20).

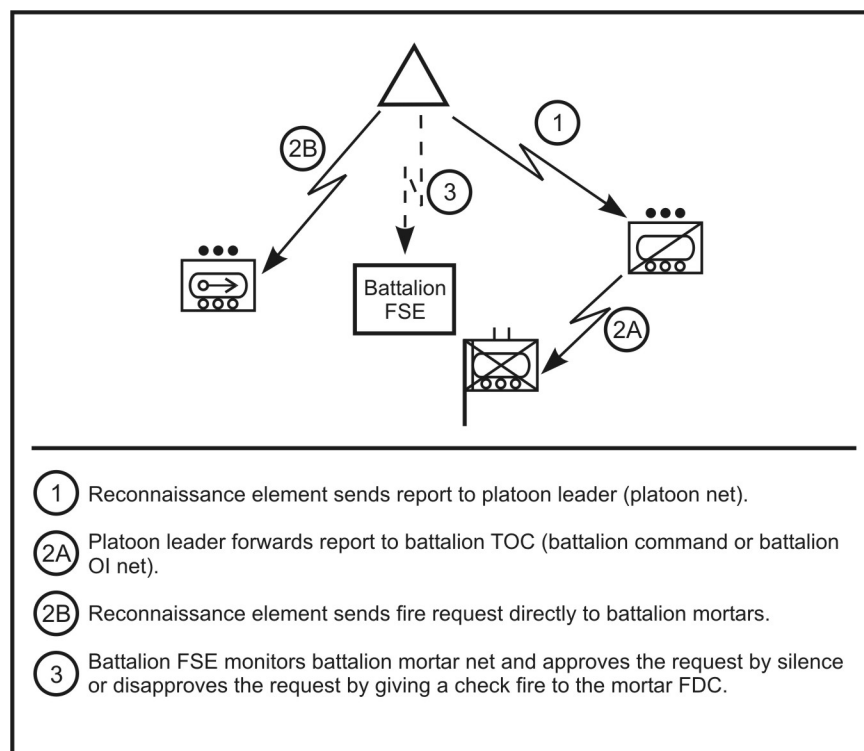


Figure 8-13. Platoon requesting fire from battalion mortars.

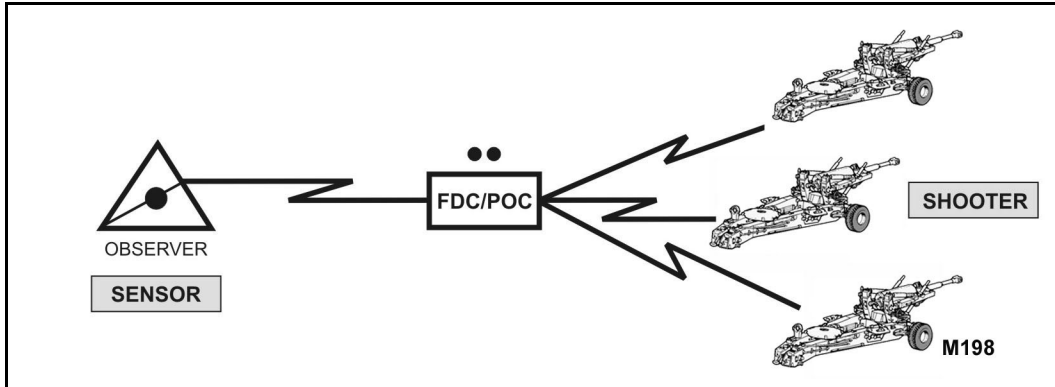


Figure 8-15. Quick fire channel illustrating sensor-to-shooter link.

8-10. CLOSE AIR SUPPORT

All services can provide CAS to the battalion. CAS missions are flown against hostile targets near friendly forces. The forward air controller (FAC) is the battalion commander’s expert in planning, requesting, and executing CAS missions. The FAC serves as a link between the maneuver element and the attacking aircraft. The platoon may provide information that the FAC or tactical air control party (TACP) uses to target enemy forces. Soldiers may provide emergency control if an FAC, FSO, or FO is not available (the battalion commander accepts responsibility for friendly casualties). This is possible only with aircraft equipped with FM radios. Most US Air Force, Navy, and Marine Corps fixed-wing aircraft only have UHF radios (A/OA-10, F16, AV-8B, F-14, F/A-18, and AC-130). (For additional information, see FM 6-30.) The platoon also may provide information on battle damage as observed. Figure 8-16 shows the format for assessing and reporting battle damage.

BATTLE DAMAGE ASSESSMENT
SUCCESSFUL OR UNSUCCESSFUL.
TARGET COORDINATES.
TIME ON TARGET.
NUMBER AND TYPE DESTROYED.
NUMBER AND TYPE DAMAGED.
KILLED BY AIR.
WOUNDED BY AIR.
DUD BOMBS.

Figure 8-16. Format for battle damage assessment.

a. **AC-130 Gunship.** If the enemy air defense is low, the battalion requests CAS from an AC-130 gunship. The AC-130 provides effective fires during day and night operations and flies CAS and special operations. The aircraft contains one 40-mm gun, two 20-mm guns, two 7.62-mm mini-guns, and one 105-mm howitzer. It is equipped with sensors and target acquisition systems that include forward-looking infrared radar (FLIR) and low-light television.

b. **Marking Friendly Positions.** Whenever possible, friendly positions are marked to enhance safety and to provide target area references. Methods of marking friendly positions are shown in Table 8-3, pages 8-23 and 8-24.

METHOD	DAY/ NIGHT	ASSETS	FRIENDLY MARKS	TARGET MARKS	REMARKS
SMOKE	D/N	ALL	GOOD	GOOD	Easily identifiable, may compromise friendly position, obscure target, or warn of fire support employment. Placement may be difficult due to structures.
SMOKE (IR)	D/N	ALL/ NVD AT NIGHT	GOOD	GOOD	Easily identifiable, may compromise friendly position, obscure target, or warn of fire support employment. Placement may be difficult due to structures. Night marking is greatly enhanced by the use of IR reflective smoke
ILLUM, GROUND BURST	D/N	ALL	N/A	GOOD	Easily identified, may wash out NVDs.
SIGNAL MIRROR	D	ALL	GOOD	N/A	Avoids compromise of friendly location. Dependent on weather and available light and may be lost in reflections from other reflective surfaces (windshields, windows, water)
SPOT LIGHT	N	ALL	GOOD	MARGINAL	Highly visible to all. Compromises friendly position and warns of fire support employment. Effectiveness is dependent upon degree of urban lighting.
IR SPOT LIGHT	N	ALL NVD	GOOD	MARGINAL	Visible to all with NVGs. Less likely to compromise than overt light. Effectiveness dependent upon degree of urban lighting.
IR LASER POINTER (below .4 watts)	N	ALL NVG	GOOD	MARGINAL	Effectiveness dependent upon degree of urban lighting.
IR LASER POINTER (above .4 watts)	N	ALL NVD	GOOD	GOOD	Less affected by ambient light and weather conditions. Highly effective under all but the most highly lit or worst weather conditions. IZLID-2 is the current example.
VISUAL LASER	N	ALL	GOOD	MARGINAL	Highly visible to all. Risk of compromise is high. Effectiveness dependant upon degree of urban lighting.
LASER DESIG- NATOR	D/N	PGM OR LST EQUIP- PED	N/A	GOOD	Highly effective with PGM. Very restrictive laser acquisition cone and requires line of sight to target. May require pre-coordination of laser codes

Table 8-3. Methods of marking friendly positions.

METHOD	DAY/ NIGHT	ASSETS	FRIENDLY MARKS	TARGET MARKS	REMARKS
TRACERS	D/N	ALL	N/A	MARGINAL	May compromise position. May be difficult to distinguish mark from other gunfire. During daytime use, may be more effective to kick up dust surrounding target.
ELECTRON- IC BEACON	D/N	SEE RE- MARKS	EXCELLENT	GOOD	Ideal friendly marking device for AC-130 and some USAF fixed wing (not compatible with Navy or Marine aircraft). Least impeded by urban terrain. Can be used as a TRP for target identification. Coordination with aircrews essential to ensure equipment and training compatibility.
STROBE (OVERT)	N	ALL	MARGINAL	N/A	Visible by all. Effectiveness dependent upon degree of urban lighting.
STROBE (IR)	N	ALL NVD	GOOD	N/A	Visible to all NVDs. Effectiveness dependent upon degree of urban lighting. Coded strobes aid in acquisition.
FLARE (OVERT)	D/N	ALL	GOOD	N/A	Visible by all. Easily identified by aircrew.
FLARE (IR)	N	ALL NVD	GOOD	N/A	Visible to all NVDs. Easily identified by aircrew.
GLINT/IR PANEL	N	ALL NVD	GOOD	N/A	Not readily detectable by enemy. Very effective except in highly lit areas.
COMBAT IDENTIFI- CATION PANEL	D/N	ALL FLIR	GOOD	N/A	Provides temperature contrast on vehicles or building. May be obscured by urban terrain.
VS-17 PANEL	D	ALL	MARGINAL	N/A	Only visible during daylight. Easily obscured by structures.
CHEMICAL HEAT SOURCES	D/N	ALL FLIR	POOR	N/A	Easily masked by urban structures and lost in thermal clutter. Difficult to acquire, can be effective when used to contrast cold background or when aircraft knows general location.
SPINNING CHEM- LIGHT (OVERT)	N	ALL	MARGINAL	N/A	Provides unique signature. May be obscured by structures. Provides a distinct signature easily recognized. Effectiveness dependent upon degree of urban lighting.
SPINNING CHEM- LIGHT (IR)	N	ALL NVD	MARGINAL	N/A	Provides unique signature. May be obscured by structures. Effectiveness dependent upon degree of urban lighting.

Table 8-3. Methods of marking friendly positions (continued).

8-11. ATTACK HELICOPTERS

The primary mission of attack helicopter units is to destroy armor and mechanized forces. Employing attack helicopters in combined arms operations increases the lethality of ground maneuver forces.

a. **Aircraft Characteristics.** The AH-64A Apache, the AH-64D Longbow Apache, the OH-58D Kiowa Warrior, and the AH-1W or AH-1Z (USMC) are employed in attack operations. Table 8-4 provides a comparison of the weapon systems and armaments on these attack helicopters. (The table also lists weaponry for the AH-1 Cobra which is no longer in the active Army inventory but might be used to provide attack support in joint operations with U.S. Marine units.)

AIRCRAFT TYPE	WEAPONS SYSTEMS						
	Hellfire/TOW ¹		Air-to-Air Stinger	2.75-inch (70-mm) rockets	Cal .50 MG (rds)	20-mm cannon (rds)	30-mm chain gun (rds)
AH-1 ²		8		76		750	
AH-64A ³	16			76			1,200
AH-64D ³	⁴ 16		4	76			1,200
OH-58D ^{2,3}	4		4	14	500		
AH-1W/Z ⁵							
Weapons Range (Max)	8 km	3,750 m	5+ km	8 km	2 km	2 km	4 km

Numbers in each column indicate the maximum load for each system.

¹ The AH-1 uses the TOW missile as its armor engagement weapon instead of the Hellfire missile.

² This aircraft carries one weapon system on each side (Hellfire, TOW, or both; air-to-air Stinger; and 2.75-inch rocket).

³ Aircraft has a laser for target designation and an ATHS.

⁴ Hellfire/Hellfire II.

⁵ USMC helicopters will have varied weapons loads. During coordination, request on-board weapon status.

Table 8-4. Helicopter weapon systems.

b. **Close Combat Attack.** The close combat attack is a technique for directing lethal fires within the context of a preplanned mission. It does not replace the integrated military decision-making process (MDMP) between ground maneuver and aviation elements.

(1) To request immediate close combat attack, the ground unit in contact executes a face-to-face coordination or uses a radio transmission to provide a situation update to the attack aircraft (METT-TC permitting). This situation update contains essential elements from the aviation close combat attack coordination checklist (Figure 8-17, page 8-26).

(2) After receipt of a request for immediate close combat attack, the attack team leader informs the ground unit leader of the battle position, attack-by-fire position, or the

series of positions his team will occupy that will provide the best observation and fields of fire into the engagement or target area. The attack team leader then provides the ground maneuver unit leader with his concept for the team's attack on the objective.

(3) Upon mission completion, the attack team leader provides the ground maneuver commander a battle damage assessment (BDA) of the intended target.

CLOSE COMBAT ATTACK CHECKLIST
<ol style="list-style-type: none">1. Enemy situation -- specific target identification.2. Friendly situation -- location and method of marking friendly positions.3. Ground maneuver mission and scheme of maneuver.4. Attack aircraft scheme of maneuver.5. Planned engagement area and BP/SBF position.6. Method of target marking.7. Fire coordination and fire restrictions.8. Map graphics update.9. Request for immediate aviation close fight support -- used for targets or for ground-to-air target handoff.

Figure 8-17. Close combat attack coordination checklist.

Section III. COMBAT ENGINEER SUPPORT

The two core qualities of the SBCT are high mobility and the ability to achieve decisive action through dismounted infantry assault. At the tactical level, overmatching mobility is critical to the success of the force. Given the significance of tactical mobility to the SBCT's successful operations, the SBCT engineers are essential.

8-12. MEDIUM ENGINEER COMPANY

The SBCT's organic medium engineer company (MEC) provides embedded, responsive mounted and dismounted maneuver support. The MEC supports the maneuver force--the SBCT infantry battalions and companies. It readily integrates into maneuver operations and organizations at all levels based on the analysis of tasks required. It is an agile organization that assures freedom to maneuver on the battlefield within the combined arms team framework. The MEC has three combat mobility platoons, one mobility support platoon, and a company headquarters section. The MEC normally task-organizes its platoons to infantry battalions and companies in a specific command-support relationship to provide a mission-specific, tailored package. It performs mounted and dismounted engineer tasks equally well.

a. **Combat Mobility Platoon.** The combat mobility platoon is normally the lowest-level engineer unit that can effectively accomplish independent mounted engineer missions and tasks. It is the basic building block of engineer force allocation and task organization. A combat mobility platoon is normally task-organized to support an infantry battalion, but it may support an infantry company based on METT-TC analysis. The combat mobility platoon may receive augmentation in the form of special equipment

from the mobility support platoon. Engineer platoon-specific common-platform equipment includes engineer squad vehicles (ESVs) with mountable rollers or blades, mine-clearing line charges (MICLICs), and multiple-delivery mine systems (Volcanos) (Figure 8-18). The combat mobility platoon's engineer squads carry a variety of explosives and demolitions. The engineer squad is normally the minimum force required to provide effective dismounted support to the infantry. The squad is the engineer organization most likely to support the reconnaissance platoon, particularly during offensive operations.

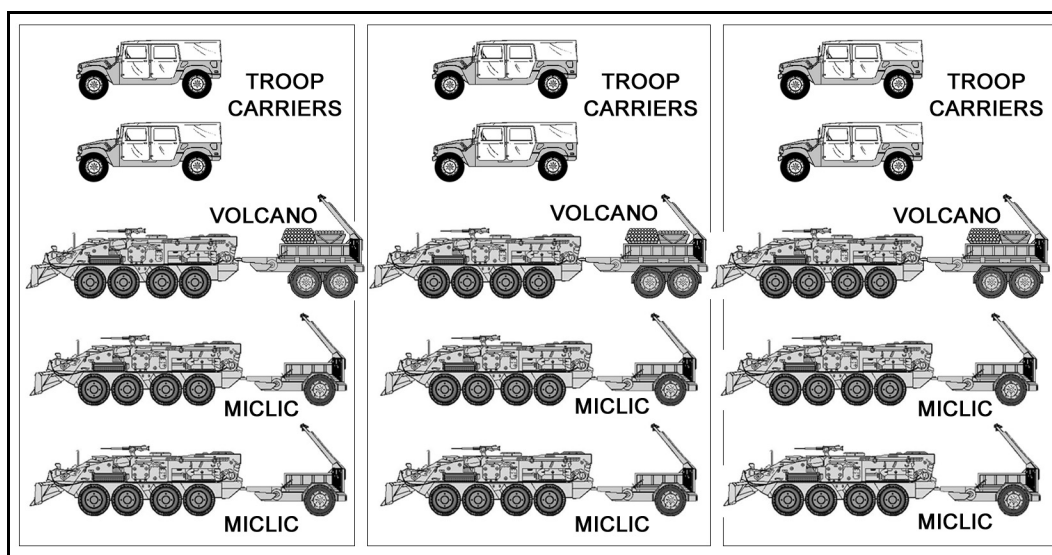


Figure 8-18. Three combat mobility platoons.

b. **Mobility Support Platoon.** The mobility support platoon consists of a platoon headquarters section and three equipment-based mobility sections (Figure 8-19, page 8-28), equipped with light assault bridges, light earthmovers (deployable universal combat earthmovers [DEUCEs]), and high mobility engineer excavators (HMEEs). Unlike the combat mobility platoon, it is not organized to operate independently during offensive operations. The mobility support platoon provides the commander with specialized equipment capabilities to weight the main effort and to perform specialized mobility tasks. Each section is structured to provide equipment augmentation, focused on reducing enemy obstacles and fortifications, to each of the three combat mobility platoons. Each section has gap-crossing, obstacle-reduction, special-tool, and heavy-blade capabilities. The mobility support platoon provides a limited capability for countermobility, survivability, and sustainment operations.

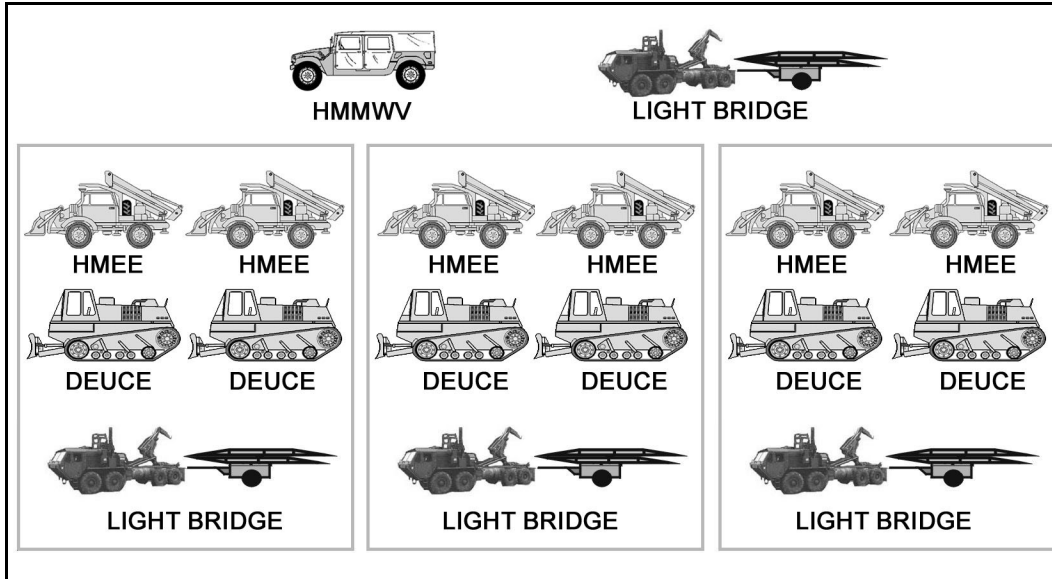


Figure 8-19. Mobility support platoon.

8-13. ENGINEER MISSIONS

Engineer missions fit into one of three categories: mobility, countermobility, and survivability. (Table 8-5 shows the tasks included in each of these categories.) An engineer may be attached to a reconnaissance platoon for specific missions. Engineers conduct reconnaissance, evaluate obstacles, and use demolitions and field expedients.

MOBILITY	COUNTERMOBILITY	SURVIVABILITY
Breaching obstacles. Clearing minefields. Clearing routes. Expedient gap crossing. Constructing combat roads or trails.	Constructing obstacles to turn, fix, block, or disrupt enemy forces.	Constructing crew-served weapons and vehicle fighting positions.

Table 8-5. Engineer missions.

8-14. MOBILITY

At the tactical level, overmatching mobility is critical to the success of the force. Engineers support infantry by performing obstacle reduction and route construction and or improvement.

a. **Obstacle Reduction.** Reduction is the creation of lanes through or over an obstacle to allow an attacking force to pass. The number and width of lanes created varies with the factors of METT-TC. The lanes must allow the assault force to rapidly pass through the obstacle. The breach force will reduce, proof (if required), mark, and report lane locations and the lane marking method by unit SOP. Engineers cannot reduce an obstacle until the obstacle has been identified, effective suppression and obscuration are in place, and the point of breach is secure. (For detailed discussions of breaching see FM 3-34.2.)

b. **Route Construction and Improvement.** Engineers have a limited capability to construct, improve, and maintain roads, bridges, and fords. In addition to providing mobility support during offensive operations, engineers can enhance mobility during defensive operations by focusing on the ability to shift forces. Enhancements to mobility during defensive operations include:

- Mobility between primary, alternate, and supplementary battle positions.
- Mobility of reserves to reinforcing positions.
- Mobility of reserves in the counterattack.

8-15. COUNTERMOBILITY

Engineers construct obstacles that prevent the enemy from successfully executing his scheme of maneuver. Commonly used obstacles include minefields, wire obstacles, antitank ditches, road craters, abatises, and log cribs. Engineers also can reinforce restricted terrain and existing obstacles to disrupt, fix, turn, or block the enemy.

8-16. SURVIVABILITY

The survivability plan will be synchronized with the battalion countermobility plan. The platoon should prepare by marking vehicle positions, identifying leaders to supervise position construction, and designating guides for the blade movement between positions. Platoons will execute the commander's plan for priority of the survivability effort. This plan should specify the following:

- Level of survivability of each subordinate unit.
- Priority of survivability support by specific unit, type of weapon system, or combination.
- Type of position to be dug for a unit or type of weapon system.

8-17. RECONNAISSANCE OPERATIONS.

In reconnaissance operations, an engineer squad can be in DS to a reconnaissance platoon. The engineer squad aids in mobility operations and provides technical advice to the platoon leader as to what effort and equipment it will take to breach a certain obstacle. The platoon leader relays this information back to the battalion to aid in its breaching preparations. The actual breaching abilities of an engineer squad are limited to manual and explosive methods. (The platoon provides security for the engineer squad while it conducts breaches.) The engineer squad can--

- Conduct route and bridge classification.
- Aid in locating bypasses around obstacles.
- Conduct limited breaching operations through log cribs, abatis, and minefields.

Section IV. AIR DEFENSE

The air defense and aviation coordination cell's (ADACC's) air and missile defense (AMD) analysis determines if the SBCT will be task organized with air defense assets from a divisional short-range air defense (SHORAD) battalion. Even if the SBCT and subsequently the SBCT infantry battalion receive air defense assets, it is unlikely that the reconnaissance platoon will be task-organized with any of the air defense assets. However, Avengers and Linebackers may operate in and around the battalion AO in

support of brigade assets. Therefore, the reconnaissance platoon must conduct its own air defense operations, relying on disciplined passive air defense measures and the ability to actively engage aerial platforms with organic weapons systems.

8-18. SYSTEMS, ORGANIZATION, AND CAPABILITIES

The systems that may operate in and adjacent to the battalion AO are the Avenger, man-portable air defense systems (MANPADS), and Linebacker (Table 8-6). All systems can operate as MANPADS Stinger teams. The battalion may be supported by an air defense platoon equipped with Avengers or MANPADS. The air defense platoon is responsible for providing DS, GS, or GS-R coverage to the battalion.




<p>Man-Portable System</p> 	<p>Personnel: 2-man crew Basic load: 6 missiles basic load w/ M998 HMMWV Acquisition/range: Visual Engagement range: 5 km Engagement altitude: 3 km + Mutual support: 2 km +</p>
<p>Bradley Linebacker</p> 	<p>Personnel: 4-man crew Basic load: 10 missiles (4 ready to fire, 6 stowed) Acquisition/range: Visual/thermal Engagement range: 5 km (Stinger), 2500 m 25-mm, 900 m coax Engagement altitude: 3 km + Mutual support: 3 km Emplacement time: Fire on the move Reload time: 4 minutes</p>
<p>Avenger</p> 	<p>Personnel: 2 man crew Basic load: 8 ready-to-fire missiles, 250 rds .50 cal Acquisition/range: Visual/FLIR 9-10 km, laser range finder Engagement range: 5 km +, .50 cal range: 6,470 m Rate of fire: 1025 rpm Engagement altitude: 3 km + Mutual support: 3 km Emplacement time: 6 min, can remote operations out to 50 meters</p>

Table 8-6. Air defense systems.

a. **Stinger.** Although other SHORAD systems support divisional units, the SBCT infantry battalion reconnaissance platoon is most likely to be supported by the Avenger (Figure 8-20) or a MANPADS (Figure 8-21, page 8-32). Stinger is designed to counter high-performance, low-level, ground attack aircraft, helicopters, and observation and transport aircraft.

(1) The Avenger's combined arms mission is to provide protection to combat forces, combat support elements, and other critical assets from attack. The Avenger is designed to counter hostile cruise missiles, unmanned aerial vehicles, and low-flying, high-speed, fixed-wing aircraft and helicopters attacking or transiting friendly airspace. The Avenger provides the battalions with highly mobile, dedicated air defense firepower. The Avenger is equipped with two standard vehicle-mounted launchers (SVML) which carry four Stinger missiles each and have the following capabilities:

- The modified fire control subsystem fires and the SVML allow the Avenger to shoot on the move.
- The Avenger weapon system has an unobstructed, 360-degree field of fire and can engage at elevations between -10 and +70 degrees.
- The .50 cal machine gun affords a measure of self-protection by providing additional coverage of the Stinger missile's inner launch boundary.
- Avenger's sensor package (FLIR, carbon dioxide, eye-safe laser range finder, and a video autotracker) provides target acquisition capability in battlefield obscuration, at night, and in adverse weather.
- The two-man crew remains in the vehicle under armor protection.
- Targeting data is provided by the forward area air defense (FAAD) command, control, communications, and intelligence (C3I).
- The Avenger system allows shoot-on-the-move and slew-to-cue capability.
- In the event of launcher system damage or failure or static mode, the system maintains dismounted Stinger missile capability.
- The firing sequence is entirely automated, including super-elevation and lead, so that the gunner only needs to push the fire button to initiate the fire sequence and immediately select and prepare the next missile for firing.



Figure 8-20. AVENGER.

(2) The MANPADS Stinger missile system employs a two-man crew (crew chief and gunner). The MANPADS team normally has assigned transportation. Unit leaders must consider carefully the consequences before separating a Stinger team from its vehicle. Stinger teams operating away from their vehicles have no more than two missiles available for resupply.

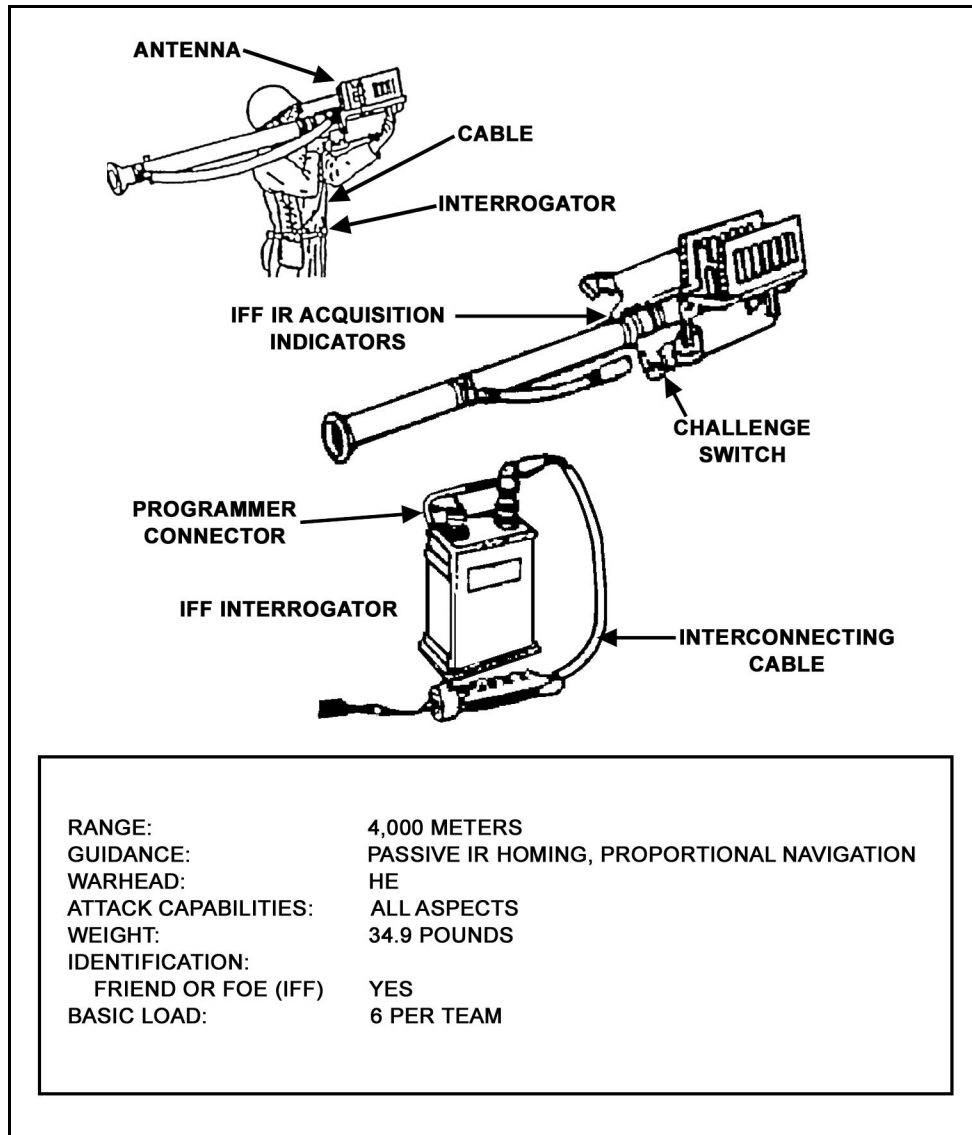


Figure 8-21. Stinger MANPADS air defense system.

b. **Early Warning Alerts.** If the brigade has an attached SHORAD battery, the platoon will receive early warning alerts from the SHORAD battery and its elements. The SHORAD C3I Sentinel radar team can broadcast early warning of threat air activity to SHORAD elements (battery, platoon, or section), to FA fire units, and to air defense liaison officers (LNOs). The SHORAD battery will then provide voice early warning on the brigade command net. If METT-TC factors permit, the SHORAD platoon provides voice early warning to the battalions. The Sentinel radar (Figure 8-22) provides a 360-degree detection capability for various air tracks (rotary- and fixed-wing aircraft, UAVs, and cruise missiles) to a range of 40 kilometers. The Sentinel radar is normally OPCON to the respective SHORAD battery commander.

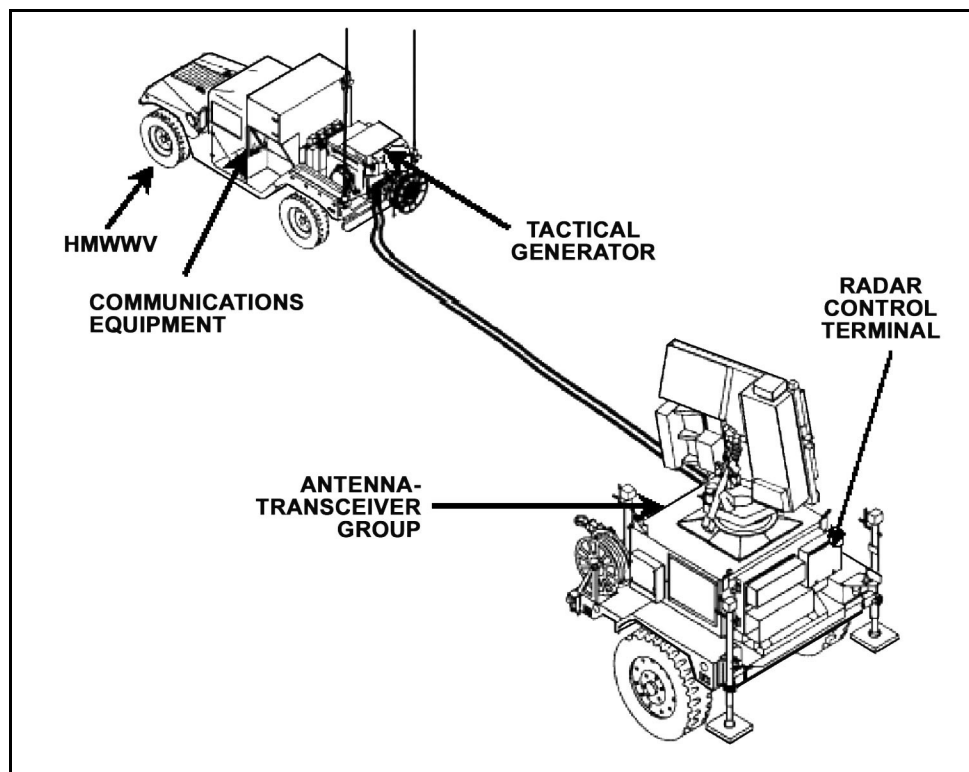


Figure 8-22 Sentinel radar system.

8-19. EMPLOYMENT OF AIR DEFENSE SYSTEMS

In offensive situations, air defense elements accompany the main attack. They may maneuver with the battalion's lead companies, orienting on low-altitude air avenues of approach. When the unit is moving or in a situation that entails short halts, air defense elements should remain within the platoon's organic weapon system maximum ranges to assure mutual support. The Stinger gunners (MANPADS) can dismount to provide air defense when the unit reaches the objective or pauses during the attack. In the defense, air defense elements may establish BPs based on available IPB information and the commander's scheme of maneuver.

8-20. WEAPONS CONTROL STATUS

The weapons control status (WCS) describes the relative degree of control in effect for air defense fires. It applies to all weapons systems. The weapons control status is dictated in the task force OPORD and may be updated based on the situation. The three levels of control are:

- a. **Weapons Free.** Crews can fire at any air target not positively identified as friendly. This is the least restrictive WCS level.
- b. **Weapons Tight.** Crews can fire only at air targets positively identified as hostile according to the prevailing hostile criteria.
- c. **Weapons Hold.** Crews are prohibited from firing except in self-defense or in response to a formal order. This is the most restrictive control status level.

8-21. EARLY WARNING PROCEDURES

Air defense warnings (ADWs) include--

- RED - Air or missile attack imminent or in progress.
- YELLOW - Air or missile attack probable.
- WHITE - Air or missile attack not likely.

While air defense warnings cover the probability of hostile air action over the entire theater of war or operations, local ADWs describe with certainty the air threat for a specific part of the battlefield. Air defense units use these local warnings to alert Army units to the state of the air threat in terms of "right here, right now." There are three local air defense warning levels:

- DYNAMITE - Air platforms are inbound or are attacking locally now.
- LOOKOUT - Air platforms are in the area of interest but are not threatening. They may be inbound, but there is time to react.
- SNOWMAN - No air platforms pose a threat at this time.

NOTE: The area air defense commander routinely issues ADWs for dissemination throughout the theater of war or operations. These warnings describe the general state of the probable air threat and apply to the entire area.

8-22. REACTION PROCEDURES

Reaction procedures include both passive and active air defense measures.

a. **Passive Air Defense.** Passive air defense is the platoon's primary method for avoiding enemy air attack. Passive air defense consists of all measures taken to prevent the enemy from detecting or locating the unit, to minimize the target acquisition capability of enemy aircraft, and to limit damage to the unit if it comes under air attack. Target detection and acquisition are difficult for crews of high-performance aircraft, and the platoon can exploit this advantage. In most cases, enemy pilots must be able to see and identify a target before they can launch an attack.

(1) **Guidelines.** The platoon should follow these guidelines to avoid detection or limit damage if detected:

- When stopped, occupy positions that offer cover and concealment and dig in and camouflage vehicles that are exposed.
- When moving, use covered and concealed routes.
- Disperse vehicles as much as possible to make detection and attack more difficult.
- Wipe out track marks leading to vehicle positions and eliminate or cover the spoil from dug-in positions.
- If moving when an enemy aircraft attacks, disperse and seek covered and concealed positions.
- Do not fire on a hostile fixed-wing aircraft unless it is clear that the aircraft has identified friendly elements. Premature engagement compromises friendly positions.
- Designate air guards for every vehicle and position; establish and maintain 360-degree security.
- Establish an air warning system in the unit SOP, including both visual and audible signals.

(2) **Procedures.** When the platoon observes fixed-wing aircraft, helicopters, or UAVs that could influence its mission, it initially takes passive air defense measures unless the situation requires immediate active measures. Passive air defense measures normally means that each platoon initiates its React to Air Attack Battle Drill; however, the commander can initiate specific passive measures if necessary. Refer to the passive air defense guidelines for the company discussed earlier in this section.

NOTE: Passive air defense also includes the platoon's preparations for conducting active air defense measures.

Passive air defense involves these three steps:

- Step 1 - Alert the battalion with a contact report.
- Step 2 - Deploy or take the appropriate actions. If the battalion is not in the direct path of an attacking aircraft, the commander orders the companies to seek cover and concealment and halt with at least a 100-meter interval between vehicles. The platoon also may be ordered to continue moving as part of the battalion.
- Step 3 - Prepare to engage. Fighting vehicle crews prepare to engage the aircraft with machine gun or main gun fire on order of the commander or their platoon leader.

b. Active Air Defense. The platoon avoids engaging enemy aircraft if possible. If engagement is unavoidable, the platoon uses a technique known as volume of fire (Figure 8-23, page 8-36). This technique is based on the premise that the more bullets a unit can put in the sky, the greater the chance the enemy will fly into them. Even if these fires do not hit the enemy, a "wall of lead" in the sky can intimidate enemy pilots, causing them to break off their attack, or it can distract them from taking proper aim. One of the most important points about volume of fire is that once the lead distance is estimated, the soldier must aim at the estimated aiming point and fire at that single point until the aircraft has flown past it. The soldier maintains the aiming point, not the lead distance. Once the soldier starts firing, he does not adjust his weapon. The platoon leader establishes the aiming point based on the type of aircraft that is attacking (Figure 8-24, page 8-36).

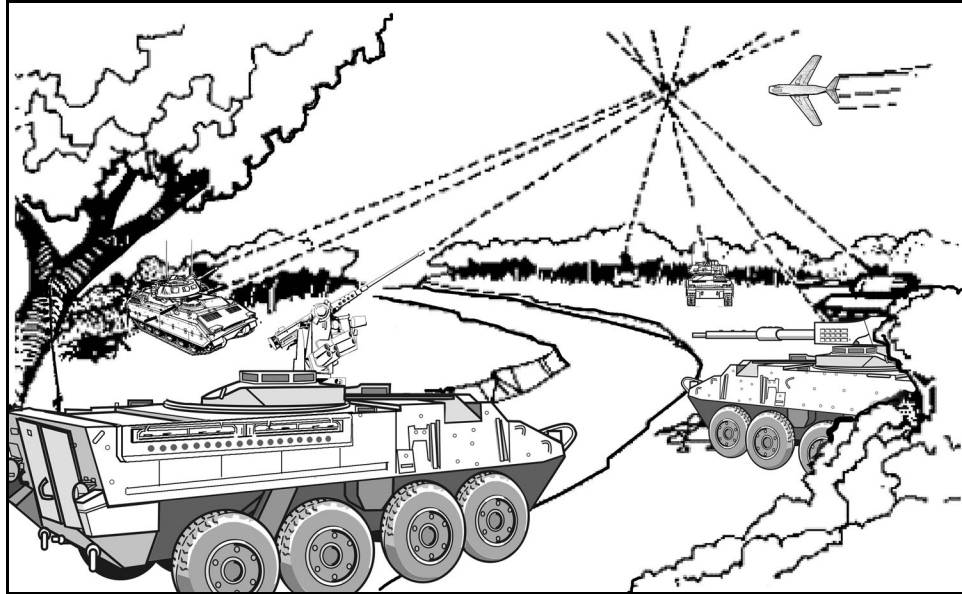


Figure 8-23. Volume of fire.

RULES FOR SELECTING THE AIM POINT

TYPE AERIAL PLATFORMS	COURSE	AIM POINT
JET/CRUISE MISSILE	CROSSING	TWO FOOTBALL FIELDS IN FRONT OF NOSE
JET/CRUISE MISSILE	OVERHEAD	TWO FOOTBALL FIELDS IN FRONT OF NOSE
JET/CRUISE MISSILE	DIRECTLY AT YOU	SLIGHTLY ABOVE AIRCRAFT NOSE
HELICOPTER/UAV	CROSSING	ONE-HALF FOOTBALL FIELD IN FRONT OF NOSE
HELICOPTER	HOVERING	SLIGHTLY ABOVE HELICOPTER BODY
HELICOPTER/UAV	DIRECTLY AT YOU	SLIGHTLY ABOVE HELICOPTER BODY

Figure 8-24. Aim points.

Section V. NUCLEAR, BIOLOGICAL, AND CHEMICAL SUPPORT

NBC assets within the SBCT are limited; therefore, it is imperative that the platoon practices the fundamentals of NBC defense, avoidance, protection, and decontamination in order to survive on a contaminated battlefield.

8-23. RECONNAISSANCE SUPPORT

The NBC reconnaissance platoon organic to the cavalry squadron (RSTA) is the only internal NBC reconnaissance available to the SBCT. The NBC reconnaissance platoon can locate, identify, and mark areas of contamination. Since NBC reconnaissance assets are limited, the SBCT infantry reconnaissance platoon must plan for alternate means of conducting NBC reconnaissance.

8-24. DECONTAMINATION SUPPORT

For operational decontamination, the platoon must request support from the battalion's decontamination team, which is equipped with the modular decontamination system (MDS). Thorough decontamination operations require the support of an external decontamination platoon. (For a more detailed discussion of decontamination requirements, refer to FM 3-5.)

CHAPTER 9

COMBAT SERVICE SUPPORT

Combat service support elements arm, fuel, fix, feed, equip, and provide health service support, transportation, and personnel for the reconnaissance platoon. The reconnaissance platoon leader is responsible for supervising CSS within the reconnaissance platoon, and the PSG is the CSS operator for the reconnaissance platoon. He advises the platoon leader on the logistical requirements and informs the platoon leader of the platoon's logistical status. The team leaders assist the PSG.

9-1. ORGANIZATION

The reconnaissance platoon has no organic CSS assets. The PSG coordinates directly with the headquarters and headquarters company's XO or first sergeant (1SG) or the battalion S4 for all CSS. He is the main recipient for all maintenance, supply, and personnel reports.

a. The reconnaissance platoon presents complex logistical considerations for the battalion staff. The reconnaissance platoon normally operates forward of the battalion. It deploys earlier and stays away longer than other battalion elements. During combat operations, the PSG coordinates directly with the 1SG or S4 to discuss support requirements and problems.

b. The HHC commander and the battalion staff plan and coordinate for all CSS. The HHC 1SG, supply sergeant, PSG, and team leaders implement the logistical plan. The reconnaissance platoon's SOP should address the duties and responsibilities to standardize routine and recurring CSS operations.

9-2. INDIVIDUAL RESPONSIBILITIES

This paragraph focuses on specific individual responsibilities within the platoon's CSS chain.

a. **Platoon Sergeant.** As the platoon's main CSS operator, the platoon sergeant executes the platoon's logistical plan based on platoon and HHC SOPs. The platoon sergeant's CSS duties include--

- Participating in CSS rehearsals at the company or battalion level and integrating CSS into the platoon's maneuver rehearsals.
- Receiving, consolidating, and forwarding all administrative, personnel, and casualty reports to the first sergeant as directed or IAW unit SOP.
- Obtaining supplies, equipment (except Class VIII), and mail from the supply sergeant and ensuring proper distribution.
- Supervising evacuation of casualties, enemy prisoners of war, and damaged equipment.
- Maintaining the platoon's manning roster.
- Using the FBCB2 system for recurring reports and coordination of CSS assets moving forward.

b. **Team and Section Leader.** Each team and section leader's CSS duties include--

- Ensuring that crews perform proper maintenance on all assigned equipment.

- Compiling personnel and logistics reports for the platoon and submitting them to the platoon sergeant as directed or IAW unit SOP.
 - Obtaining supplies, equipment (all classes), and mail from the platoon sergeant and ensuring proper distribution.
- c. **Platoon Medic.** The platoon's medic is attached to the platoon from the HHC's medical platoon. His duties include--
- Supervising triage for injured, wounded, or ill friendly personnel and EPWs.
 - Providing first aid for and stabilizing injured, wounded, or ill personnel.
 - Evacuating seriously wounded personnel under the direction of the platoon sergeant.
 - Assisting in training the platoon's combat lifesavers in first-aid procedures.
 - Requisitioning Class VIII supplies, including combat lifesaver bags and first-aid kits, for the platoon's combat lifesavers.
 - Recommending locations for the casualty collection points (CCPs).
 - Supervising the platoon's combat lifesavers.

9-3. PLANNING CONSIDERATIONS

Planning CSS operations is primarily a HHC- and battalion-level resupply operation. While the HHC commander and executive officer plan the operation, the platoon leader is responsible for his platoon's execution of the plan at platoon level, and the platoon sergeant executes the plan at the team and vehicle level.

a. **Development of the CSS Plan.** The platoon leader begins development of his CSS plan by determining exactly what he has on hand to accurately predict his support requirements. This process is important not only in confirming the validity of the CSS plan but also in ensuring the platoon submits support requests as early as possible. The platoon leader formulates his CSS execution plan and submits support requests to HHC based on his reconnaissance plan and the desired end state of the platoon at the end of the planned operation.

b. **Operational Questions.** The CSS plan should provide answers to operational questions.

(1) **Types of Support.** Based on the nature of the operation and specific tactical factors, what types of support will the platoon need?

(2) **Quantities.** In what quantities will this support be required?

(a) Will emergency resupply be required during the mission?

(b) Does this operation require prestock supplies?

(3) **Enemy.** What are the composition, disposition, and capabilities of the expected enemy force? How will these affect CSS operations during the mission?

(a) Where and when will the expected contact occur?

(b) What are the platoon's potential losses based on the nature and location of expected contact?

(c) What impact will the enemy's special weapons capabilities (such as NBC) have on the mission and on expected CSS requirements?

(d) Will the platoon be required to capture enemy soldiers and equipment? How many EPWs are expected, and where?

(4) **Terrain and Weather.** How will terrain and weather affect CSS operations during the mission?

- (a) What ground will provide the best security for maintenance and CCPs?
- (b) What are the platoon's vehicle and casualty evacuation routes?
- (c) What are the battalion's dirty routes for evacuating contaminated personnel, vehicles, and equipment?

(5) **Time and Location.** When and where will the platoon need CSS?

(a) Based on the nature and location of expected contact, what are the best sites for the CCP?

(b) Where will the EPW collection points be located?

(6) **Requirements.** What are the support requirements, by element and type of support?

(a) Which section has priority for emergency Class III resupply?

(b) Which section or team has priority for emergency Class V resupply?

(7) **Risk Factor.** Will the tempo of the mission permit support elements to conduct resupply operations in relative safety? If no lulls are expected, how can the platoon best minimize the danger to the CSS vehicles providing the required support?

(8) **Resupply Technique.** Based on information developed during the CSS planning process, which resupply technique should the platoon use: routine, emergency, or prestock?

c. **Classes of Supply Considerations.** The platoon sergeant obtains supplies and delivers them to the platoon. The platoon leader establishes priorities for delivery, but combat demands that Class I, III, V, and IX supplies and equipment take priority because they are the most critical to successful operations.

(1) **Class I.** This class includes rations, water, and ice. It also includes gratuitous issue of items related to health, morale, and welfare. The Daily Strength Report triggers an automatic request for Class I supplies. Personnel in the brigade support area (BSA) prepare rations and deliver them with the logistics package (LOGPAC). During the initial deployment, soldiers eat meals, ready-to-eat (MREs) stored on combat vehicles. Due to the probability of long lines of communication (LOCs) and resupply and the extended duration of reconnaissance missions, the platoon must keep a minimum of three-to-five days' supply of rations and water on hand for each soldier at all times. In an arid climate, the platoon should plan on at least 8.5 gallons of water per day for each soldier. Reconnaissance vehicles should carry extra water cans to store the three-to-five days' supply of water.

(2) **Class II.** This class includes clothing, individual equipment, MOPP suits, tentage, tool sets, and administrative and housekeeping supplies and equipment. The platoon sergeant distributes expendable items such as soap, toilet tissue, and insecticide during LOGPAC operations. The HHC supply sergeant normally stores the second set of MOPP suits.

(3) **Class III.** This class includes POL products. Unusual Class III requests go to the first sergeant and then to the battalion combat trains.

(a) POL includes both bulk and packaged products. Examples of bulk products include Army common fuel (JP8), diesel fuel, and motor gasoline (MOGAS).

(b) The platoon requests and receives Class III products such as 5-gallon containers, lubricants, grease, hydraulic fluid, cylinders of liquid and compressed gasses, and solvents in amounts of 55 gallons or less.

(4) **Class IV.** This class includes construction materials, pickets, sandbags, and concertina wire.

(5) **Class V.** This class covers all types of ammunition and mines including C4 and other explosives.

(6) **Class VI.** This class includes personal-demand items normally sold through the exchange system, which can include candy, soaps, cameras, and film.

(7) **Class VII.** This class includes major end items such as RVs, radios, and PLGRs. Battle loss reports trigger the issuance of Class VII items. Ready-to-fight weapons systems go forward with the LOGPAC.

(8) **Class VIII.** This class covers medical supplies. The battalion aid station (BAS) replaces combat lifesaver bags and first-aid kits on a one-for-one basis. Extra medical supplies may be needed depending on the factors of METT-TC.

(9) **Class IX.** This class includes repair parts and documents required for equipment maintenance operations. Repair parts are issued in response to a specific request or are obtained by direct exchange of repairable parts. The latter can include batteries for NVDs and man-portable radios. In combat situations, exchange and cannibalization are normal ways to obtain Class IX items.

(10) **Class X.** This class includes materials to support nonmilitary programs such as agricultural and economic development. Division level or higher will provide the platoon with instructions for requesting and issuing Class X supplies.

(11) **Miscellaneous.** This category covers anything that does not fall in one of the existing classes of supply.

9-4. RESUPPLY OPERATIONS

Resupply operations fall into one of three classifications: routine, emergency, or prestock. The HHC and platoon SOPs specify cues and procedures for each method. The platoon rehearses resupply operations during platoon training exercises. The actual method selected for resupply in the field depends on METT-TC factors.

a. **Routine Resupply.** Routine resupply operations cover items in Classes I, III, V, and IX; mail; and other items requested by the platoon. When possible, the platoon should conduct routine resupply daily. Ideally, it does so during periods of limited visibility. Although the RV is designed to operate over extended periods of time (72 hours) without Class III resupply, the platoon leader should refuel at every available opportunity, based upon the factors of METT-TC.

(1) The LOGPAC technique offers a simple, efficient way to accomplish routine resupply operations. The key feature of LOGPAC, a centrally organized resupply convoy, originates at the BSA. The convoy carries all items needed to sustain the platoon for a specific period (usually 24 hours) or until the next scheduled LOGPAC. The battalion SOP will specify the LOGPAC's exact composition and march order.

(2) As directed by the HHC commander or XO, the first sergeant establishes the platoon resupply point. He uses either the service station or tailgate method, and he briefs each LOGPAC driver on which method to use. When he has the resupply point ready, the first sergeant informs the platoon leader or PSG. The platoon leader then directs each section or team to conduct resupply based on the tactical situation.

(a) The service station method that may be used during mounted operations (Figure 9-1) allows the vehicles and their teams to move individually, or by section, to a centrally located resupply point. Depending on the tactical situation, a vehicle, section, or platoon moves out of its position, conducts resupply operations, and moves back into position. This process

continues until the entire platoon has received its supplies. In using this method, vehicles enter the resupply point following a one-way traffic flow. Only vehicles that require immediate maintenance stop at the maintenance holding area. Vehicles move through each supply location. The crews rotate individually to eat, pick up mail and sundries, and refill or exchange water cans.

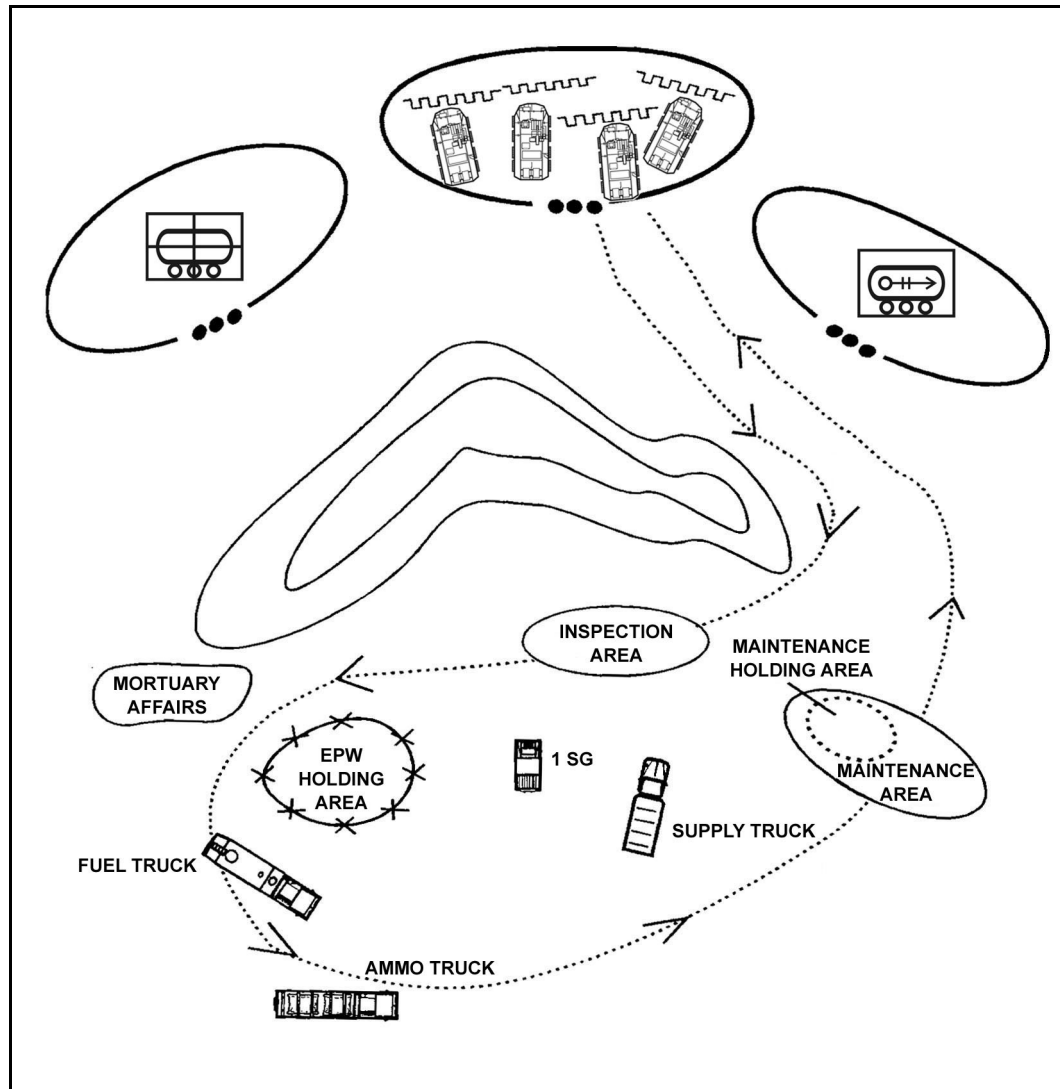


Figure 9-1. Mounted service station resupply method.

(b) The service station resupply method (Figure 9-2, page 9-6) for use during dismounted operations requires the soldiers to leave their observation posts. Selected soldiers move to the platoon resupply point, conduct resupply, and return to their OPs. This technique is used when contact is not likely and for the resupply of one or several classes of supplies.

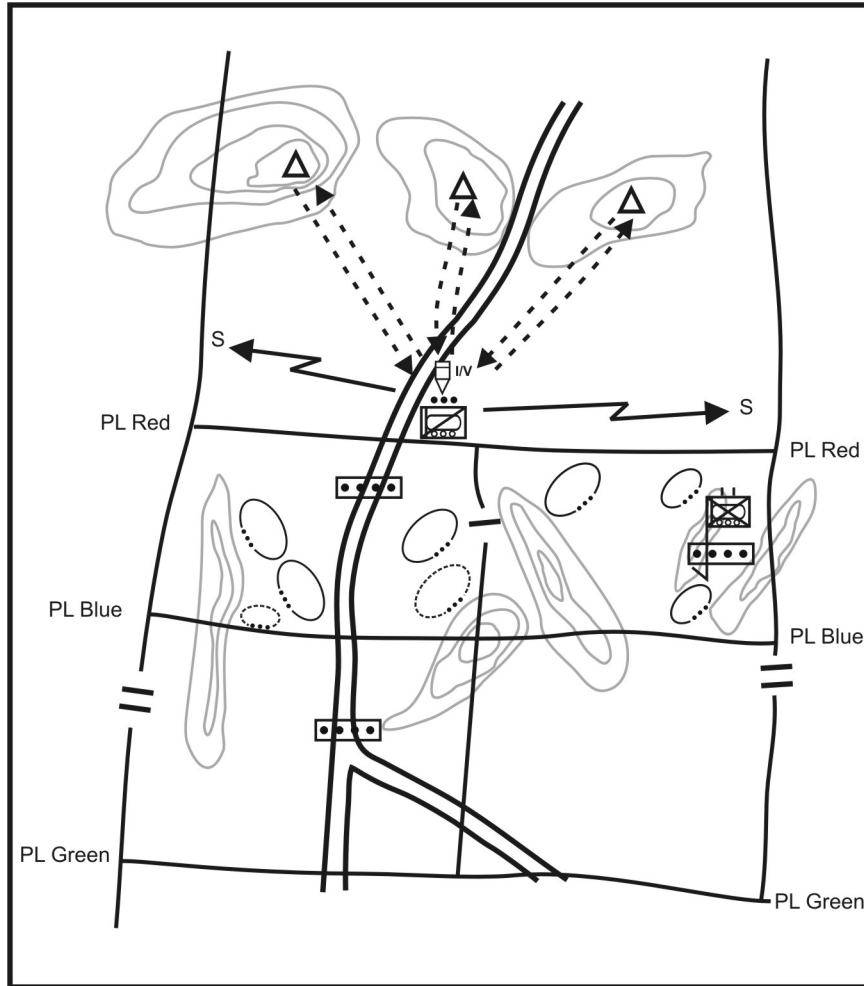


Figure 9-2. Dismounted service station resupply method.

NOTE: The platoon order should state the sequence for moving teams or portions of teams out of position.

(c) In assembly areas, the first sergeant normally uses the tailgate method (Figure 9-3). Combat vehicles remain in their vehicle positions, or they back out a short distance to allow trucks carrying Class III and V supplies to reach them. Individual soldiers rotate through the feeding area. While there, they pick up mail and sundries and refill or exchange water cans. They centralize and guard any EPWs. They take soldiers killed in action (KIA) and their personal effects to the holding area where the HHC first sergeant assumes responsibility for them.

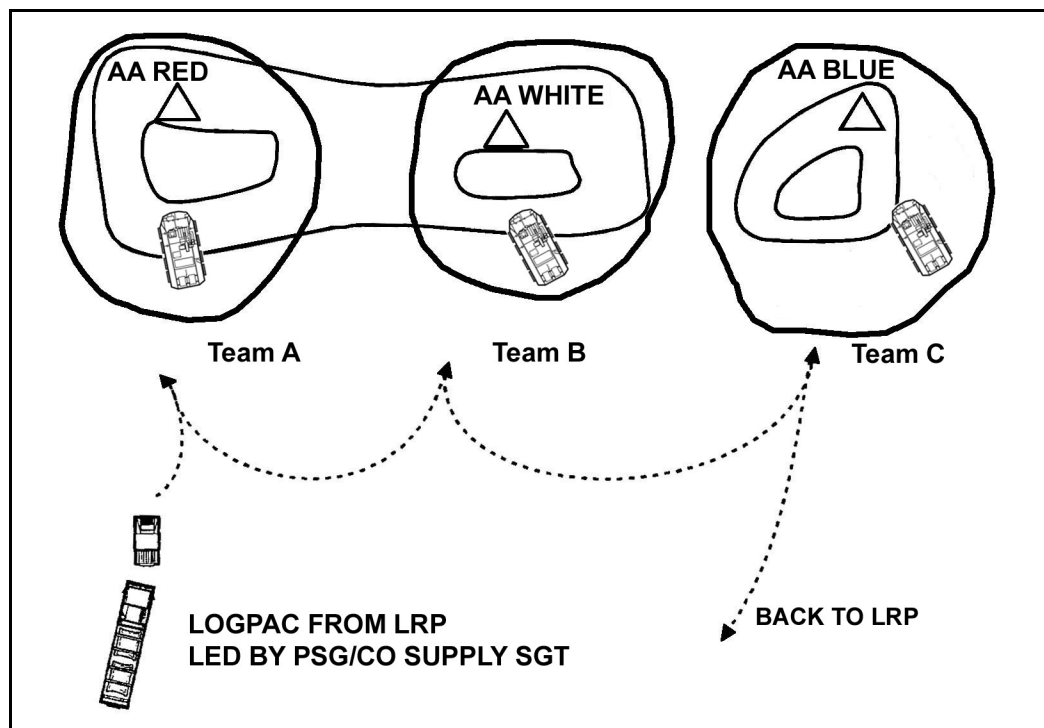


Figure 9-3. Tailgate resupply method.

(d) During operations when the platoon is separated from its vehicles and in contact, or when contact is imminent, the in-position resupply method may be required to ensure adequate supplies are available to the teams. This method requires HHC to bring forward supplies or equipment (or both) to individual positions. The platoon normally will provide a guide to ensure the supplies (Class V) are distributed to the most critical position first. This method--

- Is used when an immediate need exists.
- Is used to resupply single classes of supply.
- Enables leaders to keep team members in their OPs.

NOTE: If resupply elements cannot move near platoon positions, platoon members may need to help the resupply personnel move supplies and equipment forward.

b. **Emergency Resupply.** Occasionally (normally during combat operations), the platoon might have such an urgent need for resupply that it cannot wait for a routine LOGPAC. Emergency resupply could involve NBC equipment as well as Classes III, V, VIII, and water.

c. **Prestock Resupply.** In defensive operations and at some other times, as appropriate, the platoon most likely will need prestocked supplies, also known as pre-positioned or “cached” resupply. Normally, the platoon only pre-positions Class IV and V items, but they also can pre-position Class III supplies. The platoon must refuel their vehicles before they move into an AO for mission execution or while moving out of their AO.

(1) **Reconnaissance Operations.** During reconnaissance, the platoon can establish cache points along the intended routes of advance or near the objective. However, this method is rarely used.

(2) **Security Operations.** During security operations, the reconnaissance platoon can set up cache points throughout the AO. These points should be in each alternate or supplementary OP and at other locations throughout the depth of the sector.

(3) **Patrolling.** During patrols, the platoon can set up cache points early or during the patrol itself. To avoid carrying a heavy load during an operation, soldiers may drop items not needed at the objective en route and then recover them on their return. This technique could be used for supplies, wounded personnel, or transportation assets (boats and vehicles). The platoon must maintain security by using different routes to recover the items, by ensuring items are camouflaged, and by leaving soldiers at the cache site to guard the supplies.

(4) **Criteria.** The following criteria should be considered when planning to use caches or pre-position supply points.

(a) When selecting a possible cache point, consider if the point can be located by simple instructions that are clear to someone who has never visited the site. A point may be ideal in every respect, but if it has no distinct or permanent landmarks within a readily measurable distance, it should not be used. The point should have primary and alternate routes that avoid detection by anyone in the area. Also, consider the effects the weather will have on the cache point. For example, seasonal changes in the foliage may leave the point and routes exposed.

(b) Caches can be concealed above or below ground. An above ground point is easier to use, but it is more likely to be discovered by the enemy, civilians, or animals. There is always a security risk in using a cache point; therefore, it should be inspected for signs of enemy activity and secured before use. The cache site may have been booby-trapped, or it may be under enemy observation.

9-5. AERIAL SUSTAINMENT

Aerial supplies can be delivered by Air Force aircraft or by Army helicopters. The Air Force uses the container delivery system (CDS). (For more information on CDS operations, refer to FM 55-60. For more information on the use of Army helicopters, refer to FM 57-38.) The reconnaissance platoon should have soldiers that are trained in the use of Air Force aircraft and Army helicopters.

a. Airlanding supplies is the quickest and most accurate method of delivery. However, it poses an added risk to the helicopter and can attract enemy infantry or artillery fire into the resupply landing zone.

b. The airdrop of supplies poses less risk to the aircraft, but this can result in supplies being widely dispersed or lost, which increases the time needed for recovery and resupply.

c. Unless conducting resupply in an area under friendly control and away from direct enemy observation, the platoon should conduct resupply away from the battalion in an area that can be defended for a short time.

d. The reconnaissance platoon identifies potential LZs within its area of operations. These LZs can be used for routine or emergency resupply or for evacuation of personnel and equipment. Once the reconnaissance platoon recovers its resupply, it moves to another location to consume or distribute those supplies. Security is essential during resupply operations.

9-6. SOLDIER'S LOAD

The soldier's load is a crucial concern of the reconnaissance platoon leader. How much is carried, how far, and in what configuration are important mission considerations. The platoon leader should require soldiers to carry only mission-essential equipment. All other equipment should be loaded in the RVs and used for contingencies. This not only reduces the soldier's load for the majority of the operation but also relieves the burden on the platoon leadership regarding resupply. The RVs, in effect, act as rolling caches and arms rooms. This makes the platoon much more flexible with the added ability to conduct static reconnaissance and to shift to mounted reconnaissance with almost no transition time. All the materials needed are on the RV so there is less of a need for resupply, refit, or reorganization based on equipment. The reconnaissance platoon must not be overloaded with equipment that covers all possible contingencies, and that is the rationale of the mobile arms room concept. However, the battalion supply system must still be able to deliver contingency supplies. See FM 3-21.11 for detailed discussions on load planning, calculating, and management techniques used to assist leaders and soldiers in organizing tactical loads to ensure safety and combat effectiveness.

9-7. COMBAT LOAD AND BASIC LOAD

The platoon's combat load varies by mission and includes the supplies physically carried into the fight. The HHC commander directs some minimum requirements for the combat load. The unit SOP or the platoon leader specifies most items. The basic load includes supplies kept by the platoon for use in combat. The quantity of most basic load supply items depends on how many days in combat the platoon might have to sustain itself without resupply. For Class V ammunition, the higher commander or SOP specifies the platoon's basic load.

9-8. MAINTENANCE

Proper maintenance keeps all materiel, equipment, and vehicles in serviceable condition. This includes performing preventive maintenance checks and services, inspecting, testing, servicing, repairing, requisitioning, recovering, and evacuating. Repair and recovery are accomplished as far forward as possible. When the platoon cannot repair equipment on the site, it moves it to the rear to a maintenance recovery point. Maintenance tasks are divided into three levels: unit (operator and organizational), DS and GS, and depot. The platoon leader, however, is mainly concerned with unit maintenance and repair of equipment in DS maintenance. Maintenance responsibilities are divided among the following positions:

- a. **Platoon Leader.** The platoon leader--
 - Ensures all platoon weapons, equipment, and vehicles (NVDs, mine detectors, communications equipment) are combat-ready or reported as non-mission-capable to the commander.
 - Knows the present status of equipment to include document numbers and job order numbers. He informs the battalion staff when the status of critical equipment changes.
 - Develops and supervises a maintenance training program.

- Ensures equipment and soldiers have the appropriate technical manuals (TMs) and that soldiers are trained and supervised during maintenance operations.

- Ensures unit-level PMCS are performed on assigned equipment IAW the appropriate operator TMs.
- b. **Platoon Sergeant.** The PSG --
 - Directs and supervises unit maintenance of platoon equipment.
 - Helps the platoon leader comply with his responsibilities and assumes them in his absence.
 - Coordinates with the designated maintenance element for operator-level repair and requests organizational-level and DS-level maintenance.
 - Supervises and accounts for platoon personnel during maintenance periods.
 - Ensures the platoon uses repair parts soon after receipt.
 - Collects and consolidates the platoon's maintenance status in the field and gives the appropriate reports to maintenance personnel.
 - Keeps the platoon leader informed of maintenance and logistics status.
- c. **Team Leader.** The team leader--
 - Constantly updates the PSG on maintenance and logistical status of team equipment.
 - Ensures soldiers complete and update DA 5988-E forms IAW unit SOPs. Ensures priority of maintenance effort is to mission-essential equipment.
 - Ensures soldiers receive proper training in PMCS procedures and that they perform PMCS on equipment IAW the applicable TM.

9-9. RECOVERY AND DESTRUCTION

Recovery is required when equipment or vehicles are damaged and cannot be quickly repaired on site. The platoon conducts self-recovery using tow bars or tow cables, and unit maintenance recovery personnel also conduct recovery. The platoon evacuates damaged or inoperable equipment. When this is not possible, the platoon destroys the equipment after gaining higher approval.

- a. **Evacuation.** The platoon can carry or transport most damaged equipment until battalion or supporting elements can pick it up.
- b. **Destruction.** Instructions for destroying each item of equipment are found in the operator TMs. Pre-determined destruction criteria is established in the battalion SOP. When time permits, the reconnaissance platoon leader requests permission from the battalion commander.

9-10. EVACUATION PROCEDURES

When combat begins and casualties occur, the platoon first must provide initial treatment to those wounded in action (WIA). Combat lifesavers, platoon medics (when attached), or any other soldier qualified in first aid treatment can do this.

- a. **Wounded in Action.** Vehicle commanders and team leaders arrange for evacuation of WIAs to the CCP. The platoon normally sets up the CCP in a covered and concealed location to the rear of the platoon position. At the CCP, the platoon medic conducts triage on all casualties, takes steps to stabilize their condition, and starts the process of moving them to the rear for more treatment.

NOTE: Before the platoon evacuates casualties to the CCP or beyond, leaders should remove all key operational items and equipment from their persons. This

includes SOI, maps, position-locating devices, and laser pointers. Every unit should establish an SOP for handling the weapons and ammunition of its WIA.

b. **Killed in Action.** The platoon leader designates a location for the collection of soldiers killed in action. All personal effects remain with the body, but the team leader or vehicle commander removes and safeguards any equipment and issue items. He keeps these until he can turn the equipment and issue items over to the platoon sergeant. The platoon sergeant turns over the KIA to the HHC first sergeant. As a rule, the platoon should not transport KIA remains on the same vehicle as wounded soldiers.

9-11. ADMINISTRATION

Proper handling of paperwork is necessary for both efficiency and morale. The battalion personnel and administration center (PAC) provides most of the administrative support. Information is passed from the reconnaissance platoon to the PAC through the S1 or the PAC supervisor. Though the system is informal, the information must be accurate and timely. The reconnaissance platoon administration consists of personnel services and replacement operations.

a. **Personnel Service Support.** Although personnel service support (PSS) provides many services automatically, the reconnaissance platoon leader and PSG are responsible for ensuring the platoon receives these services.

(1) **Services.** The PSS performs these services:

- Awards and decorations.
- Leaves and passes.
- Command information.
- Mail.
- Religious services.
- Financial services.
- Legal assistance.
- Welfare.
- Rest and relaxation.

(2) **Record Changes.** The reconnaissance PSG is responsible for reporting or requesting changes in personnel records, promotions and reductions, and classifications or reclassifications.

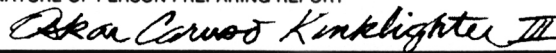
(3) **Strength Accounting Report.** Based on local SOP, the platoon sends a strength accounting report to battalion headquarters over the administrative/logistics (A/L) net, detailing strength by officer, enlisted, and attached personnel. The battalion uses these reports to determine the quantity of rations, water, and ammunition for the reconnaissance platoon, so the accuracy of the reports is important. At higher echelons, these reports determine who receives priority for replacement troops.

(4) **DA Form 1156.** The platoon completes this form (Figure 9-4, page 9-12 and 9-13) when a casualty occurs or as soon afterward as the tactical situation permits. Each soldier should keep one of these forms (with his personal and unit identification information filled in) in a common location such as in the top pocket of his battle dress uniform (BDU). If a casualty occurs, the soldier's team leader usually prepares the form and gives it to the PSG. The PSG then forwards the completed form to the battalion S1 or medical personnel. On the

form, the team leader briefly describes how, when, and where the casualty occurred, what the soldier was doing at the time, and who or what inflicted the wound. If the team leader does not know how the casualty occurred, he obtains this information from a soldier who does know. He completes DA Forms 1155 (Figure 9-5, pages 9-13 and 9-14) and 1156 within 24 hours or as soon as the tactical situation permits. The battalion S1 uses this information to inform the casualty's next of kin and to provide a statistical base for analysis of friendly or enemy tactics.

CASUALTY FEEDER REPORT <i>(AR 600-10)</i>		CONTROL NO.	CHECK APPLICABLE BOX <input checked="" type="checkbox"/> HOSTILE ACTION <input type="checkbox"/> NON-HOSTILE ACTION
1. LAST NAME - FIRST NAME - MIDDLE INITIAL <i>RAMIREZ, RICHARD</i>			
2. SERVICE NO. <i>000-00-0000</i>	3. GRADE <i>E5</i>	4. HOUR AND DATE OF INCIDENT <i>20220 Z OCT XX</i>	
5. UNIT <i>RECON PLT 7-6 IN</i>	6. GEOGRAPHICAL LOCATION (<i>nearby town</i>) AND GRID COORDINATES <i>BAMBURG</i>		
7. TYPE OF CASUALTY (<i>Check applicable box(es)</i>)			
<input type="checkbox"/> KILLED IN ACTION	<input type="checkbox"/> MISSING IN ACTION	<input checked="" type="checkbox"/>	WOUNDED OR INJURED IN ACTION
<input type="checkbox"/> DIED OF WOUNDS OR INJURIES	<input type="checkbox"/> CAPTURED	<input type="checkbox"/>	LIGHTLY WOUNDED OR INJURED IN ACTION*
<input type="checkbox"/> DIED NOT AS RESULT OF HOSTILE ACTION	<input type="checkbox"/> DETAINED	<input type="checkbox"/>	SERIOUSLY INJURED OR INJURED IN ACTION*
BODY RECOVERED <input type="checkbox"/> YES <input type="checkbox"/> NO	<input type="checkbox"/> INTERNED	<input type="checkbox"/>	SERIOUSLY INJURED NOT AS RESULT OF HOSTILE ACTION
BODY IDENTIFIED <input type="checkbox"/> YES <input type="checkbox"/> NO	<input type="checkbox"/> MISSING	<input type="checkbox"/>	LIGHTLY INJURED NOT AS RESULT OF HOSTILE ACTION
EVACUATED TO <i>BN AID STATION</i>			
<i>*To be indicated by medical personnel only.</i>			
DA FORM 1156, 1 JUN 66		REPLACES EDITION OF 1 MAY 61, WHICH WILL BE ISSUED AND USED UNTIL EXHAUSTED.	

Figure 9-4. Example completed DA Form 1156 (front).

8. WITNESSES WHO SAW INCIDENT OR IDENTIFIED REMAINS. <i>(Name, grade, service number and unit)</i> JEFF RHEINWALD E6 023-45-6789, SGT PLT, 7-6 IN JIMBO KELLER E4 222-22-2222, SGT PLT, 7-6 IN		
9. REMARKS <i>(Additional circumstances, any religious ministration performed, etc.)</i> 		
10. FOR USE BY C.O. OR MED. OFF. <i>(only for casualties not the result of hostile action)</i> LINE OF DUTY: <input type="checkbox"/> YES <input type="checkbox"/> NO <input type="checkbox"/> UNDETM	AUTHENTICATED BY <i>(CO or Med. Off.)</i>	VERIFIED BY <i>(Pers. Off.)</i>
UNIT REGON PLT, 7-6 IN	GRADE E7	SERVICE NO. 333-33-3333
DATE 20 OCT XX	SIGNATURE OF PERSON PREPARING REPORT 	

U.S. G.P.O.: 1998 445-777

Figure 9-4. Example completed DA Form 1156 (back).

WITNESS STATEMENT ON INDIVIDUAL <i>(AR 600-10)</i>			CHECK APPLICABLE BOX <input type="checkbox"/> MIS <input checked="" type="checkbox"/> MIA <input type="checkbox"/> CAP <input type="checkbox"/> DET <input type="checkbox"/> DEAD <i>(Remains not recovered)</i>		
1. LAST NAME - FIRST NAME - MIDDLE NAME FOE, ROBERT			2. SERVICE NO.		
2A. SSN - - -	3. GRADE SPA	4. DATE OF DEATH OR WHEN LAST SEEN 2030, 12 NOV XX			
5. ORGANIZATION B COMPANY, 7-6 IN			6. GEOGRAPHICAL LOCATION <i>(Include grid coordinates and nearby town)</i> AB 122 344 FULDA, FRG		
7. IF ITEMS 1 AND 2 ARE UNKNOWN OR NOT POSITIVE, COMPLETE ITEMS LISTED BELOW:					
AGE	WEIGHT	HEIGHT	HAIR	EYES	RACE
HOME TOWN		CIVILIAN OCCUPATION		NICKNAME	
WAS HE MARRIED? <i>(If so, give wife's name if known)</i>			DID HE HAVE ANY CHILDREN? <i>(If so, give names if known)</i>		
OTHER IDENTIFYING MARKS <i>(such as tattoos or birthmarks)</i>			OTHER PERSONS WHO MAY HAVE WITNESSED THIS INCIDENT OR HAVE FURTHER INFORMATION		

DA FORM 1155, 1 Jun 66 REPLACES EDITION OF 1 JUN 61, WHICH WILL BE ISSUED AND USED UNTIL EXHAUSTED.

Figure 9-5. Example completed DA Form 1155 (front).

<p>8. CIRCUMSTANCES SURROUNDING INCIDENT (If known, include cause of death or condition when last seen, and how identified)</p> <p><i>SPA FOE WAS THE RADIO OPERATOR FOR 2LT JONES, WHO WAS ATTACHED TO OUR PLATOON FOR A MISSION. HE WENT ON PATROL WITH 2LT JONES ON 12NOVXX. HE LEFT OUR LINES AT 2030. NEITHER ONE RETURNED. THEY DON'T ANSWER THE RADIO. FIRING WAS HEARD FORWARD OF OUR POSITION ABOUT 2200 HOURS.</i></p>		
<p>9. NAME OF PERSON MAKING STATEMENT</p> <p><i>Q.T. WILLIAMS</i></p>	<p>10. SERVICE NO./ SSN</p> <p><i>234-56-7890</i></p>	<p>11. UNIT</p> <p><i>B CO, 7-6 IN</i></p>
<p>12. DATE</p> <p><i>13NOVXX</i></p>	<p>13. SIGNATURE</p> <p><i>Q. T. Williams</i></p>	

☆ U.S. GOVERNMENT PRINTING OFFICE: 1997 - 429-935

Figure 9-5. Example completed DA Form 1155 (back).

b. **Replacement Operations.** Integrating replacements into the reconnaissance platoon is important. Reconnaissance platoon replacements come from the rifle companies, which provide the platoon with experienced soldiers who are familiar with a combat environment, battalion SOPs, and the chain of command. The platoon leader and PSG welcome each soldier to the platoon, explain the unit standards, and introduce the soldier to his team leader. The PSG obtains battle roster information and ensures the HHC 1SG has the information.

(1) The team leader introduces the soldier to the team and then briefs him on duty positions. He also ensures the soldier has a serviceable and zeroed weapon, ammunition, MOPP gear, and essential equipment. This in-briefing also includes recent, current, and planned activities of the team and platoon.

(2) The soldier is briefed on SOPs and special information concerning the area of operations. He may be given a form letter to send to his next of kin. The letter tells them where to mail letters and packages and how to use the American Red Cross in emergencies, and it introduces the chain of command.

9-12. MEDICAL SUPPORT

Evacuation of multiple casualties makes the platoon combat ineffective since dismounted soldiers must move the casualty from the injury site to the RV for evacuation. Thus, although the reconnaissance platoon has the organic assets to evacuate casualties, it emphasizes prevention, particularly preventing soldiers from becoming combat ineffective due to disease and non-battle injuries. By understanding and applying the principles of field hygiene, preventing weather-related injuries, and paying attention to environmental conditions, leaders can reduce casualties (FM 21-10 and FM 21-11).

a. **Health and Hygiene.** Any litter casualty in a dismounted recon team severely degrades that team's ability to perform its mission. Team leaders must maintain high standards of health and hygiene by ensuring that soldiers--

- Shave daily so their protective masks will seal.
- Bathe and change clothes regularly to prevent disease.
- Treat cuts and scratches before they become infected.
- Check hands and feet regularly to avoid trench foot, blisters, frostbite, or immersion foot.
- Drink water and eat balanced meals.

b. **Casualties.** The platoon leader must plan for casualty treatment and evacuation, and he must establish CCPs in the AO. Coordination between the platoon leader, PSG, and supporting medical platoon must occur before the mission. Soldiers and leaders must receive training in first-aid procedures. Units must train combat lifesavers in order to provide enhanced first-aid treatment for casualties.

(1) Treatment of serious casualties means stabilizing the soldier until he can be evacuated. Selected team members who are trained as combat lifesavers assist in treating and evacuating casualties. Team members are part of the platoon's aid and litter team(s) and assist with first-aid treatment as a secondary mission. The PSG supervises this process.

(2) Casualties are treated where they fall (or under nearby cover and concealment) by an aidman (if attached) or combat lifesaver and then collected at the platoon CCP. The CCP is identified by the platoon leader in the OPORD and is usually collocated with the RVs. Once casualties are collected, treated, and triaged (ranked by precedence--urgent, priority, and routine), the evacuation begins. Casualties are evacuated from the platoon CCP by any means available--RV if possible, then ground ambulance, then air ambulance. Medical evacuation vehicles from battalion are the primary outside transportation assets used for evacuation. Ambulances (ground and air) should pick up casualties as far forward as possible (or as the tactical situation permits). Deceased soldiers are evacuated by backhaul operations on supply vehicles, not in ambulances or medical evacuation (MEDEVAC) helicopters. (Figure 9-6, page 9-16, shows an example format for requesting air MEDEVAC.)

CATEGORIES OF PRECEDENCE DEFINITIONS	
URGENT	Used for emergency cases that need to be evacuated as soon as possible, and in no case more than two hours, to save life, limb, and eyesight.
PRIORITY	Used when the patient should be evacuated within four hours or his medical condition will deteriorate to such a degree that he will become an URGENT precedence.
ROUTINE	Used when evacuation is required, but condition is not expected to deteriorate seriously within the next 24 hours
TACTICAL IMMEDIATE	Used when the condition is not urgent or priority, but evacuation is required as soon as possible to avoid endangering the requesting unit's tactical mission.
<p>ARMY AEROMEDICAL EVACUATION REQUEST</p> <p>LINE 1: LOCATION _____</p> <p>LINE 2: RADIO FREQUENCY, CALL SIGN, AND SUFFIX _____</p> <p>LINE 3: PRECEDENCE URGENT ___ PRIORITY ___ ROUTINE ___ TACTICAL IMMEDIATE ___</p> <p>LINE 4: SPECIAL EQUIPMENT _____ (HOIST, JUNGLE PENETRATOR)</p> <p>LINE 5: NUMBER OF PATIENTS BY TYPE LITTER _____ AMBULATORY _____</p> <p>LINE 6: SECURITY OF PICKUP SITE _____ (NO ENEMY, POSSIBLE ENEMY, CONFIRMED ENEMY)</p> <p>LINE 7: METHOD OF MARKING PICKUP SITE _____ (PANELS, PYRO, SMOKE, NONE, OTHER)</p> <p>LINE 8: PATIENT'S NATIONALITY AND STATUS _____</p> <p>LINE 9: NBC CONTAMINATION _____</p>	

Figure 9-6. Example format for aeromedical evacuation request.

(3) In rough terrain or on patrols, aid and litter teams can evacuate casualties to CCPs, or they can carry casualties with the platoon until transportation arrives. Casualties with minor wounds can either walk or assist in carrying the seriously wounded.

(4) The platoon SOP should include the following:

- Duties and responsibilities of key personnel in planning and executing casualty evacuation.
- Priorities of evacuation.
- Provisions for retrieving and safeguarding weapons, ammunition, and equipment.

(5) Paragraph 4 of the OPORD should provide the following:

- Location of CCPs (battalion, HHC, platoon).
- Procedures and responsibilities for MEDEVAC.
- Planned use of nonmedical transportation assets (RVs) for evacuation.

- Procedures for treating and evacuating EPWs and civilian casualties.
- Communication nets for evacuation requests.

9-13. PRISONERS OF WAR

Prisoners of war are good sources of combat information. EPWs are processed and quickly evacuated to the rear. When enemy soldiers surrender or are captured, the platoon or team is responsible for taking them into custody and controlling them until evacuation is complete.

a. **Procedure.** In any tactical situation, the platoon will have specific procedures and guidelines for handling prisoners and captured material. The five-“S” procedure reminds soldiers about the basic principles for handling EPWs, which include tagging prisoners and all captured equipment and materiel:

- Search.
- Segregate.
- Silence.
- Speed.
- Safeguard.

b. **Enemy.** The platoon leader directs teams to take EPWs to an intermediate collection point. The teams then turn the EPWs over to other personnel (HHC or 1SG with guards), who evacuate them to the battalion collection point. If no one is available, teams are directed to evacuate EPWs to a collection point. Leaders should avoid this method since it detracts from the platoon's ability to accomplish its main purpose--reconnaissance. If an EPW is wounded and cannot be evacuated through medical channels, the platoon leader notifies battalion.

(1) A surrendering enemy soldier should never be approached. He could have a weapon hidden nearby, or he could be booby-trapped. The enemy soldier is gestured forward until there is no doubt that he is surrendering rather than trying to lure friendly soldiers into an ambush. A thermal sight may be used to locate possible ambushes. When searching an EPW, one soldier covers the EPW with a weapon, while another soldier searches him. Soldiers must not wear a weapon when searching the EPW. The searching soldier must not get between the EPW and the soldier covering him.

(2) The rights of EPWs have been established by international law, which the US has agreed to obey. Once an enemy soldier shows he wants to surrender, he should be treated humanely. It is a court-martial offense to physically or mentally harm, mistreat, or needlessly expose an EPW to fire.

(3) The senior officer or NCO on the scene is legally responsible for the care of EPWs, ensuring EPWs are processed IAW the five "S" procedures (see paragraph a above). If the reconnaissance platoon cannot evacuate an EPW within a short time, it must provide him with food, water, and medical treatment. It does not offer him nonessential comfort items such as coffee or cigarettes, which could affect the interrogation procedures.

(4) Before evacuating the EPW, the platoon attaches a tag to him (Figure 9-7, page 9-18). The platoon may need to make tags from materials available on the battlefield.

(5) Captured enemy documents and equipment are excellent sources of information. Documents include maps, orders, records, or photographs. If captured items are not properly handled, the information could be lost or delayed until it is useless. Documents and equipment are evacuated to the battalion collection point as rapidly as possible. Each item is

tagged (Figure 9-8, page 9-19). If the item was found on an EPW, his name is included on the tag, and the item is given to the guard. The guard delivers the item and the EPW to the battalion collection point.

(6) Evacuating EPWs can take a lot of time. The platoon leader notifies battalion when processing EPWs. When doing so slows mission accomplishment, he contacts battalion and requests guidance.

c. **Civilians.** Civilians who are captured as the result of curfew violations or suspicious actions are detained and treated the same as EPWs. The platoon evacuates them to the battalion collection point IAW the five "S" procedure.

<p>ATTACH TO PW 123456 A</p> <p>DATE OF CAPTURE () <u>170900 JAN 92</u></p> <p>NAME () <u>HECTOR ARGUELLO</u></p> <p>SERIAL NUMBER () <u>NONE</u></p> <p>RANK () <u>SERGEANT</u></p> <p>UNIT () <u>UNKNOWN</u></p> <p>LOCATION OF CAPTURE () _____</p> <p>CAPTURING UNIT () <u>2/11C</u></p> <p>SPECIAL CIRCUMSTANCES OF CAPTURE () <u>ATTEMPTING TO PROBE DEFENSIVE POSITION</u></p> <p>WEAPONS DOCUMENTS () <u>AK 49</u></p> <hr/> <p>FORWARD UNIT 123456 B</p> <p>() _____</p> <p>DATE OF CAPTURE () _____</p> <p>() _____</p> <p>NAME () _____</p> <p>SERIAL NUMBER () _____</p> <p>RANK () _____</p> <p>DATE OF CAPTURE () _____</p> <p>UNIT () _____</p> <p>LOCATION OF CAPTURE () _____</p> <p>CAPTURING UNIT () _____</p> <p>SPECIAL CIRCUMSTANCES OF CAPTURE () _____</p> <p>_____</p> <p>WEAPONS DOCUMENT () _____</p> <p>_____</p> <hr/> <p>ATTACH TO ITEM 123456 C</p> <p>() _____</p> <p>DATE OF CAPTURE () _____</p> <p>() _____</p> <p>NAME () _____</p> <p>SERIAL NUMBER () _____</p> <p>RANK () _____</p> <p>DATE OF BIRTH () _____</p> <p>UNIT () _____</p> <p>LOCATION OF CAPTURE () _____</p> <p>DESCRIPTION OF WEAPONS/DOCUMENTS () _____</p> <p>_____</p> <p>DOCUMENTS AND WEAPON CARD () ()</p>	<p>PW DO NOT REMOVE THIS PART FROM PW</p> <p>DISARM AND SEARCH THOROUGHLY ()</p> <p>REPORT IMMEDIATELY ()</p> <p>SEGREGATE BY CATEGORY ()</p> <p>SAFEGUARD FROM DANGER ()</p> <p style="text-align: center;">BACK OF PART A</p> <p>NOTE: See STANAG 2044 for reproducible copy.</p> <p>On the back of the lower part should be written in red letters: ATTACH TO CAPTURED WEAPONS AND/OR DOCUMENTS.</p> <p>Total tag should measure approximately 30 x 10 centimeters.</p>
--	--

Figure 9-7. Example of a standardized EPW tag.

●	TYPE DOCUMENT/EQUIPMENT	MAP WITH GRAPHICS
	DATE/TIME CAPTURED	201730Z OCT 89
	PLACE OF CAPTURE	BAMBERG, FRG
	(grid coordinates)	DA 402306
	CAPTURING UNIT	RECON BTL, 7-6 IN
	CIRCUMSTANCES OF CAPTURE (how it happened)	FOUND IN HIDDEN COMPARTMENT OF TRENCH
PW FROM WHOM TAKEN	NICOLA FEDEROVICH	

Figure 9-8. Example of a document and equipment tag.

CHAPTER 10

PATROLLING

Patrols are missions to gather information, to conduct combat operations, or to establish a presence in an area of operations as part of a stability operation. The reconnaissance platoon usually conducts these operations as part of a larger effort. The infantry reconnaissance platoon normally conducts two types of patrols: reconnaissance and presence. The reconnaissance platoon must also be prepared to execute combat patrols based upon the factors of METT-TC. This chapter describes the planning considerations used in preparation for patrols, conduct of patrols, and establishment of and actions taken in a patrol base.

Section I. GENERAL

The SBCT reconnaissance platoon has the ability to transport its sections to positions of advantage to conduct patrolling and to assist in sustainability operations. The platoon leader should, if possible, integrate fires from the RV as a support or security position. The RV sections can also perform communications relay. Most patrols are conducted dismounted, but the vehicles can support the operation or be left in a hide position or in the company AA. The information discussed in this section applies to all types of patrols.

10-1. ORGANIZATION

To accomplish the patrolling mission, a platoon or team must perform specific tasks. As with other missions, the leader assigns tasks in accordance with his estimate of the situation. He identifies those tasks the platoon must perform and decides which elements will perform them. Where possible, the leader should maintain team integrity. The terms “element” and “team” refer to the teams, or buddy teams, that perform the described tasks. The leader must plan carefully to ensure that he has identified and assigned all required tasks in the most efficient way. Platoons conducting patrols include the common and specific elements and teams for each type of patrol. The following elements are common to all patrols.

a. **Headquarters Element.** The headquarters consists of the platoon leader, a RATELO, and platoon sergeant. It may consist of other attachments that are assigned or that the platoon leader decides that he or the platoon sergeant must control directly.

b. **Aid and Litter Team.** Aid and litter teams are responsible for treating and evacuating casualties.

c. **Enemy Prisoner of War Search Team.** EPW teams are responsible for controlling enemy prisoners and battlefield detainees IAW the five-S procedure (Chapter 9) and the leader's guidance.

d. **Surveillance Team.** The surveillance team keeps watch on the objective from the time that the leader's reconnaissance ends until the unit deploys for actions on the objective. They then join their element.

e. **Compass Man.** The compass man assists in navigation by ensuring the lead fire team leader remains on course at all times. The compass man should be thoroughly briefed. His instructions must include an initial azimuth with subsequent azimuths provided as necessary. The platoon or team leader also should designate an alternate compass man.

f. **Pace Man.** The pace man maintains an accurate pace at all times. The platoon or team leader should designate how often the pace man is to report the pace. The pace man should also report the pace at the end of each leg. The platoon or team leader should also designate an alternate pace man.

10-2. INITIAL PLANNING

Leaders plan and prepare for patrols using the troop-leading procedures. Leaders identify required actions on the objective and then reverse plan to the departure from friendly lines and forward to the reentry of friendly lines while making a tentative plan. They normally receive the OPORD in the battalion TOC where communications are good and key personnel are available. Because patrols act independently, move beyond the direct-fire support of the parent unit, and operate forward of friendly units, coordination must be thorough and detailed.

- a. Items to be considered by the company commander and platoon leader are--
 - Changes or updates in the enemy situation.
 - Best use of terrain for routes, rally points, and patrol bases.
 - Light and weather data.
 - Changes in the friendly situation.
 - The attachment of soldiers with special skills or equipment (for example, engineers or interpreters).
 - Use and location of landing zones.
 - Departure and reentry of friendly lines.
 - Fire support on the objective and along the planned routes, including alternate routes.
 - Rehearsal areas and times. The terrain for the rehearsal should be similar to that at the objective, to include buildings and fortifications if necessary.
 - Signal plan to include call signs, frequencies, code words, pyrotechnics, digital communication instructions, as well as the challenge and password.
- b. The platoon leader or battalion staff coordinates with the unit through which his platoon or team will conduct its forward and rearward passage of lines.
- c. The battalion S3 coordinates patrol activities with the leaders of other units that will be patrolling in adjacent areas at the same time.

10-3. COMPLETION OF THE PLAN

As the platoon leader completes his plan, he considers the following:

- a. **Essential and Supporting Tasks.** The leader ensures that he has assigned all essential tasks to be performed on the objective, at rally points, at danger areas, at security or surveillance locations, along the route(s), and at passage lanes.
- b. **Movement and Execution Times.** The leader estimates time requirements for movement to the objective, leader's reconnaissance of the objective, establishment of security and surveillance, completion of all assigned tasks on the objective, movement to an objective rally point to debrief the platoon, and return to and through friendly lines.
- c. **Primary and Alternate Routes.** The leader selects primary and alternate routes to and from the objective (Figure 10-1). The return routes should differ from the routes to the objective.

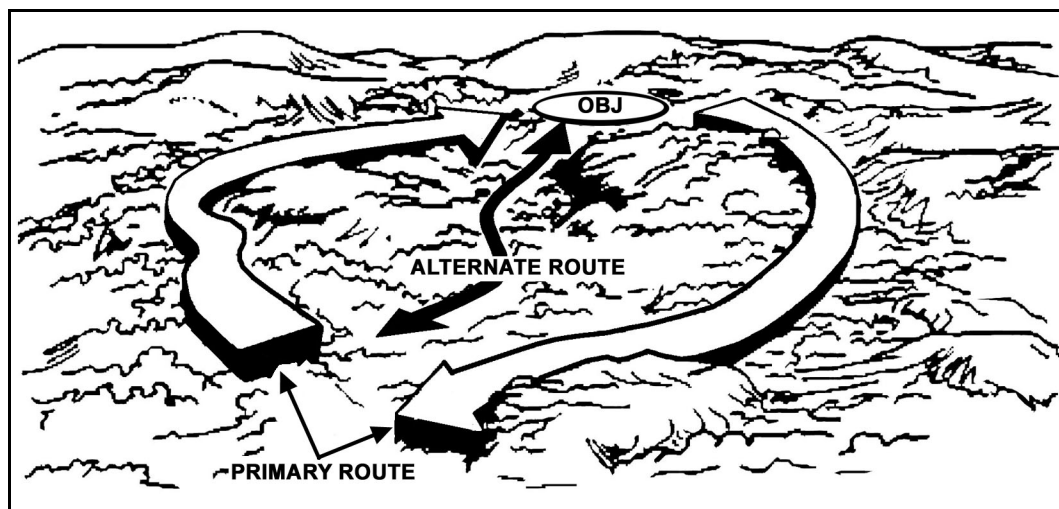


Figure 10-1. Primary and alternate routes.

d. **Signals.** The leader should consider the use of special signals. These include arm-and-hand signals, flares, voice, whistles, radios, and infrared equipment. All signals must be rehearsed so that all soldiers know what they mean.

e. **Challenge and Password Forward of Friendly Lines.** The platoon can use digital technology to inform units that it can track their progress, and as a redundancy it can use challenge and password. The platoon leader can also designate a running password. This code word alerts a unit that friendly soldiers are approaching in a less than organized manner and possibly under pressure. This may be used to get soldiers quickly through a compromised passage of friendly lines. The running password is followed by the number of soldiers approaching, for example “Warrior six.” This prevents the enemy from joining a group in an attempt to penetrate a friendly unit.

f. **Location of Leaders.** The leader considers where he and the platoon sergeant and other key leaders should be located for each phase of the patrol mission. The platoon sergeant normally is with the following elements for each type of patrol:

- On a raid or ambush, he normally controls the support element.
- On an area reconnaissance, he normally stays in the ORP.
- On a zone reconnaissance, he normally moves with the reconnaissance element that sets up the linkup point.

g. **Actions on Enemy Contact.** Unless required by the mission, the platoon avoids enemy contact. The leader’s plan must address actions on chance contact at each phase of the patrol mission. The platoon’s ability to continue the mission will depend on how early contact is made, whether the platoon is able to break contact successfully (so that its subsequent direction of movement is undetected), and whether the platoon receives any casualties as a result of the contact.

(1) The plan must address the handling of seriously wounded soldiers and KIAs.

(2) The plan must address the handling of prisoners who are captured as a result of chance contact and who are not part of the planned mission.

h. **Contingency Plans.** The leader leaves for many reasons throughout the planning, coordination, preparation, and execution of his patrol mission. Each time the leader departs

without radio or wire communications, he must issue a five-point contingency plan. The contingency plan includes--

- Where the leader is going.
- Who he is taking with him.
- The amount of time he plans to be gone.
- The actions to be taken if the leader does not return.
- The unit's and the leader's actions on chance contact while the leader is gone.

10-4. DEPARTURE FROM FRIENDLY LINES

When departing friendly lines, the platoon leader or battalion staff must coordinate with the commander of the forward unit and the leaders of other units that will be patrolling in the same or adjacent areas. This coordination includes signal plan, fire plan, running password, procedures for departure and reentry lines, dismount points, initial rally points, departure and reentry points, and information about the enemy.

a. The platoon leader provides the forward unit leader with the unit identification, the size of the patrol, the departure and return times, and the area of operation.

b. The forward unit leader provides the platoon leader with the following:

- Additional information on terrain.
- Known or suspected enemy positions.
- Likely enemy ambush sites.
- Latest enemy activity.
- Detailed information on friendly positions and obstacle locations to include the location of OPs.
- Friendly unit fire plan.
- Support that the unit can provide (for example, fire support, guides, communications, and reaction force).

c. In his plan for the departure of friendly lines, the leader should consider the following sequence of actions:

- Making contact with friendly guides at the contact point.
- Moving to the coordinated initial rally point.
- Completing final coordination.
- Moving to and through the passage point.
- Establishing a security-listening halt beyond the friendly unit's final protective fires.

d. If the platoon is dismounted, it should remain in single file. The platoon sergeant follows directly behind the guide so that he can count each soldier who passes through the passage point. He gives the count to the guide, tells him how long to wait at the passage point (or when to return), and confirms the running password. If the platoon makes contact after it is past the departure point, it fights through. Soldiers return to the departure point only if they become disorganized. They then reoccupy the initial rally point, and the leader reports to higher headquarters.

10-5. PATROL BASES

A patrol base is a position set up when a team or platoon conducting a patrol halts for an extended period. Patrol bases should be occupied no longer than 24 hours, except in an emergency. The platoon or team never uses the same patrol base twice. Platoons or teams use patrol bases--

- To stop all movement to avoid detection.
 - To hide during a long, detailed reconnaissance of an objective area.
 - To eat, clean weapons and equipment, or rest.
 - To plan and issue orders.
 - To reorganize after infiltrating an enemy area.
 - To have a base from which to conduct several consecutive or concurrent operations such as ambush, raid, reconnaissance, or security.
- a. The leader selects the tentative site from a map. Plans to establish a patrol base must include selecting an alternate patrol base site. The alternate site is used if the first site is unsuitable or if the patrol must unexpectedly evacuate the first patrol base.
- b. Leaders planning for a patrol base must consider the mission and passive and active security measures. The leader plans for--
- Observation posts.
 - Communication with observation posts.
 - Defense of the patrol base.
 - Withdrawal from the patrol base to include withdrawal routes and a rally point or rendezvous point or alternate patrol base.
 - A security system to make sure that specific soldiers are awake at all times.
 - Enforcement of camouflage, noise, and light discipline.
 - The conduct of required activities with minimum movement and noise.
- c. The leader avoids--
- Known or suspected enemy positions.
 - Built-up areas.
 - Ridges and hilltops, except as needed for maintaining communication.
 - Roads and trails.
 - Small valleys.

10-6. RALLY POINTS

A rally point is a place designated by the leader where the platoon moves to reassemble and reorganize if it becomes dispersed. (See FM 7-8 for more information.) The leader physically reconnoiters routes to select rally points whenever possible. He selects tentative points if he can only conduct a map reconnaissance, and he confirms them by actual inspection as the platoon moves through them. The most common types of rally points are initial, en route, objective, reentry, and near- and far-side rally points. Soldiers must know which rally point to move to at each phase of the patrol mission. They should know what actions are required there and how long they are to wait at each rally point before moving to another.

a. **Initial Rally Point.** An initial rally point is a place inside of friendly lines where a unit may assemble and reorganize if it makes enemy contact during the departure of friendly lines or before reaching the first en route rally point. The commander normally selects the initial rally point.

b. **En Route Rally Point.** The leader designates en route rally points every 100 to 400 meters (based on the terrain, vegetation, and visibility). When the leader designates a new en route rally point, the previously designated en route rally point is no longer in effect. To preclude uncertainty, if contact is made immediately after the leader designates the new en route rally point (within 25-50m) the soldiers should move to the previously designated en route rally point. There are three ways to designate a rally point:

- (1) Physically occupy it for a short period. This is the preferred method.
- (2) Pass by at a distance and designate using arm-and-hand signals.
- (3) Walk through and designate using arm-and-hand signals.

c. **Objective Rally Point.** The ORP is a point out of sight, sound, and small-arms range of the objective area. It is normally located in the direction that the platoon plans to move after completing its actions on the objective. The ORP is tentative until the objective is pinpointed. Actions at or from the ORP include--

- Reconnoitering the objective.
- Issuing a FRAGO.
- Disseminating information from reconnaissance, if contact was not made.
- Making final preparations before continuing operations such as recamouflaging; preparing demolitions; lining up rucksacks for quick recovery; preparing EPW bindings, first aid kits, and litters; and inspecting weapons.
- Accounting for soldiers and equipment after actions at the objective are complete.
- Reestablishing the chain of command after actions at the objective are complete.

(1) **Occupation of an ORP by a Team.** In planning the occupation of an ORP, the team leader considers the following sequence.

(a) The team halts beyond sight, sound, and small-arms weapons range of the tentative ORP (200 to 400 meters in good visibility, 100 to 200 meters in limited visibility).

(b) The team leader positions security.

(c) The team leader issues a five-point contingency plan before departure.

(d) The team leader moves forward with a compass man and one member of each element to confirm the location of the ORP and determine its suitability.

(e) The team leader positions an information gathering soldier in the ORP at 12 o'clock and a control and security soldier at 6 o'clock. He issues them a contingency plan and returns with the compass man.

(f) He then leads the team into the ORP and positions the information-gathering element from 9 to 3 o'clock and the control and security element from 3 to 9 o'clock.

NOTE: The team may also occupy the ORP by force. This requires more precise navigation but eliminates separating the team.

(2) **Occupation of an ORP by a Platoon.** The platoon leader should consider the same sequence in planning the occupation of an ORP. He brings a soldier from each team on his reconnaissance of the ORP and positions them at the 10, 2, and 6 o'clock positions. The first team in the order of march establishes the base leg (10 to 2 o'clock). The trailing teams occupy from 2 to 6 o'clock and 6 to 10 o'clock, respectively.

d. **Reentry Rally Point.** The reentry rally point (RRP) is located out of sight, sound, and small-arms weapons range of the friendly unit through which the platoon will return. This also means that the RRP should be outside the final protective fires of the friendly unit. The platoon occupies the RRP as a security perimeter.

e. **Near- and Far-Side Rally Points.** These rally points are on the near and far side of danger areas. If the platoon makes contact while crossing the danger area and control is lost, soldiers on either side move to the rally point nearest them. They establish security, reestablish the chain of command, determine their personnel and equipment status, and continue the patrol mission, link up at the ORP, or complete their last instructions.

10-7. LEADER'S RECONNAISSANCE

The plan must include a leader's reconnaissance of the objective once the platoon or team establishes the ORP. During his reconnaissance, the leader pinpoints the objective; selects security, support, and assault positions for his teams; and adjusts his plan based on his observation of the objective. Each type of patrol requires different tasks during the leader's reconnaissance. The platoon leader will take different elements with him. The leader must plan time to return to the ORP, complete his plan, disseminate information, issue orders and instructions, and allow his teams to make any additional preparations.

10-8. REENTRY OF FRIENDLY LINES

The platoon could be mounted or dismounted at the reentry rally point. The same considerations apply for coordination. The platoon leader should consider the following sequence.

- a. The platoon halts in the RRP and establishes security.
- b. The platoon leader radios the code word advising the friendly unit of its location and that it is ready to return. The friendly unit must acknowledge the message and confirm that guides are waiting before the platoon moves from the RRP.
- c. If radio communications are not possible, the platoon leader, a RATELO, and a two-man security element (buddy team) move forward and attempt to contact an OP using the challenge and password. The OP notifies the friendly unit that the platoon is ready to return and requests a guide.
- d. If the platoon leader cannot find an OP, he moves with the RATELO and security element to locate the coordinated reentry point. He must move straight toward friendly lines, never parallel to them. All lateral movement should be outside of small-arms weapons range.

NOTE: The platoon leader should attempt this procedure only during daylight. At night he should use other backup signals to make contact with friendly units. The preferred method is to wait until daylight if contact with the friendly unit cannot be made as planned, but this is METT-TC dependent.

- e. The platoon leader uses far and near recognition signals to establish contact with the guide.
- f. The platoon leader signals (radio) the platoon forward or returns and leads it to the reentry point. He may post the security element with the guide at the enemy side of the reentry point.

- g. The platoon sergeant counts and identifies each soldier as he passes through the reentry point.
- h. The guide leads the platoon to the assembly area.
- i. The platoon leader reports to the command post of the friendly unit. He tells the commander everything of tactical value concerning the friendly unit's area of responsibility.
- j. The platoon leader rejoins the platoon in the assembly area and leads it to a secure area for debriefing.

10-9. DEBRIEF

Immediately after the platoon or team returns, personnel from higher headquarters conduct a thorough debrief. This may include all members of the platoon or the leaders, RATELO, and any attached personnel. The debriefing normally is oral. Sometimes a written report is required. Information on the written report should include--

- Size and composition of platoon conducting the patrol.
- Mission of the platoon (type of patrol, location, and purpose).
- Departure and return times.
- Routes. Use checkpoints, grid coordinates for each leg, or include an overlay.
- Detailed description of terrain and enemy positions identified.
- Results of any contact with the enemy.
- Personnel status at the conclusion of the patrol.

Section II. TYPES OF PATROLS

This section discusses the types of patrols the SBCT reconnaissance platoon may be expected to conduct.

10-10. RECONNAISSANCE PATROL

Reconnaissance patrols provide timely and accurate information on the enemy and terrain. They confirm the leader's plan before it is executed. The commander must brief the platoon leader the specific information requirements for each mission. The three types of reconnaissance patrols are area, zone, and route.

a. **Area Reconnaissance Patrol.** An area reconnaissance is conducted to obtain information about a specific location and the area around it. The location may be given as a grid coordinate, an objective, on an overlay. In an area reconnaissance, the platoon or team uses surveillance or vantage points around the objective from which to observe it and the surrounding area. In planning for an area reconnaissance mission, the platoon leader considers the following sequence of actions.

(1) The leader may include a surveillance team in his reconnaissance of the objective from the ORP. He positions the surveillance team while on the reconnaissance. The subordinate leader responsible for security establishes security at the ORP and positions other security teams as required on likely enemy avenues of approach into the objective area.

(2) If required, the leader positions other surveillance elements about the objective. He may move them on one route posting them as they move, or he may direct them to move on separate routes to their assigned locations.

(3) After observing the objective for a specified time, all elements return to the ORP and report their observations to the leader or the recorder. Once all information is collected, it is disseminated to every soldier.

b. **Zone Reconnaissance Patrol.** A zone reconnaissance is conducted to obtain information on enemy, terrain, and routes within a specified zone. Zone reconnaissance techniques include the use of moving elements, stationary teams, or multiple area reconnaissance actions.

(1) **Moving Elements.** The leader plans the use of teams moving along multiple routes to cover the entire zone. Methods for planning the movement of multiple elements through a zone include the fan, the box, converging routes, and successive sectors.

(a) **Fan Method.** The leader first selects a series of ORPs throughout the zone. The platoon establishes security at the first ORP. Each team moves from the ORP along a different fan-shaped route that overlaps with others to ensure reconnaissance of the entire area (Figure 10-2). The leader maintains a reserve at the ORP. When all teams have returned to the ORP, the platoon leader collects and disseminates all information to every soldier before moving on to the next ORP.

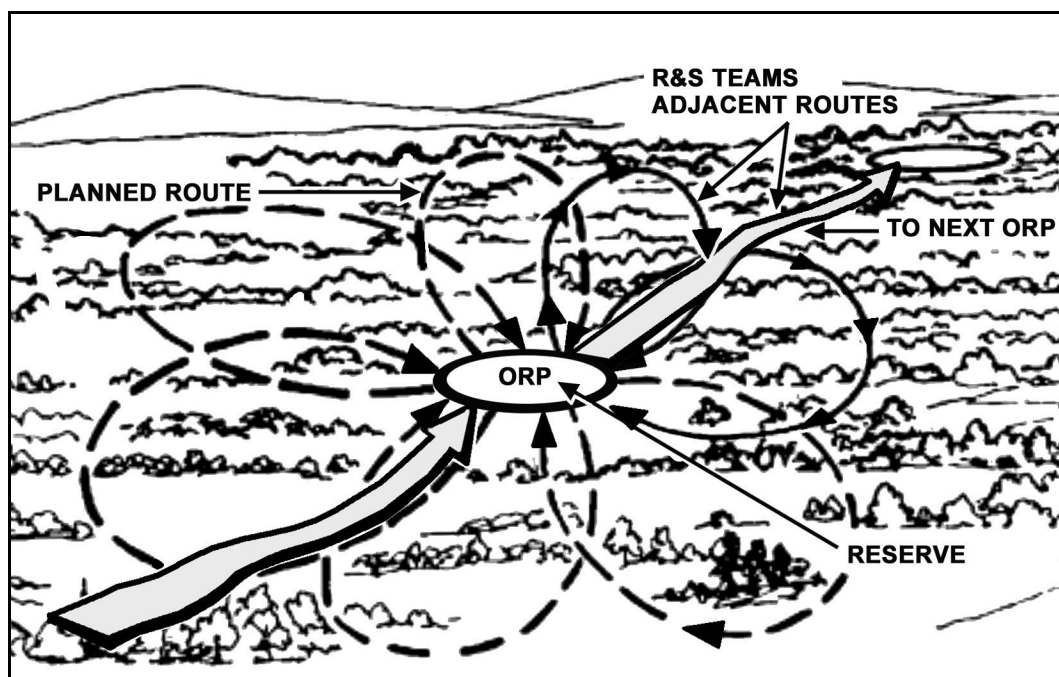


Figure 10-2. Fan method.

(b) **Box Method.** The leader sends his teams from the ORP along routes that form a boxed-in area (Figure 10-3, page 10-10). He sends other teams along routes through the area within the box. All teams meet at a link-up point at the far side of the box from the ORP.

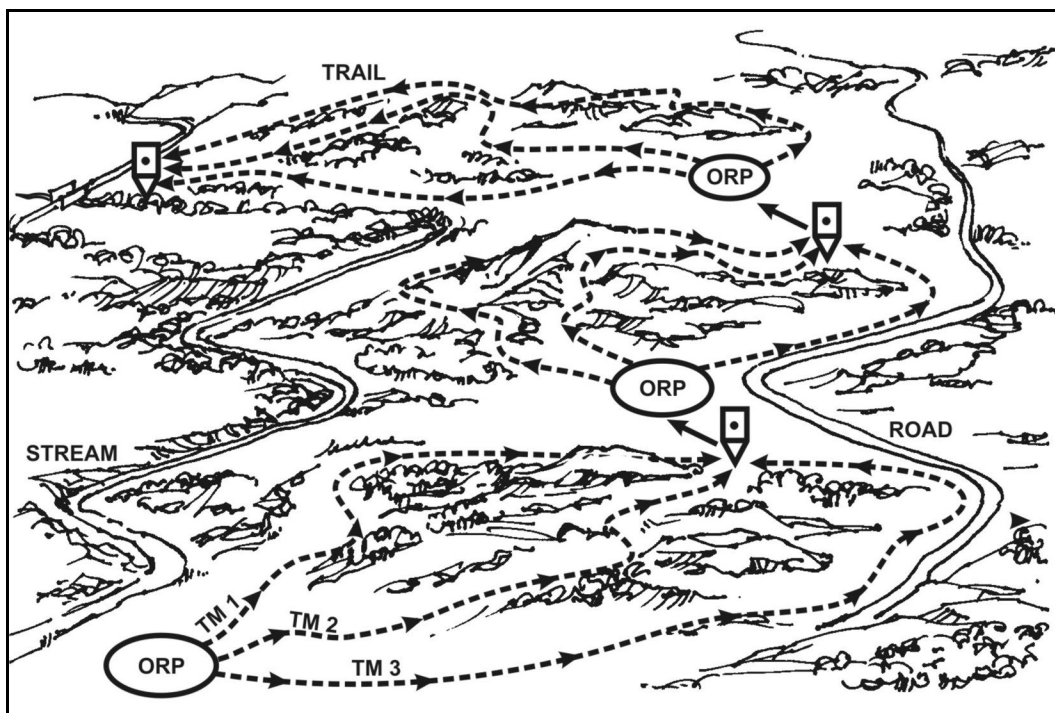


Figure 10-3. Box method.

(c) *Converging Routes Method.* The leader selects routes from the ORP through the zone to a linkup point at the far side of the zone from the ORP (Figure 10-4). Each team moves along a specified route and uses the fan method to reconnoiter the area between routes. The leader designates a time for all teams to link up.



Figure 10-4. Converging routes method.

(d) *Successive Sector Method.* The leader may divide the zone into a series of sectors (Figure 10-5). Within each sector, the platoon uses the converging routes method to

reconnoiter to an intermediate linkup point where it collects and disseminates the information gathered to that point before reconnoitering the next sector.

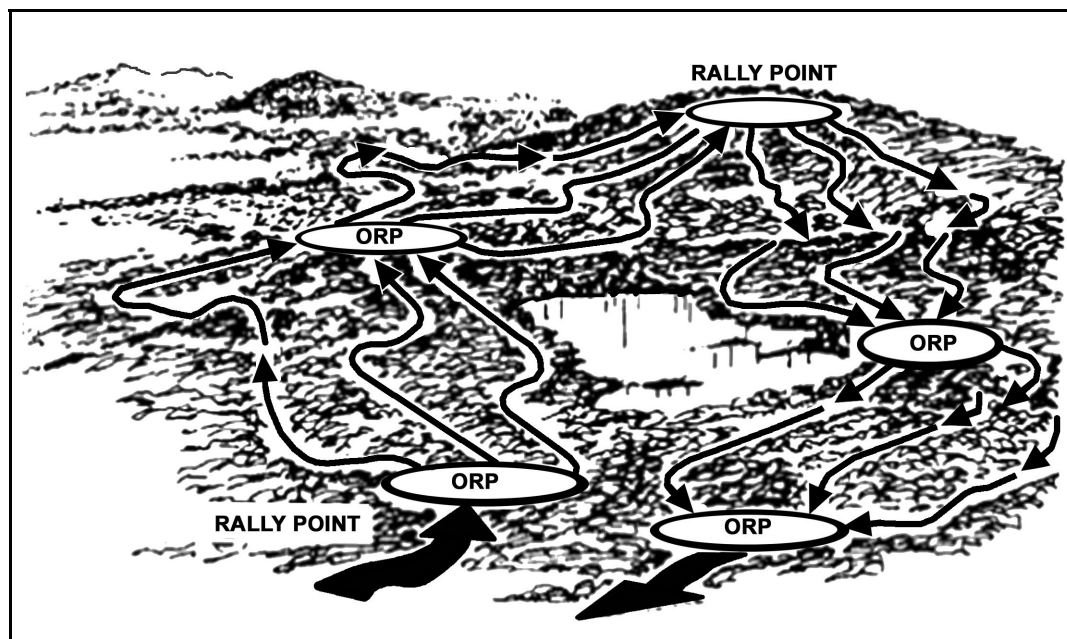


Figure 10-5. Successive sector method.

(2) **Stationary Teams.** Using this technique, the leader positions surveillance teams in locations where they can collectively observe the entire zone for long-term, continuous information gathering. He must consider sustainment requirements when developing his soldiers' load plan.

(3) **Multiple Area Reconnaissance.** The leader tasks each of his teams to conduct a series of area reconnaissance actions along a specified route.

c. **Route Reconnaissance Patrol.** A route reconnaissance is conducted to obtain detailed information about one route and all the adjacent terrain or to locate sites for emplacing obstacles. A route reconnaissance is oriented on a road, a narrow axis such as an infiltration lane, or a general direction of attack. Engineers normally are attached to the infantry unit for a complete route reconnaissance, although infantry can conduct a hasty route reconnaissance without engineer support. A route reconnaissance results in detailed information about trafficability, enemy activity, NBC contamination, and aspects of adjacent terrain from both the enemy and friendly viewpoint. In planning a route reconnaissance, the leader considers the following:

(1) The preferred method for conducting a route reconnaissance is the fan method described above. The leader must ensure that the fans are extensive enough to reconnoiter intersecting routes beyond direct-fire range of the main route (Figure 10-6, page 10-12).

(2) The platoon should use a different return route.

(3) If all or part of the proposed route is a road, the leader must treat the road as a danger area. The platoon moves parallel to the road using a covered and concealed route. When required, reconnaissance and security teams move close to the road to reconnoiter key areas.

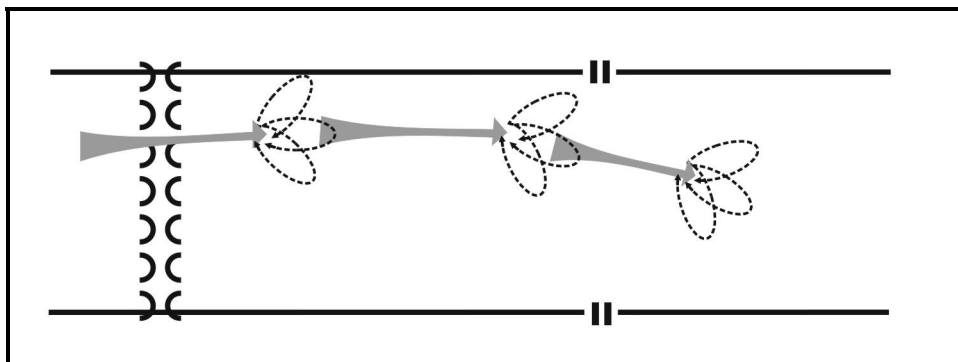


Figure 10-6. Route reconnaissance using fans.

10-11. COMBAT PATROL

Combat patrols are conducted to destroy or capture enemy soldiers or equipment; to destroy installations, facilities, or key points; or to harass enemy forces. They also provide security for larger units. The two types of combat patrol missions are ambush and raid.

a. **Organization.** The platoon leader organizes the platoon with all assets available to include the reconnaissance teams, RVs, and attachments to complete the mission. Besides the common elements, combat patrols also have the following elements and teams.

(1) **Assault Element.** The assault element seizes and secures the objective and protects special teams as they complete their assigned actions on the objective.

(2) **Security Element.** The security element provides security at danger areas, secures the ORP, isolates the objective, and supports the withdrawal of the rest of the platoon once it completes its assigned actions on the objective. The security element may have separate security teams, each with an assigned task or sequence of tasks.

(3) **Support Element.** The support element provides direct fire support and may control indirect fires for the platoon.

(4) **Breach Element.** The breach element breaches the enemy's obstacles when required.

(5) **Demolition Team.** Demolition teams are responsible for preparing and exploding the charges to destroy equipment, vehicles, or facilities on the objective.

(6) **Search Team.** The assault element may comprise two-man (buddy team) or four-man (fire team) search teams to search bunkers, buildings, or tunnels on the objective. These teams may search the objective or kill zone for casualties, documents, or equipment.

b. **Leader's Reconnaissance.** In a combat patrol, the leader has additional considerations for the conduct of his reconnaissance of the objective from the ORP. He is normally the assault element leader. He should also take the support element leader, the security element leader, and a surveillance team (a two-man team from the assault element).

(1) The leader should designate a release point half way between the ORP and the objective. Teams separate at the release point and move to their assigned positions. The release point should have wire communications with the ORP and be set up so that other elements can tie into a hot loop there.

(2) The platoon leader should confirm the location of the objective and determine that it is suitable for the assault or ambush. He notes the terrain and identifies where he can place mines or Claymores to cover dead space. He notes any other features of the objective that may cause him to alter his plan.

(3) If the objective is the kill zone for an ambush, the leader's reconnaissance party should not cross the objective because to do so will leave tracks that may compromise the mission.

(4) The platoon leader should confirm the suitability of the assault and support positions and routes from them back to the ORP.

(5) The platoon leader should post the surveillance team and issue a five-point contingency plan before returning to the ORP.

c. **Ambush.** An ambush is a surprise attack from a concealed position on a moving or temporarily halted target. Ambushes are classified by category--hasty or deliberate; by type--point, area, or antiarmor; and by formation--linear or L-shaped. The leader uses a combination of category, type, and formation in developing his ambush plan.

(1) **Planning.** The key planning considerations include--

- Covering the entire kill zone by fire.
- Using existing or reinforcing obstacles (Claymores and other mines) to keep the enemy in the kill zone.
- Protecting the assault and support elements with mines, Claymores, or explosives.
- Using security elements or teams to isolate the kill zone.
- Assaulting into the kill zone to search dead and wounded, assemble prisoners, and collect equipment. (The assault element must be able to move quickly through its own protective obstacles.)
- Timing the actions of all elements of the platoon to preclude loss of surprise.
- Using only one team to conduct the entire ambush and rotating teams over time from the ORP. This technique is useful when the ambush must be manned for a long time.

(2) **Formations.** The leader considers either the linear or L-shaped formations in planning an ambush.

(a) **Linear.** In an ambush using a linear formation, the assault and support elements deploy parallel to the enemy's route. This positions both elements on the long axis of the kill zone and subjects the enemy to flanking fire. This formation can be used in close terrain that restricts the enemy's ability to maneuver against the platoon or in open terrain, provided a means of keeping the enemy in the kill zone can be effected.

(b) **L-Shaped.** In an L-shaped ambush, the assault element forms the long leg parallel to the enemy's direction of movement along the kill zone. The support element forms the short leg at one end of and at right angles to the assault element. This provides both flanking fires (long leg) and enfilading fires (short leg) against the enemy. The L-shaped ambush can be used at a sharp bend in a trail, road, or stream. It should not be used where the short leg would have to cross a straight road or trail.

d. **Hasty Ambush.** A platoon or team conducts a hasty ambush when it makes visual contact with an enemy force and has time to establish an ambush without being detected. The actions for a hasty ambush must be well rehearsed so that soldiers know what to do on the leader's signal. They must also know what action to take if detected before they are ready to initiate the ambush. In planning and rehearsing a hasty ambush, the platoon leader should consider the following sequence of actions.

(1) Using visual signals, any soldier alerts the platoon that an enemy force is in sight. The soldier continues to monitor the location and activities of the enemy force until his team or team leader relieves him.

(2) The platoon or team halts and remains motionless.

(3) The leader determines the best nearby location for a hasty ambush. He uses arm-and-hand signals to direct soldiers to covered and concealed positions. The leader designates the location and extent of the kill zone.

(4) Security elements move out to cover each flank and the rear. The leader directs the security elements to move a given distance, set up, and rejoin the platoon on order or after the ambush (the sound of firing ceases). At team level, the two outside buddy teams normally provide flank security as well as fires into the kill zone.

(5) Soldiers move quickly to covered and concealed positions, normally 5 to 10 meters apart. Soldiers ensure that they have good observation and fields of fire into the kill zone.

(6) The leader initiates the ambush when the majority of the enemy force enters the kill zone. (If time and terrain permit, the team or platoon may place out Claymores and use them to initiate the ambush.)

NOTE: If the enemy detects a soldier, the soldier initiates the ambush by firing his weapon and alerting the rest of the platoon by saying ENEMY RIGHT (LEFT or FRONT).

(7) Leaders control the rate and distribution of fires. The leader orders cease-fire when the enemy force is destroyed or ceases to resist, and he directs the assault element to move into the kill zone to conduct a hasty search of the enemy soldiers. All other soldiers remain in place to provide security.

(8) The security elements rejoin the platoon after the assault element has cleared through the kill zone. The platoon withdraws from the ambush site using a covered and concealed route. The platoon returns to the ORP in effect, collects and disseminates all information, reorganizes as necessary, and continues the mission.

e. **Deliberate Ambush.** A deliberate ambush is conducted against a specific target at a predetermined location. The types of deliberate ambushes are point, area, and antiarmor. The leader requires detailed information in planning a deliberate ambush:

- Size and composition of the targeted enemy unit.
- Weapons and equipment available to the enemy.
- The enemy's route and direction of movement.
- Times that the targeted unit will reach or pass specified points along the route.

(1) **Point Ambush.** In a point ambush, soldiers deploy to attack an enemy in a single kill zone. The platoon leader must ensure that all elements and weapons systems are sited. In conjunction with the PSG, the platoon leader must have positive C2 of security, support, and assault elements. If using RVs, the platoon leader may or may not integrate their fires but should plan and coordinate dismount, remount, or hide positions for the vehicles, if used.

(2) **Area Ambush.** The area ambush is a dynamic ambush. Soldiers deploy in two or more related point ambushes based on real-time intelligence. There are three techniques used in employing area ambushes.

- Sequential (linear in nature).

- Concentrated (centralized in nature).
- Distributed (decentralized in nature).

The platoon leader should consider the following sequence of actions when planning a deliberate area ambush.

(a) A platoon is the smallest unit to conduct an area ambush. Platoons conduct area ambushes where enemy movement is largely restricted to trails or streams.

(b) The platoon leader should select one principal ambush site around which he organizes outlying ambushes. These secondary sites are located along the enemy's most likely approach to and escape from the principal ambush site. Team-sized elements normally are responsible for each ambush site.

(c) The platoon leader must determine that the best employment of all weapon systems and vehicle platforms is used.

(d) Isolating teams are responsible for outlying ambushes and do not initiate their ambushes until after the principal ambush is initiated. They then engage to prevent enemy forces from escaping or reinforcing.

(3) **Antiarmor Ambush.** Platoons conduct antiarmor ambushes to destroy one or two armored vehicles. The antiarmor ambush is organized around the platoon's antiarmor capabilities and supporting assets. The leader must consider additional weapons available to supplement the platoon's fires. The leader must carefully position all antiarmor weapons to ensure the best shot (rear, flank, or top). The remainder of the platoon must function as support and security elements in the same way that they do for other combat patrols.

(a) In an antiarmor ambush, the platoon leader selects a general site for the ambush that restricts the movement of armored vehicles out of the kill zone. The leader should attempt to place his elements so that an obstacle is between them and the kill zone.

(b) The leader should consider the method for initiating the antiarmor ambush. The preferred method is to use a command-detonated antiarmor mine placed in the kill zone. The armor-killer teams, typically equipped with the platoon's Javelins, attempt to kill the first and last vehicles in the column. All other weapons open fire once the ambush has begun.

(c) The leader must consider how the presence of dismounted enemy will affect the success of his ambush. Because of the speed with which other armored forces can reinforce the enemy in the ambush site, the leader should plan to keep the engagement short and the withdrawal quick. The platoon will not clear through the kill zone as in other ambushes.

f. **Raid Patrol.** The raid patrol is a combat patrol whose mission is to attack a position or installation for any or all of these purposes:

- Destroy the position or installation.
- Destroy or capture troops or equipment.
- Liberate personnel.

(1) Surprise, firepower, and violent action are the keys to a raid.

(a) Surprise is best achieved by attacking--

- When the enemy may least expect an attack.
- When visibility is poor.
- From an unexpected direction, such as from the rear or through a swamp or other seemingly impassable terrain.

(b) Fire is concentrated at critical points to suppress the enemy.

(c) Violence is best achieved by gaining surprise, by using massed fire, and by attacking aggressively.

(2) The patrol moves to the ORP as described for a reconnaissance patrol. The ORP is secured, the leaders conduct reconnaissance, and plans are confirmed. Elements and teams move to their positions. If possible, their movements are coordinated so that all reach their positions about the same time. This improves the patrol's capability for decisive action if the enemy detects the patrol early.

(3) The teams of the security element move to positions from which they can secure the ORP, give warning of enemy approach, block avenues of approach into the objective area, prevent enemy escape from the objective area, or perform any combination of these tasks within their capability.

(a) As the assault and support elements move into position, the security element keeps the leader of the patrol informed of all enemy action. It shoots only if detected or on the leader's order.

(b) Once the assault starts, the security element prevents enemy entry into, or escape from, the objective area.

(c) When the assault is completed, the security element covers the withdrawal of the assault and support elements to the ORP. It withdraws itself on order or on a prearranged signal.

(4) The support element moves into position so that it can suppress the objective and shift fire when the assault starts. It normally covers the withdrawal of the assault element from the immediate area of the objective. It withdraws itself on oral order or on signal.

(5) The assault element deploys close enough to the objective to permit immediate assault if detected by the enemy. As supporting fire is lifted or shifted, the assault element assaults, seizes, and secures the objective. It protects demolition teams, search teams, and other teams while they work. On order or signal, the assault element withdraws to the ORP.

(6) At the ORP, the patrol reorganizes and moves about 1,000 meters away to disseminate information. During reorganization, ammunition is distributed, casualties are treated, and status reports are given.

10-12. PRESENCE PATROL

US forces increasingly are deployed in support of stability and support missions all around the world. The RV-equipped infantry platoon conducts a presence patrol much the same as a combat patrol, and the planning considerations are much the same. The primary difference is that the patrol wants to be seen both as a show of force and to lend confidence and stability to the local population of the host nation. As its name implies, this patrol is constituted to effect a presence. A presence patrol can be used only if a peace agreement has been negotiated between belligerents. The presence patrol is armed, and it conducts the planning and preparation necessary for combat operations at all times. The patrol would be used as a component of a larger force conducting stability and or support operations. The platoon could be tasked to conduct mounted or dismounted patrols planned by the higher HQ to accomplish one or more of the following:

- Confirm or supervise an agreed cease-fire.
- Gain information.
- Cover gaps between OPs or checkpoints.
- Show a stability force presence.

- Reassure isolated communities.
- Inspect existing or vacated positions of former belligerents.
- Escort former belligerents or local populations through trouble spots.

APPENDIX A
**RECONNAISSANCE OVERLAYS, SYMBOLS, AND
FORMULAS**

This appendix provides leaders the necessary data to use overlays, symbols, and formulas in their reconnaissance efforts.

A-1. SYMBOLS

Figure A-1 (pages A-2 through A-6) outlines a variety of symbols that soldiers can use to illustrate reconnaissance data on their overlays. Figure A-2, page A-7, shows an example of how these graphics are used in the overlay. Figure A-3, page A-8, shows symbols for various materials, facilities, equipment, and services. (These graphics are adapted from information provided in FM 5-170.)

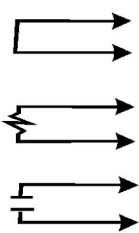
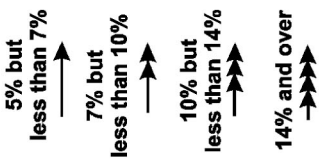
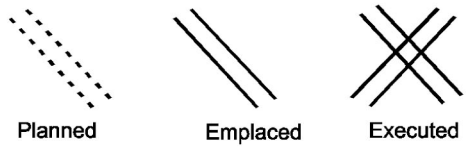
Symbols for use in the reconnaissance overlay	
Symbol	Description and criteria
<p>BYPASSES</p> 	<p>BYPASSES: Are local alternate routes which enable traffic to avoid an obstruction. Bypasses are classified as EASY, DIFFICULT, or IMPOSSIBLE. Each type bypass is represented symbolically on the line extending from the symbol to the main location and defined as follows:</p> <p>BYPASS EASY: The obstacle can be crossed within the immediate vicinity by a US 5-ton truck (or NATO equivalent) without work to improve the bypass.</p> <p>BYPASS DIFFICULT: The obstacle can be crossed within the immediate vicinity, but some work will be necessary to prepare the bypass.</p> <p>BYPASS IMPOSSIBLE: The obstacle can only be crossed by one of the following methods:</p> <ol style="list-style-type: none"> (1) Repair of item, such as bridge. (2) New construction. (3) Detour using an alternate route that crosses the obstacle some distance away.
<p>STEEP GRADES</p> 	<p>STEEP GRADES: (An obstruction.) Any grade 7% or higher. Actual % of grade will be shown. Arrows always point uphill, and length of arrow represents length of grade if map scale permits. (The percent of slope is written to the right of the arrow.)</p>
<p>OBSTACLES</p> 	<p>OBSTACLES: Are natural or manmade restrictions which impede the flow of traffic along a designated route.</p>

Figure A-1. Reconnaissance overlay symbols.


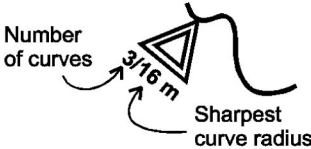

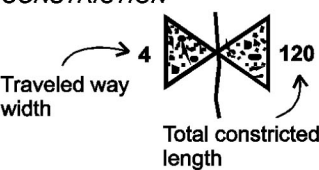
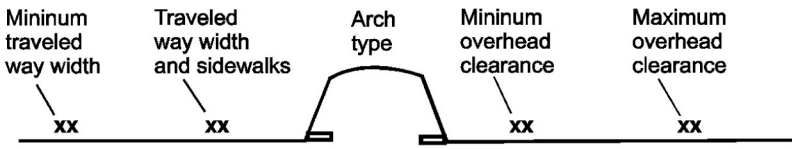
Symbols for use in the reconnaissance overlay	
Symbol	Description and criteria
<p>SINGLE CURVE</p> 	<p>SHARP CURVE: Any curve with a radius of 25 meters or less is an obstruction. All curves with a radius less than 45 meters are reportable.</p>
<p>MULTIPLE CURVES</p> 	<p>SERIES OF SHARP CURVES: The figure to the left indicates the number of curves; that to the right, the minimum radius of curvature in meters.</p>
<p>CRITICAL POINT</p>  <p>Number critical points in order and describe them on DA Form 1711-R.</p>	<p>CRITICAL POINT: A key geographic point or position important to the success of an operation; a point in time, a crisis or turning point, or any point along a route of march where interference with troop movement may occur.</p>
<p>CONSTRICTION</p> 	<p>CONSTRICTION: (An obstruction.) Any reduction in the traveled way below the minimum required. The figure to the left indicates the width of the constriction; that to the right, the total constricted length, both in meters.</p>
<p>UNDERPASS</p>  <p>UNDERPASSES: Show shape of structure (obstruction) when overhead clearance is less than 4.3 meters.</p>	
<p>ROUTE DESIGNATION</p> <p>(495)</p> <hr/>	<p>ROUTE DESIGNATION: Civil or military route designation. Written in parentheses along route.</p>

Figure A-1. Reconnaissance overlay symbols (continued).

Symbols for use in the reconnaissance overlay	
Symbol	Description and criteria
<p>BRIDGE Full NATO Bridge Symbol</p>	<p>When full NATO bridge symbol is used on an overlay, the additional information column on the DA Form 1249 will not contain bypass length, traveled way width, or overhead clearance.</p>
<p>BRIDGE Abbreviated Bridge Symbol</p>	<p>When abbreviated symbol is used, DA Form 1249 must be attached.</p>
<p>TUNNEL</p>	<p>TUNNEL: (Includes manmade snow sheds.) Show the shape of structure or obstruction when overhead clearance is less than 4.3 m.</p>

Figure A-1. Reconnaissance overlay symbols (continued).

Symbols for use in the reconnaissance overlay	
Symbol	Description and criteria
<p>FORD</p> <p>FORD: All fords are considered as obstructions to traffic.</p> <p>Type of ford: V-- Vehicular P-- Pedestrian</p> <p>Seasonal limiting factors: X-- No seasonal limitation except for limited duration sudden flooding. Y-- Significant seasonal limitations.</p> <p>Approach conditions: Difficult Easy</p> <p>Nature of bottom: M-- Mud C-- Clay S-- Sand G-- Gravel R-- Rock P-- Artificial paving</p>	
<p>FERRY</p> <p>FERRY: All ferries are considered as obstructions to traffic.</p> <p>Type of ferry: V-- Vehicular P-- Pedestrian</p> <p>Approach conditions: Difficult Easy</p>	
<p> LIMITS OF SECTOR: Limits of reconnoitered sector or of route having some road classification formula.</p>	

Figure A-1. Reconnaissance overlay symbols (continued).




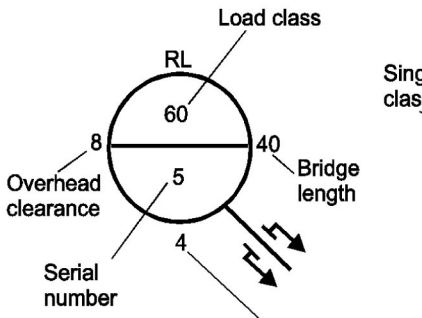
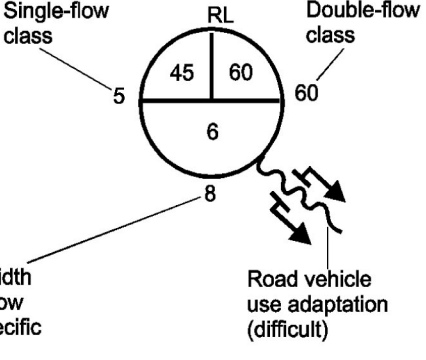
Symbols for use in the reconnaissance overlay	
Symbol	Description and criteria
RAILROAD CROSSINGS	
	Level grade crossing
	Overhead obstruction 4.3
	Combination 4.2
<p>RAILROAD (RR) CROSSING: Passing trains will interrupt traffic flow. The figure indicates overhead clearance.</p>	
RAILROAD BRIDGES	
	

Figure A-1. Reconnaissance overlay symbols (continued).

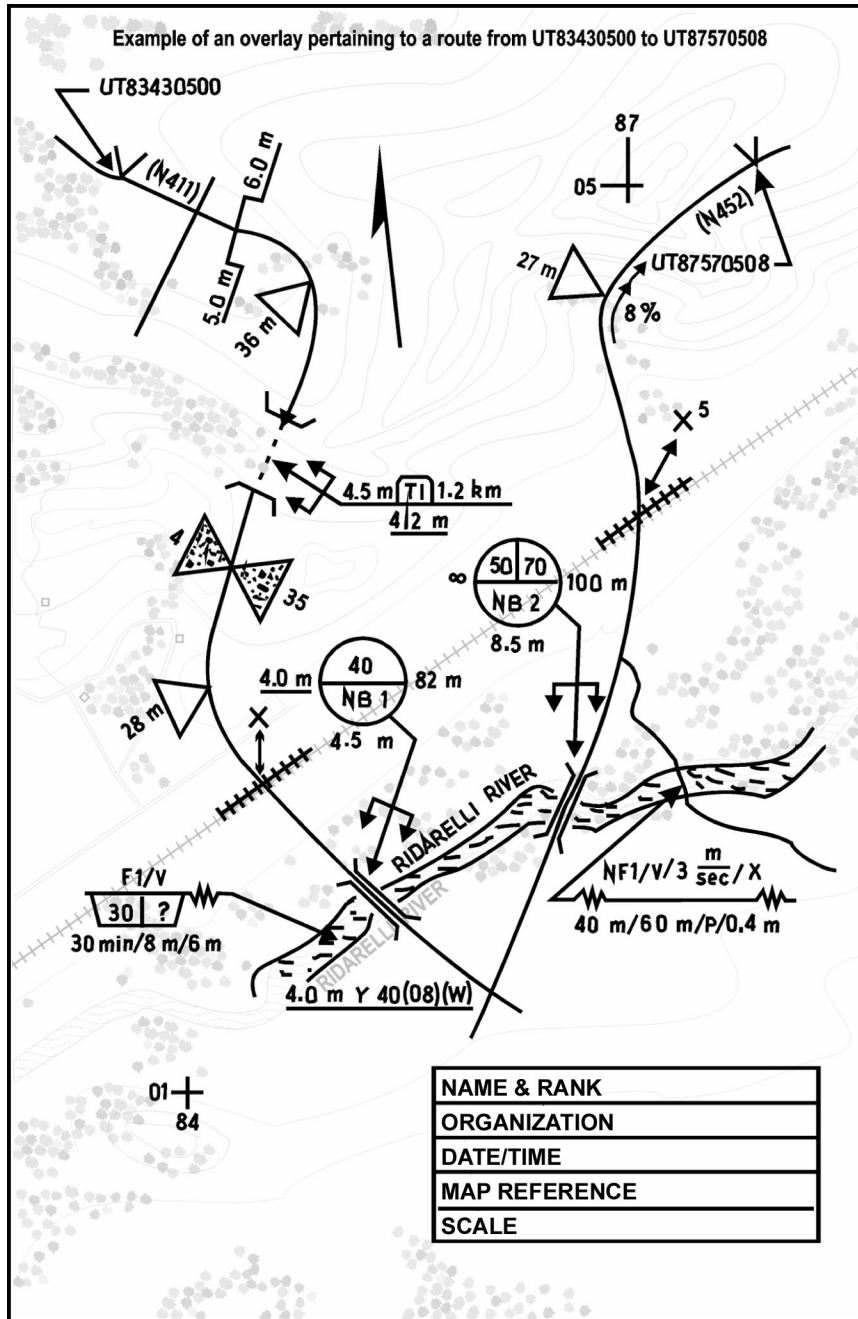


Figure A-2. Example of overlay graphics.



































	Stocks of bricks and other clay products		Electrical supply equipment
	Aggregate (including gravel, slag)		Civil engineering firms
	Lumberyard		Cement concrete products
	Glass stock		Gypsum and lime products
	Industrial gasses		Sawmill
	Mobile heavy construction equipment		Quarrying equipment
	Water purification equipment (civilian)		Factory symbol plus plant product
	Building contractors		Stores handling and transportation equipment
	Sand		Possible military water point
	Iron and steel stock		Stone
	Asphalt and bituminous stock		Paint
	Factories		Cordage, nets, yarns
	Powered hand-tools		Steel rolling mills and foundries
	Established military water point		Forestry equipment
	Engineering workshops		Building hardware
	Wire stock	Utility (civilian)	
	Stocks of roof covering		Water
			Gas
			Electric

Figure A-3. Material, facility, equipment, and service symbols.

A-2. FORMULAS

This paragraph covers formulas for the reconnaissance platoon to use in water crossing operations and in determining the slope of a road or other piece of terrain. The information is adapted from FM 5-34.

a. Formulas for Water Obstacles.

(1) **Width.** Scouts can measure the width of a river or stream using one of several available methods:

- Stretching a string or measuring tape across the river or stream.
- Using a map scale.
- Using a compass and the basic mathematical computation illustrated in Figure A-4.

(2) **Velocity.** Scouts can measure the velocity of the current of a river or stream using the procedures shown in Figure A-5, page A-10.

b. **Slope Computation.** To determine the slope of a piece of ground, whether it is an established roadway or a cross-country route, soldiers use a clinometer. If a clinometer is not available, they use the slope computation formula, which requires using one of the following methods to determine horizontal and vertical distances (Figure A-6, page A-10):

- Compute horizontal and vertical distances based on the map scale and contour differences for the road or terrain.
- Estimate horizontal and vertical distances using pacing and eyesight (hasty method).

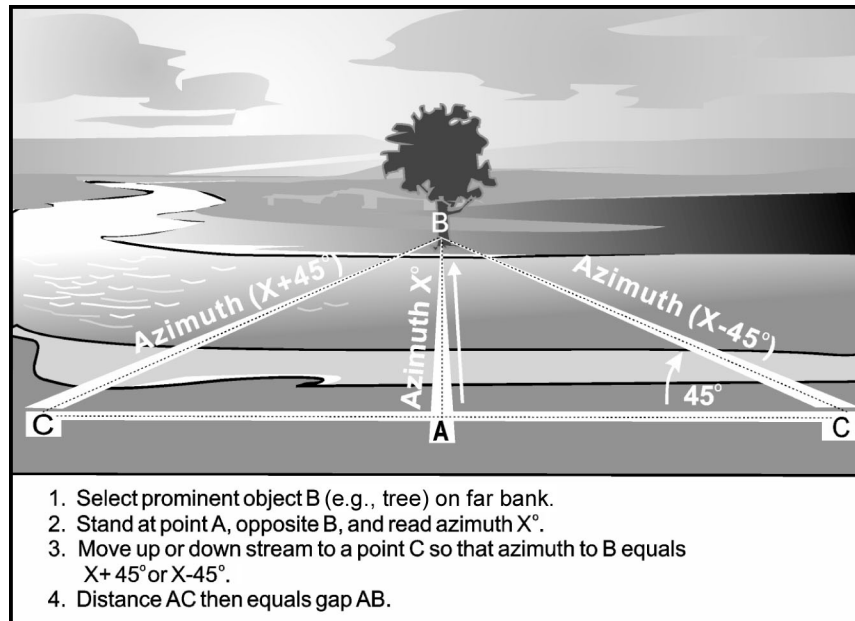


Figure A-4. Measuring stream width with a compass.

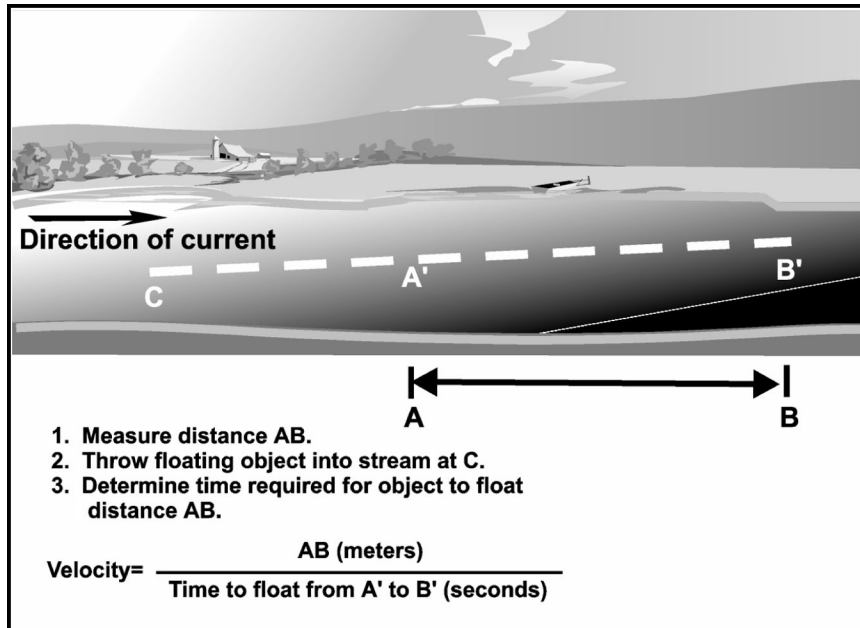


Figure A-5. Measuring stream velocity.

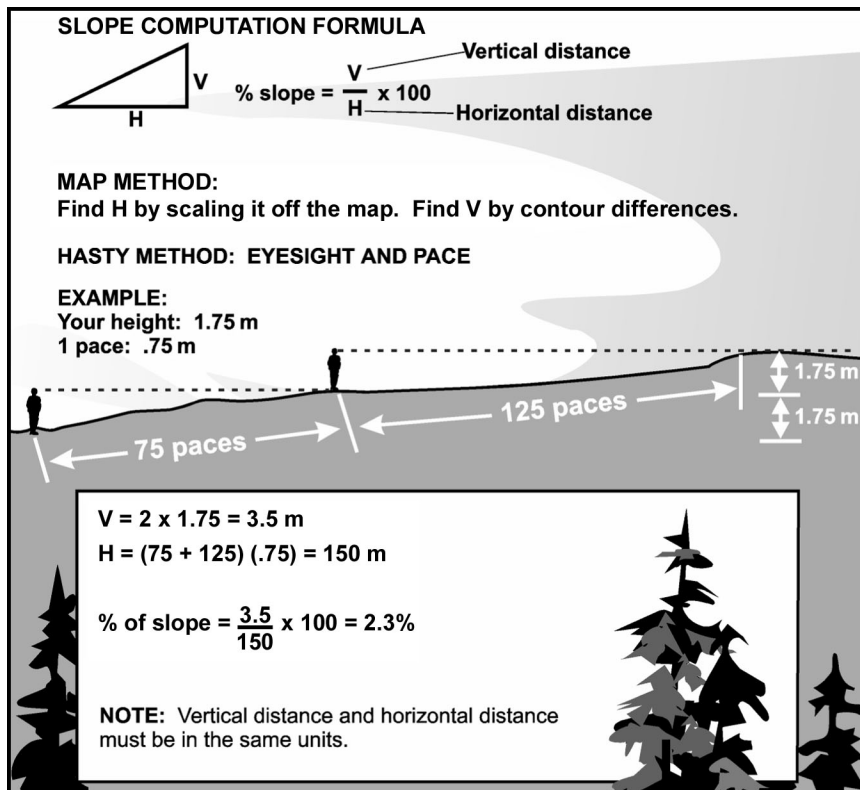


Figure A-6. Slope computation (road gradient).

A-3. CONVERSION TABLES

Soldiers can use the following tables for converting English measurements to their metric equivalents. Table A-1 lists conversions for common distance measurements (inches to centimeters; feet to meters; yards to meters; miles to kilometers). Table A-2, page A-12, shows conversions of miles per hour to kilometers per hour. Table A-3, page A-12, refers to field-expedient antenna lengths.

<p style="text-align: center;">INCHES to CENTIMETERS</p> <p>1 inch = 2.54 centimeters 2 inches = 5.08 centimeters 3 inches = 7.62 centimeters 4 inches = 10.16 centimeters 5 inches = 12.70 centimeters 6 inches = 15.24 centimeters 7 inches = 17.78 centimeters 8 inches = 20.32 centimeters 9 inches = 22.86 centimeters 10 inches = 25.40 centimeters 20 inches = 50.80 centimeters 30 inches = 76.20 centimeters 40 inches = 101.60 centimeters 50 inches = 127.00 centimeters 60 inches = 152.40 centimeters 70 inches = 177.80 centimeters 80 inches = 203.20 centimeters 90 inches = 228.60 centimeters 100 inches = 254.00 centimeters</p>	<p style="text-align: center;">FEET to METERS</p> <p>1 foot = 0.30 meters 2 feet = 0.61 meters 3 feet = 0.91 meters 4 feet = 1.22 meters 5 feet = 1.52 meters 6 feet = 1.83 meters 7 feet = 2.13 meters 8 feet = 2.44 meters 9 feet = 2.74 meters 10 feet = 3.05 meters 20 feet = 6.10 meters 30 feet = 9.14 meters 40 feet = 12.19 meters 50 feet = 15.24 meters 60 feet = 18.29 meters 70 feet = 21.34 meters 80 feet = 24.38 meters 90 feet = 27.43 meters 100 feet = 30.48 meters</p>
<p style="text-align: center;">YARDS to METERS</p> <p>1 yard = 0.91 meters 2 yards = 1.83 meters 3 yards = 2.74 meters 4 yards = 3.66 meters 5 yards = 4.57 meters 6 yards = 5.49 meters 7 yards = 6.40 meters 8 yards = 7.32 meters 9 yards = 8.23 meters 10 yards = 9.14 meters 20 yards = 18.29 meters 30 yards = 27.43 meters 40 yards = 36.58 meters 50 yards = 45.72 meters 60 yards = 54.86 meters 70 yards = 64.00 meters 80 yards = 73.15 meters 90 yards = 82.30 meters 100 yards = 91.44 meters</p>	<p style="text-align: center;">MILES to KILOMETERS</p> <p>1 mile = 1.61 km 2 miles = 3.22 km 3 miles = 4.83 km 4 miles = 6.44 km 5 miles = 8.05 km 6 miles = 9.66 km 7 miles = 11.27 km 8 miles = 12.87 km 9 miles = 14.48 km 10 miles = 16.09 km 20 miles = 32.19 km 30 miles = 48.28 km 40 miles = 64.37 km 50 miles = 80.47 km 60 miles = 96.56 km 70 miles = 112.65 km 80 miles = 128.75 km 90 miles = 144.84 km 100 miles = 160.93 km</p>

Table A-1. English to metric distance measurement conversions.

MILES PER HOUR	KILOMETERS PER HOUR
1 mph	1.609 kmph
2 mph	3.22 kmph
3 mph	4.83 kmph
4 mph	6.44 kmph
5 mph	8.05 kmph
6 mph	9.66 kmph
7 mph	11.27 kmph
8 mph	12.87 kmph
9 mph	14.48 kmph
10 mph	16.09 kmph
15 mph	24.14 kmph
20 mph	32.19 kmph
25 mph	40.23 kmph
30 mph	48.28 kmph
35 mph	56.33 kmph
40 mph	64.37 kmph
45 mph	72.42 kmph
50 mph	80.47 kmph
55 mph	88.51 kmph
60 mph	96.56 kmph
65 mph	104.61 kmph
70 mph	112.65 kmph
75 mph	120.70 kmph
100 mph	160.94 kmph

Table A-2. Miles per hour to kilometers per hour conversions.

OPERATING FREQUENCY (MHZ)	WIRE/ELEMENT LENGTH
30	2.38 meters (7 feet 10 inches)
32	2.23 meters (7 feet 4 inches)
34	2.10 meters (6 feet 11 inches)
36	1.98 meters (6 feet 6 inches)
38	1.87 meters (6 feet 2 inches)
40	1.78 meters (5 feet 10 inches)
43	1.66 meters (5 feet 5 inches)
46	1.55 meters (5 feet 1 inch)
49	1.46 meters (4 feet 9 inches)
52	1.37 meters (4 feet 6 inches)
55	1.30 meters (4 feet 3 inches)
58	1.23 meters (4 feet 0 inches)
61	1.17 meters (3 feet 10 inches)
64	1.12 meters (3 feet 8 inches)
68	1.05 meters (3 feet 5 inches)
72	.99 meters (3 feet 3 inches)
76	.94 meters (3 feet 1 inch)

Table A-3. Operating frequency and wire element length.

APPENDIX B

LIMITED VISIBILITY OPERATIONS

The reconnaissance platoon must be able to operate under limited visibility conditions. This appendix discusses the equipment and techniques used to operate in darkness, smoke, dust, fog, heavy rain, or heavy snow. Limited visibility can result in decreased target acquisition capability, difficulty in distinguishing friendly from enemy units, difficulty in controlling movement, and reduced target acquisition times.

B-1. PLANNING

In addition to normal planning, limited visibility operations require special emphasis on the following:

- Simple tactical plans while maintaining the necessary level of detail.
- Plans for the potential use of illumination and smoke.
- Surveillance with night vision and infrared devices.
- Greatest use of available daylight for reconnaissance.

In selecting a means to employ illumination or smoke, leaders must determine the type of assets that are available, to include capabilities and limitations. They plan for more than one means since enemy action, changes in weather, other missions, or logistical constraints might prevent the use of any one type.

B-2. NIGHT-VISION DEVICES

Night-vision devices (Table B-1, page B-2) aid surveillance/target engagement when darkness, vegetation, weather, camouflage, or obscurants limit natural vision. The degree of assistance depends on the type of technology and the visibility conditions. For example, image intensification devices dominate the battlefield and provide the best results under clear air and good ambient light conditions, but they are defeated by bad weather, darkness, and battlefield obscurants. Thus, thermal imagery devices are used in conditions that defeat image intensifiers. Thermal imagery can also penetrate camouflage. Remote sensors are employed in dead space or in situations of long distances. The reconnaissance platoon should use thermal imagery devices whenever possible to provide the best surveillance and engagement capability.

DEVICE	CAPABILITIES	CHARACTERISTICS	ADVANTAGES & DISADVANTAGES
AN/PVS-2 Night-Vision Sight, Individual Weapon	300-400 m	WEIGHT: 6 lb. POWER: 3.6X FIELD OF VIEW (FOV): 10.4 degrees	(See NOTE.)
AN/TVS-2 Night-Vision Sight, Crew-Served Weapon	Starlight: 800 m Moonlight: 1,000 m	WEIGHT: 16 lb. POWER: 6.5X FOV: 6 degrees	(See NOTE.)
AN/TVS-4 Tripod or vehicle mounted sight	Starlight: 1,200m Moonlight: 2,000 m	WEIGHT: 34 lb. POWER: 7X FOV: 9 degrees	(See NOTE.)
AN/PVS-4 Night-Vision Sight, Individual Weapon	Starlight: 400 m Moonlight: 600 m	WEIGHT: 3.9 lb. POWER: 3.8X FOV: 15 degrees	(See NOTE.)
AN/TVS-5 Night-Vision Sight, Crew-Served Weapon	Starlight: 1,000 m Moonlight: 1,200 m	WEIGHT: 7.5 lb. POWER: 6.5X FOV: 9 degrees	(See NOTE.)
AN/PVS-7 Night-Vision Goggles	Starlight: 75 m Moonlight: 300 m	WEIGHT: 1.9 lb. POWER: 1X FOV: 40 degrees	(SEE NOTE.)
AN/PVS 14 Night-Vision Goggles	Starlight: 150 m Moonlight: 300 m	WEIGHT: 1.5 lb. FOV: 40 degrees	(See NOTE.)
AN/TAS-5 Thermal Dragon Sight	1,200 m	WEIGHT: 22 lb.	Penetrates all conditions of limited visibility and light foliage. Has short battery and coolant bottle life.
COMMAND LAUNCH UNIT (CLU) of the Javelin AT weapon system.	Over 3,000 m	Weight (CLU only) 14.1 lb Sight magnification 4X day, 4X and 9X night	Infrared crossover. When temperature of soil, water, concrete, and vegetation are approximately the same, CLU performance is degraded (twice in a 24-hr period).
AN/UAS-12 Thermal TOW Sight	3,000 m	WEIGHT: 18.7 lb. POWER: 12X	Same as AN/TAS-5.
AN/UAS-11 Thermal Night Observation Device	3,000 m	WEIGHT: 58.4 lb. with tripod	Penetrates all conditions of limited visibility and light foliage. Has short battery and coolant bottle life.
BINOCULARS	Intensifies natural light	7X50 or 6X30	Require some type of visible light.
AN/PAQ-4 Infrared Aiming Light	150 m	WEIGHT: 9 lb.Used with AN/PVS-5 or AN/PVS-7 mounts on M16	Detectable. Permits aimed fire during darkness.
NOTE: This night-vision device performs poorly in dark, obscured, or adverse weather conditions. Bright light, such as that from street lights or headlights, defeats it. Eye fatigue occurs after 3 to 5 hours.			

Table B-1. Night vision devices.

DEVICE	CAPABILITIES	CHARACTERISTICS	ADVANTAGES & DISADVANTAGES
AN/PAS-7 Handheld Thermal Viewer	DETECTION RANGE: Vehicles: 1,000 m Personnel: 400 m	WEIGHT: 10.8 lb. POWER: 2.5X	Penetrates all conditions of limited visibility and light foliage.
AN/PPS-5B Radar	MINIMUM RANGE: 50 m MAXIMUM RANGE: Vehicles: 10,000 m Personnel: 6,000 m	WEIGHT: 112 lb.	Detectable. Degraded by heavy rain, snow, dense foliage, and high winds. Line of sight. Has 50-foot remote capability. Difficult to man-pack.
AN/PPS-15A Radar: Very Short Range	MINIMUM RANGE: 50 m MAXIMUM RANGE: Vehicles: 3,000 m Personnel: 1500 m	WEIGHT: 18 lb. Audible and visual alarm.	Detectable. Can be operated and transported by one man. Degraded by heavy rain, snow, dense foliage, and high winds. Reduced effectiveness during wind-blown rain. Line of sight. Has 30-foot remote capability.
PEWS Platoon Early Warning System	Detects target 15 m from sensor. Two types of sensors in each set distinguish personnel or vehicles. Covers a frontage of 250 m. Can be placed up to 1,500 m from platoon.	WEIGHT: 13 lb. Nine ground sensors relay to monitor through wire or radio connection.	When connected by wire, is not detectable. Easy to operate. Not affected by climatic conditions. Animals can interfere with sensors.

Table B-1. Night vision devices (continued).

B-3. EQUIPMENT EMPLOYMENT

This paragraph discusses the types of equipment that can be used during limited visibility and the factors to consider when employing them.

a. **Binoculars.** Binoculars are most effective in clear air. Even during reduced visibility, however, they are better than the unaided eye.

b. **Remotely Employed Sensors.** Remotely employed sensors (REMS), such as the PEWS, are critical to effective security in limited visibility. They may be employed to monitor avenues of approach, possible assembly areas, DZs, LZs, obstacles, and dead space forward of or between OPs. REMS have a limited range; therefore, careful analysis of where to position sensors is most important. When they are positioned parallel to the avenue of approach, REMS can detect the direction, rate of march, composition, and size of a force passing the sensors.

c. **Thermal Imagery Devices.** Thermal imagery devices lose some effectiveness during heavy rain, dense fog, or smoke. Therefore, they must be integrated with other devices to provide effective detection. Thermal imagery devices are affected by temperature gradients between the target and the target background.

d. **Image Intensification Devices.** The range of image intensification devices depends on surrounding light levels. Low light levels, rain, fog, smoke, and dust may reduce the effectiveness of image intensification devices. Low light levels during periods of otherwise clear air can be overcome by illuminating with invisible light and by using image intensifiers. Infrared light provides enough light to allow the image intensifiers to be effective. However, looking directly at a visible light source causes the device to shut off. Operators of image intensification devices develop eye fatigue and lose their unaided night vision (see paragraph B-14).

e. **Ground Surveillance Radar.** Radar energy produced by GSR penetrates light camouflage, light foliage, smoke, haze, light rain and snow, and darkness. It cannot penetrate dense undergrowth, trees, or heavy foliage. Radar sets have only a line-of-sight capability. High winds can make the radar unusable, and heavy rain or snow restricts radar detection abilities. A well-trained operator, however, can lessen these effects. Radar is effective during good visibility as well as bad. Its use should be planned for all operations--not just night operations or when expecting smoke.

(1) Normally, radar is located on dominant terrain. A radar site and an OP can be collocated, but soldiers who operate the radar should not be detailed as ground observers except in emergencies. The radar is dug in and camouflaged. The reconnaissance platoon leader (or S2) selects the general location for the radar site. The ground surveillance section leader or team leader then chooses the specific site within that location.

(2) The team's senior radar operator prepares radar surveillance cards. One copy of this card is forwarded to the S2 for use in preparing or modifying his surveillance plan.

(3) Radar can be used for the following purposes:

- To search avenues of approach, possible enemy attack positions, assembly areas, or other sectors. It can be used continuously to determine location, size, and nature of enemy activity.
- To monitor point targets such as bridges, defiles, or road junctions. It can be used to determine quantity, type, direction, and rate of target movement through the point.
- To extend a patrol's observation abilities by enabling the patrol to survey distant points or areas of special interest.
- To provide warning of enemy activity near friendly positions or routes.
- To detect partly obscured targets.
- To aid in controlling movement during limited visibility by monitoring course headings or vectoring.
- To increase the effectiveness of fire support by correctly locating targets. It can also be used to survey target areas immediately after fires are lifted, to detect enemy activity, and to determine the effectiveness of fire.
- To detect enemy radar.
- To limit the enemy's ability to detect radar and mask the emitter. Terrain is used to mask the emitter, if possible. The radar is placed in a reverse-slope position with its sector off to the flank(s). Radar that is left on is easier to detect. The flicker technique (alternately turning radar off and on) can help avoid enemy detection.

B-4. DEVICE INTEGRATION

The reconnaissance platoon leader plans the use of NVDs and surveillance devices to obtain the best coverage of his area of operations and to make best use of the abilities of the various devices (Figure B-1). A typical mix might include REMS to cover out-of-sight objectives and dead space, night-vision sights for close range, radar for long-range line of sight, and thermal imagery to penetrate smoke and for use in low-light conditions.

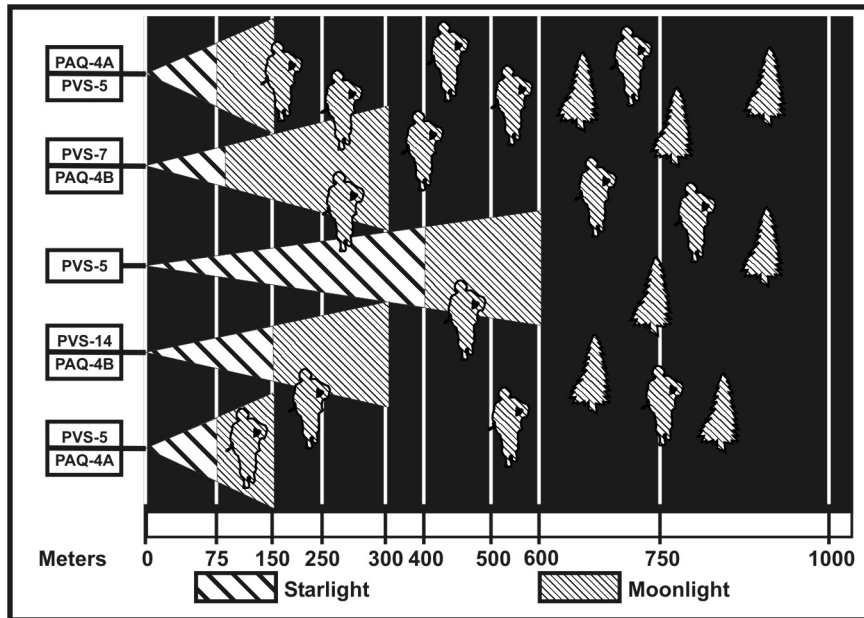


Figure B-1. Device integration.

B-5. ENEMY NIGHT-VISION AND SURVEILLANCE DEVICES

Soldiers avoid detection by the enemy by moving stealthily. Defensive measures include cover and concealment, use of appropriate camouflage devices and methods, concealment of actions with smoke, and thermal and visual decoys.

B-6. BATTLEFIELD ILLUMINATION

When night vision devices are not available, artificial light is the simplest way to operate on a battlefield during darkness. The intent is to illuminate or silhouette the enemy force without illuminating friendly elements and to prevent the illuminating force from being adversely affected by its own light source. Platoon leaders must know the characteristics of available artificial illumination systems (Table B-2, page B-6). They must also know how darkness, weather, and terrain influence these systems. The platoon leader must exercise positive control over the use of various illumination means since illumination in one area might have an unfavorable effect on elements elsewhere. He must also obtain approval from the battalion before using illumination. Artificial light is divided into two categories: visible and invisible light.

a. **Visible Light.** Visible light requires no special equipment other than the light source itself. It is used to continue operations begun during daylight, to assist troops that are untrained, or to offset an enemy advantage in NVDs. It is the simplest method of

operating during darkness. The disadvantage of using visible light is that it permits the enemy to see the friendly force.

b. **Invisible Light.** Invisible light comes from a near-infrared source, ultraviolet light, or pink light filter. It is normally impossible to see this light with the unaided eye. Although it is visible to NVDs, invisible light has greater security than visible light.

Device/System	Approximate Diameter of Usable Range of Illumination (meters)	Approximate Period of Illumination (seconds)
White Star Parachute	450	36
Illuminating Grenade	200	25
Trip Flare	300	55
40-mm White Star Parachute	150	15
60-mm Mortar	800	25
81-mm Mortar	1,100	60
120-mm Mortar	1,500	50 to 60
105-mm Howitzer	1,000	60
155-mm Howitzer	2,000	120
Air Force Drop Flare	1,500	180
Naval Gunfire, 5 Inch	350 to 550	45 to 52

Table B-2. Available light sources.

B-7. EMPLOYMENT CONSIDERATIONS FOR ARTIFICIAL LIGHT SOURCES

Various considerations govern the use of artificial light sources.

a. **Ground Flares.** Ground flares are mainly defensive, are good for early warning, and can be detonated remotely by pull-pin or trigger-release devices. Ground flares are not suitable for continuous illumination.

WARNING
Ground flares may start fires.

b. **Illuminating Shells (Parachute-Supported Flares).** After the parachute opens, windspeed, direction, and the amount of obscurant determine what ground area is lighted. Shells are normally set to detonate at a height of burst that allows the flare to burn out just before it reaches the ground. Drifting flares can illuminate friendly forces; therefore, the detonation point must be adjusted either by offsetting it or lowering the height of burst. If grass or brush fire is a hazard, the height of burst is not lowered. Strong winds require that the rate of fire be increased for continuous illumination. Fog, dust, smoke, and falling snow decrease the intensity of the illumination. Therefore, low-airburst shells can be used as navigational aids even though they provide little illumination.

WARNING

Avoid detonating illumination over or to the rear of friendly elements. This could silhouette friendly troops.

B-8. SMOKE OPERATIONS

Smoke is used to blind the enemy, to break contact with the enemy, to signal, or to deceive.

a. **Obscuration Smoke.** Obscuration smoke is placed on or near enemy positions to interfere with observation and fire. It is usually delivered by indirect fire such as artillery or mortars. Use of obscuration smoke on the enemy could cause him to reduce speed, to change direction, to deploy prematurely, or to increase radio transmissions.

b. **Screening Smoke.** Screening smoke is intended to conceal friendly forces and to help break contact with the enemy.

c. **Marking and Signaling Smoke.** Marking and signaling smoke is used to mark reference points, targets, or positions. Colored or WP smoke is usually used.

d. **Deceptive Smoke.** To confuse or mislead the enemy, deceptive smoke is used in coordination with other actions by creating the illusion that a tactically major event is occurring. It is used with other deceptive measures such as electronic deception.

B-9. SMOKE EFFECTS

Smoke can affect both the psychological and physiological aspects of soldiers' activities. Therefore, it can also affect combat operations.

a. **Psychological Effects.** Screening smoke near friendly positions to reduce enemy observation can help maintain morale when soldiers are aware of its purpose. However, soldiers operating in smoke can develop fear or anxiety due to the lack of visibility to detect the enemy, to see adjacent units, or to distinguish terrain features. This causes orientation problems. Smoke tends to isolate individuals or groups and degrades their ability to fight. Soldiers in this situation are vulnerable to deception through other sensory perceptions such as sound. Leaders at all levels can suffer these effects and, due to the need for constant and detailed command and control, can suffer mental exhaustion in a short time.

b. **Physiological Effects.** Though smoke produced by mechanical generators or munitions might not produce immediate physiological effects, extended exposure to large concentrations can produce secondary effects such as shortness of breath, inflammation of the respiratory system, dizziness, vertigo, or vomiting. Donning the protective mask limits these effects. Vertigo can be overcome by leaving the smoke area or by getting close to the ground. Chemical agents can also be delivered with smoke. The leader must analyze the risk of masking, which may be unnecessary and may cause command and control problems.

B-10. OPERATIONAL FACTORS

Battalion may direct the reconnaissance platoon to assist in smoke operations. Unless directed by battalion, the platoon uses smoke only in situations in which they must break contact. By limiting vision, smoke degrades the ability of soldiers and combat forces to maneuver, fight, and visually communicate. Furthermore, it restricts observation of

surrounding terrain and of other combat elements on the battlefield. The natural tendency of a vehicle driver is to avoid entering smoke, to move out of or around it, or to slow movement upon entering it.

B-11. TYPES OF SMOKE

White phosphorus and hexachloroethane (HC) are the two predominant types of smoke used today.

a. **Field Artillery.** Field artillery smoke ammunition includes both WP and HC (Table B-3).

b. **Mortars.** Mortars provide good initial smoke coverage due to their high rate of fire, but their small basic load size limits the size and duration of the screen mortars can provide. The only type of smoke round delivered by mortars is WP (Table B-4).

c. **Smoke Pots, Smoke Grenades, and M203 Dual-Purpose Weapons (Smoke Round).** A variety of smoke-producing items are available to the battalion through standard issue. Due to their limited ranges, these smoke producers are useful only for close obscuration requirements.

FIELD ARTILLERY DELIVERY SYSTEM	TYPE OF ROUND	TIME TO BUILD EFFECTIVE SMOKE	AVERAGE BURNING TIME	WIND DIRECTION		
				CROSS	QUARTER-ING	HEAD/TAIL
155-mm	WP	1/2 min	1 to 1 1/2 min	100	75	50
	HC	1 to 1 1/2 min	4 min	350	250	75
105-mm	WP	1/2 min	1 to 1 1/2 min	75	60	50
	HC	1 to 1 1/2 min	3 min	250	175	50
				Average Obscuration Length (m) Per Round		

Table B-3. Artillery smoke ammunition.

MORTAR DELIVERY SYSTEM	TYPE OF ROUND	TIME TO BUILD EFFECTIVE SMOKE	AVERAGE BURNING TIME	WIND DIRECTION		
				CROSS	QUARTER-ING	HEAD/TAIL
120-mm*	WP	1/2 min	1 min	200	80	40
81-mm	WP	1/2 min	1 min	100	60	40
60-mm**	WP	1/2 min	45 sec	60	30	20
* The 120-mm mortar is a better smoker than the 105-mm Howitzer firing WP.				Average Obscuration Length (m) Per Round		
** The 60-mm smoke round currently in inventory is the M302E2 (maximum range: 1,448 m).						

Table B-4. Mortar smoke ammunition.

B-12. EFFECTS OF SMOKE ON ELECTRO-OPTICAL SYSTEMS

Electro-optical systems allow soldiers to engage any target they can see with direct fire out to 3,750 meters. They also improve the soldiers' ability to see and engage targets at night. The use of smoke at night is effective in defeating electromagnetic energy-producing systems, thus making it an important element in night operations.

- a. Electro-optical systems normally found on the battlefield include--
 - Handheld thermal viewers.
 - Wire-guided, optically tracked antitank missiles and nightsights.
 - Laser range finders.
 - Television-seeker missiles and bombs.
 - Heat-seeking missiles.
- b. All electro-optical systems work by radiating or receiving electro-optical energy. Smoke affects these systems by reflecting, absorbing, scattering, or attenuating (weakening) electromagnetic energy.

B-13. TACTICAL CONTROL TECHNIQUES

To overcome the problems generated when soldiers cannot see the battlefield, the platoon leader and his subordinate leaders must employ other techniques to control their subordinates.

- a. **Identification.** Recognition means include radio, infrared, and radar. These are used with other established audible and visual signals.
- b. **Movement.** Visual contact should be maintained; soldiers should maintain closer intervals. NVDs allow soldiers to retain good dispersion while maintaining visual contact. The leaders should reduce rate of movement and establish SOPs for audible and visual signals.
- c. **Navigation.** Guides should be used whenever possible.
 - (1) Use radar or low-light sources to mark boundaries.
 - (2) Use radar, infrared beams, and landmarks to maintain direction.
 - (3) Use preplanned artillery spotting rounds to help determine location and direction.

B-14. DARK ADAPTATION

Dark adaptation is the process by which the human body increases the eyes' sensitivity to low levels of light. Soldiers adapt to darkness at varying degrees and rates. During the first 30 minutes in the dark, eye sensitivity increases about 10,000 times, but not much after that.

- a. Dark adaptation is affected by exposure to bright light such as matches, flashlights, flares, or vehicle headlights. Full recovery from these exposures can take up to 45 minutes.
- b. Using night-vision goggles impedes adaptation. However, if a soldier adapts to the dark before donning the goggles, he gains full dark adaptation within two minutes when they are removed.
- c. Soldiers must also know that color perception decreases at night. They may be able to distinguish light and dark colors depending on the intensity of reflected light. Visual sharpness is also reduced. Since visual sharpness at night is one seventh of what it is during the day, soldiers can see only large, bulky objects. This means that object identification at night is based on generalized contours and outlines. Depth perception is also affected.

B-15. NIGHT VISION

Darkness affects the senses of sight, hearing, and smell. Sharpening these senses requires training. Soldiers must know how their eyes function at night to use them best.

a. **Night-Vision Scanning.** Dark adaptation is only the first step toward making the best use of night vision. Scanning enables soldiers to overcome many of the physiological limitations of their eyes. It can also reduce visual illusions. This technique involves looking from right to left or left to right using a slow, regular scanning movement (Figure B-2). At night, soldiers must avoid looking directly at a faintly visible object when trying to confirm its presence.

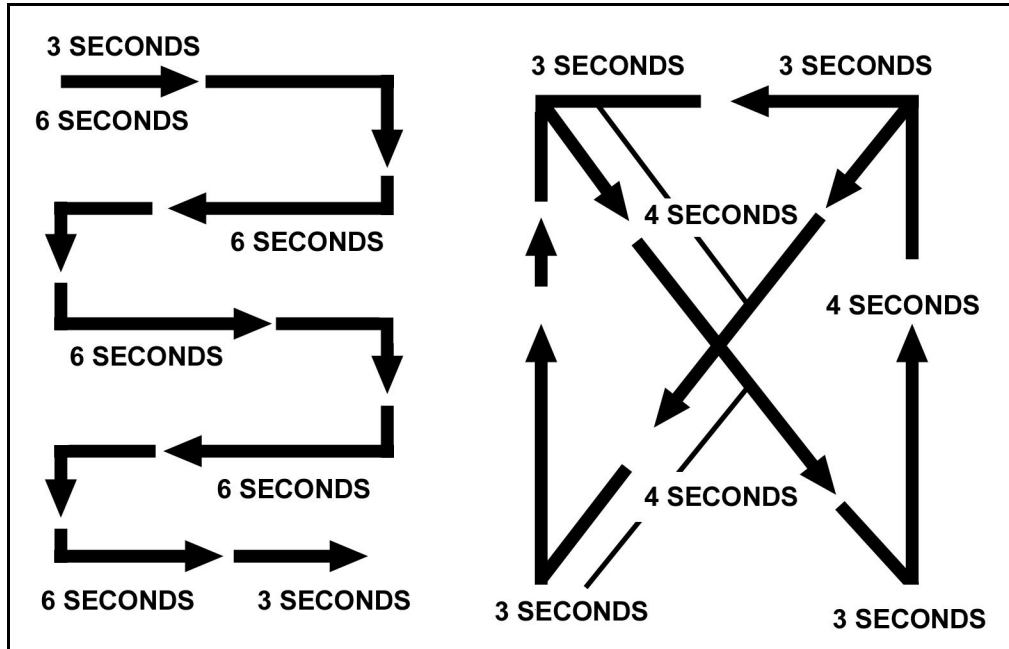


Figure B-2. Typical scanning pattern.

b. **Off-Center Vision.** The method of viewing an object using central vision is ineffective at night. This is due to the night blind spot that exists during low illumination. Soldiers must learn to use off-center vision. This method requires viewing an object by looking 10 degrees above, below, or to either side of it rather than directly at it (Figure B-3).

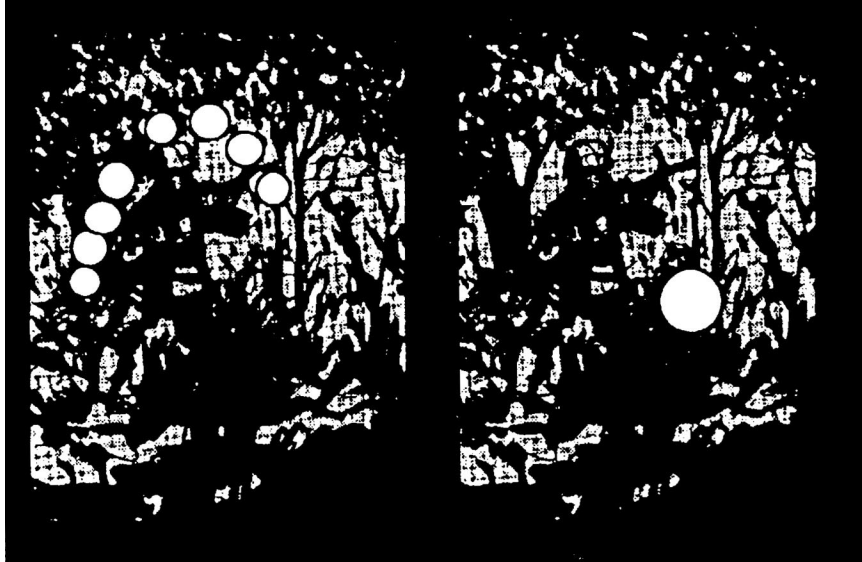


Figure B-3. Off-center viewing technique.

c. **Bleach-Out Effect.** Even when soldiers practice off-center viewing, the image of an object bleaches out and becomes a solid tone when viewed longer than two to three seconds. By shifting the eyes from one off-center point to another, the soldier can continue to pick up the object in his peripheral field of vision.

d. **Shape of Silhouette.** Visual sharpness is reduced at night; therefore, soldiers must recognize objects by shape or outline. Knowing the design of structures that are common to the area of operations enhances the success of the operation.

APPENDIX C

RISK MANAGEMENT

Risk is the chance of injury or death for individuals and damage to or loss of vehicles and equipment. Risk, or the potential for risk, is always present in every combat and training situation the reconnaissance platoon faces. Risk management must take place at all levels of the chain of command during each phase of every operation; it is an integral part of all tactical planning. The reconnaissance platoon leader, NCOs, and all other reconnaissance platoon soldiers must know how to use risk management, coupled with fratricide reduction measures, to ensure that the mission is executed in the safest possible environment within mission constraints.

The primary objective of risk management is to help units protect their combat power through accident prevention, enabling them to win the battle quickly and decisively with minimal losses. This appendix outlines the process leaders use to identify hazards and implement a plan to address each identified hazard. It also includes a detailed discussion of the responsibilities of the platoon's leaders and individual soldiers in implementing a sound risk management program. For additional information on risk management, refer to FM 100-14.

Section I. RISK MANAGEMENT PROCEDURES

This section outlines the five steps of risk management. Leaders of the reconnaissance platoon should never approach risk management with “one size fits all” solutions to the hazards the platoon will face. Rather, in performing the steps, they must keep in mind the essential tactical and operational factors that make each situation unique.

C-1. STEP 1, IDENTIFY HAZARDS

A hazard is a source of danger. It is any existing or potential condition that could entail injury, illness, or death of personnel; damage to or loss of equipment and property; or some other sort of mission degradation. Tactical and training operations pose many types of hazards. The reconnaissance platoon leader must identify the hazards associated with all aspects and phases of the platoon's mission, paying particular attention to the factors of METT-TC. Risk management must never be an afterthought; leaders must begin the process during their troop-leading procedures and continue it throughout the operation. Table C-1, page C-2, lists possible sources of risk that the reconnaissance platoon might face during a typical tactical operation. The list is organized according to the factors of METT-TC.

SOURCES OF BATTLEFIELD RISK	
MISSION	<ul style="list-style-type: none"> • Duration of the operation. • Complexity and clarity of the plan. (Is the plan well-developed and easily understood?) • Proximity and number of maneuvering units.
ENEMY	<ul style="list-style-type: none"> • Knowledge of the enemy situation. • Enemy capabilities. • Availability of time and resources to conduct reconnaissance.
TERRAIN AND WEATHER	<ul style="list-style-type: none"> • Visibility conditions, including light, dust, fog, and smoke. • Precipitation and its effect on mobility. • Extreme heat or cold. • Additional natural hazards (broken ground, steep inclines, water obstacles).
TROOPS and EQUIPMENT	<ul style="list-style-type: none"> • Equipment status. • Experience the units conducting the operation have working together. • Danger areas associated with the platoon's weapon systems. • Soldier and leader proficiency. • Soldier and leader rest situation. • Degree of acclimatization to environment. • Impact of new leaders or crewmembers. • Friendly unit status. • NATO or multinational military actions combined with U.S. forces.
TIME AVAILABLE	<ul style="list-style-type: none"> • Time available for troop-leading procedures and rehearsals by subordinates. • Time available for PCCs/PCIs.
CIVIL CONSIDERATIONS	<ul style="list-style-type: none"> • Applicable ROE or ROI. • Potential stability and support operations involving contact with civilians (such as NEOs, refugee or disaster assistance, or counterterrorism). • Potential for media contact and inquiries. • Interaction with host nation or other participating nation support.

Table C-1. Examples of potential hazards.

C-2. STEP 2, ASSESS HAZARDS TO DETERMINE RISKS

Hazard assessment is the process of determining the direct impact of each hazard on an operation (in the form of hazardous incidents). Use the following steps.

- a. Determine which hazards can be eliminated or avoided.
- b. Assess each hazard that cannot be eliminated or avoided to determine the probability that the hazard can occur.
- c. Assess the severity of hazards that cannot be eliminated or avoided. Severity, defined as the result or outcome of a hazardous incident, is expressed by the degree of injury or illness (including death), loss of or damage to equipment or property, environmental damage, or other mission-impairing factors (such as unfavorable publicity or loss of combat power).

d. Taking into account both the probability and severity of a hazard, determine the associated risk level (extremely high, high, moderate, and low). Table C-2 summarizes the four risk levels.

e. Based on the factors of hazard assessment (probability, severity, and risk level, as well as the operational factors unique to the situation), complete the risk management worksheet. Refer to FM 100-14 for an example of a completed risk management worksheet.

RISK LEVEL	MISSION EFFECTS
Extremely High (E)	Mission failure if hazardous incidents occur in execution.
High (H)	Significantly degraded mission capabilities in terms of required mission standards. Not accomplishing all parts of the mission or not completing the mission to standard (if hazards occur during mission).
Moderate (M)	Expected degraded mission capabilities in terms of required mission standards. Reduced mission capability (if hazards occur during the mission).
Low (L)	Expected losses have little or no impact on mission success.

Table C-2. Risk levels and impact on mission execution.

C-3. STEP 3, DEVELOP CONTROLS AND MAKE RISK DECISIONS

This step is accomplished in two substeps: develop controls and make risk decisions. These substeps are accomplished during the "make a tentative plan" step of the troop-leading procedures.

a. **Developing Controls.** After assessing each hazard, develop one or more controls that will either mitigate the hazard or reduce the risk (probability, severity, or both) of potential hazardous incidents. When developing controls, consider the reason for the hazard, not just the hazard by itself.

b. **Making Risk Decisions.** A key element in the process of making a risk decision is determining whether accepting the risk is justified or, conversely, is unnecessary. The decision-maker (the reconnaissance platoon leader, if applicable) must compare and balance the risk against mission expectations. He alone decides if the controls are sufficient and acceptable and whether to accept the resulting residual risk. If he determines the risk is unnecessary, he directs the development of additional controls or alternative controls; as another option, he can modify, change, or reject the selected COA for the operation.

C-4. STEP 4, IMPLEMENT CONTROLS

Controls are the procedures and considerations the unit uses to eliminate hazards or reduce their risk. Implementing controls is the most important part of the risk management process; this is the chain of command's contribution to the safety of the unit. Implementing controls includes coordination and communication with appropriate superior, adjacent, and subordinate units and with individuals executing the mission. The reconnaissance platoon leader must ensure that specific controls are integrated into

OPLANs, OPORDs, SOPs, and rehearsals. The critical check for this step is to ensure that controls are converted into clear, simple execution orders understood by all levels. If the leaders have conducted a thoughtful risk assessment, the controls will be easy to implement, enforce, and follow. Examples of risk management controls include the following:

- Thoroughly brief all aspects of the mission, including related hazards and controls.
- Conduct thorough precombat checks (PCCs) and precombat inspections (PCIs).
- Allow adequate time for rehearsals at all levels.
- Drink plenty of water, eat well, and get as much sleep as possible (at least 4 hours in any 24-hour period).
- Use buddy teams.
- Enforce speed limits, use of seat belts, and driver safety.
- Establish recognizable visual signals and markers to distinguish maneuvering units.
- Enforce the use of ground guides in assembly areas and on dangerous terrain.
- Establish marked and protected sleeping areas in assembly areas.
- Limit single-vehicle movement.
- Establish SOPs for the integration of new personnel.

C-5. STEP 5, SUPERVISE AND EVALUATE

During mission execution, leaders must ensure that risk management controls are properly understood and executed. Leaders must continuously evaluate the unit's effectiveness in managing risks to gain insight into areas that need improvement.

a. **Supervision.** Leadership and unit discipline are the keys to ensuring that effective risk management controls are implemented.

(1) All leaders are responsible for supervising mission rehearsals and execution to ensure standards and controls are enforced. In particular, NCOs must enforce established safety policies as well as controls developed for a specific operation or task. Techniques include spot checks, inspections, SITREPs, confirmation briefs, buddy checks, and close supervision.

(2) During mission execution, leaders must continuously monitor risk management controls to determine whether they are effective and to modify them as necessary. Leaders must also anticipate, identify, and assess new hazards. They ensure that imminent danger issues are addressed on the spot and that ongoing planning and execution reflect changes in hazard conditions.

b. **Evaluation.** Whenever possible, the risk management process should also include an after-action review (AAR) to assess unit performance in identifying risks and preventing hazardous situations. Leaders should then incorporate lessons learned from the process into unit SOPs and plans for future missions.

Section II. IMPLEMENTATION RESPONSIBILITIES

Leaders and individuals at all levels are responsible and accountable for managing risk. They must ensure that hazards and associated risks are identified and controlled during planning, preparation, and execution of operations. The reconnaissance platoon leader and senior NCOs must look at both tactical risks and accident risks. The same risk management process is used to manage both types. The reconnaissance platoon leader alone determines how and where he is willing to take tactical risks. With the assistance of the PSG, NCOs, and individual soldiers, the reconnaissance platoon leader manages accident risks.

C-6. BREAKDOWN OF THE RISK MANAGEMENT PROCESS

Despite the need to advise higher headquarters of a risk taken or about to be assumed, the risk management process may break down. Such a failure can be the result of several factors; most often, it can be attributed to the following:

- The risk denial syndrome in which leaders do not want to know about the risk.
- A soldier who believes that the risk decision is part of his job and does not want to bother his platoon leader or section leader.
- Outright failure to recognize a hazard or the level of risk involved.
- Overconfidence on the part of an individual or the unit in the capability to avoid or recover from a hazardous incident.
- Subordinates who do not fully understand the higher commander's guidance regarding risk decisions.

C-7. RISK MANAGEMENT COMMAND CLIMATE

The reconnaissance platoon leader gives the platoon direction, sets priorities, and establishes the command climate (values, attitudes, and beliefs). Successful preservation of combat power requires him to embed risk management into individual behavior. To fulfill this commitment, the platoon leader must exercise creative leadership, innovative planning, and careful management. Most importantly, he must demonstrate support for the risk management process.

a. The reconnaissance platoon leader and others in the platoon chain of command can establish a command climate favorable to risk management integration by taking the following actions:

- Demonstrate consistent and sustained risk management behavior through leadership by example and emphasis on active participation throughout the risk management process.
- Provide adequate resources for risk management. Every leader is responsible for obtaining the assets necessary to mitigate risk and for providing them to subordinate leaders.
- Understand his and his soldiers' limitations as well as the unit's capabilities.
- Allow subordinates to make mistakes and learn from them.
- Prevent a "zero defects" mindset from creeping into the platoon's culture.
- Demonstrate full confidence in subordinates' mastery of their trade and their ability to execute a chosen COA.
- Keep subordinates informed.
- Listen to subordinates.

b. For the reconnaissance platoon leader, subordinate leaders, and individual soldiers, responsibilities in managing risk include --

- Making informed risk decisions. Establish and then clearly communicate risk decision criteria and guidance.
- Establishing clear, feasible risk management policies and goals.
- Training the risk management process. Ensure that subordinates understand the who, what, when, where, and why of managing risk and how these factors apply to their situation and assigned responsibilities.
- Accurately evaluating the platoon's effectiveness, as well as subordinates' execution of risk controls during the mission.
- Informing higher headquarters when risk levels exceed established limits.

APPENDIX D

FRATRICIDE AVOIDANCE

Fratricide is defined as the employment of friendly weapons that results in the unforeseen and unintentional death or injury of friendly personnel or damage to friendly equipment. Fratricide avoidance is the platoon leader's responsibility. All leaders across all operating systems assist him in accomplishing this mission. This appendix focuses on actions the reconnaissance platoon leader and his subordinate leaders can take with current resources to reduce the risk of fratricide.

More than any other maneuver element, reconnaissance platoons are at risk of being victims of fratricide. The reconnaissance platoon is particularly vulnerable because it often maneuvers in dispersed elements forward and to the flanks of other friendly combat forces. In a battalion, companies often do not keep up with the plan or with the disposition of the reconnaissance platoon. For these reasons, situational understanding on the part of all reconnaissance leaders, particularly the platoon leader, is critical not only to mission success but also to survival.

In any tactical situation, it is critical that every platoon member know where he is and where other friendly elements are operating. With this knowledge, he must anticipate dangerous conditions and take steps either to avoid them or to mitigate them. The platoon leader must always be vigilant of changes and developments in the situation that may place his sections and teams in danger. He must also ensure that all reconnaissance sections' or teams' positions are constantly reported to higher headquarters so that all other friendly elements are aware of where they are and what they are doing. No-fire areas can be designated to control friendly direct and indirect fire into areas in which the reconnaissance platoon is or will be operating. When the platoon leader perceives a potential fratricide situation, he must personally use the higher net to coordinate directly with the friendly element involved.

D-1. TRAINING

The underlying principle of fratricide avoidance is simple: Leaders who know where their soldiers are, and where they want them to operate, can minimize the risks inherent in combat operations. At the same time, leaders must avoid at all costs any reluctance to employ, integrate, and synchronize all required operating systems at the critical time and place. They must avoid becoming tentative out of fear of fratricide; rather, they strive to eliminate fratricide risk through tough, realistic, combined arms training in which each soldier and unit achieves the established standard. Training allows units and soldiers to make mistakes and learn from them with the goal of reducing or eliminating the risk of errors occurring in combat. A key role of the reconnaissance platoon training program is to teach sections and teams what, when, and where to engage the enemy. Eliminating the risk of fratricide is no less critical as a training standard than are other mission requirements. All leaders must know all aspects of the applicable training standard, including fratricide avoidance, and must ensure that their soldiers train to that standard.

D-2. EFFECTS

Fratricide results in unacceptable losses and increases the risk of mission failure; it almost always affects the unit's ability to survive and function. Units experiencing fratricide suffer these consequences:

- Loss of confidence in the unit's leadership.
- Increasing self-doubt among leaders.
- Hesitancy in the employment of supporting combat systems.
- Over supervision of units.
- Hesitancy in the conduct of night operations.
- Loss of aggressiveness in maneuver.
- Loss of initiative.
- Disrupted operations.
- General degradation of unit cohesiveness, morale, and combat power.

D-3. CAUSES

The following paragraphs discuss the primary causes of fratricide. Leaders must identify any of the factors that may affect their units and then strive to eliminate or correct them.

a. **Failures in the Direct Fire Control Plan.** Failures occur when units do not develop effective fire control plans, particularly in the offense. Units may fail to designate engagement areas or to adhere to the direct fire plan, or they may position their weapons incorrectly. Under such conditions, fire discipline often breaks down upon contact. An area of particular concern is the additional planning that must go into operations requiring close coordination between mounted elements and dismounted teams.

b. **Land Navigation Failures.** Units often stray out of assigned sectors, report wrong locations, and become disoriented. Much less frequently, they employ fire support weapons in the wrong location. In either situation, units that unexpectedly encounter another unit may fire their weapons at the friendly force.

c. **Failures in Combat Identification.** Vehicle commanders and machine gun crews cannot accurately identify the enemy near the maximum range of their systems. In limited visibility, friendly units within that range may mistake one another as the enemy.

d. **Inadequate Control Measures.** Units may fail to disseminate the minimum necessary maneuver control measures and direct fire control measures. They may also fail to tie control measures to recognizable terrain or events. As the battle develops, the plan cannot address branches and sequels as they occur. When this happens, synchronization fails.

e. **Failures in Reporting and Communications.** Units at all levels may fail to generate timely, accurate, and complete reports as locations and tactical situations change. This distorts the common operating picture at battalion and brigade level (available on FBCB2) and can lead to erroneous clearance of fires.

f. **Weapons Errors.** Lapses in individual discipline can result in fratricide. These incidents include charge errors, accidental discharges, mistakes with explosives and hand grenades, and use of incorrect gun data.

g. **Battlefield Hazards.** A variety of explosive devices and materiel may create danger on the battlefield--unexploded ordnance, booby traps, and unmarked or unrecorded minefields, including scatterable mines. Failure to mark, record, remove, or otherwise anticipate these threats leads to casualties.

h. **Reliance on Instruments.** A unit that relies too heavily on systems such as the FBCB2 and GPS devices will find its capabilities severely degraded if these systems fail. The unit will be unable to maintain situational understanding. To prevent potential dangers when system failure occurs, the reconnaissance platoon leader must ensure that he and his platoon use a balance of technology with traditional basic soldier skills in observation, navigation, and other critical activities.

D-4. AVOIDANCE

The measures outlined in this paragraph provide the platoon with a guide to actions it can take to reduce or prevent fratricide risk. These guidelines are not directive in nature nor are they intended to restrict initiative. Commanders and leaders must learn to apply them as appropriate based on the specific situation and METT-TC factors.

a. **Principles.** At the heart of fratricide reduction and avoidance are five key principles:

(1) ***Identify and Assess Potential Fratricide Risks during the Troop-Leading Procedures.*** Incorporate risk reduction control measures in the OPOD and applicable FRAGOs.

(2) ***Maintain Situational Understanding.*** Focus on areas such as current intelligence, unit locations/dispositions, obstacles, contamination such as ICM and NBC, SITREPs, and METT-TC factors. FBCB2 provides the reconnaissance platoon with a distinct advantage in situational understanding.

(3) ***Ensure Positive Target Identification.*** Review vehicle and weapons identification cards. Become familiar with the characteristics of potential friendly and enemy vehicles, including their silhouettes and thermal signatures. This knowledge should include the conditions, including distance (range) and weather, under which positive identification of various vehicles and weapons is possible. Enforce the use of challenge and password, especially during dismounted operations.

(4) ***Maintain Effective Fire Control.*** Ensure fire commands are accurate, concise, and clearly stated. Make it mandatory for soldiers to ask for clarification of any portion of the fire command that they do not completely understand. Stress the importance of the chain of command in the fire control process and ensure soldiers get in the habit of obtaining target confirmation and permission to fire from their leaders before engaging targets they assume are enemy elements. Know who will be in and around the area of operations.

(5) ***Establish a Command Climate that Emphasizes Fratricide Avoidance.*** Enforce fratricide avoidance measures, placing special emphasis on the use of doctrinally sound TTP. Ensure constant supervision in the execution of orders and in the performance of all tasks and missions to standard.

b. **Guidelines and Considerations.** Additional guidelines and considerations for fratricide reduction and avoidance include the following:

(1) Recognize the signs of battlefield stress. Maintain unit cohesion by taking quick, effective action to alleviate stress.

(2) Conduct individual, leader, and collective (unit) training covering fratricide awareness, target identification and recognition, and fire discipline.

(3) Develop a simple, executable plan.

(4) Give complete and concise operation orders. Include all appropriate recognition signals in paragraph 5 of the OPORD.

(5) To simplify operation orders, use SOPs that are consistent with doctrine. Periodically review and update SOPs as needed.

(6) Strive to provide maximum planning time for leaders and subordinates.

(7) Use common language (vocabulary) and doctrinally correct standard terminology and control measures.

(8) Ensure thorough coordination is conducted at all levels.

(9) Plan for and establish effective communications.

(10) Plan for collocation of command posts (CPs) whenever it is appropriate to the mission, such as during a passage of lines.

(11) Make sure ROE are clear.

(12) Conduct rehearsals whenever the situation allows adequate time to do so.

(13) Be in the right place at the right time. Use position location/navigation devices (GPS and POSNAV), know your location and the locations of adjacent units (left, right, leading, and follow-on), and synchronize tactical movement. If the platoon or any element becomes lost, its leader must know how to contact higher headquarters immediately for instructions and assistance.

(14) Establish, execute, and enforce strict sleep and rest plans.

APPENDIX E

NUCLEAR, BIOLOGICAL, OR CHEMICAL ENVIRONMENT OPERATIONS

Nuclear, biological, and chemical weapons can cause casualties, destroy or disable equipment, restrict the use of terrain, and disrupt operations. They can be used separately or in combination to supplement conventional weapons. The reconnaissance platoon must be prepared to operate on an NBC-contaminated battlefield without degradation of the platoon's overall effectiveness. This appendix prescribes active and passive protection measures to avoid or reduce the effects of NBC weapons.

E-1. CHEMICAL AGENTS

Chemical agents cause casualties, degrade performance, slow maneuver, restrict terrain, and disrupt operations (Table E-1). They can cover large areas and may be delivered as a liquid, vapor, or aerosol and can be disseminated by artillery, mortars, rockets, missiles, aircraft spray, bombs, land mines, and covert means.

AGENT	Nerve	Blood	Blister	Choking
PROTECTION	Mask and BDO	Mask and BDO	Mask	Mask
DETECTION	M8A1, M256A1, CAM, M8 and M9 paper	M256A1, CAM, M8 and M9 paper	M256A1	Odor (freshly mowed hay)
SYMPTOMS	Difficult breathing, drooling, nausea, vomiting, convulsions, and blurred vision	Burning eyes, stinging skin, irritated nose	Convulsions and coma	Coughing, nausea, choking, headache, and tight chest
EFFECTS	Incapacitates	Blisters skin, damages respiratory tract	Incapacitates	Floods and damages lungs
FIRST AID	Mark 1 NAAK	As for 2d and 3d degree burns	None	Keep warm and avoid movement
DECON	M291 and flush eyes with water	M291 and flush eyes with water	None	None

Table E-1. Characteristics of chemical agents.

E-2. BIOLOGICAL AGENTS

- a. **Toxins.** Toxins are poisonous substances produced from living organisms. Toxins--
 - Can be synthesized (artificially produced).
 - Mirror the symptoms of nerve agents.
 - Present 8-12 hours of tactical concern (destroyed by sun).
 - Can be fast acting (neurotoxins) or slower acting (cytotoxins).
- b. **Pathogens.** These are infectious agents that cause disease in man and animals, such as bacteria, viruses, and rickettsiae. Pathogens have the following characteristics:

- Delayed reaction (incubation 1-21 days).

- Multiply and overcome natural defenses.
- Vectors (diseased infected insects) circumvent protective clothing and prolong hazards.

c. **Protection from Biological Attack.** Protective measures against biological attack include the following:

- Up-to-date immunizations.
- Good hygiene.
- Area sanitation.
- Physical conditioning.
- Water purification.

E-3. NUCLEAR WEAPONS

a. **Effects.** The following are effects of nuclear detonations:

(1) **Blast.** High-pressure shock wave crushes structures and causes missing damage.

(2) **Thermal Radiation.** Intense heat and extremely bright light causes burns, temporary blindness, and dazzle.

(3) **Nuclear Radiation.** Energy released from nuclear detonation produces fallout in the form of initial and residual radiation, both of which can cause casualties.

(4) **Electromagnetic Pulse.** Surge of electrical power occurs within seconds of a nuclear detonation and damages electrical components in equipment (radios, radar, computers, and vehicles) and weapons systems (TOW, Javelin,).

b. **Protection from Nuclear Attack.** Cover and or shielding offers the best protection from the immediate effects of a nuclear attack. This includes cover in fighting positions, culverts, and ditches. Soldiers should cover exposed skin and stay down until the blast wave passes and debris stops falling. Immediately after a nuclear attack, the platoon leader should begin continuous monitoring for radiation using the AN/VDR-2 radiacmeter.

E-4. TENETS OF NBC DEFENSE

Protect the force by adhering to three tenets of NBC defense: contamination avoidance, protection, and decontamination.

a. **Contamination Avoidance.** Avoiding NBC attacks and hazards is the key to NBC defense. Avoidance allows commanders to shield soldiers and units, thus shaping the battlefield. It involves both active and passive measures. Passive measures include training, camouflage, concealment, hardening positions, and dispersion. Active measures include detection, reconnaissance, alarms and signals, warning and reporting, marking, and contamination control.

b. **NBC Reconnaissance.** NBC reconnaissance is the detection, identification, reporting, and marking of NBC hazards. NBC reconnaissance consists of search, survey, surveillance, and sampling operations. Due to the limited availability of the M93 FOX reconnaissance vehicle, consider, as a minimum, the following actions when planning and preparing for NBC reconnaissance:

- Use the IPB process to orient on NBC threat NAIs.
- Pre-position reconnaissance assets to support requirements.
- Establish command and support relationships.
- Assess the time and distance factors for the conduct of NBC reconnaissance.

- Report all information rapidly and accurately.
- Plan for resupply activities to sustain NBC reconnaissance operations.
- Determine possible locations for post-mission decontamination.
- Plan for fire support requirements.
- Enact fratricide prevention measures.
- Establish MEDEVAC procedures.
- Identify NBC warning and reporting system (NBCWRS) procedures and frequencies.

c. **NBC Protection.** NBC protection is an integral part of operations. Techniques that work for avoidance also work for protection (for example, shielding soldiers and units and shaping the battlefield). Other activities that comprise protection involve sealing or hardening positions, protecting soldiers, assuming mission-oriented protective posture (Table E-2), reacting to attack, and using collective protection. Individual protective items include the protective mask, battle dress overgarments (BDOs), green vinyl overboots, and gloves. The corps or higher level commander establishes the minimum level of protection. Subordinate units may increase this level as necessary, but they may not decrease it.

MOPP Levels							
<i>Level</i> <i>Equip</i>	MOPP Ready	MOPP 0	MOPP 1	MOPP 2	MOPP 3	MOPP 4	Mask Only
<i>Mask</i>	Carried	Carried	Carried	Carried	Worn	Worn	Worn***
<i>BDO</i>	Ready*	Avail **	Worn	Worn	Worn	Worn	
<i>Overboots</i>	Ready*	Avail **	Avail **	Worn	Worn	Worn	
<i>Gloves</i>	Ready*	Avail **	Avail **	Avail **	Avail **	Worn	
<i>Helmet Cover</i>	Ready*	Avail **	Avail **	Worn	Worn	Worn	

* Items avail to soldier within 2 hours w/replacement avail within 6 hours
 ** Items must be positioned within arm's reach of the soldier
 *** Never "mask only" if nerve or blister agent is used in AO

Table E-2. MOPP levels.

d. **NBC Decontamination.** Use of NBC weapons creates unique residual hazards that may require decontamination (decon). In addition to the deliberate use of these weapons, collateral damage, natural disasters, and industrial emitters may require decontamination. Contamination forces units into protective equipment that degrades performance of individual and collective tasks. Decontamination restores combat power and reduces casualties that may result from exposure, thus allowing commanders to sustain combat operations.

(1) **Principles of Decontamination.** Use the four principles of decontamination when planning decon operations:

- Decon as soon as possible.
- Decon only what is necessary.
- Decon as far forward as possible (METT-TC dependent).
- Decon by priority.

(2) **Levels of Decontamination** (Table E-3, page E-4).

(a) **Immediate.** Immediate decontamination requires minimal planning. It is a basic soldier survival skill and is performed in accordance with STP 21-1-SMCT. Personal

wipedown removes contamination from individual equipment using the M291. Operator spraydown uses the on-board decon apparatus with DS2 (M11 or M13) to decontaminate surfaces that an operator must touch or contact to operate the equipment.

(b) *Operational*. Operational decontamination involves MOPP gear exchange and vehicle spraydown. MOPP gear exchange should be performed within six hours of being contaminated when thorough decon cannot be performed. Vehicle washdown should be performed within one hour of being contaminated when the mission does not permit thorough decon. The process removes gross contamination and limits the spread of contamination.

(c) *Thorough*. Thorough decontamination involves detailed troop decontamination (DTD) and detailed equipment decontamination (DED). Thorough decontamination is normally conducted by company-size elements as part of restoration or during breaks in combat operations. These operations require support from a chemical decontamination platoon.

Level	Technique	Best Start Time	Responsibility	Advantages
Immediate	Skin Decon	Within 1 minute of contamination	Individual	Prevents agents from penetrating*
	Personal Wipedown	Within 15 minutes	Individual or Crew	
	Operator Spraydown	Within 30 minutes		
Operational	MOPP Gear Exchange**	Optimal within 6 hours, but NLT 24 hours	Contaminated Unit	Temporary relief from MOPP4. Limit agent spread
	Vehicle Washdown***			
Thorough	DED	When mission allows/ reconstitution	Decon PLT	Long-term MOPP reduction with minimal risk
	DTD		Unit	
<p>* The techniques become less effective the longer they are delayed.</p> <p>** Performance degradation and risk assessment must be considered when exceeding 6 hours. See FM 3-4 for information on BDO risk assessment.</p> <p>*** Vehicle washdown is most effective if started within one hour.</p>				

Table E-3. Comparison data for decontamination levels.

(3) *Decontamination Planning Considerations*. Leaders should include the following when planning for decontamination:

- Plan decon sites throughout the width and depth of the sector.
- Tie decon sites to the scheme of maneuver and templated NBC strikes.
- Apply the principles of decontamination.
- Plan for contaminated routes.
- Plan for logistics and resupply of MOPP, mask parts, water, and decon supplies.
- Plan for medical concerns to include treatment and evacuation of contaminated casualties.
- Maintain site security.

APPENDIX F

JAVELIN EMPLOYMENT

The Javelin provides accurate, medium-range antiarmor fire for the SBCT infantry platoon. The Javelin is used in offensive operations to provide precision direct fires that suppress or destroy enemy armored vehicles and destroy fortifications. In defensive operations, the Javelin may be used to overwatch obstacles, destroy armored vehicles, and force the enemy commander to dismount prematurely, exposing his infantry to small arms and indirect fires. The Javelin can destroy targets from medium ranges (65 to 2,000 meters), including helicopters and fortified positions. The platoon leader also can use the Javelin's imaging infrared (I²R) sight capability to conduct surveillance of critical avenues of approach in all types of weather. The Javelin also may be used to engage bunkers, buildings, and other fortified targets commonly found during combat in built-up areas.

F-1. THE JAVELIN WEAPON SYSTEM

The Javelin is a dual-mode (top attack or direct attack), man-portable antitank missile with an increased capability to engage and defeat tanks and other armored vehicles (Table F-1). The Javelin has a missile contained in a disposable launch tube/container and a reusable tracker and is a fire-and-forget weapon system. Additionally, the Javelin has a soft launch that significantly reduces the visual and acoustical signature of the missile.

NOTE: The Javelin will replace the Dragon on a one-for-one basis in infantry and engineer units with no additional changes in current force structure.

Type System:	Fire and Forget
Carry Weight (Total):	49.2 lb (day & night)
Command Launch Unit:	14.1 lb (day & night)
Missile (w/launch tube):	35.2 lb
Crew:	Man portable
Ready to Fire:	Less than 30 sec.
Reload Time:	Less than 20 sec.
Method of Attack:	Top attack or direct attack (top attack is normal)
Range:	Top-attack mode: 150m-2000m Direct-attack mode: 65-2000m
Fighting Position Restrictions:	1m x 2m, ventilation is recommended
Guidance System:	<i>Imaging Infrared or I²R</i> seeker
Sights:	Integrated Day/Night sight unit
Time of Flight:	1,000m = approx. 4.6 sec 2,000m = approx. 14.5 sec
Sight Magnification:	4X day, 4X wide field of view and 9X narrow field of view night

Table F-1. Javelin technical characteristics.

a. **Command Launch Unit.** The nondisposable section of the Javelin is the CLU (Figure F-1). The Javelin's night sight and day sight are integrated into one unit. The imaging infrared or I²R sight has a 2,000-meter plus range, under most conditions, which greatly increases target acquisition by the infantryman. The sight can operate for over four hours on a single battery and requires no coolant bottles. It has a built-in test capability that alerts the gunner if the system is not functioning properly during operation.

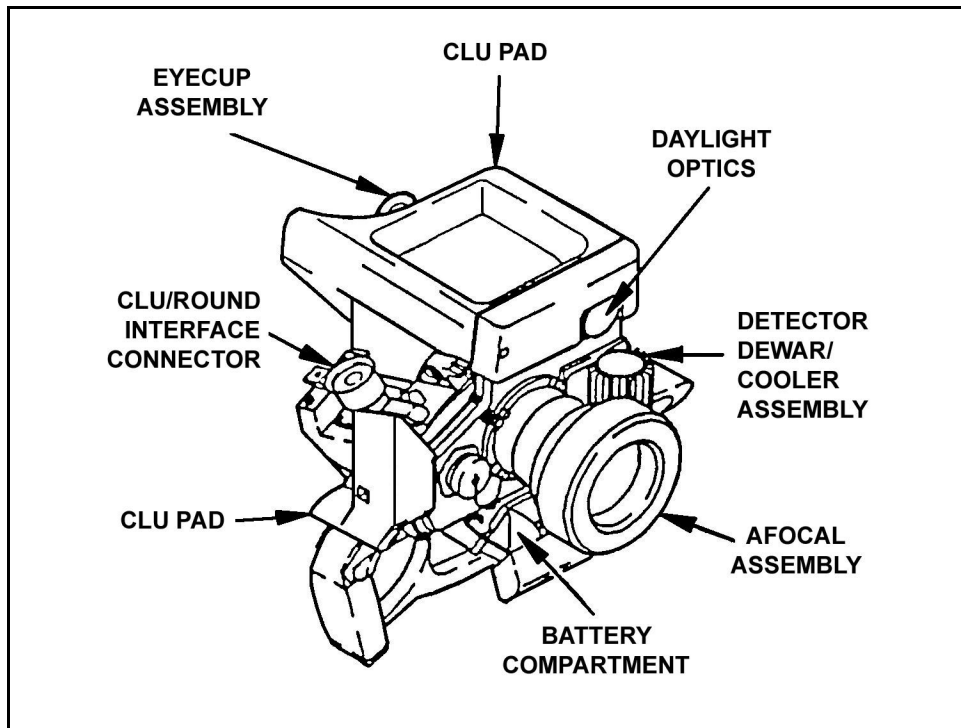


Figure F-1. Command launch unit.

b. **Missile.** The missile is contained in a disposable launch tube. It has a passive imaging infrared system that locks on to the target before launch and is self-guiding. It uses a tandem shaped-charge warhead and a two-stage solid propellant with a low signature, soft-launch motor, and a minimum smoke flight motor. The launch tube assembly and missile is shown in Figure F-2.

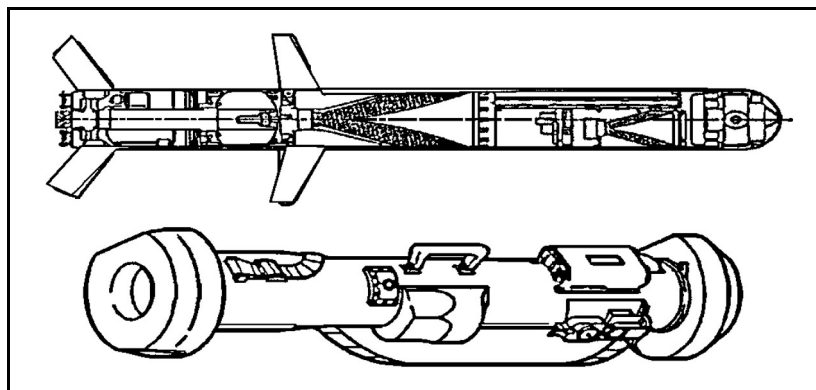


Figure F-2. Launch tube assembly and missile.

F-2. CAPABILITIES

The Javelin antitank missile has improved capabilities over the Dragon.

a. **Lethality.** The Javelin is more lethal than the Dragon. The Javelin's 2,000-meter range and its tandem warhead, which defeats all known armor, enhance the Javelin's lethality.

(1) In the top-attack mode, the missile strikes the thinner armor on the top of an armored vehicle rather than the thicker frontal and side armor plates. Top attack also prevents an enemy target from protecting itself by moving behind frontal cover. When used in urban areas or where obstacles might interfere with the top-attack flight path of the missile, the Javelin also can be fired in the direct attack mode.

(2) The fire-and-forget capability of the Javelin increases the probability of a hit. Because the gunner is no longer exposed to enemy suppressive fires while tracking the target until impact, he can use the missile's flight time to reload in a covered and concealed position and begin engaging another target.

b. **Survivability.** The Javelin's low launch signature decreases the enemy's ability to acquire gunners when they fire the missile. All gunner engagement tasks are accomplished before launching the missile, making time of flight irrelevant. The 2,000-meter range also places the Javelin gunner outside the armored vehicle's effective coaxial machine gun range. However, he is still within the range of the main gun.

(1) The Javelin uses a passive infrared system for target acquisition and lock-on. This means that it emits no infrared or radar beam for enemy vehicles or smart munitions to detect, further increasing the survivability of the Javelin gunner.

(2) The Javelin sight offers the commander a superior observation capability as compared to the Dragon. The Javelin sight can detect targets in excess of 3,000 meters.

(3) Because of the Javelin's low backblast, it can be fired from smaller, harder to locate, better protected positions that give the gunner a greater chance of remaining undetected or, if detected, surviving any suppressive fires.

c. **Agility.** The Javelin is man-portable and relatively lightweight for an antitank missile system, which allows the system to be moved about the battlefield with relative ease. The Javelin's soft launch capability allows it to be fired from inside buildings, bunkers, and other restricted spaces with less disruption to the gunner and less signature to be observed by the enemy. Although flank shots are still the preferred method of engagement, the Javelin's low signature launch and top-attack mode make frontal and

oblique engagements more effective than in the past. These capabilities give the infantry leader additional options in his antiarmor fires planning and positioning.

d. **Flexibility.** The capabilities of the Javelin give the leader more flexibility in the use and emplacement of his antiarmor systems. This new degree of flexibility challenges the leader to make a careful METT-TC analysis to ensure that he is taking full advantage of the Javelin's capabilities.

(1) The greater range of the Javelin gives the leader a system that complements MGS fires, allowing him to achieve mutual support and greater overlapping fires between the systems. The Javelin's lethality and more than 2,000-meter range allow the MGS to concentrate main gunfires on targets at standoff range. This allows the platoon leader to attack the enemy throughout the depth of his formation with antiarmor fires.

(2) Engaging at maximum standoff ranges and handing off the fight to the Javelin gunners provides more time for MGSs to be moved to alternate positions and allows the platoon leader to mass fires at the critical time and place on the battlefield.

F-3. LIMITATIONS

There are certain times when the Javelin system is not able to engage targets. These occur either when a target is not exposed long enough for the missile seeker to achieve proper lock-on or when atmospheric conditions interfere with the seeker.

a. **Limited Visibility.** Heavy rain, smoke, fog, snow, sleet, haze, and dust are referred to as limited visibility conditions. The presence of these conditions can affect the gunner's ability to acquire and engage targets with the Javelin, especially when using the day sight of the CLU. The gunner should use the I²R sight of the CLU to acquire targets because it provides the best target image during limited visibility conditions.

b. **Infrared Crossover.** Infrared crossover occurs at least twice in each 24-hour period when the temperatures of soil, water, concrete, and vegetation are approximately the same and the objects all emit the same amount of infrared energy. If there is little difference in the amount of infrared energy between a target and its background, then neither the Javelin CLU nor the missile seeker can see the target well, thus greatly degrading the performance of the Javelin. This situation may last as long as an hour until either the background or the target changes temperature enough to become detectable.

c. **Time Space Factor.** Just because a target appears in the open and within range does not always mean a Javelin gunner can acquire it, lock on it, fire, and hit it. A vehicle must be exposed long enough for the gunner to identify it as a target and then to achieve target lock-on with the Javelin missile seeker. This process is not instantaneous and varies with the skill of the gunner.

F-4. EMPLOYMENT CONSIDERATIONS

The Javelin's primary role is to destroy enemy armored vehicles. When there is not an armored threat, the Javelin can be employed in a secondary role of providing fire support against point targets such as bunkers and crew-served weapons positions. In addition, the Javelin's CLU can be used alone as a night-vision device for reconnaissance, security operations, and surveillance.

a. **Mutual Support.** Javelins should be positioned so they can support other Javelins as firing pairs (Figure F-3), MGSs, or AT4s. In terrain that has multiple narrow avenues of approach, the platoon leader may assign Javelins singly. In open terrain, the Javelin

can be positioned to achieve overlapping sectors (Figure F-4). Mutual support prevents the enemy from isolating a portion of the friendly unit and then concentrating on one sector without being subjected to fire from another. When mutual support is achieved, if one Javelin is destroyed or forced to displace, the others can continue covering the assigned sector. As a rule of thumb, gunners normally should be positioned far enough apart so that enemy fires directed at one can not suppress others.

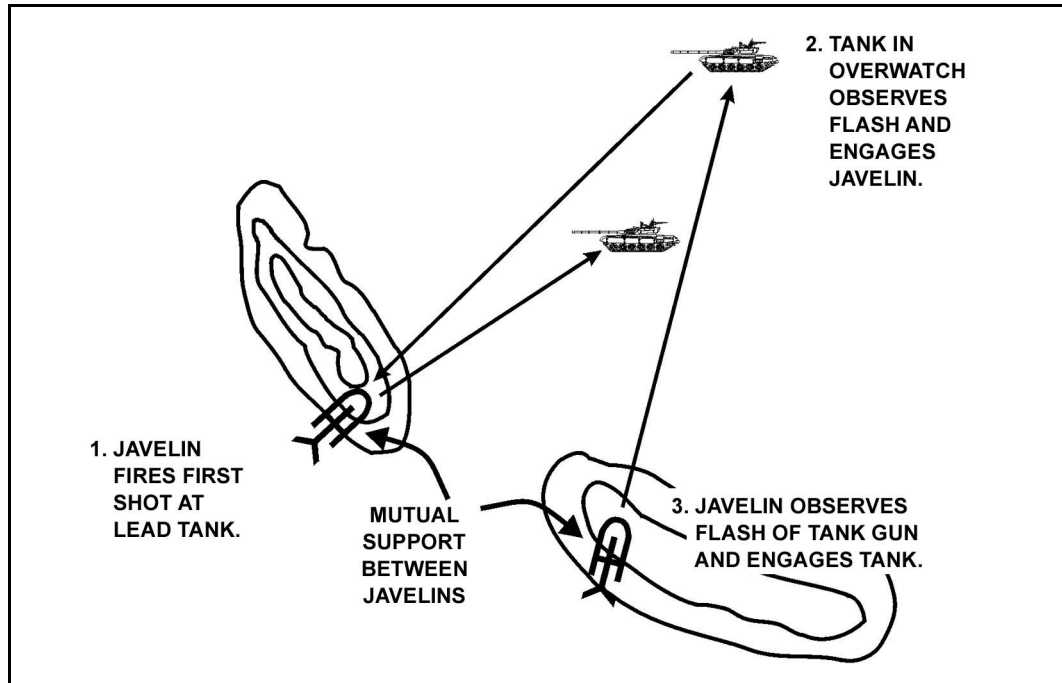


Figure F-3. Employment by firing pair.

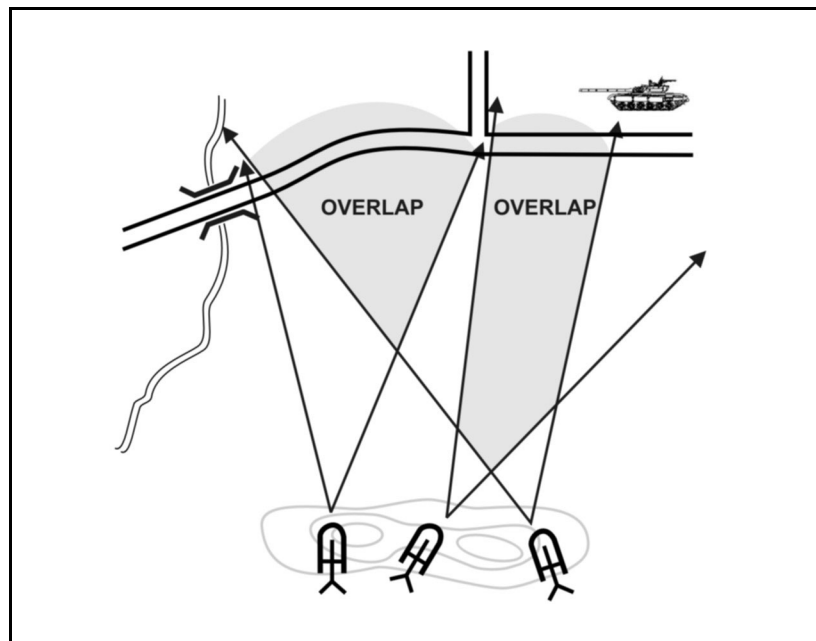


Figure F-4. Overlapping sectors of fire.

b. **Flank Shot Engagements.** Leaders should position Javelins to engage from the flank whenever possible because--

- Armored vehicles are most vulnerable from the flank.
- The focus of the crew normally will be to the front and not to the flank.
- Armored vehicles present the largest visual and infrared target from the flank.
- The vehicle's sighting systems, laser range finder, and firepower normally are oriented to the front, not the flank.
- Armored vehicles have less armor on the sides than on the front. This is important when engaging in the direct-attack mode.

c. **Javelin Standoff Advantage.** The difference between the Javelin's maximum range and the maximum effective range of the enemy tank's coaxial machine gun (Figure F-5) creates an advantage in a standoff. The Javelin's maximum range is 2,000 meters. The maximum effective range of a T-72 coaxial machine gun is 1,000 meters. The Javelin gunner should strive to engage enemy tanks in the 1,000- to 2,000-meter range.

NOTE: Most modern tanks, as well as infantry fighting vehicles, can fire high-explosive ammunition to suppress gunners out to 4,000 meters.

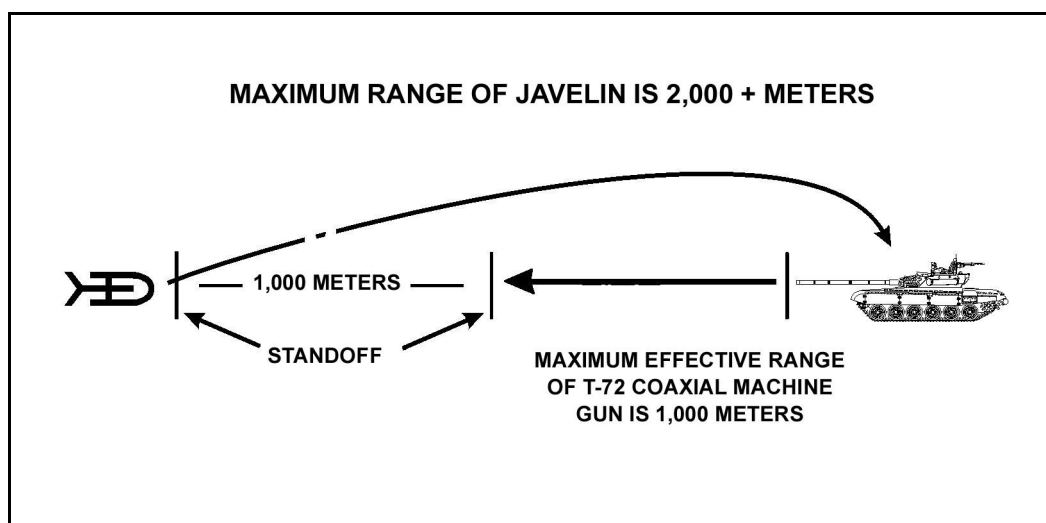


Figure F-5. Standoff range.

d. **Cover and Concealment.** Cover and concealment are critical to the survival of an antiarmor weapon system and its crew. The leader responsible for Javelin employment must analyze cover and concealment along with fields of fire and observation.

(1) **Cover.** Cover is protection from enemy weapons fire and may be natural or man-made. Natural cover includes reverse slopes, ravines, and hollows. Man-made cover includes fighting positions, walls, rubble, and craters.

(2) **Concealment.** Concealment is the ability to hide from enemy observation. Soldiers should avoid unnecessary movement, stay low and observe, and present themselves and their equipment using the lowest silhouette possible. They should alter familiar shapes by breaking up the common outlines of the position and equipment using vegetation and camouflage netting. They must pay attention to the varied colors and textures of the area to ensure the position blends in with its background. Additionally,

noises (such as engines running, talking, and moving equipment) can be heard by enemy patrols and observation posts. Shiny surfaces can reflect light for great distances; therefore, soldiers must be careful not to expose anything that shines.

e. **Soldier's Load.** When employing the Javelin in the dismounted role, the soldier's load becomes important. With a total system weight of just under 50 pounds, the Javelin is heavy. Although a man-portable weapon, one soldier cannot easily carry the Javelin cross country for extended periods. Leaders should be aware of this problem and address it as they would any other soldier's load difficulty. FM 21-18 discusses soldier's load and cross-leveling equipment during movement to reduce the burden on soldiers. Leaders should develop unit SOPs that identify and describe the details of unit equipment cross leveling.

f. **Massed Fires.** Massed fires are achieved by coordinating the total effects of the platoon's combat power at the decisive place and time to gain favorable results against the enemy. The platoon achieves mass through mutual fire support, detailed fire control, and fire distribution measures that synchronize all of the fires of the platoon's weapon systems and elements. The Javelin always should be positioned so that its fires are part of a cohesive combination including small arms, crew-served weapons, MGS, mortar and artillery, as well as the close-in fires of the squads using AT-4 light antiarmor weapons.

F-5. JAVELIN EMPLOYMENT DURING URBAN COMBAT

Javelins provide overwatching antitank fires during the attack of a built-up area and an extended range capability for the engagement of armor during the defense. Within built-up areas, they are best employed along major thoroughfares and from the upper stories of buildings to attain long-range fields of fire. The missile's minimum arming range and flight profile could limit firing opportunities within the confines of densely built-up areas.

a. **Restrictions.** Ground obstacles and water do not restrict the Javelin with its fire-and-forget capability. However, with its unique flight characteristics, overhead obstacles can limit its use in urban terrain. In the top-attack mode, the Javelin missile requires up to 160-plus meters of overhead clearance (Figure F-6, page F-8). In the direct-attack mode, the Javelin requires up to 60-plus meters of overhead clearance (Figure F-7, page F-8). Gunners must ensure that sufficient overhead clearance is available along the missile flight path before engaging targets in an urban environment.

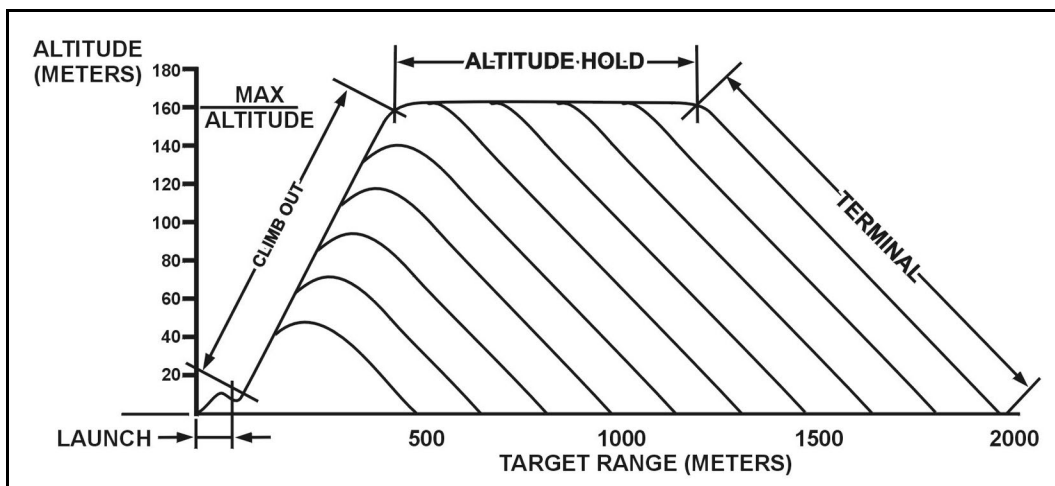


Figure F-6. Javelin flight profile in top-attack mode.

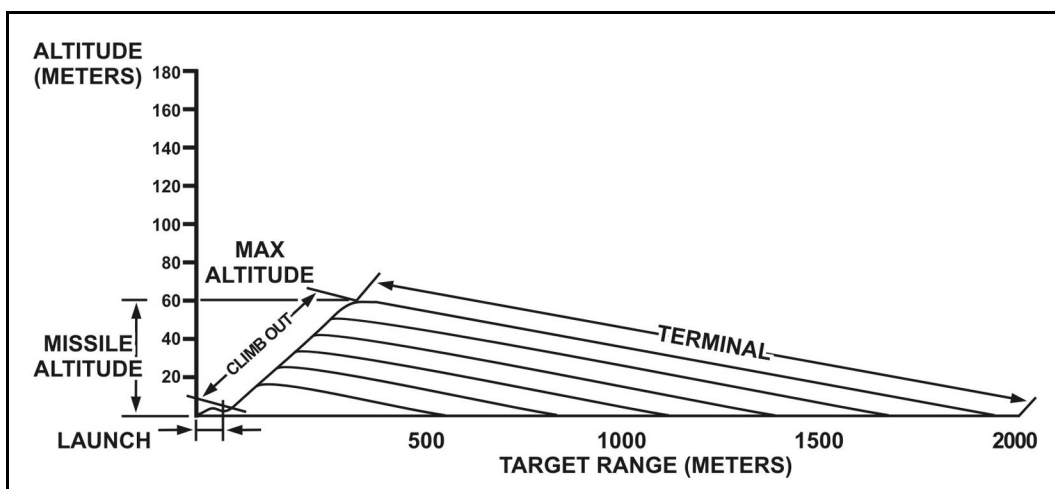


Figure F-7. Javelin flight profile in direct-attack mode.

b. **Dead Space.** The aspects of dead space that affect Javelin fires the most are arming distance and target and background temperature differences.

(1) The Javelin missile has a minimum arming window of 65-75 meters. Few areas in the inner city permit fires much beyond the minimum arming distance. Ground-level long-range fires down streets or rail lines and across parks or plazas are possible. The Javelin may be used effectively from the upper stories or roofs of buildings to fire into other buildings.

(2) The Javelin gunner must take into consideration the targeting dead space sometimes caused by the background of the target and its heat signature. When firing from the upper stories of a building towards the ground, the missile seeker sometimes cannot discriminate between the target and surrounding rubble, buildings, or paving if that background material has the same temperature as the target.

c. **Backblast.** The Javelin's soft launch capability enables the gunner to fire from within an enclosed area (Figure F-8) with a reduced danger from backblast overpressure or flying debris. Personnel within the enclosure still should wear a helmet, protective

vest, ballistic eye protection, and hearing protection. To fire a Javelin from inside a room, the following safety precautions must be taken:

- Ceiling height must be at least 7 feet.
- The floor size of the room should be at least 15 feet by 12 feet.
- Window opening must be at least 5 square feet.
- Door opening must be at least 20 square feet.
- When launching a missile from an enclosure, allow sufficient room for the missile container to extend beyond the outermost edge of the enclosure.
- All personnel in the room must be forward of the rear of the weapon.

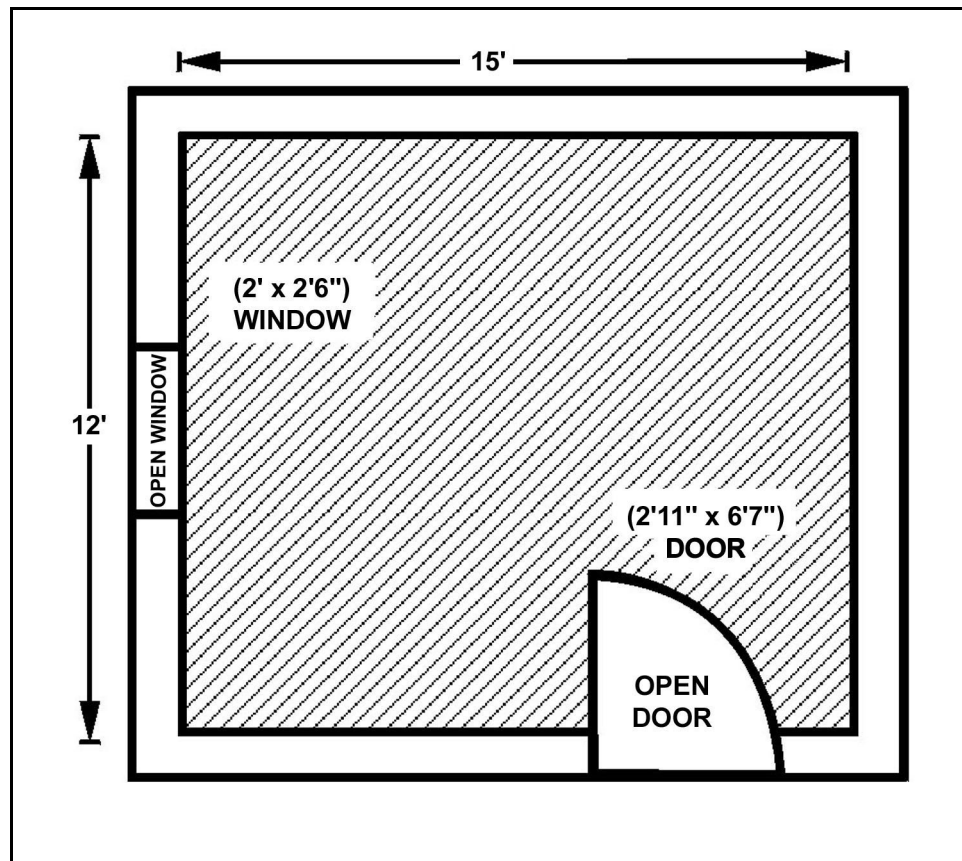


Figure F-8. Minimum room enclosure for Javelin firing.

d. **Weapon Penetration.** The warhead of the Javelin can achieve significant penetration against typical urban targets. Penetration, however, does not mean a concurrent destruction of the structural integrity of a position. When engaging a position in a building, the gunner must use the direct-attack mode to hit the target. When engaging a position or bunker in the open, the gunner may use either the top-attack or direct-attack mode.

F-6. JAVELIN FIRING POSITIONS

Each Javelin gunner should have a primary firing position and at least one alternate position. Depending on the factors of METT-TC, a supplementary position may also be assigned. A Javelin firing position must allow for target engagement and provide

protection for the soldiers and the weapon system. When selecting firing positions, leaders should consider the following:

- Cover to the front, flank, and overhead.
- Concealment from ground and aerial observation.
- Good observation and fields of fire.
- Covered and concealed routes to and between positions.
- Mutual support between squad positions and with other elements.
- Below ridgelines and crests, preferably on the sides of hills.
- Avoid positions in swampy areas and very steep hillsides as well as positions on or near prominent terrain features.

a. **Types of Javelin Positions.** The platoon leader should consider what type of positions he needs for his key weapons, including the Javelin. If time and material are available, the standard Javelin fighting position with overhead cover should be used. If time or material is short, then the platoon leader may opt to have his squads prepare flush positions. This paragraph discusses the advantages and disadvantages of the two types of Javelin positions.

(1) ***Standard Javelin Fighting Position with Overhead Cover.*** The standard Javelin fighting position has cover to protect gunners from direct and indirect fires (Figure F-9). It is a fairly large position with room for the Javelin gunner and another squad member plus their equipment. The position should be concealed among irregularities in the terrain and should be well camouflaged.

(a) The following are advantages of this position:

- Provides most protection against direct and indirect fire.
- Protects equipment from elements.

(b) The following are disadvantages of this position:

- Requires extensive Class IV items or cut timber.
- Requires extensive labor and may require engineer assistance or demolitions.
- Creates large, distinctive silhouette; difficult to hide completely in open terrain.

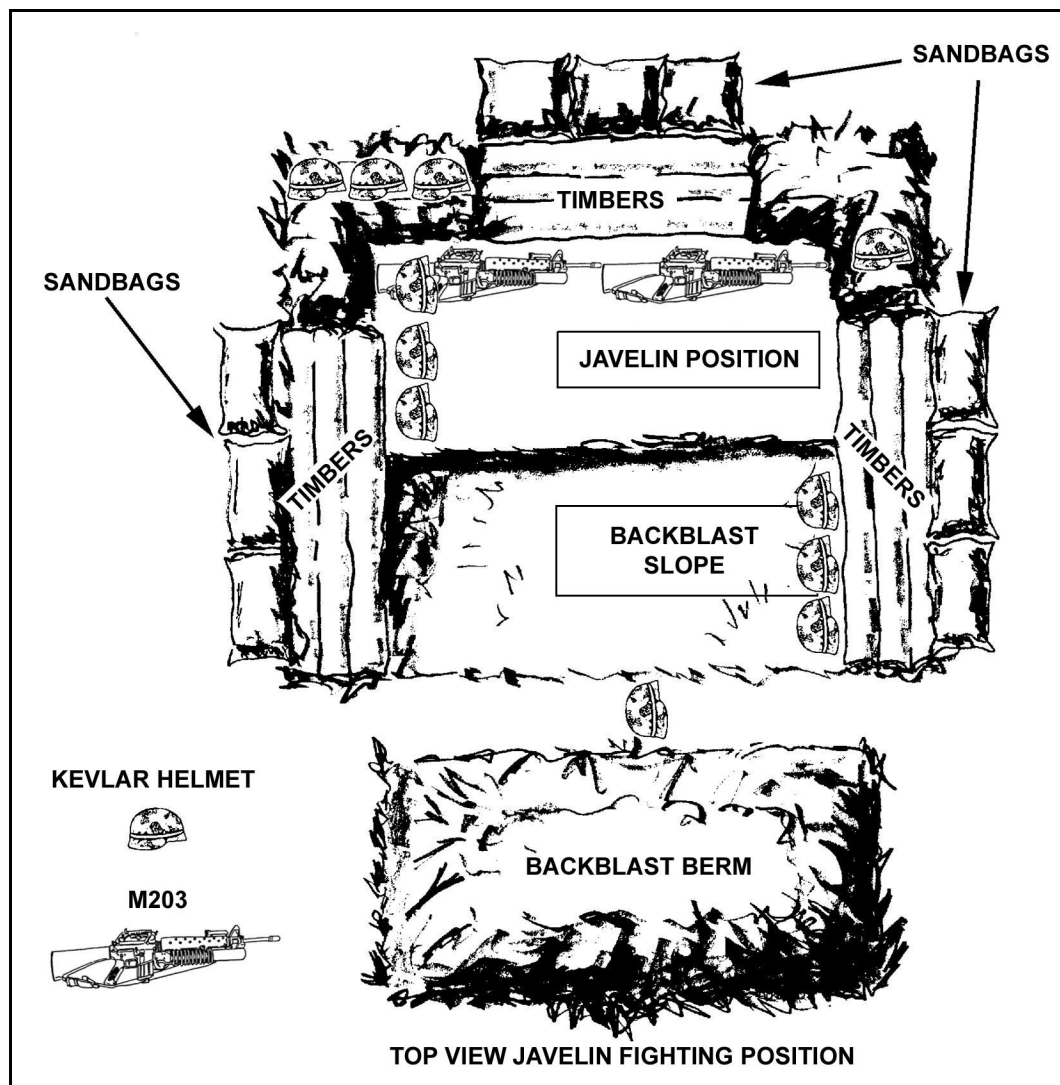


Figure F-9. Standard Javelin fighting position.

(2) **Flush Position.** The flush position (Figure F-10, page F-12) is a hasty position that does not provide overhead protection for the gunner during firing. The position is basically a hole dug to approximately armpit depth. Overhead cover can be prepared either to the center or the flanks of the position.

(a) The following are advantages of this position:

- Allows the Javelin gunner to reposition quickly.
- Is less labor intensive (more positions built in same amount of time).
- Requires less Class IV than the standard Javelin position.

(b) The following are disadvantages of the position:

- No overhead protection.
- Gunner not protected from indirect fires while in the target acquisition and firing sequence.
- Thermal signatures of gunner and assistant gunner not hidden.
- Gunner movements are easier to detect by the enemy.

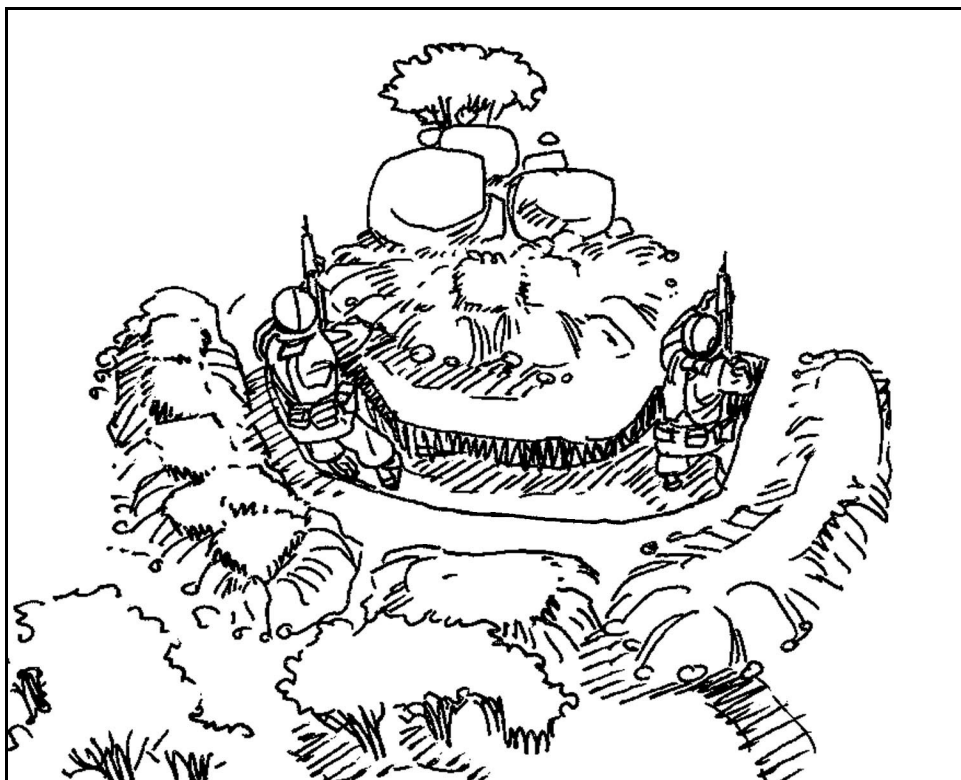


Figure F-10. Flush fighting position.

b. **Occupation of Firing Positions.** Javelin gunners should be careful to avoid detection while occupying a firing position; carelessly occupying a well-concealed position can compromise the position.

c. **Preparation.** The squad should prepare and improve a firing position from initial occupation until it is vacated. These actions include digging in, preparing a range card, and camouflaging the position. Once the position has been dug, it must be camouflaged using sod, leaves, brush, grass, or any other natural material. Camouflage nets or other man-made materials also can be used, but these work best if mixed with natural materials. Gunners must be ready to fight, even while preparing and improving the position. They must constantly observe the sector of responsibility to allow quick reaction if the enemy appears before the position is completely occupied.

d. **Movement Between Firing Positions.** Most enemy armor forces consider antitank guided missile systems to be critical targets. They expect antitank fires and will react immediately to suppress them. Because of this, Javelin gunners must be prepared to move to their alternate positions when the platoon or squad leader directs. The platoon or squad leader must coordinate the movement of their Javelins so that all of the weapons are not moving at once. Once the enemy has been destroyed, the leader can move the Javelins back to their primary firing position. Platoon fire plans must consider the amount of time needed to move Javelins between positions on the battlefield. The plans also must provide alternate methods of destroying or disrupting the enemy to offset problems associated with movement. These alternate methods include mutual support of MK19, M2, and MGS; incorporation of obstacles and obscurants; and employing indirect fire, CAS, and attack helicopters, if available.

e. **Routes Between Positions.** The squad leader must personally reconnoiter all routes to alternate and supplementary positions. The routes to, from, and between positions should offer cover and concealment and should allow the gunner to enter the firing position from a direction opposite to the enemy's location.

F-7. DETECT, CLASSIFY, AND RECOGNIZE

US forces must engage targets quickly and efficiently to win in combat. Speed of target engagement depends on each Javelin gunner's proficiency in acquiring targets, identifying targets, and determining whether targets can be engaged. Dust and smoke make locating and identifying the enemy difficult. As the battle progresses and friendly and enemy units merge into the same maneuver area, acquiring and identifying targets become crucial tasks. Gunners should be trained to acquire enemy targets that are camouflaged or partially concealed by terrain, vegetation, or smoke. They should also be trained to identify targets as friend or foe. Once soldiers know where to look, they must know how to detect enemy targets rapidly.

a. **Primary Analysis.** Because the Javelin's primary targets are armored vehicles, specifically tanks, gunners should look for terrain where these targets are most likely to appear. Understanding armor tactics and the characteristics of armor vehicles can help Javelin gunners recognize the terrain where these vehicles are most likely to be employed.

(1) **Enemy Analysis.** The tactics of many potential adversaries stress using speed and massive firepower to overwhelm and destroy an opposing force. This dictates a very high average daily rate of advance. To move consistently at a high rate, armored forces require firm ground to move rapidly and enough space to deploy, maneuver, and fire. High-speed avenues of approach, such as road networks, broad ridges, and flat or rolling terrain, should be observed constantly.

(2) **Terrain and Weather Analysis.** A detailed analysis of the terrain and weather is useful in pinpointing armored or mechanized avenues of approach and to evaluate them from the enemy's viewpoint. Questions that the leader should ask himself include:

- How can the enemy use this terrain?
- Where is he most likely to appear first?

Because weather significantly affects the trafficability of terrain, a ground reconnaissance is needed to obtain current, detailed information about roads, trails, manmade objects, density of trees and brush, and the seasonal conditions of streams and rivers. If a ground reconnaissance is not possible, an aerial reconnaissance should be conducted or recent aerial photographs should be used.

(3) **Armored and Mechanized Vehicles' Mobility Characteristics.** Javelin gunners can more easily determine where to look for enemy armored vehicles if they know the vehicles' mobility characteristics. If possible, tank and motorized rifle units will avoid terrain or obstacles that can stop or impede their movement. Terrain factors that restrict armored or mechanized vehicle mobility include--

- Slopes steeper than 30 degrees.
- Sturdy walls or embankments 3 or more feet high.
- Ditches or gullies 9 or more feet wide and 3 or more feet deep.
- Hardwood trees 10 inches or larger in diameter and 10 feet or less apart.
- Water obstacles at least 5 feet deep.

- Very swampy or very rough, rocky terrain.
- Built-up areas where vehicles are restricted to moving on confined roads, through park areas, or across sports fields.

b. **Range Estimation.** Javelin gunners do not need to know the exact range to an enemy target before engaging; they only need to know when it is in range. To speed this determination, gunners use a maximum engagement line. A Javelin maximum engagement line is an imaginary line drawn across a sector’s maximum allowable range from a Javelin firing position. To determine the location of this line on the ground, the squad leader or gunner identifies terrain features at or near maximum range. Therefore, any target that crosses or appears short of this line should be within range. Establishing a maximum engagement line greatly reduces target engagement times, especially for targets that seem to be near maximum range. Several range-determination techniques can be used to find the maximum range line or the range to specific targets.

(1) **Laser Range-Finding Method.** Most units and all forward observer teams should have laser range-finders. The range from the Javelin position to an easily identifiable terrain feature can be determined easily with the laser range finder. Once the maximum engagement line is determined, the gunner makes a note of a terrain feature at that location on his range card. Any vehicle nearing that feature will be in range.

(2) **Object Recognition Method.** Range determination by object recognition is simple and can be accurate with training. The soldier looks at the target with his naked eye, sights through 7X binoculars, or uses a Javelin optical sight. Targets listed in Table F-2 are recognizable out to the ranges indicated--for example, if a target can be recognized with the naked eye as an armored or wheeled vehicle, it is probably within 2,000 meters. When using this method, the gunner must consider terrain, visibility conditions, and target size.

TARGETS	RANGE (meters)	
	NAKED EYE	7X SCOPE
Tank crew members	500	2,000
Soldiers, machine gun, mortar	500	2,000
Antitank gun, antitank missile launchers	500	2,000
Tank, APC, truck (by model)	1,000	4,000
Tank, howitzer, APC, truck	1,500	5,000
Armored vehicle, wheeled vehicle	2,000	6,000

Table F-2. Range determination recognition method.

(3) **Map and Terrain Association Method.** The maximum engagement line can be determined from a map. For each firing position, follow these steps:

- Draw an arc on the map across the assigned sector of fire at 2,000 meters.
- Examine the map to identify the distinctive natural or man-made terrain features that the line touches.
- Study the terrain in the sector of fire using binoculars or the Javelin CLU until all the selected terrain features are located and positively identified.
- Connect these features by an imaginary line from the maximum engagement line.

F-8. PRINCIPLES OF FIRE CONTROL

Effective fire control requires a unit to rapidly acquire the enemy and mass the effects of fire in order to achieve decisive results. The following principles are fundamental to achieving effective fires. When planning and executing direct fires, the platoon leader and squad leaders should apply these principles of fire control:

- Mass the effects of fire.
- Destroy the greatest threat first.
- Avoid target overkill.
- Employ the best weapon for the target.
- Minimize friendly exposure.
- Minimize the chances for fratricide.

F-9. FIRE CONTROL MEASURES

Fire control measures must enable Javelin gunners to distribute or mass fires effectively into a given area and over time. Fire control measures are the means by which the platoon leader or subordinate leaders control fires. Application of these concepts, procedures, and techniques assists the unit in acquiring the enemy, focusing fires on him, distributing the effects of the fires, effectively shifting fires, and preventing fratricide. At the same time, no single measure is sufficient to effectively control fires. At the platoon level, fire control measures will be effective only if the entire platoon has a common understanding of what the fire control measures mean and how to employ them. When executing direct fires, the platoon leader and squad leaders should apply these methods of fire control:

- Ensure distribution of fires over a given area.
- Mass fires into a given area.
- Distribute fires over time.
- Mass fires in time and space.
- Designate target reference points.
- Designate trigger lines and phase lines.
- Define engagement priorities.

F-10. SELF-DEFENSE AGAINST HELICOPTERS

Because Javelin positions are selected to cover enemy armor avenues of approach, the medium-range fields of fire afforded by these positions also enable Javelin gunners to engage aircraft.

a. **Weapons Control Status.** The weapons control status established for air defense weapons applies to Javelin gunners, too. Unless ordered otherwise, gunners should fire in

unit self-defense only; for example, only engage aircraft that are attacking friendly positions.

b. **Self-Defense Engagements.** A Javelin gunner can automatically engage an enemy helicopter that is attacking its position. The gunner's target engagement sequence is the same as against ground targets. The Javelin should be in the direct-attack mode when engaging helicopters. The rotors of the helicopter may interfere with the sensors of the missile in the top-attack mode and result in erratic flight of the missile and a target miss.

APPENDIX G
M240B MACHINE GUN AND
M249 SAW EMPLOYMENT

The M240B machine gun and the M249 squad automatic weapon (SAW) provide the heavy volume of close and continuous fire needed to accomplish the mission, and they can engage targets beyond the capability of individual weapons with controlled and accurate fire. The long-range, close defensive, and final protective fires delivered by the M240B machine gun form an integral part of a unit's direct fire plan. This appendix addresses the fundamental techniques of fire common to both the machine gun and the SAW.

G-1. M240B MACHINE GUN

The machine gun is the infantry platoon's primary weapon against a dismounted enemy. (Table G-1 provides specifications for the M240B and M249.) It provides a high volume of lethal, accurate fire to break up an enemy assault; it has limited effects against lightly armored vehicles; and it may cause vehicle crews to button-up and operate with reduced effectiveness. The platoon leader employs his M240B machine guns with the dismounted element or with a rifle squad to provide long range, accurate, sustained fires under all visibility conditions against dismounted infantry, apertures in fortifications, buildings, and lightly armored vehicles and trucks. The M240B also provides a high volume of short-range fire in self defense against enemy aircraft. Machine gunners use point, traversing, searching, or searching and traversing fire to kill or suppress targets. Leaders position machine guns to--

- Concentrate fires where they want to kill the enemy.
- Fire across the platoon front.
- Cover obstacles by direct fire.
- Tie-in with adjacent units.

SPECIFICATIONS	M240B	M249
	7.62-mm gas operated machine gun	5.56-mm gas operated automatic
Weight	25.63 lb (11.1 kg)	15.07 lb (6.85 kg)
Length	1105 mm	1040 mm standard
Muzzle Velocity	853 m/s	965 m/s
Rate of Fire	Cyclic 650-850 rds/min	Cyclic 650-850 rds/min
Effective Ranges: Point	800 m	600 m
Area	1100 m (Tripod)	800 m

Table G-1. Specifications for M240B and M249.

a. In the offense the platoon leader has the option, based on his analysis of the factors of METT-TC, to establish his base of fire element with one or two machine guns, the SAW, or a combination of the two weapons. The platoon sergeant may position this

element and control its fires when the platoon scheme of maneuver is to conduct the assault with the three dismounted squads.

(1) The machine gun, when placed on tripods, provides stability and accuracy at greater ranges than the bipod. The machine gunners target key enemy weapons until the assault element masks their fires. They also can suppress the enemy's ability to return accurate fire or to hamper the maneuver of the assault element. They fix the enemy in position and isolate him by cutting off his avenues of reinforcement. They then shift their fires to the flank opposite the one being assaulted and continue to target any enemy automatic weapons that provide mutual support to the enemy position or engage any enemy counterattack.

(2) M240B fires also can be used to cover the gap created between the forward element of the assaulting force and terrain covered by indirect fires when the indirect fires are lifted and shifted. On signal, the machine gunners and the base-of-fire element displace to join the assault element on the objective.

b. In the defense, the machine gun provides sustained direct fires that cover the most likely or most dangerous dismounted avenues of approach and protect the unit against the enemy's dismounted close assault. The platoon leader positions his machine guns to concentrate fires in locations where he wants to do the most damage to the dismounted enemy and where they can take advantage of grazing enfilade fires, stand-off or maximum engagement range, and best observation of the target area. They provide overlapping and interlocking fires with adjacent units and cover tactical and protective obstacles with traversing or searching fires. When final protective fires are called for, machine guns (aided by SAW fires) place an effective barrier of fixed, direct fire across the platoon front.

G-2. M249 SQUAD AUTOMATIC WEAPON EMPLOYMENT

The SAW is primarily a squad leader's weapon to use in the close fight as a light automatic weapon. (Table G-1, page G-1, provides specifications for the M249.) The SAW provides the rifle squads with a light automatic weapon to take with them into the assault. These weapons fire from the bipod, from the hip, or from the underarm position. They target any enemy supporting weapons being fired from fixed positions anywhere on the squad's objective. When the enemy's supporting weapons have been destroyed, or if there are none, the SAW gunners distribute their fire over that portion of the objective that corresponds to their team's position. The SAW in the hands of a rifleman can provide mobility and a high volume of fire up front in the assault or across the squad's position in the defense. In the defense, the SAW adds the firepower of 10 or 20 riflemen without the addition of manpower. Characteristically, SAWs are light, fire rapidly, and have more ammunition than the rifles in the squad they support. Under certain circumstances, the platoon leader may designate the SAW as a machine gun and, with some adjustments, use it as a platoon weapon.

G-3. FUNDAMENTAL TECHNIQUES OF AUTOMATIC FIRE

The fundamental techniques of automatic fire are common to machine guns and squad automatic weapons. (For more detailed information refer to FM 3-22.68.)

a. **Techniques of Fire.** Techniques of fire include direct lay, assault fire, overhead fire, and fire from a defilade position. Only automatic rifles use assault fire. Only machine guns can employ overhead fire.

(1) **Direct Lay.** Gunners and automatic riflemen use the direct-lay technique by aligning the sights of the weapon on the target. This is the easiest and quickest means of delivering fire.

(2) **Assault Fire.** Automatic riflemen use assault fire when in close combat. Assault fire involves firing without the aid of sights using the hip, shoulder, and underarm positions. The underarm position is best when rapid movement is required. In all three positions, automatic riflemen adjust their fire by observing the tracer and the impact of the bullets in the target area. Additional considerations for automatic riflemen using assault fire include--

- Maintaining alignment with the rest of the assault element.
- Reloading rapidly.
- Aiming low and adjusting the aim upward toward the target.
- Distributing fires across the objective when not engaging enemy automatic weapons.

(3) **Overhead Fire.** Gunners can use overhead fire when there is sufficient low ground between the machine gun and the target area for the maneuver of friendly forces. Normally, overhead fires are conducted with the machine guns on tripods because they provide greater stability and accuracy and the vertical mil angles can be measured by using the elevating mechanism. Gunners must accurately estimate range to the target and establish a safety limit that is an imaginary line, parallel to the target, where fire would cause casualties to friendly soldiers. Gun crews and leaders must be aware of this safety limit. Leaders must designate signals for lifting or shifting fires. Gunners should not attempt overhead fires if the terrain is level or slopes uniformly, if the barrel is badly worn, or if visibility is poor.

(4) **Fire from a Defilade Position.** Defilade positions protect gunners from frontal or enfilading fires. Cover and concealment may not provide the gunner a view of some or all of the target area. In this instance, some other member of the platoon must observe the impact of the rounds and communicate adjustments to the gunner. Gunners and leaders must consider the complexity of laying on the target, the gunner's inability to make rapid adjustments to engage moving targets, the ease with which targets are masked, and the difficulty in achieving grazing fires for a final protective line.

b. **Characteristics of Fire.** To help the gunner understand the characteristics of fire for their weapons, the following definitions are helpful:

(1) **Trajectory.** Trajectory is the path of the bullet in flight. For the SAW, the path of the bullet is almost flat at ranges of 300 meters or less. At ranges beyond 300 meters, the trajectory curves as the range increases.

(2) **Maximum Ordinate.** This is the highest point the trajectory reaches between the muzzle of the weapon and the base of the target. It always occurs at a point about two-thirds of the distance from weapon to target and increases with range.

(3) **Cone of Fire.** This is the pattern formed by the different trajectories in each burst as they travel downrange. Vibration of the weapon, variations in ammunition, and atmospheric conditions all contribute to the trajectories that make up the cone of fire.

(4) **Beaten Zone.** This is the pattern formed by the rounds within the cone of fire striking the ground or the target. The size and shape of the beaten zone changes as a function of the range to and slope of the target. Gunners and automatic riflemen should engage targets to take maximum effect of the beaten zone. The simplest way to do this is to aim at the center base of the target. Most rounds will not fall over the target, and any that fall short will create ricochets into the target.

(5) **Danger Space.** This is the space between the weapon and the target where the trajectory does not rise above 1.8 meters (the average height of a standing soldier) and includes the beaten zone. Gunners should consider the danger space of their weapons when planning overhead fires.

c. **Classifications of Automatic Weapons Fire.** The US Army classifies automatic weapons fires with respect to the ground, the target, and the weapon.

(1) Fire with respect to the ground includes--

- *Grazing Fire.* Automatic weapons achieve grazing fire when the center of the cone of fire does not rise more than 1 meter above the ground. When firing over level or uniformly sloping terrain, the SAW can attain a maximum of 600 meters of grazing fire.
- *Plunging Fire.* Plunging fire occurs when weapons fire at long range, when firing from high ground to low ground, when firing into abruptly rising ground, or when firing across uneven terrain resulting in a loss of grazing fire at any point along the trajectory.

(2) Fire with respect to the target includes--

- *Enfilade Fire.* Enfilade fire occurs when the long axis of the beaten zone coincides or nearly coincides with the long axis of the target. It can be frontal or flanking. It is the most desirable class of fire with respect to the target because it makes maximum use of the beaten zone.
- *Frontal Fire.* Frontal fire occurs when the long axis of the beaten zone is at a right angle to the front of the target.
- *Flanking Fire.* Flanking fire is delivered directly against the flank of a target.
- *Oblique Fire.* Gunners and automatic riflemen achieve oblique fire when the long axis of the beaten zone is at an angle other than a right angle to the front of the target.

(3) Fire with respect to the weapon includes--

- *Fixed Fire.* Fixed fire is delivered against a stationary point target when the depth and width of the beaten zone will cover the target.
- *Traversing Fire.* Traversing distributes fires in width by successive changes in direction.
- *Searching Fire.* Searching distributes fires in depth by successive changes in elevation.
- *Traversing and Searching Fire.* This class of fire is a combination in which successive changes in direction and elevation result in the distribution of fires both in width and depth.

d. **Types of Targets.** Targets have both width and depth. The size of the target, stated in terms of the number of aiming points required to engage it completely, determines its type.

(1) **Point Target.** Point targets require a single aiming point. Examples of this include bunkers, weapons emplacements, vehicles, and troops.

(2) **Area Targets.** Area targets require more than one aiming point. Machine gunners and automatic riflemen use traversing and searching (or a combination) to engage the target. Area targets are distinguished as linear, deep, and linear with depth. Gunners and automatic riflemen engage deep targets using searching fire. They engage linear targets using traversing fire. Finally, they engage linear with depth targets using traversing and searching fire.

e. **Rates of Fires.** Automatic weapons fire in one of three rates: rapid, sustained, or cyclic. Normally machine gunners engage targets at the rapid rate to suppress the enemy quickly. Thereafter, they fire at a sustained rate to conserve ammunition. Automatic riflemen use the three-round burst, resighting their weapons as quickly as possible. In engaging aerial targets machine gunners and automatic riflemen use the cyclic rate.

(1) **Rapid Fire.** Rapid fire is 200 rounds per minute in bursts of six to nine rounds at four- to five-second intervals.

(2) **Sustained Rate.** Sustained fire is 100 rounds per minute in bursts of six to nine rounds at four- to five-second intervals.

(3) **Cyclic Rate.** The normal cyclic rate of fire is 650 to 850 rounds per minute. To fire the cyclic rate, the gunner holds the trigger to the rear while the assistant gunner feeds ammunition into the weapon.

f. **Techniques for Automatic Weapons in the Defense.** Machine gunners and automatic riflemen use a number of techniques to ensure effective fires in defensive operations. Some techniques tie the characteristics of the weapons to the nature of the terrain. Others ensure distribution of fires across the squad or platoon front. Still others facilitate the concentration of fires against likely enemy avenues of approach or in engagement areas bounded by tactical obstacles. Finally, others aid in maintaining accurate fires during limited visibility.

g. **Field-Expedient Methods.** The two most common field-expedient methods for laying the machine gun in the bipod mode on predetermined targets are the notched-stake or tree-crouch and the horizontal log or board technique.

(1) **Notched-Stake or Tree-Crotch Technique.** This technique is effective for all conditions of visibility. It involves sighting the weapon on each target and marking the position and elevation of the stock with a notched-stake or tree-crotch. The automatic rifleman then scoops out a shallow groove to provide for the movement of the bipod legs and to keep the front end of the weapon aligned.

(2) **Horizontal Log or Board Technique.** Automatic riflemen use this technique to mark sector limits and engage linear targets. It is best suited for flat, level terrain and involves placing a log or board horizontally so the weapon slides along it easily. The board may then be notched along its length to lay the weapon on a specific target reference point. It may also have limiting stakes placed to define the left and right limits of the weapon.

h. **Fire Control.** Leaders control the engagements of their automatic weapons through the use of control measures, coordinating instructions, and fire commands.

(1) In the offense, coordinating instructions to machine gunners include instructions to initiate fires, a description of how the platoon leader sees the sequence of automatic weapon engagements, and the location of other friendly soldiers in the area.

(2) In the defense, the leader describes the presence and subsequent action of friendly soldiers to the front of the platoon position (scouts, passing units), the initiation and sequence of weapon engagements, priority targets, and the planned or probable shifting of forces to displace or counterattack.

(3) The signal to initiate fires or final protective lines (FPLs) on any occasions not covered by planning can be handled through fire commands. Fire commands must be clear and concise. Machine gunners and automatic riflemen repeat all fire commands. Fire commands contain the following elements:

- *Alert.* The leader must specify WHO is to engage.
- *Direction.* The leader must clearly indicate the general direction of the target. He may do so orally (giving a general orientation or designation of a reference point), by pointing, or by directing fires with tracer rounds from his own weapon. If he uses tracers, this becomes the last part of the command, and he directs, "Watch my tracer."
- *Description.* While visually following the target, the leader briefly describes the target, generally by the type of object: troops, vehicles, aircraft.
- *Range.* Leaders provide an estimate of the range to the target. Gunners and automatic riflemen use this estimate to set their rear sights and to know how far to look to identify the target.
- *Method of Fire.* This element includes two parts: the manipulation (class of fire with respect to the weapon--fixed, traversing, searching, or traversing and searching) and the rate of fire. When the leader omits the rate of fire, the gunner assumes a rapid rate.
- *Command to Open Fire.* Timing the initiation of fires is important to gain surprise. Leaders may preface the command to commence firing with "At my command" or "At my signal." Gunners and automatic riflemen respond with "Ready" when they have identified the target and are ready to engage. Leaders then give the specified command or signal.

(4) Leaders adjust fires (direction, elevation, and rate), identify new targets, order cease-fires, or terminate the alert with subsequent fire commands.

(5) Squads and platoons establish SOPs governing the activities and automatic initiation, control, and cessation of fire for their automatic riflemen and gunners. These SOP items can include standard targets and how often to check with leaders once they have engaged the enemy.

i. **Dead Space Considerations.** Dead space defines an area where the waist of a soldier falls below a gunner's or automatic rifleman's point of aim. The most accurate method for determining dead space is to have one soldier walk the line of sight of the weapon (FPL or principal direction of fire [PDF]) and make a pace count of those areas where he encounters dead space. Dead space also can be determined by observing the flight of tracer ammunition from a position behind and to the flank of the weapon.

GLOSSARY

1SG	first sergeant
AA	avenue of approach
AAR	after-action review
ADAAC	air defense and aviation coordination cell
ADW	air defense warning
AFATDS	advanced field artillery tactical data system
A/FSO	assistant fire support officer
A/L	administrative/logistics
AMD	air and missile defense
AO	area of operations
AP	antipersonnel
ARTEP	Army training and evaluation program
ASAS	all-source analysis system
ASL	assistant section leader
AT	antitank
BAS	battalion aid station
BDA	battle damage assessment
BDO	battle dress overgarment
BDU	battle dress uniform
BFV	Bradley fighting vehicle
BHL	battle handover line
BMNT	beginning morning nautical twilight
BP	battle position
BRDM	Russian wheeled reconnaissance vehicle
BSA	brigade support area
C2	command and control
C3	command, control, and communications
C3I	command, control, communications, and intelligence
CAS	close air support
CBU	cluster bomb unit
CCIR	commander's critical information requirements
CCP	casualty collection point
CDS	container delivery system
chem-lights	chemiluminescent lightsticks
CLU	command launch unit
co	company
COA	course of action
COLT	combat observation and lasing team
COP	common operating picture
CP	command post

CS	combat support
CSS	combat service support
CSSCS	combat service support control system
CTD	commander's tactical display
DA	Department of the Army
DAT	danger close, distribution, ammunition, and trajectory
decon	decontamination
DED	detailed equipment decontamination
DEUCE	deployable universal combat earth mover
DPICM	dual-purpose improved conventional munitions
DS	direct support
DTD	detailed troop decontamination
EA	engagement area
E&E	evasion and escape
ECM	electronic countermeasures
EENT	end of evening nautical twilight
EFST	essential fire support task
EPLRS	enhanced position location and reporting system
EPW	enemy prisoner of war
ESV	engineer squad vehicle
FA	field artillery
FAAD	forward area air defense
FAC	forward air controller
FBCB2	Force XXI Battle Command Brigade and Below
FDC	fire direction center
FFE	fire for effect
FIST	fire support team
FLIR	forward looking infrared radar
FM	frequency modulated; field manual
FO	forward observer
FPF	final protective fire
FPL	final protective line
FRAGO	fragmentary order
FSE	fire support element
FSNCO	fire support noncommissioned officer
FSO	fire support officer
GCP-1	ground commander's pointer
GPS	global positioning system
GS	general support
GSR	ground surveillance radar
GS-R	general support-reinforcing
HC	hexachloroethane

HE	high explosive
HEAT	high explosive antitank
HHC	headquarters and headquarters company
HMEE	high mobility engineer excavator
HPT	high profile target
HQ	headquarters
HTU	hand-held terminal unit
HUMINT	human intelligence
I2R	imaging infrared
IAV	interim armored vehicle
IAW	in accordance with
ICM	improved conventional munitions
ICV	infantry carrier vehicle
ID	identification
ILLUM	illumination
IMINT	imagery intelligence
INU	inertial navigation unit
IPB	intelligence preparation of the battlefield
IR	infrared
IRP	initial rally point
ISR	intelligence, surveillance, and reconnaissance
IV	inter-visibility
JP8	Army common fuel
KIA	killed in action
km	kilometer(s)
kph	kilometers per hour
lb	pound(s)
LCE	load-carrying equipment
LD	line of departure
LNO	liaison officer
LOA	limit of advance
LOC	line of communication
LOGPAC	logistics package
LOS	line of sight
LRP	logistics release point
LW	land warrior
LZ	landing zone
m	meter(s)
MANPADS	man-portable air defense system
MBA	main battle area
MDMP	military decision-making process

MDS	modular decontamination system
MEC	medium engineer company
MEDEVAC	medical evacuation
METL	mission-essential task list
METT-TC	mission, enemy, terrain and weather, troops and support available, time available, and civil considerations
MCS	maneuver control system
MGS	mobile gun system
MICLIC	mine clearing line charge
min	minute(s)
MLRS	multiple launch rocket system
MOF	multioption fuze
MOGAS	motor gasoline
MOPP	mission-oriented protective posture
MPAT	multipurpose antitank
mph	miles per hour
MR	moonrise
MRE	meal, ready to eat
MS	moonset
MTW	major theater war
NAI	named areas of interest
NATO	North Atlanta Treaty Organization
NBC	nuclear, biological, chemical
NBCWRS	nuclear, biological, chemical warning and reporting system
NCO	noncommissioned officer
NCOIC	noncommissioned officer in charge
NCS	net control station
NFA	no fire area
NGF	naval gun fire
NLT	not later than
NVD	night-vision device
NVG	night-vision goggles
OAKOC	observation and fields of fire, avenues of approach, key terrain, obstacles, and cover and concealment
obj	objective
OBSTINTEL	obstacle intelligence
OAKOC	observation and fields of fire, avenues of approach, key terrain, obstacles, and cover and concealment
OIC	officer in charge
OP	observation post
OPCON	operational control
OPLAN	operation plan
OPORD	operation order
ORP	objective rally point

OT	observer-target
OTN	own the night
PAC	personnel and administration center
PCC	precombat check
PCI	precombat inspection
PD	point detonating
PDF	principal direction of fire
PEWS	platoon early warning system
PGM	precision guided munition
PIR	priority intelligence requirements
PL	platoon leader; phase line (graphics)
PLGR	precision lightweight GPS receiver
PLT	platoon
PMCS	preventive maintenance checks and services
PNS	precision navigation system
POL	petroleum, oil, lubricant
POSNAV	position navigation
PSG	platoon sergeant
PSS	personnel service support
PVC	polyvinyl chloride
PZ	pickup zone
R	rifleman
R&S	reconnaissance and surveillance
RATELO	radiotelephone operator
RDF	radio direction finding
recon	reconnaissance
REDCON	readiness condition
REMS	remotely employed sensors
retrans	retransmission
RHL	reconnaissance handover line
RLY	rally point (graphics only)
ROE	rules of engagement
ROI	rules of interaction
RP	release point
RRP	reentry rally point
RSTA	reconnaissance, surveillance, and target acquisition
RV	reconnaissance vehicle
S1	adjutant
S2	intelligence officer
S3	operations and training officer
S4	supply officer
S5	civil affairs officer
S6	communications staff officer

SALT	size, activity, location, and time
SALUTE	size, activity, location, unit identification, time, and equipment
SAW	squad automatic weapon
SBCT	Stryker brigade combat team
sec	second(s)
SHORAD	short-range air defense
SIGINT	signal intelligence
SINCGARS	single-channel ground and air radio system
SITREP	situation report
SITEMP	situational template
SL	squad leader
SMCT	soldier's manual of common tasks
smk	smoke
SNAP	size, nature, activity, and protection
SOF	special operations force
SOI	signal operation instructions
SOP	standing operating procedure
SOSRA	suppress, obscure, secure, reduce, and assault
SP	start point
SR	sunrise
SS	sunset
SSC	small-scale contingency
STP	soldier's training publication
SU	situational understanding
SVML	standard vehicle-mounted launchers
TAC CP	tactical command post
TACP	tactical air control party
TAI	target area of interest
TI	tactical internet
TIRS	terrain index reference system
TLP	troop-leading procedures
TM	technical manual
TOC	tactical operations center
TOW	tube-launched, optically tracked, wire-guided (missile)
TP-T	target practice-tracer
TRP	target reference point
TTP	tactics, techniques, and procedures
TUAV	tactical unmanned aerial vehicle
UAV	unmanned aerial vehicle
UN	United Nations
UO	urban operations
US	United States
USAF	United States Air Force

VC	vehicle commander
VMS	virtual memory system
w	watt
WARNO	warning order
WCS	weapons control status
WIA	wounded in action
WP	white phosphorus
XO	executive officer

REFERENCES

DOCUMENTS NEEDED

These documents must be available to the intended users of this publication.

FM 5-34	Engineer Field Data. 30 August 1999.
DA Form 1155	Witness Statement on Individual. 1 June 1966.
DA Form 1156	Casualty Feeder Report. 1 June 1966.
DA Form 5988-E	Equipment Inspection Maintenance Worksheet. March 1991.

READINGS RECOMMENDED

These sources contain relevant supplemental information.

FM 1-114	Air Cavalry Squadron and Troop Operations. 1 February 2000.
FM 3-06.11	Combined-Arms Operations in Urban Terrain. 28 February 2002.
FM 3-21.9	The Stryker Brigade Combat Team Rifle Squad and Platoon. NEW. In publication.
FM 3-21.11	The Stryker Brigade Combat Team Company. NEW. In publication.
FM 3-34.2	Combined Arms Breaching Operations. 31 August 2000.
FM 3-4	NBC Protection. 29 May 1992.
FM 3-5	NBC Decontamination. 28 July 2000.
FM 3-97.6 (FM 90-6)	Mountain Operations. 28 November 2000.
FM 5-170	Engineer Reconnaissance. 5 May 1998.
FM 6-30	Tactics, Techniques, and Procedures for Observed Fire. 16 July 1991.
FM 7-8	Infantry Rifle Platoon and Squad. 22 April 1992.
FM 7-90	Tactical Employment of Mortars. 9 October 1992.
FM 7-98	Operations in a Low-Intensity Conflict. 19 October 1992.
FM 21-10	Field Hygiene and Sanitation. 21 June 2000.

FM 21-11	First Aid for Soldiers. 27 October 1988.
FM 21-18	Foot Marches. 1 June 1990.
FM 3-22.68	Crew-Served Machine Guns, 5.56mm and 7.62mm. (Supersedes FM 23-67 and FM 23-14.) NEW. In publication.
FM 23-90	Mortars. 1 March 2000.
FM 55-60	Army Terminal Operations. 15 April 1996.
FM 57-38	Pathfinder Operations. 9 April 1993.
FM 71-1 (FM 3-90.1)	Tank and Mechanized Infantry Company Team. 26 January 1998.
FM 90-4	Air Assault Operations. 16 March 1987.
FM 90-8	Counter guerrilla Operations. 29 August 1986.
FM 100-14	Risk Management. 23 April 1998.
FM 100-23	Peace Operations. 30 December 1994.
FM 101-5-1 (FM 1-02)	Operational Terms and Graphics. 30 September 1997.
STP 21-1-SMCT	Soldier's Manual of Common Tasks Skill Level 1. 1 October 2001.
TC 7-98-1	Stability and Support Operations Training Support Package. 5 June 1997.

INTERNET WEB SITES USED:

The following web sites were used in the preparation of this manual.

U. S. Army Publishing Agency, <http://www.usapa.army.mil>

Army Doctrine and Training Digital Library, <http://www.adtdl.army.mil>

INDEX

- AC 130 gunship (see close air support)
- action on contact
 - examples, 3-22 through 3-24
 - forms of contact, seven, 3-13
 - four steps, 3-14 through 3-21
 - infiltration, 3-29
 - planning, 3-12
 - seven
- air assault, tactical enabling operation, 7-7
- air defense, combat support, 8-29
- through
 - 8-36
 - active, 8-35; 8-36 (illus)
 - Avenger, 8-31 (illus)
 - early warning procedures, 8-34
 - MANPADS, 8-31; 8-32 (illus)
 - passive, 8-34
 - Sentinel radar, 8-32; 8-33 (illus)
 - systems, 8-30 (illus) through 8-33 (illus)
 - weapon control status, 8-33
- ambush, 10-13 through 10-15
 - antiarmor, 10-15
 - deliberate, 10-14
 - hasty, 10-13
- angle T (see also fire support), 8-12; 8-13 (illus)
- antiarmor weapons, urban operations, use in, 7-23
- Apache helicopters, 8-25 (illus)
- area reconnaissance, 4-12 through 4-19
 - dismounted technique, 4-14
 - long-range observation, 4-16; 4-17 (illus)
 - mounted technique, 4-14
 - objective rally point, 4-15 (illus)
 - patrol, 10-8
 - short-range observation, 4-17; 4-18 (illus)
- area security, 5-15 through 5-24
 - convoy escort, 5-17 through 5-24
 - ambush, action at, 5-18; 5-19 (illus)
 - clear kill zone, 5-20; 5-21 (illus)
 - command and control, 5-18
 - obstacles, 5-23; 5-34 (illus)
 - short halt, 5-21
 - tactical disposition, 5-18 (illus)
 - echelon observation posts, 5-17 (illus)
 - platoon dispositions, 5-16 (illus)
 - route reconnaissance (see also separate entry), 5-17
- assembly area, tactical enabling operations, 7-8 through 7-10
- attack helicopters
 - fire support, CS, 8-25 (illus); 8-26 (illus)
 - urban operations, use in, 6-23
- bounding overwatch, movement technique, 3-11 (illus); 3-12 (illus)
- Bradley fighting vehicle, use in urban operations, 6-21
- bunker-type OP, 5-39 (illus)
- C2 (see command and control)
- CAS (see close air support)
- cave, observation post, 5-39
- checkpoints, security operations, 5-40 through 5-44
- close air support (CAS), fire support in CS, 8-21 through 8-24
 - AC 130 gunship, 8-21
 - battle damage assessment, 8-21 (illus)
 - marking friendly positions, 8-22 through 8-24 (table); 8-23 (table)
- combat patrol (see also ambush; see also raid), 10-12 through 10-16
- conversion tables
 - distance, English to metric, A-11 (table)
 - miles to kilometers per hour, A-12 (table)
 - operating frequency and wire element length, A-12 (table)

- COA (see course of action)
- coil, movement formation, 3-6; 3-7 (illus)
- column, movement formation, 3-5; 3-6 (illus)
 - during convoy escort, 5-21; 5-22 (illus)
- combat service support (CSS), 9-1 through 9-19
 - administrative, 9-11
 - casualty feeder report, 9-12 (illus); 9-13 (illus)
 - witness statement, 9-13 (illus); 9-14 (illus)
- aerial sustainment, 9-8
- classes of supply, 9-3
- development of plan, 9-2 through 9-4
- enemy prisoners of war, 9-17 through 9-19 (illus); 9-18 (illus)
- evacuation, 9-10
- maintenance, 9-9
- medical support, 9-14 through 9-17
 - aeromedical evacuation request, 9-16 (illus)
- responsibilities, 9-1
- resupply (see separate entry), 9-4 through 9-9
- urban operations, 6-17
- combat support (CS), 8-1 through 8-37
 - air defense (see also separate entry), 8-29 through 8-36
 - engineers (see also separate entry), 8-26 through 8-29
 - fire support (see also separate entry), 8-21 through 8-26
 - urban operations, 6-20 through 6-26
 - antiarmor weapons, 6-23
 - armored vehicles, 6-20 through 6-22 (illus); 6-21 (illus)
 - attack helicopters, 6-23
 - engineers, 6-22
 - snipers, 6-24 through 6-26
- command and control (C2), 2-1 through 2-3
- counterreconnaissance, techniques
 - during security operations, 5-13 through 5-15 (illus)
- course of action (COA)
 - actions on contact, 3-15 through 3-23
 - troop-leading procedures, analysis, 2-17 through 2-20
 - comparison, 2-19
 - criteria, 2-18 (table)
 - selection, 2-19
 - steps in analysis, 2-18
- CS (see combat support)
- CSS (see combat service support)
- enemy, analysis, during TLP, 2-14 through 2-16
- engineers
 - combat support, 8-26 through 8-29
 - medium engineer company, 8-26; 8-27 (illus); 8-28 (illus)
 - missions, 8-28
 - urban operations, use in, 6-22
- exfiltration, during movement, 3-30
 - urban operations, 6-11
- FBCB2 (see force XXI battle command brigade and below)
- fire support, 8-1 through 8-26
 - angle T, 8-12; 8-13 (illus)
 - call for fire, 8-5 through 8-8; 8-6 (illus); 8-7 (illus)
 - close air support (see also separate entry), 8-21 through 8-24
 - deviation, 8-9 (illus) through 8-12
 - binoculars, 8-11 (illus)
 - corrections, 8-11
 - hand/finger method, 8-10 (illus)
 - field artillery, 8-17
 - fire request channels, 8-19 through 8-21 (illus)
 - indirect, 8-3; 8-4 (table)
 - infiltration, 3-29
 - matrix, 8-5 (table)
 - mortars, 8-16
 - planning, CS, 8-1 through 8-3
 - quick fire channel, 8-20; 8-21 (illus)
 - range spotting (see separate entry),

- 8-13 through 8-16 (illus); 8-14 (illus); 8-15 (illus)
- urban operations, 6-12 through 6-17
- field artillery, 6-14 through 6-16 (illus)
- mortars, 6-12 through 6-14
- precision guided munitions, 6-16
- force XXI battle command brigade and below (FBCB2)
- architecture, 1-3; 1-4 (illus)
- capabilities, 1-4
- enemy activity, 1-5
- enemy information, 1-4
- enemy location, 1-5
- friendly information, 1-4
- unreported enemy, 1-5
- SBCT, 1-2
- standardized reporting, 1-5; 1-6 (illus)
- formulas
- slope, A-9; A-10 (illus)
- velocity, A-9; A-10 (illus)
- width, A-9 (illus)
- FRAGO (see fragmentary order)
- fragmentary order, combat orders, 2-6
- fratricide avoidance, D-1 through D-4
- herringbone, movement formation, 3-7 (illus)
- convoy escort, 5-21; 5-22 (illus)
- infiltration, 3-26 through 3-29
- actions on contact, 3-29
- planning, 3-27
- rally points, 3-28
- tactics, 3-27
- techniques, 3-27
- combination of methods, 3-29 (illus)
- multiple lanes, 3-29 (illus)
- single lane, 3-28 (illus)
- urban operations, 6-11
- Javelin, F-1 through F-16
- CLU, F-2 (illus)
- employment, firing pair, F-5 (illus)
- overlapping sectors of fire, F-5 (illus)
- fighting position, F-11 (illus); F-12 (illus)
- flight profiles, F-8 (illus)
- range determination recognition method, F-14 (illus)
- standoff range, F-6 (illus)
- technical characteristics, F-1 (table)
- urban operations, use in, F-7 through F-9 (illus)
- Kiowa Warrior, 8-25 (table)
- limited visibility, B-1 through B-11
- equipment, B-3
- illumination, B-5; B-6 (illus); B-7
- night vision, B-9 through B-11 (illus); B-10 (illus)
- night-vision devices, B-1; B-2 (illus); B-3 (table)
- smoke, B-7 through B-9
- line, movement formation, 35 (illus)
- linkup, tactical enabling operation, 7-1
- M-1 series tanks, use in urban operations 6-21; 6-22 (illus)
- machine gun, M240B, G-1 through G-6
- maneuver
- actions on contact, 3-15 through 3-23
- SBCT, general, 1-16
- METT-TC (see mission, enemy, terrain and weather, troops and support available, time, and civil considerations)
- mission analysis, TLP, 2-7 through 2-17
- mission, enemy, terrain and weather, troops and support available, time, and civil considerations (METT-TC), mission analysis, basis, 2-7 through 2-17
- mission statement, 2-4
- restated, platoon leader, TLP, 2-9

- mortars
 - fire support, CS, 8-16
 - urban operations, 6-12 through 6-14
- movement, 3-1 through 3-31
 - actions at danger areas, 3-24 through 3-26
 - action on contact (see separate entry), 3-12 through 3-24
 - control measures, 3-2
 - exfiltration (see separate entry), 3-30
 - formations (see separate entries), 3-3 through 3-7
 - dismounted, 3-3; 3-4 (illus)
 - mounted, 3-5 (illus); 3-6 (illus); 3-7 (illus)
 - infiltration (see also separate entry), 3-26 through 3-29
 - limited visibility navigation, 3-3
 - maps, 3-2
 - navigation, 3-1
 - route planning, 3-2
 - techniques (see separate entries), 3-7 through 3-12
- move-set, movement technique, 3-12
- NBC (see nuclear, biological, chemical)
- nuclear, biological, chemical (NBC), E-1 through E-4
 - characteristics of chemical agents, E-1 (table)
 - combat support, 8-37
 - comparison data for decontamination levels, E-4 (table)
 - MOPP levels, E-3 (table)
- observation posts, 5-24 through 5-44
 - construction techniques, 5-32 through 5-34
 - critical tasks, 5-24
 - employment, 5-34 through 5-44
 - mountainous, 5-35 through 5-37
 - types of ground OPs (see separate entries), 5-37 through 5-40
 - urban, 5-34
 - positions, 5-26 (illus)
 - sector sketch, 5-29; 5-30 (illus)
 - site selection, 5-27
 - types, 5-26
- obstacles
 - breach, 4-36
 - bypass, 4-36
 - convoy escort, 5-23; 5-34 (illus)
 - detection, 4-34
 - OAKOC, 2-10; 2-11 (illus)
 - reconnaissance, 4-34 through 4-37
 - types, 4-34
- operation order (OPORD)
 - combat orders, 2-5
 - issue, TLP, 2-21
- OPORD (see operation order)
- orders
 - combat, 2-4; 2-5 (table)
 - FRAGO, 2-6
 - OPORD, 2-5
 - TLP, 2-3
 - WARNO, 2-5
- passage of lines, tactical enabling operation, 7-2 through 7-4
- patrolling, 10-1 through 10-17
 - planning, 10-2 through 10-4; 10-3 (illus)
 - rally points, 10-5 through 10-7
 - types (see separate entries), 10-8 through 10-17
 - urban reconnaissance, dismounted, 4-32
 - mounted, 4-31
 - subterranean, 4-32
- platoon leader responsibilities, generally, 1-13
- platoon sergeant responsibilities, generally, 1-14
- presence patrol, 10-16
- quick fire channel (see also fire support) 8-20; 8-21 (illus)
- raid, combat patrol, 10-15

- range spotting/correction, fire support,
8-13 through 8-16
creeping method, 8-15; 8-16 (illus)
hasty bracketing, 8-14; 8-15 (illus)
successive bracketing, 8-14 (illus)
- reconnaissance, 4-1 through 4-37
area (see separate entry), 4-12
through 4-19
commander's guidance, 4-6 (illus)
engagement decision, during, 4-4
(illus)
handover, 4-9 through 4-12
leader's, 2-20; 4-16; 10-7; 10-12
methods, 4-6 through 4-8
obstacles (see separate entry), 4-34
through 4-37
patrol, 10-8 through 10-12
route (see separate entry), 4-24
through 4-29
sensory techniques, 4-4
urban (see separate entry), 4-29
through 4-33
zone (see separate entry), 4-19
through 4-24
- rehearsal
reconnaissance, 4-8
types, TLP, 2-22
- relief in place, tactical enabling
operation, 7-4 through 7-6
- resupply, 9-4 through 9-8
emergency, 9-7
LOGPAC, 9-4
mounted service station, 9-5
(illus)
prestock, 9-7
service station, 9-6 (illus)
tailgate, 9-7 (illus)
- risk management, C-1 through C-6
potential hazards, C-2 (table)
risk levels, C-2 (illus)
- route reconnaissance, 4-24 through 4-29
actions during security operations,
5-17
control measures, 4-29 (illus)
fan, 4-25 (illus)
overlays, 4-26; 4-27 (illus)
patrol, 10-11; 10-12 (illus)
tasks, 4-27
techniques, 4-28
- SAW (see squad automatic weapon)
- SBCT (see Stryker brigade combat
team)
- scrape, observation post, 5-37; 5-38
(illus)
- security operations, 5-1 through 5-44
area (see also area security), 5-2;
5-15 through 5-24
cover, 5-1
guard, 5-1
missions, 5-3 through 5-15
observation posts (see separate
entry), 5-24 through 5-44
checkpoints, 5-40 through 5-44
screen, 5-1
surveillance techniques, 5-5 through
5-13
task organization 5-6 (illus)
counterreconnaissance, 5-8
cueing, 5-6; 5-7 (illus)
early warning, 5-7 (illus)
harrass and impede, 5-12
maintain contact, 5-9 through
5-11; 5-10 (illus)
priority, change, 5-9 (illus)
redundant coverage, 5-6 (illus)
- snipers, urban operations, use in, 6-24
through 6-26
- spider hole, observation post, 5-37 (illus)
- squad automatic weapon (SAW), M249,
G-1 through G-6
- stay-behind, tactical enabling operations,
7-6
- Stryker brigade combat team (SBCT)
C3, 1-2
combat orders and graphics, 1-6
combat power, 1-16
employment considerations, 1-17
FBCB2, 1-3; 1-4 (illus)
limitations, 1-8
mobility, 1-7

- night-vision equipment, 1-7; 1-8
 - (table)
- organization, 1-9 through 1-11; 1-10
 - (illus)
 - dismounted element, 1-11 (illus)
 - mounted element, 1-10; 1-11
 - (illus)
 - platoon headquarters, 1-10
- reconnaissance section and teams, 1-12
- responsibilities, 1-13 through 1-16
- standardized reporting, 1-5; 1-6
 - (illus)
- survivability, 1-2
- sustainability, 1-7
- training considerations, 1-18
- symbols, A-1 through A-8
 - material, facility, equipment, and services, A-8 (illus)
 - overlay graphics, A-7 (illus)
 - overlay symbols, A-2 through A-6
 - (illus)
- tent-type, observation post, 5-38; 5-39
 - (illus)
- terrain
 - analysis, TLP, 2-9 through 2-14
 - key terrain, 2-12 (illus)
 - OAKOC, 2-4 (illus) through 2-13
 - restricted, 2-9
- TLP (see troop-leading procedure)
- traveling, movement technique, 3-8; 3-9
 - (illus)
- traveling overwatch, movement technique, 3-9; 3-10 (illus)
- troop-leading procedure (TLP), 2-6
 - (illus) through 2-22
 - course of action, 2-17 through 2-20
 - criteria, 2-18 (table)
 - steps, in analysis, 2-18
 - METT-TC, 2-7 through 2-17
- urban environment, 6-1 through 6-26
 - characteristics, 6-3 through 6-6
 - combat multipliers, 6-20 through 6-26 (see combat support)
 - CSS, 6-17
 - definitions, 6-1
 - exfiltration, 6-11
 - fire support (see separate entry), 6-12
 - infiltration, 6-11
 - Javelin (see also separate entry), F-7 through F-9 (illus)
 - planning, 6-6 through 6-18
 - urban operations sketch, 6-9 (illus)
- urban reconnaissance, 4-29 through 4-33
 - dismounted teams, 4-29
 - patrolling, 4-31
- WARNO (see warning order)
- warning order, combat orders, 2-5
 - issue, TLP, 2-7
- weather, METT-TC factors, TLP, 2-13
- wedge, movement formation, 3-5 (illus)
- zone reconnaissance, 4-19 through 4-29
 - dismounted, 4-21
 - methods, 4-21 through 4-24
 - converging routes, 4-22; 4-23 (illus)
 - fan, 4-21; 4-22 (illus)
 - successive routes, 4-23; 4-24 (illus)
 - mounted, 4-20
 - patrol, 10-8 through 10-11
 - moving, 10-9 through 10-11
 - box, 10-9; 10-10 (illus)
 - converging routes, 10-10 (illus)
 - fan, 10-9 (illus)
 - successive routes, 10-10; 10-11 (illus)
 - stationary, 10-11
- underground, observation post, 5-39
 - (illus)

FM 3-21.94
18 APRIL 2003

By Order of the Secretary of the Army:

ERIC K. SHINSEKI
General, United States Army
Chief of Staff

Official:



JOEL B. HUDSON
Administrative Assistant to the
Secretary of the Army
0308509

DISTRIBUTION:

Active Army, Army National Guard, and U. S. Army Reserve: To be distributed in accordance with the initial distribution number 115895, requirements for FM 3-21.94.

PIN: 080732-000