

Field Manual  
No. 44-18-1

**\*FM 44-18-1**

**HEADQUARTERS  
DEPARTMENT OF THE ARMY  
Washington, DC, 31 December 1984**

**S T I N G E R  
TEAM OPERATIONS**

\* This field manual supersedes FM 44-18-1, 20 October 1980.

DISTRIBUTION RESTRICTION: Approved for public release; distribution is unlimited.

# STINGER TEAM OPERATIONS

## Table of Contents

	Page
<b>PART I THE STINGER WEAPON SYSTEM .....</b>	<b>1-1</b>
CHAPTER	
1 <b>System Description .....</b>	<b>1-1</b>
2 <b>Weapon Handling .....</b>	<b>2-1</b>
3 <b>Firing the Stinger .....</b>	<b>3-1</b>
4 <b>Aircraft Detection .....</b>	<b>4-1</b>
5 <b>The Engagement Decision .....</b>	<b>5-1</b>
6 <b>Engaging Aircraft .....</b>	<b>6-1</b>
7 <b>MANPAD Team Operations.....</b>	<b>7-1</b>
8 <b>MANPAD in Defense of ADA Units.....</b>	<b>8-1</b>
9 <b>Survival on the Battlefield .....</b>	<b>9-1</b>
10 <b>Mobility and Combat Loading.....</b>	<b>10-1</b>
11 <b>System Support.....</b>	<b>11-1</b>
 <b>PART II STINGER TRAINING.....</b>	 <b>12-1</b>
CHAPTER	
12 <b>Training Stinger Teams .....</b>	<b>12-1</b>
13 <b>Stinger Training Devices and Materials ....</b>	<b>13-1</b>
14 <b>Stinger Training Concepts .....</b>	<b>14-1</b>
15 <b>Quarterly Evaluation of Gunner Proficiency .....</b>	<b>15-1</b>
16 <b>Stinger Range Operations .....</b>	<b>16-1</b>
17 <b>Operational Readiness Training Test.....</b>	<b>17-1</b>

DISTRIBUTION RESTRICTION: Approved for public release; distribution is unlimited.

	Page
APPENDIX	
A <b>Manual SHORAD Control System</b> .....	<b>A-1</b>
B <b>Binoculars in Identification of Aircraft</b> .....	<b>B-1</b>
C <b>Stinger Tactical Equipment Characteristics</b> .....	<b>C-1</b>
D <b>Stinger Crew Drills</b> .....	<b>D-1</b>
E <b>Emergency Warning Signals</b> .....	<b>E-1</b>
F <b>MANPAD in an NBC Environment</b> .....	<b>F-1</b>
GLOSSARY .....	Glossary-1
REFERENCES .....	Reference-1
INDEX .....	Index-1

“As part of the Army standardization program, the terms squad and team may be changed to crew. When implemented by ARs, TOEs, etcetera, the terms will be used in subsequent changes to this revised publication.”

When used in this publication, “he,” “him,” “his,” and “men” represent both the masculine and feminine genders unless otherwise stated.

## Preface

The purpose of this manual is to provide guidance for the Stinger team in support of air defense operations. It is also written to support the training of individuals to function as members of a Stinger team.

When skilled individuals are molded into efficient, smooth-functioning teams, their capability to accomplish assigned missions is greatly increased. The effectiveness of Stinger varies directly with the individual skills of each team member and the collective proficiency of each team. The key to both is training.

This manual focuses on the techniques and procedures used by the Stinger team to engage and destroy hostile targets.

FM 44-18-1 consists of two parts:

*Part I* describes the Stinger system and tells how to use the weapon to shoot down aircraft. This part also describes how the team operates in combat.

*Part II* discusses the means and methods of training soldiers to operate the system.

This manual should be used with the system technical manual (TM 9-1425-429-12) which tells how the system functions and how to maintain it. Information found in the technical manual, such as that on maintenance and emergency destruction procedures, is not repeated in this manual.

This is a companion manual to FM 44-18, which tells how Stinger will be employed at the platoon and section levels, along with other air defense artillery (ADA) weapons, as an integral part of the combined arms team.

The tactical doctrine and procedures contained in FM 44-18 will be of little use if the Stinger team cannot effectively engage enemy aircraft. It does little good to have the Stinger team properly positioned unless the team chief and the gunner, working together, can engage and kill an enemy aircraft when called upon to do so. This requires training in engagement procedures, as outlined in this field manual.

The material contained in this field manual is applicable to both nuclear and nonnuclear warfare without modification.

Checklists shown on pages 8 through 17 of Chapter 17, are recommended checklist formats. Those shown are samples for your guidance.

Users of FM 44-18-1 are encouraged to submit recommended changes or specific comments to improve the publication. Comments should be keyed to the specific page and line of text in which the change is recommended. Reasons should be provided for each comment to insure understanding and complete evaluation. Comments should be prepared on DA Form 2028 (Recommended Changes to Publications and Blank Forms) and forwarded directly to:

**Commandant  
US Army Air Defense Artillery School  
ATTN: ATSA-DTP-EB  
Fort Bliss, Texas 79916-7155.**

**PART I**  
**THE STINGER WEAPON SYSTEM**

CHAPTER 1

**System Description**

The Stinger weapon is a man-portable, shoulder-fired, infrared radiation (IR) homing (heat-seeking), guided missile system. It requires no control from the gunner after firing. Stinger has an identification, friend or foe (IFF), subsystem which aids the gunner and team chief in identifying friendly aircraft. Operations at night or in adverse weather conditions are somewhat restricted by the gunner's ability to see and identify the target. Stinger provides short-range air defense for maneuver units and the less mobile combat support units. The Stinger system is designed to counter high-speed, low-level, ground attack aircraft. Stinger is also a lethal weapon against helicopter, observation, and transport aircraft.

**CONTENTS**

	Page		Page
Ready-Round .....	1-2	Gripstock Assembly .....	1-6
Missile-Round .....	1-2	IFF Support Equipment .....	1-7
IFF Subsystem .....	1-5	Shipping and Storage Containers .....	1-9

### READY-ROUND

The Stinger missile-round consists of a Stinger missile sealed in a disposable launch tube assembly. The Stinger weapon-round is made up of a missile-round mated to a separable gripstock assembly. When a battery/coolant unit (BCU) is inserted into the

weapon-round to provide prelaunch power to the system, it becomes a ready-round. For IFF capability, an IFF interrogator is connected to the gripstock assembly as illustrated below.

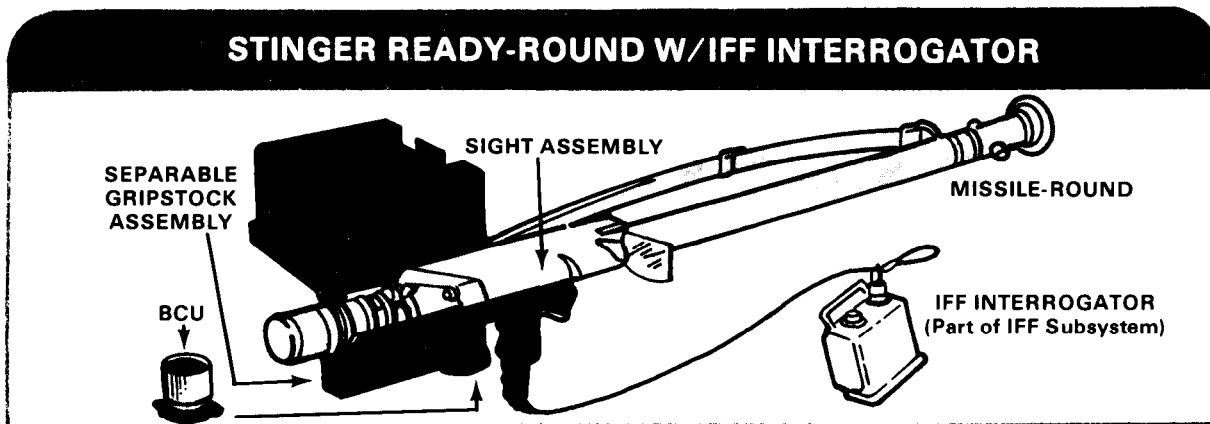

### MISSILE-ROUND

Major components that make up the missile are shown in the Stinger Missile-Round illustration.

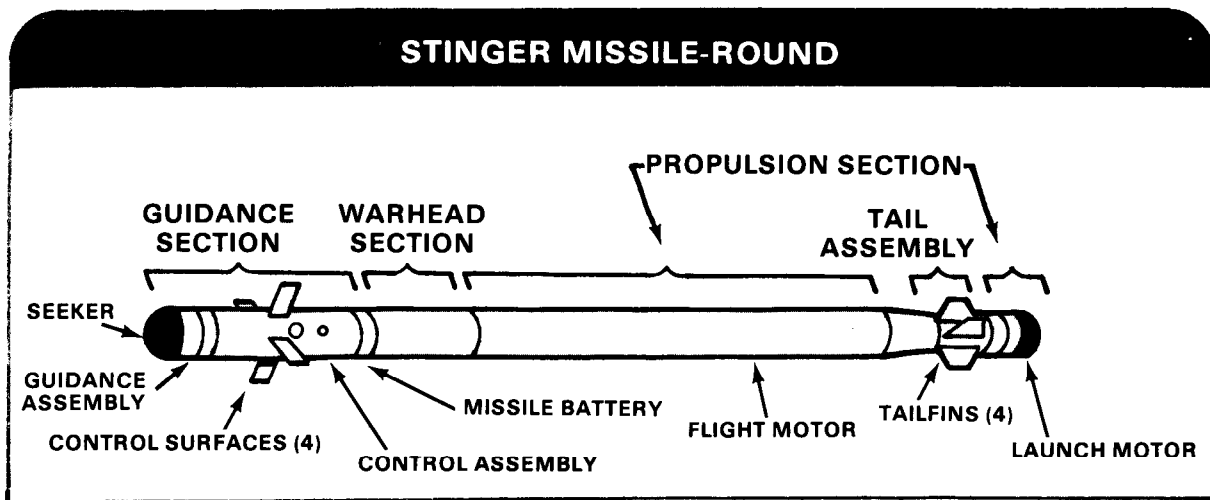

The guidance section of the missile consists of a guidance assembly, a control assembly, a missile battery, and four control

surfaces. The guidance assembly processes target IR and provides guidance commands for the missile during flight. The seeker tracks

the IR source automatically after the gyro is uncaged and during missile flight. The control assembly converts the guidance commands into movement of control surfaces which direct the flight of the missile. The missile battery provides the in-flight power for the Stinger guided missile.

The warhead section consists of a fuze assembly and a quantity of explosives, all within a cylindrical case. After the flight motor ignites, the fuze arms the warhead. The fuze can detonate the warhead in two ways: by means of a low impact switch or by a hard target sensor. Should target intercept not occur within 15-19 seconds after launch, a self-destruct circuit initiates warhead detonation. Safety features are included to insure that the missile is safe for shipping and handling.

The propulsion for the missile is provided by a separable launch motor and a dual thrust flight motor.

The launch (eject) motor provides initial thrust that ejects the missile from the launch tube. It allows the missile to coast a safe distance (about 9 meters/29 feet) from the gunner prior to ignition of the flight motor. The launch motor is expended and separated from the flight motor before the missile is out of the launch tube. The expended launch motor leaves the launch tube and falls a safe distance forward of the gunner. Also, at separation, a lanyard attached to the launch motor pulls the shorting plug from the flight motor ignition circuit, thus enabling the flight motor.

The flight motor provides propulsion for the missile during flight. The flight motor fires after the missile coasts for a safe distance from the gunner. Thrust for the flight motor is provided in two phases: boost and sustain. Initially, both burn simultaneously. The boost phase rapidly accelerates the mis-

sile to its top speed. The boost phase ends, but the sustain phase continues. The sustain phase maintains the missile speed for a time sufficient to complete the mission.

The tail assembly of the Stinger missile consists of four folding tailfins that provide roll and missile stability. Within the launch tube, the fins are in a folded position. As the missile leaves the launch tube, the fins are erected by spring action and by the force generated by missile spin, and then locked into place.

The launch tube is a fiberglass tube which provides the main support for all parts of the launcher. Both ends of the launch tube are sealed with breakable disks. The IR window (front disk) is transparent to IR. Both the IR window and the blowout disk (rear) break when the missile is fired. A desiccant cartridge\ humidity indicator on the launch tube indicates whether moisture has entered the tube.

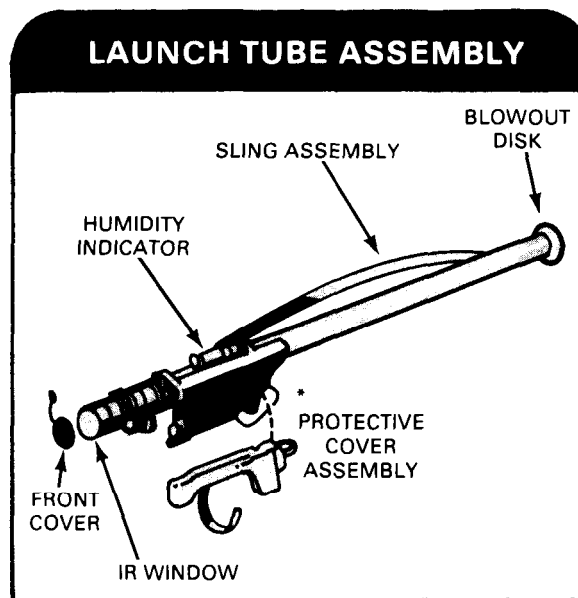

\*The protective cover assemblies should be retained for possible use in the event it becomes necessary to back pack weapons without the gripstock assemblies attached.





## IFF SUBSYSTEM

Stinger is equipped with an IFF subsystem to aid in the identification of aircraft. The IFF system classifies aircraft as either friendly or unknown. It does not identify hos-

tile aircraft (see Hostile Criteria, chapter 4). The IFF components are shown in the illustration and are described in the following paragraphs.

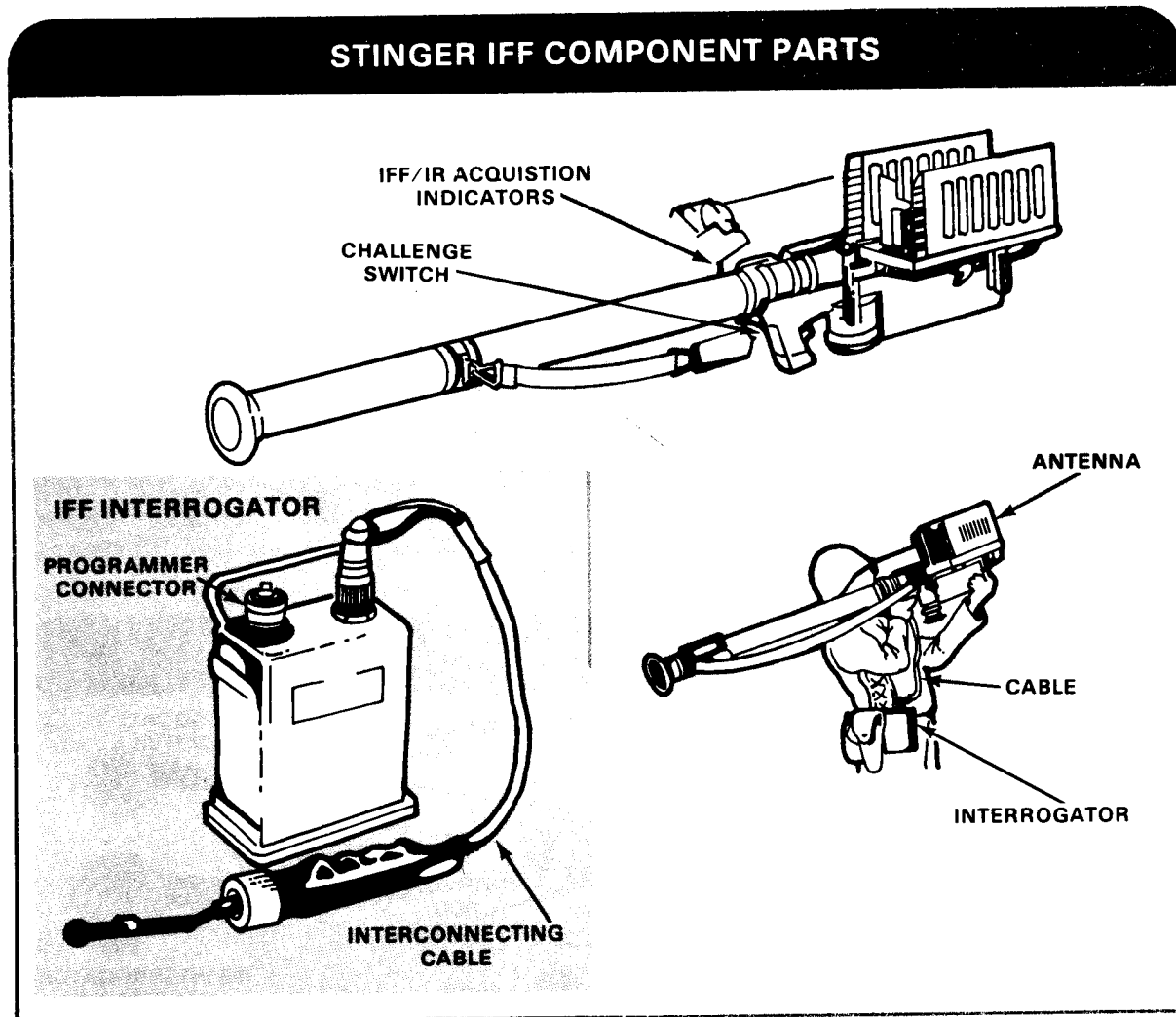

The gunner initiates the IFF sequence by pressing the IFF INTERROGATE switch on the gripstock assembly. Once the gunner issues a challenge, the rest of the sequence is automatic. The IFF interrogator, attached to the gunner's belt, sends a coded challenge (via an IFF antenna) to the aircraft.

Aircraft with Mark X or Mark XII transponders will automatically decode if the interrogator is programmed with Modes 4 and 3. Mode 3 is built into the interrogator; however, if during programming the Mode 4 position is used, Mode 3 (Mark X) will not be challenged until the 2 or 4 days of Mode 4 coded have expired.

The aircraft's transponder then prepares and sends a coded reply. The reply is received by the Stinger IFF antenna and is routed to the interrogator for decoding. The interrogator converts the reply into an audible tone which is then routed via the interconnecting cable to the gunner as a friendly tone. If the aircraft's transponder sends an incorrect reply to the IFF challenge, the reply is processed by the IFF system into an unknown tone. Additionally, aircraft not equipped with the transponders will not reply to the challenge, and this is also interpreted into an unknown tone. The gunner hears the friendly or unknown tone in his right earphone immediately after challenging the aircraft. The tones are further

described in chapter 4.

The IFF challenge is coded in either a complex, crypto secure Mode 4 form or a simpler Mode 3 form. All US combat aircraft and helicopters are equipped with transponders to provide friendly Mode 4 and 3 replies. However, some aircraft operating in the combat zone, to include US commercial aircraft and some aircraft belonging to our allies, are not capable of providing friendly Mode 4 replies. They can only provide friendly Mode 3 replies. Thus, since the Mode 4 code is secure, a friendly Mode 4 reply is considered a true friend reply. A friendly Mode 3 reply is considered only as a possible friend reply.

### GRIPSTOCK ASSEMBLY

The separate gripstock assembly contains all the necessary circuits and assemblies that allow the gunner to interrogate aircraft and to prepare and launch missiles. The gripstock is attached to and removed from a launch tube by means of a latch. Located on

the gripstock assembly are the safety and actuator device, UNCAGING switch, firing trigger, IFF antenna assembly, IFF INTERROGATE switch, IFF interrogator connector, and BCU receptacle (see illustration below).

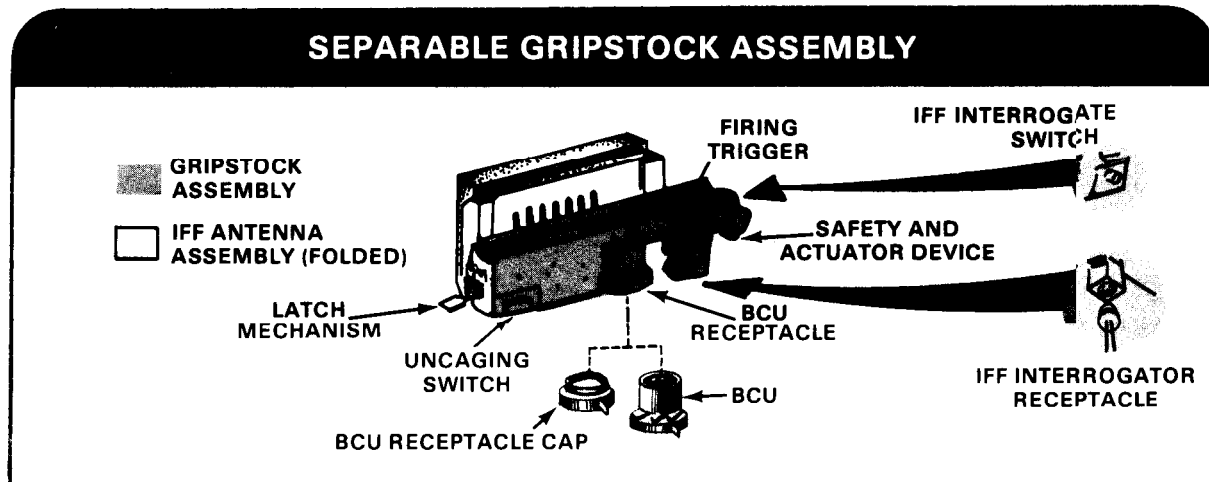

The antenna assembly folds into a holder on the right side of the gripstock assembly when not in use. When it is deployed and the interrogator is connected to the gripstock, it is capable of interrogating aircraft and

receiving coded replies. After a missile is fired, the separable gripstock assembly is removed from the launch tube assembly for reuse. The separable gripstock assembly can be reused until failure.

The BCU is used to energize the weapon's electrical circuits and to cool the IR detector in the missile's seeker prior to launch. It contains a thermal battery and pressurized argon gas coolant. Prior to use, the BCU is inserted into the BCU receptacle and tightened one-quarter turn. It is activated when the safety and actuator device on the grip-stock is pressed forward, outward, and down-

ward (until a click is heard) and then released. Once activated, the BCU supplies electrical power and seeker coolant to the weapon for 45 seconds or until missile launch. The BCU is not reusable after it is activated. Either two or three BCUs are supplied with each weapon-round and missile-round (depending on year of issue).

### IFF SUPPORT EQUIPMENT

Support equipment for the IFF system is available at section headquarters. This equipment includes a programmer/battery charger AN/GSX-1, computer KIR-1A/TSEC (with power supply model ZAC A/1), and two code changing keys KIK-18/TSEC. The computer and code changing keys (when set with classified code) are classified CONFIDENTIAL,

and must be safeguarded as outlined in AR 380-40. The interrogator (specifically, the reply evaluator module within the interrogator) is also classified CONFIDENTIAL and proper security measures for it must be taken. An IFF subsystem training set is available for training purposes and is described in chapter 13.

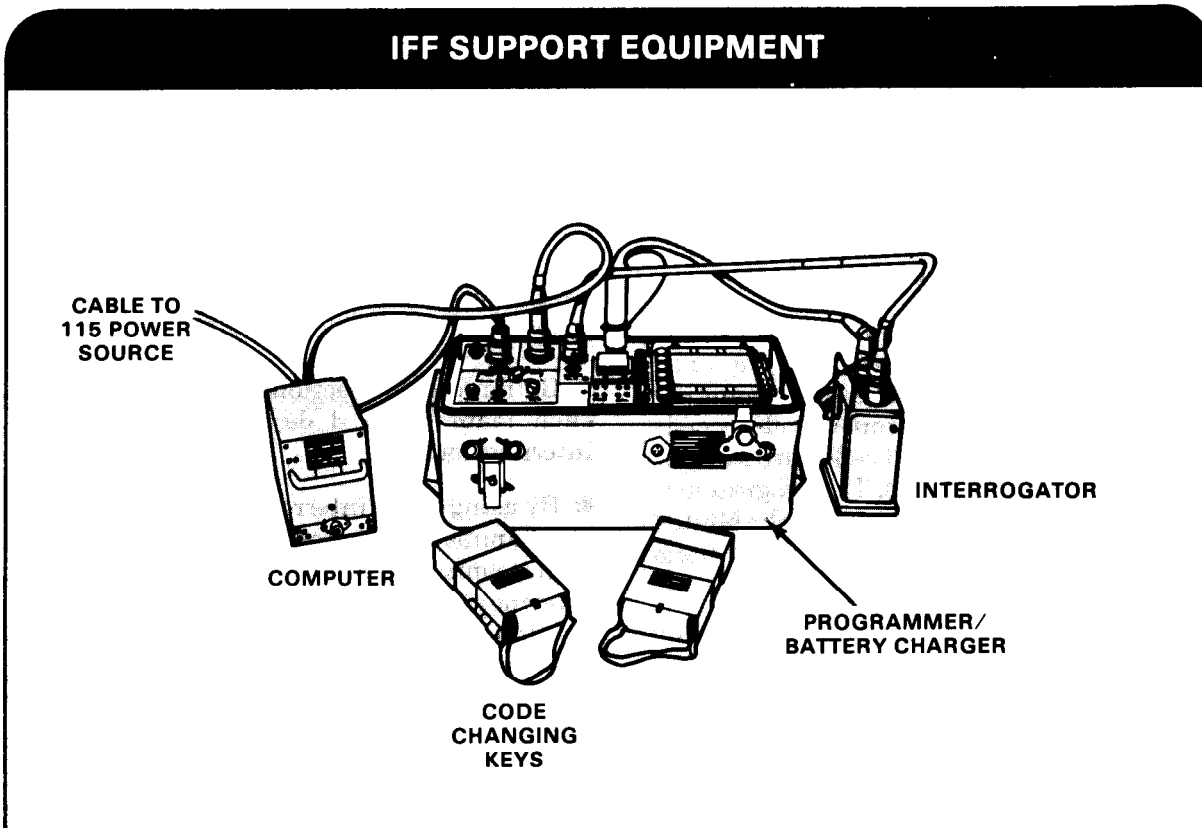

The programmer/battery charger programs the IFF interrogator and charges the interrogator batteries. Each function may be done separately or both may be done at the same time. Section headquarters personnel normally program and recharge the interrogator and battery. A brief description of each function follows. The -10 operator's manual and the KAM225C/TSEC may be consulted for more detailed interrogator programming and battery charging procedures. Also, the code book (AKAK) contains coded key numbers and instructions for destruction of the code book. The code book is kept at custodial level. Custodians will extract and annotate the code tables with the effective dates to support the situation.

### BATTERY CHARGING

The battery charger can charge up to six interrogator batteries at one time. It takes a minimum of 4 hours to fully charge the batteries. Additional charge time will not hurt the batteries. A freshly charged battery is installed in the interrogator prior to programming.

### INTERROGATOR PROGRAMMING

After a charged battery is installed, the IFF interrogator is manually programmed for 4 days of operation. The code changing key is used to insert the proper Mode 4 codes into the computer (Mode 3 codes are already built into the interrogator). The programmer provides the means for extracting the Mode 4 codes from the computer and inserting them into the interrogator.

Either one of two programs is selected by operating a function switch on the programmer. For either program, a 4-day countdown period is started in the interrogator by the programmer. At the end of the 4-day period, an automatic time clock stops. The interrogator switches to Mode 3 operation and con-

tinues operating in Mode 3 until the batteries are discharged or until the interrogator is reprogrammed.

In the Mode 4/3 position (the normal setting used for programming), the interrogator is programmed to interrogate in Modes 4 and 3. Initial interrogation is made in Mode 4. If there is no Mode 4 reply by the aircraft or the reply is incorrect, the interrogator automatically switches to Mode 3 and interrogates again.

In the Mode 4 position, the interrogator is programmed to interrogate in Mode 4 only. The interrogator will not automatically interrogate in Mode 3 after an incorrect Mode 4 reply. Certain situations may require that the interrogator be programmed for Mode 4 only operation. Tactical standing operating procedures (TSOP) dictate where the interrogators will be programmed in this matter.

Programming is done every 2 or 3 days, depending upon the tactical situation. The interrogator may be programmed—

- By having each team turn in its interrogator to section headquarters every 3 days or less. It can be exchanged for another, if available, or it can be programmed and then returned to the team.
- By having the section headquarters visit each team every 3 days to program the interrogator.
- By using spare interrogators. These can be programmed at section headquarters, taken to the teams, and exchanged there. The team's interrogator would then be taken to section headquarters, programmed, and held for another team exchange. The exchange can be done by liaison visits. For further information on how to set the code changer key and load the computer, refer to Limited Maintenance Manuals KIR-1A/TSEC; KII-1A/TSEC; and KAM 225C/ SEC.

## SELF-CHECK

Another function of the programmer is to self-check the interrogator after data transfer. An audio signal confirms that the interrogator is operational and has accepted the program selected by the programmer. An additional test should be made by coordinating

with a known friendly aircraft having an operational and correctly coded Mode 4 transponder. The friendly aircraft is interrogated to verify that the interrogator's Mode 4 codes are correct.

## SHIPPING AND STORAGE CONTAINERS

The following paragraphs describe the shipping and storage containers for the Stinger weapon system.

---

### MISSILE-ROUND CONTAINER

This container is a wooden box which provides adequate protection for one missile-round and two or three BCUs during shipping and storage. It also contains one set of ear plugs. These items, in a cardboard box, are wrapped in a sealed barrier bag, with desiccant, for protection against the environment. A humidity indicator is enclosed in the bag to indicate moisture content. The bag is inside a fiber-board liner which is inside the wooden box. Two of these boxes, containing missile-rounds, are issued to each team as the remaining part of their basic load. As rounds are expended, the gunner simply opens a missile-round container, removes the missile round, mates the gripstock assembly from the expended round to the new missile round, and installs a BCU. He then has a new ready-round to use, if needed. Empty missile-round containers and dunnage are kept to maintain the shape of the load in the trailer until resupply. At this time, the empty containers are replaced with full containers.

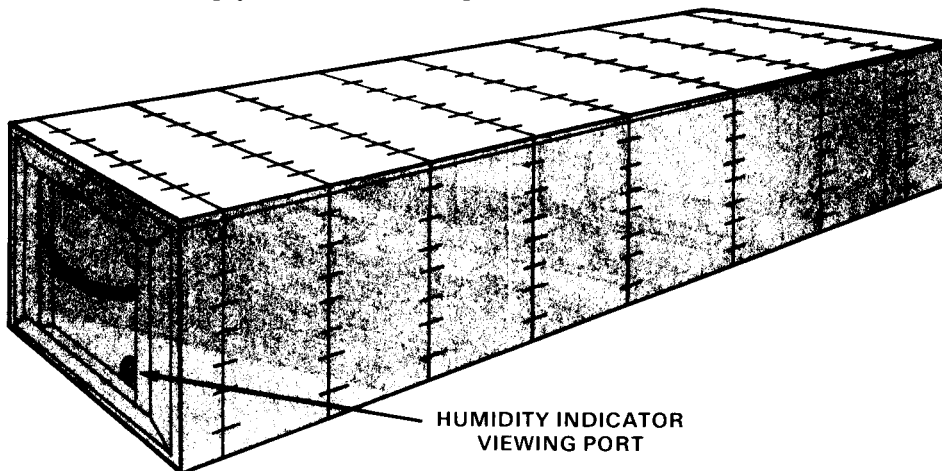

## WEAPON-ROUND CONTAINER

This container is an aluminum box which provides environmental protection for one weapon round and several BCUs during shipping and storage. Inside each container is one set of ear plugs. The container is equipped with four latches, handles for two-man carry, a pressure relief valve, humidity indicator, and a BCU storage area (for either three or five BCUs). Four of these containers with weapons are issued to each team as part of its basic load. The containers will be reused.

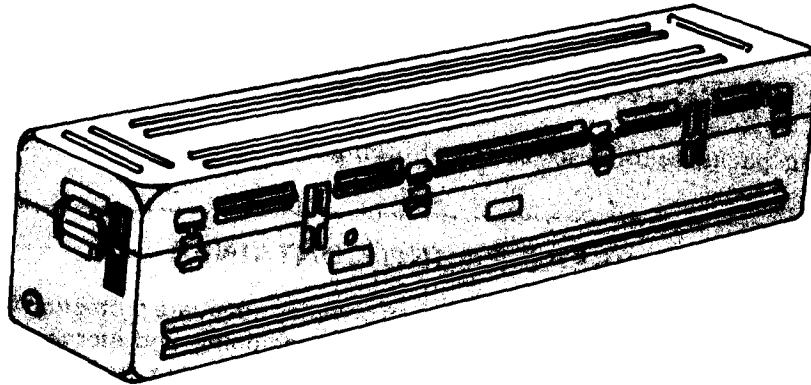

---

## READY RACK

A container is converted to a ready rack by releasing the latches which make the ready round (a weapon-round with BCU installed) readily accessible. When used as a ready rack, the closed container provides limited environmental protection for the ready round. The ready rack setup helps provide the capability for a gunner to open the container, remove, shoulder, and prepare the weapon for engagement within 10 seconds.

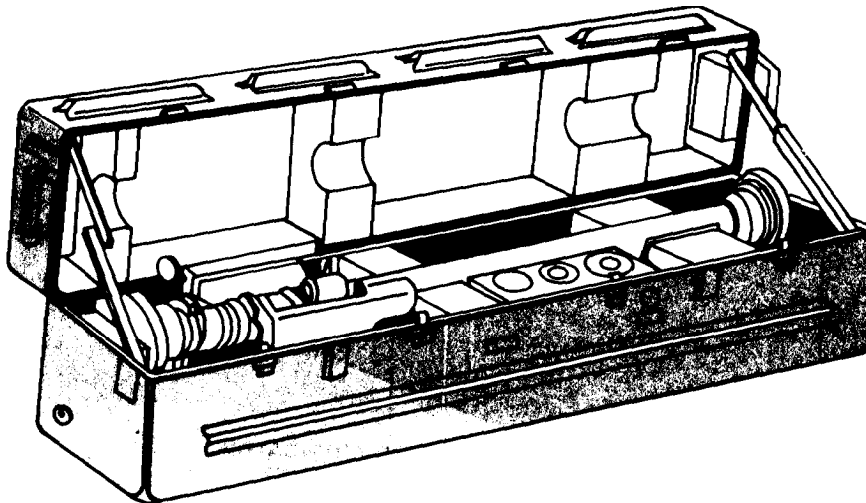

---

## TRANSPORT HARNESS

The four weapon-round and two missile-round containers are secured within the M416 1/4-ton trailer by a nylon webbing assembly called a transport harness. A strap runs lengthwise over the center of the 1/4-ton cargo trailer and fastens to either end of the trailer by strap fasteners. This strap passes through two more straps which connect to the sides of the trailer. The quick-release buckles allow immediate access to the weapons. Another strap passes through the first three straps and runs completely around the outside of the top three containers.

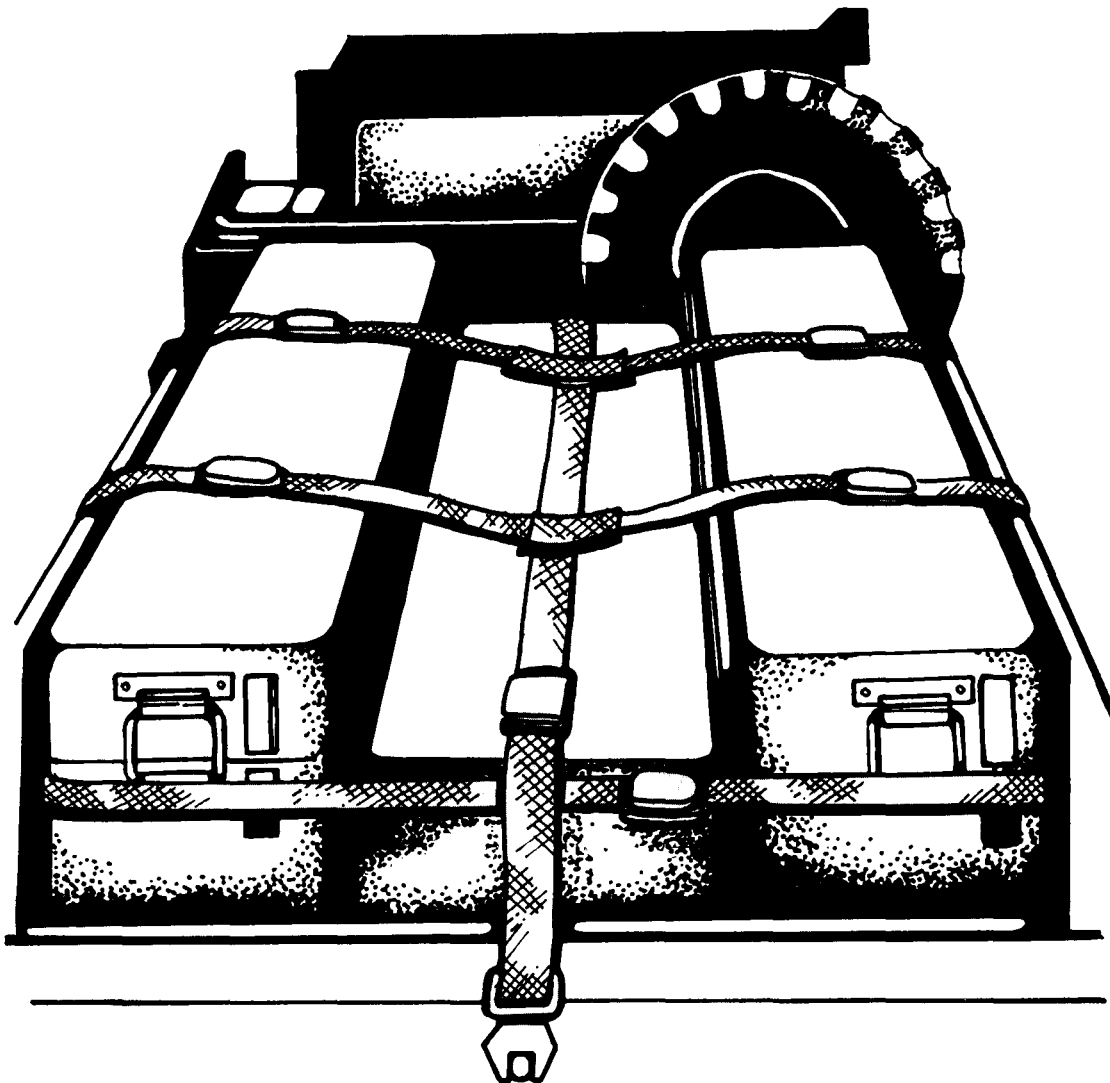

## IFF INTERROGATOR CONTAINER

This fiberglass container stores the IFF interrogator, battery, and interconnecting cable. The container is not pressurized, but it does contain a pressure relief valve to release any pressure build-up within the container.

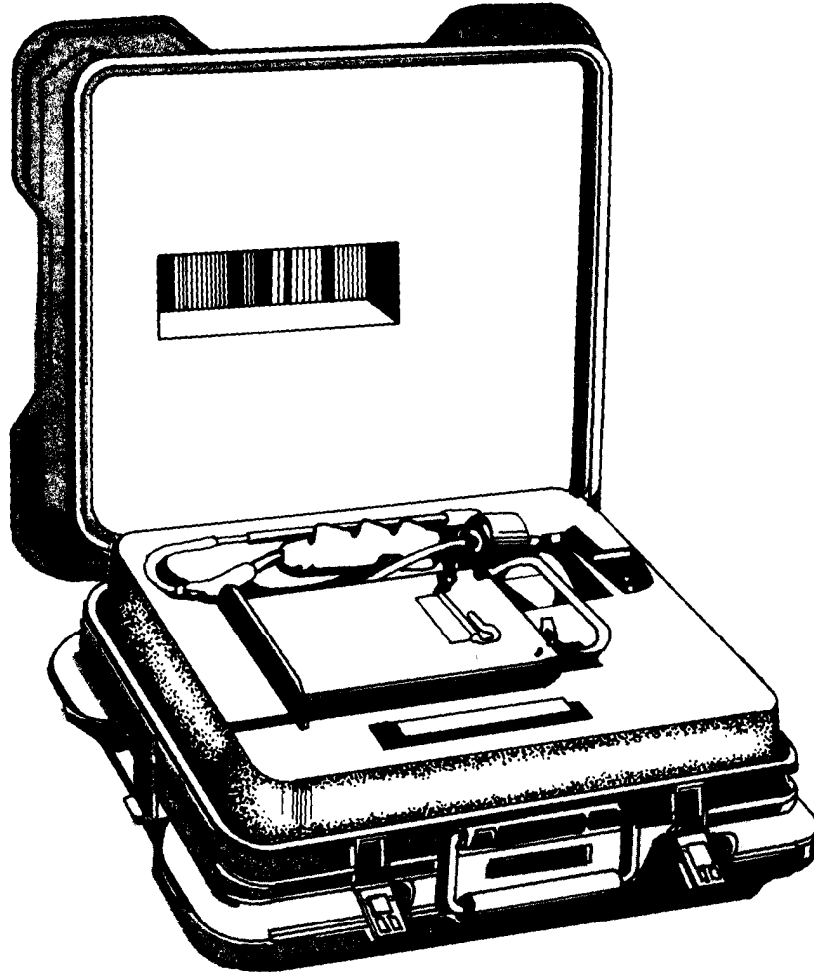



## CHAPTER 2

# Weapon Handling

Upon receipt of a Stinger weapon-round from the ammunition supply point (ASP), it must be checked to be sure it is suitable for firing. The weapon should be removed from the shipping and storage container and inspected in accordance with (IAW) the “services upon receipt” checks, which are found in TM 9-1425-429-12. This manual does not cover preventive maintenance checks and services (PMCS). However, this chapter does contain an abbreviated set of weapon checks which may be made under field conditions when the time and tactical situation permit. Such a time may be at (or near) the ASP or when converting a missile-round to a ready-round. In addition, this chapter describes weapon handling and safety precautions which must be followed by Stinger gunners to prevent injury to personnel and damage to equipment.

## STINGER HANDLING PROCEDURES

When the Stinger team first receives a weapon, the markings on the container (case) should be checked to be sure that it contains the proper weapon. Yellow squares, on two diagonally opposite corners on the case and yellow data markings, indicate it contains a live round.

Containers for trainers are marked with blue colored squares for the tracking head trainer (THT) and bronze for the field handling trainer (FHT). In addition, the data markings are white and these containers have the word “INERT” on the top of the case.

The Stinger weapon-round and IFF interrogator containers are sealed to prevent environmental damage. Before either case is opened, the pressure relief valve should be pressed with the finger. When the rushing noise (if any) stops, the internal pressure of the case is

CONTENTS	
	Page
Stinger Handling Procdures. . . . .	2-1
Weapon Checks . . . . .	2-2
Safety Precautions. . . . .	2-4

the same as the pressure outside the case. The missile-round container does not have a pressure relief valve.

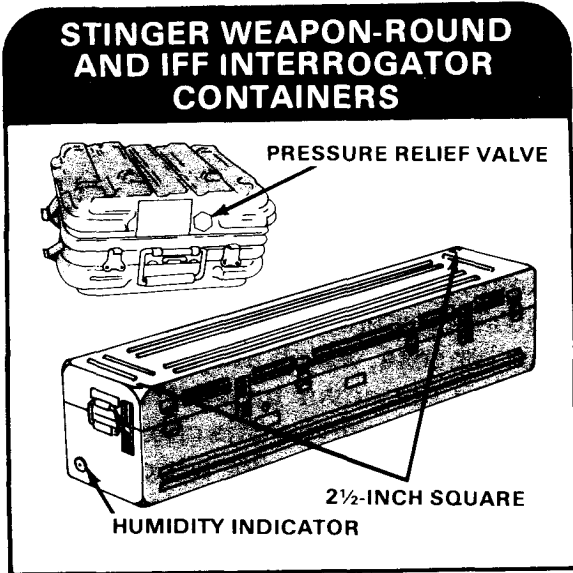

When out of its container, the weapon should be rested carefully on its side. Do not stand the weapon on end. Be sure that the launch tube has the proper color markings—four 1-inch yellow squares. If it does not, return the trainer to the ASP and exchange for a weapon-round.



While the gunner is walking, he should carry the weapon by placing the carrying sling over his shoulder. The weapon should be carried horizontally at a slight angle. The sling should be tight enough to prevent the weapon from swinging.

The protective covers (BCU receptacle front-end and IFF connector caps) should not be removed until preparing to fire or while inspecting the weapon.

Stinger equipment and trainer markings are in TM 9-1425-429-12 and TM 9-6920-429-12.

## WEAPON CHECKS

When Stinger weapons are issued, and sufficient time is not available to perform all the checks listed in the technical manual, the team chief and gunner must, as a minimum, make the checks listed on the following pages. This does *not* mean that the other checks listed in TM 9-1425-429-12 should be overlooked, if time permits.

### FULL CHECKS

Under field conditions, and if the tactical situation allows, full checks should be made

on a daily basis. Checks should be made at times when the team is in a reduced state of alert. These checks are especially important for those weapons which have been outside of their containers and exposed to bad weather. Full checks are found in TM 9-1425-429-12.

Note: Although sunlight normally will not cause damage to the seeker, care should be taken to keep an uncovered seeker pointed away from the sun.

## CRITICAL CHECKS

A well-thought-out and organized procedure for checking the Stinger weapon-round will insure that it can be fired when it is needed. If any of the items listed are defective, then the component which it belongs to is considered *not* ready/available.

### MISSILE-ROUND

Missile-round critical checks are as follows (see Stinger Weapon-Round illustration):

- Check the blowout disk **1** to insure that it is *not* cracked or broken.
- Check the launch motor squib leads **2** to insure that they are *not* damaged or broken. (Do *not* remove the adhesive cover; just run your fingers along the wires.)
- Check the launch tube **3**, while you are doing your other checks, to insure that it is *not* cracked or broken.
- Check the color in the humidity indicator **4** window. If tan, replace at *once* with a green desiccant cartridge. Do *not* use the launch tube for 24 hours. If the indicator turns tan again within that 24-hour period, there is too much moisture in the launch tube. Turn the tube into the ASP.
- Remove the front cover and inspect the IR window **5** to insure that it is clean and *not* scratched, broken or cracked. If the window needs cleaning, use lens cleaning tissue. (See paragraph 3-5 of TM 9-1425-429-12.)
- Check the range ring **6** to insure that it is *not* loose or defective.
- Check the rear sight reticle **7** to insure that it is *not* loose or defective.

If the paint seals on the screws holding the range ring or rear sight reticle to the sight assembly are broken, assume that they have been tampered with and do *not* use the launch tube until boresight has been verified.

- Check the two acquisition indicators **8** and wires (see illustration below) to insure that they are *not* damaged.

### GRIPSTOCK ASSEMBLY

Before doing these checks, check to see if a BCU is installed. If a BCU is installed, do *not* inspect the gripstock assembly. Do *not* remove the BCU. The following checks will be done during weapon firing:

- Check the safety and actuator device **9** by pressing and releasing the lever. A click should be heard and the lever should return to the normal position.
- Check the uncaging switch **10**, in three positions (center and both ends), by pressing and releasing the switch. A click should be heard each time and the switch should return to the caged position.
- Check the firing trigger **11** by squeezing and releasing the trigger. A click should be heard and the trigger should return to the normal position.
- Check that the latch mechanism **12** holds the gripstock assembly securely to the launch tube.

### BATTERY/COOLANT UNIT

The following are BCU critical checks (check all BCUs **13**):

- Check the color of the heat-sensitive indicator. It should be pink. If not, discard the BCU.
- Check the holes over the burst disc diaphragm. If the silver foil has been ruptured, discard the BCU.

Note: Do *not* remove an installed BCU to do the following checks.

- Check the rubber cap over the needle to insure that it has *not* been punctured. If so, the BCU may only be used in an emergency.

- Check the needle without removing the rubber cap to insure that it is *not* bent. Do *not* attempt to straighten a bent needle; instead, discard the BCU.
- Check the BCU housing to insure that it is *not* cracked. If so, discard the BCU.

Note: Weapon mating procedures are outlined in TM 9-1425-429-12.

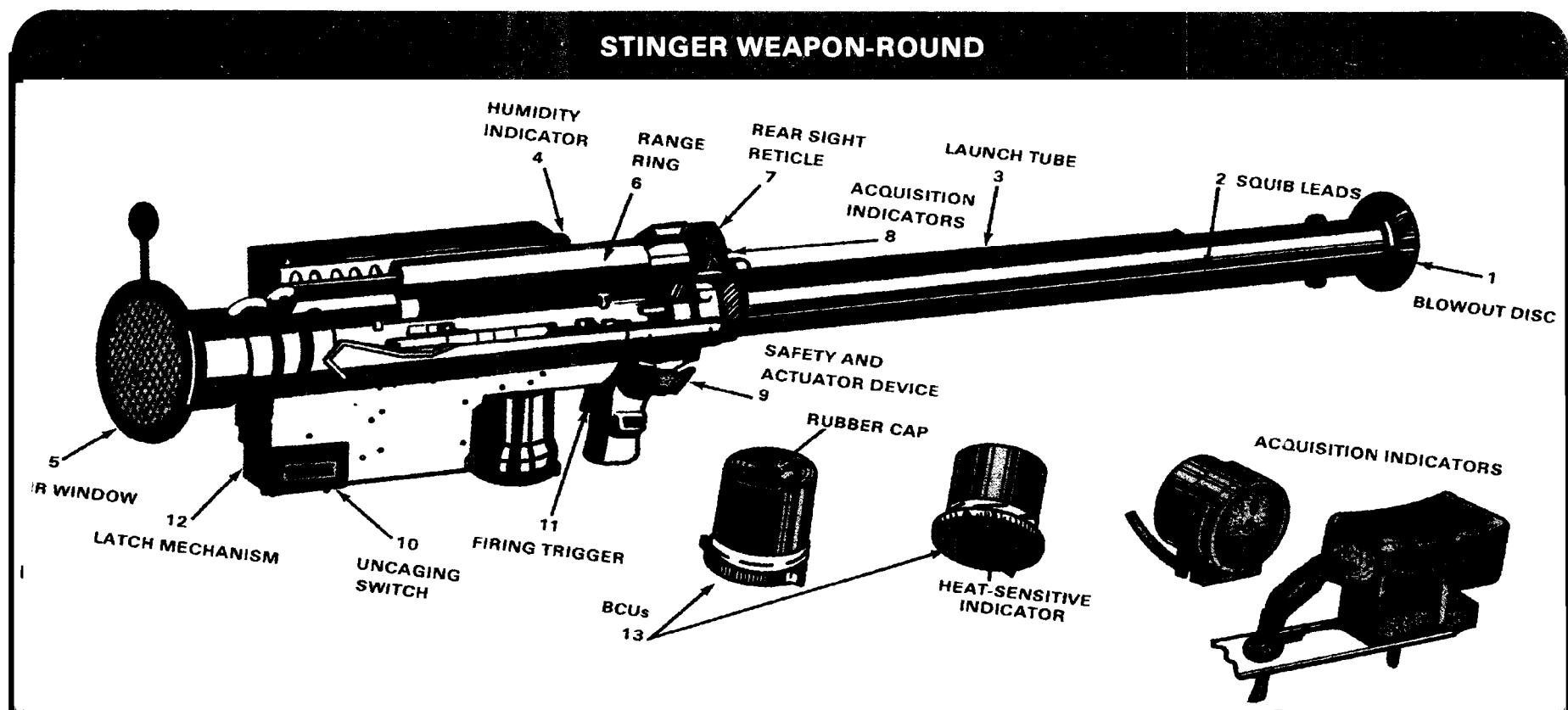

## SAFETY PRECAUTIONS

During annual service practice firing, there should be no personnel closer to a firing point than 50 meters (164 feet). Under combat conditions, personnel within 15 meters (50 feet) of the weapon run a high risk of being injured by flying glass and debris. The team chief should be close to the gunner's side to insure that he is not endangered by the weapon's backblast. Allow at least 5 meters (16 feet) safety distance from equipment. Under

combat conditions, these safety distances for personnel and equipment may not always be feasible. Damage to radio equipment may result if it is within the backblast area. Always inform the unit that you are supporting of the noise and backblast safety hazards.

Stinger firing range requirements for surface danger zones are described in (SNF) FM 44-1A.

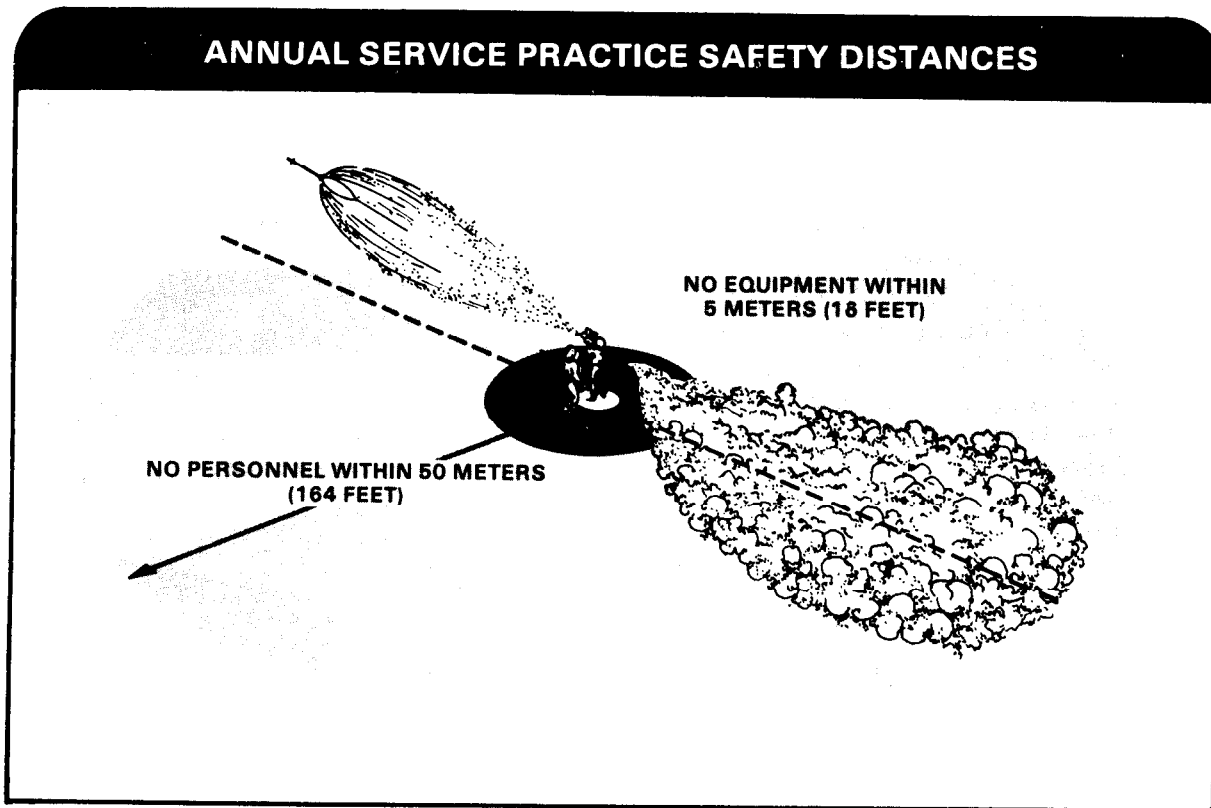

Additional safety measures to be observed are as follows:

- Fire only from a standing position.
- Wear ear protectors, helmet, and flack jacket when firing. Personnel within 125 meters (about 400 feet) should also wear ear protectors.

### WARNING

Permanent deafness will result if personnel are exposed to more than two firings. Proper hearing protection must be worn!

- Use the plastic eyeshield on the weapon sight.

- Do not fire at an angle greater than 65°. The flying debris caused by the missile backblast presents a hazard to the gunner if this angle is exceeded or if the launch tube is within 30 inches of the ground.

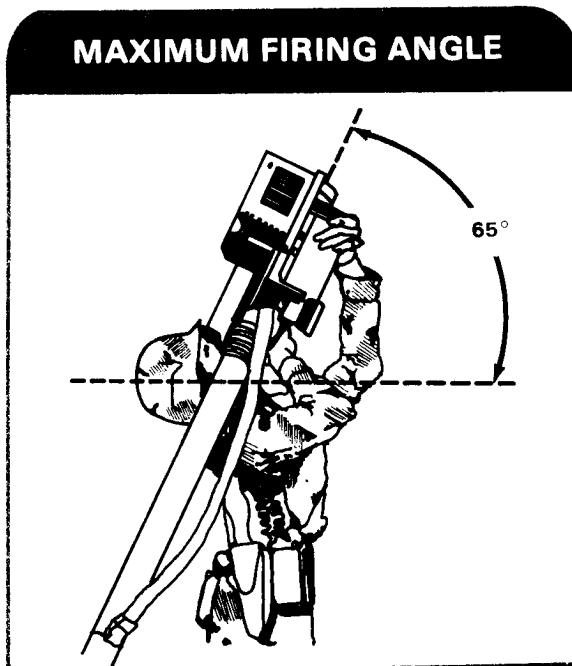

- Always superelevate. By superelevating, you make use of a built-in, 10 degree angle that compensates for missile drop during the coast phase.
- Do not discard a used BCU into dry brush or grass or near flammable materials.

Before inserting the BCU, make certain that the safety and actuator device is in the SAFE position. The Stinger weapon is shipped with a cap covering the BCU receptacle. The cap should be kept in place until just prior to BCU insertion. Remove the receptacle cap by turning it counterclockwise. Place it in the BCU container found in the shipping and storage container for use at another time. You can also place the cap on some convenient location of the body (pocket, inside shirt, etcetera). Insert a BCU into the receptacle and turn it clockwise until it locks in place.

The case of the BCU gets extremely hot (400°F) 3 to 5 minutes after activation and remains too hot to touch for approximately 30 minutes. Do not grab the BCU except by the heat-insulated cap. Remove the BCU immediately after firing.

## CHAPTER 3

# Firing the Stinger

This chapter describes the steps required to operate and fire the Stinger weapon. It describes how the gunner prepares the weapon for firing and all subsequent steps of weapon operation through target destruction. If the firing sequence is interrupted for any reason, the actions taken to reacquire the target and complete the firing sequence are also discussed. The Stinger gunner, as well as the team chief, must have a firm understanding of the basics of weapon operation prior to conducting an engagement.

## TARGET ENGAGEMENT PROCEDURE

Prior to engaging targets, the Stinger weapon must be readied for action. As a starting point, assume that the Stinger team is in position with its basic load of weapons. Four of the weapons should have BCUs installed. These weapons are in the metal containers/ready racks on the team trailer. The IFF with interconnecting cable is worn on the equipment belt or slung by a strap. The other end of the cable is clipped to the jacket. The weapon is readied for firing by performing the following steps:

- Open the weapon-round container and remove the weapon.
- Check to be sure a BCU is in place. Place the weapon on the right shoulder, grasping the pistol grip with the right hand to provide support.

- Unfold the antenna with the left hand.
- Remove the front end cap with the left hand.
- With the left hand, raise and lock the sight assembly into position.
- With the left hand, insert the IFF interconnecting cable into the gripstock.
- Move the left hand forward and grasp the UNCAGING switch but do not press the switch.

### CONTENTS

	Page
Target Engagement Procedure . . . . .	.3-1
IFF Interrogation . . . . .	.3-2

## IFF INTERROGATION

When the target is visually detected, point the launcher toward the target, sight over the sight assembly, and then look through the peep sight. Next, position the target image in the center of the range ring. Challenge the aircraft if it has not already been identified. (Chapter 4 discusses when to challenge and under what conditions.)

Listen for the IFF response. IFF responses have the following meanings:

- : Many “beeps” mean an unknown target.
- : Two “beeps” mean a positive friend (Mode 4).
- : One “beep” means a possible friend (Mode 3).
- : No “beep” means a malfunction.

Depending upon the IFF response and the rules of engagement, either disengage or proceed to engage the target.

### TRACKING AND RANGING THE TARGET

Track the target by keeping it in the range ring. The stance and upper body are determined by the aircraft’s direction of flight. The stance requires that the left foot be placed directly toward the aircraft and the body be leaned slightly forward. Then the technique of fire applicable to the type of aircraft being engaged is applied. Target tracking occurs prior to weapon activation and continues throughout the engagement sequence. Target tracking is further discussed in chapter 6.

### WEAPON ACTIVATION

Activate the weapon as soon as required by the firing doctrine. Firing doctrine is discussed in chapter 6. Weapon activation occurs when the safety and actuator device is operated. Press the device forward, outward,

and down with the right thumb until a click is heard. This activates the BCU. Then, release the safety and actuator device. Weapon “warmup” occurs within a period of 3 to 5 seconds, during which time certain components are brought up to the mechanical and electrical conditions required for system operation. Gyro spin-up noise, which indicates the system is becoming operational, should be heard.

### IR ACQUISITION/DISCRIMINATION

The Stinger missile seeker is sensitive to radiations in the infrared frequency spectrum and uses these radiations from the target as the source to guide itself to target intercept. After a target has been visually acquired and tentatively identified, the gunner must track the target to enable the missile to lock on the target IR. The IR acquisition signal is electronically processed and presented to the gunner as an audible signal. The audible signal clarity and intensity is directly related to seeker acquisition of the aircraft. The gunner must discern the audio signal as soon as possible to permit early engagement of incoming aircraft. This requires the gunner to hear low level signals in contrast to background noise.

#### Nature of Infrared Radiation

Infrared is the band of wavelengths in the electromagnetic frequency spectrum just below visible light (see Electromagnetic Spectrum illustration). All substances radiate IR energy, the amount depending largely on their temperature. IR energy has properties similar to light; that is, it travels in a straight line and at the same speed as light. The missile senses IR emitted by a target by optically focusing this energy on the surface of an infrared detector in the missile seeker system. The



detector cell is cooled by the coolant in the BCU. When the seeker acquires the IR energy emitted by a target, acquisition signals are

produced by the weapon which inform the gunner that the target has been detected.

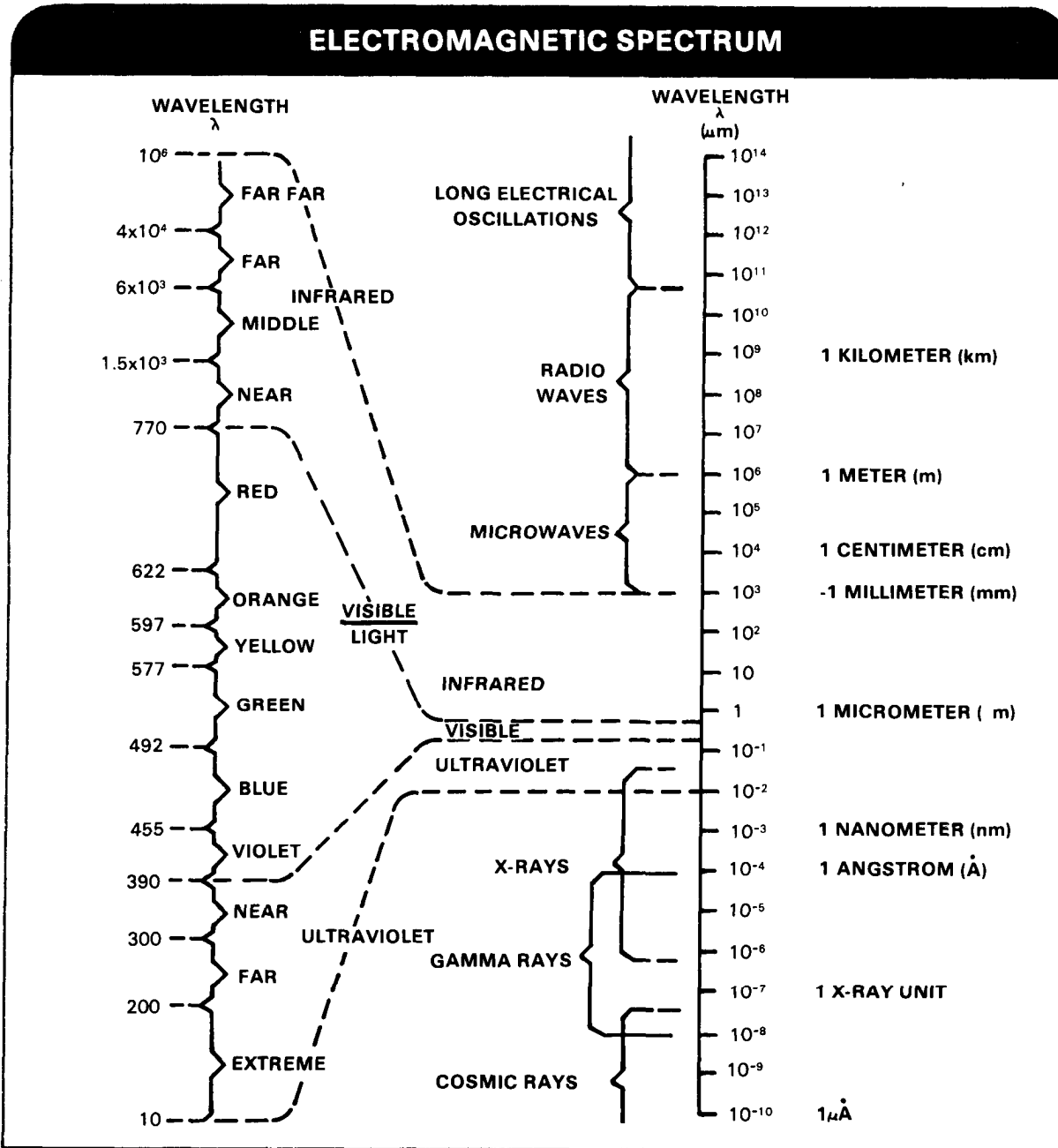

### Atmospheric Conditions

The atmosphere is not completely transparent to IR. Certain gases in the atmosphere, primarily carbon dioxide and water vapor, absorb energy in the IR frequency spectrum. Because the amount of carbon dioxide in the air is fairly constant, its effect on detection range is consistent and need not be considered by the gunner. Water vapor content varies widely with geographic location and local weather conditions. The sun's IR is also reflected from objects, causing these objects to become secondary sources of background radiation (false targets). Typical secondary sources are bodies of water, bare

hillsides, and white clouds. Some sources of secondary background radiation are shown in Background Radiations illustration.

The Stinger IR seeker can discriminate between radiation from a small point source, such as the tailpipe of a jet, and large background sources, such as clouds and terrain. With the exception of the sun, the engine exhaust or tailpipe of the target is usually the smallest and hottest object in the environment and, therefore, will be tracked by the missile seeker.

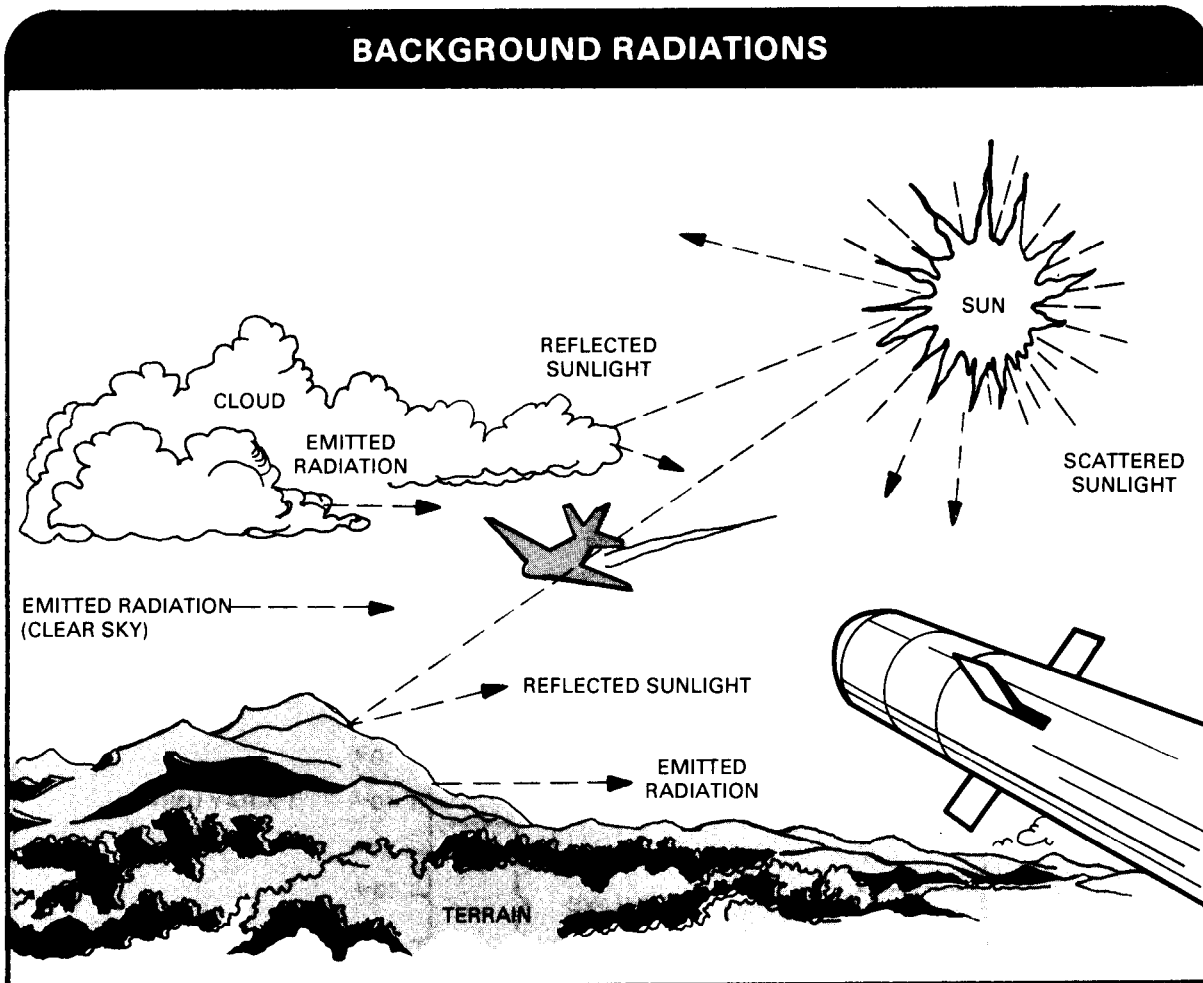

## ACQUISITION

When the target provides sufficient IR to the seeker, an acquisition signal is generated. This signal indicates that the seeker has acquired the target. Two conditions are required for the missile seeker to acquire the target's IR. The weapon must be activated and pointed at the target and the IR from the target must be strong enough to activate the acquisition indicator circuits.

Listen for distinct acquisition tone (and discriminate between target and background, if necessary). If the weapon is aimed away from the target when the gyro is caged, the tone should decrease.

## UNCAGING

After insuring that the seeker has acquired the aircraft, press the UNCAGING switch with the thumb, hold it in, and continue to track the aircraft. After uncaging, the IR tone usually gets steadier and louder.

This lets the gunner know that the seeker has locked onto the aircraft and is tracking it. If the tone does not get louder upon uncaging, release the UNCAGING switch and continue to track the aircraft in the range ring, allowing it to get closer. Then press the UNCAGING switch again.

If the IR tone is weak or distorted, the seeker may be locking on the background instead of the target. When target IR cannot be acquired, or when trying to separate target IR tone from other tones (because of the background radiation), sweeping the target or the figure eight (8) method should be used.

When the target is low on the horizon, sweep the target looking through the front sight ring. Swing the weapon in U-shaped movements through the target until the IR tone gets stronger. A clear tone should be received when the aircraft enters the range ring on the sweep (see illustration below).

### SWEEPING THE TARGET METHOD

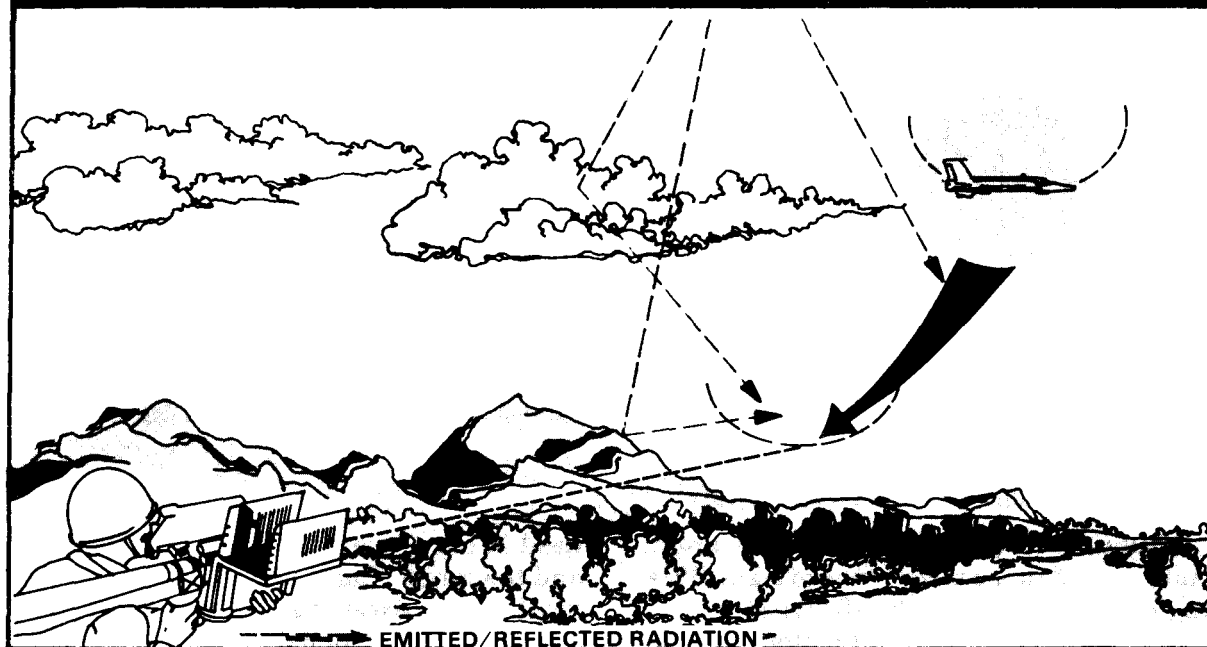

When the target is farther above the horizon, use the figure 8 method. Move the weapon, using the target as a starting point, and make two loops as in a figure 8. If IR still cannot be acquired, keep “figure eight-

ing” until the IR tone from the target gets strong enough to lock on to. Always verify tone, when a target is near a background IR source, by one of these two methods before uncaging the gyro.

**FIGURE EIGHT (8) METHOD**

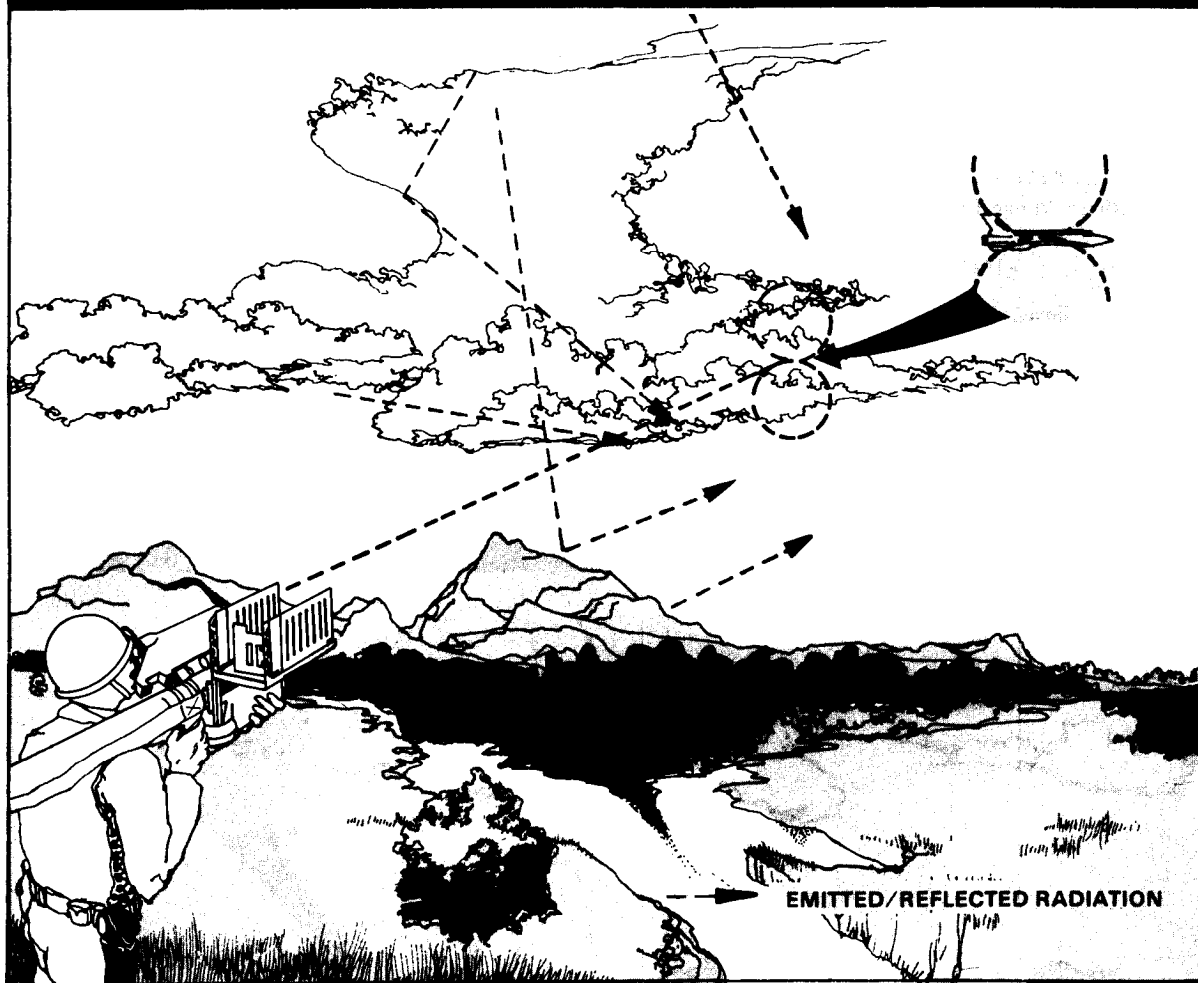

**SUPERELEVATION AND LEAD**

Superelevation is the elevation angle that is added to the missile line of sight. This angle compensates for the effects of gravity on the missile prior to flight motor ignition.

Lead is the angle between the point of aim and the target. Right or left lead is required for all targets except those fixed-wing targets directly incoming or outgoing.

The following explains in words and figures how to place the target within the rear sight reticle prior to firing.

---

### ADDING SUPER ELEVATION

First, to superelevate, raise the front of the weapon **A**.

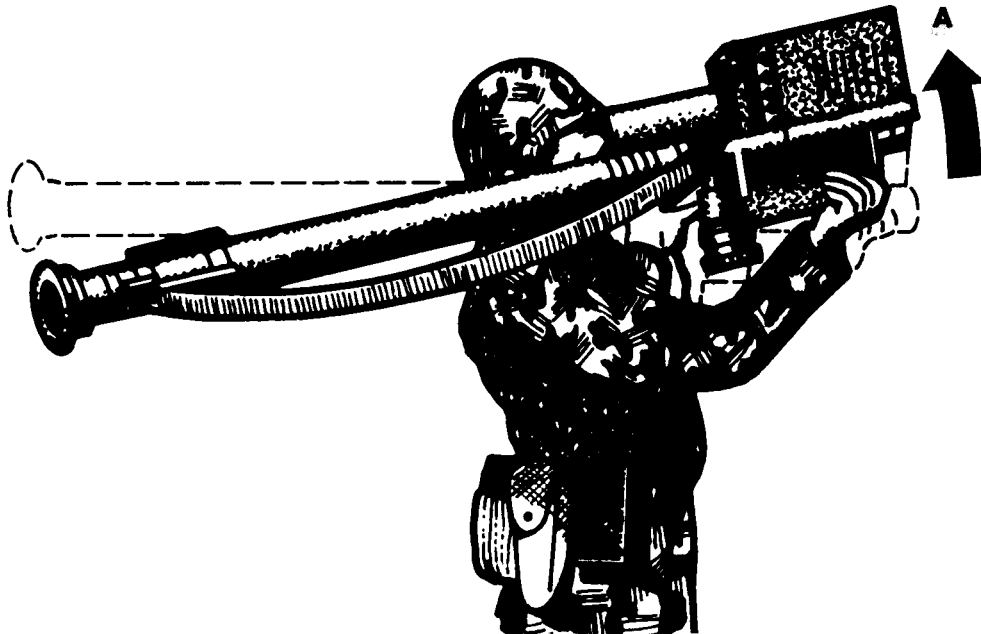

Then, move the aircraft from the range ring **B** to either the left, center, or right lower reticles **C**, **D**, or **E**.

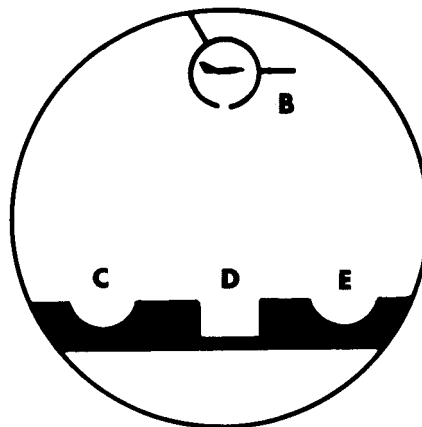

---

**RIGHT LEAD INDUCED (FIXED-WING)**

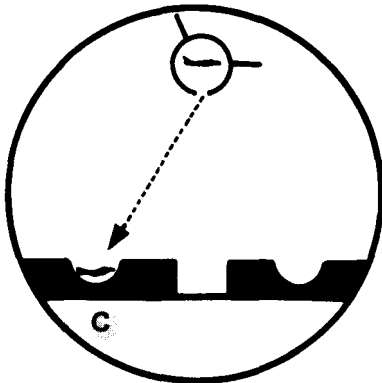

All fixed-wing aircraft and helicopters coming from the *left*, or slightly from the *left*, are placed in the *left* reticle **C**.

---

**INCOMING/OUTGOING (FIXED-WING)**

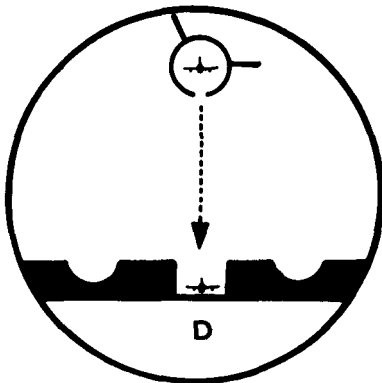

All fixed-wing aircraft directly incoming or outgoing are placed in the *center* reticle **D**.

---

**LEFT LEAD INDUCED (FIXED-WING)**

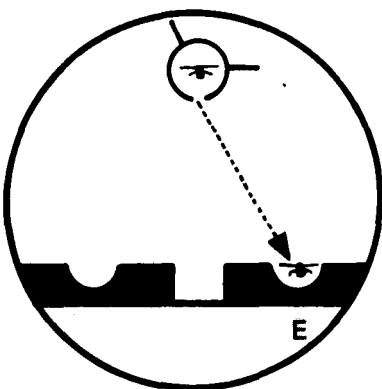

All fixed-wing aircraft and helicopters coming from the *right*, or slightly from the *right*, are placed in the *right* reticle **E**.

## LEFT LEAD INDUCED (HELICOPTERS AND HOVERING VTOL AIRCRAFT)

Directly incoming/outgoing or hovering helicopters and vertical take-off and landing (VTOL) aircraft are placed in the *left* lead reticle. Placing an incoming/outgoing or hovering helicopter in the *right* lead reticle is acceptable, but not recommended.

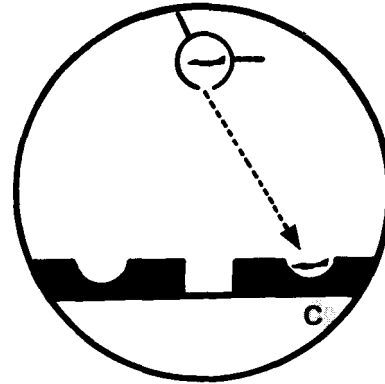

### FIRING

Before pressing the firing trigger, make sure that IR tone can still be heard. While still pressing the UNCAGING switch, squeeze and hold the firing trigger. Keep tracking the target until the missile launches. Release the trigger and uncaging switch 3 seconds after launch. When firing, *hold your breath* until you release the trigger so as to avoid inhaling toxic fumes. If the exhaust plume visibly persists at your position, move away from the plume before breathing again (reference TM 9-1425-429-12).

#### Post Fire Procedures

Post firing procedures include the following:

- Remove the expended BCU from the gripstock within 3 minutes to prevent damage to the BCU receptacle.

#### WARNING

The BCU becomes extremely hot following activation. Grasp it only by the heat-insulated cap when you remove it.

Do not point the top of the BCU toward the skin, as high-pressure gas may still be escaping. Do not handle the used BCU for 30 minutes after it has been removed.

- Remove the IFF cable by pulling straight down on the quick-release loop attached to the IFF cable connector.
- Close the IFF antenna.
- Place the expended weapon on the ground (or back in its container, with its sight assembly and IFF assembly closed). When the tactical situation permits, remove the gripstock assembly from the expended launch tube. It can be reused on another missile-round. The launch tube will be destroyed at a convenient time.
- Leave the firing site quickly to avoid fire from the enemy.

#### Hangfire and Misfire

A hangfire is a delay in the functioning of a weapon-round. It can last up to several minutes. A misfire is a complete failure to fire. If a missile does not fire, the following steps should be taken:

- Continue to track the target for an additional 3 to 5 seconds, keeping the firing trigger and uncaging switch depressed. If, after that time the missile has not ejected, release the firing trigger and uncaging switch. Remove the BCU.

■ Place the weapon-round on the ground (or place in rack during annual service practice). Both ends should be pointed away from personnel and the front end should be elevated (approximately 20°). Leave the firing site without passing in front of, over, or behind the weapon.

■ Mark the defective weapon's location and then notify the Explosive Ordnance Disposal (EOD) unit.

A dud is a missile whose flight motor does not ignite. It is ejected from the launch tube assembly, travels a short distance, then falls to the ground. In this case, also, mark

the location and then call the EOD unit. Remember the missile is classified and should not be left alone.

**WARNING**

**For a hangfire, misfire, or dud missile, personnel should evacuate the area around the missile for a distance of not less than 1,200 feet. The missile should be guarded and kept under observation and should *not* be approached for at least 3 hours.**



## CHAPTER 4

### Aircraft Detection

To successfully accomplish an engagement, the Stinger team must be proficient in detecting and identifying aircraft. This chapter focuses primarily on the methods and techniques used in detecting aircraft. Because the identification function is an integral part of the engagement sequence, it is discussed, where appropriate. However, it is not discussed in detail. Aircraft recognition training is covered in FM 44-30. FM 44-18 tells how to employ the Stinger missile system, including how to apply rules of engagement, which include hostile criteria. Also covered are the various weapon control statuses (WCS) and the procedures to follow in making the decision on whether or not to fire at an aircraft.

### VISUAL DETECTION

The first step in a Stinger engagement is visual detection of the target. This may be done by either member of the team. A Stinger team may be warned of approaching aircraft by the forward area alerting radar (FAAR) system or the early warning broadcast net. The Stinger team receives the warning on the FM receiver on the target alert data display set (TADDS) or on the R-442 auxiliary receiver. In any case, the target location must be made known to the gunner. When warning of the approach of unknown aircraft is received, the Stinger team can narrow its search sector to the general direction from which the aircraft is coming. The range at which aircraft may be detected will vary due to several circumstances. The following are some circumstances which will affect aircraft detection:

- Terrain masking.
- Aircraft characteristics.
- Meteorological conditions.
- Visual acuity.
- Search sector

### C O N T E N T S

	Page
Visual Detection . . . . .	4-1
How to Search . . . . .	4-2
Where to Search. . . . .	4-6
Aircraft Interrogation . . . . .	4-6
Aircraft Identification . . . . .	4-8

## TERRAIN MASKING

Since Stinger gunners are on the ground, the local terrain will influence the distance at which low-altitude aircraft will unmask; that is, not be hidden behind a hill or other feature. Terrain mask should be kept in mind when selecting a site.

## AIRCRAFT CHARACTERISTICS

The main features of an aircraft that affect detection range are—

- **Size.** The larger the target, the farther away it can be detected. Apparent aircraft size varies with the type of aircraft and the aspect from which it is viewed. A jet fighter flying a course directly toward an observer shows a small profile and can get quite close to the observer before it is detected. The same aircraft on a crossing course has a much larger profile; therefore, it can be detected at a greater range.
- **Color.** The color of an aircraft affects the degree that the aircraft contrasts with the background. Some jet aircraft have a smoke trail that can be used as an aid in detection at long ranges.
- **Speed.** Aircraft speed affects visual detection of aircraft. Detection range decreases as target speed increases.
- **Altitude.** Aircraft flying at altitudes of 150 to 1,200 feet (46 to 366 meters) above the ground are detected at longer ranges than

those flying above 1,200 feet or lower than 150 feet.

## METEOROLOGICAL CONDITIONS

Rain, snow, dust, fog, smoke, heat shimmer, and haze tend to reduce visibility and so tend to reduce the range of visual detection of aircraft.

## VISUAL ACUITY

Observers are required to detect, recognize, and identify small objects at long ranges. Therefore, they must have good eyesight. Their eyes should be rested periodically (about every 15 minutes) to prevent fatigue and to maintain alertness. Binoculars have little value in detection because they have narrow fields of view. This increases the time required to search a given area of space. Binoculars may help to identify a target after it has been detected. See appendix B for use of binoculars.

## SEARCH SECTOR

Search sectors should be as small as possible and still have good coverage to both sides of the expected avenues of target approach. When alerted to an approaching target, the search sector should be reduced and concentrated in the general direction of the expected approach.

## HOW TO SEARCH

An observer's capability to detect aircraft increases as the size of the search sector assigned decreases. Detection is more likely if an observer is assigned responsibility for searching a narrow sector than if he is responsible for searching the entire area surrounding his position. If an alert warnings system is supporting the observer, he maybe assigned a fairly large sector (for example, 90°) for

general surveillance. When a warning is received, he then narrows his search sector (for example, 30°) and centers it on the aircraft's approach azimuth. Decreasing the sector size to less than 30° is not advisable because the alert warning system azimuth data may not be accurate. An error of only a few degrees may cause the observer to miss an aircraft. Often observers, using the hori-

zon as a reference, tend to concentrate their search near the horizon and disregard objects high above the horizon. Therefore, when

assigning search sectors, the sector should be defined in both horizontal and vertical planes.

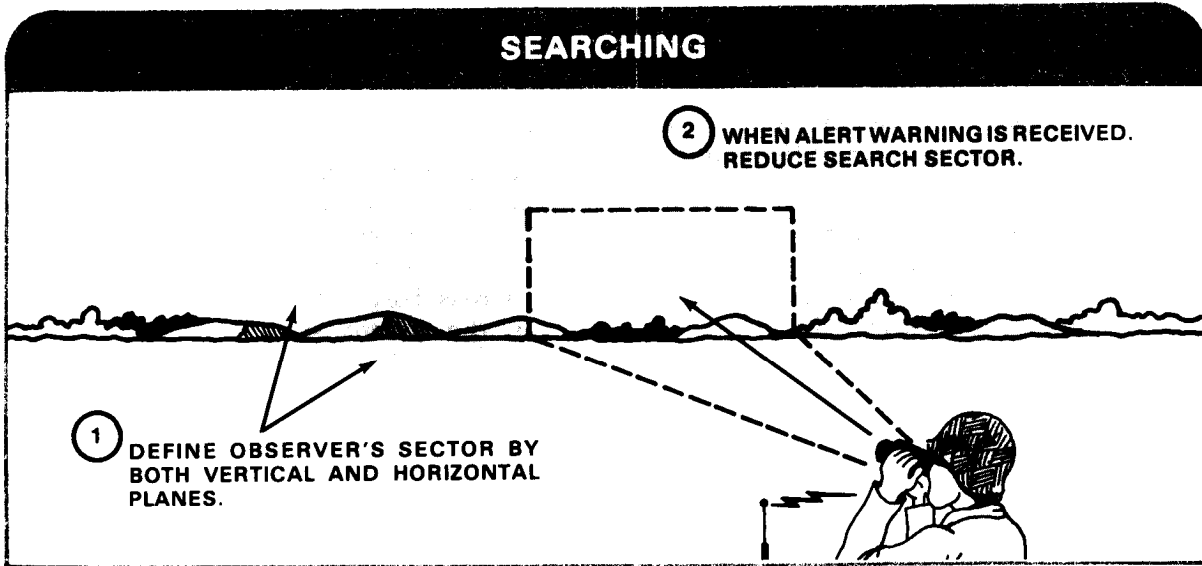

A simple way to estimate how high above the horizon to search is to use the hand. Facing the PTL, extend either the left or right arm fully and extend the fingers. The tips of the thumb and little finger should form a line

perpendicular to the ground. Now, when the little finger is touching the horizon, the tip of the thumb is approximately 20° above the horizon.

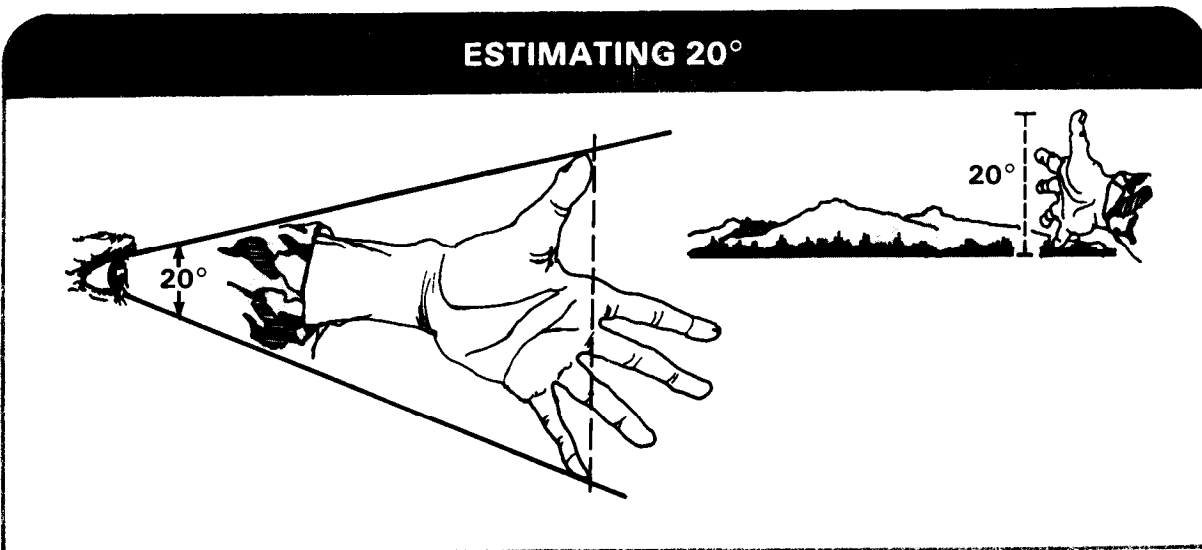

The observer should frequently focus his eyes on a distant object, such as a cloud or terrain feature (otherwise, the eyes tend to relax and distant objects become blurred).

Search the area near the sun by extending arm and hand as to block out the sun's glare. (Looking into the sun without shielding the eyes will cause them to become blinded for a few seconds. This may prove to be critical, because the observer may lose sight of the target.)

The observer should squint his eyes if he has trouble focusing at long ranges. Squinting compresses the eyeballs, thus changing their focal length and making distant objects come into focus.

The observer should keep his eyes on the aircraft once he sees it. If he has to look away from it, he notes the direction of the aircraft and moves his eyes away from it when the aircraft is near some object, such as a cloud or a terrain feature, that will guide his eyes back to it.

Observers may use one of two systematic methods of search to look for aircraft in any type of terrain.

In the first method, the observer searches the horizon to about 20° (356 roils) above the horizon by moving his eyes in short movements across the sky, working his way up and across. He continues the scan pattern to below the horizon to detect aircraft flying nap-of-the-earth.

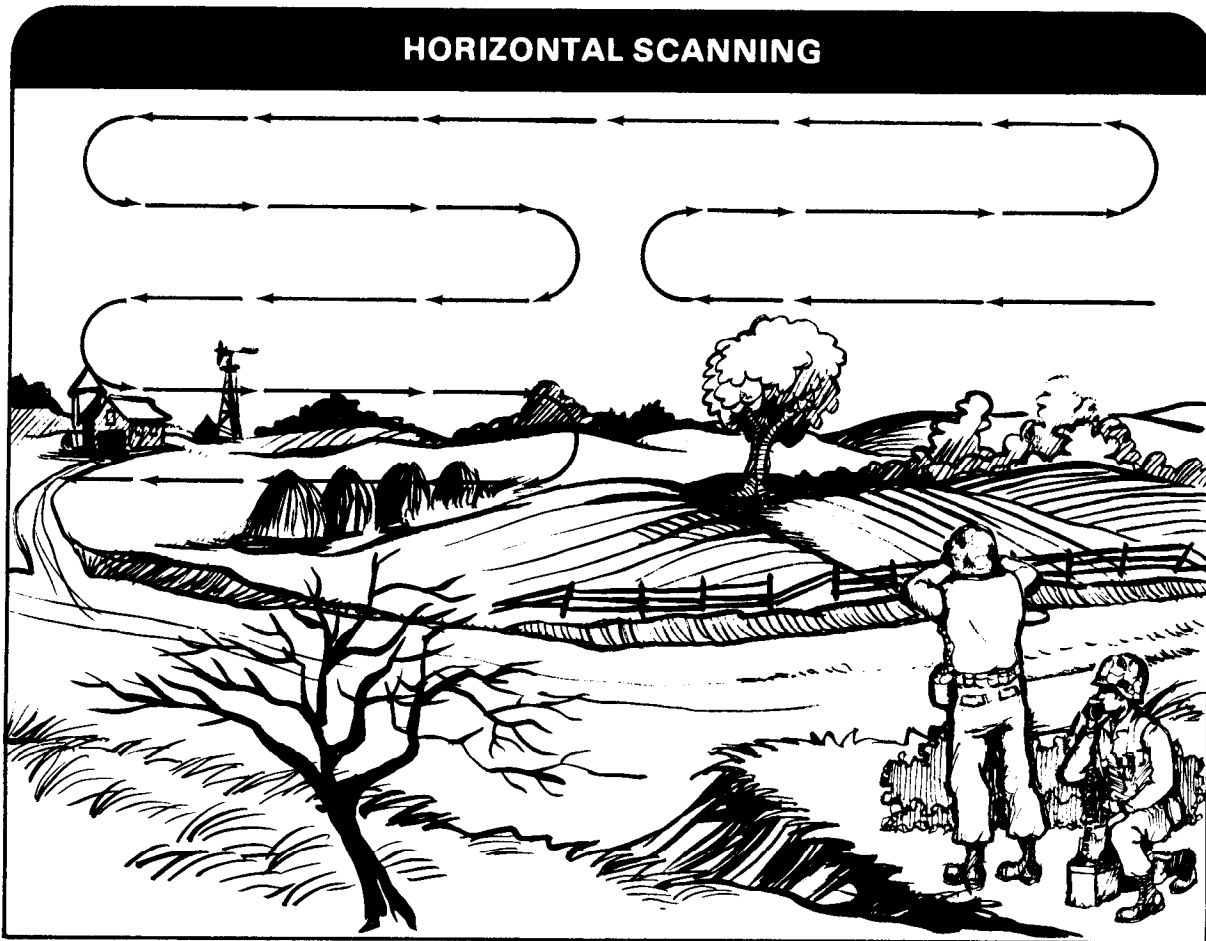

In the second method, the observer searches the sky using the horizon as a starting point and prominent terrain features as points of reference. He moves his eyes in short movements up the sky, then back down,

continuing this movement across the terrain. He scans in the same pattern below the horizon to detect aircraft flying nap-of-the-earth.

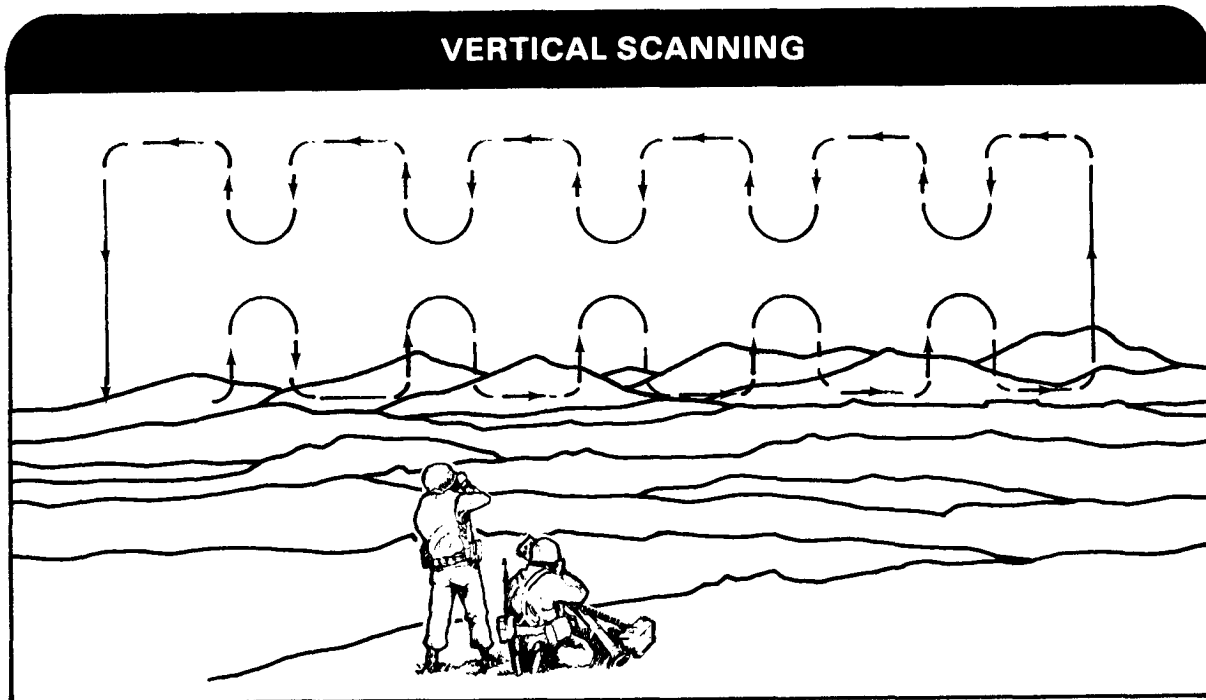

Observers with more experience and above average visual efficiency may use nonsystematic methods of search that work best for themselves such as—

- Combination of the two systematic methods.
- Search of the horizon in the shape of an oval to about 20° above the horizon.
- General/random search of the horizon.

When the Stinger team occupies a tactical position, each team member will take turns searching for aerial targets. This allows one member to search while his partner rests his eyes and provides ground security. Search sectors are arranged to provide all-around coverage of the entire area and overlapping coverage of the assigned sector of fire on likely approach routes. When an alert warn-

ing is received, both team members shift primary search emphasis to the azimuth of approach (with frequent all-around scans) until one member detects the target.

At times, the Stinger team will be assigned a sector of responsibility by the Stinger section chief or the supported unit commander. When two or more teams are defending a unit in position behind the line of contact, the Stinger team normally concentrates its search for aircraft along these avenues. At other times, the Stinger team will search for aircraft as specified by local SOP or as required by the situation. This is common when a Stinger team is defending a convoy. This is also common when it is supporting a maneuver unit which is in contact with or moving to contact with the enemy.

## WHERE TO SEARCH

A map reconnaissance of the supported unit's direction of movement or area of operation will help to pinpoint areas from which aircraft are most likely to attack the unit. Mark the far sides of woodlines, ridgelines, and significant folds in the terrain out to at least 3,000 to 5,000 meters. This is where attack helicopters can lie in wait at the maximum range of their antitank guided missiles (ATGM). Mark restricting terrain-defiles and narrow valleys—where the unit may be forced to pinch together, becoming lucrative targets for air attack.

### WITH MANEUVER UNITS

When accompanying maneuver units in contact or moving to contact with the enemy, the Stinger team usually concentrates its search for aircraft in the general direction of the enemy ground forces and occasionally searches the entire horizon. Other unit per-

sonnel should also be constantly alert to the possibility of attack by enemy aircraft. Again, the team chief marks the route of advance and monitors the TADDS and the radio for warnings of approaching aircraft.

### TELL-TALE SIGNATURES

Many aircraft have tell-tale signatures which can lead to early detection. Stinger teams should look for the following:

- Sun reflection from aircraft canopies or cockpit windows.
- Blade flash from rotating helicopter blades.
- Smoke or vapor trails from jet aircraft and missile or rockets fired from aircraft.
- Dust or excessive movement of tree tops and bushes in a particular area.
- Noise from helicopter blades or from jets breaking the sound barrier.

## AIRCRAFT INTERROGATION

Exactly when to interrogate an aircraft depends upon the WCS in effect. The WCSs

are shown in the illustration below.

WEAPON CONTROL STATUSES		
TERM	DEFINITION	INTERROGATE
<b>WEAPONS FREE</b>	Fire at any aircraft which is not positively identified as friendly. (This is the least restrictive status.)	Upon visual detection and if the direction of flight indicates that the aircraft will penetrate the defended area.
<b>WEAPONS TIGHT</b>	Fire only at aircraft which are positively identified as hostile.	Upon visual detection and if the direction of flight indicates that the aircraft will penetrate the defended area.
<b>WEAPONS HOLD</b>	Do not fire except in self-defense. (This is the most restrictive status.)	Do not interrogate.



## AIRCRAFT IDENTIFICATION

Firing a Stinger missile at an aircraft must be IAW specific hostile criteria. (Normally, the responsibility for target identification rests with the team chief.) The identification must be completed before the team chief can issue a command to engage. The gunner may complete the engagement sequence up to firing, but he *will not fire* without having first received an order to engage from the team chief. When operating as part of a split team or if the team chief becomes a casualty, the gunner must assume identification responsibilities. After an aircraft has been detected, it must be identified as friendly, hostile, or unknown.

If the aircraft is declared friendly, it must *not* be engaged (except in self-defense).

If the aircraft is declared hostile and is within range, it must be destroyed (except under a condition of WEAPONS HOLD). However, the right to fire in self-defense is never denied.

If the aircraft is unknown, the engagement decision is based on the WCS, application of hostile criteria and techniques of fire.

### HOSTILE CRITERIA

Recognition of the aircraft by name or country of manufacture is a start, but it is by no means conclusive. For example, the Mirage III/V is made in France; however, it is in service in 23 countries in Europe, the Middle East, Africa, Australia, and South America. Other aircraft are similarly spread throughout the world, including many made in the United States. Target identification as hostile must be based on visual inspection of the target and its assessment against specific hostile criteria. The exact criteria in use may vary with the tactical situation, from command to command, and in terms of time and space. For example, the TSOP may classify as hostile those aircraft that are—

- Attacking friendly elements. Any aircraft actively attacking the team or supported unit or installation may be identified as hostile. The right of self-defense is never denied.

- Responding improperly to IFF interrogation. The gunner issues an IFF challenge to the target by pressing the IFF CHALLENGE switch. If the target responds improperly to the challenge, the team chief may accept the improper response as a first assumption of hostility. However, the team chief must then successfully apply at least one more hostile criteria based on visual observation of the aircraft before making a final identification of the aircraft as hostile.

Note: If the WCS is WEAPONS FREE, gunners will engage aircraft responding improperly to IFF interrogation unless constrained by headquarters/command directives/SOPs.

- Performing any of the following acts over friendly troops or territory without prior coordination:

- Discharging smoke or spray.
- Discharging parachutists or unloading troops in excess of normal aircraft crew.
- Engaging in mine-laying operations.

### ADDITIONAL CONSIDERATIONS

Unauthorized or improper entry into an area designated as restricted or prohibited could prove dangerous or lead to personnel injury and aircraft loss. Care should be exercised in applying this criterion. This is necessary to avoid engaging a friendly aircraft that has been damaged and is retiring to the rear of our lines. Also, it may have inadvertently strayed into the restricted area due to a navigational error.

Aircraft operating at prohibited speeds or altitudes, or in prohibited directions, can pose a real problem to an observer. The determination of aircraft speed and altitude



by ground observers is difficult. Extreme care should be used in applying this criterion.

An aircraft bearing the military markings or having the configuration of an aircraft employed by a known enemy nation may also pose a real problem to the Stinger missile team. In this case, the criteria used by the Stinger team must be based on visual inspection of the aircraft. Since aircraft

markings are not usually visible at long ranges, most identifications must be made on recognition of the physical features of the aircraft. To eliminate any element of doubt, both team members must be capable of recognizing friendly as well as enemy aircraft. (For detailed discussion of aircraft recognition, refer to FM 44-30.)

## CHAPTER 5

# The Engagement Decision

When the team chief or gunner has made an identification of a target as hostile, or (under certain conditions) as unknown, and all other requirements for engagement are met, the team chief makes the engagement decision.

## THE STINGER MISSION

The mission of the Stinger team is to protect the unit which it is supporting from attack by aircraft. To be successful in their mission, the team members must work together as a team. In this chapter the actions and decisions made by the team chief and the gunner during an engagement sequence are explained. These actions and decisions must be understood by both team members prior to and during an engagement.

### STINGER TEAM

The basic combat unit is the Stinger team. The team consists of a team chief and a gunner. Both team members are trained as gunners and in communications, target detection, and aircraft recognition. During periods of intense air activity, both may act as gunners to increase the rate of fire. A basic load of six Stinger weapons (four weapon-rounds and two missile-rounds) are carried by each team, initially, during combat operations. Resupply will normally be with Redeye (until

full Stinger fielding is accomplished). Stinger teams supporting maneuver units provide such units with an additional means of air defense.

### COMMAND AND CONTROL

The Stinger teams are commanded and controlled by the section chief. The section chief controls his teams during field operations through use of a detailed TSOP. This method of control is used because the teams are usually located at long distances from the section chief's command post. Therefore, direct and personal supervision of each team normally is not possible. The link between the section chief and his teams is a tactical

### CONTENTS

	Page
The Stinger Mission . . . . .	5-1
Method of Engagement . . . . .	5-2

radio net. Over this net the section chief maneuvers his team and obtains information on their status and location. He also modifies their state of readiness by changing the air defense warning and controls their freedom

to fire by use of WCS and fire control orders. Further details on command and control are found in FM 44-18. The fire control orders used by team chiefs are shown in the illustration.

<b>FIRE CONTROL ORDERS</b>	
<b>FIRE CONTROL ORDER</b>	<b>MEANING</b>
<b>ENGAGE</b>	Engage the specified target. This order cancels any previous fire control order which may have been received.
<b>CEASE ENGAGEMENT</b>	Stop tactical activity against a specified target—prepare to engage another target. This order may be used to reallocate fire against a higher priority target. It can also be used to preclude undesired simultaneous engagement of a target by more than one weapon system.
<b>HOLD FIRE</b>	An emergency fire control order used to stop firing. This order may be used to protect friendly aircraft or in the interests of safety.

**TEAM CHIEF**

The Stinger team chief is responsible for the decision to engage. He must make the decision based on rules of engagement contained in the unit TSOP and with criteria given to him by the section chief. In addition to identifying the target, he is responsible for

selecting the method of engagement to be used and selecting the specific target to be engaged.

In the event that the gunner is alone, he engages the most threatening target first.

**METHOD OF ENGAGEMENT**

The method used to engage aircraft depends upon their number. A multiple target raid is a raid by two or more aircraft

flying the same course, at the same speed, less than 1,000 meters apart. All other raids are single target raids.

## SINGLE TARGET RAIDS

All single target raids are engaged using a SHOOT-LOOK-SHOOT technique of fire. This method is the firing of a first missile (SHOOT) as soon as the requirements for an engagement are met, then an evaluation (LOOK) of the first missile to see if it hit the target. A second (SHOOT) missile will be fired if the first does not hit the target or appears to have failed to achieve guided flight. When the gunner fires his missile, the team chief will observe the flight of the missile, make the kill evaluation and, if necessary and time permits, launch his missile.

## MULTIPLE AIRCRAFT RAIDS

Multiple aircraft raids are engaged using a SHOOT-NEW TARGET-SHOOT technique of fire. This requires the launching of as many missiles as possible at successive aircraft in the raid. When practical, fire coordination within a team will be on voice command of the team chief. When faced with multiple targets of equal threat, both team members will engage targets. The team chief should direct the gunner to fire at the lead or right aircraft in the primary sector of search. The team chief engages the trailing or left hostile target. Fire will be withheld if friendly and hostile aircraft are closely intermixed. (For further details, refer to FM 44-18 and your unit TSOP.)

## GUNNER ACTIONS

When the gunner detects the target or receives information from the team chief on the target's location, he will attempt to acquire the target in the sight. He is assisted by the team chief in acquiring the correct target. When tracking has been established, the gunner interrogates the aircraft, continues tracking, and may activate while waiting for an engagement command. The team chief's engagement command releases the gunner to fire when the gunner decides that the aircraft

meets the technical requirements for a successful engagement. Several essential elements of the engagement sequence must be met before the gunner can fire his weapon. These elements are as follows:

- The target is being tracked smoothly.
- The target has been identified as hostile (or unknown).
- The target has been determined to be within range (see chapter 6).
- The weapon has been activated.
- The IR acquisition tone has been received.
- The team chief has given the engagement command.
- The seeker has been uncaged and IR acquisition tone is clear and steady.
- Superelevation and lead have been applied.

## TEAM CHIEF ACTIONS

When the team chief has made a *firm* decision, he will issue an engagement command to the gunner. The command must include the words "hostile" and "engage." The engagement command is—

- HOSTILE ENGAGE;
- or HOSTILE ENGAGE, LEAD TARGET;
- or HOSTILE, ENGAGE RIGHT TARGET.

## SITUATIONS

The following situations show how the Stinger team chief uses his prescribed rules to make an engagement decision. It is critical that this decision be timely and accurate. To accomplish this, the team chief must thoroughly understand the rules of engagement and control measures applicable to the Stinger system. In the following four situations, place yourself in the position of a Stinger team chief.

## SITUATION 1

An aircraft is approaching my position very fast and very low. The section chief has announced a WCS of WEAPONS TIGHT. My gunner has acquired the aircraft. I cannot visually identify the aircraft at this time. I direct the gunner to interrogate. The gunner challenges and receives an unknown IFF response. (BEEP, BEEP, BEEP, BEEP - - -.)

### ACTION TAKEN

I cannot engage the aircraft because I cannot positively identify it as hostile. I do not ignore it, but direct my gunner to continue tracking the aircraft.

### REASON

WEAPONS TIGHT requires that I make positive hostile identification before engaging.

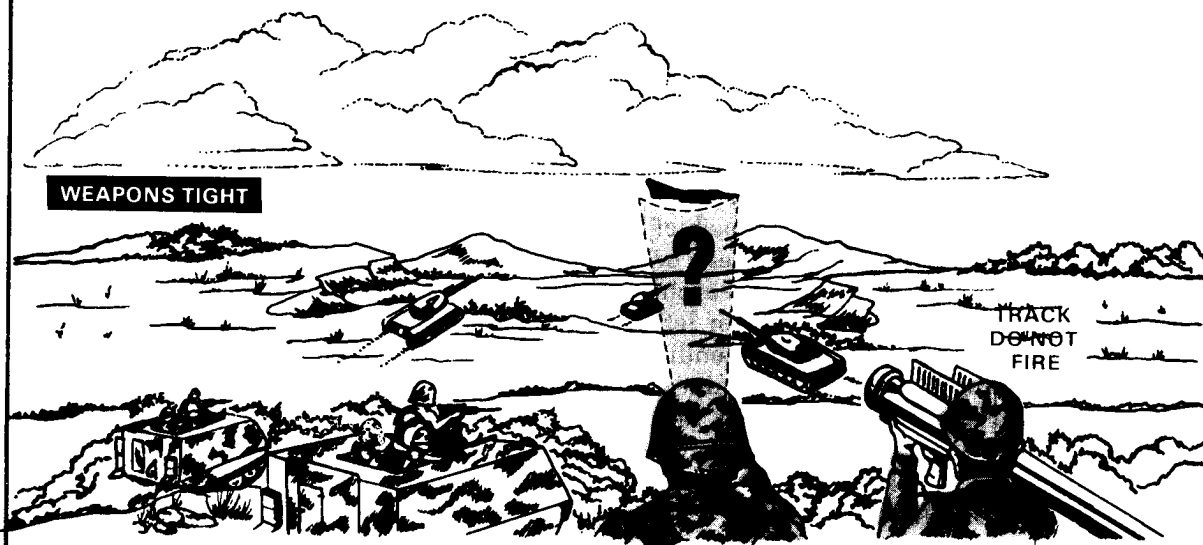

As the aircraft comes closer, I positively identify it as a MiG-23. It bears an enemy national insignia.

### ACTION TAKEN

I order my gunner to engage.

### REASON

By visually identifying the aircraft as hostile, I have met the criteria for engagement under WEAPONS TIGHT.

## SITUATION 2

At 1230, I received a message from my section chief. He stated, "WEAPONS HOLD on all jet aircraft flying westbound between 1300 and 1330. WEAPONS TIGHT for all other aircraft." At 1315, a jet aircraft I recognize as hostile approaches westbound. It is coming within range of my gunner's weapon.

### ACTION TAKEN

I don't engage but continue to observe. My gunner tracks the aircraft and waits for my command to engage. I report the incident to my section chief. If the aircraft changes its heading, so that it is no longer westbound, I will order my gunner to engage.

### REASON

Under WEAPONS HOLD, I cannot engage except in self-defense. If the aircraft changes headings, I am then under WEAPONS TIGHT. Since I've already visually identified the aircraft as hostile, I can then engage.

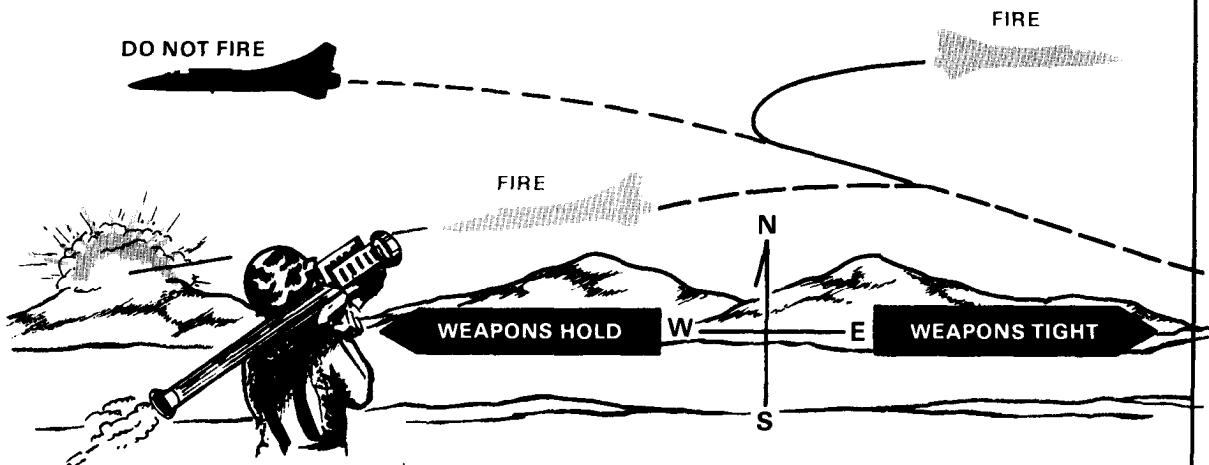

The aircraft continues on the same heading and fires two tactical air-to-surface missiles at the unit I am supporting.

### ACTION TAKEN

I order my gunner to engage.

### REASON

I have the right to engage any aircraft in self-defense. This rule applies not only to an attack on my position, but to the unit I am supporting as well.

**SITUATION 3**

At 1400 my section chief orders me to go to a new position to become part of a four-team defense of a supply depot. Upon arrival, he assigns me a primary search sector of 0° to 90° and a primary target line (PTL) of 45°. The WCS is WEAPONS TIGHT. Three aircraft approach, one at 90°, one at 45°, and one at 20°. All three are at the same range and appear to be moving at the same speed. I visually identify the aircraft at 45° as friendly. I visually identify the aircraft at 20° as hostile. I then turn my attention to the aircraft at 90°. I also visually identify this aircraft as hostile.

**ACTION TAKEN**

I direct my gunner to engage the aircraft at 90°. I then pick up a second weapon system, and engage the aircraft at 20°.

**REASON**

Since all three aircraft are at the same range and speed, they present an equal threat to the defended asset. The aircraft at 45° is on my PTL and is, therefore, the first aircraft I must look at. Since I visually identify it as friendly and there are other aircraft in the area, I ignore it and look at the second aircraft within my primary search sector and closest to my PTL. I identify it as hostile. I then look at the third aircraft and identify it as hostile. Since this is a multiple aircraft raid, I order my gunner to engage the aircraft on the right. I pick up a second weapon system and engage the aircraft on the left.

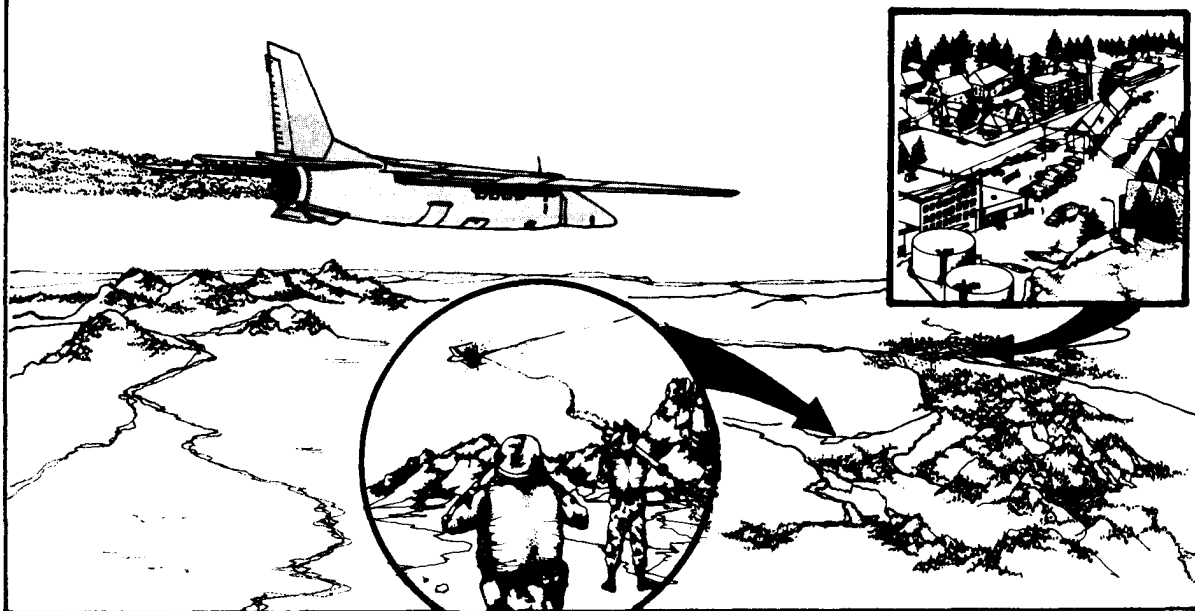

## SITUATION 4

I receive a message from my section chief changing the WCS to WEAPONS FREE. A jet aircraft approaches my position at a low altitude and high speed. I direct the gunner to challenge the aircraft on detection. He receives an unknown audible signal.

### ACTION TAKEN

I continue my attempts to visually identify the aircraft while the gunner goes through the engagement sequence. I visually identify the aircraft as hostile, so I order him to engage and then shoulder my own Stinger.

### REASON

I was authorized to order the engagement because WEAPONS FREE means I should engage aircraft *not positively identified as friendly*. This, coupled with the facts that an unknown audible signal to our IFF challenge was received, and I was unable to positively identify the aircraft as friendly, provided sufficient grounds to launch under WEAPONS FREE.\* Had there been other aircraft in the area, the engagement sequence on the first aircraft would have continued while I directed my attention at another aircraft. If I had identified the aircraft as friendly after the order to engage was given, but prior to launch, I would have called out "HOLD FIRE."



\*Stinger gunners may not be allowed to engage an unknown target in WEAPONS FREE based solely on an IFF decision if constrained by headquarters/commands directives/SOPs.



## CHAPTER 6

### Engaging Aircraft

The speed of modern aircraft is such that the time allowed for completing an engagement becomes a real challenge to the Stinger team; it may not be more than 10 to 20 seconds. To accomplish all the tasks required for a successful engagement in this short time requires a smooth, rapid, and almost automatic response by the gunner to every engagement situation. To obtain this type of response requires a set of rules and procedures which can be learned to the point that they can be applied automatically.

#### TECHNIQUES OF FIRE

Previous chapters have dealt with the subjects of detecting and identifying aircraft and how to handle and operate the Stinger weapon. This chapter outlines firing techniques necessary to engage aircraft. For the engagement to be successful, the following additional decisions must be made:

- Aircraft direction.
- Aircraft threat.
- Aircraft type.
- Aircraft range.

##### AIRCRAFT DIRECTION

Once the aircraft is detected, the weapon is sighted so that the aircraft's image is aligned within the range ring of the weapon sight. Tracking the aircraft in the proper stance will help the gunner determine whether the aircraft is on an incoming/outgoing or crossing path. The gunner assumes a proper stance by stepping directly toward the target with his left foot and lean-

ing toward the target. In this position, if the gunner has any horizontal movement of his arms or upper body as he tracks the target, then the target should be considered crossing. If there is a lack of any substantial horizontal movement, then the target should be considered incoming/outgoing. Also indicative of an incoming/outgoing aircraft is any vertical movement of the gunner's arms or upper body. Determination of "crossover" (that is, the closest point the aircraft ever gets to the gunner) is important for application of aspect or activate decisions. Target size (getting larger/smaller) can assist the gunner in determining crossover or incoming/outgoing status.

#### CONTENTS

	Page
Techniques of Fire . . . . .	6-1
The Engagement Sequence . . . . .	6-4
Launch Rules . . . . .	6-6

### AIRCRAFT THREAT

Any aircraft approaching a defended area poses a threat until properly identified. Upon detection, a decision must be made immediately by the team chief as to whether or not the aircraft is a potential threat. If its direction of flight indicates that it will penetrate the defended area, the gunner issues an IFF challenge. If the aircraft fails to correctly respond to the IFF challenge, it is considered a potential threat. The gunner may activate his weapon at this point.

### AIRCRAFT TYPE

For Stinger engagement purposes, aircraft have been placed in these two categories—jet and propeller driven.

Jets includes all jet aircraft, regardless of size or mission.

Propeller driven includes all other types of aircraft, such as propeller-driven aircraft and all helicopters.

Determination of whether the target is a jet or propeller should be made by the team chief and should come as early in the engagement sequence as possible.

### AIRCRAFT RANGE

The Stinger gunner must evaluate the target and determine if the target is within the Stinger missile's range. The type of air-

craft (jet or propeller driven) and the flight path (incoming, crossing, or outgoing) will determine what rule to follow while making the launch decision. By applying the correct rule for the type and flight path of the aircraft, the Stinger gunner can be assured that he will fire within the effective range of the missile and withhold fire on targets out of his launch boundaries, thereby maximizing hits per missile fired.

### Incoming/Outgoing Jet Aircraft

For incoming/outgoing jet aircraft, the launch and hold fire decision is based on a range ring measurement. The gunner moves the weapon so that the aircraft's image is within the range ring of the sight.

He then evaluates the size of the aircraft image relative to the width of the range ring. For example, if the aircraft's width within the range ring is approximately one-half the size of the range ring, then the aircraft is at one-half range ring. A helpful hint in estimating aircraft size within the range ring is to place the aircraft at the inner left (or right) edge of the range ring before making a size estimate. The gap at the bottom of the range ring is also used to measure range ring size. This gap measures one-fifth the size of the range ring. When an aircraft fills this gap, it is at one-fifth range ring.

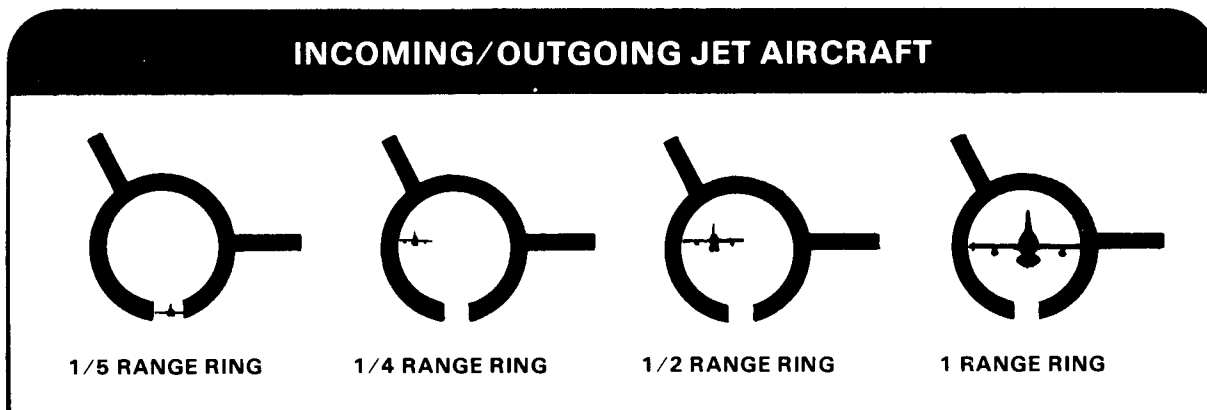

To determine when to activate, hold fire, or launch the missile at an incoming or outgoing jet, the gunner tracks the jet and makes continuous size estimates. When the jet reaches a specified range ring size, it is considered to be within range of the missile. This is the earliest point at which the gunner may launch. He is also given a second range ring measurement to indicate when he is to hold fire, a third for resume fire, and a fourth for cease fire.

The range ring measurements used in determining when to launch are classified and are contained in (SNF) FM 44-1A.

**Crossing Jet Aircraft.**

For crossing jets, the launch decision is based on a time count rule. Hold fire is based on a range ring measurement. The gunner positions the weapon sight slightly forward of a crossing jet image, then holds the weapon stationary. He waits until the jet's nose reaches a fixed point within the sight. When it reaches this fixed point, the gunner begins counting off in seconds, "one thousand one ...". He watches the jet travel horizontally to another fixed point within the sight. If the jet's nose reaches the second fixed point before or at the correct time, then the jet is within the missile's range. The gunner can

then either activate or launch the missile (depending on the point in the engagement). If the jet takes longer than the specified time to travel between points, it is beyond the missile's range. The gunner must not fire.

Refer to (SNF) FM 44-1A for the actual fixed points and the number of seconds (time count rule) or size used in determining when to activate, hold fire, or launch.

**Propeller Aircraft**

For propeller aircraft (including helicopters) no time count rule or range ring measurements are used. The gunner can launch the missile as soon as the following are obtained:

- Weapon activation.
- Positive hostile identification.
- IR acquisition lock-on.

In some cases the 45-second life of the BCU may expire prior to launch. The gunner will be cued to this event by a significant noise level decrease in the acquisition tone and gyro spin will also take place as the BCU reaches its life limits. If a BCU is expended prior to launch, the gunner merely inserts a new BCU and reactivates the weapon. The removal and insertion of a BCU can be accomplished within a few seconds.

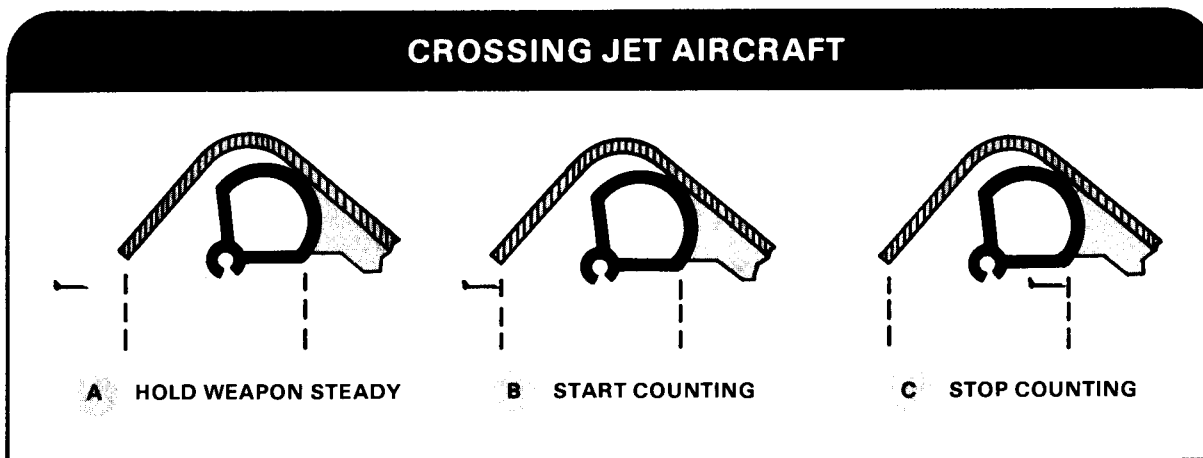

## THE ENGAGEMENT SEQUENCE

The techniques of fire are combined with other weapon operations discussed in chapters 3 and 4 to complete the engagement sequence. The following section outlines a basic sequence of events in the order that they usually occur, but is not rigid. For example, determining aircraft type (jet or propeller driven) and identification may take place at any time prior to launch. Also, certain actions, such as tracking and determining whether the jet is incoming or crossing, are done continuously throughout the engagement sequence.

### DETECT THE AIRCRAFT

This is done by either the team chief or the gunner. It may be prompted by an early warning received over the radio. (See appendix A for plotting of long range targets.)

### SHOULDER THE WEAPON

In this step, the gunner shoulders his weapon, unfolds the antenna, removes the front cover, raises the sight, and connects the IFF cable. He then moves the weapon so that the aircraft's image is placed within the range ring and begins tracking the target.

### INTERROGATE THE AIRCRAFT

The gunner interrogates the aircraft. The team chief will consider an "unknown" reply, along with the aircraft's direction of flight, in determining whether the aircraft poses a threat to the defended area.

### ACTIVATE THE WEAPON

The gunner activates the weapon when the aircraft appears to be penetrating the defended area and fails to correctly respond to an IFF challenge. The gunner will not activate if he determines that he will not be

able to successfully engage the target before it leaves the area.

### IDENTIFY THE AIRCRAFT

The responsibility for identifying an aircraft as hostile or friendly rests with the team chief (or gunner, if he is alone). He must make this decision as soon as possible within the engagement sequence, and always prior to launch. Depending upon the WCS, identification must be made visually, by applying specific hostile criteria (see chapter 4). (See appendix B for use of binoculars.)

### CONTINUE TRACKING

If the signal is strong enough for seeker lock-on, uncage the seeker. The tone should become louder and steadier. If the tone is lost, release the uncaging switch and try again. If you cannot lock on the target, try the "sweeping the target" or the "figure 8" methods (see chapter 3).

Remember, you must have IR acquisition lock-on for all targets before you can fire at them. Be sure the acquisition tone is not from the background or another IR source.

### DETERMINE AIRCRAFT TYPE

For Stinger engagement purposes, there are only two types of aircraft: jet and propeller. (For propeller, skip paragraphs indicated by an asterisk (\*).

\*For jets, this decision will determine which launch rule is to be used. The gunner's body movement will aid him in determining whether it is on an incoming, outgoing, or crossing flight path. If there is any horizontal upper body movement, then it is crossing.

The lack of any horizontal movement indicates that it is either incoming or outgoing. Any vertical movement is also indicative of an incoming/outgoing target.

### **DETERMINE RANGE**

\*Apply the proper launch rule for an incoming or crossing jet to determine if the jet is within the Stinger missile's range.

### **INSERT SUPERELEVATION AND LEAD**

Press and hold the uncage switch. The tone should become stronger. Apply super-

elevation and lead for all aircraft by placing the aircraft image in the proper superelevation and lead reticle.

If the tone is lost, release the uncaging switch and try again. If you cannot lock on the target, try the "sweeping the target" or the "figure 8" method (see chapter 3). Remember, you must have IR acquisition lock-on for all targets before you can fire at them.

### **FIRE**

Squeeze the trigger while continuing to hold the uncage switch. Remember to hold your breath for 3 seconds.

## **LAUNCH RULES**

For jet aircraft *only* for both incoming and outgoing, launch when the jet's image is the proper size within the range ring. The same rules apply for crossing aircraft. Launch is made if the jet meets the time count criteria.

For all other aircraft (propeller), launch is made when a positive hostile identification and IR acquisition lock-on are obtained.

Hold fire on all targets when the inner launch boundary dictates.

## CHAPTER 7

# Manpad Team Operations

The MANPAD team, because of the rapid pace of mobile warfare, must spend considerable time moving, communicating, positioning, and repositioning. These, as well as other tasks, must be performed under tactical conditions. Guidelines are provided in this chapter on these operations and activities which will assist the MANPAD team in performing successful missions under combat conditions. (Crew drills are at appendix D.)

### TEAM PREPARATION

For the MANPAD team to function under combat conditions, it is necessary to make certain preparations. Detailed preparation will vary IAW the mission/situation. However, the team chief must get answers to the following questions:

- Who does the team support?
- To whom does the team report?
- What are the unit's call sign and frequency?
- Where is the FAAR located and what is its radio frequency and address code?
- What is the communications schedule?
- What are the security arrangements for the team?
- What is the threat (air and ground)?
- What is the WCS and state of alert?
- Where does the team mess/refuel?
- What are the sign and countersign?
- What are the special instructions, if any?
- How will expended missiles be replaced?
- When and where will the IFF interrogators be reprogrammed?
- Will the team have to be split? If so, what about the following:
  - Where will the team members be located?
  - How will the weapons be transported?
  - If the vehicle isn't used, how will it and any other equipment be secured?
  - What will each man take with him?

### CONTENTS

	Page		Page
Team Preparation	7-1	Alert Warnings	7-10
Position Occupation	7-4	Relations with Supported Unit	7-12
Communications	7-5	How to Operate as a Split Team	7-12
Radio Communication	7-7	Protecting a Convoy or Maneuver Unit with MANPAD Weapons	7-13
Team Wire Communications	7-8	Night Operations and Security	7-15
Team Visual Signals	7-9		

The MANPAD team must have answers to questions about the operation if they are to be successful in battle. Whenever possible, the team chief should make out a checklist and attempt to find the answers to these and other questions. The questions listed above are not rigid but must be applied so as to fit the mission/situation. The team chief may receive the mission either orally or in writing. Close attention must be paid to the details which directly affect the team's mission. Making notes to yourself can be helpful. If some important information affecting the mission is vague, ask questions about the matter.

The team chief should make a tentative plan for the operation of the team. Normally, he is given specific instructions by the section chief, such as, "Join company team A (indicated by map or by pointing) as soon as possible. Occupy a position near coordinates 86350115. Your team will be close to the third platoon on this knoll. The WCS is WEAPONS FREE. Check the position on the ground for good primary and alternate positions. Be prepared for air attack at any time as you move up with the troops."

Equipment must be checked for completeness and proper functioning. If changes are required, such as radio frequency change, make sure they are done at the proper time. Sufficient rations and water must be acquired, etcetera.

The team chief should check his map frequently to make sure he knows where he is going to be positioned and how he is to get there. After receiving the oral or written order from the section chief, he briefs the gunner on the new operation. The team chief makes sure that the gunner receives all necessary information to accomplish the mission. All soldiers do a better job if they know the situation and are kept informed.

When ordered to move out, the team goes to their designated locations and effect liai-

son with the commander of the supported or nearest unit. The team chief explains the team mission and touches base on communications, ammunition resupply, refueling, and rations. He should coordinate for positioning (day and night) and security.

Upon arrival of the team at the designated location, the team chief selects the best firing position within the area selected by the section chief. This site becomes the team's primary position. Terrain evaluation precedes the selecting of a position and is a continuous process. Mission accomplishment is the prime consideration in site selection. Cover, concealment, and camouflage should also be considered when a choice of sites is available. When selecting positions, give particular attention to unobstructed fields of fire, masking clearance, and backblast area. Terrain features which present a masking problem for employment of Stinger are evaluated for height, distance, and direction from the firing positions. The team chief attempts to select a position which lessens the effect of terrain masking.

The selection of an alternate position is a very important consideration. The smoke signature of the Stinger missile and backblast can be expected to reveal the team's position during an engagement. After an engagement in a forward area, the team must quickly move to an alternate position. In rear areas, where the threat of ground/artillery fire is remote, the need to move quickly to another position is not as great. Alternate positions need not and should not be far from the primary position. An alternate position should be at least 200-300 meters from the primary position and should cover the same sector of fire as the primary position.

Time permitting, routes into and out of these positions must be reconnoitered and selected. The routes should afford cover between positions. In choosing between available positions, usually advantages and dis-

advantages must be weighed one against another. When compromises are necessary, how well the team can do its mission at the position is the determining factor. Use the following position selection checklist when picking MANPAD positions:

- Good observation and fields of fire. Positions should ideally have at least 5 kilometers of observation and all-around fields of fire. At least, the gunner must have good fields of fire along the most probable avenues of approach of hostile aircraft.
- Accessibility for team vehicles. The position should be easy for the team vehicles to move into. Concealed routes are necessary to the rear and flanks for rapid shifting of position.
- Security from ground attack. Team positions must have protection against ground attack. Two main factors to think about when changing a position are to position within or near friendly units for security and protection from enemy ground fires. Masking between the position and the enemy hides the position from enemy ground observation.
- Communications. The positions selected must allow the team to communicate effectively. Wherever possible, direct line of sight for team communications must be obtained. If you can't communicate from your position, the position is unsatisfactory.
- FAAR. MANPAD team positions should be located to receive manual SHORAD control system (MSCS) information on the FAAR early warning net. The TADDS is emplaced with as near a line of sight as possible to the FAAR.
- Safety from backblast. The gunner must stand in the open to fire. Thus, the selected firing position should be clear of dry brush and other materials which may ignite when the weapon is fired. The gunner needs a firing position clear to fire in any direction. If both

team members must fire, the team chief and gunner must each insure that neither one is in the backblast of the other's weapon.

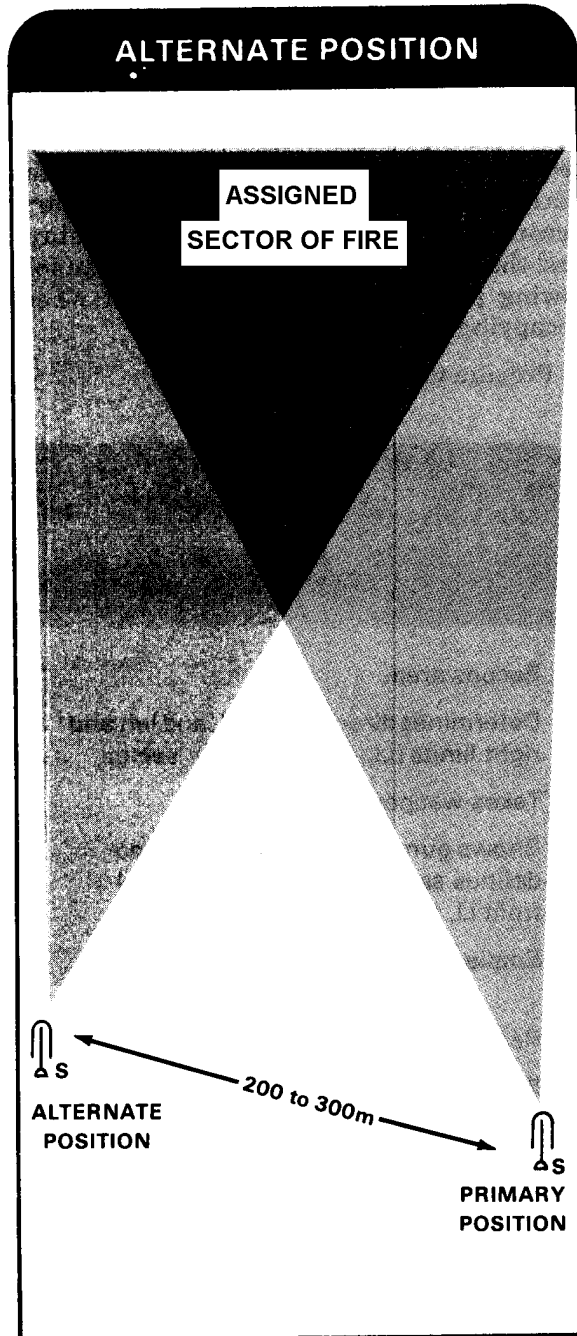



## POSITION OCCUPATION

The primary task after selecting the best firing position within the area assigned by the section chief is to become operational as quickly as possible. The first priority in occupying a position is preparing weapons for action. The team must occupy its position as fast as possible. Next, the physical security of the position must be improved as required. The extent to which the team prepares and improves a position will vary according to the mission, the length of stay, and the danger from enemy fire. Use the following position occupation checklist when occupying a position:

- Prepare weapons for firing.

- Check local security.
- Establish communications with section headquarters/the supported unit.
- Establish FAAR netting (line of sight).
- Prepare additional weapons as required.
- Prepare field fortifications (prone/foxhole positions) and camouflage for team members.
- Work on alternate positions as time allows.

The exact position occupation sequence of actions may vary between teams and team members, depending on the tactical situation. However, these guidelines should be used for a position.

### POSITION OCCUPATION GUIDELINES

#### TEAM CHIEF

Recons area.

Determines direction of PTL and left and right limits (LL) (RL) of search sector.

Takes weapon to position.

Shows gunner direction of PTL and defines sector of search (horizontal from LL to RL and verticle).

Emplaces TADDS.

Remotes radio to position.

Notifies supported unit and/or section headquarters of status.

Switches searching duties with gunner.

#### GUNNER

Takes weapon to position.

Searches for aircraft within assigned sector of search.

Begins construction of prone position

Switches searching duties and position improvement duties every 15 minutes.

## COMMUNICATIONS

Because MANPAD teams are widely dispersed and subject to frequent and rapid moves, radio is the primary means of communications during employment. Radio nets are supplemented and paralleled by wire nets when time, the tactical situation, and security permit their use.

The MANPAD team operates in the section command net when not assigned a direct support role. This is a two-way net linking the section headquarters and its assigned teams. Information received over the command net includes the following:

- Air defense warning and orders.
- Movement orders.
- Command and control information.
- Any other information essential for section operations.

MANPAD teams may be assigned to support armored, infantry, mechanized (AIM) divisions, separate brigades, armored cavalry regiments, and corps/theater artillery/ADA battalions. These teams are equipped to operate in one net and monitor another. Monitoring the section/FAAR net alerts the team to early warning information. To do all this, the team is authorized an AN/VRC-47 radio.

Teams may also be assigned to support airborne and air-assault units. MANPAD teams with an airborne division are equipped with one AN/ GRC-160 radio set. Teams operate in the section command net and the supported unit command net when autonomous. Teams with an air-assault division are equipped with two AN/PRC-77 for use in both the MANPAD command net and the supported unit command net.

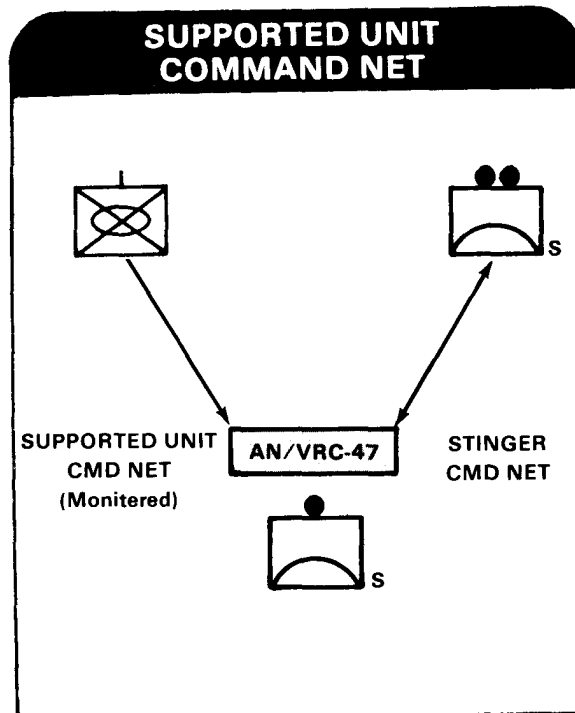
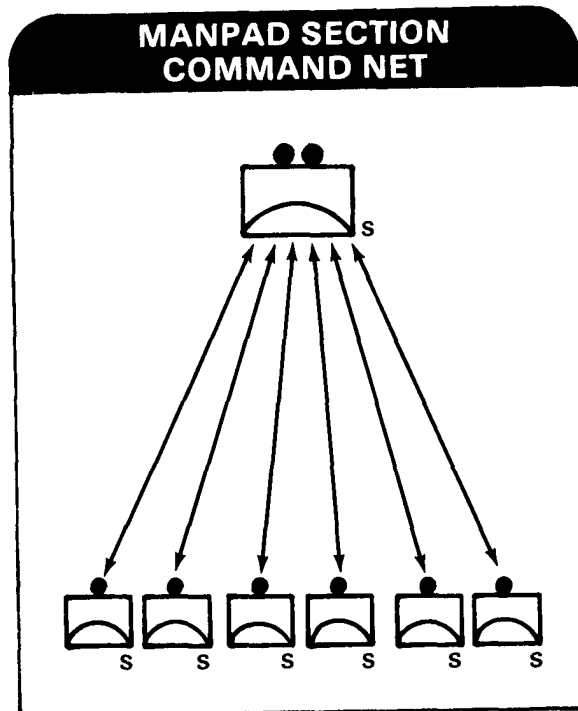

**MANPAD AND SUPPORTED UNIT COMMAND NETS**

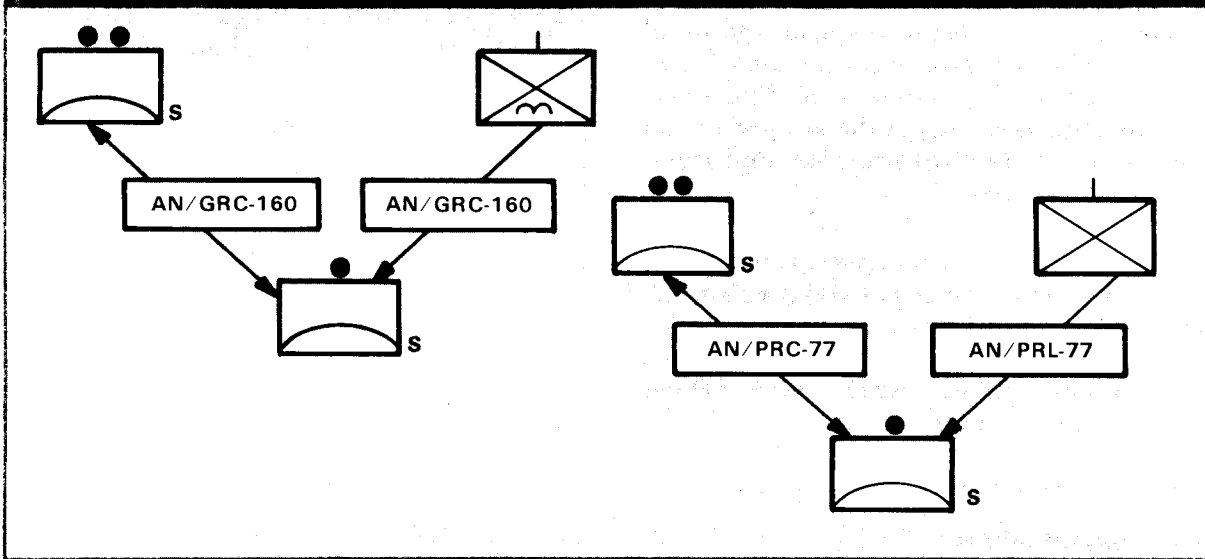

When a Vulcan/SGT York Gun platoon is in direct support of a company team which is also supported by MANPAD, the Vulcan/SGT York Gun platoon leader, Vulcan/SGT York Gun squads, and MANPAD team(s) operate in the Vulcan/SGT York Gun platoon net. By joining the Vulcan/SGT York Gun platoon command net, the team will receive all early warning information,

changes in WCS, air defense warning, alert status, and other information given to the Vulcan/SGT York Gun platoon. This method insures coordination of the air defense effort. If the MANPAD section chief needs to get information to his team, he can contact the Vulcan/SGT York Gun platoon leader who can pass on the information.

**MANPAD/VULCAN/SGT YORK GUN PLATOON NET**

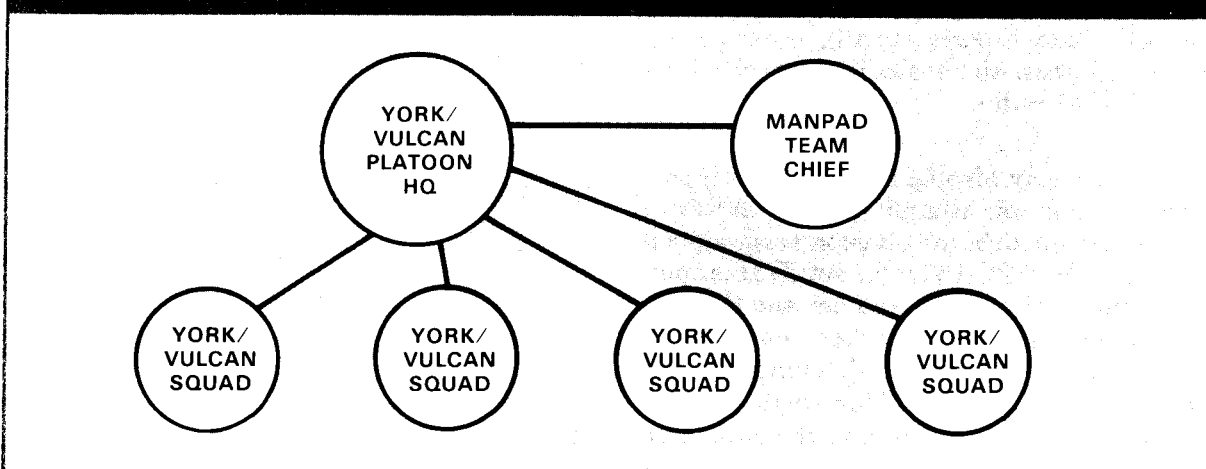

**AN/VRC-47**

The AN/VRC-47 combines the RT-524\ VRC with one additional receiver, the R-442/VRC. This radio set monitors one net while operating in another.

**AN/GRA-39**

The RT-524 can be remotod, using the AN/GRA-39 radio set control group. This battery-operated remote control system consists of a local control unit and a remote control unit. When connected to the radio with field wire, the AN/GRA-39 (remote set) can operate the radio from a distance of up to 3.2 kilometers (2 miles). By using this remote control unit, MANPAD personnel can communicate while away from their vehicles.

**AN/PRC-77**

This radio set is a short-range, light-weight, fully transistorized radio set that can be either vehicle-mounted or man-carried.

**AN/GRC-160**

The AN/GRC-160 incorporates the components and operational characteristics of the portable FM radio set AN/PRC-77 and the vehicular radio set AN/VRC-64.

**SPEECH SECURITY EQUIPMENT**

All the above radio equipment can be operated with speech security equipment.

**RADIO COMMUNICATIONS**

The team radio operator must be able to effectively communicate in a radio net. To do this, he must use correct radiotelephone procedures. Radiotelephone procedures must be used properly to prevent targeting the radio and giving the enemy useful information. Radiotelephone procedures are based on the Allied Communication Publication (ACP) series of publications.

**NET CONTROL**

Each radio is controlled by a net control station (NCS) which maintains circuit discipline within the net. The following are fundamentals that must be used when operating in a radiotelephone net:

- First, write down your message.
- Listen before transmitting to avoid interfering with other transmissions.
- Start speaking as soon as you key the mike. (Do *not* wait for the sound of the blower motor to peak out.)
- Speak in natural phrases, *not* word by word.

- Speak slowly and distinctly at normal voice level directly into the microphone, just as you would into a conventional telephone.
- Do not key the mike for longer than 15 seconds. Use "breaks" for long transmissions.

**NETS**

The type of net is determined by the NCS according to operating conditions. The types of nets are free and directed.

In a free net, traffic is exchanged without prior permission from the NCS. A net is deemed to be a free net unless otherwise ordered by the NCS.

In a directed net, stations must obtain permission from the NCS prior to conducting communications with other stations.

**CALL SIGNS**

A call sign is a letter-number-letter combination assigned to a unit. Every unit in an organization has a different call sign. The complete call sign is used under the following conditions:

- When opening and closing a net.
- When entering a net in which you do not normally operate.
- When responding to a net call.

When requested by the NCS or any other station.

- When radio reception is poor.

### CALL SIGN SUFFIXES

Call sign suffixes are two-numbered groups assigned to positions or activities within a unit. The call sign and suffix together identify the sender and receiver of a radio message.

### FREQUENCIES

Each radio net is assigned a frequency. These frequencies are established by the communications-electronics operation instructions (CEOI). Radio operators should be adept at changing radio frequencies. Refer to the

radio's technical manual for instruction on how to do this.

### RADIOTELEPHONE PROWORDS

Certain commonly used prowords have distinct meanings and are used to shorten the amount of time in voice communications and to avoid confusion. These prowords should be used when talking on the radio or the telephone.

### AUTHENTICATION

Authentication is required when—

- Opening and closing a net.
- Entering a new net.
- Coordinates of a position are requested.
- Directions are given to move or which otherwise affect the tactical situation.
- Any degradation of ADW or WCS.

## TEAM WIRE COMMUNICATIONS

Team positions may be interconnected by wire for local communications in static situations or during listening or radio silence. When the support unit establishes its wire system, the team can communicate with its section headquarters by wire. Information on how to connect a field telephone and use of field wire is found in FM 24-20.

Members of split teams also use wire to communicate. Because only one radio and one TADDS are within the team, the team chief stays with the radio and TADDS. The gunner lays wire to the second position, attaches the field telephone, and establishes communications with the team chief. A second reel of wire is required to accomplish this.

### FIELD TELEPHONE

Each Stinger team is issued two TA-1/PT telephone sets. The TA-1 is a sound-powered telephone that provides facilities for talking and signaling without batteries. It weighs only 3.5 pounds and has a range, with field wire, of approximately 10-15 kilometers. This telephone set can be used to advantage in forward areas, employed in switched wire networks (during periods when radio nets are closed), or as point-to-point circuits.

### WIRE

Each team is issued one RL-39 reeling machine with a DR-8 reel containing 0.4 kilometer (Vi mile) of field wire. A second reel can be obtained from the parent unit. This combination can be used to lay short local

circuits between field telephones and between the RT-524/VRC radio location and the AN/GRA-39 remote control unit. Field wire is

recoverable and is reusable; it should always be taken up before moving out of a position, if the situation permits.

## TEAM VISUAL SIGNALS

Arm and hand signals may be used by team members to communicate among themselves and with supported unit personnel. Arm and hand signals are useful when radio or wire is not available and battlefield noise does not permit use of voice commands. Arm and hand signals should be used only when absolutely necessary. Standard and special hand-and-arm signals to control small unit actions, recovery operations, and vehicle

movements for the tank and mechanized infantry company team are covered in FM 71-1. When MANPAD teams are supporting a maneuver unit, they they should be familiar with the visual signals used by leaders of the unit. FM 21-60, Visual Signals, contains a complete list of each type of visual signal. Six examples of arm and hand signals for the communications of MANPAD fire commands are shown in the illustration below.

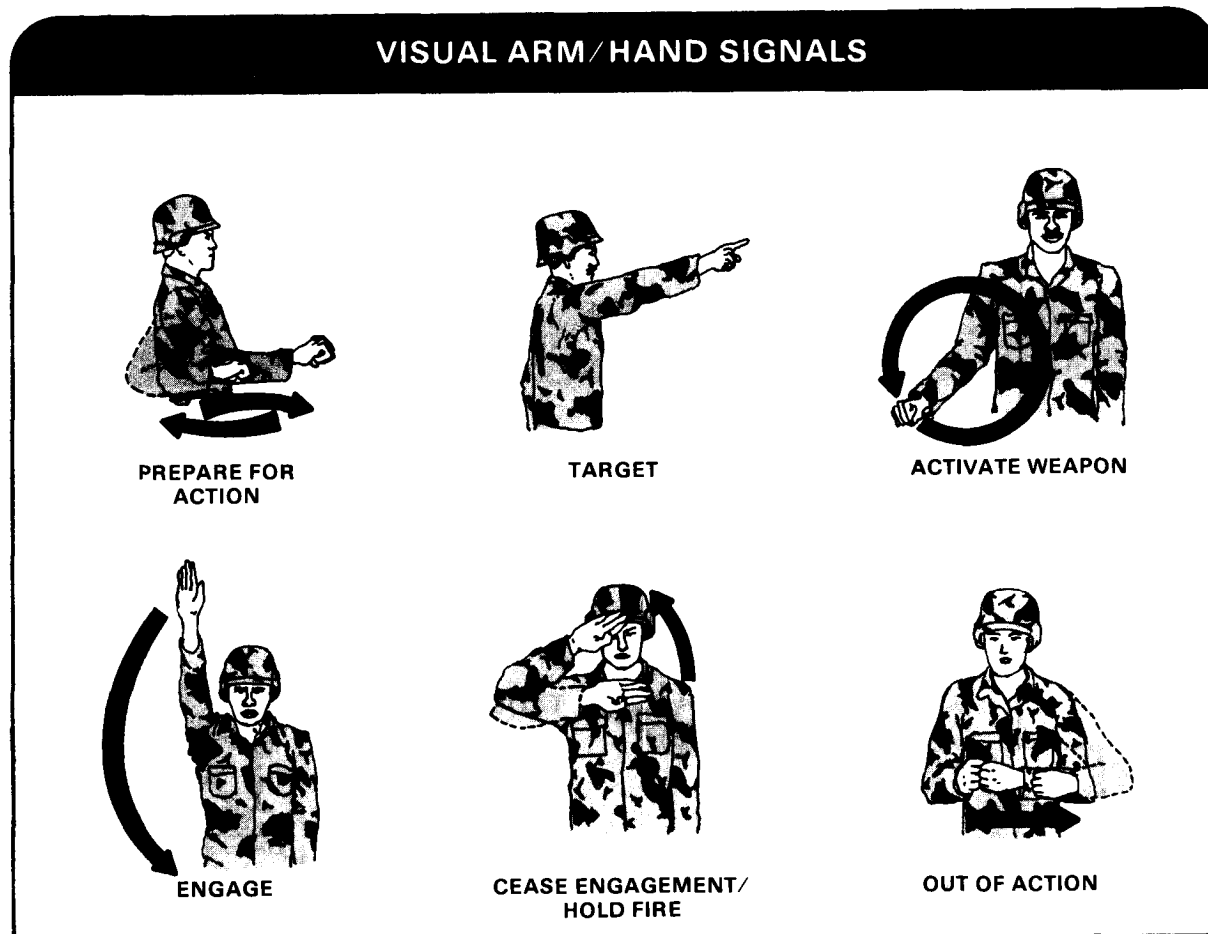

## ALERT WARNINGS

An alert warning is an early warning, or indication of air attack.

### APPROACH WARNINGS

A MANPAD team may be warned of an approaching aircraft or it may visually detect the target without prior warning. Warning of the approach of an aircraft increases the chances of successfully engaging it. An alert warning will usually give general location and heading of the aircraft and a tentative identification (see appendix A). The FAAR, together with the TADDS, furnishes early warning to the team. The team may also receive early warning/alert information from the section headquarters. This data is received at the section headquarters from the early warning broadcast net (EWBN), the air defense control net (ADCN), or the FAAR. In turn, section headquarters sends this information to the MANPAD teams over the section command net.

### FAAR/TADDS SYSTEM

The FAAR/TADDS system is the primary means of providing MSCS alerting information to the MANPAD team. This information is transmitted by radio to the TADDS receiver located with the team.

### FAAR

The FAAR system is a self-contained, pulse-doppler search radar system. Its mission is to provide early warning in the form of general target location and tentative identification. This early warning is provided to TADDS receivers located at divisional SHORAD fire units and headquarters up to platoon level. The range of the FAAR is 20 kilometers. The FAAR transmits information to the TADDS using an AN/VRC-46 FM radio. Since the AN/VRC-46 is an FM radio, line of sight is necessary between the FAAR and the TADDS.

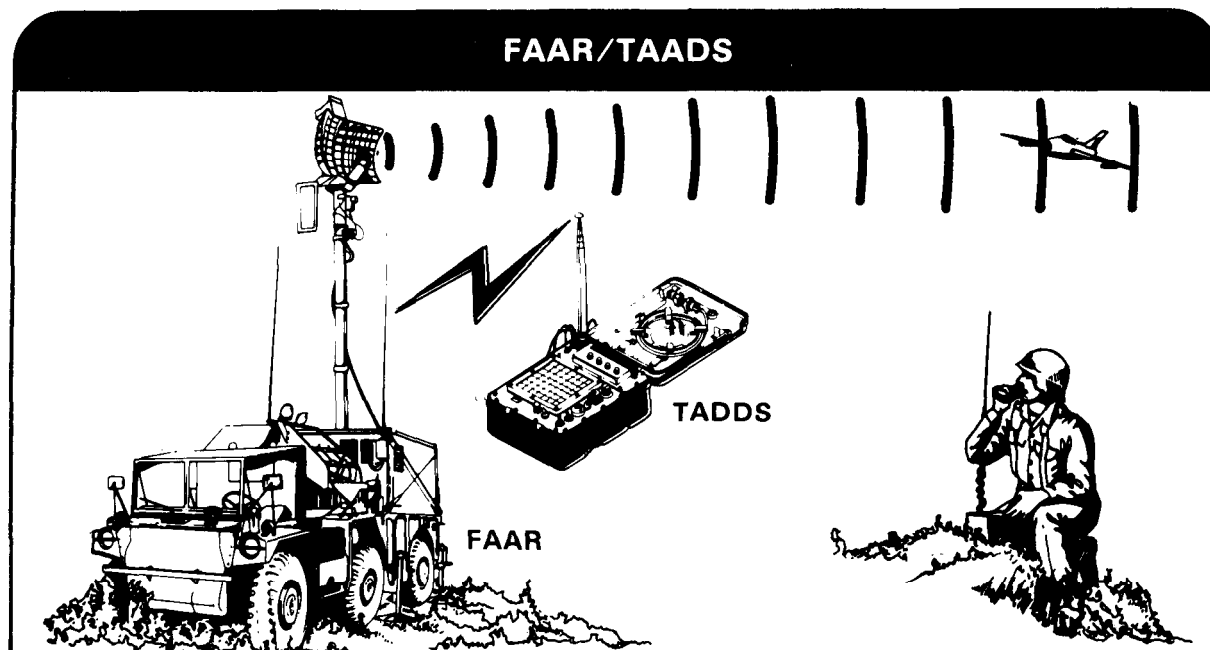

Several FAARs will normally be operating in a divisional area. Each has a different address code. Also, each is assigned a different frequency in the CEOI. The MANPAD section chief usually obtains the location of the nearest operating FAAR from the platoon headquarters. If a team cannot achieve line of sight with a FAAR, another position may have to be chosen. FAAR positions may change during a battle. Therefore, the section chief must know where the FAAR positions are located at all times.

**TADDS**

The TADDS is a lightweight receiver which can receive alert information sent from a FAAR. The TADDS has the capability of receiving voice transmission over its FM radio receiver. *This is now the primary means for passing alert information.*

**Site Selection**

For the best reception, a site for the TADDS is selected which allows as close to a clear line of sight to the FAAR as possible (see illustration). The keyed characteristic of the signal, when heard from the speaker, indicates that data link signals, not interfer-

ence, are being received. Emplacement of the TADDS is quickly accomplished by one man. The operator performs the operational checks listed in TM 9-1430-589-12 to insure proper operation.

**Using The TADDS**

The team chief tunes the TADDS receiver to the frequency and address code of the nearest FAAR. If no signal is received, he then consults the CEOI for the frequency and code of other FAARs. If he receives a signal, he informs his section chief and requests the coordinates of that FAAR.

Long-range early warning information from the SHORAD TOC and locally generated FAAR early warning are received over the TADDS FM receiver from the nearest FAAR section. The MANPAD team must monitor the team's respective platoon or section command net, and either the supported unit command net or the EWBN. The teams monitor the FAAR on the TADDS FM receiver. It must be *emphasized* that the TADDS is used *exclusively* as an FM receiver to receive early warning information from the FAAR.

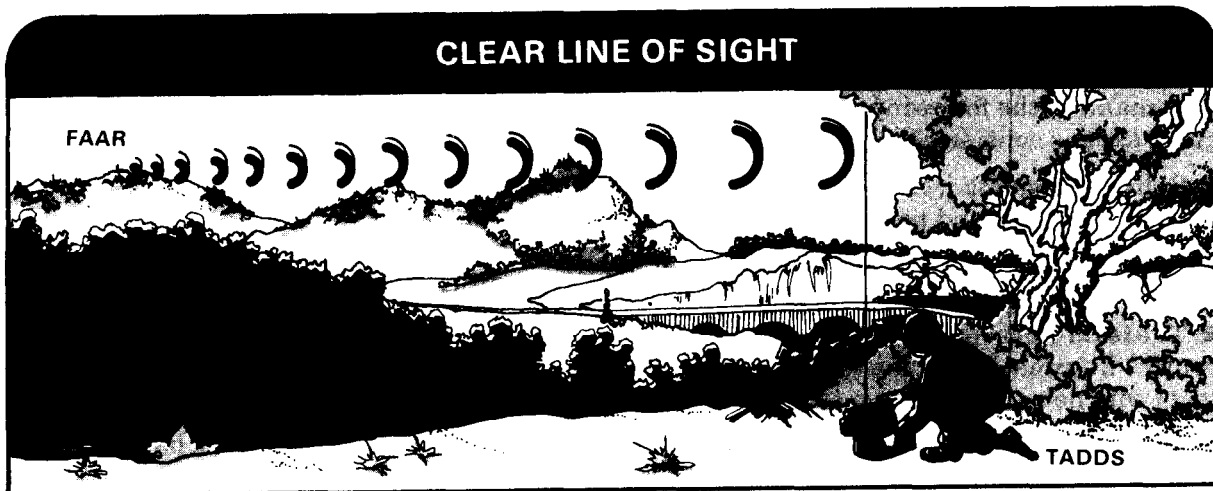



## RELATIONS WITH SUPPORTED UNIT

The team chief must coordinate with the supported unit commander or his representative as soon as he can after being given his mission. Good relations between the team and the supported unit are a must. The team chief should be prepared to offer advice on air defense matters and keep the supported unit commander informed of ongoing air activity as he receives it through his ADA channels. It is the team chief's responsibility to warn the supported unit regarding safety hazards (backblast and noise, see page 2-4.). It then becomes the unit's responsibility to take the proper protective measures (for example, wearing ear plugs and moving away from the backblast area). If such items as team messing, resupply, refueling, need to be taken care of, the team chief will have to coordinate this with the supported unit. The following are

some do's and don'ts to keep in mind to promote a good relationship and good coordination on a local level:

- Advise the supported commander on air defense matters.
- Don't do anything that might compromise the security of the supported unit.
- Follow the movement plan carefully.
- When directed to occupy a specific position, do so as quickly as possible.
- When attached, coordinate on-site selection with the unit commander.
- Be courteous and tactful in all dealings with the supported personnel and, in particular, with the supported commander. You are there to complement his defense measures by your air defense contribution.

## HOW TO OPERATE AS A SPLIT TEAM

Under certain conditions and/or situations a team may have to be split. Splitting the team degrades command and control and the ability to detect, positively identify, and engage aircraft. If a team has to operate in a split manner, the following points should be given serious consideration:

Split the basic load; two complete weapons and one missile-round per team member.

- The team chief should have access to the radio.
- The team chief should relay command and control information to the gunner over the team wire net.
- Each team member keeps the other informed of any activity, such as when an air-

craft is detected.

- When separated from the team chief, the gunner is fully responsible for correct identification of any aircraft which he engages (see chapter 4 for proper identification procedures).

When operating as a split team the land line (field telephones) are the only means of communications between the teams. The maximum distance for splitting the team should be 1/4 mile. When hand signals are the only means of communications between the split team, if feasible, the split team should be positioned so that each team has a line of sight to each position.

## PROTECTING A CONVOY OR MANEUVER UNIT WITH MANPAD WEAPONS

When protecting a convoy, MANPAD personnel normally engage aircraft only if the column is about to come under attack. If early warning information is received via the section command net or TADDS FM receiver, the Stinger team chief relays the information to the convoy commander. After sighting or being alerted to enemy aircraft, the convoy commander should alert his vehicle commanders to the possible air attack. The convoy is then prepared to engage the aircraft with all available small arms and machine guns. The convoy commander may take one of the following three options with his vehicles:

- Continue the march at increased speed.
- Stop and move to the shoulders of the road.
- Disperse and seek cover and concealment.

Regardless of the option chosen by the convoy commander, the MANPAD team reacts the same. When air attack is imminent, the team moves its vehicles off the road, dismounts, and takes up the best available firing position. (See the crew drills at appendix D.) This position should have good visibility and be located where Stinger can be safely fired.

### PROTECTING A CONVOY

Once the team is positioned, the team chief bases his engagement decision on the WCS in effect and by applying hostile criteria (see chapter 5). The right to fire in self-defense is never denied. The gunner engages the aircraft upon receiving the team chiefs engagement order. Ideally, the aircraft will be engaged on its first pass; before the attack run is made on the convoy. If the column is attacked, the combined fires of all available small arms, machine guns, MANPAD, and other ADA weapons are directed on the air-

craft. If not destroyed, the aircraft will at least have his ordnance delivery impaired.

When the immediate threat of air attack has subsided, the team notifies its section headquarters of the attack, missile expenditure, and any other information required by the local TSOP. The team must prepare a new ready rack (see crew drills) and then rejoin the convoy, passing other vehicles, as necessary, to resume its assigned position.

MANPAD teams may be prepositioned at critical points along the convoy's route. This method of employment is used when a slowdown, halt, or congestion of the convoy is likely at a critical point. These critical points, such as road junctions, bridges, and refueling points, provide prime targets for threat air strikes. Prepositioning is used when the distance to be traveled is short (5 kilometers) or when circumstances permit the teams to blend into the column after it passes the critical point. The team chief selects a suitable team position that affords an early engagement capability. This means that the position should be at least 1-2 kilometers away from the critical point, in the expected direction of air attack. If several teams are available to defend the critical point, they will be approximately 2-3 kilometers away from each other to insure overlapping fires. Other requirements described earlier in this chapter should be considered in selecting a firing position.

### PROTECTING A MANEUVER UNIT

When a MANPAD team is in support of a maneuver unit, positioning of the team is very important. Two methods can be used—deploy the team behind the maneuver unit or deploy the team with the formation. Maintaining all-around observation and fields of fire, as well as maintaining communications, will be difficult. Communications should be

maintained with the supported unit and the section frequency should be monitored. The team should be able to receive early warning information at anytime. When positioning —

- Select positions on high ground, but do not silhouette on the skyline.
- Use cover and concealment to reduce the effects of enemy ground fire.
- Remember backblast safety requirements.
- Move to an alternate position immediately after firing, if the tactical situation permits.
- Watch constantly for aircraft, especially ATGM-armed helicopters.
- Move when the supported unit/element moves, unless directed otherwise.

### **DEPLOYED BEHIND MANEUVER UNITS**

When deployed with a battalion task force, the team follows the unit by successive bounds. Teams should remain approximately 500 meters behind the lead element. The section chief has positioning authority of teams with this mission. He selects team positions and gives special instructions for engagement and sectors of fire. The team may be allowed to select the fastest and easiest route between positions rather than moving with the supported unit. The team chief must coordinate closely with the supported unit in this type of maneuver. Without this coordination, the maneuver unit may outrun its supporting air defense protection.

At each successive position, the team chief selects the best position on the ground to accomplish the mission. The team chief should be alert to displace at the same time as the maneuver unit. When in position, the team should place the vehicle under cover and conceal it as much as possible. The team should look for a good firing position not far from the vehicle. By connecting field wire between the vehicle radio and the remote set, the team chief can maintain communica-

tions while away from his vehicle. He should also emplace the TADDS immediately so that the team can receive any alert warning. Another consideration is safety. Be sure that no other troops or equipment are within the backblast danger area of the firing position.

The team chief will have to use his best judgment on how many weapons will have to be off-loaded.

The team should be always ready to defend the supported unit. However, there are times when the unit is more vulnerable to air attack than at others. This could be while the supported unit is in an assembly area. At times such as this, the Stinger team should be prepared for a surprise air attack.

Communications should be maintained with the section headquarters. In addition, the team should be able to receive FAAR early warning information.

### **DEPLOYED WITHIN THE FORMATION OF A MANEUVER UNIT**

When the team is in support of a maneuver unit, usually a company team, it moves with the unit. The company team commander has positioning authority of the team in direct support of his unit and gives special instructions for firing. Usually, a team in direct support of a maneuver unit remains with the overwatch element. The team occupies the best position available.

The team may have its own transportation or be mounted on a tracked vehicle on a share-a-ride basis. If the team is mounted and traveling when warning of an air attack is received, the team dismounts from the vehicle as quickly as possible. The team immediately takes the best firing position available. If the team is mounted on a shared tracked vehicle, reaction time (warning received until prepared to engage) will be

increased. To communicate with section headquarters, a team mounted on a tracked vehicle will have to use the vehicle's radio and may have to use the supported unit to relay messages.

Communications shall be maintained with the supported unit and the section frequency should be monitored. The team should be able to receive early warning information at any time.

## NIGHT OPERATIONS AND SECURITY

Reduced visibility during the hours of darkness may limit the intensity and effectiveness of enemy air attack. However, the air threat will increase as new night vision and target acquisition devices are developed. If an attacking aircraft is seen, it can be engaged. The difficulty encountered in visually detecting and identifying aircraft during periods of darkness and inclement weather handicaps, but does not eliminate, the use of Stinger for air defense. Therefore, MANPAD teams, armed with Stinger, generally should not attempt to engage hostile aircraft if those aircraft are not attacking the asset they are defending. Visual detection, visual identification, and determining range are difficult, if not impossible. Stinger can be used at night in a self-defense role when the supported unit or asset is under attack or if a WEAPONS FREE status is in effect.

Aircraft detection at night may be aided by early alerts, engine sounds, reflected light, moonlight, flares, and engine exhaust flames. Targets detected by sound may be located with an activated weapon by using the figure eight method. This method is described in chapter 3. Once IR lock has been achieved, proceed with the engagement as in the day-

time (approximating superelevation and lead because the reticles will be hard to see).

The missile signature is easily detectable at night. Enemy forces may well be able to determine your position. Although teams normally move to alternate positions after each engagement, enemy suppressive fire may force the supported unit to move. For this reason, teams normally respond only to direct attack on the asset they are defending at night.

### NIGHT SECURITY

MANPAD teams supporting a unit which is moving during the night or during times of reduced visibility, normally move with the unit, remaining within the unit's formation for security. Teams supporting a unit in position at nightfall should move to positions within the perimeter of the supported unit for better security against ground attack. The section chief will tell the teams when and where to displace at night. However, the team chiefs should closely coordinate with the supported unit commander on the exact location of their positions. The selected positions should not compromise the commander's plan for defense of his unit.

## CHAPTER 8

### Manpad In Defense of ADA Units

MANPAD systems are allocated to some ADA units to provide self-defense. This need has developed because of the improved capability of threat forces to destroy our ADA units. MANPAD systems can be used to protect these ADA units when they are displacing, traveling in a convoy, emplacing, refueling, or during other critical periods that make the units vulnerable to air attack. This chapter discusses how MANPAD teams can be employed to protect these ADA units (high-to-medium-altitude air defense [HIMAD] and Chaparral) from enemy air attack.

#### MANPAD TEAMS WITH HIMAD UNITS

HIMAD units, such as Patriot, Nike Hercules, and Hawk, can no longer expect the relative security previously provided by their rear area locations. Threat forces now have the ability to launch aircraft in great enough numbers and speed to penetrate and saturate our forward area air defenses. These aircraft will then be able to penetrate to the HIMAD units in the corps and theater areas. MANPAD teams can be used by these units to provide some protection from these mass air attacks.

MANPAD teams are used by HIMAD units to compensate for system limitations. MANPAD teams can be incorporated into their defense to counter this low-flying aircraft threat. HIMAD radar systems are vulnerable to electronic countermeasures (ECM). Since MANPAD systems are not radar-directed missile systems, they do not fall prey

to ECM tactics. Another advantage in positioning MANPAD systems with a HIMAD unit is that they can be used to engage threat aircraft in the HIMAD system's dead zone. Stinger's head on engagement capability can be effectively used to provide this needed close-in protection for the HIMAD unit. In effect, by adding MANPAD systems, the HIMAD unit is allowed to concentrate on its primary mission— high-to-medium-altitude air defense.

MANPAD teams should be positioned along avenues of approach likely to be used by enemy aircraft. Early engagement positions should be far enough away from the

#### CONTENTS

	Page
MANPAD Teams with HIMAD Units . . . . .	8-1
MANPAD Team with Chaparral Units . . . . .	8-4

### LOW-LEVEL AVENUES OF APPROACH

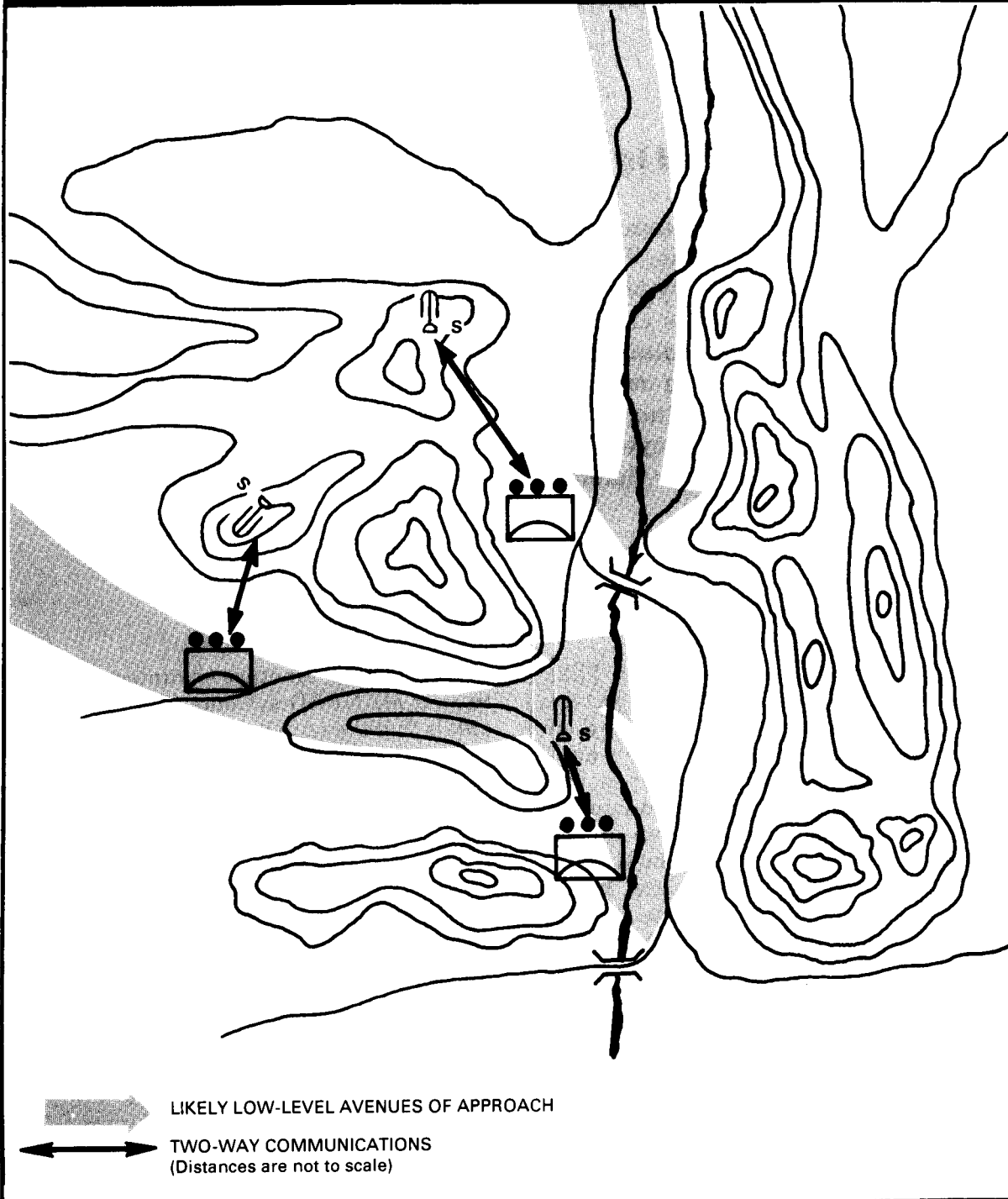

HIMAD site to insure that threat aircraft are engaged before they reach their bomb release point.

A team may be positioned to cover an area that is masked by terrain features and is unseen by HIMAD radars. In this situation, the team is positioned within the masked area. The position selected should allow good observation. If possible, this position should also allow the HIMAD unit to be seen. In this way, attempted air attacks from other directions may be seen.

On flat terrain, two teams are placed opposite each other on the site's perimeter. This will allow 240° coverage in azimuth by each team. Used in this way, Stinger can engage aircraft before they enter the HIMAD's dead zone. Impossible, more teams should be trained so that the basic load can be split and deployed.

MANPAD personnel in Hawk units usually receive their rules of engagement and firing instructions directly from the tactical control officer (TCO). By marking MANPAD team positions on their plan position indicator (PPI), Hawk personnel can direct the engagement of approaching low-flying aircraft, not engageable by Hawk.

MANPAD personnel in Patriot and Nike Hercules units may receive some guidance from the battery control officer (BCO) through his battery control station. Normally, team personnel will operate IAW their battery's TSOP. Since MANPAD teams will be used primarily to engage undetected aircraft approaching Patriot positions and Nike Hercules sites, it is unlikely that team members will receive any early warning information from the BCO.

Usually (if available), the AN/PRC-77 radio will be used for communications with the HIMAD unit. However, wire communications can also be used. Teams can be linked by wire with the following HIMAD control vans:

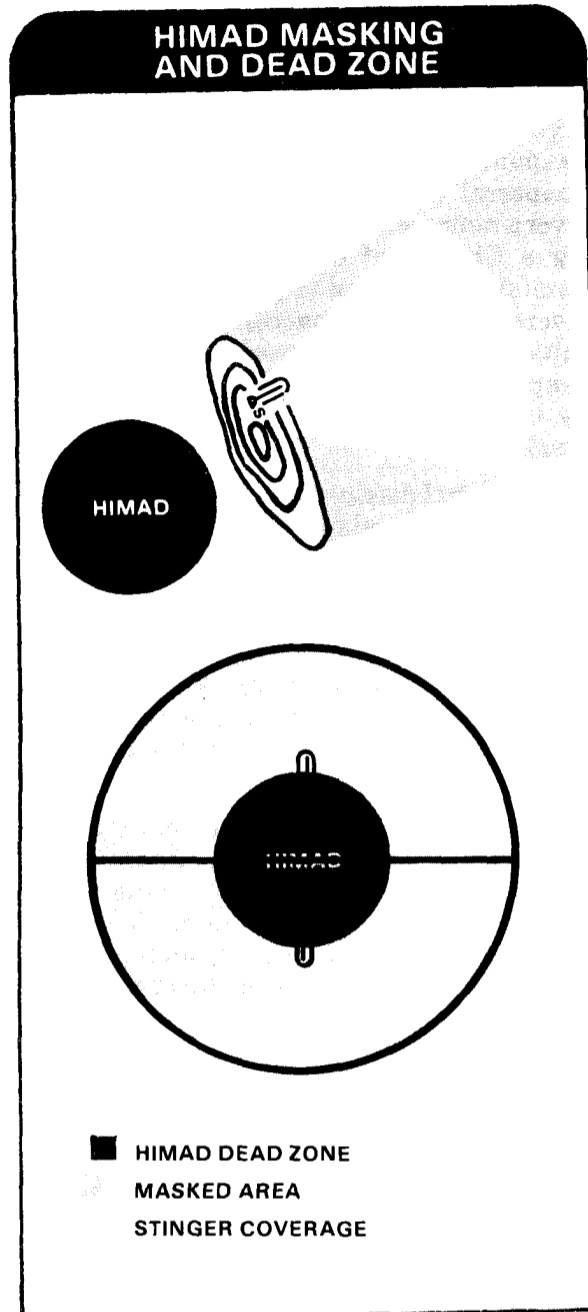

- Patriot—battalion tactical operations center (TOC) and battery command post (CP).
- Nike Hercules—director station.
- Hawk—battery control central (BCC) and platoon command post (PCP).

## MANPAD TEAMS WITH CHAPARRAL UNITS

When employed with Chaparral units, MANPAD teams can be used for self-defense, augmentation of a defense, or as a substitute weapon. As a self-defense weapon for a Chaparral unit, MANPAD can be used to cover a nonoperational fire unit. In augmenting a Chaparral defense, the MANPAD team(s) may be used to provide low-altitude coverage to areas inaccessible to the fire units. Stinger can be used as a substitute weapon for Chaparral because of the similarity in the two missile systems' effective ranges.

In a self-defense role, Stinger protects exposed Chaparral fire units. One example of this is when an emplaced Chaparral fire unit is completely masked on one side by hilly terrain. A threat attack helicopter, using a pop-up tactic, can rise behind the terrain and fire at the Chaparral fire unit. A Stinger team in this instance can be positioned on the other side of the hill to counter such an attack.

Stinger can be used to augment Chaparral's defense of a critical asset. The teams are positioned to cover vulnerable areas in the low-altitude defense. These vulnerable areas are formed because of the limited number of Chaparral units allocated to the critical

asset's defense. These areas can be formed by surrounding terrain features which may deny access to Chaparral fire units. For example, Stinger teams can be positioned on steep hills that the Chaparral fire units cannot climb.

MANPAD provides continuous air defense coverage while the Chaparral fire unit is nonoperational. This may occur during rearming, refueling, maintenance downtime, or for other reasons. Since the effective range of the Stinger missile is close to that of the Chaparral missile, the Stinger system can temporarily replace the Chaparral system. It is also during these vulnerable periods that Stinger can be utilized as a self-defense weapon. When employed in these situations, the Stinger team should be positioned as close to the fire unit as possible, observing safety restrictions.

When Chaparral elements are displacing to another location by convoy, they are vulnerable to air attack. MANPAD teams must be used to protect these elements on the road. The MANPAD quick reaction time can be most valuable to the Chaparral units at this time. MANPAD teams supporting an ADA unit in convoy are integrated into the march column to take advantage of the Stinger missile's head-on engagement capability.



## CHAPTER 9

### Survival On The Battlefield

As a part of the divisional air defense battalion, MANPAD teams become a vital part of the combined arms team. Unless the airspace over the battlefield is denied him, the enemy will attack and harass our ground forces from the air. It is the job of the team to help deny the enemy use of this airspace. Enemy air and ground forces, supported by sophisticated intelligence gathering and weapon systems, will be dedicated to air defense suppression in an effort to win control of the airspace. The answer to survival on the battlefield is to become invisible and undetectable. This chapter describes the techniques and procedures which must be used to survive on the battlefield.

#### COVER, CONCEALMENT, AND CAMOUFLAGE

Cover is protection from the fire of enemy weapons. This enemy fire includes bullets, shell fragments, flame, nuclear effects, and biological and chemical agents. Cover will also provide protection from enemy observation. Cover may be natural or artificial. Natural cover (ravines, hollows, reverse slopes) and artificial cover (foxholes, trenches, walls) provide protection from most types of fire. The battlefield provides cover such as rubble, abandoned equipment, and craters. The smallest depression or fold in the ground will provide some cover. A 6-inch depression may be enough to save your life. It is advisable to

form a habit of looking for and using every bit of cover the terrain offers. Proper use of the terrain is the key to success for all tactical operations. This means using cover and concealment.

#### CONTENTS

	Page
Cover, Concealment, and Camouflage . . . . .	9-1
Fortifying Your Position . . . . .	9-3
Additional Measures for Survival . . . . .	9-4
Mine Warfare . . . . .	9-6
Other Survivability Measures . . . . .	9-8

COVER



Concealment is protection from enemy observation. It is concealment, natural or artificial, that hides or disguises a soldier, vehicle, position, equipment, or route. Concealment includes not only camouflage but also light, noise, movement, refuse, and odor discipline. Well concealed vehicles and fighting positions will deceive the enemy as to the team's position. Natural concealment is pro-

vided by the surroundings. The best way to use this natural concealment is to leave it undisturbed when moving into an area. Against an enemy who has night vision and other detection devices, darkness will not provide enough concealment. To supplement natural cover and concealment found on the battlefield, the team must be proficient in camouflage procedures.

CAMOUFLAGE



Camouflage is man-made concealment. Camouflage is taking advantage of the natural environment as well as supplemental use of natural and artificial materials. Used properly, it will disguise the MANPAD team and its equipment and minimize the possibility of detection and identification by the enemy. If camouflage is required, plan to get it from areas other than your team's position. Camouflage can be made from branches,

bushes, leaves, and grass. Attach this material to your vehicle with old communications wire. Live foliage for camouflage purposes is best because dead foliage and artificial materials may not blend in well with the natural surroundings. Make sure that the vegetation matches what is naturally in your area. Detailed camouflage techniques are found in FM 5-20. How to pattern-paint vehicles is contained in TC 5-200.

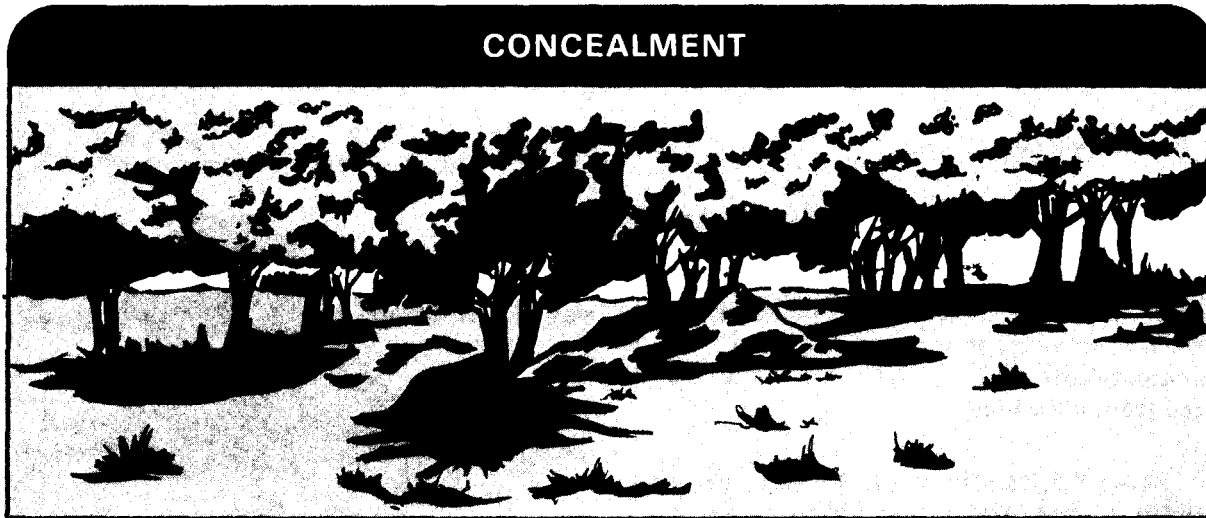

Camouflage nets are excellent if sited properly. A vehicle in an open field under a camouflage net is easily seen (though it may not be identifiable). That same vehicle between two trees under a camouflage net is more difficult to detect. The lightweight screening system (LSS) is described in TM 5-1080-200-10. Each team is authorized an LSS by the table of organization and equipment (TOE).

A well-sited, pattern-painted vehicle will have its camouflage improved by erecting the LSS. The LSS further reduces visibility. The LSS also defeats radar by scattering and absorption. Stainless steel fibers in the plastic garnish material absorb some of the radar signal and reflect most of the remaining signal in all directions. The result is that only a small percentage of the signal returns to the radar.

## FORTIFYING YOUR POSITION

The use of field fortifications reduces injury/damage to personnel and equipment. The team fortifies its position to the extent possible. With the short period of time the team usually remains in a position and only two team members to do the work, construc-

tion of fortification is limited. Fortifications are started as soon as practical upon arrival in a new position and are improved throughout the team's stay in that position. (See appendix D for crew drill.)

At a minimum, individual prone shelters must be constructed for each team member. The soldier begins a foxhole as a hasty position for basic protection. As time permits, he improves the foxhole by completing these tasks:

- Digs the hole deeper.
- Builds a protective barrier, if natural cover is not available.
- Finishes clearing fields of fire.
- Camouflages position.
- Builds overhead cover.

Although it is unlikely that the Stinger team will have to fight enemy infantrymen, the protection afforded by the foxhole will be useful if enemy artillery or rocket fire is received on or near the position. Under no circumstances will a MANPAD system be fired from a foxhole.

Make fortifications easier by selecting positions that are out of sight of enemy ground observation (the reverse slope of a hill rather than its crest). The same barrier to enemy observation also provides a barrier to enemy direct fires. Look for areas that provide natural protection. Terrain irregulari-

ties (such as defiles or mounds) provide initial fortifications that can easily be improved with a little digging. Camouflage the fresh dirt to prevent pointing out the position. Field fortifications should complement camouflage, not degrade it. FM 7-7 explains construction of fighting positions (foxholes).



## ADDITIONAL SURVIVAL MEASURES

In addition to digging in and avoiding detection, there are other measures that will help you to survive.

Alternate positions help to keep the enemy confused as to the location of MANPAD positions. Move often. When changing positions, it is not necessary to move far. Alternate positions can be selected within a short distance (at least 200-300 meters) from the primary position and occupied as required. The movement should be as rapid as

possible so that the team is again ready to engage enemy targets.

Following a weapon's firing you should continue to engage any other enemy aircraft. However, if there are no other enemy aircraft to be engaged, move to an alternate position as quickly as possible.

In forward areas, you should move quickly so you can stay alive to fire again. Enemy artillery or ground forces may see the missile signatures and locate your position.

## ALTERNATE POSTIONS

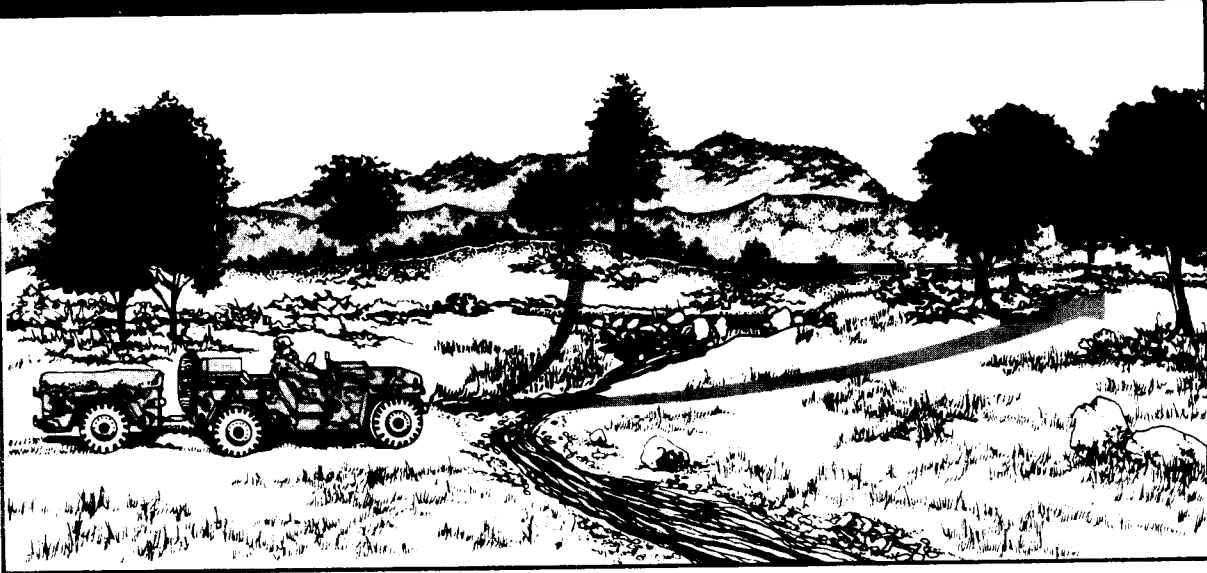

MANPAD teams are usually deployed behind the forward edge of the battle area (FEBA). They must maintain close coordination with maneuver units and must depend on the supported unit for protection against ground attack. At night and during adverse weather, teams should move into positions within a unit's defense perimeter. If teams come under enemy ground attack, they will have to defend themselves with their small arms. When teams are outside of defense perimeters, they are vulnerable to attack by guerrillas and other enemy elements operating behind friendly lines.

**Enforce light discipline.** During periods of reduced visibility, any light (even filtered flashlights and burning cigarettes) can be seen for great distances. At such times the use of lights must be strictly controlled. Lights needed for maintenance and other activities must be shielded from enemy view.

**Enforce noise discipline.** Soldiers must talk and move only when necessary. At night, it is particularly important to talk in a low

voice and to move slowly. Don't slam hatches or doors on armored vehicles. Don't start or move the team vehicle unless it is part of a plan or tactical operation.

**Communications security (COMSEC)** denies or delays unauthorized persons from gaining information of value from monitoring communications. COMSEC measures are used by the MANPAD team to accomplish this purpose. These measures include the following:

- Using authentication to insure that the other communicating station is authorized.
- Restricting the use of radio transmitters.
- Using proper radiotelephone procedures.
- Limiting transmission to official traffic.
- Selecting a radio site with a hill or other obstacle between it and the enemy.
- Organizing messages before transmission to reduce transmission time.
- Using low power.
- Using a directional antenna.

Team personnel can expect that the enemy will attempt to disrupt their radio communications through an intensive jamming effort. Jamming is the deliberate radiation of energy to prevent or degrade the receipt of information by a receiver. It is the deliberate production of radio interference. It can be likened, in a sense, to static on a TV set. The static interferes with the radio's receiver but not the transmitter. Antijamming procedures to be used include the following:

- **Recognize the jamming.** If interference is heard, do not immediately assume jamming. Symptoms of jamming are often similar to other types of radio interference. Try to determine what is causing the interference. Disconnect the receiver antenna to see if a signal is being generated internally by the receiver. If the interference decreases with the antenna removed, the interference is probably external and may be jamming.
- **Continue to operate.** Radio operations should continue in a normal manner once

jamming has been identified. This is to prevent the jammer from learning the effect of his jamming.

- **Reduce the transmitter power.** Transmitting on low power reduces the opportunities for the enemy to hear the transmission. Use only enough transmitting power to be heard within the net but not enough to be heard by the enemy. Some radios (AN/PRC-77) do not have multiple power settings. To reduce power, the radiation pattern must be modified. This can be easily done by carrying the radio upside down with the antenna tip a foot above the ground. This technique will usually provide a good strong signal within a radius of 5 kilometer. As a last resort and when authorized, change to an alternate frequency.
- **Report the jamming.** As soon as jamming is recognized, a report should be sent to the next higher headquarters. Use an alternate means of communications for this report. A jamming report format is included in the CEOI.

## MINE WARFARE

Every soldier should be aware of the destructive potential of enemy mines. Mines can inflict severe injury to troops and equipment. They can effectively prevent troops from entering certain areas and channel them into areas with concentrated enemy fire. Supply lines may be disrupted and convoys forced to bunch together due to damaged vehicles.

MANPAD teams supporting maneuver units frequently find themselves alone and in unfamiliar areas. These areas may contain mines. For this reason, team chiefs and gunners should take protective measures, be aware of likely mine locations, and be able to recognize the tell-tale signs of enemy mines.

Where to look and what to look for in recognizing a mine's location is an expertise that may come in very handy. Signs indicating possible mine locations include but are not limited to the following:

- Mud smears, grass, sticks, dirt, or other unusual material on roads.
- Fresh asphalt or other signs of road repairs.
- Markers, stakes, or other signs used to identify certain areas.
- Wires leading away from roads.
- Dead vegetation in small or scattered areas.
- Civilians avoiding certain areas.

MANPAD personnel should avoid suspected mined areas. However, if your team encounters a mined area, do not panic. Notify your next higher level of command immediately as specified in your unit TSOP. Probing for mines is a tedious process and should

not normally be attempted by MANPAD personnel. Do not probe for mines with metallic objects, as some mines are triggered magnetically. Additional information on mine warfare is contained in FM 20-32.

### MINES—WHERE TO LOOK

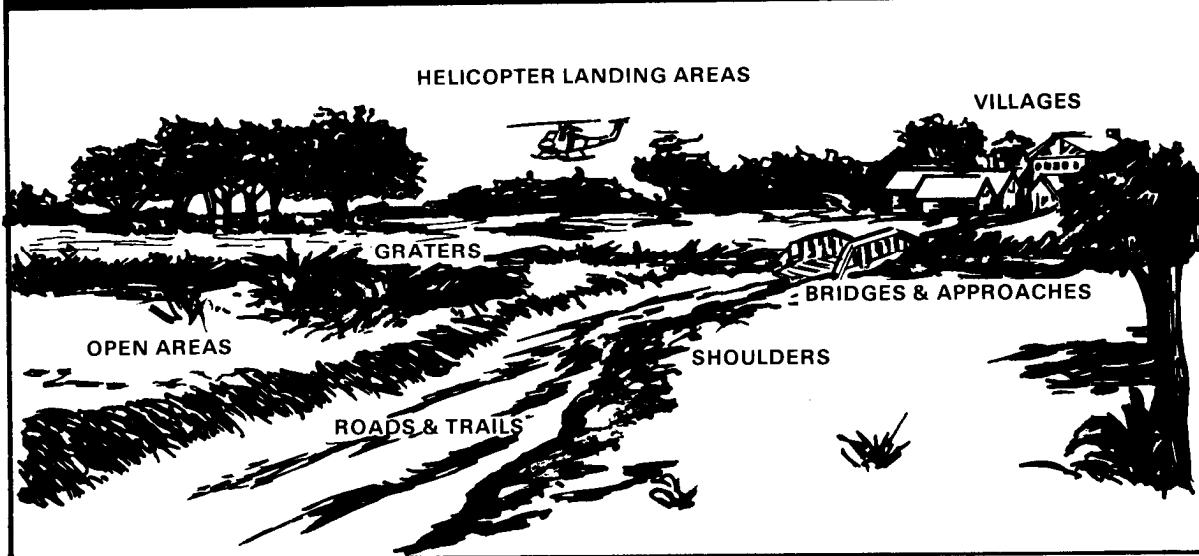

### MINES—WHAT TO LOOK FOR

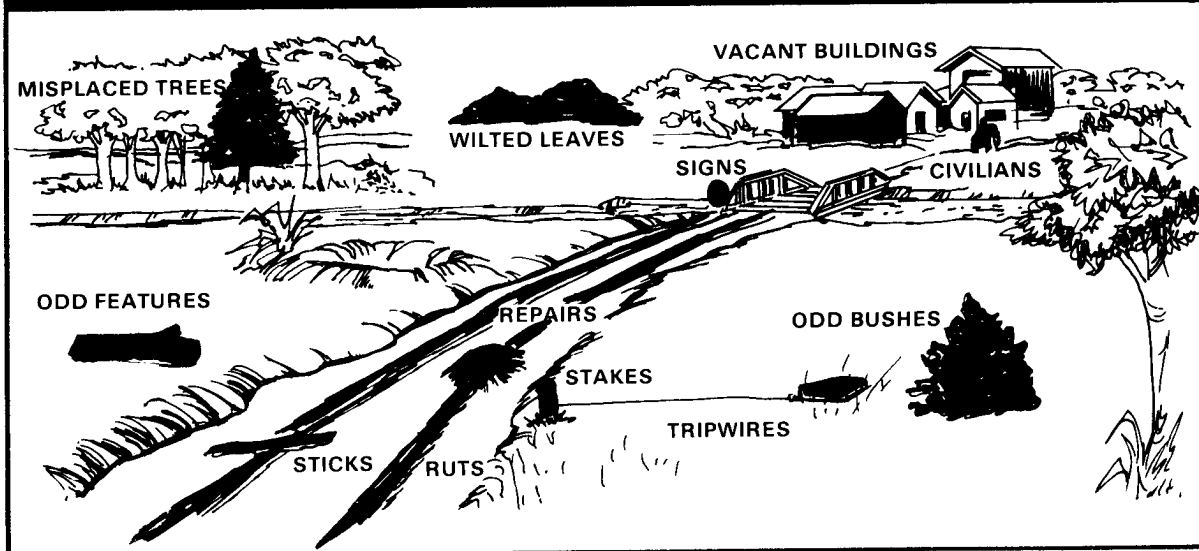

## OTHER SURVIVABILITY MEASURES

Unit TSOPs prescribe specific warning signals for ground, air, air assault, and nuclear, biological, and chemical (NBC) defense. The signals must be understood by all personnel. Periodic rehearsals and drills should be conducted to insure that the signals are understood and that the method of dissemination works (refer to appendix F for warning signals).

To survive, remember the following:

- Stay alert—see the enemy first. Seeing him first gives you the edge in the engagement. Don't lose sight of him.
- Select a position that is hidden from enemy ground observation.
- Move into positions during darkness.
- Take advantage of terrain to provide cover and concealment for the weapon.
- Do not expose anything that shines. Reflec-

tion of light from a shiny surface attracts attention and can be seen for great distances.

- Use garnish netting, pattern-painting, and natural materials to camouflage the position.
- Blend equipment into natural background.
- Erase or cover tracks.
- Keep position litter free. Be sure to replace dunnage (packing material) and barrier bags from the missile-round container into the container after the missile-round has been removed.
- Report detected mines immediately to the next higher level of command IAW unit SOP.

How MANPAD teams survive an NBC attack is dependent on the degree of NBC training and the availability and proper use of protective equipment (refer to appendix I for operations in an NBC environment).



## CHAPTER 10

# Mobility and Combat Loading

The Stinger weapon is a man-portable air defense missile system. This chapter discusses mobility, vehicular combat loading, and dismounted march loads in which Stinger team personnel should be proficient.

## TEAM MOBILITY

Normally, the Stinger team uses its own transportation to carry its basic load of weapons and team equipment. The Stinger basic load fits easily into the team's organic 1/4-ton trailer. All TOE items are carried in the truck. The 1/4-ton truck and trailer provide limited mobility in the forward area. (When the high mobility multipurpose wheeled vehicle (HMMWV) is fielded, it will become the team vehicle.)

During mobile operations with mechanized forces, the Stinger team may not be able to keep up with their supported unit. Also, the Stinger team may be vulnerable to hostile ground fire. When a Stinger team is in support of a mechanized element, the maneuver commander may provide it with tracked transportation; for example, armored person-

nel carrier(s) (APC). In such a case, the Stinger team will have to share a ride with other troops in the APC. Changing the mode of transportation of the team includes providing space for the basic load of Stinger weapons. If the team has insufficient room for the complete basic load, the load may have to be split into several carriers.

Loading Plan for a 1/4-ton truck and trailer; Normally, a Stinger team and equipment will consist of the items shown in the next illustration.

CONTENTS	
	Page
Team Mobility .....	10-1
Stinger Man Pack Load .....	10-3

Numbered items relate to numbered locations on the vehicle and trailer (see illustration). Items 1-16 refer to TOE equipment and

personnel; items 17-26 refer to vehicular equipment; and item 27 refers to personal equipment.

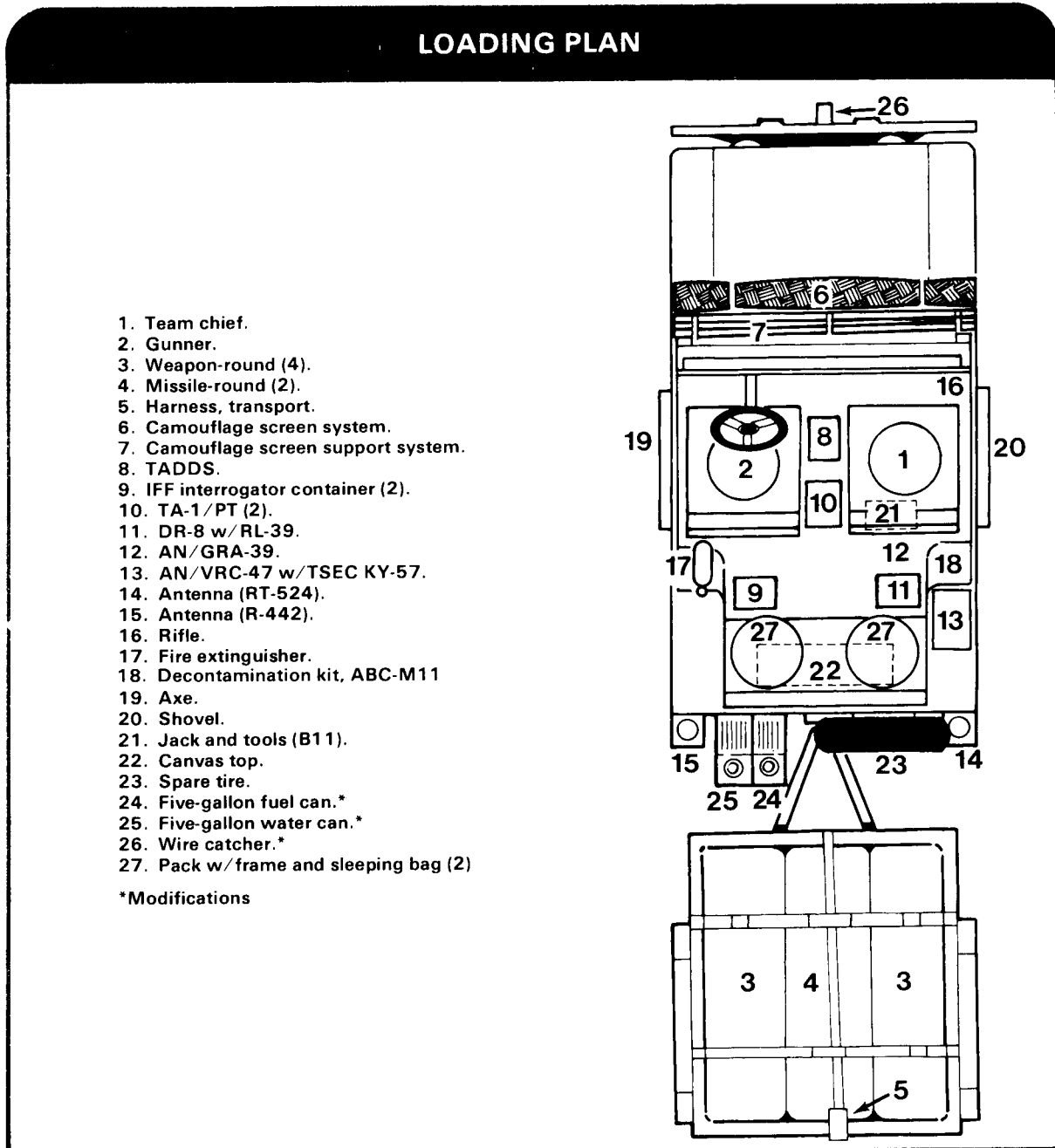

## STINGER MAN PACK LOAD

The Stinger team must have the capability to move and shoot to keep up with maneuvering combat element.

### DISMOUNTED STINGER TEAM

The Stinger team sometimes dismounts to support maneuver elements under difficult terrain conditions. The team chief must coordinate with the supported unit commander to solve the problem of carrying Stinger missile-rounds and guarding Stinger equipment left behind. Normally, the team will have to split and move with different squads/platoons because of the lack of unit personnel able to carry an extra load (missile-round).

### DISMOUNTED STINGER TEAM LOAD

The team is limited to carrying only two Stinger weapons. In addition, team radios

(man-packed) (air assault and airborne only), extra BCUs, individual weapons, and binoculars must be carried. The amount of equipment team members must carry limits their range and mobility during dismounted operations. Weights will vary according to what items are carried as indicated in illustration. Under foot march conditions, it is essential that weight be minimized and the load balanced. Multiple sling loads are difficult to carry for extended periods. Both Stinger and the M16 rifle are sling-carried weapons. Soldiers other than members of the Stinger team must be detailed as ammunition bearers to carry the remainder of the basic load. See appendix C for table of Stinger equipment weights and measures.

MAN-PORTABLE EQUIPMENT			
QUANTITY	ITEM <sup>1</sup>	WEIGHT IN POUNDS	
		EACH	TOTAL
2	Fighting load items <sup>2</sup>		
	Clothing		11.56
	Equipment		29.05
	Rations	1.75	3.50
	Existence load items <sup>2</sup>		41.29
	TOE equipment		
2	Weapon-round, w/BCU		34.50
	BCU, w/case	2.13	4.26
	IFF interrogator		5.80
	AN/PRC-77		23.50
	Binoculars, w/case		2.86
	Compass, magnetic, w/case		.43
	Sunglasses, w/case		.30
			157.05
Notes:			
1. This list does not contain all items which a MANPAD crewman might be required to carry.			
2. Extracted from FM 21-15, appendix C (1977). Weapon is M16A1.			

## CHAPTER 11

# System Support

Stinger teams must know where to obtain needed repair and service for their weapon system and training equipment. They must know what maintenance is authorized at their level on this equipment. Additionally, Stinger teams must know who to contact for needed rations and supplies when attached to maneuver elements. This chapter discusses these points and outlines the maintenance and logistics support concept for Stinger teams.

### ORGANIZATIONAL MAINTENANCE

The Stinger weapon is issued as a certified round of ammunition. Stinger weapon maintenance is done only at organizational and depot levels. There are no intermediate levels of maintenance. Organizational (user) maintenance is done by the Stinger team. Unserviceable weapons are returned to the ASP. User maintenance consists of preventive maintenance (PM) and replacement of certain parts. Maintenance tools and equipment are limited to cleaning and painting

materials and the TL-29, combination flat blade screwdriver and knife. No special tools, test equipment, or training are required to perform this maintenance.

Specific maintenance checks and services on Stinger equipment are listed in TM 9-1425-429-12. Careful attention should be given to the safety precautions listed in this technical manual.

### TACTICAL MAINTENANCE

Operator/user maintenance of the Stinger weapon and missile-rounds is performed by the individual teams. This maintenance consists of correcting visually detected faults on the exterior of the equipment. Repair parts are kept in the authorized stockage list of the direct support unit (DSU) supporting the Stinger unit.

Unserviceable by surveillance checks are returned to depot for repair or disposal.

### UNSERVICEABLE ROUNDS

In peacetime, missile-rounds found un-

### CONTENTS

	Page
Organizational Maintenance . . . . .	11-1
Tactical Maintenance . . . . .	11-1
System Training Support . . . . .	11-2
Combat Service Support . . . . .	11-2

### COMBAT MISSILE-ROUNDS

In combat, missile-rounds which do not work will be destroyed. Should a weapon-round misfire during engagement, the round and gripstock are considered unserviceable. After following appropriate safety procedures, both the gripstock and missile-round should be returned to the ASP. Procedures for handling hangfires, misfires, and duds can be found in chapter 3 and TM 9-1425-429-12.

### BATTERY COOLANT UNIT

A BCU which does not activate is discarded by the user. Activated BCUs are also discarded by the user.

### IFF INTERROGATOR

The IFF interrogator has its battery recharged and is reprogrammed by the section headquarters. The reprogramming for Mode 4 is done using the IFF programmer. With precharged batteries, the interrogator can be programmed and checked out within 10 minutes. User maintenance consists of

visual inspection of the exteriors for damage, periodic cleaning, and spot painting. Unserviceable items are turned in to the DSU for replacement. The section maintains two operational float interrogators for exchange with the teams.

### TRANSPORT HARNESS

There is no user maintenance required by the team on the transport harness other than normal routine maintenance. If the straps are torn, the harness may be taken to the DSU for sewing. If a buckle is broken, the harness will be turned in as unserviceable and a new buckle or new transport harness will be issued.

### CONTAINERS

Shipping and storage containers which cannot be repaired at the user level are turned in to the DSU for replacement. A damaged container is exchanged for a new container. Do not use a weapon if its container has been dropped a distance of 5 feet or more.

## SYSTEM TRAINING SUPPORT

Stinger training support equipment, belonging to the team, consists of the FHT M60. This item requires organizational maintenance performed on it similar to the tactical equipment.

If the FHT is defective and cannot be repaired by replacement of components at the user level, it will be turned in as unserviceable. A serviceable FHT is then issued to the unit.

## COMBAT SERVICE SUPPORT

MANPAD teams supporting companies, batteries, or troops will usually request supplies through their section headquarters. The section chief will prearrange this support when ordering for his teams such items as rations; petroleum, oils, and lubricants (POL);

clothing; spare parts; and personal health items. Combat service support is provided by the combat support company, headquarters company, or headquarters and service battery, depending on the type of battalion the section is supporting.

**PART II**  
**STINGER TRAINING**

CHAPTER 12

**Training Stinger Teams**

To be effective, training must prepare Stinger teams to perform a wide variety of tasks in combat. To have proficient Stinger teams, adequate time must be made available to conduct realistic training during tactical field exercises. Enough time must also be made available to conduct refresher training in weapon handling and practice engagements. A training program for Stinger personnel must be well planned. It must also remain flexible. Mission needs may dictate that a short, intensified program be conducted. However, the goal is still to develop and maintain Stinger gunner and team skills at a high level. This chapter discusses some factors to consider in training to reach that goal. Planning and preparing military training are covered in FM 21-6.

The Stinger section/platoon's parent unit commander has the authority and responsibility for planning, directing, conducting, and supervising training. He trains his teams to the highest degree of operational readiness allowed by the availability of personnel, equipment, time, funds, facilities, operational requirements, and installation support required. He accomplishes this by using his officers and NCOs to schedule and conduct planned training.

**CONTENTS**

	Page		Page
Training Assessment . . . . .	12-2	Individual and Team Training . . . . .	12-5
Performance-Oriented Training . . . . .	12-3	Tactical Training . . . . .	12-5
Stinger Training Program . . . . .	12-4		

## TRAINING ASSESSMENT

The Stinger platoon's parent unit commander has the authority and responsibility for planning, directing, conducting and supervising training.

### UNIT PROFICIENCY

The commander assesses the proficiency of the unit and individual based on—

- Personal observation.
- Sampling techniques.
- Performance tests.
- Field exercises.
- Soldier's skill qualification tests (SQT).
- Army Training and Evaluation Programs (ARTEP).

This assessment is essential to the success of the training program for Stinger teams and is used to identify training needed.

### INDIVIDUAL PROFICIENCY

To determine each individual's proficiency analyze his experience level, including results of previous training of the individual team members in his assigned position.

Evaluate the overall training level of the section. Conduct maintenance inspections, equipment operating tests, operational readiness training tests (ORTT), field exercises, and crew drills.

Review results of the last SQT and ARTEP to see if any deficiencies surface because of poor team performance.

### TRAINING STANDARDS

To determine what training will be necessary to meet required training standards compare results of the gunner's current proficiency with the required training standards contained in the soldier's manual.

Find out the levels of training required to bring personnel up to the proper standards.

### TIME AVAILABLE

To determine how much time is available to achieve the required standards examine the section's overall mission requirements and other obligations. Evaluate how much training needs to be done.

### RESOURCES REQUIRED

To determine what resources are required to train members refer to—

- Chapter 13, Stinger Training Devices and Materials, for innovative solutions to overcome possible shortfalls.
- Results of the latest ARTEP as an indicator of training resources required for further training.
- Unacceptable scores received on the latest SQT.
- Previous training experiences of the section indicating previous resources used.

### RESOURCES AVAILABLE

To determine what resources are available to conduct gunner training,—

- Inventory section equipment and evaluate its readiness.
- Determine what assistance is available from supporting units and higher headquarters.
- Examine available training facilities.
- Reconcile all considerations.

Differences between resources required and resources available will affect both the time required to conduct the training and the section's ability to meet the required standards.

## PERFORMANCE-ORIENTED TRAINING

Training of both individuals and teams must be performance-oriented. To accomplish this, the commander/trainer must answer the following three questions when making a training program:

- What is the soldier/team expected to do in combat (mission/task)?
- Under what conditions is the mission/task to be performed (conditions)?
- How well is it to be done (standards of performance)?

The following example shows how the above questions would be used:

- Task. Select and occupy a position.
- Conditions. Team is given location, primary sector of search, and a 1:50,000 map of the area.
- Standards.
  - Team chief conducts ground reconnaissance while the gunner maintains a ready status.
  - Team chief selects primary and alternate positions on the ground.
  - Team occupies primary position within 30 minutes.
  - Selected positions.
- Are within given approximate location (within 100 meters of given coordinates).
- Have clear fields of fire.
- Have all-around observation, if possible.
- Have access and egress routes.
- Have safe backblast area.
- Take advantage of available cover and concealment.
- Hearing protection safe distance.

The tasks, conditions, and training stan-

dards of proficiency are specified in appropriate training documents.

### SOLDIER'S MANUAL

The soldier's manual identifies, defines and describes individual tasks and standards of performance necessary for success on the battlefield. These tasks and standards, along with training guidance, provide the basis for training and evaluation of the individual soldier.

### TRAINER'S GUIDE

The trainer's guide lists for the training manager the tasks the soldier must master to be proficient in his job and survive in combat. It also lists the source and location of training and supplemental training materials.

### JOB BOOK

Job books enable NCOs to monitor and keep a record of critical and common task proficiency for each of their soldiers. Job books are issued to each NCO supervisor for all soldiers in skill levels 1 and 2 under his supervision.

### SQT

The SQT is a written performance test designed to measure a soldier's ability to do his job. This skill (or written) component is like any written military test. It consists of a number of questions with multiple choice answers.

### ARTEP

An ARTEP provides guidance for collective training and evaluation. It identifies the mission, tasks, and conditions under which the tasks are to be performed and the proficiency of each unit. The Stinger ARTEP is a common module for units receiving Stinger support.



## STINGER TRAINING PROGRAM

The goal of the training program is to maintain Stinger team, section and platoon skills throughout the training year. The program achieves its goals through continuous reinforcement training. It is composed of the following:

- Weekly crew drills.
- Monthly moving target simulator (MTS) training.
- Quarterly MTS gunner qualification.
- Quarterly live target tracking.
- Annual simulator device firing.
- Annual live firing.
- Annual certification.

### STINGER TRAINING

The Stinger training program is designed to prevent team skills from deteriorating with time. It provides a mix of crew drill training, simulated firing, and live firing. Each type of training reinforces the other, and is an essential part of the overall training. The training program is based on two principles: train from simple to complex and train engagement skills repetitively.

Begin with simple drill exercises using simulation devices and work to complex ARTEP evaluations. Precede live firings with firings of simulation devices.

The skills taught in each step are repeated by use in succeeding steps.

### SCHEDULE TRAINING

Schedule training well in advance and organize it to take advantage of existing time

and resources. Training should be scheduled for a whole year. Detailed monthly training schedules should be prepared. This tells both leaders and soldiers how time is used, where training takes place, and the subject being taught. Also, it tells who is responsible for the training, what equipment is needed, what references are available, and what, if any, coordinating instructions are necessary. Prepare these schedules as far in advance as possible to insure all teams and individuals are prepared for training.

### REALISTIC CONDITIONS

Combat is difficult to simulate, but you cannot train good Stinger teams without simulating the pressures, noises, and other problems experienced in combat,

### TRAINING WITH SUPPORTED UNITS

Whenever possible, arrange to conduct tactical training with the units you will support in combat. Stinger teams must habitually work with the units they support.

### TRAIN WHERE MOST NEEDED

Do not waste time and effort by training in the skills your teams and soldiers have already mastered. Know where the weak areas are and train to correct them.

### CROSS TRAINING

When each member becomes proficient in his own job, train him to do the other team member's job. For example, train the gunner to operate the team radio.

## INDIVIDUAL AND TEAM TRAINING

The soldier's manual is a key element in individual training. It serves as a basis for the SQT. By studying his manual, a Stinger team member can determine what makes up his SQT and how to prepare for it. The Stinger soldier's manual, FM 44-16S, identifies many MOS critical tasks.

### INDIVIDUAL SKILLS

Mastering individual skills is the beginning of an effective Stinger team. Proficiency in, these tasks insures that Stinger teams will be able to meet the threat's challenge. The tasks are broken into two groups. The first group is common tasks. These tasks must be mastered by all soldiers (see FMs 21-2 and

21-3). The second group contains those tasks required by duty positions or proficiency tasks (see FM 44-16S). When individual standards are met, the Stinger team and section must function together where Stinger gunnery and tactics are combined. Only after all Stinger personnel have been trained to perform these tasks at the required standards will the teams be able to effectively accomplish their mission on the battlefield.

### TRAINING FOR SPECIFIC TASKS

The training required for specific Stinger tasks can be found in the appropriate chapter or appendix of this manual.

## TACTICAL TRAINING

Tactical employment of Stinger requires the cooperative and timely efforts of all team members.

### CREW DRILLS

Drills develop teamwork. They are used to develop automatic reaction where time is important. An example is a situation where a team must defend against aircraft making an attack against a convoy. Teams should practice the drills with the same precision as a well-executed football play. The drills are easy to prepare, can be conducted almost anywhere, and need last only 30 to 40 minutes. Crew drills are contained in appendix D.

### TERRAIN WALK

The terrain walk is a proven method of training. When used, it should be completed

with leaders first and then with troops. It involves nothing more than a leader—any leader—taking his men on a tour (by foot or vehicle) over a predetermined route and discussing applications of various tactical principles and techniques along the route. The object is to give the team members an appreciation for various tactics or techniques in the employment of Stinger. An informal two-way questions and answer session is the most effective method. Few methods of training will implant tactical concepts better than a well-conducted terrain walk. For example, this terrain walk can be used to point out how a Stinger team can support a company team on a forward movement.

### TERRAIN MODEL EXERCISE

The principal purpose for conducting a terrain model exercise is to reinforce the

training each Stinger team member received in the classroom prior to undergoing a practical exercise in the field. The terrain model exercise is really a small tactical exercise in which each man can see how he fits into the whole picture. The terrain model exercise permits the leader to—

- Discuss the role of the supported unit, adjacent units, and other units connected with the field exercise.
- State the mission of the section and teams.
- Discuss unit SOPs for actions on contact, security, occupying positions.
- Ask questions of each team member.
- Point out terrain features which attack helicopters can slip behind and then attack friendly armored vehicles.

- Answer questions and clear up any misconceptions.
- Use scale model vehicles.

### **FIELD TRAINING EXERCISE**

Another way to train the Stinger teams and section is the field training exercise (FTX). This exercise should be conducted under complete tactical conditions so that all aspects of training are exercised. The FTX obviously requires more training and preparation than the previous methods. It requires a scenario, an operation order (OPORD), and control personnel. The best way to start the exercise is with an alert and movement to an assembly area. From this point it can take any form you desire, depending on your training needs. Chapter 17 tells you how to plan for, conduct and participate in a FTX.

## CHAPTER 13

### Stinger Training Devices and Materials

This chapter describes the devices that can be used to train and test Stinger gunners. These devices serve to promote and maintain gunner proficiency, shorten training time, and effect savings in resources.

A training program should emphasize weapon handling and firing procedures to develop and maintain gunnery proficiency at a high level. A number of training devices have been developed which, if used properly, can add realism to the training program. The use of these devices is less costly than conducting live firings and permits training to be conducted at the home station.

#### FIELD HANDLING TRAINER (FHT) M60

The Stinger gunner uses the FHT to practice basic manual skills of weapon handling, operation, sighting, and ranging. The FHT can be used to visually track actual aircraft or radio-controlled targets. It also allows the gunner to practice mating/removal of the gripstock and insertion/removal of the BCU. The FHT has the same size, weight, and external appearance as the Stinger weapon-round. Controls and mechanical operation are the same as the weapon-round. However, indications of target acquisition are not provided. Each Stinger team is issued one FHT.

Normally, during team-level training, only one FHT is available to each team. This presents a problem during field handling/quick-reaction drills, when a complete basic load of weapon and missile-round containers

is needed. These drills require that the container/ready rack be located on top of the other weapon containers, on either the right or left side of the trailer. With only one container, the necessary height and accessibility of the ready rack cannot be duplicated. There is also a problem in securing the lone container/ready rack in the trailer bed to prevent its movement and possible damage.

#### CONTENTS

	Page
Field Handling Trainer . . . . .	13-1
Training Set Guided Missile M134 . . .	13-3
Moving Target Simulator. . . . .	13-5
Launch Simulators . . . . .	13-5
Radio-Controlled Miniature Aerial Target . . . . .	13-5
Beseler Cue/See . . . . .	13-6
Training Films . . . . .	13-6

### FIELD HANDLING TRAINER (M60)

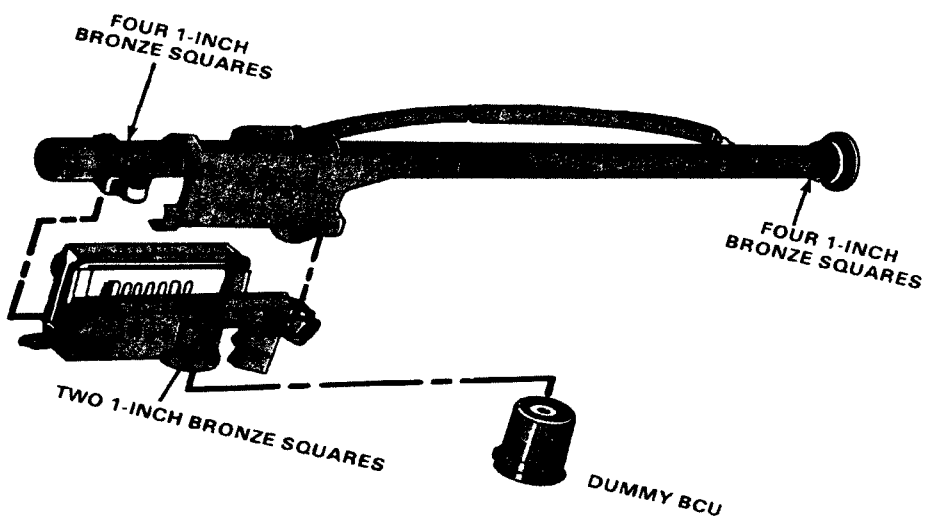

### SAMPLE BASIC LOAD DEVICE USING M416 INTERIOR DIMENSIONS

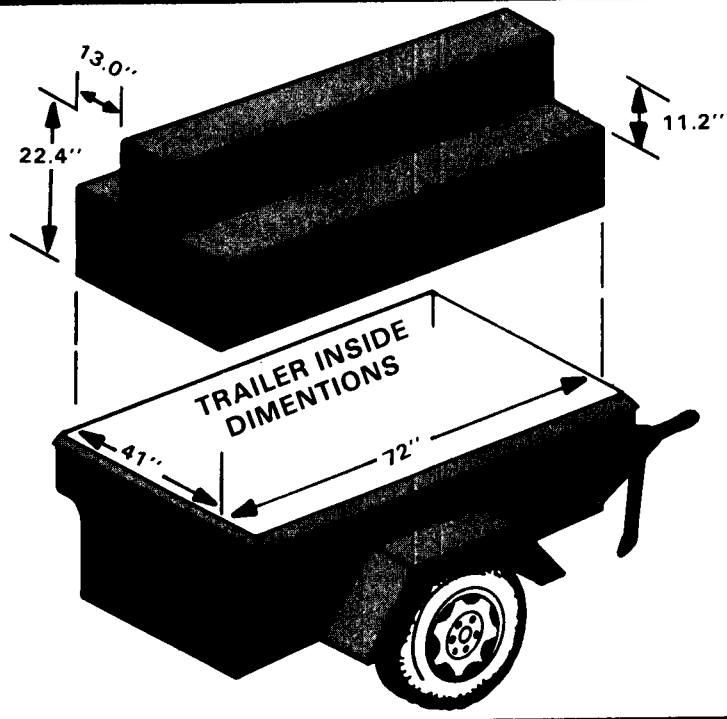

A wooden frame to simulate the missing containers of the basic load can be constructed to fill this need. This device can be made by the local TASC. The simulated basic load frame can be constructed of plywood.

For those exercises requiring the gunner and team chief to each handle a weapon, it is suggested that an FHT be borrowed from another team. An allowance for the extra weapon is built into the frame's design.

## TRAINING SET GUIDED MISSILE M134

The training set guided missile M134 consists of the THT, five rechargeable NICAD batteries, an IFF simulator with cable, and a shipping and storage container. This training set is used by the gunner to develop and maintain proficiency in tracking aircraft and firing the Stinger weapon. Each Stinger sec-

tion is issued one M134 training set.

The tactical IFF interrogator is compatible with the M134 and for training purposes can be programmed and used for field training.

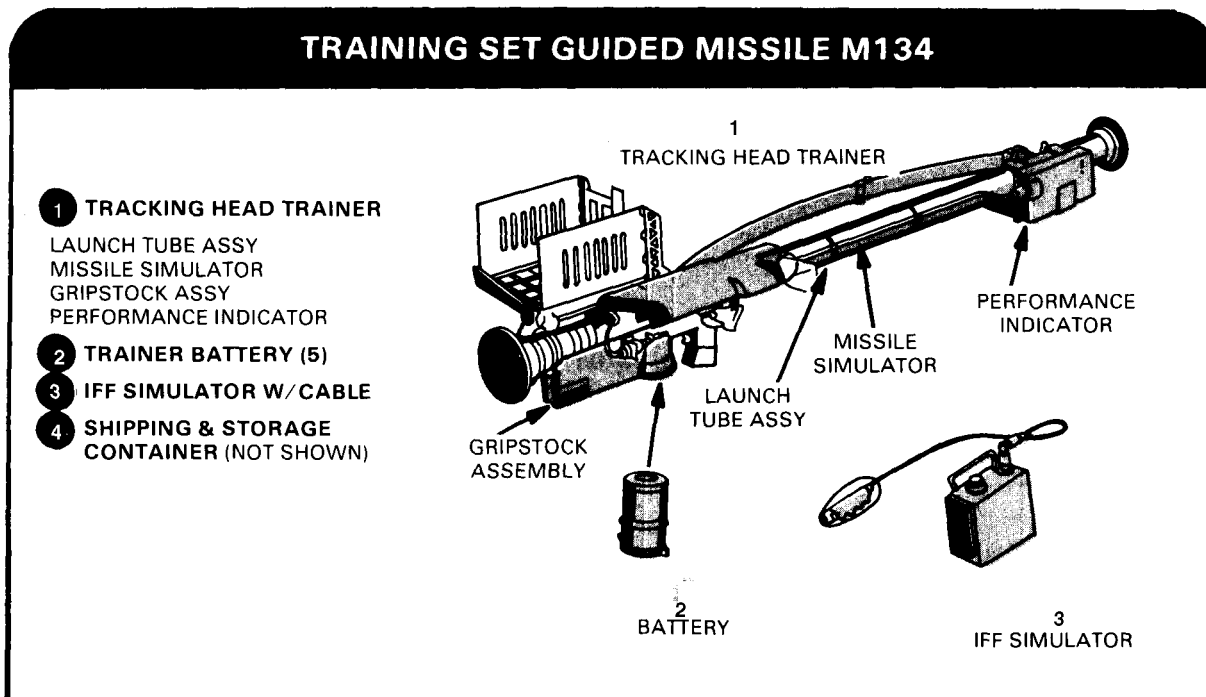

### TRACKING HEAD TRAINER (THT)

The THT consists of the launch tube assembly (which contains the missile simulator), gripstock assembly, and a performance indicator. The trainer has the same general appearance as the weapon-round except for

the performance indicator assembly. This assembly is strapped near the aft end of the launch tube. The trainer weighs about 38 pounds.

### TRAINER BATTERY

The external appearance of the trainer battery is similar to the BCU except that the trainer battery is approximately 3 inches

longer and about twice as heavy. At least 16 training missions of 47 seconds each are possible with a fully charged battery.

#### TRAINER BATTERY AND BCU

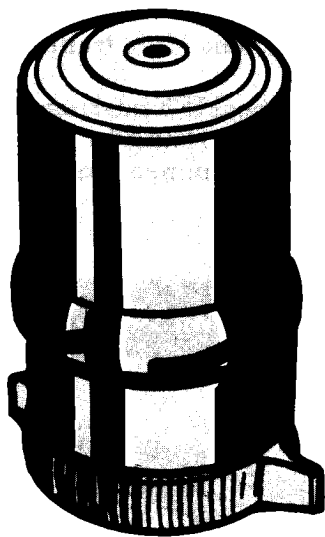

TRAINER BATTERY

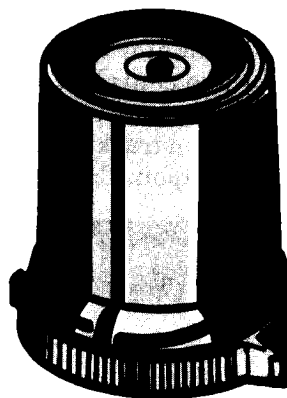

BCU

When installing a trainer battery NSN 6920-01-044-0320 in the M134 Stinger THT, be careful with the contact rings. If the rings touch any metal, they'll short out. Metal includes part of the gripstock, which may be touched during battery installations.

### IFF SIMULATOR

The IFF simulator provides random, simulated IFF interrogation responses to the audio device on the trainer as on the weapon.

### SHIPPING AND STORAGE CONTAINERS

Shipping and storage containers are shown and discussed in chapter 1 of this field manual.

### ANCILLARY EQUIPMENT

Further description of the trainer set and ancillary equipment is found in TM 9-6920-429-12. Use of the THT for gunner evaluation is found, where appropriate, in chapter 15 of this manual.

Electrical components provide the same audiovisual indications as the weapon when acquiring and tracking a target. Electrical power is provided by a rechargeable NICAD battery. Batteries are recharged in a battery charger.

The missile simulator has two major parts: the seeker section and the coolant reservoir assembly (gas bottle). The seeker works the same as the seeker on the weapon. The gas bottle contains pressurized argon gas which cools the seeker during each training mission. Under normal conditions, eighty 47-second practice engagements can be completed when the gas bottle has been fully pressurized.

The performance indicator displays the gunner's progress in a simulated engage-

ment. It provides indications that the gunner has—

- Correctly performed the engagement sequence.
- Committed a correctable error—a procedural error that can be corrected prior to squeezing the firing trigger.
- Committed an uncorrectable error—squeezing the firing trigger out of sequence.
- Allowed the 47-second timer to run down which shuts down the trainer.

## MOVING TARGET SIMULATOR

The MTS M87A1 provides representative sights and sounds of aircraft expected to be encountered by Stinger gunners. Environmental realism is achieved through the use of a large, curved projection screen, aircraft

presentation, and sound. MTSs are located at major installations in the continental US (CONUS) and overseas. A complete description of the MTS is found in TM 9-6920-427-10.

## LAUNCH SIMULATORS

Stinger simulator devices are the Stinger launch simulators (STLS) and the THT launch signature simulator. The STLS launches a dummy projectile and simulates an actual missile launch. This device allows every gunner an opportunity to fire a weapon (launch a dummy missile).

The THT/launch signature simulator

produces a simulated backblast effect when fired. Because of this, Stinger gunners using the THT/launch signature simulator are more visible during FTXs. This not only allows them to be more effectively evaluated but also allows them to enjoy a greater sense of participation in the exercise.

## RADIO-CONTROLLED MINIATURE AERIAL TARGET

The radio-controlled miniature aerial target (RCMAT) is a durable target capable of providing an accurate simulation of an attacking aircraft. An IR source device can be attached to the target. This target provides

the gunner practice in tracking and ranging. RCMATS are available through normal supply channels. They are normally issued in kit form by Federal stock number.



## BESELER CUE/SEE

The Beseler Cue/See is used with training extension course (TEC) lessons. It can be used for training in all aspects of Stinger gunner procedures. The lessons are presented via a super 8-millimeter continuous loop cassette projected on a 6 by 8-inch screen. The Beseler's light weight and small size allow it to be used almost anywhere. Eight Beseler Cue/See projectors are issued to a combat arms battalion/squadron.

This device is best used with one or two soldiers at a time. However, a lesson may be shown to a large group, if necessary. After completing each TEC lesson, the soldier may take a written test. If he answers all training objectives correctly, he goes on to the next lesson. The local TASC has a catalog of all TEC lessons produced by Army service schools. TEC lessons covering Stinger and Redeye subjects are listed in chapter 14.

## TRAINING FILMS

United States Army training films can be used to support instruction of Stinger personnel in both Army-wide skills and in Stinger operations. DA Pam 108-1 is an index of Army motion pictures and related audiovisual aids. It lists available training films and other audiovisual aids. Films of particular interest to trainers are—

- The 44-series relating to Stinger, aircraft recognition, and other air defense subjects.
- The 21-series relating to the individual soldier.
- The 8-series relating to first aid and field sanitation.
- The 5-series relating to camouflage and field fortifications.

Film and projection equipment are obtained from TASCs.

Stinger training films that are available or in production include the following:

- Stinger Guided Missile System, Introduc-

tion and Use in Defense of the Army in the Field. TF 44-6076, color, 16 minutes.

- Stinger Weapon System—IFF Programming (U). TF 5 minutes.\*
- Stinger Gunner—Target Engagement Procedure (U), TF 4420 minutes.\*

Stinger television tapes that are available or in production include the following:

- Stinger—Assembly, Checks, and Transportation. TVT 44-138, color, 17 minutes.
- Stinger Team Quick Reaction Drills. TVT 44-139, color, 10 minutes.
- Stinger Employment. TVT 44-140, 10 minutes.

DA Pam 310-1 provides a Consolidated Index of Army Publications and Forms which can be procured where appropriate to support the training of Stinger personnel.

\*Films classified CONFIDENTIAL.

## CHAPTER 14

### Stinger Training Concepts

To achieve a high state of proficiency, Stinger gunners must receive proper gunner training. If proficiency is to be maintained at an acceptable level, training must be standardized, increased, and scheduled at regular intervals.

#### MOVING TARGET SIMULATOR

The MTS is the most effective single training device for training Stinger gunners. MTS training must be supplemented by live-tracking exercises (especially low-flying helicopters) because of background IR discrimination training requirements. The units which have MTS facilities nearby and use them show a higher proficiency level, which is proportional to the amount of time spent tracking targets, than those who don't. It is critical that where MTS facilities are available, gunners receive regularly scheduled training (at least one full day) in Stinger weapon handling and tracking.

Some Stinger sections do not have ready access to an MTS. In this case, they must use other methods to train in target engagement. Use of an RCMAT can meet the requirements for Stinger gunners to simulate engagement of targets. If the section is located near a military air base or civilian airport, it can receive meaningful training in tracking live aircraft. Money restraints restrict opportunities for Stinger sections to have tactical military aircraft for training purposes. The Stinger training manager or trainer can overcome this problem by using some innovations. For example, the Stinger section's unit commander may ask one of the other services to allow Stinger personnel to practice engaging their tactical aircraft. This could entail

busing Stinger personnel in to an Air Force base.

Section and team leaders can offer their gunners valuable, meaningful training by setting up a tracking range. Examples of suitable areas are—

- Abandoned airstrips.
- Open fields.
- Parade fields.
- Maneuver areas.

Tracking simulated engagements of live aircraft with the THT gives Stinger training more realism. The realistic aspects of engaging real aircraft during bombing and strafing runs are not found in the other training methods. This is where the gunner receives background IR discrimination training. Evasive countermeasure type engagements are also important in preparing the student for his tactical missions.

CONTENTS	
	Page
Moving Target Simulator . . . . .	14-1
Aerial Targets . . . . .	14-2
Training Extension Course Lessons . . . . .	14-5
Using the Besler Cue/See . . . . .	14-7
Aircraft Recognition Training . . . . .	14-8

## AERIAL TARGETS

To maintain proficiency, Stinger gunners must track and practice engagement of aerial targets as often as possible. However, because of the cost factor involved when using real aircraft, it is difficult to obtain sufficient tracking experience. To overcome this training limitation, more gunner training must be accomplished using innovative training techniques and devices to simulate real aircraft. This training requirement has been met with the development and use of a series of model aircraft as flying targets in unit training areas.

### RADIO-CONTROLLED MINIATURE AERIAL TARGET

The radio-controlled miniature aerial target (RCMAT) is a durable target capable of providing simulation of an attacking aircraft. It provides a target for detection, acquisition, tracking, and simulated firing with the Stinger weapon. Stinger teams can also use the RCMAT at a live range to teach other units how to defend themselves against aircraft with their own weapons.

#### RADIO-CONTROLLED MINIATURE AERIAL TARGET, FQM-117A.

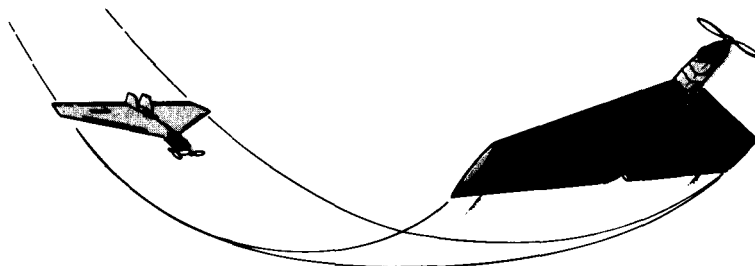

<b>Model:</b>	<b>FQM-117A</b>
<b>Engine:</b>	<b>Gas powered, propeller driven.</b>
<b>Size:</b>	<b>1/6th scale (to a full size threat aircraft).</b>
<b>Control:</b>	<b>Ground-based, radio-controlled equipment.</b>
<b>Airspeed:</b>	<b>From 25 to 80 knots.</b>
<b>Launching Requirements:</b>	<b>Hand launched.</b>
<b>Visibility:</b>	<b>Satisfactory to about 800 meters.</b>
<b>Maneuverability:</b>	<b>Representative of full-scale aircraft.</b>
<b>Maximum Flight Time:</b>	<b>About 10-15 minutes at maximum speed.</b>

As a practical matter, the target's usage is limited-only by the imagination-of the unit commanders, the target operator's skill, and the restraints of range safety. The target can be flown in almost any weather. The visual reference required for flying is normally the limiting factor. Surface winds 25 knots or below do not restrict the system's tracking usage.

A second characteristic is the combative nature of the RCMAT. The maneuver capabilities of the target match (and exceed) those of any full-size, fixed-wing aircraft and the use of these maneuvers is under the direction of the instructor. Thus, the target can challenge the gunner by flying in a realistic manner, taking full advantage of terrain features, evasive maneuvers, and scale speed.

This unrestricted presentation capability introduces a competition between target and gunner that holds the attention of the personnel in training area. Improved morale based on the competition is a most important element in the FQM-117A's success to date.

Another characteristic of the system is the low level of logistic support required. RCMATs are available through normal supply channels. They are normally issued in kit form by Federal stock number. The FQM-117A RCMAT consists of an airframe kit and a ground support kit.

The airframe kit contains an engine, three airframes, ten propellers, four glow-plugs, and assembly materials.

The ground support equipment kit consists of a station case, an operator's manual parts box, three flight boxes, two tool sets,

and electrical test equipment.

Assembly and operation of the FQM-117A is the responsibility of the using unit, normally the battalion. One trained operator, with the rank of E-7, (with an additional skill identifier [ASI]) and an assistant operator (E-7 preferred), also with additional skill identifier is required.

A 1/9 scale RCMAT will be available in the near future is a replacement to the 1/6 scale RCMAT. It will be available in two models: an MiG-27 Flogger D and F-16 Fighting Falcon.

A comparison of operating ranges versus simulated target range is depicted in the following illustration. It gives an idea of representative distances from the Stinger positions to the target (real aircraft versus miniature target) operating ranges versus simulated target range.

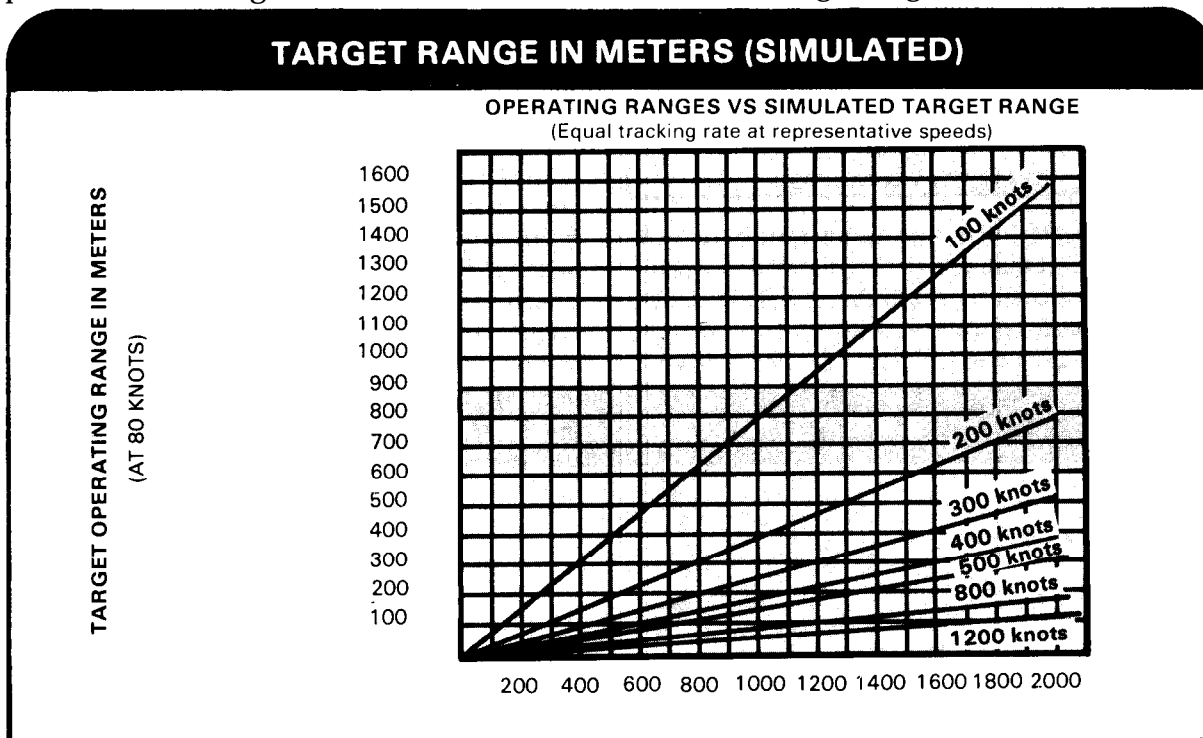

To use the illustration locate the desired simulated target range along the bottom. Move up along this line until the desired

target speed intersects with this line. Then move left to find the operating range for the FQM-117A.

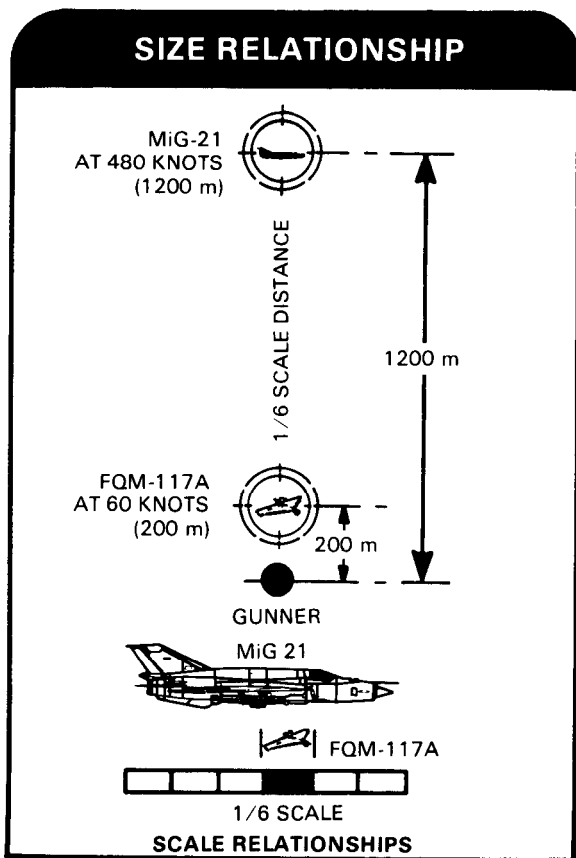

The FQM-117A has approximately 1/6 the speed and visual size of a full size aircraft. When it is flown at scale distances, it simulates the performance envelope of the target aircraft to give the trainer a realistic adver-

sary for the THT.

### TRACKING THE MINIATURE TARGET

Using a tracking range or tracking area, units can realistically simulate Stinger engagement of real aircraft. When using the target, remember to adjust the distance for the scaled down version of a real aircraft. To give relative figures, the preceding illustration, target range in meters (simulated), shows the relationship between the model and an actual aircraft when tracking a crossing target. The speed and the distance from the gunner are approximate figures.

### EXERCISES USING THE MINIATURE TARGET

The instructor coordinates closely with the target controller prior to an exercise. For example, he may want the target to execute pop-up attacks to exercise the gunner's skill in coping with this type of maneuver. Target maneuvers can range from easy to track to impossible to track. The instructor should have some flights pass over or close to the Stinger position. This provides the gunner with realistic situations when engaging high-speed aircraft at close range. A sample non-firing tracking area layout is shown below with a number of selected flight paths.

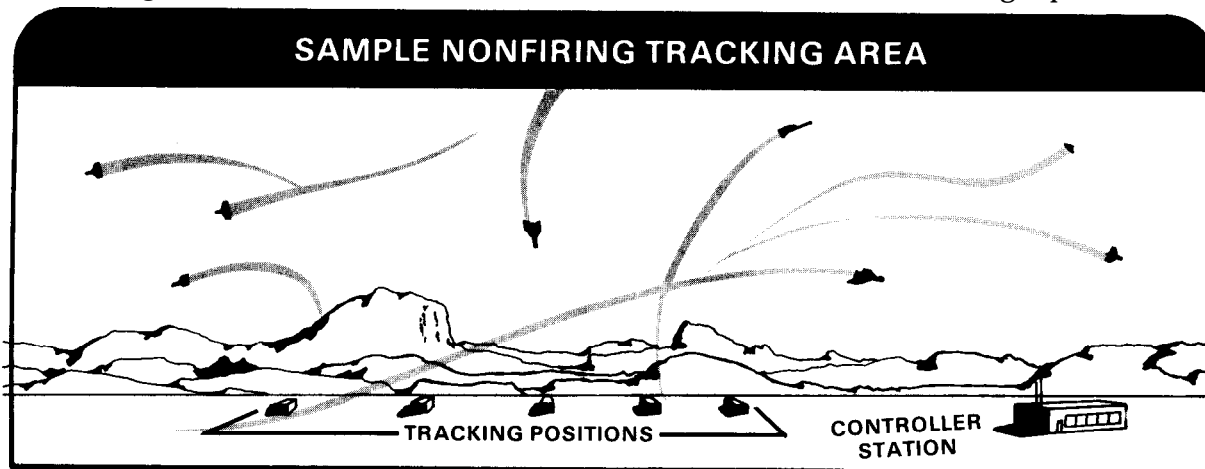

## TRAIN IN PROTECTIVE CLOTHING

Stinger teams should practice target engagements while wearing protective clothing and masks. This should occur both in the MTS and in the field. Training with the protective mask accustoms the team members to handling the weapon in an NBC environment. Some difficulty may be experienced in feeling the vibrations generated by

the IR acquisition indicators with the mask on. However, the IR tone can be heard. The gunner may have to adjust his head position slightly in order to obtain a clearer sight picture. Tracking with the mask on will reinforce the team's confidence in operating the weapon in an NBC environment.

## TRAINING EXTENSION COURSE LESSONS

The training extension course system is designed to assist soldiers and unit commanders in increasing job proficiency. It consists of audiovisual, audio only, and printed text lessons. Audiovisual projectors and cassette tape players are included to present the lessons.

### TEC AS PART OF UNIT TRAINING PROGRAM

TEC provides performance-oriented training in many subjects needed by Stinger gunners. These subjects include skills that are common to all soldiers as well as those skills needed to operate and maintain Stinger

weapon systems. This makes TEC an essential part of a unit's training program.

### TEC LESSONS

Use of TEC lessons provides flexibility in the unit training program. It allows commanders to stress skills required by individual soldiers. TEC lessons can be presented—

- In unit learning centers, classrooms, or in the field.
- To individuals or small groups.
- As self-paced instruction.
- To correct a specific shortcoming.

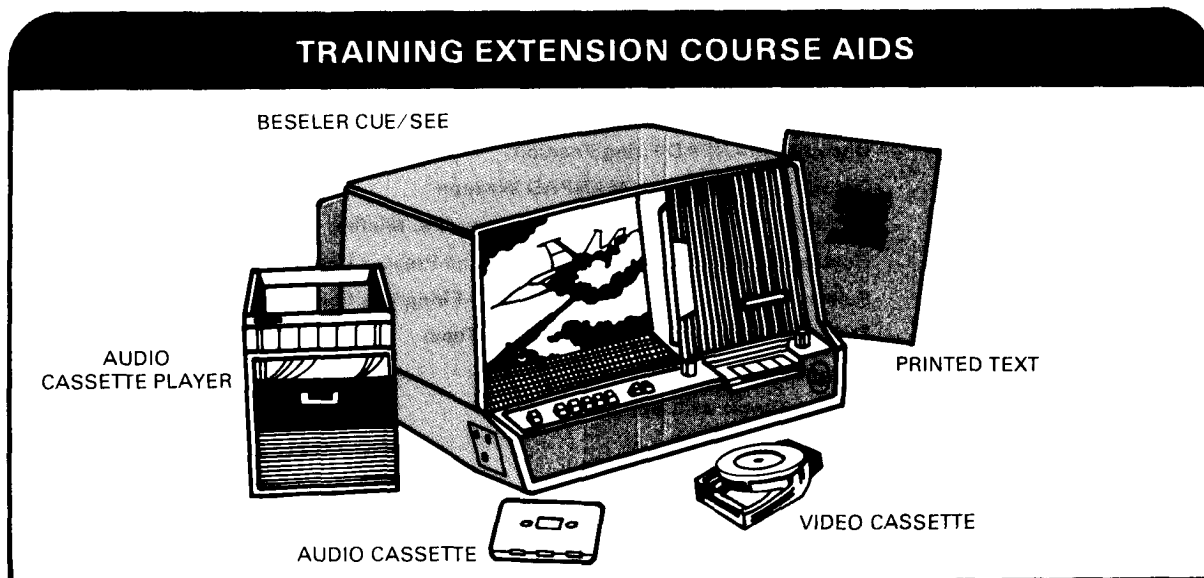

### TEC LESSONS AVAILABLE

Most TEC lessons available for Stinger are audiovisual; several are audio only. Lessons available in the field cover—

- Weapon operation.
- Stinger team deployment and tactics.
- Quick-reaction exercises.
- Maintenance.

- IFF programming.

Common subject and MOS TEC lessons are automatically distributed to units when completed or revised. In addition, each audiovisual support center receives copies of the lessons. These are used to replace, by direct exchange, lessons found to be damaged or defective.

### TRAINING EXTENSION COURSE LESSONS

The following list contains TEC lessons that are applicable to all MANPAD personnel. These lessons have either been distributed to the field or are under various stages of development. Training aids support centers maintain complete lists of all TEC lessons, including additions or changes to lessons.

043-441-1015-F	TADDS Emplacement and March Order
043-441-1016-F	TADDS Operational Checks
043-441-1017-F	TADDS Operation
043-441-1018-F	TADDS Maintenance
043-441-7870-F	Introduction/Inspection of Redeye
043-441-7871-F	Redeye Engagement of Hostile Targets, Part 1
043-441-7872-F	Redeye Engagement of Hostile Targets, Part 2
043-441-7873-F	Deployment of the Redeye Team
043-441-7874-F	Redeye:Target Engagement
043-441-7885-F	Stinger:Weapon PMCS, Part 1
043-441-7886-F	Stinger:Weapon PMCS, Part 2
043-441-7887-F	Stinger:Interrogator PMCS
043-441-7888-F	Prepare the Stinger's Basic Load for Transport
043-441-7889-F	Occupy a MANPAD Firing Position
043-441-7890-F	Defend an Asset with a MANPAD Weapon
043-441-7891-F	Perform Emergency Procedures for Hangfire, Misfire, Dud
043-441-7892-F	Destroy the MANPAD Weapon System to Prevent Enemy Use
043-441-7894-F	Select Primary and Alternate MANPAD Firing Positions
043-441-7895-F	Exercise Fire Control of the MANPAD Team
043-441-7896-F	Engage Target with Stinger, Part 1
043-441-7897-F	Engage Target with Stinger, Part 2
920-061-0500-F	Introduction to TEC
920-777-0505-A	TEC for Green Tabbers
954-441-0047-F	Introduction to Aircraft Recognition
954-441-0049-F	Mirage III, F-104, MiG-27, A-10, AV-8

## TRAINING EXTENSION COURSE LESSON—CONTINUED

954-441-0050-F	OH-58, AH-1, Mi-6, Mi-4, UH-1
954-441-0051-F	MiG-21, Jaguar, Su-17/20, MRCA, Su-19
954-441-0052-F	Mi-24, Mi-8, C-130, An-12, CH-47
954-441-0053-F	Su-7B, MiG-17, A-4, II-28, G-91
954-441-0054-F	F-5, F-4, F-111, A-7, F-105
954-441-0056-F	F-15, F-14, OV-10, Alouette 111, Mirage F-1
954-441-0057-F	Gazelle, Scout, Puma, Lynx, BO-105
954-441-0058-F	Alpha Jet, F-16, OV-1, Buccaneer, A-6
954-441-0059-F	SAAB-105, SAAB-37, Yak-28, Lightning, Hunter
954-441-0065-F	Self-Evaluation, Part 1
954-441-0066-F	Self-Evaluation, Part 2

### HOW TEC IS USED

Each lesson administrative instructions (LAI) which provide guidance on how to use the TEC training method to identify and solve training deficiencies. To identify training deficiencies, the trainer is provided with pretests and post tests in the LAI. The soldier's proficiency can be determined by having him take the pretest.

If the soldier passes the test, he does not need the training. On the other hand, if he does not pass it, the lesson is prescribed for training. The post test is used to determine whether the soldier did learn the lesson; if not, he can repeat the lesson. TEC lessons are developed to allow the soldier to work on his own time and at his own speed.

Material telling how to effectively use TEC lessons is obtained from the following:

- TEC Lesson 920-061-0500-F, Introduction to TEC.
- TEC Lesson 920-777-0505-A, TEC for Green Tabbers.
- TC 21-5-3, TEC Management Instruction, contains guidance on how to use the TEC system and develop the unit's support structure for TEC.

Stinger-related TEC lessons are listed in appendix D.

### USING THE BESELER CUE/SEE

The Beseler Cue/See can be used for training in all aspects of Stinger training. Lessons are presented via a super 8-millimeter continuous loop video cassette which is synchronized with an audio cassette. Lessons are normally presented on a 6 x 8-inch screen on the front of the Beseler Cue/See. However, by opening a small door at the rear of the device, the picture can be projected onto a

screen or classroom wall. The film speed can be adjusted from a single frame to 24 frames per second. Frames may be stopped automatically to allow some action by the student, such as reading a procedure from a technical manual or answering a question. The Beseler's light weight and small size allow it to be used almost anywhere.



## AIRCRAFT RECOGNITION TRAINING

Aircraft recognition is a real challenge. New aircraft and changing aircraft designs are adding to the list of aircraft to be recognized; it is a continuous process. This ever-changing situation poses a real challenge for those who teach visual aircraft recognition. Perhaps the biggest problem in recognition has been teaching it in an effective and realistic fashion.

Troops must be trained to be proficient in quick aircraft recognition. Hostile low-flying aircraft may appear suddenly from behind low hills, over trees, or through haze. High-speed aircraft are difficult to identify. Accurate visual recognition of aircraft is essential to Stinger personnel in making their engagement decision. It is vital that recognition be swift and accurate. Team members should be experts at recognizing all friendly and potentially hostile aircraft expected to be operating at low altitudes in a specified combat zone. Each team member should approach 100 percent recognition accuracy with 90 percent being a minimum acceptable level of proficiency.

Practicality dictates that aircraft recognition training be conducted using picture images of the aircraft to be learned. Two basic methods for presenting images are the use of the ground observer aircraft recognition (GOAR) kit, and TEC lessons designed for aircraft recognition training. In addition, graphic training aids (GTA), such as printed cards and charts, are useful supplements to the GOAR kit and TEC lessons. Numbers and titles currently available, or under production, include—

- GTA 44-2-5, Soviet and Warsaw Pact Forward Area Aircraft.
- GTA 44-2-6, Aircraft Recognition Playing Cards.
- GTA 44-2-7, Military Aircraft Markings You Should Know.

- GTA 44-2-8. Free World Forward Area Aircraft.

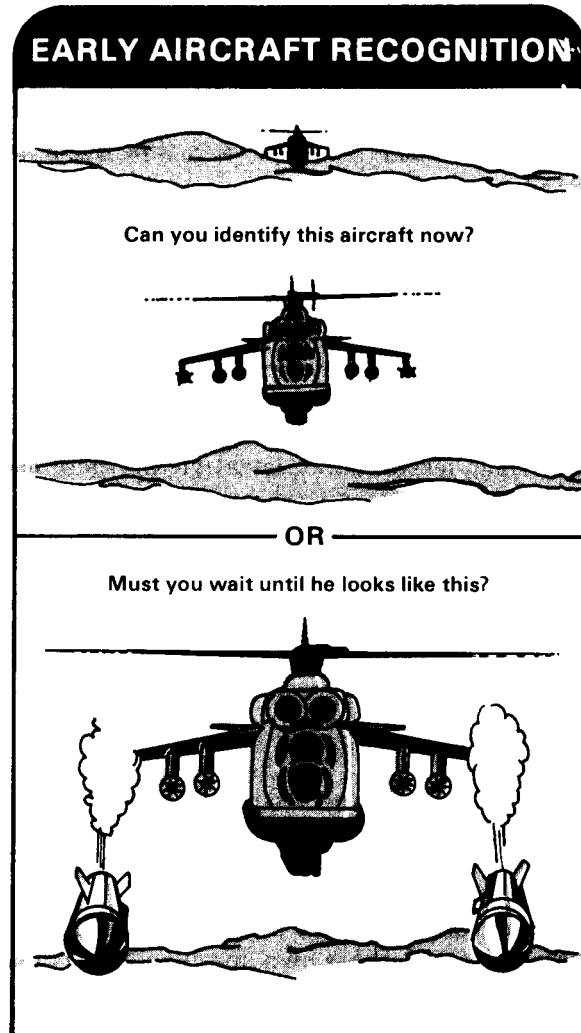

Aircraft recognition techniques are covered in detail in FM 44-30. This field manual should be used as a guide for aircraft recognition training in Stinger units. It can be used by those persons who establish training requirements and who evaluate job proficiency of individuals and the combat readiness of Stinger units.

## CHAPTER 15

### Quarterly Evaluation of Gunner Proficiency

This chapter provides procedures for evaluating the skills of MANPAD gunners in handling and firing the Stinger. Since weapons are not available for live-firing exercises, engagement simulations must be used. The MTS provides the most comprehensive means of evaluating gunner proficiency. Both the weapon handling and decision making elements of the engagement process can be accurately assessed against a variety of simulated target executing courses, speeds, and maneuvers that would be encountered in combat.

#### INTRODUCTION TO EVALUATION

The job of the evaluator is to determine if the gunner can correctly perform all the steps of the engagement sequence within set time limits. The evaluator grades on a go/no-go basis. To pass the test, the gunner must perform all the steps correctly, in proper order, and within proper time constraints. The tasks that must be performed by the gunner during an engagement can be divided into two categories for evaluation purposes; weapon handling, and decision making.

Weapon handling involves the smooth and efficient operation of the weapon. The gunner must demonstrate mastery of the weapon and its operating controls.

Decision making involves the process of determining if and when certain actions in the engagement control sequence are to be performed. These decisions require the application of a number of rules that are based on the type of target being engaged and visual

#### CONTENTS

	Page
Introduction to Evaluation. . . . .	15-1
Gunner Evaluation with the MTS. . . . .	15-2
Gunner Evaluation on a Tracking Range. . . . .	15-3
Scoring. . . . .	15-3
Gunner Performance Evaluation Sheet . . . . .	15-4

and audible indications received by the gunner during the engagement sequence. The skills and knowledge that a gunner needs to successfully execute a firing sequence are discussed in chapters 3 through 6 of this manual and in Soldier's Manual FM 44-16S.

The evaluator must consider the capabilities of the equipment and facilities he has available to him for evaluation purposes.

The THT can be used to evaluate weapon handling. However, this device used alone does not provide a means for accurately evaluating the gunner's ability at decision making.

By using the THT with an MTS, all elements of gunner proficiency can be tested against a variety of targets and target courses. When available, the MTS provides one of the most accurate means of evaluating gunner proficiency.

The THT can also be used in conjunction with live targets flying known courses on a tracking range to evaluate both weapon handling and decision making. However, detailed planning and close coordination between the various elements involved in the operation of the tracking range are required to achieve accurate test results.

## GUNNER EVALUATION WITH THE MTS

Prior to conducting the test, the evaluator should familiarize himself with the target run sheet for each target run he has selected. Also, the evaluator should familiarize himself with the gunner performance evaluation sheet and the scoring criteria and procedures used with the sheet.

Before class, the instructor should be sure that the projector is loaded with the proper film, the system energized and checked out, and that the necessary training materials are on hand. These materials should include the THT to be used, stopwatch (if required), reel tabular data, and target run analysis sheets for each reel to be used. Also, student evaluation sheets and any other materials which the instructor considers useful and appropriate.

Before starting the film run state the objectives and standards of the film reel to be used and describe the targets to be expected, including types, speeds, and maneuvers. Assign the gunner to firing positions. Have the gunner inspect the THT for proper bat-

tery voltage and gas pressure and have him take the gunner position.

Start target run. The gunner must now search, scan, detect, acquire, and track the target to perform a successful simulated launch.

There will be one evaluator assigned to each gunner being tested. The evaluator must evaluate all gunner activities during an engagement. By observing the IR and launch boundary indicator lamps on the trainer control console, the evaluator can determine if a gunner fires within IR and launch boundaries.

Since the target run sheets are keyed to time, the evaluator, using a stopwatch, will record the times between activation, acquisition, tone, and firing. If the THT indicates a procedural error, the evaluator should examine the windows/lamps, determine the cause of error, and make a note of the gunner's error.

The evaluator may stop the projector at the end of a target run or series of runs to change gunners.

## GUNNER EVALUATION ON A TRACKING RANGE

If an MTS is not available, the gunners can be evaluated against real aircraft flying over a prescribed area. The aircraft is flown over a preplanned course and the engagement is simulated using the THT. Compared to MTS training, this method (outdoor range) of presenting targets to the gunner has the advantage of realism but has disadvantages that include the following:

- Less precision in the evaluation. Aircraft courses are more difficult to control and time; therefore, the evaluator must rely more on his own judgment or the use of a Stinger sight assembly as to exactly when the aircraft is within the engagement zone.
- Difficulty of obtaining aircraft support. Aircraft support may be difficult to obtain and are more expensive in terms of the personnel and equipment required to operate and control them.
- Difficulty of locating training areas. A tracking range or suitable training area, target courses, equipment, and material must be selected. When actual aircraft are to be used, the evaluator coordinates with the pilot/air operations officer concerning target courses, number of runs, time involved, and communications.

### AIRCRAFT

If possible, targets should include jet and propeller aircraft and helicopters. Targets

should fly a variety of courses to enhance gunner training.

### TARGET COURSES

Preplanned target courses should be set up so that the evaluator and his assistant know where the launch, hold fire, and cease fire boundaries are located. The data for each course should be preplotted on a graph similar to the target run sheet used with the MTS. Target courses should include the following:

- Crossing left to right, low altitude (high-performance aircraft).
- Crossing left to right, low altitude (low/medium-performance aircraft).
- Crossing right to left (helicopter).
- Crossing right to left, low altitude (high-performance aircraft).
- Directly incoming, low altitude (high-performance aircraft).
- Incoming, transitioning mid-flight to crossing.

### CONDUCT OF EVALUATION

The conduct of the evaluation is the same as with the MTS. Normally, the gunner is given a total of five engagement runs. He must receive go on four of the engagements. At the completion of the test for record, the evaluator informs the gunner of the test score, go or no-go, and critiques his performance.

### SCORING

Gunner performance during a proficiency test will be scored using the Gunner Performance Evaluation Sheet (see page 15-5). The sheet may be reproduced locally. The scored elements are listed in the order they usually occur in an actual engagement. The evalua-

tor closely observes the gunner's actions during the engagement sequence and the THT's visual and audible indicators. When evaluating using the MTS, the evaluator looks at the target run sheet for the times at which certain events in the engagement should occur. He

also listens for target information from the film. When evaluating on a tracking range, the evaluator uses the target run sheet prepared for each target course.

The evaluator then scores the performance on each run as go or no-go on the evaluation sheet. A go rating is awarded a run if the engagement is properly performed and no uncorrectable errors are made. The

gunner may be scored go if he recovers from an error and completes the engagement in a satisfactory manner. Additional go or no-go scoring criteria can be found in the notes following the sample evaluation sheet. The standards are: Four of five hostile targets (80 percent) must be successfully engaged. No "friendly" targets may be engaged, unless declared hostile by the evaluator.

## GUNNER PERFORMANCE EVALUATION SHEET

If the gunner properly prepares the THT for operation, and does it in the correct sequence, he should be scored go. If he fails to raise the antenna (remove the front cover), lock the sight in the up position, and/or securely connect the IFF simulator cable to the THT, he should be scored no-go. Also, if he fails to install the power source, he should be scored no-go.

### DETECTION

If the gunner detects the target in time to engage it, he should be scored go. If he fails to detect the target or detects it too late to successfully complete the engagement sequence, he should be rated no-go.

### STANCE

If the gunner steps toward the target with his left foot, oversights to line up the sight with the target and then sights on the target, he may be scored go. If he demonstrates awkwardness in handling the THT, he should be scored no-go. Points to look for include the following:

- Does not step toward the target with his left foot, or move his foot as the target moves.
- Lacks good physical control of the THT.
- Does not balance the THT on his shoulder.
- Does not lean into the THT.
- Is unable to see through the sight properly.

- Holds the THT in a canted position.
- Accidentally activates the controls.

Watch for the above gunner errors throughout the engagement sequence.

### INTERROGATION

If the gunner interrogates the target and properly interprets the response, he may be scored go. If he fails to interrogate the target, or if he misinterprets the response, he should be scored no-go.

### ACTIVATION

If the gunner activates the THT in time to allow engagement (before the aircraft reaches the hold fire/crossover point), he should be scored go. If he fails to activate the THT or activates the THT too late to complete the engagement, he should be scored no-go.

### UNCAGING

If the gunner allows the gyro to fully spin up (3-5 seconds), tracks the target smoothly (steady IR tone), and uncages after IR acquisition, he should be scored go. If he uncages without IR acquisition and completes the target engagement, he should be scored no-go. He may release the UNCAGING switch at any time up to firing, if he does not have/loses IR acquisition, and then attempts to complete the engagement again.

**STINGER GUNNER PERFORMANCE EVALUATION SHEET**

*For use of this form, see FM 44-17(C) and FM 44-18-1. The proponent agency is TRADOC.*

Name _____ Date _____		Sheet _____ of _____			
Organization _____ Go No-Go _____		Date _____			
Item	PERFORMANCE STEP		Crew Memb	Score	
	GUNNER'S ACTIONS	EVALUATOR'S ACTIONS		C	D
1	Prepare the THT and begin searching for target	Tell the gunner to prepare the THT and begin searching for the target. Observe the gunner to determine that the THT is properly prepared.			
2	Detect and step towards the target with the left foot, point the THT at the target, and oversight.	Observe how the gunner over sights and handles the THT.			
3	Interrogate the target. Announce the response (MODE IV, MODE III, or UNKNOWN) and continue to track	Listen for reply and gunner response. Tell gunner that the target is a JET or PROP.			
4	Activate the THT when the target is within the activate zone	Determine the maximum range. Observe the target and listen for operation of the safety and actuator device. After the gunner activates, say, HOSTILE, ENGAGE			
5	Uncage as soon as a steady infrared radiation tone and an engagement order are received	Listen for change in tone and/or click of uncaging switch.			
6	Superelevate and lead the target, using the proper lead reticle	Observe the performance indicator after the completion of the engagement. (See item 7.)			
7	Fire at the target within the engagement zone	Listen for the beep. Observe that the target is within the engagement zone. Observe the performance indicator to verify successful performance.			
8	Remove the power source immediately after completion of the engagement	Observe that the gunner removes the power source in a timely manner.			
Evaluator's Name, Unit _____			Performance Time _____ Seconds _____		
<b>Legend</b> TC: Tank Commander D: Driver L: Loader G: Gunner		<b>Notes</b> 1. Standards: Successfully engage 80 percent of five hostile aircraft. 2. One aircraft will give a MODE IV reply. 3. For a no go, record the item number under the 7 in number.		<b>Status</b> <input type="checkbox"/> Go <input type="checkbox"/> No Go	

SAMPLE

### **SUPER ELEVATION AND LEAD**

If the gunner inserts superelevation and the proper lead, he should be scored go. If he fails to superelevate or applies the wrong lead, he should be scored no-go.

### **FIRING**

If the gunner presses and holds the firing trigger until the beep is heard while at the same time pressing and holding the UNCAGING switch and continues to track the target, he should be scored go. If he does not, he should be scored no-go. If he fires while the target is in the hold fire zone, he

should be scored no-go. If he fires before the target enters the engagement zone, he should be scored no-go. If he fires after the target is out of range, he should be scored no-go. If he fires without IR acquisition, he should be scored no-go.

### **REMOVE POWER SOURCE**

If the gunner removes the power source immediately after completing the engagement, he should be scored go. If he forgets to remove the power source, he should be scored no-go.

## CHAPTER 16

### Stinger Range Operations

Live firings are necessary to sharpen Stinger gunner skills and to provide opportunities for gunners to overcome any fear of firing the weapon. With the limited number of ranges and Stinger weapons available, live firings must be prepared, organized, and conducted so that maximum realistic training value is gained. This chapter discusses the operation involved in the live firing of Stinger.

#### RANGE RECONNAISSANCE

The Stinger range OIC should conduct a range reconnaissance before his unit occupies the range. The range reconnaissance should provide answers to the following questions:

- How many firing positions can be occupied simultaneously?
- Are tracking positions available for gunners to track targets while live firings are in progress?
- Does the range have a tower? (Is it usable?)
- Where are landline communications hookups?
- Are there communications from existing positions to the range tower?
- Are safety markers visible?
- How is access to the impact area controlled?
- What are the guard requirements?
- Who furnishes targets and operators, and where are the targets stored?
- Is the area cleared of duds?
- Who will furnish range flags and fire fighting equipment?

- Who will furnish medical assistance?

Related to the OIC's reconnaissance, the following areas as indicated must be located and established:

- Concurrent training area.
- Mess area.
- Latrines.
- Helipad.
- Aid station.
- Troop areas, billet/break.
- Briefing area.
- Parking area.

#### CONTENTS

	Page
Range Reconnaissance . . . . .	16-1
Conduct of Firing . . . . .	16-2
Range Operations Plan . . . . .	16-4
Firing Procedures . . . . .	16-5
Hints for the OIC . . . . .	16-6



## CONDUCT OF FIRING

Range requirements are contained in AR 385-62, local range regulations, medical evacuation (MEDEVAC) procedures, and unit SOPs. These references are the basis upon which plans for personnel and equipment requirements are determined. All current references should be placed in a range notebook with directions for handling emergencies. The range notebook should be continually updated regarding safety changes and any changes to established local policies. AR 385-62 should be a must in such a notebook, as well as MEDEVAC radio frequency, hospital phone numbers, and directions to the nearest aid station.

### RANGE ORGANIZATION

A well-organized range provides maximum firing time. The range should be organized to best support the firing. A sample range layout appears in the illustration below. A good range SOP will save time and energy for all concerned. The SOP should include guidelines for occupying the range and should describe actions to be taken for specific tasks, such as fighting down range fires, issuing weapons, and a sound traffic pattern for entering and exiting the range, in particular the immediate firing area. TC 25-2, contains additional information on Army range requirements.

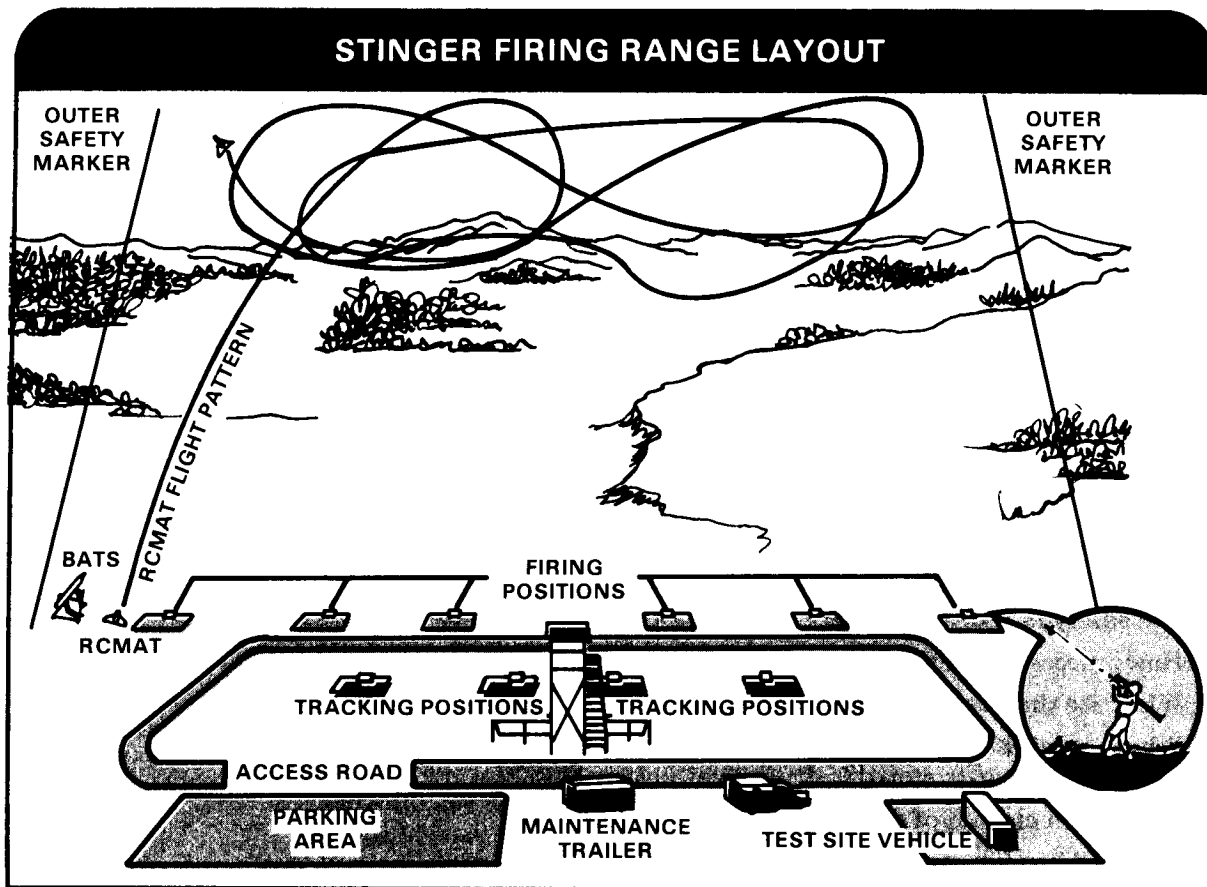

## RANGE CONTROL

Installations where firings take place will normally have a range control office. This office is responsible for the coordination and safe conduct of range firing for all units using range facilities. Normally, section chiefs will be required to receive a range briefing from this office prior to using a range. This office will also provide a set of local range regulations and policies and will usually require the unit to sign for range facilities upon occupation of the range.

## RANGE COMMUNICATIONS

The post range officer controls all ranges by wire or radio communications. The communications system is used for obtaining clearance to fire, making reports, coordination, and ceasing fire. The range communications system enables the range officer to shut down the range immediately in case of emergency.

The OIC controls firing by several means, including flag, radio, telephone, public address system, or messengers. Wire is preferred for communications with target operators and demolition personnel in the impact area. In all cases, the OIC plans for a backup communications system to prevent delays.

## RANGE PERSONNEL

The OIC designates personnel and assigns duties to assist him in preparing and running the range.

The safety officer or NCO will—

- Assist in fulfilling range safety responsibilities and insure all safety regulations are enforced.
- Insure that Stinger weapons are handled correctly.
- Enforce smoking prohibitions near the firing positions or weapon storage area.

- Insure misfires are handled as stated in AR 385-62.

- Insure accidents are investigated and promptly reported IAW all regulations.

- Insure personnel are clear of the danger area, except as authorized in AR 385-62. (Stinger firing range requirement for surface danger zones for Stinger is described in (SNF) FM 44-1 A.)

- Insure all range safety requirements (for example, posting of range guards, raising range flag, establishing safety communications) have been met and are maintained.

The NCOIC will supervise range details connected with range firing.

The ammunition NCO will—

- Insure that all Stinger weapons are delivered and properly stored and secured, both on the range and during transportation to and from the range.

- Insure the range is properly policed of expended launchers and packaging materials.

The target detail officer or senior NCO will—

- Prepare the target launch/control area.
- Provide for transportation of targets to and from the range.
- Draw and turn in targets and related equipment.
- Determine target safety requirements and, in conjunction with safety officer, insure they are met.
- Train target detail personnel in assembly, test, and launching procedures.
- Supervise the operations of target detail personnel.

- The firing station NCO (coach) will-
- Act as an instructor during the firing.
  - Insure compliance with safety procedures.

Additional range personnel include the following:

- Firefighting detail.
- Radiotelephone operators.
- Briefing NCO.
- Medical aidmen.

### RANGE EQUIPMENT

The OIC should insure that he has the following on hand:

- Targets.
- Stinger weapons and trainers.
- Range flag.
- Public address system.
- Briefing tent.

- Blackboard, chalk, eraser.
- Pens, pencils, grease pencils.
- Binoculars.
- Field telephones as required.
- Latrine supplies.
- Trash cans.
- Water supply (lister bag or trailer).
- Compass (for marking rounds out of impact area).
- Fire-fighting equipment (shovels, fire extinguishers, rakes).
- Vehicles for the fire-fighting detail, the MEDEVAC (primary and alternate), and the safety officer.
- Equipment needed for concurrent training (Beseler Cue/See tape cassette players and appropriate TEC lessons).
- All required regulations, SOPS, maps, and overlays.

### RANGE OPERATIONS PLAN

A plan must be developed for opening and closing the range and conducting Stinger firings. Duties of the OIC, NCOIC, and

safety officer or NCO should include the elements contained in the following illustration.

<b>DUTIES AND RESPONSIBILITIES</b>		
<b>OIC</b>	<b>NCOIC</b>	<b>SAFETY OFFICER</b>
<b>OPENING THE RANGE</b>		
<ul style="list-style-type: none"> <li>● Move to the range before the arrival of the Stinger teams.</li> <li>● Brief the safety officer.</li> <li>● Brief the Stinger coaches.</li> <li>● Brief the Stinger gunners.</li> <li>● Establish communications with range control and insure there are backup communications.</li> </ul>	<ul style="list-style-type: none"> <li>● Supervise positioning of Stinger gunners on the firing lines.</li> <li>● Set up the concurrent training areas.</li> <li>● Supervise weapon issue and target details.</li> <li>● Supervise other administrative details.</li> </ul>	<ul style="list-style-type: none"> <li>● Inspect the storage and handling of Stinger weapons.</li> <li>● Inspect aidmen.</li> <li>● Insure range guards are posted and briefed.</li> </ul>

## DUTIES AND RESPONSIBILITIES—CONTINUED

OIC	NCOIC	SAFETY OFFICER
<b>CONDUCT OF FIRING</b>		
<ul style="list-style-type: none"> <li>• Control the firing.</li> <li>• Maintain communications with range control.</li> </ul>	<ul style="list-style-type: none"> <li>• Supervise all details.</li> <li>• Control movement of personnel from the firing positions to the concurrent training and other administrative areas.</li> </ul>	<ul style="list-style-type: none"> <li>• Insure misfires are handled in accordance with safety regulations.</li> <li>• Observe for any safety violations.</li> </ul>
<b>CLOSING THE RANGE</b>		
<ul style="list-style-type: none"> <li>• Notify range control that firing has terminated.</li> <li>• Debrief the Stinger gunners.</li> <li>• Insure the range is cleared in accordance with local regulations and SOP.</li> </ul>	<ul style="list-style-type: none"> <li>• Supervise the weapon issue and target details.</li> <li>• Supervise the policing and cleaning of the range.</li> </ul>	<ul style="list-style-type: none"> <li>• Insure all misfires are removed from the range.</li> <li>• Insure Stinger weapons are not removed from the range.</li> <li>• Prepare certificates required by the ammunition supply point.</li> </ul>

## FIRING PROCEDURES

All personnel to fire are given a detailed briefing by the OIC. The OIC discusses the purposes, objectives, standards, and firing procedures to be followed. The OIC reviews the Stinger gunnery techniques applicable to the type of firing conducted.

### TRACKING TARGETS

Prior to live-firing exercises, gunners will track targets on both left-to-right and right-to-left crossing courses using THTs. During the firing exercises they will not fire except on orders from the NCO assigned to coach each gunner. Gunners at the tracking positions (in barricades) will track and simulate engagements on the same targets assigned to gunners at the firing positions. Coaches will make necessary corrections to gunners on both firing and tracking positions.

### FIRING SEQUENCE

On command from the OIC, the gunners proceed to the firing line, draw a Stinger weapon, and go to the designated firing point. The coach takes a position to the left of the gunner and assures that all safety measures are complied with. The coach is able to communicate with the OIC/safety officer in the tower. The coach will relay the following commands to the gunner:

- **ACTIVATE**—the target is coming within range and will be in position for engagement. If all safety precautions are met, the range safety officer gives permission to proceed with firing.
- **WEAPONS FREE**—the gunner is free to engage the target when ready.
- **CEASE ENGAGEMENT**—do not fire.

Crossover is announced when the target is at crossover to assist the gunner in performing the firing sequence, particularly in

the case of high-speed courses (when the gunner fires after crossover).

## HINTS FOR THE OIC

The OIC should have complete control over the activities taking place on the range. In addition to conducting a successful firing, he has responsibility for insuring that all safety and security procedures during the conduct of the firing exercise are enforced. Some helpful hints and key items that the

OIC should address are contained in the illustration below.

Remember to—

- Make a good range reconnaissance.
- Organize personnel and details in advance.
- Observe all safety precautions.

### HELPFUL HINTS FOR THE OIC

**REHEARSE** — Prior to moving to the range, rehearse your key personnel in setting up the range and in those actions to be taken if something happens. This will keep range down time to a minimum.

**START ON TIME** — Someone else may be waiting to use the range when you finish. Have your targets and communications set up early.

**TOWER LOG** — Have a good log available, and use people who are conscientious about keeping it correct. As a minimum, the log should have an entry that shows when the unit occupied the range, when permission to fire was received, and who gave the permission.

**GUARD** — Have a plan to check and change the guards frequently.

**FIRES** — Be prepared to control fires quickly.

**POLICE** — A clean range reduces the chance of injury. Police as you go to avoid spending valuable time cleaning up the range after firing.

**VISITORS** — Have a plan for briefing visitors. Designate someone to handle this for you, possibly a briefing NCO or officer so that you can concentrate on running the range.

**SAFETY MARKERS** — The range safety markers must be present before firing can begin. Have spares available.

**STINGER WEAPONS AND BATS** — Insure that you have coordinated closely with the support elements responsible for supplying the weapons and the BATS. This coordination pays big dividends in having the weapons and the BATS on the range at the right time.

**CONCURRENT TRAINING** — Concurrent training should stress those areas in which the gunner can sharpen his skills in handling and firing the Stinger.

CHAPTER 17

**Operational Readiness Training Test**

An operational readiness training test (ORTT) may be used to evaluate the air defense section headquarters element teams and gunners on their ability to conduct air defense operations under simulated combat conditions. Although the ORTT in this chapter has been written for Stinger sections and teams, it can also be modified to include the entire platoon. If the entire platoon is included, additional evaluators are required. However, there may be an insufficient number of evaluators to adequately assess the platoon. This situation may be remedied by designating evaluator teams to check the individual sections and teams at random.

Checklists shown on pages 8 through 17 of Chapter 17, are recommended checklist formats. Those shown are samples for your guidance.

**OBJECTIVES OF THE TEST**

The objectives of the test are to determine the combat readiness of the team, and the adequacy of training for the team.

**DETERMINE COMBAT READINESS**

To determine if the Stinger section can provide responsive and effective air defense support. This determination is made by evaluating their ability to—

- Move tactically from one area to another, maintaining air defense support while en route.
- Maintain effective communications.
- Design and execute an effective air defense under changing tactical conditions.

- Comply with the air defense annex to the battalion TSOP.
- Maintain material.

**DETERMINE ADEQUACY OF TRAINING**

The ORTT will help determine the combat readiness and adequacy of training of individual team chiefs, gunners, and section headquarters personnel. The test will determine adequacy of training in the areas of command and control and communications, visual aircraft recognition, engagement of targets, and crew drills.

**CONTENTS**

	Page		Page
Objectives of the Test . . . . .	17-1	Administrative Details for Overall Test . . . .	17-4
Nature of the Test . . . . .	17-2	Tactical Phase . . . . .	17-4
Rating System . . . . .	17-2	Firing Phase. . . . .	17-6
Test Results. . . . .	17-3	Evaluator Personnel . . . . .	17-7

## NATURE OF THE TEST

This test is conducted in two phases: tactical and firing (simulated). Each phase is conducted and rated separately and the resultant ratings are combined for the overall Stinger section rating.

### TACTICAL PHASE

The Stinger section can be tested under two conditions. The section can undergo the tactical phase test by itself without troops. It may also be tested during one of its supported unit's field training exercises. In either case, the section provides air defense of its supported unit during simulated combat operations. The tactical phase consists of defense of stationary assets, defense of maneuver units, and defense of a convoy.

#### Defense of Stationary Assets

The section is evaluated on planning for air defense of the supported unit in a static defense posture. Test elements include defense design, reconnaissance, selection and occupation of position (RSOP) procedures, command and control, and conduct of the defense.

#### Defense of Maneuver Units

The section is evaluated on its ability to defend maneuver units against hostile aircraft. For example, a Stinger section is used in defense of a maneuver unit such as the company teams of a battalion task force

when they are in contact with, or moving to contact the enemy.

#### Defense of a Convoy.

The section is evaluated on its ability to defend a convoy against air attack from low-altitude hostile aircraft.

### FIRING PHASE

During the firing phase the proficiency of individual gunners in target engagement and aircraft recognition is tested. The firing phase consists of simulated target engagements and an aircraft recognition test.

#### Target Engagement

Target engagement is simulated using the THT to simulate the Stinger weapon. The MTS should be used to test gunner proficiency. The RCMAT may be used as a target for the test, if an MTS is not available (see chapter 14). This part of the test is explained in chapter 16.

#### Aircraft Recognition Test

Stinger teams are tested on their ability to visually recognize aircraft. This part of the firing phase should be conducted in a classroom environment. Use the GOAR kit or the applicable TEC test lessons. Test only on those aircraft which are relevant to the unit's theater of operations and those aircraft listed in FM 44-16S. Scoring criteria are explained in checklist 4b.

## RATING SYSTEM

The rating awarded the air defense section at the conclusion of the test will be satisfactory or unsatisfactory. The overall rating will be determined by the chief evaluator based on the ratings awarded each area in the checklist. The narrative reports will reflect the degree to which the objectives stated previously were met, citing the strong and weak

points of performance and a recommended rating.

The checklists in this chapter will be used as guides for determining these ratings. Local evaluators should expand these checklists for the specific section and situation being tested. Checklists will be scored as satisfactory or unsatisfactory. Checklist

areas that are rated unsatisfactory will be supported by a statement justifying the rating.

At the discretion of the testing headquarters, when a section receives an overall rating of unsatisfactory, a complete retest may be ordered or the section may be retested in the unsatisfactory area(s). The following specific deficiencies concerning the ability to move, shoot, and communicate will result in an unsatisfactory rating:

- There is a shortage of two or more vehicles or two or more trailers. The shortage of one vehicle or one trailer may be a deficiency if no provision is made to carry the basic load for the entire section.
- Two or more vehicles become non-operational after reaching the assembly area. A nonoperational vehicle is defined as one which would become a safety hazard to personnel or cause further damage to the vehicle if operated in its current condition.
- The section sergeant's defense design is inadequate to accomplish the assigned mission. An inadequate defense design is defined as one leaving a primary low-level avenue of

approach to the defended area unprotected. An inadequate defense design is also one in which the teams are located in such a manner that it would be impossible to engage attacking aircraft prior to their release of ordnance.

- Both the section sergeant and his driver fail the section headquarters test.
- Both members of a team fail the aircraft recognition test.
- Both members of a team are unfamiliar with Stinger capabilities and limitations, techniques of fire, and command and control procedures.
- One or more teams fail to deploy to their assigned positions. The error must be great enough to create a gap in the defense.
- Section headquarters personnel fail to monitor the appropriate net for changes in defense conditions (DEFCON), WCS, and air defense warning.
- Section headquarters is unable to communicate with any team.
- Both team members are unable to authenticate or encode and decode coordinates using the CEOI.

## TEST RESULTS

A written report of the test results will be submitted by the senior evaluator to the commander. The report should include, but not be limited to, checklists and narrative reports.

A narrative report will include the following:

- Name of the section sergeant and date he assumed his duties.
- Where and when the test was administered.

- Overall rating awarded the section.
- Local conditions that affected the test.
- Major deficiencies and subject areas where training emphasis should be placed.
- Soundness and effectiveness of the section SOP.
- Justification for modifications made to any portion of the test.
- Number of training hours actually spent in training the Stinger section.



## ADMINISTRATIVE DETAILS FOR OVERALL TEST

The command conducting the test should be responsible for—

- Insuring that the FTX scenario includes tactical situations that are applicable to the testing of the supporting MANPAD section.
- Coordinating logistical and administrative support for the MANPAD section.
- Arranging for air attacks during the FTX and for live aircraft or RCMAT support for gunner performance (engagement) phase if an MTS is not available.
- Arranging for FAAR support.
- Arranging for the conduct of the firing phase of the test to include the following:
  - Providing tracking range facilities.
  - Providing an adequate number of training sets for Stinger teams to be tested.
  - Designing courses to be flown by targets during simulated firings.
  - Providing equipment and classroom space for the testing of aircraft recognition.
- Providing technical assistance and advice to evaluators to include the following:

- Providing technical assistance and advice to evaluators to include the following:
  - Command and control procedures.
  - Employment and tactics.
  - Communications nets.
  - Training set M134 and MTS M87A1.
- Providing combat service support for the tested unit.

The headquarters administering the test will provide sufficient FAARs to allow Stinger teams to employ the TADDS and receive early warning information.

Maps of scale 1:50,000/1:25,000 and aerial photos should be used. (Distribution will be IAW unit SOP.)

The chief evaluator conducting the test of the section may modify the test. He can do this to insure that the best use is made of existing facilities, to conform to conditions of the training situation, or to facilitate attainment of training objectives.

## TACTICAL PHASE

The tactical phase of the air defense section ORTT can be conducted by modifying the supported unit's FTX. This can be done by including air defense situations that will require the section to defend the supported unit against low-flying hostile aircraft.

### COMBAT SUPPORT

The Stinger section is a combat support element of the battalion. Therefore, employment and deployment of the section are based on the tactics employed by the supported maneuver in attack, defense, withdrawal, movement to contact, and defense of moving columns. The section should be tested during

all phases of the supported unit's tactical phase with the exception of night operations.

### TACTICAL MANEUVERS

Variations of tactical maneuvers made by the supported unit including retrograde operations, delay on successive positions, and relief, will also involve the deployment of Stinger to defend the battalion assets. The checklists covering each of the tactical operations can be modified to include requirements relating to a specific scheme of maneuver. If the supported unit does not conduct all of these type maneuvers, the Stinger section will not be rated for their actions concerning

any maneuver omitted. A rigid scenario for each part of the tactical phase is not included because its sequence of timed events could conflict with the scenario of the supported unit.

### TRAINING DEFICIENCIES

As each successive part of the tactical phase is tested, the evaluators record training deficiencies. The overall proficiency rating for each part of the tactical phase is recorded using the tactical phase checklist as a guide. Two checklists are used to evaluate the section's tactical phase. Checklist 1 is used to evaluate the section headquarters element. Checklist 2 is used to evaluate the Stinger team collectively.

### PLANNING AND CONDUCT

The following are important in planning and conducting tactical training:

- **Notification.** The exercise notification message will be delivered to the Stinger section through command channels. The section will be directed to report to an assembly area within 2 hours (plus travel time) from receipt of notification.
- **Briefing on situation.** Upon arrival at the assembly area, the chief evaluator will brief the section chief. The briefing will include a situation which has a realistic setting for the employment of Stinger. The briefing will contain the mission and administrative instructions dictated by local safety regulations and training area requirements.
- **Conduct.** While the section chief conducts a map reconnaissance and designs his defense, the evaluation team inspects vehicles, equipment and loading plans. The evaluation team then tests each team's ability to use authentication tables and operations code in the CEOI. When the section chief indicates he is ready, the chief evaluator critiques the defense design.

The section chief will take control of his teams, brief, and deploy them. The chief evaluator will remain with the section headquarters. The remainder of the evaluation team will accompany the Stinger teams to their deployment positions.

During the exercise, changes in WCS and air defense warnings are passed to the section headquarters over the supported unit's command net. (The evaluation team vehicle will be equipped with an FM radio.)

### ADMINISTRATIVE DETAILS FOR TACTICAL PHASE

Stinger teams will be evaluated on their speed and reaction to air attack during all test requirements.

- The headquarters administering the test will furnish required information usually generated by the airspace management element of the tactical operations center (TOC) in the division (or other sources in the case of nondivisional units). This information includes air alert, changes in WCS, and friendly flight information. This information may be transmitted to section headquarters by the evaluator in person or by radio.
- An adequate number of FAARs to provide early warning data to the deployed Stinger teams will be emplaced and operated by FAAR platoon personnel. FAAR frequencies and address codes will be obtained from the CEOI.
- Aircraft attacks should be used to evaluate the section's ability to detect and simulate engagement of hostile aerial targets with Stinger. During multiple attacks, each Stinger team will engage the proper target IAW the section SOP. Attacking aircraft will fly at various low altitudes and will conform to tactical procedures expected from hostile aircraft. Helicopters should be used in the antitank role, flying nap-of-the-earth, and

executing attack missions against the force. Liaison with the US Air Force and US Army aviation operations personnel should be made sufficiently in advance of the test IAW procedures and guidance found in FM 105-5 and higher headquarters SOP.

- The headquarters administering the test will allow the tested section adequate time to prepare positions and establish the defense. It will then direct the aggressor to initiate low-altitude air reconnaissance or air strikes against the battalion.
- Emphasis will be placed on signal security (SIGSEC) procedures, use of CEOI, etc.
- Stinger teams should be required to engage

aircraft while masked under specific NBC conditions for a minimum of one aircraft attack.

- Supplies of all classes not actually presented will be simulated. Each team should start the test with a full basic load of Stinger weapons. The team can simulate the basic load by having four FHTs in their shipping and storage container/ready racks. The additional FHTs can be obtained from the sections not participating in the exercise. Also, two empty missile-round containers (MRCs) should be available. (The MRC may be simulated by using wooden boxes of correct dimensions and weight.)

## FIRING PHASE

The objective of this phase is to test the ability of the Stinger teams to recognize aircraft and engage aerial targets. The firing phase of the test should be conducted separately from the tactical phase at a time and place designated by the appropriate commander. The firing phase should be conducted in two parts: a simulated target engagement and a test on aircraft recognition. Simulated target engagements may be conducted with actual targets at a suitable tracking range or with the Stinger MTS.

### SIMULATED TARGET ENGAGEMENT

Each team chief/gunner is required to engage five separate aircraft flying on courses planned by the testing command. The simulated engagements should be designed to present targets that will test the gunner's ability to visually detect targets, make correct decisions, and to demonstrate correct weapon handling procedures. Two engagements should be conducted under NBC conditions; that is, gunners masked.

Target courses described below apply to targets used to test gunners at a tracking

range. If gunners are being tested at an MTS, the testing command should select five similar courses from appropriate film programs (reels) furnished with the MTS. Each gunner should be tested in the same manner using the same criteria for consistency. Target courses presently include the following variations:

- Crossing left to right, low-altitude, high-performance aircraft.
- Crossing left to right, low-altitude, medium-performance aircraft.
- Crossing right to left, helicopter.
- Crossing right to left, low-altitude, high-performance aircraft.
- Directly incoming, low-altitude, high-performance aircraft.

Evaluators should score the target engagement part of the firing phase, using checklist 4A. (Checklists are located on pages 17-8 through 17-16.) The scoring procedure and evaluation criteria for the gunner are the same whether the MTS or the tracking range is used. This is because the THT is used for the gunner's evaluation in either case. The

evaluator must be familiar with the THT and understand the procedures for evaluating gunner performance using the readout capability of this trainer. A complete operational engagement sequence with the trainer during evaluation of gunner proficiency is described in chapter 15.

### AIRCRAFT RECOGNITION

During the aircraft recognition part of the firing phase test, 20 slides will be exposed for 5 seconds each. The slides should be limited to tactical aircraft which are relevant to the forward areas of the theater of opera-

tions. The test should be conducted using the same aircraft and criteria listed in the soldier's manual and the SQT for Stinger personnel.

Each gunner should identify the aircraft shown by writing its name or number designation in the space provided on checklist 4B. Sufficient time should be allocated between slides to allow the tested personnel to write their response.

Ratings awarded during Parts I and II of the firing phase should be transferred to checklist 5 for use in the final ORTT summary.

## EVALUATOR PERSONNEL

The requirements of the test must be thoroughly explained to all individuals in the section to be tested. Each evaluator must question personnel of the tested unit and must closely observe their performance so that he can rate effort and ability fairly and completely. In no case will members of the section being tested be detailed as evaluators. Evaluators will not give instructions or advice to unit personnel other than that necessary for the conduct of the test or to insure safety.

### PERSONNEL

The test requires two evaluator officers, one of whom will serve as senior air defense section evaluator, and two enlisted men. The two officers should be helped by two qualified enlisted evaluators. Officers selected as Stinger evaluators should be experienced in the use of forward area air defense weapons and air defense tactics and also be familiar with the characteristics, capabilities, and limitations of the Stinger weapon. Enlisted evaluators should be qualified Stinger gunners and also be proficient as vehicle drivers and radio operators. One officer, assisted by an enlisted man, should act as evaluator of the section headquarters during the tactical phase while

the other officer and enlisted man act as evaluators for Stinger team performance. During the firing phase, the evaluators should work together in evaluating gunner skills in engaging targets and in aircraft recognition.

### DUTIES

Each evaluator will perform his assigned duties IAW instructions given by the senior evaluator. He also will—

- Study and understand the checklists, scoring system, local conditions affecting the scoring, and any SOPS in effect during the test.
- Fairly determine by direct observation, ratings for each test activity to be entered on the appropriate checklist.
- Submit a narrative report to summarize ratings indicated on the checklists and take part in the critique when so requested by the chief evaluator.

### CHECKLISTS

Checklists found in this chapter may be used in whole or in part, but it is highly recommended that local commanders review them to insure that they fulfill the training

objectives in his unit. The commander and evaluators must refer to the latest pertinent field and technical manuals, local directives, and the unit SOP for current applicable information as a basis for revising the checklists.

**Tactical Phase**

Checklist 1 is used to evaluate the MANPAD section headquarters. The evaluator should check the S or U (satisfactory or unsatisfactory) column in the space provided for each item. After completing the checklist, the evaluator should award an overall rating to the section headquarters element. This overall rating should also be recorded in the appropriate space on checklist 3.

Checklist 2 is used to evaluate the Stinger teams during the tactical phase of the test. A separate checklist should be completed for each Stinger team. Team scores are entered in the appropriate spaces in checklist 3.

Checklist 3 is used to sum up the tactical phase ratings for the tested unit. The ratings awarded should approximate the average of A and B of checklist 2. The tactical phase scores from checklist 3 will be transferred to

the appropriate spaces in checklist 6.

**Firing Phase**

Checklist 4A is used to score individual team members in their ability to engage aerial targets with the THT. At least four engagement ratings of "S" for each action in five engagements must be obtained before an overall score of "S" can be entered in the right-hand column. A separate checklist should be completed for each Stinger team chief and gunner. At least 80 percent overall scores of "S" must be obtained before the final grade of "S" can be assigned in checklist 4A.

Checklist 4B will be used to score the individual in aircraft recognition skills. These scores will be converted to ratings according to the rating scale at the bottom of checklist 4B.

Checklist 5 is used to summarize the firing phase ratings for the tested unit. Final ratings for checklists 4A and 4B will be entered on checklist 5.

Checklist 6 is used to sum up the tactical and firing phases for the tested unit and arrive at an overall score.

**CHECKLIST 1, SECTION HEADQUARTERS (TACTICAL PHASE)**

**Section chief. Did the section chief accomplish the following tasks?**

- Initiate planning upon receipt of order.
- Organize this section for combat to support the mission (except when accomplished by battalion).
- Brief his section personnel on mission.
- Maintain close coordination with staff members in planning for anticipated operations.
- Advise the commander as to the air threat.
- Actively advise the unit commanders on matters pertaining to Stinger employment.

S	U

**CHECKLIST 1, SECTION HEADQUARTERS (TACTICAL PHASE)  
—CONTINUED**

	S	U
<ul style="list-style-type: none"> <li>• Supervise and coordinate the tactical operation of his section.</li> <li>• Design the defense on a reasonable evaluation of the air threat.</li> <li>• Deploy Stinger teams to allow early engagement where possible.</li> <li>• Continually evaluate the defense.</li> <li>• Advise the unit commanders on employment of nonair defense weapons against hostile aircraft (small arms and automatic weapons).</li> <li>• Keep the commander informed on the state of combat readiness of Stinger teams.</li> </ul>		
<p><b>Section headquarters personnel. Did the appropriate section headquarters personnel accomplish the following tasks?</b></p>		
<ul style="list-style-type: none"> <li>• Establish communications with each team.</li> <li>• Require an acknowledgement from each team of the receipt of important instructions or changes in status.</li> <li>• Provide the teams with FAAR locations and TADDS frequency data.</li> <li>• Monitor TADDS/early warning.</li> <li>• Transmit early warning to teams in sufficient time to be of value (if applicable).</li> <li>• Use proper radio operating procedures IAW CEOI.</li> <li>• Adhere to SOP for COMSEC.</li> <li>• Make a map reconnaissance to locate primary and alternate positions.</li> <li>• Give instructions concerning radio silence (when applicable).</li> <li>• Change and update the defense in time to meet the requirements of the situation.</li> <li>• Insure that each team knows the location of friendly air corridors.</li> <li>• Requisition shortages or take action to make replacement promptly.</li> </ul>		

**CHECKLIST 1, SECTION HEADQUARTERS  
(TACTICAL PHASE)—CONTINUED**

	S	U
<ul style="list-style-type: none"> <li>• Have equipment on hand as provided by unit TOE.</li> <li>• Maintain a situation map showing the current tactical situation, location and coverage of each Stinger team.</li> <li>• Arrange for team local security when needed and if possible.</li> <li>• Arrange for team ammunition resupply.</li> <li>• Maintain an operations journal of all changes in WCS.</li> <li>• Verify that each team is operating IAW the current air defense WCS.</li> <li>• Maintain ADA annexes for the supported unit SOP which includes as a minimum:                             <ul style="list-style-type: none"> <li>◦ Hostile target criteria.</li> <li>◦ Targets to be engaged under each air defense WCS.</li> <li>◦ Criteria for target selection during multiple attack.</li> <li>◦ Team action in case of loss of communications.</li> <li>◦ Responsibilities and duties of all MANPAD section personnel.</li> </ul> </li> <li>• Demonstrate knowledge of capabilities and limitations of Stinger system as presented in FM 44-18 and (SNF) FM 44-1A.</li> <li>• Analyze the situation and select the best method of Stinger employment on the move (leapfrogging, dispersing throughout the column, or accompanying elements).</li> <li>• Recommend best deployment method for defense of maneuver units to the commander.</li> <li>• Designate sectors of fire to each team where applicable.</li> <li>• Coordinate the movement of teams with movement of the supported unit to provide as much continuous coverage as possible.</li> <li>• Provide sufficient maps for the teams.</li> <li>• Maintain operations during succession of command if loss of key personnel occurs.</li> <li>• Notify all teams of an NBC attack.</li> </ul>		

**CHECKLIST 1, SECTION HEADQUARTERS  
(TACTICAL PHASE)—CONTINUED**

	S	U
<ul style="list-style-type: none"> <li>• Demonstrate how to program the IFF interrogator days.</li> <li>• Demonstrate how to change IFF batteries.</li> <li>• Rating _____</li> </ul>		

**CHECKLIST 2, STINGER TEAMS (TACTICAL PHASE)**

	S	U
<p><b>Team chief. Did the team chief perform the following tasks?</b></p> <ul style="list-style-type: none"> <li>• Supervise the gunner.</li> <li>• Keep the section chief informed of his team's location at all times.</li> <li>• Comply with the rules of engagement IAW the prevailing WCS and hostile criteria.</li> <li>• Comply with special friendly flight information when received.</li> <li>• Comply with rules for target selection.</li> <li>• Make a positive identification of aircraft.</li> </ul> <p>Note. When the members of the team are separated and each is to engage targets separately, each member will make positive hostile identification prior to engaging.</p> <ul style="list-style-type: none"> <li>• Properly emplace and monitor TADDS.</li> <li>• Keep section headquarters informed of operational status of TADDS.</li> <li>• Make an after-action report after each engagement IAW unit SOP.</li> </ul> <p><b>Team chief and gunner. Did the team members perform the following tasks?</b></p> <ul style="list-style-type: none"> <li>• Respond to each signal as prescribed in appendix A of this manual?</li> <li>• Demonstrate proper radiotelephone procedures.</li> <li>• Keep radio traffic to a minimum.</li> </ul>		



**CHECKLIST 2, STINGER TEAMS (TACTICAL PHASE)—CONTINUED**

	S	U
<ul style="list-style-type: none"> <li>• Establish radio communications immediately upon occupation of position (if appropriate).</li> <li>• Have knowledge of operating frequencies and call signs of all other stations in the section net.</li> <li>• Take proper action during jamming activities.</li> <li>• Have knowledge of authorized alternate frequencies and call signs.</li> <li>• Change radio frequencies (when required).</li> <li>• Install and use wire communications when time and tactical situation permit.</li> <li>• Respond promptly to orders to move to new positions.</li> <li>• Conduct a ground reconnaissance of the designated positions(s).</li> <li>• Select a position which affords a good field of view along the most probable avenue of aircraft approach.</li> <li>• Consider backblast clearance in selection of the position.</li> <li>• Use the designated route to the position.</li> <li>• Conceal and camouflage the team vehicle and trailer during occupation of position.</li> <li>• Remove or conceal vehicle tracks leading into the position.</li> <li>• Organize and improve the position promptly after the initial occupation, tactical situation permitting.</li> <li>• Prepare foxholes or prone positions for team protection.</li> <li>• Observe noise, light, and camouflage discipline.</li> <li>• Select an alternate site as soon as possible after occupation of the primary position.</li> <li>• Have individual weapons ready for immediate use and make contact with other friendly elements in the area.</li> <li>• Maintain a condition of combat readiness as prescribed in SOP.</li> <li>• Adhere to the provisions of the NBC defense SOP.</li> </ul>		

**CHECKLIST 2, STINGER TEAMS (TACTICAL PHASE)—CONTINUED**

	S	U
<ul style="list-style-type: none"> <li>• Perform search and scan procedures as prescribed in chapter 4, FM 44-18-1.</li> <li>• Detect and identify aircraft in time to be successfully engaged.</li> <li>• Employ hostile criteria as an aid in identifying aggressor aircraft.</li> <li>• Have knowledge of Stinger system capabilities and limitations as presented in (SNF) FM 44-1A.</li> <li>• Employ technique of fire rules during simulated engagement of aggressor aircraft.</li> <li>• Demonstrate proper weapon handling technique when engaging targets.</li> <li>• Have a knowledge of procedures for handling misfires, hang-fires, and duds.</li> <li>• Check vehicle, weapons, and communications equipment prior to the tactical operations.</li> <li>• Provide maximum air defense coverage for attacking elements commensurate with team survivability.</li> <li>• Accompany assault troops during airborne/airmobile operations and, after landing, move quickly to designated position(s).</li> <li>• Comply with all safety procedures listed in appropriate regulations, field manuals, and technical manuals.</li> <li>• Safeguard the Stinger weapons according to SOP.</li> <li>• Have all team equipment as prescribed by TOE.</li> <li>• Perform required operator maintenance on the Stinger weapon (FHTs) as prescribed in TM 9-1425-429-12.</li> <li>• Perform before-, during-, and after-operation services on the vehicle and trailer as prescribed in the applicable technical manual.</li> <li>• Perform required maintenance on communications equipment.</li> <li>• Adhere to the vehicle loading plans.</li> <li>• Rating _____</li> </ul>		



**CHECKLIST 4A, TARGET ENGAGEMENT (FIRING PHASE)**

Name PVT John Doe  
 Organization C Btry 2/66 ADA

Date 1 Oct 84  
 Score Satisfactory

GUNNER ACTION	ENGAGEMENTS					OVERALL SCORE	
	1	2	3	4	5	S	U
(1) Shoulders and prepares the THT.	S	S	S	S	S	1 2 3 5	4
(2) Detects aircraft at maximum range.	S	S	S	S	S		
(3) Assumes proper stance.	S	S	S	U	S		
(4) Interrogates the aircraft.	S	S	S	U	S		
(5) Interprets IFF response.	S	S	S	U	S		
(6) Determines aircraft class.	S	S	S	U	S		
(7) Ranges the target.	S	S	S	U	S		
(8) Activates the THT.	S	S	S	U	S		
(9) Tracks the target.	S	S	S	U	S		
(10) Positively identifies target.	S	S	S	U	S		
(11) Recognizes IR acquisition.	S	S	S	U	S		
(12) Uncages.	S	S	S	U	S		
(13) Applies superelevation and lead.	S	S	S	U	S		
(14) Fires.	S	S	S	U	S		
(15) Removes power source immediately.	S	S	S	U	S		
(16) Stows THT.	S	S	S	U	S		
<b>SCORE</b>						<b>4</b>	<b>1</b>

Note. Refer to Gunner Performance Evaluation Sheet for information on penalty points. The criteria are listed on page 15-7. Scoring information is discussed on pages 15-8 and 15-9.

**CHECKLIST 4B, AIRCRAFT RECOGNITION TEST  
(FIRING PHASE)**

Team Chief/Gunner's Name \_\_\_\_\_ Unit \_\_\_\_\_

Date \_\_\_\_\_ Evaluator's Name \_\_\_\_\_

NO	AIRCRAFT	ID CORRECT	ID INCORRECT
1			
2			
3			
4			
5			
6			
7			
8			
9			
10			
11			
12			
13			
14			
15			
16			
17			
18			
19			
20			
RATING		S _____	U _____

**SAMPLE**

RATING SCALE: 18-20 correct answers = S  
17 or less correct answers = U.

**CHECKLIST 5, FIRING PHASE SUMMARY**

UNIT _____		DATE _____	
TEAM	INDIVIDUAL GUNNER PROFICIENCY-TARGET ENGAGEMENT Rating: S or U	AIRCRAFT RECOGNITION TEST Rating: S or U	OVERALL TEAM FIRING PHASE RATING Rating: S or U
A			
B			
C			
D			
E			
F			
G			
<p>Overall section firing phase rating (S or U) _____</p> <p>Note: For an overall section rating of S, the total Ss in the first two rating columns combined must be at least 80% of all S and U ratings entered in these columns.</p>			

**CHECKLIST 6, ORTT SUMMARY**

ORGANIZATION _____		DATE _____	
UNIT	TACTICAL PHASE Rating: S or U	FIRING PHASE Rating: S or U	OVERALL RATING Rating: S or U
Section HQ			
Team A			
Team B			
Team C			
Team D			
Team E			
Team F			
Team G			
<p>Legend: S = Satisfactory U = Unsatisfactory</p>			

APPENDIX A

## Manual SHORAD Control System

ADA FUs are more effective if they are provided accurate, timely, and reliable early warning. Early warning serves two purposes—alerting and cueing. Alerting information tells the user that an aircraft is approaching his position or the asset he is defending. Cueing information tells the user from which direction the aircraft will be coming, its positional location, and its tentative identification in a timely manner. This enables the user to focus his attention in that direction to detect the aircraft at a greater range. To obtain this information, SHORAD units use a manual control system that provides alerting, but very limited cueing.

This appendix provides standardized procedures for the MSCS. The objectives of the MSCS are to:

- Provide near real-time transmission of early warning information to SHORAD and other divisional units.
- Provide weapons control information to the SHORAD units organic to the division.
- Integrate ADA data into the division airspace management effort.

Early warning data is available to any unit which is capable of receiving it. This includes ADA units, the divisional maneuver units, and combat support/service support units.

<b>CONTENTS</b>	
Page	Page
Section I— MSCS COMMUNICATIONS	
<b>Nets</b> . . . . .	<b>A-2</b>
<b>SHORAD Grid Matrix</b> . . . . .	<b>A-3</b>
Section II— MSCS COMMUNICATIONS OPERATIONS	
<b>Air Defense Coordination Section</b> . . . . .	<b>A-6</b>
	<b>FAAR Platoon</b> . . . . . <b>A-8</b>
	<b>Using Units and Equipment</b> . . . <b>A-11</b>
	<b>Plotting Early Warning Information</b> . . . . . <b>A-12</b>
	<b>Alternate MSCS Procedures</b> . <b>A-12</b>

## SECTION I— MSCS COMMUNICATIONS

The MSCS uses various communications nets and components to provide timely,

accurate, and reliable early warning information.

### NETS

The MSCS is implemented through three communications nets.

The air defense coordination net (ADCN) provides early warning information to the SHORAD battalion from HIMAD systems or Air Force sources. The EWBN disseminates a standardized form of manual early warning within the division. The FAAR early warning net integrates HIMAD and SHORAD early warning information. MANPAD teams receive their information from either the EWBN or the FAAR early warning net.

#### AIR DEFENSE COORDINATION NET

This net is used to transmit long-range track information and air defense weapons control information to the SHORAD battalion TOC. This information can be obtained at a HIMAD (Hawk or Patriot) fire direction

center or Air Force forward air control post (FACP), control and reporting post (CRP), or control and reporting center (CRC). The net control station for the ADCN is the SHORAD battalion air defense coordination section (ADCS).

#### EARLY WARNING BROADCAST NET

The EWBN is a one-way FM net originating at the SHORAD battalion TOC. Any unit with an FM receiver and within line of sight (LOS) and operating range restrictions can obtain early warning information simply by monitoring this net. Units unable to receive this information due to the restrictions mentioned above can obtain early warning from adjacent, subordinate, or parent units that are receiving the information.

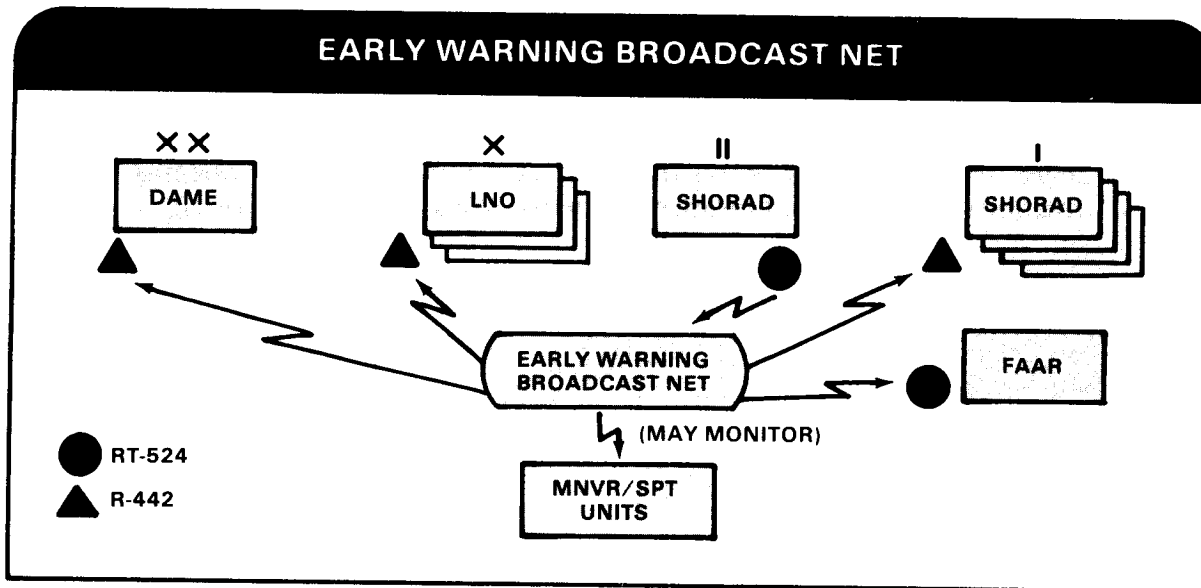



**FAAR EARLY WARNING NET**

Information transmitted by the FAAR is received at the C/V and Redeye/Stinger command posts, sections, and FUs on the FM receiver in the TADDS or on the R-442 auxiliary receiver. It can also be received by supported maneuver units, as well as by combat support/service support units.

Command nets, while not strictly part of the MSCS, contribute to the efficient functioning of the system.

**SHORAD GRID MATRIX**

The MSCS uses a unique grid system. A standard grid matrix is used with a specified reference point. The map coordinates to this reference point will normally be designated in the air defense annex of the division OPORD as will be the map sheet series number. The location of the reference point is standard on each sheet, however, it may be moved for security reasons. This can be accomplished by designating another intersection as the reference point (for example, intersection of HEMLOCK, INSECT, HAZEL, and INDIAN) and applying the specific map coordinates.

The SHORAD grid matrix is a standardized matrix consisting of 400 grid squares with a code name assigned to each square. Users need only use that portion of the matrix applicable to their areas of operation. The matrix reference point should be set to extend the matrix coverage at least 20 kilometers beyond the division boundaries.

**SHORAD GRID SYSTEM MATRIX**

- Notes:
1. Each grid square represents a map area of 10 X 10 kilometers.
  2. Use only the portion of the matrix needed for your operation.
  3. SHORAD grid overlays should be locally produced in scale compatible with standard tactical maps.

AUSTIN	BUTTON	COPPER	DUNGEON	EYEBROW	FURNACE	GUTTER	HUSBAND	IVY	JUPITER	KRYPTON	LOWELL	MUSIC	NYLON	OXEN	PYRAMID	ROYAL	SURGEON	TURTLE	WALTUWRE
AUGUST	BUTLER	CHOWDER	DUNCAN	EXPORT	FRONTIER	GUITAR	HUNTER	ISRAEL	JUNGLE	KOREA	LONDON	MUSCLE	NUTSHELL	OUTPOST	PUMPKIN	ROWBOAT	SUMMER	TURKEY	VOLCANO
ATLANTA	BUTCHER	CHIPMUNK	DUTCHESS	EXHAUST	FOUNTAIN	GREMLIN	HOWARD	ISAAC	JULY	KORAN	LIZARD	MOVIE	NUTMEG	OUTLAW	POWDER	ROMAN	SUGAR	TUNNEL	VOOKA
ASIA	BUSHEL	CHINA	DUBLIN	EVEREST	FOREST	GREGORY	HONDA	IRON	JOSEPH	KODAK	LIQUOR	MOUSE-TRAP	NOVEL	OSCAR	PONTIAC	ROBIN	SPIDER	TROPIC	VITAMIN
ARKANSAS	BURBANK	CHIMNEY	DONKEY	ESTATE	FOREHEAD	GRANITE	HOMER	IRIS	JORDAN	KLONDIKE	LION	MORGAN	NOTEBOOK	ORPHAN	PIRATE	ROBERT	SOIL	TOMB-STONE	VIRGINIA
APRICOT	BUCKET	CHILI	DONALD	ENTRANCE	FOOTBALL	GOSPEL	HOLLAND	IRENE	JOHNSON	KITCHEN	LINEN	MONSTER	NORMAN	ORLANDO	PIONEER	RICHMOND	SILVER	TIMBER	VIOLET
ANTHONY	BUBBLE	CHILDREN	DOMINO	ENGLAND	FLORIDA	GORILLA	HIGHWAY	IRELAND	JOCKEY	KINGDOM	LINCOLN	MONKEY	NOMAD	OREGON	PILLOW	REVERE	SIDEWALK	TIGER	VINEGAR
ANGEL	BRONCO	CHICKEN	DOLPHIN	ENGINEER	FLORENCE	GOODYEAR	HICKORY	IOWA	JEWEL	KIDNEY	LIMESTONE	MILLER	NITRO	ORCHARD	PILGRIM	REPTILE	SEASHORE	TICKET	VILLAGE
ANCHOR	BOULDER	CHICAGO	DOLLAR	EMMA	FLIPPER	GODDESS	HENRY	IODINE	JESSICA	KEYBOARD	LILY	MIDAS	NILE	OPAL	PIGEON	RENO	SCORPION	THUNDER	VIKING
AMBER	BOTTLE	CHEVY	DOCTOR	ELSIE	FLETCHER	GOBLIN	HEMLOCK	INSECT	JERSEY	KETTLE	LICORICE	MIAMI	NICHOLAS	ONTARIO	PETER	REINDEER	SCARLET	TEXAS	VIENNA
ALMOND	BINGO	CHESTNUT	DINOSAUR	ELLEN	FIBER	GLACIER	HAZEL	INDIAN	JELLO	KENTUCKY	LETTUCE	MEXICO	NIAGARA	O NEIL	PERSIA	REDHEAD	SATURN	TERMITE	VIDEO
ALCOHOL	BEDROOM	CHERRY	DIAMOND	ELEPHANT	FEATHER	GIBSON	HAWAII	INDEX	JEFFREY	KENNEL	LESLIE	MEDIC	NEWPORT	OMAHA	PERFUME	REBEL	SARAH	TEQUILA	VICKS-BURG
ALCATRAZ	BASEBALL	CHARCOAL	DEVIL	ELBOW	FAUCET	GAZELLE	HATCHET	INCENSE	JASPER	KENNEDY	LEOPARD	MASTER	NEVADA	OLYMPIC	PEPPER	REACTOR	SAPPHIRE	TENNIS	VICEROY
ALBERT	BARREL	CHAPTER	DETROIT	ELAINE	FARMER	GATEWAY	HAROLD	IMPERIAL	JASON	KELLOGG	LEMON	MARTIN	NEPTUNE	OLIVE	PEANUT	RAYMOND	SALOON	TEACHER	VESSEL
ALASKA	BARBER	CHAPEL	DESIGN	EGYPT	FARGO	GARMENT	HARNESS	ILLINOIS	JAPAN	KATIE	LEGION	MARSHALL	NELSON	OHIO	PARIS	RANDOLPH	SALAMI	TAXI	VERMONT
ALAMO	BANDIT	CHAMPION	DENVER	EDWARD	FALSTAFF	GARLIC	HAMMER	IDOL	JAMAICA	KAREN	LAVA	MARBLE	NEEDLE	OFFICE	PARCEL	RAINBOW	SAILBOAT	TAHITI	VENUS
AFRICA	BAMBOO	CHAIRMAN	DAYLIGHT	EDITH	FALCON	GARAGE	HAMLET	IDAHO	JAGUAR	KARATE	LAWYER	MANGO	NECKTIE	OCTOPUS	PANTHER	RAMBLER	SAHARA	TADPOLE	VELVET
ADAM	BAKER	CARSON	DAVID	EDISON	FAIRMONT	GANG-PLANK	HAMILTON	ICICLE	JACOB	KANSAS	LADDER	MAGIC	NECKLACE	OCEAN	PANCAKE	RACCOON	SAGE-BRUSH	TACOMA	VEGA
ACORN	BADGER	CAMPBELL	DANIEL	EDGAR	FAIRFAX	GAMA	HALLMARK	ICELAND	JACKSON	KANGAROO	LACROSSE	MADRID	NEBRASKA	OATMEAL	PACKAGE	RACKET	SADDLE	TABLET	VAMPIRE
ABILENE	BACON	CADILLAC	DAKOTA	EARTH-WORM	FABRIC	GABLE	HALIFAX	ICEBERG	JACKET	KAISER	LABRADOR	MADISON	NATHAN	OASIS	PACIFIC	RABBIT	SABER	TABASCO	VALLEY

The standard track report format is shown in illustration below.

### TRACK REPORT FORMAT

**PREFACE** ..... INITIAL TRACK (REPEAT TWICE), TRACK UPDATE, SCRUB TRACK OR MASS TRACK

**ID** ..... FRIEND, UNKNOWN, OR HOSTILE (FRIENDLY, NOT NORMALLY TRANSMITTED).

**LOCATION** ..... LEMON -3-3 (10KM GRID DESIGNATOR PLUS 1KM GRID INCREMENTS FOR EASTING AND NORTHING, READ TO THE RIGHT AND UP).

**HEADING** ..... SOUTHWEST, NORTH, ETCETERA.

**RAID SIZE** ..... ONE, FEW (2-4), OR MANY (MORE THAN 4—ONLY USED FOR MASS TRACKS).

**AIRCRAFT TYPE** ..... JET, PROP, OR HEL.

**TRACK DESIGNATOR** ..... A-Ø-1-ASSIGNED BY DETECTING UNIT.

### SHORAD GRID EXAMPLE

The track position is reported to 1 kilometer using the coded grid square in which the aircraft is located and by further subdividing each grid square into 1 kilometer increments. For example, consider the aircraft in the illustration. It is located at SHORAD grid "LEMON THREE-THREE."

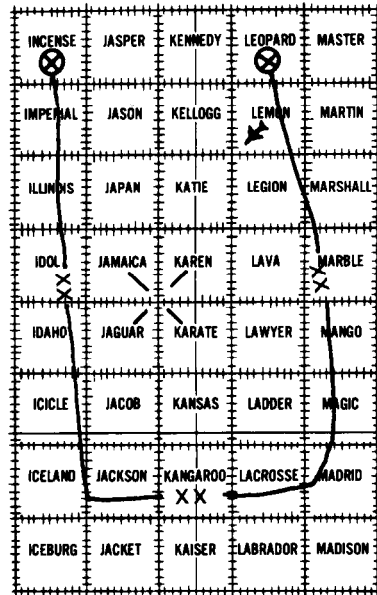

Shown below are the track report examples.

**1. INITIAL TRACK**

WHEN TRANSMITTING AN "INITIAL TRACK," ALL KNOWN INFORMATION SHOULD BE TRANSMITTED AS TIME OR THE TACTICAL SITUATION PERMITS. USING THE EXAMPLE SHOWN, AN INITIAL TRACK REPORT WOULD BE—

INITIAL TRACK, INITIAL TRACK  
UNKNOWN  
AT LEMON—THREE—THREE  
HEADING SOUTHWEST  
ONE  
JET  
TRACK DESIGNATOR: ALPHA-ZERO-ONE

**2. TRACK UPDATE**

TO TRANSMIT A TRACK UPDATE, ONLY THE PREFACE, THE TRACK DESIGNATOR, THE NEW LOCATION, AND THE NEW HEADING MUST BE SENT. USING THE EXAMPLE SHOWN, IF THE AIRCRAFT MOVES TO GRID KATIE AND IS LOCATED AT KATIE-7-8. THE TRACK THE TRACK UPDATE REPORT WOULD BE—

TRACK UPDATE  
ALPHA-ZERO-ONE  
NOW AT KATIE-SEVEN-EIGHT  
HEADING SOUTHWEST

**3. TRACK UPDATE IDENTIFIED**

TRACK UPDATE REPORTS MUST ALSO INCLUDE ANY CHANGES TO THE INFORMATION PREVIOUSLY REPORTED. FOR INSTANCE, IF, IN THE EXAMPLE SHOWN, THE AIRCRAFT IS NOW IDENTIFIED AS AS HOSTILE AND ITS NEW LOCATION IS KATIE-4-3. THE TRACK UPDATE REPORT WOULD BE—

TRACK UPDATE  
ALPHA-ZERO-ONE  
NOW AT KATIE-FOUR-THREE  
NOW HOSTILE  
HEADING SOUTHWEST

Note. Track updates should be applied about twice a minute.

**4. SCRUB TRACK**

A "SCRUB TRACK" IS REPORTED WHEN A TRACK EXITS THE AREA OF INTEREST, A TRACK NO LONGER APPEARS ON THE RADAR SCOPE BEING VIEWED, OR IS IDENTIFIED AS FRIENDLY. TO REPORT A "SCRUB TRACK," ONLY THE PREFACE AND TRACK DESIGNATOR MUST BE TRANSMITTED. AN EXAMPLE OF A "SCRUB TRACK" REPORT WOULD BE—

SCRUB TRACK  
ALPHA-ZERO-ONE

**5. MASS TRACK**

THE LAST TYPE OF TRACK REPORT IS A "MASS TRACK." A "MASS TRACK" IS TRANSMITTED INSTEAD OF AN "INITIAL TRACK" WHEN THE TRACK WHEN THE RAID SIZE IS "MANY". WHEN REPORTING A "MASS TRACK," LOCATION WILL NORMALLY BE ONE OR MORE 10-KM GRID DESIGNATIONS. TRACK UPDATES FOR A MASS TRACK ARE THE SAME AS ANY OTHER TRACK UPDATE. AN EXAMPLE OF A "MASS TRACK" REPORT WOULD BE—

MASS TRACK, MASS TRACK  
HOSTILE  
AT LEMON AND MARTIN  
HEADING SOUTHWEST  
MANY  
HEL  
TRACK DESIGNATOR: ALPHA-ZERO-TWO

## SECTION II— MSCS COMMUNICATIONS OPERATIONS

Trained personnel must understand both the standards and procedures of the MSCS for it to function smoothly. This section dis-

cusses how the MSCS operates, who performs the functions at each level and, finally, how it is used.

### AIR DEFENSE COORDINATION SECTION

The ADCS consists of three personnel: the air defense coordination officer (ADCO), an NCO, and a driver radiotelephone operator (RATELO). During operations the section deploys to the nearest source of HIMAD/Air Force track information. Once deployed the ADCS establishes two-way AM radio communications with the SHORAD battalion TOC. The ADCS passes long-range aircraft track information, air defense command and control information (ADWs, WCS, etcetera) disseminated through HIMAD/USAF control systems to the SHORAD TOC over this net.

The ADCS obtains HIMAD track infor-

mation by physically viewing a radar console and a manual plotting board.

The radar console provides the most timely early warning information. The console can either be an FU or control facility radar scope on which the division's air picture is displayed.

In situations where it is impossible for the ADCO to physically view a radar scope, adequate data can be obtained from a manual plotting board. As with the radar console method, the division's area of operations should be marked on the plotting board.

#### ADCO CLIPBOARD MAP WITH SHORAD GRID

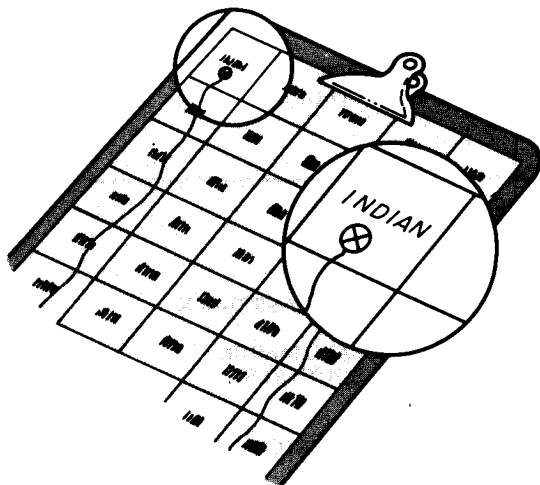

THE ADCO, VIEWING A RADAR CONSOLE OR MANUAL PLOTTING BOARD, DETECTS A HOSTILE OR UNKNOWN TRACK EITHER WITHIN, OR APPROACHING THE DIVISION'S AREA OF OPERATIONS: HE NOTES THE TRACK'S GEOREF POSITION, AND CONVERTS IT TO A DIVISION GRID POSITION. FOR THIS PURPOSE, THE ADCO HAS A CLIPBOARD-MOUNTED MAP OF THE DIVISION'S AREA OF OPERATIONS, MARKED WITH A UNIQUE SHORAD GRID OF THE DIVISION AREA OF OPERATION.

Here is how early warning track data is passed in SHORAD units.

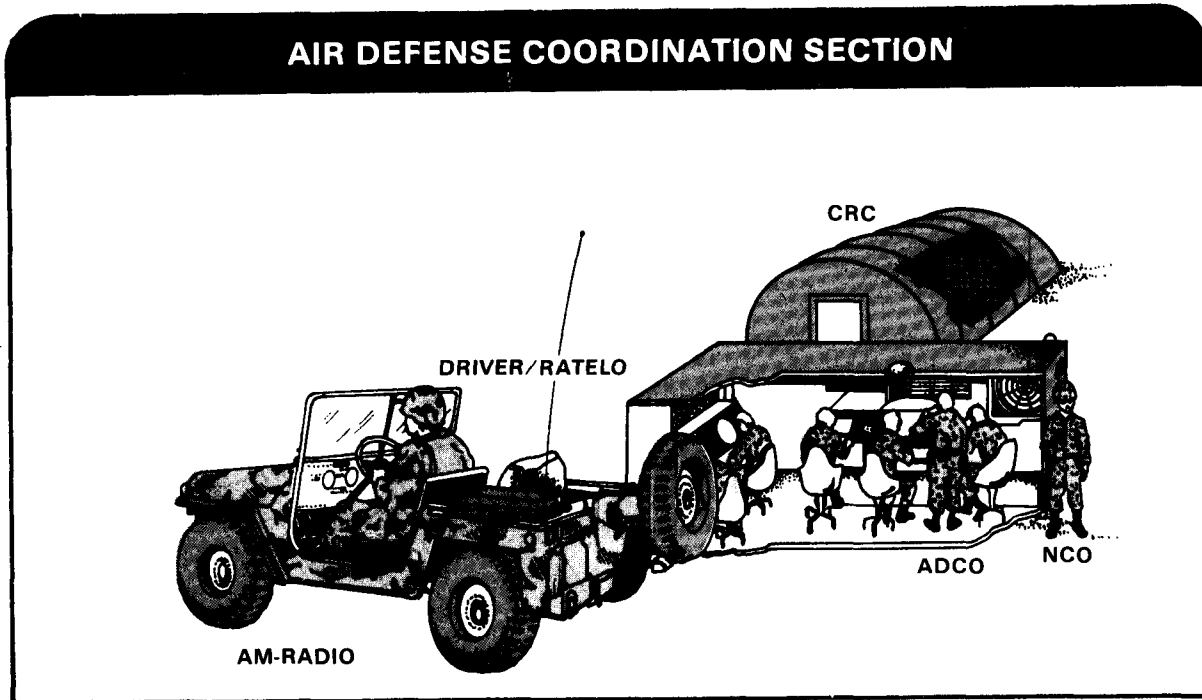

When the ADCO places his GEOREF acetate overlay over the SHORAD grid on his clipboard, he can convert the GEOREF position to a SHORAD grid position (see illustration following page).

If the ADCS has an AN/GRA-6 radio set control group (AM remote unit), the ADCO can transmit directly from the HIMAD source to the SHORAD TOC.

If the ADCS has no AN/GRA-6 radio control group, it must be issued two TA-312/PT telephones. Using a TA-312/PT, the ADCO can relay the track report to the ADCS driver/RATELO, who then transmits the report on the AN/GRC-106A.

The ADCS is the NCS for the ADCN. It uses the ADCN to transmit track reports to the SHORAD TOC. Located where he can view a radar console or manual plotting

board, the ADCO detects tracks located within or approaching the division's area of operations. He converts the track GEOREF position to a SHORAD grid position and transmits early warning to the SHORAD TOC. Position data is transmitted via a standardized format either directly or through the ADCS driver/RATELO. The ADCO also acquires and transmits air defense command and control information to the SHORAD TOC.

SHORAD TOC personnel receive the ADCS's track report. They record the track, determine if the track requires retransmission, and transmit early warning over the EWBN. ADWs and other air defense command and control information are also transmitted over the battalion command net or over the EWBN.

## ADCO CONVERSION OF GEOREF POSITION

THE CLIPBOARD HAS AN ACETATE OVERLAY ON WHICH THE HIMAD GEOREF SYSTEM IS MARKED.

BY PLOTTING THE TRACK'S POSITION ON THE GEOREF OVERLAY, THE ADCO CAN CONVERT THE GEOREF POSITION TO A DIVISION GRID POSITION.

GEOREF OVERLAY

SHORAD GRID

1:250,000 MAP

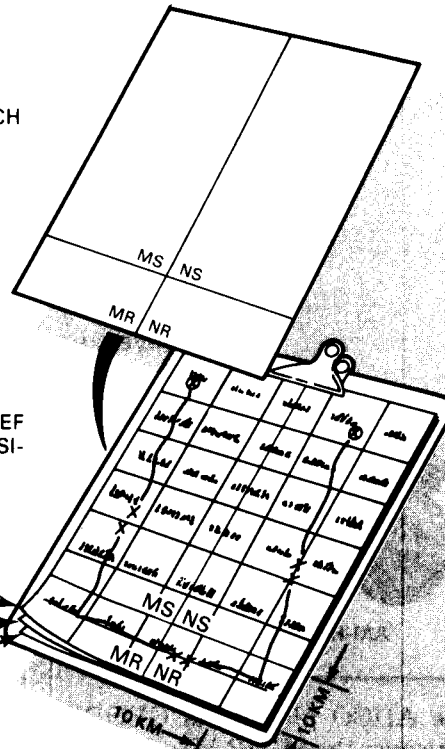

## FAAR PLATOON

Aircraft detected by the FAAR are manually tracked by the FAAR operator on the PPI using a china marker and the FAAR scope insert.

The FAAR scope insert is a plexiglass disk overprinted with the standardized SHORAD grid system. It is placed over the FAAR PPI scope to allow the FAAR operator to conduct manual tracking and voice-tell operations.

The FAAR scope insert is actually two plexiglass disks mounted one on top of the other. The lower disk is overprinted with the standardized SHORAD grid. The upper disk is hinged so that it can be raised and the grid codewords can be written on the lower disk.

The FAAR scope inserts should be locally manufactured through TASC based on the specifications in the illustration shown.

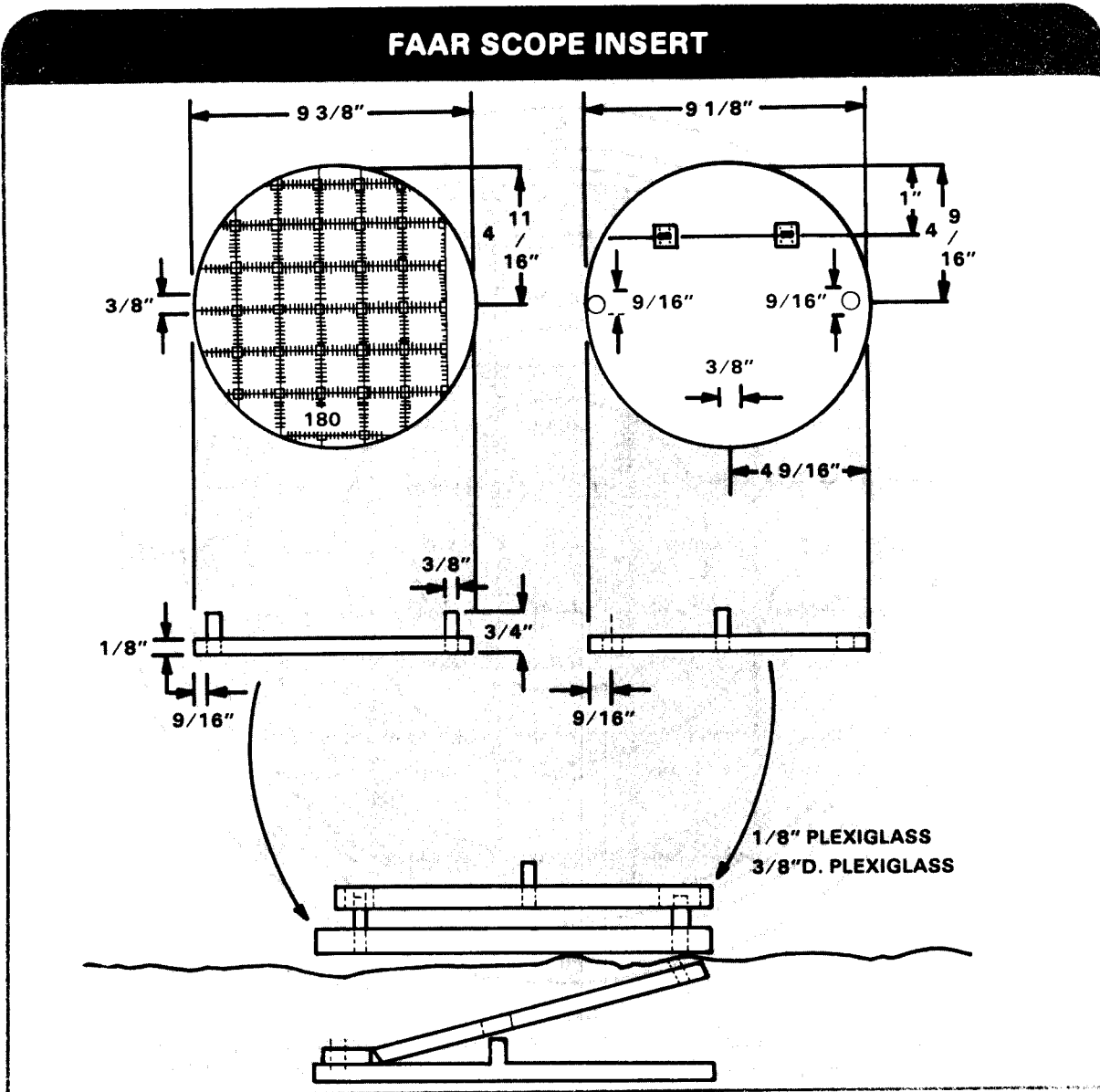

The scale of the FAAR scope is the same as a 1:250,000 map. The scale of the standardized SHORAD grid that is overprinted on the FAAR scope is also 1:250,000. To achieve the desired accuracy, the FAAR operator must know his actual location and offset the origin of the sweep display to his actual location within the center 10 kilometer grid box on the FAAR scope insert.

The FAAR operators monitor the EWBN using the AN/VRC-46 radio normally used for their platoon command net. When a track report is received from the SHORAD TOC that pertains to the FAAR area of interest, the FAAR operator interrupts his own broadcast/track plotting, plots and correlates the EWBN track on the scope insert, and relays any new information.

**SWEEP DISPLAY**

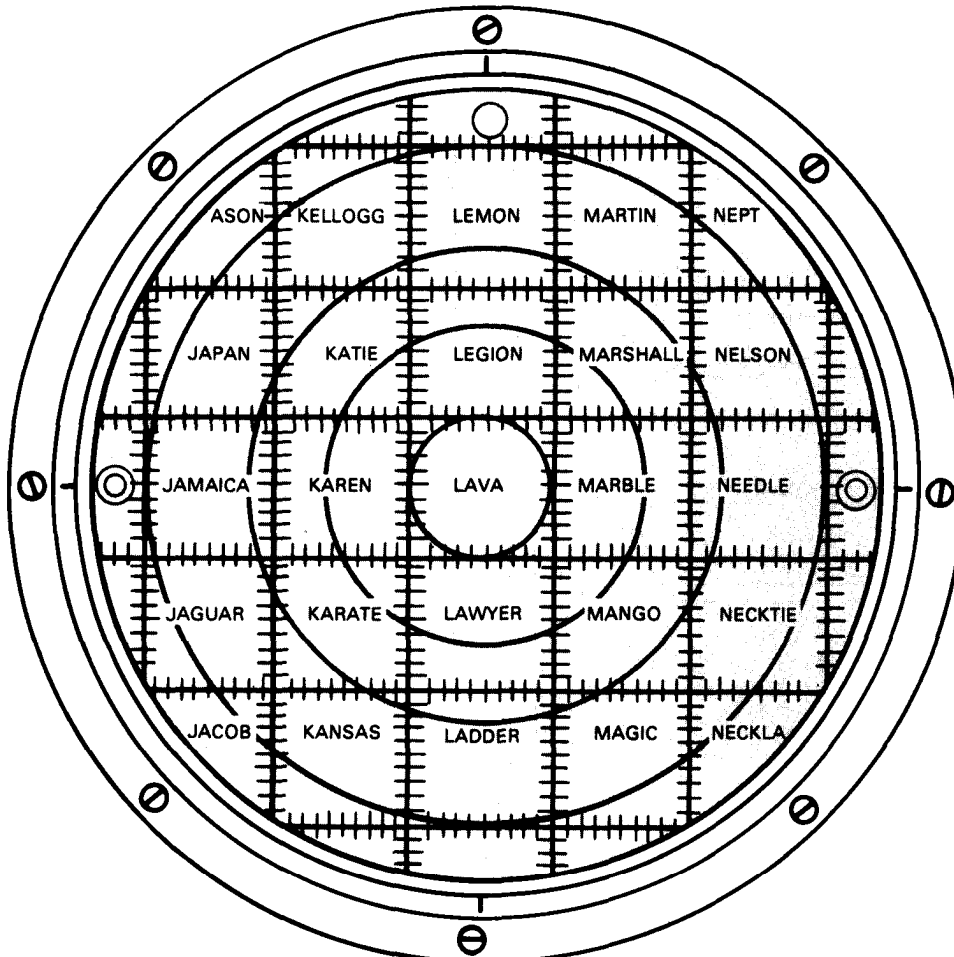

**STEPS**

1. FIND YOUR LOCATION ON THE MAP.
2. DETERMINE THE SHORAD GRID COORDINATES OF THE FAAR.
3. PLOT YOUR POSITION IN THE CENTER GRID SQUARE OF THE FAAR SCOPE INSERT.
4. WRITE THE APPROPRIATE GRID NAMES OF ALL GRID SQUARES ON THE LOWER DISK.
5. OFFSET THE ORIGIN OF THE PPI SWEEP DISPLAY TO CORRESPOND WITH THE ACTUAL POSITION OF THE FAAR.
6. LOWER THE UPPER DISK AND BEGIN MANUAL TRACKING AND VOICE-TELL OPERATIONS.

The FAAR operators voice tell the track information over the FAAR early warning net to the FUs over the AN/VRC-46 radio using the standard track report formats.

Command and control information can also be relayed by the FAAR. Authentication and acknowledgement may have to be accomplished through command channels.



## USING UNITS AND EQUIPMENT

To be of best use to SHORAD units, early warning information should be displayed. This information is used to alert personnel of aircraft in their vicinity. Command and control information received over the FAAR early warning net may require authentication and acknowledgement. This would be accomplished over command nets.

Non-ADA units may monitor the EWBN or the FAAR net for early warning by using the SHORAD grid. They may also receive this information through liaison from supporting ADA units.

The MSCs map/plotting case is a canvas and plastic map case adapted for use as a plotting board for the SHORAD FU. The plotting case consists of a 30 x 30 kilometer plotting grid; a copy of the 200 x 200 kilometer standardized SHORAD grid system; a status board; a pen, pencil, and rag storage compartment; and operating instructions. The map/plotting case was distributed on a one-time distribution basis to divisional and nondivisional units. Replacements must be obtained at local TASCs. The MSCs map/plotting case is shown in the following illustration.

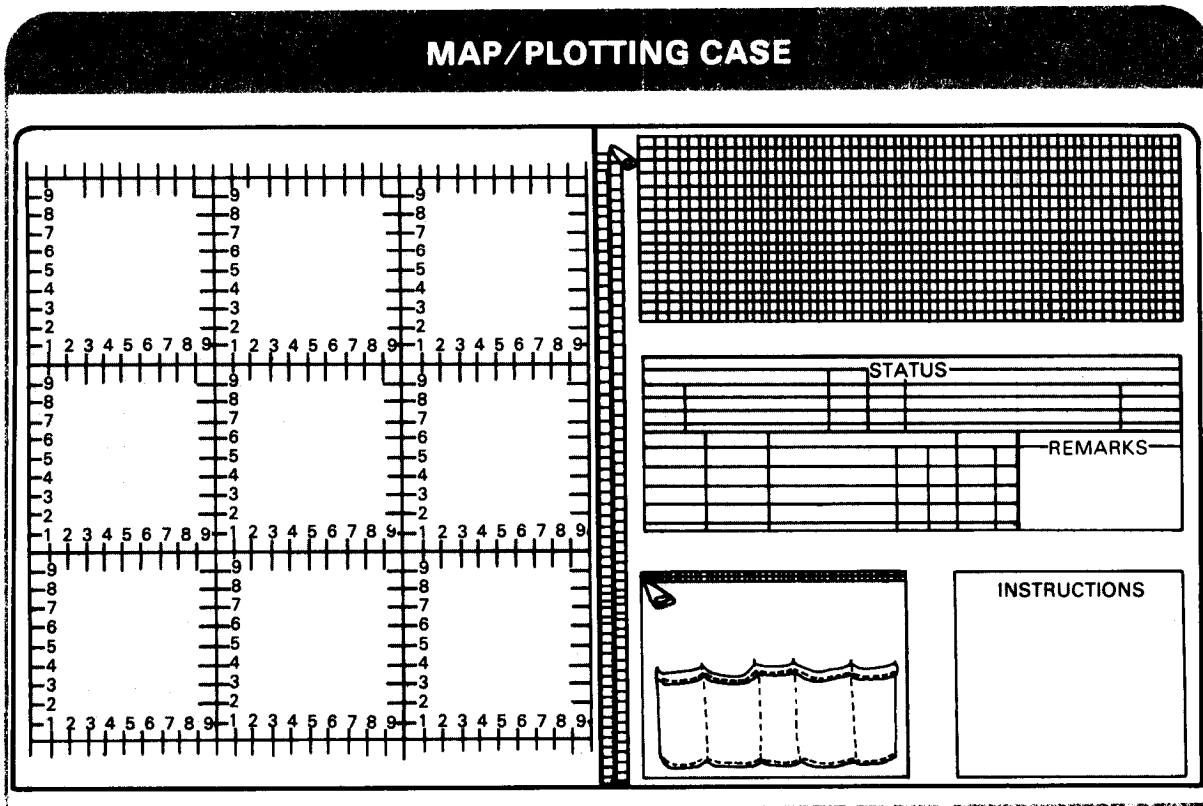

To set up the map/plotting case for operation, you must accomplish the following steps:

- Orient the map case to magnetic north.
- Find your position on the map.
- Place the map under the plastic grid with your position in the center grid box.
- Align the 10 kilometers major grid lines

with the grid printed on the plastic. Keep your position in the center grid box.

- Write the appropriate grid names on the plastic.
- Mark your position on the plastic.
- Mark your PTL on the plastic.
- Draw clock around your position (12 o'clock is on your PTL, 6 o'clock is to your rear.)

Once the map/plotting case is set up as described, you are ready to plot IAW the plotting instructions described earlier in this section.

The marks in the plotting board case should look like those in the illustration to the right.

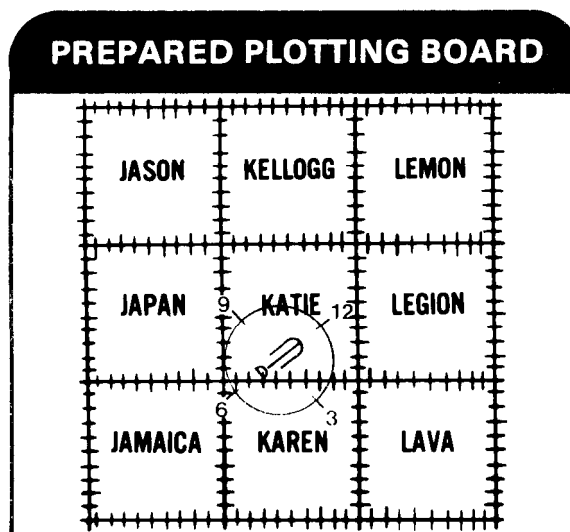

### PLOTTING EARLY WARNING INFORMATION

To be of best use to SHORAD FUs, early warning information must be displayed. This provides an immediate aid in visualizing the air picture and prioritizing engagements in a multiple target environment.

Two methods of plotting are described here. The desired method involves using three different colored china markers (grease pencils), one for each of the identification categories (normally white for FRIEND, yellow for UNKNOWN, and red for HOSTILE). When using this method, the symbol ● can be

used to designate a track.

The second method can be used when only one color china marker is available. In this case, a circle represents a FRIEND, a U represents an UNKNOWN, and a diamond represents a HOSTILE.

Using the example track reports that were shown earlier, the plotting would be done as shown in the following illustrations.

Using the example track reports that were shown earlier, the plotting would be done as shown in the following illustrations.

### ALTERNATE MSCS PROCEDURES

Alternate routes for command and control information are provided for in the MSCS; these include the EWBN and command nets. In the event of loss of communications in the MSCS, procedures are flexible enough to make maximum effective use of remaining command and control facilities. For example, WCSs, hostile criteria, and emergency information received from the ADCO, division TOC, and/or the brigade TOC, can be passed to SHORAD units via the EWBN or via the SHORAD battalion command net. (Emergency information is information that must

be disseminated rapidly throughout the division, such as NBC strike warnings and enemy airmobile assaults. The division G3 and G2 are normally the primary sources of this information, which is usually disseminated through the division intelligence net and relayed down command nets.) The EWBN provides the means to rapidly disseminate this information throughout the SHORAD battalion. Alternately, the command nets are used to disseminate emergency messages and critical warning information.

## INITIAL TRACK

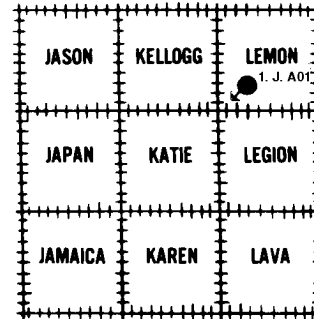
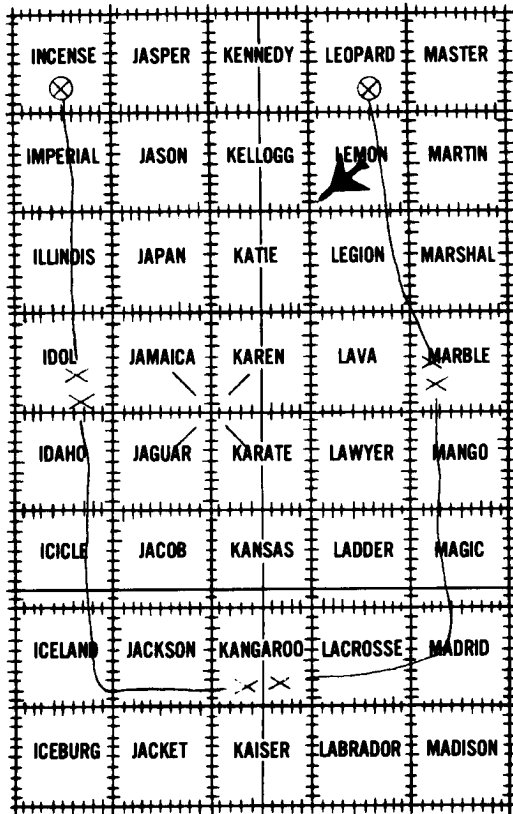

WITH COLORED GREASE PENCILS (YELLOW)

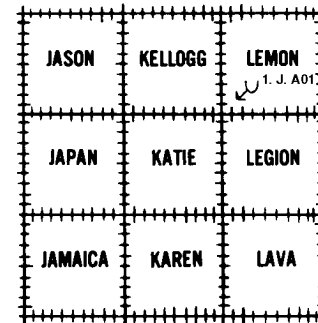

WITHOUT COLORED GREASE PENCILS

### TRACK REPORT

INITIAL TRACK, INITIAL TRACK  
 UNKOWN  
 AT LEMON-THREE-THREE  
 HEADING SOUTHWEST  
 ONE  
 JET  
 TRACK DESIGNATION: ALFA-ZERO-ONE

### ACTIONS BY PLOTTER

PREPARE TO PLOT.  
 SELECT YELLOW GREASE PENCIL.  
 PLACE TRACK SYMBOL AT LEMON 3-3.  
 (● INDICATES INITIAL TRACK).  
 PLACE HEADING VECTOR ON TRACK SYMBOL.  
 NO ACTION OR OPTIONALLY PLACE A 1 BESIDE THE TRACK SYMBOL.  
 NO ACTION OR OPTIONALLY PLACE A J BESIDE TRACK SYMBOL.  
 WRITE THE TRACK DESIGNATOR (A01) BESIDE THE TRACK SYMBOL.

### TRACK UPDATE

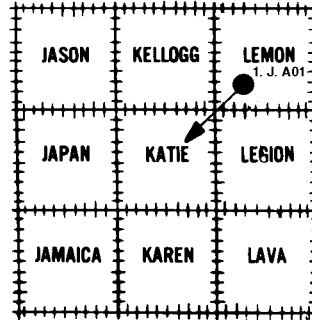
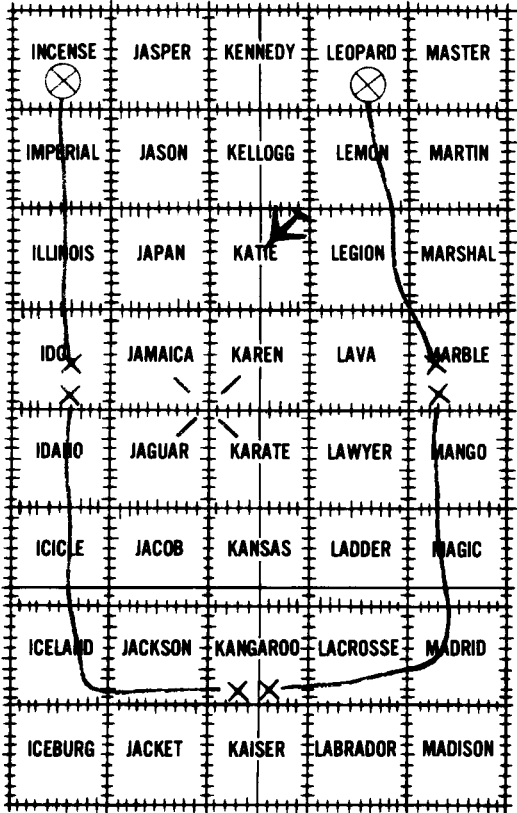

WITH COLORED GREASE PENCILS (YELLOW)

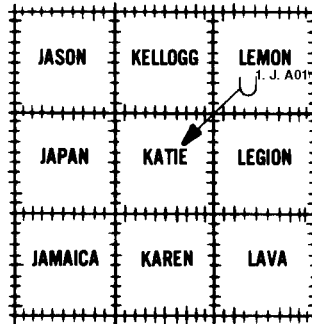

WITHOUT COLORED GREASE PENCILS

#### TRACK REPORT

TRACK UPDATE  
 ALPHA-ZERO-ONE  
 NOW AT KATIE SEVEN-EIGHT  
 HEADING SOUTHWEST

#### ACTIONS BY PLOTTER

PREPARE TO PLOT.  
 LOCATE TRACK A01.  
 LOCATE KATIE 7-8 AND MARK.  
 DRAW ARROW BETWEEN KATIE 7-8 AND LAST LOCATION OF TRACK A01.

Note: After three updates, write all known information beside the newest track location and erase the past track history.

## TRACK WITH IDENTIFICATION UPDATE

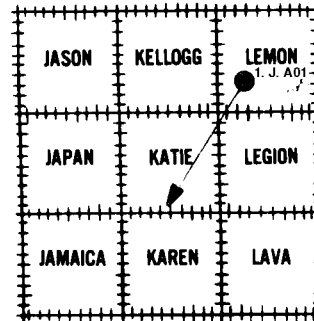
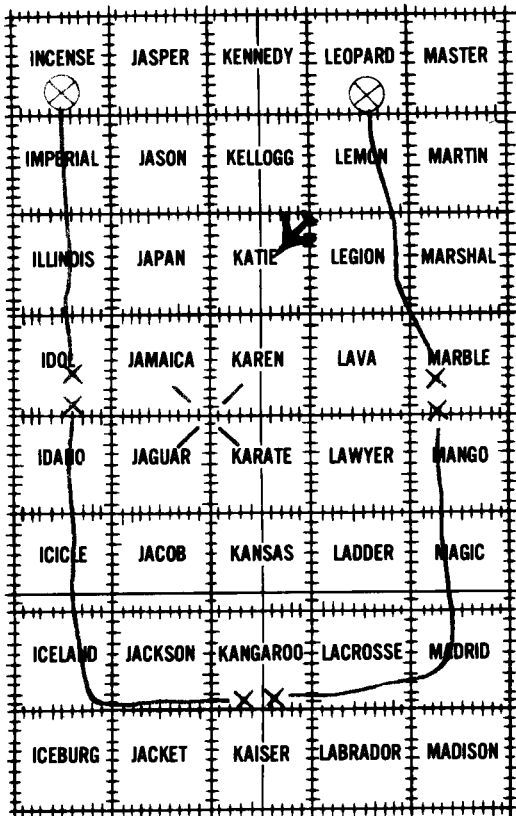

WITH COLORED GREASE PENCILS (RED)

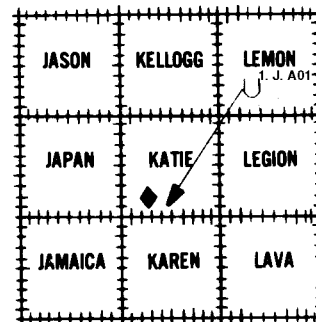

WITHOUT COLORED GREASE PENCILS

### TRACK REPORT

TRACK UPDATE  
 ALPHA-ZERO-ONE  
 NOW AT KATIE FOUR-THREE  
 NOW HOSTILE  
  
 HEADING SOUTHWEST

### ACTIONS BY PLOTTER

PREPARE TO PLOT.  
 LOCATE TRACK A01.  
 LOCATE KATIE 4-3.  
 USE RED MARKER TO MARK POSITION AND DRAW  
 ARROW BETWEEN KATIE 4-3 AND LAST LOCATION  
 OF TRACK A01.  
 IF MULTICOLOR MARKERS ARE NOT AVAILABLE,  
 DRAW A DIAMOND AT KATIE 4-3.

# SCRUB TRACK

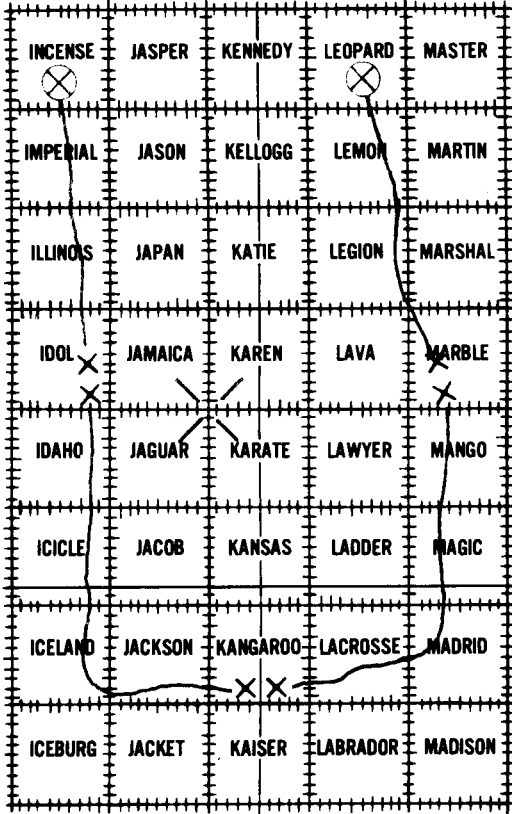

## TRACK REPORT

SCRUB TRACK  
ALPHA-ZERO-ONE

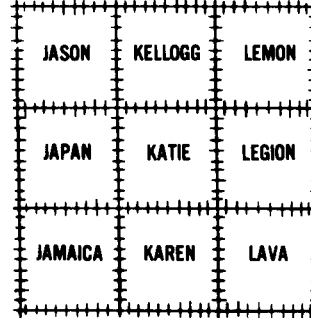

WITH COLORED GREASE PENCILS

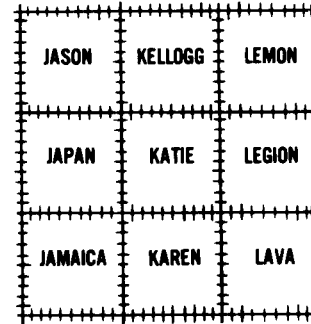

WITHOUT COLORED GREASE PENCILS

## ACTIONS BY PLOTTER

PICK UP RAG.  
ERASE TRACK A01.

# MASS TRACK

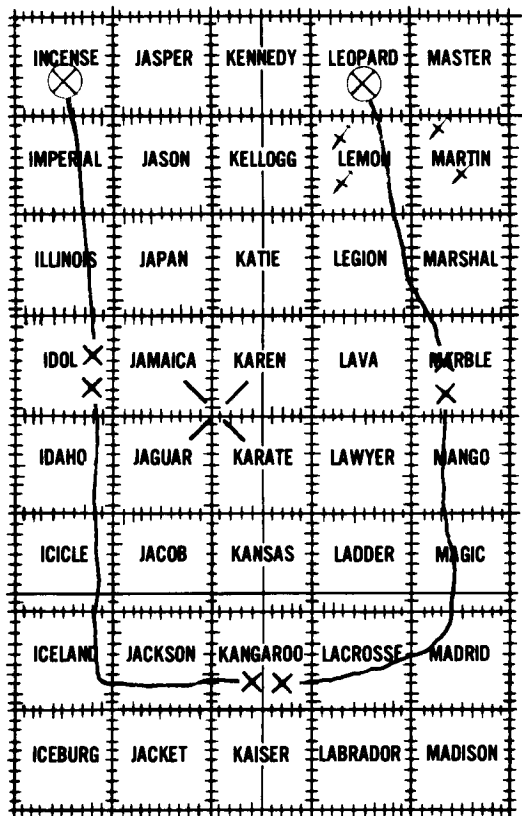

## TRACK REPORT

MASS TRACK, MASS TRACK

HOSTILE

HEADING SOUTHWEST

MANY

HEL

TRACK DESIGNATOR: ALPHA-ZERO-TWO

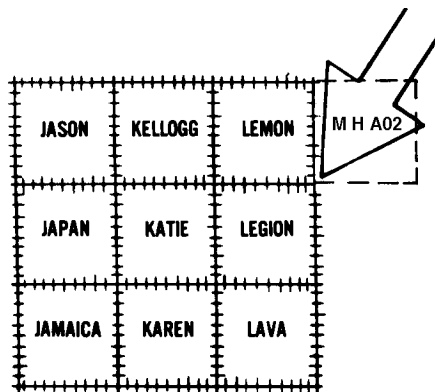

WITH COLORED GREASE PENCILS

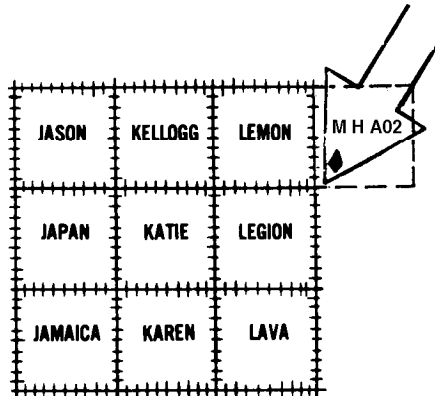

WITHOUT COLORED GREASE PENCILS

## ACTIONS BY PLOTTER

PREPARE TO PLOT.

SELECT RED GREASE PENCIL (OR DIAMOND).

DRAW A LARGE ARROW IN GRID HEADING SOUTHWEST.

PLACE M INSIDE ARROW.

WRITE TRACK DESIGNATOR (A02 INSIDE ARROW).

Note: Helicopter (HEL) mass tracks may indicate a special threat to friendly forces and should be identified as early as possible and monitored closely. The location where the HEL mass track disappears, reappears, or assumes an outbound direction could be critical to identifying a possible threat insertion force. A track report should be broadcast as a priority requirement when any of these critical events are detected.

## APPENDIX B

### BINOCULARS IN IDENTIFICATION OF AIRCRAFT

Once an aircraft has been detected, ground observers should use binoculars to aid visual recognition. Time for identification is limited. Identification of a fast-moving jet aircraft must be completed within about 5 to 15 seconds. The observer will lose valuable time if he fumbles or tries to readjust his binoculars at this stage of the game. This appendix tells how to adjust and use binoculars in identifying aircraft.

#### METHOD OF HOLDING

Loss of efficiency occurs if the binoculars are not held correctly to the eyes. Binoculars are held as shown in illustration below.

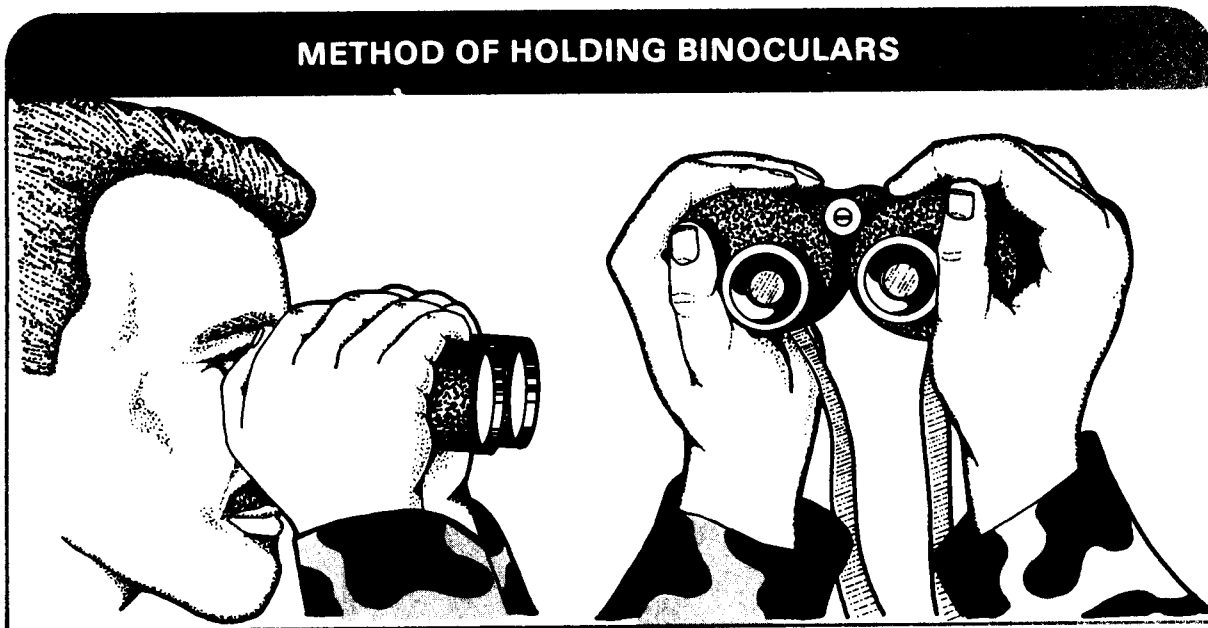

They should be held tightly, with the monoculars resting on and supported by the heels of the hands. The thumbs block out light that would enter between the eyes and eyecups. The eyecups are held lightly to the eyes to avoid transmission of body movement. When observing with the binoculars, use a stationary rest for the elbows, if possible.

#### CONTENTS

	Page
Method of Holding .....	B-1
Adjustments .....	B-2
Tips .....	B-3



## ADJUSTMENTS

Binoculars must be prefocused and adjusted prior to use.

### INTERPUPILLARY ADJUSTMENT

The distance between the eyes of individuals varies. The two monoculars that make up a pair of field glasses are hinged together so that the lenses can be centered over the pupils of the eyes. The hinge is equipped with a scale which indicates in millimeters the interpupillary distance. To find the correct setting, look through the binoculars and adjust the hinge until the field of vision appears as a single, sharply defined circle. Once the interpupillary adjustment is correctly made, remember the scale setting so that no time is lost when the glasses are used again. Record the setting for future use.

### FOCAL ADJUSTMENT

Each eye of an individual requires a dif-

ferent focal setting. Adjust the focus for each eye as follows:

- Look through the glasses at a distant object with *both eyes open*.
- Place one hand over the right monocular and turn the focusing ring of the left monocular until the object is sharply defined.
- Uncover the right lens and cover the left one.
- Rotate the right focusing ring until the object is sharply defined.
- Uncover the left lens; the distant object should be clear to both eyes.
- Note the setting on the focusing scales and record for future reference.

Polarized filters eliminate glare and should be used if available.

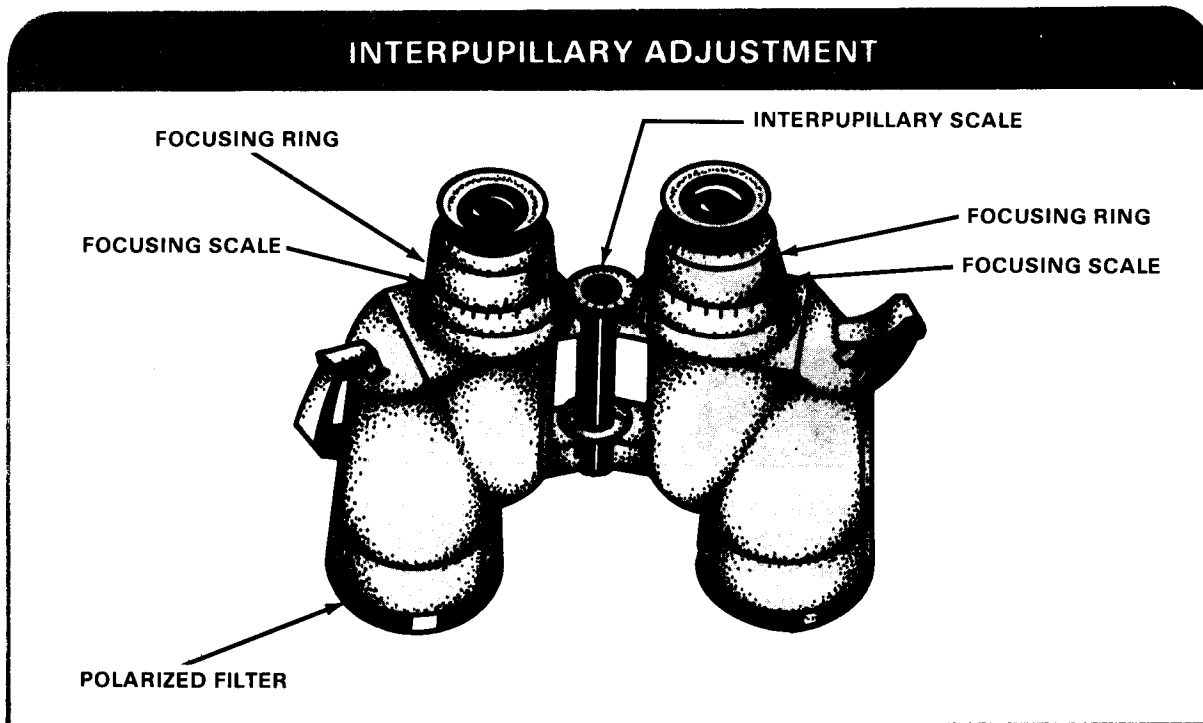

## TIPS

Binoculars are a positive aid in aircraft recognition. By magnifying the aircraft's image, they aid the observer in distinguishing recognition features at long distances. In contrast, use of binoculars for search and detection tends to reduce detection range because of their limited field of view. Some tips on using binoculars are as follows:

- Binoculars must be focused and adjusted prior to use.
- Binoculars must be focused at the range where they will most likely be used (where targets are expected to appear).
- Binoculars should be readily available whether the user is in a vehicle or a ground position. The binoculars should be uncased and ready for instant use.
- Immediately upon detection of an aircraft, the observer, keeping his eyes on the aircraft, carefully raises the binoculars to his eyes. Because of the binocular's narrow field of view, a sudden or jerky movement may cause the observer to lose the target.
- Binoculars must be protected from dust contamination.

APPENDIX C

**STINGER  
TACTICAL EQUIPMENT CHARACTERISTICS**

LIN	FSN	OFFICIAL NOMENCLATURE	COMMON NAME	TACTICAL	SHIPPING	SIZE (IN)
				WEIGHT (LB)	WEIGHT (LB)	
G95787	1425-01-024-9982	Guided Missile System, Intercept-Aerial	Weapon- Round	34.5	86.8	66 x 13 x 13.25
M51669	1427-01-024-9967	Missile-Round: Stinger Complete	Missile- Round	28.2	73.6	67.25 x 13.8 x 11.2
G92747	1440-01-024-6931	Gripstock-Control Group GM Launcher: OA-8882/T	Gripstock	4.98		
P69002	5895-01-032-4266	Programmer, Interrogator Set: AN/GSX-1	IFF Programmer	41.0	41.0	23.2 x 13.1 x 12.6
J98501	5895-01-032-4263	Interrogator Kit, IFF	IFF Interrogator	6.85	17.85	16.8 x 15.4 x 9.4
H17660	1450-01-024-6936	Harness, GM Equipment Transport: M4	Transport Harness	2.0	2.0	Straps

APPENDIX D

**Stinger Crew Drills**

This appendix sets forth the standardized crew drills for the Stinger weapon system and is designed to train the Stinger crew to perform their mission in a cohesive, efficient, and professional manner in a training/combat environment.

Modern warfare has expanded the battlefield from the old concept of frontlines, rear areas, and specific enemy and friendly lines to an in-depth, three-dimensional, 360° attack and defend environment. To add complexity to the battlefield, advances in weapon systems and electronic technology are significantly affecting military concepts and operations. These conditions demand the ultimate coordinated efficiency on the modern battlefield. Because of the lethality of the threat environment, current doctrine emphasizes winning the first battle.

This appendix emphasizes those drills which are essential in the accomplishment of the MANPAD unit mission and which add to survival and success on the modern battlefield in any part of the world where MANPAD teams will be utilized.

The four basic drills included in this appendix are to be performed in a standardized manner without error or safety violations. The drills must be practiced to the degree of proficiency that the MANPAD crewman will react from rote.

**CONTENTS**

	Page		Page
<b>Crew Drill Training</b> .....	<b>D-2</b>	<b>Preparation for Engagement from Foot-March</b>	
<b>Basic Load Rearrangement</b> .....	<b>D-2</b>	<b>Position</b> .....	<b>D-6</b>
<b>Preparation for Engagement from Mounted</b>		<b>Preparation for Engagement from Foxhole</b>	
<b>Position</b> .....	<b>D-4</b>	<b>Position</b> .....	<b>D-8</b>

## CREW DRILL TRAINING

Crew drills can serve as an effective training tool. By practicing the crew drills, the team can improve its skill, proficiency, and experience in performing combat critical tasks with the system. The frequency that these drills are performed is left to the discretion of the training manager and trainer.

Initially, team members should read their procedures carefully to understand their individual actions and how they relate to those of the other team member. Next, team members should walk through the procedures with a trained and experienced team member. During the walk through, team members rehearse the crew drill, pointing out the equipment they will use and the actions they will perform. These preliminary steps serve to resolve any doubt or questions that may exist in their minds prior to actually handling the equipment and to reinforce the safety precautions applicable to the system. Stinger technical manuals list all safety requirements in the form of notes, cautions, and warnings and they must be understood and followed. They must adhere to these safety requirements and not risk personal injury or equipment damage for the sake of speed. Once the team members are confident with their equipment and procedures, the crew drills can be run.

The crew drills should be taught in sequence, beginning with basic load rearrangement and ending with preparation for engagement from foxhole position. Once the sequence is mastered, training can be conducted on any drill with which the team is weak until the desired level of proficiency is reached. They must be performed without error and to the degree that the actions are performed automatically and without hesitation by rote. Additional guidelines for conducting the crew drills include the following:

- Conduct them in silence except for commands and reports.
- Supervise them so that mistakes are discovered and corrected immediately.
- Repeat them until team reactions are automatic, rapid, and efficient.
- Rotate team members so that each member of the team can perform all duties within the team.
- Perform them IAW performance measures as stated in the tasks, conditions, and standards listed for each drill.

## BASIC LOAD REARRANGEMENT

The load rearrangement drill will be performed with weapon-round and missile-round containers after missile expenditures. The purpose of this drill is to train team members in the proper method of loading and unloading weapon-round and missile-round containers using the M416 trailer. Both team members are required to perform this drill because of the weight of the containers and to prevent dropping the containers. Full weapon-round and missile-round containers

should always be on top for immediate use. This drill will be performed under non-MOPP and MOPP 4 conditions and during the hours of daylight and darkness, under any weather condition in which enemy aircraft may be launched against assets being protected.

**TASK:** Rearrange the weapons-round and missile-round container in the M416 trailer after missile expenditure.

CONDITIONS: Given the Stinger basic load properly loaded and secured on the M416 cargo trailer, a MANPAD team with their individual combat equipment positioned five paces from the trailer, with Stingers on their shoulders, the gunners have fired. Task must be performed under any weather conditions in a non-MOPP/MOPP 4 environment.

TNG/EVAL STANDARD(S): Team must properly rearrange the basic load after missile expenditure within 4 minutes in a non-MOPP or 5 minutes in a MOPP 4 environment with no safety/equipment violations.

REFERENCES: FM 44-18-1, TM 9-1425-429-12.

### BASIC LOAD REARRANGEMENT CREW DRILL

#### TEAM CHIEF

1. Places his weapon into left WRC and secures the lid with two latches.
3. Takes a position at the rear end of the trailer. Loosens harness waistband.
4. Grasps the handle of the empty WRC, lifts and places container at top of far left container.
5. Assists gunner in lifting and placing bottom container on top of MRC.
6. Lifts empty container and places it on the bottom of trailer.
7. Lifts full container and places it on top of empty container.

Note. Container lid is preloaded.

10. Inspects weapon-round and BCUs IAW FM 44-18-1. If time permits, inspect IAW TM 9-1425-429-12.

#### GUNNER

1. Removes gripstock and discards expended launch tube. Removes BCU.
2. Places gripstock into WRC on the right, secures lid with two center latches.
3. Takes a position at the forward end of the trailer. Loosens harness.
4. Assists team chief in lifting and placing empty container on top of far left container.
5. Grasps handle on bottom container, lifts it above trailer and places it on top of MRC.
6. Assists team chief in lifting and placing empty container on bottom of trailer.
7. Assists team chief in lifting and placing full container on top of empty container.
8. Presses pressure relief valve to release built-up pressure.

9. Opens WRC.

10. Assists team chief in inspecting weapon-round and BCUs.

11. Removes two BCUs and places them into BCU pouch with grip end up, inserts third BCU into gripstock.

**BASIC LOAD REARRANGEMENT CREW DRILL—CONTINUED**

**TEAM CHIEF**

**GUNNER**

- 16. Tightens waistband strap.
- 17. Unlatches container on left side for ready position.

- 12. Removes the IFF, cable connector dust cover from gripstock and places it inside container.
- 13. Removes styrofoam cube from behind acquisition indicator and places it inside container.
- 14. Insures weapon is in proper position inside container.
- 15. Closes and latches containers, using center latches.
- 16. Assists in reattaching transport harness.
- 17. Unlatches container on right side for ready position.

**PREPARATION FOR ENGAGEMENT FROM MOUNTED POSITION**

This drill emphasizes the expeditious teamwork necessary to prepare a team for immediate engagement from a mounted position. The team vehicle (M151) will be moving at not more than 15 miles per hour and a radio transmission alerting the team will be received initiating the drill. After a safe stop, the team dismounts and proceeds to assigned positions on sides of trailer and, working together, readies the Stinger for engaging and firing at detected and identified threat aircraft. This drill must be performed under a non-MOPP and MOPP 4 condition during the hours of daylight and darkness and under all weather conditions in which threat aircraft may be launched against assets being protected.

**TASK:** Prepare for engagement from a mounted position.

**CONDITIONS:** Given a MANPAD team seated in an M151 truck, traveling at a speed not more than 15 miles per hour, weapons in the ready-rack configuration. Team has just received an aircraft alert warning. Task may be performed under any weather condition in a non-MOPP/MOPP 4 environment.

**TNG/EVAL STANDARD(S):** Team will properly prepare for engagement from a mounted position within 10 seconds in a non-MOPP environment and within 15 seconds in a MOPP 4 environment with no safety/equipment violations. Team will implement target engagement procedures using proper voice commands and engagement procedures in a non-MOPP or MOPP 4 environment.

**REFERENCE:** FM 44-18-1

## PREPARATION FOR ENGAGEMENT FROM MOUNTED POSITION CREW DRILL

### TEAM CHIEF

1. Receives alert radio transmission. Stops vehicle.
2. Dismounts from vehicle and moves to his side of trailer.
3. Unlatches harness on his side.
4. Opens WRC and removes weapon-round. (Does not ready weapon for firing.)
5. Orients gunner toward the direction of the threat and calls out, SEARCH.
6. Moves next to gunner. (Places his weapon-round on the ground.)
7. Assists gunner in searching for aircraft until detection is accomplished.
8. Visually detects aircraft and orients gunner to target.
9. Determines aircraft category and announces to the gunner (jet, propeller, helicopter).
12. Commands, ACTIVATE, when aircraft enters defended area.
13. Positively identifies aircraft as hostile.
14. Commands, ENGAGE.

Note: The command ENGAGE may be given at any time after positive identification (ID) has been made.

### GUNNER

2. Dismounts from vehicle and moves to his side of trailer.
3. Unlatches harness on his side.
4. Opens WRC and removes weapon-round.
5. Readies the weapon round while moving to a safe firing position (minimum of 5 paces from the right side of trailer). (IFF cable will not be connected while on the move.)
6. Orients toward the direction of approach of the threat aircraft and begins searching for aircraft.
7. Calls out, READY. (Timed portion of drill stops here.)
8. Points weapon at target, oversights, then places target in the center of the range ring.
9. Issues IFF challenge and announces, IFF UNKNOWN.
10. Determines target direction (crossing, incoming, outgoing).
11. Announces, TARGET CROSSING, INCOMING, or OUTGOING.
12. Activates upon command by team chief.
14. Acquires IR tone.
15. Presses and holds UNCAGE switch.



**PREPARATION FOR ENGAGEMENT FROM MOUNTED POSITION CREW DRILL—CONTINUED**

TEAM CHIEF	GUNNER
18. Assesses target kill.	16. Inserts proper superelevation and lead.
19. Picks up, shoulders, and readies his weapon for firing.	17. Squeezes and holds firing trigger.
	18. Continues to track the target, holding trigger and UNCAGE switch for 3 to 5 seconds.
	19. Removes BCU within 3 minutes.
	20. Removes gripstock and discards expended launch tube.

**PREPARATION FOR ENGAGEMENT FROM FOOT-MARCH POSITION**

This drill will be performed by a MANPAD team from a march column while wearing full field equipment. The gunner and team chief are each carrying a Stinger weapon. The team chief carries a radio through which an alert may be received or an alert may be given by hand and arm signal or by verbal signal. Once weapons are unslung, safety procedures are adhered to and weapons readied for engagement as expeditiously as possible. Drill will be performed in a non-MOPP and MOPP 4 environment, during the hours of daylight and darkness, and under all weather conditions in which threat aircraft may be launched against assets being protected.

**TASK:** Prepare for Engagement from a Foot-March Position.

**CONDITIONS:** Given a MANPAD team with full field equipment, MANPAD weapon

at sling arms with BCUs installed, moving on foot in a march column. Team has been alerted to an aircraft attack. Task may be performed in any weather conditions in a non-MOPP/MOPP 4 environment.

**TNG/EVAL STANDARD(S):** Team will safely and properly prepare for engagement from a foot-march position within 15 seconds in a non-MOPP environment and within 25 seconds in a MOPP 4 environment with no safety\equipment violations. Team will implement target engagement procedures using proper voice commands and engagement procedures in a non-MOPP or MOPP 4 environment.

**REFERENCE:** FM 44-18-1

Note: Safe engagement position is minimal 50 meters from other personnel/equipment.

## PREPARATION FOR ENGAGEMENT FROM FOOT-MARCH POSITION CREW DRILL

### TEAM CHIEF

1. Receives alert warning; follows gunner to firing position.

2. Orients gunner to threat direction, calls out, SEARCH.

3. Assists gunner in searching and detection of aircraft.

4. Visually detects aircraft category and announces to gunner.

5. Determines aircraft category and announces to gunner.

8. Commands, ACTIVATE, when aircraft enters defended area.

9. Positively identifies aircraft as hostile.

10. Commands, ENGAGE.

Note: The command to engage may be given at any time after positive ID has been made.

14. Assesses target kill.

15. Picks up, shoulders, and readies his weapon for firing.

### GUNNER

1. Receives the alert warning; unslings and shoulders weapon; readies weapon while moving to a firing position (at least 50 meters from other personnel). (IFF cable will not be connected while gunner is moving.)

2. Begins searching for targets.

3. Calls out, READY. (Timed portion of drill stops here.)

4. Points weapon at target, oversights, then places target in the center of the range ring.

5. Issues IFF challenge and announces, IFF UNKNOWN.

6. Determines target direction (crossing, incoming, outgoing).

7. Announces, TARGET CROSSING, INCOMING, OUTGOING.

8. Activates upon command by team chief.

10. Acquires IR tone.

11. Presses and holds UNCAGE switch.

12. Insert proper superelevation and lead.

13. Squeezes and holds firing trigger.

14. Continues to track the target, holding trigger and UNCAGE switch 3 to 5 seconds.

15. Removes BCU within 3 minutes.

16. Removes gripstock and discards expended launch tube.

## PREPARATION FOR ENGAGEMENT FROM FOXHOLE POSITION

This drill is performed after the MANPAD team has had time to improve defensive positions and foxholes have been dug. Team members will be in foxholes and weapons will be set on the ground close by in ready-to-fire condition. Once initiating alert has been received by team members, they immediately climb out of foxholes and prepare their weapons to engage threat aircraft. This drill will be performed in a non-MOPP and MOPP 4 environment, during the hours of daylight and darkness, and under all weather conditions in which threat aircraft may be launched against assets being protected.

**TASK:** Prepare for engagement from a foxhole position.

**CONDITIONS:** Given a MANPAD team situated in individual foxholes with full field equipment, MANPAD weapons lying on the

ground beside foxholes, and with BCUs installed. Task may be performed in any weather conditions in a non-MOPP/MOPP 4 environment.

**TNG/EVAL STANDARD(S):** Team will safely and properly prepare for engagement from a foxhole position within 10 seconds in a non-MOPP environment and within 15 seconds in a MOPP 4 environment with no safety/equipment violations. Team will implement target engagement procedures using proper voice commands and engagement procedures in a non-MOPP or MOPP 4 environment.

**REFERENCE:** FM 44-18-1

Note: Safe engagement position is minimal 50 meters from other personnel/equipment.

### PREPARATION FOR ENGAGEMENT FROM FOXHOLE POSITION CREW DRILL

#### TEAM CHIEF

1. Moves out of foxhole; moves to gunner's firing position; lays weapon on ground.
2. Orients gunner to threat approach.
3. Assists gunner in searching for aircraft until detection is accomplished.
4. Visually detects aircraft and orients gunner to target.
5. Determines aircraft category and announces to gunner.

#### GUNNER

1. Receives alert warning, moves out of foxhole; shoulders and readies weapon while moving to a safe firing position (a minimum of 5 paces from foxhole).
2. Searches for targets as directed by team chief.
3. Calls out, READY. (Timed portion of drill stops here.)
4. Points weapon at target, oversights, then places target in the center of the range ring.
5. Issues IFF challenge and announces, IFF UNKNOWN.
6. Determines target direction (crossing, incoming, outgoing).

**PREPARATION FOR ENGAGEMENT FROM  
FOXHOLE POSITION CREW DRILL—CONTINUED**

**TEAM CHIEF**

**GUNNER**

8. Commands, **ACTIVATE**, when aircraft enters defended area.

9. Positively identifies aircraft as hostile, for firing.

10. Commands, **ENGAGE**.

Note: The command **ENGAGE** may be given at any time after positive ID has been made.

13. Assesses target kill.

14. Picks up, shoulders, and readies his weapon for firing.

7. Announces, **TARGET CROSSING**, **INCOMING**, or **OUTGOING**.

8. Activates upon command by team chief.

9. Acquires IR tone.

10. Presses and holds **UNCAGE** switch.

11. Inserts proper superelevation and lead.

12. Squeezes and holds firing trigger.

13. Continues to track the target, holding trigger and **UNCAGE** switch for 3 to 5 seconds.

14. Removes **BCU** within 3 minutes.

15. Removes gripstock and discards expended launch tube.

## APPENDIX E

### Emergency Warning Signals

Air attacks will be swift and often unexpected. Therefore, early warning of a probable attack is necessary to give troops a chance to take cover. This warning may be passed through normal command channels, given by local observation posts (OP), MANPAD teams, or air sentries. All OPs should have air watch included in their duties, and alertness for enemy aircraft required as part of normal observation. They will not always have a good view of the air around them, in which case a special air guard must be detailed. All vehicles should have an air guard detailed. High-speed, low-flying aircraft are difficult to detect. Hostile, low-flying aircraft may appear suddenly from behind low hills, belts of trees, or haze. To gain surprise, they will try to attack you with the sun behind them.

#### WARNING ALARM

The warning alarm must be given immediately if troops working in the open are to have any chance of taking cover. This warning is the responsibility of every man in the area and will be passed by whistle, voice, radio, or any other method. The whistle sig-

nal is a series of long blasts. When the alarm is given, all troops except those in close contact with the enemy must immediately take cover, if possible, below ground level, and remain there until the all clear is given.

#### EVASIVE ACTION

Evasive maneuver is the initial reaction of mounted units under air attack. Each vehicle turns away from an airplane's axis of

attack and seeks cover and concealment. They then fire at the attacking aircraft, as appropriate.

#### EMERGENCY WARNINGS

To provide a standard method of disseminating emergency warnings within NATO forces operating on land, the United States Armed Forces have concurred in the provisions of STANAG 2047 (Emergency Alarms of Hazard or Attack). Pertinent extracts from STANAG 2047 suitable for use by MANPAD team personnel are listed in the following illustration.

CONTENTS	
	Page
Warning Alarm . . . . .	E-1
Evasive Action . . . . .	E-1
Emergency Warnings . . . . .	E-1

**EMERGENCY ALARMS OF HAZARD OR ATTACK**

TYPES OF HAZARDS	VISUAL WARNING SIGN	AUDIBLE ALARM SIGNAL
Imminent Air Attack	Red Preferably square in shape.	(1) Unbroken warbling siren for 1 minute.  (2) Succession of long blasts on vehicle horns, whistles, bugles or other wind instruments in a ratio of 3:1; approximately 3 seconds on and 1 second off.  (3) Vocal "Air Attack", or corresponding national term where only one nation is involved.
Imminent arrival of, or presence of chemical or biological agents, or radiological hazards.	(1) Black Preferably triangular in shape.  (2) Donning masks and taking protective action followed by such hand signals as may be prescribed in local SOP. (See Notes 1, 2, and 3).	(1) Interrupted warbling sound on a siren.  (2) Succession of short signals on vehicle or other horns or by beating metal objects in a ratio of 1:1; approximately 1 second off.  (3) Vocal "Gas, gas, gas" or corresponding national term where only one nation is involved.  (4) Vocal "Fallout, fallout, fallout" or corresponding national term where only one nation is involved.
All Clear	Removal of appropriate warning sign.	(1) Vocal "all clear (specify type of attack)" or corresponding national term when only one nation is involved.  (2) Steady siren note for one minute or sustained blast on a vehicle horn, whistle, bugle or other wind instrument to indicate absence of all NBC and air attack hazards.

Notes:

1. If an air or ground attack is determined to be a NBC hazard, the appropriate NBC hazard alarm should replace or immediately follow the air or ground attack alarm, as appropriate.
2. The spoken word (vocal alarm) remains the most effective means of informing troops in an emergency.

## APPENDIX F

### MANPAD in an NBC Environment

All NBC weapons have an inherent residual effect that presents a hazard to both enemy and friendly forces. Nuclear bursts create local contamination of an area around ground zero and may produce radioactive fallout which can contaminate thousands of square kilometers. Some chemical and biological weapons create airborne hazards which can be carried downwind for long distances while others can contaminate terrain with long-term effectiveness. Areas affected by airborne residual effects are determined primarily by the speed and direction of the wind in the target area and the persistency of the weapon used.

### OPERATING IN A NUCLEAR ENVIRONMENT

No treaty or international agreement prohibits the use of nuclear weapons in warfare. An enemy might use such weapons from the start, or he might attack in a conventional manner first, and use nuclear weapons later on. Threat forces have nuclear weapons and, if they are employed, you must be prepared to fight on a nuclear battlefield.

#### NUCLEAR WARFARE

Threat forces plan for the use of nuclear weapons in both offensive and defensive operations. Nuclear attacks are combined with conventional fires and air attacks, and are exploited rapidly by ground forces. Nuclear weapons can also be used with chemical and biological weapons.

Threat nuclear tactics in the offense and defense will be similar to his conventional tactics. The threat will try to overwhelm the defense with the weight and speed of his attack, both by day and by night. To reduce the risk of open flanks, threat forces will use nuclear weapons to neutralize the terrain

dominating his advance. To avoid presenting worthwhile nuclear targets, he will disperse his forces. Concentration of his forces will only be for short periods of time and only when necessary. He may close with the defender not only to destroy him, but also to insure that the defender cannot use nuclear weapons without endangering his own forces.

The following are primary nuclear targets for threat attacks:

- Committed enemy units and reserves.
- Enemy nuclear systems and field artillery.
- ADA.
- Selected command and control elements.

#### CONTENTS

	Page
Operating in a Nuclear Environment . . . . .	F-1
Operating in Biological and Chemical Environments . . . . .	F-10
NBC Alarms, Emergency Reports, and Warning Signs . . . . .	F-24

MANPAD teams will fight in a nuclear environment essentially the same as in a conventional environment. Combat service support and communications may be disrupted more than in a conventional environment. Teams may also be isolated for extended periods of time. Otherwise, conventional MANPAD tactics are unchanged for use in a nuclear environment.

### **NUCLEAR WEAPONS EFFECTS**

Even when used in low yields, nuclear weapons can quickly and decisively change combat power ratios and the course of a battle. Yield is a term that refers to the energy released when a nuclear weapon explodes. It is measured in terms of kilotons (KT) or megatons (MT) of TNT needed to produce the same effect. One KT equals 2,000,000 pounds of TNT and 1 MT equals 2,000,000,000 pounds of TNT.

A 1-KT nuclear weapon has about the same killing power against troops in the open as a single volley of improved conventional munitions from seven artillery battalions. However, the 1-KT weapon is much more effective against troops in individual fighting positions or Chaparrals, as compared to the artillery option. In this case, the 1-KT weapon has 20 to 30 times the lethal area coverage of the same artillery volley.

How do nuclear weapons achieve such tremendous killing power? Casualties and damage to equipment are caused by one or more of the various nuclear effects resulting from the nuclear burst.

#### **Blast**

At a fraction of a second after nuclear detonation, a high-pressure wave develops and moves outward from the fireball. This blast wave is the cause of most destruction from a nuclear burst. The front of the wave travels quickly away from the fireball, acting like a moving wall of highly compressed air.

After the burst, when the fireball is no longer visible, the blast wave is still moving faster than the speed of sound. Strong winds are associated with the blast wave. These winds can have peak velocities of several hundred miles per hour. The overpressure (pressure more than normal air pressure) and the winds are the major causes of blast damage. The crushing overpressure can cause death or injury to personnel and damage to equipment. The high-speed winds can pick up and throw objects such as tree limbs, people, and debris, turning them into lethal missiles.

#### **Thermal Radiation — Heat**

Less than a millionth of a second after burst, extreme heat generated by the nuclear fission/fusion process forms the fireball; a hot, bright, round mass of air and nuclear residue. To an observer 80 kilometers away, the fireball would seem many times brighter than the sun at noon. The heat radiated from the fireball adds to the damage of the nuclear burst by starting fires in buildings, forests, and fields.

These fires spread quickly among the debris produced by the blast. At distances from ground zero where blast and nuclear radiation are minor, the heat from the fireball can still burn exposed skin. This distance, however, is highly dependent on terrain and weather.

#### **Thermal Radiation — Light**

The fireball is also a source of extremely bright light. This light can cause temporary blindness. At night, temporary loss of vision will last for longer periods. Persons looking directly at the fireball will likely suffer permanent blindness. This is caused by burns within the eye itself. The distance at which thermal radiation can cause burns is dependent on the terrain, weather, yield, and type of burst (that is, surface, low burst).

**Nuclear Radiation — Initial**  
Initial nuclear radiation is that emitted



## NUCLEAR WEAPONS EFFECTS

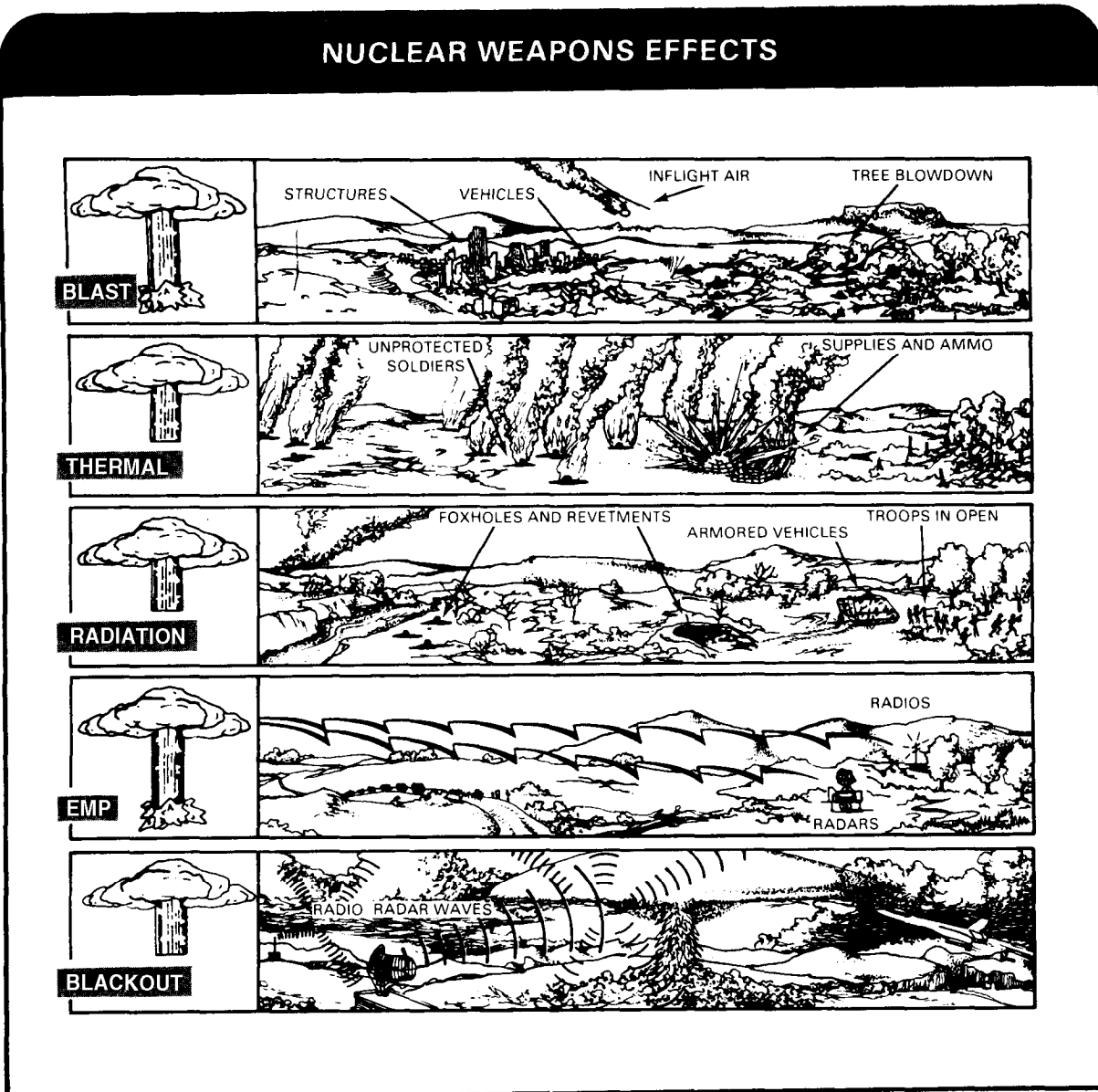

within the first minute after burst. It primarily consists of neutrons and gamma rays.

Initial radiation is very hard to protect against. This is because personnel may receive lethal or incapacitating doses before they can take any protective actions. Initial radiation effects depend on the amount (dose) of radiation received. The term centigray

(cGy) or rad is used to express radiation dose levels. For example, an active soldier suddenly exposed to 650 rads will at first show no symptoms, but will lose some of his effectiveness in about 2 hours. He may die in a few weeks. Conversely, exposure in the 100 cGy (rads) region has little effect. Other radiation effects based on cGy dose levels are shown in the table on the next page.

**INITIAL RADIATION EFFECTS**

DOSE IN cGy (rads)	EARLY SYMPTOMS*	PERSONNEL EFFECTIVENESS	FATALITIES
0 to 70	Less than 5% of personnel will show symptoms.	Full.	None.
150	About 5% in 6 hours.	Reduced effectiveness. depending on task. Completely ineffective if hospitalized.	None.
650	Within 2 hours.	Symptoms continue off and on for next few days. Effectiveness reduced significantly for 2d to 6th day. Hospitalization required.	More than half at about 16 days.
2,000 to 3,000	Within 5 minutes.	Immediate, temporary incapacitation for 30-40 minutes, followed by a recovery period during which efficiency is impaired.	In about 7 days.
8,00	Within 5 minutes.	Immediate, permanent incapacitation for personnel performing physically hard tasks. No period of latent "recovery."	In 1-2 days.
18,000	Immediate.	Permanent incapacitation regardless of task.	in 24 hours.

\*Symptoms include vomiting, diarrhea, dry heaving, nausea, lethargy, depression, and mental disorientation. At lower dose levels, incapacitation is a simple slowing down of the rate of performance due to a loss of physical mobility and/or mental disorientation. At the high dose levels, shock and coma may be the "early symptoms."

**Nuclear Radiation — Residual**

Residual nuclear radiation occurs after the first minute following a nuclear burst. It can consist of fallout, rainout, washout, or neutron-induced gamma activity. Fallout is the primary residual hazard. It is produced

when material from the earth is drawn into the fireball and vaporized. This material is then combined with nuclear wastes and condensed into particles that fall back to earth. The fallout area can be very small or cover

thousands of square kilometers. The fallout dose rate can vary from a minor level to one extremely dangerous for unprotected personnel.

**Electromagnetic Pulse**

Electromagnetic pulse (EMP) is a short duration radio frequency pulse. It is produced by the release of gamma rays from the nuclear burst. The strength and extent of the EMP field depends on the amount of gamma radiation, burst height, and atmospheric conditions.

EMP does not affect personnel. However, most radio and radar equipment can be damaged by EMP. This is because EMP energy is

higher than the circuit and component capabilities of your equipment. EMP damage can be temporary or permanent. It can range from burned out fuses, transistors, and coils to the destruction of complete power supplies.

The frequencies generated by EMP cover most of the usable frequency band, from extremely low frequencies to super high frequencies. Most EMP energy is in the high frequency (HF) and very high frequency (VHF) range.

Army tactical equipment is divided into four categories based on its vulnerability to EMP. The table below shows the equipment categories and their EMP vulnerabilities.

<b>EQUIPMENT EMP VULNERABILITY CATEGORIES</b>		
<b>EQUIPMENT CATEGORIES</b>	<b>PROBABILITY OF DAMAGE</b>	<b>EQUIPMENT INCLUDED IN CATEGORY</b>
I	Very low	Artillery, tactical equipment (excluding communications equipment).
II	Low	Fire direction control equipment, nuclear warheads, missiles.
III	Medium	Long-range communications equipment (greater than 100 km), air defense radars.
IV	High	Target acquisition radars, short-range communications equipment (less than 100 km), command and control equipment.

**Nuclear Blackout**

Nuclear weapons produce one last phenomena known as nuclear blackout. Nuclear blackout is the result of the blast fireball, itself, and of large dust clouds which may also be created. It can last from a few seconds to many hours, depending on the altitude and yield of the burst, and the frequency of victim equipment.

Nuclear blackout affects radio and radar by—

- Refraction (bending of the waves).
- Absorption (consuming of the waves).
- Scattering (waves scattered in all

directions).

All of the above result in partial or total loss of the information being transmitted.

**PROTECTION AGAINST NUCLEAR EFFECTS**

The nuclear weapon, although tremendously powerful, is not a weapon against which there is no defense. The more you know about nuclear weapons, the more effective you will be on the battlefield. More importantly, the more you know, the greater will be your chances for survival.

The three classes of nuclear protective measures are actions before the attack, during the attack, and after the attack.

### **Protective Actions Before the Attack**

You must do two things to prepare yourself and your equipment for a nuclear attack. First, you must shelter yourself and your equipment. Second, you must further protect your equipment against EMP damage. Remember, the next war may be nuclear, so you must take these precautions when operating on a future battlefield.

The best defense against a nuclear attack is to dig in. Unit defensive positions must be prepared whenever possible. These can vary from individual fighting positions to improved defensive positions. Certain common materials and types of construction provide good shielding against gamma rays and neutrons. They also provide protection against blast and heat.

A well-built fighting position gives good protection against both initial and residual radiation. A deep fighting position gives more protection than a shallow one. A fighting position with overhead cover is even better. This will reduce the amount of thermal and initial radiation that reaches you and will also prevent the entrance of fallout. If you cover your fighting position, make sure that the cover is strong enough to withstand the blast wave.

Tunnels, caves, and storm drains also provide good shelter unless there is a nearby subsurface collapse. Culverts and ditches can be used in an emergency, but they offer only partial protection. Buildings are usually not strong enough to provide effective shelter. However, if you can find the basement of a reinforced concrete or steel-framed building, it will provide good protection against all effects. If you take shelter in a building, avoid the areas around windows and other openings.

Individual clothing, equipment, and other items must be kept in fighting positions, or in a separate covered hole. None of this equipment can be left unsecured because the blast wave will convert it into deadly missiles. Unit supplies, especially explosives and flammables, must be dispersed within the unit area and protected or shielded. Debris must be kept to a minimum and not be allowed to collect where it could catch fire. Objects such as radios, generators, tools, and fuel cans must always be secured to reduce the danger of casualties from flying objects.

Protective measures taken for EMP before a nuclear attack are critical to unit survival. Cables, wires, antenna systems, and all other metal structures are good electrical conductors, and all absorb EMP energy. The term used is "coupling." Material that couples with electromagnetic energy can absorb enough EMP energy to induce voltage and currents. The key to protection is to develop techniques of equipment installation and operation that reduce EMP coupling.

EMP can enter electrical systems through intentional antennas, unintentional antennas, and direct penetration. Intentional antennas are standard radio and radar antennas. Unintentional antennas can be any device (masts, wiring loops, cables) that can act as an antenna even though it is not meant to be one. In direct penetration, internal electronic components act as loop antennas, allowing strong electromagnetic fields to be created inside equipment.

### **Protective Actions During the Attack**

Enemy nuclear attacks can come without warning. Your first indication of an attack will be a very bright flash of light. Heat and initial nuclear radiation arrive with the light and the blast will follow in a few seconds. You will have very little time—protective actions must be automatic and instinctive. Unit activities will be suspended for a short time while all personnel take

## EMP PROTECTIVE MEASURES

### For intentional antennas—

- Disconnect the antenna.
- Use the highest possible frequency and horizontally polarized antennas.
- Disconnect all coax, antennas, power sources, cables, and wires from spare equipment.

### For unintentional antennas—

- Keep cable and wire lengths as short as possible. The amount of energy collected by a cable or wire is directly related to its length.
- Bury all cables and wires at least 18 inches deep.
- Never leave cable or wire that is connected to equipment coiled on a reel. The "coil" will pick up more EMP than a straight cable run.
- Use a common ground for all equipment whenever possible.
- Insure that antenna guy lines are properly insulated.
- Never use commercial sources of power. Studies have shown that commercial power sources are extremely susceptible to EMP.

### For direct penetration—

- Shield all C-E equipment with iron or steel if available; any metal if not.
- Close all inclosure doors, vents, access panels, and ducts. Vents that must remain open during equipment operation should be covered with honeycomb metal screens. Access panels, cabinet walls, inclosure doors, etc., should be lined with aluminum foil.

cover. If you are out in the open when a nuclear burst occurs —

- Immediately drop flat on the ground (face down) or to the bottom of a fighting position. Face away from the fireball. Any depression in the ground will provide you some protection if you can get to it immediately.
- Close your eyes. Protect exposed skin by putting your hands and arms under your body. Keep your helmet on, it will protect you from flying debris.
- Remain down until the blast wave has passed and debris has stopped falling. Stay protected until the negative phase of the blast

wave has also passed. As the blast wave passes a position; there is a resulting decrease in air pressure to a point below normal atmospheric pressure. This, in effect, creates a vacuum. Air will rush in to fill the vacuum, causing high winds from the direction opposite that of the direction of travel of the blast wave.

- Stay calm, check for injury and equipment damage, and prepare to continue your mission.
- Count the number of seconds between the flash of light and bang, if possible, for inclusion in an NBC 1 report.

### Protective Actions After the Attack

After a nuclear attack, secure and organize your equipment, repair and reinforce your position, and help any casualties. To protect yourself against fallout, begin to prepare or improve your position. Designated persons will begin radiological monitoring. When warned of fallout, take cover and remain protected until the fallout has stopped or until you receive further orders.

If nuclear weapons have been used and you have no radiac equipment, you face a very real danger of exposing yourself to radiation without knowing it. If you have seen a nuclear burst, stay away from that area. If you see what looks like sand, dust, or ashes falling from the sky, assume that it is fallout. Find a good shelter or dig in quickly and cover your position and equipment. If dust particles make breathing difficult, a handkerchief or cloth can be worn over your nose and mouth. The M1 7 series protective mask cannot be used as a dust respirator.

When the dust stops falling, scrape or brush the dust away from the edges of your shelter. Stay in your position for at least 24 hours, and then move to a friendly position as fast as possible. If you are separated from your FU, try to rejoin your unit or another friendly unit as soon as possible. Your unit may be ordered to move to a less hazardous area if the radiation dose reaches a dangerous level after fallout is complete. However, movement to another area is never based solely on a fallout prediction, because the exact location of fallout cannot be reliably forecast. If you come upon an area where many trees have been blown down, change your course and stay away from that area. The same is true if you find a large crater or an area of ground which looks glassy. Keep in mind that you cannot tell when you are in a radiologically contaminated area unless you have radiac equipment.

It may be necessary for your unit to enter and/or remain in an area receiving fallout. If

so, quickly dig in, sweep the fallout away from your fighting position, and cover up with your poncho until fallout is complete. The period of time a unit may stay in a contaminated area depends on the total dose of radiation the troops can receive and still remain effective, the intensity of the radiation, and the protection available.

Take remedial actions for nuclear blackout. These actions are extremely limited. However, remember that nuclear blackout only affects certain areas and lasts for only a limited time. For radio blackout—

- Use wire. This may be a simple solution since nuclear blackout does not affect wire systems. However, remember that wire systems are extremely susceptible to EMP.
- Use routing through a manual relay or retransmission station to bypass the affected region.
- Use assigned alternate frequencies. Use higher frequencies if the blackout is caused by ionization. If it appears that dust is the problem, use lower frequencies if other corrective measures do not work.

### FALLOUT PREDICTION

Fallout prediction is used to estimate fallout areas from a nuclear burst before the actual arrival of the fallout. The two types of prediction procedures are: detailed fallout prediction and simplified fallout prediction. A detailed prediction is normally prepared at your major command headquarters. It will be sent to your unit in the NBC 3 report format (see FM 21-40). A simplified fallout prediction is usually prepared at battery level using the M5A2 radiological fallout area predictor (see FM 3-22 and TM 3-6665-304-10). Fallout predictions are used by commanders to—

- Warn or alert subordinate units to expect fallout.
- Aid in tactical planning.

- Plan radiological surveys.

### RADIOLOGICAL MONITORING AND SURVEY

Too much radiation can make you sick or perhaps kill you. You cannot see, feel, taste, smell, or hear radiation, so special instruments must be used to detect it. This is known

as radiological monitoring, and is performed to detect radiation and measure its dose rate. At squad and platoon levels, the IM-174/PD radiacmeter, IM-93/UD dosimeter, radiacmeter IM-185 and radiacmeter IM-185(UD) are used in radiological monitoring shown in the following illustrations.

#### IM-174/PD RADIACMETER

This radiac instrument is used to detect, measure, and display the dose rate of radioactivity in an area. It is a high-range dose rate meter. Gamma radiation readings are indicated in units from 0 to 500 cGy (rads) per hour.

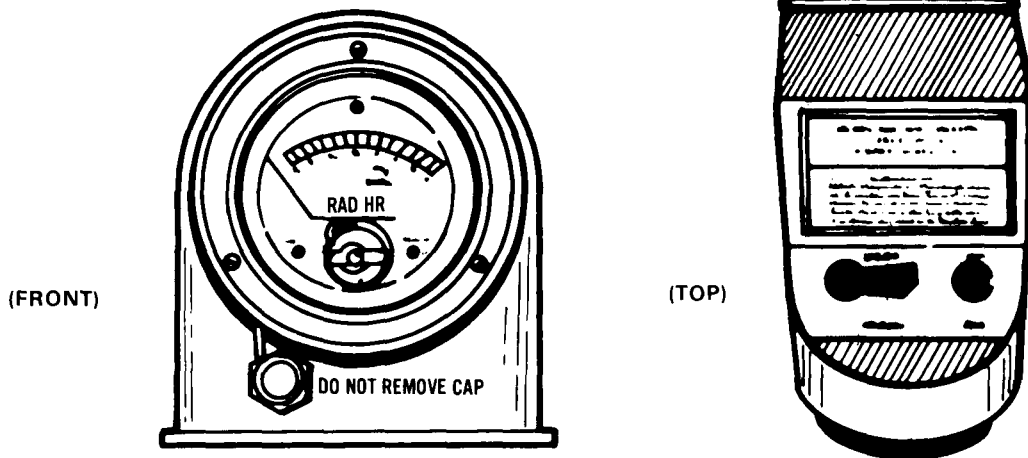

#### IM-93/UD DOSIMETER

This pocket device measures the total nuclear radiation (gamma) dose received by an individual. It must be recharged after not more than 2 or 3 days of use (preferably everyday) and when the total dose reaches or exceeds 500 cGy (rads) on the scale. Recharging times are normally designated in the unit SOP.

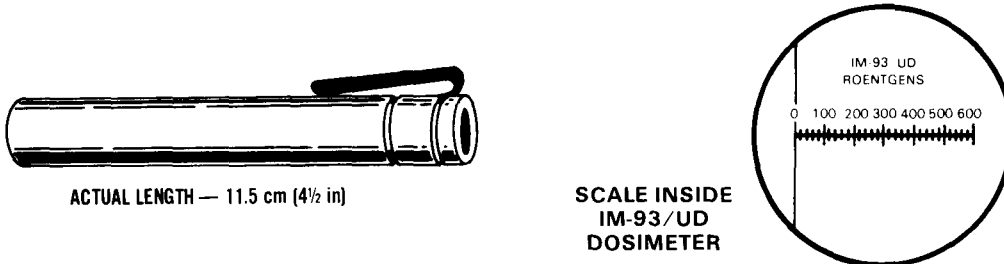

---

## RADIACMETER IM-185

Radiacmeter IM-185()/UD is a pocket size dosimeter for measuring cumulative exposure to x-ray, gamma ray, and neutron radiation. The dosimeter contains a high-vacuum chamber which must be pumped periodically, and an electrometer which must be electrically charged at required intervals. The charger provides the necessary voltage to charge the dosimeter, and provides the proper voltage and magnetic field to operate the dosimeter's internal ion pump. This tactical dosimeter measures prompt gamma and neutron dose as well as residual gamma dose. This item is type classified as standard and will be issued to units in the field.



---

It is the section chief's or team chief's responsibility to have his section or team operating area checked for radiation. Designated team members will use their IM-174/PD radiacmeter to detect any radiation and measure the dose rates. Monitoring techniques, correlation factor data, and recording forms are described in FM 3-12.

### FIRST AID FOR NUCLEAR CASUALTIES

First aid measures for nuclear casualties are limited to those for burns caused by thermal radiation and injuries caused by the blast wave. There are no immediate life-saving measures for radiation sickness or

blindness. Detailed procedures for the first aid treatment of specific types of injuries are given in FM 21-11.

### EQUIPMENT DECONTAMINATION

Nuclear fallout is a solid material and is not absorbed by equipment. The most rapid method of decontaminating vehicles, weapons, and other equipment is by brushing off the loose particles and then washing them off. Vehicles can be washed with steam or water and scrubbed with detergent. Decontamination stations may also be made available at battery or battalion level for mass decontamination of vehicles.

## OPERATING IN BIOLOGICAL AND CHEMICAL ENVIRONMENTS

The threat is the best-equipped, best trained, and most heavily armed force in the world in terms of chemical warfare. It is fully capable of producing and employing biological agents on a massive scale. Threat forces can operate either in toxic areas imposed on them or to exploit their own use of chemical agents. Their troops train and equip for

chemical warfare as if it were inevitable — so must you!

### BIOLOGICAL AND CHEMICAL WARFARE

Threat doctrine describes chemical agents as "weapons of mass destruction"



and treats their use as a basic part of warfare. It emphasizes the use of chemical weapons in close coordination with conventional and nuclear weapons.

The threat will use chemical strikes to paralyze our defensive capacity and logistic support. Specific areas may be attacked to the point of saturation. Likely targets probably will include artillery and ADA units, troops in reserve, airfields, and supply depots. In order to maintain their high-speed advance, threat forces will attempt to bypass or cross contaminated areas in sealed tanks and personnel carriers.





**PROTECTION AGAINST BIOLOGICAL AND CHEMICAL AGENT EFFECTS.**

Protective actions against biological and chemical agents depend on the threat, mission, situation, and weather. As with nuclear protective actions, chemical and biological protective actions fall into three categories: actions before the attack, during the attack, and after the attack.

**Protective Actions Before the Attack**

A mission-oriented protective posture (MOPP) is designated for your unit by your commander for combat situations. The MOPP balances mission requirements against chemical protection requirements and other factors such as temperature and work rate. Essentially, the four levels of MOPP tell you how prepared you must be for a chemical attack. However, if your unit is attacked with chemical agents without warning, go immediately to the highest state of preparedness (MOPP 4).

Based on the MOPP, you will be directed to wear protective clothing and equipment as shown in the illustration. Heavy work rate activities while wearing protective clothing should be done in the coolest part of the day. The protective clothing and equipment include the M17-series protective mask and protective clothing.

<b>MOPP PROTECTIVE CLOTHING</b>			
			
<b>MOPP LEVEL 1</b>			
<b>OVERGARMENT</b>	<b>Worn*</b>		
<b>OVERBOOTS</b>	<b>Carried</b>		
<b>MASK/HOOD</b>	<b>Carried</b>		
<b>GLOVES</b>	<b>Carried</b>		
			
<b>MOPP LEVEL 2</b>			
<b>OVERGARMENT</b>	<b>Worn*</b>		
<b>OVERBOOTS</b>	<b>Worn</b>		
<b>MASK/HOOD</b>	<b>Carried</b>		
<b>GLOVES</b>	<b>Carried</b>		
			
<b>MOPP LEVEL 3</b>			
<b>OVERGARMENT</b>	<b>Worn*</b>		
<b>OVERBOOTS</b>	<b>Worn</b>		
<b>MASK/HOOD</b>	<b>Worn*</b>		
<b>GLOVES</b>	<b>Carried</b>		
			
<b>MOPP LEVEL 4</b>			
<b>OVERGARMENT</b>	<b>Worn Closed</b>		
<b>OVERBOOTS</b>	<b>Worn</b>		
<b>MASK/HOOD</b>	<b>Worn Closed</b>		
<b>GLOVES</b>	<b>Worn</b>		
<b>*Worn open or closed based on temperature.</b>			

The M17-series protective mask, when properly fitted and worn with the hood, gives protection against all known enemy chemical agents. It also provides protection against

biological agents. Accessories and components provided for use with the mask include those items shown in the following illustration.



Chemical protective clothing is available for wear in different weather conditions and for special purposes. In addition to the M17-series protective mask, MANPAD personnel will normally be issued a chemical overgarment, protective gloves, and overboots.

Even in a full MOPP status you must remain alert and constantly aware of the chemical threat. You must know your unit's chemical alarm and signals and how to react to have the most protection.

Your equipment and supplies must be protected against liquid agents. Keep them organized and covered. Fighting position covers, brush, ponchos, shelter halves, or any other material can be used for this. Wear full protective clothing when sleeping and cover yourself and your equipment before going to sleep.

Have an alert and questioning attitude toward any indication of biological attack. Although respect for biological agents is

important, don't have an unreasonable fear of disease. Don't repeat or exaggerate rumors about biological warfare. Observe the following preventive measures to reduce the effects of potential exposure to biological agents:

- Practice good hygiene.
- Clean all wounds and cuts well.
- Keep your immunization shots up-to-date.

### Protective Action During the Attack

Whenever you recognize or are alerted to a chemical or biological attack—

- (If not already wearing MOPP level 4 clothing) hold your breath, put on your protective mask.
- Give the alarm (per SOP), put on your protective clothing.
- Continue your mission.
- Keep all protective clothing buttoned up and wear your mask until the ALL CLEAR signal is given.

In addition if—

- The situation permits, take cover.
- Symptoms of nerve agent poisoning appear, use your Mark 1 nerve agent antidote against it. These kits are used for nerve agent first aid. The individual soldier will carry three of them in his protective mask carrier. However, in very cold weather, the injectors must be carried inside your clothing to prevent them from freezing.
- Your skin becomes contaminated, use the individual decontamination kit M258A1. The M258A1 allows you to decontaminate your skin and selected personal equipment. Do not use the M258A1 on your protective overgarments.
- Your eyes are contaminated, flush them with water from your canteen.
- The attack is a spray attack, protect your body and equipment with a poncho, shelter half, or any other covering material.
- The agent is identified, follow other first aid and decontamination actions prescribed for the type of agent used.



### Protective Actions After the Attack

After the attack, remain masked and continue your mission. Give first aid to any casualties in your immediate area and report to your immediate supervisor. If exposed skin was contaminated, decontaminate it immediately.

As time permits, check your clothing and equipment for possible contamination, and decontaminate equipment and reimpregnate clothing as required.

Do not unmask after an attack until authorized by your commander. If no leader is present, follow the unmasking procedures in your SOP. These will include the use of a chemical agent detector kit and will also be applicable to situations where no such kit is available.

### **BIOLOGICAL AGENTS AND THEIR EFFECTS**

Biological agents are microorganisms that cause disease among personnel, animals and plants. To a lesser extent, they can also cause deterioration of material. It is not necessary for biological agents to kill to be effective. Their purpose may only be to reduce the ability of enemy forces to fight. This can be done by killing or incapacitating troops and by causing food or supply shortage.

Biological agents consist of groups of living microorganisms such as rickettsia, protozoa, and viruses. Most are easily destroyed by sunlight or weather within hours, but some can remain inactive for longer periods of time. Most enemy biological agents are disseminated in aerosol form. This allows them to be spread rapidly by the wind. Others are transmitted by insects (vectors) such as mosquitoes and ticks.

Toxins are also considered in the class of biological agents. These can be derived from plants, animals or bacteria. The "Yellow Rain" toxins which witnesses and victims described as toxic rain (because the agent was released from aircraft as yellow powder or liquid) used in Southeast and Southwest Asia consisted of a mixture of toxins belonging to the tricothecene mycotoxins family. The tricothecene mycotoxins are found under certain conditions in cereal grain. There are also neurotoxins such as botulinum toxin which is occasionally found in food poisoning. Depending on the type of toxin, concentration, and exposure, toxins can be used as lethal agents or incapacitants. Some of the

neurotoxins are several thousand times more lethal than CW nerve agents, such as GB. Most toxins are easily stored, stable for long periods of time, and remain effective after dissemination. The symptoms associated with the tricothecene-type toxins include any or all of the following: dizziness, severe itching or tingling of the skin, formation of multiple small, hard blisters, nausea, coughing up blood, shock, and death. Some toxins cause complete incapacitation due to nausea and vomiting, while others such as neurotoxins can kill within less than a minute. See FM 21-40 or FM 3-100 for further details regarding toxins.

The effects of biological agents are generally the same as for the diseases they are associated with, such as typhoid or influenza. These effects can be minor, such as a common cold; or prolonged illnesses which can result in death, such as plague. TM 3-216 contains complete descriptions of diseases that can be produced by possible biological agents.

### **BIOLOGICAL AGENT DETECTION**

Biological attacks are difficult to recognize. However, they can be detected by alert troops and the intelligence sources of major commands. Since sunlight reduces the effects of biological agents, the most likely time for a biological attack is in the evening and early morning hours. Cloudy and foggy days are also ideal for launching biological attacks.

The means of delivering biological agents can signal an attack. The appearance of seemingly ineffectual explosive bomblets and missiles; aircraft with spray tanks; and generators may signal a biological attack. An abnormal number of vectors, such as mosquitoes, flies, mites, ticks, and lice may also be carrying the agents. On the other hand, other subtler measures such as using enemy infiltrators to contaminate water and food supplies may escape early detection. The following illustration shows some of the alerting signs that could signal a biological attack.

## BIOLOGICAL AGENT ALERTING SIGNS

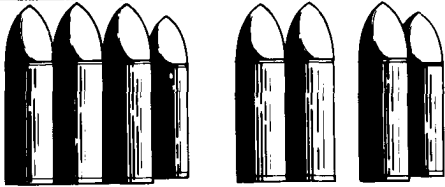

**SHELLS** - that explode less powerfully than HE rounds.

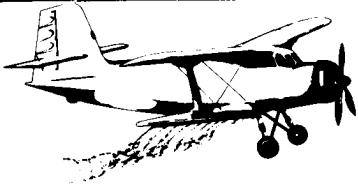

**AIRCRAFT SPRAYING** - a mist or fog.



**VECTORS** - insects that are new in your area, or large swarms of insects.

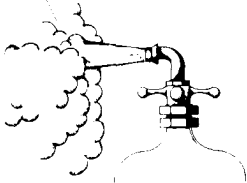

**AERIAL BOMBS** - bombs or containers that contain bomblets pop rather than explode and cause only minor damage.

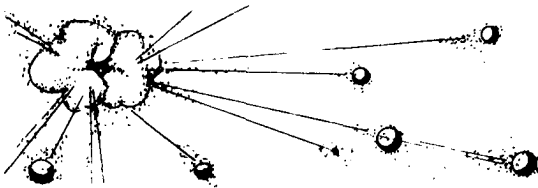

**AEROSOL GENERATORS** - any kind of device that is spraying a mist or fog.

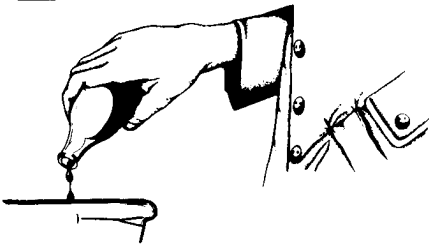

**MISCELLANEOUS** - many people sick for no known reason.

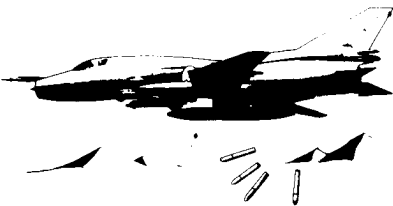

**GUIDED MISSILES AND ROCKETS** - bomblets that seem to have little immediate effect.

## CHEMICAL AGENTS AND THEIR EFFECTS

If a biological attack is detected, stay masked and buttoned up in your protective clothing. Drink and eat only from sealed containers. "Yellow rain" or other types of toxins cannot be detected by standard CW detection devices. Individual defense measures normally associated with a persistent chemical agent attack will protect personnel against toxins; that is, the wearing of the protective mask with hood, overgarment, gloves, and booties and implementation of MOPP. Upon recognition of an attack or onset of symptoms, personnel should immediately mask and put on all protective equipment (MOPP 4).

Chemical agents are used to kill, injure, or incapacitate personnel. The effects produced by these agents are dose-dependent. This means that increased doses produce a corresponding increase in the severity of the effects.

Through the use of various delivery systems, threat forces can initiate and sustain large-scale chemical warfare operations. They can deliver this chemical ordnance in a variety of ways, from mines and grenades to using tactical aircraft. The following illustration presents some of these delivery means.

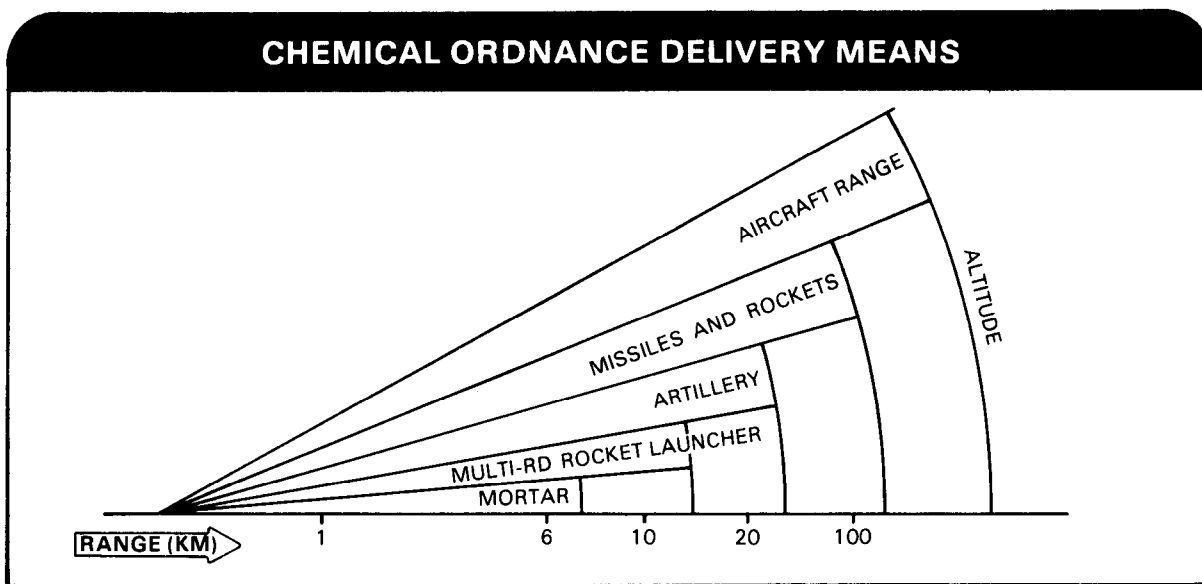

If a chemical agent is detected, perform the following procedures as quickly as possible:

- Stop breathing.
- Put on your protective mask.
- Clear and check your mask.
- Resume normal breathing.
- Sound the NBC alarm (per SOP).
- Put on your protective clothing.
- Remove your mask only after an ALL CLEAR signal is given and you are ordered by appropriate authority to remove it.

Other actions will vary with the chemical agent being used. The four types of chemical agents and their corresponding first aid measures are described in the following paragraphs. Detailed techniques for chemical agent first aid are listed in FM 21-11.

### Nerve Agents

Nerve agents directly affect the nervous system and are highly toxic in both liquid and vapor form. Nerve agent vapor is readily absorbed by the eyes and by tissues in the nose, throat, and lungs. The liquid readily penetrates the skin, eyes, and tissues of the body. Its effects are similar whether inhaled or absorbed.

The following are symptoms of nerve agent exposure:

- Tightness of the chest and difficult breathing.
- Excessive sweating and drooling.
- Nausea, stomach cramps, and vomiting.
- Dimness of vision and pinpointing of the pupils of the eyes.
- Convulsions and death.
- Unexplained runny nose.
- Sudden headache.
- Localized twitching in an area of exposed/contaminated skin.

Most nerve agents are quick acting when inhaled with some symptoms developing in 1 to 2 minutes. They act quicker when absorbed through damaged skin. When the eyes are exposed to nerve agent vapor, the pupils will become pinpointed. However, this pinpointing may not occur for 10 minutes or longer if exposure was to a low concentration vapor. When only the skin is exposed to liquid nerve agent, the pupils may remain normal or be only slightly reduced in size. The casualties caused by nerve agents can range from mild disability to death. This will depend on the dose received and the adequacy and speed of first aid treatment.

If you or one of your buddies experience any or all of the mild symptoms of nerve agent poisoning, you must perform first aid measures immediately.

*Self aid.* Immediately put on the protective mask. Remove a nerve agent antidote kit Mark I from the protective mask carrier and inject yourself in the thigh with the two injectors from the kit. Use the small injector first. Hold the injector against the thigh for at least 10 seconds. Follow this procedure with the second injector (large auto-injector) on the other thigh. Remove the injectors and place each injector needle through the pocket flap of the overgarment and bend the needle to form a hook. Massage the area of injection if time permits. If you experience dryness in the mouth and a rapid heartbeat in about 5 minutes after injecting a set, you have received enough antidote. However, if symptoms of nerve agent poisoning persist or recur after 10-15 minutes, you may inject another set of auto-injectors from the Mark I nerve agent antidote kit. The maximum number of sets you may administer to yourself is three. The administration of more than three sets must be authorized by medical support personnel.

*Buddy aid.* If an individual experiences severe symptoms after nerve agent poisoning and is unable to treat himself, another soldier will be required to perform buddy aid measures. If your buddy experiences nerve agent poisoning, mask him. Using the victim's nerve agent antidote kits Mark I, administer three sets immediately and in rapid succession in the thigh muscles of the legs. Hook the expended auto-injectors to his overgarment pocket flap. Administer the back pressure arm lift method of artificial respiration if breathing is difficult or has ceased. Seek medical attention for the casualty.

### Blister Agents

Blister agents come in liquid or vapor form. They may appear as colorless or dark brown oily droplets. The agents are effective even in small amounts and produce delayed effects. For example, a pinhead-size drop of

mustard agent (one of the most common types of blister agents) can produce a blister 1 inch in diameter. The effects are often more serious than what is first seen. Exposure to some agents may go unnoticed because they usually do not cause immediate pain or signs of injury. Unprotected troops exposed to low vapor concentrations for long periods of time can eventually become casualties.

Primarily, blister agents affect the eyes and lungs and blister the skin. However, they can burn or blister any part of the body they contact. The degree of this effect depends on the type and concentration of the agent, the victim's activity, and the exposure time. Some types of blister agents are painless, others sting, and still others cause burning welts.

Blister agents which come in direct contact with the eyes will produce marked effects such as redness, inflammation, and temporary or permanent blindness.

They are quickly absorbed through the skin. The affected area may redden anytime up to 12 hours after exposure, depending on the concentration and weather conditions. Blisters may appear in a day or less following the reddening. Healing time varies from 6 days to as much as weeks in severe cases, particularly those involving moist skin areas, such as the crotch and armpits.

Inhalation of blister agents will cause serious damage to tissues in the mouth, nose, throat, and lungs.

The main danger from blisters is infection. If a blister agent has come into contact with your eyes, flush your eyes immediately with water. Decontaminate any agent on your skin using the M258A1 decontamination kit (described later in this chapter) or by using soap and water.

### **Blood Agents**

Blood agents come in vapor (gas) form.

Individual reactions to these agents are headache, dizziness, pink skin color, eye and nose irritation, nausea, convulsions, slow or rapid breathing, rapid heartbeat, and coma.

If the symptoms of blood agent poisoning appear, you should immediately crush two amyl nitrite ampules and place them inside the face piece of the mask, next to the eyes. Repeat this every 4 to 5 minutes until normal breathing returns, or a total of eight ampules have been used. Medical personnel must approve the use of more than eight ampules. Artificial respiration may be necessary in some cases.

### **Choking Agents**

Choking agents are usually disseminated as gases and are taken into the body by breathing. The victim usually feels no initial effects from choking agents. Delayed effects usually occur 2 to 4 hours after exposure.

Choking agents affect the respiratory system by damaging the lungs and, in severe cases, causing the lungs to fill with fluid. This causes a victim to literally drown in his own fluids. Other symptoms include the following:

- Rapid and shallow breathing.
- Painful coughing and choking.
- Tightness in the chest.
- Nausea and headache.
- Watering of the eyes.
- Discomfort and fatigue.
- Shock and death.

If the symptoms for a choking agent develop, let another crew member or buddy know. Take cover and keep warm. Move only if absolutely necessary and await medical attention.



MAJOR CHEMICAL AGENTS					
TYPE OF AGENT	HOW NORMALLY DISSEMINATED	MEANS OF DETECTION	SYMPTOMS IN MAN	EFFECTS ON MAN	RATE OF ACTION
NERVE	Aerosol or vapor	Automatic chemical agent alarm and chemical agent detector kits to detect vapors and aerosols; chemical agent detector paper to detect liquids.	Difficult breathing, drooling, nausea, vomiting, convulsions, and sometimes dim vision.	Incapacitates; kills if high concentration is inhaled.	Very rapid by inhalation:
	Liquid droplet.			Incapacitates; kills if contaminated skin is not decontaminated rapidly.	Delayed through skin. more rapid through eyes.
BLISTER	Liquid droplet.		Mustard; nitrogen mustard—no early symptoms. Lewisite; mustard-Lewisite—searing of eyes and stinging of skin. Phosgene oxime—irritation of eyes and nose.	Blisters skin; is destructive to respiratory tract; can cause temporary blindness. Some agents sting and form wheals on skin.	Blistering delayed hours to days; eye effects more rapid. Mustard-Lewisite and phosgene oxime very rapid.
BLOOD	Vapor (gas)		Convulsions and coma.	Incapacitates; kills if high concentration is inhaled.	Rapid.
CHOKING	Vapor (gas)		Coughing, choking, nausea and headache.	Damages and floods lungs.	Immediate to 3 hours.

**PROTECTIVE ACTIONS AGAINST CHEMICAL AGENTS**

TYPE OF AGENT	INDIVIDUAL		PROTECTION REQUIRED	US AGENTS EQUIVALENT	
	FIRST AID	DECONTAMINATION*		SYMBOL/NAME	FIELD CHARACTERISTICS
NERVE	Give 2 pam chloride and atropine injections. Artificial respiration maybe necessary.	*None needed.	Protective mask and protective clothing.	GA/Tabun CB/Sarin	Colorless.
		Flush eyes with water. Decontaminate skin using M258A1 Kit.		VX Thickened G-agent.	
BLISTER	None.	Flush eyes with water. Decontaminate skin with M258A1 Kit or wash with soap and water.	Protective mask and protective clothing.	HD/Mustard H/N Nitrogen Mustard L/Lewisite HL/Mustard-Lewisite CX/Phosgene Oxime	Pale yellow droplets. Dark droplets. Dark, oily droplets. Dark, oily droplets. Colorless droplets.
BLOOD	Inhale amyl-nitrite. Artificial respiration may be necessary.	None.	Protective mask.	AC/Hydrogen Cyanide CKk/Cyanogen Chloride	Colorless.
CHOKING	For severe symptoms. avoid movement and keep warm.	None.	Protective mask.	CG/Phosgene	Colorless.

\*This remark only applies for aerosol and vapor.

## CHEMICAL AGENT DETECTION AND IDENTIFICATION

Chemical agents can be detected by use of an automated chemical agent alarm system and the M256 chemical agent detection kit.

### Automatic Chemical Agent Alarm

The automatic chemical agent alarm is an automatic miniature chemistry laboratory which continuously samples the air. It detects persistent and nonpersistent threat agents when they are in vapor or inhalable

aerosol form. The two major components in the alarm system—M43 detector unit and M42 alarm unit—are shown in the following illustration. The alarm sounds when the detector discovers nerve agent (G or V), blood agent (Cyanide compounds), or choking agents (Phosgene). The alarm system will be issued by MTOE. TM 3-6665-225-12 provides instructions for the use of the alarm by operator and organizational personnel.

### ALARM SYSTEM DETECTOR AND ALARM UNIT

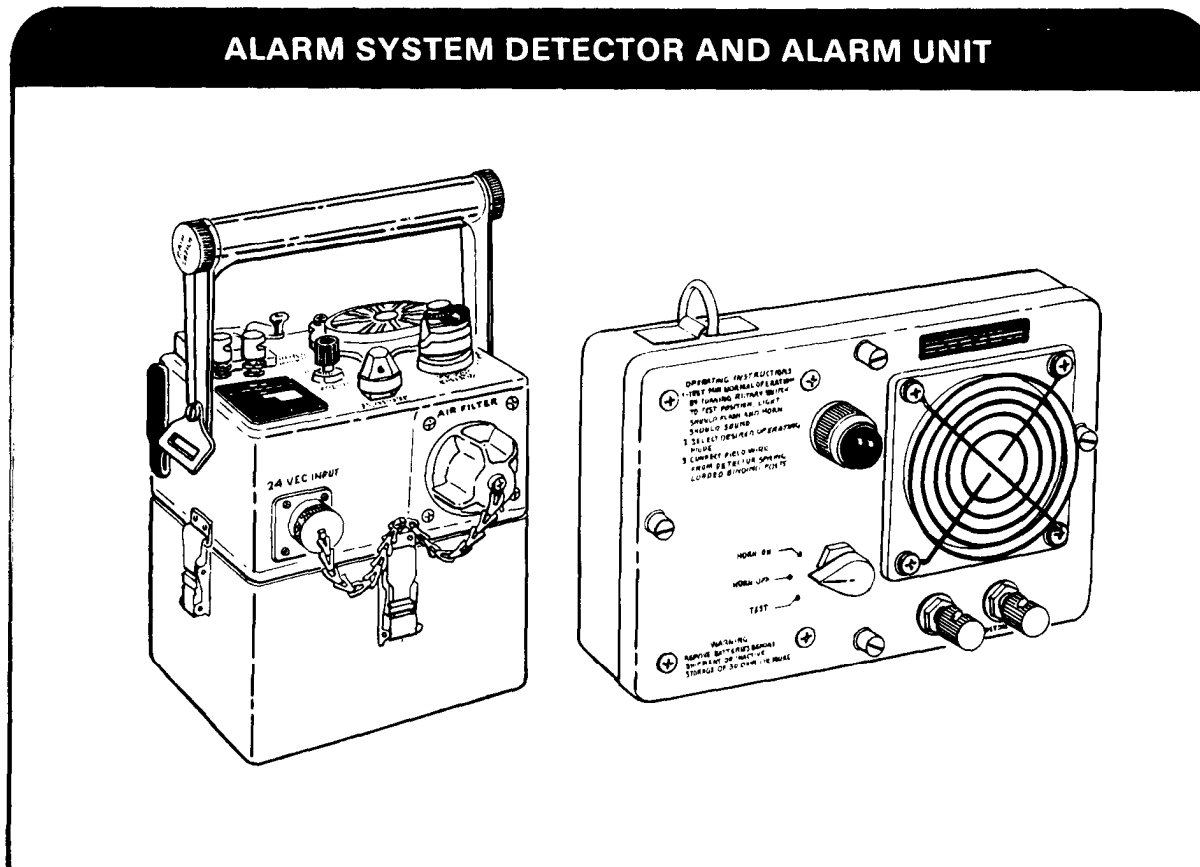

### M256 Chemical Agent Detector Kit

This kit detects dangerous vapor concentrations of all known nerve, blister, and blood agents. It can detect residual surface contamination. Detailed operating instructions are contained in the kit. The kit is used when the

unit is under chemical attack, when a chemical attack is reported to be imminent, or when the presence of a chemical agent is suspected. See TM 3-6665-307-10 for further information on this kit.

**M256 CHEMICAL AGENT DETECTOR KIT, FRONT VIEW**

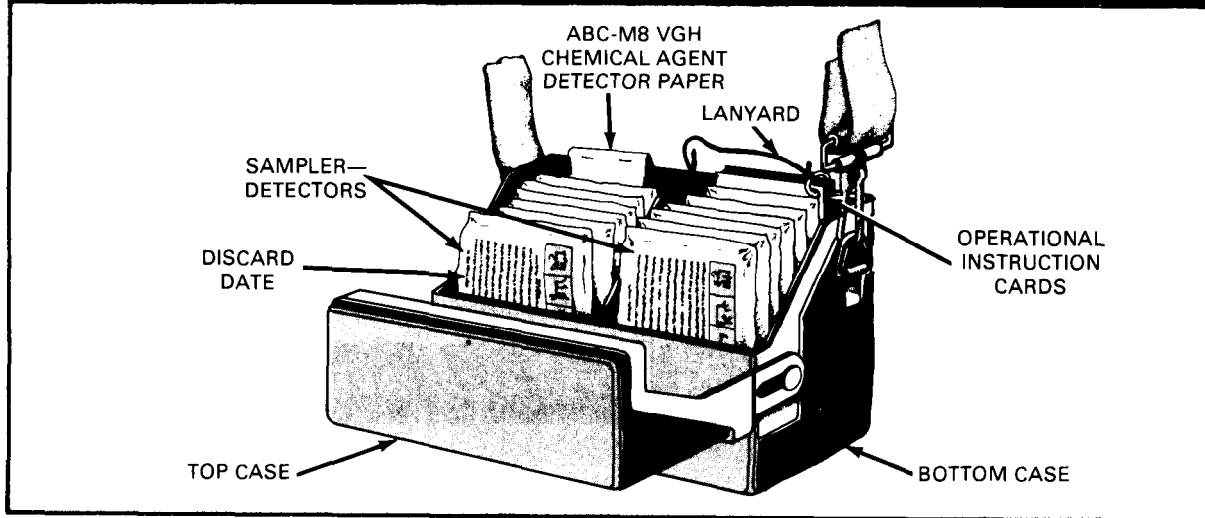

**ABC-M8 Chemical Agent Detector Paper**

A booklet of this paper is part of each detector kit and is also issued to individuals. The sheets are impregnated with chemicals that turn different colors when in contact with liquid chemical agents. A color chart is included in the booklet to aid in interpreting the test.

indicates the presence of a liquid chemical agent. The detector paper is worn by individuals and/or attached to vehicles or other pieces of equipment. The paper will detect all known liquid chemical agents under all types of weather conditions. It will not detect vapors. The paper will replace M8 detector paper except for that which is included as a component in the M256 kit and M34 sampling kit.

**Liquid Agent Detector Paper M9**

This adhesive-backed gray-green paper

**ABC-M8 CHEMICAL AGENT DETECTOR PAPER**



## CHEMICAL AGENT DECONTAMINATION

Chemical decontamination includes the prompt removal of agents from the eyes and the decontamination of the skin. Decontamination must be performed automatically and without orders when required.

### Individual Decontamination

Chemical decontamination is done by removing, neutralizing, absorbing, or weathering of the chemical agent. If you detect a chemical agent on your skin or a buddy sees it and tells you, act immediately.

Face contaminated. If your face is contaminated, follow these procedures:

- Snap open your decon kit. Pull out one DECON 1 WIPE packet by its tab.
- Fold packet on solid line marked BEND, then unfold.
- Tear open quickly at notch, remove wipe and fully unfold.

### WARNING

**Poisonous and caustic hazard. Keep out of eyes and mouth.**

- Hold your breath, close eyes, and lift hood and mask from chin.
- Continue to hold your breath. Wipe your face quickly.
- Quickly wipe inside of mask which touches your face.
- Drop wipe to ground.
- Reseal, clear, and check mask.
- Pull out one DECON 2 WIPE packet. Crush the enclosed glass ampules between thumb and fingers or smash the glass ampules with the palm of the hand.
- Fold packet on solid line marked CRUSH AND BEND, then unfold.
- Tear open quickly at notch and remove wipe.

- Hold your breath, close eyes, and lift hood and mask from chin.

### WARNING

**Poisonous and caustic hazard. Keep out of eyes and mouth.**

- Continue to hold your breath. Wipe your face quickly.
  - Quickly wipe inside of mask which touches your face.
  - Drop wipe to ground.
  - Reseal, clear, and check mask.
- Face not contaminated. If your face is not contaminated, follow these procedures:
- Snap open your decon kit. Pull out one DECON 1 WIPE packet by its tab.
  - Fold packet on solid line marked BEND, then unfold.
  - Tear open quickly at notch, remove wipe and fully unfold.
  - Wipe skin for 1 minute.
  - Drop wipe to ground.
  - Pull out one DE CON 2 WIPE packet. Crush enclosed glass ampules between thumb and fingers or smash glass ampules with palm of hand.
  - Fold packet on solid line marked CRUSH AND BEND, then unfold.
  - Tear open quickly at notch and remove wipe.
  - Fully open wipe. Let the encased crushed ampules fall to the ground.
  - Wipe contaminated skin for 2 to 3 minutes.
  - Drop wipe to ground.

### Equipment Decontamination

MANPAD personnel are provided calcium hypochloride and M11 decontaminating

apparatuses for decontaminating their unit equipment.

**Biological agent decontamination.** To decontaminate vehicles with biological agents, use any of the following methods:

- Apply calcium hypochloride. Leave on 30 minutes, then remove by washing with a stream of water.
- Wash with detergent and high-pressure water stream.
- Steam clean, using detergent.
- Weathering (sunlight and weather will quickly kill or incapacitate most biological agents).

**Chemical agent decontamination.** Lightly contaminated vehicles may be decontaminated by airing. Each tactical vehicle is authorized one M11 decontamination apparatus that contains 1 1/3 quarts of DS-2 decontaminating agent. It is used to partially

decontaminate parts of the vehicle that must be touched, such as controls.

A complete decontamination of a vehicle is done using DS-2, soapy water, solvents, or slurry.

Key weapons are decontaminated using DS-2, soapy water, solvents, or slurry. Ammunition is decontaminated with DS-2 solution, wiped with gasoline-soaked rags, and then dried. After decontamination, weapons are disassembled, washed, rinsed, dried, and oiled to prevent corrosion.

Optical instruments are decontaminated by blotting with rags, wiping with lens cleaning solvent, and then allowing time for drying.

C-E is decontaminated by airing, weathering, or hot air (if available). The metal parts of field telephones and radios are decontaminated with DS-2 and then wiped with rags.

## NBC ALARMS, EMERGENCY REPORTS, AND WARNING SIGNS

The US, along with other NATO nations, has adopted a standard method of disseminating emergency warnings to its land forces. The following emergency warnings are provided for use by MANPAD personnel. A complete listing of emergency warnings is contained in FM 21-40 and STANAG 2047.

### VOCAL AND/OR AUDIBLE ALARMS

These are given in all cases as soon as an attack or hazard is detected. They include the following:

- Rapid and continuous beating on any metal object or any other object which produces a loud noise.
- A succession of very short blasts on a vehicle horn or other suitable device.
- A broken warbling siren; for example, 10 seconds on, 10 seconds off, 10 seconds on, 10 seconds off.

- Sounding of automatic chemical alarm.
- Other sound signals as augmented by SOP.

### NBC REPORTS

The warning and reporting of threat or unidentified NBC attacks and resulting hazardous areas are made by telephone or message according to the provisions of STANAG 2103.

There are a total of six NBC reports. The reports are used as follows:

- NBC 1 Observer's initial report, giving basic data.
- NBC 2 Report used for passing evaluated data.
- NBC 3 Report used for immediate warning of expected contamination.

- NBC 4 Report used for radiation dose-rate measurements.
- NBC 5 Report used for areas of contamination.

- NBC 6 Report used for detailed information on chemical or biological attack.
- The following illustration lists the meaning of the letter items used in all NBC reports.

**MEANING OF LETTER ITEMS IN NBC REPORTS**

<b>LETTER</b>	<b>NUCLEAR FORMS</b>	<b>CHEMICAL OR BIOLOGICAL FORMS</b>
<b>ALFA</b>	STRIKE SERIAL NUMBER(S).	SAME.
<b>BRAVO</b>	POSITION OF OBSERVER (UTM OR PLACE).	SAME.
<b>CHARLIE</b>	DIRECTION OF ATTACK FROM OBSERVER IN DEGREES OR MILS (STATE WHICH) FROM GRID OR MAGNETIC NORTH (STATE WHICH)	SAME.
<b>DELTA</b>	DATE/TIME OF DETONATION (LOCAL OR ZULU TIME, STATE WHICH).	DATE/TIME ATTACK STARTED (LOCAL OR ZULU TIME, STATE WHICH).
<b>ECHO</b>	ILLUMINATION TIME (DURATION REPORTED IN SECONDS).	DATE/TIME ATTACK ENDED (LOCAL OR ZULU TIME, STATE WHICH).
<b>FOXTROT</b>	LOCATION OF ATTACK (UTM OR PLACE) (ACTUAL OR ESTIMATED, STATE WHICH).	AREA ATTACKED (ACTUAL OR ESTIMATED, STATE WHICH).
<b>GOLF</b>	MEANS OF DELIVERY, IF KNOWN.	MEANS OF DELIVERY.
<b>HOTEL</b>	TYPE OF BURST—AIR, SURFACE, OR UNKNOWN (STATE WHICH)—INCLUDING HEIGHT, IF KNOWN.	TYPE OF AGENT, IF KNOWN (CHEMICAL OR BIOLOGICAL). TYPE OF ATTACK (CHEMICAL OR BIOLOGICAL).
<b>INDIA</b>	NA	TYPE AND NUMBER OF MUNITIONS OR AIRCRAFT (STATE WHICH).
<b>JULIET</b>	FLASH-TO-BANG TIME (SECONDS).	NA
<b>KILO</b>	CRATER PRESENT OR ABSENT, AND DIAMETER, IF KNOWN (METERS).	NA
<b>LIMA</b>	CLOUD WIDTH AT H+5 MIN (DEGREES OR MILS, STATE WHICH).	NA
<b>MIKE</b>	CT OR CB ANGLE OR CLOUD HEIGHT, TOP OR BOTTOM (STATE WHICH) AT H+10 MIN. (DEGREES, MILS, METERS, OR FEET).	NA
<b>NOVEMBER</b>	ESTIMATED YIELD (KT).	NA
<b>OSCAR</b>	REFERENCE DATE/TIME FOR ESTIMATED CONTOURS WHEN NOT H+1 HR.	NA

**MEANING OF LETTER ITEMS IN NBC REPORTS—CONTINUED**

<b>PAPA</b>	FOR RADAR PURPOSES ONLY:	AREA OF EXPECTED CONTAMINATION (UTM).
<b>PA</b>	UTM COORDINATES OF POINTS TO OUTLINE EXTERNAL CONTOURS OF CLOUD.	
<b>PB</b>	WIND DIRECTION (FROM) (DE- GREES OR MILS, STATE WHICH).	
<b>QUEBEC</b>	LOCATION OF READING (UTM).	NA
<b>ROMEO</b>	DOSE-RATE (cGy/HR). THE WORDS "INITIAL," "INCREASING," "PEAK," OR "DECREASING" MAY BE ADDED. WHEN DECAY RATE IS REPORTED, THE WORDS "DECAY NORMAL," "DECAY FAST," OR "DECAY SLOW" OR THE ACTUAL VALUE OF DECAY EXPONENT MAY BE INSERTED.	NA
<b>SIERRA</b>	DATE/TIME OF READING (LOCAL OR ZULU TIME).	DATE/TIME CONTAMINATION INITIALLY DETECTED (CHEMICAL OR BIOLOGICAL).
<b>TANGO</b>	H+1 DATE/TIME (LOCAL OR ZULU TIME).	DATE/TIME OF LATEST SURVEY OF CONTAMINATION (CHEMICAL OR BIOLOGICAL).
<b>UNIFORM</b>	1,000 (cGy/HR) CONTOUR LINE COORDINATES (UTM) (RED).	NA
<b>VICTOR</b>	300 (cGy/HR) CONTOUR LINE COORDINATES (UTM) (GREEN).	NA
<b>WHISKEY</b>	100 (cGy/HR) CONTOUR LINE COORDINATES (UTM) (BLUE).	NA
<b>XRAY</b>	20 (cGy/HR) CONTOUR LINE COORDINATES (UTM) (BLACK).	AREA OF MEASURED CONTAMINATION (UTM) (YELLOW) (CHEMICAL OR BIOLOGICAL).
<b>YANKEE</b>	BEARING OR AZIMUTH OF LEFT THEN RIGHT RADIAL LINES (4 DIGITS EACH) (STATE DEGREES OR MILS).	NA
<b>ZULU</b>	EFFECTIVE WIND SPEED (KMPH), 3 DIGITS; DOWNWIND DISTANCE OF ZONE 1 (KM), 3 DIGITS; CLOUD RADIUS (KM), 2 DIGITS. (WHEN EFFECTIVE WIND SPEED IS LESS THAN 8 KMPH, 3 DIGITS ONLY FOR RADIAL DISTANCE OF ZONE 1.)	EFFECTIVE WIND SPEED (KMPH).



### NBC CONTAMINATED LAND AREA MARKERS

As soon as possible following an NBC attack, units will mark off areas where contamination is still on the ground, plants, or bushes unless the area is to be abandoned to threat forces. Markers as shown by NBC contaminated area markers illustration indicating the type of contamination will be used. These markers are different-colored, right-angled isosceles triangles for each type of contamination with ATOM, GAS, or BIO printed in large letters on the front side only. Units will indicate on the front (side of marker away from the contaminated area) of GAS and BIO markers, if known, the con-

taminating agent and the date and time of contamination. ATOM markers may indicate the dose-rate and the time the dose-rate was measured and, if known, the burst date and time. If you come to one of these signs STOP! If you can read the information, don't go any farther. Conversely, if you do not see any written information on the sign, you have just walked through a contaminated area. Check the other side of the marker to determine the contamination agent, check yourself for contamination and decontaminate yourself.

NBC CONTAMINATED AREA MARKERS			
<b>CHEMICAL</b>		(AGENT) (DATE) (TIME)	
<b>BIOLOGICAL</b>		(AGENT) (DATE) (TIME)	
<b>RADIOLOGICAL</b>		(DOSE RATE) (DATE) (TIME) (BURST TIME) (BURST DATE)	
<b>CHEMICAL MINEFIELD (UNEXPLODED MINES)</b>		(OPTIONAL) (TYPE OF AGENT) (DATE EMPLACED)	
DANGER	PRIMARY COLORS	SECONDARY COLORS	
		MARKINGS	INSCRIPTIONS
RADIOLOGICAL CONTAMINATION	WHITE	NONE	BLACK
BIOLOGICAL CONTAMINATION	BLUE	NONE	RED
CHEMICAL CONTAMINATION	YELLOW	NONE	RED
CHEMICAL MINEFIELDS	RED	YELLOW STRIPE	YELLOW

## Glossary

<b>A</b>	angstrom	<b>cm</b>	centimeter
<b>ACP</b>	allied communication publication	<b>COMSEC</b>	communications security
<b>ADA</b>	air defense artillery	<b>CONUS</b>	Continental United States
<b>ADCN</b>	air defense control net	<b>CRC</b>	control and reporting center
<b>ADCO</b>	air defense coordination officer	<b>CRP</b>	control and reporting post
<b>ADCS</b>	air defense coordination section	<b>C/V</b>	chaparral/vulcan
<b>ADW</b>	air defense warning	<b>DAME</b>	division air management element
<b>AIM</b>	armored, infantry, mechanized	<b>DEFCON</b>	defense readiness condition
<b>APC</b>	armored personnel carrier	<b>DSU</b>	direct support unit
<b>ARTEP</b>	army training and evaluation program	<b>ECCM</b>	electronic counter-countermeasures
<b>ASI</b>	additional skill identifier	<b>ECM</b>	electronic countermeasures
<b>ASP</b>	ammunition supply point	<b>EMP</b>	electromagnetic pulse
<b>ATGM</b>	antitank guided missile	<b>EOD</b>	explosive ordnance disposal
<b>BATS</b>	ballistic aerial target system	<b>EWBN</b>	early warning broadcast net
<b>BCC</b>	battery control central	<b>FAAR</b>	forward area alerting radar
<b>BCO</b>	battery control officer	<b>FACP</b>	forward air control post
<b>BCP</b>	battery command post	<b>FEBA</b>	forward edge of the battle area
<b>BCU</b>	battery/coolant unit	<b>FHT</b>	field handling trainer
<b>BTOC</b>	battalion tactical operation center	<b>FM</b>	frequency modulated
<b>C-E</b>	communications electronics	<b>FSN</b>	federal stock number
<b>CEOI</b>	communications-electronics operating instructions	<b>FTX</b>	field training exercise
<b>cGy</b>	centigray (see rad)	<b>FU</b>	fire unit

**FM 44-18-1**

<b>GEOREF</b>	world geographic reference system	<b>LSS</b>	lightweight screening system
<b>GM</b>	guided missile	<b>m</b>	meter
<b>GOAR</b>	ground observer aircraft recognition	<b>MANPAD</b>	man-portable air defense
<b>GTA</b>	graphic training aids	<b>MEDEVAC</b>	medical evacuation
<b>HE</b>	high explosive	<b>mm</b>	millimeter
<b>HEL</b>	helicopter	<b>MNVR</b>	maneuver
<b>HF</b>	high frequency	<b>MOPP</b>	mission-oriented protective posture
<b>HIMAD</b>	high-to-medium altitude air defense	<b>mph</b>	miles per hour
<b>HMMWV</b>	high mobility multipurpose wheeled vehicle	<b>MRC</b>	missile-round container
<b>IAW</b>	in accordance with	<b>MSCS</b>	manual SHORAD control system
<b>ID</b>	identification	<b>MT</b>	megaton
<b>IFF</b>	identification, friend or foe	<b>MTOE</b>	modified table of organization and equipment
<b>in</b>	inch	<b>MTS</b>	moving target simulator
<b>IR</b>	infrared, infrared radiation	<b>NBC</b>	nuclear, biological and chemical
<b>km</b>	kilometer	<b>NCO</b>	noncommissioned officer
<b>KT</b>	kiloton	<b>NCOIC</b>	noncommissioned officer in charge
<b>LAI</b>	lesson administration instruction	<b>NCS</b>	net control station
<b>lb</b>	pound	<b>nm</b>	nanometer
<b>LIN</b>	line item number	<b>OIC</b>	officer in charge
<b>LL</b>	left limit	<b>OP</b>	observation post
<b>LNO</b>	liaison officer	<b>OPORD</b>	operation order
<b>LOS</b>	line of sight		

<b>ORTT</b>	operational readiness training test	<b>STLS</b>	Stinger launch simulator
<b>PAM</b>	pamphlet	<b>SQT</b>	skill qualification test
<b>PCP</b>	platoon command post	<b>TADDS</b>	target alert data display set
<b>PM</b>	preventive maintenance	<b>TASC</b>	training aids support center
<b>PMCS</b>	preventive maintenance checks and services	<b>TC</b>	training circular
<b>POL</b>	petroleum, oils and lubricants	<b>TCO</b>	tactical control officer
<b>PPI</b>	plan position indicator	<b>TEC</b>	training extension course
<b>PTL</b>	primary target line	<b>TOC</b>	tactical operations center
<b>RAD</b>	radiation	<b>TOE</b>	table of organization and equipment
<b>RATELO</b>	radio telephone operator	<b>TSOP</b>	tactical standing operating procedure(s)
<b>RCMAT</b>	radio-controlled miniature aerial target	<b>TV</b>	television
<b>RL</b>	right limit	<b>TVT</b>	television trainer/tape
<b>RP</b>	reference point	<b>um</b>	micrometer
<b>RSOP</b>	reconnaissance selection and occupation of position	<b>USAF</b>	United States Air Force
<b>SHORAD</b>	short-range air defense	<b>VHF</b>	very high frequency
<b>SIGSEC</b>	signal security	<b>VTOL</b>	vertical take-off and landing
<b>SOP</b>	standing operating procedures	<b>w</b>	with
<b>SPT</b>	support	<b>WCS</b>	weapon control status
		<b>WRC</b>	weapon-round container

## References

### REQUIRED PUBLICATIONS

Required publications are sources which users must read in order to understand or to comply with FM 44-18-1.

#### FIELD MANUALS (FM)

(SNF) 44-1A	US Army Air Defense Artillery Materiel (U)
44-3(HTF)	Air Defense Artillery Employment Chaparral/Vulcan/Stinger
44-18(HTF)	Air Defense Artillery Employment Stinger

#### TECHNICAL MANUALS (TM)

9-1425-429-12	Operator's and Organizational Maintenance Manual: (Stinger Air Defense Guided Missile System)
9-6920-429-12	Operator's and Organizational Maintenance Manual: (Stinger Guided Missile Training Set)

### RELATED PUBLICATIONS

Related publications are sources of additional information. Users do not have to read them to understand FM 44-18-1.

#### ARMY REGULATION (AR)

350-1	Army Training
-------	---------------

#### FIELD MANUALS (FM)

5-15	Field Fortifications
5-20	Camouflage
7-7(HTF)	The Mechanized Infantry Platoon and Squad
20-32	Mine/Countermine Operations at the Company Level
21-2	Soldier's Manual of Common Tasks, Skill Level 1
21-3	Soldier's Manual of Common Tasks, Skill Level 2/3/4
21-6	How to Prepare and Conduct Military Training
21-15	Care and Use of Individual Clothing and Equipment
21-40	NBC (Nuclear, Biological and Chemical) Defense

## **FM 44-18-1**

21-60	Visual Signals
24-18	Field Radio Techniques
24-20	Field Wire and Field Cable Techniques
24-24	Radio and Radar References Data
25-4	How to Conduct Training Exercises
44-I(HTF)	US Army Air Defense Artillery Employment
44-6	Operations and Training Forward Area Alerting Radar (FAAR) and Target Alert Data Display Set (TADDS)
44-16S	Soldier's Manual, ADA Stinger Crewman
44-102	Procedures for Ballistic Aerial Target System
71-I(HTF)	The Tank and Mechanized Infantry Company Team

### **TECHNICAL MANUALS (TM)**

5-1080-200-10	Operator's Manual: Camouflage Screen Woodland Lightweight Radar Scattering
9-1430-589-12	Operator's and Organizational Maintenance Manual: Target Alert Data Display Set, AN/GSQ-137 (XO-2) (Forward Area Alerting Radar System)
9-6920-427-10	Operator's Manual: Moving Target Simulator Trainer Device M87 (Stinger/Redeye Air Defense Guided Missile System)
11-5820-401-12	Operator's and Organizational Maintenance Manual: (Including Repair Parts and Special Tool List): Radio Set AN/VRC-47
11-5820-498-12	Operator's and Organizational Maintenance Manual: Radio Set AN/GRC-160

### **ALLIED COMMUNICATIONS PUBLICATIONS (ACP)**

125	Communications Instructions-Radiotelephone Procedures
-----	---

## **PROJECTED RELATED PUBLICATIONS**

These related publications are scheduled for printing. Upon print, they will be distributed automatically via pinpoint distribution and will not be available for requisition from USA AG Publications Center, Baltimore, until indexed in DA Pam 310-1.

### **FIELD MANUALS (FM)**

(SNF) 44-1A	US Army Air Defense Artillery Operational Planning Data (U)
44-II(HTF)	Air Defense Artillery Employment Chaparral/Vulcan/Stinger

## **References-2**

# Index

## A

	Page		Page
Activate rule .....	6-3	Engaging .....	4-7
Activate the weapon .....	3-2	Identification .....	5-8
Administrative detail for overall test (ORTT) .....	17-4	Interrogation .....	4-6
Aircraft		Jet .....	6-2
Altitudes .....	4-2	Propeller .....	6-3
Characteristics .....	4-2	Recognition .....	4-8, 14-8
Color .....	4-2	Alert warning .....	7-10
Meteorological visibility .....	4-2	Alternate positions .....	7-4
Search sector size .....	4-3	Army training and evaluation program (ARTEP) .....	12-3
Detection .....	4-1	Audible indicators .....	15-4

## B

Background radiations .....	3-4	Binoculars .....	B-1
Battery coolant unit (BCU) .....	2-3	Biological agents .....	F-14
Battery charger (programmer) .....	1-8	Blister agents .....	F-17
Battlefield survival .....	9-1	Blood agents .....	F-18
Beseler Cue/See .....	14-7		

## C

Camouflage .....	9-2	Chemical agent decontamination .....	F-23
Challenges (IFF) .....	4-7	Choking agent .....	F-18
Check		Code changing keys .....	1-7
Aquisition indicator .....	2-3	Code input computer .....	1-8
IR window and blowout disk .....	2-3	Command and control .....	5-1
Safety and actuator device .....	2-3	Chaparral units .....	8-4
Chemical agents .....	F-16	HIMAD units .....	8-1
Chemical agent detection .....	F-21	Section chief .....	6-1, 7-9

# FM 44-18-1

	Page		Page
Communications security (COMSEC) . . .	9-5	Convoy protection . . . . .	7-13
Concealment . . . . .	9-2	Cover . . . . .	9-1
Containers . . . . .	1-9	Crew drill training . . . . .	D-1
Loading/Unloading . . . . .	1-11	Critical checks . . . . .	2-3
Markings . . . . .	2-1	Crossing jet aircraft . . . . .	6-3
Shipping and storage . . . . .	1-9		
Conversion of container to a ready rack . . . . .	D-2		

## D

Defense of ADA units . . . . .	8-1	Detection, aircraft . . . . .	4-1
Deployed behind maneuver units . . . . .	7-14		

## E

Early warning broadcast nets . . . . .	A-3	Engagement sequence . . . . .	6-4
Electromagnetic spectrum . . . . .	3-2	Evaluation	
Electronic counter - countermeasures (ECCM) . . . . .	9-6	Gunner proficiency . . . . .	15-1
Engagement commands . . . . .	5-2	ORTT . . . . .	17-4
Engagement communications . . . . .	5-4	Evaluator personnel and duties . . . . .	17-13, 17-14
Engagement decision . . . . .	5-2	Exercises, field handling . . . . .	12-6

## F

FAAR/TADDS system . . . . .	7-10	Firing	
Field handling trainer (FHT) M60 . . . . .	13-1	Phase . . . . .	17-6
Figure 8 method . . . . .	3-6	Safety precautions . . . . .	2-4
Films, training . . . . .	13-6	Fortify your position . . . . .	9-3
Fire control orders . . . . .	5-2	Forward area alerting radar (FAAR) . . .	7-10

## Index-2



**G**

	Page		Page
Guidance section .....	1-2	Gunner performance evaluation sheet .....	15-4
Gunner evaluation on a tracking range .....	15-4	Gunner's firing actions .....	15-4, 5-4
Gunner evaluation with the MTS .....	15-2	Gyro spinup tone .....	15-6, 3-2

**H**

Handling procedures .....	2-1	Hasty occupation .....	7-4
Hangfire, misfires, and duds .....	3-9, 3-10	Humidity indicator check .....	2-3

**I**

Identification, aircraft .....	4-8	Index of Stinger TEC lessons .....	14-6
Identification, friend or foe (IFF) .....	1-5	Indicator .....	2-3
Interrogator .....	1-2	Acquisition .....	2-3
Interrogator and interconnecting cable check .....	1-8	Error .....	15-2
Interrogator and programmer .....	1-8	Humidity .....	2-3
Interrogator containers .....	1-12	Individual and team training .....	12-5
Receptacle check .....	2-3	Insert superelevation and lead .....	6-5
Simulator .....	13-4	IR aquisition .....	3-2
Tones .....	4-7	IR window and blowout disk check .....	2-3
Incoming/Outgoing jet aircraft .....	6-2		

**L**

Launch determination .....	6-5	Load rearrangement of missile-round containers .....	D-2
Launch tube assembly .....	1-3	Load rearrangement of weapon-round containers .....	D-2
Light discipline .....	9-5	Local security against ground attack .....	7-3

**M**

	Page		Page
Manual SHORAD control system (MSCS) .....	A-1	Missile, Stinger .....	1-2
Manpack Stinger load .....	10-3	Guidance section .....	1-2
Sample march load and weight allocation .....	10-2	Propulsion section .....	1-3
Maximum firing angle .....	2-5	Tail assembly .....	1-3
Method of engagement .....	5-2	Warhead section .....	1-3
Multiple aircraft raids .....	5-3	Missile-round container .....	1-9
Single target raids .....	5-3	Missile Signature, night .....	7-15
Mine warfare .....	9-6	Mobility and combat loading .....	10-1
What to look for .....	9-6	Mounted team drill .....	D-4
Where to look .....	9-6	Moving target simulator (MTS) M87A1 .....	14-1
Missile-round .....	1-2	Moving target simulator training .....	15-2
Launch tube assembly .....	1-3	Multiple aircraft raids .....	5-3
Sight assembly .....	1-4	M60, field handling trainer .....	13-1

**N**

NBC .....	F-1	Weapons .....	F-1
Alarms .....	F-14	Nets, communications .....	A-3
Biological and chemical warfare .....	F-10	Nets, early warning .....	A-3
Emergency reports .....	F-24	Night operations and security .....	7-15
Mission oriented protective posture (MOPP) .....	F-11	Noise discipline .....	9-5
Protective mask training .....	F-12	Nuclear warfare .....	F-1
Nuclear warfare .....	F-1	Nuclear weapons effects .....	F-2
Warning signs .....	F-24		

**O**

Objective of the test, ORR .....	17-1	Organizational maintenance .....	11-1
Operating ranges, miniature target .....	14-3	IFF Interrogator .....	11-2
Operational readiness training test (ORTT) .....	17-1	Shipping and storage containers .....	11-2
		Stinger weapon .....	11-1
		Transport harness .....	11-2

**P**

Page	Page		
Performance - oriented training . . . . .	12-3	Fortification of . . . . .	9-3
Army training and evaluation program (ARTEP) . . . . .	12-3	Hasty occupation . . . . .	7-4
Job book (JB) . . . . .	12-3	Occupy . . . . .	7-4
Skill qualification test (SQT) . . . . .	12-3	Post fire procedures . . . . .	3-9
Soldier's manual (SM) . . . . .	12-3	Programmer/Battery charger . . . . .	1-8
Trainer's guide (TG) . . . . .	12-3	Protecting a convoy . . . . .	7-13
Position . . . . .	9-4	Protective mask training . . . . .	F-19
Alternate . . . . .	9-6	Publications, training . . . . .	13-7

**R**

Radio-controlled miniature aerial target (RCMAT) . . . . .	14-3	Firing procedures . . . . .	16-5
Radiological (nuclear) contamination . . . . .	F-3	ACTIVATE . . . . .	16-5
Radio set AN/PRC 77 . . . . .	7-7	CEASE ENGAGEMENT . . . . .	16-5
Radio set AN/VRC 47 . . . . .	7-7	WEAPONS FREE . . . . .	16-5
Radio set AN/VRC 160 . . . . .	7-7	Hints for the OIC . . . . .	16-6
Radio set control group AN/GRA 39 . . . . .	7-7	Operations plan . . . . .	16-4
Radio/Telephone prowords . . . . .	7-8	Reconnaissance . . . . .	16-1
Range, firing . . . . .	16-2	Rating system . . . . .	17-2
Communications . . . . .	16-3	Ready Stinger weapon for firing . . . . .	3-1
Control . . . . .	16-3	Relations with supported unit . . . . .	7-12
Equipment . . . . .	16-4	Resources available, training . . . . .	12-2
		Resources required, training . . . . .	12-2

**S**

Safety and actuator device checks . . . . .	2-3	Sample march load and weight allocation . . . . .	10-2
Safety precautions . . . . .	2-4	Search sector size . . . . .	4-2
Firing safety . . . . .	2-4	Search sectors . . . . .	4-2
Hangfire, misfire, and duds . . . . .	3-9, 3-10	Separable gripstock . . . . .	1-6
Maximum firing angle . . . . .	2-5		
Superelevation angle . . . . .	2-5		

	Page		Page
Shipping and storage containers . . . . .	1-9	Skill qualification test (SQT) . . . . .	12-3
IFF interrogator container . . . . .	1-12	Soldier's manual (SM) . . . . .	12-3
Missile-round container . . . . .	1-9	Speed, aircraft . . . . .	4-2
Weapon-round container/ ready rack . . . . .	1-10	Stinger missile-round . . . . .	1-2
Sight assembly . . . . .	1-4	Superelevation and lead . . . . .	2-5
Sight assembly check . . . . .	2-3	Superelevation angle . . . . .	2-5
Simulated target range . . . . .	14-3	Supported unit command net . . . . .	7-5
Single pulse tone . . . . .	15-4	Survival on battlefield . . . . .	9-1
Single target raids . . . . .	5-3	Sweeping the target method . . . . .	3-5
Site selection, TADDS . . . . .	7-13	System support . . . . .	11-1

**T**

Tactical phase . . . . .	17-8	Team radio sets . . . . .	7-7
Tactical phase checklists . . . . .	17-8	Team visual signals . . . . .	7-9
Tactical training . . . . .	12-5	Team wire communications . . . . .	7-8
Terrain model exercise . . . . .	12-5	Teams within the formation of a maneuver unit . . . . .	7-14
Terrain walk . . . . .	12-5	Techniques of fire . . . . .	6-1
Tail assembly . . . . .	1-3	Television tapes . . . . .	13-7
Targets . . . . .	14-2	Terrain evaluation . . . . .	7-3
Target alert data display set (TADDS) . . . . .	7-11	Terrain masking . . . . .	4-2
Target courses . . . . .	15-3	Terrain model exercise . . . . .	12-5
Target run sheet . . . . .	15-4	Terrain walk . . . . .	12-5
Team chief . . . . .	5-2	Test results, ORTT . . . . .	17-3
Team chief planning . . . . .	7-2	Tracking . . . . .	3-2, 6-4
Team chief's engagement decisions, actions, and situations . . . . .	5-4	Tracking head trainer (THT) . . . . .	13-3
Team drill from a foxhole . . . . .	D-8	Audible indicators . . . . .	15-4
Team, footmarch drill . . . . .	D-6	Gyro spinup tone . . . . .	15-6, 3-2
Team mobility . . . . .	10-1	IR aquisition tone . . . . .	15-4, 3-2
Team operations at night . . . . .	7-15	Single pulse tone . . . . .	15-4
		Battery . . . . .	13-4
		Timer . . . . .	13-5

	Page		Page
Tracking live targets .....	14-2	Training on a tracking range .....	14-5
Trainer, field handling, M60 .....	13-1	Training set guided missile M134 .....	13-3
Training assessment .....	12-2	IFF simulator .....	13-4
Resources available .....	12-2	Tracking head trainer (THT) .....	13-3
Resources required .....	12-2	Trainer battery .....	13-4
Time available .....	12-2	Training, aircraft recognition .....	14-8
Training equipment .....	13-1	Training Stinger teams .....	12-1
Training extension course (TEC)		Training, support .....	11-2
lessons .....	14-6	Transport harness .....	1-11, 11-2

**U**

Uncaging .....	3-5	Uncaging switch check .....	2-3
----------------	-----	-----------------------------	-----

**V**

Vehicle loading plan .....	10-2	Visual acuity, aircraft .....	4-2
----------------------------	------	-------------------------------	-----

**W**

Warhead section .....	1-3	Weapons control statuses .....	4-6
Weapon activation .....	3-2	WEAPONS FREE .....	4-6
Weapon checks, critical .....	2-3	WEAPONS HOLD .....	4-6
Weapon handling .....	2-1	WEAPONS TIGHT .....	4-6
Weapon-round container/ready rack ...	1-10		

31 DECEMBER 1984

By Order of the Secretary of the Army:

**JOHN A. WICKHAM, JR.**  
*General, United States Army*  
*Chief of Staff*

Official:

**DONALD J. DELANDRO**  
*Brigadier General, United States Army*  
*The Adjutant General*

**DISTRIBUTION:**

*Active Army, ARNG, and USAR:* To be distributed in accordance with DA Form 12-11A, Requirement for Redeye Guided Missile System (Qty rqr block no. 192).

Additional copies may be requisitioned from the US Army Adjutant General Publications Center, 2800 Eastern Boulevard, Baltimore, MD 21220.

**PIN: 047126-000**