

BASIC DOCTRINE MANUAL FOR SUPPLY AND STORAGE

- . SUPPLY OPERATIONS
OFFICER**
- . SUPPLY PLATOON
LEADER**
- . PETROLEUM PLATOON
LEADER**
- . TECHNICAL SUPPLY
OFFICER**

This copy is a reprint which includes current pages from Change 1.

Headquarters, Department of the Army

DISTRIBUTION RESTRICTION. Approved for public release; distribution is unlimited.

CHANGE
NO 1

HEADQUARTERS
DEPARTMENT OF THE ARMY
Washington, DC, 30 September 1993

BASIC DOCTRINE MANUAL FOR SUPPLY AND STORAGE

FM 10-15, 12 December 1990, is changed as follows:

1. New or changed material is identified by a star (★).
2. Remove and insert pages as indicated below.

Remove pages	Insert pages
i through viii	i through x
2-3 and 2-4	2-3 and 2-4
2-17 and 2-18	2-17 and 2-18
4-1 through 4-12	4-1 through 4-9
5-1 through 5-6	5-1 through 5-6
6-7 through 6-13	6-7 through 6-11
7-7 and 7-8	7-7 and 7-8
8-1 through 8-20	8-1 through 8-13
9-3 and 9-4	9-3 and 9-4
10-1 through 10-12, A-1 and A-2	10-1 through 10-12 A-1 and A-2 Glossary-5 References-7

3. File this transmittal sheet in front of the publication for reference purposes.

Post these changes per DA Pamphlet 310-13.

By Order of the Secretary of the Army:

Official:

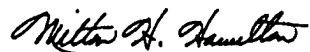

MILTON H. HAMILTON
Administrative Assistant to the
Secretary of the Army

05017

GORDON R. SULLIVAN
General, United States Army
Chief of Staff

DISTRIBUTION:

Active Army, USAR, and ARNG: To be distributed in accordance with DA Form 12-11-E, requirements for FM 10-15, Basic Doctrine Manual for Supply and Storage (Qty rqr block no. 0863).

DISTRIBUTION RESTRICTION: Approved for public release;
distribution is unlimited.

CHANGE
NO 1HEADQUARTERS
DEPARTMENT OF THE ARMY
Washington, DC, 12 December 1990

BASIC DOCTRINE MANUAL FOR SUPPLY AND STORAGE

TABLE OF CONTENTS

	Page
★ PREFACE	x
PART ONE	
SUPPLY OFFICERS AND LEADERS	
CHAPTER 1	
SUPPLY OPERATIONS OFFICER	
Determine Your Responsibilities	1-1
Determine Demand Satisfaction	1-1
Determine and Monitor ASL Size	1-1
Reduce Excess Stocks	1-2
Coordinate and Monitor Stock Accounting and Stock Control Operations	1-2
Schedule ADP Runs	1-3
Safeguard Electronic Data Transmissions	1-3
Prepare for ADPE Outages	1-3
Ensure Security of ADP Facilities and Software	1-5
Review Stock Status Report	1-5
Schedule and Coordinate Inventories	1-8
Determine Supply Support of Deploying Units	1-8
Compute and Monitor Supply Performance Indicators	1-8
Review Receipt Not Due In Listing	1-8
Review Supply Status	1-9
Follow-Up on Outstanding Requisitions	1-11
Reconcile Due-Outs With Supported Units	1-11
Direct Personnel to Process Manual Off-Line Replenishment Requisitions	1-11

DISTRIBUTION RESTRICTION: Approved for public release: distribution is unlimited.

Monitor Turn-In of Recoverable and	
Automatic Return Items	1-11
Coordinate Receipt, Storage, and Issue	1-11
Coordinate Transportation Requirements	1-12
Coordinate Class I Operations	1-12
Coordinate Class II, IV, and VII Operations	1-13
Monitor Bulk Fuel Operations	1-13
Coordinate Service Functions	1-13

CHAPTER 2**SUPPLY PLATOON LEADER**

Review Your Responsibilities	2-1
Improve Customer Support	2-1
Monitor Materiel Release Denials	2-1
Monitor Receipt Operations	2-2
★ Supervise Unloading	2-4
★ Review Reports of Discrepancies	2-4
★ Review Storage Layout Plans and Use	
of Storage Space	2-4
Monitor Storage Operations	2-6
Maintain Security of Pilferable Tools	2-6
Safeguard Classified and Sensitive Material	2-8
Perform Storage Checks and Inspections	2-8
Spot-Check Stock Locations	2-8
Monitor Location Surveys	2-8
Coordinate Inventories	2-11
Compute Location Accuracy and Inventory Accuracy	2-11
Supervise Issue and Shipment of Supplies	2-11
Perform Night Delivery Operations	2-12
Set Up a Class I Distribution or Supply Point	2-12
Monitor Class I Storage	2-12
Check Excess Class I Stocks	2-13
Supervise Water Point Operations	2-15
Monitor Water Requirements	2-15
Review Water Supply Summary Reports	2-16
Supervise Rigging of Water Drums for	
External Sling Loads	2-16
Set Up Class II, IV, and VII Distribution	
or Supply Points	2-17
Supervise Class II, IV, and VII Support Operations	2-17
Monitor Class VII Issue Controls	2-18
★ Direct Helicopter External Air Transport	
(Sling Load) or Request Airdrop Support	2-18

★ Establish a Map Point	2-18
★ Maintain Security of Classified Maps	2-18
Establish a Salvage Collection Point	2-19
Establish and Operate a CIF	2-19
Review CIF Property Records and Adjustment Documents	2-19
Manage a Self-Service Supply Center	2-20
Coordinate Laundry, Bath, and Renovation Operations	2-21
Decontaminate Clothing and Textiles	2-21
Manage Unit Graves Registration Operations	2-23

CHAPTER 3**PETROLEUM PLATOON LEADER**

Review Your Responsibilities	3-1
Establish a Class III Supply Point	3-1
Supervise Bulk Petroleum Receipt and Distribution	3-1
Inspect Petroleum Tank Trucks and Tank Semitrailers	3-3
Verify Accuracy of Bulk Petroleum Inventory	3-3
Supervise Helicopter Refueling	3-5
Establish Mobile Filling Stations	3-6
Supervise Hose Line Operations	3-6
Supervise Pipeline Operations	3-6
Control Pipeline Corrosion	3-6
Control Environmental Pollution	3-8
Supervise Packaged Petroleum Storage and Distribution	3-8
Perform Quality Surveillance	3-13
Monitor Storage and Handling of Compressed Gases	3-13
Coordinate Local Purchase	3-13
Maintain Returnable and Refillable Cylinders or Containers	3-13
Prepare or Update POL Safety Program	3-16
Control Pilferage and Sabotage	3-16

CHAPTER 4**TECHNICAL SUPPLY OFFICER**

Review Your Responsibilities and Concerns	4-1
★ Review Mandatory Parts Lists and Determine Impact on ASL	4-1
Use LIF to Determine Supply Status	4-1
★ Determine Size of Class IX ASL	4-2
★ Incorporate ASL Change List Recommendations	4-2
★ Analyze Impact of PLL Change List on ASL Size and Depth	4-2
★ Monitor Demand Satisfaction and Other Supply Indicators	4-2

Verify Critical Equipment Deadlined Due to Zero Balances	4-2
Monitor Stock Control	4-2
Set Up Card File for a Part or Reference Number	4-3
★ Use of STANAG and QSTAG Agreements	4-3
Monitor ADP Support	4-3
★ Standardize Receipt, Storage, and Issue Procedures	4-3
Monitor Stock Locations and Storage Procedures	4-3
★ Change Storage Records and Storage Aids to	
Agree With Monthly Cross-Reference List	4-7
★ Maintain or Manage RMA	4-7
Store Batteries	4-7
Monitor Tire Storage	4-7
Manage a QSS	4-8

PART TWO SUPPLY OPERATIONS

CHAPTER 5 CONTROLLING STORAGE SPACE

Section I	Determining Space	
	Responsibilities	5-1
	Storage Space	5-1
Section II	Making a Storage Layout	
	Storage Layout	5-2
	Storage Layout Plan	5-2
	Storage Factors	5-4
	Storage Layout Drawing	5-4.1
	Open Storage Layout	5-8
	Tent Storage Layout	5-9
	Bin Storage Layout	5-9
	Bulk Storage Layout	5-11
	Van Storage Layout	5-13
	Field Storage Layout	5-13
	Storage Aids	5-14
Section III	Computing Storage Space	
	Responsibilities	5-17
	Gross Storage Space	5-17
	Net Storage Space	5-18
	Covered Storage Space	5-18
	Dollar Value Per Cubic Foot	5-18
	Vertical Space in Use	5-18

Section IV	Reporting Storage Space	
	Responsibilities	5-19
	Space Allocation Map	5-19
	Planograph	5-19
	Storage Space Survey Work Sheet	5-20
	Storage Space Status Report	5-21
	Space Recapitulation Record	5-21
	Storage Space Management Report	5-21

CHAPTER 6 SETTING UP AND MAINTAINING A STOCK LOCATOR SYSTEM

	Using the System	6-1
	Setting Up the Locator System	6-1
	Marking Locations	6-5
	Setting Up the Locator File	6-7
	Maintaining the Locator File	6-7
	Making Location Changes	6-8
	★ Making Location Site Forms	6-10

CHAPTER 7 RECEIVING SUPPLIES

	Responsibilities	7-1
	Receipt Documents	7-1
	Document Control Register	7-5
	DSS and DSS Air Line of Communication Shipments	7-6
	DSS Shipments	7-7
	Documents Received with DSS and DSS Air Lines of Communication Shipments	7-8
	Non-DSS Shipments	7-10
	Substitute Items	7-10
	Misrouted Items	7-12
	Overages or Shortages and Damaged Items	7-13
	Turn-Ins From Supported Units	7-13

★ CHAPTER 8 STORING AND SELECTING SUPPLIES FOR ISSUE

Section I	Storing Supplies	
	Supervising Personnel	8-1
	Storing Incoming Supplies	8-2
	Processing Substitute Items for Storage	8-3
	Identifying Incorrectly Stored Items	8-4
	Relocating Stored Supplies	8-5

	Page
Section II	
Selecting Items From Storage	
Choosing Items for Issue	8-5
Sorting Materiel Release Orders by Priority	8-5
Sorting Materiel Release Orders by Storage Location	8-6
Pulling Items From Stock	8-6
Section III	
Processing Supplies for Issue	
Processing Materiel Release Orders	8-6
Processing a DA Form 2765 Materiel Release Order	8-7
Processing a DD Form 1348-1 Materiel Release Order	8-7
★ Processing a SARSS-Produced Materiel Release Order	8-8
Processing Materiel Release Orders for	
Sensitive and Pilferable Items	8-8
Processing Materiel Release Orders for Partial Issues	8-8
Processing Materiel Release Denials	8-11
Processing Materiel Release Denials	
for Partial Issues	8-11
Processing Materiel Release Denials	
for Complete Denials	8-11
Processing Materiel Release Order List	
(Supply Management Report)	8-12
★ Processing MROs for Partial Issue or Denials in SARSS	8-12
Issuing a Materiel Release Denial	8-12
CHAPTER 9	
ISSUING AND SHIPPING SUPPLIES AND EQUIPMENT	
Section I	
Planning Issue and Shipping Activities	
Responsibilities	9-1
Issue/Shipping Section	9-1
Section II	
Issuing Items	
Using Issue Documents	9-1
Issuing Supplies	9-2
Picking Up Supplies	9-2
Preparing Customer Unit Notification Log	9-3
★ Checking Customer Identification	9-3
Section III	
Shipping Materiel	
Shipping Supplies	9-5
Preparing Release Orders	9-5
Planning the Shipment	9-6
Picking the Stock	9-7
Making a Release Denial	9-7

	Page
	9-10
	9-10
	9-11
	9-11
Section IV	
Using Pallets	
Description	9-14
Types of Pallets	9-14
Section V	
Using Cargo Containers	
Responsibilities	9-16
Description	9-16
MILVAN	9-16
SEAVAN	9-16
Preparation for Loading	9-16
CHAPTER 10	PERFORMING PHYSICAL INVENTORIES
Section I	Overview
★ Responsibilities	10-1
Physical Inventories	10-4
Preparation	10-4
Section II	The Location Survey
Preparing for Survey	10-6
★ Performing the Survey	10-7
Using Handmade Location Survey Work Cards	10-7
Processing Manual Location Survey Work Cards	10-7
Using Preprinted Location Survey Work Cards	10-8
★ Using SARSS Location Survey Listing	10-8
★ Correcting Location Survey Problems and Storage Errors	10-8
Comparing Survey Results With Stock Records (Manual Procedures)	10-8
Section III	Preinventory Procedures
Setting Up Controls	10-10
Setting Cutoff Controls on Receipts	10-11
Setting Cutoff Controls on Materiel Release Orders	10-13
Getting an Inventory Voucher Number	10-13
Preparing Inventory Count Cards	10-14
Preparing Inventory Count Card Control Listings	10-17
Preparing Stored Items for Inventory	10-17

	Page
Section IV	The Inventory
	Working with Key Inventory Personnel 10-20
	Issuing Items During the Inventory 10-20
	Inventorying Lumber 10-21
	Performing the Inventory 10-21
	Accepting the Count 10-26
	Requesting a Recount (Manual Procedures) 10-26
	Completing the Inventory 10-29
	Evaluating Inventory Performance 10-29
CHAPTER 11	USING MATERIALS-HANDLING EQUIPMENT
	Determining Responsibilities 11-1
	Choosing Materials-Handling Equipment 11-1
	Using Powered Materials-Handling Equipment 11-1
	Using Nonpowered Materials-Handling Equipment 11-3
	Controlling Materials-Handling Equipment 11-4
	Maintaining Materials-Handling Equipment 11-6
CHAPTER 12	UPLOADING AND STORING THE COMBAT ASL
Section I	Overview
	Purpose 12-1
	Combat ASL Items 12-1
	Special Considerations 12-1
	Location and Storage Aids 12-1
	Location System 12-1
	Deployment 12-1
Section II	Computation and Configuration of Usable Storage Capacity
	Computation 12-2
	Storage Aids 12-2
	Vehicles 12-2
★ APPENDIX A	LOGISTICS HOT LINES A-1
B	SOP FOR CENTRAL ISSUE FACILITY B-1
C	INTERNAL SOP FOR QUICK SUPPLY STORE C-1

Page

E	JULIAN DATE CALENDAR	E-1
F	QUALITY CONTROL/ASSURANCE PROGRAM	F-1
GLOSSARY	Glossary-1
REFERENCES	References-1
INDEX	Index-1

★ PREFACE

PURPOSE

This field manual provides supply support activity officers with a handy guide. It covers critical mission task common to SSA officers. This manual is only a guide. It does not present all the information you need. However, it cites sources of additional information.

SCOPE

This FM gives specific guidance on planning, organizing, directing, coordinating, and controlling supply support and field services. It highlights DA requirements and provides time and personnel planning factors on which to base supervisory logistics decisions. This manual will be more useful to you if you adapt the information in it to your duty position and local policies and procedures. The task checklists are in chronological or logical sequence. You may find it helpful to enter a number in the task box to identify the priority you or higher headquarters places on that task. Also, you may want to darken those boxes next to the tasks performed by the materiel management center or those assigned to your section chiefs or platoon sergeant. Appendix A has a hotline of logistical agencies and activities.

RECOMMENDED CHANGES

The proponent for this publication is HQ TRADOC. Submit changes for improving this publication on DA Form 2028 (Recommended Changes to Publications and Blank Forms). Key your comments to the page, paragraph, and line of the text in which the change is recommended. Provide reasons for each comment to ensure understanding and complete evaluation. Forward the DA Form 2028 to-

Commander
US Army Quartermaster Center and School
ATTN: ATSM-SPT-I
Fort Lee, Virginia 23801-5036

Unless otherwise stated, whenever the masculine gender is used, both men and women are included.

PART ONE - SUPPLY OFFICERS AND LEADERS

CHAPTER 1 Supply Operations Officer

DETERMINE YOUR RESPONSIBILITIES

Success on tomorrow's battlefields may depend on the Army's ability to feed and clothe its fighting forces, fuel its combat vehicles, fortify its positions, and replace its weapons systems. Your office acts as the supply mission control element of your unit. Depending on your unit's supply mission, you must ensure that food, water, clothing, petroleum, barrier material, and major end items are available when and where they are needed. You may even determine the quantity and types of items to be stored in distribution or supply points. A major concern will be ASL size versus mobility requirements. A supply platoon can receive as many as 5,000 demands per month for stocked items and 1,000 demands for nonstocked items. You are responsible for coordinating with your MMC or SCS, operating platoons, supported units, and higher sources of supply to ensure that demands are met. While the MMC or SCS manages your supply assets, your soldiers prepare and process stock accounting and stock location records for all supplies received, stored, and issued from your unit supply and storage elements. You will need to learn how to use computer listings to monitor DIs, MROs, and DOs to identify problem areas. You will also be concerned with the security of ADP software and hardware and contingency planning for ADPE outages.

DETERMINE DEMAND SATISFACTION

The mission of the SSA is to supply supported units. How well your unit provides this support

will depend on whether requests are for ASL or NSL items and on the number of items in stock. You must make sure your SSA stocks the line items demanded as part of your ASL and that stocks are on hand to fill requests upon demand. DA objectives and acceptable management levels are prescribed in AR 710-2, Chapter 1. The formulas for measuring demand satisfaction is covered later in this chapter.

DETERMINE AND MONITOR ASL SIZE

Your main concern is that your SSA will be able to supply supported units upon demand or within acceptable time limits. The problem is that your SSA cannot stock all demand-supported items and still remain mobile. Table 1-1 lists ASL stockage criteria. Your tasks are listed below.

- Review the ASL semiannually for potential reductions in range.
- Monitor the quarterly ASL continually to determine and drop nonessential lines.
- Review action codes on the ASL change list which recommend addition, deletion, or retention of items. DS4 makes automatic increases to ASL lines.
- Analyze the impact of stockage level changes on movement and storage requirements.
- Ask the supply manager to set minimum RO and ROP quantities, so that automated supply systems will not be adjusted below the set minimum.

Table 1-1. ASL stockage criteria

The following items qualify for stockage:

- Demand-supported items (nine recurring demands in the most recent 360-day period to stock and three demands to retain).

NOTE: Items with less than three recurring demands will be considered for deletion. Automated supply systems automatically adjust demand-supported stockage levels based on the quantity demanded. The ASL review board will determine ASL additions and deletions.

- Mission-essential or mandatory stockage items.
- ORF items specifically authorized.
- Initial provisioning items required for mission loads.
- Aviation and missile repair parts (receiving three demands to stock and one to retain).
- Request that the supply manager fix the RO at a specific level.
- Check the ASL lines against the DO lists to determine if manual replenishment or passing action is warranted when lines are frozen due to inventory actions.
- Seasonal demand items.

REDUCE EXCESS STOCKS

Excess stocks are those which exceed the authorized retention level. DA policy requires that automated systems run the process monthly to determine excess. During wartime, this process is run at the option of the local command. DS level automated systems produce an excess report list and a deck of candidate cancellation cards. Sample DS4 formats are in TM 38-L32-13. Note that excess quantities are not automatically canceled. SSAs must determine which recommendations to accept and which to reject. In wartime, when demands are unpredictable and stocks are expected to be used, it may not be wise to dispose of all excess stocks. Depending on the extended price, the owning SSA may retain excess stocks in DSUs or GSUs until they can be issued as interchangeable or substitute items or until their price exceeds the amount prescribed in AR 710-2, Chapter 3. Your tasks are listed below.

- Review and carry out disposition and retention policies for ARIs, material return

program items, field returns, and captured and unwanted material.

- Review the current DI file list.
- Select DIs to be canceled. Select the most recent DIs with the lowest priority first.
- Have stock control soldiers process MROs, materiel release confirmation cards, shipping documents (if required), and possible partial cancellations. DS4 processing instructions are in TM 38-L32-13.
- Request disposition instructions as directed by your command.

COORDINATE AND MONITOR STOCK ACCOUNTING AND STOCK CONTROL OPERATIONS

If you do not know the NSN of an item or if an item is not listed on the AMDF, contact the following:

Management Information Research Assistance Center
US Army Materiel Command Catalog Data Activity
New Cumberland Army Depot
New Cumberland, PA 17070-5010
AUTOVON: 977-7431
COMMERCIAL: (717) 782-7431

As the supply operations officer, you must periodically review the preparation and submission of stock accounting and stock control records kept by your materiel control specialists. Your ability to review stock records and listings produced by your MMC or SCS will help improve supply responsiveness to supported units. Your tasks are listed below.

- Have personnel review requests for excessive quantities, questionable prices, and old document dates.
- Review supporting document files for reasons for rejections from higher supply sources.
- Make it SOP that personnel classify work by priority of request.
- Ensure that your office personnel are comparing requests against the ASL, SSSC, RX, QSS, and controlled-item listings.
- Monitor MRO processing times (see Table 1-2).
- Review reasons for MRDs.
- Ensure that inventory count cards are controlled.
- Ensure that stock location data are kept current.

Table 1-2. MRO processing times

PRIORITY DESIGNATOR	TIME LIMITATION
PDs 01 through 03 and NMCS	Must be processed within 24 hours from the time received ¹
PDs 04 through 15	Must be processed within two workdays from time received
NMCS items ²	Must be processed within 24 hours from time received ¹
¹ Based on a 24-hour day, 7-day workweek. ² DD Form 1348-1 (DOD Single Line Item Release/ Receipt Document) will have 999 or N in Req'd Del Date block for these items	

SCHEDULE ADP RUNS

You need to schedule ADP runs to provide timely supply and services to supported units. Table 1-3 lists various ADP runs and gives their frequencies. Your tasks are listed below.

- Identify daily, weekly, monthly, semiannual, and annual program runs.
- Identify cyclic and as required runs. TM 38-L32-13 describes daily, cyclic, and periodic processes under DS4.
- Analyze the interrelationships between required program runs.

NOTE: Request and issue documents should be entered into the system before supply status documents. Cancellations should be processed before follow-up documents.

- Schedule those sequential programs that depend on one another.
- Estimate special requirements.
- Establish priorities and suspense dates.
- Adjust work load schedules to meet priority demands. Requests should be batched by PD code.
- Obtain ADP run schedules from your supporting data processing activity. Note cutoff dates and submission times.
- Project time requirements by reviewing run time statistics listed in console logs and utilization records.

SAFEGUARD ELECTRONIC DATA TRANSMISSIONS

ADP systems may be configured for electronic data exchange with other computer systems or

terminals by way of radio, AUTODIN, reference data networks, mobile subscriber equipment, or other electronic transmission facilities. To safeguard electronic data transmissions, you must coordinate electronic interconnection with the attached signal support unit. Your tasks are to ensure that—

- Modem is operational.
- Communications software is operational.
- Cryptographic equipment is operational, if applicable.
- Individual is available that knows about the system.

PREPARE FOR ADPE OUTAGES

ADPE may become inoperative because of a mechanical failure in the power source. It may be damaged or destroyed because of enemy action. Normal procedures should be altered as little as possible. Follow short-term outage procedures until it is determined that long-term backup procedures prescribed in automated system TMs are warranted. See Figure 1-1 for actions during outages. You may need assistance to determine the cause of the problems that interrupt normal processing. Problems may be the result of hardware malfunction, operator error, incorrect data, or a systems incident. The US Army Information Software Support Systems Command maintains a 24-hour customer assistance office to support major commands using DS4. See Figure 1-2 for customer assistance locations and telephone numbers.

Table 1-3. DS4 ADP functional processes and frequencies

DAILY PROCESS	
<ul style="list-style-type: none"> • Daily cycle 	<ul style="list-style-type: none"> • Catalog update process • Demand history update • Supply performance report • Excess stocks • Recoverable item control process • Monthly consolidation
WEEKLY PROCESSES	
<ul style="list-style-type: none"> • Stock status report • Weekly reports • DI and DO reports • Weekly consolidation 	
SEMIMONTHLY PROCESS	
<ul style="list-style-type: none"> • Customer DO reconciliation 	
MONTHLY PROCESSES	
<ul style="list-style-type: none"> • ASL • Bottom-up reconciliation • Monthly transaction register 	AS REQUIRED PROCESSES <ul style="list-style-type: none"> • Location survey • Special inventory • Mass cancellation • Stand alone ASL and NSL • Replenishment cycle

OUTAGES	ACTIONS
<p>Short-Term (72 hours or less)</p>	<p>Direct soldiers to process high-priority requests manually on a postpost basis.</p> <p>Have your soldiers hold low-priority requests until the end of the outage.</p> <p>Update records when ADPE is operational again.</p>
<p>Long-Term (more than 72 hours)</p>	<p>Seek out replacement, substitute, or float ADPE or arrange for time-sharing on another command's equipment.</p> <p>Determine and direct only essential processing.</p> <p>Direct soldiers to process high-priority requests on a postpost basis.</p> <p>*Authorize the use of manually prepared requests.</p> <p>Have soldiers use the latest listings and card files to set up manual stock records following procedures in DA Pamphlet 710-2-2.</p> <p>Direct soldiers to maintain additional records in a suspense or hold file to aid in returning to the automated system.</p>
<p>*NOTE: Reverting to manual procedures is the least desired backup support.</p>	

Figure 1-1. Actions during outages

MAJOR COMMANDS	CUSTOMER ASSISTANCE AUTOVON NUMBER	MESSAGE ADDRESS
CONUS	687-1051 Commercial: (804) 734-1051	CDR USAISSDCL FT LEE VA//ASQBI-LTSI//
USAREUR	ZM 6613	CDR USAISECE ZWEIBRUEKEN GERMANY// ASBE-FSD//
PACIFIC	438-9377	CDR USAISECP FT SHAFTER HI// ASBP-OB//
KOREA	738-3757	CDR USAISEC-FE SEOUL KOREA//ASBPF-SD//

Figure 1-2. Customer assistance information for DS4 users

ENSURE SECURITY OF ADP FACILITIES AND SOFTWARE

Data processing facilities are vulnerable to destruction, sabotage, and compromise. Therefore, you must plan for the secure operation of ADPE authorized your office. This includes physical security of ADPE software programs and procedures (see Table 1-4). Detailed guidance is in AR 380-380. Your tasks are listed below.

- Ensure strict accountability for keys or access combinations.
- Ensure that physical security deficiencies are eliminated or kept to a minimum through the use of guards, barriers, protective lighting, entry control checks, and intrusion detection systems.
- Check that van cables and generators have been protected.
- Limit access. Prevent unauthorized access to ADP area, equipment, documents, listings, card decks, and system TMs. Establish a system of checks and controls on personnel entering the area.
- Plan for storage and safeguarding of alternate files.
- Establish a system of input and output control logs.
- Report extra data found in printouts as possible ADP system penetration or Threat agent attack.

- Review distribution plans. Reduce the number of copies of reports. Require periodic justification of the number of reports.
- Identify an alternate site for the transfer of ADP operations, if necessary.
- Destroy all printouts of reports, lists, and alternate files as new ones are printed.

REVIEW STOCK STATUS REPORT

The weekly stock status report is the only automated listing which shows all assets on hand. It lists stockage levels for ASL items. This report is the basic listing required to continue operations in case of a computer failure. Figure 1-3 shows a sample report. More information on this report is in TM 38-L32-13. Your tasks are listed below.

- Monitor increases and decreases in total lines and total dollar values.
- Note ASL items with no location.
- Note date of last inventory.
- Note ASL lines with zero balance and DOs.
- Note ASL lines with DOs and no DIs.
- Note ASL lines with SLC other than "Z" and RO quantity of zero.
- Investigate causes of conditions listed above and mark necessary corrections.

Table 1-4. ADP security list

CAUTION:

Do not use this list as a sole basis for determining your security needs. Use it to assess current ADP systems security.

ACCESS CONTROL:

- Do you have a photo badge system for positive identification of personnel?
- Is access restricted to selected personnel?
- Have you established visitor control and escort procedures?
- Are keys and locks changed at regular intervals or after dismissal (service separation) of personnel?

EQUIPMENT USE AND AUDIT CONTROLS:

- Do you have backup equipment available or access to other ADPE?
- Do you spot-check output listings for possible misuse of the system?
- Has equipment been tested for emanations?
- Are computer use and production controls employed?

ELECTRICITY:

- Do you have backup generators?
- Has backup power been tested at regular intervals?

REMOTE TERMINAL SECURITY CHECKS:

- Do you employ keywords or passwords to identify a specific terminal or user?

NOTE: Change file or systems passwords, at a minimum, on reassignment or separation of any persons having knowledge of the password, when the password is known to have been compromised, or annually.

- Do you employ software scrambling techniques or hardware cryptographic devices during transmission of vital data?

SOFTWARE SECURITY:

- Have you provided backup files at a secondary location?
- Do you have a contingency plan covering destruction of classified material in the event of evacuation?
- Do you perform periodic checks on access codes?
- Are the retention cycles for data files reviewed regularly?
- Are program changes controlled and recorded?
- Do you store files in fire resistant containers?

THREAT MONITORING:

- Do you maintain a monitor log of those who have access to data banks or sensitive files?
- Do you use software security routines to monitor access to sensitive files or data records? Do the routines provide a printout record at the end of the day of all illegal access attempts?

DS4 SUPPLY MANAGEMENT REPORT

1 PREPARED 19 FEB 90										STOCK STATUS REPORT																								
2 CLASS IX COMMON																																		
3 P										C																								
4 I										N																								
5 I										D																								
STOCK NUMBER	MC	MAT CAT	SD	CF	PR	RR	A	SC	ER	UI	DI	OH	STG	LCN	NOLOC	EA	NOLOC	EA	DGA75	5	0	0	19	2	1	0	0	A000	5203	6027	5166	S	0.95	A
MC	MC	CAT	CC	LC	CC	CC	CC	CC	MC	UI	DI	OH	STG	LCN	NOLOC	EA	NOLOC	EA	DGA75	5	0	0	19	2	1	0	0	A000	5203	6027	5166	S	0.95	A
*4730-00-188-3504		Z0 0								EA	A	NOLOC	0	3	3	0	0	0	0	19	2	1	0	0	0	0	A000	6048	6048	6048	E	99999.99	A	
*4730-00-188-3515		J2200 Q1	0	U	O	Z	C	X	9B	EA	A	DGA75	5	0	0	0	0	0	0	19	2	1	0	0	0	0	A000	5203	6027	5166	S	0.95	A	
*5960-00-188-3565		Z0 0								EA	A	NOLOC	0	3	3	0	0	0	0	0	0	0	0	0	0	0	A000	6047	6047	6047	E	99999.99	A	
*5310-00-188-7721		T2200 P1	0	U	O	Z	C	X	9T	EA	A	C2541	24	0	0	0	0	0	0	45	4	1	29	4	0	0	A000	5090	5282	5166	S	0.35	A	
*5960-00-188-8506		Z0 0								EA	A	NOLOC	0	2	2	0	0	0	0	0	0	0	0	0	0	0	A000	6047	6047	6047	E	99999.95	A	
*5306-00-189-1775		T2200 Q2	0	U	O	Z	G	X	9T	EA	A	OCA71	19	101	0	130	20	0	0	0	0	0	0	0	0	0	A000	4294	5315	5279	S	0.81	A	
*4730-00-189-3017		J2200 Q1	0	U	O	Z	C	X	9B	EA	A	C5E51	2	0	0	7	1	0	0	0	0	0	0	0	0	0	A000	4297	6030	5166	S	0.81	A	
*4730-00-189-3019		J2200 Z0	0	U	O	Z	G	X	9B	EA	A	NOLOC	0	3	3	0	0	0	0	0	0	0	0	0	0	0	A000	5100	5100	5100	S	9.83	A	
*5910-00-189-5518		Q2200 Z0	0	U	O	Z	F	9T	CAPACITY	EA	A	NOLOC	0	1	1	0	0	0	0	0	0	0	0	0	0	0	A000	5160	5160	5160	S	0.92	A	
*1025-00-189-5762		M22JQ Q1	0	U	O	Z	C	X	9H	EA	A	D1D12	1	2	0	4	2	1	0	0	0	0	0	0	0	0	A000	8091	6046	5166	S	98.56	A	
A1025-00-236-6873		M22JQ Q1	0	U	O	Z	C	X	9H	EA	A	D2E13	1	0	0	0	0	0	0	0	0	0	0	0	0	0	A000	1203	6017	5166	S	0.14	A	
*5310-00-189-8907		T2200 Q1	0	U	O	Z	C	X	9T	EA	A	B2A52	149	0	0	153	12	2	0	0	0	0	0	0	0	0	A000	8091	5209	5166	S	0.04	A	
*5330-00-189-8908		T2200 Q2	0	U	O	Z	C	X	9T	EA	A	G4748	4	174	0	178	5	1	0	0	0	0	0	0	0	0	A000	8091	5209	5166	S	0.04	A	
*5820-00-190-4405		G22RB Q2	0	U	O	Z	C	X	9G	EA	A	H1221	150	0	0	122	148	40	0	0	0	0	0	0	0	0	A022	4273	5224	5169	S	3.01	A	
*5820-00-190-4405		G22RB S1	0	U	O	Z	C	X	9G	EA	A	D1E11	8	14	0	22	10	9	22	10	9	22	10	9	22	10	A022	1297	5168	3167	S	3.01	B	
*5820-00-190-4405		G22RB Q1	0	U	O	Z	C	X	9G	EA	A	V3N43	43	0	0	53	34	6	22	10	9	22	10	9	22	10	A022	2073	6030	5169	S	3.01	A	
*5820-00-190-4405		G22RB S1	0	U	O	Z	C	X	9G	EA	A	V3H21	9	13	0	22	10	9	22	10	9	22	10	9	22	10	A022	1257	3191	5165	S	3.01	D	
*4940-00-190-5164		J2200 Q1	2	U	O	Z	C	X	9H	EA	A	L5C42	1	0	4	20	6	1	0	0	0	0	0	0	0	0	A000	8091	6039	5166	S	7.12	C	

Legend:
 Print Line 1: STANDARD HEADER LINE DATA - Include date prepared, title, and product control number (PCN)
 Print Line 2: SUPPLY CLASS - CLASS IX SPECIAL INTEREST TITLE - COMMON
 SPECIFIC REPORT TITLE - STOCK STATUS REPORT
 Print Line 3-5:
 PII - Preferred item indicator field
 STOCK NUMBER - Stock number field
 MC - Item manager code
 MAT CAT - Material category code
 SLC - Stockage list code
 DSC - Distribution of stockage code
 CTL - Management review code field
 FRZ - Freeze code
 PIC - Piffage code
 RIC - Reportable item control code
 REC - Recoverability code
 EC - Essentiality code
 ARC - Accounting requirements code
 SCMC - Supply category of materiel code
 NOMEN - Nomenclature

UI - Unit of issue code
 CND - Condition code
 STG LCN - Storage location code
 OH QTY - On-hand quantity
 DI QTY - Due-in quantity
 DO QTY - Due-out quantity
 RO QTY - Requisitioning objective quantity
 ROP QTY - Reorder point quantity
 SAF LEV - Safety level quantity
 MIN RO - Minimum requisition quantity
 MIN ROP - Minimum reorder point quantity
 OST - Order shipping time source code and order shipping time days
 DATE SLC CHNG - Date stockage list code changed
 DATE LAST CHNG - Date ABF last changed in system
 DATE LAST INV - Date last inventoried
 PSC - Price signal code
 UNIT PRICE - Unit price
 DSU - Direct support unit code at which item is stocked
 * - Preferred
 A - Described

Figure 1-3. Sample stock status report

SCHEDULE AND COORDINATE INVENTORIES

Inventories determine the actual quantity and status of stocks on hand. AR 710-2 requires that all items be inventoried at least annually. You may schedule cyclic inventories to fulfill the annual inventory requirement. You must schedule an inventory when pilferage is suspected, when an MRD occurs, or when directed by higher HQ. During wartime, inventories will be conducted only when the tactical situation allows. Discrepancies occurring during wartime have to be recorded. They do not have to be reported. Your tasks are listed below.

- Coordinate with the supply platoon leader on location survey dates and findings.
- Establish a cutoff date for receipts.
- Ensure that customers are notified of cutoff dates.
- Have personnel prepare a receiving cutoff control register.
- Setup issue controls. Have personnel prepare an MRO cutoff control register.
- Request an inventory control list and inventory count cards from the MMC.
- Ensure that items in maintenance are included in the inventory count.

NOTE: You may recommend changing the lot size if you find that soldiers in your storage activity cannot count a certain lot within the set time frame.

DETERMINE SUPPLY SUPPORT OF DEPLOYING UNITS

Since departing units should have their basic loads on hand, SSAs need only fill all DOs for units deployed for less than 15 days. However, you must develop detailed contingency plans for continuing or transferring supply support of forces deployed for an extended period. TM 38-L32-11 contains procedures for deploying a supported unit using DS4. TM 38-L32-13 contains deployment procedures for DSUs and larger elements. You must coordinate with the supporting SAILS activity to ensure requisitioning support. Your tasks are listed below.

- Ensure transferring units resubmit requests to your office for high-priority (PD 01 or 02) requests only.
- Notify supply elements of new routing address for deploying units.

- Ensure that items on which delivery status has been received are shipped directly to the unit, if possible.

- Direct supply elements to fill as many DOs as possible.

- Provide supply cancellation notices to the supported units.

- Cut off transactions pertaining to the deploying units. Higher commands may cancel all outstanding requisitions.

- Ensure that the MMC will produce a copy of the demand history file for forwarding to the gaining DSU.

- Extract unit demand history data if long-term support is to be provided by another DSU.

COMPUTE AND MONITOR SUPPLY PERFORMANCE INDICATORS

As the supply operations officer, you must continually review supply support. Supply performance indicators help you to determine trends, isolate deficient areas, and correct deficiencies. Table 1-5 lists DA objectives and acceptable management levels prescribed by AR 710-2 for a number of supply performance indicators. Areas which do not fall within acceptable ranges should receive intensive review and management. DS4 produces a supply performance report which lists demand data needed to compute supply performance indicators. Figure 1-4 shows a sample of Class II support provided by DSUs in a division. A separate page would be printed for packaged Class III and Class IV support. Note that the automated system has already computed the percent of demand accommodation and demand satisfaction for you. See TM 38-L32-13 for details of each column on the report. The supply performance report does not report the number of NSL demands filled. Compute it by subtracting the total ASL demands filled and the total demands passed to the main DSU from the total valid demands.

REVIEW RECEIPT NOT DUE IN LISTING

Your soldiers report receipts to your MMC by keypunching or preparing materiel receipt cards or shipping documents for processing in the daily cycle run. TMs 38-L32-12 and 38-L32-13 give details on how to process receipt documents

Table 1-5. Supply performance objectives and acceptable levels of customer unit supply support

SUPPLY PERFORMANCE INDICATOR	OBJECTIVE	ACCEPTABLE LEVEL
Demand Satisfaction or Net Availability $\frac{\text{Valid ASL demands completely filled}}{\text{Total valid ASL demands}} \times 100\%$	DSU - 75% > 1 Div - 82% < 1 Div - 82%	70% - 80% 77% - 87% 77% - 87%
Average Customer Wait Time for— CONUS Alaska, Hawaii, South America, Caribbean, or North Atlantic Northern Europe, Mediterranean, or Africa Western Pacific	11 days 19 days 21 days 25 days	15 days 24 days 31 days 35 days
Zero Balance with Due-Outs $\frac{\text{ASL zero balance lines with due-outs}}{\text{Total ASL lines}} \times 100\%$	No more than 8%	8 - 10%
SSSC Lines at Zero Balance	10%	15%
Inventory Accuracy $\frac{\text{Total lines without substantial \$25 difference}}{\text{Total lines inventoried}} \times 100\%$	95%	
MRD Rate $\frac{\text{MRDs}}{\text{Total MROs}} \times 100\%$	1%	0 - 3%
Location Accuracy Index $\frac{\text{Number correct locations}}{\text{Total locations surveyed}} \times 100\%$	98%	95%
UMMIPS High-Priority Requisition Rates PDs 01 - 03 PDs 01 - 08	5% 15%	10% 20%
Legend: > greater than < less than		

through the DS4. Your duties deal mainly with reviewing the receipt not DI listing. Your tasks are listed below.

- Research incorrect stock numbers when the remark "Skeleton ABF Created" appears in the Remarks block of the receipt not DI listing.
- Check for possible keypunch errors when duplicate document numbers appear on the listing. If necessary, have soldiers prepare a decrease adjustment document.
- Coordinate with storage supervisors to determine if there has been a double shipment.

- Prepare a SF 361 (Transportation Discrepancy Report) for duplicate shipments.

REVIEW SUPPLY STATUS

Under DS4, supply status documents on ASL and non-ASL outstanding requisitions will be sent automatically to SSAs. DS4 also produces an ASL status review list on the status of ASL replenishment requisitions that require manager review. Your office will also receive supply status cards in response to requests for follow-up. TM 38-L32-13

PREPARED 01 SEP 90		DS4 SUPPLY MANAGEMENT REPORT										PCN AGL-C17		
CLASS II		SUPPLY PERFORMANCE REPORT										REPORTING PERIOD 90214-90243		
DSU	TOTAL VALID DEMANDS RECEIVED	TOTAL VALID ASL DEMANDS	TOTAL ASL DEMANDS FILLED	% DEMAND SATISFACTION	WAREHOUSE DENIALS	DENIAL RATE	HI-PRI REQN	HI-PRI RATE						
A	75	74	63	85.1%	1	1.5%	27	36.4%						
B	80	80	45	56.2%	0	0.0%	15	18.7%						
C	0	0	0	0.0%	0	0.0%	0	0.0%						
D	70	70	53	75.7%	0	0.0%	10	12.2%						
E	0	0	0	0.0%	0	0.0%	0	0.0%						
DIVISION	225	224	161	72.3%	1	1.5%	52	22.4%						

DSU	TOTAL ASL LINES	ASL LINES AT ZERO BAL W/DO	% ASL LINES AT ZERO BAL W/DO	TOTAL FROZEN RECORDS	TOTAL DSU REPARABLE LINES	TOTAL QSS LINES	% QSS LINES ZERO BAL	TOTAL SSSC LINES	% SSSC LINES ZERO BAL
A	65	10	8.0%	10	0	0	0.0%	62	14.0%
B	40	0	0.0%	0	0	0	0.0%	0	0.0%
C	0	0	0.0%	0	0	0	0.0%	0	0.0%
D	31	0	0.0%	0	0	0	0.0%	0	0.0%
E	0	0	0.0%	0	0	0	0.0%	0	0.0%
DIVISION	136	10	8.0%	10	0	0	0.0%	62	14.0%

Figure 1-4. Sample supply performance report

illustrates sample status cards and explains how to process them. Your tasks are listed below.

- Research to determine if request is a late status. Has it already been filled? Is it still pending?
- Review the net asset position to determine if the items are still required.

FOLLOW-UP ON OUTSTANDING REQUISITIONS

If you desire follow-up on outstanding requisitions, DS4 will automatically prepare requests to the next higher supply source after the number of days for follow-up has passed and status has not been received. However, you may prepare follow-up requests manually. TM 38-L32-11 and TM 38-L32-13 give details on how to prepare a manual request for follow-up. Take emergency follow-up action if the situation is urgent and there is no record of the original requisition at the supply source.

RECONCILE DUE-OUTS WITH SUPPORTED UNITS

Every two weeks, automated systems produce a customer DO reconciliation list of outstanding DOs as of a cutoff date and receipt, issue, and cancellation actions since the last reconciliation. TM 38-L32-11 and TM 38-L32-13 describe how to process this list. Your tasks are listed below.

- Schedule a cutoff date for validation and reconciliation of open DIs.
- Have unit soldiers compare DO listings with their document register.
- Ensure that reconciliations are performed biweekly during peacetime. Have supported units confirm a continued need and either verify or cancel part of the quantity requested.
- Provide supported units with the latest status information on their requests. DS4 does this automatically.
- Identify any DOs that were omitted from the automated listing.
- Process customer requests for cancellation.

DIRECT PERSONNEL TO PROCESS MANUAL OFF-LINE REPLENISHMENT REQUISITIONS

DS4 will automatically generate replenishment requisitions to the next higher supply source and establish DIs for ASL stocks when the ROP is reached or penetrated. However, off-line manual

replenishment is possible. In the case of non-NSN requisitions, it is often necessary. On an exception basis, such issues may be needed to replenish a forward DSU storage site when automatic replenishment is blocked. For example, requisitions for ASL replenishment may be blocked for controlled items by a manager-introduced blockage parameter card. Another reason to process off-line requisitions may be the need to obtain more stocks to meet seasonal change requirements. TM 38-L32-13 explains manual replenishment procedures for SSAs under DS4.

MONITOR TURN-IN OF RECOVERABLE AND AUTOMATIC RETURN ITEMS

Each month, automated systems generate a recoverable item control list of recoverable items for which no turn-ins are recorded or for which turn-ins with no corresponding issue are recorded. TM 38-L32-13 explains how to process this list. Each quarter, a list of ARIs is distributed along with the AMDF. Its purpose is to speed up the retrograde of selected reparable and recoverable secondary items and repair parts in critical supply. AR 710-1, Chapter 3, prescribes ARI policies and procedures. Table 1-6 explains ARI codes. The ARI code is a one-position alphabetic code indicating items in a critical stock position which may be returned to CONUS depots without receipt of disposition instructions. Your tasks are listed below.

- Review several months' listings of recoverable items to identify situations in which follow-up actions are required.
- Contact supported units to ask the status of pending turn-ins.
- Report reasons which make the turn-in unnecessary. For example, report an increase in stockage level or the fact that the items were lost or destroyed and reported in a report of survey.
- Request premium transportation for ARIs coded E for expedite. Disposition instructions are not needed. SSAs that do not report excess directly to a wholesale supply source will ship ARIs to their supported SSA. Those that report excess to a wholesale supply source will ship ARIs to the closest area-oriented depot.

COORDINATE RECEIPT, STORAGE, AND ISSUE

TM 38-L32-12 describes receipt, storage, and issue procedures. Your office receives requests

Table 1-6. Automatic return item codes

CODE	DEFINITION
C	Automatic return is required to maintain active supply support. Use PD 06.
E	This item is currently in a low stock position. A fast return of this item is required. Use return PD 03.
D	This item has been removed from previous ARIL. Automatic return is no longer required because item is in long supply. Report this item (using normal excess reporting procedures) when it is excess to retain retention level outlined in AR 710-1, Chapter 6.

COORDINATE TRANSPORTATION REQUIREMENTS

from supported units and MROs from your supporting MMC or SCS. Your tasks are listed below.

- Notify platoon HQ of arrival times, type, and quantity of supplies to be received or issued and the time they are due to arrive at the loading or off-loading site.
- Check to make sure you have space to store incoming supplies. The MMC provides a printout listing storage locations.
- Assign initial stock locations if applicable. Local SOP will state whether the MMC or your office assigns locations.
- Ensure that transportation officers have received specific instructions for spotting carriers at the proper location.
- Coordinate use of MHE used to prepare sites and to load, off-load, and position supplies and equipment.
- Inspect supplies when they are delivered.
- Notify the MMC of the receipt of supplies and when they are ready to be issued.
- Develop an external SOP detailing what is required of the requesting unit (for example, blocking and bracing items and unit soldiers to help load trucks).
- Assign areas to undergo a location survey.
- Inspect warehouses and other storage areas.
- Send MROs to the appropriate platoon for issue of the supplies.
- Refer to Chapter 8 for recommendations on sorting MROs.
- Review all postpost issues, or have your stock control sergeant do so.

Your office informs the MMC when supplies are ready for shipment. The MMC then coordinate transportation requirements with the MCC. Your tasks are listed below.

- Consolidate transportation requirements.
- Provide the MCC data on the type, cubage, and destination of supplies.
- Coordinate with the transportation officer regarding vehicle requirements. FM 101-10-1/1 recommends using two-thirds of the vehicle payload capacity as a guide.
- Look up payload capabilities in TBs 55-46-1 and 55-46-2.
- Determine time required for local haul and line haul round trips to and from supported and supporting units.
- Determine how the above time estimates will change when vehicles are forced to use alternate supply routes.
- Follow up on transportation requests, when necessary.
- Request airlift support, when necessary.

COORDINATE CLASS I OPERATIONS

Routine resupply demands and emergency resupply requests for Class I rations must pass through your office. Your soldiers edit those from supported units. They keypunch or transmit data to the MMC. DS4, SAILS, and SARSS do not provide automated printouts on Class I demands. Your tasks are listed below.

- Review the stockage objective. DS and GS units maintain an operating stock of 3 to 10 days of supply.

- Require units operating field kitchens to request their rations from your Class I supply point on a scheduled basis, normally three to five days in advance.

- Coordinate with the Class I manager in the MMC and with the Assistant Chief of Staff, Materiel, in the DISCOM, COSCOM, or TAACOM.

- Pass along information on ration policy, order frequency, ration and issue cycle, and OST.

- Have your office overprint DA Form 3294-R (Field Ration Issue Slip) for each day of the ration cycle.

- Submit a consolidated operational ration issue report to the MMC at the end of each month.

- Sign off on DA Form 2060-R (Status Report (Report of Class I Supplies)).

COORDINATE CLASS II, IV, AND VII OPERATIONS

Requests for Class II, IV, and VII items first come into your office. Your materiel control and accounting specialists post the requests to stock accounting records, transmit the requests to the MMC or SCS, and process the MROs. Your tasks are listed below.

- Prepare support plans and schedules to regulate incoming and outgoing supplies.

- Ensure your soldiers review all requisitions for old document dates and questionable prices and quantities.

- Review critical supply directives.

- Ensure that your office personnel check lists of regulated or command-controlled items for costly, scarce, or critical Class IV and VII items. The command that made up the command-controlled lists must approve the release before your office personnel can approve the request and the MMC can process an MRO.

- Review proposed command-controlled items lists for repair parts required to maintain Class VII items so they are ready for issue (to include in-storage maintenance services).

- Review all postpost request fills, or delegate this task.

MONITOR BULK FUEL OPERATIONS

Supported units send their daily forecasts for bulk petroleum to your office. Your soldiers total

the amounts required daily. They notify the MMC or SCS of bulk fuel requirements and of total fuel received, issued, and OH in Class III supply points. Your tasks are listed below.

- Make sure all petroleum SOPs are updated and enforced.

- Ensure that Class III supply point soldiers are performing a daily inventory reconciliation to identify shortages and losses.

- Schedule bulk petroleum inventories and monthly inventory reconciliations for the last day of the month. Rotating inventory teams conduct these inventories.

- Determine allowable losses for bulk petroleum.

- Investigate losses above acceptable levels.

- Have your personnel adjust property records to reflect losses.

- Process an adjustment for losses exceeding the allowance when the total value of the loss is less than \$500. Process a DA Form 4697 (Department of the Army Report of Survey) for losses exceeding the stated allowance when the total value of the entire loss is more than \$500.

- Compute fuel requirements to support line hauls and local hauls to supported and supporting units.

- Consolidate and forward daily fuel forecasts and totals from daily status reports.

- Inspect Class III storage areas daily for safety, hazards, accountability, inventory, receipt and issue procedures, and maintenance.

- Review contamination reports, determine feasibility of reclaiming products, and follow unit SOPs on disposition of contaminated fuel.

- Provide strapping charts for all bulk storage facilities.

COORDINATE SERVICE FUNCTIONS

Depending on your unit mission, your personnel may have to ensure that necessary field services are provided to supported units. These units request services through your office. If necessary, you coordinate with them to ensure that they provide you any needed manpower, tentage, space, or water. You must maintain accountability for the float stock of clothing that is exchanged on a one-for-one basis for dirty BDUs.

CHAPTER 2

SUPPLY PLATOON LEADER

REVIEW YOUR RESPONSIBILITIES

As the supply platoon leader, you are responsible for ensuring that supported units receive supplies on time, in the quantity requested, and in good condition. This chapter lists specific tasks and responsibilities. You may have to supervise, direct, and coordinate the receipt, storage, and issue operations of a Class I section, a water section, or Class II, IV, and VII sections. Pay particular attention to the tables which list causes for MRDs and which suggest ways to correct storage problems so that there is less delay in supply fill. Your platoon may also have to operate a map point, a salvage collection point, and an SSSC or a CIF (in peacetime). Upon augmentation, your platoon may also provide such services as rigging supplies for air delivery and graves registration. This chapter includes CEB, laundry, and renovation, which may be eliminated as a result of the new AOE concept.

IMPROVE CUSTOMER SUPPORT

SSAs may process from 5,000 to 9,000 demands per month for ASL items and 1,000 demands for nonstocked items. As the supply platoon leader, you will be concerned mainly with continually monitoring receipt, storage, and issue operations to improve demand satisfaction. Your tasks are listed below.

- Standardize receipt, storage, and issue procedures to eliminate unnecessary, time-consuming moves.
- Review document flow to eliminate bottlenecks where time may be lost.
- Review storage layouts and use of space.
- Inspect storage areas often to monitor any problem areas which may cause, invalid MRDs.
- Perform location surveys regularly.

- Develop step-by-step lists to aid location survey and inventory teams.
- Perform a location survey during the 30-day period between monthly AMDF change notices.
- Perform a location survey of all stock semiannually in installation DSUs.

MONITOR MATERIEL RELEASE DENIALS

An MRD can cause a delay or failure in filling a supply request. It affects demand accommodation and demand satisfaction rates. SSAs have only 48 hours to determine the reasons for a denial and to correct the stock records involved. An MRD requires a special inventory to determine why supplies are not on hand. Your tasks are listed below.

- Verify that the receiving section has frozen all inventory receipts for items with the NSN of the item requested.
- Have the stock records section freeze the stock record to prevent issuing anymore MROs for that item.
- Verify all affected MROs collected which have not been processed.
- Have storage personnel perform troubleshooting checks listed in Table 2-1.
- Notify the stock records section that your storage personnel will need to perform a special inventory.
- Review any required adjustment documents.
- Determine MRD rate using the formula below.

$$\text{MRD Rate} = \frac{\text{MRDs}}{\text{Total MROs}} \times 100\%$$

Your objective is to have no MRDs. AR 710-2 allows no more than a 1 percent MRD rate.

Table 2-1. MRD troubleshooting chart

POSSIBLE CAUSES	TROUBLESHOOTING PROCEDURES
<p>Duplicate receipt records</p> <p>Stock being relocated:</p> <ul style="list-style-type: none"> • New location not listed on old locator card • Old locator card not removed from the locator deck and placed in the inactive file <p>Incorrect location recorded</p> <p>Incorrect NSN, quantity, or condition code recorded on receipt document or stock locator card</p> <p>Delay in placing items in storage location</p> <p>Postpost transaction or walk through filled prior to pulling all MROs</p>	<p>Check with stock records section.</p> <p>Check with SCS for a location addition card, location change card, and old location bin labels.</p> <p>Check the locator deck for any other locations listed for the items that are not shown on the MRO.</p> <p>Search locations listed on the MRO and all locations above, below, and next to those locations for missing stock.</p> <p>Review past location changes.</p> <p>Check with stock records section to determine if a keypunch or computer error occurred.</p> <p>Refer to catalog change notices to determine if the NSN or UI was changed and was not recorded.</p> <p>Determine if a part number or service stock number was listed in place of the NSN.</p> <p>Determine if package or container data were not changed to show new NSN or UI.</p> <p>Check with receiving section for backlog documents.</p> <p>Check for receipt documents which may have been sent to the stock records section before items were placed in stock.</p> <p>Search storage and receiving areas for the misplaced items.</p> <p>Check with technical inspection sections. Items may be field turn-ins logged in as received but awaiting inspection before being sent to storage.</p> <p>Check the next morning cycle output.</p>

MONITOR RECEIPT OPERATIONS

You must check on receipt operations to make sure they are efficient. Guidance on receiving operations is found in Chapter 7. Your tasks are listed below.

- Ensure that MHE is available at the unloading site.
- Have soldiers lay dunnage before supplies arrive.

- Have soldiers put up signs identifying where different supplies should be unloaded. This will help to avoid delays in unloading.
- Monitor tally-in operations. Periodically spot-check the checker's count.
- Require that soldiers verify quantities, condition, description, and markings of items received against shipping documents.

★ **NOTE:** If DD Form 1348-1 has a customer's document number (card columns 30 through 43), supplies should be sent to the issue section for customer pickup. A storage location in the supplementary address field (card columns 45 through 50) indicates that the supplies are ASL and should be placed in storage.

★ • Suggest that the receiving section maintain a document control register to determine which supplies to process first. Process supplies by PD as explained in Chapter 8. You can design one to fit the needs of your unit.

NOTE: You may also want to add a column labeled "Issuing Priority/Transportation Priority." All items with PD codes of 01 through 03 could be entered as 1 in this column since they need to be processed within 24 hours. Items with a PD of 04 and above could be entered as 2 in the column. When all units are automated, the need for this document will cease.

• Review your receiving area's suspense files to ★ help in determining reasons for receipts not due in. Table 2-2 lists the major reasons for invalid due-ins and possible corrective actions.

Table 2-2. Troubleshooting chart for invalid due-ins

POSSIBLE CAUSES	RESULT	CORRECTIVE ACTION
Receiving report was not prepared and submitted for processing and transmission to the automated system	Increase in due-ins	Require prompt preparation of receiving reports so that issues can then be processed.
Due-ins were not adjusted or canceled	Increase in due-outs	Require timely adjustments or cancellations.
Shipment overdue -- contract or purchase order remains in the suspense file	Aged due-ins and due-outs	Monitor required delivery dates. Notify procurement officer of overdue contract shipments.
Supplies received with commercial vendor's delivery ticket but no contract can be found	Delay in issuing items Delay in paying commercial vendors Loss of discounts Interest penalties on late payments Credit holds	Appoint an NCO to search for the contract. If investigation is unsuccessful, report problem to the supply operations office.
Shipment frustrated because of incorrect contract number, mistaken quantities, or COD orders shipped prepaid	Supplies backlogged in receiving area Delay in supply fill Increase in MRDs	Notify supply operations office and stock control section.

- Ensure receiving reports are prepared promptly and submitted to your supply operations office for processing and input of data into the automated system.
- Ensure that timely actions are taken to resolve frustrated shipments.
- Monitor required delivery dates and begin follow-up action on overdue shipments from commercial vendors. Alert the procurement officer to overdue contract shipments.

SUPERVISE UNLOADING

TM 743-200-3, Chapter 2, lists step-by-step procedures and soldiers and equipment needed to unload trucks, trailers, vans, and railcars. Figure 2-2 is a sample set of unloading procedures from the TM. Your tasks are listed below.

- Check with SCS soldiers to determine if they have an advance copy of the receipt document.
- Analyze types of supplies to be unloaded.
- Evaluate available storage space.
- Verify personnel and special handling equipment requirements.
- Ensure that the carrier is correctly positioned.
- Verify that the seals on trucks or boxcars are unbroken and that serial numbers agree with those listed on bills of lading, advance shipment documents, or notices of shipment. Report discrepancies.
- Determine if the shipment will be accepted.
- Contact the SCS for data required to complete receipt from commercial carriers.

NOTE: Ensure that all soldiers are made aware of holdover costs (demurrage) that can result from keeping trucks or railcars not owned by the government past time limits set for unloading.

- Place emphasis on making as few moves as possible. Each additional move increases time and costs and the danger of damage.
- Ensure that the supply operations office has been notified that the carrier is ready for release.

★ REVIEW REPORTS OF DISCREPANCIES

You must report shipping-type (item) or packaging discrepancies on SF 364 (Report of Discrepancy (ROD)). Include on the form the reporting, adjusting, and accounting for supply (item) discrepancies; preservation, packaging, packing, and supply item identification marking; lost or damaged parcel post shipments; and overages and shortages on single consignee SEAVANS or containers that were loaded at the supply source and were improperly packed by the cargo consignee with original seals intact. ARs 12-12, 735-5, and 735-11-2 explain when and how to use the form. Use SF 361 (Transportation Discrepancy Report) to report overages, shortages, and lost or damaged military freight due to transportation-type discrepancies. AR 55-38 explains how to use this form. Your tasks are listed below.

- Report all discrepancies to your supply operations office.
- Ensure storage personnel have placed damaged supplies or supplies in question in a holding area.
- Ensure the ROD is prepared within time standards listed in AR 735-5.
- Review AR 735-5 carefully to determine if the discrepancy is subject to a dollar limitation. Only discrepancies valued at more than \$100 per line item will be processed further. However, for those from contractor, manufacturers, or vendors, regardless of dollar value, you will initiate an ROD. Report discrepancies pertaining to classified materiel or protected items on SF 364 regardless of dollar value or condition. Discrepancies involving COMSEC items must be reported on SF 153 (COMSEC Material Report).
- Adjust account records on DD Form 1487 (DOD Materiel Adjustment Document).

REVIEW STORAGE LAYOUT PLANS AND USE OF STORAGE SPACE

Plan storage area layouts carefully so that supplies are processed efficiently through receipt, storage, and issue cycles. DOD 4145.19-R-1 and Chapter 5 list guidelines and give sample layout plans

METHOD DESCRIPTION

Job Unload Flatbed Truck
Location Warehouse Platform
Condition Truck to Storage Location
Method (2) Forklift Trucks Handling Unit Loads

Personnel Required:

2-Forklift truck operator—checker/
warehouseman

1-Truck driver (commercial or government)

Equipment Required:

2-Forklift trucks

Procedure:

1. Documents:

a. Receive advance documentation from document control

2. Prepare truck for unloading:

a. Truck driver removes canvas, tie downs and/or stakes and position truck for unloading

b. Warehouse personnel receive instructions

c. Travel to work area

d. Open warehouse doors (as required)

e. Receive freight bill or copy of GBL

f. Check GBL or freight bill

3. Forklift handling of material:

a. One forklift truck operator-checker unloads the right and left side of the truck and places the load on the platform or inside the warehouse door.

b. One forklift truck operator-checker on ramp or inside warehouse transports all loads of material to storage area and stacks same in permanent location.

c. One forklift truck operator-checker tallies and makes visual check of condition of containers

4. Annotate and finalize documents incident to receiving operations:

a. Annotate receiving document

(1) Date received

(2) Sign document

b. Annotate Government B/L

c. Annotate freight bill

(1) Pieces received

(2) Date

(3) Sign freight bill

(4) Stamp freight bill—stamp date and time in

d. When material is damaged, short, etc., prepare all necessary documentation

e. Return copy of freight bill to driver

5. After unloading:

a. Clean work area

b. Truck driver replaces tarps, tie downs, and/or stakes onto the truck and secures the truck for traveling

c. Close warehouse doors (as required)

d. Proceed to next assignment or to office

Special Instructions:

1. Commercial or government truck driver time will not be charged to this operation.

2. Broken or damaged unit loads are set aside in the warehouse pending repair determination by the warehouseman in charge.

Figure 2-2. Sample extract from TM 743-200-3

to help you manage storage space effectively. Your tasks are listed below.

- Obtain data from the SCS on the type and quantity of items to be stored.
- Review demand rate for each item.
- Analyze size, shape, and weight of items and whether they are perishable, pilferable, hazardous, or flammable.
- Recalculate storage area capability.
- Verify maximum allowable stacking height for supplies and floor load limitations.
- Analyze the number of line items to be stored in bin areas.
- Note mandatory or preferred types of storage for various items. These are listed on the AMDF. See SBs in the 740 series for codes to identify guidance.
- Review requirements in DOD 4145.19-R-1 and regulations regarding storage of petroleum and subsistence items and sensitive or classified items.
- Analyze traffic flow.
- Evaluate the cost of rewarehousing (in terms of soldiers needed, time, and money) against the value of space to be reclaimed.
- Fill out DD Form 805 (Storage Space Management Report) once or twice a year according to AR 740-1. Use data from local storage space status reports.

MONITOR STORAGE OPERATIONS

Incorrect storage procedures may delay demand fill and cause unnecessary MRDs. They cost SSAs time, labor, and stocks and waste MHE and transportation assets. Your tasks are listed below.

- Monitor stockage procedures. Ensure that soldiers issue older stocks first.
- Spot-check stock locations. Have storage personnel maintain a file listing empty locations.
- Ensure that soldiers are taking adequate preservation and security measures.

SUGGESTION: Have storage personnel flag stock locator cards in some way to, identify classified and pilferable items.

- Ensure aisles are clearly marked.
- Make sure supplies are stacked correctly.
- Take proper care in storing combustible or hazardous supplies.
- Setup a storage control system for shelf-life stocks.
- Check on the preservation and condition of unpackaged items.

- Ensure that soldiers perform maintenance and inspections on equipment in storage. Review equipment maintenance records.

- Monitor storage problems. Common storage problems and corrective actions are listed in Table 2-3.

MAINTAIN SECURITY OF PILFERABLE TOOLS

Tools have a ready resale value on the illegal market, and they are especially subject to theft. You must make sure they are strictly controlled and stored in secured areas. Refer to ARs 190-11 and 710-2 for more information. Your tasks are listed below.

- Establish adequate inventory measures and accounting controls.
- Make it SOP that soldiers flag locator file cards in some way to indicate that the items are pilferable.
- Set up a materiel control system, to include inspection of delivery and vendor vehicles.
- Investigate evidence of tampering in a shipment.
- Restrict access to areas in which pilferable items are stored.
- Reduce in-transit exposure. Have storage personnel unload and package tools at the storage site.

SAFEGUARD CLASSIFIED AND SENSITIVE MATERIAL

Sensitive and classified items require special controls when they are moved and stored. To identify these items, check the CIIC listed on the AMDF. AR 740-1 has instructions on how to store these items. For CIIC items, special handling codes are printed on the issue or receipt document. Your tasks are listed below.

- *Restrict Access.* Maintain an access roster, maintain a sign-in and sign-out register, and assign responsibility for locked and sealed or restricted areas. Ensure that documents pertaining to classified supplies are handled by properly cleared personnel.

- *Ensure Safe Storage.* Maintain separate storage areas for classified and sensitive material, and have signs posted displaying security status. Ensure that an armed guard is posted, if circumstances warrant it. Require that classified and sensitive items be inventoried more frequently than required, if necessary. Ensure that personnel pack items in restricted storage areas.

Table 2-3. Storage problem troubleshooting chart

STORAGE PROBLEM	RESULT	CORRECTIVE ACTION
<p>Mixed Stock — Two or more items (separate NSN) stored in one location. Often a different NSN item is behind another on a shelf or rack.</p> <p>NOTE: Sometimes the location listed on a receipt document for a substitute item is for the original item requested. Substitute items must be stored separately under the substitute item NSN, not with the item originally requested.</p>	<p>Incorrect inventory counts</p> <p>Delay in performing location surveys and inventories</p> <p>Delay in supply fill</p> <p>MRD on original item or substitute item</p>	<p>Make change, complete with needed bin label or location placard. Note all changes on receipt documents.</p> <p>Submit location addition cards to your stock control section.</p> <p>Ensure storage personnel check card column 66 on DD Form 1348-1, receipt documents. Code BH indicates that an interchangeable item is being shipped. (See Figure 2-5.)</p>
<p>Stored item incorrectly identified.</p> <p>Items stored in location do not agree with bin tag, location placard, or locator card.</p>	<p>Mixed stock</p> <p>Duplicate MROs</p> <p>Stock record imbalance</p> <p>Increase in inventory investigation time</p> <p>Delay in supply fill</p> <p>Increase in MRDs</p> <p>Incorrect item or quantity shipped to requesting unit</p> <p>Waste of MHE assets and transportation assets</p>	<p>Correct all data listed on labels, tags, or placards.</p> <p>Notify stock records section of change to correct accounting records.</p> <p>Prepare an MRD with code 5 in card column 72 to indicate the item is being reidentified.</p>
<p>Multiple open boxes of supplies</p>	<p>Incorrect inventory count</p> <p>Incorrect issue quantities</p>	<p>Recount.</p> <p>Adjust stock record balances to match on-hand quantities.</p>
<p>Improper (nonuniform) stacking</p>	<p>Hidden containers</p> <p>Crushed or damaged supplies</p> <p>Incorrect count of stock on hand</p>	<p>Restack.</p> <p>Relocate stocks, if necessary.</p> <p>Reinventory.</p>
<p>Old markings on containers or packages (the NSN or UI has changed)</p>	<p>Incorrect inventory count</p> <p>Delay in performing location survey and inventory</p> <p>Delay in supply fill</p> <p>Increase in MRDs</p>	<p>Restencil container or package markings.</p> <p>Prepare new bin labels or location placards.</p> <p>Note problem on stock locator cards to avoid confusion during location surveys and inventories.</p>

NOTE: Stress that issue personnel must never place sensitive or pilferable items in customer bins or at customer pickup points. These items must remain in the restricted storage area. Storage personnel are to send only the MRO to the issue point.

- *Provide In-Transit Controls.* Take steps to reduce in-transit exposure. Provide escort controls, if necessary.

PERFORM STORAGE CHECKS AND INSPECTIONS

DOD 4145.19-R-1 has special instructions for inspecting items, such as lumber, which require special handling checks. AR 740-3 has more on inspection of shelf-life items. Your tasks are listed below.

- Perform biweekly quality control inspections of storage buildings, holding areas, and storage facilities to ensure that supplies are protected from the weather, rodents, and insects.
- Check on the suitability of each storage site for the items stored there.
- Require a periodic 10 percent check on items subject to rust, corrosion, fungus, or mildew to determine quality and adequacy of preservatives.
- Require routine cyclic inspections to ensure that the first-in, first-out rule is being followed.
- Require special inspections at the request of higher authority on suspect lots, quantities, or items.
- Require special inspections after hard rains, heavy snows, high winds, or sudden changes in the weather. Stress that soldiers check for torn or loose protective canvas and coverings; damage from water, hail, or flying debris; and loss of preservatives.

SPOT-CHECK STOCK LOCATIONS

When an MRD has occurred, you will probably want to spot-check from 5 to 10 storage locations to verify the availability of stock in primary or secondary locations. Your tasks are listed below.

- Compare the location on the locator file card or the receipt or requisition document with the warehouse location. Figure 2-3 shows how to use the five-character stock locator system to find an item in a warehouse.
- Determine if a possible location change is in process.
- Follow up to ensure that location changes have been submitted, if required.

- Ensure that personnel change the NSN, condition code, UI, or security code data before the inventory date, if required.

MONITOR LOCATION SURVEYS

The purpose of a location survey is to ensure that supplies are stored in locations specified on locator decks and that all identifying data are correct. They are generally conducted annually or prior to a wall-to-wall inventory. Table 2-4 lists corrective actions for common problems found during location surveys. Your tasks are listed below.

- Coordinate with the supply operations officer in scheduling location surveys.

SUGGESTION: Try to schedule surveys during the 30-day period between monthly AMDF change notices.

- Set up a cutoff date for posting changes to the locator file.
- Ensure that all new data have been posted before the survey.
- Ensure that the survey supervisor groups locator cards into survey lots according to rows, aisles, or survey areas.
- Have survey teams check whether the item is serviceable.
- Review the location error list. As shown in TM 38-L32-13, this list identifies quantities on hand with no recorded location on the ABF. It also identifies invalid locations and shows when items of two different stock numbers are stored in the same location.

NOTE: DS4 records only one location on location survey listings and locator cards for each stock number.

- Use the location survey listing to monitor the survey. The survey supervisor will use this list to control location change cards and record alternate locations.

COORDINATE INVENTORIES

You may be required to inventory monthly (sensitive items), quarterly, semiannually, or annually, depending upon the type of item. You may request an inventory when a location survey indicates the following:

- There is material in stock without a recorded location.
- No stock is on hand even though the stock status report indicates that there should be.

AREA	ROW	STACK	LEVEL	SECTION
D	F	C	3	1

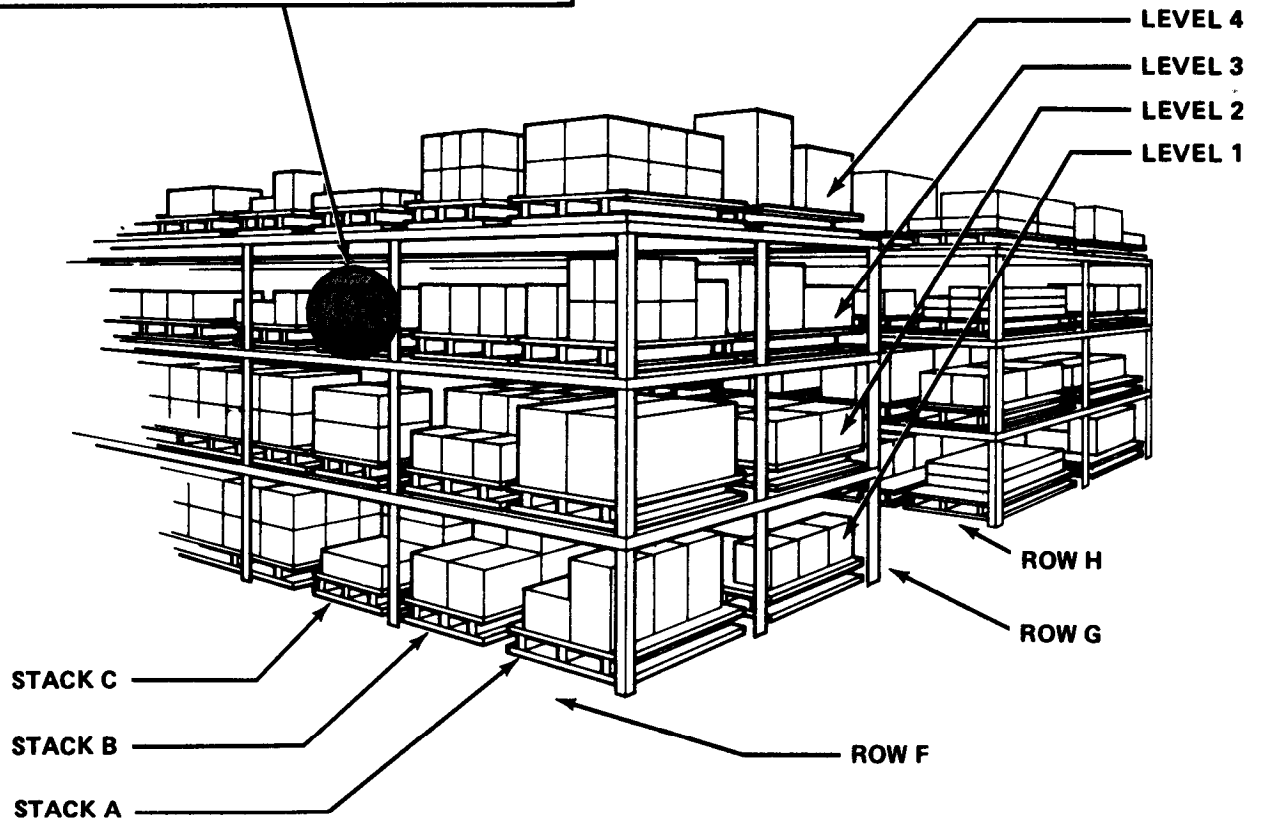

AREA D. Building, van, tent, or open storage space

ROW F. Row of storage aids or aisle between two rows of storage aids

STACK C. Column in the row

LEVEL 3. Level of the storage column

SECTION 1. Compartment or section of the level

NOTE: Nine-character stock locator codes are used in depots and larger installations. For further information on the nine-character stock locator system, see TM 743-200-1.

Figure 2-3. Five-character stock locator code

Table 2-4. Location survey problems and corrective actions

PROBLEM	CORRECTIVE ACTION
<p>Material in location with no survey work card</p>	<p>Check locator deck for other locations.</p> <p>If another location is listed, move supplies to the correct location.</p> <p>If no location is listed, make a location request card.</p>
<p>Mixed stock</p>	<p>Check active locator file for locations of supplies.</p> <p>If several NSNs are listed, move supplies to correct locations.</p> <p>If no NSNs are listed, establish a new location for the supplies and make a location request card.</p>
<p>Unidentified stock</p>	<p>Contact storage supervisor to identify the supplies.</p> <p>If item in location matches NSN and other data listed on survey work card, check locator deck for correct location code.</p> <p>Move supplies to correct location or establish new location (if one is not listed on locator deck) by making a location request card.</p> <p>If supplies cannot be identified, describe the item fully in the Remarks block of the survey work card.</p> <p>Send a copy of the survey work card to the SCS for help in identification.</p> <p>File the original copy of the survey work card in suspense file until supplies are identified.</p>
<p>Multiple stock locations (same item in more than one location)</p>	<p>Sort survey work cards for items in question into NIIN sequence so that multiple locations can be identified. (Multiple locations will show up as items with duplicate NIINs in more than one location.)</p> <p>Check locator for correct locations of items involved.</p> <p>Move supplies to correct locations.</p> <p>If no location is listed for an NSN item, establish a new location and make a location request card.</p> <p>Make location addition, deletion, or change requests, as needed, to correct locator deck so that only one item is listed for each location.</p> <p>Update or change bin tags or placards.</p>
<p>NOTE: Sometimes multiple locations are needed because of limited storage space. In this case, list all locations on each locator card involved for a cross-reference. Flag or color code all locator cards with multiple listings for easy identification.</p>	

- Mixed stocks are stored in one location.
- The recorded on-hand balance may be incorrect.

TM 38-L32-12 has information on how to prepare for and conduct an inventory. TM 38-L32-13 gives information on how to process inventory count cards and related DS4 inventory listings. Your tasks are listed below.

- Require a special inventory of a single stock number item for reasons listed in Table 2-5. TM 38-L32-13 gives information on how to start a special inventory.

NOTE: You must conduct an unscheduled spot inventory each time you process a total or partial MRD.

- Coordinate cutoff dates with your supply operations officer.
 - Set up a receiving cutoff control register.
 - Freeze all receipt, storage, and issue activities for items to be inventoried except for items with PDs 01 through 03 and NMCS requests. You can continue to process NSL items since they are not listed in the stock location files.
 - Ensure that quantities in secondary locations are counted and recorded on the count cards. Count cards list only prime locations.
 - Monitor the return of inventory count cards.
 - Verify that count cards have been sent to the MMC within seven days of the inventory cutoff date. The MMC will produce a delinquent count card list daily until all count cards have been returned.
 - Perform causative research as required.
 - Review the inventory adjustment report list.

The MMC will automatically prepare a DA Form 444 (Inventory Adjustment Report (IAR)) for discrepancies of \$50 or more.

COMPUTE LOCATION ACCURACY AND INVENTORY ACCURACY

Use the following formula to compute how well inventory location records compare with the actual physical location of items on hand.

$$\text{Percent of Location Accuracy} = \frac{\text{Number of correct locations}}{\text{Total locations surveyed}} \times 100\%$$

DA Objective = 98%

Acceptable Level = 95%

Table 2-5. Reasons for conducting a special inventory

- A credit balance is recorded (negative balance).
- A locator survey finds an item in an unrecorded location.
- A location survey finds an item in the wrong location.
- Evidence shows an illegal forced entry into a warehouse. When this occurs, all items stocked in the warehouse must be inventoried. The SSA commander will decide, according to the situation, which transactions the SSA will process and the period during which the SSA may not be operational.
- The SRO, SSA commander, or other commanders in the SSA chain of command directs a special inventory.

Use the following formula to compute the percent of lines inventoried for which the difference on the count card is less than \$50:

$$\text{Percent of Inventory Accuracy} = \frac{\text{Total lines with difference less than \$50}}{\text{Total locations inventoried}} \times 100\%$$

DA Objective = 95%

Acceptable Level = 85%

NOTE: Lines with a discrepancy of \$50 or more remain frozen until the MMC generates an IAR list following the third inventory count.

SUPERVISE ISSUE AND SHIPMENT OF SUPPLIES

Issue and shipping procedures are covered in Chapter 9. Automated system procedures are covered in TM 38-L32-12. Table 2-6 lists time requirements for processing MROs. UMMIPS standards are listed in AR 725-50. Your tasks are listed below.

- Review listings of DIs and DOs.
- Check with your supply operations soldiers to determine if they have an advance copy or notice of shipments.
- Research lost or missing MROs.

Table 2-6. MRO processing times

PRIORITY DESIGNATORS	TIME LIMITATION
01 through 03 and NMCS	Within 24 hours after the storage section receives the MRO. (7-day workweek, 24-hour workday basis).
04 through 15 other than NMCS	Within two regular workdays after the storage section receives the MRO.
NOTE: Non-DSS items without a receipt document should be processed within five days.	

- Make it SOP that storage section personnel sort MROs by PD.
- Set time frames for customer pickups so that supplies do not pile up in bin and pickup areas.
- Monitor dates entered on customer unit notification logs. Figure 2-4 provides a sample notification log.
- Monitor postpost issues to fill high-priority requests. A high postpost issue rate could cause a high warehouse denial rate.
- Ensure that bulk, sensitive, or pilferable items are issued from secure storage areas, not from the usual customer pickup point.
- Inform your supply operations office of item types, quantity, weight, and cube data needed to determine transportation required.
- Try to plan shipments in truckload lots. This will save time, packing material, and transportation assets.

PERFORM NIGHT DELIVERY OPERATIONS

Often the tactical situation is such that supplies must be delivered at night. Since the use of MHE is reduced by darkness, have supplies prepared and loaded on trucks during the day. Your external SOP should -require supported units to send extra soldiers to serve as walking guides and help load supplies by hand onto the trucks. Figure 2-5 shows light signals used at night. To follow blackout procedures, you should—

- Use flashlights that have lens filters.
- Black out doors and windows on storage buildings.
- Block light from large tents with salvage tentage.

- Use ponchos as blackout flaps on other tents.
- Use blackout lights on vehicles and forklift trucks.

SET UP A CLASS I DISTRIBUTION OR SUPPLY POINT

Set up the Class I point near the water point but far away from the Class III distribution or supply point. Select a site close to the main supply route. To prevent traffic congestion, plan for entrances and exits separate from each other. Your tasks are listed below.

- Coordinate with your supply operations officer and ration distribution sergeant to determine subsistence items to be stocked.
- Compute weight and cube of Class I stocks to provide movement requirement data for your supply operations officer. Use Table 2-7.
- Use Part Two of FSCC-8900-SL to determine how many items are in a case. (GS units do not break cases.)
- Review stock status data reported on DA Form 2060-R (Status Report (Report of Class I Supplies)).
- Use DA Form 3294-R (Field Ration Issue Slip) to plan receipt and distribution operations. FM 10-24 covers ration breakdown point operations.

MONITOR CLASS I STORAGE

Storage of Class I supplies may range from 5.5 STONs at forward distribution points to 44.37 STONs at main supply points. Supplies received at the Class I point must be inspected and placed on dunnage. Quantities must be verified against data listed on the DD Form 1348-1.

UNIT	JULIAN DATE NOTIFIED	TIME NOTIFIED	PERSON NOTIFIED	REMARKS
3d 3d Inf Bn Mech	9325	1400	SFC Robert A Short	Pickup 9329
6th 32d Inf Bn Mech	9325	0900	SFC Robert D Cole	To be picked up 9332 as agreed upon in telecom with LT Carter
2d 32d Inf Bn Mech	9327	0900	SFC Sam E Jones	Pickup past due, notified that supplies were sent back to storage
506th Spt Troops Co	9328	1000	SFC John Due	Contacted LT Johnson on 9335

Figure 2-4. Sample customer unit notification log

Supplies may then be divided into unit or item piles for temporary storage prior to issue to supported units. Your tasks are listed below.

- Ensure subsistence is protected from weather, vermin, spoilage, theft, and contamination according to DOD 4145.19-R-1 and FMs 10-23 and 10-60.

- Ensure that open stockage is on dunnage, no more than two pallets high, and covered.

- Require that rations be rotated and guarded.

- Ensure that personnel have separated Class I stock by date of pack with an ISSUE sign for older stocks and a DO NOT ISSUE sign for newer stocks.

- Ensure that an authenticated list of supported units authorized to enter the supply area is available at the supply point entrance and exit.

NOTE: Security guards should know the entries required on issue documents so that they can check the contents of trucks as they leave.

- Monitor sanitation standards using procedures in AR 40-5.

CHECK EXCESS CLASS I STOCKS

Class I stockage is based on personnel strength reports. In wartime, the number of soldiers supported will change often. Your initial stockage should provide for surges in the number of soldiers

supported. In addition, you may want to maintain a small excess stock to take care of unexpected surges in soldier strength. Since GSUs issue only full cases of pallet loads, Class I points will gradually build up excess stocks from the full cases or pallets and the same size orders they place again and again. While Class I items must never be under issued, excess stock hampers mobility and increases the hours required to inventory and rotate stock. Class I soldiers can best control excess by reducing orders by the amount on hand over your requirements. Your tasks are listed below.

- Keep a close check on excess shown on stock records.

- Have Class I section soldiers maintain a running count on DA Form 3293-R (Subsistence Consumption Card) of excess cans or MREs in each case or pallet load.

- Coordinate with the supply operations officer, soldiers at higher HQ, and the MMC Class I manager to develop an SOP for handling excess Class I stock.

- Supervise the end of month inventory of subsistence supplies on hand.

SUGGESTION: To speed up and simplify the inventory, have the NSN, item identification, and UI preprinted on DA Form 2060-R.



1. Start engines. The light is moved to describe a horizontal figure 8 in front of the body.

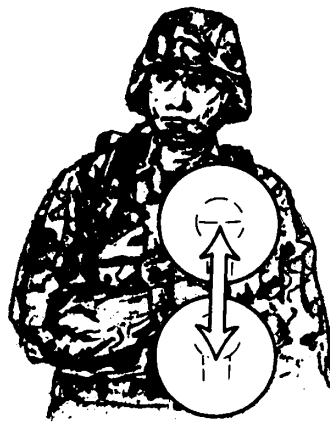

2. Go; Forward; Move out; Increase speed; or Double time. The light is moved vertically several times in front of the body.



3. Move in reverse. The light is held at shoulder level and blinked several times toward the vehicles.

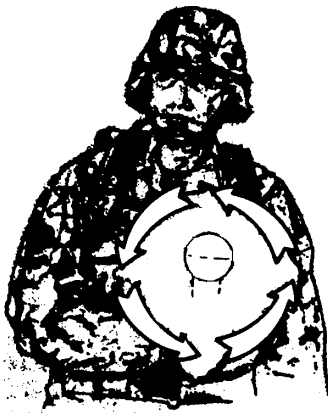

4. Turn right. The light is rotated clockwise (from the individual giving the signal) from top to bottom, describing a circle 12 to 18 inches in diameter.



5. Turn left. The light is rotated counterclockwise (from the individual giving the signal) from top to bottom, describing a circle 12 to 18 inches in diameter.



6. Stop; or Stop engines. The light is moved horizontally back and forth several times across the path of approaching traffic to stop vehicles. The same signal is used to stop engines.

Figure 2-5. Light signals

Table 2-7. Weight and volume planning factors for operational rations

ITEM	CONTENTS (PER CASE)	GROSS WEIGHT (LB PER CASE)	VOLUME (CU FT PER CASE)	AVERAGE UNIT WEIGHT (LB)
Meal, ready-to-eat, individual	12 meals	16	0.83	1.03 per ration
Food packet, long-range patrol	40 packets	39	1.65	0.706 per packet
Food packet, survival, general-purpose	24 packets	20	0.43	0.75 per packet
Ration supplement (sundries pack (one pack per 100 soldiers per day))	1 packet	36 to 39	1.57 to 1.67	
Ration supplement, aid station (makes 100 8-oz drinks)	1 packet	16	1.01	
T Ration	6 trays	95	3.6	6.5 per ration

SUPERVISE WATER POINT OPERATIONS

Soldier morale, welfare, and health depend on a safe water supply. Depending on your assignment, you may have to supervise water purification, storage, testing, and distribution. Water is provided by supply point distribution. Your tasks are listed below.

- Reconnoiter operation sites. The S3 coordinates water reconnaissance efforts with the S4.
- Coordinate with the logistics staff on projected water requirements of supported units.
- Coordinate with the preventive medicine soldier on water quality checks. Refer to TB MED 576 and TB MED 577.
- Ensure an adequate supply of chemicals is available for water purification.
- Coordinate with your supply operations officer on well construction and water point improvements to be provided by engineer units.
- Review daily inspection reports on water purification. Refer to FM 10-52-1.
- Review daily water production, issue and distribution logs, and summaries.
- Allocate water production resources.
- Review distribution and issue schedules.

- Coordinate with your supply operations officer and the MCC for additional transportation and aviation assets to distribute water.

- Monitor traffic control and drainage operations.
- Request augmentation to increase water support capabilities.

MONITOR WATER REQUIREMENTS

Logistics officers project water requirements for supported units. The type of environment affects water requirements. There are other factors which affect water requirements. They include type of battlefield (conventional or NBC), type of warfare (short or sustained), soldier and equipment density, local command policy on ration type, and shower frequency. See Table 2-8 adapted from FM 10-52, Tables 3-1 through 3-4, for planning purposes. Table 2-8 does not include water required for decontamination support or for support of PWs, refugees, or civilians. Water required to care for equipment will depend on the number and types of items authorized. Water may be

Table 2-8. Water consumption planning factors (gallons per soldier per day) for sustaining and minimum operations

CLIMATE								
	TEMPERATURE (32° TO 80° F)		ARTIC (less than 32° F)		TROPICAL (More than 80° F)		ARID (More than 80° F)	
Unit	Sustaining ^a	Minimum ^b	Sustaining	Minimum	Sustaining	Minimum	Sustaining	Minimum
Company	3.9	2.9	4.4	3.4	5.7	4.7	5.9	5.0
Battalion	6.6	3.6	7.2	4.2	8.5	5.5	8.7	5.7
BSA					8.9	5.9	11.1	6.2
DSA					8.9	5.9	11.9	6.4
BSA/DSA	7.0	4.1	7.6	4.6				
Corps/EAC	7.8	4.8	8.4	5.4	9.9	6.9	18.4	9.5

^aSustaining level factors are designed to provide enough water to support continuous operations for extended periods.
^bMinimum level factors are designed to provide enough water to support essential operations for less than seven days.

required also for medical treatment, chemical decontamination, engineer construction, and GRREG.

REVIEW WATER SUPPLY SUMMARY REPORTS

Future water requirements can often be projected from data reported on daily water point production and distribution summaries. You can reproduce these forms locally from the blank forms in FM 10-52-1. Your tasks are listed below.

- Review DA Forms 1713-R and 1713-1-R (Daily Water Production Logs) and DA Form 1716-R (Water Point Daily Production Summary) to determine if production assets need to be shifted to another water point.

NOTE: Since these forms report results of water quality control tests, they may also indicate a change in the characteristics of the water source.

- Review DA Form 1714-R (Daily Water Issue Log), DA Form 1714-1-R (Daily Water Distribution Log), and DA Form 1717-R (Water Point Daily Distribution/Issue Summary) for any unusual consumption by supported units.

- Review data on monthly or quarterly activity reports required by higher HQ. Make sure data is

accurate. Check also for any indication of problem areas or inability to continue providing water supply support.

SUPERVISE RIGGING OF WATER DRUMS FOR EXTERNAL SLING LOADS

Road nets may make it impossible to transport potable water to our soldiers in time by normal means. There will be times when storage personnel will have to rig water drums for external helicopter sling load. Soldiers with MOS 76Y or MOS 77W, as well as all QM officers, have received training in external transport operations. Your tasks are listed below.

- Coordinate time, requirements, and helicopter landing site with your battalion S4, supply operations officer, and water section chief.

- Determine rigging requirements. They are shown in FM 55-450-3. See Figure 2-6.

- Assign soldiers to rig the water drums, inspect the rigging, and guide the helicopter using proper hand and arm signals.

- Provide derigging and distribution instructions to receiving units. Stress that these units must recover and return the sling equipment to the sending unit for reuse.

ONE TO SIX 250-GALLON WATER DRUMS

1. APPLICABILITY.

This load is suitable for the UH-1 (one drum) at speeds of 80 knots, and the CH-47 (six drums) at speeds of 110 knots.

2. LOAD DESCRIPTION.

a. Drum, fabric, water, 250-gallon capacity, LIN G68998.

b. *Weight:

- (1) Drum, empty - 210 pounds.
- (2) One drum - 2,210 pounds.
- (3) Two drums - 4,420 pounds.
- (4) Three drums - 6,630 pounds.
- (5) Four drums - 8,840 pounds.
- (6) Five drums - 11,050 pounds.
- (7) Six drums - 13,260 pounds.

*Weight is based on 2,000-pound/250-gallon drum as a planning guide; percent of fill of drum(s) will normally be less than this planning figure.

3. MATERIALS.

Sling set (10,000-pound-capacity); two additional 10,000-pound capacity sling legs, chains and grabhooks; and 25,000-pound capacity apex fitting are required for five- or six-drum configuration.

4. PERSONNEL.

One man can prepare and rig one drum in 5 minutes; add 5 minutes for each additional drum.

5. PREPARATION.

Align all drums side by side (if appropriate) and rotate hubs of each drum so that a clevis is at the top. Route sling legs so that the odd numbered sling legs are to one end of the drum(s) and the even numbered sling legs are to the other end(s).

6. RIGGING.

a. For one drum:

- (1) Route one outer and one inner leg (1 and 3) to one end of drum and other sling legs (2 and 4) to the other end of drum.
- (2) Loop chain end of each sling leg through the clevis at the top of the hub of the drum and insert link 3 of each chain in its own grabhook.
- (3) A single drum may be transported by only two sling legs, attaching one leg to each hub.

Figure 2-6. Sample of procedures extracted from FM 55-450-1

SET UP CLASS II, IV, AND VII DISTRIBUTION OR SUPPLY POINTS

Class II, IV, and VII items may be located in the same general area as the Class I distribution or supply point. Class II items maybe packaged in lots designed to support a specific number of soldiers. Class IV stock may be limited to preconfigured hasty fortifications and barrier materials. Class VII items will be limited to combat-essential critical items needed to support combat readiness.

SUPERVISE CLASS II, IV, AND VII SUPPORT OPERATIONS

Class IV and VII items are costly, critical to combat missions, and often scarce. This means you must

increase management over stock levels and inventory actions and control over storage and issue procedures. Your task are listed below.

- Review issue control lists for Class IV and VII items.
- Review stock locator file system.
- Coordinate location surveys.
- Coordinate inventories.
- Report discrepancies and damaged cargo to your supply operations office at once.
- Coordinate with your supply operations office regarding disposition of damaged cargo.

MONITOR CLASS VII ISSUE CONTROLS

Class VII items have a direct impact on operational readiness and our ability to win the first battle. Major end items, especially major weapons systems, must be replaced quickly when they are damaged or destroyed. You will need to monitor the storage and issue of Class VII items listed on command-controlled or regulated-items lists. These items require command approval prior to release.

★ DIRECT HELICOPTER EXTERNAL AIR TRANSPORT (SLINGLOAD) OR REQUEST AIRDROP SUPPORT

Heavy, outsized, or critically needed end items can be transported by helicopters or airdropped from Air Force aircraft. Ground units can then obtain these items when and where they are needed in accordance with METT-T factors. FM 55-450-series manuals describe how to hookup loads for helicopter external air transport (sling-load) and provide information on equipment and personnel needs and the use of dual-point hook loads. FM 10-500-series manuals describe procedures used in rigging supplies and equipment for airdrop. Only in airdrop missions will you require special assistance from soldiers with MOS 43E (Parachute Rigger) to assist or rig and to recover and derig items used in airdrop support operations. Your tasks are listed below.

- Requisition slings, A-22 bags, cargo nets, and containers needed to assemble the load or items for sling-load.
- Assign crews to assemble and inspect all loads (and guide helicopters) for sling-load operations.
- Plan for appropriate actions for airdrop needs or sustainment requirements, to include rigging support. Coordinate through appropriate command channels for airdrop requests. Use FM 10-500-1 and FM 100-27 to plan, coordinate, and request airdrop of supplies and equipment.
- Provide control and return instructions for receiving and aviation units.
- Ensure that adjustment documents are prepared for damaged or loss of supplies and equipment and air item delivery equipment not recovered or damaged or destroyed.

NOTE: Turn in slings used in external air transport operations to the supporting supply element on DA Form 2765-1 (Request for Issue or Turn-In).

★ ESTABLISH A MAP POINT

General support supply of standard maps and map products (both classified and nonclassified) are now logistical functions. Unlike most other items of supply, however, quantities and types of maps and map products stocked are established in response to directives from unit intelligence and training elements, rather than from past supply and consumption factors. Maps are requisitioned from local installations or directly from the Defense Mapping Agency through depots in CONUS and overseas using SF 344 (Multi-use Standard Requisitioning/Issue System Document). Map quantities will vary depending on--

- Size and makeup of the envisioned task force.
- Deployment phasing and security considerations.
- Quantity and currency of map stocks presently on hand in unit basic loads.
- Possible duration of the tactical operation.
- Anticipated map shortfall and replenishment requirements. Replenishment of small-scale maps is estimated at 50 percent of initial requirements. Replenishment of medium- and large-scale maps may reach 100 percent of initial requirements.

NOTE: Map stock and issue control will follow the provisions of AR 710-2 for entry of map requisitions in the Military Standard Requisitioning and Issue Procedure. FM 10-27, Chapter 3, discusses the initial issue, theater reserve stocks, requirements, requisition procedures, and the requisition and distribution flow of maps.

★ MAINTAIN SECURITY OF CLASSIFIED MAPS

Classified maps are requisitioned on an exception basis in accordance with the provisions of DA Pamphlet 710-2-1 and OPSEC SOPs. Unit S2s, G2s, or commanders will validate requests for classified maps. Classified maps are distributed to the requester IAW the provisions of AR 380-5 and applicable OPSEC SOPs, rather than through the supply system. Theft of classified maps could jeopardize the mission and cause loss of life. Classified maps must be stored in secured areas. They also require special handling. Your tasks are listed below.

- Require a 100 percent verification of shipment quantity.
- Store classified maps in enclosed security areas.
- Maintain classified maps separate from sensitive but unclassified material.

NOTE: According to AR 115-11, some map requisitions must be classified. They must be classified when map indexes indicate that a map is classified, when size or nature of the requisition indicates a classified operation, or when geographic coverage reveals the location of a classified operation. AR 380-5 describes how to prepare classified map requisitions.

- Setup a lock and key control system. Monitor the system regularly.
- Require frequent inventories.
- Reduce in-transit exposure. Load vehicles in secure areas. Distribute from secure areas.
- Apply stringent escort or visual controls during preshipment processing and movement.

ESTABLISH A SALVAGE COLLECTION POINT

Recovery and evacuation operations can reclaim military equipment for reuse and they may aid our intelligence efforts. You may be tasked to set up a salvage collection point to receive, identify, classify, and process serviceable, unserviceable, abandoned, captured, and scrap items. When the tactical situation permits, the owning or finding unit is responsible for recovering the items and evacuating them to the collection point. In an NBC environment, the owning unit must first decontaminate the items or arrange for them to be decontaminated prior to sending them to your collection point. Your tasks are listed below.

- Ensure that collection point soldiers have a list of critically needed items and components that can be taken from the end item. They should screen all items to determine if they are on either list.
- Report all materiel to the MMC for disposition instructions.
- Send reparable items to supporting maintenance units. Table 2-9 lists RCs and related disposition actions.
- Send serviceable clothing and canvas items to the laundry and renovation platoon.

- Send unserviceable items and scrap through salvage channels to a defense reutilization and marketing office.
- Notify the intelligence officer of any captured items.
- Release captured items which are of no military value to civil affairs units for distribution to civilian agencies involved in relief programs.

ESTABLISH AND OPERATE A CIF

Upon mobilization, operation and control of AAFES clothing sales stores in overseas theaters will be transferred to the military when the MACOM determines that civilians operating the sales stores should be evacuated. During peacetime, you may be tasked to establish a CIF. According to AR 710-2, Chapter 2, only one CIF may be established on an installation. Personnel to operate the CIF must be authorized by TOE, MTOE, or TDA. Your tasks are listed below.

- Use DA Pamphlet 710-2-1, Chapter 10, to determine CTA 50-900 items authorized for stockage. Stockage may be limited to recoverable items only.
- Compute stockage according to AR 710-2, Chapter 2, and DA Pamphlet 710-2-1, Chapter 10.

NOTE: Stockage must be recomputed at least semiannually by CIFs supported by automated systems and annually by those supported nonautomated systems.

- Develop a CIF SOP for supported units. See Appendix B for a sample SOP.
- Develop an external SOP for supported units.
- Schedule issue and turn-in for units or individuals.
- Supervise or coordinate inventories.
- Monitor cash collection procedures.

REVIEW CIF PROPERTY RECORDS AND ADJUSTMENT DOCUMENTS

A separate page is required for each LIN authorized. You will review property book pages and adjustment documents. Your tasks are listed below.

- Ensure that all completed receipts and turn-ins have been posted to the property records prior to your review.

Table 2-9. Recoverability codes and actions

CODE	TYPE ITEM	DISPOSITION ACTION FOR UNSERVICEABLE ITEMS
A	High-Dollar Value Item Critical or Hazardous Material Precious-Metal-Content Item	Refer to appropriate manuals or directives for instructions. Special handling or condemnation procedures are required.
D	Reparable Item	Return the item to depot when the item is beyond lower level repair capability. Condemnation and disposal not authorized below depot level.
F	Reparable Item	Condemn and dispose of at DS level when uneconomically reparable.
H	Reparable Item	Condemn and dispose of at GS level when uneconomically reparable.
L	Reparable Item	Repair, condemnation, and disposal not authorized below depot or specialized repair activity level.
O	Reparable Item	Condemn and dispose of at organization level when uneconomically reparable.
Z	Nonreparable Item	Condemn and dispose of at the level authorized to replace the item when unserviceable.
Blank	Likely an End Item	Dispose of according to the policies in AR 725-50.

NOTE: Recoverability codes will appear on PLL and ASL listings and on customer receipt documents.

- Ensure that balances recorded on the property book page include items in laundry or maintenance as well as those on the shelves.
- Indicate whether each item is to be reported by NSN or size.
- Require a quarterly reconciliation of records with documented personnel losses.
- Conduct causative research as required.
- Account for overages and shortages and for lost, damaged, or destroyed property according to AR 735-5 and DA Pamphlet 710-2-1, Chapter 9.

MANAGE A SELF-SERVICE SUPPLY CENTER

Any SSA that stocks low-cost, fast-moving Class II and IV expendable and durable CTA 50-970 items may operate an SSSC if the commander authorizes one. You may be assigned to manage that SSSC. The SRO supervises SSSC operations. They are described in DA Pamphlet 710-2-2, Chapter 13. DS4 SSSC procedures are

covered in TMs 38-L32-12 and 38-L32-13. Your tasks are listed below.

- Setup a register to control issue of DA Forms 3733-R (Self-Service Supply Center Account Card) or plastic charge cards.
- Develop an external SOP for customer use, to include such data as hours of operation and purchase procedures.
- Ensure that SSSC items meet stockage criteria. See Table 2-10.
- Review Class II and IV stock status reports and CTA 50-970 to identify items that should be added or removed from the SSSC. Do this at least once every three months.

NOTE: Selection of SSSC stocks is manual. Stock control soldiers compute an EOQ RO. However, DS4 determines automatic replenishment when the ROP is penetrated.

- Add or delete stock items from the semiannual SSSC list. Delete items for which

Table 2-10. SSSC stockage criteria

- Unit price is no more than \$100.
- SEC must be U or M for hand tools.
- Accounting requirements code must be X or D.
- Recoverability code must be Z.
- The second position of the MATCAT structure code must be 2.
- The first position (class of supply) of the SCMC must be 2, 36, or 4 (9 for AMC only).
- Item must be on the ASL.
- Item must be demand-supported.

For an otherwise qualified item to be included in the SSSC stockage under the DS4, the following must also apply:

- Item must be serviceable.
- Stockage list code must be Q.
- Distribution of stockage code must be set at 6.

there was no demand within the last 90 days and lack of demand is considered permanent.

- Monitor stock control procedures. (SSSC stocks may range from 15 to 30 days of supply.)
- Conduct inspections. Review the inventory adjustment journal and customer deposit and withdrawal journal.
- Supervise maintenance of accounting records. Your involvement in SSSC accounting will depend on the degree of automation at your installation.
- Prepare monthly statement of customer accounts.
- Coordinate with the battalion S4 on how much money the units have left to spend.
- Coordinate with the finance office to find out how much money is open.
- Prepare monthly statements of financial operations.
- Supervise the required semiannual inventory. Set a cutoff date for postings to journals.
- Prepare a DA Form 4697 to adjust financial records to the inventory totals.
- Publish and distribute the semiannual SSSC list. This list may be updated monthly.

COORDINATE LAUNDRY, BATH, AND RENOVATION OPERATIONS

Division units must be augmented to provide CEB services. Supply and service DS units have organic sections authorized. CEB sections provide showers and clothing exchange, bring soiled clothing back to be laundered, and make such repairs on clothing and tents as prescribed by FM 10-16. If your unit operates in the corps or COMMZ, you may have to supervise field laundry and renovation services as well as CEB operations. Your tasks are listed below.

- Review the CEB SOP. FM 10-280, Appendix E, provides a sample. Update the records and reports requirements portions of that SOP, as applicable.
- Reconnoiter and select the general operating site. To save time, collocate the laundry and renovation sections. See Figure 2-7.
- Approve the CEB layout. Figure 2-8 shows a sample layout.
- Request operating supplies and initial CEB float stocks.
- Arrange for water shipments through your supply operations office if no adequate water supply is available.
- Coordinate laundry and bath schedules. Notify supported units of the schedules and of any changes.
- Notify unit commanders about any help which units should provide the CEB section at the bath point.
- Arrange for CEB soldiers to have their meals with supported units.
- Review work loads. Adjust work loads to meet peak requirements.
- Regulate movement of supported soldiers into the bath facility.
- Submit a consolidated DA Form 4766-R (Bath and Clothing Exchange Activity Record) to higher HQ.
- Inspect operations periodically.

DECONTAMINATE CLOTHING AND TEXTILES

Laundering is the primary way of removing NBC contamination. FM 10-280 describes the different methods. FM 10-280, Appendix B lists laundry formulas for each type of contamination. Your tasks are listed below.

- Request permission from higher HQ to burn heavily contaminated items. Higher HQ sets contamination tolerance levels. Downwind vapors can expose soldiers to contamination.

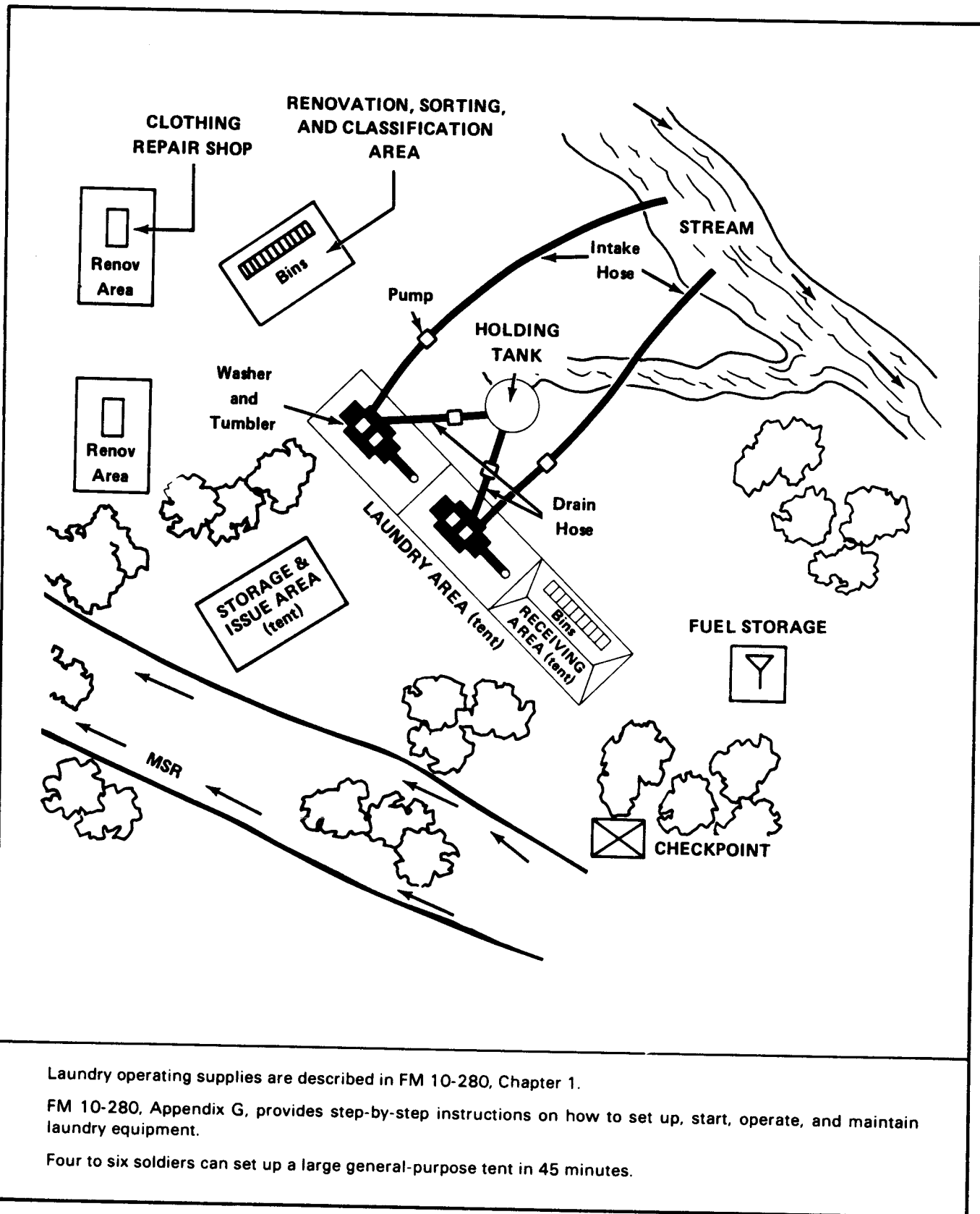

Figure 2-7. Sample layout for laundry and renovation operations

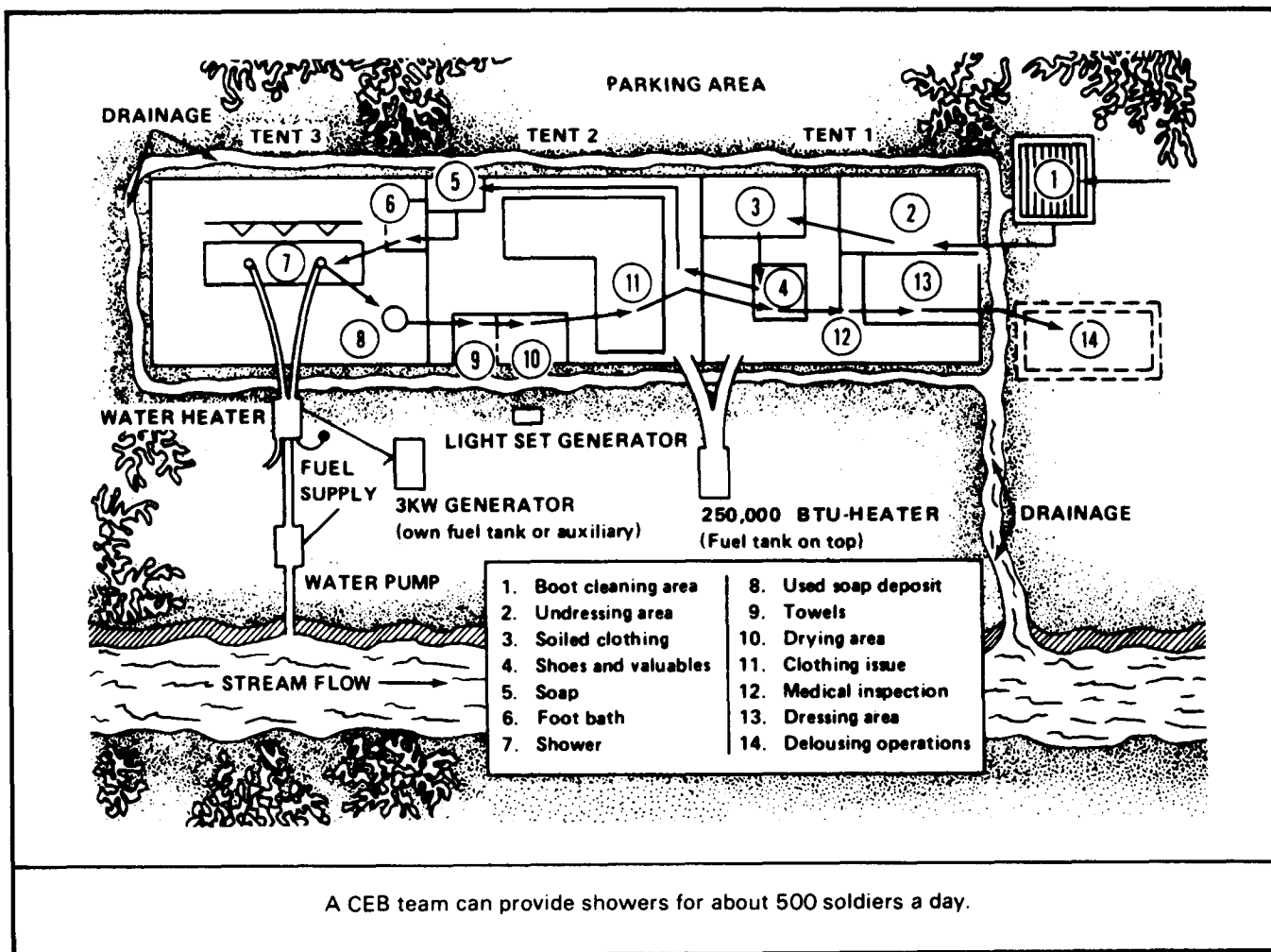

Figure 2-8. Sample layout for CEB operations

- Request engineer support to dig a drain pit for contaminated wastewater.
- Ensure that soldiers have set up a separate receiving point area.
- Ensure that the laundry section has radiacmeters, protective overgarments, dust respirators, rubber gloves, and appropriate NBC markers on hand.
- Report the location of wastewater pits to higher HQ. Do not allow water to drain into the water supply.

MANAGE UNIT GRAVES REGISTRATION OPERATIONS

You are responsible for supervising search, recovery, evacuation, and burial of remains. These tasks are performed by other than GRREG

personnel. Their responsibilities are described below.

Search and Recovery Team Leader

The search and recovery team leader plans for the search and performs a map or aerial reconnaissance of the search area. He determines and requests additional support. He also—

- Assigns area of search and determines search pattern.
- Contacts NBC and EOD specialists.
- Supervises the search, recovery, and evacuation operations.
- Briefs search and recovery soldiers.
- Issues personal effects bags, human remains pouches, NBC agent tags, record of recovery of remains, and statement of recognition forms.

- Monitors search and recovery team operations.
- Supervises emergency burials.
- Determines specific burial sites.
- Coordinates approval of burials, evacuation operations, engineer support, and security of area with next higher HQ.
- Forwards burial sketch and map overlay through next higher HQ.

Search and Recovery Team

The search and recovery team searches assigned areas for remains and personal effects and marks location of remains. The team also—

- Collects personal effects.
- Records location of remains and personal effects.
- Recovers remains.

- Checks for booby traps and contaminated or contagious remains.
- Makes initial identification.
- Tags remains with the correct search and recovery tag.
- Attaches NBC tag or tag marked with a large C to contaminated or contagious remains.
- Shrouds remains.
- Prepares a record of recovery of remains and record of effects.
- Prepares a recovery site sketch of recovery site and a map overlay of the site.
- Evacuates remains to a GRREG collection point, temporary cemetery, or mortuary.
- Performs emergency burials.
- Prepares and marks the grave site.
- Buries remains, ensuring that US, allied, and enemy soldiers are buried in separate grave sites.
- Prepares a register of remains.

CHAPTER 3

PETROLEUM PLATOON LEADER

REVIEW YOUR RESPONSIBILITIES

A fighting force can move and fight only as long as it receives required supplies when and where they are needed. Your platoon supplies the fuel needed to sustain the attack. You and your platoon sergeant are responsible for supervising the receipt, storage, and issue of bulk petroleum whether your unit is authorized FARE, a FSSP, 10 miles of hose line, or 90 miles of multiproduct pipeline. You also may supervise the receipt, storage, and issue of packaged products if your company commander decides to place them with your sections instead of with the Class II, IV, and VII sections. Packaged petroleum operations are covered in this chapter. You are concerned mainly with mission accomplishment, accountability, quality surveillance, pollution control, fire and safety, and pilferage and sabotage. Whenever possible, control measures or suggestions are included in this chapter. See Table 3-1 for some key publications.

ESTABLISH A CLASS III SUPPLY POINT

You may supervise a forward Class III supply point, which may maintain 55,600 gallons of bulk fuel for light infantry units in the brigade support area. You may supervise a main supply point, which may store up to 302,600 gallons of bulk fuel to support heavy division units in the division support area. In both cases, your duties are much the same. Your tasks are listed below.

- Conduct a reconnaissance of sites proposed by higher HQ. Site selection may be constrained by local host nation policy.
- Recommend supply point location. Table 3-2 lists recommended distances between FSSP components. FM 10-69, Chapter 11, describes required terrain features.

- Request engineer support to prepare the site. Depending upon the situation and availability of equipment, your unit may be required to perform this task.

- Review the flow of product and vehicles through the supply point. Ensure a one-way traffic plan is maintained. Determine if you can safely cut out some steps or combine some of them.

NOTE: The FSSP can handle two types of fuel when properly divided and manifolded.

SUPERVISE BULK PETROLEUM RECEIPT AND DISTRIBUTION

Bulk petroleum accounts for over half the total tonnage moving into theaters of operations. To supervise receipt and distribution operations at Class III supply points, refer to FM 10-69, Chapter 13. Your tasks are listed below.

- Notify section chiefs of tank vehicle arrival times.
- Prepare delivery and distribution schedules to avoid delays. Vehicle backup increases the danger of being a target.
- Ensure that soldiers use DA Form 3857 (Commercial Deliveries of Bulk Petroleum Products Checklist) to receive petroleum from commercial sources.
- Total the quantity received data listed on DA Form 3643 (Daily Issues of Petroleum Products).
- Inspect all connections, hoses, and valves daily before, during, and after operations.
- Ensure that a sample log is maintained on all sample fuel.
- Inspect the tanker. Review DA Form 2765-1, DD Form 1348-1, and DD Form 1970 (Motor Equipment Utilization Record).

Table 3-1. Key petroleum publications

PUBLICATION	SUBJECT AREAS
FM 10-68	Operation of aircraft refueling systems and equipment, defueling and refueling operations for fixed wing and rotary wing, fuel quality surveillance, fire fighting, and safety
FM 10-69	FARE system, tank vehicles, safety, railcar operations, packaging and storage, quantity and quality surveillance, receipt, storage, issue, and transportation
FM 10-71	Operation and maintenance of tank and pump unit, 5,000-gallon tanker series, 49C 1,200-gallon tanker, HEMTT 2,500-gallon tanker vehicle
FM 10-427	Set up of petroleum field operations

Table 3-2. Recommended distances between FSSP components

FROM	TO	FEET *
Receiving manifold	Receiving pump	60
Receiving pump	Manifold on first tank	60
10,000-gallon tank	10,000-gallon tank	40
20,000-gallon tank	20,000-gallon tank	60
Manifold on last tank	Discharge pump	60
Discharge pump	Filter/separator	40
Filter/separator	First fuel-servicing nozzle	60
Fuel-servicing nozzle	Fuel-servicing nozzle	25
Last fuel-servicing nozzle	First 500-gallon drum filling point	75
500-gallon drum filling point	500-gallon drum filling point	50
Last 500-gallon drum filling point	First bottom-loading point	75
Bottom-loading point	Bottom-loading point	75

***NOTE:** Terrain and situation may alter the recommended distances.

- Supervise rigging and derigging of 500-gallon fuel drums by soldiers with MOS 77F. See Figure 3-1. Also refer to FM 10-564 for additional guidance on rigging the 500-gallon fuel drum. Ensure soldiers follow all safety measures.

NOTE: Do not free-fall airdrop a full collapsible drum.

- Incorporate issue procedures from FM 10-69, Chapter 13, in your section SOP.

- Total the daily issues listed on DA Form 3643, and enter the total on your daily stock status report.

- Determine if loss or gain figures fall within the allowable loss or gain ranges. Investigate any unacceptable range deviation immediately to determine the cause.

- Ensure all safety measures are taken prior to receiving or issuing fuel.

INSPECT PETROLEUM TANK TRUCKS AND TANK SEMITRAILERS

Use Table 3-3 to help identify and correct fuel-handling component malfunctions on petroleum tank trucks and tank semitrailers. If your unit is authorized petroleum tank vehicles, your soldiers

must perform the daily PMCS identified in the applicable TMs before each operation. Use Table 3-4 to check on the daily preventive maintenance required on tank vehicles.

VERIFY ACCURACY OF BULK PETROLEUM INVENTORY

As the officer responsible for bulk petroleum stocks in Class III supply points, mobile filling station sites, bulk storage facilities, or tank farms, you must verify the results of monthly inventories conducted by your petroleum inventory control specialists. Your tasks are listed below.

- Ensure that an all-level sample is taken of all storage facilities and tank vehicles. Ensure DA Form 1804 (Petroleum Sample) is completed and attached to the sample container.

- Check on the determination of the API gravity.

- Review volume correction to 60 degrees Fahrenheit using the petroleum volumetric tables cited in FM 10-69, Appendix B.

- Review DA Form 4702-R (Monthly Bulk Petroleum Accounting Summary). This form serves as the supporting document for adjustment

4. PERSONNEL.

Two men can rig the load (one to four drums) in 5 to 15 minutes.

5. PREPARATION.

Align drums side by side in a row.

6. RIGGING.

a. Sling set (10,000-pound or 25,000-pound capacity).

(1) For one drum:

(a) Route one outer and one inner sling leg (1 and 3) to the same side of a drum and the other two sling legs to the other side.

(b) Rotate the hub so one clevis is at the top.

(c) Loop the chain end of sling leg 1 through the clevis and insert link 3 in the grabhook.

(d) Repeat this procedure for sling leg 3 using the same clevis.

(e) Attach sling legs 2 and 4 to the opposite side of the drum in the same manner

(2) For two drums:

Figure 3-1. Sample extract from FM 55-450-1 of materials, personnel, and procedures required to rig and derig 500-gallon fuel drums

Table 3-3. Troubleshooting chart for tank vehicles

AUXILIARY ENGINE		
Malfunction	Proable Cause	Corrective Action
Cranks too stiffly. Will not start when cranked. Power drops under load. Backfire at carburetor. Low oil pressure. High oil pressure. Excessive oil consumption (blue smoke). Knocks	Incorrect oil.	Change to recommended oil.
	Faulty ignition.	Check spark plug for fouling. Check for broken or defective wiring.
	Faulty fuel system.	Check fuel supply and grade. Fill tank with correct grade of fuel.
	Restricted exhaust line.	Check muffler, exhaust pipe, and spark arrester.
	Governor not adjusted.	Adjust governor or notify organizational maintenance.
	Faulty fuel system.	Check fuel supply and grade. Fill tank with correct grade of fuel.
	Incorrect fuel.	Refill with correct fuel.
	Dirty sediment bowl.	Clean sediment bowl.
	Oil too low or diluted.	Drain and fill with correct grade of oil.
	Oil too heavy.	Drain and fill with correct grade of oil.
Oil too viscous or diluted. Too much oil. Oil filter tube cap leaks air.	Oil too viscous or diluted.	Drain and fill with correct grade of oil.
	Too much oil.	Drain to proper level.
	Oil filter tube cap leaks air.	Check gasket for condition and proper fit. If defective, notify organizational maintenance.
	Oil too low or diluted.	Drain and fill with correct grade of oil.
CENTRIFUGAL PUMP		
Malfunction	Proable Cause	Corrective Action
Fails to deliver product or delivery is slow, erratic, and inadequate.	Air is leaking into the pump or connections.	Tighten all connections. Replace gasket.
	Pump has lost prime or has not been primed.	Prime pump.
	Clogged line strainer or lines.	Clean strainer or lines.

Table 3-4. Preventive maintenance checks for petroleum tank vehicles

ITEM	PROCEDURES
Auxiliary engine	<p>Inspect for leaks and cracks in fuel, oil, and exhaust lines.</p> <p>Check for unusual noises.</p> <p>Check the level of oil and fuel.</p> <p>Inspect fuel shutoff valve and sediment bowl for leaks, dirt, and damage.</p>
Battery	<p>Inspect for tight connections and corroded terminals.</p> <p>Check the electrolyte level.</p>
Filter/separator	<p>Inspect for leaks and damage.</p> <p>Check pressure differential each time you use the filter/separator.</p>
Filter/separator dump valve or manual water drain valve	<p>Open valve and drain water. Leave valve open until fuel appears.</p>
Fire extinguisher	<p>Inspect controls, nozzles, tubing, connections, and mountings for leaks, corrosion, and damage. Check date of last weight test. Have extinguisher weight-tested if necessary.</p>
Grounding assembly and nozzle bonding wire	<p>Inspect for cable breaks, tight connections, and firm mountings.</p>
Hoses, hose reels, and nozzles	<p>Inspect for bulges, blisters, tears, cuts, gouges, soft spots, tightness, and leaks.</p>
Line strainers	<p>Inspect for leaks. (Check weekly.) Inspect for sediment. (Check quarterly.)</p>
Manhole and filler cover assembly	<p>Inspect for loose or missing parts and tight mountings. Check the pressure on the vacuum relief vent.</p>
Meter, instrument panel, and pressure gages	<p>Inspect for broken lens and missing or broken levers.</p> <p>Check for proper operation.</p>

actions. The operating SOP outlines the procedures for emergency issues while the inventory is being conducted. Normally the inventory is scheduled, customers notified, and operations discontinued until the inventory is completed.

SUPERVISE HELICOPTER REFUELING

The FARE system was designed to refuel helicopters in forward combat areas. FM 10-68, Chapter 4, and FM 10-69, Chapter 5, describe

FARE components, site selection criteria, equipment layout, and operational step-by-step instructions. Your tasks are listed below.

- Select a site which is flat or has only a slight slope. In sandy desert areas, your operations office may have to arrange for engineers to treat the area with a dust suppressant.
- Requisition materials needed to rig the FARE for helicopter external load. Refer to Figure 3-2 for a sample list of required rigging materials.

- Plan the FARE layout so that helicopters do not have to land or take off downwind. (It is very dangerous to try to land or take off when the helicopter tail is to the wind.)
- Ensure that helicopters being refueled are at least 80 feet apart. The recommended distance is 100 feet.
- Provide three fire extinguishers for each FARE system. (Fire extinguishers are not components of the FARE system.) Used fire extinguishers should be taken to the nearest engineer unit for recharge or replacement on an RX basis.
- Specify the amount and type of refueling support required.
- Ensure all aircraft passengers disembark and disperse at least 50 feet from the aircraft during refueling.

ESTABLISH MOBILE FILLING STATIONS

You can use the FARE to refuel motor convoys or ground vehicles. Tank and pump units may also be used to support mobile filling stations. See FM 10-69 for more information on FARE and tank and pump units. Your tasks are listed below.

- Require that refueling points be at least 25 feet apart.
- Make it SOP that soldiers check the nozzle screens for dirt, test the hose, and take a visual sample from each nozzle.
- Require FARE operators to check vehicle dispatch against vehicle markings. Verify identification card of vehicle operator. This is necessary because no DA Form 2765 request document is required.
- Include daily issues recorded on DA Form 3643 in the totals recorded each day on the monthly DA Form 3644 (Monthly Abstract of Issues of Petroleum Products and Operating Supplies).

SUPERVISE HOSE LINE OPERATIONS

Hose lines can transport from 500 to 550 barrels of fuel per hour over rough terrain where it would be costly to build roads and rail nets. Hose lines relieve congestion on roads and rail networks. FMs 10-20 and 10-69 describe how to lay, operate, retrieve, and repair the hose line. Your tasks are listed below.

- Request a crane or 5-ton wrecker to load and off-load hose line flaking boxes. Do NOT use forklifts to lift the boxes.

- Require or assign a petroleum supply specialist to monitor changes in hose line pressure at all times. Changes in pressure readings or in the sound of the 350-GPM pump often indicate breaks, leaks, closed valves, or lack of suction.
- Schedule hose line patrols.
- Ensure that fire extinguishers and spill control materials are available before each operation and when the system must be shut down to repair leaks.

SUPERVISE PIPELINE OPERATIONS

If you are the platoon leader of a pipeline operating platoon, you are responsible for supervising the movement of large volumes of bulk petroleum through 90 miles (150 kilometers) of multiproduct pipelines for extended periods. Use FM 10-18 as a format guide for preparing consumption graphs, monthly pipeline schedules, and daily pumping schedules and pumping orders. Your tasks are listed as follows.

- Develop a consumption graph for each product.
- Prepare a monthly pipeline schedule.
- Prepare a daily pumping schedule or pumping order.
- Establish a petroleum batching sequence.
- Ensure line soldiers sample and test the product in the pipeline as they follow the progress and arrival time of interfaces between product changes.
- Require that flowmeters be verified semiannually.

CONTROL PIPELINE CORROSION

If you are a platoon leader in a petroleum pipeline and terminal operating company, you will be tasked to develop or review a corrosion control program to prevent fuel contamination. Corrosion control procedures are prescribed in TM 5-678 and MIL-HDBK-201B. Your tasks are listed below.

- Require that soldiers inspect the pipeline and manifold system weekly for signs of corrosion or deterioration.
- Have corrosion inhibitors in petroleum products tested semiannually for effectiveness according to procedures in FM 10-20.
- Require that soldiers apply protective paint to the pipeline according to procedures in TM 5-678.

FORWARD AREA REFUELING EQUIPMENT (FARE)**1. APPLICABILITY.**

This load is suitable for the CH-47 helicopter at speeds of 100 KIAS.

2. LOAD DESCRIPTION.

- a. Forward area refueling equipment (FARE) consisting of:
 - (1) Generator, 1.5kW (1 each).
 - (2) Hoses, fuel with reels (2 each).
 - (3) Hoses, fuel with carrying bags (2 each).
 - (4) Assembly, pump (1 each).
 - (5) Extinguishers, fire (3 each).
- b. LIN H94824; weight: 820 pounds.

3. MATERIALS.

- a. Net, helicopter, cargo-carrying, external (5,000-pound capacity).
- b. Webbing, nylon, 1/2-inch tubular.
- c. Cord, nylon, type III.

4. PERSONNEL.

Two men can prepare and rig this load in 15 minutes.

5. PREPARATION.

- a. Secure two fire extinguishers to inside frame of fuel hose reels with 1/2-inch tubular nylon webbing. Secure the two fuel hose reels together with type III nylon cord.
- b. Spread a 5,000-pound-capacity net on the ground. Center the two fuel hose reels on the net. Place pump assembly on either side of reels. Place a 1.5kW generator, with 5-gallon gas can attached, on the opposite side of reels. Place fuel hose carrying bags in front of reels. Secure the two carrying bags with the remaining fire extinguisher together with type III nylon cord. Secure net carrying bag to top of reels.

6. RIGGING.

- a. Place four grabhooks onto apex fitting.
- b. Tape lifting legs of net with masking tape every 2 to 3 feet.

7. HOOKUP.

Hookup man stands alongside load.

Figure 3-2. Sample extract from FM 55-450-1 of materials, personnel, and procedures required to rig the FARE

- Ensure that line scraper operations are conducted periodically to remove rust, scale, and other debris, according to procedures in FM 10-20.
- Verify that sand traps have been cleaned.

CONTROL ENVIRONMENTAL POLLUTION

Petroleum spills present a threat to your soldiers, the mission, and the environment. Whether you are a petroleum platoon leader, a supply platoon leader, or a platoon leader in a terminal or pipeline operating platoon, you must prepare or update an oil spill prevention control countermeasures plan according to CFR 40, AR 200-1, and oversea host nation regulations. Include in your plan detailed descriptions of spill countermeasures and applicable spill control materials from Table 3-5. FM 10-71 details spill control procedures to follow when loading or unloading petroleum tank vehicles. Your tasks are listed below.

- Schedule cleanup drills so that section personnel become expert at spill cleanup.
- Require daily inspections of storage, handling, and transfer equipment.
- Ensure that section personnel document regular equipment checks on DA Form 2404 (Equipment Inspection and Maintenance Worksheet).
- Report immediately, through command channels, any offshore oil and hazardous substance discharges of 50 gallons or more.
- Request engineer support to construct containment devices. CFR 40 lists specific construction requirements.
- Submit a spill report according to CFR 40, through command channels, for any oil spills of 1,000 gallons or more or whenever two oil spills occur in a 12-month period.

- Dispose of mixed petroleum and water according to the unit SOP and EPA regulations.
- Dispose of sludge according to instructions in AR 200-1.

SUPERVISE PACKAGED PETROLEUM STORAGE AND DISTRIBUTION

Set up separate areas for each product and type of package to simplify inventory and stock control of packaged petroleum products. Figures 3-3 through 3-5 illustrate suggested storage layouts for 5-gallon cans, 55-gallon drums, and 500-gallon collapsible drums. Your tasks are listed below.

- Ensure that high-flash and low-flash products are stored separately.
- Require that containers be inspected before they are placed in storage. Table 3-6 lists other inspection checks.
- Check that no containers are stored in direct contact with the ground.
- Ensure that packaged lubes stored outdoors are covered with tarpaulins or stored in sheds.
- Ensure that stocks are rotated so that oldest stocks are issued first.
- Inspect containers weekly for damage and leaks. Use Tables 3-7 and 3-8, which list can and drum deterioration limits.
- Supervise the yearly inventory of packaged products.
- Adjust inventory discrepancies according to AR 735-5.
- Require gate guards to collect matches and lighters from customers.
- Inspect vehicles making deliveries and picking up items.

Table 3-5. Material and equipment to control spills

ON SHORE
<ul style="list-style-type: none">• Containment curbs, berms, and retaining walls.• Oil draining pans or tubs under tank vehicle receiving manifolds, tank car bottom outlets, pumps, drain lines, pump station valves, flanges, and joints. Ensure containment systems at tank truck loading or unloading areas can hold, at a minimum, the capacity of a single tank truck compartment.• Culverts, gutters, and other drainage systems.• Sumps or spill diversion and retention ponds.

Table 3-5. Material and equipment to control spills (continued)

- Guide wire across 10,000- and 50,000-gallon fabric tanks to help prevent overfilling.
 - Drain pipes at the base of fire walls around each collapsible fabric tank.
 - Absorbents, adsorbents, and detergents.
 - Truck vacuum pump.
 - Bulldozers.
 - Sand barrels.
- ON WATER**
- Floating containment booms.
 - Chemical dispersants.
 - Watercraft.
 - Containment systems.
 - Absorbents, adsorbents, and detergents.

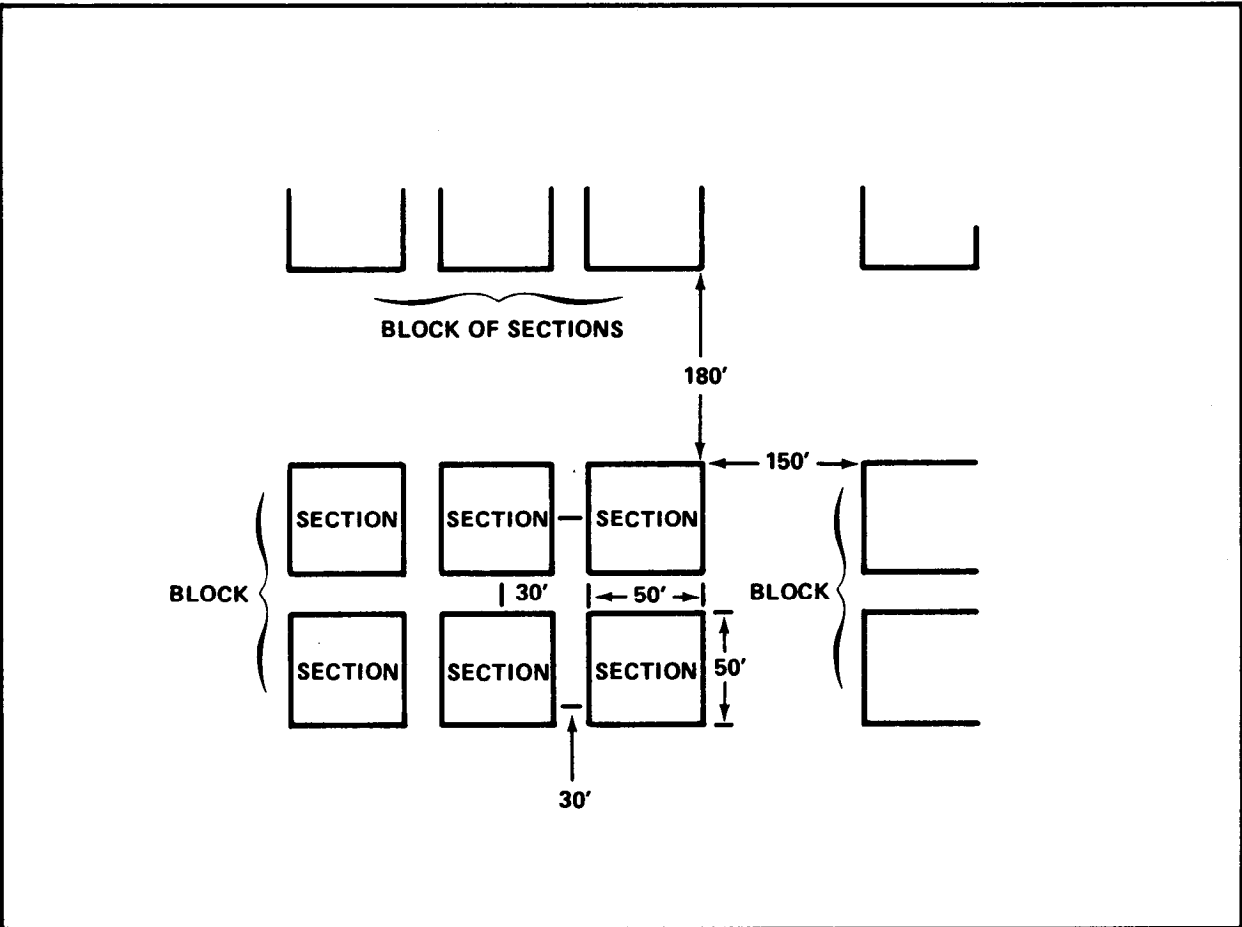

Figure 3-3. Storage layout for 5-gallon cans

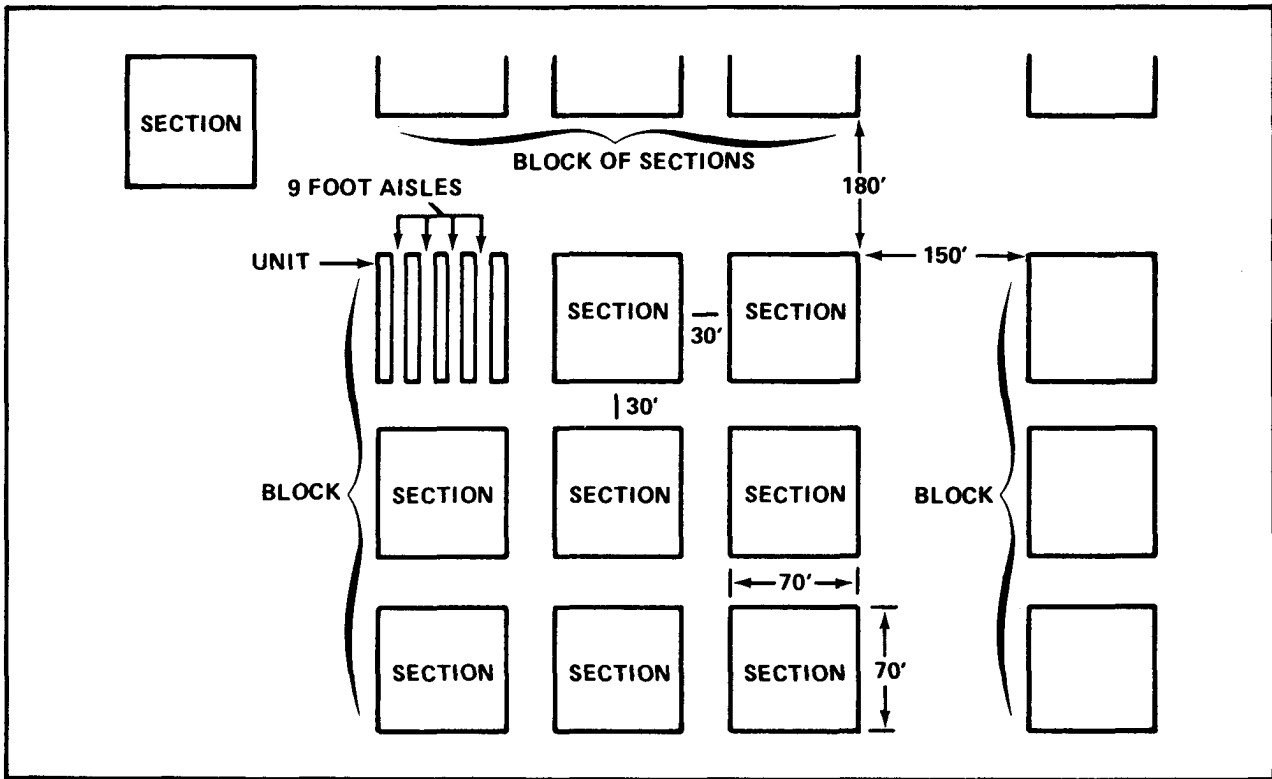

Figure 3-4. Storage layout for 55-gallon drums

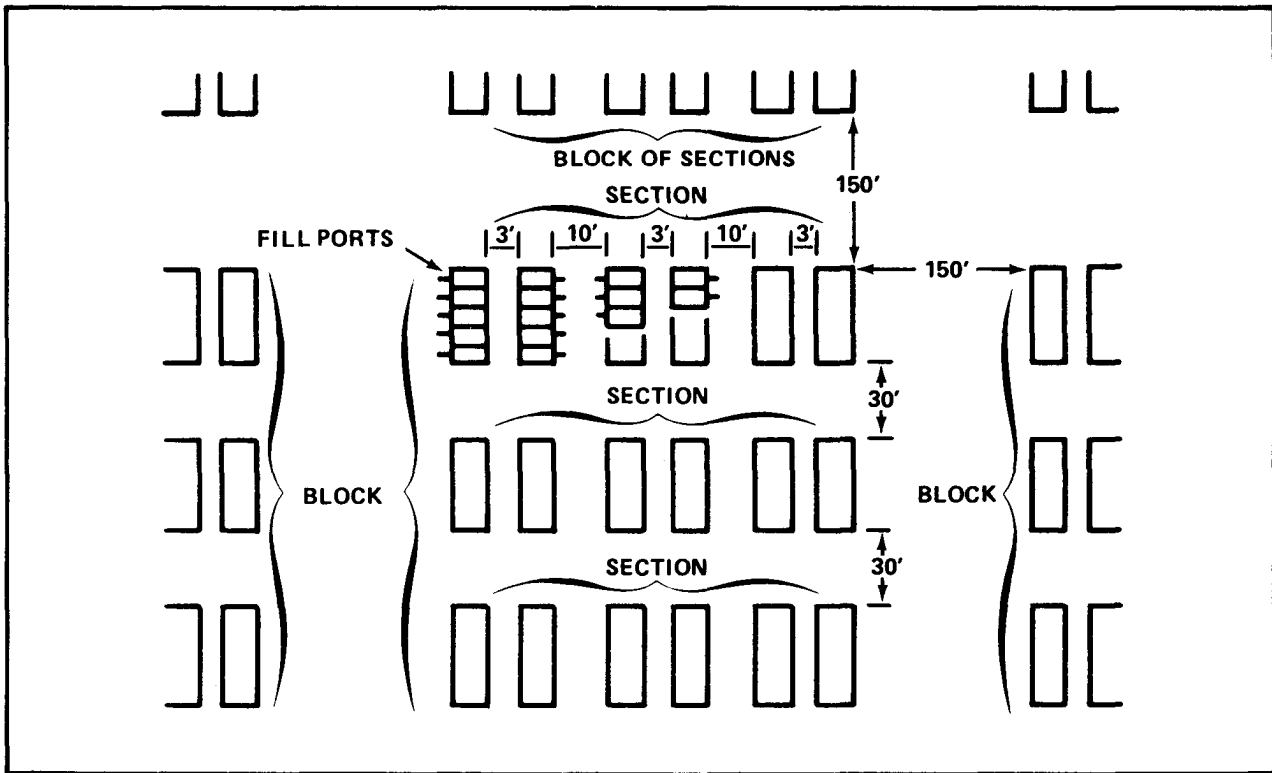

Figure 3-5. Storage layout for 500-gallon collapsible drums

Table 3-6. Inspection checklist

- Are drums stored on their sides? This prevents rainwater from collecting and rusting container tops and seeping through bungs to contaminate the product.
- Are the bungs positioned horizontally?
- Do drum bungs and vents face outward? This makes it easier to detect leaks.
- Are pallets or dunnage and tarpaulins used to store and cover containers that are stored outside?
- Are different products and grades stored separately?
- Are stocks rotated so that the oldest products can be issued first?
- Are stocks with similar filling dates stored together?
- Have all packages which were opened for spot-checking been marked to show that they had been opened?
- Are stained cartons marked to indicate that leaking containers have been removed? This will prevent reinspection.
- Are drums stacked too high?

Table 3-7. Serviceability inspection checklist for 5-gallon cans

PART	EQUIPMENT REQUIREMENTS	DENTS ALLOWED	HOLES ALLOWED	ALLOWABLE CONDITION OF METAL SURFACES
Body	<p>Dents can be removed if the metal will not be weakened.</p> <p>Contaminants must be removable by cleaning. (Asphalt, tar, or similar substances cannot be removed.)</p>	No more than six, less than 1/2 inch deep.	None	<p>Rust on outside. Must be removable by buffing or sand-blasting.</p> <p>Rust on inside. Must be removable by cleaning with solvent or caustic washing.</p>
Chime		Less than 1/2 inch long.	None	
Flange	Threads must not be crossed, stripped, rusted, or worn.		None	
Vent tube	Use only in an emergency if tube is broken or bent.		None	
Handle assembly	<p>Use only if it can be carried without hurting hands.</p> <p>Discard if badly smashed or broken.</p>			

Table 3-8. Serviceability inspection checklist for 55-gallon drums

PART	EQUIPMENT REQUIREMENTS	DENTS ALLOWED	HOLES ALLOWED	ALLOWABLE CONDITION OF METAL SURFACES
Body	<p>Numerous small dents are acceptable.</p> <p>Condition of paint of no importance.</p>	<p>Up to 3 inches deep if not more than six dents in body.</p> <p>No restriction on length.</p>	<p>None resulting from rust.</p> <p>Others up to 3/4 inch in greatest dimension acceptable if not more than four holes in body.</p>	<p><i>Exterior.</i> Must be free of severe pitting that would weaken drum structure.</p> <p><i>Interior.</i> Must be free of pitting. (If product residue prevents the deterioration, drum will be considered acceptable until it is cleaned and inspected.)</p>
Chime	<p>Should be tight on both types of drums. Reinforcing metal strips should be in place on 16-gage drums.</p>	<p><i>16-gage.</i> None greater than 1/4 inch deep with no restriction on length or number.</p> <p><i>18-gage.</i> None greater than 3/4 inch deep and 5 inches in length with no more than four dents per chime.</p>	<p><i>16-gage.</i> No holes allowed and no ruptures acceptable if they separate reinforcement from chime.</p> <p><i>18-gage.</i> No holes allowed and no ruptures acceptable.</p>	<p>See information for body, above.</p>
Flange	<p>No defective thread, gasket seat, or weld.</p>	<p>None</p>	<p>None</p>	<p><i>Exterior.</i> Moderate rusting if gasket seat and threads are not impaired.</p> <p><i>Interior.</i> See information for body, above.</p>
Head	<p>Must be restorable to approximate original contour.</p>	<p>Up to 2 inches deep if not more than two dents per head.</p>	<p>None resulting from rust. Up to 3/4 inch if not more than one hole per head. None located within 2 inches of flange weld or chime.</p>	<p>See information for body, above.</p>
Hoops	<p>Should be restorable to approximate original shape.</p>	<p>None greater than 5/8 inch deep; no limitation in number.</p>	<p>Up to 3/4 inch, not to exceed three holes per hoop.</p>	<p>See information for body, above.</p>
Side Weld	<p>No indication of cracking or deterioration.</p>	<p>Up to 2 inches deep, not to exceed three dents per weld.</p>	<p>None</p>	<p>See information for body, above.</p>

PERFORM QUALITY SURVEILLANCE

You must take samples and test them if petroleum products are to be released as suitable for their intended use. Minimum sampling and testing requirements from MIL-HDBK-200G are listed in Tables 3-9 and 3-10. Quality surveillance specialists must test products upon receipt and before shipment. They must also inspect and test all stored products for serviceability and possible contamination. Your tasks are listed below.

- Ensure that the same grade of product is kept in a tank car, truck, or semitrailer. Plan the flow so that only one type of product is stored or distributed by each type of equipment.
- Make it SOP that soldiers clean line strainers and nozzle screens daily.
- Ensure that aviation fuel flows through a filter/separator before it is issued from a petroleum tank vehicle. Change filters every 2 years or when changing type of fuel being used. Maintain a pressure differential log. See FMs 10-20, 10-68, and 10-69 for more information on the use of a filter/separator.
- Drain water daily before and after every operation.
- Make it SOP that dust caps or plugs are placed over any loading or dispensing hoses or nozzles not in use.
- Make sure that bulk fuel has been tested before it is allowed to enter a pipeline.
- Ensure that soldiers follow the first-in, first-out rule when issuing packaged petroleum products. This prevents deterioration due to prolonged storage.
- Ensure that contaminated or off-specification fuel is segregated.
- Determine the source of any contamination and the feasibility of removing it so that you can reclaim the product.
- Set up prescribed points or time intervals for sampling and testing petroleum products. FM 10-70 prescribes these procedures.
- Determine the source of contamination and take corrective action to prevent reoccurrence.

MONITOR STORAGE AND HANDLING OF COMPRESSED GASES

Compressed gas cylinders are potentially hazardous. A gas cylinder explosion can equal that of a bomb. Store all compressed gas cylinders away from petroleum products and ammunition. Soldiers must use extreme caution when lifting,

storing, and transporting gas cylinders. Storing and handling precautions are described below.

- Place valve protection safety caps on all small cylinders.
- Close the valves on all empty as well as full cylinders.
- Store empty cylinders separately from full ones.
- Allow 50 feet of space between storage sheds for flammable gas and other buildings. DOD 4145.19-R-1, Chapter 5, lists criteria for open-sided and enclosed storage sheds.
- Store acetylene cylinders in a separate building or within a solid wall compartment.
- Fasten cylinders in racks or cradles when they are to be moved, and brace them so they do not overturn or strike other objects.

COORDINATE LOCAL PURCHASE

In peacetime, packaged products, especially acetylene and oxygen cylinders, are often obtained through local purchase. While local procedures may vary, the request and issue flows are basically the same. You coordinate requirements with the Class III item manager in your supporting MMC. The requisitions are then sent through the DOL item manager to the finance office for a check on fund availability. Upon approval of the requisitions, local purchase of the items is authorized. The requisitions are then sent to the contracting division for purchase from an authorized source. Then, depending on time and distance factors, your soldiers may either pick up supplies at the contractor or vendor storage area or from the installation DOL warehouse.

MAINTAIN RETURNABLE AND REFILLABLE CYLINDERS OR CONTAINERS

Supported units should turn in an equal number of empty cylinders for full ones. If the unit has no empty container, it must submit a request for a cylinder or container before the gas can be issued. Requests for government-owned containers must show Advice Code 2S. Requests for vendor-owned containers must show Advice Code 2Y. Your storage activity must mark the appropriate manufacturer control number on vendor-owned containers. Supported units must turn these containers in to your stock control activity when the units are transferred permanently.

Table 3-9. Bulk petroleum sampling and testing requirements

WHEN TO SAMPLE	TYPE OF SAMPLE	TYPE OF TEST REQUIRED
<p>Before filling railcars and tank vehicles.</p> <p>Before discharge of railcars or tank vehicles.</p> <p>Daily from all working tanks and from railcars and tank vehicles.</p> <p>Monthly from all working tanks.</p> <p>Overseas areas. Every 6 months for aviation gasolines; every 12 months for jet fuels, automotive gasolines, and diesel fuels when fuel is dormant or suspected of being off-specification.</p> <p>In CONUS. Every 6 months for aviation gasolines; every 12 months for automotive gasolines, jet fuels, and diesel fuels when fuel is dormant or suspected of being off-specification.</p>	<p>Discharge hose sample</p> <p>Refueler all-level sample*</p> <p>Collapsible tank bottom drainage outlet</p> <p>Refueler sample</p> <p>Collapsible tank bottom drainage outlet</p> <p>Refueler sample</p> <p>Upper, middle, and lower level sample</p> <p>Upper, middle, and lower level sample</p>	<p>Visual check for appearance, water, and sediment.</p> <p>Visual check for appearance, water, and sediment.</p> <p>Visual check for appearance, water, and sediment.</p> <p>Aqua-Glo test of all aviation fuels.</p> <p>Laboratory analysis for water and sediment.</p> <p>Aqua-Glo test of all aviation fuels.</p> <p>Laboratory tests: API gravity, distillation, flash and fire, copper strip corrosion, water, and sediment. Analysis for A and B-2 tests** must be forwarded to the base laboratory.</p> <p>Laboratory tests: API gravity, distillation, flash and fire, copper strip corrosion, water, and sediment. Analysis for A and B-2 tests** must be forwarded to the base laboratory.</p>

*For compartmented vehicles, a sample is required from each compartment.
 **Refer to Table III of MIL-HDBK-200G.

Table 3-10. Packaged fuels sampling and testing requirements

TYPE OF FUEL	TYPE OF TEST REQUIRED *	WHEN TO SAMPLE
Aviation gasoline	Aqua-Glo and Set Aqua-Glo and Sediment (Visual) Color (Visual) API Gravity Distillation Copper Strip Corrosion	Daily, using Aqua-Glo kit. When identity is uncertain. Every six months for dormant stocks.
Jet fuels	Aqua-Glo Visual Appearance Color API Gravity Distillation Copper Strip Corrosion Flash Point (Except JP-4)	Daily, using Aqua-Glo kit. When identity is uncertain. Every 12 months for dormant stocks.
Automotive gasoline	Appearance Water and Sediment (Visual) Color API Gravity Distillation Copper Strip Corrosion	When identity is uncertain. Every 12 months for dormant stocks.
Diesel fuels	Color API Gravity Distillation Flash Point Viscosity Water and Sediment by Centrifuge	When identity is uncertain. Every 12 months for dormant stocks.
*As limited by test capability of the petroleum testing kit.		

PREPARE OR UPDATE POL SAFETY PROGRAM

Petroleum products present unique fire, safety, and health hazards. As the petroleum platoon leader, you must review, update, or develop a fire fighting plan according to FM 10-69. Your tasks are listed below.

- Ensure that flammable liquids are stored at least 100 feet from wooden structures and 50 feet from noncombustible structures. Store compressed gases separately.
- Prohibit smoking within 100 feet of storage areas, FARE, or FSSP. Require gate guards to collect matches and lighters from those who enter the area.
- Ensure that the correct types of fire extinguishers are on hand and positioned ready for use. All soldiers should know the location of every fire extinguisher in the area.
- Examine fire extinguishers at least twice a year. Monitor dates when fire extinguishers were last inspected.
- Require that maps show critical shutdown valves, location of water supply, evacuation routes, and reporting areas following a fire alarm.
- Ensure that all vehicles and equipment are bonded and grounded prior to starting any operation. TC 11-6 gives details on how to ground equipment.
- Require that engineers construct a fire wall around each 50,000-gallon collapsible tank. The fire wall should be 4 feet high and 18 inches wide at the top, 73 feet long and 33 feet wide.
- Require all section soldiers to inspect all fittings daily for slippage or signs of leaks. They should also inspect all FSSP or FARE hoses daily for blisters, nicks, and cuts.

- Conduct night and day fire drills.

CONTROL PILFERAGE AND SABOTAGE

Fake invoices and tanker trucks with false bottoms can be used to pilfer bulk petroleum. Saboteurs can contaminate products. Packaged products can be hidden in trash or salvage disposal drums. You must devise a control program to prevent product loss. Your tasks are listed below.

- Locate vehicle turnaround areas near a guarded security gate.
- Require that all trucks entering and leaving the supply point pass through a security gate.
- Permit only one-way traffic.
- Have section soldiers document all cargo according to DOD 4140.25-M and current regulations.
- Require section supervisors to verify that no locks and seals have been tampered with before off-loading and after loading. Ensure that seals are applied whenever possible.
- Require that any discrepancies in the amount of petroleum loaded or discharged from commercial trucks be reported at once to you or your section chief and investigate discretion.
- Implement perimeter controls.
- Initiate a parcel check system for packaged petroleum products.
- Ensure physical security. Use guards, barriers, protective lighting, entry control checks, and intrusion detection devices, as applicable.
- Monitor and compare monthly gains and losses to determine patterns.

CHAPTER 4

TECHNICAL SUPPLY OFFICER

REVIEW YOUR RESPONSIBILITIES AND CONCERNS

In general, your responsibilities and concerns will be similar to those of a supply platoon leader. You need to review the responsibilities of the supply platoon leader, especially in the operation of Class II, IV, and VII sections. However, your concerns are multiplied due to the number of repair parts which your SSA must maintain. Almost 92 percent of the total Army inventory consists of repair parts lines. Estimates are that each soldier may consume as many as 4.83 pounds of repair parts each day during theater operations in an intense European conflict. Even this figure may be too low. Older items in the Army's inventory will still need repairs, and repair parts must be stocked for newer and more complex items. You will be concerned mainly that your Class IX ASL contains enough lines and has enough depth to support the maintenance of critical equipment in supported units during wartime. You also will be concerned with filling NMCS and high-priority requests for parts to fix critical weapons systems and end items. Your SSA must be able to transport these essential repair parts in organic repair parts vans. You may be tasked to supervise RM and QSS items.

★REVIEW MANDATORY PARTS LISTS AND DETERMINE IMPACT ON ASL

As the technical supply officer, you should review the MPLs of supported units to determine possible impact on your ASL. MPLs identify mandatory stockage quantities of combat-essential repair parts. The ASL is required to umbrella customer MPL stocks. As a result of the continuing effort to standardize a

combat ASL and reduce the number of decisions needed to determine which ASL lines to stock, MPLs have been consolidated into three pamphlets. DA Pamphlet 710-2-3 is for combat arms, DA Pamphlet 710-2-4 is for combat support units, and DA Pamphlet 710-2-6 is for aviation units. The consolidated MPLs are to be updated semiannually.

NOTE: Proposals have been made to eliminate combat prescribed load lists and mandatory parts lists and to abolish retention authority. If this becomes policy, it will be explained in AR 710-2.

USE LIF TO DETERMINE SUPPLY STATUS

The LIF is a computer data bank of supply requisitions and transportation documents maintained by the US AMC LCA. It covers requisitions for all items except subsistence, bulk petroleum, and ammunition. AR 725-50, Chapter 6, describes the file, management data provided, and inquiry capabilities. You can use data from this file to take the following actions:

- Check on the latest status of a requisition. You should first request status through your supporting supply activities. You may call in urgent inquiries on DSN 586-5823 or 5824 or send a priority message. Refer to DA Pamphlet 700-30 for information on using the LIF. ★
- Divert, split, reconsign, or expedite items or shipments on short notice. Ensure you submit standard transactions to effect these actions as well, since all activities in your chain of support must also be aware of these actions. ★

- Reconstruct requisitions for shipments lost in transit or damaged while en route overseas.

- Trace a requisition from the date it was submitted to the date the item was delivered.

- ★ • Analyze requisition demand history. Send requests for remote terminal access to the LIF to:

Commander

LCA

ATTN: AMXLC-M

Building 650

Presidio of San Francisco, CA 94129-6900

★ DETERMINE SIZE OF CLASS IX ASL

Maintaining large stocks of repair parts impedes mobility and increases vulnerability. DSU stockage must umbrella the MPLs of supported units.

★ INCORPORATE ASL CHANGE LIST RECOMMENDATIONS

Automated systems produce an ASL change list. The list identifies automatic stockage level increases and decreases. It also gives recommended stockage level or stockage list code changes and recommended ASL additions or deletions. If an item qualifies for retention on the ASL, the automated system recomputes the RO and ROP and prints the recommended quantities. For more information, see TM 38-L32-13. (NOTE: This change deletes Figures 4-1, 4-2, and 4-3.)

★ ANALYZE IMPACT OF PLL CHANGES ON ASL SIZE AND DEPTH

The ULLS maintains demand data through its demand analysis process. Each recommended change to a PLL may cause a change in that ASL. You should review the ULLS listing on an as-required basis to determine the impact of any PLL changes. After completion of your review, analyze the impact on the size or depth of your Class IX ASL. You may need to add or delete line items. You also may need to adjust stockage levels to correspond to increases or decreases in the PLL stockage levels of supported units.

NOTE: The update of the unit PLL is a semiannual requirement within the USAR and ARNG.

★ MONITOR DEMAND SATISFACTION AND OTHER SUPPLY INDICATORS

Supply performance reports are used to measure support of customer units. The reports alert managers to problem areas. These areas include warehouse denials, overuse of high PDs, number of ASL lines at or below safety level or at zero balance with due-outs, and number of lines frozen due to inventory. The reports will provide balance on statistical data for common repair parts, aircraft repair parts, and missile repair parts. The forms will vary depending on the STAMIS used.

VERIFY CRITICAL EQUIPMENT DEADLINED DUE TO ZERO BALANCES

Major weapons systems and critical end items can be deadlined due to a zero balance. A zero balance may result from inadequate depth of ASL, RM, or QSS items or inadequate safety levels. It may result from a lack of inventory accuracy, delinquent deliveries on contracts, or problems with cancellations. Your tasks are listed below.

- Verify that the correct part has been ordered. If not, have the unit reorder.

- Verify that the NMCS request had been received, processed, and (if necessary) transmitted to the MMC.

- Have soldiers check the AMDF for an interchangeable or substitute item when using manual operations. SARSS automation considers relationships with interchangeable and substitute items. ★

- Coordinate with your MMC on possible lateral issue.

- Consider cannibalization to obtain the part.

MONITOR STOCK CONTROL

During the initial stages of deployment of a DSU, stock control will be decentralized. Although the MMC often deploys a small element as early as possible, there may be only limited capability to manage stocks. Fewer than 1,000 lines maybe managed. In the future, the DSUs that are authorized a dedicated automated system will be responsible for routine stock control and stock record accounting. The MMC will perform supply and stock control on an exception basis. Therefore, as the technical supply officer, you

must be able to check on and edit requests before submitting them to the DS4.

SET UP CARD FILE FOR A PART OR REFERENCE NUMBER

Part, model, and type numbers are listed in alphanumeric order on the MCRL. This list, on microfiche, is updated semiannually. It lists all unclassified manufacturers' part and reference numbers recorded in the Federal Catalog System and the NSN of each. You must maintain a DD Form 1348-6 (DOD Single Line Item Requisition System Document (Manual Long-Form)) when the manufacturers' part numbers have more than 15 digits. Automated systems cannot accept such numbers. Also, have soldiers set up a card file of non-NSN items requested by supported units. This will reduce time needed to search the MCRL.

★ USE OF STANAG AND QSTAG AGREEMENTS

The United States Federal Supply Classification System (STANAG 3150 and QSTAG 680) was adopted as the NATO Supply Classification System. The NATO Supply Classification System and the NATO Item Identification System (STANAG 3151 and QSTAG 642) form the basis for the NATO Codification of Equipment System. Procedures for the NATO Codification of Equipment System are published in the NATO Manual for Codification. The United States Federal System of Item Identification is explained in DOD 4130.2-M.

★ MONITOR ADP SUPPORT

Sustained Class IX supply depends on ADPE support. This support includes a solid backup and a Continuity of Operations Plan. The COOP is a formal agreement between two facilities to use computer hardware. This plan ensures support provided to an organization is consistent with mission requirements while under emergency conditions. Keep in mind that backups must be in compatible formats. For more details on a COOP, see AR 380-19. Your tasks are listed below.

- Incorporate backup automated procedures in your SOP. Refer to TM 38-L32-13 for DS4 procedures to

follow during short-term (less than 72 hours) and long-term outages. During deployment and redeployment operations, the best backup is other ADPE.

- Identify all outstanding requests and those requests which must be filled.
- Direct your soldiers to process NMCS requests manually on a postpost basis.
- Have soldiers hold low-priority requests until the end of the expected short-term outage.
- Determine availability, capability, and compatibility of host-nation ADPE assets.
- Transfer operations to alternate or replacement ADPE in floats during long-term outages.

★ STANDARDIZE RECEIPT, STORAGE, AND ISSUE PROCEDURES

Figure 4-4, page 4-4 shows a standard method for issuing items. Have your section supervisors prepare pages similar in format to the page shown. Such pages can then be used to train new personnel in standard, efficient procedures. You may use performance measures from soldier's manuals and trainer's guides. This would serve not only to train storage personnel in standard methods, but it would help them to pass their SDT, also. Emphasize that they should make as few moves as possible. Each move increases time and costs. Additional handling also increases the chance for damage.

★ MONITOR STOCK LOCATIONS AND STORAGE PROCEDURES

Incorrect storage locations can cause MRDs and prolong critical equipment deadlines. As the technical supply officer, you should periodically spot-check the locations of 5 to 10 items. Figure 4-5, page 4-5 shows how the five-character stock locator code can be used to locate an item in a repair parts van. Most repair parts will be stored in bins and on shelves in a warehouse or in bins which are truck- or van-mounted. See Figure 4-6, page 4-6 for some basic guidelines for bin and shelf storage. Items stored in bins must be truck- or van-mounted according to policies in AR 710-2. For more information on stock locator codes and bin storage, see DOD 4145. 19-R-1 and Chapter 5 of this manual.

ISSUE METHOD DESCRIPTION

Job Select Bin Material

Location Warehouse Bin Area

Condition Stock Picker's Cart and
Conveyor Line

Method Hand Pick from Bin Opening

Personnel Required:

1 - Stock Picker

Equipment Required:

- Stock Picker's Cart with Ladder (Figure 3)
- Small Bags and / or Tote Pans

Procedures:

1. Documents:

- a. Stock picker proceeds to document pick up point and obtains sorted issue documents. Issue documents have been sorted into proper picking sequence.
- b. If any documents are found to be out of sequence, sort and place into proper picking sequence.

2. Prepare for issue operation:

- a. Receive instructions (as required).
- b. Travel to designated locations and obtains stock pickers cart, sufficient bags and/or tote pans as required.
- c. Push stock pickers cart to location of first item to be selected.

3. Perform selection operation:

- a. Check and select the quantity ordered on the MRO's from the designated location.
- b. Annotate the issue document.
- c. Attach or place the annotated document with the selected material.
- d. Move to next locations with cart and repeat steps 3a-3c.
- e. Place material onto conveyor system.

4. After selection operation:

- a. Travel to document pick up point for next assignment.
- b. Return stock pickers cart, unused bags tote pans to designated area (once per day).
- c. Clean up work area (once per day).

Special Instructions:

- 1. Issues can be made from drawers, cartons, or shelves located in the bin storage area. Normally the bins are 36" x 18" x 12" or less in size.
- 2. Small items should be placed in bags (Jiffy) with the document attached wherever possible at the time of pulling stock item (not at packer's work station).
- 3. Guidance is furnished under Chapter 2-- Joint Storage and Material Handling Manual on proper utilization of bin spaces.

Figure 4-4. Issue method page extracted from TM 743-200-3

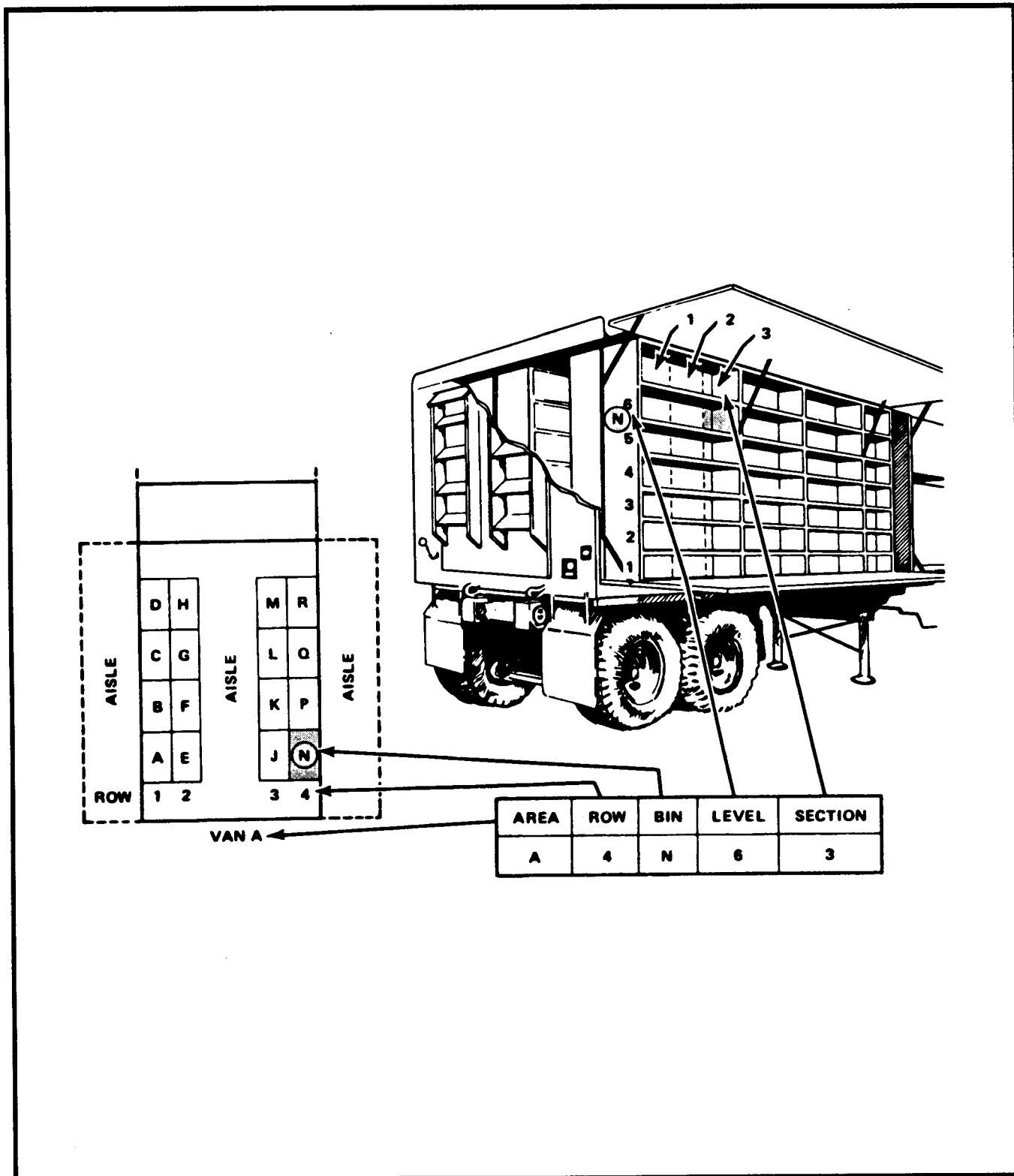

Figure 4-5. Five - character stock locator code applied to repair parts van

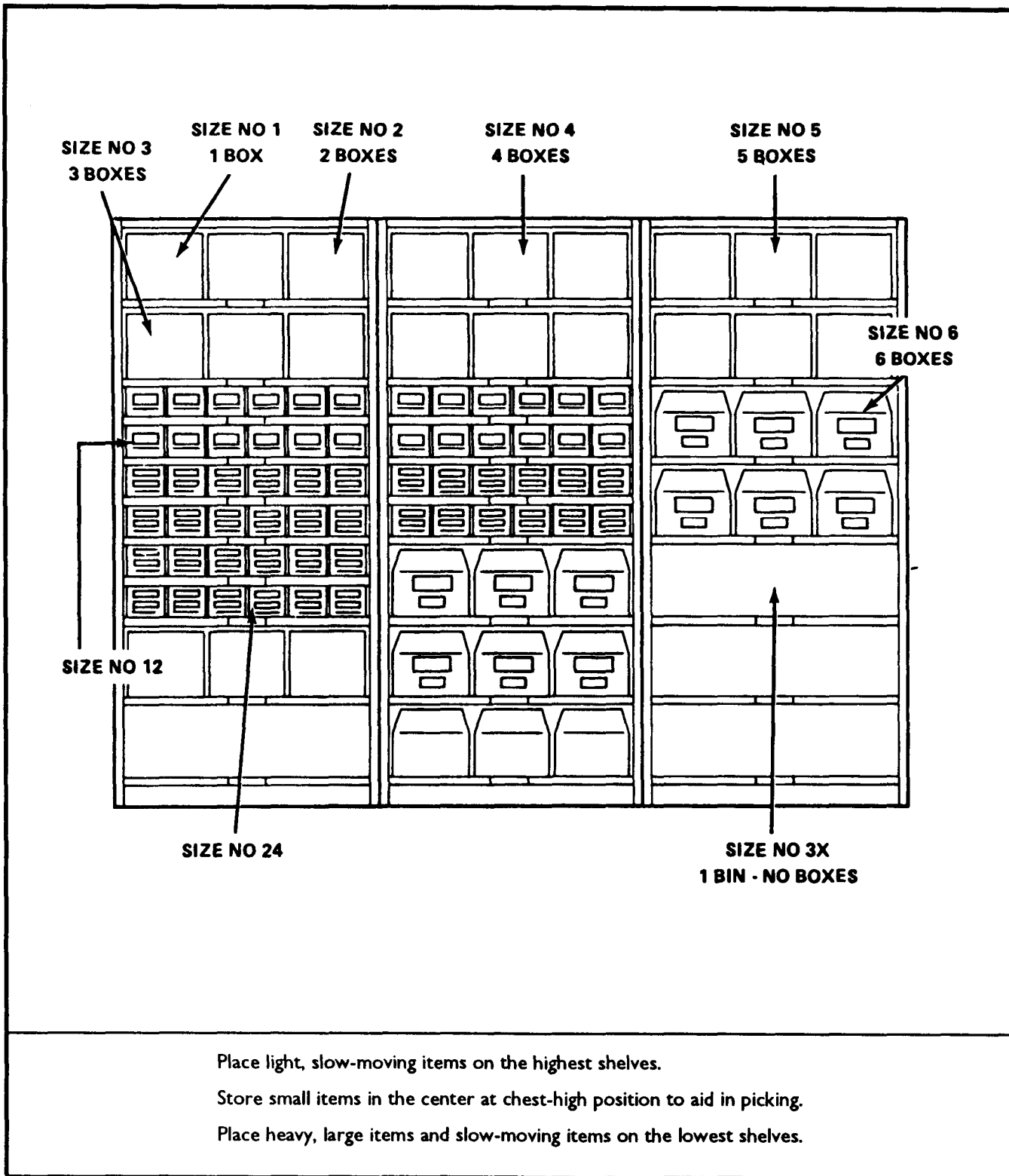

Figure 4-6. Sample bin and shelf box arrangement

★ CHANGE STORAGE RECORDS AND STORAGE AIDS TO AGREE WITH MONTHLY CROSS-REFERENCE LIST

Each month, as a result of the catalog update process, the MMC will send your DSU a cross-reference list for each supported unit. The list shows changes of stock number, units of issue, or both identified by the catalog update process. You must make sure that storage personnel use the information on this list to update bin tags, placards, and parts identification. Failure to make these changes could result in incorrect quantity fills, delays in supply fills, and MRDs. MRDs require a special inventory. (NOTE: This change deletes Figure 4-7.)

★ MAINTAIN OR MANAGE RMA

Using units turn in unserviceable items and request serviceable items from their supporting supply activity. There is no longer an exchange of items. Everything must be formally turned in and requested, to include those items previously exchanged. AR 710-2, paragraph 3-18; DA Pamphlet 710-2-2, Chapter 11; and TM 38-L32-12 give details on how to manage an RMA. Stockage selection is based on demand history, maintenance repair dates, and maintenance capabilities. Table 4-1 lists criteria used to select the DS repair items which will be issued from your RMA. Your tasks are listed below.

- Ensure that unserviceable are job-ordered within three workdays of receipt. You must send DA Form 5504 (Maintenance Request) with UND C with the item to maintenance. DA Form 5504 replaces DA Form 2407 for those units supported by an automated system. Follow the instructions of your automated system, as they are printed in facsimile maintenance requests, materiel release orders, and location tickets.

- Check that there are no excess SIMS-X items or ARIs and no excess stock of items with an RC of D, F, H, or L each day activity occurs on the line. All other items will be reviewed for excess on a monthly basis. In CONUS, there is no retention limit above the RO. OCONUS may retain twice the RO.

- Ensure that all excess stocks above the RO and OST are turned in within 10 days after determination that they are excess.

- Review stockage level computations.

Table 4-1. DS repair items package criteria

- Class II, IV, or IX reparable.
- Automated to repair at DS level.
- Recoverability code must be D, F, H, or L.

STORE BATTERIES

Batteries are perishable items. Their storage life will depend on storage practices and the climate. Proper storage can extend battery life, ensuring that the battery is charged and ready for issue when required. Table 4-2, page 4-8 lists storage requirements for vehicle and dry cell batteries. For more information, see DOD 4145.19-R-1, SB 11-30, and TM 11-415. Your tasks are listed below.

- Consider the lead time required to obtain replacement batteries.
- Monitor storage. Dry batteries should be stored at 35 degrees Fahrenheit or less. CTA 50-909 authorizes refrigerators for storage at unit and activity level.
 - Request refrigerator transportation.
 - Monitor shelf life expiration dates.
 - Require that lot samples be inspected and tested when the issue date exceeds the expiration date.
 - Ensure unsuitable dry batteries are disposed of. Continuing corrosion can create health and safety hazards. Check with the defense reutilization and marketing office for disposal instructions.

MONITOR TIRE STORAGE

You must rotate stock and issue oldest stock first. This will prevent deterioration of tires and inner tubes. Ensure that soldiers follow proper storage precautions and stock control measures. Your tasks are listed below.

- Store tires in a vertical position when possible. Require that tires stored horizontally be reversed each six months so that the tire that was on the bottom is on the top. Ensure stacking limits shown in DOD 4145.19-R-1, Chapter 5, are not exceeded.
- Ensure tires are stored away from direct sunlight when possible.
- Make sure that no unmounted tires and tubes are stored in the open for more than 90 days.

Table 4-2. Battery storage requirements

GENERAL REQUIREMENTS

- Store batteries on pallets, in bins, or on racks. Never pile batteries on top of one another.

CAUTION

Batteries removed from containers must never come into contact with steel shelving. This can cause short circuits or discharge.

- Never store batteries in direct sunlight or beneath a metal roof.
- Issue oldest stock first.
- Never store batteries directly on a concrete floor.
- Store lead-acid batteries upright to prevent spillage or leakage of electrolyte.

VEHICLE BATTERIES

- Store batteries in a cool location (between 60° and 80°F).
- Maintain a continuous trickle charge or perform a periodic recharge once each month on charged and wet batteries.
- Add water and check specific gravity every week on charged and wet batteries.

DRY CELL BATTERIES

- Store in a refrigerated well-ventilated storage area (30° to 35°F is recommended).
- Never remove batteries from sealing bags until they have been allowed to warm up to surrounding temperatures.

MANAGE A QSS

Any divisional main or nondivisional DSC for repair parts supply may be authorized a QSS. DS4 procedures are in TMs 38-L32-12 and 38 L32-13. Basic operating procedures are covered in DA Pamphlet 710-2-2, Chapter 12. Appendix C of this FM provides a sample internal SOP for a QSS. Your tasks are listed below.

- Review the quarterly ASL change list to identify those items for which QSS additions or deletions have been approved. Figure 4-8 lists QSS stockage criteria.
 - Screen carefully any candidates for deletions which have a UI other than each. The prorated cost of items in the unit pack may be less than the amount specified in DA Pamphlet 710-2-2.
 - Establish an effective date when ASL items are to be converted to QSS or QSS items are to be returned to detailed accounting. Do not stock QSS items in other sections.

- Submit change cards for automated processing.
- Ensure storage sections have completed rewarehousing using storage item data change cards.
 - Check that the ROP quantity has been physically segregated (placed in a plastic bag, paper bag, or small box) and that the QSS reorder point card has been attached.
 - Monitor the number of QSS lines at zero balance. Your objective is to have no more than 10 percent of all QSS lines at zero balance.
 - Submit inventory count cards showing new locations to the MMC or SCS for processing.
 - Distribute quarterly QSS listings to supported units. (These listings will not be processed during wartime.)
 - Forward QSS reorder point cards to the MMC or SCS when the ROP has been penetrated.

NOTE: The DS4 will recompute the RO and ROP.

1. Stockage list code (SLC) must be Q, except for EC G items; see 9 below.
2. Unit price must be \$10 or less except where the unit of issue contains more than one item. However, the cost of an item (in unit of measurement quantity) must not exceed \$10.
3. CIIC code must be U.
4. Accounting requirements code (ARC) must be X.
5. Recoverability code (RC) must be Z.
6. MATCAT code position 2 must be 2.
7. Fund code (FC) must be either I or blank.
8. Reportable item control code (RICC) must be 0.
9. Essentiality code (EC) must be J, except that where a QSS is established, EC G items that receive nine demands in the control period and meet all other QSS criteria will be transferred to QSS accounting.
10. Supply category of materiel code (SCMC) position 1 is 9.

Notes:

1. All critical except I are found in the ARMS Monthly AMDF.
2. Criterion I is found in the stock record account.

Figure 4-8. QSS stockage criteria extracted from DA Pamphlet 710-2-2

PART TWO – SUPPLY OPERATIONS

CHAPTER 5 CONTROLLING STORAGE SPACE

Section I Determining Space

This chapter is for the storage supervisor.

RESPONSIBILITIES

Storage space is the most critical and basic resource of any DSU storage facility. The amount of storage space that is available is often limited. Most DSUs usually cannot obtain additional space. Therefore, you must make the best use of all available space in many types of storage facilities. How effectively your storage section operates depends upon how fully you use the MHE assigned to your section. You will need to plan your storage areas so that this equipment can be used as much as possible. As storage supervisor, you are responsible for storing and protecting many kinds of supplies. Some of the items such as end items, repair parts, ammunition, petroleum products, subsistence, and classified and sensitive items may need special handling or may require special storage facilities. DOD 4145. 19-R-1 and this FM explain the storage requirements for these special kinds of items. You will need to keep these requirements in mind when you setup your storage areas.

STORAGE SPACE

Be sure an area has proper drainage before you use it for storage. Adequate drainage protects the supplies from water damage and lets you

maneuver MHE more easily. Even if you have proper drainage in a storage area, you still need to use some type of dunnage when you place supplies on the ground. As storage supervisor, you will be working with covered and open storage space.

Covered

Covered storage space is space within any facility that has a roof. This includes buildings, sheds, or any other covered areas that are used for storing supplies or that are assigned for storage operations. It can also include hangars, Quonset huts, and other stationary units.

Open

Open storage space is any improved or unimproved open area that is used for storing supplies. An improved area is one that is graded or topped with concrete, tar, or gravel. Open storage areas should be used for supplies that are not affected by adverse weather conditions and changes in temperatures. This type of storage area is generally used for items that are too large or too heavy to be placed in covered storage areas or on shelves.

Section II

Making a Storage Layout

STORAGE LAYOUT

A storage layout is a floor plan of the storage area or building that shows where the columns, stairs, elevators, latrines, and doors are located. Use the layout to help you plan where to place storage and working areas, shelves, and offices. The amount of time you need to spend in setting up the floor plan depends on the kinds of supplies your DSU stores and the types of facilities you have to use as storage areas. Before you begin to plan the storage layout, use your microfiche reader to check the physical security; arms, ammunition, and explosives security; and the risk or pilferage code of all of the items you will be storing. This code is listed on the AMDF. Check the NSN of all items to see if they fall into any of the SEC categories. Sensitive and pilferable items require special controls when they are stored and moved. Figure 5-1 describes some of the types of

items that come under these categories. You can find a complete listing in CDA Pamphlet 18-1. AR 740-1, Chapter 6, also gives instructions on how to store these kinds of items. Because your DSU receives irregular demands and large numbers of different supplies, the stock positions are always changing. To help you move the supplies through the receipt, storage, and issue sections quickly and efficiently, you will need to spend time and effort planning day-to-day operation procedures and storage layouts.

STORAGE LAYOUT PLAN

To aid you in planning the layout, the SCS can furnish you with the types and number of items on its ASL and NSL. Consider the following when you plan your layout.

SEC	PILFERABLE ITEMS
IAircraft engine equipment and parts.
MHand tools and shop equipment.
NFirearms.
PAmmunition and explosives.
QControlled drugs (requiring secure storage).
RAlcohol, alcoholic beverages, precious metals, drugs, or other substances requiring vault storage.
VIndividual clothing and equipment.
WOffice machines.
XPhotographic equipment and supplies.
YCommunications/electronic equipment and parts.
ZVehicular equipment and parts.
JPilferable items, due to the size, shape, and utility, which do not fall under one of the above categories. Pilferage controls may be designated by the coding activity to items coded U (Unclassified) by recoding the item to J.

Figure 5-1. Extract from CDA Pamphlet 18-1

Maximum Use of Space

Space is vertical as well as horizontal. Stack material to use this space. Oddly shaped, heavy, or hard-to-move items should be stored in low-ceiling areas. Leave the high-ceiling areas for items that can be stacked higher.

Time and Labor Savings

The less distance an item is moved, the more time your personnel can spend on another operation.

Accessibility of Supplies

Store supplies in specific, marked locations so that they can be easily located. Consider the locations of doors and aisles and the use of your MHE when you are deciding whereto store items.

Maximum Protection of Supplies

Store supplies where they can be protected from theft, fire, weather damage, rodents, and insects.

STORAGE FACTORS

You must consider certain storage factors before you can begin drawing your layout. These factors will help you plan where various groups of items should be located. They are described below.

Similar Items

To speed storage and issue operations, group items according to their type. For example, all items in Class 7105 (office supplies) should be stored in one general area, if possible.

Rate of Turnover

Place fast moving items close to the issue point. This cuts down on the amount of time you spend pulling the item and bringing it to the issue and breakdown point.

Item Size or Weight

Place very heavy or large items close to the issue point. This shortens the distance items must be moved. It also reduces the need for MHE and helps to hold down labor costs. Heavy or large items may not be issued often, but you still should place

them close to the issue section and not within their class groupings. You should make sure that MHE can get to the items.

Quantity

Know the quantity of the items you need to store. This helps you determine the amount and type of space you will need. You can get this information from the SCS. Estimate the amount of space you will need so that you can keep the entire supply of an item in one place. By using one location for each item, you make it easier to restock supplies and set up the stock locator system.

Special Storage Requirements

Some items such as lumber, ammunition and explosives, vehicles, hazardous supplies, subsistence, petroleum, and metal products have special properties. You need to be aware of these properties if you are to provide the proper type of storage for these items. DOD 4145.19-R-1, Chapter 5, describes these items and explains the special type of storage and handling each item requires.

Hazardous Material

Some materials are dangerous if they are stored with other stock or if storage personnel do not handle them correctly. For example, explosives, poisons, and magnetic and corrosive materials require special storage and MHE.

Sensitive and Pilferable Items

Some items are medically regulated. Others may be subject to theft. Store these items where they can be protected. Sensitive and pilferable items usually have a high resale value on the illegal market and need to be strictly controlled and stored in an area that can be locked. Place restrictions on personnel moving in and out of these areas. You should assign one of your soldiers to be responsible for secured areas. Give the keys to the locked portions only to the key custodian and the officer in charge of the storage section. You will need to inventory most of these items quarterly. Some sensitive items require a monthly inventory. Check AR 190-11 for other information you will need to know in controlling these items.

Classified Items

Classified items include documents and supply items that need protection because of their importance to the national security. Store these items in specific types of secured areas. They also require special handling. Any storage personnel who work with classified items must have a security clearance and be under constant supervisory control.

Perishable Items

Perishable items such as food, film, and batteries can stay in storage for a limited time only because they will spoil or become outdated. Sometimes these items also require special handling. Many perishable items must be kept in areas that are refrigerated or temperature-controlled. If you must store perishable items in a single storage area, be sure to keep items that give off odors away from those that can absorb odors. For example, do not store onions and fish near butter or milk. Check AR 30-18 for information on the storage of perishables.

Oddly Shaped or Fragile Items

These items require special handling because of their shape or composition. They may also require special storage because of their bulk. Be sure the type of storage aid you use to stack these items can support the items easily. Items included in this category are reels, glass items, and construction materials. DOD 4145.19-R-1 gives instructions on storing unusual items.

STORAGE LAYOUT DRAWING

The storage layout drawing is a floor plan showing the way the open or covered storage area is divided into different sections. These sections can include storing and shipping areas, aisles, latrines, and offices. The floor plan shows the location of all columns, posts, exits, and stairs. It should also show the gross and net square footage of the areas. Use the floor plan to help you decide the best places for storage areas, working areas, and storage aids. Table 5-1 is a checklist for preparing a storage layout. Use it to help you make the best use of your storage space. Once you have a copy of the basic layout, fill in the required

sections. These sections include the bins, bulk, pallet rack, other storage areas, work areas, and aisles. Figure 5-2 shows samples of a basic floor plan and a prepared storage layout. Estimate the amount of space you need for different areas by using past storage reports that show item quantities, sizes, and demand rates. Estimate the amount of work space you will need by the amount of activity that will be in each area. The locator file area, for example, may take less space than the receiving or packing area. Plan for the best placement of areas so that work flow and personnel movement are simplified and in a straight line. Try to put stacks of large items next to an aisle so that you can issue them without having to move other supplies to get to them with MHE. Remember, if you think you will need to make any changes, try to make them before you set up the storage aids. The following guidelines will help you plan a better storage layout:

- Make as few aisles as possible and try to keep them as straight as possible.
- Make the aisles as narrow as possible, but allow enough space to use MHE. Table 5-2 gives the recommended aisle width for MHE.
- Make sure that areas where MHE will be used are near the front or rear of the storage warehouse so that it is easier to use the MHE.
- Locate offices and locker and break rooms against sidewalls so that your soldiers will not have to walk through work or traffic areas.
- Try to combine all scattered storage areas into one area.
- Put offices and support areas in low-ceiling sections. Save high-ceiling areas for storage.

After you have filled in where you think storage areas and operation areas should go, you need to decide where you will store specific supplies. Try to make the best use of vertical space when you plan supply storage. Remember that you must also consider the windows, light fixtures, and sprinkler systems when you plan to use MHE for stacked materials. Table 5-3 gives some guidelines for required space above stacks and below lights and sprinkler systems. Once you have made a general sketch of the way you want the supplies stored, have your soldiers move in the storage aids. You may have to make some minor adjustments once you see the way the bins and shelves fit into the actual building. Be sure to enter these changes in your layout sketch. Because you will store

Table 5-1. Checklist for preparing storage layout

FOR TOTAL LAYOUT AREA:

- Determine length of building.
- Determine width of building.
- Determine total square feet available for storage facility.
- Subtract structural losses (for example, latrines, posts, pillars, stairwells) from total square feet.
- Determine distance from floor to ceiling or to overhead obstructions.
- Find maximum allowable floor load limitations.
- Determine maximum stacking heights allowed for supplies.
- Determine required fire clearances and the condition of fire walls in the building. Use DOD 4145.19-R-1 to find clearances needed around fire doors and fire aisles.
- Determine required clearances for fire-fighting equipment and fire alarms.

NOTE: If the building does not have a sprinkler system, subtract 18 inches from the maximum stacking height. If it has a sprinkler system, subtract 36 inches.

- Determine types of supplies to be stored.
- Use DOD 4145.19-R-1 to find the required clearances for exterior walls. The clearances depend on the types of supplies to be stored.
- Set aside and mark storage areas for hazardous and flammable supplies.

FOR BIN AND BULK AREAS:

- Analyze commodity characteristics (size, weight, and shape) of supplies.
- Determine number of line items to be stored.
- Determine volume of items to be stored.
- Find out what types of storage aids are available.
- Find out what types of MHE are available.
- Determine the amount of space needed for each bin or bulk area.

FOR STORAGE SUPPORT FUNCTION AREAS:

- Determine space required for preservation, packaging, and packing area.
- Determine the space required for receiving area.
- Determine space required for assembly, shipping, and issue area.
- Allocate office space.
- Assign space for smoking area within storage facility.
- Compute total space required for storage support functions.

FOR SIZES AND TYPES OF AISLES:

- Determine need for fire aisles.
- Determine need for main aisles.
- Determine need for cross aisles.
- Determine need for bin aisles.
- Determine locations and sizes of warehouse doors and columns.
- Determine quantities, types, and turnover rates of supplies to be stored.
- Determine types and sizes of MHE to be used.
- Sketch storage layout plan.

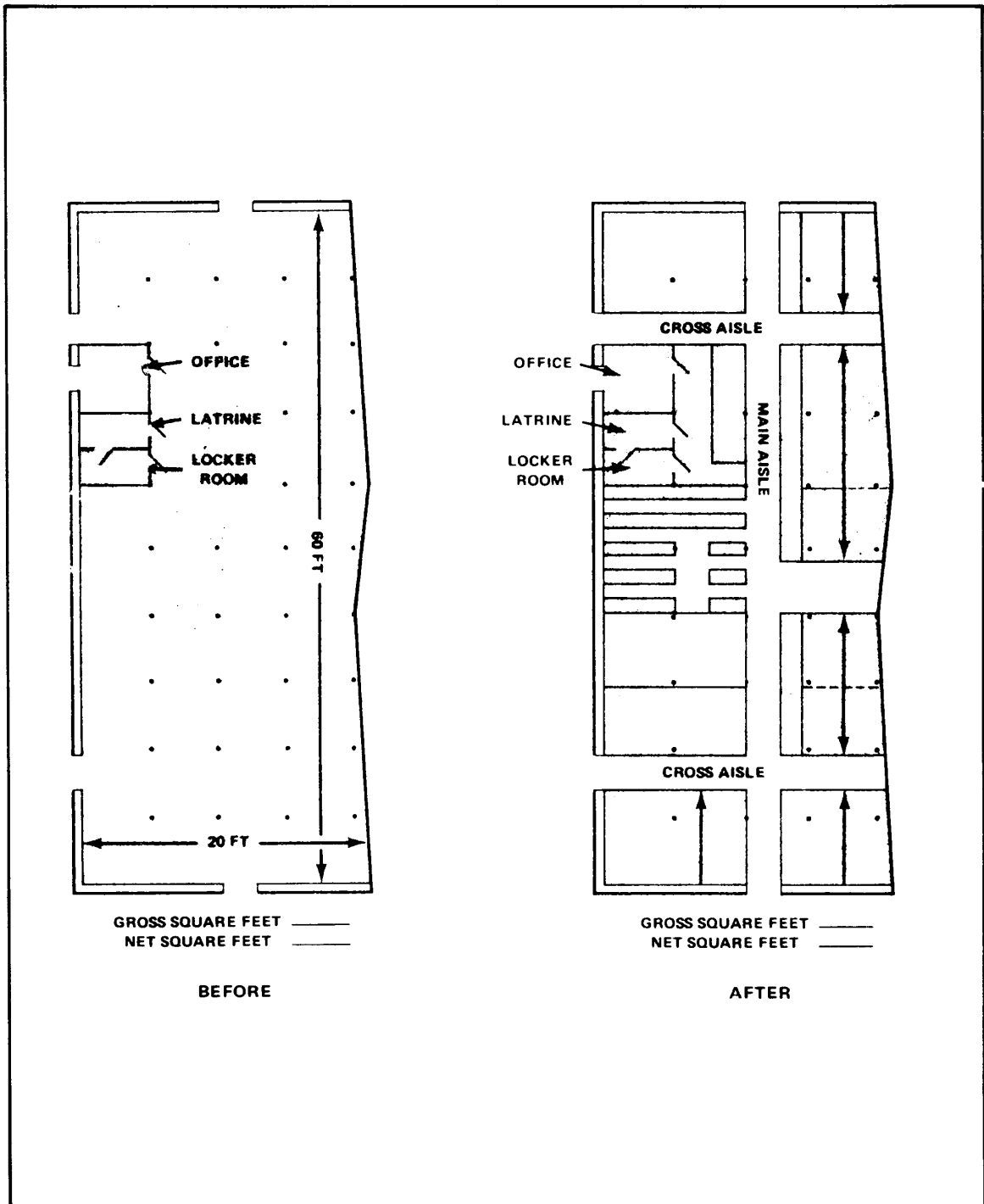

Figure 5-2. Samples of a basic floor plan and a prepared storage layout

Table 5-2. Recommended aisle width for MHE

TYPE OF MHE	RECOMMENDED AISLE WIDTH
2,000-pound-capacity forklift truck	9 feet 6 inches
3,000-pound-capacity forklift truck (extensive reach)	7 feet 0 inches
4,000-pound-capacity forklift truck	10 feet 0 inches
6,000-pound-capacity forklift truck	11 feet 6 inches
8,000-pound-capacity forklift truck (narrow aisle)	6 feet 0 inches
Stock selector truck	30 to 36 inches
<p>Table shows width for standard 40-inch load. For every 8 inches added to load width, add approximately 6 inches to aisle width. (Aisle width is determined by turning radius required for MHE.)</p> <p>NOTE: Common types of MHE are described and illustrated in Chapter 11 of this FM.</p>	

Table 5-3. Recommended vertical and horizontal clearances for storage areas

<p>Vertical and horizontal clearances are normally required in all storage areas because of floor load capacities and fire or safety regulations. The following list contains the most common clearances required in storage areas. Additional safety clearances are listed in DOD 4145.19-R-1, Chapter 6.</p> <p>VERTICAL CLEARANCES</p> <ul style="list-style-type: none"> • An 18-inch vertical clearance is required between all lighting and heating fixtures and the top of all stacks of nonhazardous supplies. • In storage areas with sprinkler systems: <ul style="list-style-type: none"> • An 18-inch vertical clearance is required between the sprinkler system and all stacks of nonhazardous supplies that are less than 15 feet tall. • A 36-inch vertical clearance is required between the sprinkler system and all stacks of nonhazardous supplies that are more than 15 feet tall. • A 36-inch vertical clearance is required between all rafters, beams, and roof trusses and all stacks of supplies, regardless of stack height. <p>HORIZONTAL CLEARANCES</p> <ul style="list-style-type: none"> • A 24-inch horizontal clearance is required between all stored material and substandard firewalls. • A 36-inch horizontal clearance is required between stored supplies and fire doors located next to aisles. • A 24-inch horizontal clearance is required between hazardous supplies stored in a general-purpose warehouse and any walls or nearby supplies. • A 12-inch maximum horizontal clearance between top of stacks and sprinkler system or rafters and beams is required if stored supplies are subject to excessive swelling.
--

different types of items and the quantity of items you store will change, you will have to move some of the storage aids periodically. Make the adjustments on the layout sketch before you make the changes in the storage area. It will save you time and effort when you start moving storage aids to different positions if you know exactly where they should be placed to make the best use of the space.

OPEN STORAGE LAYOUT

Determine the layout of open storage areas by the location of the access roads. Because of the layout of roads and changes in terrain, each storage area presents different problems in layout planning. However, the same general storage principles used in storing supplies in covered areas also apply to open areas. Figure 5-3 is a sample of a typical open storage layout. Remember that your storage layouts must be

flexible so they can be adapted to the constant changes in quantities and sizes of stocked items. Use the guidelines below when planning open storage layouts.

- Allow 20 to 30 feet for aisles so that soldiers can operate rough-terrain forklift trucks and cranes for handling heavy supplies.
- Ensure that easy access and transportation can be provided for each type of item stored.
- Stack supplies according to their packaging, weight, shape, and turnover rate for stability.
- Limit stack heights to the lift capacity of your MHE and to the stability of the stacks.
- Cover supplies that require protection from the elements with tarpaulins.
- Provide adequate drainage to keep supplies from being water damaged.
- Use dunnage on all ground-level storage if supplies can be harmed by standing water or ground moisture.

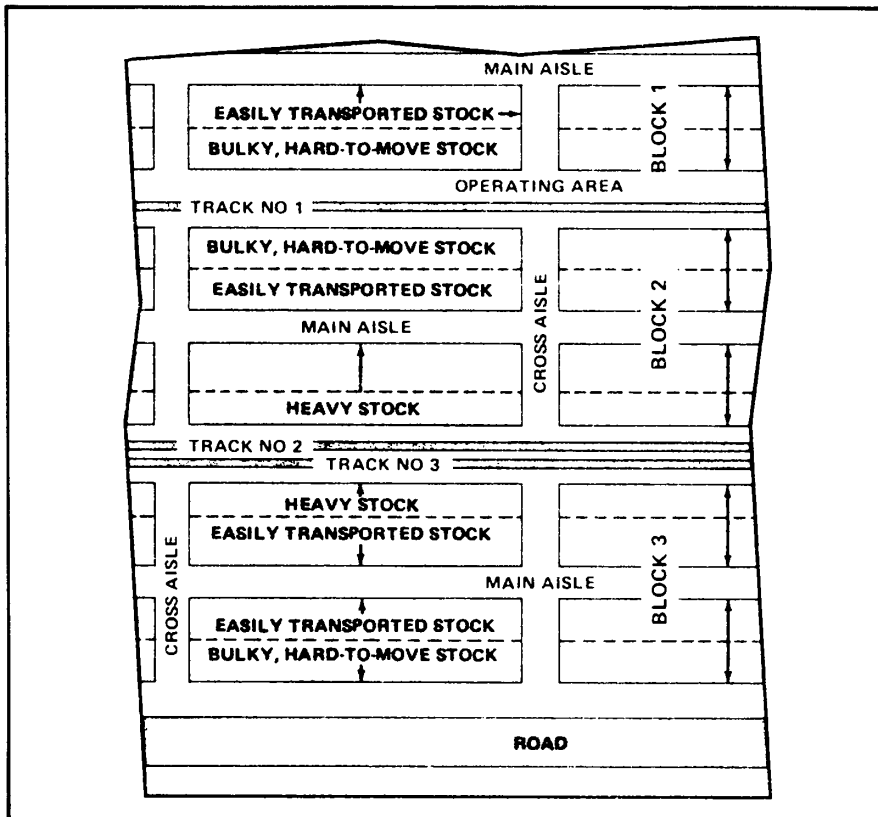

Figure 5-3. Typical open storage layout

- Keep the aisles as straight as possible from the unloading point to storage.
- Reserve storage space next to railroad tracks for very heavy stock so that cranes can be used.

TENT STORAGE LAYOUT

You may be involved in field exercises where there are no permanent warehouses or sheds. You must also be able to plan a layout for tent storage areas. A typical tent layout, as shown in Figure 5-4, includes a work area, pallet support set storage area, bin storage area, customer pickup bins, and a fire point where fire-fighting equipment is kept. The number and types of storage aids, the quantity of supplies that can be stored, and the amount of work area space needed in the tent will depend upon the type of unit you are supporting. This type of space is not reportable under the guidance related to storage space management reporting described elsewhere in this chapter. (In the sample layout about 300 to 350 stock-numbered items could be stored.) Try to follow the guidelines below when setting up your tent layout.

- Block one of the exits so that soldiers and supplies can be better controlled. Be sure the blocked exit will not be needed in case of a fire.
 - Allow room for a long table to use as a desk, work counter, or packing space.
 - Store fast-moving supplies close to the work areas. Store slow-moving supplies and pilferable supplies to the rear of the tent.
 - Store heavy items near the issue point.
 - Dig a trench around the outside of the tent to keep water from damaging the supplies. Be sure that the drainage trench is sloped away from the tent so that water does not backup but flows freely to an outlet.

BIN STORAGE LAYOUT

In a DSU, most of the items you stock and issue will be bin-type items. Therefore, you must plan the layout so that the maximum available space can be used for storing bin items. The amount of space you give an item will depend on the size of the package and the quantity of the item to be stored. Use the bin area to store supplies that have a high turnover rate or that are issued daily.

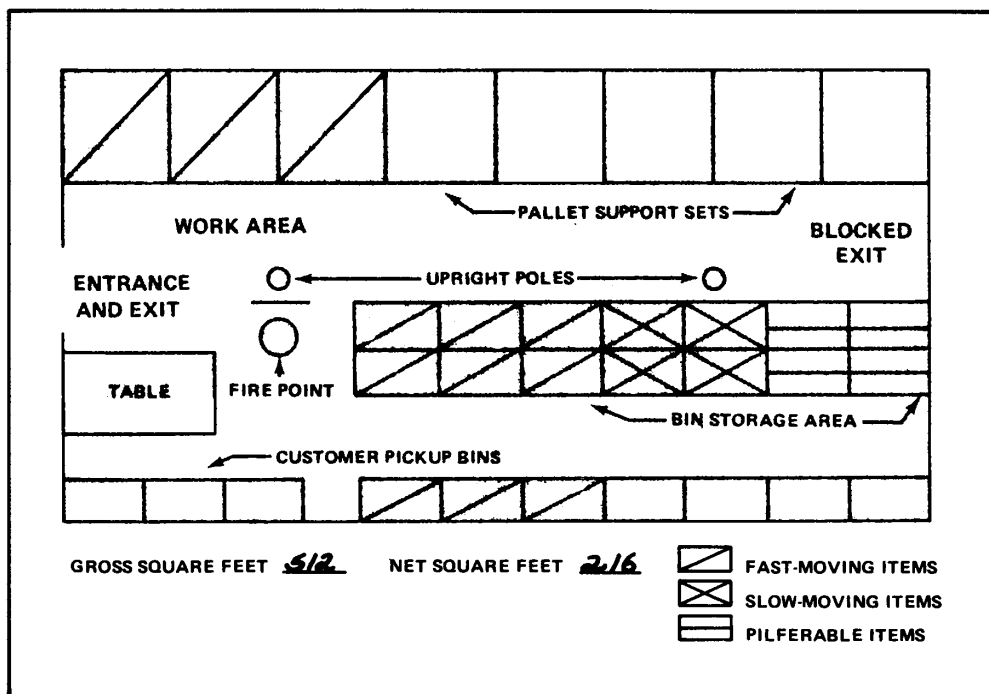

Figure 5-4. Typical tent storage layout

Locate the shopkeeper's office and the receiving area close to the bin area. This keeps your issue trips short and saves you time and labor. Figure 5-5 shows how a bin storage area in your warehouse should look. When bins run the same direction as the ends of your warehouse, you should receive bin items at one end of the warehouse and issue them at the other end. This arrangement will help you avoid bottlenecks and confusion. Figure 5-6 shows how to setup bin rows in your warehouse. You should build your bin storage area with standard shelves, pallet racks, and special or nonstandard shelves. Arrange them according to the physical limitations of the storage area and the characteristics of the items you are storing. Generally, sectional shelves are used in bin areas. These shelves are 87 to 99 inches high, 36 inches wide, and 18 inches deep. Because they are sectional, you can relocate them with

MHE whether they are empty or filled. Use the guidelines below when you arrange shelf space or when you arrange bin and shelf boxes within shelves.

- Place small lots in the center so that most items are in chest-high position for easy picking.
- Place heavy or large items toward the bottom with the slowest-moving items on the lowest shelf.
- Place light, large items toward the top with the slowest-moving items on the highest shelf.
- Place single rows of shelves side to side along the walls, if possible. You should also use the space along walls for storing irregular items, such as those with odd shapes or long handles.
- Use posts and columns as bin boundaries so that no space is lost.
- Place small bins in areas where powered MHE cannot fit but where manual MHE can move.

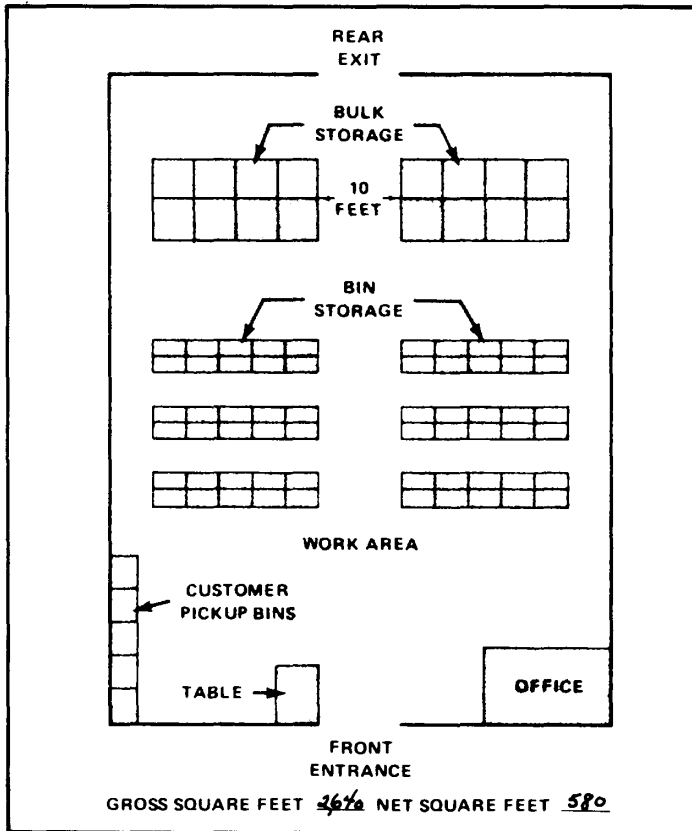

Figure 5-5. Typical layout of bin and bulk storage areas in a storage warehouse

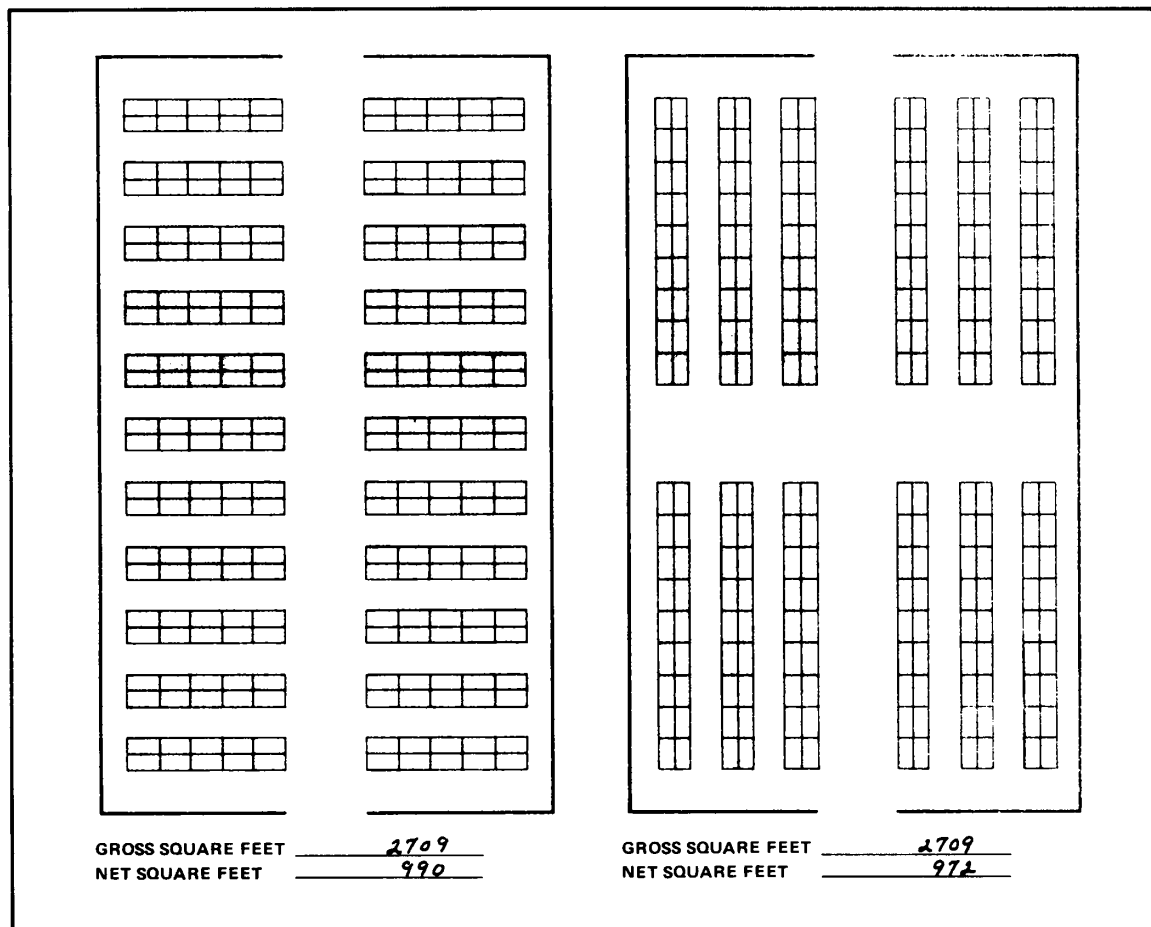
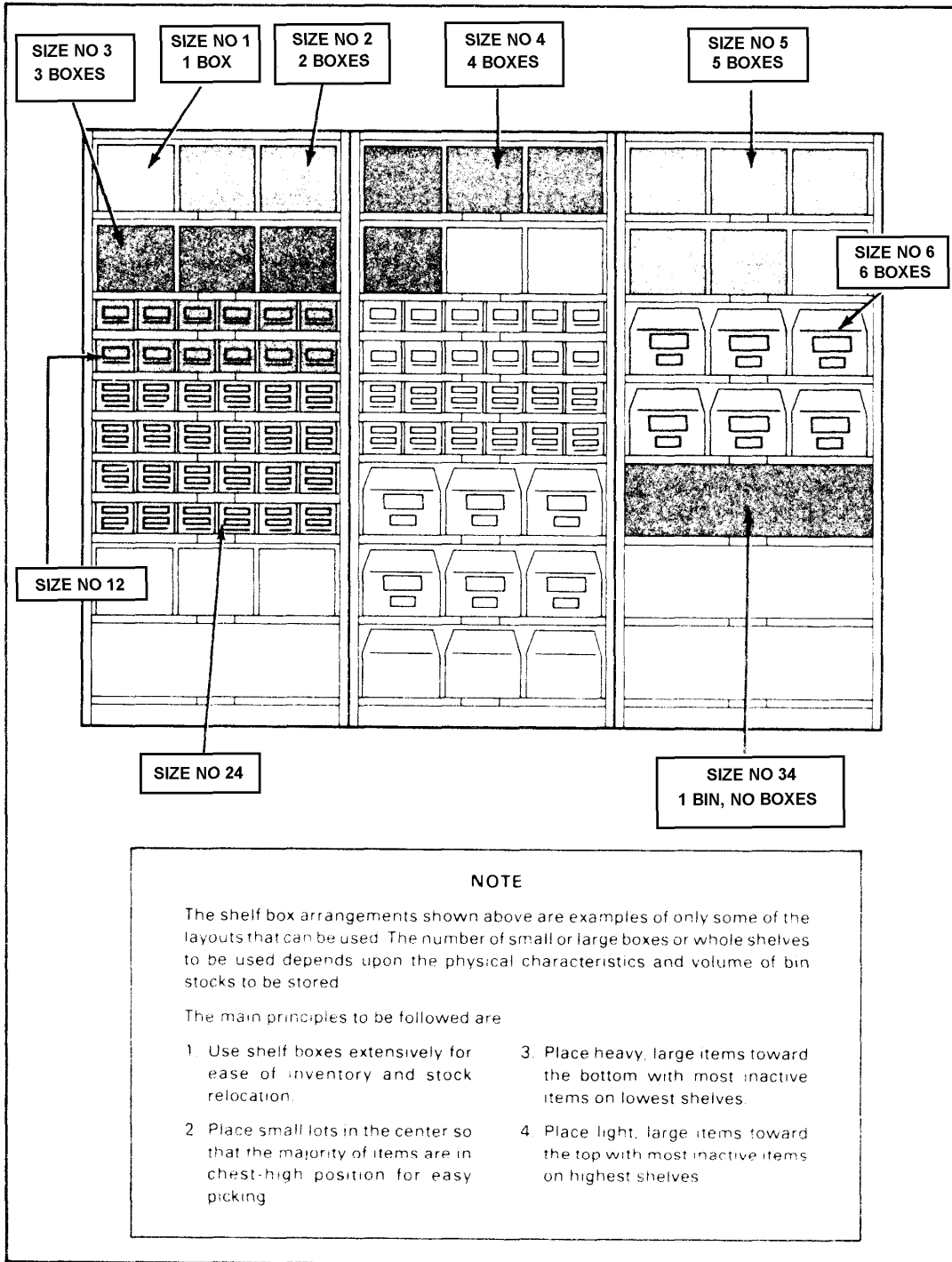

Figure 5-6. Typical layout of bin rows in a warehouse

- Do not mix items in bins. Store small, loose items in boxes instead of directly on the shelves. You can stack items in them since their walls support the items. You can double-stack boxes on a bin shelf. You can also relocate an item with the contents still inside the box. Figure 5-7 shows how the various sizes of shelf boxes can be used to store bin items. If no containers are available, put retaining strips across the front of the shelves to hold items in place. You should estimate the number and kinds of storage aids you need before you sketch the final bin layout. When you use bins, you reduce the problems with security and inventory that arise when broken cases of bin-type supplies are found in bulk storage locations.

BULK STORAGE LAYOUT

When you prepare the layout for heavy bulk items, you should increase the width of the main aisles or any aisles that are next to the bulk area to 11 1/2 feet. You will need to use MHE to move most of the bulk items. If your bulk items are in the same warehouse as the bin items, you should move all the bin items near the front entrance. Your heavy bulk items should be loaded and unloaded through the rear exits. This will save time, use of MHE, and labor because you can issue bulk items directly from their storage location without having to move them through the issue point. Refer to Figure 5-5 which shows a typical layout with bin and bulk storage areas. For more on planning bulk storage, check DOD 4145.19-R-1, Chapter 2.



NOTE

The shelf box arrangements shown above are examples of only some of the layouts that can be used. The number of small or large boxes or whole shelves to be used depends upon the physical characteristics and volume of bin stocks to be stored.

The main principles to be followed are

1. Use shelf boxes extensively for ease of inventory and stock relocation.
2. Place small lots in the center so that the majority of items are in chest-high position for easy picking.
3. Place heavy, large items toward the bottom with most inactive items on lowest shelves.
4. Place light, large items toward the top with most inactive items on highest shelves.

Figure 5-7. Shelf box arrangement

VAN STORAGE LAYOUT

Use the mobile van only for those items that are critical to the unit mission. Plan your layout so that you use all possible storage space. Store fast-moving items near the entrance. Store slow-moving and pilferable items in the rear of the van. Figure 5-8 shows a van storage layout. Note that the van has preassembled bins and extended sides. This type of space is not reportable under the guidance related to storage space management reporting described elsewhere in this manual.

FIELD STORAGE LAYOUT

When your DSU operates in a field environment, you must work with the accountable officer or supply platoon leader to set up the supply point. You will help choose the best places to store each class of supply. You must have room at the supply point for all supply sections and activities. For example, you will have to stock hundreds or even

thousands of items to meet the needs of the units you support. Your DSU will be handling clothing, canteens, lumber, barbed wire, generators, vehicles, and hundreds of other kinds of supplies and equipment. As storage supervisor, you have to provide storage areas for them. Before the supply soldiers set up the new supply point, you and the supply platoon leader should make a layout plan. To do this, make a sketch of the area and then draw your layout onto the sketch. You should be able to pick out general locations for each section by looking at the drawing. Remember to show the direction of the traffic flow and the locations of parking areas for customer units. Figure 5-9 shows how a field supply and storage point layout looks for Classes II, IV, and VII. After the supply platoon leader approves your layout, make sure your soldiers set up the sections correctly. Put soldiers at the entrance and exit areas to control the flow of traffic. If you can, setup a parking area

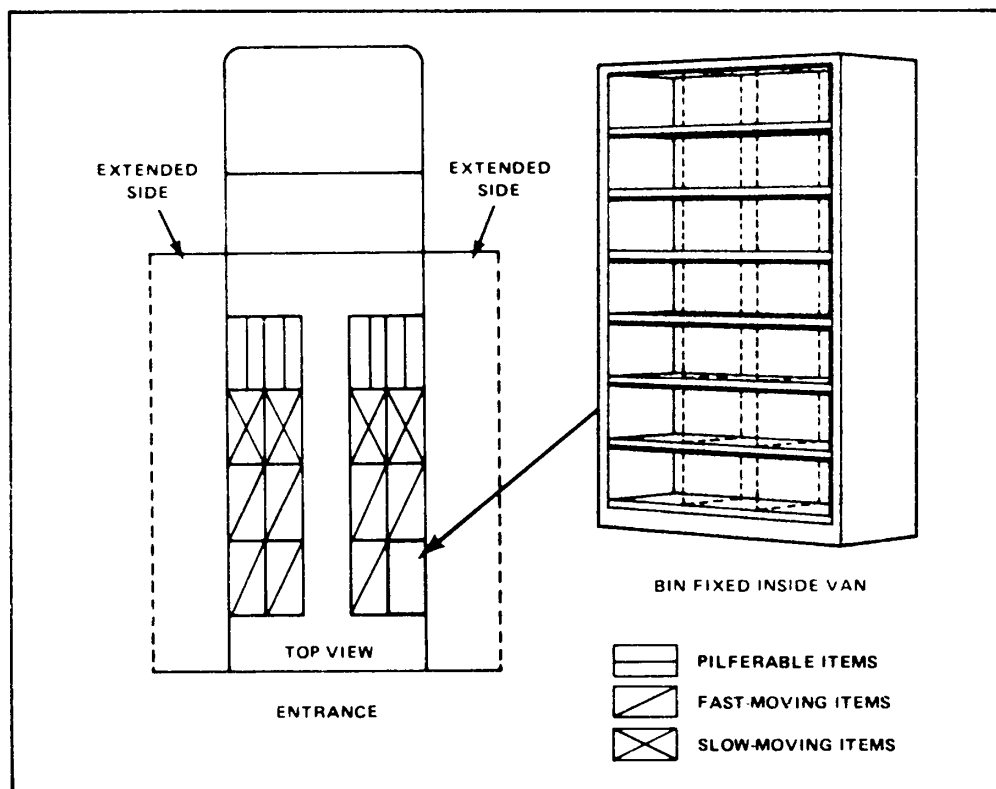

Figure 5-8. Van storage layout

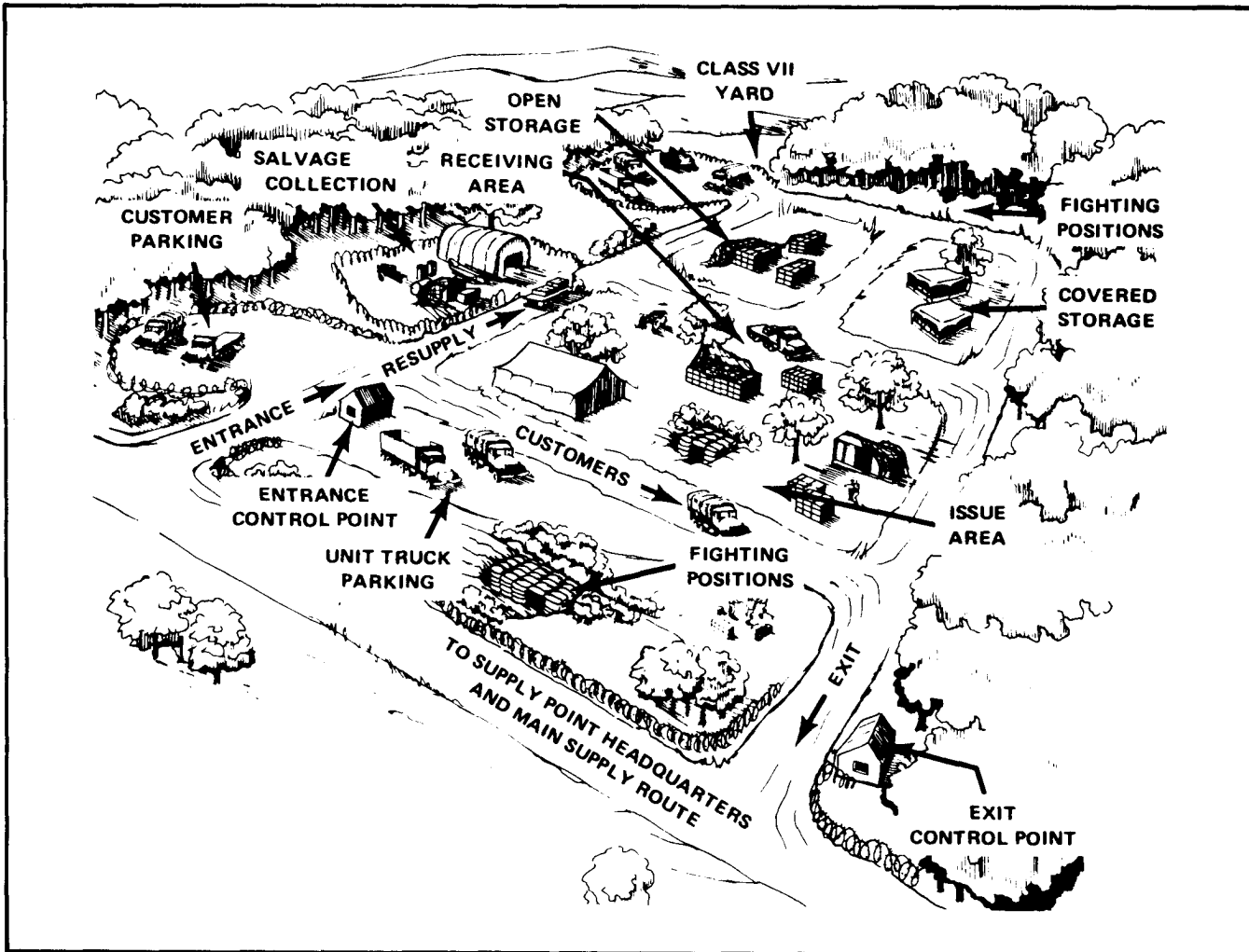

Figure 5-9. Field supply and storage point

near the entrance and the loading and unloading areas to keep the roads from becoming jammed. Your soldiers at the exit point need to check trucks and vehicles as they leave to make sure all supplies for the units are authorized and signed for. Do not forget to include a Class VII storage area for large equipment, such as generators and vehicles when you make the layout. As you plan and draw the supply and storage field layouts, follow the guidelines below.

- Make sure you have enough roads to allow supplies and equipment to be loaded, unloaded, and moved quickly.

- Try to provide cover and concealment for your tents and equipment. Use natural terrain to provide camouflage, or use camouflage nets if you cannot use natural terrain. FM 5-20 explains camouflage techniques.

- Make sure your area has adequate drainage. This will protect supplies from damage and will allow you to use MHE in all kinds of weather.

- Do not place tents, equipment, and supplies close to streams. Sudden rains can cause streams to flood.

- Protect items stored near unpaved roads from the dust and road spray from passing vehicles.

STORAGE AIDS

Storage aids help you use all available space. They make moving supplies easier. Storage aids also help prevent supplies from being damaged when stored on the ground. There are many kinds of storage aids. The most commonly used ones are described below and are shown in Figure 5-10.

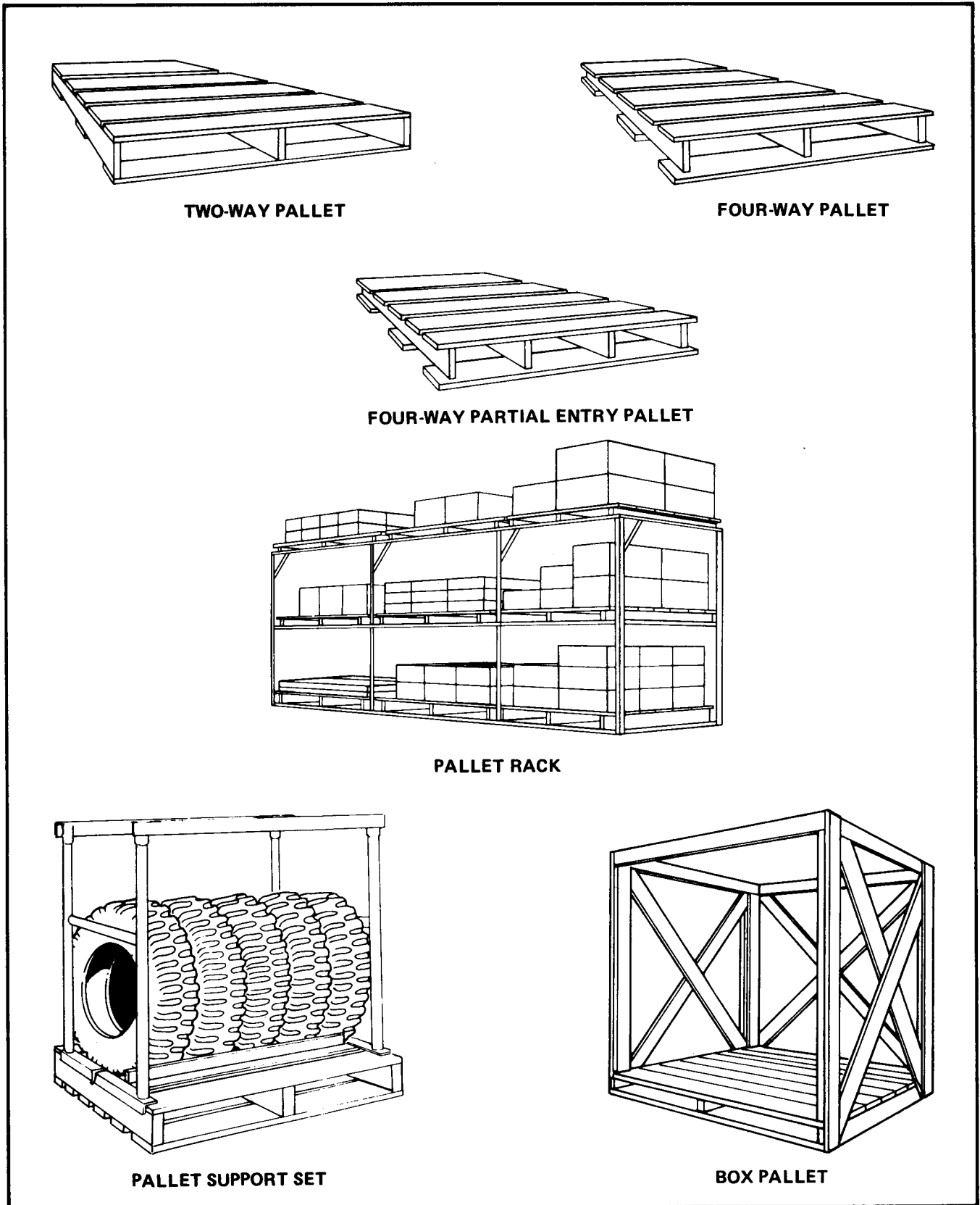

Figure 5-10. Storage aids

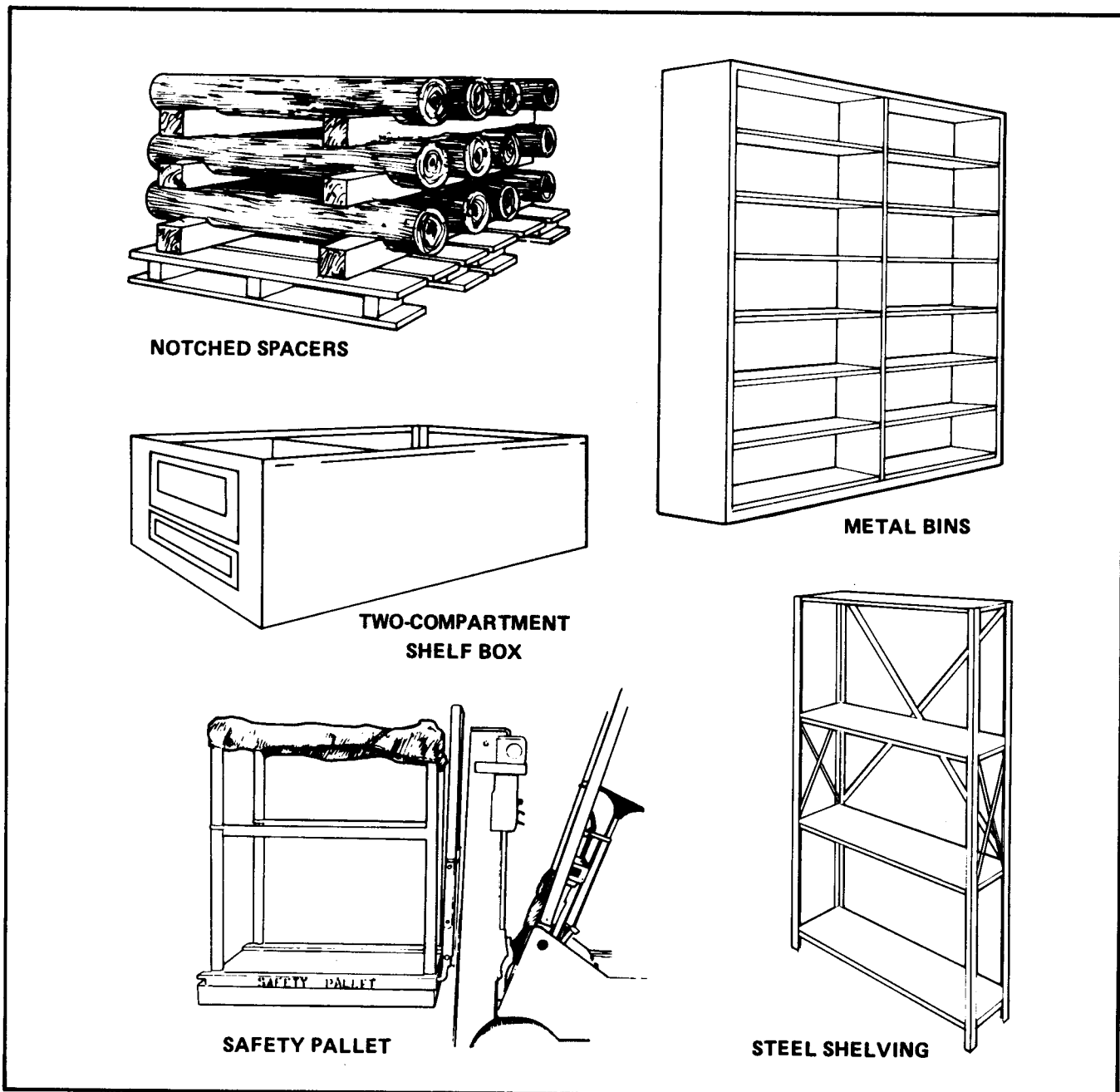

Figure 5-10. Storage aids (continued)

Pallets

A pallet is a portable platform upon which small quantities of material are placed so that they may be handled and stored. You can handle pallet loads with forklift trucks, transporters, and cranes. Soldiers manually place material on the pallet when it is received. It remains on the pallet for mechanical handling throughout the complete cycle of storage and issue operations. The types of pallets used are as follows:

Two-way pallet. The two-way pallet is not the standard DOD pallet, but it is in fairly common use in storage areas. It can be entered into on two opposite sides by forklift and pallet-type, hand-lift trucks. This pallet usually measures 40 by 48 by 6 inches.

Four-way pallet. The wing-end, four-stringer, four-way-entry-type pallet is the general-purpose

pallet. It is the standard one for procurement and use within DOD. The standard dimensions of this pallet are 40 by 48 by 5 1/2 inches.

Box pallet. This is the standard pallet with a frame mounted on it. There are several types of box pallets in use. The box pallet is used to hold supplies that are difficult to stack, such as mops, brooms, and bagged items. It is also used to hold partial pallet loads and loads which require additional support.

Safety pallet. The safety pallet is used for placing materials into or removing them from storage. It has special safety features—raised edges to keep small items from falling off, a metal back guard, mitered corners, a handrail, and safety chains around the pallet area. The safety pallet is generally painted yellow for easy visibility.

Pallet rack. The pallet rack is used when the quantity or physical characteristics of supplies do not permit full pallet stacks, when small lot items are stored back-to-back in retail areas, and when small lot items are stored in the end zone in bulk storage areas.

Pallet support set. The pallet support set is used for the same purpose as the pallet rack. An

advantage of this set is that it can be disassembled and broken down for storage when it is not needed.

Steel Shelving

Steel shelving is used for storing small quantities of items for retail issue. The material can be stored either loosely on the shelves or in shelf boxes.

Shelf Box

The shelf box is used to store small items which cannot be stored efficiently on open shelving.

Notched Spacers

Notched spacers are made of lengths of hardwood that have been cut a special way so cylinders can rest in the depressions. Cylinders or pipes can be stacked neatly. They also allow some items to be removed without destroying the balance of the stack.

Bin

A bin is used for storing small items, such as repair parts and electronic parts. Have open lots in divided storage bins so that you can select and issue these items easily.

Section III

Computing Storage Space

RESPONSIBILITIES

As storage supervisor, you must fill out many different storage space reports. You will also be asked to provide storage data for briefs and other reports that require you to make various mathematical computations. To get the necessary information, you must be able to compute storage space.

GROSS STORAGE SPACE

The gross storage space for an area is the total number of square feet in an area, including aisles, minus the space unusable for storage operations. The space not used for storage is referred to as

standby, out-granted, or unusable space. For example, if your storage area is 35 by 60 feet with an area of unusable space that measures 12 by 8 feet, what is the *gross storage space*? The steps below show you how to compute the gross storage space.

- *Step 1.* (Find total area.) 35×60 feet = 2,100 square feet total space
- *Step 2.* (Find area of unusable space.) 12×8 feet = 96 square feet unusable space
- *Step 3.* (Subtract unusable area from total area.) $2,100$ square feet - 96 square feet = $2,004$ square feet of gross storage space

NET STORAGE SPACE

The net storage space of an area is the gross storage space minus the space taken up by aisles, structural losses, and support space. It is expressed in square feet. For example, if your storage area has 2,004 square feet of gross storage space, two aisles that are each 10 feet wide by 40 feet long, 10 posts that measure 1 foot in diameter by 2 feet high each, and a latrine that measures 5 feet wide by 10 feet long. What is your *net storage space*? The steps below show you how to complete net storage space.

- *Step 1.* (Aisle area) two each x 10 feet x 40 feet = 800 square feet
- *Step 2.* (Post area) 10 each x 1 foot x 2 feet = 20 square feet
- *Step 3.* (Latrine area) one each x 5 feet x 10 feet = 50 square feet
- *Step 4.* (Subtract support space, structural loss, and aisle areas from gross storage space.) $2,004 - (800 + 20 + 50) = 1,134$ square feet of net storage space

COVERED STORAGE SPACE

Find the capacity of covered storage in cubic feet by multiplying the amount of net storage space of an area by the highest stacking height permitted by safety regulations. For example, your storage area has 1,134 square feet of net storage space. Under perfect conditions, you could stack items to a height of 12 feet. What is your capacity in cubic feet?

Attainable Cubic Capacity

The attainable capacity in cubic feet is affected by the MHE capability, floor load limitations, and safety regulations. For example, your storage area has 1,134 square feet of net storage space. Due to an overhead sprinkler system and floor load limitations for this section, the maximum height you can stack items safely is 9 feet. To find your *attainable capacity in cubic feet*, multiply the net storage area by the maximum stacking height: $1,134 \text{ square feet} \times 9 \text{ feet} = 10,206$ capacity in cubic feet.

Bin Cubic Capacity

To find the cubic capacity of a storage bin, multiply the outside dimensions of the bin length x width x height together.

NOTE: Do not include the unused space above the bin in figuring the dimensions.

Rack Cubic Capacity

To find the cubic capacity of a rack section, multiply the outside dimensions of the rack (length x width x height) and add this result to the cubic space of the area above the racks that can be safely used for storage.

DOLLAR VALUE PER CUBIC FOOT

To find the dollar value per cubic foot of storage space, divide the total dollar value of a specific stored item by the cubic feet it occupies. For example, you are storing cases of paper plates in 576 cubic feet of space. The total cost for the paper plates is \$7,874. To find how much it is costing you to store 1 cubic foot of paper plates, divide the dollar value by cubic feet of storage space: $\$7,874 \div 576 \text{ cubic feet} = \13.67 per cubic foot. Once you know the dollar value per cubic foot, you can figure approximately how much room you need to store an incoming shipment of the same item. To determine the cubic feet needed to store a certain dollar amount of an item, divide the total cost of the incoming items by the dollar value per cubic foot of the same item you have on hand. For example, you have an incoming shipment of paper plates which costs \$3,922. The dollar value of the paper plates you have in storage is \$13.67 per cubic foot. To find approximately how much room you will need to store the incoming shipment, divide the cost of the shipment by the dollar value per cubic foot: $3,922 \div \$13.67 = 286.9$ cubic feet.

VERTICAL SPACE IN USE

To find the percent of vertical space you are using, divide the actual storage height by the potential storage height. Your answer will be expressed as a percentage. For example, a survey shows that cases of batteries can be stacked safely to an average height of 14 feet under most conditions. However, you can stack them only 12 feet high in your warehouse due to overhead beams. To find what percentage of the available vertical space are you using, divide actual storage height by the potential storage height: $12 \text{ feet} \div 14 \text{ feet} = 86$ percent.

Section IV Reporting Storage Space

RESPONSIBILITIES

Storage of US government-owned supplies and equipment is a huge business. Millions of cubic feet of storage space are used in depots and storage facilities all over the world. The cost of constructing and maintaining these storage areas amounts to several billion dollars each year. To be sure that the best use is made of all storage space available, storage managers at all levels need to know how to use storage space under their control. To control the use of space, different aids and reports have been developed. As a storage supervisor, you need to know how to use these aids to help make the most efficient use of space and how to report your space use to higher HQ.

SPACE ALLOCATION MAP

The space allocation map is a map of your area showing the current status of areas that are designated for storage operations and the location of other related activities. Your input will be combined with that of other units until a map of the whole installation is completed. This map will

show the type of space, the use of the space (receiving, shipping, bulk storage, loose issue storage, office space, or other), and the type of material stored (repair parts, construction materials, end items, or other). For easier identification, each of these areas may be color-coded. Overlays may be used to keep the map current.

PLANOGRAPH

The planograph is the approved floor plan of the storage area drawn to scale. It shows the direction of bin and rack areas and the locations of the aisles, structural space, support areas, offices, and latrines. The planograph also shows the gross square feet and the net square feet of all available storage space. See Figure 5-11. Each major storage area within the total area should also show the gross and net square feet available. As chief of the storage activity, you are responsible for the preparation and use of the planographs. You do not have to show occupied or vacant spaces on each planograph within the storage areas. You

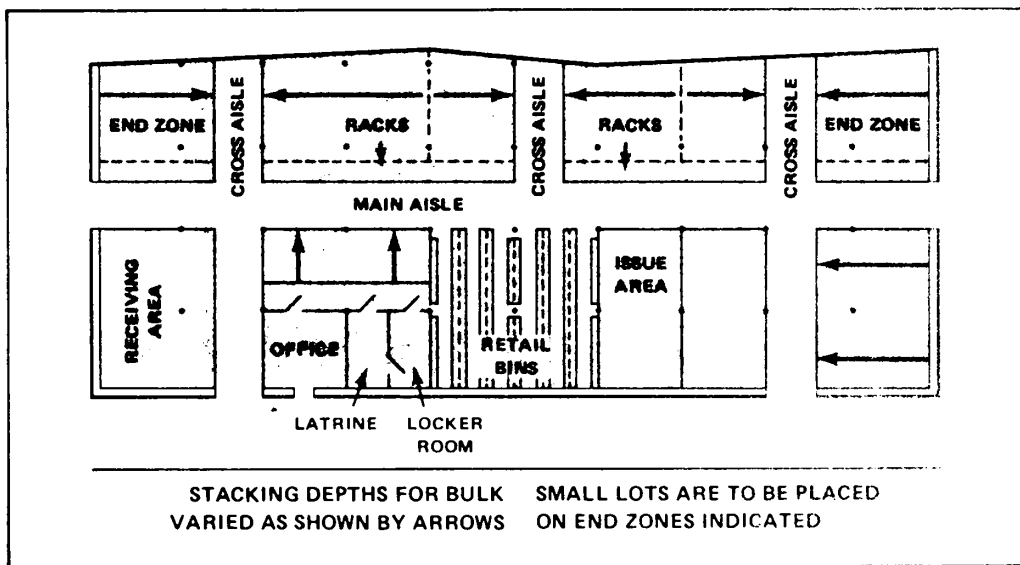

Figure 5-11. Planograph

must place a completed planograph of each warehouse, shed, or other storage area where it is highly visible. Mount it on wood and cover it with clear acetate so that you can use a grease pencil to make changes on it as needed. Maintain ammunition storage space data planographs also.

STORAGE SPACE SURVEY WORK SHEET

The storage space survey work sheet or space audit is a scaled drawing which shows the aisles and the amount of storage space available in a storage section. You must draw a work sheet for each supply warehouse section, shed, or open storage area. Figure 5-12 is an example of how a storage space survey work sheet is prepared. (The sample space worksheet in the figure does not apply to ammunition storer.) You should use the

information on the work sheet to update your space control and space assignment data and to compile reports for higher HQ. It is important that the information on the work sheet is an accurate measurement of the amount of space you have available and how much you are using. Therefore, before you can complete the work sheet, you will need to conduct a storage space survey. Every time the storage layout changes, you will need to change the storage space survey work sheet. When this happens, you should reproduce the storage space survey work sheets locally and change them as needed. The number of times per year that you compile this report is determined by your installation or depot HQ. However, you must complete at least one report each quarter. Additional information on storage space survey work sheets can be found in DOD 4145.19-R-1.

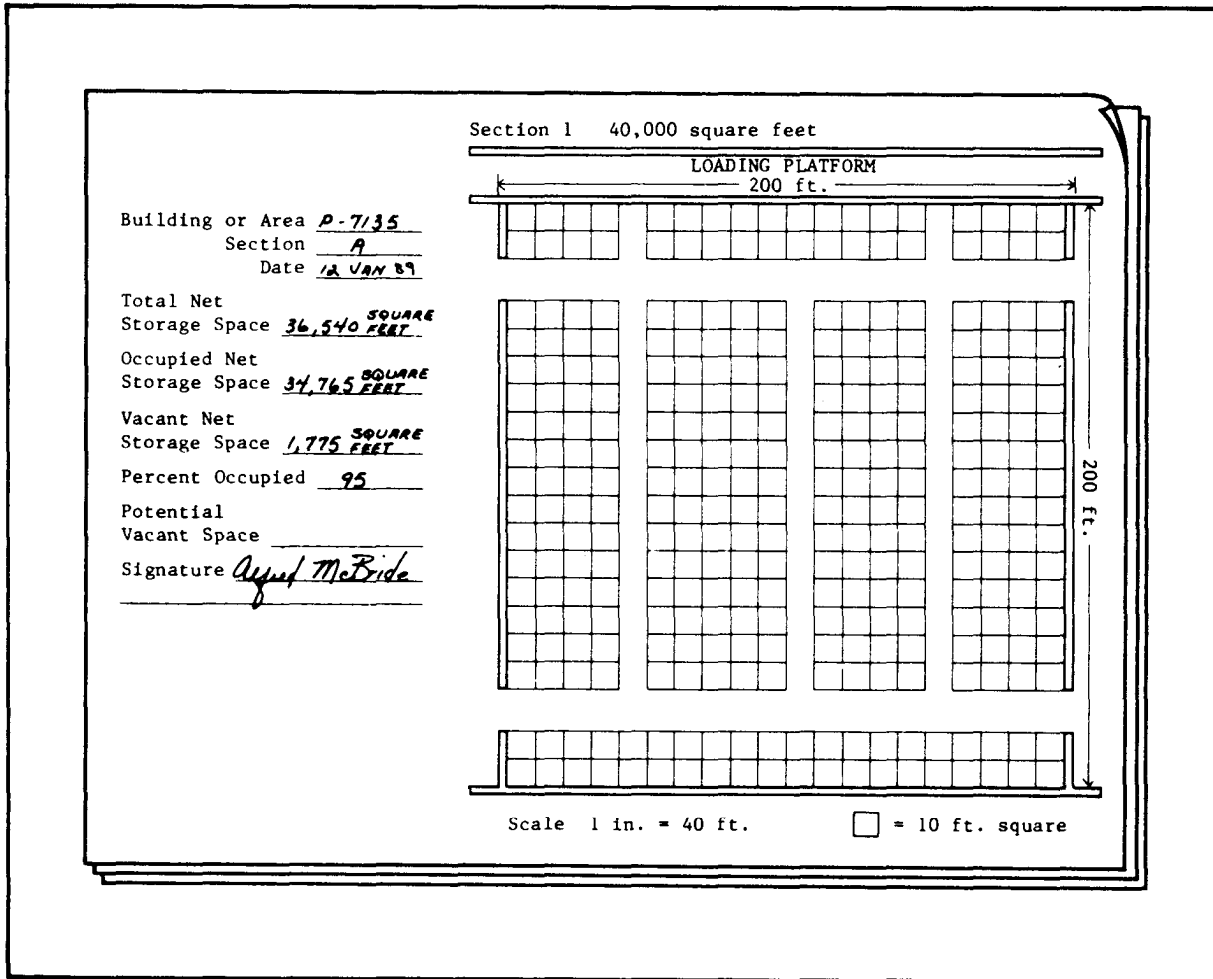

Figure 5-12. Storage space survey work sheet

STORAGE SPACE STATUS REPORT

You may be required to prepare storage space status reports quarterly, monthly, or as often as your HQ directs. There is no standard format for these reports. You will need to contact the activity requiring the report to find out what information is needed. This report is basically the current record of how much space your unit is assigned and how much space it uses. To prepare one of these reports, you need to know the types of material your unit stores, the types of storage used (bin area, tank space, or ammunition space), and the amount of space you are assigned. You also may be required to report how many gross and net square feet of storage space you control. Most of the data you need to prepare the storage space status report can be taken from storage layouts. To save time and effort when you prepare these reports, keep the layout and work sheets updated with changes as they occur.

SPACE RECAPITULATION RECORD

The space recapitulation record is a locally designed form which you use to report your unit's storage space data. It lists all storage information, including building number, section number, gross and net square feet, type of space, type of storage, and type of facility. You should use this record with the storage space status report to complete DD Form 805 (Storage Space Management Report). Figure 5-13 shows a sample of a space recapitulation record.

STORAGE SPACE MANAGEMENT REPORT

DD Form 805 is used to determine how much space is available for storage operations and how much space is currently being used Armywide. From this information, the DA procures, assigns, and controls its storage space. You will complete

SPACE RECAPITULATION RECORD										USING AGENCY <u>814 TH SSA</u> <u>ABO NY 32157</u>		REPORTING DATE <u>10 SEP 89</u>		(FEDER REPORT FOR CIGLD-1) (R4)													
TYPE OF BUILDING (Warehouse, shed)			NUMBER OF BUILDINGS <u>93</u>			TYPE OF SPACE			TOTAL GROSS SQUARE FEET IN BUILDING		OPEN AREA NUMBER		TOTAL GROSS SQUARE FEET IN OPEN AREA														
<u>WAREHOUSE</u>			<input type="checkbox"/> HEATED <input checked="" type="checkbox"/> UNHEATED			<u>180,000</u>					<input type="checkbox"/> IMPROVED <input type="checkbox"/> UNIMPROVED																
GROSS SPACE FOR STORAGE OPERATIONS			NET STORAGE SPACE			TOTAL SQUARE FEET OCCUPIED			ACTUAL VACANT SPACE		STRATEGIC AND CRITICAL MATERIALS		ALL OTHER NON-ODD OWNED MATERIALS		EXCESS SURPLUS, SALVAGE, OR SCRAP		UNSERVICEABLE BUT REPAIRABLE		UNCLASSIFIED OR UNIDENTIFIABLE		OTHER NON-RELIABLE		TOTAL OF COLUMNS 10 THRU 16				
SECTION NO.	ITEM 1	ITEM 2	BY COM. 1&2	BY COM. 3	BY SUBS. COM. 4	BY POL. COM. 5	TOTAL ITEM 7	ITEM 8	ITEM 9	ITEM 10	ITEM 11	ITEM 12	ITEM 13	ITEM 14	ITEM 15	ITEM 16	ITEM 17	ITEM 18	ITEM 19	ITEM 20	ITEM 21	ITEM 22	ITEM 23	ITEM 24	ITEM 25	ITEM 26	
<u>1</u>	<u>44,000</u>	<u>29,000</u>		<u>27,000</u>			<u>27,000</u>	<u>1,500</u>																			
<u>2</u>	<u>70,000</u>	<u>28,000</u>		<u>26,400</u>			<u>26,400</u>	<u>1,400</u>																			
<u>3</u>	<u>36,000</u>	<u>26,000</u>		<u>24,600</u>			<u>24,600</u>	<u>1,200</u>																			
PREPARED BY (Signature and Title)										CHECKED BY (Signature and Title)																	

Figure 5-13. Sample space recapitulation record

this report once or twice a year, depending on the installation to which your unit is assigned. AR 740-1, Table 6-1, lists all Army installations and their reporting times. To make filling out the report easier, you should examine all recent storage space status reports. These reports will provide most of the information you need. DD Form 805 covers the total amount of your assigned storage space—even if this space is temporarily being used for other purposes. However, you DO NOT report storage space used for—

- Bulk petroleum, oils, and lubricants.

- Post exchange and supporting storage space.
- Installation civil or post engineer and supporting storage space.
- Clothing sales stores and supporting storage space.
- Commissary and supporting storage space.
- Bench and backup stocks in shops.
- Transit sheds and open areas at terminals or depots used only for cargo throughput operations.

Figure 5-14 shows a completed DD Form 805. Check AR 740-1, Chapter 6, for instructions on how to fill out the form for your type of unit.

STORAGE SPACE MANAGEMENT REPORT		DATE (CY Mo-Day) 90630	FREQ. A	INSTALL CODE HQH	DOD COMPONENT A	NAME OF INSTALLATION Fort Lee	CITY NAME Petersburg	STATE/COUNTRY CODE VA		
ITEM (In thousands)	COVERED SPACE							OPEN SPACE		
	TOTAL COVERED (b)	GFCH FLM HAZ (c)	FREEZE CHILL (d)	SHED (e)	ICLDO AND MAGAZINE (f)	OTHER (g)	IMPROVED (h)	UNIMPROVED (i)		
SECTION A - GROSS STORAGE SPACE (Sq. Ft.)										
1. PRIOR 30 JUNE REPORT	4770	2393	11	114	1519	733	3490	2570		
2. THIS REPORT	4770	2393	11	30	1519	817	3490	2667		
3. UNUSABLE									NA	
4. STANDBY	14					19			NA	
5. OUTGRANTED TO NON-DOD USERS										
6. OUTGRANTED TO DOD USERS										
7. USED FOR STORAGE OPERATION (Line 2 Minus Lines 3, 4, 5 and 6)	4756	2393	11	30	1500	817	3490	2667		
8. AISLES, STRUCTURAL LOSS, SUPPORT SPACE	1463	1060	3	1	300	99	1786			
SECTION B - NET STORAGE										
9. TOTAL SQUARE FEET (Line 7 Minus Line 8)	3288	1333	8	29	1200	718	1704	2667		
10. TOTAL CUBIC FEET	40834	20195	99	287	12600	7653	17040	26670		
11. ATTAINABLE CUBIC FEET	36823	18709	99	287	10440	7348	17040	26670		
12. OCCUPIED SQUARE FEET	3002	1207	0	23	1089	676	1489	2667		
13. OCCUPIED CUBIC FEET (Line 12 x 13b)	29449	14522	54	201	8704	5968	14890	26670		
a. REPORTING COMPONENT'S MATERIEL	25376	14359	54		6656	4114	10110	18220		
b. COMMON/CROSS SERVICED	4073	163			2048	1854	4780	8450		
(1) DOD MATERIEL	3963	53				1854	4780	50		
(2) NON-DOD MATERIEL	110	110						8400		
14. VACANT SQUARE FEET (Line 9 Minus 12)	286	126		6	112	42	215	NA		
15. VACANT CUBIC FEET (Line 11 Minus 13)	7534	4187		86	1736	1380	2150	NA		
16. UNOBLIGATED SQUARE FEET								NA		
17. UNOBLIGATED CUBIC FEET								NA		
18. RECOUPABLE CUBIC FEET THROUGH REWAREHOUSING (From Line 13)	128	123	1	2		2	NA	NA		
SECTION C - STORAGE SPACE ANALYSIS (Net Cubic Feet)										
19. REQUIREMENTS (Next Fiscal Year)										
20. RECOUPABLE WITH ADDITIONAL RESOURCES										
21. REQUIRES MAJOR REPAIR/MODIFICATION										
22. REQUIRES REPLACEMENT										
SECTION D - FIVE YEAR STORAGE SPACE REQUIREMENTS (Net Cubic Feet) FOR YEARS 2 THRU 5										
	FY COVERED		FY OPEN		FY COVERED		FY OPEN		FY COVERED	
23. ATTAINABLE										
24. REQUIREMENTS										
25. EXCESS (+ Plus) / DEFICIT (- Minus)										
26. RECOUPABLE WITH ADDITIONAL RESOURCES										
Line 02, Column e: Decrease of 84M SF result of transitory shelters being erroneously reported as sheds on prior report.										

Figure 5-14. Completed DD Form 805

CHAPTER 6

SETTING UP AND MAINTAINING A STOCK LOCATOR SYSTEM

USING THE SYSTEM

A storage facility receives, stores, issues, and ships thousands of items of all shapes and sizes. These items must be stored in specific places so that they can be located quickly and easily when they are issued. The system used to store and locate supplies is called the stock locator system. A stock location is simply an address for each item of stock that is stored in the facility. As the storage supervisor of a DSU, you are responsible for setting up and maintaining a stock locator system. The two types of systems are the five-character and the nine-character. For information on the nine-character system, see TM 743-200-1, Chapter 3. As a DSU storage supervisor, you will be concerned only with the five-character system. You must also make sure that your soldiers understand and use the system. You should have the stock location file placed in a central area. Make sure that a separate record is kept for each location that has an item in it or that has been held open for an incoming item. You should have a location reserved for every item on your unit ASL. You can get the ASL listing from the SCS. If you have ADPE available, use it to set up and maintain the stock location system.

SETTING UP THE LOCATOR SYSTEM

To set up a good stock locator system, you should start with the layout plan you prepared for the storage area. Your completed planograph should show the location of storage areas or sections; working, shipping, and receiving areas; main and working aisles; locker rooms and rest rooms; and offices. Use this planograph to assign stock location codes. Each character of the

five-character code describes a certain row, column, level, or segment of the storage area. Only 23 letters and 9 numbers can be used for labeling. The letters I, O, and Z and the number 0 are not used. You begin labeling with the letters. If you have 32 or less rows or columns to label, use steps 3 and 4 below. If you have more than 32 rows or columns, use step 7 below.

- *Step 1.* Get a planograph for each major storage area. To make sure you have all the rows and aisles running in the right direction, label the bottom of the planograph **BOTTOM** before you begin. Write the name of the storage area or the building number across the bottom of the planograph for identification.

- *Step 2.* Use TM 743-200-1 as a guide, and sketch in the aisles, rows, and columns in each storage area. The size of the bins, shelves, and storage aids should serve as a guide for the layout.

- *Step 3.* Label the storage rows. If the rows on your planograph run across the page, label them in ascending order from bottom to top. If the rows run up and down, label them in ascending order from left to right. Figure 6-1 shows how to label storage rows.

- *Step 4.* Label the columns (or bins) of the rows. (The columns are the sections of the rows that start at the floor and go toward the ceiling.) Label the columns the same way you labeled the rows—from bottom to top and from left to right. Figure 6-2 shows how to label columns. Figure 6-3 shows a planograph with rows and columns labeled correctly.

- *Step 5.* Label the levels of each column from bottom to top.

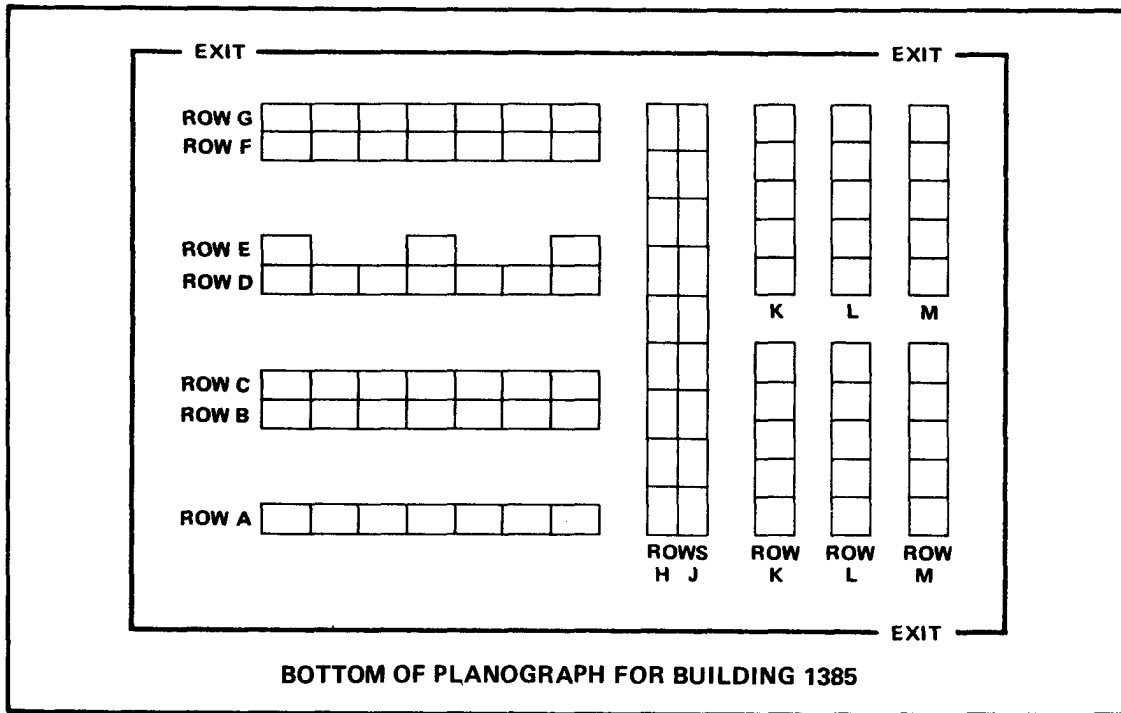

Figure 6-1. Planograph with storage rows labeled

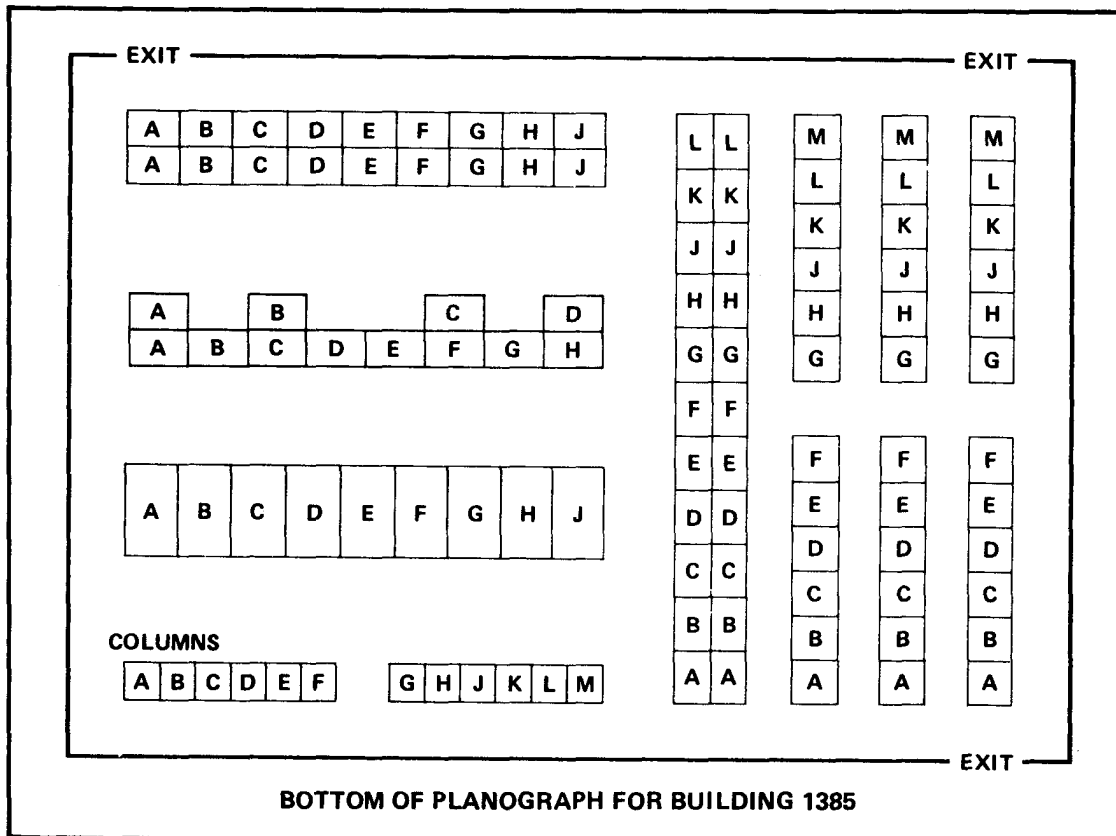

Figure 6-2. Planograph with columns labeled

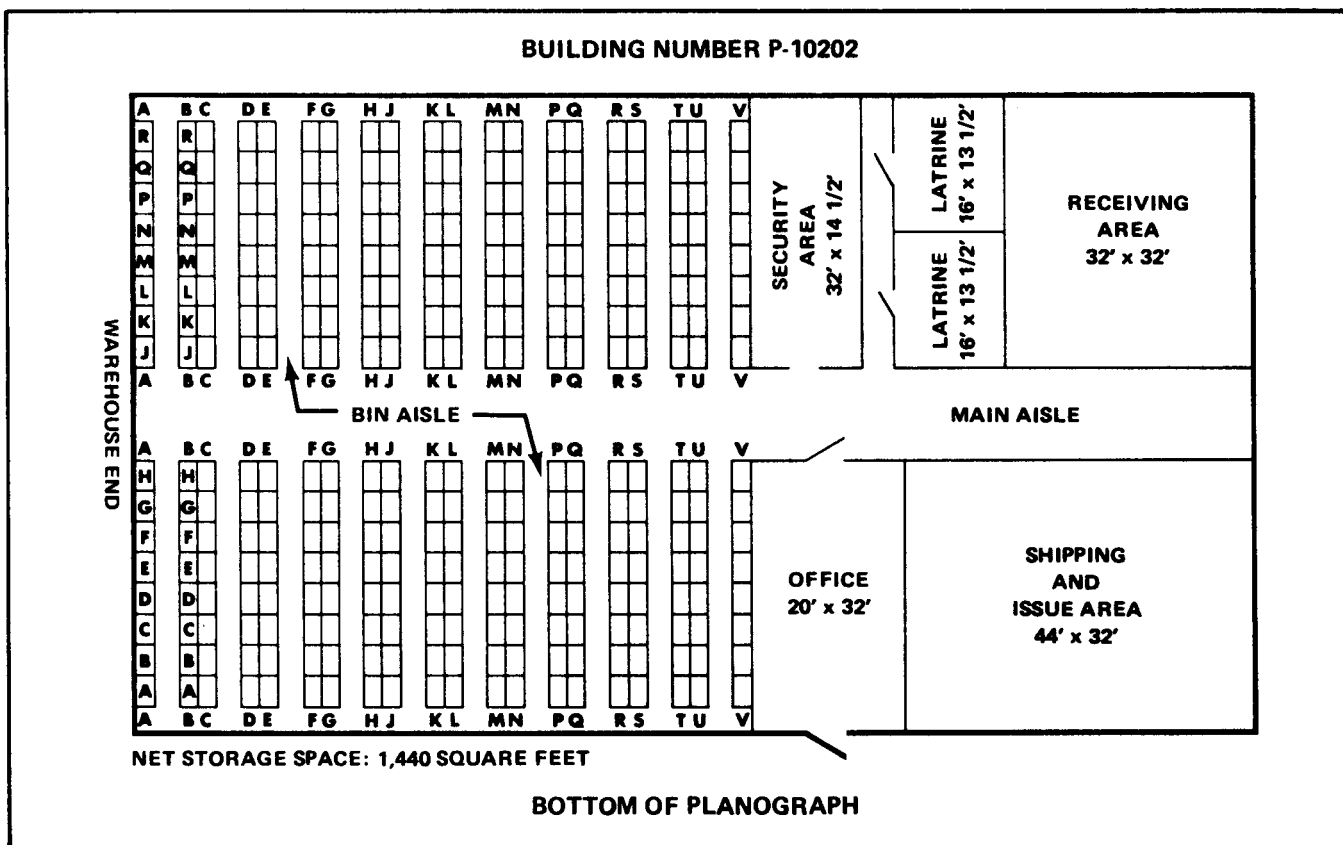

Figure 6-3. Planograph with columns and rows labeled

- **Step 6.** Label each compartment or section of the levels. You may have more than one section per level. Label each section from left to right. Figure 6-4 shows how to label levels and compartments or sections.

- **Step 7.** To label more than 32 rows or columns, take one of the steps below.

- If there are more than 32 rows but not more than 16 columns, label the aisles instead of each row. This will give you two rows per labeled aisle.

- If there are more than 32 rows and 32 columns, divide the storage area into two separate sections and label them separately.

- If there are more than 32 rows and less than 32 columns, use two letters or numbers (for example, AA or 11) to label the rows. Do this only if there is just one compartment or section in each level to label, as in bulk storage.

- If there are 32 or less rows and more than 32 columns or stacks, use two letters or numbers to label them. Do this only if you have just one compartment or section in each level.

- **Step 8.** You have now given a stock location code to every storage space shown on your

planograph. The stock location code should look like this: KHE36. This number will help you find the location of an item by reading the special address code. Figure 6-5 shows a sample five-character location code. The following steps show how a location code is assigned.

- The first letter or number is the area (building, van, tent, or open storage space) where the item is stored.

- The second letter or number is the row of storage aids or the aisle between two rows of storage aids where the item is kept.

- The third letter or number is the column in the row where an item is stored.

- The fourth letter or number is the level of the storage column where the item is stored.

- The fifth letter or number is the compartment or section of the level where the item is stored.

The system you have just used to give every storage space a special code is called the stock locator system. Each item will have a record card that shows its stock number and stock location

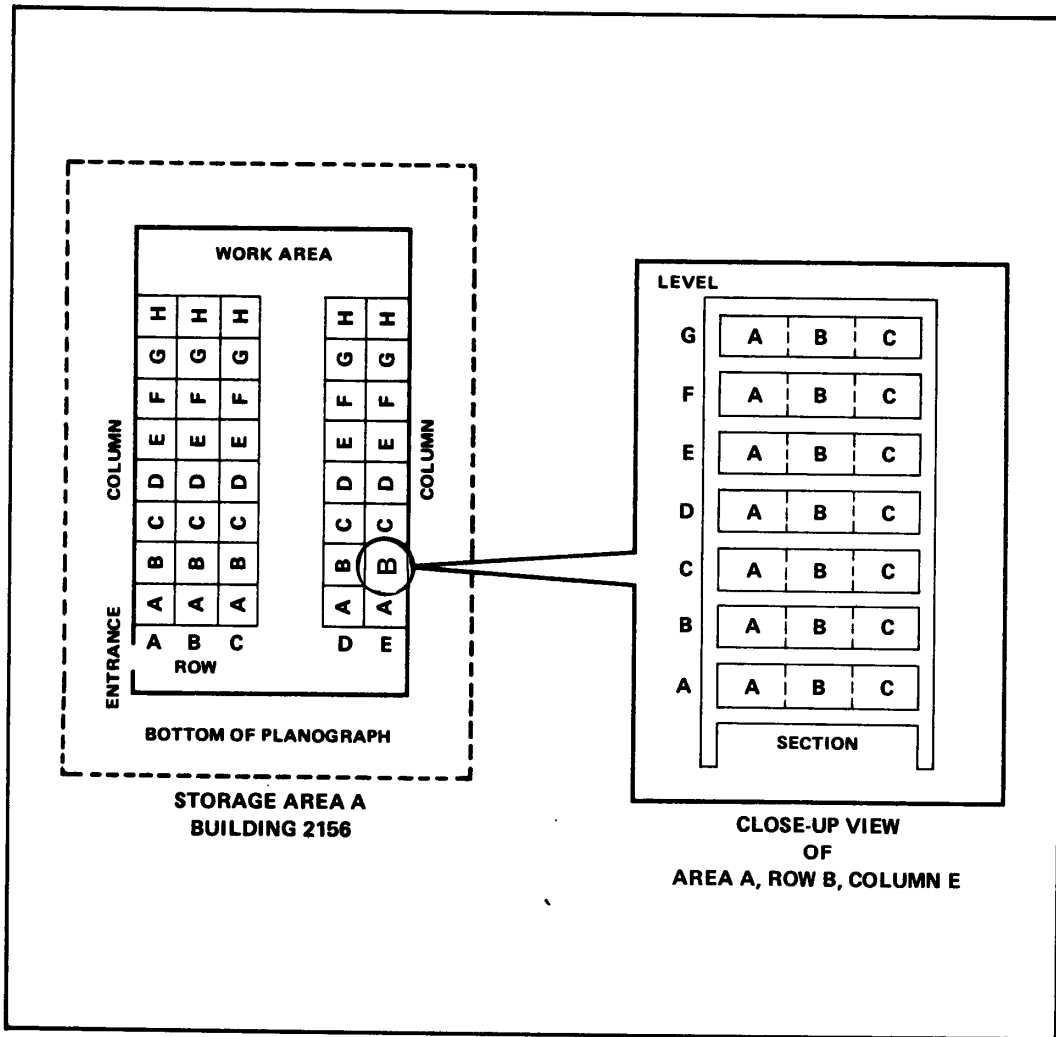

Figure 6-4. Planograph with levels and compartments or sections labeled

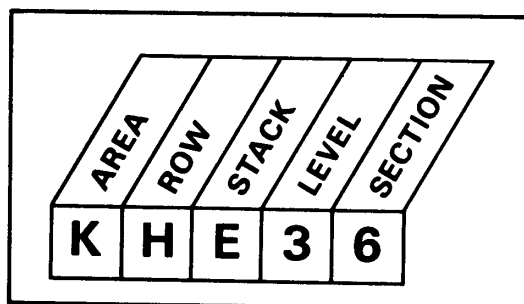

Figure 6-5. Five-character location code

code. This system will make it easier and faster for you to find an item. When you need to issue an item, find the locator card with the NSN for that item and go to the location listed on the card. If you have more questions about the stock locator system or about how to set up a system for loose issue and bulk storage items, check TM 743-200-1, Chapter 3. Figures 6-6 and 6-7 show you how to use the code to find an item in a warehouse and in a storage van.

MARKING LOCATIONS

When you finish marking the planograph so that each row, aisle, column, level, and compartment has been labeled, you will need to mark the actual storage areas to match the planograph. Figure 6-8 shows a storage area that has been

properly marked with location markings. Be sure you follow the guidelines in AR 385-30 to make the location markings. In storage areas where floor surfaces permit, you should mark the aisle labels directly on the floor. Make these labels with decals, paint, tape, or stencils. Be sure to put a coat of clear lacquer over them so they will last longer. Put these labels as close to the row or column as possible. Try to keep them out of the direct traffic areas and make them large enough so that they can be seen easily. If you have an area where you cannot put the markings on the floor, put them on posts or other easily seen structures. When you mark the shelf levels, center and place the signs that show the letter or number below the level you are coding. Place segment labels directly on each compartment or section drawer.

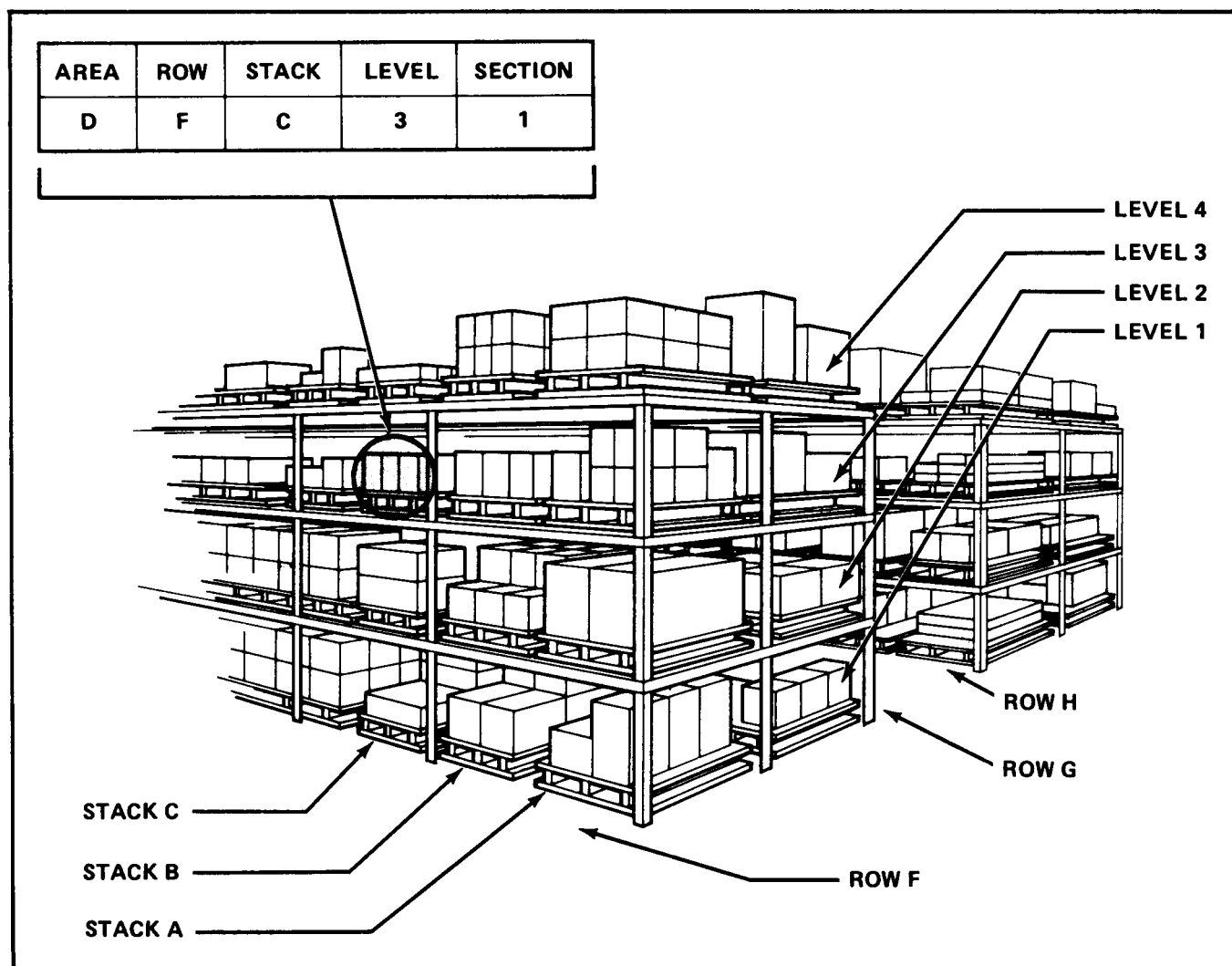

Figure 6-6. Warehouse with location codes

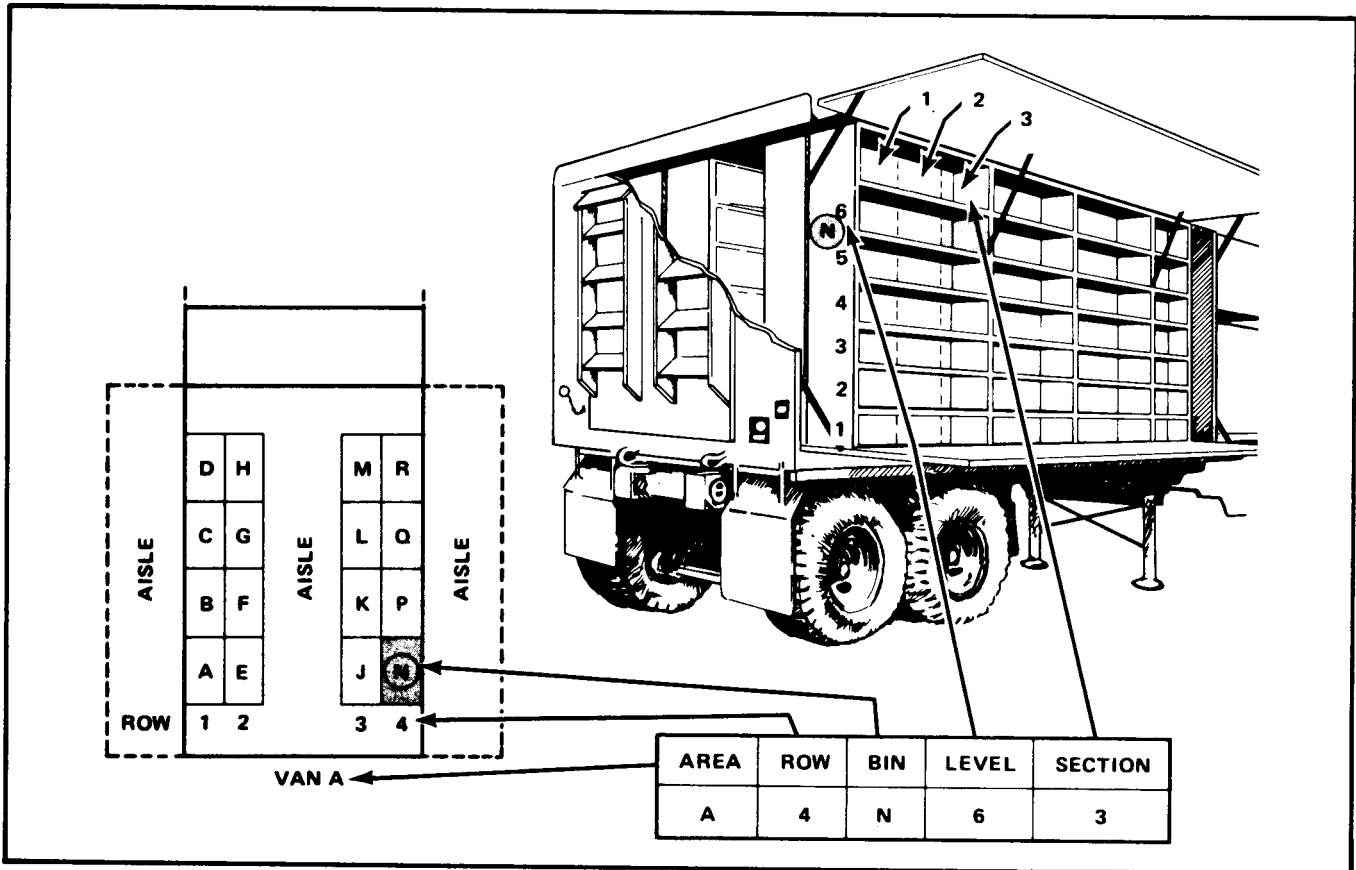

Figure 6-7. Storage van with location codes

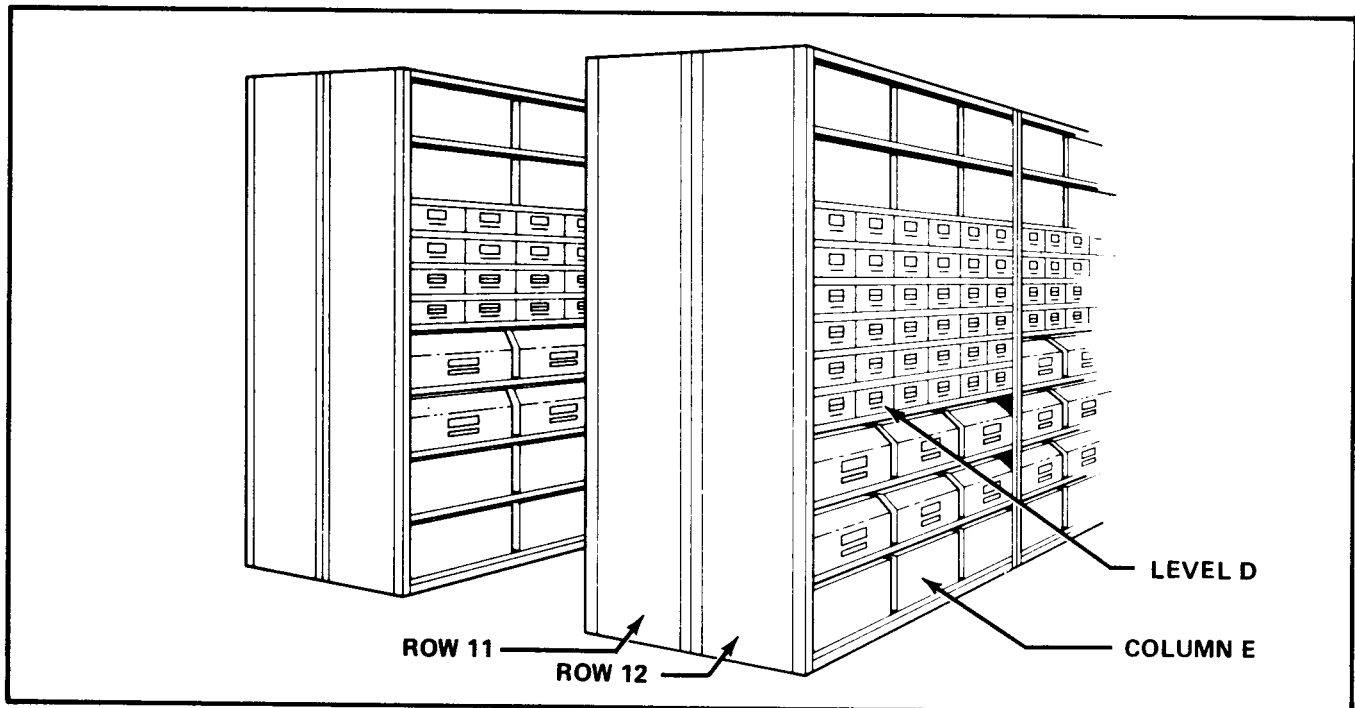

Figure 6-8. Placement of location markings

★ SETTING UP THE LOCATOR FILE

A stock locator file is the heart of the stock location system. It is an address directory of all stored items. The file is made up of a deck of cards. There is one card for every NSN in stock. These cards show the item's storage location, UI, and condition code. You can find a list of the condition codes that the Army supply system uses and their explanations in AR 708-1, Chapter 7, and AR 725-50, Table C-28. For manual locator files, place the cards in NUN order. When you file locator cards by NIIN order and the first two digits of the NIIN are the same, file these cards in ascending order of the next three digits. If your DSU operates using SARSS, the location is maintained by the SARSS at the DSU. When the SARSS interfaces with DS4, setting up and maintaining the locator file becomes a SARSS responsibility. For more information on setting up and maintaining the locator file, see TM 38-L19-2, Chapter 4. If your DSU operates under the DS4 or SAILS automated systems, file the cards in location sequence. TMs 38-L32-12 and 38-L32-13 explain how to setup locator files under automated systems. Other information can be added to the cards, such as nomenclature, expiration date, and the CIIC. The locator file will also have a card for each empty storage location. You can use these cards when you assign new storage locations. If your unit has no ADPE, use DA Form 2765 (Request for Issue or Turn-In) (showing DIC YDL) to make a temporary location card. Send a stock location card also to the SCS and MMC. The temporary location card will be maintained until the SCS and MMC provide a printed DA Form 2000-3 (Installation Inventory Count Card) (showing DIC YDL) as an output to your unit. If your DSU has ADPE, the SCS and MMC provide a preprinted deck of stock location cards (showing DIC YDL) for each NSN in stock. The deck is in stock number sequence. DA Form 2000-3 is a multipurpose card that can also be used as a location survey work card. Use DA Form 2765 to report items that need locations added to or deleted from the locator deck. You should also use it to combine two or more locations into one. Stock location cards for shelf-life items should first be placed in NSN order and then filed by condition code. The first locator card within a specific condition code should be for the item having the least amount of shelf life left. This card should be

followed by the card with the next-oldest date. File the card with the oldest shelf-life date last. Make sure that this first-in, first-out rule is followed in all sections.

NOTE: There will be no locator card decks used under SARSS or DS4 desktop. There will be location listings available in either stock number or location sequence. The listing of stock numbers in NIIN sequence can help relocate stocks and identify stocks with no location. (NOTE: This change deletes Figures 6-9 and 6-10.)

MAINTAINING THE LOCATOR FILE

Keep the locator file at a central point near the receiving section since this is the area where most of the locator activity takes place. Set up step-by-step rules to follow to make additions, deletions, or changes in the locator file. Make sure everyone in your section understands and follows the rules. You should also set up guidelines for special arms control and security guidance. To ensure that security storage areas are correctly identified and used for storing only classified and highly pilferable supplies, you must setup locator file controls. One way you can mark the locator file to show which items are pilferable supplies is to use some type of color coding or a different corner cut. Be sure to place these guidelines in your storage SOP. The basic SOPS for the stock locator system apply to all types of locator systems. The manual and automated systems are very much alike in function and purpose. The major difference is that manual locator system record cards are handwritten while the cards of the automated system are machine-printed. Both systems list the item stock number, nomenclature, and UI. Stock locator file maintenance includes the following procedures.

- When a new item is received, search the locator file for the item stock number and its assigned location.
- If a location is already assigned for the stock number, write the location code on the receipt document and route the item to the warehouse section for storage. Chapter 7 explains receiving procedures.
- Sometimes new material has to be placed in a temporary storage location until a permanent location

is ready. Be sure to provide these materials, especially the items with sensitive or pilferage codes, with the necessary protection while they are in the temporary location.

- It is a good idea to keep a file on locations as they become empty. This file should list the types of locations and their sizes. As a new item comes in, the right type and size of location can be found quickly and easily by searching the file. Once a location has been assigned, its card must be removed from the file to avoid assigning the same location to a different item. If you do not keep a file listing empty locations, send new items to the correct storage area. A storage specialist will decide where to store the item. After he picks a location, he must make sure it is posted to the locator card.

- If you are at a DSU that has a shortage of storage space, you will have to add and delete locations and make changes to the locator file to make room for incoming supplies. Before assigning a new item to an empty location or before making changes to the locator file, check to see if the location in question is assigned to an ASL item. You should delete or change locations for non-ASL items first. It is easier to do this when the balance on hand of an item is zero. Your local storage SOP should list the times when you must reserve certain storage locations. It should also list the times when you can delete ASL locations.

- Normally, you should not delete an ASL location even if all the items in the location have been issued. However, if you find you do not have enough space for incoming items, you may be forced to delete the ASL location and assign that location to a new item. Inform the SCS of any changes in ASL and non-ASL locations. These changes affect the storage locations that the SCS lists on the receipt document.

- Sometimes a location is specially designed for a particular type of item, such as cylinders or extra large items. Other times a location may be used for storing fast-moving items which are generally replenished quickly. In these cases, you should keep the location open even if the balance on hand is zero.

- Be sure to make the necessary loose-issue labels and location placards when new material is received and assigned to a location. Take these forms with you

when you place the material in a storage location. This saves you from making more than one trip to a location.

MAKING LOCATION CHANGES

Sometimes you will need to move items to new locations or move items from two different locations to one location. Since the locator files of both the automated and manual supply systems are similar, the way you request these changes is also very similar. However, the forms you use are different.

Manual Procedures

You should have only one storage location for each NSN. If there is a change in the primary storage location or a new location is established, enter Loc Chgd or New Loc and the prime location code in block 15 on DA Form 2765. Figure 6-11 shows the DA Form 2765 completed as a new location card. Figure 6-12 shows the form completed as a location change card.

★ Automated Procedures

Try to have only one location for each item. If you need to delete, change, or add a location, make sure your soldiers use the correct procedures for your type of automated system. Most automated systems use DA Form 2765 or DA Form 2000-3 to make changes. Most of the data you will need to fill out these cards are in the locator file or deck. Sometimes, due to electrical or equipment problems, you may have to make a manual location change. Use DA Form 2765 to make such a change. TM 38-L32-12 gives step-by-step procedures for making automated and manual location change requests. Most automated systems use DA Form 2000-3 as a stock locator card. This card is machine-printed and filed in the locator deck in NSN order. The DSUs which operate using SARSS-1(I) will update the locator file through the location maintenance process. This process provides the capability to change existing locations and establish new ones. SARSS will allow you to have up to five different storage locations. The location maintenance process consists of keyboard entries. It requires no preparation of manual YDL cards.

NOTE: These locations are maintained by SARSS; therefore, there is no input to DS4 as a result of the location maintenance process. The operator also has

the capability of creating bin labels. (NOTE: This change deletes Figures 6-13 and 6-14.)

DA FORM 2765 (1-72) (REV. 7-69)

REQUEST FOR ISSUE ON TURN-IN

DATE OF ISSUE: 1 2 3 4 5 6 7 8 9 10 11 12 13 14 15 16 17 18 19 20 21 22 23 24 25 26 27 28 29 30 31

DOC IDENT: YDL

ROUTING IDENTIFIER: 3

STOCK NUMBER: 312000982005

UNIT OF ISSUE: EA

ITEM DESCRIPTION: SPARK PLUG

SUPPLEMENTARY ADDRESS: NEW LOC K 4281

COST DETAIL ACCOUNT NUMBER: L

UNIT PRICE: M

TOTAL PRICE: N

FUND: 17 18 19 20 21 22 23 24 25 26 27 28 29 30 31

MCS CODE: A A 5118 C

ISSUED: O

DATE FORGED: Y

DUE OUT: R

DATE AVAILABLE: U

RECEIVED: S

DATE RECEIVED: V

SIGNATURE: WIT

Figure 6-11. DA Form 2765 completed as a new location card

DA FORM 2765 (1-72) (REV. 7-69)

REQUEST FOR ISSUE ON TURN-IN

DATE OF ISSUE: 1 2 3 4 5 6 7 8 9 10 11 12 13 14 15 16 17 18 19 20 21 22 23 24 25 26 27 28 29 30 31

DOC IDENT: YDL

ROUTING IDENTIFIER: 3

STOCK NUMBER: 312000982003

UNIT OF ISSUE: EA

ITEM DESCRIPTION: LOC CHGD

SUPPLEMENTARY ADDRESS: NEW LOC K 4282

COST DETAIL ACCOUNT NUMBER: L

UNIT PRICE: M

TOTAL PRICE: N

FUND: 17 18 19 20 21 22 23 24 25 26 27 28 29 30 31

MCS CODE: A A 5119 C

ISSUED: O

DATE FORGED: Y

DUE OUT: R

DATE AVAILABLE: U

RECEIVED: S

DATE RECEIVED: V

SIGNATURE: WIT

Figure 6-12. DA Form 2765 completed as a location change card

★ MAKING LOCATION SITE FORMS

As storage supervisor, you must be able to show your soldiers how to make location placards for new bulk supplies and how to replace location placards that are missing at the location site. You must also be able to show them how to make loose-issue labels for new bin supplies or make labels to replace those missing from storage bins. Loose-issue labels are sometimes called bin tags or bin labels. Use DA Form 3779 (Location Placard) and DA Form 3778 (Loose Issue Label) to make these location markers. Make out the location form when you receive the item. Take it with the item when you put it into storage. This will help you avoid making more than one trip to a new location. Figure 6-15 shows how to fill out DA Forms 3778 and 3779 using data from the receipt document. To complete these location markers copy the item's stock number, condition code, expiration date, and UI from the receipt document or the item container. Use AR 708-1 or the AMDF to find the correct SEC and the shelf-life code. Write U in the block for the physical security classification and Q in the block for the shelf-life code if none apply. Copy the stock location code from the location site. Give the completed location placard or loose-issue label to storage personnel to place at the location. You may also work with other location forms. A label and some of the forms and the ways they are used are listed below. See TM 743-200-1 for details on their use.

DA Form 3780

DA Form 3780 (Pallet Count) is put at the end of each pallet row. It shows the total number of pallets

and the total number of items in that row. The placard makes taking inventory easier by showing these totals.

DA Form 3781

DA Form 3781 (Check Unit of Issue Notice) is used when an item could be issued in the wrong quantity because of an unusual UI.

DA Form 3782

DA Form 3782 (Suspended Notice) is used when an item is suspended and cannot be issued. List the reason on the notice.

DA Form 3783

DA Form 3783 (Stock Change and/or Physical Security Change Notice) shows that an item UI or stock number has been changed. It is placed on a storage site to show that the item has more than one location due to the change. If you use this card, you do not have to move all items to one location. You can issue from two locations until the quantity is low and the items can be combined in one location.

DA Label 141

DA Label 141 (Open Box) is placed on open boxes in the loose issue or bulk sections. It points out which box is open so that you issue from it. You must have no more than one open box per item. The lid must be kept closed to keep the materials clean.

LOCATION PLACARD

STOCK NUMBER 2920-00-204-3092					
CONDITION A	UNIT OF ISSUE EA	PSC U	SLI 0	EXP DATE	TYPE STORAGE CODE
LOCATION GAHCA				CUSTODY CODE	
REMARKS:					

DA FORM 3770
1 SEP 71

STOCK NUMBER
UA
CC
EXP DATE

2920-00-204-3092

PSC
SLC
CUS
TYPE STOR
LOCATION

U 0 GAHCA

DA FORM 3770
1 SEP 71

LOOSE ISSUE LABEL

DELETE (V)

FREIGHT CLASSIFICATION NOMENCLATURE											
SHIPPED FROM New Cumberland Army Depot New Cumberland, PA 17070						SHIP TO 703 MAINT BN APO NY 12345			MARK FOR PROJECT 179 A42		
WAREHOUSE LOCATION A		TYPE OF CARBON G		UNIT WEIGHT H		UNIT CUBE I		MPC J		MSPC K	
FREIGHT RATE L		FREIGHT CLASSIFICATION NOMENCLATURE U		FREIGHT CLASSIFICATION NOMENCLATURE X Spark Plug		FREIGHT RATE M		FREIGHT CLASSIFICATION NOMENCLATURE V		FREIGHT CLASSIFICATION NOMENCLATURE W	
RECEIVED BY AND DATE 1		TYPE OF UNIT ADDRESS 2		TOTAL WEIGHT 3		RECEIVED BY AND DATE 7		INSPECTED BY AND DATE 8		RECEIVED BY AND DATE 9	
PACKED BY AND DATE 4		NO OF CONTAINERS 5		TOTAL CUBE 6		WAREHOUSED BY AND DATE 10		WAREHOUSE LOCATION 11		WAREHOUSE LOCATION 12	
REMARKS AA		REMARKS BB		REMARKS CC		REMARKS DD		REMARKS EE		REMARKS FF	
FIRST DESTINATION ADDRESS 13				DATE SHIPPED 14				RECEIVERS DOCUMENT NUMBER 15			

Figure 6-15. DA Forms 3778 and 3779 filled out, using data from receipt document

MAKING LOCATION SITE FORMS

As storage supervisor, you must be able to show your soldiers how to make location placards for new bulk supplies and how to replace location placards that are missing at the location site. You must also be able to show them how to make loose issue labels for new bin supplies or remake labels missing from storage bins. Loose-issue labels are sometimes called bin tags or bin labels. Use DA Form 3779 (Location Placard) and DA Form 3778 (Loose Issue Label) to make these location markers. Make out the location form when you receive the item. Take it with the item when you put it into storage. This will help you avoid making more than one trip to a new location. Figure 6-15 shows how to fill out DA Forms 3778 and 3779 using data from the receipt document. To complete these location markers copy the item's stock number, condition code, expiration date, and UI from the receipt document or the item container. Use AR 708-1 or the AMDF to find the correct SEC and the shelf-life code. Write U in the block for the physical security classification and O in the block for the shelf-life code if none apply. Copy the stock location code from the location site. Give the completed location placard or loose issue label to storage personnel to place at the location. You may also work with other location site forms. A label and some of the forms and the ways they are used are listed below. See TM 743-200.1 for detailed use of these forms.

DA Form 3780

DA Form 3780 (Pallet Count) is put at the end of each pallet row. It shows the total number of pallets and the total number of items in that row.

The placard makes taking inventory easier by showing these totals.

DA Form 3781

DA Form 3781 (Check Unit of Issue Notice) is used when an item could be issued in the wrong quantity because of an unusual UI. An example would be a set of boxes with each as the UI. In this case, each means the whole set.

DA Form 3782

DA Form 3782 (Suspended Notice) is used when an item is suspended and cannot be issued. List the reason on the notice.

DA Form 3783

DA Form 3783 (Stock Change and/or Physical Security Change Notice) shows that an item UI or stock number has been changed. It is placed on a storage site to show that the item has more than one location due to the change. If you use this card, you do not have to move all items to one location. You can issue from two locations until the quantity is low and the items can be combined in one location.

DA Label 141

DA Label 141 (Open Box) is placed on open boxes in the loose issue or bulk sections. It points out which box is open so that you issue from it. You must have no more than one open box per item. The lid must be kept closed to keep the materials clean.

LOCATION PLACARD

STOCK NUMBER 292φ-φφ-2φ4-3φ92					
CONDITION A	UNIT OF ISSUE EA	PSC U	SLI φ	EXP DATE	TYPE STORAGE CODE
LOCATION GAHCA				CUSTODY CODE	
REMARKS:					

STOCK NUMBER 292φ-φφ-2φ4-3φ92			U/I EA	CC A	EXP DATE
PSC U	SEC φ	CUS	TYPE STOR GAHCA	LOCKED GAHCA	
DA FORM 3778 1 SEP 71			LOOSE ISSUE LABEL		DELETE I <input type="checkbox"/>

A5A AN5 K 292φ-φφ-2φ4-3φ92															00005 A K4712 3159 0002															GAHCA															179															A42															00001														
SHIPPED FROM New Cumberland Army Depot New Cumberland, PA 17070															SHIP TO 703 MAINT BN APO NY 12345															MARK FOR															PROJECT															TOTAL PRICE DOLLARS CTS 0002																													
WAREHOUSE LOCATION					TYPE OF CARBO			UNIT PACK		UNIT WEIGHT			UNIT CUBE		LPC		NSPC		FREIGHT RATE			DOCUMENT RATE			UNIT		QUANTITY			TOTAL PRICE DOLLARS CTS 00005																																																											
SUBSTITUTE DATA (ITEM ORIGINALLY REQUESTED)															FREIGHT CLASSIFICATION NOMENCLATURE															ITEM NOMENCLATURE Spark Plug																																																											
SELECTED BY AND DATE					TYPE OF CONTAINER					TOTAL WEIGHT					RECEIVED BY AND DATE					INSPECTED BY AND DATE																																																																					
PACKED BY AND DATE					NO OF CONTAINERS					TOTAL CUBE					WAREHOUSED BY AND DATE					WAREHOUSE LOCATION																																																																					
REMARKS															AA															BB															CC															DD															EE														
FIRST DESTINATION ADDRESS															DATE SHIPPED															FF															GG																																												
13 TRANSPORTATION CHARGEABLE TO															14 SIGNATURE AND OR RECEIVER'S SIGNATURE (AND DATE)															15 RECEIVERS DOCUMENT NUMBER																																																											

Figure 6-15. DA Forms 3778 and 3779 filled out, using data from receipt document

CHAPTER 7

RECEIVING SUPPLIES

RESPONSIBILITIES

All supplies enter a DSU at the receiving point of the storage section. They come from the next higher source of supply (depot, GSU, or installation) or from another DSU as customer turn-ins. Your job is to make these supplies ready for issue as soon as possible by coordinating the actions of all the sections in the storage activity. Set up guidelines for your soldiers to follow as they receive and process supplies. You will need to contact the SCS for information on all items clue in so that you can plan to receive and store the supplies. The SCS can tell you the approximate date the supplies will arrive, the type and quantity, and the security data. Coordinate this information with storage, transportation, receiving, packing, and inspection personnel. Remember that your receiving section soldiers will also have to work with the quality assurance and maintenance sections when items need to be identified and classified. Plan your guidelines carefully. Your first priority will be to keep your soldiers from being injured and the supplies from being damaged or lost. You must also avoid extra cost to the government caused by keeping railcars or trucks past the time limits set for loading and unloading when government transportation is not used. This holdover cost is called demurrage.

RECEIPT DOCUMENTS

.411 supplies that come to your DSU will have some kind of receipt document. This document helps you identify the supplies. It tells you if the supplies are for stock or if they were ordered for a specific unit. The document also tells you the quantity of supplies shipped and the dates they were ordered and chipped. It gives their storage location and shows if any supplies are still clue in. You will use this document as a tally sheet when

you check in the containers as they are unloaded. Your DSU will use five receipt documents. Figures 7-1 through 7-4 show samples of these documents.

DA Form 2765, DA Form 2765-1 and DD Form 1348-1

DA Form 2765, DA Form 2765-1 (Request for Issue or Turn-In), and DD Form 1348-1 (DOD Single Line Item Release/Receipt Document) are used as receipt documents for supplies shipped from military depots and military storage activities. At a DSU, you will handle mostly DD Forms 1348-1. However, items representing recurring requests and emergency issue items may be received with DA Forms 2765 or 2765-1.

DD Form 250

DD Form 250 (Material Inspection and Receiving Report) is sent with supplies ordered from civilian procurement sources. These items do not have NSNs or part numbers, are not in the federal catalog system, or are urgently needed. The form is also used to ship standard issue items with NSNs directly from the manufacturer.

DD Form 1155

DD Form 1155 (Order for Supplies or Services/Request for Quotations) is used when supplies are ordered from local civilian sources.

DA Form 2407

Your DSU may sometimes receive homemade or fabricated items from a maintenance support activity. If this happens, check to see if there is a copy of DA Form 2407 (Maintenance Request)

ASAI		P2530 002946891		EA00005WK4FB6.3068 03 03A5K43		015		AA		2946891	
DOCUMENT IDENTIFICATION NO. STOCK NUMBER											
DOC IDENT DOC IDENT DOC IDENT DOC IDENT DOC IDENT DOC IDENT DOC IDENT DOC IDENT DOC IDENT DOC IDENT DOC IDENT											
A5K43											
ITEM DESCRIPTION											
PUBLICATION DATA											
DATE FORWARDED DATE RECEIVED											

Figure 7-1. DA Form 2765 completed as a receipt document

D6S														
DEFENSE ELECTRONICS SUP CENTER, 1507 WILMINGTON PIKE, DAYTON, OH 4544														
SHIP TO TRANS OFF FORT CARSON, CO 80913														
MARK FOR PROJECT														
FREIGHT RATE LTL 13390														
ITEM NOMENCLATURE SHAFT DROOP COMPENSAT														
SELECTED BY AND DATE SC 6126			TYPE OF CONTAINER PG			TOTAL WEIGHT 0.13			RECEIVED BY AND DATE EA 6130			INSPECTED BY AND DATE BC 6130		
PACKED BY AND DATE EK 6126			NO. OF CONTAINERS 1			TOTAL CUBE 0.17			WAREHOUSED BY AND DATE EB 6130			WAREHOUSE LOCATION		
REMARKS NO D6S														
FIRST DESTINATION ADDRESS														
DATE SHIPPED 6127														
SIGNATURE AND OR RECEIVER'S SIGNATURE (AND DATE) TCNW34AF66121000100X														
15 RECEIVERS DOCUMENT NUMBER														

Figure 7-2. DD Form 1348-1 completed as a receipt document

MATERIAL INSPECTION AND RECEIVING REPORT		1. PROC. INSTRUMENT IDEN (CONTRACT)		ORDER NO.	6. INVOICE	7. PAGE OF	8. ACCEPTANCE POINT
		DABE0183-0001-0001			Supp P-2765	1 1	D
2. SHIPMENT NO.	3. DATE SHIPPED	4. W/L CB/L #W3-1075		5. DISCOUNT TERMS			
B007	30 Mar 83	TCN					
9. PRIME CONTRACTOR CODE				10. ADMINISTERED BY CODE			
Johnsons Chemical Company Distribution and Order Department Tandem Station New York, NY 10019				Procurement Division Bldg P-1172 Fort Blank, NJ 07891			
11. SHIPPED FROM (If other than B) CODE			FOB:	12. PAYMENT WILL BE MADE BY CODE			
Products Division - Eastern Troy, NY 12100				Finance and Accounting Division Bldg P-1200 Fort Blank, NJ 07891			
13. SHIPPED TO CODE				14. MARKED FOR CODE			
34th Supply Company Fort Blank, NJ 07891							
16. ITEM NO.	18. STOCK/PART NO. (Indicate number of shipping containers - type of container - container number.)	DESCRIPTION TYPE of	17. QUANTITY SHIP/RECD*	18. UNIT	19. UNIT PRICE	20. AMOUNT	
1.	6850-00-865-8584	Silicone Compound: Silicone plus toluene petroleum spirits basic ingredients; PSCM 24446; P.N DRI - FILM 88; 1 gal per can	4	CN	325.00	1,300.00	
21. PROCUREMENT QUALITY ASSURANCE				22. RECEIVER'S USE			
<input type="checkbox"/> POA <input type="checkbox"/> A. ORIGIN ACCEPTANCE of listed items has been made by me or under my supervision and they conform to contract, except as noted herein or on supporting documents.		<input type="checkbox"/> POA <input type="checkbox"/> B. DESTINATION ACCEPTANCE of listed items has been made by me or under my supervision and they conform to contract, except as noted herein or on supporting documents.		Quantities shown in column 17 were received in apparent good condition except as noted.			
DATE: <u>16 Feb 83</u> SIGNATURE OF AUTH GOVT REP: <u>J. Doaks</u> TYPED NAME AND OFFICE: <u>J. Doaks, CPT, QM</u> MO 4022	DATE: _____ SIGNATURE OF AUTH GOVT REP: _____ TYPED NAME AND TITLE: _____		DATE RECEIVED: <u>16 Feb 83</u> SIGNATURE OF AUTH GOVT REP: <u>J. Doaks</u> TYPED NAME AND OFFICE: <u>L. Baker, CPT, QM</u> MO 4022				
23. CONTRACTOR USE ONLY				Signifies acceptance of supplies listed.			

DD FORM 250
1 NOV 66

REPLACES EDITION OF 1 AUG 67 WHICH MAY BE USED

1

Figure 7-3. DD Form 250 completed as a receipt document

<input type="checkbox"/> CHECKED BOX APPLIES <input type="checkbox"/> ORDER FOR SUPPLIES OR SERVICES <input type="checkbox"/> REQUEST FOR QUOTATIONS NO. RETURN COPIES OF THIS QUOTE BY THIS IS NOT AN ORDER, SEE DD FORM 1155A		PAGE 1 OF			
1. CONTRACT/PURCH ORDER NO.		2. DELIVERY ORDER NO. DABC 03-81-2001A			
3. DATE OF ORDER 23 Jul 83		4. ACQUISITION/PURCH REQUEST NO. 11650001			
5. ISSUED BY: Purchasing and Contracting Office Bldg 222 Fort Artillery, NM 84111		6. DELIVERY FOR: <input checked="" type="checkbox"/> GERT <input type="checkbox"/> OTHER (See Schedule if other)			
7. ADMINISTERED BY: (If other than 5):		8. DELIVER TO FOR POINT BY: 15 Aug 83			
9. CONTRACTOR/COMPETITOR NAME AND ADDRESS: Whimsey Gadget Co. 800 Petrified Blvd Burnt Sands, NM 84116		10. DISCOUNT TERMS: Net			
11. CONTRACTOR/COMPETITOR CODE: FACILITY CODE:		12. MAIL INVOICES TO: See Block 15			
13. SHIP TO: 1094th Supply & Service Co Bldg 1000 Fort Artillery, NM 84111		14. PAYMENT WILL BE MADE BY: Finance and Accounting Office Bldg 444 Fort Artillery, NM 84111			
15. DELIVERY <input checked="" type="checkbox"/> This delivery order is subject to instructions contained on this side of form only and is issued on another Government agency or in accordance with and subject to terms and conditions of above numbered contract.		16. CHECK IF: <input checked="" type="checkbox"/> SMALL BUSINESS <input type="checkbox"/> MINORITY BUSINESS			
17. PURCHASE Reference form furnish the following on terms specified herein, including, for U.S. purchases, General Provisions of Purchase Order on DD Form 1155; EXCEPT CLAUSE NO. 13 APPLIES ONLY IF THIS BOX <input type="checkbox"/> IS CHECKED, AND NO. 15 IF THIS BOX <input type="checkbox"/> IS CHECKED; special provisions: and delivery as indicated. This purchase is negotiated under authority of		18. MAKE ALL PACKAGES AND PAPERS WITH CONTRACTOR ORDER NUMBER			
19. ACCOUNTING AND APPROPRIATION DATA/LOCAL USE: 2122-2-81-8100 F500000(1003)					
20. ITEM NO.	21. SCHEDULE OF SUPPLIES/SERVICES	22. QUANTITY ORDERED/ACCEPTED	23. UNIT	24. UNIT PRICE	25. AMOUNT
1	5910-00-252-4104 Gadget, right hand	6	EA	150.00	900.00
2	5905-00-252-4210 Gadget, left hand	6	EA	160.00	960.00
26. UNITED STATES OF AMERICA LARRY PARK		27. TOTAL 1860.00		28. OFFER SHEET	
BY: LARRY PARK, MAJ, QM CONTRACTING/ORDERING OFFICER		29. INITIALS		30. AMOUNT VERIFIED CORRECT FOR	
31. QUANTITY IN COLUMN 20 HAS BEEN: <input type="checkbox"/> IMPROVED <input type="checkbox"/> RECEIVED <input type="checkbox"/> ACCEPTED AND CONFORMS TO THE CONTRACT EXCEPT AS NOTED		32. SHIP NO.		33. PAID BY	
DATE SIGNATURE OF AUTHORIZED GOVERNMENT REPRESENTATIVE		34. PAYMENT: <input type="checkbox"/> PARTIAL <input type="checkbox"/> COMPLETE <input type="checkbox"/> PARTIAL <input type="checkbox"/> FINAL		35. CHECK NUMBER	
DATE SIGNATURE AND TITLE OF CERTIFYING OFFICER		36. TOTAL CONTAINERS		37. BILL OF LADING NO.	
38. RECEIVED AT	39. RECEIVED BY	40. DATE RECEIVED	41. S/N ACCOUNT NUMBER	42. S/N VOUCHER NO.	

DD FORM 1 FEB 77 1155

PREVIOUS EDITION OBSOLETE

Figure 7-4. DD Form 1155 completed as a receipt document

with the item. Use the information on the maintenance request to make a DD Form 1348-1 receipt document so that the item can be issued. If your DSU receives supplies with documents different from the ones listed, check DA Pamphlet 25-30. This microfiche pamphlet lists all forms used by the Army. It gives the number of the publication that explains how to fill out and process each form. See Figure 7-5 for an extract of a page from DA Pamphlet 25-30. As storage supervisor, you need to set up a system to help your soldiers keep track of the supplies and receipt documents your section receives. The best way to do this is to set up a suspense file. Make a file folder for each day of the workweek and an extra one for delayed action receipts. Use these folders to keep track of receipt documents and to help you decide in what order you should send the supplies to the storage section. After you receive the receipt document from the locator section where the location code was checked, put it in the file folder for that day. Each day check your folders before you decide which supplies to process first. If there are any receipts in the delayed action file, they must be

processed first each day. Next check the folder that has the previous day's receipt documents. If you must skip a document for some reason, place it in the delayed action file. This way, if you have a heavy work load on Tuesday, you can place a document in the delayed action file and it will be the first one processed on Wednesday.

DOCUMENT CONTROL REGISTER

As storage supervisor, you should set up a document control register to help keep track of the shipments your section receives and processes. This register can also be used to look up the history of particular shipments when claims are filed and to provide tonnage estimates for reports to higher HQ. DOD 4145.19-R-1 discusses the need for a document control register and gives suggestions on how to use it. Because each DSU needs different reporting data, there is no set design for a document control register. Figure 7-6 shows a sample of a register that you can use or adapt to fit the needs of your DSU.

DA FORMS					
No.	Date	Title	Unit of Issue	Prescribing Directive	Proposal
2666-R	JUL 63	PRISONER OF WAR MAIL NOTIFICATION OF ADDRESS (LRA)	CD	AR 633-50	DCSPER
2667-R	JUL 63	PRISONER OF WAR MAIL LETTER (LRA)	CS	AR 633-50	DCSPER
2668-R	JUL 63	PRISONER OF WAR MAIL POST CARD (LRA)	CD	AR 633-50	DCSPER
2669-R	JUL 63	CERTIFICATE OF DEATH (PRISONER OF WAR) (LRA)	CS	AR 633-50 & 633-61	DCSPER
2738-R	APR 72	WEIGHT CONTROL (LRA)	CS	AR 632-1	MILPERCEN
2740	MAR 69	APPLICATION TO USE DEPARTMENT OF THE ARMY FILES (S&I, TAGCEN)	PD50	AR 340-1, DA MEMO 340-3	TAG/TAGCEN
2740-1	NOV 63	ACTION ON APPLICATION TO USE DEPARTMENT OF THE ARMY FILES (S&I, TAGCEN)	CS	AR 340-1, DA MEMO 340-3	TAG/TAGCEN
2741	MAR 68	LAUNDRY LIST (FOR PIECE-RATE PATRONS)	ST3	AR 210-130	DCSLOG
2748	AUG 76	REQUEST FOR ALLOTMENT OF COMPENSATION FOR INCOME TAX PURPOSES	CS	AR 37-105	COA
2749-R	OCT 70	ADRE WORK REQUEST (LRA)	CS	AR 689-4	MILPERCEN
2751-R	DEC 63	WORK ORDER (LRA)	CS	AR 689-4	MILPERCEN
2752	JAN 64	UNION DUES CONTROL REGISTER	CS	AR 37-105	COA
2755-1-R	MAR 77	CURRENT AND PROJECTED COLONEL REQUIREMENTS SECTION B (LRA)	CS	AR 614-102	MILPERCEN
2755-R	MAR 77	CURRENT AND PROJECTED COLONEL REQUIREMENTS SECTION A (LRA)	CS	AR 614-102	MILPERCEN
2764	FEB 64	JOB PLANNING WORKSHEET	PD50	DA PAM 420-S	OCB
2765	APR 76	REQUEST FOR ISSUE OR TURN-IN	TCBX	AR 710-2	DCSLOG
2765-1	APR 76	REQUEST FOR ISSUE OR TURN-IN	ST4	AR 710-2	DCSLOG
2769-R	NOV 77	CRYTOFACILITY INSPECTION REPORT (LRA)	CS	TR 380-41	INSCOM
2771-R	MAR 64	MONTHLY SUMMARY JOURNAL DISPOSAL ACTIVITIES (LRA)	CS	AR 37-335	COA
2773-R	MAR 65	STATEMENT OF IDENTIFICATION (LRA)	CS	AR 638-40, FM 10-286	TAG/TAGCEN
2776-R	FEB 64	STATEMENT OF PRE-AWARD INSPECTION (LRA)	CS	AR 638-40	TAG/TAGCEN
2784-R	AUG 75	REQUEST FOR COUNTERINTELLIGENCE INVESTIGATION (LRA)	CS	AR 381-20	ACSI

See Section I for footnotes.

Figure 7-5. Extract of a page from DA Pamphlet 25-30

DOCUMENT NUMBER	DATE ASSIGNED	CONSIGNOR	BILL OF LADING NUMBER	CAR OR CARRIER NUMBER	PURCHASE ORDER OR CONTACT NUMBER	DATE RECEIVED FROM STORAGE	DATE FORWARDED TO STOCK CONTROL	NUMBER LINE ITEMS	NSN/ NOMENCLATURE	TOTAL WEIGHT
1	2	3	4	5	6	7	8	9	10	11
AK9T34 5028 0037	5045	Sharpe Army Depot	NA	NA	NA	5047	5049	1	2520-00-294-7828	30

Figure 7-6. Sample of document control register

**DSS AND DSS AIR LINES
OF COMMUNICATION SHIPMENTS**

Your DSU will receive most of its supplies from depots, GSUs, and installations. These supplies are shipped to your DSU under the DSS, DSS ALOC, or the non-DSS system. The DSS is the Army standard shipping system for Class II, III (packaged), IV, V (missile components only), VII, and IX supplies. Your unit receives items faster that are shipped under the DSS. Under this system, the supplies and equipment are shipped directly from a depot or distribution point to the SSA without in-between stops. Non-DSS supplies are shipped from supply level to supply level until they reach your unit. The DSS currently includes the six classes of supply shown in Table 7-1. For more information on how the DSS works, check FM 38-725-1. Most supplies your DSU receives will have receipt documents with PDs 09 through 15. These are normal requests. Since they are not emergency requests, your section has two working

days to process the supplies for issue. For DSUs receiving supplies by DSS and DSS ALOC, depending on where you are located, you have the time shown in Table 7-2 to process receipts. Mission-essential items are ordered under PDs 01 through 03. They are shipped to arrive as quickly as possible. Your section must process them and have them ready for issue within 24 hours after your DSU receives them. Sometimes you will receive supplies that have no PD listed on the receipt document. You may also receive supplies that have no receipt documents with them. In these cases, your section should process the item without the PD within two working days and the item without a receipt document within five working days. Always check with the SCS to see if it has an advance copy of the receipt document. It may provide the information you need to help you process the supplies.

★ *Table 7-1. Classes of supply included in DSS*

CLASS II	Clothing, individual equipment, storage, tentage, tool sets and tool kits, hand tools, and administrative and housekeeping supplies and equipment. These items are prescribed in authorization and allowance tables.
CLASS III	Packaged POL.
CLASS IV	Construction/base development materiel.
CLASS V	Missile components only.
CLASS VII	Major end items of equipment prescribed in authorization tables.
CLASS VIII	Medical materiel, including repair parts used only on medical end items.
CLASS IX	Repair parts, including expendables and consumable (does not include medical items repair parts).

★ *Table 7-2. DSS and DSS air lines of communication processing time*

	DSS	DSS AIR LINES OF COMMUNICATION		DSS	DSS AIR LINES OF COMMUNICATION
	Days	Days		Days	Days
Europe	5	4	Japan	5	4
Alaska	5	4	Okinawa	5	NA
Caribbean	5	NA	Korea	6	4
Hawaii	5	3	CONUS	5	NA

★ DSS SHIPMENTS

The accurate checking in of supplies and equipment is an important part of the storage operation. As storage supervisor, you must make sure your soldiers know how to check in and inspect the supplies correctly and how to process the receipt documents. Before unloading begins, they must look over the containers for damage to decide if the shipment will be accepted. If some containers are damaged or missing, a more detailed inspection is necessary. Check DA Pamphlet 710-2-2 for the procedures to follow when receiving and inspecting new supplies under the manual supply system. The TMs in the 38-L03 and 38-L32 series explain how to inspect and receive supplies under the automated system. Follow the procedures in AR 735-5 to report damages. Be sure your soldiers take the following steps when checking in supplies and equipment:

- Tally the containers against the receipt document.

- Compare the information on the receipt document (NSN, nomenclature, UI, and quantity) with the supplies received.

- If data do not match, circle the wrong entry and write the correct information from the container on the document. See Figure 7-7, page 7-8 for a sample of a corrected receipt document.

- Check the container for damage. Open all damaged containers immediately. If your DSU receives a multipack container, open it and check the contents. Do not open smaller packages within the containers unless they are damaged. If the container is open, check the contents. Make a list of all damages and shortages. Contact the supervisor of the receipt and storage section.

- After the shipment has been accepted and signed for, send copies of documents that are attached to the containers through your supervisor to the SCS. Be sure to attach a copy of the receipt document to the supplies

before you send them to the storage or issue section. If the document number (card columns 30 through 43) is for a unit, the receipt is dedicated for immediate issue to that customer. Deliver the D6S card to the SCS and MMC, and send the DD Form 1348-1 with the items for the unit. If the document number (card columns 30 through 43) is for the DSU, the receipt is for stockage. Enter the location in columns 46 through 50 of the D6S card. If no location is shown or if there has been a location change, place C in card column 79. DSUs using SARSS will input the receipt document using the keyboard or LOGMARS(T). If the information is for stockage, then a location issue ticket (PCN: AJH-112) is produced and indicates the recorded storage location of the item received. If a DOCKS location is indicated, then a location must be assigned using location maintenance process. If the receipt is for a unit, the receipt is dedicated for immediate issue. (NOTE: The receipt

is taken to the warehouse to issue the equipment to the unit. The receipt goes to the SCS and the MMC when the SARSS-1(I) close-out process is done at the end of the day.)

DOCUMENTS RECEIVED WITH DSS AND DSS AIR LINES OF COMMUNICATION SHIPMENTS

Your section will receive three types of documents with each DSS shipment--a receipt document, an in-transit data card if you also serve as a DSS distribution drop point, and a materiel receipt card. These are usually attached to the outside of the shipping container in a plastic envelope. Remove them carefully. The documents are used to record information that shows how well the DSS works. Make sure your soldiers understand how to handle these cards to ensure the in-transit data cards are returned to the

The image shows a DD Form 1348-1 (Shipment Receipt) with handwritten entries and several boxes highlighting specific corrections and counts. The form is divided into several sections:

- Header:** Contains document number (AK93T4 30 01 0041), project (YFGAK), and date (14 012).
- SHIPPED FROM:** NE TALLEY COUNT, DEPOT 17070.
- SHIP TO:** 132d MAINT BN, APO NY 34563.
- ITEM NOMENCLATURE:** X SPARK PLUG.
- QUANTITY CORRECTION:** A box highlights the quantity field with the handwritten value '00180' and an arrow pointing to the label 'QUANTITY CORRECTION'.
- RECEIVED BY AND DATE:** NSU 3012, 27 01 12.
- WAREHOUSE BY AND DATE:** BBT 3012.
- WAREHOUSE LOCATION:** YFGAK.
- REMARKS:** AA NEW ON CONTAINER, 5770-00-097-7176.
- QUANTITY:** A box highlights the quantity field with the handwritten value '1755' and an arrow pointing to the label 'QUANTITY CORRECTION'.
- NSN CORRECTION:** A box highlights the NSN field with the handwritten value '5770-00-097-7176' and an arrow pointing to the label 'NSN CORRECTION'.

Figure 7-7. DD Form 1348-1 showing tally count, quantity and NSN corrections, and receiving activity entries

Logistic Control Activity at the Presidio of San Francisco, CA, and the D6S receipt card to the Defense Automatic Addressing System.

Receipt Documents

The receipt documents received with DSS and DSS air lines of communication shipments are discussed earlier in this chapter.

In-Transit Data Cards

In-transit data cards are computer cards coded with information used to measure how long a container takes to reach its destination. Cards are marked with special DICs in the top left corner. These codes show whether the shipment was a CONUS or oversea shipment. They also show whether the items were shipped by air or by surface transportation. (See Figure 7-8 for a sample in-transit data card.) A DIC of TK6 means that the item was shipped by air, and a DIC of TK9 means surface shipment. These two codes are used only for oversea shipments. All cards used in CONUS are marked TK4 regardless of how the

supplies were shipped. When a DSS or DSS ALOC shipment arrives at your DSU, your soldiers should remove the in-transit data cards when they inspect the supplies for damage. They should then forward the cards to the SCS. The SCS will keypunch the delivery data onto the cards and forward them to the correct activity. If you receive a DSS or DSS ALOC shipment with a torn or damaged in-transit data card, make sure your soldiers send a copy of the shipping document, DD Form 1384 (Transportation Control and Movement Document), to the SCS with the damaged card. The SCS will use the information on the TCMD to make a new card. If the in-transit data card is missing, have your soldiers attach a note to the TCMD before it is sent to the SCS. The note should state what kind of data card (TK4, TK6, or TK9) is missing so that the SCS can make a new one. Check the top of the TCMD to find out what kind of card is missing. The words SURFACE or AIR should be printed on the form on oversea shipments. If the word listed is SURFACE, a TK9 card is missing. If the word AIR is listed, a TK6 card is missing. All shipments within the US have TK4 cards only.

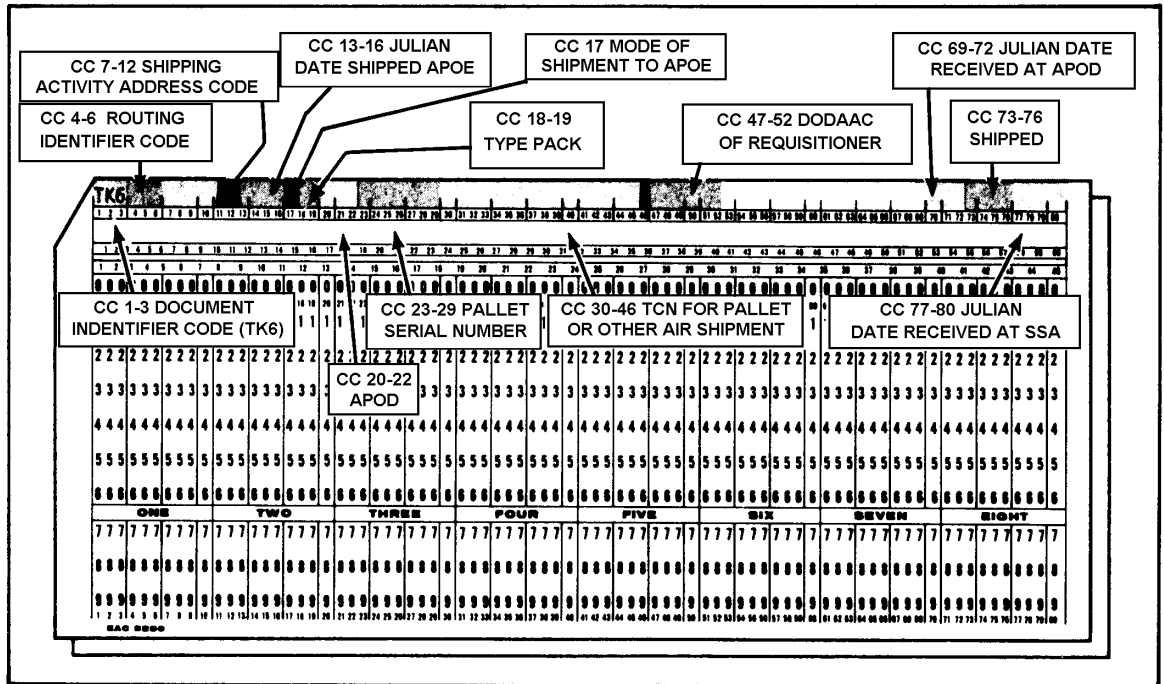

Figure 7-8. DSS air in-transit data card (DIC TK6)

Materiel Receipt Card

These are computer-printed cards that carry the same ordering information as the DD Form 1348-1 receipt document. These cards, like the in-transit data cards, have a special DIC in the top left corner. A materiel receipt card has a DIC of D6S. Therefore, they are sometimes called D6S cards. Your soldiers need to know how to process these cards so that the necessary information can be sent back to the Defense Automatic Addressing System. Each D6S card shows the quantity of supplies that was shipped. If the container is damaged or if some of the items are missing, your receiving and storage personnel must conduct an inventory. They must report all damages and shortages. Follow the guidelines given in AR 735-5. Notify the SCS of any mistakes so that a new D6S card with the correct quantities can be made. If your unit does not work under an automated system, send a list of all the information to be entered on each D6S card to the data processing center that supports your unit. The center will keypunch this information onto the D6S card and return it to the SCS. Under some systems, the materiel receipt card may be coded DWA instead of D6S. Follow the guidelines below and process the DWA card the same way as you would a D6S card. Figure 7-9 shows how a D6S card can be made from the information on a receipt document. If no D6S card was received with the materiel and the DSU is operating under DSS procedures, enter "No D6S" in block AA of the DD Form 1348-1. Verify the entries on the DD Form 1348-1. If there is a change in the primary storage location or a new location is established (no location previously assigned for the stock number), enter Loc Chgd or New Loc in block AA of the form and the prime location code in the Supplementary Address field. Also mark the warehouse locator file to show the new prime location. Send an annotated copy of the DD Form 1348-1 to the SCS. If there is no documentation with the materiel but the receipt can be identified as a receipt against an established due-in, prepare a materiel receipt card, DIC D6S, on DA Form 2765 with all available information. Include at least the stock number, UI, quantity received, document number, assigned storage location, DSU code, and condition code.

NON-DSS SHIPMENTS

As storage supervisor, you are also responsible for setting up procedures for processing non-DSS

shipments. Your soldiers will be handling supplies such as local purchases, fabricated items, and supplies from overseas reserve stocks and other DSUs. Most of these supplies are shipped with a DD Form 1348-1. However, your soldiers may at times be required to process DD Forms 250 and 1155 or other shipping documents that come with non-DSS supplies. Process these supplies in the same way as DSS shipments. Generally, shipments which are not MI LSTRIP and DSS do not have a PD listed on the receipt document. In this case, your section has up to two workdays to process the supplies for issue. If a PD is listed, follow the guidelines given earlier in this chapter. If the non-DSS shipment has no receipt document, contact the SCS for the advance copy of the document. If it is not on file, your soldiers should use the information on the shipping document and on the container to make a DA Form 2765. Figure 7-10 shows how to make a new receipt document from container information. Be sure your personnel check the NSN, quantity, and condition of the item. Discrepancies your personnel note while receiving supplies must be verified by the accountable officer or a designated representative. When the discrepancy has been verified, explain it on the receipt document. The purpose of reporting discrepancies is to find the cause, take corrective action, and prevent a recurrence. Report shipping type (item) packing, and in parcel post shipment discrepancies on SF 364 (Report of Discrepancy (ROD)), according to AR 735-5. Report transportation type discrepancies in shipments according to AR 55-38. Check the location against the locator file before the item is sent to the storage section. (Chapter 6 explains the locator system.) Send a copy of all receipt documents and any changes to the SCS.

SUBSTITUTE ITEMS

Sometimes a higher source of supply will ship your DSU a substitute item instead of the one requested. As storage supervisor, you must make sure that your receiving personnel know when they have received substitute items. Substitute items have a BH status code on the receipt document. This code is listed in columns 65 and 66 of the DD Form 1348-1. On a DA Form 2765-1, look for this code in the Advice Status block. Your personnel should follow the guidelines in Chapter 8 when they receive substitute items.

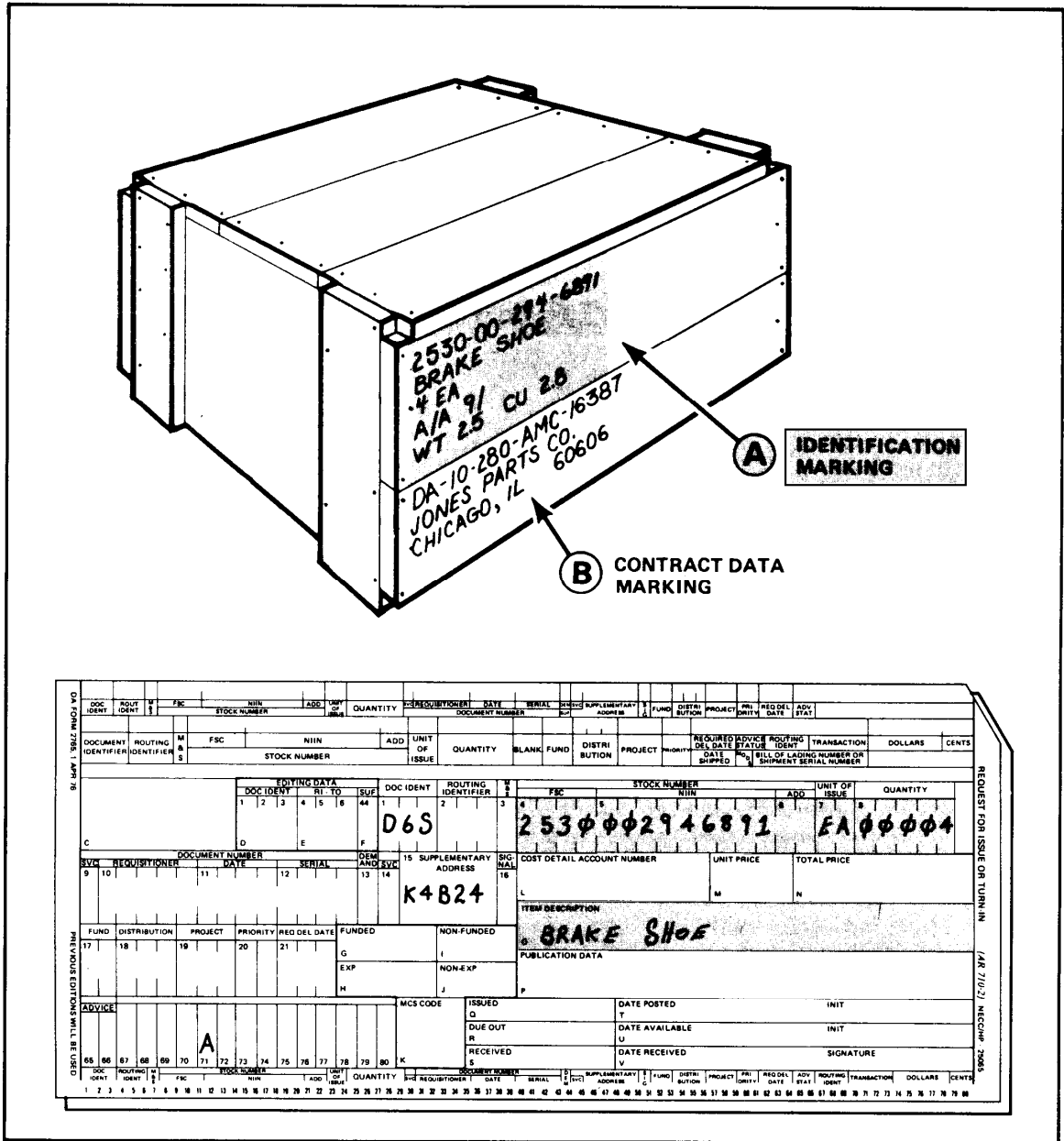

Figure 7-10. Receipt document made from container information, showing a temporary location

MISROUTED ITEMS

Sometimes your DSU will get an item that another DSU ordered. When this happens, your personnel should check the receipt or shipping

document to find out which DSU was to have received the item. If your DSU receives medical classified, or sensitive supplies that belong to

another unit, contact that unit at once. Have that unit pick up the items, or discuss how the items should be forwarded. Make sure your personnel report mistakes on SF 364. Instructions on when to use the form and how to fill it out are in AR 735-5. After your personnel finish the report, they should send the item to the shipping section of your DSU. The shipping section will send the item to the correct unit.

OVERAGES OR SHORTAGES AND DAMAGED ITEMS

The type of problems your personnel find when they unload and inspect materiel determines the kind of report they must send to the SCS. They will not have to decide who pays for the damages when they make the report. They will list only the damages and other related data. Transportation personnel usually decide who is responsible for the cost of the damages. Photographs of the damages are very helpful when details of the problem cannot be explained easily. These photos can also be used to document claims.

Supply Discrepancies

AR 735-5 establishes the policies and procedures prescribing the methods and conditions under which supply-type, packaging, and parcel post shipment discrepancies are reported. Supply-type or packaging discrepancies which are the responsibility of the shipper are reported on SF 364. The purpose of the SF 364 is to determine the cause of the discrepancies, have them corrected, and prevent recurrence.

Transportation Discrepancies

AR 55-38 provides procedures for reporting various transportation discrepancies. SF 361 (Transportation Discrepancy Report) is the form used. Do not prepare an SF 361 until shipment status has been received. Each consignee is responsible for preparing his reports on multistop shipments.

Reimbursement

AR 37-111, Chapter 3 provides instructions governing allowance of credits for the return of any stock fund material. It also provides details as to when no credit will be allowed.

TURN-INS FROM SUPPORTED UNITS

There are several reasons a unit may turn in items of supply. Some reasons for turn-ins are described below.

Items Serviceable or Unserviceable Due to FWT

Units generally turn in serviceable and unserviceable items due to FWT using DA Form 2765-1. SCS soldiers should use DA Pamphlet 710-2-2, Chapter 14, to edit requests for turn-in. Make sure your receiving personnel do not accept the DA Form 2765-1 on any accountable item unless the paperwork showing that the item has been inspected and classified by the quality assurance and maintenance sections is attached to the item. When your personnel process a DA Form 2765-1 as a turn-in document, they should enter the quantity turned in, the date of receipt, and their initials. It is important that they return a copy of this document to the unit turning in the item. The unit needs the completed turn-in document for its property records. After your personnel process the DA Form 2765-1, they should forward a copy to the SCS and send the supplies to the storage section. Refer to TM 38-L-32-12 for turn-in procedures under DS4.

Items Unserviceable Through Other Than FWT

Sometimes the classification portion of the maintenance section determines accountable items to be unserviceable for reasons other than FWT. In order to turn in these items, units must have approval and documentation showing that they are no longer responsible for the item. Check each DA Form 2765-1 to make sure that the authorization document is listed. The REMARKS block must contain the statement, "Excess-unserviceable—AR 735-5." AR 735-5 gives more details on the methods used to gain relief from responsibility for items.

Items Found on the Installation

Supplies and equipment that have been lost or abandoned can be turned in as property found on the installation if they do not appear on local units' property records. These items must be turned in immediately to the DSU that handles that class of supply. The DSU will accept this property as is. Units are not required to spend time

or money fixing or upgrading the items before they turn them in. The unit is also authorized to turn in the item without paperwork. When a unit turns in an item found on the installation, it does not receive turn-in credit for it. Once the item is accepted by your DSU, the quality assurance and maintenance sections must inspect and classify it. It is then sent to the receipt section where turn-in paperwork is prepared. Make sure your soldiers have written the NSN, quantity, nomenclature, condition code, and date of receipt on the turn-in document. Then send the supplies to the storage section and the documents to the SCS. The item found on the installation can be reissued to the

unit turning it in as a free issue (no billing) if the item is within that unit's authorized allowance. If the unit wants the item, it should follow the procedures listed in DA Pamphlet 710-2-1, Chapter 2, and DA Pamphlet 710-2-2, Chapter 14.

Other Turn-Ins

For information on how to process turn-ins of Army Reserve, National Guard, and ROTC units, check AR 710-2. AR 710-1 gives procedures for processing ARIs. Follow the guidelines in AR 37-111 to inventory property that is temporarily in use.

★ CHAPTER 8

STORING AND SELECTING SUPPLIES FOR ISSUE

Section I

Storing Supplies

SUPERVISING PERSONNEL

As storage supervisor, you must make sure your personnel store items correctly and issue them promptly. You must also be sure they maintain and safeguard the supplies in their area. Appendix D contains information helpful in caring for stored supplies. Set up housekeeping rules for all personnel to follow. Make each section responsible for its housekeeping. Make sure personnel follow a clean-as-you-go plan to keep all storage areas neat and accessible. Set aside certain times for trash collecting, sweeping, and

general cleaning. Include these tasks in your storage SOP. As storage supervisor, you will have to shift personnel within sections or between sections because of heavy work loads. Make sure that each individual assigned to you understands his major job and what he is responsible for. Remind your personnel that the shifts do not relieve them of their major responsibilities. Figure 8-1 shows a shortcoming, as extracted from DOD 4145.19-R-1.

SHORTCOMING	CAUSES	RESULTS
<p>Failure to accomplish daily warehouse housekeeping actions (such as stock alignment and closing lids).</p>	<ul style="list-style-type: none"> • Lack of management emphasis. • Lack of training. • Heavy workloads. • No routine schedule for examination or correction of such deficiencies. 	<ul style="list-style-type: none"> • Actions accumulate to major tasks. • Can create safety hazards. • General relaxation in discipline for accomplishing such actions. • Unsightly appearance.

Figure 8-1. Extract from DOD 4145.19-R-1 showing a shortcoming

STORING INCOMING SUPPLIES

When supplies are delivered to the receiving section, your personnel should first check them over for damages and then forward them to the stock locator and storage sections. These supplies should have receipt documents (DA Form 2765-1; DD Forms 1348-1, 250, or 1155; or PCN: AJH-112) with them. These forms help your soldiers identify the supplies so they can place them in the right storage location. If your DSU works under an automated system, some receipt documents for ASL items may list a storage location when you receive them. You can generally find the location on the Supplementary Address block of the receipt document. Sometimes no storage location codes will be on the documents, especially those for NSL items. In these cases, your soldiers will have to write the code on the form. They should enter the code in block F on the DD Form 1348-1. If this block already has the nine-digit depot location code listed, they should write your DSU location code in block 10. If the DD Form 1348-1 lists the wrong location code, cross it out and write the correct location in block 10. When your unit is operating under SARSS, the receipt document will NOT contain a storage location. When the receipt is processed into SARSS, the system will produce a location issue ticket which will identify how much of the receipt to store and all recorded storage locations. Also, the receipt should be entered into the SARSS computer before moving items to storage, since the system will produce the necessary documents should due-out release be required. Entering the receipt before moving to storage eliminates double handling of stocks. Storage personnel should go to the location listed and compare the information on the receipt document with the data on the bin label or locator placard. They must compare the NSNs, UI codes, nomenclatures (if listed), and condition codes to make sure they are putting the supplies in the right location. Next they should compare the supplies with the items already in the location to make sure they are the same. If data on the receipt document match those on the bin tag or location placard, compare the supplies. If the supplies are alike, this is the right location for the items. Before your personnel put the items in storage, they must check to see if there are any *shelf-life items*. A shelf-life item has

an expiration date listed on the package. They must store these items in the order they are to be issued. Compare the expiration dates of the items you are storing and the items already in the location. Store the oldest items in front. Issue these items first. Sometimes the receipt document will list more than one storage location code. When the items are shelf-life items, the code listed first is for supplies with the least amount of shelf life left. Check the expiration dates of the supplies you are storing to make sure you put them with the correct shelf-life group. Sometimes data on the receipt document do not match the bin or stock tag at the listed location. At other times, the data may match, but the new supplies will not match the items already stored. In either case, check the locator deck or the recorded ABF location on SARSS-1(I) to make sure the location code was listed correctly. If there is a mistake, line out the incorrect code, and write in the correct one. Put the items in the correct location. If the same location is listed for two different stock numbers, you must move one of the items involved. Each storage location should have items of only one NSN. Figure 8-2 shows a shortcoming, as extracted from DOD 4145.19-R-1.

Chapter 6 of this FM explains how to make location changes. Which supplies you will move and where you move them will depend on the size, quantity, and popularity of the items. After you move the supplies to a new location, be sure you make new bin or stock tags, as needed. Ensure your storage personnel write all the changes on the receipt document. After your personnel place the items in the correct storage location, they must sign and date the receipt document. Check to make sure the storage specialist signs and writes the date of storage in the Warehoused/Stored By block of DD Form 1348-1. DA Form 2765, DA Form 2765-1, DD Form 250, and DD Form 1155 have no block for this information. Your storage SOP must explain where to sign and date these forms when they accompany supplies to be stored. After you have checked the completed document, forward it to the SCS. Do not send PCN: AJH-112 to the SCS. It is filed according to your local SOP.

SHORTCOMING	CAUSES	RESULTS
<p>Placing different stock numbered items behind other stock numbered items in shelf and rack locations.</p>	<ul style="list-style-type: none"> • Lack of proper training of warehousing personnel. • Inattention to warehousing tasks • Lack of sufficient storage space for additional items being received coupled with poor enforcement of proper warehousing procedures. 	<ul style="list-style-type: none"> • Possible lost assets. • Delay in requisition fill. • May result in erroneous inventory counts.

Figure 8-2. Extract from DOD 4145.19-R-1

STORAGE HINT: Store serviceable and unserviceable items in different locations. Separating the items will make it easier to keep track of items for reorder purposes. Dividing them will also keep your personnel from issuing an unserviceable item as a new issue by mistake.

PROCESSING SUBSTITUTE ITEMS FOR STORAGE

Sometimes the supply depot will not have the item your DSU requested and will send a substitute item instead. As storage supervisor, you must make sure your personnel know how to tell when they receive a substitute item. Substitute items have the status code BH in card columns 65 and 66 on a DD Form 1348-1. Store the substitute item separately under the substitute NSN. Do not store it under the NSN of the item requested. Sometimes the location listed on the receipt document is for the original item. To make sure the substitute item is stored in the correct location, your personnel should take the following steps:

- Check the locator deck or the recorded ABF location on SARSS-1(I) to see if the NSN of the substitute item is listed.
- If the NSN of the substitute item is listed, your

personnel should compare the location code on the receipt document or that on the location/issue ticket with the one on the locator deck. If the location codes are the same, then the code listed on the receipt document or location/issue ticket is correct. Your personnel should place the item in the location listed and forward the completed document to the SCS. The location/issue ticket is filed.

- If the NSN on the receipt document is listed in the locator deck or recorded ABF location but the locations do not match, your personnel should change the location shown on the receipt document. Then they should send the item to the corrected location for storage and the receipt document to the SCS.

- If the NSN on the receipt document is not listed in the locator file or the recorded ABF location, the locator clerk must assign a new location. Your personnel must also make a new locator card and matching stock placard or bin tag. (See instructions in Chapter 6.) Your personnel should check the receipt document to make sure the correct location has been added. Then they should send the supplies, with a copy of the corrected document, to the storage section. After they place the item in the new storage location, they should forward the completed receipt document to the SCS. File the location/issue ticket according to local SOP.

IDENTIFYING INCORRECTLY STORED ITEMS

When your personnel go to a storage location to select an item for issue, they sometimes find that the item stored in the location is not the item listed on the bin tag, location placard, or locator card. At other times, they find that the condition of the item changed while in storage. Many problems can occur as a result of incorrect identification. Figure 8-3 shows a

shortcoming, as extracted from DOD 4145.19-R-1. When your personnel find that the information on the bin tag or locator card is not correct, they should change the tag or card to correct it. Then they should notify the stock records section of the change. The stock records section personnel need to correct their accounting records.

SHORTCOMING	CAUSES	RESULTS
<p>Incorrect item or quantity.</p>	<ul style="list-style-type: none"> • Inadequate lighting. • Duplicate MROs. • Incorrect item or location identification. • Incorrect data on forms, labels or placards. • Failure to consider unit of issue or unit of measure quantity. • Mixed stock and failure to recognize such. • Inadequate training of stock selection personnel. 	<ul style="list-style-type: none"> • Imbalance of stock records. • Increase in inventory investigation. • Possible increase in warehouse denials. • Incorrect item or quantity possibly shipped to the requisitioner. • Possible delay in supply fill. • Possible waste of assets and processing resources. • Possible unnecessary transportation costs.

Figure 8-3. Extract from DOD 4145.19-R-1 showing incorrect item or quantity

RELOCATING STORED SUPPLIES

Your section is responsible for storing different types and sizes of items. As storage supervisor, you may decide to rearrange these items to make better use of your storage space. You may need to relocate supplies because you receive a catalog change notice or a notice of consolidation.

Rearrange to Save Space

When you decide to rearrange to save space, you and your personnel should take the following steps:

- Select a new storage location and make a new bin label or stock tag.
- Put all new receipts of the item in the new location.
- Mark this additional listing on the old locator card.
- Make a new locator card and a location change card.
- Send the location change card to the SCS.
- Check to make sure the old locator card was

removed from the locator dock and discarded. See Chapter 6 for information on how to make new locator cards, locator change cards, and location addition cards.

- When the DSU is operating under SARSS-1(I), SARSS will initiate the location maintenance process.

Relocate Because of a Change or Consolidation Notice

Sometimes you will need to relocate supplies because you receive a catalog change notice or a notice of consolidation. The catalog change notice is a cross-reference listing that your storage section can use to identify stock numbers and UI changes. This notice tells you when the stock number is no longer valid. It also tells where items with the old stock number are stored: SARSS users follow the procedures in ADSM18-L19-AJH-BUR-EM. DS4 users follow the procedures in TM 38-L32-13 for the catalog change process.

Section II

Selecting Items from Storage

CHOOSING ITEMS FOR ISSUE

As storage supervisor, you are responsible for seeing that the correct supplies are selected for issue. When a unit requests an item, the SCS personnel make an MRO for the storage section. They compile these MROs and send them to your storage section once or twice daily. An MRO lists the item and the quantity requested, the storage location, and the priority of the request. Check and sort the MROs before you give them to your storage specialists to process. This sorting makes it easier for them to issue the correct item within the proper time limits. The procedures they use

to process MROs for issues under DS4 are in TM 38-L32-12, Chapter 3. Chapter 6 of the TM covers procedures for shipment.

SORTING MATERIEL RELEASE ORDERS BY PRIORITY

Sort the MROs into groups by their PDs. (The PD is in columns 60 and 61.) The priority of a request tells how urgently the item is needed for the unit mission. The lower the PD, the more urgently the item is needed. For a complete description of the priority issue system,

see AR 725-50, Chapter 2. Group the MROs into three stacks. Put PDs 01,02, and 03 (priority requests) into stack 1. Put PDs 04 through 08 into stack 2. Put PDs 09 through 15 into stack 3. Put MROs with a PD of 01 on top of stack 1. Put MROs with PDs 02 and 03 on the stack next. Put MROs with a PD of 04 on top of stack 2, and put MROs with PDs 05 through 15 next. If two MRO documents have the same priority, check the required delivery date. Place the MRO with the earlier delivery date on top. *IF ANY OF THE PRIORITY MROs (PDs 01, 02, or 03) HAVE 999 IN THE REQUIRED DELIVERY BLOCKS, PLACE THEM ON TOP OF THE STACK. THESE MROs ARE FOR NMCS ITEMS AND MUST BE ISSUED FIRST.*

SORTING MATERIEL RELEASE ORDERS BY STORAGE LOCATION

Once you sort all MROs into stacks by their PDs, you then need to sort these stacks by warehouse location. Look at the first letter or number of the location code on each MRO in the first stack. (The location code is listed in columns 46 through 50 and in block F on the DD Form 1348-1 MRO. On the DA Form 2765 MRO, the code is listed in card columns 46 through 50. It is located in the upper left-hand corner of a SARSS-1(I)-produced MRO.) If your warehouse locations are lettered, sort the MROs into alphabetical order. If the locations are numbered, sort them into counting order. When two MROs have the same first letter or number, arrange them in order of the second letter or number. After you sort the MROs by priority and location, give them to your warehouse personnel. They will use the MROs to identify the items that are to be issued.

Remember, high-priority items must be issued within set time frames.

PULLING ITEMS FROM STOCK

Once your warehouse personnel locate the items listed on the MROs, they will use two methods to decide exactly which items in a location are to be pulled for issue. The two methods are progressive and selective.

Progressive Method

Your personnel should use this method for all items with a shelf-life code of zero. This method is also called the first-in, first-out method. When they use this method, they select the items that have been in the storage locations the longest. To make reaching the oldest items easier, be sure your warehouse personnel store new items to the back of the storage locations.

Selective Method

Your personnel should use this method for items that have expiration dates or shelf-life codes. Under this method, they choose items by their dates of pack or expiration dates. These dates generally are listed on the supply containers. Your personnel should issue the items with the closest expiration dates or oldest dates of pack first. If your personnel receive an MRO with an advice code of 2G, they must not use the selective method. The 2G advice code means that the unit wants the item with the newest date of pack. Even when an advice code of 2G is not listed on the MRO, your personnel should try to make sure that they issue supplies with enough shelf life left to fit the unit's mission and needs. If they issue film, batteries, or petroleum products, they should make sure the items are not near their expiration dates.

Section III

Processing Supplies for Issue

PROCESSING MATERIEL RELEASE ORDERS

When a unit requests an item that is in storage, the storage section receives an MRO from the SCS. An

MRO lists the item requested, its NSN, quantity, the priority of the request, the item condition, the storage

location, and the name of the unit requesting the item. Your personnel will generally handle several kinds of MRO documents. They are DA Form 2765, DD Form 1348-1, PCN: AJH-101, and PCN: AJH-102. Use DA Form 2765 for items currently in stock. Use DD Form 1348-1 to issue items that were not available when the request was processed, when the supplies are shipped and transfers are made between stock record accounts, and when items are turned into the Defense Reutilization and Marketing Office. If your DSU operates under DS4, check TM 38-L32-12 for guidelines on how to process MROs. If your DSU operates under SARSS-1(I), see ADSM 13-L19-AJH-BUR-UM for procedures on the use of MRO forms. Your personnel can tell when these forms are used as MROs by checking the letters in the Document Identifier block. An MRO has an A5_-series Document Identifier Code. These codes and their explanations are listed in AR 725-50, Appendix G. MRO codes are A51, A52, A54, A55, A57, A5A, A5B, A5D, and A5E. Table 8-1 lists the amount of time your DSU is given to process each MRO according to its PD.

PROCESSING A DA FORM 2765 MATERIEL RELEASE ORDER

When your personnel receive a DA Form 2765 MRO from the SCS, there are steps they should take. These steps are described in this paragraph.

- Check the locator deck for the correct location code if the MRO does not show a storage location and write this code in block C on the DA Form 2765.
- Check the data on the MRO against the data on the bin/stock tags. Also check the data against the information on the items in storage to make sure the correct item for issue is pulled
- Remove the quantity of the item listed on the MRO, and send it to the issue/shipping section with a copy of the MRO.

- Place the MRO and supplies at the customer unit pickup point if the total quantity is on hand. **NOTE:** Sometimes your personnel should NOT send supplies listed on the MRO to the issue/shipping section. If the supplies are very large, heavy, or bulky (such as lumber, cement, or other construction materials), let the unit pick up the supplies directly from the storage location. This keeps your personnel from having to use time and MHE to take the supplies to the issue point. Be sure you setup guidelines about issuing and loading these kinds of materials directly from the storage location. Include these instructions in your storage SOP.

PROCESSING A DD FORM 1348-1 MATERIEL RELEASE ORDER

When your personnel receive a DD Form 1348-1 MRO from the SCS, they should take the following steps:

- If the MRO shows no storage location, they should check the locator deck for the correct location code. They should write this code in block F.
- Next, they should compare the data on the DD Form 1348-1 with the data on the bin labels. They must also check the supplies in the storage location to make sure they match the item description and NSN.
- If the data match, they should remove the quantity listed on the MRO and send it to the issue/shipping section with a copy of the MRO (see the previous NOTE.)
- They must make sure the Julian date (Appendix E) and the initials of the person who pulled the item from storage are written in block 1 (Selected By and Date block). If the information is missing, your issue/shipping personnel should contact the storage personnel so that the mistake can be corrected.

Table 8-1. MRO processing times

PRIORITY DESIGNATOR	TIME LIMITATION
01 through 03	Must be processed within 24 hours from the time received. DA Pam 710-2-2
04 through 15	Must be processed within two workdays from time received. DA Pam 710-2-2

PROCESSING A SARSS-PRODUCED MATERIEL RELEASE ORDER

When your personnel receive the SARSS-produced MROs, they should take the following steps:

- Proceed to the location that is printed in the location field. If there is no location, contact your storage supervisor.
- Next, they should compare the data on the SARSS-produced MROs with the data on the bin label.
- They should also check the supplies in the storage location to make sure they match the item description and NSN. If the data match, they should remove the quantity listed on the MRO and send it to the issue/shipping section with a copy of the MRO (see previous NOTE).
- They must make sure the Julian date and the initials of the person are written on the line "pick/pull by" on the PCN: AJH-101.

PROCESSING MATERIEL RELEASE ORDERS FOR SENSITIVE AND PILFERABLE ITEMS

Your storage section should get two copies of each MRO for sensitive and pilferable items from the SCS, DMMC, or the SARSS document control section. Instructions for identifying MROs for sensitive and pilferable items should be outlined in your DSU's SOP. When your personnel receive an MRO for a sensitive or pilferable item, use the following guidelines:

- Check to make sure the storage location listed is correct. If a storage location is not listed or is invalid, enter the one listed in the locator deck or contact the storage supervisor.
- Proceed to the storage location. Make sure the item in storage matches the data on the bin label and the MRO.
- Select the quantity listed on the MRO, and send the supplies with the MRO attached to the issue section. The issue section will place the item in the security cage. (NOTE: DSUs without security cages should separate the quantity listed on the MRO from the rest of the supplies in the storage location. They should not remove the items from the storage location.)

- Initial and date the MRO. If the supplies have serial numbers, write them on the MRO where they can be seen easily.

- Pull the supplies from the security cage or storage location when the unit arrives to pickup the supplies. The issue/shipping section will maintain one copy of the MRO.

- Make sure the customer compares the serial numbers on the supplies with those on the MRO.

- Check to see that the customer signs both copies of the MRO. His signature shows that he agrees that the quantity and any serial numbers listed on the MRO are correct.

- Give one copy of the MRO to the customer to use as a receipt document.

Figure 8-4 has examples of MROs showing issue of sensitive or pilferable items.

PROCESSING MATERIEL RELEASE ORDERS FOR PARTIAL ISSUES

Sometimes your DSU will not have the quantity of supplies in stock that a unit requests. Before your personnel issue the items on hand, they must make sure that the additional quantities of the items were not stored in a wrong location or that they were not overlooked. They should search the bins and stacks above, below, and next to the location listed on the MRO. They should also check the locator deck to see if there is more than one location listed for the items. If they still cannot find enough supplies, they will have to make a partial issue. When making a partial issue, your storage personnel should take the following steps:

- Prepare a manual MRO or DA Form 2765 and write "partial release" in block O.

- Place the manual MRO and supplies in the customer's pickup bin.

- Forward the MRD to the SCS and MMC for review and machine processing.

Figure 8-5, page 8-10 shows a manually prepared MRO for a partial release.

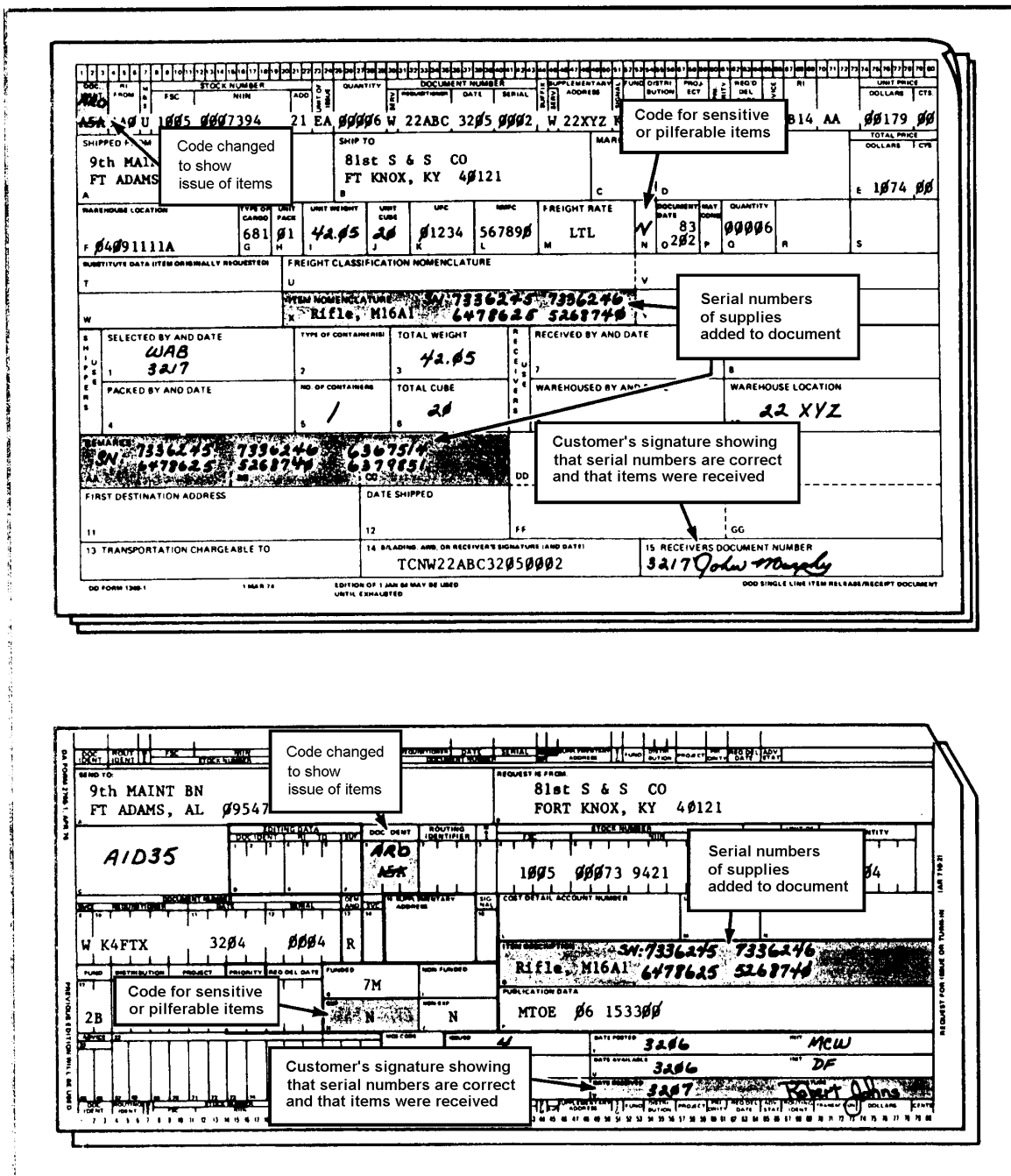

Figure 8-4. MROs showing issue of sensitive or pilferable items

A5A	2530 042946891		EA00008		WK4B6A3064 0307 W		LEVXB7NSI12341										
DOCUMENT IDENTIFIER	ROUTING IDENTIFIER	PSC	ISSN	ADD	UNIT OF ISSUE	QUANTITY	BLANK	FUND	DISTRN BUTION	PROJECT	ISSUED DATE	ISSUED QUANTITY	ISSUED PRICE	ISSUED VALUE	TRANSACTION	DOLLARS	CENTS
C	1 2 3 4 5 6 7 8 9 10 11 12 13 14 15 16 17 18 19 20 21 22 23 24 25 26 27 28 29 30 31 32 33 34 35 36 37 38 39 40 41 42 43 44 45 46 47 48 49 50 51 52 53 54 55 56 57 58 59 60 61 62 63 64 65 66 67 68 69 70 71 72 73 74 75 76 77 78 79 80 81 82 83 84 85 86 87 88 89 90 91 92 93 94 95 96 97 98 99 00		A5A		P2530002946891		EA00008										
D	1 2 3 4 5 6 7 8 9 10 11 12 13 14 15 16 17 18 19 20 21 22 23 24 25 26 27 28 29 30 31 32 33 34 35 36 37 38 39 40 41 42 43 44 45 46 47 48 49 50 51 52 53 54 55 56 57 58 59 60 61 62 63 64 65 66 67 68 69 70 71 72 73 74 75 76 77 78 79 80 81 82 83 84 85 86 87 88 89 90 91 92 93 94 95 96 97 98 99 00		WK4B6A3064 0307 W		K4GE4		PARTIAL RELEASE										
E	1 2 3 4 5 6 7 8 9 10 11 12 13 14 15 16 17 18 19 20 21 22 23 24 25 26 27 28 29 30 31 32 33 34 35 36 37 38 39 40 41 42 43 44 45 46 47 48 49 50 51 52 53 54 55 56 57 58 59 60 61 62 63 64 65 66 67 68 69 70 71 72 73 74 75 76 77 78 79 80 81 82 83 84 85 86 87 88 89 90 91 92 93 94 95 96 97 98 99 00		12341		A A												

A5A	2530 042946891		EA00008		WK4B6A3064 0307 W		LEVXB7NSI12341										
DOCUMENT IDENTIFIER	ROUTING IDENTIFIER	PSC	ISSN	ADD	UNIT OF ISSUE	QUANTITY	BLANK	FUND	DISTRN BUTION	PROJECT	ISSUED DATE	ISSUED QUANTITY	ISSUED PRICE	ISSUED VALUE	TRANSACTION	DOLLARS	CENTS
C	1 2 3 4 5 6 7 8 9 10 11 12 13 14 15 16 17 18 19 20 21 22 23 24 25 26 27 28 29 30 31 32 33 34 35 36 37 38 39 40 41 42 43 44 45 46 47 48 49 50 51 52 53 54 55 56 57 58 59 60 61 62 63 64 65 66 67 68 69 70 71 72 73 74 75 76 77 78 79 80 81 82 83 84 85 86 87 88 89 90 91 92 93 94 95 96 97 98 99 00		A5A		P2530002946891		EA00008										
D	1 2 3 4 5 6 7 8 9 10 11 12 13 14 15 16 17 18 19 20 21 22 23 24 25 26 27 28 29 30 31 32 33 34 35 36 37 38 39 40 41 42 43 44 45 46 47 48 49 50 51 52 53 54 55 56 57 58 59 60 61 62 63 64 65 66 67 68 69 70 71 72 73 74 75 76 77 78 79 80 81 82 83 84 85 86 87 88 89 90 91 92 93 94 95 96 97 98 99 00		WK4B6A3064 0307 W		K4GE4		PARTIAL RELEASE										
E	1 2 3 4 5 6 7 8 9 10 11 12 13 14 15 16 17 18 19 20 21 22 23 24 25 26 27 28 29 30 31 32 33 34 35 36 37 38 39 40 41 42 43 44 45 46 47 48 49 50 51 52 53 54 55 56 57 58 59 60 61 62 63 64 65 66 67 68 69 70 71 72 73 74 75 76 77 78 79 80 81 82 83 84 85 86 87 88 89 90 91 92 93 94 95 96 97 98 99 00		12341		A A												

Figure 8-5. MROs corrected to show partial issue of item requested

PROCESSING MATERIEL RELEASE DENIALS

An MRD (also known as a warehouse denial) is a written notice your storage section makes when all or part of the requested supplies is not on hand. This notice goes to the issue section and SCS. You need to make sure your personnel are careful when they check for the supplies. When they issue an MRD, they are signifying that the supplies listed on the stock record account as being in storage are not on hand. Sometimes your personnel might issue an MRD by mistake when there are supplies on hand. Some of the causes for these mistakes are listed in Figure 8-6. Your personnel must check for these before they make an MRD.

PROCESSING MATERIEL RELEASE DENIALS FOR PARTIAL ISSUES

When only part of the supplies is available for issue, your personnel must prepare a manual MRD for the amount that is not on hand. Then they issue the supplies on hand, using the MRO that was received from the SCS. Storage personnel then make an MRD for the quantity denied. To do this, they do the following:

- Line out the A5_ on the original MRO.
- Write A6_ in the DIC in block 1. (AR 725-50 lists and explains A6_ codes.)
- Write the quantity denied entered in block 8 on the original MRO.

- Prepare a manual MRO on DA Form 2765 duplicating the original MRO but showing the quantity issued, and write "partial release" in block O. Storage personnel then place the manual MRO and the supplies in the customer's pickup bin. They send the MRD to the SCS and MMC.

PROCESSING MATERIEL RELEASE DENIALS FOR COMPLETE DENIALS

When none of the requested supplies are on hand, your personnel must change the MRO to an MRD. It is important that your storage personnel understand that they must check all possible sources for the missing supplies before they pass the MRD onto the next level. When personnel pass on the MRD, they verify that all areas assigned to them have been checked thoroughly. To make the MRD, storage personnel should do the following:

- Line out the DIC A5_ on the DA Form 2765 or the DD Form 1348-1 MRO.
- Write in the A6_ code for an MRD. AR 725-50 lists and explains the MRD codes.
- Send the MRD through the storage section's chain of command. The storage supervisor will send the MRD to the SCS so that the missing supplies can be ordered.

SHORTCOMING	CAUSES	RESULTS
Quantity in storage does not match quantity listed on stock account records.	<ul style="list-style-type: none"> • Incorrect inventory count. • Relocation of stock taking place. • Delay in placing materiel in location. • Erroneous location recorded. • Erroneous quantity, stock number, owner, or condition code recorded on receipt actions. 	<ul style="list-style-type: none"> • Special inventory required. • Delay or failure in supply fill. • Additional manpower or paperwork requirements. • Materiel release denial.

Figure 8-6. Extract from DOD 4145.19-R-1 showing shortcoming in quantity record

PROCESSING MATERIEL RELEASE ORDER LIST (SUPPLY MANAGEMENT REPORT)

As storage supervisor, you may have to check and update the MRO list. The storage activity uses the list to verify MROs. Storage activity personnel use the list to show the quantity, date pulled, and the person who pulled the item. They also annotate the list to indicate denials for full or partial quantity. The storage activity manager returns one annotated copy of the list to the MMC and SCS and retains his copy for one year.

PROCESSING MROS FOR PARTIAL ISSUE OR DENIALS IN SARSS

When only part or none of the supplies requested are on hand or available for issue, your personnel must change SARSS-produced MROs to MRDs. To change an MRO to an MRD, You must take the following steps:

- Line out A5_ on the original MRO.
- Write A6_ above the A5_.
- Write the quantity denied in the quantity denied block.
- Use an annotated copy as input to the denial process.
- If partial MRDs occur, attach a copy of the original A5_ to the item of supply, and then forward the A5_ to the issue section.

ISSUING A MATERIEL RELEASE DENIAL

An MRD is a supply failure. It reflects an accounting mistake, a misplaced item, an incorrect stock locator deck, or stolen items. Your personnel should search all areas carefully before they pass the MRD on to the next level. Some of the mistakes they should look for include duplicate receipt records and wrong items listed on receipt records. They should check the

stock locator cards for mistakes in NSN, location, or name of item. They should also check for changed NSNs that were not recorded and a listing with part number or service stock number in place of the NSN. As soon as your section issues an MRD, your DSU has only 48 hours to find out the reasons for the denial. Conduct an inventory, and correct the stock records that are involved. As storage supervisor, you coordinate the actions of your sections with those of other sections of the DSU during the inventory and the following adjustments. You will be the first supervisor notified of the MRD. When you find that an MRD needs to be issued, you should take the following steps:

- Order the receiving sections to freeze all incoming receipts with that NSN.
- Order the stock records section to freeze the stock record. This will keep that section from issuing any more MROs for the NSN involved.
- Collect all MROs with that NSN that have not been processed.
- Have your storage personnel check the storage section for mistakes and the missing items.
- Have your personnel check the troubleshooting procedures listed in Table 8-2 to find out why the supplies are not in stock.
- Have your personnel take a physical inventory of the missing item after they have thoroughly researched the MRD. Physical inventory procedures are in Chapter 10.
- Notify the stock records section personnel that you need to conduct an inventory, and tell them the NSN involved. You will need to get an inventory voucher number from them before you begin.
- List the inventory voucher number on all adjustment documents you use to make any changes to the stock records. Give this adjustment document to the SCS so it can make all changes necessary.

Table 8-2. MRD troubleshooting procedures

1. Search the locations listed on the MRO and all locations as above, below, and next to them.
2. Check the locator deck to see if there are any other locations listed for the items that are not shown on the MRO.
3. Examine the history of past location changes and NSN changes for clues to other storage locations.
4. Search the entire storage and receiving areas for misplaced items.
5. Check with the stock records section to see if a computer or accounting error occurred.
6. Check the receipt section. Sometimes documents are backlogged in the section. When this happens, a receipt document for the item may have been forwarded to the stock records section before the items were placed in stock.
7. Check the quality assurance and technical inspection sections. In some cases, the missing items may be field turn-ins that have been logged in as received but that are being inspected before they are sent to storage.

FROM	TO	UNIT	QUANTITY	UNIT PRICE	TOTAL PRICE
W U	EA	80006	21	179.00	3759.00
SHIP TO 81st S & S CO FT KNOX, KY 40121		SHIP FROM 9th MAINT FT ADAMS			
Code changed to show issue of items		Code for sensitive or pilferable items			
FREIGHT CLASSIFICATION NOMENCLATURE Rifle, M16A1		TOTAL WEIGHT 42.05		RECEIVED BY AND DATE John Murphy	
DATE SHIPPED 3 MAR 74		TOTAL CUAB 20		RECEIVED BY AND DATE John Murphy	
FIRST DESTINATION ADDRESS TCNW22ABC3205002		DATE SHIPPED		RECEIVED BY AND DATE John Murphy	

SHIP TO	SHIP FROM	UNIT	QUANTITY	UNIT PRICE	TOTAL PRICE
W K4FTX	EA	80006	21	179.00	3759.00
SHIP TO 81st S & S CO FORT KNOX, KY 40121		SHIP FROM 9th MAINT BN FT ADAMS, AL 09547			
Code changed to show issue of items		Code for sensitive or pilferable items			
FREIGHT CLASSIFICATION NOMENCLATURE Rifle, M16A1		TOTAL WEIGHT 42.05		RECEIVED BY AND DATE John Murphy	
DATE SHIPPED 3 MAR 74		TOTAL CUAB 20		RECEIVED BY AND DATE John Murphy	
FIRST DESTINATION ADDRESS TCNW22ABC3205002		DATE SHIPPED		RECEIVED BY AND DATE John Murphy	

Figure 8-15. MROs showing issue of sensitive or pilferable items

make sure that the additional quantities of the items were not stored in a wrong location or that they were not overlooked. They should search the bins and stacks above, below, and next to the location listed on the MRO. They should also check the locator deck to see if there is more than one location listed for the items. If they still cannot find enough supplies, they will have to make a partial issue. When making a partial issue, your storage personnel should take the following steps:

- Prepare a manual MRO or DA Form 2765 and write "partial release" in block O.

- Place the manual MRO and supplies in the customer's pickup bin.
- Forward the MRD to the SCS and MMC for review and machine processing.

Figure 8-16 shows a manually prepared MRO for partial release.

PROCESSING MATERIEL RELEASE DENIALS

An MRD (also known as a warehouse denial) is a written notice your storage section makes when all or part of the requested supplies is not on hand.

The figure shows two DA Form 2765 (MRO) forms. The top form is a blank template with handwritten numbers. The bottom form is filled out with handwritten data, including 'A5A', 'P2530002946891', 'EA00004', 'WK4FB630640307', 'K4GE4', and 'PARTIAL RELEASE' in block O.

Figure 8-16. MROs corrected to show partial issue of item requested

This notice goes to the issue section and the SCS. You need to make sure your personnel are careful when they check for the supplies. When they issue an MRD, they are signifying that the supplies listed on the stock record account as being in storage are not on hand. Sometimes your personnel might issue an MRD by mistake when there are supplies on hand. Some of the causes for these mistakes are listed in Figure 8-17. Your personnel must check for these before they make an MRD.

PROCESSING MATERIEL RELEASE DENIALS FOR PARTIAL ISSUES

When only part of the supplies is available for issue, your personnel must prepare a manual MRD for the amount that is not on hand. Then they issue the supplies on hand, using the MRO that was received from the SCS. Then storage personnel must make an MRD for the quantity denied. To do this, they do the following:

- Line out the A5_{on} on the original MRO.
- Write A6_{in} in the DIC in block 1. (AR 725-50 lists and explains A6_{codes}.)
- Write the quantity denied in block 8 on the original MRO.
- Prepare a manual MRO on DA Form 2765 duplicating the original MRO but showing the quantity issued and write “partial release” in block O.

Storage personnel then place the manual MRO and the supplies in the customer’s pickup bin. They send the MRD to the SCS and MMC. Figures 8-18 and 8-19 show how to make an MRD

for partial issue using the information on the MRO.

PROCESSING MATERIEL RELEASE DENIALS FOR COMPLETE DENIALS

When none of the requested supplies are on hand, your personnel must change the MRO to an MRD. Figure 8-20 shows how to do this. It is important that your storage personnel understand that they must check all possible sources for the missing supplies before they pass the MRD on to the next level. When personnel pass on the MRD, they verify that all areas assigned to them have been checked thoroughly. To make the MRD, storage personnel should do the following:

- Line out the DIC A5_{on} on the DA Form 2765 or the DD Form 1348-1 MRO.
- Write in the A6_{code} for an MRD. AR 725-50 lists and explains the MRD codes.
- Send the MRD through the storage section’s chain of command. The storage supervisor will send the MRD to the SCS so that the missing supplies can be ordered.

PROCESSING MATERIEL RELEASE ORDER LIST (SUPPLY MANAGEMENT REPORT)

Another of your duties as storage supervisor may be to check and update the MRO list that the SCS will periodically send to your storage section. This list is prepared in PD sequence. When two or more MROs have the same PD, list them in location order. The list gives information on all MROs processed within the time frame listed, generally one month. Your personnel will need to

SHORTCOMING	CAUSES	RESULTS
Quantity in storage does not match quantity listed on stock account records.	<ul style="list-style-type: none"> • Incorrect inventory count. • Relocation of stock taking place. • Delay in placing materiel in location. • Erroneous location recorded. • Erroneous quantity, stock number, owner, or condition code recorded on receipt actions. 	<ul style="list-style-type: none"> • Special inventory required. • Delay or failure in supply fill. • Additional manpower or paperwork requirements. • Materiel release denial.

Figure 8-17. Extract from DOD 4145.19-R-1

DA FORM 2765, 1 APR 76

ASAANS02530 002946891 EA00009 WK4B6A3064 0307 WK4GE4LEVKB7NSI120802B AA

DOC IDENT	ROUT IDENT	FSC	STOCK NUMBER	ADD	UNIT OF ISSUE	QUANTITY	BLANK	FUND	DISTRIB	PROJECT	PRI	REQ DEL DATE	ADV STAT	ROUTING IDENT	TRANSACTION	DOLLARS	CENTS																																																																															
<table border="1"> <tr> <td colspan="4">EDITING DATA</td> <td>DOC IDENT</td> <td>ROUTING IDENTIFIER</td> <td colspan="3">STOCK NUMBER</td> <td>ADD</td> <td>UNIT OF ISSUE</td> <td>QUANTITY</td> <td colspan="5"></td> </tr> <tr> <td>1</td><td>2</td><td>3</td><td>4</td> <td>5</td><td>6</td> <td>7</td><td>8</td><td>9</td><td>10</td> <td>11</td><td>12</td> <td>13</td><td>14</td><td>15</td><td>16</td><td>17</td><td>18</td> </tr> <tr> <td></td><td></td><td></td><td></td> <td></td><td></td> <td></td><td></td><td></td><td></td> <td></td><td></td> <td></td><td></td><td></td><td></td><td></td><td></td> </tr> </table>																	EDITING DATA				DOC IDENT	ROUTING IDENTIFIER	STOCK NUMBER			ADD	UNIT OF ISSUE	QUANTITY						1	2	3	4	5	6	7	8	9	10	11	12	13	14	15	16	17	18																																													
EDITING DATA				DOC IDENT	ROUTING IDENTIFIER	STOCK NUMBER			ADD	UNIT OF ISSUE	QUANTITY																																																																																					
1	2	3	4	5	6	7	8	9	10	11	12	13	14	15	16	17	18																																																																															
<table border="1"> <tr> <td>9</td><td>10</td><td colspan="4">DOCUMENT NUMBER</td> <td>15</td><td>SUPPLEMENTARY ADDRESS</td> <td>SIG-NA</td><td colspan="2">COST DETAIL ACCOUNT NUMBER</td> <td>UNIT PRICE</td><td>TOTAL PRICE</td> <td colspan="4"></td> </tr> <tr> <td></td><td></td><td></td><td></td><td></td><td></td> <td></td><td></td> <td></td><td></td><td></td><td></td><td></td><td colspan="4"></td> </tr> <tr> <td colspan="17">ITEM DESCRIPTION</td> </tr> <tr> <td colspan="17">MRO</td> </tr> </table>																	9	10	DOCUMENT NUMBER				15	SUPPLEMENTARY ADDRESS	SIG-NA	COST DETAIL ACCOUNT NUMBER		UNIT PRICE	TOTAL PRICE																						ITEM DESCRIPTION																	MRO																												
9	10	DOCUMENT NUMBER				15	SUPPLEMENTARY ADDRESS	SIG-NA	COST DETAIL ACCOUNT NUMBER		UNIT PRICE	TOTAL PRICE																																																																																				
ITEM DESCRIPTION																																																																																																
MRO																																																																																																
<table border="1"> <tr> <td>FUND</td><td>DISTRIBUTION</td><td>PROJECT</td><td>PRIORITY</td><td>REQ DEL DATE</td><td>FUNDED</td><td>NON-FUNDED</td><td colspan="10">PUBLICATION DATA</td> </tr> <tr> <td></td><td></td><td></td><td></td><td></td><td></td><td></td><td colspan="10"></td> </tr> <tr> <td></td><td></td><td></td><td></td><td></td><td></td><td></td><td colspan="10"></td> </tr> </table>																	FUND	DISTRIBUTION	PROJECT	PRIORITY	REQ DEL DATE	FUNDED	NON-FUNDED	PUBLICATION DATA																																																																								
FUND	DISTRIBUTION	PROJECT	PRIORITY	REQ DEL DATE	FUNDED	NON-FUNDED	PUBLICATION DATA																																																																																									
<table border="1"> <tr> <td colspan="12">ADVISE</td> <td>MCS CODE</td> <td>ISSUED</td> <td>DATE POSTED</td> <td>INIT</td> </tr> <tr> <td colspan="12"></td> <td></td> <td>Q</td> <td>T</td> <td></td> </tr> <tr> <td colspan="12"></td> <td></td> <td>R</td> <td>U</td> <td></td> </tr> <tr> <td colspan="12"></td> <td></td> <td>S</td> <td>V</td> <td></td> </tr> <tr> <td colspan="12"></td> <td></td> <td></td> <td></td> <td></td> </tr> </table>																	ADVISE												MCS CODE	ISSUED	DATE POSTED	INIT														Q	T															R	U															S	V																	
ADVISE												MCS CODE	ISSUED	DATE POSTED	INIT																																																																																	
													Q	T																																																																																		
													R	U																																																																																		
													S	V																																																																																		

PREVIOUS EDITIONS WILL BE USED

REQUEST FOR ISSUE OR TURN-IN (AR 710-2) RECIP-2008

DA FORM 2765, 1 APR 76

ASAANS02530 002946891 EA00009 WK4B6A3064 0307 WK4GE4LEVKB7NSI120802B AA

DOC IDENT	ROUT IDENT	FSC	STOCK NUMBER	ADD	UNIT OF ISSUE	QUANTITY	BLANK	FUND	DISTRIB	PROJECT	PRI	REQ DEL DATE	ADV STAT	ROUTING IDENT	TRANSACTION	DOLLARS	CENTS																																																																															
<table border="1"> <tr> <td colspan="4">EDITING DATA</td> <td>DOC IDENT</td> <td>ROUTING IDENTIFIER</td> <td colspan="3">STOCK NUMBER</td> <td>ADD</td> <td>UNIT OF ISSUE</td> <td>QUANTITY</td> <td colspan="5"></td> </tr> <tr> <td>1</td><td>2</td><td>3</td><td>4</td> <td>5</td><td>6</td> <td>7</td><td>8</td><td>9</td><td>10</td> <td>11</td><td>12</td> <td>13</td><td>14</td><td>15</td><td>16</td><td>17</td><td>18</td> </tr> <tr> <td></td><td></td><td></td><td></td> <td></td><td></td> <td></td><td></td><td></td><td></td> <td></td><td></td> <td></td><td></td><td></td><td></td><td></td><td></td> </tr> </table>																	EDITING DATA				DOC IDENT	ROUTING IDENTIFIER	STOCK NUMBER			ADD	UNIT OF ISSUE	QUANTITY						1	2	3	4	5	6	7	8	9	10	11	12	13	14	15	16	17	18																																													
EDITING DATA				DOC IDENT	ROUTING IDENTIFIER	STOCK NUMBER			ADD	UNIT OF ISSUE	QUANTITY																																																																																					
1	2	3	4	5	6	7	8	9	10	11	12	13	14	15	16	17	18																																																																															
<table border="1"> <tr> <td>9</td><td>10</td><td colspan="4">DOCUMENT NUMBER</td> <td>15</td><td>SUPPLEMENTARY ADDRESS</td> <td>SIG-NA</td><td colspan="2">COST DETAIL ACCOUNT NUMBER</td> <td>UNIT PRICE</td> <td>TOTAL PRICE</td> <td colspan="4"></td> </tr> <tr> <td></td><td></td><td></td><td></td><td></td><td></td> <td></td><td></td> <td></td><td></td><td></td><td></td><td></td><td colspan="4"></td> </tr> <tr> <td colspan="17">ITEM DESCRIPTION</td> </tr> <tr> <td colspan="17">MRO CONVERTED TO MRD</td> </tr> </table>																	9	10	DOCUMENT NUMBER				15	SUPPLEMENTARY ADDRESS	SIG-NA	COST DETAIL ACCOUNT NUMBER		UNIT PRICE	TOTAL PRICE																						ITEM DESCRIPTION																	MRO CONVERTED TO MRD																												
9	10	DOCUMENT NUMBER				15	SUPPLEMENTARY ADDRESS	SIG-NA	COST DETAIL ACCOUNT NUMBER		UNIT PRICE	TOTAL PRICE																																																																																				
ITEM DESCRIPTION																																																																																																
MRO CONVERTED TO MRD																																																																																																
<table border="1"> <tr> <td colspan="12">ADVISE</td> <td>MCS CODE</td> <td>ISSUED</td> <td>DATE POSTED</td> <td>INIT</td> </tr> <tr> <td colspan="12"></td> <td></td> <td>Q</td> <td>T</td> <td></td> </tr> <tr> <td colspan="12"></td> <td></td> <td>R</td> <td>U</td> <td></td> </tr> <tr> <td colspan="12"></td> <td></td> <td>S</td> <td>V</td> <td></td> </tr> <tr> <td colspan="12"></td> <td></td> <td></td> <td></td> <td></td> </tr> </table>																	ADVISE												MCS CODE	ISSUED	DATE POSTED	INIT														Q	T															R	U															S	V																	
ADVISE												MCS CODE	ISSUED	DATE POSTED	INIT																																																																																	
													Q	T																																																																																		
													R	U																																																																																		
													S	V																																																																																		

PREVIOUS EDITIONS WILL BE USED

REQUEST FOR ISSUE OR TURN-IN (AR 710-2) RECIP-2008

Figure 8-18. DA Form 2765 MRO converted to an MRD showing a partial denial

DA FORM 2765, 1 APR 68	DOC IDENT	ROUT IDENT	FBC	STOCK NUMBER	ADD	UNIT OF ISSUE	QUANTITY	REQ	DATE	SERIAL	SUPPLEMENTARY ADDRESS	FUND	DISTRIB	PROJECT	PRI	REQ DEL DATE	ADV	STAT	ROUTING IDENT	TRANSACTION	DOLLARS	CENTS
C	1	2	3	4	5	6	7	8	9	10	11	12	13	14	15	16	17	18	19	20	21	22
A5A	A	B	C	D	E	F	G	H	I	J	K	L	M	N	O	P	Q	R	S	T	U	V
WK4B6A30640307	KAGE4	A5A	A	B	C	D	E	F	G	H	I	J	K	L	M	N	O	P	Q	R	S	T
120802B	A	A	A	A	A	A	A	A	A	A	A	A	A	A	A	A	A	A	A	A	A	A
PARTIAL RELEASE	MANUALLY PREPARED MRO	120802B	A	A	A	A	A	A	A	A	A	A	A	A	A	A	A	A	A	A	A	A

REQUEST FOR ISSUE ON TURN-IN (AR 710-2) NCSFORM 2800A

DA FORM 2765, 1 APR 68	DOC IDENT	ROUT IDENT	FBC	STOCK NUMBER	ADD	UNIT OF ISSUE	QUANTITY	REQ	DATE	SERIAL	SUPPLEMENTARY ADDRESS	FUND	DISTRIB	PROJECT	PRI	REQ DEL DATE	ADV	STAT	ROUTING IDENT	TRANSACTION	DOLLARS	CENTS
C	1	2	3	4	5	6	7	8	9	10	11	12	13	14	15	16	17	18	19	20	21	22
A6A	A	B	C	D	E	F	G	H	I	J	K	L	M	N	O	P	Q	R	S	T	U	V
WK4B6A30640307	KAGE4	A6A	A	B	C	D	E	F	G	H	I	J	K	L	M	N	O	P	Q	R	S	T
120802B	A	A	A	A	A	A	A	A	A	A	A	A	A	A	A	A	A	A	A	A	A	A
MRD	MRD	120802B	A	A	A	A	A	A	A	A	A	A	A	A	A	A	A	A	A	A	A	A

REQUEST FOR ISSUE ON TURN-IN (AR 710-2) NCSFORM 2800A

Figure 8-19. DA Form 2765 MRD for partial issue completed from data on an MRO

Figure 8-20. Complete denial MRD

add any MROs and MRDs that are not on the list and return the list to the SCS. Figure 8-21 shows an MRO list that has been checked and updated by the storage section.

ISSUING A MATERIEL RELEASE DENIAL

An MRD is a supply failure. It reflects an accounting mistake, a misplaced item, an incorrect stock locator deck, or stolen items. Your personnel should search all areas carefully before they pass the MRD on to the next level. Some of the mistakes they should look for include duplicate receipt records and wrong items listed on receipt records. They should check the stock locator cards with mistakes in NSN, location, or name of item. They should also check for changed NSNs that were not recorded and a listing with part number or service stock number in place of the NSN. As soon as your section issues an MRD, your DSU has only 48 hours to find out the reasons for the denial. Conduct an inventory, and correct the stock records that are involved. As storage supervisor, you coordinate the actions of your sections with those of other sections of the DSU during the inventory and the following adjustments. You will be the first supervisor notified of the MRD. When you find that an MRD needs to be issued, you should take the following steps:

- Order the receiving sections to freeze all incoming receipts with that NSN.
- Order the stock records section to freeze the stock record. This will keep that section from issuing any more MROs for the NSN involved.
- Collect all MROs with that NSN that have not been processed.
- Have your storage personnel check the storage section for mistakes and the missing items.
- Have your personnel check the troubleshooting procedures listed in Table 8-2 to find out why the supplies are not in stock.
- Have your personnel take a physical inventory of the missing item after they have thoroughly researched the MRD. Physical inventory procedures are in Chapter 10.
- Notify the stock records section personnel that you need to conduct an inventory, and tell them the NSN involved. You will need to get an inventory voucher number from them before you begin.
- Use the inventory voucher number on all adjustment documents you use to make any changes to the stock records. Give this adjustment document to the SCS so that they can make all changes necessary.

PREPARED 20 FEB 90		DS 4 SUPPLY MANAGEMENT REPORT							PCN AGL-C04		
DSU A		MRO LIST									
LOC	STOCK-NUMBER-FLD	UI	QTY	DOCUMENT NUMBER	PROJ	PD	RECEIVE DSU	DATE	QTY	INITIALS	COMMENTS
ABA55	2920-00-259-1688	EA	1	W34OVT 3051 0001		02			306/1	JDR	
DEB16	6625-00-264-8011	EA	1	W34OVT 3051 0004		02	E		306/1	JDR	
NGA44	4120-00-618-1802	EA	1	W34OVT 3051 0006		02			306/1	JDR	
ABA55	2920-00-259-1688	EA	7	W34OVT 3051 0002		05			306/2	JDR	5 EA DENIED
ASI43	3040-00-260-4012	EA	1	W34OVT 3051 0003		05			306/1	JDR	
MNC14	2520-00-617-7631	EA	1	W34OVT 3051 0005		03			306/1	JDR	
NOA44	3120-00-618-1802	EA	5	W34VCE 3051 0007		12			306/0	JDR	WHSE DENIAL A6A
MNC16	2530-00-001-3428	EA	1	W34QUZ 3051 0010		02			306/1	JDR	
TOTAL MROS FOR THIS UNIT: 8								END PAGE 1			

Figure 8-21. MRO list after update by storage personnel

Table 8-2. MRD troubleshooting procedures

1. Search the locations listed on the MRO and all locations as above, below, and next to them.
2. Check the locator deck to see if there are any other locations listed for the item that are not shown on the MRO.
3. Examine the history of past location changes and NSN changes for clues to other storage locations.
4. Search the entire storage and receiving areas for misplaced items.
5. Check with the stock records section to see if a computer or accounting error occurred.
6. Check the receipt section. Sometimes documents are backlogged in this section. When this happens, a receipt document for the item may have been forwarded to the stock records section before the items were placed in stock.
7. Check the quality assurance and technical inspection sections. In some cases, the missing items may be field turn-ins that have been logged in as received but that are being inspected before they are sent to storage.

CHAPTER 9

ISSUING AND SHIPPING SUPPLIES AND EQUIPMENT

Section I

Planning Issue Shipping Activities

RESPONSIBILITIES

The issue/shipping section is an important part of the DSU storage operation. Your personnel must carry out the issue/shipping activities efficiently if your customer units are to receive their supplies on time, in the quantity requested, and in usable condition. You must select an issue/shipping section supervisor to help you carry out your duties. Be sure to explain the supervisor's duties in the issue/shipping portion of your storage section SOP. Your duties are listed below.

- See that all necessary documents are received with the supplies.
- Make sure your personnel use these documents to verify the quantity, condition, and destination of the supplies.
 - Report all discrepancies, and put all supplies in question in a holding area until your personnel are able to make the changes.
 - Make sure your personnel put the supplies in the correct customer bin at the pickup point.

- Maintain the customer notification log.
- Consolidate and pack supplies for other DSUs.
 - Make sure all issue documents are completed correctly and sent to the SCS daily.
 - Process, protect, and store supplies held in the issue section until customers pick them up or until they are shipped.

ISSUE/SHIPPING SECTION

Personnel in the issue/shipping section are the only part of the storage section who deal with the customer on a face-to-face basis. They receive requested items from the warehouse with an MRO. They use the MRO to determine which unit ordered the supplies. After your personnel notify a unit that its supplies are ready to be picked up, they attach the MRO to the supplies. The MRO acts as an issue document to show the quantity and type of supplies a unit is to receive.

Section II

Issuing Items

USING ISSUE DOCUMENTS

The documents a DSU uses to issue supplies to customer units are described below. The documents are DA Forms 2765, 2765-1, and 3161, and DD Form 1348-1.

DA Form 2765

Units use this form to order PLL items, repair parts, or other expendable items. Only one line

item can be issued on this form at a time. The DA Form 2765 generally is used with ADPE. When ADPE is available, the DSU gives prepunched and preprinted cards to customer units. The units use these cards when they order PLL or other expendable items on a recurring basis. The DSU gives the unit a new card each time a replenishment quantity is ordered.

DA Form 2765-1

This four-part carbon form is used for ordering nonexpendable items. Units can also use it to order expendable items in place of the DA Form 2765 if no ADPE is available or authorized. Your personnel give the bottom (hard) copy of the form to the customer as a receipt.

DD Form 1348-1

This six-part carbon form is used to issue items your DSU orders from another supply source. Only one line item is ordered or issued at a time on this form.

DA Form 3161

Your DSU uses DA Forms in the 3161 series instead of DA Forms in the 2765 series for special types of supplies. It uses DA Form 3161 when more than one item is to be ordered or issued at a time. Before your personnel can issue these special items, the installation commander must authorize the use of the form. Use DA Form 3161 to order and issue—

- Ten or more line items of supplies normally provided by SSSC. This is authorized only when no SSSC is available.
- Five or more line items of packaged Class III items.
- Expendable medical items within a medical facility or for issue to satellites.

ISSUING SUPPLIES

As storage supervisor, you must make sure your personnel issue the correct supplies on time and in good condition. Under your direction, the chief of the issue/shipping section is responsible for seeing that these actions are carried out. Steps personnel must follow in issuing supplies are described below.

- Check to see if the supplies have the correct documents with them and that the documents are filled out correctly.
- Check the documents for NSN, nomenclature, and quantity. Make sure you are issuing the correct item in the correct amount.
- Report any errors found in the supplies or on the issue documents to the chief of the issue/shipping section. If you find errors in the supplies, move the supplies to a temporary holding area so personnel will not issue them by mistake. Make all corrections while the supplies are in this holding area.

- Place the supplies to be issued in the correct customer bin at the pickup point. Make sure that the DODAAC on the issue document matches the DODAAC on the unit bin.

- Notify the unit by telephone that the supplies are ready to be picked up. Enter the call in the customer unit notification log. Preparation and maintenance of the log are covered in this chapter.

- Before you issue the supplies to the unit representative, check the signature card file to see if he is authorized to pick up supplies for the unit. These subjects are covered in this chapter.

- When you issue the supplies, make sure the customer signs and dates all issue documents correctly as follows:

- DA Form 2765. Customer enters the amount received in block S and the Julian date and his signature in block V.

- DD Form 1348-1. Customer enters Julian date and signature in block 7.

- DA Form 3161. Customer writes quantity received in the Supply Action column, then enters date and signature in block 15.

- Attach a copy of the issue document to the supplies. The unit needs this receipt for its property records.

- Send all completed documents through the chief of the issue/shipping section to the SCS each day.

PICKING UP SUPPLIES

The number of times a unit will pickup supplies from your DSU during a week depends on the distance the unit has to travel and how often it can arrange for transportation. Some nearby units will pick up supplies two or three times a day. Other units will pick up supplies once a week. To keep supplies from piling up in the customer's bins at the pickup point, you must set time frames for the pickup of supplies. Be sure to include these time limits in your storage SOP. It is also a good idea to make a handout that lists these time frames for each of your customer units. After putting the supplies in a unit's bin, your personnel should telephone personnel in the unit supply section to let them know they have supplies to be picked up. Your personnel will need to keep track of any calls they make to units in a customer unit notification log. Procedures for setting up and maintaining this log are discussed later in this chapter. If the unit does not pick up the supplies

within *five days* after the unit was first notified, call the unit supply officer or NCOIC. Try to set up a specific date for the pickup of the supplies. Be sure your personnel enter this information in the notification log also. If the unit has not picked up the supplies after *three days* have passed since the second call, send the supplies back to the storage warehouse with a copy of the issue document. Write on the document the reason you are sending the supplies back. Send the other copy of the document to the SCS. Telephone the unit to tell the supply officer or NCOIC that the supplies have been turned back to the storage section because the unit did not pick them up. If the unit still needs the supplies, it must reorder them. Be sure to enter the information from the last phone call in the notification log. The only time you should allow supplies to stay in the customer's bin past the eight-day time limit is when special arrangements have been made. If the unit will not be able to pick up the supplies on time, the unit supply officer or NCOIC should contact the chief of the issue/shipping section to make special arrangements to pickup the supplies at a later date. Be sure to put a note with the new pickup date in the customer's

bin so that the supplies will not be sent back to the storage section by mistake.

PREPARING CUSTOMER UNIT NOTIFICATION LOG

You will need to setup a customer unit notification log to keep track of the calls your soldiers make when they contact units for supply pickup. Each time your personnel contact a unit, they should enter the call in the notification log. The log is your only record that shows the date the unit was contacted and who was notified. There is no required form you must use to make the customer unit notification log. However, the data in Figure 9-1 must be included.

★ CHECKING CUSTOMER IDENTIFICATION

Your issue/shipping section must keep a file of current PBOs and responsible officers for each unit your DSU supports. You must also keep a current file of DA Forms 1687 (Notice of Delegation of Authority--Receipt for Supplies) for each unit. This form lists those authorized to pickup supplies for a unit and their signatures. When unit representatives come to pickup supplies, your issue/shipping section soldiers must

UNIT	JULIAN DATE NOTIFIED	TIME NOTIFIED	PERSON NOTIFIED	REMARKS
3/3 INF BN MECH	9325	1400	SFC ROBERT A. SHORT	PICKUP 9329
6/32 INF BN MECH	9325	0900	SFC ROBERT D. COLE	TO BE PICKED UP 9332 PER TELECOM WITH LT CARTER
2/32 INF BN MECH	9327	0900	SFC SAM E. JONES	PICKUP PAST DUE NOTIFIED THAT SUPPLIES WERE SENT BACK TO STORAGE
506 SPT TROOPS CO	9328	1000	SFC JOHN DOE	CONTACTED LT JOHNSON ON 9335

Figure 9-1. Sample customer unit notification log

compare the unit's DA Form 1687 with the customer's identification form. They must check the expiration dates on both forms. The names and signatures should be the same. Figure 9-2 shows a sample of both forms and the entries that are to be checked. Customers may also present a DA Form 5977 (Authorization Card) when picking up supplies. This form is used in lieu of DA Form 1687 and is issued by the organization requesting and receiving supplies from the SSA or DSU. Details concerning the use of this form are in DA Pamphlet 710-2-1, Chapter 2. Do not use this form

to issue sensitive items such as weapons, ammunition, or COMSEC materiel. Your issue clerk is responsible for making sure only authorized personnel receive supplies. Be sure to include customer identification procedures in your storage SOP. Your issue/shipping section personnel should set up a filing system to protect the signature forms from wear and tear. A filing system also makes it easier to locate the correct signature form for the identification check. File these forms in DODAAC, numerical, or alphabetical order by unit name.

NOTICE OF DELEGATION OF AUTHORITY - RECEIPT FOR SUPPLIES					DATE	
<i>For use of this form, see DA Pam 710-2-1. The proponent agency is ODCSLOG.</i>					30 SEPT 93	
AUTHORIZED REPRESENTATIVE(S)						
ORGANIZATION RECEIVING SUPPLIES 9th Maint Bn				LOCATION Ft Adams, AL		
LAST NAME-FIRST NAME-MIDDLE INITIAL		SOCIAL SECURITY NUMBER	AUTHORITY REQ REC		SIGNATURE AND INITIALS	
HUDSON, TED C.			YES NO		Ted C. Hudson T.C.H.	
CRANSTONE, LAMONT S.			YES NO		Lamont S. Cranstone L.S.C.	
GIBBS, RICHARD W.			YES YES		Richard W. Gibbs, R.W.G	
BRYANT, WILLIAM J.			NO YES		William J. Bryant W.J.B.	
AUTHORIZATION BY RESPONSIBLE SUPPLY OFFICER OR ACCOUNTABLE OFFICER						
THE UNDERSIGNED HEREBY <input checked="" type="checkbox"/> DELEGATES TO <input type="checkbox"/> WITHDRAWS FROM THE PERSON(S) LISTED ABOVE,						
THE AUTHORITY TO: Receipt for Class II, IV, and VII supplies						
REMARKS Installation Supply Division						
I ASSUME FULL RESPONSIBILITY						
UNIT IDENTIFICATION CODE WA4ZAA			DODAAC/ACCOUNT NUMBER WK5ABL			
LAST NAME-FIRST NAME-MIDDLE INITIAL		GRADE	TELEPHONE NUMBER	EXPIRATION DATE	SIGNATURE	
CARTER, GENE T.		MAJ	734-2216	31 MAR 94	Gene T. Carter	
DA FORM 1687		EDITION OF DEC 57 IS OBSOLETE.			☆ GPO: 1981 O - 361-646 (8100)	



ARMED FORCES OF THE UNITED STATES		
		
SGT/E5		ACTIVE
		EXPIRATION DATE 11 Aug 94
SIGNATURE Lamont S. Cranstone		
ID NUMBER 123-45-6789		

Figure 9-2. Customer identification forms

Section III Shipping Materiel

SHIPPING SUPPLIES

To get items ready for shipment, your issue/shipping and storage sections need to work together. You need to set up guidelines for each section. They should explain how these sections must work together to plan the shipment, process the documents, and select and prepare the supplies for loading. Some supplies, such as ammunition and classified items, require special handling and control procedures. Include these special procedures in your storage section SOP. Specific instructions for preparing and shipping ammunition and other hazardous or sensitive items are listed in DOD 4500.32-R, Volume 1; DOD 5100.76-M; and DOD 4145.19-R-1. Manuals in the TM 746 series give packing instructions for major and selected end items.

PREPARING RELEASE ORDERS

Your DSU ships items to other SSAs, Defense Reutilization and Marketing Offices, and between storage sites. You will not issue an item to a customer by shipping it. When an item is to be pulled from storage for shipping, your storage personnel will receive a release order from the SCS. The SCS prepares the release orders on DD Form 1348-1. Figure 9-3 shows completed DD Form 1348-1 as an MRO. Figure 9-4 shows DD Form 1348-1 issued as a disposal release order. An MRO is issued when the items are to be shipped to another supply support activity or if the item is being moved to another storage site. A disposal release order is issued when the item is to be transferred to the Defense Reutilization and Marketing Office that supports your DSU. When

1		2		3		4		5		6		7		8		9		10		11		12		13		14		15		16		17		18		19		20		21		22		23		24		25		26		27		28		29		30		31		32		33		34		35		36		37		38		39		40		41		42		43		44		45		46		47		48		49		50		51		52		53		54		55		56		57		58		59		60		61		62		63		64		65		66		67		68		69		70		71		72		73		74		75		76		77		78		79		80	
DOC IDENT	RI FROM	M S	FSC	STOCK NUMBER	NIIN	ADD	UNIT OR UNIT OF MEASURE	QUANTITY	DOCUMENT NUMBER	REQUISITIONER	DATE	SERIAL	SUPPLEMENTARY ADDRESS	FUND	DISTRI	PROJ	PRJ	ORLT	RECD DEL DATE	ADJ/W	RI	UNIT PRICE	DOLLARS	CTS																																																																																																																																							
A5AAXB	B		2920	002943892		EA	00006	W22SU2	3068	0002	Y271A2	A											47																																																																																																																																								
SHIPPED FROM				SHIP TO				MARK FOR		PROJECT				TOTAL PRICE																																																																																																																																																	
21st MAINT BN FT KNOX, KY 40120				75th SUPPORT CO FORT KNOX, KY 40120						REC 81017 D6S Required DSS				DOLLARS CTS 0000282																																																																																																																																																	
WAREHOUSE LOCATION		TYPE OR CARGO	UNIT PACK	UNIT WEIGHT	UNIT CUBE	UFC	NMFC	FREIGHT RATE	DOCUMENT DATE	MAT COND	QUANTITY	PAM53	UNIT PRICE																																																																																																																																																		
C49D3		Z9	01	1.5	.01	07760	12546	LTL 67	83	021	00006	PLC2	001/01																																																																																																																																																		
SUBSTITUTE DATA (ITEM ORIGINALLY REQUESTED)				FREIGHT CLASSIFICATION NOMENCLATURE				ITEM NOMENCLATURE																																																																																																																																																							
FCN				U				Stock Fund																																																																																																																																																							
W				x Spark Plug				Y																																																																																																																																																							
SHIPMENTS	SELECTED BY AND DATE			TYPE OF CONTAINER(S)		TOTAL WEIGHT		RECEIVED BY AND DATE	INSPECTED BY AND DATE																																																																																																																																																						
	1			2		3			8																																																																																																																																																						
SHIPMENTS	PACKED BY AND DATE			NO. OF CONTAINERS		TOTAL CUBE		WAREHOUSED BY AND DATE			WAREHOUSE LOCATION																																																																																																																																																				
	4			5		6		9			10																																																																																																																																																				
REMARKS				MATERIEL RELEASE ORDER																																																																																																																																																											
AA		BB		CC		DD		EE																																																																																																																																																							
FIRST DESTINATION ADDRESS				DATE SHIPPED																																																																																																																																																											
11				12				13																																																																																																																																																							
13 TRANSPORTATION CHARGEABLE TO				14 BLADING AWP OR RECEIVER'S SIGNATURE (AND DATE)				15 RECEIVERS DOCUMENT NUMBER																																																																																																																																																							
DD FORM 1348-1		1 MAR 74		EDITION OF 1 JAN 64 MAY BE USED UNTIL EXHAUSTED				DOD SINGLE LINE ITEM RELEASE/RECEIPT DOCUMENT																																																																																																																																																							

Figure 9-3. DD Form 1348-1 MRO

1	2	3	4	5	6	7	8	9	10	11	12	13	14	15	16	17	18	19	20	21	22	23	24	25	26	27	28	29	30	31	32	33	34	35	36	37	38	39	40	41	42	43	44	45	46	47	48	49	50	51	52	53	54	55	56	57	58	59	60	61	62	63	64	65	66	67	68	69	70	71	72	73	74	75	76	77	78	79	80
DOC IDENT FROM					STOCK NUMBER					QUANTITY					DOCUMENT NUMBER					SUPPLEMENTARY ADDRESS					FUNCTION DISTRIBUTION PROJECT PRIORITY					REG DEL DATE					ADVICE					RI					UNIT PRICE																																		
A5J AXB					2920 002943892					EA 00006 W22PEQ 3112 0021					0000000					NAN AXB MA										47					DOLLARS					CTS																																							
SHIPPED FROM										SHIP TO										MARK FOR										PROJECT										TOTAL PRICE																																							
W22PEQ										SY2434																														000282																																							
WAREHOUSE LOCATION					TYPE OF CARGO					UNIT PACK					UNIT WEIGHT					UNIT CUBE					UFC					MMFC					FREIGHT RATE					DOCUMENT DATE					MAT COND					QUANTITY																													
C49D3																																																																															
SUBSTITUTE DATA (ITEM ORIGINALLY REQUESTED)										FREIGHT CLASSIFICATION NOMENCLATURE																																																																					
										ITEM NOMENCLATURE																																																																					
										X SPARK PLUG																																																																					
SELECTED BY AND DATE					TYPE OF CONTAINER(S)					TOTAL WEIGHT					RECEIVED BY AND DATE					INSPECTED BY AND DATE																																																											
1					2					3					7					8																																																											
PACKED BY AND DATE					NO OF CONTAINERS					TOTAL CUBE					WAREHOUSED BY AND DATE					WAREHOUSE LOCATION																																																											
4					5					6					9					10																																																											
REMARKS																				DISPOSAL RELEASE ORDER																																																											
AA										BB										CC										DD										EE																																							
FIRST DESTINATION ADDRESS										DATE SHIPPED										FF										GG																																																	
11										12										14										15																																																	
13 TRANSPORTATION CHARGEABLE TO										14 (LOADING AND/OR RECEIVER'S SIGNATURE (AND DATE))										15 RECEIVERS DOCUMENT NUMBER																																																											
DD FORM 1348-1										1 MAR 74										EDITION OF 1 JAN 64 MAY BE USED UNTIL EXHAUSTED										DOD SINGLE LINE ITEM RELEASE/RECEIPT DOCUMENT																																																	

Figure 9-4. DD Form 1348-1 disposal release order

your storage personnel receive an MRO or a disposal release order, they select the item and quantity listed and send the item to the shipping section with a copy of the release order. The PD listed on the MRO or disposal release order determines how long your personnel have to process and prepare the items for shipping. Your storage and shipping personnel need to work together to meet the deadlines as given in Table 9-1.

PLANNING THE SHIPMENT

Planning shipments begins long before the storage section receives an MRO. You should set up the location of the receipt, storage, and issue/shipping sections so your personnel can withdraw stock and prepare items for shipping easily and quickly. You begin planning for an individual shipment when the storage section receives the release order. As storage supervisor, you must decide what shipping arrangements need to be made. Use the questions below to help you set up guidelines for handling the shipment:

- What is the quantity, weight, and cube of the items being shipped? (If the item weighs more than 10,000 pounds, check with the installation transportation officer that supports your DSU. You may need a special release authorization.)
 - Will the item need any special security, packing, marking, or MHE?
 - What is the PD? (The PD tells you how soon an item must be shipped.)
 - Is the item to be shipped by air, truck, water, or rail or is it to be mailed?
 - Where are the supplies being shipped? It is your responsibility to give the transportation office personnel all the information they will need to get a route order for the carrier.

Discuss any special problems with the supervisor of the warehouse and shipping sections before the items are pulled from the warehouse. The two sections will have to work together to get the items moved from the storage section to the packing section. When you set up guidelines for preparing shipments, try to keep your personnel from

Table 9-1. Release order processing times

PRIORITY DESIGNATOR	TIME LIMITATION
01 through 03 or not mission capable shipment (On a not mission capable shipment, 999 will be listed in the Req'd Del Date block of the DD Form 1348-1.)	Item must be ready to load within 24 hours after the storage section receives the MRO.
04 through 08	Item must be ready to load within two regular workdays after the storage section receives the MRO.
09 through 15	Item must be ready to load within four regular workdays after the storage section receives the MRO.

handling and moving the items more than necessary. Try to plan the shipments in truckload lots. If you have more than one item going to another DSU, combine the items into one shipment. This will protect the items as well as save packing material, time, and transportation costs. Sometimes you will not be able to pack items in the same box or crate because of their weight, size, or type. Consider these items bulk items for shipping purposes and pack them according to the guidelines in TM 38-230-2. After you finish planning the shipment, send the MRO to the warehouse section.

PICKING THE STOCK

Once warehouse personnel locate the items listed on the release order, they must use either the progressive or selective method to pick the items from stock. These methods are described in Chapter 8. When selecting the items, the stock clerk should process the DD Form 1348-1 release document by—

- Comparing the NSN on the document (blocks 8 through 22) with that of the supplies.
- Comparing the unit of issue (blocks 23 and 24).
- Comparing the nomenclature (block X).
- Comparing the quantity shown on the document in blocks 25 through 29 with the quantity of supplies selected.
- Writing the quantity pulled from stock in block Q.

- Signing and dating block 1 (Selected By And Date).
- Sending the supplies with all copies of the release document to the issue/shipping section.

Figure 9-5 shows release documents filled in by your stock clerk.

MAKING A RELEASE DENIAL

If the quantity of the item in stock is less than the amount to be shipped, your warehouse personnel must prepare a release denial. There are two kinds of release denials—MRDs and disposal release denials. To make an MRD for an item that is to be shipped, follow the directions in Chapter 8. Figure 9-6 shows two completed MRDs. As shown in the figure, make sure you enter A6A as the document identifier. You make a disposal release denial the same way you make the MRD. However, a DD Form 1348-1 generally is the only form used as a disposal release denial. Make sure you enter A6J in the Identifier Code block. This code shows that the document is for a disposal release denial and not an MRD. Figure 9-7 gives a sample of a completed disposal release denial. You should remember that a release denial is a supply failure. Anytime your section prepares a release denial, you must take a special inventory to find out why the supplies are not on hand. Chapter 8 gives the steps you must take as storage supervisor when a release denial is going to be issued.

2	3	4	5	6	7	8	9	10	11	12	13	14	15	16	17	18	19	20	21	22	23	24	25	26	27	28	29	30	31	32	33	34	35	36	37	38	39	40	41	42	43	44	45	46	47	48	49	50	51	52	53	54	55	56	57	58	59	60	61	62	63	64	65	66	67	68	69	70	71	72	73	74	75	76	77	78	79	80
DOC IDENT	FROM	FSC	STOCK NUMBER	ADD	QUANTITY	DOCUMENT NUMBER	DATE	SERIAL	SUPPLEMENTARY ADDRESS	MARK FOR	PROJECT	UNIT PRICE																																																																		
AS5AAXB	E	2920	002943892	EA	00006	W22SU2	3068	0002	Y271A2	A	13	47																																																																		
SHIPPED FROM 21st MAINT BN FORT KNOX, KY 40120				SHIP TO 75th SUPPORT CO FORT KNOX, KY 40120				MARK FOR		PROJECT REC 81017 D6S Req'd DSS		TOTAL PRICE DOLLARS CTS																																																																		
A				B				C		D		E																																																																		
WAREHOUSE LOCATION C49D3		TYPE OF CARGO G	UNIT PACK H	UNIT WEIGHT I	UNIT CUBE J	UPC K	NMFC L	FREIGHT RATE M	DOCUMENT DATE N	MAT CODE O	QUANTITY P	PAM53 PLC2	S																																																																	
T		FREIGHT CLASSIFICATION NOMENCLATURE FCN										U								V																																																										
W		ITEM NOMENCLATURE G145H										X								Y																																																										
B		SELECTED BY AND DATE Collins 3/15		TYPE OF CONTAINER(S) 2		TOTAL WEIGHT 3 1.5		RECEIVED BY AND DATE 7		INSPECTED BY AND DATE 8																																																																				
U		PACKED BY AND DATE 4		NO OF CONTAINERS 5 1		TOTAL CUBE 6 001		WAREHOUSED BY AND DATE 9		WAREHOUSE LOCATION 10																																																																				
REMARKS												MATERIEL RELEASE ORDER																																																																		
AA				BB				CC				DD				EE																																																														
FIRST DESTINATION ADDRESS 11				DATE SHIPPED 12				FF				GG																																																																		
13 TRANSPORTATION CHARGEABLE TO				14 BLADING AMB. OR RECEIVER'S SIGNATURE (AND DATE)				15 RECEIVERS DOCUMENT NUMBER TCN WK4FTX 2678-0036																																																																						
DD FORM 1348-1												1 MAR 74												EDITION OF 1 JAN 66 MAY BE USED UNTIL EXHAUSTED												DDG SINGLE LINE ITEM RELEASE/RECEIPT DOCUMENT																																										

2	3	4	5	6	7	8	9	10	11	12	13	14	15	16	17	18	19	20	21	22	23	24	25	26	27	28	29	30	31	32	33	34	35	36	37	38	39	40	41	42	43	44	45	46	47	48	49	50	51	52	53	54	55	56	57	58	59	60	61	62	63	64	65	66	67	68	69	70	71	72	73	74	75	76	77	78	79	80
DOC IDENT	FROM	FSC	STOCK NUMBER	ADD	QUANTITY	DOCUMENT NUMBER	DATE	SERIAL	SUPPLEMENTARY ADDRESS	MARK FOR	PROJECT	UNIT PRICE																																																																		
ASJ AXB	2920	002943892	EA	00006	W22PEQ	3112	0021					47																																																																		
SHIPPED FROM W22PEG				SHIP TO SY2434				MARK FOR		PROJECT		TOTAL PRICE DOLLARS CTS																																																																		
A				B				C		D		E																																																																		
WAREHOUSE LOCATION C49D3		TYPE OF CARGO G	UNIT PACK H	UNIT WEIGHT I	UNIT CUBE J	UPC K	NMFC L	FREIGHT RATE M	DOCUMENT DATE N	MAT CODE O	QUANTITY P		S																																																																	
T		FREIGHT CLASSIFICATION NOMENCLATURE										U								V																																																										
W		ITEM NOMENCLATURE SPARK PLUG										X								Y																																																										
B		SELECTED BY AND DATE Meyers 3/167		TYPE OF CONTAINER(S) 2		TOTAL WEIGHT 3		RECEIVED BY AND DATE 7		INSPECTED BY AND DATE 8																																																																				
U		PACKED BY AND DATE 4		NO OF CONTAINERS 5		TOTAL CUBE 6		WAREHOUSED BY AND DATE 9		WAREHOUSE LOCATION 10																																																																				
REMARKS												DISPOSAL RELEASE ORDER																																																																		
AA				BB				CC				DD				EE																																																														
FIRST DESTINATION ADDRESS 11				DATE SHIPPED 12				FF				GG																																																																		
13 TRANSPORTATION CHARGEABLE TO				14 BLADING AMB. OR RECEIVER'S SIGNATURE (AND DATE)				15 RECEIVERS DOCUMENT NUMBER																																																																						
DD FORM 1348-1												1 MAR 74												EDITION OF 1 JAN 66 MAY BE USED UNTIL EXHAUSTED												DDG SINGLE LINE ITEM RELEASE/RECEIPT DOCUMENT																																										

Figure 9-5. Release documents filled in by stock clerk

DA FORM 2765-1 MAR 74	A5AAN502530 002946891 EA00001WK4B6A30640307 WK4GE4 LEVXB7NSL12000 2B AA	REQUEST FOR ISSUE OR TURN-IN (AF 710.2) RECEIPT 2008
DOC IDENT FROM	STOCK NUMBER	QUANTITY
ROUTING IDENTIFIER	FUND	PROJECT
M	NMIN	ADD
S	UNIT OF ISSUE	QUANTITY
A6A	00001	00001
ISSUED	DATE POSTED	INIT
DUE OUT	DATE AVAILABLE	INIT
RECEIVED	DATE RECEIVED	SIGNATURE
MRD		

DD FORM 1348-1	A5AAN502530 002946891 EA00001WK4B6A30640307 WK4GE4 LEVXB7NSL12000 2B AKZ AA	TOTAL PRICE
SHIP FROM	SHIP TO	MARK FOR
45th MAINT BN	125th MAINT CO	PROJECT
APO NY 01234	APO NY 09334	REC 81071
A	B	Sim Label required
WAREHOUSE LOCATION	TYPE OF CARGO	UNIT PRICE
F K4GE4	FCN	197 90
SUBSTITUTE DATA	FREIGHT CLASSIFICATION	ITEM NOMENCLATURE
T	U	Coml Pkg
W	V	Stock Fund
REMARKS	DATE SHIPPED	RECEIVED BY AND DATE
Select Code A	BB	Airloc
FIRST DESTINATION ADDRESS	DATE SHIPPED	WAREHOUSE BY AND DATE
11	12	GG
13 TRANSPORTATION CHARGEABLE TO	14 BLADING ARR. OR RECEIVER'S SIGNATURE	15 RECEIVERS DOCUMENT NUMBER
		MRD

Figure 9-6. DA Form 2765 and DD Form 1348-1 completed as MRDs

1	2	3	4	5	6	7	8	9	10	11	12	13	14	15	16	17	18	19	20	21	22	23	24	25	26	27	28	29	30	31	32	33	34	35	36	37	38	39	40	41	42	43	44	45	46	47	48	49	50	51	52	53	54	55	56	57	58	59	60	61	62	63	64	65	66	67	68	69	70	71	72	73	74	75	76	77	78	79	80
DOC IDENT	RI FROM	N	FSC	NIIN	ADD	UNIT OF ISSUE	QUANTITY	DOCUMENT NUMBER	SUPPLEMENTARY	FUNCTION	DISTRIBUTION	PROJECT	UNIT PRICE	DOLLARS	CTS															UNIT PRICE	DOLLARS	CTS																																															
R63	AS AXB	2920	00294	3892	EA	00006	W22PEQ	3112	0021	000000	NAN	AXB	MA	47															0000282																																																		
SHIPPED FROM	SHIP TO	MARK FOR	PROJECT	TOTAL PRICE	DOLLARS	CTS															TOTAL PRICE	DOLLARS	CTS																																																								
A	W22PEQ	B	SY2434	C	D	E															0000282																																																										
WAREHOUSE LOCATION	TYPE OF CARGO	UNIT PACK	UNIT WEIGHT	UNIT CUBE	UFC	NMFC	FREIGHT RATE	DOCUMENT DATE	MAT COND	QUANTITY	TOTAL PRICE	DOLLARS	CTS															TOTAL PRICE	DOLLARS	CTS																																																	
F	C4903	G	H	I	J	K	L	M	N	O	P	Q	R	S															00006																																																		
SUBSTITUTE DATA (ITEM ORIGINALLY REQUESTED)	FREIGHT CLASSIFICATION NOMENCLATURE	ITEM NOMENCLATURE	QUANTITY	TOTAL PRICE	DOLLARS	CTS															TOTAL PRICE	DOLLARS	CTS																																																								
T	U	V	W	X	Y																																																																										
W	X	Y	Z	AA	BB	CC	DD	EE	FF	GG	HH	II	JJ	KK	LL	MM	NN	OO	PP	QQ	RR	SS	TT	UU	VV	WW	XX	YY	ZZ	AAA	BBB	CCC	DDD	EEE	FFF	GGG	HHH	III	JJJ	KKK	LLL	MMM	NNN	OOO	PPP	QQQ	RRR	SSS	TTT	UUU	VVV	WWW	XXX	YYY	ZZZ																								
SHIPPED BY AND DATE	TYPE OF CONTAINER(S)	TOTAL WEIGHT	RECEIVED BY AND DATE	INSPECTED BY AND DATE	PACKED BY AND DATE	NO OF CONTAINERS	TOTAL CUBE	WAREHOUSED BY AND DATE	WAREHOUSE LOCATION	REMARKS	DISPOSAL RELEASE ORDER	FIRST DESTINATION ADDRESS	DATE SHIPPED	13 TRANSPORTATION CHARGEABLE TO	14 (BLADING AND OR RECEIVER'S SIGNATURE (AND DATE))	15 RECEIVERS DOCUMENT NUMBER																																																															
1	2	3	4	5	6	7	8	9	10	11	12	13	14	15	16	17	18	19	20	21	22	23	24	25	26	27	28	29	30	31	32	33	34	35	36	37	38	39	40	41	42	43	44	45	46	47	48	49	50	51	52	53	54	55	56	57	58	59	60	61	62	63	64	65	66	67	68	69	70	71	72	73	74	75	76	77	78	79	80

Figure 9-7. DD Form 1348-1 completed as a disposal release denial

PACKING THE SUPPLIES

Your issue/shipping section is responsible for packing, marking, and loading the supplies to be shipped. When the supplies arrive from the warehouse, have personnel move them to a central area where they can prepare and combine them before they are crated. As storage supervisor, you must set up controls to keep your personnel from doing any unnecessary preservation, packaging, or packing. They should try to consolidate shipments to save packing material and to reduce shipping costs. Combining shipments will also help protect the supplies. However, do not combine shipments that have high priorities or short due dates unless you can ensure that the supplies will arrive before the closest required delivery date. To

further reduce costs, your personnel should use reusable shipping containers, if possible. Refer to TM 38-230-2 for guidance in selecting the appropriate packing container. As storage supervisor, you will need to make arrangements with the receiving units to return these containers to your DSU.

PROCESSING THE RELEASE ORDER

In order for your DSU to ship items on time, you must fill out and process the release order correctly. It is your responsibility to make sure your storage and shipping personnel know how to process the DD Form 1348-1 release order. Before

Organic Transportation

packing the item, the packer should pull Copies 2 and 3 (first and second carbon copies) from the form. They must put these copies inside the shipping container with the item. After your personnel prepare, pack, and mark the supplies, they process the DD Form 1348-1 by taking the following actions:

- Write the type of shipping container used in the Type Of Container block (block 2).
- Write the total weight of the container in the Total Weight Container block (block 3).
- Write the number of containers in the shipment in the No. Of Containers block (block 5).
- Write the total cube in the Total Cube block (block 6).
- Sign and date the Packed By And Date block (block 4).
- Pull Copy 4 from the DD Form 1348-1 (third carbon copy). Put this copy in a water resistant (PPP-E-540) envelope, and attach the envelope to the outside of the shipping container.
- Keep the last copy (fifth carbon copy) of the form with the shipping container. Give this copy to the carrier when the supplies are loaded. The carrier will use it as a manifest. A manifest is a document that lists all the supplies in a shipment and their destination.
- Write the date shipped (released) in the Date Shipped block (block 12).
- Write one of the following control or shipment numbers in block 14:
 - Transportation control number.
 - Government bill of lading number.
 - Commercial bill of lading number.
 - Airway bill number.
 - Ensured or registered parcel post number.
 - Motor vehicle number.
- Send Copies 2 and 3 with the supplies. The original copy of the DD Form 1348-1 will be retained as the supply copy.
- Mail Copy 5 to the address shown in block B.

Figure 9-8 is an example of a correctly prepared MRO and disposal release order your shipping clerk sends to the SCS.

PREPARING TRANSPORTATION DOCUMENTS

The chief of your issue/shipping section arranges for the transportation of the supplies. The two kinds of transportation used to ship items from DSUs are organic and installation.

The DSU or your supporting unit provides organic transportation. When you use organic transportation, your issue/shipping section will need no transportation documents. The only form needed to ship items by organic transportation is the release order. Your shipping clerk should pull Copy 6 from the DD Form 1348-1. The driver will use this copy as a listing of the items being transported and their destinations.

Installation Transportation

The installation where your DSU is located provides installation transportation. You will need to coordinate the shipment with the installation transportation officer. There may be special packing or marking requirements for the type of item you are shipping. It is your duty to see that your personnel give the Transportation Office the information necessary to get the supplies shipped. Your issue\ shipping section is also responsible for filling out the address label, DD Form 1387 (Military Shipment Label), that goes on each container. Section personnel fill out this label differently for oversea shipments and for shipments within CONUS. Figure 9-9 shows samples of how this is done. Check DOD 4500.32-R, Volume 1 or STP 10-76V24-SM-TG for step-by-step guidelines on how to fill out the labels.

RETURNING RETROGRADE CARGO

Retrograde cargo is materiel that is being returned to the US from oversea commands because they cannot provide the proper level of maintenance support or repair parts. Retrograde items can include hazardous or dangerous items which might cause fires or damage to the environment if mishandled during shipment. In these cases, you will need special equipment (such as waterproof barriers, special cushioning, or blocking and bracing of items), special facilities for storage, and specially-trained personnel to process the supplies. These items may also require special inspection and shipping procedures. You must make sure your personnel know how to pack, mark, preserve, store, and transfer retrograde items. Not all retrograde materiel requires special packing and handling. However, for retrograde items such as repair parts, your personnel need to give the items enough packing protection to keep them from being damaged during shipment, handling, and storage. Instructions on processing and shipping retrograde cargo are in AR 700-93.

1	2	3	4	5	6	7	8	9	10	11	12	13	14	15	16	17	18	19	20	21	22	23	24	25	26	27	28	29	30	31	32	33	34	35	36	37	38	39	40	41	42	43	44	45	46	47	48	49	50	51	52	53	54	55	56	57	58	59	60	61	62	63	64	65	66	67	68	69	70	71	72	73	74	75	76	77	78	79	80
DOC IDENT	RI FROM	MA	FSC	STOCK NUMBER	NMIN	ADD	UNIT OF MEASURE	QUANTITY	DOCUMENT NUMBER	SUPPLEMENTARY	FUNCTION	DISTRIBUTION	PROJECT	REQ'D DEL DATE	ADVISE	RI	UNIT PRICE	DOLLARS	CTS																																																												
A5AAXB	B			2920	002943892		EA	00006	W22SU2	3068	0002	Y271A2	A				13		A	47																																																											
SHIPPED FROM 21st MAINT BN FT KNOX, KY 40120							SHIP TO 75th SUPPORT CO FORT KNOX, KY 40120							MARK FOR		PROJECT REC 81017 D6S Required DSS				TOTAL PRICE DOLLARS CTS E 0002 82																																																											
WAREHOUSE LOCATION K4QA2		TYPE OF CARGO Z9	UNIT PACK 01	UNIT WEIGHT 1.5	UNIT CUBE 01	UFC 07760	NMFC 12546	FREIGHT RATE LTL 67		DOCUMENT DATE 83	MAT CODE 021	QUANTITY 00006	PAM53 PLC2		001/01																																																																
SUBSTITUTE DATA (ITEM ORIGINALLY REQUESTED) FCN							FREIGHT CLASSIFICATION NOMENCLATURE U Stock Fund																																																																								
ITEM NOMENCLATURE X Spark Plug							Y																																																																								
S	H	I	U	P	E	R	S	SELECTED BY AND DATE Lead 3074	TYPE OF CONTAINER(S) 2 BX		TOTAL WEIGHT 3 1.5		RECEIVED BY AND DATE 7		INSPECTED BY AND DATE 8																																																																
S	H	I	U	P	E	R	S	PACKED BY AND DATE Bunrough 3075	NO. OF CONTAINERS 5 1		TOTAL CUBE 6 01		WAREHOUSED BY AND DATE 9		WAREHOUSE LOCATION 10																																																																
REMARKS AA							CC							DD MATERIEL RELEASE ORDER							EE																																																										
FIRST DESTINATION ADDRESS 11							DATE SHIPPED 12 3076							FF							GG																																																										
13 TRANSPORTATION CHARGEABLE TO							14 BLADING ARR. OR RECEIVER'S SIGNATURE (AND DATE) TCN W22542 3068 0002							15 RECEIVERS DOCUMENT NUMBER																																																																	

1	2	3	4	5	6	7	8	9	10	11	12	13	14	15	16	17	18	19	20	21	22	23	24	25	26	27	28	29	30	31	32	33	34	35	36	37	38	39	40	41	42	43	44	45	46	47	48	49	50	51	52	53	54	55	56	57	58	59	60	61	62	63	64	65	66	67	68	69	70	71	72	73	74	75	76	77	78	79	80
DOC IDENT	RI FROM	MA	FSC	STOCK NUMBER	NMIN	ADD	UNIT OF MEASURE	QUANTITY	DOCUMENT NUMBER	SUPPLEMENTARY	FUNCTION	DISTRIBUTION	PROJECT	REQ'D DEL DATE	ADVISE	RI	UNIT PRICE	DOLLARS	CTS																																																												
A5J	AXB			2920	002943892		EA	00006	W22PEQ	3112	0021						0000000		NAN AXB MA	47																																																											
SHIPPED FROM W22PEQ							SHIP TO SY2434							MARK FOR		PROJECT				TOTAL PRICE DOLLARS CTS E 0002 82																																																											
WAREHOUSE LOCATION C49D3		TYPE OF CARGO	UNIT PACK	UNIT WEIGHT	UNIT CUBE	UFC	NMFC	FREIGHT RATE		DOCUMENT DATE	MAT CODE	QUANTITY	PAM53		001/01																																																																
SUBSTITUTE DATA (ITEM ORIGINALLY REQUESTED)							FREIGHT CLASSIFICATION NOMENCLATURE U																																																																								
ITEM NOMENCLATURE X SPARK PLUG							Y																																																																								
S	H	I	U	P	E	R	S	SELECTED BY AND DATE Lead 3117	TYPE OF CONTAINER(S) 2 BX		TOTAL WEIGHT 3 6		RECEIVED BY AND DATE 7		INSPECTED BY AND DATE 8																																																																
S	H	I	U	P	E	R	S	PACKED BY AND DATE Bunrough 3117	NO. OF CONTAINERS 5 2		TOTAL CUBE 6 1.5		WAREHOUSED BY AND DATE 9		WAREHOUSE LOCATION 10																																																																
REMARKS AA							CC							DD DISPOSAL RELEASE ORDER							EE																																																										
FIRST DESTINATION ADDRESS 11							DATE SHIPPED 12 3118							FF							GG																																																										
13 TRANSPORTATION CHARGEABLE TO							14 BLADING ARR. OR RECEIVER'S SIGNATURE (AND DATE)							15 RECEIVERS DOCUMENT NUMBER																																																																	

Figure 9-8. MRO and disposal release order completed by shipping clerk

MILITARY SHIPMENT LABEL		Form Approved OMB No 0704-0188	
1 TRANSPORTATION CONTROL NUMBER W62G2T70621979XXX		2 POSTAGE DATA	
3 FROM W25G1W TOBYHANNA ARMY DEPOT TOBYHANNA, PA 13466		4 TYPE SERVICE	
5 SHIP TO POE W62G2T SHARPE ARMY DEPOT LATHROP, CA 95330		6 TRANS PRIORITY	
7 POD		8 PROJECT	
9 ULTIMATE CONSIGNEE OR MARK FOR	10 WT. (This piece) 150	11 ROD	
	12 CUBE (This piece) 3	13 CHARGES	
	14 DATE SHIPPED	15 FMS CASE NUMBER	
	16 PIECE NUMBER 1		
17 TOTAL PIECES 1		17 TOTAL PIECES	

MILITARY SHIPMENT LABEL		Form Approved OMB No 0704-0188	
1 TRANSPORTATION CONTROL NUMBER AT401521502016XXX		2 POSTAGE DATA	
3 FROM A25TBB TOBYHANNA ARMY DEPOT TOBYHANNA, PA 18466		4 TYPE SERVICE	
5 SHIP TO POE 3DK MILITARY OCEAN TERMINAL OAKLAND, CA 66666		6 TRANS PRIORITY	
7 POD UC2 FOREIGN CITY, FOREIGN COUNTRY 99999		8 PROJECT	
9 ULTIMATE CONSIGNEE OR MARK FOR AT4015 USA ASCOM DEPOT FOREIGN CITY, FOREIGN COUNTRY 99999	10 WT. (This piece) 500	11 ROD	
	12 CUBE (This piece) 12	13 CHARGES	
	14 DATE SHIPPED	15 FMS CASE NUMBER	
	16 PIECE NUMBER 1		
17 TOTAL PIECES 1		17 TOTAL PIECES	

Figure 9-9. Military shipment labels for CONUS and oversea shipments

Section IV Using Pallets

DESCRIPTION

A pallet is a portable platform on which supplies are placed to facilitate handling and transportation. This platform is generally a two-deck structure which permits mechanical handling and tiering of unit loads of supplies and equipment.

TYPES OF PALLETS

Pallets are classified as expendable and permanent. Permanent pallets are also classified as general purpose and special purpose.

Expendable Pallets

Expendable pallets generally are designed for one shipment and are then discarded. They are

usually constructed of wood, fiberboard, or a combination of the two. In order to be effective as one-trip pallets, they must be light in weight and low in cost. Figure 9-10 shows expendable pallets.

Permanent Pallets

Permanent pallets are termed general purpose or special purpose.

General purpose. General-purpose pallets, the most commonly used pallets, are constructed of hardwood and are normally 40 inches by 48 inches. They fit economically into railroad cars, motor vehicles, and trailers. Two general-purpose pallets are the four-way entry-post pallet and

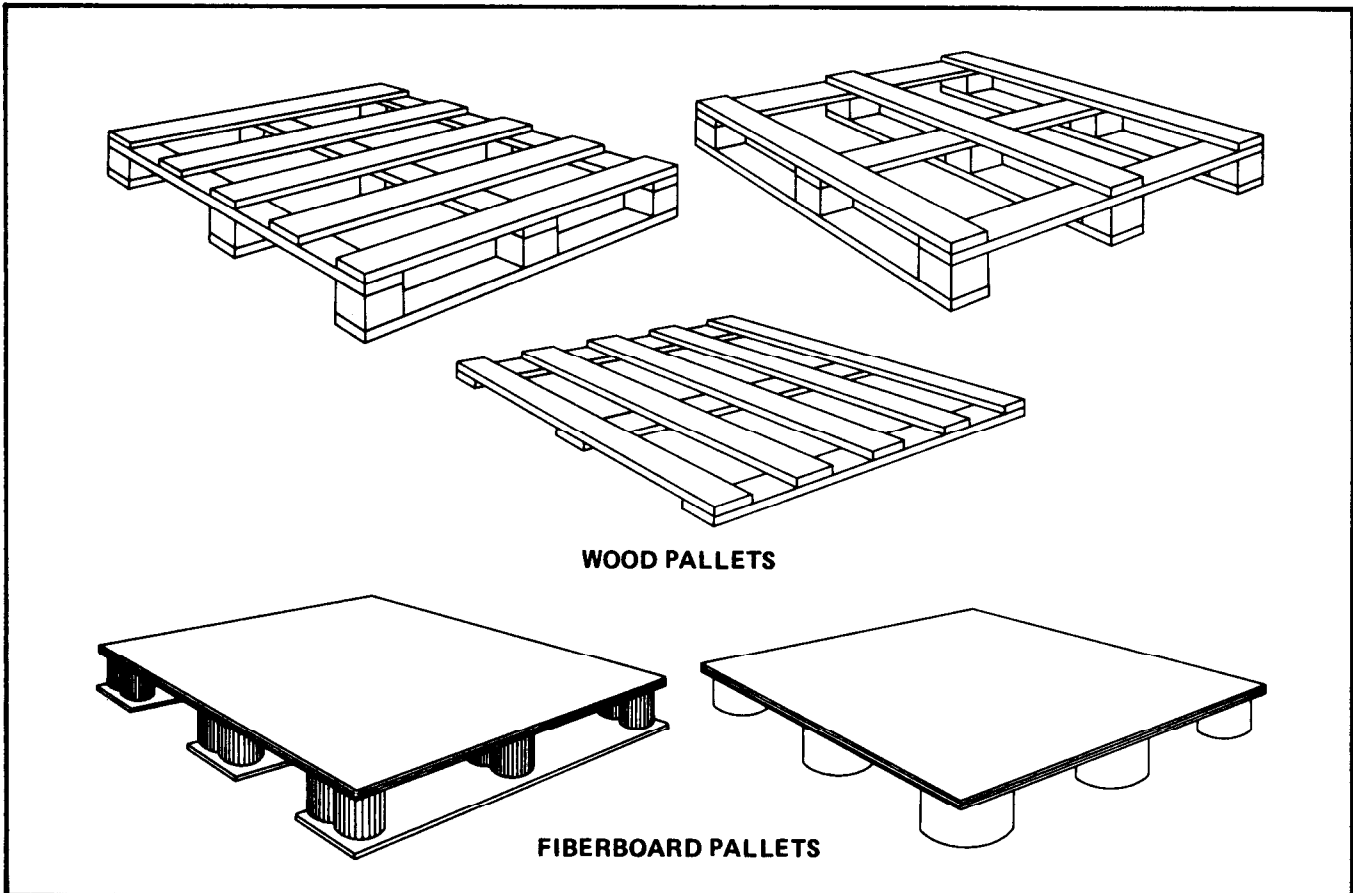

Figure 9-10. Expendable pallets

the four-way (partial) four-stringer pallet. See Figure 9-11.

Special purpose. Special-purpose pallets made of metal are suitable for heavy-duty use. They are more rugged and will withstand more abuse than wood pallets. There are no fasteners to work loose

and cause damage to flexible containers and their contents. The initial cost of metal pallets is high in comparison to pallets made of wood. Pallets made of aluminum that are light in weight are also available. The special-purpose pallets are designed on a case-by-case basis to conform to an item requiring special handling.

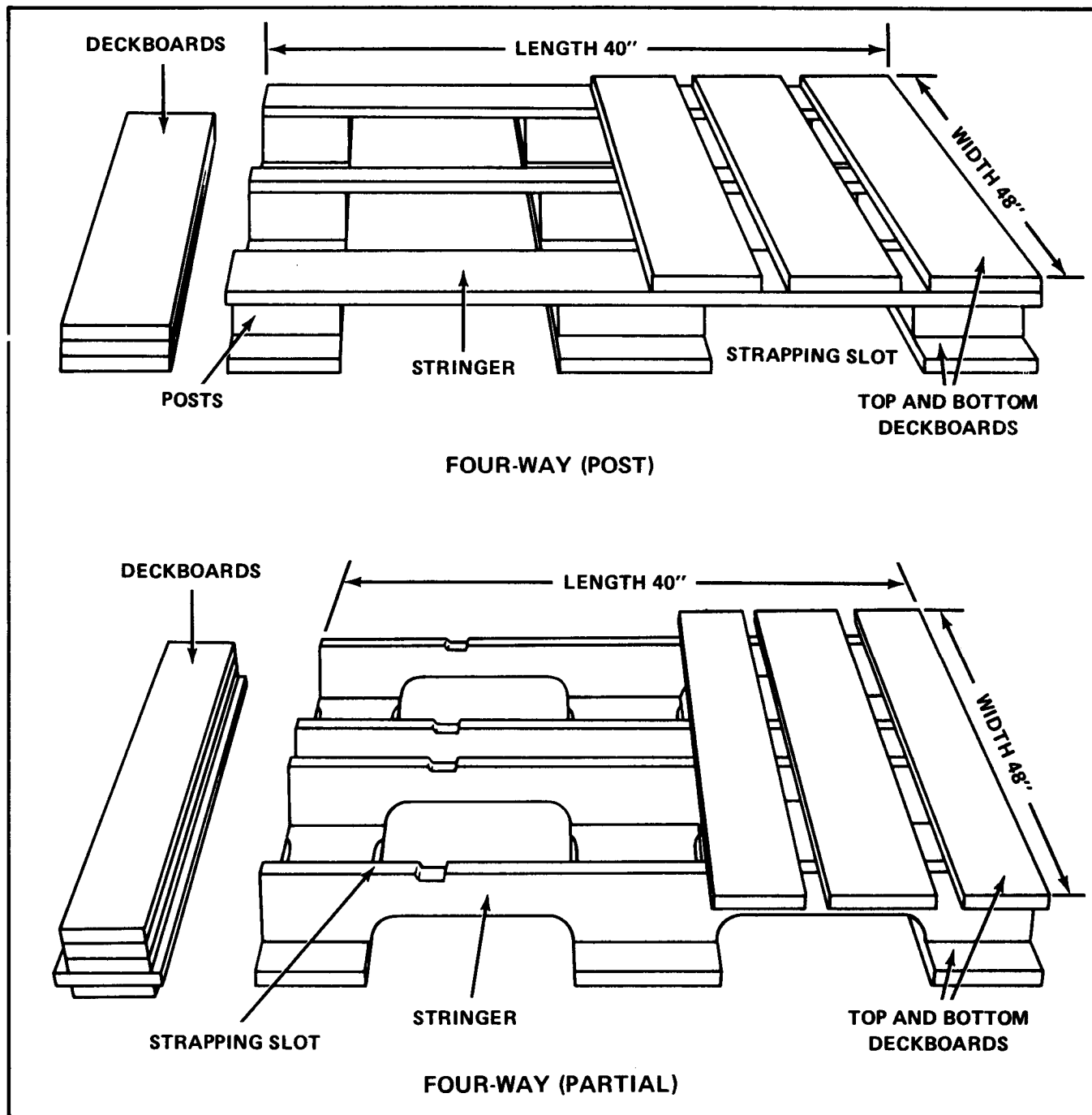

Figure 9-11. Construction of four-way pallets

Section V

Using Cargo Containers

RESPONSIBILITIES

As a storage supervisor, you are responsible for ensuring that your shipping personnel make the best use of the space within the cargo containers. They must take extreme care to safeguard the equipment and supplies that are to be shipped and to load the container correctly so as not to exceed the loading limitations.

DESCRIPTION

Your shipping section will be provided with many different types of containers into which they will load equipment or supplies. The following are a few of the many types that will be available to them.

MILVAN

MILVANS are 231 inches long, 92 inches wide, and 87 inches high. The gross weight rating for each 20-foot container is 44,800 pounds. When the double doors are closed properly, the MILVAN affords waterproof protection.

SEAVAN

SEAVANs vary from approximately 20 to 40 feet in length. The standard length used by the military is 40 feet. SEAVANs are 8 feet high and 8 feet wide. They have a maximum gross weight capacity of 67,200 pounds. SEAVANs can be moved by motor and rail and may be stored for shipment on specially containerized ships. They may be transported on a semitrailer chassis or railcar and are lifted easily, minus the chassis, by the 50,000-pound rough-terrain container handler or a commercial equivalent. The most common type you will see at your shipping section is the dry-cargo container. This container is weatherproof and designed to protect the cargo from water. It is ideally suited for shipping items packed in domestic packs and any other commodities that can be damaged by water. The dry-cargo

container is completely enclosed and must be loaded and unloaded by hand or forklift truck.

Breakbulk Semitrailers

These semitrailers vary from 30 to 40 feet in length and from 22 to 40 tons in weight capacity. Check the data plate on the trailer for specifications prior to loading. The breakbulk semitrailers have varying styles of side bracing and corner posts. A semitrailer is designed to carry high-density and oddly shaped cargo. The canvas cover that normally comes with the trailer can provide protection from water as long as the height of the load does not exceed the top of the side racks by more than 12 inches.

Railcars

Refer to DOD 4145.19-R-1 for detailed descriptions and loading guidelines for railcars.

PREPARATION FOR LOADING

It is the joint responsibility of the shipper and the carrier to ensure safety of the cargo, equipment, and personnel during loading, while in transit, and on arrival at the destination. You or someone you designate must inspect the cargo. See Table 9-2 for a checklist. This paragraph describes some other factors you must consider.

Importance of Proper Loading

The delivery of shipments in good condition depends to a large extent on the manner in which the truck or trailer was loaded and on the care which was taken in preparing it for loading.

Tight Loading

The most important way you can prevent damage in truck and trailer loading is tight loading. Rarely do the items to be shipped fit a closed truck, van, or trailer without side slack or end slack. In most instances, you can take up slack with bulkheads or dunnage. Refer to DOD

4145.19-R-1 for guidance in using bulkheads and dunnage.

Difficulty of Tie-down

The construction of closed trucks, vans, and trailers makes tight loading, blocking, or bracing more difficult. The shells of most commercial closed trucks, vans, and trailer bodies are made of

aluminum, plywood, or other thin metal shells designed to protect the items from the weather. Your personnel must use good judgment in loading items in closed trucks, vans, and trailers.

Balanced Load

Figures 9-12 and 9-13 show methods of distributing weight correctly.

Table 9-2. Loading checklist

- Are sideboards and floorboards present, and are they serviceable?
- Do doors close properly, providing a waterproof seal?
- Is the container large enough for the cargo or equipment to be shipped (length, height, width, and load limitations)?
- Are there enough tie-downs, and are they serviceable?
- Is the roof leakproof, or is a serviceable canvas cover available?
- Are tires serviceable? Is there a spare?
- Do all brakes work properly?
- Are all brake lights and running lights present and operable?

The above checklist is by no means complete. You should have a section of your SOP dedicated to inspecting cargo containers. Check with your local TMO for further guidance.

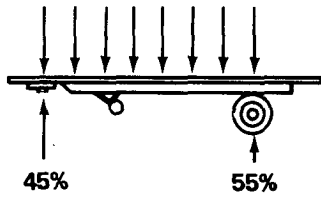

Trailers are also designed for uniform load distribution, as shown by the above sketches. The fundamental difference between loading trailers and trucks is: in the case of trucks, the average design provides for about 90% of the payload on the rear

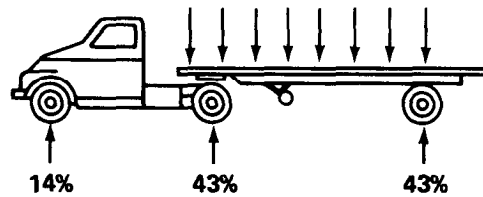

tires and 10% on the front tires. In the case of trailers, the payload should be distributed equally between the rear tires and the fifth wheel which transfers its load to the truck-tractor.

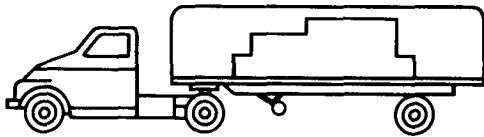

WRONG

With a part load or with a very heavy load having little bulk, it is common practice to put it at the front end of the trailer to get traction on truck-tractor rear tires. This overloads the truck tires and shortens their mileage life. It can also cause bending of the truck

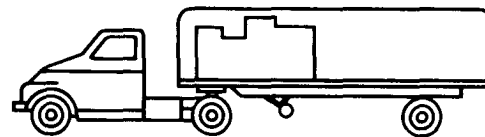

RIGHT

rear axle housing. Application of trailer brakes may lock wheels, cause tire flat spots, skidding, or both.

This load should be distributed over the full length of the trailer floor or platform.

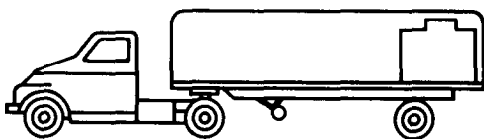

WRONG

This example is obviously wrong. In the case of the first trailer, the heavy load at the rear is overloading the rear trailer tires. There is practically no load on the fifth wheel, and the truck-tractor rear tires would certainly slip and wear away rubber. Braking distribution would also be very uneven.

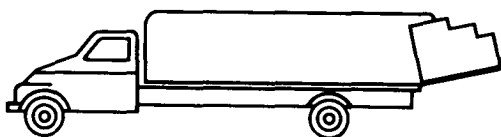

WRONG

Tail gate loading should never be practiced, even in the interest of speed, as it puts a severe strain on the equipment and frequently results in serious accidents.

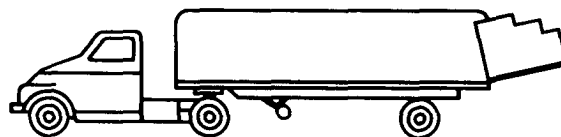

See above for the correct method of loading.

Figure 9-12. Correct and incorrect weight distribution

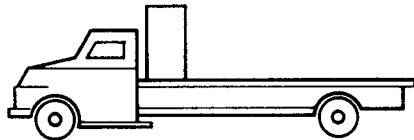

WRONG

A heavy load, like a big piece of machinery or a safe, should not be loaded against the cab. This loading will bend the frame, perhaps permanently. It will also overload the front tires, may even cause a blowout on a worn tire. Hard steering will also result, and the load may be top-heavy.

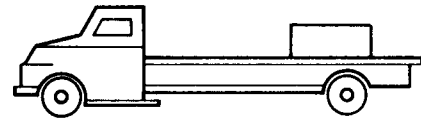

RIGHT

A heavy concentrated load should be placed near the rear and on its long side if at all possible. Most of the load should be over the rear axle to get proper tire loading and eliminate bending of the frame.

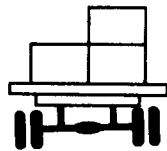

WRONG

A very heavy load should not be loaded at one side. This overloads one spring and the tires at that side. This loading could be bad enough to allow the brakes to lock on the wheels at the light side and cause flat spots on the tires or a skid on a wet surface.

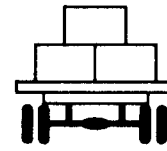

RIGHT

This loading has equal loads on rear tires and eliminates twisting of the frame, which might loosen rivets of cross members or frame brackets. Uniform loading crosswise prevents axle housing and wheel bearing overloading.

This above example applies to trucks and trailers alike.

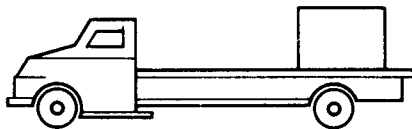

WRONG

This loading should never be permitted. The frame bends, the rear tires are very much overloaded, and enough weight is taken from the front tires to make steering almost impossible.



RIGHT

Again, the proper place for a concentrated load like this is just ahead of the rear axle, with the longest side on the floor.

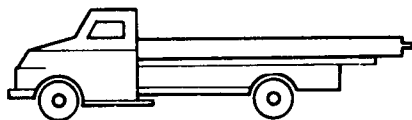

WRONG

This type of loading results from the use of the wrong vehicle for the job. Such loading can result, on rough roads, in an actual pivoting of the truck on its rear wheel and taking the front wheels entirely off the road.

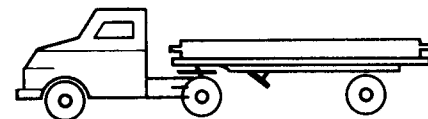

RIGHT

A tractor-trailer combination is the proper vehicle for use in service like this. By using the proper vehicle, damage to the truck and tires, and even serious accidents, may be avoided.

Figure 9-13. Correct and incorrect loading

CHAPTER 10

PERFORMING PHYSICAL INVENTORIES

Section I

Overview

★ RESPONSIBILITIES

Keeping property records up to date is a big job. One way to find out if your storage records are correct is for you, as storage supervisor, to conduct an inventory. An inventory is the physical count of supply items on hand at your storage facility. It is important that the quantity and type of items you show on hand on the stock record match the quantity and type of items you count in your storage facilities. When these totals do not match, it is your job to find the mistakes. To help locate the mistakes and correct them, you must make a complete physical inventory. Before you begin the inventory, you must take certain actions. You must make a physical location survey to ensure all supplies are in the correct locations and the locations match the locator deck. You must make sure all identification labels and bin placards are correct. You must also post all new data before you begin the survey. To do this, you and the accountable officer should work with the receiving section to setup a cutoff date for posting changes to the locator file. If you are operating under SARSS-1(I) automated system, ensure that all personnel responsible for operating the TACCS/SARSS equipment are familiar with the automated procedures as outlined in ADSM 18-L19-AJH-BUR-EM. (NOTE: It is particularly important that bar code readers be inspected for operational readiness prior to training and conduct of inventory. Also ensure that you have enough batteries

on hand to power the bar code readers.) You should develop a plan (or update the written SOP) for conducting the inventory and the location survey. The plan should include the following:

- A time frame schedule for the location survey.
 - Cutoff dates for the receiving, storage, shipping, stock location, and data processing sections so that records can be brought up to date before the survey and the inventory.
 - A time frame schedule for the inventory.
 - Appointment of a survey supervisor.
 - Organization and appointment of the survey team.
- You should tell how you determined the number and grades of personnel required. You should also list special equipment needed, the areas of responsibility for each person on the team, the reporting date and place, and the schedule for the team members.
- An outline for the training of survey and inventory personnel. All personnel involved in a location survey or an inventory need training to perform all counts and complete all records correctly. Use the checklist in Table 10-1, page 10-2 to help set up a training program for your personnel.
 - Assignment of an inventory voucher number.
 - An explanation of how to prepare and distribute the survey work cards, work card decks, and location survey listings.

- An explanation of how to report, control, and verify the inventory findings.
- An explanation of how to notify customers and other unit personnel of the delayed processing of requests and issues that will occur during a wall-to-wall inventory.
- If LOGMARS-T bin labels are used, ensure that damaged or missing labels are replaced prior to conducting location survey and inventory.

NOTE: You should include the announcement of your DSU closing in the installation daily bulletin to notify all interested units and personnel. AR 25-30 governs daily bulletin entries and explains format. A sample announcement might read: Consolidated Supply Warehouse, Building 7166, will be closed 12-16 October 19XX for annual inventory. Issues will be limited to requests with UND A and PDs 01, 02, and 03.

★ *Table 10-1. Inventory training checklist*

- What is the purpose of the inventory/location survey?
- How does the inventory/location survey relate to normal storage operations?
- What are the duties and responsibilities of the inventory/survey supervisor and team members, the accountable officer, the storage supervisor, and the stock record supervisor during an inventory/survey? (Need to include duties and responsibilities of personnel when using automated procedures.)
- By what date must the inventory/survey supervisor and team members be trained?
- How long will the inventory last? What are the beginning and ending dates? How much additional time will be required for corrective action?
- Will your unit use its own personnel for the inventory/survey?
- What additional personnel do you need to complete the inventory/survey? How do you obtain them?
- What inventory training aids do you need? What aids are available?
- What other assistance is available for training?
- What controls need to be set up to ensure proper inventory/survey counts?
- How is a location survey conducted?

★ *Table 10-1. Inventory training checklist (continued)*

- What are the different kinds of inventories? When does your DSU perform each type? Are personnel trained for all types?
- Do inventory/survey personnel understand the stock location numbering system?
- Do inventory/survey personnel know how to recognize improper or unsafe storage practices? Do they know how to report them?
- Are serviceable and unserviceable supplies stored in separate locations?
- Are all broken and damaged items classified or repaired?
- Are all supplies in the correct locations? Do these locations match the locations on the locator file?
- Do personnel know how to recognize and compare stock numbers, nomenclature, and other entries on labels, packages, and count cards?
- Do inventory personnel know how to count and report the correct number of items in a package or on a pallet?
- Do inventory personnel know how to record recount information on location survey and inventory cards?
- Do the inventory supervisor, the storage supervisor, the accountable officer, and the stock control supervisor know how to reconcile storage records with inventory counts and with accountable records?
- Are personnel using LOGMARS-T properly trained in its use and functions?

PHYSICAL INVENTORIES

Inventories play an important part in keeping your storage and financial records straight. Without inventories, you would not discover posting errors. Some ways inventories help you are listed below.

- They find storage problems and errors. See Table 10-2.
- They find the total quantity of supplies on hand.
- They compare and adjust the recorded stock balances to match the on-hand quantities.
- They give the accountable officer the information he needs to compare his records with the records of the finance and accounting office during the annual audit.

PREPARATION

You and your personnel must ensure all inventories are thorough and conducted step by step. Keep in mind that your total inventory period must not exceed five workdays. This does not include the time that you and your personnel spend getting ready for the inventory or taking corrective actions after the inventory. As storage supervisor, you must publish an annual inven-

tory schedule. Be sure to show the date of each inventory and list the types of items to be inventoried. Distribute these schedules to all of your customer units. Table 10-3 lists inventory frequencies. Before you can decide what type of inventory to conduct, you need to know the number of transactions your DSU processes, quantity of items your DSU stores, kinds of supplies your DSU stores, and the mission of your DSU. You also need to know what coordination with other sections you will need before you begin the inventory. The three basic types of inventories at the DSU level are described below.

Scheduled Wall-to-Wall Inventory

In this type of inventory, you count all items in the entire storage section as of a certain date. During the inventory, you will not process receipts, and you will not issue stockage items unless they have PDs 01, 02, or 03 or are NMCS transactions. You can continue to process and issue nonstocked items not listed in your stock location files.

Table 10-2. Storage problems and errors

ERROR/PROBLEM	DESCRIPTION
Mixed stock.	Two or more national stock numbers stored in one location.
Questionable condition of items in stock.	Damaged items that need to be technically inspected to find out if they are unserviceable.
Questionable identity of items in stock.	Items that do not have stock numbers on their containers or that cannot be identified by storage personnel.
Unclear markings on containers or packages.	Containers or packages that do not have readable labels to help identify the items.
Improper stacking of supplies.	Supplies not stacked neatly and uniformly. Improper stacking can hide containers and crush or break supplies.
Multiple open boxes of supplies.	Boxes that have items missing. This can cause incorrect inventory counts or improper issues.

Table 10-3. Frequency of inventories

TYPES OF SUPPLIES	FREQUENCY	AUTHORITY
Sensitive items (items shown on the AMDF with SEC 1, 2, 3, 4, 5, 6, 8, N, P, Q, and R)	Quarterly	DA Pam 710-2-2
Controlled substances and tax-free alcohol	Quarterly	AR 40-61
Hazardous items	Quarterly	AR 40-61
Precious metals	Varies	AR 40-61
Medical items		AR 40-61
Communication security items	Semiannually	TB 380-41
Weapons and ammunition	Quarterly	AR 190-11 AR 710-2
Selection items	As directed by commander	AR 710-2 DA Pam 710-2-2
NOTE: All other items are inventoried ANNUALLY. Sample inventories are NOT permitted.		

Scheduled Cyclic Inventory

You conduct this type of inventory weekly, monthly, or quarterly. In this inventory, you count only a part of your DSU authorized stockage and nonstockage items within a set timeframe. It is easier to conduct this type of inventory if you limit it to a specific storage area, a certain type of item, or a certain group of supplies. The two disadvantages to a scheduled cyclic inventory are explained below.

- Since inventory count cards are made only on those items listed on the stock record, the scheduled cyclic inventory does not account for unrecorded stock items. Also, since the primary location is the only location recorded on the ABF, you must instruct your inventory personnel to count all alternate locations for that particular item. Alternate locations are posted on the location placard or loose issue label located at the primary location and also on the alternate location card

for that particular stock number and condition code located in the locator deck.

★ • All locations are recorded on the ABF in SARSS. When an inventory on a stock number is initiated, all locations will be identified on the Inventory Count Control Document or downloaded to LOGMARS-T equipment. When operating with SARSS, there is no need to look manually for alternate locations.

- You must keep your DSU open for business during a cyclic inventory to process any item not involved in the inventory. You must also process inventory items if they have PDs 01, 02, and 03.

Special Inventory

A special inventory is not a scheduled inventory. You conduct a special inventory when you need to

count a certain item for a specific reason. These reasons are listed in Table 10-4. You must keep your DSU open for normal business during the special inventory to process all requests for items not being inventoried. If you receive a request for an item that is being counted hold it until after the inventory is finished. Make an exception when the request has a PD of 01, 02, or 03 or is an NMCS request. You have only 72 hours to conduct a special inventory. If you conduct an inventory because of an illegal forced entry into the warehouse, the SSA commander will decide which transactions the SSA will process and how long the SSA maybe nonoperational.

★ **NOTE:** You must conduct an unscheduled inventory each time you process a total or partial MRD. Count only the item in question, and compare this count with the quantity listed on the stock record.

★ **Inventories Under the SARSS-1(I)
Automated System**

Although many of the measures taken to prepare and conduct an inventory are standard, there is specific

procedural guidance for conducting inventories within the SARSS-1(I) automated system. It is in ADSMs 18-L19-AJH-BUR-UM and 18-L19-AJH-BUR-EM.

★ *Table 10-4. Reasons for a special inventory*

- **A credit balance on hand occurs (negative balance).**
- **A materiel release denial occurs.**
- **A location survey finds an item in an unrecorded location or in an incorrect location.**
- **There is evidence of forced or unauthorized entry.**
- **The commander or an accountable officer directs that an inventory be conducted.**
- **There is a change of accountable officer.**

Section II
The Location Survey

PREPARING FOR SURVEY

Before you and your personnel begin the inventory, you must conduct a location survey to make sure all data have been posted to the records and that all supplies are in the correct locations. A location survey is a check of the storage locations against the locations listed on the locator deck and stock records. During the survey, you compare the supplies in storage with the data on the locator cards to ensure they match. If there are any mistakes in the NSN, condition code, quantity, security code, or type of item, you must make these

changes before the inventory begins. Chapter 6 explains how to make location changes. As storage supervisor, you must update or write an SOP covering all parts of the location survey. Be sure to include--

- Purpose and objectives of the survey.
- Time frame outline for conducting the survey.
- Assignment of survey supervisor and survey team.
- Cutoff dates for shipping and receiving sections.
- List of areas not included in the survey.

- Reporting date, reporting point, and schedule for survey team members.
- Explanation of training for survey team members.
- Explanation of the duties of the survey team members.

★ PERFORMING THE SURVEY

A location survey is a physical check of actual storage locations against items recorded on the ABF. This survey is very important to ensure storage of items in the locations identified on the ABF. It is usually done once a year or prior to a wall-to-wall inventory. Also, during daily operations, it may be necessary to relocate items to store material correctly. Report these location changes promptly to the SCS, MMC, or the SARSS document control section. To conduct the survey, the survey teams compare each location survey work card with the data on the bin label or item placard at each storage location. The procedures they use for locating, marking, and recording the storage locations and errors depend on whether your DSU uses pre-printed or handmade location survey work cards and location listings. Specific procedural guidance for conducting the location survey within SARSS-1(I) is in ADSMs 38-L19-AJH-BUR-UM and 18-L19-AJH-BUR-EM.

USING HANDMADE LOCATION SURVEY WORK CARDS

If your DSU keeps a manual locator file or if it does not use a locator deck, your location survey teams must write all the location data on blank DA Forms 2000-3. You must also give these cards serial numbers for control purposes. Number the first card 00001. (NOTE: This change deletes Figures 10-1 and 10-3.)

NOTE: Sometimes it is not convenient for a DSU to use DA Form 2000-3 for the location survey. When your unit is not using DA Form 2000-3, be sure your local storage SOP explains what form and procedures to use.

PROCESSING MANUAL LOCATION SURVEY WORK CARDS

The survey supervisor should check the location survey work cards (DA Forms 2000-3) to ensure they are in the correct serial number order and no cards are missing. The supervisor should make a note of the beginning and ending numbers for later reference. For example, if the last card is numbered 02508, all cards from 00001 to 02508 must be turned in when the survey is finished. The supervisor should also record the survey date and starting time. He should give each survey team a stack of cards to use to record the location information. He should log the cards out by listing each soldier's name and card numbers. Survey teams should go to each location. They should first ensure the information on the label and card matches the supplies in the location. Then they copy the information from the bin label or placard onto a survey work card. If there is more than one NSN in a location, the team should contact the storage and survey supervisors. The supervisors will check the locator deck for the correct locations of the items and move the supplies to the right places. If there are supplies in a location that does not have a bin tag or placard, the survey team should notify the storage supervisor. He will help identify the supplies and have a bin label made. The team then copies the information onto the survey work card. As the teams copy the information from the locations onto the cards, they should place the completed cards at the locations where they can be seen easily. This will let other teams know that the locations have been checked. Figure 10-2, page 10-9 shows the positioning of the work cards. After the teams finish, the survey supervisor should check the storage areas to make sure all locations have cards. If a location has no DA Form 2000-3, the supervisor must send one of the survey teams to the location to make a new survey work card. After checking all locations, the supervisor should have the survey teams collect the cards in location sequence. Then the supervisor should check both used and unused cards by serial number to see if any are missing. The survey supervisor then records the survey completion time. If any cards are missing, the teams must make a thorough search for them. If a missing card cannot be found, the survey supervisor

should make a replacement, using a blank DA Form 2000-3. You must number the new card with the serial number of the missing card. Then the supervisor sends a survey team to the location that is without a card to fill out the new card from the data on the bin label. After all the cards are turned in, the survey supervisor checks the cards to see that they are filled out correctly. He then sends them to the locator section. The locator clerk puts the cards in the same location order as the active locator file. He compares them to see if any locations are missing or if there are differences in entries, such as nomenclature, NSN, or condition code. If there are differences between the cards and the locator file, the locator clerk must notify the storage supervisor of the problems. The supervisor sends a survey team to the location to check the card to see if any of the information was copied wrong. If no mistakes were made, the storage supervisor must have storage personnel make the necessary corrections to the locator deck so the data on the deck will match those given on the stock location survey cards. Chapter 6 explains how to make location additions, deletions, and changes. The storage supervisor must also have storage personnel correct any problems found during the location survey, such as mixed stock, unidentified stock, open containers, and items in more than one location. After checking all cards and correcting all problems, the survey supervisor will send the stock location cards through the storage supervisor to the SCS. The SCS will make the necessary additions, deletions, and changes to the stock records and return the cards to the storage supervisor. The storage supervisor should file the survey work cards in the completed survey file until completion of the the next location survey.

USING PREPRINTED LOCATION SURVEY WORK CARDS

If your DSU works under the automated system of DS4, the location survey work cards will be printed by machine. The stock control or ADP section of your DSU will make a copy of all cards in the original locator deck in location order, using DA Form 2000-3. The survey teams will use blank cards to list data for any location that has no preprinted location survey

card. The ADP section will also prepare three computer printouts when it makes the location survey cards. The first printout is in NSN sequence and lists all the survey work cards. The second is in location sequence and also lists all the survey work cards. The third is a location error list of all errors recorded on the ABF. Refer to TM 38-L32-12, Chapter 7, for an explanation of the location error list. When you get the location survey work cards and the printouts from the ADP section, you must first correct all the errors that are annotated on the location error list. Once all errors are corrected and the corrections noted on the printouts that are in NSN and location sequence, give one copy of each printout and the survey work cards to the survey supervisor. Be sure both of you update and correct your printouts as the survey teams check each location.

★ USING SARSS LOCATION SURVEY LISTING

If your DSU works under the SARSS automated system, the location survey will be output in computer printout format. PCN: AJH-104 will be in location sequence. PCN: AJH-113 will be in stock number sequence. TM 38-L19-2 gives a detailed explanation of these listings. *NOTE: No cards will accompany these listings.* (NOTE: This change deletes Table 10-5.)

★ CORRECTING LOCATION SURVEY PROBLEMS AND STORAGE ERRORS

During the physical location survey, the survey teams will usually find storage problems such as mixed and unidentified stock and other minor errors. If these problems are found in a location survey where manually completed cards are used, the survey teams should contact the survey supervisor. He should keep track of the problems and their locations and work with the storage supervisor to make sure they are corrected.

COMPARING SURVEY RESULTS WITH STOCK RECORDS (MANUAL PROCEDURES)

After the survey teams have finished the survey, you and the stock control supervisor need to compare the survey results with the stock records. Do this AFTER

making all corrections and posting them to the new locator file. You and the stock control supervisor must match stock number, location, UI, and condition code of all changed and corrected locator cards with the stock records. Table 10-6, page 10-10 shows you what actions you must take when the stock records and the location survey cards do not agree. Before you take the cards to the SCS, your stock locator clerks will need to check each corrected locator card against the AMDF to ensure the NSNs and other codes agree. They should

make necessary changes to the locator cards at this time. When matching the locator cards against the stock record, change the stock record if the data do not match. The stock control supervisor will leave the quantity blank on the new stock record card until a physical inventory is taken. After reconciling the stock record and the locator file, you must ensure posting of all changes to the location deck, the bin labels and placards, materials in storage, and any other records your locator section may use.

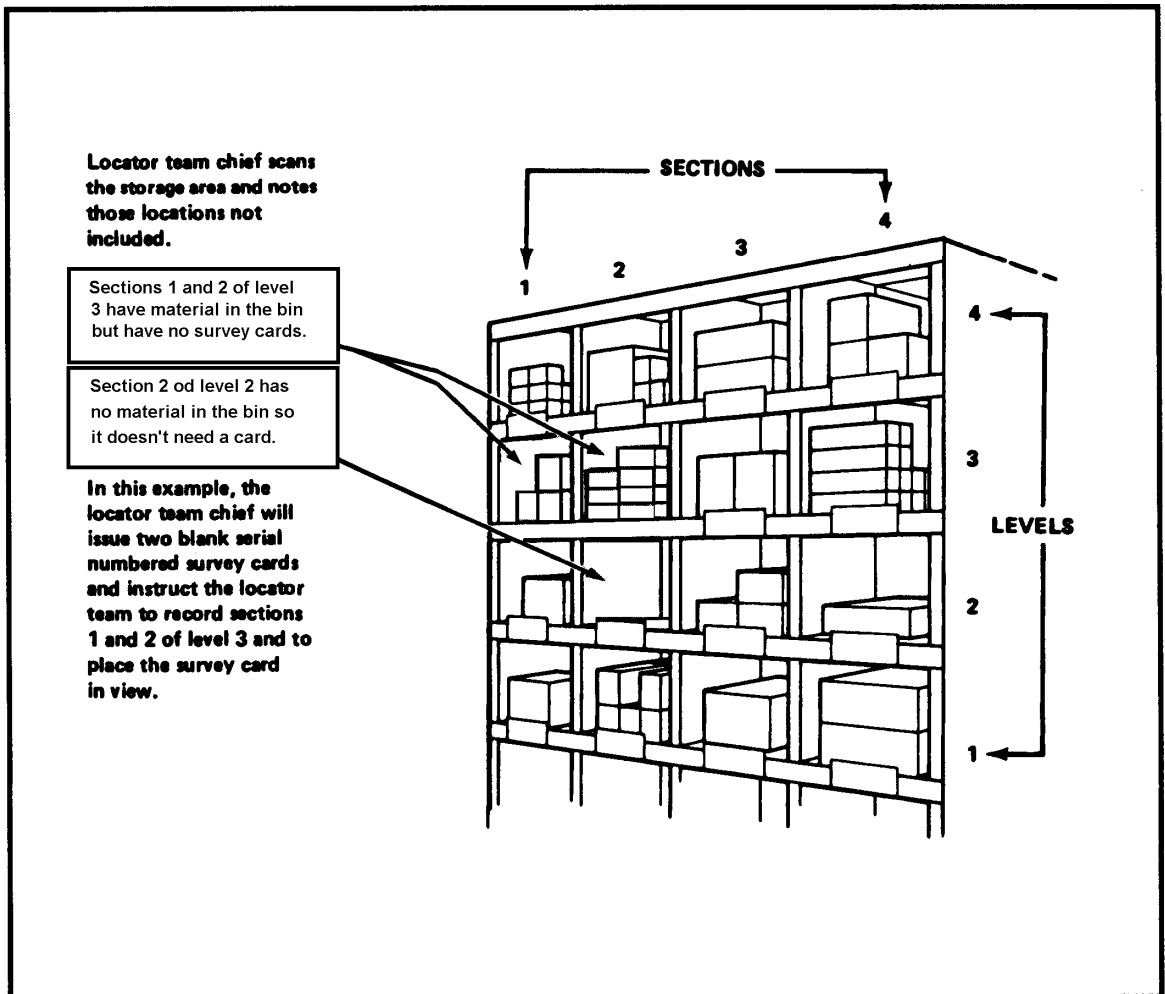

Figure 10-2. Positioning of completed location survey work cards

Table 10-6. Locator card and stock record card reconciliation table

	STOCK NUMBER	LOCATION NUMBER	NOUN NOMEN	UNIT OF ISSUE	ACTION REQUIRED
LOCATOR CARD MATCHES STOCK RECORD CARD	Yes	Yes	Yes	Yes	None.
	Yes	No	Yes	Yes	Change stock record card location number to agree with locator card.
	Yes	No	No	Yes	Same as above. Verify with AMDF. If stock record card is correct, change locator card, bin tag, and material. If stock record card is not correct, change stock record card.
	Yes	Yes	No	Yes	Same as above.
	Yes	No	No	No	Same as above.
	No	NA	NA	NA	Verify with AMDF. If stock number is changed, correct locator card, bin tag, and material, then match to stock record card. If stock number is valid and no match to stock record card, prepare new stock record card.

Section III Preinventory Procedures

SETTING UP CONTROLS

The actions you must take before the inventory begins are as important as the counting of supplies. You must work with the other section chiefs to setup reasonable cutoff dates. On these dates, you must stop

all incoming receipt documents and related actions so the inventory records can be caught up to a specified date. You decide on a specific beginning date for the inventory and a date for reconciling balances. It is a

good idea to know these dates at least 30 days before the inventory cutoff time so you can notify all supported units that will be affected by the inventory. Table 10-7 shows all the actions you will need to coordinate when you plan an inventory. You can use this as a checklist.

SETTING CUTOFF CONTROLS ON RECEIPTS

You will need to work with the accountable officer and the stock control, shipping, storage, and receipt section chiefs to decide on a cutoff date for receipts. You must decide if the receipt section will begin using a receiving cutoff control register on the cutoff date. This register makes it easier to keep up with the status of all documents your DSU receives during the inventory period. There is no set format for the register. Figure 10-4, page 10-13 shows a sample register. Actions you need to take when you receive documents before the cutoff date, and those you need to take when you receive documents after the cutoff date, are described below.

Documents Received Before the Cutoff Date

Once the cutoff date is set, the receipt section must mark or stamp all incoming documents "BEFORE INVENTORY." This helps separate those

receipts from the ones received after the cutoff date. On the cutoff date, the receipt section must hold all new documents until after the inventory. By keeping the stock record and the locator deck frozen until after the inventory is completed, you will keep the inventory count the same throughout the inventory period. The day before the inventory begins, you must check to ensure all documents marked "BEFORE INVENTORY" have been posted. Compare the receiving control register with the stock record. All items listed on the register should also be listed on the stock record. Also, check the storage section to ensure all supplies received before the cutoff date have been moved from the receipt section into storage locations. Your receiving section will process all nonstockage list items as normal since they do not affect the ABF.

Documents Received After the Cutoff Date

Your receiving section soldiers must mark "AFTER INVENTORY" on all documents received tier the cutoff date. They must also separate these documents from those marked "BEFORE INVENTORY" so they will not be counted. To help the inventory teams, you should move all documents and items received after the cutoff date to a separate storage area. If you do not have enough room to set these items aside, ensure each item involved is marked with a "DO NOT INVENTORY" sign.

Table 10-7. Coordination of activities for an inventory

- | |
|--|
| <ul style="list-style-type: none"> <input type="checkbox"/> Conduct location survey. <input type="checkbox"/> Establish shipping cutoff. On cutoff date, freeze the posting of MROs. Use shipping cutoff control register to process and/or account for outstanding MROs. <input type="checkbox"/> Establish receiving cutoff. On cutoff date, freeze new receipts and segregate. Process all old receipts. Use receiving cutoff control register to trace postings to stock records. <input type="checkbox"/> Stock records section posts all receipts after cutoff date. |
|--|

Table 10-7. Coordination of activities for an inventory (continued)

- Cutoff date.
- Process outstanding MROs.
- Conduct physical inventory. Perform recounts where necessary. Reconcile outstanding MROs for bulk items.
- Post accepted count cards to stock records. Prepare IAR.
- Lift the freeze on issuance of MROs.
- Lift the freeze on receipts.
- Prepare reports of survey.
- Perform inventory recomputations.
- Resume normal operations.
- Turn in excess according to AR 710-2.

NOTE: Workdays required will vary according to size of inventory and transaction volume.

DATE RECEIVED	STOCK NUMBER	DOCUMENT NUMBER	QUANTITY	DATE POSTED TO STOCK RECORD
OCT 83	2820002824466	41950001	5 EA	3 OCT 83
OCT 83	2910001642232	42010001	1 EA	3 OCT 83
OCT 83	5		16 EA	
OCT 83	5		20 DZ	3 OCT 83
24 OCT 83	7840009261492	42200007	8 EA	
24 OCT 83	9695000382197	42290001	12 EA	7 OCT 83

These "floating receipt documents" must be located and posted to stock record cards before the inventory.

Figure 10-4. Receiving cutoff control register

SETTING CUTOFF CONTROLS ON MATERIEL RELEASE ORDERS

You and the accountable officer need to decide on a cutoff date for processing MROs. (They are described and explained in Chapter 8.) After this date, the stock record section must post only MROs for high-priority (PDs 01, 02, and 03) requisitions or for nonstocked items. You also need to decide if the SCS will use an MRO cutoff control register during the inventory. This register helps keep track of all MROs and shows you which ones have been filled. There is no set format for the register (manual procedures only). Figure 10-5 shows a sample MRO register that includes all the information you will need to list. If you decide to use a register, the stock control supervisor must ensure that personnel number and date all MROs they receive daily. Your personnel must list, by serial number, all MROs sent to the pickup point before the cutoff date in the Date To Shipping/Pickup Point column of the register. On the cutoff date, you and the stock control supervisor must check the register to ensure all MROs listed have been sent to the pickup or shipping section. If you find MROs with no entry in the Date To Shipping/Pickup Point column, you will know that these MROs have not been processed. You

and the stock control supervisor must locate and account for all MROs that are outstanding. To ensure that the listed supplies are ready for inventorying, you must change the count in the SCS and send the MRO back to the receiving section or move the supplies and the MRO to the issue/shipping section. If you have any MROs that are outstanding for items such as lumber or barricade materials, send the MROs to the SCS or to the inventory supervisor so the inventory count can be changed. Because of their size, do not send these items to the issue point for loading. Therefore, even though the MROs have been processed, count bulk items as part of the stored supplies since they are kept in the storage section until they are loaded.

GETTING AN INVENTORY VOUCHER NUMBER

You will need to contact the stock control supervisor for an inventory voucher number before the inventory begins. A special number from the DA Form 272 (Register of Vouchers to a Stock Record Account) is assigned for each inventory.

CONTROL NUMBER	STOCK NUMBER	DOCUMENT NUMBER	QUANTITY	DATE TO SHIPPING/PICKUP POINT
0001	2820004449618	32010002	3 EA	4 OCT 83
0002	2821001162213	32010001	2 EA	4 OCT 83
0003	4718001821419	32000001	5 EA	4 OCT 83
0004	5625002162981	32010008	1 EA	4 OCT 83
0005	32180019618	32010001	1 EA	4 OCT 83
0006	11260000026	32010001	1 EA	4 OCT 83
0007	00673	32010001	1 EA	4 OCT 83
0861				
0862	2736002198736	32020001	2 EA	
0863	6119001963745	32190001	2 EA	
0864	7536002011918	32190001	5 DZ	21 OCT 83
0865	8210001962222	32200001	1 EA	23 OCT 83

These outstanding material release orders must be processed or accounted for before the inventory.

Figure 10-5. MRO cutoff control register

When you and the inventory supervisor get the inventory count cards and the machine listings, you will find this number on each card and on each page of the listing. You will use this number later when you make stock record adjustments with DA Form 444 (Inventory Adjustment Report) and DA Form 4697 (Department of the Army Report of Survey). Figure 10-6 shows entries on a DA Form 272.

PREPARING INVENTORY COUNT CARDS

When your DSU accountable officer receives the MRO cutoff dates, he tells the ADP section or the SCS to make inventory count cards. These are preprinted DA Forms 2000-3 for the inventory teams to use to record the supply count during the

inventory. Figure 10-7 shows preprinted (machine-prepared) and manually-prepared inventory count cards. The SCS will make a card from each item listed on the stock record to be inventoried. The data to be listed on a preprinted card and a manually-prepared card are given below.

Preprinted Cards

Preprinted cards must include the following:

- DIC YDK.
- NSN.
- UI.
- Quantity.
- Inventory voucher number.
- Inventory cutoff date.
- Inventory serial number.
- Storage location.

- DSU code.
- Condition code.
- Storage location code C (if location changed).
- Inventory count code.
- Date posted and counter's signature.
- Date and recorder's signature.

The SCS puts the cards in location order. They are numbered from 0001 to 9999 so you can tell how many items will be involved in the inventory. This helps the inventory supervisor keep track of the cards. The SCS also puts serial numbers on some blank cards so that the inventory teams can make a card for any item that does not have a preprinted card.

Manually-Prepared Cards

If your DSU does not have the use of ADPE, your ADP and SCS personnel must work together

to fill out the inventory count cards by hand. You must check the cards to make sure they have the following:

- DIC YDK.
- Special interest code.
- Supply category of materiel code.
- Pilferable item code.
- NSN, MCN, or MPN.
- UI code.
- Voucher control code.
- Inventory cutoff date (Julian date).
- Inventory count serial number.
- Storage location.
- DSU code.
- Condition code.
- Inventory count code (1, 2, or 3).

Ensure count cards are made for all items on the stock record, even those that show a zero balance. When your personnel have completed the cards,

DODAAC		PAGE NUMBER		SUPPLY SUPPORT ACTIVITY		REGISTER OF VOUCHERS TO A STOCK RECORD ACCOUNT	
WK4ABC		3		156TH MAINT BN		FOR THE USE OF THIS FORM, SEE DA PAM 710-22. THE PROPONENT AGENCY IS THE OFFICE OF THE DEPUTY CHIEF OF STAFF FOR LOGISTICS.	
DATE	SERIAL	PD	DATE COMPLETE	TO/FROM	STOCK NUMBER	ITEM NOUN	REMARKS
3159	7002	D	3189	AKZ	6140000572553	BATTERY	
3230	7001	D	3285	AKZ	6140000572553	BATTERY	1ST PARTIAL RECD 3246
3323	7001			59I	5330007998905	PACKING	
3323	7002			59E	5935008126347	CONNECTOR	
3323	7003	D	3343	N32	5962008168858	MICROCIRCUIT	
3323	7004	C	3323	B16	7920011016686	BRUSH	SHIPPED TO WK4987
3323	7005			AKZ	2940000000145	FILTER ELEMENT	
3323	7006			59E	5955000037594	CRYSTAL UNIT	
3323	7007			59G	6220000253675	CAP	
3323	7008			59G	6220000253697	LENS	
3323	7009	D	3010	AKZ	6140000572553	BATTERY	
3363	7001	D	3363	B17	2995000282242	CLUTCH	FOUND ON INSTALLATION
3363	7002			59C	2510000306537	REAR WINDOW	
3363	7003	D	3021	AKZ	6140000572553	BATTERY	

DA FORM 272 JAN 82 EDITION OF DEC 67 IS OBSOLETE.

Figure 10-6. Entries on a DA Form 272

YDK	A9AJ2910008	9259:72	EA	99351520006	BA143	D	A	1	
LOCATION				NOUN				COUNT QUANTITY	
LOCATION				COUNTER AND DATE				COUNT QUANTITY	
NUMBER OF PALLETS	PACKAGES PER PALLET	QUANTITY PER PACKAGE	TOTAL QUANTITY	RECORDED BALANCE	UNIT PRICE	QUANTITY OVER	SHORT	VALUE OVER	SHORT
				MACHINE PREPARED				3 3 3	
				ACCEPTED				4 4 4	
				RECOUNT				5 5 5	
				SUSPEND				6 6 6	
				QUANTITY OVER				7 7 7	
				SHORT				8 8 8	
				VALUE OVER				9 9 9	
				SHORT				0 0 0	

DOC IDENT	ROUTING IDENTIFIER	FPC	STOCK NUMBER	ADD	UNIT OF ISSUE	QUANTITY	DOC IDENT	ROUTING IDENTIFIER	FPC	STOCK NUMBER	ADD	UNIT OF ISSUE	QUANTITY
YDK			1500001522983			EA00016							
DOC IDENT	ROUTING IDENTIFIER	FPC	STOCK NUMBER	ADD	UNIT OF ISSUE	QUANTITY	DOC IDENT	ROUTING IDENTIFIER	FPC	STOCK NUMBER	ADD	UNIT OF ISSUE	QUANTITY
99350530006													
FUND	DISTRIBUTION	PROJECT	PRIORITY	REQ DEL DATE	FUNDED	NON-FUNDED	G	I	H	J	K	M	N
D	A												
MGR CODE	ISSUED	DATE POSTED	INIT	DUE OUT	DATE AVAILABLE	INIT	RECEIVED	DATE RECEIVED	INIT	SIGNATURE			
		5061	A.W. Wilhag		5061	J. Smith							

Figure 10-7. Preprinted and manually-prepared inventory count cards

they must put them in location order and number them. Be sure they also number some blank cards for the inventory teams to use. After the inventory count cards are completed and numbered, you must give the stack to the inventory supervisor. He will check them and then issue them to the inventory teams to use to record the supply count.

PREPARING INVENTORY COUNT CARD CONTROL LISTINGS

At the same time they make the inventory count cards, the ADP or SCS of your DSU will also make two separate control listings from the information on the count cards. If your DSU does not have ADPE available, your ADP and SCS personnel must work together to prepare two listings manually. One of these listings will go to the inventory supervisor for controlling the inventory. The other will go to the accountable officer for accountability adjustments and budget reporting. Ensure these listings do not include items in the RX, CIF, QSS, SSSC, and shipping and receiving sections.

Accountable Officer's Listing

This listing must include the following:

- Count card serial number.
- NSN of item.
- Name of item.
- UI.
- Condition code of item.
- Security and pilferage code of item.
- Unit price.
- Recorded balance on stock record.
- Location code.

Figure 10-8 gives an example of a page of the control listing made for the accountable officer. He must keep this list in a secure place. He must not let storage personnel use it. He will use the listing when he reports and reconciles his records with the installation FAO.

Inventory Supervisor's Listing

This listing has less detail than the listing the accountable officer needs. Figure 10-9 gives an example of a page of the control listing made for the inventory supervisor. His list must include the inventory count card serial number, NSN of item, name of item, and location code. After completing

the listings, the SCS will send them to you along with the inventory count cards. Check them to ensure they are ready for the inventory. Give them to your locator clerk to check against the location file. He compares the cards, the listings, and the locator file to see if there are any differences. The clerk also must check to see if there are any locator cards that have multiple locations in the locator deck. If so, he checks to see if inventory count cards have been made for these locations. If a locator card has no matching inventory count card, the next numbered blank count card must be filled out using the information on the locator card. After checking the cards, the locator clerk will give the count cards and listings back to you. After you have looked over the listings and cards for any mistakes, give the accountable officer a copy of the listing. As soon as you give the inventory supervisor the listing and the deck of inventory count cards, the inventory can start.

PREPARING STORED ITEMS FOR INVENTORY

You must try to maintain stored supplies in the most secure manner possible. As storage supervisor, you must also ensure your personnel use the proper storage techniques and that they follow all guidelines given in DOD 4145.19-R-1 for storing supplies. However, before each inventory, there are special actions to take that will make the inventory go smoothly and quickly. These actions will also help ensure an accurate inventory count. You must ensure—

- All supplies are properly identified and clearly marked.
- All supplies not to be counted are marked with DO NOT INVENTORY signs.
- All supplies are stored in the least number of separate locations.
- All opened containers either contain the quantity listed or have the new quantity marked on the outside of the container.
- All supplies stored on pallets are placed neatly and uniformly to make counting easier.
- All members of the inventory teams are given enough on-the-job training to do the following: Fill out inventory count cards correctly, identify all items being inventoried, and count all types of packaged items. They must know and follow safety and security requirements.

**VOUCHER NUMBER 350
PAGE 1 OF 3**

NOUN	*STOCK NUMBER	*UNIT OF ISSUE	*COND CODE	*LOCATION NUMBER	*COUNT CARD SERIAL NUMBER	UNIT PRICE	RECORD BALANCE	COUNT QTY	QTY OVER/SHORT	EXTENDED DOLLAR VALUE QTY OVER/SHORT
Spring	1040000100047	EA	A	WO135	001	.50	0010			
Mod Kit	1560000105476	EA	A	LO348	002	1.65	0015			
Mod Kit	1560000105476	EA	F	LO348	003	1.65	0002			
Tire Pnuus	2610000234692	EA	A	K7714	004	.95	0000			
Shim	2510002340481	EA	F	P3326	1241	10.14	0009			
Shim	2510002340481	EA	F	P3326	1242	10.14	0009			
Gear	5310002378633	HD	A	B0024	1243	1.50	0350			
Guide	2530002389139	PR	A	D0126	1244	1.50	0001			
Guide	2530002389139	PR	F	D0127	1244	1.50	0001			
Washer	5306002398038	HD	A	E0112	1245	.06	0000			
					1441					
					1442					
					1443					
					1444					
					1445					

OPTIONAL	1205	Serviceable count cards produced
	40	Unserviceable count cards produced
	1245	Total count cards produced
	200	Blank count cards produced
	1446	Next count card number for voucher number 350

* Minimum entries for an automated system

Figure 10-8. Accountable officer's inventory count card control listing

VOUCHER NUMBER 350					
PAGE 1 OF 3					
NOUN	*STOCK NUMBER	*UNIT OF ISSUE	*COND CODE	*LOCATION NUMBER	*COUNT CARD SERIAL NUMBER
Spring	1040000100047	EA	A	WO 135	001
Mod Kit	1560000105476	EA	A	LO348	002
Mod Kit	1560000105476	EA	F	LO349	003
Tire Pneu	2610000234692	EA	A	K7714	004
Modifier	2510000875526	EA	A	WO126	005
Modifier	2510000875526	EA	F	WO127	006
Adapter	2840001112986	EA	A	B0252	007
Shim	2510002340481	EA	F	P3326	1241
Shim	2510002340481	EA	F	P3326	1241
Gear	5310002378633	HD	A	B0024	1242
Guide	2530002389139	PR	A	D0126	1243
Guide	2530002389139	PR	F	D0127	1244
Washer	5305002398038	HD	A	E0112	1245

OPTIONAL	1205	Serviceable count cards produced
	40	Unserviceable count cards produced
	1245	Total count cards produced
	200	Blank count cards produced
	1446	Next count card number for voucher number 350

*Minimum entries for an automated system

Figure 10-9. Inventory supervisor's inventory count card control listing

Section IV

The Inventory

WORKING WITH KEY INVENTORY PERSONNEL

You work with many people when you set inventory controls and when you conduct the inventory. You need to know the duties of the major inventory personnel. They are described in this paragraph.

Inventory Supervisor

The inventory supervisor is assigned to the DSU accountable officer for the entire inventory period. He is in charge of the inventory and the inventory count teams. The inventory supervisor may not normally be assigned to your DSU. However, he will be attached to your unit until the inventory count is posted to the stock record. It is his job to instruct and train inventory count teams in the correct inventory procedures. He is responsible for controlling and checking all inventory count cards and control listings before, during, and after the inventory to ensure they are complete and without errors. You will need to help him with any storage problems or mistakes which the teams find and with any inventory difficulties.

Inventory Count Teams

These teams consist of a counter and a checker or recorder. Because wall-to-wall inventories are so large and must be completed within five working days, you may need six or more teams working at the same time. Normally, they may not be assigned to your storage section. If you do not have enough personnel to help with the inventory, you can borrow the teams from other supply and local activities such as your DSU SCS or the SSSC. The teams come under the direct control of the inventory supervisor.

Stock Control Supervisor

The stock control supervisor is one of the most important persons you work with in setting up and conducting the inventory. His section is in charge of making all inventory count cards, the control listings, and any other automated documents you may need. Section personnel are also responsible

for numbering the cards and listings with the inventory voucher numbers and serial numbers needed for control purposes. You work closely with the stock control supervisor when you set the cutoff dates and when you verify and post the inventory counts to the stock record. He helps you figure and prepare the inventory adjustments and budget information for the accountable officer.

ISSUING ITEMS DURING THE INVENTORY

If at all possible, your storage section personnel should not make issues during an inventory since the chance of making errors increases when issues are made while counting is in progress. However, you must fill all requests and issue supplies for high-priority items (PDs 01, 02, and 03) and NMCS items. If you receive a priority request for issue when the inventory teams are counting, the inventory supervisor should hand-carry the MRO to the storage location. If the requested item has already been counted, the inventory supervisor pulls the item from storage and subtracts the amount being issued from the total quantity listed on the count card. He must be sure to write the MRO document number on the count card when he writes the number of items he is subtracting. He can then move the item to the issue/shipping section. If an item being issued has not been counted, the inventory supervisor should write the amount that he is pulling from storage on the count card. He also should write a short note on the count card explaining what he did. Then he issues the items in the normal way and processes the MRO document following the instructions in this chapter. You may issue nonstockage list items processed through the receiving section to customer units since they do not affect the ABF. If your DSU works under an automated system such as SAILS or DS4, you may have to use a reverse procedure when you issue supplies during an inventory. This will freeze the inventory record until the count card is accepted. You make issues under this kind of system on a postpost basis. Do not record a

postpost transaction until after the inventory. Check TMs 38-L03-17 and 38-L32-12 for the procedures to use under SAILS and DS4 when you need to issue an item during the inventory.

INVENTORYING LUMBER

The general inventory procedures in this chapter also apply to inventorying lumber. Some special inventory differences to make your job easier are described below.

Measuring Lumber

When you speak of lumber size, you are talking about its thickness and width. For example, a 2- by 4-inch piece of lumber is actually 2 inches thick and 4 inches wide *before* it is milled. After it has been seasoned and milled, its thickness and width will be less. However, it is still called a 2 by 4. This is nominal thickness and width. You measure most lumber in the Federal Supply System in terms of board feet. Figure the board feet of a piece of lumber by multiplying its thickness (in inches) by its width (in inches) by its length (in feet) and dividing by 12. If you have more than one piece of lumber the same size, once you figure the board foot measurement of one piece, multiply it by the number of pieces. When you have a large quantity of lumber to inventory, use Table 10-8. This table shows the board foot calculations for different sizes of lumber.

Using Stock Records

You can find out how much lumber you have on hand by checking the stock records for the different types of lumber. Since all stock records are kept in NSN order, you need to know the NSN for each kind of lumber that you stock. To find the NSN for a piece of lumber, you need to know the size, kind, and use of the piece of lumber. You also need to know the FSC code. The FSC code for lumber is 5510. Get the other information by checking and measuring the lumber in question. When you have this information, check the Federal Supply Catalog identification listing. These listings are issued quarterly on microfiche. The SCS or the editing section of your DSU should have a copy. The listings are made in FSC-code sequence to help you locate items easily. Look under the FSC code 5510 until you find the description of the lumber you are inventorying. The description also will list the NSN. After you find the NSN, check the stock record for this

number. It will give the total number of board feet which you have on hand for that piece of lumber.

Recording Lumber Counts

You inventory lumber by size and length. When you make a count card on lumber, you must relabel some of the columns. Figure 10-10 shows how to relabel the count card. It also shows which section of the card the inventory team fills out and which section the SCS fills out after the inventory.

PERFORMING THE INVENTORY

After completing the preinventory actions, you are ready to start the inventory. The inventory supervisor assigns the inventory teams to specific portions of the storage areas and gives them the count cards for those areas. He should log the names of the team members and the serial numbers of the count cards he gives them to his count card control listing. He will use this listing to keep track of all the cards. The steps in the inventory are described below.

Counting Stock

The teams go to the storage locations listed on the count cards. At each location, the counter reads aloud the location, stock number, and UI from the bin label and supply containers. The recorder compares this information with the data listed on the count card.

Loose stock. If the location is filled with loose stock, the counter will count each item and tell the recorder the total number of supplies in that location. Since the supplies are not in packages as listed on the count card, the team should write the word "LOOSE" on the card and enter the final count in the Total Quantity column. Figure 10-11 shows a count card prepared for loose stock.

Packaged stock. If the location has supplies that are in packages or boxes, the counter calls out the number of packages and the number of supplies in each package. The recorder writes this information in the correct columns and multiplies the two figures. He writes the total in the Total Quantity column. Figure 10-12 shows a count card prepared for packaged stock.

Table 10-8. Lumber measurement conversion table

NOMINAL CROSS SECTION	8 FEET	10 FEET	12 FEET	14 FEET	16 FEET	18 FEET
Inches	Board feet	Board feet	Board feet	Board feet	Board feet	Board feet
1 x 2	1 1/3	1 2/3	2	2 1/3	2 2/3	3
1 x 3	2	2 1/2	3	2 1/2	4	4 1/2
1 x 4	2 2/3	3 1/3	4	4 2/3	5 1/3	6
1 x 6	4	5	6	7	8	12
1 x 8	5 1/3	6 2/3	8	9 1/3	10 2/3	15
1 x 10	6 2/3	8 1/3	10	11 2/3	13 1/3	18
1 x 12	8	10	12	14	16	9
1 1/2 x 4	4	5	6	7	8	9
1 1/2 x 6	6	7 1/2	9	10 1/2	12	13 1/2
1 1/2 x 8	8	10	12	14	16	18
1 1/2 x 10	10	12 1/2	15	17 1/2	20	22 1/2
1 1/2 x 12	12	15	18	21	24	27
2 x 4	5 1/3	6 2/3	8	9 1/3	10 2/3	12
2 x 6	8	10	12	14	16	18
2 x 8	10 2/3	13 1/3	16	18 2/3	21 1/3	24
2 x 10	13 1/3	16 2/3	20	23 1/3	26 2/3	30
2 x 12	16	20	24	28	32	36
3 x 4	8	10	12	14	16	18
3 x 6	12	15	18	21	24	27
3 x 8	16	20	24	28	32	36
3 x 10	20	25	30	35	40	45
3 x 12	24	30	36	42	48	54
4 x 4	10 2/3	13 1/3	16	18 2/3	21 1/3	24
4 x 6	16	20	24	28	32	36
4 x 8	21 1/3	26 2/3	32	37 1/3	42 2/3	48
4 x 10	26 2/3	33 1/3	40	46 2/3	53 1/3	60
4 x 12	32	40	48	56	64	72
6 x 6	24	30	36	42	48	54
6 x 7	28	35	42	49	56	63
6 x 8	32	40	48	56	64	72
6 x 10	40	50	60	70	80	90
6 x 12	48	60	72	84	96	108
7 x 9	42	52 1/2	63	73 1/2	84	94 1/2
8 x 8	42 2/3	53 1/3	64	74 2/3	85 1/3	96
8 x 10	53 1/3	66 2/3	80	93 1/3	106 2/3	120
8 x 12	64	80	96	112	128	144

NOTE: This table should be copied and placed in the lumber storage area. It can be used in computing board footage if the number of pieces needed is known. Thus, 1,000 2 x 4's 12 feet long would contain 8,000 board feet of lumber.

LOCATION										NOUN										COUNT QUANTITY																													
L1824										55100022061 94										ABF LUMBER 2x4																													
DA FORM 3863, 1 OCT 68 SERIAL NUMBER	1	NUMBER OF PALLETS	LENGTH PER PALLETS	BOARD FT QUANTITY PER PACKAGE	TOTAL QUANTITY IN BOARD FEET	COUNTER AND DATE					RECORDER AND DATE					ACCEPTED					RECOUNT					SUSPEND																							
	2	3	8	5 2/3	16	Lee 3139					EVANS 3139					<input type="checkbox"/>					<input type="checkbox"/>					<input type="checkbox"/>																							
	3	5	12	8	40											<input type="checkbox"/>					<input type="checkbox"/>					<input type="checkbox"/>																							
	4	GRAND TOTAL			56											<input type="checkbox"/>					<input type="checkbox"/>					<input type="checkbox"/>																							
	5	These entries are made by the inventory team.				These entries are made by the stock control section.				BALANCE					UNIT PRICE					QUANTITY					SHORT																								
																				OVER										VALUE										SHORT									
																				OVER										VALUE										SHORT									
LOCATION										NOUN										COUNT QUANTITY																													

1. Change number of pallets to number of pieces.
2. Change packages per pallet to length in feet.
3. Change quantity per package to board feet per length.
4. Change total quantity to total quantity in board feet.

Figure 10-10. Inventory count card relabeled for lumber

Palletized stock. If the supplies to be counted are stored in boxes on pallets, the counter calls out the number of pallets, the number of packages on each pallet, and the number of supplies in each package. The recorder writes this information in the correct columns, multiplies the figures, and writes the total in the Total Quantity column. If an inventory team has a preprinted count card with a location listed, make sure that the team checks all storage areas for missing supplies before it marks the quantity as zero. Figure 10-13 shows a count card prepared for palletized stock.

Completing the Count

After the team writes all the information on the count card, both the counter and the recorder

should sign and date the card. Figure 10-14 shows a completed count card signed by the counter and recorder. They must place the card on the location where it can be easily seen. Then they go to the location listed on their next count card. When the count team has filled out all the cards, signed and dated them, and placed them at the locations, the inventory team will tell the inventory supervisor that it has finished the count.

Inspecting the Area

When all the teams have finished counting, the inventory supervisor must inspect the storage area to ensure all locations have a count card posted. If he sees a location without a count card,

R0145		6140000572		553	AEA	BATTERY		00271W		KAA BC 30850004						
LOCATION		PFC		ASSET CODE	ASSET CLASS	ASSET TYPE	ASSET UNIT	ASSET R. I. TO	NOUN	INC NO	LOT NO	SERIAL NUMBER	QTY NO	DSI	DEPOT/ IN FROM	COUNT QUANTITY
DA FORM 2000-3, 1 OCT 83 INC NO LOT NO SERIAL NUMBER QTY NO	1	NUMBER OF PALLETS	PACKAGES PER PALLET	QUANTITY PER PACKAGE	TOTAL QUANTITY	COUNTER AND DATE		0 0 0 0 0 0 0 0 0 0 0 0 0 0 0 0								
	2			Loose	38	RECORDER AND DATE		0 1 0 0 1 0 0 1 0 0 1 0 1 0 1 0 1 0								
	3					ACCEPTED RECOUNT SUSPEND		0 2 0 0 2 0 0 2 0 0 2 0 2 0 2 0 2 0 2 0								
	4					RECORDED BALANCE UNIT PRICE		0 3 0 0 3 0 0 3 0 0 3 0 3 0 3 0 3 0 3 0								
	5					QUANTITY		0 4 0 0 4 0 0 4 0 0 4 0 4 0 4 0 4 0 4 0								
	6					OVER SHORT		0 5 0 0 5 0 0 5 0 0 5 0 5 0 5 0 5 0 5 0								
	7					OVER VALUE SHORT		0 6 0 0 6 0 0 6 0 0 6 0 6 0 6 0 6 0 6 0								
	8					OVER SHORT		0 7 0 0 7 0 0 7 0 0 7 0 7 0 7 0 7 0 7 0								
	9					OVER SHORT		0 8 0 0 8 0 0 8 0 0 8 0 8 0 8 0 8 0 8 0								
	10					OVER SHORT		0 9 0 0 9 0 0 9 0 0 9 0 9 0 9 0 9 0 9 0								
LOCATION		PFC		ASSET CODE	ASSET CLASS	ASSET TYPE	ASSET UNIT	ASSET R. I. TO	NOUN	INC NO	LOT NO	SERIAL NUMBER	QTY NO	DSI	DEPOT/ IN FROM	COUNT QUANTITY
															MPT 16745	

Figure 10-11. Count card for loose stock

R0145		6140000572		553	AEA	BATTERY		00271W		KAA BC 30850004						
LOCATION		PFC		ASSET CODE	ASSET CLASS	ASSET TYPE	ASSET UNIT	ASSET R. I. TO	NOUN	INC NO	LOT NO	SERIAL NUMBER	QTY NO	DSI	DEPOT/ IN FROM	COUNT QUANTITY
DA FORM 2000-3, 1 OCT 83 INC NO LOT NO SERIAL NUMBER QTY NO	1	NUMBER OF PALLETS	PACKAGES PER PALLET	QUANTITY PER PACKAGE	TOTAL QUANTITY	COUNTER AND DATE		0 0 0 0 0 0 0 0 0 0 0 0 0 0 0 0								
	2					RECORDER AND DATE		0 1 0 0 1 0 0 1 0 0 1 0 1 0 1 0 1 0								
	3					ACCEPTED RECOUNT SUSPEND		0 2 0 0 2 0 0 2 0 0 2 0 2 0 2 0 2 0 2 0								
	4					RECORDED BALANCE UNIT PRICE		0 3 0 0 3 0 0 3 0 0 3 0 3 0 3 0 3 0 3 0								
	5					QUANTITY		0 4 0 0 4 0 0 4 0 0 4 0 4 0 4 0 4 0 4 0								
	6					OVER SHORT		0 5 0 0 5 0 0 5 0 0 5 0 5 0 5 0 5 0 5 0								
	7					OVER VALUE SHORT		0 6 0 0 6 0 0 6 0 0 6 0 6 0 6 0 6 0 6 0								
	8					OVER SHORT		0 7 0 0 7 0 0 7 0 0 7 0 7 0 7 0 7 0 7 0								
	9					OVER SHORT		0 8 0 0 8 0 0 8 0 0 8 0 8 0 8 0 8 0 8 0								
	10					OVER SHORT		0 9 0 0 9 0 0 9 0 0 9 0 9 0 9 0 9 0 9 0								
LOCATION		PFC		ASSET CODE	ASSET CLASS	ASSET TYPE	ASSET UNIT	ASSET R. I. TO	NOUN	INC NO	LOT NO	SERIAL NUMBER	QTY NO	DSI	DEPOT/ IN FROM	COUNT QUANTITY
															MPT 16745	

Figure 10-12. Count card for packaged stock

R0145		6140:000572:553										AEA		BATTERY				00271W		KAA BC300850004				COUNT QUANTITY	
LOCATION		STOCK NUMBER										NOUN		SERIAL NUMBER		DSI		DEPOT/AT PRGME				COUNT QUANTITY			
DA FORM 2080-3, 1 OCT 83	SERIAL NUMBER	1	NUMBER OF PALLETS	PACKAGES PER PALLET	QUANTITY PER PACKAGE	TOTAL QUANTITY	COUNTER AND DATE		00000000000000000000																
		7	1	20	2	40	RECORDER AND DATE		01001001001001001001																
		2	3	12	2	72	ACCEPTED RECOUNT SUSPEND		02002002002002002002																
		0			TOTAL	112	RECORDED BALANCE UNIT PRICE		03003003003003003003																
		0					QUANTITY		04004004004004004004																
						OVER SHORT		05005005005005005005																	
						VALUE		06006006006006006006																	
						OVER SHORT		07007007007007007007																	
LOCATION		STOCK NUMBER										NOUN		SERIAL NUMBER		DSI		DEPOT/AT PRGME				COUNT QUANTITY			
/A/P/T 15745		COUNT QUANTITY																							

Figure 10-13. Count card for palletized stock

R0145		6140:000572:553										AEA		BATTERY				00271W		KAA BC300850004				COUNT QUANTITY	
LOCATION		STOCK NUMBER										NOUN		SERIAL NUMBER		DSI		DEPOT/AT PRGME				COUNT QUANTITY			
DA FORM 2080-3, 1 OCT 83	SERIAL NUMBER	1	NUMBER OF PALLETS	PACKAGES PER PALLET	QUANTITY PER PACKAGE	TOTAL QUANTITY	COUNTER AND DATE		3057																
		7	1	20	1	20	RECORDER AND DATE		Dick & Dean																
		2	1	13	1	13	ACCEPTED RECOUNT SUSPEND		3057																
		0			TOTAL	33	RECORDED BALANCE UNIT PRICE		Paul Wilson																
		0					QUANTITY		01001001001001001001																
						OVER SHORT		02002002002002002002																	
						VALUE		03003003003003003003																	
						OVER SHORT		04004004004004004004																	
LOCATION		STOCK NUMBER										NOUN		SERIAL NUMBER		DSI		DEPOT/AT PRGME				COUNT QUANTITY			
/A/P/T 15745		COUNT QUANTITY																							

Figure 10-14. Count card completed by inventory team

he should give a blank, serial-numbered card to the count team and have them inventory the location and fill in all the identification data on the card. If the location is listed on his control listing, he can fill in the data before he gives the card to the count team. The inventory supervisor must list all missing count cards on his control listing. He must also list the inventory totals of any new cards that were made. The SCS will need this information to check the stock record and to make sure that these items are listed as part of the stock.

Completing the Inventory

The inventory supervisor must account for all count cards by serial number. He can use his control listing to check off the cards as he gets them. He should also check each card to see if it has been filled out correctly. Once all corrections are made, he should put the cards into location sequence. He can use his location listing to help determine the order in which they should go. After the cards are in order, he should give them to you to take to the accountable officer.

ACCEPTING THE COUNT

After the accountable officer receives the count cards, he checks off their serial numbers on his control listing. Once he is satisfied that no cards are missing, he writes the unit price and total quantity from the control listing onto each card. After he writes this data on the cards, he compares the total quantity the inventory team counted with the quantity that he wrote on the card. If the quantities match, he check marks the Accept box. He does the same for each card in the stack. Figure 10-15 shows sample cards, with matching and different totals, that have been accepted. If the count of the inventory team is different from the total listed on the control listing, the accountable officer must take the following steps:

- Figure the amount short or over that the inventory team found for the item.
- Figure the amount of money this overage or shortage represents by multiplying the difference by the unit price.
- Write this figure on the count card.

If the quantities do not match, he can still accept the count if the adjusted value is \$50 or less and the

item does not have an SEC on the AMDF of 1, 2, 3, 4, 5, 6, 8, N, P, Q, or R. CDA Pamphlet 18-1 explains these codes.

REQUESTING A RECOUNT (MANUAL PROCEDURES)

There are times when the inventory team count and the total listed on the accountable officer's control listing do not match. This does not always require a recount. Under certain conditions, the count can still be accepted as valid. However, the accountable officer *must* have the items recounted when it is determined that the adjusted value is more than \$50 or the item is sensitive or controlled. To tell if the item is a sensitive or controlled item, the accountable officer checks the item NSN on the monthly AMDF. If the SEC column has a 1, 2, 3, 4, 5, 6, 8, N, P, Q, or R, the item is sensitive or controlled. The accountable officer checks the Recount box on the inventory count card and returns the card to you or the inventory supervisor. Figure 10-16 shows a count card marked for recount. When a recount must be made, you or the inventory supervisor needs to make up a new count card from the information on the control listing for each item to be recounted. Be sure you number the card with the same serial number as that on the original count card. You will also need to mark the number of the recount, such as 2, 3, or 4, in the Cnt No block of the count card. This shows how many times you have counted the items. The inventory supervisor gives the remade count card to a different team from the one that originally counted the items. The second team recounts the items and fills out the count card. When it has finished the count, the team gives the card back to the inventory supervisor. He will check it to make sure it is filled out correctly. If any two counts agree, the stock record officer accepts the recount. If the totals still do not match, the inventory supervisor will have a third inventory team recount the items and remake the cards until the total agrees with the control listing or until two recount totals match. (Each time a recount is made, make sure each stock number is checked for multiple locations. Stock placed in a separate location can cause the difference in quantity and can be corrected easily.) Figure 10-17 shows a completed recount card with recount quantity accepted.

R0145													61400005725 53													AEA			BATTERY													0001 W K4A BC30850004																									
LOCATION													NOUN													COUNT QUANTITY																																									
LOCATION													NOUN													COUNT QUANTITY																																									
DA FORM 2000-3, 1 OCT 63	CITY NO	SERIAL NUMBER	LOT NO	REC NO	NUMBER OF PALLETS	PACKAGES PER PALLET	QUANTITY PER PACKAGE	TOTAL QUANTITY	COUNTER AND DATE <i>Dickson 3057</i>													RECORDED BALANCE 33													UNIT PRICE \$41.01																																
					1	20	1	20	RECORDED BALANCE													UNIT PRICE																																													
					1	13	1	13	QUANTITY													OVER													SHORT																																
								TOTAL	33	OVER													VALUE													SHORT																															
										OVER													VALUE													SHORT																															
LOCATION													NOUN													COUNT QUANTITY																																									

L1471													8315002536 289													ARL			TAPE TEXTILE													01541 W K4 FTX 3076-0062																									
LOCATION													NOUN													COUNT QUANTITY																																									
LOCATION													NOUN													COUNT QUANTITY																																									
DA FORM 2000-3, 1 OCT 63	CITY NO	SERIAL NUMBER	LOT NO	REC NO	NUMBER OF PALLETS	PACKAGES PER PALLET	QUANTITY PER PACKAGE	TOTAL QUANTITY	COUNTER AND DATE <i>Rex Michael 3077</i>													RECORDED BALANCE 155													UNIT PRICE \$7.09																																
					12	12	12	144	RECORDED BALANCE													UNIT PRICE																																													
					LOOSE	7	7	7	QUANTITY													OVER													SHORT																																
								TOTAL	151	OVER													VALUE													SHORT																															
										OVER													VALUE													SHORT																															
LOCATION													NOUN													COUNT QUANTITY																																									

Figure 10-15. Inventory count cards with accepted count totals

J34K2		1305:00182:3081		AEA	CARTRIDGE	0053	W K4FTX 3191-0002	
LOCATION		NOUN		COUNT QUANTITY				
DA FORM 2000-3, 1 OCT 83 SERIAL NUMBER 01053	NUMBER OF PALLETS	PACKAGES PER PALLET	QUANTITY PER PACKAGE	TOTAL QUANTITY	COUNTER AND DATE	000000000000000000		
	5	72	1	72	Ralph Math 3192	010001010101010101		
	0		TOTAL	72	RECORDER AND DATE	020002020202020202		
	1				George Murphy 3192	030003030303030303		
	0				ACCEPTED RECOUNT SUSPEND	040004040404040404		
(AMDF SHOWS ITEM TO HAVE SEC OF 3)					RECORDED BALANCE	UNIT PRICE	050005050505050505	
					72	\$6.17	060006060606060606	
					QUANTITY	SHORT	070007070707070707	
					OVER	SHORT	080008080808080808	
					OVER	VALUE	SHORT	090009090909090909
					0	0	100010101010101010	
					0	0	110011111111111111	
					0	0	120012121212121212	
LOCATION		NOUN		COUNT QUANTITY		MPT 15745		

Figure 10-16. Count card marked for recount

J34K2		1305:001823:001		REA	CARTRIDGE	0054	W K4FTX 3191-0002	
LOCATION		NOUN		COUNT QUANTITY				
DA FORM 2000-3, 1 OCT 83 SERIAL NUMBER 01054	NUMBER OF PALLETS	PACKAGES PER PALLET	QUANTITY PER PACKAGE	TOTAL QUANTITY	COUNTER AND DATE	000000000000000000		
	4	75	1	75	Ralph Math 3192	010001010101010101		
	0	LOOSE	3	3	RECORDER AND DATE	020002020202020202		
	1		TOTAL	78	George Murphy 3192	030003030303030303		
	0				ACCEPTED RECOUNT SUSPEND	040004040404040404		
SERIAL NUMBER OF ORIGINAL COUNT CARD					RECORDED BALANCE	UNIT PRICE	050005050505050505	
					78	\$6.17	060006060606060606	
					QUANTITY	SHORT	070007070707070707	
					OVER	SHORT	080008080808080808	
					OVER	VALUE	SHORT	090009090909090909
					0	0	100010101010101010	
					0	0	110011111111111111	
					0	0	120012121212121212	
LOCATION		NOUN		COUNT QUANTITY		MPT 15745		

Figure 10-17. Completed recount card with recount quantity accepted

COMPLETING THE INVENTORY

After the accountable officer accepts all inventory counts and corrects his control listing, he sends the count cards and the control listing to the SCS. The SCS then makes the necessary changes to the stock record at this time. DA Pamphlet 710-2-2, Chapter 9, explains how the information from the inventory is put onto the stock accounting record. After posting the inventory counts, you and the accountable officer lift the freeze on the receiving and issuing sections. They can begin processing requests and issues normally. Your personnel should process all DOS that were placed on hold during the inventory as soon as possible. Be sure to tell your personnel to watch for any new MROs that are dated before the inventory cutoff date. These are floating MROs. If your personnel find any of these MROs, they should bring them to you at once. You and the stock control supervisor must work together to cancel these old MROs and issue new MROs under the current date. After all inventory changes are made, the SCS sends the control listing to the depot that supports your DSU. Section personnel compare the inventory counts with their stock accounting record totals. If they find any major problems, personnel at the inventory control point can request a recount of all items in question. After the balances are checked, the inventory control

point makes a special report on the inventories for all supported GSUs or DSUs. This report goes to the major Army commander so that he will know the status of supplies in his command.

EVALUATING INVENTORY PERFORMANCE

You need to set up a checklist of required inventory procedures so that you can tell how well your section personnel performed during the inventory and how well they understand their inventory duties. Table 10-9 is a checklist of performance standards for a properly conducted inventory. Use it to train your personnel in inventory procedures. You can also use it to set up inventory guidelines in your storage section SOP. This checklist gives you formulas to use when you figure inventory accuracy. You must furnish the accountable officer with these figures for his inventory reports. When you make up a checklist, be sure to leave room to write comments about some of the problems found during the inventory. You also will need room to list problems or areas not covered on the checklist. Your commander or accountable officer may want to use the checklist when he conducts briefings or prepares reports for staff visits or inspections.

Table 10-9. Sample inventory performance checklist

	YES	NO
1. Are inventories conducted at least annually?	<input type="checkbox"/>	<input type="checkbox"/>
2. Is there an IAR file?	<input type="checkbox"/>	<input type="checkbox"/>
3. Are reports of survey filed with the IARs to support items disapproved?	<input type="checkbox"/>	<input type="checkbox"/>
4. Does the report of survey have the same voucher number as the IARs?	<input type="checkbox"/>	<input type="checkbox"/>
5. Are IARs supported by count cards?	<input type="checkbox"/>	<input type="checkbox"/>
6. Are the following procedures explained in the inventory SOPs?	<input type="checkbox"/>	<input type="checkbox"/>
a. Cutoff controls for receipts.	<input type="checkbox"/>	<input type="checkbox"/>
b. Cutoff controls for issue/shipments.	<input type="checkbox"/>	<input type="checkbox"/>
c. Preparation of inventory count cards.	<input type="checkbox"/>	<input type="checkbox"/>
d. Preparation and use of inventory control listings.	<input type="checkbox"/>	<input type="checkbox"/>
e. Conducting the inventory.	<input type="checkbox"/>	<input type="checkbox"/>
f. Issuing during the inventory.	<input type="checkbox"/>	<input type="checkbox"/>
g. Inventory adjustment preparation.	<input type="checkbox"/>	<input type="checkbox"/>
h. After-inventory procedures.	<input type="checkbox"/>	<input type="checkbox"/>

Table 10-9. Sample inventory performance checklist (continued)

	YES	NO
7. Is the percentage of materiel release refusals less than two?	<input type="checkbox"/>	<input type="checkbox"/>
<u>Total Materiel Release Refusals</u>		
Total Materiel Release Orders = Percent Materiel Release Refusals		
8. Is the percentage of inventory accuracy in the unit records 85 or above?	<input type="checkbox"/>	<input type="checkbox"/>
<u>Total Items Correct</u>		
Total Items Inventoried = Percent Inventory Accuracy		
 NOTE: Whenever an inventory is taken, you must take certain precautions to reconcile count quantities with unposted receipts and unprocessed MROs.		
9. Is the percentage of inventory accuracy 85 or above for the following?	<input type="checkbox"/>	<input type="checkbox"/>
a. 100 lines inventoried from the records to the stock.	<input type="checkbox"/>	<input type="checkbox"/>
b. 100 lines inventoried from the stock to the records.	<input type="checkbox"/>	<input type="checkbox"/>
10. Is the percentage of gross adjustments less than 20?	<input type="checkbox"/>	<input type="checkbox"/>
<u>Total \$ Value of Adjustments</u>		
Total \$ Value of Inventory = Percent Gross Adjustment		
11. Is the percentage of net adjustments less than two?	<input type="checkbox"/>	<input type="checkbox"/>
<u>Difference Between Shortages and Overages</u>		
Total \$ Value of Inventory = Percent Net Adjustments		

CHAPTER 11

USING MATERIALS-HANDLING EQUIPMENT

DETERMINING RESPONSIBILITIES

As storage supervisor, it is up to you to decide when and what kind of MHE to use to move supplies within your storage section. You must also teach your storage personnel how to use MHE to save time and labor. Try to handle supplies as little as possible. However, when you must move items—

- Plan in advance for storage problems such as weather damage, breakage, and safety hazards.
- Decide on the kind of MHE you need by the number, weight, and size of the items.
- Choose the right MHE for the job and stay within the capabilities of the MHE.
- Keep the length and number of moves to a minimum.
- Try to move supplies in a straight line flow to keep the distance short.
- Allow only licensed drivers to operate powered MHE.

CHOOSING MATERIALS-HANDLING EQUIPMENT

There are many different types of MHE used in storage operations. To save time and labor, you should use the type you have available as much as possible. MHE can be powered and nonpowered. To determine what kind of MHE is best for a job, you need to know its capacity and capabilities. Also, you need to consider the construction of the building and the characteristics of the storage area in which you are working. The MHE your storage section may use is described in this chapter. If you need information on a piece of MHE that is not given, check DOD 4145.19-R-1, Chapter 4. It describes all types of MHE currently used in the DOD. Before you choose the MHE, you

also need to know which types of MHE your personnel are authorized to operate.

USING POWERED MATERIALS-HANDLING EQUIPMENT

The powered MHE most often used in storage operations are the forklift truck and the warehouse tractor and trailer. Before your personnel use them, they need to be trained in operator maintenance.

Forklift Truck

The forklift truck is used to pick up, carry, and stack unit loads of supplies and equipment. The trucks are available with lifting capacities from 2,000 to 20,000 pounds and lifting heights from 100 to 210 inches. Most storage sections use the light-duty and rough-terrain forklift trucks. Figure 11-1 shows both types. They are described below.

Light-duty forklift truck. This truck has a 2,000-pound-load capacity and a 100-inch lift. It can be used in areas with low overhead clearance. It also can be used indoors because it can be gasoline- or electric-powered and have either solid or semisolid rubber tires. Use this forklift for loading and unloading trucks that have low mast heights.

Rough-terrain forklift truck. This truck has a load capacity that ranges from 4,000 to 10,000 pounds, depending upon the model. It can be gasoline- or diesel-powered and has high-floatation pneumatic tires that help it move in unprepared or unstabilized areas. You should use

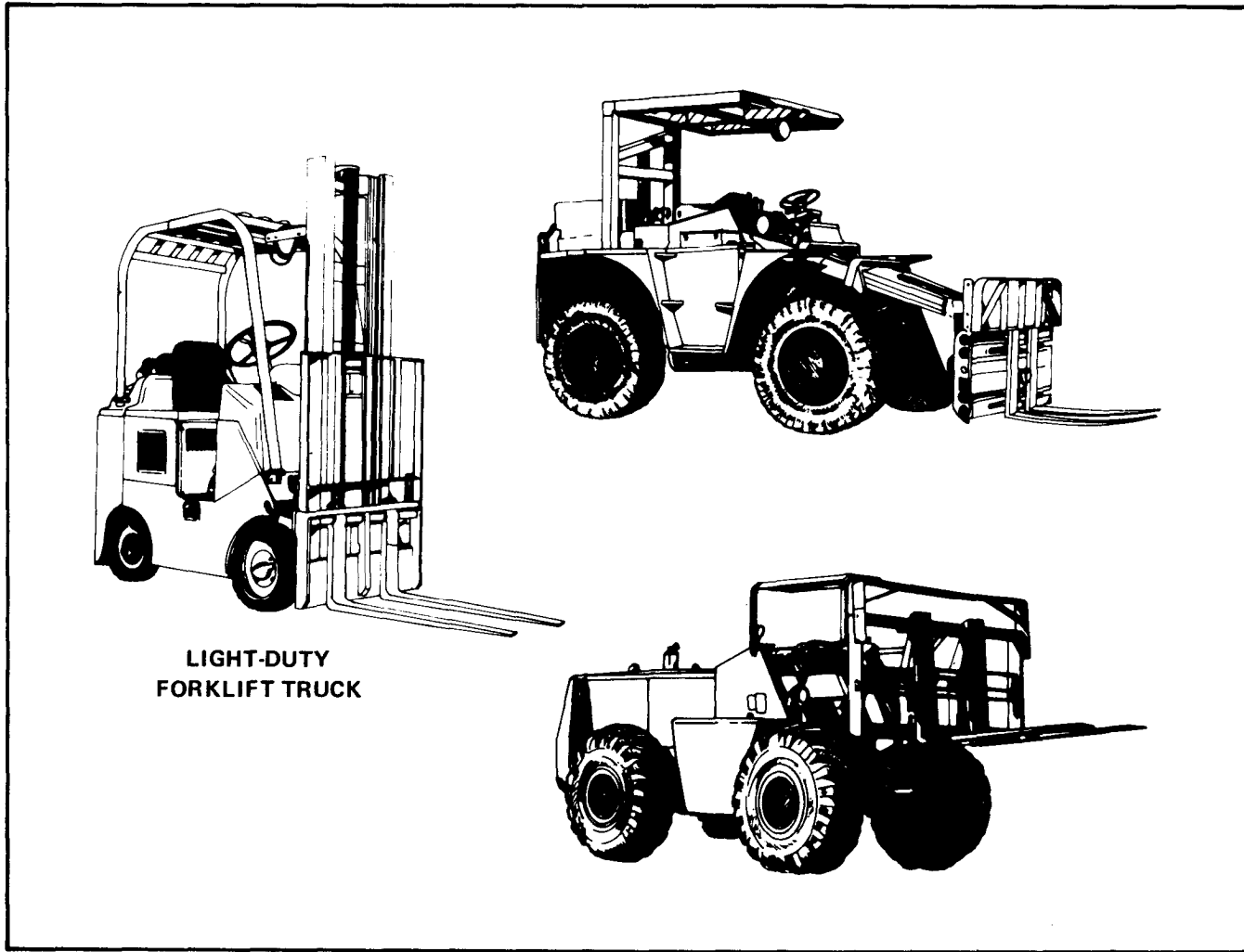

Figure 11-1. Light-duty and rough-terrain forklift trucks

this forklift in field areas. Use it mainly for loading and unloading flatbed semitrailers and for stacking large, heavy loads.

Warehouse Tractor and Trailer

A warehouse tractor is a gasoline- or electric-powered vehicle used to pull one or more warehouse trailers. The tractor has a drawbar pull ranging from 2,000 to 7,500 pounds and has either solid rubber or pneumatic tires. The warehouse trailer is platform-mounted on wheels. It is used to carry loads of various sizes. You can hook two or more trailers together to form a train when you need to move a large number of supplies. The warehouse tractors and trailers most often used in storage sections are shown in Figure 11-2. They are described below.

Light-duty warehouse tractor. The light-duty, electric-powered warehouse tractor has a 2,000-pound drawbar pull and solid rubber tires. It can be used in closed warehouses. Since it emits no fumes, it also can be used to transport food items. You should use this tractor for light loads in warehouses and in cold-storage areas since varying temperatures do not affect its performance.

Medium-duty warehouse tractor. This gasoline-powered tractor has a 4,000-pound drawbar pull and pneumatic tires. It can be used in outdoor storage areas for general-purpose towing. It has enough horsepower and traction to operate on all types of surfaces.

Warehouse trailer. The trailer used with a warehouse tractor is a load-carrying platform on

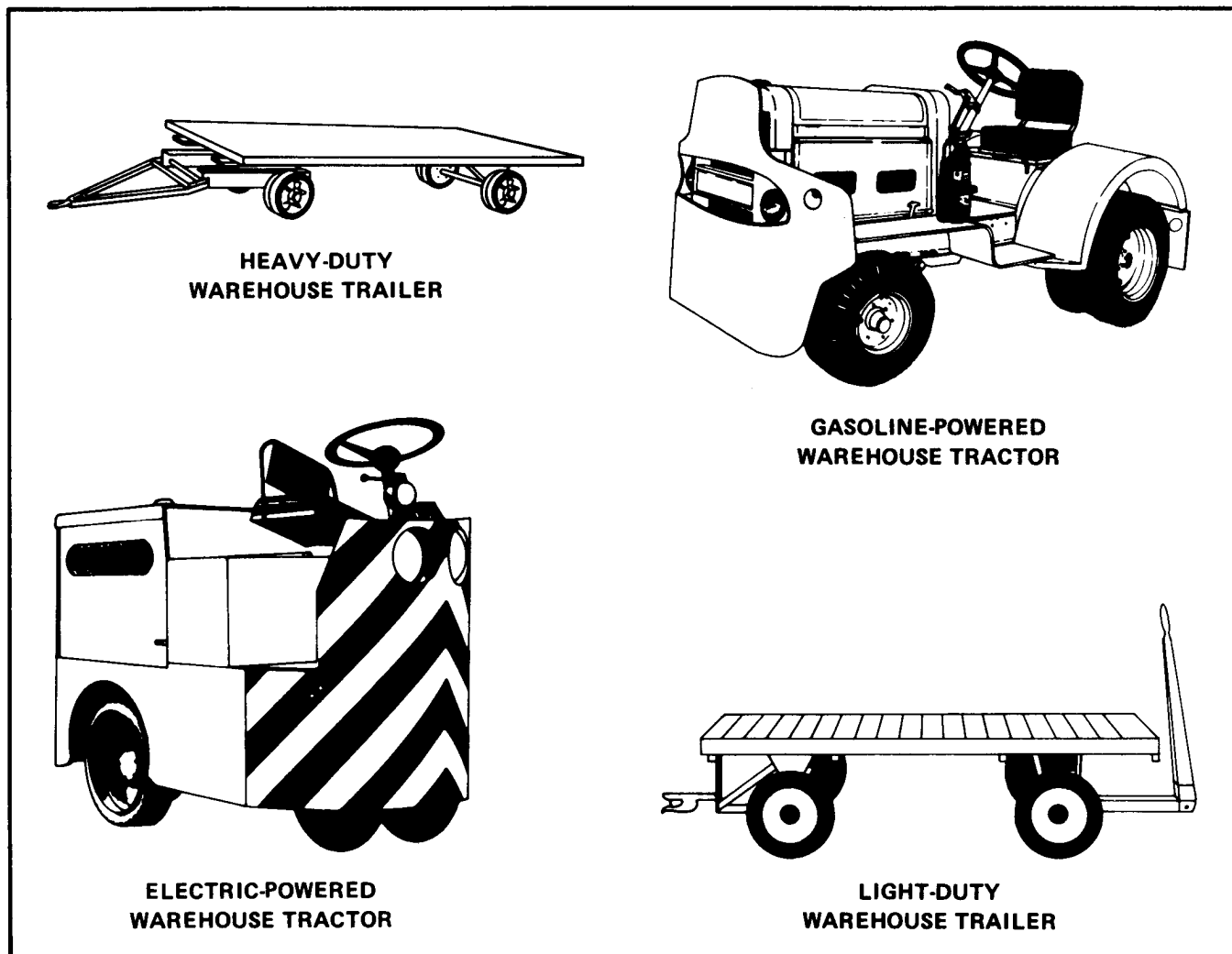

Figure 11-2. Warehouse tractors and trailers

pneumatic tires. The normal capacities for a trailer used in storage areas range from 6,000 to 20,000 pounds. Because the rear wheels of the heavy-duty trailer are mounted on a rigid axle that carries about two-thirds of the load, it can be used for oversized loads and rough surfaces. You should use the light-duty trailer for indoors storage operations.

USING NONPOWERED MATERIALS-HANDLING EQUIPMENT

Your personnel should use nonpowered MHE for all operations that do not require powered MHE. You should also remind them to use nonpowered MHE if it is more economical, even though it may take a little more effort. Figure 11-3 shows the conveyors and Figure 11-4 shows the

hand-lift trucks, platform trucks, and other nonpowered MHE most often used in storage sections.

Conveyors

Conveyors are used to move supplies in a fixed line of travel. They are used mainly for loading and unloading trucks and railroad cars. The three major kinds used in most storage operations are gravity roller, roller, and skatewheel conveyors. The skatewheel conveyor is probably used most often because it is lightweight, easy to setup, and easily transported. Be sure that you and your personnel know the weight limits of each type of conveyor before anyone places heavy supplies on it.

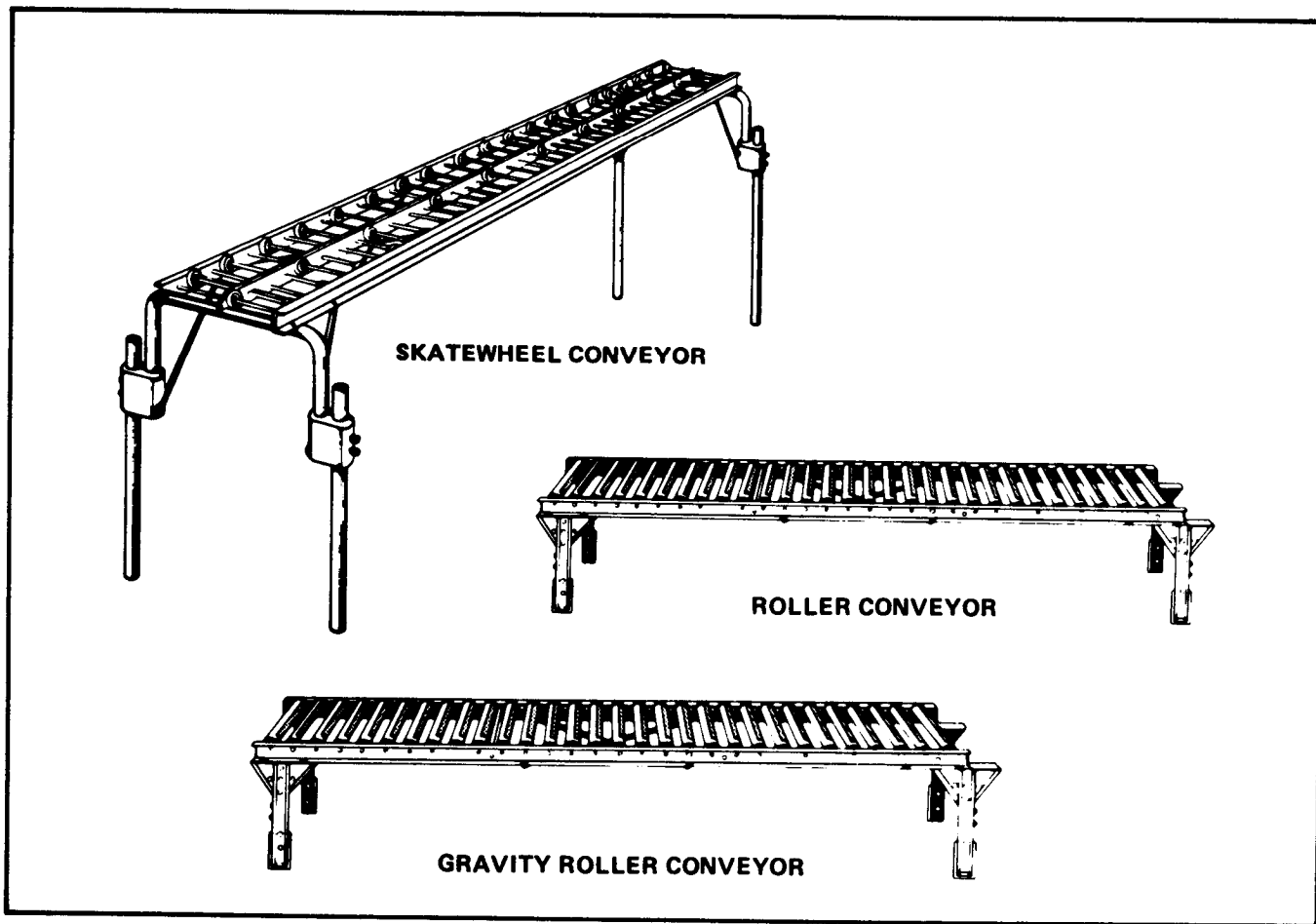

Figure 11-3. Conveyors

Hand-lift Truck

This truck is sometimes called a pallet jack or hydraulic jack. It has two load-carrying tracks that can be raised about 4 inches to carry pallet loads. Use it to move pallet loads that do not have to be stacked and to move loads short distances. It can be operated in small spaces where forklifts cannot fit.

Platform Truck

This truck is used mainly for moving short distances with frequent stops. It is used also in close areas since it is easy to maneuver in areas with limited space. The two basic types of platform trucks are the two-wheeled, which is called a dolly, and the four-wheeled, which is known as a hand truck. Some warehouses also use a stockpicker truck to move large quantities of small items at one time. It has a built-in stepladder that

storage personnel use to reach the higher shelves. You should use the two-wheeled truck for moving cartons, cases, bags, and barrels short distances. Use the four-wheeled hand truck in stocking and packing areas.

CONTROLLING MATERIALS-HANDLING EQUIPMENT

The MHE your storage section uses is probably controlled by a central office. When you need a piece of MHE, contact the personnel in this office and they will dispatch it to you. When you finish a job, you must return the MHE to the central office. If you need MHE for longer periods of time, such as for maneuvers or special operations, you must contact the central office for a special dispatch. Since not all DSUs use these controls, you should check with your accountable officer to find out what procedures your DSU follows.

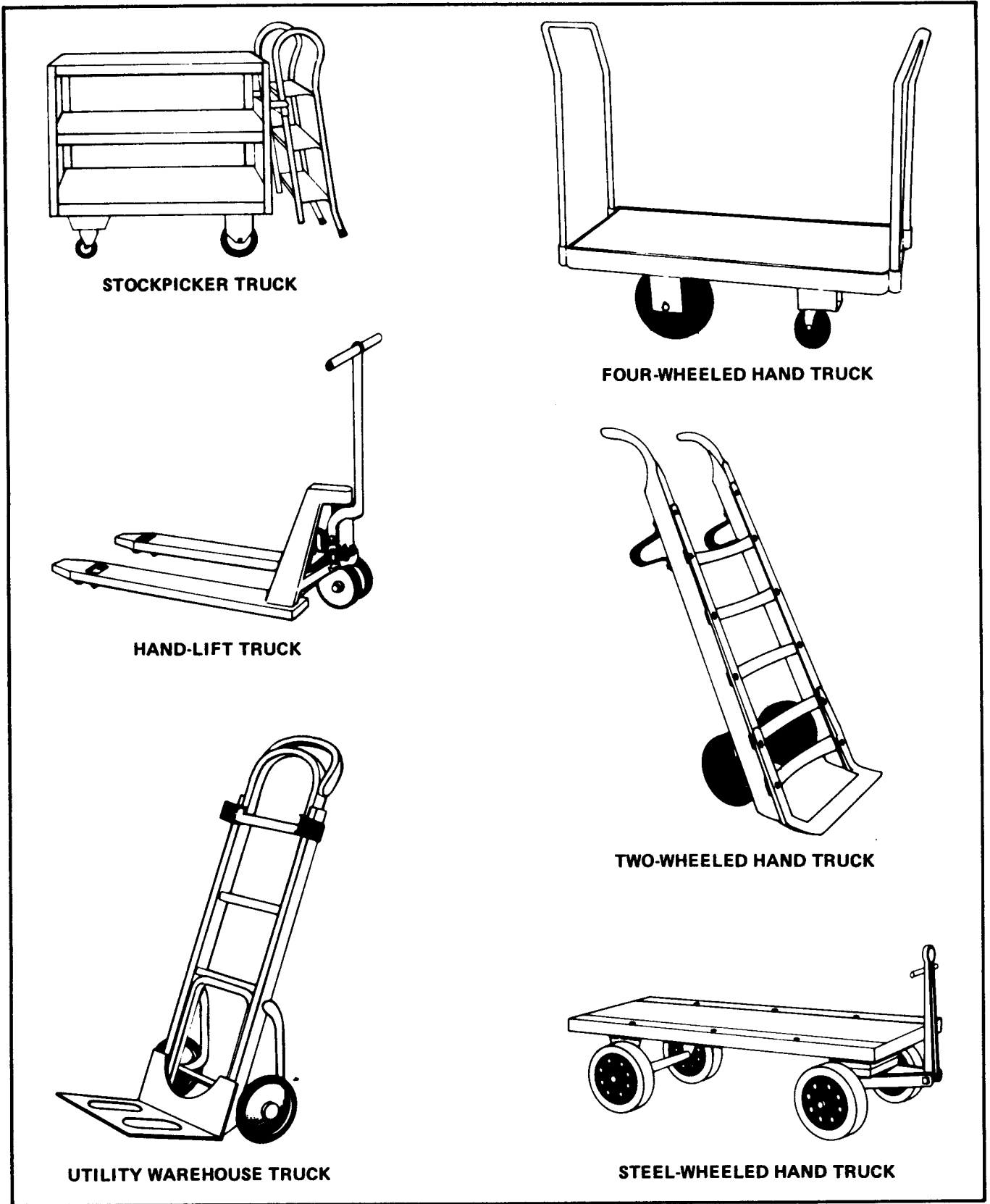

Figure 11-4. Hand-lift trucks and platform trucks

MAINTAINING MATERIALS-HANDLING EQUIPMENT

You and your personnel must keep the MHE under your care in good working order. The MHE operators must make the checks, perform all the services needed, and report any problems or deficiencies promptly. If your storage section is assigned MHE on a regular basis, you must work with the maintenance activity to schedule the MHE for maintenance checks and repairs. If the maintenance activity that supports your DSU is located a distance away, you can sometimes request a contact team to come to your storage section to perform maintenance. Teach your personnel that MHE is only as good as the care it receives. Make sure that they use the correct operator's manuals as a guide when they perform minor maintenance.

NOTE: PS Magazine articles give helpful tips on maintaining your MHE. They also give telephone numbers that you can call for information and assistance. You should file these magazines where your personnel can find them. The January issue

(beginning in 1981) contains an index of all items and problems discussed in articles during the previous year. Before 1981, a separate index was printed each year. To get back issues of PS Magazine, contact:

Editor
PS Magazine
c/o US Army Materiel Readiness Support
Activity
Lexington, KY 40511-5101

As storage supervisor, you must make sure your MHE operators are trained and licensed. Only licensed operators can drive and operate the powered MHE. You should keep a list of those in your DSU who have MHE licenses. You may need to contact them in an emergency. All powered MHE that your personnel use must have a fully charged fire extinguisher. Make sure your personnel know and follow the safety guidelines for MHE operation. These guidelines are listed in each MHE operator's manual.

CHAPTER 12

UPLOADING AND STORING THE COMBAT ASL

Section I Overview

PURPOSE

As a storage supervisor, you are responsible for maintaining and uploading the combat ASL. This chapter will help you and your storage personnel carry out the storage functions involved in mobilization of the combat ASL.

COMBAT ASL ITEMS

A critical and basic mission of any DSU is to transport designated items of supply needed to sustain operations in a hostile environment for a given period of time. Those items designated by the command are known as the combat ASL. The combat ASL requires wartime transportation. It consists of repair parts which are essential in support of the MPDL end items. Specific elements of this component are—

- MPL items, to include provisioning items for force modernization equipment.
- Demand-supported, (EC C) parts applicable to MPDL end items.
- Command discretionary essential parts (EC C) applicable to MPDL end items.

Transport and storage space is limited to the vehicles that a unit is authorized under its TOE or MTOE. For this reason, you must compute usable space and use it wisely.

SPECIAL CONSIDERATIONS

The MPL portion of the combat ASL must have first priority of movement and storage. Some items such as end items, repair parts, petroleum products, and classified or sensitive items may need special handling or storage. Follow special storage requirements explained in DOD 4145.19-R-1 and FM 10-14.

LOCATION AND STORAGE AIDS

Make sure all bin items in the combat ASL are uploaded at all times. Review these items periodically to ensure storage space is being used properly. Do not store a small item, such as a 1-inch fuse, in an area the size of a footlocker. Consider size and quantity of items as you choose storage locations and storage aids. Also consider the quantity of a given ASL line. Use the RO quantity as a minimum when you choose a storage aid. Pallets, bins, shelving, frames, unit deployment storage containers, CONEXs, and forward logistics exchange pallets are readily available through normal supply channels. Many new aids are being developed and tested. Your choice of storage aids will depend on what is available or authorized for your organization. The storage aids discussed in this chapter are not the only aids that you might use for a particular vehicle.

LOCATION SYSTEM

Combat ASL is maintained in a mobile or load-ready configuration. Use the location system the same as in any other storage area. The system must allow identification of MPL stocks and command-essential items and their segregation from nonessential items. Normal storage functions such as rewarehousing and location updating must be performed. You must give particular attention to maintaining all combat ASL items readily accessible and mobile.

DEPLOYMENT

In the event of unit deployment, load all combat ASL items before any other ASL items. Upload all MPL lines before any other combat ASL items. Leave behind nonessential and excess items of supply for which there is no space.

Section II

Computation And Configuration Of Usable Storage Capacity

COMPUTATION

At times, you will need to compute and configure the usable storage capacity of a vehicle. The steps you must take are described below.

- Determine unusable length, and subtract unusable length from total vehicle length.
- Then determine unusable height, and subtract unusable height from total vehicle height.
- Determine unusable width, and subtract unusable width from total vehicle width.
- Compute total cubic feet available (usable length x width x height). (If aisle space is needed, aisle cubic feet must be subtracted from total usable cubic feet available.)
- Select an appropriate storage aid and compute its cubic feet.
- Compute number of storage aids required.

STORAGE AIDS

Storage aids can be standard wooden pallets, metal bins, cabinets, racks, shelving, frames, and CONEXs. Storage aids obtained through supply channels are normally of a uniform size. If the storage aids are unit-produced or manufactured, ensure that they do not become the bulk of the vehicle load. The number of individual combat ASL items to be carried on a vehicle and the size of the storage aid you choose will dictate the number of storage aids you need for that vehicle.

VEHICLES

You may use one or more of the following vehicles listed in Table 12-1 for storing and transporting combat ASL items. You are not limited to those listed. No matter which vehicle you use, you must be able to compute the usable cubic feet for both bulk and bin items. In computing storage space requirements, you must first decide whether you will use the vehicle for bin or for bulk storage. As a rule, vans are more suitable for bin storage. Stake and flatbed trucks are more suitable for bulk items. However, you may use both for bin and bulk storage. Three different types of vehicles are described below to show you how to make the best use of storage capacity with

Table 12-1. Vehicles for storing and transporting ASL items

VEHICLE	DESCRIPTION
M750	6-ton semitrailer van
M129-series	12-ton semitrailer van
M127-series	12-ton semitrailer
M871	22.5-ton flatbed semitrailer
MILVAN	MILVAN with chassis

storage aids. To make the best use of cargo capacity, you must select storage aids suited to the combat ASL items.

12-Ton M129A2C Semitrailer Van

This van is 29.72 feet long, 8 feet wide, and 6.3 feet high as shown in Figure 12-1. To determine the total usable storage capacity of the vehicle, multiply the length by the width by the height. For the vehicle shown in Figure 12-1, this would be 1,497.89 cubic feet. Subtract from this any unusable storage space. Next determine what type of storage aid would make the best use of this storage capacity. Use the procedures below to determine the number of storage aids you will need.

- For each type of aid that is used, you must determine its cubic feet.
- For the M129A2C van example, use aids 36 inches by 18 inches by 75 inches.
- To determine the capacity of this storage aid in cubic feet, multiply its length by its height by its width as shown below. For convenience, first convert inches to feet.

$$\text{Length} \times \text{Width} \times \text{Height} =$$

$$36 \text{ inches} \times 18 \text{ inches} \times 75 \text{ inches} =$$

$$3 \text{ feet} \times 1.5 \text{ feet} \times 6.25 \text{ feet} = 28.13 \text{ cubic feet}$$

- One bin has 28.13 cubic feet of storage capacity. To determine how many of these bins

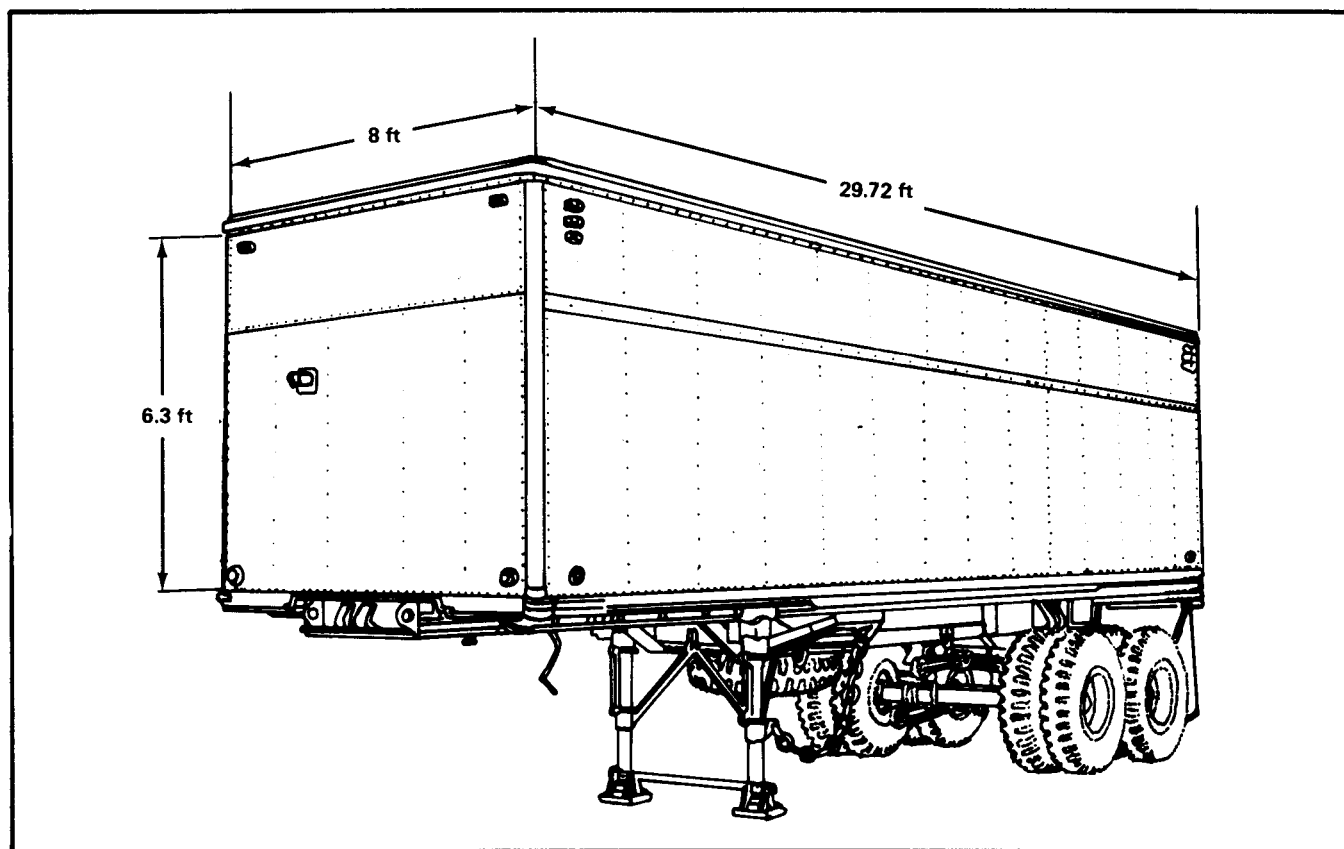

Figure 12-1. The 12-ton M129A2C semitrailer van

can be dated in one row in the M129A2C van, divide the length of the bin into the length or adjusted length of the van and round down as follows:

$$\frac{29.72 \text{ feet}}{3 \text{ feet}} = 9.9 = 9 \text{ aids (rounded down)}$$

• At least one row of nine aids will go into the van. Can two rows of nine aids fit into the van? Take the width of the storage aid, multiply it by two (the number of rows desired), and subtract this amount from the van width to determine if the remaining aisle width will permit two rows of bins. Remember, aisle width must allow access to load and unload items. For the M129A2C van example, two rows of bins will yield the following:

$$1.5 \text{ feet} \times 2 \text{ rows} = 3 \text{ feet}$$

8 feet (vehicle width) - 3 feet = 5 feet of aisle space

The M129A2C van can hold at least two rows of nine aids for 506.34 cubic feet of storage space (18 x 28.13 cubic feet). Two rows of aids provides an oversized aisle of 5 feet for loading and

unloading. As noted previously, aisle space is to be considered unusable for storage and is subtracted from the total usable cubic feet of the vehicle.

• To compute the usable cubic feet of storage capacity remaining with the use of two rows of storage aids, multiply aisle length by aisle width by aisle height and subtract the total from the total usable cubic feet of the vehicle. The computation is as follows:

$$29.72 \text{ feet} \times 5 \text{ feet} \times 6.3 \text{ feet} = 936.18 \text{ aisle cubic feet of aisle space}$$

$$1,497.89 \text{ cubic feet (vehicle)} - 936.18 \text{ aisle cubic feet (aisle space)}$$

$$= 561.71 \text{ usable cubic feet}$$

• Storage capacity could be increased further by adding another row of nine aids in the center of the van (see Figure 12-2). This would increase usable storage space to 759.24 cubic feet (253.08 + 506.16), but it would reduce aisle width. In this case, only small items could be moved through the narrow aisles and stored.

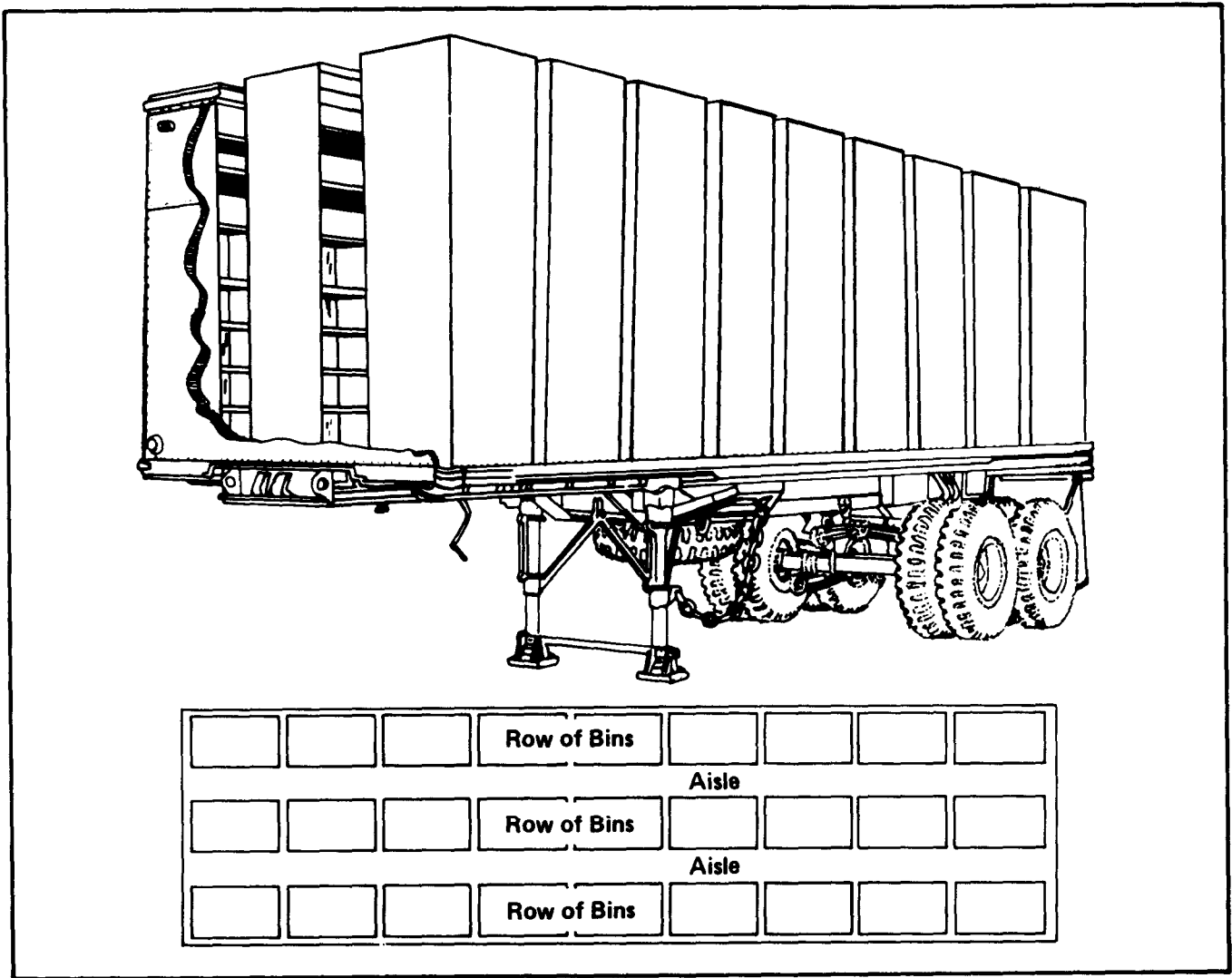

Figure 12-2. The 12-ton M129A2C semitrailer van with bins

22.5-Ton M871 Breakbulk Semitrailer

The M871 breakbulk semitrailer (Figures 12-3 and 12-4) is 29.83 feet long, 8 feet wide, and 4 feet high from the bed to the top of the sideboards. Stake-type vehicles adapt themselves more readily to bulk storage than to bin storage. Under normal conditions storage aids will be stacked no more than two high.

- Select a storage aid that will make the best use of the M871 storage capacity. This example uses FLEX pallets which can be used for both bin and bulk storage. The standard FLEX pallet is 48 inches long, 33 inches wide, and 38 inches high. Figure 12-5 shows the types of FLEX pallets. The unit cube requirements of the ASL can often assist in the selection of the proper storage aid. Each

type of FLEX pallet can support different types of line items depending on the unit cube of the ASL items, Table 12-2 shows the unit cube and average line capacities for each FLEX pallet shown in Figure 12-5. To determine the cubic feet available in the storage aid, follow the steps below.

- Multiply the length by the height by the width. For convenience, first convert inches to feet.

$$\text{Length} \times \text{Width} \times \text{Height} =$$

$$48 \text{ inches} \times 33 \text{ inches} \times 38 \text{ inches} =$$

$$4 \text{ feet} \times 2.75 \text{ feet} \times 3.17 \text{ feet} = 34.87 \text{ cubic feet}$$

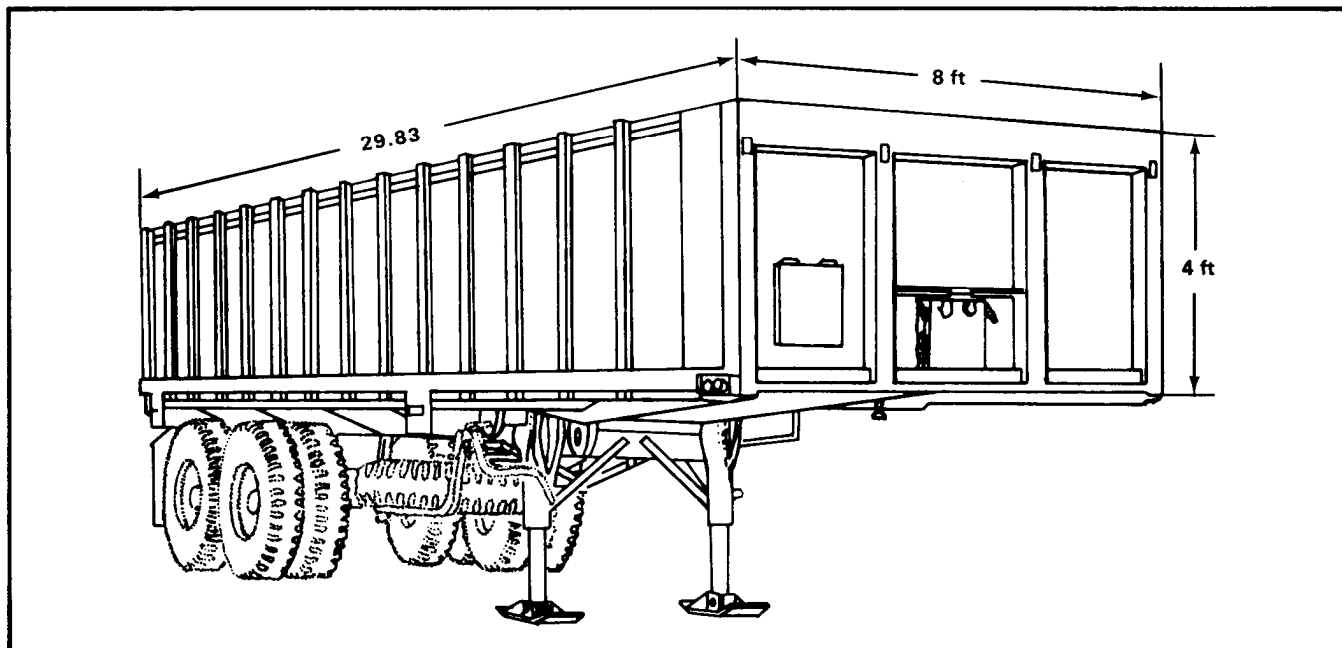

Figure 12-3. The 22.5-ton M871 breakbulk semitrailer

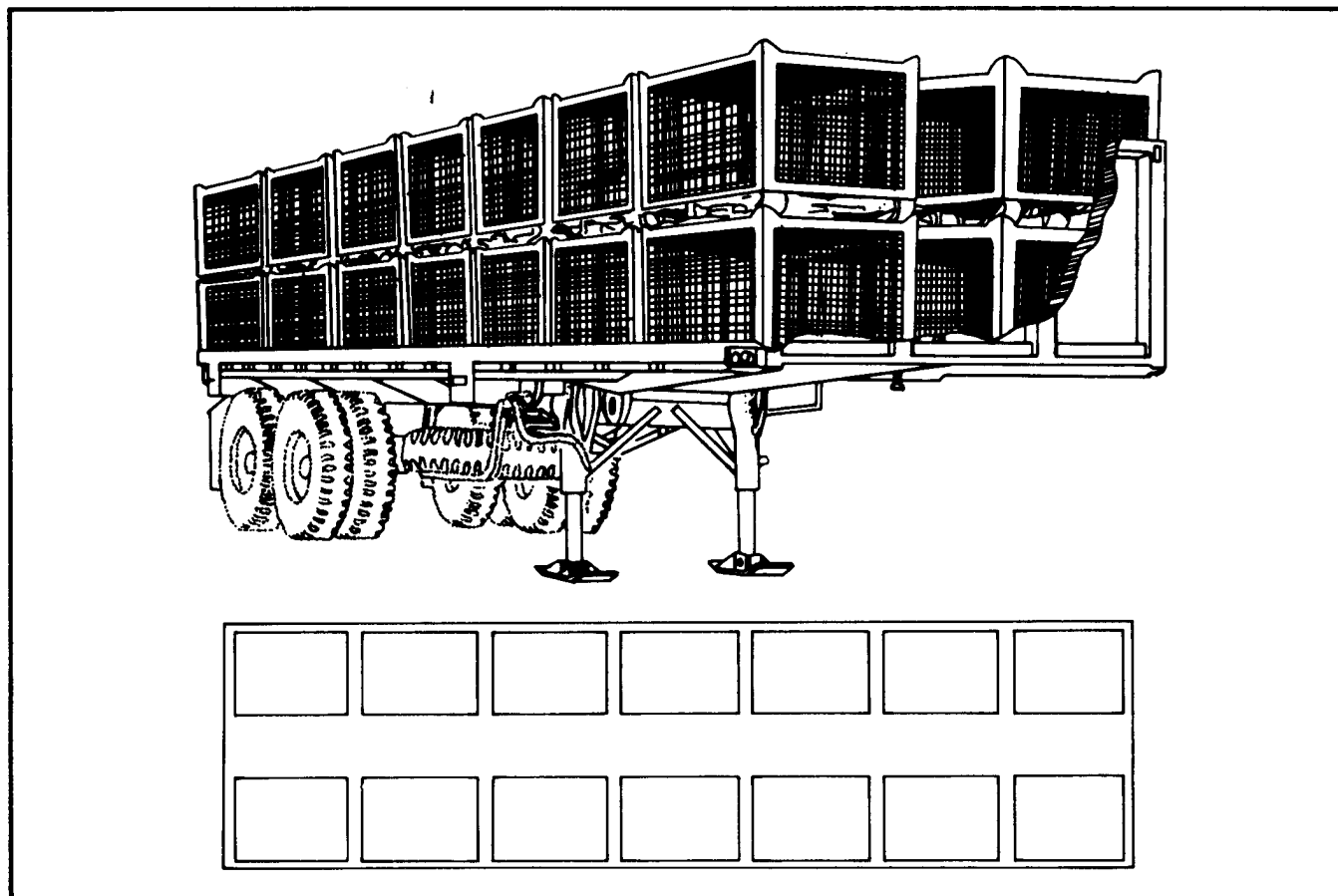

Figure 12-4. The 22.5-ton M871 breakbulk semitrailer with mesh FLEX pallets

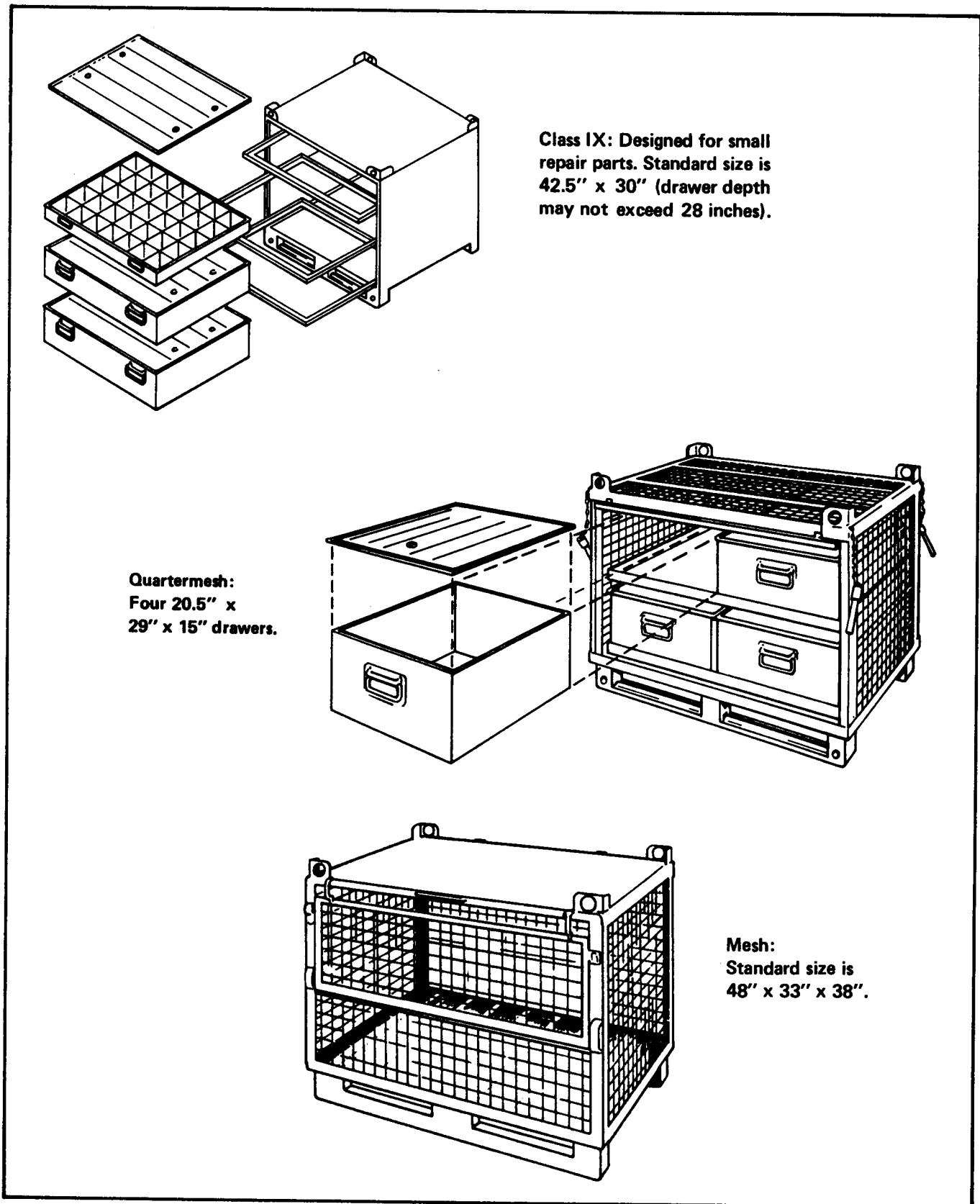

Figure 12-5. Types of FLEX pallets

Table 12-2. Flex pallet unit cube range

TYPE	UNIT CUBIC FEET	AVERAGE LINES
CLASS IX	0.001 to 0.5	30-35
QUARTERMESH	0.25 to 5.0	8-10
MESH	2.5 to 26.0	3-4

- You can store up to 34.87 cubic feet of supplies in the standard mesh FLEX pallet. To determine how many of these storage aids can be placed in one row of the vehicle (M871 semitrailer), divide the length of the storage aid into the length of the vehicle and round down.

$$\frac{29.83 \text{ feet}}{4 \text{ feet}} = 7.46 = 7 \text{ aids (rounded down)}$$

At least one row of seven FLEX pallets can be placed on this vehicle.

- Depending on the width of the storage aid used, you may add more rows. Take the width of the storage aid, multiply it by two (the number of rows desired), and subtract this amount from the vehicle width to determine if the remaining aisle width will permit two rows of pallets. For the M871 semitrailer, two rows of pallets will yield 2.5 feet of aisle space.

- For this example, the load height has been increased from 4 to 8 feet. Two FLEX pallets stored one on top of the other will give a total pallet height of 6.34 feet. Thus, stacking of the storage aids will be no problem.

- By stacking the FLEX pallets on this vehicle, you have two rows of 14 pallets for a total

of 28 FLEX pallets, This will yield a total usable storage space of 976.36 cubic feet.

- The aisle has approximately 596.60 unusable cubic feet which must be subtracted from the total usable cubic feet.

$$29.83 \text{ feet} \times 2.5 \text{ feet} \times 8 \text{ feet} = 596.60 \text{ unusable aisle cubic feet}$$

$$1,909.12 \text{ cubic feet (vehicle)} - 596.60 \text{ cubic feet} = 1,312.52 \text{ total usable cubic feet}$$

- When increasing storage height above the sideboards, you must make sure that the height of the storage aids is within safe limits.

6-Ton M750 Semitrailer Van

This van (used for repair parts storage) may be used in uploading the combat ASL. See Figure 12-6. The M750 van is a unique type of storage facility. It has certain design features that enhance its storage capabilities. It has foldout sides and integral bins and shelves with 400 cubic feet of storage space. The foldout sides form working platforms. The user stands on these when placing or removing stock.

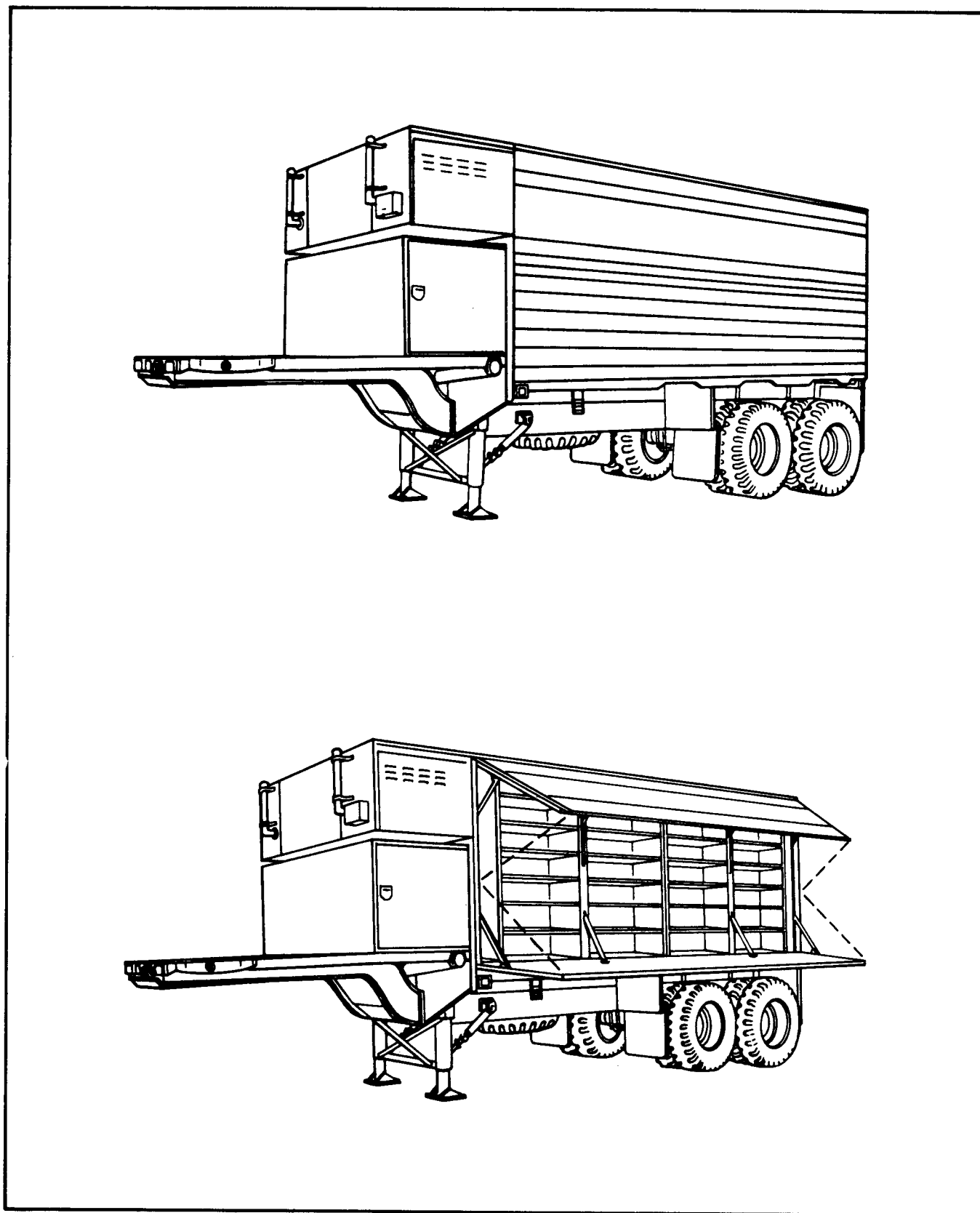

Figure 12-6. The 6-ton M750 semitrailer van with factory-issued storage aids

★ APPENDIX A
LOGISTICS HOT LINES

Telephone numbers for logistics activities and agencies are listed below. Both the Defense Switch Network (DSN) and commercial numbers are listed.

	DSN	Telephone Number Commercial	Activity
Defense Logistics Services Center Customer Service	932-4725	(616) 961-4725	DLSC
Logistics Intelligence file data, including status of requisitions, materiel returns, force modernization, Direct Support System activity performance reports, commander's summaries	586-5823/5824/5825	(415) 561-5823/ 5824/5825	Logistics Control Activity
Logistics Control Activity services	586-5705/2354	(415) 561-5705/2354	LCA Customer Plans and Operations Division
New Cumberland customer complaints; transportation and requisitions	977-6503/6192	(717) 770-6503/6192	New Cumberland Army Depot
Policy guidance on ARs 710-2 and 735-5, DA Pamphlets 710-4 and 710-5, and TC 43-4	977-6842	(717) 770-6842	Logistics Evaluation Agency
Procedural guidance on DA Pamphlets 710-2-1 and 710-2-2	687-6626/6628	(804) 734-6626/6628	U S Army Quartermaster Center and School

C1, FM 10-15

	DSN	Telephone Number Commercial	Activity
Sacramento customer complaints	839-2705	(916) 388-2705	Sacramento Army Depot
Management Information Research Assistance Center (Substitute NSNs, item identifications, pricing errors, AMDF code problems)	977-7431/74321 7433	(717) 770-7431/7432/ 7433	Catalog Data Activity
Procedural guidance on petroleum	687-6668/1368	(804) 734-6668/1368	US Army Quartermaster Center and School
US Army Quartermaster Center and School	687-3767/5838	(804) 734-3767/ 800-258-9440 (Outside Virginia) 800-552-4820 (Inside Virginia)	US Army Quartermaster Center and School DOES
TAMMS, DA Pamphlet 738-750	745-3690/4110	(804) 734-3690/4110	AMC

APPENDIX B

SOP FOR CENTRAL ISSUE FACILITY

SUBJECT: SOP for CIF

TO: Using Activities of the CIF

1. REFERENCES

AR 340 series
AR 710-2
AR 735-5
CTA 50-900
DA Pamphlet 710-2-1

2. PURPOSE

The purpose of this SOP is to prescribe policies and procedures pertaining to the operation and organization of the CIF.

3. APPLICABILITY

This SOP applies to all units, organizations, activities, and individuals involved with the CIF for the issue, turn-in, and exchange of OCIE.

4. MISSION

The mission of the CIF is to provide a facility that issues OCIE to personnel in units and activities supported by the CIF and maintain a property book for CTA 50-900 items of OCIE. The CIF-

- a. Receives, stores, issues, exchanges, and turns in all CTA 50-900 OCIE items.
- b. Receives and processes statements of charges, cash collection vouchers, or report of surveys for lost or damaged items.
- c. Documents individual clothing records for items issued or turned in.

5. PRINCIPLES OF OPERATION

All OCIE the CIF issues will be serviceable and clean and will meet standards of appearance established by the command. Clothing and equipment turned in to (or exchanged by) the CIF must have been cleaned, maintained, and used for their intended purpose. Items which have not been cleaned prior to turn-in or exchange will be rejected.

- a. With the exception of minor repairs by qualified personnel of the CIF, repairs to all OCIE will be made by maintenance personnel.
- b. The CIF will maintain all OCIE records. It is the responsibility of the CIF to ensure that a duplicate copy of DA Form 3645 (Organizational Clothing and Individual Equipment Record) and DA Form 3645-1 (Additional Organization Clothing and Equipment Record) is made available to the unit to which the individual is assigned.
- c. The commanders of using activities are responsible for ensuring that their personnel clear the CIF before they depart from their duty station.

6. SECURITY

The designated individual will ensure that all storage areas are secured and that all lights are turned off after personnel have left the area. He will make sure the area is inspected to make sure there are no fire hazards and all appliances are disconnected.

7. FILES

All files will be complete and up to date at all times according to ARs in the 340 series. All changes to ARs will be posted upon receipt. No change will be placed in the files without the basic AR.

8. GENERAL FUNCTIONS

- a. Maintain loose issue and bulk storage areas.
- b. Issue OCIE to individuals, units, or activities.
- c. Perform inventories quarterly and annually.
- d. Perform biweekly inventory count for ordering purposes.
- e. Receive items turned in by individuals and units.
- f. Perform direct exchange of items.
- g. Inspect, classify, and segregate items received from individuals and units.
- h. Process items for laundry.
- i. Transport all reparable items to and from the maintenance section.
- j. Turn in all unserviceable items to the defense reutilization and marketing office.

9. RECEIPT

- a. The storage section will notify the CIF when shipments are ready for pickup. A truck driver will be sent to the warehouse.
- b. Personnel receiving items from the warehouse will ensure—
 - (1) The item is identified as listed on DD Form 1348-1 (DOD Single Line Item Release/Receipt Document).
 - (2) The quantity is correct.
- c. When items arrive, CIF personnel will make sure that each shipment is matched to a DD Form 1348-1. Items will be placed in stock and the receipt document sent to the PBO.

10. STORAGE

- a. All items stored in CIF bin and bulk areas will be stored neatly by size and type.
- b. Loose serviceable items returned from repair will be used to fill bin shortages.
- c. Issue bins will be filled at all times to permit issues without delay.

11. ISSUES

- a. Personnel obtain across-the-counter service for items listed on DA Forms 3645 or 3645-1. After items have been issued, the issue clerk will make entries and obtain a signature and date on DA Forms 3645 or 3645-1.
- b. Issues will be made only to personnel who present a properly prepared DA Form 3645 or DA Form 3645-1.

12. CIF PROPERTY ACCOUNTING FUNCTIONS

The PBO will compute replenishment requirements, establish stock record levels, and order OCIE as required. CIF personnel—

- a. Prepare and submit requests.
- b. Maintain a transaction register.
- c. Check stock position.
- d. Maintain property records.
- e. Prepare and submit operating reports.

- f. Prepare maintenance work orders.
- g. Maintain files for all supply transactions.

13. REQUISITIONS

- a. All OCIE will be counted monthly for reorder purposes. These counts will not be posted to the property book.
- b. Requests will be submitted on DA Form 2765-1 (Request for Issue or Turn-In).
- c. The PBO or PBO representative will review requests to ensure they are complete and accurate.
- d. If items have not been received within the allowable order ship time, a follow-up document will be prepared.

14. RECEIPT DOCUMENTS

Receipt documents will be delivered to the PBO for posting to the property book and for filing. Expendable items will not be posted to the property book.

15. ISSUE DOCUMENTS

- a. Use DA Form 3161 (Request for Issue or Turn-In) or an issue abstract to transfer or issue items.
- b. Hand receipts will rarely be used and only with prior approval. If approved, issues will be made to an established hand-receipt account.
- c. OCIE items will be consolidated and abstracted from the property book on DA Form 3645 or DA Form 3645-1 at least once a month. More frequent posting is allowed if desired by the PBO. OCIE items are charged to an individual on DA Form 3645 or DA Form 3645-1. Each column of the abstract form will be lined out, except where items have been noted.

16. TURN-INS

OCIE items turned in will be abstracted to the property book on DA Form 3645 or DA Form 3645-1. Abstracts will be consolidated at least once a month and posted to the property book.

17. PROPERTY BOOK AND DOCUMENT REGISTER

The property book and all supporting documents will be maintained in strict accordance with AR 710-2 and procedures in DA Pamphlet 710-2-1.

Signature

APPENDIX C

INTERNAL SOP FOR QUICK SUPPLY STORE

SUBJECT: Internal SOP for QSS Section

TO: QSS Section Personnel

1. REFERENCES

AR 710-2
CTA 50-970
DA Pamphlet 710-2-1
TM 38-L32-12
TM 38-L32-13
TM 38-L32-14

2. PURPOSE

The purpose of this SOP is to outline duties and responsibilities for the stockage and resupply of the QSS section.

3. RESPONSIBILITY

The QSS NCOIC is responsible for QSS supply. He is also responsible for resupply.

4. PROCEDURES

a. QSS stock should be stored and maintained in a central location (usually in the same warehouse as the rest of the ASL). This speeds up customer support and replenishment transactions.

b. Only individuals authorized to shop at the QSS will be issued QSS stock. They must be identified on a DA Form 1687 (Notice of Delegation of Authority—Receipt for Supplies) from the supported unit.

c. If there are not enough items in stock to fill a unit request, the QSS clerk must prepare an informal DO. If a unit submits a high-priority request which cannot be filled by the QSS section, the QSS clerk must instruct the unit to request the item through the SSA on a DA Form 2765-1 (Request for Issue or Turn-In).

d. When supported units return serviceable items to the QSS section, the QSS clerk should identify the items and return them to QSS stock.

(1) QSS personnel do not need to notify the SCS each time they accept a turn-in.

(2) QSS personnel must notify the SCS when the on-hand count is larger than the RO limit because of turn-ins.

e. QSS section personnel must review QSS stock at least twice a month to determine RO and ROP for each item.

f. At the end of the review, QSS personnel should request any items below the reorder points, following the procedures in DA Pamphlet 710-2-2, Chapter 12.

g. When the requested items are received from the SSA, the QSS clerk should process them for stockage, following the instructions in DA Pamphlet 710-2-2, Chapter 8.

h. QSS personnel will work with the SCS to make a QSS catalog that lists all the items stocked by the QSS section. The catalog will contain the NSN, nomenclature, UI, and unit price for each item stocked. The cover of the catalog must include the hours of operation and the location of the QSS section. The catalog will be issued to each supported unit. The QSS clerk will also maintain a 3- by 5-inch data card on each item. The cards will list the NSN, noun, QSS location, TM data, and stockage and reorder points.

i. The QSS catalog will be maintained and updated by QSS personnel. It should be reviewed and updated quarterly, following instructions in TM 38-L32-14.

Signature

APPENDIX D

CARE OF SUPPLIES IN STORAGE

The COSIS program covers the inspection, minor repair, testing, exercising, preservation, packaging, and packing of supplies in storage. The following are objectives of the COSIS program:

- To ensure that the true condition of supplies in storage is known and recorded.
- To establish accurate resource requirements.
- To maintain supplies in a state of readiness.
- To establish controls to ensure that no obsolete supplies are scheduled for COSIS processing and that supplies are maintained with the least cost in manpower, equipment, and money.
- To ensure that supplies and equipment are preserved and packed according to the degree of protection set forth in AR 700-15.

Under the COSIS program, supplies are stored to receive maximum protection from rodents, insects, and weather. Sealed containers and packages remain sealed until they are used. A container may be opened for inspection if there is reason to question its serviceability or if it is not clearly marked. Containers which are opened are resealed and returned to storage.

The COSIS program establishes plans for the inspection of stored material. The frequency of these inspections depends on the kind of material

stored, method of packaging, local weather conditions, and type of storage facilities. Inspections include checks of preservation and packaging adequacy and the condition of unpackaged items and clothing. Inspections also make sure that items with a shelf-life date (rubber, cork, neoprene, and dry batteries) are within time limits and that older stock is issued first.

Deficiencies uncovered by inspections are corrected promptly under AR 740-3, the COSIS program. Minor repair, preservation, and packing are limited to supplies in storage. The COSIS program does not cover the receipt and shipment of supplies.

Major repairs are not part of the COSIS program. Items which require minor mechanical repair or adjustment or supplies which need repacking and preservation are classified condition code E (unserviceable). These items are repaired by the storage activity or units when the costs do not exceed the limits set forth in AR 740-15.

AR 740-3 covers the COSIS program and provides guidance on budgeting, forecasting, cyclic inspection, and scheduling. TMs 38-230-1 and 38-230-2 cover preservation, packaging, and packing of supplies and equipment.

APPENDIX E JULIAN DATE CALENDAR

(PERPETUAL)

Day	Jan	Feb	Mar	Apr	May	June	July	Aug	Sep	Oct	Nov	Dec	Day
1	001	032	060	091	121	152	182	213	244	274	305	335	1
2	002	033	061	092	122	153	183	214	245	275	306	336	2
3	003	034	062	093	123	154	184	215	246	276	307	337	3
4	004	035	063	094	124	155	185	216	247	277	308	338	4
5	005	036	064	095	125	156	186	217	248	278	309	339	5
6	006	037	065	096	126	157	187	218	249	279	310	340	6
7	007	038	066	097	127	158	188	219	250	280	311	341	7
8	008	039	067	098	128	159	189	220	251	281	312	342	8
9	009	040	068	099	129	160	190	221	252	282	313	343	9
10	010	041	069	100	130	161	191	222	253	283	314	344	10
11	011	042	070	101	131	162	192	223	254	284	315	345	11
12	012	043	071	102	132	163	193	224	255	285	316	346	12
13	013	044	072	103	133	164	194	225	256	286	317	347	13
14	014	045	073	104	134	165	195	226	257	287	318	348	14
15	015	046	074	105	135	166	196	227	258	288	319	349	15
16	016	047	075	106	136	167	197	228	259	289	320	350	16
17	017	048	076	107	137	168	198	229	260	290	321	351	17
18	018	049	077	108	138	169	199	230	261	291	322	352	18
19	019	050	078	109	139	170	200	231	262	292	323	353	19
20	020	051	079	110	140	171	201	232	263	293	324	354	20
21	021	052	080	111	141	172	202	233	264	294	325	355	21
22	022	053	081	112	142	173	203	234	265	295	326	356	22
23	023	054	082	113	143	174	204	235	266	296	327	357	23
24	024	055	083	114	144	175	205	236	267	297	328	358	24
25	025	056	084	115	145	176	206	237	268	298	329	359	25
26	026	057	085	116	146	177	207	238	269	299	330	360	26
27	027	058	086	117	147	178	208	239	270	300	331	361	27
28	028	059	087	118	148	179	209	240	271	301	332	362	28
29	029		088	119	149	180	210	241	272	302	333	363	29
30	030		089	120	150	181	211	242	273	303	334	364	30
31	031		090		151		212	243		304		365	31

FOR LEAP YEARS ONLY

Day	Jan	Feb	Mar	Apr	May	June	July	Aug	Sep	Oct	Nov	Dec	Day
1	001	032	061	092	122	153	183	214	245	275	306	336	1
2	002	033	062	093	123	154	184	215	246	276	307	337	2
3	003	034	063	094	124	155	185	216	247	277	308	338	3
4	004	035	064	095	125	156	186	217	248	278	309	339	4
5	005	036	065	096	126	157	187	218	249	279	310	340	5
6	006	037	066	097	127	158	188	219	250	280	311	341	6
7	007	038	067	098	128	159	189	220	251	281	312	342	7
8	008	039	068	099	129	160	190	221	252	282	313	343	8
9	009	040	069	100	130	161	191	222	253	283	314	344	9
10	010	041	070	101	131	162	192	223	254	284	315	345	10
11	011	042	071	102	132	163	193	224	255	285	316	346	11
12	012	043	072	103	133	164	194	225	256	286	317	347	12
13	013	044	073	104	134	165	195	226	257	287	318	348	13
14	014	045	074	105	135	166	196	227	258	288	319	349	14
15	015	046	075	106	136	167	197	228	259	289	320	350	15
16	016	047	076	107	137	168	198	229	260	290	321	351	16
17	017	048	077	108	138	169	199	230	261	291	322	352	17
18	018	049	078	109	139	170	200	231	262	292	323	353	18
19	019	050	079	110	140	171	201	232	263	293	324	354	19
20	020	051	080	111	141	172	202	233	264	294	325	355	20
21	021	052	081	112	142	173	203	234	265	295	326	356	21
22	022	053	082	113	143	174	204	235	266	296	327	357	22
23	023	054	083	114	144	175	205	236	267	297	328	358	23
24	024	055	084	115	145	176	206	237	268	298	329	359	24
25	025	056	085	116	146	177	207	238	269	299	330	360	25
26	026	057	086	117	147	178	208	239	270	300	331	361	26
27	027	058	087	118	148	179	209	240	271	301	332	362	27
28	028	059	088	119	149	180	210	241	272	302	333	363	28
29	029	060	089	120	150	181	211	242	273	303	334	364	29
30	030		090	121	151	182	212	243	274	304	335	365	30
31	031		091		152		213	244		305		366	31

APPENDIX F

QUALITY CONTROL/ASSURANCE PROGRAM

INITIAL CHECKS AND INSPECTIONS

On receipt of material, the receiving activity decides whether a spot-check or an inspection (up to 100 percent) is necessary. The extent of the inspection will depend on the source of the material, its type, and its general appearance on arrival. Local conditions, quality history of like commodities, desired quality level, and command directives will also be factors. A 5-percent check is sufficient unless the material is subject to internal damage, deterioration, or miscount. A 10-percent check is then required. Used, aged, damaged, or otherwise suspect material requires a more thorough inspection. Deficiencies and discrepancies are reported for corrective action and preventive measures.

Required Checks

A spot-check of shipments, including bulk lots, must cover the following: item identification check (NIIN, nomenclature, and any others), quantity check, and a check for proper marking (contract number, date of pack, level of pack). Do not open containers and unit packs unless the material is suspect. Opened packs should be resealed if they are returned to stock. Unpackaged items should be 100 percent inspected for identification, damage, deterioration, count, and completeness. Uncrated or open-crated equipment is inspected to ensure that protective coatings or materials have not worn off.

Operational Checks

Supply elements are not equipped for operational checks on mechanical equipment. Such

material receives only the checks named above. Report obvious operational deficiencies for corrective action.

Material Requiring Special Handling

Give careful attention to items subject to rust, corrosion, fungus, or mildew. Make a 10-percent check on such material to determine its quality. You must open the checked packs. If the preservation is not adequate, the item may deteriorate even if the outer packaging is correct. Special instructions for inspection and handling of material such as lumber and hazardous materials are in DOD 4145.19-R-1.

PROTECTION OF MATERIAL FROM ENVIRONMENTAL DAMAGE

The supply quality control inspection makes biweekly checks of storage buildings, holding areas, and other facilities to ensure that supplies are protected from the weather, rodents, and insects. At the same time, it determines the suitability of each storage site for the items stored there. Premium storage space (reefers, dehumidified areas, and heated areas) is not used for material that does not need such protection. Report deficiencies to the storage officer or his alternate.

PRESERVATION AND PACKAGING

The initial care and preservation of material at the source and the supplemental care and preparation before storage at the supply unit are followed

by periodic inspections. DS units have a fairly quick turnover of supplies. This helps to prevent long-term deterioration, but it does not relieve the supply officer of his responsibility for the condition of the material. In addition to the biweekly inspection of unit storage facilities, cyclical and special checks of the material must be made. Basic guidance is in DOD 4145.19-R-1. More specific instructions are in the storage serviceability standards, supply manuals, and bulletins.

Routine Inspections

During routine (cyclic) inspections, the emphasis is on ensuring that the first-in, first-out rule is being followed. This is especially important for stock that is known to deteriorate with age. This kind of inspection must be very thorough in areas where large quantities of slow-moving stocks are stored. Where the first-in, first-out rule is not being observed, inspectors notify the storage officer so that action can be taken.

Special Inspections

Special inspections of suspect lots, quantities, or items are made on request of higher authority and after periods of hard rains, heavy snows, high winds, and sudden changes in the weather. They are requested by higher authority for a variety of reasons and are carried out according to the need. Inspections after bad weather cover such things as torn or loose protective canvas and coverings; damage from flying debris; water and hail; and loss of preservatives on exposed bare metal surfaces, hydraulic cylinder rods, and gears.

SHELF-LIFE ITEMS

Items that deteriorate at a known rate are assigned storage time (shelf-life) periods. There are two types of shelf-life items. Type 1 items have shelf-life periods that end after a specified time.

Type 2 items have shelf-life periods that may be extended if they meet certain standards after inspection or restoration. Controls are established at the storage facility to maintain records on shelf-life stocks. Regardless of the time remaining, shelf-life material is issued by the first-in, first-out rule to ensure its use before the expiration date. Shelf-life material is coded at the source. These codes are listed in AR 708-1. Information on inspections and coding changes is in AR 740-3.

MATERIAL CLASSIFICATION

Condition codes indicate the condition of material and determine its distribution. These codes show the extent of needed repairs, where repairs can be made, and whether an item is worth repairing. There are strict rules for the use of the codes with material received, stored, or issued.

Collection and Classification

Because of time and equipment limitations, collection and classification inspectors often cannot make a final decision on the serviceability of an item. Their main purpose is to divide materials into commodity groups and to determine their general condition. A complete inspection is made after the material has been sent to the DSU.

Coding

At the DSU level, material is inspected and classified by condition codes in AR 725-50. To ensure that the correct code is assigned, DSU units verify the inspection sheets for equipment sent to them from collection and classification inspectors. When verification shows the need for inspection training, it will be provided by quality assistance contact teams. DSU units also inspect and classify organic equipment sent to higher levels of maintenance.

GLOSSARY

AAFES	Army and Air Force Exchange Service	CA	California
ABF	availability balance file	Cav	cavalry
ADP	automatic data processing	cc	card column
ADPE	automatic data processing equipment	CDA	United States Army AMC Catalog Data Activity
AL	Alabama	CDR	commander
ALOC	air lines of communication	CEB	clothing exchange and bath
AMC	United States Army Materiel Command	CFR	Code of Federal Regulations
AMDF	Army Master Data File	Chgd	changed
AOE	Army of Excellence	CIF	Central Issue Facility
API	American Petroleum Institute	CIIC	controlled inventory item code
APO	Army Post Office	cn	can
APOD	aerial port of debarkation	cnt	count
APOE	aerial port of embarkation	c/o	in care of
Apr	April	co	company
AR	Army regulation	CO	Colorado
ARC	accounting requirements code	COD	collect on delivery
ARI	automatic return item	COMMZ	communications zone
ARIL	automatic return items list	COMSEC	communications security
ARMS	Army Master Data File Retrieval Microform System	cond	condition
ARNG	Army National Guard	CONEX	container express
ASL	authorized stockage list	CONUS	continental United States
attn	attention	COSCOM	corps support command
Aug	August	COSIS	care of supplies in storage
AUTODIN	automatic digital network	CPT	captain
AUTOVON	automatic voice network	C-RL	cross-reference list
bal	balance	crnt	current
BDU	battle dress uniform	CS	combat support
B/L	bill of lading	CSS	combat service support
bldg	building	CTA	common table of allowances
Blvd	Boulevard	cu	cubic
bn	battalion	DA	Department of the Army
BSA	brigade support area	DC	District of Columbia
BTU	British thermal unit	DD	Department of Defense
BX	box	Dec	December
		del	delivery
		DI	due-in
		DIC	document identifier code

FM 10-15

DISCOM	division support command	HI	Hawaii
div	division	hi-pri	high priority
DLA	Defense Logistics Agency	HQ	headquarters
DLSC	Defense Logistics Services Center	IAR	inventory adjustment report
dmd	demand	IL	Illinois
DO	due-out	in	inch
DOD	Department of Defense	Inf	infantry
DODAAC	DOD activity address code	inl	initial
DOL	Director of Logistics	inv	inventoried
DS	direct support	Jan	January
DSA	division support area	JP-4	jet propulsion fuel
DSC	distribution of stockage code	Jul	July
DS4	Direct Support Unit Standard Supply System	Jun	June
DSS	Direct Support System	KIAS	knots indicated air speed
DSU	direct support unit	kw	kilowatt
dz	dozen	KY	Kentucky
ea	each	lb	pound(s)
EAC	Echelons Above Corps	LCA	Logistic Control Activity
EC	essentiality code	LIF	logistics intelligence file
EOD	explosive ordnance disposal	LIN	line item number
EOQ	economic order quantity	loc	location
EPA	Environmental Protection Agency	Lt	lieutenant
ERPSL	essential repair part stockage list	MACOM	major Army command
estab	established	MAJ	major
F	Fahrenheit	maint	maintenance
FAO	finance and accounting officer	Mar	March
FARE	forward area refueling equipment	MATCAT	materiel category
FC	fund code	MCC	movement control center
Feb	February	MCN	management control number
fld	field	mech	mechanized
FLEX	flexible	MED	medical
FM	field manual	MHE	materials handling equipment
frz	freeze (code)	MILHDBK	military handbook
FSC	federal supply catalog	MILSTAMP	Military Standard Transportation and Movement Procedures
FSSP	fuel system supply point	MILSTRIP	Military Standard Requisitioning and Issue Procedures
ft	feet/foot	MILVAN	military-owned remountable container
FT	fort	min	minimum
FWT	fair wear and tear	MMC	Materiel Management Center
gal	gallon	MOS	military occupational specialty
GBL	Government bill of lading	MPDL	mission profile development list
GPM	gallons per minute	MPL	mandatory parts list
GRREG	graves registration	MPN	mandatory parts number
GS	general support	MQS	Military Qualifications Standards
GSU	general support unit	MRD	Materiel Release Denial
HEMTT	heavy expanded mobility tactical truck	MRE	meal, ready-to-eat
		MRO	materiel release order

MSR	main supply route	reqd	required
MTOE	modification table of organization and equipment	reqn	requisition
NA	not applicable	RICC	Reportable Item Control Code
NBC	nuclear, biological, chemical	RO	requisitioning objective
NC	North Carolina	ROD	report of discrepancy
NCO	noncommissioned officer	ROP	reorder point
NCOIC	noncommissioned officer in charge	ROTC	Reserve Officers' Training Corps
NIIN	national item identification number	rqr	requirement
NJ	New Jersey	RX	reparable exchange
NM	New Mexico	RXA	reparable exchange activity
NMCS	not mission capable supply	S3	Operations and Training Officer (US Army)
no	number	S4	Supply Officer (US Army)
nomen	nomenclature	SAF LEV	safety level
Nov	November	SAILS	Standard Army Intermediate Level Supply Subsystem
NSL	nonstockage list	S&S	supply and service
NSN	national stock number	SARSS	Standard Army Retail Supply System
NY	New York	SB	supply bulletin
OCIE	organizational clothing and individual equipment	SCMC	supply category of materiel code
Oct	October	SCS	stock control section
off	officer	SEAVAN	commercial - or government-owned (or leased) shipping container
OH	Ohio; on hand	SEC	Physical Security/Arms, Ammunition, and Explosives Security Risk/Pilferage Code
ORF	operational readiness float	Sep	September
OST	order ship time	SF	standard form
oz	ounce	SFC	sergeant first class
PA	Pennsylvania	SIMS-X	Selected Item Management System—Expanded
Pam	pamphlet	SL	safety level
PBO	property book officer	SLC	stockage list code
PCN	product control number	SM	soldier's manual
PD	priority designator	SOP	standing operating procedure
PLL	prescribed load list	SPT	support
PMCS	preventive maintenance checks and services	SQT	skill qualification test
POL	petroleum, oils, and lubricants	SRO	stock record officer
prev	previous	SSA	supply support activity
PROJ	project	SSSC	self-service supply center
PSC	price signal code	STG LCN	storage location (code)
PW	prisoner of war	STON	short ton
QM	quartermaster	STP	Soldier Training Publication
QMC	quartermaster center	sup	supply
QSS	quick supply store	TAACOM	Theater Army Area Command
qty	quantity	TAMMS	The Army Maintenance Management System
RC	recoverability code	TB	technical bulletin
rcmd	recommended	TC	training circular
REC	recoverability (code)		
rec'd	received		
renov	renovation		

FM 10-15

TCMD	transportation control and movement document	USAISEC	United States Army Information Systems Engineering Command
TCN	transportation control number	USAISECE	United States Army Information Systems Engineering Command Europe
TDA	tables of distribution and allowances		
TDR	transportation discrepancy report	USAISEC-FE	United States Army Information Systems Engineering Command—Far East
telecom	telephone communication		
TG	trainer's guide	USAISECP	United States Army Information Systems Engineering Command Pacific
TM	technical manual		
TMO	transportation management office	USAISSDCL	United States Army Information Systems Software Development Center Lee
TOE	table of organization and equipment		
TRADOC	United States Army Training and Doctrine Command	USAMC	United States Army Materiel Command
trans	transportation	USAR	United States Army Reserve
typ	type	USAREUR	United States Army, Europe
		VA	Virginia
UI	unit of issue	veh	vehicle
UMMIPS	Uniform Materiel Movement and Issue Priority System	vol	volume
UND	Urgency of Need Designator	w	with
US	United States (of America)	whse	warehouse
		wt	weight

★ With this change, 23 new acronyms are added.

D S M	automated data systems manual	NATO	North Atlantic Treaty Organization
BCR	bar code reader	OCONUS	outside continental United States
C	change	OPSEC	operations security
COOP	continuity of operations plan	QMC&S	Quartermaster Center and School
DMMC	division materiel management center	QSTAG	quadripartite standardization agreement
DOES	Directorate of Evaluation and Standarization	RMA	reparable management activity
DSN	Defense Switch Network	S2	Intelligence Officer (U.S. Army)
G2	Assistant Chief of Staff, G4 (Logistics)	SDT	self-development test
LOGMARS-T	Logistics Application of Marking and Reading	STAMIS	Standard Army Management Information System
MCRL	master cross reference list	STANAG	standardization agreement
METT-T	mision, enemy, terrain, troops, and time available	TACCS	Tactical Army Combat Service Support Computer System
		ULLS	unit level logistics system

REFERENCES

RELATED PUBLICATIONS

Related publications are sources of additional information. They are not required in order to understand this publication.

ARMY REGULATIONS

12-12	Processing Discrepancy Reports Against Foreign Military Sales Shipments
25-30	The Army Integrated Publishing and Printing Program
30-18	Army Troop Issue Subsistence Activity Operating Procedures
37-111	Working Capital Funds-Army Stock Fund; Uniform Policies, Principles, and Procedures Governing Army Stock Fund Operations
40-5	Preventive Medicine
40-61	Medical Logistics Policies and Procedures
55-38	Reporting of Transportation Discrepancies in Shipments
115-11	Army Topography
190-11	Physical Security of Arms, Ammunition and Explosives
200-1	Environmental Protection and Enhancement
340 series	Office Management
380-5	Department of the Army Information Security Program
380-380	Automation Security
385-30	Safety Color Code Markings and Signs
700-15	Packaging of Materiel
700-93	Processing and Shipping DOD Sponsored Retrograde Materiel Destined for Shipment to the United States, Its Territories, Trusts, and Possessions
708-1	Cataloging and Supply Management Data
710-1	Centralized Inventory Management of the Army Supply System
710-2	Supply Policy Below the Wholesale Level
725-50	Requisitioning, Receipt, and Issue System
735-5	Policies and Procedures for Property Accountability

FM 10-15

740-1	Storage and Supply Activity Operations
740-3	Care of Supplies in Storage (COSIS)
740-15	Storage of Military Service-Owned Retail Stocks in the DLA Materiel Distribution System

COMMON TABLES OF ALLOWANCES

50-900	Clothing and Individual Equipment
50-909	Field and Garrison Furnishings and Equipment
50-970	Expendable/Durable Items (Except: Medical, Class V, Repair Parts and Heraldic Items)

DEPARTMENT OF THE ARMY CATALOG

C-8900-SL	Federal Supply Catalog: Stock List, FSC Group 89, Subsistence
-----------	---

DEPARTMENT OF THE ARMY FORMS

12-11-E	Subscription Numbers, Part V (FMs, MQSs, STPs, and TCs)
272	Register of Vouchers to Stock Record Account
444	Inventory Adjustment Report (IAR)
1687	Notice of Delegation of Authority—Receipt for Supplies
1713	Daily Water Production Log
1713-1-R	Daily Water Production Log
1714-R	Daily Water Issue Log
1714-1-R	Daily Water Distribution Log
1716-R	Water Point Daily Production Summary
1717-R	Water Point Daily Distribution/Issue Summary
1804	Petroleum Sample
2000-3	Installation Inventory Count Card
2028	Recommended Changes to Publications and Blank Forms
2060-R	Status Report (Report of Class I Supplies)
2404	Equipment Inspection and Maintenance Worksheet
2407	Maintenance Request
2765 series	Request for Issue or Turn-In
2765	Request for Issue or Turn-In
2765-1	Request for Issue or Turn-In
3161 series	Request for Issue or Turn-In
3161	Request for Issue or Turn-In
3293-R	Subsistence Consumption Card
3294-R	Field Ration Issue Slip
3643	Daily Issues of Petroleum Products

References-2

3644	Monthly Abstract of Issues of Petroleum Products and Operating Supplies
3645	Organizational Clothing and Individual Equipment Record
3645-1	Additional Organization Clothing and Equipment Record
3733-R	Self-Service Supply Center Account Card
3778	Loose Issue Label
3779	Location Placard
3780	Pallet Count
3781	Check Unit of Issue Notice
3782	Suspended Notice
3783	Stock Change and/or Physical Security Change Notice
3857	Commercial Deliveries of Bulk Petroleum Products Checklist
4697	Department of the Army Report of Survey
4702-R	Monthly Bulk Petroleum Accounting Summary
4766-R	Bath and Clothing Exchange Activity Record

DEPARTMENT OF THE ARMY LABEL

141 Open Box

DEPARTMENT OF THE ARMY PAMPHLETS

25-30	Consolidated Index of Army Publications and Blank Forms
700-30	Logistic Control Activity (LCA) Information and Procedures
710-2-1	Using Unit Supply System (Manual Procedures)
710-2-2	Supply Support Activity Supply System: Manual Procedures
710-4	Management of Excess Materiel and Materiel Returns
710-5	Unit Commander's Supply Handbook
738-750	The Army Maintenance Management System (TAMMS)

DEPARTMENT OF DEFENSE FORMS

250	Material Inspection and Receiving Report
805	Storage Space Management Report
1155	Order for Supplies or Services/Request for Quotations
1348-1	DOD Single Line Item Release/Receipt Document
1348-6	DOD's Single Line Item Requisition System Document (Manual Long-Form)
1384	Transportation Control and Movement Document
1387	Military Shipment Label
1487	DOD Materiel Adjustment Document
1970	Motor Equipment Utilization Record

DOD REGULATIONS AND MANUALS

4140.25-M	Procedures for the Management of Petroleum Products
-----------	---

FM 10-15

4145.19-R-1	Storage and Materials Handling
45W.32-R, Vol 1	Military Standard Transportation and Movement Procedures
5100.76-M	Physical Security of Sensitive Conventional Arms, Ammunition, and Explosives

FIELD MANUALS

5-20	Camouflage
5-105	Topographic Operations
10-14	Unit Supply Operations (Manual Procedures)
10-16	General Fabric Repair
10-18	Petroleum Terminal and Pipeline Operations
10-20	Organizational Maintenance of Military Petroleum Pipelines, Tanks and Related Equipment
10-23	Army Food Service Operations
10-24	Ration Distribution Operations
10-52	Water Supply in Theaters of Operations
10-52-1	Water Supply Point Equipment and Operations
10-60	Subsistence Supply and Management in Theaters of Operations
10-68	Aircraft Refueling
10-69	Petroleum Supply Point Equipment and Operations.
10-70	Inspecting and Testing Petroleum Products
10-71	Petroleum Tank Vehicle Operations
10-280	Mobile Field Laundry, Clothing Exchange, and Bath Operations
10-427	Petroleum Supply Company
10-564	Airdrop of Supplies and Equipment: Rigging Fuel Drums
38-725-1	Direct Support (DSS): Commander's Handbook
55-450-1	Army Helicopter External Load Operations
55-450-3	Multi-Service Helicopter External Air Transport: Basic Operating Equipment
55-450-4	Multi-Service Helicopter External Air Transport: Single Point Load Rigging
55-450-5	Multi-Service Helicopter External Air Transport: Dual-Point Load Rigging
100-10	Combat Service Support
101-10-1/1	Staff Officers Field Manual—Organizational, Technical and Logistical Data (Volume 1)
101-10-1/2	Staff Officers Field Manual—Organizational, Technical, and Logistical Data, Planning Factors (Volume 2)

MILITARY HANDBOOKS

200G	Quality Surveillance Handbook for Fuels, Lubricants, and Related Products
------	---

References-4

201B Petroleum Operations
 Military handbooks are available from:
 Commanding Officer
 Naval Publications and Forms Center
 ATTN: NPFC 106
 5801 Tabor Avenue
 Philadelphia, PA 19120-5099

MISCELLANEOUS PUBLICATIONS

AMDF Army Master Data File
 C-RL Consolidated Master Cross Reference List
 CDA Pamphlet
 18-1 Code Reference Guide for the ARMS Monthly AMDF
 Above publications available from:
 Chief
 US Army Materiel Command
 Catalog Data Activity
 ATTN: AMXCA-BTM
 New Cumberland Army Depot
 New Cumberland, PA 17070-5010

CFR 40 Protection of Environment
 Code of Federal Regulation available from:
 Superintendent of Documents
 US Government Printing Office
 Washington, DC 20402

SOLDIER TRAINING PUBLICATION

10-76V24-SM-TG Soldier's Manual, Skill Levels 2/3/4 and Trainer's Guide, MOS 76V, Materiel Storage and Handling Specialist

STANDARD FORMS

344 Multiuse Standard Requisitioning/Issue System Document
 361 Transportation Discrepancy Report
 364 Report of Discrepancy (ROD)

SUPPLY BULLETINS

11-30 FSC Class 6135: Primary Battery Management Data
 740 series Storage of Supplies and Equipment

TECHNICAL BULLETINS

55-46-1 Standard Characteristics (Dimensions, Weight, and (Cube) for Transportability of Military Vehicles and Other Outsize/Overweight Equipment (In TOE Line Item Number Sequence)
 55-46-2 Standard Transportability Characteristics (Dimensions, Weight, and Cube) for Military Vehicles and Equipment (In NSN Sequence)
 380-41 Procedures for Safeguarding, Accounting, and Supply Control of COMSEC Material

FM 10-15

MED 576	Occupational and Environmental Health Sanitary Control and Surveillance of Water Supplies at Fixed Installations
MED 577	Occupational and Environmental Health: Sanitary Control and Surveillance of Field Water Supplies

TECHNICAL MANUALS

5-678	Repairs and Utilities: Petroleum, Oils, and Lubricants (POL)
11-415	Primary Batteries (Dry and Reserve Types)
38-L03 series	Standard Army Intermediate Level Supply System
38-L03-17	Standard Army Intermediate Level Supply System (SAILS) Storage Operations
*38-L32 series	Direct Support Unit Standard Supply System (DS4)
*38-L32-11	Functional Users Manual for Direct Support Unit Standard Supply System (DS4): Customer (User) Procedures (Divisional and Nondivisional)
*38-LJ2-12	Functional Users Manual for Direct Support Unit Standard Supply System (DS4): Storage Operations Procedures (Divisional and Nondivisional)
*38-L32-13	Functional Users Manual for Direct Support Unit Standard Supply System (DS4): Stock Control and Supply Control Procedures (Division and Nondivision)
*38-L32-14	Functional Users Manual for Direct Support Unit Standard Supply System (DS4): Executive Management Procedures (Divisional and Nondivisional)
38-230-1	Packaging of Materiel: Preservation (Vol I)
38-230-2	Packaging of Materiel: Preservation (Vol II)
743-200-1	Storage and Materials Handling
743-200-2	Storage Modernization
743-200-3	Storage and Materials Handling
746 series	Marking and Packaging of Supplies and Equipment

*Technical manuals in the 38-L32 series are not available through normal distribution. Requests for these publications must be submitted to Commander, US Army Logistics Center, ATTN: ATCL-SRR, Fort Lee, Virginia 23801-5036.

TRAINING CIRCULARS

11-6	Grounding Techniques
43-4	Commanders and Shop Officers Guide for Support Maintenance Management

★ With this change, 10 new references are added.

AR 380-19	Information Systems Security
DA Form 5504	Maintenance Request
DA Form 5977-R	Data Analysis Summary(LRA)
DD Form 1348-1 (A) Blue	DOD Single Line Item Release/Receipt Document (With Address Label)
DD Form 1348-A (Brown)	DOD single Line Item Release/Receipt Document (Used to identify PDs 04-08)
DD Form 1348-1A (Red)	DOD Single Line Item Release/Receipt Document (Used to identify PDs 01-03 (Incl all NORs/ANORS))
DOD 4130.2-M	Federal Catalog System Policy Manual
MCRL	Master Cross Reference List

The following manuals are not available through normal distribution. Request for these publications must be submitted to Commander, Combined Arms Support Command, ATTN: ATCL-SRR, Fort Lee, Virginia 23801-6000.

AUTOMATED DATA SYSTEMS MANUALS

18-L19-AJH-BUR-EM	Standard Army Retail Supply System (SARSS-1(1)) End User Manual
18-L19-AJH-BUR-UM	Standard Army Retail Supply System (SARSS-1(1)) Users Manual

NOTE: Technical manuals in the 38-L32 series are now available through distribution.

INDEX

- Address
 Directory 6-7
 Label 9-11
 Adjustment documents 2-19
 ADP
 Run schedules 1-3
 Security 1-5, 1-6
 Support 4-6
 Allowable loss or gain ranges 3-3
 ARIs 1-2, 7-14
 ARI codes 1-11, 1-12
 ASL
 Change list 4-3
 Change list recommendations 4-2
 Replenishment 1-11
 Stockage criteria 1-1
 As required processes 1-4
 Augmentation 2-1
 Automated system procedures 2-11
 Automatic stockage level 4-2
 Aviation and missile repair parts 1-2
 Basic floor plan 5-6
 Batteries
 Dry cell 4-12
 Vehicle 4-12
 Battery storage requirements 4-12
 BH status code 7-10, 8-4
 Bin 5-17
 Bin cubic capacity 5-18
 Bin storage layout 5-9, 5-10
 Blockage parameter card 1-11
 Breakbulk semitrailers 9-16
 Bulk fuel operations 1-13
 Bulk petroleum
 Distribution 3-1
 Inventory 3-3
 Receipt 3-1
 Bulk storage layout 5-11
 Camouflage techniques 5-14
 Candidate cancellation cards 1-2
 Captured and unwanted material 1-2
 Cargo containers 9-16
 CIF 2-19
 CIF property records 2-19
 Class I
 Operations 1-12
 Storage 2-12
 Class II
 Supply point 2-18
 Support operations 2-18
 Class III supply point 3-1
 Class IV
 Supply point 2-18
 Support operations 2-18
 Class VII
 Issue controls 2-18
 Supply point 2-18
 Support operations 2-18
 Class IX ASL 4-1
 Classified
 Items 5-4
 Maps 2-18
 Material 2-16
 Clearances
 Horizontal 5-7
 Vertical 5-7
 Combat ASL
 Items 12-1
 Location system 12-1
 Storage aids 12-1
 Compressed gases
 Handling 3-13
 Storage 3-13
 Condition code 6-8
 Consolidated operational ration issue
 report 1-13

Controlling storage space	5-1	Emergency issues	3-5
Conveyors	11-3, 11-4	Environmental pollution	3-8
Corrosion inhibitors	3-6	Equipment maintenance records	2-6
Count		Excess report list	1-2
Accepting	10-26	Excess stocks	1-2
Completing	10-23	External sling loads	2-16
Stock	10-21	FARE	3-7
Count cards	2-11	FARE system	3-5
Covered storage space	5-1, 5-18	Field returns	1-2
Credit balance	2-11	Field storage layout	5-13
Cubic capacity		Field supply and storage point	5-14
Attainable	5-18	Forklift handling	2-5
Bin	5-18	Frustrated shipments	2-3
Rack	5-18	Graves registration operations	2-23
Customer DO reconciliation list	1-11	Gross storage space	5-17
Customer unit notification log	9-2, 9-3	Hazardous material	5-3
Cutoff controls	10-11	Helicopter refueling	3-5
Daily process	1-4	Horizontal clearances	5-7
Daily stock status report	3-3	Hose line operations	3-6
Decontaminate clothing and textiles	2-21	Identifying incorrectly stored items	8-5
Demand		Initial provisioning items	1-2
Accommodation	2-1, 4-2	Inspection checklist	3-11
Satisfaction	1-1, 2-1, 4-2	Installation transportation	9-11
Demurrage	2-4	Interchangeable items	1-2
Determining space	5-1	In-transit controls	2-8
DICs		In-transit data cards	7-9
D6S	7-10	Invalid due-ins	2-4
TK4	7-9	Inventory	
TK6	7-9	Completing	10-26, 10-29
TK9	7-9	Evaluating performance	10-29
Discrepancies		Issuing items	10-20
Supply	7-13	Key personnel	10-20
Transportation	7-13	Lumber	10-21
Disposal release order	9-5, 9-6	Performing	10-21
Document control register	2-3, 7-5, 7-6	Special	2-11
Documents		Inventory adjustment report list	2-11
DSS shipments	7-8	Inventory count cards	
DSS ALOC shipments	7-8	Control Listings	10-17 through 10-19
Receipt	7-9	Preparing	10-14
Transportation	9-11	Process	2-11
D6S card	7-8	Inventory voucher number	10-13
DS4		Issue	
Catalog update process	4-6	Control lists	2-18
Inventory listings	2-11	Documents	9-1, 9-2
DSS		Procedures	3-3
Shipments	7-6, 7-7	Items	
Systems	7-6	Automatic return	1-11
DSS ALOC		Classified	5-4
Shipments	7-6	Combat ASL	12-1
Systems	7-6	Damaged	7-13
Dunnage	2-13		
Dust respirators	2-23		

Demand-supported	1-2	Material	
Fragile	5-4	Classified	2-6
Misrouted	7-12	Sensitive	2-6
MPL	12-1	Material return program items	1-2
Oddly-shaped	5-4	Material control system	2-6
ORF	1-2	Material release card	7-10
Overages	7-13	MHE	
Perishable	5-4	Choosing	11-1
Pilferable	5-2, 5-3	Controlling	11-4
Recoverable	1-11	Maintaining	11-6
Selecting	8-7	Nonpowered	11-3
Sensitive	5-2, 5-3	Powered	11-1
Shelf-life	6-8, 8-2	MILVANs	9-16
Shortages	7-13	Mission-essential	1-2
Substitute	7-10, 8-4	Mixed stock	2-10, 10-7
Turn-ins	7-13	Mobile filling stations	3-6
		Monthly PLL change lists	4-6
Layouts		Monthly processes	1-4
CEB operations	2-23	MRD rate	2-1
Laundry and renovation operations	2-22	MRDs	
LIF	4-1	Issuing	8-19
Light signals	2-14	Monitor	2-1
Loading	9-16	Processing	8-15, 8-16
Location		MRD troubleshooting chart	2-2
Additions	10-7	MROs	
Aids	12-1	Cutoff controls	10-13
Changes	6-9, 10-7	Processing	8-10 through 8-13
Deletions	10-7	Sorting by priority	8-7
Error list	2-8, 10-8	Sorting by storage location	8-8
Markings	6-5, 6-6	Multiple stock locations	2-10
Site forms	6-12		
Location survey		Negative balance	2-11
Problems and corrective actions	2-10, 10-9, 10-10	Net storage space	5-18
Location survey work cards		NMCS	4-2
Handmade	10-5	Non-DSS	
Manual	10-6	Shipments	7-10
Preprinted	10-8	Systems	7-6
Locator surveys	2-8, 10-5, 10-9	Numbers	
Location system	12-1	Control	9-11
Location		Shipment	9-11
Deck	10-5	Off-line requisitions	1-11
File	6-7, 6-8	Open containers	10-7
Survey	2-11	Open storage layout	5-8
Mandatory parts lists	4-1	Open storage space	5-1
Manual replenishment	1-2, 1-11	Operational rations	2-15
Manually-prepared inventory count cards	10-14 through 10-16	Operations	
Manually prepared stock location change card	6-11	Hose line	3-6
Map point	2-18	Pipeline	3-6
		Operating stock	1-12
		ORF items	1-2
		Organic transportation	9-11

Outages		Quarterly PLL change list	4-2, 4-4
Short-Term	1-4	Rack cubic capacity	5-18
Long-Term	1-4	Radiacmeters	2-23
Pallet rack	5-17	Railcars	9-16
Pallet support set	5-17	Ration breakdown point	2-12
Pallets		Receipt documents	7-1 through 7-4
Box	5-17	Receipt not due in listing	1-8
Four-way	5-16	Receipt operations	2-2
Safety	5-17	Receiving cutoff control register	2-11, 10-11
Two-way	5-16	Receiving reports	2-3
Types	9-14, 12-6	Receiving supplies	7-1
Petroleum platoon leader	3-1	Recommended stockage level	4-2
Physical inventories		Recount	10-26
Performing	10-1	Recoverability codes	2-20
Scheduled cyclic inventory	10-3	Reimbursement	7-13
Scheduled wall-to-wall inventory	10-3	Release denial	9-7
Special	10-4	Release order	9-10
Physical location survey	10-1	Relocating stored supplies	8-6
Pilferable tools	2-6	Remote terminal access	4-1
Pipeline corrosion	3-6	Remote terminal security checks	1-6
Pipeline operations	3-6	Replenishment requisitions	1-11
Planning issue/shipping activities	9-1	Reports of discrepancies	2-4
Planning the shipment	9-6	Requisition demand history	4-1
Planograph	5-19, 6-1	Restrict access	2-6
PLL change list	4-4, 4-10	Returning retrograde cargo	9-11
Postpost issues	2-12	Rewarehousing	4-11
Preinventory procedures	10-11	Rigging	2-18
Prepared storage layout	5-6	Rigging supplies	
Preparing release orders	9-5	Air delivery	2-1
Preventive maintenance checks	3-5	Graves registration	2-1
Priority designator	1-3	RXA	4-6
Procedures		Salvage collection point	2-19
Automated	6-10	Sample performance report	4-5
Manual	6-9	Sample register	10-12
Preinventory	10-11	Schedule and coordinate inventories	1-8
Processes		Search and recovery team leaders	2-23
As required	1-4	Seasonal change requirements	1-11
Daily	1-4	Seasonal demand items	1-2
Monthly	1-4	Seasonal requirements	4-2
Semimonthly	1-4	SEAVANs	9-16
Weekly	1-4	Security	1-1
Processing times		Self-service supply center	2-20
DSS	7-7	Semimonthly process	1-4
DSS ALOC	7-7	Shelf box	5-17
MRO	1-3, 2-12	Shipments	
Proposed command-controlled items lists	1-13	DSS	7-6, 7-7
Pulling items from stock		DSS ALOC	7-6
Progressive Method	8-9	Non-DSS	7-10
Selective Method	8-10	Shipping materiel	9-5
QSS	4-11	Site selection	3-1
QSS stockage criteria	4-12	Software security	1-6
Quality surveillance	3-13	Space allocation map	5-19

Space audit	5-20	Supplies	
Space recapitulation record	5-21	Issuing	9-2
Special instructions	2-8	Packing	9-10
Special inventory	2-11	Picking up	9-2
SSSC stockage criteria	2-21	Shipping	9-5
Steel shelving	5-17	Types	10-4
Stock		Supply discrepancies	7-13
Counting	10-21	Supply mission control element	1-1
Loose	10-21	Supply operations officer	1-1
Packaged	10-21	Supply performance indicators	1-8, 1-9
Palletized	10-23	Supply performance report	1-10, 4-2, 4-5
Picking	9-7	Supply platoon	1-1
Stock control	4-2	Supply platoon leader	2-1
Stock location change card	6-11, 10-9	Supply points	
Stock location code	6-1, 6-3	Class II	2-18
Stock locations	2-8, 4-6	Class III	3-1
Stock locator code	2-9	Class IV	2-18
Stock locator file system	2-18	Class VII	2-18
Stock locator system	6-1,6-5	Supply point distribution	2-15
Stock picker	4-7	Supply point location	3-1
Stock record adjustments	10-14	Supply responsiveness	1-2
Stock status	2-12	Supply support of deploying units	1-8
Stock status report	1-5, 1-7, 2-20	Supply status	1-9
Stockage objective	1-12	Support operations	
Storage aids	5-14 through 5-16, 12-1, 12-2	Class II	2-18
Storage checks and inspections	2-8	Class IV	2-18
Storage factors	5-3	Class VII	2-18
Storage layout		Survey lots	2-8
5-gallon cans	3-9	Survey work card	2-10
55-gallon drums	3-10	Systems	
500-gallon collapsible drums	3-10	DSS	7-6
Bin	5-9, 5-10	DSS ALOC	7-6
Bulk	5-11	Non-DSS	7-6
Field	5-13	Tally sheet	7-1
Floor plan	5-2	Technical supply officer	4-1
Open storage	5-8	Tent storage layout	5-9
Prepared	5-6	Threat monitoring	1-6
Tent	5-9	Tire storage	4-11
Van	5-13	Transportation	
Storage layout drawing	5-4	Installation	9-11
Storage layout plans	2-4, 5-2	Organic	9-11
Storage operations	2-6	Transportation discrepancies	7-13
Storage problem troubleshooting chart	2-7	Turn-ins	
Storage space		Found	7-13
Covered	5-1, 5-18	Other	7-14
Gross	5-17	Serviceable	7-13
Management report	5-21	Unserviceable	7-13
Net	5-18	Types of supplies	10-4
Open	5-1	Unidentified stock	2-10, 10-7
Status report	5-21	Unscheduled spot inventory	2-11
Survey work sheet	5-20	Usable storage capacity	
Storing incoming supplies	8-1	Computation	12-2
Storing supplies	8-1		

FM 10-15

Van storage layout5-13
Vertical clearances 5-7
Vertical space.....5-18

Warehouse denial rate 2-12
Water consumption planning factors..... 2-16

Water purification2-15
Water requirements 2-15
Water supply summary reports 2-16
Weekly processes 1-4
Weekly stock status report 1-5

Zero balances 4-2

By Order of the Secretary of the Army:

CARL E. VUONO
General United States Army
Chief of Staff

Official:

THOMAS F. SIKORA
Brigadier General, United States Army
The Adjutant General

DISTRIBUTION:

Active Army, USAR, and ARNG: To be distributed in accordance with DA Form 12-1 I-E, requirements for FM 10-14-4, Handbook for the Supply Support Activity Officer (Qty rqr block no. 0862); FM 10-15, Loading Container Inserts and Cargo Transporters (Qty rqr block no. 0863); and FM 38-741, Direct Support Unit Storage Operations (Qty rqr block no. 1157).

PIN: 023679-001