

Change 1

Headquarters
Department of the Army
Washington, DC, 10 February 2011

Rifle Marksmanship M16-/M4-Series Weapons

1. Change FM 3-22.9, 12 August 2008, as follows:

Remove old pages:

No pages
i through xiv
5-3 through 5-4
5-17 through 5-42
6-19 through 6-20
7-57 through 7-70
8-27 through 8-28
B-1 through B-6
F-1 through F-8
Index-1 to Index-16
DA Form 5789-R
DA Form 5790-R
No pages

Insert new pages:

Summary of Changes
i through xiv
5-3 through 5-4
5-17 through 5-38
6-19 through 6-20
7-57 through 7-74
8-27 through 8-28
B-1 through B-6
F-1 through F-12
Index-1 to Index-14
DA Form 5789-R
DA Form 5790-R
DA Form 7682-R

2. A star (*) marks new or changed material.
3. File this transmittal sheet in front of the publication.

DISTRIBUTION RESTRICTION: Approved for public release; distribution is unlimited.

By Order of the Secretary of the Army:

GEORGE W. CASEY, JR.
General, United States Army
Chief of Staff

Official:



JOYCE E. MORROW
*Administrative Assistant to the
Secretary of the Army*
1034702

DISTRIBUTION: Active Army, Army National Guard, and U.S. Army Reserve: To be distributed in accordance with initial distribution number 110187, requirements for FM 3-22.9.

This page intentionally left blank.

*Summary of Changes

Change 1 of FM 3-22.9, Rifle Marksmanship, M16-/M4-Series Weapons, integrates the new combat field fire into the advanced rifle marksmanship training strategy. This change outlines the combat field fire portion of the training program (concept, conduct, and record of performance; found in Section VII of Chapter 7, found on page 7-59) and introduces its associated scorecard (blank scorecard is located at the end of the publication; example completed scorecard is located on page B-6).

This change also integrates the supplemental 200-meter zeroing procedures as an alternative to 300-meter zeroing (found in Section II of Chapter 5). Appendix F includes target offsets for these procedures.

Further, minor changes are made to correct the content of the publication. These include the following:

- In paragraphs 5-5, 5-6, 5-7, 5-45, 5-46, and 5-47 (pages 5-3, 5-4, 5-17, 5-18, and 5-19), changes were made to accommodate the five-round shot groups fired in initial entry training (IET).
- Paragraphs 5-49 and 5-50 (page 5-19) were added to address the conduct of a 200-meter zero firing.
- In Figure 5-20 (page 5-21), “100-meter” is changed to “75-meter” and “200-meter” is changed to “175-meter.”
- In Figure 5-31 (page 5-33), the lengths of the rounds have been corrected.
- The notes on page 5-35 and 5-36 were modified to indicate new paragraph placement.
- In Table 6-16 (page 6-19), the Number of Rounds column reflects the following changes:
 - In the Table 1 row, the column is changed to read “20-round magazine, two rounds for each silhouette.”
 - In the Table 3 row, the column is changed to read “10-round magazine, two rounds for each silhouette at 50 to 100 meters and one round at each 150-meter silhouette.”
- Paragraph 6-91 (page 6-20) was modified to include additional information about scoring.
- In paragraph 6-93 (page 6-20), the NSNs have been corrected.
- In Table 7-21 (page 7-57), “Short/45 m” is changed to read “Short/40 m.”
- In paragraphs 8-93 and 8-94 (page 8-28), the number of rounds fired from the prone unsupported position was raised to 20, and the 10 rounds fired from the kneeling firing position was reduced to 0.
- In Figure B-5 (page B-4), updates reflect the changes in DA Form 5789-R (Record Fire Scorecard—Known Distance Course).
- Appendix F has been modified to include 200-meter zero offsets. This impacts the chapter introduction (page F-1). Also, a portion of the appendix has been added to address marking 25-meter zero offsets for 200 meters (beginning with paragraph F-3 on page F-9).
- In Table F-1 (page F-7), the zero offset for the M16A4 MWS with the M68 accessory has been corrected.
- In DA Form 5789-R, the Range column reflects the following changes:
 - In Table 2, “300” is changed to “200.”
 - In Table 3, “300” is changed to “100.”
- In DA Form 5790-R (Record Firing Scorecard—Scaled Target Alternate Course), the rear of the scorecard is changed to read—

(3) Table 3—Kneeling Firing Position. The firer is given one 10-round magazine to engage 10 silhouettes on the target sheet. Table 3 includes 2 rounds for each silhouette positioned at 50 and 100 meters and 1 round for each silhouette positioned at 150 meters. Firing must be completed in 60 seconds. No more than 2 hits are scored for the 50- and 100-meter silhouettes, and 1 hit is scored for each 150-meter silhouette.

SCORING

The same target sheet is used for every 40-round qualification table that a firer completes. One hit is awarded for each round that strikes within or touches some part of the silhouette. A maximum of 40 hits is comprised of 3 hits per target at 200, 250, and 300 meters; 4 hits per target at 150 meters; and 5 hits per target at 50 and 100 meters.
- In DA Form 5790-R, the front of the scorecard was changed to remove the following phrase: “No more than 4 rounds per target.”

This page intentionally left blank.

Rifle Marksmanship M16-/M4-Series Weapons Contents

	Page
	PREFACE..... xiv
Chapter 1	MARKSMANSHIP TRAINING 1-1
	Section I. Training Strategy 1-1
	Objectives 1-1
	Marksmanship Training Strategy 1-1
	Training Phases 1-5
	Section II. Unit Marksmanship Training Program 1-8
	Mission-Essential Tasks 1-9
	Training Assessment 1-9
	Trainers 1-11
	Trainer Certification Program 1-13
	Qualification Training 1-15
	Unit Live-Fire Exercises 1-17
Chapter 2	WEAPON CHARACTERISTICS, ACCESSORIES, AND AMMUNITION 2-1
	Section I. Rifles and Carbines 2-1
	Characteristics of M16-/M4-Series Weapons 2-1
	M4-Series Carbine 2-2
	M16A2/A3 Rifle 2-5
	M16A4 Rifle 2-7
	M16A1 Rifle 2-9
	Section II. Accessory Mounting 2-10
	M4/M5 Adapter Rail System 2-10
	Rail Grabbers 2-13
	Section III. Accessories 2-16
	M68 Close Combat Optic 2-17
	AN/PAQ-4B/C Infrared Aiming Light 2-19
	AN/PEQ-2A/B Target Pointer/Illuminator/Aiming Light 2-21
	AN/PEQ-15 Advanced Target Pointer/Illuminator Aiming Light 2-24
	AN/PAS-13B/C/D (V1) Light Weapon Thermal Sight and AN/PAS-13B/C/D (V3) Heavy Weapon Thermal Sight 2-26
	AN/PVS-4 Night Vision Sight 2-28

DISTRIBUTION RESTRICTION: Approved for public release; distribution is unlimited.

*This publication supercedes FM 3-22.9, 24 April 2003.

	Backup Iron Sight.....	2-30
	Advanced Combat Optical Gunsight.....	2-31
	Section IV. 10-Meter Boresight and 25-Meter Zero Offset	2-33
	Borelight	2-33
	10-Meter Boresight.....	2-34
	25-Meter Zero Offset.....	2-34
	Section V. Ammunition.....	2-35
	Authorized Ammunition	2-35
	Trajectory	2-37
	Storage.....	2-39
Chapter 3	TROUBLESHOOTING AND DESTRUCTION	3-1
	Stoppages	3-1
	Malfunctions	3-2
	Destruction Procedures	3-7
Chapter 4	PRELIMINARY MARKSMANSHIP INSTRUCTION.....	4-1
	Section I. Introduction to Basic Rifle Marksmanship and Mechanical Training	4-1
	Clearing	4-2
	Cycles of Functioning.....	4-4
	Modes of Fire	4-11
	Peer Coaching	4-12
	Section II. Marksmanship Fundamentals I	4-14
	Interceptor Body Armor	4-15
	Four Fundamentals	4-16
	Dominant Eye Training	4-24
	Basic Firing Positions.....	4-24
	Training Devices and Exercises.....	4-28
	Section III. Marksmanship Fundamentals II	4-29
	Engagement Skills Trainer 2000.....	4-29
	Laser Marksmanship Training System.....	4-30
Chapter 5	DOWNRANGE FEEDBACK.....	5-1
	Section I. Grouping Procedures	5-1
	Concept.....	5-2
	Organization of a 25-Meter Grouping Range.....	5-2
	Conduct of a 25-Meter Grouping Firing	5-2
	*Shot Group Marking	5-3
	Single Shot Group Analysis	5-4
	Multiple Shot Group Analysis.....	5-7
	Troubleshooting the Fundamentals	5-14
	Section II. Zeroing Procedures	5-14
	Purpose.....	5-15
	Sight Variance.....	5-15

	Organization of a 25-Meter Zero Range.....	5-15
	Conduct of a 25-Meter Zero Firing	5-15
	Section III. Known Distance Range	5-19
	Concept	5-19
	*Known Distance Target Description.....	5-20
	*Marking Known Distance Range Targets	5-21
	Known Distance Shot Grouping Analysis.....	5-22
	*Known Distance Zeroing	5-23
	*Conduct of a Standard Known Distance Range	5-23
	*Known Distance Record Fire Range.....	5-24
	*Modified Field Fire Range	5-24
	*Record of Performance	5-25
	*25-Meter Zero Standard.....	5-26
	*Section IV. Effects of Wind and Gravity.....	5-26
	*Effects of Gravity	5-26
	*Effects of Wind	5-27
	*Section V. Ballistics	5-33
	*Internal Ballistics	5-33
	*External Ballistics	5-35
	*Terminal Ballistics	5-37
	*Bullet Dispersion at Range	5-37
Chapter 6	FIELD FIRE	6-1
	Section I. Target Detection	6-1
	Locating Targets.....	6-1
	Marking Targets.....	6-4
	Range Determination.....	6-5
	Section II. Field Fire Training	6-6
	Conduct of a Field Fire Range	6-7
	Field Fire I (Single Timed Target).....	6-8
	Field Fire II (Multiple or Single Timed Targets)	6-9
	Section III. Record Qualification	6-10
	Practice Record Fire I and II.....	6-10
	Record Fire	6-13
	Section IV. Alternate Qualification Courses	6-16
	Known Distance Record Fire Range	6-17
	25-Meter Scaled Target Alternate Course.....	6-18
	15-Meter Scaled Target Alternate Course.....	6-20
Chapter 7	ADVANCED RIFLE MARKSMANSHIP	7-1
	Section I. Advanced Firing Positions	7-1
	Kneeling Supported Firing Position	7-2
	Standing Unsupported Firing Position.....	7-3
	Standing Supported Firing Position Around Obstacles	7-4

	Modified Firing Positions	7-5
	Urban Operations Firing Positions	7-6
	Section II. Combat Fire Techniques	7-8
	Rapid Semiautomatic Fire	7-8
	Automatic or Burst Fire	7-12
	Suppressive Fire	7-16
	Quick Fire	7-19
	Section III. Chemical, Biological, Radiological, and Nuclear Firing	7-24
	Mission-Oriented Protective Posture Equipment Fire	7-24
	Section IV. Night Fire Training	7-30
	Unassisted Night Fire Training	7-30
	Artificial Illumination Training	7-35
	Section V. Moving Target Engagements	7-36
	Modifications for Moving Target Engagements	7-36
	Moving Target Live-Fire Exercise	7-41
	Section VI. Short-Range Marksmanship Training	7-41
	Conduct of Short-Range Marksmanship Training	7-41
	Fundamentals of Short-Range Marksmanship	7-42
	Preliminary Short-Range Marksmanship Instruction	7-47
	Phase I—Reflexive Fire Training	7-51
	Phase II—Target Discrimination Training	7-53
	Phase III—Short-Range Marksmanship Qualification	7-55
	Phase IV—Shotgun and Automatic or Burst Firing Familiarization	7-57
	*Section VII. Combat field fire	7-57
	*Concept	7-57
	*Conduct	7-58
	*Record of Performance	7-62
	*Section VIII. Squad Designated Marksman Training	7-62
	*Mission of the Squad Designated Marksman	7-62
	*Selection	7-63
	*Squad Designated Marksman Skills Progression	7-63
Chapter 8	ADVANCED OPTICS, LASERS, AND IRON SIGHTS	8-1
	Section I. Borelight	8-1
	Concept	8-2
	Zeroing the Borelight	8-2
	Boresighting	8-6
	Section II. Training Strategies and Qualification Standards	8-11
	Backup Iron Sight	8-11
	M68 Close Combat Optic	8-12
	Advanced Combat Optical Gunsight	8-16
	AN/PAS-13B/C/D (V1) Light Weapon Thermal Sight and AN/PAS-13B/C/D (V3) Heavy Weapon Thermal Sight	8-20
	AN/PAQ-4B/C and AN/PEQ-2A/B Infrared Aiming Lasers	8-23

AN/PVS-4 Night Vision Device 8-28

***Appendix A TRAINING AIDS, DEVICES, AND EXERCISES A-1**

Appendix B SCORECARDS B-1

Appendix C NIGHT FIGHTING C-1

Appendix D RANGE SAFETY AND RISK MANAGEMENT..... D-1

Appendix E RANGE PROCEDURES AND RANGE OPERATIONS CHECKLIST.....E-1

***Appendix F 10-METER TARGET OFFSETS AND 25-METER ZERO OFFSETS.....F-1**

***Glossary Glossary-1**

References References-1

***Index Index-1**

Figures

Figure 1-1. Initial entry training marksmanship training strategy..... 1-2

Figure 1-2. Unit marksmanship sustainment strategy..... 1-3

Figure 1-3. Active Army home station marksmanship training strategy..... 1-4

Figure 1-4. National Guard home station marksmanship training strategy..... 1-4

Figure 1-5. Army Reserve home station marksmanship training strategy..... 1-5

Figure 1-6. Deployed unit marksmanship training strategy..... 1-5

Figure 2-1. M4/M4A1 carbine with accessories..... 2-2

Figure 2-2. M4 MWS with accessories..... 2-3

Figure 2-3. M4/M4A1 and M4/M4A1 MWS..... 2-3

Figure 2-4. M4/M4A1 or M4 MWS mechanical zero..... 2-4

Figure 2-5. M4/M4A1 or M4 MWS battlesight zero..... 2-4

Figure 2-6. M16A2/A3 rifle with accessories..... 2-5

Figure 2-7. M16A2/A3 mechanical zero..... 2-6

Figure 2-8. M16A2/A3 battlesight zero..... 2-6

Figure 2-9. M16A4 rifle with accessories..... 2-7

Figure 2-10. M16A4 mechanical zero..... 2-8

Figure 2-11. M16A4 battlesight zero..... 2-8

Figure 2-12. M16A1 rifle..... 2-9

Figure 2-13. M16A1 mechanical zero..... 2-9

Figure 2-14. M16A1 battlesight zero..... 2-10

Figure 2-15. Adapter rail system..... 2-11

Figure 2-16. M5 rail covers/heat shields..... 2-11

Figure 2-17. Address markings on the adapter rail system..... 2-12

Figure 2-18. Vertical pistol grip..... 2-13

Figure 2-19. Insight rail grabber..... 2-14

Figure 2-20. Insight rail grabber MILES training extender..... 2-15

Figure 2-21. Picatinny rail grabber..... 2-15

Figure 2-22. M68 close combat optic..... 2-17

Figure 2-23. Mounting the M68 on an M16A4 rifle or M4-series carbine.	2-17
Figure 2-24. Mounting the M68 on an M16A1/A2/A3 rifle.....	2-18
Figure 2-25. Mounting the M68/AN/PVS-14 combination on an M4 MWS.....	2-19
Figure 2-26. AN/PAQ-4B/C infrared aiming light.	2-19
Figure 2-27. Mounting the AN/PAQ-4B/C on the M4 MWS top or left.	2-20
Figure 2-28. Mounting the AN/PAQ-4B/C on the M16A1/A2/A3 rifle and M4 carbine.....	2-21
Figure 2-29. AN/PEQ-2A/B target pointer/illuminator/aiming light.	2-22
Figure 2-30. Mounting the AN/PEQ-2A/B on the M16A4 rifle and M4 MWS.....	2-22
Figure 2-31. Mounting the AN/PEQ-2A/B on M16A1/A2/A3 rifles and M4 carbines.	2-23
Figure 2-32. MILES training extender bracket installation on M16-/M4-series weapons.	2-24
Figure 2-33. AN/PEQ-15 advanced target pointer illuminator aiming light.	2-25
Figure 2-34. AN/PEQ-15 mounted on M4 carbine.....	2-25
Figure 2-35. AN/PAS-13B/C/D (V1) light weapon thermal sight and AN/PAS-13B/C/D (V3) heavy weapon thermal sight.....	2-26
Figure 2-36. Mounting the TWS on M16A4 rifle or M4 carbine.	2-26
Figure 2-37. Mounting the TWS on an M16A1/A2/A3 rifle.....	2-27
Figure 2-38. AN/PVS-4 night vision sight.....	2-28
Figure 2-39. Mounting the AN/PVS-4 on an M4 carbine or M4 MWS.	2-28
Figure 2-40. Mounting the AN/PVS-4 on an M16A1/A2/A3 rifle.	2-29
Figure 2-41. Backup iron sight.	2-30
Figure 2-42. Backup iron sight in the stowed position.	2-30
Figure 2-43. Advanced combat optical gunsight.....	2-31
Figure 2-44. Mounting the ACOG on M16A4 rifle and M4 carbine.....	2-31
Figure 2-45. Mounting the ACOG on an M16A1/A2/A3 rifle.	2-32
Figure 2-46. ACOG locking screw.	2-33
Figure 2-47. Borelight with a 5.56-millimeter mandrel.	2-33
Figure 2-48. 10-meter boresighting target and 25-meter zero offset.....	2-34
Figure 2-49. M855 drop during 25-meter zeroing (M16A2 at 8/3+1, M4 at 6/3).....	2-37
Figure 2-50. Bullet drop of M855 ammunition with M16A2 (8/3).	2-37
Figure 2-51. Bullet drop of M855 ammunition with M4 (6/3).....	2-38
Figure 2-52. M4 carbine and M16A2 rifle bullet trajectory comparison.	2-38
Figure 2-53. Bullet drop of M4/M855 during 25-meter zeroing on 6/3.....	2-39
Figure 3-1. Failure to feed, chamber, or lock.....	3-2
Figure 3-2. Failure to fire.....	3-4
Figure 3-3. Other possible malfunctions.	3-7
Figure 4-1. Clearing.	4-3
Figure 4-2. Feeding.....	4-4
Figure 4-3. Chambering.	4-5
Figure 4-4. Locking.	4-6
Figure 4-5. Firing.....	4-7
Figure 4-6. Unlocking.....	4-8

Figure 4-7. Extracting. 4-8

Figure 4-8. Ejecting. 4-9

Figure 4-9. Cocking. 4-10

Figure 4-10. Semiautomatic and automatic fire mode selector positions. 4-11

Figure 4-11. Burst fire mode selector position. 4-11

Figure 4-12. Prone position of coach (right-handed firer). 4-14

Figure 4-13. Interceptor body armor. 4-15

Figure 4-14. Steady position. 4-17

Figure 4-15. Correct sight alignment. 4-19

Figure 4-16. Focus of the eye and correct sight picture. 4-20

Figure 4-17. Side aiming technique. 4-21

Figure 4-18. Breath control for engaging single targets. 4-22

Figure 4-19. Breath control for engaging short-exposure targets. 4-22

Figure 4-20. Individual foxhole supported firing position. 4-25

Figure 4-21. Basic prone unsupported firing position. 4-26

Figure 4-22. Alternate prone unsupported firing position. 4-26

Figure 4-23. Basic prone supported firing position. 4-27

Figure 4-24. Alternate prone supported firing position. 4-27

Figure 4-25. Kneeling unsupported firing position. 4-28

Figure 5-1. 25-meter range. 5-2

Figure 5-2. Shot group marking. 5-4

Figure 5-3. Central point of an odd-shaped group. 5-4

Figure 5-4. 25-meter match grade performance. 5-5

Figure 5-5. Shot groups with no firer error. 5-5

Figure 5-6. Shot groups with minor shooting error. 5-6

Figure 5-7. Shot groups with considerable shooting error. 5-6

Figure 5-8. Shot groups with major shooting error. 5-7

Figure 5-9. Central point of three shot groups. 5-8

Figure 5-10. Acceptable shot grouping performance. 5-8

Figure 5-11. Shot groups with inconsistent aiming. 5-9

Figure 5-12. Shot groups with consistent aiming and major shooting error. 5-10

Figure 5-13. Shot groups with inconsistent aiming and major shooting error. 5-11

Figure 5-14. Shot groups with improper vertical placement. 5-12

Figure 5-15. Improper shot groups on the edge of the target. 5-13

Figure 5-16. Correct aiming (A), initial shot group results (B). 5-16

Figure 5-17. Final shot group results. 5-16

Figure 5-18. M16A1 25-meter zero target. 5-17

Figure 5-19. M16A2 and M4 25-meter zero target. 5-18

*Figure 5-20. Downrange feedback targets. 5-21

Figure 5-21. Target marking with spotters (markers). 5-21

Figure 5-22. Comparison of firing performance. 5-22

*Figure 5-23. Known distance range. 5-25

*Figure 5-24. 25-meter zero standard.....	5-26
*Figure 5-25. M16-/M4-series weapon aiming points.	5-27
*Figure 5-26. Determine wind value using the clock method.....	5-28
*Figure 5-27. Determine wind speed using the flag method.....	5-29
*Figure 5-28. Determine wind speed using the pointing method.....	5-30
*Figure 5-29. Calculate the adjusted point of aim based on wind speed.....	5-31
*Figure 5-30. M16-/M4-series weapons adjusted point of aim based on wind speed.	5-32
*Figure 5-31. Projectile differences.....	5-33
*Figure 5-32. Ammunition impact comparison.....	5-34
*Figure 5-33. Minute of angle.....	5-38
*Figure 5-37. Increase in shot group size as range increases.	5-38
Figure 7-1. Kneeling supported firing position.	7-2
Figure 7-2. Standing unsupported firing position.	7-3
Figure 7-3. Standing supported firing position around obstacles.	7-4
Figure 7-4. Modified supported prone firing position.	7-5
Figure 7-5. Firing over a rooftop.	7-6
Figure 7-6. Firing around an obstacle.....	7-7
Figure 7-7. Firing from a window.	7-8
Figure 7-8. Landscape target.....	7-18
Figure 7-9. Aimed quick fire.....	7-20
Figure 7-10. Pointed quick fire.....	7-21
Figure 7-11. Sight picture when canting the rifle while wearing a protective mask (75-meter target).....	7-26
Figure 7-12. Engagement of 175-meter target.	7-27
Figure 7-13. Engagement of 300-meter target.	7-27
Figure 7-14. Lower weapon—target alignment.....	7-32
Figure 7-15. Daytime field of view using pinpoint focus.....	7-33
Figure 7-16. Nighttime field of view using off-center vision.	7-33
Figure 7-17. Night-fire target.....	7-34
Figure 7-18. Lead requirement based on distance and approach angle.....	7-37
Figure 7-19. Sight-target relationship for the single-lead rule.....	7-38
Figure 7-20. Lead increasing at greater ranges.....	7-38
Figure 7-21. Target movement (distance) at various angles.....	7-39
Figure 7-22. High ready position.....	7-43
Figure 7-23. Low ready position.....	7-44
Figure 7-24. Lethal zone.....	7-46
Figure 7-25. Incapacitation zone.....	7-46
Figure 7-26. Right-side parallel magazine changing method.	7-49
Figure 7-27. Left-side parallel magazine changing method.....	7-49
Figure 7-28. Right-side L-shaped magazine changing method.....	7-50
Figure 7-29. Left-side L-shaped magazine changing method.	7-51
Figure 7-30. Dimensions and placement of bowling pin targets.....	7-51

*Figure 7-31. Combat field fire barricade.. 7-59

*Figure 7-32. Combat field fire—kneeling unsupported position..... 7-60

*Figure 7-33. Combat field fire—barricade supported position.. 7-60

*Figure 7-34. Combat field fire—prone unsupported position.. 7-61

*Figure 7-35. Bullet trajectory comparison. 7-71

*Figure 7-36. Windage effects of a 10-mph crosswind. 7-72

Figure 8-1. Example of a zeroing mark. 8-3

Figure 8-2. Borelight in the START POINT position..... 8-4

Figure 8-3. Borelight in the HALF-TURN position. 8-4

Figure 8-4. Example of a start point, half-turn, and reference point..... 8-5

Figure 8-5. Close combat optic, 25-meter zeroing target..... 8-15

Figure 8-6. Width of horizontal hash marks..... 8-18

Figure 8-7. Advanced combat optical gunsight reticle point of aim at 100 meters..... 8-18

Figure 8-8. Advanced combat optical gunsight reticle point of aim at 25 meters..... 8-19

Figure 8-9. Example of thermal weapon sight zeroing adjustments. 8-22

Figure 8-10. Example of shot group adjustment with strike zone. 8-26

Figure A-1. Engagement skills trainer (five-lane configuration). A-1

Figure A-2. Exercise 1..... A-8

Figure A-3. Exercise 2..... A-10

Figure A-4. Exercise 3..... A-11

Figure A-5. Exercise 4..... A-12

Figure A-6. M15A1 aiming card..... A-15

Figure A-7. Riddle sighting device..... A-16

Figure A-8. M16 sighting device..... A-17

Figure A-9. Blank firing attachment..... A-18

Figure A-10. Weaponeer set up in the standing supported position. A-21

Figure A-11. Replay of shot..... A-22

Figure A-12. Weaponeer printouts..... A-23

Figure A-13. Target box exercise..... A-24

Figure A-14. Rifle-holding device (TA-G-12A)..... A-25

Figure A-15. Staked rifle holding box. A-25

Figure A-16. Paper being placed on a stationary object..... A-26

Figure A-17. Target box paddle (DVC-T-7-86)..... A-27

Figure B-1. Example of completed DA Form 5239-R
(100-, 200-, and 300-Meter Downrange Feedback Scorecard)..... B-2

Figure B-2. Example of completed DA Form 3601-R (Single Target—Field Fire I Scorecard). B-2

Figure B-3. Example of completed DA Form 5241-R
(Single and Multiple Targets—Field Fire II Scorecard)..... B-3

Figure B-4. Example of completed DA Form 3595-R (Record Fire Scorecard)..... B-3

*Figure B-5. Example of DA Form 5789-R (Record Fire Scorecard—
Known Distance Course). B-4

*Figure B-6. Example of completed DA Form 5790-R
(Record Fire Scorecard—Scaled Target Alternate Course)..... B-4

Figure B-7. Example of completed DA Form 7489-R (Record Night Fire Scorecard)..... B-5

Figure B-8. Example of completed DA Form 7649-R
(Squad Designated Marksman—Record Fire I and II). B-5

*Figure B-9. Example of completed DA Form 7682-R (Combat Field Fire Scorecard). B-6

Figure D-1a. Sample DA Form 7566 (Composite Risk Management Worksheet). D-8

Figure D-1b. Sample DA Form 7566 (Composite Risk Management Worksheet)(page 2). D-9

Figure E-1. Rifle/machine gun zero range (17801)..... E-11

Figure E-2. Automated field fire range (17803). E-12

Figure E-3. Automated record fire range (17805)..... E-13

Figure E-4. Modified record fire range (17806)..... E-14

Figure E-5. Qualification training range (17809)..... E-15

Figure F-1. 10-meter target offset symbols..... F-1

Figure F-2. Blank 10-meter target offset. F-3

Figure F-3. M16A2 10-meter boresighting target/25-meter zeroing target offsets. F-4

Figure F-4. M4 MWS 10-meter boresighting target/25-meter zeroing target offsets. F-4

Figure F-5. M4/M4A1 10-meter boresighting target/25-meter zeroing target offsets. F-5

Figure F-6. M16A4 MWS 10-meter boresighting target/25-meter zeroing target offsets..... F-5

*Figure F-7. 200-meter zero of the back-up iron sights for M4 carbine. F-9

*Figure F-8. 200-meter zero of the iron sights/back-up iron sights
for M16-series weapons. F-10

*Figure F-9. 200-meter zero of the close combat optic for M16-series weapons. F-10

*Figure F-10. 300-meter zero of the advanced combat optical gunsight. F-11

*Figure F-11. Advanced combat optical gunsight points of aim (100 to 300 meters)..... F-11

Tables

Table 1-1. Training simulators, devices, and exercises..... 1-17

Table 2-1. Characteristics of M16-/M4-series weapons. 2-1

Table 2-2. Point of impact for the M4/M4A1 and M4 MWS. 2-5

Table 2-3. Point of impact for the M16A2/A3 rifle. 2-7

Table 2-4. Point of impact for the M16A4 rifle. 2-9

Table 2-5. Point of impact for the M16A1 rifle. 2-10

Table 2-6. Accessory compatibility and mounting. 2-16

Table 2-7. Characteristics of various accessories. 2-16

Table 2-8. Authorized ammunition. 2-35

Table 2-8. Authorized ammunition (continued)..... 2-36

Table 3-1. Other malfunctions..... 3-6

Table 3-2. Methods of destruction and their applications. 3-8

Table 4-1. Introduction to basic rifle marksmanship and mechanical training. 4-1

Table 4-2. Marksmanship Fundamentals I training program. 4-14

Table 4-3. Marksmanship Fundamentals II training program. 4-29

Table 5-1. Grouping procedures. 5-1

Table 5-2. Techniques used to identify errors in Soldiers' application of the fundamentals..... 5-14

Table 5-3. Zeroing procedures. 5-14

*Table 5-4. Downrange feedback..... 5-20

*Table 5-5. M16A2/3 and front sightpost of an M16A4. 5-23

*Table 5-6. M4/M4A1 and windage of an M16A4..... 5-31

*Table 5-7. Drift for 10 mile-per-hour wind using M855 ammunition..... 5-32

Table 6-1. Field Fire I and II training program..... 6-1

Table 6-2. Number of rounds that must be fired from each position during Field Fire I..... 6-8

Table 6-3. Field Fire I firing tables..... 6-9

Table 6-4. Number of rounds that must be fired from each position during Field Fire II. 6-10

Table 6-5. Field Fire II firing tables..... 6-10

Table 6-6. Practice Record Fire I and II training program..... 6-11

Table 6-7. Number of rounds that must be fired from each position during Practice Record Fire I and II. 6-11

Table 6-8. Qualification ratings for Practice Record Fire I and II. 6-12

Table 6-9. Record Fire training program. 6-13

Table 6-10. Probability of hits..... 6-14

Table 6-11. Results from an adequate unit training program..... 6-14

Table 6-12. Number of rounds that must be fired from each position during Record Fire. 6-14

Table 6-13. Qualification ratings for Record Fire..... 6-16

Table 6-14. Known distance record fire range firing tables and related information..... 6-17

Table 6-15. Qualification ratings for the known distance record fire range..... 6-18

*Table 6-16. 25-meter scaled target alternate course firing tables and related information. 6-19

Table 6-17. Qualification ratings for the 25-meter scaled target alternate course. 6-20

Table 7-1. Rapid semiautomatic fire training program. 7-11

Table 7-2. Rapid semiautomatic fire training and related information..... 7-11

Table 7-3. Automatic or burst fire training program..... 7-15

Table 7-4. Automatic or burst fire training and related information. 7-15

Table 7-5. Suppressive fire training program. 7-18

Table 7-6. Suppressive fire training and related information..... 7-19

Table 7-7. Quick fire training program..... 7-24

Table 7-8. Quick fire training and related information. 7-24

Table 7-9. Chemical, Biological, Radiological, and Nuclear fire training program. 7-28

Table 7-10. Unassisted night fire training program. 7-30

Table 7-11. Artificial illumination training program. 7-35

Table 7-12. Moving target engagement training program..... 7-36

Table 7-13. Modifications for a steady position when firing at moving targets..... 7-37

Table 7-14. Angle of target movement. 7-39

Table 7-15. Target angle when dead center; hits occur using the single-lead rule..... 7-40

Table 7-16. Short-range marksmanship training program.....	7-42
Table 7-17. Preliminary SRM tasks and explanation.....	7-48
Table 7-18. Familiarization (stationary).....	7-52
Table 7-19. Familiarization (moving).....	7-53
Table 7-20. Record and practice fire.....	7-55
Table 7-21. Barricade transition fire.....	7-57
*Table 7-22. Combat field fire training program.....	7-58
*Table 7-23. Targets fired from the kneeling unsupported position.....	7-60
*Table 7-24. Targets fired from the barricade supported position--Set 1.....	7-61
*Table 7-25. Targets fired from the barricade supported position--Set 2.....	7-61
*Table 7-26. Targets fired from the prone unsupported position--Set 1.....	7-61
*Table 7-27. Targets fired from the prone unsupported position--Set 2.....	7-62
*Table 7-28. Ratings for combat field fire.....	7-62
*Table 7-29. Zero/zero confirmation firing event.....	7-66
*Table 7-30. Elevation knob, M16A2/3 and front sightpost, M16A4.....	7-70
*Table 7-31. Elevation knob, M4/M4A1 and windage, M16A4.....	7-70
*Table 7-32. Known distance (mech. adj.) firing event.....	7-70
*Table 7-33. Calculated adjusted point of aim based on wind speed (full value).....	7-72
*Table 7-34. Drift for 10-mph wind using M855 ammunition when fired from M16A2 rifle with 300-meter battlesight zero.....	7-73
*Table 7-35. Firing event, known distance (hold off).....	7-73
*Table 7-36. Firing event, Record Fire I and II.....	7-73
Table 8-1. Weapon/aided-vision device combinations.....	8-1
Table 8-2. Borelight training program.....	8-2
Table 8-3. Backup iron sights training program.....	8-11
Table 8-4. M68 close combat optic training program.....	8-13
Table 8-5. Advanced combat optical gunsight training program.....	8-17
Table 8-6. AN/PAS-13B/C/D thermal weapon sight training program.....	8-20
Table 8-7. AN/PAQ-4B/C or AN/PEQ-2A/B infrared aiming laser training program.....	8-24
Table 8-8. AN/PVS-4 night vision device training program.....	8-28
Table A-1. Laser marksmanship training strategy parts list.....	A-5
Table A-1. Laser marksmanship training strategy parts list (continued).....	A-6
Table A-2. Action, conditions, and standards for a reflective target exercise.....	A-8
Table A-3. Action, conditions, and standards for an interactive dry-fire exercise.....	A-9
Table A-4. Action, conditions, and standards for a grouping and zeroing exercise.....	A-10
Table A-5. Action, conditions, and standards for a laser marksmanship training strategy prequalification exercise.....	A-11
Table A-6. Training aids and devices.....	A-13
Table A-7. Target ordering numbers.....	A-14
Table D-1. Five levels of probability.....	D-4
Table D-2. Four levels of severity.....	D-5
Table D-3. Risk assessment matrix.....	D-5

Table D-4. Four levels of risk..... D-6
Table D-5. Worksheet instructions D-10
Table E-1. Primary/alternate range selection.....E-10
Table F-1. Offset mounting.....F-6
Table F-1. Offset mounting (continued).....F-7
Table F-1. Offset mounting (continued).....F-8

Preface

This manual provides guidance for planning and executing training on the 5.56-millimeter M16-series rifle (M16A1/A2/A3/A4) and M4 carbine. It is a guide for commanders, leaders, and instructors to develop training programs, plans, and lessons that meet the objectives or intent of the United States Army rifle marksmanship program and FM 7-0.

This manual is organized to lead the trainer through the material needed to conduct training during initial entry training (IET) and unit sustainment training. Preliminary subjects include discussion on the weapon's capabilities, mechanical training, and the fundamentals and principles of rifle marksmanship. Live-fire applications are scheduled after the Soldier has demonstrated preliminary skills.

This manual was revised to include references to new materiel and systems. This revision includes—

- The new Army total marksmanship training strategy, to include specific strategies for the United States Army Reserve (USAR) and the Army National Guard (ARNG).
- Information about the advanced combat optical gunsight (ACOG), the AN/PEQ-15 advanced target pointer/illuminator aiming light (ATPIAL), various thermal sights, and the MK 262 round.
- Information about the alternate qualification record fire courses (known distance [KD] record fire, 25-meter scaled target alternate course, 15-meter scaled target alternate course).
- Information about the rapid magazine change and barricade transition fire for short-range marksmanship (SRM).
- Changes to all of the scorecards.
- Updated terminology.

*This publication prescribes DA Form 3595-R (Record Fire Scorecard), DA Form 3601-R (Single Target—Field Firing Scorecard), DA Form 5239-R (100-, 200-, and 300-Meter Downrange Feedback Scorecard), DA Form 5241-R (Single and Multiple Targets—Field Firing Scorecard), DA Form 5789-R (Record Firing Scorecard—Known-Distance Course), DA Form 5790-R (Record Firing Scorecard—Scaled Target Alternate Course), DA Form 7489-R (Record Night Fire Scorecard), DA Form 7649-R (Squad Designated Marksman—Record Fire I and II Scorecard), DA Form 7650-R (Squad Designated Marksman—Position Evaluation), and DA Form 7682-R (Combat Field Fire Scorecard).

This publication applies to the Active Army, the Army National Guard (ARNG)/National Guard of the United States (ARNGUS), and the US Army Reserve (USAR).

Terms that have joint or Army definitions are identified in both the glossary and the text. Terms for which FM 3-22.9 is the proponent FM are indicated with an asterisk in the glossary.

Uniforms depicted in this manual were drawn without camouflage for clarity of the illustration. Unless this publication states otherwise, masculine nouns and pronouns refer to both men and women.

The proponent for this publication is the US Army Training and Doctrine Command. The preparing agency is the Maneuver Center of Excellence (MCoE). You may send comments and recommendations by any means (US mail, e-mail, fax, or telephone) as long as you use DA Form 2028 (Recommended Changes to Publications and Blank Forms) or follow its format. Point of contact information is as follows:

E-mail: benn.29IN.229-S3-DOC-LIT@conus.army.mil
Phone: Commercial: 706-545-8623
DSN: 835-8623
Fax: Commercial: 706-545-8600
DSN: 835-8600
US Mail: Commander, MCoE
ATTN: ATSH-INB
6650 Wilkin Drive, Building 74, Room 102
Fort Benning, GA 31905-5593

-
- NOTES:**
1. Since this is not a zeroing exercise, few sight adjustments are made unless the shot group is off of or barely on the 25-meter zeroing target.
 2. No sight adjustments should be made until the firer can shoot six consecutive shots (two shot groups) inside a 4-centimeter circle. Once this is accomplished, the Soldier is ready to conduct zeroing procedures.
-

5-5. To conduct a 25-meter grouping firing—

NOTE: Before beginning the 25-meter grouping firing, each Soldier ensures that his sights are set for 25-meter firing.

(1) The Soldier fires a three-round shot group at the 25-meter zeroing target.

***NOTE:** During IET, Soldiers fire three 5-round shot groups at the 25-meter zeroing target. To achieve the standard, 8 out of 10 rounds in two consecutive shot groups must hit within a 4-cm circle.

(2) The firing line is cleared, and the Soldier and coach move downrange to examine the shot group for fundamental errors, triangulate the shot group, and put the number 1 in the center of the shot group (Figures 5-2 and 5-3).

NOTE: If the shot group is off of the 25-meter zeroing target, the Soldier should mechanically zero the weapon. If the shot group is barely on the target, the Soldier should make a bold adjustment.

*3) The Soldier returns to the firing line and fires a second shot group.

(4) The firing line is cleared, and the Soldier moves downrange to examine the second shot group, triangulate, and mark the center of the shot group with the number 2.

(5) The Soldier groups the two shot groups and marks the center.

*5-6. The Soldier repeats Steps 1 through 5 until he places six out of six consecutive rounds inside a 4-centimeter circle. If the Soldier has not grouped with the rounds allotted, he should be removed from the firing line and given remedial training before attempting to group again.

***NOTE:** Grouping standard for IET: Group an M16 Series Rifle/M4 Carbine on a 25m zero target by achieving 8 out of 10 rounds in two consecutive five-round shot groups within a 4cm circle within 10 rounds.

NOTE: To be counted, the majority of the round must be inside of the circle.

*5-7. Once the Soldier has demonstrated firing proficiency from the supported firing position, grouping exercises can be conducted from the unsupported firing position.

SHOT GROUP MARKING

5-8. If the Soldier is to benefit from this exercise and if the instructor/trainer (or coach) is to provide useful guidance, the Soldier must mark each shot group for a clear record of his firing practice. The instructor/trainer must understand how to analyze shot groups correctly.

5-9. To properly mark the shot groups (Figure 5-2)—

- (1) Connect the three bullet holes on the target with a straight line.
- (2) Place a number inside of the shot group.

- NOTES:**
1. The number represents the center of the three shots.
 2. When two shots are near one end of the group and the third shot is toward the other end, the number is placed closer to the two near shots (Figure 5-3).
 3. This is not a precise marking that requires a measurement, but a procedure to help with shot group analysis.

5-10. The three-round shot group allows the firer's performance to be evaluated.

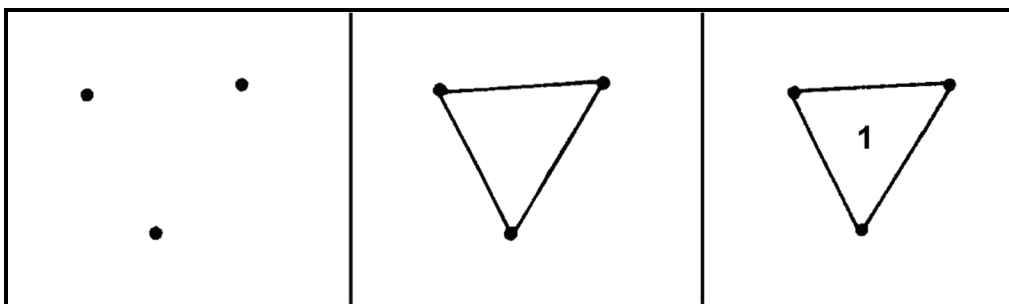


Figure 5-2. Shot group marking.

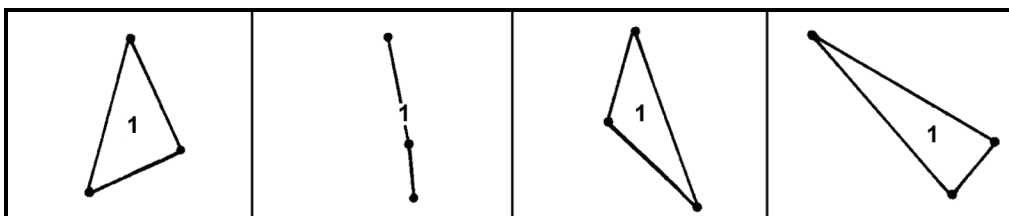


Figure 5-3. Central point of an odd-shaped group.

SINGLE SHOT GROUP ANALYSIS

5-11. The purpose of single shot group analysis is to identify firer errors on the single shots of a shot group so the Soldier can correct these errors while firing the next shot group.

5-12. Shot group analysis begins with the instructor/trainer observing the Soldier while he fires, looking for proper position, aim, trigger squeeze, and breathing. Then, the instructor/trainer analyzes the shot group to confirm problem areas.

NOTE: Coaches should not use shot group analysis without observing the firer.

5-13. The ideal shot group will have all three rounds within a 2-centimeter circle. Three rounds within a 4-centimeter circle is the minimum standard.

NOTE: M16A2 zeroing target squares are .96 centimeter in size, while M4 zeroing target squares are 1.3 centimeters in size.

5-45. To conduct a 25-meter zero range—

- NOTES:**
1. Each Soldier ensures that his sights are set for 25-meter zeroing.
 2. Soldiers fire each shot from a supported firing position using the same point of aim (target's center of mass).
 3. Ensure that the correct 25-meter zero target is being used. For M16A1s, use NSN 6920-01-167-1392 (Figure 5-18); for M16A2s, M16A3s, M16A4s, M4s, and M4As, use NSN 6920-01-395-2949 (Figure 5-19; M16A2/A3 is printed on one side, and M16A4/M4/M4A is printed on the other).

(1) The Soldier fires a three-round shot group at the 25-meter zeroing target.

***NOTE:** During IET, Soldiers fire three 5-round shot groups at the 25-meter zeroing target. To achieve the standard, 8 out of 10 rounds in two consecutive shot groups must hit within a 4-cm circle.

(2) The firing line is cleared, and he moves downrange to examine the shot group for fundamental errors, triangulates the shot group, and puts the number 1 in the center of the shot group.

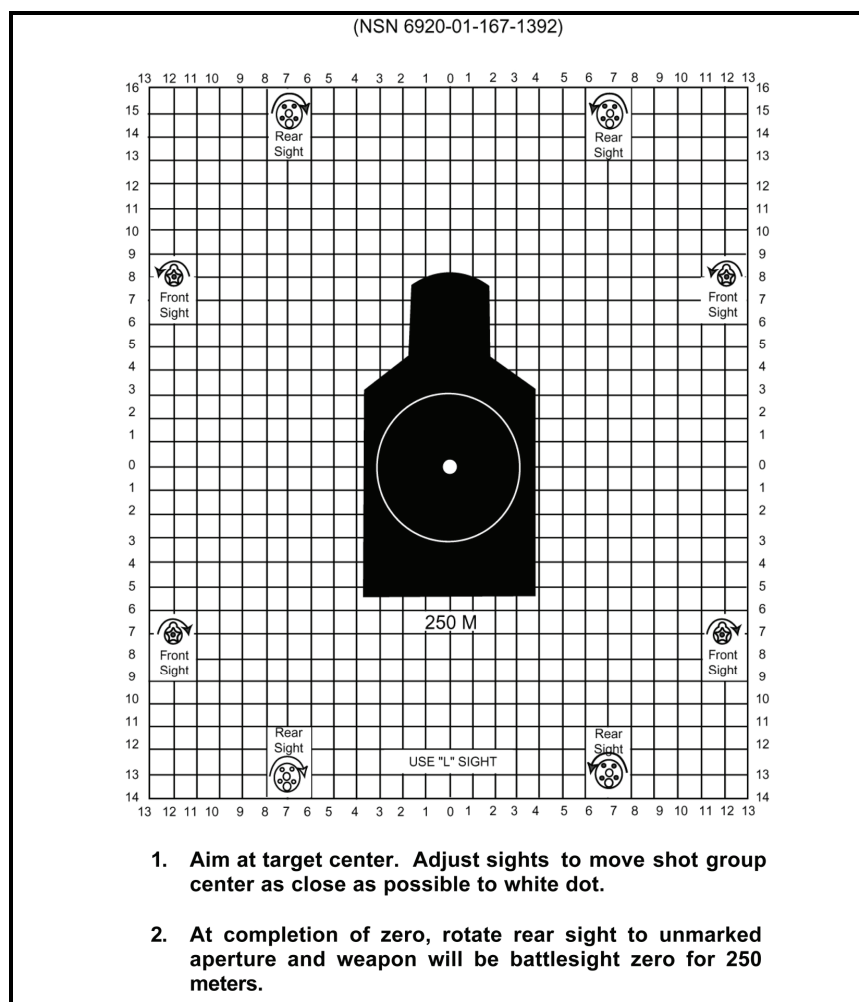


Figure 5-18. M16A1 25-meter zero target.

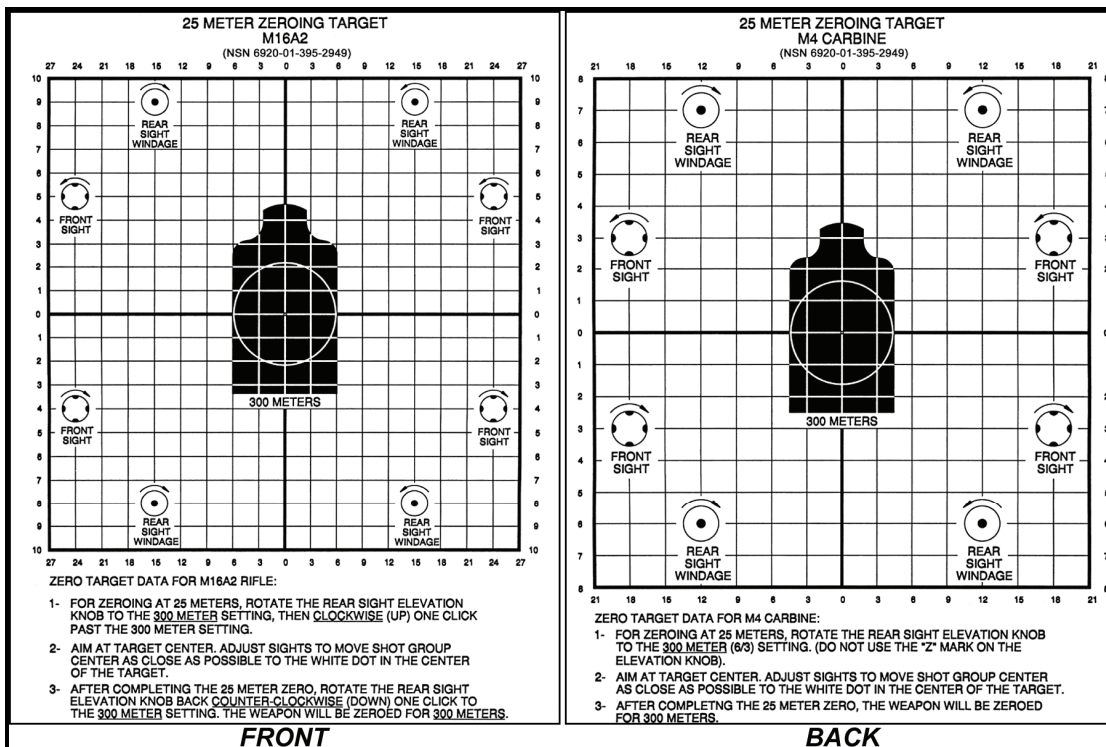


Figure 5-19. M16A2 and M4 25-meter zero target.

- NOTES:**
1. The Soldier fires two individual shot groups before a sight change is considered.
 2. If the initial shot group is not on the target paper, the weapon should be mechanically zeroed before the Soldier fires this weapon again.

- *3) The Soldier returns to the firing line and fires a second shot group.
- (4) The firing line is cleared, and the Soldier moves downrange to examine the second shot group, triangulate, and mark the center of the shot group with the number 2.
- (5) The Soldier groups the two shot groups and marks the center of the two shot groups with an X.
- (6) If the two shot groups fall within a 4-centimeter circle, the firer determines the sight adjustments he needs to make, identifies the horizontal and vertical lines closest to the X, and reads the 25-meter zeroing target to determine the proper sight adjustments. If the two shot groups do not fall within a 4-centimeter circle, the Soldier continues grouping.

NOTE: The majority of the round must be inside of the circle to be counted.

- (7) The Soldier annotates any sight adjustments that need to be made to the weapon on the 25-meter zeroing target and ensures that his name is on the target.
 - (8) If five out of six rounds fell within the 4-centimeter circle, the Soldier is zeroed and can be removed from the firing line. If not, the Soldier returns to the firing line and makes sight adjustments.
- *5-46. Steps 1 through 8 are repeated until the Soldier places five out of six consecutive rounds inside the 4-centimeter circle. If the Soldier is not zeroed with the rounds allotted, he should be removed from the firing line and given remedial training before attempting to zero again.

NOTE: Zeroing standard for IET: Zero an M16 Series Rifle/M4 Carbine by achieving 8 out of 10 rounds in two consecutive five-round shot groups inside the 4cm circle on a 25m zero target within 20 rounds.

*5-47. Once firing proficiency has been demonstrated from the supported firing position, zeroing exercises can be conducted from the unsupported firing position.

CONDUCT OF A 25-METER ZERO FIRING USING THE LOCATION OF MISSES AND HITS SYSTEM

*5-48. When using the LOMAH system on a KD range, zero confirmation is part of the program and will be shot as the first scenario. To achieve a 300-meter zero using the LOMAH system, the Soldier shoots six rounds at the 175-meter/200-yard target while aiming at the target's center of mass. The outcome is evaluated using the following guidelines:

- If the shot group falls within the 11-inch circle on the LOMAH monitor, the Soldier continues the programmed scenario, which is identical to the downrange feedback scenario without LOMAH.
- If the Soldier shoots a shot group that is 11 inches or smaller but is clearly not zeroed, the instructor/trainer assists the Soldier in making sight adjustments based upon the data provided on the LOMAH monitor.
- If the shot group is not tight (greater than 11 inches), the Soldier should be removed from the firing line and given remedial training on the four fundamentals of marksmanship.

* CONDUCT OF A 200-METER ZERO FIRING

*5-49. For a unit deployed to an urban area, many engagements happen at 200 meters or closer. Out to 200 meters, a 200-meter zero keeps the point of impact closer to the point of aim than a 300-meter zero.

*5-50. The 200-meter zero is not an alternate to the 300-meter zero; rather, it is a supplemental zero. The standard 300-meter zero will continue to be used when units are conducting standard rifle qualification or when units are deploying to an area where most engagements occur at distances greater than 200 meters.

***NOTE:** 200-meter zero procedures mirror those of standard zero procedures, with the exception of the target offsets. See Appendix F for more information about preparing 200-meter zero target offsets for various sights.

SECTION III. KNOWN DISTANCE RANGE

This section provides guidelines for the instructor/trainer to conduct a KD range and apply the effects of wind and gravity. This section also addresses three types of KD ranges: the standard KD range, the KD record fire range, and the modified field fire range.

NOTE: See Table 5-4 for the current training program.

CONCEPT

5-51. A KD range has three primary objectives:

- (1) Fire tight shot groups at a known distance.
- (2) *Make sight adjustments at range while experiencing the effects of wind and gravity.
- (3) Participate in marksmanship testing.

5-52. KD firing brings the Soldier one step closer to being able to fire during combat. The Soldier is provided information concerning the precise hit-or-miss location of every bullet fired. KD firing is conducted with a single, clearly visible target at a known distance, and the Soldier can establish a position that provides a natural point of aim on that single target. Consider the following:

- On the standard KD range, Soldiers fire at 100-, 200-, and 300-meter targets without any time constraints.

Table 5-4. Downrange feedback.

DOWNRANGE FEEDBACK	
Instructional Intent	
<ul style="list-style-type: none"> Reinforce PMI while shooting from the prone supported and unsupported firing positions. Build the Soldier's confidence in his ability to hit where he aims while applying the effects of wind and gravity at range. 	
Special Instructions	
Ensure that—	
<ul style="list-style-type: none"> The effects of wind and gravity are thoroughly explained. The rear sight is on the proper setting (M16A2/3=8/3; M16A4 and M4=6/3 flush; M16A1=the unmarked aperture, short-range). The rear sight aperture is set on 300, not 800. 	
Observables	
<ul style="list-style-type: none"> Spotters provide correct feedback to firers. Soldiers hit 8 of 10 targets at 100 meters. Soldiers hit 14 of 20 targets at 200 meters. Soldiers hit 5 of 10 targets at 300 meters. 	

- On the KD record fire range, Soldiers fire at 100-, 200-, and 300-meter targets with time constraints.
- On the modified field fire range, Soldiers fire at 100-, 200-, and 300-meter targets on a standard 50- to 300-meter field fire qualification range.

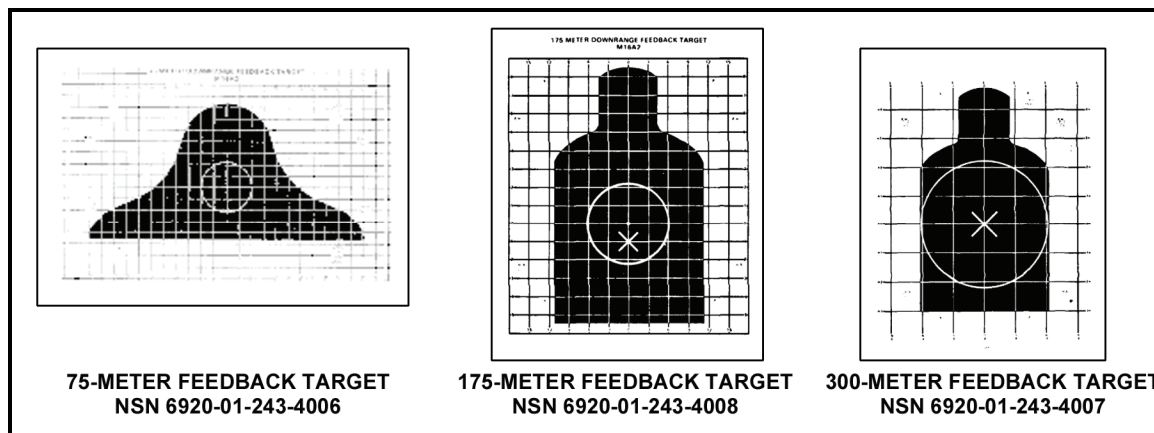
- NOTES:**
- If a qualification range is not available, this exercise may be shot on a standard 75- to 300-meter field fire range. Targets and target frames must be set up to accommodate this training.
 - On ranges that are built in yards instead of meters, the same KD targets will be used. The difference is so small that it does not need to be considered.

- The KD range does not require Soldiers to detect targets, estimate ranges to targets, scan sectors of fire, respond to surprise targets, respond to short-exposure targets, or engage multiple targets.
- An advantage of a KD range is the ability to see precisely where each bullet hits. To benefit from this training, Soldiers must clearly see the results of each firing, whether a group, single shot, or 10-round exercise.

KNOWN DISTANCE TARGET DESCRIPTION

5-53. Downrange feedback training should include detailed explanations of the targets. Consider the following:

- KD targets are large enough to capture all bullets fired. Standard E-type and F-type silhouettes can be used if standard KD targets are not available.
- *The 16-centimeter circle on 75-meter targets, the 32-centimeter circle on 175-meter targets, and the 48-centimeter circle on 300-meter targets equate to the 4-centimeter zeroing target at 25 meters. If the Soldier's shot group falls within the 4-centimeter circle at 25 meters, it will fall within the circle on the target being shot. If the round falls outside of the circle, the round will clearly miss the 300-meter target (Figure 5-20).
- *An X is located in the bottom portion of the circle to show the firer where to aim to achieve a center of mass hit when his weapon is zeroed for 300 meters.
- The grid system on the targets in Figure 5-20 equates to that of the 25-meter zeroing target. For example, one click on the front sightpost equals one square on the 25-meter zeroing target and also equals one square on the target being shot. Information similar to that on the zeroing target has been overprinted to help Soldiers apply sight adjustments.



*Figure 5-20. Downrange feedback targets.

MARKING KNOWN DISTANCE RANGE TARGETS

5-54. When the initial shot group is fired, target spotters/markers (Figure 5-21) should be placed in each bullet hole, placing the white side on the silhouette and the black side off of the silhouette. This procedure ensures that the firer can see where the rounds impacted and has two benefits:

- Instructors/trainers can observe the firer's performance and focus their attention on the Soldiers having the greatest problems.
- Soldiers are motivated to fire better since their peers can observe their performance.

*5-55. On the second and subsequent shot groups, the target spotters/markers should be moved and placed in the holes of the new shot group. The old holes must be pasted using black pasters on black and white pasters on white. Failure to paste all bullet holes makes it difficult to determine one shot group from another.

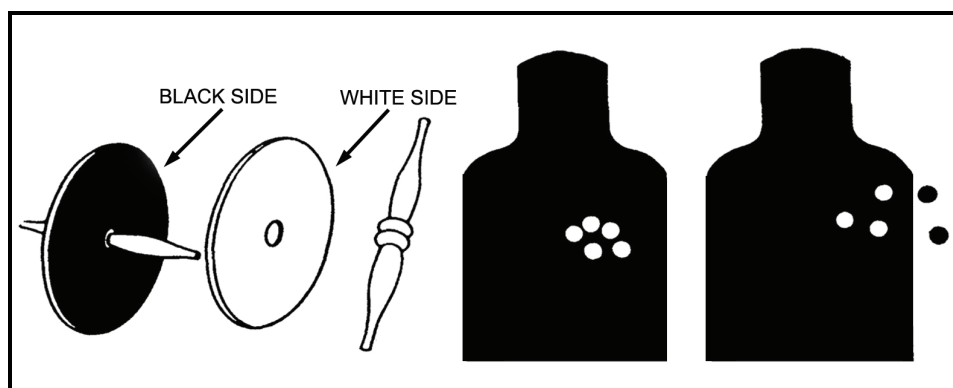


Figure 5-21. Target marking with spotters (markers).

KNOWN DISTANCE SHOT GROUPING ANALYSIS

5-56. Figure 5-22 shows two targets that were both shot with three individual rounds (A). On a pop-up target, these two firing performances would provide the same information to the firing line; each target was hit once and missed twice. Once the targets are properly marked with spotters, it becomes clear why only one round hit either target: The firer on the left is failing to properly apply the four fundamentals; the firer on the right needs to make an adjustment to his iron sights (assuming that wind was not a factor), triangulate the shot group, and read the appropriate adjustments from the target.

5-57. Figure 5-22 shows another two targets that were both shot with three individual rounds (B). On a pop-up target, these two firing performances would appear to be the same. Once properly marked with spotters, it is obvious that the firer on the left needs more training on the four fundamentals.

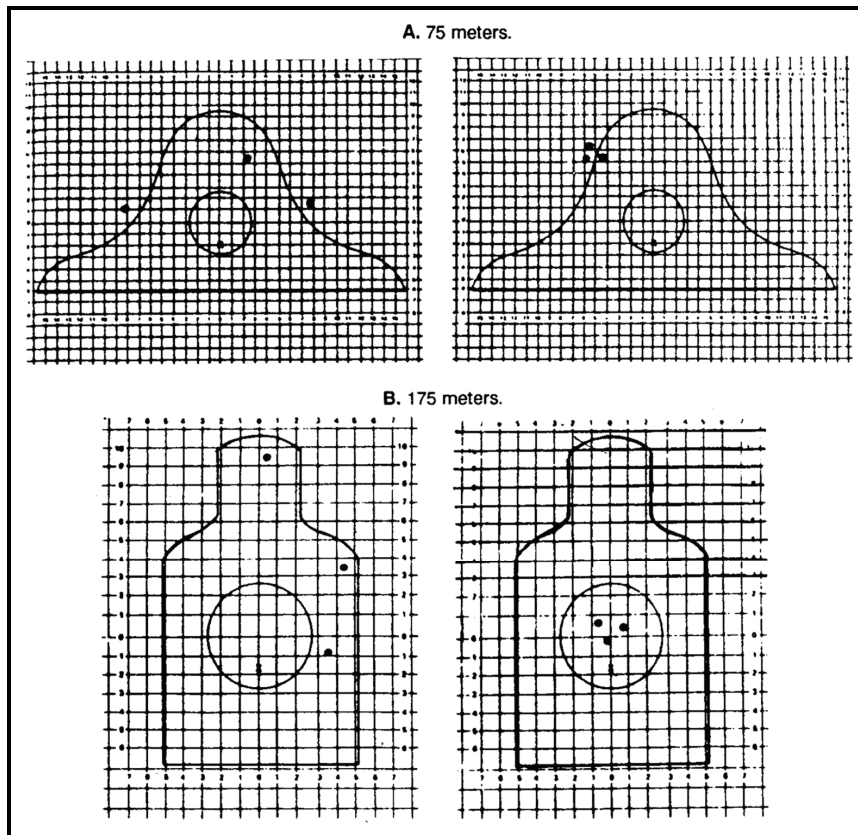


Figure 5-22. Comparison of firing performance.

KNOWN DISTANCE ZEROING

5-58. The 300-meter target can be used to confirm weapon zero or to refine the zero obtained on the 25-meter range. When Soldiers properly compensate for the wind, the zero on this target is more valid than the zero obtained on the 25-meter range. Soldiers should fire two five-round shot groups to confirm zero or three-round shot groups to refine their zero. The pit crews should spot targets after each shot group is fired. If the crosswind exceeds five miles per hour, KD zeroing should not be attempted.

-
- *NOTES:** 1. For M16A2/3/4, M4, and M4A1 weapons only: Soldiers should use the unmarked aperture for zeroing and target engagement at all distances on the KD range. When engaging targets beyond 300 meters, the elevation wheel should be adjusted to the range of the target. When zeroed at 300 meters, the numbers on the elevation wheel correspond to the range of the target (expressed in meters). For example, the firer would click the elevation wheel to 4 to engage a 400-meter target.
2. For M16A1 rifles only: Soldiers should use the unmarked aperture (short-range) for refining zero at 300 meters. For target engagements beyond the 300-meter line, Soldiers should use the long-range aperture (L).
-

*MINUTE OF ANGLE

*5-59. M16A2/A4 and M4 sights are calibrated in minutes of angle (MOAs). A MOA is a unit of angular measurement that is used to tell how much a click on the iron sight or scope will move the strike of the round. One minute of angle is equal to approximately 1 inch per 100 yards or meters. The difference between yards and meters is minimal; therefore, they are used interchangeably when speaking in MOAs. Table 5-5 shows the value of clicks in MOAs for iron sights.

***Table 5-5. Value of clicks in minutes of angle for iron sights (for 1 click).**

WEAPON	1 CLICK		
	ELEVATION KNOB	WINDAGE KNOB	FRONT SIGHTPOST
M16A2	1 MOA	½ MOA	1 ¼ MOA
M16A4	½ MOA	½ MOA	1 ¼ MOA
M4	¾ MOA	¾ MOA	1 ½ MOA

CONDUCT OF A STANDARD KNOWN DISTANCE RANGE

NOTE: If the range is equipped with the LOMAH system, a firing order will be used to operate the LOMAH throughout the period of instruction and will be fired last.

- *5-60. Standard KD ranges (Figure 5-23) are conducted using the following considerations:
- *The standard KD range is conducted with paper targets at 100, 200, and 300 meters to obtain downrange feedback.
 - Half of the bullets are fired from the supported firing position, and the other half are fired from the unsupported firing position.
 - The wind speed and direction must be determined before firing, and the firer must know the distance to the target.
 - *Soldiers mark the targets after firing each shot group. Based on this feedback, Soldiers receive a critique from their instructor/trainer or coach.
 - The downrange feedback exercise must be conducted within the constraints of time, ammunition, and available ranges.
 - If 30 rounds of ammunition are available for training, firing three-round shot groups 10 times is preferable to firing five-round shot groups 6 times.

- Once the Soldier understands the concept for adjusting the point of aim to compensate for the effects of wind and gravity, he is ready to apply his knowledge on the field fire range.

***100-METER TARGETS**

5-61. Instructors/trainers can provide feedback after each round, each three-round shot group, or each five-round shot group on the 100-meter feedback targets. No time limit is placed on the firer. Soldiers fire from the supported firing position and from the unsupported firing position. Then, the targets are marked and evaluated. Feedback consists of a critique of performance, adjustments to the point of aim, effects of wind and gravity, and shot placement. Target spotters mark the bullet holes so hits can be viewed from the firing line.

NOTE: IET Soldiers fire one five-round shot group from the supported firing position and one five-round shot group from the unsupported firing position. They must hit 8 out of 10 targets.

***200-METER TARGETS**

5-62. Firers engage the 200-meter target using the same downrange procedures as when engaging the 100-meter target.

NOTE: IET Soldiers fire 10 rounds from the supported firing position and 10 rounds from the unsupported firing position. They must hit 14 out of 20 targets.

300-METER TARGETS

5-63. Firers engage the 300-meter target using the same downrange procedures as when engaging the 100-meter target.

NOTE: IET Soldiers fire one five-round shot group from the supported firing position and one five-round shot group from the unsupported firing position. They must hit 5 out of 10 targets.

KNOWN DISTANCE RECORD FIRE RANGE

NOTE: See paragraphs 6-79 through 6-82 of Chapter 6 for information about the alternate course KD record fire range.

MODIFIED FIELD FIRE RANGE

5-64. A modified field fire range can be used for downrange feedback. To conduct downrange feedback, minor changes must be made to a standard field fire range. Target frames, like those used on the 25-meter range, are placed on a standard qualification range at 100, 200, and 300 meters. The standard KD range or the KD record fire range can be conducted on the modified field fire range.

NOTE: The firing line must be cleared, moved to the targets for marking, and returned each time a firing order fires.

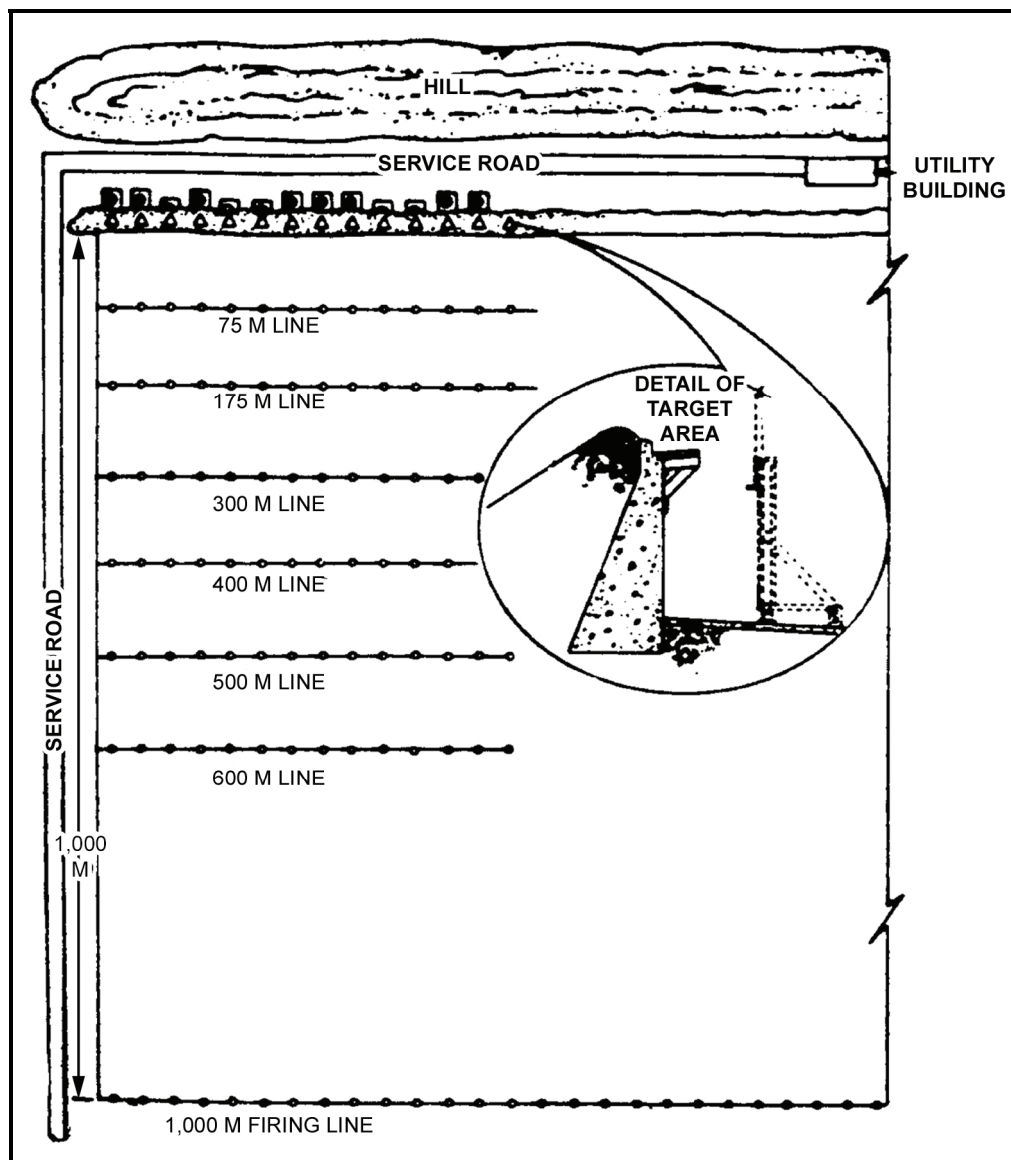


Figure 5-23. Known distance range.

RECORD OF PERFORMANCE

5-65. During the conduct of downrange feedback, a record of performance should be kept on DA Form 5239-R (100-, 200-, and 300-Meter Downrange Feedback Scorecard) for the AAR.

NOTE: See Appendix B for a sample completed form and the end of this publication for a blank, reproducible copy.

5-66. As Soldiers complete each phase and achieve the performance standard for that range, they should receive a critique. Instructors/trainers must ensure that Soldiers do not progress to a greater range until they become proficient at closer ranges.

25-METER ZERO STANDARD

*5-67. A standard E-type silhouette is 48.26 centimeters wide; a cone of fire that is 48.26 centimeters at 300 meters is 4 centimeters at 25 meters. A Soldier who can fire all bullets in a 4-centimeter circle at 25 meters and adjust the sights for zero will hit the target at ranges as far away as 300 meters (Figure 5-24).

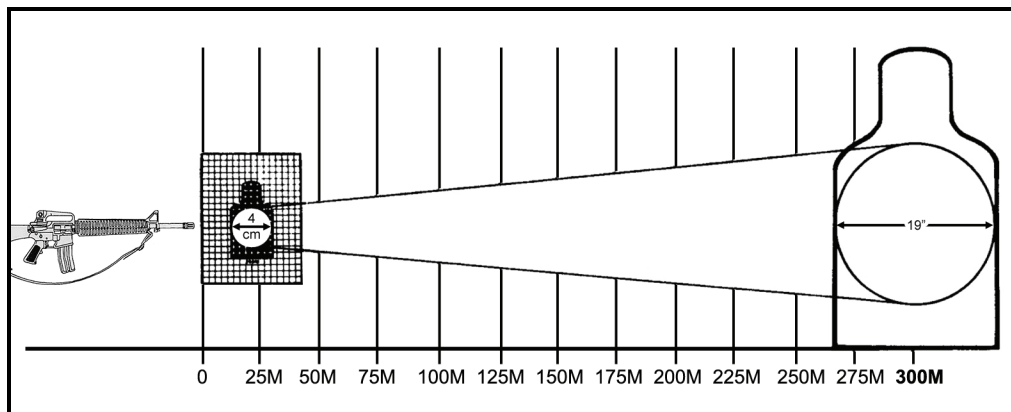


Figure 5-24. 25-meter zero standard.

SECTION IV. EFFECTS OF WIND AND GRAVITY

Marksmanship instructors/trainers should know how the effects of wind and gravity influence the flight of the bullet, and Soldiers should know how to compensate for such bullet displacement. This instruction is appropriate for all marksmanship training and concurrent training.

EFFECTS OF GRAVITY

5-68. Gases created by gunpowder push each round out of the end of the barrel. The barrel must be elevated slightly to allow the round to travel farther, creating an arc. The round will travel straight until it slows down and is gradually pulled to the ground by gravity. Each round fired will be pushed approximately the same distance and will roughly follow the same path.

NOTE: The farther the round travels, the faster it begins to fall.

5-69. When the firer zeroes his weapon, he aligns his line of sight to cross the path of the round at the distance at which he wants to zero his weapon. For example, a 300-meter zero means that the line of sight crosses the path of the round at 300 meters. If the firer engages a target at a distance other than 300 meters (excluding 25 meters), the path of the round hits the target either before or after it crosses the line of sight. If the firer wants his rounds to impact the center of mass, he must adjust his point of aim up or down to account for gravity.

ADJUSTED POINT OF AIM BASED ON GRAVITY

5-70. An adjusted point of aim (Figure 5-25) is intended to increase hit probability when properly presented. However, Soldiers can become confused, which could result in degraded performance. All Soldiers should be taught to aim at the target's center of mass unless they are confident that they know the range to the target. If adjusting the point of aim confuses the Soldier, he should aim at the target's center of mass. These points of aim place the center of each shot group in the target's center of mass (assuming a perfect zero and no firer error).

- NOTES:**
1. These adjustments are small and should only be applied by competent firers who wish to improve their firing performance.
 2. Because the difference between M16- and M4-series weapons is so small and to avoid confusion, the same adjusted points of aim should be used regardless of the weapon being fired.

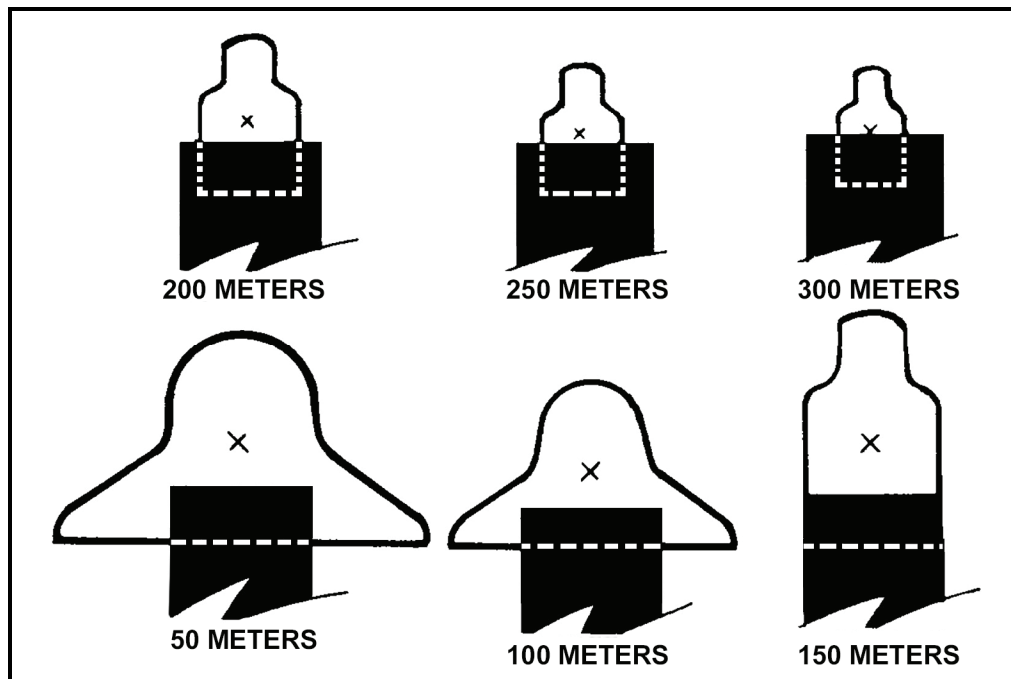


Figure 5-25. M16-/M4-series weapon aiming points.

EFFECTS OF WIND

5-71. Wind affects the bullet similar to the way gravity does: the farther the round travels, the farther the wind will push the round in the direction the wind is blowing. The faster the wind is blowing, the farther the wind will push the bullet.

WIND DIRECTION

5-72. The effects of wind vary depending on changes in wind speed and direction. Wind is classified by the direction it is blowing in relationship to the firer/target line. The clock system is used to indicate wind direction and value (Figure 5-26). This system works as follows:

- Winds that blow from the left (9 o'clock) or right (3 o'clock) are called full-value winds because they have the most effect on the bullet.
- Winds that blow at an angle from the front or rear are called half-value winds because they have about half the effect on the bullet as full-value winds.
- Winds that blow straight into the firer's face or winds that blow straight into the target are termed no-value winds because they have minimal effect on the bullet.

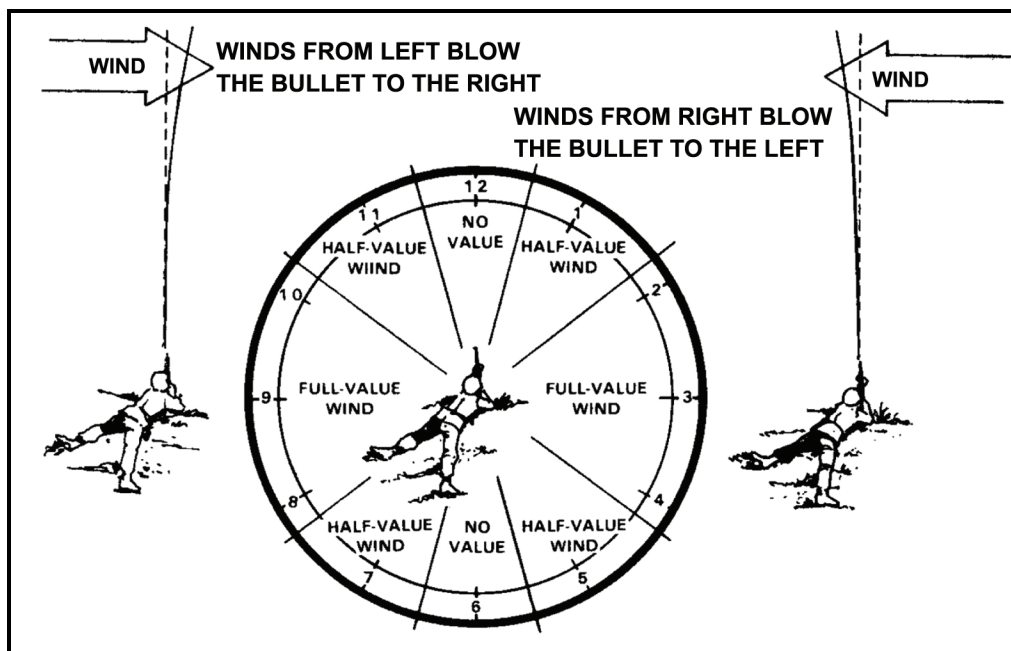


Figure 5-26. Determine wind value using the clock method.

WIND SPEED

5-73. Wind is variable and sometimes quite different at the firing position than at the target's position. Consider the following:

- When wind is blowing hard at the firing line, trees, brush, or terrain could protect the bullet's path.
- Wind can vary by several miles per hour between the time a measurement is taken and when the bullet is fired.

5-74. Therefore, training time should not be wasted trying to teach Soldiers an exact way to measure wind speed. Soldiers should understand that wind can blow a bullet off course, but they should not overcompensate and miss targets by applying too much hold-off.

5-75. A wind gauge can be used for precise measurement of wind velocity. When a gauge is not available, velocity is estimated using one of the following methods:

- Flag method.
- Pointing method.
- Observation method.

Flag Method

- 5-76. To perform the flag method (Figure 5-27)—
- (1) Observe a flag or any cloth-like material hanging from a pole.
 - (2) Estimate the angle formed at the juncture of the flag and pole.
 - (3) Divide this angle by the number 4.

NOTE: The answer is the wind velocity expressed in miles per hour.

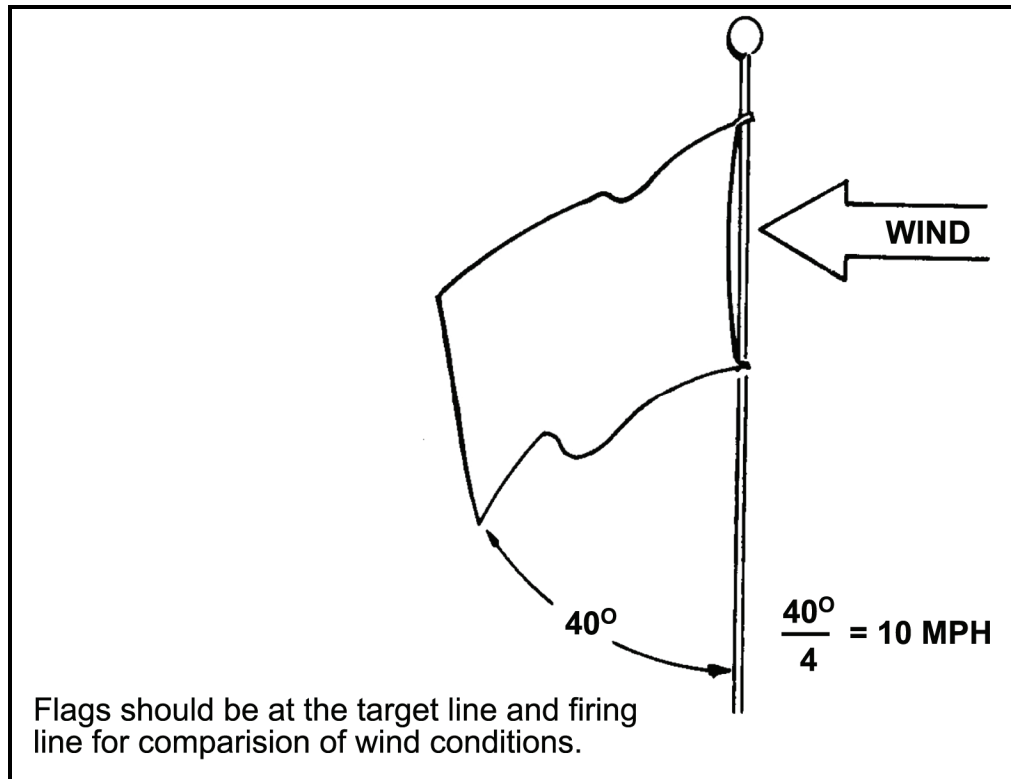


Figure 5-27. Determine wind speed using the flag method.

Pointing Method

5-77. If a flag is not visible, the firer can use the pointing method. To perform the pointing method (Figure 5-28)—

- (1) Drop a piece of paper, leaf, or other light material from the shoulder.
- (2) Point directly at the place where it lands.
- (3) Estimate the angle created by the pointing arm.
- (4) Divide this angle by the number 4.

NOTE: The answer is the approximate wind speed at the firing position expressed in miles per hour.

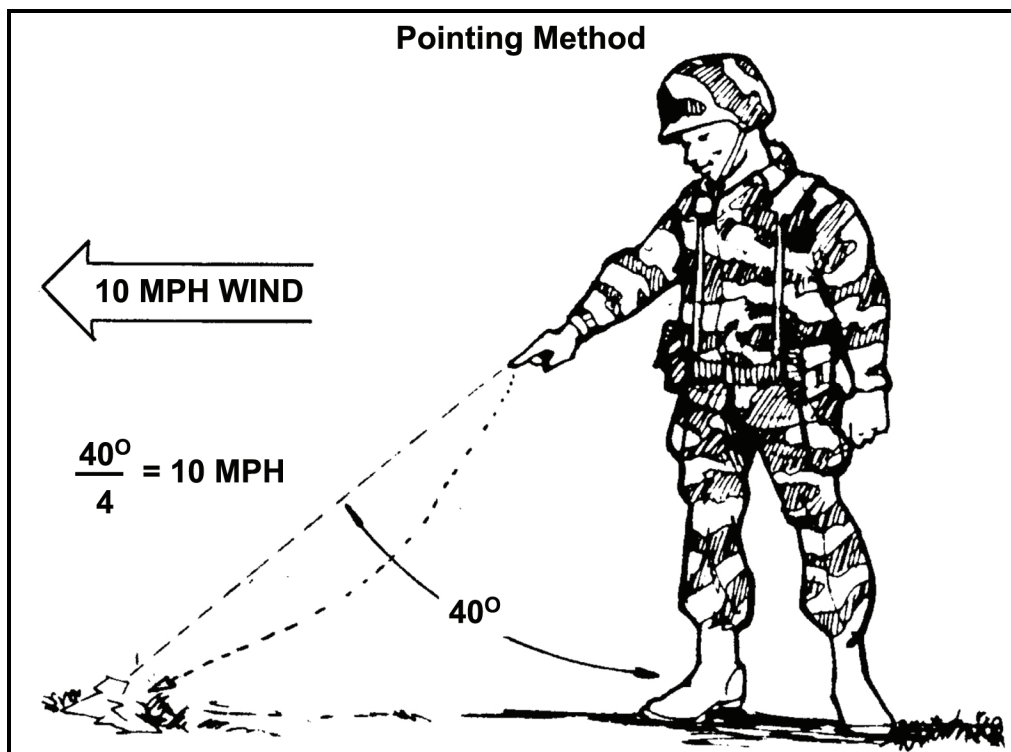


Figure 5-28. Determine wind speed using the pointing method.

Observation Method

5-78. If the flag or pointing methods cannot be used, the following information can assist in determining wind velocities:

- Winds less than 3 miles per hour can barely be felt by the firer, but the presence of slight wind can be determined by drifting smoke.
- Winds of 3 to 5 miles per hour can be felt lightly over the firer's face.
- Winds of 5 to 8 miles per hour constantly move the leaves of trees.
- Winds of 8 to 12 miles per hour raise dust and loose paper.
- Winds of 12 to 15 miles per hour cause small trees to sway.

ADJUSTED POINT OF AIM BASED ON WIND SPEED

5-79. Figure 5-29 illustrates how the effects of wind on the bullet are similar to the effects of gravity—as range increases, the effect of wind increases. For example, a 10 mile-per-hour full-value wind moves an M16A1 (M193) bullet from about ½ of an inch at 25 meters to about 15 inches at 300 meters.

*5-80. Table 5-6 displays the wind effects for all conditions for the M16A1 (M193 ammunition)—a wind of greater speed increases bullet movement by a uniform amount. For example, a 15 mile-per-hour wind moves the bullet ¾ of an inch at 25 meters and about 22 ½ inches at 300 meters. A half-value wind moves the strike of the round in a 10 mile-per-hour wind ¼ of an inch at 25 meters and 7 ½ inches at 300 meters.

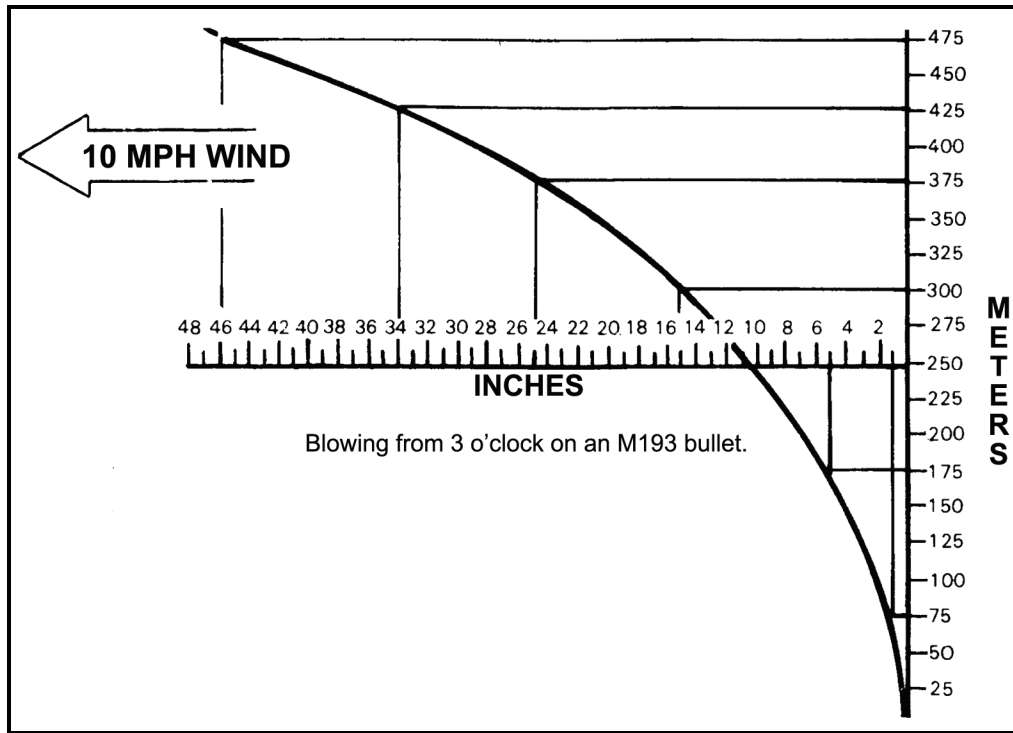


Figure 5-29. Calculate the adjusted point of aim based on wind speed.

*NOTE: Table 5-6 can be used to calculate the M193 adjusted point of aim based on wind speed.

***Table 5-6. M193 calculated adjusted point of aim based on wind speed (full value).**

WIND SPEED (mph)	RANGE (m)								
	25	50	75	100	150	175	200	250	300
	DISTANCE MOVED (in)								
5	1/4	3/8	1/2	1	2	2.5	3.5	5	7.5
10	1/2	3/4	1	2	4	5	7	10	15
15	3/4	1-1/8	1.5	3	6	7.5	10.5	15	22.5

DRIFT FOR A 10 MILE-PER-HOUR WIND USING 5.56-MILLIMETER M855 AMMUNITION

*5-81. Table 5-7 illustrates the drift using M855 5.56-millimeter ball ammunition fired in an M16A2 rifle with a 300-meter battlesight zero.

***Table 5-7. Drift for 10 mile-per-hour wind using M855 ammunition.**

WIND SPEED (mph)	RANGE (m)								
	0	100	200	300	400	500	600	700	800
	DISTANCE MOVED (in)								
10	0.0	1.1	4.9	11.8	22.4	38.0	59.5	88.4	124.9

ADJUSTED POINT OF AIM BASED ON GRAVITY AND WIND SPEED

5-82. Wind has a minor effect on the M16 bullet (relative to the size of the target) at ranges out to 100 meters. When engaging targets in excess of 150 meters in heavy winds, Soldiers adjust the point of aim for the wind to increase the probability of a hit. Wind effects are uniform in relation to speed—that is, a 5 mile-per-hour wind has half the effect of a 10 mile-per-hour wind, and a 20 mile-per-hour wind has twice the effect of a 10 mile-per-hour wind.

5-83. Firers must adjust their points of aim into the wind to compensate for its effects. If they miss a distant target and wind is blowing from the right, they should aim to the right for the next shot. A guide for the initial adjustment is to split the front sightpost on the edge of the target facing the wind (Figure 5-30).

5-84. Newly assigned Soldiers should aim at the target's center of mass for the first shot, and then adjust for wind when they are confident that wind caused the miss. Experienced firers should apply the appropriate hold-off for the first shot, but should follow the basic rule—when in doubt, aim at the center of mass.

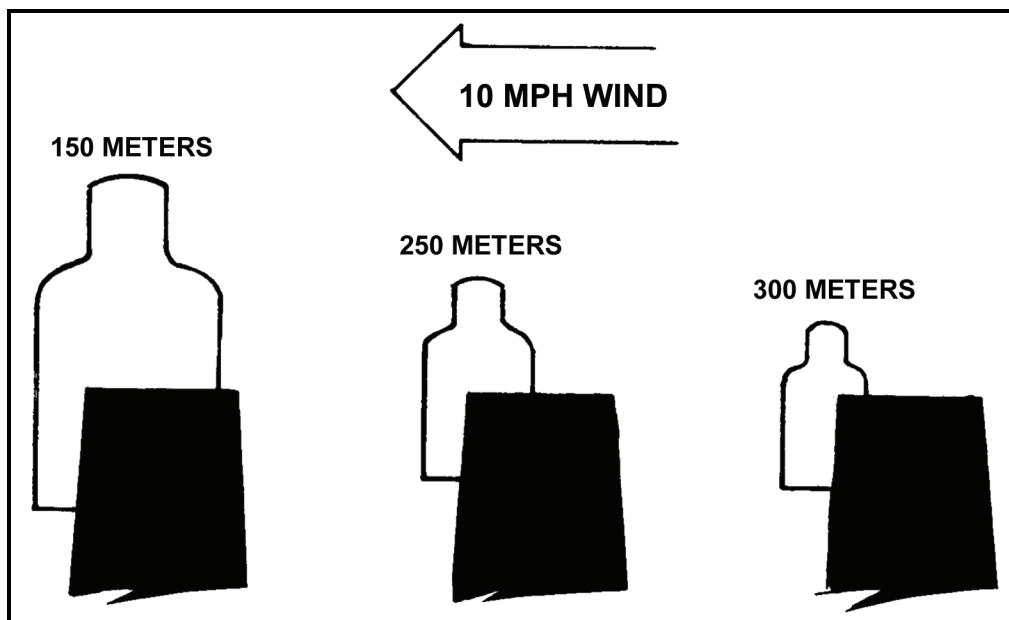


Figure 5-30. M16-/M4-series weapons adjusted point of aim based on wind speed.

SECTION V. BALLISTICS

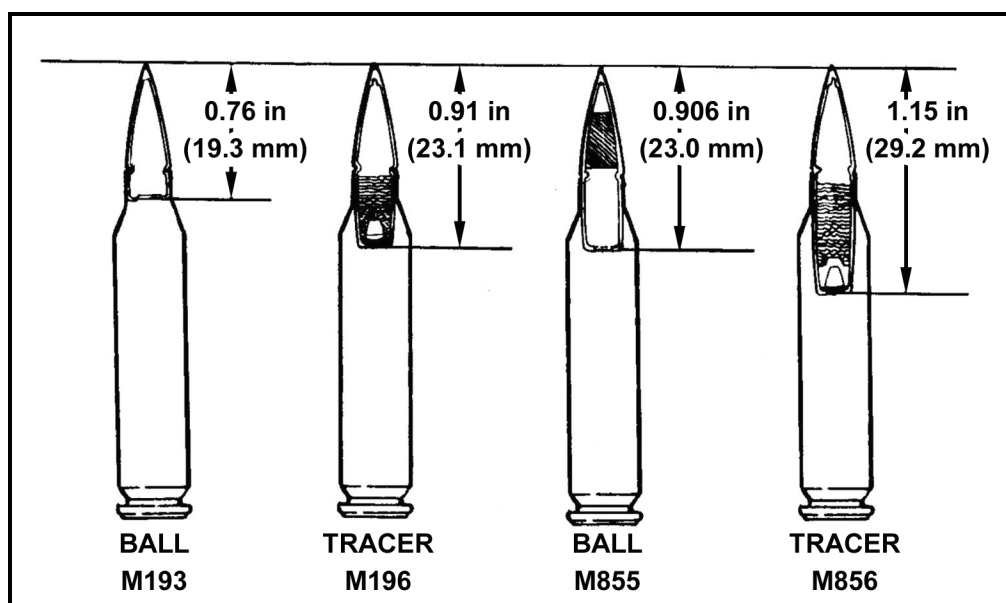
Commanders and marksmanship trainers must understand some aspects of ballistics to teach the principles of zeroing and engagement of long-range targets. Ballistics is a science dealing with the motion and flight characteristics of projectiles. The study of ballistics in rifles and carbines is divided into three categories:

- Internal ballistics.
- External ballistics.
- Terminal ballistics.

INTERNAL BALLISTICS

5-85. Internal ballistics deals with what happens to the bullet before it leaves the weapon's muzzle.

5-86. The overall dimensions of the combat service 5.56-millimeter cartridges are the same, which allows cartridges to be fired safely in M16-series rifles and M4 carbines, but there are internal differences that affect firing accuracy (Figure 5-31).



*Figure 5-31. Projectile differences.

M855 AND M193 AMMUNITION

5-87. The M855 bullet is longer and wider than the M193 bullet and has a different configuration. These differences require different twists in the barrels, lands, and grooves to stabilize the bullet in flight. These differences include the following:

- The M16A1 has a 1:12 barrel twist (the bullet rotates once for every 12 inches of travel down the barrel).
- The M16A2/A3/A4 and the M4 have a 1:7 barrel twist (the bullet rotates once for every 7 inches of travel down the barrel).

5-88. The M16A1 does not put enough spin on the heavier M855 bullet to stabilize it in flight, causing erratic performance and inaccuracy (Figure 5-32). The shot groups are—

- 30.48 to 35.56 centimeters (12 to 14 inches) at 91.4 meters (100 yards).
- 182.88 centimeters (72 inches) at 274.2 meters (300 yards).

NOTE: Although firing the M855 cartridge in the M16A1 rifle is safe, it should only be used in a combat emergency, and then only for close ranges of 91.4 meters (100 yards) or less.

5-89. The M16A2/A3/A4 rifle and M4/M4A1 carbine fire both M193 and M855 ball ammunition with little difference in accuracy to a range of 500 meters. The M16A2/A3/A4 and M4/M4A1 and their ammunition are more effective than the M16A1 at ranges out to and beyond 500 meters due to better stabilization of the round.

5-90. The three 10-round shot groups in Figure 5-32 (A) were fired by a skilled marksman at a distance of 274.2 meters (300 yards) and 91.4 meters (100 yards) using the same M16A1 rifle.

- At 300 yards, the 25.4-centimeter shot group (shown on the left) was fired (and zeroed) with M193 ammunition.
- The 6-foot shot group (shown on the right) was fired with M855 ammunition.
- At 100 yards, the 35.56-centimeter (14-inch) shot group (shown in the center) was fired with M855 ammunition.

5-91. Figure 5-32 (B) shows two 25.4-centimeter (12-inch) shot groups fired by the same skilled marksman at a distance of 274.2 meters (300 yards) using an M16A2 rifle.

- The shot group on the left was fired and zeroed with M855 ammunition.
- The shot group on the right was fired using M193 ammunition.

NOTE: Both M193 and M855 ball ammunition can be used in training and accurately function in M16A2/3/4 rifles and M4/M4A1 carbines. Due to the different characteristics of each round, zero with the type of ammunition used for training. Do not switch between the types during firing. Do not zero with one type, and then fire the other for any type of training.

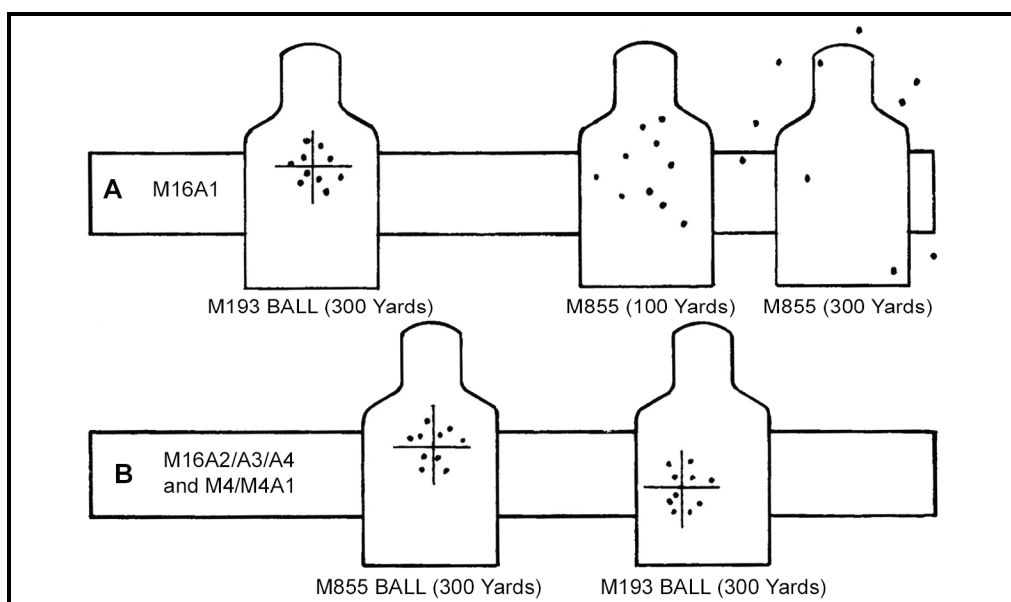


Figure 5-32. Ammunition impact comparison.

*5-92. A simple rule of thumb that will preclude any problem is to use only the ammunition specifically designed for each weapon (M193 ball ammunition for M16A1 rifles; M855 ball ammunition for M16A2/3/4 rifles and M4 carbines). For M855 and M193 ammunition, the difference in a 300-meter zero is negligible, and the firer does not need to compensate for it.

EXTERNAL BALLISTICS

5-93. External ballistics deals with factors affecting the flight path of the bullet between the weapon's muzzle and the target.

5-94. Soldiers must understand the basics of external ballistics so they can make necessary scope adjustments or hold compensations to allow them to hit the target. The external ballistic factors that affect bullet trajectory are:

- Gravity.
- Muzzle velocity.
- Air resistance (drag).
- Altitude or air density.
- Temperature.
- Trajectory.
- Wind.
- Angles.

GRAVITY

*5-95. The force of gravity on a bullet is constant regardless of its weight, shape, or velocity.

*NOTE: See paragraphs 5-68 through 5-70 for more information about the effects of gravity.

MUZZLE VELOCITY

*5-96. Muzzle velocity is the speed of a bullet as it leaves the barrel, measured in feet per second. The bullet begins to slow down as soon as it exits the barrel.

AIR RESISTANCE (DRAG)

5-97. Air resistance, or drag, immediately produces a slowing effect on a bullet.

ALTITUDE OR AIR DENSITY

5-98. The greater the altitude, the thinner the air and the longer the bullet will travel (with a correspondingly flatter trajectory). Each 5,000-foot elevation will raise the strike of the bullet $\frac{1}{2}$ to 1 minute of angle (MOA).

TEMPERATURE

5-99. Deviation from standard daytime temperature (59 degrees Fahrenheit/15 degrees Celsius) affects bullet trajectory.

Cold Temperatures

5-100. Cold air is denser than warm air; the bullet must travel through more tightly packed air particles. This causes the bullet to lose velocity, causing the bullet to impact lower than intended. Cooler air also causes lower chamber pressure, which reduces the initial velocity.

Hot Temperatures

5-101. Warm or hot temperatures cause the strike of the round to move up.

TRAJECTORY

*5-102. When a projectile exits the barrel, gravity immediately takes effect, causing the bullet to drop from the line of departure, otherwise known as the line of bore. As the projectile travels downrange, air drag decreases the velocity. These effects create the projectile's trajectory.

Line of Sight

5-103. The line of sight is an imaginary straight line extending from the firer's eye through the telescopic sight, or rear and front sight, to the target.

Line of Departure

5-104. The line of departure is an imaginary straight line extending from the center of the barrel to infinity.

Zero Range

5-105. Zero range is where the projectile intersects the line of sight. It occurs twice—once on the way up and once on the way down.

Apex

5-106. Otherwise known as midrange trajectory, the apex is the point where the projectile is at its highest in relation to the line of sight.

Bullet Path

5-107. The bullet path is the relationship of a projectile and the line of sight at any given range (normally expressed in inches).

WIND

5-108. External factors influence the trajectory relative to the point of aim, such as wind, altitude, temperature, humidity, and barometric pressure. Wind is by far the most significant. Consider the following effects of wind:

- Because the bullet is moving through the air, the air moves the bullet. Wind deflection is always in the same direction the wind is moving. A wind blowing from the left will move the bullet to the right.
- Deflection decreases as the angle of the wind to the line of flight decreases.

5-109. Effectively reading and correcting for wind effects takes practice, especially at longer ranges where accuracy in correcting is more critical. To shoot accurately in the wind, a firer must know the wind velocity, the wind direction, and the value of deflection at the range at which he is shooting.

*NOTE: See paragraph 5-71 for more information on the effects of wind.

ANGLES

5-110. Firing uphill or downhill normally causes the bullet to hit high relative to a horizontal trajectory. If the firer is firing on an angle up or down at a slanted range of 100 meters, the point of impact will be higher than it would be for a level shot of 100 meters. The height depends on the angle.

5-111. Gravity acts on a bullet only during the horizontal component of its flight (the distance from the firer to the target measured as if they were both at the same level). Since the horizontal component will always be less than the slanted range, gravity will not pull the bullet down as far as it would if the range were level.

5-112. Firing uphill or downhill causes the wind to affect the shot over the entire slant range. The firer should aim at the target as if it were 25 meters away and correct for wind as if it were 400 meters away. The correct method for shooting uphill or downhill is to adjust elevation based on the horizontal range and correct for wind deflection based on the slanted range.

TERMINAL BALLISTICS

5-113. Terminal ballistics deals with what happens to the bullet when it comes in contact with the target.

5-114. Bullet penetration depends on the range, velocity, bullet characteristics, and target material. Greater penetration does not always occur at close range with certain materials, since the high velocity of the 5.56-millimeter bullet causes it to disintegrate soon after impact.

BULLET DISPERSION AT RANGE

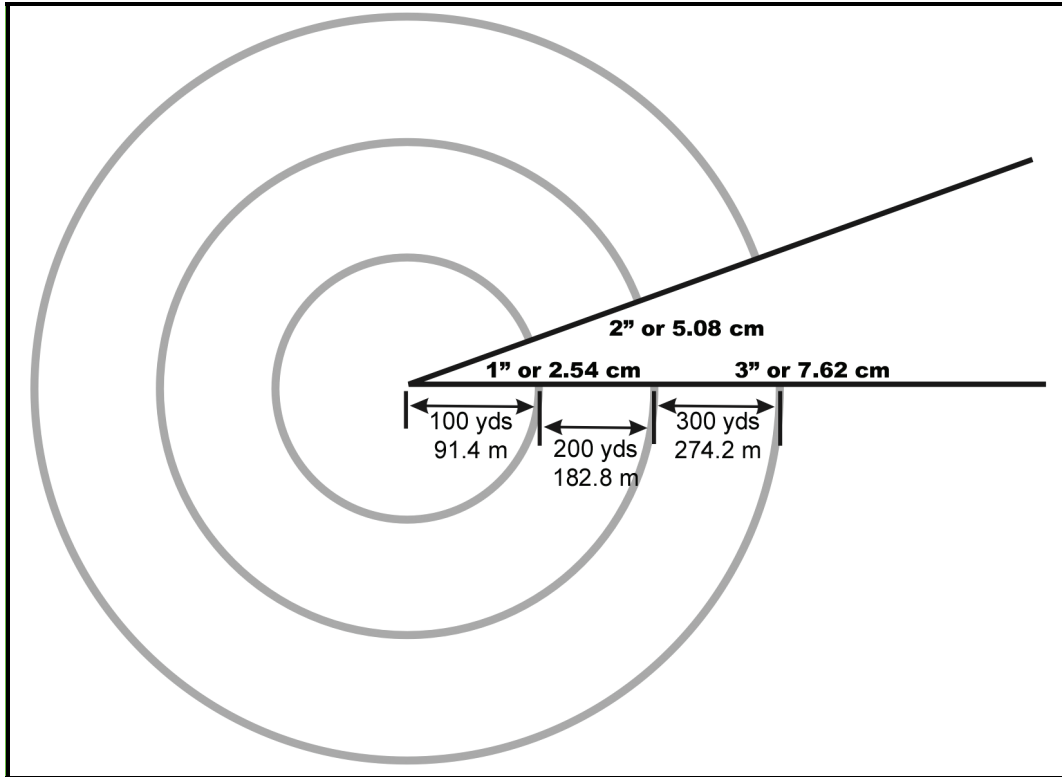
5-115. Instructors/trainers must have a working knowledge of the effects of bullet dispersion and accuracy at various ranges.

MINUTE OF ANGLE

5-116. An MOA is the standard unit of measurement used in adjusting a weapon's sights and other ballistic-related measurements. It is also used to indicate the accuracy of a weapon.

*5-117. A circle is divided into 360 degrees. Each degree is further divided into 60 minutes. Each minute is an MOA (1/60 of a degree).

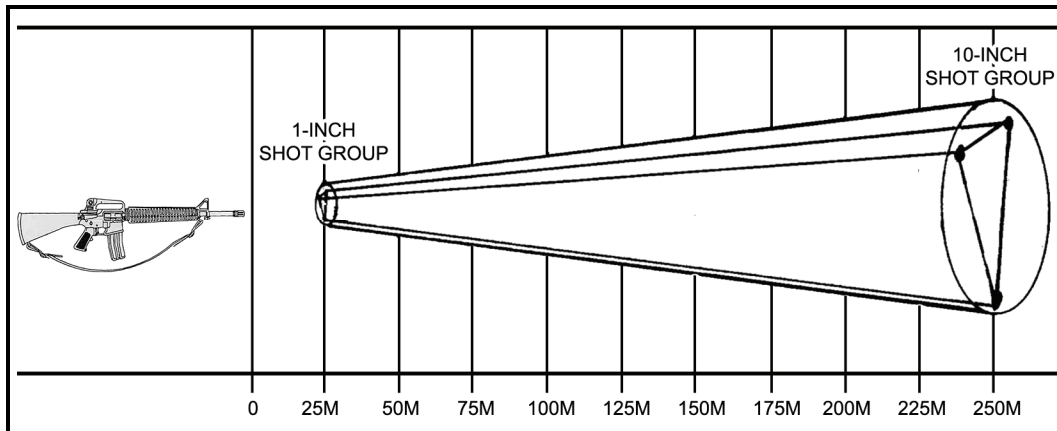
5-118. An MOA is an angle beginning at the muzzle that covers 2.54 centimeters at a distance of 91.4 meters (Figure 5-33). Often, these measurements are expressed as yards; therefore, 1 MOA is 1 inch at 100 yards, 2 inches at 200 yards, and so on. To further simplify the calculation, meters can be substituted for yards.



***Figure 5-33. Minute of angle.**

INCREASE OF SHOT GROUP SIZE

*5-119. Just as the distance covered by an MOA increases each time the range increases, a shot group can be expected to do the same. If there are 2.54 centimeters between bullets on a 25-meter target, there will be an additional 2.54 centimeters of dispersion for each additional 25 meters of range. A 2.54-centimeter shot group at 25 meters (about 3.5 MOA) is equal to a 25.4-centimeter shot group at 250 meters (Figure 5-34).



***Figure 5-34. Increase in shot group size as range increases.**

***Table 6-16. 25-meter scaled target alternate course firing tables and related information.**

TABLE	POSITION	TIME CONSTRAINTS	NUMBER OF ROUNDS	NUMBER OF SILHOUETTES	ADDITIONAL INFORMATION
Table 1	Prone supported firing position or foxhole supported firing position	120 sec	20-round magazine, two rounds for each silhouette	10 silhouettes on the same target sheet	No more than two hits for each silhouette will be scored for this table.
Table 2	Prone unsupported firing position	60 sec	10-round magazine, one round for each silhouette	10 silhouettes on the same target sheet	No more than one hit for each target will be scored for this table.
Table 3	Kneeling unsupported firing position	60 sec	10-round magazine, two rounds for each silhouette at 50 to 100 meters and one round at each 150-meter silhouette	5 silhouettes on the same target sheet (50 to 150 m)	No more than two hits for each target will be scored for this table.

Time Between Firing Positions

6-85. The time between each firing position is not specified, but enough time should be allotted to allow the firer to clear his weapon, quickly change firing positions, and reload before beginning the next firing table.

DUTIES OF RANGE PERSONNEL

6-86. The following personnel perform range duties:

- Officer in charge (OIC).
- Range safety officer (RSO).
- Firing line safety crew.

Officer In Charge

6-87. The OIC briefs all Soldiers on the proper scoring procedures.

Range Safety Officer

6-88. To facilitate the timely flow of the record fire qualification table, the RSO ensures that enough time is given between firing positions.

Firing Line Safety Crew

6-89. Firing line safety crew personnel—

- Perform as scorers.
- Inform the chief range officer of crossfires.
- Inform the chief range officer of allowable alibis.
- Accurately count hits and misses.
- Count only four hits for each silhouette for score.
- Complete the scorecard.
- Assist the Soldier with target repair.
- Total, sign, and return the completed scorecard to the chief range officer.

SCORING

6-90. One hit is awarded for each round that strikes within or touches some part of the silhouette. If a bullet hole does not touch some part of the scaled silhouette, it is counted as a miss. Ricochets are counted as hits or misses.

*6-91. The same target sheet is used for every 40-round qualification table that a firer completes. A maximum of 40 hits comprises 3 hits per target at 200, 250, and 300 meters; 4 hits per target at 150 meters; and 5 hits per target at 50 and 100 meters.

6-92. DA Form 5790-R (Record Fire Scorecard—Scaled Target Alternate Course) is used to score alternate course record fire qualifications.

NOTE: See Appendix B for a sample completed form and the end of this publication for a blank, reproducible copy.

6-93. The NSNs for scaled silhouette targets are—

- *25-meter (NSN 6920-01-167-1398).
- *15-meter (NSN 6920-01-167-1396).

RATINGS

6-94. Qualification ratings for the 25-meter scaled target alternate course are shown in Table 6-17.

Table 6-17. Qualification ratings for the 25-meter scaled target alternate course.

QUALIFICATION RATINGS	NUMBER OF TARGETS HIT
Expert	36 to 40
Sharpshooter	30 to 35
Marksman	23 to 29
Unqualified	22 and below

15-METER SCALED TARGET ALTERNATE COURSE

NOTE: Units are permitted to use the 15-meter scaled alternate course only when standard record fire and KD ranges, and 25-meter scaled target alternate courses are unavailable.

6-95. The 15-meter scaled target alternate course is conducted on a 50-foot indoor range using a .22-caliber rimfire adapter (RFA). Qualification is conducted using the 15-meter alternate course C target (NSN 6920-01-167-1396).

-
- NOTES:**
1. See Appendix A for more information about the RFA.
 2. Prior to qualification, all Soldiers battlesight zero their weapons using the 15-meter battlesight zeroing target (NSN 6920-01-167-1393).
 3. The conduct of fire, scoring, scorecard, and qualification ratings are the same as those used for the 25-meter scaled target alternate course.
-

***Table 7-21. Barricade transition fire.**

BARRICADE/DISTANCE	POSITION	ROUNDS FIRED	METHOD
Start with 28-round magazine in the open.			
Open/50 m	Standing	2	Controlled pair
	Kneeling	2	Controlled pair
	Prone	2	Controlled pair
	Sitting	2	Controlled pair
Tall/50 m	Left	2	Controlled pair
	Right	2	Controlled pair
Short/40 m	Left	2	Controlled pair
	Top	2	Controlled pair
	Right	2	Controlled pair
Tall/35 m	Left	2	Controlled pair
	Right	2	Controlled pair
Short/25 m	Left	2	Controlled pair
	Top	2	Controlled pair
	Right	2	Controlled pair
Transition back to the tall 35-m barricade. Perform parallel or L-shaped magazine change. Insert 4-round magazine.			
Tall/35 m	Left	2	Controlled pair
	Right	2	Controlled pair
Transition back to short 40-m barricade. Perform parallel or L-shaped magazine change. Insert 4-round magazine.			
Short/40 m	Left	2	Controlled pair
	Right	2	Controlled pair
Transition back to tall 50-m barricade. Perform parallel or L-shaped magazine change. Insert 4-round magazine.			
Tall/50 m	Left	2	Controlled pair
	Right	2	Controlled pair

PHASE IV—SHOTGUN AND AUTOMATIC OR BURST FIRING FAMILIARIZATION

7-227. Shotgun and automatic or burst firing familiarization is no different for SRM than for BRM.

NOTE: Publications for shotgun firing familiarization are currently being developed.

*SECTION VII. COMBAT FIELD FIRE

The objective of combat field fire is to assess and confirm the individual proficiency of firers in performing combat-related advanced rifle marksmanship skills, such as engaging multiple target arrays, using multiple hits to neutralize a target, assuming combat relevant firing positions, clearing malfunctions, and performing magazine changes.

NOTE: See Table 7-22 for the current training program.

*CONCEPT

7-228. Combat field fire should simulate combat conditions by requiring the firer to use single and multiple shots to engage 15 targets with different exposure times and ranges.

***Table 7-22. Combat field fire training program.**

COMBAT FIELD FIRE
Instructional Intent
<ul style="list-style-type: none"> Reinforce advanced rifle marksmanship skills and apply the techniques of target detection by engaging a course of fire with multiple pop-up targets with different exposure times and required hits.
Special Instructions
Ensure that— <ul style="list-style-type: none"> The rear sight is on the proper setting (M16A2/3=8/3; M16A4 and M4=6/3 flush; M16A1=the unmarked aperture, short-range). The rear sight aperture is set on 300, not 800. The small aperture is being used.
Observables
<ul style="list-style-type: none"> Soldiers apply all aspects of ARM. Soldiers transition between stations without being prompted. Soldiers perform magazine changes and SPORTS without being prompted. Soldiers must attain a minimum of 16 hits to be considered trained. Soldiers that do not meet the standard receive remedial training before refiring.

***CONDUCT**

NOTE: When firing combat field fire, each Soldier must wear the proper uniform: the helmet, LBE, and IBA with all SAPI plates (if available). No other armor is required.

7-229. Combat field fire is performed on a standard qualification range set up so that 15 targets are exposed a total of 26 times at ranges from 50 to 300 meters. The target exposures are grouped into firing tables by position. The three positions associated with combat field fire are—

- Kneeling unsupported.
- Barricade supported.
- Prone unsupported.

NOTE: Combat field fire requires the use of a barricade (Figure 7-31). The barricade is used for concealment for the kneeling unsupported and prone unsupported positions, and is used for support for the barricade supported firing position. Barricade panels can be locally produced using ½- to ¾-inch plywood and 2- by 4-inch lumber. The dimensions are illustrated in Figure 7-31. The panel must have a base for proper support; however, it can be constructed at the unit's discretion.

7-230. Each firer receives 30 rounds of 5.56-millimeter ball ammunition (3 magazines containing 10 rounds) and 1 randomly placed dummy round in each magazine. The Soldier assumes a firing position and engages each target until it falls and stays down. Once a Soldier has completed a table, he transitions to the next position without prompting, and once he has emptied a magazine, he should change magazines without prompting. Each Soldier must attain a minimum of 16 hits to be considered trained.

- NOTES:**
1. Targets will bob between hits.
 2. Ten to twenty seconds should elapse between firing tables to allow Soldiers to transition to the next firing position or to prompt Soldiers to watch the area for additional targets.
 3. A Soldier should not stop firing unless he has completed the firing table and is transitioning to the next position (making a brief halt in fire necessary), has completed all firing tables, or is out of ammunition.
 4. The dummy round placed in each magazine (1 round for each magazine) simulates a malfunction. To properly simulate a malfunction, the dummy round must be randomly placed; it cannot be the first or last round in the magazine. Soldiers should address this malfunction (by performing SPORTS) without prompting.



***Figure 7-31. Combat field fire barricade.**

NOTE: The positions demonstrated in the following graphics are for a right-handed firer. For a left-handed firer, turn the barricade to place the L-shaped cutout on the opposite side so that the firer can engage targets left-handed.

***KNEELING UNSUPPORTED**

7-231. Soldiers begin combat field fire in a kneeling unsupported position (Figure 7-32) next to a barricade. On a signal, four targets expose at the same time.

NOTE: Table 7-23 depicts the distance from the firer to the target, the number of hits required, and the time that a target will be exposed.

7-232. Soldiers fire at each target until it falls and stays down. After 60 seconds have elapsed, the last target will fall and stay down. Without prompting, Soldiers transition to the barricade supported position.

***BARRICADE SUPPORTED**

7-233. To assume a barricade supported position (Figure 7-33), Soldiers stand behind the lower portion of the barricade. When in this position, Soldiers are exposed to two sets of targets:

- In the first set, two targets expose at the same time. After 40 seconds have elapsed, the last target will fall and stay down.
- In the second set, three targets will expose at the same time. After 40 seconds have elapsed, the last target will fall and stay down.

NOTE: Tables 7-24 and 7-25 depicts the distance from the firer to the target, the number of hits required, and the time that a target will be exposed.

7-234. Soldiers engage each target until it falls and stays down. Without prompting, Soldiers transition to the prone unsupported position.



*

***Figure 7-32. Combat field fire—kneeling unsupported position.**

***Table 7-23. Targets fired from the kneeling unsupported position.**

RANGE (METERS)	HITS REQUIRED	EXPOSURE TIME (SECONDS)
50 (Left)	2	31
50 (Right)	2	31
100	1	45
150	2	60



***Figure 7-33. Combat field fire—barricade supported position.**

***Table 7-24. Targets fired from the barricade supported position--Set 1.**

RANGE (METERS)	HITS REQUIRED	EXPOSURE TIME (SECONDS)
50 (Left or Right)	3	26
100	2	40

***Table 7-25. Targets fired from the barricade supported position--Set 2.**

RANGE (METERS)	HITS REQUIRED	EXPOSURE TIME (SECONDS)
100	1	19
150	2	21
200	1	40

***PRONE UNSUPPORTED**

7-235. To assume a prone unsupported position (Figure 7-34), the Soldier positions himself so that he fires around the edge of the barricade, using it for cover. When in this position, Soldiers engage two sets of targets:

- In the first set, three targets expose at the same time. After 50 seconds have elapsed, the last target will fall and stay down.
- In the second set, three targets will expose at the same time. After 50 seconds have elapsed, the last target will fall and stay down.

NOTE: Tables 7-26 and 7-27 depicts the distance from the firer to the target, the number of hits required, and the time that a target will be exposed.

7-236. Soldiers fire at each target until it falls and stays down. Upon completion of the firing table, Soldiers should stay in position, clear their weapons, and follow the orders given by the tower operator.



***Figure 7-34. Combat field fire—prone unsupported position.**

***Table 7-26. Targets fired from the prone unsupported position--Set 1.**

RANGE (METERS)	HITS REQUIRED	EXPOSURE TIME (SECONDS)
100	2	23
200	2	36
250	1	50

***Table 7-27. Targets fired from the prone unsupported position--Set 2.**

RANGE (METERS)	HITS REQUIRED	EXPOSURE TIME (SECONDS)
150	2	21
250	2	37
300	1	50

***RECORD OF PERFORMANCE**

7-237. Accurate performance data are critical. The firer's score is manually recorded using DA Form 7682-R (Combat Field Fire Scorecard) or automatically documented using a computer printout provided on the automated range. Based on the data recorded, an AAR can be performed by range and firing position to discuss firing performance.

NOTE: See Appendix B for a sample of a completed DA Form 7682-R and the end of this publication for a blank, reproducible copy.

***RATINGS**

7-238. Ratings for combat field fire are shown in Table 7-28.

***Table 7-28. Ratings for combat field fire.**

RATINGS	NUMBER OF HITS
Trained	24 to 26
Partially trained	16 to 23
Untrained	15 and below

***SECTION VIII. SQUAD DESIGNATED MARKSMAN TRAINING**

Advances in technology have led to the development of weapon systems that are increasingly more accurate and able to engage targets at much longer ranges. Conversely, today's rifleman is trained to engage targets only out to 300 meters. This 300-meter limit is well short of the weapon/ammunition combination's capability. Snipers engage targets at 600 meters and beyond. The SDM engages targets with direct small arms fire in the gap between the engagement range of the average combat Soldier and the sniper. Possessing the ability to estimate range, detect targets, and place effective, well-aimed fire on intermediate range targets, the SDM plays a vital role on the modern battlefield.

MISSION OF THE SQUAD DESIGNATED MARKSMAN

7-239. The SDM program provides the squad with a designated marksman that has been trained to engage targets from 300 to 500 meters. He will operate and maneuver as a rifleman, but will have the added responsibility of engaging targets out to 500 meters with effective, well-aimed fires. The SDM is a vital member of his individual squad, not a squad sniper. The SDM has neither the equipment nor training to engage targets at extended ranges with precision fires while operating individually or in a small team. He can also be used to help direct the fires of other squad members into enemy positions. Due to the increased skill level required for his position, the SDM must maintain a high level of proficiency through continued training of the required skills. The SDM must possess a thorough understanding and mastery of—

- The fundamentals of rifle marksmanship.
- Ballistics.
- Elevation and windage.
- Hold-off (adjusted points of aim).
- Sight manipulation.
- Range estimation.

SELECTION

7-240. The platoon sergeant and squad leaders must take special consideration in selecting the SDM. The SDM must have—

- A solid marksmanship performance.
- A clear understanding of the fundamentals.
- The ability to apply these fundamentals consistently during dry-fire and live-fire training.

SQUAD DESIGNATED MARKSMAN SKILLS PROGRESSION

7-241. The skills progression program assesses the Soldier's ability to apply the fundamentals of marksmanship and trains and assesses the Soldier's proficiency in several key areas. Firing events will serve to both reinforce and assess these areas.

CONDUCT

7-242. While conducting the skills progression program, instructors-trainers will adhere to the following guidelines:

- The skills progression program for the SDM is based on the M16-/M4-series weapon system and a 98-rounds-per-man ammunition requirement.
- Soldiers will use their assigned weapon during the training.
- The firing events will be conducted with the iron sights or BUISs only.
- The firing events will be conducted on a KD range that enables firing out to 600 meters at a minimum.

QUALIFICATION

7-243. SDM qualification requires the completion of five phases:

- (1) Position evaluation.
- (2) Dry-fire training.
- (3) Range estimation and sight manipulation.
- (4) Hold-off.
- (5) Field fire.

7-244. Each phase stresses marksmanship fundamentals and specific skill areas required to perform as an SDM. To continue training, Soldiers must receive a GO in each phase. Soldiers who fail in any area should be removed from training.

NOTE: If an optic is issued for use, the phases dealing with hold-off and field record fire will be removed and relevant optics training and testing will be substituted.

PHASE I—POSITION EVALUATION

7-245. Phase I of the training consists of demonstrating the ability to consistently assume proper firing positions. The foxhole supported and prone unsupported firing positions will provide the Soldier with the smallest target exposure to the enemy and will be used during this training cycle. The prone supported position can be substituted for the foxhole supported position dependent on range configurations. Prior to this phase of training, trainers ensure that the—

- Weapon is cleared and that no ammunition is loaded prior to training.
- Weapon is zeroed prior to training.
- Soldier is able to assume a steady firing position.

Foxhole Supported

7-246. The Soldier must be able to successfully assume a proper supported position while firing from a foxhole. The trainer must ensure that the Soldier has a good steady position. After the Soldier has assumed a good supported position in the foxhole—

- (1) The trainer uses DA Form 7650-R (Squad Designated Marksman—Position Evaluation) to evaluate his position and take notes on all of the following characteristics:

NOTE: See the end of this publication for a blank, reproducible copy of DA Form 7650-R.

- Eye relief.
- Trigger finger.
- Elbows.
- Nonfiring hand.
- Legs.

NOTE: The main areas that will differ between the foxhole supported and the prone supported positions are in the placement of the elbows, legs, and nonfiring hand. These body positions will be similar to those of the prone unsupported position.

- (2) After all characteristics have been noted, the trainer has the Soldier lay his weapon down, relax, and then assume another supported position in the foxhole.
- (3) The trainer evaluates this position by comparing his notes from the original supported position. The Soldier should maintain the same characteristics in the second evaluation as he did in the first.
- (4) Once the trainer is satisfied that the Soldier has demonstrated the proper position and is able to show it in two consecutive attempts, the Soldier moves to the unsupported prone position.

Eye Relief

7-247. To evaluate the Soldier's eye relief, ensure that the Soldier—

- Demonstrates a consistent eye relief by checking the placement of the Soldier's cheek on the weapon's buttstock.
- *Places his eye the same distance from the rear sight each time he is evaluated.

Trigger Finger

7-248. To evaluate the placement of the Soldier's trigger finger, ensure that the Soldier—

- Uses his own style; not all Soldiers place their finger on the trigger in the same place.
- Places his finger on the trigger the same way each time he is evaluated.

Elbows

7-249. To evaluate the placement of the Soldier's elbows, ensure that the Soldier—

- Places his elbows firmly a comfortable distance apart on the outside edge of the foxhole.
- Uses a sandbag, and not his arms, to support the weapon's weight.
- Assumes a stable position each time he is evaluated by slightly nudging him.

Nonfiring Hand

7-250. To evaluate the placement of the Soldier's nonfiring hand, ensure that the Soldier—

- Places the nonfiring hand in a position that is comfortable and provides the best weapon stability and support. Show the Soldier different ways this can be done.
- Is supporting the weapon properly by nudging him after the weapon has been stabilized.

Legs

- 7-251. To evaluate the placement of the Soldier's legs, ensure that the Soldier—
- Places the legs inside the foxhole while firing.
 - Plants the legs firmly for a stable position while firing. Slightly nudge the Soldier to make sure that his legs are firmly planted in the foxhole.

Prone Unsupported

7-252. The Soldier must be able to successfully assume a proper unsupported firing position. The trainer must ensure that the Soldier has a good steady position. After the Soldier has assumed a good unsupported firing position —

- (1) Taking special care to observe the positioning of the elbows, the nonfiring hand, and the legs, the trainer uses DA Form 7650-R (Squad Designated Marksman—Position Evaluation) to evaluate the same characteristics as with the supported firing position with the exception of the—
 - Elbows.
 - Nonfiring hand.
 - Legs.

NOTE: See the end of this publication for a blank, reproducible copy of DA Form 7650-R.

- (2) Once the trainer has noted the Soldier's position, he has the Soldier lay his weapon down, stand up, relax, and then get back down into another unsupported prone position.
- (3) The trainer evaluates this position by comparing his notes from the original position. The Soldier should maintain the same characteristics in the second evaluation as he did in the first evaluation.
- (4) The trainer lets the Soldier hold this firing position for approximately 15 seconds to check for shaking. If the Soldier starts to shake, have him relax and reposition himself.
- (5) Once the trainer is satisfied that the Soldier has demonstrated the proper position and is able to accomplish it in two consecutive attempts, the Soldier moves on to the next phase of training.

Elbows

- 7-253. To evaluate the placement of the Soldier's elbows, ensure that the Soldier—
- Places the elbows a comfortable distance apart on the ground.
 - Uses the bone, not the muscles, to support the weapon's weight. This will prevent any unnecessary muscle fatigue and will allow for a steadier firing position.
 - Assumes a stable position. Slightly nudge the Soldier to ensure that his position is stable.

Nonfiring Hand

- 7-254. To evaluate the placement of the Soldier's nonfiring hand, ensure that the Soldier—
- Places his nonfiring hand in a comfortable position on the handguards.
 - Does not support his nonfiring hand on the ground, sandbag or anything that would create a supported position.

Legs

- 7-255. To evaluate the placement of the Soldier's legs, ensure that the Soldier—
- Positions his legs in such a way that he has a stable position; not all Soldiers position their legs the same way while shooting from the prone position.
 - Spreads his legs a comfortable distance apart, with the heels on the ground or as close as possible without causing strain.

Zero Confirmation

*7-256. After completing Phases I and II, the Soldier conducts a firing event (Table 7-29) to zero or confirm the zero on his weapon and reinforce the fundamentals of marksmanship. This firing event will be conducted on a 25-meter range. If the Soldier cannot zero within 18 rounds, the trainer recommends retraining, retesting, or possible removal from the course. After the weapon is zeroed, any additional rounds will be fired and the coach will observe the Soldier for deficiencies in his marksmanship fundamentals.

***Table 7-29. Zero/zero confirmation firing event.**

FIRING EVENT	ROUNDS	TARGET RANGE (m)
Zero/Zero Confirmation	18	25

PHASE II—DRY-FIRE TRAINING

7-257. SDMs must have a solid grasp on the fundamentals to successfully engage targets at longer ranges. During this phase of training, the Soldier must demonstrate that he can apply the fundamentals of marksmanship correctly. If the Soldier does not receive a GO in this phase of training, he will be dropped from the course. The components of this phase of training are—

- Follow-through.
- Borelight exercise.
- Target box exercise.
- Dime/washer drill.
- Zero confirmation.

7-258. Prior to this phase of training trainers ensure that the—

- Weapon is cleared and no ammunition is loaded prior to training.
- Weapon is zeroed prior to training.
- Soldier is able to consistently apply the fundamentals of marksmanship.

Follow-Through

7-259. Follow-through involves applying all of the marksmanship fundamentals while and after the weapon fires. A good follow-through ensures that the weapon is allowed to fire and recoil naturally. The Soldier/weapon combination reacts as a single unit to such actions. It consists of the following:

- Keeping the cheek in firm contact with the stock (stock weld).
- Keeping the finger on the trigger all the way to the rear.
- Continuing to look through the rear aperture.
- Keeping muscles relaxed.
- Avoiding reaction to recoil or noise.
- Releasing the trigger only after the recoil has stopped.

Borelight Exercise

7-260. The borelight dry-fire exercise provides evaluation of the Soldier throughout the integrated act of firing.

NOTE: If a borelight is not available, the target box exercise will be used.

7-261. To perform a borelight exercise—

- (1) The trainer attaches a 25-meter zero target to a flat surface.
- (2) The trainer positions the Soldier 10 meters away, facing the target.
- (3) *The Soldier assumes a good prone supported firing position with the borelight inserted in the weapon's barrel and with the borelight placed in the dry-fire mode.

- (4) The trainer uses DA Form 7650-R (Squad Designated Marksman—Position Evaluation) to evaluate the Soldier's position:

NOTE: See the end of this publication for a blank, reproducible copy of DA Form 7650-R.

- (5) The Soldier aims at the silhouette's center of mass on the 25-meter zero target and squeezes the trigger.
 (6) The borelight is activated as the trigger is fired. The laser is seen on the 25-meter zero target.
 (7) The trainer marks the 25-meter zero target exactly where the borelight laser hit the target.
 (8) The Soldier gets out of position and then back into a prone supported firing position.

7-262. This process will be done until a three-round shot group has been achieved. The Soldier will do the same from the prone unsupported firing position. To receive a GO, the Soldier must place a three-round shot group in a 3-centimeter circle from both prone positions.

Target Box Exercise

7-263. The target box exercise checks the consistency of aiming and placement of three-round shot groups in a dry-fire environment. To conduct the exercise—

- (1) The target man places the silhouette on a plain sheet of paper 25 or 15 meters away from the firer and moves the correct silhouette target as directed by the Soldier.
- (2) *When the Soldier establishes proper aiming, he tells the target man to mark the target.
- (3) The target man marks through the silhouette with a pen or pencil at the target's center of mass.
- (4) The target man moves the silhouette to another spot on the paper and tells the firer to repeat the process twice more to obtain a shot group.

NOTE: A simulated shot group covered within a 1/2-centimeter circle indicates consistent aiming.

Dime/Washer Drill

7-264. The dime/washer drill is an effective way of measuring the Soldier's trigger squeeze. To conduct the exercise—

- (1) The Soldier takes aim and squeezes the trigger.
- (2) If the dime or washer remains in place, he has successfully squeezed the trigger.

*7-265. The Soldier must successfully obtain five out of five consecutive shots without allowing the dime or washer to drop. The trainer evaluates the Soldier's performance and gives the Soldier a GO or NO GO. If the Soldier receives a NO GO, the trainer recommends retraining, retesting, or possible removal from the course.

Zero Confirmation

7-266. Zero confirmation is conducted as shown in Table 7-6.

PHASE III—RANGE ESTIMATION AND SIGHT MANIPULATION 100 TO 500 METERS

7-267. SDMs must use range estimation methods to determine the distance between their position and the target. Trainers ensure that the—

- Weapon is cleared and no ammunition is loaded prior to training.
- Weapon is zeroed prior to training.
- Soldier knows how to adjust for wind and gravity.
- Soldier can manipulate the rear sight for different ranges.

7-268. The trainer sets up a range estimation course using E-type silhouettes at ranges from 100 meters to 700 meters. Soldiers practice on this course until they find the method that works best for them.

7-269. Once the Soldiers have had time to practice, trainers test their ability to estimate range. The Soldier is given six targets. He must estimate the range within 50 meters of the actual range to receive a GO. The Soldier must estimate range correctly six out of six targets to move on to the next portion of this phase.

Methods of Range Determination

7-270. SDMs can use five different methods of range determination:

- 100-meter unit-of-measure method.
- Range card method.
- Front sightpost method.
- Appearance of objects method.
- Combination method.

100-Meter Unit-of-Measure Method

7-271. To use this method, the SDM must be able to visualize a distance of 100 meters on the ground.

- For ranges up to 500 meters, the SDM determines the number of 100-meter increments between the two objects he wishes to measure.
- Beyond 500 meters, he must select a point halfway to the object, determine the number of 100-meter increments to the halfway point, and then double the number.

-
- NOTES:**
1. See Chapter 6 for more information about this method of range determination.
 2. For example, terrain with much dead space limits the accuracy of the 100-meter method.
-

Range Card Method

7-272. SDMs use a range card to quickly determine ranges throughout the target area. Once a target is detected, the SDM determines its location on the card and then reads the proper range to the target.

Front Sightpost Method

7-273. Using the front sightpost as a scale is another method of estimating range. This method can be used for a quick on-the-spot estimation and engagement.

- *If a man-sized target is $\frac{1}{2}$ of the width of the front sightpost, he is approximately 300 meters away.
- *If a man-sized target is the width of the front sightpost, he is approximately 175 meters away.

NOTE: See Chapter 6 for more information about this method of range determination.

Appearance of Objects Method

7-274. This method of range determination is based on the size and visible characteristics of an object. To use this method with any degree of accuracy, the SDM must be familiar with the appearance and visible detail of an object at various ranges. Some common guidelines can be used to determine the range of a human target:

- At 200 meters, a human target is clear and details can be seen.
- At 300 meters, the target is still clear, but no details can be seen.
- At 400 meters, the target's outline is clear; however, the target itself is blurry.
- At 500 meters, the body tapers and the head disappears.
- At 600 meters, the body resembles a wedge shape.

NOTE: See Chapter 6 for more information about this method of range determination.

Combination Method

7-275. In a combat environment, perfect conditions rarely exist. Therefore, only one method of range estimation may not be enough for the SDM's specific mission. By using a combination of two or more methods to determine an unknown range, an experienced SDM should arrive at an estimated range close to the true range.

Factors Affecting Range Estimation

7-276. Three factors affect range estimation:

- Nature of the target
- Nature of the terrain.
- Light conditions.

Nature of the Target

7-277. The nature of the target affects its perceived range:

- An object with a regular outline, such as a house, appears closer than one with an irregular outline, such as a clump of trees.
- A target that contrasts with its background appears to be closer than it actually is.
- A partly exposed target appears more distant than it actually is.

Nature of the Terrain

7-278. The contour of the terrain affects the observer's ability to estimate range:

- As the observer's eye follows the contour of the terrain, he tends to overestimate distant targets.
- Observing over smooth terrain, such as sand, water, or snow, causes the observer to underestimate distant targets.
- Looking downhill, the target appears farther away.
- Looking uphill, the target appears closer.

Light Conditions

7-279. Light conditions affect range estimation:

- The more clearly a target can be seen, the closer it appears.
- When the sun is behind the observer, the target appears to be closer.
- When the sun is behind the target, the target is more difficult to see and appears to be farther away.

Elevation Knob Training

*7-280. Elevation knob training involves nothing more than being able to adjust the rear elevation knob for the various ranges that the SDM must engage. With this knowledge, he can better determine his range settings for the different distances between the 100-meter adjustments.

7-281. The rear elevation knob adjusts the point of aim—

- From 300 to 800 meters on the M16A2.
- From 300 to 600 meters on the M16A4 and M4.

Conduct

*7-282. During elevation knob training, the Soldier determines the number of adjustments (clicks) between the different range settings on his rear elevation adjustment knob (Tables 7-30 and 7-31). Once the Soldier understands how to set the proper point of aim for his target using his rear elevation knob, the instructor/trainer has him conduct another range estimation course. This time, the instructor/trainer has him estimate the range and set the rear elevation for the range that he has estimated. The Soldier must estimate range and set his rear elevation knob properly six out of six times to receive a GO. If the Soldier receives a NO GO, the trainer recommends retraining, retesting, or possible removal from the course.

*7-283. Once the Soldier has an understanding of range estimation and sight manipulation, he can begin the live-fire training exercise (Table 7-32). The Soldier will be given 20 rounds in which to engage 20 targets at ranges from 100 to 500 meters using mechanical sight adjustments.

***Table 7-30. Elevation knob, M16A2/3 and front sightpost, M16A4.**

DISTANCE (m)	DISTANCE ONE CLICK WILL ADJUST THE POINT OF IMPACT		
	FRONT SIGHTPOST	WINDAGE KNOB	ELEVATION WHEEL
25	.83 cm (3/8 in)	.33 cm (1/8 in)	.5 cm (1/4 in)
50	1.50 cm (5/8 in)	.5 cm (1/4 in)	1.5 cm (1/2 in)
75	2.50 cm (1 in)	1.0 cm (3/8 in)	2.0 cm (3/4 in)
100	3.50 cm (1 3/8 in)	1.5 cm (1/2 in)	2.75 cm (1 in)
150	5.00 cm (2 in)	2.0 cm (3/4 in)	4.0 cm (1 1/2 in)
175	6.00 cm (2 3/8 in)	2.25 cm (7/8 in)	5.0 cm (2.0 in)
200	6.50 cm (2 5/8 in)	2.5 cm (1 in)	5.5 cm (2 1/4 in)
250	8.50 cm (3 3/8 in)	3.5 cm (1 1/4 in)	7.0 cm (2 3/4 in)
300	10.0 cm (4 in)	4.0 cm (1 1/2 in)	8.5 cm (3 1/4 in)
400	13.5 cm (5 3/8 in)	5.5 cm (2 1/4 in)	11.0 cm (4 1/2 in)
500	17.0 cm	6.5 cm (2 1/2 in)	14.0 cm (5 1/2 in)
600	20.5 cm	8.0 cm (3 1/8 in)	16.75 cm (6 1/2 in)
700	24.0 cm	9.0 cm (3 5/8 in)	19.5 cm (7 1/2 in)
800	27.5 cm	10.5 cm (4 1/8 in)	22.5 cm (8 3/4 in)

NOTE: All values were rounded off.

***Table 7-31. Elevation knob, M4/M4A1 and windage, M16A4.**

DISTANCE (m)	DISTANCE ONE CLICK WILL ADJUST THE POINT OF IMPACT		
	FRONT SIGHTPOST	WINDAGE KNOB	ELEVATION WHEEL
25	1.2 cm (1/2 in)	.5 cm (1/4 in)	.5 cm (1/4 in)
50	2.4 cm (1 in)	1.5 cm (1/2 in)	1.5 cm (1/2 in)
75	3.6 cm (1 1/2 in)	2.0 cm (3/4 in)	2.0 cm (3/4 in)
100	4.8 cm (1 7/8 in)	2.75 cm (1 in)	2.75 cm (1 in)
150	7.2 cm (2 7/8 in)	4.0 cm (1 1/2 in)	4.0 cm (1 1/2 in)
175	8.4 cm (3 3/8 in)	5.0 cm (2.0 in)	5.0 cm (2.0 in)
200	9.6 cm (3 3/4 in)	5.5 cm (2 1/4 in)	5.5 cm (2 1/4 in)
250	12.0 cm (4 3/4 in)	7.0 cm (2 3/4 in)	7.0 cm (2 3/4 in)
300	14.4 cm (5 3/4 in)	8.5 cm (3 1/4 in)	8.5 cm (3 1/4 in)
400	19.2 cm (7 1/2 in)	11.0 cm (4 1/2 in)	11.0 cm (4 1/2 in)
500	24.0 cm (9 1/2 in)	14.0 cm (5 1/2 in)	14.0 cm (5 1/2 in)
600	28.8 cm (11 1/4 in)	16.75 cm (6 1/2 in)	16.75 cm (6 1/2 in)

NOTE: All values were rounded off.

***Table 7-32. Known distance (mech. adj.) firing event.**

FIRING EVENT	ROUNDS	TARGET RANGE (m)
Known Distance (Mech. Adj.)	20	100 to 500

PHASE IV—HOLD-OFF 100 TO 500 METERS

*7-284. To engage targets at ranges other than that of the current zero or when firing at targets in varying wind conditions, Soldiers may use hold-offs.

NOTE: The windage knob should not be used to make adjustments for wind.

- 7-285. Prior to this phase of training, trainers ensure that the—
- Weapon is cleared and that no ammunition is loaded prior to training.
 - Weapon is zeroed prior to training.
 - Soldier knows how to adjust for wind and gravity.
 - Soldier can manipulate the rear sight for different ranges.

Elevation

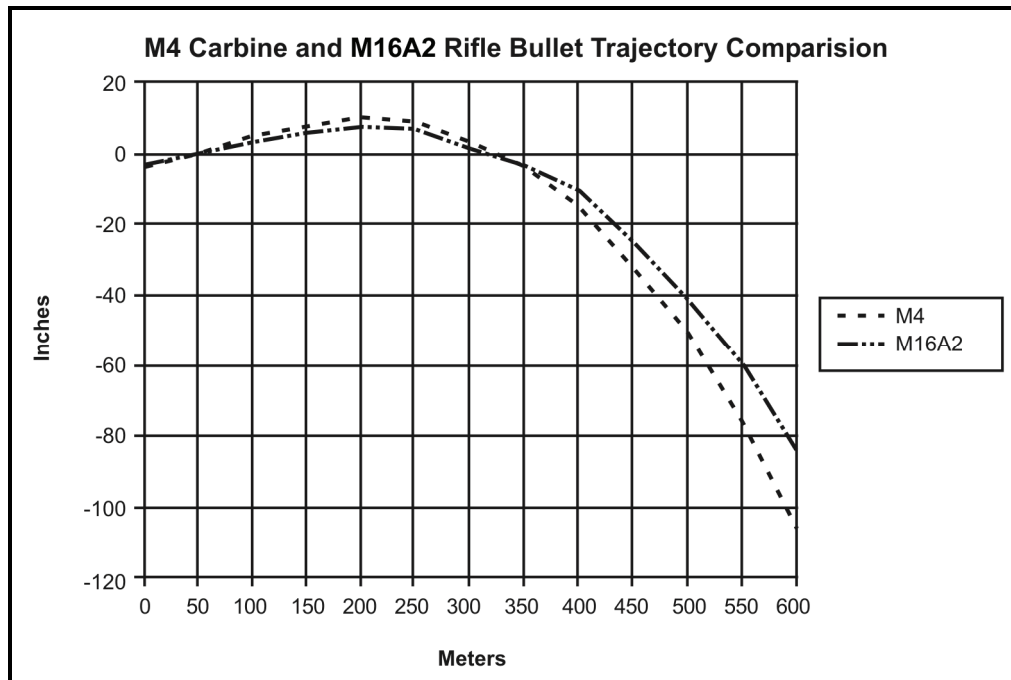
7-286. When a Soldier aims directly at a target at ranges greater than the set range, his bullet will hit below the point of aim. At lesser ranges, his bullet will hit higher than the point of aim. If the SDM understands this and knows about trajectory and bullet drop, he will be able to hit the target at ranges other than that for which the weapon was adjusted.

7-287. For example, the SDM adjusts the weapon for a target located 500 meters downrange, and another target appears at a range of 600 meters. The hold-off would be 25 inches; that is, the SDM should hold off 25 inches above the center of visible mass in order to hit the center of mass of that particular target. If another target were to appear at 400 meters, the SDM would aim 14 inches below the center of visible mass in order to hit the center of mass.

*7-288. The chart in Figure 7-35 shows the projectile’s trajectory when fired from the M4 carbine and the M16A2 rifle. This demonstrates the drop of the round at various ranges.

NOTE: This diagram will assist the trainer in teaching vertical hold-off during this phase.

*7-289. As the chart in Figure 7-35 shows, the hold-off at 400 meters is about half the height of the standard E-type silhouette; to hold-off at 400 meters, the firer aims half the height of the target over the target to hit it. The drop at 500 meters is considerably larger, so holding off will not be practical. The firer will have to adjust his rear elevation knob to get the proper point of aim for that distance.



***Figure 7-35. Bullet trajectory comparison.**

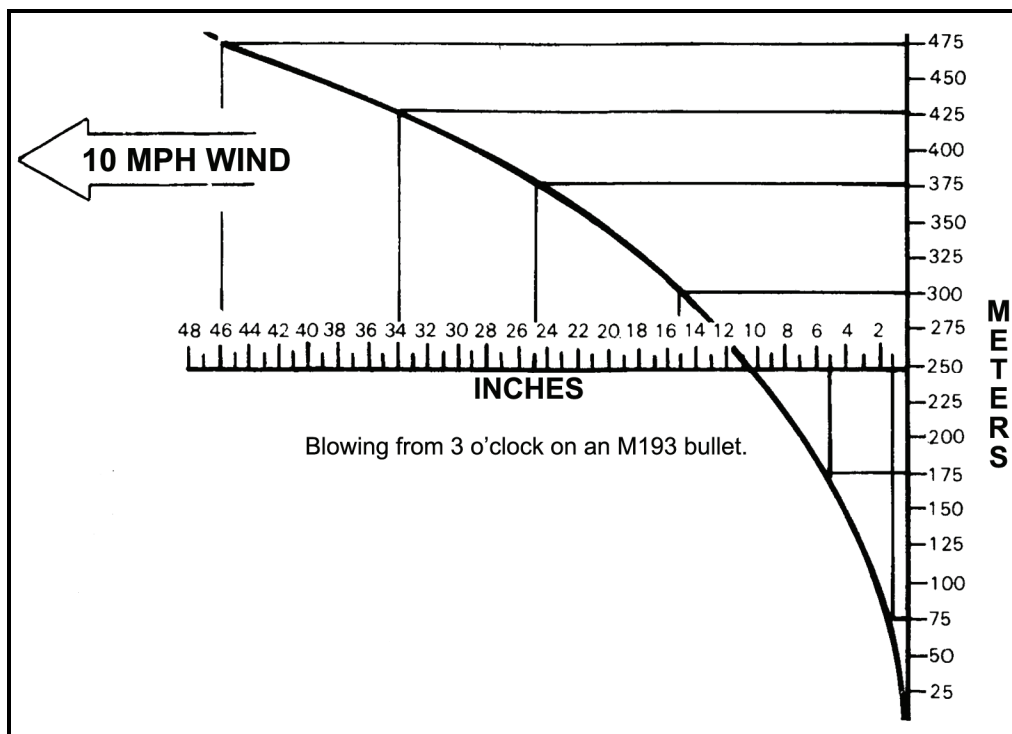
Windage

*7-290. When firing during windy conditions, the SDM must use hold-off to adjust for windage (Figure 7-36).

- When holding off, the SDM aims into the wind. If the wind is moving from the right to left, his point of aim is to the right. If the wind is moving from left to right, his point of aim is to the left.
- If the SDM misses the target and the point of impact of the round is observed, he notes the lateral distance of his error and refires, holding off that distance in the opposite direction.

*7-291. Table 7-33 shows calculated adjusted points of aim based on wind speed.

*7-292. Table 7-34 shows the drift for a 10-mph wind using 5.56-millimeter M855 ball ammunition fired in a M16A2 rifle with a 300-meter battlesight zero.



***Figure 7-36. Windage effects of a 10-mph crosswind.**

***Table 7-33. Calculated adjusted point of aim based on wind speed (full value).**

WIND SPEED	RANGE (m)								
	25	50	75	100	150	175	200	250	300
5 mph	1/4 in	3/8 in	1/2 in	1 in	2 in	2.5 in	3.5 in	5 in	7.5 in
10 mph	1/2 in	3/4 in	1 in.	2 in	4 in	5 in	7 in	10 in	15 in
15 mph	3/4 in	1 1/8 in	1.5 in	3 in	6 in	7.5 in	10.5 in	15 in	22.5 in

***Table 7-34. Drift for 10-mph wind using M855 ammunition when fired from M16A2 rifle with 300-meter battlesight zero.**

RANGE (m)	VELOCITY (fps)	TRAJECTORY (in)	DROP (in)	DRIFT (in)
0	3,100	-2.5	0.0	0.0
100	2,751	4.4	-2.3	1.1
200	2,420	5.8	-10.2	4.9
300	2,115	0.0	-25.3	11.8
400	1,833	-15.0	-49.5	22.4
500	1,569	-42.9	-86.7	38.0
600	1,323	-88.2	141.3	59.5
700	1,106	-156.1	-220.9	88.4
800	1,010	-267.7	-339.2	124.9

7-293. Firers use the M15 sighting device to demonstrate that they understand holding off. To do so, the firer aligns the sights on the silhouette on the proper adjusted point of aim.

NOTE: See Appendix A for information about the M15 sighting device.

*7-294. Once the firer has an understanding of elevation and windage hold-off, he can begin the live-fire training exercise (Table 7-35). The firer will be given 20 rounds in which to engage 20 targets at ranges from 100 to 500 meters using elevation and windage hold-off.

***Table 7-35. Firing event, known distance (hold off).**

FIRING EVENT	ROUNDS	TARGET RANGE (m)
Known Distance (Hold Off)	20	100 to 500

PHASE V—FIELD FIRE 100 TO 500 METERS

*7-295. The field fire events (Table 7-36) will test the individual's marksmanship, range estimation, and target detection skills. Field fire will consist of both a Record Fire I and a Record Fire II course. The Record Fire I course requires the individual to use mechanical elevation and windage adjustments. The Record Fire II course requires the individual to use elevation and windage hold-off (adjusted points of aim).

Conduct

7-296. To complete this course, Soldiers fire two firing events: Record Fire I and Record Fire II.

*7-297. During each event, each Soldier will engage a total of 20 targets with 20 rounds. Soldiers must attain a total of 14 hits out of 20 targets on each record fire to pass. Table 7-36 depicts these two events and provides related information, such as number of rounds that must be fired, position that must be used, and the distance away from the firer that the target must be placed.

***Table 7-36. Firing event, Record Fire I and II.**

FIRING EVENT	POSITION	ROUNDS	NUMBER OF TARGETS	TARGET RANGE (m)
Record Fire I	Foxhole supported or prone supported position and the prone unsupported firing position	20	20	100 to 500
Record Fire II	Foxhole supported or prone supported position and the prone unsupported firing position	20	20	100 to 500

NOTE: If the SDM is issued an optic, the Record Fire II course will substitute use of that optic instead of using adjusted points of aim.

7-298. Prior to training, ensure that—

- The weapon is zeroed prior to training.
- Each Soldier assumes a steady firing position.
- Each Soldier consistently applies the fundamentals of marksmanship.
- Each Soldier knows how to adjust for wind and gravity.
- Each Soldier manipulates the rear sight for different ranges.

NOTE: See Appendix B for a sample completed form and the end of this publication for a blank, reproducible copy.

CERTIFICATION

7-299. Once the firer has successfully completed the SDM program, he is designated as an SDM and will be able to perform all duties and responsibilities set forth by these guidelines.

NOTE: SDM skills are highly perishable, and sustainment training should be conducted to ensure retention of the skills. At a minimum, sustainment training should be conducted semiannually.

- (6) Adjust the AN/PEQ-2A/B (top-mounted) target illuminator as follows:
 - For windage and elevation, one click equals 1 centimeter or one square at 25 meters.
 - For elevation, one clockwise click moves the bullet strike down.
 - For windage, one clockwise click moves the bullet strike right.
- (7) Retighten the rail grabber and the AN/PEQ-2A/B.
- (8) Once the aiming beam is zeroed, rotate the selector knob to the DUAL LO, DUAL LO/HI, or DUAL HI/HI mode to observe both aiming and illumination beams.
- (9) Rotate the illumination beam adjusters to align the illumination beam with the aiming beam.

-
- NOTES:**
1. Failure to fully tighten the mounting brackets and AN/PEQ-2A/B thumbscrew may cause zero retention problems. Confirm that equipment is tight prior to zeroing.
 2. To retain zero, remove the TPIAL and rail grabber as a whole assembly and place back onto the same notch as removed.
-

TARGET DETECTION

8-87. Soldiers should receive in-depth instruction on the proper use and fit of night vision goggles, to include characteristics and capabilities, maintenance, and mounting procedures. Extensive testing has proven that the average Soldier does not properly use NVDs. Unit leaders must be proficient in the train-the-trainer strategy. At night, Soldiers should conduct a terrain walk to become more familiar and build confidence using the night vision goggles.

Scanning for Targets

8-88. NVDs have a 40-degree field of view, which causes the average firer to miss easy targets of opportunity. Soldiers must be trained to aggressively scan their sectors of fire for targets.

8-89. The art of target detection at night is only as good as the Soldier practices. Regular blinking during scanning relieves some of the eyestrain that Soldiers experience when trying to spot distant targets. Regular blinking must be reinforced during training. After Soldiers have mastered the art of scanning, they will find that targets are more easily detected by acknowledging the flicker or movement of a target.

Infrared Discipline

8-90. Soldiers must be taught that what they can see downrange or on the battlefield through NVGs, the enemy can also see. Soldiers must train to activate the laser at the base of the target and engage the target as soon as the target is detected. After the target has been engaged, the laser is deactivated.

8-91. When a Soldier uses proper IR discipline while scanning for targets, he must keep his weapon oriented within his sector of fire. When the target is detected, the Soldier orients his weapon around the base of the target, activates his laser, and walks the laser to the target's center of mass for engagement.

FIELD FIRE

8-92. During dry-fire exercises, Soldiers acquire a sight picture on all exposed silhouette targets before conducting the field fire scenario. This allows Soldiers to focus on the targets at range. The procedures for field fire include the following:

- Conduct a dry-fire exercise prior to conducting a live-fire.
- Conduct Field Fire in the same manner as Field Fire II.
- Engage targets at 50, 150, and 250 meters.
- Fire 36 rounds:
 - 18 rounds from the supported firing position.
 - 18 rounds from the prone unsupported firing position.

PRACTICE QUALIFICATION

- 8-93. The procedures for practice qualification include the following:
- Conduct a dry-fire exercise.
 - Use coaches.
 - Fire 40 rounds:
 - 20 rounds from the prone supported firing position.
 - *20 rounds from the unsupported firing position.
 - Engage targets from 50 to 250 meters.
 - Meet the standards (17 hits out of 40 target exposures).

RECORD QUALIFICATION

- 8-94. The procedures for record qualification include the following:
- Conduct a dry-fire exercise.
 - Fire 40 rounds:
 - 20 rounds from the prone supported firing position.
 - *20 rounds from the unsupported firing position.
 - Engage targets from 50 to 250 meters.
 - Meet the standards (17 hits out of 40 target exposures).

AN/PVS-4 NIGHT VISION DEVICE

8-95. The AN/PVS-4 NVD is a portable, battery-operated electro-optical instrument used for observation and aimed fire of weapons at night. It amplifies reflected light, such as moonlight, starlight, and sky glow, so that the viewed scene becomes clearly visible to the operator. It can be mounted on the M16A2/A3/A4 rifle and M4/M4 MWS. Mounting brackets are provided for each type of weapon.

NOTE: See Table 8-8 for the current training program.

Table 8-8. AN/PVS-4 night vision device training program.

AN/PVS-4 NIGHT VISION DEVICE
Instructional Intent
<ul style="list-style-type: none"> ● Soldiers qualify with the AN/PVS-4 NVD.
Special Instructions
Ensure that Soldiers— <ul style="list-style-type: none"> ● Are proficient with the AN/PVS-4 NVD. ● Install the spacer and Picatinny rail grabber when mounting on the MWS. ● Use the proper 10-meter boresighting target during boresighting procedures. ● Use the proper reticle. ● Confirm 10-meter boresight with a 25-meter zero.
Observables
<ul style="list-style-type: none"> ● Soldiers zero the AN/PVS-4 to the same standard as with the iron sight. ● Soldiers achieve the same practice and qualification standards as with day record fire.

Appendix B

Scorecards

During live-fire events, a Soldier's hit-and-miss performance is recorded to facilitate the instructor/trainer's critiques or to indicate where more training is needed. The following are examples of completed scorecards.

EXAMPLES OF COMPLETED SCORECARDS

B-1. *Figures B-1 through B-9 show examples of completed scorecards.

REPRODUCIBLE FORMS

B-2. Blank copies of the following can be found at the end of this publication:

- DA Form 3595-R (Record Fire Scorecard).
- DA Form 3601-R (Single Target—Field Fire I Scorecard).
- DA Form 5239-R (100-, 200-, and 300-Meter Downrange Feedback Scorecard).
- DA Form 5241-R (Single and Multiple Targets—Field Fire II Scorecard).
- DA Form 5789-R (Record Fire Scorecard—Known-Distance Course).
- DA Form 5790-R (Record Fire Scorecard—Scaled Target Alternate Course).
- DA Form 7489-R (Record Night Fire Scorecard).
- DA Form 7649-R (Squad Designated Marksman—Record Fire I and II).
- DA Form 7650-R (Squad Designated Marksman—Position Evaluation).
- *DA Form 7682-R (Combat Field Fire Scorecard).

NOTE: These forms, scorecards, and position evaluation sheets are not available through the normal supply channels. You may reproduce them locally on 8 1/2- x 11-inch paper or download them from the Army Publishing Directorate at <http://www.apd.army.mil/>.


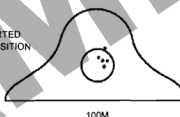
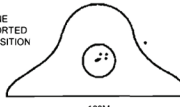




100-, 200- AND 300-METER DOWNRANGE FEEDBACK SCORECARD										
For use of this form see FM 3-22.9, the proponent agency is TRADOC.										
ID CODE <i>D258119</i>			UNIT <i>Cco 329TH INF</i>		DATE (YYYYMMDD) <i>20080311</i>		EVALUATOR'S ID CODE <i>C229001</i>			
ZERO CONFIRMATION			TABLE 1 - DOWNRANGE SILHOUETTES, SUPPORTED FIRING POSITION				TABLE 2 - DOWNRANGE SILHOUETTES, PRONE FIRING POSITION			
RANGE (m)	HIT	MISS	RDS	RANGE (m)	HIT	MISS	RDS	RANGE (m)	HIT	MISS
300	3	0	5	100	5	0	5	100	4	1
ZERO CONFIRMATION REFIRE			10	200	9	1	10	200	10	0
			5	300	3	2	5	300	2	3
RANGE (m)	HIT	MISS	TOTAL				TOTAL			
300					17	3			16	4
ZERO SHOT LOCATIONS			SHOT LOCATIONS							
 300M WIND SPEED (mph): <i>10</i> WIND DIRECTION (use arrow): <i>A</i>			SUPPORTED FIRING POSITION TABLE 1  100M PRONE UNSUPPORTED FIRING POSITION TABLE 2  100M  200M  200M  300M  300M							
REMARKS										
DATE INITIALED (YYYYMMDD) <i>20080311</i>					SCORER'S INITIALS <i>SGB</i>					

Figure B-1. Example of completed DA Form 5239-R (100-, 200-, and 300-Meter Downrange Feedback Scorecard).

SINGLE TARGET FIELD FIRE I SCORECARD																			
For use of this form see FM 3-22.9, the proponent agency is TRADOC.																			
ID CODE <i>D258119</i>				UNIT <i>Cco 329TH INF</i>			DATE (YYYYMMDD) <i>20080306</i>			EVALUATOR'S ID CODE <i>C229001</i>									
TABLE 1 SUPPORTED FIRING POSITION				TABLE 2 SUPPORTED FIRING POSITION				TABLE 3 PRONE FIRING POSITION				TABLE 4 KNEELING FIRING POSITION							
RD	RANGE (m)	TIME (sec)	HIT	MISS	RD	RANGE (m)	TIME (sec)	HIT	MISS	RD	RANGE (m)	TIME (sec)	HIT	MISS	RD	RANGE (m)	TIME (sec)	HIT	MISS
1	75	6	X		1	75	6	X		1	75	6	X		1	75	6	X	
2	175	8	X		2	175	8	X		2	175	8	X		2	175	8	X	
3	300	10	X		3	300	10	X		3	300	10	X		3	75	6	X	
4	175	8	X		4	175	8	X	X	4	175	8	X	X	4	175	8	X	X
5	75	6	X		5	75	6	X		5	75	6	X		5	75	6	X	X
6	300	10	X		6	300	10	X		6	300	10	X		6	175	8	X	X
7	300	10		X	7	300	10		X	7	300	10		X	7	75	6		X
8	75	75	X		8	75	6	X		8	75	6	X		8	75	6	X	
9	175	175	X		9	175	8	X		9	175	8	X		9	175	8	X	
10	175	8	X		10	175	8	X											
11	300	10	X		11	300	10	X	X										
12	175	8	X		12	175	8	X											
13	75	6		X	13	75	6	X											
14	300	10		X	14	300	10	X											
15	175	8	X		15	175	8	X											
16	75	6	X		16	75	6	X											
17	300	10	X		17	300	10	X	X										
18	75	6	X		18	75	6	X											
TOTAL			14	4	TOTAL			14	4	TOTAL			6	3	TOTAL			6	3
SCORE				REMARKS															
TABLE	HIT	MISS	NO FIRE																
1	14	4																	
2	14	4																	
3	6	3																	
4	6	3																	
DATE INITIALED (YYYYMMDD) <i>20080306</i>					SCORER'S INITIALS <i>SGB</i>														



Figure B-2. Example of completed DA Form 3601-R (Single Target—Field Fire I Scorecard).

SINGLE AND MULTIPLE TARGETS FIELD FIRE II SCORECARD																					
For use of this form see FM 3-22.9, the proponent agency is TRADOC.																					
ID CODE D258119				UNIT C Co 729th INF				DATE (YYYYMMDD) 20080117				EVALUATOR'S ID CODE C229001									
TABLE 1 SUPPORTED FIRING POSITION					TABLE 2 SUPPORTED FIRING POSITION					TABLE 3 PRONE FIRING POSITION					SCORE						
RD	RANGE (m)	TIME (sec)	HIT	MISS	RD	RANGE (m)	TIME (sec)	HIT	MISS	RD	RANGE (m)	TIME (sec)	HIT	MISS	TABLE	HIT	MISS				
1	75	5	X		1	175	7	X		1	75	6	X		2	18	4				
2	175	7	X		2	75	10	X		2	175	8	X		3	16	6				
3	75	11	X		3	300			X	3	75		X								
4	300			X	4	75	9	X		4	300			X							
5	75	9	X		5	175		X		5	75	11	X								
6	175			X	6	300	9	X		6	175		X								
7	75	10	X		7	75	9	X		7	75	12	X								
8	300			X	8	175		X		8	300		X								
9	175	11	X		9	175	11	X		9	175	13	X								
10	300			X	10	300			X	10	300			X							
					11	75	9	X		11	75	11	X								
					12	175		X		12	175		X								
					13	175	11	X		13	175	8		X							
					14	300			X	14	75	6	X								
					15	75	5	X		15	75	11	X								
					16	175	11	X		16	175		X								
					17	300			X	17	75	12	X								
					18	75	9	X		18	300			X							
					19	175		X		19	75	11	X								
					20	75	10	X		20	175		X								
					21	300			X	21	175	13		X							
					22	175	7	X		22	300			X							
TOTAL				6	4	TOTAL				18	4	TOTAL				16	6	TOTAL		34	10
REMARKS																					
DATE INITIALED (YYYYMMDD) 20080117										SCORER'S INITIALS SB											

Figure B-3. Example of completed DA Form 5241-R (Single and Multiple Targets—Field Fire II Scorecard).

RECORD FIRE SCORECARD																													
For use of this form see FM 3-22.9, the proponent agency is TRADOC.																													
ID CODE D258119						UNIT C Co 729th INF						DATE (YYYYMMDD) 20080311						EVALUATOR'S ID CODE C229001											
TABLE 1 PRONE SUPPORTED OR FOXHOLE SUPPORTED FIRING POSITION										TABLE 2 PRONE UNSUPPORTED FIRING POSITION										TABLE 3 KNEELING UNSUPPORTED FIRING POSITION									
RD	RANGE (m)	TIME (sec)	HIT	MISS	NO FIRE	RD	RANGE (m)	TIME (sec)	HIT	MISS	NO FIRE	RD	RANGE (m)	TIME (sec)	HIT	MISS	NO FIRE	RD	RANGE (m)	TIME (sec)	HIT	MISS	NO FIRE						
1	50	3	X			11	100	8	X			1	200	6	X			1	150	8	X								
2	200	6	X			12	200		X			2	250	8	X			2	50	4	X								
3	100	4	X			13	150	10	X			3	150	6	X			3	100	5	X								
4	150	5			X	14	300		X			4	300		X			4	150	6	X								
5	300	8			X	15	100	9	X			5	200		X			5	100	5	X								
6	250	7	X			16	250		X			6	150	12	X			6	50	4	X								
7	50	3	X			17	200	6	X			7	200		X			7	100	5	X								
8	200	6	X			18	150	5	X			8	250	9	X			8	150	6	X								
9	150	5	X			19	50		X			9	150		X			9	50	4	X								
10	250	7	X			20	100	6	X			10	150	6	X			10	100	5	X								
TOTAL					8	1	1	TOTAL					9	1	0	TOTAL				10	0	0	TOTAL				9	1	0
SCORE						QUALIFICATION SCORE RATINGS (Check One)												AIMING DEVICE USED (Check One)											
TABLE	HIT	MISS	NO FIRE													Qualified with IBA? <input checked="" type="checkbox"/> YES <input type="checkbox"/> NO													
1	17	2	1	36-40 -- EXPERT												X IRON SIGHT AN/PAS-13 (DAY)													
2	10	0	0	23-25 -- MARKSMAN												BACKUP IRON SIGHT AN/PAS-13 (NIGHT)													
3	9	1	0	30-35 -- SHARPSHOOTER												M8, CCO AN/PAQ-4B/C													
FIRER'S QUALIFICATION SCORE						36												ACOG AN/PEQ-2A/B											
NIGHT FIRE EXERCISE												REMARKS																	
DATE (YYYYMMDD)	HIT	MISS	GO	NO GO																									
20080311	8	2	X																										
CBRN FIRE EXERCISE																													
DATE (YYYYMMDD)	HIT	MISS	GO	NO GO																									
20080311																													
DATE INITIALED (YYYYMMDD) 20080311												SCORER'S INITIALS SB																	
DATE INITIALED (YYYYMMDD) 20080311												OFFICER'S INITIALS SM																	

Figure B-4. Example of completed DA Form 3595-R (Record Fire Scorecard).

RECORD FIRING SCORECARD -- KNOWN DISTANCE COURSE																	
ID CODE (NOT SSN) DZS 8119				UNIT CLB 2/29th INF				DATE (YYYYMMDD) 2011 02 15				EVALUATOR'S ID CODE (NOT SSN) C229001					
TABLE 1 PRONE SUPPORTED OR FOXHOLE SUPPORTED FIRING POSITION (TIME: 120 SECONDS)								TABLE 2 PRONE UNSUPPORTED FIRING POSITION (TIME: 60 SECONDS)				TABLE 3 KNEELING FIRING POSITION (TIME: 60 SECONDS)					
RD	RANGE (m)	HIT	MISS	RD	RANGE (m)	HIT	MISS	RD	RANGE (m)	HIT	MISS	RD	RANGE (m)	HIT	MISS		
1	300 E-SIL	<input checked="" type="checkbox"/>	<input type="checkbox"/>	11	300 E-SIL	<input checked="" type="checkbox"/>	<input type="checkbox"/>	1	200 E-SIL	<input checked="" type="checkbox"/>	<input type="checkbox"/>	1	100 F-SIL	<input checked="" type="checkbox"/>	<input type="checkbox"/>		
2		<input checked="" type="checkbox"/>	<input type="checkbox"/>	12		<input checked="" type="checkbox"/>	<input type="checkbox"/>	2		<input checked="" type="checkbox"/>	<input type="checkbox"/>	2		<input checked="" type="checkbox"/>	<input type="checkbox"/>		
3		<input checked="" type="checkbox"/>	<input type="checkbox"/>	13		<input checked="" type="checkbox"/>	<input type="checkbox"/>	3		<input checked="" type="checkbox"/>	<input type="checkbox"/>	3		<input checked="" type="checkbox"/>	<input type="checkbox"/>		
4		<input checked="" type="checkbox"/>	<input type="checkbox"/>	14		<input checked="" type="checkbox"/>	<input type="checkbox"/>	4		<input checked="" type="checkbox"/>	<input type="checkbox"/>	4		<input checked="" type="checkbox"/>	<input type="checkbox"/>		
5		<input checked="" type="checkbox"/>	<input type="checkbox"/>	15		<input checked="" type="checkbox"/>	<input type="checkbox"/>	5		<input checked="" type="checkbox"/>	<input type="checkbox"/>	5		<input checked="" type="checkbox"/>	<input type="checkbox"/>		
6		<input checked="" type="checkbox"/>	<input type="checkbox"/>	16		<input checked="" type="checkbox"/>	<input type="checkbox"/>	6		<input checked="" type="checkbox"/>	<input type="checkbox"/>	6		<input checked="" type="checkbox"/>	<input type="checkbox"/>		
7		<input checked="" type="checkbox"/>	<input type="checkbox"/>	17		<input checked="" type="checkbox"/>	<input type="checkbox"/>	7		<input checked="" type="checkbox"/>	<input type="checkbox"/>	7		<input checked="" type="checkbox"/>	<input type="checkbox"/>		
8		<input checked="" type="checkbox"/>	<input type="checkbox"/>	18		<input checked="" type="checkbox"/>	<input type="checkbox"/>	8		<input checked="" type="checkbox"/>	<input type="checkbox"/>	8		<input checked="" type="checkbox"/>	<input type="checkbox"/>		
9		<input checked="" type="checkbox"/>	<input type="checkbox"/>	19		<input checked="" type="checkbox"/>	<input type="checkbox"/>	9		<input checked="" type="checkbox"/>	<input type="checkbox"/>	9		<input checked="" type="checkbox"/>	<input type="checkbox"/>		
10		<input checked="" type="checkbox"/>	<input type="checkbox"/>	20		<input checked="" type="checkbox"/>	<input type="checkbox"/>	10		<input checked="" type="checkbox"/>	<input type="checkbox"/>	10		<input checked="" type="checkbox"/>	<input type="checkbox"/>		
TOTAL				6	2	TOTAL				9	1	TOTAL				10	0
SCORE				QUALIFICATION SCORE RATINGS (Check One)								LIGHT		WIND			
TABLE	HIT	MISS	NO FIRE	<input type="checkbox"/> 38-40 -- EXPERT <input type="checkbox"/> 28-32 -- MARKSMAN <input checked="" type="checkbox"/> 33-37 -- SHARPSHOOTER <input type="checkbox"/> 25 AND BELOW -- UNQUALIFIED													
1	17	3	0	FIRER'S QUALIFICATION SCORE								30					
NIGHT FIRE EXERCISE				THE FIRER WILL BE ISSUED 40 ROUNDS. THE ROUNDS WILL BE PRELOADED IN FOUR 10-ROUND MAGAZINES - TWO FOR TABLE 1, AND ONE FOR EACH REMAINING TABLE.								ZERO	D-2	M16A2	FRONT		
DATE (YYYYMMDD)	HIT	MISS	GO									ELEV	4/3	AZ	▲		
2011 02 20	8	2	<input checked="" type="checkbox"/>									WIND	L-3	AZ	▼		
CBRN FIRE EXERCISE																	
DATE (YYYYMMDD)	HIT	MISS	GO														
2011 02 20			<input type="checkbox"/>														
SCORER'S INITIALS				DATE INITIALED (YYYYMMDD)								2011 02 20					
OFFICER'S INITIALS				DATE INITIALED (YYYYMMDD)								2011 02 20					
SGB																	
JBM																	

*Figure B-5. Example of DA Form 5789-R (Record Fire Scorecard—Known Distance Course).

RECORD FIRING SCORECARD -- SCALED TARGET ALTERNATE COURSE																	
ID CODE (NOT SSN) DZS 8119				UNIT CLB 2/29th INF				DATE (YYYYMMDD) 2011 02 20				EVALUATOR'S ID CODE (NOT SSN) C229001					
TABLE 1 PRONE SUPPORTED OR FOXHOLE SUPPORTED FIRING POSITION (TIME: 120 SECONDS)								TABLE 2 PRONE UNSUPPORTED FIRING POSITION (TIME: 60 SECONDS)				TABLE 3 KNEELING FIRING POSITION (TIME: 60 SECONDS)					
RD	RANGE (m)	HIT	MISS	RD	RANGE (m)	HIT	MISS	RD	RANGE (m)	HIT	MISS	RD	RANGE (m)	HIT	MISS		
1	300	<input checked="" type="checkbox"/>	<input type="checkbox"/>	11	150	<input type="checkbox"/>	<input checked="" type="checkbox"/>	1	300	<input type="checkbox"/>	<input checked="" type="checkbox"/>	1	150	<input checked="" type="checkbox"/>	<input type="checkbox"/>		
2	300	<input checked="" type="checkbox"/>	<input type="checkbox"/>	12	150	<input type="checkbox"/>	<input checked="" type="checkbox"/>	2	250	<input checked="" type="checkbox"/>	<input type="checkbox"/>	2	150	<input checked="" type="checkbox"/>	<input type="checkbox"/>		
3	250	<input checked="" type="checkbox"/>	<input type="checkbox"/>	13	100	<input checked="" type="checkbox"/>	<input type="checkbox"/>	3	200	<input checked="" type="checkbox"/>	<input type="checkbox"/>	3	100	<input checked="" type="checkbox"/>	<input type="checkbox"/>		
4	250	<input checked="" type="checkbox"/>	<input type="checkbox"/>	14	100	<input checked="" type="checkbox"/>	<input type="checkbox"/>	4	200	<input checked="" type="checkbox"/>	<input type="checkbox"/>	4	100	<input checked="" type="checkbox"/>	<input type="checkbox"/>		
5	200	<input checked="" type="checkbox"/>	<input type="checkbox"/>	15	100	<input checked="" type="checkbox"/>	<input type="checkbox"/>	5	150	<input checked="" type="checkbox"/>	<input type="checkbox"/>	5	100	<input checked="" type="checkbox"/>	<input type="checkbox"/>		
6	200	<input checked="" type="checkbox"/>	<input type="checkbox"/>	16	100	<input checked="" type="checkbox"/>	<input type="checkbox"/>	6	150	<input checked="" type="checkbox"/>	<input type="checkbox"/>	6	100	<input checked="" type="checkbox"/>	<input type="checkbox"/>		
7	200	<input checked="" type="checkbox"/>	<input type="checkbox"/>	17	100	<input checked="" type="checkbox"/>	<input type="checkbox"/>	7	100	<input checked="" type="checkbox"/>	<input type="checkbox"/>	7	100	<input checked="" type="checkbox"/>	<input checked="" type="checkbox"/>		
8	200	<input checked="" type="checkbox"/>	<input type="checkbox"/>	18	100	<input checked="" type="checkbox"/>	<input type="checkbox"/>	8	100	<input checked="" type="checkbox"/>	<input type="checkbox"/>	8	100	<input checked="" type="checkbox"/>	<input type="checkbox"/>		
9	150	<input checked="" type="checkbox"/>	<input type="checkbox"/>	19	50	<input checked="" type="checkbox"/>	<input type="checkbox"/>	9	100	<input checked="" type="checkbox"/>	<input type="checkbox"/>	9	50	<input checked="" type="checkbox"/>	<input type="checkbox"/>		
10	150	<input checked="" type="checkbox"/>	<input type="checkbox"/>	20	50	<input checked="" type="checkbox"/>	<input type="checkbox"/>	10	50	<input checked="" type="checkbox"/>	<input type="checkbox"/>	10	50	<input checked="" type="checkbox"/>	<input type="checkbox"/>		
TOTAL				9	1	TOTAL				8	2	TOTAL				9	1
SCORE				QUALIFICATION SCORE RATINGS (Check One)								FIRER ISSUED 40 ROUNDS TO ENGAGE 10 TARGETS. THE ROUNDS WILL BE PRELOADED IN ONE 20-ROUND MAGAZINE FOR TABLE 1, ONE 10-ROUND MAGAZINE FOR TABLE 2, AND ONE 10-ROUND MAGAZINE FOR TABLE 3.					
TABLE	HIT	MISS	NO FIRE	<input type="checkbox"/> 36-40 -- EXPERT <input type="checkbox"/> 23-29 -- MARKSMAN <input checked="" type="checkbox"/> 30-35 -- SHARPSHOOTER <input type="checkbox"/> 22 AND BELOW -- UNQUALIFIED													
1	17	3	0	FIRER'S QUALIFICATION SCORE								35					
NIGHT FIRE EXERCISE				REMARKS													
DATE (YYYYMMDD)	HIT	MISS	GO														
20 02 20	8	2	<input checked="" type="checkbox"/>														
CBRN FIRE EXERCISE																	
DATE (YYYYMMDD)	HIT	MISS	GO														
2011 02 20			<input type="checkbox"/>														
SCORER'S INITIALS				DATE INITIALED (YYYYMMDD)								2011 02 20					
OFFICER'S INITIALS				DATE INITIALED (YYYYMMDD)								2011 02 20					
SGB																	
JBM																	

*Figure B-6. Example of completed DA Form 5790-R (Record Fire Scorecard—Scaled Target Alternate Course).

RECORD NIGHT FIRE SCORECARD																															
For use of this form see FM 3-22.9; the proponent agency is TRADOC.																															
ID CODE					UNIT					DATE (YYYYMMDD)					EVALUATOR'S ID CODE																
D258119					Co 2/29th INF					20080301					C229001																
TABLE 1 FOXHOLE SUPPORTED FIRING POSITION										TABLE 2 PRONE UNSUPPORTED FIRING POSITION																					
RD	RANGE (m)	TIME (sec)	HIT	MISS	NO FIRE	RD	RANGE (m)	TIME (sec)	HIT	MISS	NO FIRE	RD	RANGE (m)	TIME (sec)	HIT	MISS	NO FIRE	RD	RANGE (m)	TIME (sec)	HIT	MISS	NO FIRE								
1	50L	3	X			11	100	8	X			1	100	5	X			11	150	8			X								
2	200	6	X			12	200		X			2	200	8	X			12	50R	5			X								
3	100	4	X			13	150	8	X			3	150	6	X			13	100	12			X								
4	150	5		X		14	50R		X			4	50L	12	X			14	200	12			X								
5	100	8		X		15	100	8	X			5	200		X			15	150	12			X								
6	150	5	X			16	150		X			6	150	12	X			16	50L	12			X								
7	50R	3	X			17	200	6	X			7	100	12	X			17	100	12	X		X								
8	200	6	X			18	150	5	X			8	50R		X			18	150	12			X								
9	150	5	X			19	50L	9	X			9	150		X			19	200	12			X								
10	250	7	X			20	250		X			10	100	8	X			20	100				X								
TOTAL					8	2	0	TOTAL					8	2	0	TOTAL					10	0	0	TOTAL					7	3	0
SCORE					QUALIFICATION SCORE RATINGS (Check One)										AIMING DEVICE USED (Check One)																
TABLE	HIT	MISS	NO FIRE		35-40 -- EXPERT					17-23 -- MARKSMAN					AN/PEQ-2A/B																
1	16	4	0		24-34 -- SHARPSHOOTER					16 AND BELOW -- UNQUALIFIED					X AN/PAQ-4B/C																
TOTAL	33	7	0		FIRER'S QUALIFICATION SCORE 33										AN/PIVS-4																
REMARKS																															
DATE INITIALED (YYYYMMDD)										SCORER'S INITIALS																					
20080301										SGB																					
DATE INITIALED (YYYYMMDD)										OFFICER'S INITIALS																					
20080301										JEM																					

Figure B-7. Example of completed DA Form 7489-R (Record Night Fire Scorecard).

SQUAD DESIGNATED MARKSMAN RECORD FIRE I AND II																			
For use of this form, see FM 3-22.9; the proponent agency is TRADOC.																			
ID CODE					UNIT					DATE (YYYYMMDD)					EVALUATOR'S ID CODE				
D258119					Co 2/29th INF					20080115					C229001				
RECORD FIRE I - MECHANICAL SIGHT ADJUSTMENT										RECORD FIRE II - ADJUSTED AIMING POINTS/OPTIC									
TARGET RANGE/POSITION				HIT	MISS	TARGET RANGE/POSITION				HIT	MISS								
100m unsupported				X		100m unsupported					X								
100m unsupported				X		100m unsupported				X									
100m unsupported				X		100m unsupported				X									
100m unsupported				X		100m unsupported				X									
200m supported					X	200m supported				X									
200m supported				X		200m supported				X									
200m unsupported				X		200m unsupported				X									
200m unsupported				X		200m unsupported				X									
300m supported					X	300m supported				X									
300m supported				X		300m supported				X									
300m unsupported				X		300m unsupported				X									
300m unsupported				X		300m unsupported				X									
400m supported				X		400m supported				X									
400m supported				X		400m supported				X									
400m supported				X		400m supported				X									
400m supported				X		400m supported				X									
500m supported				X		500m supported				X									
500m supported				X		500m supported				X									
500m supported				X		500m supported				X									
500m supported				X		500m supported				X									
TOTAL					17	3	TOTAL					19	1						
X PASS (14-20)					FAIL (13 and below)					X PASS (14-20)					FAIL (13 and below)				
DATE INITIALED (YYYYMMDD)										SCORER'S INITIALS									
20080115										SGB									
DATE INITIALED (YYYYMMDD)										OFFICER'S INITIALS									
20080115										JEM									

Figure B-8. Example of completed DA Form 7649-R (Squad Designated Marksman—Record Fire I and II).

COMBAT FIELD FIRE SCORECARD						
For use of this form, see FM 3-22.9; the proponent agency is TRADOC.						
NAME <i>Bradshaw Ethan</i>		RANK <i>SFC</i>		UNIT <i>40 2/29th INF</i>		
EVALUATOR'S NAME <i>Morello, James E</i>		RANK <i>SFC</i>		DATE (YYYYMMDD) <i>2011 01 24</i>		
TABLE 1 KNEELING UNSUPPORTED FIRING POSITION						TOTAL NUMBER OF HITS <i>6</i>
RANGE (METERS)	HITS REQUIRED	EXPOSURE TIME (SECONDS)	HITS			
50 (Left)	2	31	<input checked="" type="checkbox"/>	<input checked="" type="checkbox"/>		
50 (Right)	2	31	<input checked="" type="checkbox"/>	<input checked="" type="checkbox"/>		
100	1	45	<input type="checkbox"/>	<input type="checkbox"/>		
150	2	60	<input checked="" type="checkbox"/>	<input checked="" type="checkbox"/>		
TABLE 2 - SET 1 BARRICADE SUPPORTED FIRING POSITION						TOTAL NUMBER OF HITS <i>8</i>
RANGE (METERS)	HITS REQUIRED	EXPOSURE TIME (SECONDS)	HITS			
50 (Left or Right)	3	26	<input checked="" type="checkbox"/>	<input checked="" type="checkbox"/>	<input checked="" type="checkbox"/>	
100	2	40	<input checked="" type="checkbox"/>	<input checked="" type="checkbox"/>		
TABLE 2 - SET 2 BARRICADE SUPPORTED FIRING POSITION						TOTAL NUMBER OF HITS <i>8</i>
RANGE (METERS)	HITS REQUIRED	EXPOSURE TIME (SECONDS)	HITS			
100	1	19	<input checked="" type="checkbox"/>	<input type="checkbox"/>		
150	2	21	<input checked="" type="checkbox"/>	<input type="checkbox"/>		
200	1	40	<input checked="" type="checkbox"/>	<input type="checkbox"/>		
TABLE 3 - SET 1 PRONE UNSUPPORTED FIRING POSITION						TOTAL NUMBER OF HITS <i>10</i>
RANGE (METERS)	HITS REQUIRED	EXPOSURE TIME (SECONDS)	HITS			
100	2	23	<input checked="" type="checkbox"/>	<input checked="" type="checkbox"/>		
200	2	36	<input checked="" type="checkbox"/>	<input checked="" type="checkbox"/>		
250	1	50	<input checked="" type="checkbox"/>	<input type="checkbox"/>		
TABLE 3 - SET 2 PRONE UNSUPPORTED FIRING POSITION						TOTAL NUMBER OF HITS <i>10</i>
RANGE (METERS)	HITS REQUIRED	EXPOSURE TIME (SECONDS)	HITS			
150	2	21	<input checked="" type="checkbox"/>	<input checked="" type="checkbox"/>		
250	2	37	<input checked="" type="checkbox"/>	<input checked="" type="checkbox"/>		
300	1	50	<input checked="" type="checkbox"/>	<input type="checkbox"/>		
AIMING DEVICE USED (Check One)		RATINGS			TOTAL NUMBER OF HITS FOR ALL TABLES <i>24</i>	
<input type="checkbox"/> IRON SIGHT <input type="checkbox"/> BACKUP IRON SIGHT <input checked="" type="checkbox"/> M68, CCO <input type="checkbox"/> ACOG	<input type="checkbox"/> AN/PAS-13 (DAY) <input type="checkbox"/> AN/PAS-13 (NIGHT) <input type="checkbox"/> AN/PAQ-4B/C <input type="checkbox"/> AN/PEQ-2A/B	<input checked="" type="checkbox"/> Trained - 24 to 26 hits <input type="checkbox"/> Partially Trained - 16 to 23 hits <input type="checkbox"/> Untrained - 15 or fewer hits				
REMARKS						
EVALUATOR'S INITIALS <i>JEM</i>				DATE INITIALED <i>2011 01 24</i>		
OFFICER'S INITIALS <i>LBC</i>				DATE INITIALED <i>2011 01 24</i>		

*Figure B-9. Example of completed DA Form 7682-R (Combat Field Fire Scorecard).

Appendix F

10-Meter Target Offsets and 25-Meter Zero Offsets

*This section provides the 10-meter target offsets and the 25-meter zero offsets for M16- and M4-series weapons mounted with iron sights, optics, MILES, or aiming lasers. A blank, reproducible 10-meter target offset (Figure F-2) and an example of each weapon configuration (Figures F-3 through F-6) are provided. The M16A2 300-meter zeroing target is used for 25-meter zeroing with all weapon configurations, except when zeroing with iron sights. 200-meter supplemental zero 10- and 25-meter offsets are also shown in Figures F-7 through F-10.

MARKING 10-METER TARGET OFFSETS

- F-1. To mark the proper 10-meter target offsets—
- (1) Find the correct template for the weapon configuration.
 - (2) Starting from the center of the borelight circle on the offset, count the number of squares to the desired point of aim.

EXAMPLE

L2.0, U2.4

Starting from the center of the borelight circle (0.0, 0.0), move left 2 squares and up 2.4 squares.

NOTE: Each template also provides a number formula for the proper offset.

- (3) Place the appropriate symbol or mark (Figure F-1).

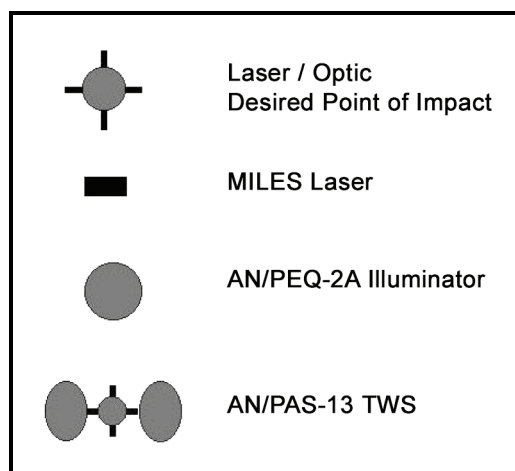


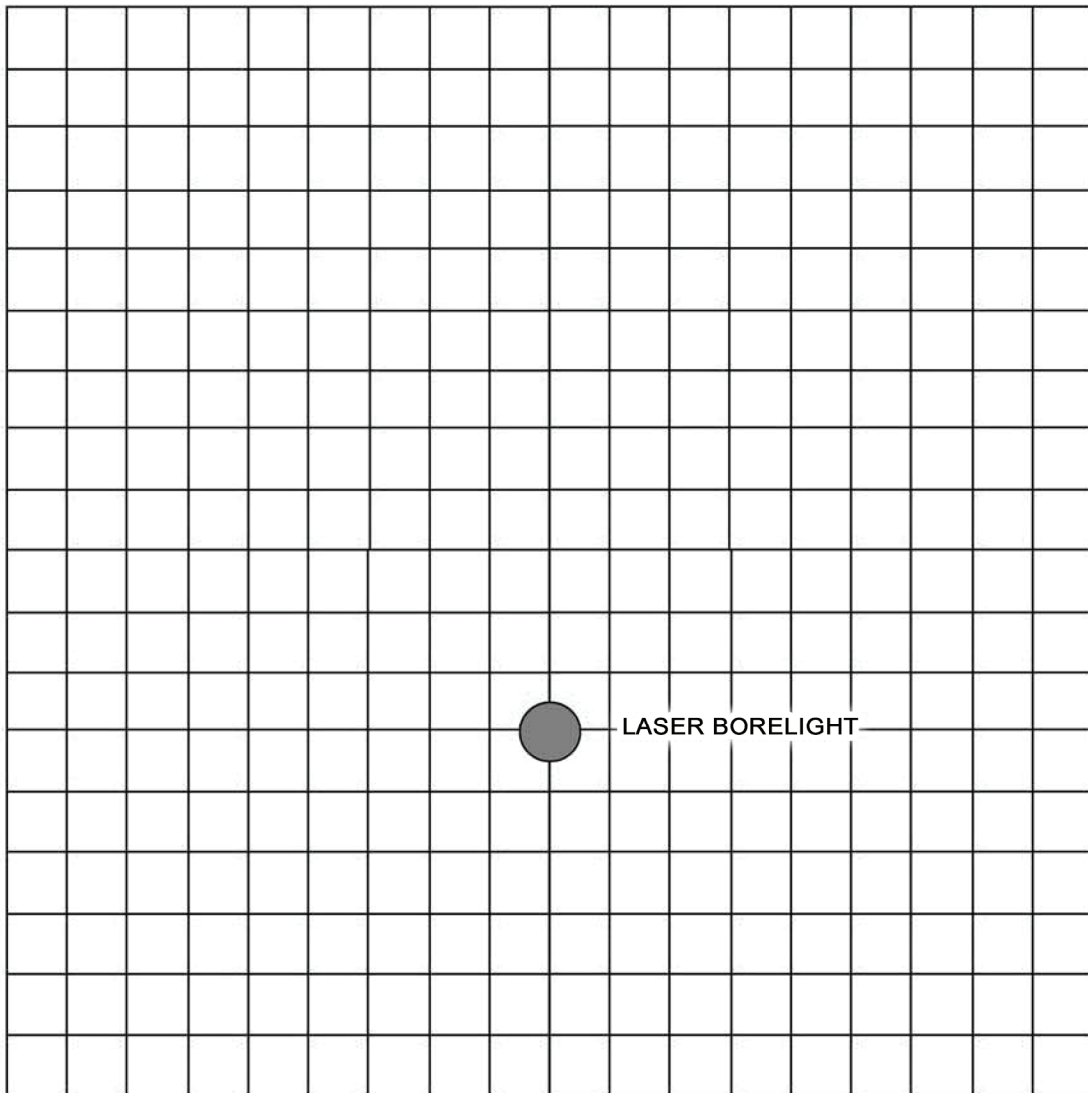
Figure F-1. 10-meter target offset symbols.

MARKING 25-METER ZERO OFFSETS

- F-2. To mark the proper 25-meter zero offsets—
- (1) Use only a M16A2 300-meter zeroing target.
 - (2) Find the correct target template for the weapon configuration.
 - (3) Count the number of squares, starting from the center of the 300-meter zeroing silhouette.
 - (4) Mark the designated strike point by drawing a small circle at the appropriate number of squares from the center of the 300-meter zeroing silhouette.
 - (5) Draw a 4- by 4-centimeter square, keeping the designated strike point at the center.

-
- NOTES:**
1. To reproduce the 10-meter target offset, copy the blank 10-meter target offset and place the example of the weapon being used on the back. This reproducible copy can be laminated and used repeatedly.
 2. Table F-1 provides offset mounting information for various weapon configurations.
-

10-METER BORESIGHT TARGET



- 1 - USE THE CORRECT OFFSET FOR THE WEAPON, SIGHT AND LOCATION CONFIGURED
- 2 - STABILIZE THE WEAPON AND THE OFFSET
- 3 - ZERO BORELIGHT WHILE INSIDE THE BARREL OF THE WEAPON
- 4 - ALIGN THE LASER OF THE BORELIGHT WITH THE DOT ON THE 10M OFFSET
- 5 - ALIGN THE MILES LASER WITH THE MILES RECTANGLE ON THE 10M OFFSET (IF APPLICABLE)
- 6 - ADJUST AIMING LASER UNTIL CENTERED ON CROSSHAIR
- 7 - PLACE OPTIC AIMPOINT CENTERED ON CROSSHAIR AND MAKE ADJUSTMENTS ON OPTIC UNTIL THE BORELIGHT LASER IS ALIGNED WITH THE DOT ON THE 10M OFFSET
- 8 - RECONFIRM ALL DEVICES ARE STILL ALIGNED TO THEIR AIMING MARK

US Army ARDEC
AMSTA-AR-CCL-A
AMSTA-AR-FSF-R
Picatinny Arsenal, NJ 07089

Figure F-2. Blank 10-meter target offset.

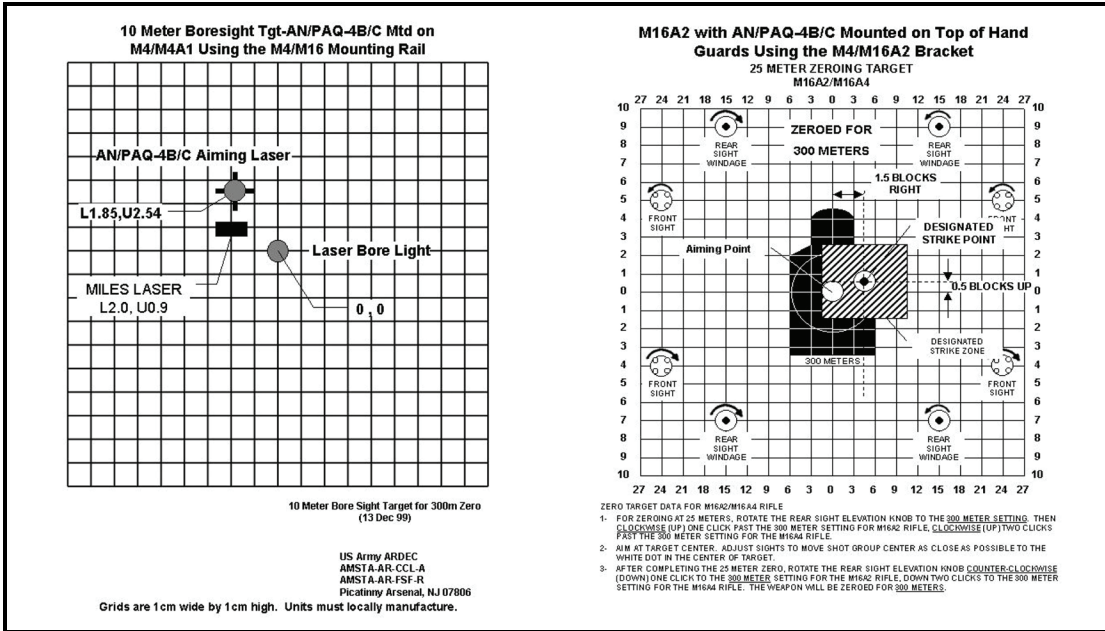


Figure F-3. M16A2 10-meter boresighting target/25-meter zeroing target offsets.

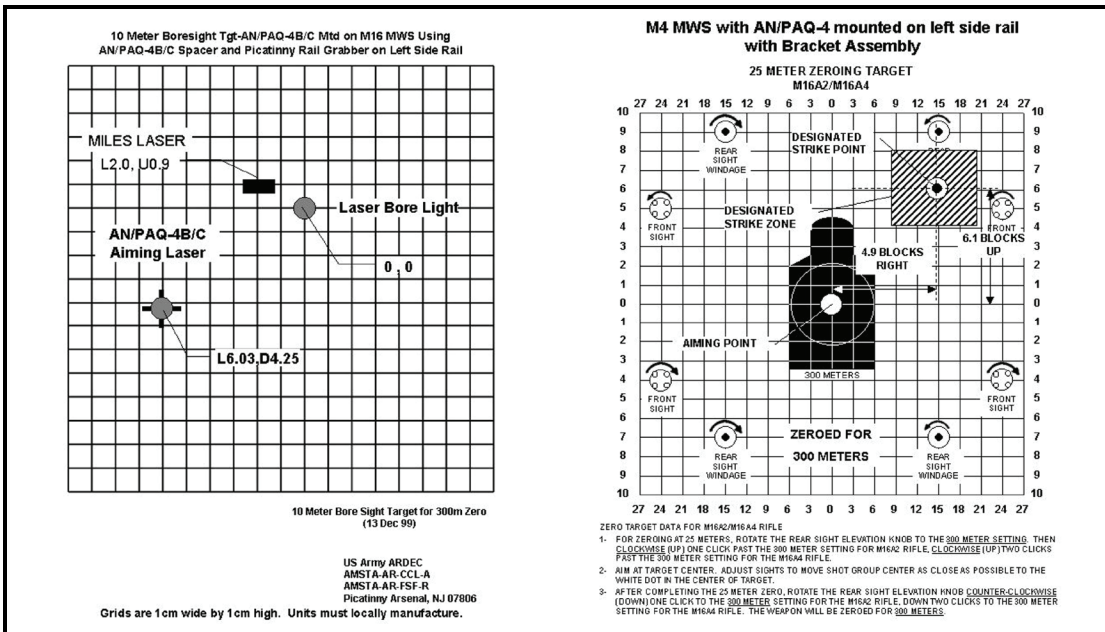


Figure F-4. M4 MWS 10-meter boresighting target/25-meter zeroing target offsets.

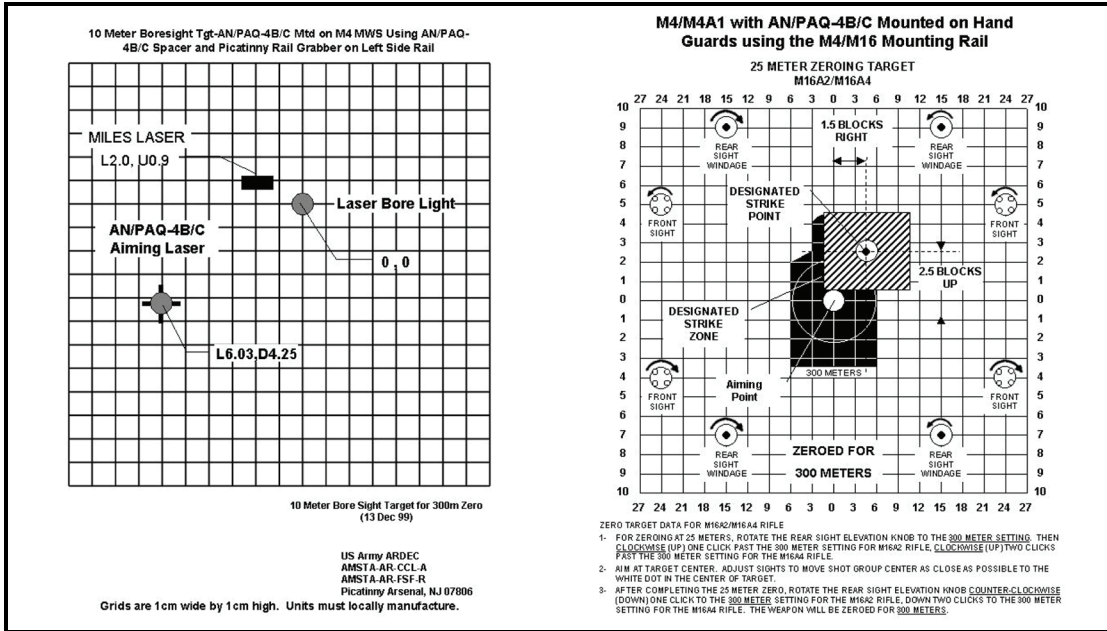


Figure F-5. M4/M4A1 10-meter boresighting target/25-meter zeroing target offsets.

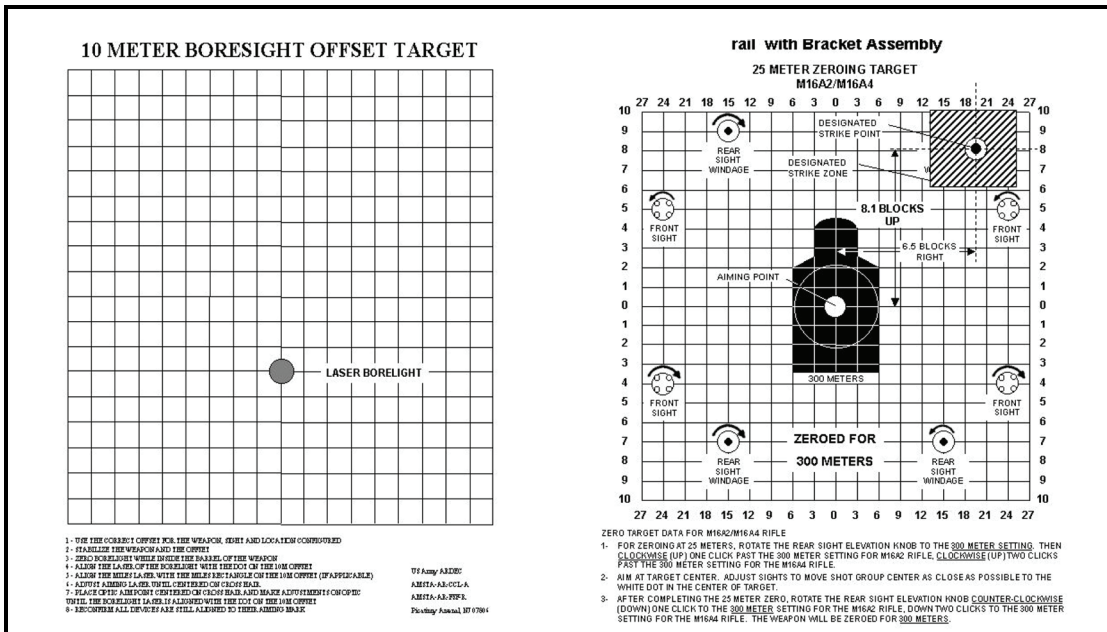


Figure F-6. M16A4 MWS 10-meter boresighting target/25-meter zeroing target offsets.

Table F-1. Offset mounting.

WEAPON	ACCESSORY	RAIL GRABBER	MOUNT	LOCATION	RANGE TO ZERO	ZERO OFFSET	BORESIGHT TARGET	MILES OFFSET
M16A2	Iron sight	N/A	N/A	N/A	300 m	0.0 0.0	0.0 4.2U	2.0L 0.9U
M16A2	M68	N/A	M68 gooseneck bracket	Carrying handle	300 m	0.0 1.4 cm DN	0.0 5.2U	2.0L 2.4U
M16A2	LTWS	TWS	TWS bracket assembly	Carrying handle	300 m	0.0 10D	0.0 13.4U	2.0L 2.4U
M16A2	TWS	N/A	TWS bracket assembly	Carrying handle	300 m	0.0 8.1D	0.0 11.5U	2.0L 2.4U
M16A2	AN/PVS-4	N/A	AN/PVS-4 mounting knob	Carrying handle	300 m	0.0 7.0D	0.0 9.4U	2.0L 0.9U
M16A2	AN/PAQ-4B/C	N/A	M4/M16 bracket	Hand guards	300 m	1.5R 0.5U	1.85L 2.54U	2.0L 0.9U
M16A2	AN/PEQ-2A/B	N/A	M4/M16 bracket	Hand guards	300 m	1.5L 0.5U	1.8R 2.4U	2.0L 0.9U
M16/M203	AN/PAQ-4B/C	N/A	Spacer and AN/PVS-4 mounting knob	Carrying handle	300 m	1.85R 2.6D	1.85L 8.6U	2.0L 3.9U
M16/M203	AN/PVS-4	N/A	AN/PVS-4 mounting bracket assembly	Carrying handle	300 m	4.2R 9.8D	TBD	2.0L 0.9U
M4/M4A1	BUIS	N/A	N/A	Upper receiver	300 m	0.0 0.0	0.0 4.01U	2.0L 0.9U
M4/M4A1	AN/PAQ-4B/C	N/A	M4/M16 bracket	Hand guards	300 m	1.5R 2.5U	1.85L 2.54U	2.0L 0.9U
M4/M4A1	LTWS	TWS	N/A	Upper receiver	300 m	0.0 4.5D	0.0 7.9U	TBD
M4/M4A1	TWS	Picatinny	TWS spacer and rail grabber	Upper receiver	300 m	0.0 5.7D	0.0 9.4U	2.0L 2.4U
M4/M4A1	AN/PEQ-2A/B	N/A	M4/M16 bracket	Hand guards	300 m	1.0L 0.3U	1.8R 2.4U	2.0L 0.9U
M4/M4A1	AN/PVS-4	Picatinny	Spacer and rail grabber	Upper receiver	300 m	0.0 3.4D	0.0 7.6U	2.0L 0.9U
M4/M4A1	M68	M68	Half-moon spacer	Upper receiver	300 m	0.0 1.4 cm DN	0.0 5.63U	2.0L 2.4U
M4/M203	BUIS	N/A	N/A	Upper receiver	300 m	0.0 0.0	0.0 6.01U	2.0L 0.9U
M4/M203	AN/PAQ-4B/C	N/A	Spacer and AN/PVS-4 mounting knob	Carrying handle	300 m	1.3R 1.9D	1.85L 8.6U	2.0L 0.9U
M4/M203	AN/PVS-4	Picatinny	Spacer and rail grabber	Upper receiver	300 m	0.0 3.4D	0.0 9.6U	2.0L 3.9U

NOTE: Target offsets not yet developed are indicated by TBD (to be developed).

*Table F-1. Offset mounting (continued).

WEAPON	ACCESSORY	RAIL GRABBER	MOUNT	LOCATION	RANGE TO ZERO	ZERO OFFSET	BORESIGHT TARGET	MILES OFFSET
M4 MWS	BUIS	N/A	N/A	Upper receiver	300 m	0.0 0.0	0.0 4.01U	2.0L 0.9U
M4 MWS	AN/PVS-4	Picatinny	Spacer and rail grabber	Upper receiver	300 m	0.0 3.4D	0.0 7.6U	2.0L 0.9U
M4 MWS	M68	M68	Rail grabber	Upper receiver	300 m	0.0 1.4 cm DN	0.0 5.63U	2.0L 2.4U
M4 MWS	LTWS	TWS	N/A	Upper receiver	300 m	0.0 4.5D	0.0 7.9U	2.0L 2.4U
M4 MWS	TWS	TWS	Spacer	Upper receiver	300 m	0.0 5.7D	0.0 9.4U	2.0L 2.4U
M4 MWS	ANPEQ-2A	Insight	N/A	Left	300 m	TBD	4.5L 1.0D	2.0L 0.9U
M4 MWS	AN/PEQ-2A/B	Insight	N/A	Right	300 m	N/A	5.5R 5.4D	2.0L 0.9U
M4 MWS	AN/PEQ-2A/B	Insight	N/A	Top	300 m	1.5L 0.5D	2.9R 2.3U	2.0L 0.9U
M4 MWS	AN/PEQ-2A/B	Picatinny	Spacer	Top	300 m	N/A	1.95R 4.1U	2.0L 0.9U
M4 MWS	AN/PEQ-2A/B	Picatinny	Spacer	Right	300 m	N/A	6.35R 4.4D	2.0L 0.9U
M4 MWS	AN/PEQ-2A/B	Picatinny	Spacer	Left	300 m	6.9R 2.0U	6.2L 0.60D	2.0L 0.9U
M4MWS	AN/PEQ-2A/B	Insight	Training adapter	Top	300 m	2.0L 1.5D	N/A	2.0L 0.9U
M4 MWS	AN/PAQ-4B/C	Picatinny	AN/PAQ-4B/C bracket adapter	Top	300 m	4.9R 6.1U	1.75L 3.9U	2.0L 0.9U
M4 MWS	AN/PAQ-4B/C	Picatinny	AN/PAQ-4B/C bracket adapter (spacer)	Right	300 m	N/A	6.9R 0.9D	2.0L 0.9U
M4 MWS	AN/PAQ-4B/C	Insight	N/A	Top	300 m	N/A	1.75L 2.15U	2.0L 0.9U
M4MWS	AN/PAQ-4B/C	Insight	N/A	Right	300 m	N/A	4.35R 0.65D	2.0L 0.9U
M4MWS	AN/PAQ-4B/C	Insight	N/A	Left	300 m	N/A	4.30L 4.25D	2.0L 0.9U
M4 MWS M203	BUIS	N/A	N/A	Upper receiver	300 m	0.0 0.0	0.0 6.01U	2.0L 0.9U
M4 MWS M203	AN/PAQ-4B/C	Picatinny	Bracket adapter (spacer)	Left	300 m	4.9R 6.1U	6.0L 4.0D	2.0L 3.9U
M4 MWS M203	AN/PVS-4	Picatinny	Spacer	Upper receiver	300 m	0.0 3.4D	0.0 9.6U	2.0L 3.9U
M16A4 MWS	BUIS	N/A	N/A	Upper receiver	300 m	0.0 0.0	0.0 4.01U	2.0L 0.9U
M16A4 MWS	AN/PAQ-4B/C	Picatinny	AN/PAQ-4B/C bracket adapter (spacer)	Left	300 m	6.5R 8.1U	6.03L 4.25D	2.0L 0.9U
M16A4 MWS	TWS	TWs	Spacer	Upper receiver	300 m	0.0 6.0D	0.0 9.4U	2.0L 2.4U
M16A4 MWS	M68	M68	N/A	Upper receiver	300 m	0.0 1.4 cm DN	0.0 5.63U	2.0L 2.4U
M16A4 MWS	AN/PEQ-2A/B	Insight	N/A	Left	300 m	3.0R 3.0U	4.5L 1.0D	2.0L 0.9U
M16A4 MWS	AN/PVS-4	Picatinny	Spacer	Upper receiver	300 m	0.0 4.6D	0.0 7.6U	2.0L 0.9U

NOTE: Target offsets not yet developed are indicated by TBD (to be developed).

Table F-1. Offset mounting (continued).

WEAPON	ACCESSORY	RAIL GRABBER	MOUNT	LOCATION	RANGE TO ZERO	ZERO OFFSET	BORESIGHT TARGET	MILES OFFSET
M16A4 MWS M203	BUIS	N/A	N/A	Upper receiver	300 m	0.0 0.0	0.0 6.01U	2.0L 0.9U
M16A4 MWS M203	AN/PAQ-4B/C	Picatinny	AN/PAQ-4B/C bracket adapter (spacer)	Left	300 m	6.5R 8.1U	6.0L 4.0D	2.0L 3.9U
M16A4 MWS M203	AN/PVS-4	Picatinny	Spacer	Upper receiver	300 m	0.0 4.6D	0.0 9.6U	2.0L 3.9U
M16A4 MWS	AN/PEQ-2A/B	Picatinny	Spacer	Left	300 m	6.0R 2.0U	6.2L 0.60D	2.0L 0.9U
M16A4 MWS	AN/PEQ-2A/B	Picatinny	Spacer	Right	300 m	TBD	6.35R 4.4D	2.0L 0.9U
M16A4 MWS	AN/PEQ-2A/B	Picatinny	Spacer	Top	300 m	TBD	1.95R 4.1U	2.0L 0.9U
M16A4 MWS	AN/PEQ-2A/B	Insight	N/A	Right	300 m	TBD	5.5R 5.4 D	2.0L 0.9U
M16A4 MWS	AN/PEQ-2A/B	Insight	N/A	Top	300 m	1.5L 0.5D	2.0R 2.3U	2.0L 0.9U
M16A4 MWS	AN/PEQ-2A/B	Insight	Training adapter	Top	300 m	2.0L 1.5D	TBD	2.0L 0.9D
M16A4 MWS	AN/PAQ-4B/C	Picatinny	AN/PAQ-4B/C bracket adapter	Top	300 m	4.9R 6.1U	1.75L 3.9U	2.0L 0.9U
M16A4 MWS	AN/PAQ-4B/C	Picatinny	AN/PAC-4B/C bracket adapter	Right	300 m	N/A	6.0R 0.9D	2.0L 0.9U
M16A4 MWS	AN/PAQ-4B/C	Insight	N/A	Top	300 m	N/A	1.75L 2.15U	2.0L 0.9U
M16A4 MWS	AN/PAQ-4B/C	Insight	N/A	Right	300 m	N/A	4.35R 0.65D	2.0L 0.9U
M16A4 MWS	AN/PAQ-4B/C	Insight	N/A	Left	300 m	N/A	4.30L 4.25D	2.0L 0.9U

NOTE: Target offsets not yet developed are indicated by TBD (to be developed).

***MARKING 25-METER ZERO OFFSETS FOR 200 METERS**

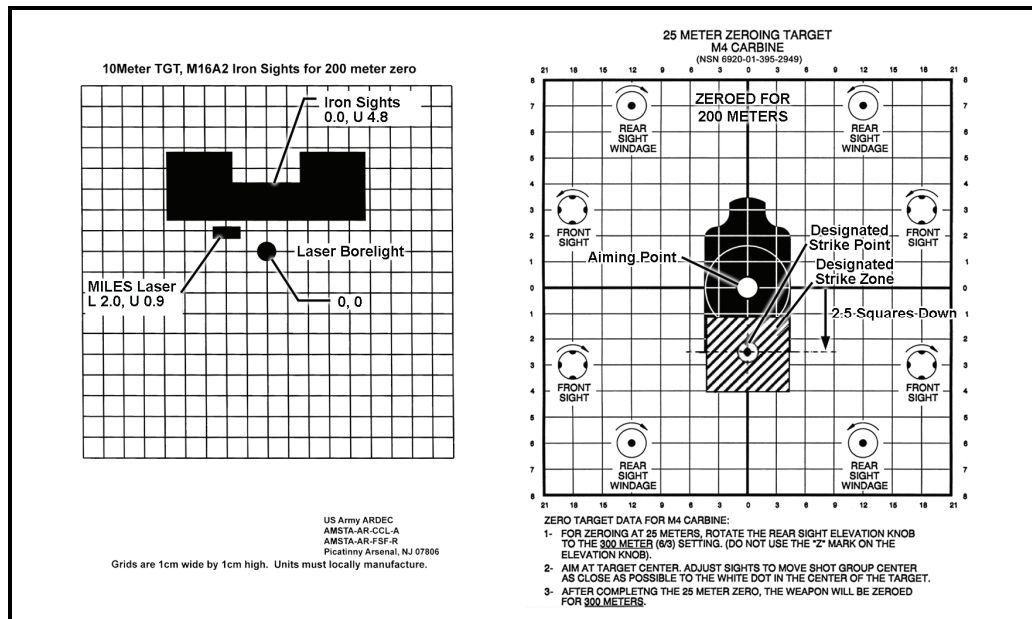
F-3. To mark the proper 25-meter zero offsets for 200 meters (Figures F-7 through F-10)—

- (1) Use an M16A2 300-meter zeroing target.

NOTE: If zeroing iron sights, use the target appropriate to the weapon being zeroed.

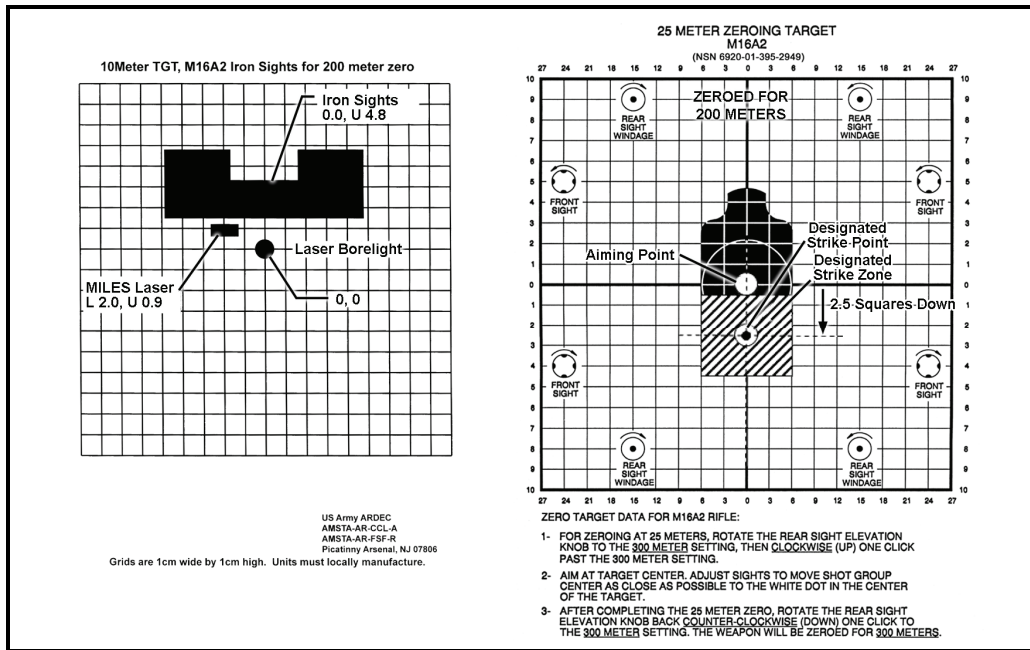
- (2) Find the correct target template for the weapon configuration.
- (3) Count the number of squares, starting from the center of the 300-meter zeroing silhouette.
- (4) Mark the designated strike point by drawing a small circle at the appropriate number of squares from the center of the 300-meter zeroing silhouette.
- (5) Draw a 4- by 4-centimeter square, keeping the designated strike point at the center.

NOTE: For zeroing at 25 meters with the BUIS (Figure F-7), place the elevation knob on the 200-meter setting. The point of impact for the rounds will be a 4- by 4-centimeter square, with the center of the square 2.5 centimeters down from the target's center of mass.



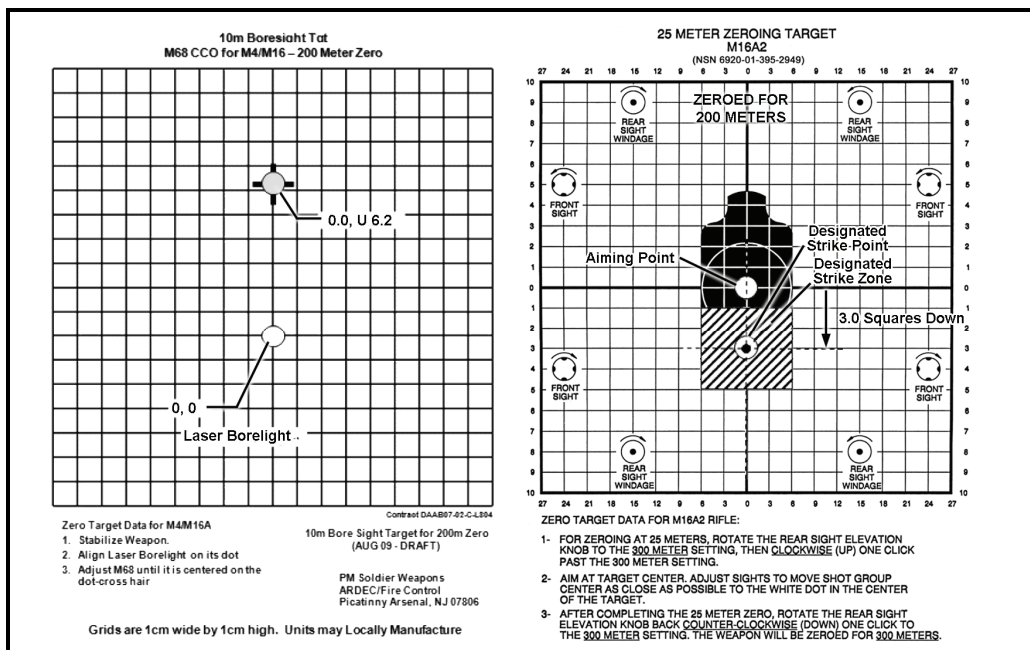
***Figure F-7. 200-meter zero of the back-up iron sights for M4 carbine.**

NOTE: For zeroing at 25 meters with the BUIS (Figure F-8), place the elevation knob on the 200-meter setting. The point of impact for the rounds will be a 4- by 4-centimeter square, with the center of the square 2.5 centimeters down from the target's center of mass.



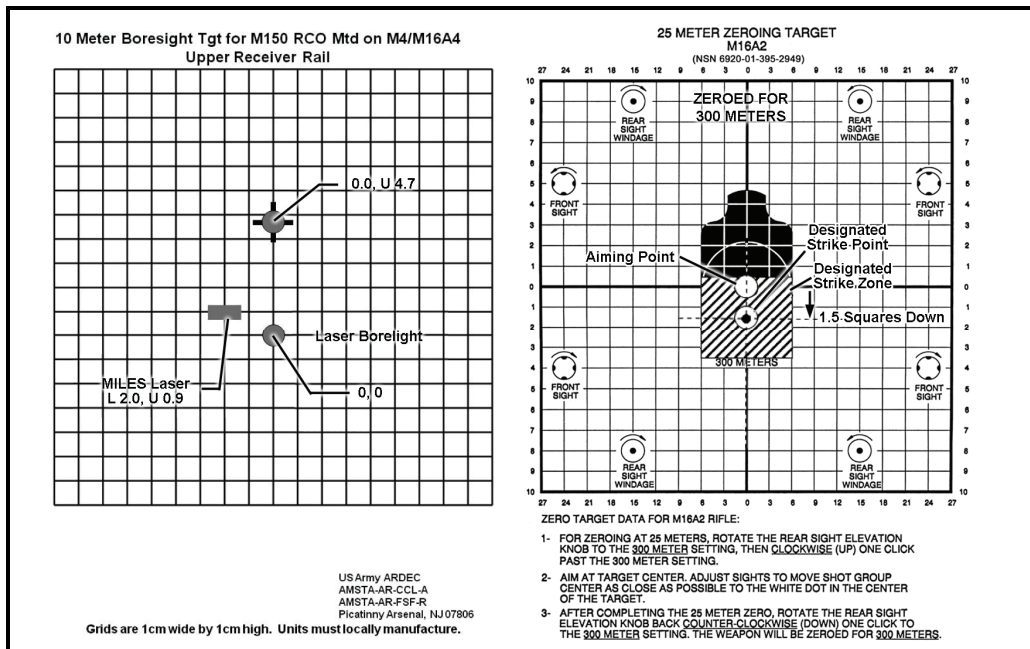
***Figure F-8. 200-meter zero of the back-up iron sights for M16-series weapons.**

NOTE: For zeroing at 25 meters with the CCO (Figure F-9), place the dot at the target's center of mass. The point of impact for the rounds will be a 4- by 4-centimeter square, with the center of the square three centimeters down from the target's center of mass.

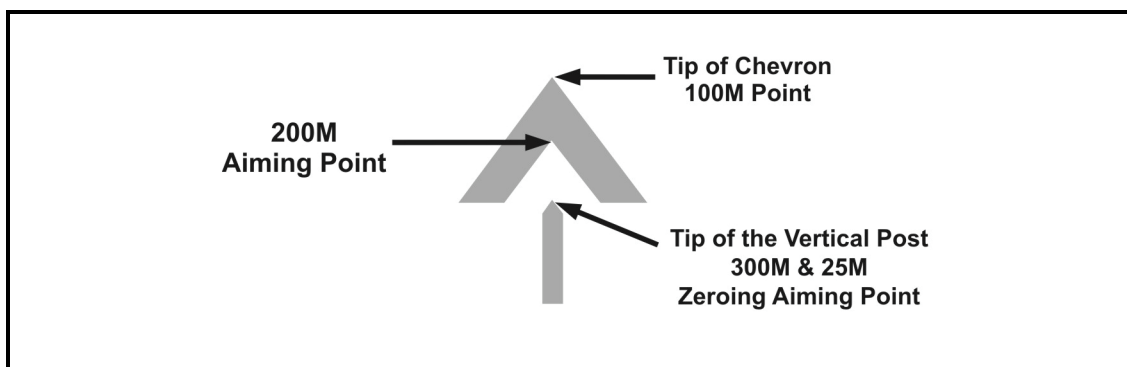


***Figure F-9. 200-meter zero of the close combat optic for M16-series weapons.**

- NOTES:**
1. When zeroing the ACOG (Figure F-10), a 100-meter true zero is preferred. When engaging targets at 200 meters with the ACOG, use the 200-meter aiming point tip (tip at the inside of the chevron), if time allows (Figure F-11).
 2. For the ACOG 25-meter zero, Soldiers should use the 300-meter point of aim (tip of the 300-meter post at the target's center of mass) and point of impact (a 4- by 4-centimeter square drawn 1.5 centimeters down from the target's center of mass).
 3. The 10-meter boresight offset shown in Figure F-10 is for use with the M150 rifle combat optic. Soldiers equipped with earlier versions of the ACOG should use the M68 CCO 10-meter boresight offset for 300 meters.



***Figure F-10. 300-meter zero of the advanced combat optical gunsight.**



***Figure F-11. Advanced combat optical gunsight points of aim (100 to 300 meters).**

This page intentionally left blank.

*Index

NUMBERS

10-meter boresight (*see also* weapon characteristics, accessories, and ammunition), 2-33 to 2-34
10-meter boresight, 2-34, 2-34 (*illus*)
borelight, 2-33 to 2-34, 2-33 (*illus*)
*10-meter target offsets, F-1 to F-8 marking, F-1, F-1 (*illus*), F-3 (*illus*), F-4 (*illus*), F-5 (*illus*), F-6 to F-8 (*table*)
*25-meter zero offsets (*see also* weapon characteristics, accessories, and ammunition and zeroing procedures), 2-34, 2-34 (*illus*), F-2 to F-11 marking, F-2
M16A2, F-4 (*illus*)
M16A4 MWS, F-5 (*illus*)
M4/M4A1, F-5 (*illus*)
M4 MWS, F-4 (*illus*)
*offset mounting, F-6 to F-8 (*table*)
marking for 200 meters, F-9, F-9 (*illus*)
advanced combat optic gunsight, F-11, F-11 (*illus*)
close combat optic, F-10, F-10 (*illus*)
iron sights/back-up iron sights, F-10, F-10 (*illus*)

A

accessories (*see also* weapon characteristics, accessories, and ammunition), 2-16 to 2-39
advanced combat optical gunsight (*see also* advanced combat optical gunsight, M4-series carbine, and M16-series rifle), 2-31 to 2-33 2-31 (*illus*)
AN/PEQ-15 advanced target pointer/illuminator/aiming light (*see also* AN/PEQ-15 advanced target pointer/-illuminator/aiming light, M4-series carbine, and M16-series rifle), 2-24 to 2-25, 2-25 (*illus*)

AN/PVS-4 night vision sight (*see also* AN/PVS-4 night vision sight, M4-series carbine, and M16-series rifle), 2-28 to 2-29, 2-28 (*illus*)
backup iron sight (*see also* backup iron sight), 2-30, 2-30 (*illus*)
characteristics, 2-16 (*table*)
compatibility and mounting, 2-16 (*table*)
heavy thermal weapon sight (*see also* heavy weapon thermal sight, M4-series carbine, and M16-series rifle), 2-26 to 2-27, 2-26 (*illus*)
infrared aiming light (*see also* infrared aiming light, M4-series carbine, and M16-series rifle), 2-19 to 2-21, 2-19 (*illus*)
light thermal weapon sight (*see also* light thermal weapon sight, M4-series carbine, and M16-series rifle), 2-26 to 2-27, 2-26 (*illus*)
M68 close combat optic (*see also* M68 close combat optic, M4-series carbine, and M16-series rifle), 2-17 to 2-19, 2-17 (*illus*)
target pointer/illuminator/aiming light (*see also* target pointer/illuminator/aiming light, M4-series carbine, and M16-series rifle), 2-21 to 2-24, 2-22 (*illus*)

accessory mounting (*see also* weapon characteristics, accessories, and ammunition), 2-10 to 2-16
M4/M5 adapter rail system (*see also* M4/M5 adapter rail system), 2-10 to 2-13, 2-3 (*illus*), 2-11 (*illus*)
rail grabbers (*see also* rail grabbers), 2-13 to 2-16

advanced combat optical gunsight (*see also* accessories, M4-series carbine, M16-series rifle, and advanced optics, lasers, and iron sights), 2-31 to 2-33, 2-31 (*illus*)
boresighting, 8-7
mounting on
M16A1, 2-32 to 2-33, 2-32 (*illus*), 2-33 (*illus*)
M16A2, 2-32 to 2-33, 2-32 (*illus*), 2-33 (*illus*)
M16A3, 2-32 to 2-33, 2-32 (*illus*), 2-33 (*illus*)
M16A4, 2-31 to 2-32, 2-31 (*illus*)
M4 carbine, 2-31 to 2-32, 2-31 (*illus*)
training strategies and qualification standards, 8-16 to 8-20, 8-17 (*table*)
concept, 8-17
conduct of training, 8-17
modified fundamentals, 8-19
operation, 8-17 to 8-18, 8-18 (*illus*)
practice qualification, 8-19
record qualification, 8-20
target detection, 8-19
zeroing the advanced combat optical gunsight, 8-18 to 8-19, 8-18 (*illus*), 8-19 (*illus*)
advanced optics, lasers, and iron sights (*see also* accessories), 8-1 to 8-30
borelight (*see also* borelight), 8-1 to 8-11
training strategies and qualification standards, 8-11 to 8-28
*advanced rifle marksmanship, 7-1 to 7-74
advanced firing positions (*see also* firing positions), 7-1 to 7-8

chemical, biological, radiological, and nuclear firing (*see also* chemical, biological, radiological, and nuclear firing), 7-24 to 7-29

*combat field fire (*see also* combat field fire), 7-57 to 7-62

combat fire techniques (*see also* combat fire techniques), 7-8 to 7-24

moving target engagements (*see also* moving target engagements), 7-36 to 7-41, 7-36 (*table*)

night fire training (*see also* night fire training), 7-30 to 7-35

short-range marksmanship training (*see also* short-range marksmanship training), 7-41 to 7-57

*squad designated marksman training (*see also* squad designated marksman training), 7-62 to 7-74

aided night vision (*see also* aided night vision), C-4 to C-9

aiming lasers (*see also* aiming lasers), C-6

electromagnetic (light) spectrum, C-4

image-intensification devices, C-4

thermal weapon sight, C-4

image-intensification devices, C-4 to C-5

adjustments, C-4 to C-5

thermal weapon sight (*see also* thermal weapon sight), C-6 to C-9

aiming lasers (*see also* night fighting *and* aided night vision), C-6

infrared discipline, C-6

scanning, C-6

walking, C-6

alternate qualification courses (*see also* field fire *and* record qualification), 6-17 to 6-21

15-meter scaled target alternate course, 6-21

25-meter scaled target alternate course, 6-18 to 6-20

*conduct, 6-18 to 6-19, 6-19 (*table*)

time between firing positions, 6-19

*duties of range personnel, 6-19

ratings, 6-20, 6-20 (*table*)

scoring, 6-20

known distance record fire range, 6-17 to 6-18

conduct, 6-18, 6-18 (*table*)

qualification ratings, 6-18, 6-18 (*table*)

record of performance, 6-18

ammunition (*see also* weapon characteristics, accessories, and ammunition), 2-35 to 2-39

authorized ammunition, 2-35 to 2-36, 2-35 (*table*), 2-36 (*table*)

storage, 2-39

trajectory, 2-37 to 2-39, 2-37 (*illus*), 2-38 (*illus*), 2-39 (*illus*)

AN/PEQ-15 advanced target pointer/illuminator/aiming light (*see also* accessories, M4-series carbine, and M16-series rifle), 2-24 to 2-25, 2-25 (*illus*)

mounting on

M16A4, 2-25, 2-25 (*illus*)

M4 MWS, 2-25, 2-25 (*illus*)

AN/PVS-4 night vision sight (*see also* accessories, M4-series carbine, M16-series rifle, *and* advanced optics, lasers, and iron sights), 2-28 to 2-29, 2-28 (*illus*)

mounting on

M16A4, 2-28 to 2-29, 2-28 (*illus*)

M4 carbine, 2-28 to 2-29, 2-28 (*illus*)

M16A1, 2-29, 2-29 (*illus*)

M16A2, 2-29, 2-29 (*illus*)

M16A3, 2-29, 2-29 (*illus*)

boresighting, 8-10 to 8-11

training strategies and qualification standards, 8-28 to 8-30, 8-28 (*table*)

25-meter zeroing procedures, 8-29

concept, 8-29

conduct of training, 8-29

field fire, 8-30

modified fundamentals, 8-29

practice qualification, 8-30

record qualification, 8-30

target detection, 8-30

automatic or burst fire (*see also* combat fire techniques), 7-12 to 7-16

effectiveness and control, 7-12

factors for use, 7-12 to 7-13

modifications, 7-13 to 7-14

training, 7-15 to 7-16, 7-15 (*table*)

B

backup iron sight (*see also* accessories *and* advanced optics, lasers, and iron sights), 2-30, 2-30 (*illus*)

boresighting using, 8-6

training strategies and qualification standards, 8-11 to 8-12, 8-11 (*table*)

concept, 8-11

conduct of training, 8-12

*ballistics (*see also* downrange feedback), 5-33 to 5-38

*bullet dispersion at range, 5-37

*increase of shot group size, 5-38, 5-38 (*illus*)

*minute of angle, 5-37, 5-38 (*illus*)

*external ballistics, 5-35 to 5-37

*air resistance (drag), 5-35

*altitude or air density, 5-35

*angles, 5-36 to 5-37

*gravity, 5-35

*muzzle velocity, 5-35

*temperature, 5-35

*trajectory, 5-36

*wind, 5-36

*internal ballistics, 5-33 to 5-34, 5-34 (*illus*)

*M855 and M193 ammunition, 5-33 to 5-34, 5-34 (*illus*)

*terminal ballistics, 5-37

borelight (*see also* advanced optics, lasers, and iron sights), 8-1 to 8-11

boresighting, 8-6 to 8-11

advanced combat optical gunsight (*see also* advanced combat optical gunsight), 8-7

AN/PAQ-4B (*see also* infrared aiming light), 8-8 to 8-9

AN/PAQ-4C (*see also* infrared aiming light), 8-8 to 8-9

AN/PEQ-2A (*see also* target pointer/illuminator/aiming light), 8-9 to 8-10

AN/PEQ-2B (*see also* target pointer/illuminator/aiming light), 8-9 to 8-10

AN/PVS-4 (*see also* AN/PVS-4 night vision sight), 8-10 to 8-11

thermal weapon sight (*see also* light weapon iron sight and heavy weapon iron sight), 8-8

using the backup iron sights (*see also* backup iron sights), 8-6

using the M68 close combat optic (*see also* M68 close combat optic), 8-6 to 8-7

concept, 8-2

training program, 8-2 (*table*)

weapon/aided-vision device combinations, 8-1 (*table*)

zeroing, 8-2 to 8-5, 8-3 (*illus*), 8-4 (*illus*), 8-5 (*illus*)

C

chemical, biological, radiological, and nuclear firing (*see also* advanced rifle marksmanship), 7-24 to 7-29

mission-oriented protective posture equipment fire, 7-24 to 7-29

modifications, 7-24 to 7-28

immediate action, 7-25

marksmanship fundamentals, 7-25 to 7-28, 7-26 to 7-27 (*illus*)

operation and function, 7-25

training, 7-28 to 7-29

50-meter live-fire exercise, 7-29

alternate fire exercise, 7-29

conduct, 7-28, 7-28 (*table*)

downrange feedback, 7-28 to 7-29

dry-fire exercises, 7-28

clearing (*see also* preliminary marksmanship instruction), 4-2 to 4-3, 4-3 (*illus*)

*combat field fire (*see also* advanced rifle marksmanship), 7-57 to 7-62

*conduct, 7-58 to 7-62, 7-58 (*table*), 7-59 (*illus*), 7-60 (*illus*), 7-60 (*table*), 7-61 (*illus*), 7-61 (*table*), 7-62 (*table*)

*concept, 7-57, 7-58 (*table*)

*record of performance, 7-62, 7-62 (*table*)

combat fire techniques (*see also* advanced rifle marksmanship), 7-8 to 7-24

automatic or burst fire (*see also* automatic or burst fire), 7-12 to 7-16

quick fire (*see also* quick fire), 7-19 to 7-24

rapid semiautomatic fire (*see also* rapid semiautomatic fire), 7-8 to 7-12

suppressive fire (*see also* suppressive fire), 7-16 to 7-19

composite risk management, D-3 to D-9, D-4 (*table*), D-5 (*table*), D-6 (*table*)

DA Form 7566 (Composite Risk Management Worksheet) (*see also* DA Form), D-7 to D-9, D-8 (*illus*), D-9 (*table*)

responsibilities, D-6 to D-7

computer-controlled ranges (*see also* range procedures and range operations checklist), E-10 to E-15

range selection, E-10 to E-15, E-10 (*table*)

automated field fire range, E-12, E-12 (*illus*)

automated record fire range, E-13, E-13 (*illus*)

modified record fire range, E-14, E-14 (*illus*)

qualification training range, E-15, E-15 (*illus*)

rifle/machine gun zero range, E-11, E-11 (*illus*)

cycles of functioning (*see also* preliminary marksmanship instruction), 4-4 to 4-10

chambering, 4-5, 4-5 (*illus*)

cocking, 4-10, 4-10 (*illus*)

ejecting, 4-9, 4-9 (*illus*)

extracting, 4-8, 4-8 (*illus*)

feeding, 4-4, 4-4 (*illus*)

firing, 4-7, 4-7 (*illus*)

locking, 4-6, 4-6 (*illus*)

unlocking, 4-8, 4-8 (*illus*)

D

DA Form

3595-R (Record Fire Scorecard)

example of completed form, B-3 (*illus*)

reproducible form, B-1

3601-R (Single Target—Field Fire I Scorecard)

example of completed form, B-2 (*illus*)

reproducible form, B-1

5239-R (100-, 200-, and 300-Meter Downrange Feedback Scorecard)

example of completed form, B-2 (*illus*)

reproducible form, B-1

5241-R (Single and Multiple Targets—Field Fire II Scorecard)

example of completed form, B-3 (*illus*)

reproducible form, B-1

5789-R (Record Fire Scorecard—Known Distance Course)

example of completed form, B-4 (*illus*)

reproducible form, B-1

5790-R (Record Fire Scorecard—Scaled Target Alternate Course)

example of completed form, B-4 (*illus*)

reproducible form, B-1

7489-R (Record Night Fire Scorecard)

example of completed form, B-5 (*illus*)

reproducible form, B-1

7566 (Composite Risk Management Worksheet) (*see also* composite risk management), D-7 to D-9, D-8 (*illus*), D-9 (*table*)

7649-R (Squad Designated Marksman—Record Fire I and II)
 example of completed form, B-5 (*illus*)
 reproducible form, B-1

7650-R (Squad Designated Marksman—Position Evaluation)
 reproducible form, B-1

*7682-R (Combat Field Fire Scorecard)
 *example of completed form, B-6 (*illus*)
 *reproducible form, B-1

destruction procedures (*see also* troubleshooting and destruction), 3-7 to 3-8
 degree of damage, 3-8
 methods of destruction, 3-8, 3-8 (*table*)
 priorities of destruction, 3-8

dominant eye training (*see also* preliminary marksmanship instruction), 4-24

*downrange feedback, 5-1 to 5-38
 ballistics (*see also* ballistics), 5-33 to 5-38
 *effects of wind and gravity (*see also* effects of wind and gravity), 5-26 to 5-32
 grouping procedures (*see also* grouping procedures), 5-1 to 5-14, 5-1 (*table*)
 *known distance range (*see also* known distance range), 5-19 to 5-26, 5-20 (*table*)
 zeroing procedures (*see also* zeroing procedures), 5-14 to 5-19, 5-14 (*table*)

*dry-fire training (*see also* squad designated marksman training), 7-66 to 7-67
 *borelight exercise, 7-66
 *dime/washer drill, 7-67
 *follow-through, 7-66
 *target box exercise, 7-67
 *zero confirmation, 7-67

E

*effects of wind and gravity (*see also* downrange feedback), 5-26 to 5-32
 *gravity (*see also* gravity), 5-26 to 5-27, 5-27 (*illus*)
 *wind (*see also* wind), 5-29 to 5-32

Engagement Skills Trainer 2000 (*see also* preliminary marksmanship instruction and training aids, devices, and exercises), 4-29 to 4-30, A-1 to A-4, A-1 (*illus*)
 general characteristics, A-2 to A-3
 laser safety, A-4
 marksmanship training, A-2
 basic rifle marksmanship training, A-2
 individual and unit sustainment training, A-2
 remedial marksmanship training, A-2
 scenario editor, A-3
 shoot/don't shoot rules of engagement training, A-3
 tactical collective training, A-3
 weapon safety, A-4

F

*field fire, 6-1 to 6-21, 6-1 (*table*)
 100 to 500 meters (*see also* squad designated marksman training), 7-73 to 7-74
 *certification, 7-74
 *conduct, 7-73 to 7-74, 7-73 (*table*)
 alternate qualification courses (*see also* alternate qualification courses), 6-17 to 6-21
 field fire training (*see also* field fire training), 6-7 to 6-10
 record qualification (*see also* record qualification), 6-11 to 6-17
 target detection (*see also* target detection), 6-1 to 6-6

field fire training (*see also* field fire), 6-7 to 6-10
 conduct of a field fire range, 6-7 to 6-8
 organization, 6-7
 peer coaching, 6-7
 recording, 6-8

automated, 6-8
 manual, 6-8
 remedial training, 6-7

Field Fire I (single timed target), 6-8 to 6-9
 concept, 6-8
 conduct, 6-8 to 6-9, 6-9 (*table*)

Field Fire II (multiple or single timed targets), 6-9 to 6-10
 concept, 6-9
 conduct, 6-10, 6-10 (*table*)

firing positions
 advanced (*see also* advanced rifle marksmanship), 7-1 to 7-8
 kneeling supported firing position, 7-2, 7-2 (*illus*)
 modified firing positions, 7-5, 7-5 (*illus*)
 standing supported firing position
 around obstacles, 7-4, 7-4 (*illus*)
 standing unsupported firing position, 7-3, 7-3 (*illus*)
 urban operations firing positions, 7-6 to 7-8
 firing around obstacles, 7-7, 7-7 (*illus*)
 firing from windows, 7-8, 7-8 (*illus*)
 firing over rooftops, 7-6, 7-6 (*illus*)

basic (*see also* preliminary marksmanship instruction), 4-24 to 4-28
 individual foxhole supported firing position, 4-25, 4-25 (*illus*)
 kneeling unsupported firing position, 4-28, 4-28 (*illus*)
 prone supported firing position, 4-27, 4-27 (*illus*)
 prone unsupported firing position, 4-25 to 4-26, 4-26 (*illus*)

interceptor body armor adjustments to firing positions (*see also* interceptor body armor), 4-16

fundamentals

- of marksmanship (*see also* preliminary marksmanship instruction), 4-16 to 4-24
- aiming, 4-19 to 4-21, 4-19 (*illus*), 4-20 (*illus*), 4-21 (*illus*)
- breath control, 4-21 to 4-22, 4-22 (*illus*)
- steady position, 4-16 to 4-19, 4-17 (*illus*)
- trigger squeeze, 4-22 to 4-24
- of short-range marksmanship (*see also* short-range marksmanship training), 7-42 to 7-47
- aiming techniques, 7-45
- aimed quick kill, 7-45
- instinctive fire, 7-45
- rapid aimed fire, 7-45
- slow aimed fire, 7-45
- firing stance, 7-42 to 7-43
- movement techniques, 7-44 to 7-45
- point of aim, 7-45 to 7-46
 - incapacitating shot placement, 7-46, 7-46 (*illus*)
 - lethal shot placement, 7-46, 7-46 (*illus*)
- trigger manipulation, 7-47
 - automatic fire, 7-47
 - controlled pair, 7-47
 - failure drill, 7-47
- weapon ready positions, 7-43 to 7-44
 - high ready position, 7-43, 7-43 (*illus*)
 - low ready position, 7-44, 7-44 (*illus*)

G

- *gravity (*see also* effects of wind and gravity), 5-26 to 5-27
- *adjusted point of aim based on gravity, 5-26 to 5-27, 5-27 (*illus*)
- grouping procedures (*see also* downrange feedback), 5-1 to 5-14, 5-1 (*table*)
- concept, 5-2
- conduct of a 25-meter grouping firing, 5-2 to 5-3
- multiple shot group analysis (*see also* multiple shot group analysis), 5-7 to 5-13, 5-8 (*illus*)

- organization of a 25-meter grouping range, 5-2, 5-2 (*illus*)
- shot group marking, 5-3 to 5-4, 5-4 (*illus*)
- single shot group analysis (*see also* single shot group analysis), 5-4 to 5-7
- troubleshooting the fundamentals, 5-14, 5-14 (*table*)

H

- heavy thermal weapon sight (*see also* accessories, M4-series carbine, M16-series rifle, *and* advanced optics, lasers, and iron sights)
 - AN/PAS-13B (V3), 2-26 to 2-27, 2-26 (*illus*)
 - boresighting, 8-8
 - compatibility and mounting, 2-16 (*table*)
 - mounting on
 - M16A1, 2-27, 2-27 (*illus*)
 - M16A2, 2-27, 2-27 (*illus*)
 - M16A3, 2-27, 2-27 (*illus*)
 - M16A4, 2-26 to 2-27, 2-26 (*illus*)
 - M4 carbine, 2-26 to 2-27, 2-26 (*illus*)
 - training strategies and qualification standards, 8-20 to 8-23, 8-20 (*table*)
 - 25-meter zeroing procedures, 8-21 to 8-22, 8-22 (*illus*)
 - concept, 8-20
 - conduct of training, 8-20
 - modified fundamentals, 8-21
 - practice qualification, 8-23
 - record qualification, 8-23
 - target detection, 8-22 to 8-23
- AN/PAS-13C (V3), 2-26 to 2-27, 2-26 (*illus*)
- boresighting, 8-8
- compatibility and mounting, 2-16 (*table*)
- mounting on
 - M16A1, 2-27, 2-27 (*illus*)
 - M16A2, 2-27, 2-27 (*illus*)
 - M16A3, 2-27, 2-27 (*illus*)
 - M16A4, 2-26 to 2-27, 2-26 (*illus*)
 - M4 carbine, 2-26 to 2-27, 2-26 (*illus*)
- training strategies and qualification standards, 8-20 to 8-23, 8-20 (*table*)

- 25-meter zeroing
 - procedures, 8-21 to 8-22, 8-22 (*illus*)
 - concept, 8-20
 - conduct of training, 8-20
 - modified fundamentals, 8-21
 - practice qualification, 8-23
 - record qualification, 8-23
 - target detection, 8-22 to 8-23
- AN/PAS-13D (V3), 2-26 to 2-27, 2-26 (*illus*)
- boresighting, 8-8
- compatibility and mounting, 2-16 (*table*)
- mounting on
 - M16A1, 2-27, 2-27 (*illus*)
 - M16A2, 2-27, 2-27 (*illus*)
 - M16A3, 2-27, 2-27 (*illus*)
 - M16A4, 2-26 to 2-27, 2-26 (*illus*)
 - M4 carbine, 2-26 to 2-27, 2-26 (*illus*)
- training strategies and qualification standards, 8-20 to 8-23, 8-20 (*table*)
- 25-meter zeroing
 - procedures, 8-21 to 8-22, 8-22 (*illus*)
 - concept, 8-20
 - conduct of training, 8-20
 - modified fundamentals, 8-21
 - practice qualification, 8-23
 - record qualification, 8-23
 - target detection, 8-22 to 8-23

*hold-off

- *100 to 500 meters (*see also* squad designated marksman training), 7-70 to 7-73
- *elevation, 7-71, 7-71 (*illus*)
- *windage, 7-72 to 7-73, 7-72 (*illus*), 7-72 (*table*), 7-73 (*table*)

I

- infrared aiming light (*see also* accessories, M4-series carbine, M16-series rifle, *and* advanced optics, lasers, and iron sights)
 - AN/PAQ-4B, 2-19 to 2-21, 2-19 (*illus*)

boresighting, 8-8 to 8-9
 compatibility and mounting, 2-16 (*table*)
 mounting on
 M16A1, 2-21, 2-21 (*illus*)
 M16A2, 2-21, 2-21 (*illus*)
 M16A3, 2-21, 2-21 (*illus*)
 M16A4, 2-20, 2-20 (*illus*)
 M4 carbine, 2-21, 2-21 (*illus*)
 M4 MWS, 2-20, 2-20 (*illus*)
 training strategies and
 qualification standards, 8-23 to 8-28, 8-24 (*table*)
 25-meter zeroing procedures, 8-25 to 8-27, 8-26 (*illus*)
 concept, 8-24
 conduct of training, 8-24
 field fire, 8-27
 modified fundamentals, 8-24 to 8-25
 practice qualification, 8-28
 record qualification, 8-28
 target detection, 8-27
 AN/PAQ-4C, 2-19 to 2-21, 2-19 (*illus*)
 boresighting, , 8-8 to 8-9
 compatibility and mounting, 2-16 (*table*)
 mounting on
 M16A1, 2-21, 2-21 (*illus*)
 M16A2, 2-21, 2-21 (*illus*)
 M16A3, 2-21, 2-21 (*illus*)
 M16A4, 2-20, 2-20 (*illus*)
 M4 carbine, 2-21, 2-21 (*illus*)
 M4 MWS, 2-20, 2-20 (*illus*)
 training strategies and
 qualification standards, 8-23 to 8-28, 8-24 (*table*)
 25-meter zeroing procedures, 8-25 to 8-27, 8-26 (*illus*)
 concept, 8-24
 conduct of training, 8-24
 field fire, 8-27
 modified fundamentals, 8-24 to 8-25
 practice qualification, 8-28
 record qualification, 8-28
 target detection, 8-27
 initial entry training (*see also* marksmanship training strategy and training), 1-2, 1-2 (*illus*)

interceptor body armor (*see also* preliminary marksmanship instruction), 4-15 to 4-16, 4-15 (*illus*)
 adjustments to firing positions (*see also* firing positions), 4-16
 proper wear and fit, 4-15
 wear of helmets with interceptor body armor, 4-16

K

*known distance range (*see also* downrange feedback), 5-19 to 5-26, 5-20 (*table*)
 25-meter zero standard, 5-27, 5-27 (*illus*)
 *concept, 5-19 to 5-20
 *conduct of a standard known distance range, 5-23 to 5-24, 5-25 (*illus*)
 *75-meter targets, 5-24
 *175-meter targets, 5-24
 *300-meter targets, 5-24
 *known distance record fire range, 5-24
 known distance shot grouping analysis, 5-22, 5-22 (*illus*)
 known distance target description, 5-20 to 5-21, 5-21 (*illus*)
 *known distance zeroing, 5-23
 marking known distance range targets, 5-21, 5-21 (*illus*)
 *modified field fire range, 5-24
 *record of performance, 5-25

L

Laser Marksmanship Training System (*see also* preliminary marksmanship instruction and training aids, devices, and exercises), 4-30, A-5 to A-12
 equipment, A-5, A-5 (*table*), A-6 (*table*)
 exercises, A-8 to A-12
 grouping and zeroing exercise, A-10 to A-11, A-10 (*table*), A-11 (*illus*)
 interactive dry-fire exercise, A-9 to A-10, A-9 (*table*), A-10 (*illus*)

laser marksmanship training strategy
 prequalification exercise, A-11 to A-12, A-11 (*table*), A-12 (*illus*)
 reflective target exercise, A-8 to A-9, A-8 (*table*), A-8 (*illus*)
 marksmanship training, A-6 to A-7
 remedial training, A-7
 sustainment training, A-7
 sound and recoil replicator, A-12
 light thermal weapon sight (*see also* accessories, M4-series carbine, M16-series rifle, and advanced optics, lasers, and iron sights)
 AN/PAS-13B (V1), 2-26 to 2-27, 2-26 (*illus*)
 boresighting, 8-8
 compatibility and mounting, 2-16 (*table*)
 mounting on
 M16A1, 2-27, 2-27 (*illus*)
 M16A2, 2-27, 2-27 (*illus*)
 M16A3, 2-27, 2-27 (*illus*)
 M16A4, 2-26 to 2-27, 2-26 (*illus*)
 M4 carbine, 2-26 to 2-27, 2-26 (*illus*)
 training strategies and
 qualification standards, 8-20 to 8-23, 8-20 (*table*)
 25-meter zeroing procedures, 8-21 to 8-22, 8-22 (*illus*)
 concept, 8-20
 conduct of training, 8-20
 modified fundamentals, 8-21
 practice qualification, 8-23
 record qualification, 8-23
 target detection, 8-22 to 8-23
 AN/PAS-13C (V1), 2-26 to 2-27, 2-26 (*illus*)
 boresighting, 8-8
 compatibility and mounting, 2-16 (*table*)
 mounting on
 M16A1, 2-27, 2-27 (*illus*)
 M16A2, 2-27, 2-27 (*illus*)

- M16A3, 2-27, 2-27 (*illus*)
M16A4, 2-26 to 2-27, 2-26 (*illus*)
M4 carbine, 2-26 to 2-27, 2-26 (*illus*)
training strategies and qualification standards, 8-20 to 8-23, 8-20 (*table*)
25-meter zeroing procedures, 8-21 to 8-22, 8-22 (*illus*)
concept, 8-20, conduct of training, 8-20
modified fundamentals, 8-21
practice qualification, 8-23
record qualification, 8-23
target detection, 8-22 to 8-23
AN/PAS-13D (V1), 2-26 to 2-27, 2-26 (*illus*)
boresighting, 8-8
compatibility and mounting, 2-16 (*table*)
mounting on
M16A1, 2-27, 2-27 (*illus*)
M16A2, 2-27, 2-27 (*illus*)
M16A3, 2-27, 2-27 (*illus*)
M16A4, 2-26 to 2-27, 2-26 (*illus*)
M4 carbine, 2-26 to 2-27, 2-26 (*illus*)
training strategies and qualification standards, 8-20 to 8-23, 8-20 (*table*)
25-meter zeroing procedures, 8-21 to 8-22, 8-22 (*illus*)
concept, 8-20, conduct of training, 8-20
modified fundamentals, 8-21
practice qualification, 8-23
record qualification, 8-23
target detection, 8-22 to 8-23
- M**
- M16A1 rifle (*see also* M16-series rifle), 2-9 (*illus*)
battlesight zeroing, 2-10, 2-10 (*illus*)
point of impact, 2-10 (*table*)
characteristics, 2-1, 2-1 (*table*)
mechanically zeroing, 2-9 to 2-10, 2-9 (*illus*)
mounting accessories (*see also* accessories)
advanced combat optical gunsight (*see also* advanced combat optical gunsight), 2-32 to 2-33, 2-32 (*illus*), 2-33 (*illus*)
AN/PVS-4 night vision sight (*see also* AN/PVS-4 night vision sight), 2-29, 2-29 (*illus*)
compatibility and mounting, 2-16 (*table*)
heavy thermal weapon sight (*see also* heavy weapon thermal sight)
AN/PAS-13B (V3), 2-27, 2-27 (*illus*)
AN/PAS-13C (V3), 2-27, 2-27 (*illus*)
AN/PAS-13D (V3), 2-27, 2-27 (*illus*)
infrared aiming light (*see also* infrared aiming light)
AN/PAQ-4B, 2-21, 2-21 (*illus*)
AN/PAQ-4C, 2-21, 2-21 (*illus*)
light thermal weapon sight (*see also* light weapon thermal sight)
AN/PAS-13B (V1), 2-27, 2-27 (*illus*)
AN/PAS-13C (V1), 2-27, 2-27 (*illus*)
AN/PAS-13D (V1), 2-27, 2-27 (*illus*)
M68 close combat optic (*see also* M68 close combat optic), 2-18, 2-18 (*illus*)
target pointer/illuminator/aiming light (*see also* target pointer/illuminator/aiming light)
AN/PEQ-2A, 2-23, 2-23 (*illus*)
AN/PEQ-2B, 2-23, 2-23 (*illus*)
- M16A2 rifle (*see also* M16-series rifle), 2-5 to 2-33, 2-5 (*illus*)
battlesight zeroing, 2-6 to 2-7, 2-6 (*illus*)
point of impact, 2-7 (*table*)
characteristics, 2-1, 2-1 (*table*)
mechanically zeroing, 2-6, 2-6 (*illus*)
- mounting accessories (*see also* accessories)
advanced combat optical gunsight (*see also* advanced combat optical gunsight), 2-32 to 2-33, 2-32 (*illus*), 2-33 (*illus*)
AN/PVS-4 night vision sight (*see also* AN/PVS-4 night vision sight), 2-29, 2-29 (*illus*)
compatibility and mounting, 2-16 (*table*)
heavy thermal weapon sight (*see also* heavy weapon thermal sight)
AN/PAS-13B (V3), 2-27, 2-27 (*illus*)
AN/PAS-13C (V3), 2-27, 2-27 (*illus*)
AN/PAS-13D (V3), 2-27, 2-27 (*illus*)
infrared aiming light (*see also* infrared aiming light)
AN/PAQ-4B, 2-21, 2-21 (*illus*)
AN/PAQ-4C, 2-21, 2-21 (*illus*)
light thermal weapon sight (*see also* light weapon thermal sight)
AN/PAS-13B (V1), 2-27, 2-27 (*illus*)
AN/PAS-13C (V1), 2-27, 2-27 (*illus*)
AN/PAS-13D (V1), 2-27, 2-27 (*illus*)
M68 close combat optic (*see also* M68 close combat optic), 2-18, 2-18 (*illus*)
target pointer/illuminator/aiming light (*see also* target pointer/illuminator/aiming light)
AN/PEQ-2A, 2-23, 2-23 (*illus*)
AN/PEQ-2B, 2-23, 2-23 (*illus*)
- M16A3 rifle (*see also* M16-series rifle), 2-5 to 2-33, 2-5 (*illus*)
battlesight zeroing, 2-6 to 2-7, 2-6 (*illus*)

- point of impact, 2-7 (*table*)
- characteristics, 2-1, 2-1 (*table*)
- mechanically zeroing, 2-6, 2-6 (*illus*)
- mounting accessories (*see also* accessories)
 - advanced combat optical gunsight (*see also* advanced combat optical gunsight), 2-32 to 2-33, 2-32 (*illus*), 2-33 (*illus*)
 - AN/PVS-4 night vision sight (*see also* AN/PVS-4 night vision sight), 2-29, 2-29 (*illus*)
 - compatibility and mounting, 2-16 (*table*)
 - heavy thermal weapon sight (*see also* heavy weapon thermal sight)
 - AN/PAS-13B (V3), 2-27, 2-27 (*illus*)
 - AN/PAS-13C (V3), 2-27, 2-27 (*illus*)
 - AN/PAS-13D (V3), 2-27, 2-27 (*illus*)
 - infrared aiming light (*see also* infrared aiming light)
 - AN/PAQ-4B, 2-21, 2-21 (*illus*)
 - AN/PAQ-4C, 2-21, 2-21 (*illus*)
 - light thermal weapon sight (*see also* light weapon thermal sight)
 - AN/PAS-13B (V1), 2-27, 2-27 (*illus*)
 - AN/PAS-13C (V1), 2-27, 2-27 (*illus*)
 - AN/PAS-13D (V1), 2-27, 2-27 (*illus*)
- M68 close combat optic (*see also* M68 close combat optic), 2-18, 2-18 (*illus*)
- target pointer/illuminator/aiming light (*see also* target pointer/illuminator/aiming light)
 - AN/PEQ-2A, 2-23, 2-23 (*illus*)
 - AN/PEQ-2B, 2-23, 2-23 (*illus*)
- M16A4 rifle (*see also* M16-series rifle), 2-7 (*illus*)
 - battlesight zeroing, 2-8 to 2-9, 2-8 (*illus*)
 - point of impact, 2-9 (*table*)
 - characteristics, 2-1, 2-1 (*table*)
- mechanically zeroing, 2-8, 2-8 (*illus*)
- mounting accessories (*see also* accessories)
 - advanced combat optical gunsight (*see also* advanced combat optical gunsight), 2-31 to 2-32, 2-31 (*illus*)
 - AN/PEQ-15 advanced target pointer/illuminator/aiming light (*see also* AN/PEQ-15 advanced target pointer/illuminator/aiming light), 2-25, 2-25 (*illus*)
 - AN/PVS-4 night vision sight (*see also* AN/PVS-4 night vision sight), 2-28 to 2-29, 2-28 (*illus*)
 - compatibility and mounting, 2-16 (*table*)
 - heavy thermal weapon sight (*see also* heavy weapon thermal sight)
 - AN/PAS-13B (V3), 2-26 to 2-27, 2-26 (*illus*)
 - AN/PAS-13C (V3), 2-26 to 2-27, 2-26 (*illus*)
 - AN/PAS-13D (V3), 2-26 to 2-27, 2-26 (*illus*)
 - infrared aiming light (*see also* infrared aiming light)
 - AN/PAQ-4B, 2-20, 2-20 (*illus*)
 - AN/PAQ-4C, 2-20, 2-20 (*illus*)
 - light thermal weapon sight (*see also* light weapon thermal sight)
 - AN/PAS-13B (V1), 2-26 to 2-27, 2-26 (*illus*)
 - AN/PAS-13C (V1), 2-26 to 2-27, 2-26 (*illus*)
 - AN/PAS-13D (V1), 2-26 to 2-27, 2-26 (*illus*)
- M68 close combat optic (*see also* M68 close combat optic), 2-17, 2-17 (*illus*), 2-18 to 2-19, 2-19 (*illus*)
- target pointer/illuminator/aiming light (*see also* target pointer/illuminator/aiming light)
 - AN/PEQ-2A, 2-22 to 2-23, 2-22 (*illus*)
 - AN/PEQ-2B, 2-22 to 2-23, 2-22 (*illus*)
- M16-series rifle (*see also* weapon characteristics, accessories, and ammunition), 2-5 to 2-10
 - M16A1 (*see also* M16A1 rifle), 2-9 (*illus*)
 - M16A2 (*see also* M16A2 rifle), 2-5 to 2-33, 2-5 (*illus*)
 - M16A3 (*see also* M16A3 rifle), 2-5 (*illus*)
 - M16A4 (*see also* M16A4 rifle), 2-7 (*illus*)
- M4 carbine (*see also* M4-series carbine), 2-2 (*illus*), 2-3 (*illus*)
 - characteristics, 2-1, 2-1 (*table*)
 - battlesight zeroing, 2-4 to 2-5, 2-4 (*illus*)
 - point of impact, 2-5 (*table*)
 - mechanically zeroing, 2-4, 2-4 (*illus*)
 - mounting accessories (*see also* accessories)
 - advanced combat optical gunsight (*see also* advanced combat optical gunsight), 2-31 to 2-32, 2-31 (*illus*)
 - AN/PVS-4 night vision sight (*see also* AN/PVS-4 night vision sight), 2-28 to 2-29, 2-28 (*illus*)
 - compatibility and mounting, 2-16 (*table*)
 - heavy thermal weapon sight (*see also* heavy weapon thermal sight)
 - AN/PAS-13B (V3), 2-26 to 2-27, 2-26 (*illus*)
 - AN/PAS-13C (V3), 2-26 to 2-27, 2-26 (*illus*)
 - AN/PAS-13D (V3), 2-26 to 2-27, 2-26 (*illus*)
 - infrared aiming light (*see also* infrared aiming light)
 - AN/PAQ-4B, 2-21, 2-21 (*illus*)
 - AN/PAQ-4C, 2-21, 2-21 (*illus*)
 - light thermal weapon sight (*see also* light weapon thermal sight)

- AN/PAS-13B (V1), 2-26 to 2-27, 2-26 (*illus*)
- AN/PAS-13C (V1), 2-26 to 2-27, 2-26 (*illus*)
- AN/PAS-13D (V1), 2-26 to 2-27, 2-26 (*illus*)
- M68 close combat optic (*see also* M68 close combat optic), 2-17, 2-17 (*illus*)
- target pointer/illuminator/aiming light (*see also* target pointer/illuminator/aiming light)
- AN/PEQ-2A, 2-23, 2-23 (*illus*)
- AN/PEQ-2B, 2-23, 2-23 (*illus*)
- M4A1 carbine (*see also* M4-series carbine), 2-2 (*illus*), 2-3 (*illus*)
- battlesight zeroing, 2-4 to 2-5, 2-4 (*illus*)
- point of impact, 2-5 (*table*)
- characteristics, 2-1, 2-1 (*table*)
- mechanically zeroing, 2-4, 2-4 (*illus*)
- mounting accessories (*see also* accessories)
- advanced combat optical gunsight (*see also* advanced combat optical gunsight), 2-31 to 2-32, 2-31 (*illus*)
- AN/PVS-4 night vision sight (*see also* AN/PVS-4 night vision sight), 2-28 to 2-29, 2-28 (*illus*)
- compatibility and mounting, 2-16 (*table*)
- heavy thermal weapon sight (*see also* heavy weapon thermal sight)
- AN/PAS-13B (V3), 2-26 to 2-27, 2-26 (*illus*)
- AN/PAS-13C (V3), 2-26 to 2-27, 2-26 (*illus*)
- AN/PAS-13D (V3), 2-26 to 2-27, 2-26 (*illus*)
- infrared aiming light (*see also* infrared aiming light)
- AN/PAQ-4B, 2-21, 2-21 (*illus*)
- AN/PAQ-4C, 2-21, 2-21 (*illus*)
- (*illus*)
- light thermal weapon sight (*see also* light weapon thermal sight)
- AN/PAS-13B (V1), 2-26 to 2-27, 2-26 (*illus*)
- AN/PAS-13C (V1), 2-26 to 2-27, 2-26 (*illus*)
- AN/PAS-13D (V1), 2-26 to 2-27, 2-26 (*illus*)
- M68 close combat optic (*see also* M68 close combat optic), 2-17, 2-17 (*illus*)
- target pointer/illuminator/aiming light (*see also* target pointer/illuminator/aiming light)
- AN/PEQ-2A, 2-23, 2-23 (*illus*)
- AN/PEQ-2B, 2-23, 2-23 (*illus*)
- M4A1 MWS (*see also* M4-series carbine), 2-3 (*illus*)
- characteristics, 2-1, 2-1 (*table*)
- M4/M5 adapter rail system (*see also* accessory mounting), 2-10 to 2-13, 2-3 (*illus*), 2-11 (*illus*)
- numbered recoil grooves, 2-12, 2-12 (*illus*)
- rail covers, 2-11 to 2-12, 2-11 (*illus*)
- vertical pistol grip, 2-13, 2-13 (*illus*)
- M4 MWS (*see also* M4-series carbine), 2-3 (*illus*)
- battlesight zeroing, 2-4 to 2-5, 2-4 (*illus*)
- point of impact, 2-5 (*table*)
- characteristics, 2-1, 2-1 (*table*)
- mechanically zeroing, 2-4, 2-4 (*illus*)
- mounting accessories (*see also* accessories)
- AN/PEQ-15 advanced target pointer/illuminator/aiming light (*see also* AN/PEQ-15 advanced target pointer/illuminator/aiming light), 2-25, 2-25 (*illus*)
- compatibility and mounting, 2-16 (*table*)
- infrared aiming light (*see also* infrared aiming light)
- AN/PAQ-4B, 2-20, 2-20 (*illus*)
- AN/PAQ-4C, 2-20, 2-20 (*illus*)
- M68 close combat optic (*see also* M68 close combat optic), 2-18 to 2-19, 2-19 (*illus*)
- target pointer/illuminator/aiming light (*see also* target pointer/illuminator/aiming light)
- AN/PEQ-2A, 2-22 to 2-23, 2-22 (*illus*)
- AN/PEQ-2B, 2-22 to 2-23, 2-22 (*illus*)
- M4-series carbine (*see also* weapon characteristics, accessories, and ammunition), 2-2 to 2-5, 2-2 (*illus*)
- M4 (*see also* M4 carbine), 2-2 (*illus*), 2-3 (*illus*)
- M4A1 (*see also* M4A1 carbine), 2-2 (*illus*), 2-3 (*illus*)
- M4A1 MWS (*see also* M4A1 MWS), 2-3 (*illus*)
- M4 MWS (*see also* M4 MWS), 2-3 (*illus*)
- M68 close combat optic (*see also* accessories, M4-series carbine, M16-series rifle, and advanced optics, lasers, and iron sights), 2-17 to 2-19, 2-17 (*illus*)
- boresighting using, 8-6 to 8-7
- characteristics, 2-16 (*table*)
- compatibility and mounting, 2-16 (*table*)
- mounting on
- M16A1, 2-18, 2-18 (*illus*)
- M16A2, 2-18, 2-18 (*illus*)
- M16A3, 2-18, 2-18 (*illus*)
- M16A4, 2-18 to 2-19, 2-19 (*illus*)
- M16A4, 2-17, 2-17 (*illus*)
- M4 MWS, 2-18 to 2-19, 2-19 (*illus*)
- M4-series carbine, 2-17, 2-17 (*illus*)
- training strategies and qualification standards, 8-12 to 8-16, 8-13 (*table*)
- 25-meter zeroing procedures, 8-14 to 8-15, 8-15 (*illus*)
- concept, 8-13
- conduct of training, 8-13

modified fundamentals, 8-13 to 8-14
 practice qualification, 8-16
 record qualification, 8-16
 target detection, 8-16
 zeroing without a borelight, 8-14

magazine changing drills (*see also* short-range marksmanship training), 7-48 to 7-51
 l-shaped method, 7-50 to 7-51, 7-50 (*illus*), 7-51 (*illus*)
 parallel method, 7-48 to 7-49, 7-49 (*illus*)

malfunctions (*see also* troubleshooting and destruction), 3-2 to 3-7
 failure to eject, 3-6
 failure to extract, 3-5
 failure to feed, chamber, or lock, 3-2 to 3-3, 3-2 (*illus*)
 failure to fire cartridge, 3-3 to 3-4, 3-4 (*illus*)
 other malfunctions, 3-6 to 3-7, 3-6 (*table*), 3-7 (*illus*)

marking targets (*see also* field fire *and* target detection), 6-4 to 6-5
 exposure time of target, 6-4
 good and poor points of aim, 6-5
 number of targets, 6-4
 spacing of targets, 6-5

marksmanship training strategy (*see also* training), 1-1 to 1-5
 initial entry training (*see also* initial entry training), 1-2, 1-2 (*illus*)
 sustainment training (*see also* sustainment training), 1-2 to 1-5, 1-3 (*illus*)

modes of fire (*see also* preliminary marksmanship instruction), 4-11 to 4-12, 4-11 (*illus*)
 automatic mode of fire, 4-12, 4-11 (*illus*)
 burst mode of fire, 4-12, 4-11 (*illus*)
 semiautomatic mode of fire, 4-11 to 4-12, 4-11 (*illus*)

moving target engagements (*see also* advanced rifle marksmanship), 7-36 to 7-41, 7-36 (*table*)
 modifications, 7-36 to 7-41
 marksmanship fundamentals, 7-36 to 7-41, 7-37 (*table*), 7-37 (*illus*), 7-38 (*illus*), 7-39 (*illus*), 7-39 (*table*), 7-40 (*table*)
 moving target live-fire exercise, 7-41

multiple shot group analysis (*see also* grouping procedures), 5-7 to 5-13, 5-8 (*illus*)
 acceptable shot grouping performance, 5-8 to 5-9, 5-8 (*illus*)
 improper shot groups on the edge of the target, 5-13, 5-13 (*illus*)
 shot groups with
 consistent aiming and major shooting error, 5-10, 5-10 (*illus*)
 inconsistent aiming, 5-9, 5-9 (*illus*)
 inconsistent aiming and major shooting error, 5-11, 5-11 (*illus*)
 improper vertical placement, 5-12, 5-12 (*illus*)

N

night fighting, C-1 to C-9
 aided night vision (*see also* aided night vision), C-4 to C-9
 unaided night vision (*see also* unaided night vision), C-1 to C-3

night fire training (*see also* advanced rifle marksmanship), 7-30 to 7-35
 artificial illumination training, 7-35, 7-35 (*table*)
 effectiveness and control of artificial illumination, 7-35
 live-fire exercise, 7-35
 unassisted night fire training, 7-30 to 7-34, 7-30 (*table*)
 modifications, 7-30 to 7-33
 firing positions, 7-31
 immediate action, 7-31

marksmanship
 fundamentals, 7-31 to 7-32
 operation and maintenance of the weapon, 7-31
 target detection, 7-32 to 7-33, 7-32 (*illus*), 7-33 (*illus*)
 training, 7-34
 live-fire exercises, 7-34, 7-34 (*illus*)

P

peer coaching (*see also* preliminary marksmanship instruction), 4-12 to 4-14
 advantages and disadvantages, 4-12 to 4-13
 benefits, 4-13
 checklist for the coach, 4-13
 duties, 4-13
 position of the coach, 4-13 to 4-14, 4-14 (*illus*)

*position (*see also* squad designated marksman training), 7-63 to 7-66
 *foxhole supported, 7-64 to 7-65
 *prone unsupported, 7-65
 *zero confirmation, 7-66, 7-66 (*table*)

preliminary marksmanship instruction, 4-1 to 4-30
 Introduction to Basic Rifle Marksmanship and Mechanical Training, 4-1 to 4-14, 4-1 (*table*)
 clearing (*see also* clearing), 4-2 to 4-3, 4-3 (*illus*)
 cycles of functioning (*see also* cycles of functioning), 4-4 to 4-10
 modes of fire (*see also* modes of fire), 4-11 to 4-12, 4-11 (*illus*)
 peer coaching (*see also* peer coaching), 4-12 to 4-14
 Marksmanship Fundamentals I, 4-14 to 4-30, 4-14 (*table*)
 basic firing positions (*see also* firing positions), 4-24 to 4-28

- dominant eye training (*see also* dominant eye training), 4-24
- four fundamentals (*see also* fundamentals), 4-16 to 4-24
- interceptor body armor (*see also* interceptor body armor), 4-15 to 4-16, 4-15 (*illus*)
- training devices and exercises (*see also* training aids, devices, and exercises), 4-28 to 4-29
- Marksmanship Fundamentals II, 4-29, 4-29 (*table*)
- Engagement Skills Trainer 2000 (*see also* training aids, devices, and exercises *and* Engagement Skills Trainer 2000), 4-29 to 4-30
- Laser Marksmanship Training System (*see also* training aids, devices, and exercises *and* Laser Marksmanship Training System), 4-30
- Q**
- qualification training (*see also* unit marksmanship training program *and* training), 1-15 to 1-18
- downrange feedback, 1-16
- feedback, 1-16
- field fire, 1-16
- grouping and zeroing, 1-16
- record fire, 1-17
- remedial training, 1-17, 1-17 (*table*)
- quick fire (*see also* combat fire techniques), 7-19 to 7-24
- effectiveness and control, 7-19 to 7-21
- aimed, 7-20, 7-20 (*illus*)
- pointed, 7-21, 7-21 (*illus*)
- factors for use, 7-22
- modifications, 7-22 to 7-23
- training, 7-23 to 7-24, 7-24 (*table*)
- R**
- rail grabbers (*see also* accessory mounting), 2-13 to 2-16
- Insight rail grabber, 2-14 to 2-15, 2-14 (*illus*)
- MILES training extender for the insight rail grabber, 2-14 to 2-15, 2-15 (*illus*)
- Picatinny rail grabber, 2-15 to 2-16, 2-15 (*illus*)
- *range determination (*see also* field fire, target detection, *and* squad designated marksman training), 6-5 to 6-6, 7-67 to 7-70
- *100-meter unit of measure method, 6-5 to 6-6, 7-68
- *appearance of objects method, 6-6, 7-68
- *combination method, 7-69
- *elevation knob training, 7-69 to 7-70
- *conduct, 7-69 to 7-70, 7-70 (*table*)
- *factors affecting range estimation, 7-69
- *light conditions, 7-69
- *nature of the target, 7-69
- *nature of the terrain, 7-69
- *front sightpost method, 6-6, 7-68
- *range card method, 7-68
- range operations checklist (*see also* range procedures *and* computer-controlled ranges), E-5 to E-10
- range procedures (*see also* range operations checklist *and* computer-controlled ranges), E-1
- firing order lineup, E-2
- personnel and duties, E-2 to E-3
- tower commands (*see also* tower commands), E-2 to E-5
- range safety, D-1 to D-3
- ammunition positioning and issuance, D-3
- personnel and duties, D-2 to D-3
- recommended briefing, D-1
- rapid semiautomatic fire (*see also* combat fire techniques), 7-8 to 7-12
- effectiveness and control, 7-9
- modifications, 7-9 to 7-10
- immediate action procedures, 7-10
- marksmanship fundamentals, 7-9 to 7-10
- training, 7-10 to 7-12, 7-11 (*table*)
- record qualification (*see also* field fire), 6-11 to 6-17
- practice record fire I and II, 6-11 to 6-13, 6-11 (*table*)
- alibi firing, 6-12
- concept, 6-11
- conduct, 6-11 to 6-12, 6-12 (*table*)
- practice record fire standards, 6-13, 6-13 (*table*)
- range training areas, 6-12
- orientation area, 6-12
- ready area, 6-12
- retired area, 6-12
- record of performance, 6-13
- record fire, 6-13 to 6-17, 6-13 (*table*)
- concept, 6-14
- conduct, 6-15 to 6-16, 6-15 (*table*)
- alibi firing, 6-15 to 6-16
- refire, 6-16
- troubleshooting performance, 6-16
- development of standards, 6-14, 6-14 (*table*)
- probability of hits, 6-14 (*table*)
- qualification ratings, 6-16, 6-16 (*table*)
- record of performance, 6-17
- target function, 6-14
- reflexive fire training, (*see also* short-range marksmanship training), 7-51 to 7-53
- conduct, 7-52 to 7-53, 7-52 (*table*), 7-53 (*table*)
- range setup, 7-52
- reflexive firing targets, 7-51, 7-51 (*illus*)

S

scanning for targets (*see also* field fire *and* target detection), 6-2 to 6-3

50-meter overlapping strip method of search, 6-2

maintaining observation of the area, 6-3

self-preservation method of search, 6-2

*scorecards, B-1 to B-6

*examples of completed scorecards, B-1 to B-6

*reproducible forms, B-1

short-range marksmanship qualification (*see also* short-range marksmanship training), 7-55 to 7-57

barricade transition qualification firing, 7-56 to 7-57

conduct, 7-56

evaluation, 7-56 to 7-57, 7-57 (*table*)

range setup, 7-56

record and practice fire, 7-55 to 7-56

conduct, 7-55, 7-55 (*table*)

evaluation, 7-56

short-range marksmanship training (*see also* Advanced Rifle Marksmanship), 7-41 to 7-57

conduct of short-range marksmanship training, 7-41 to 7-42, 7-42 (*table*)

fundamentals of short-range marksmanship (*see also* fundamentals of short-range marksmanship), 7-42 to 7-47

Phase I—Reflexive Fire Training (*see also* reflexive fire training), 7-51 to 7-53

Phase II—Target Discrimination Training (*see also* target discrimination training), 7-53 to 7-55

Phase III—Short-Range Marksmanship Qualification (*see also* short-range marksmanship qualification), 7-55 to 7-57

Phase IV—Shotgun and Automatic or Burst Firing Familiarization (*see also*

shotgun and automatic or burst firing familiarization), 7-57

Preliminary Short-Range Marksmanship Instruction, 7-47 to 7-51, 7-48 (*table*)

magazine changing drills (*see also* magazine changing drills), 7-48 to 7-51

shotgun and automatic or burst firing familiarization (*see also* short-range marksmanship training), 7-57

single shot group analysis (*see also* grouping procedures), 5-4 to 5-7

2-centimeter shot groups, 5-5, 5-5 (*illus*)

3- to 4-centimeter shot groups, 5-6, 5-6 (*illus*)

match-grade performance, 5-5, 5-5 (*illus*)

over 4- to 5-centimeter shot groups, 5-6, 5-6 (*illus*)

shot groups larger than 5 centimeters, 5-7, 5-7 (*illus*)

*squad designated marksman training, 7-62 to 7-74

*mission, 7-62

*selection, 7-63

*skills progression, 7-63 to 7-74

*certification, 7-74

*conduct, 7-63

*Phase I—Position Evaluation (*see also* position), 7-63 to 7-66

*Phase II—Dry-Fire Training (*see also* dry-fire training), 7-66 to 7-67

*Phase III—Range Estimation and Sight Manipulation 100 to 500 Meters (*see also* range determination), 7-67 to 7-70

*Phase IV—Hold-Off 100 to 500 Meters (*see also* hold-off), 7-70 to 7-73

*Phase V—Field Fire 100 to 500 Meters (*see also* field fire), 7-73 to 7-74

*qualification, 7-63

stoppages (*see also* troubleshooting and destruction), 3-1 to 3-2

immediate action, 3-1

remedial action, 3-1 to 3-2

suppressive fire (*see also* combat fire techniques), 7-16 to 7-19

effectiveness and control, 7-16

modifications, 7-16 to 7-17

training, 7-17 to 7-19, 7-18 (*table*), 7-18 (*illus*), 7-19 (*table*)

sustainment training (*see also* marksmanship training strategy *and* training), 1-2 to 1-5, 1-3 (*illus*)

Active Army home station marksmanship training strategy, 1-4 (*illus*)

Army Reserve home station marksmanship training strategy, 1-5 (*illus*)

deployed unit marksmanship training strategy, 1-5 (*illus*)

National Guard home station marksmanship training strategy, 1-4 (*illus*)

T

target detection (*see also* Field Fire), 6-1 to 6-6

locating targets, 6-1 to 6-4

marking targets (*see also* marking targets), 6-4 to 6-5

range determination (*see also* range determination), 6-5 to 6-6

scanning (*see also* scanning for targets), 6-2 to 6-3

selection of a position, 6-2

target indicators (*see also* target indicators), 6-3 to 6-4

target discrimination training (*see also* short-range marksmanship training), 7-53 to 7-55

conduct, 7-54

evaluation, 7-55

range setup, 7-54

target discrimination targets, 7-53 to 7-54

target indicators (*see also* field fire *and* target detection), 6-3 to 6-4

- improper camouflage, 6-3 to 6-4
- movement, 6-3
- sound, 6-3
- target pointer/illuminator/aiming light (*see also* accessories, M4-series carbine, M16-series rifle, *and* advanced optics, lasers, and iron sights)
- AN/PEQ-2A, 2-21 to 2-24, 2-22 (*illus*)
- boresighting, 8-9 to 8-10
- characteristics, 2-16 (*table*)
- compatibility and mounting, 2-16 (*table*)
- mounting on
- M16A1, 2-23, 2-23 (*illus*)
- M16A2, 2-23, 2-23 (*illus*)
- M16A3, 2-23, 2-23 (*illus*)
- M16A4, 2-22 to 2-23, 2-22 (*illus*)
- M4 carbine, 2-23, 2-23 (*illus*)
- M4 MWS, 2-22 to 2-23, 2-22 (*illus*)
- training strategies and qualification standards, 8-23 to 8-28, 8-24 (*table*)
- 25-meter zeroing procedures, 8-25 to 8-27, 8-26 (*illus*)
- concept, 8-24
- conduct of training, 8-24
- field fire, 8-27
- modified fundamentals, 8-24 to 8-25
- practice qualification, 8-28
- record qualification, 8-28
- target detection, 8-27
- use in conjunction with MILES, 2-24, 2-24 (*illus*)
- AN/PEQ-2B, 2-21 to 2-24, 2-22 (*illus*)
- boresighting, 8-9 to 8-10
- characteristics, 2-16 (*table*)
- compatibility and mounting, 2-16 (*table*)
- mounting on
- M16A1, 2-23, 2-23 (*illus*)
- M16A2, 2-23, 2-23 (*illus*)
- M16A3, 2-23, 2-23 (*illus*)
- M16A4, 2-22 to 2-23, 2-22 (*illus*)
- M4 carbine, 2-23, 2-23 (*illus*)
- M4 MWS, 2-22 to 2-23, 2-22 (*illus*)
- training strategies and qualification standards, 8-23 to 8-28, 8-24 (*table*)
- 25-meter zeroing procedures, 8-25 to 8-27, 8-26 (*illus*)
- concept, 8-24
- conduct of training, 8-24
- field fire, 8-27
- modified fundamentals, 8-24 to 8-25
- practice qualification, 8-28
- record qualification, 8-28
- target detection, 8-27
- use in conjunction with MILES, 2-24, 2-24 (*illus*)
- M4 MWS, 2-22 to 2-23, 2-22 (*illus*)
- training strategies and qualification standards, 8-23 to 8-28, 8-24 (*table*)
- 25-meter zeroing procedures, 8-25 to 8-27, 8-26 (*illus*)
- concept, 8-24
- conduct of training, 8-24
- field fire, 8-27
- modified fundamentals, 8-24 to 8-25
- practice qualification, 8-28
- record qualification, 8-28
- target detection, 8-27
- use in conjunction with MILES, 2-24, 2-24 (*illus*)
- thermal weapon sight (*see also* night fighting *and* aided night vision), C-6 to C-9
- absorption, C-7
- adjustments, C-7 to C-9
- brightness knob, C-8
- contrast switch, C-8 to C-9
- diopter focus ring, C-8
- fields of view, C-8
- objective focus ring, C-8
- polarity switch, C-9
- diurnal cycle, C-7
- emissivity, C-7
- exposure, C-7
- reflection, C-7
- tower commands (*see also* range procedures), E-2 to E-5
- field firing exercises, E-3 to E-4
- general commands, E-3
- grouping commands, E-3
- practice record fire, E-4
- rapid fire exercises, E-4 to E-5
- record fire, E-4
- zero commands, E-3 to E-4
- trainers (*see also* unit marksmanship training program *and* training), 1-12 to 1-14
- cadre/trainer, 1-12 to 1-13
- duties of the instructor/trainer, 1-13 to 1-14
- instructor/trainer selection, 1-12
- trainer certification program, 1-14 to 1-15
- certification program outline, 1-14 to 1-15
- training base, 1-15
- training the trainer, 1-13
- training, 1-1 to 1-18
- training strategy, 1-1 to 1-8
- marksmanship training strategy (*see also* marksmanship training strategy), 1-1 to 1-5
- objectives, 1-1
- training phases (*see also* training phases), 1-6 to 1-8
- unit marksmanship training program (*see also* unit marksmanship program), 1-9 to 1-18
- training aids, devices, and exercises (*see also* preliminary marksmanship instruction), A-1 to A-28, 4-28 to 4-29
- Engagement Skills Trainer 2000 (*see also* preliminary marksmanship instruction *and* Engagement Skills Trainer 2000), A-1 to A-4, A-1 (*illus*)
- Laser Marksmanship Training System (*see also* preliminary marksmanship instruction *and* Laser Marksmanship Training System), A-5 to A-12
- other training devices and exercises, A-12 to A-28
- selection of training aids and devices, A-13, A-13 (*illus*)
- target ordering numbers, A-14, A-14 (*table*)
- training devices (*see also* training devices), A-14 to A-24
- training exercises (*see also* training exercises), A-24 to A-28
- training support centers, A-13
- training assessment (*see also* unit marksmanship training program *and* training), 1-9 to 1-12
- commander's evaluation guide, 1-10 to 1-12
- commander's priorities and intent, 1-10

Soldier assessment, 1-10 to 1-11
 trainer assessment, 1-12
 direct observation of training, 1-9
 review of past training, 1-10
 spot checks, 1-9

training devices (*see also* training aids, devices, and exercises), A-14 to A-24
 aiming card, A-15, A-15 (*illus*)
 location of miss-and-hit system, A-18 to A-19
 M15A1 aiming card, 4-28
 M15A2/M23 blank firing attachment, A-18, A-18 (*illus*)
 M16 sighting device, A-17, A-17 (*illus*)
 M261 .22-caliber rimfire adapter, A-19 to A-20
 riddle sighting device, A-16, A-16 (*illus*)
 short-range training ammunition, A-20
 weaponeer, A-20 to A-24, A-21 (*illus*), A-22 (*illus*), A-23 (*illus*)

training exercises (*see also* training aids, devices, and exercises), A-24 to A-28
 ball and dummy exercise, A-27
 dime/washer exercise, A-27 to A-28, 4-29
 target box exercise, A-24 to A-27, A-24 (*illus*), A-25 (*illus*), A-26 (*illus*), A-27 (*illus*), 4-29

training phases (*see also* training), 1-6 to 1-8
 Phase I—Basic Rifle Marksmanship Preliminary Marksmanship Instruction, 1-6 to 1-7
 Phase II—Basic Rifle Marksmanship Downrange Feedback Range Firing, 1-7
 Phase III—Basic Rifle Marksmanship Field Firing, 1-8
 Phase IV—Advanced Rifle Marksmanship, 1-8
 Phase V—Advanced Optics, Lasers, and Iron Sights, 1-8

troubleshooting and destruction, 3-1 to 3-8
 destruction procedures (*see also* destruction procedures), 3-7 to 3-8
 malfunctions (*see also* malfunctions), 3-2 to 3-7
 stoppages (*see also* stoppages), 3-1 to 3-2

U

unaided night vision (*see also* night fighting), C-1 to C-3
 avoiding night blind spots, C-2
 dark adaptation, C-2 to C-3
 daylight vision, C-2
 night vision, C-3
 twilight vision, C-2
 illusion, C-3
 night blind spots and viewing techniques, C-1 to C-2
 normal blind spots, C-1
 protecting
 before operation, C-3
 during operation, C-3

unit marksmanship training program (*see also* training), 1-9 to 1-18
 mission-essential tasks, 1-9
 qualification training (*see also* qualification training), 1-15 to 1-18
 trainers (*see also* trainers), 1-12 to 1-14
 training assessment (*see also* training assessment), 1-9 to 1-12
 unit live-fire exercises, 1-18

W

weapon characteristics, accessories, and ammunition, 2-1 to 2-39
 10-meter boresight and 25-meter zero offset (*see also* 10-meter boresight and 25-meter zero offset), 2-33 to 2-34
 accessories (*see also* accessories), 2-16 to 2-39
 characteristics, 2-16 (table)
 compatibility and mounting, 2-16 (table)

mounting (*see also* accessory mounting), 2-10 to 2-16
 ammunition (*see also* ammunition), 2-35 to 2-39
 rifles and carbines, 2-1 to 2-10
 M16-series rifle (*see also* M16-series rifle), 2-5 to 2-10
 M4-series carbine (*see also* M4-series carbine), 2-2 to 2-5, 2-2 (*illus*)

*wind (*see also* effects of wind and gravity), 5-26 to 5-32
 *adjusted point of aim based on gravity and wind speed, 5-32, 5-32 (*illus*)
 *adjusted point of aim based on wind speed, 5-31, 5-31 (*illus*), 5-31 (table)
 *drift for a 10 mile-per-hour wind using 5.56-millimeter M855 ammunition, 5-32, 5-32 (table)
 *wind direction, 5-27, 5-28 (*illus*)
 *wind speed, 5-28 to 5-30
 *flag method, 5-29, 5-29 (*illus*)
 *observation method, 5-30
 *pointing method, 5-30, 5-30 (*illus*)

Z

zeroing procedures (*see also* downrange feedback and 25-meter zero offsets), 5-14 to 5-19, 5-14 (table)
 conduct of a 25-meter zero firing, 5-15 to 5-19, 5-16 (*illus*), 5-17 (*illus*), 5-18 (*illus*)
 conduct of a 25-meter zero firing using the Location of Misses-and-Hits System, 5-19
 *conduct of a 200-meter zero firing, 5-19
 organization of a 25-meter zero range, 5-15
 purpose, 5-15
 sight variance, 5-15

RECORD FIRING SCORECARD -- KNOWN DISTANCE COURSE

For use of this form, see FM 3-22.9; the proponent agency is TRADOC.

ID CODE (NOT SSN)	UNIT	DATE (YYYYMMDD)	EVALUATOR'S ID CODE (NOT SSN)						
TABLE 1 PRONE SUPPORTED OR FOXHOLE SUPPORTED FIRING POSITION (TIME: 120 SECONDS)									
RD	RANGE (m)	RD	RANGE (m)	HIT	MISS	RD	RANGE (m)	HIT	MISS
1	300	11	300	<input type="checkbox"/>	<input type="checkbox"/>	1	200	<input type="checkbox"/>	<input type="checkbox"/>
2		12		<input type="checkbox"/>	<input type="checkbox"/>	2		<input type="checkbox"/>	<input type="checkbox"/>
3		13		<input type="checkbox"/>	<input type="checkbox"/>	3		<input type="checkbox"/>	<input type="checkbox"/>
4	300	14	300	<input type="checkbox"/>	<input type="checkbox"/>	4	100	<input type="checkbox"/>	<input type="checkbox"/>
5		15		<input type="checkbox"/>	<input type="checkbox"/>	5		<input type="checkbox"/>	<input type="checkbox"/>
6		16		<input type="checkbox"/>	<input type="checkbox"/>	6		<input type="checkbox"/>	<input type="checkbox"/>
7	E-SIL	17	E-SIL	<input type="checkbox"/>	<input type="checkbox"/>	7	F-SIL	<input type="checkbox"/>	<input type="checkbox"/>
8		18		<input type="checkbox"/>	<input type="checkbox"/>	8		<input type="checkbox"/>	<input type="checkbox"/>
9		19		<input type="checkbox"/>	<input type="checkbox"/>	9		<input type="checkbox"/>	<input type="checkbox"/>
10	20	<input type="checkbox"/>	<input type="checkbox"/>	<input type="checkbox"/>	<input type="checkbox"/>	10	<input type="checkbox"/>	<input type="checkbox"/>	
TOTAL		TOTAL		TOTAL		TOTAL		TOTAL	
TABLE 2 PRONE UNSUPPORTED FIRING POSITION (TIME: 60 SECONDS)				TABLE 3 KNEELING FIRING POSITION (TIME: 60 SECONDS)					
SCORE TABLE HIT MISS NO FIRE 1 2 3				QUALIFICATION SCORE RATINGS (Check One) <input type="checkbox"/> 38-40 -- EXPERT <input type="checkbox"/> 26-32 -- MARKSMAN <input type="checkbox"/> 33-37 -- SHARPSHOOTER <input type="checkbox"/> 25 AND BELOW -- UNQUALIFIED					
FIRER'S QUALIFICATION SCORE				NIGHT FIRE EXERCISE DATE (YYYYMMDD) HIT MISS NO GO CBRN FIRE EXERCISE DATE (YYYYMMDD) HIT MISS NO GO					
SCORER'S INITIALS				THE FIRER WILL BE ISSUED 40 ROUNDS. THE ROUNDS WILL BE PRELOADED IN FOUR 10-ROUND MAGAZINES - TWO FOR TABLE 1, AND ONE FOR EACH REMAINING TABLE.					
OFFICER'S INITIALS				DATE INITIALED (YYYYMMDD)					
DATE INITIALED (YYYYMMDD)				DATE INITIALED (YYYYMMDD)					

This scorecard is used to score known distance course record fire qualification when the known distance range is used. This course is used only when the standard record fire course is not available.

CONDUCT OF FIRE

The uniform for qualification is a helmet, LBE/LBV, and interceptor body armor with front and back SAPI plates (if available). No other armor is required.

(1) Table 1 -- Prone supported or foxhole supported firing position.

The firer is given two 10-round magazines to engage an E-silhouette at 300 meters within 120 seconds.

(2) Table 2 -- Prone unsupported firing position.

The firer is given a 10-round magazine to engage an E-silhouette at 200 meters within 60 seconds.

(3) Table 3 -- Kneeling firing position.

The firer is given a 10-round magazine to engage an F-silhouette at 100 meters within 60 seconds.

SCORING

Scoring is conducted in the pits, with the results provided after each table. A hit is scored for any bullet hole that is within or touches some part of the silhouette facing.

RECORD FIRING SCORECARD -- SCALED TARGET ALTERNATE COURSE

For use of this form, see FM 3-22.9; the proponent agency is TRADOC.

ID CODE (NOT SSN)	UNIT	DATE (YYYYMMDD)	EVALUATOR'S ID CODE (NOT SSN)
-------------------	------	-----------------	-------------------------------

TABLE 1 PRONE SUPPORTED OR FOXHOLE SUPPORTED FIRING POSITION (TIME: 120 SECONDS)										TABLE 2 PRONE UNSUPPORTED FIRING POSITION (TIME: 60 SECONDS)					TABLE 3 KNEELING FIRING POSITION (TIME: 60 SECONDS)				
RD	RANGE (m)	HIT	MISS	RD	RANGE (m)	HIT	MISS	RD	RANGE (m)	HIT	MISS	RD	RANGE (m)	HIT	MISS	RD	RANGE (m)	HIT	MISS
1	300	<input type="checkbox"/>	<input type="checkbox"/>	11	150	<input type="checkbox"/>	<input type="checkbox"/>	1	300	<input type="checkbox"/>	<input type="checkbox"/>	1	150	<input type="checkbox"/>	<input type="checkbox"/>	2	150	<input type="checkbox"/>	<input type="checkbox"/>
2	300	<input type="checkbox"/>	<input type="checkbox"/>	12	150	<input type="checkbox"/>	<input type="checkbox"/>	2	250	<input type="checkbox"/>	<input type="checkbox"/>	3	100	<input type="checkbox"/>	<input type="checkbox"/>	3	100	<input type="checkbox"/>	<input type="checkbox"/>
3	250	<input type="checkbox"/>	<input type="checkbox"/>	13	100	<input type="checkbox"/>	<input type="checkbox"/>	3	200	<input type="checkbox"/>	<input type="checkbox"/>	4	100	<input type="checkbox"/>	<input type="checkbox"/>	4	100	<input type="checkbox"/>	<input type="checkbox"/>
4	250	<input type="checkbox"/>	<input type="checkbox"/>	14	100	<input type="checkbox"/>	<input type="checkbox"/>	4	200	<input type="checkbox"/>	<input type="checkbox"/>	5	100	<input type="checkbox"/>	<input type="checkbox"/>	5	100	<input type="checkbox"/>	<input type="checkbox"/>
5	200	<input type="checkbox"/>	<input type="checkbox"/>	15	100	<input type="checkbox"/>	<input type="checkbox"/>	5	150	<input type="checkbox"/>	<input type="checkbox"/>	6	100	<input type="checkbox"/>	<input type="checkbox"/>	6	100	<input type="checkbox"/>	<input type="checkbox"/>
6	200	<input type="checkbox"/>	<input type="checkbox"/>	16	100	<input type="checkbox"/>	<input type="checkbox"/>	6	150	<input type="checkbox"/>	<input type="checkbox"/>	7	100	<input type="checkbox"/>	<input type="checkbox"/>	7	100	<input type="checkbox"/>	<input type="checkbox"/>
7	200	<input type="checkbox"/>	<input type="checkbox"/>	17	100	<input type="checkbox"/>	<input type="checkbox"/>	7	100	<input type="checkbox"/>	<input type="checkbox"/>	8	100	<input type="checkbox"/>	<input type="checkbox"/>	8	100	<input type="checkbox"/>	<input type="checkbox"/>
8	200	<input type="checkbox"/>	<input type="checkbox"/>	18	100	<input type="checkbox"/>	<input type="checkbox"/>	8	100	<input type="checkbox"/>	<input type="checkbox"/>	9	50	<input type="checkbox"/>	<input type="checkbox"/>	9	50	<input type="checkbox"/>	<input type="checkbox"/>
9	150	<input type="checkbox"/>	<input type="checkbox"/>	19	50	<input type="checkbox"/>	<input type="checkbox"/>	9	100	<input type="checkbox"/>	<input type="checkbox"/>	10	50	<input type="checkbox"/>	<input type="checkbox"/>	10	50	<input type="checkbox"/>	<input type="checkbox"/>
10	150	<input type="checkbox"/>	<input type="checkbox"/>	20	50	<input type="checkbox"/>	<input type="checkbox"/>	10	50	<input type="checkbox"/>	<input type="checkbox"/>	TOTAL							

SCORE			QUALIFICATION SCORE RATINGS (Check One)		
TABLE	HIT	MISS	NO FIRE	36-40 - EXPERT	23-29 -- MARKSMAN
1				<input type="checkbox"/>	<input type="checkbox"/>
2				<input type="checkbox"/>	<input type="checkbox"/>
3				<input type="checkbox"/>	<input type="checkbox"/>
FIRER'S QUALIFICATION SCORE			22 AND BELOW -- UNQUALIFIED		
			<input type="checkbox"/>	<input type="checkbox"/>	

FIRER ISSUED 40 ROUNDS TO ENGAGE 10 TARGETS. THE ROUNDS WILL BE PRELOADED IN ONE 20-ROUND MAGAZINE FOR TABLE 1, ONE 10-ROUND MAGAZINE FOR TABLE 2, AND ONE 10-ROUND MAGAZINE FOR TABLE 3.

REMARKS			
DATE (YYYYMMDD)	HIT	MISS	NO GO
NIGHT FIRE EXERCISE			
CBRN FIRE EXERCISE			
DATE (YYYYMMDD)	HIT	MISS	NO GO
SCORER'S INITIALS			
DATE INITIALED (YYYYMMDD)			
OFFICER'S INITIALS			
DATE INITIALED (YYYYMMDD)			

This scorecard is used to score alternate course record fire qualification when the 25-meter scaled silhouette target (NSN 6920-01-167-1398) is used. The alternate course is used only when standard record fire and known distance ranges are unavailable.

NOTE: If zeroing/grouping exercises are not performed on the day of record fire, six rounds of training/sustainment ammunition will be fired for 25-meter zero confirmation prior to conducting the qualification course.

CONDUCT OF FIRE

Alternate course qualification firers will have one 20-round magazine and two 10-round magazines. To ensure that firers do not forget which targets they engaged and shoot a given target more than the prescribed number of times, firers should adhere to the following guideline: Engage targets on the sheet from left to right and nearest to farthest. Engagement should follow this order: 50m, 100m left, 100m center, 100m right, 150m left, 150m right, 200m left, 200m right, 250m, and 300m.

Though the time between each firing position is not specified, enough time should be allotted to allow the firer to clear his weapon, quickly change firing positions, and reload before beginning the next firing table. The range RSO ensures that enough time is given between each change in firing position to facilitate the timely flow of the record fire qualification table.

(1) Table 1-- Prone Supported Firing Position or (at the unit commander's discretion) Foxhole Supported Firing Position.

The firer is given one 20-round magazine to engage 10 silhouettes on the same target sheet. Table 1 includes 2 rounds for each silhouette. Firing must be completed in 120 seconds. No more than 2 hits are scored for each silhouette.

(2) Table 2 -- Prone Unsupported Firing Position.

The firer is given one 10-round magazine to engage 10 silhouettes on the same target sheet. Table 2 includes 1 round for each silhouette. Firing must be completed in 60 seconds. No more than 1 hit is scored for each silhouette.

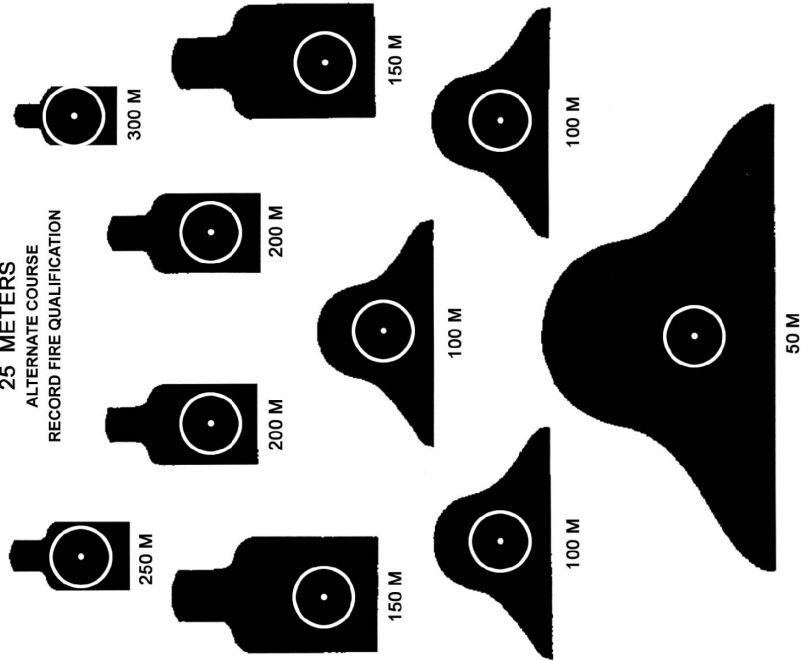
(3) Table 3 -- Kneeling Firing Position.

The firer is given one 10-round magazine to engage 10 silhouettes on the target sheet. Table 3 includes 2 rounds for each silhouette positioned at 50 and 100 meters and 1 round for each silhouette positioned at 150 meters. Firing must be completed in 60 seconds. No more than 2 hits are scored for the 50- and 100-meter silhouettes, and 1 hit is scored for each 150-meter silhouette.

SCORING

The same target sheet is used for every 40-round qualification table that a firer completes. One hit is awarded for each round that strikes within or touches some part of the silhouette. A maximum of 40 hits is comprised of 3 hits per target at 200, 250, and 300 meters; 4 hits per target at 150 meters; and 5 hits per target at 50 and 100 meters.

**25 METERS
ALTERNATE COURSE
RECORD FIRE QUALIFICATION**



THE WHITE DOT ON EACH TARGET SHOWS THE CENTER OF MASS AIMING POINT. BULLETS SHOULD HIT WITHIN THE CIRCLE, BUT ARE SCORED AS HITS IF THEY HIT ANY PART OF THE SILHOUETTE.

COMBAT FIELD FIRE SCORECARD

For use of this form, see FM 3-22.9; the proponent agency is TRADOC.

NAME	RANK	UNIT
EVALUATOR'S NAME	RANK	DATE (YYYYMMDD)

TABLE 1 KNEELING UNSUPPORTED FIRING POSITION				TOTAL NUMBER OF HITS
RANGE (METERS)	HITS REQUIRED	EXPOSURE TIME (SECONDS)	HITS	
50 (Left)	2	31	<input type="checkbox"/> <input type="checkbox"/> <input type="checkbox"/> <input type="checkbox"/>	
50 (Right)	2	31	<input type="checkbox"/> <input type="checkbox"/> <input type="checkbox"/> <input type="checkbox"/>	
100	1	45	<input type="checkbox"/> <input type="checkbox"/> <input type="checkbox"/> <input type="checkbox"/>	
150	2	60	<input type="checkbox"/> <input type="checkbox"/> <input type="checkbox"/> <input type="checkbox"/>	

TABLE 2 - SET 1 BARRICADE SUPPORTED FIRING POSITION				TOTAL NUMBER OF HITS
RANGE (METERS)	HITS REQUIRED	EXPOSURE TIME (SECONDS)	HITS	
50 (Left or Right)	3	26	<input type="checkbox"/> <input type="checkbox"/> <input type="checkbox"/> <input type="checkbox"/>	
100	2	40	<input type="checkbox"/> <input type="checkbox"/> <input type="checkbox"/> <input type="checkbox"/>	

TABLE 2 - SET 2 BARRICADE SUPPORTED FIRING POSITION				TOTAL NUMBER OF HITS
RANGE (METERS)	HITS REQUIRED	EXPOSURE TIME (SECONDS)	HITS	
100	1	19	<input type="checkbox"/> <input type="checkbox"/> <input type="checkbox"/> <input type="checkbox"/>	
150	2	21	<input type="checkbox"/> <input type="checkbox"/> <input type="checkbox"/> <input type="checkbox"/>	
200	1	40	<input type="checkbox"/> <input type="checkbox"/> <input type="checkbox"/> <input type="checkbox"/>	

TABLE 3 - SET 1 PRONE UNSUPPORTED FIRING POSITION				TOTAL NUMBER OF HITS
RANGE (METERS)	HITS REQUIRED	EXPOSURE TIME (SECONDS)	HITS	
100	2	23	<input type="checkbox"/> <input type="checkbox"/> <input type="checkbox"/> <input type="checkbox"/>	
200	2	36	<input type="checkbox"/> <input type="checkbox"/> <input type="checkbox"/> <input type="checkbox"/>	
250	1	50	<input type="checkbox"/> <input type="checkbox"/> <input type="checkbox"/> <input type="checkbox"/>	

TABLE 3 - SET 2 PRONE UNSUPPORTED FIRING POSITION				TOTAL NUMBER OF HITS
RANGE (METERS)	HITS REQUIRED	EXPOSURE TIME (SECONDS)	HITS	
150	2	21	<input type="checkbox"/> <input type="checkbox"/> <input type="checkbox"/> <input type="checkbox"/>	
250	2	37	<input type="checkbox"/> <input type="checkbox"/> <input type="checkbox"/> <input type="checkbox"/>	
300	1	50	<input type="checkbox"/> <input type="checkbox"/> <input type="checkbox"/> <input type="checkbox"/>	

AIMING DEVICE USED <i>(Check One)</i> <input type="checkbox"/> IRON SIGHT <input type="checkbox"/> AN/PAS-13 (DAY) <input type="checkbox"/> BACKUP IRON SIGHT <input type="checkbox"/> AN/PAS-13 (NIGHT) <input type="checkbox"/> M68, CCO <input type="checkbox"/> AN/PAQ-4B/C <input type="checkbox"/> ACOG <input type="checkbox"/> AN/PEQ-2A/B	RATINGS <input type="checkbox"/> Trained - 24 to 26 hits <input type="checkbox"/> Partially Trained - 16 to 23 <input type="checkbox"/> Untrained - 15 or fewer hits	TOTAL NUMBER OF HITS FOR ALL TABLES _____
---	--	---

REMARKS

EVALUATOR'S INITIALS	DATE INITIALED
OFFICER'S INITIALS	DATE INITIALED

CONDUCT OF A COMBAT FIELD FIRE RANGE

CONDUCT

NOTE: When firing combat field fire, each Soldier must wear the proper uniform: the helmet, LBE, and IBA with all SAPI plates (if available). No other armor is required.

Each firer receives 30 rounds of 5.56-millimeter ball ammunition (3 magazines containing 10 rounds) and 1 randomly placed dummy round in each magazine. The Soldier assumes a firing position and engages each target until it falls and stays down. Once a Soldier has completed a table, he transitions to the next position without prompting, and once he has emptied a magazine, he should change magazines without prompting. Each Soldier must attain a minimum of 16 hits to be considered trained.

- NOTES:**
1. Targets will bob between hits.
 2. Ten to twenty seconds should elapse between firing tables to allow Soldiers to transition to the next firing position or to prompt Soldiers to watch the area for additional targets.
 3. A Soldier should not stop firing unless he has completed the firing table and is transitioning to the next position (making a brief halt in fire necessary), has completed all firing tables, or is out of ammunition.
 4. The dummy round placed in each magazine (1 round for each magazine) simulates a malfunction. To properly simulate a malfunction, the dummy round must be randomly placed; it cannot be the first or last round in the magazine. Soldiers should address this malfunction (by performing SPORTS) without prompting.

Table 1 - Kneeling Unsupported Firing Position.

Soldiers begin combat field fire in a kneeling unsupported position next to a barricade. On a signal, four targets expose simultaneously. Soldiers fire at each target until it falls and stays down. After 60 seconds have elapsed, the last target will fall and stay down. Without prompting, Soldiers transition to the barricade supported position.

Table 2 - Barricade Supported Firing Position.

To assume a barricade supported position, Soldiers stand behind the lower portion of the barricade. When in this position, Soldiers are exposed to two sets of targets:

- In the first set, two targets expose simultaneously. After 40 seconds have elapsed, the last target will fall and stay down.
- In the second set, three targets will expose simultaneously. After 40 seconds have elapsed, the last target will fall and stay down.

Soldiers engage at each target until it falls and stays down. Without prompting, Soldiers transition to the prone unsupported position.

Table 3 - Prone Unsupported Firing Position.

To assume a prone unsupported position, the Soldier positions himself so that he fires around the edge of the barricade, using it for cover. When in this position, Soldiers engage two sets of targets:

- In the first set, three targets expose simultaneously. After 50 seconds have elapsed, the last target will fall and stay down.
- In the second set, three targets will expose simultaneously. After 50 seconds have elapsed, the last target will fall and stay down.

Soldiers fire at each target until it falls and stays down. Upon completion of the firing table, Soldiers should stay in position, clear their weapons, and follow the orders given by the tower operator.

SCORING

Accurate performance data are critical. Based on the data recorded, an AAR can be performed by range and firing position to discuss firing performance.

RATINGS

Trained - 24 to 26 hits. The Soldier is trained and has demonstrated proficiency in accomplishing the task to wartime standards.

Partially Trained - 16 to 23 hits. The Soldier needs to practice the task. Performance has demonstrated that the Soldier does not achieve standard without some difficulty or has failed to perform some task steps to standard.

Untrained - 15 or fewer hits. The Soldier does not demonstrate an ability to achieve wartime proficiency.

This page intentionally left blank.

This page intentionally left blank.

