

**SEPTEMBER 2003**

**FM 4-01.30** (FM 55-10)

**MOVEMENT  
CONTROL**

DISTRIBUTION RESTRICTION:  
Approved for public release; distribution is unlimited.

**HEADQUARTERS,  
DEPARTMENT OF THE ARMY**

**This publication is available at Army  
Knowledge Online ([www.us.army.mil](http://www.us.army.mil))  
and the General Dennis J. Reimer  
Training and Doctrine Digital Library at  
([www.adtdl.army.mil](http://www.adtdl.army.mil))**

# MOVEMENT CONTROL

## TABLE OF CONTENTS

	<u>Page</u>
<b>PREFACE</b> .....	i
<b>CHAPTER 1      MOVEMENT CONTROL OVERVIEW</b>	
Definition of Movement Control.....	1-1
Elements of a Transportation System .....	1-1
Basic Principles of Movement Control.....	1-2
The Functions of Movement Control.....	1-4
Other Considerations.....	1-6
Emerging Doctrine .....	1-9
<b>CHAPTER 2      MOVEMENT CONTROL IN THE FORCE PROJECTION PROCESS</b>	
Force Projection .....	2-1
Intratheater Unit Movement.....	2-1
Intertheater Unit Movement.....	2-2
Transformation .....	2-2
Movement Control .....	2-3
Unit Movement Coordinator .....	2-3
Brigade Movement Coordinator .....	2-4
Mobility Support Element.....	2-4
<b>CHAPTER 3      STRATEGIC MOVEMENT CONTROL</b>	
Strategic Movement Control Organizations.....	3-1
Theater Joint Movement Control Organizations .....	3-1
<b>CHAPTER 4      MOVEMENT CONTROL AT ECHELONS ABOVE CORPS (EAC)</b>	
The Army in an Area of Operations .....	4-1
Transportation Command .....	4-2
Theater Support Command .....	4-6
Transportation Command Element.....	4-7
Movement Control Battalion (EAC) .....	4-10
Movement Control Teams .....	4-11

DISTRBUTION RESTRICTION: Approved for public release; distribution is unlimited.

\*This publication supersedes FM 55-10, dated 9 February 1999.

**CHAPTER 5 MOVEMENT CONTROL IN THE CORPS**

Corps Movement Control Staff .....	5-2
Corps Support Command .....	5-3
Corps Movement Control Battalion.....	5-4
Division Support Movement Control Team.....	5-6
Functional Relationships.....	5-7
Movement Control Battalion and Corps Support Group Interface.....	5-8

**CHAPTER 6 MOVEMENT CONTROL IN THE DIVISION**

Organization.....	6-2
Division Transportation Officer .....	6-3
Mobility Warrant Officer .....	6-3
Division Support Command.....	6-4
Movement Control Officer.....	6-4
Movement Control Cell in the Division Rear Command Post.....	6-6
Brigade Movement Control .....	6-6

**CHAPTER 7 DEVELOPING A MOVEMENT PROGRAM**

Introduction .....	7-1
Assess the Distribution Pattern.....	7-2
Determine Requirements.....	7-3
Determine Capabilities.....	7-3
Balance Requirements Against Capabilities.....	7-9
Planning Sequence for Reception and Onward Movement .....	7-9
Requirements Schematic.....	7-11
Mode Schematic .....	7-12
Selecting a Mode .....	7-13
Determine Critical Points .....	7-15
Determine Check Points.....	7-16
Determine Shortfalls and Recommended Solutions.....	7-17
Coordinate the Program .....	7-17
Format and Publish the Program.....	7-18
Executing the Movement Program .....	7-20
Preparing the Port Clearance Program .....	7-21

**CHAPTER 8 TRANSPORTATION REQUEST PROCEDURES**

Planning for Highway Regulation.....	8-2
Principles of Routing .....	8-6
Methods of Scheduling .....	8-7
Clearance Requests .....	8-8
Coordinating Movements.....	8-9
Diverting and Rerouting .....	8-9
Large Unit Movements.....	8-9
Sample Highway Regulation Plan .....	8-11

**CHAPTER 9 HIGHWAY REGULATION PROCEDURES**

Supply System Interface.....	9-1
------------------------------	-----

	Transportation Request Procedures.....	9-3
	Division Transportation Request Procedures.....	9-6
	Corps Transportation Request Procedures.....	9-7
	Echelons Above Corps Transportation Request Procedures.....	9-8
	Clearance Requests.....	9-10
	Coordinating and Monitoring Movements.....	9-11
	Request for Theater Airlift.....	9-12
	Army Airlift.....	9-12
	Air Force Airlift.....	9-16
<b>CHAPTER 10</b>	<b>CONTAINER OPERATIONS</b>	
	Container Management.....	10-1
	Container Control.....	10-1
<b>CHAPTER 11</b>	<b>AUTOMATED IDENTIFICATION TECHNOLOGY</b>	
	General Preparation for AIT Use.....	11-1
	Unit Responsibilities.....	11-2
	AIT in Aerial Port Operations.....	
	AIT in Seaport Operations.....	
	AIT in Railhead Operations.....	
<b>APPENDICES</b>		
<b>APPENDIX A</b>	<b>AUTOMATION INFORMATION SYSTEMS.....</b>	<b>A-1</b>
<b>APPENDIX B</b>	<b>GEOGRAPHICAL CONSIDERATIONS.....</b>	<b>B-1</b>
<b>APPENDIX C</b>	<b>AUTOMATED IDENTIFICATION TECHNOLOGY EQUIPMENT.....</b>	<b>C-1</b>
<b>APPENDIX D</b>	<b>TABLES OF ORGANIZATION AND EQUIPMENT.....</b>	<b>D-1</b>
<b>APPENDIX E</b>	<b>TRANSPORTATION MOVEMENT RELEASE.....</b>	<b>E-1</b>
<b>APPENDIX F</b>	<b>COMMUNICATIONS.....</b>	<b>F-1</b>
<b>APPENDIX G</b>	<b>ROAD MOVEMENT PLANNING.....</b>	<b>G-1</b>
<b>APPENDIX H.</b>	<b>INTERMODAL TERMINALS.....</b>	<b>H-1</b>
<b>APPENDIX I.</b>	<b>EXAMPLE HIGHWAY REGULATION PLAN.....</b>	<b>I-1</b>
<b>APPENDIX J.</b>	<b>TYPES OF INTERMODAL ASSETS AND HANDLERS.....</b>	<b>J-1</b>
<b>GLOSSARY.....</b>		<b>Glossary-1</b>
<b>REFERENCES.....</b>		<b>Reference-1</b>

## PREFACE

This manual describes the organizations, processes, procedures, and systems involved in the control of movements across the military spectrum. The focus of this manual is for the reader to gain an understanding of the movement control system and how it functions from the strategic to the tactical level. It focuses on the planning, controlling, and managing of the use of available modes of transport to move units, equipment, and materiel. It also describes transportation request procedures, container operations, and how transportation resources are controlled and managed.

The Chief of Staff of the Army has mandated that the Army be able to move a combat capable brigade anywhere in the world within 96 hours. To put a viable combat capability on the ground anywhere in the world in this time frame will require effective movement control.

This manual remains consistent with Army operations, logistics doctrine, and concepts currently published or in the process of being published. However, the reader is cautioned that logistics doctrine is changing — and changing rapidly. The on-going efforts to reduce the Army logistics footprint and move to the Objective Force will require doctrinal change. Users acting within the scope of their authority may vary from this doctrine in this manual when such variation will result in improved operations.

The Army's environmental strategy into the 21st century defines its philosophy and commitment in protecting and preserving the environment and natural resources for present and future generations. Sound environmental practices and considerations must be integrated into all Army documents, missions, and operations. In keeping with the Army's vision to be a national leader in environmental stewardship, commanders and leaders must ensure that all local, state, federal, and host nation laws and regulations pertaining to the environment are included in the planning process and followed to an extent consistent with operational considerations.

The proponent of this publication is the United States Army Combined Arms Support Command (CASCOM). Send comments and recommendations on Department of the Army (DA) Form 2028 to Commander, US Army Combined Arms Support Command and Fort Lee, ATTN: ATCL-T, Fort Lee, Virginia, 23801.

Unless this publication states otherwise, masculine nouns and pronouns do not refer exclusively to men.

## Chapter 1

# Movement Control Overview

### DEFINITION OF MOVEMENT CONTROL

1-1. Movement control is the planning, routing, scheduling, controlling, coordination, and in-transit visibility of personnel, units, equipment, and supplies moving over Line(s) of Communication (LOC) and the commitment of allocated transportation assets according to command planning directives. It is a continuum that involves synchronizing and integrating logistics efforts with other programs that span the spectrum of military operations. Movement control is a tool used to help allocate resources based on the combatant commander's priorities, and to balance requirements against capabilities.

### ELEMENTS OF A TRANSPORTATION SYSTEM

1-2. The transportation system is comprised of three distinct elements (see Figure 1-1). These elements are mode operations (highway, rail, water, and air), terminal operations, and movement control. Of these elements, movement control is the most critical component of the system. A movement control system must coordinate the efforts of transportation modes, terminals, services, commands, contractors, and host nations during deployment, sustainment, and redeployment. The timely insertion of movement control capability into the area of operation is critical.

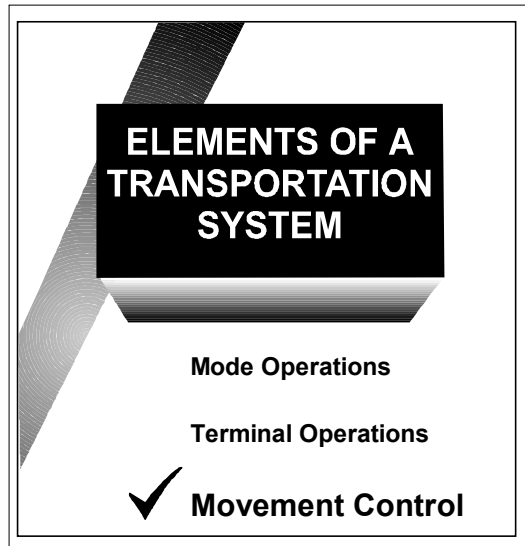

Figure 1-1. Movement Control is the Most Critical of the Three Elements of a Transportation System.

## BASIC PRINCIPLES OF MOVEMENT CONTROL

1-3. The five basic principles of movement control provide a basis for all transportation operations (see Figure 1-2). These principles are discussed below:

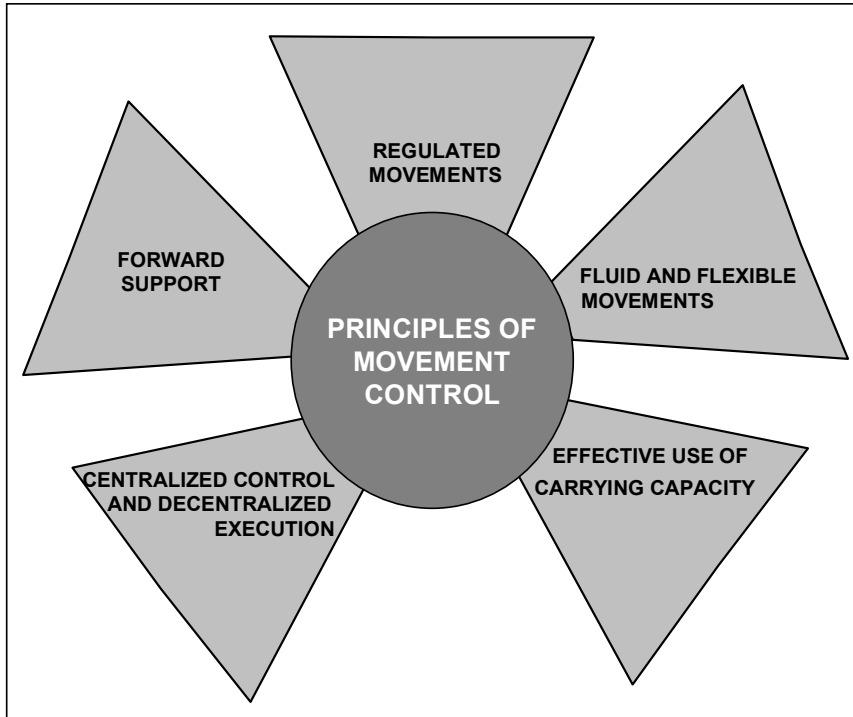

Figure 1-2. Movement Control Principles

- **Centralized Control and Decentralized Execution.** *Centralized Control* means that a focal point for transportation planning and resource allocation exists at each level of command involved in an operation. The focal point is an individual or unit that is aware of the current and future requirements of the supported force as well as the capabilities available to meet the requirements. Centralization of movement control normally occurs at the levels charged with integrating logistics support. *Decentralized Execution* of mode and terminal operations is equally important. Decentralized execution of transportation missions means terminal and mode operators remain free to assign and control the specific transportation assets that will meet the requirement. This practice enhances the flexibility to prioritize support and accomplish the mission.
- **Regulated Movements.** Movement control authorities regulate moves to prevent terminal congestion and scheduling conflicts among Service components. Proper management of transportation assets and the transportation network is critical.



The regulation of movements has three applications. One application is the apportionment of cargo carrying capacities to movement requirements. The second is the regulation of traffic through the LOCs, including MSRs. The third deals with force projection. Transportation planners must determine which traffic and LOCs require control.

**Comment:** Add "Main Supply Route" (MSR)

The free flow of goods and services will work in a non-saturated environment. However, saturation of the system normally occurs because highly mobile forces extend resupply lines. As we move to the objective force, one critical aspect is the reduction of consumption. However, the concept of support (i.e., number of distribution points, dispersion of forces, frequency of resupply, distance of LOCs, non-contiguous area of operations, etc.) can saturate the transportation system. Inadequate transportation capabilities in relationship to the size of the force supported will require prioritization. Movement controllers must therefore regulate movements and execute the commander's priorities for use.

An additional consideration is the support the Army provides to the other Services. In joint and combined environment, regulation of transportation assets and LOCs will prevent congestion and enforce priorities. Regulation of LOC movements is critical. This is always important when US forces must share available airfields, roads, rail lines, water terminals, and inland waterways with allied forces, contractors, commercial users, and the host nation. A clear articulation of priorities is essential.

- **Fluid and Flexible Movements.** Transportation systems must provide the uninterrupted movement of personnel, supplies, and services. To do this, the system must be capable of rerouting and diverting traffic. Maintaining flexibility is one of the biggest challenges facing transportation planners and operators in a changing battlefield with shifting conditions and priorities. The assurance of an uninterrupted flow of traffic is essential to battlefield superiority. Movement control has failed if it does not provide uninterrupted flow of traffic. To accomplish this task, the transportation system must be linked to information and communications systems, without these systems movement control cannot support the future force.
- **Effective Use of Carrying Capacity.** This principle is simple: Keep transportation assets fully loaded and moving as much as the tactical situation permits. This includes the disciplined use of returning transportation assets to support retrograde of equipment, personnel, and supplies; and fast off-loading to return them to the system to increase capability for later operations. Transport capability that is not used one day cannot be stored to provide an increase in capability for subsequent days. Similarly, fully loaded transport equipment sitting idle is as inefficient as moving partially loaded equipment. Maximum use includes the prompt return of transportation assets to ensure their rapid availability for subsequent operations. (It also avoids demurrage, storage, and other penalty charges against the government.). Planners must temper this principle with appropriate attention to adequate equipment maintenance and crew rest.
- **Forward Support.** Forward support is rapid delivery of supplies and personnel as far forward as possible. It is dependent on fast, reliable transportation to move supplies and personnel as far forward as the tactical situation requires and permits. The key to forward support is rapid reception and clearance at destination units. It is frequently necessary to temporarily augment destination units' reception and clearance capabilities to ensure success.

## THE FUNCTIONS OF MOVEMENT CONTROL

1-4. The functions of movement control consist of planning, allocating, routing, coordinating, and in-transit visibility (ITV). Figure 1-3 shows these functions.

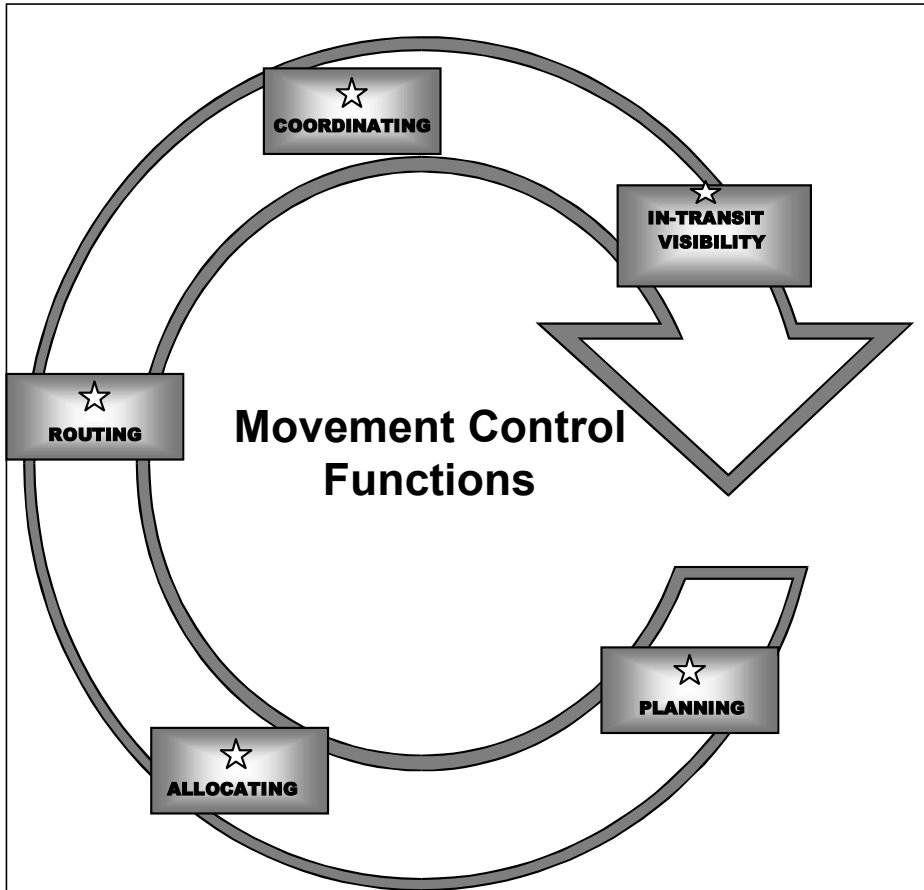

Figure 1-3. Movement Control Functions

- **Planning.** Planning involves the known and anticipating the unknown. Anticipation means being prepared to support combat operations at decisive times and places. It demands flexibility to accommodate change, the ability to see the battlefield, and a thorough understanding of the mission and concept of operations. For movement planners, anticipation includes developing alternative plans to make up for routes and assets lost due to enemy action. Movement planners must also know the distribution system, the location of supply customer activities, the frequency and magnitude of their transportation requirements, and their material and container-handling capabilities. The transportation

planning function is vital to the success of military operations at all levels of command. Staff planners serve on the coordinating or special staffs at each echelon of command. Integral to staff planning is coordination with other functional planners to ensure plans are synchronized with supporting and supported commands, and that they support the concept of operation.

- **Allocating.** The allocation function assigns transportation capability against planned transportation tasks. It is a critical function in decision making because it forces planners to analyze and synchronize transportation tasks, capabilities, and priorities. An army's ability to marshal, transport, and distribute large quantities of materiel and personnel over the strategic, operational, and tactical levels of war can make the difference between victory or defeat. Maneuver and exploitation of tactical gains often depend on the adequacy of the forces' ability to respond to changing and competing priorities. Rapid response is required to meet emergencies and support unexpected opportunities. Frequent movement of combat forces using transport capability normally committed to other tasks, makes maintaining continuity of sustainment support a challenge. Plans are made to respond to these kinds of contingencies. When the response is demanded, the planner must have the needed information immediately available with which to make decisions on how best to meet the emergency or support the discovered opportunity. Knowledge of LOC status, MSR condition, asset location and eligibility, are all crucial elements to the transporters decision process. The transportation planner must constantly review and adjust available capabilities to maximize the support provided. Movement control personnel allocate needs to capabilities based on priorities when there are not enough assets to satisfy all transportation demands. Movement control units require automated information system support coupled with assured communications to execute the allocation function in a timely manner.
- **Routing.** The routing function is the process of coordinating and directing movements on Main Supply Routes (MSR) or alternate supply route, and regulating movement on LOCs to prevent conflict and congestion. When routing traffic, movement planners consider the following routing principles.
  - Assign highest priority traffic to routes that provide the minimum time-distance.
  - Consider the sustained capabilities of roads and bridges when assigning movements.
  - Separate motor movements from pedestrian movements.
  - Separate civilian traffic (vehicular or pedestrian) from military movements.
  - Consider consolidating shipments that can be applied to a selected route.

The routing fundamentals are balance, separation, and distribution.

- **Balance.** This fundamental matches vehicle characteristics with route characteristics. Balance ensures that traffic never routinely exceeds the most limiting feature of a route. It considers the military load classification of the vehicles, bridges, and the route. Balancing also identifies requirements for upgrading routes or ordering caution crossings for certain bridges. Planners should use TB 55-46-1 to obtain vehicle characteristics. Route characteristics are obtained during the planning process using automated information systems, maps, or route reconnaissance.
- **Separation.** This technique allocates road space for movements to ensure that movements do not conflict. The goal of separation is to prevent congestion on regulated

routes. Planners must not allocate road space or time blocks to more than one movement requirement.

- **Distribution.** This practice uses as many routes as possible to reduce the potential for congestion and prevent deterioration of road surfaces. Distribution also promotes passive defense by distributing and separating traffic.
- **Coordinating.** Coordinating is where movement control units interface with units and shippers to provide transportation support. During this process, they match requirements with modes based on priorities, the principles of movement control, and the mode selection guidelines. Movement control units then task mode and terminal operators to provide support. Coordination extends to allied forces, host nations, and non-governmental agencies. Reliable communications are crucial to this process.
- **In-transit Visibility.** ITV is the capability to track from origin to destination, equipment, personnel, and supplies, as they move through the transportation system. Gathering information from different sources (including automated information systems) meets the need to keep track of equipment, personnel, and supplies, as they move through the transportation system. ITV enables movement control units to answer the commanders information needs and accomplish the planning and allocation functions to support them. The United States Transportation Command (USTRANSCOM) uses the Global Transportation Network (GTN) for tracking strategic movements. Theater Transportation Commanders will use the Movement Tracking System to track movements.

## OTHER CONSIDERATIONS

1-5. In addition to the basic principles and functions of movement control, there are several other considerations that are involved. The other considerations have a direct bearing on how movement control is performed. They are discussed in the following paragraphs.

- **Improvising.** Improvising is taking an action with assets immediately available to accomplish something that would not ordinarily be attempted with them. The key to improvising is not to limit one's thinking. Unexpected tactical opportunity, enemy action, interrupted communication lines, and unexpected weather conditions disrupt plans and require improvisation. When this happens, normal procedures are bypassed and unusual transportation actions taken. Improvising involves risk, but the risk of not improvising is greater.
- **Continuity.** The frequent movement of combat forces using transport capability, normally committed to other tasks, makes maintaining continuity of sustainment support a challenge. The transportation planner must constantly review and adjust available capabilities to maximize the support provided. While it is very difficult to balance these two tasks (transport of combat forces and maintaining sustainment), it remains the goal of the transportation planner.
- **Peace to War.** To the maximum extent possible, commanders assign transportation responsibilities, establish procedures, and train using the same organizational structure in peacetime as it will use in war. The initiation of a military operation should only represent

an increase in intensity, not a shift to new structure, procedures, and systems. Movement control elements should be among the early elements deployed in the theater force. Early deployment allows for the timely establishment of a transportation system with the capability to receive and manage the onward movement of the deploying force.

- **Throughput.** The goal of the Army transportation system is the movement of passengers and cargo from origin to destination. This goal can be achieved most efficiently when cargo and personnel proceed with minimum disruptions while in-transit. This concept of operations is called throughput. To the maximum extent possible, Army transportation planners strive to move cargo and personnel from origin to destination using throughput. If throughput cannot be accomplished, Army transportation organizations use intermodal capabilities available. Intermodality is the use of multiple modes for the same shipment.
- **Geographic Location.** Each theater faces its own unique set of challenges when planning a transportation network and its associated movement control capability, because of varied world geography and climatology. Appendix D provides guidance for transportation and movement control managers when planning for a specific geographic area.

1-6. **Hostile Environment.** Transportation units must be prepared to perform their mission in an environment where the enemy's capabilities vary widely. In high- or mid-intensity conflicts, these may be modern tank, motorized, or airborne forces. In low-intensity conflicts, less mechanized but otherwise well-equipped regular and irregular forces and terrorist groups will operate against US forces. Transportation units and infrastructure will be prime targets for all threat levels. Transportation units can expect the use of nuclear, biological, and chemical (NBC) weapons on logistical facilities such as ports, airfields, supply points, and other areas where transporters must operate. One way to lower the threat level is with good intelligence. Good intelligence is critical to any military operation. Mission, enemy, terrain, troops, time available, and civilian considerations (METT-TC) is a guide for intelligence preparation of the battlefield. METT-TC components are:

- **Mission.** The first consideration in planning a CSS mission is to know and understand the mission of the supported combat commander. What is his objective? What is his intent? What is his scheme of maneuver? What is the timeframe for achieving the objective?
- **Enemy.** Movement planners must anticipate enemy intentions and capabilities and how they can affect CSS operations. The enemy's nature and capabilities should be considered in making and executing CSS plans. The enemy's air capability affects the location of critical ports, airfields, and transportation routes. It also influences the decision on conducting CSS activities at night.
- **Terrain (and weather).** CSS commanders and staff officers must continually assess terrain over which they will operate. The availability and condition of routes and facilities are of vital interest. The transporter must determine whether port facilities, rail lines, road networks, and airfields are available and usable. He must identify potential inhibitors to mission accomplishment such as choke points on supply routes and the ability of the enemy to interdict the routes. Weather also influences decisions. Areas with rain and heavy fog will slow ground movement of personnel and supplies and make aerial resupply almost impossible. Extremely hot weather will increase requirements for water transport and cause heat-related casualties to personnel and equipment. Extremely cold weather presents an

equal number of cautions. The transportation planner must keep all these considerations in mind for the whole area through which his transportation must move.

- **Troops.** The elements over which the commander can exert the most influence are his or her troops. It is also the element which, more than any other can effect success. The commander and staff must consider the training, readiness, morale and well being of their personnel, preferably prior to engaging in combat operations. The morale and training of the troops will influence how successfully the transportation mission is accomplished. Differences in skills, experience, training, and leadership make some units more suitable for some missions than others.
- **Time.** The amount of time available to plan and execute a transportation mission is measured by the clock and distance. Fifty miles on a first-class four-lane highway is shorter *in time* than 50 miles on an unimproved two-lane road. At the operational level, time for planning is probably adequate. At the tactical level, time is more critical because the situation changes rapidly as tactical situations and requirements change. The commander that has learned to most effectively use time and distance has learned something valuable.
- **Civilian Considerations.** Civilian considerations relate to civilian populations, culture, organizations, and leaders within the area of operation (AO). Commanders consider the natural environment, to include religious and cultural sites, in all operations directly or indirectly affecting civilian populations. Operational considerations include civilian political, economic, and information matters, as well as more immediate civilian activities and attitudes.
  - At the operational level, civil considerations include the interaction between military operations and the other instruments of national power. It also includes decisions relating to the use of contractors accompanying the force. The consideration of METT-TC impacts how contractors will be used in support of a military operation. These considerations assist commanders and staff planners in evaluating the risk of using contractors throughout the AO. When the commander determines the contractor's risk to be unacceptable, contractors will not be used until the risk is reduced.
  - At the tactical level, commanders must first consider protection of the force. After that consideration is satisfied, commanders must then consider of the impact of *civilians on the operation* — a different perspective than at the operational level (where impact of *operations on civilians* is the consideration). Even so, the tactical commander must be sensitive to diplomatic, economic, and informational issues and concerns. The tactical commander is rarely staffed well to handle civilian issues, unless the mission includes that task. For instance, the presence of local population, displaced persons, and the related need to address their control and welfare presents resource problems. Therefore, civilian considerations and related problems will tax command resources. When missions include civilian considerations, as do stability operations, the civilian population is a central feature of the mission and therefore a prime consideration of the tactical commander.

## EMERGING DOCTRINE

1-7. U.S. forces seek to dominate an expanded combat zone through depth and simultaneous attack with a minimal number of deployed forces. This implies that future operations happen in a nonlinear, noncontiguous combat zone; therefore, movement control operations will face vast challenges. They will have to meet simultaneous demands across a potentially large combat zone with a reduced transportation presence. They can accomplish this only with an agile system in which the distribution flow suffers no breaks in the seams between levels and with dedicated force protection of convoys. As the Army emphasizes even more rapid deployment timeliness, the requirement to have a capable, yet limited in size, operational-level movement control element up front in the deployment sequence becomes even more critical.

1-8. The Army increasingly leverages contracted and HN support assets, develops split-based operations, and uses intermediate staging bases when they present an operational advantage.

## Chapter 2

# Movement Control In Force Projection Operations

## FORCE PROJECTION

2-1. Current US military strategy rests on forward presence and power projection to facilitate the accomplishment of military objectives in pursuit of US policy. Complementing overseas presence, power projection is the ability of the US to apply all the necessary elements of national power (military, economic, diplomatic, and informational) at the place and time necessary to achieve national security objectives. Credible power projection requires the capability to rapidly move sufficient military forces to terminate conflicts on terms favorable to the US and its allies. Effective and demonstrated power projection capability can deter potential adversaries, demonstrate US resolve, and if necessary, enable successful military operations anywhere in the world.

2-2. Deployments are unit movement operations, which are part of the force projection process. Deployment is the planning, preparation, and movement of forces and their support from any location to an area of operations in response to a military need

## INTRATHEATER UNIT MOVEMENT

2-3. Figure 2-1 depicts present doctrine for *intratheater* unit movements. Intratheater unit movements normally involve units moving from an origin location to a Tactical Assembly Area (TAA). Based on the transportation assets available and the unit movement plan, any available mode may be used for intratheater movements. How the unit moves from the origin to the TAA depends on the modes selected (e.g., a unit may move by highway directly from its motor pool to the TAA). Some of the functions depicted in Figure 2-1 may occur at the same geographical location. For instance, if there are rail ramps in or near the motor pool, a unit moving by rail may find the origin and rail marshalling areas collocated.

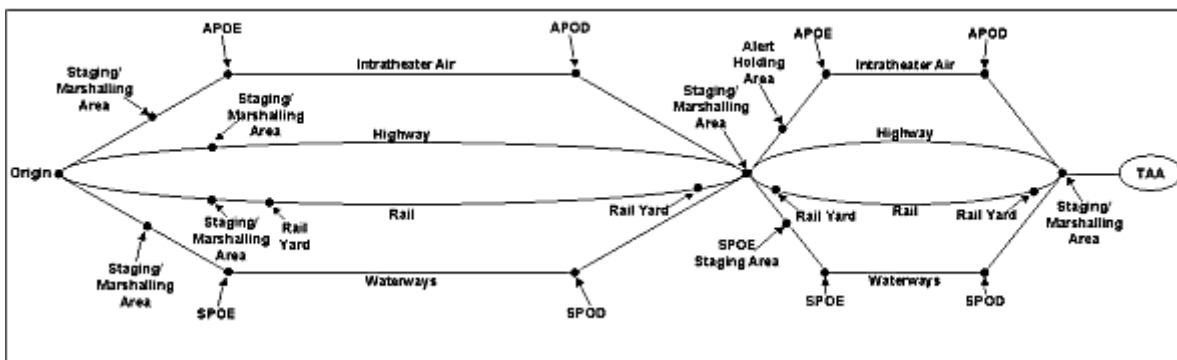

Figure 2-1. Intratheater Unit Movement



## INTERTHEATER UNIT MOVEMENT

2-4. Figure 2-2 depicts present doctrine for *intertheater* unit movements. Intertheater unit movements normally involve units moving from an origin location to a TAA. The strategic lift portion of intertheater unit movements is by air or sea. As in intratheater moves, all available modes can be used for intertheater moves. And depending on the facilities available and activities to be performed, staging and marshaling area functions may be collocated.

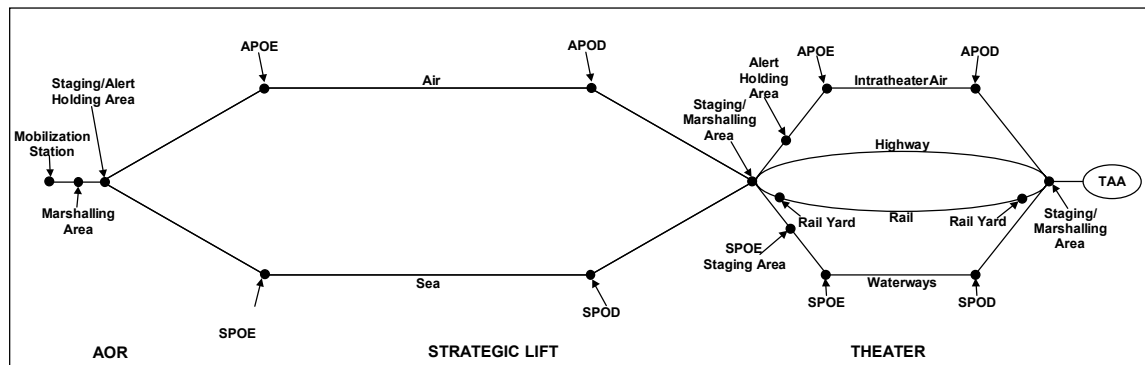

Figure 2-2. Intertheater Unit Movement (Current Doctrine)

## TRANSFORMATION

2-5. The military element of power projection is **force projection**. Force projection is the demonstrated ability to alert, mobilize, and deploy rapidly to operate effectively anywhere in the world. The US Army is the nation's strategic land force and the core of US forces for joint or combined operations. The Army is developing changes to organizational designs and their employment. Transformation of the force into lighter and more mobile forces is driving change to the force projection doctrine.

2-6. Future intertheater unit movements may occur in the absence of Reception, Staging, Onward movement, and Integration (RSOI) capabilities. Future movements of Army forces may not conduct traditional RSOI in the area of operations. The RSOI functions may take place at an intermodal transfer point (this could be as simple as the unit home station) as depicted in Figure 2-3, or the unit may deploy directly into the theater in a maximum ready to fight configuration as depicted in Figure 2-4.

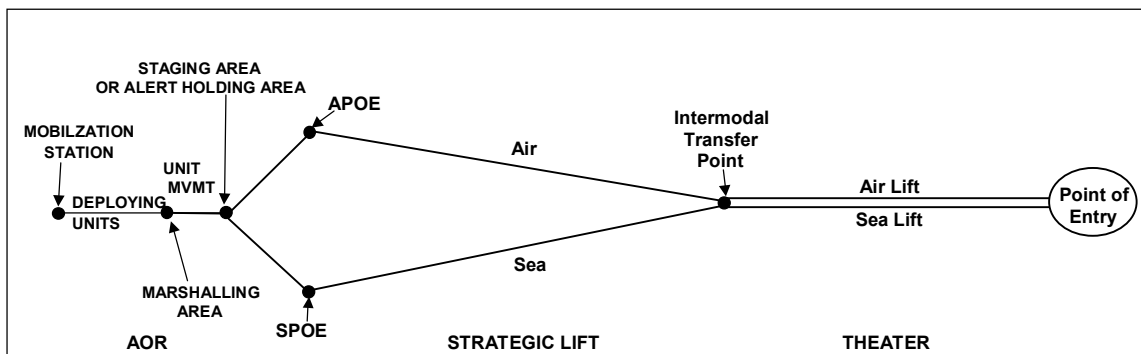

Figure 2-3. Future Intertheater Unit Movement (With Intermodal Transfer)

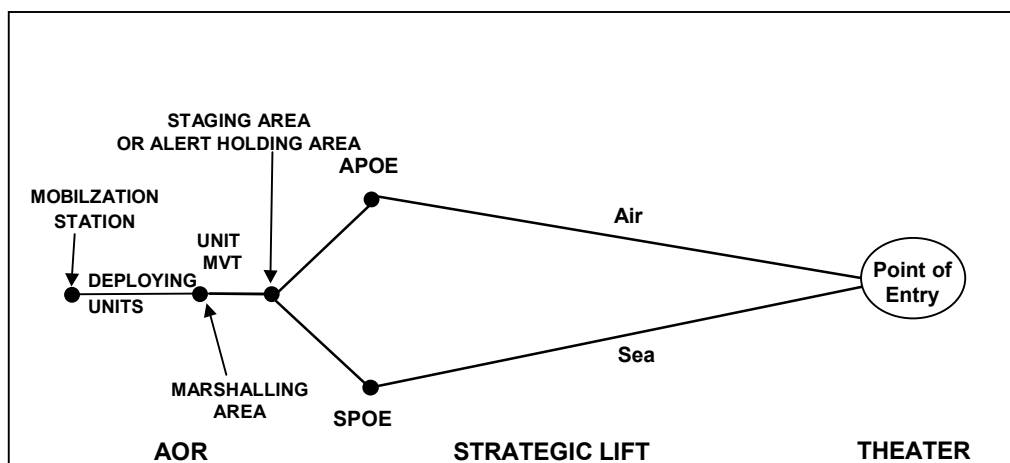

Figure 2-4. Future Intertheater Unit Movement (Direct)

## MOVEMENT CONTROL

2-7. The employment of military ground forces and combat power decides the outcome of campaigns and operations. The success of these forces often depends on sound, timely deployment and sustainment support. A well-defined, integrated, transportation system is important to the success of these operations. Movement control is the most critical component of a transportation system. It is also the linchpin for all transportation actions in a theater of operations. Movement control contributes significantly toward the success (or failure) of any operation. Effective movement control of forces, units, and logistics enhances combat effectiveness. Inadequate control results in reduced efficiency and loss of potential combat power.

## UNIT MOVEMENT COORDINATOR

2-8. Deployment strategy is changing to support Army transformation efforts. It is changing to meet the needs of a smaller force that is primarily CONUS-based. One of the changes is the renewed emphasis on the Unit Movement Coordinator (UMC). The UMC is usually found in the Installation Transportation Office (ITO) in CONUS, and OCONUS; the function is normally performed by the

Movement Control Team (MCT) OCONUS. However, especially in CONUS, the UMC location is the commander's discretion and can be found outside the ITO or its equivalent.

2-9. The UMC is the command technical movements expert. As such, the UMC provides advice to those in both superior and subordinate positions. The position is responsible for providing guidance and training to units and command elements relating to preparation, maintenance, and execution of movement plans. When reviewing plans, the UMC ensures that they adequately address all aspects of logistics and are designed to meet the needs of the unit. This ensures their feasibility, and that they adequately meet the needs of the unit. UMCs coordinate and monitor unit movement via military and commercial transport and can also prepare reports and process requests for convoy clearances and permits.

## **BRIGADE MOVEMENT COORDINATOR**

2-10. Normally located in the S4 office, the brigade movement coordinator (BMC) coordinates the movement of personnel and equipment beyond the capability of organic unit assets with the ITO or UMC. The BMC is the liaison between the UMO (at battalion and company) and the ITO in CONUS locations, the MCT in OCONUS locations; and in both locations, the UMC. BMCs are appointed to coordinate and support brigade movement activities and to assist in the development, maintenance, and evaluation of subordinate units' movement plans. BMC is responsible to:

2-11. The BMC provides the UMC consolidated unit movement plans via TC-AIMS II. If the BMC has access to the UMC server, the transfer is accomplished electronically, otherwise it is transferred via electronic media and hand carried to the UMC. The BMC also provides the UMC a transportation request. These documents provide the UMC with the non-organic transportation and other support requirements for the move. The UMC uses TC-AIMS II to plan the support requirements for each OPLAN to facilitate moving the units.

## **MOBILITY SUPPORT ELEMENT (MSE)**

2-12. The MSE is a new Transportation organization recently approved to support deployment and operational mobility for brigade, regiment, battalion and squadron headquarters level units.

2-13. The organizational designs the MSE in three variations to support deployments and operational maneuver in several type organizations. The basic structure that forms the foundation of the MSE consists of a two-member team composed of an 882A CW2 Mobility Officer and an 88N30 Transportation Movement Coordinator, which provides this element the capability to perform 24-hour operations. This team is assigned to brigade and regimental level commands. A similar element, consisting of an 88N30 Transportation Coordinator, is assigned to battalion and squadron level headquarters. This single person element is developed into two separate variants to support battalion units with a Direct Combat Position Coding (DCPC) of 1 and 2. The MSE provides fielding flexibility based on availability of spaces and the current training base.

2-14. The MSE will be assigned to the S3 of the supported brigade, regiment, battalion or squadron to be fully involved in the deployment planning and force tracking process. The personnel who comprise the MSE will use automation equipment in the supported unit authorized by that unit's TOE, e.g. TC-AIMS II.

## Chapter 3

# Strategic Movement Control

3-1. This chapter describes strategic level movement control organizations. Movement control at the strategic level of war is primarily the responsibility of the Department of Defense (DOD). JCS Pub 4-01.3 outlines the procedures for conducting movement control in a joint environment.

3-2. Movement control is the cornerstone of strategic movements because it coordinates integration of modes and ports in executing strategic movement.

## STRATEGIC MOVEMENT CONTROL ORGANIZATIONS

### US Transportation Command (USTRANSCOM)

3-3. USTRANSCOM is the single transportation manager for DOD. It is responsible for providing global transport in support of national security objectives. It also uses Global Transportation Network (GTN) and the Joint Operation Planning and Execution System (JOPEX) to manage the movement of cargo and passengers through the Defense Transportation System (DTS). Three Transportation Component Commands (TCC) are subordinate to USTRANSCOM. These TCCs are:

- Military Sealift Command (MSC). Responsible for providing all strategic sealift movements.
- Military Traffic Management Command (MTMC). Manages the surface transport of defense materiel and the CONUS air and surface transport of passengers.
- Air Mobility Command (AMC). Responsible for providing all strategic air movements.

3-4. USTRANSCOM coordinates the efforts of these commands with the supported and supporting commanders. (See figure 3-1.)

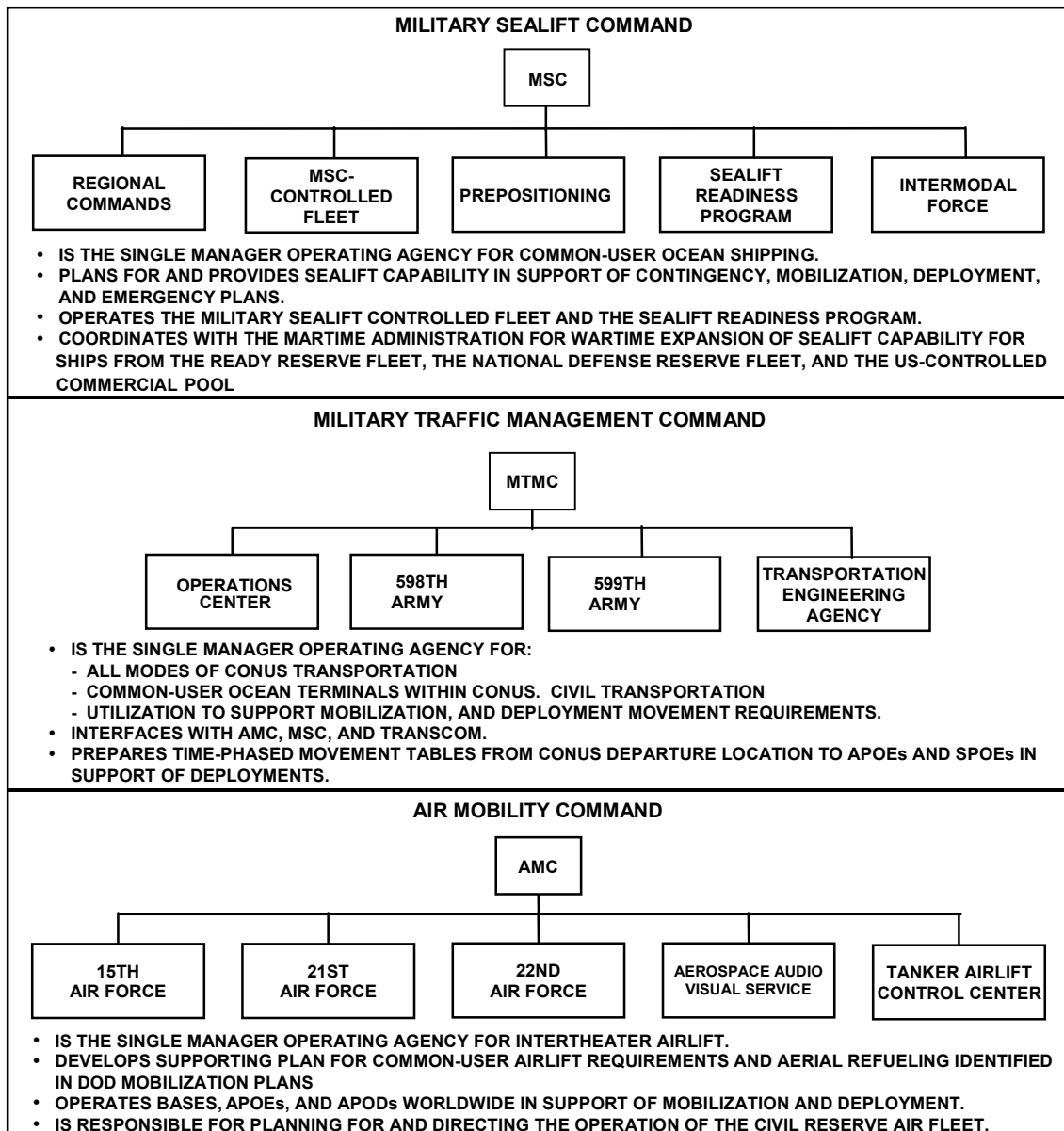

Figure 3-1. USTRANSCOM Component Commands

### Military Sealift Command (MSC)

3-5. MSC provides sealift for the support of strategic deployment and sustainment operations, mobilization, and emergency plans. MSC acquires ships with funding provided by the Department of the Navy. MSC may be augmented from the US-flag ships from the Ready Reserve Force, the National Defense Reserve Fleet, and through charter agreements from US and foreign flag commercial carriers.

## **Military Traffic Management Command (MTMC)**

3-6. MTMC manages the surface transport of defense materiel and the CONUS air and surface transport of passengers. Transport is from the point of origin to the Seaport of Embarkation (SPOE) or Aerial Port of Embarkation (APOE). MTMC does the following:

- Coordinates all activities with the supported combatant commander.
- Works with the combatant commander to create water terminal force packages for situations where reliable stevedore labor or support infrastructure is needed.
- Recommends SPOEs, establishes cargo-booking procedures, and manages the movement of cargo onto ships.
- Operates USTRANSCOM CONUS SPOEs and some SPODs in theater.

3-7. USTRANSCOM, through the MTMC, is the DOD-designated single port manager for all worldwide DOD seaports. MTMC performs all functions necessary to support the strategic flow of the deploying force's equipment and its follow-on sustainment supply to the SPOE and transitions them to the combatant commander at the SPOD. MTMC is responsible for all phases of the theater port operational continuum, which ranges from a bare beach deployment (logistics-over-the-shore operation) to a totally commercial contract-supported deployment. In all cases, MTMC is responsible for coordinating with the combatant commander to workload the SPOD port operator in a manner that responds to the combatant commander's priorities, and to provide movement status information to the SPOD and other interested parties.

## **Air Mobility Command (AMC)**

3-8. The US Air Force Air Mobility Command provides the airlift for strategic deployment and sustainment operations and for other missions such as theater aeromedical evacuation. The Air Mobility Command is also responsible for operating some aerial ports in CONUS and some theater aerial ports. (Other aerial ports are operated by civilian authority.) During strategic deployment, Air Mobility Command aircraft may be augmented by aircraft from US commercial carriers, either through contracts or activation of the Civil Reserve Air Fleet (CRAF).

## **State Area Command (STARC)**

3-9. STARCs are state area commands. Defense Movement Coordinators (DMC) in the state movement control centers manages military highway movements. They assign road space for units based on port calls, monitor all DOD military movements, and coordinate with federal and state agencies for the units' mobilization and deployment needs. For mobilization, the STARCs and installations play an important role in military convoy movements in CONUS. STARCs grant convoy clearances for routine convoys that do not have special requirements (e.g., hauling ammunition).

## **Military Installations**

3-10. Military installations play an important role in movement control. When serving as mobilization stations, coordinating installations, or supporting installations, military installations perform the following:

- Prepare units for deployment.
- Guide and assist assigned and supported units in preparing, maintaining, and executing unit move plans.
- Process convoy clearances and special hauling permits for moves that have special requirements.
- Procure transportation for movement to the POE.
- Provide an Arrival/Departure Airfield Control Group (A/DACG) to the APOE and a port support activity (PSA) to the SPOE.
- Provide selected logistics support to the POEs and en route deploying units as outlined in coordinated plans, Standard Operating Procedures (SOPs), or regulations.
- Control units until deployed from POE.
- Provide marshaling and convoy holding areas.
- Serve as Point of Contact (POC) for updating unit movement data through OEL refinement.

3-11. The unit movement coordinator (UMC) is the command technical movements expert. As such, it is the principal transportation point of contact for deploying units. When reviewing plans, the UMC ensures that they adequately address all aspects of logistics and are designed to meet the needs of the unit. UMCs are located at the installation staff in CONUS and within the MCT structure OCONUS and supports movement preparation and planning.

## **Federal and State Agencies**

3-12. Federal and state agencies play an important role in movement control. When directed by the President of the United States, the Federal Emergency Management Agency (FEMA) coordinates and settles issues involving priorities and allocation of non-industrial facilities. FEMA, as one of its many responsibilities, maintains a national system for emergency coordination of transportation activities to include resource mobilization policy guidance and procedures. State Departments of Transportation (DOT) or equivalent agencies for public highways, toll roads, bridges, and tunnels administer traffic regulations for their states and agencies.

## **Logistics in a Joint Force**

3-13. The combatant commander exercises directive authority over logistics operations within his area of responsibility. This authority is given to the combatant commander so he can do the following:

- Ensure the effective execution of OPLANs.
- Provide effectiveness and economy in operations.
- Prevent or eliminate unnecessary duplication of facilities and overlapping of functions among the components.

3-14. The theater movement plan is key to a sound movement control system. The plan integrates the transportation capabilities of the various component commands and produces a movement control system with centralized planning and decentralized execution. Figure 3-2 depicts the structure of the transportation movement control organizations in a joint command. The following paragraphs describe the transportation and movement control capabilities of each joint force component.

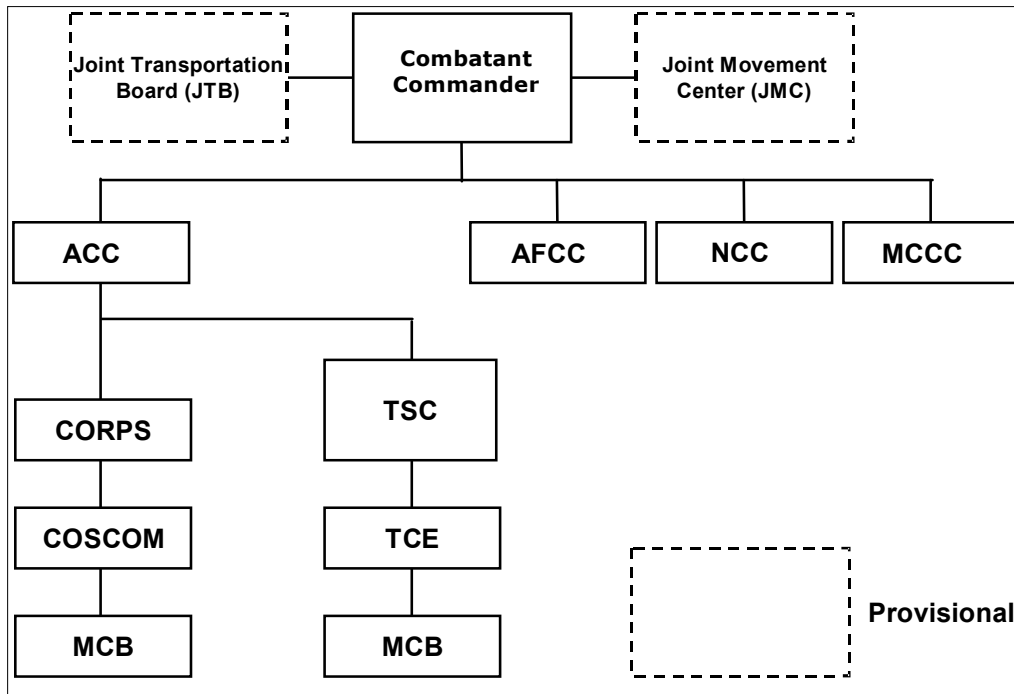

Figure 3-2. Transportation Movement Control Organizations in a Joint Command

### Army Component

3-15. The Army Component Command (ACC) provides land, intratheater water, and inland waterway transportation to the joint force. It also furnishes water, rail, and intermodal terminal operations and when necessary, logistics-over-the-shore operations. It provides land and water transportation through the Theater Support Command (TSC), Transportation Command Element (TCE), and Movement Control Battalions (MCB).

### Air Force Component

3-16. The Air Force Component Command (AFCC) provides theater airlift to the joint force. The theater combatant commander exercises command authority over all theater-assigned airlift forces through the Air Force Component Commander. USTRANSCOM exercises command authority of strategic airlift forces supporting the theater.

### Navy Component

3-17. The Navy Component Command (NCC) provides movement control operations using advanced logistics sites and advanced logistics support sites, or a designated fleet port representative. The Navy provides sealift for the theater, and cargo-handling and port group organizations can also provide limited port operations.

### Marine Corps Component



3-18. The Marine Corps Component Command (MCCC) has a Strategic Movement Officer (SMO) organic to its air-ground task force staff. The SMO coordinates Marine Corps movement requirements with the TSC. The Marine Corps activates a Force Movement Control Center (FMCC) within theater to coordinate and provide transportation services to all its land-based elements. As the Marine Corps primary movement control agency within theater, the FMCC establishes liaison and communications with the Joint Movement Center (JMC) and forwards all transportation shortfalls to the TSC.

## **THEATER JOINT MOVEMENT CONTROL ORGANIZATIONS**

3-19. The theater commander may decide to form a JMC or a Joint Transportation Board (JTB). The usual activities of these organizations are discussed generally below, but since the theater commander creates them, their mission and function are totally tailorable by the theater commander.

### **Joint Movement Center (JMC)**

3-20. A JMC is normally established by the combatant commander. It coordinates the employment of all means of theater transportation (including that provided by allies or host nations) to support the concept of operations. The JMC is also the single coordinator of strategic movements.

3-21. The JMC oversees the execution of theater transportation priorities. It is also responsible for planning movement operations and for monitoring the overall performance of the theater transportation system. In the absence of a JTB, the JMC is the primary advisor to the combatant commander in the transportation apportionment process. The JMC identifies the difference between forecasted requirements and current capabilities of all modes to assist in the planning process.

3-22. The JMC is organized along functional lines and is designed with a peacetime nucleus that can expand in proportion to the size of the joint forces and the desires of the combatant commander. The theater transportation command provides the Army resources to the JMC. A fully developed JMC will have an administrative section and two divisions such as plans and programs and operations. The combatant commander will first use his own staff and Service component staff personnel resources for the nucleus of the JMC. When expanding a JMC, the combatant commander will consider the structure of his dominant force and component-unique movement control requirements. The combatant commander may also draw on reserve personnel to augment the JMC. The JMC's major responsibilities include the following:

- Forecasting long-term movement requirements.
- Planning theater transportation by land, sea, and air (excluding bulk liquid fuel that moves by pipeline).
- Apportioning transportation capability available within the command among the projected transportation tasks and components.
- Receiving and validating airlift requests and coordinating with Air Mobility Command for intratheater air and USTRANSCOM for intertheater airlift.
- Monitoring sea deployment and recommending changes to movement requirements in JOPES.
- Coordinating all seaport operations and reviewing and validating sea channels
- Monitoring container control activities of all joint force components.

- Managing transportation requirements that cannot be met at lower levels in the movement control system.

### **Joint Transportation Board (JTB)**

3-23. A theater JTB is not normally established. However, the combatant commander may establish a JTB to review and manage policies, priorities, and transportation apportionment, beyond the authority of a JMC. The theater transportation command provides the Army resources if a JTB are established. The JTB may consist of representatives from the Service components, movement control agencies, and the command J3 (Operations), J4 (Logistics), and J5 (Plans and Policy). The combatant commander determines who should chair the theater JTB (normally the J4). The JTB is not a day-to-day activity. The JTB's major responsibilities include the following:

- Recommend priorities.
- Recommend allocation of assets.
- Review priorities and policies.
- Resolve conflicts between service component commands.

## Chapter 4

# Operational Movement Control At Echelons Above Corps (EAC)

The weakest segment is in the theater of operations. Specifically, the hand-off of personnel, equipment and materiel from USTRANSCOM to the [Combatant Commander] at the ports of debarkation appears to be the "critical seam" where disruption of the deployment flow is most likely to occur.

Report of the Defense Science Board Task Force on Strategic Mobility  
August 1996

4-1. This chapter describes movement control functions performed by the theater support command (TSC), Army transportation command (TRANSCOM), transportation command element (TCE), movement control battalions (MCB), and movement control teams (MCT). Movement control organizations above corps are in the operational and tactical phases of wartime movement control.

## THE ARMY IN AN AREA OF OPERATIONS

4-2. Each geographic combatant commander has a Service component commander from each Service-level organization (Army, Navy, Marines, and Air Force). In order to fulfill the requirement to provide a Service component commander, the combatant commander activates an Army service component command (ASCC) headquarters.

4-3. The ASCC commander is specifically responsible for service-related U.S. Code (USC) Title 10 tasks to prepare, train, equip, administer, and provide combat service support (CSS) to Army forces assigned or attached to combatant commands. The ASCC may also have many lead service responsibilities, which entail common-user logistics (CUL) support to other services, multinational forces, government agencies (OGAs), and/or nongovernmental organizations (NGOs). (See FM 4-93.4 (63-4) for more details.)

4-4. At theater level, centralized movement control coordinates the flow of units, personnel, and material (including sustainment) into the theater and forward destinations. These actions are vital for processing deploying units and sustaining them in theater. The ASCC headquarters provides command and staff supervision of movement control units through the assigned TSC and TCE. The ASCC calls for deployment of a TSC, or elements of a TSC, to open lines of communications (LOC) in the theater. LOC components include facilities required to move, maintain, and sustain theater forces. LOC components consist of the following:

- Aerial ports of embarkation and debarkation.
- Seaports of embarkation and debarkation.
- Water, rail, and highway networks.
- Host Nation (HN) resources.

4-5. Movement control organizations perform a vital role in establishing and supporting the theater distribution system. The theater distribution system provides the ASCC the ability to control the reception, distribution, and retrograde of materiel and to maintain total asset visibility (TAV) through communication and information systems. The ASCC normally establishes a TSC in the theater to

manage the theater level logistics effort and provide command and control to the theater level logistics units.

## **TRANSPORTATION COMMAND (TRANSCOM)**

4-6. The Army Transportation Command, (TRANSCOM) is a one-of-a-kind multi-component organization designed to provide worldwide planning and operational skill. (See figure 4-2.) TRANSCOM is a major subordinate command of the Army Service Component Command. The Army TRANSCOM has the single multi-theater role as the transportation organization that serves the warfighting combatant commanders by forming the link between operational and strategic transportation. The Army TRANSCOM is the appropriate operational interface between the Defense Transportation System and the theater distribution system. The organization can react to all levels of the spectrum of conflict by providing transportation support in the form of early entry modules, command cells for command and control of transportation units and planning support to functional commands.

4-7. The TRANSCOM is to the Army Service Component Commander as the TCE is to the Theater Support Command Commander. That is, they work on different levels and have a different scope. They are as dissimilar as the Corps Transportation Officer is to the COSCOM.

4-8. The Army TRANSCOM provides the ASCC commander with a transportation workforce to use to support joint requirements with the combatant commander. The Army TRANSCOM provides a substantial number of trained transporters in the right grades to support ARCENT or J4 requirements. The TRANSCOM staff element is used to working together because they train as a unit. This provides a cohesive workforce to the ASCC commander (who does not have to strain his J4 transportation staff) to call into play as needed.

**NOTE:** The TRANSCOM is already helping the various ASCC with transportation planning functions during peacetime on a daily basis, so they are prepared to join the ASCC staff seamlessly when called to serve.

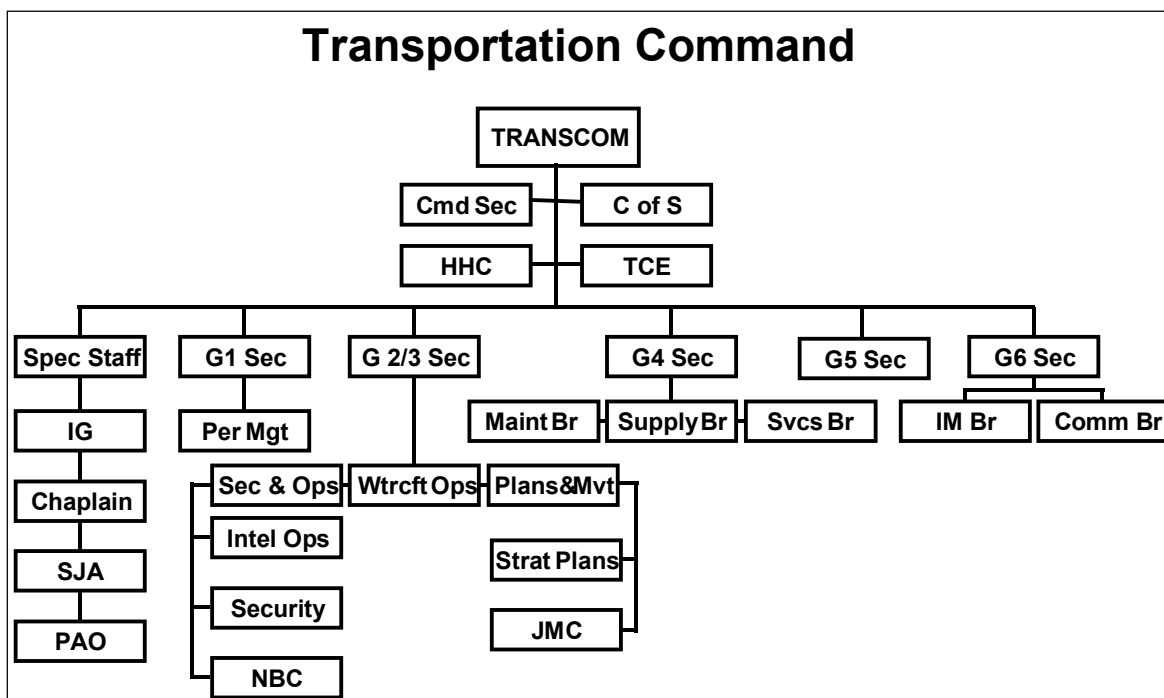

Figure 4-2. Army TRANSCOM

4-9. The Army TRANSCOM is best employed on the battlefield by apportioning operational modules that enable the combatant commander to turn to a single competent organization for the management of transportation services and support. The TRANSCOM supports the theater through the deployment of the entire TRANSCOM headquarters, or through the deployment of modular components of staff from the TRANSCOM. The TRANSCOM, from its fixed base in CONUS and its ability to rapidly project into a theater, is a provider of a responsive right-sized core of subject matter experts (SME) that can be called upon to enable transportation support to rapid force projection throughout the phases of a campaign plan. The TRANSCOM can provide the Army component of two joint movement control centers (JMC) at a time. Once employed, it is built up or relocated to expedite critical or time sensitive transportation operations based upon METT-TC. This employment capability also includes theater watercraft operations planning and capabilities analysis or validation.

4-10. Task organization is accomplished to provide the mix needed to conduct transportation operations. The provided capability includes not only functional expertise in transportation, but also a capability to accomplish internal support for administration, logistics and special staff functions. Taken as a whole, the TRANSCOM is employed to provide all theater transportation functions required by the ASCC, land force commander, or theater level command, as dictated by METT-TC. The TRANSCOM deployable module, in short, provides flexibility and transportation specific augmentation tailored to theater commander requirements.

4-11. In short, the TRANSCOM can be built up, reorganized, or dismantled incrementally as a crisis escalates or is eliminated over time. This flexibility allows for the right capability at the right time and, when introduced in a time-phased manner, minimizes the transportation logistics footprint in

theater while maintaining the highest efficiency and capability in the business of transportation and distribution of personnel and materiel.

4-12. Prior to deployment, the TRANSCOM will concentrate on mission and readiness tasks and on training personnel on mission essential tasks. It will provide focused transportation training exercise, planning, execution and functional analysis of deliberate, contingency and exercise plans. It is the only Army organization structured with the capability to provide analytical planning and operational oversight for the entire transportation spectrum in all AOs.

## Modular Support

4-13. The Army TRANSCOM functions at the theater level as the Army piece of the joint transportation structure. The TRANSCOM ensures the maneuver commander gets the priority of transportation support needed to accomplish a given mission or campaign. The TRANSCOM provides subject matter expertise in the form of deployable modules that are tailored and apportioned to meet the METT-TC operational requirements of a theater commander's campaign. The TRANSCOM provides early entry modules to the theater commander, ASCCs, and joint force commanders for theater transportation plans, policies and procedures. Among the deployable module actions the TRANSCOM can take are:

- Provides SMEs to the Strategic Movements Center (SMC) which works with the deploying combatant commander to deconflict strategic movement priorities.
- Provides tailored modules to establish the Army component of a joint movements center (JMC) at Theater level.
- Provides Army transportation SMEs to a joint transportation board and other boards and centers, as needed.
- Provides expertise to the conduct of other joint transportation requirements such as joint logistics-over-the-shore operations.
- Provides staff augmentation for existing staff functions of the TCEs, which can include: providing for administrative support, intelligence, force protection, NBC, information management, special staff, miscellaneous logistics, mobilization, and deployment support.
- Provides modules directly to the TSC, ASCC, land component commander, and the theater commander to support all operations worldwide, as required.

## Planning Capabilities

4-14. The TRANSCOM is the enabler for critical planning and operational linkage for worldwide transportation operations. Home station and deployable modules can:

- Perform initial crisis, contingency and deliberate planning.
- Provide theater level deliberate and contingency transportation throughput analysis, movement capability assessment, development of time-phased force deployment data (TPFDD), and synchronized operations in a theater, coordinating with USTRANSCOM and the TSC, contractors, and wartime host nation support.
- Prior to mobilization and deployment, the TRANSCOM, coordinating with the TSCs, provide training and readiness oversight, exercise opportunities, and integrated operational planning focus to the TCEs.

## Command and Control

4-15. The Army TRANSCOM —

- Commands, controls and provides technical direction to all transportation units subordinate to the ASCC.
- Provides peace time training and readiness support to non deployed TCEs.
- Controls designated wartime host nation support resources, and acts as liaison with other United States and allied forces.
- Coordinates military transportation support to civilian authorities and synchronizes the transportation needs of non-governmental organizations and humanitarian organizations.

## Concept of Employment

4-16. As the Army's operational level transportation planning organization, the TRANSCOM works with the supported combatant commanders to develop and validate theater transportation plans in support of current and future operations. The TRANSCOM bridges the strategic and operational levels of Transportation logistics. In this role, the TRANSCOM also provides training, readiness support, and integrated operational planning focus to the TCEs. It is the only Army organization structured with the capability for analytical and operational and training oversight to the entire transportation spectrum in all areas of responsibilities (AOR). In this capacity the TRANSCOM provides —

Coordination and operational transportation support to combatant commanders OPLAN and CONPLAN. Staff planning for coordination of transportation combat service support activities as assigned by the ASCC or joint force commander. As organized under this concept, the TRANSCOM provides all combatant commanders a centralized single source of strategic, operational, and tactical transportation expertise.

- The Army core component to staff the joint movements center. Combatant commanders establish JMCs at the component level to enable the interface of strategic and theater movements. The JMC executes the combatant commander's movement priorities, deconflicts, manages, reports, and validates theater movement requirements within the AOR. The TRANSCOM can generate an Army core to a JMC to support two combatant commanders simultaneously when needed. This capability allows the combatant commander to interject the organization that was directly engaged in the writing of the transportation portions of the OPLAN.
- Command, control, and staff supervision in the training and readiness of TCEs prior to deployment. Once deployed, the TCE is OPCON to the TSC or the joint force commander.
- Augmentation for the TCE for prolonged contingencies or campaigns. If a campaign requires two TCEs, the TRANSCOM may deploy additional logistics, administrative or other functional structure to augment the TSC or TCE as the operational environment expands.
- Modular deployable capability for the ASCC to provide information analysis, current and future transportation planning, staff linkage and horizontal and vertical staff coordination.

This capability is configured as early entry modules to fill battle rostered positions within the ASCC, JMC, TSC and TCE staffs.

FM 4-01 (55-1) provides additional information on transportation services in the theater.

## THEATER SUPPORT COMMAND

4-17. The TSC is designed to be a modular organization that can deploy incrementally into an AO to command and control various operational-level support functions. The ASCC commander determines the composition and flow of TSC elements into an AO. Within an AO, the ASCC determines the scope of TSC responsibilities over the array of operational-level support functions, on the basis of the ASCC commander's plan and subsequent guidance. The TSC reports to the ASCC and serves as the coordinating agent with links to both the strategic and tactical levels. The ASCC commander may attach other units for specific operations. Support requirements at the operational-level vary considerably depending on the type of operations and the scale of the deployment. The usual mission of the TSC is to maximize throughput and follow-on sustainment of Army forces and other supported elements and to provide area support to the operational-level units in the area of operations. This support may include tactical-level support to early deploying units. The TSC also executes any lead Service common user logistic support requirements that the ASCC commander assigns to it. Also, the TSC can help synchronize support operations of all the ASCC's lead Service support responsibilities to the joint force. (FM 4-93.4 discusses the TSC in detail.) Within this framework, the TSC provides support to the theater and tactical level support on an area basis to units operating within and passing through its area of operations. This support might include the following:

- Movement control
- Materiel management
- Supply
- Contracting
- Property disposal
- Maintenance
- Transportation
- Field services
- Health services
- Civil military affairs
- Finance
- Postal
- Personnel management
- Religious services

4-18. Due to the continued emphasis on force projection operations and the desire to increase the strategic responsiveness of the Army, **TSC forces will remain a vital early deploying force.** As the Army emphasizes even more rapid deployment timelines, the requirement to have a capable, yet small, operational-level support element up front in the deployment sequence, becomes even more critical. The ASCC headquarters and the supporting TSC must plan to lead the opening of the AO in every possible case that offers *permissive* entry.

4-19. Because the TSC and its supporting organizations are of modular design, it is capable of deploying in whole or in selected parts. Modular design provides the ASCC commander the capability of a more balanced, proportional building the support command and control structure for limited and early entry operations. What is to be deployed, and its configuration in any given situation, depends on the circumstances that must be planned for in early entry considerations. The TCE deploys with the TSC, as the senior transportation headquarters, commanding and controlling all transportation functions in theater. The TCE commands and controls the transportation movement control and mode operating units in the area. The movement control section of the TCE



provides movement control throughout the area. The TCE provides supervision of the movement control and mode operations efforts to maintain a seamless distribution continuum in the area and as part of the theater distribution system as a whole.

4-20. The distribution management center (DMC) coordinates the efforts of the movement control section in the TCE and the material management center (MMC). The TCE mode assets support the material movement requirements from the MMC. The TCE mode assets support the material movement requirements from the MMC.

### **Transportation Command Element (TCE)**

4-21. The TCE is the senior transportation command and control headquarters in a theater of operations when no TRANSCOM is assigned. It commands all EAC level transportation units, (movement control, terminal, mode, etc). The TCE is responsible for developing theater plans, policies, procedures, and programs for transportation requirements, use of Army transportation, and terminal transfer operations. It prepares estimates, plans, and policies for mode and terminal operations. It advises the TSC on the effective use and operation of transportation units and services. The TCE provides transportation policy as input to the plans and policies directorate. It also provides supervision for subordinate transportation units. The TCE is functionally organized to plan for all modes of theater transportation operations. The TCE supports the Army and provides common transportation support to joint or combined commands.

4-22. The Army executes in-theater EAC movement control through a TCE with subordinate movement control battalions (MCB). The TCE implements the theater priorities established by the ASCC in support of the combatant commander's concept of the operation. The TCE is focused on transportation operations in a specific AO, regardless of the nature of the contingency operation. This requires close direct coordination with the ASCC deputy chief of staff for operations. It also requires close coordination with the MMC.

4-23. The TCE organization is flexible and designed to meet the specific transportation and movement control requirements of the theater. A detailed description of a TCE organization is in Appendix D. The TCE uses a building block concept, which assigns the correct mix of battalions and teams to perform its missions based upon the following:

- Geographic characteristics of the theater.
- Number of forces.
- Transportation infrastructure.
- Number and type of movement requirements.

4-24. The TCE plans and coordinates reception and onward movement so units, personnel, and materiel are received in the theater and delivered to destinations with minimum delays. It also coordinates and maintains the status of shipments into the theater and their delivery to destinations.

4-25. The TCE's mission is to provide movement management services and highway traffic regulation to coordinate personnel and materiel movement into, within, and out of the theater. It coordinates with allied nations, HNs, other Service component movement control organizations, and USTRANSCOM or its components as needed. As the senior movement control (MC) organization, the TCE does the following:

- Coordinates with the DMC to balance the existing transportation capabilities of the distribution system with the day-to-day and projected operational requirements.
- Manages transportation flow capability by maintaining visibility of resources that are being transshipped at transshipping nodes.
- Coordinates the use of road networks.
- Monitors the movement of personnel, equipment and supplies from their arrival into theater until their delivery to destinations.
- Plans and coordinates reception and onward movement so that units, personnel, and materiel are received in the theater and delivered to destinations.
- Develops procedures and programs for transportation requirements, uses of Army transportation, and terminal transfer operations.
- Supports US, allied nations, and HN forces as required.
- Prepares movement and port clearance plans and programs, including reception and onward movement.
- Prepares estimates, plans, and policies for movement control, mode operations, and terminal operations.
- Conducts liaison with higher and lower movement control organizations, HN transportation agencies, commercial agencies, transportation mode operators, and customers.
- Maintains status of movement capabilities.
- Commands and controls movement control battalions (Figure 4-3).
- Commands and controls assigned mode transportation groups and battalions (Figure 4-3).
- Commands and controls rail and terminal operation units (Figure 4-3).
- Serves as the functional transportation command and control headquarters for a corps when a corps acts as the ASCC for a JTF.
- Supports the transportation requirements of its MCBs and a corps MCB.
- Develops theater movement control procedures.
- Coordinates the movement of major units.
- Prepares and recommends policies to control, regulate, and expedite the movement of intermodal assets (leased containers, flatracks, 463L pallets, and so forth) within the theater.
- Recommends site selection for transportation activities (MCBs, MCTS, truck units, trailer transfer points, transshipment locations, air terminals, railheads, pipeline take-off points, and inland waterway terminals).
- Selects the transportation mode suited for each movement and coordinates cargo transfer operations.
- Exchanges reports and plans with USTRANSCOM and Military Traffic Management Command. These include traffic and port analyses and reports on emergency situations that might curtail service over any portion of the transportation system.

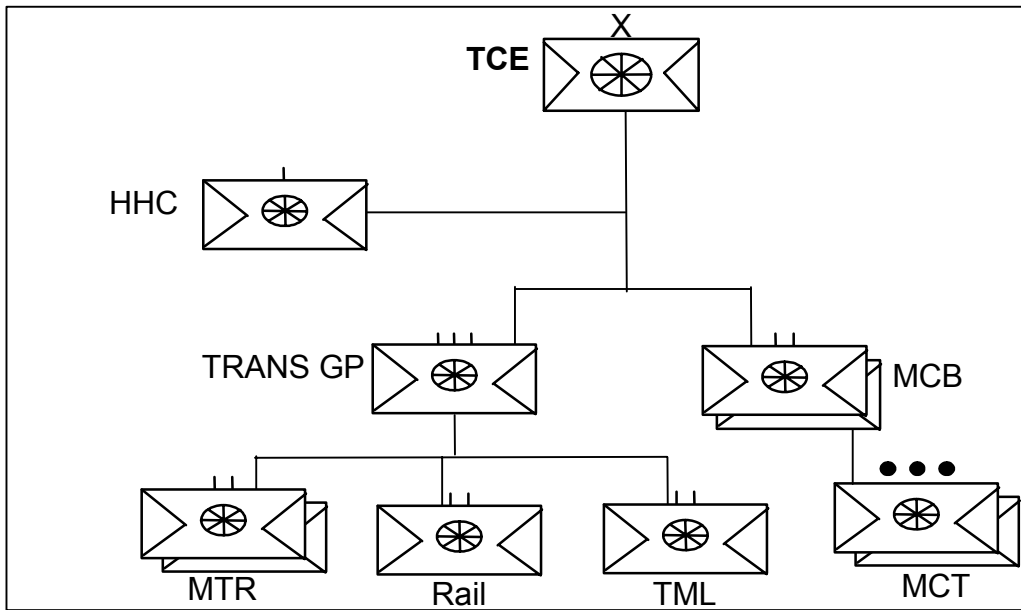

Figure 4-3. Transportation Command Element

4-26. The TRANSCOM provides reach capability to the deployed TCE for additional staff support as needed. Figure 4-4 shows the TCE organized along internal functional lines.

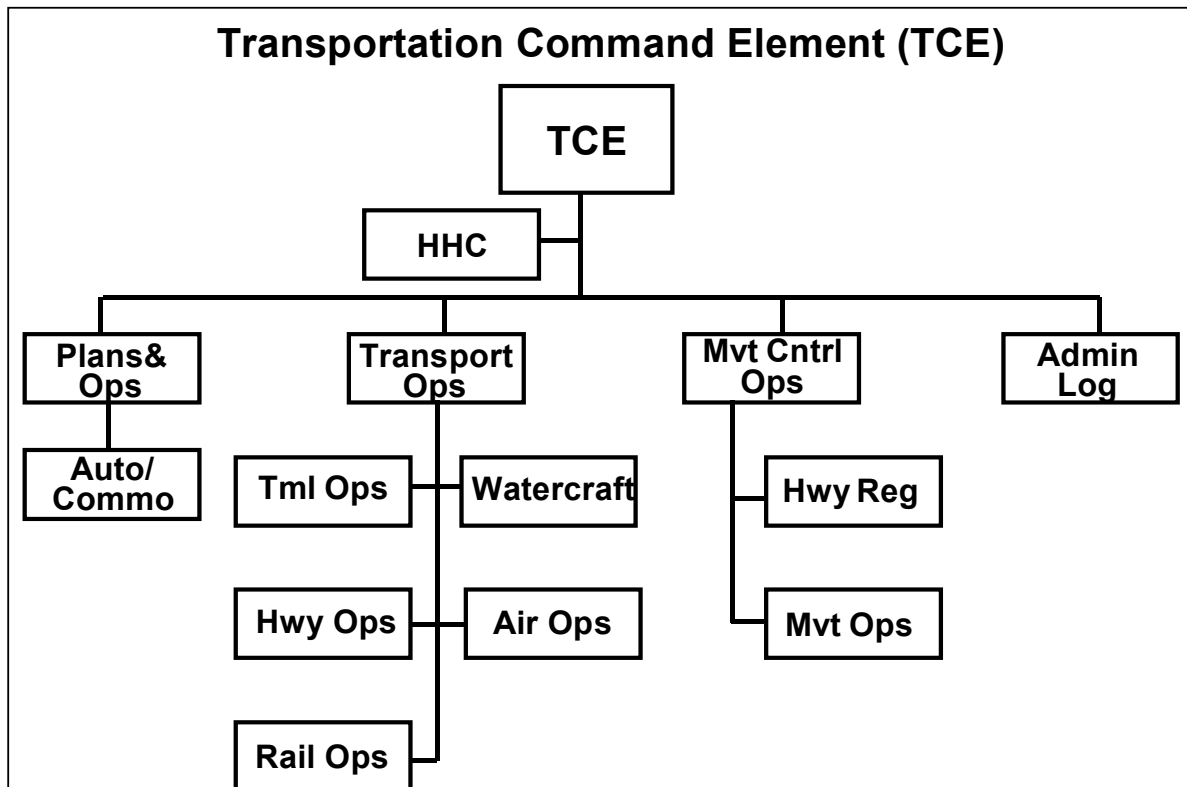

Figure 4-4. TCE Organization

### Movement Control Battalion (EAC)

4-27. The MCB (EAC) commands, controls, and supervises MCTs. An MCB will have as many subordinate MCTs as needed to operate in its AO, based on factors such as number of customers; air terminals, rail terminals, and sea ports; and MSRs. The battalion provides asset visibility and maintains in-transit visibility of tactical and nontactical moves within the TCE defined geographical area. To decentralize execution of its transportation management and movement control functions, the TCE may divide the AO into transportation movement regions each with an MCB. The number of customers served, number of modes and nodes, and the geographical size of the AO influence the size of the regions. MCBs (EAC) provide command and control of movement control functions in these regional areas, and are responsible to the TCE for the management of movement matters that take place in their respective regions. The MCB (EAC) is organized as shown in figure 4-5. The MCB is responsible to the TCE for the control and management of movement control activities that take place in their respective regions. The TCE determines which specific functions the MCB will perform. Some responsibilities of MCBs are as follows:

- Coordinates with corps MCBs, HN transportation agencies, transportation mode operators, and customers.
- Assists in planning and executing plans for the reception, staging, onward movement, and retrograde of personnel, equipment and sustainment supplies. This includes actions associated with marshaling and staging areas.

- Monitors, manages, and executes the TCE's movement and port clearance plans and programs.
- Monitors the use of trailers, containers, and flatracks located in its AOR. Coordinates with users to expedite return of these assets to the transportation system.
- Applies and meets the priorities provided by the TCE. Performs highway regulation functions in its AOR to prevent congestion. Balances transportation assets with requirements according to directed priorities. Advises the TCE on the need for cross leveling.
- Coordinates with HN authorities for cargo transfer locations and for transportation support.

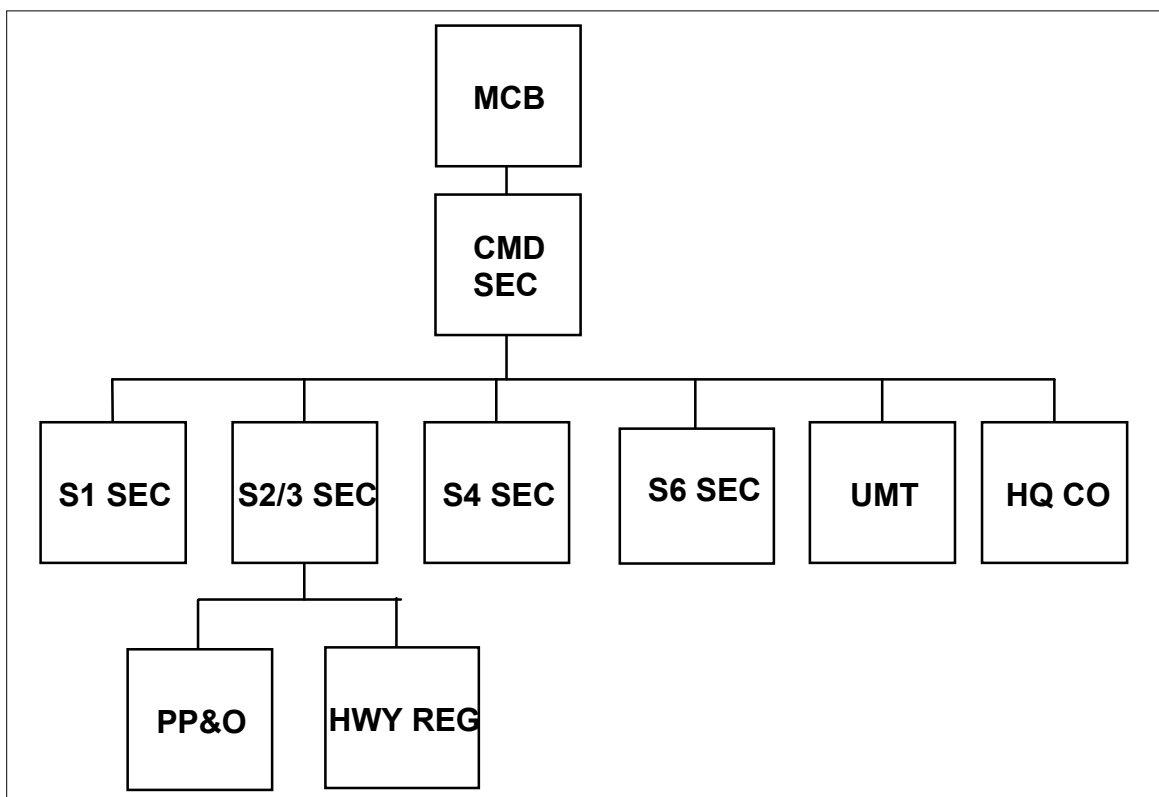

**Figure 4-5. MCB (EAC) Organization**

4-28. The battalion and its subordinate teams provide area movement control support for all units in an area assigned by the TCE. The TOE for the MCB (EAC) is at Appendix D.

### **Movement Control Teams (MCT)**

4-29. MCTs are attached to MCBs in the theater to decentralize execution of movement responsibilities on an area basis or at essential transportation nodes. The various sizes and capabilities of the MCTs provide flexibility in assignment based on anticipated workload.

4-30. The mission of MCTs is movement control of personnel, equipment, sustainment supplies and the coordination of bulk fuel and water transportation at pipeline and take-off points. To this end, the MCTs contribute to development of procedures, documents, and practices to facilitate local

movement. MCTs are the common point of contact for mode operators and users of transportation. Their role is to expedite, coordinate, and monitor traffic moving through the transportation system. When requested or directed to, MCTs participate in shipment planning for the activities they serve. MCTs can also provide field assistance in container control. To carry out their responsibilities, the MCTs rely heavily on close coordination with mode operating units and users of transportation.

4-31. The MCT's duties and functions will depend on the immediate situation. MCT's duties include:

- Processing movement requests and arranging transport for moving personnel, equipment, and sustainment supplies.
- Processing convoy clearance requests and special hauling permits.
- Selecting the mode (air, rail, inland waterway, or highway) for unprogrammed moves.
- Commit the mode assets.
- Maintaining communication with the transport services, shippers, receivers, and if applicable, HN movement control agencies.
- Keeping a status of and advising the movement control battalions, as applicable, on the location of units, installations, and pipeline take-off points; transportation requirements; availability of modes of transport; shipper and receiver capabilities; trends of asset use capacity and the general transportation movements' situation in their areas.
- Assisting the unit commanders and service representatives on transportation matters.
- Assisting in carrying out the movement program and directives from higher headquarters.
- Enforcing movement priorities.
- Investigating delays in moving personnel or materiel. Providing transportation reference data and intelligence.
- Assisting in highway regulation by forwarding movement bids and providing technical advice to units in movement planning.
- Coordinating movement from origin to final destination and inbound clearing movements when required.
- Monitoring and reporting on the use and disposition of controlled vehicles, 463L pallets, Palletized Load System Sideless Container (PLSSC), and containers for which the TCE is responsible.
- Maintaining surveillance of accountable containers and chassis for other services and commercial carriers and ensuring that they are promptly returned to the appropriate transport system.

4-32. Movement control battalions will assist the TCE in selecting the sites where the MCTs will operate. Site selection will consider the number and types of MCTs available, location and types of customers requiring service, location of major shipper and receiver activities, and location of mode operators. Ideally, MCTs should be centrally located for close coordination with customers and mode operators. An additional consideration is that MCTs operating away from their headquarters will require logistical support from other units.

4-33. The four types of MCTs operating at EAC are as follows:

- Port movement
- Area movement
- Movement regulating
- Cargo documentation

A more detailed description of organization MCTs can be found in Appendix D.

### **Port Movement Control Teams (Port MCT)**

4-34. Port MCTs are positioned at air terminals or seaports within the theater to coordinate expeditious clearance of personnel and cargo. This is the principal MCT that coordinates transportation requirements for movement of units as they arrive in theater. Responsibilities include scheduling, controlling, and coordinating movements. It is responsible for ITV of personnel, unit equipment, and sustainment supplies moving over the node. It includes tasking of assigned modes and terminal assets according to command planning directives. The port MCT expedites the port clearance of Army cargo and personnel by completing the following:

- Assists in preparing plans for expeditious handling and loading of freight.
- Provides technical transportation expertise at air or sea terminals on a 24-hour basis.
- Informs the TCE of the progress of shipments.
- Corrects congestion areas or conditions that reduce movement capability.
- Ensures prioritized shipments designated by movement programs or other directives are made.
- Receives requests from shippers and allocates movement capabilities to fulfill movement requirements, including non-programmed requirements for which local release is authorized.
- Submits requests for transport capacity for movement not contained in movement programs or other directives for which local release has not been authorized.
- Determines the ability of consignee to accept shipment through the destination MCT.
- Coordinates, prepares and distributes movement instructions to shippers, consignees, and transport services.
- Coordinates the arrival, spotting, loading, unloading, dates and times, that are mutually acceptable to the shipper, consignee and transport service.
- Ensures packing, marking and documentation procedures, to include international requirements, are complied with.
- Provides technical expertise for efficient and expeditious handling, loading, and unloading of transport equipment.
- Monitors the before movement of convoys to ensure equipment or cargo is loaded for one destination.
- Ensures convoy vehicles are properly marked.
- Ensures cargo is properly marked and containers have working AIT tags.
- Requests escorts and communications for shipments of classified materials.
- Maintains asset visibility and communicates with the destination control element on any deviations which may assist the consignee in receiving shipment.

- Enforces embargoes and priorities that have been established by proper authorities.
- Communicates with installations on impending arrivals of all movements.
- Regulates movements bound to or from the installation or area by granting or refusing clearances to local installations originating or receiving documents.
- Assists arriving personnel through customs and immigration at air and sea ports of entry.

### **Area Movement Control Teams (Area MCT)**

4-35. Area MCTs coordinate transportation support for movement requirements of theater storage areas, corps storage areas, supply support activities, and medical supply points in a given geographical location and non-divisional units operating in a division area. Responsibilities include scheduling, controlling, and coordinating movements. They are also responsible for the ITV of personnel, unit equipment, and sustainment supplies moving along LOCs. This includes tasking of assigned modes according to command planning directives. The Area MCT performs movement control functions for movements within an assigned geographic area by performing the following:

- Validates transportation requirements and coordinates transportation support, and inbound clearance for moving units, personnel, and cargo.
- Arranges movement to personnel, equipment, and sustainment supplies.
- Coordinates transportation movements, diversions, and transfers of units, cargo, and personnel.
- Provides technical expertise to transportation users within its assigned geographic area of responsibility.
- Provides intransit visibility of unit equipment and sustainment cargo movements.
- Processes convoy clearance and special hauling permits.
- Maintains custody of, accounts for, and issues transportation requests, warrants, bills of lading or tickets for travel on commercial or military railways.
- Furnishes travel information and obtains passenger accommodations for persons traveling on official business in military or commercial rail equipment.
- Maintains familiarity with schedules, services, facilities, rates, fares, and charges of commercial rail carriers and provides such information to US sponsored travelers.
- Supervises the operation of a consolidated and distribution facility.
- Obtains schedules for special military trains.
- Arranges for provisioning of military passenger trains originating in or transiting the area.
- Prepares passenger manifests.
- Assists arriving personnel through customs and immigration at rail ports of entry.

### **Movement Regulating Team (MRT)**

4-36. The mission of an MRT is to operate in separate sections employed throughout the AO in essential locations to observe, assess, and report progress of tactical and nontactical movements along MSRs. These teams also implement movement schedule changes as necessary to coordinate the movement of authorized traffic, resolve movement conflicts, and provide first destination reporting points. On a round-the-clock basis, the functions of this unit are:



- To observe, assess, and report progress of tactical and non-tactical transportation movements along main supply routes.
- To adjust movement schedules as necessary, to coordinate the movement of authorized traffic.
- To implement changes in unit moves or vehicle/convoy routings.
- To divert cargo and resolve movement problems.
- To provide first destination reporting points.

### **Cargo Documentation Team**

4-37. The Mission of the Cargo Documentation Team is to provide cargo documentation for the transshipment of cargo in water, air, motor, and rail terminals. The Cargo Documentation Team supports onward movement of combat units and sustainment operations. On a round-the-clock basis, the functions of the cargo documentation team are:

- Performs documentation required to load, discharge or transship 500 short tons of general cargo or 480 containers daily in a water, rail, intermodal, or air terminal.
- Assists in the coordinated defense of the unit's area or installation.

## Chapter 5

# Movement Control In The Corps

5-1. The corps combines the operational and tactical levels of war. In this environment, both unit and sustainment transport moves must be coordinated and executed to ensure a continuous flow of available transportation assets, infrastructure, and Line of Communications (LOCs). Particular attention must be directed to coordinating movements that occur concurrently.

5-2. Movement planning is conducted by the corps G3 and G4 staffs, and by the corps support command (COSCOM) support operations staff. (See figure 5-1.) The corps G3 plans and directs maneuver and recommends corps priorities. The G4, in coordination with the Corps Transportation Office (CTO) and COSCOM support operations staff, recommends logistical support priorities. The CTO receives technical support from the COSCOM Movement Control Battalion (MCB) and the transportation support branch of the COSCOM support operations staff.

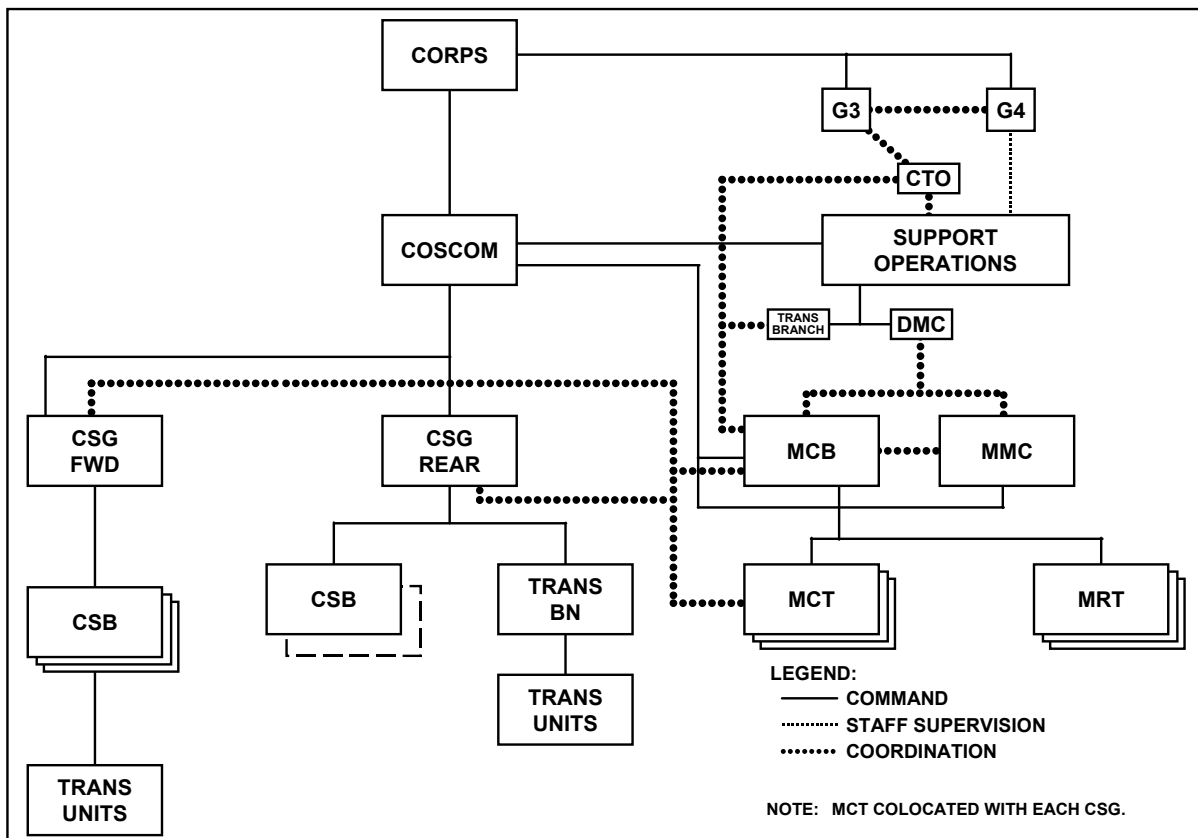

Figure 5-1. Corps Transportation Command and Control

5-3. The COSCOM provides logistical support to the corps and an integrated distribution system in the corps area. It does this through the coordinated planning of the COSCOM staff, subordinate Corps Support Group (CSG), and its materiel management and movement control units. The corps MCB centralizes movement control and highway regulation to support corps operations.

## CORPS MOVEMENT CONTROL STAFF

5-4. Within the corps headquarters, the movement control staff consists of the G3, G4, and CTO. Each of their duties is described below.

- **G3 Plans, Operations, and Training.** The G3 plans and directs movement and maneuver of combat units through or within the corps area. This may require rapidly projecting these forces over extended distances on main supply routes (MSRs). The G3, coordinating with the G4, establishes priorities for using MSRs for movements and maneuver. Maneuver will normally have priority over movements. However, maneuver must be well coordinated with movements to prevent route congestion, enforce movement priorities, and provide continuous logistical support. MCB movement planners assist the G3 in planning the movement of combat forces. The G3 air allocates Army aviation support. The G3 also coordinates with the CTO and MCB for unit movement, force tracking, and maneuver planning.
- **G4 Logistics.** The G4 plans for the logistical support of the corps, and directs the execution of the plans. The G4, using the recommendations of the CTO, establishes plans and implements logistical support priorities for movement. These priorities become the basis of the corps distribution plan developed by the COSCOM support operations staff, the movement program and highway regulation plan prepared by the Highway Traffic Division of the MCB in coordination with CTO, and the traffic control plan prepared by the Provost Marshal (PM).
- **Corps Transportation Officer.** The CTO is a special staff officer who works for the corps Chief of Staff (CofS). The CofS has the option of placing the CTO under the staff supervision of the G3 or G4. The CTO assists the G3 with transportation planning during unit movement and maneuver planning. The CTO assists the G4 in the areas of logistic and unit movement requirements, and prepares transportation portion of corps plans and orders. The CTO also assesses the impact for transportation requirements and highway regulation in the corps area. This may include support of reception and onward movement of forces, replacement operations, and reconstitution. The MCB works directly with the CTO establishing movements and highway regulation. The CTO assesses the overall effectiveness of the corps movement programs and recommends the type of transportation units and assets required to accomplish the corps mission. Other CTO duties include the following:
  - ⇒ Coordinate transportation planning with theater Transportation Command Element (TCE), COSCOM support operations staff, and division and separate brigade transportation officers to determine requirements.
  - ⇒ Plan, coordinate, and monitor large or special movements in conjunction with the MCB.
  - ⇒ Guide and assist major subordinate commands and units transiting the corps area.
  - ⇒ Recommend road repair priorities and improvements for the road network in the corps area in coordination with the corps engineer.
  - ⇒ Assess and recommend requirements for host nation transportation support (HNS).

## CORPS SUPPORT COMMAND

5-5. The COSCOM is a multifunctional support command at the corps level. COSCOM operations are the focal point for tactical logistics support to the corps. Both the corps MCB and transportation mode operating units are assigned to the corps and attached to the COSCOM.

**NOTE:** As the Army moves toward the objective force, redesign of some CSS organizations is occurring. This is true of the COSCOM. As this FM is written, the COSCOM is undergoing the careful scrutiny needed to ensure that its new organizational design is one that provides the support needed by the objective force.

5-6. **Transportation Support Branch.** The transportation support branch is a planning staff that integrates and coordinates transportation planning with all other support operations provided by the COSCOM. This branch is under the supervision of the DCSO. The transportation support branch executes planning responsibilities vested in the DCSO for the movement function. These responsibilities include the following:

- Preparing and coordinating plans, policies, and programs to support transportation, movement control, highway regulation, and cargo transfer operations.
- Preparing movement management policies for the COSCOM.
- Preparing estimates, plans, and recommending policies for mode operations, and terminal operations.
- Developing input for corps movement annexes and transportation estimates.
- Reviewing corps orders for transportation supportability, specified, and implied tasks.
- Coordinating plans for throughput from theater to the tactical level, intermodal operations, and trailer transfer operations.
- Coordinating with the COSCOM procurement support branch on the acquisition and use of host nation (HN) transportation resources based on the corps movement program or other planning documents.
- Developing and recommending locations of transportation nodes and units to support the distribution system and corps movement program.
- Preparing changes in allocation of transportation units based upon changes in the distribution plan or to influence the corps battle.
- Advising the COSCOM deputy commander for support operations on the effective use and operation of transportation units.
- In coordination with the MCB, reviews materiel distribution plans to ensure that the existing transportation infrastructure can support them.
- Developing input to the transportation portion of contingency plans.
- Recommending requirements to construct, improve, or maintain transportation facilities.
- Providing input to the MCB for inclusion in the corps movement program.
- Coordinating transportation plans and policies with the CTO, corps G4, CSG transportation branch staff, DTOs, TCE, and TSC DMC.
- Developing the transportation movements annex to COSCOM operation plans (OPLANs) and consolidating input to the corps administrative/logistics plan for personnel and materiel movements.

## CORPS MOVEMENT CONTROL BATTALION

5-7. The corps movement control battalion (MCB) controls the movement of all personnel, units, and materiel in the corps AO. It commands, controls, and supervises movement control teams. The battalion maximizes the use of available transportation assets. The battalion plans, coordinates, and manages movement programming, highway regulation, and transportation support for the corps. It provides a central headquarters for all movement control teams assigned or attached to the battalion. It plans, programs, coordinates, manages, and analyzes transportation and movement requirements and adheres to and enforces corps priorities. The battalion receives reports of vehicle asset visibility for tactical and nontactical moves within the corps geographical area. The corps MCB is organized as shown in figure 5-2. The table of organization and equipment (TOE) for the MCB (Corps) is at Appendix D.

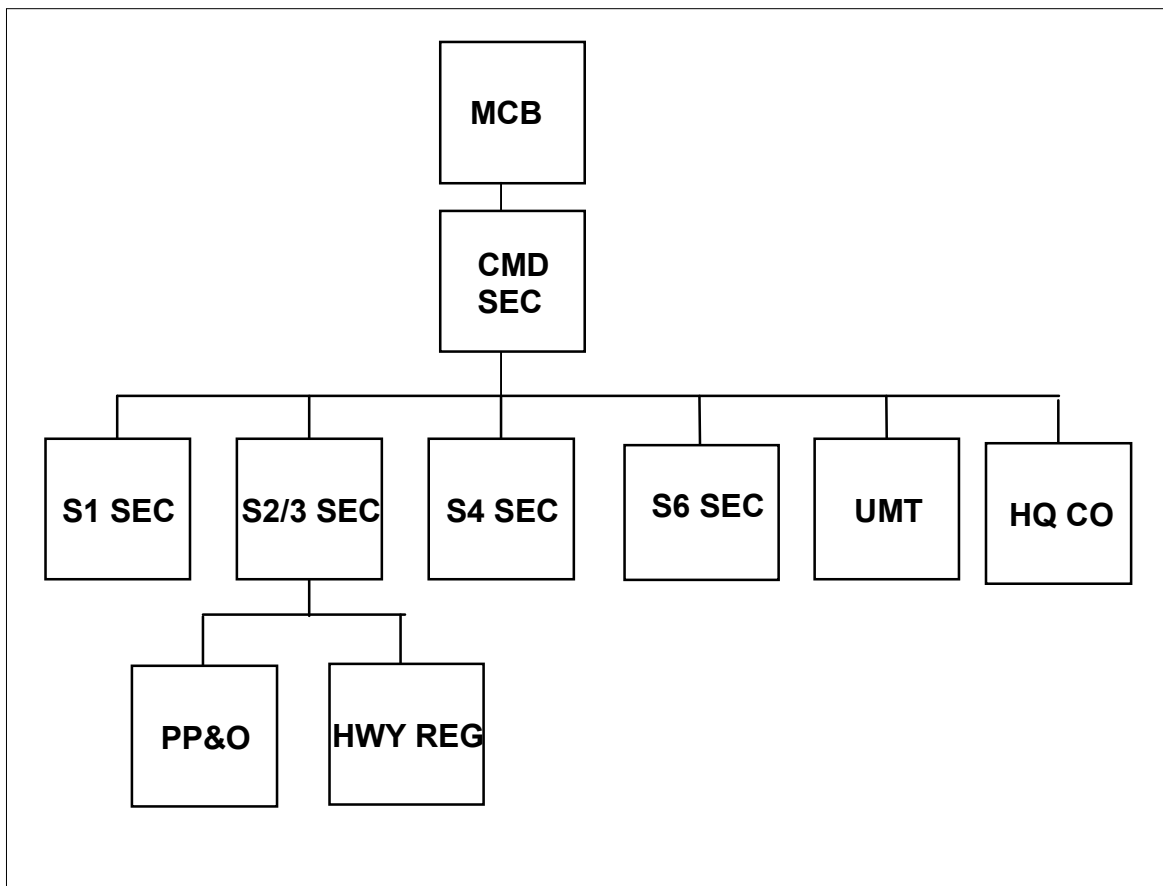

Figure 5-2. MCB (Corps) Organization

5-8. The MCB commands and controls its functional divisions. It also commands, allocates, and supervises the operation of attached or assigned movement control teams (MCTs) and movement regulating teams (MRTs). The MCB and its attached teams require personnel, administrative, food service, and maintenance support from other COSCOM units.

5-9. The command section and headquarters detachment normally collocate with elements of the plans, programs, and operations (PP&O) section and the highway traffic section. These two sections may also provide personnel to other locations in the corps area based on mission requirements. Portions of the highway traffic section may collocate with the corps rear command post (CP) operations cell. The CP operates on a 24-hour basis normally with two 12-hour shifts. Personnel staffing per shift is based on anticipated workload. The Corps' MCB and MMC must be collocated to allow the close coordination between movement and materiel managers that is essential to making distribution based logistics work.

- **Detachment Headquarters.** The detachment headquarters provides or coordinates administrative and logistics support for the MCB and its attached teams.
- **Plans, Programs, and Operations Section.** The PP&O section is responsible for surface, logistics air, rail, barge movements, and container management. If assigned, the Air Mobility Command liaison officer will operate in this section. This section coordinates support and maintains the status of transportation activities throughout the corps. This section also does the following:
  - ⇒ Develops and implements the corps movement program based on movement requirements submitted by corps major subordinate commands and the COSCOM.
  - ⇒ Performs Force Tracking for the G3 and provides ITV for critical shipments moving to the Corps AO.
  - ⇒ Coordinates and monitors the status of inbound and outbound movements from the corps rear area.
  - ⇒ Plans support for reception and onward movement.
  - ⇒ Performs transportation planning according to priorities established by the corps G3 and G4 in coordination with the COSCOM DCSO. Provides planners to assist the CTO during initial planning stages of each operation.
  - ⇒ Programs and commits transportation assets to meet movement requirements according to corps priorities.
  - ⇒ Coordinates transportation support and maintains status of transportation activities throughout the corps.
  - ⇒ Recommends reallocation or relocation of transportation units or transportation assets to meet exceptional movement requirements.
  - ⇒ Coordinate policy and procedures with the joint movements' center when the corps is the Army component of a joint force
  - ⇒ Maintains liaison with theater, joint, combined, and adjacent corps movement control activities.
  - ⇒ Coordinates with Corps MMC to provide ITV on shipments moving within the Corps area on the Movement Program.

⇒ Constantly assess and determine support requirements for corps movement control operating units and facilities.

Deleted:

- **Highway Traffic Section (HTS).** The HTS performs highway regulation within the corps area. It coordinates with the TCE, other MCB highway traffic sections, DTOs, and appropriate HN authority, for any movements that originate in the corps area, but which terminate outside the corps. This section also does the following:

- ⇒ Provides highway regulation planning assistance to the corps G4 and CTO to designate main supply routes (MSRs) and establish control measures to support the concept of operations.
- ⇒ Develops highway regulation plans.
- ⇒ Provides transportation route overlays and traffic circulation plans to support corps OPLANs.
- ⇒ Coordinates with the corps G2, engineer, PM, and military police (MP) for route classification and selection.
- ⇒ Coordinates placement of MRTs.
- ⇒ Collects, processes, and distributes information on MSR status.
- ⇒ Plans, routes, schedules, and manages traffic according to command priorities.
- ⇒ Issues movement credits for approved movements.
- ⇒ Provides instruction for diversion or rerouting based upon the condition of MSRs, enemy activity, or congestion.
- ⇒ Coordinates large unit movement tables with other movements and maneuvers.
- ⇒ Coordinates enforcement of Highway Regulation Plans with the PM, MP brigade, and HN.
- ⇒ Tracks movements of convoys; maintains status of movements to include current position or last reported checkpoint.

- **Movement Control Teams.** The corps MCB commander positions teams throughout the corps area to extend his control to critical transportation nodes, facilities, or operating units. Allocation of teams includes the following:

- ⇒ One MCT per CSG and division and at each critical transportation node in the corps area, and at air, rail, and sea ports.
- ⇒ MRTs at key transportation nodes and other critical locations on MSRs to expedite surface movements.
- ⇒ Corps also has an MCT not found at EAC. The Division Support MCT as allocated one per division.

### Division Support Movement Control Team

5-10. The mission of division support MCTs is to augment the division transportation officer (DTO). The DTO in the division structure is limited in the manning required to conduct the full range of transportation support planning, programming, and operations required for combat operations. This team provides movement control functions on a 24-hour basis. They assist the DTO in scheduling, controlling, and coordinating movements. They also maintain ITV of personnel,

unit equipment, and sustainment supplies moving in a division area. On a round-the-clock basis, the functions of the division support movement control team are:

- Execute highway regulation in the division area for all non-tactical movements to plan and coordinate use of main supply routes.
- Plan and coordinate use of main supply routes within the Division.
- Operate first destination reporting point.
- Provide technical expertise to transportation users in the Division area.
- Provide intransit visibility of unit equipment and sustainment cargo movements in a Division area.
- Provide movement control support to tactical road marches and division movements.
- Provide additional capability to the movements control officer for support of operations.

## FUNCTIONAL RELATIONSHIPS

5-11. The functional relationships of the corps MCB to the TCE, HN, and other staffs and headquarters are shown below:

- **Transportation Command Element.** The TCE provides guidance and technical assistance to the corps MCB. The TCE provides movement programs, policies, and procedures established by the Army Service Component Command (ASCC). Close working relationships and direct communications between the corps MCB and the TCE are required. The TCE also coordinates theater plans with the corps MCB to ensure unity of effort. The TCE provides additional MCTs to the corps MCB when the corps MCB requires additional movement control capabilities to meet operational requirements of the theater army.

**NOTE:** The corps MCB furnishes the corps commander's priorities to the TCE and must coordinate corps personnel and materiel movements with the TCE. The corps MCB provides the TCE corps reception and processing capabilities.

- **Host Nation.** The HN may provide transportation assets, facilities, movement control, and highway regulating capabilities to the corps area. These arrangements and plans are normally coordinated between the COSCOM staff and HN authorities. The corps MCB then implements these plans and interfaces with HN movement control.
- **Corps Provost Marshals and Military Police.** The corps PMs and MPs integrate movement control and highway regulation plans into the MP battlefield circulation control plan. They provide traffic control on MSRs and enforce highway regulation plans. They reroute and divert traffic as required by the tactical situation or as directed by the corps MCB. They also provide reports to the MCB on the status of MSRs.
- **Division and Separate Brigade Transportation Officers.** Division and separate brigade TOs coordinate with the corps MCB and the CSGs through the supporting CSG MCT to obtain transportation assets to meet division requirements beyond the division's organic capability. They also provide input to the MCB to coordinate the corps movement control and highway regulation plan.



## MOVEMENT CONTROL BATTALION and CORPS SUPPORT GROUP INTERFACE

5-12. CSGs are subordinate commands of the COSCOM. CSGs provide responsive logistics support to corps units, whether those units are employed in the corps rear area, a division rear area, or in support of a separate brigade. The COSCOM tailors its CSGs to meet the needs of the supported force. The basic mission of the CSG will vary depending on whether the CSG is employed as a forward CSG behind a division, or as a rear CSG to support the corps rear area. Transportation units are assigned (in the tailoring process) to the CSGs to facilitate distribution. The CSGs must be responsive to the direction of the MCB when tasked to provide transportation support.

5-13. Forward CSGs are the primary source of logistics support for corps organizations in their AO. This includes corps forces in the division forward area and the armored cavalry regiment area during covering force operations. They also provide backup support to the division. It provides this support through its subordinate multifunctional corps support battalions (CSB). Each CSB in a forward CSG has truck companies (normally light/medium truck companies or medium truck companies operating PLS) assigned to support local haul transportation requirements in its assigned geographic area. The CSG coordinates support among transportation units and conventional ammunition and petroleum units. The CSG also supports other movement requirements in its area on a mission basis. Normally, one CSB will be located in the division rear. The CSG commander may task force organize the CSBs to weight support as needed.

5-14. The rear CSG focuses on supporting the corps and providing reinforcing support to the forward CSGs. The rear CSG consists of functional battalions and one or more multifunctional CSBs. The rear CSG's transportation battalion provides corps-wide transportation line haul support. Depending on its organization, its truck companies move cargo, unit equipment, and ammunition and relocate heavy maneuver forces. The cargo transfer companies operate either a breakbulk or container operation at air, rail, motor, intermodal, and water terminals.

5-15. An additional transportation battalion is located in the rear CSG for command and control of the combat heavy equipment transporter (HET) companies. The HET companies are assigned to corps to provide operational and tactical mobility to the heavy force. Using the HET to displace heavy armored forces, either tactically or operationally, increases the maneuver commander's capability to quickly and efficiently shift his forces on the battlefield to attain and keep the initiative. It also keeps the forces available in a high state of operational readiness.

5-16. The forward and rear CSGs and their subordinate CSBs have support operations sections with transportation support branches. Within the rear CSG, the transportation support branch tasks transportation units of the transportation battalion based on commitments from the area MCT collocated with the rear CSG headquarters. Based on local command policy, the MCT may send commitments directly to the transportation battalion. In the forward CSGs, the transportation support branch tasks the transportation units of its CSBs based on commitments for the area MCT collocated with the CSG headquarters and may also reallocate transportation units among its subordinate CSBs. The CSB transportation support branch does the following:

- Places truck companies in routine support of ammunition and petroleum companies.
- Matches requirements against capabilities.
- Reports assets availability to the area MCT.

- Tasks subordinate truck companies for mission support.

5-17. The MCB collocates an area MCT with each CSG HQ to commit CSG transportation assets to execute the movement program, fill validated requirements in the CSG, and monitor transportation asset use, availability, and readiness of CSG transportation assets. This MCT remains under the command and control of the MCB. The area MCT will also maintain asset visibility, including containers and trailers in their area, through the CSG support branches. It will request additional transportation support and coordinate backhaul from the corps MCB.

## Chapter 6

# Movement Control In The Division

Division transportation forges the other logistics functions into a network dedicated to supporting the division commander's scheme of maneuver and support operations.

6-1. Movement planning and execution in the division is a staff responsibility, not vested in operational units as found at corps and echelons above corps (EAC). The division transportation officer (DTO), division support command (DISCOM) distribution management center (DMC), and the DISCOM movement control officer (MCO) coordinate and control division transportation operations. This includes the control of any movement of non-divisional units in the division area. Because the G3 plans and directs maneuver; the G3 (air) allocates aviation assets to combat service support (CSS); the G4 (through the DTO and DISCOM) supports operations, plans, and movements; close coordination between the G3, G4, DTO, and DISCOM, is absolutely essential to accomplishing the division mission.

6-2. Movement and maneuver of combat, combat support, and CSS forces in support of maneuver operations are normally given priority over other movements. Other CSS traffic is usually assigned a lower priority. Planning and regulating movement requires close coordination among the division staff and the commanders and staffs of the brigades, battalions, and companies. (Figure 6-1).

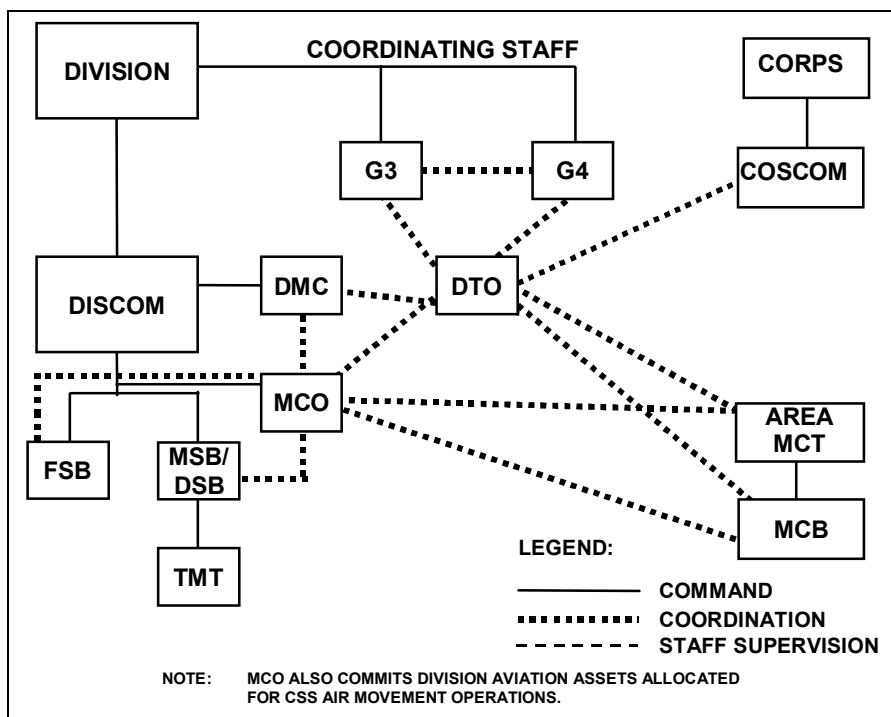

Figure 6-1. Command and Coordination of Division Transportation

## ORGANIZATION

6-3. Movement control planning and transportation management functions are the responsibility of the DTO. The DTO is a special staff officer involved in the movement of units and maneuver elements. (Movement control of sustainment and other distribution moves is routinely handled by the DISCOM MCO.) The composition of the division transportation office varies with the type of division, however, it has an MCT from the corps MCB attached to support routine DTO functions. (See paragraph 6-7.)

6-4. Within the brigade HQ, the S4 staff performs transportation functions. The S4 staff (which includes the brigade movement coordinator) does the following:

- Establishes main supply routes (MSRs) in the brigade area in coordination with the DTO and DISCOM DMC.
- Coordinates with the DTO and conducts highway regulation for movements that cross the brigade rear boundary.
- Coordinates with the forward support battalion (FSB) support operations section for transportation support when requirements exceed the organic capability of the brigade.

6-5. Divisional combat and combat support (CS) battalions and squadrons do not have separate transportation staffs. The battalion S4 staff performs transportation functions with help from the support platoon leader of the headquarters company. Their table(s) of organization and equipment (TOEs) provide vehicles to support limited transport requirements, such as resupplying their companies. The battalion S4 staff requests transportation support and movement clearances from its brigade S4.

6-6. FSBs for the new Stryker Brigade Combat Teams (SBCT) have transportation management personnel on the battalion staff. The role of the transportation management cell is to coordinate and monitor all cargo-related movements (specifically logistics packages) in and out of the brigade support area. It includes synchronizing movement and maintaining integrated end-to-end visibility of the transportation network and assets at the brigade level. It serves as the committing authority for all common-user land transportation assets within the SBCT. Transportation operations and movement control is a CSS staff responsibility that must be integrated with tactical movements, which are managed and approved by the SBCT S3. The SBCT S4 retains overall staff responsibility for highway regulation and supply route establishment, accomplished within the S3's priority of movement and traffic circulation plans. The movements officer and movements NCO coordinate with the supply and services officer on a constant basis. The movements officer controls the employment of BSB surface transportation assets, maintains in-transit visibility of all commodities, movements, and units inbound, outbound, and within the SBCT area of operation (AO). These assets include the transportation platoon's 14 trucks and trailers, and the fuel and water platoon's 14 fuelers and six trucks for bulk water distribution. The movements officer also has access, through the SBCT S4, to CSS transportation assets above the brigade echelon.

6-7. Brigades and separate units depend on the DISCOM to provide transportation support when requirements exceed their organic capabilities. Each brigade, depending upon the type of division, receives logistical support from an FSB in the brigade support area (BSA). The movement control noncommissioned officer (MCNCO), in the support operations office of the FSB, is the brigade S4's point of contact (POC) for DISCOM transportation support. The FSB MCNCO forwards requirements to the DISCOM MCO. The DISCOM MCO coordinates tasking of truck assets

assigned to the transportation motor transport (TMT) company assigned to the main support battalion (MSB) in the division support area (DSA). (See paragraph 6-12.)

## DIVISION TRANSPORTATION OFFICER

6-8. The DTO, as a special staff officer, is a staff planner who advises the commander and coordinates support with the division G3 and G4 on tactical moves and operations. The DTO coordinates with the G4 on logistical and administrative matters, and also provides guidance on transportation matters to all other staff sections and commanders. The DTO provides the formal link between the division and the corps transportation office (CTO), and is normally located in the division rear command post (CP). The DTO has four primary functions: advisory, planning, coordination, and technical assistance.

- **Advisory.** The DTO, as the division staff transportation expert, advises the commander and staff on transportation matters. The DTO recommends division priorities for transportation and movement to support division plans and orders. The DTO recommends the allocation of division transportation assets and the establishment of MSRs and provides the DISCOM DMC and MCO with policies and priorities. The DTO assists the G4 in preparing, updating, and maintaining the transportation portion of the logistics estimate.
- **Planning.** The DTO participates in the decision-making process as a member of the division planning staff. The DTO conducts concurrent planning with the staff to integrate movement and maneuver. This includes providing movement control expertise for planning tactical road marches and for preparing movement orders and movement tables. The DTO develops the deployment, movement, and highway regulation portions of the division operation plans (OPLANs) and operation orders (OPORDs).
- **Coordinating.** The DTO coordinates with other division staff offices, subordinate staffs, the provost marshal (PM), division engineer, the CTO, and corps movement control battalion (MCB). DTO movement control efforts require close coordination with the DISCOM MCO.
- **Technical Assistance.** The DTO is the focal point for transportation technical guidance and assistance for the staff. The Mobility Warrant Officer assigned to this office and the one assigned to the MCT, attached to support the DTO, provide a depth of technical expertise needed for this role. The DTO provides technical assistance in planning for unit movement by all modes. The DTO provides technical assistance to the divisional units for movement training which includes preparing vehicles for transport, developing load plans, loading and securing vehicles on railcars and Air Force aircraft, and convoy procedures.

## MOBILITY WARRANT OFFICER (MWO)

6-9. The mobility warrant officer (MWO) (MOS 882A) provides deployment training and execution expertise. The mobility warrant officer is the commander's key staff officer for deployment planning, execution, advice, coordination, and training. The mobility officer is a movement technician who manages and controls the flow of Army Transportation during unit movement operations. The mobility officer plans, organizes, and supervises the movement of Army personnel and equipment. The MWO coordinates movement operations issues with joint, Army, and commercial agencies, and provides technical interpretation and guidance on the implementation and use of transportation

automation systems. The MWO also coordinates training of unit personnel, and advises and assists commanders and staffs on the elements of unit movement operations.

## DIVISION SUPPORT MOVEMENT CONTROL TEAM

6-10. The division support MCT is an element of the corps movement control battalion that is attached to the DTO to augment and provide support to the DTO operations. The mission of the division support MCT is solely to augment the DTO. It does not perform the usual functions of an MCT. This team provides the DTO support needed on a 24-hour basis.

## DIVISION SUPPORT COMMAND

6-11. The DISCOM commander is the principal logistics operator of the division and units of the DISCOM provide division-level logistics support to all organic and attached elements of the division. While the division G4 has staff responsibility for logistics planning, and develops division-level logistics plans, policies, and procedures, the DISCOM commander must make them a reality. Therefore, the relationship between the division G4 and the DISCOM commander must be extremely close for either to succeed.

- **DISCOM S3.** The S3 is the principal staff advisor to the DISCOM commander. The S3 plans and directs movement and maneuver of DISCOM units within the division area. To accomplish this task, the S3 coordinates with the DTO, as do all other organizations making unit moves in the division's AO.
- **DISCOM S4.** The S4 is responsible for all logistics matters pertaining to DISCOM units. (The S4 is not concerned with division-level logistics.) The S4 submits transportation requests for DISCOM administrative moves and submits requests for highway clearances to the MCO.
- **DISCOM Distribution Management Center.** A DMC is located within the DISCOM support operations staff. While the DISCOM DMC operates at a smaller scale than the TSC DMC, the basic functions are essentially the same. The DISCOM DMC is the center responsible for providing timely distribution information and accurate logistics information to the DISCOM commander and the DISCOM staff. The DISCOM DMC coordinates the distribution plan with the DTO, MCO, and the DISCOM materiel management center (DMMC) and monitors distribution operations. The DISCOM DMC focuses on the distribution lines of communication (LOC) as they extend into the division area. The DISCOM DMC also monitors the establishment of the distribution system within the division to include lateral redistribution and retrograde.

## MOVEMENT CONTROL OFFICER

6-12. The MCO is the link between the division transportation mode operators and the division users of transportation. The MCO is normally located in the division rear with the DISCOM CP.

6-13. The MCO provides movement management support to the division by controlling the division's motor transport assets employed in distribution support. Movement management includes planning, coordinating, and controlling the allocation and use of available transportation resources to

fulfill the commander's distribution movement requirements. There must be close working relationship between the MCO and the following:

- DISCOM DMC
- DMMC
- DTO (and its attached MCT)
- Supporting corps and area MCT's
- Support operations section of the DISCOM MSB
- Support operations section of the DISCOM FSB
- Operations office of the PM

6-14. The MCO commits MSB/DSB TMT company assets. The MCO coordinates with the supporting area MCT's to get transportation resources when requirements exceed capabilities. If the requirement for additional transportation is excessive, the MCO coordinates the request through the DTO. The MCO ensures the accountability and return of throughput assets, including containers and pallets. The MCO requests aviation assets (from the air assets G3 (Air) allocates for CSS purposes) to support logistical requirements

6-15. The MCO develops the division distribution program in coordination with the DMC. The MCO coordinates with the DMMC to determine and plan for the transportation of materiel. The DMMC has visibility over materiel distribution requirements that will require either transportation assets or movement clearance. The MCO coordinates with the G1 for personnel movement requirements. The MCO also maintains close coordination with division units to project transportation and movement requirements. The MCO also does the following:

- Advises the DISCOM commander and staff on transportation matters.
- Enforces division priorities in tasking transportation assets and seeks to resolve priority conflicts and competition by employing alternate modes and times or requesting support from corps or area MCT's.
- Maintains information on the status of transportation assets allocated to support movement requirements to include additional transportation assets placed in direct support (DS), attached, or allocated for CSS operations.
- Coordinates transportation movements in the division rear with the FSBs, MSB/DSBs, and other units as required.
- Monitors the status of containers, flatracks, pallets, and trailers in the division area. Reports their availability for retrograde.
- Provides transportation intelligence data to the DISCOM DMC and the DTO. This data is usually obtained through contact with the transport mode operators. These operators are movement control teams, dispatchers, truck drivers, pilots, and users of surface and air transportation facilities.
- Coordinates with units to ensure adequate materials handling equipment (MHE) and container handling equipment (CHE) are available for loading and unloading.
- Assists the brigade movement coordinator in preparing unit movements.

## MOVEMENT CONTROL CELL IN THE DIVISION REAR COMMAND POST

6-16. The division rear CP is usually collocated with the DISCOM CP in the DSA. The DTO, its MCT, and the MCO normally collocate and the combined elements comprise the **movement control cell**. The collocation of these elements in the rear CP enables a coordinated transportation effort. To accomplish this mission, the DTO prepares the highway regulation and traffic circulation plan for the division road network. The MCO plans and controls division transportation assets and develops the division movement program.

6-17. The movement control cell personnel maintain situation maps and overlays of the road networks that reflect current information on the following:

- Traffic disruptions
- Obstructions
- Surface conditions
- Regulation and control measures
- Capacities
- Classifications

6-18. Movement control cell personnel coordinate with the G3, G2, air defense artillery, aviation, chemical fire support element, PM, and signal cells of the division rear CP for current information on enemy activity such as conventional or chemical strikes on MSRs, bridges, and tunnels that could interrupt movement. Close coordination with the other cells is necessary to coordinate movement and maneuver, ensure support of current operations. The movement control cell coordinates with the appropriate cells to accomplish all the functions and activities that are the responsibility of the separate offices.

## BRIGADE MOVEMENT CONTROL

6-19. The Force XXI brigade includes a movement control NCO as the link between the brigade transportation mode operators and the brigade users of transportation. The movement control NCO controls the brigade's common user motor transport assets employed in distribution support. Movement management includes planning, coordinating, and controlling the allocation and use of available transportation resources to fulfill the commander's distribution movement requirements.

6-20. The Stryker Brigade Combat Team has a Mobility Warrant Officer and a movement control NCO in the brigade. The Mobility Support Element will support other brigades, regiments, and battalion/squadrons for deployment and operational mobility.



## Chapter 7

# Developing A Movement Program

### INTRODUCTION

7-1. This chapter is for the movement managers at all command levels. It explains how to develop a movement program. Developing a movement program requires the direct coordination of coordinating staff officers, material managers, movement managers, and mode operators.

7-2. A movement program is a command directive prepared by planners in the transportation command element (TCE), movement control battalion (MCB) at echelons above corps (EAC), MCB (Corps), and division transportation officer (DTO) at division. To plan an integrated distribution system, these planners must coordinate with the following:

- Deputy chief of staff for logistics (DCSLOG/G4).
- TSC distribution management center (DMC) and support operations staff
- Corps support command (COSCOM) and support operations staff
- Materiel management centers (MMC)
- Mode operators to plan an integrated transportation system.
- Joint transportation board (JTB)
- Joint movement center (JMC)
- Deputy chief of staff for operations (DCSOPS/G3)

7-3. The movement program is used to preplan anticipated transportation requirements for movement and flow of units, personnel, materiel, and sustainment supplies. During the movement planning process, movement planners allocate available transportation resources based on the commander's priorities.

7-4. Implementing the commander's priorities is a responsibility of logisticians at each level of command. The movement program supports the commander's priorities by establishing what requirements can be resourced given available transportation assets, units, and infrastructure. Doing this effectively uses these assets and identifies competing requirements and shortages.

7-5. An effective movement program is vital for successful support of combat operations. Therefore, supported units must provide accurate data when developing transportation requirements and inform movement planners of current and projected operating sites. Movement planners must be flexible because requirements often change based on changes in priority, unit locations, asset availability, and conditions of the LOCs. Therefore, supporting movement plans should have fully developed alternatives based on likely courses of action. The TCE MCBs and the Corps MCB must also be resourced with sufficient movement control teams (MCTs) and communications equipment to provide adequate movement control and operational flexibility.

7-6. The movement program serves as an authority to commit transportation assets. It authorizes the MCTs to issue transportation movement releases (TMR), directs mode operators to furnish

assets, arrange commercial movements, and alerts receiving units to accept programmed shipments so that they can unload transportation assets promptly. There are nine basic steps used to develop a movement program. These steps are as follows:

- *Step One.* Assess the distribution pattern.
- *Step Two.* Determine requirements.
- *Step Three.* Determine transportation capabilities.
- *Step Four.* Balance the requirements against the capabilities.
- *Step Five.* Determine Critical Points.
- *Step Six.* Determine Check Points.
- *Step Seven.* Determine shortfalls and recommended solutions for handling the shortfalls.
- *Step Eight.* Coordinate the movement program.
- *Step Nine.* Publish and distribute the program.

## **ASSESS THE DISTRIBUTION PATTERN**

7-7. The distribution pattern is a complete logistics picture that shows the locations of ports, locations of supply, locations of consignees, maintenance activities, nodes, and transportation activities. It is the tool by which planners know where support should normally flow and where it may be diverted as operational needs dictate. The distribution pattern constantly evolves as the theater develops. The commander's concept of operations, number, types, and locations of in-place and incoming units guide development of the distribution pattern and their time phased arrival in theater. The distribution pattern delineates throughput and interzonal transportation requirements directly affecting the coordination and preparation of movement programs.

7-8. Movement planners use the distribution pattern to develop the transportation network. The network consists of the complete system of routes pertaining to all modes of transportation available in the theater. Movement planners study intelligence and engineer information on the area of operation (AO) to determine the capabilities of transportation networks. They analyze the enemy situation to determine existing or potential threats to movement. Concurrently, they determine the suitability and feasibility of moving supplies and personnel over those transportation networks. Based on these studies, movement planners recommend locations for transportation units and modes to make full use of the transportation networks.

7-9. Movement planners in the TCE and corps MCB coordinate with the TSC and COSCOM regarding the positioning of transportation units and supply activities. These units are positioned so that their capabilities will enhance the distribution system.

7-10. Movement planners also coordinate with shippers and receivers to determine their capability to receive, handle, and load by various transportation modes. This capability is based on the availability of materials handling equipment (MHE), container handling equipment (CHE), ramps, labor, storage capacity, and other factors that affect transportation services. This information is necessary to efficiently schedule transportation and prevent congestion.

## DETERMINE REQUIREMENTS

7-11. Having accurate requirements is the key to developing an effective movement program. Forecasts must be submitted far enough in advance for the transportation and supply systems to adjust their resources to carry out the program.

7-12. Movement planners use planning periods for forecasting requirements. The length of these periods is based upon the number and frequency that changes are experienced or anticipated. A 14-day planning period is desirable to allow a firm forecast of requirements for the current 7-day period and a tentative forecast for the succeeding 7-day period. This method provides a basis on which to operate during the current period and a tool for planning during the succeeding period. With a 14-day planning period, a new planning cycle is initiated every seven days. The availability of an integrated information system that integrates movement and supply information increases the accuracy of forecasts. It also allows for more accurate movement programming.

7-13. Materiel movement requirements are developed and grouped in terms of classes of supply, estimated weight and cube, required delivery date (RDD), priority, origin, and destination. Special handling requirements such as refrigerated cargo, hazardous cargo, and controlled or sensitive cargo should also be identified.

7-14. Personnel movement estimates are grouped by category such as troops, civilians, patients, and prisoners of war.

7-15. Major subordinate commands must provide their movement requirements that exceed organic transportation capability for inclusion in the movement program. Requirements should be identified as indicated in paragraphs 7-13 and 7-14.

## DETERMINE CAPABILITIES

7-16. Movement planners at each command level determine the capabilities of the transportation mode operators in their AO. They obtain from mode operators the characteristics and capabilities of the following:

- Number of transportation units and their equipment available to support common-user movement requirements.
- Total number of host nation (HN) transportation assets allocated to support common-user movement requirements (including commercial, rail, inland waterways, and coastal shipping).
- Number of third country and US-contracted assets.
- Reception, material handling, and in-transit storage capabilities.

7-17. Theater airlift and airdrop may be planned for if the JTB or JMC apportions assets for logistics air movement operations to the theater. The TSC will allocate apportioned airlift based on command priorities. Movement planners should realize that requirements normally exceed allocated airlift. They should also take advantage of opportune lift.

7-18. Movement planners must update capabilities with changes as they occur and adjust movement programs accordingly.

7-19. When developing transport capabilities, planners must use planning factors or experience based on the type of equipment, availability of MHE and CHE, weather, and terrain. Planners should obtain planning factors from mode operators or from planning publications such as FM 4-01.40 (FM 55-30). Figures 7-1 through 7-4 reflect capabilities data, truck capacities and technical data for the divisional and non-divisional truck companies. This data can be used when developing transport capabilities

**Divisional TC Truck Company TOE Capability Data**

13-Feb-03								
TOE	DISPATCHES PER DAY TRK CGO	PLS or TRAC/ STLR	HET	SINGLE LIFT TONS		PAX	VEH	REMARKS 1,2
				GEN	AMMO			
<b>LEVEL 1 CAPABILITY</b>								
55288F000	31	30	22	235	412	1664	22	3,4
55158L000	34	10		135	174	801		3
55168L000	34	8		143	245	984		3
55178L000	28	7		117	200	804		3
55188L000	31	28	22	226	396	1597	22	3,4
<b>LEVEL 2 CAPABILITY</b>								
55288F000	29	24	18	212	370	1491	18	3,4
55158L000	32	10		127	164	921		3
55168L000	32	8		135	231	930		3
55178L000	27	6		110	189	760		3
55188L000	29	26	18	213	374	1510	18	3,4
<b>LEVEL 3 CAPABILITY</b>								
55288F000	26	22	18	191	333	1344	18	3,4
55158L000	29	9		115	148	830		3
55168L000	29	7		122	209	838		3
55178L000	24	6		99	171	685		3
55188L000	26	24	18	192	337	1361	18	3,4

1. All data rounded to nearest whole number
2. TMT Companies normally do not perform Line or Local Haul missions as normally defined in doctrine; they are organic to the division.
3. These units normally do not transport ammunition.
4. HETs used for evacuation missions - one tank per HET.

**Figure 7-1. Divisional TC Truck Company TOE Capability Data**

**Availability Rate and Capacity Data for Trucks in TC Divisional Truck unit TOEs**

13-Feb-03										
TOE	TITLE	TRKS	AVAILABILITY RATE			BB TONS/TRIP		PAX / TRIP	LIFT/ TRIP	NOTES
			LVL1	LVL2	LVL3	GEN	AMMO			
55288F000	TMT CO, DSB, FXX1 DIV									1,2
	5T CARGO	36	0.859	0.812	0.732	2.97	5.00	20		
	PLSw/TLR	33	0.905	0.801	0.722	4.79	8.62	35		
	HET	24	0.916	0.75	0.75				1	3
55158L000	TMT CO, MSB, ABN DIV									1,2
	2.5T CARGO	40	0.859	0.812	0.732	2.50	2.50	18		
	TRAC/STLR	12	0.847	0.801	0.722	4.79	8.62	35		
55168L000	TMT CO, MSB, AASLT DIV									1,2
	5T CARGO	40	0.859	0.812	0.732	2.97	5.00	20		
	TRAC/STLR	10	0.847	0.801	0.722	4.79	8.62	35		
55178L000	TMT CO, LID									1,2
	5T CARGO	33	0.859	0.812	0.732	2.97	5.00	20		
	TRAC/STLR	8	0.847	0.801	0.722	4.79	8.62	35		
55188L000	TMT CO, MSG,HVY DIV									1,2
	5T CARGO	36	0.859	0.812	0.732	2.97	5.00	20		
	TRAC/STLR	33	0.847	0.801	0.722	4.79	8.62	35		
	HET	24	0.916	0.75	0.75				1	3

1. The Trucks and tractor/trailers in this unit normally do not carry ammunition.
2. These units are not equipped to carry water or bulk POL
3. Assumes one tank per HET. Some tracks (M113) can go two per HET.

Figure 7-2. Availability Rates and Capacity Data for Trucks in TC Divisional Truck unit TOEs.

Task Vehicle Availability Rate (TVAR) and Capacity Data for Individual Trucks in Transportation TOE - Non-divisional Companies

TOE	TITLE	# TRKS	TVAR LVL1	# DIS-PATCHES PER DAY	# CONTAINERS/TRIP			CONTAINERIZED				BB TONS PER TRIP	GALLONS PER TRIP		TROOPS PER TRIP	CBT VEH PER TRIP	NOTES	
					40 FT	20 FT	CROP	GEN	20 FT	20 FT	AMMO		POL	H2O				
																		PLS FR/
55719F000	LT MDM TRK CO 5T CARGO TRAC/STRL	50	0.859	43														
		10	0.847	8		1		6.47	13.90		2.96	5.00		17				7
55727F100	MDM TRK CO (EAC-CGO)	60	0.875	53	1	2		15.42	12.94	27.80	7.02	12.61			4570			1, 7
55727F200	MDM TRK CO (EAC-POL) 7500 GAL	60	0.875	53									7500					2
55727F300	MDM TRK CO (EAC-POL) 5000 GAL	60	0.875	53									5000					2
55728F100	MDM TRK CO (CORPS-CGO)	60	0.847	51		1			6.47	13.90	4.80				3000			1, 7
55728F200	MDM TRK CO (CORPS-POL)	60	0.847	51									5000					2
55728F300	MDM TRK CO (PLS)	60	0.905	54		2	2		12.94	27.80	7.02	22.00			4000			1, 3, 5
55728F300	MDM TRK CO (PLS)	60	0.905	54		2	2		12.94	27.80	7.02	22.00			4000			1, 3, 6
55739L100	CBT HET CO	96	0.9	86														86

General Comments: The TVAR data, while based upon truck type, applies only at TOE level of detail. TVAR data source is TRAC-Lee TVAR Study, May 1995.

BB Tons per trip data source is USATSCH/CASCOM Cargo Density Factor Study, 1994. Containerized tons per trip data source is USATSCH/CASCOM Mean

Container Content Weight Study, 1994. The capacity data is individual truck specific.

Notes:

1. Water is carried in Semitrailer Mounted Fabric Tanks (SMFTs) on cargo semitrailers. SMFTs are 4570 or 3000 gallons; they can be carried full or empty but not partially loaded. Water can also be hauled by PLS truck companies using 2000 gallon tank flatracks (one per truck and one per trailer).
2. POL is carried in tanker semitrailers (7500 or 5000 gallons).
3. PLS trucks normally carry ammunition in Combat Configured Loads (CCLs) on flatracks/CROPs. Mean weight is 11.0 tons per CCL.
4. PLS is the only truck which normally carries ammo in the corps; it also carries all other dry cargo commodities.
5. This unit has 48 trucks plus 48 trailers; each can carry one PLS flatrack or one 20' container (two per truck/trailer combination per trip).
6. This unit has 60 trucks plus 60 trailers; each can carry one PLS flatrack or one 20' container (two per truck/trailer combination per trip).
7. The only semitrailer authorized for personnel transport is the van, personnel carrier 80-passenger, Line Item No. S-74901, NSN 2330-01-090-7846; this semitrailer is not on the TOE of any Transportation truck company. In accordance with AR 385-55, Prevention of Motor Vehicle Accidents, (para 2.17, Safe Movement of Personnel), no other semitrailers are considered safe to transport personnel; consequently, troop carrying capability is not shown for semitrailers.
8. Non-divisional HETs perform tactical/operational maneuver unit relocations which are "long haul" missions; HETs are not normally employed in traditional line or local HETs do not normally carry other types of cargo.

Figure 7-3. Non-Divisional TC Truck Company SRC Capability Data

**Transportation Truck Company Capability Data - Non-divisional Companies**

As of 22 AUG 02

TOE	CONTAINER TONS/DAY										BB TONS		TROOPS		CBT VEH PER LIFT	NOTES	
	CONTAINERS		GENERAL		AMMO		TONS/DAY		GALS/DAY		GEN	AMMO	POL	H2O			PER LIFT
	40 FT	20 FT	40 FT	20 FT	40 FT	20 FT	40 FT	20 FT	40 FT	20 FT							
<b>LEVEL 1 - LINE HAUL</b>																	
55719F000	LT MDM TRK CO		17		110		235	336	576								9
55727F100	MDM TRK CO (EAC)(CGO)	105	210	1619	1359		2919	737	1324					479850			1, 7
55727F200	MDM TRK CO (EAC)(POL) W/7500 GAL TANKER													787500			2
55727F200	MDM TRK CO (EAC)(POL) W/5000 GAL TANKER													525000			2
55728F100	MDM TRK CO (CORPS)(CGO)		102		658			488						304920			1, 7
55728F200	MDM TRK CO (CORPS)(POL)													508200			2
55728F300	MDM TRK CO (PLS) (60)		217		1405			762	2389					434400			3, 4, 5
55728F300	MDM TRK CO (PLS) (60)		217		1405			762	2389					434400			3, 4, 6
55739L100	CBT HET CO																8
<b>LEVEL 1 - LOCAL HAUL</b>																	
55719F000	LT MDM TRK CO		34		219		471	671	1151								9
55727F100	MDM TRK CO (EAC)(CGO)	210	420	3238	2717		5838	1474	2648					959700			1, 7
55727F200	MDM TRK CO (EAC)(POL) W/7500 GAL TANKER													1575000			2
55727F200	MDM TRK CO (EAC)(POL) W/5000 GAL TANKER													1050000			2
55728F100	MDM TRK CO (CORPS)(CGO)		203		1315			976						609840			1, 7
55728F200	MDM TRK CO (CORPS)(POL)													1016400			2
55728F300	MDM TRK CO (PLS) (60)		434		2811			1525	4778					868800			3, 4, 5
55728F300	MDM TRK CO (PLS) (60)		434		2811			1525	4778					868800			3, 4, 6
55739L100	CBT HET CO																8
<b>LEVEL 1 - ONE TIME LIFT</b>																	
55719F000	LT MDM TRK CO		8		55		118	168	288								7
55727F100	MDM TRK CO (EAC)(CGO)	53	105	810	679		1460	369	662					239925			1, 7
55727F200	MDM TRK CO (EAC)(POL) W/7500 GAL TANKER													393750			2
55727F300	MDM TRK CO (EAC)(POL) W/5000 GAL TANKER													262500			2
55728F100	MDM TRK CO (CORPS)(CGO)		51		329			244						152460			1, 7
55728F200	MDM TRK CO (CORPS)(POL)													254100			2
55728F300	MDM TRK CO (PLS) (60)		869		5621			3049	1195					1737600			3, 4, 5
55728F300	MDM TRK CO (PLS) (60)		869		5621			3049	1195					1737600			3, 4, 6
55739L100	CBT HET CO																86

Figure 7-4. Availability Rate and Capacity Data for Trucks in TC Non-Divisional Truck Unit TOEs

- General Comments:**
- a. The data in the cells for each SRC represent exclusive capability. For example: the Level 1 line haul capability for 55727L100 is 105 40 foot containers per day or 210 20 foot containers per day or an intermediate value reflecting a combination; but, if the unit is carrying containers, it cannot carry breakbulk cargo. If the cargo trucks are equipped with SMFTs, the unit cannot carry any cargo other than water as long as the SMFTs are mounted on the semitrailer. A POL truck company (727L200) does not carry any other type cargo.
  - b. The data in this table is rounded. Normally local haul capability for a unit is exactly double the line haul capability. When this data is shown in the capabilities paragraph of a TOE it may be further rounded.
  - c. The TVAR data, while based upon truck type, applies only at TOE level of detail. TVAR data source is TRAC-Lee TVAR Study, May 1995. BB Tons per trip data source is USATSCH/CASCOM Cargo Density Factor Study, 1994. Containerized tons per trip data source is USATSCH/CASCOM Mean Container Content Weight Study, 1994. The capacity data is individual truck specific.
- Notes:**
1. Water is carried in Semitrailer Mounted Fabric Tanks (SMFTs) on cargo semitrailers. SMFTs are 4570 or 3000 gallons; they can be carried full or empty but not partially loaded. Water can also be hauled by PLS truck companies using 2000 gallon tank flatracks (one per truck and one per trailer).
  2. POL is carried in tanker semitrailers (7500 or 5000 gallons). They can be transported partially filled.
  3. PLS trucks normally carry ammunition in Combat Configured Loads (CCLs) on flatracks/CROPs. Mean weight is 11.0 tons per CCL.
  4. PLS is the only truck which normally carries ammo in the corps; it also carries all other dry cargo commodities.
  5. This unit has 48 trucks plus 48 trailers; each can carry one PLS flatrack or one 20' container (two per trk/tr combination per trip).
  6. This unit has 60 trucks plus 60 trailers; each can carry one PLS flatrack or one 20' container (two per trk/tr combination per trip).
  7. The only semitrailer authorized for personnel transport is the van, personnel carrier 80-passenger, Line Item No. S-74901, NSN 2330-01-090-7846; this semitrailer is not on the TOE of any Transportation truck company. In accordance with AR 385-55, Prevention of Motor Vehicle Accidents, (para 2.17, Safe Movement of Personnel), no other semitrailers are considered safe to transport personnel; consequently, troop carrying capability is not shown for semitrailers.
  8. Non-divisional HETs perform tactical/operational maneuver unit relocations which are "long haul" missions; they are not normally employed in line or local haul missions. HETs do not normally carry other types of cargo.
  9. Troops are not normally local hauled or line hauled.

**Figure 7-4. Availability Rate and Capacity Data for Trucks in TC Non-Divisional Truck Unit TOEs  
(Continued)**



## BALANCE REQUIREMENTS AGAINST CAPABILITIES

7-20. Balancing requirements against capabilities determine whether the available mode assets will support movement requirements. As a result of this step, movement planners determine the workload for each mode and segment of the transportation network. They should not limit this process to simply programming the use of available transportation capability. Planners must also consider command relationships and geographic area of responsibility (AOR).

7-21. Movement planners must assign requirements against all capabilities in a logical manner. They must not only consider the capabilities but also the total transportation network, the tactical situation, the priority of movement, and the risk of failure. For example, if a critical shipment must move into an area that is accessible by multiple road routes, but only one rail route, it would be wise to program the movement by motor transport. The rail segment could make less critical movements. Planners must consider the following workload requirements:

- Direct shipments
- Multistops
- Retrograde
- Intermodal shipments

7-22. If planners identify transportation shortfalls, they will plan movement according to command priorities and the transportation priority of the shipment. The remainder will be adjusted and these adjustments will be coordinated with the shipper, receiver, materiel managers, and logistics staffs.

7-23. Schematics may be used to assist movement planners when balancing requirements and capabilities. Their purpose is to graphically portray total shipping requirements and available transportation capabilities as they relate to the distribution plan. Planners use two types of schematics (requirements and mode).

## PLANNING SEQUENCE FOR RECEPTION AND ONWARD MOVEMENT

7-24. The senior movement control element develops a comprehensive plan for reception and onward movement that adheres to a step-by-step process similar to that used to develop a movement program. Planning must estimate the workload at specific transportation nodes to determine requirements for movement control, mode operating, and cargo transfer units. Planning should be done for operational periods for each mode. It must also identify requirements for MHE, container handling equipment (CHE), and host nation support (HNS) (Figure 7-5).

STRATEGIC PLANNING TIMELINE	DEPART CONUS DATE	ARRIVE APOD/SPOD DATE	ARRIVE HOLDING AREA DATE	ARRIVE SPOD DATE	DEPART SPOD DATE	ARRIVE MA DATE	PRESTOCK POINTS DATE	STAGING AREA DATE	ARRIVE FINAL DESTINATION
	DAYS	DAYS	DAYS	DAYS	DAYS	DAYS	DAYS	DAYS	DAYS
INCREMENT 1									
INCREMENT 2									
INCREMENT 3									
STRATEGIC PLANNING SEQUENCE	DETERMINE REQUIREMENTS	DETERMINE CAPABILITIES	BALANCE REQUIREMENTS & CAPABILITIES		DETERMINE CRITICAL POINTS	COORDINATE AMONG PLANNERS			
	For each increment, for each leg. Requirement equals total lift required minus unit's lift capability.	Availability for a given time period. Examine alternate modes and routing. Consider military, civilian, and host nation.	Include all workloads to include loading and off-loading. Identify short-falls. Develop alternatives.		Identify bottlenecks or choke points. Apply intelligence generated by US or host nation sources.	Ensure inclusion of supply and maintenance planners and host nation. Involve all commands and territorial authorities along route.			

Figure 7-5. Planning for Reception and Onward Movement.

7-25. During this planning, process, senior movement control element planners at the do the following:

- Obtain advance arrival information for intertheater sea and air movement from port operators and operational planners.
- Assess the movement requirements data such as required delivery date (RDD), priority of movement, equipment characteristics, and special requirements.
- Group the requirements for each POD by destination geographic location in RDD sequence.
- Obtain movement priority for requirements that have the same destination and RDD.
- Determine available modes for onward movement based upon planning requirements. Consider requirements, equipment characteristics, priorities, and modes servicing the PODs, SAs, and TAAs.
- Select mode for each requirement.
- Program the mode for each requirement for reporting to POD based upon estimated time for POD clearance. This is dependent on the type of strategic asset lift; air or sea.
- Determine availability of equipment for follow-on missions at the POD. Estimate uploading and processing time for each mode at the POD. Apply time-distance factors to estimate transit time to other transportation nodes, or arrival at the SA or TAA. Determine total transit time, maintenance, crew rest, and return time.
- Resolve conflicts by rerouting, changing modes, rescheduling, or obtain guidance from operational planners. Reconfirm that the selected route can accommodate any oversize or overweight cargo being moved.
- Identify requirements for MHE and CHE for each mode at the POD, cargo and trailer transfer points, and at destination. Coordinate with the TSC to provide sufficient MHE and CHE to meet the needs at the points and times required.
- Coordinate to establish holding and storage areas outside the POD marshaling area if ports become congested.
- Identify en route support needs for fuel, mess, maintenance, and billeting. Identify need and potential location of **convoy support centers**. Coordinate with the TSC for this support.

- Determine critical points where highway regulation or traffic control should be established to maintain the flow of traffic. Provide for en route communications.

**NOTE**

**CONVOY SUPPORT CENTERS** provide food service, medical service, maintenance, crew rest facilities and other personnel and equipment support for line haul drivers, equipment, and convoys moving along the MSR and ASR. They are located along the MSR with the mission to support, enhance, and otherwise facilitate long haul convoy operations. Their capabilities and capacities are tailored to the meet the requirements of the situation.

7-26. Plan retrograde missions for equipment returning from the SA and TAA in the same manner as above.

### Requirements Schematic

7-27. Prepare a requirements schematic as shown in figure 7-6. Prepare the schematic as follows:

- Draw and circle origin and destination points obtained from movement requirement forecasts. Identify each origin and destination point.
- Connect each point with lines and arrows showing direction of movement.
- List the daily shipping requirements between each origin and destination point. The requirements list the classes of supply, the tonnage, and the movement program line number.
- Create a legend as shown in figure 7-6.

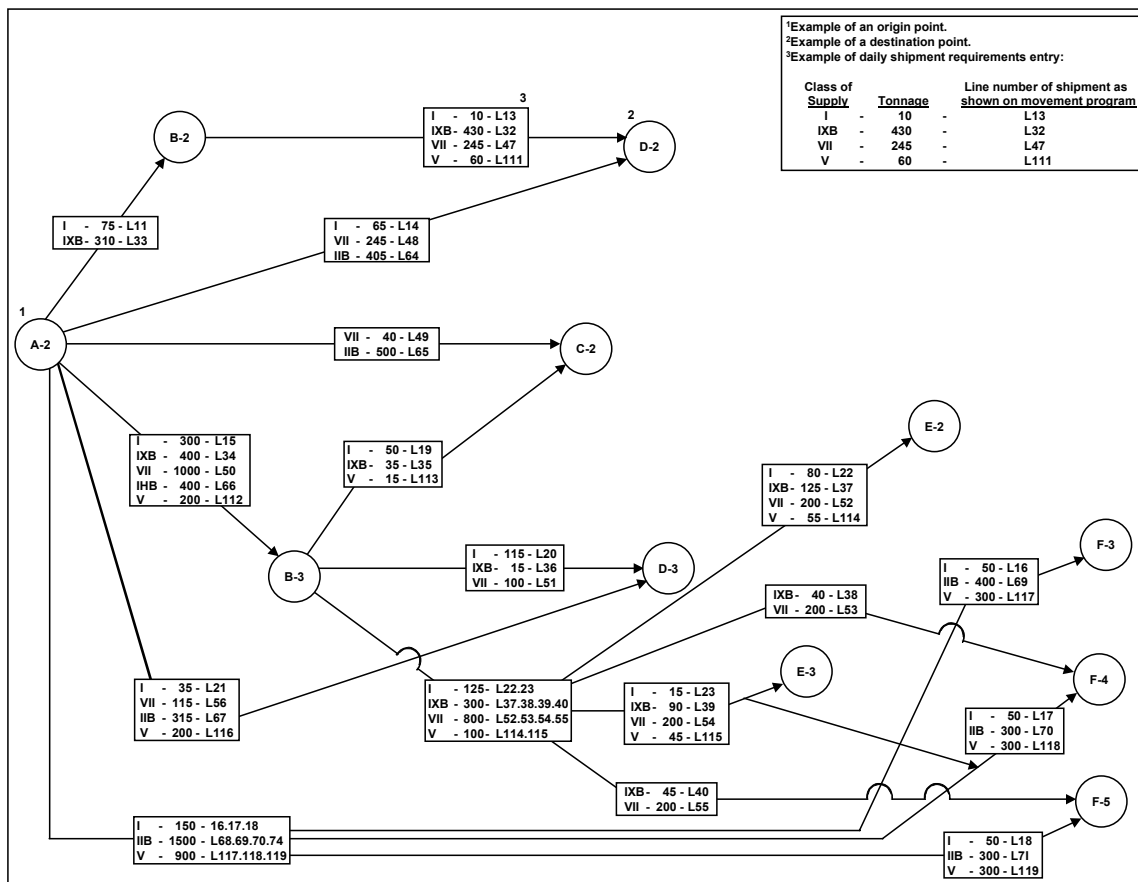

Figure 7-6. Requirements Schematic

### Mode Schematic

7-28. Prepare a mode schematic (figure 7-7) for each available mode. Prepare the schematic as follows:

- Draw and label mode origin and destination nodes and connect with lines. Connect the lines whether or not the current program requires movement on a segment.
- Note the mode capacity on the outside of the lines. Mode capacity can be expressed as follows: for rail and air as the total daily tonnage capacity between major terminals. For motor transport compute capacity in a particular area or as segments of a line-haul operation.
- Identify the schematic.
- On the outside of the lines note the mode capacity. Mode capacity can be expressed in several forms: for rail and air, as daily tonnage capacity between major terminals. Motor transport is the daily ton-mile capacity in a particular area or as segments of a line-haul operation.
- Assign program line numbers to each mode and list them between the nodes as classes of supply, tonnage, and the movement program line numbers.
- Note the type of mode under the schematic.
- Create a legend as shown in figure 7-7.

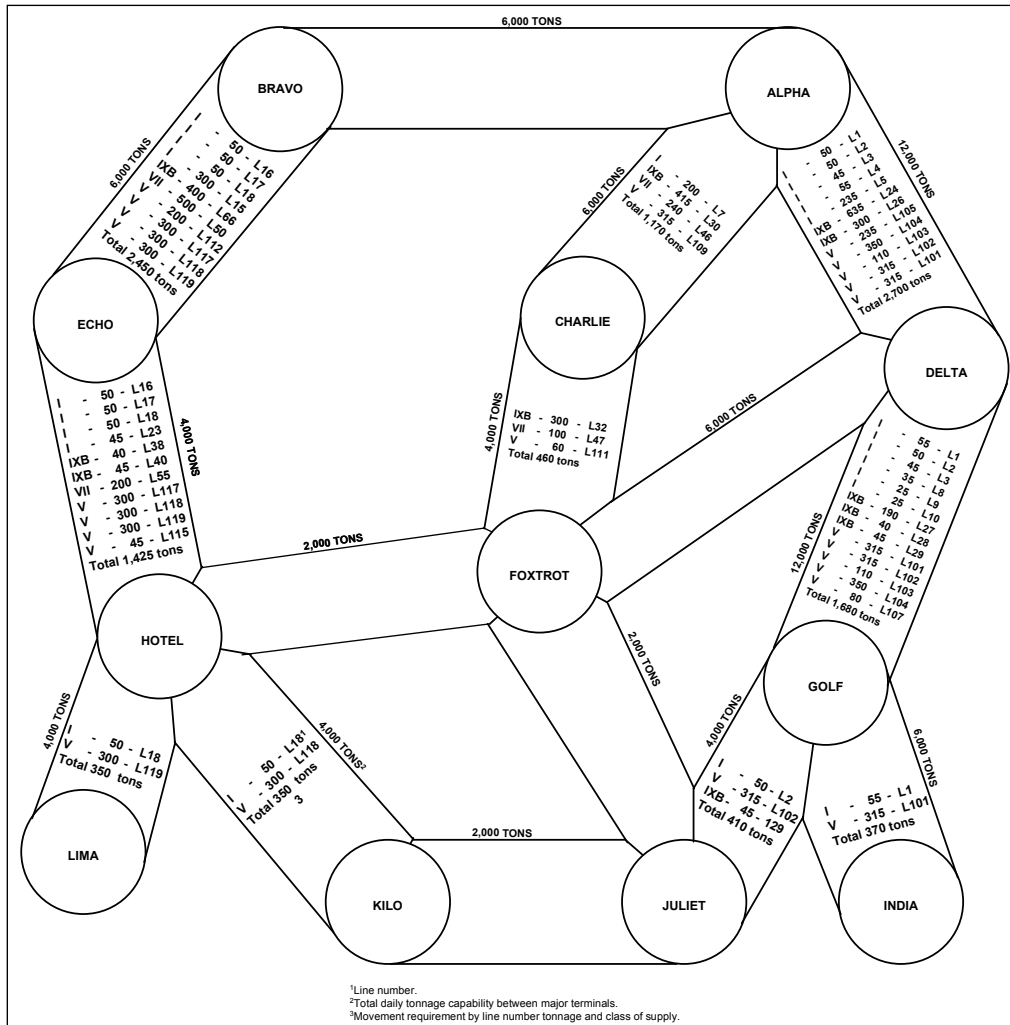

Figure 7-7. Mode Schematic - Rail

## Selecting A Mode

7-29. Movement planners use the following basic guidelines to allocate the mode of transport.

- Provide service according to command and transportation priority. Other factors such as shipment characteristics, security requirements, and political considerations are also evaluated.
- Whenever possible, reduce or eliminate cargo rehandling, avoid crosshauls, and plan for backhauls.
- Allocate all available transport equipment necessary to fulfill known requirements.
- Use the most efficient mode for the complete movement or as far forward as possible (see Figure 7-8).

ORDER OF ECONOMY	MOST EFFECTIVE USE	CAPABILITIES	LIMITATIONS
Pack animals and human bearers	Supplementary mode to extend surface transportation net over terrain impassable to other modes.	All tactical terrain, all weather conditions. Pack animals can transport about 250 pounds per pack animal. Human bearer can transport about 80 pounds subject to pack configuration.	Most inefficient means when terrain is trafficable to other surface modes. Human bearers most wasteful of human resource.
Pipeline	Primary mode for bulk liquids and solids suspended in liquid.	All weather conditions; few terrain restrictions; most economical and reliable mode for bulk liquids; relatively few personnel required for operation and maintenance.	Flexibility limited by immobile facilities: vulnerable to sabotage and enemy action; large construction tonnage required.
Water	Primary over-ocean mode. Inland surface mode for moving large quantities of cargo.	All weather conditions; any commodity; most economical overall long-distance carrier; particularly useful for relieving other modes to more suitable employment.	Relatively slow; flexibility limited by adequacy of waterways, facilities, and channels; vulnerable to enemy action and difficult to restore. Inland waterways are subject to flooding and freezing.
Rail	Primary inland mode for sustained flow of large quantities of traffic over long distances.	All weather conditions; any commodity; most economical continuous line-haul operations; greatest sustained ton-mile capability; variety of specialized equipment and services.	Flexibility limited by fixed routes; rail-line clearances restrict outsize movements; capability limited by availability of tractor power; rail line highly vulnerable to enemy action.
Motor transport	Supplementary mode for making possible an integrated transportation system. Effective in scheduled line-haul operations by the trailer-relay system: primary mode for distribution operations and logistical support operations in a CZ.	Most flexible mode over trafficable terrain; practically all weather conditions (terrain factor important); increases flexibility of other modes; can transport nearly any commodity with a variety of specialized equipment for both on- and off-road movement.	Over-the-road operations affected by route interference and obstacles created by weather, terrain, or enemy action; sustained line-haul operations over long distances; uneconomical in terms of ton-mile output versus expenditure of manpower and equipment.
Army Air (Helicopter)	The most costly Army mode for the movement of supplies. Becomes the primary mode of transport when all others are ineffective because of limitations or physical restrictions. Used to move only those high-priority items and critically needed supplies as determined by mode managers.	All terrain. Effective over short distances (less than 40 km for external loads). Helicopter can use unimproved PZ and LZ during external lift opns. Capable of lifting nearly any load that can be safely rigged and that is within the weight limitations of the helicopter. CH47 helicopters are capable of using Air Force 463L pallets and standard NATO warehouse pallets when they are equipped with the helicopter internal cargo handling system.	Operational capabilities limited by weather. Restricted flights in snow conditions and thunderstorms. Freezing levels above surface may limit capabilities. Aircraft capabilities limited by cargo load weight, cargo hook limits, or cargo door sizes. Aircraft availability is affected by flying hour program or crew rest requirements. Internal cargo loading may require MHE.
Air: Army Air Force	Complementary mode for expediting movement of mission-essential traffic; primary or major supplementary mode when terrain reduces effectiveness of surface modes; scheduled operation is most economical method of employment and produces greatest sustained ton-mile capability.	Greatest potential speed of delivery; most flexible with respect to terrain obstacles; economically more favorable (when these factors are combined with substantial lift capability and air transport over long distances). Capabilities are: heavy drop, container delivery system, low altitude parachute extraction system, air land, adverse weather aerial delivery system, and aerial bulk fuel delivery system.	Operational capabilities and effectiveness limited by climate and trafficability of takeoff and landing areas; high ton-mile operating costs.

Figure 7-8. Mode Selection Guide

## DETERMINE CRITICAL POINTS

7-30. Movement planners must identify critical points where restrictions could slow down or stop movement. Critical points include the following:

- Facilities
- Terminals
- Ports
- Railheads
- Bridges
- Tunnels
- Congested highways
- Cargo transfer points

7-31. Congested critical points limit the efficiency and effectiveness of the entire transportation network.

7-32. After identifying the critical points, planners determine alternative plans or control measures that could reduce or eliminate the risk of congestion. The MCB will place movement regulating teams on the ground where the problems are expected so they can respond before delays congest the system. They should also coordinate with the engineer, military police (MP), and air defense artillery support where necessary. (See figures 7-9 and 7-10.)

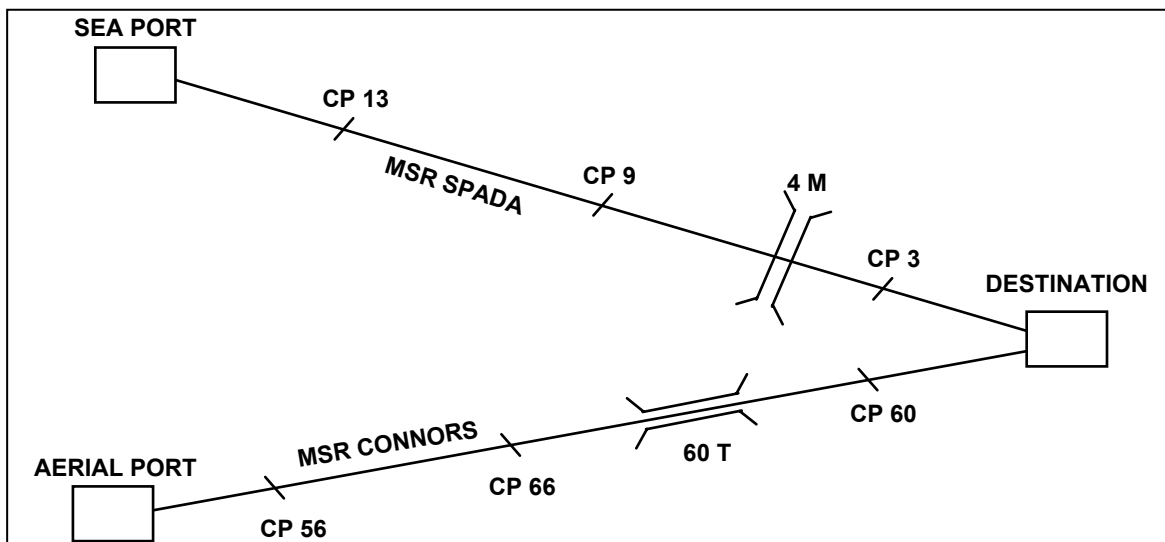

Figure 7-9. Critical Points Schematic

MSR SPADA		E/W ROUTE – 41.5 KM				DAILY HWY TONNAGE (STONS)	DAILY 5-TON TRUCK CAPACITY	HOURLY 5-TON TRUCK CAPACITY
CRITICAL POINTS	DISTANCE	LOCAL HWY	ROAD TYPE	SURFACE TYPE	REDUCTIONS			
SEA PORT – CP 13	15.2 KM	37	1	BITUMINOUS	N/A	27,000	4,500	188
CP 13-CP9	13.1 KM	37	3	GRAVEL	N/A	6,090	1,050	42
	4.0 KM	37	1	BITUMINOUS	N/A	27,000	4,500	188
CP 9-CP 3	3.6 KM	37	0	CONCRETE	BRIDGE – 4 KM	36,000	6,000	250
MSR CONNORS		E/W ROUTE – 41 KM						
CHECKPOINTS	DISTANCE	LOCAL HWY	ROAD TYPE	SURFACE TYPE	REDUCTIONS			
AERIAL PORT – CP 56	2.5 KM	42	2	BITUMINOUS	NARROW – 25%	20,250	3,375	141
	11.0 KM	42	1	BITUMINOUS	HILLS/CURVES 20%	18,900	3,150	131
CP 56-CP 66	7.0 KM	42	3	GRAVEL	MOUNTAINS 80%	588	98	4
	3.0 KM	42	1	BITUMINOUS	HILLS/CURVES 10%	24,300	4,050	169
	7.0 KM	42	5	DIRT	HILLS/CURVES 60%	1,176	196	8
CP 66-CP 60	5.0 KM	42	4	GRAVEL	HILLS/CURVES 30%	4,263	710	30
	5.5 KM	42	0	CONCRETE	BRIDGE 60T	588	98	5
LEGEND: ROAD TYPE/SURFACE TYPE					3 – 4-LANE LOOSE SURFACE-GRAVEL/ALL WEATHER			
0 – SUPER HIGHWAY – CONCRETE					4 – 2-LANE LOOSE SURFACE-GRAVEL/ALL WEATHER			
1 – 4-LANE HARD SURFACE-BITUMINOUS					5 – TRAIL-DIRT ROAD			
2 – 2-LANE HARD SURFACE-BITUMINOUS								

Figure 7-10. Critical Points Table

### DETERMINE CHECK POINTS

7-33. Included in the movement program is a main supply route (MSR) checkpoint list. It provides ready reference data about the MSR network such as checkpoints, link numbers, feeder routes into the MSR, and distances. Movement control personnel and customers can use this information to identify what path to use from origin to destination and to identify segment numbers for use in requesting movement bids and receiving movement credits. Movement planners must identify checkpoints along the route to control movements. Checkpoints should be easily recognizable features that can be clearly identified on both the MSR checkpoint list and on the route. Automatic Identification Technology (AIT) devices can be used to report the passing of vehicles and convoys at checkpoints or they can be manned or the when the vehicle or convoy passes the checkpoint it can just be reported by the Movement Tracking System (MTS) or some other source of communication. (See figure 7-11.)



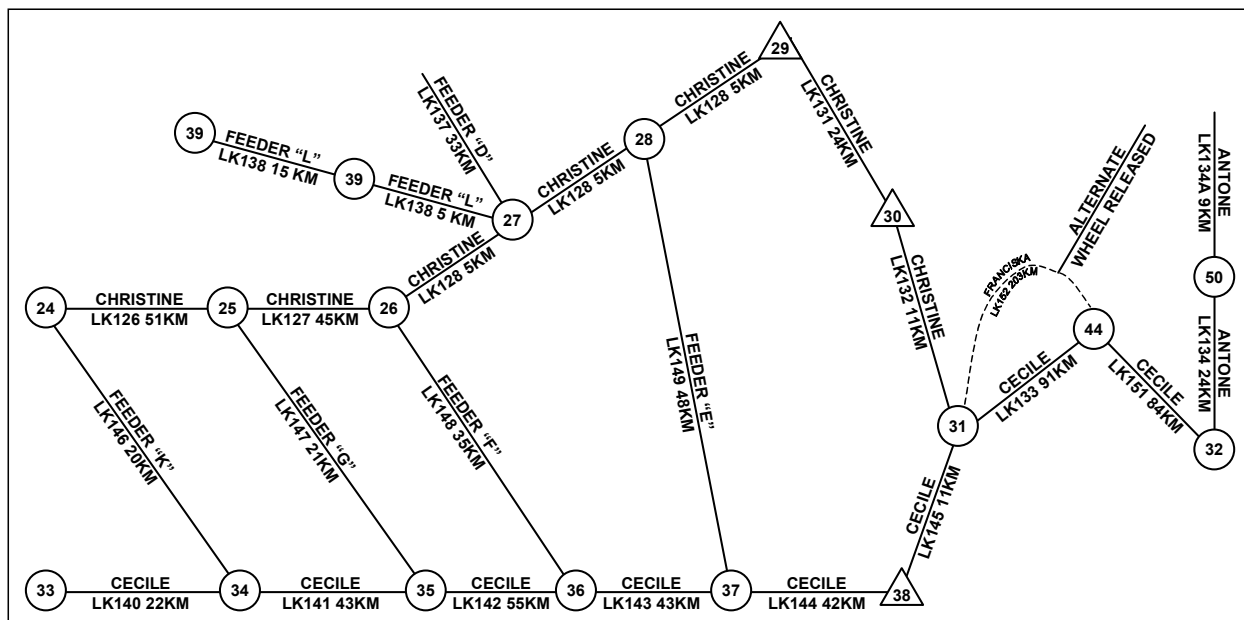

Figure 7-11. MSR Checkpoint List

## DETERMINE SHORTFALLS AND RECOMMENDED SOLUTIONS

7-34. Once shortfalls between material to be moved and the transportation assets to move the material are identified, solutions for moving the material must be developed. These include the following:

- Changing the date of the move to a later date.
- Assigning another motor transport unit to move the material.
- Assigning another mode (e.g., moving the material by rail rather than motor transport units).
- Using HN or commercial assets.
- Holding the material until transportation assets can be use to move it.

## COORDINATE THE PROGRAM

7-35. The movement program must be coordinated with movement planners and distribution managers at each command level during its development and also afterwards to ensure integrated planning and coordinated execution. It also requires coordination with operations, supply, MP, engineer, and air staffs so that each one knows its responsibilities during execution.

7-36. Movement control organizations distribute the completed movement program to each command level for comment and concurrence. During this phase, the program is used to facilitate planning and to show the evolving distribution patterns and projected logistic activity but does not authorize shipments to take place. It becomes directive once it is approved by the DCSLOG or G4.

## FORMAT AND PUBLISH THE PROGRAM

7-37. During the planning process, planners assign each movement requirement a movement program line number. This line number is used to identify the requirement and provide additional information throughout the development of the movement program. Figure 7-12 is a sample of a movement program for a cargo movement. Figure 7-13 is a sample of a movement program for passenger movement. The movement program planning process can also be used to identify and plan for the expected arrival of units into the theater. Information in the cargo format includes the following:

- Program line number
- Class of supply
- Estimated weight (short tons and cube)
- Origin
- Origin location
- Destination
- Destination location
- Destination MCT
- Container type
- Pieces
- Short tons
- Cube
- Transportation priority
- RDD
- Mode
- Remarks

7-38. The remarks column should be used to identify characteristics for items requiring special handling. For example, the remarks column could include the dimensions of outsize/overweight cargo. Other examples include items requiring special handling such as controlled temperature, controlled environment, hazardous cargo, or cargo security.

MCT: MOVEMENT PROGRAM -- CARGO													PLANNING PERIOD: 230-244 EFFECTIVE DATE: 230-237	
MVMT PRG LINE NO	SUPPLY CLASS	ORIGIN	LOCATION	DESTN	LOCATION	DEST MCT	CNTNR TYPE	PIECES	STON	CUBE	T P	RDD	MODE	REMARKS
51000	1	JG2	FU330044	AK4SQC	FR282922	793 <sup>RD</sup>	/	028905	000245	52028.0	2	232	H	
51001	5	JG9	ET400000	AK4RJA	LC979250	793 <sup>RD</sup>	20/40	006964	003995	181422.0	3	232	H	
51002	5	JG8	ET770599	AK4RJB	LC914722	793 <sup>RD</sup>	20/40	006292	003614	149284.9	3	232	H	
51003	5	JH1	ES160875	AK4RKA	LC410321	27AD DTO	20/40	006292	003614	149284.8	3	232	A	
51004	5	JG9	ET400000	AK4RKB	LC124262	27AD DTO	20/40	005964	003580	154622.0	3	232	H	
51005	8	JG6	ET995488	WK4NEC	MC520537	536 <sup>TH</sup>	/	155896	000105	18621.0	2	232	R	
51006	5	JG9	ET400000	WK4RCA	MC685976	536 <sup>TH</sup>	20/40	002119	001155	50533.7	3	232	R	
51007	5	WK4SJC	ET770599	WK4RCD	MC441610	429 <sup>TH</sup>	20/40	002156	001271	52855.0	3	232	R	
51008	5	WK4SHD	ET400000	WK4REA	MC812223	793 <sup>RD</sup>	20/40	002195	001251	52428.7	3	232	R	
51009	1	WK4SGC	MC736246	WK4SAY	NC078547	793 <sup>RD</sup>	/	004983	000042	8969.4	3	232	H	
51010	1	WK4SQC	MC708466	WK4SBY	NC018317	793 <sup>RD</sup>	/	004986	000042	8974.8	3	232	A	
51011	1	WK4SQC	MC785828	WK4SCY	NC056843	27AD DTO	/	005115	000043	9207.0	3	232	A	
51012	1	WK4SQC	FR282922	WK4SGC	MC785826	27AD DTO	/	005544	000056	11779.2	2	232	H	
51014	1	WK4SQC	FR282922	WK4SHD	MC708466	536 <sup>TH</sup>	/	006910	000058	12438.0	2	232	H	
51015	1	WK4SQC	FR282922	WK4SJC	MC736246	536 <sup>TH</sup>	/	006909	000059	12436.2	2	232	H	
51016	7	JH2	ES960720	9SQD22	LC854443	429 <sup>TH</sup>	/	000140	001022	186160.8	3	232	A	
51017	7	JH2	ES960720	22AVBN	LC854443	793 <sup>RD</sup>	/	000157	000765	224409.1	3	232	A	
51019	8	JG2	FU330044	AK4NNF	FU230026	793 <sup>RD</sup>	/	049440	000049	6635.2	2	232	H	
51020	8	JG2	FU330044	AK4NNG	FS662988	793 <sup>RD</sup>	/	049850	000050	6676.2	2	232	H	
51021	1	AK4SQC	FR282922	AK4SWC	FT765045	27AD DTO	/	004566	000039	8218.8	2	232	R	
51022	1	WK4SQC	FR282922	AK4STA	MC332864	27AD DTO	/	003975	000034	7156.8	2	232	R	
61000	1	JG1	ET995488	WK4NEC	FR282922	536 <sup>TH</sup>	/	028906	000246	52029.0	2	233	H	
61001	5	JG9	ET400000	AK4RJA	LC979250	536 <sup>TH</sup>	20/40	003679	003445	124335.5	3	233	H	
61002	5	JG6	ET770599	AK4RJB	LC914722	429 <sup>TH</sup>	20/40	003402	003156	115608.0	3	233	H	
61003	5	JH1	ES180875	AK4RKA	LC410321	793 <sup>RD</sup>	20/40	003309	003154	118570.8	3	233	R	
61004	5	JG9	ET400000	AK4RKB	LC124262	793 <sup>RD</sup>	20/40	003578	003445	124335.5	3	233	H	

Figure 7-12. Movement Program - Cargo

7-39. Information in the personnel format includes the following:

- Program line number
- Passenger Type
- Estimated weight (short tons and cube)
- Origin
- Origin location
- Destination
- Destination location
- Destination MCT
- Container type
- Pieces
- Short tons
- Cube
- Transportation priority
- RDD
- Mode

MCT: MOVEMENT PROGRAM -- PERSONNEL														PLANNING PERIOD: 225-238 EFFECTIVE DATE: 225-232	
MVMT PRG LINE NO	TYPE PASSENGER	ORIGIN	LOCATION	DESTN	LOCATION	DEST MCT	CNTNR TYPE	PIECES	STON	CUBE	T P	RD D	MODE	REMARKS	
P0001	PATIENTS	AMS	FT230970	AK4PUC	FT220830	793 <sup>RD</sup>	/	000400	000028	4000.0	2	226	A		
P0002	PATIENTS	A,S	FT230970	AK4PUG	FT220830	793 <sup>RD</sup>	/	000400	000028	4000.0	2	226	A		
P0003	PATIENTS	A,S	FT230970	AK4PUL	FT220930	793 <sup>RD</sup>	/	000400	000028	4000.0	2	226	H		
P0004	TROOPS	BRU	FS043390	AK4PVJ	FS040340	27AD DTO	/	000400	000048	4000.0	2	226	H		
P0005	TROOPS	BRU	FS043390	AK4PVN	FS040430	27AD DTO	/	000400	000048	4000.0	2	226	H		
P0006	EPW	AK4PUC	FT220930	WK4PKU	MC782766	536 <sup>TH</sup>	/	000300	000038	4000.0	2	227	H		
P0007	EPW	AK4PUG	FT220930	WK4PRU	MC684510	536 <sup>TH</sup>	/	000300	000038	4000.0	2	227	H		
P0008	EPW	AK4PVJ	FS040340	WK4PJU	MC760336	429 <sup>TH</sup>	/	000400	000048	4000.0	2	227	R		
P0009	PATIENTS	AMS	FT230970	AK4PUC	FT220930	793 <sup>RD</sup>	/	000400	000048	4000.0	2	227	R		
P0010	PATIENTS	AMS	FT230970	AK4PUG	FT220930	793 <sup>RD</sup>	/	000400	000048	4000.0	2	227	H		
P0011	PATIENTS	AMS	FT230970	AK4PUL	FT220930	793 <sup>RD</sup>	/	000400	000048	4000.0	2	227	H		
P0012	TROOPS	BRU	FS043390	AK4PVJ	FS040340	27AD DTO	/	000400	000048	4000.0	2	227	H		
P0013	TROOPS	BRU	FS043390	AK4PVN	FS040430	27AD DTO	/	000400	000048	4000.0	2	227	A		
P0014	EPW	AK4PUC	FT220930	WK4PKU	MC782166	536 <sup>TH</sup>	/	000300	000038	4000.0	2	228	H		
P0015	EPW	AK4PUG	FT220930	WK4PRU	MC684510	536 <sup>TH</sup>	/	000300	000038	4000.0	2	228	H		
P0016	EPW	AK4PVJ	FS040340	WK4PJU	MC780336	429 <sup>TH</sup>	/	000400	000048	4000.0	2	228	R		
P0017	PATIENTS	AMS	FT230970	AK4PUC	FT220930	793 <sup>RD</sup>	/	000400	000028	4000.0	2	228	R		
P0018	PATIENTS	AMS	FT230970	AK4PUG	FT220930	793 <sup>RD</sup>	/	000400	000028	4000.0	2	229	H		
P0019	PATIENTS	AMS	FT230970	AK4PUL	FT220930	793 <sup>RD</sup>	/	000400	000028	4000.0	2	229	H		
P0020	TROOPS	BRU	FS043390	AK4PVJ	FS040340	27AD DTO	/	000400	000048	4000.0	2	229	H		
P0021	TROOPS	BRU	FS043390	AK4PVN	FS040430	27AD DTO	/	000400	000048	4000.0	2	229	H		
P0022	EPW	AK4PUC	FT220930	WK4PKU	MC782766	536 <sup>TH</sup>	/	000300	000038	4000.0	2	230	H		
P0023	EPW	AK4PUG	FT220930	WK4PRU	MC684510	536 <sup>TH</sup>	/	000300	000038	4000.0	2	230	A		
P0024	EPW	AK4PVJ	FS040340	WK4PJU	MC760336	429 <sup>TH</sup>	/	000400	000048	4000.0	2	230	A		
P0025	PATIENTS	AMS	FT230970	AK4PUC	FT220930	793 <sup>RD</sup>	/	000400	000048	4000.0	2	230	H		
P0026	PATIENTS	AMS	FT230970	AK4PUG	FT220930	793 <sup>RD</sup>	/	000400	000048	4000.0	2	230	H		
P0027	PATIENTS	AMS	FT230970	AK4PUL	FT220930	793 <sup>RD</sup>	/	000400	000048	4000.0	2	230	H		
P0028	TROOPS	BRU	FS043390	AK4PVJ	FS040340	27AD DTO	/	000400	000048	4000.0	2	230	H		

Figure 7-13. Movement Program – Personnel

7-40. The TCE compiles activity address files for units in the theater (Figure 7-14). These files list in-the-clear unit locations and points of contact. Therefore, these files must be designated as classified documents and must be safeguarded. The TCE provides a copy of each file to subordinate movement control units. These subordinate units also compile activity address files for units in their geographical area and update the TCE master file. The MCT and DISCOM movement control officer (MCO) will accept transportation requests from those units located in their geographic AOR and also update their customer list.

<b>CUSTOMER LIST (ALPHABETICAL LISTING)</b>				
<b>AAC</b>	<b>NOMENCLATURE</b>	<b>GRID COORD</b>	<b>UIC</b>	<b>MCT</b>
WK4CFC	C CO 704 SIG BN AREA	NV228645	WCFCAA	793 <sup>RD</sup> MCT
WK4CFD	D CO 704 SIG BN AREA	NV086625	WCFDAA	793 <sup>RD</sup> MCT
WK4CFE	HHC 704 SIG BN AREA	NV399791	WCFUAA	793 <sup>RD</sup> MCT
WK4CGA	A CO 705 SIG BN AREA	NV279958	WCGAAA	792 <sup>ND</sup> MCT
WK4CGB	B CO 705 SIG BN AREA	NV270869	WCGBAA	792 <sup>ND</sup> MCT
WK4CGC	C CO 705 SIG BN AREA	MV997883	WCGCAA	792 <sup>ND</sup> MCT
WK4CGD	D CO 705 SIG BN AREA	MV982803	WCGDAA	792 <sup>ND</sup> MCT
WK4CGU	HHC 705 SIG BN AREA	NV270869	WCGUAA	792 <sup>ND</sup> MCT
WK4CHA	A CO 706 SIG BN AREA	NA995238	WCHAAA	791 <sup>ST</sup> MCT
WK4CHB	B CO 706 SIG BN AREA	NA007067	WCHBAA	791 <sup>ST</sup> MCT
WK4CHC	C CO 706 SIG BN AREA	MA859181	WCHCAA	791 <sup>ST</sup> MCT
WK4CHD	D CO 706 SIG BN AREA	MV863984	WCHDAA	791 <sup>ST</sup> MCT

Figure 7-14. Sample Transportation Customer Alphabetical List

7-41. The movement program planning format may also be used to develop individual movement plans. Movement plans are initial developmental stages of a movement program that support specific OPLANs. As such, these movement programs are only plans until they are executed.

7-42. Included in the movement program is an MSR checkpoint list. It provides ready reference data about the MSR network such as checkpoints, link numbers, feeder routes into the MSR, and distances. Movement control personnel and customers can use this information to identify the path to be used from origin to destination and to identify segment numbers for use in requesting movement bids and receiving movement credits.

## EXECUTING THE MOVEMENT PROGRAM

7-43. To activate a movement program line number, the shipper contacts its servicing MCT or MCO and requests its line number to be activated. The MCT or MCO verifies that the program data is still valid by coordinating with the shipper. The MCT or MCO will coordinate with the receiver if positive inbound clearance is required. If command priorities change during the current program cycle and these priority changes affect program executions, movement planners coordinate with affected shippers and receivers. Shippers or receivers should immediately contact their servicing MCT or MCO when there is a change in requirements, capabilities, or locations.

## PREPARING THE PORT CLEARANCE PROGRAM

7-44. The port clearance program is part of the theater movement program. The TCE begins preparing the port clearance program as soon as it receives advance manifest data from the continental United States (CONUS) ports, terminal units, or other ports of origin. Once the manifest (lists what is actually on the ship or plane and where stowed) is available, the port MCT does the following:

- Programs actual transportation assets to provide onward transportation based on anticipated arrival date.
- Activates line numbers and/or programs.

7-45. The port MCT coordinates through movement control channels the status of program execution.

7-46. The TCE provides input to the terminal port commander if diversion is required. The TCE makes recommendations based on the following:

- Cargo destinations.
- Available port capacities, capabilities, and workload.
- Capacities and projected workload for the various modes and segments of the transportation network.

7-47. A close working relationship between the TCE and MMC is required to program and expedite moving non-unit equipment and supplies; especially those shipped in containers.

## Chapter 8

# Highway Regulation

There are many ways of going forward, but only one way of standing still.

-- *Franklin D. Roosevelt*

8-1. Highway regulation is the responsibility of commanders having area jurisdiction. Commanders must ensure that highway movement program moves occur as planned, while meeting the immediate daily requirements. See FM 4-01.40, Army Motor Transport Units and Operations for doctrine pertaining to actual execution of the plan. The following activities perform the highway regulation mission:

- Transportation command element (TCE) and movement control battalion (MCB) at echelons above corps (EAC).
- MCB (corps) in the corps rear area.
- Division transportation officer (DTO) in the division rear area.
- Brigade S4 in the brigade rear area.

8-2. The TCE and MCB (corps) monitor main supply routes (MSR) using movement regulating teams (MRT) employed throughout the area of operation (AO) in essential locations to observe, assess, and report progress of tactical and nontactical movements. The TCE, MCB (corps), and DTO also monitor highway regulation in subordinate command areas and may regulate some of the routes based upon the tactical situation.

8-3. The highway regulation function consists of planning, routing, and scheduling, of ground traffic to deconflict the use of highways and facilitate movements. It provides order, prevents congestion, and enforces movement priorities. The extent of regulation required depends upon the number of planned or anticipated movements, the routine level of immediate requirements, and the capacity of the road networks.

Planned movement requirements are identified in advance. They are found in distribution plans, movement programs, and operation plans and orders. They involve onward movement of forces from port of debarkations (PODs), movement of supplies and equipment, and movement of units.

Immediate requirements are unplanned and based on requirements generated during the conduct of operations. They include requirements such as unit displacement, unprogrammed resupply, and evacuation. Immediate requirements are normally of a higher priority than planned requirements and must be quickly acted upon.

8-4. The extent of the regulation needed depends upon the number of moves and the capacity of the road network. Highway regulation is crucial when operating over underdeveloped and saturated road networks. The more developed the road network and the more capacity it provides, the less regulation is required. In a highly developed highway and road network, regulation may not be

necessary and free-flow of traffic may be allowed. Free-flow of traffic allows for the maximum movement of cargo and personnel. Transportation planners and operations should only use free-flow when the road network and security requirements allow.

## PLANNING FOR HIGHWAY REGULATION

8-5. The goal of highway regulation planning is to sustain movements according to the commander's priorities and make the most effective and efficient use of the road networks. It requires synchronization and coordination with planners of unit movement and maneuver. Planning is done in a logical sequence and results in the publication of the **highway regulation plan** and the **traffic circulation plan**. The first step in the planning process is to assemble critical information. This information can be found in the following:

- Operation plans (OPLAN), operation orders (OPORD), and estimates. OPLANs, OPORDs, and estimates contain essential information. Movement planners must read and understand the concept of operation to effectively support the commander's intent while executing highway regulation. Information such as geographic boundaries, task organization, priorities, and locations of major supply activities are also contained in these plans.
- Engineer route reconnaissance or classification overlays. The engineer route reconnaissance or classification overlays provide detailed information on the characteristics of the road network such as road surface, width, restrictive features, and bridge classifications. This information is necessary to determine critical points and route capacity. The characteristics of the route are contained in the route classification formula. Current information is required and thorough route reconnaissance may not always be possible or feasible. Therefore, movement planners may also obtain information from aerial photographs, local authorities, intelligence reports, and military police (MP) hasty route reconnaissance to supplement information obtained from maps or intelligence studies.
- Traffic density information. Traffic density information is the anticipated volume of traffic on route segments during specific periods. It comes from planned requirements contained in the distribution plan, movement program, the OPLAN or OPORD, or fragmentary orders (FRAGO). Planners must extract specified and implied requirements for unit movements, sustainment movements, and retrograde movements. These documents may also require moving civilian refugees, unit displacement, or shared uses by allied or host nation (HN) forces. Each type of movement must be prioritized, planned, and coordinated.
- Terminals and facilities data. Terminals and facilities data obtained from the theater distribution plan, include the location of supply points, terminal transfer points, staging and assembly areas, aerial ports and sea ports, airfields and drop zones, and refuel points. These are considered in terms of their total clearance and reception capabilities. Specific considerations include location, access from military supply routes (MSR), and their capability to receive, load, unload, and stage.

8-6. When the data is assembled and studied, movement planners must identify the road networks that are capable of supporting the volume of traffic necessary to meet planned and anticipated movement requirements. These road networks will be recommended as MSRs and ASRs. Planners

must also plan extensions of the MSRs to anticipate forward movement of maneuver forces. ASRs are used when the MSRs are disabled or too congested, and should be planned for in the same manner as MSRs. At this point in planning, it is necessary to obtain approval of the G4 and G3. The G4 has staff supervision for movement planning. The G3 is responsible for terrain management. The G3 must approve the selection of MSRs and ASRs before movement planners can conduct detailed highway regulation planning.

8-7. Movement planners will develop the highway regulation plan and traffic circulation plan after the G3 approves the MSRs and ASRs. The highway regulation plan is a written plan that describes the MSR network and establishes control measures to promote effective regulation (an example of a highway regulation plan is shown at Appendix I). The traffic circulation plan is a map overlay or graphic representation of the MSR network. Both are published as an annex to the OPLAN or OPOD. They are used by the provost marshal (PM) to develop the traffic control plan. The development process involves the following:

- Naming each MSR according to command directives. Avoid using colors to name MSRs since the MSR status and other logistics statuses are normally reported as green, amber, red, or black. Avoid using numbers to name MSRs because they may conflict with existing route numbers.
- Determining critical points. Critical points are areas of interest to movement planners. See chapter 7, paragraph 7-30 for detailed discussion of critical points. See chapter 7, paragraph 7-24, for discussion of planning the support of onward movement which involves, among other things, the establishment of **convoy support centers**.
- Establishing checkpoints (CPs) on each MSR to segment the MSRs. Segmenting the MSR facilitates highway regulation and traffic control planning and execution. See chapter 7, paragraph 7-33 for detailed discussion of checkpoints. CPs should be established at the following:
  - ⇒ Major crossroads.
  - ⇒ Locations where road conditions change.
  - ⇒ Major supply or service areas.
  - ⇒ Geographic boundaries.
  - ⇒ Assembly areas.
  - ⇒ Other critical points.

8-8. CPs are predetermined points on the MSR that are used as a means of regulating and controlling movement. Units use CPs when requesting movement clearance by using CPs to identify their start point, release point, and en route CPs. CPs enable quick dissemination of information during execution such as a point where traffic will be rerouted. CPs are also used when describing the MSR in the highway regulation plan. Some examples are as follows:

- MSR Spear is a paved, all weather road from CP 22 to CP 34.
- From CP 34 to the 54th Division rear boundary, the MSR is an improved fair weather road. The MSR can accommodate two-way traffic.



- The route is classified as an open route from CP 22 to CP 34.
- It is a supervised route from CP 34 to CP 8 at the division rear boundary. Convoys of eight or more vehicles, tracked vehicles, or vehicles that cannot maintain a 30 km march rate require a movement credit on that segment.
- The most restrictive route feature is at CP 35, a bridge with a military load classification (MLC) of 30. Vehicles with an MLC greater than 30 must use the ford at NJ334098. Signs for the ford are posted.

8-9. Planners should identify sufficient CPs to adequately exercise control, but no more than they have the capability to manage when the plan is executed. This requires careful balancing so that excessive CPs do not impede execution.

- **Establishing control measures for each route.** Control measures should be based on the engineer route classifications, planned and anticipated traffic volume, mission, enemy, terrain and weather, troops, time available, and civilian considerations, and critical points. Planners must also consider the capabilities of movement control and traffic control units to enforce the control measures. Control measures may change based on the conduct of operations. Movement planners must ensure that changes generated as the result of operational needs are incorporated into the OPORD or otherwise disseminated quickly. Below are the five control measures:
  - ⇒ **Open Route.** This is the least restrictive control measure. Any unit may use the route without a movement credit. Minimum control is exercised.
  - ⇒ **Supervised Route.** The movement control headquarters will specify the size of convoys, the type of traffic, or characteristics of vehicles that require a movement credit to use the route. Limited control is exercised.
  - ⇒ **Dispatch Route.** A movement credit is required to use this route regardless of the number or types of vehicles. A dispatch route will normally be designated when traffic volume is expected to exceed capacity or when the route is critical to operations and priority of use must be strictly enforced. Full control is exercised.
  - ⇒ **Reserved Route.** The route is reserved for the exclusive use of a particular unit(s) or type of traffic and no other units or traffic may use the route. Reserved routes may be identified for large unit movements. Examples are when a maneuver unit must pass another forward, when reserve formations are committed, or when units are withdrawn for reconstitution.
  - ⇒ **Prohibited Route.** The route is closed and no unit or traffic may use the route. A route may be prohibited due to washouts, destroyed bridges, maintenance, or construction work. It may be prohibited for only short periods, such as the time necessary to do repairs.
- **Making a traffic circulation plan** (see Figure 8-1). The overlay will show all MSRs, CPs, and highway regulation points. It will also include route names, direction of travel, boundaries, and principal supply activities. It will reflect any restrictive route features, critical points, and convoy support centers. It may include traffic control points if provided by the PM before publication of the traffic circulation plan.

- **Determining reporting requirements.** These requirements are for units using the MSR if reporting is necessary.
- **Developing the highway regulation plan.** The highway regulation plan is included in the operation plan or order. The written plan will describe the information contained on the overlay and specify the control measures that apply to each MSR or critical segments of MSRs. Control measures should be coordinated to phases of the operation if they can be determined in advance. These should be coordinated with the DMC, then the G3, especially requirements for reserved routes to support large unit movements.
- **Staffing and coordinating the plan.** Recommend points where traffic control will be required. Recommend locations and priorities for engineer repair and upgrade efforts.

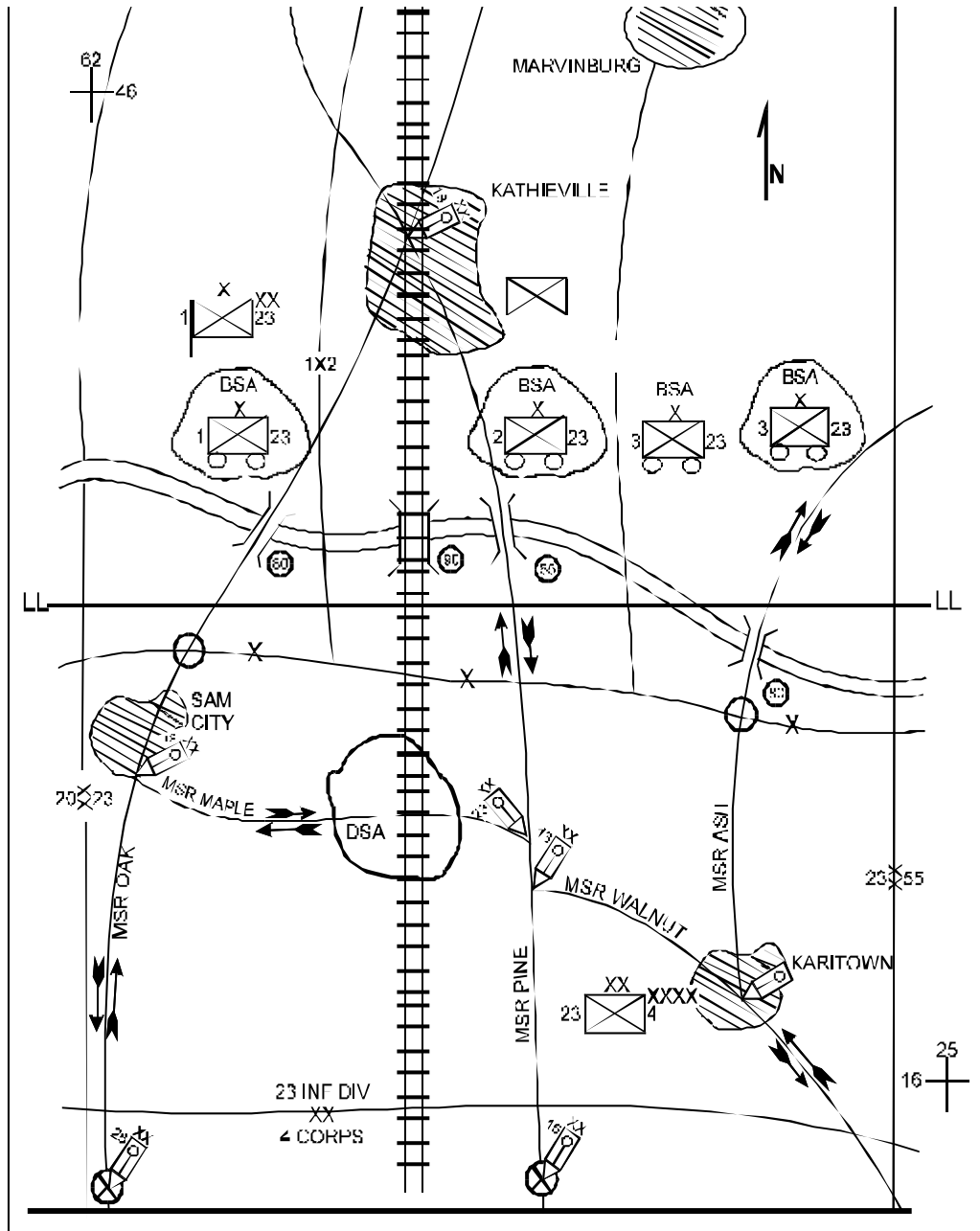

Figure 8-1. Sample Traffic Circulation Plan

### PRINCIPLES OF ROUTING

8-10. Routing is the process of coordinating or directing movements on MSRs or ASRs. When routing traffic, movement planners should consider the four principles that govern routing.

- **Balance.** Balance is the matching of vehicle characteristics with route characteristics to ensure that vehicle traffic does not exceed the most limiting feature of a route.

- **Separation.** Separation is allocating the road space to ensure that military movements do not conflict with each other, with pedestrian movements, or with civilian traffic.
- **Distribution.** Distribution is allocating as many routes as possible to reduce the potential for congestion, enhance the useful life of roads and bridges (sustained capability), and prevent deterioration of road surfaces (due to overuse). Distribution also promotes passive defense by distributing and separating traffic.
- **Prioritize.** Assign highest priority traffic to routes that provide the minimum time-distance.

## METHODS OF SCHEDULING

8-11. Scheduling is the process of coordinating times for road and highway movements. It involves receiving and managing movement requests, and issuing clearances. Scheduling is essential to the application of the principles of routing (paragraph 8-10).

8-12 Apply the following guidelines in scheduling movements:

- Movements on routes requiring movement clearance must be scheduled.
- Movements that cross movement control boundaries must be scheduled, coordinated, and inbound cleared by the movement control organization responsible for the area where the movement originates to the movement control organization where the movement terminates.
- Large unit movements must be scheduled.
- Movements in one direction, on routes that require a movement clearance, are treated as a single movement, regardless of the distance or time involved. Each movement retains the same movement clearance to destination.
- Schedules and changes to schedules (due to changes in the tactical situation or in immediate movement requirements) are provided to the movement regulation teams (MRT) to execute highway regulation and to the PM to provide traffic control.

8-13. The method of scheduling road movements is based on the control measures specified for the route. The four types of scheduling methods (from the least restrictive to the most restrictive) are described below.

- **Infiltration Schedule.** This schedule is a rate of dispatch assigned to units for specific routes and time blocks to achieve an average traffic flow that is within the capacity of the route. By assigning rates of dispatch to different units that need to use the same route, average traffic flow can be held within desired limits. An infiltration schedule may be used for open or supervised routes.
- **Route Schedule.** This schedule is a flexible scheduling method. It apportions blocks of time on MSRs to units, types of movements, phases of the operation, or for route maintenance. A route schedule may be used for supervised, dispatch, or reserved routes.

- **Location Schedule.** This schedule is more restrictive than an infiltration or route schedule. It assigns arrive and clear times to different units needing to use the same entry point onto MSRs. The location will normally be a CP. For example, at a particular CP, unit A may be scheduled to arrive at 1000 and to clear at 1015, unit B to arrive at 1020 and to clear at 1030, and so on. A location schedule may be used for supervised or dispatch routes.
- **Column Schedule.** This schedule is the most restrictive scheduling method. It specifies arrive and clear times at CPs along an entire route. It may be based on the requestor's movement request or movement table or on movement tables issued by the movement control organization. Based upon the extent of control required, a column schedule can provide the most effective highway regulation because it provides in-transit times to reach CPs and helps the pacesetter maintain the prescribed rate of march. It may be used for supervised, dispatch, or reserved routes. It should also be used when congestion is anticipated.

## CLEARANCE REQUESTS

8-14. Units needing to move on controlled routes that require a movement credit must request and receive clearance before beginning movement. The request is submitted through the chain of command to the DTO or Corps/EAC MCT within whose area the movement originates. In the Corps, the MCT forwards the request to its servicing highway traffic division. In the COMMZ, the MCT forwards the request to its MCB. Based on procedures established in SOPs, the request may be transmitted in hard copy, electronically, or verbally.

8-15. The DTO, HTD, or MCB reviews requests and considers them based on command priorities for the type of movement and the unit requiring movement. Priorities for types of movements are normally specified in SOPs, OPLANs, or OPORDs. They include categories such as unit movement, movement of reserves, logistical movement, and movement of replacements. Unit or task force priorities are specified in OPLANs and OPORDs. Unit priorities are based on the commander's requirements to meet the tactical situation. These priorities frequently change. Movement planners must anticipate changes and frequently obtain planning guidance from the G3 and G4.

8-16. The DTO or HTD either schedules the movement as requested or notifies the unit if it cannot be granted. The DTO or MCT will coordinate with the lower priority requestor to reschedule the move at a different time or on a different route. If conflicts arise during planning that cannot be resolved by the DTO or HTD, they must seek resolution of the priority conflict through the staff that approved the priorities.

8-17. Movement credits are returned to the requesting unit through the same channels used for the request. Information on all movement credits issued is provided to the PM, MP units, and MRTs for traffic control and movement regulating purposes. The movement credit gives the requesting unit the authority to move on a controlled route. The credit is a control number. Policies for developing the codes used for movement credits are governed by command directives. Movement credits normally include a command identifier, Julian date, and sequence number. For example, a unit of the 54th Infantry Division will move on Julian date 043. The credit was the third issued for that date. The movement credit would be 54-043-003. Additional codes may be added after the sequence number to further identify the unit or type of movement. Command directives normally prescribe

that moving units chalk the movement credit on the sides of their vehicles to identify that the movement is authorized.

## **COORDINATING MOVEMENTS**

8-18. Movement control organizations must coordinate the planned movement of convoys on controlled MSR in order to issue movement credits, reroute, or divert. They must also monitor the in-transit status of some convoys on controlled routes to find out if movements are going according to scheduling. This does not require monitoring every convoy, but should include monitoring certain critical points or CPs. The function can be performed by either MRTs or MPs. Both require communications capability to relay information.

8-19. Without positive control measures and monitoring, the MSR may become congested and movements will be delayed. Planners, when coordinating movement bids, must be able to visualize the location of convoys at any time and know when they should arrive and clear CPs.

## **DIVERTING AND REROUTING**

8-20. Movement planners in the MCO and HTD must monitor the in-transit status of convoys to find out if movements are going according to scheduling. They are also the focal point for diverting and rerouting, and must be able to communicate with MRTs and MPs to enforce control measures on MSR or to divert and reroute. SOPs must provide detailed guidance for coordinating and disseminating information.

8-21. Traffic disruptions may be caused by enemy action that destroys bridges, damages MSR, or contaminates MSR. Refugees clogging an MSR may also cause disruptions. Movement planners must also anticipate traffic disruptions caused by congestion due to breakdowns, weather, and degradation of road surfaces. They also request route repair, decontamination, and traffic control support. Movement planners advise the G3 and G4 of any actions required to reduce the impact of disruptions.

8-22. Movement planners must continuously seek out information from other staff sections to make assessments. In addition to receiving reports from MCTs and MRTs, they must coordinate regularly with the G2, G3, and PM to obtain current information as reported through command channels. Upon receiving reports of problems on an MSR, the movement control organizations can progressively adjust traffic plans. They can issue instructions to hold unit movements that have not begun, issue new routing instructions, or hold unit movements at a staging area or CP if the movement has begun.

## **LARGE UNIT MOVEMENTS**

8-23. Large unit movements must be quickly executed. Coordination is critical during planning to open routes for movement and to reschedule previously planned movements. Maintaining logistical support and uninterrupted transportation to other supported units in conjunction with large unit moves requires continuous coordination. Large unit movements will normally be planned by the

moving units under parameters defined by the G3 and/or movement control headquarters. This depends upon their location and whether the movement commits the forces or moves them from one assembly area to another. Planning for movement of large units consists of four concurrent steps:

- Determining the requirements for the move.
- Determining the timeframe for the move.
- Analyzing organic and nonorganic movement capabilities.
- Establishing movement priorities.

8-24. The fundamental precepts of METT-TC drive the planning for large unit movements as they form the base requirement for the time and space factors characterizing the movement. The following factors are considered:

- Task organization of units, current location, and concentration.
- Adequacy of routes to support vehicles and tonnages.
- Available assembly areas and transportation modes at origin.
- Control measures, coordination, and logistics support for the movement and at destination.
- Assembly areas at destination.
- Deception measures before and during the movement and at destination.
- Enemy situation, route and geographic conditions, and weather.

8-25. Preplanned movements must be reevaluated in terms of their priority in relation to the unit movement. Critical supplies may have to be pre-positioned or moved by alternate modes such as air, rail, or inland waterway if they are available. En route logistics support such as ROM, maintenance, and life support must be pre-positioned. Traffic control and MRTs must also be pre-positioned.

8-26. HETs may support the movement. Using HETs to move heavy forces increases the capability of the maneuver commander to quickly and efficiently relocate forces. They can assist in moving the maximum amount of combat power to the decisive point and time to attain or keep the initiative and have forces arrive in a high state of readiness. Using HETs will be governed by their availability, the conditions of the road network, and the distance to be traveled.

8-27. Highway Regulation planning must be extensive and thoroughly coordinated. Critical road junctions must be identified and managed. Less critical movements must be rerouted, delayed, or shifted to alternate modes. Engineering may be required to upgrade routes or to construct bypasses or bridges. Scheduling guidance must be provided to the moving units. This guidance allows the

units to conduct their internal planning for the movement. The main factor will be the availability of routes. Movement planners can use the following scheduling techniques:

- Creating reserved routes for particular units.
- Using location or column scheduling to allocate time blocks for movement if units share routes.
- Developing movement tables if routes are limited and the requirement for control is greatest (see Appendix G).

8-28. Detailed movement tables are necessary for smaller units to execute their portion of the plan. However, the moving unit can develop these plans based on the allocation of routes or time blocks. Movement control organizations will not normally develop detailed movement tables for large unit movements.

#### EXAMPLE HIGHWAY REGULATION PLAN

1. **PURPOSE.** The Highway Regulation Plan is used to inform all units within the theater of operations of the policies and procedures governing convoy or oversize/overweight vehicle movements.

2. **SCOPE**

a. Highway Regulation Plan should be developed for all OPLANs or exercises and be included within the Transportation Annex of the applicable OPLAN or exercise directive.

b. It is the responsibility of all organizations with a wartime Highway Regulation mission to develop Highway Regulation Plans. Responsible organizations include DTOs, MCBs, and TCEs.

c. Whenever two or more regulating agencies operate in the same theater of operation, coordination to standardize policies and procedures must be accomplished. Development of the Traffic Circulation Plan must also be coordinated to ensure mutual use MSR are given one name throughout the theater to avoid confusion. Movement priority codes and other policies and procedures must be standardized.

3. **RECOMMENDED FORMAT AND INFORMATION FOR THE HIGHWAY REGULATION PLAN**

ANNEX \_\_\_\_ HIGHWAY REGULATION PLAN TO OPERATION \_\_\_\_

Reference: Maps, Traffic Circulation Plan, and other relevant documents.

Time zone used throughout the order



Dates: Julian for COP system (movement request dates)

### 1. SITUATION

Include information affecting movement.

### 2. MISSION

Include provisions of effective highway regulation, reporting, support of operations, and coordination of movement and maneuver. Identify responsible organizations (who controls routes).

### 3. EXECUTION

- a. Concept of movements. Briefly state the Highway Regulation concept and coordination of movements and maneuver and battlefield circulation control.
- b. Tasks to subordinate units.
  - (1) Units perform route reconnaissance or get information from TCP pertaining to theater route network.
  - (2) Units responsible for abiding by all policies and procedures listed in the plan.
- c. Coordination of use of MSRs.
  - (1) Request procedures.
    - (a) Convoy Request Form or oversize/overweight request form. Put example(s) at appendix. Identify required data (mandatory). Hazardous cargo and oversize/overweight information must be put in remarks. Round trip, use request form with stopover time.
    - (b) Submit to. Identify locations units will submit convoy movement requests or oversize/overweight. Telephone procedures/telephone numbers, FAX, walk in locations, MCT, system modem numbers, and so on. Hours of operation.
    - (c) Submit when. How many days before movement peace/war, emergency procedures, and authorization.
    - (d) Convoy movement priorities. Use numbers 1: highest priority and so on. Coordinate with all clearance activities to use same number system.
    - (e) Minimum number of vehicles that constitute a convoy.

(f) Infiltration rules (less vehicles than a convoy). Ensure infiltrating vehicles yield to convoys at intersection and do not hinder convoy movement.

(g) Special movement consideration information must be entered in remarks on the request for movement form.

(2) Route utilization information. Discuss MSR listed in TCP. Explain controlled versus MSR (open).

(a) MSR listed on TCP is open route, any unit can use. No clearance required. First come, first serve. Minimum speed on MSR and any restrictions. Direction of travel.

(b) Controlled route. Listed in TCP (same as dispatch route). Convoy request must be submitted and a clearance issued prior to movement. Minimum speed for controlled routes and any restrictions. Direction of travel.

(c) Supervised route. Identify route(s) rules and procedures.

(d) Prohibited route. Identify which route in TCP or not on TCP is prohibited.

(e) Reserved route (identify who can use and duration).

(f) Lightlines.

(g) Hardening of vehicles.

#### 4. SERVICE SUPPORT

a. Provide logistical support request procedures. Rest, refueling, and so forth. The TCP (text version) identifies convoy halt locations, facilities, and services available to include units responsible for providing service.

b. Maintenance and recovery procedures. Vehicle breakdown procedures.

c. Medical evacuation procedures.

d. Halts.

#### 5. PROCEDURES. (Note: Should be same information as in system parameter table.)

a. Planning factors (convoy).

- Distance between vehicles.

- Time gap between march units/serials.
- Time gap between convoys.
- Oversize/overweight criteria. Procedures to submit request for clearance.
- Vehicles per march unit.
- March units per serial.
- Blackout procedures/light lines.
- Hardening of vehicles.
- Convoy/hazardous cargo marking/flags.
- Delay in meeting SP time procedures.

b. Planning factors (route information). Refer to TCP for location and type routes, halt locations and services, traffic control point locations, critical point locations, and restrictions.

6. ENFORCEMENT. Include command actions that will be taken in the event units do not follow policies and procedures. Stress the requirement that units must have approved march table/movement order prior to using controlled routes. Identify who will monitor and control movements.

#### 7. COMMAND AND SIGNAL.

a. Command. Identify communications reporting locations and procedures with Highway Regulation and police officials.

b. Signal. Describe reporting requirements, method of communication, and radio frequencies.

#### APPENDIXES:

Traffic Circulation Plan (text copy attached and system disk distributed to system users)  
Convoy Request Form and Oversize/Overweight (same form)

## Chapter 9

# Transportation Request Procedures

### SUPPLY SYSTEM INTERFACE

9-1. Movement control in a theater of operations is closely linked to the supply system. The supply system generates much of the requirement for transportation needed to support combat forces. Movement planners at all echelons must understand that supply priorities and competing demands for logistics resources affect the movement of supplies. Understanding the relationship of the supply system to the transportation system is essential to effectively plan and execute movement control. This section explains how supply priorities are translated to transportation priorities for movement of material.

9-2. Transportation priorities are derived from the priority designator (PD) found on all material requisitions. The PD is based upon a combination of factors that relate to the mission of the unit requesting material and the urgency of need for the material. The requesting unit puts a PD on all requests it submits to a supply support activity. The PD is determined according to the Uniform Materiel Movement and Issue Priority System (UMMIPS). For a thorough discussion of how the supply community determines its PDs, see AR 735-50.

9-3. Before selecting the mode of transportation, the transportation officer converts the supply PD on the supply document to a transportation priority as follows. The following chart shows the conversion of the supply PD to the transportation priority (TP).

<u>PD</u>	<u>TP</u>
01-03	1
04-08	2
09 to 15	3

9-4. Mode selection is governed by the resulting TP, the standard delivery date (SDD), or the required delivery date (RDD), the weight and cube of the shipment, the nature of the materiel, the cost of the transportation, the distance to be shipped, and the modes of transportation available. The following chart gives the preferred mode for each TP.

<u>TP</u>	<u>PREFERRED MODE</u>
1	air
2	air
3	ordinary surface

9-5. There are times when the transportation officer selects a mode other than the preferred mode. For example, TP 1 and 2 shipments that normally move by air might move by surface under the following circumstances:

- The items to be shipped are too heavy or too bulky to fit in an aircraft.
- Surface transportation is the only mode available.
- Surface transportation is more advantageous or more expeditious due to the short distance.

9-6. On the other hand, there are times when the transportation officer selects other than surface mode for TP 3 shipments. They might move by air under the following circumstances:

- Air transportation is the only mode available.
- The overall cost of shipping via surface is greater than shipping via air.
- The materiel being shipped is of high value or a security risk and it would be in the best interests of the Government to ship it by air.
- The nature of the cargo demands movement by air for other reasons (e.g., cargo may be time sensitive, as are some highly specialized batteries).

9-7. The SDD is the calendar date that materiel must be delivered to the requisitioner. It is based on UMMIPS criteria and includes the normal processing and shipping time the supply and transportation personnel use to process and move supplies. When the SDD does not meet the requisitioner's requirements, the requisitioner may specify an RDD, which is the date the materiel is needed. The RDD is entered on the requisition as an adjustment from the SDD. The RDD does not change the priority of the shipment. An RDD signals the system to expedite the shipment. Requisitioners may enter "999" in the RDD block of TP1 shipments (PD 01,02, and 03 requisitions). The presence of the 999 indicates that the requisition is to be filled and shipped ahead of all other TP 1 shipments.

9-8. Once materiel has been released by a supply activity for shipment, the transportation officer selects a mode of transportation to ship the materiel. This puts the materiel in the transportation system.

## TRANSPORTATION REQUEST PROCEDURES

9-9. Movement managers, through mode selection and transportation request procedures, are key to the support of transportation requirements. They are primarily responsible for prioritizing requirements and selecting the mode most appropriate to satisfy the requirement. (See 9-1.)

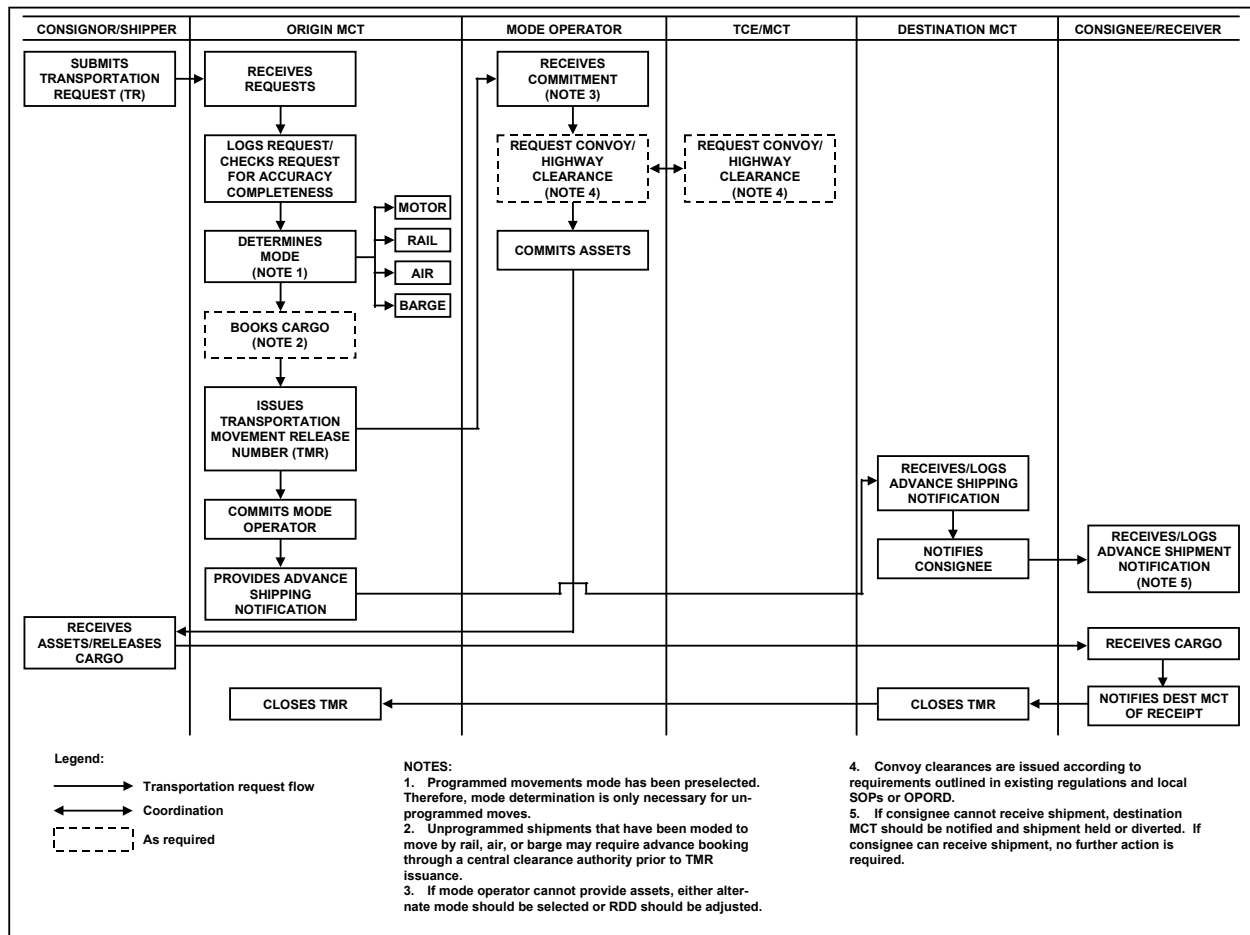

Figure 9-1. Transportation Request Procedures

## Movement Control Team (MCT) Responsibilities

9-10. The MCTs are the immediate interface with the organization that is requesting transportation support. The MCT's responsibilities are as follows:

- Origin MCT review
- Mode considerations
- Mode selection
- Issue transportation movement release (TMR)
- Request positive in-bound clearance (PIC)

- Commit mode operators
- Close TMR

9-11. **Origin MCT review.** On receipt of a transportation request, the origin MCT ensures that the request is complete and accurate. Based on the review, some coordination may be effected by the MCT.

9-12. **Mode considerations.** The MCT deliberately plans to task all available transportation modes to fulfill known requirements. Assets should not be reserved to meet unforeseen requirements. The MCT should meet requirements as they occur by committing transportation mode operators according to command priorities, selecting the most efficient and effective mode, and planning to meet the RDD.

9-13. **Mode selection.** The origin MCT must consider many other factors in selecting a mode. These factors include the following (see 9-2):

- Need considerations. Provide service according to need-based on command priorities.
- Security considerations. Consider security requirements for shipments involving nuclear materials, hazardous or classified cargo, ammunition, or other sensitive cargo.
- Sensitive/Classified Materiel. This may require cargo to be guarded and conduct the movement at night, by air, or by any other means to safeguard sensitive/classified cargo.
- Political considerations. Coordinate with the G5 to determine if there is any political sensitivity to materiel being shipped. This may require movement at night, by air, or by any other means ship cargo.
- Tactical considerations. Coordinate with the requesting and destination units to determine potential changes in pickup or delivery locations.
- Highway considerations. Rerouting may be required if there are changes to route classifications or the distribution pattern.
- Rail considerations. Suitable for bulk, high tonnage and speed for locations along the rail line or where transloading can be accomplished with material handling equipment (MHE), personnel, and trucks. Limited to locations serviced by rail.
- Air considerations. Use of aircraft as a logistics delivery mode is constrained to the air assets allocated for combat service support (CSS) air movement operations. (See Section III Request for Intratheater Airlift in this chapter).
- Water considerations. Suitable for bulk and high tonnage for locations along the waterway. Use is limited by the availability of barges or boats, cargo transfer units and equipment, and channels capable of accommodating the types of craft available.
- Host nation (HN) assets. Use is limited to those modes and assets provided by the host country. Host nation support (HNS) is coordinated by the G5 or units having a HNS coordinating mission.

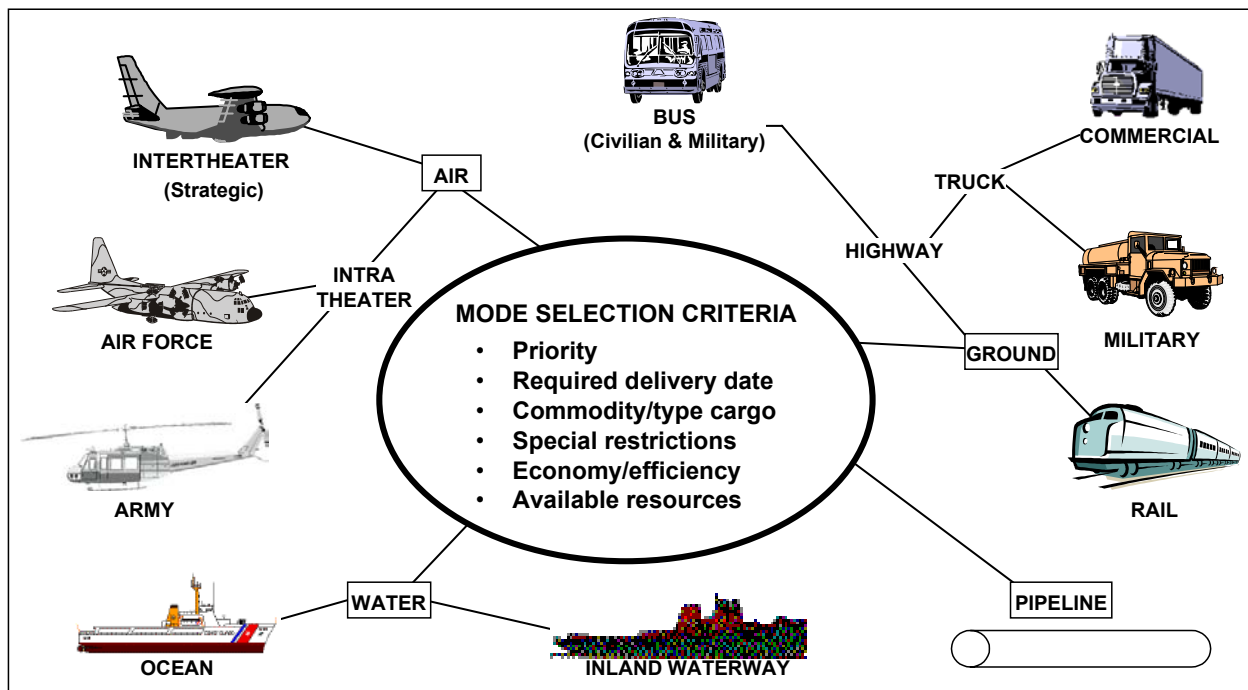

Figure 9-2. Modes of Transportation

9-14. **Issue TMR.** The MCT issues the TMR, which is a document that specifies and authorizes movement and directs the use of a transportation asset through movement control channels. See Appendix E for further discussion of TMRs.

9-15. **Request PIC.** The origin MCT requests positive inbound clearance (PIC) for sensitive, classified, oversize, overweight, or other theater-directed shipments through the destination MCT before issuing a TMR. Unit capabilities to have MHE, storage, and personnel available may also affect PICs. Requests are forwarded to the destination MCT that, in turn, contacts the consignee. The destination MCT confirms the consignee's location and ability to off-load the cargo back to the origin MCT. If the consignee is unable to receive a shipment, the origin MCT reschedules the shipment by coordinating for alternate delivery dates. The origin MCT schedules routine shipments without an inbound clearance unless the receiving activity, through the destination MCT, notifies the origin MCT that it cannot receive the shipment and requests the origin MCT to hold the shipment.

9-16. **Commit mode operator.** For all movements, the origin MCT selects the mode and commits a mode operator. If the request is in response to OPORD execution or other preplanned moves, the MCT checks the movement program for predetermined mode selection and commits the mode operator. The MCT commits a mode operator identified either in the movement program or one in the origin MCT's geographic area. Commitments flow through predetermined channels developed between the movement control headquarters (TCE or corps movement control battalion (MCB)) and the mode operating headquarters. The mode operator submits a movement request for convoy or highway clearance to its supporting MCT. If the mode operator cannot support the TMR for any reason, it must notify the MCT immediately. The MCT either attempts to establish an alternate delivery date that satisfies the consignee, select another operator, another mode, request HN assets, request commercial assets, delay lower priority shipments, or request assistance from its HQ.



9-17. **Close the TMR.** The consignee notifies the destination servicing MCT when it receives the shipment so the MCT can close out the TMR. Supply activities or consignees may not have reliable communications with their servicing MCT. If this is the case, the mode operator reports shipment delivery through the Movement Tracking System (MTS) or automatic identification technology (AIT) or other means.

## DIVISION TRANSPORTATION REQUEST PROCESS

9-18. Division units request transportation support from the division support command (DISCOM) movement control officer (MCO). Depending upon the type of division, location of units on the battlefield, and defined support relationships, the request may flow from the brigade, separate battalion or company through a forward support battalion (FSB) or main support battalion (MSB) to the MCO.

- The MCO coordinates with the division materiel management center (DMMC) and other division units to plan and program transportation requirements. This includes movement of supplies and equipment between the division support area (DSA) and the brigade support area (BSA). The DMMC has visibility over the location and status of supply quantities in the division and directs repositioning. The MCO also coordinates with the G1 to forecast transportation requirements to move replacement personnel. (For more information, see paragraph 6-11, Chapter 6.)
- The FSB coordinates in advance with the MCO to use loaded trucks moving forward to the BSAs for retrograde of damaged and captured equipment, salvage, or enemy prisoners of war on the return leg.
- As the supply and maintenance companies in the DSA receive MROs from the DMMC, they request transportation support from their battalion support operations officer. The support operations officer consolidates the requests and submits requirements to the MCO. The MCO selects and commits the mode based on division priorities, but if the division is unable to provide the required transportation support using its organic assets, the MCO forwards a request for transportation support to the supporting MCT ( 9-3). The MCO normally coordinates requests of an exceptional nature through the division transportation officer (DTO). The DTO coordinates support from the corps MCB.
- The MCO coordinates to ensure that MHE is available to off-load the supplies upon delivery. This prior coordination reduces transportation delays and increases the availability of these trucks for other missions.

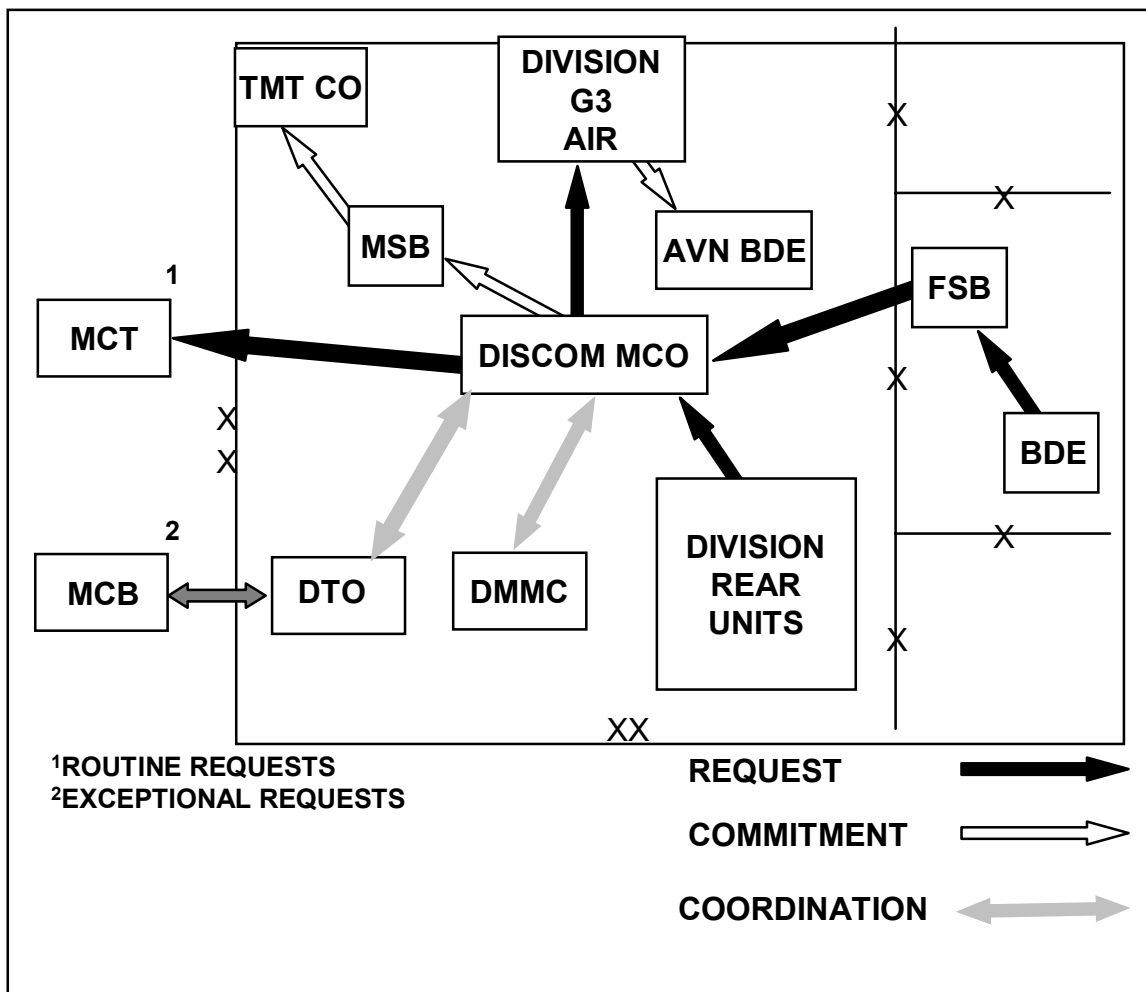

Figure 9-3. Division Transportation Request Process

### CORPS TRANSPORTATION REQUEST PROCESS

9-19. The corps resupplies its assigned divisions and separate units. The corps may establish supply point or unit distribution depending upon the situation. The corps predetermines these arrangements as part of the logistics planning process. Resupply requirements are based on supply requests from the DMMC to the corps materiel management center (CMMC) or by predetermined daily resupply. The CMMC issues MROs to corps support units. The corps support unit requests transportation from its servicing MCT to move the supplies forward. Corps transportation assets are also used to support units in the corps rear area. Units in the corps area request transportation support from their servicing MCT. (See 9-4.)

- The MCT commit the mode operator in its area of operation to provide transportation. This may be a corps support battalion or functional transportation battalion depending on the transportation alignment within the corps support groups (CSGs). For shipments

requiring PIC, the origin MCT coordinates the details of delivery and any retrograde movements with the destination MCT or MCO.

- If an MCT needs additional transportation support to satisfy requirements, it forwards the request to the supporting echelons above corps (EAC) MCT.
- The corps MCB coordinates directly with the transportation command element (TCE) for requirements of an exceptional nature such as the movement of large forces, contingency operations, and intratheater airlift.

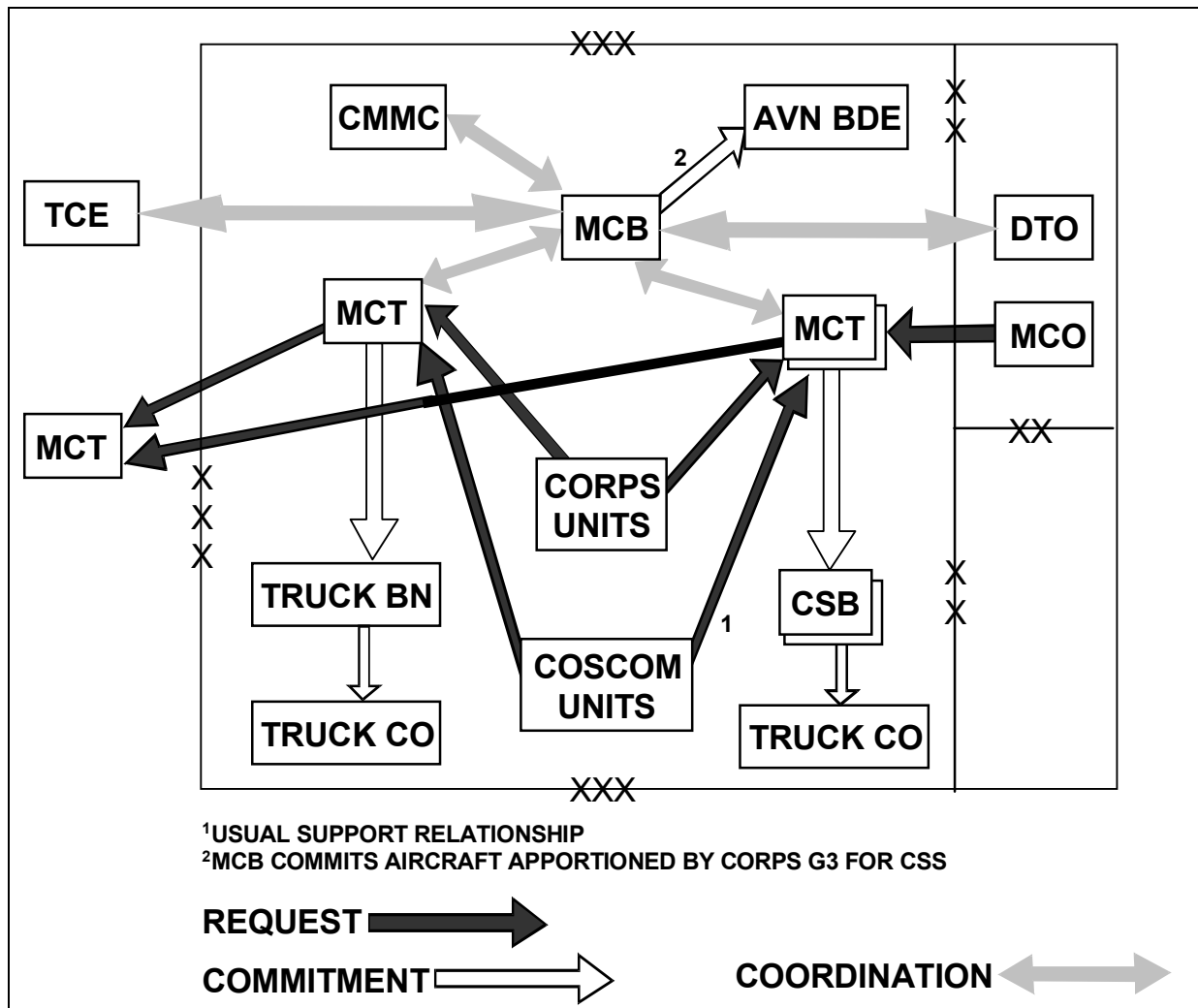

Figure 9-4. Transportation Request Process (Corps)

### ECHELONS ABOVE CORPUS (EAC) TRANSPORTATION REQUEST PROCESS

9-20. The same relationship between the corps and division exists between the theater support command (TSC) and corps. (See 9-5.)

- If mode operators in the corps MCT's area of responsibility (AOR) cannot satisfy all transportation requests, the MCT requests assistance from its EAC area MCT. If unable to obtain required support at EAC, it passes the request to the corps MCB. The corps MCB passes the requirement to the TCE for resolution.
- The TCE reviews established priorities. It looks at the possibility of cross-leveling mode assets to meet the requirement. It also looks at using HN or other service transportation assets. If the TCE cannot find sufficient assets, it goes back to the requestor and see if the RDD can be changed.
- Theater units pass their requests directly to their supporting EAC MCT, which tasks mode assets or arranges for HN or commercial transportation support.

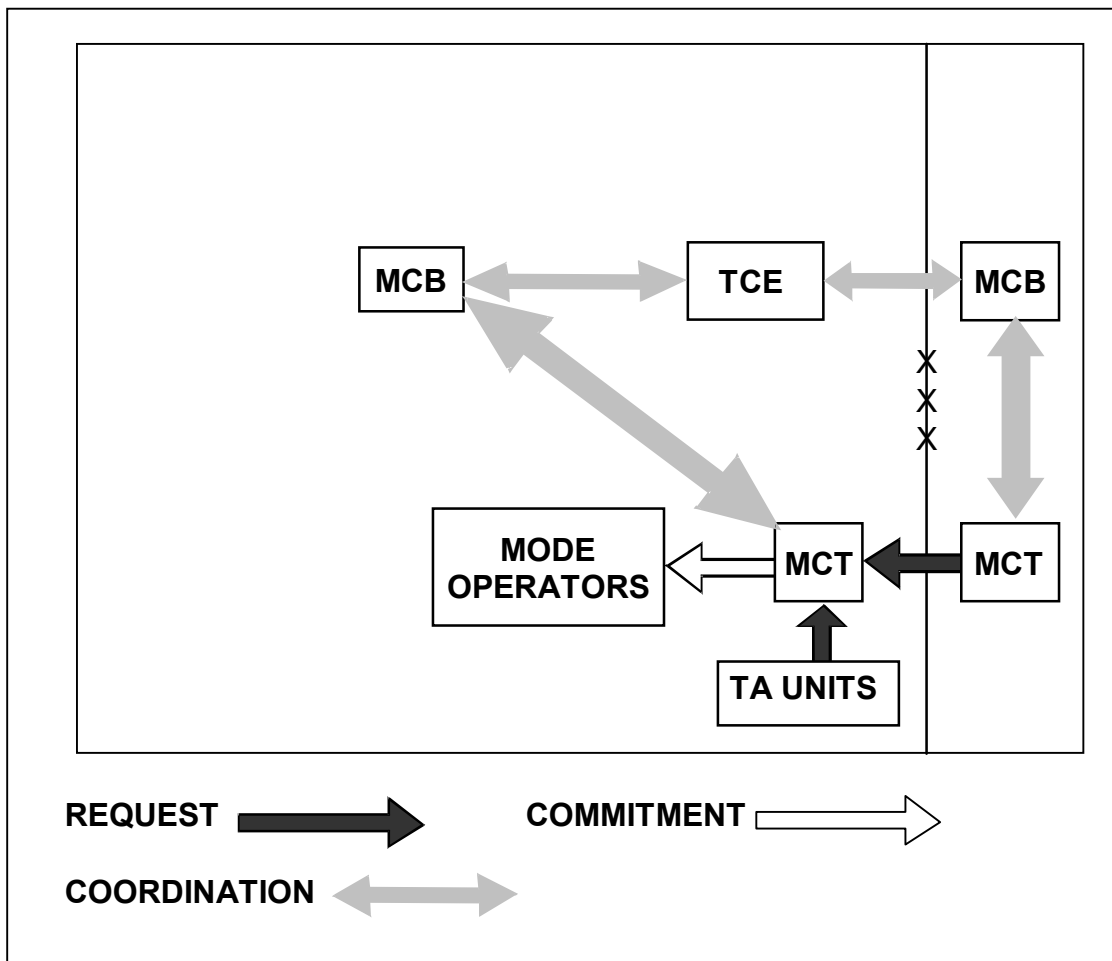

Figure 9-5. Transportation Request Process (EAC)

## CLEARANCE REQUESTS

9-21. Units needing to move on controlled routes that require a movement credit must request and receive clearance before beginning movement. (A movement credit is the allocation granted to one or more vehicles in order to move over a controlled route in a fixed time according to movement instructions. For purposes of clarity and consistency in this discussion, the term clearance will continue to be used, since it is the subject being discussed.) The request is submitted through the chain of command to the DTO at division, or MCT at corps or EAC, within whose area the movement originates. In the EAC or the corps, the MCT forwards the request to its MCB. Based on procedures established in standard operating procedures (SOP), the request may be transmitted in hard copy, electronically, or verbally.

9-22. The DTO, corps MCB, or EAC MCB reviews requests and considers them based on command priorities for the type of movement and the unit requiring movement. Priorities for types of movements are normally specified in operation plans (OPLAN), SOPs, or operation orders (OPORD). They include categories such as unit movement, movement of reserves, logistical movement, and movement of replacements. Unit or task force priorities are specified in OPLANs and OPORDs. Unit priorities are based on the commander's requirements to meet the tactical situation. Because these priorities frequently change, movement planners must frequently obtain planning guidance from the G3 and G4.

9-23. The DTO or MCT either schedules the movement as requested or notifies the unit if it cannot be granted. The DTO or MCT coordinates with the denied requestor to reschedule the move at a different time or on a different route.

9-24. Movement clearances (called movement credits) are returned to the requesting unit through the same channels used for the request. Information on all movement clearances issued is provided to the provost marshal, military police (MP) units, and movement regulating teams (MRT) for traffic control and movement regulating purposes.

9-25. The movement clearance gives the requesting unit the authority to move on a controlled route, and is usually expressed as a control number. Methods for constructing the control numbers are governed by command directives. They normally include a command identifier, Julian date, and sequence number. For example, a unit of the 54th Infantry Division will move on Julian date 043. The clearance was the third issued for that date. The control number would be 54-043-003. Additional control numbers may be added after the sequence number to further identify the unit or type of movement.

### NOTE

Army units operate OCONUS in many environments — hostile, friendly, a mix of both. They sometimes share transportation resources and facilities with other services and sometimes with other nations, frequently with host nations. In situations where host nation or other governing regulation, law, or treaty is in force, they must be considered in developing the plans for operating on the roads, rails, and air ways of the environment.

## COORDINATING AND MONITORING MOVEMENTS

9-26. Without positive control measures and monitoring, controlled routes may become congested and movements delayed. When coordinating movements, planners must be able to visualize the location of convoys at any time and know when they should arrive and clear CPs. To avoid congestion and movement delay, movement control organizations must coordinate the planned movement of convoys on controlled main supply routes (MSR) to issue movement clearances and any changes thereto. They must also monitor the in-transit status of convoys on controlled routes to find out if movements are proceeding according to plan. Movement control elements at all levels, battalion and above, will have the MTS Control Station. The MTS gives movement control elements the ability to let the commander know where a specific convoy is, the MSR status, and when it will arrive at its destination.

9-27. The monitoring function can be performed by either MRTs or MPs. MTS will be used by the Military Police at Division and above to track traffic/circulation control teams and to provide Command and Control (C2) information. The teams will use MTS to pass road condition and enemy action information along the major supply route (MSR) to Movement Regulating Teams (MRT). The traffic control teams will coordinate closely with the movement control elements to update and pass information on MSR interdiction, traffic congestion, or any other situation influencing movement in the area. They will pass information to their MTS Control Station or directly to affected transportation. Upon receiving reports of problems on a controlled route, movement control organizations can adjust traffic plans. They can issue instructions to hold unit movements that have not begun, issue new routing instructions, or hold unit movements at a staging area or CP if the movement has begun.

## REQUEST FOR THEATER AIRLIFT

9-28. Airlift is a flexible and essential element of the transportation system. Wide-ranging logistics needs within a theater require Army and Air Force airlift support. While motor transport normally is the primary mode to support Army forces, airlift becomes an increasingly important mode as the intensity, depth, and duration of operations increase. Airlift can provide rapid movement of cargo, passengers, and equipment without regard to terrain restrictions. It also makes possible resupply of critical items over extended distances. However, there are limitations to the use of airlift to support logistics. Among these are adverse weather conditions, enemy air interdiction, high weight or large cube of cargo, and the need for specialized logistics crews and equipment for air operations. The following paragraphs discuss the process for obtaining Army and Air Force airlift to support logistics requirements.

## ARMY AIRLIFT

9-29. The primary Army aviation unit is the aviation brigade. The Army aviation brigade is a versatile organization found at division, corps, and EAC. It may contain observation, attack, utility, and cargo helicopters and a limited number of fixed-wing command and control (C2) aircraft.

- **Division.** An aviation brigade is organic to each division. Each division aviation brigade is designed to meet the tactical requirements of the type of division to which it is assigned. The brigade can provide aircraft for logistics air movement operations to move troops, supplies, and equipment. The primary asset used by the brigade is the utility helicopter, either the UH-60 or UH-1.
- **Corps.** An aviation brigade is organic to each corps. Each corps aviation brigade is tailored to meet the specific mission requirements of that particular corps. The corps aviation brigade mission is to plan, coordinate, and execute aviation and combined arms operations in support of the corps scheme of maneuver. In its logistics support role, corps aviation provides movement of critical forces, supplies, and equipment needed to support the battle. The corps commander should routinely allocate sorties for sufficient logistics air movement missions. The brigade uses a combination of UH-60, UH-1, and CH-47 helicopters.
- **EAC.** EAC aviation brigades are tailored and configured to meet the needs of the theater. They may be organized with attack, utility, and cargo aviation assets. The utility and medium helicopters of the EAC aviation brigades provide reinforcing support to the corps for logistics air movement needs.
- **Air Liaison Officers.** An air liaison officer (ALO) is designated by the aviation brigade at each echelon to serve with supported units as a link between movement control elements, their aviation support, and airlift users. The ALO coordinates the commitment of air sorties for support based on tasking of movement control elements. The ALO assists passing advance information to the aviation mode units and by providing technical advice to movement planners.

9-30. Army logistics air movement request procedures. Requirements for logistics air movement operations are characterized as either **preplanned** (as a result of the movement program) or **immediate**.

- Preplanned requests.** Requirements for preplanned airlift are established in advance as part of movement program development. (See Chapter 7.) Movement program planners determined in advance that air is the most effective mode based on the urgency of the requirement and characteristics of the personnel, supplies, and equipment to be moved (figure 9-6). Division, corps, and EAC requests for preplanned (movement program) air support of logistics are processed as follows —

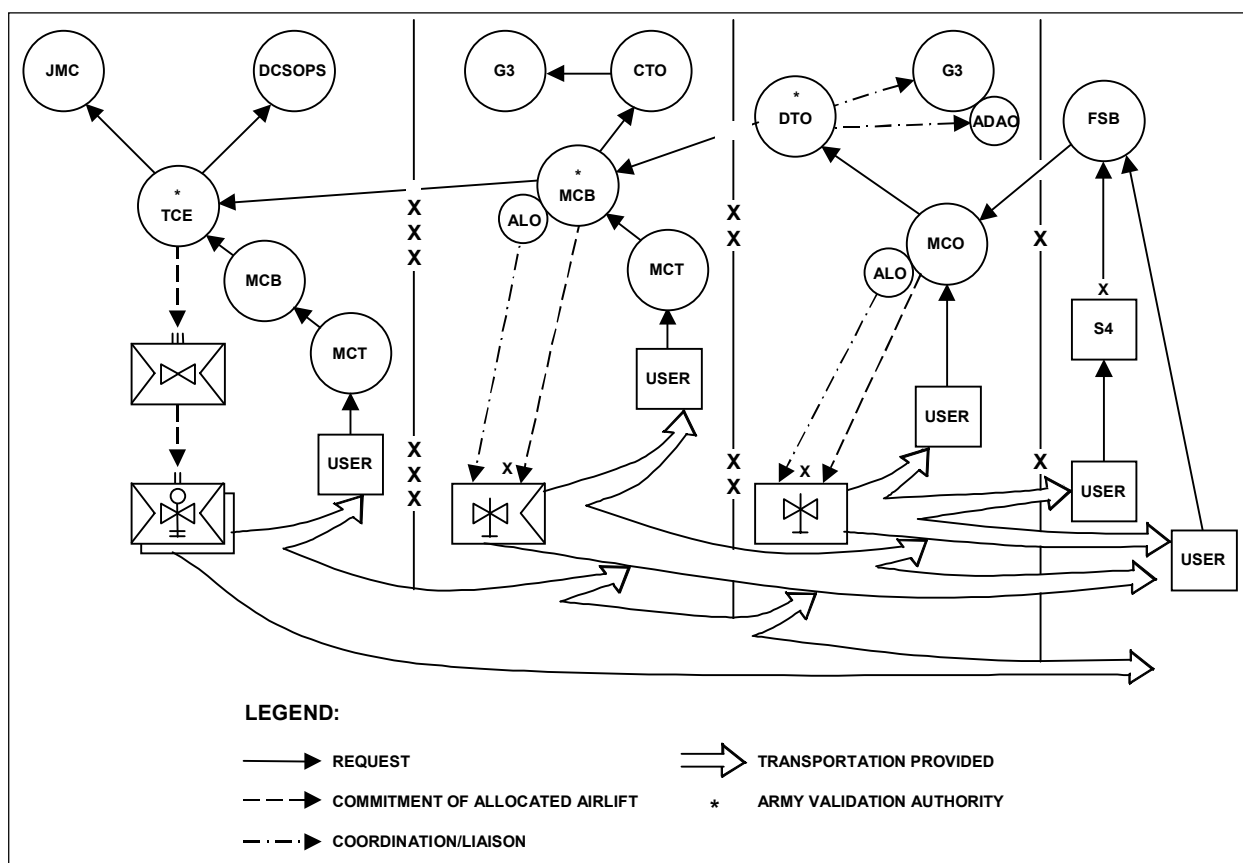

Figure 9-6. Preplanned Requests (Army Air)

⇒ *Division.* Preplanned requests are forwarded to the MCO as part of the planning process to obtain airlift. The MCO reviews the requests and either validates them or recommends an alternate mode. If the MCO validates the requests, the requests are forwarded to the DTO. The DTO coordinates the requirements with the G3 (Air), a member of the G3 battle staff, to get aircraft allocated by the G3. Once the G3 allocates assets for logistics air movement operations, the MCO programs the requirement and tasks the aviation brigade through coordination with the aviation liaison officer (ALO) in the rear command post. The MCO also tasks truck assets to be used in moving cargo to the airfield, sling point, or landing area. NOTE: If division



aircraft are not available for the preplanned logistics air movement operations, the DTO either works through the G3 and G4 to manage priorities; or validates and passes the requests to the corps MCB for corps aviation or US Air Force (USAF) support.

- ⇒ *Corps.* The corps MCB receives preplanned (movement program) requests through the MCTs from corps units or validated division airlift requests during the planning process. For corps units, the MCT reviews requests and either passes requests to the corps MCB, or recommends another mode. The corps MCB coordinates requirements with the corps transportation officer (CTO) to obtain G3 allocation. **If the G3** has allocated airlift assets to the corps MCB for preplanned logistics air movement operations, the corps MCB validates requests, programs, and commits the allocated airlift assets through the ALO to support the missions. The corps MCB informs the origin MCT of the validation and committal of air assets. The MCT concurrently tasks highway assets to move the personnel or cargo to the on-load site or airfield. The MCT also clears the inbound movement with the destination MCT, DTO, or MCO. For validated division preplanned requests, the corps MCB either commits allocated corps aviation assets or validates the requests and passes them to the TCE.
- ⇒ *EAC.* The TCE receives transportation requests from units in the theater, and validated corps (and division) airlift requests. The request process for EAC units is basically the same as for corps units. MCTs forward airlift requests through their MCB to the TCE. If airlift assets have been allocated for preplanned logistics operations, the TCE is the tasking authority. If the TCE tasks an MCB to commit Army airlift allocated for logistics air movement operations, then the MCB also becomes the validating authority for requirements it must pass to the TCE. If the EAC aviation brigade cannot support the preplanned (movement program) mission, the TCE forwards the requests to the joint movement center (JMC). The JMC either tasks other service or HN aviation units or returns the request to the TCE for mode change.
- **Immediate requests.** Immediate airlift missions result from unanticipated, urgent, or priority movement requirements. Immediate requests are all requests that are not preplanned. Movement controllers must quickly determine if air is the most effective mode based on the urgency of the requirement and characteristics of the personnel, supplies, and equipment to be moved. Immediate air support request procedures must be responsive and flexible to respond to rapidly changing situations (figure 9-7). Division, corps, and EAC requests for immediate air support of logistics are processed as follows —
  - ⇒ *Division.* Immediate requests are forwarded by unit S4s, the DISCOM, or through operational channels to division G3. Concurrently, the information must also pass through movement and support operations channels to coordinate logistical aspects of the movement. The G3 allocates aviation assets for logistics purposes and, when aviation assets are not available, validates requests passed to corps. The DTO and G3 (Air) coordinate to obtain G3 validation. Once allocated, the assets are available for tasking by the MCO via coordination with the ALO. The MCO and ALO coordinate needs and missions requiring aviation capability, and when needs exceed allocated capability, prepare requests for additional aviation support and send them to the DTO and G3 (Air).

- ⇒ *Corps*. If airlift assets have not previously been allocated for logistics missions, the corps MCB, or requesting unit, passes requests to the G3. The G3 is the tasking authority for immediate requests. If the corps cannot support immediate logistics support missions at that time, the G3 may validate and pass the airlift requests to the theater. If the G3 does not validate the requests, they are returned to the MCB, which must select alternate modes.
- ⇒ *EAC*. If airlift assets have not been previously allocated for logistics missions, the TCE or requesting unit passes requests to the Army Service Component Command (ASCC) Deputy Chief of Staff for Operations (DCSOPS). The DCSOPS is the tasking authority for immediate requests. If the ASCC cannot support immediate logistics missions at that time, the DCSOPS may validate and pass the airlift requests to the J3. If the DCSOPS does not validate the requests, they are returned to the TCE, which must select alternate modes.

9-31. **Army logistics airlift request validation.** Requests are reviewed and validated at each level. Requests are considered valid if forwarded to the next echelon for subsequent validation or to the mode operator for execution. The review considers the following:

- Priority and urgency of the movement requirement.
- Commander's priorities.
- Competing requirements and aircraft availability.
- Adequacy of other modes.
- METT-TC factors.
- Availability of MHE at the destination if required.
- Location and adequacy of origin and destination landing zones.

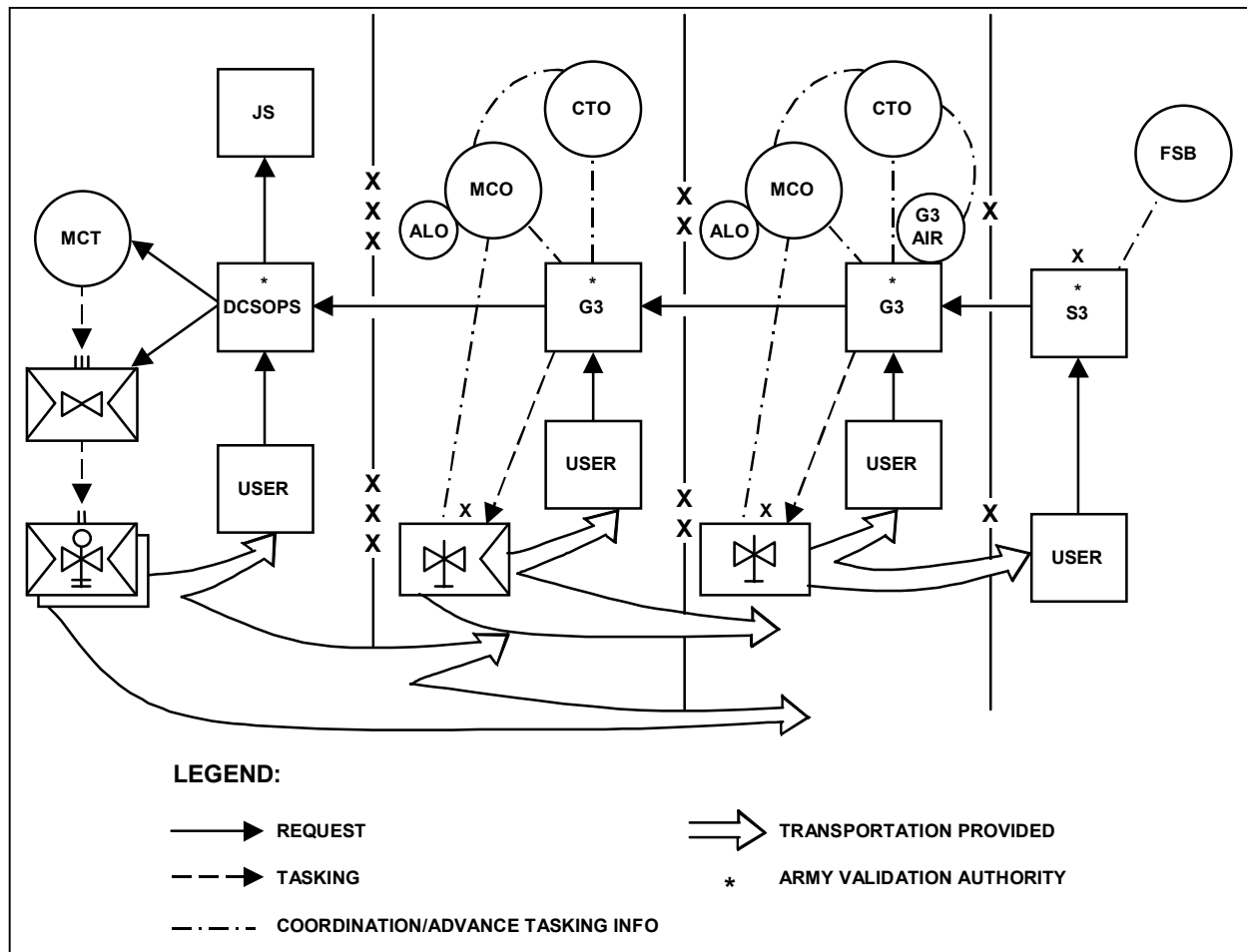

Figure 9-7. Immediate Airlift Requests (Army Air)

## AIR FORCE AIRLIFT

9-32. Air Force airlift and airdrop is generally designated as common-user airlift to support the air movement requirements of all Service components assigned to the theater of operations. Air Force airlift and airdrop is used to provide the Army needed transportation support. However, Air Force airlift and airdrop generally require much longer lead times to plan and coordinate than Army logistics air movement operations because load plans and an arrival/departure airfield control groups (ADACG) are required.

9-33. The ASCC must validate and prioritize all Army airlift and airdrop requests. The TCE is normally designated to be the Army validator for the ASCC. The TCE passes validated Army airlift and airdrop requests to the theater combatant commander’s agent (normally the JMC) to prioritize and validate all Service component requests for common-user airlift within the theater. The agent aligns requests with theater priorities. Once validated, the request becomes an airlift/airdrop requirement.

9-34. The agent then tasks the Air Force component commander who passes the tasking to the Air Force C2 agency to support the requirement. The C2 agency then tasks an Air Force unit to execute the mission for the Army.

9-35. Airlift requests are executed according to the theater combatant commander's priorities and are not normally changed below the component command level. The theater combatant commander may establish a joint transportation board (JTB) to resolve conflicts between the Service components regarding airlift.

9-36. As with Army aviation requests, Air Force airlift requests are either preplanned or immediate, but, within the immediate category, requests can be noted as emergency requests. Therefore, Air Force airlift requests can either be preplanned, immediate, or emergency. Air Force airlift requirements can begin at any level, either as a request for Air Force airlift or airdrop, or as a request for transportation that movement managers determine can best be satisfied using airlift or airdrop. See figure 9-8 for Air Force airlift and air drop organization.

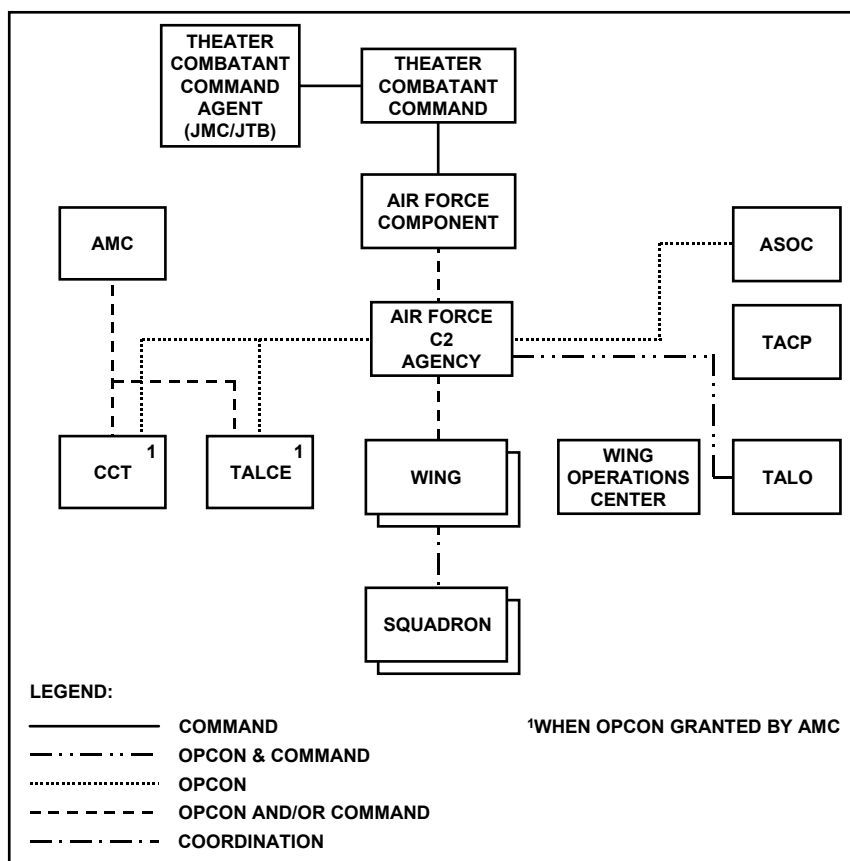

Figure 9-8. Air Force Airlift Organization

- **Preplanned requests.** Preplanned airlift missions are based on known or projected requirements and are programmed in advance per command directives. They include requirements to provide airlift of personnel, cargo, mail, and courier materiel on a regular, routine basis or to meet programmed one-time requirements. The amount of time required

to coordinate preplanned airlift is established by the Air Force component based on operational requirements and the capability of the available airlift apportioned by the theater combatant commander. Preplanned airlift requests are validated through movement control channels (see 9-9).

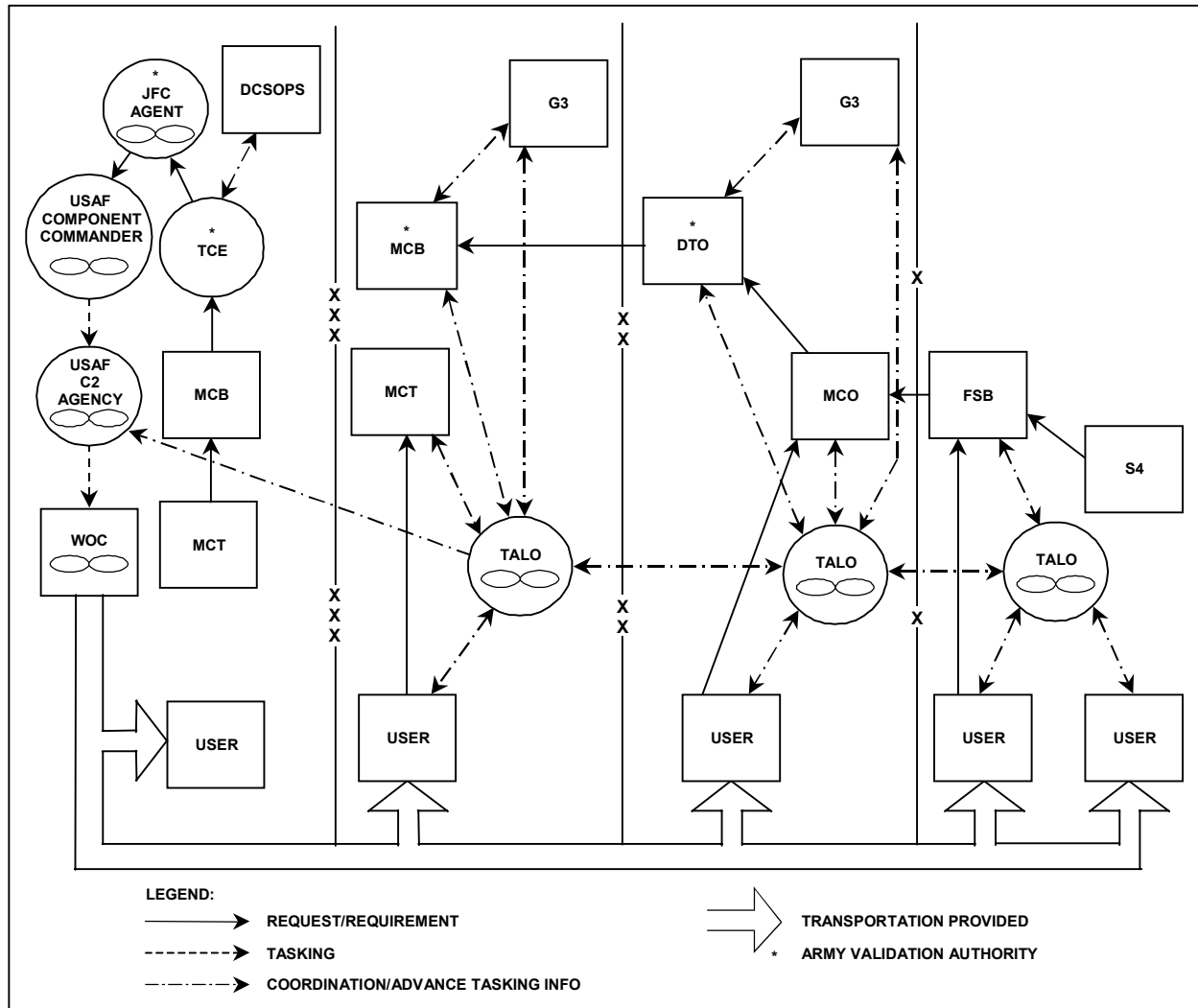

Figure 9-9. Preplanned Airlift Requests (Air Force)

⇒ *Division.* The MCO receives transportation requests that are reviewed to determine the most effective mode. If the MCO decides that Air Force airlift or airdrop is the most effective mode, the MCO coordinates with the requestor and forwards requests to the DTO as Air Force airlift requests. The DTO coordinates details of each request with the theater airlift liaison officer (TALO), validates each request, and forwards them to the corps MCB. The TALO acts as a coordinator and assists with the preparation of the request. The TALO also provides early notification and coordination through Air Force channels.

- ⇒ *Corps*. The corps MCB receives transportation or airlift requests from corps units or validated airlift requests from DTOs and either validates each request or selects an alternate mode. If the corps MCB validates a request, it forwards the request to the TCE. If the corps MCB does not validate a request, it selects another mode. The CTO integrates airlift requirements for logistics and other intratheater movement to support priorities established by the G3.
- ⇒ *EAC*. The TCE receives transportation or airlift requests from units located in the theater or validated requests from corps MCB. The TCE either validates each request or selects an alternate mode. If the TCE validates a request, it forwards the request to the agent for the theater commander. The agent validates the request for the commander and passes the request as a requirement to the USAF C2 agency. TALOs are located at each echelon to provide early warning to USAF C2 agencies that an Army request for Air Force support is being processed. If the request is not validated at any level, it is returned to the originator for alternate mode selection.
- **Immediate requests.** Unanticipated or urgent ground force requirements and priority transportation requests are validated and passed as immediate airlift requests. Immediate request validation is expedited through command channels. The TALO, attached to the lowest echelon closest to the requesting command, notifies the USAF C2 agency of the impending request through an *advance notification net*. Coordination between the S3/G3 and S4/G4 ensures that movement control channels are kept current on airlift request status. The USAF C2 agency executes validated immediate airlift requirements by directing an alert sortie to launch or, if the urgency of the situation warrants, by diverting a mission in progress. Immediate airlift requests are supported only with validation by the Army and the theater combatant command agent (figure 9-10).
  - **Emergency requests.** Emergency requests are special types of immediate requests for requirements that are critical to accomplish the tactical mission or for unit survival. The same validation procedure is required for emergency requests. These missions are the highest priority established by the combatant commander.

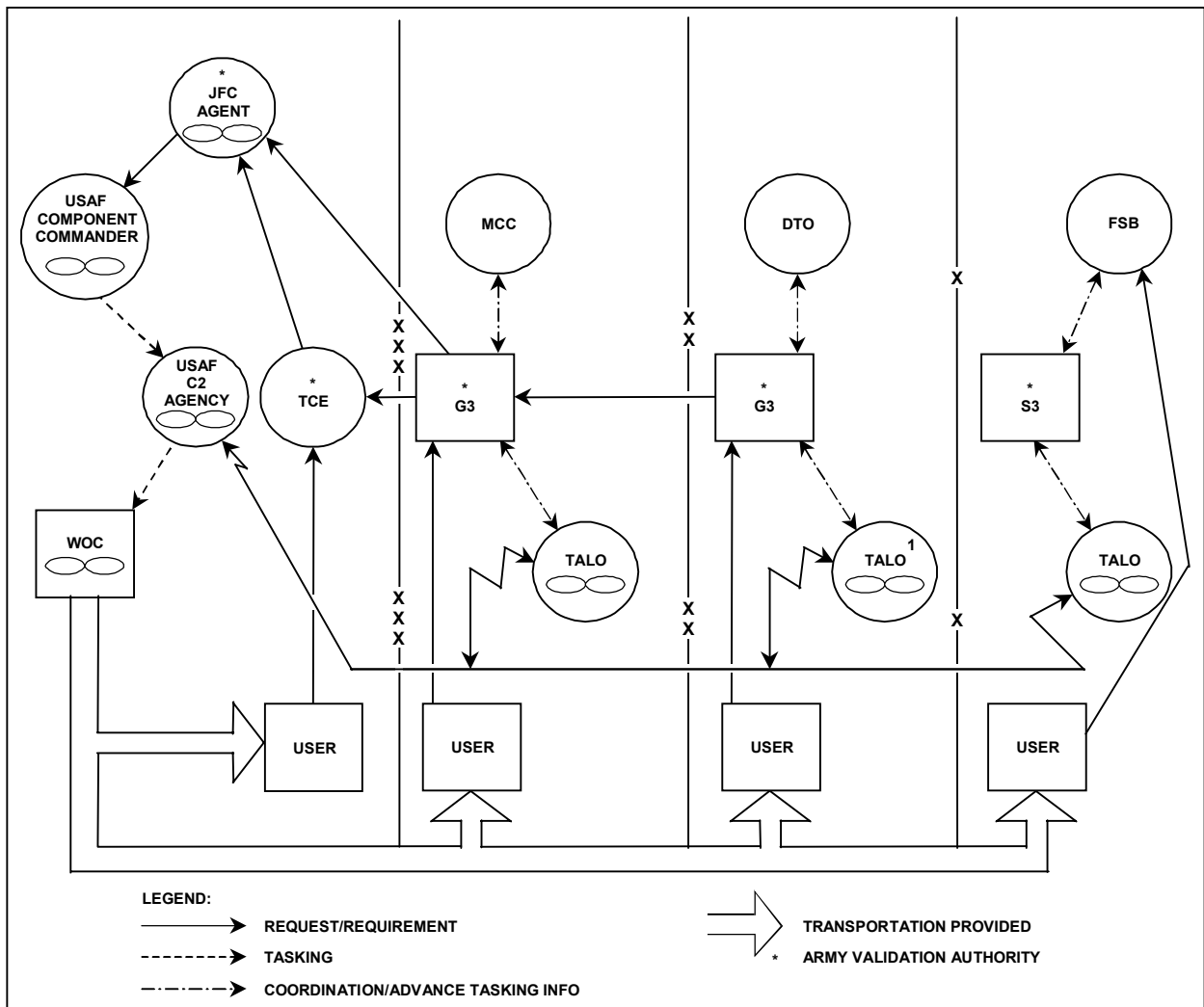

Figure 9-10. Immediate Airlift Request (Air Force)

## Chapter 10

# Container Operations and Management

### CONTAINER MANAGEMENT

10-1. This chapter describes container operations and management in an overseas theater. Containers are a permanent type of transport equipment designed for transport by various modes of transportation. They facilitate and optimize cargo carrying by one or more modes without intermediate handling of their contents. Containers can be moved by all modes of transport, and are therefore involved in intermodal movement of equipment and materiel by air, land, and sea. Containers are equipped with features permitting their ready handling and transfer from one mode to another.

**NOTE:** For information on specific containers and container handlers see **APPENDIX J**, Types Of Intermodal Assets and Intermodal Asset Handlers.

### Container Management Objectives

10-2. The objectives of container management are:

- Expedite the movement of throughput and high-priority container shipments.
- Minimize the time for holding or consolidating cargo.
- Maintain 100 percent in-transit visibility of containers and contents.
- Achieve economical movements via container use.
- Move containers as fast as mode operators and consignees can handle them.
- Avoid container congestion in ports and staging areas.
- Integrate the military and commercial container management systems.
- Consolidate single consignee shipments.
- Reduce detention and demurrage.
- Use containers for retrograde movements.

### CONTAINER CONTROL

10-3. Because control of containers must be established at a theater echelon that permits centralized management, the transportation command element (TCE) is normally responsible for management of containers and flatracks within the theater. The TCE develops detailed policies and procedures for container and flatrack use and monitors compliance. Coordinating with the theater support command materiel management center (TSC MMC), the TCE sets priorities for container shipment and diversion. The TCE maintains information on the location and status of all containers and flatracks in the theater. Much of this information comes from movement control teams (MCT), but automatic identification technology (AIT) plays a major role in reporting the contents and location of the containers. See chapter 11 for details on AIT.



10-4. **Container Events.** Timely and accurate reporting of container event information is essential to the TCE as the theater container manager. Container event information includes —

- When the container was delivered to a trailer transfer point, a container holding area, or the consignee.
- When the container was discharged.
- When the container was released to the container owner.
- When the container was picked up by the container owner.

10-5. **Reporting.** MCTs report container events to their controlling movement control battalion (MCB). The MCB reports the container events to the TCE. If the mode asset carrying the container is equipped with the Movement Tracking System (MTS), that system can be used to report container events. The purpose of having visibility of container events is to ensure that cargo is delivered to the consignee as rapidly as possible and return the container to the transportation system in a timely manner. Rapid return of containers to the system reduces detention and demurrage charges to the Government. Maintaining visibility also reduces the diversion of containers for other purposes such as permanent storage.

### Daily Container Management Activities

10-6. As noted in paragraph 10-3, the TCE develops, disseminates policies and procedures for containerized shipments moving in the theater. These responsibilities include:

- Ensure that automated cargo manifests and ETAs are promptly forwarded to the concerned organizations.
- Tracking the movement of containers within the theater.
- Receive all container event information (see para 10-4) and ensure it is submitted to the regional server.

10-7. Echelons above corps (EAC) and corps MCBs through their subordinate MCTs will:

- Provide inbound container information to consignees.
- Provide disposition instructions to the TCE based on information received from customers.
- Notify consignees of the scheduled arrival of multistop containers and the need for priority discharge of these containers at intermediate stops.
- Report the receipt of unscheduled containers to the TCE.
- Release empty containers to the applicable mode operator and coordinate the pickup.
- Maintain records for containers that are inbound and for those that have arrived.
- Create records for unscheduled containers.
- Notify the TCE when a consignee reports receipt of an unserviceable or damaged container.
- Monitor retrograde operations to minimize retrograde backlog.

10-8. Containers are routinely moved as far forward as the division rear area, consistent with availability of container handling equipment (CHE). (They usually are not moved into brigade areas, except in exceptional cases.) Containers are not “grounded” in the division area. Containers on chassis will be unstuffed as soon as possible, while on the chassis, and the chassis and container returned immediately. The container roll-in/roll-out platforms (CROP) inside the container continue

to move forward into the brigade area. CROPs are extracted from containers in the corps storage area and corps hub and loaded onto trucks with the load handling system for onward movement to the division area. Upon arrival in the division AO, flatrack management responsibility passes to the DISCOM DMC movement manager. A flatrack control point (FCP) is established at the division support area and the division ammunition storage area in the vicinity of their supply support activities. The DISCOM DMC reports the status report through the corps DMC to the theater DMC.

## Overseas Container Support

10-9. Much of the material arriving in a theater will be in containers. Effective use of logistics support requires the efficient movement and handling of containers throughout Defense Transportation System (DTS). Within the theater, containers are throughput as far forward as practicable.

10-10. Department of Defense (DOD) policy is to make optimum use of the capability of intermodal container resources and services furnished by the commercial transportation industry when doing so is responsive to military requirements. Military Traffic Management Command (MTMC) coordinates the lease of containers and intermodal equipment required to meet DOD container system requirements as delegated by United States Transportation Command (USTRANSCOM). MTMC manages and monitors status of DOD-owned and leased intermodal surface containers while these containers are in the DTS.

## SEAPORT OPERATIONS

10-11. The theater commander provides for the prompt discharge of containers arriving in the theater and for their rapid movement to destination. U.S. military operations at seaports are managed by MTMC. MTMC, TCE, or host nation (HN) will operate U.S. military operations at seaports. (U.S. military operations at aerial ports are operated by the Air Force elements.) In combined operations being conducted on friendly soil, the HN may choose to exercise its territorial responsibilities and continue to operate friendly ports in the theater. The responsibilities of U.S. forces at these HN ports will be based upon agreements between the U.S. and the HN government. The TCE develops the movement program (see chapter 7) that allocates transportation for the movement of all cargo and personnel from the ports of debarkation (POD). Based on general guidance from the joint movement center (JMC), the TCE establishes container management policies and procedures. The TCE will normally assign MCTs to manage the flow of cargo from PODs. The port MCT arranges transportation for onward movement of containers.

## Container Discharge At Seaports

10-12. Fixed-port terminals normally provide suitable facilities to off-load containers and transfer them to inland transportation nodes. Fixed-port facilities are used to the maximum extent possible because they can normally discharge a large volume of containers at a rapid pace, are equipped with CHE, and are located close to inland transportation centers.

10-13. Logistics-over-the-shore (LOTS) operations are a means of providing container discharge support when established ports are not available or are not adequate. LOTS operations involve discharging ships offshore and bringing the cargo over the beach. LOTS operations are inherently less efficient than fixed-port operations, because they do not have the specialized CHE found at

fixed points. While LOTS operations are not efficient, LOTS capabilities are essential in the absence of fixed ports and in some cases to supplement fixed ports.

## Seaport Clearance

10-14. The theater first gains visibility of inbound containers from the advance ocean cargo manifest. Using the Worldwide Port System (WPS), the manifest is sent from the MTMC area command responsible for the port of embarkation (POE). MTMC transmits the manifest to seaport of debarkation (SPOD) within 72 hours after the vessel departs from the seaport of embarkation (SPOE).

10-15. The following actions occur upon receipt of the manifest or arrival of the vessel:

- Port operators begin preparing documentation to clear the containers through the port for delivery to their consignees.
- Using the data reported by the port MCT and other transportation nodes maintains theater visibility of containers. The intransit visibility (ITV) data may be gained using AIT. (See chapter 11.) The port MCT provides the estimated time of arrival (ETA) to the destination MCT, TCE, EAC MCB, and corps transportation battalion. The destination MCT provides the ETA information to the consignee. If the container requires a positive inbound clearance (PIC) the destination MCT obtains the PIC from the consignee and sends it to the port MCT.
- The port MCT processes the advance manifest into its automated system. This produces an initial master record of every container expected to arrive in the theater. These data are sent to the destination MCT, EAC MCB, corps transportation battalion, and other interested elements.
- The port MCT receives any hold, expedite, or divert instructions from the destination MCT or the TCE prior to arranging onward movement of the containers. The port MCT notifies MTMC of containers to be held, diverted, or expedited.
- The advance manifest is a planning document. Port operators perform 100 percent reconciliation during vessel off-loading. Actual containers discharged are matched against the advance ocean manifest and all discrepancies noted. When there are differences, the port MCT notifies the TCE and destination MCTs for disposition instructions. The port MCT and TCE updates their container records. When a container arrives at a consignee without prior notification, the consignee reports the arrival to the destination MCT. The destination MCT creates a record for the unscheduled container and reports its arrival.
- Port operators, the port MCT and mode operators strive to move containers from the vessel using the mode of transportation for onward movement. This prevents accumulation of containers at the port.
- Consignees must unstuff their containers as quickly as possible and report their availability for pickup to the destination MCT.

- Rail, when available, is the most efficient method of moving large quantities of containers from ports. Rail is used to move containers as far forward as feasible. Rail is less affected by adverse weather than other modes, but its flexibility is restricted because its use still needs wheeled vehicles at the delivery end.
- Inland water transport and coastal transport are used when available. It is the slowest mode, but can help relieve pressure on rail and truck transportation modes. Inland water and coastal suffer from the same flexibility limitation that rail does: its use still needs wheeled vehicles at the delivery end.
- Highway transport is the preferred method of moving containers and is employed in line-haul, local haul, terminal clearance, and transfer operations. It is the primary mode used to forward containers from rail and inland water terminals directly to the consignee.

## Chapter 11

# Automated Identification Technology

11-1. The purpose of this chapter is to briefly outline the use, employment, application, and capabilities of automated identification technology (AIT) as it pertains to movement control purposes.

**NOTE:** For information on AIT equipment, see Appendix C.

11-2. The Army uses AIT to assist in movement operations. AIT use in operations consists of a suite of tools designed to provide commanders in-transit visibility (ITV) of forces and material. When integrated with automation information systems (AIS), AIT provides managers with timely ITV. This visibility allows commanders to control the movement of forces and equipment and redirect the movement as necessary to meet changing tactical situations and objectives.

11-3. AIT is an enabling technology and must be fully integrated with AISs to be an effective ITV tool. The basic AIT components for ITV are source data that populate AIT data storage devices; AIT data capture devices (interrogators, scanners, and readers); and source and movement data transfer to AISs. These components work together as follows:

- An AIT data storage device containing essential transportation and supply data is created. The data storage device is then attached to a piece of equipment, or in the case of smart cards, issued to a soldier.
- As the piece of equipment or soldier moves through the transportation system, the data on the storage device is collected by AIT interrogators and readers that are strategically located throughout the system.
- After collecting the data on the storage device, the interrogator, scanner, or reader passes the data to a host AIS. The host AIS passes the data to a worldwide AIS that provides near real-time ITV data to the logistics and warfighting communities.

11-4. Kinds of AIT devices. The Army uses five basic kinds of AIT data storage devices: bar codes, optical memory cards (OMC), smart cards, radio frequency tags (RFID), and contact memory buttons (CMB). These are discussed in some detail in Appendix C.

## GENERAL PREPARATIONS FOR AIT USE

11-5. In most unit movement scenarios, the Army will use AIT at each node in the movement. The key to the successful use of AIT is unit AIT preparation before deployment. The unit has the ability at home station to capture source data, in its entirety, in AISs. Home station is also the logical location to prepare AIT data storage devices for all deploying forces and equipment. If the AIT mission is not performed correctly at the beginning of the unit movement, the age-old problem of limited or no ITV will continue.

## UNIT RESPONSIBILITIES

11-6. Home station is the permanent location of active and reserve component battalion and company units. AIT equipment is distributed with the Transportation Coordinators-Automation Information for Movements System II (TC-AIMS II). After receiving an alert for impending deployment, units have AIT-related responsibilities at home station. Among them are:

- Plan for the use of AIT based on the unit mission and requirements of the supported combatant commander.
- Ensure the unit deployment list (UDL) is complete, accurate, and current.
- Pass the UDL to higher headquarters and to the installation the unit is to use as a departure point.
- After receiving transportation data from the installation, properly label all UDL equipment with AIT storage devices.
- Use TC-AIMS II (or other system) to write RFID tags when RFID tags are being used.
- Use hand held interrogators (HHI) to verify AIT storage device batteries are functional.
- Ensure every deploying soldier has an accurate and current Smart Card. This requirement is supported by the installation and accomplished during SRP.
- Ensure the security of AIT data and equipment in accordance with applicable supply and information security procedures.

11-7. AIT is a powerful tool that can provide receiving commanders and theater logistics elements ITV and force tracking information. This information can enhance theater reception management and enable efficient reception and processing of units and equipment as they move into the theater.

## AIT IN AERIAL PORT OPERATIONS

11-8. There are three primary organizations operating at an aerial port that possess AIT tools: the Air Force tanker airlift control element (TALCE), the Army aerial port MCT, and the Army A/DACG. The A/DACG is the primary organization responsible for Army operations at aerial ports. The TALCE is the primary Air Force organization responsible for loading and unloading aircraft. A/DACGs that are provided by port MCTs and TO&E cargo transfer or cargo documentation elements are equipped with TC-AIMS II and AIT equipment.

### AIT Planning Considerations at Aerial Ports

11-9. Aerial port operations (both embarkation and debarkation), by their very nature, cross military service boundaries for unit movement operations. Detailed inter-service support agreements or other arrangements are established in advance of operations if no theater ITV plan is developed detailing port AIT requirements. These arrangements must address each organization's AIT functions and responsibilities.

## **AIT IN SEAPORT OPERATIONS**

### **AIT Planning Considerations at the Seaport**

11-10. The organization responsible for seaport operations is the Military Traffic Management Command (MTMC). Both MTMC and the port support activity (PSA) use AIT in the seaport complex to capture information for ITV reporting.

### **Vessel Loading**

11-11. MTMC elements control all equipment departing the staging area for vessel loading. Normally the equipment is scanned at the final stowage location. After scanning, the data is passed to WPS. For unit movements, this data must be visible in GTN within one hour of vessel departure. For sustainment shipments, data must be visible in GTN within four hours.

## **AIT AT RAILHEAD OPERATIONS**

11-12. For OCONUS units moving intertheater by rail, the following activities involve AIT as part of the movement process:

- Sequence loads for rail spurs. The area support group (ASG) or base support battalion (BSB) develops and publishes the rail load plan based on the time-phased force deployment data and UDLs. UMOs or other unit representatives ensure AIT data storage devices are functional.
- Once in the staging area, the UMO or MCT personnel will use TC-AIMS II to conduct a final check of AIT data storage devices to ensure they are functional and properly attached. RFID batteries are checked and replaced as necessary.
- The unit uses TC-AIMS II to provide documentation for rail transport to the ASG or BSB responsible for railhead operations. The ASG or BSB reads arriving equipment AIT data storage devices and verifies the collected data with advanced movement data provided by the unit.
- The movement control element captures railhead departure information for equipment by interrogating equipment AIT data storage devices as they depart. This data is then reported to GTN.
- For passenger movements, the MCT reads the Smart Card of all soldiers to verify rail manifest data. Once the train departs, this data is passed to GTN for ITV.

## Appendix A

# Automation Information Systems (AIS)

A-1. Automation for military operations must focus on joint operations. The Joint Transportation Corporate Information Management Center (JTCC) assessed the functional, technical, and programmatic capabilities of existing transportation systems.

A-2. The JTCC goal was to eliminate unnecessary duplication, save resources, retain or secure required functionality, and improve the DTS. The recommendations of the JTCC ultimately changed movement control operations. This appendix lists movement control and related automation systems and describes what they do.

## MOVEMENT CONTROL AUTOMATION CAPABILITY

A-3. TC-AIMS II is an automated information system that will support day-to-day operations for Unit Movement Officers (UMO), movement controllers, staffs from battalion/separate company to theater level, mode managers, and Installation Transportation Offices (ITO). It will interface with Joint and Service systems that provide Intransit and Total Asset Visibility to all services and will be the basic building block of source data. GTN and GCCS-Army force-tracking software will translate the raw data into ITV and force tracking information.

A-4. The following paragraphs briefly address each major automation information system that supports movements.

### Automated Air Load Planning System (AALPS)

A-5. AALPS is a knowledge-based system that assists with loading military cargo aircraft for large-scale air deployments. It is designed to serve four basic functions: generate valid air load plans; generate and validate user defined air load plans; modify existing air load plans; and track movement statistics during actual deployments. AALPS has the capability to air load plan an Army division of 15,000 soldiers and 5,000 pieces of equipment in less than three minutes. AALPS can interface with TC-AIMS II and GTN.

### Combat Service Support Control System (CSSCS)

A-6. CSSCS is designed to collect, analyze, and disseminate critical logistical, transportation, medical, financial, and personnel information. CSSCS receives data directly from GTN.

### Department of the Army Movements Management System-Redesign (DAMMS-R)

A-7. DAMMS-R provides automation support for transportation staffs and organizations. It is a vital link in the maintenance of ITV over units, personnel, and material. DAMMS-R interfaces with all AISs, all services, and all friendly foreign governments of the countries where the Army is deployed.



## **Global Air Transportation Execution System (GATES)**

A-8. GATES is a system used at aerial ports that integrates command and control operations, passenger operations, and cargo movement processes. It assists management of cargo manifested for air shipment, cargo awaiting air shipment, and cargo departed from aerial ports via air or ground transportation. GATES (1) processes and tracks cargo and passenger information; (2) supports management of resources; (3) provides logistical support information; (4) supports scheduling and forecasting; (5) provides tracking and tracing of aerial port assets (including personnel, vehicles, equipment, and supplies); (6) supports processing service short-term cargo requirements and long-term passenger and cargo requirements; (7) supports channel mission management; (8) manages tariff data regarding baggage, passenger, and pet fares; (9) manages passenger reservations; and (10) provides reports and transportation status for customers.

## **Global Command and Control System (GCCS)**

A-9. GCCS provides DOD combat commanders with a single source of secure information. It assists joint force commanders with coordinating air, land, sea, space, and special forces operations of widely dispersed units in fast moving operations. It is flexible enough for combat operations or humanitarian assistance missions. GCCS allows greater software flexibility, reliability, and interoperability with other automated systems. Commanders can establish their own secure homepage and communicate worldwide using E-mail.

## **Global Command and Control System-Army (GCCS-A)**

A-10. GCCS-A provides a single seamless C2 system. It is integrated with the DOD GCCS. GCCS-A is fundamentally GCCS with additional Army specific functionality.

## **Global Combat Support System (GCSS)**

A-11. GCSS provides the joint warfighter with a single, end-to-end capability to manage and monitor units, personnel, and equipment from mobilization through deployment, employment, sustainment, and demobilization.

## **Global Combat Support System-Army (GCSS-Army)**

A-12. GCSS-Army is still in development. When fielded, GCSS-Army enables the commander to leverage information technology to coordinate and prioritize material management and movement operations to optimize the distribution pipeline's capability to throughput units, their materiel, and follow-on sustainment. It provides commanders at each echelon the asset and in-transit visibility required to optimize the distribution system within their echelon.

## **Global Positioning System (GPS)**

A-13. GPS is a collection of satellites owned by the U.S. Government that provides highly accurate, worldwide positioning and navigation information, 24 hours a day. It is made up of twenty-four NAVSTAR GPS satellites which orbit 12,000 miles above the earth, constantly transmitting the precise time and their position in space. GPS receivers on (or near) the earth's surface, listen in on

the information received from three to twelve satellites and, from that, determine the precise location of the receiver, as well as how fast and in what direction the receiver is moving.

### **Global Transportation Network (GTN)**

A-14. GTN is an automated C2 system used for collecting transportation information from selected DOD systems. It provides automated support for planning, providing, and controlling common user airlift, surface, and terminal services for unit movement operations. It provides the user with the ability to track the status, identity, and location of DOD unit and sustainment cargo and passengers, medical patients, and personal property from origin to destination. GTN also does the following:

- Provides ITV information about units, forces, passengers, cargo, patients, schedules, and actual movements.
- Displays current operational asset information and provides transportation intelligence information on airfields, seaports, and transportation networks using graphics and imagery.
- Provide future operations information and models to support transportation planning and courses of action.
- Provides efficient routing for patient movement and provides ITV of individual patients.
- Interfaces with CAPS II, CFMS, CMOS, Defense Automated Addressing System (DAAS), Defense Transportation Tracking System (DTTS), GCCS, JOPES, Global Decision Support System (GDSS), Mechanized Export Traffic System (METS), Passenger Reservation and Manifest System (PRAMS), TC-ACCIS, TC-AIMS II, and WPS.

### **Integrated Booking System (IBS)**

A-15. IBS is the execution system for the Defense Transportation System (DTS) to move international cargo. IBS provides a worldwide, automated booking system to move military cargo OCONUS. IBS allows DOD shippers to automatically process movement requests directly using Military Traffic Management Command (MTMC) booking offices. IBS automatically determines the “best value” ocean carrier supporting the move. IBS supports the deployment, employment, and sustainment. IBS interfaces with the ocean carrier industry, WPS, and GTN.

### **Integrated Computerized Deployment System (ICODES)**

A-16. ICODES is an automated information system that develops stowage plans for deployments. It can predict problems and design alternative solutions. ICODES is designed to support division-sized moves and cargo planning across the available fleet of ships. It supports multi-ship planning while maintaining unit integrity. ICODES is responsive to unplanned changes and contingencies. It interfaces with TC-AIMS II and WPS.

### **Joint Force Requirements Generator II (JFRG II)**

A-17. JFRG II System Description: JFRG II is a computer based planning tool designed to support the Services in the development of both deliberate and crisis action plans. It supports tactical and administrative planning by providing the following capabilities: Import of Service type unit characteristic data, rapid force list creation, lift analysis, time phased force deployment data

development and manipulation, and declassifies the import and export of data to the Joint Operation Planning and Execution System (JOPES).

### **Joint Operations Planning and Execution System (JOPES)**

A-18. JOPES furnishes joint commanders and war planners, at all levels, standardized policy procedures and formats to execute a variety of required tasks. It assists planners in development of operation plans, concept plans, functional plans, campaign plans, and operation orders. JOPES is used for time-phased force and deployment data management and development. It defines requirements and gains visibility of the movement of combat forces into the combat commanders' area of responsibility. JOPES combines individual service terminology into one standard system. It standardizes the joint planning system used to execute complex multi-service exercises, campaigns, and operations. The JOPES automated data processing resides in the computer network of the GCCS.

### **Movements Tracking System (MTS)**

A-19. MTS provides automated tracking of containerized cargo and vehicles. It provides fleet monitoring using vehicle map displays, sensors, communications log storage and retrieval capability, and remote monitoring worldwide. The MTS supports missions through the full spectrum of military operations from peacetime to war. It provides commanders with near real-time data on the location and status of transportation platforms, including specialist and other selected tactical wheeled vehicles, watercraft, flatracks, and containers, using cabin, console mounted hardware, and satellite technology. MTS automatically provides updated position tracking and two way, over the horizon, digital message capability between C2 elements and vehicle and watercraft operators.

### **Transportation Coordinators Automated Command and Control Information System (TC-ACCIS)**

A-20. TC-ACCIS automates the transportation functions of installation level transportation and unit movement planning and execution. It provides accurate and timely movement information to the Army and joint deployment community for the deployment of active and reserve component units. TC-AIMS II is replacing this system.

### **Transportation Coordinators Automated Information for Movements System II (TC-AIMS II)**

A-21. TC-AIMS II is a joint transportation system that integrates the functionality of CMOS, TC-ACCIS, DAMMS-R, United States Marine Corps Marine Air-Ground Task Force Deployment Support System II (MDSS II), and the USMC TC-AIMS automation systems. TC-AIMS II combines these systems into one single automated system, for use by all the services. TC-AIMS II is used by all the services for unit movement functionality, installation transportation functionality, UMC, and mode management. When fielded, TC-AIMS II will replace TC-ACCIS.

### **Worldwide Port System (WPS)**

A-22. WPS is the primary source system for intransit and total asset visibility of surface cargo movement in the DTS. WPS provides timely and accurate information to the supporting and

supported commander-in-chiefs through the GTN. Upgrades to WPS include a ship load planning module, capable of concurrent planning for multi-ship operations.

## Appendix B

# Geographical Considerations

B-1. This appendix contains general descriptive information relating to some of the unified commands and a generic description of theater movement control organizations. Even as the Army is going through a transformation, changes are being made among the unified and specified command structure. What is depicted here is current or forecast as of the publication date of this field manual.

## UNITED STATES CENTRAL COMMAND (USCENTCOM)

### Area of Responsibility (AOR)

B-2. The southwest Asia region is a diverse and tumultuous area. The population is over 316 million with 17 different ethnic groups, 420 major tribal groupings, six major language groupings, hundreds of dialects, and three major religions. The command's AOR (figure B-1) begins in the east with Pakistan and includes, among others, Afghanistan, Iran, Iraq, and Jordan on the Asian continent, the entire Arabian peninsula, and west to Egypt, Sudan, Ethiopia, Djibouti, Somalia, Eritrea, and Kenya on the African continent. It includes the waters of the Red Sea and Persian Gulf.

B-3. Host nation support (HNS) ranges from good to nonexistent, depending on the specific country involved. HNS in Saudi Arabia, Egypt, and Kuwait is good. Civilian contracted assets or LOGCAP support are frequently used to augment military assets. Lines of communication (LOC) vary from the few regularly used in support of pre-positioned supplies, equipment, and personnel; to those used periodically for exercises; to those identified but not used because of political or other considerations.

B-4. US forces apportioned to USCENTCOM are both forward-deployed and Continental United States (CONUS) based forces. In terms of numbers, there are few permanently forward-deployed Army forces in the area. However, permanent forward-deployed Army, Air Force, and Navy organizations are present in the region. As this is written, forces from all four Services are engaged in Afghanistan and Pakistan, among other countries in the AOR.

### USCENTCOM Command Relationships

B-5. Headquarters, USCENTCOM is located at McDill AFB, Florida, but is planning a permanent move to a location in the AOR. Headquarters, Third US Army (TUSA), located at Fort McPherson, Georgia, is the headquarters of the Army component command for USCENTCOM. (The Army component is referred to as ARCENT.) It provides planning guidance for Army units that would be deployed in contingencies and for those already deployed.



Figure B-1. USCENTCOM AOR

## UNITED STATES EUROPEAN COMMAND (USEUCOM)

### Area of Responsibility

B-6. The USEUCOM AOR (figures B-2, B-3) is vast and diverse. It encompasses 30 million square miles, extends from the northern tip of Russia to the southern tip of Africa (less the African area assigned to USCENTCOM), and from Portugal in the west of Europe to Azerbaijan on the Asian continent in the east. This array includes 91 countries and territories. This territory extends out to the waters of the Atlantic Ocean from 500 miles off the U.S. east coast, and includes the Baltic, Adriatic, Black, and Mediterranean Seas, most of Europe, most of Africa, and very significant countries of the Middle East (Israel, Syria, and Lebanon). (USPACOM assists with eastern areas of Russia.) The USEUCOM AOR is an extremely complex one.

B-7. USEUCOM HNS ranges from the very good to the nonexistent, depending on the specific country involved. The NATO countries (and European countries in general) offer excellent HNS, whereas most of the African countries, for example, vary from good to non-existent. LOCs vary from the few regularly used; to those used periodically for exercises; to those identified but not used because of political or other considerations..

B-8. US forces apportioned to USEUCOM include both forward-deployed and CONUS-based forces. Those forward-deployed consist mainly of US Army Europe (USAREUR) and US Air Force in Europe (USAFE) command elements.

### USEUCOM Command Relationships

B-9. Headquarters USEUCOM is located in Stuttgart, Germany. USAREUR is the Army component of USEUCOM and is headquartered in Heidelberg, Germany. HQ, USAREUR provides planning guidance for Army units that would be deployed in contingencies and for those already deployed.

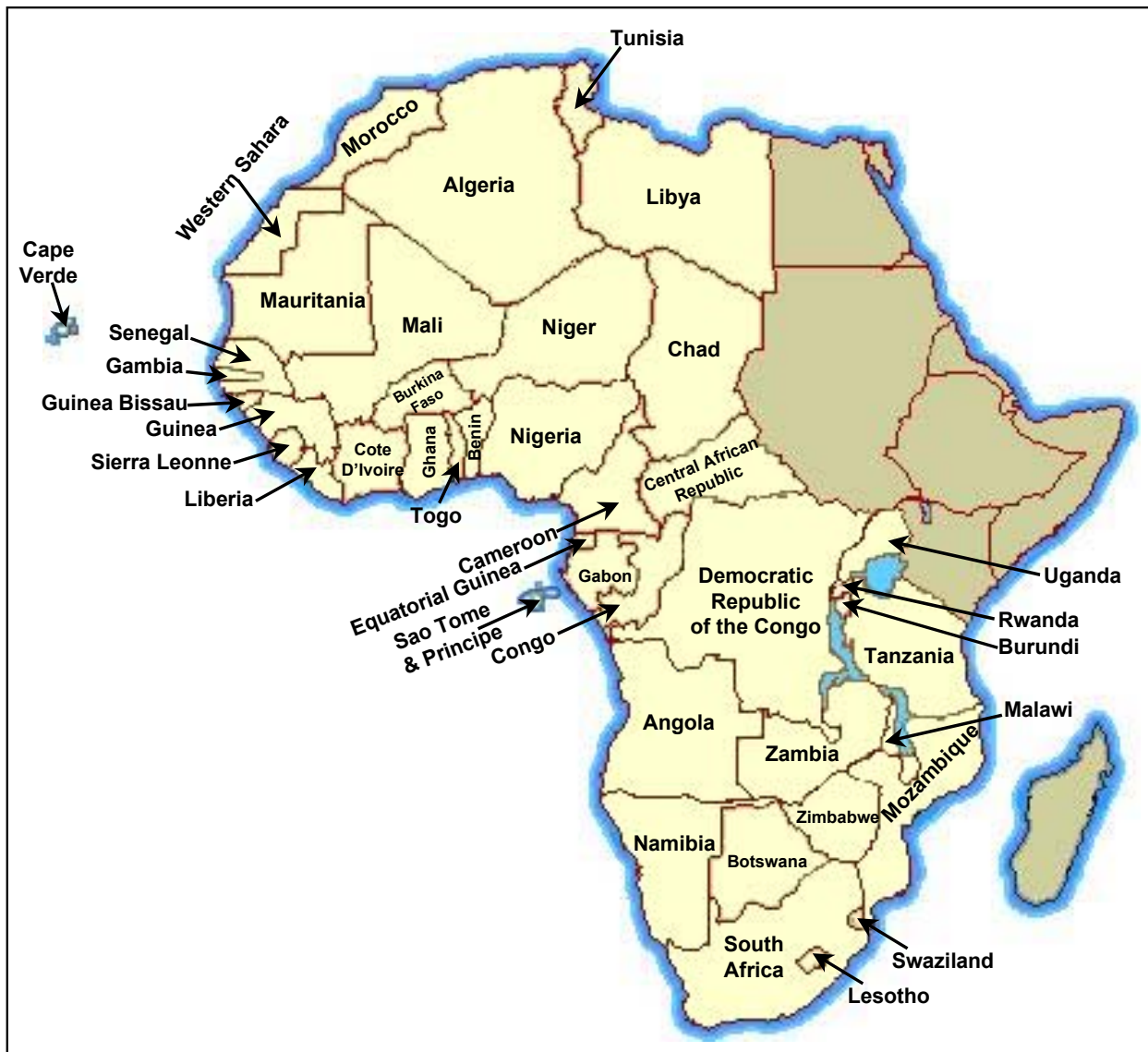

Figure B-2. USEUCOM Africa AOR



Figure B-3. USEUCOM Europe and Middle East AOR

## UNITED STATES PACIFIC COMMAND (USPACOM)

### Area of Responsibility

B-10. The USPACOM AOR is huge, complex, and unique because of its vast water areas. It encompasses 105 million square miles, extends in the east from Madagascar (east of Mozambique) in the Indian Ocean to Samoa in Oceania in the west, and includes Asia. It also runs from the northern tips of Mongolia and China to the southern tip of New Zealand. USPACOM also includes Hawaii and Alaska (see Figure B-4). It is an extremely diverse AOR.

B-11. USPACOM HNS a wide range from good to nonexistent, depending on the specific country involved. LOCs vary from the few regularly used; to those used periodically for exercises; to those identified but not used because of political or other considerations.

B-12. US forces apportioned to USPACOM include both forward-deployed and CONUS-based forces. Those USPACOM forces deployed forward consist of US Forces Japan (USFJ), US Forces Korea (USFK), Alaskan Command (ALCOM), Special Operations Command, Pacific (SOCPAC), US Army Pacific (USARPAC), US Pacific Fleet (PACFLT), Marine Forces, Pacific (MARFORCENT), and Fleet Marine Forces, Pacific (FMFPAC). Even though Alaska is part of USNORTHCOM, US forces there are commanded by USPACOM.



## USPACOM COMMAND RELATIONSHIPS

B-13. HQ, USPACOM is located in Hawaii, as is headquarters, USARPAC. The Army component command for USPACOM is USARPAC, which provides planning guidance for Army units that would be deployed in contingencies and for those already deployed.



Figure B-4. USPACOM AOR

## **UNITED STATES SOUTHERN COMMAND (USSOUTHCOM)**

### **Area of Responsibility**

B-14. The USSOUTHCOM AOR is diverse (see Figure B-5). The USSOUTHCOM AOR includes the land mass of Latin America south of Mexico; the waters adjacent to Central and South America; the Caribbean Sea, its 13 island nations (less those assigned to USNORTHCOM), European and U.S. territories; the Gulf of Mexico; and a portion of the Atlantic Ocean. It encompasses 32 countries (19 in Central and South America and 13 in the Caribbean) and covers about 15.6 million square miles. The region represents about one-sixth of the landmass of the world assigned to regional unified commands.

B-15. Unlike some other unified commands, USSOUTHCOM HNS potential ranges only from poor to nonexistent, depending on the specific country involved. The region is generally poor, and with few exceptions, the U.S. has no significant HN agreements in the area, because few U.S. forces are forward-deployed there. LOCs vary from the few regularly used; to those used periodically for exercises; to those identified but not used because of political or other considerations..

B-16. US forces apportioned to USSOUTHCOM include both temporarily deployed and CONUS based forces. Those consist mainly of US Army South (USARSO) and US South Air Force (USSOUTHAF) command missions.



Figure B-5. USSOUTHCOM AOR

## USSOUTHCOM Command Relationships

B-17. Headquarters, USSOUTHCOM is located in Miami, Florida. US Army South (USARSO) has its headquarters at Fort Buchanan, Puerto Rico and is the Army component command for USSOUTHCOM. It provides planning guidance for Army units that would be deployed in contingencies and for those that are already deployed.

## UNITED STATES NORTHERN COMMAND (USNORTHCOM)

### Area of Responsibility

NOTE: On 17 April 2002, U.S. Secretary of Defense Donald Rumsfeld formally announced the establishment of the U.S. Northern Command, with the primary missions of homeland and continental security. It will be formally established on 1 October 2002.

B-18. The USNORTHCOM AOR (see Figure B-6) is unique because it includes homeland defense. The USNORTHCOM AOR includes the land mass of North America north of Guatemala to Ellesmere Island in the Arctic Ocean; island territories of Puerto Rico and Bermuda; nations of Cuba and The Bahamas; the waters adjacent to North America; the Gulf of Mexico; and a portion of the Atlantic and Pacific Oceans. It encompasses five countries (United States, Canada, Mexico, Cuba, The Bahamas), island territories in the Caribbean not covered by USSOUTHCOM, and includes assisting USEUCOM with the eastern areas of Russia.

B-19. USNORTHCOM HNS potential ranges from very good to nonexistent, depending on the specific country involved. LOCs also vary from the few regularly used; to those used periodically for exercises; to those identified but not used due to political or other considerations. USNORTHCOM is different from other unified commands in that it includes the continental United States. It is responsible for homeland defense on the ground, the sea, as well as aerospace defense (North American Aerospace Command — a U.S. and Canada command). In this regard, the command is responsible for forces that operate in the continental US in support of civil authorities in cases of attack and natural disaster.

B-20. US forces apportioned to USNORTHCOM include CONUS based forces and forces in Cuba. However, while Alaska will fall under USNORTHCOM, forces stationed there will remain under USPACOM command.

## USNORTHCOM Command Relationships

B-21. USNORTHCOM is planned to be headquartered at Petersen AFB, Colorado. USAFORSCOM headquartered at Fort McPherson, Georgia is the Army component command for USNORTHCOM. It provides planning guidance for Army units that could be deployed in prosecution of the varied missions of USNORTHCOM.



Figure B-6. NORTHCOM AOR

## Appendix C

# Automated Identification Technology (AIT) Equipment

C-1. The purpose of this chapter is to describe the automated identification technology (AIT) equipment, hardware, and technology, as it pertains to transportation purposes. For explanation of the functional application of the technology, see Chapter 11 of this FM.

## AIT DATA STORAGE DEVICES

C-2. The essence of AIT is the storage of information of some kind in a device that accepts the storage in some coded form that can be retrieved by being read, either by scanning or interrogation. The device is handcarried by personnel or attached in some way to equipment and containers. There are four basic components of AIT:

- An automated identification data storage device, (e.g., bar code label, optical memory card [OMC], Smart Card, radio frequency identification [RFID] tag, or contact memory button [CMB]).
- AIT hardware used to write information onto the data storage devices and later, read the data from the devices.
- Automation information systems (AISs) that can receive and use AIT data.
- A reliable communications infrastructure that links the AIT hardware to the AISs and further links the AISs to global in-transit and total asset visibility (TAV) systems.

## Bar Coded Data

C-3. Department of Defense (DOD) and the Army use two types of bar codes, linear and two-dimensional. All logistics nodes are to read and write both types. Each node of the DOD transportation system, including commercial vendors, read and write linear and two-dimensional bar coded shipping labels that contain both transportation and supply information. Reader equipment scans the bar code, decodes it, and transfers the data to a supporting AIS.

## Linear Bar Code

C-4. The linear bar code provides item identification and document control information for individual items and shipments. Linear bar codes have limited storage capacity, normally consisting of about 20 characters. The commercial automated identification manufacturer's BC-1 (Code 39), the standard for linear bar codes, is used throughout DOD. Linear bar codes are used to represent essential data elements (e.g., a national stock number, document number, or transportation control number). Figure C-1 shows an example of linear bar code.



Figure C-1. Linear Bar Code (example)

### Two Dimensional (2D) Bar Code

C-5. A 2D bar code has a much greater data storage capacity than a linear bar code. It is currently capable of holding 1,850 characters. A 2D bar code can sustain considerable damage and still be read because of the redundancy of data within the bar code. The DOD standard 2D bar code is the commercial standard Portable Data File 417 (PDF 417). The 2D symbology provides comprehensive data on documents, individual items or shipments, and consolidation data on multi-packs and air pallets. Figure C-2 shows an example of a 2D bar code matrix.



Figure C-2. Two Dimensional Bar Code (example)

C-6. Military shipping labels (MSLs) incorporate 2D bar code fields as well as linear bar codes. Figure C-3 shows an example of an MSL with linear bar codes used in blocks 1, 9 and 16 and 2D bar code technology being used in block 18.

3. From <b>SW3123</b>		9. ULTIMATE CONSIGHNEE OR MARK FOR <b>WK4GEY</b>	
			
1. TRANSPORTATION CONTROL NUMBER <b>*SW31238013E221XXX*</b>			
			
16. PIECES <b>1 OF 1</b>	5. SHIP TO/POE <b>DOV</b>	6. TRANSP PRIORITY	
			
8. PROJECT <b>9BU</b>	14. DATE SHPD <b>20000127</b>	11. RDD <b>042</b>	7. POD <b>TZL</b>
10. WT/CU THIS PC <b>03965/0451</b>	4. TYPE SERVICE <b>A</b>	13. CHARGES	15. FMS CASE
18. TCMD/SUPPLY INFO		2. POSTAGE DATA/TAC <b>F8WR</b>	
			
<small>DOD AIT TEST IN EUCOM MSL, VERSION 1.1 15 JANUARY 1998</small>			

Figure C-3. MSL Using Both 2D and Linear Bar Code (example)

## Optical Memory Card (OMC)

C-7. An OMC uses compact disk technology. Data is etched to the card with a high-intensity laser creating a series of pits in the card. A low-power light beam is used to read the pits and collect the data. Data is written to an OMC in sequential order. As changes occur, all the shipment data is rewritten on the card (data on the card cannot be over-written). The card can be reused until all available memory space is filled. The OMC has a very large data capacity (2.4 megabytes), and DOD accepts the Drexler European License Association (DELA) standard format. OMCs are relatively inexpensive, reusable, and unaffected by climatic changes. They are best used to carry large amounts of shipment data to facilitate receipt processing at final destination.

C-8. OMCs are normally used for sustainment cargo that is being containerized. Army supply practices strive to create single consignee packs that can be throughput to the end user's location.

C-9. OMCs can also be used to support container movement in a unit movement operation. OMCs can be used to account for detailed container and pallet content. The UMO uses the TC-AIMS II hand held reader to scan bar codes as items are packed into the container. Once the container is loaded, the UMO coordinates to produce OMCs for containers, using the supporting TC-AIMS II system. (This scenario would require advance coordination with intermediate and destination nodes, as OMC use for unit packed containers is not a normal business practice.) Figure C-4 shows an example of an OMC.

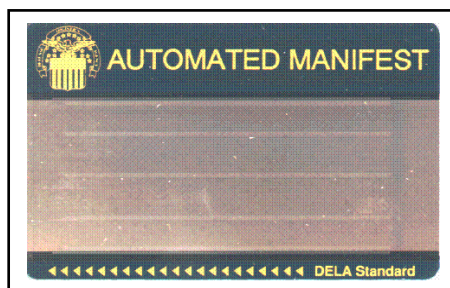

Figure C-4. OMC (example)

## Smart Cards (also known as Common Access Cards)

C-10. A Smart Card is a plastic card similar in shape to a credit card. Unlike a credit card, the Smart Card contains an integrated circuit chip with an 8-bit embedded microprocessor and 1 to 8 kilobyte memory capacities. Smart Cards may also contain one or more other methods (i.e., magnetic strip, bar code, digitized photo, printed information) for storing information related to the cardholder. Newer cards will have 16 and 32-bit microprocessors and a data storage capacity between 16 and 32 kilobytes. In addition to memory capacity, Smart Cards can contain security measures such as personal identification numbers, passwords, encrypted data, photos, or thumb print technology. Figure C-5 depicts a sample Smart Card.





Figure C-5. Smart Card (sample)

## Radio Frequency Identification (RFID) Technology

C-11. RFID is used to provide automated data capture of movements at transportation nodes. RFID also provides commanders container or pallet content visibility and can be used to locate tagged items in congested ports, container yards, or staging areas.

C-12. RFID tags contain a microchip, a long life battery, and an RFID transceiver. The microchip contains unique tag identification information and can be loaded with data to identify the items traveling with the tag. RFID write stations are used at the point of origin to write supply and transportation data to the tag and to report the same information to a central database. As the tag passes an interrogator during movement, the tag responds by sending data to the interrogator. The interrogator then passes this information and a date-time stamp to a supporting AIS or a regional in-transit visibility (ITV) server. The interrogator can also be set to activate a tag beeper for all the tags within its range, or activate a specific tag number. Using this option, operators can find specific tags and associated equipment.

### Types of Radio Frequency Tag

C-13. The Army is currently using two RFID tags, the older Seal Tag II and a newer Tag 410 (figure C-6). Eventually the Army intends to transition to a single tag. Both tags hold data in the same format and transmit the data on the same frequency. Each tag has a unique tag number, has a “beeper” option, and can store up to 128 kilobytes of data. The tags have an omnidirectional unobstructed range of approximately 300 feet. The battery life of the tag is approximately nine years, based on two collections per day. Battery life is an important consideration and should be checked closely when source data is written to the tag. The organization writing the tag should ensure that low batteries are replaced. Additionally, the theater ITV plan will identify nodes in the force projection process where the battery life should be checked and low batteries replaced. Battery life can be checked by a fixed or handheld interrogator or by viewing the regional ITV server low battery pages.



**Figure C-6. RFID Tags.**  
Seal Tag II is on the left. Tag 410 is on the right.

### **Contact Memory Buttons (CMB)**

C-14. CMBs are an AIT tool used by the Department of the Navy. The Naval Supply Systems Command attaches the buttons to pieces of equipment to provide ready access to a component's maintenance history. The Army Logistics Integration Agency (LIA) and the Army maintenance community are currently exploring using CMBs for similar purposes on Army equipment. A CMB is a very small, fast, read-write data storage device impervious to the elements in most harsh operating environments. It has a data storage capacity of between 128 and 32,000 bytes. A button does not require a battery to retain its memory and has a life expectancy of 100 years or one million read-write cycles. CMBs cannot be read remotely. Data is read from the button by touching a probe to the outside of the container. CMBs can be read-only, write-once-read-many-times, or read/write to allow updates. Figure C-7 shows a CMB and its probe.



**Figure C-7. Contact Memory Button and Probe**

### **AIT HARDWARE**

C-15. AIT hardware consists of tools used by operators to write information to AIT data storage devices, and to interrogate and read the data stored on the data storage device. Some of the tools currently used by the Army are discussed in the following paragraphs.

## RFID Write Station

C-16. The RFID write station is a hardware interface unit called a tag docking station, which is connected to an AIS. The tag docking station is used to write data to RFID tags, one tag at a time. The tags are inserted into the docking station and data is transferred. Figure C-8 shows the docking stations for the SealTag II and the Tag 410.



**Figure C-8. RFID Tag Docking Stations**  
Seal Tag II is on the left. Tag 410 is on the right.

## Fixed RFID Interrogator

C-17. A fixed RFID interrogator transmits queries to and receives data from all active RFID tags in its area. The maximum unobstructed radius is approximately 300 feet. The interrogator passes the data to a computer that can update the appropriate AIS. The data is passed to regional ITV servers and the Global Transportation Network (GTN) to provide in-transit and total asset visibility. Fixed RFID interrogators are positioned permanently in warehouses, central receiving points, and at selected points within transportation networks. The interrogator operates by sending a 'wake-up' signal to the RFID tag, which then transmits data back to the interrogator on a different frequency. (In some configurations, such as a GateReader, a motion sensor is included to activate the interrogator for data collection of tags on vehicles approaching the sensor). Fixed RFID interrogators are also used to write data to tags. Although interrogators take more time to write the data to an individual tag, the fixed interrogator can write to multiple tags, as opposed to a tag docking station that can only write data to one tag at a time. Interrogators are compatible with both models of RFID tags. Figure C-9 shows a picture of a fixed RFID interrogator mounted on a pole.



**Figure C-9. Fixed RFID Interrogator**

### **Radio Frequency (RF) Relay**

C-18. The RF relay functions as a wireless modem and is used as a substitute for cable connections between fixed interrogators and the host computer. The RF relay has a 7,500-foot range (unobstructed). RF relays can be used in pairs to form a repeater for data transmission over longer distances or around obstructions. Figure C-10 shows a RF relay.

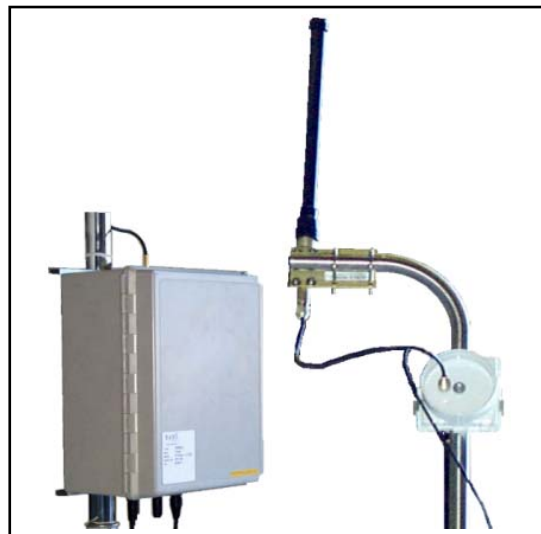

**Figure C-10. RF Relay**

### **Hand Held Interrogators (HHI), Scanners, and Data Collection Devices**

C-19. RFID hand held interrogators (HHI) and scanners operate much like fixed interrogators but are not directly connected to the host computer. Data from HHIs are downloaded to the host computer using a cable or infrared port. HHIs can be used to locate a specific tag, view the tag details, or to locate a specific item contained within one of several tagged containers or pallets. HHIs can change (update) tag data without using a tag docking station, and they can write data to a new RFID tag (but see note below). HHIs are also used to scan bar codes if that feature is available. Figure C-11 depicts a HHI currently in use by DOD.

**NOTE:** It is normally not recommended to change information on a tag using an HHI unless it is certain that the changed data will be uploaded to the regional ITV server. If the data is not uploaded, viewers of the tag data on the regional ITV server (via WWW) will see different tag information than what is actually on the tag.



**Figure C-11. Hand Held RFID Interrogator**

C-20. Hand held data collection devices are used by personnel to scan and record bar coded data. Some of the devices are directly connected to the computer (tethered), while others are portable. The portable devices store information for a connected download to the computer system or they may have the ability to transmit data directly to the computer using a wireless local area network (LAN). Figure C-12 shows an example of a tethered bar code reader and a portable data collection device.

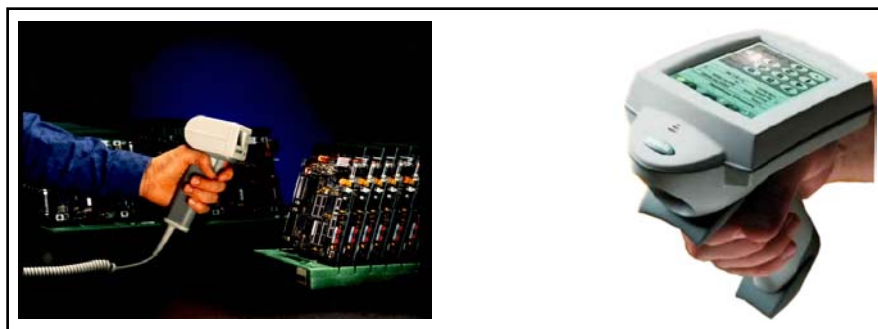

**Figure C-12. Bar Coded Data Collection Devices.**  
Tethered reader on the left, portable reader on the right.

## Bar Code Label Printer

C-21. Bar code readability is affected by print quality, smears, poor contrast, improper label stock, incorrect ink, and poor printer adjustment. Operational tests have found that these factors can cause

as much as 50% of the bar coded labels printed at some locations to be unreadable. Proper printer maintenance and care are important for producing readable bar codes. Figure C-13 shows a desktop bar code printer as well as a ruggedized portable bar code printer.



**Figure C-13. Bar Code Printers**  
Desktop version on the left. Ruggedized version on the right.

## Appendix D

### Tables of Organization and Equipment (TO&E)

D-1. This appendix contains a detailed description of the mission, assignment, methods of operation, and function of most movement control organizations.

D-2. The following organizations are described in this appendix:

- Transportation Command (TRANSCOM).
- Transportation Command Element (TCE).
- Movement Control Battalion Echelons Above Corps (MCB EAC).
- MCB (Corps).
- Port Movement Control Team (MCT).
- Area MCT.
- Division Support MCT.
- Movement Regulating Team (MRT).
- Cargo Documentation Team.

### MOVEMENT CONTROL ORGANIZATIONS

#### Transportation Command

D-3. **Mission.** To command, control and provide technical supervision of assigned and attached units supporting Army service component commands (ASCC) with all modes of transportation, terminal operations, movement control and related services including maintenance for rail and army watercraft. To control designated wartime host nation support (WHNS) resources; and to liaise with other United States and allied forces. Serves as the Army's executive agent responsible for providing combatant commanders functional expertise in concept plan (CONPLAN) and operation plan (OPLAN) preparation and deconfliction, transportation force capability assessment and time phased force deployment data (TPFDD) development.

D-4. Through deployable modules, provides technical supervision and staff augmentation to TCEs, ASCCs, and theater commander for all theater transportation requirements.

D-5. **Assignment.** The TRANSCOM is assigned to an ASCC.

- **Methods of Operation.** The theater TRANSCOM when deployed is a major subordinate command under the ASCC. The TRANSCOM is the single worldwide transportation operational planning organization. It serves as a critical linkage between United States Transportation Command (USTRANSCOM) and the supported combatant commander by providing a globally-focused operational interface between the Defense Transportation System (DTS) and the theater distribution system. The TRANSCOM provides crisis and deliberate planning for worldwide transportation operations, and critical planning and operational linkage to the USTRANSCOM. It provides theater and contingency

transportation throughput analysis, movement capability assessment, TPFDD development, and it synchronizes theater operations with USTRANSCOM. Prior to deployment, the TRANSCOM provides training, readiness oversight, and integrated operational planning focus to the TCEs. It is the only Army organization structured with the capability to provide analytical planning and operational oversight for the entire transportation spectrum in all area of responsibilities (AOR).

- **Functions.** The following provide a variety of functions to ensure the successful mission of the TRANSCOM.
  - ***Paragraph 01, Command Section.*** The TRANSCOM headquarters commands all transportation units subordinate to the ASCC. The TRANSCOM provides modules directly to the TSC, ASCC, and the theater commander to support all operations worldwide. The Command Section provides administrative functions for the unit. It provides overall command and control (C2) of the operating elements of the unit to accomplish duties imposed by statute regulations, directives, and assigned missions tasks. The minimum number of personnel requirements for this section is as follows:
    - Commander
    - Deputy Commander
    - 2 Aides-de-camp
    - Command Sergeant Major
    - 2 Executive Assistants
    - 2 Chauffeurs
    - Inspector General
    - Transportation Inspector General
    - Administrative Specialist
  - ***Paragraph 02, Chief of staff (CofS).*** The CofS, commensurate with the authority delegated by the commander, directs the TRANSCOM staffs, both special and general, in the execution of staff tasks, coordination of staff members, and the efficient and prompt response of the staff. Personnel requirements consists of the following: Coordinate transportation services and planning with other headquarter's (HQ) at ASCC. Advises on employment, deployment, and capabilities of transportation assets required to accomplish personnel and cargo movement.
    - CofS.
    - 2 Liaison Officers.
    - Secy General Staff.
  - ***Paragraph 03, Inspector General (IG) Section.*** The IG Section is a special staff section which inquires into and reports on matters about the performance of the mission, state of discipline, efficiency, and economy by conducting inspections, investigations, surveys, and studies as directed by the commander and as prescribed by



- law and regulations; and receiving, investigating, and reporting on allegations, complaints, and grievances.
  - IG.
  - Trans IG.
  
- **Paragraph 04, Staff Judge Advocate (SJA) Section.** This special staff section supervises the administration of military justice and other legal matters in the command. It advises the commander, staff, and subordinate commanders and provides legal services on military law; administrative and contract law; claims; criminal law; legal assistance; and other related legal matters. The chief of the section, the SJA, serves on the commander's personal staff and as the senior judge advocate in the command. In this capacity the SJA is responsible for providing legal advice to the commander on all matters that affect the morale, good order, and discipline of the command.
  - SJA.
  - Senior Paralegal Non-Commissioned Officer (NCO).
  
- **Paragraph 05, Unit Ministry Team (UMT) Section.** This special staff section plans, manages, and executes religious support policies and programs. It supervises and coordinates area and denominational religious support for the TRANSCOM. The Chaplain advises the commander on religion, unit morale, and ethical issues as affected by religious support, and the impact of indigenous religions, to meet the religious and spiritual needs of the soldiers and other personnel. Establishes liaison and maintains contact with unit ministry teams of higher and subordinate units. This section provides a chaplain to Transportation Command Elements when requested. The senior chaplain in this section serves on the commander's personal staff.
  - 3 Chaplains.
  - 3 Chaplain Assistants.
  
- **Paragraph 06, Public Affairs Section.** The Public Affairs Section is a special staff section which advises the commander on the public affairs impact of planned or implemented operations; formulates, implements, and supervises public affairs actions for the command; informs soldiers of command information and their roles and responsibilities; serves as command spokesman to media; ensures information for public release is in compliance with security and policy requirements; conducts liaison with media representatives for support as authorized and appropriate; ensures that community relations activities support command mission; and serves in an advisory capability to the media.
  - Public Affairs Officer.
  - Public Affairs NCO.
  
- **Paragraph 07, G1 Section.** The G1 Section is the principal section handling all matters pertaining to military and civilian human resources. The G1 monitors personnel readiness and personnel services and manages the headquarters. Specific responsibility includes personnel management readiness; health and personnel service support; and

administration of discipline, awards, punishments, and transfers. This section requires the following personnel:

- Assistant Chief Of Staff (ACofS) G1.
  - Ch Human Resources SGT.
  - 2 Plans Officers.
  - Exec Admin Asst.
- ***Paragraph 08, Personnel Mgmt Br G1.*** The Personnel Management Branch has primary coordinating staff responsibility for managing personnel assets to include strength accounting, casualty reporting, and personnel requisitioning. It establishes and maintains the TRANSCOM safety program; coordinates postal services; provides advice and assistance to subordinate commanders on personnel support matters and maintains liaison with medical units to coordinate medical support. The Personnel Management Branch coordinates mortuary affairs support; develops estimates and studies of personnel requirements and recommends allocations based on priorities established by the commanders. The Branch establishes and maintains morale support activities; and in the absence of a Theater Army Personnel Command (TA PERSCOM), inprocesses and assigns personnel within the TRANSCOM and subordinate elements.
- Adjutant General.
  - Pers Management OFF.
  - Personnel Actions OFF.
  - Military Personnel Tech.
  - Sr Human Resources SGT.
  - Human Resources SGT.
  - 3 Human Resources Spec.
- ***Paragraph 09, G4 Section.*** The G4 Section prepares general logistics and operations plans and orders. Determines supply and transportation requirements. Monitors and analyzes maintenance functions and equipment readiness status. Conducts and coordinates meeting of operational and tactical transportation requirements supporting movement control functions. The G4 coordinates for all types of services including food preparation, organizational clothing & individual equipment (OCIE) operations, aerial delivery, transportation, handling, and storage of hazardous material. Personnel requirements are as follows:
- ACofS G4.
  - 3 Plans Officers.
  - Sr Transportation Supv.
  - Exec Admin Asst.
- ***Paragraph 10, Maintenance Br G4 .*** This branch provides staff supervision and overall coordinating responsibility for developing plans, policies, and procedures for internal maintenance support coordination for internal maintenance support for TRANSCOM and its subordinate units.

- Maintenance Mgmt Officer.
  - Marine Maint Officer.
  - Chief Maint Log NCO.
  - Marine Maint SGT.
  - Maintenance Mgmt NCO.
- **Paragraph 11, Supply Br G4** . This branch provides staff supervision and overall coordination responsibility for developing plans, policies, and procedures for internal supply support for the TRANSCOM and it's subordinate units
- Supply Management Officer.
  - Supply Systems Tech.
  - Sr Log Svc Supv.
  - 3 Supply Sergeants.
  - Mat Con/Acctg NCO.
- **Paragraph 12, Services Br G4** . This branch provides Engineer staff supervision and overall coordination responsibility for developing plans, policies, and procedures for internal services to include food service and subsistence operations for the TRANSCOM and it's subordinate units.
- Engineer Staff Officer.
  - Command Food Svc Tech.
- **Paragraph 13, G5 Section**. The G5 coordinates requirements for civilian/host nation support to Transportation Operations.
- Chief.
  - Government Functions Officer.
  - Intelligence Sergeant.
- **Paragraph 14, G6 Section**. The G6 provides automation and communications support for the TRANSCOM and subordinate transportation units. This section establishes electronic countermeasure procedures for subordinate headquarters.
- Chief.
  - Communications and Electronics (C-E) Officer
  - Info Management OFF
  - Info Systems Chief
- **Paragraph 15, Information Management Br G6**. The Information Management branch installs, troubleshoots, and maintains all internal automation requirements. It conducts automation security for subordinate units. It manages computer programs and equipment for the TRANSCOM and it's subordinate.
- Info Management Officer.

- Info Systems Tech.
  - Sr Info Systems OPR-MNT.
  - 2 Info Systems OPR-MNT.
- **Paragraph 16, C-E Br G6.** The C-E Branch manages the installation, troubleshooting, and maintenance of TRANSCOM and all subordinate units internal communications requirements.
- C-E Officer.
  - Signal Support Sys Chief.
  - Sr Sig Spt Sys Maint.
- **Paragraph 17, Deputy Commander for Transportation, G2/3.** The G-2/3 Section supervises the communications and security link between higher and lower headquarters. It is the operations and security center. It is the principal staff officer for all matters concerning security, training, operations and plans, and force development and modernization, prepares operation plans (OPLANs) and operation orders (OPORDs), coordinates and plans troop movements, route selection, movement priorities, locations, and prepares movement orders. The G-2/3 has the Internal Operations and Transportation Operations working directly for them.
- DC for Trans Ops/G2/3.
  - Aide-de-Camp.
  - Sr Trans Supervisor.
  - Executive Admin Asst.
  - Chauffeur.
- **Paragraph 18 Security/Ops Section, G2/3.** The deputy for internal operations develops deployment and placing plans for the TRANSCOM. This section has primary responsibility for force development and plans, watercraft operations, rear area operations and Nuclear, Biological, and Chemical (NBC). The G-2/3 specifically supervises the command training program. The Security and Operations Section develops deployment and placing plans.
- ACoS Scty/Plans/Ops.
  - Operations Sergeant.
- **Paragraph 19, Intel/Operations Br G2/3.** This branch prepares, authenticates, and publishes administrative/logistic plans and orders and operation plans and orders. It coordinates the displacement of subordinate commands and assignment of facilities and areas. It exercises staff supervision over deception activities.
- Plans Officer.
  - 2 Tactical Intelligence Officers.
  - 2 Plans Officers.

- Operations Sergeant.
- Senior Intelligence Sergeant.
- **Paragraph 20, Security Br G2/3.** Develops policies and reviews rear area protection (RAP) plans for the TRANSCOM commander and for the units and bases under the TRANSCOM
  - Physical Security Officer.
  - Physical Security NCO.
- **Paragraph 21, NBC Br G2/3.** This branch advises the TRANSCOM commander and staff on all matters pertaining to NBC defense and the concept for chemical unit support operations for subordinate units.
  - Chemical Officer.
  - NBC Officer.
  - Chemical Ops NCO.
- **Paragraph 22, Plans Movements G2/3.** The Plans and Movements Division provides strategic to operational planning for transportation operations worldwide. This section also deploys elements that serve as the Army component core of a joint movements center or combined movement center in support of an ASCC serving as a joint task force (JTF) or, when tasked, in support of a combatant commander.
  - Chief.
  - Transportation Officer.
  - Operations sergeant.
- **Paragraph 23, Watercraft Operations Section.** The Watercraft Operations Section provides strategic to operational level planning and oversight for all Army watercraft during both peacetime and contingency operations worldwide.
  - Water Move Officer.
  - Plans Officer.
  - 2 Terminal Ops OFF.
  - Marine Ops Officer.
  - Maine Maint Officer
  - Operations Sergeant.
  - 2 Operations Sergeant
- **Paragraph 24, Strategic Plans Br.** This Branch consists of two strategic planning cells that develop strategic and operational transportation plans for two major combat operations. They also perform transportation contingency planning for lesser regional conflicts and peacekeeping support operations.

- Two Team Chief.
  - Circulation Control Officer.
  - 6 Plans Officer.
  - Assistant Movements Officer
  - Terminal Officer
  - 2 Mobility Officer.
  - 2 Transportation Supervisor.
  - 2 Staff Movements NCO.
  - 2 Movements Supervisor.
- **Paragraph 25, Joint Movement Center (JMC).** This section provides two joint movements teams for major combat operations, or other joint requirements. They will deploy to provide the Army component core of two JMCs or combined movements centers in support of ASCCs serving as a JTF or, when tasked, in support of a combatant commander.
- 2 Team Chief.
  - Freight Movements Officer.
  - Terminal Operations Officer
  - Movements Control Officer.
  - Marine Terminal Ops Officer.
  - Assistant Movements Officer
  - Passenger Movements Officer
  - 2 Motor/Rail Trans Officer.
  - 2 Mobility Officers
  - 2 Transportation Supv.
  - 2 Operations Sergeant.
  - 2 Sr Movements NCO.
  - 2 Movements Supervisor.
  - Trans Mgmt NCO.
  - 2 Marine Ops NCO.
  - 2 Vehicle Drivers.
- **Paragraph 26, Company Headquarters.** The Company Headquarters provides command, control, administrative, and limited logistics support to the TRANSCOM and assigned or attached teams. This section provides internal security, training, food service, supply, organic maintenance support, visitor reception and accommodations, and Uniform Code of Military Justice for all assigned and attached personnel.
- Commander
  - First Sergeant.
  - Senior Food Opns SGT.
  - Supply SGT.
  - First Cook.
  - Human Resource SGT.

- Equip Rec/Parts SGT.
- Lt Wh Veh Mechanic.
- Vehicle Driver.
- 3 Cooks.
- Armorer.
- Supply Spec.

### Transportation Command Element (TCE)

D-6. **Mission.** To command, control and provide technical supervision of assigned or attached units supporting a contingency operation with all modes of transportation, terminal operations, movement control and related services including maintenance for rail and Army watercraft. When directed by the TRANSCOM, attaches to the TSC and serves as the TSC's executive agent for tactical transportation operations. When acting in this capacity, the TCE commander is dual hatted as the TSC's deputy commander for transportation. This organization may also be employed as the senior transportation element for a corps when the corps is employed as an Army force (ARFOR) headquarters.

D-7. **Assignment.** The TCE is assigned to a TRANSCOM; attached to a TSC as directed.

- **Methods of Operation.** The requirements for force projection operations demand that the TCE be able to deploy early and operate as the senior TRANSCOM in theater. The TSC will provide C2 for the unit. The TCE will also operate as the executive agent for tactical transportation operations for the TSC. They must have the C2 capability organic to the unit to provide all transportation services throughout the theater.
- **Functions.** The following provide a variety of functions to ensure the successful mission of the TCE.
  - **Paragraph 01, Command Section.** The Command Section commands, controls, and supervises all transportation organizations operating at EAC. It is responsible for transportation operations and plans, and force development and modernization, prepares OPLANs and OPORDs, coordinates and plans troop movements, route selection, movement priorities, locations, and prepares movement orders. The command has the Movement Control Division and the Transportation Operations Division working directly for them.
    - Commander.
    - Deputy Commander.
    - IG
    - Aide-de-Camp.
    - Command Sergeant Major.
    - IG NCO
    - Executive Admin Assistant
    - Chauffeur

- ***Paragraph 02, Plans and Operations Section.*** The Plans and Operations Section provides limited staff expertise to the TCE in security, rear area protection, and NBC. It also develops, coordinates, publishes, and distributes the movements program using the available intratheater common-user transportation assets. It coordinates and forecasts long-term movement and communications requirements, receives and updates higher headquarters on movement activities, intelligence, and any information concerning transportation systems, facilities, equipment, and personnel. Collects, monitors, and evaluates data concerning lines of communication (LOC) capabilities. It develops theater container policy with the USTRANSCOM and develops standard formats and procedures for collecting and presenting statistical data. This section coordinates requirements for HNS to transportation operations. The Plans and Operations Section provides the commander advice on military law and public affairs.
  - Plans Officer.
  - Judge Advocate.
  - Psyop/CA Officer.
  - 3 Plans Officer.
  - MMS Ops Officer.
  - Public Affairs Officer
  - NBC Officer.
  - Mobility Officer.
  - Chemical Ops NCO.
  - Transportation Supr.
  - Operations Sergeant
  - Staff Movements NCO.
  - Force Protection Supv
  - Intelligence Sergeant.
  - Movements Supervisor.
  - Movements NCO
  - Movements Specialist
  
- ***Paragraph 03, Communications and Automation Branch.*** This branch maintains the equipment and systems for the Headquarters & Headquarters Company (HHC) and supervises and assists in the maintenance of communications and automation equipment and systems in subordinate units. In this section personnel coordinate the communications system organic to the HHC and subordinate elements of the TCE. They provide technical advice and staff assistance to the TCE commander, TCE headquarters staff, and subordinate commanders. They coordinate with area communications elements to ensure efficient communications within the TCE, with the TSC C-E officer, and with attached and supported units. This section interacts with the TRANSCOM G6 and integrates databases for new units. It coordinates signal support actions requirements with the corps signal officer. It maintains data on combat service support (CSS) hardware and software use on all automated information system (AIS) operated by TCE units.



- Info Systems Tech.
  - Signal Support Sys Ch.
  - Info Systems Team Ch.
  - Sr Info Systems Specialist
  - 2 Info Sys Opr-Mnt.
  - 2 Signal Support Sys Maint.
- ***Paragraph 04, Movement Control Division.*** The Movement Control Division integrates movement control plans, operations, and highway regulation. This section has a Movements Plans Branch, a Movements Operations Branch, and a Highway Regulation Branch. All branches communicate and exchange data with the transportation community. These branches are discussed below.
- Transportation Officer.
  - Movement Control Officer.
  - Operations Sergeant.
- ***Paragraph 05, Movements Operation Branch.*** The Movement Operations Branch is responsible for all movement activities in the theater. This section develops, implements, and monitors theater and corps movements, and programs and commits transportation ground and air assets for logistical support. It maintains operational status, provides information and guidance to subordinate groups and battalions, maintains in-transit visibility (ITV), conducts transportation planning, plans support for contingency operations, and coordinates exceptional movement requirements. It will coordinate the evacuation of civilian refugees and US civilians with appropriate authorities.
- 3 Movements Control Officers
  - Plans Officer
  - Mobility Officer.
  - Transportation Supervisor.
  - Staff Movements NCO.
  - Movements Supervisor.
  - 2 Movements NCO
  - 4 Movements Specialists
- ***Paragraph 06, Highway Regulation Branch.*** The Highway Regulation Branch is responsible for highway regulation plan for theater and coordinates the plan with the Corps Support Commands (COSCOM) Movement and Transport Division. When augmented by appropriate detachments, it five movements control officers provides a central headquarters to execute highway regulation and maintain intransit visibility of tactical and non-tactical moves within its area of responsibility.
- 3 Movements Control Officer.
  - Plans Officer.
  - 2 Circulation Control Officer.
  - Transportation Supervisor.

- 2 MMS NCO
  - Senior Movements NCO.
  - Movements Supervisor.
  - 2 Movements NCO
  - 4 Movements Specialists
- ***Paragraph 07, Transportation Operations Division.*** The Operations Division integrates transportation management, examines priorities, and evaluates transportation plans ensuring compliance with command guidance. It evaluates and ensures that the appropriate mode is used. The operations division has a Highway Operations Branch, Air Operations Branch, Rail Operations Branch, Terminal Operations Branch, and a Watercraft Operations Branch. All branches communicate and exchange data with the transportation community. These branches are discussed below.
- 2 Transportation Officer.
  - Operations Sergeant.
- ***Paragraph 08 Highway Operations Branch.*** The Highway Operations Branch advises on the use and implementation of assigned motor assets. Provides guidance on positioning of truck units throughout the theater. It maintains status of motor assets in the area of operations. Monitors theater-assigned motor assets to ensure they are not over tasked.
- Transportation Officer.
  - 2 Motor Rail Officer.
  - Transportation Supervisor.
  - Operations Sergeant.
  - Movements Supervisor.
  - Transportation Mgmt NCO.
  - 3 Movements Specialists
- ***Paragraph 09, Airlift Operations Branch.*** The Airlift Operations Branch advises on the use and implementation of assigned Army and Air Force air assets. Provides guidance on positioning of air assets throughout the theater. It receives airlift requests from the transportation command element (TCE). Maintains status of air assets in the area of operations. Monitors assigned airlift assets to ensure they are not over tasked. Reviews, validates, and recommends changes to regularly scheduled airlift routes.
- 2 Transportation Officers.
  - Transportation Supervisor.
  - Transportation Logistics NCO.
- ***Paragraph 10, Rail Operations Branch.*** The Rail Operations Branch advises on the use and implementation of assigned rail assets. Provides guidance on positioning of rail units throughout the theater. It maintains status of rail assets in the area of operations. Monitors assigned rail assets to ensure they are not over tasked.

- 2 Motor/Rail Transportation Officers.
  - Transportation Supervisor.
  - Senior Train Movements Supervisor
- ***Paragraph 11, Terminal Operations Branch.*** The terminal branch advises on the use and implementation of subordinate terminal units. Monitors and coordinates operations for all terminal operations in the theater; motor, rail, intermodal, air, and sea. Maintains status of terminal transportation assets in the area of operations.
- 3 Terminal Operations Off.
  - Transportation Supervisor.
  - Operations Sergeant.
  - Movements Supervisor.
  - Movements NCO.
  - 2 Movements Specialists
- ***Paragraph 12, Watercraft Operations Branch.*** The Watercraft Operations Branch advises on the use and implementation of assigned watercraft assets. Provides guidance on positioning of watercraft units throughout the theater. It maintains status of watercraft assets in the area of operations. Monitors assigned watercraft assets to ensure they are not over tasked. Monitors operational status of all direct support watercraft maintenance assets.
- 2 Terminal Operations Officer.
  - Marine Operations Officer.
  - Transportation Supervisor.
  - Operations Sergeant.
- ***Paragraph 13, Admin Log Section.*** The Admin Log Section provides limited staff expertise to the TCE in personnel, maintenance, supply, and services. This section supplements the Admin Log capability of the TSC.
- Logistics Officer.
  - Engineer Staff Officer.
  - Personnel Management Officer.
  - Senior Ord Log Officer.
  - Chief Engineer.
  - Supply Systems Tech.
  - Construction Operation SGT.
  - Sr, Human Resources Sergeant.
  - Ch, Mech Maint MgmtLog NCO
  - Marine Maintenance NCO.
  - Subsistence Supervisor.
  - Supply Sergeant

- **Paragraph 14, Company Headquarters.** The company headquarters supports all soldiers assigned or attached to the TCE headquarters. It also provides maintenance personnel to assist in the maintenance of equipment authorized the TCE. As applicable, company headquarters personnel: develop the perimeter defense plan, secure the TCE headquarters area and provide details as required, provide unit administrative support, provide unit supply, provide power generation, and maintain unit discipline.
  - Commander.
  - First Sergeant.
  - Senior First Cook.
  - Supply Sergeant.
  - Human Resources Sergeant.
  - Lt Wheeled Vehicle Mech.
  - Vehicle Driver
  - 3 Cooks.
  - Armorer.

### **Movement Control Battalion (Echelons Above Corps) (MCB[EAC])**

D-8. **Mission.** The MCB (EAC) commands, controls, and supervises MCTs. The battalion controls the movement of all personnel, units, and materiel in the theater. The battalion maximizes the use of available transportation assets.

#### **D-9. Capabilities.**

- Commands, controls, and provides technical supervision of assigned or attached transportation movement control detachments as listed below.
  - 55506LA00 - Port Movement Control Team
  - 55506LB00 - Area Movement Control Team
  - 55506LD00 – Movement Regulating Team
  - 55506LE00 - Movement Control Cargo Documentation Team
- Coordinates movement programming, highway regulation, and transportation support.
- When augmented by appropriate teams
  - Operates a central headquarters to execute these missions and maintain intransit visibility of tactical and non-tactical moves within a geographical AOR. These areas are defined by the TCE.
  - Coordinates with engineers on MSR repair and maintenance schedules.
  - Manages a consolidated property book for subordinate teams.

D-10. **Assignment.** The MCB (EAC) is assigned to a TSC and normally attached to a TCE.

- **Methods of Operation.** The Headquarters and Headquarters Detachment (HHD) MCB commands and controls MCTs behind the corps rear boundary. The battalion plans,

coordinates, and manages movement programming, highway regulation, and transportation support for the theater. It provides a central headquarters for all MCT's assigned or attached to the battalion. The battalion provides asset visibility and maintains in-transit visibility of tactical and nontactical moves within the TCE defined geographical area.

- **Functions.** The following provide a variety of functions to ensure the successful mission of the MCB (EAC).
  - ***Paragraph 01, Battalion Headquarters.*** The battalion headquarters commands and controls the planning, direction, and supervision of attached and assigned MCT's. Personnel requirements are as follows:
    - Commander.
    - Executive Officer.
    - S2/3
    - S6
    - Chaplain
    - S1
    - S4
    - Command Sergeant Major.
    - Vehicle Driver
  - ***Paragraph 02, Battalion S1 Section.*** The S1 section performs internal administrative services, personnel actions, mail distribution, and awards support to the battalion. Personnel requirements are as follows:
    - 2 Human Resource SGT's.
    - Paralegal Specialist.
    - Human Resource specialist.
  - ***Paragraph 03, S2/3 Section.*** The S2/3 is responsible for movement planning, security, and the manning of the operations center. The S2/3 provides supervision for the Plans, Programming, and Operations Section (paragraph 04) and Highway Traffic Section (paragraph 05). Personnel requirements are as follows:
    - Transportation supervisor
    - NBC NCO
    - Intelligence analyst
    - Vehicle Driver
    - Trans Management Coordinator
  - ***Paragraph 04, Plans, Programs, and Operations Section.*** The Plans, Programs, and Operations section works for the S3. It is responsible for movement activities in its designated geographical area. The section develops, implements, and monitors theater movements and program; and commits transportation ground and air assets for logistical support. Personnel requirements are as follows:

- 3 Movement control officers
  - Mobility warrant officer
  - Senior movements NCO
  - Two movement NCOs
  - 4 Transportation movement coordinators
- ***Paragraph 05, Highway Traffic Section.*** This section works for the S3. It is responsible for the area highway regulation plan. This section plans, schedules, develops, coordinates, and regulates the traffic circulation plan (TCP). This section also requires two radios operating on the alternate net control station (NCS). Personnel requirements include the following:
- 2 Circulation control officers
  - 2 Movement control officer
  - Circulation control NCOs
  - 3 Movements control NCOs
  - Trans management coordinator
- ***Paragraph 06, Battalion S4 Section.*** The S4 section plans, coordinates, and supervises all unit logistical activities. The S4 communications systems operate on the command net and the admin/log nets. Personnel requirements are as follows:
- Property book officer
  - 2 Supply NCOs
  - Supply specialist
- ***Paragraph 07, Unit Ministry Team.*** The Unit Ministry Team plans and provides religious support to all personnel assigned or attached to the battalion including collective worship services, ministry for mass casualties and hospitalized soldiers. Advises commander and staff on religious, moral soldier welfare issues, and the impact of indigenous religions. Establishes liaison and maintains contact with unit ministry teams of higher and adjacent units. It is comprised of one Chaplain and one Chaplain's Assistant.
- ***Paragraph 08, S6 Section.*** This section maintains the equipment and systems for the HHC and supervises and assists in the maintenance of communications and automation equipment and systems in subordinate units. The section personnel coordinate the communications system organic to the headquarters company and subordinate elements of the BN. It provides technical advice and staff assistance to the BN commander, BN headquarters staff, and subordinate commanders. It coordinates with area communications elements to ensure efficient communications within the BN and with attached and supported units. This section interacts with the transportation group S6 and integrates databases for new units. It maintains data on CSS hardware and software use on all AIS operated by subordinate units.

- Section Chief
  - Sr Info Systems Team Chief
  - Signal Support Maint
  - 2 Info Sys Specialist
  - 2 Signal Support Sys Spec
- ***Paragraph 09, Detachment Headquarters.*** The Headquarters Detachment headquarters commands, controls, and provides limited administrative and logistical support to the battalion and attached teams. Personnel requirements are as follows:
- Commander
  - Detachment sergeant
  - Armorer/Supply SGT
  - Human Resource Specialist
  - NBC specialist
  - Cook (to provide support to the battalion)

## **Movement Control Battalion (Corps)**

D-11. **Mission.** The Corps MCB commands, controls, and supervises MCTs. The battalion controls the movement of all personnel, units, and materiel in the theater. The battalion maximizes the use of available transportation assets.

### **D-12. Capabilities.**

- Provides command, control, and supervision of assigned and attached movement control detachments as listed below.
  - 55506LA00 - Port Movement Control Team
  - 55506LB00 - Area Movement Control Team
  - 55506LC00 - Division Support Movement Control Team
  - 55506LD00 – Movement Regulating Team
  - 55506LE00 - Movement Control Cargo Documentation Team
- Maintains intransit visibility of tactical and nontactical vehicle movements in the corps.
- Provides asset visibility throughout the corps.

D-13. **Assignment.** The Corps MCB is assigned to a corps.

- **Methods of Operation.** The HHD MCB commands and controls MCTs forward of the CORPS rear boundary. The battalion plans, coordinates, and manages movement programming, highway regulation, and transportation support for the CORPS. It provides a central headquarters for all MCTs assigned or attached to the battalion. The battalion

provides asset visibility and maintains in-transit visibility of tactical and nontactical moves within the corps AOR.

- **Functions.** The following provide a variety of functions to ensure the successful mission of the corps MCB.
  - ***Paragraph 01, Battalion Headquarters.*** The battalion headquarters commands and controls the planning, direction, and supervision of attached and assigned MCTs. Personnel requirements are as follows:
    - Commander.
    - Executive Officer.
    - S2/3
    - S6
    - Chaplain
    - S1
    - S4
    - Command Sergeant Major.
    - Vehicle Driver
  - ***Paragraph 02, Battalion S1 Section.*** The S1 section performs internal administrative services, personnel actions, mail distribution, and awards support to the battalion. Personnel requirements are as follows:
    - 2 Human Resource SGTs.
    - Paralegal Specialist.
    - Human Resource specialist.
  - ***Paragraph 03, S2/3 Section.*** The S2/3 is responsible for deployment planning, security, and the manning of the operations center. This section provides supervision for the Plans, Programming, and Operations Section (paragraph 04) and Highway Traffic Section (paragraph 05). Personnel requirements are as follows:
    - Plans Officer
    - Transportation supervisor
    - NBC NCO
    - Intelligence analyst
    - Vehicle Driver
    - Trans Management Coordinator
  - ***Paragraph 04, Plans, Programs, and Operations Section.*** The Plans, Programs, and Operations section works for the S3. It is responsible for movement activities in its designated geographical area. The section develops, implements, and monitors theater movements; and programs and commits transportation ground and air assets for logistical support. Personnel requirements are as follows:



- 3 Movement control officers
  - Mobility warrant officer
  - Senior movements NCO
  - Two movement NCOs
  - 4 Transportation movement coordinators
- ***Paragraph 05, Highway Traffic Section.*** The section works for the S3. The section regulates the TCP. It also plans, schedules, develops, and coordinates the highway regulation plan and unit movement requirements. Personnel requirements for this section include the following:
- 2 Circulation control officers
  - 2 Movement control officer
  - Circulation control NCOs
  - Sr, Movement control NCO
  - 2 Movements control NCOs
  - Trans management coordinator
- ***Paragraph 06, Battalion S4 Section.*** The S4 section plans, coordinates, and supervises all unit logistical activities. The S4 communications systems operate on the command net and the admin/log nets. Personnel requirements are as follows:
- Property book officer
  - 2 Supply NCOs
  - Supply specialist
- ***Paragraph 07, Unit Ministry Team.*** The Unit Ministry Team plans and provides religious support to all personnel assigned or attached to the battalion including collective worship services, ministry for mass casualties and hospitalized soldiers. Advises commander and staff on religious, moral soldier welfare issues, and the impact of indigenous religions. Establishes liaison and maintains contact with unit ministry teams of higher and adjacent units. It is comprised of one Chaplain and one Chaplain' Assistant.
- ***Paragraph 08, S6 Section.*** This section maintains the equipment and systems for the HHC and supervises and assists in the maintenance of communications and automation equipment and systems in subordinate units. The section coordinates the communications system organic to the headquarters company and subordinate elements of the BN. It provides technical advice and staff assistance to the BN commander, BN headquarters staff, and subordinate commanders. It coordinates with area communications elements to ensure efficient communications within the BN, and with attached and supported units. The section interacts with the Group S6 and integrates databases for new units. It coordinates signal support actions requirements with the S6 officer. It maintains data on CSS hardware and software use on all automated information systems (AIS) operated by subordinate units.

- Section Chief
  - Sr Info Systems Team Chief
  - 2 Info Sys Specialist
  - 2 Signal Support Sys Spec
- ***Paragraph 09, Detachment Headquarters.*** The detachment headquarters commands, controls, and provides limited administrative and logistical support to the battalion and attached teams. Personnel requirements are as follows:
- Commander
  - Detachment sergeant
  - Armorer/Supply SGT
  - Human Resource Specialist
  - NBC specialist
  - Cook (to provide support to the battalion)

## Port MCT

D-14. **Mission.** The port MCT expedites, coordinates, and supervises transportation support of units, cargo, and personnel into, through, and out of air, land, or water ports. The exception is the movement of bulk POL using a pipeline.

### D-15. Capabilities.

- Provides movement control functions at aerial port of debarkation (APOD) or seaport of debarkation (SPOD) and small army operated air and sea terminals.
- Expedites throughput of cargo through the transportation system.
- Expedites the port clearance of cargo and personnel arriving or departing by air or sea.
- Provides technical expertise to transportation users transiting the port area.
- In conjunction with the port commander, coordinates transportation support and highway clearance for forward movement.
- Provides intransit visibility of units, cargo, and personnel transiting an aerial or seaport.
- Coordinates with the mode battalion for transportation of personnel and materiel.
- Trains and assists transportation users with transportation and discrepancy reporting documentation procedures.
- Commits mode operators to transport personnel and materiel.
- Maintains visibility of transportation assets.

D-16. **Assignment.** The Port MCT is assigned to a Corps or Theater, attached to a Movement Control Battalion 55406F000 or 55606F000.

- **Methods of Operation.** The Port MCT operates at aerial and seaports. This team expedites the throughput of cargo through the transportation system. It provides in-transit visibility of units, cargo, and personnel transiting PODs and POEs. The team deploys on an as needed basis supporting onward movement and sustainment operations.

- **Functions.** The following provide a variety of functions to ensure the successful mission of the Port MCT.
  - **Paragraph 01, Port MCT.** The Port MCT expedites the port clearance of Army cargo and personnel. Personnel requirements are as follows:
    - Transportation officer as the officer in charge and operations supervisor.
    - Movement control officer.
    - Personnel officer.
    - Health service material officer.
    - Mobility warrant officer.
    - Movement supervisor.
    - Trans Management NCO
    - Stock control supervisor.
    - Vehicle driver
    - 6 Traffic management specialists.

## Area MCT

D-17. **Mission.** The Area MCT expedites, coordinates, and supervises transportation support of units, cargo, and personnel into, through, and out of air, land, or water ports. The exception is the movement of bulk POL using a pipeline.

### D-18. Capabilities.

- Validates transportation requirements, coordinates transportation support, highway clearance and inbound clearance for moving units, personnel, and cargo.
- Coordinates transportation movements, diversions, reconsignments, and transfers of units, cargo and personnel.
- Provides technical expertise to transportation users within its assigned geographic area of responsibility.
- Provides intransit visibility of movements of unit equipment and sustainment cargo in a corps or theater army area.
- Coordinates with the mode battalion for transportation of personnel and materiel.
- Trains and assists transportation users with transportation and discrepancies reporting documentation procedures.

D-19. **Assignment.** The Area MCT is assigned to a Corps or Theater, attached to a Movement Control Battalion 55406F000 or 55606F000.

- **Methods of Operation.** The Area MCT supports inland transfer points and supply support activities. It expedites cargo throughput and provides ITV of units, cargo and personnel moving through an assigned geographic area. An MCB provides command and control and

administrative support for the team. The MCT deploys, as needed, to support combat units and sustainment operations.

- **Functions.** The following provide a variety of functions to ensure the successful mission of the Area MCT.
  - ***Paragraph 01, Area MCT.*** The Area MCT performs movement control functions for movements of units, cargo, and personnel (except bulk POL by pipeline). The team validates transportation requirements and coordinates transportation support, highway clearance, cargo and personnel movements, diversions, and reconsignments. It provides technical expertise to transportation users and provides ITV of unit equipment and sustainment cargo. The team has mode tasking authority for transportation assets. Personnel requirements are as follows:
    - Movement control officer
    - Mobility warrant officer.
    - Chief, Movements supervisor
    - Movements supervisor.
    - Transportation management supervisor
    - 2 Transportation management NCOs
    - Vehicle operator
    - 5 Transportation management coordinators.

## Division Support Movement Control Team

D-20. **Mission.** The Division Support MCT augments the Division Transportation Office (DTO).

D-21. **Capabilities.**

- Executes highway regulation for non-tactical movements within the division.
- Plans and coordinates the use of main supply routes (MSRs) within the division.
- Operates the first destination reporting point.
- Provides technical expertise to transportation users in the division area.
- Provides intransit visibility of unit equipment and sustainment cargo movements in the division area.
- Provides movement control support to tactical road marches and division movements.
- Provides additional capability to the movements control officer for support of operations.

D-22. **Assignment.** The Division Support MCT is assigned to a corps, attached to a division.

- **Methods of Operation.** The Division Support MCT assists the DTO with movement programming, highway regulation, and division transportation support. The team deploys as needed to support the division. It assists with the execution of division highway regulation for nontactical movements, the planning and coordinating of the division MSRs, and provides movement control for tactical and nontactical road marches.

- **Functions.** The following provide a variety of functions to ensure the successful mission of the Division Support MCT.
  - **Paragraph 01, Division Support MCT.** The Division Support MCT plans, coordinates, and executes highway regulation for all division movements on the division MSRs. It provides technical expertise and assistance to transportation users in the division area. They assist the DTO with ITV in the division area. Personnel requirements are as follows:
    - Movement control officer.
    - Mobility warrant officer.
    - Movement supervisor.
    - Transportation management NCO.
    - 3 Transportation management coordinator.

## Movement Regulating Team (MRT)

D-23. **Mission.** The MRT operates up to four separate movement regulating points.

D-24. **Capabilities.**

- Observes, assesses, and reports progress of tactical and non-tactical transportation movements along MSRs.
- Adjusts movement schedules as necessary to coordinate the movement of authorized traffic.
- Implements changes in unit moves or vehicle and convoy routings.
- Resolves movement conflicts.
- Provides first destination reporting points.

D-25. **Assignment.** The MRT is assigned to a Corps or Theater, attached to a Movement Control Battalion 55406F000 or 55606F000.

- **Methods of Operation.** This unit operates on MSRs and other designated controlled routes to regulate convoys and serve as the eyes and ears of the MCB. The unit deploys on an as needed basis on mission requirements.
- **Functions.** The following provide a variety of functions to ensure the successful mission of the MRT.
  - **Paragraph 01, MRT.** The MRT observes, assesses, and reports progress of tactical and nontactical movements along MSRs. The team adjusts movement schedules as necessary. It coordinates and implements changes in unit moves and convoy routing. The team resolves movement conflicts and operates first destination reporting points. Personnel requirements are as follows:
    - 4 Movement control officers.
    - Chief, Movements Supervisor.

- 3 Movements Supervisor.
- Transportation management supervisor.
- 2 Transportation management NCO
- 5 Transportation management coordinators.

## Cargo Documentation Team

D-26. **Mission.** The Cargo Documentation Team provides cargo documentation for the transshipment of cargo in water, air, motor, and rail terminals.

D-27. **Capabilities.**

- Performs documentation required to load, discharge or transship 500 short tons of general cargo or 480 containers daily in a water, rail, intermodal, or air terminal.
- Assists in the coordinated defense of the unit's area or installation.

D-28. **Assignment.** The Cargo Documentation Team is assigned to a Corps or Theater, attached to a Movement Control Battalion 55406F000 or 55606F000.

- **Methods of Operation.** The Cargo Documentation Team deploys, as needed, to support onward movement of combat units and sustainment operations.
- **Functions.** The following provides the function to ensure the successful mission of the Cargo Documentation Team.
  - **Paragraph 01, Cargo Documentation Team.** This team provides cargo documentation for the transshipment of cargo in water, air, rail, and motor terminals. Personnel requirements are as follows:
    - Movements supervisor.
    - Transportation management supervisor.
    - 2 Transportation management NCOs.
    - 4 Transportation management coordinators.

## Appendix E

# Transportation Movement Release (TMR)

E-1. This appendix is a guide for developing the TMR. The TMR is not a standard form, but it is a set of data elements in a format that is flexible and can be adapted to any theater. Each theater must publish implementing procedures for its own TMR.

E-2. The TMR commits transportation assets, verifies the capability of the consignee to receive the shipment, and serves as the unique identifier of movement requirements. The TMR is used to account for the transportation assets during movement. Figure E-1 shows an example of a TMR.

**NOTE:** Figure E-1 depicts the data that may be included in a TMR but each theater TCE must tailor the information in the TMR to fit their situational needs.

**Transportation Movement Release (TMR)**  
**TMR General Information and Associated Documentation**

TMR No:	<input type="text"/>	GBL/CBL No:	<input type="text"/>
Movement Request Control No:	<input type="text"/>	Export Traffic Release No:	<input type="text"/>
Requestor Organization:	<input type="text"/>	Freight Warrant No:	<input type="text"/>
Requestor POC:	<input type="text"/>	Exercise Name:	<input type="text"/>
Requestor Phone No:	<input type="text"/>	Project Cd:	<input type="text"/>
Prime TCN:	<input type="text"/>	Transportation Priority Cd:	<input type="text"/>
RDD:	<input type="text"/>	Fund Cite:	<input type="text"/>
DTG TMR Sent to Mode:	<input type="text"/>	PIC Date:	<input type="text"/>
DTG TMR Created:	<input type="text"/>	PIC Required:	<input type="text"/>
ACA No:	<input type="text"/>	PIC POC:	<input type="text"/>
Movement Credit No:	<input type="text"/>	PIC POC Phone No:	<input type="text"/>

**Requested Spot, Load, and Pull Information**

Requested Spot Date:	<input type="text"/>	Requested Load Time:	<input type="text"/>
Requested Spot Time:	<input type="text"/>	Requested Pull Date:	<input type="text"/>
Requested Load Date:	<input type="text"/>	Requested Pull Time:	<input type="text"/>

**Mode Information**

Mode Meth Cd	Mode Unit Cd	Commercial Carrier Cd	Type Asset Cd	No of Assets

**Origin Pick-up Locations**

Origin DODAAC	Origin MCE Cd	Origin Unit Designation	Origin Unit POC	Origin POC Phone No	Origin City	Origin Installation	Origin Street Address/Bldg No	Origin Grid Coord

**Origin Cargo**

Origin Cmdty Desc	Origin Water Cmdty Cd	Origin Type Cgo Cd	Origin Water Spec Hdl Cd	Origin Air Cmdty Cd	Origin Air Spec Hdl Cd	Origin NSN	Origin HAZMAT PSN	Origin Compatibility Group Cd	Origin UN Class Cd/Division No	Origin Supply Class Cd

Origin TCN	Origin Pes	Origin Wt	Origin Cu	Origin Lgth	Origin Wdth	Origin Ht	Origin Container No	Origin Compatibility Container No	Origin Pallet Designator
Total									

**Origin Passengers**

Origin Pass Type Cd	Origin Pass Qty	Origin Pass Bag Pes	Origin Pass Bag Wt	Origin Pass Bag Cu
Total				

**Figure E-1. Transportation Movement Release (TMR)**

Delivery Locations										
Dest Stop-Off	Dest DODAAC	Dest MCE Cd	Dest Unit Designation	Dest Unit POC	Dest POC Phone No	Dest City	Dest Installation	Dest Street Address/Bldg No	Dest Grid Coord	
A										
B										
Z										

Destination Cargo												
Dest Stop-Off	Dest DODAAC	Dest Cmdty Desc	Dest Water Cmdty Cd	Dest Type Cgo Cd	Dest Water Spec Hdl Cd	Dest Air Cmdty Cd	Dest Air Spec Hdl Cd	Dest NSN	Dest HAZMAT PSN	Dest Compatibility Group Cd	Dest UN Class Cd/Division No	Dest Supply Class Cd
A												
B												
Z												

Dest TCN	Dest Pcs	Dest Wt	Dest Cu	Dest Lgth	Dest Width	Dest Ht	Dest Container No	Dest Compatibility Container No	Dest Pallet Designator
Total Stop									
Total Stop									
Total Stop									
Total									

Destination Passengers						
Dest Stop-Off	Dest DODAAC	Dest Pass Type Cd	Dest Pass Qty	Dest Pass Bag Pcs	Dest Pass Bag Wt	Dest Pass Bag Cu
A						
Total Stop						
B						
Total Stop						
Z						
Total Stop						
Total						

Intermodal Assets							
Intermodal Asset Cd	Intermodal Asset Cd Desc	No of Assets	Consolidated Container No	Pallet Designator	Intermodal Asset Serial No	Intermodal Asset Owner Cd	Intermodal Asset Dest DODAAC

Container Information								
Type Shipment	Van No	Container Owner Cd	Container TCN	Container No	Container Size	Ocean Carrier Cd	Container Dest DODAAC	

**Movement Release Remarks**

Figure E-1. Transportation Movement Release (TMR) (Continued)

**TMR GENERAL INFORMATION AND ASSOCIATED DOCUMENTATION DESCRIPTIONS:**

- The TMR No (Transportation Movement Release Number) entry should be an eight-position alphanumeric entry.
  - The first two-positions of the TMR number is the Origin MCE Cd (Movement Control Element Code). It is the MCE Cd of the organization creating the TMR.
  - The third position of the TMR number is the Month Cd. The month code will be the month code of the Requested Spot Date.
  - The fourth position of the TMR number is the Mode Meth Cd. The mode method code is the code of the mode method assigned to the TMR.



- Positions five through eight of the TMR number are the sequence number. This is a number given to each TMR for its own unique identity.
- The Movement Request Control No entry is used to identify movement request that the TMR was created for.
- The Requestor Organization entry is used to identify the organization requesting the movement.
- The Requestor POC (Requestor Point of Contact) entry is used to enter the name of the POC for the unit requesting the transportation.
- The Requestor Phone No entry is used to enter the telephone number of the POC for the unit requesting the transportation.
- The Prime TCN (Prime Transportation Control Number) entry should be a seventeen-position entry. Positions 1 through 6 are the Consignor DODAAC. Positions 7 through 10 are the four-position Julian date of when the request was created. Positions 11 through 14 are the serial number and positions 15 through 17 are all Xs.
- The RDD (Required Delivery Date) entry is the date that the cargo or passengers must be delivered.
- The DTG TMR Sent to Mode (Date Time Group Transportation Movement Release Sent to Mode) entry is the date that the TMR was provided to the Mode unit delivering the cargo or passengers.
- The DTG TMR Created (Date Time Group Transportation Movement Release Created) entry is the date that the TMR was created.
- The ACA No (Airlift Clearance Authority Number) entry is used to enter the airlift clearance authority number for cargo being shipped by air.
- The Movement Credit No entry is used to enter the Movement Credit No for a convoy issued by the clearance authority. (A movement credit is the allocation, a clearance, granted to one or more vehicles in order to move over a controlled route in a fixed time according to movement instructions.)
- The GBL/CBL No (Government/Commercial Bill of Lading Number) entry is the bill of lading number of cargo assigned to the TMR.
- The Export Traffic Release No entry is issued by the Ocean Cargo Clearance Authority (OCCA) to authorize cargo to be exported.
- The Freight Warrant No entry is the freight warrant number of cargo assigned to the TMR.
- The Exercise Name entry is used to connect movements to a specific exercise.

- The Project Cd entry is used to depict that the TMR is in support of a specific exercise.
- The Transportation Priority Cd entry is used to depict the transportation priority of the cargo or passengers being moved.
- The Fund Cite entry specifies a fund citation that a movement can be charged to.
- The PIC Required (Positive Inbound Clearance Required) entry indicates if a positive inbound clearance is required.
- The PIC Date (Positive Inbound Clearance Date) entry is the date that the PIC was received from the destination MCT.
- The PIC POC (Positive Inbound Clearance Point of Contact) entry is the name of the point of contact with whom the PIC was confirmed.
- The PIC POC Phone No (Positive Inbound Clearance Point of Contact Phone Number) entry is the phone number of the point of contact with whom the PIC was confirmed.

#### **REQUESTED SPOT, LOAD, AND PULL INFORMATION ENTRY DESCRIPTIONS:**

- The Requested Spot Date entry is the day that the customer wants the asset spotted at the consignor.
- The Requested Spot Time entry is the time that the customer wants the asset spotted at the consignor.
- The Requested Load Date entry is the date requested by the shipper that the asset be loaded.
- The Requested Load Time entry is the time that the customer wants to load the asset at the consignor.
- The Requested Pull Date entry is the date requested by the shipper that the asset be pulled from the consignor.
- The Requested Pull Time entry is the time that the customer wants the asset pulled from the consignor.

#### **MODE INFORMATION ENTRY DESCRIPTIONS:**

- The Mode Meth Cd (Mode Method Code) entry is the mode method used to ship the cargo.
- The Mode Unit Cd entry identifies the military mode unit that is assigned to the movement.
- The Commercial Carrier Cd entry is the code of the commercial carrier assigned to the movement.

- The Type Asset Cd entry is the code of the asset assigned to the movement.
- The No of Assets (Number of Assets) entry is the number of assets assigned to the movement.

### **ORIGIN PICK-UP LOCATIONS ENTRY DESCRIPTIONS:**

- The Origin DODAAC (Origin Department of Defense Activity Address Code) entry is the DODAAC of the consignor where the cargo or passengers are to be picked up.
- The Origin MCE Cd (Origin Movement Control Element Code) entry is the MCE supporting the consignor where the cargo or passengers are to be picked up.
- The Origin Unit Designation entry is a narrative designation that uniquely identifies a specific unit at whose location pick-up is to occur.
- The Origin Unit POC (Origin Unit Point of Contact) entry identifies the POC of the consignor.
- The Origin POC Phone No (Origin Point of Contact Phone Number) entry is the phone number of the origin POC.
- The Origin City entry is the city where the cargo or passengers are to be picked up.
- The Origin Installation entry is the installation where the cargo or passengers are to be picked up.
- The Origin Street Address/Bldg No (Origin Street Address/Building Number) entry is the street address/building number where the cargo or passengers are to be picked up.
- The Origin Grid Coord (Origin Grid Coordinates) entry is the grid coordinate where the cargo or passengers are to be picked up.

### **ORIGIN CARGO ENTRY DESCRIPTIONS:**

- The Origin Cmdty Desc (Origin Commodity Description) entry is the description of the cargo to be picked up.
- The Origin Water Cmdty Cd (Origin Water Commodity Code) entry is the commodity code of the cargo to be picked up.
- The Origin Type Cgo Cd (Origin Type Cargo Code) entry identifies certain types of cargo, primarily those that are hazardous.
- The Origin Water Spec Hdl Cd (Origin Water Special Handling Code) entry indicates the type of special handling required by an item to ensure proper transportation without damage to the item, its surroundings, or its security.
- The Origin Air Cmdty Cd (Origin Air Commodity Code) entry is the commodity code of the cargo to be picked up.

- The Origin Air Spec Hdl Cd (Origin Air Special Handling Code) entry indicates the type of special handling required by an item to ensure proper transportation without damage to the item, its surroundings, or its security.
- The Origin NSN (Origin National Stock Number) entry identifies the NSN of the cargo to be picked up.
- The Origin HAZMAT PSN (Origin Hazardous Material Proper Shipping Name) entry identifies the PSN of the hazardous cargo to be picked up.
- The Origin Compatibility Group Cd entry identifies the compatibility code of the hazardous cargo to be picked up.
- The Origin UN Class Cd/Division No (Origin United Nations Class Code/Division Number) entry identifies the United Nations class code/division number of the hazardous cargo to be picked up.
- The Origin Supply Class Cd entry identifies the supply class of the cargo to be picked up.
- The Origin TCN (Origin Transportation Control Number) entry identifies the TCNs of the cargo to be picked up.
- The Origin Pcs (Origin Pieces) entry is the total number of pieces for the shipment unit that is being picked up.
- The Origin Wt (Origin Weight) entry is the total weight of the shipment unit that is being picked up.
- The Origin Cu (Origin Cube) entry is the total cubic feet of the shipment unit that is being picked up.
- The Origin Lgth (Origin Length) entry is the total length of the largest piece of cargo being picked up when the cargo is oversized.
- The Origin Wdth (Origin Width) entry is the total width of the largest piece of cargo being picked up when the cargo is oversized.
- The Origin Ht (Origin Height) entry is the total height of the largest piece of cargo being picked up when the cargo is oversized.
- The Origin Container No entry identifies the number of the container being picked up.
- The Origin Consolidated Container No entry identifies the number of the consolidated container being picked up.
- The Origin Pallet Designator entry identifies the pallet being picked up.

- The Origin Total Pcs (Origin Total Pieces) entry identifies the total number of pieces of cargo or baggage.
- The Origin Total Wt (Origin Total Weight) entry identifies the total weight of cargo or baggage.
- The Origin Total Cu (Origin Total Cube) entry identifies the total cubic feet of cargo or baggage.

### **ORIGIN PASSENGERS ENTRY DESCRIPTIONS:**

- The Origin Pass Type Cd (Origin Passenger Type Code) entry is a code that identifies the type of passengers to be moved.
- The Origin Pass Qty (Origin Passenger Quantity) entry is the number of passengers to be moved.
- The Origin Pass Bag Pcs (Origin Passenger Baggage Pieces) entry contains the number of pieces of baggage that the customer is requesting to be moved with the passengers.
- The Origin Pass Bag Wt (Origin Passenger Baggage Weight) entry contains the total weight of the baggage that the customer is requesting to be moved with the passengers.
- The Origin Pass Bag Cu (Origin Passenger Baggage Cube) entry contains the total cube of the baggage that the customer is requesting to be moved with the passengers.
- The Origin Pass Total Qty (Origin Passenger Total Quantity) entry contains the total number of passengers of all types.
- The Origin Pass Bag Total Pcs (Origin Passenger Baggage Total Pieces) entry identifies the total number of pieces of passenger baggage.
- The Origin Pass Bag Total Wt (Origin Passenger Baggage Total Weight) entry identifies the total weight of passenger baggage.
- The Origin Pass Bag Total Cu (Origin Passenger Baggage Total Cube) entry identifies the total cubic feet of passenger baggage.

### **DELIVERY LOCATIONS ENTRY DESCRIPTIONS:**

- The Dest Stop-Off (Destination Stop-Off) entry should be a one-position alphabetic entry. If the movement is a single stop movement (i.e., one consignee), the user will enter an "S". If the movement is a multi-stop movement (i.e., more than one consignee), an "A" will be entered for the first stop and a "Z" for the last stop. A four stop movement request would have A, B, C, and Z stops. For a multi-stop movement, all letters may be used except O, S, and I.
- The Dest DODAAC (Destination Department of Defense Activity Address Code) entry is the DODAAC of the organization where the cargo or passengers will be delivered.

- The Dest MCE Cd (Destination Movement Control Element Code) entry is the MCE supporting the consignee where the cargo or passengers are to be delivered.
- The Dest Unit Designation (Destination Unit Designation) entry is a narrative designation that uniquely identifies a specific unit.
- The Dest Unit POC (Destination Unit Point of Contact) entry identifies the POC of the consignee.
- The Dest POC Phone No (Destination Point of Contact Phone Number) entry is the phone number of the destination POC.
- The Dest City (Destination City) entry is the city where the cargo or passengers are to be delivered.
- The Dest Installation (Destination Installation) entry is the installation where the cargo or passengers are to be delivered.
- The Dest Street Address/Bldg No (Destination Street Address/Building Number) entry is the street address/building number where the cargo or passengers are to be delivered.
- The Dest Grid Coord (Destination Grid Coordinates) entry is the grid coordinate where the cargo or passengers are to be delivered.

#### **DESTINATION CARGO ENTRY DESCRIPTIONS:**

- The Dest Cmdty Desc (Destination Commodity Description) entry is the description of the cargo to be delivered.
- The Dest Water Cmdty Cd (Destination Water Commodity Code) entry is the commodity code of the cargo to be delivered.
- The Dest Type Cgo Cd (Destination Type Cargo Code) entry identifies certain types of cargo, primarily those that are hazardous
- The Dest Water Spec Hdl Cd (Destination Water Special Handling Code) entry indicates the type of special handling required by an item to ensure proper transportation without damage to the item, its surroundings, or its security.
- The Dest Air Cmdty Cd (Destination Air Commodity Code) entry is the commodity code of the cargo to be delivered.
- The Dest Air Spec Hdl Cd (Destination Air Special Handling Code) entry indicates the type of special handling required by an item to ensure proper transportation without damage to the item, its surroundings, or its security.
- The Dest NSN (Destination National Stock Number) entry identifies the NSN of the cargo to be delivered.

- The Dest HAZMAT PSN (Destination Hazardous Material Proper Shipping Name) entry identifies the PSN of the hazardous cargo to be delivered.
- The Dest Compatibility Group Cd entry identifies the compatibility code of the hazardous cargo to be delivered.
- The Dest UN Class Cd/Division No (Destination United Nations Class Code/Division Number) entry identifies the United Nations class code/division number of the hazardous cargo to be delivered.
- The Dest Supply Class Cd (Destination Supply Class Code) entry identifies the supply class of the cargo to be delivered.
- The Dest TCN (Destination Transportation Control Number) entry identifies the TCNs of the cargo to be delivered.
- The Dest Pcs (Destination Pieces) entry is the total number of pieces for the shipment unit that is being delivered.
- The Dest Wt (Destination Weight) entry is the total weight of the shipment unit that is being delivered.
- The Dest Cu (Destination Cube) entry is the total cubic feet of the shipment unit that is being delivered.
- The Dest Lgth (Destination Length) entry is the total length of the largest piece of cargo being delivered when the cargo is oversized.
- The Dest Width (Destination Width) entry is the total width of the largest piece of cargo being delivered when the cargo is oversized.
- The Dest Ht (Destination Height) entry is the total height of the largest piece of cargo being delivered when the cargo is oversized.
- The Dest Container No entry identifies the number of the container being delivered.
- The Dest Consolidated Container No entry identifies the number of the consolidated container being delivered.
- The Dest Pallet Designator entry identifies the pallet being delivered.
- The Dest Total Stop Pcs (Destination Total Stop Pieces) entry identifies the total number of pieces of cargo or baggage for all stops.
- The Dest Total Stop Wt (Destination Total Stop Weight) entry identifies the total weight of cargo or baggage for all stops.

- The Dest Total Stop Cu (Destination Total Stop Cube) entry identifies the total cubic feet of cargo or baggage for all stops.
- The Dest Total Pcs (Destination Total Pieces) entry identifies the total number of pieces of cargo or baggage.
- The Dest Total Wt (Destination Total Weight) entry identifies the total weight of cargo or baggage.
- The Dest Total Cu (Destination Total Cube) entry identifies the total cubic feet of cargo or baggage.

### **DESTINATION PASSENGERS ENTRY DESCRIPTIONS:**

- The Dest Pass Type Cd (Destination Passenger Type Code) entry is a code that identifies the type of passengers to be moved.
- The Dest Pass Qty (Destination Passenger Quantity) entry is the number of passengers that are to be moved.
- The Dest Pass Bag Pcs (Destination Passenger Baggage Pieces) entry contains the total number of pieces of baggage that are being dropped off at the consignee for the stop-off.
- The Dest Pass Bag Wt (Destination Passenger Baggage Weight) entry contains the total weight of the baggage that is being dropped off at the consignee for the stop-off.
- The Dest Pass Bag Cu (Destination Passenger Baggage Cube) entry contains the total cube of the baggage that is being dropped off at the consignee for the stop-off.
- The Dest Pass Total Stop Qty (Destination Passenger Total Stop Quantity) entry contains the total number of passengers of all types by stop-off.
- The Dest Pass Bag Total Stop Pcs (Destination Passenger Baggage Total Stop Pieces) entry identifies the total number of pieces of passenger baggage for all stops.
- The Dest Pass Bag Total Stop Wt (Destination Passenger Baggage Total Stop Weight) entry identifies the total weight of passenger baggage for all stops.
- The Dest Pass Bag Total Stop Cu (Destination Passenger Baggage Total Stop Cube) entry identifies the total cubic feet of passenger baggage for all stops.
- The Dest Pass Total Qty (Destination Passenger Total Quantity) entry contains the total number of passengers of all types at all stops.
- The Dest Pass Bag Total Pcs (Destination Passenger Baggage Total Pieces) entry identifies the total number of pieces of passenger baggage for all stops.



- The Dest Pass Bag Total Wt (Destination Passenger Baggage Total Weight) entry identifies the total weight of passenger baggage for all stops.
- The Dest Pass Bag Total Cu (Destination Passenger Baggage Total Cube) entry identifies the total cubic feet of passenger baggage for all stops.

## INTERMODAL ASSETS ENTRY DESCRIPTIONS:

**NOTE:** Intermodal assets are assets that can be moved on more than one conveyance. For example, a 463L pallet can be moved by air, barge, rail, or on a trailer. The Intermodal Assets section of the TMR is used to track these assets so that they can be returned to their owner. Although containers are intermodal assets, they are tracked separately in the Container Information section.

- The Intermodal Asset Cd entry is a code that identifies the kind of intermodal asset used in the movement of cargo.
- The Intermodal Asset Cd Desc entry is the in-the-clear description of an intermodal asset code.
- The No of Assets entry is the number of intermodal assets that are associated with the intermodal asset type used in the movement of cargo.
- The Consolidated Container No entry is the number of the consolidated container being delivered.
- The Pallet Designator entry identifies the pallet being delivered.
- The Intermodal Asset Serial No entry is the serial number of the intermodal asset being delivered.
- The Intermodal Asset Owner Cd entry identifies the owner of the intermodal asset being delivered.
- The Intermodal Asset Dest DODAAC (Intermodal Asset Destination Department of Defense Activity Address Code) entry is the DODAAC that the intermodal asset is being delivered to.

## CONTAINER INFORMATION ENTRY DESCRIPTIONS:

- The Type Shipment entry is the type of container that is being moved.
- The Van No entry is the number of the van being moved.
- The Container Owner Cd entry is the code of the owner of the container being moved.
- The Container TCN (Container Transportation Control Number) entry is the transportation control number of the container being moved.
- The Container No (Container Number) entry is the number of the container being moved.
- The Container Size entry is the size of the container being moved.

- The Ocean Carrier Cd entry is the code of the ocean carrier moving the container.
- The Container Dest DODAAC (Container Destination Department of Defense Activity Address Code) entry is the DODAAC of the organization where the container is to be delivered.

**MOVEMENT RELEASE REMARKS ENTRY DESCRIPTION:**

- The Movement Release Remarks entry is used to add remarks associated with the movement release.

## Appendix F

# Movement Control Communications

### CRITICAL COMMUNICATIONS

F-1. Movement control organizations must have access to a dedicated communications system in order to adequately support the same operating tempo (OPTEMPO) of the warfighter. Situational awareness is critical to providing timely support through anticipatory logistics. Movement control commanders need reliable long-range communications capability in order to command and control, or direct the activities of their subordinate executing elements which doctrinally operate 50 to 500 miles apart across the battlespace. Just as combat commanders require reliable communications to focus combat power to execute dominant maneuver and precision engagement, movement control commanders must have the same communications capability to focus logistics power and conduct force tracking. Without this capability, we put at risk the combat commander's confidence in the logistics process and the Army's ability to reach the objectives of our force projection strategy. Communications equipment required by transportation movement control units includes radios, telephones, and satellite terminals.

### Radio Communications

F-2. The communication requirements of a unit's mission determine the type and extent of radio equipment required. Radios are mounted in vehicles organic to the unit. Movement control units typically require long-range very high frequency (VHF) and high frequency (HF) radio sets. These radios are used for mobile operations or to supplement common-user communications facilities. Long-range HF radio sets are required to permit communications between movement control command headquarters (HQ) and their subordinate elements, which often operate at remote locations great distances from its higher headquarters.

F-3. Movement control commanders, S2/S3s, command posts, and operations sections require dual long-range FM radios or because of the demand to operate in two radio nets. Typically, one radio is used to monitor the higher HQ command/operations net, and the other is used to participate in the element's own unit net.

### Telephone Communications

F-4. Digital non-secure voice landline (wire) telephones are a quick, efficient means of communication from a fixed location. Movement control HQ elements, command posts, operations and highway traffic division sections, maintenance sections, and detachments all require wire subscriber access.

### Satellite Communications

F-5. Transportation movement control units are essential to the efficient use of the limited transportation assets. Movement control units regulate the flow of units and materiel, and report the progress of units and materiel across the transportation system. These units require reliable long-range voice and data communications to ensure communications with shippers, mode operators,

customers and subordinate executing elements from 50 to 500 miles away. The mission of the movement control teams (MCTs) requires them to disperse and operate throughout the distribution network at various operational nodes and locations, such as hubs, aerial port of debarkations (APODs), seaport of debarkations (SPODs), and along MSRs. The MCTs doctrinally operate autonomously at remote locations that are great distances from the movement control battalion (MCB) HQ. Many of these sites are out of the Tri-Service Tactical (TRITAC) and mobile subscriber equipment (MSE) signal grids and these units have critical communications requirements prior to TRITAC or MSE systems availability. Tactical and commercial satellite communications (SATCOM) provides these units with the required non-line of sight, long-range communications capability for command and operational control. Additionally, movement management AISs use SATCOM to send and receive data used to process lift requirements, manage and coordinate movements, plan and execute deployments/redeployments, and to conduct force and asset tracking.

F-6. At the strategic level, movement command and control elements, responsible for coordinating strategic lift in an austere environment, require satellite-based voice and data communications with CONUS. This helps obtain the information required to plan, program, and execute entry of arriving forces.

### **In-transit Visibility (ITV)**

F-7. Movement control elements require the MTS to determine the location and communicate with tactical wheeled vehicle assets located throughout the battlespace. MTS is a satellite based tracking and communication system consisting of a mobile unit mounted in the vehicle and a base unit station controlled and monitored by movement control operators. MTS incorporates Global Positioning System, automatic identification technology, non-line of site message capability between the mobile and base systems, and mapping technologies. MTS primary function is to allow movement control personnel to track, locate, and communicate with in-transit transportation vehicles at a near real-time basis anywhere on the battlefield. It allows the movement control community the ability to redirect and divert all prime movers mounted with MTS based on changing battlefield requirements and tactical unit relocations, thus providing velocity to a transportation-based distribution system. MTS can provides an embedded movement control capability that can improve the distribution flow on MSRs, thus reducing the prospect of fratricide. Movement control personnel can directly communicate with drivers anywhere on the battlefield, thus warning them of dangers, submitting new tasks, and redirecting them around route obstacles and congestion. Integrating the automatic identification technology into MTS will provide visibility of the cargo that the vehicle is transporting.

## Appendix G

# Road Movement Planning

G-1. A movement graph is a method of graphically portraying movements along a single route. It shows the relationship between time and distance and highlights any conflicts between columns scheduled for movement on the route. Movement planners can use movement graphs during planning when conflicts are anticipated or when restrictions are applied to routes.

G-2. This appendix is divided into four sections. Section I shows planning factors for highway movement. Section II outlines fundamentals of graphing, route restrictions, and movement tables. Section III describes the graphing, managing, and preparing of movement tables for a highway movement. Section IV outlines how to manage movements over multiple routes using a critical time and point graph.

## Highway Movement Planning Factors

### MOVEMENT MEASUREMENT

G-3. Movements are measured by calculating how long it takes to move a given distance. The three methods of measurement are speed, pace, and rate of march. Movement planners normally use rate of march in performing movement calculations.

- **Speed.** Speed is the actual rate at which a vehicle is moving at a given time as shown on the speedometer. It is expressed as kilometers or miles per hour (kmph or mph).
- **Pace.** Pace is the regulated speed of a convoy or an element as set by a lead vehicle, the pacesetter. It is constantly adjusted to suit road, terrain, and weather conditions. Pace is also expressed as kmph or mph.
- **Rate of March.** Rate of march is the average number of kilometers or miles traveled in any specific time period. It includes short periodic halts and short delays, but it does not include long halts, such as those for consuming meals or for overnight stops. It is expressed in kilometers or miles in the hour (kmih or mih).

### TIME AND DISTANCE FACTORS

G-4. Time and distance factors (see Figure G-1) are used to perform a wide range of calculations for planning highway movements. They can be used to conduct detailed planning to develop movement tables. They can also be used to conduct expedient planning and calculating to manage movement request.

#### Distance Factors

G-5. Distance factors are expressed in kilometers or meters. The terms used to describe distance factors are as follows:

- Length of any column or element of a column is the length of roadway that it occupies. It is measured from the front bumper of the lead vehicle to the rear bumper of the trail vehicle and includes all gaps inside the column.

- Road space is the length of a column, plus any additional space (safety factor) added to the length to prevent conflict with preceding or succeeding traffic.
- Gap is the space between vehicles, march units, serials, and columns. It is measured from the trail vehicle of one element to the lead vehicle of the following element. The gap between vehicles is normally expressed in meters. The gap between march elements is normally expressed in kilometers.
- Lead is the space between the heads of elements in a convoy or between heads of successive vehicles, march units, serials, or columns.
- Road distance is the distance from point to point on a route, normally expressed in kilometers.
- Road clearance distance is the distance that the head of a column must travel for the entire column to clear the RP or any point along the route. Route clearance distance equals the column's length or road space plus road distance.

## Time Factors

G-6. Time is expressed in hours or minutes. The terms used to describe time factors are as follows:

- Pass time (or time length) is the time required for a column or its elements to pass a given point on a route.
- Time space is the time required for a column or its elements to pass any given point on a route plus any additional time (safety factor) added to the pass time.
- Time gap is the time measured between vehicles, march units, serials, or columns as they pass a given point. It is measured from the trail vehicle of one element to the lead vehicle of the following element.
- Time lead is the time measured between individual vehicles or elements of a column, measured from head to head, as they pass a given point.
- Time distance is the time required for the head of a column or any single vehicle of a column to move from one point to another at a given rate of march.
- Road clearance time is the total time a column or one of its elements requires to travel the road distance and clearance point along the route or the RP. Road clearance time equals the column's pass time or time space plus time distance.

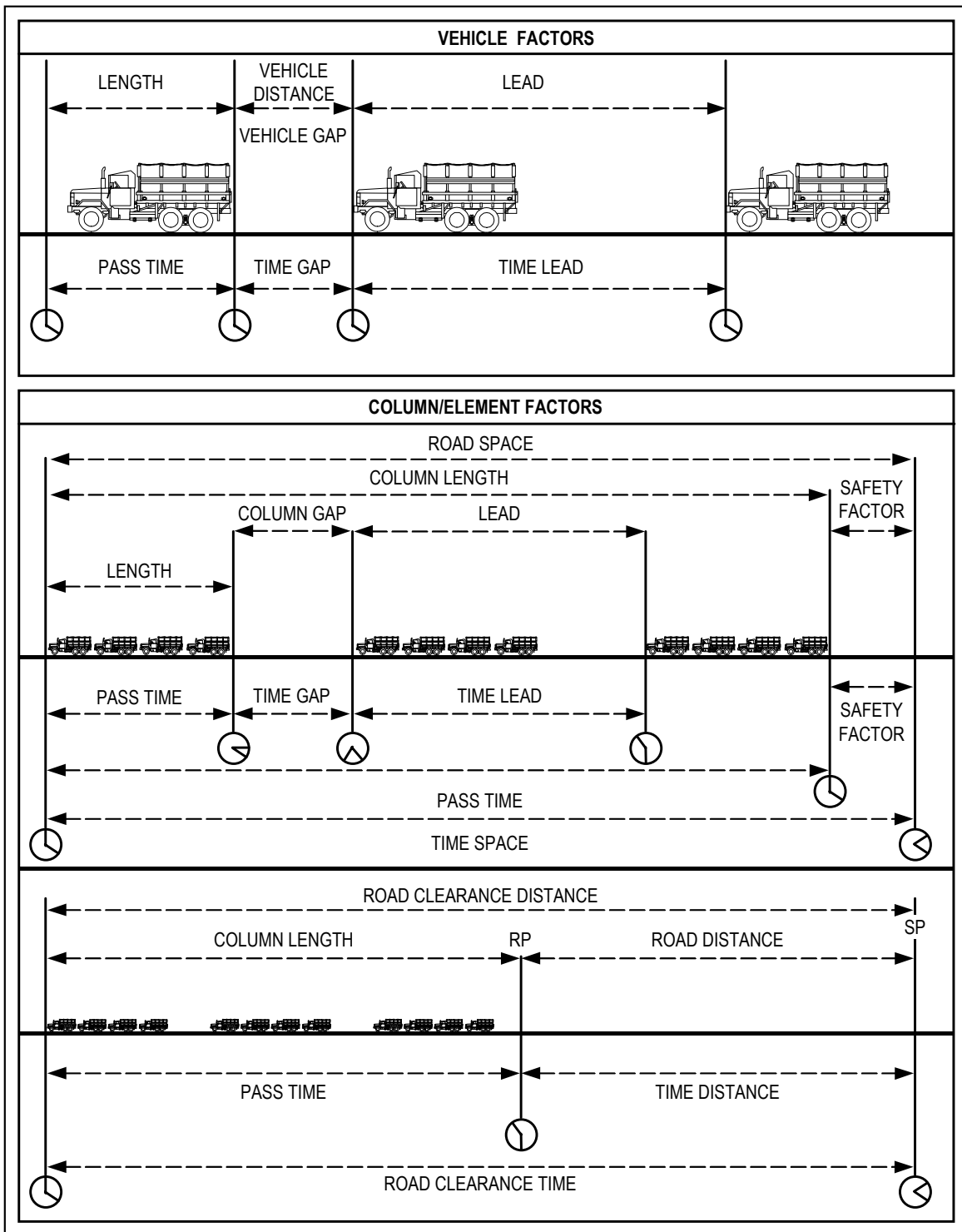

Figure G-1. Time and Distance Factors

## Time, Distance, and Rate Calculations

G-7. Time, distance, and rate factors are used to make scheduling calculations for columns of any size. When two of the three factors are known, the third can be found by using one of following equations as shown in Figure G-2.

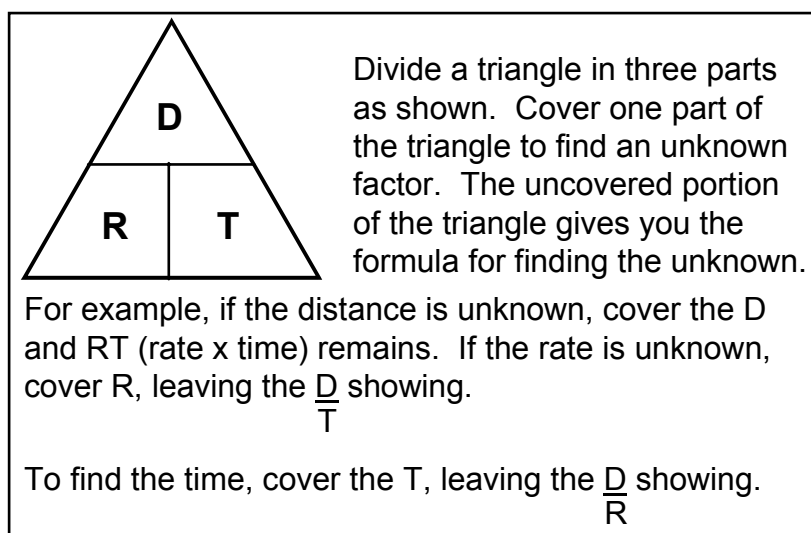

Figure G-2. Finding an Unknown Factor of Time, Distance, or Rate

- **Determining Time.** Time equals distance divided by rate. If the distance is 210 km and the rate of march is 42 kmih, the time is 5 hours:  $210 \div 42 = 5$ .
- **Determining Distance.** Distance equals rate multiplied by time. If the rate of march is 40 kmih and time is 4 hours, the distance is 160 km:  $40 \times 4 = 160$ .
- **Determining Rate.** Rate equals distance divided by time. If a convoy travels for 5 hours to complete a 190 km trip, its rate of march is 38 kmih:  $190 \div 5 = 38$ .

## Arrive and Clear Time Calculations

G-8. To manage movements on main supply routes (MSR) by using location or column scheduling, movement control organizations can use an expedient method of planning and calculating. Both requestors and movement control organizations must understand and apply time and distance factors associated with the movement of convoys on MSRs. Moving units must make calculations as part of their movement planning and movement requests.

G-9. The minimum essential information needed is the arrive and clear times at SPs, intermediate CPs, and RPs. Therefore, theater Army (TA), corps, and division standard operating procedures (SOPs) should specify a clearance request format that requires requesting units to calculate these arrive and clear times (see Figure G-3). The division transportation officer (DTO), highway traffic division (HTD), or movement control battalion (MCB) may have to perform these calculations for large unit movements or special movements. They should check the accuracy of unit requests.



TO: CDR 112th MCB ATTN: 1124th MCT		THRU: CDR 34th CSG		FROM: 32nd Corps Spt Bn ATTN: S4		DATE: 26 Mar 19XX EXT # X6060		
<b>SECTION I MOVEMENT DATA</b>								
MOVING UNIT 128th S&S Co.	CONVOY CDR CPT SMITH	START POINT GRID: NX110300 LOC: CP 7	RELEASE POINT GRID: NX410410 LOC: CP 2	TYPE OF MOVEMENT UNIT RELOCATION				
MOVEMENT DATE: 29 Mar 19XX				SP TIME: 0700				
CONVOY ORGANIZATION	# SERIALS 1	SERIAL GAP N/A	# MU 2	MU GAP 5 min	VEH GAP 50M			
CHECK POINTS	DISTANCE (KM) BETWEEN PTS	ARRIVE	CLEAR	ROUTE DESCRIPTION	CRITICAL PTS/HALTS			
SP CP 7	XXXXXXXXXXXXXXXXX X	0700	0709	MSR DODGE				
CP 4	15 km	0723	0732	MSR DODGE				
CP 10	6 km	0732	0741	MSR DODGE				
RP CP 2	14 km	0753	0802	MSR DODGE				
<b>SECTION II VEHICLE/LOAD DATA - CONVOY COMPOSITION</b>								
# OF TRACKS 0	# WHEELS 43		HEAVIEST VEH/WT/MLC M932 TRACT W/M871 TRL/92, 340/51					
QTY	MODEL	DESCRIPTION	LOAD INFO	L	W	H	WT	OTHER/ HAZMAT
24	M871	TRL, 22 1/2T		358	96	103	60,760	
27	M932	TRACT, 5T		280	115	113	31,580	
2	M1009	CUCV		192	95	75	6,720	
8	M1008	CUCV, P/U		185	89	76	8,400	
5	M925	TRK, 5T, D/S		327	115	116	32,458	
6	M105A2	TRL, 1 1/2T		166	83	98	5,670	
6	M101A1	TRL, 3/4T		147	74	83	2,850	
1	M936	TRK, WRKR, 5T		356	115	113	36,729	
REQUESTORS NAME, TITLE, PHONE: TALBERT, RAYMOND, SSG, X6666								
SIGNATURE								
<b>SECTION III</b>								
MOVEMENT CLEARED BY:				MOVEMENT CREDIT #:				
CLEARANCE PASSED TO:				AT DTG:				
POSITIVE INBOUND CLEARANCE BY:				AT DTG:				
				DTG:				

**Figure G-3. Sample Clearance Request**

G-10. Use time, distance, and rate factors to calculate arrive and clear times. The arrive time is the time the first vehicle in the column will reach an SP, CP, or RP. The arrive time is derived from calculating the time distance. The clear time is the time the last vehicle in the column will clear that SP, CP, or RP. The clear time is derived from calculating the pass time.

G-11. Calculate arrive times as follows:

- To calculate the arrive time at the first CP (see also Table G-1), take the distance from the SP to the first CP, divide by the planned rate of march, and multiply by 60 minutes.

**Table G-1. Calculating Arrive Times (First CP)**

EXAMPLE	Distance from SP to first CP - 8 km March rate - 30 km/h
SOLUTION	$8 \div 30 = .26$ hours $\times 60 = 16$ minutes  If the SP time is 0800, then the arrive time at the first CP will be 0816.

- To calculate the arrive time at the second CP (see also Table G-2), take the distance from the first CP to the second CP, divide by the rate of march, and multiply by 60.

**Table G-2. Calculating Arrive Times (Second CP)**

EXAMPLE	Distance between CPs - 9 km March rate - 30 km/h
SOLUTION	$9 \div 30 = .30$ hours $\times 60 = 18$ minutes  If the arrive time at the first CP is 0816, then the arrive time at the second CP will be 0834.

**NOTE: Continue this method to calculate the arrive time at succeeding CPs through the RP.**

- To calculate the clear times at each CP, planners must determine the pass time. Calculating pass time requires calculations for density (Table G-3), time gaps (Table G-4), road space (Table G-5), and pass time (Table G-6).

**Table G-3. Calculating Pass Times (Density)**

DENSITY =	$\frac{1,000 \text{ (meters)}}{\text{gap} + \text{average length of vehicle}}$		
EXAMPLE	If the gap is 50 meters and the average length of the vehicle in the column is 9 meters, then--		
DENSITY =	$\frac{1,000}{50 + 9}$	=	$\frac{1,000}{59}$ = 16.94 = 17 vehicles per km

**Table G-4. Calculating Pass Times (Time Gaps)**

**NOTE:** Time gaps =  $(\text{number of march units} - 1) \times \text{march unit time gap} + (\text{number of serials} - 1) \times [\text{serial time gap} - \text{march unit time gap}]$ .

EXAMPLE	If a column has two serials with three march units and the time gap between the march unit is 5 minutes and the time gap between serials is 10 minutes, then--
TIME GAPS	$= ([6 - 1] \times 5) + ([2 - 1] \times 5) = (5 \times 5) + (1 \times 5) = 25 + 5 = 30 \text{ minutes}$

**Table G-5. Calculating Pass Times (Road Space)**

	$\frac{\text{Number of vehicles}}{\text{density}} + \frac{\text{time gaps} \times \text{rate}}{60 \text{ minutes}}$
EXAMPLE	Number of vehicles = 102 Density = 17 per km rate = 30 km/h time gaps = 30 minutes $\text{road space} = \frac{102}{17} + \frac{30 \times 30}{60} = 6 + 15 = 21 \text{ km}$

**Table G-6. Calculating Pass Times (Pass Time)**

Pass time =	$\frac{\text{road space} \times 60}{\text{rate}}$
EXAMPLE	Continuation from previous examples.  $\text{Pass time} = \frac{21 \times 60}{30} = \frac{1,260}{30} = 42 \text{ minutes}$

G-12. The pass time at the SP is 42 minutes after the first vehicle crosses the SP. If the arrive time at the SP is 0800, the clear time at the SP will be 0842. If the arrive time at the first CP is 0816, the clear time at the first CP will be 0858. Use this same method to calculate the arrive and clear times at succeeding CPs to the RP.

G-13. The pass time will stay the same throughout the route as long as the march rate and density do not change. If the march rate or density changes, then recalculate the pass time to determine the new clear time. Calculations are simplified by the following:

- Preparing and using conversion tables for changing US common distances to metric distances, number of vehicles to pass time, and distance to time.

- Standardizing variables to reduce calculation time. When possible, use standard march rates and density.
- Using automated programs to calculate arrive and clear times such as the military application program package.

## GRAPHING

G-14. Movement graphs can be prepared on any type of graph paper. The vertical axis shows distance and the horizontal axis shows time. The lower left corner of the graph represents zero kilometers (or miles) and the earliest start time of the movement. The planner creating the graph must apply a scale to the vertical and horizontal axis as shown in Figure G-4.

G-15. The scale of the vertical axis is a division of the total distance. The top number on the vertical axis is the greatest number of km (or miles) to be traveled by any element on the route. The distance scale shown in Figure G-4 is 3 km per block.

G-16. The scale of the horizontal axis is a division of the total time. The time at the end of the horizontal scale shows the latest planning time to complete all movements planned for the route. The time scale shown in Figure G-4 is 12 minutes per block.

G-17. Critical points along the route, such as built up areas, road junctions, and checkpoints (CPs) are shown along the vertical axis on the same scale as that of the graph. The start point (SP) and release point (RP) can also be annotated alongside the CP if all movements begin and end at the same CP.

G-18. The graph at Figure G-4 shows the time and distance scales, critical points, CPs, and a plotted line representing the movement of one vehicle (or the first vehicle of a column) from the SP (Newport) to Jackson Heights. Based on the scale of each block representing 3 km and 12 minutes, the head of the convoy will leave Newport at 0400, travel 90 km to Jackson Heights, and arrive at 0700. Using the formula to determine march rate ( $R = D \div T$ ) the march rate is 30 kmph.

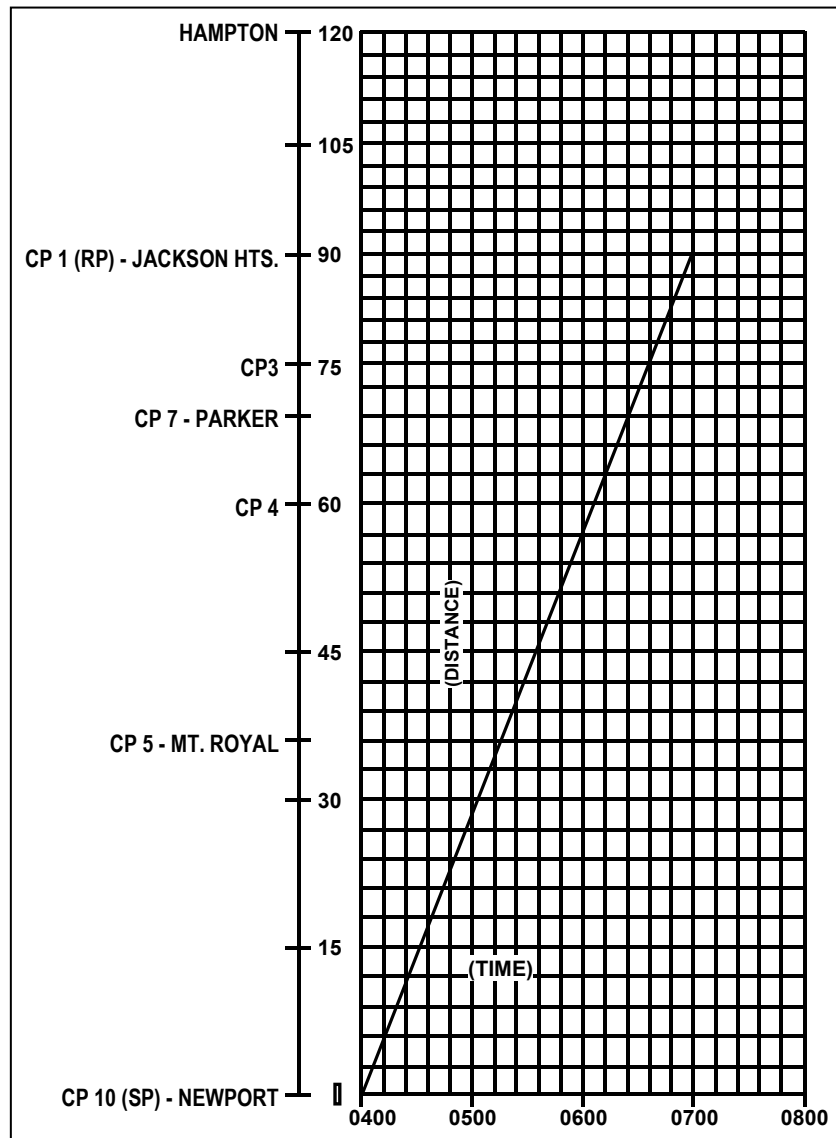

Figure G-4. Schedule of Head of Column

G-19. March columns, serials, and march units are represented on a graph by parallel diagonal lines like the ones shown in Figure G-5. The vertical space between the diagonal lines is the length of roadway (length) occupied by the column. It is measured along the vertical scale. The horizontal space is the time it takes for the column to pass any given point (pass time or time length).

G-20. The head of the column is plotted at the intersection of the SP on the vertical scale and start time on the horizontal scale. The clear time of the head of the column is plotted at the intersection of the RP on the vertical scale and the clear time on the horizontal scale.

G-21. The trail of the column is plotted at the intersection of the same SP on the horizontal scale. The trail vehicle's start time is calculated by adding the pass time to the start time of the first vehicle.

The clear time of the trail vehicle is plotted at the intersection of the RP on the vertical scale and its clear time on the horizontal scale. The trail vehicle's clear time is calculated by adding the pass time to the clear time of the first vehicle.

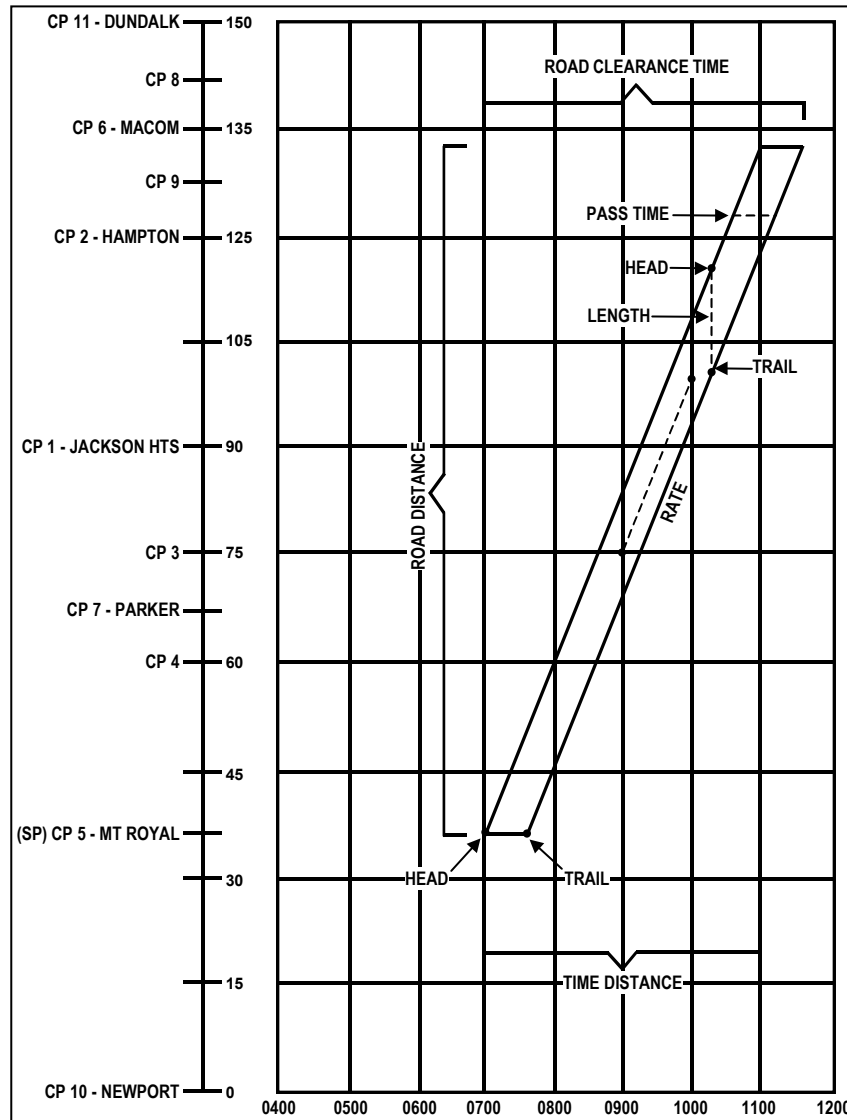

**Figure G-5. March Graph Showing Movement of a Column**

G-22. The graph now completely pictures the movement of one column. The vertical and horizontal scales reveal the following information:

- The two parallel diagonal lines show the head and the trail movements.
- The column's length is about 14 km.

- The pass time of the column is 36 minutes. That means that it will take 36 minutes for the column to clear any point along the route.
- The road distance from SP to RP is about 96 km. The time distance is 4 hours (0700 to 1100). That means it will take 4 hours for the head of the column to clear the RP.
- Road clearance time, calculated by adding the pass time to the time distance, is 4 hours and 36 minutes.
- Road clearance distance, calculated by adding the length to road distance, is 110 km.

G-23. March graphs are normally used to show multiple columns traveling over the same routes as shown in Figure G-6. Each of these columns is explained below.

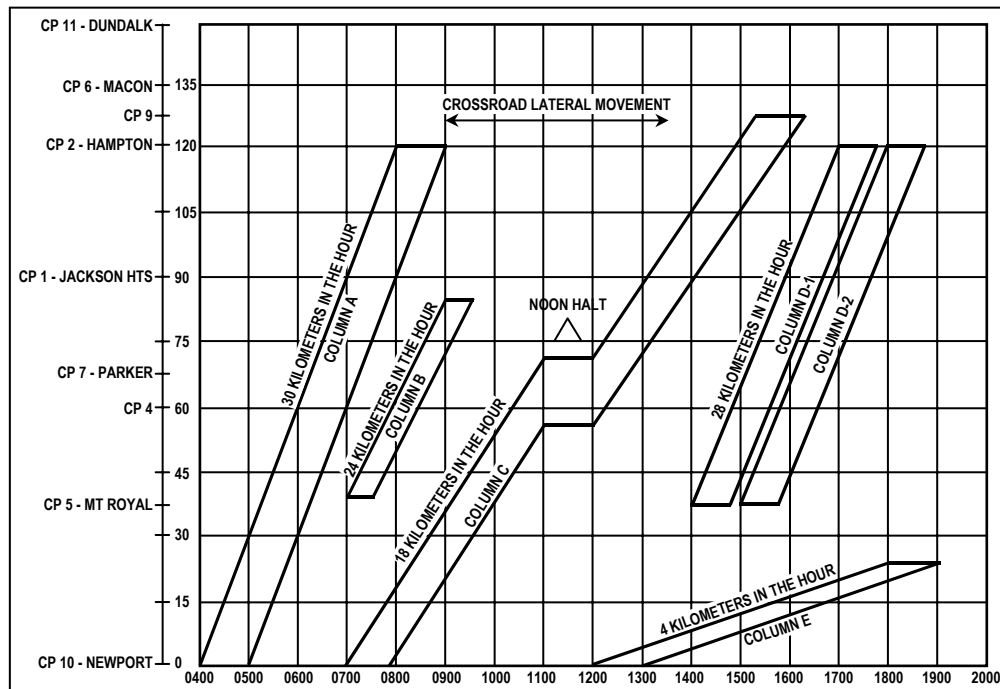

Figure G-6. Scheduling Moves

- Column A is scheduled to leave its SP (Newport) at 0400 and clear the SP at 0500, a pass time of 1 hour. Distance to the RP (Hampton) is 120 km. The rate of march is 30 km/h. The time distance is 4 hours (120 km ÷ 30 km/h). The head will arrive at the RP at 0800 and the trail at 0900. Therefore, the road clearance time is 5 hours, which is the time distance plus the pass time.
- Column B makes a shorter move at a different time. It is scheduled to leave its SP (Mount Royal) at 0700 and clear the CP at 0730, a pass time of 30 minutes. Distance to the RP is 48 km. The rate of march is 24 km/h. The time distance is 2 hours (48 ÷ 24 km/h). The head



will arrive at the RP at 0900 and the trail at 0930. Therefore, the road clearance time is 2 1/2 hours. The graph shows that this move does not conflict with the first move.

**NOTE:** A crossroad lateral movement is scheduled to cross at CP 1 from 0906 until 1312. The graph shows that the lateral movement will not interfere with any of the scheduled moves.

- Column C makes a longer and slower move than the other columns. The graph shows this because the diagonal lines representing time distance are not as steep as the lines of columns A, B, and D. The steepness of a diagonal line on the graph indicates the rate of march. Column C is scheduled to leave its SP (Newport) at 0700 and clear the SP at 0750, a pass time of 50 minutes. Distance to the RP is 132 ÷ km. The rate of march is 18 kmih. Column C is also scheduled for a 1 hour rest halt on the road. Rest halt time is added to the time distance when calculating. Therefore, the time distance is 132 km ÷ 18 kmih + 1 hour or 8 hours and 20 minutes. The road clearance time is 9 hours and 10 minutes.
- Columns D-1 and D-2 are two serials of one column. They are scheduled to travel at 28 kmih from the same SP to the same RP, one leaving 24 minutes after the other. The graph shows that the head of Column D-1 is scheduled to leave the SP at 1400 and arrive at the RP at 1700, a distance of 84 km in 3 hours. The rate of march is 28 kmih (84 ÷ 3 hours). Because both elements of the move are shown on the graph parallel to each other, the rate is the same for both.
- Column E is a foot march on the route. It is traveling slowly (24 km in 6 hours of walking time).

## PLANNING FOR ROUTE RESTRICTIONS

G-24. Planners must consider route restrictions when graphing movements. These restrictions normally add greater control measures to a route. They may be imposed to allow for route maintenance, large unit movements, or maneuver. They should be specified in highway regulation plans, operations orders (OPORDs), or fragmentary orders (FRAGOs).

G-25. Restrictions are marked on graphs by blocking out the time and space on the graph when traffic may not use a route or cross an intersection. To plan around restrictions, planners can calculate either earliest or latest time a column can leave the SP to miss the restriction.

G-26. When passing after restriction ends, use the following formula. Compute the earliest time the head of the column can cross the SP to clear the ending time of a route restriction without halting at the restriction.

G-27. The earliest time the first vehicle can cross the SP = end of restriction time + safety factor - time distance from start point to restriction point.

**EXAMPLE:** A restriction is in effect from 1140 to 1240. The distance from the SP to the restriction is 32 km. A safety factor of 15 minutes is in force before and after the restriction. This is a close column move executed at the rate of 16 kmih. Pass time is 12 minutes. Using the formula, calculate the earliest time the first vehicle can cross the SP.

$$1240 + 15 \text{ min} - \frac{32 \text{ km}}{16 \text{ km/h}} = 1255 - 2 \text{ hr} = 1055$$

The earliest time the column can leave the SP is 1055.

G-28. When passing before restriction begins, use the following formula. Compute the latest time the first vehicle of a column can cross the SP to have the last vehicle arrive at the 1140 to 1240 restriction before it begins.

G-29. The latest time the first vehicle of a column can cross the SP = beginning of restriction time - safety factor - time distance from SP to the restriction - time length. Using the data in the example above, calculate the time.

$$1140 - 15 \text{ min} - \frac{32 \text{ km}}{16 \text{ km/h}} - 12 \text{ min} = 1125 - 2 \text{ hr} - 12 \text{ min} = 0913$$

The latest time the first vehicle can leave the SP is 0913.

## Preparing Movement Tables for a Highway Movement

### REVIEWING THE SITUATION

G-30. This section provides a step-by-step example of how to compute a highway movement, prepare a road movement graph, and prepare road movement tables for a convoy consisting of five serials.

#### Convoy Data

G-31. On 23 February, elements of the 439th Transportation Battalion will move from the unit's present position to an area near CP 106. The movement will consist of five serials, organized as shown in Figure G-7. The first and second serials have six march units each; the third and fourth serials have seven march units each; and the fifth has five march units. The SP is CP 97, and the RP is CP 106. The route of march is from CP 97 to CP 106 by way of CPs 99, 103, 104, and 105. The lead vehicle of the first serial will cross the SP at 0800.

SERIALS	UNIT	NUMBER OF VEHICLES	NUMBER OF MARCH UNITS
First	2439th and 2440th Transportation	126	6
Second	2441st and 2442d Transportation	135	6
Third	2443d and 2444th Transportation Companies and Headquarters and Headquarters Detachment, 439th Transportation Battalion	150	7
Fourth	2445th and 2446th Transportation Companies	144	7
Fifth	2447th and 2448th Transportation Companies (attached)	124	5

**Figure G-7. Organization of Serial March Units**

#### Movement Conditions

G-32. Extracts of the highway regulation plan specify the following conditions on the movement:

- The rate of march during daylight hours is 24 km/h and the density of vehicles during daylight hours is 12 per km.

- The rate of march during hours of darkness (1835 to 0630) is 16 km/h and the density of vehicles during hours of darkness is 48 per km.
- Gaps will be 10 minutes between serials and 2 minutes between march units.
- When an en route restriction is applied to the movement, a 15-minute safety factor will be allowed before and after the restriction.

## Restrictions

G-33. The following restrictions are in effect on 23 February:

- CP 99 to CP 103 from 1100 to 1200.
- CP 105 from 1500 to 1530.
- CP 104 from 1510 to 1630.
- CP 105 from 1700 to 1830.

## Additional Guidance

G-34. The fourth serial will halt in place at the 1500 to 1530 restriction at CP 105 and will continue as soon as possible after the restriction. The head of the fifth serial will depart the SP as soon as possible to clear the restriction at CP 104. The fifth serial will stop at the 1700 to 1830 restriction at CP 105 and disperse vehicles until the restriction is lifted.

G-35. All computations in minutes resulting in a fraction are raised to the next full minute; km are rounded up to the nearest tenth. For example:

- 15.6 minutes - 16 minutes.
- 15.3 minutes - 16 minutes.
- 13.67 km = 13.7 km.
- 13.43 km = 13.5 km.

## Computing Time Distance of the Route

G-36. The planner must first determine how long it will take each serial to travel from the SP to the RP, the time distance of the route.

- **Formula.** Compute the time distance by dividing the distance from the SP to the RP by the rate of march ( $TD = D \div R$ ).
- **Data.** The distances between CPs and total distance are shown in Table G-7.

**Table G-7. CP Distances**

KILOMETERS	
CP 97 to CP 99	24
CP 99 to CP 103	6
CP 103 to CP 104	9
CP 104 to CP 105	18
CP 105 to CP 106	18
TOTAL	75

- Computation.** The distance from SP to RP is 75 km. The lead vehicle will cross the SP at 0800 and the rate of march during daytime is 24 kmih. Substituting in the formula  $TD = D \div R$ ,  $TD = 75 \div 24$ , or 3.125 hours. Since .125 hours is 8 minutes (.125 X 60), the time distance is 3 hours and 8 minutes.

### Computing Road Space of the First Serial

G-37. Road space is the length of a column. The formula for computing road space is shown in Table G-8. Figure G-7 shows 126 vehicles in the first serial. The rate of march is 24 kmih; the density is 12 vehicles per kilometer. The time gap is 2 minutes between march units. Because six march units make up the serial, there are five gaps making a total time gap in the serial of 10 minutes. The formula for computing road space for the first serial is shown in Table G-9.

**Table G-8. Computing Road Space**

$\text{Road space} = \frac{\text{number of vehicles}}{\text{vehicle density}} + \frac{\text{time gaps} \times \text{rate}}{60 \text{ minutes}}$
---

**Table G-9. Computing Road Space (First Serial)**

$\text{Road space} = \frac{126}{12} + \frac{10 \times 24}{60} = 10.5 + 4 = 14.5 \text{ km}$
---

### Computing Pass Time of the First Serial

G-38. Pass time is the time required for a column to pass a point on the route. The formula for computing pass time is shown in Table G-10. Use the road space computed in Table G-9 (14.5 km) to compute road space (Table G-11).

**Table G-10. Computing Pass Time**

$\text{Pass time} = \frac{\text{road space} \times 60 \text{ min}}{\text{Rate}}$
--

**Table G-11. Computing Road Space**

$$\text{Pass time} = \frac{14.5 \text{ km} \times 60 \text{ min}}{24 \text{ km/h}} = 36.3 \text{ or } 37 \text{ min}$$

### Computing Road Space and Pass Time of the Second, Third, Fourth, and Fifth Serials

G-39. Using the same formulas and methods of computation as for the first serial, compute the road space and pass time for the second serial (Table G-12), third serial (Table G-13), fourth serial (Table G-14), and fifth serial (Table G-15).

**Table G-12. Computing Road Space and Pass Time (Second Serial)**

$$\text{Road space} = \frac{135}{12} + \frac{10 \times 24}{60} = 11.3 + 4 = 15.3 \text{ km}$$

$$\text{Pass time} = \frac{15.3 \times 60}{24} = 38.25 \text{ or } 39 \text{ min}$$

**Table G-13. Computing Road Space and Pass Time (Third Serial)**

$$\text{Road space} = \frac{150}{12} + \frac{12 \times 24}{60} = 12.5 + 4.8 = 17.3 \text{ km}$$

$$\text{Pass time} = \frac{17.3 \times 60}{24} = 43.2 \text{ or } 44 \text{ min}$$

**Table G-14. Computing Road Space and Pass Time (Fourth Serial)**

$$\text{Road space} = \frac{144}{12} + \frac{12 \times 24}{60} = 12 + 4.8 = 16.8 \text{ km}$$

$$\text{Pass time} = \frac{16.8 \times 60}{24} = 42 \text{ min}$$

**Table G-15. Computing Road Space and Pass Time (Fifth Serial)**

$$\text{Road space} = \frac{124}{12} + \frac{8 \times 24}{60} = 10.3 + 3.2 = 13.5 \text{ km}$$

$$\text{Pass time} = \frac{13.5 \times 60}{24} = 33.7 \text{ or } 34 \text{ min}$$

## Publishing Road Movement Tables

G-40. The road movement graph is a planning work sheet for movement planners. It is not normally disseminated to subordinate units or published in plans and orders. Information obtained from the graph is published in road movement tables.

## Preparing a Road Movement Graph

G-41. A road movement graph is a time and space diagram. After computing for a move, the planner can then see where he plotted the move. The following explains how to plot the move.

- Designating Hours.** From the lower left corner across the bottom of the graph designate the time needed for the movement. Since the first serial is to arrive at the SP at 0800, the timing of this graph should start at 0800 in the lower left corner. The computations performed in paragraphs G-36, G-37, and G-38 show that more than 12 hours are required to complete the movement of the five serials. This is derived from adding the time distance, sum of pass times, restricted times, and gaps. Therefore, the time of this graph must extend to at least 2100. In this example, each horizontal block represents 12 minutes and every six blocks represents 1 hour as shown in Figure G-8.

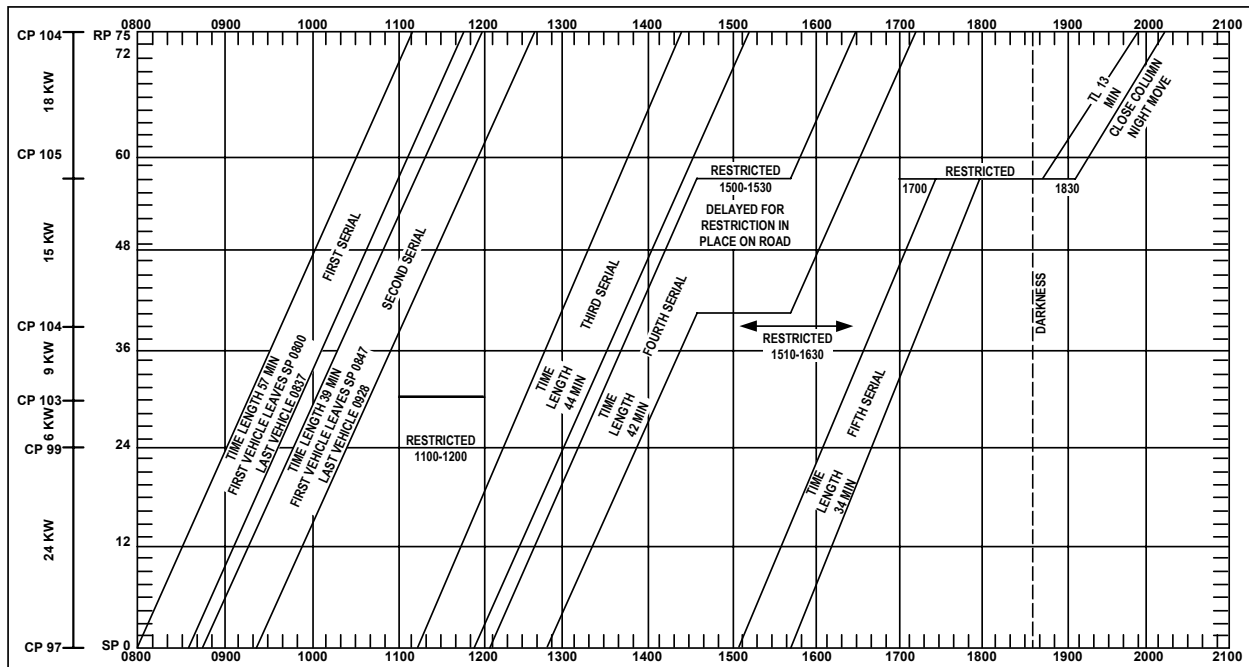

Figure G-8. Road Movement Graph for Five Serials

- Designating Kilometers.** Indicate the distance to be moved in kilometers on the vertical axis. Begin at the SP in the lower left corner of the graph with 0 km. Since this move is 75

km, the top of the vertical axis should be marked as 75 km. In this example, each vertical block between 0 and 75 km represents 1.5 km as shown in Figure G-8. It is important to show critical points, checkpoints, or other important points directly opposite the correct distance blocks of the graph. For example, CP 99 is 24 km from the SP and is noted on the scale opposite the 24 km line. CP 103 is noted on the scale opposite the 30 km line.

- **Plotting the Restrictions.** Mark route restrictions within the graph as described below.
  - The first restriction is from CP 99 to CP 103 between 1100 and 1200. CP 99 is 24 km (16 blocks) from the SP and CP 103 is 6 km (4 blocks) from CP 99. To show the restriction, the time from 1100 to 1200 between CP 99 and CP 103 is blocked out.
  - The second restriction is at CP 105 between 1500 and 1530. CP 105 is at the 57 km point. In this example, the restriction is only at the CP. To show the restriction, a horizontal line from 1500 to 1530 at the CP is marked. It extends horizontally from 1500 over three blocks (30 minutes).
  - The third and fourth restrictions are also only at the CP. They are shown as above.

### Graphing the First Serial

G-42. Once the hours, kilometers, and restrictions are marked on the graph, plot the serials. The first vehicle of the first serial is scheduled to leave the SP at 0800. Put a dot at the beginning of the 0800 line in the lower left corner of the graph. Figure G-8 shows the first vehicle is to arrive at the RP at 1108. This was calculated by adding the time distance (3 hours and 8 minutes) to the time the first vehicle crosses the SP. Locate the 1108 hour line at the top of the graph at the RP (75 km line) and put a dot there and then connect the dots.

G-43. The next step is to plot the trail (last vehicle) of the first serial. To find the time the last vehicle crosses the SP, add the pass time to the time the first vehicle crosses the SP. As determined in paragraph G-37, the pass time of the first serial is 37 minutes. Therefore, adding 37 minutes to 0800 gives 0837 as the time the last vehicle of the first serial leaves the SP. Make a dot at 0837 on the bottom of the graph. Then add the time distance of 3 hours and 8 minutes to 0837 start time to compute the time the last vehicle clears the RP. This is 0837 plus 3 hours and 8 minutes, or 1145. Make another dot at the top of the graph at 1145. Connect the dots. This second line parallels the first line drawn, which shows the movement of the first vehicle of the first serial. The horizontal space between the two lines represents the 37-minute pass time of the serial.

### Graphing the Second Serial

G-44. Because the last vehicle of the first serial is scheduled to clear the SP at 0837 and a 10-minute time gap is required between serials, the second serial cannot begin movement until 0847. To show the first vehicle of the second serial on the graph, place a dot at 0847 on the bottom of the graph. The time distance for the second serial is the same as that of the first serial. Therefore, the trail vehicle of the second serial will clear the RP at 1155 (0847 plus 3 hours and 8 minutes). To show the last vehicle of the second serial on the graph, place a dot at 1155 at the top of the graph at the RP and connect the dots with a line.



G-45. Plot the trail vehicle of the second serial the same as the first serial. To find the time the last vehicle of the second serial crosses the SP, add the pass time of the second serial to the time the first vehicle of the second serial crosses the SP. From Table G-12, this was determined to be 39 minutes. Therefore, adding 39 minutes to the 0847 SP time gives 0926 as the time the trail vehicle of the second serial leaves the SP. Make a dot at 0926 on the bottom of the graph. Since the first vehicle clears the RP at 1155 and the pass time is 39 minutes, the trail vehicle will clear the RP at 1234 (1155 plus 39 minutes). Make another dot on the top of the graph at 1234. Connect the two dots. The second serial is now complete.

### Graphing the Third Serial

G-46. Graphing the third serial is more complicated than the first two. The reason is that the third serial will not be able to clear the SP 10 minutes after the second serial clears the SP because this would cause it to run into the 1100 to 1200 restriction at CP 99. Therefore, compute for the earliest time the first vehicle can leave in order to pass the restriction after the restriction ends at 1200 (plus the 15-minute safety factor). As shown in Figure G-8, the computation is 1200 (time the restriction ends) plus 15-minute safety factor minus 1 hour (time distance to the restriction [24 km at 24 km/h]) equals 1115. This time (1115) is the earliest time the first vehicle of the third serial can leave the SP. Place a dot at 1115 to show this SP time. Time distance is still 3 hours and 8 minutes. Therefore, the first vehicle of this serial will clear the RP at 1423. Put a dot at 1423 at the top of the graph and connect the two dots.

G-47. Since pass time for this serial is 44 minutes, the last vehicle will leave the SP at 1159. Time distance is still 3 hours and 8 minutes. Adding this to the starting time of the trail of the serial gives the clear time for the trail at the RP of 1507. Place dots at the times computed for the trail and connect them as with the two previous serials.

### Graphing the Fourth Serial

G-48. Graphing the fourth serial is also more complicated than the others because it must halt at the 1500 to 1530 restriction at CP 105. The first step is to compute the time distance from the SP to the restriction. The distance is 57 km and the rate is 24 km/h. Using the formula to calculate time distance,  $TD = D \div R$ ,  $57 \div 24 = 2$  hours and 23 minutes. Because the last vehicle of the third serial cleared the SP at 1159 and a 10-minute gap is required between serials, the fourth serial cannot begin movement until 1209.

G-49. The first vehicle of this serial will arrive at the restriction (CP 105) 2 hours and 23 minutes after it clears the SP, or 1423. Adding the pass time of this serial (42 minutes) to this gives 1514 as the time when the trail vehicle of the serial would clear CP 105 if it moved on without stopping. Since the restriction at this point is from 1500 to 1530, the column must halt at CP 105 and cannot move on until 15 minutes (safety factor) after the restriction ends. Thus the serial begins moving again at 1545.

G-50. The remaining distance of 18 km will take 45 minutes ( $18 \text{ km} \div 24 \text{ km/h}$ ), so the lead vehicle clears the RP at 1630. The trail vehicle leaves CP 105, 42 minutes after the lead vehicle at 1627 and clears the RP, 45 minutes later at 1712.

### Graphing the Fifth Serial

G-51. For the fifth vehicle, as with the third serial, a 10-minute time gap will not work because the fourth serial will be halted on the road for the restriction at CP 104. If the fifth serial was to leave 10 minutes after the fourth serial cleared the SP, it would run into the fourth serial at its halt.

G-52. Therefore, compute the earliest time the lead vehicle can leave the SP in order to avoid running into the fourth serial at CP 104. As described in paragraph G-31, first find how long it takes the lead vehicle to travel the 39 km to CP 104:  $39 \text{ km} \div 24 \text{ km/h} = 1 \text{ hour and } 38 \text{ minutes}$ . The restriction at CP 104 is in effect from 1510 to 1630. Adding the 15-minute safety factor, 1645 is the earliest time at which the lead vehicle of the serial can clear the restriction. Subtracting 1 hour, 38 minutes from 1645 gives 1507 as the earliest time the fifth serial can leave the SP. It will clear the CP 104 at 1645 without halting.

G-53. Another problem arises at this point. If the fifth serial leaves at 1507, it will arrive at CP 105 at 1730, 45 minutes after clearing CP 104. Since there is a 1700 to 1830 restriction at CP 105, the serial must halt and wait until 1845 to resume movement. Because this serial has been ordered to disperse off the road at CP 105, the halt is shown differently than with the fourth serial, which halted on the road and occupied road space.

G-54. The pass time of this serial must also be recomputed from this point since the movement instructions specified that a slower march rate and larger density apply to movements during darkness after 1835. Accordingly, the rate of march becomes 16 km/h, and vehicle density becomes 48 vehicles per kilometer. To find the new pass time, first calculate the new road space (see Table G-16). To recalculate the new pass time see Table G-17.

**Table G-16. Calculating New Road Space**

Road space =	number of vehicles	+	time gaps x rate
	vehicle density		60 minutes
	$= 124 + 8 \times 16 = 2.6 + 2.2 = 4.8 \text{ km}$		

**Table G-17. Recalculating New Pass Time**

Pass time =	Road space x 60 min	=	$\frac{4.8 \times 60}{16} = 18 \text{ min}$
	rate		

G-55. Traveling at 16 km/h, it takes the lead vehicle 1 hour and 8 minutes to travel the remaining 18 km to the RP. It arrives there at 1953 (1845 + 1 hour and 8 minutes). The trail vehicle leaves CP 105, 18 minutes later than the lead vehicle, or at 1903; and arrives at the RP at 2011.

### Using a Road Movement Table

G-56. Data is taken from the graph and put into a road movement table, which can be issued as an annex to an OPORD for a road movement. Convoy commanders can use the information to track their progress during movement and ensure they arrive and clear each CP on schedule. Movement

Regulation Teams (MRTs), Traffic Control Points (TCPs), and others can use the information for control purposes.

G-57. Figure G-9 shows the front and back sides of a sample road movement table. The data in this table is derived from the information found on the graph in Figure G-8.

Serial	Date	Units/ Formation	# of Vehicles	Load Class of Heaviest Vehicle	From	To	Route	Route to SP	Checkpoints			Route from RP	Remarks
									Ref	Due (hrs)	Clear (hrs)		
(a)	(b)	(c)	(d)	(e)	(f)	(g)	(h)	(i)	(j)	(k)	(l)	(m)	(n)
1	23 Feb	2439 Trans Co (Lt Trk) 2440 Trans Co (Lt Trk)	126	21	CP97	CP106	A	N28	CP97(SP) CP99 CP103 CP104 CP105 CP106(RP)	0800 0900 0915 0938 1023 1108	0837 0937 0952 1015 1100 1145	N16	
2	23 Feb	2441 Trans Co (Lt Trk) 2442 Trans Co (Lt Trk)	135	21	CP97	CP106	A	N45	CP97 CP99 CP103 CP104 CP105 CP106	0847 0947 1002 1025 1110 1155	0926 1026 1041 1104 1149 1234	N14	
3	23 Feb	2443 Trans Co (Lt Trk) 2444 Trans Co (Lt Trk) Hq & Hq Det 439th T Bn (Trk)	144	21	CP97	CP106	A	N280	CP97 CP99 CP103 CP104 CP105 CP106	1115 1215 1230 1253 1338 1423	1159 1259 1314 1337 1422 1507	N16	
4	23 Feb	2445 Trans Co (Lt Trk) 2446 Trans Co (Lt Trk)	144	21	CP97	CP106	A	N4	CP97 CP99 CP103 CP104 CP105 CP106	1209 1309 1324 1347 1432 1630	1251 1351 1406 1429 1627 1712	N53	Halt in place at CP 105 from 1432 to 1545 until restriction ends
5	23 Feb	2447 Trans Co (Lt Trk) 2448 Trans Co (Lt Trk) (attached)	124	21	CP97	CP106	A	N16	CP97 CP99 CP103 CP104 CP105 CP106	1507 1607 1622 1645 1730 1953	1541 1641 1656 1719 1919 2011		Stop at CP 105 from 1730 to 1845 and disperse vehicles until restriction ends. Resume march at 1845

Figure G-9. Road Movement Table (Front)

MAPS:	
1	AVERAGE SPEED Serials 1-4 - 24 km/h Serials 5-24 km/h after 1845 - 16 km/h
2	AVERAGE DENSITY Serials 1-5 - 12 vehicles per km Serial 5 - 47 vehicles per km after 1845
3	HALTS Fourth serial at CP 105 - 1432 to 1545 Fifth serial at CP 105 - 1730 to 1845
4	ROUTES - Route A
5	CHECKPOINTS a. Start Points - CP 97 b. Release Points - CP 106 c. Other Critical Points - CP 99, CP 103, CP 104, CP 105
6	Main Routes to Start Points - N28, N45, N280, N4, N16
7	Main Routes from Release Points - N16, N53

Figure G-9. Road Movement Table (Back)

# Road Management Planning

## MOVEMENT PLANNING

G-58. Movement planners must manage the planned movement of convoys on controlled MSRs in order to issue movement credits, reroute, or divert. A critical time and point graph is a tool that may be used by movement planners to aid in preventing conflicts at critical points when planning and scheduling movements. It is an alternative method of managing movements from the grid system. Both methods accomplish the same function of tracking the planned itineraries of convoys as they arrive and clear planned checkpoints along MSRs. This method is more detailed and may be useful for planning movements on road networks that have many MSRs crossing each other.

### Critical Time and Point Graph

G-59. Data for developing a critical time and point graph is taken from highway regulation plans or traffic circulation plans. These plans identify the critical points or checkpoints that will be used to plan movements. Movement planners also receive movement information for preplanned or immediate requirements. Preplanned information is derived from movement graphs or tables used to support the movement program. Immediate requirements are generated on short notice from clearance requests (movement bids).

G-60. The movement planner posts the movement data for each movement requirement to the critical time and point graph for the day or days involved. The planner will either confirm the availability of the road network for the requesting unit or makes changes to separate, balance, or distribute based upon command priorities.

G-61. An example of a critical time and point graph is shown in Figure G-10. Critical time and point graphs are composed of subgraphs, one for each critical point. The name or number of the critical point is marked along the left margin. Each critical point has four paths, one for each direction (north, south, east, and west). These paths are marked along the left side to show the predominant direction of movement or change of direction. Time is annotated along the top on the vertical divisions of the graph in short time blocks, normally 15 minutes or less. A graph may reflect any time period. However, graphs do not normally exceed 24 hours.

G-62. The critical time and point graph reflects a route with three critical points (25, 26, and 27). In this example, the vertical lines represent five-minute time blocks. Two convoys are planned.

- Convoy 225 travelling eastward on MSR Sparrow will arrive at critical point 25 at 0020 and will clear that point at 0040. Therefore, the block representing convoy 225 extends from the arrive time to the clear time.
- Convoy 225 then continues to travel eastward and will arrive at critical point 26 at 0130. At critical point 26, convoy 225 turns northward on MSR Hawk as shown by the flag extending from the eastbound to northbound paths. Changes in direction of travel at critical points are always indicated by a flag extending into the appropriate path on the graph opposite N, S, E, W. Convoy 225 clears critical point 26 about 0145.

- Convoy 226 travelling northward on MSR Hawk arrives at critical point 27 at 0230 and will clear that point at 0300.

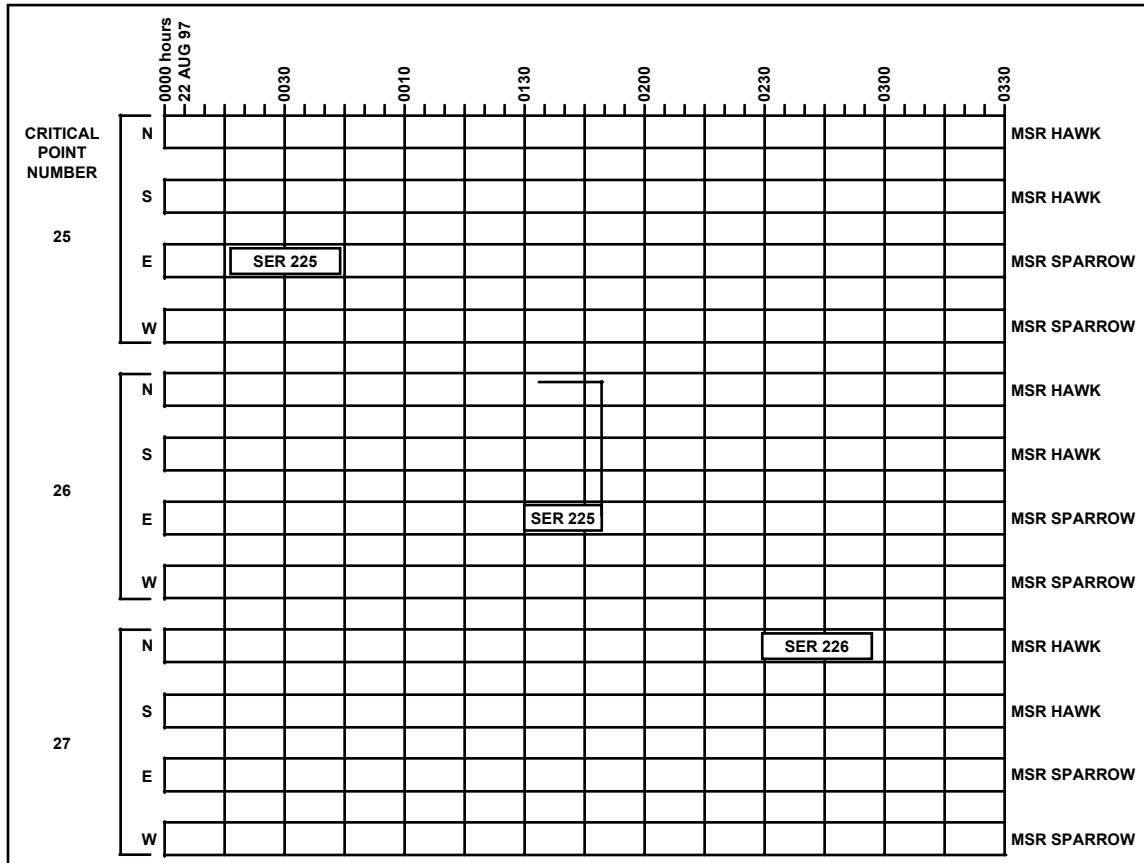

Figure G-10. Critical Time and Point Graph

G-63. Critical time and point graphs should be prepared for each MSR in advance for a specified planning period to manage programmed moves over multiple routes. The data for arrive and clear times at critical points can be obtained from movement graphs, movement bids, or automated planning programs such as movement plan (MOVEPLAN). The planning period will vary depending upon the level of command. Generally, the Movement Control Agency (MCA) and MCB work with longer planning periods than does the DTO because movements in the communication zone (COMMZ) and Corps rear area can be programmed further in advance.

G-64. On the day of movement, movement planners receive the in-transit status of convoys as reported by MRTs, TCPs, or the moving unit. They check the progress of movement against the critical time and point graph for that day. When a convoy is reported off schedule, they check the graph for time and space separations from other convoys. If necessary, planners may reroute or stop a movement or reschedule convoys to prevent conflicts. They provide these changes to the affected commands and the military police (MPs).

## Appendix H

### Intermodal Terminals

H-1. The role of a intermodal terminal is to expedite the onward movement of sustainment cargo in a theater of operations. The intermodal terminal may be staffed with personnel from the cargo transfer company (CTC), freight consolidation and distribution team (FCDT) and cargo documentation team. The term intermodal terminal includes activities that support hub-and-spoke operations or intermodal terminals. Unit equipment, mail, class III, Class V, Class VII and personnel do not normally pass through intermodal terminals, although all other commodities and hazardous materials do. The intermodal terminal will:

- Receive and document containerized and breakbulk cargo destined for multiple consignees.
- Unstuff the containers and arrange for transport of the container contents.
- Load vehicles and prepare vehicle manifests or related documentation (e.g., transportation control and movement document (TCMD), commercial bill of lading (CBL), or freight warrant).
- Receive smaller shipments from distribution 'spokes.'
- Prepare, update, and deactivate radio frequency (RF) tags or other automatic identification technology (AIT) devices.
- Route the shipments to their destination using scheduled truck services.
- Account for containers, flatracks, pallets, and trailers at its facility.
- Report in-transit visibility (ITV) events to Global Transportation Network (GTN) and regional ITV and total asset visibility (TAV) databases.

H-2. The CTC documentation section or cargo documentation team will accomplish the following tasks:

- **Identify Inbound Shipments.** The intermodal terminal receives a bill of lading as a notice of inbound cargo. The bill of lading establishes a 'due-in' record accessible by TCN, movement number, and AIT device name. Advanced transportation control and movement document (ATCMD)-related information and anticipated arrival date at intermodal terminal should be recorded, also.
- **Plan Workload.** The CTC personnel create reports that display the manifest due in by hour/day of anticipated receipt. These reports are the basis for workload planning. The reports also account for shipments already received but not yet released. Intermodal terminal managers allocate workload to a specific shift or timeframe, not just a specific day. The workload should identify:
  - Floor space available to handle shipments in transit.
  - Handling capacity (number of pallets and containers moved per shift) of available material handling equipment (MHE) and operators.
  - Yard space available to temporarily store empty containers, pallets, and flatracks.

- **In-Check/Validate Shipment Receipt.** CTC personnel place an automated workstation at the intermodal terminal receiving dock. This workstation allows access to the CTC server due-in database and permits electronic in-check of shipments that arrive at the terminal. CTC personnel record loading dock number, date-time of item receipt, and location where placed. CTC personnel record shipment condition for discrepancy reporting. When the item received is not identified in the CTC server due-in database, a new record is added using data on the AIT or by keyboard entry.
- **Report Shipment Arrival.** Intermodal terminals use AIT and automated systems such as Transportation Coordinators-Automated Information for Movements System II (TC-AIMS II) to report the ITV arrival event to the regional ITV server which updates GTN.
- **Generate Discrepancy Reports.** CTC personnel will create and transmit a cargo discrepancy report (DISREP) based on presence of discrepancy data in shipment arrival records. Discrepancy reporting can result from the in-check process, a shipment release process, or any inspection process conducted while the shipment is in the intermodal terminal.
- **Load Planning for Outbound Shipments.** CTC personnel use information about dues-in and received shipments to prepare load plans for outbound shipments. Load plans are based on the ability to manipulate the cargo data by date, customer, route, and load compatibility. The theater surface distribution plan is used to support the load planning functions when a single movement supports multiple consignees. Load plans organize the shipments into loads for specific vehicle types and produce a sequenced load list for each vehicle. This load list is used by CTC vehicle loading personnel in hard copy or electronic feed to remote hand-held terminals. The terminal loading dock consolidates individual shipments into pallet, container roll-in/roll-out platform (CROP) or container configurations; assigns a new consolidation transportation control number (TCN), and prepares required TCMD. The actions of the CTC personnel in load-planning vehicles include wheeled vehicles, rail cars, barges, other watercraft, helicopters, and fixed-wing transport aircraft.
- **Prepare Documents for Onward Movement.** CTC personnel at the loading dock prepare final vehicle manifests with places for driver and receiver to sign. They will also create TCMDs, military shipment labels, RF tags, and optical memory cards (OMC). They also prepare hazardous material certification documents and customs clearance documents when origin shippers have not provided the documentation.
- **Offer Shipments to Movement Control Team (MCT).** Once shipment load planning is completed, CTC personnel generate a request for transport services from area MCTs. Intermodal terminals assign a unique transport request number to the shipment or use lead-TCN. The transportation request identifies shipment origin, destination, priority, characteristics, delivery instructions, and preferred mode. The MCT provides a copy of the TMR to the intermodal terminal. This process need not occur if the intermodal terminal loads the shipments on vehicles which are dispatched with standing TMR (e.g., scheduled truck service).

- **Establish and Maintain an RF AIT Interrogator Network.** CTC personnel use RF AIT interrogators to identify locations of shipments and empty containers or flatracks within the intermodal terminal. CTC personnel read and write tags using joint total asset visibility (JTAV) standard formats. Tag information will be used to validate receipt of a due-in shipment (i.e., container, pallet, and flatrack). The interrogator is used to identify a shipment event. A date-time stamp for the event updates the intermodal terminal server database. When the shipment is not listed as due in, additional data is read from the RF tag to establish the cargo identification in the CTC database.
- **Record Shipment Release Data.** CTC personnel use RF AIT interrogators to update the their database as shipments depart. The terminal allows AIT or keyboard entry of departure time, date, location, releaser identification, carrier, movement number and anticipated arrival time at next stop.
- **Provide a Bill of Lading to Next Delivery Location and Ultimate Consignee.** The CTC personnel creates a bill of lading when the shipment is released and ensures the next designated delivery location receives it (i.e., the consignee, a port complex, or another intermodal terminal).
- **Receive Discrepancy Report (DISREP).** The CTC personnel receive transportation DISREP from shipment receivers. The transaction identifies a transportation discrepancy for a shipment that was processed by the intermodal terminal. The transaction updates the shipment record to register the discrepancy.
- **Identify Histogram of Shipments in Intermodal Terminal.** CTC personnel generate a report identifying the shipments processed through the terminal and the age of each shipment. The system calculates average processing time for shipments based on customer and type cargo. It also supports calculation of average processing time for internal terminal activities.
- **Trace Shipments.** At the intermodal terminal, the CTC personnel can query the database about specific shipments or movements and display all information about the shipment. Personnel will be able to print a report of the information being displayed.
- **Process Hold and Divert or Expedite Actions.** The intermodal terminal receives hold and diversion transactions from the material management center (MMC). Expedite shipment transactions are also received. CTC personnel hold, divert, or expedite the shipment as required. If the record cannot be identified, a negative response is provided and the action is placed in suspense in the intermodal terminal database for later action. Requesters are notified of the status of the requested action.
- **Report Frustrated Cargo.** The CTC personnel establish cargo records for intermodal terminal cargo that is frustrated (i.e., cargo documentation has been destroyed or cargo cannot be delivered to a recognized location). These records are forwarded to the servicing distribution management center (DMC) for disposition instructions.
- **Daily Activity Report (DAR).** At the discretion of intermodal terminal managers, CTC personnel may create a DAR showing the status of the terminal. This status may include



terminal assets (MHE available, storage capacity used and available), the identification of shipments on hand, and an accounting of containers, flatracks or pallets at the terminal.

- **Maintain Department of Defense Activity Address Code (DODAAC) Data.** The intermodal terminal will receive DODAAC updates to the database.
- **Movement Tracking System (MTS).** CTC personnel may use MTS to contact inbound vehicles and determine shipment receipt status.

## Appendix I

### Example Of A Highway Regulation Plan

I-1. The highway regulation plan is used to inform all units within the theater of operations of the policies and procedures governing convoy or oversize/overweight vehicle movements.

I-2. Highway regulation plan should be developed for all OPLANs or exercises and be included within the transportation annex of the applicable OPLAN or exercise directive.

I-3. It is the responsibility of all organizations with a wartime highway regulation mission to develop highway regulation plans. Responsible organizations include DTOs, MCBs, and TCEs.

I-4. Whenever two or more regulating agencies operate in the same theater of operation, coordination to standardize policies and procedures must be accomplished. Development of the traffic circulation plan (TCP) must also be coordinated to ensure mutual use MSR are given one name throughout the theater to avoid confusion. Movement priority codes and other policies and procedures must be standardized.

I-5. Recommended Format and Information for the Highway Regulation Plan:

#### **ANNEX \_\_\_\_ HIGHWAY REGULATION PLAN TO OPERATION \_\_\_\_**

Reference: Maps, Traffic Circulation Plan, and other relevant documents.

Time zone used throughout the order

Dates: Julian Dates (movement request dates)

#### 1. SITUATION

Include information affecting movement.

#### 2. MISSION

Include provisions of effective highway regulation, reporting, support of operations, and coordination of movement and maneuver. Identify responsible organizations (who controls routes).

#### 3. EXECUTION

a. Concept of movements. Briefly state the Highway Regulation concept and coordination of movements and maneuver and battlefield circulation control.

b. Tasks to subordinate units.

(1) Units perform route reconnaissance or get information from TCP pertaining to theater route network.

(2) Units responsible for abiding by all policies and procedures listed in the plan.

c. Coordination of use of MSRs.

(1) Request procedures.

- (a) Convoy request form or oversize/overweight request form. Put example(s) at appendix. Identify required data (mandatory). Hazardous cargo and oversize/overweight information must be put in remarks. Round trip, use request form with stopover time.
- (b) Submit to. Identify locations units will submit convoy movement requests or oversize/overweight. Telephone procedures/telephone numbers, FAX, walk in locations, MCT, system modem numbers, and so on. Hours of operation.
- (c) Submit when. How many days before movement peace/war, emergency procedures, and authorization.
- (d) Convoy movement priorities. Use numbers 1: highest priority and so on. Coordinate with all clearance activities to use same number system.
- (e) Minimum number of vehicles that constitute a convoy.
- (f) Infiltration rules (less vehicles than a convoy). Ensure infiltrating vehicles yield to convoys at intersection and do not hinder convoy movement.
- (g) Special movement consideration information must be entered in remarks on the request for movement form.

(2) Route utilization information. Discuss MSR listed in TCP. Explain controlled versus MSR (open).

- (a) MSR listed on TCP is open route, any unit can use. No clearance required. First come, first serve. Minimum speed on MSR and any restrictions. Direction of travel.
- (b) Controlled route. Listed in TCP (same as dispatch route). Convoy request must be submitted and a clearance issued prior to movement. Minimum speed for controlled routes and any restrictions. Direction of travel.
- (c) Supervised route. Identify route(s) rules and procedures.
- (d) Prohibited route. Identify which routes are prohibited.
- (e) Reserved route (identify who can use and duration).
- (f) Lightlines.
- (g) Hardening of vehicles.

#### 4. SERVICE SUPPORT

- a. Provide logistical support request procedures. Rest, refueling, and so forth. The TCP (text version) identifies convoy halt locations, convoy support centers, facilities, and services available to include units responsible for providing service.
- b. Maintenance and recovery procedures. Vehicle breakdown procedures.
- c. Medical evacuation procedures.
- d. Halts.

#### 5. PROCEDURES. (Note: Should be same information as in system parameter table.)

- a. Planning factors (convoy).
  - Distance between vehicles.
  - Time gap between march units/serials.
  - Time gap between convoys.
  - Oversize/overweight criteria. Procedures to submit request for clearance.
  - Vehicles per march unit.
  - March units per serial.
  - Blackout procedures/light lines.
  - Hardening of vehicles.
  - Convoy/hazardous cargo marking/flags.
  - Delay in meeting SP time procedures.
- b. Planning factors (route information). Refer to TCP for location and type routes, halt locations and services, traffic control point locations, critical point locations, and restrictions.

6. ENFORCEMENT. Include command actions that will be taken in the event units do not follow policies and procedures. Stress the requirement that units must have approved march table/movement order prior to using controlled routes. Identify who will monitor and control movements.

#### 7. COMMAND AND SIGNAL.

- a. Command. Identify communications reporting locations and procedures with Highway Regulation and police officials.
- b. Signal. Describe reporting requirements, method of communication, and radio frequencies.

#### APPENDIXES:

1. Traffic Circulation Plan (text copy attached and system disk distributed to system users)
2. Convoy Request Form and Oversize/Overweight (same form)

## Appendix J

### Types of Intermodal Assets and Intermodal Asset Handlers

J-1. A wide variety of military and commercial container handling equipment (CHE) exists. Figures J-1 through J-8 show some of the available military material- and container-handling equipment. Because of the variety, an all-inclusive list of commercial CHE is beyond the scope of this appendix. Commercial CHE, such as top picks, side picks, and straddle carriers are generally available for lease through a port facility. Military CHE is capable of handling 20- or 40-foot containers.

J-2. Some longer containers (45-feet and 48-feet) have American National Standards Institute/International Organization for Standardization (ANSI/ISO) corner fittings at 40-foot spacing and can usually be handled by the 40-foot CHE. Smaller containers can also be handled by military CHE if configured into a 20-foot ANSI/ISO unit.

### Container Handling Equipment

J-3. The unique quality of an ocean-freight container is its ability to travel over road, rail, and ocean without transferring its cargo at any point. Thus, it is commonly referred to as intermodal. Accomplishing intermodal handling requires complementary CHE.

J-4. The container trailer chassis is the most adaptable over-the-road unit capable of hauling empty or loaded containers. The chassis is suitable for carrying the different types of containers, and depending on its size, will accommodate 20-, 35-, 40-, or 45-foot containers. The chassis are designed and manufactured in accordance with the statutory requirements for over-the-road use. The container is secured to the chassis by twist locks, which are individually operated, and which lock into the lower container corner castings.

J-5. In the absence of a trailer chassis, a flat bed trailer may be used to carry a container over the road. When securing a container to a flat bed trailer, the container corner castings must be employed, as they are built into the container for this specific purpose. Other means of holding down a container may cause structural damage to the unit, in turn jeopardizing safe cargo delivery.

J-6. When a container travels by rail, it may be situated on a chassis (referred to as trailer on a flatcar service). Or, it may be secured on the railroad flatcar without wheels (referred to as container on a flatcar service). In either case, the container must be secured correctly at all times to avoid any possible damage.

J-7. For loading or unloading 20-foot containers from chassis, flatcars, and flatbed trailers, large forklift trucks may be used if the container has built-in forklift pockets (FLP). Loaded containers longer than 20 requires special handling equipment. Other complementing container equipment such as cranes with specialized lifting devices or slings, straddle carriers, and heavy-duty lift trucks are also employed. Shipboard gear, as well as on-shore cranes, are used for loading and unloading containers from the ocean carrier.

## 50,000 POUND ROUGH TERRAIN CONTAINER HANDLER (RTCH) AND TOP HANDLER

J-8. The RTCH is a diesel powered container handler capable of lifting, stacking, and moving 20, 25, and 40-foot containers weighing up to 50,000 pounds (figure J-1). It is a rough terrain vehicle designed for operating on soft soil conditions such as unprepared beaches. The RTCH has four-wheel drive and is capable of operating in up to five feet of seawater. Tophandler attachments in 20, 35, and 40-foot sizes are required for container. These top handlers are placed on the forks of the RTCH to allow for handling different lengths of ANSI/ISO containers. If needed, it could also handle longer containers fitted with ANSI/ISO fittings at 40-foot locations along the top of the container. Future procurements of the RTCH will include expandable tophandlers that are considered part of the end item.



Figure J-1. 50,000 Pound RTCH and Top Handler

## INTERMODAL CONTAINER-HANDLING SPREADER BARS

J-9. Spreader bars (figure J-2) are connected by slings to the hook of a crane such as a rough terrain container crane (RTCC) or the 140-ton truck-mounted container-handling crane and are used to handle ANSI/ISO and other intermodal containers. The 40-foot spreader bars can also handle many longer containers since they usually have ANSI/ISO corner fittings at 40-foot spacing. Both spreader bar types conform to Military Specification MIL-S-52713 and are fixed frame designs with manually locking twist locks.

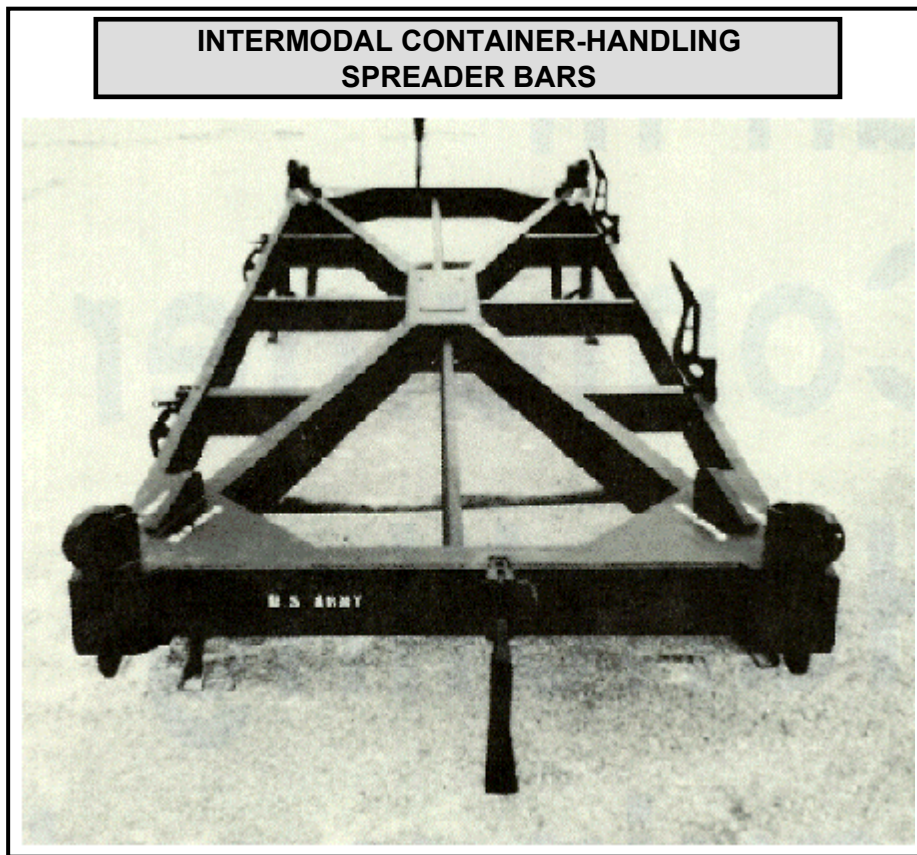

Figure J-2. Intermodal Container-Handling Spreader Bars

### Rough Terrain Container Crane

J-10. The RTCC (figure J-3) is a wheel-mounted crane available through commercial sources. The RTCC is capable of lifting a 20-foot container weighing 44,800 pounds at a radius of 27 feet and a 35/40-foot container weighing 67,200 pounds at a radius of 22 feet. General support (GS) ammunition units, located in theater and corps ammunition storage areas, use the RTCC to load or transship 20-foot ANSI/ISO containers from one mode of transportation to another. Transportation units use the RTCC to augment the 50,000-pound rough terrain container handler in the transfer and handling of 20, 35, or 40-foot containers and other cargo between transportation modes and in storage areas.



Figure J-3. 40-Ton Rough Terrain Container Crane

### 4,000-Pound Rough Terrain Forklift (RTF)

J-11. The 4K RTF (see figure J-5) is the Army's smallest capacity rough terrain forklift. Its primary function is to stuff and unstuff pallets from ground mounted containers. It is capable of handling, lifting, and stacking palletized cargo containers and boxes weighing up to 4,000 lbs. The Army's logistics system relies on this forklift to load and unload ammunition, supplies and equipment; and to transfer cargo between ground vehicles, watercraft, and aircraft. It is found in Quartermaster, Transportation, Ordnance, Missile & Munitions, Medical, Aviation, and Engineer units. This versatile 4,000 lb forklift can be deployed for wartime or contingency operations in a 20-foot container.





**Figure J-4. 4,000 Pound Rough Terrain Forklift**

### **6,000-Pound Variable Reach Forklift**

J-12. This forklift (figure J-6) is designed primarily to load and unload palletized ammunition from resupply vehicles in the theater, corps, division, and brigade rear area ammunition storage areas. It has advantages over the 4K RTF in that it can load and unload cargo from trucks without the assistance of a ramp. When outfitted with special tool attachments it can extract Multiple-Launch Rocket System (MLRS) pods from containers.



**Figure B-5. 6,000 Pound Variable Reach Forklift**

## All-Terrain Lifter, Army System

J-13. The All-Terrain Lifter, Army System (ATLAS) (figure J-7) is a 10,000 lb, variable reach, air transportable, rough terrain forklift. The ATLAS is a key materiel handling system in aviation, engineer, medical, ordnance, transportation, and supply units. This materiel handling equipment (MHE) is used to load and unload ammunition, supplies, and equipment; transload cargo between watercraft, ground vehicles, and aircraft; and stuff and unstuff these containers. Unlike the current 10K forklift, ATLAS can safely lift 10,000 pound 463L pallets and unstuff these pallets from 20-foot containers.

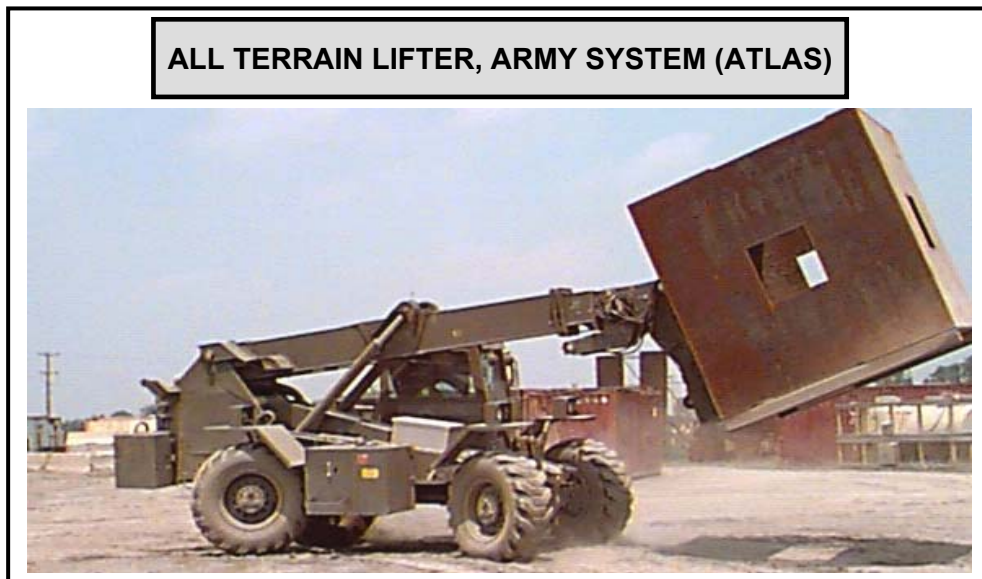

Figure J-6. All Terrain Lifter, Army System (ATLAS)

## Load Handling System Container Handling Unit

J-14. The Load Handling System Container Handling Unit (CHU) attaches to the load handling system on the Palletized Load System (PLS). It allows the PLS to self-load 20-foot containers without requiring the container to be loaded on a flatrack. The PLS truck can carry the CHU aboard the vehicle in addition to the standard flatrack hook. The PLS with a CHU is capable of lifting 20-foot ANSI/ISO containers weighing up to 36,250 pounds. Figure J-8 shows a PLS lifting a 20-foot container with a CHU attached to the lifting arm.



Figure J-7. Container Handling Unit (CHU)

### 20/40-Foot Container Sideloader

J-15. The diesel-powered container sideloader is a commercial item capable of transferring or self-loading and transporting 20- through 40-foot ANSI/ISO containers. Typically, the maximum lifting capability is 66,150 pounds. Units are available with a telescoping spreader bar for 20-, 35-, and 40-foot length containers and can also lift containers with slings. The sideloader can transport containers within maximum road height limitations. It also has an air ride suspension enabling it to transport ANSI/ISO containers containing delicate equipment. These are primarily found at commercial facilities and at depots. Sideloaders use a reduced amount of maneuver space compared to RTCHs, which makes them more attractive. Rough terrain container sideloaders are offered through commercial sources.

## Container Characteristics and Types

**NOTE:** This section provides an overview of the various types of containers available for Army use. The Equipment Deployment and Storage System (EDSS) family of containers and the 20-foot ANSI/ISO container is the standard for unit equipment deployment. Units interested in procuring ANSI/ISO containers may purchase only 20-foot versions. Procurements must be coordinated through the Joint Transportation Movement Officer (JTMO).

### STANDARDIZATION

J-16. The key to the use of more than one form of transportation and use of intermodal containers is the establishment and compliance with commercially approved common standards. These serve to ensure interoperability in the movement of containers between modes and countries. They increase efficiency and effectiveness and foster a seamless flow of cargo.

J-17. Certain provisions of this field manual are the subject of North Atlantic Treaty Organization (NATO) standardization agreements (STANAG). They are: STANAGs 2828 (Military Pallets, Packing and Containers); 2829 (Material Handling Equipment); 2926 (Procedures for the Use and Handling of Freight Containers for Military Supplies); 2998 (Materials Handling Glossary of Terms and Definitions); and 4062 (Slings and Tie-Down Facilities for Lifting and Tying Down Military Equipment for Movement by Land and Sea). The aim of NATO standardization is to increase interoperability and interchangeability of materiel and to improve the combined operational effectiveness of the military forces of the Alliance.

### CONTAINER SIZES

J-18. Container dimensions and capabilities vary dramatically, depending upon the manufacturer and the target customer. The majority of containers conform to ANSI/ISO specifications. Figure J-9 shows the characteristics of the ANSI/ISO 20- and 40-foot containers. These standards allow for some variance. External dimensions are required dimensions; however, internal dimensions and the door opening size are minimum dimensions.

DIMENSIONS (inches)		20-foot ISO	40-foot ISO
Internal	Length	230.9	472.3
	Width	91.7	91.7
	Height	*	*
External	Length	238.5	480
	Width	96	96
	Height	96 and 102	96 and 114
Door	Width	90	90
	Height	83.5-89.5	83.5-101.5
Max Gross Weight		52900 pounds	67200 pounds
* Maximum height is external height minus 9.5 inches			

**Figure J-8. ISO Standard Characteristics**

J-19. Having to containerize increasing volumes of goods, customers have sought containers of increased height, length, and width. Containers with the original ANSI/ISO external height of 8 feet are generally being replaced by containers measuring 8 1/2 feet high. Also increasing numbers of containers of 45-, 48-, 53-foot lengths have been brought into domestic service within the United States, Canada, and Mexico.

## CONTAINER TYPES

J-20. Samples of container types are depicted in figures J-10 through J-18. They include both military and commercial intermodal containers, most of which are identical in nature.

### ANSI/ISO End Opening Commercial

J-21. The commercial 20-foot end-opening container can be used to transport munitions or general cargo. The door end corner posts are modified with angle iron to enhance blocking and bracing. As there is no permanent restraint system, wooden blocking and bracing is used to restrain munitions.

J-22. End-opening dry cargo units are the most common intermodal containers in the inventory (figure J-10). ANSI/ISO End-opening containers come in various lengths. DOD uses only 20- and 40-foot lengths. The outside dimensions can vary slightly. Both are approximately 8 feet high by 8 feet wide. DOD owns several container types that fit into this category. All military vans (MILVANS) and ANSI/ISO end-opening containers can be readily transported by most military and commercial CHE.



Figure J-9. Common Intermodal Container

## MILVAN

J-23. The Ammunition Restraint MILVAN is made of steel, with wood flooring and walls and is capable of transporting 39,015 pounds of ammunition. The tare weight of this MILVAN is 5,785 pounds. The total gross weight per MILVAN is 44,800 pounds. It has an internal restraint system of eight slotted steel rails permanently installed on each sidewall with 25 adjustable crossbars that can be inserted into the slots.

J-24. The General Cargo MILVAN container is made of steel, with hardwood flooring and plywood lined walls and is capable of transporting 40,100 pounds of general cargo. The tare weight of this MILVAN is 4,700 pounds. The total gross weight per MILVAN is 44,800 pounds.

J-25. MILVANs are still in use today. In 1989 there was a procurement for 1,160 of the ammunition restraint MILVANs. The older ones are gradually being phased out of the system and replaced by commercial containers. The Containerized Ammunition Distribution System (CADS) now uses Army-owned and leased standard 20-foot ANSI/ISO containers.

## Refrigerated Container (REEFER)

J-26. REEFERS (figure J-11) provide the capability to transport, temporarily store, and distribute temperature-sensitive cargo such as perishable food or blood. Military-owned REEFERS include a refrigeration unit with a 10 KW generator. They can be plugged into an external power source or run off their own generators. Most ships are equipped with a power source into which the containers can be plugged. Commercial REEFERS are available with their own generator installed in the front wall of the container with the refrigeration unit. Some commercial REEFERS are plugged into a separate generator that fits into an adjoining container cell. REEFERS have the outer dimensions of ANSI/ISO containers and meet all ANSI/ISO requirements for intermodal shipments.

J-27. The Army only uses 20-and 40- foot length REEFERS. A 20-foot REEFER is 8' wide by 8 feet high. The one shown in figure J-11 has its own generator system installed in the nose of the container with the refrigeration unit.



**Figure J-10. Refrigerated Container (REEFER)**

### **Side-Opening Container**

J-28. Twenty-foot side-opening ANSI/ISO containers have two double doors located on one side (figure J-12). These doors open to allow easy access to the container's contents. The side-opening container can be lifted and transported by commercial and military conveyances. Military versions have internal tie-down rings that can be used to secure cargo during shipment. The military often uses side-opening containers for transporting munitions.

J-29. Side-opening containers have the same dimensions as the 20-foot end opening ANSI/ISO container. The Air Force is procuring side-opening containers to use as their standard munitions container.

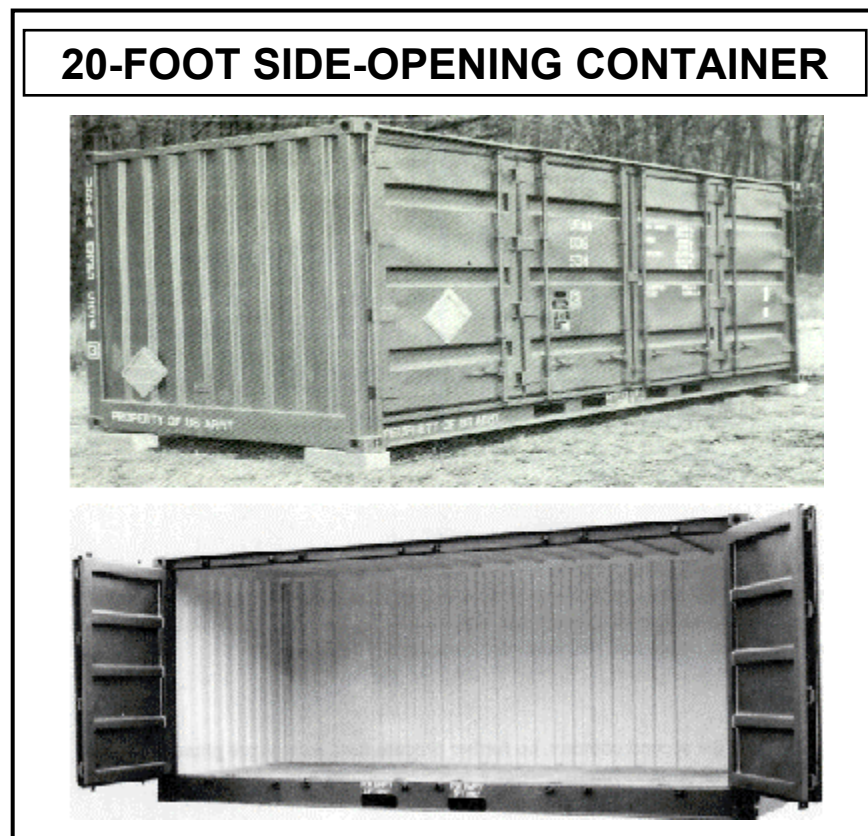

Figure J-11. Side-Opening Container

### Open Top Container

J-30. The open top container is used primarily by commercial industry to transport cargo items that are too large and bulky for standard containers. An open top container can be stuffed from the top, or one end can be opened and it can be stuffed from there. It has ANSI/ISO standard corner fittings at the top and bottom and commercial and military handlers and conveyances can readily lift and transport it. Open top containers require tarpaulins for cover during shipping and storage. Open top containers cannot be used for sensitive items requiring high security and may also have agricultural restrictions.

### Half-Height Container

J-31. Half-height containers have the footprint of an ANSI/ISO container with ANSI/ISO standard structural members and corner fittings (figure J-13). They are approximately half the height of a standard end-opening container. They have fixed sides, an open top, and one drop-end opening. Material is accessible by either MHE or crane. Tarpaulins accompany the containers for cover during shipping and storage. These containers are useful to ship drummed oils and lubricants.



J-32. The 20-foot half-height container used by the Army is 20"x8"x4'3". The Army uses the half-height container primarily to ship ammunition having a high weight to volume ratio, such as 155mm projectiles.



Figure J-12. Half-Height Container

### Tank Container

J-33. Commercial tank containers are 8 and 1/2 feet in length and are used to haul liquids, gases, and dry bulk cargo. They can be pressurized or non-pressurized. Prototypes of military PLS compatible ANSI/ISO bulk tank containers are being developed. They are used for intermodal transport of liquids such as Class III and other liquids and gases.

### Equipment Deployment and Storage System (EDSS)

J-34. EDSS containers are designed to support unit deployments. This category includes QUADCON, TRICON, and internal airlift/helicopter slingable container unit (ISU) containers. QUADCONs and TRICONs are primarily for ground and sea transport ISUs are intended for air transport. All are available in multiple configurations including different doors, internal shelves, and dividers. ISUs are not covered by ANSI/ISO specifications and are not used for marine transport in ANSI/ISO 20- and 40-foot configurations.

- **QUADCON.** QUADCONs (figure J-14) are not a common-use asset. They are unit-owned military containers that are lockable, watertight, and made of steel construction. They were first used as part of the Marine Corps Family of Intermediate Size Containers.

Other Services plan to procure QUADCONs in the near future. They are available to Army units as CTA 50-900 items. The QUADCON is fast becoming the primary EDSS container for surface movements. The QUADCON has ANSI/ISO corner fittings to allow for coupling of the QUADCONs into arrays of up to four units. An array of four QUADCONs has the same external length and width as a 20-foot ANSI/ISO container and is designed to be lifted as a 20-foot unit or moved as a 20-foot unit in ocean shipping. The QUADCON is certified to meet all ANSI/ISO standards. Each has four-way forklift pockets and lockable double doors on each end that provide full access to the contents. To accommodate smaller items, a small item storage cabinet can be installed or removable inserts may be placed as shelves inside the QUADCON.

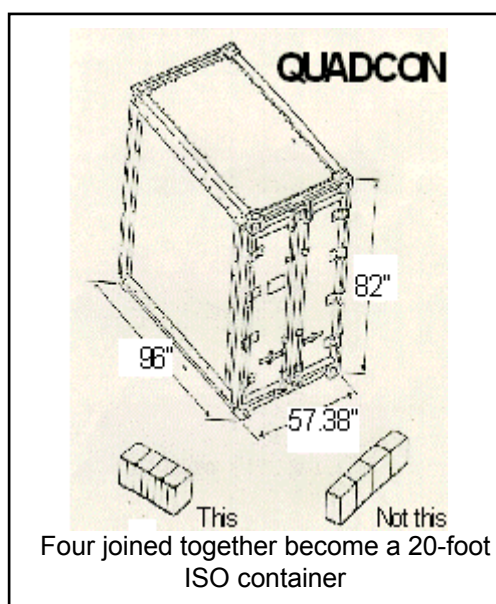

**Figure J-13. QUADCON**

- TRICON.** TRICONs (figure J-15) are not a common-use asset. They are military containers owned by the Army and the Navy. Like QUADCONs, they are lockable, watertight, and made of steel construction. TRICONs have standard ANSI/ISO corner fittings and 3-way forklift pockets on the side and back. The TRICON has ANSI/ISO corner fittings to allow for coupling into arrays of up to three units. An array of three TRICONs has the same external length and width dimensions as a 20-foot ANSI/ISO container and is designed to be lifted as a 20-foot unit in ocean shipping. Two styles of containers have been procured: bulk and configured. Bulk containers do not have drawers, shelves, or rifle racks. Configured containers consist of cabinets with drawers, shelves, rifle racks, or a combination thereof.

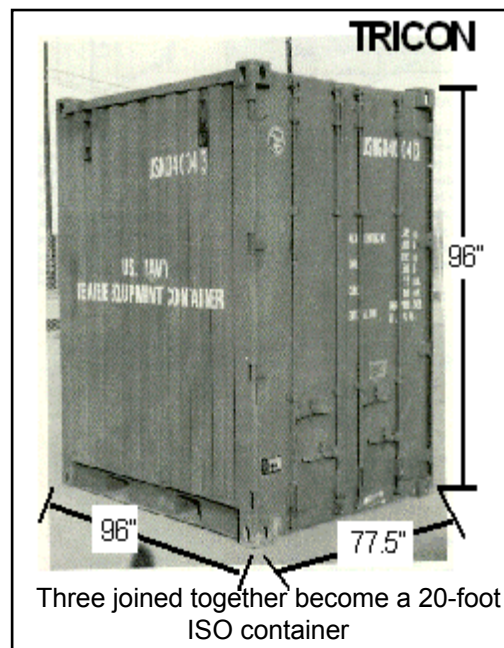

**Figure J-14. TRICON**

- **ISU-60, -90, and -96.** ISUs are 463L compatible, transportable in C-130 & CH 47 aircraft, external air transport certified, and can be picked up with a forklift. They can be fitted with removable bins and drawers as shown below in figure J-16. These ISU containers provide weather resistant storage and transport, but do not meet ANSI/ISO structural standards. They are certified for internal or external helicopter transport and for all AMC transport aircraft. If transported aboard a ship, they would be secondary loads. A number of these units have been procured by US Army Airborne and Air Assault units. The ISU-96 is a refrigeration model used primarily to transport medical supplies. They are not ANSI/ISO compatible.

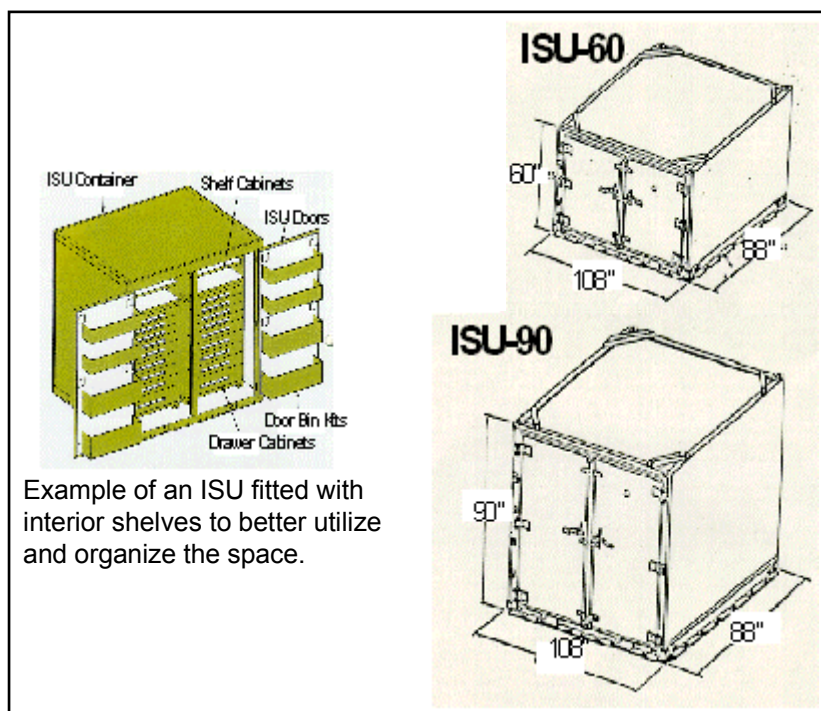

Figure J-15. ISU-60, -90, and -96

## Flatracks

J-35. Flatracks are topless, sideless ISO containers (figure J-17). Flatracks enable containerships to transport bulky items such as lumber, steel products, and piping (regular flatrack) and heavy or outsized cargo such as tanks and armored vehicles (heavy-duty flatrack). The flatrack is a structural steel frame, decked over and fitted with tie-down points. When loaded side-by-side in containership cells, multiple flatracks can be used between decks to accommodate over-width cargo. Some flatracks have corner posts while others have end walls. The corner posts or end walls on most flatracks fold down to facilitate stacking and storage.

J-36. The military flatracks come in three sizes: 20-, 35-, and 40-foot. Twenty-foot flatracks are PLS compatible. They are used to carry light items that do not fit into a 20-foot container. There are several types of heavy-duty flatracks. Some are equipped with telescoping corner posts adjustable from 102 to 162 inches for various cargo heights. Some have fixed corner posts 156 inches high. Corner posts of all three types fold to facilitate stacking and storage. These flatracks were designed for over-ocean movement and have height restrictions when used in highway or rail transport roles.

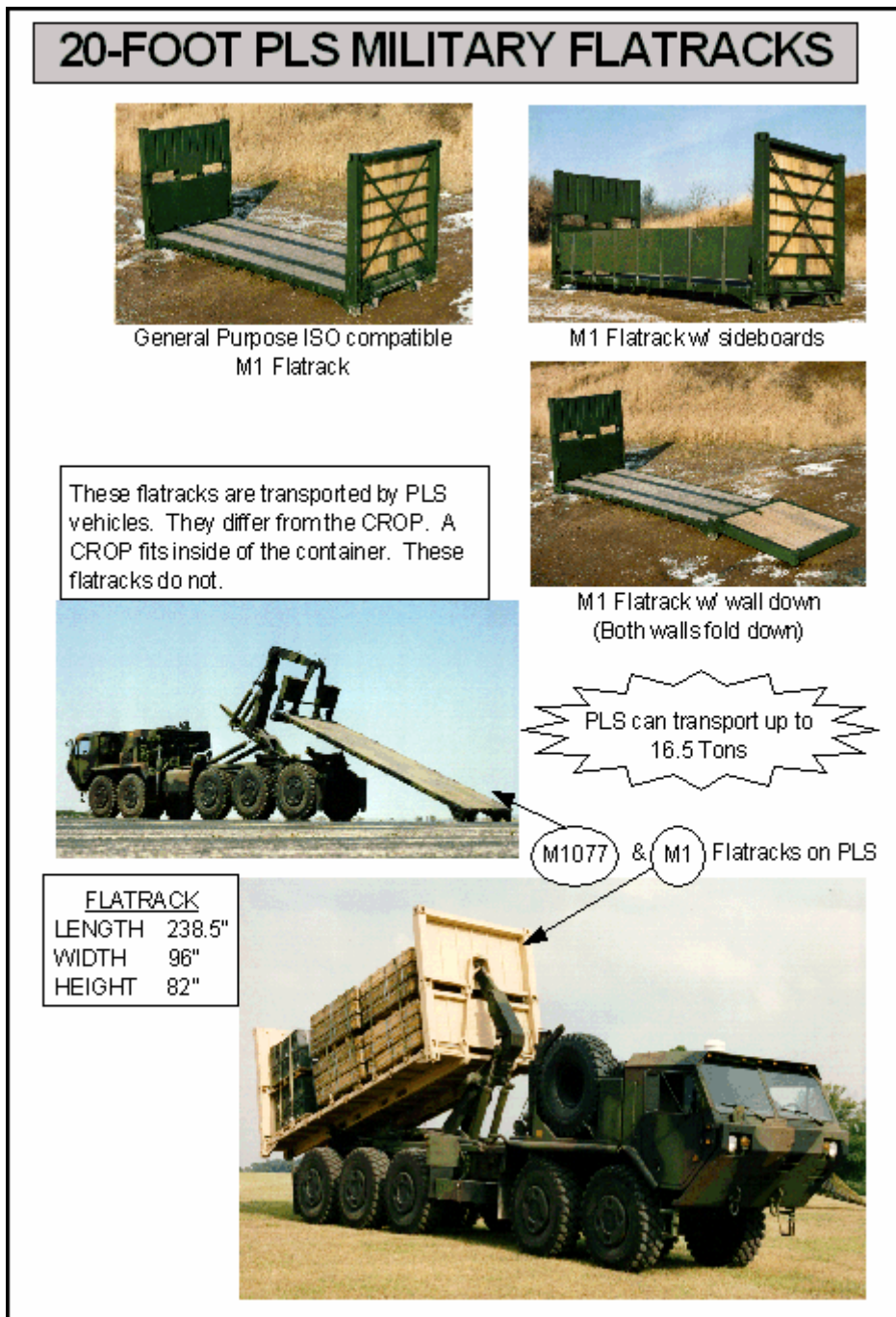

Figure J-16. 20-Foot PLS Flatracks

### Container Roll-In/Roll-Out Platform (CROP)

J-37. The CROP is a PLS flatrack that fits inside an ANSI/ISO standard 20-foot container. Figure J-18, shows a PLS truck pulling a CROP out of a 20-foot container. The CROP is similar in function

to the standard M1077 PLS flatrack except for its dimensions. The CROP is 91.5" wide and 230" long so it fits securely inside an ANSI/ISO container. A benefit of using the CROP is that of external protection of ammunition verses tarps. The CROP does not require additional blocking and bracing or materials and only the PLS truck is required to unload it.



Figure J-17. Container Roll-In/Roll-Out Platform (CROP)

**NOTE**

**The world of containers and container handlers continues to develop and evolve. The transportation world must accept that there will be many different models and names associated with intermodal assets and asset handlers in the near future.**

# GLOSSARY

## Acronyms

2D	Two dimensional
A/DACG	Arrival/Departure Airfield Control Group
AA	Assembly Areas
AAI	Air-to-Air Interface
AALPS	Automated Air Load Planning System
ABS	Automated Battlefield System
AC	Active Component
ACA	Airlift Clearance Authority
ACOFS	Assistant Chief Of Staff
ADAO	Assistant Division Aviation Officer
AEI	Automatic Equipment Identification
AIS	Automated Information Systems
AIT	Automatic Identification Technology
ALCOM	Alaskan Command
AMC	Air Mobility Command
AMC-LSE	Army Material Command Logistics Support Element
AMFT	Automated Movement Flow Tracking
AmovP	Allied Movement Publications
AMS	Automated Manifest System
AO	Area of Operation
AOR	Area of Responsibility
APOD	Aerial Port of Debarkation
APOE	Aerial Port of Embarkation
APS	Army Pre-Positioned Stocks
ARCENT	Army Component Command
ARFOR	Army Forces
ASCC	Army Service Component Commander
ASG	Area Support Groups
ASP	Ammo Supply Points
ASR	Alternate Supply Routes
ATAV	Army Total Asset Visibility
ATCMD	Advanced Transportation Control and Movement Document
AWIS	Army World-Wide Military Command and Control Information System
AWRDS	Army War Reserve Deployment System
BBPCT	Blocking, Bracing, Packing, Crating, and Tie-Down
BMC	Brigade Movement Coordinator
BSA	Brigade Support Area
BSB	Base Support Battalion
C2	Command and Control
CAPS II	Consolidated Aerial Port System II
CBL	Commercial Bill of Lading
CCP	Consolidation and Containerization Point
CD-ROM	Compact Disk-Read Only Memory
C-E	Communications and Electronics
CFMS	Continental United States Freight Management System

CHE	Container Handling Equipment
CIM	Corporate Information Management
CINC	Commander-in-Chief
CMCC	Corps Movement Control Center
CMMC	Corps Materiel Management Center
CMOS	Cargo Movement Operations System
CofS	Chief of Staff
COMSEC	Communications Security
COMMZ	Communication Zone
CONPLAN	Concept Plan
CONUS	Continental United States
COSCOM	Corps Support Command
CP	Checkpoint
CP	Command Post
CRC	CONUS Replacement Centers
CS	Combat Support
CSB	Corps Support Battalions
CSC	Convoy Support Center
CSG	Corps Support Group
CSS	Combat Service Support
CSSCS	Combat Service Support Control System
CTC	Cargo Transfer Company
CTMC	Combined Transportation Movement Center
CTO	Corps Transportation Officer
DAAS	Defense Automated Addressing System
DAMMS-R	Department of the Army Movements Management System- Redesign
DAR	Daily Activity Report
DCSLOG	Deputy Chief of Staff for Logistics
DCSO	Deputy Commander for Support
DCSOPS	Deputy Chief of Staff for Operations and Plans
DDN	Defense Data Network
DELA	Drexler European License Association
DIMHRS	Defense Integrated Military Human Resource System
DISCOM	Division Support Command
DISREP	Discrepancy Report
DLA	Defense Logistics Agency
DMC	Defense Movement Coordinator
DMMC	Division Materiel Management Center
DNVT	Digital Non-secure Voice Terminal's
DOD	Department of Defense
DODAAC	Department of Defense Activity Address Code
DOT	Department of Transportation
DS	Direct Support
DS2T	Deployment and Sustainment Support Tool
DSA	Division Support Area
DSS	Distribution Standard System
DST	Division Support Teams
DTG	Date Time Group
DTO	Division Transportation Officer
DTS	Defense Transportation System
DTTS	Defense Transportation Tracking System
E2DSK	Early Entry Deployment Support Kit
EAC	Echelons Above Corps
EDI	Electronic Data Interchange
EEM	Early Entry Module



eMILPO	Electronic Military Personnel Management Office System
EPW	Enemy Prisoner of War
ETA	Estimated Time of Arrival
ETR	Export Traffic Release
EUSA	Eighth United States Army
FAD	Force Activity Designator
FCDT	Freight Consolidation and Distribution Team
FDRP	First Destination Reporting Point
FMFPAC	Fleet Marine Forces, Pacific
FORSCOM	United States Army Forces Command
FPP	Force Projection Platforms
FRAGO	Fragmentary Orders
FSB	Forward Support Battalion
GATES	Global Air Transportation Execution System
GBL	Government Bill of Lading
GCCS	Global Command and Control System
GCCS-A	Global Command and Control System-Army
GCSS	Global Combat Support System
GCSS-Army	Global Combat Support System-Army
GDSS	Global Decision Support System
GOPAX	Groups Operational Passenger System
GPS	Global Positioning System
GS	General Support
GSU	General Support Unit
GTN	Global Transportation Network
HAZMAT	Hazardous Materiel
HET	Heavy Equipment Transporter
HF	High Frequency
HHC	Headquarters & Headquarters Company
HHD	Headquarters and Headquarters Detachment
HHI	Hand Held Interrogators
HMCT	Highway Movement Control Team
HN	Host Nation
HNS	Host Nation Support
HQ	Headquarters
HTD	Highway Traffic Division
IBS	Integrated Booking System
ICODES	Integrated Computerized Deployment System
IG	Inspector General
ISSA	Inter-Service Support Agreement
ITO	Installation Transportation Officer
ITV	In-Transit Visibility
JCS	Joint Chief of Staff
JMC	Joint Movement Center
JOPEs	Joint Operation Planning and Execution System
JTAV	Joint Total Asset Visibility
JTB	Joint Transportation Board
JTCC	Joint Transportation Corporate Information Management Center
JTF	Joint Task Force
LAN	Local Area Network
LCA	Logistic Control Activity

LIA	Logistics Integration Agency
LIF	Logistics Intelligence Files
LIN	Line Identification Number
LO/LO	Lift-On/Lift-Off
LOC	Lines Of Communication
LOTS	Logistics-Over-The-Shore
LPT	Logistics Preparation of the Theater
LZ	Landing Zone
MA	Marshalling Area
MACOM	Major Army Command
MAGTF	Marine Air-Ground Task Force
MARFORCENT	Marine Forces, Pacific
MCA	Movement Control Agency
MCB	Movement Control Battalion
MCNCO	Movement Control Noncommissioned Officer
MCO	Movement Control Officer
MCS	Multi-Purpose Communications and Signaling
MCT	Movement Control Team
MDSS	Marine Air-Ground Task Force Deployment Support System
METS	Mechanized Export Traffic System
METT-TC	Mission, Enemy, Terrain and Weather, Troops and Support Available, Time Available, and Civil Considerations
MHE	Materiel Handling Equipment
MILVAN	Military-Owned Demountable Container
MLC	Military Load Classification
MMC	Material Management Center
MOU	Memorandum of Understanding
MOVEPLAN	Movement Plan
MP	Military Police
MRE	Meal, Ready-To-Eat
MRO	Material Release Order
MRT	Movement Regulating Team
MS	Mobilization Station
MSB	Main Support Battalion
MSC	Military Sealift Command
MSE	Mobile Subscriber Equipment
MSL	Military Shipping Label
MSR	Main Supply Route
MTMC	Military Traffic Management Command
MTS	Movement Tracking System
MTS-CS	Movement Tracking System-Control Station
MWO	Mobility Warrant Officer
NATO	North Atlantic Treaty Organization
NBC	Nuclear, Biological, and Chemical
NCO	Non-Commissioned Officer
NCS	Net Control Station
NEO	Noncombatant Evacuation Operation
NICP	National Inventory Control Point
NSN	National Stock Number
OCCA	Ocean Cargo Clearance Authority
OCIE	Organizational Clothing & Individual Equipment
OCONUS	Outside the Continental United States
OEL	Organizational Equipment List
OIC	Officer In Charge

OMC	Optical Memory Card
OPLAN	Operation Plan
OPORD	Operation Order
OPSEC	Operations Security
OPTEMPO	Operating Tempo
PACFLT	US Pacific Fleet
PD	Priority Designator
PDF	Portable Data File
PERSCOM	Personnel Command
PIC	Positive Inbound Clearance
PM	Provost Marshal
POC	Point of Contact
POCD	Process Operational Concept Document
POD	Port of Debarkation
POE	Port of Embarkation
POL	Petroleum, Oil, and Lubricants
PP&O	Plans, Programs, and Operations
PRAMS	Passenger Reservation and Manifest System
PSA	Port Support Activity
PSN	Proper Shipping Name
PZ	Pickup Zone
RAP	Rear Area Protection
RC	Reserve Component
RDD	Required Delivery Date
RF	Radio Frequency
RFDC	Radio Frequency Data Communication
RFID	Radio Frequency Identification
RGATES	Remote Global Air Transportation Execution System
RLAN	Remote Local Area Network
RMMT	Rail Movement Management Team
ROKA	Republic of Korea Army
ROM	Refuel On The Move
RP	Release Point
SA	Staging Area
SAAM	Special Assignment Airlift Mission
SAAS-MOD	Standard Army Ammunition System – Modernized
SAI	Surface-To-Air Interface
SARSS	Standard Army Retail Supply System
SATCOM	Satellite Communications
SDD	Standard Delivery Date
SJA	Staff Judge Advocate
SOCPAC	Special Operations Command, Pacific
SOO	Support Operations Officer
SOP	Standard Operating Procedures
SP	Start Point
SPBS-R	Standard Property Book System – Redesigned
SPOD	Seaport of Debarkation
SPOE	Seaport of Embarkation
SRP	Soldier Readiness Processing
SSA	Supply Support Activity
STACCS	Standard Theater Army Command and Control System
STANAG	Standardization Agreements
SWA	Southwest Asia

TA	Theater Army
TAA	Tactical Assembly Area
TAACOM	Theater Army Area Command
TALCE	Tanker Airlift Control Element
TALO	Tactical Air Liaison Officer
TAT	To Accompany Troops
TAV	Total Asset Visibility
TC-ACCIS	Transportation Coordinators-Automated Command and Control Information System
TC-AIMS II	Transportation Coordinators' Automated Information for Movements System II
TCC	Transportation Component Command
TCE	Transportation Command Element
TCMD	Transportation Control & Movement Document
TCN	Transportation Control Number
TCP	Traffic Circulation Plan
TEU	Twenty-Foot Equivalent Unit
TFOP	Theater Force-Opening Package
TMO	Traffic Management Office
TMR	Transportation Movement Release
TMT	Transportation Motor Transport
TO&E	Tables of Organization and Equipment
TOE	Table of Organization and Equipment
TOFM	Theater-Opening Force Module
TP	Transportation Priority
TPFDD	Time Phased Force Deployment Data
TPS	Tactical Personnel Dystem
TRANSCOM	Transportation Command
TRITAC	Tri-Service Tactical
TSC	Theater Support Command
TTP	Trailer Transfer Point
TUSA	Third US Army
TWV	Tactical Wheeled Vehicle
UDL	Unit Deployment List
UMC	Unit Movement Coordinator
UMMIPS	Uniform Materiel Movement and Issue Priority System
UMO	Unit Movement Officer
UMT	Unit Ministry Team
UMT	Unit Movement Team
USAF	US Air Force
USAFE	US Air Force in Europe
USAREUR	US Army Europe Commands
USARPAC	US Army Pacific
USARSO	US Army South
USCENTCOM	United States Central Command
USEUCOM	United States European Command
USFJ	US Forces Japan
USFK	US Forces Korea
USMC	United States Marine Corps
USPACOM	United States Pacific Command
USSOUTHAF	US South Air Force
USTRANSCOM	United States Transportation Command
VHF	Very High Frequency
WHNS	Wartime Host Nation Support
WPS	Worldwide Port System
WWW	World Wide Web

## Terms And Definitions

### A

**Active Component (AC)** – The active Army component of the United States Army refers to units on full-time active duty, as distinguished from the Reserve component that is composed of units of the United States Army Reserve and the Army National Guard.

**Advanced Transportation Control and Movement Document (ATCMD)** - The ATCMD function is used to provide advance information concerning equipment that will be moving to an airport or seaport for shipment.

**Aerial Port of Debarkation (APOD)** - An aerial port within the theater of operations where the strategic transportation of forces is completed.

**Aerial Port of Embarkation (APOE)** – A station which serves as an authorized port to process and clear aircraft (scheduled, tactical, and ferried) and traffic for departure from the country in which located.

**Air Mobility Command (AMC)** – Air Mobility Command's primary mission is rapid, global mobility and sustainment for America's armed forces. The command also plays a crucial role in providing humanitarian support at home and around the world. They also provide tactical and strategic airlift and aerial refueling for all of America's armed forces.

**Air-to-Air Interface (AAI)** - AAI is used when units or reinforcements are critical or when the strategic aircraft is diverted from its original APOD due to the tactical situation, weather, or other reasons. AAIs are normally short notice, short duration missions.

**Airlift Clearance Authority (ACA)** – Service activity that controls the movement of traffic, cargo and personal property, into the airlift system.

**Alert Holding Area** – The equipment, vehicle, and passenger control area. It is normally located in the vicinity of the departure airfield. It is used to assemble, inspect, hold, and service aircraft loads. Control of the load is transferred from the individual unit to the DACG at this point.

**Alternate Supply Routes (ASR)** - A route or routes designated within an area of operations to provide for the movement of traffic when main supply routes become disabled or congested.

**Ammo Supply Points (ASP)** - The Ammunition Supply Point (ASP) has the mission of supporting installations with ammunition and explosives (Class V). The ASP is staffed and equipped to support all Class V missions and is capable of storing all categories of munitions and explosives.

**Apportionment** - In the general sense, distribution for planning of limited resources among competing requirements. Specific apportionment's (e.g., air sorties and forces for planning) are described as apportionment of air sorties and forces for planning, etc.

**Area of Operation (AO)** – An operational area defined by the joint force commander for land and naval forces. Areas of operation do not typically encompass the entire operation

area of the joint force commander, but should be large enough for the component commanders to accomplish their missions and protect their forces.

**Area of Responsibility (AOR)** - The geographical area associated with a combatant command within which a combatant commander has authority to plan and conduct operations.

**Army Material Command Logistics Support Element (AMC-LSE)** - The LSE is an organization deployed by the USAMC to help commanders manage USAMC contractors and works as part of the TSC.

**Army Pre-Positioned Stocks (APS)** - APS constitute one leg of the strategic mobility triad. The purposes of APS are to reduce the initial amount of strategic lift required to support a CONUS-based force projection Army; and to sustain the warfight until sea lines of communication (SLOC) with CONUS are established. Accordingly, APS is pre-positioned at several sites to quickly project power to potential contingency areas.

**Army Service Component Commander (ASCC)** - The commander of the Army component in support of a theater commander, combatant commander, or joint force command. The ASCC is responsible for preparing, maintaining, training, equipping, administering, and supporting Army forces assigned to unified and specified commands. The ASCC normally advises the combatant or subordinate unified commander on the proper employment of the forces of the Army component.

**Army Total Asset Visibility (ATAV)** - The ATAV Program is a comprehensive U.S. Army initiative that dramatically improves the logisticians' ability to obtain and act on information about the location, quantity, condition, and movement of assets. It provides visibility of assets in use, in storage, in process, and in transit, as well as other logistics information.

**Army War Reserve Deployment System (AWRDS)** - This operational data store was designed to enable Army War Reserve to rapidly deploy forces around the globe for combat and humanitarian missions. This system is a distributed database application that allows military personnel in the United States and in Europe and Asia (both on land and sea) to maintain and access current equipment availability and readiness information. Military personnel from around 20 pre-positioned sites update the information into their local database and every 6 hours the updated information is replicated from their local machines to a centralized server. This ensures that all Army War Reserve sites have access to the most up-to-date information.

**Army World-Wide Military Command and Control Information System (AWIS)** - When the Army is currently called upon to rapidly deploy its forces, AWIS provides the support for the entire operation: from mobilization and deployment through employment and sustainment. AWIS fulfills the Army's strategic C2 requirements for software, hardware, and databases for the implementation of the Joint Operations Planning and Execution System (JOPES) and other Joint Service systems that support the Unified Commands and the Joint Staff. In addition, AWIS modernizes the Army's C2 system, supporting conventional military planning and execution. AWIS-developed software systems provide the capability for Army commands to analyze courses of action; develop, manage, and support the execution of the Army's responsibilities in the Joint Chiefs of Staff (JCS) War Plans; ensure that the Army's plan is feasible in a global environment; and perform status reporting, mobilization, deployment, employment, and sustainment support actions for Army forces supporting conventional joint-military operations.

**Arrival/Departure Airfield Control Group (A/DACG)** – A provisional organization provided by the designated installation to perform aerial port functions during unit deployment/employment/ redeployment.

**Assembly Area** - An area in which a command is assembled to prepare for further operations.

**Automated Air Load Planning System (AALPS)** – A computerized system to rapidly estimate total airlift requirements and to produce individual aircraft load plans. The system allows preplanned equipment deployment packages to be built, analyzed, and maintained.

**Automated Battlefield System (ABS)** - The ABS is a fully automated man-portable system capable of supporting Air Force accounting requirements and military pay service. It uses laptop computers to provide deployed forces direct, on-line access to accounting and payroll systems from any location. The ABS, which consists of a simple piece of software that works with ground-based communication equipment or a portable satellite transmission device, permits the user to access all financial information resident in stateside computers.

**Automated Information Systems (AIS)** - A discrete set of information resources organized using information technology. Automated information systems may be used for the collection, processing, maintenance, transmission, or dissemination of information.

**Automated Manifest System (AMS)** – AMS is a Defense Logistics Agency (DLA) initiative that utilizes laser-readable optical cards in place of paper packing slips on the exterior of shipment containers. The AMS is used at depots, Central Receiving Points (CRPs), and Supply Support Activities (SSAs) such as the DSU in a forward support battalion of a division to facilitate manifesting and tracking of multipack shipments from the depot to the CRP or SSA. AMS provides "in the box" asset visibility and may be used as the source of intransit visibility data. The AMS reader can be connected directly to the STAMIS at the receiving unit thereby increasing the accuracy of data by automating the input of source data.

**Automated Movement Flow Tracking (AMFT)** – AMFT is an Army software tool that provides automated support for deployment planning and execution. It also develops deployment schedules, updates and modifies chalks, creates and prints movement flow tables, and is capable of sending electronic messages.

**Automatic Equipment Identification (AEI)** - AEI reader systems provide automated tracking of railcars and shipments via RF tags, and make shipment location information available to railroads and their customers. Although not an Army asset, it may be possible to use this technology and Electronic Data Interchange (EDI) from the rail company to Global Transportation Network (GTN) to provide ITV data of Army equipment moving on commercial rail carriers.

**Automatic Identification Technology (AIT)** – A suite of tools for facilitating total asset visibility (TAV) source data capture and transfer. Automatic Identification technology (AIT) includes a variety of devices, such as bar codes, magnetic strips, optical memory cards, and radio frequency tags for marking or tagging individual items, multi-packs, equipment, air pallets, or containers, along with the hardware and software required to create the devices, read the information on them, and integrate that information with other logistic information. AIT integration with logistic information systems is key to the Department of Defense's TAV efforts.

**Automation Network** - The automation network combines all of the information collection devices, automatic identification technologies, and the automated information systems, that either support or facilitate the joint reception, staging, onward movement, and integration process.

## B

**Balance** - Balance is the matching of vehicle characteristics with route characteristics to ensure that vehicle traffic does not exceed the most limiting feature of a route.

**Bar Code** - A code consisting of a group of printed and variously patterned bars, spaces, rectangles, or other shapes that encode data that is designed to be scanned and read into computer memory to provide identification or other information relating to the object it labels.

**(1) Linear Bar Code** - A code consisting of a group of printed and variously patterned bars and spaces, and sometimes numerals, that is designed to be scanned and read into computer memory as identification for the object it labels. An ordinary linear barcode, with vertical bars and stripes, can hold about 16 ASCII characters.

**(2) Two Dimensional Barcode** - Data encoded in many different size rectangles, can hold between 1000 and 2000 ASCII characters. Two Dimensional barcodes have to be scanned in a raster format (like a television) to cover their whole area.

**Base Support Battalion (BSB)** - BSB provides command and control of assigned and attached units and facilities to ensure the sustainment of the community in its Area of Operation. It supports Operations Other Than War, receives and prepares augmentation forces for onward movement, processes and provides individual replacements, transitions the community during deployments and crises, and provides community support operations.

**Blocking, Bracing, Packing, Crating, and Tie-Down (BBPCT)** - Materials used to contain and immobilize materiel and equipment and to protect it from damage during transportation. BBPCT materials may include lumber, CONEX inserts, cardboard boxes, paper wrapping, plastic "bubble wrap", Styrofoam, metal banding, chains, and cleats.

**Boundary** - A line that delineates surface areas for the purpose of facilitating coordination and deconfliction of operations between adjacent units, formations, or areas.

**Brigade Movement Coordinator (BMC)** - BMCs are appointed to coordinate and support Brigade movement activities and to assist in the development, maintenance, and evaluation of subordinate units' movement plans.

**Brigade Support Area (BSA)** - A designated area in which combat service support elements from division support command and corps support command provide logistics support to a brigade. The brigade support area normally is located 20 to 25 kilometers behind the forward edge of the battle area.

## C

**Call Forward Area** - The area is that portion of the departure airfield where the DACG and TALCE conduct joint inspections of aircraft loads. A final briefing is provided to deploying troops by the TALCE. The DACG and TALCE review all load plans and manifests for accuracy. The deploying unit corrects all discrepancies found by the joint inspection in this area.



**Campaign** - A series of related military operations aimed at accomplishing a strategic or operational objective within a given time and space.

**Campaign Plan** - A plan for a series of related military operations aimed at accomplishing a strategic or operational objective within a given time and space.

**Cargo Documentation Team** - A Cargo Documentation Team is a small TOE detachment staffed with 88N Documentation Specialists. Its mission is to administrate the document associated with moving cargo. The Cargo Documentation Team has no MHE. The team is normally assigned to augment a Cargo Transfer Company to prepare documentation for cargo and equipment being loaded on vessels.

**Cargo Movement Operations System (CMOS)** - CMOS classifies and consolidates cargo, determines cargo priority, and provides the capability to schedule and move cargo expeditiously.

**Cargo Transfer Company (CTC)** - A CTC is organized with four Cargo Transfer Platoons and a Documentation Section. The four platoons have MHE to support transshipping cargo, containers, and unit equipment to ships and aircraft. Each platoon can operate independently at a remote site to support transshipment operations. The company assists in loading ships and operating a staging area.

**Centralized Control** - Centralized Control means that a focal point for transportation planning and resource allocation exists at each level of command involved in an operation. The focal point is an individual or unit that is aware of the current and future requirements of the supported force as well as the capabilities available to meet the requirements. Centralization of movement control normally occurs at the levels charged with integrating logistics support.

**Checkpoint (CP)** - 1. A predetermined point on the surface of the Earth used as a means of controlling movement, a registration target for fire adjustment, or reference for location. 2. Center of impact; a burst center. 3. Geographical location on land or water above which the position of an aircraft in flight may be determined by observation or by electrical means. 4. A place where military police check vehicular or pedestrian traffic in order to enforce circulation control measures and other laws, orders, and regulations.

**Close Column** - A form of convoy organization that provides the greatest degree of convoy control. It is characterized by vehicle intervals of 25 to 50 meters and speeds under 25 mph. Close column is normally used during limited visibility or on poorly marked or congested roads.

**Column Schedule** - Specifies arrive and clear times at checkpoints (CPs) along an entire route. Based upon the extent of control required, a column schedule can provide the most effective highway regulation because it provides in-transit times to reach CPs and helps the pacesetter maintain the prescribed rate of march. It may be used for supervised, dispatch, or reserved routes. It should also be used when congestion is anticipated.

**Combat Power** - The total means of destructive and/or disruptive force which a military unit/formation can apply against the opponent at a given time.

**Combat Service Support (CSS)** - The essential capabilities, functions, activities, and tasks necessary to sustain all elements of operating forces in theater at all levels of war.

**Combat Service Support Control System (CSSCS)** - CSSCS is designed to collect, analyze, and disseminate critical logistical, transportation, medical, financial, and personnel information. CSSCS will receive data directly from TC-AIMS II and GTN.

**Combatant Commander** - A commander in chief of one of the unified or specified combatant commands established by the President.

**Combined Operation** - An operation conducted by forces of two or more Allied nations acting together for the accomplishment of a single mission.

**Combined Transportation Movement Center (CTMC)** - The CTMC serves as the single transportation manager for coordinating theater-level transportation movements and asset management in support of contingency operations.

**Command and Control (C2)** - The exercise of command that is the process through which the activities of military forces are directed, coordinated, and controlled to accomplish the mission. This process encompasses the personnel, equipment, communications, facilities, and procedures necessary to gather and analyze information, to plan for what is to be done, and to supervise the execution of operations.

**Commercial Bill of Lading (CBL)** - Carrier documentation used for transportation of shipments, such as that used by small package express carriers. It includes the commercial procedures related to the use of such documentation.

**Communication Zone (COMMZ)** - The COMMZ extends from the CONUS base to the rear of the Combat Zone (CZ) in the theater of operations. Its size may vary depending on the size of the theater of operations, number of forces required for operations and sustainment, need for depth, the number and direction of lines of communication (LOC), and the enemy's capability to interdict and disrupt sustainment operations, geography, and political boundaries. The COMMZ contains the LOC; the establishments within the theater logistics bases that provide supply, maintenance, field services, transportation, health services, personnel support, and evacuation; and other agencies required for the immediate support and sustainment of the field forces.

**Concept Of Operations** - A verbal or graphic statement, in broad outline, of a commander's assumptions or intent in regard to an operation or series of operations. The concept of operations frequently is embodied in campaign plans and operation plans; in the latter case, particularly when the plans cover a series of connected operations to be carried out simultaneously or in succession. The concept is designed to give an overall picture of the operation. It is included primarily for additional clarity of purpose.

**Concept Plan (CONPLAN)** - An operation plan in a concept format that would require considerable expansion or alteration to convert to an OPLAN and OPORD.

**Consolidated Aerial Port System II (CAPS II)** - CAPS II is an umbrella system that includes cargo, passenger, and command and control operations. It provides a standardized worldwide automated network of computers for processing cargo and passengers through the major aerial ports. The cargo system records receipts, staging, and unloading at APOEs, and prints out the aircraft manifest upon completion of loading. The passenger system will accomplish passenger processing, seat allocation, cash collection, flight update processing to ASIFICS/PRAMS, boarding pass, and final manifest preparation/issue.

**Container Handling Equipment (CHE)** – Material-handling equipment (MHE) designed specifically to receive, maneuver, and dispatch containers.

**Continental United States (CONUS)** – The 48 contiguous states and the District of Columbia.

**Continental United States Freight Management System (CFMS)** - CFMS provides an automated, electronic capability for the procurement of commercial freight transportation services. It covers freight shipments at all sources. It provides the central DOD database for filing all commercial freight transportation rates and services. It provides automation support for preparing freight shipping documents, carrier selection, electronic filing of Government bill of lading (GBL), prepayment, shipment status, quality control, and intransit visibility. The CFMS interfaces with GTN and the defense transportation tracking system for shipment status and GBL maintenance.

**Contingency** - An emergency involving military forces caused by natural disasters, terrorists, subversives, or by required military operations. Due to the uncertainty of the situation, contingencies require plans, rapid response, and special procedures to ensure the safety and readiness of personnel, installations, and equipment.

**Control Point** - 1. A position along a route of march at which personnel are stationed to give information and instructions for the regulation of traffic. 2. A position marked by a buoy, boat, aircraft, electronic device, conspicuous terrain feature, or other identifiable object which is given a name or number and used as an aid to navigation or control of ships, boats, or aircraft.

**Controlled Route** - A route, the use of which is subject to traffic or movement restrictions.

**Convoy Commander** – An officer, designated to command the convoy, subject to the orders of the commander.

**Corporate Information Management (CIM)** - CIM is a strategic, collaborative management initiative to guide the evolution of the DoD enterprise and capture the benefits of the information revolution. It represents a partnership of functional and technical management to achieve a combination of improved business processes and effective application of information technology across the functional areas of the DoD. It is embodied in policies and programs, implementation guidance, and supporting resources, to help functional managers guide and implement changes to processes, data, and systems across the DoD.

**Corps Transportation Officer (CTO)** - Performs these critical transportation staff functions and integrates airlift requirements into the overall corps transportation requirements.

**Countermeasures** - Employment of devices and/or techniques designed to impair the operational effectiveness of enemy activity.

**Crisis Action Planning (CAP)** - The time-sensitive planning for the deployment, employment, and sustainment of assigned and allocated forces and resources that occurs in response to a situation that may result in actual military operations. Crisis action planners base their plan on the circumstances that exist at the time planning occurs.

**Critical Point** - 1. A key geographical point or position important to the success of an operation. 2. In point of time, a crisis or a turning point in an operation. 3. A selected

point along a line of march used for reference in giving instructions. 4. A point where there is a change of direction or change in slope in a ridge or stream. 5. Any point along a route of march where interference with a movement may occur.

## D

**Date Time Group (DTG)** - A set of characters, usually in a prescribed format, used to express the day of the month, the hour of the day, the minute of the hour, the time zone, and the year.

**Decentralized Execution** - The delegation of execution authority to subordinate commanders.

**Defense Automated Addressing System (DAAS)** - Automated system that allows logistics personnel to access data through DoD to asset management. It provides updated information to databases.

**Defense Data Network (DDN)** - A global communications network serving the U.S. Department of Defense composed of MILNET, other portions of the Internet, and classified networks that are not part of the Internet. The DDN is used to connect military installations and is managed by the Defense Information Systems Agency.

**Defense Integrated Military Human Resource System (DIMHRS)** - DIMHRS is an unclassified, single, integrated military personnel and pay management system for all DOD military personnel during peace, war mobilization, and demobilization. DIMHRS provides near real-time information from the foxhole to the Human Resource National Provider.

**Defense Logistics Agency (DLA)** - The DLA is a logistics combat support agency whose primary role is to provide supplies and services to America's military forces worldwide. The DLA manages over four million consumable items, processes more than 30 million distributions annually, and administers \$900 billion in DoD contracts. Their responsibility has grown so much that if a war fighter comes in contact with an item, chances are the DLA has had something to do with it.

**Defense Movement Coordinator (DMC)** - The DMC is a designated official established in each State Movement Control Center to routinely coordinate defense highway movements. The DMC coordinates military movement plans that traverse or originate in his/her State including those that originate elsewhere. In coordination with his/her State counterparts, the DMC requests permits, obtains clearances, monitors and coordinates moves, resolves problems, and reroutes moves as necessary.

**Defense Transportation System (DTS)** - The infrastructure supporting DOD's common-user transportation needs. The DTS consists of military and commercial assets, services, and systems organic to, contracted for or controlled by DOD.

**Defense Transportation Tracking System (DTTS)** - A joint Service program that uses satellite positioning and communications technology to fulfill its primary mission of ensuring the safe and secure movement of all DoD ordnance transported by approved munitions carriers in CONUS. DTTS supports DOD's In-transit Visibility (ITV) structure by forwarding its complete database of by-product ordnance movement position data to USTRANSCOM's Global Transportation Network on an hourly basis.

**Deliberate Planning** - The process used when time permits the total participation of commanders and staff of the supported and supporting commands. Procedures involve

developing an OPLAN, which consists of detailed planning for both the strategic movement of forces and for committing those forces upon their arrival in the theater.

**Demobilization** - The process of transitioning a conflict or wartime military establishment and defense-based civilian economy to a peacetime configuration while maintaining national security and economic vitality.

**Demurrage** - A penalty fee assessed when cargo isn't discharged from a conveyance and the conveyance is not released to the owner.

**Department of Defense Activity Address Code (DODAAC)** - A distinctive code assigned to identify specific units, activities, and/or organizations.

**Department of the Army Movements Management System-Redesign (DAMMS-R)** - DAMMS-R provides automation support for transportation staffs and organizations within a tactical theater of operations and the CONUS. It is a vital link in the maintenance of ITV over units, personnel, and material. DAMMS-R interfaces with all Standard Army Management Information System (STAMIS), all services, and all foreign governments of the countries where the Army is deployed. DAMMS-R consists of seven modules. These modules are: system management, mode operations, movement control team operations, highway regulation, convoy planning, operational movements programming, and transportation addressing.

**Department of Transportation (DOT)** - Establishes the nation's overall transportation policy.

**Deployment** - The planning, preparation, and movement of forces and their support from any location to an area of operations in response to a military need or crisis.

**Deployment Planning** - Operational planning directed toward the movement of forces and sustainment resources from their original locations to a specific operational area for conducting the joint operations contemplated in a given plan. Encompasses all activities from origin or home station through destination, including intra-continental United States, intertheater, and intratheater movement legs, staging areas, and holding areas.

**Digital Nonsecure Voice Terminal's (DNVT)** - The DNVT is a four-wire terminal contained in a ruggedized case, which transmits and receives conditioned diphasemodulated digitized voice and loop signaling information at 16 or 32 kb/s. The DNVT has a 16-key push button keyboard, receiver and ring volume controls, an incoming call/off-hook indicator light, and writing pad. It contains built-in protection from nuclear energy electromagnetic pulses and lightning. Handset H-350/U is issued with the DNVT. The DNVT provides a digital communications interface with Tri-Service Tactical Communications (TRI-TAC) and Mobile Subscriber Equipment (MSE) circuit switches.

**Direct Support (DS)** - A mission requiring a force to support another specific force and authorizing it to answer directly to the supported force's request for assistance.

**Discrepancy Report (DISREP)** - DISREP refers to any type of deficiency or discrepancy that reflects on the quality of product received, stocked, or issued to DLA customers, and are reported to DSCs.

**Dispatch Route** - A route over which full control, both as to priorities of use and the regulation of movement of traffic in time and space, is exercised. Movement authorization is required for its use, even by a single vehicle.

**Distribution** - As used in transportation doctrine, the operational process of synchronizing all elements of the logistic system to deliver the "right things" to the "right place" at the "right time" to support the geographic combatant commander.

**Distribution Management Center (DMC)** - The Distribution Management Center serves as the logistics fusion center to collect and analyze overall total Asset visibility (TAV) and intransit visibility (ITV) information.

**Distribution Manager** - The executive agent for managing distribution with the combatant commander's area of responsibility.

**Distribution Pattern** - A complete logistics picture that shows the locations of ports, locations of supply, locations of consignees, maintenance activities, nodes, and transportation activities. It is the tool by which planners know where support should normally flow and where it may be diverted as operational needs dictate.

**Distribution Pipeline** - Continuum or channel through which the Department of Defense conducts distribution operations. The distribution pipeline represents the end-to-end flow of resources from supplier to consumer and, in some cases, back to the supplier in retrograde activities.

**Distribution Plan** - A reporting system comprising reports, updates, and information systems feeds that articulate the requirements of the theater distribution system to the strategic and operational resources assigned responsibility for support to the theater. It portrays the interface of the physical, financial, information and communications networks for gaining visibility of the theater distribution system and communicates control activities necessary for optimizing capacity of the system. It depicts, and is continually updated to reflect changes in, infrastructure, support relationships, and customer locations to all elements of the distribution system (strategic, operational, and tactical).

**Distribution Standard System (DSS)** - DSS is an automated information system that manages all functional business processes of DOD's warehouse operations. These processes include receiving, storage, consolidation, packing, shipping, inventory, inspection, and workload management. The system includes both commercial-off-the-shelf (COTS) software packages and developed application software.

**Distribution System** - That complex of facilities, installations, methods, and procedures designed to receive, store, maintain, distribute, and control the flow of military materiel between the point of receipt into the military system and the point of issue to using activities and units.

**Diversions** - As used in transportation doctrine, a rerouting of cargo or passengers to a new transshipment point or destination or on a different mode of transportation prior to arrival at ultimate destination.

**Division Materiel Management Center (DMMC)** - Provides materiel management for the division. DMMC is the division's logistics coordinating and control element. It provides materiel management for all classes of supplies but Class 8 and controls maintenance priorities and procedures.

**Division Support Area (DSA)** - An area normally located in the division rear and often positioned near air-landing facilities along the main supply route. The DSA contains the portions of the division rear command post, DISCOM CP, and units organic and attached to

the DISCOM. It may also contain COSCOM units supporting the division and nondivisional units in the division area.

**Division Support Command (DISCOM)** - The Division Support Command (DISCOM) fixes, fuels, arms, transports, or replaces anything within the division. DISCOM's ensures that the maneuver brigades never run-out of bullets, fuel, or food and repair items the brigades cannot fix.

**Division Support Team (DST)** - Provided by corp to augment division transportation offices (DTOs).

**Division Transportation Officer (DTO)** - The DTO is a staff planner who coordinates with the division G3 on tactical moves and operations and with the G4 on logistical and administrative matters. The DTO also provides transportation guidance to other staff sections and commanders within the division. The DTO is the formal link between the division and the Corps transportation officer. The four primary DTO functions are advisory, planning, coordination, and technical assistance.

**Doctrine** - Fundamental principles by which the military forces or elements thereof guide their actions in support of national objectives. It is authoritative but requires judgment in application.

**Drexler European License Association (DELA)** - DELA refers to the optical member card (OMC) standard developed by Drexler Technology that encompasses ISO11693 and 11694.

**Drop Zone** - A specific area upon which airborne troops, equipment, or supplies are airdropped.

**Dunnage** - Lumber or other material used to brace and secure cargo to prevent damage.

## E

**Early Entry Module (EEM)** - Provides command and control of many of the elements initially supporting RSO&I.

**Echelon** - 1. A subdivision of a headquarters, i.e., forward echelon, rear echelon. 2. Separate level of command. As compared to a regiment, a division is a higher echelon; a battalion is a lower echelon. 3. A fraction of a command in the direction of depth to which a principal combat mission is assigned; i.e., attack echelon, support echelon, reserve echelon. 4. A formation in which its subdivisions are placed one behind another, with a lateral and even spacing to the same side.

**Echelons Above Corps (EAC)** - Army headquarters and organizations that provide the interface between the theater commander (joint or multinational) and the corps for operational matters.

**Electronic Data Interchange (EDI)** - A process which allows computer-to-computer exchange of routine business information in a standard format.

**Embarkation** - The process of putting personnel and/or vehicles and their associated stores and equipment into ships and aircraft.

**Embarkation Plans** - The plans prepared by the landing force and appropriate subordinate commanders containing instructions and information concerning the organization for embarkation, assignment to shipping, supplies and equipment to be embarked, location and assignment of embarkation areas, control and communication arrangements, movement schedules and embarkation sequence, and additional pertinent instructions relating to the embarkation of the landing force.

**eMILPO** - eMILPO is a web application accessible worldwide by all echelons of users. eMILPO is the Active Army's interim personnel system as the Department of Defense transitions into the Defense Integrated Management Human Resources System (DIMHRS) architecture.

**Employment** - The strategic, operational, or tactical use of forces.

**Estimated Time of Arrival (ETA)** - The date and time a package or shipment is scheduled or expected to arrive at a given destination; or the date and time a vehicle is expected to arrive at a given destination.

**Exploitation** - 1. Taking full advantage of success in military operations, following up initial gains, and making permanent the temporary effects already achieved. 2. Taking full advantage of any information that has come to hand for tactical, operational, or strategic purposes. 3. An offensive operation that usually follows a successful attack and is designed to disorganize the enemy in depth.

**Export Traffic Release (ETR)** - Shipping instructions issued by a clearance authority in response to an offering which specifies the mode of shipment and the means by which an export shipment will move.

## F

**Fleet** - An organization of ships, aircraft, Marine forces, and shore-based fleet activities all under the command of a commander or commander in chief who may exercise operational as well as administrative control.

**Focused Logistics** — For the Army, focused logistics will be the fusion of logistics and information technologies, flexible and agile combat service support organizations, and new doctrinal support concepts to provide rapid crisis response to deliver precisely tailored logistics packages directly to each level of military operations. (from Army Vision 2010)

**Force Activity Designator (FAD)** - Identifies urgency of movement within the supply/transportation community.

**Force Closure** - The point in time when a supported joint force commander determines that sufficient personnel and equipment resources are in the assigned operational area to carry out assigned tasks.

**Force Projection** – The ability to invoke the military element of national power from the continental United States (CONUS) or outside CONUS (OCONUS), in response to requirements for military operations.

**Ford** – A shallow part of a body of water that may be crossed by wading.



**Fragmentary Order (FRAGO)** - A FRAGO provides brief, specific, and timely instructions without loss of clarity, FRAGOs contain changes or information of immediate concern. These orders may be written or oral. The FRAGO will be issued to change an order that has already been issued."

**Freight Consolidation and Distribution Team (FCDT)** – An FCDT is a small TOE detachment staffed to prepare documentation for personnel, supplies, and equipment being loaded on vessels. It is located at small terminals to provide independent loading and documentation services; or at larger port complexes, as a tailored augmentation to the TTB.

**Frustrated Cargo** - Any shipment of supplies and/or equipment which, while en route to destination, is stopped prior to receipt and for which further disposition instructions must be obtained.

## G

**General Support (GS)** - That support which is given to the supported force as a whole and not to any particular subdivision thereof.

**General Support Unit (GSU)** – A unit that provides an organization with supply maintenance and medical support that the DSU does not provide.

**Global Air Transportation Execution System (GATES)** - GATES provides US Air Force Air Mobility Command, the DOD, and commercial partners with automated functionality to process and track cargo and passenger information, support management of resources, support scheduling and forecasting, provide logistical support information, generate standard and ad hoc reports, and provide message routing and delivery service for virtually all airlift data. Intended users of GATES include, but are not limited to, Tanker Airlift Control Center (TACC), Airlift Clearance Authorities (ACAs), Service Airlift Validators, Passenger Reservation Centers (PRC), Military Transportation Offices (MTO), commercial reservation systems users, and various work centers such as the Air Terminal Operations Center (ATOC). Planned GATES operation sites are headquarters (HQ) Air Mobility Command (AMC) and the aerial ports.

**Global Combat Support System (GCSS)** - GCSS provides the joint warfighter with a single, end-to-end capability to manage and monitor units, personnel, and equipment from mobilization through deployment, employment, sustainment, redeployment, and demobilization.

**Global Combat Support System-Army (GCSS-Army)** - The GCSS-Army will enable the commander to leverage information technology to coordinate, prioritize, and synchronize material management and movement operations to maximize the distribution pipeline's capability to throughput units and follow-on sustainment. It will provide commanders at each echelon the asset and in-transit visibility required to optimize the distribution system within their echelon. The visibility over the CSS pipeline will allow commanders to direct or divert assets en route, and shift assets quickly in order to meet changing distribution requirements. This centralized distribution management capability will give the commander the ability to quickly and effectively influence the distribution system.

**Global Command and Control System (GCCS)** - GCCS provides combat commanders with a single source of secure information. It assists joint force commanders with coordinating air, land, sea, space, and special forces operations of widely dispersed units in fast moving operations. It is flexible enough for combat operations or humanitarian

assistance missions. GCCS integrates deliberate and crisis action planning, force deployment and employment, fire support, air operations and planning, intelligence, and force status. It is designed to allow the expansion of planning and execution capabilities as new systems are designed. GCCS allows greater software flexibility, reliability, and interoperability with other automated systems. Commanders can establish their own secure homepage and communicate through worldwide using E-mail.

**Global Command and Control System-Army (GCCS-A)** - GCCS-A provides a single seamless command and control (C2) system. It is integrated with the Department of Defense (DOD) GCCS. GCCS-A is fundamentally GCCS with additional Army specific functionality. It is an integral part of a coordinated DOD and Joint Technical Architecture-Army that provides information support to all military command levels.

**Global Decision Support System (GDSS)** - GDSS is a survivable, recoverable, distributed command and control system which provides the Air Force's Air Mobility Command (AMC) with the information necessary in planning, scheduling, flight following, and managing all of AMC's airlift missions and resources. This distributed database system provides near real-time decision support to the top management echelons of AMC at the eight command centers worldwide.

**Global Positioning System (GPS)** - GPS is a collection of satellites owned by the U.S. Government that provides highly accurate, worldwide positioning and navigation information, 24 hours a day. It is made up of twenty-four NAVSTAR GPS satellites which orbit 12,000 miles above the earth, constantly transmitting the precise time and their position in space. GPS receivers on (or near) the earth's surface, listen in on the information received from three to twelve satellites and, from that, determine the precise location of the receiver, as well as how fast and in what direction it is moving.

**Global Transportation Network (GTN)** - GTN is an automated C2 system used for collecting transportation information from selected DOD systems. It provides automated support for planning, providing, and controlling common user airlift, surface, and terminal services to deploying forces. It provides the user with the ability to track the status, identity, and location of DOD unit and non-unit cargo and passengers, medical patients, and personal property from origin to destination. GTN also provides ITV information about units, forces, passengers, cargo, patients, schedules, and actual movements; displays current operational asset information and provides transportation intelligence information on airfields, seaports, and transportation networks using graphics and imagery; provide future operations information and models to support transportation planning and courses of action; provides efficient routing for patient movement and will provide ITV of individual patients; and interfaces with CAPS II, CFMS, CMOS, Defense Automated Addressing System (DAAS), Defense Transportation Tracking System (DTTS), GCCS, JOPES, Global Decision Support System (GDSS), Mechanized Export Traffic System (METS), Passenger Reservation and Manifest System (PRAMS), TC-ACCIS, TC-AIMS II, and WPS.

**Government Bill of Lading (GBL)** - A government document used to procure freight and cargo transportation and related services of commercial carriers for the movement of material at government expense.

**Groups Operational Passenger System (GOPAX)** - GOPAX is used to support all operational functions associated with arranging commercial group movement transportation. The system aids considerably in the timely movement of troops between training bases and mobilization sites in CONUS and international aerial ports of embarkation and debarkation. GOPAX provides an automated electronic capability for the arrangement of commercial transportation for DOD, group, and unit troop movements. GOPAX interfaces with all TC-

ACCIS sites using the Defense Data Network (DDN). GOPAX has links with the Navy, Marine Corps, National Guard, and Air Mobility Command (AMC).

## H

**Hand Held Interrogators (HHI)** – A hand held-portable unit that combines the functionality of a fixed Interrogator with a keypad for command and data entry. Its menu driven software allows a standoff read/write capability to RF tags. HHIs communicate with tags through radio frequency, infrared signal, or direct wire connectivity. The collected data files may be displayed on a small LCD screen, and/or transferred to or from a PC loaded with INTRANSIT software package.

**High Frequency (HF)** – This radio frequency covers the spectrum 3 to 30 MHz, and is used for long-range communication over ranges of up to 4 828km (3,000 miles) as well as by advanced radars. HF airband frequencies are split amongst several different ranges, such as the 5 MHz band, 11 MHz band, etc. all the way up to 30 MHz.

**Highway Traffic Division (HTD)** - A HTD within each echelon controls movement on the command's highway network.

**Holding Area** – A site where a unit's progress (personnel or equipment) is halted temporarily.

**Host Nation (HN)** - A nation that receives the forces and/or supplies of allied nations, coalition partners, and/or NATO organizations to be located on, to operate in, or to transit through its territory.

**Host Nation Support (HNS)** – Civil and military assistance provided by host nations to allied forces and organizations in peacetime, transition to war, and in wartime.

## I

**Infiltration Schedule** - A rate of dispatch assigned to units for specific routes and time blocks to achieve an average traffic flow that is within the capacity of the route. An infiltration schedule may be used for open or supervised routes.

**Infrastructure** – In relation to deployment and sustainment all buildings and permanent installations necessary for the support of deployment, redeployment, and sustainment of military forces operations (e.g. barracks, headquarters, airfields, communications, facilities, stores, port installations, and maintenance stations).

**Installation Transportation Officer (ITO)** - Person(s) designated or appointed to perform traffic management functions at the CONUS installation level.

**Integrated Booking System (IBS)** - IBS is the lead execution system of the Defense Transportation System for the booking of international surface cargo during both peacetime and wartime operations. The system supports traffic management within Military Transportation Management Command (MTMC), the greatest percentage of which is booking non-unit peacetime cargo. IBS must also satisfy the MTMC mission to execute the plans developed in deliberate planning for international cargo. In addition, the system is responsible for booking cargo during contingency operations. IBS must be responsive to requirements of commodity managers and war planners requiring continuous access to international surface cargo movement. IBS is fielded to both CONUS and outside

continental United States (OCONUS) sites and exchanges data with Worldwide Port System and other systems.

**Integrated Computerized Deployment System (ICODES)** - The ICODES system is a ship load planning software application that utilizes artificial intelligence (AI) principles and techniques to assist embarkation specialists in the rapid development of cargo stow-plans. It includes expert agents with knowledge in specific domains (e.g., hazardous material handling, trim and stability, ramps, cranes, and internal access paths) to evaluate and propose loading alternatives and recommendations. ICODES integrates with information management and documentation systems such as Worldwide Ports System (WPS), TC-AIMS II, and IBS, to receive cargo lists and send completed load plans.

**Integration** - The synchronized transfer of units into an operational Commander's force prior to mission execution.

**Intermodal Systems** - Specialized transportation facilities, assets, and handling procedures designed to create a seamless transportation system by combining multimodal operations and facilities during the shipment of cargo.

**Intermodal Terminals** - Intermodal terminals segregate and ship cargo to satellite SSAs and other nodes in the theater distribution network. Major types of shipments received in a Intermodal Terminal include multiconsignee and frustrated cargo. The Intermodal Terminal segregates, consolidates, manifests, stages and transports cargo and delivers to customers over established routes on a time definite delivery schedule. Modes are changed at intermodal terminals. The intermodal terminal is not a SSA. It does not receipt, store and issue supplies as it maintains no stocks. The intermodal terminal is focused on maintaining a rapid flow of cargo that cannot be throughput.

**Intermodal Transfer Point** - Location that Army Forces arrive via air or sea, perform staging and integration operations prior to movement into theater. Forces then transfer to strategic maneuver assets, air or sea, to arrive in theater mission ready. An area in which a command is assembled preparatory to further action.

**Intermodality** - Intermodality is the capability to use of multiple modes for the same shipment.

**Interoperability** - The ability of systems, units, or forces to provide services to and accept services from other systems, units, or forces and to use the services so exchanged to enable them to operate effectively together.

**Inter-Service Support Agreement (ISSA)** - A written agreement between two or more Services that delineates terms of a support arrangement.

**Intertheater** - Between theaters or between the continental United States and theaters.

**In-Transit Visibility (ITV)** - The ability to track the identity, status, and location of Department of Defense cargo and passengers; and personal property from origin to destination across the range of military operations.

**Intratheater** - Within a theater.



**Jamming** – To make transmissions unintelligible by sending out interfering signals or messages.

**Joint Force** - A general term applied to a force composed of significant elements, assigned or attached, of two or more Military Departments operating under a single joint force commander.

**Joint Movement Center (JMC)** – The center established to coordinate the employment of all means of transportation (including that provided by allies or host nations) to support the concept of operations. This coordination is accomplished through establishment of transportation policies within the assigned operational area, consistent with relative urgency of need; port and terminal capabilities, transportation asset availability, and priorities set by a joint force commander.

**Joint Operation** - A general term to describe military actions conducted by joint forces or by Service forces in relationships (e.g., support, coordinating authority) which, of themselves, do not create joint forces.

**Joint Operation Planning and Execution System (JOPES)** – JOPES supports integrated planning and command control of mobilization, deployment, employment and sustainment activities using an improved information system.

**Joint Total Asset Visibility (JTAV)** – JTAV is the capability to provide users with timely and accurate information on the location, movement, status, and identity of units, personnel, equipment, and supplies. It facilitates the capability to act upon that information to improve overall performance of DOD's logistics practices.

**Joint Transportation Board (JTB)** - Responsible to the Chairman of the Joint Chiefs of Staff, the Joint Transportation Board assures that common-user transportation resources assigned or available to the Department of Defense (DOD) are allocated as to achieve maximum benefit in meeting DOD objectives.

**Joint Transportation Corporate Information Management Center (JTCC)** - Improves the efficiency and effectiveness of the Defense Transportation System (DTS) through the application of functional process improvement techniques and the central control of transportation-related command, control, communications and computer systems development. Recommends changes to the policies, procedures, organizations, and command, control, communications and computer systems (C4S) of the Department of Defense (DoD) and its components as well as the USTRANSCOM staff and TCCs. In streamlining DTS, applies selected management technology to recommend changes that will maximize operational effectiveness and achieve cost savings throughout DoD. Coordinates directly with DoD components and the Joint Staff to ensure their future requirements are considered. Employs process and data standardization and ensures system compatibility and interoperability. Coordinate directly with DoD components to prioritize the funding allocation for solutions developed through process reengineering and C4S migrations.

**Joint Task Force (JTF)** - A joint force that is constituted and so designated by the Secretary of Defense, a combatant commander, a subunified commander, or an existing joint task force commander. JTFs are established on a geographical area or functional basis when the mission has a specific limited objective and does not require overall centralized control of logistics.

## L

**Landing Zone (LZ)** - Any specified zone used for the landing of aircraft.

**Legs** - Legs refers to different modes used to move the personnel and cargo for each segment.

**Liaison** - That contact or intercommunication maintained between elements of military forces or other agencies to ensure mutual understanding and unity of purpose and action.

**Lift-On/Lift-Off (LO/LO)** - A containership onto which and from which containers are lifted by crane.

**Line Identification Number (LIN)** - A number assigned to a generic nomenclature for the purpose of identifying the line on which the official generic nomenclature is listed. The LIN is used as a tool for sorting items into sequence, consolidating assets, requirements, and other data for federally stocked-numbered items to which it is related.

**Lines Of Communication (LOC)** - All the land, water, and air routes connecting an operating military force with one or more bases of operation and along which supplies and military forces move.

**Local Area Network (LAN)** - A LAN is a group of computers and associated devices that share a common communications line and typically share the resources of a single processor or server within a small geographic area (for example, within an office building). Usually, the server has applications and data storage that are shared in common by multiple computer users. A LAN may serve as few as two or three users (for example, in a home network) or many as thousands of users (for example, in an FDDI network).

**Location Schedule** - Assigns arrive and clear times to different units needing to use the same entry point onto MSRs. A location schedule may be used for supervised or dispatch routes.

**Logistic Control Activity (LCA)** - LCA is the Army's central source for supply and transportation information. Using this information, LCA can select and control the flow of materiel to CONUS installations and overseas theaters of operation. Through its Army Shipper Service Control Office and Army Airlift Clearance Authority (AACAA), LCA maintains visibility of all Army shipments into Military Airlift Command (MAC) and Military Traffic Management Command (MTMC) systems. With this visibility, LCA provides port liaison services and carries out air and surface over-ocean cargo forecasting duties for Department of the Army (DA) and USAMC. LCA provides, through the use of its databases, visibility of the Army's logistics pipeline not available from any other single Department of Defense (DOD) activity. Further, LCA provides remote computer inquiry services to its customers for near real-time supply and transportation information. LCA tailors logistics management reports for units at the retail level through the DA level. LCA transportation functions involve those actions necessary to monitor, select, and coordinate cargo movement. LCA serves as the Army Airlift Clearance Authority (AACAA), forecasts cargo tonnage requirements, expedites cargo, and reports on the movement of Army-sponsored cargo from supply source to destination. Also, LCA serves as the Army shipper service control office (SSCO) providing on-site liaison at CONUS air and surface ports of embarkation as required.

**Logistic Support** - Logistic support encompasses the logistic services, materiel, and transportation required to support the continental United States-based and worldwide-deployed forces.

**Logistics** - Planning and carrying out the movement, supply, services, and maintenance of forces. In its most comprehensive sense, those aspects of military operations which deal with: a. design and development, acquisition, storage, movement, distribution, maintenance, evacuation, and disposition of materiel; b. movement, evacuation, and hospitalization of personnel; c. acquisition or construction, maintenance, operation, and disposition of facilities; and d. acquisition or furnishing of services.

**Logistics Integration Agency (LIA)** - The mission of the LIA is to identify, develop, and recommend logistics concepts, policy, programs, plans, and systems. This responsibility includes assessing logistics readiness and sustainability and recommending improvements in the Army logistics performance. Other duties include evaluating logistics aspects of contingency plans and force structure; executing and monitoring selected DCSLOG programs; serving as the DCSLOG functional proponent for the development and extension of selected standard automated supply, maintenance, transportation, and troop support systems; and providing technical guidance and assistance to MACOMs and units.

**Logistics Intelligence Files (LIF)** - The LIF is an on-line computerized database that centralizes the collection, correlation, and retrieval of supply and transportation data on Army-sponsored requisitions maintained by the LSA. The LIF furnishes historical supply and transportation pipeline progress of a requisition from the time it is sent through the DAAS to the time materiel is received.

**Logistics Preparation of the Theater (LPT)** - LPT is those actions (force structure, resources, and strategic lift) taken to reduce the cost of logistically supporting an operations plan or a contingency plan. LPT minimizes or eliminates potential problems during deployment, at the outbreak of hostilities, and throughout the campaign. It is a systematic tool used by logistician and commanders to complete their mission. It becomes the basis for deciding where, when, and how to deploy limited resources--supplies, equipment, and people.

**Logistics-Over-The-Shore (LOTS)** - The loading and unloading of ships without the benefit of deep draft-capable, fixed port facilities in friendly or nondefended territory and, in time of war, during phases of theater development in which there is no opposition by the enemy; or as a means of moving forces closer to tactical assembly areas dependent on threat force capabilities.

## M

**Main Supply Route (MSR)** - The route or routes designated within an area of operations upon which the bulk of traffic flows in support of military operations.

**Maneuver** - 1. A movement to place ships, aircraft, or land forces in a position of advantage over the enemy. 2. A tactical exercise carried out at sea, in the air, on the ground, or on a map in imitation of war. 3. The operation of a ship, aircraft, or vehicle, to cause it to perform desired movements. 4. Employment of forces in the battlespace through movement in combination with fires to achieve a position of advantage in respect to the enemy in order to accomplish the mission.

**Manifest** - A document specifying in detail the passengers or cargo carried for a specific destination.

**March Column** – The largest of the three convoy organization elements, it is a group of two to five serials, and represents approximately a battalion-to-brigade size element. Each column has a column commander.

**March Unit** – The smallest of the three convoy organizational elements. It is a subdivision of the serial and comes under the direct control of the march unit commander. It is the smallest organized subgroup of the convoy and usually will not exceed 20 vehicles.

**Marine Air-Ground Task Force (MAGTF)** - A MAGTF is a task organization of Marine forces (division, aircraft wing, and service support groups) under a single command and structured to accomplish a specific mission. The MAGTF components will normally include command, ground combat, aviation combat, and combat service support elements (including Navy Support Elements).

**Marine Air-Ground Task Force Deployment Support System (MDSS)** - MDSS is the unit level deployment planning and execution system that provides MAGTF's and subordinate elements the ability to develop plan specific force structures (personnel, supplies and equipment) and associated embarkation plans.

**Marshalling Area** – A location in the vicinity of a reception terminal or prepositioned equipment storage site where arriving unit personnel, equipment, material, and accompanying supplies are reassembled, returned to the control of the unit commander, configured in an effective way, and prepared for onward movement. The joint complex commander and designating the location will coordinate the use of the facilities with other allied commands and the host nation, and will provide life support to the units while in the marshalling area.

**Material Management Center (MMC)** - Provides materiel management for all assets (except class VI and X supplies, classified maps, and classified communications security (COMSEC) devices); and provides automated information management support for logistical functions.

**Material Release Order (MRO)** - An MRO document is prepared by the supply activity releasing material for shipment. The MRO instructs a storage facility to ship a particular item to a customer. The MRO identifies the item's stock number, unit and quantity of issue, where to ship the item, priority, and other information required to process the transaction.

**Materiel Handling Equipment (MHE)** - Mechanical devices for handling of supplies and equipment with greater ease and economy.

**Mechanized Export Traffic System (METS)** - METS is the MTMC Area Command's unclassified system for managing ocean cargo clearance authority functions for booking cargo on MSC or commercial ships. METS provides schedules for unit arrival at ports, issues port calls to the units, and also provides information concerning bookings of containerized and break bulk cargo on scheduled voyages.

**Memorandum of Understanding (MOU)** - A document which, if meeting the other criteria, can be, in law, a contract. Generally, in the world of commerce or international negotiations, a MOU is considered to be a preliminary document; not a comprehensive agreement between two parties but rather an interim or partial agreement on some elements, in some cases a mere agreement in principle, on which there has been accord. Most MOU's imply that something more is eventually expected.



**Military Load Classification (MLC)** - A standard system in which a route, bridge or raft is assigned class number(s) representing the load it can carry; vehicles are also assigned class number(s) indicating the minimum class of route, bridge or raft they are authorized to used.

**Military Objective** - A derived set of military actions to be taken to implement National Command Authorities guidance in support of national objectives. A military objective defines the results to be achieved by the military and assign tasks to commanders.

**Military Sealift Command (MSC)** - A major command of the US Navy, and the US Transportation Command's component command responsible for designated common-user sealift transportation services to deploy, employ, sustain, and redeploy US forces on a global basis.

**Military Shipping Label (MSL)** - This document is used as an address label for military shipments.

**Military Strategy** - The art and science of employing the armed forces of a nation to secure the objectives of national policy by the application of force or the threat of force.

**Military Traffic Management Command (MTMC)** - A major command of the U.S. Army and USTRANSCOM's component command responsible for designated CONUS land transportation, common-user water terminals, and traffic management for global movement by the Services.

**Military-Owned Demountable Container (MILVAN)** - A military-owned demountable container that conforms to U.S. and international standards and operates in a centrally controlled fleet for movement of military cargo.

**Mission, Enemy, Terrain and Weather, Troops and Support Available, Time Available, and Civil Considerations (METT-TC)** - The phrase or acronym used to describe the factors that must be considered during the planning or execution of a tactical operation.

**Mobile Subscriber Equipment (MSE)** - MSE is a fully automated area communications system. It ensures that mobile and static subscribers, regardless of location, can communicate via a nodal system throughout the battlefield. MSE is the communications network for corps and divisions. MSE is a SECRET high network. All equipment attached to the network is classified SECRET. All personnel operating on the network must have a SECRET security clearance. MSE is designed to meet the requirements of a five division corps for a secure area switched system capable of supporting dispersed command posts. Using MSE, finance units have the ability to communicate with supported units, supporting units, deployed finance detachment and finance support teams, and other finance units.

**Mobility** - A quality or capability of military forces which permits them to move from place to place while retaining the ability to fulfill their primary mission.

**Mobilization** - The act of assembling and organizing national resources to support national objectives in time of war or other emergencies.

**Mobilization Station (MS)** - The designated military installation to which a Reserve Component unit or individual mobilizes or moves upon mobilization for further processing, training, and movement.

**Movement Control** - 1. The planning, routing, scheduling, and control of personnel and cargo movements over lines of communications. 2. An organization responsible for the planning, routing, scheduling, and control of personnel and cargo movements over lines of communications.

**Movement Control Battalion (MCB)** - The Movement Control Battalions command, control, and supervise MCTs. Movement control battalions control the movement of all personnel, units, and materiel in the theater. They provide movements management, highway regulation, and coordination as required, for personnel and materiel movements into, within, and out of the theater of operations. They ensure timely responsiveness and maximum use of available transport capability.

**Movement Control Cell** - The collocation of the DTO, its MCT, and the MCO.

**Movement Control Officer (MCO)** - The MCO is the movement manager within the division. The MCO controls the employment of the division's motor transport assets, and is the link between the division transportation mode operators and the division users of transportation. MCO support to units includes committing divisional truck assets to assist the unit during predeployment or movement to POE activities.

**Movement Control Team (MCT)** - There are two types of MCTs; area MCTs and port MCTs.

Area MCTs perform movement control functions for movement of units, cargo, and personnel (except bulk POL by pipeline) within an assigned geographic area. Area MCTs validate transportation requirements, coordinate transportation support, highway clearance and inbound clearance for moving units, personnel, and cargo. They coordinate transportation movements, diversions, reconsignments, and transfers of units, cargo and personnel. Area MCTs provide technical expertise to transportation users within its assigned geographic area of responsibility. They provide intransit visibility of unit equipment and sustainment cargo movements in a corps or theater of operations area. Area MCTs coordinate with mode units for transportation of personnel and materiel. Area MCTs train and assist transportation users with transportation and discrepancies reporting documentation procedures.

Port MCTs expedite, coordinate, and supervise, transportation support of units, cargo, and personnel into, through, and out of air or water ports (except bulk POL by pipeline). This team provides movement control functions at airport of debarkation or seaport of debarkation and small army operated air and sea terminals. It expedites throughput of cargo through the transportation system. The port MCT expedites the port clearance of cargo and personnel arriving or departing by air or sea. It provides technical expertise to transportation users transiting the port area. In conjunction with the port commander, the port MCT coordinates transportation support and highway clearance for forward movement. It provides intransit visibility of units, cargo, and personnel transiting an air or seaport. The port MCT coordinates with supporting mode units for transportation of personnel and materiel. It trains and assists transportation users with transportation and discrepancy reporting documentation procedures.

**Movement Credit** - The allocation granted to one or more vehicles in order to move over a controlled route in a fixed time according to movement instructions.

**Movement Plan (MOVEPLAN)** - In amphibious operations, the naval plan providing for the movement of the amphibious task force to the objective area. It includes information

and instructions concerning departure of ships from loading points, the passage at sea, and the approach to and arrival in assigned positions in the objective area.

**Movement Regulating Team (MRT)** – The MRT operates at critical terminals and at critical highway points. This team helps with the diversion of cargo and by troubleshooting movement control problems.

**Movement Requirement** - A stated movement mode and time-phased need for the transport of units, personnel, and/or materiel from a specified origin to a specified destination.

**Movement Table** - A table giving detailed instructions or data for a move. When necessary it will be qualified by the words road, rail, sea, air, etc., to signify the type of movement. Normally issued as an annex to a movement order or instruction.

**Movement Tracking System (MTS)** – MTS is a satellite-based tracking/communication system consisting of a mobile unit mounted in the vehicle and a base unit controlled/monitored by movement control and mode operators. The MTS includes a global positioning system capability, a capability to send messages between base and mobile units, and a capability to locate/track a vehicle position on a map background using personal computer-based software.

**Movement Tracking System-Control Station (MTS-CS)** - MTS-CS is a base unit station for MTS that is controlled and monitored by movement control operators

## N

**National Inventory Control Point (NICP)** - The NICP is the Army organization responsible for wholesale inventory management of assigned items, either for the Department of the Army (DA) only or Department of Defense (DOD) as a whole. These activities are within the Army Materiel Command (AMC) with its subordinate commands of the Materiel Readiness Command (MRC), Operations Support Command (OSC), the U.S. Army Communication Security Logistics Activities (COMSECLOG), and the U.S. Army Electronic Material Readiness Activity (EMRA).

**National Security** - A collective term encompassing both national defense and foreign relations of the United States. Specifically, the condition provided by: a. a military or defense advantage over any foreign nation or group of nations; b. a favorable foreign relations position; or c. a defense posture capable of successfully resisting hostile or destructive action from within or without, overt or covert.

**National Stock Number (NSN)** – The 13-digit stock number replacing the 11-digit Federal Stock Number. It consists of the 4-digit Federal Supply Classification code and the 9-digit National Item Identification Number. The National Item Identification Number consists of a 2-digit National Codification Bureau number designating the central cataloging office of the NATO or other friendly country which assigned the number and a 7-digit (xxxxxxx) nonsignificant number.

**Net Control Station (NCS)** - A radio station that performs net control functions, such as controlling traffic and enforcing operational discipline.

**Node** - A location in a mobility system where a movement requirement is originated, processed for onward movement, or terminated.

**Noncombatant Evacuation Operation (NEO)** - NEOs are conducted to assist the USA Department of State in evacuating noncombatants, nonessential military personnel, selected host-nation citizens, and third country nationals whose lives are in danger from locations in a host foreign nation to an appropriate safe haven. They usually involve a swift insertion of a force, temporary occupation of an objective (e.g., a USA Embassy), and a planned withdrawal after mission completion. NEOs are usually planned and operated by a JTF and conducted under an Ambassador's authority.

## O

**Ocean Cargo Clearance Authority (OCCA)** - The MTMC activity which books DOD sponsored cargo and passengers for surface movement, performs related contract administration, and accomplishes export/import surface traffic management functions for DOD cargo moving within the DTS.

**Onward Movement** - Moving from the staging area to the TAA.

**Open Route** - A route not subject to traffic or movement control restrictions.

**Operating Tempo (OPTEMPO)** - The annual operating miles or hours for the major equipment system in a battalion-level or equivalent organization. OPTEMPO is used by commanders to forecast and allocate funds for fuel and repair parts for training events and programs.

**Operation** - 1. A military action or the carrying out of a strategic, operational, tactical, service, training, or administrative military mission. 2. The process of carrying on combat, including movement, supply and maintenance, medical, services, attack, defense, and maneuvers needed to gain the objectives of any battle or campaign

**Operation Order (OPORD)** - A directive issued by a commander to subordinate commanders for the purpose of coordinating the execution of an operation.

**Operation Plan (OPLAN)** - Any plan for the conduct of military operations. Plans are prepared by combatant commanders in response to requirements established by the Chairman of the Joint Chiefs of Staff and by commanders of subordinate commands in response to requirements tasked by the establishing unified commander. Operation plans are prepared in either a complete format (OPLAN) or as a concept plan (CONPLAN).

**Operational Control** - Command authority that may be exercised by commanders at any echelon at or below the level of combatant command. Operational control is inherent in combatant command (command authority) and may be delegated within the command. When forces are transferred between combatant commands, the command relationship the gaining commander will exercise (and the losing commander will relinquish) over these forces must be specified by the Secretary of Defense. Operational control is the authority to perform those functions of command over subordinate forces involving organizing and employing commands and forces, assigning tasks, designating objectives, and giving authoritative direction necessary to accomplish the mission. Operational control includes authoritative direction over all aspects of military operations and joint training necessary to accomplish missions assigned to the command. Operational control should be exercised through the commanders of subordinate organizations. Normally this authority is exercised through subordinate joint force commanders and Service and/or functional component commanders. Operational control normally provides full authority to organize commands

and forces and to employ those forces as the commander in operational control considers necessary to accomplish assigned missions; it does not, in and of itself, include authoritative direction for logistics or matters of administration, discipline, internal organization, or unit training.

**Operational Level Of War** - The level of war at which campaigns and major operations are planned, conducted, and sustained to accomplish strategic objectives within theaters or other operational areas. Activities at this level link tactics and strategy by establishing operational objectives needed to accomplish the strategic objectives, sequencing events to achieve the operational objectives, initiating actions, and applying resources to bring about and sustain these events. These activities imply a broader dimension of time or space than do tactics; they ensure the logistic and administrative support of tactical forces, and provide the means by which tactical successes are exploited to achieve strategic objectives.

**Operational Procedures** - The detailed methods by which headquarters and units carry out their operational tasks.

**Operational Readiness** - The capability of a unit/formation, ship, weapon system, or equipment to perform the missions or functions for which it is organized or designed. May be used in a general sense or to express a level or degree of readiness.

**Operational Requirement** - An established need justifying the timely allocation of resources to achieve a capability to accomplish approved military objectives, missions, or tasks.

**Operations Security (OPSEC)** - Actions taken to protect information concerning planned, ongoing, and completed operations from unauthorized disclosure. It includes all actions a command takes to deny the enemy information about friendly units and their operations.

**Opportune Lift** - That portion of lift capability available for use after planned requirements have been met.

**Optical Memory Card (OMC)** - The OMC uses the optical technology popularized by audio compact disks (CDs) and audio visual CDROM (read only) products. Although users of those products can write-once/read many (WORM) times, the OMC differs in that information is written to the card in increments rather than at one time. An OMC can have data written to it in a sequential order on many occasions until all available memory has been used. The OMC technology works on the principle of reflectivity. Users write data on the card with a narrowly focused, high intensity light beam (e.g., a laser) which puts "pits" in the cards surface. A low power light beam is used to read the "pits" created during the writing process. Optical technology products have similar functions in conveying data; the OMC's primary distinguishing characteristic is form. Because an OMC is similar in size to a credit card, a person can carry it easily in a pocket or wallet.

**Organic** - Assigned to and forming an essential part of a military organization. Organic parts of a unit are those listed in its table of organization for the Army, Air Force, and Marine Corps, and are assigned to the administrative organizations of the operating forces for the Navy.

**Organizational Clothing & Individual Equipment (OCIE)** - A force multiplier which supports the soldier system and enhances soldier survivability, performance and comfort.

**Organizational Equipment List (OEL)** - An OEL is a computerized listing (in printed and data file formats) of on-hand equipment, personnel and supplies in a unit. The OEL

supports cargo manifesting for movements and provides input to transportation managers to identify movement requirements.

**Outside the Continental United States (OCONUS)** – Any location beyond the limits of the 48 contiguous United States and the District of Columbia. (Alaska, Hawaii, Puerto Rico, and U.S. territories and possessions are OCONUS).

**Overlay** - A printing or drawing on a transparent or semi-transparent medium at the same scale as a map, chart, etc., to show details not appearing on the map.

## P

**Passenger Reservation and Manifest System (PRAMS)** - Used by Passenger Reservation Centers and Passenger Reservation sites to schedule international air travel on Organic AMC aircraft or commercial aircraft under contract to AMC.

**Petroleum, Oil, and Lubricants (POL)** - A broad term which includes all petroleum and associated products used by the Armed Forces.

**Pickup Zone (PZ)** - A geographic area used to pick up troops or equipment by helicopter.

**Pipeline** - 1. The channel of support or a specific portion thereof by means of which materiel or personnel flow from sources of procurement to their point of use. 2. A line of pipe with pumps, valves, and control devices for conveying liquids, gases, or finely divided solids. 3. A direct channel for information.

**Plans, Programs, and Operations (PP&O)** - The PP&O section of the movement control battalion is responsible for surface, logistics air, rail, barge movements, and container management. If assigned, the Air Mobility Command liaison officer will operate in this section. This section coordinates support and maintains the status of transportation activities throughout the corps.

**Point Of Entry** – An area where strategic maneuver assets discharge units. Place where units make final preparations (pre-combat checks and inspections) prior to moving to the line of departure.

**Port Complex** - A port complex comprises one or more port areas of varying importance whose activities are geographically linked either because these areas are dependent on a common inland transport system or because they constitute a common initial destination for convoys.

**Port of Debarkation (POD)** – The geographic point at which cargo or personnel are discharged. It may be a seaport or aerial port of debarkation. For unit requirements, it may or may not coincide with the destination.

**Port of Embarkation (POE)** – The geographic point in a routing scheme from which cargo or personnel depart. May be a seaport or aerial port from which personnel and equipment flow to port of debarkation. For unit and nonunit requirements, it may or may not coincide with the origin.

**Port Support Activity (PSA)** – A flexible support organization composed of assets from a designated installation which ensures the equipment of the deploying units is ready to load.

The PSA operates unique equipment in conjunction with ship loading operations. The PSA is operationally controlled by the military port commander or TTB commander.

**Portable Data File (PDF)** – The PDF is also known as a 2D (two-dimensional) bar code, this is a high density, non- linear symbology that reminds you of a crossword puzzle. But the difference between the PDF and the other bar codes is that it is really a portable data file (PDF) as opposed to simply being a reference number.

**Power Projection** - The ability of a nation to apply all or some of its elements of national power - political, economic, informational, or military - to rapidly and effectively deploy and sustain forces in and from multiple dispersed locations to respond to crises, to contribute to deterrence, and to enhance regional stability.

**Preposition** - To place military units, equipment, or supplies at or near the point of planned use or at a designated location to reduce reaction time, and to ensure timely support of a specific force during initial phases of an operation.

**Prepositioned Material Site** – Location of strategically located unit configured stocks.

**Priority Designator (PD)** - The PD is a 2-position numeric code (01-15) that identifies the relative priority of the competing requisitions. The PD is used by the materiel management systems to allocate available stocks among competing requisitions. The PD is based on the combination of the FAD assigned to the requisitioning activity and the Urgency of Need Designator (UND).

**Prohibited Route** - The route is closed and no unit or traffic may use the route. A route may be prohibited due to washouts, destroyed bridges, maintenance, or construction work. It may be prohibited for only short periods, such as the time necessary to do repairs.

## R

**Radio Frequency (RF)** - Radio frequency (RF) refers to electromagnetic waves that have a wavelength suited for use in radio communication.

**Radio Frequency Data Communication (RFDC)** - Radio frequency data communications replaces the wire between a computer terminal and the host computer. Information that would normally be transmitted on a wire is transmitted via radio waves instead. Anything you could do with a wire-linked CRT can be done with radio waves instead

**Radio Frequency Identification (RFID)** - Systems that read or write data to RF tags that are present in a radio frequency field projected from RF reading/writing equipment. Data may be contained in one or more bits for the purpose of providing identification and other information relevant to the object to which the tag is attached. It incorporates the use of electromagnetic or electrostatic coupling in the radio frequency portion of the spectrum to communicate to or from a tag through a variety of modulation and encodation schemes.

**Rail Movement Management Team (RMMT)** - The RMMTs are responsible for the control of US forces cargo and passengers moving.

**Reception** - The process of receiving, offloading, marshalling, and transporting of personnel, equipment, and materiel from the strategic and/or intratheater deployment phase to a sea, air, or surface transportation point of debarkation to the marshalling area.

**Reception, Staging, Onward Movement, and Integration (RSO&I)** – RSO&I is a phase of Force Projection occurring in the operational area. It is the essential processes that transition arriving personnel and materiel into forces capable of meeting operational requirements. Its principal value is that it speeds the assembly of combat power.

**Reconnaissance** - A mission undertaken to obtain, by visual observation or other detection methods, information about the activities and resources of an enemy or potential enemy, or to secure data concerning the meteorological, hydrographic, or geographic characteristics of a particular area.

**Redeployment** – The transfer of a unit, an individual, or supplies from one area to another area, to another location within the area, or to the zone of interior for the purpose of further employment.

**Refuel On The Move (ROM)** - ROM operations are driven by the mission, enemy, terrain, troops, and time. This concept is equipment independent and can be employed anywhere on the battlefield where there is a need to rapidly refuel combat vehicles. The ROM kit consists of enough hoses, valves, and fittings to refuel up to eight combat vehicles at the same time.

**Release Point (RP)** - A well-defined point on a route at which the elements composing a column return under the authority of their respective commanders, each one of these elements continuing its movement towards its own appropriate destination.

**Remote Global Air Transportation Execution System (RGATES)** - RGATES is an aerial port system that combines and integrates command and control operations, passenger operations, and cargo movement processes remotely. It assists handling cargo manifested for air shipment, cargo at aerial ports awaiting air shipment, and cargo departed from aerial ports via air or ground transportation. RGATES (1) process and track cargo and passenger information; (2) support management of resources; (3) provide logistical support information; (4) support scheduling and forecasting; (5) provide tracking and tracing of aerial port assets (including personnel, vehicles, equipment, and supplies); (6) support processing service/agency short-term cargo requirements and long-term passenger and cargo requirements; (7) support channel mission management; (8) manage tariff data regarding baggage, passenger, and pet fares; (9) manage passenger reservations; and (10) provide reports/transportation status for AMC and AMC customers.

**Remote Local Area Network (RLAN)** - Allows a user to access their office LAN from a remote location via, in this case, DSL. A User can use all systems, databases, and software as if they are in their office.

**Required Delivery Date (RDD)** – The date that a force or materiel must arrive at the destination and be ready for employment.

**Requirement** - An established need justifying the timely allocation of resources to achieve a capability to accomplish approved military objectives, missions, or tasks.

**Reserve Component (RC)** – The Reserve Components of the Armed Forces of the United States are the Army National Guard, Army Reserve, Naval Reserve, Marine Corps Reserve, Air National Guard, Air Force Reserve, and the Coast Guard Reserve. Each component has three reserve categories: The Ready Reserve, the Standby Reserve, and the Retired Reserve.



**Reserved Route** - In road traffic, a specific route allocated exclusively to an authority or formation.

**Retrograde Cargo** - Cargo evacuated from a theater.

**Retrograde Operations** - Any movement of a command to the rear, or away from the enemy. It may be forced by the enemy or may be made voluntarily. Such movements may be classified as withdrawal, retirement, or delaying action.

**Road Network** - The system of roads available within a particular locality or area.

**Road Space** - The length of roadway allocated to and/or actually occupied by a column on a route, expressed in miles or kilometers.

**Route** - The prescribed course to be traveled from a specific point of origin to a specific destination.

**Route Capacity** - 1. The maximum traffic flow of vehicles in one direction at the most restricted point on the route. 2. The maximum number of metric tons which can be moved in one direction over a particular route in one hour. It is the product of the maximum traffic flow and the average payload of the vehicles using the route.

**Route Schedule** - This schedule is a flexible scheduling method. It apportions blocks of time on MSRs to units, types of movements, phases of the operation, or for route maintenance. A route schedule may be used for supervised, dispatch, or reserved routes.

**Routing** - The routing function is the process of coordinating and directing movements on MSR or alternate supply route (ASR), and regulating movement on LOCs to prevent conflict and congestion.

## S

**Satellite Communications (SATCOM)** - SATCOM has dramatically changed when, where and how the world communicates. SATCOM provides rapid, accurate communications almost anywhere in the world, linking ground and airborne users via space-based satellites. This capability is being demonstrated in oceanic airspace for controller-pilot communications and aircraft-position reporting. SATCOM will also be used by the U.S. to broadcast data to augment the integrity and accuracy of GPS in the GPS Wide Area Augmentation System (WAAS).

**Scheduling** - The process of coordinating times for road and highway movements. It involves receiving and managing movement requests, and issuing clearances. Scheduling is essential to the application of the principles of routing

**Schematics** - Used to assist movement planners when balancing requirements and capabilities. Their purpose is to graphically portray total shipping requirements and available transportation capabilities as they relate to the distribution plan. Planners use two types of schematics (requirements and mode).

**Seaport of Debarkation (SPOD)** - A sea port within the theater of operations where the strategic transportation of forces and material is completed.

**Seaport of Embarkation (SPOE)** - An authorized point of departure from a foreign country or the United States located at a water port.

**Segment** -Segments refer to the personnel and cargo being move from the origin to the destination.

**Separation** - This technique allocates road space for movements to ensure that movements do not conflict. The goal of separation is to prevent congestion on regulated routes.

**Serials** -A subdivision of the march column. It consists of elements of a march column (convoy) moving from one area over the same route at the same time. All the elements move to the same area and are grouped under a serial commander. The serial commander is directly responsible to the convoy commander. A serial may be divided into two or more march units.

**Shortfall** - The lack of forces, equipment, personnel, materiel, or capability, reflected as the difference between the resources identified as a plan requirement and those apportioned to a combatant commander for planning, that would adversely affect the command's ability to accomplish its mission.

**Situation Map** - A map showing the tactical or the administrative situation at a particular time.

**Soldier Readiness Processing (SRP)** - The program established to ensure that all soldiers are maintained administratively ready for deployment at all times.

**Special Assignment Airlift Mission (SAAM)** - SAAM is defined as airlift requirements for special pickup or delivery by AF Air Mobility Command at points other than established routes, and which require special consideration because of the number of passengers involved, the weight or size of the cargo, the urgency or sensitivity of movement, or other special factors.

**Special Forces** - US Army forces organized, trained, and equipped specifically to conduct special operations. Special forces have five primary missions: unconventional warfare, foreign internal defense, direct action, special reconnaissance, and counterterrorism. Counterterrorism is a special mission for specially organized, trained, and equipped special forces units designated in theater contingency plans.

**Staging** - Assembling, holding, and organizing arriving personnel, equipment, and sustaining materiel in preparation for onward movement. The organizing and preparation for movement of personnel, equipment, and materiel at designated areas to incrementally build forces capable of meeting the operational commander's requirements.

**Staging Area** - A general locality established for the concentration of troop units and transient personnel between movements over the lines of communications.

**Standard Army Ammunition System - Modernized (SAAS-MOD)** - SAAS-MOD integrates all retail munitions supply functions and processes. It is used at three levels: corps and theater MMCs, ammunition supply points (ASPs), and the division ammunition office (DAO). The primary purpose of SAAS-MOD is to provide conventional ammunition assets to tactical commanders during wartime conditions. SAAS-MOD manages all conventional ammunition, guided missile large rockets (GMLRs) and their related components, and packaging materiel. The system uses desktop-type computers and

associated AIT to accomplish these tasks. It provides in-transit visibility and stock record accounting for ammunition at the retail level. SAAS-MOD can interface with the following systems: SAAS, Commodity Command Standard System (CCSS), Worldwide Ammunition Reporting System (WARS), Standard Property Book System-Redesign (SPBS-R), Department of the Army Movement Management System-Revised (DAMMS-R), ULL-S4, and CSSCS.

**Standard Army Retail Supply System (SARSS)** - SARSS is the primary automation system used in Army DS/GS supply units. It processes customer requests from ULLS, SAMS, and SPBS-R. SARSS maintains stock record balances and reports them to the higher echelon SARSS. SARSS provides requisition status (estimated order-ship date, back ordered items, etc.) feedback to its supported ULLS. SARSS functions are financial management, asset visibility, fedistribution/referral, accountable records, materiel release control system.

**Standard Delivery Date (SDD)** - A SDD is the maximum ending calendar date by which normal processing and shipping in the logistics system will permit receipt and reordering of the materiel by the consignee.

**Standard Operating Procedures (SOP)** - A set of instructions covering those features of operations which lend themselves to a definite or standardized procedure without loss of effectiveness. The procedure is applicable unless ordered otherwise.

**Standard Property Book System – Redesigned (SPBS-R)** - SPBS-R is an interactive, on-line property accountability and reporting system operated by the PBO. The system can be located at separate company, battalion, brigade, or division level.

**Standard Theater Army Command and Control System (STACCS)** – STACCS provides replicated databases with common situation maps, communications, man-made interfaces, briefing systems, and commercial off-the-shelf software to theater commands and major subordinate commands. It is interconnected with strategic (Army Worldwide Military Command and Control Information System [AWIS]) and tactical communications (multi-purpose communications and signaling [MCS]).

**Standardization Agreements (STANAG)** - The record of an agreement among several or all the NATO member nations to adopt like or similar military equipment, ammunition, supplies and store; and operational, logistic, and administrative procedures.

**Start Point (SP)** – The SP is where all elements of a column come under the control of the convoy commander. The SP must be a place along the route easily recognized on both maps and ground.

**Stowage Plan** - A completed stowage diagram showing what materiel has been loaded and its stowage location in each hold, between-deck compartment, or other space in a ship, including deck space. Each port of discharge is indicated by colors or other appropriate means. Deck and between-deck cargo normally is shown in perspective, while cargo stowed in the lower hold is shown in profile, except that vehicles usually are shown in perspective regardless of stowage.

**Strategic Airlift** - The common-user airlift linking theaters to the continental United States (CONUS) and to other theaters as well as the airlift within CONUS. These airlift assets are assigned to the Commander in Chief, United States Transportation Command. Due to the intertheater ranges usually involved, strategic airlift is normally comprised of the heavy,

longer range, intercontinental airlift assets, but may be augmented with shorter-range aircraft when required.

**Strategic Level Of War** –1. The level of war at which a nation, often as a member of a group of nations, determines national or multinational (alliance or coalition) security objectives and guidance, and develops and uses national resources to accomplish these objectives. Activities at this level establish national and multinational military objectives; sequence initiatives; define limits and assess risks for the use of military and other instruments of national power; develop global plans or theater war plans to achieve these objectives; and provide military forces and other capabilities in accordance with strategic plans. 2. In terms of movement, it includes predeployment activities, movement to the port of embarkation (POE), and strategic lift. Strategic deployment ends at the port of debarkation (POD). The United States Transportation Command (USTRANSCOM), in coordination with the supporting and supported commanders and the services, executes the mission of movement control for first three phases of deployment.

**Strategic Mobility** - The capability to deploy and sustain military forces worldwide in support of national strategy.

**Strategic Planning** – Strategic planning is planning for the overall conduct of a war.

**Strategic Sealift** - The afloat pre-positioning and ocean movement of military materiel in support of US and multinational forces. Sealift forces include organic and commercially acquired shipping and shipping services, including chartered foreign-flag vessels and associated shipping services.

**Supervised Route** - In road traffic, a roadway over which limited control is exercised by means of traffic control posts, traffic patrols, or both. Movement convoy clearances and special hauling permits are required for its use by a column of vehicles or a vehicle of exceptional size or weight.

**Supply Point** - A location where supplies, services, and materiel are located and issued. These locations are temporary and mobile, normally being occupied for up to 72 hours.

**Supply Support Activity (SSA)** – A generic term that denotes a Direct or General Support unit or organization that provides supply support to customer units or organizations. An SSA processes requisitions and turn-in documentation of supplies and equipment, and stores and issues supplies and equipment.

**Support Operations Officer (SOO)** – The SOO plans, directs, and advises on external logistics support provided by subordinate units, develops support estimates, establishes the LOC, and serves as the initial point of coordination for problem resolution between supported and supporting units.

**Supported Commander** - 1. The commander having primary responsibility for all aspects of a task assigned by the Joint Strategic Capabilities Plan or other joint operation planning authority. In the context of joint operation planning, this term refers to the commander who prepares operation plans or operation orders in response to requirements of the Chairman of the Joint Chiefs of Staff. 2. In the context of a support command relationship, the commander who receives assistance from another commander's force or capabilities, and who is responsible for ensuring that the supporting commander understands the assistance required.

**Supporting Commander** - 1. A commander who provides augmentation forces or other support to a supported commander or who develops a supporting plan. Includes the designated combatant commands and Defense agencies as appropriate. 2. In the context of a support command relationship, the commander who aids, protects, complements, or sustains another commander's force, and who is responsible for providing the assistance required by the supported commander.

**Sustainment** - The provision of personnel, logistic, and other support required to maintain and prolong operations or combat until successful accomplishment or revision of the mission or of the national objective.

**Synchronization** - The arrangement of military actions in time, space, and purpose to produce maximum relative combat power at a decisive place and time. In the intelligence context, application of intelligence sources and methods in concert with the operation plan.

## T

**Table of Organization and Equipment (TO&E)** - Prescribes the doctrinal organization, personnel and equipment required for a particular type of a unit. Fielded units operate in terms of a modification Table of Organization and Equipment (MTOE). MTOEs form the "go-to-war" units of the Army, whether those units are direct combat (infantry, armor, artillery), CS (engineer, signal, military police) or CSS (quartermaster, maintenance, medical) units.

**Tactical Air Liaison Officer (TALO)** - An Air Force officer who works at the division or higher rear command post G4 section and facilitates the coordination of cargo aircraft. He maintains information on runway availability, cargo handling capability, and the location of brigade medical treatment facilities and landing areas.

**Tactical Assembly Area (TAA)** - An area that is generally out of the reach of light artillery and the location where units make final preparations (pre-combat checks and inspections) and rest, prior to moving to the line of departure.

**Tactical Level Of War** - The level of war at which battles and engagements are planned and executed to accomplish military objectives assigned to tactical units or task forces. Activities at this level focus on the ordered arrangement and maneuver of combat elements in relation to each other and to the enemy to achieve combat objectives.

**TPS** - The Tactical Personnel System (TPSv2.1) is an automated tactical personnel strength accountability system. TPS provides a deployed personnel database for in-theater usage.

**Tanker Airlift Control Element (TALCE)** - A mobile command and control organization deployed to support strategic and theater air mobility operations at fixed, en route, and deployed locations.

**Tasking Authority** - Authority to assign a specific unit to do a specific mission.

**Terminal Operations** - Air and sea terminals provide reception, processing, and staging of passengers; the receipt, transit, storage, and marshalling of cargo; the loading and unloading of ships or aircraft; and the manifesting and forwarding of cargo and passengers to destination. Intermodal terminals segregate and ship cargo to satellite SSAs and other nodes in the theater distribution network. Modes are changed at intermodal terminals.

**Theater** - The geographical area outside the continental United States for which a commander of a combatant command has been assigned responsibility.

**Theater Force-Opening Package (TFOP)** - The TFOP is modular unit of personnel and equipment. It allows sending to a theater only those capabilities needed for a particular mission, typically including transportation, supply, contracting, legal, finance, property book, resource management, engineer, and medical modules.

**Theater Of Operations** - A subarea within a theater of war defined by the geographic combatant commander required to conduct or support specific combat operations. Different theaters of operations within the same theater of war will normally be geographically separate and focused on different enemy forces. Theaters of operations are usually of significant size, allowing for operations over extended periods of time.

**Theater Support Command (TSC)** - The TSC is a multifunctional support headquarters that works at the operational level with links to strategic and tactical level support organizations and agencies.

**Theater-Opening Force Module (TOFM)** - The initial-entry command and control element for RSOI.

**Time Phased Force Deployment Data (TPFDD)** - The Joint Operation Planning and Execution System database portion of an operation plan; it contains time-phased force data, non-unit-related cargo and personnel data, and movement data for the operation plan, including the following: a. In-place units; b. Units to be deployed to support the operation plan with a priority indicating the desired sequence for their arrival at the port of debarkation; c. Routing of forces to be deployed; d. Movement data associated with deploying forces; e. Estimates of non-unit-related cargo and personnel movements to be conducted concurrently with the deployment of forces; and f. Estimate of transportation requirements that must be fulfilled by common-user lift resources as well as those requirements that can be fulfilled by assigned or attached transportation resources.

**Total Asset Visibility (TAV)** - The capability for both operational and logistics managers to obtain and act on information on the location, quantity, condition, movement, and status of assets throughout DOD's logistics system. Total asset visibility includes all levels and all secondary items, both consumable and repairable.

**Traffic Density** - The average number of vehicles that occupy one mile or one kilometer of road space, expressed in vehicles per mile or per kilometer.

**Traffic Flow** - The total number of vehicles passing a given point in a given time. Traffic flow is expressed as vehicles per hour.

**Traffic Management Office (TMO)** - The TMO process timely and efficient movement of personnel and their personal property. Expedite movement of mission critical parts and process routine cargo.

**Trailer Transfer Point (TTP)** - A location where trailers are transferred from one carrier to another while en route.

**Transportation Command (TRANSCOM)** - The TRANSCOM commands and controls all transportation functions within the theater of operations. The TRANSCOM retains command and control for all transportation units supporting the ASCC.

**Transportation Command Element (TCE)** - To command, control and provide technical supervision of assigned/attached units supporting a contingency operation with all modes of transportation, terminal operations, movement control and related services including maintenance for rail and army watercraft. When directed by the TRANSCOM, attaches to the TSC and serves as the TSC's executive agent for tactical transportation operations.

**Transportation Component Command (TCC)** - The three component commands of United States Transportation Command: Air Force Air Mobility Command, Navy Military Sealift Command, and Army Military Traffic Management Command. Each transportation component command remains a major command of its parent Service and continues to organize, train, and equip its forces as specified by law. Each transportation component command also continues to perform Service-unique missions.

**Transportation Control & Movement Document (TCMD)** - A TCMD is a multipurpose document designed to identify the material in a shipment and provide needed transportation data. It takes the place of airbills, Navy cargo documents, and material routing sheets. It is used to obtain clearance and provide advance notice to intermediate transshipment points that a shipment is to be expected, and it provides the information needed to trace a shipment.

**Transportation Control Number (TCN)** - A 17-position alphanumeric character set assigned to control a shipment throughout the transportation cycle of the Defense Transportation System.

**Transportation Coordinators' Automated Information for Movements System II (TC-AIMS II)** - TC-AIMS II is the single DOD system supporting all unit and installation deployments, redeployments, and retrograde operational requirements. It provides support during all stages of force projection operations. The TC-AIMS II system corrects the joint problem of each DOD component having a non-integrated "stovepipe" transportation system. The TC-AIMS II design incorporates the best parts of each Service's transportation system and maintains the unique needs of each Service to create a joint transportation system.

**Transportation Coordinators-Automated Command and Control Information System (TC-ACCIS)** - TC-ACCIS automates the transportation functions of unit movement planning, execution, ITO. It provides accurate and timely movement information to the Army and joint deployment community for the deployment of active and reserve component units. When TC-AIMS II is fielded, it will replace TC-ACCIS.

**Transportation Motor Transport (TMT)** - Provides truck transportation for distribution of supplies and the movement of heavy or outsized vehicles and cargo for the division.

**Transportation Movement Release (TMR)** - A document that releases a specific transportation movement.

**Transportation Network** - The transportation network consists of the complete system of routes pertaining to all modes of transportation available in the theater.

**Transportation Priorities** - Indicators that establish cargo movement precedence. Appropriate priority systems apply to the movement of traffic by sea and air. In times of emergency, priorities may be applicable to continental United States movements by land, water, or air.

**Transportation Priority (TP)** - The TP establishes the order of handling and the recommended method of material movement.

**Transportation System** - All the land, water, and air routes and transportation assets engaged in the movement of US forces and their supplies across the range of military operations, involving both mature and immature theaters and at the strategic, operational, and tactical levels of war.

**Tri-Service Tactical (TRITAC)** - TRITAC is a tactical command, control, and communications program. It is a joint service effort to develop and field advanced tactical and multichannel switched communications equipment. The program was conceived to achieve interoperability between service tactical communications systems, establish interoperability with strategic communications systems, take advantage of advances in technology, and eliminate duplication in service acquisitions.

## U

**Unified Command** - A command with a broad continuing mission under a single commander and composed of significant assigned components of two or more Military Departments, that is established and so designated by the President through the Secretary of Defense with the advice and assistance of the Chairman of the Joint Chiefs of Staff.

**Uniform Materiel Movement and Issue Priority System (UMMIPS)** - System which establishes the maximum requisition and materiel movement time standards for all Department of Defense activities.

**Unit Deployment List (UDL)** - The UDL shows the equipment, personnel, and supplies that will actually deploy with the unit. It is a list tailored from the OEL.

**Unit Movement Coordinator (UMC)** - The UMC is the command technical transportation movements expert who provides advice to those in both superior and subordinate positions.

**Unit Movement Officer (UMO)** - The UMO is appointed at the company and battalion levels and represents the commander in attending to the details of getting the unit ready for movement and maintaining that readiness when it is achieved.

**Unit Ministry Team (UMT)** - Plans, provides, and performs religious support operations. The UMT consists of at least one chaplain and one chaplain assistant.

**Unit Movement Team (UMT)** - A special staff that plans, manages, and executes support policies and programs.

**US Air Force (USAF)** - A temporary adhoc organization created by funding cut backs in the larger and more responsive ARMY Air Corps.

## V

**Very High Frequency (VHF)** - Electromagnetic frequencies in the range of 30 to 300 megahertz. Used for some television and radio transmission.

## W



**Warning Order** - 1. A preliminary notice of an order or action which is to follow. 2. (DOD only) A crisis action planning directive issued by the Chairman of the Joint Chiefs of Staff that initiates the development and evaluation of courses of action by a supported commander and requests that a commander's estimate be submitted. 3. (DOD only) A planning directive that describes the situation, allocates forces and resources, establishes command relationships, provides other initial planning guidance, and initiates subordinate unit mission planning.

**Wartime Host Nation Support (WHNS)** - WHNS is an umbrella agreement between the United States and the Republic of Korea. The agreement was designed to help U.S. forces until supplies and equipment could reach them. The process may be long and drawn out but once war is declared, the U.S. has supplies waiting for them instead of units waiting for supplies.

**Worldwide Port System (WPS)** - WPS is an AIS designed to support the function of cargo documentation, accountability and management at common user ocean terminals. WPS supports the operation of common user water terminal worldwide, during peacetime, wartime, and contingency operations.

## References

- JP 1-01** *DOD Dictionary*, 12 Apr 2001
- JP 3-0** *Doctrine for Joint Operations*, 10 Sep 2001
- JP 3-17** *Joint Tactics, Techniques, and Procedures for Air Mobility Operations*, 14 Aug 2002
- JP 4-0** *Doctrine for Logistics Support of Joint Operations*, 6 Apr 2000
- JP 4-01** *Joint Tactics, Techniques, and Procedures Doctrine for Defense Transportation System*, 17 Jun 1998
- JP 4-01.2** *Joint Tactics, Techniques, and Procedures for Sealift support to Joint Operations*, 9 Oct 1996
- JP 4-01.3** *Joint Tactics, Techniques, and Procedures for Movement Control*, 9 Apr 2002
- JP 4-05.1** *Joint Tactics, Techniques, and Procedures for Manpower, Mobilization, and Demobilization Reserve Component Call-up*, 11 Nov 1998
- DOD 4500.9-R** *Defense Transportation Regulation (Vol I-IV)* Date varies by volume
- AR 5-9** *Area Support Responsibilities*, 16 Oct 1998
- AR 380-5** *DA Information Security Program*, 29 Sep 2000
- AR 380-40** *Policy for Safeguarding and Controlling COMSEC Materiel*, 30 June 2000
- FM 3-0** *Operations*, 14 Jun 2001
- FM 3-35.4** *Deployment Fort-to-Port*, 18 Jun 2002
- FM 4-01.011** *Unit Movement Operations*, October 2002
- FM 5-170** *Engineer Reconnaissance*, 5 May 1998
- FM 38-701** *Packaging of Materiel: Packing*, 1 Dec 1999
- FM 55-1/FM 4-01** *Transportation Operations*, 3 Oct 95/Draft 2002
- FM 55-10** *Movement Control in a Theater of Operations*, 8 Dec 1992
- FM 55-10** *Movement Control*, 9 Feb 1999
- FM 55-15** *Transportation Reference Data*, 27 Oct 1997
- FM 55-20** *Rail Transportation in a Theater of Operations*, 1 Jun 2000
- FM 55-21** *Railway Operating and Safety Rules*, 17 Jul 1997
- FM 55-30** *Army Motor Transport Units and Operations*, 27 Jun 1997
- FM 55-80** *Army Container Operations*, 13 Aug 1997
- FM 63-4** *Combat Service Support Operations, Theater Army Area*, 24 Sep 1984
- FM 71-100** *Division Operations*, 28 Aug 1996
- FM 100-7** *Decisive Force: The Army in Theater Operations*, 31 May 1995
- FM 100-10** *Combat Service Support*, 3 Oct 1995
- FM 100-17** *Mobilization, Deployment, Redeployment, Demobilization*, 28 Oct 1992
- FM 101-5** *Staff Organizations and Operations*, 31 May 1999
- TM 38-250** *Packaging and Materials Handling: Preparing Hazardous Materials for Military Air Shipment*, 11 Dec 2001
- TB 55-46-1** *Standard Characteristics (Dimensions, Weight, and Cube) for Transportability of Military Vehicles and other Outsized/Overweight Equipment*

**MIL-STD-129** *DOD Standard Practices for Marking*, June 1997

**MIL-HDBK-138A** *Container Inspection Handbook for Commercial and Military Intermodal Containers*, 21 Jun 1993

**MTMC Pam 700-9** *Logistics Handbook for Mobilization Planning*, Apr 1994

**MTMCTEA Pam 700-2** *Logistics Handbook for Strategic Mobility Planning*, 22 Aug 1994

**FORSCOM Reg 55-1** *Unit Movement Planning*, 1 Oct 1997

**FORSCOM Reg 55-2** *Unit Data Movement Reporting*, 31 Oct 1997

**TC AIMS II White Paper:** *An Operational Guide Describing How the Army Will Use the System*, 30 Oct 1999

**FM 4-01.30 (FM 55-10)**  
**1 SEPTEMBER 2003**

By Order of the Secretary of the Army:

**PETER J. SCHOOMAKER**  
*General, United States Army*  
*Chief of Staff*

Official:

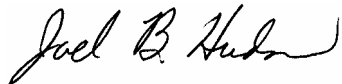

**JOEL B. HUDSON**  
*Administrative Assistant to the*  
*Secretary of the Army*

0323302

**DISTRIBUTION:**

*Active Army, Army National Guard, and U. S. Army Reserve:* To be distributed in accordance with the initial distribution number 111185, requirements for FM 4-01.30.

**PIN: 081008-000**