

Tactics, Techniques, and Procedures for

OBSERVED FIRE

DISTRIBUTION RESTRICTION: Approved for public release;
distribution is unlimited.

HEADQUARTERS, DEPARTMENT OF THE ARMY

TACTICS, TECHNIQUES, AND PROCEDURES FOR
OBSERVED FIRE

Table of Contents

	PAGE
PREFACE	ix
CHAPTER 1	
FIELD ARTILLERY EFFECTIVENESS	
1-1. FIELD ARTILLERY TEAM	1-1
1-2. FIRE SUPPORT EFFECTIVENESS	1-2
1-3. CAPABILITIES AND LIMITATIONS	1-4
1-4. MANEUVER COMMANDER	1-5
CHAPTER 2	
DUTIES OF THE FIRE SUPPORT TEAM AND THE OBSERVER	
2-1. FIRE SUPPORT TEAM	2-1
2-2. DUTIES OF FIRE SUPPORT TEAM PERSONNEL	2-2
2-3. FORWARD OBSERVER CONTROL	2-3
2-4. FIRE SUPPORT TEAM VEHICLE (M981) EMPLOYMENT OPTIONS	2-3
2-5. OBSERVATION POST SELECTION	2-3
2-6. FIRE SUPPORT TEAM VEHICLE (M981) POSITIONING	2-4
2-7. COMMUNICATIONS	2-5
CHAPTER 3	
TARGET LOCATION	
<i>Section I. REQUIREMENTS FOR LOCATING TARGETS</i>	3-1
3-1. TERRAIN-MAP ASSOCIATION	3-1
3-2. TARGET LOCATION METHODS	3-1

DISTRIBUTION RESTRICTION: Approved for public release; distribution is unlimited.

*This publication supersedes FM 6-30, 17 June 1985, and rescinds DA Form 5430-R, June 1985.

3-3. DIRECTION	3-4
3-4. DISTANCE	3-6
3-5. TERRAIN SKETCH	3-8
<i>Section II. AIDS TO TARGET LOCATION</i>	<i>3-9</i>
3-6. OBSERVED FIRE FAN	3-9
3-7. HAND MEASUREMENT OF ANGULAR DEVIATION	3-11

**CHAPTER 4
CALL FOR FIRE**

<i>Section I. ELEMENTS OF THE CALL FOR FIRE</i>	<i>4-1</i>
4-1. DESCRIPTION	4-1
4-2. OBSERVER IDENTIFICATION	4-1
4-3. WARNING ORDER	4-1
4-4. TARGET LOCATION	4-2
4-5. TARGET DESCRIPTION	4-3
4-6. METHOD OF ENGAGEMENT	4-3
4-7. METHOD OF FIRE AND CONTROL	4-4
4-8. CORRECTIONS OF ERRORS	4-5
4-9. CALLS FOR FIRE FROM HEADQUARTERS HIGHER THAN BATTALION	4-6
4-10. MESSAGE TO OBSERVER	4-6
4-11. ADDITIONAL INFORMATION	4-6
4-12. AUTHENTICATION	4-6
4-13. SAMPLE MISSIONS	4-7
<i>Section II. SHELL-FUZE COMBINATIONS</i>	<i>4-9</i>
4-14. DESIRED EFFECTS	4-9
4-15. SHELL HE AND FUZES	4-9
4-16. SHELL WHITE PHOSPHORUS	4-11
4-17. SHELL SMOKE	4-11
4-18. SHELL ILLUMINATING	4-11
4-19. SHELL FASCAM	4-11
4-20. SHELL COPPERHEAD	4-11
4-21. SHELLS ICM AND DPICM	4-11

**CHAPTER 5
ADJUSTMENT OF FIRE**

<i>Section I. SUBSEQUENT CORRECTIONS</i>	<i>5-1</i>
5-1. PURPOSE OF ADJUSTMENT	5-1
5-2. ADJUSTING POINT	5-1
5-3. SPOTTINGS	5-1

5-4. TYPES OF CORRECTIONS 5-4

5-5. SEQUENCE OF SUBSEQUENT CORRECTIONS 5-6

Section II. AREA FIRE (ADJUSTMENT AND FIRE FOR EFFECT) 5-8

5-6. ADJUSTMENT TECHNIQUES 5-8

5-7. FIRE FOR EFFECT 5-10

5-8. REFINEMENT AND SURVEILLANCE 5-11

Section III. PRECISION FIRE 5-12

5-9. TYPES OF PRECISION MISSIONS 5-12

5-10. PRECISION REGISTRATION MISSION 5-12

5-11. DESTRUCTION MISSION 5-22

Section IV. MOVING TARGETS 5-23

5-12. ENGAGEMENT 5-23

5-13. TARGET OF OPPORTUNITY 5-23

5-14. PLANNED TARGET 5-25

**CHAPTER 6
SPECIAL MUNITIONS**

Section I. IMPROVED CONVENTIONAL MUNITIONS AND DUAL-PURPOSE IMPROVED CONVENTIONAL MUNITIONS 6-1

6-1. CHARACTERISTICS OF ICM AND DPICM 6-1

6-2. CALL FOR FIRE AND ADJUSTMENT 6-1

6-3. SAMPLE ICM MISSIONS 6-2

6-4. IMPROVED CONVENTIONAL MUNITIONS CONSIDERATIONS 6-3

Section II. FIELD ARTILLERY DELIVERED FASCAM 6-3

6-5. CHARACTERISTICS OF FASCAM 6-3

6-6. RAAMS PROJECTILES M718 AND M741 6-3

6-7. ADAM PROJECTILES M692 AND M731 6-4

6-8. TYPES OF MINEFIELDS 6-4

6-9. SELECTION OF MINES 6-4

6-10. SELECTION OF MINE DENSITY 6-5

6-11. SELECTION OF SELF-DESTRUCT TIME 6-5

6-12. TARGET LOCATION 6-6

6-13. CALL FOR FIRE AND ADJUSTMENT 6-7

6-14. SAMPLE FASCAM MISSIONS 6-7

Section III. ILLUMINATION 6-7

6-15. CHARACTERISTICS OF ILLUMINATION 6-7

6-16. EMPLOYMENT CONSIDERATIONS 6-7

6-17. CALL FOR FIRE AND ADJUSTMENT OF ILLUMINATION 6-9

6-18. CALL FOR FIRE AND ADJUSTMENT UNDER ILLUMINATION 6-10

6-19. SAMPLE ILLUMINATION MISSIONS 6-11

<i>Section IV. SMOKE</i>	6-12
6-20. CHARACTERISTICS OF SMOKE	6-12
6-21. SMOKE DELIVERY TECHNIQUES	6-13
6-22. EMPLOYMENT CONSIDERATIONS	6-14
6-23. IMMEDIATE SMOKE	6-18
6-24. QUICK SMOKE	6-20
6-25. SAMPLE SMOKE MISSIONS	6-21
6-26. MORTAR PROCEDURES	6-21
<i>Section V. COPPERHEAD</i>	6-22
6-27. CHARACTERISTICS OF COPPERHEAD	6-22
6-28. EMPLOYMENT	6-22
6-29. ENGAGEMENT	6-22
6-30. TARGETS OF OPPORTUNITY	6-24
6-31. PLANNED TARGETS	6-25
6-32. COPPERHEAD CALL FOR FIRE	6-25

**CHAPTER 7
SPECIAL OBSERVER MISSIONS**

7-1. AERIAL FIRE SUPPORT OBSERVER	7-1
7-2. HIGH-ANGLE FIRE	7-3
7-3. FINAL PROTECTIVE FIRES	7-4
7-4. MULTIPLE MISSIONS	7-5
7-5. OBSERVING HIGH-BURST OR MEAN-POINT-OF-IMPACT REGISTRATIONS	7-7
7-6. AUXILIARY ADJUSTING POINT	7-10
7-7. OBSERVER NOT ORIENTED	7-10
7-8. IRREGULARLY SHAPED TARGETS	7-10
7-9. ADJUSTMENT BY SOUND	7-11
7-10. EMERGENCY OBSERVER PROCEDURES	7-12

**CHAPTER 8
ADJUSTMENT OF OTHER FIRE SUPPORT MEANS**

<i>Section I. CLOSE AIR SUPPORT</i>	8-1
8-1. TYPES OF REQUESTS	8-1
8-2. EMPLOYMENT	8-1
8-3. MISSION CONTROL	8-3
<i>Section II. ATTACK HELICOPTERS</i>	8-6
8-4. MISSION AND EMPLOYMENT	8-6
8-5. FIRE SUPPORT ROLE	8-6
8-6. CAPABILITIES	8-6

8-7. ATTACK AND SCOUT TEAMS	8-6
8-8. ARMY AND AIR FORCE COORDINATION	8-6
8-9. TARGET HAND OVER	8-6
<i>Section III. NAVAL GUNFIRE</i>	<i>8-7</i>
8-10. INTRODUCTION	8-7
8-11. COMMUNICATIONS	8-8
8-12. FIRE UNIT STATUS	8-8
8-13. ELEMENTS OF THE CALL FOR FIRE	8-8
8-14. SPOTTER (OBSERVER) IDENTIFICATION	8-8
8-15. WARNING ORDER AND TARGET NUMBER	8-8
8-16. TARGET LOCATION	8-8
8-17. TARGET DESCRIPTION	8-8
8-18. METHOD OF ENGAGEMENT	8-9
8-19. METHOD OF FIRE AND CONTROL	8-10
8-20. PREFIRING REPORT	8-11
8-21. AUTHENTICATION	8-11
8-22. REPORT UPON FIRING	8-11
8-23. CORRECTION OF ERRORS	8-11
8-24. EXAMPLES OF NAVAL GUNFIRE CALLS FOR FIRE	8-12
8-25. ADJUSTMENT OF NAVAL GUNFIRE	8-13
8-26. ADJUSTMENT OF AIRBURSTS	8-14
8-27. ILLUMINATION	8-14
8-28. FRESH TARGET SHIFT	8-16
8-29. SIMULTANEOUS ENGAGEMENT OF TWO TARGETS	8-17
8-30. FIRING ON A RECORDED TARGET	8-17
8-31. 16-INCH NAVAL GUNFIRE MISSIONS	8-18
8-32. DESTRUCTIVE FIRE	8-18
8-33. MASSED FIRE	8-18
8-34. SPECIAL NAVAL GUNFIRE COMMANDS AND REPORTS	8-18

APPENDIX A
**LASER RANGE FINDERS AND DESIGNATORS
 AND WEAPON SYSTEMS**

A-1. INTRODUCTION	A-1
A-2. GROUND/VEHICULAR LASER LOCATOR DESIGNATOR	A-1
A-3. SELF-LOCATION	A-2
A-4. SECOND G/VLLD-EQUIPPED OBSERVER ASSISTANCE	A-5
A-5. OBSERVER ACTIONS AFTER BEING LOCATED	A-7
A-6. ADJUSTMENT OF FIRE	A-8
A-7. AUXILIARY ADJUSTING POINT	A-9

A-8. OBSERVER CLOUD HEIGHT	A-11
A-9. REGISTRATION	A-12
A-10. TARGET RANGING AND DESIGNATING WITH THE NIGHT SIGHT	A-12
A-11. NIGHT-SIGHT TRAINING	A-13
A-12. AN/GVS-5 LASER RANGE FINDER	A-13
A-13. HELLFIRE MISSILE	A-14
A-14. AH-64 TARGET ACQUISITION AND DESIGNATION SIGHT	A-14
A-15. OH-58D MAST-MOUNTED SIGHT	A-15
A-16. LASER TARGET DESIGNATOR	A-15
A-17. MODULAR UNIVERSAL LASER EQUIPMENT	A-15
A-18. UNITED STATES AIR FORCE LASER SYSTEMS	A-16
A-19. MARINE CORPS SYSTEM	A-16
A-20. LASER SAFETY DURING TRAINING	A-16
A-21. LASER SAFETY GOGGLES	A-17
A-22. G/VLLD EVALUATOR	A-17
A-23. ADDITIONAL LASER HAZARD INFORMATION	A-17
A-24. G/VLLD SAFETY FAN AND LASER RANGE SAFETY CARD	A-18

**APPENDIX B
DIGITAL MESSAGE DEVICES**

<i>Section I. DIGITAL MESSAGE DEVICE AN/PSG-2A</i>	B-1
B-1. OPERATION OF THE DIGITAL MESSAGE DEVICE	B-1
B-2. PREPARATION FOR USE	B-5
B-3. DMD MESSAGE FORMATS	B-6
B-4. MESSAGE COMPOSITION, STRUCTURE, AND FLOW	B-7
B-5. AUTHENTICATION	B-8
B-6. MODE MENU	B-10
B-7. PROCEDURE FOR PURGING THE MEMORY	B-11
B-8. PROCEDURE FOR MAKING INITIAL STATUS SELECTIONS	B-11
B-9. PROCEDURE FOR STORING THE AUTHENTICATION CODE LIST AND OPERATOR'S KEY	B-11
B-10. MESSAGE COMPOSITION AND TRANSMISSION	B-12
<i>Section II. FORWARD ENTRY DEVICE</i>	B-18
B-11. OPERATION OF FORWARD ENTRY DEVICE CP-1995/U	B-18
B-12. FORWARD ENTRY DEVICE MESSAGE FORMATS	B-18
B-13. MESSAGE TRANSFER MODES	B-20
B-14. PREPARATION FOR USE	B-20
B-15. POWER OR COMMUNICATIONS FAILURE	B-22
B-16. SAVE OR PURGE DATA AND POWER DOWN	B-22

B-17. UP-LOAD AND DOWN-LOAD THE CURRENT FORWARD ENTRY DEVICE SOFTWARE	B-23
B-18. MESSAGE PROCESSING PROCEDURES	B-23
B-19. FIRE MISSION PROCESSING PROCEDURES	B-24
B-20. CHECK FIRE AND CANCEL CHECK FIRE PROCEDURES	B-28
<i>Section III. FIST DIGITAL MESSAGE DEVICE</i>	<i>B-29</i>
B-21. OPERATION OF THE FIST DMD (AN/PSG-5)	B-29
B-22. FUNCTIONAL DESCRIPTION	B-31
<i>Section IV. MORTAR BALLISTIC COMPUTER M23</i>	<i>B-32</i>
B-23. DESCRIPTION	B-32
B-24. CAPABILITIES	B-32
B-25. MEMORY STORAGE	B-32
B-26. DMD SUPPORTED MISSION PROCESSING	B-32
<i>Section V. SPECIAL-PURPOSE POWER SOURCES</i>	<i>B-33</i>
B-27. VEHICLES	B-33
B-28. INTERNAL BATTERIES	B-33
B-29. EXTERNAL BATTERIES	B-33
B-30. SPECIAL HANDLING PROCEDURES FOR LITHIUM BATTERIES	B-33
<i>Section VI. MNEMONICS</i>	<i>B-34</i>
B-31. DMD, FIST DMD, AND FED MNEMONICS	B-34
B-32. TARGET EQUIVALENTS	B-38

**APPENDIX C
TRAINING DEVICES**

C-1. PURPOSE	C-1
C-2. MATCHBOX PROBLEM	C-1
C-3. 14.5-MM FIELD ARTILLERY TRAINER M31	C-2
C-4. TRAINING SET, FIRE OBSERVATION	C-2
C-5. TSFO-G/VLLD SIMULATION ENHANCEMENT	C-2
C-6. LASER TRAINING KIT	C-2
C-7. HELLFIRE GROUND SUPPORT SYSTEM	C-3
C-8. COMBINED ARMS TEAM INTEGRATED EVALUATION SYSTEM	C-3
C-9. OBSERVER TRAINING FOR NONARTILLERY PERSONNEL	C-3

**APPENDIX D
FIRE SUPPORT TEAM VEHICLE**

D-1. INTRODUCTION	D-1
D-2. DESCRIPTION	D-1
D-3. FUNCTIONAL DESCRIPTION	D-1

D-4. FISTV OPERATIONS STATIONS D-1
D-5. OBSERVED FIRE PROCEDURES D-2
D-6. RESPONSIBILITIES AND DUTIES OF THE FIST D-3

**APPENDIX E
TARGET ANALYSIS AND MUNITIONS EFFECTS**

E-1. OBSERVER RESPONSIBILITIES E-1
E-2. TARGET DESCRIPTION E-1
E-3. MOST SUITABLE AMMUNITION E-5
E-4. METHOD OF ATTACK E-6

GLOSSARY Glossary-1
REFERENCES References-1
INDEX Index-1

PREFACE

The purpose of this publication is to explain observed fire procedures used by units in combat and to explain how observed fire training is conducted in peacetime to meet combat requirements. The material presented herein applies to both nuclear and nonnuclear warfare.

This publication discusses observed fire procedures, with the firing unit using both manual and automated fire direction techniques. The observed fire procedures are usually the same; only those instances in which differences occur are indicated. Digital and automated observed fire procedures are discussed in the appendixes. This publication covers only technical observed fire procedures. The operational and organizational aspects of employing observers are discussed in other publications, particularly in the FM 6-20 series manuals.

The target audience for this publication is the field artillery fire support team (FIST) personnel and other fire support observers, to include aerial fire support observers (AFSOs), combat observation/lasing teams (COLTs), infantry scouts, and personnel who may become involved in rear area combat operations.

This publication is fully compatible with the Army's AirLand Battle doctrine and is consistent with current joint and combined doctrine.

This publication implements the following international agreements (standardization agreements [STANAGs] and quadripartite standardization agreements [QSTAGs]):

- QSTAG 224, Edition 2, *Manual Fire Direction Equipment Target Classification, and Methods of Engagement*,
- QSTAG 225, Edition 3, *Call for Fire Procedures*.
- QSTAG 246, Edition 3, *Radio Telephone Procedures for the Conduct of Artillery Fire*.
- QSTAG 503, Edition 1, *Bombing, Shelling, Mortaring, and Location Reports*.
- QSTAG 505, Edition 2, *Adjustment of Artillery Fire*.
- STANAG 1034, Edition 8, *Allied Spotting Procedures for Naval Gunfire Support*.
- STANAG 2088, Edition 6 and QSTAG 182, Edition 2, *Battlefield Illumination*.
- STANAG 2934, Edition 1, *Artillery Procedures*.
- STANAG 3736 Edition 7, *Offensive Air Support Operations*.

The proponent of this publication is HQ, TRADOC. Send comments and recommendations on DA Form 2028 (Recommended Changes to Publications and Blank Forms) directly to:

Commandant
US Army Field Artillery School
ATTN: ATSF-DD
Fort Sill, OK 73503-5600

Unless this publication states otherwise, masculine nouns and pronouns do not refer exclusively to men,

CHAPTER 1

FIELD ARTILLERY EFFECTIVENESS

1-1. FIELD ARTILLERY TEAM

The fire support gunnery problem is solved through the coordinated efforts of the field artillery team (Figure 1-1). This team consists of the observer, the fire direction center (FDC), and the firing unit—all linked by an adequate communications system. Doctrine requires team members to operate with a sense of urgency and to continually strive to reduce the time required to execute an effective fire mission.

a. Observer. The observer serves as the “eyes” of all indirect fire systems. He detects and locates suitable indirect fire targets within his zone of observation. To attack a target, the observer transmits a request for indirect fires and adjusts the fires onto the target when necessary. An observer provides surveillance data pertaining to his fires. See Chapter 2 for a discussion of the fire support team and the observer.

b. Fire Direction Center. The FDC serves as the “brain” of the system. It receives the call for fire from the observer, determines firing data, and converts them to fire commands (technical fire direction). The FDC transmits

the fire commands to the sections designated to fire the mission. Because of the great distance between artillery units on the battlefield and requirements for improved responsiveness, technical fire direction normally is conducted by the battery FDC. The battalion FDC does the following:

- Provides tactical fire direction (how to attack a target).
- Monitors all fire nets.
- Provides technical fire direction assistance to battery FDCs; for example, fire plan firing data and fire direction backup.

c. Firing Unit. The firing unit serves as the “brawn” of the system. It consists of the firing unit headquarters and the firing sections. The normal function of the firing section is to deliver fires as directed by the FDC. See the FM 6-20 series for a discussion of the fire support system, TC 6-40 and TC 6-40A for a discussion of field artillery (FA) fire direction, and FM 6-50 for a detailed discussion of the cannon battery.

Figure 1-1 THE FIELD ARTILLERY TEAM

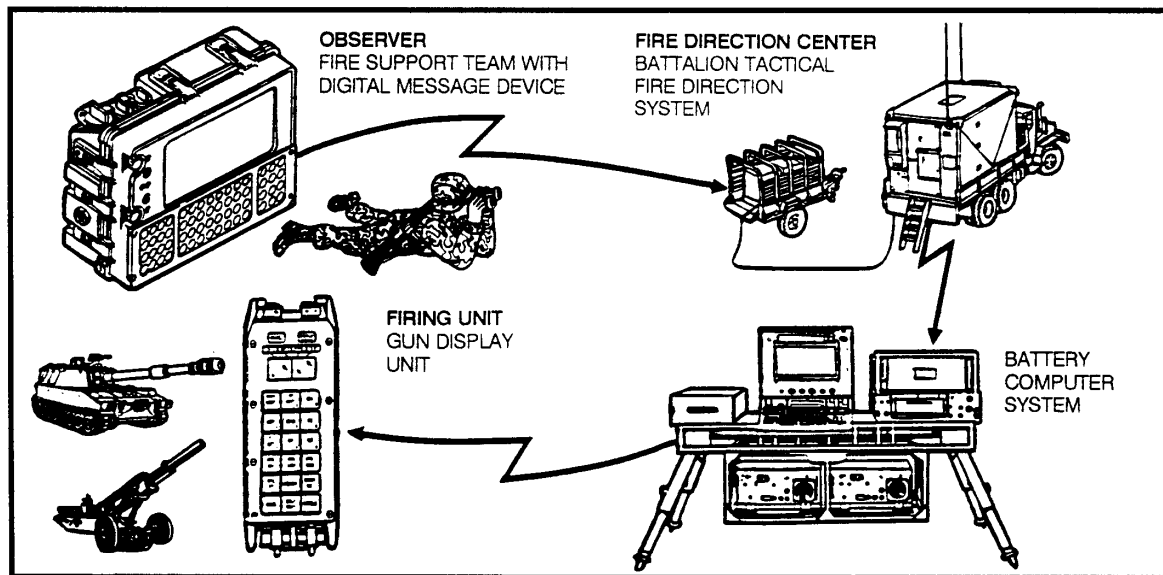

1-2. FIRE SUPPORT EFFECTIVENESS

a. System Responsiveness. In addition to gunnery, the fire support system consists of target acquisition, weapons and munitions, and command and control. To be an effective force in battle, fire support must be responsive to the needs of our maneuver forces. Procedures must be streamlined to minimize the time lag between target acquisition and effects on the target. Unnecessary delay can result in a failure to have adequate effects on the target. Responsiveness can be achieved if we do the following:

- Plan fire support requirements in advance.
- Streamline the call for fire.
- Limit radio transmissions on fire nets to time-sensitive, mission-essential traffic only.

b. Effect on Target. The ability of the fire support system to place effective fires on a target will depend, in part, on the method of fire and type of ammunition selected to attack the target. Maximum effect can be achieved through accurate initial fires and massed fires.

(1) **Accurate Initial Fires.** Accurate initial fires (surprise fires) inflict the greatest number of casualties. The observer must strive for first-round fire for effect (FFE) or make a one-round adjustment if adjustment is necessary. Figure 1-2 compares effect achieved to length of adjustment.

Figure 1-2. EFFECTIVENESS COMPARED TO LENGTH OF ADJUSTMENT

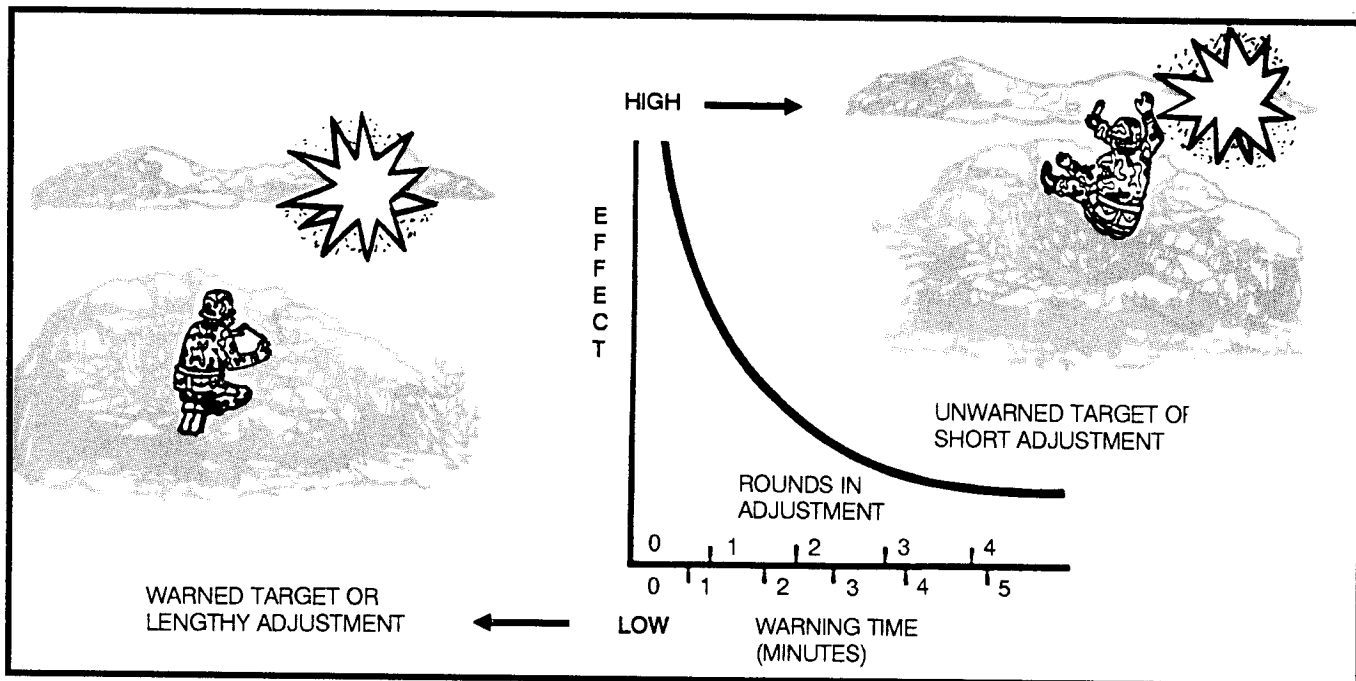

(2) Massed Fires. Massing all available fires normally enables us to inflict maximum effect on a target with a minimum expenditure of ammunition. It also reduces our vulnerability to enemy target acquisition (TA) devices. Failure to mass fires gives the enemy time to react and seek protection. Figure 1-3 compares massed fire and successive volley ammunition expenditures to get equivalent effect. Massed fires of three battalions firing one round are more effective against soft targets than one

battalion firing the same total number of rounds in successive volleys. This is because of the minimum time lag between volley impacts. Massed fires ensure maximum effect in attacking targets that can easily change their posture category for example, a soft target (personnel in the open) can easily become a hard target (personnel with overhead cover). Massed fires do not necessarily provide increased effectiveness against hard targets, because volume of fire is more critical than round impact timing.

Figure 1-3. NUMBER OF ROUNDS REQUIRED FOR EQUIVALENT EFFECT

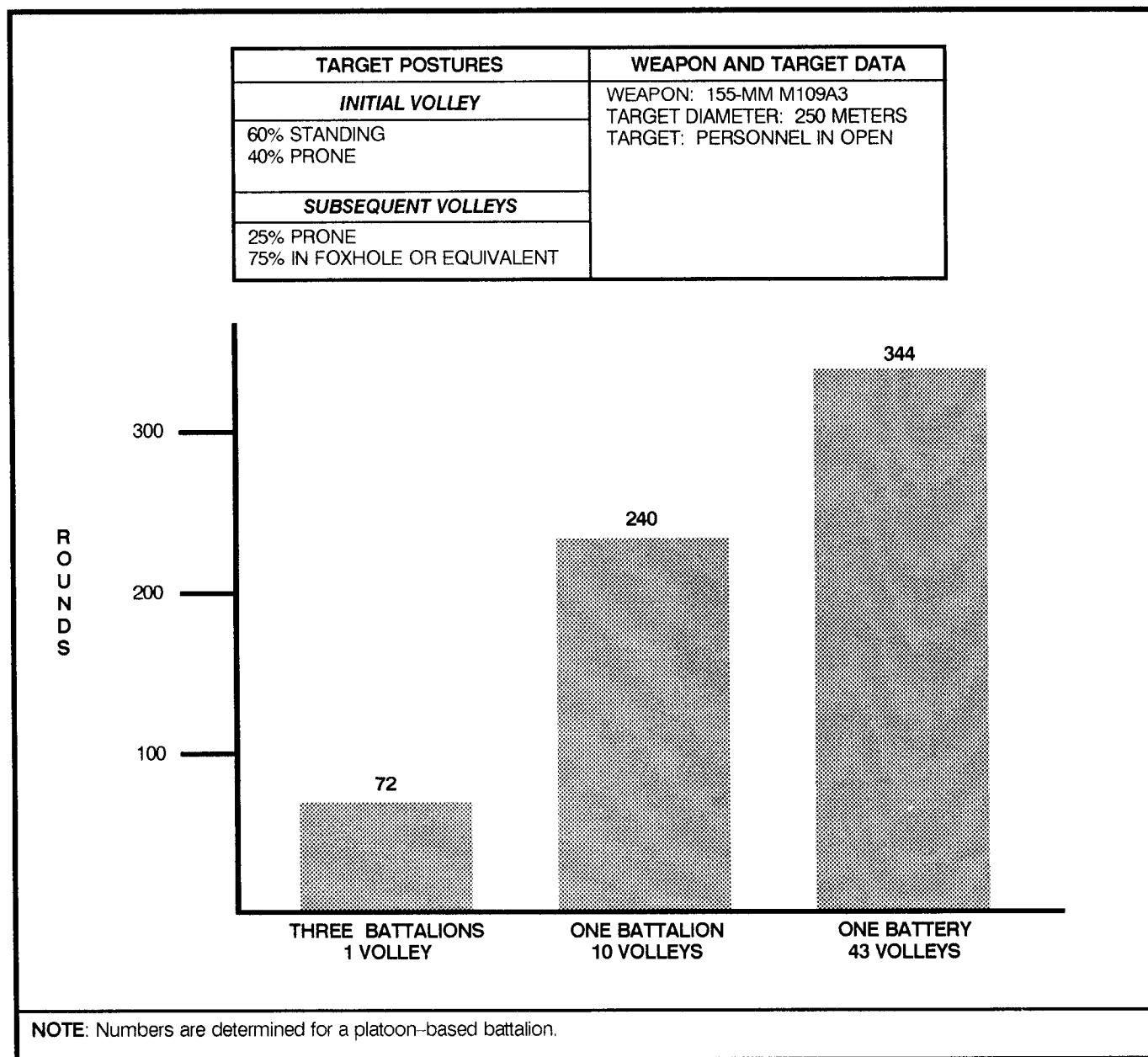

(3) Proper Munitions. In attacking a target, the shell-fuze combination selected must be capable of producing desired results against the most vulnerable part of the target; for example, the gun crew versus the gun. Failure to select proper shell-fuze combinations will result in an excessive expenditure of ammunition and a reduction in effects on target. Figure 1-4 compares ammunition expenditures and relative effects.

(4) Law of War Considerations. In addition to the above tactical considerations, the selection of targets, munitions, and techniques of fire must comply with the Geneva and Hague Conventions regarding prohibited targets and tactics. The FIST personnel must ensure that the target they select is a legal target and that they use lawful tactics. An example is a battalion of 155-mm

howitzers firing improved conventional munitions (ICM) to neutralize a sniper or an armored personnel carrier (APC) in a heavily populated town. This not only is a waste of firepower but also may violate the rule of proportionality and the prohibition of unnecessary suffering in the law of war.

1-3. CAPABILITIES AND LIMITATIONS

a. The accuracy of calls for fire depends on the actions and capabilities of forward observers (FOs) and company fire support officers (FSOs) and the accuracy of fire support plans.

b. Error-free self-location and precise target location are ideals for which the forward observer must strive.

Figure 1-4. AMMUNITION EXPENDITURES AND RELATIVE EFFECTS

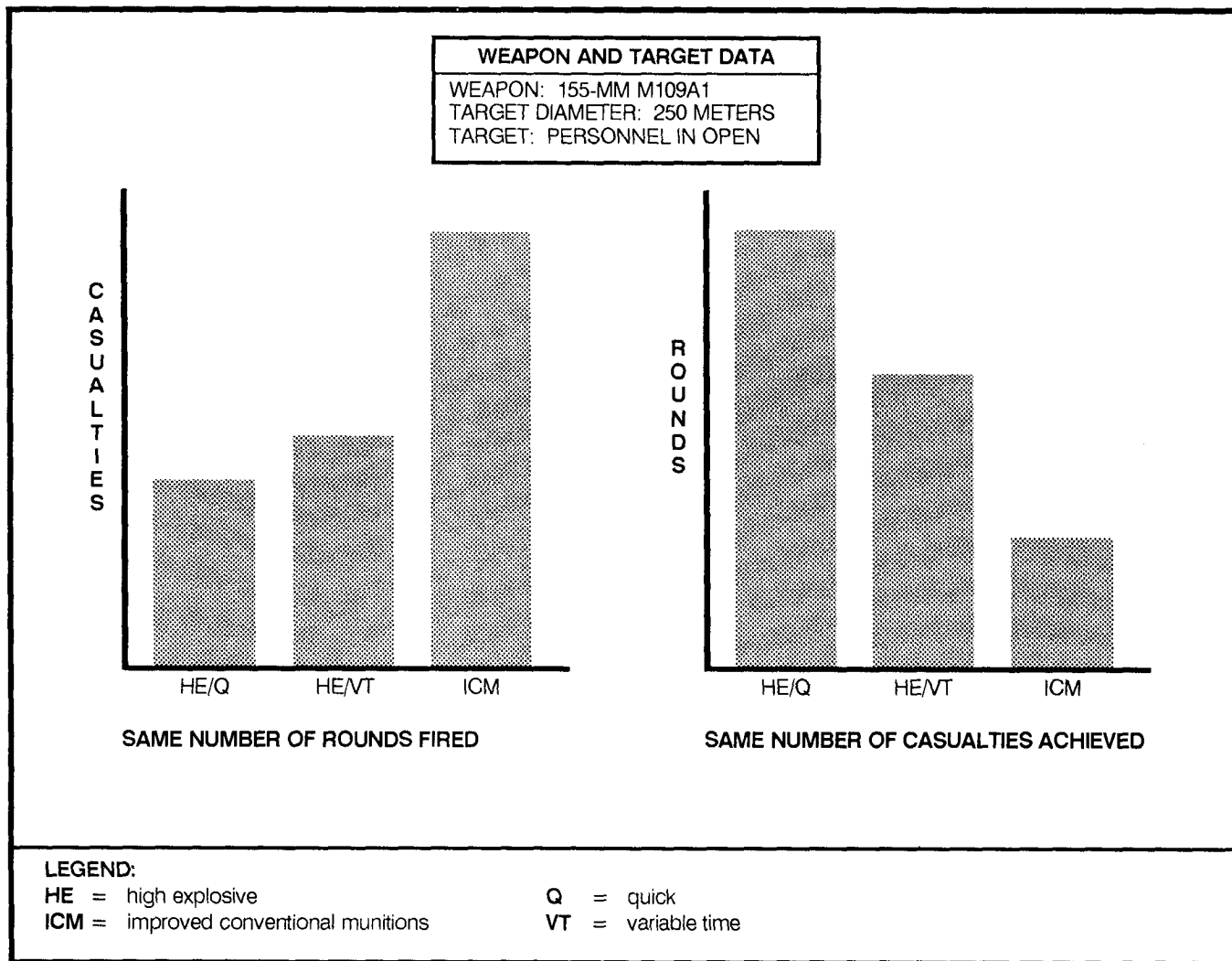

First-round FFE on a target of opportunity and immediate and effective suppression of enemy direct fire systems are musts if the supported maneuver unit is to accomplish its mission. Moreover, accurate location of planned targets is imperative to effective execution of a fire support plan. Accurate location of planned targets is possible only if the enemy is under actual observation by a forward observer or other targeting asset. Fire support may be indirect fire-but it must be directed!

c. Achievement of these goals is primarily situation-dependent. Accuracy of FA fires also depends to a great extent on the skill and experience of the observer who calls for fire and the equipment he uses for self-location and target location.

d. The traditional forward observer, equipped with a map, compass, and binoculars, can expect a mean target location error of about 500 meters. This is not enough for reliable first-round FFE or target suppression; it is no better than it was in World War II. Lengthy adjustments of fire are required to move the rounds onto the target. This wastes time and ammunition and gives the enemy a chance to take cover or leave the area.

e. Attainable accuracy for modern observer teams (FISTs, COLTs, and AFSOs), equipped with electronic and optical devices such as laser range finders and position-locating systems, is considerably improved. When properly used by trained and qualified observers, these devices enable the observer to attain first-round accuracy never before possible; but they have inherent hazardous characteristics. Lasers are not eye-safe and can inflict severe eye injuries. Thus, their use in training environments is severely restricted. Even in an actual conflict, care must be taken to prevent injuring unprotected friendly troops. Eye-safe laser range finders for use in training areas are currently under development and will be fielded when available. Appendix A provides additional information on laser-equipped systems.

WARNING

Lasers have inherently hazardous characteristics. Current lasers are not eye-safe and can inflict severe eye injury.

f. Forward observer teams, especially the force fire support coordinator (FSCOORD) (company or task force FSO), must ensure the maneuver commander recognizes

limitations on attainable accuracy of indirect fire systems and considers these capabilities and limitations when developing his scheme of maneuver.

1-4. MANEUVER COMMANDER

a. The maneuver commander has the responsibility to ensure that fire support is thoroughly integrated into his scheme of maneuver. When he develops his plan of attack or defensive framework, the FSO, as fire support coordinator, must be at his side. Likewise, when the platoon leader makes his reconnaissance, the platoon FO is with him every step of the way. Before the battle starts, the maneuver leader must assign actions to the company FSO and the FO to ensure they are carried out during the battle. For example, he must **clearly** assign individual responsibility for firing planned targets.

b. The maneuver commander and his FSCOORD should remember that if a task is not specifically assigned to an individual, everyone will tend to believe it is someone else's responsibility and the task will never be carried out. For example, simply assigning responsibility for firing on a planned target is not enough. The criteria for shooting must be made clear, and provisions must be made to ensure the responsible FO or FSO will indeed be able to carry out the task. As a minimum, in a defensive situation, specific guidance is needed to answer these questions regarding planned targets:

- Should the observer call for fire when only one enemy vehicle is near the target, or should he shoot only at platoon-sized enemy formations?
- Is the platoon FO to stay close to the platoon leader even in conditions of obscurity, or should he go elsewhere to be in a better position to observe the target?
- If the observer is authorized or required to be elsewhere, how and when is he to get there?
- Who will cover the assigned sector and targets if the assigned FO team does not make it to the assigned position?
- Does the observer have adequate communications, and how will they be tested?

These example considerations are by no means exhaustive. The maneuver commander should remember that the FIST members are assigned down to the platoon level. He must use them before and during the battle.

CHAPTER 2
**DUTIES OF THE
 FIRE SUPPORT TEAM AND THE OBSERVER**

2-1. FIRE SUPPORT TEAM

a. Personnel and Equipment. Indirect fire support is critical to the success of all maneuver operations. To ensure the accuracy of indirect fires, qualified observers are needed to locate targets and fires. Forward air controllers (FACs) and firepower control teams (FCTs) provide the expertise for close air support (CAS) and naval gunfire (NGF) respectively. For artillery and mortar support, FIST personnel act as the observers, or eyes, for the maneuver company. The FISTs are attached to maneuver elements at company level during deployment for training or hostilities. They are

normally assigned to the artillery units providing direct support to maneuver. Although the personnel and equipment in each FIST vary depending on the type of force supported, each FIST has (at least) a four-man headquarters. The headquarters personnel include the company FSO (an FA lieutenant), a fire support sergeant (an SSG), a fire support specialist (an SPC), and a radiotelephone operator (RATELO) and driver (a PFC). In addition to the FIST headquarters, a two-man FO party is authorized for each infantry platoon. Table 2-1 shows personnel and major equipment authorizations for each FIST. Transportation for platoon FO parties is provided by the supported force.

Table 2-1. FIST PERSONNEL AND EQUIPMENT

PERSONNEL AND EQUIPMENT	TYPE UNIT					
	MECHANIZED INFANTRY	ARMOR/CAVALARY	INFANTRY	LIGHT DIVISION	AIRBORNE	AIR ASSAULT
Company FSO (LT)	1	1	1	1	1	1
Fire support sergeant (SSG)	1	1	1	1	1	1
Forward observer (SGT)	3	0	3	3	3	3
Fire support specialist (SPC)	1	1	1	1	1	1
RATELO and driver (PFC)	4	1	4	4	4	4
HMMWV	0	0	1	0	1	1
AN/VRC-88	5	2	1	0	1	1
AN/VRC-91	1	1	1	0	1	1
AN/PRC-119	0	0	4	5	4	4
DMD	4	1	4	4	4	4
FIST DMD	1	1	1	1	1	1
FISTV or APC	1	1	0	0	0	0
G/VLLD	1	1	1	0	0	1

LEGEND:

<p>DMD = digital message device (Appendix B gives detailed information on the DMD.)</p> <p>FISTV = fire support team vehicle</p> <p>G/VLLD = ground/vehicular laser locator designator</p> <p>HMMWV = high-mobility multipurpose wheeled vehicle</p>	<p>LT = lieutenant</p> <p>PFC = private first class</p> <p>SGT = sergeant</p> <p>SPC = specialist</p> <p>SSG = staff sergeant</p>
--	--

b. Responsibilities. The mission of the FIST is to provide fire support for the maneuver company. To accomplish this mission, the FIST is responsible for the five tasks discussed below.

(1) **Fire Support Planning.** Fire support planning includes developing fire plans (target lists and overlays) and determining FO control options to ensure fire support is integrated into the company commander's scheme of maneuver and can be executed in a timely manner.

(2) **Fire Support Coordination.** The FIST must stay abreast of the maneuver situation at all times and monitor requests for fire support within the company to prevent fratricide as the result of friendly fire support. The FIST must advise the maneuver commander on fire support coordinating measures in effect.

(3) **Target Location and Calls for Indirect Fire.** With an accurate target location and a proper match of fire support asset to a target, the FIST can increase the effectiveness of indirect fire support.

(4) **Battlefield Information Reporting.** The observers are the eyes of the field artillery and a major source of information for the fire support community. Information may be sent in the form of artillery target intelligence (ATI) reports or spot reports. Information is also gathered from the target description and the surveillance received in each call for fire.

(5) **Emergency Control of Close Air Support and Naval Gunfire.** Forward air controllers and naval gunfire spotter teams (NGSTs) may not always be available. Therefore, the FIST must be proficient in controlling CAS and NGF.

2-2. DUTIES OF FIRE SUPPORT TEAM PERSONNEL

a. Company Fire Support Officer. The primary duty of the company FSO is being the FSCoord at company level. He is a full-time fire support advisor to the maneuver company commander, planner, and coordinator. The company FSO advises the commander on the capabilities, limitations, and employment of all fire support assets available to support his operation. These assets may include the M981 FISTV, the laser target designators, and the fire support weapon systems. The company FSO bases his actions on the needs of the supported force as directed by the maneuver commander's guidance. Additional responsibilities of the company FSO include the following:

- Employ all means of fire support.
- Integrate fire support assets into the maneuver commander's battle plan.

- Control the actions of the platoon FOs.
- Employ the M981 FISTV and/or laser equipment to maximize their capabilities.

b. Fire Support Sergeant. The fire support sergeant is the company FSOs assistant. Therefore, he must be able to perform all of the duties of the FSO and act in his absence. The duties of the fire support sergeant include the following:

- Employ all means of fire support.
- Act as the senior enlisted supervisor for the FIST.
- Supervise the maintenance of team equipment.
- Conduct and evaluate FIST training.

NOTE: Several training devices exist that the fire support sergeant can use to train the FIST. Appendix C provides information on these training devices.

- Supervise the establishment of FIST communications.
- Designate targets for "smart" munitions.

c. Fire Support Specialist. The duty of the fire support specialist is to help the fire support sergeant in the performance of his duties. His duties include the following:

- Employ all means of indirect fire support.
- Perform all duties of a platoon FO.
- Assist in the setup, operation, and maintenance of all equipment assigned to the FIST headquarters.

d. Forward Observer. At platoon level, except in tank companies and armored cavalry troops, the FO acts as the eyes of the field artillery and mortars. As the maneuver platoon's fire support representative, the primary duty of the FO is to locate targets and call for and adjust indirect fire support. Also, the FO must be able to do the following:

- Submit key targets for inclusion in the company fire plan (limited fire planning).
- Prepare, maintain, and use situation maps.
- Advise the platoon leader as to the capabilities and limitations of available indirect fire support.
- Report battlefield intelligence.
- Designate targets for smart munitions.

e. Radiotelephone Operator. The RATELO must be able to set up, operate, and maintain the equipment of the FIST headquarters or the platoon FO party. As a member

of the FIST headquarters or the FO party, the RATELO must be able to perform the duties of the fire support specialist at the FIST headquarters or of the FO at the infantry platoon.

2-3. FORWARD OBSERVER CONTROL

a. Control Options. When monitoring his FO's calls for fire, the company FSO has three control options available. After considering the tactical situation, the degree of training of his FOs, and the availability of fire support assets, he determines which option is best suited to the mission. He monitors all calls for fire regardless of the option employed.

(1) **Decentralized Option.** The platoon FO may call for fire from any fire support asset available to support his operation. This option gives him the most responsive fires; however, it allows the FIST headquarters (HQ) the least amount of control. Since the FO is allowed to determine which asset should engage each target, this option generally requires a highly trained observer.

(2) **Predesignated Option.** The FO is assigned a particular fire support asset from which he may request fire support, and he operates on that unit's net. If the FO thinks his target should be engaged with a different fire support asset, he must request permission from the FIST HQ to change assets. Permission is granted on a mission-to-mission basis. Under this option, fire support is highly responsive if the asset is suitable to the type of target.

(3) **Centralized Option.** The FO must contact the FIST HQ for each call for fire; and the FIST HQ refers the observer, or relays his request, to an appropriate fire support asset. This option is least responsive for the observer, but it offers the highest degree of control to the FIST HQ. This option generally is used when maneuver platoon leaders act as forward observers for their platoons.

b. Tailoring. Since the level of training and the tactical situation vary for each observer, the company FSO may assign each observer under his control an appropriate option. For example, the 1st Platoon FO may be decentralized, the 2d Platoon FO may be predesignated, and the 3d Platoon FO may be centralized.

2-4. FIRE SUPPORT TEAM VEHICLE (M981) EMPLOYMENT OPTIONS

The FISTV, when used as a FIST HQ, may be employed by use of one of three options. The company FSO must advise his maneuver commander as to the means of employment that will best allow him to do his job. Appendix D provides additional information on the FISTV.

a. Option One. In the first option, the entire FIST HQ operates inside the FISTV to provide fire support to the maneuver company. From the FIST HQ, the company FSO monitors all calls for fire from the platoon FOs. He monitors all company activities on the company command net and coordinates fire support with the battalion (bn) FSO on a fire support coordination net. This method allows the company FSO to be at the focal point of all fire support communications within the company zone of action. The disadvantage of this option is that the company FSO is completely dependent on frequency modulated (FM) radio communications to coordinate with the maneuver commander.

b. Option Two. In the second option, the company FSO or his representative works out of the commander's vehicle. The FISTV is positioned elsewhere in the company area to optimize its lasing and communications capability. The person with the commander takes an AN/PRC-119 and a DMD to the commander's vehicle so he can request fires and maintain contact with the FISTV. If the company FSO is with the commander, he can receive clear, concise guidance from the commander as to his plans. The disadvantage is that the company FSO is removed from the center of fire support activity; his ability to conduct any coordination is severely degraded. Any representative with the commander must still relay the commander's intent to the FIST HQ by radio. When advising the commander, the company FSO must consider the type of commander's vehicle. For example, if the commander's vehicle is a tank, he has no room in it for extra personnel. Removing one of his crew would degrade the capability of his main gun. Fire support personnel in the commander's vehicle must be able to see the battlefield.

c. Option Three. The third option is not selected by the company FSO but is directed by higher headquarters. The company FSO and the fire support specialist take two AN/PRC-119s and the FIST DMD and work from the commander's vehicle. The FISTV and the remaining equipment are used by higher headquarters as a COLT. This option severely inhibits fire support by taking away both the company's lasing capability and half of its fire support communications capability.

2-5. OBSERVATION POST SELECTION

The selection of the observation post (OP) is critical to the ability of the observer to effectively call for fire and to survive. The maneuver commander and FSCoord share responsibility to ensure that fire support personnel are in a position to call for fires according to the plan. This should include consideration of placing FIST or COLT members with the scout element.

a. Self-Location. The observer must accurately determine his position as soon as it is selected. Accurate self-location is a must for accurate target location and, thus, for effective fire with a minimum expenditure of time and ammunition. The observer must aggressively pursue every means to aid him in self-location. In addition to his map and compass, he should use laser range finders, position-locating systems, tank sights for resection, and so forth, whenever these devices are available. The selected position must enable him to do the following:

- Observe targets in the supported unit's area of operation (identifiable points on the ground).
- Evaluate the effects of fire brought on targets.
- Cover obstacles with indirect fire.

NOTE: The supported maneuver unit should always keep obstacles under surveillance and be able to call for fires through the supporting FIST. An obstacle not observed and covered by fire is no obstacle at all. The company FSO must check with the maneuver commander to ensure obstacles are under surveillance. This is also verified during rehearsals.

- Observe target reference points (TRPs) the same as other targets.

b. Observation. The OP must permit observation of the zone of action of the supported unit. The selection of the OP must be coordinated with that of other observer and maneuver OP in order to prevent or minimize gaps or dead spaces. Visibility diagrams should be constructed as time permits.

c. Characteristics. Elevated points, such as crests and trees, are often used for OPs. Landmarks and prominent terrain features should be avoided as these are probably targeted. When selecting an OP, the observer must consider the characteristics of forward slope versus reverse slope. Advantages and disadvantages are shown in Table 2-2.

d. Reconnaissance. Selection of an OP must be based on both map and ground reconnaissance. During the map reconnaissance, the maneuver unit's situation overlay must be used to determine the unit's area of action, potential OP locations, and routes to and from the OP. During the ground reconnaissance, care must be taken not to disclose the OP. A concealed route to and from the OP must be considered. Once selected, the OP must be occupied, communications must be established, and the OP location must be reported to the FDC. After occupation, the OP should be camouflaged and reinforced to provide cover; and a terrain sketch and a visibility diagram should be constructed. The observer must ensure that any position improvements do not make the OP vulnerable to enemy aerial observation.

2-6. FIRE SUPPORT TEAM VEHICLE (M981) POSITIONING

a. Considerations for the positioning of the FISTV are similar to those for OP selection. The FISTV should be positioned within the unit's zone of action where it can optimize its observation (lasing) capability yet maintain its survivability and communications capability. The crew must consider the factors of mission, enemy, terrain, troops, and time available (METT-T) when selecting a position.

Table 2-2. CHARACTERISTICS OF FORWARD AND REVERSE SLOPE POSITIONS

ADVANTAGES	DISADVANTAGES
FORWARD SLOPE POSITION (MILITARY CREST)	
<ul style="list-style-type: none"> ● View of front and flanks is better. ● Fires impacting on the topographical crest will not neutralize the position. ● The hillside provides background; this aids in concealment. 	<ul style="list-style-type: none"> ● Occupation during daylight is difficult without risking disclosure of the position. ● Radio communications may be difficult. It may be necessary to remote the antennas to the reverse slope. ● No cover from direct fire is provided.
REVERSE SLOPE POSITION	
<ul style="list-style-type: none"> ● The position may be occupied in daylight. ● Greater freedom of movement is possible. ● Installation, maintenance, and concealment of communications equipment are easier. ● Protection from direct fire is afforded. 	<ul style="list-style-type: none"> ● Often, field of view to the front is limited. ● Enemy fire adjusted on the topographical crest may neutralize the OP.

(1) Where is the area of observation? Is the FISTV being used as a FIST HQ or a COLT? If used as a FIST HQ, the FISTV is primarily a coordination center for company fire support command and control. If used as a COLT, it is primarily a laser and/or observation platform.

(2) What is the enemy's communications direction-finding capability? Digital communications signals are highly vulnerable to direction finding and may disclose the company's position.

(3) How long will the unit be in position? How long does it take the crew to set up or break down the FISTV? When does the FISTV have to move? The FISTV is slower than maneuver vehicles, and it may need to be moved early.

(4) What security support can the FISTV receive? A small crew cannot provide security. The FISTV must be positioned within the supported unit's area.

b. Additional considerations should include the capabilities and limitations of the equipment being employed.

(1) The FISTV is a thin-skinned vehicle, and it should be positioned away from thicker-skinned maneuver vehicles. When lasing capability is critical, the FISTV should be positioned in hull defilade with the targeting head erected for overwatch. This should provide the vehicle with cover from direct fire weapons.

(2) If an ideal position cannot be found, the crew should consider ground-mounting the G/VLLD and positioning the FISTV where the communications signal is masked. The G/VLLD should be positioned in a hardened OP to maximize its lasing capability.

(3) The effectiveness of the laser should be considered on the basis of the distance to the target area, the time available, and the range of the laser. For example, the G/VLLD offers good target location at extended distances but might prove ineffective in a close-in fight. The availability of smart munitions must also be considered.

(4) The FISTV should have a covered and concealed route of exit. It is a high-priority target.

c. When the FISTV is positioned in an offensive operation, it should bound forward, providing overwatch as much as possible. Because of setup time for lasing operations, the FISTV will primarily be a fire support coordination center in an offensive operation. Because of its lack of firepower and protection, it should not be located with the lead element. The FISTV should be positioned where it can communicate with the observers, the commander, and the supporting firing units. If the laser is to be used during the offense, the crew must have advance warning of any impending requirement to move. The FISTV is slower than the supported maneuver vehicles and may have difficulty keeping up during movement.

2-7. COMMUNICATIONS

a. The FIST communications are commensurate with the needs of the force. Therefore, the primary means of communication is normally dictated by the current battlefield situation. Tactical radio (either voice or digital) is used most of the time.

b. Digital communications equipment available for the FIST includes the DMD and the FIST DMD. The DMD is a two-way device that transmits and receives digital bursts over any standard communications equipment. The DMD is portable and is powered by a battery or a vehicle power source. It is easily attached to any -12 series radio, single-channel ground and airborne radio system (SINCGARS), or WD-1 wire. Since the DMD is a two-way device, the observer can send a fire mission and receive a message to observer digitally.

c. The FIST DMD has a four-channel communications capability. It can perform the same functions as the DMD and can serve as a communications relay point. As a relay, it lets the FIST headquarters review, modify, and/or forward calls for fire from the FOs to the appropriate fire support agency.

d. Communications options for the FIST and FIST radio nets are discussed in detail in FM 6-20-40 and FM 6-20-50 and will be included in FM 6-20-20 (now ST 6-20-20) when it is published.

CHAPTER 3 TARGET LOCATION

Section I REQUIREMENTS FOR LOCATING TARGETS

3-1. TERRAIN-MAP ASSOCIATION

a. One of the key requirements for the delivery of accurate predicted fire on a target is accurate target location. To successfully perform his duties, the observer must be able to determine an accurate position of a target on the ground. The keys to accurate target location are as follows:

- Self-locating to within 100 meters each time he moves.
- Using prominent terrain features to relate potential target areas to grid locations on the map.
- Making a thorough study of terrain by drawing a terrain sketch (in a static environment).
- Associating the direction in which he is looking with a direction line on the map.
- Ensuring that a planned target is **always** a recognizable point on the ground (except for "cannot observe" missions).

b. Terrain-map association may not be possible when maps are unavailable or the terrain has no features. Using large-scale maps (1:250,000 or larger) may also make terrain-map association difficult. In these situations, the use of position-locating systems or other navigational aids is essential for observer self-location and the accurate location of targets.

3-2. TARGET LOCATION METHODS

Once a thorough terrain-map study has been conducted, the observer will be well prepared to locate targets. Accurate location of targets is critical to achieving first-round effects on targets. Often, errors in target location can be corrected only by adjusting fires onto a target, thereby losing the surprise and effects of a fire-for-effect mission. The use of position-locating systems or laser devices that are operating from known locations can greatly enhance target location. The three methods of target location available to the observer are as follows:

- Polar plot—the observer describes the target location in relation to himself.
- Grid coordinates—the observer locates the target by giving the actual grid location.
- Shift from a known point—the observer describes the target location in relation to a point of known location (planned target or known point).

a. **Polar Plot.** In this method, the observer's location must be known to the FDC. The observer does not need a map. This method is easy and quick; however, the observer must transmit his location by secure means to avoid revealing his location to the enemy. Also, in a mobile situation it is more difficult for the observer to determine his location and send it to the FDC. The steps used in the polar plot method are discussed below (also see Figure 3-1).

Figure 3-1. POLAR PLOT

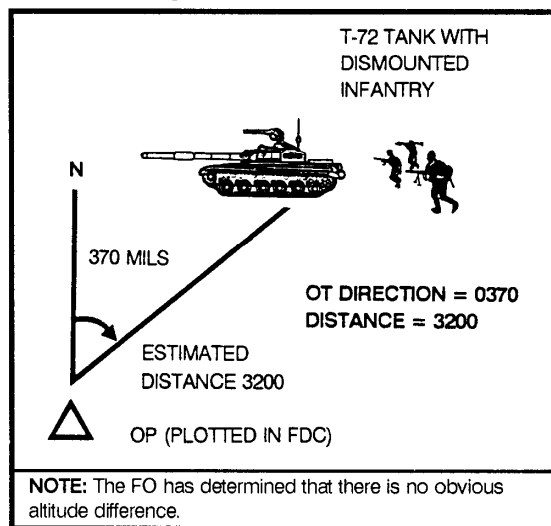

(1) Determine the observer-target (OT) direction by one of the methods discussed in paragraph 3-3.

(2) Estimate the distance to the target (nearest 100 meters). Use all information obtained from the terrain-map study to determine the OT distance. (See paragraphs 3-4 and 3-6 and Appendix A.)

(3) Determine a vertical shift, if significant. Determine an up or down shift if the difference between the observer altitude and the target altitude is significant (greater than 35 meters). See paragraph c(5) below for a further discussion of vertical shift.

NOTE: Target location methods using lasers provide for greater accuracy and are discussed in Appendix A. The laser range finder AN/GVS-5 and the G/VLLD AN/TVQ-2 are examples of equipment available.

b. Grid Coordinates. Target location by grid coordinates is a natural extension of the polar plot method. The observer's location need not be known to the FDC. The observer normally locates targets to an accuracy of 100 meters (six-place grid). He does this by polar-plotting on the appropriate map and then reading the grid. When additional accuracy is required (for example, for registration points and known points), the observer should locate targets to the nearest 10 meters (eight-place grid). Although there is no requirement to send target altitude, transmitting it to the FDC increases the accuracy of the initial fires.

c. Shift From a Known Point. The observer may have one or more known points in his area of responsibility. These are readily identifiable points whose locations are known to both the observer and the FDC. The observer does not need a map to use this method; he needs only a known point. The steps in locating a target by shift from a known point are described below.

(1) Identify to the FDC the known point to be used; for example **SHIFT KNOWN POINT 1**.

(2) Determine the OT direction. This direction can be a grid azimuth (the preferred method) or a cardinal direction. Examples are (grid azimuth) **DIRECTION 4360** and (cardinal direction) **DIRECTION, SOUTHWEST**.

(3) Determine a lateral shift from a known point to the OT line. If the angular deviation from the observer-known point line to the OT line can be determined, a shift in

meters can be computed by using the mil relation formula, $W = R \times m$ (Figure 3-2). This formula is based on the assumption that an angle of 1 mil will subtend an arc of 1 meter at a distance of 1,000 meters.

Figure 3-2. MIL RELATION FORMULA

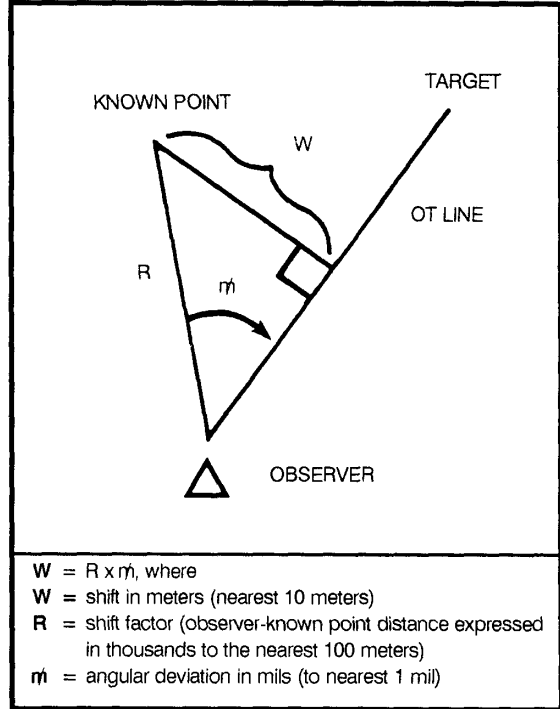

EXAMPLE
 The observer knows that the distance from his location to the known point (CHURCH) is 2,500 meters. He also knows the direction is 850 mils. With his binoculars, he measures an angular deviation of 62 mils from the church to the target. He calculates the lateral shift as follows (Figure 3-3):

$$2500 \div 1000 = 2.5$$

(2500 is already expressed to the nearest 100.)

$$W = R \times m$$

$$W = 2.5 \times 62$$

$$W = 155 \text{ meters} \quad 160 \text{ meters (the lateral shift is expressed to the nearest 10 meters.)}$$

LEFT 160

Figure 3-3. LATERAL SHIFT

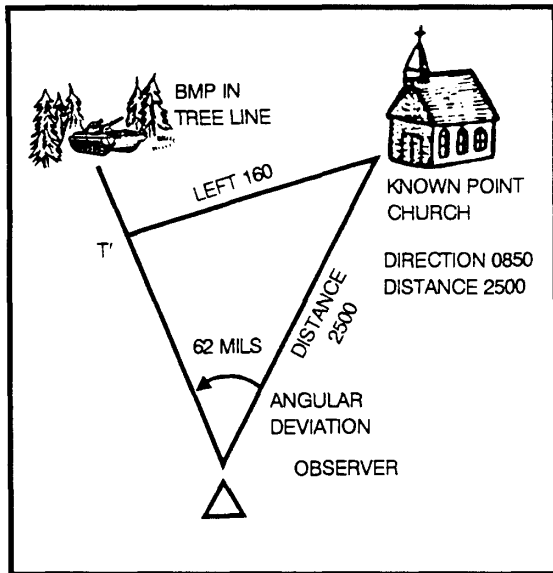

NOTE: When a shift of greater than 600 mils is required, the accuracy of computing the lateral shift decreases. Another method of target location should be used.

(4) Determine a range change along the OT line. The observer must determine whether the target is at a greater or lesser distance than the known point. The lateral shift gives the observer a point on the OT line (T') assumed to be the same distance from him as the known point. If the target is **farther away** than the known point, the observer must **add** the estimated distance from T' to the target (Figure 3-4 (A)). If the target is **closer**, the observer must **drop** the estimated distance (Figure 3-4 (B)). The correction for a difference in distance between the known point and the target is expressed to the nearest 100 meters.

(5) Determine a vertical shift, if significant. If there is a significant difference (more than 35 meters) in altitude between the known point and the target, the observer must include it in his target location. If the target is at a **higher** altitude than the known point, the observer determines an **up** correction based on the difference in altitude (Figure 3-5). If the target is at a **lower** altitude, he must give a **down** correction based on the difference in altitude. Whether a vertical shift is sent or not depends on several factors. Normally, if the mission is an FFE mission, a vertical shift should be sent to improve accuracy. The observer should weigh the time needed to determine and send a vertical shift against the time available. Experienced observers who can quickly determine differences in altitude should send a vertical shift when the difference in altitude is greater than 35 meters. When responsiveness is paramount, inexperienced observers should not try to send a vertical shift. The correction for a difference in altitude is expressed to the nearest 5 meters.

Figure 3-4. RANGE SHIFT

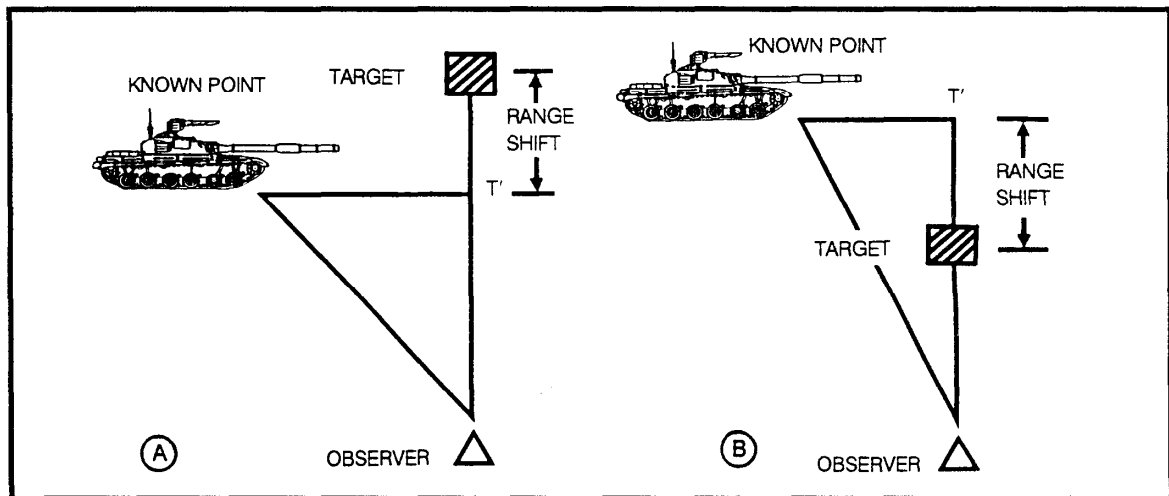
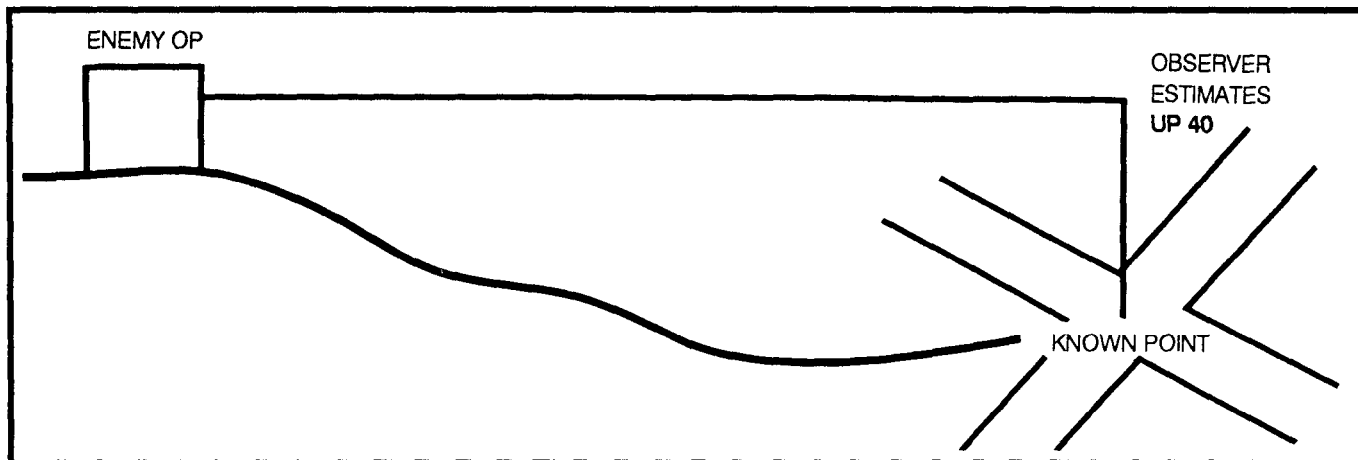

Figure 3-5. VERTICAL SHIFT



3-3. DIRECTION

Determining direction is an essential skill for the observer. Direction is an integral part of terrain-map association, adjustment of fire, and target location. There are five methods by which to determine direction.

a. Estimating. With a thorough terrain-map analysis of his zone of operation, the observer can estimate direction on the ground. As a minimum, the observer should be able to visualize the eight cardinal directions (N, NE, E, SE, S, SW, W, and NW). Because of the inaccuracy of this method, it is the least preferred method of determining direction.

b. Scaling From a Map. Using a protractor, the observer can scale direction from a map to an accuracy of 10 mils.

c. Using a Compass. Using an M2 or a lensatic compass, the observer can measure direction to an accuracy of 10 mils. Care must be taken when a compass is used around radios or large concentrations of metal such as vehicles. Observers should move about 50 meters away from vehicles to avoid incorrect readings.

d. Measuring From a Reference Point. Using a reference point with known direction, the observer can measure horizontal angular deviations and apply them to the reference direction. Angular deviations may be measured with binoculars (Figure 3-6) or with the hand (paragraph 3-7). In measuring with binoculars, angular deviation is determined to the nearest 1 mil.

(1) The horizontal scale of the binocular reticle pattern is divided into increments of 10 mils on both the M17 (Figure 3-6(A)) and the M19 (Figure 3-6(B)) binoculars.

(2) The vertical scale on the right of the M17 lens is not used by the FO in determining data for target location. The scale is used primarily by the infantry for sighting direct fire weapons (Figure 3-6(A)).

(3) The vertical scales on the left and in the center of the M17 lens are divided into increments of 5 mils and are used in height-of-burst (HOB) adjustments (Figure 3-6(A)).

NOTE: Direction increases to the right and decreases to the left. To determine the direction to another point or target, apply the number of mils measured right or left of the reference point known direction by use of the RALS rule (right, add; left, subtract). For example, the azimuth to the reference point is 2,100 mils. The target is 40 mils to the left of the reference point. The direction to the target is 2,060 mils (2,100-40).

(4) The vertical scale in the center of the M19 lens is divided into increments of 10 mils and is used in HOB adjustment (Figure 3-6(B)).

(5) The horizontal and vertical scales on the AN/GVS-5 laser range finder reticle are divided into increments of 10 mils. The centerlines are further divided with hash marks at 5-mil increments (Figure 3-6(C)).

e. Using Other Measuring Devices. When properly oriented, the aiming circle or G/VLLD provides direction to the nearest mil. The heading indicator in an aircraft can be used by the aerial observer.

Figure 3-6. MEASURING ANGULAR DEVIATIONS WITH BINOCULARS AND AN/GVS-5

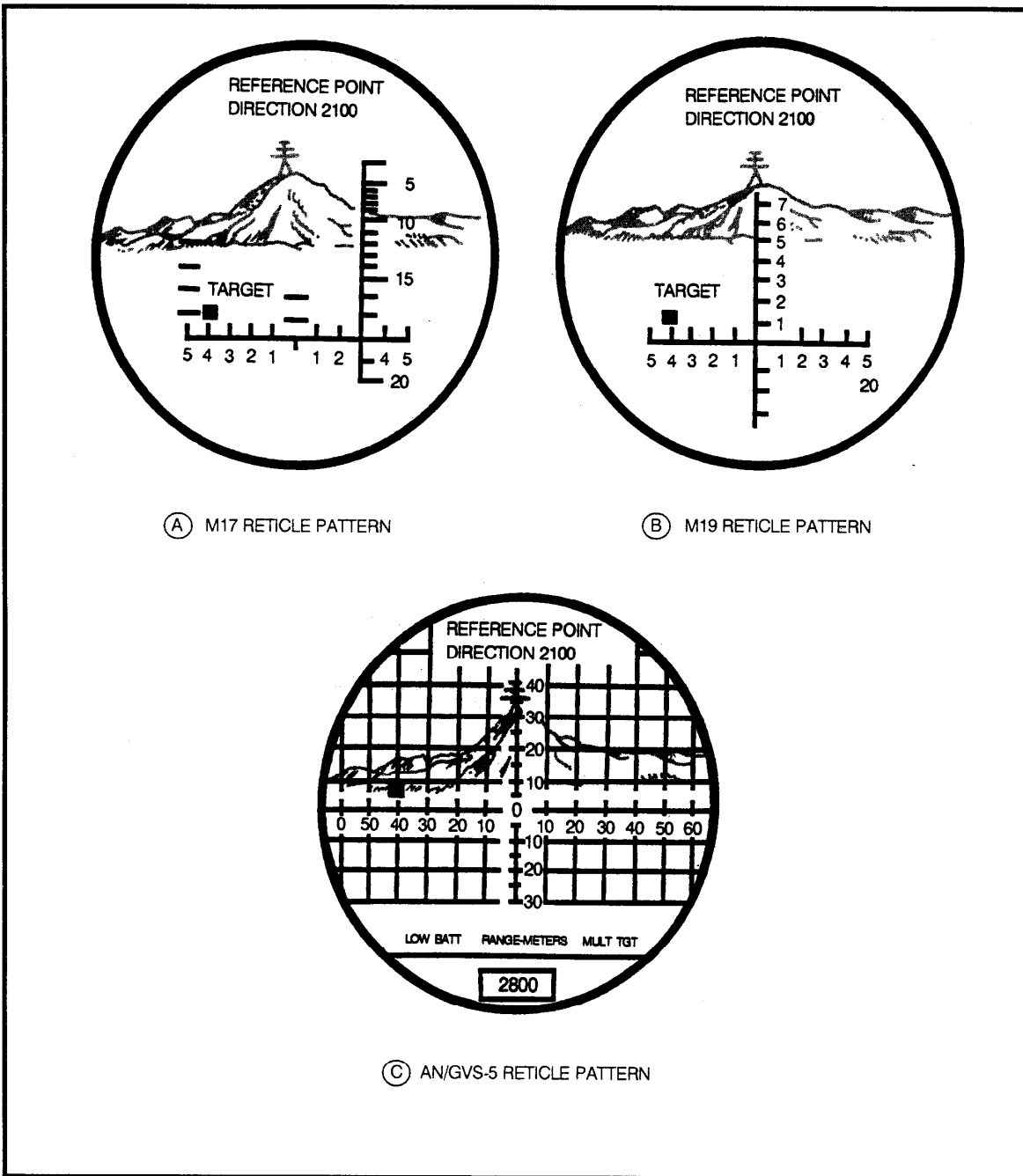

(A) M17 RETICLE PATTERN

(B) M19 RETICLE PATTERN

(C) AN/GVS-5 RETICLE PATTERN

3-4. DISTANCE

Once a direction to the target is determined, the observer must determine a distance to the target. There are several methods.

a. Laser. Lasers are the preferred means of determining the OT distance. When a laser is used, distance may be determined to the nearest 10 meters.

b. Flash-to-Bang. When it is necessary to verify OT distance, the flash-to-bang technique is helpful. Sound travels at a speed of approximately 350 meters per second. Use the following equation:

$$\text{Elapsed time between impact and sound} \times 350 = \text{Distance}$$

Multiply the number of seconds between round impact (flash) and when the sound reaches the observer (bang) by 350 meters. The answer is the approximate number of meters between the observer and the round. (This procedure can also be used to determine the distance to enemy weapon muzzle flashes.)

EXAMPLE

The observer wants to determine the approximate distance from his position to a burst. He begins counting when the burst appears and stops counting when he hears the sound. He counts 4 seconds. Therefore, the distance from the burst to his position is approximately 1,400 meters (350 x 4).

c. Estimation. In the absence of a more accurate method of determining distance to a target, the observer must estimate distance. The degree of accuracy in this method depends on several factors, such as terrain relief, time available, and the experience of the observer. Generally, the longer the observer remains stationary, the better he can use this technique. Some methods of estimating distance are discussed below.

(1) Mental estimation can be made by use of a known unit of measure. Distance is estimated to the nearest 100 meters by determining the number of known units of measure, such as a football field (100 yards), between the observer's position and a target. For longer distances, the observer may have to progressively estimate distance. To do this, he determines the number of units of measure (for example, 100 yards) to an intermediate point and doubles the value.

(2) The observer should consider the following effects of estimating distances:

- Object appears nearer—

- When in bright light.
- When in clear air at higher altitude.
- When the observer is looking down from a height.
- When the observer is looking over a depression, most of which is hidden.
- When the observer is looking down a straight feature, such as a road.
- When the observer is looking over water, snow, or a uniform surface such as a cultivated field.
- When the background is in contrast with the color of the object.
- Object appears more distant—
 - When it is in poor light or in fog.
 - When only a small part of the object can be seen.
 - When the observer is looking over a depression, most of which is visible.
 - When the background is similar in color to that of the object.
 - When observing from a kneeling or sitting position on hot days, especially when the ground is moist.

(3) When visibility is good, distances can be estimated by using the appearance of tree trunks, their branches, and foliage (using the naked eye) in comparison with map data (Table 3-1).

Table 3-1. ESTIMATION BY APPEARANCE OF TREES

DISTANCE	TREE DESCRIPTION
1,000 meters	Trunk and main branches are visible. Foliage appears in cluster-like shape. Daylight may be seen through foliage.
2,000 meters	Trunk is visible, main branches are distinguishable, foliage appears as smooth surface. Outline of foliage of separate trees is distinguishable.
3,000 meters	Lower half of trunk is visible. Branches blend with foliage. Foliage blends with adjoining trees.
4,000 meters	Trunk and branches blend with foliage. Foliage appears as a continuous cluster. Motion caused by wind cannot be detected.
5,000 meters and beyond	Whole area covered by trees appears smooth and dark.

(4) Distance can be estimated by using known dimensions of vehicles and the mil relation formula ($W = R \times m$). By applying the width of a vehicle appearing perpendicular to an observer as the lateral distance (W) and measuring the width in mils (m), the distance can be determined by solving the formula for range (R) in thousands, or $R = W \div m$. These data, when compared to with map data, will help an observer estimate distance. The dimensions of selected equipment are shown in Table 3-2.

Table 3-2. EQUIPMENT DIMENSIONS

EQUIPMENT	DIMENSIONS (IN METERS)	
	SIDE VIEW	FRONT VIEW
Tank (T-62) (T-72)	6.6 6.9	3.3 3.6
Reconnaissance vehicle (BRDM-2) (BTR-60)	5.7 7.2	2.4 2.8
Armored personnel carrier (BMP)	6.8	2.9
Air defense weapons (ZSU 23-4)	6.5	3.0

EXAMPLE

An observer sees an armored personnel carrier (BMP). He measures its width (as seen from the side view) as 2 mils. Using the formula, he determines the distance as follows:

$$R = W \div m$$

$$m = 2 \text{ mils}$$

$$W = 6.8 \text{ meters}$$

$$R = 6.8 \div 2 = 3.4, \text{ or } 3,400 \text{ meters.}$$

(5) The observer should always use map-terrain analysis to help him estimate distance. A thorough study of the terrain in comparison with features or objects identifiable on the map can enhance the estimation of distance. The observer should make a mental terrain walk to the target. He compares the features or objects with those found on the map along the same direction (OT line). The use of an observed fire (OF) fan will help the observer in this. Particular emphasis should be given to color contrasts along the OT line. For example, the distance across successive ridge lines or depressions in the distance maybe identifiable to the eye by only slight changes in color.

3-5. TERRAIN SKETCH

a. Another aid in target location in a static environment is the terrain sketch (Figure 3-7). This is a rough panoramic sketch of the terrain in the observer's area of responsibility prepared by the observer. Items that should be included in a terrain sketch are as follows:

- The skyline (horizon).
- Intermittent crests, hills, and ridges.
- Other natural terrain features (distinctive bodies of water and vegetation).
- Man-made features (buildings, roads, power lines, towers, antennas, and battlefield debris).
- Labels (reference points and targets).

b. Each labeled item should include as much information as possible to aid the observer. This information should be identified by using a T (see Figure 3-7). Reference point names, target numbers, or known point (kn pt) designations should be placed at the top of the T to

identify the feature. Labels for direction (dir), distance (dis), altitude (alt), and grid should be placed on the left side of the T. The observer should fill in all available data for targets and known points. Reference points usually require only the direction to the reference point. The terrain sketch should also include the observer's name, date, and location. All information included on the terrain sketch should be organized neatly to avoid clutter and confusion.

c. The terrain sketch is used primarily as a means of analyzing the terrain in an observer's area of responsibility. It helps him determine direction to the target. Once it is constructed, an observer can use the terrain sketch to help him quickly and accurately locate targets by referencing from information already known in his area of responsibility. Also, a well-constructed terrain sketch provides a rapid means of orienting relief personnel. Terrain sketches must be continually refined and updated with data from available fire support planning documents, to include target numbers, final protective fires (FPFs), and fire support coordinating measures.

Figure 3-7. TERRAIN SKETCH

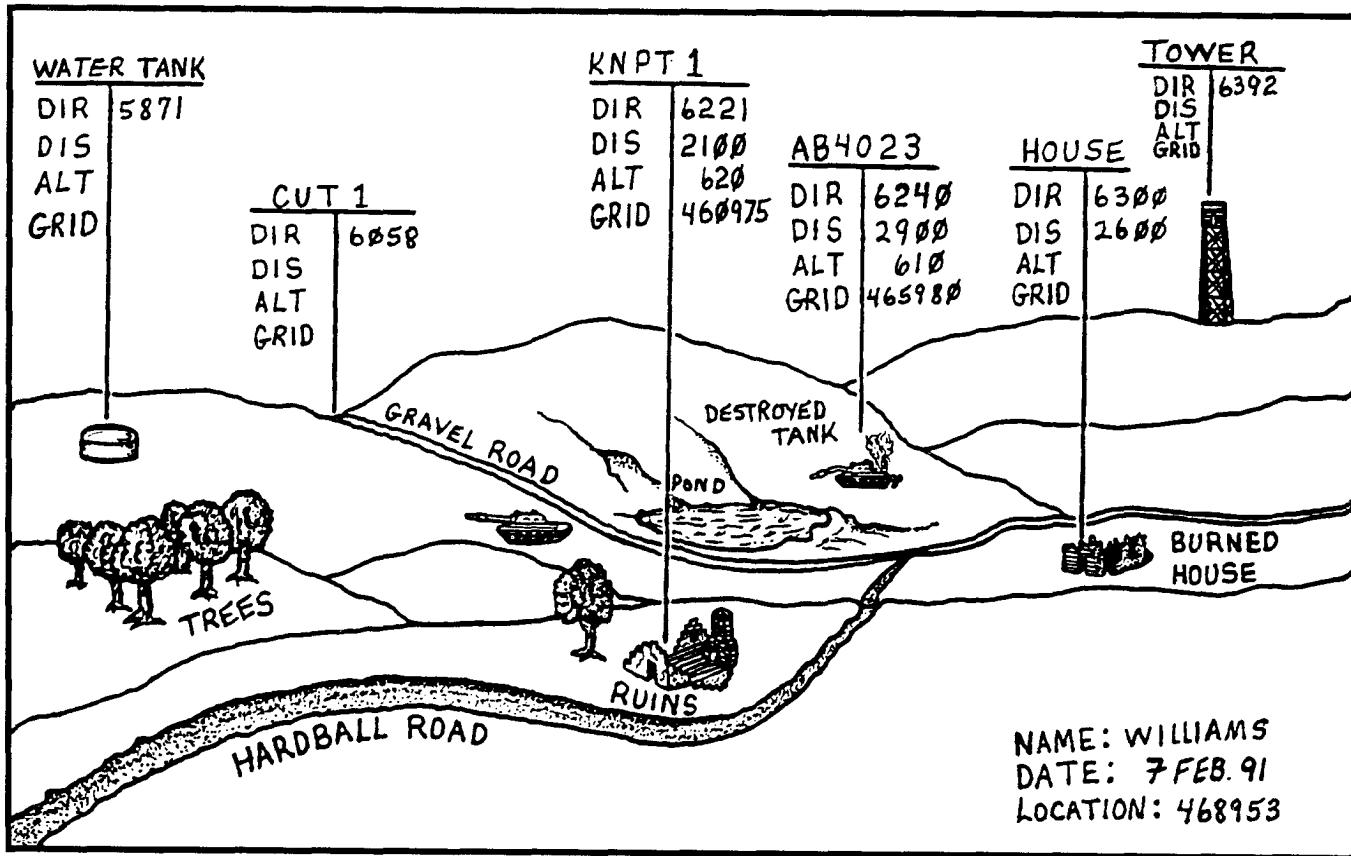

Section II
AIDS TO TARGET LOCATION

3-6. OBSERVED FIRE FAN

a. Description. The OF fan, GTA 6-7-3 (Figure 3-8), is a transparent protractor that helps the observer identify on the map the terrain he sees on the ground. The OF fan has 17 radial arms that are 100 mils apart and cover

a total of 1,600 mils. The OT distance is represented by arcs marked on the radial arms every 500 meters starting at 1,000 and extending to 6,000 meters. Once the observer has determined an OT direction, he can use the OF fan to help him determine an OT distance on the map.

Figure 3-8. OBSERVED FIRE FAN (1:50,000 METERS) (GTA 6-7-3)

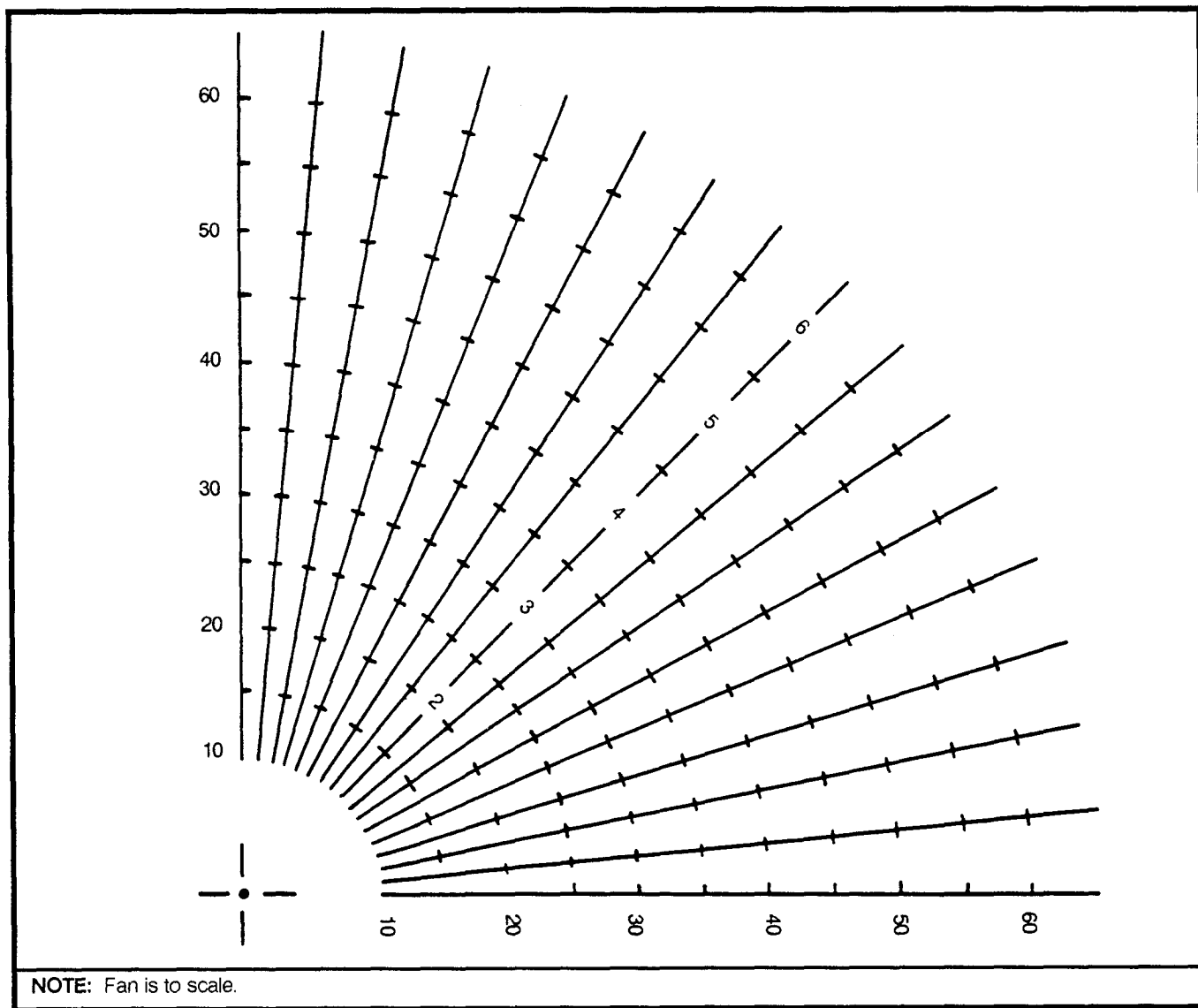

b. Preparation. The scale of the OF fan must match the scale of the map. Prepare the OF fan as discussed below.

(1) Place the vertex of the fan over the observer's location.

(2) Place the center radial in the direction of the center of the observer's area of responsibility.

(3) Move the fan slightly until one of the radial lines is parallel to a grid line. The direction of that radial line is the same cardinal direction as the grid line; for example, a radial line parallel to an east-west grid line, with the OF fan oriented generally east, would be direction 1600.

(4) With a grease pencil, number the radial of known direction. Drop the last two zeros (1600 would be 16). Then label every second radial with the appropriate direction. (Labeling each radial is unnecessary and makes the fan too cluttered.)

NOTE: Remember that radial lines are 100 mils apart.

c. Use. Use the OF fan as discussed below.

(1) Look at the terrain the target occupies.

(2) Determine the direction to the target. (Use the compass, the terrain sketch with binoculars, or other means.) (See paragraph 3-7.)

(3) Estimate the distance to the target.

(4) Set off the direction on the OF fan. Plot the OT direction on the OF fan by finding the two radial lines between which the OT direction falls and visually interpolating to determine the target area.

(5) Set off the estimated distance to the target. Look out along this interpolated radial line at the estimated OT distance. This is an estimated target location.

(6) Use terrain association to refine distance. Compare the terrain near the target with the terrain of the estimated target location on the map. If they do not agree, search along the radial line until the terrain and the map match (Figure 3-9).

(7) Determine target location. Use the refined polar plot data or determine the grid from the map.

Figure 3-9. TARGET LOCATION WITH OF FAN

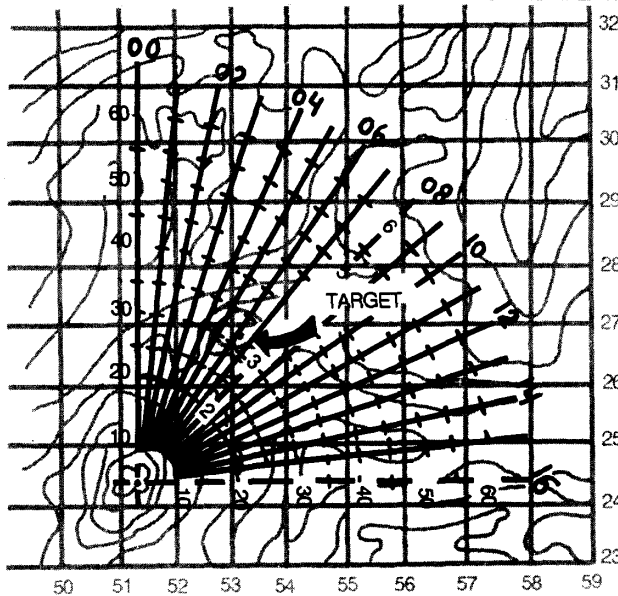

NOTE: The target is approximately 3,000 meters from the observer in a direction of 0680 mils. The grid location is approximately 531269.

3-7. HAND MEASUREMENT OF ANGULAR DEVIATION

a. When it is necessary to measure angular deviations to determine direction quickly, the observer may use his hand and fingers as a measuring device (Figure 3-10).

b. Each observer should calibrate his hand and fingers to determine the values of the angles for the various

combinations of finger and hand positions shown, since finger width and hand size vary for each observer.

c. When using his hand or fingers in measuring angular deviation, the observer should fully extend his arm (lock his elbow) so that his hand and fingers are always the same distance from his eyes. The palm of his hand is always pointed toward the target area.

Figure 3-10. EXAMPLE HAND MEASUREMENT OF ANGULAR DEVIATION

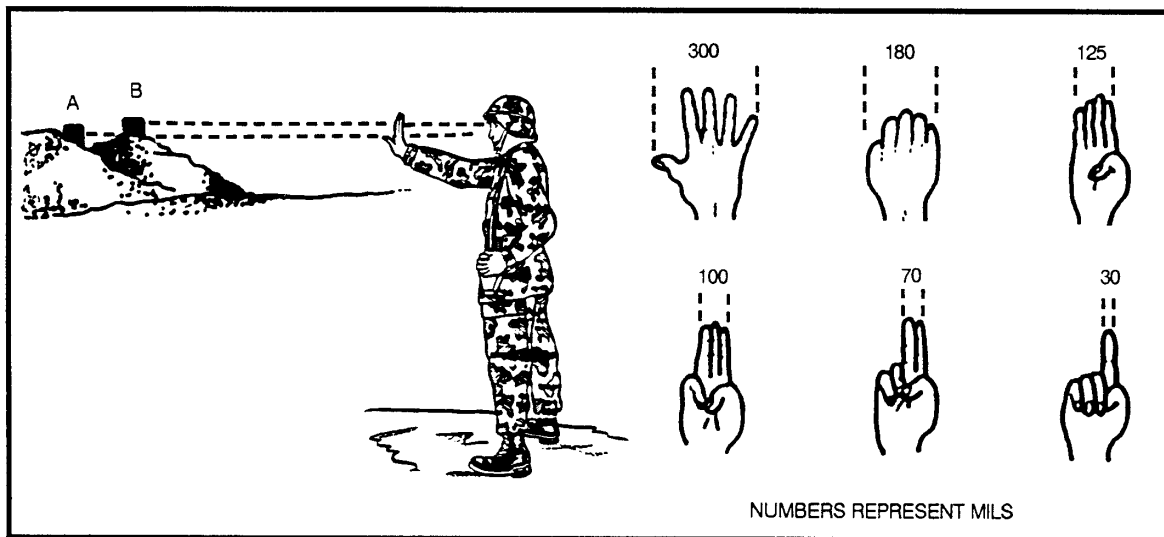

CHAPTER 4

CALL FOR FIRE

This chapter implements STANAG 2934, Chapters 5 and 6; QSTAG 225; and QSTAG 246.

Section I

ELEMENTS OF THE CALL FOR FIRE

4-1. DESCRIPTION

a. A call for fire (CFF) is a concise message prepared by the observer. It contains all information needed by the FDC to determine the method of target attack. It is a request for fire, not an order. It must be sent quickly but clearly enough that it can be understood, recorded, and read back, without error, by the FDC recorder. The observer should tell the RATELO that he has seen a target so the RATELO can start the call for fire while the target location is being determined. Information is sent as it is determined rather than waiting until a complete call for fire has been prepared.

b. Regardless of the method of target location used, the normal call for fire is sent in three parts consisting of six elements. The six elements, in the sequence in which they are transmitted, are discussed in paragraphs 4-2 through 4-7. They are as follows:

- Observer identification.
 - Warning order.
 - Target location.
 - Target description.
 - Method of engagement.
 - Method of fire and control.
- c. The three transmissions in a call for fire are as follows:
- Observer identification and warning order.
 - Target location.
 - Description of target, method of engagement, and method of fire and control.

There is a break after each transmission, and the FDC reads back the data.

d. DA Form 5429-R (Conduct of Fire) is used by the observer in conducting fire missions and recording mission data. The front page, Section I, is organized to help him record his call for fire and subsequent adjustment data. Section II, on the back of the form, is used to record registration data. Portions of DA Form 5429-R are shown with examples throughout this publication. Reproducible copies are at the back of this manual.

4-2. OBSERVER IDENTIFICATION

This element of the call for fire tells the FDC who is calling for fire.

4-3. WARNING ORDER

The warning order clears the net for the fire mission and tells the FDC the type of mission and the type of target location that will be used. The warning order consists of the type of mission, the size of the element to fire for effect, and the method of target location. It is a request for fire unless prior authority has been given to order fire.

a. Type of Mission.

(1) Adjust Fire. When the observer believes that an adjustment must be made (because of questionable target location or lack of registration corrections), he announces **ADJUST FIRE**.

(2) Fire for Effect. The observer should **always** strive for first-round FFE. The accuracy required to fire for effect depends on the accuracy of target location and the ammunition being used. When the observer is certain that

the target location is accurate and that the first volley should have the desired effect on the target so that little or no adjustment is required, he announces **FIRE FOR EFFECT**.

(3) Suppression. To quickly bring fire on a target that is not active, the observer announces **SUPPRESS** (followed by the target identification). Suppression (S) missions are normally fired on preplanned targets, and a duration is associated with the call for fire.

(4) Immediate Suppression and Immediate Smoke. When engaging a planned target or target of opportunity that has taken friendly maneuver or aerial elements under fire, the observer announces **IMMEDIATE SUPPRESSION** or **IMMEDIATE SMOKE** (followed by the target location). Though the grid method of target location is the most common, any method of target location may be used in firing an immediate suppression or immediate smoke mission.

b. Size of Element to Fire for Effect. The observer may request the size of the unit to fire for effect; for example, **BATTALION**. Usually, he does this by announcing the last letter in the battalion FDC's call sign. For example, T6H24 is announced H. The observer should never refer to a battery or other unit in the clear. He should refer to it by call sign. If the observer says nothing about the size of the element to fire, the battalion FDC makes that decision. It is based on the target attack guidance received and the graphical munitions effectiveness table (GMET) or joint munitions effectiveness manual (JMEM) solution.

c. Method of Target Location.

(1) Polar Plot. If the target is located by the polar plot method of target location, the observer announces **POLAR**; for example, **ADJUST FIRE, POLAR, OVER**.

(2) Laser Polar Plot. The FDC needs to know as quickly as possible if the observer is using a laser. Although the data are still polar, the backup computer system (BUCS) uses a different format from the fire mission index. From the initial transmission of the call for fire, the FDC will know which of its four mission formats to display; for example, **ADJUST FIRE, LASER POLAR OVER**.

(3) Shift From a Known Point. If the target is located by the shift from a known point method of target location, the observer announces **SHIFT** (followed by the known point); for example, **ADJUST FIRE, SHIFT KNOWN POINT 1, OVER**.

(4) Grid. If the grid method of target location is being used, the word *grid* is not announced; for example, **ADJUST FIRE, OVER**.

EXAMPLES

The following are examples of observer identification and warning order.

ADJUST FIRE MISSION

Grid method: **A57 THIS IS A71, ADJUST FIRE, OVER.**

FIRE-FOR-EFFECT MISSION

Polar plot method: **A57 THIS IS A71, FIRE FOR EFFECT, S** (battalion call sign is B6S13), **POLAR, OVER.**

Shift from a known point method: **A57 THIS IS A71, FIRE FOR EFFECT, SHIFT KNOWN POINT 3, OVER.**

SUPPRESSION MISSION

F28 THIS IS F72, SUPPRESS AA7749, OVER.

IMMEDIATE SUPPRESSION MISSION

F28 THIS IS F72, IMMEDIATE SUPPRESSION, GRID NK453215, OVER.

4-4. TARGET LOCATION

This element enables the FDC to plot the location of the target to determine firing data.

a. In a grid mission, six-place grids normally are sent. Eight-place grids should be sent for registration points or other points for which greater accuracy is required. The OT direction normally will be sent after the entire initial call for fire, since it is not needed by the FDC to locate the target.

NOTE: Direction is expressed to the nearest 10 mils.

b. In a shift from a known point mission (Figure 4-1), the point or target from which the shift will be made is sent in the warning order. The point must be known to both the observer and the FDC. The observer then sends the OT direction. Normally, it is sent in mils. However, the FDC can accept degrees or cardinal directions, whichever is specified by the observer. The corrections are sent next:

- The lateral shift (how far **left** or **right** the target is) from the known point.
- The range shift (how much farther [**ADD**] or closer [**DROP**] the target is in relation to the known point, to the nearest 100 meters).
- The vertical shift (how much the target is above [**UP**] or below [**DOWN**] the altitude of the known point, to the nearest 5 meters). (The vertical shift is ignored unless it exceeds 30 meters.)

Figure 4-1. SHIFT FROM A KNOWN POINT

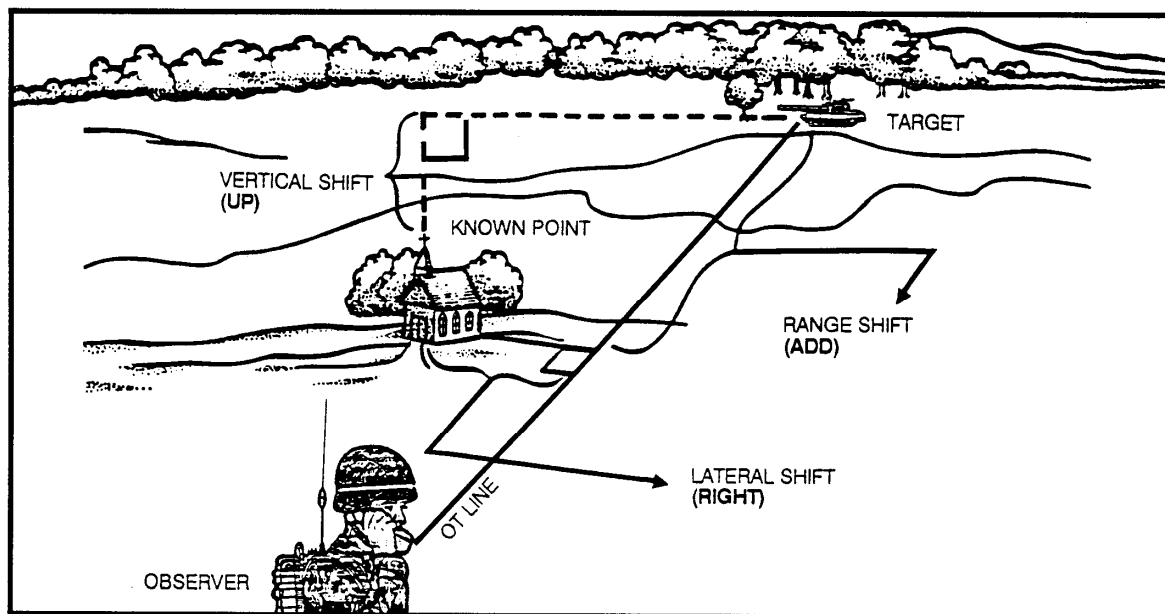

c. In a **polar plot** mission, the word *polar* in the warning order alerts the FDC that the target will be located with respect to the observer's position. The observer's location must be known to the FDC. The observer then sends the direction and distance. A vertical shift tells the FDC how far, in meters, the target is located above or below the observer's location. Vertical shift may also be described by a vertical angle (VA), in mils, relative to the observer's location.

NOTE: Laser data are sent to the nearest 1 mil and nearest 10 meters.

4-5. TARGET DESCRIPTION

The observer must describe the target in enough detail that the FDC can determine the amount and type of ammunition to use. The FDC selects different ammunition for different types of targets. The observer should be brief but accurate. The description should contain the following:

- What the target is (troops, equipment, supply dump, trucks, and so forth).
- What the target is doing (digging in, in an assembly area, and so forth).

- The number of elements in the target (squad, platoon, three trucks, six tanks, and so forth).
- The degree of protection (in open, in foxholes, in bunkers with overhead protection, and so forth).
- The target size and shape if these are significant. If the target is rectangular, the length and width (in meters) and the attitude (azimuth of the long axis 0000-3199) to the nearest 100 mils should be given; for example, **400 BY 200, ATTITUDE 2800**. If the target is circular, the radius should be given; for example, **RADIUS 200**. Linear targets may be described by length, width, and attitude.

4-6. METHOD OF ENGAGEMENT

The observer may indicate how he wants to attack the target. This element consists of the type of adjustment, trajectory, ammunition, and distribution. **DANGER CLOSE** and **MARK** are included as appropriate.

a. Type of Adjustment. Two types of adjustment may be employed—precision and area. Unless precision fire is specified, area fire will be used.

(1) Precision fire is conducted with one weapon on a point target. It is used either to obtain registration

corrections or to destroy a target. When the mission is a registration, it is initiated by the FDC with a message to observer. If the target is to be destroyed, the observer announces **DESTRUCTION**.

(2) Area fire is used to attack an area target. Since many area targets are mobile, the adjustment should be as quick as possible, consistent with accuracy, to keep the target from escaping. A well-defined point at or near the center of the area to be attacked should be selected and used as an aiming point. This point is called the adjusting point during adjust fire missions. To achieve surprise, fire may be adjusted on an auxiliary adjusting point and, after adjustment is completed, the fire for effect shifted to the target. Normally, adjustment on an area target is conducted with one adjusting weapon.

b. Danger Close. **DANGER CLOSE** is included in the method of engagement when the target is (rounds will impact) within 600 meters of friendly troops for mortar and artillery, 750 meters for naval guns 5-inch and smaller, and 1,000 meters for naval guns larger than 5-inch. For naval 16-inch ICM, danger close is 2,000 meters.

c. Mark. **MARK** is included in the method of engagement to indicate that the observer is going to call for rounds for either of the following reasons:

- To orient himself in his zone of observation.
- To indicate targets to ground troops, aircraft, or fire support.

d. Trajectory. Low-angle fire is standard for field artillery. If high-angle fire is desired, it is requested immediately after the type of engagement. If high angle is not specified, low angle will (normally) be used. If the firing unit determines that high angle must be used to attack a target, the unit must inform the observer that high angle will be used. Mortars fire only high angle.

e. Ammunition. The observer may request any type of ammunition during the adjustment or the FFE phase of his mission. Shell HE with fuze quick is normally used in adjustment. If that is what the observer desires, he need not request it in his call for fire. If the observer does not request a shell-fuze in effect, the fire direction officer (FDO) determines the shell-fuze combination. Unit SOP may designate a standard shell-fuze combination. (See also Section II.)

NOTE: Ammunition standards may vary from unit to unit. The observer must learn these standards upon assignment to a unit.

(1) Projectile. Examples of requests for other than HE projectile are **ILLUMINATION**, **ICM**, and **SMOKE**.

(2) Fuze. Most missions are fired with fuze quick during the adjustment phase. If fuze quick is desired or if a projectile that has only one fuze is requested, fuze is not indicated. Illuminating, ICM, and smoke projectiles are fuzed with time fuzes; therefore, when the observer requests **ILLUMINATION**, **ICM**, or **SMOKE**, he does not announce **TIME**.

(3) Volume of Fire. The observer may request the number of rounds to be fired by the weapons firing in effect. For example, **3 ROUNDS** indicates that the firing unit will fire three volleys.

f. Distribution. The observer may control the pattern of bursts in the target area. This pattern of bursts is called a sheaf. Unless otherwise requested, the battery computer system (BCS) assumes a circular target with a 100-meter radius. The BCS determines individual weapon aiming points to distribute the bursts for best coverage of this type of target. A **converged sheaf** places all rounds on a specific point and is used for small, hard targets. Special sheafs of any length and width may be requested. An **open sheaf** separates the bursts by the maximum effective burst width of the shell fired. If target **length** and **width** are given, attitude also must be given. If target length is equal to or greater than five times the target width, the BCS assumes a linear target. The mortar ballistic computer assumes the target is linear and fires a parallel sheaf unless a special sheaf is requested.

4-7. METHOD OF FIRE AND CONTROL

The method of fire and control element indicates the desired manner of attacking the target, whether the observer wants to control the time of delivery of fire, and whether he can observe the target. Methods of control at my command (AMC) and time on target (TOT) are especially useful in massing fires. The AMC and TOT missions achieve surprise and maximize the effects of the initial volley on a target. When used by the observer, these methods of control can reduce the sporadic engagement of the target, or "popcorn effect," which can be the result of rounds fired when ready. Methods of fire and control are announced by the observer by use of the terms discussed below.

a. Method of Fire. In area fire, the adjustment normally is conducted with one howitzer or with the center gun of a mortar platoon or section. If for any reason the observer determines that **PLATOON RIGHT (LEFT)** will be more appropriate, he may request it. (Adjusting at extreme

distances may be easier with two guns firing.) The normal interval of time between rounds fired by a platoon or battery right (left) is 5 seconds. If the observer wants some other interval, he may so specify.

b. Method of Control.

(1) At My Command. If the observer wishes to control the time of delivery of fire, he includes **AT MY COMMAND** in the method of control. When the pieces are ready to fire, the FDC announces **PLATOON** (or **BATTERY** or **BATTALION**) **IS READY, OVER**. (Call signs are used.) The observer announces **FIRE** when he is ready for the pieces to fire. **AT MY COMMAND** remains in effect throughout the mission until the observer announces **CANCEL AT MY COMMAND, OVER**.

(2) Cannot Observe. **CANNOT OBSERVE** indicates that the observer cannot see the target (because of vegetation, terrain, weather, or smoke); however, he has reason to believe that a target exists at the given location and that it is important enough to justify firing on it without adjustment.

(3) Time on Target. The observer may tell the FDC when he wants the rounds to impact by requesting **TIME ON TARGET (so many) MINUTES FROM...NOW, OVER** or **TIME ON TARGET 0859, OVER**. The FO must conduct a time hack to ensure that 0859 on his watch is 0859 on the FDC's watch.

(4) Continuous Illumination. If no interval is given by the observer, the FDC determines the interval by the burning time of the illuminating ammunition in use. If any other interval is required, it is indicated in seconds.

(5) Coordinated Illumination. The observer may order the interval between illuminating and **HE** shells, in seconds, to achieve a time of impact of the **HE** coincident with optimum illumination; or he may use normal **AT MY COMMAND** procedures.

(6) Cease Loading. The command **CEASE LOADING** is used during firing of two or more rounds to indicate the suspension of loading rounds into the gun(s). The gun sections may fire any rounds that have already been loaded.

(7) Check Firing. **CHECK FIRING** is used to cause an immediate halt in firing.

(8) Continuous Fire. In field artillery, mortars, and naval gunfire, continuous fire means loading and firing as rapidly as possible, consistent with accuracy, within the prescribed rate of fire for the equipment. Firing will continue until suspended by the command **CEASE LOADING** or **CHECK FIRING**.

(9) Repeat. **REPEAT** can be given during adjustment or FFE missions.

(a) *During Adjustment.* **REPEAT** means fire another round(s) with the last data and adjust for any change in ammunition if necessary. **REPEAT** is not sent in the initial call for fire.

(b) *During Fire for Effect.* **REPEAT** means fire the same number of rounds using the same method of fire for effect as last fired. Changes in the number of guns, the previous corrections, the interval, or the ammunition may be requested.

(10) Followed By. This is part of a term used to indicate a change in the rate of fire, in the type of ammunition, or in another order for fire for effect; for example, **WP FOLLOWED BY HE**.

4-8. CORRECTIONS OF ERRORS

a. Errors are sometimes made in transmitting data or by the FDC personnel in reading back the data. If the observer realizes that he has made an error in his transmission or that the FDC has made an error in the read back, he announces **CORRECTION** and transmits the correct data.

EXAMPLE

The observer transmitted **SHIFT KNOWN POINT 2, OVER, DIRECTION 4680**. . . . He immediately realizes that he should have sent **DIRECTION 5680**. He announces **CORRECTION, DIRECTION 5680**. After receiving the correct read back, he may continue to send the rest of the call for fire.

b. When an error has been made in a subelement and the correction of that subelement will affect other transmitted data, **CORRECTION** is announced. Then the correct subelement and all affected data are transmitted in the proper sequence.

EXAMPLE

The observer transmitted **LEFT 200, ADD 400, UP 40, OVER**. He then realizes that he should have sent **DROP 400**. To correct this element, he sends **CORRECTION LEFT 200, DROP 400, UP 40, OVER**. The observer must read back the entire subelement, because the **LEFT 200** and **UP 40** will be canceled if they are not included in the corrected transmission.

4-9. CALLS FOR FIRE FROM HEADQUARTERS HIGHER THAN BATTALION

Calls for fire from higher headquarters and from the observer are similar in format. The call for fire from higher headquarters may specify the unit to fire for effect. However, the observer's call for fire can only **request** the firing unit. An example of a call for fire from higher headquarters is shown below.

	EXAMPLE
Warning order:	FIRE FOR EFFECT, B (battalion call sign), OVER.
Target location:	TARGET AA7731 (or GRID NB432789, ALTITUDE 520), OVER.
Method of engagement:	VT, 3 ROUNDS.
Method of control	TIME ON TARGET IS 10 MINUTES FROM...NOW, OVER.

4-10. MESSAGE TO OBSERVER

After the FDC receives the call for fire, it determines how the target will be attacked. That decision is announced to the observer in the form of a message to observer (MTO). The MTO consists of the four items discussed below.

a. Unit(s) to Fire. The battery (or batteries) that will fire the mission is (are) announced. If the battalion is firing in effect with one battery adjusting, the FDC designates the FFE unit (battalion) and the adjusting unit by using the last letter of the call sign.

EXAMPLE
The battalion call sign is A8T36. Battery A is R6G36. Battery A will adjust, and battalion will fire for effect. The MTO would begin T, G.

b. Changes to the Call for Fire. Any change to what the observer requested in the call for fire is announced.

EXAMPLE
The observer requested ICM in effect and the FDO decides to fire VT in effect. The MTO begins T, G, VT IN EFFECT.

c. Number of Rounds. The number of rounds per tube in fire for effect is announced; for example, **T, G, VT IN EFFECT, 4 ROUNDS.**

d. Target Number. A target number is assigned to each mission to facilitate processing of subsequent corrections; for example, **T, G, VT IN EFFECT, 4 ROUNDS, AA7732, OVER.**

NOTE: Messages to observers for registrations are shown in TC 6-40.

4-11. ADDITIONAL INFORMATION

The additional information shown below normally is transmitted separately from the MTO.

a. Probable Error in Range. If probable error in range (PER) is 38 meters or greater during a normal mission, the FDC informs the observer. If PER is 25 meters or greater in a precision registration, the FDC informs the observer.

b. Angle T. Angle T is sent to the observer when it is 500 mils or greater or when requested.

c. Time of Flight. Time of flight is sent to an observer during a moving target mission, during an aerial observer mission, during a high-angle mission, and for shell HE in a coordinated illumination mission when using **BY SHELL AT MY COMMAND**, or when requested.

4-12. AUTHENTICATION

a. When nonsecure communications are used and excluding unique fire support operations (such as suppressive fires posture), challenge and reply authentication is considered a **normal** element of initial requests for indirect fire. The FDC challenges the FO after the last read back of the fire request (see examples in paragraph 4-13). The FO transmits the correct authentication reply to the FDC immediately following the challenge. Authentication replies exceeding 20 seconds are automatically suspect and a basis for rechallenge. Subsequent adjustment of fire or immediate engagement of additional targets by the FO originating the initial fire request normally would not require continued challenge by the FDC. FM 24-35 provides information on authentication procedures.

b. Two methods of authentication are authorized for use: challenge and reply and transmission (which is commonly referred to as self-authentication). The operational distinction between the two is that challenge and reply requires two-way communications, whereas transmission authentication does not. Challenge and reply authentication will be used whenever possible.

Transmission authentication will be used if authentication is required and it is not possible or desirable for the receiving station to reply; for example, imposed radio silence, final protective fire, and immediate suppression.

EXAMPLES

Transmission authentication for final protective fire would be **FIRE THE FPF. AUTHENTICATION IS WHISKEY HOTEL, OVER.**

Transmission authentication for immediate suppression would be **T23 THIS IS T44, IMMEDIATE SUPPRESSION, GRID NK124321, AUTHENTICATION IS TANGO UNIFORM, OVER.**

c. The FO is given a transmission authentication table as per unit standing operating procedures (SOP). The transmission authentication table consists of 40 columns of authenticators with 5 authenticators in each column. For immediate suppression, the FO must use the column assigned to his supporting unit. Authenticators from the numbered columns of the transmission authentication table should be used only once. The first unused authenticator in the assigned column is used, and a line is drawn through that authenticator to preclude its reuse.

4-13. SAMPLE MISSIONS

The following are sample calls for fire and FDC responses for various type missions.

EXAMPLES
FIRE MISSION (GRID)
Initial Fire Request

Observer	FDC
Z57 THIS IS Z71, ADJUST FIRE, OVER.	THIS IS Z57, ADJUST FIRE, OUT.
GRID NK180513, OVER.	GRID NK180513, OUT.
INFANTRY PLATOON IN THE OPEN, ICM IN EFFECT, OVER.	INFANTRY PLATOON IN THE OPEN, ICM IN EFFECT, AUTHENTICATE PAPA BRAVO, OVER.
I AUTHENTICATE CHARLIE, OUT.	

EXAMPLES (Continued)
Message to Observer

Observer	FDC
Z, 2 ROUNDS, TARGET AF1027, OUT.	Z, 2 ROUNDS, TARGET AF1027, OVER.
DIRECTION 1680, OVER.	DIRECTION 1680, OUT.

NOTE: Direction is sent before or with the first subsequent correction.

FIRE MISSION (SHIFT)
Initial Fire Request

Observer	FDC
H66 THIS IS H44, ADJUST FIRE, SHIFT AA7733, OVER.	THIS IS H66, ADJUST FIRE, SHIFT AA7733, OUT.
DIRECTION 5210, LEFT 380, ADD 400, DOWN 35, OVER.	DIRECTION 5210, LEFT 380, ADD 400, DOWN 35, OUT.
COMBAT OP IN OPEN, ICM IN EFFECT, OVER.	COMBAT OP IN OPEN, ICM IN EFFECT, AUTHENTICATE LIMA FOXTROT, OVER.
AUTHENTICATE PAPA, OUT.	

Message to Observer

	H, 1 ROUND, TARGET AA7742, OVER.
H, 1 ROUND, TARGET AA7742, OUT.	
FIRE MISSION (POLAR) Initial Fire Request	
Observer	FDC
Z56 THIS IS Z31, FIRE FOR EFFECT, POLAR, OVER.	THIS IS Z56, FIRE FOR EFFECT, POLAR, OUT.

EXAMPLES (Continued)

Observer FDC

DIRECTION 4520,
DISTANCE 2300,
DOWN 35, OVER.

DIRECTION 4520,
DISTANCE 2300,
DOWN 35, OUT.

INFANTRY COMPANY
IN OPEN, ICM, OVER.

INFANTRY COMPANY
IN OPEN, ICM,
AUTHENTICATE TANGO
FOXTROT, OVER.

I AUTHENTICATE
ECHO, OUT.

Message to Observer

Y, VT, 3 ROUNDS,
TARGET AF2036, OVER.

Y, VT, 3 ROUNDS,
TARGET AF2036, OUT.

FIRE MISSION (SUPPRESSION)

Observer FDC

H18 THIS IS H24,
SUPPRESS AB3104,
OVER.

THIS IS H18, SUPPRESS
AB3104, AUTHENTICATE
DELTA JULIET, OVER.

I AUTHENTICATE
DELTA, OUT.

FIRE MISSION (IMMEDIATE SUPPRESSION)

Observer FDC

H18 THIS IS H24,
IMMEDIATE
SUPPRESSION,
GRID 211432,
AUTHENTICATION IS
TANGO UNIFORM,
OVER.

THIS IS H18, IMMEDIATE
SUPPRESSION,
GRID 211432, OUT.

NOTE: Immediate suppression missions are normally fired by a two-gun section using two rounds of HE or VT. However, this procedure is addressed in individual unit SOP and may vary between units.

Section II

SHELL-FUZE COMBINATIONS

4-14. DESIRED EFFECTS

Once the observer has located a target, he must decide how he wants to attack the target to get maximum effect. A thorough knowledge of the ammunition available will allow a rapid selection of the correct type of shell and fuze to use against the target. If it is not specified by commander's guidance, the type of effect is the first decision the observer must make. He has three choices—destruction, neutralization, or suppression.

a. Destruction puts a target out of action permanently. Thirty percent or more casualties normally will render a unit combat ineffective. Direct hits with HE or concrete-piercing (CP) shells are required to destroy hard materiel targets.

b. Neutralization knocks a target out of action temporarily. Ten percent or more casualties will neutralize a unit. Neutralization can be achieved by using any type of shell-fuze combination suitable for attacking a particular type of target. Neutralization does not require an extensive expenditure of ammunition and is the most practical type of mission.

c. Suppression of a target limits the ability of the enemy personnel in the target area to perform their jobs. Firing HE/VT or smoke creates apprehension and confuses the enemy. The effect of suppressive fires usually lasts only as long as the fires are continued. Suppression requires a low expenditure of ammunition; however, its inability to have lasting effect on a target makes it an unsuitable type of mission for most targets.

d. When deciding whether to use impact fuze action (produces ground bursts) or time fuze or proximity action (produces airbursts), the observer should consider the following:

- The nature of the target.
- The cover available to the enemy.
- The mobility of the target.
- Whether adjustment is required.

e. See Appendix E for a discussion of munitions effects and examples of optimum shell-fuze combinations for particular targets.

4-15. SHELL HE AND FUZES

Shell HE is the shell most often used by the observer in adjustment. It can be used with impact, time, or proximity (VT) fuzes for various effects.

a. Shell HE, Fuze Quick. Shell HE, fuze quick bursts on impact. It is used against the following:

- Personnel standing.
- Personnel prone on the ground.
- Unarmored vehicles.
- Light materiel.

Shell HE, fuze quick loses its effect if troops are in trenches, on uneven ground, in frame buildings, or on earthworks.

b. Shell HE, Fuze Delay. A 0.05-second delay can be set on the quick fuze to allow either ricochet fire or penetration (Figure 4-2). If the observer is firing into dense woods, against light earthworks or buildings, or against unarmored vehicles, he should use fuze delay for penetration. If a very high charge is fired at a small angle of impact on a very hard surface, a ricochet may occur, which results in low airbursts.

Figure 4-2. FUZE DELAY



c. Shell HE, Fuze Time. Shell HE, fuze time bursts in the air at a given time along the trajectory. An airburst is shown in Figure 4-3. It is used against the following:

- Troops in the open.
- Troops in trenches.
- Troops in deep foxholes.
- Troops in soft-skinned vehicles.

Fuze time must be adjusted to the proper height of burst unless the firing unit has corrections for nonstandard conditions computed. Therefore, consideration should be given to another shell-fuze combination if time is critical and airbursts are desired. Fuze time should never be used for high-angle missions.

Figure 4-3. FUZE TIME OR VT

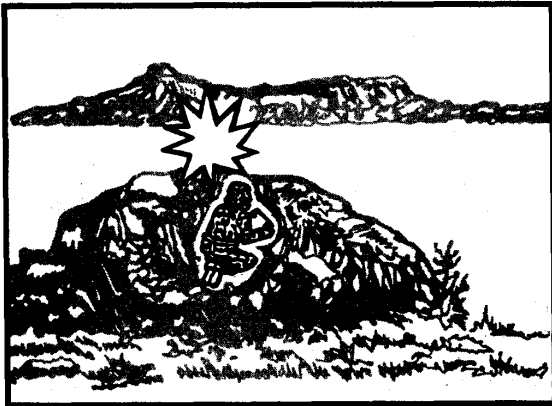

d. Shell HE, Fuze Proximity. The VT (or proximity) fuze is a radio-activated fuze that detonates at a predetermined height of burst. A VT fuze provides the same effect as fuze time but does not have to be adjusted. It is an excellent fuze to fire with shell HE for surprise and unobserved fires. Also, it is very effective in high-angle fires. It should be used in missions conducted by an aerial observer when an airburst is desired. It is used against all targets that can be attacked with fuze time.

NOTE: The VT fuzes M513 and M514 should not be used in the rain or on targets that are on water, snow, or ice. The M532, M728, and M732 VT fuzes are not sensitive to water, snow, ice, or rain and may be used. M728 and M732 VT fuzes function at approximately 7 meters HOB and can easily be misspotted as graze bursts by inexperienced observers. (A 7-meter HOB looks like a fireball at ground level.) M513 and M514 fuzes function at approximately 20 meters HOB.

e. Shell HE, Fuze Concrete-Piercing. The CP fuzes are used with shell HE in all cannon weapon systems except the M110A2 against concrete structures or earth- and log-reinforced emplacements. There are two types of CP fuzes: nondelay (used primarily for spotting or for clearing rubble and shattering concrete) and delay (used to destroy the concrete target) (Figure 4-4).

NOTE: Current CP fuzes (M78 and M78A1) are not safety-certified for peacetime use but may be used in combat. This problem is expected to be eliminated with the future production of the MK399 fuze (for use in military operations on urbanized terrain [MOUT]).

Figure 4-4. FUZE CONCRETE-PIERCING

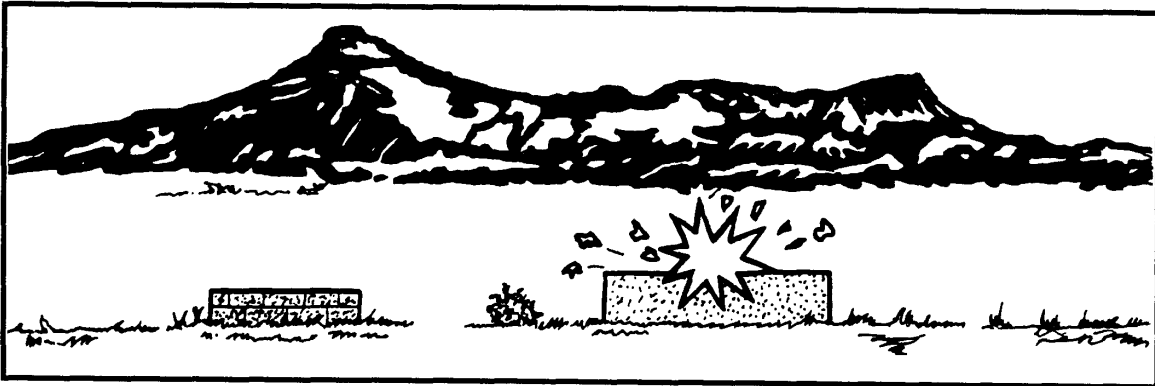

4-16. SHELL WHITE PHOSPHORUS

Shell white phosphorus (WP) has four uses: incendiary, marking, obscuring, and screening. It can be used to destroy the enemy's equipment or to limit his vision. It is used against the following:

- Vehicles.
- Petroleum, oils and lubricants (POL) and ammunition storage areas.
- Enemy observers.

Also, shell WP can be used as an aid in target location and navigation. It can be fired with fuze time to obtain an airburst.

EXAMPLE

The following is an example of a WP call for fire:
Z57 THIS IS Z18, ADJUST FIRE OVER. MARK CENTER OF SECTOR, OVER. WP 200 METERS HOB, OVER.

4-17. SHELL SMOKE

Shell smoke is a base-ejection projectile that is filled with canisters containing smoke. It is more effective than WP as a screening agent, because it lasts longer and has less tendency to pillar. The direction of the wind must be considered in the use of any smoke shell (WP or hexachloroethane [HC]). Further employment considerations are in Chapter 6, Section IV.

4-18. SHELL ILLUMINATING

The illuminating shell is a base-ejection projectile containing a flare attached to a parachute. Normally, it is used to illuminate areas of known or suspected enemy activity or to adjust artillery fire at night. Shell illuminating with a fuze setting for a graze burst may also be used to mark targets. Depending on the caliber, an illuminating shell can provide light for up to 2 minutes and can light an

area of up to 1,000 meters in diameter. Further employment considerations are in Chapter 6, Section III.

4-19. SHELL FASCAM

a. The family of scatterable mines (FASCAM) includes shell FASCAM, which is fired by a 155-mm artillery weapon. It delivers antipersonnel or antitank mines against an enemy force to deny access to a particular area, to delay the attacking force, or to canalize them.

b. This all-weather, day-or-night mine emplacement system can be used in offensive, defensive, or retrograde operations. Antitank mines (remote antiarmor mine system [RAAMS]) are used to create antitank or antivehicle obstacles. Antipersonnel mines (area denial artillery munitions [ADAM]) are used in conjunction with antitank mines to create antitank obstacles difficult for dismounted personnel to breach.

c. Antipersonnel mines also can be used alone to create antipersonnel obstacles, to disrupt dismounted personnel operations, to restrict enemy use of terrain, and in counterfire.

d. All of these mines have a short or long self-destruct time depending on the type of shell fired to the target area. Further employment considerations are in Chapter 6, Section II.

4-20. SHELL COPPERHEAD

The cannon-launched guided projectile (CLGP) (Copperhead) is a high-explosive 155-mm projectile. It has a high hit probability on point targets, moving or stationary, and is extremely lethal. To use Copperhead, the observer must have a laser target designation capability and the proper pulse repetition frequency (PRF) setting. Also, he must be aware of the commander's Copperhead targeting priorities. Further employment considerations are in Chapter 6, Section V.

4-21. SHELLS ICM AND DPICM

For employment of ICM and dual-purpose ICM (DPICM), see Chapter 6, Section I.

CHAPTER 5

ADJUSTMENT OF FIRE

This chapter implements STANAG 2934, Chapter 6 and QSTAG 505.

Section I

SUBSEQUENT CORRECTIONS

5-1. PURPOSE OF ADJUSTMENT

An observer's prime concern is the placement of timely and accurate fires on targets. If an observer can locate the target accurately, he will request **FIRE FOR EFFECT** in his call for fire. Failure to locate the target accurately may result from poor visibility, deceptive terrain, poor maps, or the observer's difficulty in pinpointing the target. If the observer cannot locate the target accurately enough to warrant FFE, he may conduct an adjustment. Even with an accurate target location, if current firing data corrections are not available, the FDO may direct that an adjustment be conducted. Normally, one gun is used in adjustment. Special situations in which more than one gun is used are so noted throughout this discussion.

NOTE: Some helpful notes for the observer are at the end of this chapter, on page 5-26.

5-2. ADJUSTING POINT

When it is necessary for the observer to adjust fire, he must select an adjusting point. In area missions, he must select a well-defined point near the center of the target area on which to adjust the fire. The point selected is called an adjusting point (Figure 5-1). The location of this point is included in the target location element of the call for fire in an area fire mission. In the conduct of a registration or destruction mission (precision fire), the adjusting point is the target itself.

5-3. SPOTTINGS

A spotting is the observer's determination of the location of the burst (or the mean point of impact [MPI] of a group

of bursts) with respect to the adjusting point as observed along the OT line. Spottings are made for the following

- Deviation (the number of mils right or left of the OT line).
- Distance (whether the burst occurred beyond or short of the target).
- When fuze time is fired, the HOB (the number of mils the burst is above the target).

Figure 5-1. ADJUSTING POINT IN AN AREA FIRE MISSION

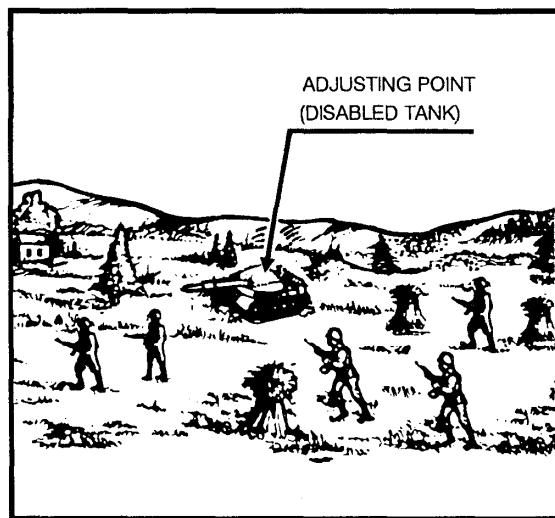

Spottings must be made by the observer the instant the bursts occur except when the spottings are delayed deliberately to take advantage of drifting smoke or dust. The observer is usually required to announce his spottings during his early training; experienced observers make spottings mentally. The observer should consider the most difficult spottings first. The sequence of spottings is HOB (air or graze), range (over or short), and deviation (left or right).

a. Height-of-Burst Spotting. The HOB spotting may be any one of the following:

- **AIR**- a round or group of rounds that bursts in the air. The number of mils also is given. For example, a burst 10 mils above the ground would be spotted as **AIR 10**.
- **GRAZE**- a round or group of rounds that detonates on impact.
- **MIXED**- a group of rounds that results in an equal number of airbursts and graze bursts,
- **MIXED AIR**- a group of rounds that results in both airbursts and graze bursts when most of the bursts are airbursts.
- **MIXED GRAZE**- a group of rounds that results in both airbursts and graze bursts when most of the bursts are graze bursts.

b. Range Spotting. Definite range spottings are required to make a proper range adjustment. Any range spotting other than **DOUBTFUL**, **LOST**, or **UNOBSERVED** is definite. Normally, a round which impacts on or near the OT line results in a definite range spotting. Figure 5-2

shows the approximate areas for various range spottings. An observer may make a definite range spotting when the burst is not on or near the OT line by using his knowledge of the terrain, drifting smoke, shadows, and wind. However, even experienced observers must use caution and good judgment when making such spottings. Possible range spottings are as follows:

- **OVER**- a round that impacts beyond the adjusting point.
- **SHORT**- a round that impacts between the observer and the adjusting point.
- **TARGET**- a round that impacts on the target. This spotting is used only in precision fire (registration or destruction missions).
- **RANGE CORRECT**- a round that impacts at the correct range.
- **DOUBTFUL**- a round that can be observed but cannot be spotted as **OVER**, **SHORT**, **TARGET**, or **RANGE CORRECT**.
- **LOST**- a round whose location cannot be determined by sight or sound.
- **UNOBSERVED**- a round not observed but known to have impacted (usually heard).

NOTE: For safety considerations regarding lost and unobserved rounds, refer to AR 385-63.

- **UNOBSERVED OVER** or **SHORT**— a round not observed but known to have impacted over or short.

Figure 5-2. RANGE SPOTTINGS

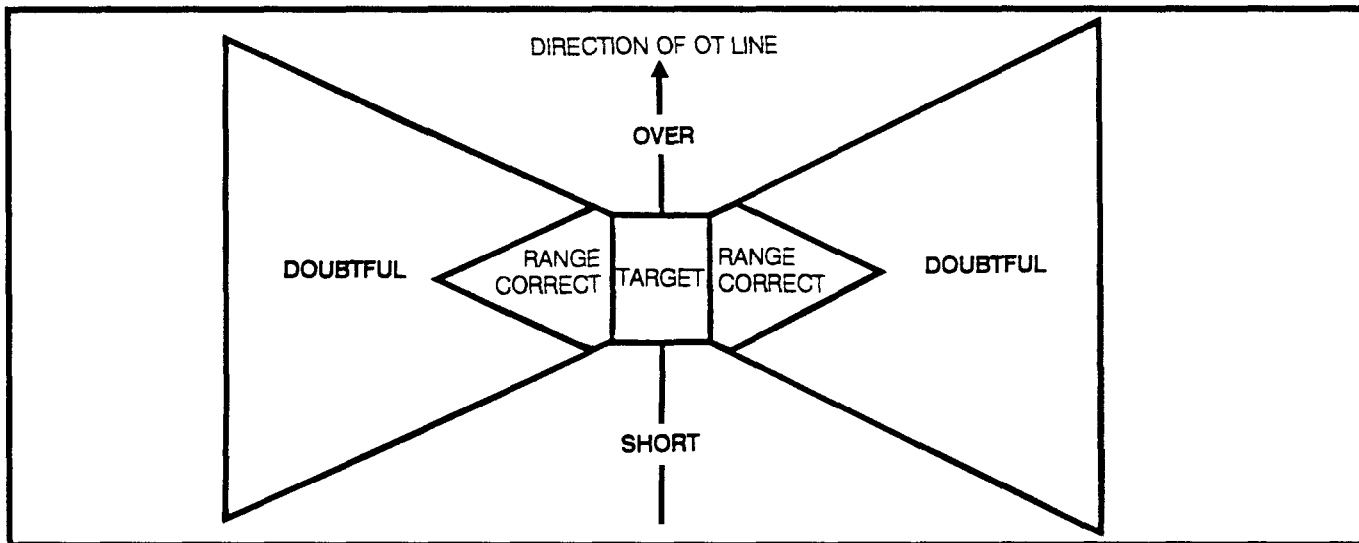

c. Deviation Spotting.

(1) A deviation spotting is the angular measurement from the adjusting point to the burst as seen from the observer's position. During a fire mission, the observer measures the deviation, in mils, with his binoculars (or another angle-measuring instrument). Deviation spottings are measured to the nearest 5 mils for area fires and 1 mil for precision fires. Possible deviation spottings are as follows:

- **LINE**- a round that impacts on line (LN) with the adjusting point as seen by the observer (on the OT line).
- **LEFT**- a round that impacts left (L) of the adjusting point in relation to the OT line.
- **RIGHT**- a round that impacts right (R) of the adjusting point in relation to the OT line.

EXAMPLE

An observer spots a round to the right of the OT line. He measures the angular deviation as 40 mils. His deviation spotting is **40 RIGHT**.

(2) Deviation spottings are taken from the center of a single burst or, in the case of platoon or battery fire, from the center of the group of bursts. Deviation spottings should be made as accurately as possible to help in obtaining definite range spottings.

EXAMPLES

If the adjusting point is at the center of the binocular reticle pattern, the observer would spot the round in Figure 5-3 for deviation as **30 LEFT**.

The observer would spot the round in Figure 5-4 for deviation as **LINE**.

d. Unobserved Spotting. At times, the observer may be able to make a spotting even though he is unable to see the round impact.

EXAMPLE

The observer hears but does not see the round impact, and the only possible place the round could have impacted and not been visible to the observer is in a ravine beyond the adjusting point. He assumes that the burst is beyond the adjusting point and spots it as **UNOBSERVED, OVER**.

Figure 5-3. DEVIATION SPOTTING 30 LEFT

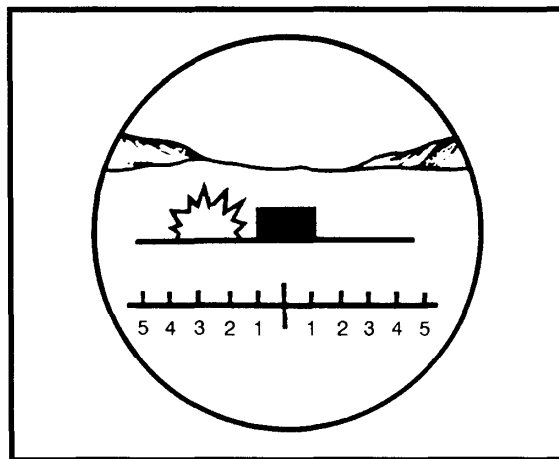
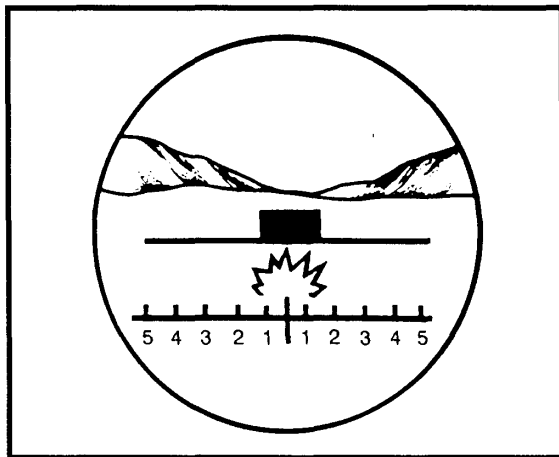

Figure 5-4. DEVIATION SPOTTING LINE



e. Lost Spotting. If the observer is unable to locate the round (either visually or by sound), the round is spotted **LOST**.

(1) A round maybe lost for various reasons:

- It maybe a dud (nonfunctioning fuze), resulting in no visual or audible identification.
- The terrain may prevent the observer from spotting the round or its smoke,
- The weather may prevent the observer from spotting the round or its smoke.

- Enemy fire may prevent the observer from hearing or seeing the round.
- The FO simply may have failed to spot the round.
- Errors by the FDC or the firing piece may cause the round to be lost.

(2) When dealing with a lost round, the FO must consider his own experience, the level of FDC and/or gun section training, and the location of friendly elements with respect to the target. The observer should take corrective action based on his confidence in the target location, the accuracy of fire on previous missions, whether the lost round is an initial round or a subsequent round, and the urgency of the mission.

(3) When a round is lost, positive action must be taken. The observer can start a number of corrective procedures, such as one or more of the following:

- Begin a data check throughout the system, starting with his target location data and his call for fire.
- Request a WP round, a smoke round, or a 200-meter airburst with HE on the next round.
- Repeat.
- End the mission and start a new mission.
- Make a bold shift. The observer should be very careful in making a bold distance or deviation change when the target plots in the vicinity of friendly troops.

5-4. TYPES OF CORRECTIONS

After a spotting has been made, the observer must send corrections to the FDC to move the burst onto the adjusting point. The corrections are sent, in meters, in reverse of the order used in making spottings; that is, deviation, range, and HOB.

a. Deviation Corrections.

(1) The distance in meters that the burst is to be moved (right or left) is determined by multiplying the

observer's deviation spotting in mils by the OT distance in thousands of meters (the OT factor). Deviation corrections are expressed to the nearest 10 meters. A deviation correction less than 30 meters is a minor deviation correction. It should not be sent to the FDC except as refinement data or in conduct of a destruction mission.

(2) To determine the OT factor when the OT range is greater than 1,000 meters, the range from the observer to the target (OT distance) is expressed to the nearest thousand and then expressed in thousands.

EXAMPLE

OT range = 4,200 meters
 OT distance (expressed to nearest thousand) = 4,000
 OT factor (expressed in thousands) = 4

For an OT range less than 1,000 meters, the distance is expressed to the nearest 100 meters and expressed in thousands.

EXAMPLE

OT range = 800 meters
 OT factor = 0.8

(3) The computed deviation correction is announced to the FDC as **LEFT** (or **RIGHT**) (**so much**). The correction is opposite the spotting.

(4) Determination of deviation corrections is shown in Table 5-1.

NOTE: Table 5-1 expresses 1,500 and 2,500 meters to the nearest even OT factor. For an explanation of artillery expressions see TC 6-40. For example, express to the nearest even number when halfway between two numbers.

Table 5-1. DETERMINATION OF DEVIATION CORRECTIONS

OT RANGE (METERS)	OT FACTOR	SPOTTING	DEVIATION CORRECTION
4,000	4	45R	LEFT 180
2,500	2	100L	RIGHT 200
3,400	3	55L	RIGHT 160
1,500	2	20R	LEFT 40
700	0.7	45L	RIGHT 30

(5) Angle T is the angle formed by the intersection of the gun-target (GT) line and the OT line with its vertex at the target. If angle T is 500 mils or greater, the FDC should tell the observer this. If the observer is told that angle T is 500 mils or greater, at first he continues to use his OT factor to make his deviation corrections. If he sees that he is getting more of a correction than he asked for, he should consider cutting his corrections to better adjust rounds onto the target.

Figure 5-5. ANGLE T

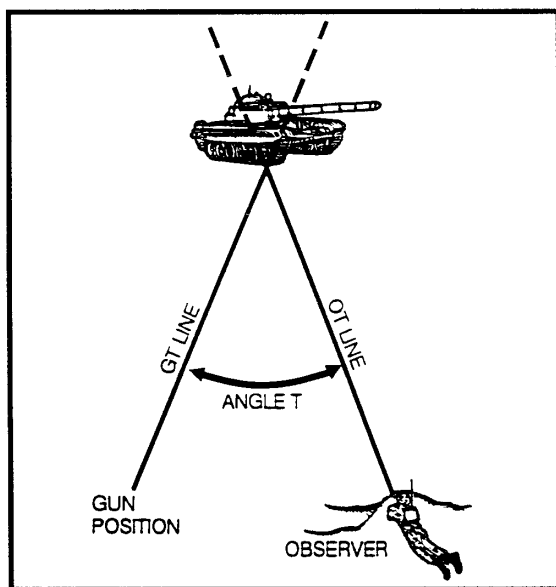

b. Range Corrections. When making a range correction the observer attempts to "add" or "drop" the adjusting round, along the OT line, from the previous burst to the target. If his spotting was **SHORT**, he will add; if his spotting was **OVER**, he will drop. The observer must be aggressive in the adjustment phase of an adjust fire mission. He must use every opportunity to shorten that phase. He should make every effort to correct the initial round onto the target and enter FFE as soon as possible. Successive bracketing procedures should be used only when time is not critical. When conducting an adjustment onto a target, the observer may choose to establish a range bracket. Different types of range adjustments are discussed in Section II.

c. Height-of-Burst Corrections. See Figure 5-6.

(1) One gun is used in adjusting fuze time. The observer adjusts **HOB** (after a 100-meter range bracket has been established by using fuze quick) to obtain a 20-meter HOB in fire for effect. He does this by announcing a correction of **UP** or **DOWN** (so many meters).

(2) If the spotting of the initial round is **GRAZE**, an automatic correction of **UP 40** is sent. If the round is an airburst, the HOB of the round (in meters) is computed (HOB spotting in mils above the adjusting point multiplied by the OT factor). The appropriate HOB correction is given (to the nearest 5 meters) to obtain the desired 20-meter HOB.

(3) Fire for effect is entered only when a correct HOB is reasonably assured. Therefore, fire for effect is never begun when either the last round observed was spotted as a graze burst or the HOB correction is greater than 40 meters. If the initial rounds in fire for effect are spotted as **MIXED**, the subsequent surveillance report normally includes the correction **UP 20**.

Figure 5-6. HEIGHT-OF-BURST SPOTTINGS

<p>SPOTTING: GRAZE</p>	<p>HOB CORRECTION:</p> <p>(WITHOUT PREVIOUS AIRBURST) UP 40</p> <p>(WITH PREVIOUS AIRBURST) UP 20</p>
<p>SPOTTING: AIR (SO MANY MILS)</p>	<p>HOB CORRECTION:</p> <p>CORRECT TO 20-METER HOB AND FIRE FOR EFFECT.</p>

5-5. SEQUENCE OF SUBSEQUENT CORRECTIONS

After the initial round(s) impact(s), the observer transmits subsequent corrections until the mission is complete. If the FDC is using BCS or BUCS, all subsequent corrections or transmissions must include the target number or a means of identifying the mission to which the correction applies. These corrections include appropriate changes in elements previously transmitted and the necessary corrections for deviation, range, and HOB. Elements that may require correcting and the order in which corrections are announced are as follows:

- Observer-target direction.
- Danger close.
- Trajectory.
- Method of fire.
- Distribution.
- Projectile.
- Fuze.
- Volume.
- Deviation correction.
- Range correction.
- Height-of-burst correction.
- Target description.
- Mission type and/or method of control.
- Splash.
- Repeat.

Any element for which a change or correction is not desired is omitted. Guidelines for subsequent corrections are discussed below.

a. Observer-Target Direction. In the sequence of corrections, the OT direction is the first item sent to the FDC. It is sent if it has not been sent previously or if the OT direction changes by more than 100 mils from the previously announced direction. (Direction is normally sent to the nearest 10 mils but it can be sent to the nearest 1 mil, depending on the accuracy of the observer's equipment.)

EXAMPLE

An observer began an adjustment on several self-propelled (SP) guns. He used a tree at direction 5620 as the adjusting point. During the adjustment, the guns moved to a new position an appreciable distance from the initial adjusting point. The observer selects a new adjusting point and measures a direction of 5840 to the new point. Since the difference between the directions to the old and new adjusting points exceeds 100 mils the first element in the observer's next correction is **DIRECTION 5840**.

b. Danger Close. If the adjustment of fires brings impacting rounds within danger close distance during the conduct of the mission, the observer must announce **DANGER CLOSE** to the FDC. The observer, using creeping fire (paragraph 5-6d), makes corrections from the round impacting closest to friendly troops. If the adjustment of fire moves the round outside the danger close distance, the observer transmits **CANCEL DANGER CLOSE**. Danger close distances are as follows:

- Artillery or mortars - 600 meters.
- Naval gun 5-inch or smaller- 750 meters.
- Naval gun larger than 5-inch - 1,000 meters.
- 16-inch naval gun (ICM or controlled variable time (CVT)) - 2,000-meters.

c. Trajectory. The observer requests a change in the type of trajectory if it becomes apparent that high-angle fire is necessary during a low-angle adjustment or that high-angle fire is no longer necessary during a high-angle adjustment. For example, if during the conduct of the mission a target moves into a defilade position, the observer may change trajectory by transmitting the correction **HIGH ANGLE**. Conversely, if a target moves out of defilade into open terrain and high-angle fire is no longer necessary, the observer requests **CANCEL HIGH ANGLE**.

d. Method of Fire. The observer transmits any correction he wants to make in the method of fire. For example, if the observer wants to change from one gun to a platoon firing in order from left to right, he transmits the correction **PLATOON LEFT**. If he wants to change to a platoon firing in order from right to left, he transmits the correction **PLATOON RIGHT**.

e. Distribution. (See Figures 5-7 and 5-8.) If an observer wants to change the distribution of fire from a BCS sheaf

(circular with a 100-meter radius) to another type of sheaf, he transmits the sheaf desired (for example, **CONVERGE**, **OPEN**, or **LINEAR** or the target length, width, and attitude). Conversely, if the observer wants to change from a specific sheaf to a BCS sheaf, he transmits the correction **CANCEL**, followed by the type of sheaf being used (for example, **CANCEL CONVERGE** [or **OPEN**] **SHEAF**).

f. Projectile. If the observer wants to change the type of projectile, he announces the desired change (for example, **SMOKE** or **WP**).

g. Fuze. If the observer wants to change the type of fuze or fuze action, he announces the desired change (for example, **TIME**, **DELAY**, or **VT**).

h. Volume. If the observer wants to change the volume of fire, he announces the desired change (for example, **2 ROUNDS** or **3 ROUNDS**). Volume refers to the number of rounds in the fire-for-effect phase.

i. Deviation Correction. If the round impacts to the right or left of the OT line, the observer determines the correction required, to the nearest 10 meters, to bring the round onto the OT line. To make the correction, the observer transmits **RIGHT** (or **LEFT**) (so many meters). (Deviation corrections less than 30 meters are not sent to the FDC except when conducting a destruction mission or as refinement data.)

j. Range Correction. If the round impacts beyond the target on the OT line, the observer's correction is **DROP** (so many meters). If the round impacts between the observer and the target, the range correction is **ADD** (so many meters).

k. Height-of-Burst Correction. The observer transmits HOB corrections to the nearest 5 meters with the correction **UP** (or **DOWN**). In firing fuze time in an area mission, HOB corrections are made after the deviation and range have been corrected to within 50 meters of the target by using fuze quick in adjustment.

l. Target Description. Target description is sent before a control correction during immediate suppression missions and when a new target is being attacked without sending a new call for fire.

m. Mission Type and/or Method of Control. If the observer wants to change the mission type and/or method of control, he transmits the desired method of control (for example, **ADJUST FIRE**, **FIRE FOR EFFECT**, or **AT MY COMMAND**). If the method of control being used includes **AT MY COMMAND**, his correction is **CANCEL AT MY COMMAND**.

Figure 5-7. CONVERGED SHEAF

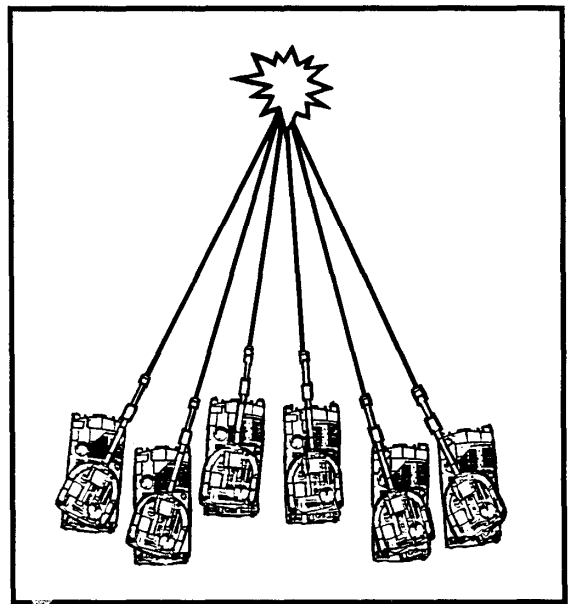
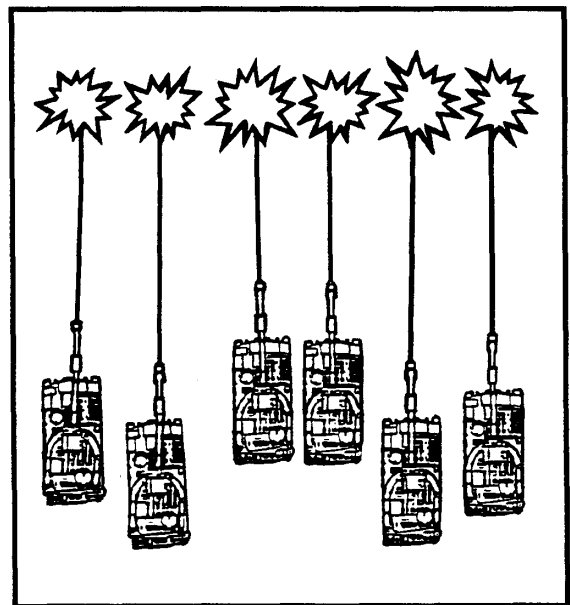

Figure 5-8. OPEN SHEAF



n. **Splash.** An observer in a tactical situation may have difficulty identifying or observing his rounds. This may be because he has to stay down in a concealed position much of the time or because of other fire missions being conducted in the area. In any case, he may request assistance from the FDC by requesting **SPLASH**. The FDC informs the observer that his round is about to impact by announcing **SPLASH** 5 seconds before the round impacts. The observer may end splash by announcing **CANCEL SPLASH**.

o. **Repeat.** **REPEAT** is used (in the adjustment phase) if the observer wants a subsequent round or group of rounds fired with no corrections to deviation, range, or HOB (for example, **TIME, REPEAT**). **REPEAT** is also used by the observer to indicate that he wants fire for effect repeated with or without changes or corrections to any of the elements (for example, **ADD 50, REPEAT**).

Section II

AREA FIRE (ADJUSTMENT AND FIRE FOR EFFECT)

5-6. ADJUSTMENT TECHNIQUES

There are four techniques that can be used to conduct area adjustment fires. **Successive bracketing** is best when observers are inexperienced or when precise adjustment is required, such as precision registrations and destruction missions. It mathematically ensures that FFE rounds will be within 50 meters of the target. **Hasty bracketing** is best when responsive fires are required and the observer is experienced in the adjustment of fire. **One-round adjustment** provides the most responsive fires but generally requires either an experienced observer or an observer equipped with a laser range finder. **Creeping fire** is used in danger close missions. Upon completion of each mission, refinement data and surveillance are required. From this surveillance the FDC can determine the effectiveness of the fires.

a. **Successive Bracketing.** After the first definite range spotting is determined, the observer should send a range correction to the FDC to establish a range bracket of known distance (one round over and one round short). Once the bracket has been established, the observer successively splits the bracket until he is assured the rounds will be within 50 meters of the adjusting point when he fires for effect. Normally, range changes of 100, 200, 400, or 800 meters are used to make splitting the bracket easier. **The observer enters FFE when he is sure of rounds impacting within 50 meters of the adjusting point.**

EXAMPLE

The first round impacts over the adjusting point (see Figure 5-9). The observer should send a drop correction enough to place the next round short of the adjusting point.

Figure 5-9. ROUND IMPACTING OVER THE ADJUSTING POINT

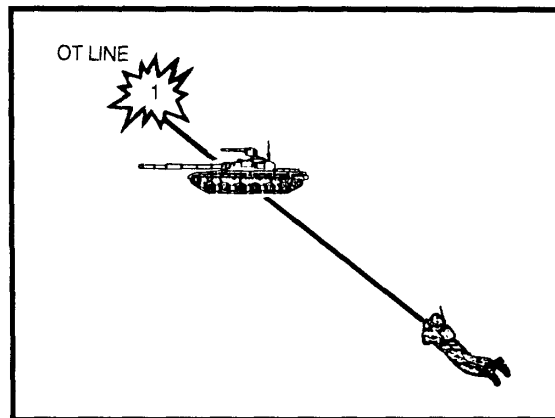

EXAMPLE (Continued)

The observer sent **DROP 400** (-400) after observing his first round. The next round impacted short of the adjusting point (Figure 5-10).

The observer has now established a range bracket. He has had one round over and one short of the adjusting point, separated by 400 meters. Using the successive bracketing technique, the observer sends **ADD 200** (+200).

The third round impacts over the adjusting point (Figure 5-11). The observer has a 200-meter bracket because round 2 impacted short of the adjusting point and the distance between the two rounds was 200 meters. Splitting the bracket, the observer sends **DROP 100** (-100). The fourth round impacts short (Figure 5-12). The observer has established a 100-meter bracket. He now sends **ADD 50, FIRE FOR EFFECT**. The center of impact of the FFE rounds is now mathematically certain of being within 50 meters of the adjusting point.

Figure 5-10. ROUND IMPACTING SHORT OF THE ADJUSTING POINT

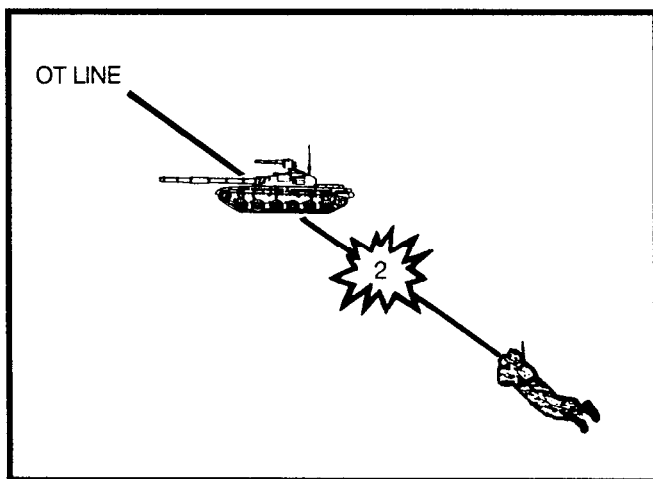

Figure 5-12. ROUND IMPACTING SHORT OF THE ADJUSTING POINT

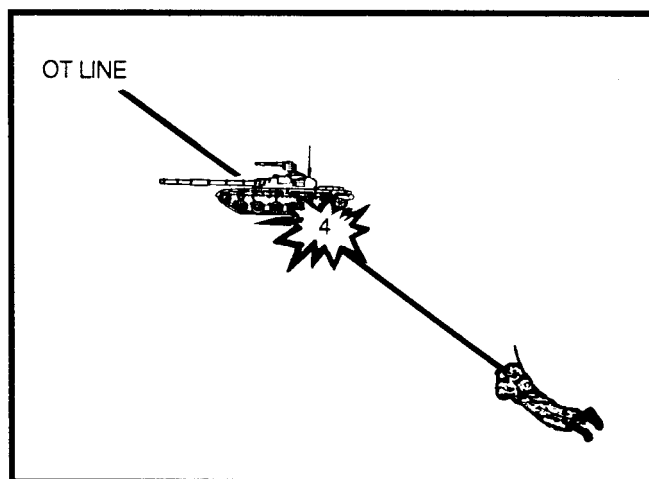
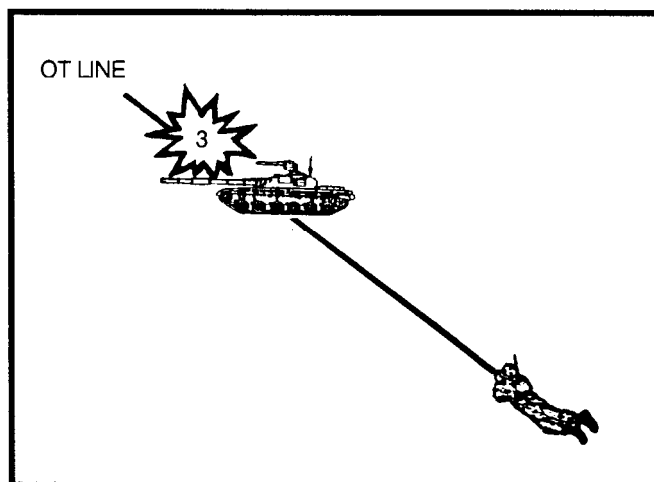

Figure 5-11. ROUND IMPACTING OVER THE ADJUSTING POINT



b. Hasty Bracketing. Experience has shown that effectiveness on the target decreases as the number of rounds used in adjustment increases. An alternative to successive bracketing is the hasty bracketing technique. Successive bracketing mathematically ensures the observer that the FFE rounds will impact within 50 meters of the adjusting point; however, it is a slow and unresponsive technique. Therefore, if the nature of the target dictates that effective fires are required in less time than the successive bracketing technique would take, the hasty bracketing technique should be used. The success of hasty bracketing adjustment depends on a thorough terrain analysis that gives the observer an accurate initial target location. The observer gets a bracket on his first correction much as in the successive bracketing technique. He uses this initial bracket as a yardstick to determine his subsequent correction. He then sends the FDC the correction to move the rounds to the target and **FIRE FOR EFFECT**.

EXAMPLE

The first round impacts approximately 35 mils right and 100 meters short of the adjusting point (Figure 5-13). The observer spots it as **SHORT, 35 RIGHT**. With an OT factor of 4, the observer sends **LEFT 140, ADD 200**.

The next round impacts approximately 10 mils left and 50 meters over the adjusting point (Figure 5-14). The observer spots it as **OVER, 10 LEFT**. He looks at the round and the adjusting point and decides that he needs to go right 40 meters (10 x OT factor of 4) and drop 50. He will then be on his adjusting point. Therefore, he sends **RIGHT 40, DROP 50, FIRE FOR EFFECT**.

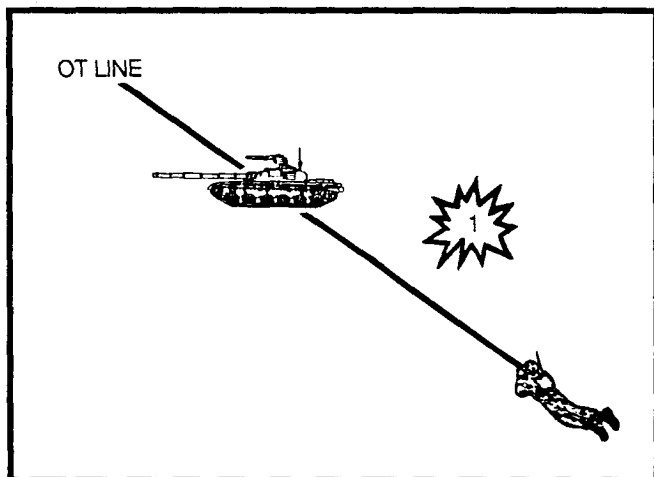
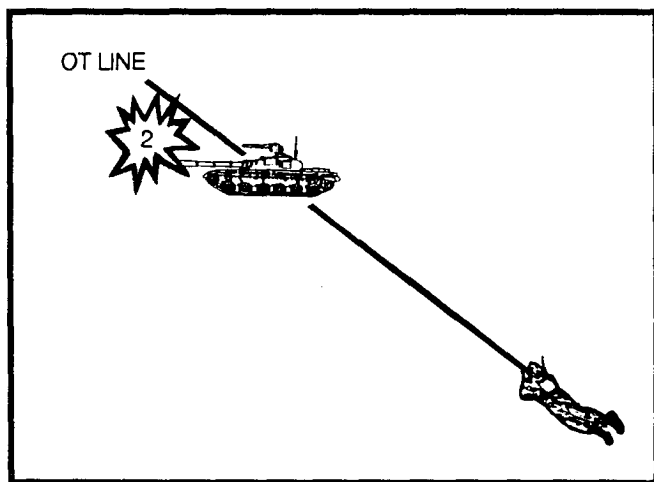
Figure 5-13. **SHORT, 35 RIGHT**Figure 5-14. **OVER, 10 LEFT**

The hasty bracketing technique improves with observer experience and judgment. Each observer must strive to improve his abilities in order to increase responsiveness on the battlefield.

c. One-Round Adjustment. Unlike the preceding two adjustment techniques, this method does not require the establishment of a bracket. The observer spots the location of the first round, calculates and transmits to the FDC the corrections necessary to move the burst of the round to the adjusting point, and fires for effect. This technique requires either an experienced observer or one with accurate distance-measuring equipment such as a laser range finder. All missions conducted by using a G/VLLD should be FFE or one-round adjustments.

d. Creeping Fire (Danger Close). The creeping method of adjustment is used during danger close missions. The observer should make range changes by creeping the rounds to the target, using corrections of 100 meters or less, rather than making large range corrections.

5-7. FIRE FOR EFFECT

The purpose of area fire is to cover the target area with dense fire so that the greatest possible effects on the target can be achieved. The type and amount of ammunition requested by the observer depend on the type of target, its posture, and its activity. Fire for effect is entered during an adjust fire mission when a satisfactory adjustment has been obtained; that is, when the deviation, range, and HOB (if firing fuze time) have been corrected to provide effects on target.

a. Normally, the observer using successive bracketing requests FFE when he splits a 100-meter bracket. Under certain conditions when the PE_r of the weapon is 38 meters or larger, an observer is justified in calling for FFE when a 200-meter bracket is split. (In this situation, the FDC notifies the observer that the PE_r is greater than 38 meters).

b. If time fuze is used, the observer requests **FUZE TIME** after range and deviation have been corrected but before announcing **FIRE FOR EFFECT**. With fuze time, fire for effect is not requested until the HOB is correct or until the observer can compute the correction that should result in the correct HOB. Rules for adjusting fuze time are as discussed below.

(1) In splitting the 100-meter bracket, the correction is **TIME, ADD (or DROP) 50, OVER**. If range and HOB are correct (20 meters above ground), the observer sends **FIRE FOR EFFECT, OVER**.

(2) After **FUZE TIME** is requested, no more range or deviation corrections are sent to the FDC.

(3) If a round with fuze time is spotted as a graze burst and there have been no previous airbursts, the correction is **UP 40, OVER**.

(4) If a round with fuze time is spotted as a graze burst and the observer has spotted a previous airburst, the correction is **UP 20, FIRE FOR EFFECT, OVER**.

(5) If the observer spots an airburst, he should send the correction to achieve a 20-meter HOB and fire for effect. For example, if the HOB of the last round is 40 meters, the correction is **DOWN 20, FIRE FOR EFFECT, OVER**.

(6) Do not fire for effect -

- From a graze burst.
- If the correction is greater than **DOWN 40**.

5-8. REFINEMENT AND SURVEILLANCE

The observer should observe the results of the fire for effect and then take whatever action is necessary to complete the mission. Table 5-2 shows the observer's actions and example transmissions after the FFE rounds have been observed.

Table 5-2. REFINEMENT AND SURVEILLANCE

RESULTS OF FFE	OBSERVER'S ACTIONS	OBSERVER'S TRANSMISSION
Accurate and sufficient	End mission and surveillance	END OF MISSION, RPG SILENCED, OVER.
Accurate and sufficient; replot desired	Request replot, end mission, and surveillance	RECORD AS TARGET, END OF MISSION, BMP NEUTRALIZED, OVER.
Inaccurate and sufficient	Refinement, end mission, and surveillance	RIGHT 20, ADD 20, END OF MISSION, RPG SILENCED, OVER.
Inaccurate, sufficient, target replot desired	Correction, request replot, end mission, and surveillance	RIGHT 10, RECORD AS TARGET, END OF MISSION, BMP NEUTRALIZED, OVER.
Inaccurate and insufficient	Refinement and repeat or reenter adjust fire	RIGHT 10, ADD 50, REPEAT or RIGHT 10, ADD 100, ADJUST FIRE, OVER.
Accurate and insufficient	Repeat	REPEAT, OVER.

Section III
PRECISION FIRE

5-9. TYPES OF PRECISION MISSIONS

Precision fire procedures place a great deal of responsibility on the observer. The two types of precision missions are precision registration and destruction. In precision fire, the adjusting point must be accurately located. An eight-digit grid should be sent for precision missions unless the observer is equipped with a laser range finder, which ensures accurate target location.

NOTE: Precision missions, by their nature, require a high ammunition expenditure and make the firing unit vulnerable to enemy target acquisition.

5-10. PRECISION REGISTRATION MISSION

A registration is conducted with a single piece. Normally, the FDO directs the observer to conduct the registration on a designated point; however, the observer may be directed to select the registration point. The registration point should be accurately located (within 10 meters), near the center of the zone of fire, semipermanent, located on fairly level terrain if possible, and on common survey with the firing unit.

a. Initiation. The precision registration is initiated with a message to observer as shown in the examples on this page.

b. Impact Registration. The objective of a registration is to get spottings of four rounds (two overs and two shorts) along the OT line from rounds fired with the same data or from rounds fired with data 25 meters apart (50 meters apart when PE_r is greater than or equal to 25 meters). Normally, this requires the spottings from four separate rounds. However, a target hit or a round spotted as range correct provides spottings of both over and short. Thus, the objective could be achieved with two consecutive target hits or range correct spottings. Applicable rules and procedures are discussed below.

(1) The observer spots the rounds for deviation to the nearest 1 mil and brings the rounds onto the OT line before splitting a 200-meter bracket. As a rule of thumb, no deviation corrections should be made after a 200-meter bracket has been established. Once the observer brings the rounds onto the OT line, he measures and records

deviation but makes no correction. If a doubtful range spotting is obtained, the observer corrects for deviation only. If a deviation correction is made after a 200-meter bracket is established, the last round fired and all previous rounds cannot be considered as usable rounds for determining range and deviation refinement data.

(2) When the 50-meter range bracket has been established, two rounds are fired with data 25 meters in the direction opposite that of the last range spotting. If both rounds result in spottings of short (or over), an add (or a drop) of 25 meters with a change in volume to one round is sent. Then firing is continued until another definite range spotting is obtained at the opposite end of the 25-meter range bracket.

EXAMPLES

REGISTRATION ON A KNOWN POINT

FDC to FO: **H18 THIS IS H44, REGISTER ON KNOWN POINT 2, QUICK AND TIME', OVER.** (Read back by FO)

FO to FDC: **DIRECTION 6400, OVER.**²
(Read back by FDC)

FDC to FO: **SHOT, OVER.** (Read back by FO)

REGISTRATION POINT SELECTED BY THE OBSERVER

FDC to FO: **H18 THIS IS H44, SELECT REGISTRATION POINT VICINITY GRID NK6138, QUICK AND TIME, OVER.** (Read back by FO)

FO to FDC: **GRID NK61243843³, DIRECTION 6310, OVER.**² (Read back by FDC)

FDC to FO: **SHOT, OVER.** (Read back by FO)

¹The announcement of quick **and** time alerts the observer that impact **and** time portions will be conducted.

²The FO's response to the message to observer indicates that he is ready to observe.

³The FO sends eight-digit grid coordinates for the registration.

(3) When the requirement of two overs and two shorts with the same data or data fired 25 meters apart has been met, the impact registration is ended with necessary refinement data. Refinement data may include either a deviation correction or a range correction, or both, to the nearest 10 meters.

(4) In determining refinement data for range, the location of the registration point is determined with respect to the two sets of spottings. Then refinement data are determined and announced. The criteria for determining range refinement data are discussed below.

(a) If the registration point is nearer the last round(s) fired, **no range refinement** is necessary to move the impact toward the registration point (Figure 5-15).

(b) If the registration point is equidistant between the two sets of rounds, the observer determines the range refinement to be **ADD 10** or **DROP 10** from the last data fired (Figure 5-16).

(c) If the registration point is nearer the pair of rounds at the opposite end of the bracket, the observer determines the range refinement to be **ADD 20** or **DROP 20** (Figure 5-17).

Figure 5-16. DROP 10

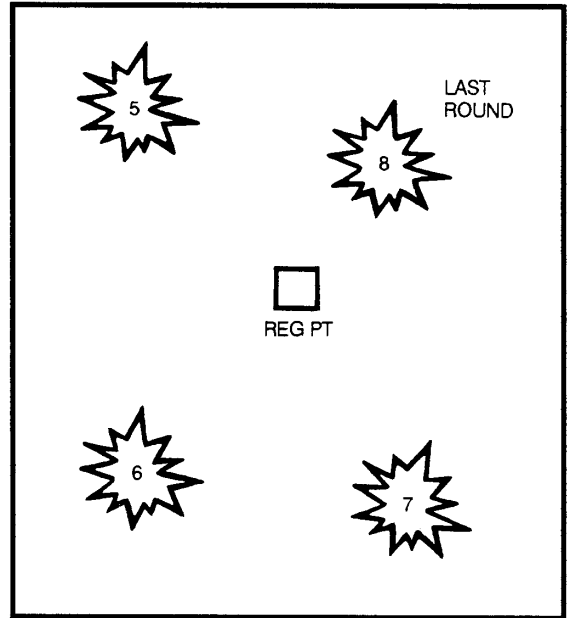

Figure 5-15. NO RANGE REFINEMENT NECESSARY

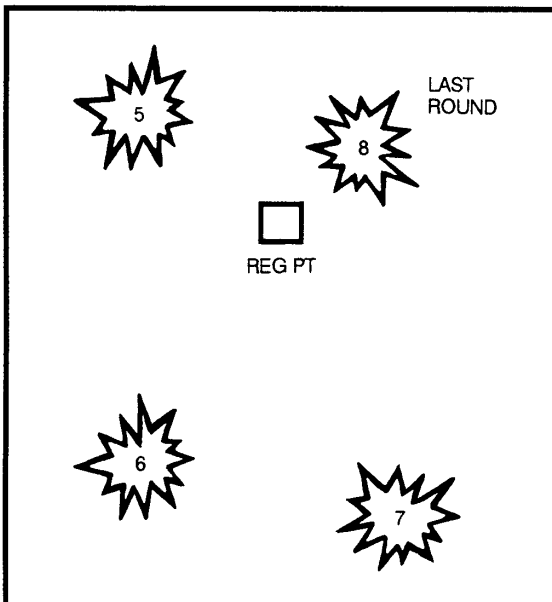
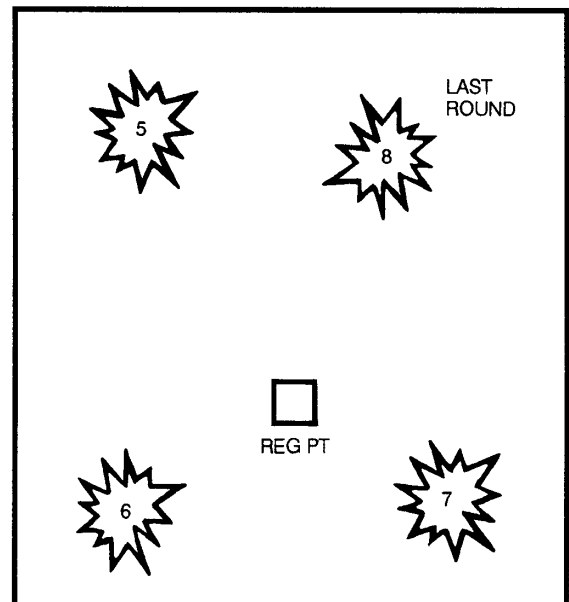

Figure 5-17. DROP 20



(d) The observer must keep track of the rounds and how they are spotted in relation to the registration point. This is most easily done by drawing a picture and numbering the rounds on DA Form 5429-R (Figure 5-18).

(5) Deviation refinement is determined by adding the deviation spottings of the rounds (rds) establishing the two overs and two shorts (this may include two, three, or four deviation spottings). This total is then divided by the number of rounds (two, three, or four) to get an average deviation, which is then expressed to the nearest mil.

average deviation multiplied by the OT factor equals the correction, which is expressed to the nearest 10 meters.

(6) After the impact phase of a registration, the observer transmits refinement data to the FDC (for example, **LEFT 10, DROP 20**). Normally he commands **RECORD AS REGISTRATION POINT**. However, since BCS or BUCS uses only known points, the observer may be required to transmit **RECORD AS KNOWN POINT**. In either case, the FDC must send an MTO assigning a known point number to the registration point.

Figure 5-18. EXAMPLE REGISTRATION DIAGRAM

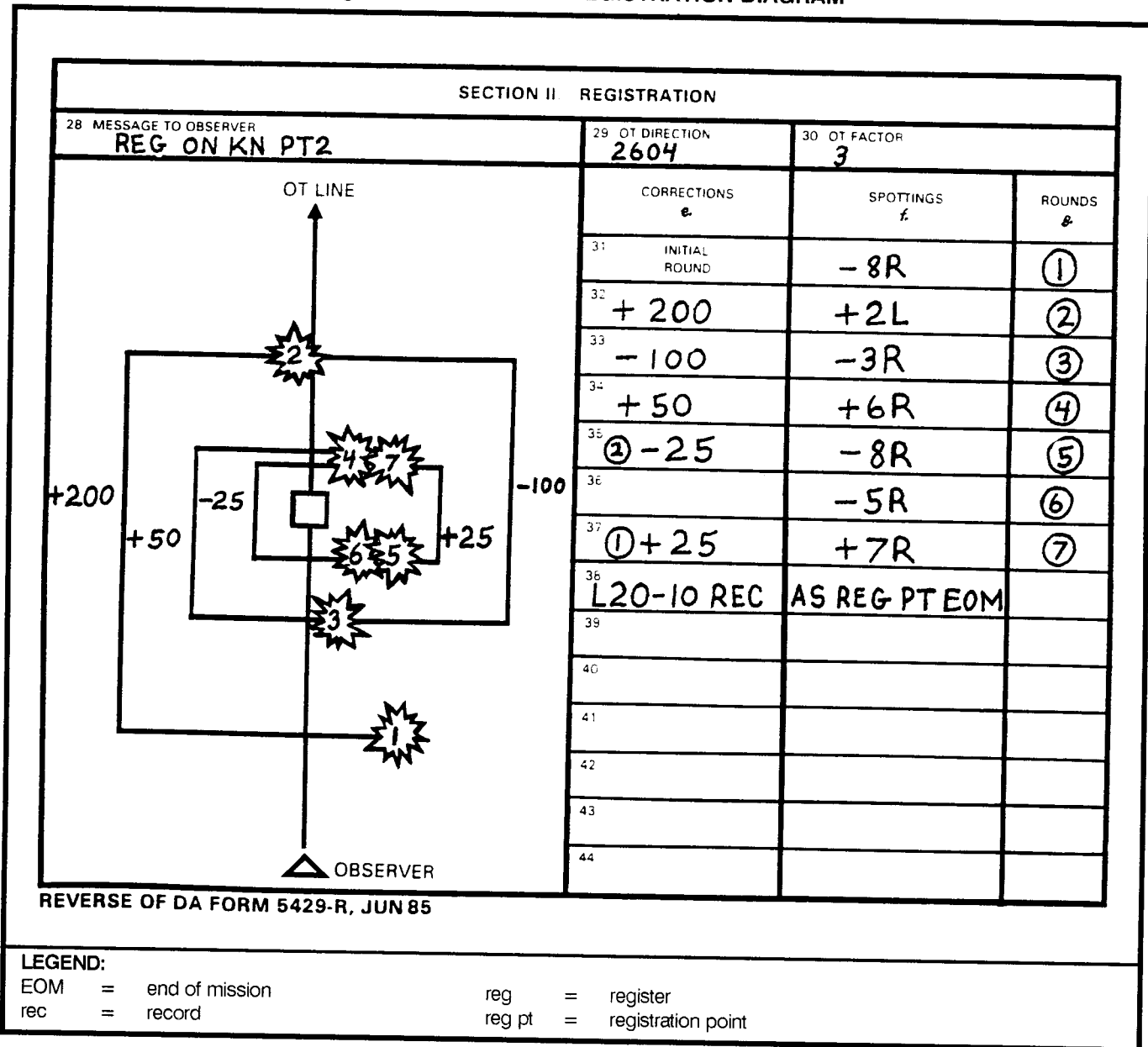

EXAMPLES
OBSERVER DIRECTED TO CONDUCT AN IMPACT
REGISTRATION

NOTE: Refinement data for impact portion were determined by using rounds 4, 5, 6, and 7.

Round	Spotting
1	+6R
2	-8R
3	-5R
4	+7R

Sum of deviations is $6R + 8R + 5R + 7R = 26R$.
Average deviation is $26R \div 4 \text{ rounds} = 6.5R \approx 6R$.
OT factor is 3.
MPI is $3 \times 6R = 18 \text{ meters R} \approx 20 \text{ meters R}$.
Correction is **LEFT 20, DROP 10, RECORD AS REGISTRATION POINT, END OF MISSION, OVER.**

NOTE: Deviation spottings are expressed to the nearest whole number, and deviation refinement corrections are expressed to the nearest 10 meters.

IMPACT REGISTRATION

Round	Spotting
1	Target
2	+7R
3	-3L

Sum of deviations is $0 + 7R + 3L = 4R$.
Average deviation is $4R \div 3 \text{ rounds} = 1.33R \approx 1R$.
OT factor is 2.
MPI is $2 \times 1R = 2 \text{ meters R} \approx 0$ (no deviation correction).
Correction is **ADD 10, RECORD AS REGISTRATION POINT.**

c. Mortar Registration. Precision registration procedures for mortars are identical to the impact registration procedures for artillery. The exception is that once a 100-meter range bracket has been split and the last fired round is within 50 meters of the target, refinement corrections are sent to the FDC and the mission is ended. Range corrections are made to the nearest 25 meters. Also, only one round over and one round short are required. An example of the last two transmissions to the FDC appear in Figure 5-19.

d. Adjusting the Sheaf for Mortars. One additional step that is not done for artillery but may be required for mortars is adjusting the sheaf. This may be done anytime during a fire mission but maybe directed by the FDC after

Figure 5-19. MORTAR REGISTRATION

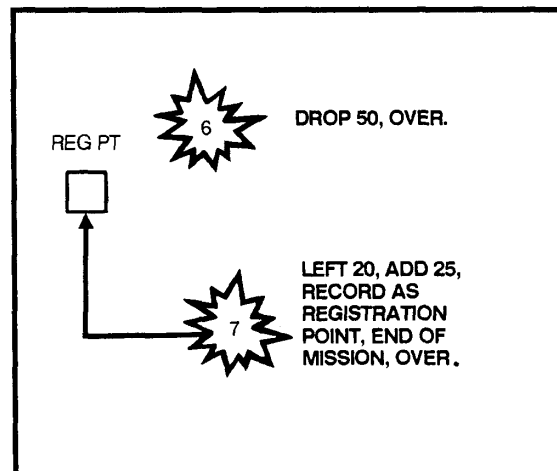

a registration. If so, the FDC will send **PREPARE TO ADJUST THE SHEAF, OVER.** The purpose of adjusting the sheaf is to get all mortars firing parallel. The mortars will be positioned with tubes numbered 1 through 4 for an 81-mm platoon from right to left as seen from behind the tubes. For a 107-mm mortar platoon, the tubes will be numbered 1 through 6 when employed as a platoon or 1 through 3 when employed by sections. A 60-mm mortar platoon has two tubes,

(1) To start adjustment of the sheaf, the observer requests **SECTION RIGHT (or LEFT) REPEAT, OVER.** The entire section will then fire, in order, starting at the right (or left), with 10-second intervals between rounds. The mortar that was used to register will not fire. If the observer requests **SECTION RIGHT, REPEAT, OVER** for a 107-mm section, Numbers 1 and 3 will fire (in that order). (Number 2 conducted the registration.)

(2) To adjust the sheaf, all rounds must be adjusted on line at approximately the same range (within 50 meters) and with 40 meters lateral spread between rounds. In adjusting the sheaf, range corrections for rounds impacting within 50 meters of the sheaf are ignored. The sheaf is adjusted perpendicular to the gun-target line. (If angle T is greater than 500 mils each piece is adjusted onto the registration point and the FDC computes data for the sheaf.) Lateral refinement corrections are made to the nearest 10 meters, but corrections less than 50 meters are not fired. Once refinement corrections for all mortars have been determined, the sheaf is adjusted. An adjusted sheaf for an 81-mm section is shown in Figure 5-20.

Figure 5-20. ADJUSTED MORTAR SHEAF

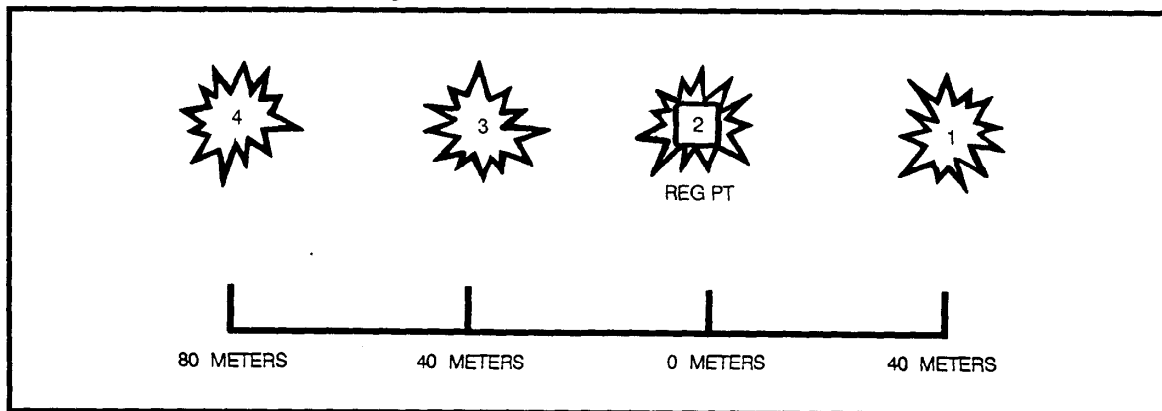

EXAMPLE

The sheaf of an 81-mm section is being adjusted. Number 2 conducted the registration. The observer has requested **SECTION RIGHT, REPEAT, OVER**. The rounds fired impact as shown in Figure 5-21.

All rounds are within 50 meters of the correct range. Only Number 3 is more than 50 meters out in lateral adjustment, so the adjustment for Number 3 is sent first. Then the refinement data for Numbers 1 and 4 are sent as follows: **NUMBER 3, RIGHT 60, REPEAT; NUMBER 1, RIGHT 30, NUMBER 4 IS ADJUSTED; NUMBER 4, LEFT 20, NUMBER 4 IS ADJUSTED, OVER.**

Number 3 is now fired, and the round impacts 10 meters right of the desired burst location as indicated in Figure 5-22. The observer then sends **NUMBER 3, LEFT 10, NUMBER 3 IS ADJUSTED, SHEAF IS ADJUSTED, END OF MISSION, OVER.**

e. Time Registration. If a time registration is required after the impact registration has been completed, the observer determines and announces refinement data and commands the time registration to be fired; for example, **RIGHT 10, ADD 10, RECORD AS REGISTRATION POINT, TIME, REPEAT, OVER.**

NOTE: Mortars do not conduct time registration.

(1) The objective of the time portion of the precision registration is to correct the mean HOB of four rounds

fired with the same data to 20 meters above the registration point. If the first round is a graze burst, a correction of **UP 40** is given. Once a measurable airburst has been obtained, the command is **3 ROUNDS REPEAT**. When four rounds have been fired with the same data, the registration is ended with the appropriate correction to achieve a 20-meter HOB.

(2) When four airbursts are spotted, the HOB is corrected to 20 meters. The mean HOB is determined by adding the four spottings (in mils), dividing by 4, expressing the sum to the nearest mil, and then multiplying by the OT factor. (This is the same technique used in determining deviation corrections.) The sum is then expressed to the nearest 5 meters, and the appropriate correction is determined to achieve the desired 20-meter HOB. For example, **UP 10, RECORD AS TIME REGISTRATION POINT, END OF MISSION, OVER.**

(3) When three airbursts and one graze burst are spotted, the HOB is correct; and no correction is required.

(4) With two airbursts and two graze bursts, the HOB correction sent is **UP 10**.

(5) With one airburst and three graze bursts, the HOB correction sent is **UP 20**.

(6) Check rounds may be fired to verify the validity of the time registration; however, they are not necessary. If the first airburst is extremely high, the observer may make a down correction and fire one round. If that round is at a measurable HOB, he can then fire the additional three rounds.

Figure 5-21. SECTION RIGHT, REPEAT

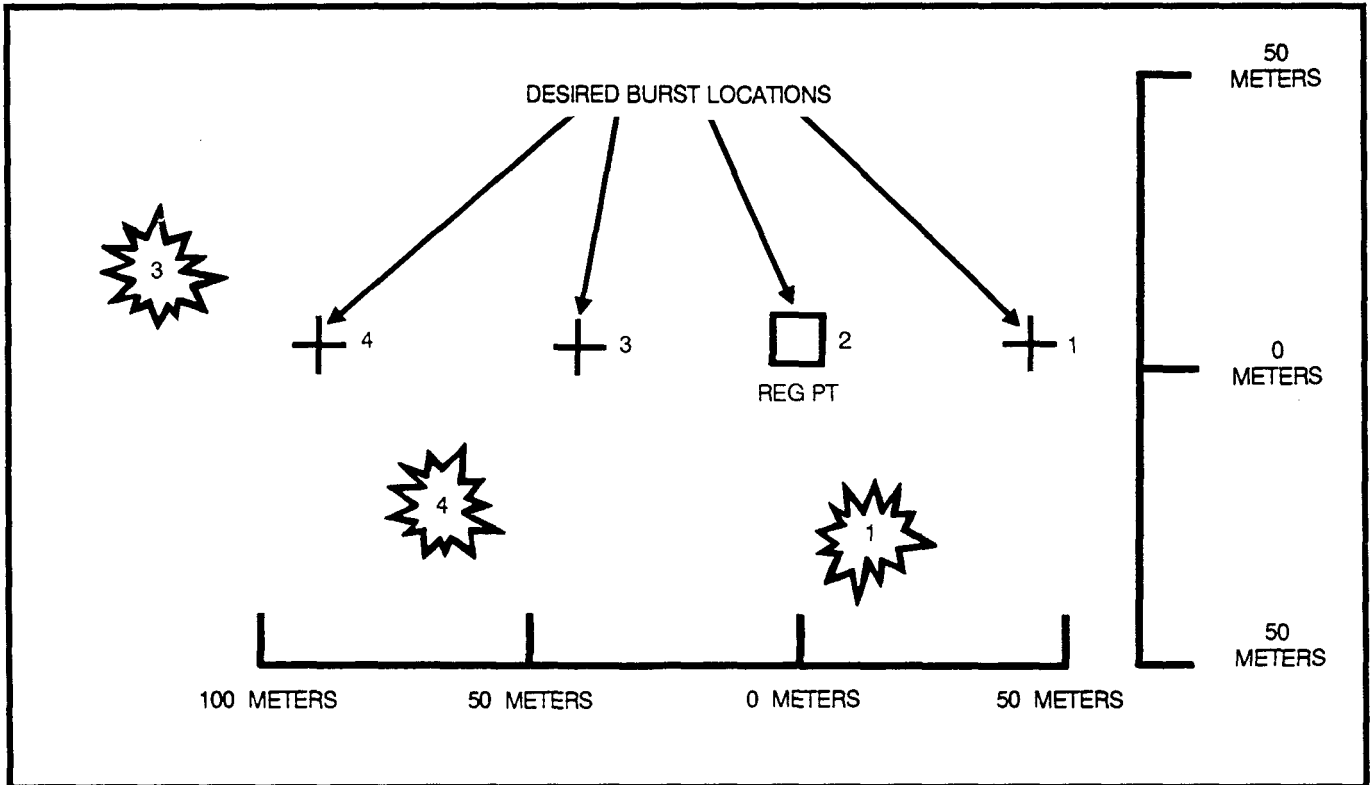
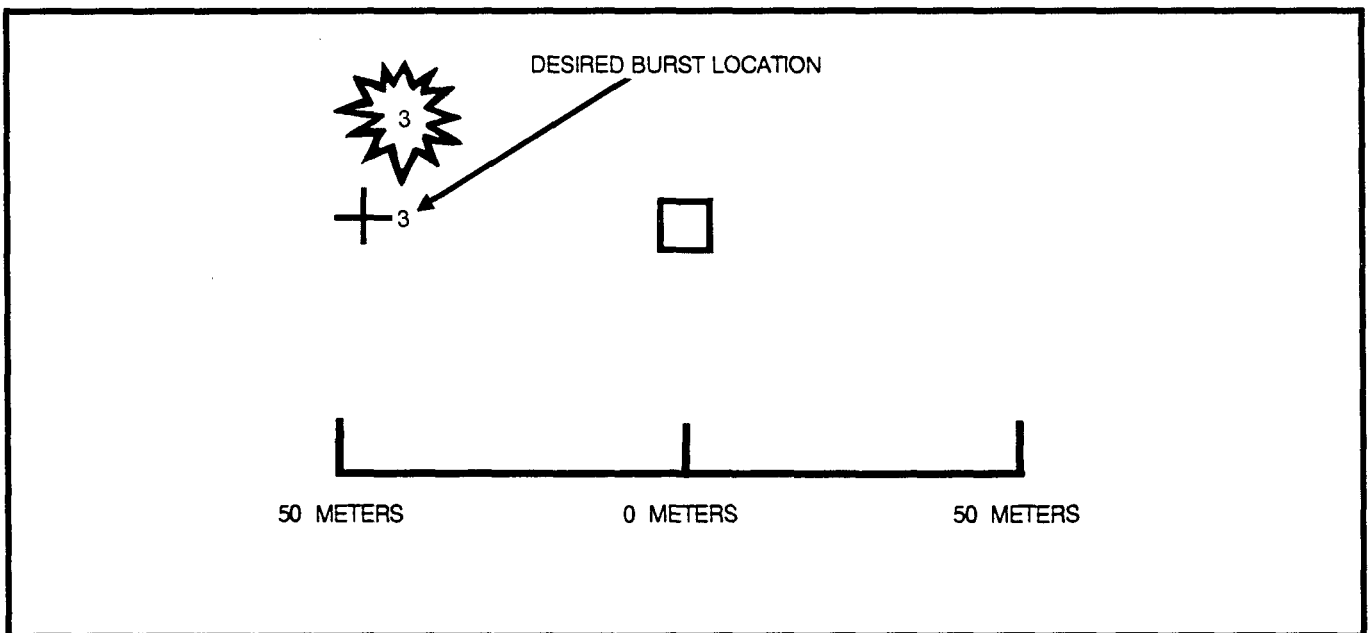

Figure 5-22. NUMBER 3 IS ADJUSTED



EXAMPLE

QUICK AND TIME REGISTRATION (FIGURE 5-23)

Refinement data for the impact portion were determined by using rounds 5, 6, 7, and 8.

Sum of deviation spottings is $6R + 0 + 4R + 2R = 12R$.

Average deviation is $12R \div 4 = 3R$.

OT factor is 3.

MPI is $3 \times 3R = 9$ meters $R \approx 10$ meters R.

The registration point is nearer the pair of rounds at the opposite end of the bracket from the last round fired.

Correction is **LEFT 10, DROP 20, RECORD AS REGISTRATION POINT, TIME REPEAT, OVER.**

Refinement data for the time portion were determined by using rounds 9, 10, 11, and 12.

Sum of HOB spottings is as follows:

$AIR 5 + AIR 6 + AIR 3 + AIR 5 = AIR 19$.

Average HOB is $AIR 19 \div 4 = AIR 4.75 \approx AIR 5$.

OT factor is 3.

Mean HOB is $3 \times AIR 5 = AIR 15$ meters.

Correction is **UP 5, RECORD AS TIME REGISTRATION POINT, END OF MISSION, OVER.**

Summary of airbursts and fuze corrections for four rounds is as follows:

All graze = **UP 40.**

Three graze and one air = **UP 20.**

Two graze and two air = **UP 10.**

One graze and three air = no correction.

No graze and all air = must measure to ensure 20-meter HOB.

Figure 5-23. QUICK AND TIME REGISTRATION

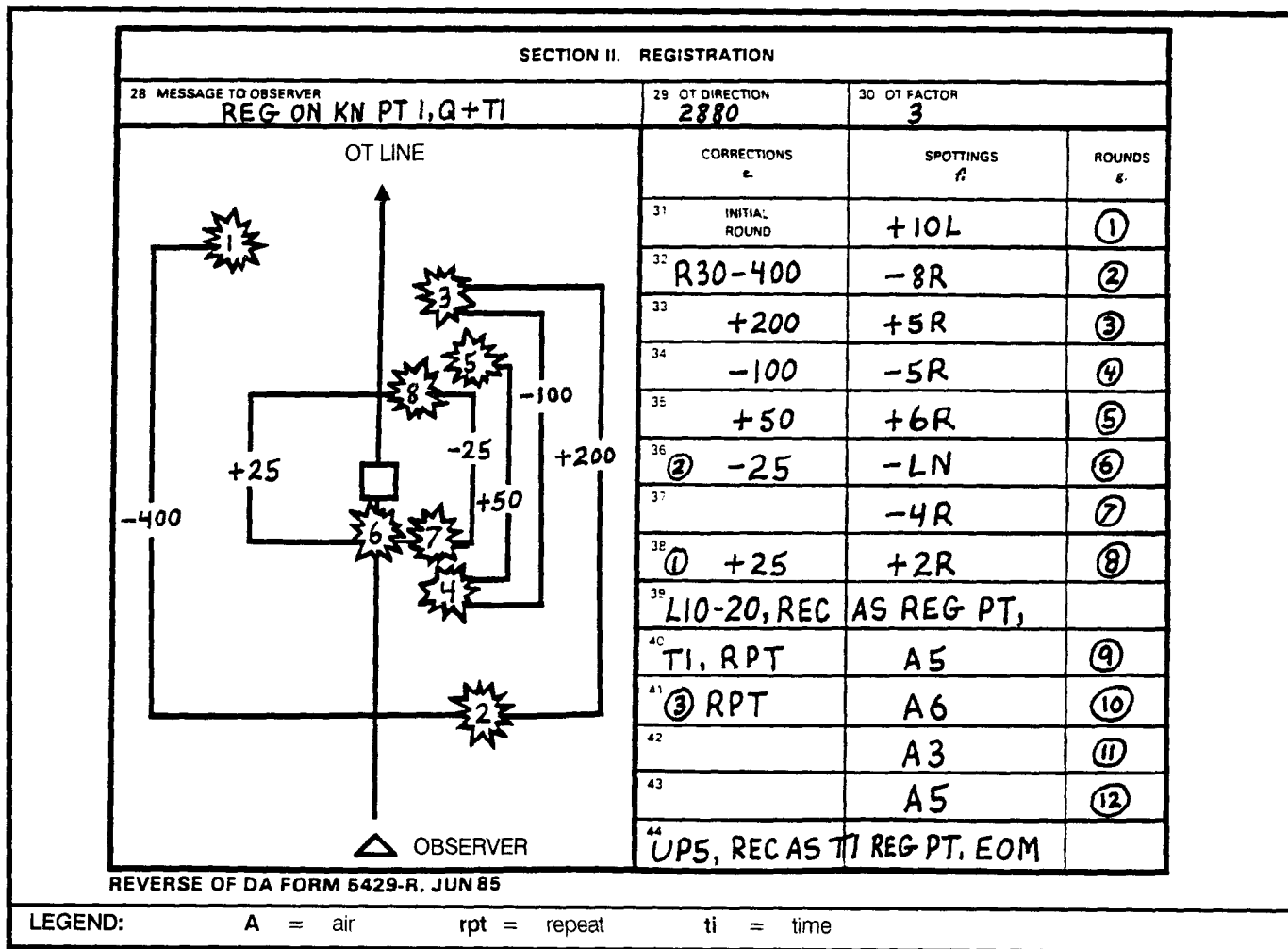

EXAMPLE

QUICK AND TIME REGISTRATION-RANGE CORRECT (RC) SPOTTING (FIGURE 5-24)

Refinement data for the impact portion were determined by using rounds 4, 5, and 6.
 Sum of deviation spottings is $1R + 3L + 2L = 4L$.
 Average deviation is $4L \div 3 = 1.33L \approx 1L$.
 OT factor is 3.
 MPI is $3 \times 1L = 3$ meters $L \approx 0$ meters
 The registration point is nearer the last round fired.

Correction is **RECORD AS REGISTRATION POINT, TIME REPEAT, OVER.**
 Refinement data for the time portion were determined by using rounds 7, 8, 9, and 10.
 The time portion spottings were 3 AIR and 1 GRAZE (G).
 Correction is **RECORD AS TIME REGISTRATION POINT, END OF MISSION, OVER.**

Figure 5-24. QUICK AND TIME REGISTRATION-RANGE CORRECT SPOTTING

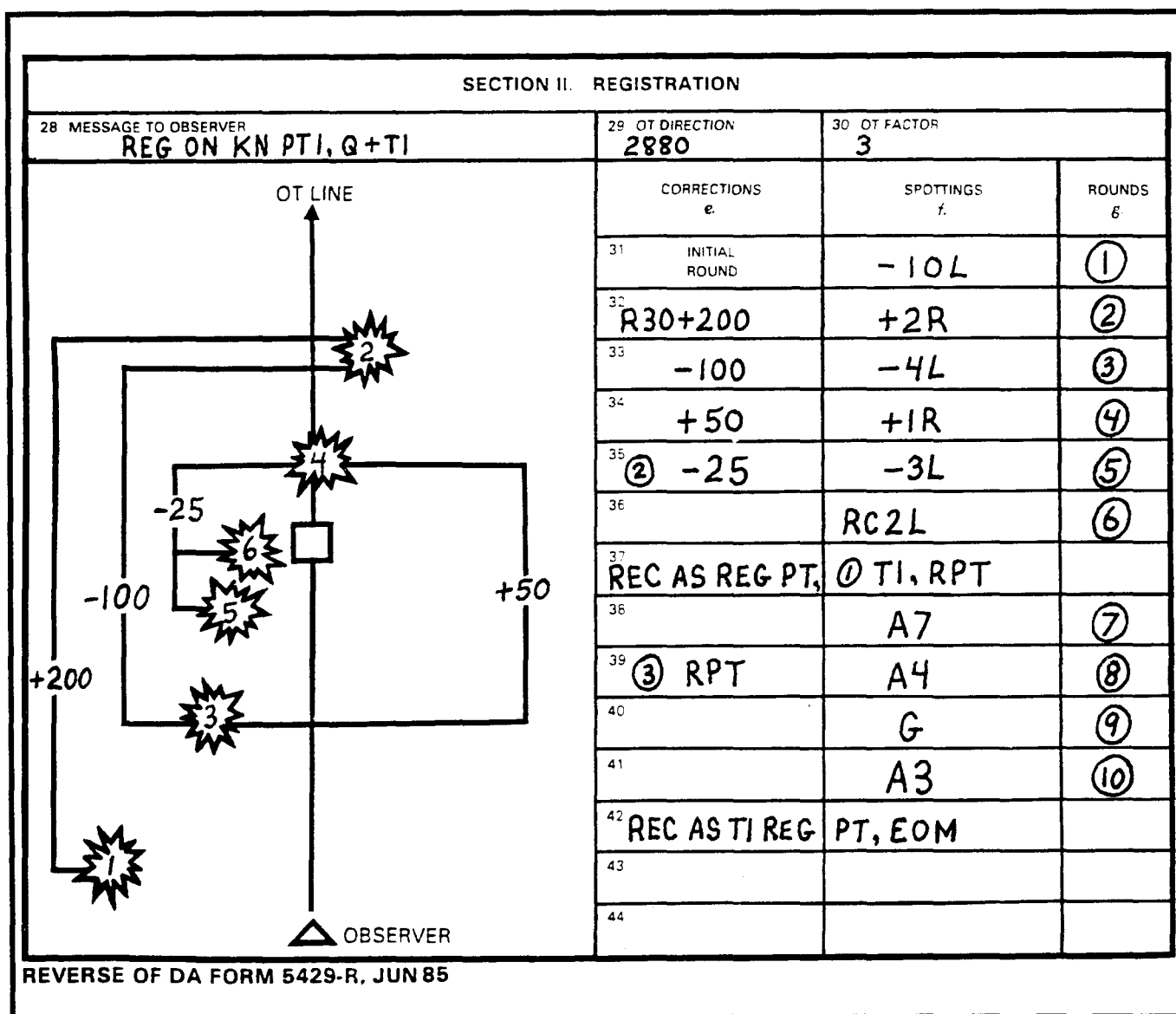

EXAMPLE

QUICK AND TIME REGISTRATION DURING ADJUSTMENT (FIGURE 5-25)

Refinement data for the impact portion were determined by using rounds 4, 6, 7, and 8.
 Sum of deviation spottings is $4R + 1L + 5R + 1R = 9R$.
 Average deviation is $9R \div 4 = 2.25R = 2R$.
 OT factor is 4.
 MPI is $4 \times 2R = 8$ meters R = 10 meters R.
 The registration point is equidistant between the two pairs of rounds.

Correction is **LEFT 10, ADD 10, RECORD AS REGISTRATION POINT, TIME, REPEAT, OVER.**

Refinement data for the time portion were determined by using rounds 9, 10, 11, and 12.
 Spottings were 2 AIR and 2 GRAZE.
 Correction is **UP 10, RECORD AS TIME REGISTRATION POINT, END OF MISSION.**

Figure 5-25. QUICK AND TIME REGISTRATION DURING ADJUSTMENT

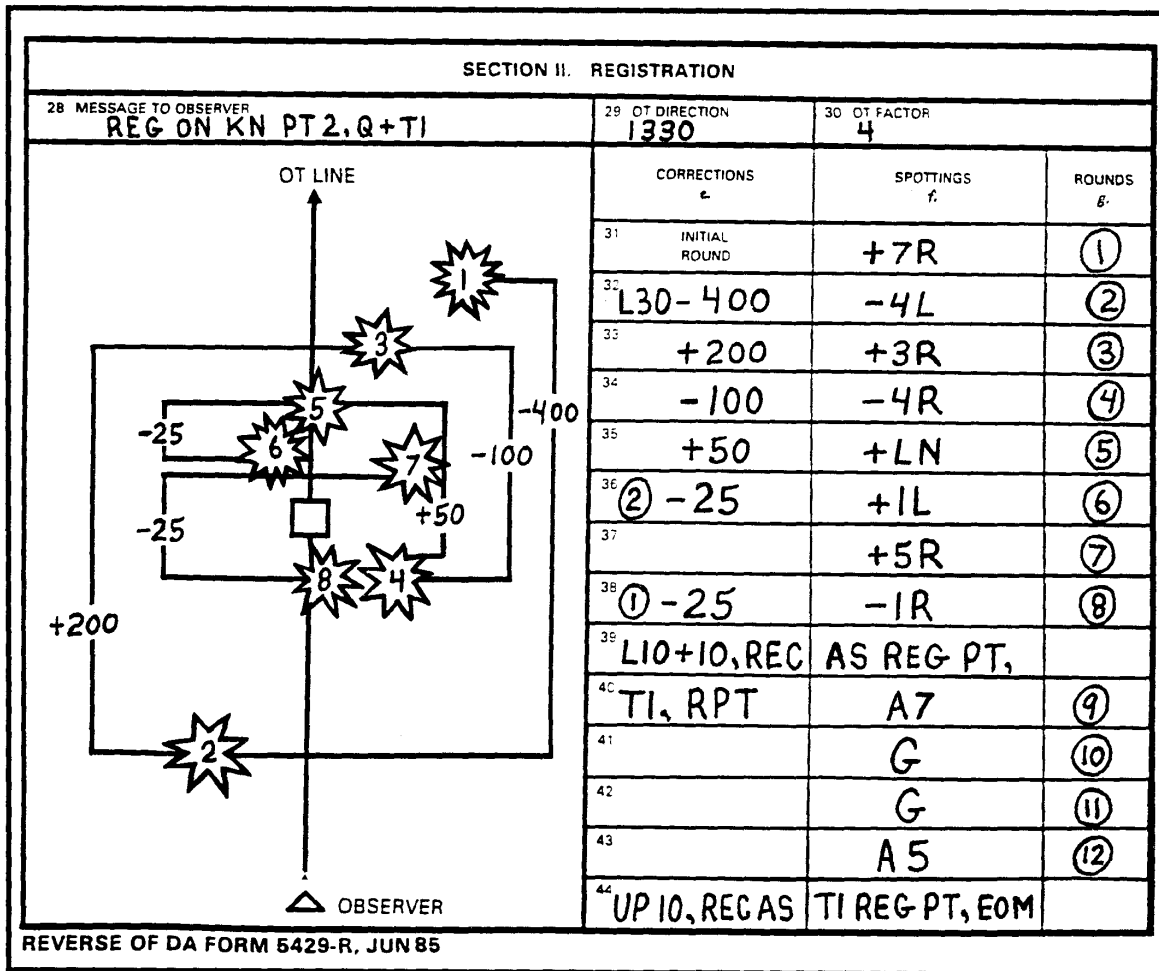

f. Second-Lot Registrations. Second-lot registrations are conducted in much the same manner as are first-lot (single) registrations. After the first-lot impact registration has been completed, a time registration is conducted, if required. The FDC must announce to the observer **OBSERVE SECOND-LOT REGISTRATION**. The observer must reestablish the appropriate range bracket and complete the second-lot registration by using the same procedures as for the first lot. The time portion of the registration is not fired with the second lot.

EXAMPLE

MESSAGE TO OBSERVER FOR A TWO-LOT
REGISTRATION

FDC to FO: **H18 THIS IS H44, REGISTER ON
KNOWN POINT 2, QUICK AND TIME,
2 LOTS, OVER.** (Read back by FO)

AT COMPLETION OF FIRST-LOT REGISTRATION

FO to FDC: **RECORD AS TIME REGISTRATION
POINT, OVER.** (Read back by FDC)

FDC to FO: **OBSERVE SECOND-LOT
REGISTRATION, OVER.**

g. Abbreviated Precision Registration.

(1) At times, the tactical situation or ammunition constraints may prohibit conduct of a full-scale precision registration. Although not as accurate, an abbreviated (abbr) precision registration (Figure 5-26) can provide adequate corrections for the effects of nonstandard conditions. The decision to conduct an abbreviated registration rests with the FDC. For this type of registration, the observer merely shortens the standard procedures.

(a) Normal adjust fire procedures are followed until a 100-meter bracket is split.

(b) The correction then sent is **ADD (or DROP) 50 METERS**.

(c) The burst which is a result of this correction is spotted, and minor corrections for both deviation and range are sent to the FDC in the following format:

- For both impact and time portion registration **LEFT 10, DROP 40, RECORD AS REGISTRATION POINT, TIME, REPEAT, OVER.**
- For an impact only registration **RIGHT 30, DROP 10, RECORD AS REGISTRATION POINT, END OF MISSION, OVER.**

(d) Normal adjust fire, time adjustment procedures are followed in the time portion:

- An airburst is obtained and then corrected to a 20-meter HOB.
- Instead of firing additional rounds, refinement is sent to the FDC in the following format: **UP 10, RECORD AS TIME REGISTRATION POINT, END OF MISSION, OVER.**

(2) Abbreviated registrations are much more accurate and therefore more feasible if the observer is equipped with a G/VLLD.

5-11. DESTRUCTION MISSION

a. In a destruction mission, one weapon is freed to destroy a point target. It is similar to a registration in that the

observer continues adjustments to establish a 25-meter bracket. Once it is established, the observer splits the 25-meter bracket by adding or dropping 10 meters and continues to fire additional rounds. After every third round, an additional refinement is made, and firing is continued until the target is destroyed or the mission is ended. (The observer may make corrections after each round.) For example, the FO makes his refinement as shown in Figure 5-27. The OT factor is 2.

b. Because of the amount of time and ammunition required, destruction missions should be avoided. Only a target that is critical to support a maneuver operation should be engaged in this manner and only if the target cannot be engaged with Copperhead.

Figure 5-26. ABBREVIATED PRECISION REGISTRATION

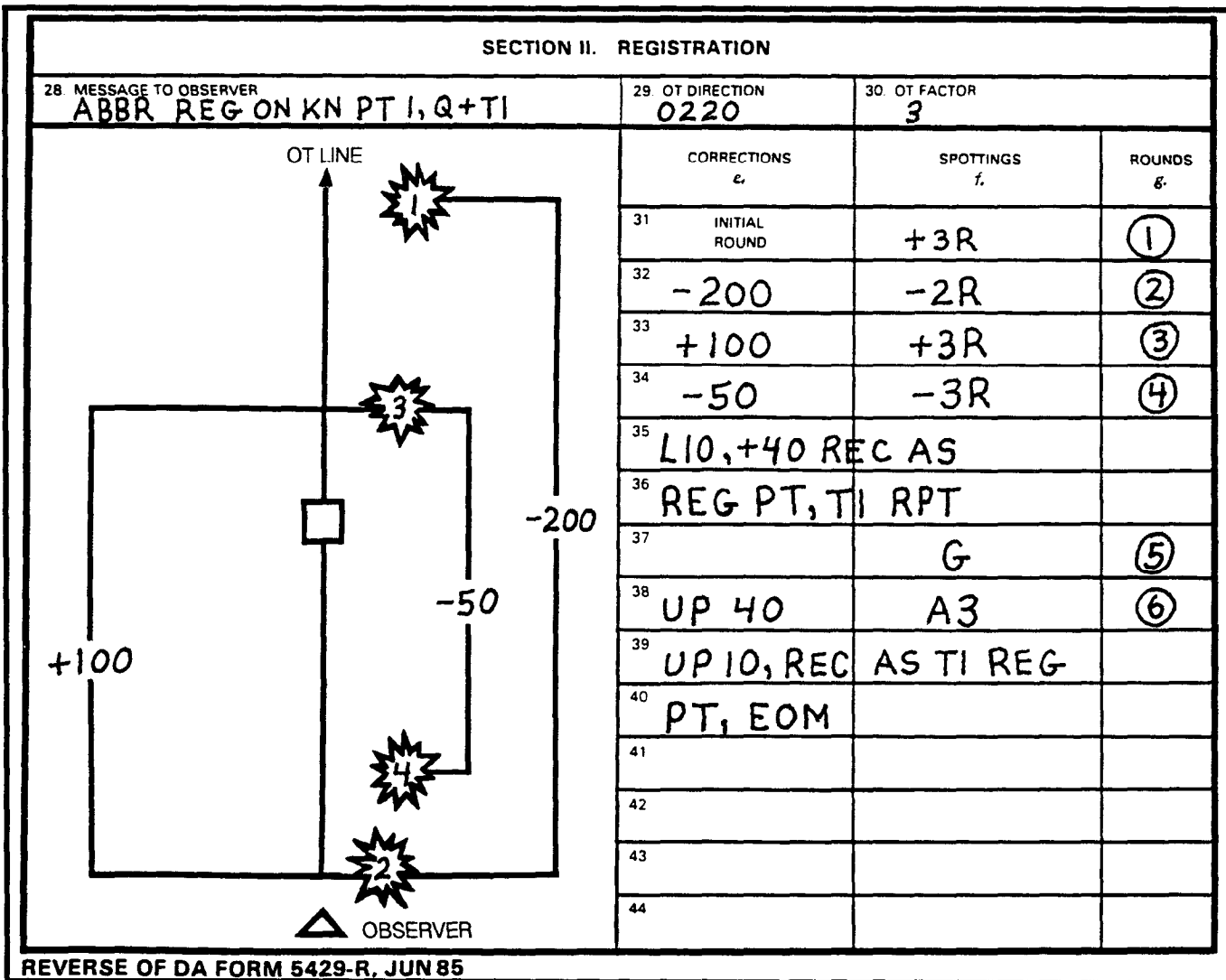

REVERSE OF DA FORM 5429-R, JUN 85

Figure 5-27. DESTRUCTION MISSION

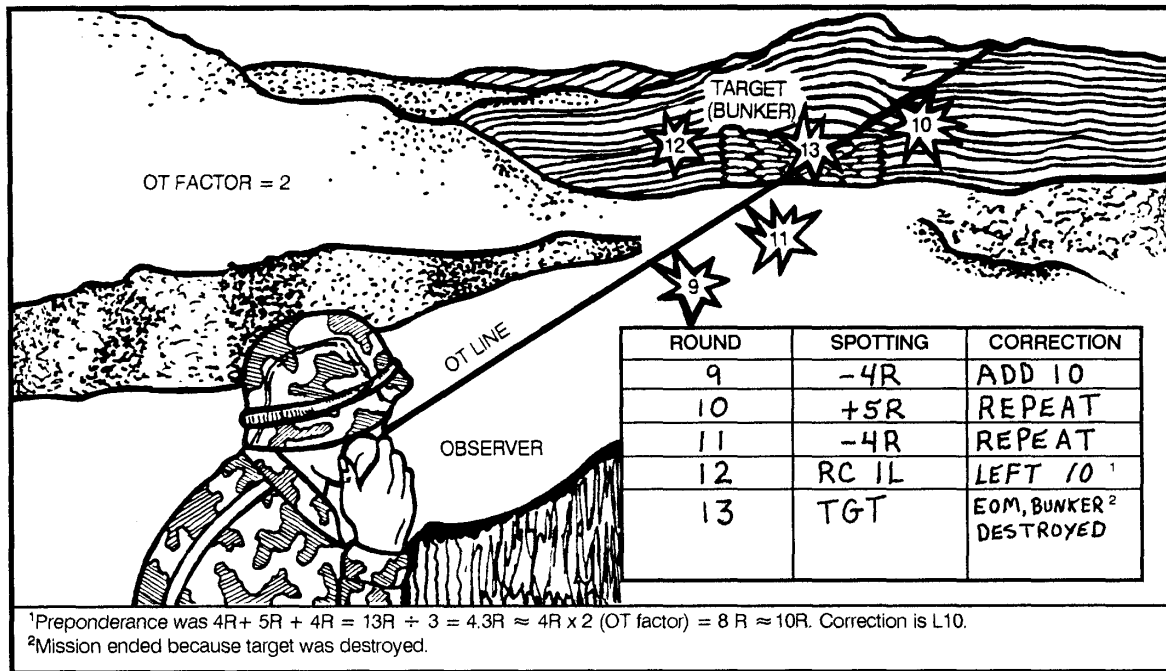

Section IV MOVING TARGETS

5-12. ENGAGEMENT

Targets, both planned and opportunity, will often move on the battlefield or begin to move after being engaged during adjustment or FFE. Realistically, targets will not remain stationary for long periods of time. Therefore, observers must be proficient at engaging moving targets. For engagement of targets of opportunity, see paragraph 5-13. For engagement of planned targets, see paragraph 5-14. For engagement of moving targets with Copperhead, see Chapter 6, Section V.

5-13. TARGET OF OPPORTUNITY

A target of opportunity is a target that appears during combat and against which no attack has been prearranged. These targets are expected to be more frequent in highly

mobile situations. Requesting fire against a stationary target is a simple matter. The observer determines the target location and sends the call for fire. Requesting fire against a moving target is more complex. The observer must call for fire by using a grid in front of and on the intended path of the vehicle or vehicles and timed so that the rounds and the vehicle(s) arrive at the desired location at the same time.

a. Intercept Point. The point or grid at which the observer wants to engage the moving target is called the intercept point. To predict the intercept point, the observer takes the actions discussed below.

(1) He determines the moving target direction and speed of travel. After acquiring the target, the observer tracks it until he is sure of the direction in which it is

moving. As the target moves from point A to point B (Figure 5-28), the observer can use one of three methods to determine its speed.

(a) First, he can estimate the speed as follows:

- Slow - 3 meters per second (7 miles per hour [mph]).
- Medium - 5 meters per second (11 mph).
- Fast - 8 meters per second (18 mph).

(b) Second, he can use the G/VLLD to measure the distance the target moves during a certain time interval. As the target moves, the operator lases it and converts the polar data to grid locations, points A and B. Then he determines how far the target moved by measuring the distance between points A and B and rounding to the nearest 1 meter. He divides the distance traveled by the time interval between points A and B to determine the target speed in meters per second.

(c) Third, the observer can use the reticle pattern in the standard binoculars or the AN/GVS-5 to measure the distance the target moves during a certain time interval. As the target moves across the reticle pattern, the observer measures the number of mils traveled to the nearest 5 mils. He multiplies that number by the OT factor to convert the distance traveled by the target to meters. He divides the distance traveled by the time interval to determine the target speed, in meters per second, and then rounds to the nearest 1 meter.

NOTE: The observer can also designate, by using the G/VLLD, binoculars, or AN/GVS-5, a distance on the ground; for example, 100 meters. He then times how long the target takes to travel that distance and divides that distance by the time interval.

(2) Once the speed and direction are determined, the observer must predict the intercept point. To do this, he first gathers and adds the following information:

- Total processing time (observer, FDC, and gun times).
- Time of flight.

He then multiplies that sum by the target speed. The product is the minimum distance to plot the intercept point in front of the moving target in the direction it is traveling. So the target will not pass the intercept point before the round impacts, the observer must plot the intercept point distance well ahead of the moving target to allow himself enough time to get the grid and prepare his call for fire. Experience dictates how far ahead of the target to plot the intercept point. An untrained observer should add to the

intercept distance half the distance determined to allow enough time. More time is better than not enough time. To simplify plotting, the observer can round up the intercept distance to the nearest 100 meters.

NOTE. If, through experience, the observer knows how long it will take the firing unit to be ready to fire the mission, he should use that time. If not, he should use 200 seconds as the time from the initiation of the call for fire to round impact. He converts this time to distance, in meters, and applies the distance in the direction of movement to determine an intercept point as explained above.

EXAMPLE

The distance measured between points A and B by using the G/VLLD is 50 meters.
 The time interval between A and B is 10 seconds.
 Speed of the target is 50 meters in 10 seconds, or 5 meters per second.
 Total processing time is 180 seconds (3 minutes).
 Time of flight is 20 seconds.
 The distance at which to plot the intercept point is 5 meters per second x 200 seconds, or 1,000 meters. (See Figure 5-28).

NOTE: Minutes must be converted to seconds for this to work.

Figure 5-28. DETERMINING THE INTERCEPT POINT

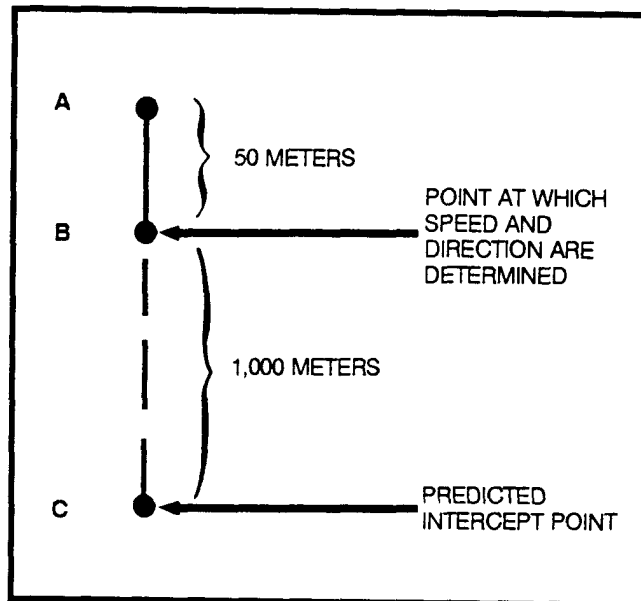

(3) Given the above example, the intercept point must be at least 1,000 meters in front of the target along the intended path of the target. The method of control should be observer control (at my command). The intercept point grid is then used in the call for fire as the target location.

b. Trigger Point. Once the intercept point is determined and the mission is sent to the firing unit, the observer must determine a point at which to "pull the trigger." This trigger point tells the unit when to fire. This point is determined to ensure the rounds and target arrive at the intercept point at the same time. Ideally, the trigger point will be an easily identifiable point. When the target passes over or near the trigger point, the observer commands the guns to fire.

(1) In choosing a trigger point, the observer must consider the intended path of the target, target speed, time of flight (TOF), and CFF transmission time. If it is a Copperhead mission, the size and shape of the footprint are also considered.

(a) The first step is to determine the distance from the planned target location or intercept point to the trigger point. This is done by adding the transmission time (an average of 5 seconds) to the time of flight received in the MTO and multiplying this sum by the speed of the target.

EXAMPLE

Time of flight is 20 seconds.
 Target speed is 5 meters per second.
 Distance to trigger point = (transmission time + TOF) x target speed, or (5 seconds + 20 seconds) x 5 meters per second = 125 meters.

(b) The trigger point is then plotted by measuring the distance determined above from the planned target location or intercept point along the intended path toward the moving target (Figure 5-29).

(2) If the target passes the trigger point before the battery reports **READY**, the observer should make a bold shift to a new target location by using the same trigger point and intercept distances. A grid for the new location should be sent to the FDC immediately.

(3) If the observer does not intend to request **AT MY COMMAND** or **BY ROUND AT MY COMMAND**, the trigger point becomes the point at which he initiates his call for fire. In this case, mission reaction time must be included in determining the distance to the trigger point. Normal mission reaction times are as follows:

- Priority targets — 30 to 60 seconds (plus time of flight).

- On-call targets — 90 to 120 seconds (plus time Of flight).
- Targets of opportunity — 150 to 180 seconds (plus time of flight).

Figure 5-29. DETERMINING THE TRIGGER POINT

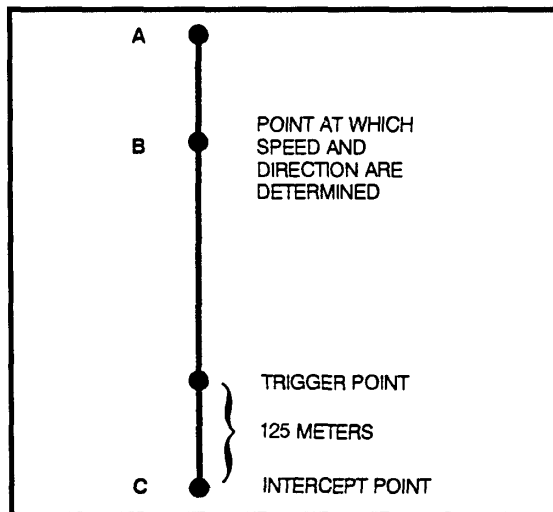

5-14. PLANNED TARGET

A planned target is a target upon which fires are prearranged. The degree of prearrangement varies, but some prior coordination of action is done to facilitate engagement. Planned targets may be further subdivided into scheduled on-call and priority targets. For more detailed information on planned targets, see FM 6-20-40 and FM 6-20-50.

a. Engaging planned moving targets is basically the same as explained above for engaging targets of opportunity. However, a moving target may change its direction of travel and not travel over the initially planned intercept point. In this case, the observer must select a new intercept point and trigger point and engage the target as a target of opportunity by using the procedures in paragraph 5-13.

b. The planned target location will be the intercept point. As soon as the observer sees the vehicles to be engaged, he must verify their direction and speed of travel and confirm his intercept and trigger point distances by using the procedures in paragraph 5-13. The planned intercept point and trigger point may not allow enough time for total processing time plus time of flight. Then, the observer must determine a new intercept point and a new trigger point and engage the target as a target of opportunity by using the procedures in paragraph 5-13.

HELPFUL NOTES FOR THE OBSERVER

1. Often, initial rounds can be located more quickly with the naked eye than with field glasses. The spotting should be instantaneous and the correction sent immediately to the FDC.
2. For observers who wear glasses, the protective plastic lens cap on the binoculars can be removed to increase the field of vision. Masking tape can be used on the metal retaining ring to prevent scratching the glasses.
3. The diopter adjustment ring can be taped in the correct position so that the observer does not have to adjust the diopter setting every time he uses his binoculars.
4. For adjust fire missions, angular deviations measured with the binoculars are measured to the nearest 5 mils for deviation and 1 mil for HOB.
5. The observer should memorize the width (in mils) of his fingers and hand. Then, when shifts of 100 mils or more are required, he can use his hand instead of binoculars for determining shifts to place fire in the vicinity of the adjusting point as quickly as possible.
6. The OT factor must be applied to obtain corrections for HOB as well as for deviation.
7. A good terrain sketch provides an observer direction and a means for making a good terrain-map association.
8. An observer can use the direction and flash-to-bang time of an impacting round to determine its approximate grid location.
9. The observer must take immediate action if communications equipment is not working properly.
10. The importance of accurate initial fires (fire for effect) cannot be overemphasized. The enemy will change posture (dig in or move) if he knows that he is being fired upon.
11. A sketch is a must in determining usable rounds on a precision registration.
12. The OP is not the place to learn procedures for conduct of fire. All procedures should be learned before going to the OP.

CHAPTER 6 SPECIAL MUNITIONS

Section I IMPROVED CONVENTIONAL MUNITIONS AND DUAL-PURPOSE IMPROVED CONVENTIONAL MUNITIONS

6-1. CHARACTERISTICS OF ICM AND DPICM

Improved conventional munitions are base-ejection projectiles that consist of a mechanical time fuze and a body assembly containing a number of submunitions. There are two types of ICM rounds: the antipersonnel (AP) round and the dual-purpose (DP) round.

a. The AP round is most effective against unwarned, exposed personnel. When the fuze functions, a black powder expelling charge forces the grenades out through the base of the projectile. Small vanes on the grenade flip upward, arming the grenade and stabilizing it in flight. When the striker plate (on the base of the grenade) contacts the ground, the grenade is hurled upward 4 to 6 feet and then detonates.

b. The DP round is most effective against lightly armored vehicles and other materiel. However, it is also effective against personnel. After the grenade is ejected, a ribbon streamer arms and stabilizes it. Upon impact, a shaped

charge that can pierce light armor is detonated. Also, fragments which are effective against personnel are expelled.

c. Table 6-1 shows the number of grenades in the various ICM rounds.

6-2. CALL FOR FIRE AND ADJUSTMENT

The call for fire for ICM is the same as any call for fire. The observer identifies which type of ICM he wants to be fired in effect by referring to antipersonnel ICM as APICM and to DPICM as ICM. Procedures for the adjustment of ICM are similar to those for a normal HE adjustment. Exceptions are discussed below.

a. **Range and Deviation.** Because of the size of the effects pattern, deviation shifts of less than 50 meters and range corrections of less than 100 meters should not be made. Normal range and deviation corrections are used when adjusting DPICM in the self-registering (SR) mode.

Table 6-1. NUMBER OF GRENADES IN EACH ICM ROUND

WEAPON	PROJECTILE	NUMBER OF GRENADES
ANTIPERSONNEL ICM		
105-mm (Figure 6-1)	M444	18
155-mm (Figure 6-2)	M449 family	60
203-mm (Figure 6-2)	M404	104
DUAL-PURPOSE ICM		
155-mm (Figure 6-3)	M483A1	88
203-mm (Figure 6-3)	M509	180

Figure 6-1. 105-MM APICM GRENADE

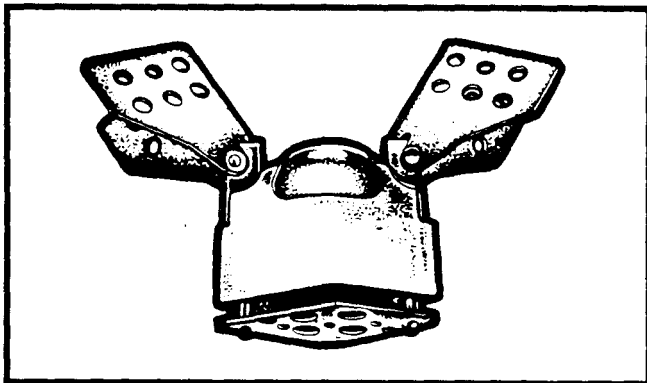

b. Height of Burst. Because of the reliability of the round, no adjustment for HOB is required before firing for effect. If a repeat of FFE is required, HOB may then be adjusted. Height of burst is adjusted in increments of 50 meters.

(1) If a large number of duds are observed or if the effects pattern is too small, the observer should give an UP correction. This correction should not exceed 100 meters.

(2) An HOB that is too high is not critical. Normally, attempts to adjust the HOB should not be made.

c. Danger Close. When adjusting close-in fires with ICM, the observer must start the adjustment at least 600 meters from friendly troops, depending on the relative locations of weapons, target, and friendly troops. Special consideration must be given to the direction and speed of the wind in the target area. The adjustment should be made with the entire battery. Corrections should be made from the near edge of the effects pattern.

6-3. SAMPLE ICM MISSIONS

The following are samples of missions firing various munitions.

Figure 6-2. 155-MM OR 203-MM APICM GRENADE

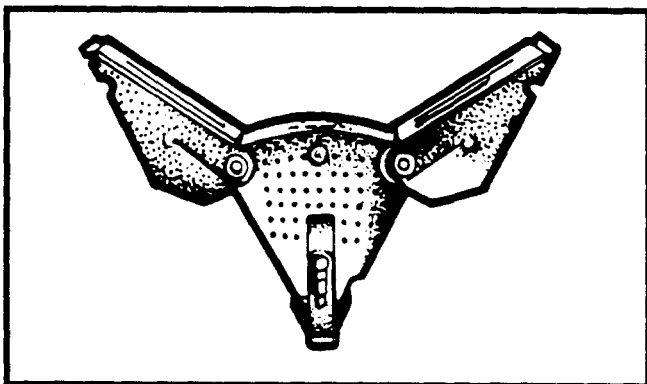

EXAMPLE
FIRE FOR EFFECT WITH DPICM
P51 THIS IS P87, FIRE FOR EFFECT, OVER.
GRID NK372461, OVER.
PLATOON ASSEMBLY AREA, ICM, OVER.

Figure 6-3. 155-MM OR 203-MM DPICM GRENADE

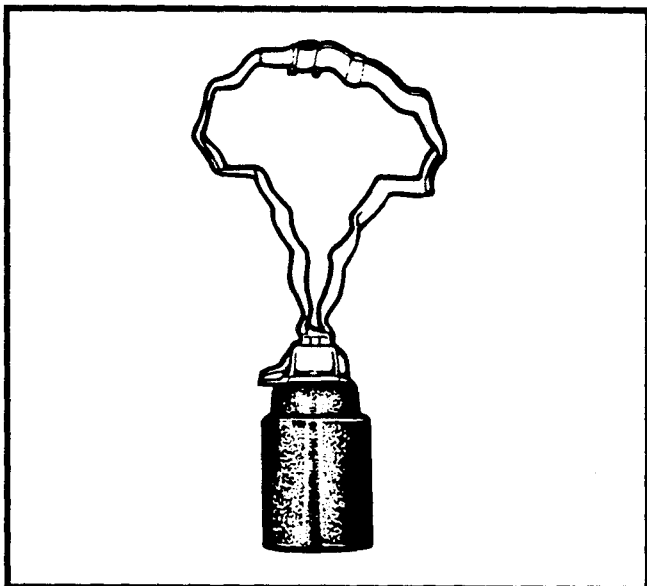

EXAMPLE
HE ADJUSTMENT APICM IN EFFECT
P51 THIS IS P87, ADJUST FIRE, OVER.
GRID NK933876, OVER.
INFANTRY COMPANY HALTED, APICM IN EFFECT
OVER.

EXAMPLE
DPICM ADJUSTMENT DPICM IN EFFECT
P51 THIS IS P87, ADJUST FIRE, OVER.
GRID NK361290, OVER.
COMPANY ASSEMBLY AREA, ICM, OVER.

6-4. IMPROVED CONVENTIONAL MUNITIONS CONSIDERATIONS

a. Anytime ICM or DPICM rounds are fired, between 2 and 3 percent of the submunitions (bomblets) fail to detonate. About 50 percent of these duds will be armed and may become a hazard to friendly personnel and equipment. This hazard must be considered in planning and firing missions with ICM or DPICM.

b. The ICM or DPICM should not be fired into forests: mountainous areas (slope greater than 60 percent); or rocky, uneven terrain. This type of terrain may increase the dud rate and reduce the effectiveness of the rounds.

c. Also, the effectiveness of ICM and DPICM rounds may decrease if the target area is marshy or covered with deep snow or water.

Section II

FIELD ARTILLERY DELIVERED FASCAM

6-5. CHARACTERISTICS OF FASCAM

The FASCAM consists of antiarmor mines, RAAMS, and antipersonnel mines, ADAM.

6-6. RAAMS PROJECTILES M718 AND M741

a. The following are characteristics of the M718 and M741:

- Each projectile contains nine antiarmor mines.
- The M718 projectile has a long factory-set self-destruct (SD) time.
- The M741 projectile has a short factory-set SD time.
- The mines are magnetically fuzed.
- The antiarmor mines are base-ejected.
- Random mines are equipped with antidisturbance features.

b. The RAAMS round is fired by a 155-mm howitzer, and nine antiarmor mines (Figure 6-4) are base-ejected over the target area. After a short delay to allow for mine free-fall, impact, and roll, the magnetically fuzed mines arm themselves. A number of the mines have

antidisturbance features. These cause the mines to detonate if they are moved or picked up. If the RAAMS mines are not engaged by a target, they will self-destruct after the factory-set SD time elapses.

Figure 6-4. RAAMS MINE

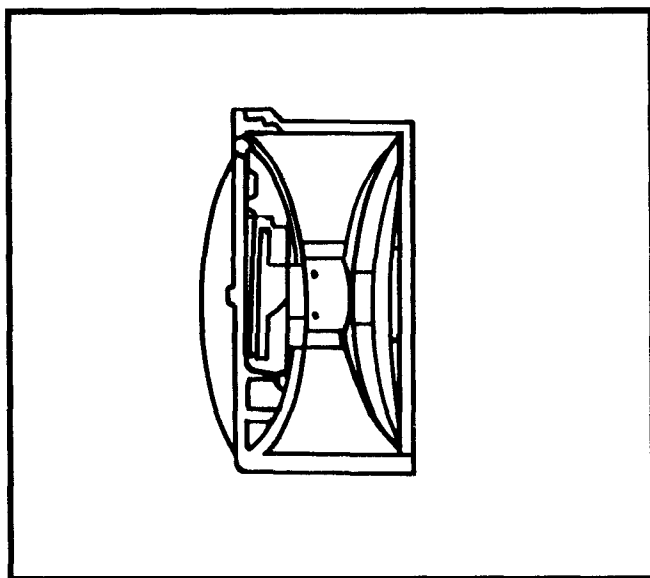

6-7. ADAM PROJECTILES M692 AND M731

a. The following are characteristics of the M692 and M731:

- Each projectile contains 36 antipersonnel mines.
- The M692 projectile has a long factory-set SD time.
- The M731 projectile has a short factory-set SD time.
- The antipersonnel mines are base-ejected.
- Each mine deploys antidisturbance trip-wire sensors.

b. The ADAM round is fired by a 155-mm howitzer, and 36 antipersonnel mines (Figure 6-5) are base-ejected over the target area. When an ADAM mine comes to rest on the ground, seven trip-wire sensors are deployed out to a maximum distance of 20 feet from the mine. When a sensor is disturbed or tripped, a small ball-like munition is propelled upward 2 to 8 feet. The ball detonates, projecting approximately 600 1.5-grain steel fragments in all directions. If the mine trip-wire sensors are not disturbed, the mine will self-destruct after a factory-set time has elapsed.

Figure 6-5. ADAM MINE

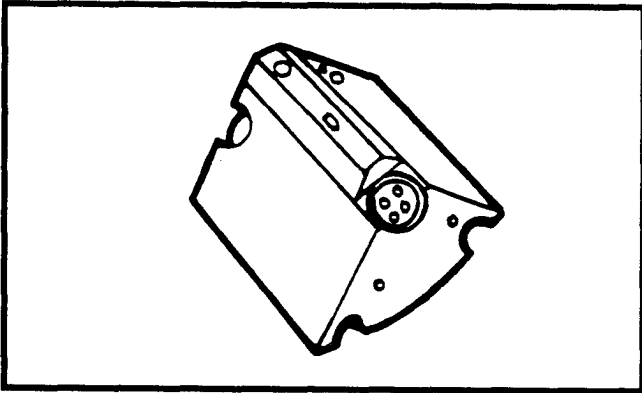

6-8. TYPES OF MINEFIELDS

Three types of RAAMS and ADAM minefield are used to ensure conformance with the commander's scheme of maneuver and to provide maximum troop safety.

a. Planned minefield –

- Are started as a result of a target list.
- Support barrier or obstacle plans.
- Normally are less than 600 meters wide.

- Are emplaced as scheduled or on-call targets.
- Require extensive coordination between maneuver, engineer, and fire support coordinators.
- Require extensive logistical support.
- Use primarily long SD mines.
- Allow safety zones to be computed before firing.

b. Target of opportunity minefields –

- Are started as a result of a call for fire.
- Support the maneuver commander with an immediate minefield.
- Are standard minefield (400- by 400-meter module).
- Are emplaced in response to the maneuver commander's guidance.
- Consist of a combination of 24 RAAMS and 6 ADAM projectiles (these numbers may change depending on the threat and the commander's guidance).
- Use only short SD mines (carried as part of the basic load).

NOTE: The safety zone is based on a single aimpoint and is computed immediately after the minefield is fired.

c. Minefield established in conjunction with attack by other munitions –

- Are started as a result of a target list or a call for fire.
- Support operations by harassing enemy targets within constraints set by the supported maneuver commander.
- Are sized according to the method of attack.
- Have RAMMS, ADAM, or a combination fired in the last volley.
- Use only short SD mines (carried as part of basic load).

NOTE: The safety zone is computed immediately after the minefield is fired.

6-9. SELECTION OF MINES

The type of projectile used is determined by the observer or other requester. The type is based on the nature of the target.

a. A RAAMS minefield is used against enemy armored vehicles. When intelligence sources indicate that the enemy has a dismounted breaching capability, ADAM mines should be delivered directly on top of the RAAMS minefield. **Always deliver ADAM as the last rounds fired when used in conjunction with RAAMS or other munitions.**

b. The ADAM mines are used without antitank mines when the primary target is dismounted personnel. The ADAM mines can also be delivered onto existing antitank obstacles to hinder dismounted breaching.

c. If the type of unit is self-propelled or is undetermined, a mix of ADAM and RAAMS should be used to attack a counterfire target.

6-10. SELECTION OF MINE DENSITY

Selection of mine density is based on the purpose of the minefield. Table 6-2 shows the density selections available for RAAMS and ADAM.

6-11. SELECTION OF SELF-DESTRUCT TIME

a. The selection of the SD time is based on several considerations:

- Scheme of maneuver (current as well as future operations).
- Type of minefield (planned or standard target of opportunity).
- Minefield location.
- Tactical situation (offense or defense).
- Nature of enemy forces.
- Availability of projectile (RAAMS or ADAM).
- Time frame involved.
- Command authority to emplace FASCAM.

b. Normally, RAAMS and ADAM minefields planned to support a barrier or obstacle plan use long SD mines. This allows for longer minefield effectiveness. Projectiles should be stockpiled before emplacement to ensure responsiveness.

Table 6-2. MINEFIELD DENSITY FOR RAAMS AND ADAM

PURPOSE OF MINEFIELD	DENSITY DESIGNATION FOR MINEFIELD PLANNING SHEET	DENSITY OF MINES PER SQUARE METER
RAAMS		
Harassment	Low	0.001
Minefield covered by heavy direct fire	Medium	0.002
Minefield covered by light direct fire	High	0.004
ADAM		
Used with RAAMS or other antitank obstacles or for harassment	Low	0.0005
Minefield covered by heavy direct fire	Medium	0.001
Minefield covered by light direct fire	High	0.002
<p>NOTE: A density of 0.001 gives an average of one mine in every 1,000 square meters of minefield or one mine in every 32- x 32-meter square.</p>		

6-12. TARGET LOCATION

a. Moving Targets. The aimpoint for a moving target is placed directly in front of the enemy axis of advance 1,000 meters (m) in front of the enemy target for every 10 kilometers per hour (kmph) of speed as shown in Figure 6-6. This allows enough time for mine delivery and arming before enemy encounter.

Figure 6-6. AIMPOINT LOCATION FOR MOVING TARGETS

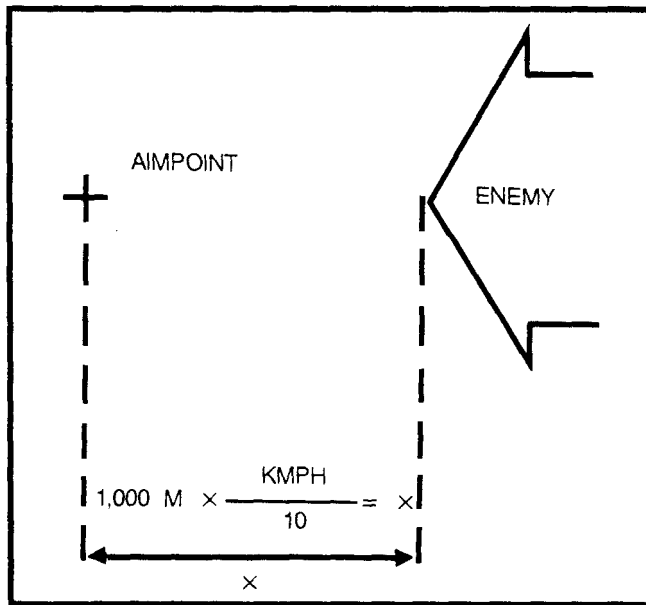

b. Stationary Targets. The aimpoint for a stationary target is placed directly over the target center as shown in Figure 6-7. Aimpoints are located to an accuracy of 100 meters (adjust fire) and 10 meters (fire for effect). If adjustment is necessary, it will be conducted with shell M483A1, DPICM, in the SR mode.

Figure 6-7. AIMPOINT LOCATION FOR STATIONARY TARGETS

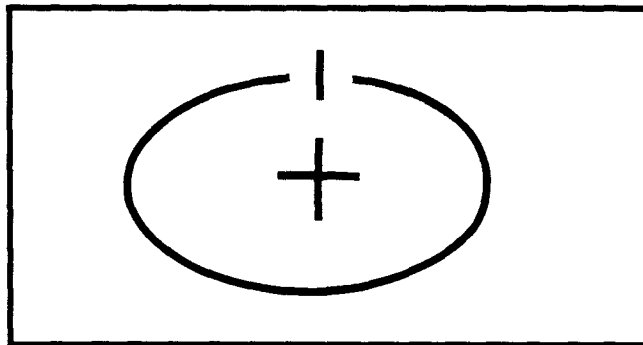

6-13. CALL FOR FIRE AND ADJUSTMENT

a. Generally, the call for fire is transmitted and processed the same as other requests for target-of-opportunity fire missions. Unless the observer requests ammunition for adjustment, he will receive DPICM (self-registering) in adjustment and the standard minefield in effect (24 RAAMS and 6 ADAM).

b. Targets of opportunity are either fire-for-effect or adjust-fire missions. Fire-for-effect missions will not be requested if the center of the minefield is less than 700 meters from the nearest friendly position. Adjust-fire missions will not be requested if the center of the minefield is less than 425 meters from the nearest friendly position.

c. Adjustment procedures for FASCAM are identical to those described in paragraph 6-2.

6-14. SAMPLE FASCAM MISSIONS

The following are samples of FASCAM missions.

EXAMPLE
FIRE-FOR-EFFECT MISSION
Z57 THIS IS 242, FIRE FOR EFFECT, OVER.
GRID NK18045132, OVER.
PLATOON IN THE OPEN, ADAM, OVER.

EXAMPLE
ADJUST-FIRE MISSION
Z57 THIS IS 742, ADJUST FIRE, OVER.
GRID NK180513, OVER.
FIVE T-72 TANKS ATTACKING, RAAMS IN EFFECT,
OVER.

Section III ILLUMINATION

This section implements STANAG 2088 and QSTAG 182.

6-15. CHARACTERISTICS OF ILLUMINATION

Battlefield illumination gives friendly forces enough light to aid them in ground operations at night. It facilitates operations for both the forward observer and the maneuver unit. The illumination shell is used to -

- Illuminate areas of suspected enemy activity.
- Provide illumination for night adjustment.
- Harass enemy positions.
- Furnish direction to friendly troops for attacks or patrol activities.
- Mark targets (by air and ground bursts) for attack by close air support.

- "Wash out" enemy passive night-sight systems when used at ground level.

6-16. EMPLOYMENT CONSIDERATIONS

The amount of illumination required for a particular mission depends on the OT distance; the conditions of visibility; and the size, width, and depth of the area to be lit. By selecting the proper illuminating pattern and by controlling the rate of fire, the observer can light an area effectively with a minimum expenditure of ammunition. The different illuminating patterns are discussed in the subparagraphs below. The rates of fire for continuous illumination and other information pertinent to the use of illuminating shells are given in Table 6-3. The optimum HOB for the older M118 projectile is 750 meters. However, because of the longer burning time and slower rate of descent, the optimum HOB for the M485 projectile is 600 meters.

Table 6-3. EMPLOYMENT FACTORS FOR ILLUMINATING SHELLS

HOWITZER OR MORTAR	PROJECTILE	INITIAL HEIGHT OF BURST (METERS)	DISTANCE BETWEEN BURSTS (SPREAD) (METERS)	BURNING TIME (SECONDS)	RATE OF CONTINUOUS ILLUMINATION (ROUNDS PER MINUTE)	RATE OF DESCENT (METERS PER SECOND)
105-mm	M314A2	750	800	60	2	10
105-mm	M314A3	750	800	70 to 75	2	10
155-mm	M118	750	800	60	2	10
155-mm	M485A2	600	1,000	120	1	5
107-mm	M335	700	500	60	2	10
107-mm	M335A1	700	500	70	2	10
107-mm	M335A2	400	1,000	90	1	5
81-mm	M301A1	400	500	60	2	6
81-mm	M301A2	400	500 <td 60	2	6	
81-mm	M301A3	600	500	60	2	6

a. The **one-gun illumination** pattern is used when effective illumination can be accomplished by firing one round at a time. To obtain this pattern, the observer calls for **ILLUMINATION** as the type of adjustment and type of projectile.

b. The **two-gun illumination** pattern is used when an area requires more illumination than can be furnished by one-gun illumination. In this pattern, two rounds are caused to burst simultaneously in the target area. To obtain this pattern, the observer calls for **ILLUMINATION TWO GUNS**.

c. The **two-gun illumination range spread** pattern (Figure 6-8) is used when the area to be lit has greater depth than width as seen along the GT line. Spread illumination causes less shadows than illumination that is concentrated in one place. To obtain this pattern, the observer calls for **ILLUMINATION RANGE SPREAD**. The FDC centers the spread over the point indicated by the observer. See Table 6-3 for distances between bursts.

d. The **two-gun illumination lateral spread** pattern (Figure 6-9) is used when the area to be lit has greater width than depth. To obtain this pattern, the observer calls for **ILLUMINATION LATERAL SPREAD**. The FDC centers the spread over the point indicated by the observer and orients the spread perpendicular to the GT line. Distances between bursts are the same as those for range spread (Table 6-3).

e. The **four-gun illumination** pattern is used to light a large area (Figure 6-10). Four rounds are caused to burst simultaneously in a diamond pattern. This pattern lights an area with practically no shadows or dark spots. To obtain this pattern, the observer calls for **ILLUMINATION RANGE AND LATERAL SPREAD**. The pattern of the bursts is the combination of a range spread and a lateral spread.

Figure 6-8. ILLUMINATION RANGE SPREAD

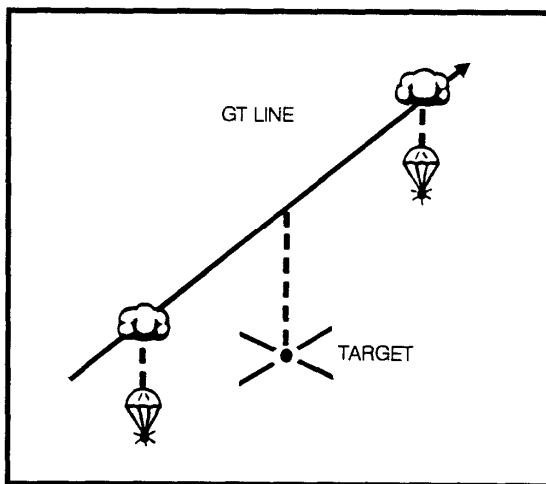

Figure 6-9. ILLUMINATION LATERAL SPREAD

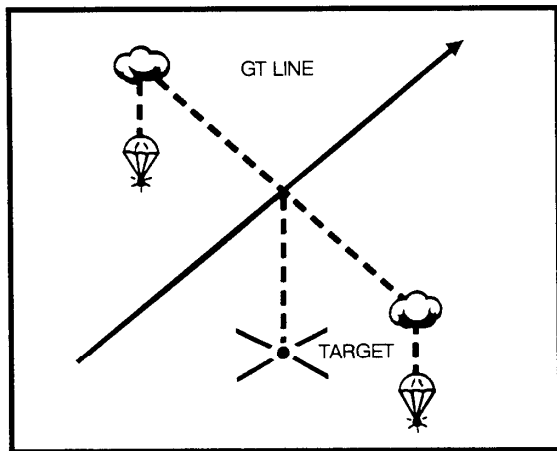
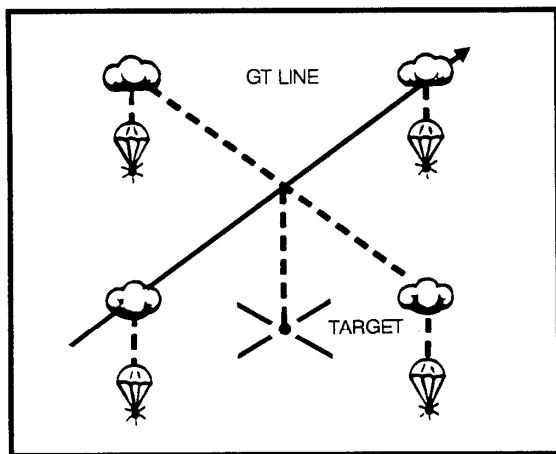

Figure 6-10. ILLUMINATION RANGE AND LATERAL SPREAD



6-17. CALL FOR FIRE AND ADJUSTMENT OF ILLUMINATION

In the call for fire, **ILLUMINATION** is given as the type projectile and the appropriate range or lateral spread is given as the distribution. Procedures for adjusting illumination are discussed below.

a. Range and Deviation. Range and deviation are adjusted by use of standard observed fire procedures. The adjustment of the illumination to within 200 meters of the

adjusting point is considered adequate because of the size of the area lit by the flare. Range and deviation corrections of less than 200 meters should not be made.

b. Position of Flare. The correct position of the flare in relation to the area to be lit depends on the terrain and wind. Generally, the flare should be to one flank of the area and at about the same range. In a strong wind, the point of burst must be some distance upwind from the area to be lit, because the flare will drift. If the area is on a forward slope, the flare should be on the flank and at a slightly shorter range. For illuminating a very prominent object, better visibility can be obtained if the flare is placed beyond the object so that the object is silhouetted.

c. Height of Burst. The proper HOB allows the flare to strike the ground just as it stops burning. The HOB corrections are made in multiples of 50 meters. Variations in time of burning between individual flares make any freer adjustment of the height of burst pointless.

NOTE: When using a night observation device (NOD), the observer should ensure that the flare burns out appreciably (100 mils) above his adjusting point so as not to cause the

(1) When burnout occurs during descent, the HOB correction is estimated from the height of the flare when it burned out. When visibility permits, the spotting (height above the ground of the burnout) may be measured with binoculars. The HOB spotting (in mils) is multiplied by the OT factor to determine the height of burnout (in meters). This height is expressed to the nearest 50 meters and is sent as a **DOWN** correction.

EXAMPLE

The flare burns out 20 mils above the ground. The OT factor is 3; $20 \text{ mils} \times 3 = 60 \text{ meters} \approx 50 \text{ meters}$. The correction is **DOWN 50**.

(2) When the flare continues to burn after it strikes the ground, a correction is required to raise the HOB. The length of time, in seconds, that the flare burns on the ground is counted and multiplied by the rate of descent (see Table 6-3). The product is expressed to the nearest 50 meters and sent as an **UP** correction.

EXAMPLE

The flare burned 23 seconds on the ground; 23×5 (rate of descent for M485A2) = 115. The correction is **UP 100** (correction expressed to the nearest 50 meters).

6-18. CALL FOR FIRE AND ADJUSTMENT UNDER ILLUMINATION

a. When the observer has located a target suitable for HE or other fire, he initiates a call for fire in the normal manner. If no better means of designating the location of the target is possible, the burst center of the illumination can be used as a reference point.

b. If the observer decides to adjust the illuminating fire and the HE fire concurrently, he prefaces corrections pertaining to illumination with the word **ILLUMINATION** and those pertaining to HE with the letters **HE**; for example, **ILLUMINATION, ADD 200; HE, RIGHT 60, ADD 200.**

c. Once the observer has adjusted the illuminating shell to the desired location, he should control the rate of fire and number of pieces firing. This reduces ammunition expended to the minimum necessary for the required observation.

(1) The observer may allow the FDC to control the firing of both illumination and HE by announcing **COORDINATED ILLUMINATION** in his call for fire. When the illumination has been adjusted to yield the best light on the target, the observer announces **ILLUMINATION MARK** to tell the FDC the exact time the target is best illuminated. The FDC times the interval between the actual firing of the illuminating round and the receipt of the observer's **ILLUMINATION MARK**. By comparing this time interval with the time of flight of the HE, the FDC can control the firing of the HE rounds so that they arrive at the target during maximum illumination.

(2) As an alternate method, the observer may request **COORDINATED ILLUMINATION** and announce the method of control as **BY SHELL, AT MY COMMAND**. This indicates that both HE and illumination will be fired only at the observer's command. As soon as the FDC reports that the illuminating and HE fires are ready, the observer commands the firing of illumination. Then he gives the command to fire the HE so that it impacts during the period of maximum illumination of the target. The observer can request the HE time of flight to better coordinate the firing of each round. The observer may want to change the method of control to let the FDC fire illumination when ready while he controls the firing of the HE shell. If so, he announces **ILLUMINATION, CANCEL AT MY COMMAND**. An experienced observer may be able to adjust more than one HE round under each round of illumination.

(3) Because of the amount of ammunition expended, the least desirable method is for the observer to request **CONTINUOUS ILLUMINATION**. In this technique, the FDC fires illumination continuously (intervals between firing depend on the type of projectile) while the observer adjusts HE.

6-19. SAMPLE ILLUMINATION MISSIONS

The example below portrays various illumination missions.

EXAMPLE

The observer hears a number of heavy vehicles at an azimuth estimated at 5800. He cannot detect any lights, and the entire area is in complete darkness. Judging from the sounds and a study of his map, the observer estimates the source of the noises as grid NB616376. This location is about 2,000 meters from his observation post. He sends the following call for fire to a 155-mm battery using M485A2:

P53 THIS IS P67, ADJUST FIRE, OVER.

GRID NB616376, OVER.

VEHICLE NOISES, SUSPECTED TANKS, ILLUMINATION, OVER.

The first illuminating round bursts about 100 mils left of the suspected area and burns out 40 mils too high (measured with binoculars) (Figure 6-11). Using an OT factor of 2, the observer transmits the following:

DIRECTION 5800, RIGHT 200, DOWN 100, OVER.

(Deviation = 100 mils x 2 = 200 meters.

HOB = 40 mils x 2 = 80 meters \approx 100 meters.)

The second round bursts short near the OT line but is too low. It burns 6 seconds on the ground. The observer requests **ADD 400, UP 50, OVER** ($6 \times 5 = 30 \approx 50$).

The third round bursts at the appropriate height over the suspected area; but haze, along with the distance of the area from the observer, causes poor visibility with only one round of illuminating shell. The observer believes that two rounds will be adequate but desires a lateral spread along a section of road that he is observing in order to extend the visible

area and reduce shadows. The observer requests **LATERAL SPREAD, OVER.**

Two rounds burst in a spread over the suspected area. The observer notices two tanks and a number of infantrymen moving over to the right at the extreme edge of the lighted area. He then prepares and sends a separate call for fire and moves his illumination over to the adjusting point. His call is as follows:

RIGHT 400, COORDINATED ILLUMINATION, OVER.

ADJUST FIRE, OVER.

GRID NB621382, OVER.

2 TANKS AND PLATOON OF INFANTRY, ICM IN EFFECT, OVER.

The observer may also have sent his target location by polar plot (**ADJUST FIRE, POLAR, OVER**) or by shifting from the center of the illumination (**ADJUST FIRE, SHIFT, ILLUMINATION, OVER**).

With the next rounds of illumination, the observer transmits **ILLUMINATION MARK** when the illumination has best lit the target. He then adjusts the HE and fires for effect as in a normal mission.

NOTE: For any illuminating round that in the observer's judgment provides maximum or enough illumination for the mission, the observer may transmit **ILLUMINATION MARK**. A separate marking round is a waste of ammunition.

Figure 6-11. INITIAL ILLUMINATING ROUND

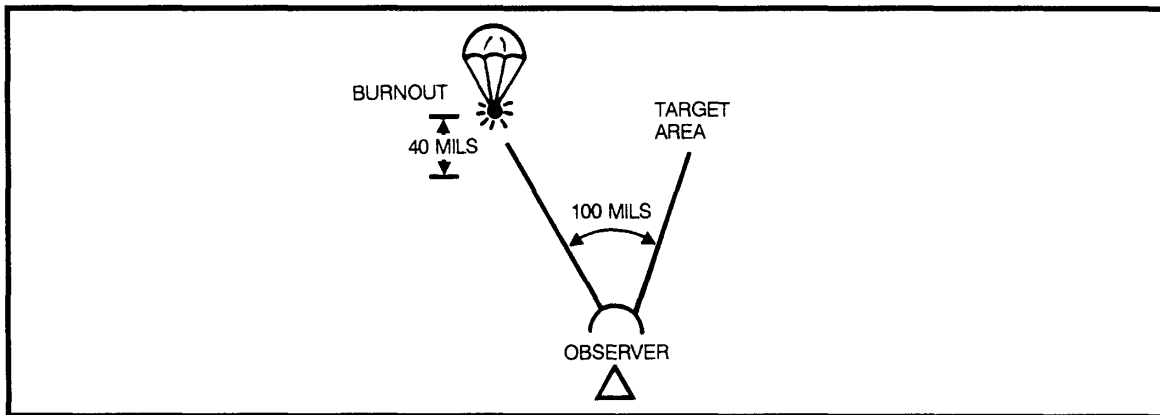

 Section IV
SMOKE

6-20. CHARACTERISTICS OF SMOKE

When used correctly, smoke (smk) can significantly reduce the enemy's effectiveness both in the daytime and at night. Combined with other suppressive fires, it gives more opportunities for maneuver forces to deploy and aircraft to attack frontline targets. This enhances the chances of mission accomplishment without catastrophic losses. Smoke reduces the effectiveness of laser beams and inhibits the use of optically-guided missiles, such as the Sagger. Smoke may be used to reduce the ability of the enemy to deliver effective fires, to hamper hostile operations, and to deny the enemy information on friendly positions and maneuvers. The effective delivery of smoke by the field artillery at the critical time and place helps the combined arms team accomplish its mission. (See Table 6-4 for smoke capabilities and effects.) Smoke is used for obscuration, screening, deception, and signaling.

- Obscuring smoke – Use and effects of a smoke screen placed directly on or near the enemy with the primary purpose of suppressing observers and minimizing their vision (Figure 6-12).
- Screening smoke – A smoke curtain used on the battlefield between enemy observation points and friendly units to mask maneuvers (Figure 6-13).

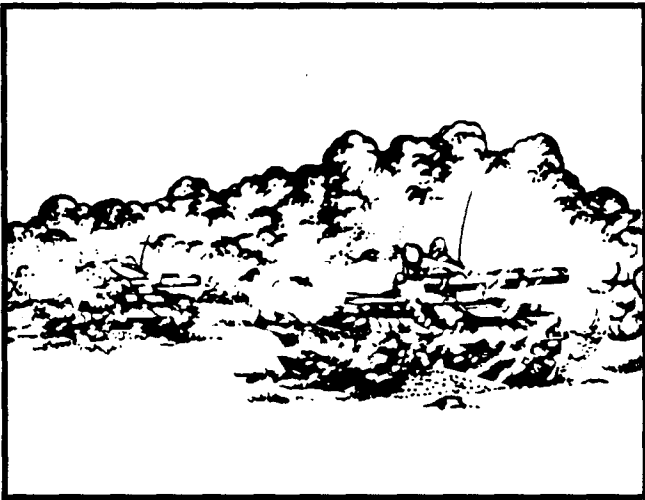
Figure 6-12. **OBSCURING SMOKE**Figure 6-13. **SCREENING SMOKE**

- Deception smoke — A smoke curtain used to deceive and confuse the enemy as to the nature of friendly operations.
- Signing smoke — Smoke used to establish a reference for friendly forces.

Do not neglect the use of smoke at night. Enemy direct fire weapons, such as the Sagger, are equipped with night vision devices. Darkness can bring on a false sense of security which can be fatal to the maneuver elements.

NOTE: Whether used in offensive or defensive operations, smoke can decrease vulnerability and increase

a. Obscuring smoke is used as follows:

- To defeat flash ranging and restrict the enemy's counterfire program.
- To obscure artillery OPs and reduce the accuracy of enemy observed fires.
- To obscure enemy direct fire weapons, including wire-guided missiles, to reduce their effectiveness up to 90 percent.

- To obscure enemy lasers to reduce their effectiveness.
- To instill apprehension and increase enemy patrolling.
- To slow enemy vehicles to blackout speeds.
- To increase command and control problems by preventing effective visual signals and increasing radio traffic.
- To defeat night observation devices and reduce the capability of most infrared (IR) devices.
- To increase effectiveness of obstacles.

b. Screening smoke is used as discussed below.

(1) **Deceptive Screens.** Smoke draws fire. Deceptive screens cause the enemy to disperse his fires and expend his ammunition.

(2) **Flank Screens.** Smoke may be used to screen exposed flanks.

(3) **Areas Forward of the Objective.** Smoke helps the maneuver units consolidate on the objective unhindered by enemy ground observers.

(4) **River-Crossing Operations.** Screening the primary crossing site denies the enemy information. Deceptive

screens deceive the enemy as to the exact location of the main crossing.

(5) **Obstacle Breaching.** The enemy is denied the ability to observe the breaching unit and is prevented from placing accurate fires on that unit.

c. Non-field-artillery smoke ammunition and delivery means are described below.

(1) **Mortars.** Mortars can provide good initial smoke coverage with WP ammunition because of their high rates of fire. Mortar smoke information is shown in Table 6-4.

(2) **Tanks.** Tanks firing from overwatch positions can suppress antitank guided missile gunners at 1,500 to 3,000 meters with WP ammunition.

6-21. SMOKE DELIVERY TECHNIQUES

Using different amounts of smoke on the battlefield against targets of various sizes requires different gunnery techniques. The use of the two delivery techniques (immediate and quick) does not preclude the use of smoke on other occasions or for different objectives. The objective of the two prescribed techniques is to obscure the enemy's vision or screen the maneuver element. The two delivery techniques are outlined in Table 6-5 and are discussed in detail in paragraphs 6-23 and 6-24.

Table 6-4. FIELD ARTILLERY AND MORTAR SMOKE CAPABILITIES AND EFFECTS

DELIVERY SYSTEM	TYPE ROUND	NOMENCLATURE	FUZE	TIME TO BUILD EFFECTIVE SMOKE	AVERAGE BURNING TIME	AVERAGE OBSCURATION LENGTH PER ROUND (METERS) WIND DIRECTION	
						CROSS	HEAD OR TAIL
155-mm	WP	M110A2	M557	1/2 minute	1 to 1 1/2 minutes	100	50
	Smoke	M116B1	M501A1	1 to 1 1/2 minutes	4 minutes	350	75
	Improved smoke	M825	M577	1/2 minute	7 minutes	100	95
105-mm	WP	M60A1	M557	1/2 minute	1 to 1 1/2 minutes	75	50
	Smoke	M84B1	M501A1	1 to 1 1/2 minutes	3 minutes	250	50
107-mm ¹	WP	M328A1	-	1/2 minute	1 minute	150	40
81-mm	WP	M375A2	-	1/2 minute	1 minute	100	40

¹The 107-mm mortar WP projectile is a better smoker than the 105-mm howitzer WP projectile.

Table 6-5. SMOKE DELIVERY TECHNIQUES

DELIVERY TECHNIQUE	TYPE OF TARGET	NUMBER OF GUNS	TYPE OF AMMUNITION	SHEAF	OBSCURATION TIME	COMMAND AND CONTROL
Immediate smoke ¹ (point or suppression)	Point or small area 150 meters or less	1 platoon ² (2 guns)	First rounds WP or smoke; second rounds smoke	BCS	1/2 to 5 minutes	By SOP and/or maneuver commander's approval
Quick smoke (small area or suppression)	Small area 150 to 600 meters ³	1, 2, or 3 platoons ²	Smoke or WP	BCS	4 to 15 minutes	Maneuver battalion commander's approval
Immediate smoke (mortar)	150 meters or less	2	2 rounds (each) WP	Parallel	1 to 3 minutes	By SOP and commander's approval
Quick smoke (mortar)	150 to 600 meters	2 (60-mm section) 4 (81-mm platoon) 3 (107-mm section) 6 (107-mm platoon)	WP	Parallel or open and/or special (as required)	4 to 15 minutes (depending on ammunition availability)	Battalion

¹The immediate smoke technique can be used in an immediate suppression mission on a target of opportunity. A mix of WP and HC normally will follow the initial suppression rounds when immediate smoke is requested (established by unit SOP).

²Responsiveness dictates that both immediate and quick smoke missions be fired by platoon.

³For larger areas, consider multiple aiming points and use of the quick smoke technique.

6-22. EMPLOYMENT CONSIDERATIONS

a. Weather. The observer is the normal source of wind data for the target area. He determines the data (head wind, tail wind, or crosswind) on the basis of what he sees and feels. Atmospheric stability, wind direction, and wind speed are the major factors influencing the effectiveness of smoke. (See Figure 6-14.)

(1) **Atmospheric Stability.** The weather conditions, the time of day, and the wind speed all affect atmospheric stability. Although they are determined by the FDC, the observer must be aware of the effects of three temperature gradients, which are discussed in Table 6-6.

Figure 6-14. WEATHER FACTORS WHICH AFFECT SMOKE EMPLOYMENT

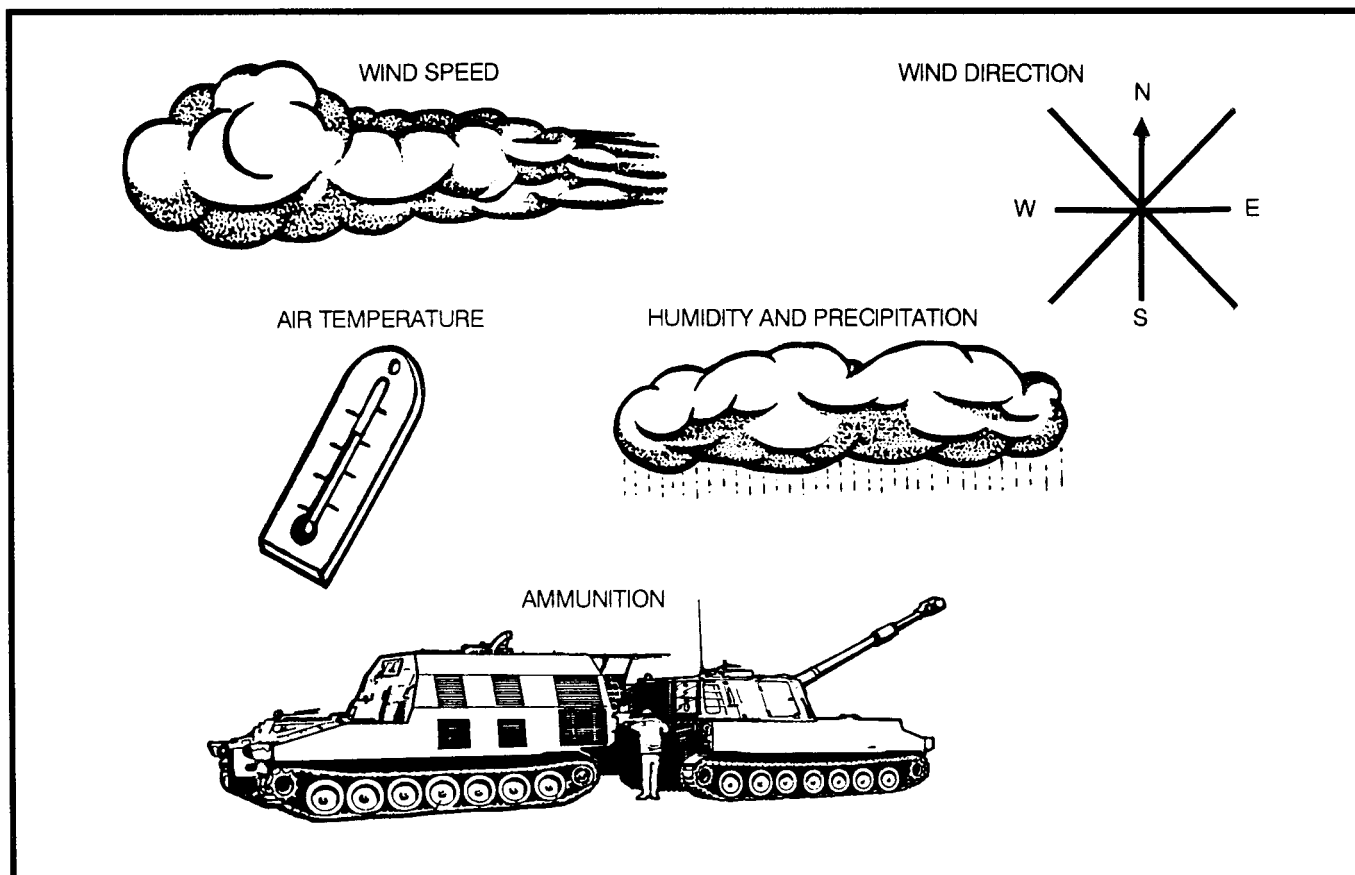





Table 6-6. GENERAL ATMOSPHERIC CONDITIONS AND THE EFFECTS ON SMOKE

SMOKE CONDITION (TEMPERATURE GRADIENT)	TIME OF DAY WEATHER CONDITIONS	EXPECTED SMOKE BEHAVIOR AS IT DRIFTS DOWNWIND (WIND DIRECTION → →)
Ideal (inversion)	<ol style="list-style-type: none"> 1. Night—until 1 hour after sunrise. 2. Wind speed less than 5 knots. 3. Sky cover less than 30 percent. <p>All three conditions must be met.</p>	 <p>Stable condition—ideal for smoke employment</p>
Favorable	<p>This condition occurs most often 1 to 2 hours before and after sunrise and when the wind speed is 5 knots or more and/or the sky cover is 30 percent or more.</p>	 <p>Neutral condition—favorable for smoke employment</p>
Marginal (lapse)	<ol style="list-style-type: none"> 1. Day—beginning 2 hours after sunrise. 2. Wind speed less than 5 knots. 3. Sky cover less than 30 percent. <p>All three conditions must be met.</p>	 <p>Unstable condition—marginal for smoke employment</p>

(2) **Wind Speed.** The movement of smoke depends on the speed and direction of the wind. Wind speeds ranging from 4 to 14 knots are best for the production of smoke screens. Optimum speeds vary with the type of smoke used. (See Figure 6-15.) To determine an approximate wind speed, the observer can use either the equivalent wind scale table (Table 6-7) or the grass-drop (expedient) method. With the grass-drop method, extend your arm downwind and drop grass from your hand. Point your extended arm at the dropped grass on the ground. Divide the angle (in degrees) between your arm and your body by 4 to determine the approximate wind velocity in knots.

(3) **Wind Direction.** Wind direction influences the desired location of smoke in the target area. To determine wind direction in the target area, observe drifting of smoke or dust, bending of grass or trees, and ripples on water.

Figure 6-15. OPTIMUM WIND SPEED CHART

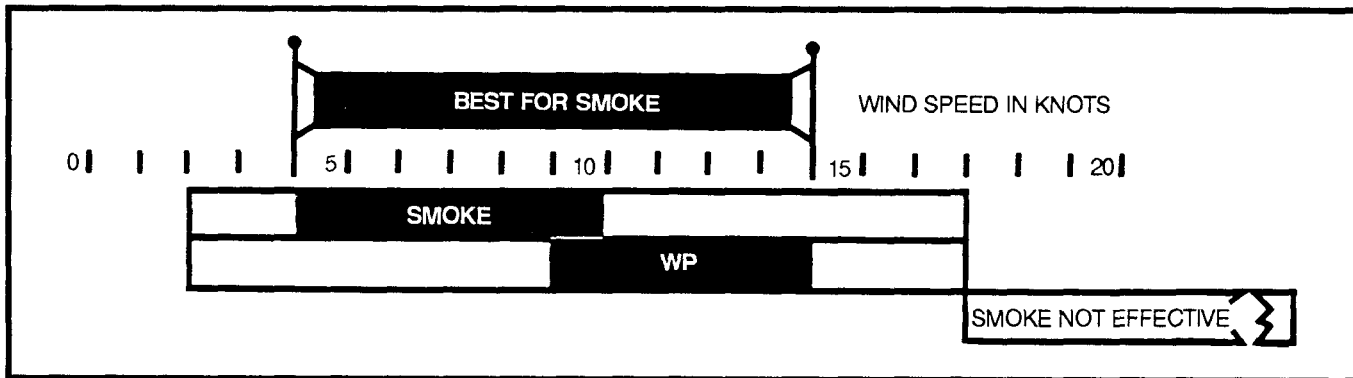

Table 6-7. EQUIVALENT WIND SCALE

KNOTS	OBSERVATION
1	Smoke, vapor from breath, or dust raised by vehicles or personnel rises vertically. No leaf movement.
1 to 3	Direction of wind slightly shown by smoke, vapor from breath, or dust raised by vehicles or personnel. Slight intermittent movement of leaves.
4 to 6	Wind slightly felt on face. Leaves rustle.
7 to 10	Leaves and small twigs in constant motion.
11 to 16	Wind raises dust from ground. Loose paper and small branches move.
17 to 21	Small trees with leaves sway. Coastal wavelets form on inland waters.
22 to 27	Large branches on trees in motion. Whistle heard in telephone or fence wires.
28 to 33	Whole trees in motion. Inconvenience felt walking against wind.

NOTE: One knot equals 1.15 miles per hour.

(4) **Maneuver-Target Line.** Determine the wind direction in relation to the maneuver-target line. The wind direction only in terms of crosswind, tail wind, or head wind needs to be determined (Figure 6-16). The maneuver-target line is an imaginary line from the maneuver unit to the target. Smoke is generally required when the maneuver unit is at its most vulnerable point along the route of march. Therefore, in planning smoke, draw the maneuver-target line from the most vulnerable point along the route of march to the target.

(5) **Temperature.** A rise in temperature may increase the rate of evaporation. This causes the smoke screen to dissipate more rapidly.

(6) **Humidity and Precipitation.** High humidity and precipitation may enhance the effectiveness of smoke.

b. Ammunition. The amount of smoke ammunition in basic loads is limited. Expenditures of smoke ammunition vary considerably with each specific mission. All observers must know the amount of ammunition available and how much smoke it will provide. Large requirements for smoke may require redistribution of the basic loads of several units or an issue of additional smoke ammunition for a specific operation. Combat experience has shown that smoke ammunition will not be available to support all smoke requests.

c. Available Means. Before firing a smoke mission, the observer, FDO, and FSO must consider the means available. The company FSO recommends to the maneuver commander whether mortars or artillery should be used. The battalion FDO decides which battery will fire or whether to have a reinforcing unit, if available, support the mission. The FSO provides tactical information that could affect the fire support available. All assets are limited, and for each mission the decision must be made as to who can best fulfill the requirements.

d. Terrain. The terrain affects the employment of smoke. The following rules apply:

- If smoke is placed on tanks in defilade, they lose their sense of direction.
- Smoke seeks low spots.
- Firing smoke on dry vegetation may start fires.
- Smoke should not be fired on deep mud, water, or snow. The smoke canisters normally will not function properly.
- Smoke should not be fired on steep slopes. The canisters roll downhill.

Figure 6-16. MANEUVER-TARGET LINE

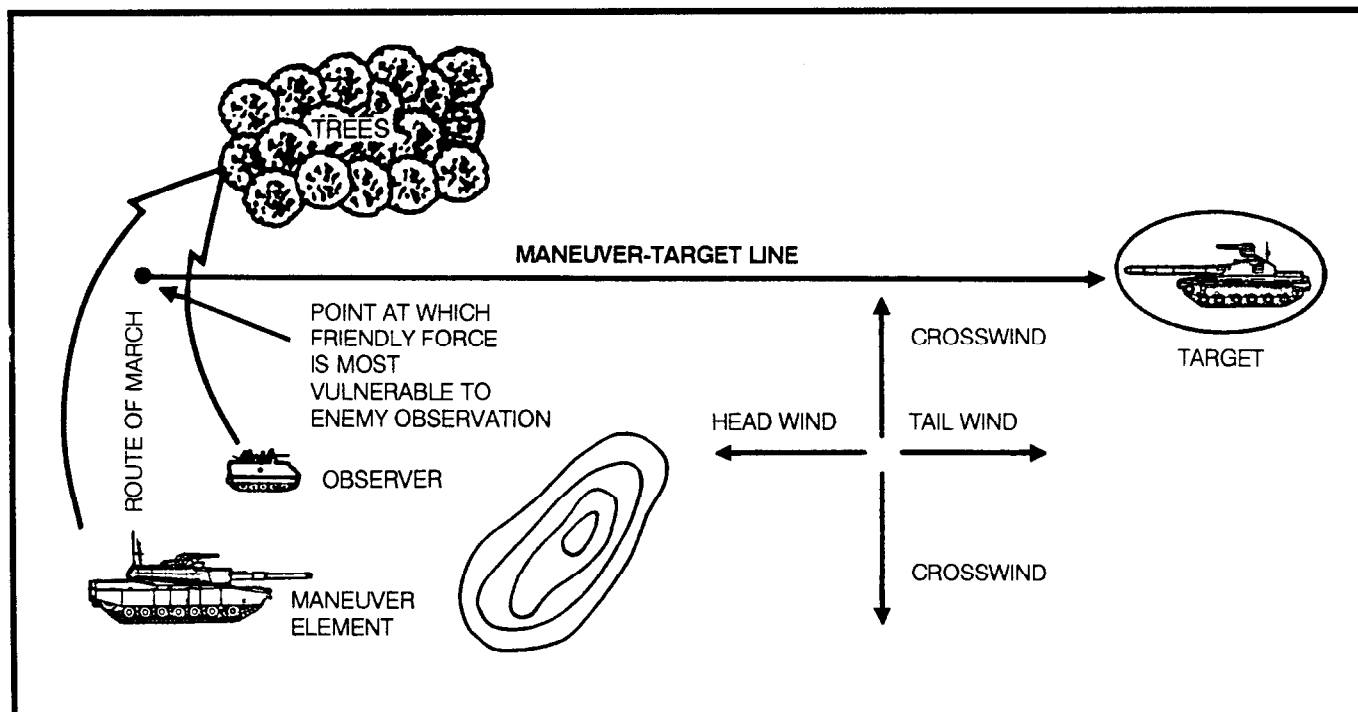

e. **Enemy.** Know and anticipate the enemy. Some rules are as follows:

- Fire smoke on enemy artillery OPs and gunners to greatly reduce their effectiveness.
- Fire smoke and HE on the enemy when he deploys from column to line formation. The HE will keep him buttoned up. The smoke will cause maximum confusion.
- Fire smoke and HE on minefield to cause maximum confusion. (Avoid concealing enemy breaching operations.)
- Understand the effects of smoke on friendly positions. Smoke used without enough thought and planning reduces the user's effectiveness more than that of the enemy.

f. **Command and Control.** The maneuver commander for whom the smoke is planned must approve its use. When he issues his plans and concept for an operation, he should state the guidelines on the amount of smoke that can be used and any restriction on its use. To ensure that smoke is responsive, the company FSO, battalion FSO, and/or FSCoord must request this smoke planning guidance if it has not been stated. The maneuver commander responsible for the operation must coordinate smoke operations with all units participating in or potentially affected by the operation. The operations officer (S3 or G3) is responsible for integrating smoke into the plan of maneuver. The FSO and FSCoord must keep the maneuver commander advised on the availability of munitions and delivery systems. Combat arms troops must be well trained in smoke operations, and comprehensive SOPs must be available to and known by all. This shortens reaction time.

6-23. IMMEDIATE SMOKE

a. **Description.** The objective of immediate smoke is to obscure the enemy's vision. Suppression of a small location can be achieved by use of immediate smoke to reduce the enemy's ability to observe. Immediate smoke can be planned, as other planned suppressive fires, or it can be used after immediate suppressive fire. When immediate smoke is planned, the immediate smoke target is sent to the FDC as part of the target list. Weather conditions must be considered in planning immediate smoke, since a change in wind direction could make the planned smoke ineffective. If immediate suppressive fire is ineffective because of inaccurate target location, the

observer has the option of giving a bold shift and requesting that the smoke be fired.

<p>EXAMPLE</p> <p>H18 THIS IS H24, IMMEDIATE SUPPRESSION, GRID NK439892, OVER. (Suppression was ineffective, and the observer wishes smoke instead.) IMMEDIATE SMOKE, DIRECTION 5300, LEFT 300, DROP 200, OVER.</p>
--

b. Employment Considerations.

(1) Before firing immediate smoke, the observer must realize that suppression by smoke will not be as immediate as suppression by HE, since it takes time for the smoke to build up. Inaccurately placed smoke may still provide obscuration, whereas inaccurately placed HE may not give the desired results. Although immediate smoke will provide suppression (by obscuration) for a longer period of time than will HE, it is effective only against a pinpoint target or a small area target less than 150 meters in diameter.

(2) The type of ammunition to be fired should be dictated by SOP. A suggested mix is firing WP (for initial quick buildup) and tiring smoke (for duration). Once the smoke has built up, all subsequent volleys should be shell smoke.

(3) Immediate smoke normally is used on a planned suppressive target or when shifting after immediate suppression with HE has been found to be ineffective because of positioning. Therefore, corrections for deviation, range, and height of burst must be made. The minimum corrections are 50 meters for deviation and 100 meters for range. The height of burst of shell smoke (M116A1) can be adjusted as follows:

- Ground burst: UP 100.
- Canisters bouncing excessively UP 50.
- Canisters too spread out: DOWN 50.

(4) When a mixture of smoke and WP is fired, it can be expected that the smoke will be effective 30 seconds after the shells impact and that it will last about 4 to 5 minutes. If the smoke is required for a longer period, additional volleys of smoke should be requested.

(5) The adjusting point on which the smoke is placed depends on weather conditions (Figure 6-17). Under normal circumstances, the point at which it is

directed should be about 100 meters short on the maneuver-target line and 100 meters upwind of the enemy location. If the wind is a crosswind (blowing across the maneuver-target line), the smoke is placed upwind so that it obscures the enemy's vision along the maneuver-target line. If the wind is a head wind (blowing away from the target), the smoke is placed 100 meters short on the maneuver-target line.

CAUTION

Care must be used with head winds, since the smoke may blow onto the maneuver element.

When the wind is a tail wind (blowing toward the target), the smoke is placed at least 200 meters short of the target to keep the smoke from landing beyond the target.

Figure 6-17. PLACEMENT OF IMMEDIATE SMOKE

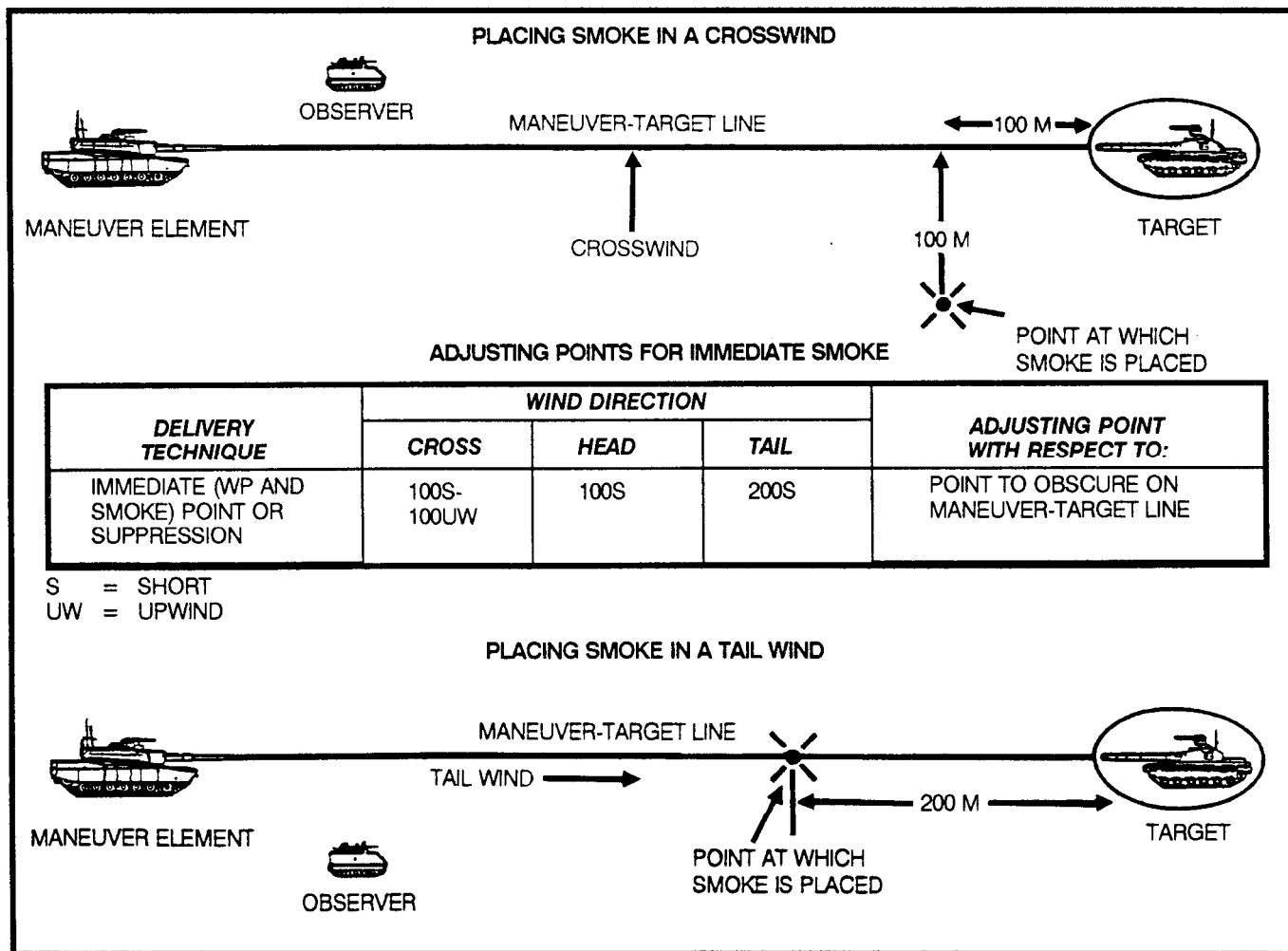

6-24. QUICK SMOKE

a. Description. The objective of quick smoke is to obscure the enemy's vision or to screen maneuver elements. The quick smoke mission equates to the normal HE adjust fire mission: Obscuring the enemy is required, but the urgency of the situation does not dictate immediate smoke procedures. The mission is begun by adjusting with HE, changing to smoke when within 200 meters of the adjusting point, and then firing for effect with smoke.

b. Employment Considerations.

(1) The quick smoke mission is used to obscure an area up to 600 meters wide. For areas larger than 600 meters, the observer can fire multiple quick smoke missions. Smoke may be effective up to 1,500 meters downwind.

(2) When preparing a quick smoke mission, the observer first determines the nature of the target and the location of the adjusting point (see Figure 6-18). Then he determines the size of the area and the wind direction in relation to the maneuver-target line (Figure 6-16).

(3) To select the adjusting point, the observer determines the wind direction and whether WP or smoke is to be fired in effect.

(4) The FDC must be informed of the target length, the target attitude, the wind direction, and the length of time the smoke is required. This information is sent to the FDC as early as possible (usually in the third transmission of the call for fire as part of the method of engagement but before **FIRE FOR EFFECT**). The observer also has the option of extending the time of effective smoke by requesting subsequent volleys.

(5) If the smoke must be effective beginning at a specific time, the observer requests **AT MY COMMAND** and the time of flight. To determine when to order the smoke fired, the observer adds the time of flight to the average buildup time of 30 seconds for WP and 60 seconds for smoke.

(6) If the smoke is ineffective, the observer must decide whether to shift the smoke or to fire HE. If the decision is to shift, there may be a break in the screen while new data are being computed.

Figure 6-18. PLACEMENT OF QUICK SMOKE

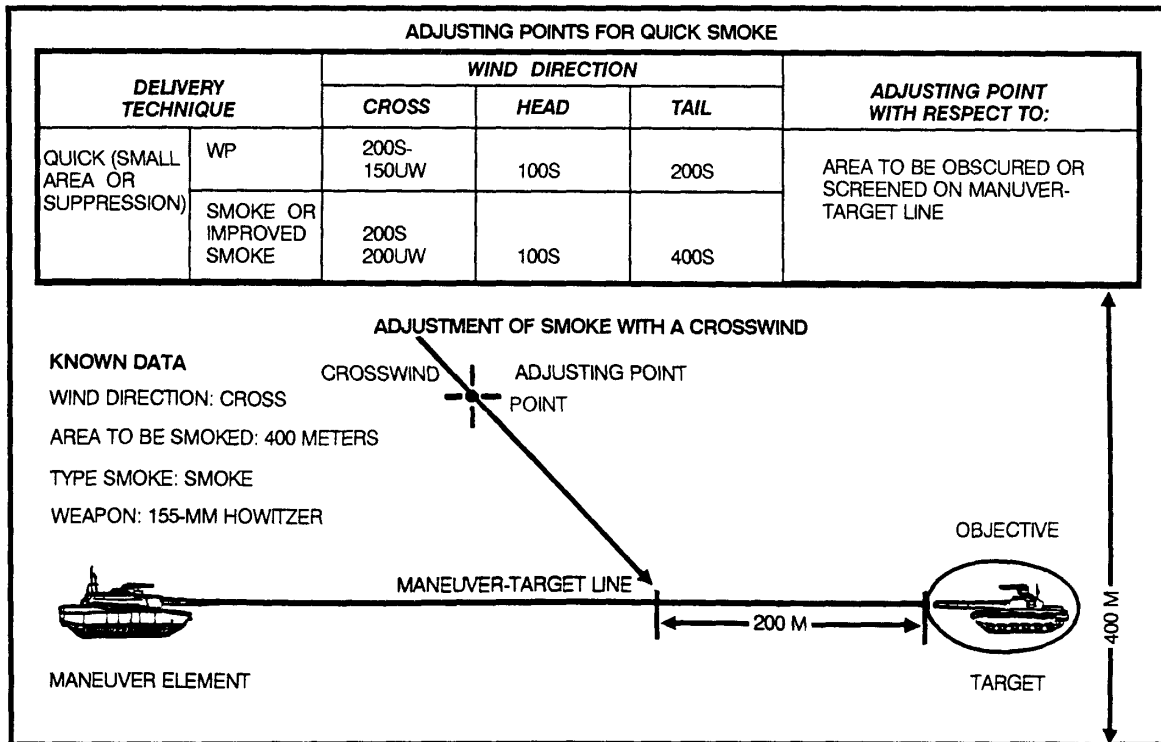

c. Adjustment.

(1) Shell Smoke. High explosive will be used in adjustment until a 200-meter bracket is split. The observer will then request shell smoke. One smoke round is fired, and any necessary corrections are made (in accordance with [IAW] subparagraph b(3) above). Then FFE is requested.

(2) Shell White Phosphorus. This adjustment is conducted like an adjust tire (AF) mission with WP in effect.

(3) Improved Smoke (M825). This is the predominant 155-mm smoke round. It does not need HOB adjustment. As a result, a 200-meter bracket is not split and FFE is started after a 200-meter bracket is achieved.

6-25. SAMPLE SMOKE MISSIONS

The examples below portray various types of smoke missions.

EXAMPLE

IMMEDIATE SMOKE AS A CONTINUATION OF AN IMMEDIATE SUPPRESSION MISSION

IMMEDIATE SMOKE, DIRECTION 5600, RIGHT 200, ADD 400, REPEAT, OVER.

NOTE: Direction is given if it was not sent previously in an immediate suppression mission.

EXAMPLE

IMMEDIATE SMOKE AS THE INITIAL CALL FOR FIRE H18, THIS IS H24, IMMEDIATE SMOKE, GRID NK628543, OVER.

EXAMPLE

QUICK SMOKE

H18 THIS IS H24, ADJUST FIRE, SHIFT KNOWN POINT 1, OVER.
DIRECTION 2400, RIGHT 100, ADD 200, OVER.
SUSPECTED PLATOON LOCATION, 200 METERS, 1600, TAIL, DURATION 5 MINUTES, SMOKE IN EFFECT, OVER.

or

H18 THIS IS H24, ADJUST FIRE, OVER.
GRID NK432895, OVER.
SCREEN TREE LINE, 200 METERS, 1800, CROSSWIND, DURATION 8 MINUTES, SMOKE IN EFFECT, OVER.

EXAMPLE

QUICK SMOKE, MULTIPLE AIMING POINTS

The observer fires a quick smoke mission, observes effects, and announces to FDC **SECOND AIMING POINT, RIGHT 500, DROP 200, REPEAT, OVER.**

NOTE: Had the observer simply wanted to move the quick smoke to another point, he would have made a normal subsequent correction and said **RIGHT 500, DROP 200, REPEAT, OVER.**

SECOND AIMING POINT tells the FDC that the observer wants to fire on a second point at this time and that the battery should be prepared to replenish smoke on either point. By observing how long the smoke remains effective near either aiming point, the observer can determine a time interval at which to replenish his smoke should he want to do so.

Interval = effective screen time – build-up time.

He can pass this information to the FDC by sending **CONTINUE SMOKE AT 3-MINUTE INTERVALS FOR 15 MINUTES, OVER.**

EXAMPLE

QUICK SMOKE, MULTIPLE AIMING POINTS CALLED FOR AT THE BEGINNING OF THE MISSION

H18 THIS IS H24, FIRE FOR EFFECT, OVER.
GRID NK843321 AND GRID NK840322, OVER.
TRENCH LINE, 800 METERS, CROSSWIND, DURATION 12 MINUTES, SMOKE, OVER.

6-26. MORTAR PROCEDURES

Quick smoke procedures for mortars are the same as for the artillery with the exceptions discussed below.

a. If the smoke rounds do not impact on or near the selected point, the observer makes corrections as necessary. Deviation corrections for individual guns may be sent back to the FDC.

b. When using 81-mm smoke, the observer may select a second aiming point halfway between the target and the first aiming point. The second aiming point may be used to supplement firing on the first aiming point or to shift fires quickly after smoke is fired for effect and is ineffective.

NOTE: WP is the only smoke round for mortars.

c. Corrections for rate of fire or deviation can be made for individual mortars or for the entire section after fire for effect.

Section V
COPPERHEAD

6-27. CHARACTERISTICS OF COPPERHEAD

Copperhead is a 155-mm cannon-launched guided projectile with a shaped charge warhead and a laser seeker. When fired at moving or stationary hard point targets, Copperhead homes in on laser energy reflected from the target during the final portion of its trajectory. Laser energy is provided by a remote laser designator, such as the G/VLLD or the modular universal laser equipment (MULE).

6-28. EMPLOYMENT

The optimum use of Copperhead is against multiple targets in large target arrays outside the range of maneuver direct fire weapon systems (approximately 3,000 meters). Single targets or very few, widely separated targets may be engaged by Copperhead if they are judged to be high-value targets; for example, the enemy commander's vehicle. Targets appearing within the range of maneuver direct fire weapon systems should be engaged by Copperhead only when the direct fire systems are unable to engage them or when the maneuver company commander directs.

a. Engagement Ranges. Fire planning for Copperhead should consider the engagement ranges of the G/VLLD. Moving targets can be engaged at 3 kilometers (km) and, depending on the skill of the observer, out to 4 kilometers (day sight only). Stationary targets can be engaged out to 5 kilometers. Targets should be planned so that engagement is within these maximum ranges.

b. Target Types. Copperhead targets can be engaged as either planned targets or targets of opportunity. Planned targets are preferred. Normally, the target-of-opportunity technique is used only during mobile operations and before planned targets are developed. Planned targets fall into two categories: priority and on-call.

(1) **Priority Targets.** For priority targets, data are precomputed and set on the guns, and the Copperhead round is laid in its loading tray.

(2) **On-Call Targets.** On-call targets are processed the same as priority targets, except the guns are not laid on firing data until after receipt of the mission.

6-22

6-29. ENGAGEMENT

a. Minimum Visibility Requirements. Laser designation requires an uninterrupted line of sight between the designator and the target. Anything that obstructs or weakens the laser signal will cause a significant decrease in the performance of the Copperhead round. On the battlefield, the terrain, vegetation, fog, smoke, dust, cloud height, and general battlefield turbulence all obstruct visibility of the target. The minimum visibility for effective Copperhead use is 5,000 meters. Soon after occupying a position, the observer should sight through the G/VLLD, range the farthest visible terrain feature, and determine its distance. If the distance measured by the G/VLLD is 5,000 meters or greater, the minimum visibility requirement for Copperhead is met. Minimum visibility should be rechecked periodically.

b. Laser Engagement Probabilities. On the downward leg of the Copperhead flight, the round acquires the laser energy reflected from the target and begins maneuvering toward it. However, the ground surface area in which the round can successfully engage is limited. The optimum limit of engagement of the Copperhead round is called a footprint. Footprints are roughly oval in shape and form around the target location sent in by the observer. Although a round can maneuver to the outside limits of the footprint, the greatest chance of hitting the target is when it is at or near the target location sent to the FDC. The greater the target location error, the lower the probability the round will hit the target. The outer boundary of the footprint represents a 50-percent probability of hit; the location sent to the FDC has a hit probability substantially higher than 50 percent. The size and shape of the footprint are affected by the target cloud height, the GT range, visibility, and the angle of fire (high or low).

c. Footprint Template. Trajectory templates (to 1:50,000 scale) have been developed to accurately portray the engagement area of each adjusting point. The template packet consists of two cover cards and 12 templates, labeled A through L.

(1) The cover cards give instructions for using the templates and a cloud height table. Each template depicts the shape of the footprint.

(2) The template cards are clear plastic graphic devices, (1:50,000 scale). Each card has the shape of the footprint (to scale based on the GT range and the cloud height) partially cut into the card. In addition each card is marked with the footprint letter code (A through L), a centerline, a target location pinhole, and an Angle T scale (Figure 6-19).

d. Selecting the Footprint. The observer or FSO selects the template according to the visibility of the target area, the weapon system, the cloud height ceiling, and the GT range. The instructions are printed on the cover cards. The instructions for footprint selection are shown in Table 6-8.

e. Orienting the Template Card. To orient the template card, center the pinhole in the footprint over the planned

target location. Align the centerline with the OT line. Using the OT line as an index, set off the Angle T by using the Angle T scale at the bottom of the template card. **The centerline should now be aligned with the GT line.** For the Copperhead seeker to get the best view of the laser spot, Angle T should not exceed 800 mils left or right. If the observer does not have the battery location to determine Angle Ts, he should contact the battery FDC and request one of the following:

- The battery location.
- The Angle T and guns left or right of his G/VLLD location for a target in the center of his area of responsibility.

Table 6-8. CLOUD HEIGHT

WEAPONS	CLOUD HEIGHT	GT RANGE	TEMPLATE
VISIBILITY 1.0 (MORE THAN 7,500 METERS)—DMD CODE 3			
All	150 meters or less	All ranges	A
M198, M109A2/A3	More than 150 meters	Less than 8.8 km	B
		8.8 to 11 km	C
		More than 11 km	D
M109A1	More than 150 meters	Less than 8.8 km	B
		8.8 to 11 km	J
		More than 11 km	D
VISIBILITY 0.5 (4,000 TO 7,499 METERS)—DMD CODE 2			
M198, M109A2/3	All cloud heights	Less than 8.8 km	E
		8.8 to 11 km	F
		More than 11 km	G
M109A1	More than 150 meters	Less than 8.8 km	E
		8.8 to 11 km	K
		More than 11 km	G
VISIBILITY 0.3 (2,000 TO 3,999 METERS)—DMD CODE 1			
All	All cloud heights	Less than 7.7 km	H
		More than 7.7 km	I
HIGH-ANGLE BALLISTIC			
All	All cloud heights	All ranges	L

Figure 6-19. COPPERHEAD FOOTPRINT TEMPLATE CARD

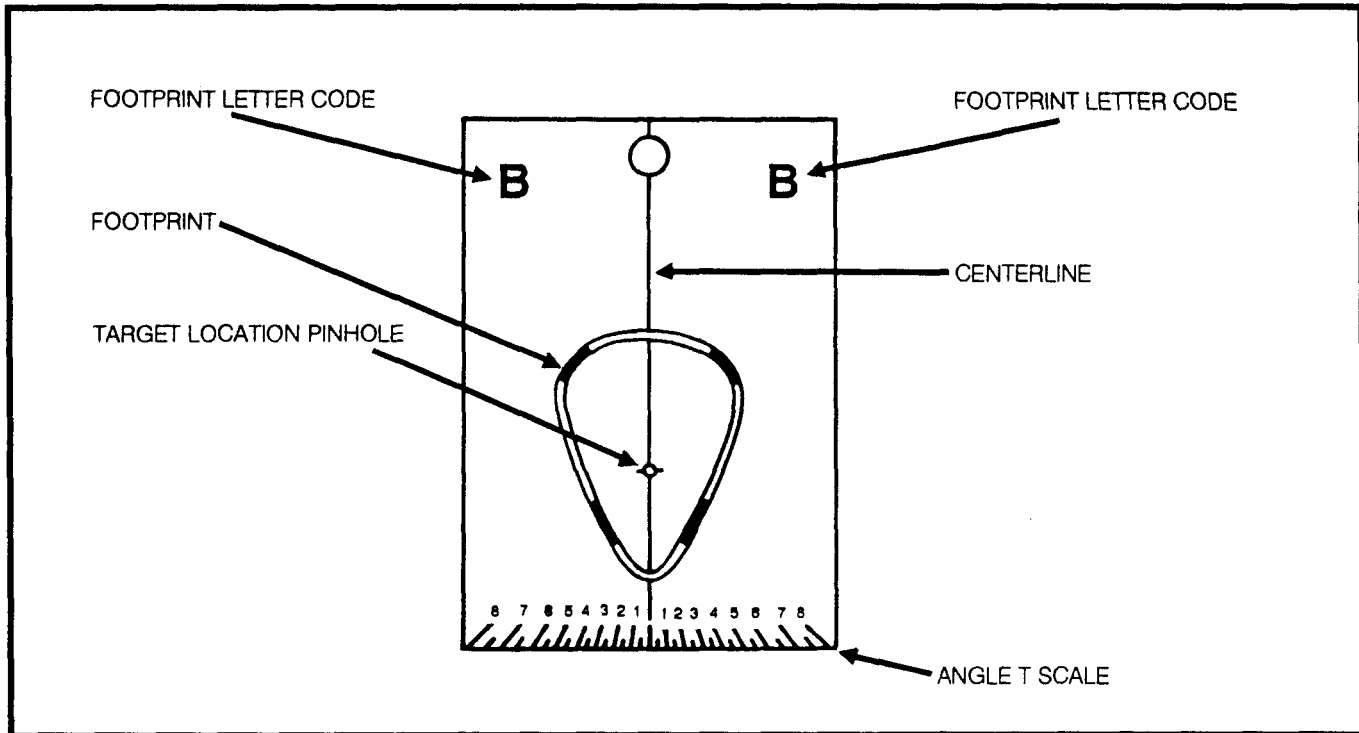

The Angle T and gun orientation to be considered when actually engaging a given target and the actual footprint to be used will be reported to the observer by the FDC. As already mentioned, the observer may reorient and redraw the footprint or he may visually interpolate the change.

f. Drawing the Footprint. After the template card has been properly oriented, the footprint can be drawn by inserting a pencil or other marking device in the openings on the card. The drawing is completed by removing the card and connecting the broken lines.

g. Visualizing the Footprint. The observer uses his G/VLLD to help him visualize the footprints on the ground. Once he has drawn the footprints on his map, he selects several points around the edges of the footprints and determines the direction and distance to each of them. He then locates these points on the ground by using the G/VLLD. By visually connecting the points, he can determine the shape of the footprints on the ground. The ability of the observer to visualize Copperhead footprints on existing terrain is essential to effective Copperhead target planning. Use of the Copperhead footprint template and the ability to construct a visibility diagram for the areas of likely enemy activity greatly help the observer in fire planning.

6-30. TARGETS OF OPPORTUNITY

a. As explained in Chapter 5, Section IV, targets of opportunity are expected to be more prevalent in highly mobile situations. To request Copperhead against a moving target, the observer must determine an intercept point and a trigger point. The determination of intercept and trigger points is detailed in Chapter 5.

b. Ideally, the battery will be prepared to fire before the target reaches the trigger point. However, if the target passes the trigger point before the battery reports **READY** but will still be within the footprint when the round arrives, the observer should fire the round immediately. If the target passes through the footprint before the battery reports **READY** or will pass through by the time the round arrives, the observer should make a bold shift to a new target location with the same trigger point and intercept distances. A grid for the new location should be sent to the FDC immediately.

c. Visualization of the Copperhead footprint is as important to the successful engagement of targets of opportunity as it is for planned targets. However, good footprint visualization for targets of opportunity is more difficult. Since there will probably not be enough time to draw a footprint on the map, neither the battalion nor the

battery FDC will tell the observer which footprint template card to use. Instead, the observer estimates the dimensions of the footprint on the basis of the size of the planned target footprints in the general vicinity of the target of opportunity. If planned target footprints have not been established, the observer estimates footprint dimensions. He selects an average footprint from the footprint template on the basis of the GT range or time of flight and visualizes it on the ground.

6-31. PLANNED TARGETS

a. Basically, planned moving targets are engaged the same as targets of opportunity. However, a moving target may change its direction of travel and not travel over the initially planned intercept point. In this case, the observer should select his trigger point so that the target will be as near as possible to the planned target location when the Copperhead round arrives (Figures 6-20 and 6-21).

b. The planned target location will be the intercept point. As soon as the observer sees the vehicles to be engaged, he must verify their direction and speed of travel and confirm his intercept and trigger point distances by using the procedures in Chapter 5. If the planned intercept point and trigger point do not allow enough time for total processing time plus time of flight, the observer must

determine a new intercept point and a new trigger point and engage the target as a target of opportunity.

6-32. COPPERHEAD CALL FOR FIRE

When a Copperhead target is acquired, the request for fire is sent over an established fire net to a battery FDC. Often, the same battery that fires other close support FA missions for an observer will also fire Copperhead against targets of opportunity and planned targets. However, the direct support (DS) battalion commander may designate specific units to fire all Copperhead missions.

a. **Planned Targets.** Once the target (or target array) is identified by the observer, he estimates its speed and direction to determine which planned target location should be used for engagement. A call for fire can then be sent. The following are elements in the call for fire (voice or digital) for planned targets:

- Observer identification: **THIS IS A71.**
- Warning order: **FIRE TARGET AY4781, OVER.**
- Target description: **4 TANKS.**
- Method of engagement: **4 ROUNDS.**
- Method of control: **AT MY COMMAND, OVER.**

Figure 6-20. TRIGGER POINT FOR PLANNED TARGET

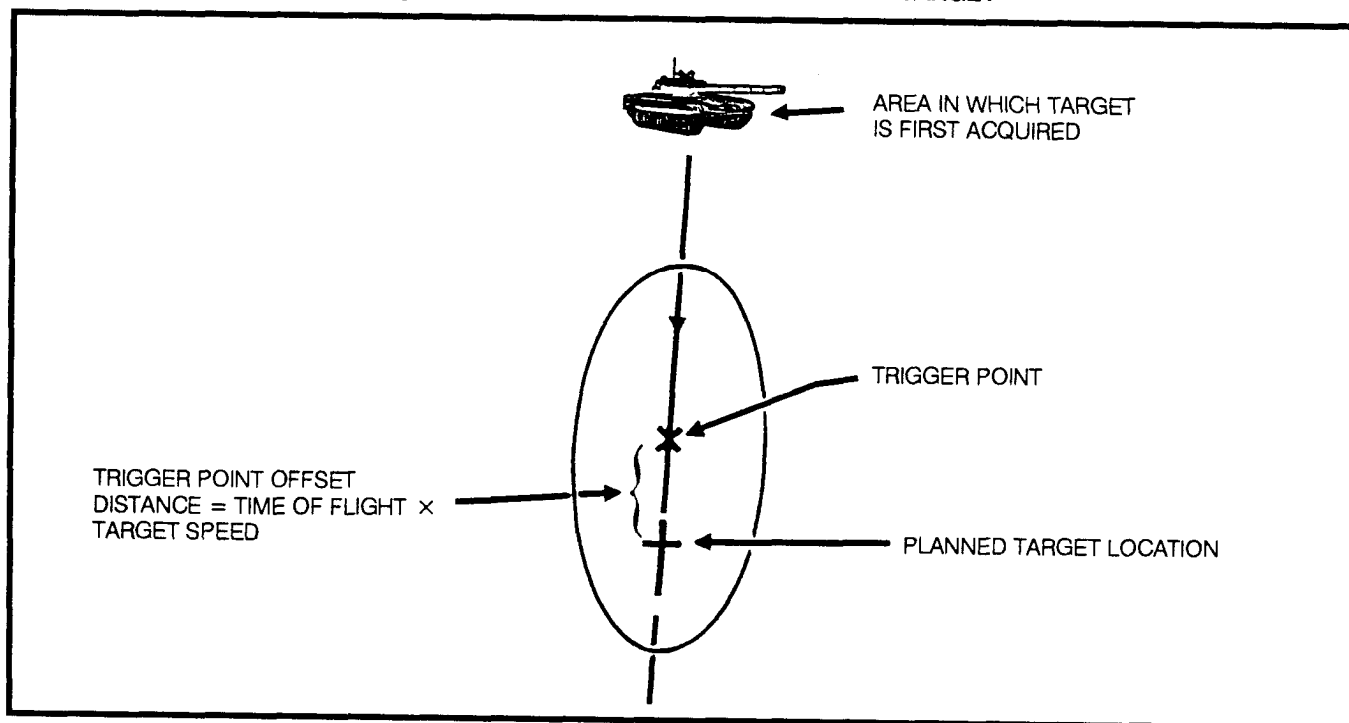
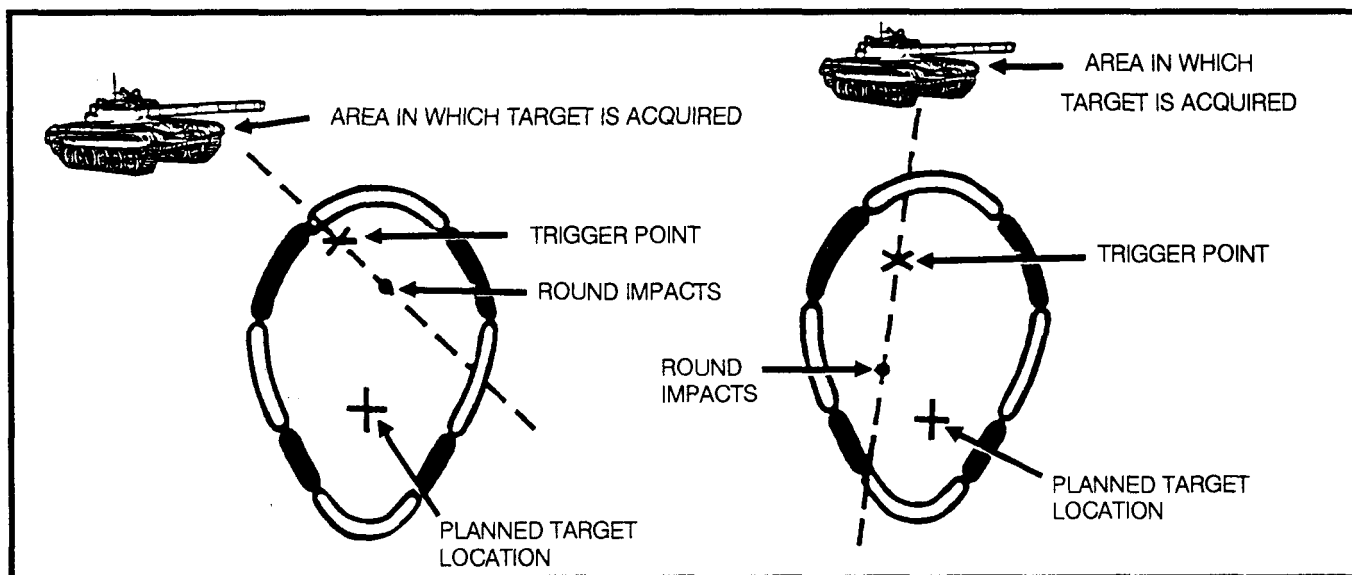

Figure 6-21. TRIGGER POINTS FOR TARGET NOT IN CENTER OF FOOTPRINT



(1) Unless otherwise specified on the Copperhead target list, the battery FDC will plan to fire two Copperhead rounds on each planned target. The BCS version 9 will compute and send data for one gun to fire a Copperhead round and will tell a second gun **DO NOT LOAD**. Two rounds are not automatically fired unless requested. If more than two rounds are required at the time of engagement, they must be requested in the call for fire. Table 6-9 gives criteria for determining the number of Copperhead rounds per target to be fired.

(2) When the observer requests **AT MY COMMAND**, the battery fires the Copperhead rounds at intervals of 30 seconds after the observer gives the command to fire. When **BY ROUND AT MY COMMAND** is requested, the observer controls the firing of each Copperhead round.

(3) For immediate responsiveness in engaging priority targets, the observer can streamline his call for fire. He can omit the target description, method of engagement, and method of control. For example, **THIS IS A71, FIRE TARGET AY4781, OVER**. The first round will impact at time of flight plus radio transmission time. Subsequent rounds will arrive at intervals of at least 20 seconds thereafter.

NOTE: The streamlined planned target call for fire should be used only when more rounds than planned are required.

Table 6-9. ROUNDS PER TARGET

TARGETS	NUMBER OF ROUNDS
1	2
2	2
3	3
4	4
5	5
6	6

b. Targets of Opportunity. When planned target locations are not available, the observer engages the target as a target of opportunity. Calls for fire for Copperhead targets of opportunity follow the same format as the

- Observer identification: **Y5A57 THIS IS Y5A71.**
- Warning order: **FIRE FOR EFFECT, POLAR, OVER.**
- Location of target: **DIRECTION 1800, RANGE 3450, VERTICAL ANGLE +5, OVER.**
- Target description: **2 TANKS.**
- Method of engagement (see Table 6-8): **COPPERHEAD, 2 ROUNDS.**
- Method of control: **BY ROUND, AT MY COMMAND, OVER.**

NOTE: Normally, the observer uses **AT MY COMMAND** or **BY ROUND AT MY COMMAND** for targets of opportunity.

c. Message to Observer. After the call for fire is received by the FDC and the mission processing is started, an MTO is sent as soon as possible. This applies to all Copperhead targets except priority targets. The MTOs are sent before firing. The MTO for the Copperhead mission includes the following elements:

- Unit tiring: **Q**.
- Laser PRF code: **CODE 241**.
- Time of flight: **TIME OF FLIGHT 25**.

d. Laser PRF Code. The G/VLLD can emit laser pukes of different frequencies. The Copperhead projectile can sense these frequencies. These frequencies are set as a three-digit PRF code on the G/VLLD and on the Copperhead projectile. For a Copperhead mission to be successful, the observer must ensure that the PRF code on the Copperhead round matches the PRF code on the GNLLD. The FDC has a list of all observer PRF codes matched with their call signs. On the basis of the observer's identification in the call for fire, the FDC selects the proper PRF code and sends it to the guns, where it is placed on the Copperhead round. The FDC verifies this code in the MTO. If the FDC sends the observer a different code in the MTO than the one set on the G/VLLD, the observer immediately changes the code on the G/VLLD so that it matches the code sent by the FDC. Normally, however, an observer does not change his PRF code unless directed. Battalion FSOs must ensure that their G/VLLD operators have the correct codes. One PRF code is indicated as primary for each operator to use for all his Copperhead missions. This code setting is changed only when absolutely necessary.

e. Copperhead Engagement Commands.

(1) **Shot.** As soon as the first Copperhead round is fired in a mission, the observer receives **SHOT** from the FDC. If he specified **AT MY COMMAND** or omitted the method of control in the call for fire (battery fires when ready), he receives **SHOT** only once. The subsequent rounds are fired at intervals of at least 20 seconds without notification. (The exact interval is set by unit SOP.) If the observer specified **BY ROUND AT MY COMMAND**, he receives **SHOT** for each round fired. If an observer fails to acknowledge **SHOT** for a given round, it will not be retransmitted because the observer's timing will be affected.

(2) **Designate.** The next and most critical engagement command is **DESIGNATE**. When the observer receives the command **DESIGNATE** from the FDC, he begins designating the target with the G/VLLD. This command is sent 20 seconds before impact. If the time of flight is 20 seconds or less, **SHOT** and **DESIGNATE** are sent in the same transmission. **DESIGNATE** is used when communicating digitally. If operating in the voice mode, the command is **LASER ON**.

(a) It is mandatory that the observer designate the target during the last 13 seconds of time of flight. Once the observer has received **SHOT**, he should begin his own countdown using the time of flight received in the message to observer. If for some reason he has not received a **DESIGNATE** message, he should begin designation when 13 seconds are left in his countdown.

(b) If the battery is firing the Copperhead rounds automatically at 20-second intervals, the command **DESIGNATE** is sent only for the first round fired. The observer continues designating for the subsequent rounds while moving the laser spot to the next target.

(c) If **SHOT** is given for each round or if the firing interval is greater than 20 seconds, **DESIGNATE** is given for each round.

(3) **Designate Now.** If an observer fails to acknowledge the **DESIGNATE** command, the command **DESIGNATE NOW** is sent by the FDC until the observer acknowledges or the time of flight of the round elapses. If the observer fails to acknowledge the **DESIGNATE NOW** command, **SHOT** and **DESIGNATE** are sent on the next round fired, regardless of the method of control.

(4) **Rounds Complete.** The FDC reports **ROUNDS COMPLETE** after the engagement commands for the last round are transmitted and acknowledged. If the observer wants to terminate firing before the last round is fired and the FDC is controlling the firing of subsequent rounds, he sends **CHECK FIRING**, **CANCEL CHECK FIRING**, **END OF MISSION**. If the observer is controlling the firing of subsequent rounds, he simply sends **END OF MISSION** to terminate the mission.

(5) **Requests for Additional Rounds.** If additional rounds are required to engage the target array, the observer may request them by sending (so many) **ROUNDS, REPEAT, OVER** after the last Copperhead round is fired. The criteria in Table 6-9 will be followed in requesting additional rounds.

CHAPTER 7

SPECIAL OBSERVER MISSIONS

This chapter implements STANAG 2934, Chapter 5 and QSTAG 246.

7-1. AERIAL FIRE SUPPORT OBSERVER

Because of the helicopter's speed, range, and ability to bypass obstacles, the AFSO can observe for indirect fire out to a greater distance than an observer with a ground unit.

a. If possible, the AFSO and the pilot should be given a detailed preflight briefing by the battalion FSO and the supported unit S3 or S2. The preflight briefing should cover the following:

- The tactical situation to include enemy locations and anti-aircraft weapons, friendly locations and capabilities, front lines, zones of action of support troops, and all coordinating measures. (Maps and overlay with this information should be available to the AFSO.)
- The location of all indirect fire units, known points, targets, mess to be searched, and ordnance available.
- Flight instructions, time on and off the mission, obstacles, checkpoints, and equipment needed.
- Communications details such as channels to use, call signs, check-in time(s), and prearranged signals.

- Any unit SOP items regarding calling for and executing registrations, immediate suppressions, special munitions, and suppression of enemy air defenses (SEAD).

b. The spotting line is the line along which the observer is going to adjust. The spotting line and its direction must be known by the FDC personnel. There are several possible spotting lines that the AFSO can use:

- Gun-target line.
- Observer-target line.
- Cardinal direction.
- Readily identifiable terrain feature.

(1) Gun-Target Line. Knowledge of the firing unit location allows the AFSO to determine the GT line (Figure 7-1) without requesting ranging rounds. The use of ranging rounds is undesirable, since they may help the enemy determine the firing battery position. The FDC assumes that the GT line is being used unless otherwise specified by the observer. If the observer does use the GT line, he should select a terrain feature (for example, a road, stream, or ridge line) that will help him remember the GT direction. Because of the low altitudes at which the observer is flying, using a spotting line other than the GT line often will be required. If the AFSO uses a spotting line other than the GT line, he must report it to the FDC.

Figure 7-1. REFERENCE LINE AND GT LINE

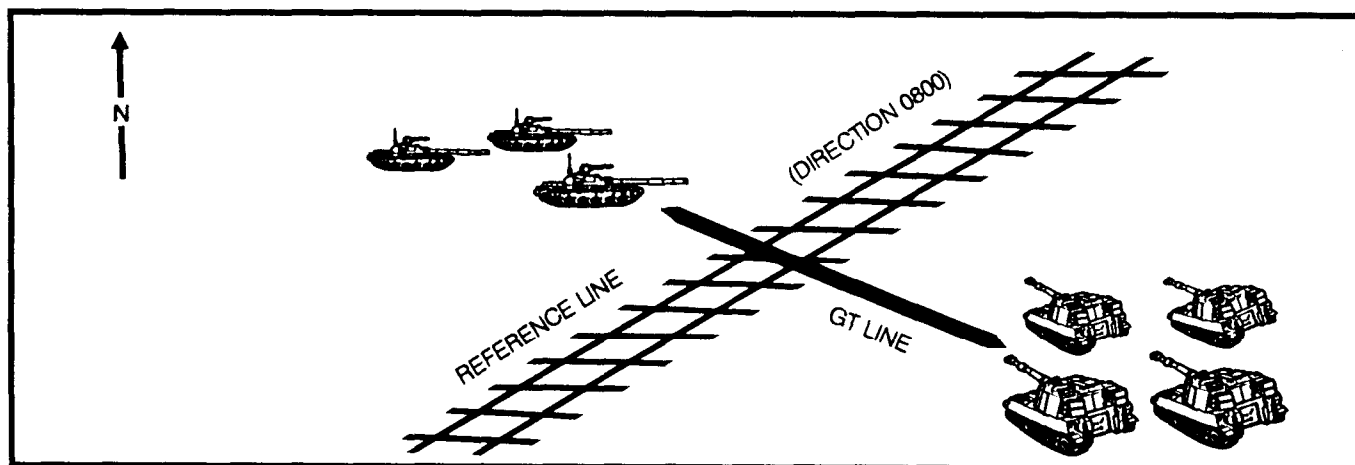

(2) Observer-Target Line. The aircraft heading indicator can be used to determine the OT direction. Since the aircraft is normally in a head-on posture when the observer is looking at the target, the heading indicator will provide an accurate direction in most cases. When this technique is used, direction should be sent to the nearest 10° (for example, **DIRECTION 70 DEGREES MAGNETIC** or **GRID**). If the OT direction changes more than 10° during a mission, the new direction should be sent to the FDC (assuming that the next corrections are sent in relation to the new OT line). This is the preferred method, as it minimizes observer reorientation and exposure time while maximizing aircraft maneuverability.

(3) Cardinal Direction. The observer may use cardinal direction (Figure 7-2) for sending his orientation. This is the least accurate method and therefore the least preferred.

(4) Readily Identifiable Terrain Feature. The observer may select a terrain feature which provides a reference line (for example; a railroad, a canal, or any series of objects). Before flight, if possible, the observer selects the line and sends the data to the FDC.

c. Obtaining accurate target location is difficult, since targets are normally acquired with the naked eye. Use of binoculars is limited because of distortion caused by the windscreen and vibration of the aircraft. Hand measurements or estimations should be used to measure angular deviation.

d. Target location is indicated by grid or by shift from a known point. The announced direction of the shift is with respect to the spotting line. If any spotting line other than the GT line is used, it must be identified.

e. When adjusting fire, the AFSSO will usually use either the stationary hover or the pop-up technique.

(1) In stationary hover, the pilot positions the aircraft behind trees or other terrain features that conceal the aircraft and still permit observation of the target.

(2) In pop-up, the pilot "unmasks" the aircraft 2 to 3 seconds before impact of the round. The AFSSO observes the burst, and the pilot then returns the aircraft to the hide position or moves to another hide position. The observer sends his corrections as the pilot is "remasking" the aircraft. Time of flight is automatically sent to the AFSSO. This allows the pilot to position the aircraft properly if "splash" time is not sufficient. Set patterns of movement must be avoided to enhance survivability.

f. Sample calls for fire are discussed below.

(1) An example of a call for fire in which the AFSSO uses grid coordinates as the means of locating the target follows.

EXAMPLE
H18 THIS IS H90, ADJUST FIRE, OVER.
GRID NK421791, OVER.
INFANTRY PLATOON AND 10 TRUCKS IN THE
OPEN, ICM IN EFFECT, OVER.

When adjusting rounds on a grid fire mission, the observer must identify the spotting line before making subsequent corrections, or the FDC will plot the corrections along the GT line.

Figure 7-2. **CARDINAL DIRECTIONS**

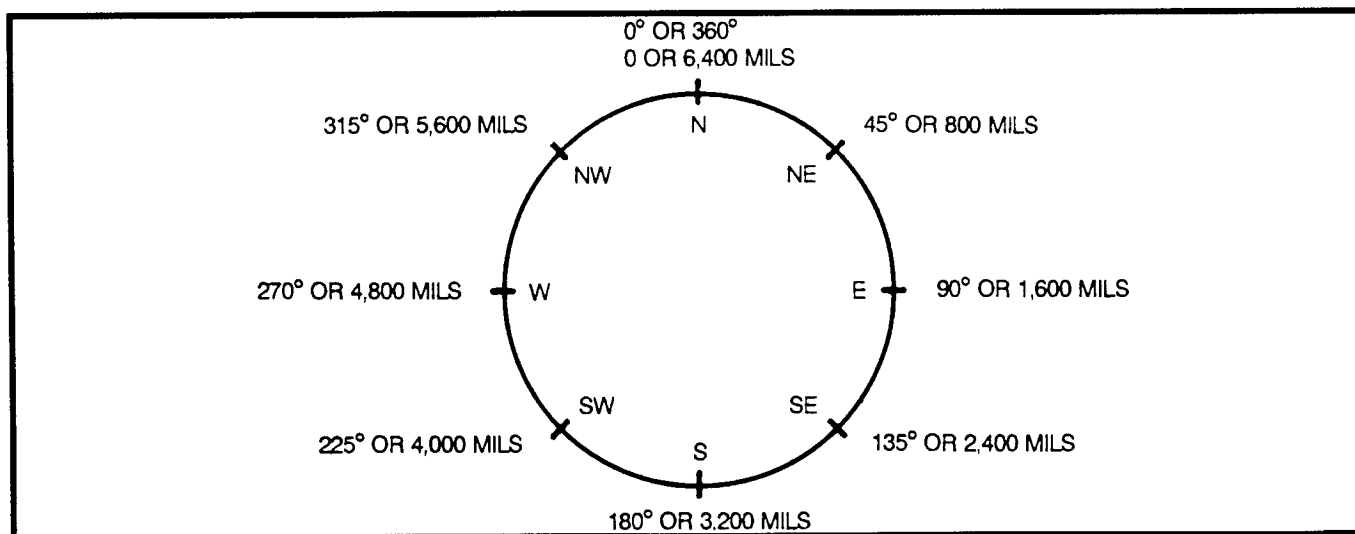

(2) An example of an AFSSO's initial call for fire in which the target location is based on a shift from a known point and the GT line is used as the spotting line follows.

EXAMPLE

H18 THIS IS H90, ADJUST FIRE, SHIFT KNOWN POINT 1, OVER.
RIGHT 400, ADD 800, OVER.
INFANTRY PLATOON AND 10 TRUCKS IN THE OPEN, ICM IN EFFECT, OVER.

(3) An example of an AFSSO's call for fire in which the target location is based on a shift from a known point and a line of known direction is used as the spotting line follows.

EXAMPLE

H18 THIS IS H90, ADJUST FIRE, SHIFT KNOWN POINT 3, OVER.
400 METERS NORTHEAST, OVER.
4 TRUCKS STALLED AT FORD, OVER.

7-2. HIGH-ANGLE FIRE

a. Fire delivered at quadrant elevations greater than the quadrant elevation for maximum range is called high-angle fire (Figure 7-3). High-angle fire is often required when the weapons fire out of deep defilade, from within built-up areas, or over high terrain features near friendly troops. High-angle fire may also be required when the target is located on a reverse slope, in jungles, or in deep gullies or ravines and cannot be reached by low-angle fire.

b. Generally, those weapons with a maximum elevation substantially in excess of 800 mils can fire high angle. All US field artillery weapons are capable of both low-angle and high-angle fire. Mortars are capable of only high-angle fire. Naval guns are not suitable for high-angle fire. Because of their high muzzle velocity, they are primarily used for low-angle fire. The observer procedure for the adjustment of high-angle fire is the same as that for the adjustment of low-angle fire. The observer must realize that small deviation corrections during adjustment may be unnecessary and time consuming because of the increased dispersion during high-angle fire. Since the time of flight is long in both adjustment and fire for effect, the FDC should announce **SHOT** and **SPLASH**. Fuze time is not used in high-angle fire. If an airburst is desired, fuze VT gives excellent results.

Figure 7-3. HIGH-ANGLE FIRE

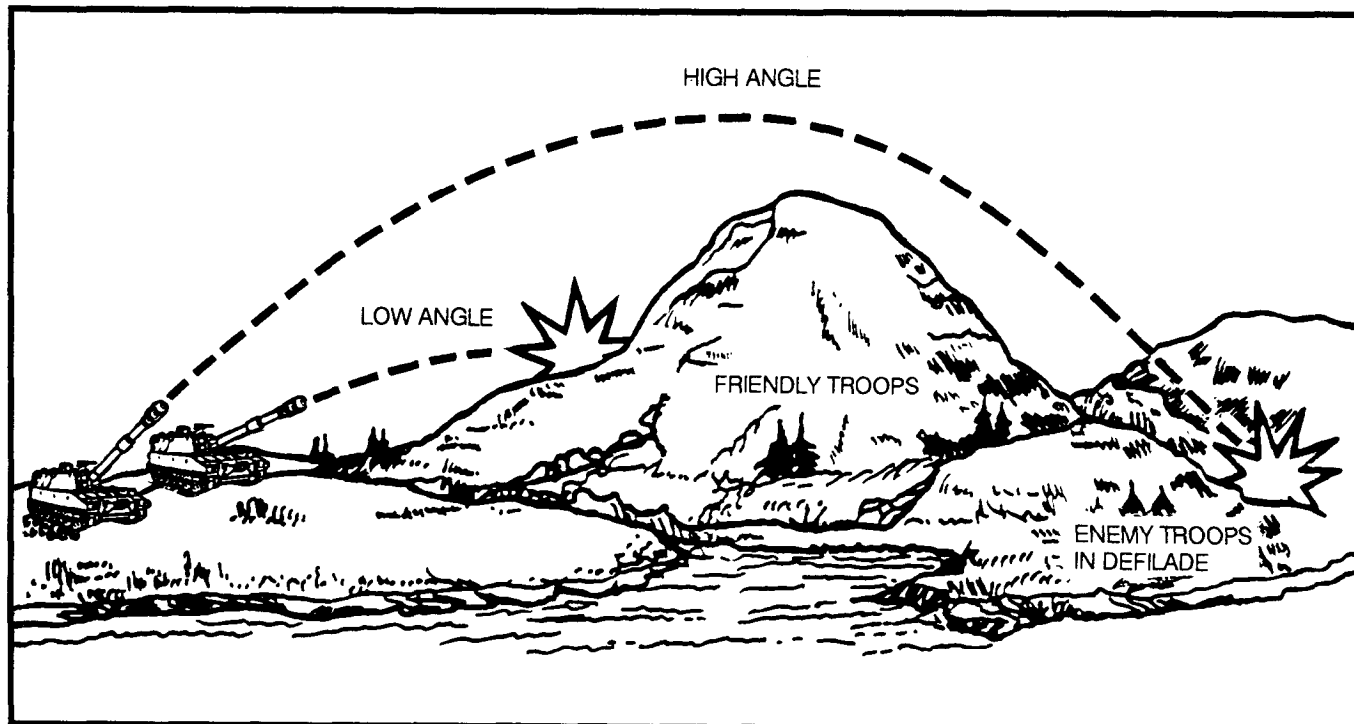

7-3. FINAL PROTECTIVE FIRES

a. A final protective fire is an immediately available preplanned barrier of direct and indirect fire designed to provide close protection to friendly positions and installations by impeding enemy movement into defensive areas. Basically, it is an entire battery or mortar platoon firing so that the rounds are arranged on line. The size of the FPF depends on the number and type of weapon systems.

NOTE: Though this is the planning formula, a maneuver commander may increase or decrease the length of an FPF to suit his needs. He must understand that an increase in the FPF length decreases the concentration of fires and therefore decreases its effectiveness. Naval gunfire ships are not normally assigned FPFs.

b. The location of the FPF is designated by the maneuver commander for whom it is being planned. The FPF is planned to support a defense and may be any distance from the friendly position. Normally, the FPF is within 200 to 400 meters (danger close) and is integrated into the final protective line of the maneuver unit. The importance of accurate defensive fires and the danger close situation require that each weapon firing the FPF be adjusted into place, if at all possible.

c. When an FPF with a manual FDC is established, the call for fire is similar to the normal call for fire in an adjust fire mission (with some exceptions).

(1) If an adjustment is to be done, the target location first sent is not the location of the center of the FPF but is a grid a safe distance (400 to 600 meters) from friendly troops. Because this grid is part of a final defensive plan, it should be sent by secure means or encoded. The attitude of the FPF is also announced.

(2) Instead of a target description, **FINAL PROTECTIVE FIRES** is announced.

(3) **ATTITUDE AND DANGER CLOSE** (if applicable) are announced in the method of engagement.

d. The firing unit will fire a battery 1 volley centered on the initial grid sent by the observer. Assume that the rounds impact as shown in Figure 7-4. The observer begins his adjustment with the flank piece impacting closest to the FPF line (in this case, Number 1). (Creeping fire must be used in a danger close situation.) Corrections of 50 meters or less are not fired.

Figure 7-4. ADJUSTMENT OF THE FPF BEGINS WITH ROUND NEAREST THE FPF LINE

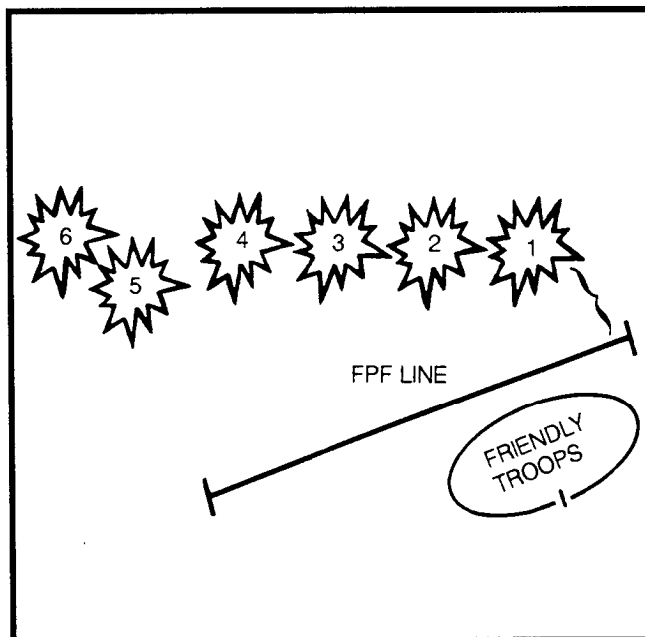

NOTE: FDCs using muzzle velocity variations (MVVs) and special corrections adjust only the one piece.

e. Once the first gun is adjusted, the observer sends **NUMBER 2, REPEAT** and adjusts each weapon in succession.

EXAMPLE

The weapons firing are a 105-mm battery. The observer is shown the FPF line by the maneuver commander and sends the following call for fire:

H12 THIS IS H18, ADJUST FIRE, OVER.

GRID NK123456, OVER.

FINAL PROTECTIVE FIRE, ATTITUDE 1900, DANGER CLOSE, DELAY, OVER.

The unit fires a battery 1 round. The sheaf is shown in Figure 7-5. The observer notes that Number 6 is closest to the FPF line. He begins the adjustment with it:

DIRECTION 0810, NUMBER 6, LEFT 100, DROP 50, OVER.

The round is fired and the observer believes that the round is within 50 meters. He sends a correction (the round is not fired) and calls for Number 5 to fire:

NUMBER 6, DROP 50, NUMBER 6 IS ADJUSTED. NUMBER 5, REPEAT, OVER.

The other weapons are adjusted as discussed above.

Figure 7-5. ADJUSTMENT OF FPF BEGINS WITH NUMBER 6

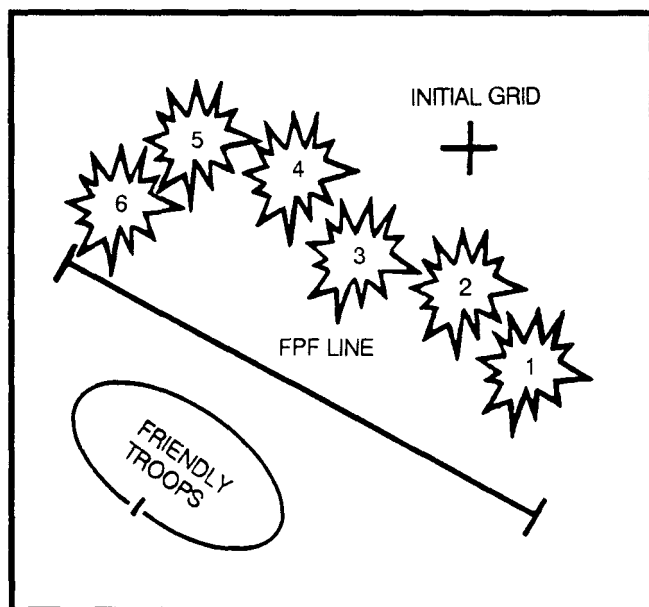

f. If the FDC is using a computer (BCS or BUCS), MVVs, and special corrections, only the center weapon will be adjusted onto the center grid of the FPF and the adjustment will be ended.

g. Fuze delay should be used in adjustment to minimize the safety hazard to friendly units.

h. In some instances, there will not be time to "shoot in" the FPF. In this instance, the FPF will be called in. The grids of the two ends or the center grid and attitude will be given. If the FDC is using a BCS, then length, width, and attitude or a laser draw should be sent.

7-4. MULTIPLE MISSIONS

Contact with the enemy may be so intense that the forward observer must transmit two or more calls for fire and adjust all missions simultaneously. He should consult the maneuver unit commander, if possible, or use his own best judgment to determine which of several important targets should be engaged first. The experienced observer will have little trouble handling multiple missions if he tracks missions by target numbers. He may also record the corrections determined for each target to eliminate any confusion that may arise in the heat of battle. If other observers are using the same fire net, each observer should continue to use his call sign during the mission.

EXAMPLE

OBSERVER

FDC

H66 THIS IS H44, ADJUST FIRE, OVER.

H44 THIS IS H66, ADJUST FIRE, OUT.

GRID NK180513, OVER.

GRID NK180513, OUT.

INFANTRY PLATOON IN THE OPEN, ICM IN EFFECT,
OVER.INFANTRY PLATOON IN THE OPEN, ICM IN EFFECT,
AUTHENTICATE PAPA BRAVO, OVER.

I AUTHENTICATE CHARLIE, OUT.

TIME, 2 ROUNDS, TARGET AA7731, OVER.

TIME, 2 ROUNDS, TARGET AA7731, OUT.

DIRECTION 1830, LEFT 40, ADD 400, OVER.

DIRECTION 1830, LEFT 40, ADD 400, OUT.

H66 THIS IS H44, ADJUST FIRE, POLAR, OVER.

H44 THIS IS H66, ADJUST FIRE, POLAR, OUT.

DIRECTION 4600, DISTANCE 2100, OVER.

DIRECTION 4600, DISTANCE 2100, OUT.

RADAR IN OPEN, OVER.

RADAR IN OPEN, OUT.

TIME, 1 ROUND, TARGET AA7732, OUT.

TIME, 1 ROUND, TARGET AA7732, OVER.

AA7731 DROP 200, OVER.

AA7731 DROP 200, OUT.

AA7732 ADD 100, FIRE FOR EFFECT, OVER.

AA7732 ADD 100, FIRE FOR EFFECT, OUT.

AA7731 ADD 100, FIRE FOR EFFECT, OVER.

AA7731 ADD 100, FIRE FOR EFFECT, OUT.

AA7732 END OF MISSION, RADAR NEUTRALIZED,
OVER.

AA7732 END OF MISSION, RADAR NEUTRALIZED, OUT.

AA7731 END OF MISSION, INFANTRY PLATOON
NEUTRALIZED, ESTIMATE 10 CASUALTIES, OVER.AA7731 END OF MISSION, INFANTRY PLATOON
NEUTRALIZED, ESTIMATE 10 CASUALTIES, OUT.

7-5. OBSERVING HIGH-BURST OR MEAN-POINT-OF-IMPACT REGISTRATIONS

The opportunities for a precision registration are limited, since it requires visual observation on a clearly defined, accurately located registration point in the target area. At night, visual adjustment of fire on a registration point is impossible without some type of illumination or night observation device. In desert, jungle, or arctic operations, clearly defined registration points in the target area are not usually available. Special procedures, including observation techniques, have been developed to provide for registration under these conditions. One such procedure is the high-burst (HB) (Figure 7-6) or MPI registration. In an HB registration, two observers (referred to as O1 and O2) simultaneously observe time fire aimed at a point in the air above the target area. The FDC selects the point at which the fire is to be aimed. It does this by selecting a point on the ground in the area where the registration is desired and projecting this point into the air with a prescribed height of burst. The FDC controls the firing of the high-burst registration. A single weapon is used to fire the registration. All rounds are fired with the same data. Each observer, using an aiming circle, a G/VLLD, or a MULE, reports the direction from his position to the bursts. One observer reports the vertical angle after each round. An MPI registration is the same, except the rounds are fired with fuze quick.

a. Location and Initial Orientation of the Observing Instruments. In an HB registration, the accurate location of each OP and the proper orientation of each observing instrument are very important. Each OP location is surveyed and a line of known direction is established on the ground so that the observer can orient his instrument for direction. If

possible, the observer should establish his OP and orient his instrument for direction during daylight. However, the exact location of the instrument and the line of known direction should be marked so that they can be identified during darkness. These precautions allow the observer to position and orient his instrument during darkness if necessary. To establish the OP, the observer sets his instrument over the position marker, makes sure that the instrument is level, and then orients the instrument on the line of known direction. To orient the instrument on the line of known direction, the observer sets the azimuth of the line of known direction on the azimuth scales of the instrument by using the upper recording motion. Then, using the lower motion, he aligns the vertical crossline in the reticle on the marker or the point that identifies the known direction. The instrument is then properly oriented for direction. If using a laser, the observer places the vertical crossline on the known direction marker and uses the azimuth zero knob to put the known direction on the display. Once this is done, the instrument is oriented for direction.

b. Orientation of the Observing Instruments on the Orienting Point. The FDC tells each observer the direction and vertical angle from his position to the orienting point. The example below is a typical message from the FDC to the observers.

EXAMPLE
OBSERVE HIGH-BURST REGISTRATION, O1
DIRECTION 1164, VERTICAL ANGLE PLUS 12,
MEASURE THE VERTICAL ANGLE. O2 DIRECTION
0718, VERTICAL ANGLE MINUS 3. REPORT WHEN
READY TO OBSERVE.

Figure 7-6. HIGH-BURST REGISTRATION

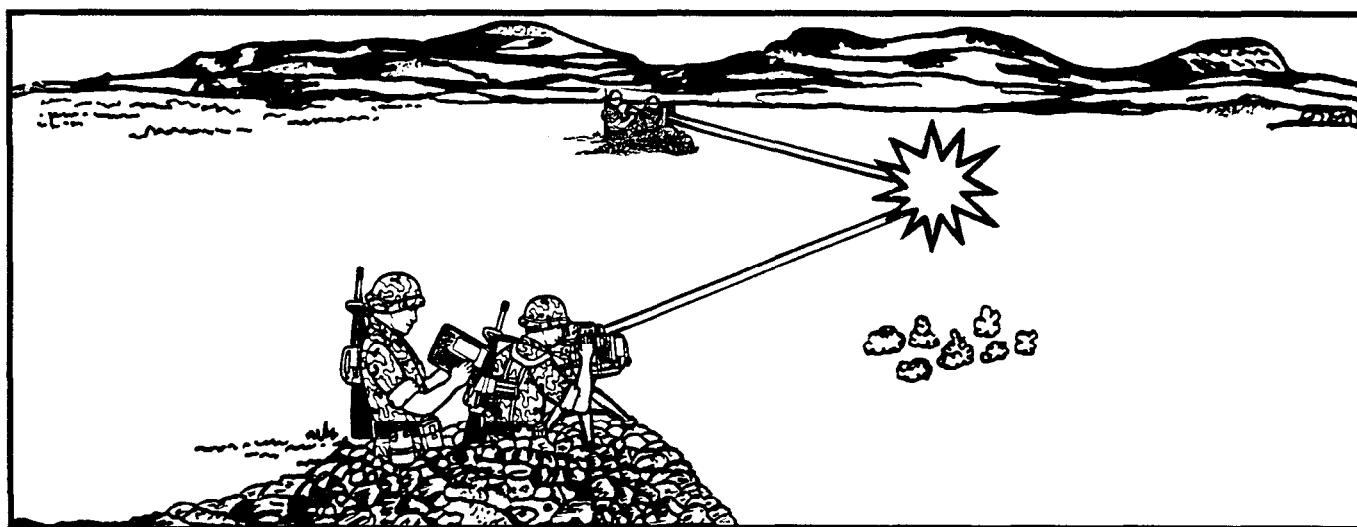

(1) Each observer, using the upper motion, sets the direction given him on the azimuth scales of his instrument. The horizontal line of sight of the instrument now coincides with the horizontal line of sight from the observer's position to the orienting point. Each observer also sets the vertical angle given him on the elevation scales of his instrument to orient the instrument for height of burst. The manner in which the observer sets the vertical angle on the scales of his instrument depends on the type of observing instrument he is using.

(2) The elevation scales on the M2 aiming circle are graduated so that a 0 reading on the scales corresponds to a vertical angle of 0. The scales are graduated and numbered in each direction from 0. The graduations and numbers in one direction from 0 are printed in black; those in the other direction are printed in red. Positive (plus) vertical angles are indicated by the black numbers, and negative (minus) vertical angles are indicated by the red numbers. The elevation scales on the aiming circle are operated with the elevation micrometer knob. If the vertical angle given the observer is a positive (plus) angle, he sets its value on the elevation scales in the direction represented by the black numbers. If the vertical angle given the observer is a negative (minus) angle, he sets its value on the elevation scales in the direction represented by the red numbers. This action places the center of the crosslines in the reticle of the instrument in line with the point in the air selected as the orienting point.

c. Measuring and Reporting the First Round. When the observers report **READY TO OBSERVE**, the FDC directs the firing of the rounds one at a time. The FDC reports **SHOT** and **SPLASH** after each round is fired. When the burst of the first round appears, each observer determines the direction to the round. He does this by spotting the horizontal deviation from the vertical crossline in the reticle of the instrument and then combining this value with the reading on the azimuth scales. If the deviation is to the left of the vertical crossline, he subtracts the value from the reading on the azimuth scales. If it is to the right of the vertical crossline, he adds the value to the reading on the instrument.

EXAMPLE

A round bursts 20 mils right of the vertical crossline and the reading on the azimuth scales is 0480. The azimuth to the burst is 0500 ($0480 + 20 = 0500$).

The vertical angle to the burst is determined as discussed below.

(1) If the observer directed to measure the vertical angle is using an aiming circle, he spots the number of mils the burst appears above or below the horizontal crossline in the reticle of the instrument and combines this reading with the reading on the elevation scales.

EXAMPLE

The burst appears 10 mils above the horizontal crossline, and the reading on the elevation scales is +20. The vertical angle to the burst is +30 ($20 + 10 = 30$).

(2) The observers report in turn.

EXAMPLE

O1 DIRECTION 0500, VERTICAL ANGLE +30, OVER
O2 DIRECTION 0167, OVER.

(3) If the observer does not observe the initial round within the field of view of his instrument, he should report this and the approximate direction and vertical angle to where the round burst to the FDC.

EXAMPLE

O2 ROUND UNOBSERVED TOO FAR LEFT,
DIRECTION 0300, VERTICAL ANGLE +25, OVER.

d. Reorienting on the First Round. Once the observer reports his direction (and vertical angle, if applicable) to the first round, he reorients his instrument (Figure 7-7) on the direction and vertical angle to where that initial round burst. This allows for smaller deviation measurements for subsequent rounds.

e. Measuring and Reporting Subsequent Rounds. The procedures for measuring and reporting direction and vertical angle for subsequent rounds are the same as those for the first round. However, the observer does **not** reorient his instrument after subsequent rounds.

Figure 7-7. REORIENTATION AFTER THE FIRST ROUND

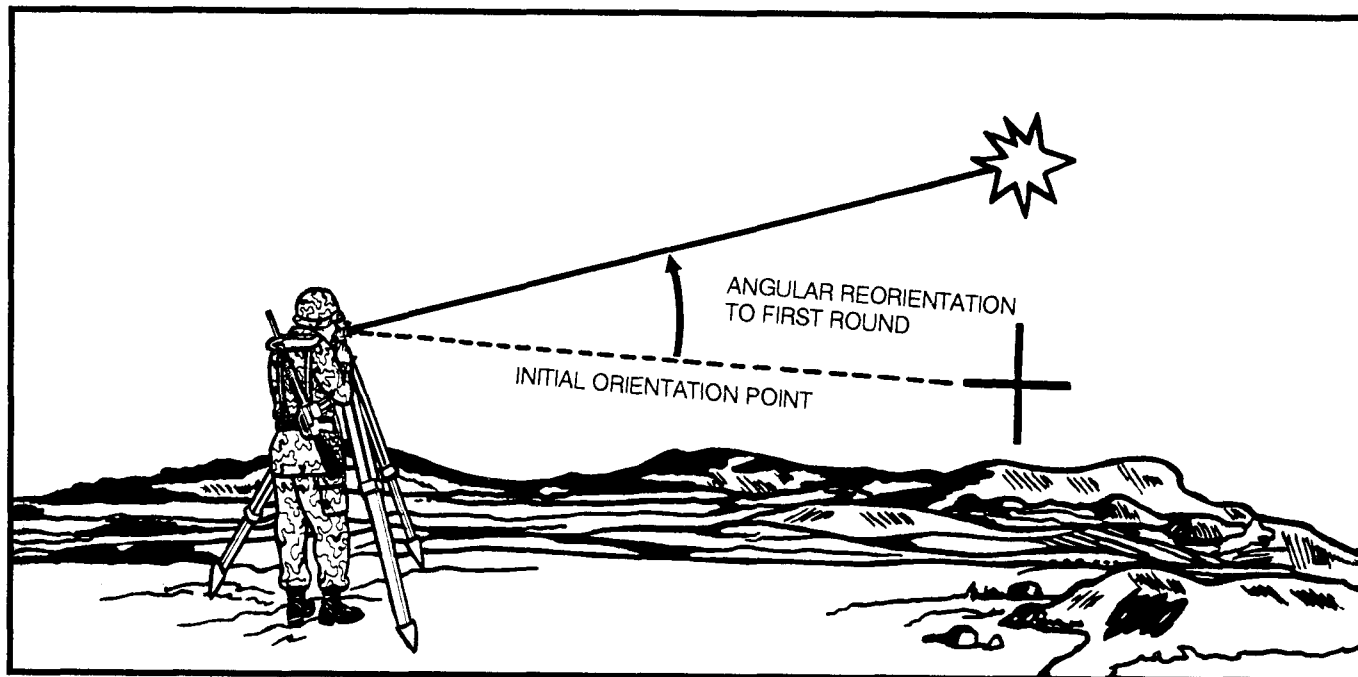

f. Observer Procedures in a High-Burst Registration. The following example illustrates the observer procedures in the conduct of a high-burst registration. Only observer O1 is discussed.

EXAMPLE

Observer O1 arrives at his position and locates the survey stake that marks the exact location of his instrument. The tag on the survey stake indicates that the azimuth of the known direction is 1,860 mils and that the direction is identified on the ground as the left edge of a red building approximately 1,500 meters to the right flank. Observer O1 places his aiming circle over the marking stake. With the upper recording motion, he sets off an azimuth of 1,860 mils on the azimuth scales. Using the lower motion, he aligns the crosslines in the reticle of the instrument on the left edge of the red building. He reports to the FDC that he is in position. Observer O1 receives the following message from the FDC: **OBSERVE HIGH-BURST REGISTRATION, O1 DIRECTION 0430, VERTICAL ANGLE PLUS 15, MEASURE THE VERTICAL ANGLE.**

With the upper motion, O1 turns the azimuth scales to 0430 and sets off +15 on the elevation scales. O1 reports the following to the FDC: **O1 READY TO OBSERVE.**

The FDC sends commands to the weapon to fire the first round. When the round is fired, the FDC reports to O1: **SHOT, OVER. SPLASH, OVER.**

When the first round bursts, O1 observes the burst 40 mils left of the vertical crossline and 5 mils below the horizontal crossline. Since the deviation is to the left of the vertical crossline, O1 subtracts 40 from the setting on the azimuth scales (0430) and obtains a direction of 0390. The burst appeared 5 mils below the horizontal crossline. Therefore, O1 subtracts 5 from the setting on the elevation scales (+15) and obtains a vertical angle of +10. O1 reports the instrument readings for the first round as follows: **O1 DIRECTION 0390, VERTICAL ANGLE PLUS 10, OVER.**

O1 reorients his aiming circle on a direction of 0390 and a vertical angle of +10. He then prepares to measure the deviation of subsequent rounds.

The FDC directs the weapon to fire. When the second round is fired, the FDC reports to O1: **SHOT, OVER. SPLASH, OVER.**

The procedures for measuring and reporting subsequent rounds are the same as those for the first round, except that measurement is read from the reoriented direction and vertical angle. When the FDC has enough instrument readings to compute the registration data, it terminates the registration by telling O1 **END OF MISSION.**

g. Mean-Point-of-Impact Registration. In an MPI registration, the FDC selects a ground location as the orienting point and uses impact fuzes in the registration. The establishment of the OPs and the procedures followed by the observers are the same as those in a high-burst registration. Vertical angle is still measured and reported, as this determines a more accurate altitude than is available from just a map spot.

7-6. AUXILIARY ADJUSTING POINT

To achieve surprise, the observer may decide not to adjust directly on the target but to adjust on a nearby point. This nearby point, the auxiliary adjusting point (Figure 7-8), must be far enough from the target (500 meters) that the real purpose of the adjustment is obscured. At the same time, the auxiliary adjusting point must be selected so that an accurate (preferably lateral) shift to the target can be determined. When the adjustment on the auxiliary adjusting point is complete, the shift to the target is made.

Figure 7-8. AUXILIARY ADJUSTING POINT

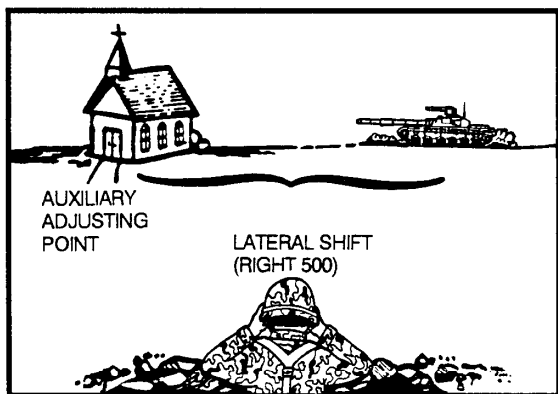

prepares data that will place the round at the point requested by the observer. If the observer fails to see the round, the FDC prepares data that will move the next round to a different point of impact or that will raise the burst higher in the air. This procedure is continued until the observer positively identifies the round. He then orders a shift from the point of impact (burst) of the identified round to a target or an object that is permanent or semipermanent in nature, such as a road junction or the ruins of a building. Once this point has been located by adjustment of fire and has been plotted at the FDC, the observer may use it as a known point from which shifts can be made to subsequent targets.

7-8. IRREGULARLY SHAPED TARGETS

When calling for fire on an irregularly shaped target, the observer must locate the target in sufficient detail to allow the FDO to decide the best method of attack.

a. The observer can send the grid, size, and attitude of the target. The grid he sends is the location of the center of the target. The target attitude is best described as a clockwise angle, in mils measured from grid north to a line passing through the long axis of the target (Figure 7-9). Attitude is sent to the nearest 100 mils and is always less than 3,200 mils.

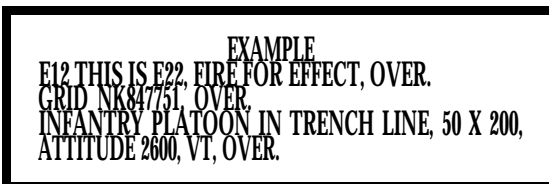

7-7. OBSERVER NOT ORIENTED

Poor visibility, unreliable maps, deceptive terrain, or rapid movement through unfamiliar terrain sometimes makes it difficult for the observer to orient himself. He may call for a marking round(s) to be fired on a known point, a previously fired target, or a prominent terrain feature (for example, MARK KNOWN POINT 1 or MARK HILL 37). As a last resort, the observer may call for a round(s) to be fired into the center of the target area (for example, MARK CENTER OF SECTOR). The observer usually requests a type of projectile that is easily identifiable (such as white phosphorus) or a high airburst, or both. (The unit may have an SOP for shell-fuze combination.) The FDC

Figure 7-9. TARGET ATTITUDE

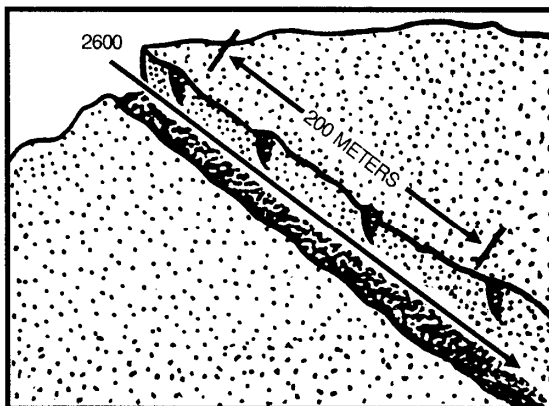

b. The observer can describe the target location by sending the two end grids (Figure 7-10).

EXAMPLE

E12 THIS IS E22 FIRE FOR EFFECT OVER
GRIDS NL168198 TO NL171196, OVER.
3 BTR-60s HALTED IN TREE LINE, DELAY, OVER.

Figure 7-10. TARGET IDENTIFIED BY TWO END GRIDS

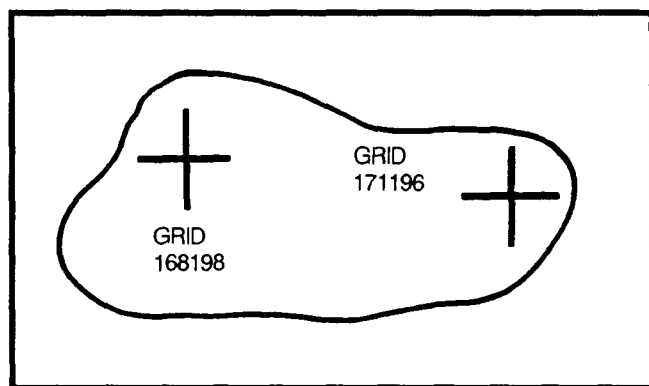

c. If the target cannot be described by a straight line between two grids, the observer can send three or more grids. For example, if the target is in a tree line that is V-shaped, the observer sends the grids of the two ends and the grid of the turning point (Figure 7-11).

EXAMPLE

E12 THIS IS E22, FIRE FOR EFFECT, OVER.
GRIDS NL168197 TO NL169198 TO NL170197, OVER.
INFANTRY COMPANY IN TREE LINE, OVER.

Figure 7-11. TARGET IDENTIFIED BY THREE GRIDS

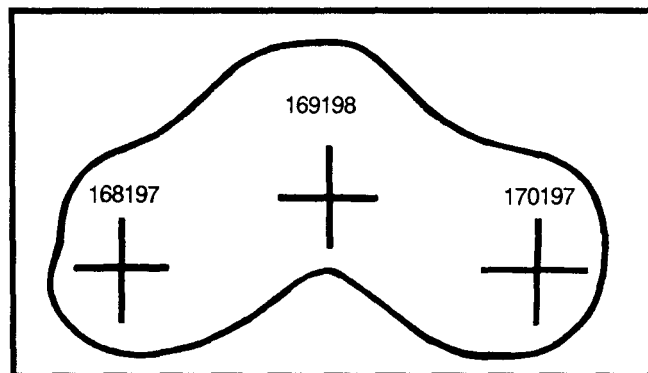

d. If a target might best be described as a circle, the observer would send the grid of the circle center and the radius of the circular target (Figure 7-12).

EXAMPLE

E12 THIS IS E22, FIRE FOR EFFECT, OVER.
GRID NK642377, OVER.
SAGGER MISSILE CLUSTER, RADIUS 150, ICM,
OVER.

Figure 7-12. CIRCULAR TARGET

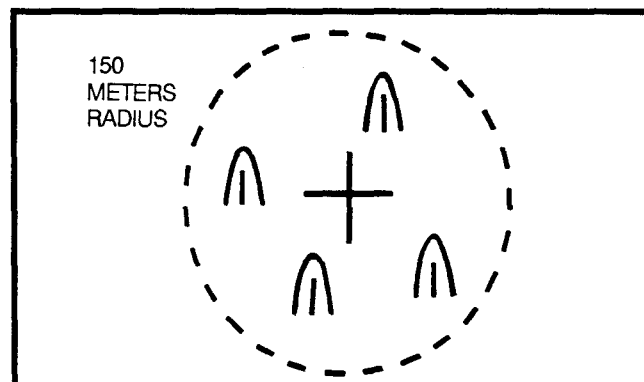

e. When BCS or BUCS is being used in the FDC, the observer cannot send multiple grid target locations. He may send the center location and length, width, and attitude. On an irregularly shaped target, he may send polar data to multiple points on the target and identify these points to the FDC as a laser draw.

7-9. ADJUSTMENT BY SOUND

a. If observer visibility is limited, fire may be adjusted by the use of sound. The target location may be reported to the observer by the supported unit, or it may be determined by the observer. If the observer can hear noises at the enemy position (weapons firing or vehicle or troop movement), he can estimate a direction and a distance from his position. The observer must alert the FDC when he is adjusting by sound.

b. Upon hearing the burst of the adjusting round, the observer estimates the direction to the burst and compares it with the direction to the target. He converts the deviation to a lateral shift, in meters (using estimated range to the target). Distance to the adjusting point is difficult to judge. Therefore, the observer may have to use a creeping technique to adjust onto the target. He can determine the distance by measuring the time it takes the sound of the burst to reach him and multiplying the time interval by the

speed of sound (350 meters per second) (flash to bang). To help the observer determine distance accurately, the FDC must announce the precise moment of impact.

c. The observer must use caution in very broken terrain. In hills and mountains, the sound may travel around a hill mass before it arrives at the observer's position and may produce a false direction to the burst.

7-10. EMERGENCY OBSERVER PROCEDURES

a. In an emergency situation when an FDC is not available, the observer may determine and send fire commands directly to the battery. Initial data are determined by the steps discussed below.

- (1) Estimate the range from the battery to the target.
- (2) Determine the charge by using the following rules:
 - 105-mm: Charge equals range in thousands plus 1 (for example, for range 4000, the charge is 5).
 - 155-mm: Charge equals range in thousands (for example, for range 5000, the charge is 5).
 - 203-mm: Charge equals range in thousands minus 1 (for example, for range 5000, the charge is 4).

(3) Determine the deflection from the battery to the target by converting the azimuth to the target into deflection. You must know the battery azimuth of lay. Azimuth of lay equals deflection 3200. Using the LARS (left, add; right, subtract) rule, determine the deflection to fire by adding or subtracting the difference between the azimuth of lay and the azimuth to the target to or from 3200.

(4) Fire quadrant 240 mils.

b. Subsequent corrections are made with respect to the GT line.

(1) Determine 100/R. 100/R equals 100 divided by the range in thousands to the nearest hundred; for example, range 4600, $100/R = 100/4.6 \approx 22$.

(2) Determine correction in deflection. Correction in deflection, in mils, equals the change in meters (divided by

100) times 100/R (left, add; right, subtract); for example, correction R120 = $120/100 = 1.2 \times 22$ (100/R) = $26.4 \approx 26$ mils.

(3) Determine the number of mils change to quadrant that will give a 100-meter range change (C-factor). Use Table 7-1. Change in quadrant is expressed in mils (range change in hundreds of meters times C-factor).

Table 7-1. EMERGENCY OBSERVER PROCEDURES

WEAPON	C-FACTOR
105-mm M101A1	13 minus charge
105-mm M102	12 minus charge
155-mm M114A1	12 minus charge
155-mm M109, M114A1, M109A1/A2/A3, and M198	11 minus charge
203-mm M110/M110A1	10 minus charge

(4) Determine the fuze setting by estimating time of flight.

(5) Adjust the height of burst by using a factor of 2 divided by the initial fuze setting for each 10-meter change to HOB (up, subtract; down, add).

c. This system is valid only for charges 3, 4, and 5 of all weapon systems.

EXAMPLE

GIVEN

Weapon: 155-mm M198 = C-factor 11 minus charge.

Range: 5000 = charge 5, quadrant 240.

Azimuth of lay: 3200.

GT direction: 0600.

Deflection: 2,600 meters.

First round is spotted as 600 meters short, 100 meters right.

SUBSEQUENT CORRECTION

100/R: For range 4400, $100/R = 100/4.4 \approx 23$.

Correction in deflection: Left 100 = $100/100 = 1.0 \times 23 = 23$ mils; deflection 2623.

Correction to quadrant: $11 - 5 = 6 \times 6 = 36 =$ quadrant $240 + 36 = 276$.

CHAPTER 8

ADJUSTMENT OF OTHER FIRE SUPPORT MEANS

Section I

CLOSE AIR SUPPORT

This section implements STANAG 3736.

8-1. TYPES OF REQUESTS

a. There are two types of CAS requests: preplanned and immediate. Actual request procedures are outlined in the FM 6-20 series manuals. The CAS requests may be initiated by any level and must include the following elements:

- Observer identification.
- Warning order (immediate or preplanned CAS request).
- Target type and quantity.
- Target location:
 - Six-digit grid
 - Elevation (in mean feet above sea level).
- Desired time on target.
- Results desired on target (destroy, neutralize, or interdict).
- Final control:
 - call signs.
 - Frequencies.
 - Contact points.
- Remarks:
 - Friendly locations.
 - Weather.
 - Threats.

b. The procedures for the forward air controller or the acting FAC included in this chapter conform to the methods and procedures in TC 90-7 and FM 90-20. (Normally, the Air Force air liaison officer [ALO] or other tactical air control party [TACP] personnel will perform FAC duties.)

8-2. EMPLOYMENT

a. **Control Measures.** There are three control measures for CAS missions (Figure 8-1) with which the company FSO will be concerned.

(1) The **contact point** (CP) is the point at which the aircraft will make initial radio contact with the ground controller (company FSO).

(2) The **initial point** (IP) is the point from which the aircraft starts the timed run toward the pull-up point (PUP).

(3) The **pull-up point** is the point at which an aircraft at low level begins a climb to identify the target and to gain altitude for the strike on the target.

b. **Processing.** The maneuver battalion fire support element determines if the target and the current situation are appropriate for a CAS request. If so, a CAS request (preplanned or immediate, as appropriate) is submitted. If the request is approved, the ALO or the FSO obtains mission data, prepares attack information, and transmits these data to the individual who directs the mission. (If no Air Force FAC is in position to control the mission and the aircraft are equipped with FM radios, the company FSO directs the mission.) Examples of mission data and attack information are given in paragraphs c and d.

c. **Mission Data.** Mission data (also referred to as lineup) may be as follows:

- Mission number: 1210027.

- Fighter call sign: HAMMER 11.
- Type and/or number of aircraft: Two A-7s.
- Ordnance: Six Mavericks (antitank missile) and 20-mm.
- On-station time (loiter time): 30 minutes.

d. Attack Information. This information in the nine-line brief format (Figure 8-2) may be as follows:

- Initial point: (Grid) NP459854.
- Heading (IP to target): 069 (degrees magnetic) (offset L or R).
- Distance (IP to target): 9.8 (nautical miles).

- Target elevation 1,140 (feet above mean sea level).
- Target description: Five tanks attacking west.
- Target location (Grid) NP 675920.
- Type mark WP (or beacon or laser and code).
- Location of friendlies: 1,000 meters southwest of target.
- Egress: Northwest to avoid artillery suppression

NOTE: The observer must transmit the attack information to the aircraft if the pilots do not already have the information.

Figure 8-1. CAS MISSION CONTROL MEASURES

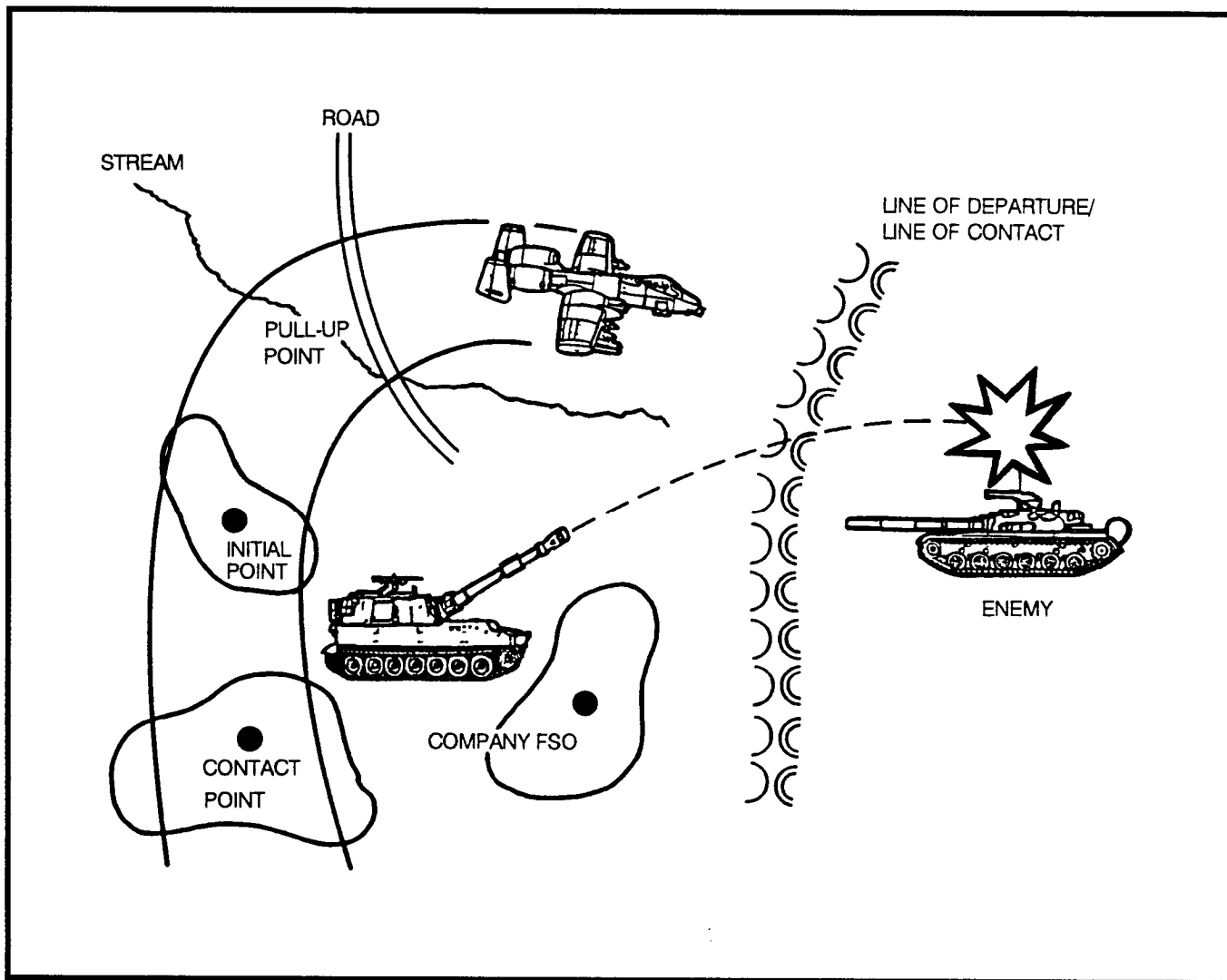

Figure 8-2. SAMPLE CAS BRIEF

(1. INITIAL POINT (IP))	<u>NP459854 (or) XRAY</u>
(2. HEADING (IP TO TARGET))	<u>069</u> MAGNETIC (OFFST: LEFT/RIGHT)
(3. DISTANCE (IP TO TARGET))	<u>9.8</u> (NAUTICAL MILES)
(4. TARGET ELEVATION)	<u>1,140</u> (FEET ABOVE MEAN SEA LEVEL)
(5. TARGET DESCRIPTION)	<u>5 TANKS ATTACKING WEST</u>
(6. TARGET LOCATION)	<u>NP675920</u> (UTM, LAT/LONG, VISUAL REFERENCES, ETC.)
(7. TYPE OF MARK)	<u>LASER</u> (CODE) <u>372</u>
(8. LOCATION OF FRIENDLIES)	<u>1,000M SW OF TARGET</u>
(9. EGRESS)	<u>NW TO AVOID ARTILLERY SUPPRESSION</u> (REMARKS)
(TIME ON TARGET) TOT	_____
(TIME TO TARGET (TTT))	STANDBY _____ PLUS _____ (minutes) (seconds)

OMIT DATA NOT REQUIRED. LINE NUMBERS ARE NOT TRANSMITTED. ALL UNITS OF MEASURE ARE STANDARD. SPECIFY IF OTHER UNITS OF MEASURE ARE BEING USED.

e. Target Marking.

(1) The most accurate method of marking a target is by use of a laser (if the available aircraft has an airborne passive laser tracker, Pave Penny). The Pave Penny is mounted on A-7, A-10, and some F-16 aircraft. If this is the method to be used, the laser PRF codes will normally be passed as part of the attack aircraft information or CAS brief (Figure 8-2). To make the Air Force four-digit code match the laser designator three-digit code, simply insert a 1 as the first digit when transmitting the code to the pilot. For example, a PRF code of 381 will be sent to the pilot as 1381. The target is designated when the pilot commands **LASER ON** or as the aircraft approaches the apex of the PUP maneuver, whichever happens first. Designation continues until the pilot has identified the target, he commands **TERMINATE**, or 20 seconds has elapsed, whichever occurs first.

(2) Alternate methods of marking a target for a CAS mission are with smoke, WP, or ground burst illumination. As a rule of thumb, the marking round should impact no later than 20 seconds before the aircraft reaches the target.

The company FSO can get the aircraft IP-to-target time from the ALO or battalion FSO and the time of flight of the round from the FDC. The time to fire the marking round is determined by adding 20 seconds and TOF and then subtracting that total from the aircraft IP-to-target time. The answer is the time that should elapse from when the aircraft departs the IP until the marking round is fired. If smoke is used to mark the target, an additional 10-second buildup time must be added.

NOTE: If smoke is used to mark the target, ensure that the smoke is beyond or downwind of the target. This will keep the smoke from obscuring the target from the pilot's view. In describing the target, distance and direction should be given from the base of the smoke.

EXAMPLE

IP-to-target time for aircraft is 2 minutes 30 seconds.
Time of flight of round is 35 seconds.
WP is being used.
 $20 \text{ seconds} + 35 \text{ seconds (TOF)} = 55 \text{ seconds.}$
 $2 \text{ minutes } 30 \text{ seconds (IP-to-target time)} - 55 \text{ seconds} =$
 $1 \text{ minute } 35 \text{ seconds.}$
Fire round 1 minute 35 seconds after aircraft departs the IP.

8-3. MISSION CONTROL

a. The company FSO's control of the mission begins when the flight leader makes initial contact at the CP. Once communication is established, the company FSO must ask the flight leader for his lineup information. The company FSO must then verify that the flight leader has the current attack information. The received mission data may differ from the mission data provided earlier by the ALO. If the pilot does not have the attack information or if some information has changed, the company FSO transmits the needed information to him in the format of the CAS brief (Figure 8-2).

b. Before the aircraft reaches the IP, the company FSO must determine the desired back-off time for firing the marking round. He should send his fire mission to the battery as an at my command mission.

c. Once ready, the company FSO clears the aircraft to depart the IP. He asks the flight leader to report his departure so that the company FSO can determine the time to fire the marking round. The company FSO should be prepared to fire the marking round at the desired time even if communication with the aircraft is interrupted.

d. The company FSO must watch for the aircraft. As soon as it is in sight, he orients the flight leader to the marking smoke by using the clock method with the nose of the aircraft being 12 o'clock. Once the flight leader has identified the marking smoke, the company FSO gives him a cardinal direction and a distance in meters to the target from the marking smoke. Once the company FSO is certain the flight leader has identified the target correctly and the aircraft is pointed at the target, he clears the aircraft to strike the target (cleared hot). The company FSO must be prepared at any time before actual ordnance delivery to call off the attack (abort) if the aircraft starts to attack the wrong target. He must be ready to reattack the target if additional ordnance is required or if the pilot requests a reattack.

The three mandatory radio transmissions for CAS missions with which the company FSO will be concerned are discussed below.

(1) **Cleared to Depart the Initial Point.** This transmission must be made when all preparations are complete for the attack and the FAC or company FSO is in position to observe and control the attack.

(2) **Cleared Hot.** This transmission is made when the FAC or company FSO is certain that it is safe for the aircraft to release the ordnance without endangering friendly ground forces. It is given as soon as possible after the aircraft is pointed at the target area.

(3) **Cleared for Reattack.** This transmission is given if the pilot requests permission to reattack the target. Normally, permission to reattack the target is given if there are no planned fires scheduled for the target immediately after the first attempt to attack the target.

NOTE: It is the company FSO's responsibility to ensure that the correct target is attacked and that friendly troops are not needlessly endangered.

EXAMPLE
CAS MISSION USING THE G/VLLD

FLIGHT LEADER (HAMMER 11)

COMPANY FSO (K12)

K12 THIS IS HAMMER 11, NOW AT CP.

THIS IS K12, REQUEST LINEUP, OVER.

HAMMER 11, MISSION NUMBER 1210027. I HAVE 2 A-7s, 6 MAVERICKS AND 20-MM ON EACH. ON STATION FOR 20 MINUTES.

THIS IS K12, ROGER. DO YOU HAVE ATTACK INFORMATION? OVER.

HAMMER 11, AFFIRMATIVE.

THIS IS K12, ROGER, OUT.

K12 THIS IS HAMMER 11, APPROACHING IP.

THIS IS K12, ROGER. YOU ARE CLEARED TO DEPART IP. REPORT DEPARTING IP, OVER.

HAMMER 11, DEPARTING IP.

HAMMER 11 THIS IS K12, I HAVE YOU IN SIGHT. TARGET IS AT YOUR 2 O'CLOCK, OVER.

HAMMER 11, ROGER.
HAMMER 11, LASER ON.

THIS IS K12, LASER ON, OVER.

HAMMER 11, I HAVE THE SPOT.

THIS IS K12. YOU ARE CLEARED HOT, OVER.

HAMMER 11, TERMINATE.

HAMMER 11 THIS IS K12, END OF MISSION. T-62s DESTROYED, OVER.

EXAMPLE

CAS MISSION USING A MARKING ROUND

FLIGHT LEADER (HAMMER 11)
K12 THIS IS HAMMER 11, NOW AT
CP, OVER.

COMPANY FSO (K12)

BATTERY (K28)

HAMMER 11, MISSION NUMBER
1210027. I HAVE TWO A-7s, 6
MAVERICKS AND 20-MM ON EACH.
ON STATION FOR 20 MINUTES.

THIS IS K12, REQUEST LINEUP,
OVER.

HAMMER 11, AFFIRMATIVE.

THIS IS K12, ROGER. DO YOU HAVE
ATTACK INFORMATION? OVER.

THIS IS K12, ROGER, OUT.
K28 THIS IS K12, FIRE FOR EFFECT,
OVER. GRID NK132968, OVER.
MARKING ROUND WP AT MY
COMMAND, REQUEST TIME OF
FLIGHT, OVER.

Message to observer: KILO, AA7000,
OVER.
THIS IS K28, READY, TIME OF
FLIGHT 46 SECONDS, OVER.

K12 THIS IS HAMMER 11, NOW
APPROACHING IP.

THIS IS K12, ROGER. YOU ARE
CLEARED TO DEPART IP. REPORT
DEPARTING IP, OVER.

HAMMER 11, DEPARTING IP.

K28 THIS IS K12, FIRE, OVER.

THIS IS K28, SHOT, OVER.

HAMMER 11, AFFIRMATIVE.

HAMMER 11 THIS IS K12, I HAVE
YOU IN SIGHT. DO YOU SEE
SMOKE AT YOUR 10 O'CLOCK?
OVER.

HAMMER 11, ROGER, I SEE THE
TARGET.

THIS IS K12, YOUR TARGET IS 200
METERS SOUTH OF THE SMOKE. A
GROUP OF T-62 TANKS ON THE
RIDGE. CAN YOU IDENTIFY? OVER.

THIS IS K12. YOU ARE CLEARED
HOT, OVER. HAMMER 11 THIS IS
K12, END OF MISSION. T-62s
DESTROYED, OVER.

K28 THIS IS K12, END OF MISSION,
OVER.

THIS IS K28, END OF MISSION, OUT.

NOTE: For simplicity, read-back transmissions between the company FSO and the battery are not shown.

e. In a low-threat situation, the same basic procedures may be used. The aircraft may proceed from the IP to the target at higher altitudes; thus, they can see the target area from a greater distance. They may also be able to orbit the target area before their attack, allowing time for a good verbal description of the target by the company FSO. The

timing of the marking round can be much less restricted (if the aircraft altitude is above the maximum altitude of the round), and the verbal description can be much more thorough. Therefore, the probability of the aircraft locating and successfully attacking the desired target could increase significantly.

Section II

ATTACK HELICOPTERS

8-4. MISSION AND EMPLOYMENT

The primary mission of an attack helicopter (AH) is to destroy armor and mechanized threat forces. Attack helicopters are used as maneuver forces in combined arms operations. This maximizes their weapon and aircraft system capabilities. They are ideally suited for situations in which rapid reaction time is important or terrain restricts ground forces.

8-5. FIRE SUPPORT ROLE

Infrequently, on the basis of the commander's risk versus payoff assessment, attack helicopters may be tasked to provide fire support when no other assets are available. The attack helicopter, when tailored for this mission, loses its primary antiarmor capability. It is tasked to trade precision antiarmor weapon systems for area suppression weapons.

8-6. CAPABILITIES

Attack helicopters can fire aerial rockets indirectly at extended ranges; however, the fires are not accurate enough to warrant the large amount of ammunition needed for this type mission. The loiter time of the attack helicopter is a function of the armament and fuel load it is configured to carry. For example, a heavy antiarmor mission profile results in the aircraft being loaded with tube-launched, optically tracked, wire-guided missiles (TOWS) or Hellfire missiles but carrying the minimum fuel needed to conduct the mission. This gives it a relatively short loiter time.

8-7. ATTACK AND SCOUT TEAMS

Attack and scout helicopters are always used as a team. Within each team, there is a team leader. He controls the actions of the team, coordinates the battle with ground forces, adjusts artillery fires, and directs tactical air units,

8-8. ARMY AND AIR FORCE COORDINATION

The joint air attack team (JAAT) is a combination of Army attack and scout helicopters and Air Force close air support aircraft. Normally, the team operates with ground maneuver forces, field artillery, mortars, and air defense weapon systems to attack high-priority targets. These systems complement and reinforce each other when used together. Fire support team members and fire support officers from company to brigade levels are involved in coordinating and supporting this joint effort. Target hand-over procedures are the method by which they help accomplish the mission of attack helicopters.

8-9. TARGET HAND OVER

a. If attack helicopters are operating in the company zone of action, the FIST or COLT can use its G/VLLD to designate targets for attack helicopters. This can be done in several different ways. When the attack helicopters are carrying TOWS, the FIST hands over the target to the aeroscout, and the scout maneuvers the attack helicopter into position to engage. Or, the FIST can hand over directly to an attack helicopter. If Hellfire is the weapon system to be used, other options are also available. Hellfire can be guided by the attack helicopter, the aeroscout, or the FIST. Thus, the FIST or COLT can lase for the attack helicopter with the aeroscout or the FIST coordinating. The target can be passed to the aeroscout by the FIST, and he can designate for the attack helicopter. Hellfire has a lock-on-after-launch local function. That means that if someone besides the attack helicopter is designating, the attack helicopter does not have to unmask to fire its missile.

b. To prevent the Hellfire missile from locking onto the designator instead of the target, the Angle T formed between the designator-target line and the missile-target line should be less than 1,065 mils (600). Before engaging

the target, the observer should relay his position to the helicopter so the pilot can position the aircraft properly for safety. To keep the missile from tracking laser backscatter energy, the designator should keep a clear, unobstructed line of sight to the target. Special care should be taken to avoid lasing through dust, trees, or other obstructions which could cause the Hellfire to impact near the designator. This is especially true in designating moving targets.

Section III
NAVAL GUNFIRE

This section implements STANAG 1034.

control team will be attached to control and coordinate naval gunfire. If an NGF spotter is not available, the FIST is responsible to call for and adjust naval gunfire. The procedures, except for a few differences, are the same as already outlined. It is essential for the company FSO to be aware of these differences if he wishes to accomplish the mission in a timely manner.

8-10. INTRODUCTION

a. On most occasions when naval gunfire is available, elements of an air and naval gunfire liaison company (ANGLICO) will be attached to the appropriate Army unit. Normally, at the maneuver company level, a firepower

b. Table 8-1 shows types of Navy ships and characteristics of their armament.

Table 8-1. NAVAL SHIPS AND THEIR ARMAMENT

SHIP	GUN SIZE/CALIBER	RANGE (METERS) MAXIMUM/MINIMUM	RATE OF FIRE (ROUNDS PER MINUTE) MAXIMUM/SUSTAINED	AMMUNITION AVAILABLE
Battleship	16-inch/50 5-inch/38	35,909/910 15,700/910	2/1 22/15	HE, AP, ICM HE, WP, illum
Guided missile cruiser (CGN and CG)	5-inch/38 5-inch/54	15,700/910 22,999/910	22/15 40/20	HE, WP, illum HE, WP, illum
Guided missile destroyer (DDG)	5-inch/54	22,999/910	40/20	HE, WP, illum
Destroyer (DD)	5-inch/54	22,999/910	40/20	HE, WP, illum
Guided missile frigate (FFG)	5-inch/38	15,700/910	22/15	HE, WP, illum
Frigate (FF)	5-inch/38 5-inch/54	15,700/910 22,999/910	22/15 40/20	HE, WP, illum HE, WP, illum
Amphibious assault ship (LHA)	5-inch/54	22,999/910	40/20	HE, WP, illum
LEGEND:				
AP	= armor piercing	DDG	= guided missile destroyer	
CG	= guided missile cruiser	FF	= frigate	
CGN	= guided missile cruiser, nuclear	FFG	= guided missile frigate	
DD	= destroyer	LHA	= amphibious assault ship, general purpose	

8-11. COMMUNICATIONS

The spotter, if attached, conducts NGF missions over the NGF ground spot net with a high frequency (HF) radio. The lack of an HF radio may pose a problem if any observer other than a spotter is required to adjust naval gunfire. To solve this problem, the observer should contact the supporting arms liaison team (SALT) officer who is located in the battalion FSE. The SALT officer can talk to the ship over the NGF ground spot net, and the adjustment can be relayed through him.

8-12. FIRE UNIT STATUS

When a ship arrives in its assigned firing position (fire support station [FSS] or fire support area [FSA]) and it has completed its prefiring tasks, it will report ON STATION AND READY FOR CALL FOR FIRE. A fire unit status report may be sent. It includes pertinent information such as types and quantities of ammunition available for naval gunfire support. This information may be requested by the observer.

8-13. ELEMENTS OF THE CALL FOR FIRE

To perform the duty of providing naval gunfire, the observer must communicate effectively with the fire support ship. To do this with the least confusion and the greatest speed, the observer uses a standardized call for fire. The call for fire is transmitted to the ship in two transmissions, consisting of six elements, with a read-back break after each transmission. The sequence of these two transmissions is as follows:

- Spotter identification and warning order and target number.
- Target location, target description, method of engagement, and method of fire and control.

8-14. SPOTTER (OBSERVER) IDENTIFICATION

This element tells the ship who is calling. The observer and the ship use call signs. Once given, call signs are normally omitted from subsequent transmissions in the course of the mission.

8-15. WARNING ORDER AND TARGET NUMBER

a. The warning order tells the ship that a call for fire is being transmitted. It clears the net and warns the ship that

naval gunfire support is desired. For naval gunfire, the warning order consists of the words **FIRE MISSION**.

b. For the ship and the naval gunfire liaison officer (NGLO) who is monitoring the call for fire to keep track of each location being fired upon, each mission is assigned a target number. The observer gives the target number to the ship. The target number consists of two letters followed by four numbers. For targets of opportunity, the FIST assigns each fire mission a number in numerical sequence from the block of target numbers allocated by the battalion fire support element (battalion FSO), or the battalion FSO may assign the target number. In the case of planned targets, the observer uses the previously assigned target number from the fire plan. The assignment of target numbers to fire missions in the call for fire does not cause the targets to be recorded as targets. An example of the warning order and target number element in the call for fire is **A1B THIS IS C2D, FIRE MISSION, TARGET NUMBER AB2135, OVER**.

8-16. TARGET LOCATION

This element gives the ship information needed to plot the target and determine firing data. Target location data are determined in the same manner as for artillery. Target location data are transmitted as follows:

- Grid: The observer provides the grid coordinates of the target; the altitude of the target (in meters, measured from sea level); and if the method of control is spotter (observer) adjust, direction.
- Polar: The observer provides the OT direction to the target, the distance (in meters), and a vertical shift (in meters).
- shift from a known point The observer identifies the known point (target number) in the warning order of the call for fire. He includes in the target location element the OT direction, the lateral and/or range shift, and the vertical shift.

8-17. TARGET DESCRIPTION

This element gives a brief description of the target. The observer considers the items below when formulating this element.

a. **Type of Target.** What the target is and what the target is doing (for example, troops digging in).

b. **Size.** Number of elements in the target or its physical dimensions (for example, 5 trucks or 400 x 200, attitude 0700).

c. **Degree of Protection.** Does the target have protection (in the open or dug in)?

8-18. METHOD OF ENGAGEMENT

a. **Danger Close.** The term **DANGER CLOSE** is included in the call for fire when there are friendly troops or positions within a prescribed distance of the target. Depending on the caliber of the gun and the ammunition being fired, there are three different distances that are considered danger close for naval gunfire (Table 8-2).

Table 8-2. **DANGER CLOSE DISTANCES FOR NAVAL GUNFIRE**

CALIBER OF THE GUN	ORDNANCE	DANGER CLOSE DISTANCE
Less than 6-inch	All	750 meters
6-inch or larger (including 16-inch)	HE/Q or time	1,000 meters
16-inch	ICM or HE/CVT (controlled variable time)	2,000 meters

(1) The observer reports **DANGER CLOSE** followed by a cardinal direction and a distance in meters from the target to the nearest friendly position. The observer also designates the place where the first salvo is to impact. The first salvo can be either offset or directed at the target.

(a) The first salvo should be offset to impact on the opposite side of the target from the friendly position. This is done by making a normal correction (left or right, add or drop) in relation to the OT direction or by giving a cardinal direction. The offset between the nearest friendly position and the first salvo can be any distance specified by the observer. However, it is normally used to place the first salvo at least the applicable danger close distance (Table 8-2) from friendly troops.

EXAMPLES

DANGER CLOSE, SOUTH 350 SOUTH 350 indicates friendly position in relation to the target.

FIRST SALVO AT ADD 400: **ADD 400** positions the offset at least 750 meters from the nearest friendly position (350 + 400 = 750).

(b) The first salvo may be directed at the target when the tactical situation does not permit an offset; for example, **FIRST SALVO AT TARGET**.

(2) The creeping method of adjustment is always used in danger close missions. The observer makes corrections by moving each round toward the target in increments of 100 meters. The combined effect of each correction should not exceed 200 meters. If more than one gun is to fire for effect, the observer should check the mean point of impact of all guns to be used before entering fire for effect.

(3) In a danger close situation, the fires may be crept to within minimum safe distance of friendly positions. Recommended minimum safe distance for an adjusted salvo of a 5-inch gun is 200 meters when firing parallel to the front lines, or 350 meters when not firing parallel to the front line. The ship normally advises the observer when a predicted fall of shot approaches minimum safe distance.

b. **Trajectory.** Because of the high muzzle velocity and the flat trajectory of naval gunfire, intervening terrain may prevent engagement of targets in defilade. Also, a reduced charge may be required to prevent ripping of the illumination parachute or to increase accuracy at short ranges. The observer or the ship can raise the trajectory, thereby increasing the angle of fall, by announcing **REDUCED CHARGE**. If this subelement is omitted in the call for fire, the ship will fire full charge. Once a reduced charge has been initiated, it can be terminated by the command **CANCEL REDUCED CHARGE**.

c. **Ammunition.** Several types of ammunition are available to the observer. If the type of ammunition is not specified in the call for fire, shell HE with fuze quick will be fired during the adjustment and FFE phases. If a different type of ammunition or fuze action is required during either the adjustment or the FF3 phase, the observer must specify the type desired. As much warning as possible should be provided to the ship when a mission requires a nonstandard projectile, such as WP. This allows time to ready the ammunition in the gun mount.

(1) **Projectile.** The observer must specify all projectiles except HE; for example, **SHELL WP**.

(2) **Fuze.** The observer must specify all fuzes except fuze quick; for example, **FUZE DELAY**. (When illumination is fired, the fuze is understood to be fuze time.)

d. **Armament.** When supported by a multicaliber ship (such as a battleship with 5-inch and 16-inch guns), the observer may specify if he desires main or secondary armament. Main (larger caliber) armament is understood if this element is omitted.

e. Number of Guns. The observer may specify the number of guns for effect. If not specified, it is understood to be the same number as in adjustment. One gun is considered standard and need not be specified. An example command is **TWO GUNS**.

f. Number of Salvos. This element is sent when entering fire for effect. The term *salvo* refers to the method of fire in which a weapon or a number of weapons are fired at a target. It indicates the number of rounds to be fired from each gun. For example, **1 GUN 5 SALVOS** means 5 rounds are to be fired, while **2 GUNS 5 SALVOS** means 10 rounds are to be fired. If the method of control is spotter (observer) adjust, this element is omitted until the observer is ready to enter fire for effect; or it can be included if the observer wants to adjust with multiple salvos. If omitted, the ship fires only one salvo. An example command is **2 SALVOS**.

g. Special Instructions. Various special instructions the observer may use in attack of the target are discussed below.

(1) **Interval.** This is used to cause FFE rounds to be fired with a specific time interval between each salvo. The observer announces **INTERVAL** followed by a desired time interval (seconds understood); for example, **10 SALVOS, INTERVAL 30, FIRE FOR EFFECT**.

(2) **Sustained Fire.** If there is a requirement for fire for effect to be spread over a specific period of time, the observer may specify **SUSTAINED FIRE**. The command includes the number of salvos and the period of time in which they are required to be fired; for example, **20 SALVOS, SUSTAINED FIRE, 5 MINUTES, FIRE FOR EFFECT**.

(3) **Time on Target.** The observer may require the initial salvos in fire for effect to impact on the target at a specified time.

(4) **Coordinated Illumination.** The observer may inform the ship that the firing of illuminating and HE projectiles will be coordinated to illuminate the target and surrounding area only at the time required for spotting and adjusting the HE fires. He does this by announcing **COORDINATED ILLUMINATION**.

(5) **Continuous Illumination.** The observer may require constant light on a target. He may specify a period of time the illumination is to be effective. The ship determines the interval to fire the subsequent illumination salvos based on the burning time of the projectile. The observer commands **CONTINUOUS ILLUMINATION**. This command should be used with discretion to avoid excessive expenditure of ammunition.

8-19. METHOD OF FIRE AND CONTROL

This element of the call for fire indicates the observer's desire and ability to control the delivery of fires. Methods of control are announced by the observer by using the terms described below.

a. Spotter (Observer) Adjust. When the observer believes that an adjustment must be made, he adjusts the salvos until he is sure fire will take effect on the target. This method is understood to be standard if omitted from the call for fire. It may be used when the observer wishes to revert to adjustment anytime during the mission.

b. Ship Adjust. This method of control is used when the observer believes the ship has a better view of the target than he does. Since direct fire is faster and more accurate, this method is used whenever possible. After the observer positively identifies the target to the ship, he announces **SHIP ADJUST**. The ship then takes the target under fire. The observer may assist the ship by providing range spottings along the GT line, particularly when he is looking perpendicular to the GT line.

c. Fire for Effect. The observer should strive for fire for effect with the first round or as soon as possible in the adjustment phase. When determining whether to fire for effect on the first round, the observer must consider the target location and how accurately the ship has been firing its initial rounds on previous missions. He must also consider the dispersion pattern of naval gunfire. If the first salvo is believed to have effect on the target, the best results are normally achieved by surprise fire. When fire for effect is desired, the observer specifies the number of salvos (and guns if different from that used in adjustment) and announces **FIRE FOR EFFECT**; for example, **6 SALVOS, FIRE FOR EFFECT** or **2 GUNS, 6 SALVOS, FIRE FOR EFFECT**.

d. Cannot Observe. The command **CANNOT OBSERVE** is used when neither the observer nor the ship can see the target yet the target must be engaged. Normally, the location is received through intelligence sources. **FIRE FOR EFFECT** and the number of salvos are always transmitted with this method of control; for example, **2 GUNS, 4 SALVOS, FIRE FOR EFFECT, CANNOT OBSERVE**.

e. At My Command. The command **AT MY COMMAND** is used as a modifier to the methods of control. If the observer needs to control when the ship fires each round, he includes **AT MY COMMAND** in the method of control. When the ship is prepared to fire each round, it transmits **READY OVER**. The observer then commands **FIRE** when he is ready for the ship to fire the

round. At my command remains in effect throughout the mission or until the observer announces **CANCEL AT MY COMMAND**. This method of control is often used by aerial observers. To initiate it, the observer announces **FIRE FOR EFFECT, AT MY COMMAND**.

8-20. PREFIRING REPORT

After the ship receives the call for fire and determines firing data, a report will be made to the observer before fire is begun. The observer reads back this transmission to the ship and commands **BREAK...FIRE, OVER**. Information the ship reports is discussed below.

a. Gun-Target Line. The ship reports its firing direction, using the same north reference and units used by the spotter. The ship notifies the observer of subsequent changes to the GT line of 200 mils (10°) or more. If the direction used for adjustment is the GT line, the ship reports changes of 100 mils (5°) or more.

b. Line of Fire. When the ship fires an illumination mission, wind drift may cause the flare parachute to miss the target. To indicate a different firing direction, the ship reports **LINE OF FIRE** for illumination missions; for example, **LINE OF FIRE, 110 DEGREES TRUE**. This direction is to the new illumination aiming point, not the GT line.

c. Summit. If the observer is airborne, the ship routinely reports the highest altitude above mean sea level the projectile will reach on its flight path to the target. Summit may also be requested by ground observers or the NGLO. Summit is reported in feet to air observers and in meters to ground agencies (observer or NGLO).

d. First Salvo at (Point of Aim). When the observer has reported a danger-close situation the ship confirms the first salvo aiming point identified previously by the observer; for example, **FIRST SALVO AT ADD 300**.

e. Any Changes. If the ship must change any portion of the observer's fire request, it notifies him of the change. For instance, if the observer requests **SHELL WP IN EFFECT** and the ship has none remaining, the ship announces **CANNOT COMPLY WITH WP, HE IN EFFECT**.

f. Ready and Time of Flight. When the ship is prepared to fire the first salvo, it reports **READY** followed by the time of flight in seconds. The observer reads back the entire prefiring report and commands **FIRE**. If the method of control included at my command, the ship also reports **READY** before firing each round. The ship informs the observer when there is a time of flight change of more than 5 seconds. An example of a prefiring report follows.

EXAMPLE	
SHIP TRANSMISSION	OBSERVER TRANSMISSION
GUN-TARGET LINE 1680, READY 17, OVER.	GUN-TARGET LINE 1680, READY 17, BREAK... FIRE, OVER.
FIRE, OUT.	

8-21. AUTHENTICATION

To avoid deception, the ship should initiate authentication procedures upon establishing initial communications with the observer.

8-22. REPORT UPON FIRING

The ship transmits the **SHOT** and **SPLASH** reports to the observer each time an adjustment salvo is fired and for the first salvo only in the FFE phase.

a. SHOT is transmitted at the moment the guns are fired.

b. SPLASH is transmitted 5 seconds before the round is expected to detonate. **SPLASH** is not reported during fire for effect when two or more ships are conducting a massed-fire mission. In illumination missions, it is reported for star shells before the beginning of the HE adjustment phase of coordinated illumination missions and thereafter for the HE round only; for example, **SHOT...SPLASH, OUT**.

8-23. CORRECTION OF ERRORS

Errors by the observer or by the ship are sometimes made in transmitting data. The procedures below should be used to correct the data.

a. Correction. If the observer realizes he has made an error in his transmission, he immediately transmits the word **CORRECTION** followed by the corrected data. If the correction affects other subelements, his correction includes a restatement of the entire data.

b. Wrong. If an error is made during a read back, the word **WRONG** followed by the correct data is transmitted at the end of the transmission. The word **WRONG** is then read back, along with the corrected version.

8-24. EXAMPLES OF NAVAL GUNFIRE CALLS FOR FIRE

Shown below are examples of various NGF calls for fire.

EXAMPLE	
SPOTTER (OBSERVER) ADJUST MISSION, GRID	
OBSERVER TRANSMISSION	SHIP TRANSMISSION
E6R THIS IS N7R, FIRE MISSION, TARGET NUMBER AF3001 , OVER.	N7R THIS IS E6R, FIRE MISSION, TARGET NUMBER AF3001 , OUT.
GRID MB786543, ALTITUDE 05, DIRECTION 2660, 50 TROOPS IN THE OPEN, FUZE CVT IN EFFECT, OVER.	GRID MB786543, ALTITUDE 05, DIRECTION 2680, 50 TROOPS IN THE OPEN, FUZE CVT IN EFFECT, OUT.
GT LINE 0870, READY 13, BREAK... FIRE, OVER.	GT LINE 0870, READY 13, OVER.
	FIRE, OUT.
SPOTTER (OBSERVER) ADJUST MISSION, AMC, POLAR	
OBSERVER TRANSMISSION	SHIP TRANSMISSION
E6R THIS IS N7R, FIRE MISSION, TARGET NUMBER AF3002, OVER.	N7R THIS IS E6R, FIRE MISSION, TARGET NUMBER AF3002, OUT.
DIRECTION 4880 MAGNETIC, DISTANCE 2900, UP 35, THREE TRUCKS REFUELING IN OPEN, SHELL WP IN EFFECT, AT MY COMMAND, OVER.	

EXAMPLE (Continued)	
OBSERVER TRANSMISSION	SHIP TRANSMISSION
	DIRECTION 4880 MAGNETIC, DISTANCE 2900, UP 35, THREE TRUCKS REFUELING IN OPEN, SHELL WP IN EFFECT, AT MY COMMAND, OUT.
GT LINE 0260 MAGNETIC, READY 17, BREAK..FIRE, OVER.	GT LINE 0260 MAGNETIC, READY 17, OVER.
	FIRE, OUT.
FIRE-FOR-EFFECT MISSION SHIFT FROM A KNOWN POINT METHOD	
OBSERVER TRANSMISSION	SHIP TRANSMISSION
E6R THIS IS N7R, FIRE MISSION, TARGET NUMBER AF3003, OVER	N7R THIS IS E6R, FIRE MISSION, TARGET NUMBER AF3003, OUT.
FROM TARGET NUMBER AB3772, DIRECTION 3470, LEFT 260, ADD 500, SUPPLY DEPOT IN DEFILADE, RADIUS 200, REDUCE CHARGE, 2 GUNS 5 SALVOS, FIRE FOR EFFECT, OVER.	FROM TARGET NUMBER AB3772, DIRECTION 3470, LEFT 280, ADD 500, SUPPLY DEPOT IN DEFILADE, RADIUS 200, REDUCE CHARGE, 2 GUNS 5 SALVOS, FIRE FOR EFFECT, OUT.
GT LINE 5340 READY 31, BREAK... FIRE, OVER.	GT LINE 5340, READY 31, OVER.
	FIRE, OUT.

8-25. ADJUSTMENT OF NAVAL GUNFIRE

The following paragraphs apply to adjustment procedures unique to naval gunfire. The characteristic flat trajectory and high muzzle velocity of naval gunfire make the NGF adjustment somewhat difficult, particularly on flat terrain. The observer must use sound observed firing procedures discussed previously, such as accurate target location. He also must take the actions discussed below.

a. Identify the Gun-Target Line. When notified of the GT line in the prefiring report, the observer must visualize its position in relation to the target and his own position. This provides the basis for the observer to identify round-to-round dispersion in adjustment.

b. Be Aware of the Dispersion Pattern of Naval Gunfire. The fall of shot of naval gunfire can be described as a narrow, elongated pattern as seen along the GT line. The size of the pattern varies with range. For example, at 2,100 meters, the 5-inch gun mount causes a round-to-round dispersion pattern which is about 150 meters long and 50 meters wide. Figure 8-3 shows the dispersion pattern of naval gunfire.

Figure 8-3. NGF DISPERSION PATTERN

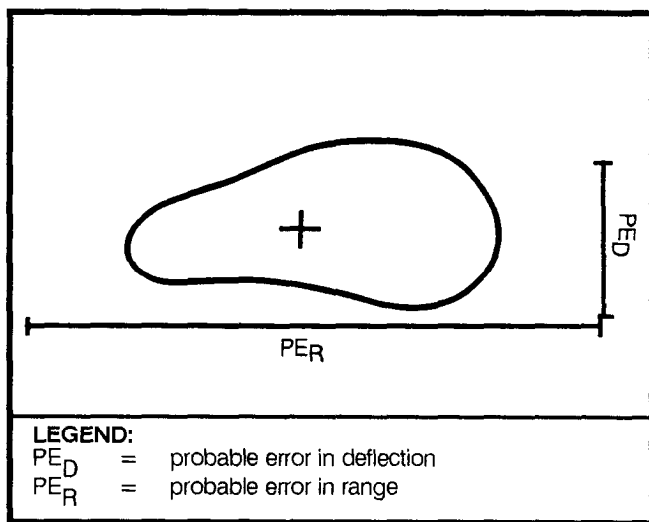

c. Predict Each Fall of Shot Before Impact. While the ship determines firing data for the next round, the observer should visualize the fall of shot based on his corrections. He compares the actual impact of the round with the predicted fall of shot. Differences that occur along the GT line may indicate round-to-round dispersion.

d. Ignore Errors to the Fall of Shot Attributed to Round-to-Round Dispersion. If a round impacts contrary to its predicted fall of shot as a result of dispersion, the observer makes a correction from its predicted point of impact instead of its actual impact. This should result in the next fall of shot impacting as predicted. This avoids the observer getting a “ping-pong” effect in adjustment.

EXAMPLE

The observer visualizes the GT line. His first spotting is **SHORT, 35 MILS RIGHT** (OT factor = 2). He transmits a correction of **LEFT 70, ADD 200**. His predicted fall of shot is **OVER, ON LINE**. The second spotting is **OVER, 25 MILS LEFT**. (The apparent error is along the GT line.) The observer transmits a correction of **DROP 100**. The third spotting impacts as predicted (**SHORT, ON LINE**). The observer’s final correction is **ADD 50, 5 SALVOS, FIRE FOR EFFECT**.

e. Correct From the Mean Point of Impact. When consecutive rounds impact differently from their predicted fall of shot, the observer should make a correction from the average or mean point of impact of the rounds.

EXAMPLE

The first spotting is **SHORT, 35 MILS RIGHT** (OT factor = 2). The first correction is **LEFT 70, ADD 200**. The predicted fall of shot is **OVER, ON LINE**. The second spotting is **OVER, 25 MILS LEFT**. (The apparent error is along the GT line.) The spotter transmits a correction of **DROP 100**. The third spotting is **SHORT, 30 MILS LEFT**. The observer notes that two consecutive rounds have impacted left of their predicted point of impact. The final correction is **RIGHT 50, ADD 50, 5 SALVOS, FIRE FOR EFFECT**. The observer made his deviation correction from the MPI of the last 2 rounds (**25 MILS LEFT and 30 MILS LEFT**).

f. Use Multiple Rounds in Adjustment. At times, the observer may need to adjust with multiple rounds, firing multiple salvos from a single gun or using multiple guns in adjustment. This method requires the observer to adjust from the mean point of impact of all rounds fired. Normally, this method is used in firing on a large area target, in firing 16-inch projectiles, or in visualizing the GT line. The technique can also be used for observers having difficulties in range dispersion in adjustment.

g. Use Elevation or Height-of-Burst Adjustment of Impact Fires. On steep terrain, **UP** or **DOWN** corrections may be used to bring the fall of shot to the same elevation as the target. These corrections are reflected on the ground with reference to the GT line.

(1) **UP** or **DOWN** corrections are transmitted in increments of 5 meters. Using the map helps to determine these corrections.

(2) Avoid mixing **ADD** or **DROP** with **UP** or **DOWN** corrections for impact fires. Both of these corrections involve an elevation change on the gun, and the results will be unpredictable. Deviation and range adjustments along the OT line usually equate to elevation changes on the gun when transformed to GT line corrections. Use **UP** or **DOWN** corrections to bring the impacts to the same altitude as the target; then switch to deviation and/or range corrections.

8-26. ADJUSTMENT OF AIRBURSTS

In time fires, special fuzes are used to achieve an airburst over the target. These fuzes include mechanical and electronic time fuzes which require a time setting before firing. Airbursts may also be delivered by proximity fuzes (VT and CVT) designed to explode at an optimal height of burst according to a radio-activated signal (20 meters for 5-inch, 7 meters for 16-inch CVT). Time fires using time or electronic time fuzes must be adjusted to ensure detonation at an optimal HOB (20 meters) in fire for effect. Proximity fuzes do not require adjustment.

a. Adjustment of Time Fires. The observer announces **FUZE TIME IN EFFECT** in the method of engagement element of his call for fire. He conducts adjustment with fuze quick in the same manner as discussed previously. He enters the time phase of the adjustment process when -

- Splitting a 200-meter bracket for an area target.
- Splitting a 100-meter bracket for a point target.
- An adjusting round has effect on the target.

The transmission to enter the time phase of adjustment is **FUZE TIME** followed by a correction (or **REPEAT**); for example, **FUZE TIME, RIGHT 30, ADD 50, OVER** or **FUZE TIME, REPEAT, OVER**.

b. Height-of-Burst Corrections.

(1) If the initial time round is spotted as **GRAZE**, the correction is **UP 40**. A 40-meter HOB correction will be applied until a spotting of **AIR** is obtained. Consecutive **GRAZE** spottings may indicate an error in the altitude of the target reported in the call for fire or an error by the

mechanical fuze setter on the gun. The observer must avoid making deviation and range corrections from a graze burst. Usually, a graze burst will be over the target on the GT line.

(2) Once an initial **AIR** spotting is achieved, the observer measures the spotting (to the nearest roil) and computes an HOB correction by multiplying the spotting by the OT factor. The HOB correction is made to the nearest 5 meters to correct the HOB to 20 meters. If a correct HOB can reasonably be expected, the observer enters fire for effect. If the **AIR** spotting is excessively high (60 meters or greater), the observer should observe another salvo before entering fire for effect. Excessively high bursts will normally be short on the GT line and out of the target area because the fuze functioned prematurely in the projectile trajectory.

(3) If a graze burst is obtained after an airburst, the correction is **UP 20**. Fire for effect is never begun when the last burst observed resulted in a spotting of **GRAZE**.

8-27. ILLUMINATION

Battlefield illumination facilitates observation for both the observer and the combat unit and restrains the enemy's freedom of movement. Illuminating shells can be used -

- To illuminate areas of suspected enemy activity.
- To provide illumination during adjustment of night fire missions.
- To harass the enemy.
- For incendiary effects.

The two methods of employing illumination are continuous and coordinated.

a. Continuous Illumination. In some situations, an observer may need continuous light on the target area. This method of illumination can be used in surveillance and will be used automatically during the FFE phase of coordinated illumination missions. When firing continuous illumination, the ship fires one round about every 15 seconds. Thus, three fired rounds will result in one round bursting, one flare at midpoint of descent, and one flare near burnout. This technique should be used with discretion to avoid wasting the limited number of star shells (illuminating projectiles) available in the ship's magazine.

b. Coordinated Illumination. This is the common technique used by NGF observers to adjust fire during darkness. The observer transmits a call for fire for a suspected target the location of which is not sufficiently

accurate to fire for effect. The ship fires an illuminating round over the initial target location. The observer then moves the illumination by subsequent adjustments. When the flare is adjusted to provide good target location, the observer informs the ship of the moment of best illumination by transmitting the command **STANDBY, MARK**. The ship then computes gun data to fire the initial round for HE adjustment to impact directly under the point of illumination burst at the moment of best illumination. There will be a single salvo of HE fire for each adjustment. When fire for effect begins, the ship will fire enough continuous illumination to ensure the observer can see the target.

c. Illumination Call for Fire. The observer uses the standard call for fire format. He announces either **CONTINUOUS ILLUMINATION** or **COORDINATED ILLUMINATION** in the special instructions subelement of the call for fire. The number of guns is omitted, since one gun is standard. The ammunition (illuminating projectile and fuze) is also omitted. To prevent ripped chutes, the mission may require reduced charge, particularly in firing at ranges of less than 7,000 meters. An example of a coordinated illumination call for fire is shown below.

EXAMPLE

AIB THIS IS C2D, FIRE MISSION, TARGET NUMBER
AF1011 OVER.
GRID MB344677, ALTITUDE 55, DIRECTION 2680,
SUSPECTED ENEMY ACTIVITY, COORDINATED
ILLUMINATION, OVER.

d. Prefiring Report. To differentiate between the illumination trajectory and that to be used for subsequent HE, the ship announces **LINE OF FIRE** followed by **READY** and **TIME OF FLIGHT** for the illuminating projectile. The observer must consider the path of the empty canister and its probable impact point along the line of fire. The observer reads back the prefiring report and commands **FIRE**.

e. Illumination Adjustment Procedures. Spottings are made to determine the location of the flare at the midpoint of its descent and the height of burnout of the flare. The flare is normally corrected to position it over (behind) the target along the OT line to achieve a silhouette of the target. If the target is on a slope, the flare normally is positioned short of the target to allow the light to shine back onto the target. The direction and speed of the wind also affect the positioning of the flare.

(1) **Deviation and Range Corrections.** These corrections are given in multiples of 100 meters with a

minimum correction of 100 meters. Because the lighted area is large, bold corrections normally are used instead of bracketing.

(2) **Height of Burnout.** The height of burnout should be between 0 (as it touches the ground) and 50 meters above the ground. Corrections are given in multiples of 50 meters with a minimum correction of 50 meters.

(a) If the flare **burns on the ground**, the observer counts the number of seconds it burns on the ground, multiplies by the rate of descent, and rounds up to the nearest 50 meters. For the 5-inch illuminating projectile, the rate of descent is 10 meters per second. For example, a flare burns on the ground for 4 seconds. The correction is **UP 50** (4 seconds x 10 meters per second = 40 meters [\approx 50 meters]).

(b) If the flare **burnout is in the air**, the observer must determine the height of burnout. This can be done by using binoculars (measure roils x OT factor). A second technique is to count the number of seconds that it takes the flickering ember from the flare to reach the ground and then multiply by the rate of descent. After rounding down to the nearest 50 meters, a correction is given to place the height of burnout between 0 and 50 meters. For example, a flare burns out in the air. The observer counts 7 seconds from the burnout until the ember touches the ground. The correction is **DOWN 50** (7 seconds x 10 meters per second = 70 meters [\approx 50 meters]).

f. Continuous Illumination Procedures. The observer adjusts the illumination as discussed above. Once the target has been properly lit, the observer can begin the FFE phase of the mission. In this phase, the ship fires illuminating projectiles at such a rate of fire that they keep the target area continuously lit. The observer may increase or decrease the rate of fire by ordering an interval or sustained fire. Examples of entering the FFE phase are shown below.

EXAMPLES

10 SALVOS, FIRE FOR EFFECT, OVER. (The ship determines the rate of fire.)

SUSTAINED FIRE, 5 MINUTES, FIRE FOR EFFECT, OVER.

10 SALVOS, INTERVAL 10, FIRE FOR EFFECT, OVER.

(1) When the observer wants to terminate illumination early during the FFE Phase, he should transmit **CEASE ILLUMINATION**.

(2) The observer may acquire a target during a continuous illumination mission and want to change to coordinated illumination. He should transmit the command **COORDINATED ILLUMINATION**. This command should be followed by desired illumination corrections, target description, method of engagement, and method of control changes; for example, **COORDINATED ILLUMINATION, LEFT 200, TROOPS IN THE OPEN, FUZE CVT IN EFFECT, OVER**. The ship will fire one illuminating projectile and be prepared to mark. Coordinated illumination procedures are described below.

g. Coordinated Illumination Procedures. The observer's request for coordinated illumination may result from acquiring a target during a continuous illumination mission, or it may be a part of the observer's method of engagement in the initial call for fire. This request alerts the ship that the observer will adjust the illumination and that he will subsequently request and adjust HE projectiles timed to impact at the moment of best illumination. During the illumination adjustment phase of the mission, the ship will time every illuminating projectile fired. It will be prepared to mark when commanded by the spotter.

(1) **Illumination Adjustment.** The observer adjusts the illumination on the target area by the procedures outlined previously.

(2) **Marking Procedure.** Once the illuminating flare has been positioned to yield the optimum light on the target, the observer transmits **STANDBY...MARK, OVER**. The **MARK** informs the ship of the optimum illumination. The ship responds **MARK, OUT**. The ship then times the firing of each HE projectile to impact at the optimum, or marked, time.

(3) **High-Explosive Adjustment.** Immediately after receiving the read back of **MARK, OUT**, the observer begins the HE adjustment phase. He transmits any subsequent corrections to improve the accuracy of the initial HE salvo. If no HE correction is sent, the ship fires the initial HE projectile at the point of flare deployment. That point may be positioned off the target location (for silhouette or wind purposes). Example corrections are **HE LEFT 200, DROP 200, OVER** and **HE REPEAT, OVER**.

(a) The ship transmits a new prefiring report for the HE projectile. The observer reads it back and commands **FIRE**.

(b) The ship transmits **SHOT** for the illuminating projectile and **SPLASH, OUT** for the HE.

(c) The observer must preface each command with the type of projectile to which the correction is to be applied. Examples are **ILLUM ADD 200, HE LEFT 200,**

OVER and **HE ADD 50, 10 SALVOS, FIRE FOR EFFECT, OVER**.

(4) **Mark Modification.** During the mission, the observer may want to change the timing between the illuminating and HE projectiles. To modify this interval, the observer uses the term **ADVANCE** or **RETARD**.

(a) **Advance.** If the observer wants the HE to fire and impact sooner, he commands **HE ADVANCE (so many)** (seconds are understood); for example, **HE LEFT 200, ADVANCE 05, OVER**.

(b) **Retard.** If the observer wants the HE to impact later, he commands **HE RETARD (so many)** (seconds are understood); for example, **HE RETARD 03, OVER**.

(5) **Fire for Effect.** During the fire-for-effect phase, the ship automatically fires limited continuous illumination. This ensures that the observer has enough illumination for surveillance. The ship fires the last illuminating projectile immediately after the last impact round in FFE unless the observer commands **CEASE ILLUMINATION** sooner.

h. Illuminating Projectile Malfunctions. Two types of malfunctions are unique to illuminating rounds. Special procedures for ships and observers to compensate for these malfunctions are discussed below.

(1) **Ripped Chutes.** Because of high muzzle velocity at shorter ranges, flare chutes may rip or separate upon deployment. Should this occur, the observer reports to the ship **RIPPED CHUTE, REPEAT** or **RIPPED CHUTE, REDUCED CHARGE, REPEAT**. The procedure to use depends upon how often ripped chutes occur and whether the reduced charge can range the target area. The observer also may request that the ship increase the range.

(2) **Dark Star.** A dark star is an illuminating round that fails to deploy at all or fails to ignite. Such malfunctions are due to either faulty ammunition or improper fuze settings. When a dark star occurs, report **DARK STAR, REPEAT, OVER**. The ship should immediately check its time fuze settings and note the time fuze lot being used. If further dark stars occur, there is probably an error in the time fuze lot.

8-28. FRESH TARGET SHIFT

Anytime during a mission, before transmitting **END OF MISSION**, an observer may want to shift fire to a higher priority target. To do this, he uses the fresh target shift technique. The advantage of this technique is that the ship can shift to the fresh target more quickly than if another call for fire with new target location data were introduced into the gunfire control computer. The fresh target shift

lets the observer temporarily suspend the adjustment of fire for the original target, bring fire onto a higher priority target, and then resume fire on the original target if desired. Procedures are discussed below.

a. Call for Fire. The observer sends an abbreviated call for fire, applying corrections from the impact of the last salvo to the fresh target. If started before the impact of the first salvo, corrections are made from the target location data sent in the call for fire. The abbreviated call for fire is discussed below.

(1) Observer identification is omitted.

(2) Warning order and target number are transmitted as **FRESH TARGET, TARGET NUMBER** (next succeeding target number). There is no break in transmission.

(3) Target location is expressed as deviation, range, and/or altitude correction from the last salvo fired (at the original target) to the fresh target. The shift is based on the **original OT** direction. The direction to the fresh target is not transmitted until after the first salvo of the fresh target shift has been fired. Then it is sent only if it differs from the original direction by more than 100 mils or 5°.

(4) Target description must always be included.

(5) Method of engagement is omitted unless a change from the initial call for fire is required. Since the essence of the fresh target shift is timeliness, changes that may cause a delay, such as changes in ammunition, should be avoided. The observer may consider using a less preferred shell-fuze combination to retain a timely response.

(6) Method of control is omitted unless a change from the initial call for fire is desired. If the observer was in the FFE phase on the original target, that phase will continue unless the observer announces, **SPOTTER (OBSERVER) ADJUST, OVER**.

b. Adjust Fire. Once the first salvo impacts for the fresh target shift, the observer transmits a new OT direction (if required) and conducts adjustment onto the fresh target.

c. Complete Firing. The observer continues adjustment until he has achieved the desired effects on the fresh target. If he wants to resume firing on the original target, he again uses the fresh target shift technique to return to the original target. The target is referred to by its original target number.

d. Record as Target. If the observer wants the ship to record a target for future firing, he must transmit **RECORD AS TARGET, TARGET NUMBER (so-and-so)**

after fire for effect on that target is completed but before sending **END OF MISSION**.

e. End Mission. When he is satisfied with the effects on each of the targets (fresh and original targets), the mission is terminated in target number sequence. Each target must be referred to by target number in reporting the damage assessment. For example, **END OF MISSION, TARGET NUMBER AB4007 (original target), 3 TRUCKS DESTROYED, TARGET NUMBER AB4008 (fresh target), SAGGER WEAPON SILENCED, OVER**.

8-29. SIMULTANEOUS ENGAGEMENT OF TWO TARGETS

The procedures for the simultaneous engagement of two targets differ from those of the new target shift in that the target location is not sent by using the shift from the last salvo. If the ship can conduct multiple missions (MK-86 or two separate gunfire control systems [BB]), the observer can adjust fire onto two targets simultaneously.

a. The call for fire for the second target in simultaneous engagement is the standard six-element call for fire listed in paragraph 8-13.

b. The observer must preface each correction with the target number to which it is to be applied.

c. The ship will not transmit **SPLASH** in order to provide more time for the observer to transmit corrections.

8-30. FIRING ON A RECORDED TARGET

If fires are desired on a previously recorded target or a planned target, the observer sends an abbreviated call for fire as discussed below.

a. Observer identification is required.

b. Warning order and target number consist of the word **FIRE** followed by the target number; for example, **FIRE TARGET NUMBER (so-and-so)**. There is no break in transmission.

c. Target location is omitted. It is already known by the ship.

d. Target description is omitted unless changed from the recorded description.

e. Method of control is transmitted as required. If firing a recorded target from the same ship in the same firing track as when the data were recorded, a first-salvo FFE may be feasible.

8-31. 16-INCH NAVAL GUNFIRE MISSIONS

Adjusting fire from the 16-inch guns of a battleship is somewhat different than adjusting that from the 5-inch guns.

a. Characteristics. The 16-inch gun produces a significantly larger dispersion pattern than does the 5-inch. The pattern is about 150 meters (or greater) wide and 500 meters (or greater) long. The pattern depends on the terrain, target range, and number of guns in effect. The observer should expect 2 to 5 minutes between transmitting a correction and shot of the next salvo.

b. Call for Fire. The standard call for fire is used. The armament and number of guns must be considered.

(1) Armament. If the observer does not specify the armament, the main (16-inch) gun will be fired. If the observer wants the 5-inch gun fired, he announces **SECONDARY ARMAMENT**.

(2) Number of Guns. Ship operating procedures may differ in the number of mounts and/or turrets to be used in adjustment and fire for effect. Coordination with the battleship is encouraged on this subject.

c. Corrections. Because of the rather large dispersion pattern and the slow response time for each shot, observers should use bold corrections to hit the target as rapidly as possible. Bracketing is not feasible.

d. Erratic Rounds. The observer may want to use the MPI adjustment technique. On occasion, the dispersion pattern will contain an erratic round. When determining the MPI, the observer should ignore erratic rounds and determine the MPI from those impacts which form a reasonable group.

8-32. DESTRUCTIVE FIRE

Destructive fire missions by NGF ships involve deliberate, accurate gunfire normally using a single gun or turret against each target. This can be expensive in ammunition and take a considerable amount of time to execute. During the mission, the gun or turret and ammunition lot are not changed. The ship should be positioned to allow for the best conditions and orientation with respect to the GT line and the terrain in the target area. The GT range should be as short as possible in order to reduce the dispersion zone.

a. Adjustment. Ship adjustment should be used if possible. If the observer conducts the adjustment, he does so in the normal manner described previously until the MPI is at the split of the 100-meter range bracket.

b. Fire for Effect. Groups of rounds, usually five for a single gun, are fired and the averages for deviation and range spottings are noted. A correction based on the MPI of all the rounds is then sent. Five rounds are fired again. The correction is made as accurately as possible; for example, **RIGHT 10, DROP 25, REPEAT, OVER** or **LEFT 5, REPEAT, OVER**.

8-33. MASSED FIRE

a. Two or more ships may be required to engage large or important targets simultaneously. If they have not already been given a direct support mission, gunfire request procedures must be started.

b. A collective call sign is used. All orders from the observer are read back by the senior ship. The other ships acknowledge the transmissions. The first ship to report **READY** is adjusted onto the target in the normal manner. The other ships are individually adjusted as they report **READY**. Usually, one or two bold corrections are used to bring the MPI into the required target area. To facilitate observer control, **AT MY COMMAND** may be used. At the completion of adjustment, the observer announces **CANCEL AT MY COMMAND, ALL GUNS (required number) SALVOS, FIRE FOR EFFECT, OVER**.

8-34. SPECIAL NAVAL GUNFIRE COMMANDS AND REPORTS

a. The commands below are given for **safety reasons**.

(1) **CHECK FIRING.** Anyone can command **CHECK FIRING** when an unsafe situation becomes apparent. This command causes the ship to instantly stop firing.

(2) **CANCEL CHECK FIRING.** The originator of check firing must announce **CANCEL CHECK FIRING** for the fire mission to continue.

b. The commands below would be given by the observer.

(1) **SPREADING FIRES.** This command is used after fire for effect has been delivered. It notifies the ship that the observer wants to distribute the fires over a large area. The words **SPREADING FIRES** are followed by a correction and the command **REPEAT** (pertaining to the volume of fire); for example, **SPREADING FIRES, RIGHT 200, REPEAT, OVER**.

(2) **TREND.** The observer may notice the rounds drifting away from the target. Then this report, along with an indication of direction and drift in meters, is sent to the ship. This facilitates the identification of the gunnery problem by the ship. An example command is **TREND, SOUTHWEST, 100 PER SALVO**.

(3) **STRADDLE**. A multigun salvo may bracket a target. Then the observer announces **STRADDLE**, followed by a correction, to place the MPI on the target. The term is normally used during a ship-adjust or massed-fire mission.

(4) **CHECK SOLUTION**. This command is transmitted if the observer suspects an error in the gunnery solution for a salvo. Before sending **CHECK SOLUTION**, the observer should check his target location data, particularly direction if the error is in a subsequent salvo. Another common cause for errors in adjustment is a change in the OT factor resulting from a target location error. The ship will respond with either **SOLUTION CHECKS** or **NEGLECT**.

c. The commands below would come from the **ship**.

(1) **NEGLECT**. This report is sent by the ship to report that the last salvo was fired with incorrect data. The ship corrects the settings and transmits **READY, OVER** when it is prepared to fire.

(2) **DELAY**. This command is followed by an estimate of time in minutes. It means that the ship is not ready to fire until the given time has elapsed – usually a short duration. When the ship is prepared to fire, it reports **READY, OVER**.

(3) **WILL NOT FIRE**. This command is followed by an explanation. It means that the ship will not continue the mission for the stated reason. Normally, the reason is a gun mount malfunction (mount casualty), a higher priority mission, or a circumstance such as counterbattery fire.

APPENDIX A

LASER RANGE FINDERS AND DESIGNATORS AND WEAPON SYSTEMS

A-1. INTRODUCTION

Modern battles are fought and won by a combination of air, land, and naval forces working together. As the complexity of the battlefield increases, we, as a nation, have turned to developing technology to help us meet the challenges we face. One of the most promising of the new technologies is the development of laser systems to increase our capability. (Laser stands for light amplification by stimulated emission of radiation.)

a. Laser Use on the Battlefield. The use of laser technology on the battlefield has developed in three primary areas: laser target ranging and designation systems, laser acquisition systems, and laser-guided munitions (LGMs).

(1) Laser target ranging and designation systems provide accurate directional distance and vertical angle information for use in locating enemy targets. These systems may vary from hand-held to aircraft-mounted devices, but they all perform the same basic function. Once a target has been selected and accurately located, the laser designation capability is used to identify the specific target for laser-guided munitions.

(2) Laser acquisition devices are used to acquire reflected laser energy. These devices are used in conjunction with laser designation systems to pinpoint targets or other specific items. Normally, laser acquisition devices are mounted on fixed-wing aircraft or helicopters.

(3) Laser-guided munitions home in on reflected laser energy during the terminal portion of the attack to accurately hit the specific target. Such munitions are part of the precision guided munition (PGM) family.

b. Requirements. Three basic requirements for using laser designators with laser acquisition devices or laser-guided munitions are discussed below.

(1) The PRF code of the laser designator and the laser acquisition device or LGM must be the same.

(2) An agreed-upon direction of attack is necessary. The laser acquisition device or LGM must be able to "sense" the reflected energy from the laser designation device.

(3) The laser designator must be lasing or designating the target at the correct time.

c. Value. The value of laser devices and LGMs has been recognized by all branches of the armed services. Each service has developed laser systems to meet its own particular needs. The proliferation of laser devices has already resulted in the development of service-specific procedures and international standardization agreements (STANAGs and/or QSTAGs). To achieve our goal of fighting together efficiently, we must use procedures to which all services have agreed. These procedures are still being developed. This appendix gives information on the use of the Army's primary laser systems and a brief description of those of other services.

A-2. GROUND/VEHICULAR LASER LOCATOR DESIGNATOR

a. Description. The G/VLLD is the Army's long-range designator for precision guided semiactive laser weapons. It is two-man portable for short distances and can be mounted on the M981 FIST vehicle. The G/VLLD gives the observer accurate OT distance, vertical angle, and azimuth data. Accurate azimuth information depends on initial orientation of the G/VLLD. All three items of information are shown in the eyepiece display.

(1) The laser designator places coded laser energy on stationary or moving targets. Reflected coded laser energy provides guidance information for terminal homing munitions such as Hellfire and Copperhead. The code transmitted by the designator is manually set on the G/VLLD PRF code switches by the observer. This same code is also set on the laser-guided projectiles to be fired for that observer. Coded laser energy allows for multiple designators to operate in the same target area without mutual interference. The G/VLLD is equipped with an AN/TAS-4 night sight (Figure A-1). This night sight significantly increases the observer's ability to detect and engage targets during periods of reduced visibility caused by darkness or battlefield obscuration.

(2) Detailed procedures for the technical operation of the G/VLLD are in TM 9-1260-477-12. This manual discusses those operational aspects of using the G/VLLD not covered in the TM.

NOTE: The division FSE is the overall manager of PRF codes for the division area. Blocks of codes are assigned to division artillery, to maneuver brigades or battalions, and to the division. The lowest level for management of PRF codes is the brigade FSE, which controls fire support for the brigade. The brigade FSE provides positive coordination of the codes for both the designator and the artillery FDC as a part of fire mission processing. For information on Air Force PRF codes, see Chapter 8, Section I.

Figure A-1. G/VLLD WITH NIGHT SIGHT

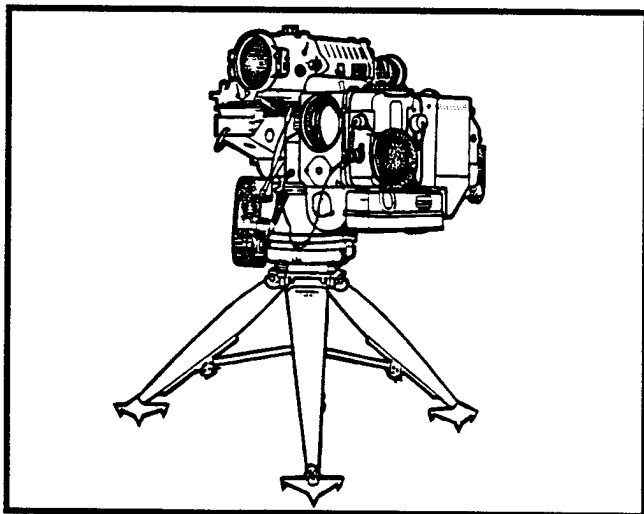

b. Boresighting the G/VLLD. The manufacturer's tolerance on the G/VLLD laser designator/range finder (LD/R) is enough to ensure that the laser line of sight and the day optics remain in boresight under normal conditions. However, unusually rough handling of the G/VLLD may cause a boresighting problem. If the observer suspects the laser and optical alignment, he should turn in the G/VLLD to DS maintenance. The night sight of the G/VLLD also requires boresighting. The observer should be familiar with these procedures. The night-vision sight is boresighted at the time of mounting. A field boresight check is performed on the G/VLLD.

c. Initial Orientation of the G/VLLD. Since target locations are determined by the polar plot technique, target location accuracy depends on the accuracy of the observer's location as reported to the FDC and of his initial orienting azimuth. The G/VLLD gives accurate distance, direction, and vertical angle data. However, the accuracy of the azimuth information depends on the initial orientation of the G/VLLD. Upon occupation of a position, the observer should ensure that accurate orienting information is placed on the G/VLLD and that his

accurate location is encoded and sent to the FDC. As a minimum, he should do the following as soon as possible after occupying an observation post:

- Using an M2 compass, measure the grid azimuth to a reference point that is easily identifiable on the ground.
- Orient the G/VLLD on the reference point, and set the grid azimuth reading in the azimuth display of the G/VLLD eyepiece.
- With the G/VLLD thus oriented for direction, determine the azimuth, distance, and vertical angle to any point that he can observe with the G/VLLD and can identify on his map.
- Determine his location through resection and terrain analysis and report his grid coordinates to the FDC.

A-3. SELF-LOCATION

The observer should refine his location and the orientation of the G/VLLD as soon as possible. If possible, his location should be determined by survey. Lacking survey control, however, he can use the G/VLLD to locate himself through a procedure called self-location. In this procedure, the observer sends to the FDC the direction, distance, and vertical angle to two known points separated by at least 300 mils. He must also specify which known point is on his left. The FDC determines the G/VLLD location. Then the FDC determines the correct orienting azimuth to one of the known points. This information is sent through secure means to the observer. The observer then plots his location on the map and reorients his G/VLLD on the known point with the corrected azimuth. Self-location can be done by using two known points, one known point and one burst, or two bursts.

NOTE: The observer's location can also be determined by using only one point. However, the accuracy of the observer's location depends on the accuracy of the initial azimuth orientation of the G/VLLD.

a Self-Location by Use of Two Known Points.

(1) With this method, the observer uses two known points (Figure A-2). A known point may be established through survey, firing, or measuring from a map. If measured from a map, the point must be easily identifiable on the ground; for example, a church steeple, a water tower, or a prominent road junction. The observer must be sure that he can associate the known point on the ground with the same point on the map. This method of self-location is the most accurate and, therefore, the preferred technique. When using a voice call for fire, the observer will announce trilateration in the method of fire.

EXAMPLE

A24 THIS IS A58, TRILATERATION, OVER.
 KNOWN POINT CADDO, DIRECTION 1743 (encoded),
 DISTANCE 1230 (encoded), VERTICAL ANGLE PLUS
 10 (encoded), KNOWN POINT FLATTOP (encoded),
 DIRECTION 2338 (encoded), DISTANCE 3180
 (encoded), VERTICAL ANGLE MINUS 10 (encoded),
 OVER.
 KNOWN POINT CADDO ON LEFT, OVER.
 A58 THIS IS A24, LOCATION NK47253824 (encoded),
 DIRECTION TO CADDO 1723 (encoded), OVER.

(2) If the observer has a DMD, the DMD FR LASER message is used for this function as follows. Select TRILAT to determine the grid coordinates of the G/VLLD location. Tell the FDC in a FREETEXT message which known points will be lased and which known point is on the observer's left. The leftmost known point must be lased first and identified as point 1. The

rightmost known point must be lased second and identified as point 2.

b. Self-Location by Use of One Known Point and One Burst. If only one known point is available, the second point may be established by a planned burst of an HE or a WP round (Figure A-3). The observer should plan the location of the burst so that it is separated from the known point by at least 300 mils. Graze bursts should be used. Using the G/VLLD, the observer ranges the known point and the burst of the round to determine the direction, distance, and vertical angle (VA) for each of the two points. He reports these to the FDC. The FDC computes the G/VLLD location and corrected azimuth to the known point and sends the information to the observer.

NOTE: The accuracy of the computed G/VLLD location and the reference azimuth is affected by the accuracy of the firing data used to fire the round. The FDC should use the most accurate data available.

Figure A-2. SELF-LOCATION BY USE OF TWO KNOWN POINTS

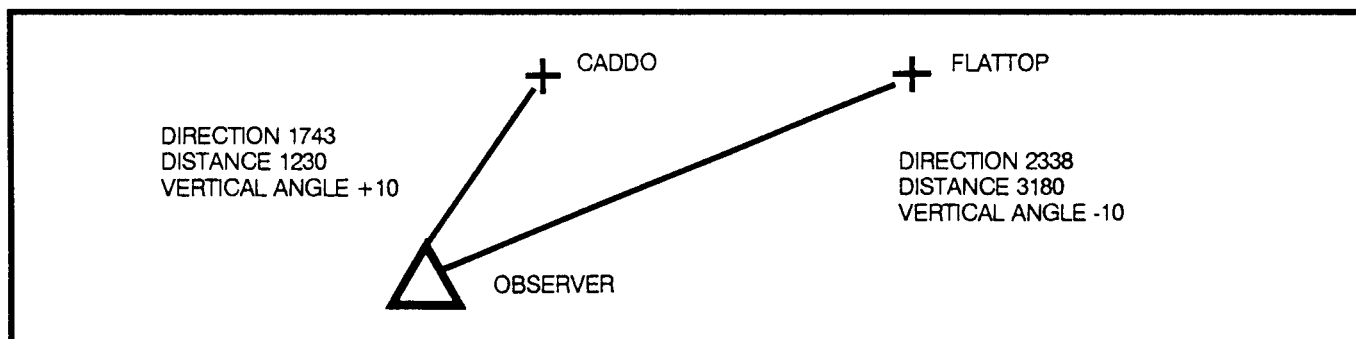
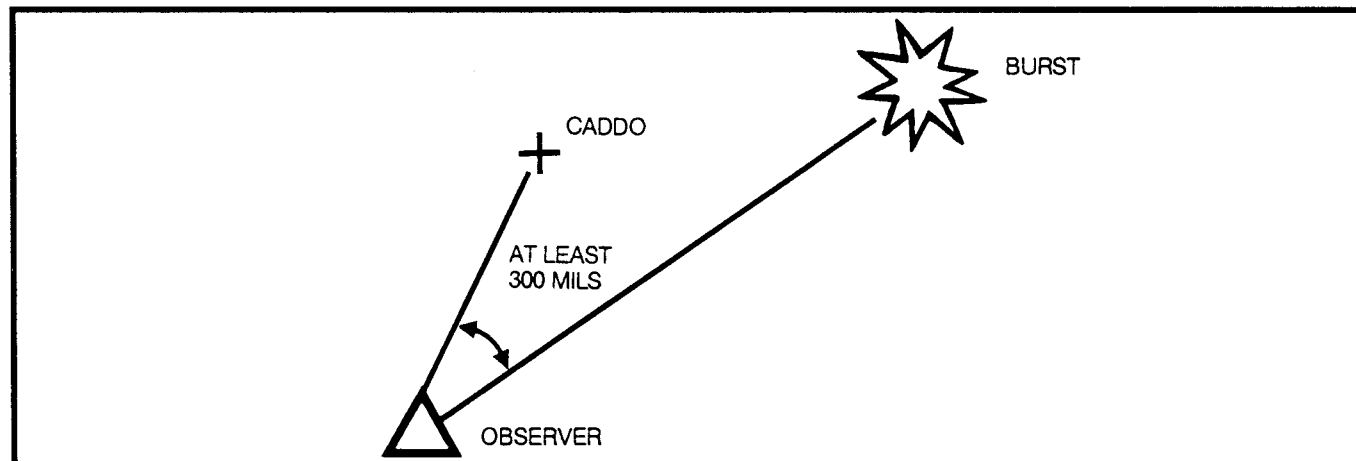

Figure A-3. SELF-LOCATION BY USE OF ONE KNOWN POINT AND ONE BURST



EXAMPLE

A24 THIS IS A58, SELF-LOCATION, 1 ROUND, OVER.
 KNOWN POINT CADDO, DIRECTION 1743 (encoded),
 DISTANCE 3180 (encoded), VERTICAL ANGLE PLUS
 10 (encoded), OVER.
 1 ROUND, GRID NK598376, OVER.
 (Round is fired and observed.)
 DIRECTION 2105 (encoded), DISTANCE 3420
 (encoded), VERTICAL ANGLE MINUS 12 (encoded),
 OVER.
 KNOWN POINT CADDO ON LEFT, OVER.
 A58 THIS IS A24, LOCATION NK47253824 (encoded),
 DIRECTION TO CADDO 1723 (encoded), OVER.

- After the round is fired, lase or range the burst. (Laser polar data are “dumped” into the FR LASER format.)
- Select active mission buffer 1, and compose an EOM SURV message with EOM RAT in the CONTROL field.
- From the FDC receive the MTO assigning a known point number.
- Compose and transmit a FREETEXT message telling the FDC that a RESEC follows the known point number received in the previous MTO.
- Select active mission buffer 2.
- Enter the known point number from the previous MTO, and transmit it to the FDC.

NOTE: The FDC determines and transmits a location back to the G/VLLD-equipped observer.

c. Self-Location by Use of One Known Point.

(1) This method is used by a DMD-equipped observer communicating with a BCS-equipped FDC. The FR LASER message format is used for this method as follows:

- Select RESEC in the MSN field of the format.
- Tell the FDC in a FREETEXT message that RESEC is being used and on which known point.

NOTE: If no known point has been established, one can be established by using an FR GRID message with EOM RAT in the control field. An MTO will then be sent from the FDC to notify the G/VLLD-equipped observer of the known point number assigned to that grid location.

(2) The one known point method also may be used with a burst as follows:

- Compose and transmit FR GRID with ADJ FIRE entered in the control field (active mission buffer 1).
- Compose an FR LASER message in active mission buffer 2 with RESEC entered in the MSN field of the format and DIR, DIST, VA, and KN PT # entries blank

d. Self-Location by Use of Two Bursts. If no known points are available, the bursts of two rounds may be used as the prearranged points. The observer selects the locations at which he wants the rounds to burst, ensuring that they are separated by at least 300 mils (Figure A-4). Also, the direction to a reference point is determined. When the rounds are fired, the observer ranges the bursts to determine the direction, distance, and vertical angle of each burst point. He reports these to the FDC and records the direction to the second burst point. The FDC computes the G/VLLD location and corrected azimuth to the second burst point and sends the information to the observer. The observer determines the difference between his measured azimuth to the second burst point and the azimuth that the FDC reported to the second burst point. The angular difference, in mils, is **plus** if the reported azimuth from the FDC is **greater** than the azimuth the observer measured. It is **minus** if the reported azimuth from the FDC is less than the azimuth measured by the observer. The difference is applied to the initial reference point azimuth by either adding or subtracting, as the sign indicates. The observer places the resulting azimuth on the G/VLLD while sighting on his initial reference point.

Figure A-4. SELF-LOCATION BY USE OF TWO BURSTS

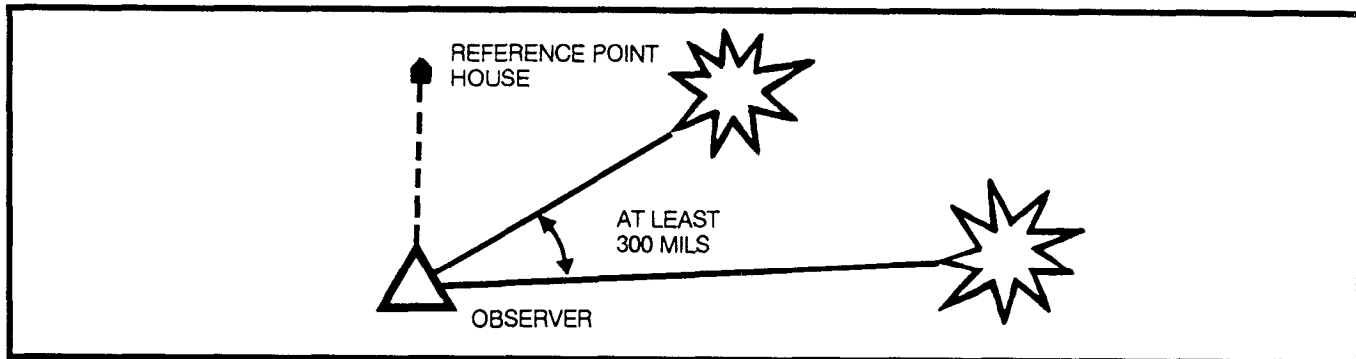

EXAMPLE

The observer occupies a position and initially orients the G/VLLD by using an M2 compass. He selects a reference point (BARN) and measures the azimuth to BARN as 5,796 mils. No known points are available, so he requests self-location using two bursting rounds.

A24 THIS IS A58, SELF-LOCATION, 2 ROUNDS, OVER.

1 ROUND, GRID NK603368, OVER.

(Round is fired and observed.)

DIRECTION 6398, DISTANCE 4110, VERTICAL ANGLE MINUS 9, 1 ROUND, GRID NK564381, OVER.

(Round is fired and observed.)

DIRECTION 5927, DISTANCE 3840, VERTICAL ANGLE MINUS 11, FIRST ROUND ON LEFT, OVER.

The FDC determines and sends to the observer his G/VLLD location and orienting azimuth to the second burst point.

A58 THIS IS A24, LOCATION NK58723423 (encoded), DIRECTION TO SECOND ROUND 5918 (encoded), OVER.

Having recorded the G/VLLD-measured azimuth to the second burst point, the observer records the FDC-reported information and makes the following computations:

G/VLLD-measured azimuth	5927
FDC-reported azimuth	5918
Angular difference	<u>-9</u>

Observer azimuth to reference point (M2 compass)	5769
Angular difference	<u>-9</u>
Corrected azimuth to reference point (BARN)	5760

The observer places this resulting azimuth on the G/VLLD while sighting on reference point BARN.

A-4. SECOND G/VLLD-EQUIPPED OBSERVER ASSISTANCE

A G/VLLD-equipped observer who has been accurately located and oriented through survey or through self-location can help other G/VLLD-equipped observers locate themselves. The second observer can establish known points for another G/VLLD-equipped observer to use in self-location, or he can perform a simultaneous observation with the other observer on two illuminating

rounds. The FDCs can refer G/VLLD-equipped observers requiring self-location to G/VLLD-equipped observers accurately located to coordinate assistance.

a. Establishment of Known Points for Other Observers.

An observer emplacing a G/VLLD may have no preestablished known points and no readily identifiable terrain feature that can be measured from a map. A second observer with an accurately located and oriented G/VLLD can use his G/VLLD to establish known points for the other observer. To do this, both observers must be able to see a common area well enough to clearly identify and locate two objects to serve as known points for self-locations; for example, a prominent lone tree and an abandoned tank. These points should be separated by at least 300 mils as observed from the G/VLLD position being located. This requires very careful and thorough coordination between the two observers. Once mutually agreeable points have been identified they can be established as known points as outlined in the example below.

EXAMPLE

A G/VLLD-equipped observer, A23, has no known points in his area. The FDC, A16, instructs him to contact A47, a nearby observer with a G/VLLD that is accurately located and oriented, for assistance in establishing known points in his area. Mutually agreeable points have been identified.

A16 THIS IS A47, KNOWN POINTS FOR A23, OVER.

KNOWN POINT TREE, DIRECTION 0832 (encoded), DISTANCE 5740 (encoded), VERTICAL ANGLE MINUS 9 (encoded), KNOWN POINT TANK BODY, DIRECTION 0947 (encoded), DISTANCE 6370 (encoded), VERTICAL ANGLE MINUS 11 (encoded), OVER.

With two known points established, the observer operating the G/VLLD being located can now locate himself through self-location by using two known points.

A16 THIS IS A23, SELF-LOCATION, OVER.

KNOWN POINT TREE, DIRECTION 5823 (encoded), DISTANCE 6240 (encoded), VERTICAL ANGLE MINUS 10 (encoded), KNOWN POINT TANK BODY, DIRECTION 6207 (encoded), DISTANCE 5970, VERTICAL ANGLE MINUS 14 (encoded), KNOWN POINT TREE ON LEFT, OVER.

A23 THIS IS A16, LOCATION NK38374512 (encoded), DIRECTION TO TREE 5815 (encoded), OVER.

b. Location by Simultaneous Observation. An observer with an accurately located and oriented G/VLLD can help determine the location of another G/VLLD. He does this by performing a simultaneous observation on two illuminating (illum) rounds with the other G/VLLD observer (Figure A-5). This technique is especially useful during periods of limited visibility. Both observers must be able to see and lase the illuminating rounds. Also, these illuminating rounds must be separated by at least 300 mils as observed from the G/VLLD position being located. Thorough prior coordination between the two observers must take place for this technique to be effective. The observer with the G/VLLD being located records the direction to a reference point and prepares to observe. The observer with the accurately located G/VLLD acts as the

controlling station and initiates the illumination call for fire as outlined in the example on the next page.

NOTE: Ranging an illuminating canister may be difficult for some observers. A variation of this technique is to adjust the illumination so that it burns on the ground. Both observers then range the flare.

WARNING

Lasing or ranging above the skyline requires specific authorization from range control during peacetime training.

Figure A-5. LOCATING SECOND OBSERVATION POST BY SIMULTANEOUS OBSERVATION

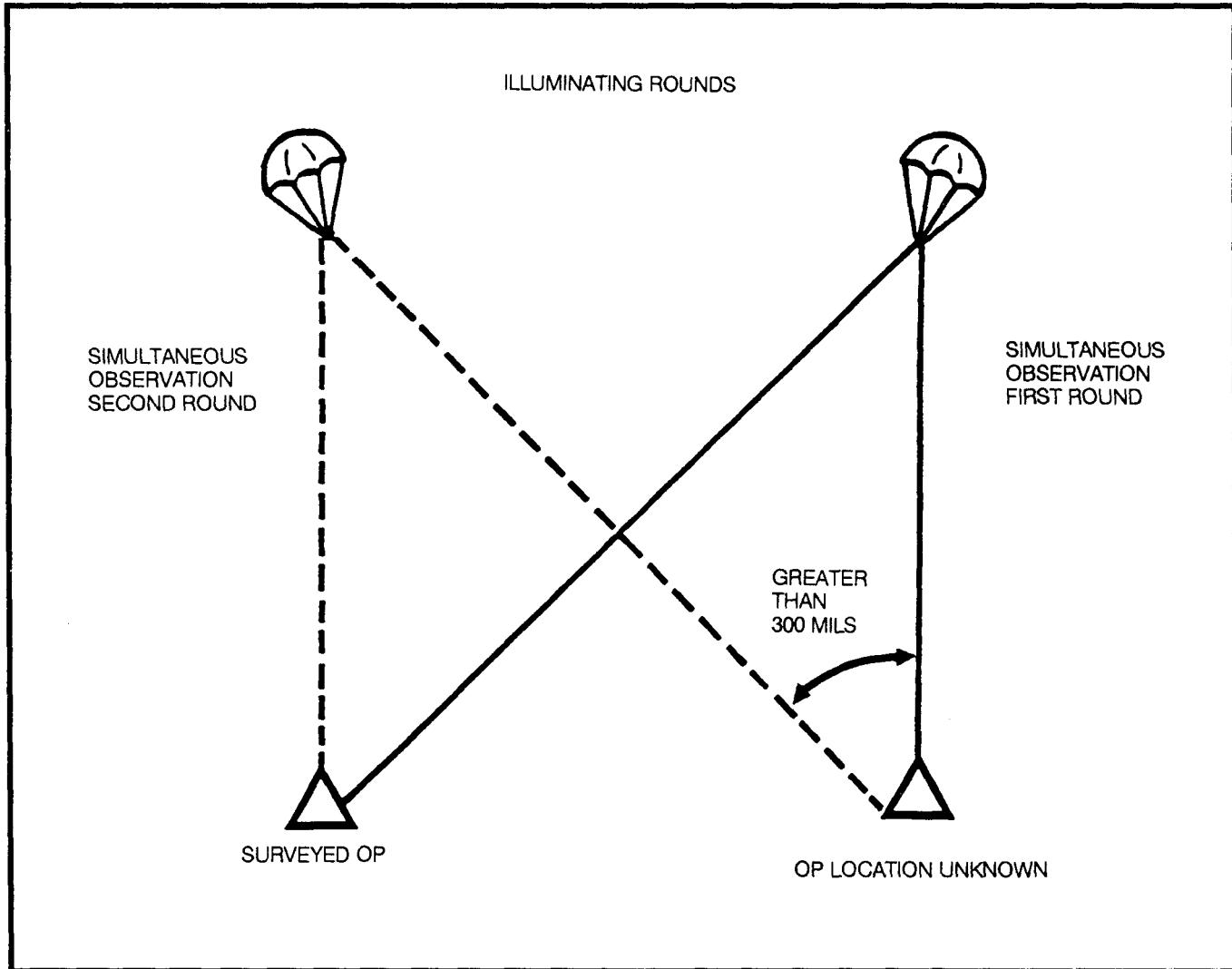

EXAMPLE

A47 is the observer with the accurately located G/VLLD. A23 is the observer with the G/VLLD being located. A16 is the battery FDC. Coordination between A47 and A23 has already taken place.
A16 THIS IS A47, SIMULTANEOUS OBSERVATION WITH A23, OVER.

1 ROUND, GRID NK374522, 1 ROUND, GRID NK391516, OVER.

ILLUMINATION, BY ROUND AT MY COMMAND, OVER.

A47 THIS IS A23, READY TO OBSERVE, OVER.

A47 THIS IS A16, READY, OVER.

(A47 commands the first round to be fired.)

As the illuminating round descends, the observer with the accurately located G/VLLD coordinates simultaneous lasing on the flare. He begins tracking the descending flare and has his RATELO transmit **TRACKING, TRACKING, TRACKING, ... LASE.**

Once the command **LASE** is given, both observers lase or range the flare simultaneously.

A16 THIS IS A47, DIRECTION 0437 (encoded), DISTANCE 3780 (encoded), VERTICAL ANGLE PLUS 21 (encoded).
A16 THIS IS A23, DIRECTION 6377 (encoded), DISTANCE 4120 (encoded), VERTICAL ANGLE PLUS 23 (encoded).

The observers must use their judgment to determine if they have received an accurate return from the flare. If one of the observers believes that he has an inaccurate return, the tracking phase should be repeated before any data are sent to the FDC. Once the observation data have been completed for both rounds, the FDC determines the location and orienting azimuth correction.

A23 THIS IS A16, LOCATION NK49163842 (encoded), DIRECTION TO SECOND ROUND 0317 (encoded), OVER.

The observer with the G/VLLD being located records his G/VLLD location on the map and adjusts the azimuth to his reference point as described in the procedures for self-location using two bursts.

A-5. OBSERVER ACTIONS AFTER BEING LOCATED

a. As soon as the observer knows his accurate location, he should determine polar plot data to several prominent points around his position. The FDC

can determine the grids of these points for the observer, making them known points (Figure A-6). Then the observer can refer to these known points when he moves. He can use them in self-location by using the two known points technique to locate his new position.

Figure A-6. USING A LASER TO DETERMINE KNOWN POINTS AND NEW LOCATION

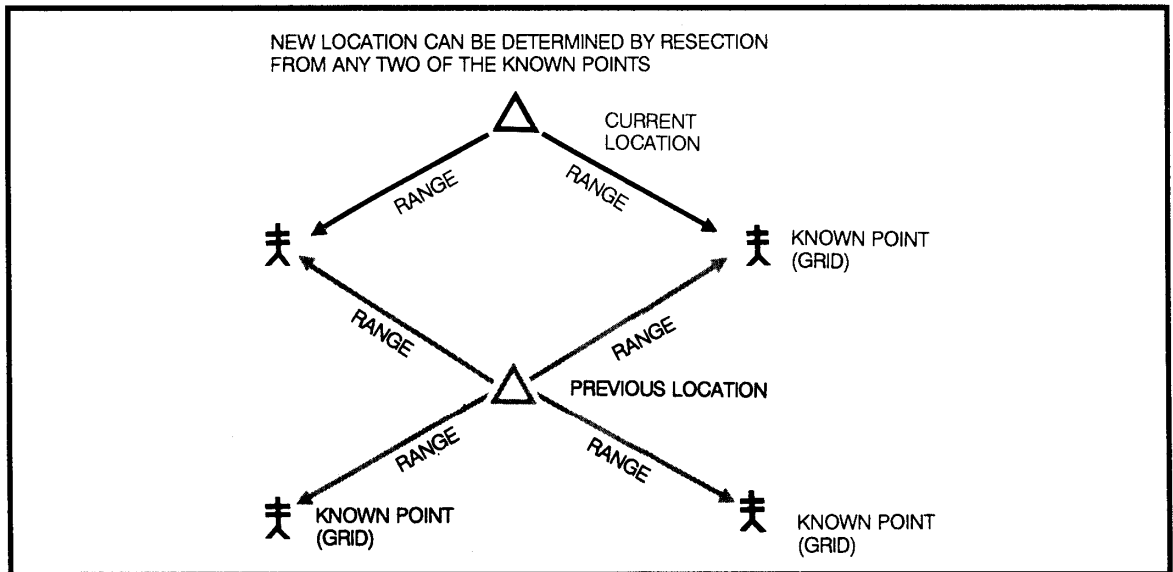

b. When the G/VLLD location has been accurately determined and is known by the FDC, the observer uses the G/VLLD to measure distance, direction, and vertical angle to targets from his location (Figure A-7).

Figure A-7. TARGET LOCATION BY POLAR PLOT

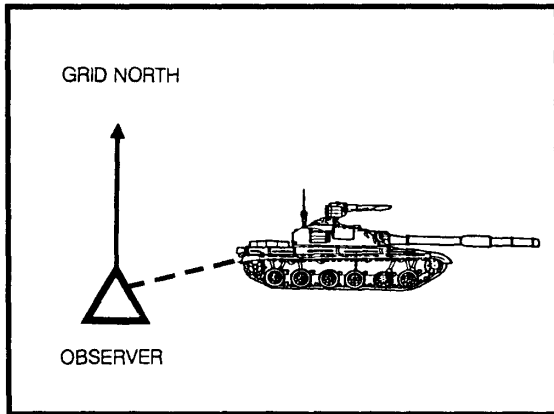

c. Polar plot data (encoded) taken from the G/VLLD can be sent directly to the FDC (preferred), or it can be converted to a grid location and then sent to the FDC.

This paragraph implements STANAG 2934, Chapter 6, Annex A and QSTAG 505.

A-6. ADJUSTMENT OF FIRE

a. If the G/VLLD is accurately located and is properly oriented, resulting target locations will be accurate enough for first-round FFE missions. However, many times, some of the requirements for accurate first-round FFE are lacking at the firing battery. If the observer is not sure he can achieve first-round FFE on the target, he should request an adjust-fire mission. The G/VLLD then gives him a superior capability to adjust fire for conventional munitions. Once the first adjustment round impacts, the observer determines whether the round impacted right or left of the target. Then he determines angular deviation by finding the difference between the measured direction to the target and the measured direction to the burst of the adjusting round.

NOTE: The call for fire formats outlined in Chapter 4 are used. Target locations are usually laser polar plots.

b. If the angle of deviation exceeds 100 mils, the mil relation and observer adjustment techniques are not accurate enough. In this case, the observer sends the laser polar plot data of the burst to the FDC to compute the shift. In a unit equipped with BCS or BUCS, the observer always sends the laser plot to the FDC. The computer determines the shift to place accurate fires on the target.

EXAMPLE

**BURST DIRECTION 5872, DISTANCE 4350
VERTICAL ANGLE MINUS 11, FIRE FOR EFFECT,
OVER.**

c. If the angle of deviation is 100 mils or less and the supporting FDC does not have BCS or BUCS, the observer computes his own shift as follows: (Figure A-8 illustrates the example.)

- Compute the observer-burst (OB) distance factor by expressing the OB distance to the nearest 1,003 meters.

EXAMPLE

Distance to burst = 3480 = 3 (OB factor).

- Determine the horizontal shift by multiplying the angular deviation by the OB factor and expressing the answer to the nearest 10 meters by using artillery expression.

EXAMPLE

25 x 3 = 75, or L80 meters
(Angular deviation) x (OB factor) = horizontal shift, in meters.

- Determine the range shift by finding the difference between the OT range and the OB range and expressing it to the nearest 10 meters.

EXAMPLE

Distance to target	3,680 meters
Distance to burst	-3,480 meters
	+ 200 meters
(OT range) - (OB range) = range shift	

- Compute a vertical shift (required only if it exceeds 30 meters) by determining the vertical angle difference between the burst and the target, multiplying by the OB factor, and expression to the nearest 5 meters.

EXAMPLE

Vertical angle to target +2 mils
 Vertical angle to burst (-) -1 mil
 Vertical shift +3 x 3 = 9 meters =
 10 meters, Less than 30 meters;
 no correction is needed.
 (Vertical angle) x (OB factor) = vertical shift (meters)
 Correction sent to FDC: LEFT 80, ADD 200, FIRE
 FOR EFFECT, OVER.

Figure A-8. USE OF G/VLLD FOR DETERMINATION OF SUBSEQUENT CORRECTIONS

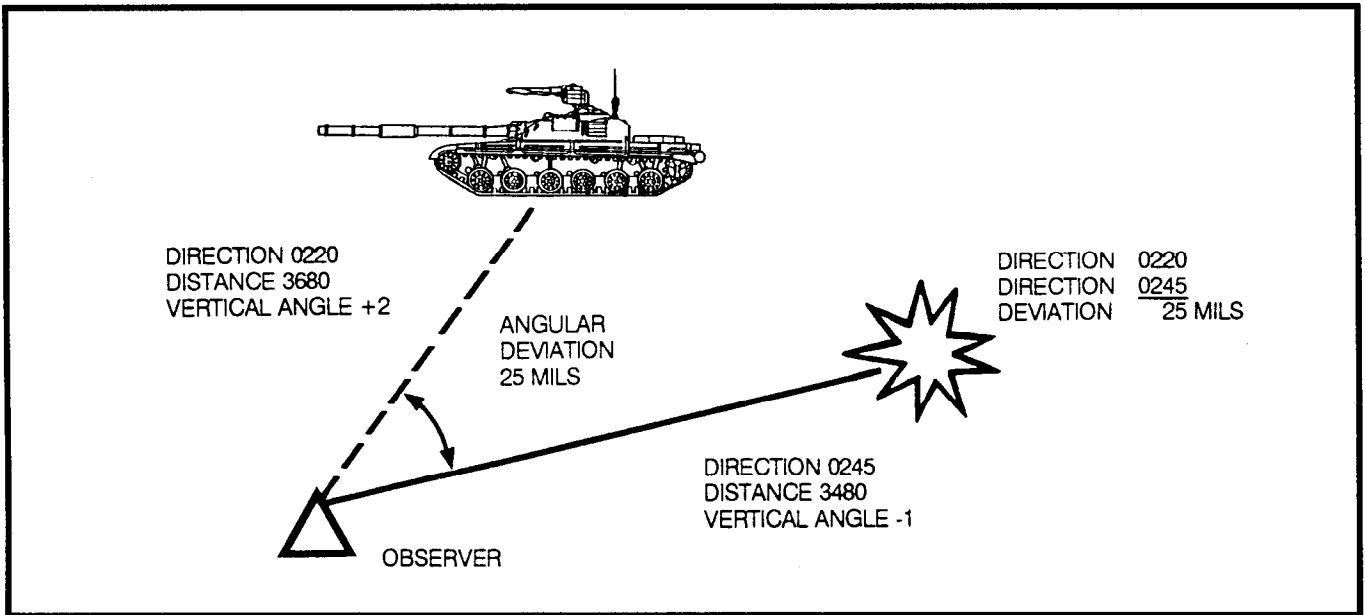

A-7. AUXILIARY ADJUSTING POINT

a. To achieve surprise on the target, an adjusting point may be selected that is well away from the target. To ensure that the adjusting point is far enough away, the angle of deviation between the target and the adjusting point should be at least 100 mils. In any case, the FDC computes the shift.

EXAMPLE

An observer's position is map-spotted, and the G/VLLD is oriented for direction by using the M2 compass. Registration corrections are not available. The observer ranges the target and obtains the following data (Figure A-9):

Direction	0220 mils
Distance	3,680 meters
Vertical angle	+2 mils

b. If the observer has a DMD, he uses the following procedures to adjust on an auxiliary adjusting point:

- Select OK TGT to identify a new target location.
- Select OK BT if the adjusting round was observed and the burst location has been ranged. The BCS will compute the shift required. Normally, fire for effect can be specified after one adjusting round has been observed and ranged.
- Select DNO TGT or LOST TGT if the adjusting round was not observed or was lost and the target location has been ranged. This procedure can be used to identify the original or a new target location.
- Select LOST BT if the adjusting round is lost and the estimated burst location has been ranged. Because the actual burst location is uncertain, another adjusting round is requested.

- Select IGN RD if the adjusting round was erratic and another one must be fired.

NOTE: To facilitate accurate fires on the target, the observer should select an auxiliary adjusting point whose range from the guns is close to the GT range and is within 400 mils left or right of the GT line.

EXAMPLE (Continued)

The observer then selects an adjusting point at grid coordinates NK633374, well removed from the vicinity of the target, and sends a call for fire for adjustment to that point.

H24 THIS IS H58, ADJUST FIRE, SHIFT AUXILIARY ADJUSTING POINT, OVER.
 ADJUSTING POINT GRID NK633374, OVER,
 TARGET DIRECTION 0220, DISTANCE 3680,
 VERTICAL ANGLE PLUS 2, OVER.
 BATTALION ASSEMBLY AREA, ICM IN EFFECT,
 OVER.

NOTE: When the adjusting round bursts, the observer ranges the burst and sends the data to

BURST DIRECTION 0803, DISTANCE 5010,
 VERTICAL ANGLE PLUS 1, FIRE FOR EFFECT,
 OVER.

The FDC computes the shift and fires for effect on the original target.

c. To digitally accomplish an adjust fire mission by using an auxiliary adjusting point, the following procedure must be used (see also Appendix B):

- Compose and transmit an FR LASER message with data to the auxiliary adjusting point.
- Receive the MTO with target number assigned.
- Compose and transmit an SA LASER message with data to the target and OK TGT entered in the OBSN field of the message.
 - Receive SHOT (round impact).
 - Compose and transmit an SA LASER message with data to the burst. Enter OK BT in the OBSN field and FFE in the CONTROL field.

NOTE: The following example shows the message formats as they would appear on the DMD display.

Figure A-9. SHIFT FROM AN AUXILIARY ADJUSTING POINT

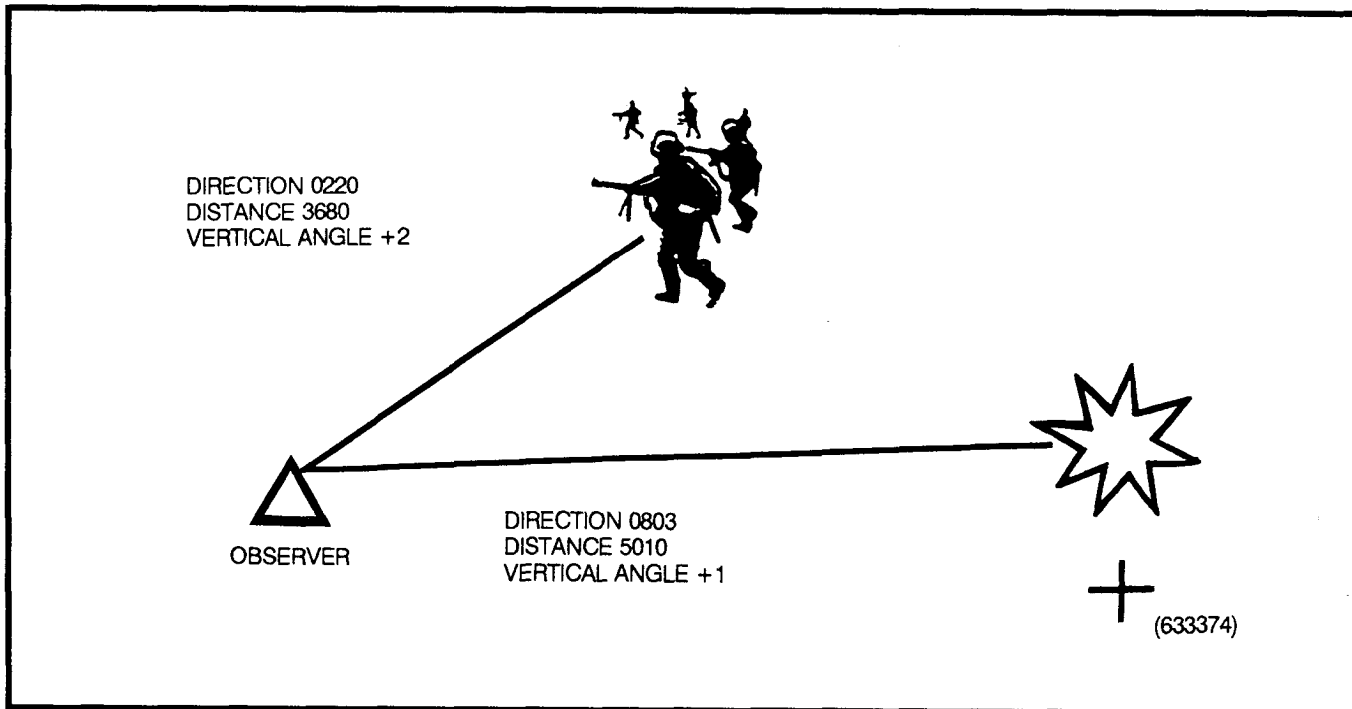

EXAMPLE		
FR LASER TO AUXILIARY ADJUSTING POINT		
FR LASER	MI AUTH—	D TNO DEST—
DIR—	STR—	ANGLE—
SLT DIST—	DOP—	PRI—
VA—	RAD/LGTH—	
MSN—	WIDTH—	
	ATTITUDE—	
TGT—	SHELL/FZ—	
	CONTROL—	
SA LASER TO TARGET		
SA LASER	MI AUTH—	D TNO DEST—
DIR—	TGT NO—	
SLT DIST—	SHELL/FZ	
VA—	CONTROL—	
OBSN — OK TGT	ANGLE—	
RECEIVE SHOT (FO CMD MESSAGE)		
Round impacts		
SA LASER TO BURST		
SA LASER	MI AUTH—	D TNO DEST—
DIR—	TGT NO—	
SLT DIST—	SHELL/FZ	
VA—	CONTROL—FFE	
OBSN — OK BT	ANGLE—	

(2) If the slant range is greater than 6,300 meters, the observer reports **OBSERVER CLOUD HEIGHT GREATER THAN 2,120 METERS.**

(3) If the slant range is less than or equal to 6,300 meters, the observer enters the cloud height table (Table A-1) and determines the cloud height. Entry values for the table are row and column headings which total the slant range measured.

Table A-1. **OBSERVER CLOUD HEIGHT**

RANGE	0	100	200	300	400
1500	510	540	570	610	640
2000	670	710	740	780	810
2500	840	880	910	940	980
3000	1010	1040	1080	1110	1140
3500	1180	1210	1250	1280	1310
4000	1350	1380	1420	1450	1480
4500	1520	1550	1580	1620	1650
5000	1680	1720	1750	1790	1820
5500	1850	1890	1920	1950	1990
6000	2020	2060	2090	2120	

NOTES:

1. Angle of measurement is +350 mils.
2. Enter with slant range to the nearest 100 meters.

A-8. OBSERVER CLOUD HEIGHT

a. In addition to reporting his location to the battery FDC, the observer must report observer cloud height (height of clouds above the observer). The cloud height over the target (target cloud height) significantly affects the performance of the Copperhead round. Cloud ceilings that are too low will not allow the Copperhead round enough time to lock on and maneuver to the designated target. The FDC uses the reported observer cloud height to compute target cloud heights.

b. The observer must use his judgment in evaluating the potential effects of clouds over the target area on Copperhead performance. On cloudy and partly cloudy days, observer cloud height must be determined. The observer should not hesitate to report separate observer cloud heights for target areas having significantly different cloud coverage. The procedures below are used to determine observer cloud heights.

(1) The observer elevates the G/VLLD to a vertical angle of +350 mils toward his area of responsibility, selects RNG 1 mode, and measures the slant range to the cloud base. Slant range is then expressed to the nearest 100 meters.

EXAMPLE

Slant range at vertical angle of +350 mils = 2,570 meters (expressed to 2,600 meters). Enter with 2500 (left side) and 100 (top) (2500 + 100 = 2600). Read an observer cloud height of 880 meters and report **OBSERVER CLOUD HEIGHT 880 METERS.**

NOTES:

1. A table similar to Table A-1 is on the cover card of the Copperhead footprint template set. The observer should report observer cloud height as soon as possible after occupying a position. He then reports changes only when the change in observer cloud height exceeds 100 meters.
2. An increase or decrease of 300 meters in measured slant range corresponds to an approximate 100-meter increase or decrease in observer cloud height.

A-9. REGISTRATION

The G/VLLD also may be used to determine data for computation of an HB, an MPI, or a precision registration. If the accuracy of the observer's location meets the standards for an HB or MPI registration, the HB or MPI is the preferred method of conducting a registration with the G/VLLD. If the location for the G/VLLD is doubtful, the G/VLLD may be used to help conduct a precision registration.

a. High-Burst or Mean-Point-of-Impact Registration. Orienting data are provided the observer through a message to observer from the FDC as currently outlined in TC 6-40 under HB and MPI registrations. The observer uses the G/VLLD to determine laser polar plot data for the burst of each round fired during the registration and sends the data to the FDC.

WARNING

Safety restrictions may prevent ranging the high burst if the burst is above the skyline.

NOTE: The G/VLLD may be used by either observer in the HB or MPI procedure outlined in Chapter 7. Ranging (firing the laser) is not necessary when the azimuth adjust mode is used.

b. Precision Registration. In a precision registration, the observer uses the G/VLLD to determine corrections as described in the procedures for using the G/VLLD in the adjustment of fire. When a 50-meter bracket has been established (100 meters when the PER is 25 meters or more), the procedures in Chapter 5, Section III are used.

c. Abbreviated Registration. In an abbreviated registration, the impact portion is conducted with two rounds. The observer lases the burst of the first adjusting round and determines corrections as outlined for the adjustment of fire with the G/VLLD. The FDC computes new firing data and fires a second adjusting round. The observer lases the burst of the second adjusting round and determines corrections. If a time portion has also been requested, two airbursts are fired to establish the mean height of burst. The observer sends corrections to adjust the mean height of burst to 20 meters.

EXAMPLE

A23 THIS IS A16, OBSERVE ABBREVIATED REGISTRATION, KNOWN POINT 1, QUICK AND TIME, OVER.

A16 THIS IS A23, DIRECTION 6216(encoded), OVER, (First adjusting round is fired; angle of deviation is greater than 100 mils.)

DIRECTION 6327, DISTANCE 3140, VERTICAL ANGLE MINUS 11, OVER.

(Second adjusting round is fired; angle of deviation is less than 100 mils.)

LEFT 30, ADD 50, RECORD AS REGISTRATION POINT, TIME, REPEAT, OVER.

(Two HE or time rounds are fired.)

DOWN 25, RECORD AS TIME REGISTRATION POINT, END OF MISSION, OVER.

A-10. TARGET RANGING AND DESIGNATING WITH THE NIGHT SIGHT

a. The night-vision sight can be used in both day and night operations. It has an effective range of 3,000 meters. An observer can effectively detect and ultimately bring fires on targets that would otherwise be obscured because of smoke, dust, haze, fog, or darkness. The night-vision sight, however, lets an observer see a target through smoke and other battlefield obscurants that would attenuate and weaken laser energy. To verify that the laser energy will penetrate these obscurants for successful designation, he should range the target several times in the RNG 2 mode. If he is sure he is receiving consistent and accurate ranging data, he can expect the target to be successfully engaged with Copperhead. Any field-expedient technique that can be used to verify that the range readings in the G/VLLD are accurate is acceptable.

b. If the target is near a known point, the observer should compare the range read to the target with the distance to the known point. If they are about equal, it is a good indication that the laser energy penetrated the obscurant.

c. Another technique is to range the target several (four to six) times. Determine if the variation of the range readings is consistent with the target motions. If so, locate and range to a terrain feature at a much greater distance from (greater than 500 meters, if possible) but along or very close to the line of sight to the intended target. If the return remains essentially the same as was observed in ranging the intended target, the laser energy is probably not penetrating the obscurant. If a reasonable range is observed, this is a good indication that laser energy is penetrating the obscurant.

A-11. NIGHT-SIGHT TRAINING

All observers must be thoroughly proficient in the use of the AN/TAS-4 night sight with the AN/TVQ-2 G/VLLD. Procedures for training with the night sight for target detection, identification, and tracking are as follows:

- Set the field of view control to wide field of view (WFOV).
- Sight through the night-sight eyepiece, and scan a sector of your area of responsibility until you detect a target.
- Place the night-sight reticle on the center of the identified target, and set the field of view to narrow field of view (NFOV). Turn the RANGE FOCUS knob to focus the target image. Adjust the BRT and CTRS controls to give the best target image detail.
- Determine whether the target image is a wheeled or tracked vehicle. Then identify it as friendly or enemy.

NOTE: To track and designate for precision guided weapons, such as Copperhead, using the night sight, it is recommended that engagements be restricted to targets within the optimum operating range of the night sight (0 to 3,000 meters).

- Analyze the image seen in the night sight, and place the cross hairs at the best aiming point. Maintain smooth tracking, and follow the target image.

A-12. AN/GVS-5 LASER RANGE FINDER

a. The AN/GVS-5 (Figure A-10) is a lightweight, hand-held, laser range finder that can accurately determine the range to a target within 1 second after the FIRE button has been pressed. The device emits a laser burst and detects its return when the burst is reflected from a distant object. The time lapse between emission of the beam and its return is converted to meters and displayed in the eyepiece on the range-to-target display. The entire AN/GVS-5 package, including battery, weighs 5 pounds. The AN/GVS-5 provides a range to the target that is accurate to within ± 10 meters.

b. To use the AN/GVS-5, an observer simply aims the device by superimposing the circle at the center of the reticle pattern over the target and presses the FIRE button. The range is displayed in the range-to-target window and remains there as long as the FIRE button is pressed. The observer should not automatically consider the displayed range to be the correct range to the target.

Figure A-10. AN/GVS-5 HAND-HELD LASER RANGE FINDER

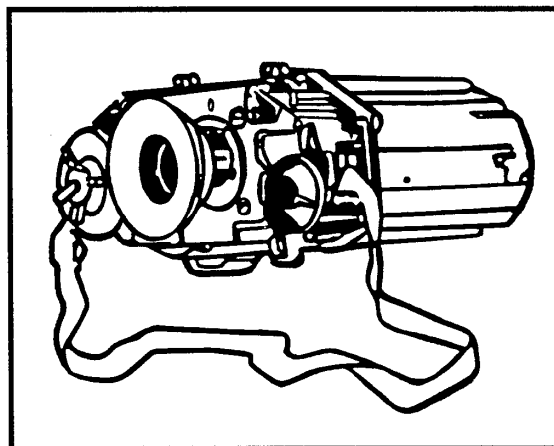

On the contrary, clutter in front of or behind the target may, at times, produce false ranges. The observer must continually associate the displayed range with a terrain-map analysis and his own range estimate to decide whether the reading is accurate. If, in the observer's opinion, all of these figures do not correlate, he should consider the information below.

(1) **Multiple Firings.** To ensure that the observer is aiming at the correct target, he should take a series of readings on the same target. Three consistent readings generally indicate that the observer has aimed in the same place each time.

(2) **Minimum Range Set.** Although the emitted laser beam is relatively narrow, it is wide enough to reflect from more than one target or object. The AN/GVS-5 has a multiple target warning light inside the eyepiece that lights when more than one return signal is received. When multiple target readings are indicated, the range displayed is the range to the first object from which the beam is reflected. To prevent obtaining a false reading from an intermediate object between the observer and the target, the AN/GVS-5 is equipped with a minimum range set (MIN RG SET). Ranges to the nearest 10 meters and up to 5,000 meters may be set on the MIN RG SET by using the variable control. The MIN RANGE SET indicates the minimum range at which the AN/GVS-5 will register a return, thereby eliminating false readings from intermediate objects. The observer can continue a trial-and-error process of eliminating false ranges by adjusting the MIN RG SET until the range read in the display correlates with the observer's own range estimate.

based on map and terrain analysis. The observer can save time in this process by establishing on the MIN RG SET the range beyond which he is certain the target lies before he begins ranging a target. Upon completion of a mission, the MIN RG SET should always be set back to zero.

(3) Self-Location. The AN/GVS-5 can help the observer locate himself by giving him accurate distances to two known points. The observer can report these distances to his FDC, which will in turn, using graphical or computer means, give him his location. Self-location also may be obtained by giving the FDC distances to, two burst locations of rounds that have been fired after the unit has completed registration. A combination of one round and one known point may also be used for self-location. The two points or bursts should be separated by at least 300 mils.

(4) Adjustment of Fire. Lateral and vertical shifts in the adjustment of fire are computed by using the mil relation in the same way as adjustment of fire by using binoculars. Range adjustments are made by taking the difference in range between the target and the burst and making the correction in the appropriate direction.

(5) Target Location. The distance provided by the AN/GVS-5 should always be used with the most accurate direction to the target available and a quick, but thorough, map analysis. The observer should remember that the AN/GVS-5 is designed to help him refine distance. The distances determined by the device should always be correlated with known information before a target location is produced.

A-13. HELLFIRE MISSILE

Hellfire is a third-generation air-launched antiarmor weapon. It homes in on a laser spot that can be projected from a number of sources, including ground observers, other aircraft, and the launch aircraft itself. The ground observer uses lasing procedures for Hellfire which are similar to those for Copperhead. Hellfire weighs 99 pounds, and its range is classified.

DANGER

To keep the Hellfire missile from locking onto the designator instead of the target, Angle T between the designator-target line and the missile-target line should be less than 1,065 mils (60°). The FIST must ensure the launch platform pilot knows the location of the observer so that the launch platform can be repositioned if necessary for safety.

a. Designating Modes.

(1) Remote Designation. A designator other than the one on the launch platform is used for missile guidance.

(2) Autonomous Designation. The platform carrying Hellfire provides its own laser designation.

b. Firing Methods.

(1) Direct. Direct fire can be achieved by using autonomous or remote designation.

(2) Indirect. Vulnerability of the launch platform can be minimized by using the missile in the indirect method. The missile is launched while the launch platform is positioned behind masking terrain. A pilot-selected switch action programs the missile autopilot to fly a preprogrammed, elevated trajectory over the mask. The seeker then locates and locks on the designated target.

c. Firing Techniques.

(1) Single. One missile is fired.

(2) Rapid. Two or more missiles are fired on the same code. Once the first missile impacts, the designator slews the laser spot to the next target in succession. An interval between missile launches allows time for the missiles to maneuver to their individual targets.

(3) Ripple. Two or more missiles are launched on different laser codes by use of multiple designators. With this option, the missiles are fired virtually one after the other.

d. Seeker Lock-On Options.

(1) Lock on after launch (LOAL) can be used in the direct or indirect method. The missile is launched before the target being designated, and the seeker lock-on occurs during flight.

(2) Lock on before launch (LOBL) requires direct line of sight to the target and requires the missile to be locked on before launch.

A-14. AH-64 TARGET ACQUISITION AND DESIGNATION SIGHT

a. The target acquisition and designation sight (TADS) gives the US Army AH-64 a day, night, and adverse weather target acquisition and designating capability.

b. Target acquisition is provided by means of the multiple fields of view TADS sensors, the direct view (DV) optics, day television (DTV), and forward-looking infrared (FLIR).

c. The TADS laser can designate targets for its own or remotely fired LGMs; it gives the AH-64 precision laser ranging.

d. The TADS laser spot tracker (LST) facilitates target handoffs from other laser designators. Once acquired, the targets can be manually or automatically tracked.

e. The AH-64 is a day, night, adverse weather aircraft that has a maximum laser-guided munition load of 16 Hellfire missiles. The crew can launch the missiles either singly or in multiples by using a LOBL or a LOAL mode against stationary or moving targets. Three launch methods are used: autonomous, using the TADS designator; indirectly, in coordination with a ground designator or in cooperation with another airborne designation system. In the indirect and cooperative modes, the crew may use the Hellfire as a fire-and-forget missile.

f. The AH-64 can also carry conventional munitions of up to 1,203 rounds of 30-mm ammunition and/or up to 762.75-inch rockets. The aircraft is equipped with secure very high frequency (VHF), ultra high frequency (UHF), and/or FM radios.

A-15. OH-58D MAST-MOUNTED SIGHT

a. The US Army OH-58D provides battlefield reconnaissance; aerial observation target acquisition, and designation during day, night, and adverse weather operations.

b. The laser locator/designator of the OH-58D is combined with the attitude and heading reference system (AHRS) enclosed in the mast-mounted sight (MMS). Like the G/VLLD, the OH-58D laser can designate for Copperhead and Hellfire missiles and Air Force and Navy smart munitions.

c. The communications system provides simultaneous communications capability for UHF, VHF, FM, and HP SSB radios. Automatic target handoff is provided by a digital data link through the radios. Security is provided for each radio to prevent the compromise of voice or data transmissions.

A-16. LASER TARGET DESIGNATOR

The laser target designator (LTD) (Figure A-11) is a battery-operated, lightweight, hand-held laser designator. It transmits a coded laser beam that is used to designate point or area targets. The designated targets or areas can be detected by aircraft, by munitions equipped with laser trackers, and by laser-guided weapons (such as Copperhead) set to the same code as that of the LTD. The LTD is issued to ranger and airborne units. Procedures for use of the LTD are the same as those for use of the G/VLLD as a designator. However, its maximum effective range is 1,500 meters, and it cannot interface with a DMD.

Figure A-11. AN/PAQ-1 LASER TARGET DESIGNATOR

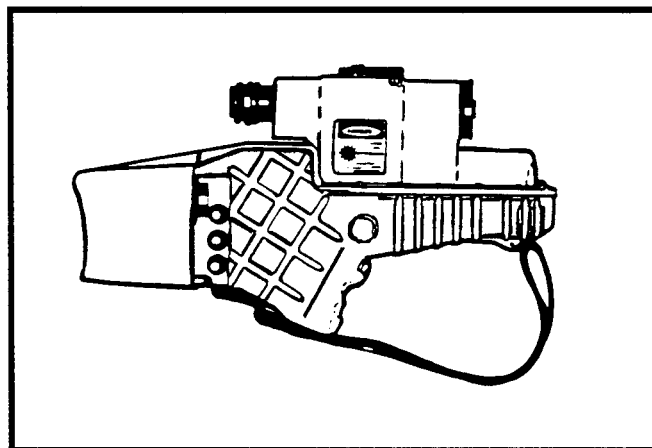

A-17. MODULAR UNIVERSAL LASER EQUIPMENT

a. The MULE is the laser designator/range finder used by the US Marine Corps (Figure A-12). This system is similar to the G/VLLD with a few notable differences.

Figure A-12. AN/PAQ-3 MODULAR UNIVERSAL LASER EQUIPMENT

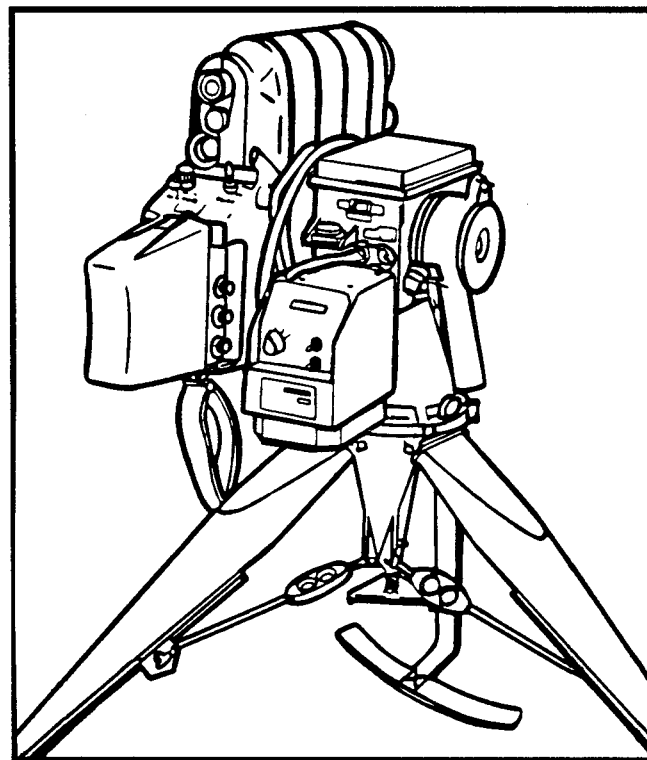

- The MULE has a built-in, north-seeking capability which allows for self-orientation for direction, easier self-location, and readout for both grid and true azimuths.
- The MULE can detect multitarget reflections and establish a minimum range for range finding.
- The data determined by the system during range finding are displayed to three different locations: direction on the north-finding module, distance in the eyepiece, and VA on the tripod module.
- The MULE has a digital interface capability when used with a digital communications terminal (DCT).

b. Otherwise, procedures for use of the MULE are the same as those for use of the G/VLLD.

A-18. UNITED STATES AIR FORCE LASER SYSTEMS

a. **Pave Spike.** Pave Spike is an electro-optical target acquisition, laser designator, and weapon delivery system. It provides precision laser designation, ranging, and tracking of ground targets for attack with conventional ordnance or laser-guided weapons. It uses a cockpit-selectable four-digit code and is PRF or PIM (pulse interval module) capable.

b. **Pave Penny.** Pave Penny is a passive laser tracker which uses reflected laser energy to give the pilot precise target location. It uses a cockpit-selectable four-digit code and can use either a ground or airborne designator. Pave Penny is currently used by A-10 and A-7 aircraft.

c. **Pave Tack.** The Pave Tack system gives high-speed tactical aircraft the ability to acquire, recognize, and attack tactical targets during day, night, and adverse weather conditions. The Pave Tack pod was developed for common usage on the F-4E, RF-4C, and F-111F aircraft. It is fully integrated into the host aircraft digital computer avionics system. The pod uses an imaging infrared sensor and laser designator/ranger for navigational updates, target acquisition and recognition, and weapon delivery. The laser designator gives guidance for laser-guided weapons and has four-digit cockpit-selectable PRF or PIM coding.

d. **Laser-Guided Bombs.** Paveway II and III are the Air Force designations for 500- and 2,000-pound-class laser-guided bombs (LGBs). A guidance control unit is attached to the front of the bomb, and a wing assembly is attached on the rear. Both generations are compatible with current Army, Navy (Marine), and Air Force designators. Paveway II and III have preflight selectable coding. Paveway III is the third-generation LGB, commonly called

the low-level laser-guided bomb (LLLGB). It is designed to be used under relatively low ceilings, from low altitude, and at long standoff ranges.

e. **Low-Altitude Navigation and Targeting Infrared System.** The low-altitude navigation and targeting infrared (LANTIRN) system is designed to be used for night attack. It has two avionics pods: a navigation pod and a targeting pod. A laser designator and ranger are in the targeting pod. The designator is a four-digit PRF-coded laser that can designate for its own weapons or for other acquisition devices or munitions. The LANTIRN system is used by F-15E and F-16 aircraft.

f. **AC-130 Spectre.** This special operations aircraft can use its infrared target acquisition system and low-light-level TV equipment to acquire targets. It is equipped with a laser target designator which can provide guidance for laser-guided weapons, laser acquisition systems, or laser trackers.

A-19. MARINE CORPS SYSTEM

The OV-10D night observation system (NOS) is the Marine Corps version of the OV-10 Bronco aircraft. It has upgraded engines, FUR, and an LD/R. The pulse code generator is a cockpit-selectable four-digit coder which allows airborne coding of the laser pulse. The LD/R is used to determine precise target range and can be used to designate the target for other acquisition systems or laser-guided munitions.

A-20. LASER SAFETY DURING TRAINING

Lasers have been used at a number of Army installations in training demonstrations and tests without injury to personnel. However, use of the G/VLLD and other lasers requires strict safety controls. Installation range officers and training planners should follow the safety procedures in AR 385-63 when planning the training with laser systems. The safety officers and noncommissioned officers (NCOs) should be familiar with the use of the laser systems, know the local range regulations, and know the information in AR 385-63. All personnel involved in training with laser systems should also comply with the following guidelines:

- Treat the G/VLLD as a direct fire weapon, such as a rifle. Unless you have a backstop, it can be hazardous as far as 80 kilometers.
- Never look into a laser; assume it is always dangerous.
- Do not aim the laser at unprotected people or animals or at flat, reflective surfaces.
- Warn personnel before firing the laser or operating the G/VLLD set.

- Operate only on approved laser ranges which have been cleared of reflective objects.
 - Laser beams should terminate within the impact area of large-caliber ranges.
 - Laser targets should be emplaced below the horizon. If this is not possible, backstops should be built to stop the beam.
- Do not rely solely on the front window cover of the G/VLLD to stop the laser beam.
- Allow only trained personnel to operate the G/VLLD, unless untrained personnel are properly supervised.
- Always follow the laser range safety procedures of AR 385-63 and TB MED 524.

NOTE: Special laser surface danger zone parameters apply to designators used with the Hellfire missile. These zones protect laser operators from possible missile failure and missile tracking laser backscatter.

- Approved laser goggles are required only for people who may be exposed to the direct laser beam or its reflection from a flat, shiny surface. Goggles should have a density of 4.0 at 1,064 meters (5.0 density for people using optical devices like binoculars).
- Report to your commander if you think you may have been hit by the laser beam. You may need an eye examination.
- Use the laser attenuator filter on the G/VLLD to reduce emission hazards. Even when using the attenuator filter, a potential eye hazard still exists. See AR 385-63 for operating limitations.

NOTE: The US Army Training and Doctrine Command Safety Office should review and approve the installation laser range safety SOP.

A-21. LASER SAFETY GOGGLES

- a.** Only personnel downrange in the laser safety fan need laser eye protection. If the range is cleared of exposed flat, reflective surfaces, no hazardous reflections could come back to the observer or to anyone behind the laser site. Hence, these personnel do not need laser eye protection.
- b.** At this time, no standard laser protective goggles are available for general distribution through the supply system. However, one pair of laser safety

goggles, NSN 4240-00-258-2054, will be supplied in each G/VLLD test set at the direct support or higher level laser designator maintenance facility. In general, laser safety goggles are not necessary for routine training involving laser designators. However, personnel involved in two-sided tactical exercises and personnel downrange from the laser source must be protected.

c. The hazard of looking directly into a laser beam (intrabeam viewing) is increased by using binoculars, an aiming circle, or any telescopic sight. In effect, the viewer is placed closer to the laser source by a factor of the multiplying power of the sight. Laser light filters, if available, can be installed in optical systems to make them eye-safe for laser viewing, much like the laser goggles. Operator's manuals state whether the instrument has laser filters. The operator of the G/VLLD is protected from the G/VLLD her by a built-in filter. However, he is not protected from external laser radiation (other laser devices).

DANGER

Do not use sunglasses for eye protection. Sunglasses of any type, including polarized, do not provide adequate protection from the laser beam.

d. Normally, observers operating the G/VLLD do not need a laser eye examination. However, a person who may be exposed to hazardous levels of optical radiation will be included in an occupational vision program. The local medical authorities will determine who should be included in such a program.

A-22. G/VLLD EVALUATOR

The G/VLLD trainer set transmits no laser energy; therefore, no laser hazard is present.

A-23. ADDITIONAL LASER HAZARD INFORMATION

Other sources of laser hazard information include the following

- The post environmental health officer.
- TB MED 524.
- AR 40-46 with Change 1.
- AM 385-63, Chapter 19.

A-24. G/VLLD SAFETY FAN AND LASER RANGE SAFETY CARD

A laser range safety card similar to a range safety card will be issued by the local range control authority for use by each laser OP. The laser range safety officer must understand the terms *buffer zone* and *backstop* to correctly construct a laser range danger fan (LRDF).

a. Buffer Zone. The laser buffer zone is the distance left or right or up or down that may be exposed to direct laser beams. The size of this target area buffer zone is measured in mils. The size changes according to the type of laser and the stability of the laser mount. The horizontal and vertical buffer zone for the G/VLLD, both on the tripod and on the stationary FISTV, is 2 mils. This 2-mil buffer zone must be built into the range safety card.

b. Backstop. A backstop is an opaque structure or terrain in the controlled area — such as a dense tree line, a windowless building, or a hill — which completely obstructs any view beyond it and therefore completely terminates a laser beam that might miss the target (Figure A-13). Unless the nominal ocular hazard distance (NOHD) (see AR 385-63) has been exceeded, the hazard distance of the laser device is the distance to the backstop. This hazard distance must be controlled. The terrain profile from the

laser device field of view is very important, since the laser presents only a line-of-sight hazard. **The optimal use of natural backstops is the obvious key to minimizing laser range control problems.**

NOTE: Figure A-14 shows the laser safety fan with a natural backstop.

c. Maximum and Minimum Safe Vertical Angles. The safety card should specify the left and right azimuth limits of the laser range. Maximum and minimum vertical angles for lasing should also be listed. If no maximum or minimum vertical angles are given and maximum and minimum ranges are listed, the maximum and minimum safe vertical angles for laser firing are computed as follows:

CAUTION

Despite the computed minimum safe vertical angle, it must be clear that the total zone between the laser and the minimum range line is an active laser area. Access must be controlled and restricted.

- Determine the altitude of the laser OP.

Figure A-13. LASER BACKSTOP, TERRAIN DRAWING

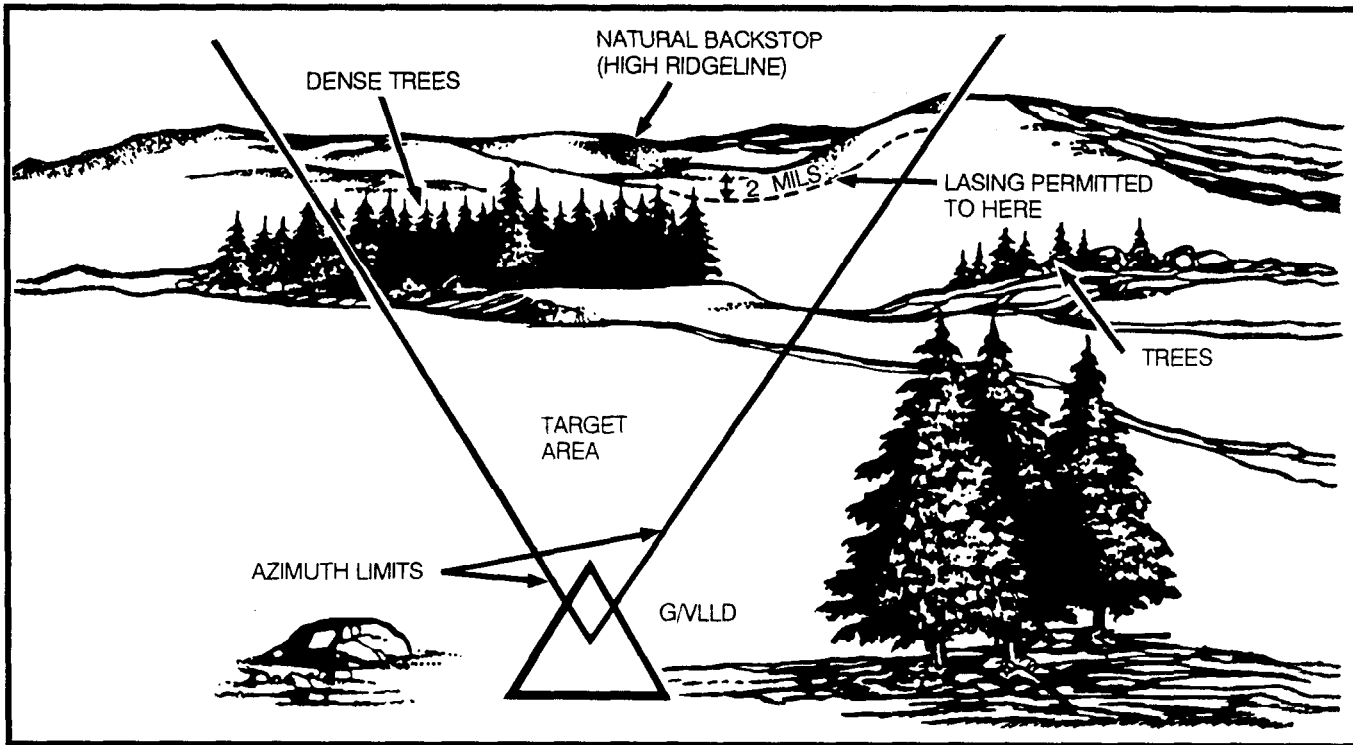

- Determine the altitude of the **highest point on the minimum range line between authorized azimuth limits**.
- Determine the vertical interval (VI), in meters, by subtracting minimum range altitude from the OP altitude.
- Divide the VI by the minimum range (in thousands) ($2500 = 2.5$) on the safety card to get the minimum VA.
- Add 2 mils to the VA to get the minimum safe G/VLLD VA. (Pay attention to signs of VA; for example, $VA - 8 + 2 \text{ mils} = -6$; $VA + 8 + 2 \text{ mils} = +10$.)
- Determine the altitude of the **lowest point on the maximum range**.
- Determine the VI by subtracting the maximum range altitude from the OP altitude.
- Divide the VI by the maximum range in thousands ($8400 = 8.4$) to get the maximum VA.
- Subtract 2 mils from the maximum VA to get the maximum safe G/VLLD VA, for example, $VA + 10 - 2 \text{ mils} = +8$; $VA - 10 - 2 \text{ mils} = -12$.

NOTE: The maximum safe G/VLLD VA applies only if there is no backstop for the laser within the laser impact area that is higher than the maximum VA. When there is such a backstop, the observer may lase to within 2 mils of the top of the backstop.

WARNING

Lasing above the skyline is forbidden except when specifically authorized by the range safety card.

d. Cleared Area. For OP personnel safety, a 30-meter area must be cleared in the direction the G/VLLD is used (Figures A-14 and A-15). This area must be cleared of trees, bushes, or anything that could be hit accidentally by the laser beam. The reflection of the laser beam from any surface at this range could be hazardous. All personnel in the OP area must stay behind this area. To warn them of laser activation, the observer must call out loudly **LASING**.

e. Warning Signs. AR 385-63 and AR 385-30 give detailed instructions on construction of laser-safe ranges and the duties of the laser range safety officer.

Figure A-14. LASER BEAM TERMINATED BY BACKSTOP (SAFETY DIAGRAM)

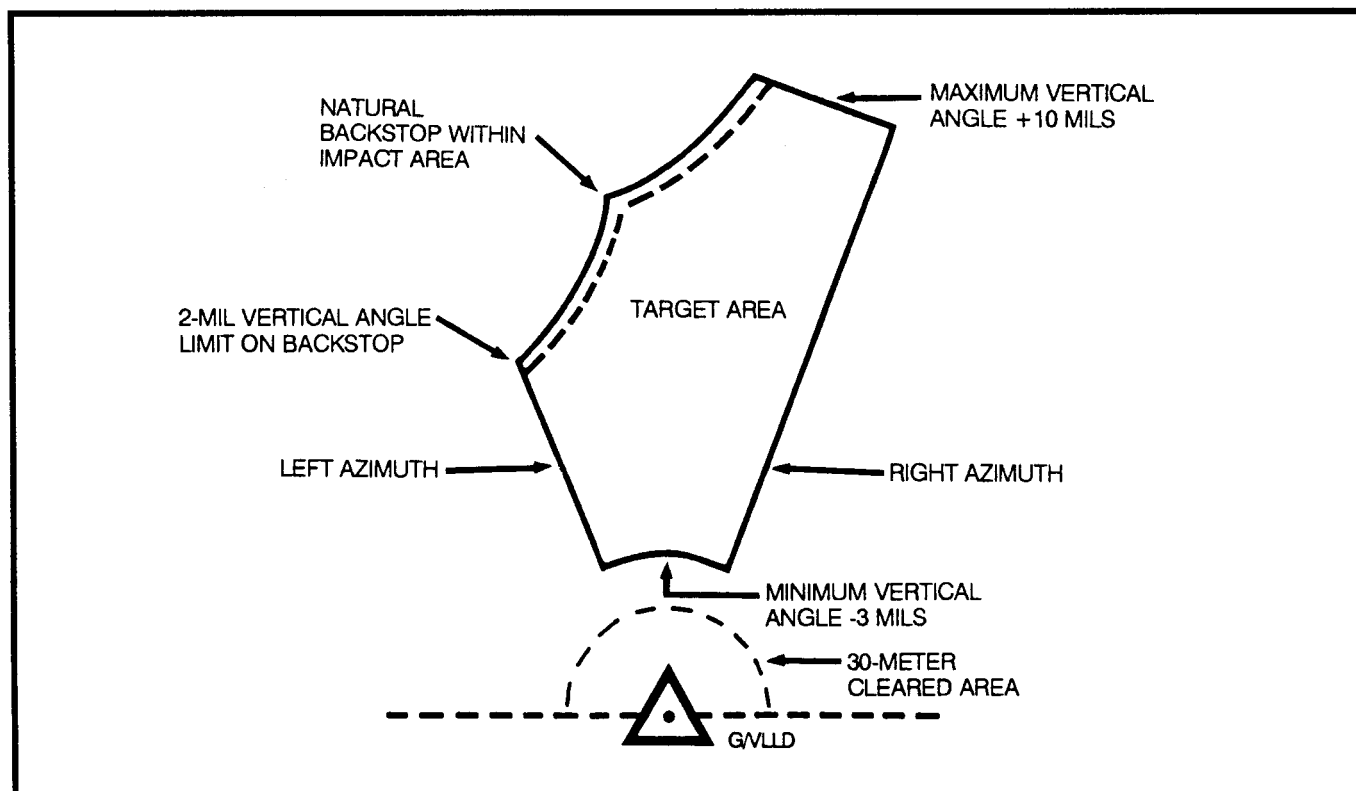
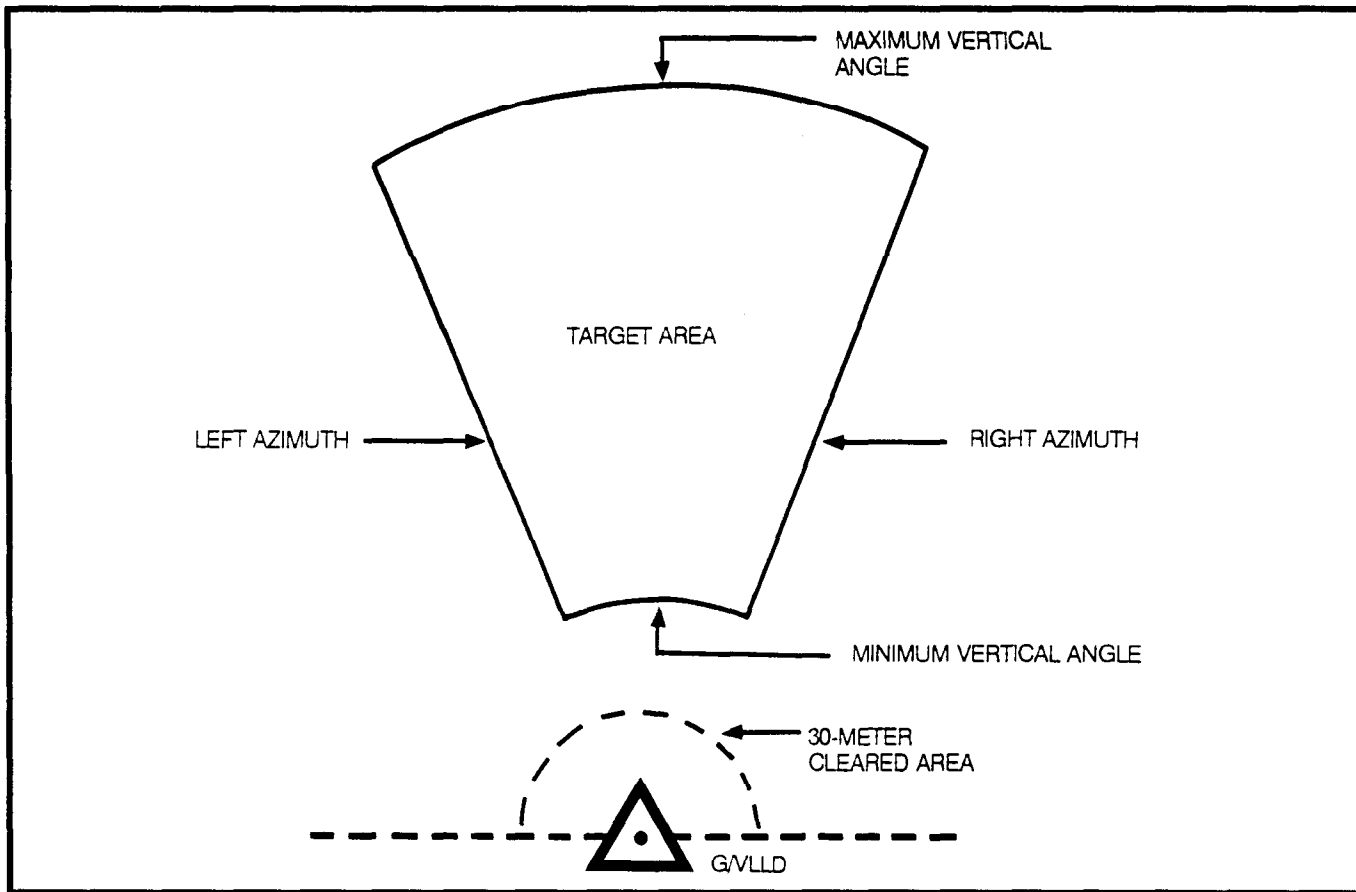

Figure A-15. G/VLLD SAFETY DIAGRAM WITHOUT BACKSTOP



APPENDIX B

DIGITAL MESSAGE DEVICES

Section I

DIGITAL MESSAGE DEVICE AN/PSG-2A

This section implements STANAG 2934, Chapter 13, Annex A and QSTAG 503.

B-1. OPERATION OF THE DIGITAL MESSAGE DEVICE

a. Description. The digital message device AN/PSG-2A is a small, rugged, lightweight, portable, two-way communications terminal. It is used by FA observers to transmit and receive high-speed digital messages. The DMD can communicate with the tactical fire direction system (TACFIRE), the BCS, the FIST DMD, the mortar ballistic calculator (MBC), and other DMDs through wire or radios. Mnemonics used with the DMD are listed and interpreted in Tables B-1 and B-2 at the end of this appendix (pages B-34 and B-38).

b. Data Entry and Message Composition. Information is entered into the DMD, and messages are composed by means of a keyboard and a display located on the front panel. Data entry menus and message formats are presented in an easily understood manner. Information is entered by using a

step-by-step procedure. The DMD prompts the operator for proper entries by displaying all possible choices for each data or message element. Entries are made as direct data or as a multiple-choice selection from a displayed menu. Illegal entries are prevented. Completed data entry menus and messages are displayed for operator viewing so that errors can be identified and corrected. Some fields contain preset default values. The default is assigned if the operator selects no other value for that field.

c. Memory Capacity. The DMD memory has several buffers and files:

- Four received message buffers.
- One received message save buffer.
- Two active mission buffers.
- Seven off-line compose message files.
- One authentication code file.

d. Functional Sections. The DMD AN/PSG-2A has four functional sections as shown in Figure B-1.

Figure B-1. DMD FUNCTIONAL SECTIONS

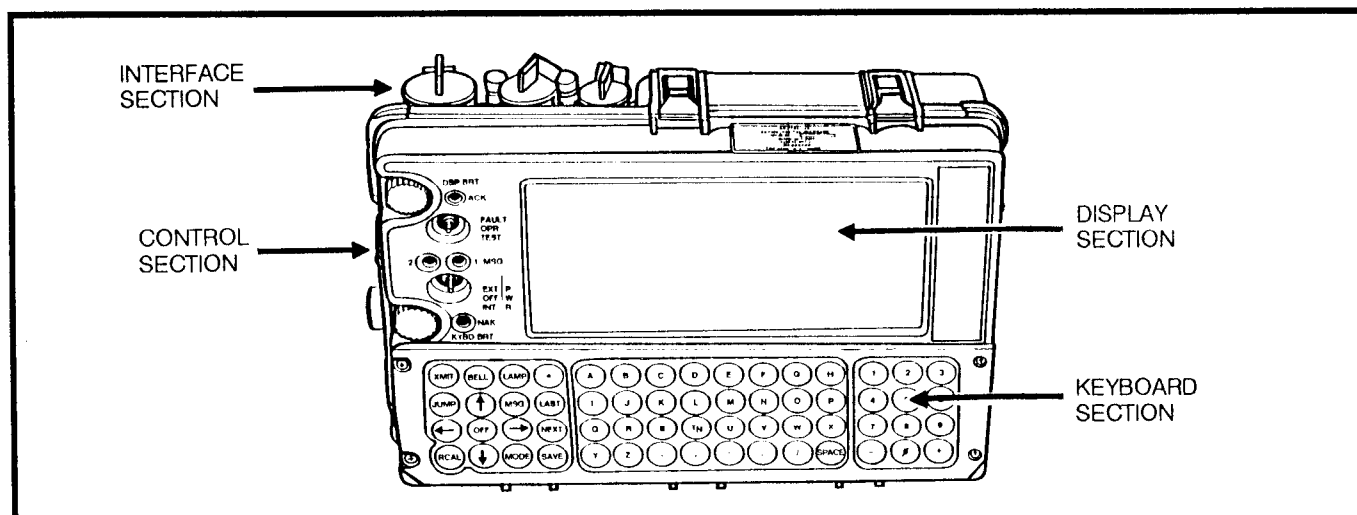

(1) Control Section. The control section consists of indicator lamps, brightness control knobs, the operational mode switch, and the power switch.

(a) *Indicator Lamps.* Figure B-2 shows the four DMD indicator lamps. Their purposes are as follows:

- ACK: Flashes two times per second upon receipt of an acknowledge (ACK) message and one time per second upon receipt of a nonacknowledge (NAK) message.
- MSG 1: Flashes when a message is received. It flashes four times per second when an FO CMD message is received and one time per second when other messages are received.
- MSG 2: Flashes when two, three, or four messages are stored in the received message buffers awaiting review. If the lamp is flashing four times per second, at least one FO CMD message has been received.
- NAK: Flashes two times per second upon receipt of a NAK message and one time per second upon receipt of an ACK message.

(b) *Brightness Control Knobs.* The two brightness control knobs are shown in Figure B-3. Their functions are as follows:

- DSP BRT: Adjusts the brightness of characters on the display panel and the intensity of the indicator lamps.
- KYBD BRT: Adjusts the brightness of the keyboard

background. To save battery power, the keyboard brightness should be set at the lowest usable level.

(c) *Operational Mode Switch.* The operational mode switch selects the DMD operational mode. It has three positions as shown in Figure B-3.

- FAULT: Is used by maintenance personnel only. Operators are not authorized to use the FAULT position.
- OPR: Places the DMD in the operating mode when power is applied.
- TEST: Provides a check of the input power, the display, and all indicator lamps. Also, it enables the keyboard test.

(d) *PWR Switch.* The power switch applies power to the DMD (Figure B-3). It has three positions:

- EXT: Applies power to the DMD from an external source (vehicle or battery).
- OFF: Turns off internal and external power.
- INT: Applies power to the DMD from the internal battery pack.

(2) Display Section. The display is a low-power, dot matrix plasma panel which can display 256 total characters on eight lines. It displays incoming messages; it enables the operator to compose, review, and edit messages before transmission; and it enables the operator to select and observe the operational status of the DMD.

Figure B-2. DMD INDICATOR LAMPS

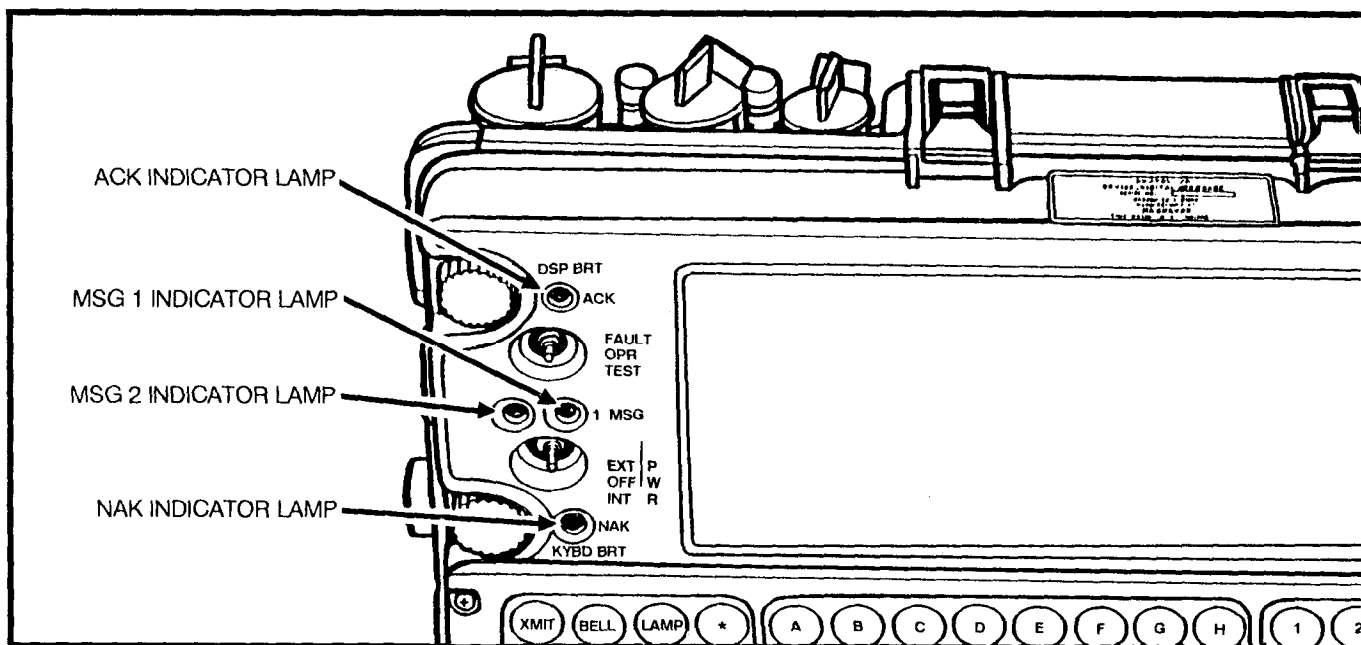
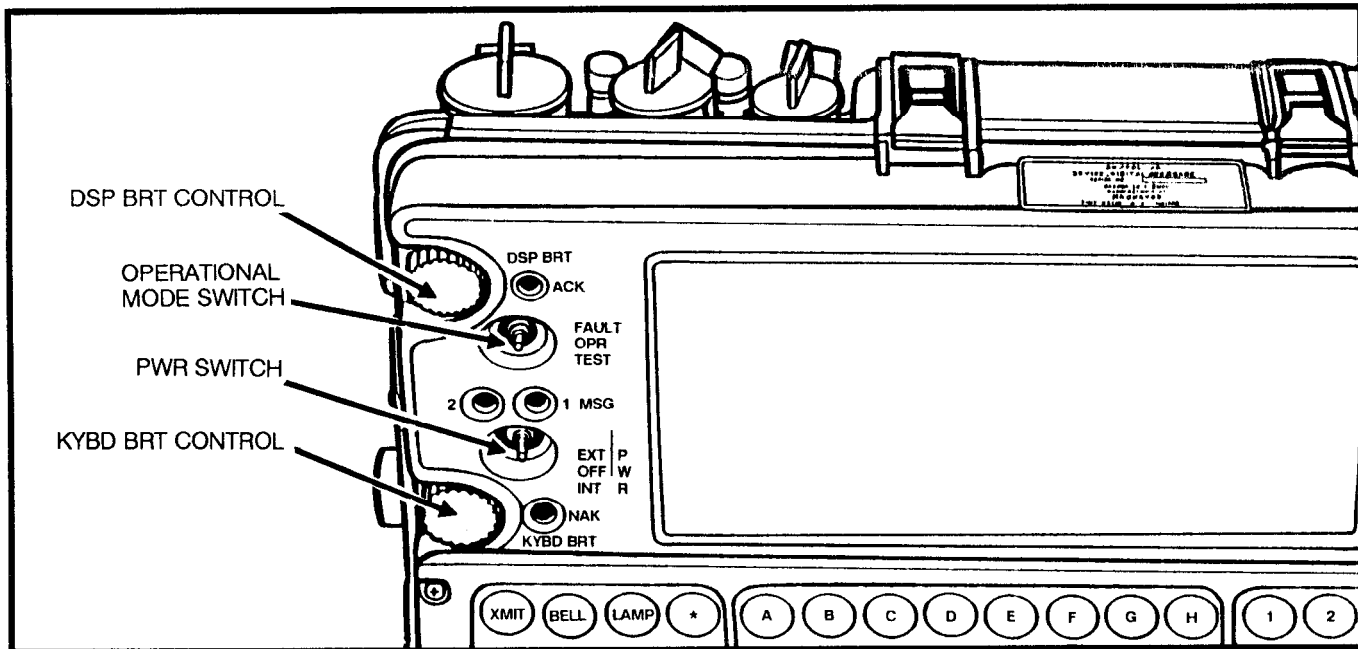
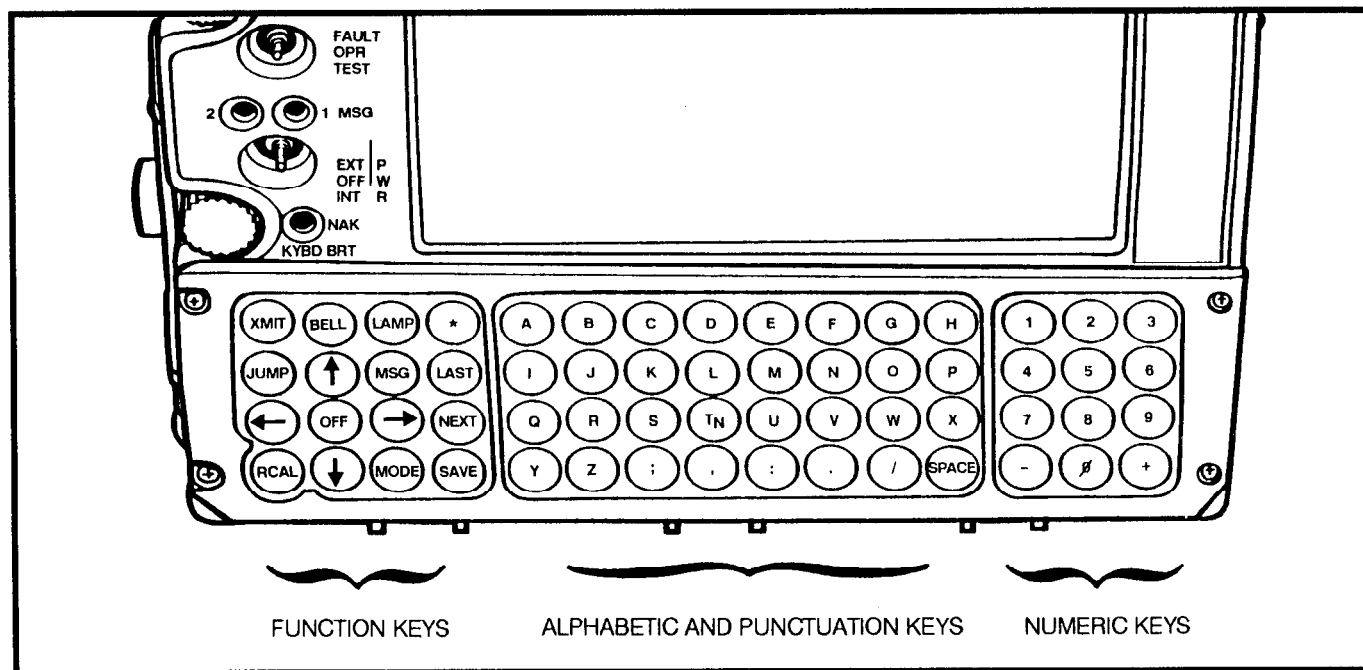

Figure B-3. DMD CONTROL SECTION



(3) Keyboard Section. The keyboard section (Figure B-4) has three functional areas: function keys, alphabetic and punctuation keys, and numeric keys.

Figure B-4. DMD KEYBOARD SECTION



(a) *Function Keys.* These keys are used to perform operations associated with message reception and transmission, display of data and message fields, and cursor movements. Their functions are as follows:

- XMIT: Transmits messages.
- BELL: Silences the audible tone which can be made to sound upon message receipt.
- LAMP: Turns off the indicator lamps.
- *: Allows entry of the operator's key code for authentication codes.
- JUMP: Causes the fields of a message format or data entry menu to be displayed for editing.
- \leftarrow : Move the cursor in the direction indicated.
- MSG: Causes messages stored in the received message buffers to be displayed in the order of their receipt.
- LAST: Pages backward through the authentication code file or through the off-line composed message files and active mission buffers.
- OFF: Turns off the display without losing data.
- NEXT: Pages forward through the authentication code file or through the off-line composed message files and active mission buffers.
- RCAL: Recalls the display after automatic or manual turnoff. To conserve power, the display automatically turns off if no key is pressed for approximately 24 seconds.
- MODE: Displays the mode menu.

- SAVE: Saves a received message.

(b) *Alphabetic and Punctuation Keys.* These keys are used to enter alphabetic and punctuation characters for composing and editing messages. Alphabetic keys are also used to display message formats, to display messages composed in active mission buffers or off-line files, to display mission data, and to enter authenticator codes. Two special function keys are included among the alphabetic and punctuation keys:

- T_N: Enables the entry of a try number in the header line display. It also serves as the alphabetic T key.
- SPACE: Puts spaces in the text of a FREETEXT message.

(c) *Numeric Keys.* Keys 1 through 0 and the sign keys (+ and -) are used to enter numerical data.

(4) *Interface Section.* The interface and power connectors (Figure B-5) are located on the top left side of the DMD rear case. Their functions are described below.

- The RADIO connector is used to connect the DMD to standard US Army radios and to Air Force and other amplitude-modulated (AM) radios.
- The GLLD connector is used to connect the DMD to a G/VLLD.
- The POWER connector is used to connect the DMD to an external power source.
- The LINE connector (two binding posts) enables the DMD to communicate over standard field wire.

Figure B-5. DMD INTERFACE SECTION

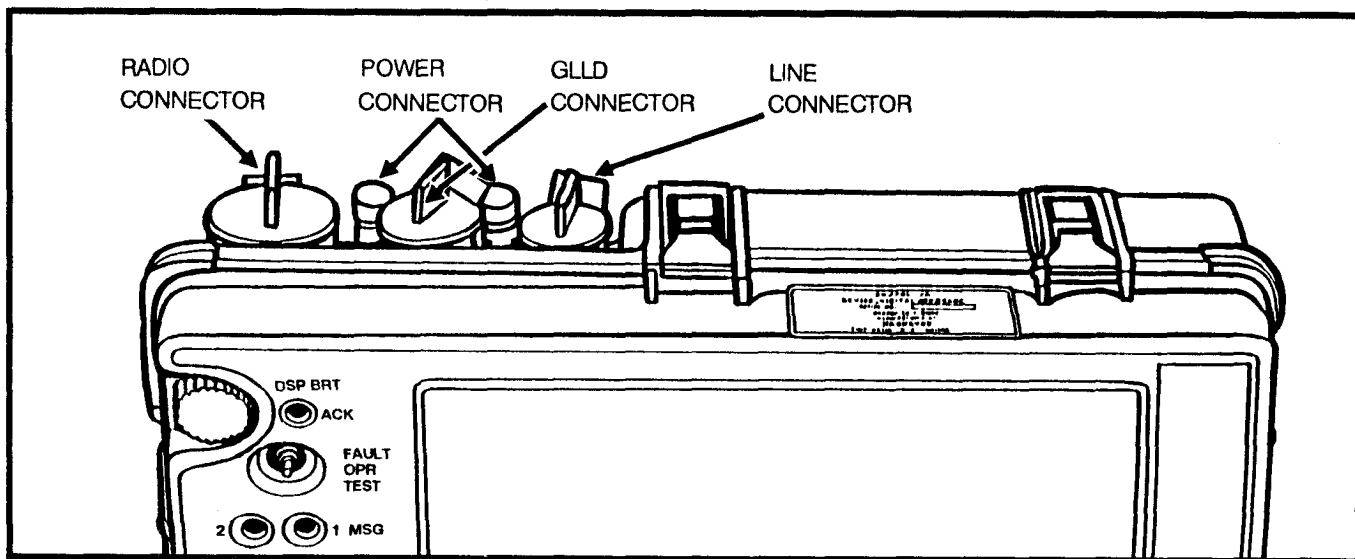

e. Audible Tone. The DMD has an audible tone, or beep, which can be made to sound when a message is received and/or when a key is pressed. It can be set at different intensity levels. The audible tone sounds one time per second for regular messages, two times per second for ACK and NAK messages, and four times per second for FO CMD messages.

B-2. PREPARATION FOR USE

Before the DMD can send and receive messages, it must be prepared for use. Preparation includes the procedures discussed below.

a. Assembly. The manner in which the FA observer assembles his DMD is determined by the tactical situation, the observer's mission, and his method of operation.

(1) **Dismounted Operations.** The DMD must be prepared for portable operation when the observer conducts dismounted operations. It can be operated from its carrying case, or it can be attached to and operated from a backpack. In either configuration, power must be applied from a portable power source. This source normally is the internal battery pack, but an external battery may be used. To communicate, the DMD must be connected to field wire or to a radio set. If the observer has a G/VLLD, he may also connect the DMD to the G/VLLD via the interface cable.

(2) **Mounted Operations.** During mounted operations, the DMD may be installed in its carrying case or it may be removed. In either configuration, the observer must position the DMD where it can be readily used. It must be secured and protected to prevent damage during vehicle movement. The DMD normally is powered by a vehicular power source and is connected to a vehicular radio.

b. Memory Purge. The DMD memory may be purged. Purging deletes all previously stored information in the DMD status menu, authentication code file, received message buffers, off-line compose message files, and active mission buffers. Any message or data element having a default will be assigned that default value. The memory normally is purged only when it is necessary to completely reinitialize the DMD or under emergency conditions to prevent enemy access to stored information.

c. Diagnostic Checks. The DMD has built-in test circuits which enable the operator to determine the operational status of the DMD. Diagnostic checks may be made anytime. They should be made when preparing the DMD for use.

(1) **Display and Indicator Lamp Test.** The operational mode switch is used to determine if power is properly applied to the DMD and if the DMD is functioning properly. This tests the display and indicator lamps.

(2) **Keyboard Test.** When the display and indicator lamp test is completed, the DMD is placed in a special keyboard test mode. The proper functioning of each key can be verified at this time.

(3) **Operational Check.** The communications interface may be checked for proper function by the operational check.

(4) **Message Bell Volume Test.** The message bell volume may be set and tested.

d. Initial Status Selection. The status menu is used to establish certain communications parameters, DMD functional characteristics, and battery condition information. Most of the data fields have default values. The fields are discussed below.

(1) **ORIG.** This field is used to establish the origin of messages transmitted from the DMD. The alphanumeric character that serves as the unique address (digital call sign) of the DMD is entered in this field. No default value is assigned.

(2) **DEST.** This field is used to establish the destination to which messages will be transmitted. The unique address of the receiving device (TACFIRE, BCS, FIST DMD) is entered in this field. No default value is assigned.

(3) **T/D.** This field is used to indicate whether a message transmitted from the DMD is a test message or contains data. Data is the default value.

(4) **XMT BLK.** This field is used to select the transmit block mode employed by the DMD. If SNG is selected, then the message contents are transmitted once. If DBL is selected, the message contents are automatically transmitted twice. The single block mode is the default value. The transmit block selected is dictated by unit SOP or tactical conditions. The double block mode may be specified during periods of heavy radio interference or jamming. The DMD block mode must match the block mode specified in the destination device.

(5) **XMT RATE.** This field is used to specify the rate at which the DMD will transmit and receive messages, 600 or 1,200 bits per second may be selected; 1,200 is the default value. The transmit rate selected is dictated by unit SOP or tactical conditions. The DMD transmit rate must match the rate specified in the destination device.

(6) **PREAMBLE.** The DMD must key the radio or wire circuit before transmitting a message, just as radio operators must do. The preamble field specifies the amount of time the radio or wire circuit is keyed before message transmission. A value between 0.1 and 4.0 seconds may be specified; 2.2 seconds is the default value.

(7) AUTH GROUP NO. This field is used to indicate the current group of authenticators. Group number 00 is the default value.

(8) AUTH LINE NO. This field is used to indicate the line number of the authenticator pair that will be sent with the next message transmitted from the DMD. Line number 01 is the default value.

(9) DSPL DLY. This field is used to specify the time the DMD will wait from the last data entry until the next display is presented. A value between 0.0 and 2.0 seconds may be specified; 0.4 second is the default value.

(10) KBD BELL VOL. An audible tone can be made to sound when a key is pressed. The volume is set by selecting a value from 0 (completely off) to 7; 0 is the default value.

(11) MSG BELL VOL. An audible tone can be made to sound when a message is received. The volume is set by selecting a value from 0 (completely off) to 7; 0 is the default value. This field is also used to conduct the message bell test.

(12) WATT HRS. The DMD counts and displays the number of watt hours of power consumed from the internal battery. WATT HRS should be set at 00.0 when a fully charged battery is installed. There is no default value assigned.

(13) BATT LMT. This field is used to indicate the total number of watt hours of power the operator believes the internal battery can produce. The DMD compares the values in this field and in the WATT HRS field to alert the operator to **battery weak** and **battery required** conditions. There is no default value assigned.

e. Entry of the Authentication Code List and Operator's Key.

(1) Digital messages transmitted by TACFIRE, the BCS, the variable format message entry device (VMED), the FIST DMD, and the DMD contain an authenticator pair and a try number. These entries enable messages to be self-authenticated. Authenticator pairs are extracted from an authentication code book and stored in the DMD authentication code file. When composing a message, the DMD operator can cause the DMD to transmit the proper authenticator pair with the message. See subparagraph B-5a(l)(a).

(2) The operator's key is also stored in the DMD authentication code files. See subparagraph B-5a(l)(a) for information on the operator's key.

f. Establishment of Digital Communications. Once the DMD has been prepared for use, digital communications must be established with the destination

device. Normally, voice communications are established first to ensure that all radios are operating and are properly set or to ensure the wire circuit is complete. Once this has been done, a FREETEXT message is transmitted to ensure that communications parameters have been properly set and that the DMD can transmit and receive.

B-3. DMD MESSAGE FORMATS

The DMD can transmit and receive 20 preprogrammed, fixed-format message types, which are divided into five categories as discussed below.

a. Standard Fire Requests. Standard fire request messages contain all the information in a conventional call for fire:

- Observer identification.
- Warning order.
- Target location.
- Target description.
- Method of engagement.
- Method of fire and control.

They are used by observers to initiate fire missions. The five standard fire request messages are as follows:

- FR QUICK (fire request, quick response): Used to request that TACFIRE or BCS assign a known point number to a previously stored target, to fire an FPF, to terminate firing an FPF, and to request fire on a known point or target which is stored in TACFIRE or BCS.
- FR GRID (fire request, grid coordinates): Used to request fire by using the grid coordinates method of target location.
- FR SHIFT (fire request, shift from a known point): Used to request fire by using the shift from a known point method of target location.
- FR POLAR (fire request, polar coordinates): Used to request fire by using the polar coordinates method of target location.
- FR LASER (fire request, laser, polar coordinates): Used to request fire by using the laser polar coordinates method of target location. The DMD-G/VLLD interface enables the laser polar data to be transferred directly from the G/VLLD into the FR LASER message.

b. Adjustments. Adjustment messages contain all the information required for the adjustment of fire. The three adjustment messages are as follows:

- SUBQ ADJ (subsequent adjustment): Used to adjust fires onto a target when an FR GRID, SHIFT, or POLAR. format was used for the initial request.

- SA LASER (subsequent adjustment laser): Used to adjust artillery fires by using the G/VLLD when an FR LASER format was used for initial request. When the round impacts, the observer lases the burst, and the laser polar data of the impact location are entered into the SA LASER format. The TACFIRE and BCS use this information to calculate the necessary adjustment.
- EOM&SURV (end of mission and surveillance): Permits the observer to end a fire mission, make refinements, report target surveillance, and request that a target be recorded.

c. Registrations. Registration messages are used in observing a precision, an HB or MPI, or a radar registration. The three registration messages are as follows:

- PREC REG (precision registration): Used to adjust the firing of a precision registration or destruction mission.
- HB/MPI (high burst or mean point of impact): Used to report the spottings made in observing an HB or MPI registration.
- RDR REG (radar registration): Used by a radar section to report the impact grid coordinates of rounds fired in a radar registration.

d. Intelligence. Intelligence messages are used to report enemy locations and other information of intelligence value. The three intelligence messages are as follows:

- ATI GRID (artillery target intelligence, grid coordinates): Used to report enemy locations by use of grid coordinates.
- ATIPOLAR (artillery target intelligence, polar coordinates): Used to report enemy locations by use of polar coordinates.
- SHELREP (shelling report, artillery target intelligence, crater analysis): Used by an observer to report information concerning the impact of enemy artillery or mortar fire at his location.

e. Information. Information messages can be transmitted and received by the DMD. The six information messages are as follows:

- FIREPLAN (planned fire mission): Used by the observer to establish a planned fire mission.
- FO CMD (forward observer command): Used by the observer to fire a mission established at his command and to order check firing. Also used by the FDC to report SHOT, SPLASH, and READY to the observer.

- MTO (message to the observer): Used by the FDC to report fire mission data to the observer.
- OBSR LOC (observer location, grid coordinates): Used by the observer to report his location to the FIST or FDC. Also used by the FDC to report the observer's location to the observer when the location is determined by resection or trilateration.
- FL TRACE (frontline trace): Used by the observer to report the front line of troops of his associated maneuver element.
- FREETEXT: For nonformatted messages.

B-4 MESSAGE COMPOSITION, STRUCTURE, AND FLOW

Messages may be composed in the active mission buffers or in the off-line compose message files.

a. Message Composition in Active Mission Buffers. The active mission buffers, M1 and M2, are used to transmit messages and conduct fire missions. They permit an observer to conduct two simultaneous missions from the DMD, one in each active mission buffer. Messages must be composed in an active mission buffer or be transferred from an off-line composed message file into an active mission buffer before they can be transmitted.

b. Message Composition in Off-Line Compose Message Files. A message composed in one of the seven off-line compose message files, F3 through F9, may be stored there until transmission is desired. This enables the observer to anticipate future requirements and to prepare messages in advance of their use. Messages stored in the off-line files must be transferred into an active mission buffer before they can be transmitted.

c. Message Structure. A DMD does not transmit messages as they appear to the operator. They are transmitted as a string containing 44 alphanumeric characters. Each DMD message is composed of two parts: the header and the body. The header uses six character positions. The first position of the body designates the message type, and the rest of the body can use up to 37 characters.

(1) Message Header. The DMD automatically selects the information included in the message header and inserts it into the character positions (Figure B-6).

(a) The unique address of the destination device is inserted in character position 1. The DMD extracts this alphanumeric character from the DEST field of the status menu.

Figure B-6. DMD MESSAGE HEADER

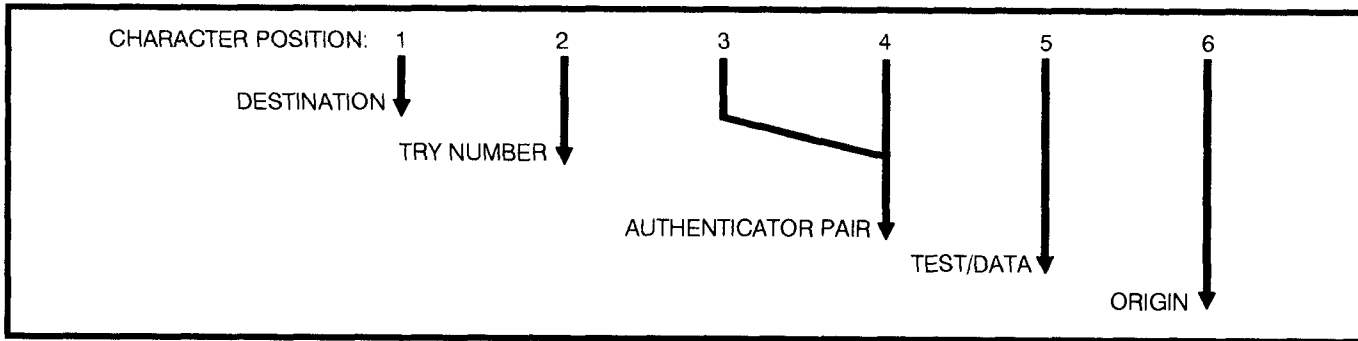

(b) When a message is not received by the destination device, it must be retransmitted. The try number indicates the number of times a message has been retransmitted. This number, a numerical value 0 to 3, is automatically inserted into character position 2 of the message header. The try number is used in message authentication.

(c) An authenticator pair is used in conjunction with the try number to provide message self-authentication. The operator can store a group of authenticator pairs in the authentication code file and cause the DMD to transmit them in order. If the operator has not previously stored authenticator pairs, he may enter them through the keyboard during message composition. In either case, the two alphanumeric characters are inserted into positions 3 and 4 of the message header.

(d) The entry in position 5 indicates whether the message contains data or is a test message. The DMD extracts this information from the T/D field of the status menu.

(e) The unique address of the DMD is inserted in character position 6. The DMD extracts this alphanumeric character from the ORIG field of the status menu.

(2) Message Body. Character position 7, the leading character of the message body, indicates the type of message being transmitted. The remaining 37 characters compose the text of the message. The DMD uses an encoding scheme which automatically converts a composed message into a string of characters. Upon receipt, the destination device decodes the character string and displays the message in a format the operator can read and understand. Each message type uses a different encoding scheme, which is identified by the character in position 7. The entire process of encoding and decoding is not apparent to the DMD operator. It is done automatically by the DMD.

d. Message Flow. When a DMD, FIST DMD, FED, TACFIRE computer, VFMED, or battery computer unit

(BCU) receives a digital message, it automatically transmits a brief digital response called an ACK message. The TACFIRE computers can automatically verify message authenticity. When TACFIRE receives a properly self-authenticated message, it transmits an ACK message. When TACFIRE receives an improperly self-authenticated message, it transmits a NAK message. The DMD display shows that an ACK or a NAK message has been received, and the ACK and NAK indicator lamps flash. The operator can clear these indications by pressing the X key. When a NAK has been received, this action causes the AUTH LINE NO field of the status menu to be reset, thereby desynchronizing the DMD with TACFIRE. The other devices cannot automatically verify message authenticity, and they will always transmit an ACK message if a DMD message is received. If neither the ACK nor the NAK light flashes, the destination device did not receive the message.

B-5. AUTHENTICATION

Deception is a form of electronic warfare which might be used against automated FA systems. An enemy force may try to transmit messages which imitate the digital transmissions of legitimate subscribers on the fire direction nets. If TACFIRE or BCS were permitted to process deceptive messages, the enemy could direct artillery fires on friendly positions or input false intelligence information. If FA observers accept deceptive messages as authentic, the enemy could give them erroneous tactical information or direct them to take improper actions. The authenticity of received messages must be determined to counter the electronic threat. This may be done by using the self-authentication or challenge and response technique.

a. Self-Authentication. Self-authentication is the preferred method of authenticating digital messages, because all required information is transmitted in the message header. Several requirements must be met for this technique to be used. First, the transmitting station must have a current group of authenticators. The DMD operators are issued code books

which contain the authenticators they must use. Second, the receiving station must be able to compare the transmitted authentication information with that which should have been transmitted. The DMD destination must, therefore, have a copy of the DMD operator's authenticators. Likewise, the DMD operator must have a copy of the destination codes. Third, the transmitting and receiving stations must be synchronized. Each must know which authenticator pairs have been transmitted and which should be transmitted next. The DMD operator can do this by marking through the codes in the reception code book as messages are received. The DMD can keep track of the codes used for transmission.

(1) Authenticator Codes. Authenticators are grouped in pairs. Authenticator pairs consist of two alphanumeric characters which are transmitted in a message header. One hundred authenticator pairs form a group, and several groups form a code book. Unit communications security (COMSEC) custodians issue code books to DMD operators. Within a group, each authenticator pair is assigned to a line. The lines are numbered from 01 through 100. The first message transmitted by using the current group must contain the authenticator pair associated with line number 01. Subsequent messages must contain, in order, the authenticators associated with subsequent line numbers. An authenticator pair may be transmitted only once. When a message is composed, the DMD operator must insert the appropriate authenticators into the message header. One of two techniques may be used: retrieval from the authentication code file or input directly from the keyboard.

(a) *Retrieval From the Authentication Code File.* An entire group of authenticator pairs may be extracted from a code book and recorded in the DMD authentication code file. Extreme care must be taken to ensure that each authenticator pair is recorded without error. When this is done, the operator must enter an operator's key. The operator key is a unique, easily remembered, alphanumeric pair which the operator selects. The AUTH LINE NO field of the status menu contains the line number of the next authenticator pair to be transmitted. Before any messages are transmitted by using the current group, the value in this field should be 01. When a message is composed, the operator must make an operator's key entry in the AUTH field. When the operator enters the operator's key, the DMD permits continued message composition. When the message is transmitted, the DMD retrieves the authenticator pair stored on the line number specified in the AUTH LINE NO field. That code is transmitted in the message header. The DMD then increments the value in the AUTH LINE NO field by one. If the DMD is synchronized with its destination (the value stored in the AUTH LINE NO field was correct) and if the authenticator pairs have been properly recorded in the

file, then the message will be properly self-authenticated. Because the AUTH LINE NO field has been automatically incremented, subsequent messages will also be properly self-authenticated. This technique does not require the operator to manually extract authenticator pairs from his code book each time a message is composed. For this reason, it is the preferred method of message authentication.

(b) *Input Directly From the Keyboard.* At times, it may not be possible or desirable to retrieve authenticator pairs from the authentication code file. In these cases, the proper codes are not on file and they must be entered directly from the keyboard. To do this, the DMD operator displays the message AUTH field. He then opens his authentication code book, turns to the current group, and identifies the authenticator pair associated with the next line number to be transmitted. This authenticator pair is entered in the AUTH field. Because the DMD expects the operator key to be entered, an error message will be displayed as follows:

- *** AUTHENTICATION ERROR
- *** INCORRECT KEY

If the operator disregards the error message and reenters the authenticator pair, the DMD accepts the input and permits continued message composition. The operator should mark through the code in his book to ensure that it is not used again. The authenticator pair that was entered is transmitted in the message header. Because this technique requires the manual extraction of authenticators each time a message is composed, it is not the preferred technique. It can be used effectively, however, when the current group has not been recorded in the authentication code file and a message must be temporarily transmit to an alternate destination. Directly entered alphanumeric pairs are transmitted in lieu of the stored codes, which will remain unexposed for future use when communicating with the primary destination. Thus, unauthorized personnel (those persons unfamiliar with the operator key) can be kept from transmitting properly authenticated messages using previously stored authenticators.

(2) *Verifying Message Self-Authentication.* If a message is transmitted and no ACK or NAK message is received, the operator should assume that the destination did not receive the message and it must be retransmitted. The DMD increments the value of the AUTH LINE NO field of the status menu. Because the destination is unaware of the attempt of the DMD to communicate, it does not increment the line number of the next authenticator pair it expects to receive. This failure to communicate causes the DMD to lose synchronization with its destination. To enable

verification of message authenticity under these conditions, a try (retransmission) number is transmitted with the authenticators in the message header. The try number and the authenticators are used together to determine message authenticity.

(a) *Procedure for Verifying Message Authenticity.* Upon receipt of a digital message, the header must be examined to identify the try number and authenticator pair. The try number (a numeric value of 0 to 3) is added to the line number of the next authenticator expected from the originator. The sum is the line number that should correspond to the transmitted authenticator pair. If the transmitted authenticator pair does not match the authenticator pair on that line, then the message should be considered authentic. If they do not match, then the authenticity of the message should be questioned. The operator should line through the authenticator pair and any preceding codes which have not been previously marked as having been used.

(b) *Authenticating the First Transmission of a Digital Message.* When a message is transmitted for the first time, the try number is 0. The sum of the try number and the next expected line number equals the expected line number. Authentication is done by comparing the transmitted authenticator pair with the one on the expected line.

(c) *Authenticating a Message Retransmission.* The DMD will permit three retransmissions before it tells the operator to reestablish voice communication with his destination. When a message is retransmitted, the try number has a value of 1 to 3. Consequently, the sum of the try number and the next expected line number is greater than the expected line number.

EXAMPLE

A is transmitting to B. They are synchronized. An extract of A's current code group is shown.

LINE NUMBER	AUTHENTICATOR CODE
05	5G
06	BZ

A transmits a message to B by using line 05 (try number = 0 and authenticator pair = 5G). B does not receive the message.

A retransmits the message by using line 06 (try number = 1 and authenticator pair = BZ). B still expects to receive the authenticator corresponding to line 05.

Upon receipt, B adds try number 1 and expected line 05. The sum is 06. Because BZ is the authenticator pair associated with line 06, the message is properly self-authenticated.

b. Challenge and Response Authentication.

Normally, a DMD operator is issued one set of authentication code books. These allow him to transmit self-authenticated messages to his primary destination. Because of the limited availability of COMSEC materials, it is unlikely that alternate destinations will have a copy. Consequently, it generally is not possible to transmit self-authenticated messages to alternate destinations. Authentication must be done by using the challenge and response technique that is currently used in voice communications. The challenge and response may be transmitted by using FREETEXT messages. It is not practical to authenticate every message in this manner. The DMD operator may be challenged only after his initial transmission and anytime the destination suspects imitative deception. A DMD operator generally communicates with **an alternate destination for a limited time.** Communications eventually will be reestablished with the primary destination. To prevent exposing the stored authenticator pairs, the DMD operator should enter phony codes by using the direct keyboard input technique. To prevent the loss of synchronization with the primary destination, the DMD operator should note the value stored in the AUTH LINE field of the status menu before destinations are changed. This value must be reentered when communications are reestablished with the primary destination.

B-6. MODE MENU

If the DMD has been properly assembled and power has been applied, the mode menu (Figure B-7) will be displayed. The mode menu is the DMD's main index - the starting point for all DMD operations. It can be displayed anytime by pressing the MODE key. If the mode menu does not appear on the display panel, then adjust the DSP BRT control knob. It may be necessary to press the MODE key to recall the display. If the mode menu still does not appear, take the following corrective actions:

Figure B-7. **MODE MENU**

1=MSN 1 ACTV	D=OPNL CHECK
2=MSN2 - - -	E=STATUS / 000WH
FILE MSN= #	F=AUTH CODES
A=MSG TYPES	G=ENABLE FILE MSG
B=COMPSD MSG	H=RECALL SAVED MSG
C=MSN DATA	Y=MEMORY PURGE

- Check the external power source and external power cable if external power is used.
- Check the internal battery pack if internal power is used. It may be necessary to replace the battery with one that is fully charged.
- If the mode menu still is not displayed, evacuate the DMD to the next higher maintenance level.

B-7. PROCEDURE FOR PURGING THE MEMORY

The DMD memory may be purged when it is prepared for use or in emergency situations. This prevents enemy access to the stored information. Purge the memory of the DMD as follows:

- Display the mode menu by pressing the MODE key.
- Note the mode menu entry Y = MEMORY PURGE. Purge the memory by pressing the Y key. The entry changes to Y = MEMORY PURGED, indicating successful completion of the operation.

NOTE: For diagnostic test procedures, see subparagraph B-2c above.

B-8. PROCEDURE FOR MAKING INITIAL STATUS SELECTIONS

Establish communications parameters, DMD functional characteristics, and battery conditions by making initial status selections.

- a. Display the mode menu by pressing the MODE key.
- b. Note the mode menu entry E = STATUS. Press the E key to display the status menu. Entries must be made in all fields with a question mark (?). All other fields except WATT HRS and BATT LMT have default values.
- c. Press the JUMP key to display the ORIG field. Enter the unique address of the DMD.
- d. DEST is displayed. Enter the unique address of the destination device.
- e. T/D is displayed. Select TEST when transmitting test messages; otherwise, select DATA.
- f. XMT BLK is displayed. Select DBL when transmitting through heavy radio interference or jamming otherwise, select SNG. The DMD XMT BLK must match that of the destination.

g. XMT RATE is displayed. Select 600 or 1,200 bits per second in accordance with unit SOP or communications instructions. The DMD XMT RATE must match that of the destination.

h. PREAMBLE is displayed. Enter a 0.1- to 4.0-second preamble in accordance with unit SOP or communications instructions.

i. AUTH GROUP NO is displayed. Enter the number of the current authenticator group.

j. AUTH LINE NO is displayed. Enter the line number of the next authenticator pair to be transmitted. If no transmission has been made by using the current group, enter 01.

k. DSPL DLY is displayed. Enter the time (0.0 to 2.0 seconds) a menu or message element will remain displayed after an entry or selection has been made.

l. KBD BELL VOL is displayed. Set the keyboard bell volume to the desired intensity (0 is completely off, and 7 is the maximum level).

m. MSG BELL VOL is displayed. Set the message bell volume to the desired intensity (0 is completely off, and 7 is the maximum level).

n. WATT HRS is displayed. If a fully charged battery has just been installed or if no internal battery is presently installed, enter 00.0 watt hour; otherwise, press the V key to select the displayed value.

o. BATT LMT is displayed. Enter the number of watt hours that a fully charged battery can be expected to produce. If no battery limit has been determined by experience, enter 12.0.

p. The completed status menu is displayed. Review the status menu and make corrections where appropriate.

B-9. PROCEDURE FOR STORING THE AUTHENTICATION CODE LIST AND OPERATOR'S KEY

An entire group of 100 authenticator pairs and an operator's key may be stored in the authentication code file by using the procedures discussed below.

- a. Display the mode menu by pressing the MODE key.
- b. Note the mode menu entry F = AUTH CODES. Display the authentication code file instructions by pressing the F key.
- c. Enter the line number of the first authenticator pair to be entered. Normally, this will be 01.
- d. Press the X key to enter the authentication code file at the line number specified.

CAUTION

Pressing the X key to enter the authentication code file will delete previously used authenticator pairs. The code, beginning with the entry line and continuing to (but not including) the line specified in the AUTH LINE NO of the status menu, will be erased. When the file is entered, at least one code (on the entry line) will be deleted. Always enter at line 01.

e. Beginning with the entry line and continuing to line 00, extract all the authenticator pairs from the current group in the code book, and record them in the authentication code file. Extreme caution must be taken to ensure the codes are stored on the appropriate line and without error.

f. After an entry is made on line 00, select and enter an operator's key. The selected key should be easy to remember. It is used each time a message is composed to cause the DMD to retrieve and transmit the authenticators which have been stored in the file.

B-10. MESSAGE COMPOSITION AND TRANSMISSION

Messages may be composed in active mission buffers, M1 and M2, or in off-line compose message files, F3 through F9. A message can be transmitted only from an active mission buffer. Consequently, a message must be composed in M1 or M2, or it must be transferred from an off-line file into M1 or M2 before it can be transmitted. The paragraphs below discuss composing and transmitting various types of messages.

a. Composing a Message in an Active Mission Buffer and Transmission.

(1) Display the mode menu by pressing the MODE key.

(2) Note the mode menu entry 1 = MSN1 ACTV or 2 = MSN2 ACTV. It indicates the mission buffer in which the message will be composed. To activate the other mission buffer, press the 2 or 1 key, as appropriate.

(3) Note the mode menu entry A = MSG TYPES. Display the message types menu by pressing the A key.

(4) Note the M1 ACTIVE or M2 ACTIVE entry on the message type menu. This indicates the active mission buffer in which the message will be composed. Select the message to be composed, and display its skeleton by pressing the appropriate alphabetic key.

(5) Those fields assigned a default value will have the default displayed. Default values will be transmitted if no other selections or entries are made. Those fields with a

question mark (?) require an operator entry before transmission is permitted. Some fields, such as DIR or TGT NO, may have previously specified values displayed. These values were drawn from the mission data portion of the active mission buffer.

(6) The cursor flashes in the AUTH field. Press the JUMP key to display the AUTH field.

(7) The AUTH field permits the operator to specify the authenticator pair which will be transmitted in the message header. Either of two techniques may be used.

(a) *Retrieval From the Authentication Code File.* If the current group of authenticator pairs has been stored and one of these is to be transmitted, enter the operator's key in the AUTH field. This entry must match the previously stored key in the authentication code file.

(b) *Direct Input From the Keyboard.* This technique may be used if the operator has not stored the current group of authenticator pairs. It also may be used if the operator is transmitting to an alternate destination and does not want to expose the previously stored codes. Select the authenticators to be transmitted (not the operator's key), and enter the alphanumeric pair in the AUTH field of the message. This entry will cause an error message to be displayed. Disregard the error message, and reenter the pair.

(8) Compose the rest of the message. The default or previously specified values may be selected by pressing the key. When entries have been made in all fields, the completed message is displayed for operator review. To make a correction, move the cursor to the appropriate field, and display it by pressing the JUMP key. Correct the error, and display the corrected message by pressing the JUMP key.

(9) Listen to the net. If there is no other traffic, transmit the message by pressing the XMIT key.

NOTE: The completed message must be displayed before transmission is permitted.

(a) If the destination is a TACFIRE computer and it received the message and the authentication was correct or if the destination is a BCS or DMD and it received the message, an ACK message is transmitted back to the DMD. The display and ACK and NAK indicator lamps indicate receipt of the ACK message. The ACK light flashes at twice the speed of the NAK light. Clear the display and turn off the indicator lamps by pressing the X key.

(b) If the destination is a TACFIRE computer and it received the message and the authentication was incorrect, a NAK message is transmitted back to the DMD. The display and ACK and NAK indicator lamps indicate receipt of the NAK message. The NAK light flashes at twice the speed of the ACK light. The display indicates the line number of the authenticators TACFIRE expected to receive. Clear the display and turn off the indicator lamps by pressing the X key. This action desynchronizes the AUTH LINE NO field of the status menu. Transmit the message again.

(c) If the destination did not receive the message, no ACK or NAK indications are displayed. The try (retransmission) number is incremented. Transmit the message again.

b. Composing a Message in an Off-Line Compose Message File and Transmission.

(1) Display the mode menu by pressing the MODE key.

(2) Note the mode menu entry FILE MSN = #. Select the off-line compose message file, F3 through F9, in which the message is to be composed by pressing the appropriate numeric key. The file number specified replaces the #.

(3) Note the mode menu entry A = MSG TYPES. Display the message type menu by pressing the A key.

(4) Note the F# ACTIVE entry on the message type menu. The # indicates the off-line compose message file in which the message will be composed. Select the message to be composed, and display its skeleton by pressing the appropriate alphabetic key.

(5) Compose the message as described in subparagraphs a(6), (7), and (8) above.

(6) The message cannot be transmitted from the off-line compose message file. It must be transferred to an active mission buffer. Display the mode menu by pressing the MODE key.

(7) Note the 1 = MSN1 ACTV or 2 = MSN2 ACTV entry. This indicates the mission buffer into which the message will be transferred. Note the FILE MSN = # entry. Select the off-line file in which the message was composed. The specified file number replaces #.

(8) Note the mode menu entry G = ENABLE FILE MSG. Press the G key to transfer the composed message from the selected off-line file into the active mission buffer.

(9) Transmit the message as described in subparagraph a(9) above.

c. Composing the FR QUICK Message.

(1) Make an entry in the AUTH field (subparagraph a(7) above).

(2) Make one of the following entries or selection

- Enter a known point number to request fire on a previously recorded known point.
- Select ASGN KNPT to assign a known point number to a previously recorded target. The target number must be subsequently entered.
- Select FIRE FPF to command the firing of a previously established final protective fire.
- Select FIRE TGT NO to request fire on a previously recorded target. The target number must be subsequently entered.
- Select END FPF to terminate the firing of the FPF.

(3) Select a LOW or HIGH angle trajectory.

(4) Assign an URGENT or NORMAL priority to this fire request.

d. Composing the FR GRID Message.

(1) Make an entry in the AUTH field (subparagraph a(7) above).

(2) Enter the target location grid coordinates (subparagraph v below).

(3) Enter the OT direction (to the nearest 10 mils), or select the GT line.

(4) Enter the target type and description (subparagraph w below).

(5) Select the desired shell-fuze combination to be fired in effect.

(6) Select the desired method of control.

(7) Select a LOW or HIGH angle trajectory.

(8) Assign an URGENT or NORMAL priority to the fire request. Select FPF (ASSIGN ONLY) to establish an FPF or Copperhead priority mission.

e. Composing the FR SHIFT Message.

(1) Make an entry in the AUTH field (subparagraph a(7) above).

(2) Enter the number of the known point from which the target location is determined.

(3) Enter the OT direction (to the nearest 10 mils).

(4) Enter the shift information which locates the target with respect to the known point (subparagraph x below).

(5) Enter the target type and description (subparagraph w below).

(6) Select the desired shell-fuze combination to be fired in effect.

(7) Select the desired method of control.

(8) Select a LOW or HIGH angle trajectory.

(9) Assign an URGENT or NORMAL priority to the fire request. Select FPF (ASSIGN ONLY) to establish an FPF or Copperhead priority mission.

f. Composing the FR POLAR Message.

(1) Make an entry in the AUTH field (subparagraph a(7) above).

(2) Enter the target location polar data (subparagraph w below).

(3) Enter the target type and description (subparagraph w below).

(4) Select the desired shell-fuze combination to be fired in effect.

(5) Select the desired method of control.

(6) Select a LOW or HIGH angle trajectory.

(7) Assign an URGENT or NORMAL priority to the fire request. Select FPF (ASSIGN ONLY) to establish an FPF or Copperhead priority mission.

g. Composing the FR LASER Message.

(1) Make an entry in the AUTH field (subparagraph a(7) above).

(2) Enter the target location laser polar data (subparagraph z below).

(3) Specify the type of laser mission to be conducted.

(a) Select STA TGT to request tire on a stationary target.

(b) Select PRED PNT to request an FFE fire mission (at the observer's command) on a position to which the observer expects the target to move.

(c) Select TRAK TGT to request a time on target on a position to which a target is predicted to move. The target must be lased at two locations. The TACFIRE or BCS assumes the target is traveling in a constant direction and at a fixed rate. An engagement point is determined accordingly.

(d) Select DRAW TGT to describe an irregularly shaped target. The target size and shape may be specified by lasing two to eight locations. DRAW TGT must be specified for each point except the final one, when LAST PNT must be selected.

(e) Select TRILAT to determine the observer's location (grid coordinates) by using two known points. The FDC must be told (by FREETEXT message) which known points will be lased and which known point is on the observer's left. The leftmost known point must be lased first and identified as PT NO -1. The rightmost known point must be lased second and identified as PT NO -2. The BCS then computes the observer's location.

(f) Select RESECT to determine the observer's location by using one known point. The FDC must be told (by FREETEXT message) which known point will be lased.

(4) Enter the target type and description (for fire requests) (subparagraph w below).

(5) Select the desired shell-tie combination to be fired in effect (for fire requests).

(6) Select the desired method of control (for fire requests).

(7) Select a LOW or HIGH angle trajectory (for fire requests).

(8) Assign an URGENT or NORMAL priority to the fire request. Select FPF (ASSIGN ONLY) to establish an FPF or Copperhead priority mission.

h. Composing the SUBQ ADJ Message.

(1) Make an entry in the AUTH field (subparagraph a(7) above).

(2) Enter the OT direction (to the nearest 10 mils), or select the GT line. This may be inserted by the DMD.

(3) If the adjusting round was observed and a shift will be made, select OK. If the adjusting round was not observed, lost, or erratic, select DNO, LOST, or IGN RD, respectively.

(4) Enter the shift information which adjusts the fire onto the target (subparagraph x below).

(5) Enter the fire mission target number. This is extracted from the message to observer and may be inserted into the message by the DMD.

(6) Select the desired shell-fuze combination. Specify NO PREF if no change to the adjusting or FFE munitions is desired.

(7) Select the desired method of control.

(8) Select a LOW or HIGH angle trajectory. It should match the trajectory specified in the fire request.

i. Composing the SA LASER Message.

(1) Make an entry in the AUTH field (subparagraph a(7) above).

(2) Enter the burst or target location laser polar data (subparagraph z below).

(3) Specify the status of the adjusting round and which location (burst or target) has been lased as follows:

- Select OK TGT to identify a new target location.
- Select OK BT if the adjusting round was observed and the burst location has been lased. The TACFIRE or BCS computes the shift required. Fire for effect can normally be specified after one adjusting round has been observed and lased.
- Select DNO TGT or LOST TGT if the adjusting round was not observed or was lost and the target location has been lased. This can be used to specify a new target location or the original target location.
- Select LOST BT if the adjusting round was lost and the estimated burst location has been lased. Because the actual burst location is uncertain, another adjusting round should be requested.
- Select IGN RD if the adjusting round was erratic and another must be fired.

(4) Enter the fire mission target number. This is extracted from the MTO and may be inserted into the message by the DMD.

(5) Select the desired shell-fuze combination. Specify NO PREF if no change to the adjusting or FFE munitions is desired.

(6) Select the desired method of control.

(7) Select a LOW or HIGH angle trajectory. It should match the trajectory specified in the fire request.

j. Composing the PREC REG Message.

(1) Make an entry in the AUTH field (subparagraph a(7) above).

(2) Enter the OT direction (to the nearest 10 mils), or select the GT line. This may be inserted by the DMD.

(3) Select the appropriate command as follows:

- Select N/G if no change to the previously specified command is desired.
- Select 1 RND, 2 RNDS, or 3 RNDS to command the firing of 1, 2, or 3 rounds, respectively, using the same firing data.
- Select RCRD REG PT to terminate the impact phase of a precision registration.
- Select RCRD AS TI REG PT to terminate the time phase of a precision registration.

- Select REG NEXT LOT in a two-lot registration to terminate the impact or time phases of the first-lot registration and begin registration of the second lot.

(4) Enter the desired shift information (subparagraph x below).

(5) Enter the fire mission target number. This is extracted from the MTO and may be inserted into the message by the DMD.

(6) Select the fuze to be fired. Specify N/G if no change is desired.

(7) Select the desired method of control.

k. Composing the EOM&SURV Message.

(1) Make an entry in the AUTH field (subparagraph a(7) above).

(2) Enter the OT direction (to the nearest 10 mils), or select the GT line. This may be inserted by the DMD.

(3) Enter the desired refinement (shift) information if the target will be recorded as a known point (subparagraph x below).

(4) Enter the target type (subparagraph w below). This has been specified in the fire request and may be inserted into the message by the DMD.

(5) Select the target disposition.

(6) Enter or select the estimated number of casualties.

(7) Enter the the mission target number. This is extracted from the MTO and may be inserted into the message by the DMD.

(8) Select EOM to end the mission or EOM RAT to end the mission and record the target as a known point.

l. Composing the HB/MPI Message.

(1) Make an entry in the AUTH field (subparagraph a(7) above).

(2) Enter the reference direction. This is extracted from the orienting data received from the FDC and may be inserted by the DMD.

(3) Select the observed error in the burst location as follows:

- Select RA if the burst location is right of the reference direction and above the reference vertical angle.
- Select RB if the burst location is right of the reference direction and below the reference vertical angle.
- Select LA if the burst location is left of the reference direction and above the reference vertical angle.

- Select LB if the burst location is left of the reference direction and below the reference vertical angle.

(4) Enter the reference vertical angle. This is extracted from the orienting data received from the FDC and may be inserted by the DMD.

(5) Enter the number of roils the burst location was right or left of the reference direction.

(6) Select YES if you have been designated to measure the vertical angle; otherwise, select NO. This is extracted from the orienting data and may be inserted by the DMD.

(7) If you have been designated to measure the vertical angle, enter the number of roils the burst location was above or below the reference vertical angle; otherwise, select N/G.

(8) Enter the fire mission target number. This is extracted from the MTO or orienting data and may be inserted by the DMD.

(9) If the burst was observed, select OK. If the burst was not observed, lost, or erratic, select DNO, LOST, or IGN RD, respectively.

(10) Select HB if observing a high-burst registration or MPI if observing a mean-point-of-impact registration. This is extracted from the orienting data and may be inserted by the DMD.

m. Composing the RDR REG Message.

(1) Make an entry in the AUTH field (subparagraph a(7) above).

(2) Enter the impact location grid coordinates (subparagraph v below).

(3) If the impact was observed, select OK. If the impact was not observed, lost, or erratic, select DNO, LOST, or IGN RD, respectively.

(4) Enter the fire mission target number. This is extracted from the MTO or orienting data and may be inserted by the DMD.

n. Composing the FO CMD Message.

(1) Make an entry in the AUTH field (subparagraph a(7) above).

(2) Make one of the following selections:

- Select FIRE to command the firing of a mission whose control is at the observer's command. The target number must be subsequently entered.
- Select CHECK FIRE to command the check firing of a specific mission. The target number must be subsequently entered.

- Select CHECK FIRE ALL to command the check firing of all fire missions.

o. Composing the SHELREP Message.

(1) Make an entry in the AUTH field (subparagraph a(7) above).

(2) Enter the direction to the location from which the projectiles were fired.

(3) Enter the impact location grid coordinates (subparagraph v below), omitting altitude.

(4) Select the type of projectiles.

(5) Enter the caliber of the projectiles. Select UNK if unknown.

(6) Enter or select the number of rounds that were fired.

(7) Enter the time the incident occurred.

p. Composing the FL TRACE Message.

(1) Make an entry in the AUTH field (subparagraph a(7) above).

(2) The FLOT is specified by two or more location entries. Enter an entry number and the frontline grid coordinates (subparagraph v below), omitting altitude.

(3) Enter the entry number for another frontline location, and enter the second frontline location grid coordinates (subparagraph v below), omitting altitude, for the second entry.

(4) If an observer wishes to send more than two frontline grid coordinates, he must use a second FL TRACE message.

q. Composing the OBSR LOC Message.

(1) Make an entry in the AUTH field (subparagraph a(7) above).

(2) Enter the observer location grid coordinates (subparagraph v below).

r. Composing the ATI GRID Message.

(1) Make an entry in the AUTH field (subparagraph a(7) above).

(2) Enter the target location grid coordinates (subparagraph v below).

(3) Enter the target type and description (subparagraph w below).

(4) Make one of the following selections:

- Select N/G if no reliability is specified.
- Select GOOD, FAIR, or EXC to indicate the reliability of the target acquisition source.
- Select DNA if the target coordinates are not to be adjusted.
- Select DNC if the target is not to be combined with another.

s. Composing the FIREPLAN Message.

(1) Make an entry in the AUTH field (subparagraph a(7) above).

(2) Enter the names of the FIREPLAN in which this target is to be included.

(3) Enter the target location grid coordinates (subparagraph v below). The coordinates may be omitted (and N/G selected) if the target has been previously recorded (target number must be entered subsequently).

(4) Enter the target type and description (subparagraph w below).

(5) Select CONFIRMD if the target is confirmed or SUSPECTD if the target is suspected.

(6) Select the accuracy to which the target was located.

t. Message to Observer. Messages to observers are not composed on the DMD. They are transmitted from TACFIRE or BCS and received by the DMD.

u. Composing the FREETEXT Message.

(1) Make an entry in the AUTH field (subparagraph a(7) above).

(2) Compose the desired message. It must not exceed 37 characters.

v. Entering Location Grid Coordinates.

(1) Enter a five-digit casting. In the FR GRID, FL TRACE, and FIREPLAN messages, the last digit is a zero, and the specified casting is accurate to the nearest 10 meters.

(2) Enter a five-digit northing. In the FR GRID, FL TRACE, and FIREPLAN messages, the last digit is a zero, and the specified casting is accurate to the nearest 10 meters.

(3) Enter a four-digit altitude. In the FR GRID and FIREPLAN messages, the last digit is a zero, and the specified altitude is accurate to the nearest 10 meters. It may be necessary to enter a leading zero.

(4) In those regions of the world near grid zone boundaries, two grid coordinate systems may be used. Select

STD if the standard (westernmost) grid zone coordinates are used; select EST if the easternmost grid zone coordinates are used. If the location is not near a grid zone boundary, select STD.

w. Entering Target Type and Description.

(1) Select the target type and subtype. If N/G is selected, TACFIRE and BCS will assume a personnel target.

(2) Enter the number of elements in the target.

(3) For personnel targets, select their degree of protection. For other target types, select N/G.

(4) Select the target radius or length. If N/G is selected, TACFIRE and BCS will assume a circular target with a 100-meter radius.

(5) For rectangular targets, select the target width. For circular targets, select N/G.

(6) For rectangular targets, enter the target attitude.

x. Entering Shift Information.

(1) Select the direction of the desired lateral shift. The magnitude of the lateral shift must be entered subsequently. If no lateral shift is desired, select N/G.

(2) Select the direction of the desired range shift. The magnitude of the range shift must be entered subsequently. If no range shift is desired, select N/G.

(3) Select the direction of the desired vertical shift. The magnitude of the vertical shift must be entered subsequently. If no vertical shift is desired, select N/G.

y. Entering Target Location Polar Coordinates.

(1) Enter the OT direction.

(2) Enter the OT horizontal distance.

(3) Select the direction of the desired vertical shift. The magnitude of the vertical shift must be entered subsequently. If no vertical shift is desired, select N/G.

z. Entering Target Location Laser Polar Coordinates.

(1) Enter the OT direction.

(2) Enter the OT slant distance.

(3) Select the direction, and enter the magnitude of the vertical angle.

NOTE: This information can be transferred across the DMD-G/VLLD interface and entered automatically when the target is lased. Section II

Section II
FORWARD ENTRY DEVICE

B-11. OPERATION OF FORWARD ENTRY DEVICE CP-1995/U

a. Description. The forward entry device (FED) is a lightweight, hand-held communications message processor. It can compose, transmit, receive, edit, store, and display messages to conduct fire support. Messages that it transmits and receives include requests for fire, artillery target intelligence messages, messages to observers, plaintext messages, observer locations, registrations, fire plans, and the forward line of own troops (FLOT). The FED performs polar-to-grid conversions, calculates the observer's position location, and interfaces with the G/VLLD to process laser missions. The message processor performs the tasks of message composition, editing, address coding, error control, checking, and net protocol. The operator can specify message data rates, addresses of receiving agencies, and keying times. The FED can transfer its software to another FED. The FED can be programmed either to function as a FIST FED or for use by an observer. The FED is shown in Figure B-8.

b. Data Entry and Display. Information is entered into the FED by use of a keyboard consisting of 64 alphanumeric, symbol, and function keys. The display screen can display 25 lines of text with 40 characters per line.

c. Memory Capacity. With the FED, an observer can store nine active messages at one time, including two fire

missions. The FED can hold 40 messages in the received buffer and can store 10 messages in the save buffer. The FED also stores copies of the last 25 messages transmitted.

d. Communications. The FED communicates either over radio by use of a CX-8830 cable or over wire. It gives the observer a single-channel digital capability with point-to-point and netted (multiple subscriber) communications.

e. Authentication. Authentication procedures with a FED are similar to those with a DMD. The FED can store up to four authentication code tables of 100 authenticator pairs each as well as an authentication key code.

f. Power Supply. The FED is powered either by an internal battery (BA-5800 lithium battery) or by 28 volts DC using a DCA-11 DC adapter with a CX-8835 cable.

B-12. FORWARD ENTRY DEVICE MESSAGE FORMATS

The FED communicates with other digital devices by using 25 fixed-format message types. These types are divided into the six categories discussed below.

a. Standard Fire Requests. FED-equipped observers use seven standard fire request messages to conduct fire missions.

Figure B-8. FORWARD ENTRY DEVICE

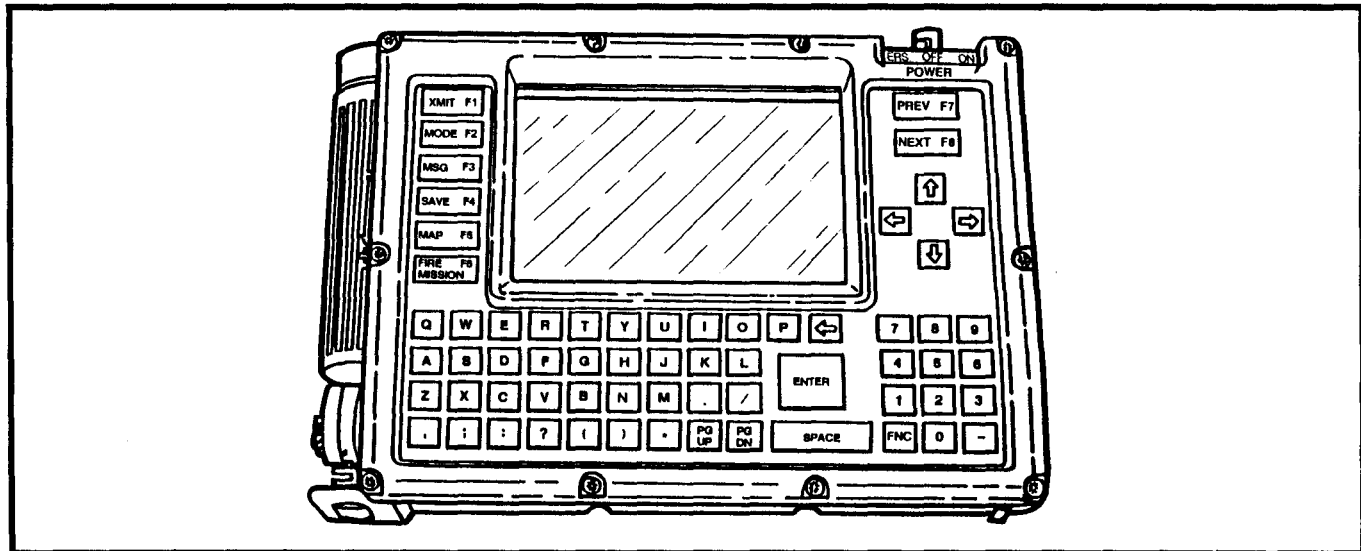

(1) **FR QUICK** (Fire Request, Quick Response). The FR QUICK message is used to request that TACFIRE or BCS assign a known point number to a previously stored target, to fire an FPF, to terminate firing an FPF, and to request fire on a known point or target that is stored in TACFIRE or BCS.

(2) **FR GRID** (Fire Request, Grid Coordinates). The FR GRID message is used to request fire by using the grid coordinates method of target location.

(3) **FR SHIFT** (Fire Request, Shift From a Known Point). The FR SHIFT message is used to request fire by using the shift from a known point method of target location.

(4) **FR POLAR** (Fire Request, Polar Coordinates). The FR POLAR message is used to request fire by using the polar coordinates method of target location.

(5) **FR LASER** (Fire Request, Laser, Polar Coordinates). The FR LASER message is used to request fire by using the laser polar coordinates method of target location. Interface with the G/VLLD enables data to be transferred directly from the G/VLLD into the FR LASER message.

(6) **FR MOV1** (Fire Request, Moving Target, One Point). The FR MOV1 message is used to request fire on a moving target by using one set of grid coordinates.

(7) **FR MOV2** (Fire Request, Moving Target, Two Points). The FR MOV2 message is used to request fire on a moving target by using two sets of grid coordinates.

b. Adjustment Messages. The four adjustment messages are used to make necessary corrections for previously requested missions.

(1) **SUBQ ADJ** (Subsequent Adjustment). The SUBQ ADJ message is used to adjust fires onto a target when an FR SHIFT or FR POLAR message has been used in the initial request for fire.

(2) **SA COORD** (Subsequent Adjustment, Grid Coordinates). The SA COORD message is used to adjust fires onto a target when an FR GRID message has been used in the initial request for fire.

(3) **SA LASER** (Subsequent Adjustment, Laser). The SA LASER message is used to adjust fires onto a target when an FR LASER message has been used in the initial request for fire.

(4) **EOM&SURV** (End of Mission and Surveillance). The EOM&SURV message permits the observer to end a fire mission, make refinements, report target surveillance, and request that a target be recorded.

c. Registration Messages. The three registration messages are used in observing precision, HB or MPI, and radar registrations.

(1) **PREC REG** (Precision Registration). The PREC REG message is used to adjust the timing of a precision registration or a destruction mission.

(2) **HB/MPI** (High Burst or Mean Point of Impact). The HB/MPI message is used to report spottings made in observing an HB or MPI registration.

(3) **RDR REG** (Radar Registration). The RDR REG message is used by a radar section to report the impact grid coordinates of rounds fired in a radar registration.

d. Intelligence Messages. The three intelligence messages are used to report information of intelligence value.

(1) **ATI GRID** (Artillery Target Intelligence, Grid Coordinates). The ATI GRID message is used to report enemy locations by use of grid coordinates.

(2) **ATI POLAR** (Artillery Target Intelligence, Polar Coordinates). The ATI POLAR message is used to report enemy locations by use of polar coordinates.

(3) **SHELREP** (Shelling Report). The SHELREP message is used to report information concerning the impact of enemy artillery or mortar fire.

e. Information Messages. The seven information messages are used to send and receive various important information.

(1) **FIRE PLAN** (Planned Fire Mission). The FIRE PLAN message is used to establish a planned fire mission.

(2) **FL TRACE** (Frontline Trace). The FL TRACE message is used to report the front line of troops of the observer's associated maneuver element.

(3) **FM ALERT** (Fire Mission Alert). The FM ALERT message is used to alert the FDC or another subscriber about a fire mission.

(4) **FO CMD** (Forward Observer Command). The FO CMD message is used to fire a mission established at the observer's command and to order check firing. The FDC uses this message to report **SHOT**, **SPLASH**, and **READY** to the observer.

(5) **MTO** (Message to Observer). The MTO is used by the FDC to report fire mission data to the observer.

(6) **OBSR LOC** (Observer Location). The OBSR LOC message is used to report the observer's location to the FIST or FIX. The FDC uses this message to report the observer's location to the observer when that location is determined by resection or trilateration.

(7) FREETEXT (Plaintext). The FREETEXT message is used for nonformatted messages.

f. Remote Loop Test. The remote loop test (LOP TEST) message is used to conduct a test of the communications link between digital subscribers. The loop test interval is established during initialization. Under normal operations, a warning message is received if the loop test fails.

B-13. MESSAGE TRANSFER MODES

The FIST's FED can be programmed to function in one of three message transfer modes for each observer.

a. Review Mode. All message traffic from an observer's FED is addressed to the FIST's FED. The message must be called up, modified if desired, and then retransmitted to the subscriber selected by the FIST.

b. Automatic Mode. A link is established between two subscribers of the FIST's FED. A message addressed to the FIST's FED for another subscriber is automatically readdressed and transmitted to the receiving subscriber. No action by the FIST is necessary when the automatic mode has been programmed for two subscribers.

c. Fire Request Approval Mode. A link is established between an observer and a fire support asset. The initial request for fire is actioned by the FIST as in the review mode. A link is then established, and subsequent messages between the observer and the fire support asset are transmitted as in the automatic mode.

B-14. PREPARATION FOR USE

Before use, the FED must be prepared as discussed below.

a. Power Source Installation. Take the following steps to install the power source:

- Turn the POWER switch to OFF.
- Remove the battery compartment cap.
- Install either a BA-5800/U battery or a DCA-11 DC adapter.

b. Communications Interface.

(1) Radio. Remove the cap from the communications (comm) port, and connect the CX-8830 cable to the FED comm port and to a radio receptacle.

(2) Wire. Strip one-half inch of insulation from the ends of the wire line, and insert them into the FED binding posts.

c. Operational Checks. Take the following steps to ensure proper operation of the FED:

- Turn the POWER switch to ON. The FED will show a self-test prompt. The self-test can be bypassed by pressing the SPACE key.
- If the main menu is displayed, press the 1 key and the ENTER key.
- Adjust the DIM and CONT knobs.
- Press the MODE key.
- Display OPERATIONAL SERVICE from the mode menu.
- Display the diagnostics menu. Select and perform diagnostic checks as needed.
- Press the MAP (F5) key to quit diagnostics.
- Press the 1 key and the ENTER key to return to the FED program.

d. Initialization. The following steps explain how to establish the FED status, net status, subscriber (member) data, and authentication table:

- Display FED STATUS from the mode menu.
- Enter FED status data in the following fields
 - NXT TARGET NO.
 - TIME SET.
 - LOP TEST.
 - OBSERVER.
 - LOCAL ADDRESS.
 - FED ADDRESS.
 - KEY BELL VOLUME.
 - MSG BELL VOLUME.
 - DISPLAY DELAY.
 - TEST DATA.
- Enter location data in the following fields:
 - EASTING.
 - NORTHING.
 - ALTITUDE.
 - GRID ZONE.

NOTE: If self-location is to be used, go to subparagraph e below.

- If equipped with a G/VLLD, enter data in the following fields:
 - CPH TIMER MOD.
 - CLOUD HEIGHT.
 - G/VLLD CODE.
 - VISIBILITY CODE.
 - Display NET STATUS from the mode menu.
 - Enter the net status data in the following fields:
 - BLOCK.
 - PREAMBLE.
 - RATE.
 - DELAY.
 - CONNECTION.
 - SQUELCH.
 - Display MEMBER DATA SUMMARY from the mode menu.
 - Enter the member's address and member data in the following fields for up to 14 members:
 - TYPE.
 - ROUTING.
 - UNIT.
 - EASTING.
 - NORTHING.
 - ALTITUDE.
 - GRID ZONE.
 - CLOUD HEIGHT.
 - G/VLLD CODE.
 - VISIBILITY CODE.
 - DEVICE TYPE.
 - ROUTING MODE.
 - OBSERVER.
 - Display AUTHENTICATION TABLE SUMMARY from the mode menu.
 - Enter authentication data consisting of member addresses, group numbers, line numbers, authenticator pairs, and an operator's key code.
 - Press the X key to enable the authentication table.
- e. Self-Location.** Calculate the FED self-location as follows:
- (1) Display FED STATUS from the mode menu.
 - (2) Display SURVEY MODE METHODS. The observer uses one of four methods in calculating FED self-location.
 - (a) *Laser One-Point Method.* The following are steps in calculating self-location by the laser one-point method:
 - Select LASER ONE POINT METHOD.
 - Enter data in the EASTING, NORTHING, ALTITUDE, and GRID ZONE fields.
 - Designate the known point.
 - Enter data in the DIRECTION, VERT ANGLE, and SLANT DIST fields.
 - Press the C key. The FED location is displayed.
 - (b) *Laser Two-Point Method.* The following are steps in calculating self-location by the laser two-point method:
 - Select LASER TWO POINT METHOD
 - Enter data in the EASTING, NORTHING, and ALTITUDE fields for the left known point.
 - Designate the left known point.
 - Enter data in the DIRECTION, VERT ANGLE, and SLANT DIST fields for the left known point.
 - Repeat the preceding three steps for the right known point.
 - Enter data in the GRID ZONE field.
 - Press the C key. The FED location is displayed.
 - (c) *Manual Direction Method.* The following are steps in calculating self-location by the manual direction method:
 - Select MANUAL DIRECTION METHOD.
 - Enter data in the EASTING, NORTHING, and DIRECTION fields for the left known point.

NOTE: Cloud height, G/VLLD code, and visibility code are laser data for an FO with a laser device.

- Display MEMBER MONITOR from the mode menu.
- Enter member monitor data consisting of addresses for each member and message groups to be monitored.

- Enter data in the EASTING, NORTHING, and DIRECTION fields for the right known point.
- Enter data in the GRID ZONE field.
- Press the C key. The FED location is displayed.

(d) *Manual Distance Method.* The following are steps in calculating self-location by the manual distance method:

- Select MANUAL DISTANCE METHOD.
- Enter data in the EASTING, NORTHING, and DISTANCE fields for the left known point.
- Enter data in the EASTING, NORTHING, and DISTANCE fields for the right known point.
- Enter data in the GRID ZONE field.
- Press the C key. The FED location is displayed.

B-15. POWER OR COMMUNICATIONS FAILURE

In case of power or communications failure, certain steps must be taken to restore the FED to operation.

WARNING

Before reestablishing power, always turn the POWER switch to OFF.

a. Battery Power. The following are steps for restoring battery power:

- Replace the BA-5800/U battery.
- Turn the POWER switch to ON and wait 60 seconds. If FED POWER UP does not appear on the display screen, change to an alternate power source or send the FED to maintenance.

b. External Power. The following are steps for restoring power from an external source:

- Check the CX-8835 cable for damaged or loose connections. If it is damaged, replace it with an undamaged cable or change to internal battery power.
- Remove the CX-8835 cable, and remove the DCA-11 DC adapter from the cable.
- Check the adapter for damage. If it is damaged, insert another adapter and replace the CX-8835 cable.
- Turn the POWER switch to ON and wait 60 seconds. If FED POWER UP does not appear on the display screen, change to alternate power source or send the FED to maintenance.

c. Communications Failure. The following are steps for restoring communications:

- If a “no acknowledgement” is received, the FED will try to transmit the message three additional times.
- If attempts are unsuccessful, contact the subscriber by alternate means.
- Determine if incorrect net status data is the reason for failure. Correct net status data and try message transmission again.
- If still unable to communicate and if using wire, check the binding posts for loose connections and the wire for breaks. Repair and replace wire as necessary.
- If still unable to communicate and if using radio, troubleshoot the radio IAW appropriate technical publications. If troubleshooting is unsuccessful, replace the radio.
- After problems have been corrected, display MESSAGE TYPES from the mode menu.
- Display FREETEXT message, and enter data in the AUTH, DEST, and TEXT fields.
- Transmit the FREETEXT message. If digital communication is unsuccessful, send the FED to maintenance.

B-16. SAVE OR PURGE DATA AND POWER DOWN

The following paragraphs cover how to save or purge all operational data, how to power down the FED, and how to disconnect the communications and power sources.

a. Save Data. The following are steps to save data

- Display the mode menu.
- Press the S key. DATA BASE SAVE COMPLETE should appear on the screen.
- Turn the POWER switch to OFF.

b. Purge Data. The following are steps to purge operational data:

- Display the mode menu.
- Press the Z key, and turn the POWER switch to OFF.

c. Disconnect Power Source. Remove either the BA-5800/U battery or the DCA-11 DC adapter from the FED.

d. Disconnect Communications Equipment. Remove the CX-8830 cable if using a radio. If using wire, remove the wire.

B-17. UP-LOAD AND DOWN-LOAD THE CURRENT FORWARD ENTRY DEVICE SOFTWARE

The following paragraphs provide information on how to connect a host FED to a target FED and how to transfer current software data from the host FED to the target FED.

a. Connect a host FED to a target FED by using a CX-8834 cable.

b. If the target FED has no software, initialize it as follows:

- Turn the POWER switch to ON. The main menu should be displayed.
- Display the setup menu.
- Display DATE CHANGE, and enter the current date.
- Display TIME CHANGE, and enter the current time.
- Display DISK VOLUME, and enter 016 for the random-access memory (RAM) disk volume.

c. If the target FED has software, down-load the host FED current software as follows:

- Turn the POWER switch to ON.
- Display the main menu from OPERATIONAL SERVICE.
- Display UPLOAD/DOWNLOAD.
- Display PERIPHERAL DEVICE INTERFACE from CHANNEL SET UP.
- Enter and save setup data (Ensure data rate is 56000.)
- Display SEND FILE.
- Enter drive name C:/ and file name FED.FL; then start file transfer.

d. Up-load at the target FED as follows:

- Turn the POWER switch to ON.
- Display the main menu from OPERATIONAL SERVICE (only at target FED with software).
- Display UPLOAD/DOWNLOAD.
- Display PERIPHERAL DEVICE INTERFACE from CHANNEL SET UP.
- Enter and save set-up data. (Ensure data rate is 56000.)
- Display GET FILE.
- Enter drive name C:/ and file name FED.FL; then start file transfer.
- Repeat the procedures to down-load the host FED and down-load the target FED, as shown above, to up-load file FED.EXE by using drive C:\HTUAPP.

e. Return the host and target FEDs to mode menu as follows:

- Display MAIN MENU.
- Select the option to load applications program.
- Press the MODE key.

f. Complete the up-load and down-load of software as follows:

- Disconnect the host FED from the target FED.
- Turn the POWER switch to OFF on both FEDs.
- Remove the CX-8834 cable from both FEDs.

B-18. MESSAGE PROCESSING PROCEDURES

a. **Processing Messages in the Received or Saved Message Queues or the Message Copies File.** This paragraph covers procedures on how to display a message from the received or saved message queue and from the message copies file, how to edit and transmit a message from the received or saved message queue, and how to save or delete a message in the received or saved message queue.

(1) Display a message from the received or saved message queue as follows:

- Press the MSG key to display a received message.
- Press the SAVE key to display a saved message.

(2) Display a message from the message copies file as follows:

- Press the MODE key.
- Select MESSAGE COPIES; then select the desired message.

NOTE: Messages from the MESSAGE COPIES file can only be displayed.

(3) Edit and transmit a message in the received or saved message queue as follows:

- Display and edit the selected fields.
- Transmit the message. The status line should display an ACK.

(4) Save a message in the received or saved message queue as follows:

- Select the message to be saved.
- Press the S key.

(5) Delete a message in the received or saved message queue as follows:

- Select the message to be deleted.
- Press the D key.

b. Moving and Copying Messages in the Local Files.

(1) Move a message in the local files as follows:

- Display LOCAL FILES from the mode menu.
- Select the message to be moved.
- Press the D key.
- Select the file to which the message will move.

(2) Copy a message in local files as follows:

- Display LOCAL FILES from the mode menu.
- Select the message to be copied.
- Press the E key.
- Select the file to which the message will be copied.

c. Processing Information Messages. Process information messages as follows:

- Select MESSAGE TYPES from the mode menu.
- Select the desired message format; complete and review the message.
- Transmit the message. ACK should appear in the status line.

d. Processing Mission Data in the Mission Data Files. The following are procedures to display mission data from the active mission list or member data summary and to edit or delete a mission data record:

- Display ACTIVE MISSION LIST or MEMBER DATA SUMMARY from the mode menu.
- Select the mission data record from ACTIVE MISSION LIST or MEMBER DATA SUMMARY.
- Edit mission data as follows:
 - Enter changes to data in selected fields of the displayed MISSION DATA record. The fire request or last mission message can be edited while viewing the MISSION DATA display. Editing the fire request updates the last mission message and the original fire request.
 - Redisplay the ACTIVE MISSION LIST or MEMBER DATA SUMMARY.
- Delete the mission data record by pressing the D key. ACTIVE MISSION LIST or MEMBER DATA SUMMARY will appear on the screen.

e. Processing Local Known Points.

(1) Create a local known point as follows:

- Display MESSAGE TYPES from the mode menu.
- Display the FR GRID message.
- Enter data as required, including SPC EOM RAT in the CONTROL field.
- Press the XMIT key. The status line will not appear.

(2) Delete a local known point as follows:

- Display LOCAL KNOWN POINTS from the mode menu.
- Select the local known point to be deleted, and press the D key.

f. Processing Recorded Targets.

(1) Create a recorded target as follows:

- Display RECORDED TARGETS from the mode menu.
- Display the next blank RECORDED TARGET DATA display.
- Enter data as required.

(2) Display a recorded target as follows:

- Display RECORDED TARGETS from the mode menu.
- Select the recorded target record.

(3) Edit a recorded target as follows:

- Enter changed data in fields to be updated.
- Display RECORDED TARGETS file.

(4) Delete a recorded target as follows:

- Select the recorded target record.
- Press the D key to delete the record.
- Press the Y key. A FREETEXT message is shown addressed to the subscriber that created the recorded target.
- Transmit the FREETEXT message. ACK should appear in the status line.

B-19. FIRE MISSION PROCESSING PROCEDURES

a. Area Fire Mission Procedures.

(1) Initiate an area fire mission as follows:

- Display MESSAGE TYPES from the mode menu.

- Display the fire request message. The FR GRID, FR SHIFT, FR POLAR, or FR LASER format is used to initiate an area fire mission.
 - Enter data as required.
 - Transmit the fire request to the FDC, ACK should appear in the status line.
 - Display the MTO, FO CMD:SHOT, and FO CMD:SPLASH messages in sequence as received.
- (2) Process subsequent adjustments as follows:
- Display MESSAGE TYPES from the mode menu.
 - Display the subsequent adjustment message. The SUBQ ADJ, SA COORD, or SA LASER format is used to process a subsequent adjustment.
 - Enter refinement data for each subsequent observed round.
 - Transmit the subsequent adjustment message. ACK should appear in the status line.
- (3) End the fire mission as follows:
- Display MESSAGE TYPES from the mode menu.
 - Display the EOM&SURV message.
 - Enter final refinement and surveillance data and either EOM or EOM RAT.
 - Transmit the EOM&SURV message. ACK should appear in the status line.
 - Display the received MTO if a recorded target will be created.

b. Precision Registration Mission Procedures. The FDC initiates the precision registration mission by requesting the observer's direction to a target specified by the FDC or selected by the observer.

- (1) Initiate a precision registration mission as follows:
- Display MESSAGE TYPES from the mode menu.
 - Display the FR GRID message.
 - Enter data as required, including REG AF or AMC REG in the CONTROL field.
 - Transmit the message to the FDC. ACK should appear in the status line.
 - Display the MTO, FO CMD:SHOT, and FO CMD:SPLASH messages in sequence as received.
- (2) Process subsequent adjustments as follows:
- Display MESSAGE TYPES from the mode menu.
 - Enter data as required.

- Transmit the message. ACK should appear in the status line.
 - Display the FO CMD:SHOT and FO CMD:SPLASH messages in sequence as received.
- (3) End the impact phase of the precision registration as follows:
- Display MESSAGE TYPES from the mode menu.
 - Display the PREC REG message.
 - Enter data as required including RCRD REG PT in the COMMAND field. Enter TIME RPT in the FUZE field if a time phase is to be conducted.
 - Transmit the message. ACK should appear in the status line.
 - Display the FO CMD:SHOT and FO CMD:SPLASH messages in sequence as received.
- (4) Conduct the time phase of the precision registration as follows:
- Display MESSAGE TYPES from the mode menu.
 - Display the PREC REG message.
 - Enter data as required.
 - Transmit the message. ACK should appear in the status line.
 - Display the FO CMD:SHOT and FO CMD:SPLASH messages in sequence as received.
- (5) End the time phase of the precision registration as follows:
- Display MESSAGE TYPES from the mode menu.
 - Display the PREC REG message.
 - Enter data as required, including RCRD AS TI REG PT in the COMMAND field and EOM in the CONTROL field.
 - Transmit the message. ACK should appear in the status line.

c. High Burst/Mean-Point-of-Impact Registration Mission Procedures.

- (1) Initiate an HB or MPI registration mission as follows:
- Display the received HB/MPI message.
 - Display MESSAGE TYPES from the mode menu.
 - Display the FREETEXT message.
 - Enter READY TO OBSERVE in the FREETEXT message.

- Transmit the FREETEXT message to the FDC. ACK should appear in the status line.
- Display the FO CMD:READY, FO CMD:SHOT, and FO CMD:SPLASH messages in sequence as received.

(2) Process subsequent adjustments as follows:

- Display MESSAGE TYPES from the mode menu.
- Display the HB/MPI message.
- Enter data as required, including OBSERVED ERROR and DIRECTION ERROR, and VERT ANGLE ERROR if required to report vertical angle spotting.
- Transmit HB/MFI message. ACK should appear in the status line.
- Display the received FO CMD:SHOT message.

(3) To end the HB/MPI mission, the FDC sends a FREETEXT message when it has sufficient data. End the mission as follows:

- Display the received FREETEXT message.
- Display the LOCAL FILES from the mode menu.
- Delete the HB/MPI mission.

d. Copperhead Mission Procedures.

(1) Initiate the Copperhead mission as follows:

- Display MESSAGE TYPES from the mode menu.
- Display the fire request message. The FR (HUD, FR POLAR, or FR LASER format is used to initiate a Copperhead mission.
- Enter data as required. If a priority target, CONTROL is DNL and PRIORITY is ASGN FPF. If a target of opportunity, CONTROL is AMC/FFE and PRIORITY is URGENT.
- Transmit the message to the FDC. ACK should appear in the status line.

(2) Issue the command to fire as follows:

- Display the received MTO.
- Display the received FO CMD:READY (target of opportunity) or the MTO from MISSION DATA through the local fires (priority target).
- Prepare the FO CMD:FIRE message (target of opportunity).
- Transmit the FO CMD:FIRE message. ACK should appear in the status line. (Target of opportunity procedures for issuing the command to fire end here.)
- Prepare the FR QUICK message (priority target).

- Store the FR QUICK message in an off-line file of the local files (priority target). Other functions can be performed until it is time to execute the priority fire mission.

- Select the stored FR QUICK message from the local files (priority target).

- Move the FR QUICK message to file 1 or 2 (priority target).

- Transmit the message. ACK should appear in the status line. (Priority target procedures for issuing the command to fire end here.)

(3) Execute the Copperhead mission as follows:

- The observer should receive an FO CMD:SHOT message within 15 to 20 seconds. When that message is received the counter starts automatically. If the FO CMD is not received, press the S key to start the counter.

- **When the counter reaches 20 seconds, **DESIGNATE** will appear on the screen.** Designate the target until all rounds have impacted. When multiple rounds are fired, the FDC will transmit FO CMD:RNDS COMP after all rounds have been fired.

(4) Delete the Copperhead mission as follows:

- Display MESSAGE TYPES from the mode menu.
- Display the EOM&SURV message format (target of opportunity) or the FR QUICK message format (priority target).
- Enter data as required, including EOM in the CONTROL field (target of opportunity) or DELETE in the KNOWN POINT field (priority target).
- Transmit the message. ACK should appear in the status line.

e. Final Protective Fire (FPF) Mission Procedures.

The following procedures detail how to conduct a center point or a laser draw FPF mission.

(1) Initiate the FPF mission as follows:

NOTE: When conducting a laser draw mission, the automatic target numbering capability must be turned off first.

- Display MESSAGE TYPES from the mode menu.
- Display the fire request message. To initiate an FPF, use the FR GRID, FR LASER, FR POLAR, or FR SHIFT format.

- Enter data as required. If conducting a laser draw mission, MISSION is DRAW TGT, CONTROL is FFE, and PRIORITY is ASGN FPF. If conducting a center point mission, CONTROL is DC AF and PRIORITY is ASGN FPF.
- Transmit the message. ACK should appear in the status line.

NOTE: If conducting a laser draw mission, transmit an FR LASER message for each aimpoint requested by the FDC. For the last aimpoint transmitted, MISSION is LAST PNT.

- Display the MTO, FO CMD:SHOT, and FO CMD:SPLASH messages in sequence as received.
- (2) Process subsequent adjustments as follows:
- Display MESSAGE TYPES from the mode menu.
 - Display the subsequent adjustment message. If conducting a laser draw mission, use SA LASER. If conducting a center point mission, use SUBQ ADJ or SA LASER.
 - Enter data as required, including DC AF in the CONTROL field.
 - Transmit the SUBQ ADJ or SA LASER message. ACK should appear in the status line.

NOTE: The preceding procedures for subsequent adjustments are followed until the adjustment phase is completed.

- (3) End the adjustment phase of the FPF as follows:
- Display MESSAGE TYPES from the mode menu.
 - Display the EOM&SURV message.
 - Enter data as required, including EOM or EOM RAT in the CONTROL field.
 - Transmit the EOM&SURV message. ACK should appear in the status line. If the location will not be recorded as a target, the end of adjustment phase is complete.
 - Display the MTO message received from the FDC.
- (4) Execute the FPF as follows:
- Display MESSAGE TYPES from the mode menu.
 - Display the FR QUICK message.

- Enter data as required, including FIRE FPF in the KNOWN POINT field.
 - Transmit the FR QUICK message. ACK should appear in the status line.
 - Display the FO CMD:SHOT and FO CMD:SPLASH messages in sequence as received.
- (5) End the FPF as follows:
- Display MESSAGE TYPES from the mode menu.
 - Display the FR QUICK message.
 - Enter data as required including END FPF in the KNOWN POINT field.
 - Transmit the FR QUICK message. ACK should appear in the status line.
 - Display the received FO CMD:SHOT message.

NOTE: To save an FPF in the off-line file for reexecution later, follow the procedures in subparagraph B-18b above.

- (6) Delete the FPF as follows:
- Display MESSAGE TYPES from the mode menu.
 - Display the FR QUICK message.
 - Enter data as required, including DELETE in the KNOWN POINT field.
 - Transmit the FR QUICK message. ACK should appear in the status line.

f. Moving Target Mission Procedures.

- (1) Initiate a moving target mission as follows:
- (a) Display MESSAGE TYPES from the mode menu.
 - (b) Display FR MOV1 or FR MOV2 message.
 - (c) Enter data as required, including PRTY FS in the PRIORITY field.
 - (d) Transmit FR MOV1 or FR MOV2 message to the FDC. ACK should appear in the status line.
 - (e) Display MTO received from the FDC.

NOTE: If the following messages are received, go to the subparagraphs indicated and continue the procedures:

FO CMD:UPDTGT	f(l)(f)
Accurate FO CMD:PREDPT—not under check fire	f(l)(i)
Inaccurate FO CMD:PREDPT	f(l)(j)
Accurate FO CMD:PREDPT—under check fire	f(l)(o)

- (f) Form FR MOV1 or FR MOV2 message.
- (g) Enter updated information as required.
- (h) Transmit FR MOV1 or FR MOV2 message. ACK should appear in the status line.

NOTE: Go to subparagraph f(1)(f) to process the next FO CMD.

- (i) Press the PREV key.
- (j) Form the FO CMD:CHECK FIRE message.
- (k) Transmit the FO CMD:CHECK FIRE message. ACK should appear in the status line.
- (l) Form the last FR MOV1 or FR MOV2 message.
- (m) Enter updated information as required.
- (n) Transmit the FR MOV1 or FR MOV2 message. ACK should appear in the status line.

NOTE: Go to subparagraph f(1)(f) to process the next FO CMD.

- (o) Press the PREV key.
- (p) Display MESSAGE TYPES from the mode menu.
- (q) Display the FO CMD message.
- (r) Enter data as required, including CANCEFR in the MISSION INFO field.
- (s) Transmit the FO CMD message. ACK should appear in the status line.

- (2) Delete a moving target mission as follows:
 - Display local files from the mode menu.
 - Display MISSION DATA for the moving target mission.
 - Press the D key to delete the mission.

g. Immediate Suppression Mission Procedures.

- (1) Initiate an immediate suppression mission as follows:
 - (a) Press the FIRE MISSION (F6) key.

NOTE: If FR GRID is displayed, go to subparagraph g(1)(d). If LOCAL FILES is displayed with a warning, go to subparagraph g(1)(b).

- (b) Select MESSAGE TYPES.
- (c) Display the FR GRID message.
- (d) Enter data as required, including FFE in the CONTROL field and URGENT in the PRIORITY field.
- (e) Transmit the fire request to the FDC. ACK should appear in the status line.
- (f) Display the MTO, FO CMD:SHOT, and FO CMD:SPLASH messages in sequence as received.

- (2) Process subsequent adjustments as follows:
 - Display MESSAGE TYPES from the mode menu.
 - Display the SUBQ ADJ message.
 - Enter required refinement and surveillance data for each subsequent observed round including RFFE in the CONTROL field.
 - Transmit subsequent adjustment message. ACK should appear in the status line.

- (3) End the fire mission as follows:
 - Display MESSAGE TYPES from the mode menu.
 - Display the EOM&SURV message.
 - Enter final refinement and surveillance data and either EOM or EOM RAT.
 - Transmit the EOM&SURV message. ACK should appear in the status line.
 - Display the received MTO if a recorded target is to be created.

B-20. CHECK FIRE AND CANCEL CHECK FIRE PROCEDURES

- a. Check fire a fire mission as follows:
 - Display MESSAGE TYPES from the mode menu.
 - Display the FO CMD message.
 - Enter data as required.
 - Transmit the message. ACK should appear in the status line.
- b. Cancel check fire on a fire mission as follows:
 - Display MESSAGE TYPES from the mode menu.
 - Display the FO CMD message.
 - Enter data as required.
 - Transmit the message. ACK should appear in the status line.

Section III

FIST DIGITAL MESSAGE DEVICE

B-21. OPERATION OF THE FIST DMD (AN/PSG-5)

The FIST DMD (Figure B-9) has three major functions:

- Reduce the number of subscribers handled by the TACFIRE computer.
- Provide internet communications.
- Coordinate local company FSO resources.

a. Use of the FIST DMD reduces the number of TACFIRE computer subscribers. All communicating resources assigned to a FIST normally communicate only with the FIST DMD. All forward observer-TACFIRE communications can be controlled by the FIST DMD. The company FSO decides which information must be forwarded to TACFIRE.

b. Instead of each FO communicating directly with TACFIRE, all FOs assigned to a FIST normally communicate only with the FIST DMD. The company FSO has control in deciding the destination of information from each subscriber. Two obvious benefits from this system are:

- The elimination of duplicate targets before they reach TACFIRE.
- The elimination of targets from TACFIRE that can be accommodated by the local FIST resources, such as the company and battalion mortars.

The net effect of these changes is to reduce the number of messages handled by TACFIRE, thus improving reaction time of the system.

c. The FIST DMD allows communication among the various communications nets. Thus, an FO on one radio net can communicate, through the FIST DMD, with a subscriber on a different radio net without changing his radio. The only requirement is that both subscribers appear in the net assignment table of the FIST DMD. Figure B-10 shows one possible configuration with the subscribers shown in the FIST DMD net assignment table. With this arrangement, it is possible, with the approval of the company FSO, for DMD A on net 2 to run a mission with a howitzer platoon BCS (S) on net 1. The FIST DMD provides the communications link between nets 1 and 2.

Figure B-9. FIST DMD

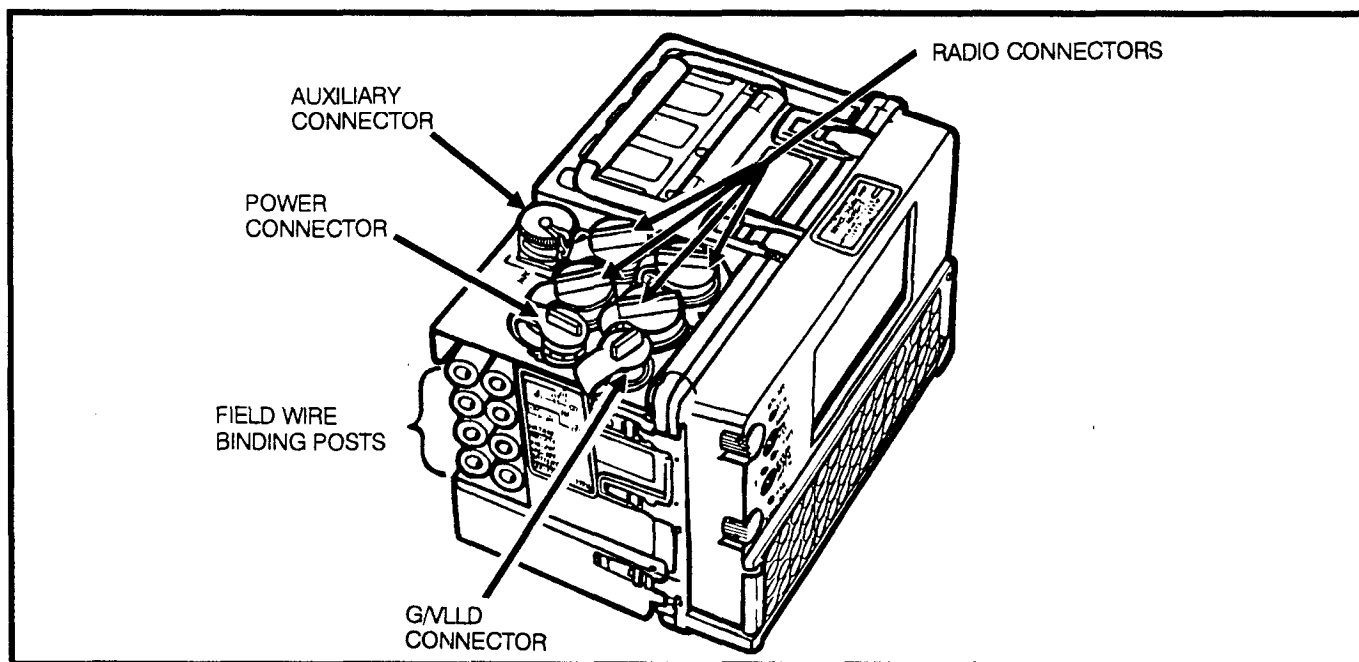

d. Except for the relay function, all traffic is addressed to the FIST DMD (F in Figure B-10). The company FSO decides which subscribers can communicate with each other and under what circumstances this communication will be allowed. For example, if DMD A initiates a fire request, the company FSO may decide that the battalion mortars are the proper choice for the particular target type. The company FSO can route the fire request and all subsequent messages related to that target to the battalion mortars (R). This type of operation is called the fire request approval mode.

e. There are two other modes of operation. Before DMD A started the fire request, the company FSO could have decided that all traffic from DMD A should automatically be routed to another subscriber; for example, the battalion

FDC. This is called the automatic mode. The company FSO also could have placed DMD A in the review mode. In this mode, all traffic from a subscriber (for example, DMD A) must be viewed by the company FSO. The company FSO then has the choice of forwarding the unaltered traffic to another subscriber (for example, battalion FDC), changing the text of the traffic and forwarding it to another subscriber, or terminating the message.

f. Thus, some of the decisions that were previously made at the battalion TACFIRE level are now made by the company FSO. The FIST DMD gives the company FSO the means to use and coordinate his local resources, provide the necessary communications links, and reduce the traffic volume at the battalion TACFIRE level.

Figure B-10. TYPICAL NET ASSIGNMENTS

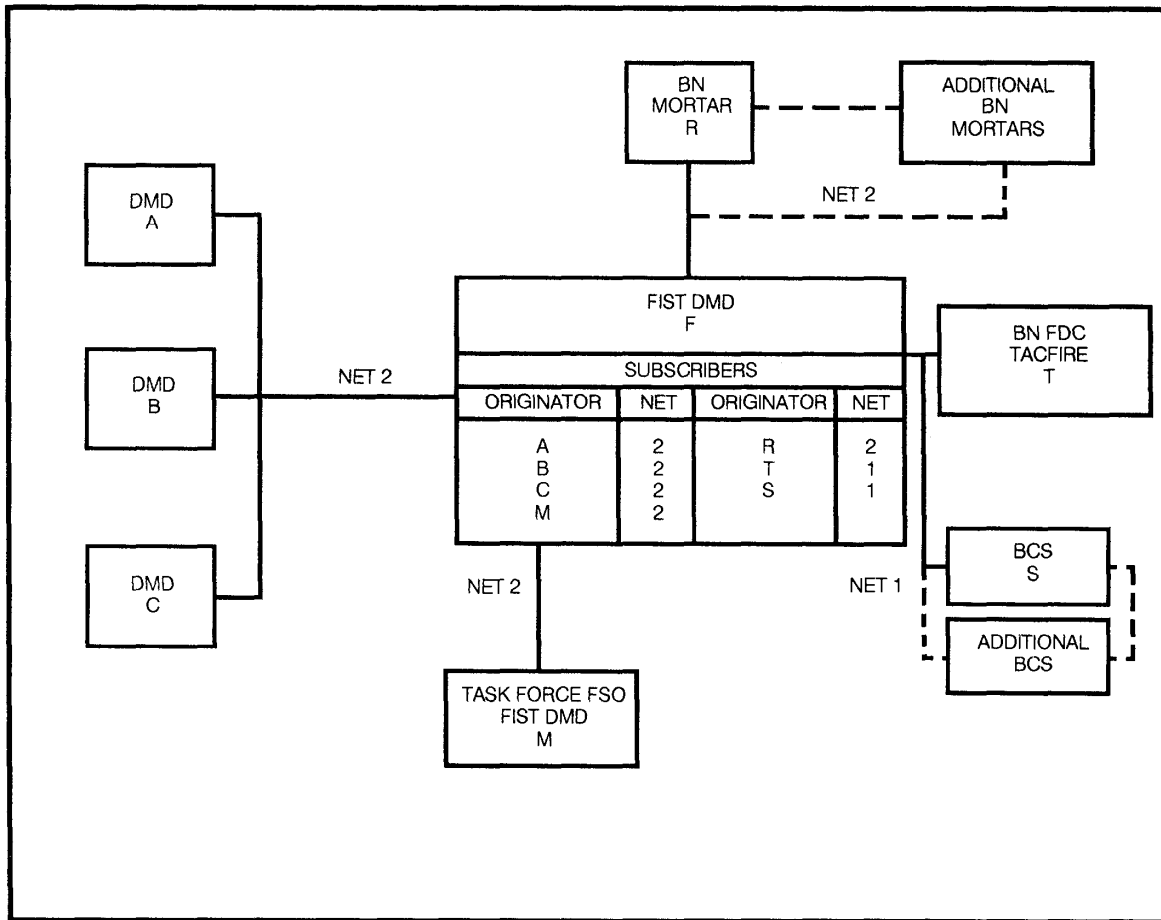

B-22. FUNCTIONAL DESCRIPTION

In addition to its other functions, the FIST DMD can be used as an FO DMD. All operations that are possible with an FO DMD are also possible with the FIST DMD. In addition, expanded capabilities are provided. These capabilities which are unique to the FIST DMD, are explained in the following paragraphs.

a. FIST Location. The FIST location, casting, northing, and altitude, can be entered in the FIST DMD any one of three ways. If the absolute grid location of the FIST is known, it can be manually entered directly into the FIST DMD. The second method involves observation of a single known point in calculating the FIST location. The observation data may be entered manually through the keyboard or automatically from the G/VLLD. The FIST location also can be determined by use of observations to two known points. The calculation necessary to determine the FIST location in grid coordinates is done automatically by pressing one key of the FIST DMD. The location calculated is displayed in the STATUS display of the FIST DMD and is used in converting polar data to grid data.

b. Polar to Grid Conversion. The FIST DMD operator may convert polar data to grid data. He can convert the following message types:

- From ATI POLAR to ATI GRID.
- From FR POLAR to FR GRID.
- From FR LASER to FR GRID.

For example, the FIST DMD operator may use his laser range finder to supply polar data in an FR LASER message he is composing. He may transmit the completed FR LASER message, or he may choose to have the FIST DMD automatically convert it to an FR GRID message before he transmits it.

c. Mission Buffers. The MSN1 and MSN2 buffers are the only two buffers from which messages can be transmitted, only one of these buffers can be active at a time. Unlike the FO DMD, a mission can be initiated in the active mission buffer and then stored in the off-line message files. When done in this manner, the mission data are also stored in the off-line file, and the file is protected against any changes. When a message that was originally composed in a mission buffer is moved from the off-line message files back to the active mission buffer, the current message in the active mission is destroyed. The mission data in the off-line file are also transferred along with the message. Using this feature, it is possible to interrupt a mission and start a new one. When the new mission is completed the old mission can be resumed without loss of data.

d. Message Files. As with the FO DMD, the message files, F3 through F9, can be used for off-line message composition.

A unique feature of these buffers in the FIST DMD is that a mission data file is associated with each buffer.

e. Message Transfer. Just as with an FO DMD, messages also can be composed directly in the off-line message files. However, in this case, a separate mission data buffer is not associated with the composed message. Also, when the message is transferred to the active mission buffer, the current message in the active mission buffer is destroyed and the message that is transferred uses the mission information in the active mission data file. The message that was composed in the off-line message file is not erased from the message file when it is transferred to the active mission buffer. However, active missions that were transferred to the message files are erased from the message files when they are moved back to the active mission buffer.

EXAMPLE

A priority Copperhead mission is stored in buffer F3. There is a mission data file associated with buffer F3 that contains data such as target number, time of flight, and mission number. These data are used in the composition of several different messages when this mission is running. MSN1 buffer is active, and the FIST DMD operator is running a non-Copperhead mission. In the middle of this mission, the Copperhead priority target appears. The FIST DMD operator decides that the target is more important than the mission he is currently running. He files the active mission. This moves the message in the MSN1 buffer and the associated mission data to a message file. Then message file F3 is activated. This moves the message and associated mission data from buffer F3 to the active buffer, MSN1. The proper mission data and message are now in the active mission buffer, MSN1, and the active mission data file. The Copperhead mission can be completed. After completion of the Copperhead mission, the old mission can be resumed by repeating the message or data transfer procedure.

f. File Protection. If a message is composed in an active mission buffer and stored in off-line files or is currently in the active mission huller, it will be protected from changes. If a Copperhead-related message or an FPF message that was originally composed in the active mission buffer is stored in the off-line files, it will be shown in the MESSAGE FILES display with an underlined C for Copperhead or an underlined F for an FPF mission. Other types of missions that were originally started in the active mission buffer and then transferred to the off-line message files are indicated by an underlined A in the MESSAGE FILES display. Any attempt to change any of these stored messages or to file another message in the same file will cause an error message to be displayed. It will state either CANNOT CHANGE FILED ACTIVE MSN or ACTION WOULD DELETE FPF OR COPPERHEAD PRIORITY MESSAGE.

Section IV
MORTAR BALLISTIC COMPUTER M23

B-23. DESCRIPTION

The MBC (Figure B-11) is hand-held, lightweight, and battery-powered. It is used for automated computations, digital communications, and displaying mortar-related information.

B-24. CAPABILITIES

The MBC performs the following functions:

- Communicates with the DMD and FIST DMD.
- Computes firing data.
- Computes and applies meteorological corrections.
- Applies registration corrections.

B-25. MEMORY STORAGE

The MBC storage contains the following:

- Three active fire mission.
- Three messages.

- Eighteen weapons (three sections with up to six weapons each).
- Twelve forward observers.
- Fifty known points or registrations.
- Sixteen registration points.
- Ten no-fire zones.
- Three FPFs.
- Three safety fans.
- One no-free line (eight points each).

B-26. DMD SUPPORTED MISSION PROCESSING

The MBC transmits and receives digital communications from DMDs or FIST DMDs. This capability reduces mission processing time and provides a more secure communications network. The MBC receives and processes digital fire requests (FR) and subsequent adjust (SA) messages. It can transmit ACL MTO, and shot or splash messages.

Figure B-11. MORTAR BALLISTIC COMPUTER M23

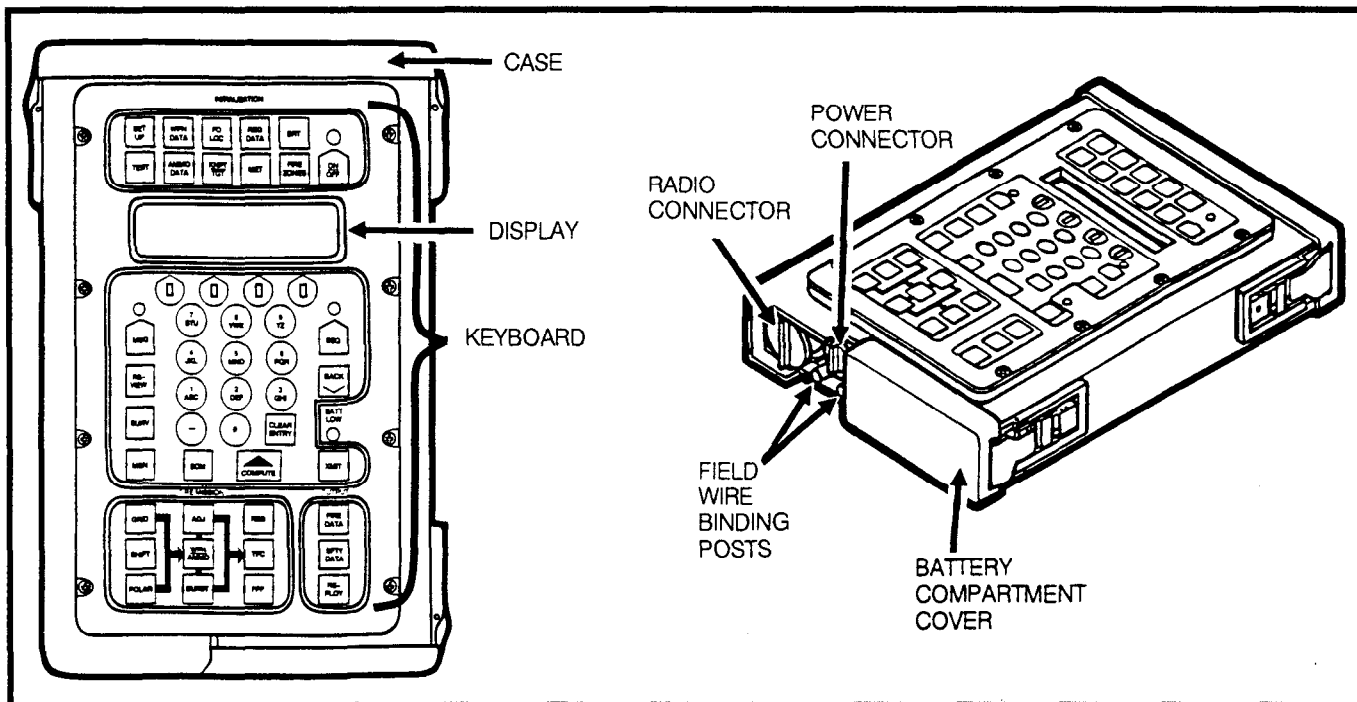

Section V

SPECIAL-PURPOSE POWER SOURCES**B-27. VEHICLES**

The DMD AN/PSG-2A and the FIST DMD AN/PSG-5 may be operated with 24-volt DC vehicular power. A receptacle cable assembly unique to, each device listed herein is available for connection to vehicle receptacles. (The DMD may be connected directly to the vehicle battery terminals by using a battery cable assembly.)

NOTES:

1. Refer to the operator's manual for each of the above devices before connecting electrical power because of the characteristics peculiar to each device.
2. Operator's manual references are for the DMD, TM 11-7440-281-12&P and for the FIST DMD, TM 11-7025-244-12&P.
3. Maintenance of vehicular power sources is critical with the additional drain of energy. Periodic checks and recharging of batteries are required. The appropriate type of vehicle operator's manual should be referenced for proper care of electrical systems.

B-28. INTERNAL BATTERIES

Sealed, rechargeable, nickel-cadmium (NICAD) batteries (BB-557/U) are issued for the DMD. A nonrechargeable lithium battery BA-5557/U (paragraph B-30) may also be used. The NICAD operating capacity varies depending on the storage time, energy level, temperature, and charge-discharge cycles.

NOTES:

1. Before NICAD batteries are recharged, they should be discharged if they have not been in the normal mode of operation or in storage. This is to avoid "memory" effects.
2. NICAD maintenance and recharging requirements for normal and extended operational needs must be considered. Refer to the appropriate TM for recommended maintenance.

B-29. EXTERNAL BATTERIES

The DMD may be powered by an external lithium battery BA-5590/U (paragraph B-30) or a NICAD battery BB-590U.

The batteries which can be used internally (BB-557/U and BA-5557/U) may also be used externally.

B-30. SPECIAL HANDLING PROCEDURES FOR LITHIUM BATTERIES

a. Description. The BA-5557/U and BA-5590/U batteries are high-energy power sources that contain lithium metal, sulfur dioxide, and organic solvents under pressure in sealed stainless steel cells. The contents are potentially flammable and noxious.

b. Safety Features.

(1) The batteries are protected by a 1.0-ampere slow-blow replaceable fuse to protect against excessive currents or external short circuits. These could lead to overheating, cell venting, or rupture. This fuse should not be bypassed or replaced with a higher rated fuse.

(2) Each cell has a venting device which releases internal cell pressure if it becomes excessive. Venting occurs when the cells are overheated (200° to 220°F). This prevents the cells from rupturing. If a cell vents, sulfur dioxide gas, which is a noxious eye and respiratory irritant, will be released. Irritation will occur long before toxic concentrations of sulfur dioxide are reached. These batteries contain no radioactive materials.

c. Precautions.

(1) Storage. Lithium batteries should be stored in a well-ventilated, cool facility. Refrigeration is not required. Battery life decreases with storage time and increasing temperatures. For this reason, temperatures above 130°F should be avoided.

(2) Handling. Lithium batteries contain pressurized cells similar to aerosol cans. To avoid cell rupture, the batteries should not be deliberately opened, crushed, punctured, disassembled, or otherwise mutilated. Lithium batteries should not be heated or incinerated, as overheating may cause cell venting or rupture. Under no circumstances should the batteries be recharged.

(3) Transportation. Shipment of lithium batteries is regulated by TM 38-250.

(4) Disposal. Lithium batteries are environmentally harmful. Therefore, users must turn them in to support maintenance for proper disposal.

(5) Overheating. In the unlikely event you detect the battery compartment becoming unusually hot, hear cells venting, or smell sulfur dioxide, take the following actions.

- Turn off the DMD.
- Carefully remove or disconnect the battery from the DMD, and place it away from equipment and personnel.
- If the battery cannot be removed, place the DMD away from other equipment and personnel.

- Dispose of the battery IAW subparagraph (4) above when it has cooled (after 30 to 60 minutes).

(6) Fire. Fires in which lithium batteries are involved can generally be extinguished by using enough water to "flood" the burning materials. Exposed lithium metal will burn and may not respond to the water treatment. A graphite compound will extinguish burning lithium. Carbon dioxide extinguishers are ineffective against lithium fires.

(7) Removal. When the DMD will not be used for 30 days or more, the lithium battery should be removed.

Section VI
MNEMONICS

**B-31 . DMD, FIST DMD, AND FED
MNEMONICS**

Table B-1 shows mnemonics used by the DMD, the FIST DMD, and the FED.

Table B-1. MNEMONICS USED BY THE DMD, THE FIST DMD, AND THE FED

MNEMONIC	INTERPRETATION
ACTV	activity—operational check in progress
ADA	air defense artillery
A/D	add or drop
ADJ FIRE	adjust fire
ALT	altitude
AMC AF	at my command adjust fire
AMC DEST	at my command destruction
AMC FFE	at my command fire for effect
AMC REG	at my command registration
AMC/RFFE	at my command repeat fire for effect
AMC RPT	at my command repeat
AMMO	ammunition
ANGLE T	Angle T
APC	armored personnel carrier
APERS	antipersonnel
ARTY	artillery

Table B-1. MNEMONICS USED BY THE DMD, THE FIST DMD, AND THE FED (Continued)

MNEMONIC	INTERPRETATION
ASGN KNPT	assign known point number
AT GUN	antitank gun
ATI GRID	artillery target intelligence grid
ATIPOLAR	artillery target intelligence polar
AUF	adjusting unit to fire
AUTH	authentication
BAD A2	bad A2—defective A2 assembly; will be displayed during operational check if unit is defective
BATT LMT	battery limit
BATT REQD	battery required—100 percent of specified battery limit has been used
BATT WEAK	battery weak—at least 80 percent of specified battery limit has been used
BN	battalion
BRG EQPT	bridge equipment
BURN	burning
CAL	caliber
CAS	casualties
CLGP	cannon-launched guided projectile—shell Copperhead
CMD	command
CNO	cannot observe

Table B-1. MNEMONICS USED BY THE DMD, THE FIST DMD, AND THE FED (Continued)

MNEMONIC	INTERPRETATION
CNO/AF	cannot observe adjust fire
CNO/FFE	cannot observe fire for effect
CNO/RFFE	cannot observe repeat fire for effect
COMPSD MSG	composed message
CONT ILL	continuous illumination
CORD ILL	coordinated illumination
CP	concrete piercing
CTR	center
D	data
DBL	double—double block mode
DC/AF	danger close adjust fire
DC/FFE	danger close fire for effect
DEST	destination or destroyed
DEST/AF	destruction adjust fire
DEST/DC	destruction danger close
DEST/REG	destruction registration
DIR	direction
DIR ERR	direction error
DISPL DLY	display delay
DIST	distance
DN	down
DNA	do not adjust—do not adjust this target's coordinates
DNC	do not combine—do not combine this target with another
DNO	did not observe
DNO TGT	did not observe target
DOP	degree of protection
DRAW TGT	draw target
DRP	drop
DSPO	disposition
DUGIN	dug in—in foxholes
EAST	easting
ENTRY NO	entry number
EOM	end of mission
EOM RAT	end of mission record as target
EOM&SURV	end of mission and surveillance

Table B-1. MNEMONICS USED BY THE DMD, THE FIST DMD, AND THE FED (Continued)

MNEMONIC	INTERPRETATION
EQUIP	equipment
EST	eastern—the eastern grid zone coordinates
EW	electronic warfare
EXC	excellent
FFE	fire for effect
FIRE FPF	fire final protective fire
FIREPLAN	fire plan
FIRE TGT NO	fire on target number
FL TRACE	frontline trace
FO CMD	forward observer command
FOOT PON	foot pontoon—bridge
FREETEXT	free text—plaintext message
FR GRID	fire request grid
FR LASER	fire request laser
FR MOV1	fire request move 1 (FED only)
FR MOV2	fire request move 2 (FED only)
FR POLAR	fire request polar
FR QUICK	fire request quick
FR SHIFT	fire request shift from known point
GAS NONP	gas nonpersistent
GAS PERS	gas persistent
HB	high burst
HB/MPI	high burst/mean point of impact
HC SMK	white smoke
HE/DELAY	high explosive/delay—high explosive with a delay fuze
HE/QUICK	high explosive/quick—high explosive with a quick fuze
HE/TIME	high explosive/time—high explosive with a time fuze
HE/VT	high explosive/variable time—high explosive with a variable time fuze
HE&WP	high explosive and white phosphorus
HIGH/DC	high angle/danger close
HIGH/REG	high angle/registration
HIGH/TOT	high angle/time on target
HVY MGUN	heavy machine gun

Table B-1. MNEMONICS USED BY THE DMD, THE FIST DMD, AND THE FED (Continued)

MNEMONIC	INTERPRETATION
HVY MSL	heavy missile
HVYWHEEL	heavy wheeled vehicle
ICM	improved conventional munition
IGN RD	ignore round
ILL1GUN	illumination 1 gun
ILL2GUN	illumination 2 gun
ILL2GUND	illumination 2 gun deflection spread
ILL2GUNR	illumination 2 gun range spread
ILL4GUN	illumination 4 gun
ILLUM	illumination
KBD BELL VOL	keyboard bell volume
KNPT	known point
LA	left above
LAST PNT	last point
LB	left below
LDG STRP	landing strip
LFT	left
LOST BT	lost burst
LOST TGT	lost target
LOUDSPKR	loudspeaker
LOW/DC	low angle/danger close
LOW/REG	low angle/registration
LOW/TOT	low angle/time on target
LT MGUN	light machine gun
LT MSL	light missile
LT WHEEL	light wheeled vehicle
M1	mission 1—active mission buffer number 1
M2	mission 2—active mission buffer number 2
MASNRY	masonry
MDM MSL	medium missile
ME	method of engagement
MPI	mean point of impact
MSG BELL VOL	message bell volume
MSG TYPES	message types
MSN	mission
MSN INFO	mission information

Table B-1. MNEMONICS USED BY THE DMD, THE FIST DMD, AND THE FED (Continued)

MNEMONIC	INTERPRETATION
MSN NO	mission number
MTO	message to observer
NEUT	neutralized
NEUTBURN	neutralized and burning
N/G	not given
NO PREF	no preference
NORTH	nothing
NO UNITS	number of units—units to fire for effect
NO VOL	number of volleys—volleys in fire for effect
OBS VA	observe vertical angle
OBSD ERR	observed error
OBSN	observation
OBSR LOC	observer location
OK BT	ok burst
OK TGT	ok target
OP	observation post
OPNL CHECK	operational check
ORIG	origin
PE	probable error
PRAND	standing on first volley and prone on subsequent volleys
PREC REG	precision registration
PRED PNT	predicted point
PRI	priority
PRONE	prone on first and subsequent volleys
PROVER	prone on first and under cover on subsequent volleys
PRUG	prone on first and dug (digging) in on subsequent volleys
PTL, OIL	petroleum oil
PT NO	point number
RA	right above
RAD/LGTH	radius/length
RB	right below
RCLR	recoilless rifle
RCRD AS TI REG PT	record as time registration point
RCRD REG PT	record as registration point

Table B-1. MNEMONICS USED BY THE DMD, THE
FIST DMD, AND THE FED (Continued)

MNEMONIC	INTERPRETATION
RDR REG	radar registration
RECON	reconnaissance
REF DIR	reference direction
REF VA	reference vertical angle
REG AF	registration adjust fire
REG NEXT LOT	register next lot of powder
REGT	regiment
RELBL	reliability
RESECT	resection
RKTMSL	rocket missile
R/L	right or left
1 RND	one round
2 RNDS	two rounds
3 RNDS	three rounds
RNDS	number of rounds that impacted
RT	right
RV	reliability value
SA LASER	subsequent adjustment with laser
SF, ADJ	shell/fuze adjustment—combination to be used in adjustment
SF, 1ST	shell/fuze first—combination to be used for first volley(s)
SF, SUBQ	shell/fuze subsequent—combination to be used for subsequent volley(s)
SHELL/FZ	shell/fuze
SHELREP	shelling report
SHFT	shift
SLT	search light
SLT DIST	slant distance
SNG	single block mode
STA TGT	stationary target
STD	standard—the western grid zone coordinates
STR	strength
SUBQADJ	subsequent adjustment
T/D	type of data—test or data
TGT	target

Table B-1. MNEMONICS USED BY THE DMD, THE
FIST DMD, AND THE FED (Continued)

MNEMONIC	INTERPRETATION
TGT NO	target number
TIME FLT	time of flight
TIME RPT	time repeat
TM	test message
TNO	try number
TOT	time on target
TRAK TGT	track target
TRILAT	trilateration
TRP&ARM	troops and armor combined
TRP MECH	troops mechanized—troops in personnel carriers
TRP&VEH	troops and vehicles
TYPE REG	type of registration
U/D	up/down
UNK	unknown
USE GT	use gun-target line
VA	vertical angle
VA ERR	vertical angle error
VCORR	vertical correction
VEH	vehicle
VEH PON	vehicle pontoon
VERY HVY	very heavy
WATT HRS	watt hours
WKPTY	workparty
WP/DELAY	white phosphorus with delay fuze
WPN	weapon
WP/QUICK	white phosphorus with quick fuze
WP/TIME	white phosphorus with time fuze
WR/AF	when ready adjust fire
WR/FFE	when ready fire for effect
WR/RFFE	when ready repeat fire for effect
XMT BLK	transmit block
XMT RATE	transmit rate
#	indicates entry of a numerical character
@	indicates entry of an alphabetical character
?	indicates entry required for transmission

B-32. TARGET EQUIVALENTS

Table B-2 equates common target descriptions with an appropriate DMD, FED, and FIST DMD mnemonic. The target's primary function or weapon, not the most vulnerable characteristic, should be used to describe the target. (For example, for BRDM with Sagger, use RKTMSL/ATANK, not VEH/RECON).

Table B-2. TARGET EQUIVALENTS

NOMENCLATURE	GENERAL TYPE	TACFIRE TARGET TYPE/SUBTYPE
PT-76	Tracked amphibious reconnaissance vehicle	ARMOR/LT
T-54 or -55	Medium tank	ARMOR/MDM
T-62	Medium tank	ARMOR/MDM
T-64	Medium tank	ARMOR/MDM
T-72	Medium tank	ARMOR/MDM
T-30	Medium tank	ARMOR/MDM
T-10	Heavy tank	ARMOR/MDM
BTR-152	Wheeled APC	ARMOR/APC
BTR-50	Tracked APC	ARMOR/APC
BTR-60	Tracked APC	ARMOR/APC
BMP	Tracked APC	ARMOR/APC
BRDM-1	Wheeled reconnaissance vehicle	VEH/RECON
BRDM-2	Wheeled reconnaissance vehicle	VEH/RECON
FUC/OT-65	Wheeled reconnaissance vehicle	VEH/RECON
FUC D-944	Wheeled reconnaissance vehicle	VEH/RECON
ASU-57	Tracked airborne assault gun	ARTY/LT
ASU-85	Tracked airborne assault gun	ARTY/LT
RPG-7	Shoulder-fired antitank missile	WPN/RCLR
AT-1 Snapper	Vehicle- or ground-mounted antitank missile	RKTMSL/ATANK
AT-2 Swatter	Vehicle- or ground-mounted antitank missile	RKTMSL/ATANK
AT-3 Sagger	Vehicle- or ground-mounted antitank missile	RKTMSL/ATANK
AT-5 Spandrel	Vehicle- or ground-mounted antitank missile	RKTMSL/ATANK
BM-21 (122-mm rocket launcher)	Truck-mounted multiple rocket launcher	RKTMSL/APERS
BM-14 (140-mm rocket launcher)	Truck-mounted multiple rocket launcher	RKTMSL/APERS
BM-24 (240-mm rocket launcher)	Truck-mounted multiple rocket launcher	RKTMSL/MDMSL
FROG-3	Track-mounted missile	RKTMSL/MDMMSL
FROG-4	Track-mounted missile	RKTMSL/MDMMSL

APPENDIX C

TRAINING DEVICES

C-1 . PURPOSE

With the rising cost of equipment and ammunition and for the observer to be proficient at his job, more and more training must be done by using training devices. These devices range from the very simple to modern computerized systems.

C-2. MATCHBOX PROBLEM

Familiarity with procedures can be attained by firing simulated missions. A simple and effective method for practicing simulated missions is the "matchbox problem" (Figure C-1). This problem requires no equipment except a small object (such as a matchbox), a pencil, and a piece of paper on which a mil scale has been drawn to represent the scale of the reticle in the binoculars. Two or more persons should work together on these problems. The

matchbox, which represents the target, is placed on a table or on any convenient surface; and the mil scale is placed on the table in front of the target. The person acting as the observer faces the target and mil scale. He announces the call for fire and the OT distance to the second person, who stands beside the table and announces the message to observer and **SHOT**. After announcing **SHOT**, the person at the table places the top of a pencil on the table for a moment to simulate each burst. The observer determines the location of (spots) the burst(s) as over or short and determines the amount of deviation, in mils, in relation to the paper mil scale as seen from his position. He then determines and sends a correction to the other person. The other person again places the pencil on the table. This procedure is continued until the mission is completed. The person at the table critiques the mission and changes places with the person acting as the observer.

Figure C-1. MATCHBOX PROBLEM SETUP

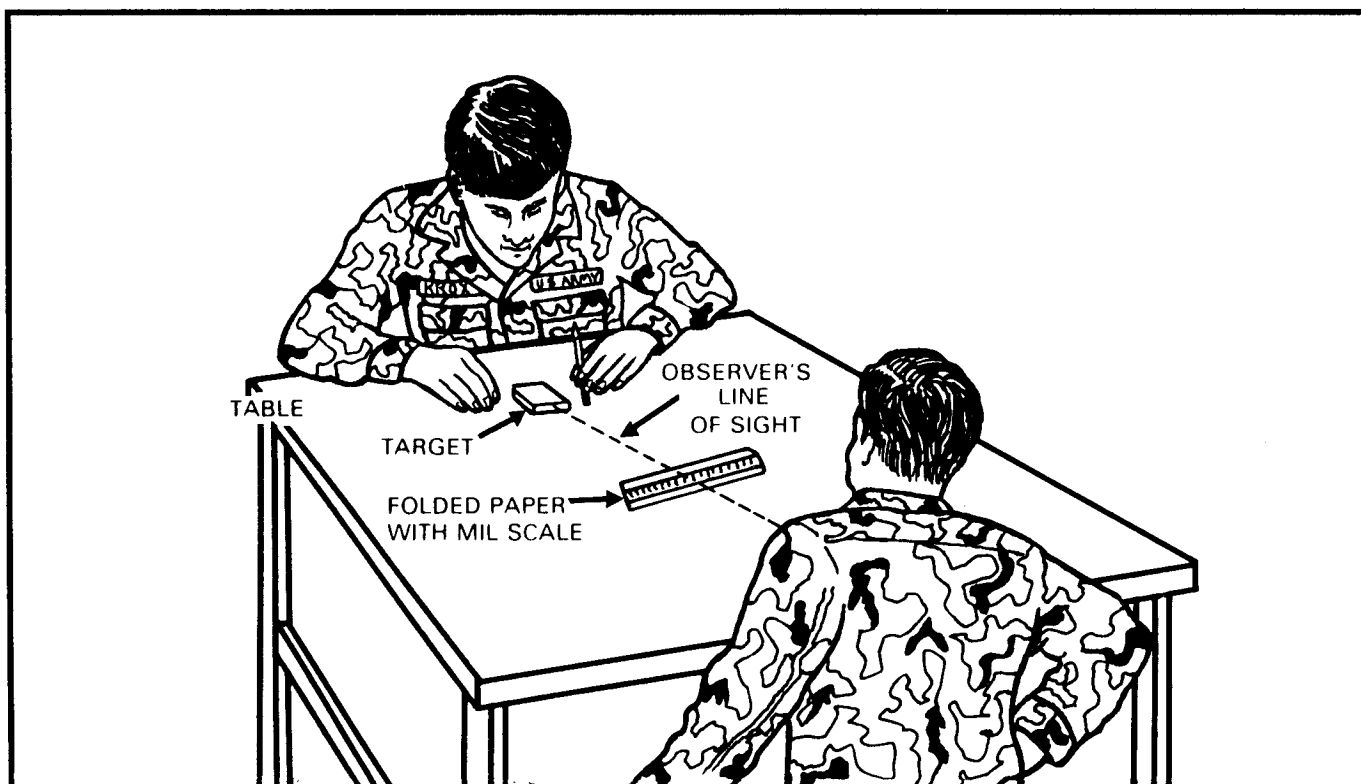

C-3. 14.5-MM FIELD ARTILLERY TRAINER M31

a. The M31 field artillery trainer was designed to provide a low-cost but realistic trainer which allows FA units to train all personnel, including gun crews, fire direction personnel, forward observers, and survey crews, in the delivery of fire. The trainer also allows realistic training in geographical areas where full-scale artillery ranges are not available.

b. To get the maximum benefit from the M31 trainer, units must —

- Construct a miniature range.
- Develop a special 1:5,000-scale map with grid lines every 100 meters (1,000 decimeters) instead of 1,000 meters normally found on maps.
- Instruct personnel on the use of the equipment.

The technical manual for the trainer is TM 9-6920-361-13&P. Safety procedures are covered in AR 385-63.

c. When the observer is given a special map, as previously discussed, normal observer procedures, including the use of the OF fan, are used for determining the location of targets. The OT factor determined by the observer is based on thousands of decimeters rather than thousands of meters. For example, an OT distance of 2,800 decimeters (280 meters) would result in an OT factor of 3. The observer corrects for deviation by multiplying the measured deviation by the OT factor and announcing his corrections to the nearest 10 decimeters; for example, **RIGHT 60**. The bracketing method of adjusting for range is used by the observer. Caution should be used in establishing the range bracket. In many cases, the observer thinks his rounds are much closer to the target than they actually are. For example, if the rounds are 30 meters (300 decimeters) short of the target, the observer should announce **ADD 400** to obtain a range bracket.

C-4. TRAINING SET, FIRE OBSERVATION

a. The training set, fire observation (TSFO) was designed to permit realistic instruction to forward observers in the observation and adjustment of artillery fire and fire planning. The TSFO simulates the visual and sound effects that an FO can expect to experience at an OP when overlooking a typical battlefield. The TSFO can also be used for exercise planning, basic and advanced map reading, and terrain recognition training. The TSFO can simulate the effects of four 8-gun batteries, each equipped with 155-mm howitzers with a variety of ammunition types including HE/Q, HE/VT, HE/ti, smoke, and illum. A variety of targets can also be simulated. These include

machine guns, wheeled and tracked vehicles, and helicopters. The entire system can be operated by one person.

b. The TSFO simulates the visual and sound effects of artillery fire on terrain views projected on a classroom screen. A series of computer-controlled slide projectors provides the following:

- Terrain views as seen from a variety of OPs.
- Burst simulation of the number, type, location, and pattern of rounds called for in the call for fire.
- Target simulation as selected through the remote target control (RTC) box.

c. The sound system is controlled by the computer. It is programed to realistically portray the sounds typically generated by artillery rounds in flight and at the moment of impact. The sound level may be controlled by the operator to realistically tailor the sound to the size of the classroom and number of observers being instructed.

d. The TSFO can simulate day and night battlefield operations as well as visual characteristics of smoke and illuminating ammunition, including the effects of drift caused by wind speed and direction. The TSFO consists of the following main units:

- Projection screen.
- Projector stand.
- Operator's console.
- Observer facilities.

C-5. TSFO-G/VLLD SIMULATION ENHANCEMENT

The TSFO-G/VLLD enhancement is a replica of a tactical G/VLLD mounted in a TSFO facility. It uses a high-intensity light instead of laser components and interfaces directly with the TSFO screen. This device is used to train all critical tasks. The TSFO-G/VLLD uses existing G/VLLD-trainer tripods and traversing units.

C-6. LASER TRAINING KIT

a. Laser-safe ranges are needed to train G/VLLD operators. Areas where target ranging and laser designation may occur often are not available or practical for sustainment training with the AN/TVQ-2 G/VLLD. For this reason, the laser training kit was developed. It consists of an attenuator filter assembly and a laser inhibit (shorting) plug. The kit is part of the basic issue items in TM 9-1260-477-12.

b. The attenuator filter assembly is mounted with the glass filter placed over the laser window and the switch cover placed over the DES-RNG1-RNG2 switch. The attenuator filter assembly prevents the use of the designate mode and reduces the laser output power, thus reducing the laser hazard area.

c. The laser inhibit (shorting) plug is mounted on the left side of the G/VLLD to prevent the emission of laser energy. Thus, the G/VLLD operator can track a target anywhere and simulate designation without the hazard of actually firing a laser in the range finding mode. Target direction and vertical angle are displayed in the eyepiece. Since no target distance is determined, range is displayed as 9760.

WARNING

Even when using the attenuator filter, a potential eye hazard exists. Accidental firing may occur if the plug is not properly installed or if it is damaged. Always assume the laser is dangerous.

C-7. HELLFIRE GROUND SUPPORT SYSTEM

a. The Hellfire ground support system (HGSS) is a simulator for multiple integrated laser engagement system (MILES) air-ground engagement exercises. The HGSS is a component of the air-ground engagement simulation (AGES) II.

b. The HGSS is designed as a direct replacement for the G/VLLD for training purposes. It has a laser optical path and a visual optical path. The HGSS accurately duplicates the interfaces (mechanical, electrical, and optical) and the physical shape, size, and weight of the G/VLLD LD/R. It simulates, for MILES-AGES purposes, the offensive (range finding and designation) and vulnerability characteristics of the G/VLLD LD/R.

c. The HGSS supports force-on-force exercises at the Army combat training centers (National Training Center, Combat Maneuver Training Center, and Joint Readiness Training Center) and initial training at the USAFAS.

C-8. COMBINED ARMS TEAM INTEGRATED EVALUATION SYSTEM

a. The combined arms team integrated evaluation system (CATIES) is designed to realistically simulate the effects of indirect fire and, through integration with the MILES, to provide training on how to react to indirect fire.

b. The CATIES consists of the following components:

- The master control station (MCS) consists of a microcomputer and the necessary communications equipment to link with unit fire direction and fire support elements.
- The receiver-transmitter device (RTD) consists of a microprocessor, an antenna, cabling, and an auxiliary communications device.
- The player detector device/vehicle detector device (PDD/VDD) is a sensor on a soldier or a vehicle and is the link to MILES.

c. The basis of issue is one set to the National Training Center at Fort Irwin, California.

C-9. OBSERVER TRAINING FOR NONARTILLERY PERSONNEL

a. Proficiency as an observer requires much experience. It is required only of those whose primary duties include calling for and adjusting fires. However, all personnel should be able to take at least the minimum action required to get fire on a target. This includes all soldiers, from the combat arms soldier on the forward line of own troops (FLOT) to the DISCOM soldier far in the rear who may become involved in rear area combat operations. This manual provides the information necessary to train all personnel in the basics of observed fire procedures.

b. In most cases, nonartillery units are unable to provide live-fire training for their personnel. There are several alternatives that can provide excellent training opportunities.

(1) The first action should be to ask for the help of local artillery units and mortar sections. In most cases, these units will be happy to give expert instruction as time permits. It is imperative that the soldier learn the call for fire and the basics of adjustment before going to the field.

(2) Personnel may observe live fire from an OP set up near the artillery or mortar unit OP. From there, personnel can practice spotting and making corrections. To get the maximum training from this environment, a qualified instructor must be present.

(3) In some areas, a 14.5-mm subcaliber range is available. These ranges provide an excellent opportunity for realistic observer training without the high cost of artillery ammunition.

(4) Artillery units have training devices such as those described in this appendix. The use of these devices by

qualified instructors or operators provides excellent instruction. The matchbox device described in paragraph C-2 may be setup and used by any unit.

c. Keep in mind that you are not trying to make every soldier an expert observer, but every soldier should be able to call for fire support when needed.

APPENDIX D

FIRE SUPPORT TEAM VEHICLE

D-1. INTRODUCTION

This appendix presents a general description of the FISTV. Operating procedures and additional technical information on the M981 FISTV are in TM 9-2350-266-10.

D-2. DESCRIPTION

The M981 FISTV is built on an M113A2 chassis which includes an upgraded suspension and electrical system. The design is derived from the M901 improved TOW vehicle (ITV). Its hydraulically erected missile launcher is modified to house the targeting station. Subsystems of the targeting station include the G/VLLD, DMD, FIST DMD, and communications equipment. They can be used as a part of the vehicle or removed from the vehicle and used in other applications. The storage for components allows equipment to be quickly dismounted for ground operations.

D-3. FUNCTIONAL DESCRIPTION

The following are the functions of the FISTV:

- Perform systems tests. It tests its internal functioning the functioning of the LD/R and north-seeking gyrocompass (NSG), and all associated circuitry.
- Provide controls for LD/R and NSG power, systems initialization, erection and stowage of the targeting head, lamp and LD/R reticle brightness, lamps test, and remote setting of PRF codes of the LD/R.
- Store vehicle and target-known point location.
- Compute target coordinates based on vehicle location and data determined by the LD/R (slant distance) and NSG (direction and vertical angle).
- Compute vehicle coordinates based on a known point location and data provided by the LD/R (slant distance) and NSG (direction and vertical angle).
- Store and send polar data to the FIST DMD.
- Provide direction and vertical angle data to the LD/R eyepiece display.
- Display vehicle heading or targeting head direction and vertical angle.

D-4. FISTV OPERATIONS STATIONS

The operations stations of the FISTV are the targeting, communications, and observation stations,

a. Targeting Station. The targeting station consists of three major components: the turret, the erection arm assembly, and the targeting head. The targeting station can rotate 6,400 mils (360°) in either direction in azimuth. The **turret** houses the targeting station operator's controls and indicators. These include the targeting station control display (TSCD), the hand controls, the night-sight controls, and the hydraulic components that supply the motive power for the entire targeting station. The **erection arm assembly** erects the targeting head for target location or designation and stows the head for travel. The **targeting head** houses the LD/R component of the G/VLLD, the night sight, the wide field of view (3X) sight, and the NSG. It can be elevated to $+37^\circ$ (657 mils) and depressed to -23° (408 mils). The targeting head must be erect for target location and designation equipment to be used.

(1) **North-Seeking Gyrocompass.** The NSG determines true north and converts the azimuth to a grid direction based on the vehicle position. The NSG module also measures the vertical angle to the target (based on the horizontal plane). This is used by the TSCD to convert the G/VLLD slant range to a horizontal distance when computing vehicle or target location.

(2) **Tank Periscope.** The tank periscope assembly allows the targeting station operator to select one of three sights:

- The wide field of view sight (3X channel) provides a wide ($2.8 \times 25^\circ$) field of view. This sight is not intended for use in adjustment of fire; therefore, it does not have a mil reticle.
- The night-sight channel provides either a wide ($4 \times 6.6^\circ$) or a narrow ($12 \times 2.2^\circ$) field of view.
- The sight LD/R (13X channel) with a $12 \times 4^\circ$ field of view has the same eyepiece display as the G/VLLD.

b. Communications Station. The communications station includes the FIST DMD AN/PSG-5. It allows digital communications with current systems such as the TACFIRE, the BCS, the MBC, and the DMD AN/PSG-2.

Security for voice communications is provided by the TSEC KY-57 COMSEC device. The FIST DMD and components of the AN/VRC-88 radio sets are man-portable and can be operated away from the vehicle.

(1) The communications system in the FISTV is extensive. It gives all four personnel both internal and external communications capabilities as follows:

- The FISTV has four-frequency FM capability for external communications. The radios and the FIST DMD are located at the communications stations and may be used for voice or digital operations.
- The FISTV also has an internal intercom system. This allows the crew to converse during operations.

(2) Each crew member has a combat vehicle crewman's (CVC) helmet. The CVC helmet has a headset, a microphone, and a keying switch. The helmet hooks into an intercommunications control unit. This unit allows each crewman to talk within the communications system. Each individual can monitor from one to four radio frequencies and the intercom. Also, each member can communicate over any one of these nets by properly positioning the TALK switch on his control unit.

c. Observation Station. This station contains a four-power, 7° (125 mils) field of view periscope for use in target detection and vehicle defense. The optical system includes a mil reticle pattern as an aid for the adjustment of conventional fires. The reticle also contains an azimuth position indicator, which provides direction relative to the front of the vehicle. No leveling capability is provided.

D-5. OBSERVED FIRE PROCEDURES

Target location and burst location data are in polar form. Therefore, when the FISTV is used, accurate vehicle location is critical in the determination of accurate target or burst locations.

a. Determining Vehicle Location. Until the FISTV is equipped with a position locating reporting system (PLRS), the FIST is limited to map spotting and/or using existing on-board systems in determining vehicle location.

(1) Survey Function. The FIST DMD can determine the FIST location on the basis of polar data measured from either one known point or two known points. The one known point method requires direction, distance, and vertical angle. The two known point method requires only direction and vertical angle to both known points.

(2) Calculate Function. The TSCD contains a microprocessor that enables it to perform several functions.

One of these functions is to determine vehicle location from one known point on the basis of polar data. (See TM 9-2350-266-10.)

b. Target Location.

(1) With an accurate vehicle location determined, the FIST can locate targets very accurately with the targeting station and its components. The NSG provides grid azimuth and vertical angle to the target, while the LD/R provides slant distance.

(2) Once the targeting station operator has determined laser-polar data to the target, there are three methods available to the FIST through which target location can be determined and/or transmitted to the FDC.

(a) *FR LASER Format.* As soon as the laser fire trigger on the targeting station hand controls is squeezed, direction (grid azimuth), slant distance, and vertical angle to the target are not only entered into the memory of the TSCD but are automatically sent to the FIST DMD. When the FR LASER message format is displayed by the DMD operator, direction, distance, and vertical angle will have been entered into the appropriate fields of the message format by the FIST DMD. Once the remaining required entries are made, the message may be transmitted to the FDC.

(b) *FIST DMD Polar Convert Function.* The FIST DMD can convert laser-polar data to grid coordinates. Once the required entries are made in an FR LASER format (as discussed in the preceding paragraph), the DMD operator can use the FIST DMD to convert those data to a grid by displaying an FR GRID format. All appropriate entries previously made in the FR LASER format are transferred automatically to the FR GRID format. The request may then be transmitted to the FDC.

(c) *TSCD Calculate Function.* The TSCD not only calculates vehicle location (as described previously) but also calculates the target coordinates on the basis of vehicle location and polar data to the target. Once the targeting station operator squeezes the laser fire triggers and determines polar data to the target, he can use the TSCD to determine grid coordinates to the target. (See TM 9-2350-266-10.) These coordinates are then relayed to the DMD operator. He brings up the appropriate message format, makes the required entries, and transmits the message to the FDC.

c. Determining Subsequent Corrections. Once the call for fire has been transmitted and ADJ FIRE has been selected in the CONTROL field of the DMD format, the targeting station operator must be prepared to spot and locate the burst or bursts of the adjusting rounds. In

preparing to observe the burst, the 3X channel of the image transfer assembly (ITA) must be used. This gives the targeting station operator a much wider field of view than the 13X channel and, therefore, a better chance to spot the burst. Once the burst is acquired and centered in the 3X reticle, the operator selects the 13X channel, centers the burst in the reticle, and lases the burst. Corrections from the burst are determined in the same manner as with the G/VLLD in the ground mode. If the fire request was transmitted by use of the FR LASER format, the SA LASER format must be used for subsequent corrections. If

the FR GRID format was used, then the SUBQ ADJ message format must be used for corrections.

D-6. RESPONSIBILITIES AND DUTIES OF THE FIST

When the FIST operates as one element, the company FSO assigns responsibilities for manning the vehicle stations to team members. All members of the FIST headquarters must be able to perform all of the duties inherent with each station in the vehicle.

APPENDIX E
TARGET ANALYSIS AND MUNITIONS EFFECTS

This appendix implements QSTAG 224.

E-1. OBSERVER RESPONSIBILITIES

As the eyes of the artillery and mortars, the observer has two major responsibilities regarding target analysis and munitions effects:

- He must properly describe the target so that the FDO can decide on attack of the target.
- He may recommend the best method of attack based on the size, type, and posture of the target.

E-2. TARGET DESCRIPTION

The following is a brief description of considerations in describing a target properly to the FDC. It is based on weapons effects analysis in TACFIRE. For common target type equivalents, see Table B-2.

a. Target Characteristics.

(1) Targets vary considerably in composition, degree of protection, shape, mobility, and recuperability. Therefore, the observer should describe the target as accurately as possible to the FDC. The TACFIRE uses 16 target types with subtypes for each type of target (Table E-1).

Table E-1. TARGET TYPES

1ST SUBFIELD (TARGET TYPE)		2D SUBFIELD (TARGET SUBTYPE)	
ENTRY	DESCRIPTION	ENTRY	DESCRIPTION
ADA	Air defense artillery	UNK LT MDM HV MSL POS	Unknown Light Medium Heavy Missile Position
ARMOR	Armor	UNK LT HV APC POS	Unknown Light Heavy Armored personnel carrier Position
ARTY	Artillery	UNK LT MDM HV POS	Unknown Light Medium Heavy Position
ASSY	Assembly area	UNK TRP TRPVEH TRPMEC TRPARM	Unknown Troops Troops and vehicles Mechanized troops Troops and armor

Table E-1. TARGET TYPES (Continued)

1ST SUBFIELD (TARGET TYPE)		2D SUBFIELD (TARGET SUBTYPE)	
ENTRY	DESCRIPTION	ENTRY	DESCRIPTION
BLDG	Building	UNK WOOD MASNRY CONC MET SPCL	Unknown Wood Masonry Concrete Metal Special purpose
BRIDGE	Bridge	UNK FTPON VEHPON CONC WOOD STEEL SITE RAFT FERRY	Unknown Foot pontoon Vehicle pontoon Concrete Wood Steel Site Raft Ferry
CEN	Center	UNK SMALL BN REGT DIV FWD	Unknown Small Battalion Regiment Division Forward
EQUIP	Equipment	UNK RADAR EW SLT GDNC LS	Unknown Radar Electronic warfare Searchlight Guidance unit Loudspeaker
MORT	Mortar	UNK LT MDM HV VH POS	Unknown Light Medium Heavy Very heavy Position
PERS	Personnel	UNK INF OP PTL WKPTY POS	Unknown Infantry Observer post Patrol Work party Position

Table E-1. TARGET TYPES (Continued)

1ST SUBFIELD (TARGET TYPE)		2D SUBFIELD (TARGET SUBTYPE)	
ENTRY	DESCRIPTION	ENTRY	DESCRIPTION
RKTMSL	Rocket/missile	UNK APERS LTMSL MDMMSL HVMSL POS ATANK	Unknown Antipersonnel Light missile Medium missile Heavy missile Position Antitank
SPEC	Special mission	ONCALL ILL1 ILL2 ILL2DS ILL2RG ILL4 GASNON GASPER LEAF	Not used Illumination—1 gun Illumination—2 guns Illumination—2 guns with lateral spread Illumination—2 guns with range spread Illumination—4 guns Nonpersistent gas Persistent gas Leaflets
SUPPLY	Supply dump	UNK AMMO PTL BRGEQ CLI CLII	Unknown Ammunition Petroleum, oil Bridging equipment Class 1 Class 2
TER	Terrain features	UNK ROAD JCT HILL DEFILE LDGSTR RR	Unknown Road Road junction Hill Defile Landing strip Railroad
VEH	Vehicle	UNK LTWHL HWWHL RECON BT ACFT HEL	Unknown Light wheeled Heavy wheeled Reconnaissance Boat Aircraft Helicopter
WPN	Weapon	UNK LTMG ATG HVMG RCLR POS	Unknown Light machine gun Antitank gun Heavy machine gun Recoilless rifle Position

(2) For personnel targets in particular, the posture of the target is extremely important. Target postures normally used for personnel targets are standing, prone, and dug in (Table E-2). Information in weapons effects manuals is based on the assumption that personnel are wearing helmets and winter uniforms and that those in foxholes are in a crouching position. When describing a given target's posture, consideration must be given to the protection afforded by the terrain. For example, an infantry platoon may be attacking in a standing posture; however, the irregularities of the terrain may provide protection equivalent to that provided by the prone position. Normally, personnel targets will seek a more protective posture during an engagement (for example, from a standing to a prone position). This change is called posture sequencing. This characteristic causes considerable degradation of effects as additional volleys are fired and is the reason for the emphasis on surprise or massed fires.

Table E-2. DEGREE OF PROTECTION

ENTRY	DESCRIPTION	
	FIRST VOLLEY FIRED	SUBSEQUENT VOLLEYS FIRED
PRAND	Half prone, half standing	All prone
PRONE	Prone	Prone
PRUG	Prone	Dug in
PROVER	Prone	Under overhead cover
DUGIN	Dug in	Dug in
COVER	Under overhead cover	Under overhead cover

(3) A target must be analyzed to determine its weak points. The decision as to where the target is most vulnerable and what fires will best exploit its weaknesses is influenced by the degree of damage desired. Often there is a tendency to overkill the target when less combat power would suffice. On the basis of the commander's criteria, the observer must ascertain the degree of effects needed (destruction, neutralization, or suppression) to support the tactical plan. The acceptable degree of damage is that level that yields a significant military advantage. For example, fire from a heavily protected machine gun emplacement may be silenced by obscuration with FA smoke and subsequent engagement by direct fire rather than expending an excessive number of HE rounds for destruction.

b. Target Location. The proximity of the target to friendly troops and the accuracy of the target location must be weighed. The importance of certain targets that are not accurately located may justify the fire of several units to ensure coverage. Close-in direct support fire requirements may dictate the use of a specific type or caliber of weapon or a specific type of munition.

c. Terrain. The terrain in the target area has a direct effect on the vulnerability of a target. Rugged terrain affords considerable natural cover and makes target location difficult. Certain terrain provides a complete defile from some angles of fire but not from others. This influences the type of weapon and munition to be used. The nature of the vegetation in the target area should be considered in recommending ammunition.

d. Weather. Weather is of little consequence in evaluating a target to be attacked with HE/Q. Precipitation and wind are of particular importance in evaluating a target to be attacked with ICM, smoke, FASCAM, or illuminating projectiles. Low clouds, thick fog, surface water, and rain degrade the effectiveness of VT fuzes M513 and M514. Fuzes M728 and M732 are not affected.

e. Commander's Criteria. All phases of target analysis are conducted within constraints established by the commander. On the basis of ammunition constraints, a commander will stipulate the type of effects he desires against specific target categories. The three target effects categories are discussed below.

(1) **Suppression** of a target limits the ability of the enemy personnel to perform their mission. Firing HE and VT reduces the combat effectiveness of personnel and armored targets by creating apprehension or surprise and causing tanks to button up. Smoke is used to screen or obscure. The effect of suppressive fires usually lasts only as long as the fires are continued. Suppressive fires can be delivered by small delivery units and require a low expenditure of ammunition.

(2) **Neutralization** of a target knocks the target out of the battle temporarily. Experience has shown that 10 percent or more casualties will neutralize a unit. The unit will become effective again when the casualties are replaced and damage is repaired. Neutralization fires are delivered against targets located by accurate map inspection, by indirect fire adjustment, or by a target acquisition device. The assets required to neutralize a target vary according to the type and size of the target and the weapon-ammunition combination used.

(3) **Destruction** puts the target out of action permanently. Thirty percent casualties or materiel damage inflicted during a short time span normally renders a unit ineffective. Direct

hits are required to destroy hard materiel targets. Targets must be located by accurate map inspection, by indirect fire adjustment, or by a target acquisition device. Destruction usually requires large expenditures of ammunition from many units. Destruction of armored or dug-in targets with artillery weapons is not economical.

E-3. MOST SUITABLE AMMUNITION

Once an observer has decided to attack a target, he must select a weapon-ammunition combination that can achieve the desired effect with a minimum expenditure of available ammunition stocks. To do this, the observer must know the characteristics, capabilities, and vulnerabilities of all fire support assets.

a. Ammunition Type and Quantity. The nature of the target and its surroundings and the desired effects dictate the type and amount of ammunition to be used. For a detailed discussion of ammunition and fuzes, refer to Table E-3. The ammunition resupply system may sometimes rule out an optimum ammunition selection. For example, extensive smoke fires may be needed to screen maneuver movement, but such fires would probably impose a considerable resupply problem on the parent organization. Some types of fires require greater ammunition expenditures than others. Suppression and neutralization fires usually consume less ammunition than destruction fires.

b. Troop Safety. Troop safety is a major concern when considering the weapon and ammunition selection for firing close-in targets. The observer ensures that fires do not endanger friendly troops, equipment, and facilities.

c. Residual Effects in Target Area. Residual effects from special ammunition influence the occupation of an area. Use of FASCAM may change the direction of movement of supported elements. If supported troops are to occupy an area immediately following attack by certain munitions, conditions may be hazardous. Weather changes may alter choices of certain munitions; for example, smoke, illumination, and special ammunition. The incendiary effects of munitions may make areas untenable for supported forces. These effects also can deny the enemy use of selected terrain.

d. Effectiveness. When properly delivered against appropriate targets, artillery and mortar fire support can be the decisive factor in a battle. The observer must ensure that maximum effectiveness is attained from every mission. To match a munition to a target, the observer must know what damage a munition can produce and the damage required to defeat the target. The lethality of a munition must be matched to the specific vulnerability of the target. Thus, the observer must understand the damage potential of blast, cratering, fragmentation, incendiary, and penetration effects from specific munitions.

Table E-3. GUIDE FOR ARTILLERY OR MORTAR ATTACK OF TYPICAL TARGETS

SHELL AND WEAPON	FUZE	SUITABLE FOR
DPICM 155-mm, 203-mm	Time Base ejecting	Personnel in open Light armored vehicles in open
APICM 105-mm, 155-mm	Time Base ejecting	Personnel in open
HE 81-mm, 107-mm, 105-mm, 155-mm, 203-mm	Quick	Adjusting Personnel in open Light armored vehicles
HE	Delay 0.05 second	Targets in trees Unarmored vehicles
HE	Concrete piercing 0.25-second delay	Bunkers Earth and log emplacements Hard targets
HE	VT radio-activated M514 20-meter HOB M728/732 7-meter HOB No HOB adjustment required	Personnel in open, in trenches, or in fighting positions Light armored vehicles
HE	Time HOB adjustment required	Same as VT

Table E-3. GUIDE FOR ARTILLERY OR MORTAR ATTACK OF TYPICAL TARGETS (Continued)

SHELL AND WEAPON	FUZE	SUITABLE FOR
WP 81-mm, 107-mm, 105-mm, 155-mm, Tanks	Quick Superquick	Incendiary Marking Screening Obscuring Vehicles
WP	Time	Mark center sector
Smoke 105-mm, 155-mm		Screening Obscuration
Illuminating 81-mm, 107-mm, 105-mm, 155-mm	Time Base ejecting	Harassment Marking
CLGP (Copperhead) 155-mm		Point targets Command posts Armored targets
Rocket-assisted projectile (RAP) 105-mm, 155-mm, 203-mm	Quick Superquick Delay	Same as HE (used when increased range is necessary)
ADAM 155-mm	Time Base ejecting	Deny territory to personnel
RAAMS 155-mm	Time Base ejecting	Deny territory to vehicles
Beehive 105-mm	Time	Personnel—direct fire, battery defense

E-4. METHOD OF ATTACK

The final step in target analysis is the selection of a method of attack. The observer must select a method of attack that ensures target area coverage and desired target effects. To determine an optimum method of attack, the FDO must consider aiming points and density and duration of fires.

a. Aiming Points. Normally, the size of the area to be attacked is determined by the size of the target or the size of the area in which the target is known or suspected to be located. A single aiming point located on the center of the target is used to attack small targets. In attacking large targets, multiple aiming points must be designated to distribute the fires and ensure adequate coverage. The BCS determines aiming points for each howitzer. Chapter 6 gives procedures for establishing multiple aiming points.

b. Density and Duration of Fires. Intense fires of short duration generally produce the best target effect. However, the tactical situation may require fires to be continued over

a long period of time. Some examples are interdiction fires, screening smoke fires, continuous illumination, and suppressive fires supporting a maneuver final assault on an objective.

NOTES:

1. Regardless of type, targets with an estimated target radius greater than 150 meters usually require massing for effective attack.
2. The first objective in firing on moving vehicles is to stop the movement. For this purpose, a bracket is established. Speed of adjustment is essential. If possible, the column should be stopped at a point where vehicles cannot change their route and where one stalled vehicle will cause others to stop. Vehicles moving on a road can be attacked by adjusting on a point on the road and then timing the rounds fired so that they arrive at that point when the vehicle is passing it. A firing unit or several units, if available, may fire at different points on the road simultaneously.

GLOSSARY

A	air (spotting)	AT MY COMMAND	the command used by the forward observer or FDC to control the time of opening fire
AA	antiaircraft	az	azimuth
abbr	abbreviated	BC	battery commander
abbreviated registration	a shortened precision registration procedure which requires less time and ammunition	BCS	battery computer system
ABCA	American, British, Canadian, Australian	BCU	battery computer unit
ACK	acknowledge	BMP	enemy vehicle
ADA	air defense artillery	bn	battalion
ADAM	area denial artillery munitions	BTR	enemy armored personnel carrier
add (+)	denotes a shift correction, an increase in the OT distance	BUCS	backup computer system
adjust fire	the process of moving the center of impact to the adjusting point by using one gun firing one round at a time and normally using some type of bracketing procedure	call for fire	a clear, concise formatted message sent from the observer to the FDC which includes all the information the FDC needs to engage the target
adjusting point	the target itself or a point near the center of an area target; spotfings are made from this point, and corrections are made to this point	CAS	close air support
AF	adjust fire	CATIES	combined arms team integrated evacuation system
AFSO	aerial fire support observer	CFF	call for fire
AGES	air-ground engagement simulation	CG	guided missile cruiser
AH	attack helicopter	CGN	guided missile cruiser, nuclear
AHRS	attitude and heading reference system	CLGP	cannon-launched guided projectile
ALO	air liaison officer	cmd	command
alt	altitude	co	company
AM	amplitude modulated	COLT	combat observation/lasing team
AMC	at my command	COMSEC	communications security
ANGLICO	air and naval gunfire liaison company	CONUS	continental United States
AP	antipersonnel (FA), armor-piercing (naval gunfire)	CP	concrete-piercing (ammunition), contact point (CAS)
APC	armored personnel carrier	CVC	combat vehicle crewman
APICM	antipersonnel improved conventional munitions	CVT	controlled variable time (fuze)
ATI	artillery target intelligence		

- DANGER CLOSE** command used by an observer to warn the FDC that rounds will impact within 600 meters of friendly elements (for artillery) or (for naval gunfire) within 750 meters for 5-inch guns and less and within 1,000 meters for guns larger than the 5-inch
- DCT** digital communications terminal
- DD** destroyer
- DDG** guided missile destroyer
- DESIGNATE** a command given to laser a target for a laser-guided weapon
- destruction** a precision mission in which minor refinement-type corrections are made every third round or as necessary until the target is destroyed
- dir** direction
- dis** distance
- DISCOM** division support command
- div arty** division artillery
- DMD** digital message device
- down (D)** denotes a shift in the vertical plane; can apply to height of burst or to target attitude
- DP** dual purpose
- DPICM** dual-purpose improved conventional munitions
- drop (-)** denotes a shift correction, a decrease in the OT distance
- DS** direct support
- DTV** day television
- DV** direct view
- EOM** end of mission
- FA** field artillery
- FAC** forward air controller
- FASCAM** family of scatterable mines
- FCT** firepower control team
- FDC** fire direction center
- FDO** fire direction officer
- FED** forward entry device
- FF** frigate
- FFE** fire for effect
- FFG** guided missile frigate
- final protective fire** a prearranged line of fire used to destroy an enemy attack, usually planned to cover dead space in a maneuver unit final protective line
- FIRE FOR EFFECT** the command to fire the ammunition in the type and quantity to achieve the amount of casualties desired for the mission
- FIST** fire support team
- FIST DMD** fire support team digital message device
- FISTV** fire support team vehicle
- FLIR** forward-looking infrared
- FLOT** forward line of own troops
- FM** frequency modulated
- FO** forward observer
- FPF** final protective fire
- FR** fire request
- FSA** fire support area (Navy)
- FSCOORD** fire support coordinator
- FSE** fire support element
- FSO** fire support officer
- FSS** fire support station (Navy)
- G** graze (spotting)
- GMET** graphical munitions effectiveness table
- GT** gun-target
- gun-target line** an imaginary line extending from the guns to and through the target
- G/VLLD** ground/vehicular laser locator designator-used to designate or determine direction, distance, and vertical angle to a burst, target, or other location in the target area
- HB** high burst

HC	hexachloroethane (smoke), high capacity (naval gunfire)	kn pt	known point
HE	high explosive	L	left
HF	high frequency	LANTIRN	low-altitude navigation and targeting infrared
HGSS	Hellfire ground support system	LARS	left, add; right, subtract
high-angle fire	fires at an elevation which exceeds the elevation corresponding to the maximum range for a weapon and charge	LD/R	laser designator/range finder
HMMWV	high-mobility multipurpose wheeled vehicle	left (L)	denotes a shift perpendicular to the observer-target line
HOB	height of burst	LGB	laser-guided bomb
HQ	headquarters	LGM	laser-guided munition
hr	hour	LHA	amphibious assault ship, general purpose
hvy	heavy	LLLGB	low-level laser-guided bomb
IAW	in accordance with	LN	line (deviation spotting)
ICM	improved conventional munitions	LOAL	lock on after launch
illum	illuminating	LOBL	lock on before launch
immediate smoke	a mission fired, normally by a platoon, to screen or obscure the enemy immediately	LRDF	laser range danger fan
immediate suppression	an FFE-type mission, fired normally by battery SOP, in which a platoon fires one gun with HE/VT and one gun with HE/Q to force the enemy to take cover; it is a harassing-type fire	LST	laser spot tracker
in	inch	LT	lieutenant
IP	initial point	LTD	laser target designator
IR	infrared	m	meter
ITA	image transfer assembly	mi	mil
ITV	improved TOW vehicle	MBC	mortar ballistic computer
JAAT	joint air attack team	MCS	master control station
JMEM	joint munitions effectiveness manual	message to observer	the message sent from the FDC to the observer which tells the observer who will fire his mission, any changes to the CFF, the number of volleys in effect, and the target number
km	kilometer	METT-T	mission, enemy, terrain, troops, and time available
kmph	kilometers per hour	MILES	multiple integrated laser engagement system
known point	a point known to both the observer and the FDC and recorded or plotted in the FDC	min	minute
		MMS	mast-mounted sight
		MOUT	military operations on urbanized terrain
		mph	miles per hour

MPI	mean point of impact	PEd	probable error in deflection
MTO	message to observer	PER	probable error in range
MULE	modular universal laser equipment	PFC	private first class
mvr	maneuver	PGM	precision guided munition
MVV	muzzle velocity variation	PIM	pulse interval module
NAK	nonacknowledge	PLRS	position locating reporting system
NCO	noncommissioned officer	plt	platoon
neutralization	any type of mission which achieves 10 percent casualties in the target area	POL	petroleum, oils and lubricants
NFOV	narrow field of view	precision registration	a precision mission used to determine total corrections for nonstandard conditions
NGF	naval gunfire	PRF	pulse repetition frequency
NGLO	naval gunfire liaison officer	PUP	pull-up point
NGST	naval gunfire spotter team	Q	quick
NICAD	nickel-cadmium	QSTAG	quadrupartite standardization agreement
NOD	night observation device	R	range, right (deviation spotting)
NOHD	nominal ocular hazard distance	RAAMS	remote antiarmor mine system
NOS	night observation system	RAM	random-access memory
NSG	north-seeking gyrocompass	RAP	rocket-assisted projectile
OB	observer-burst	RATELO	radiotelephone operator
observed the fan	a device used to refine an observer's estimation of distance in the target area	RC	range correct
observer-target factor	the distance from the observer to the target expressed in thousands to the nearest hundred (for example, 6,300 meters ~ 6.3)	rd	round
observer-target line	an imaginary line extending from the observer to, and through, the target	rec	record
OF	observed fire	reference point	a prominent, easily identified terrain feature to which an observer knows the direction
OP	observation post	refinement	a final correction sent to the FDC to move the center of impact to the adjusted point; always given for any mission
OT	observer-target	reg	register
OT dis	range from the observer to the target	reg pt	registration point
over	a burst farther away than the adjusting point as seen by the observer	repeat	1. In an FFE-type mission, it means to fire another volley of the same type or quantity of ammunition while applying the correction; for example, RIGHT 110 PLUS 300, REPEAT, OVER. 2. In an AF mission, it means firing the same data, but the type or quantity of ammunition may change; for example, TIME, REPEAT, OVER.
PDD/VDD	player detector device/vehicle detector device		

right (R)	denotes a shift perpendicular to the OT line	TACP	tactical air control party
rpt	repeat	TADS	target acquisition and designation sight
RTC	remote target control	target	any enemy personnel, equipment, or terrain feature which may be fired on or used as a reference for fires
RTD	receiver-transmitter device	ti	time
s	suppress, suppression	TOF	time of flight
SA	subsequent adjust	TOT	time on target
SALT	supporting arms liaison team	TOW	tube-launched, optically tracked wire-guided missile
SD	self-destruct	TRADOC	United States Army Training and Doctrine Command
SEAD	suppression of enemy air defenses	TRP	target reference point
sec	second	TSCD	targeting station control display
SGT	sergeant	TSFO	training set, fire observation
SHORT	a spotting of a burst between the observer and the target	TTT	time to target
smk	smoke	UHF	ultrahigh frequency
SOP	standing operating procedures	up (U)	denotes a shift in the vertical plane; it can apply to height of burst or target altitude
SP	self-propelled	USAFAS	United States Army Field Artillery School
SPC	specialist	USAREUR	United States Army Europe
SPLASH	sent by the FDC to the observer 5 seconds before impact; may be requested by the observer	VA	vertical angle
spotting	an instantaneous visual and mental determination of the location of a burst with respect to the adjusting point; announced as both over (short) and magnitude and direction; for example, OVER, 30 LEFT or SHORT, 120 RIGHT.	vertical angle	the angle formed between the observer's horizontal line of sight and the OT line as used by the observer with the vertex at the observer's location
SR	self-registering	VFMED	variable format message entry device
SSB	single sideband	VHF	very high frequency
SSG	staff sergeant	VI	vertical interval
STANAG	standardization agreement	VT	variable time
TA	target acquisition	WFOV	wide field of view
TACFIRE	tactical fire direction system	WP	white phosphorus

REFERENCES

SOURCES USED

These are the sources quoted or paraphrased in this publication.

- AR 40-46. *Control of Health Hazards From Lasers and Other High Intensity Optical Sources*. 6 February 1974.
- AR 310-25. *Dictionary of United States Army Terms*. 15 October 1983.
- AR 310-50. *Authorized Abbreviations and Brevity Codes*. 15 November 1985.
- AR 385-30. *Safety Color Code Marking and Signs*. 15 September 1983.
- AR 385-63. *Policies and Procedures for Firing Ammunition for Training Target Practice and Combat*. 15 October 1983.
- FM 6-2. *Field Artillery Survey*. 3 November 1986.
- FM 6-20-10. *Tactics, Techniques, and Procedures for the Targeting Process*. 29 March 1990.
- FM 6-50. *Tactics, Techniques, and Procedures for the Cannon Battery*. 10 November 1990.
- FM 7-90. *Tactical Employment of Mortars*. 11 June 1985.
- FM 21-26. *Map Reading and Land Navigation*. 30 September 1987.
- FM 90-20. *Multi-Service Procedures for the Joint Application of Firepower (J-FIRE)*. July 1989.
- FM 101-5-1. *Operational Terms and Symbols*. 21 October 1985.
- FMFM 7-2. *Naval Gunfire Support*. 3 August 1978.
- Goldsmith, Martin, et al. *Applying the National Training Center Experience: Artillery Targeting Accuracy*. The Arroyo Center. A Rand Note prepared for the United States Army. April 1990.
- JCS Pub 1-02. *DOD Dictionary of Military and Associated Terms*. January 1986.
- QSTAG 182. *Battlefield Illumination*. Edition 2. 14 November 1980.
- QSTAG 224. *Manual Fire Direction Equipment, Target Classification and Methods of Engagement*. Edition 2. 25 March 1987.
- QSTAG 225. *Call for Fire Procedures*. Edition 3. 1 August 1988.
- QSTAG 246. *Radio Telephone Procedures for the Conduct of Artillery Fire*. Edition 3. 7 November 1986.
- QSTAG 503. *Bombing Shelling Motoring, and Location Reports*. Edition 1. 28 September 1979.
- QSTAG 505. *Adjustment of Artillery Fire*. Edition 2. 16 February 1989.
- STANAG 1034. *Allied Spotting Procedures for Naval Gunfire Support*. Edition 8. 24 November 1987.
- STANAG 2088. *Battlefield Illumination*. Edition 6. 25 March 1988.
- STANAG 2934. *Artillery Procedures*. Edition 1. 20 June 1989.
- STANAG 3736. *Offensive Air Support Operations*. Edition 7. 26 September 1988.
- TB MED 524. *Occupational and Environmental Health: Control of Hazards to Health from Laser Radiation*. 20 June 1985.
- TC 6-40. *Field Artillery, Manual Cannon Gunnery*. 27 December 1988.
- TC 6-40A. *Field Artillery Automated Cannon Gunnery*. 21 April 1989.
- TC 90-7. *Tactical Air Control Party/Fire Support Team (TACP/FIST) Close Air Support Operations*. 20 September 1988.
- TM 9-1260-477-12. *Operator and Organizational Maintenance Manual for Electro-Optical Target Designator Set AN/TVQ-2 (GVLLD) and GVLLD M113A1 Vehicle Adapter Kit*. 23 January 1982.
- TM 9-1260-479-12. *Operator's and Organizational Maintenance Manual for Laser Target Designator AN/PAQ-1*. 15 November 1980.
- TM 9-2350-266-10. *Operator's Manual for Carrier, Personnel, Fuel Tracked; Armored Fire Support Vehicle M981*. 10 April 1985.

TM 11-7025-244-12&P. *Operator's and Organizational Maintenance Manual Fire Support Team Digital Message Device, AN/PSG-5*. 15 September 1987.

TM 11-7440-281-12&P. *Operator's and Organizational Maintenance Manual Including Repair Parts and Special Tools List for Digital Message Device, AN/PSG-2B*. 18 May 1982.

TM 11-5860-201-10. *Operator's Manual for Laser Infrared Observation Set, ANIGVS-5*. 2 February 1982.

DOCUMENTS NEEDED

These documents must be available to the intended users of this publication.

ARTEP 6-115-20-MTP. *Mission Training Plan for the Field Artillery Cannon Battalion Fire Support*. 24 January 1990.

ARTEP 71-1-MTP. *Mission Training Plan for Tank and Mechanized Infantry Company and Company Team*. 3 October 1988.

DA Form 2028. *Recommended Changes to Publications and Blank Forms*. February 1974.

DA Form 5429-R. *Conduct of Fire*. June 1985.

FM 3-5. *NBC Decontamination*. 24 January 1985.

FM 6-20-40. *Tactics, Techniques, and Procedures for Fire Support for Brigade Operations (Heavy)*. 5 January 1990.

FM 6-20-50. *Tactics, Techniques, and Procedures for Fire Support for Brigade Operations (Light)*. 5 January 1990.

FM 7-10 (HTF). *The Infantry Rifle Company (Infantry, Airborne, AirAssault, Ranger)*. 8 January 1982.

FM 24-35. (O) *Communications-Electronics Operations Instructions (The CEOI)*. 23 September 1986.

FM 71-1. *Tank and Mechanized Infantry Company Team*. 22 November 1988.

ST 6-20-20. *Fire Support Handbook*. 13 November 1989.

NOTE: This publication can be obtained from Commandant US, Army Field Artillery School ATTN: ATSF-TF, Fort Sill, OK 73503-5600.

TM 9-6920-361-13&P. *Operator, Organizational and Direct Support Maintenance Manual (Including Repair Parts and Special Tools List): Field Artillery Trainer Kits*. 22 September 1976.

TM 38-250. *Packaging and Materials Handling Preparing of Hazardous Materials for Military Air Shipments*. 15 January 1988.

TM 43-0001-28-1. (C) *Army Ammunition Data Sheets for Artillery Ammunition: Guns, Howitzers, Mortars, Recoilless Rifles, Grenade Launchers and Artillery Fuses (U)*. 28 November 1978.

READINGS RECOMMENDED

These readings contain relevant supplement information.

FM 6-20. *Fire Support in the AirLand Battle*. 17 May 1988.

FM 6-20-30. *Tactics, Techniques, and Procedures for Fire Support for Corps and Division Operations*. 18 October 1989.

FM 23-91. *Mortar Gunnery*. 7 October 1985.

FM 25-3. *Training in Units*. 12 December 1984.

FM 25-4. *How to Conduct Training Exercises*. 10 September 1984.

STP 6-13F14-SM-TG. *Soldier's Manual and Trainers Guide: MOS 13F, Fire Support Specialist (Skill Levels 1/2/3/4)*. 24 August 1989.

TC 6-71. *Fire Support Handbook for the Maneuver Commander*. 10 November 1988.

TM 9-1220-246-12&P. *Operator's and Organizational Maintenance Manual Including Repair Parts Special Tools List for Mortar Ballistics Computer Set M23*. 27 August 1985.

INDEX

- abbreviated precision registration, 5-21, 5-22
- AC-130 Spectre, A-16
- accurate initial fires, 1-2
- adjust fire (mission type), 4-1
- adjusting point, 5-1
- adjustment
 - AN/GVS-5, using the, A-14
 - DMD, using the, B-6, B-7, B-14 through B-17
 - G/VLLD, using the, A-8, A-9
 - length of, 1-2
 - naval gunfire, of, 8-13, 8-14
 - sound, by, 7-11, 7-12
 - techniques of (AFSO), 7-2
 - techniques of (area fire), 5-8 through 5-10
 - types of, 4-3
- aerial fire support observer, 7-1 through 7-3
- AH-64 target acquisition and designation sight, A-14, A-15
- aiming circle, 3-4, 7-7, 7-8
 - determining direction with, 3-4
- aiming points, E-6
- ammunition
 - as method of engagement, 4-4
 - selecting suitable, E-5
- Angle T, 4-6, 5-5, 6-23, 6-24
- angular deviations
 - measuring, 3-5
 - measuring with hand, 3-11
- AN/GVS-5 laser range finder, 5-24, A-13, A-14
 - adjustment of fire with, A-14
 - self-location with, A-14
- AN/PAQ-1 laser target designator, A-15
- AN/TAS-4 night vision sight, A-1, A-2, A-12, A-13
 - ranging and designating with, A-12
 - training with, A-13
- APICM, 6-1
- area adjustment, 4-4
- area denial artillery munition (ADAM) shell, 4-11
- area fire, 5-8 through 5-11
- at my command (method of control), 4-4
- attack and scout teams, 8-6
- attack helicopters, 8-6, 8-7
 - capabilities of, 8-6
 - employment of, 8-6
 - target handover for, 8-6, 8-7
- authentication, 4-6
 - challenge and reply method, 4-7
 - DMD, using the, B-8 through B-13
 - FED, using the, B-18
 - transmission authentication method, 4-6, 4-7
- auxiliary adjusting point, use of, 7-10, A-9 through A-11
- battery computer system (BCS) sheaf, 4-4
- binoculars, use of to measure angular deviations, 3-5
- call for fire, 4-1
 - changes to, 4-6
 - DMD, using a, B-13, B-14
 - elements of, 4-1
 - examples of, 4-7
 - from higher headquarters, 4-6
 - naval gunfire, for, 8-8 through 8-11
- cannot observe (method of control), 4-5
- cease loading (method of control), 4-5
- centralized control option, 2-3
- C factor, 7-12
- challenge and reply
 - authentication method, 4-6
 - using a DMD, B-10
- check firing (method of control), 4-5
- close air support, 2-1, 8-1 through 8-6
 - attack information for, 8-1, 8-2
 - control measures for, 8-1
 - employment of, 8-1 through 8-3
 - marking of target for, 8-3
 - mission control procedures for, 8-3 through 8-6
 - mission data for, 8-1, 8-2
 - PRF codes for, 8-3
 - types of requests for, 8-1
- combined arms team integrated evaluation system, C-3
- communications, 2-5, 8-8
 - digital, establishing with the DMD, B-6
 - with the FED, B-20
- company FSO, 2-2
- compass, determining direction with, 3-4
- conduct of fire form (DA Form 5429-R), 4-1
- continuous fire (method of control), 4-5
- continuous illumination (method of control), 4-5, 6-10
- control of observers, 2-3
- converged sheaf, 4-4

- coordinated illumination (method of control), 4-5, 6-10
- Copperhead, 5-22, 5-23, 5-25, 6-22 through 6-27
 - Angle T requirements for, 6-23, 6-24
 - call for fire for, 6-25 through 6-27
 - characteristics of, 6-22
 - employment of, 6-22
 - engagement commands, 6-27
 - footprint templates for, 6-22 through 6-24
 - laser PRF codes for, 6-27
 - message to observer, 6-27
 - minimum visibility requirements for, 6-22
 - planned targets, 6-25, 6-26
 - priority targets, 6-26
 - procedures using FED, B-26
 - targets of opportunity, 6-24 through 6-26
- correction of errors, 4-5
- creeping fire, 5-10

- danger close (method of engagement), 4-4, 5-6, 5-10, 6-2, 7-4, 8-9
- decentralized control option, 2-3
- deception smoke, 6-12
- delay (fuze setting), 4-9
- destruction
 - as effect on target, 4-9
 - naval gunfire mission, 8-18
 - precision fire mission, 4-3, 5-22
- deviation corrections, 5-4, 5-5, 5-7
- deviation spottings, 5-3
- digital communications, 2-5, B-6, B-20
- direction, determining, 3-4
- distance, determining, 3-6
- distribution (method of engagement), 4-4, 5-6, 5-7
- DMD AN/PSG-2A, B-1 through B-17, D-1 through D-3
 - authentication codes for, B-6, B-8 through B-12
 - authentication with, B-8 through B-12
 - description of, B-1
 - diagnostic checks for, B-5
 - establishing communications with, B-6
 - functional sections of, B-1 through B-4
 - memory capacity of, B-1
 - memory purge of, B-5
 - message composition and transmission, B-12 through B-17
 - message formats of, B-6, B-7
 - message structure, composition, and flow, B-7, B-8
 - mnemonics for, B-34 through B-38
 - mode menu for, B-6, B-7
 - preparation for use of, B-5, B-6
 - purging memory of, B-11
 - special-purpose power sources for, B-33, B-34
- dual-purpose ICM, 4-11, 6-1

- effects on target, 4-9
- emergency observer procedures, 7-12
- errors, correction of during call for fire, 4-5

- family of scatterable mines (FASCAM), 6-3 through 6-7
 - ADAM, 4-11, 6-3, 6-4
 - adjustment of, 6-7
 - call for fire for, 6-7
 - characteristics of, 6-3
 - mine density, 6-5
 - minefield types, 6-4
 - RAAMS, 4-11, 6-3
 - self-destruction times, 4-11, 6-3 through 6-5
 - use of shell, 4-11
- field artillery team, 1-1
- field artillery trainer M31, 14.5-mm, C-2, C-3
- final protective fires, 7-4, 7-5, B-26, B-27
- fire direction center, 1-1
- fire for effect (area fire), 5-10, 5-11
- fire for effect (mission type), 4-1
- firepower control team (FCT), 2-1
- fires
 - accurate initial, 1-2
 - massed, 1-3
- fire support
 - coordinator (FSCOORD), 1-5
 - effectiveness of, 1-2
 - sergeant, 2-2
 - specialist, 2-2
 - team, 2-1
 - team equipment, 2-1
- fire support team vehicle (FISTV), D-1 through D-3
 - capabilities of, D-1
 - communications station, D-1, D-2
 - description of, D-1
 - determining target location with, D-2
 - determining vehicle location with, D-2
 - observation station, D-2
 - positioning, 2-4, 2-5
 - targeting station, D-1
- firing unit, 1-1
- first-round FFE, 1-5
- FIST DMD, B-29 through B-31, D-1 through D-3
 - description of, B-31
 - mnemonics for, B-34 through B-38
 - operation of, B-29, B-30
- flash-to-bang technique, 3-6

- forward air controller, 2-1
- forward entry device (FED), B-18 through B-28
 - authentication procedures for, B-18
 - check fire and cancel check fire procedures, B-28
 - communications, B-20
 - communications, failure of, B-22
 - description of, B-18
 - fire mission processing procedures, B-24 through B-28
 - initialization of, B-20, B-21
 - memory capacity of, B-18
 - message formats, B-18 through B-20
 - message processing procedures for, B-23, B-24
 - message transfer modes, B-20
 - mnemonics for, B-34 through B-38
 - operational checks for, B-20
 - power failure of, B-22
 - preparation for use, B-20 through B-22
 - self-location, calculating with, B-21, B-22
 - transferring software data with, B-23
- forward observer, 2-2
 - control of, 2-3
 - self-location, 2-4
- fuze (method of engagement), 4-4, 5-7
- fuzes, selection considerations, 4-9
- grid
 - method of target location, 3-1, 4-2
 - mission, 4-2, B-13
- G/VLLD, 3-4, A-1 through A-13, D-1
 - adjustment of fire with, A-8, A-9
 - AN/TAS-4 night vision sight, use with, A-1, A-2, A-12, A-13
 - auxiliary adjusting point with, A-9 through A-11
 - boresighting of, A-2
 - description of, A-1, A-2
 - determining direction with, 3-4
 - establishing known points with, A-5
 - laser training kit, C-2, C-3
 - operator cloud height, A-11
 - orienting, A-2
 - polar plot with, A-7, A-8
 - registrations with, A-12
 - safety fan and range safety card, A-18 through A-20
 - second G/VLLD assist of, A-5 through A-7
 - self-location with, A-2 through A-5
 - simultaneous observation with, A-6, A-7
 - TSFO-G/VLLD simulation enhancement, C-2
- hand measurement of angular deviation, 3-11
- hasty bracketing, 5-9, 5-10
- height-of-burst corrections, 5-5, 5-7
- height-of-burst spottings, 5-1, 5-2
- Hellfire
 - missile, 8-6, A-14
 - ground support system (training device), C-3
- high-angle fire, 7-3
- high-burst/mean-point-of-impact registrations, 7-7 through 7-10, B-15, B-16, B-25, B-26
- high-explosive (HE)
 - fuze concrete piercing, use with, 4-10
 - fuze delay, use with, 4-9
 - fuze quick, use with, 4-9
 - fuze time, use with, 4-10
 - fuze VT, use with, 4-10
 - shell, 4-9
- ICM, 6-1 through 6-3
 - adjustment of, 6-1, 6-2
 - call for fire for, 6-1
 - characteristics of, 6-1
 - employment considerations of, 6-3
- identification, observer (CFF element), 4-1
- illuminating shell, 4-11
- illumination, 6-7 through 6-11
 - adjustment of, 6-9
 - call for fire for, 6-9
 - characteristics of, 6-7
 - continuous, 6-10
 - coordinated, 6-10
 - employment considerations of, 6-7 through 6-9
 - naval gunfire, 8-14 through 8-16
 - patterns, 6-7 through 6-9
- immediate smoke, 6-14, 6-18, 6-19
- immediate suppression (mission type), 4-2
- impact registration, 5-12 through 5-15
- improved conventional munitions (ICM), 4-11
- intercept point, 5-23 through 5-25
- irregularly shaped targets, 7-10, 7-11
- joint air attack teams, 8-6
- known point
 - shift from, 4-2
 - determining with G/VLLD, A-5
- laser, 1-5, 3-6, A-1 through A-20
 - DMD messages for use with a, B-14, B-15, B-17
 - safety, A-16 through A-20
 - safety goggles, A-17
 - target designation, 4-11
 - target designator AN/PAQ-1, A-15
 - training kit, G/VLLD, C-2, C-3

- used to determine distance, 3-6
- use on the battlefield, A-1
- laser-guided
 - bombs, A-16
 - munitions, A-1, A-16
- laser polar plot, 4-2
- laser range finder, 1-5
 - AN/GVS-5, 5-24, A-13, A-14
 - used to measure angular deviation, 3-4, 3-5
- lateral shift, determining, 3-2
- law of war, 1-4
- lithium batteries, B-33, B-34
- lost spottings, 5-3, 5-4
- low-altitude navigation and targeting infrared system (LANTIRN), A-16

- maneuver commander, 1-5
- map
 - determining direction from, 3-4
 - terrain analysis, 3-7
- marking targets for CAS, 8-3
- mark (method of engagement), 4-4
- massed fires, 1-3
- massing of naval gunfire, 8-18
- mast-mounted sight (OH-58D), A-15
- matchbox problem (training device), C-1
- message formats
 - for the DMD, B-6, B-7
 - for the FED, B-18 through B-20
- message to observer, 4-6
- message transfer modes, FED, B-20
- method
 - of attack, selecting, E-6
 - of control, 4-5, 5-7
 - of engagement, 4-3
 - of fire, 4-4, 5-6
 - of fire and control, 4-4
- mil relation formula, 3-2, 3-7
- mine density, FASCAM, 6-5
- minefield types, FASCAM, 6-4
 - planned, 6-4
 - target of opportunity, 6-4
- mines, FASCAM, 4-11, 6-3 through 6-7
- missions, types of, 4-1
- mission type, subsequent correction of, 5-7
- mnemonics for digital devices, B-34 through B-38
- modular universal laser equipment (MULE), 6-22, A-15, A-16

- mortar
 - ballistic computer M23, B-32
 - registration, 5-15
 - sheaf adjustment, 5-15, 5-16
 - smoke procedures, 6-21
- moving targets
 - engagement of, 5-23 through 5-25
 - planned targets, 5-25
 - procedures using FED, B-27, B-28
 - targets of opportunity, 5-23 through 5-25
- M31 14.5-mm field artillery trainer, C-2, C-3
- multiple missions, 7-5, 7-6
- munitions, 1-4

- naval gunfire, 8-7 through 8-19
 - adjustment of, 8-13, 8-14
 - authentication for, 8-11
 - communications for, 8-8
 - destruction fire missions, 8-18
 - dispersion pattern of, 8-13
 - elements of call for fire for, 8-8 through 8-11
 - firing on a previously recorded target, 8-17
 - illumination, 8-14 through 8-16
 - massed fires, 8-18
 - prefiring report for, 8-11, 8-15
 - shift to a fresh target, 8-16, 8-17
 - ship and armament types for, 8-7
 - simultaneous engagement of two targets, 8-17
 - 16-inch missions, 8-18
 - special commands and reports, 8-18, 8-19
- neutralization (effect on target), 4-9
- night observation system (NOS) OV-10D, A-16
- night vision sight AN/TAS-4, A-1, A-2, A-12, A-13
- number of rounds (element of MTO), 4-6

- obscuring smoke, 6-12, 6-13
- observation, 2-4
- observation post
 - characteristics, 2-4
 - selection of, 2-3
- observed fire (OF) fan, 3-7, 3-9
 - preparation and use of, 3-10
- observer
 - emergency procedures, 7-12
 - helpful notes for, 5-26
 - identification (CFF element), 4-1
 - not oriented, 7-10
 - responsibilities in target analysis and munitions effects, E-1
- observer-target
 - direction, 3-2, 5-6

- distance, 3-9, 5-4
- factor, 5-4
- line, 5-1 through 5-3, 5-5, 5-12
- observer training for nonartillery personnel, C-3, C-4
- OH-58D mast-mounted sight, A-15
- one-round adjustment, 5-10
- open sheaf, 4-4
- operator cloud height, A-11
- operator's key (for DMD authentication), B-6
- OV-10D night observation system (NOS), A-16

- Pave Penny, A-16
- Pave Spike, A-16
- Pave Tack, A-16
- Paveway II and III laser-guided bombs, A-16
- planned targets for Copperhead, 6-25, 6-26
- polar plot
 - method of location, 3-1, 4-2
 - mission, 4-3, B-14, B-17
- position-locating system, 1-5, 3-1
- power sources, special purpose, for DMD and FIST
 - DMD, B-33, B-34
- precision fire (type of adjustment), 4-3, 5-12 through 5-22
- precision registration, 5-12 through 5-22, B-15, B-25
- predesignated control option, 2-3
- PRF codes, 4-11, 6-27, 8-3, A-1
 - for CAS, 8-3
 - for Copperhead, 6-27
- probable error in range (element of MTO), 4-6, 5-10, 5-12
- projectile (method of engagement), 4-4, 5-7
- proximity (VT) fuze, use with HE, 4-10

- quick fuze, use with HE, 4-9
- quick smoke, 6-20, 6-21

- radar registration, B-16
- radio telephone operator (RATELO), 2-2
- range change, determining, 3-3
- range corrections, 5-5, 5-7
- range safety card, G/VLLD, A-18 through A-20
- range spottings, 5-2
- reconnaissance, 2-4
- reference point, measuring direction from, 3-4
- refinement and surveillance (area fire), 5-11
- registrations
 - abbreviated (using G/VLLD), A-12
 - HB/MPI, 7-7 through 7-10, A-12, B-15, B-16, B-25, B-26
 - precision, 5-12 through 5-22, A-12, B-15, B-25
 - radar, B-16
 - remote antiarmor mine system (RAAMS) shell, 4-11
 - repeat (method of control), 4-5, 5-8
 - responsibilities, 2-2
 - ricochet fire, 4-9

 - safety fan, G/VLLD, A-18 through A-20
 - safety, laser, A-16 through A-20
 - screening smoke, 6-12, 6-13
 - second-lot registration, 5-21
 - self-authentication, 4-7
 - using a DMD, B-8, B-9
 - self-location, 1-4, A-2 through A-5
 - with AN/GVS-5, A-13
 - with FED, B-21, B-22
 - with G/VLLD, A-2 through A-5
 - shell-fuze combination, 1-4, 4-9
 - shift from known point
 - method of target location, 3-1, 3-2, 4-2
 - mission type, 4-2, B-13 through B-15
 - sheafs, 4-4
 - signaling smoke, 6-12
 - size of element to fire for effect (element of warning order), 4-2
 - smoke, 6-12 through 6-21
 - characteristics of, 6-12, 6-13
 - for deception, 6-12
 - delivery techniques of, 6-13, 6-14
 - employment considerations for, 6-14 through 6-18
 - immediate, 6-14, 6-18, 6-19
 - mortar procedures, 6-21
 - non-field-artillery, 6-13
 - obscuring, 6-12, 6-13
 - quick, 6-20, 6-21
 - screening, 6-12, 6-13
 - shell, 4-11
 - signaling, 6-12
 - sound, speed of, 7-12
 - Spectre, AC-130, A-16
 - splash (method of control), 5-8
 - spotting lines (for AFSO), 7-1, 7-2
 - spottings, types of, 5-1 through 5-4
 - subsequent corrections, 5-1 through 5-8, B-14, B-15, D-2, D-3
 - deviation, 5-4, 5-5, 5-7
 - height of burst, 5-5, 5-7
 - range, 5-5, 5-7
 - sequence for, 5-6 through 5-8
 - types of, 5-4, 5-5

- successive bracketing, 5-8, 5-9
 - suppression
 - as effect on target, 4-9
 - type of mission, 4-2
 - TACFIRE target types, E-1 through E-3
 - tailoring, 2-3
 - target
 - describing a, E-1 through E-4
 - description (CFF element), 4-3, 5-7
 - equivalents for mnemonics, B-38
 - number (element of MTO), 4-6
 - size and shape, 4-3
 - types (TACFIRE), E-1 through E-3
 - target acquisition and designation sight (AH-64), A-14, A-15
 - target analysis and munitions effects, E-1 through E-6
 - observer responsibilities in, E-1
 - TACFIRE target types, E-1 through E-3
 - target location
 - element of call for fire, 4-2
 - error, 1-5
 - FISTV, determining with, D-2
 - methods of, 3-1, 4-2
 - OF fan, determining with, 3-10
 - target posture, 1-3
 - targets of opportunity for Copperhead, 6-24 through 6-26
 - terrain-map association, 3-1
 - terrain sketch, 3-8
 - technical fire direction, 1-1
 - temperature gradients 6-14, 6-15
 - time fuze, use with HE, 4-10
 - time of flight (element of MTO), 4-6
 - time on target (TOT), 4-4, 4-5
 - time registration, 5-16 through 5-20
 - training devices, C-1 through C-4
 - training set, fire observation (TSFO), C-2
 - trajectory (method of engagement), 4-4, 5-6
 - transmission
 - authentication table, 4-7
 - method of authentication, 4-7
 - trees, using to estimate distance, 3-6
 - trigger point, 5-25
 - TSFO-G/VLLD simulation enhancement, C-2
 - units to fire (element of MTO), 4-6
 - unobserved spottings, 5-3
 - USAF laser systems, A-16
 - vertical shift, determining, 3-2, 3-3
 - volume of fire (method of engagement), 4-4, 5-7
 - VT fuze, use with HE, 4-10
 - warning order (CFF element), 4-1
 - white phosphorus, shell, 4-11
 - wind speed, methods of determining, 6-16
-

FM 6-30
16 JULY 1991

By Order of the Secretary of the Army:

CARL E. VUONO
General, United States Army
Chief of Staff

Official

PATRICIA P. HICKERSON
Colonel, United States Army
The Adjutant General

DISTRIBUTION:

Active Army, ARNG, and USAR: To be distributed in accordance with DA Form 12-11 E. Requirements for Tactics Techniques, and Procedures for Observed Fire (Qty rqr block no, 71).

*U.S. Government Printing Office: 1993 — 342-421/80971

PIN: 034434-000