



U.S. Department
of Transportation

**National Highway
Traffic Safety
Administration**

**DOT HS 807 675
NHTSA Technical Report**

November 1990

Motor Vehicle Fires in Traffic Crashes and the Effects of the Fuel System Integrity Standard

The United States Government does not endorse products or manufactures. Trade or manufacturer's names appear only because they are considered essential to the object of this report.

| | | | | | |
|--|--|--|--|---|-----------|
| 1. Report No. DOT HS 807 675 | | 2. Government Accession No. | | 3. Recipient's Catalog No. | |
| 4. Title and Subtitle MOTOR VEHICLE FIRES IN TRAFFIC CRASHES AND THE EFFECTS OF THE FUEL SYSTEM INTEGRITY STANDARD | | | | 5. Report Date NOVEMBER 1990 | |
| | | | | 6. Performing Organization Code NPP-10 | |
| 7. Author(s) Glenn G. Parsons | | | | 8. Performing Organization Report No. | |
| 9. Performing Organization Name and Address Office of Standards Evaluation National Highway Traffic Safety Administration | | | | 10. Work Unit No. (TRAIS) | |
| | | | | 11. Contract or Grant No. | |
| 12. Sponsoring Agency Name and Address U. S. Department of Transportation National Highway Traffic Safety Administration Washington, D.C. 20590 | | | | 13. Type of Report and Period Covered NHTSA Technical Report | |
| | | | | 14. Sponsoring Agency Code | |
| 15. Supplementary Notes An agency staff review of existing Federal regulations performed in compliance with Executive Order 12291. | | | | | |
| 16. Abstract To reduce fatalities and injuries due to fire in motor vehicle crashes, Federal Motor Vehicle Safety Standard 301 was issued. This Standard, which applies to passenger cars, light trucks, and school buses, prescribes impact test requirements aimed at reducing the chances of fuel-fed fires caused by fuel system breaching in vehicle crashes. This study is an evaluation of the effectiveness, benefits, and costs of fuel system improvements made in response to the Standard. It is based on analysis of on-road crash data from 5 States, FARS, and on information supplied by automobile manufacturers. The study found that: | | | | | |
| <ul style="list-style-type: none"> o Standard 301 has reduced fires in passenger car crashes; the effect on burn injuries is uncertain; fatalities were not affected. For light trucks, no fire reduction was found. Fires in school bus crashes were too sparse for reliable assessment. o Fires in fatal passenger car crashes have increased, primarily due to an aging vehicle fleet. Fire risk increases with vehicle age. o The contributions of fire and impact forces in causing death and injury cannot be separated in crash data files. o The consumer cost of FMVSS 301 ranges from \$9.70 for passenger cars to \$234 for Type I (conventional) school buses. | | | | | |
| 17. Key Words Fire, crash fire, motor vehicle crashes, motor vehicle accidents, fuel system, fuel leakage, motor vehicle fatalities, motor vehicle injuries, burn injuries, accident analysis, FARS. | | | | 18. Distribution Statement | |
| 19. Security Classif. (of this report) Unclassified | | 20. Security Classif. (of this page) Unclassified | | 21. No. of Pages 282 | 22. Price |

Table of Contents

| | |
|---|-------|
| Executive Summary | xi |
| Chapter 1 Introduction | 1-1 |
| 1.1 Requirements of FMVSS 301 | 1-2 |
| 1.2 Study Objectives | 1-4 |
| 1.3 Data Sources | 1-5 |
| 1.4 Limitations of Fire Data in Motor Vehicle Accident Files. | 1-6 |
| 1.5 Prior Fire Studies | 1-7 |
| 1.6 Report Outline | 1-8 |
| Chapter 2 Effectiveness Analysis of FMVSS 301: Fuel System Integrity | 2-1 |
| 2.0 Introduction | 2-1 |
| 2.1 Data Sources Used | 2-2 |
| 2.1.1 Reporting of Vehicle Fires | 2-4 |
| 2.2 Effectiveness Analysis for Passenger Cars | 2-10 |
| 2.2.1 Analysis of State Accident Data | 2-12 |
| 2.2.2 Analysis of State Injury Accident Data. | 2-42 |
| 2.2.3 Analysis of Fatal Accident Data | 2-52 |
| 2.3 Effectiveness Analysis for Light Trucks. | 2-64 |
| 2.3.1 Analysis of State Accident Data | 2-65 |
| 2.3.2 Analysis of Fatal Accident Data | 2-90 |
| 2.4 Effectiveness Analysis for School Buses. | 2-96 |
| 2.4.1 Analysis of State Accident Data | 2-99 |
| 2.4.2 Analysis of Fatal Accident Data | 2-105 |
| 2.5 Discussion of Effectiveness Analysis Performed | 2-107 |
| Chapter 3 The Nature and Magnitude of Fires in Motor Vehicle Crashes. | 3-1 |
| 3.1 Fires in Fatal Crashes | 3-1 |
| 3.1.1 Trends in Fatal Fire Crashes | 3-3 |
| 3.1.2 Comparisons of Fire Fatal Crashes and All Fatal Crashes | 3-15 |
| 3.2 Fires in All Reported Crashes | 3-22 |
| 3.2.1 Fire Rates and Total Fires in Motor Vehicle Crashes | 3-25 |
| 3.2.2 Severity of Fire Crashes in All Reported Crashes | 3-28 |
| 3.3 Fuel Leakage in Motor Vehicle Crashes | 3-35 |

| | | |
|------------|---|------|
| Chapter 4 | The Benefits and Costs of FMVSS 301 | 4-1 |
| 4.1 | The Benefits of FMVSS 301. | 4-1 |
| 4.1.1 | The Benefits for Passenger Cars | 4-2 |
| 4.2 | The Implementation Costs of FMVSS 301 | 4-7 |
| 4.2.1 | The Nature of Vehicle Modifications Made for FMVSS 301. | 4-11 |
| 4.2.2 | The Weight and Cost of Vehicle Modifications Made | 4-25 |
| 4.2.3 | The Overall Cost of Standard 301. | 4-30 |
| References | | R-1 |
| Appendix A | Federal Motor Vehicle Standard 301 Requirements | A-1 |
| Appendix B | State and FARS Accident Report Forms | B-1 |
| Appendix C | Frequency Counts of Fires and Vehicle Crashes | C-1 |
| Appendix D | Letters to Motor Vehicle Manufacturers. | D-1 |
| Appendix E | Additional Analyses of the Effect of Vehicle Age on Fire Rates | E-1 |

List of Tables

| | | |
|-------------|---|-------|
| Table 1-1 | Chronological Summary of Requirements: Federal Motor Vehicle Standard 301, Fuel System Integrity | 1-3 |
| Table 2-1 | Sources of Accident Data Analyzed | 2-3 |
| Table 2-2 | Fire Rates in Passenger Car Crashes by State and Vehicle Model Year | 2-11 |
| Table 2-2a | Fire Rates in Passenger Car Injury Crashes by State and Vehicle Model Year | 2-43 |
| Table 2-3 | Fire Rates in Fatal Passenger Car Accidents by Vehicle Model Year | 2-55 |
| Table 2-4 | Selected Comparisons of Pre-standard and Post-standard Fire Rates for Passenger Cars, Fatal Accident Data | 2-61 |
| Table 2-5 | Adjustment for Vehicle Age on the Selected Comparisons of Pre-standard and Post-standard Passenger Cars | 2-63 |
| Table 2-6 | Fire Rate in Light Truck Crashes by State and Vehicle Model Year | 2-66 |
| Table 2-7 | Fire Rate in Fatal Light Truck Accidents by Vehicle Model Year | 2-91 |
| Table 2-8 | Selected Comparisons of Pre-standard versus Post-standard Fire Rates in Fatal Light Truck Crashes | 2-97 |
| Table 2-9 | Age Adjustment Factors for Selected Comparisons of Fire Rates in Pre- and Post-standard Light Truck Crashes | 2-98 |
| Table 2-10a | Fire Rates in School Bus Crashes by State and Vehicle Model Year | 2-100 |
| Table 2-10b | Fire Rates in School Bus Crashes by State and Vehicle Model Year | 2-101 |
| Table 2-11 | Fire Rates in School Bus Crashes by State and Pre-standard versus Post-standard Vehicles | 2-102 |
| Table 2-12 | School Buses Involved in Fatal Crashes by Calendar Year, Pre-standard versus Post-standard, and Fire Occurrence | 2-108 |

List of Tables (continued)

| | | |
|-------------|--|------|
| Table 3-1 | Fires in Fatal Motor Vehicle Accidents | 3-2 |
| Table 3-2 | Percentage of Total Passenger Cars in Fatal Crashes, and Fire-Involved Passenger Cars in Fatal Crashes That were Ten Years Old or Older at the Time of the Crash | 3-14 |
| Table 3-3 | Passenger Cars: Occupant Fatality Rates for Fatal Crashes with Fire and for All Fatal Crashes | 3-16 |
| Table 3-4 | Light Trucks: Occupant Fatality Rates for Fatal Crashes with Fire and for All Fatal Crashes | 3-17 |
| Table 3-5 | Distribution (percent) of Fatal Fire Crashes and All Fatal Crashes by First Harmful Event | 3-19 |
| Table 3-6 | Distribution (percent) of Fatal Fire Crashes and All Fatal Crashes by Roadway Speed Limit | 3-21 |
| Table 3-7 | Distribution (percent) of Fatal Fire Crashes and All Fatal Crashes by Impact Direction | 3-23 |
| Table 3-8 | Fire Rates in All Police Reported Crashes by Vehicle Class and State | 3-24 |
| Table 3-8a | Number of Fires per One Thousand Injury Crashes | 3-28 |
| Table 3-9 | Percent Distribution of Injury Severity for Fire Crashes and for All Reported Crashes. | 3-29 |
| Table 3-10 | Estimated Annual Injuries in Fire Crashes for Passenger Cars and Light Trucks. | 3-29 |
| Table 3-10a | Driver Injury Severity by Type of Fire, Passenger Cars | 3-31 |
| Table 3-11 | Percent Distribution of Fire Crashes and All Crashes by Vehicle Damage - Passenger Cars. | 3-33 |
| Table 3-12 | Percent Distribution of Fire Crashes and All Crashes by Vehicle Damage Severity - Light Trucks. | 3-33 |

List of Tables (continued)

| | | |
|------------|---|------|
| Table 3-13 | Distribution (percent) of Fire Crashes and All Crashes by Direction of Impact, State of Michigan | 3-36 |
| Table 3-14 | Distribution (percent) of Fire Crashes and All Crashes by Point of Impact, State of Maryland | 3-37 |
| Table 3-15 | Fuel Leakage Rates for Cars and Light Trucks by Vehicle Model Year | 3-38 |
| Table 4-1 | Fuel System Components | 4-12 |
| Table 4-2 | Summary of Types of Vehicle Modifications Made to Passenger Cars in Response to Federal Motor Vehicle Safety Standard 301 | 4-15 |
| Table 4-3 | Summary of Types of Vehicle Modifications Made to Trucks, Multipurpose Passenger Vehicles, and Buses in Response to Federal Motor Vehicle Safety Standard 301 | 4-18 |
| Table 4-4 | Estimated Proportion of Vehicle Miles Travelled Per Calendar Year, Passenger Cars, and Light Trucks. | 4-36 |
| Table 4-5 | Estimated Fuel Prices for Lifetime Fuel Penalty Costs | 4-37 |
| Table 4-6 | Discount Factors for Estimating Present Value of Future Energy Consumption | 4-38 |
| Table C-1 | Counts of Vehicle Fires and Total Accident - Involved Passenger Cars by Vehicle Model Year; States of Michigan, Ohio, and Maryland | C-2 |
| Table C-2 | Counts of Vehicle Fires and Total Accident - Involved Passenger Cars by Vehicle Model Year; States of Illinois and Indiana | C-3 |
| Table C-2a | Counts of Vehicle Fires and Total Passenger Cars Involved in Injury Crashes by Vehicle Model Year; States of Michigan, Ohio, and Maryland | C-4 |
| Table C-3 | Counts of Vehicle Fires and Total Accident - Involved Light Trucks by Vehicle Model Year; States of Michigan, Ohio, and Maryland | C-5 |

List of Tables (continued)

| | | |
|-----------|---|------|
| Table C-4 | Counts of Vehicle Fires and Total Accident - Involved Light Trucks by Vehicle Model Year; States of Illinois and Indiana | C-6 |
| Table E-1 | Statistical Comparison of the Effect of Age on Fire Rates in Accident Data - Passenger Cars | E-5 |
| Table E-2 | Statistical Comparison of the Effect of Age on Fire Rates in Accident Data - Light Trucks | E-6 |
| Table E-3 | Summary of Effectiveness Analyses, Restricting Accident Data to Vehicles of Equal Age for Pre-standard and Post-standard Samples. | E-10 |

List of Figures

| | | |
|--------------|---|------|
| Figure 2-1 | Plot of Fire Rate by Age, Michigan, Passenger Cars | 2-15 |
| Figure 2-2 | Plot of Fire Rate by MY, Michigan, Passenger Cars | 2-16 |
| Figure 2-3 | Plot of Fire Rate by Age, Ohio, Passenger Cars | 2-21 |
| Figure 2-4 | Plot of Fire Rate by MY, Ohio, Passenger Cars | 2-22 |
| Figure 2-5 | Plot of Fire Rate by Age, Maryland, Passenger Cars | 2-26 |
| Figure 2-6 | Plot of Fire Rate by MY, Maryland, Passenger Cars | 2-27 |
| Figure 2-7 | Plot of Fire Rate by Age, MI, OH, MD, Passenger Cars | 2-30 |
| Figure 2-8 | Plot of Fire Rate by MY, MI, OH, MD, Passenger Cars | 2-31 |
| Figure 2-9 | Plot of Fire Rate by Age, Illinois Passenger Cars | 2-35 |
| Figure 2-10 | Plot of Fire Rate by MY, Illinois Passenger Cars | 2-36 |
| Figure 2-11 | Plot of Fire Rate by Age, Indiana Passenger Cars | 2-37 |
| Figure 2-12 | Plot of Fire Rate by MY, Indiana Passenger Cars | 2-38 |
| Figure 2-12a | Plot of Fire Rate by Age, Michigan, Passenger Car Injury Crashes | 2-46 |
| Figure 2-12b | Plot of Fire Rate by MY, Michigan, Passenger Car Injury Crashes | 2-47 |
| Figure 2-12c | Plot of Fire Rate by Age, Ohio, Passenger Car Injury Crashes | 2-50 |
| Figure 2-12d | Plot of Fire Rate by MY, Ohio, Passenger Car Injury Crashes | 2-51 |

List of Figures (continued)

| | | |
|-------------|---|------|
| Figure 2-13 | Plot of Fire Rate by Age, FARS Passenger Cars | 2-57 |
| Figure 2-14 | Plot of Fire Rate by MY, FARS Passenger Cars | 2-58 |
| Figure 2-15 | Plot of Fire Rate by Age, Michigan, Light Trucks | 2-68 |
| Figure 2-16 | Plot of Fire Rate by MY, Michigan, Light Trucks | 2-69 |
| Figure 2-17 | Plot of Fire Rate by Age, Ohio, Light Trucks | 2-72 |
| Figure 2-18 | Plot of Fire Rate by MY, Ohio, Light Trucks | 2-73 |
| Figure 2-19 | Plot of Fire Rate by Age, Maryland, Light Trucks | 2-75 |
| Figure 2-20 | Plot of Fire Rate by MY, Maryland, Light Trucks | 2-76 |
| Figure 2-21 | Plot of Fire Rate by Age, MI, OH, MD, Light Trucks | 2-80 |
| Figure 2-22 | Plot of Fire Rate by MY, MI, OH, MD, Light Trucks | 2-81 |
| Figure 2-23 | Plot of Fire Rate by Age, Illinois Light Trucks | 2-84 |
| Figure 2-24 | Plot of Fire Rate by MY, Illinois Light Trucks | 2-85 |
| Figure 2-25 | Plot of Fire Rate by Age, Indiana Light Trucks | 2-87 |
| Figure 2-26 | Plot of Fire Rate by MY, Indiana Light Trucks | 2-88 |
| Figure 2-27 | Plot of Fire Rate by Age, FARS Light Trucks | 2-93 |
| Figure 2-28 | Plot of Fire Rate by MY, FARS Light Trucks | 2-94 |
| Figure 3-1 | Plot of Fire Rate by Calendar Year, FARS, Passenger Cars | 3-4 |

List of Figures (continued)

| | | |
|------------|--|------|
| Figure 3-2 | Plot of Fire Rate by Calendar Year, FARS, Light Trucks | 3-5 |
| Figure 3-3 | Plot of Fire Rate by Calendar Year, FARS, Other Vehicles | 3-6 |
| Figure 3-4 | Plot of Fire Rate by Age, FARS, Passenger Cars | 3-11 |
| Figure 3-5 | Plot of Fire Rate by Vehicle Weight, FARS, Passenger Cars | 3-12 |
| Figure 4-1 | Typical Fuel System, Passenger Car | 4-13 |
| Figure 4-2 | Fuel Tank Shield, Type I School Bus | 4-24 |

EXECUTIVE SUMMARY

Introduction

The National Highway Traffic Safety Administration (NHTSA) is required, under Executive Order 12291, to conduct periodic reviews of the regulations it has issued. The purpose of these reviews is to measure the impact of those regulations in terms of both the benefits and costs to the American public.

This study is a review of Federal Motor Vehicle Safety Standard 301 - Fuel System Integrity (FMVSS 301). The Fuel System Integrity Standard is intended to reduce the chances of injury and fatality due to fires which result from motor vehicle crashes.

Though crashes with fires are relatively rare, fires in motor vehicle crashes have long been a topic of interest and concern. By its very nature, the occurrence of fire can significantly increase the risk of injury in motor vehicle crashes. Fire is of particular concern in crashes where entrapment of the vehicle occupants has occurred, due to jammed doors, or other collapsed vehicle structures that may have pinned the occupant(s) inside the vehicle. Fire is also of concern in crashes where the nature or extent of injury prohibits occupants from extricating themselves. In both of these instances, the presence of fire has the significant potential for increasing injury beyond that caused by crash impact forces.

Due to the hazard it creates, and the speed with which it can spread, it is obviously preferable to attempt to reduce the risk of crash fires occurring rather than to rely on potential rescue efforts, once a fire has started. This is the aim of FMVSS 301. The requirements of this Standard are intended to strengthen and protect the vehicle's fuel system, so that in a crash event, the chances of fuel leakage, and consequently the chances of fire and occupant injury, will be reduced. Because of the highly flammable properties of gasoline, it is an obvious first choice as the source of combustible material in motor vehicle crash fires.

FMVSS 301 was first issued by the National Highway Traffic Safety Administration in 1967. In its initial version, the Standard applied only to passenger cars, manufactured after January 1, 1968, and the fuel system requirements covered only impacts to the front of the vehicle.

Subsequently, the Standard was revised, both to increase the individual performance requirements, and to extend the requirements to other classes of vehicles. In 1975, protection against rollover crashes was added to the frontal requirements for passenger cars. In 1976, these requirements were further increased to include protection against rear and side impacts. In 1976 and 1977, the requirements for cars were extended to light trucks (pickups, vans, multipurpose passenger vehicles, and buses) with gross vehicle weight ratings of 10,000 pounds or less. Finally, in 1977, a fuel system integrity requirement was established for Type I (large) school buses which included frontal, rear, and side protection.

In order to comply with the FMVSS 301 requirements, vehicles must withstand certain specified impact tests ranging from 20 to 30 miles per hour, without leaking fuel in excess of one ounce per minute following the tests.

Study Approach

This study is a statistical evaluation of the effectiveness of the 1975 through 1977 (upgrade) versions of FMVSS 301 in reducing vehicle crash fires, and associated injuries and fatalities. Descriptions of vehicle modifications resulting from the Standard are also included together with estimates of the consumer costs of these modifications. Thirdly, selected statistics which portray the magnitude and nature of fires in motor vehicle crashes are presented.

The effectiveness analyses are based on the police reported motor vehicle crash files from five States, plus the files of NHTSA's Fatal Accident Reporting System (FARS). Multiple years of data from both sources are used, providing a total of over 14.5 million police-reported crashes from the States and approximately 700,000 fatal vehicle crashes from FARS. Thus, the data represent real-world traffic crashes, and the primary basis for estimating effectiveness is the statistical comparison of fire rates for vehicles manufactured after Standard 301 went into effect, as compared with the fire rates for vehicles produced before the Standard.

Estimates of the costs of Standard 301 are based on information obtained from the motor vehicle manufacturers. Both vehicle modification costs, and fuel penalty costs to cover the added weight of the vehicle modifications are considered.

In most of its evaluation projects, NHTSA develops cost information through independently conducted vehicle teardown studies. These studies disassemble affected components from actual production vehicles, and estimate the costs of the component changes by comparison with baseline components produced prior to the issuance of the Federal standard. Due to the more subtle and varied nature of the vehicle modifications made in response to FMVSS 301, the vehicle teardown approach to cost estimation was not practicable.

Data Limitations

While police reported accident files are considered the best source of data on motor vehicle crash fires, they are nonetheless subject to certain limitations.

First, fires in traffic crashes include both those that result from the crash (post-crash fires) as well as those that are initiated prior to the crash (pre-crash fires). While it is not possible to reliably distinguish between post-crash and pre-crash fires, limited data indicate that pre-crash fires could approach 1/2 of all fires reported in police reported traffic crash data. The proportion of total fires that are post-crash would be expected to increase as the severity of the crash impact increases. FMVSS 301 is primarily designed to affect post-crash fires.

Secondly, in police reported accident data, it is not possible to distinguish between injuries caused by fire and injuries caused by crash impact forces. Since both injury severity and the likelihood of vehicle fire increase with

increasing crash severity (i.e., impact force), delineating the role of fire in injury causation is further compounded.

Lastly, the data obtained from motor vehicle manufacturers concerning the cost and type of vehicle modifications made in response to FMVSS 301 was less complete than desirable. While some companies supplied quite detailed data, other firms were able to provide only limited, or in some instances, no data. One of the hindrances to providing information was the span of several years between the time FMVSS 301 was issued and the time the information was requested from the manufacturers.

Prior Studies

Several prior studies have dealt with fires in motor vehicle crashes and the effects of FMVSS 301 in reducing these fires. Primarily, these earlier efforts studied only fires in passenger car crashes, and all were conducted several years ago when both the available sources and quantity of fire data were much more limited than today. One of the reasons for lack of data at the time the earlier studies were made was that insufficient time had elapsed, following the issue of FMVSS 301, to permit the accumulation of a large sample of on-road accident experience for vehicles incorporating FMVSS 301 modifications.

Generally, the safety effects of Standard 301 found in this study, for passenger cars, are in agreement with those found in the earlier studies, with one principal exception. This study finds no significant reduction for

fatalities in fire crashes whereas an earlier (1983) NHTSA evaluation estimated a substantial reduction in fatalities. The principal reason for this difference in findings for fatalities is the limited amount of data used in the earlier study. The study was based on only three years of data from one State and did not analyze data on fatal passenger car crashes.

Principal Findings

The Frequency of Fires in Motor Vehicle Crashes

- o Motor vehicle fires in all police-reported traffic crashes are relatively rare, occurring at the rate of approximately 3 fires for every 1,000 vehicles involved in crashes.
- o For all vehicles involved in fatal crashes, fires are considerably more frequent, with about 26 fires per 1,000 vehicles in crashes - nearly 9 times the rate for all crashes.
- o For each of the 3 classes of vehicles of primary interest in this study - passenger cars, light trucks, and school buses, the fire rate and estimated number of fire crashes annually are:

| | <u>Fires per 1,000 Vehicle Crashes</u> | <u>Total Number of Fires Annually</u> |
|-----------------|--|---|
| passenger cars: | 2.9 | 23,600 |
| light trucks: | 2.9 | 5,200 |
| school buses: | 2.4 | 60 |

- o For injury crashes involving passenger cars or light trucks, the fire rate is higher at 7 to 8 fires per 1,000 crashes.

- o Fire in fatal collisions of passenger cars has increased significantly over the last several years, from 20 per 1,000 crashes in 1975 to 28 per 1,000 crashes in 1988. A primary reason for this increase is believed to be an increasing proportion of older vehicles in the car population. Older vehicles are more likely to experience fire, given a crash. The fire rate was not found to be related to car size, as defined by vehicle curb weight. Therefore, the trend to smaller cars over the last several years does not appear to be a factor in the increased rate of fires in fatal passenger car crashes.

Casualties in Fire Crashes

- o From 1975 to 1988, over 1,600 people per year died in vehicles involved in fire crashes. The number of fire-related fatalities has increased over the 14-year period, from 1,300 in 1975 to over 1,800 in 1988, due primarily to the increase in fire rate for passenger cars.

- o Slightly more than 4 percent of all occupant fatalities occur in fire crashes. For passenger cars, the rate is just under 4 percent, and for light trucks, the rate is 5 percent.

- o Over the same period, total estimated occupant casualties in fire crashes involving cars and light trucks, annually, are:

| <u>Injury Severity</u> | <u>Number of Casualties</u> | |
|------------------------|-----------------------------|---------------------|
| | <u>Passenger Cars</u> | <u>Light Trucks</u> |
| K (fatal) | 1,020 | 345 |
| A (serious) | 2,900 | 600 |
| B (moderate) | 4,300 | 800 |
| C (minor) | 2,800 | 500 |

- o The available sample of school bus fires was insufficient for estimating occupant casualties in fire crashes.

The Effectiveness of FMVSS 301

Passenger Cars:

- o It is estimated that FMVSS 301 has reduced fires in all passenger car crashes by 14 percent. This translates to 3,900 fewer fires annually, once the entire car fleet has been modified in accordance with the Standard's requirements. Presently, about 85 percent of the car fleet contain these modifications.
- o Some evidence exists that fire rates in injury crashes may be lower for post-standard vehicles, but the information is insufficient for definitive statistical conclusions.

- o In fatal passenger car crashes, there was no significant reduction in the fire rate for vehicles produced after the Standard took effect. Fire is associated with the more severe impact crashes which also tend to be fatal crashes.

Light Trucks:

- o No significant reduction in crash fires was found for post-standard light trucks, both for all police-reported crashes, and fatal crashes alone. While data were insufficient for analysis of fire rates in injury crashes, the finding of no fire reduction for all crashes or for fatal crashes implies that none would be found for injury crashes as well.

School Buses:

- o Data were insufficient to develop reliable estimates of the effect of FMVSS 301 for school buses.

The Costs of Modifications Made for FMVSS 301:

- o Various types of vehicle modifications were made in response to FMVSS 301. As would be expected, most of these changes were designed to provide increased protection to the fuel tank. Some of the modifications involved the fuel tank itself, while other changes involved vehicle components in or near the vicinity of the tank, which could come into contact with the tank, and cause fuel leakage during a crash situation.

- o The estimated increases in vehicle weight, due to FMVSS 301 modifications, and the resultant cost, in 1988 dollars, to the consumer are:

| | <u>Passenger Car</u> | <u>Light Truck</u> | <u>School Buses</u> | |
|--------------------|----------------------|--------------------|---------------------|----------------|
| | | | <u>Type I</u> | <u>Type II</u> |
| <u>Per Vehicle</u> | | | | |
| Weight Increase | 3.1 lbs. | 7.8 lbs. | 140 lbs. | 7.8 lbs. |
| Cost Increase | \$9.70 | \$30 | \$234 | \$25.60 |

Other Findings

The Age Factor

- o The presence of fire in vehicle crashes is strongly related to the age of the vehicle. Older vehicles are more likely to experience fires. This is believed to result from the general degradation (corrosion, weakening of metal structures; hardening, cracking of flexible hoses, etc.) of vehicles over time. Another possible factor that could contribute to the age effect is the probable under-reporting of accidents involving older vehicles, owing to their decreased worth.

The Severity of Fire Crashes

- o Fire is associated with substantially more serious accidents, in terms of injury severity to vehicle occupants. Even for crashes at

the most extreme level of injury -- i.e., fatal crashes - vehicles with fire experience anywhere from 70 to 80 percent more occupant fatalities than do vehicles in all fatal crashes.

- o For nonfatal crashes, occupants of vehicles with fire sustain 3 to 4 times the chance of serious (A) injuries as occupants of vehicles in all crashes. For moderate (B) injuries, the risk is about 2 times greater for occupants of vehicles in a fire crash.

- o Crashes with fire are also more severe in terms of crash impact forces exerted on the vehicle and its occupants, and in terms of the extent of damage sustained by the vehicle:
 - among all crashes resulting in fatal injury, those that involved fire are 30 percent more likely to occur on roadways with the highest speed limits. Higher speed limits indicate higher traveling speed and hence, higher impact speeds and crash forces.

 - among all fatal crashes, those that involve fire are 70 to 90 percent more likely to be single vehicle collisions with fixed objects; this indicates more severe impacts for crashes with fire.

 - for all police reported crashes, vehicles with fires are 2 1/2 to 5 times more likely to have sustained the highest levels of damage due to the crash, as recorded by vehicle damage indices.

Fire Crashes by Direction of Impact

- o Impacts to the front of the vehicle account for 60 to 70 percent of the crash fires, for both passenger cars and light trucks. This applies to fatal, as well as non-fatal crashes.

- o Rear impacts are over-represented (3 times as likely) in fatal fire crashes involving passenger cars, but not for light trucks. This may be a reflection of the more vulnerable location of fuel tanks in cars than in light trucks. For less severe, non-fatal collisions, this over-representation of fire in rear impacts does not appear.

Conclusions

- o FMVSS 301 has been effective in reducing the incidence of fire in passenger car crashes. No reduction in fire-related fatalities was found; the force levels encountered in fatal fire crashes may generally exceed the levels set by the Standard. Burn injuries may have been reduced, but available information is insufficient for definitive conclusions.
- o For light trucks built after FMVSS 301 took effect, no reduction in fires was found, either for all police-reported crashes or for fatal crashes, alone. It is possible that the pre-existing design and location of fuel system components afforded greater impact protection for light trucks than for passenger cars.
- o Data on fires in school bus crashes were insufficient to permit reliable conclusions of the effect of FMVSS 301 in these vehicles.
- o Older vehicles are more likely to experience fire crashes than new vehicles. One reason for this is believed to be the general degradation and weakening of vehicle structures and components over time.
- o The fire rate in fatal passenger car crashes has increased significantly during 1975 - 1988. An increased proportion of older cars in the population (greater longevity of cars) is believed to be a principal reason behind this increase. Vehicle downsizing does not appear to be an important factor since fire rates did not vary with vehicle weight.
- o In police accident data, burn injuries cannot be distinguished from injuries caused by impact forces. Since both fire risk and injury severity increase with increasing impact forces, the role of fire in injury causation cannot be determined.

CHAPTER 1

INTRODUCTION

This report is another in a continuing series of studies that have been completed by the National Highway Traffic Safety Administration (NHTSA) in recent years for the purposes of reviewing and evaluating the effects of certain Federal safety regulations which the agency has promulgated. NHTSA along with other Federal agencies are required to carry out such studies in order to measure the actual benefits and costs which result from their regulations.¹ In addition, a more recent directive requires that agencies develop, and make public, a plan for the review of their existing regulations.²

This study is a review of Federal Motor Vehicle Safety Standard 301; Fuel System Integrity (FMVSS 301). The purpose of FMVSS 301 is to provide a specified level of protection to the fuel system of motor vehicles in order to reduce deaths and injuries that result from fires caused by fuel spillage in motor vehicle crashes.

¹ Federal Register 46, February 17, 1981, 13193.

² Federal Register 50, January 8, 1985, 1036.

1.1 REQUIREMENTS OF FMVSS 301

FMVSS 301, the fuel system integrity standard, first became effective in 1968. Only passenger cars were covered by the initial version of the Standard. Subsequently, FMVSS 301 was revised several times, both to upgrade the individual requirements of the standard and to extend the requirements to other classes of vehicles.

Table 1-1 summarizes the test requirements, showing the period, 1968 through 1977, over which FMVSS 301 was implemented, and the classes of vehicles covered.³ The test requirements show the direction and speed of impacts which the vehicles are required to sustain, during and after which fuel leakage from the vehicle's fuel system shall not exceed specified maximum limits. A static rollover requirement also applies (currently) to all covered vehicles except school buses. Appendix A contains a copy of the detailed FMVSS 301 requirements as listed in the Code of Federal Regulations.

Essentially, the intent of FMVSS 301 is to strengthen, or protect the vehicle's fuel system such that, in a crash event, the chances of fuel system breaching will be reduced. Less chance of fuel leakage, of course, means less chance of vehicle fire which poses an additional hazard and potential source of injury to the vehicle occupants, apart from the crash forces experienced.

³ 49CFR 571.301 Standard No. 301; Fuel System Integrity.

Table 1-1
 Chronological Summary of Requirements:
 Federal Motor Vehicle Standard 301,
 Fuel System Integrity

| <u>Period of Vehicle Manufacture</u> | <u>Vehicle Type(s):</u> | <u>Test Requirements</u> | | |
|--|---|--------------------------------------|---------------------------------------|---------------------------------|
| | | <u>Impact Velocity</u> | <u>Impact Mode</u> | <u>With Static Rollover</u> |
| 1-1-1968 to 8-31-1975 | Passenger Cars | 30 mph | Frontal | No |
| 9-1-1975 to 8-31-1976 | Passenger Cars | 30 mph | Frontal | Yes |
| after 9-1-1976 | Passenger Cars | 30 mph 30 mph 30 mph 20 mph | Frontal Oblique Rear Lateral | Yes Yes Yes Yes |
| 9-1-1976 to 8-31-1977 | Trucks, MPVs, and Buses (6000#>GVWR<10000#) | 30 mph | Frontal | No |
| 9-1-1976 to 8-31-1977 | Light Trucks, MPVs, and Buses (GVWR< 6000 #) | 30 mph 30 mph | Frontal Rear | Yes Yes |
| after 9-1-1977 | Light Trucks, MPVs, and Buses (GVWR< 6000 #) | 30 mph 30 mph 30 mph 20 mph | Frontal Oblique Rear Lateral | Yes Yes Yes Yes |
| after 9-1-1977 | Trucks, MPVs, and Buses (6000#>GVWR<10000#) | 30 mph 30 mph 30 mph 20 mph | Frontal Oblique Rear Lateral | Yes Yes Yes Yes |
| after 4-1-1977 | School Buses (GVWR>10000 #) | 30 mph | Any Point and Angle | No |

NOTE: MPV - multipurpose passenger vehicle
 GVWR - gross vehicle weight rating.

1.2 STUDY OBJECTIVE

The primary objective of this study is to statistically estimate the effectiveness of the Federal Motor Vehicle Safety Standard 301, as it currently applies to three principal classes of vehicles - passenger cars, light trucks (including MPV's), and school buses.⁴ Effectiveness is defined in terms of the reduction in motor vehicle crash fires, and the reduction in occupant casualties (fatalities, injuries) that can be attributed to vehicles produced subsequent to the effective date of the Standard, as compared with vehicles manufactured prior to the Standard.

⁴ The 1968 version of FMVSS 301 for passenger cars is not studied in this report. An insufficient sample of data to cover this period would be available in current crash data files. Two earlier studies of effects of the 1968 version found no significant difference in fire rates between pre-1968 and post-1968 vehicles. Also, an earlier study of the costs associated with pre-1968 version of Standard 301 found the costs to be negligible and that most pre-1968 passenger car designs already met the requirements imposed by this first version of the Standard. (Ref: Evaluation of Federal Motor Vehicle Safety Standard 301-75, Fuel System Integrity: Passenger Cars, DOT HS-806-335, January 1983).

A second objective of the study is to describe the vehicle modifications which were made in response to the Standard, and to estimate the cost, to the consumer, of these modifications.

Thirdly, it is intended to present selected statistics which assist in describing the frequency, nature, and severity of fires which accompany motor vehicle accidents.

1.3 DATA SOURCES

Data for the study come from three principal sources. For the estimation of effectiveness, State compiled motor vehicle accident files are used, together with fatal motor vehicle crash data from NHTSA's Fatal Accident Reporting System (FARS). The presence of fire in motor vehicle accident data is recorded in only a few States. A review of the State reporting procedures for data files available at NHTSA resulted in 5 States, Michigan, Ohio, Maryland, Illinois, and Indiana being selected as the best sources for fires as reported in police accident data. For each of these States, six calendar years of data, spanning the period from 1982 through 1987, were used. For fatal accidents, FARS data from 1975 through 1988 are used. FARS has contained a data element for reporting vehicle fires since the system's inception in 1975. Altogether, data from over 14.5 million State reported vehicles in accidents plus data from nearly 700,000 vehicles in fatal crashes are represented in the effectiveness analyses.

To support the cost side of the study and to provide information on vehicle modifications due to FMVSS 301, special data were solicited from the motor vehicle manufacturers.

1.4 LIMITATIONS OF FIRE DATA IN MOTOR VEHICLE ACCIDENT FILES

While police reported accident data are the best source of information on fires accompanying motor vehicle crashes, certain difficulties emerge in using these data to evaluate the safety impacts of FMVSS 301.

The first issue involves the cause of fire, whether it was a result of the crash, or whether it resulted from other causes -- i.e., occurred before the crash. Of course, FMVSS 301 can only be expected to have an effect on post-crash fires. However, in the available accident data, it is generally not possible to distinguish between post-crash and pre-crash fires. It can be expected that, as accident or crash severity increases, the proportion of reported fires that are post-crash in nature would also increase. For fatal crashes, while some reported fires could have a pre-crash origin, it is believed safe to assume that the vast majority of the fires would have stemmed from the crash forces involved.

A second concern in police reported data on crash fires is the contribution the fire may have had on injury to the vehicle occupants, as distinguished from the injury due to the forces experienced from the crash itself. Only injuries (for fatalities) that result from fire (i.e., burn injuries) can be

expected to be affected by FMVSS 301. Again, such distinctions as to cause of injury are not available in either the State data or the FARS data.

A third, less important concern is whether a fire, given it was post-crash in nature, resulted from leakage from the vehicle's fuel system. Once more, this level of detail is not available in the data. However, it is assumed that post-crash fires would most likely be fuel fed-fires.

In summary, it is emphasized that the last two deficiencies noted above - contribution of fire to injury, and role of fuel in post-crash fires - are not deficiencies peculiar to the data used in this study. While some fragmentary estimates exist, no source is known that provides reliable information on these issues. To attempt to acquire this information would require intensive accident follow-up studies involving medical and autopsy specialists, vehicle/fire specialists, etc. Even then, the phenomenon of our study, fire, would doubtless have destroyed, or consumed, much of the evidence needed to successfully complete such studies.

1.5 PRIOR FIRE STUDIES

Other studies of motor vehicle crash fires and the effects of FMVSS 301 have been conducted. These studies began in the late 1970's and were either conducted by NHTSA or were contractor studies sponsored by NHTSA. The earliest efforts were searches for data which recorded fire in motor vehicle crashes in sufficient quality and quantity to support a definitive evaluation

of the effects of the Standard. All earlier studies of the benefits of Standard 301 were based on limited quantities of State accident data. Fatal accident data were not analyzed in any of the studies. These prior studies are discussed in Chapter 3 of this report.

1.6 REPORT OUTLINE

The study is presented in the three chapters which follow. Chapter 2 contains a detailed discussion of the statistical analyses conducted to estimate the effects of FMVSS 301 in reducing vehicle fires and associated injuries and fatalities. Analyses are conducted for each of three vehicle classes, passenger cars, light trucks, and school buses. In this chapter, the various accident data sources are also discussed with the methods used to report vehicles fires, for each data source, described.

Chapter 3 contains statistics and analyses which describe the nature, frequency, and trends of fires in motor vehicle crashes. Comparisons are made, for various accident parameters, between crashes involving fire and all motor vehicle crashes. Chapter 4 estimates the safety benefits attributable to FMVSS 301, in terms of vehicle fires and associated occupant casualties avoided. In this chapter the overall consumer costs (including both hardware and fuel penalty costs) of the Standard are also developed, for each of the three vehicle classes, together with descriptions of vehicle modifications made for each class of vehicles.

Appendix A contains a copy of the requirements of FMVSS 301 as taken from the applicable Code of Federal Regulations. Appendix B contains copies of the State and FARS accident report forms – the data sources used in the study. Appendix C contains tables of frequency counts of fires and vehicles from the State sources. Copies of letters to motor vehicle manufacturers requesting information on FMVSS 301 modifications are shown in Appendix D. Appendix E discusses the results of certain analyses conducted to examine the effect of vehicle age on fire rates.

CHAPTER 2

EFFECTIVENESS ANALYSIS OF FMVSS 301: FUEL SYSTEM INTEGRITY

2.0 INTRODUCTION

This chapter describes the analyses which were conducted to estimate the effectiveness of FMVSS 301. The primary measure of effectiveness of the Standard, as chosen in this study, is defined as the magnitude of the reduction in vehicle fires, as reported by police, per accident involved vehicle.¹ Both State accident files and NHTSA's fatal accident files (Fatal Accident Reporting System) have been analyzed. Separate analyses have been conducted for each of the three classes of vehicles to which the Standard applies - passenger cars, light trucks, and school buses.

In order to estimate the effectiveness of Standard 301, accident experience for vehicles manufactured prior to the Standard (Pre-standard vehicles) will be compared with the accident experience of vehicles produced subsequent to the Standard (Post-standard vehicles). For passenger cars, Pre-standard vehicles are those produced in Model Year 1975 or earlier, while Post-standard vehicles are those manufactured in

¹ The stated purpose of FMVSS 301 (Title 49, CFR, Section 571.301) is to "reduce fatalities and injuries resulting from fires which occur from fuel spillage during and after motor vehicle crashes." The potential effect of reduced fires on injuries and fatalities is addressed later in this chapter and in Chapter 4.

1976 and later years. Pre-standard vehicles for both light trucks and for school buses correspond to Model Years 1976 and earlier while Post-standard vehicles are represented by Model years 1977 and later.

2.1 DATA SOURCES USED

The sources of data for this study consist of motor vehicle crash files as compiled by five States (Michigan, Ohio, Maryland, Illinois, and Indiana) and the Fatal Accident Reporting System files (FARS) which are maintained by NHTSA. In recent years, several States have made their accident data bases available to NHTSA as a source of assistance in various highway safety research and other analytical studies. These State data have been particularly useful to the agency in its evaluation studies of the effectiveness of its motor vehicle standards. The Fatal Accident Reporting System has been in operation by the agency since 1975. Compiled and maintained with the assistance of the States, FARS produces, annually, computerized records of every fatal motor vehicle crash which occurs within the United States.

The occurrence of fire in motor vehicle accidents is recorded by only a few States in their annual compilation of motor vehicle accident files. Those States that do record fire data typically use different reporting formats. The FARS system, which augments the data collected in a typical police accident report, has contained information on vehicle fires since the system's inception in 1975.

Table 2-1 summarizes the data sources used in this study, showing the number of calendar years of accident data from each source, the time period represented by the data, and the total number of accident involved vehicles of the three types (passenger cars, light trucks, school buses) subject to analysis.

Table 2-1
Sources of Accident Data Analyzed

| <u>Source</u> | <u>Number of Accident Years</u> | <u>Time Period of Data</u> | <u>Total Number of Accident Vehicles</u> |
|--|---------------------------------|----------------------------|--|
| State Data: [All accident severities] | | | |
| Michigan | 6 | 1982 through 1987 | 3,158,237 |
| Ohio | 6 | 1982 through 1987 | 3,407,259 |
| Maryland | 6 | 1982 through 1987 | 1,185,915 |
| Illinois | 6 | 1982 through 1987 | 4,772,105 |
| Indiana | 6 | 1982 through 1987 | 2,037,231 |
| Fatal Accident Data: | | | |
| FARS | 14 | 1975 through 1988 | 687,530 |

The above data set represents over 14.5 million individual crashes and almost 700,000 fatal crashes involving a passenger car, a light truck (i.e., pickups, vans, multipurpose passenger vehicles, and small buses), or a school bus, where the presence of fire is a recordable item. These sources represent the best accident data available to NHTSA on the occurrence of vehicle fires in accidents.

2.1.1 Reporting of Vehicle Fires

The mechanism for reporting vehicle fires differs among the five States used in this study. Appendix B contains a copy of the State Accident Report Form for each of the States, Michigan, Ohio, Maryland, Illinois, and Indiana, and a copy of the FARS report form with the data element(s) for recording vehicle fires highlighted.

Fire Data From Michigan

The State of Michigan uses a four-part code to record the occurrence of fire for each vehicle in the accident. The coding is as follows:

- Code "1" - fuel leaked from vehicle
- Code "2" - vehicle/cargo caught fire
- Code "3" - fuel leaked from vehicle and there was a fire
- Code "4" - no vehicle fuel leak or fire occurred

Note that in order to capture all vehicle fires, both codes 2 and 3 must be retrieved from the computer records. Also note that fuel leakage is recorded as part of the reporting mechanism to capture vehicle fires. This variable could be analyzed along with the fire variable since the purpose of FMVSS 301 is to prevent fires by reducing the chances of fuel leakage in a vehicle crash. It was decided not to analyze the fuel leakage data since Michigan was the only State, among the States chosen for analysis, to record this item. Furthermore, it is believed that fuel leakage is more likely to escape detection, in a vehicle crash, compared to the occurrence of fire which should leave more distinct evidence. Also, for fuel-fed fires, the presence of fuel, as the ignition material, might often be difficult to judge by the investigating officer, particularly in more severe fires which do major damage to the vehicle.

Fire Data from Ohio

The State of Ohio uses a different convention to record the presence of fire in its accident files. As per Michigan, a separate block for each involved vehicle is contained on the Ohio Traffic Accident Report Form (see Appendix B) for the recording of fire. However, the reporting convention covers only fire (not fuel leakage), and the coding possibilities are:

code "1" - no fire
code "2" - fire due to crash
code "3" - other fire

Ohio attempts to distinguish between fires which result from crash forces (i.e., crash fires) and "other" fires. Presumably, these other fires are pre-crash fires. Fires which do not result from crash forces (and are also fuel-fed) would not be fires that are reducible by FMVSS 301. Here again, however, it might be difficult for the investigating police officer to discern between fires which are pre-crash versus post-crash in origin.

Fire Data From Maryland

Still a third reporting convention is used by the State of Maryland to record vehicle fires. Instead of a direct "box" on the Motor Vehicle Accident Report Form (see Appendix B), a more indirect method is employed by Maryland. Under a variable for "Areas Damaged" is a general damage category of "fire damage". Typically, areas damaged refers to specific areas of the vehicle (front, top, rear, etc.) which sustain physical damage due to crash or impact force. Under the areas damaged variable, up to three areas may be recorded for each involved vehicle. Fire damage may be recorded in one of these three areas and is a general damage code which does not refer to any specific part, or area of the vehicle. The State of Maryland has yet a second way in which fire can be reported. "Primary Contributing Factor" and "Secondary Contributing Factor" are variables for

reporting factors which contributed to, or caused (in the opinion of the reporting officer) the accident to happen. Under these contributing factors is an exhaustive list of possibilities, one of which is fire. The reporting instructions here for the police officer are that "fire is not to be listed as a causative factor (either primary or secondary), if the fire resulted from the accident. Fire reported under primary or secondary cause is an accident level variable (not tied to a specific vehicle), whereas fire reported under vehicle damage is a vehicle specific variable. Once again, it may be difficult for the officer to distinguish between these possibilities, and attempting to separate vehicle fires on this basis in the accident data analysis may be somewhat tenuous.

Fire Data From Illinois

The State of Illinois provides for the reporting of vehicle fires in a block titled "Miscellaneous Information". This block also provides for three other items labeled "traffic control/sign visible?", "tested for drugs?" and "controls functioning?" The fire categories are as follows:

Did Fire Occur? 1 Yes - No 2 Yes - No

While the Illinois convention does provide for reporting fire on a (two) vehicle level, the placement of the information block is away from the basic vehicle ID data at the beginning of the report form, in contrast to

some of the report forms cited earlier, such as Michigan and Ohio (see Appendix B). Also placing the fire items under "miscellaneous," near the end of the accident report, and along with other miscellaneous data may result in less reliable reporting of vehicle fires. This may be one reason why the unreported rate for fire in the Illinois files is so high, running up to 40 percent unreported.

Fire Data From Indiana

The fifth State, Indiana, whose data are used in this study, provides for the reporting of fire on a vehicle level. A separate coding block called "Fire" is located in each of the "Vehicle 1," "Vehicle 2" sections near the top of the "Indiana Officer's Standard Accident Report" (see Appendix B). The fire block is set up as follows:

Fire? Yes
 No

Fire Data in FARS

The Fatal Accident Reporting System, which is a compilation of (fatal) accident data from all 50 States, augmented by special reporting procedures, has a simple, two element code for reporting fires:

code "1" - fire occurred in vehicle during accident

code "0" - no fire

The fire variable is on a per vehicle level. However, it is understood that in multi-vehicle fatal crashes where two or more vehicles catch fire, FARS reporting cannot distinguish whether the fire originated in one vehicle and subsequently spread to another vehicle. It is entirely likely that this restriction applies as well to all State reported accident data. However, such accidents should be very rare events, and the inability to distinguish the "fire starter" vehicle in such cases should have no bearing on the analysis of fire data from accident files to estimate the effect of FMVSS 301.

Pre-crash Versus Post-crash Fires

To conclude this section on the reporting of vehicles fires, a few comments are offered on the subject of pre-crash fires as opposed to post-crash fires.

Since FMVSS 301 is intended to increase the crashworthiness of motor vehicle fuel systems against rupturing or leakage, it follows that data on post-crash fires is the preferred choice for analysis as to the Standard's effectiveness. One might suppose that most, if not, all fire data reported in motor vehicle crash, or accident files would be of the post-crash variety. However, such is not the case. Pre-crash fires do occur. Pre-crash fires could result from a variety of sources such as

electrical shorts; oil or transmission fluid leaks that come into contact with sufficiently hot surfaces, such as exhaust manifolds; or gasoline from a flooded carburetor, loose line fitting, or deteriorated/cracked fuel hose. Also pre-crash fires could start from flammable cargo being transported in the vehicle, or from personal items such as cigarettes, matches, or other flammable/explosive items.

After working with the accident data from a number of States, it is concluded that while some States make an attempt to do so, in general, post-crash fires cannot reliably be distinguished from pre-crash fires. More will be said about this later as it is germane to the interpretation of the analyses performed in this study.

2.2 EFFECTIVENESS ANALYSIS FOR PASSENGER CARS

The analysis of the effectiveness of FMVSS 301, Fuel System Integrity, for passenger cars is presented in two sections. First, State data are analyzed to estimate the effect of the Standard on all accidents (i.e., all accident severities - those that result in injury as well as those that result in property damage only). This is followed by analyses of State data on injury crashes and of the FARS data to estimate the effect of the Standard on injury crashes and on fatal crashes (i.e., accidents which result in one or more fatalities).

Table 2-2
 Fire Rates* in Passenger Car Crashes by State
 and Vehicle Model Year

| Model Year | S T A T E | | | | |
|---------------|-----------|-------|----------|----------|---------|
| | Michigan | Ohio | Maryland | Illinois | Indiana |
| 1987 | 1.451 | 1.641 | 1.026 | 0.382 | 0.489 |
| 1986 | 1.375 | 2.553 | 0.853 | 0.689 | 0.664 |
| 1985 | 1.365 | 1.863 | 0.821 | 0.636 | 0.570 |
| 1984 | 1.377 | 2.415 | 1.180 | 0.697 | 0.702 |
| 1983 | 1.557 | 2.092 | 1.227 | 0.715 | 0.542 |
| 1982 | 1.582 | 2.416 | 1.493 | 0.814 | 0.591 |
| 1981 | 1.697 | 2.511 | 1.763 | 0.837 | 0.808 |
| 1980 | 1.915 | 2.954 | 2.085 | 0.891 | 0.731 |
| 1979 | 1.882 | 3.200 | 2.435 | 0.896 | 0.870 |
| 1978 | 2.247 | 3.442 | 2.542 | 0.934 | 0.967 |
| 1977 | 2.232 | 3.760 | 3.007 | 1.032 | 0.900 |
| 1976 | 2.429 | 4.092 | 3.559 | 0.922 | 0.906 |
| ----- | | | | | |
| 1975 | 2.660 | 5.024 | 5.012 | 1.027 | 1.165 |
| 1974 | 3.160 | 5.329 | 5.526 | 1.171 | 1.201 |
| 1973 | 3.343 | 5.169 | 4.539 | 1.352 | 1.300 |
| 1972 | 3.594 | 5.602 | 4.636 | 0.966 | 1.650 |
| 1971 | 3.917 | 5.463 | 4.781 | 1.300 | 1.719 |
| 1970 | 3.380 | 5.173 | 5.130 | 1.249 | 2.189 |
| 1969 | 3.299 | 5.305 | 6.800 | 1.352 | 1.567 |
| 1968 | 2.894 | 6.206 | 4.952 | 1.437 | 1.283 |
| 1967 | 3.265 | 4.431 | 5.746 | 1.532 | 1.030 |
| 1966 | 2.932 | 4.103 | 3.338 | 1.315 | 2.000 |

* Fire rates are police reported fires per 1,000 passenger cars in accidents. Appendix C contains the actual counts of fires and passenger cars for each Model Year and State.

The data are for calendar years 1982-87.

2.2.1 Analysis of State Accident Data

Fire data from five States are analyzed - Michigan, Ohio, Maryland, Illinois, and Indiana. As a first step in the analysis process, an array of the data has been constructed in Table 2-2, showing the fire rate (i.e., number of fires per 1,000 accident-involved vehicles) by Vehicle Model Year and State. The actual frequencies of fires and accident-involved passenger cars are contained in Appendix C. For each State, six calendar years of data, 1982-1987, are represented. Model Year 1966, 10 years prior to the implementation date of FMVSS 301 has been chosen as a convenient truncation point. The resulting range, Model Year 1966 through Model Year 1987, spans a 22-year period and accounts for the vast majority of the accident-involved passenger cars (well over 90 percent even including unknown Model Year vehicles) for the six year period in each State.

The incidence of fire is based on the individual reporting methods for the five States, as described in the preceding section (2.1). For Michigan, the fire rates include both code 2, "vehicle/cargo caught fire and," and code 3, "fuel leaked from vehicle and there was a fire". For Ohio, codes 2 and 3, "fire due to crash", and "other fire" are included. In the Maryland files, fire occurrence is based on the AREA DAMAGE variable. Three AREA DAMAGE variables per vehicle are permissible, and the fire rates in Table 2-2 for Maryland include all such cases where the AREA DAMAGE variable is coded as fire (i.e., area damage 1 = fire, area damage 2 = fire, and area damage 3 = fire).

Fire rate data for the State of Illinois include all such cases where the MISCELLANEOUS INFORMATION variable, "Did Fire Occur?" is coded "YES". For the fifth State, Indiana, the incidence of fire is based on all cases where the designated vehicle coding block for "FIRE?" is coded "YES".

Based on the above definitions for recording the incidence of vehicle fire, it is evident that pre-crash fires, as well as post-crash fires (i.e., fires due to the crash event) could be included in the fire rate data. In general, it is not possible to separate fires which result from crash forces from fires which were initiated prior to the crash.

Returning to Table 2-2, a brief perusal of the data reveals several preliminary observations. First, a Model Year, or age trend is noted in the fire rates - older vehicles tend to have higher rates than newer vehicles. This observation is generally consistent throughout the entire model year range of 22 years, and the trend is evident among all five State data bases. The rate of fire varies from about 0.4 per 1,000 vehicle crashes (Illinois, Model Year 1987) to as high as 6.8 per 1,000 vehicle crashes (Maryland, Model Year 1969). The actual frequencies on which the individual fire rates are based range from 9 to 935 for fire counts and from 5,393 to 368,30 for vehicle counts (See Appendix C).

Another observation from Table 2-2 is that fire rates vary among the States, particularly between Michigan, Ohio, and Maryland, which have consistently higher rates, and Illinois and Indiana, which have similar rates, but

considerably below those for the first three States. Reasons for these differences are not readily apparent, but the most likely candidate is believed to be reporting differences among the States.

Finally, with respect to fire rates before and after FMVS 301 - the primary focus of this study - it is noted that the rates for Model Year 1976, the first year of the Standard, are in all instances lower than the rates for Model Year 1975, the year immediately preceding the Standard. While rather large rate decreases are observed for Ohio and Maryland (changes consistent with a beneficial effect of FMVSS 301), it is not possible to ascertain the extent to which these decreases may be attributed to the Standard without further statistical analyses of the data.

2.2.1.1 Analysis of Data From Michigan, Ohio, and Maryland

Since the fire rates from Michigan, Ohio, and Indiana are considerably higher than the rates for Illinois and Indiana, data from these three States will be analyzed first.

Data From Michigan

As a first step in analyzing the Michigan data, plots were made of the fire rate as a function of vehicle age and as a function of vehicle model year. The plots appear in Figures 2-1 and 2-2, respectively. The data points

PLOT OF R+AGE LEGEND: A = 1 OBS, B = 2 OBS, ETC.

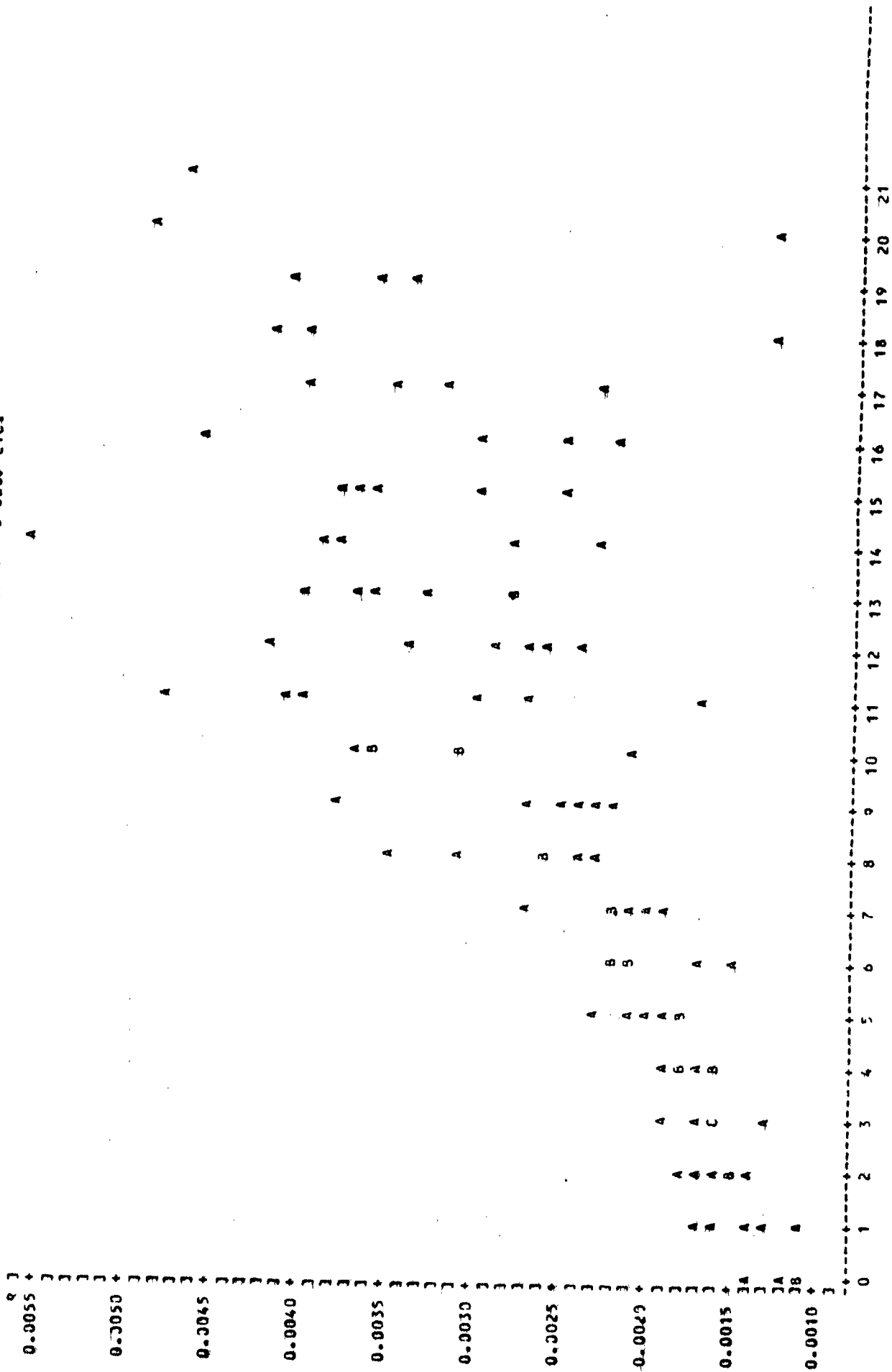

AGE
 Figure 2-1
 Michigan, Passenger Cars

PLOT OF R*MY LEGEND: A = 1 OBS, B = 2 OBS, ETC.

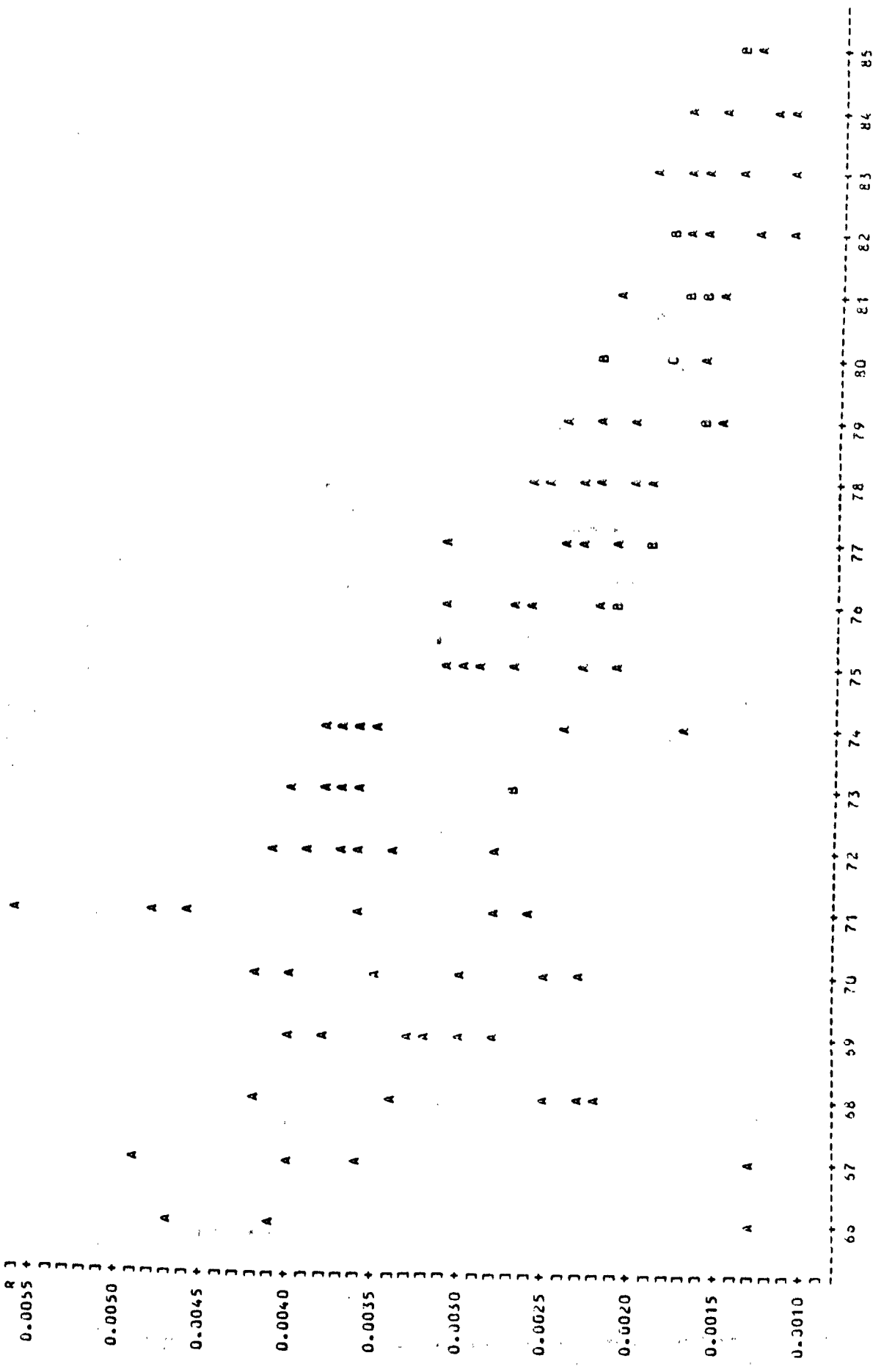

Figure 2-2
Michigan, Passenger Cars

represent fire rates for each model year by calendar year combination (or cell) in the six years of Michigan data. These plots clearly illustrate the age trend in the data. The age plot and the model year plot are virtual "mirror images" of each other.

Simple linear models (regression) were fitted to the data in the two plots. The following functions were fitted:

$$\text{Age Model: } R_{ij} = a + bx_{ij}$$

where R_{ij} = fire rate (fires per accident involved vehicle) for model year i and calendar year j

and x_{ij} = vehicle age at time of crash (i.e., calendar year minus model year) for model year i and calendar year j .

$$(i = 66 \text{ to } 87; j = 82 \text{ to } 87)$$

Model Year Model:

Same model as above except x_{ij} = vehicle model year for model year i and calendar year j .

The total number of observations (i.e., number of calendar year - model year combinations) was 117, for each model. The observations were weighted since considerable variation existed among the number of accident involved vehicles per cell.

The resulting equations were:

$$\text{Age model: } R = 0.001204 + 0.0001593x$$

$$\text{Model Year Model: } R = 0.01348 - 0.0001439x$$

In both models, the x-coefficients are highly significant (t age = 16.09; t model year = -15.04), indicating a significant increase in fire rate with vehicle age, or conversely, a significant decrease in fire rate as model year increases (i.e., as vehicles become newer).² The fit of the models was reasonably high with R^2 s of .69 and .66, respectively, for age and model year, indicating that nearly 70 percent of the variation in fire rate is explained by the single variable, vehicle age, or vehicle model year).

In order to estimate the effect of FMVSS 301 on fire rates, it is obvious that the concomitant effect of vehicle age must also be taken into account. The model must consider age, together with the effect of the standard. A multiple linear model was chosen:

$$R_{ij} = a + b x_{1(i,j)} + c x_{2(i,j)}$$

where R_{ij} , and $x_1(i,j)$ = fire rate, and vehicle age, as before
and $x_2(i,j)$ = standard effect (= 0 for Pre-standard vehicles,
= 1 for Post-standard vehicles)

² In this study, statistical significance is assessed at the $\alpha = .05$ level (5 percent risk, or 95 percent confidence). The probability of greater t-values in each of the above models is 0.0001. Therefore, the age and model year effects are significant at much higher levels - 99.99 percent confidence).

Observations were weighted, as before, and an additional step was taken to "balance" the sample of Pre-standard and Post-standard vehicles. Within each calendar year, the number of Model Years of Pre-standard vehicles was kept equal to the number of model years of Post-standard vehicles. This reduced the total number of observations for the model to 108.

The fitted model, incorporating both age and FMVSS 301 effects was:

$$R = 0.001820 + 0.0001253X_1 - 0.0005285X_2$$

Both the age effect ($t = 8.98$) and standard effect ($t = -3.95$) are significant.³ Since the analysis shows a significant effect for the standard, the effectiveness, in terms of percent reduction in vehicle fires will be estimated.

The average (weighted) age of the Pre-standard sample of passenger cars is 11.171 years. Therefore, the effectiveness estimate of FMVSS 301 is:

³ Probability of greater $t = .0001$ for both age and standard effects. Hence, both effects are highly significant.

$$\begin{aligned}
 \text{Effectiveness} &= \frac{-0.0005285}{0.001820 + 11.171 (0.0001253)} \\
 &= \frac{-0.0005285}{0.0032195} \\
 &= -0.1641 = -16.41 \text{ percent}
 \end{aligned}$$

Hence, there is a 16.4 percent reduction in fire rate for cars produced after the Standard became effective. The 95 percent confidence limits on this reduction are ± 8.14 percent giving a 95 percent confidence band of 8.27 percent to 24.55 percent. The Pre-standard fire rate is 3.2195 fires per 1,000 cars (from the denominator of the above equation); the Post-standard fire rate is 2.691 fires per 1,000 cars (i.e., $3.2195 - 0.5285$). These rates take into account the age effect on fire rates which is a very strong effect. The R^2 value for the multiple variable model was .73, indicating 73 percent of the variation in fire rates explained, somewhat more than the single variable models of age and model year.

Similar to the plots for Michigan, Figures 2-3 and 2-4 contain plots of fire rate versus vehicle age and vehicle model year for the State of Ohio. Again, the distinct relationship of fire rate and age is seen, although the Ohio data exhibits somewhat less variation in fire rates than did the data from Michigan.

Simple linear (weighted) models of fire rate as functions of age, and model year produced the following equations:

PLOT OF R=AGE LEGEND: A = 1 OBS, B = 2 OBS, ETC.

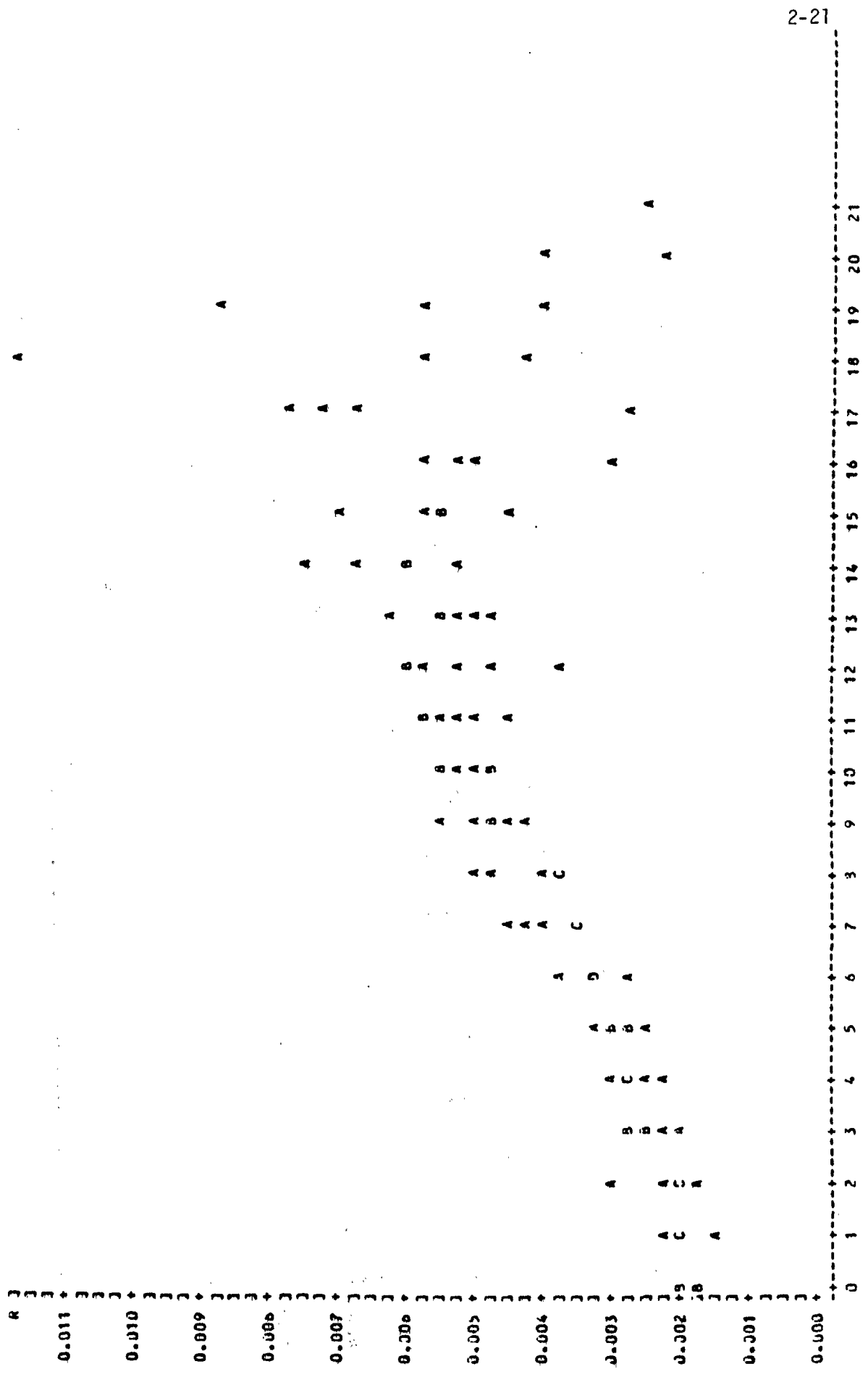
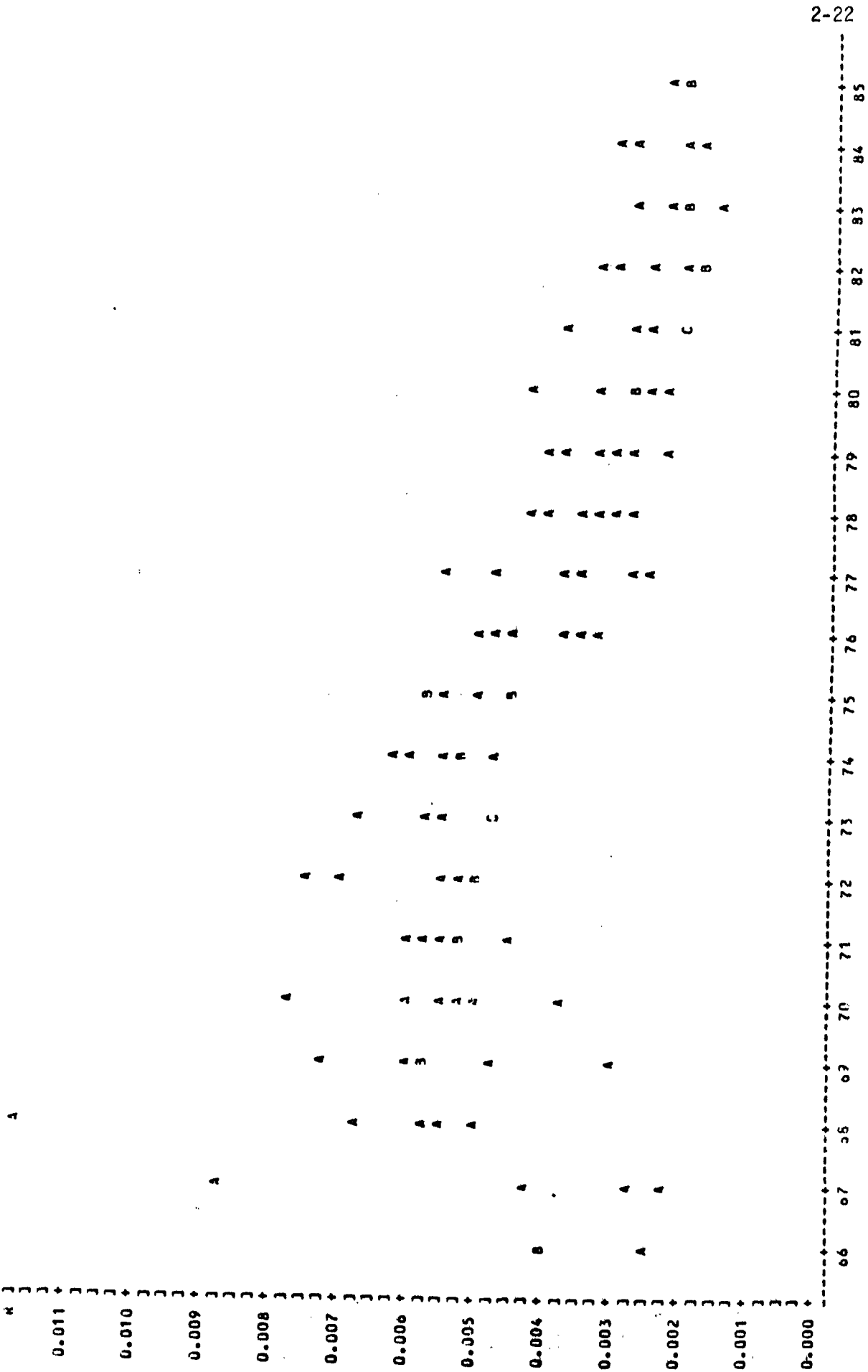

Figure 2-3
Ohio, Passenger Cars

PLUT OF R+MY LEGEND: A = 1 OBS, B = 2 OBS, ETC.



MY
Figure 2-4
Ohio, Passenger Cars

Age model: $R = 0.001746 + 0.0002876X_1$ (age)

Model Year Model: $R = 0.02246 - 0.00024135X_2$ (model year)

As with the Michigan data, the age and model year effects are significant having very large t-values of 21.78 and -14.63, respectively.⁴ For the Ohio data, the fit of the age model was even better than for the Michigan data, with an R^2 value of .81 versus .69 for Michigan. The model year equation for Ohio gave a fit very close to that for Michigan, with an R^2 of .65, compared to .66 for Michigan. Once again, the single variable, age, is seen to be very closely associated with fire rate, the correlation being 0.9, and this single variable produces a model which accounts for the major portion of the variation in fire rate.

The next step is to add a second variable to the model to determine the effect of FMVSS 301 on fire rates in the Ohio data, given the effect of the age factor. The same model as before will be used, i.e.,

$$R = a + bX_1 \text{ (age)} + cX_2 \text{ (Std)}$$

The model was weighted, as with Michigan, and balanced for equal number of Pre-standard and Post-standard model year cells within each of the six

⁴ Probability of great t = 0.0001 for both effects; hence, they are highly significant.

calendar years. Again, the total number of observations was 108 (model year by calendar year combinations).

The resulting equation was:

$$R = 0.002361 + 0.0002574 X_1 (\text{age}) - 0.0005736 X_2 (\text{Std})$$

Both effects are highly significant with $t = 13.64$ for age and $t = -3.33$ for the Standard.⁵ R^2 for the fitted model was .84, indicating about 4 percent more explained variation over the simple model with age only.

The average (weighted) age of the Pre-standard cars in the Ohio data is 11.356 years. The estimated effect of Standard 301 on fire rate is thus:

$$\begin{aligned} \text{Effectiveness} &= \frac{-0.0005736}{0.002361 + 11.356 (.0002574)} \\ &= \frac{-0.0005736}{0.005284} \\ &= -.1086 = -10.86 \text{ percent} \end{aligned}$$

After accounting for vehicle age, the Standard is estimated to have reduced the fire rate by 10.86 percent over the fire rate for passenger cars built prior to the Standard. Ninety-five percent confidence limits on the estimate are:

$$\pm 6.39\% \text{ or } 4.47\% \text{ to } 17.25\%$$

⁵ Probability of greater $t = .0001$ for age; probability of greater t for Standard = .0012.

In the data, the fire rate for Pre-standard vehicles is estimated at 5.284 fires per 1,000 vehicles and the fire rate for Post-standard vehicles at 4.710 fires per 1,000 vehicles.

Overall, the analyses of the Ohio data give results which closely parallel the results from the Michigan data, with the single exception that the overall fire rates are higher for Ohio.

Data from Maryland

The last State to be analyzed in the first group is Maryland. Following the procedure used for Michigan and Ohio, the data are first plotted in Figures 2-5 and 2-6 to provide a visual picture of the relationship of fire rate with vehicle age and with model year. Trends very similar to those noted before are seen - fire rates distinctly increase with vehicle age.

Simple linear functions for age and for model year give:

$$\text{Age model: } R = 0.0006493 + 0.0003550 X_1 \text{ (age)}$$

$$\text{Model Year Model: } R = 0.02677 - 0.0003076 X_2 \text{ (model year)}$$

As with the first two States, the age and model year coefficients are highly significant, with t-values of 19.93 and -15.24, respectively.⁶ R^2 for the age model is .78 and .69 for the model year function, again showing good fits, as with the previous States.

PLOT OF R*AGE LEGEND: A = 1 OBS, B = 2 OBS, ETC.

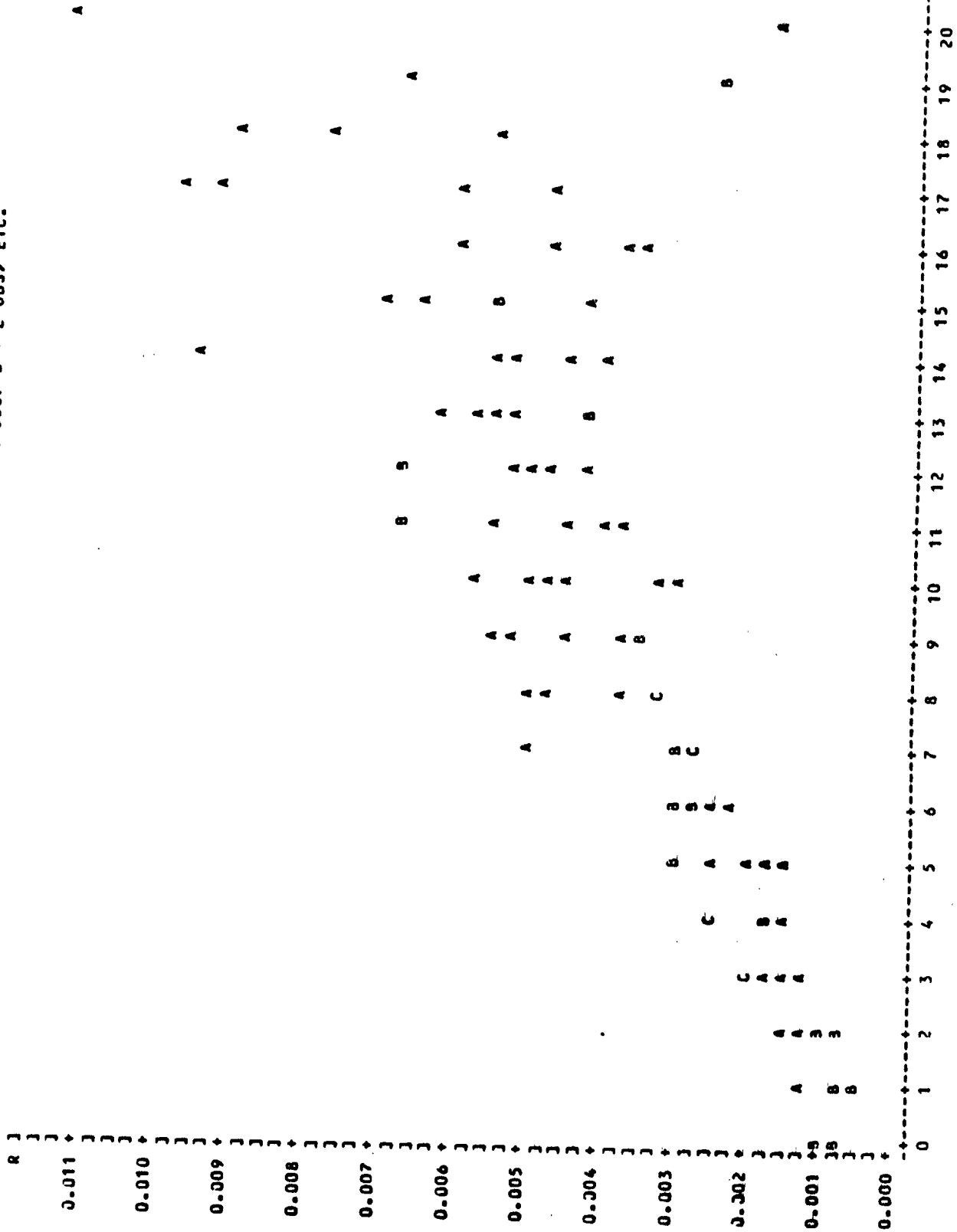
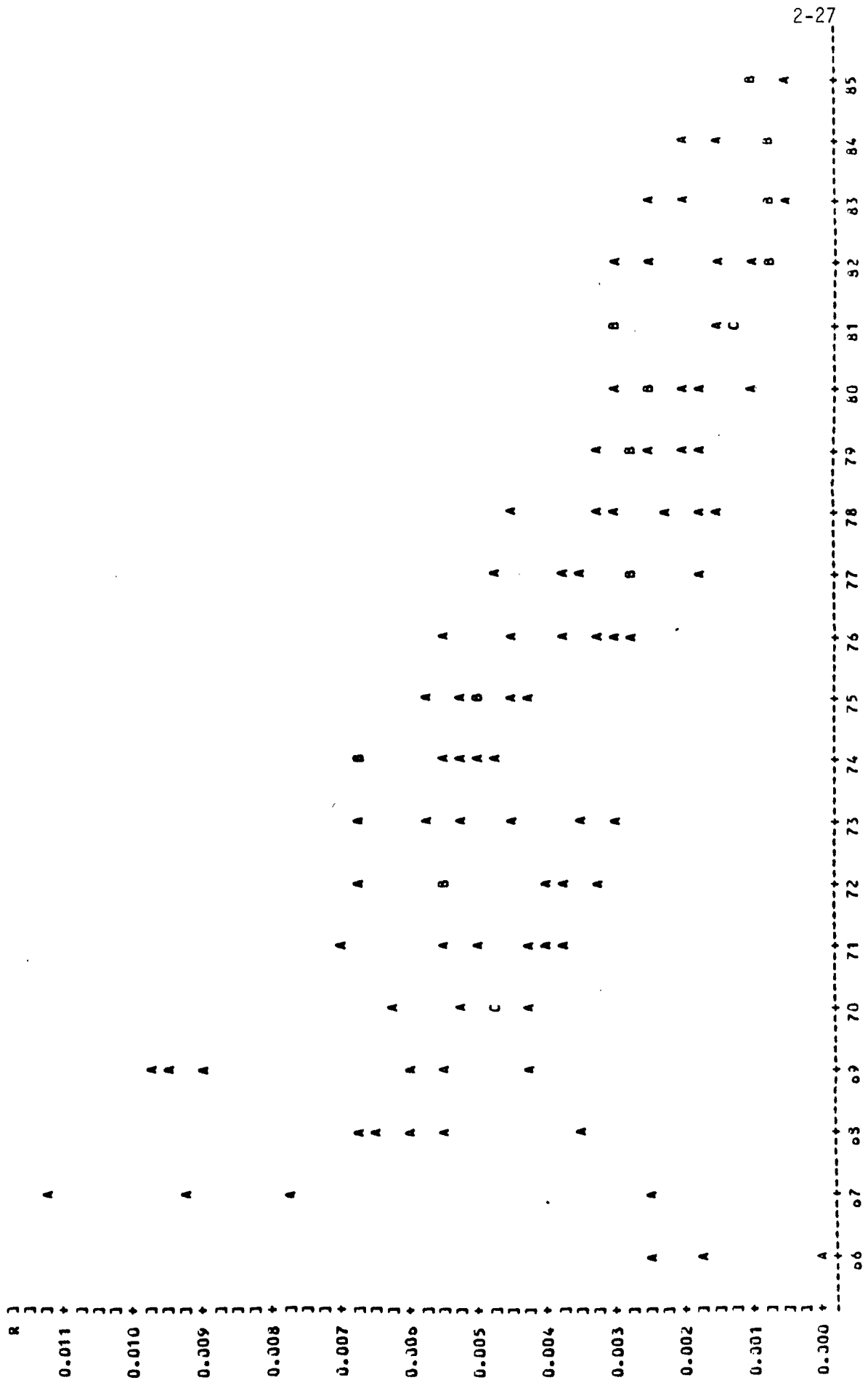

Figure 2-5
Maryland, Passenger Cars

PLOT OF R*MY LEGEND: A = 1 OBS, B = 2 OBS, ETC.



MY
Figure 2-6
Maryland, Passenger Cars

Converting to the 2-variable model to estimate the effect of the Standard resulted in the following equation:

$$R = 0.001511 + 0.0003104 X_1 (\text{age}) - 0.0007670 X_2 (\text{Std})$$

T-values for the age and Standard effects are 11.01 and -2.84, respectively, indicating, once again, high significance.⁷ R^2 was .80 - a good fit but only slightly better than the age model.

Turning to the effectiveness estimate for FMVSS 301, given the average age of the Maryland cars to be 11.484 years:

$$\begin{aligned} \text{Effectiveness} &= \frac{-0.0007670}{.001511 + 11.484 (.0003104)} \\ &= \frac{-0.0007670}{.005075} \\ &= -.1511 = -15.11 \text{ percent} \end{aligned}$$

After accounting for the effect of vehicle age, passenger cars produced after FMVSS 301 took effect show a 15.11 percent lower fire rate in the Maryland data, than cars made prior to the Standard.

⁶ Probability of greater t = .001 for both effects.

⁷ Probability of great t for age coefficient = .0001; probability of greater t for Standard coefficient = .0054.

Attaching 95 percent confidence limits to the estimate of effectiveness gives:

$$15.11 \pm 10.43\% = 4.68\% \text{ to } 25.54\%$$

The fire rate for Pre-standard vehicles in Maryland is estimated at 5.075 fires per 1,000 crash involved cars compared to the Post-standard rate of 4.308 fires per 1,000 crash involved cars.

Overall, the results from the Maryland data are quite similar to the results from Michigan and Ohio. With respect to the overall fire rate, Maryland data are quite close to the Ohio data, with both States showing higher fire rates than the State of Michigan.

Overall Results from Michigan, Ohio, and Maryland

Since the analyses results from Michigan, Ohio, and Maryland were so similar, the data were combined and analyses performed on the composite data set. The modeling procedures were the same as for the individual State analysis. Plots of the data appear in Figures 2-7 and 2-8.

At this juncture, the primary interest is in obtaining a "best" estimate for the effect of FMVSS 301. In the preceding analyses, generally similar relationships were noted for fire rate as a function of vehicle age and fire rate as a function of vehicle model year. Furthermore, this similarity was noted among all three States, Michigan, Ohio, and Maryland. The most reasonable explanations for these findings is believed to be that vehicles

PLOT OF R*AGE LEGEND: A = 1 OBS, B = 2 OBS, ETC.

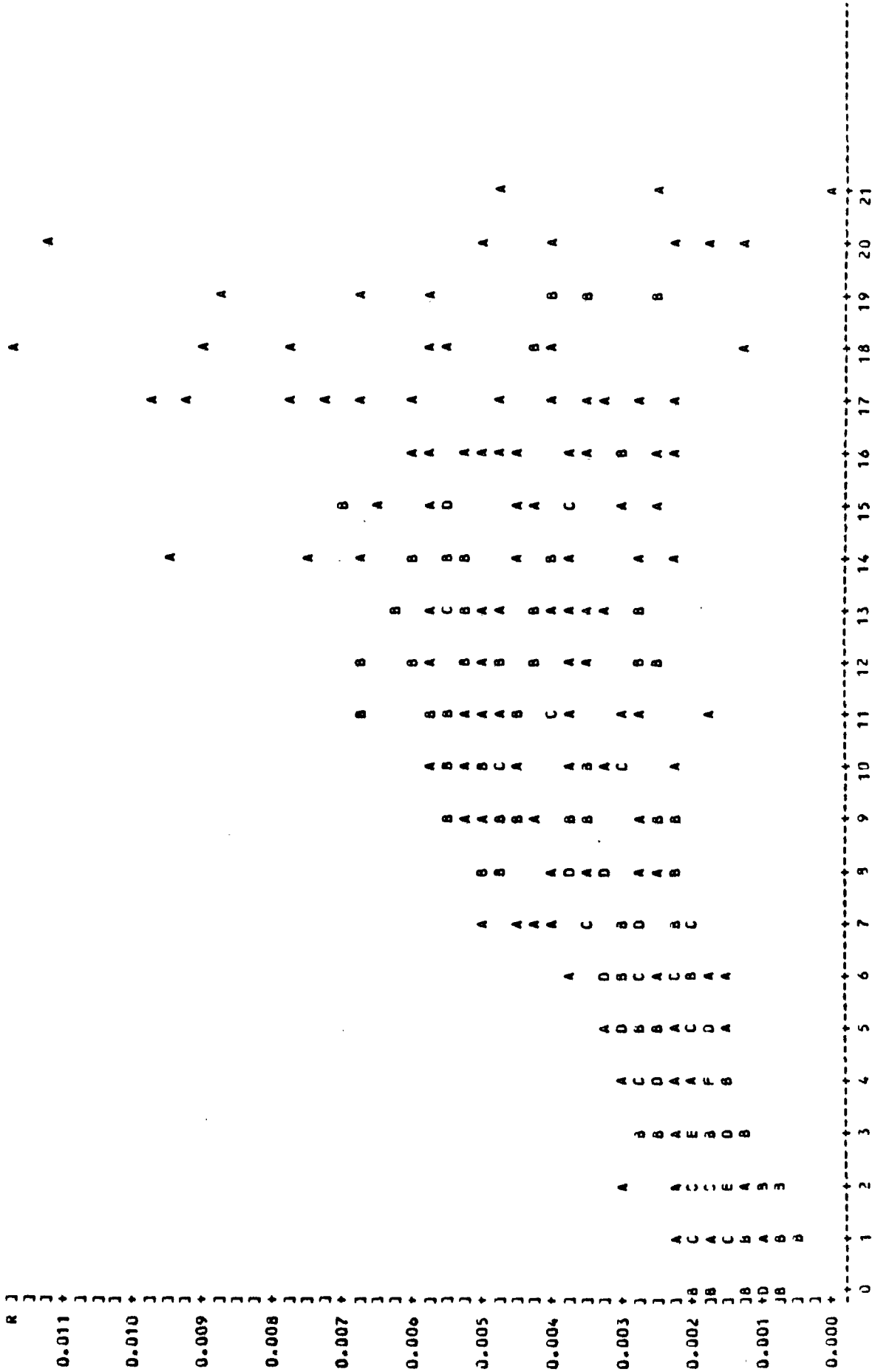

Figure 2-7
Michigan, Ohio, Maryland; Passenger Cars

PLOT OF R=MY LEGEND: A = 1 OBS, B = 2 OBS, ETC.

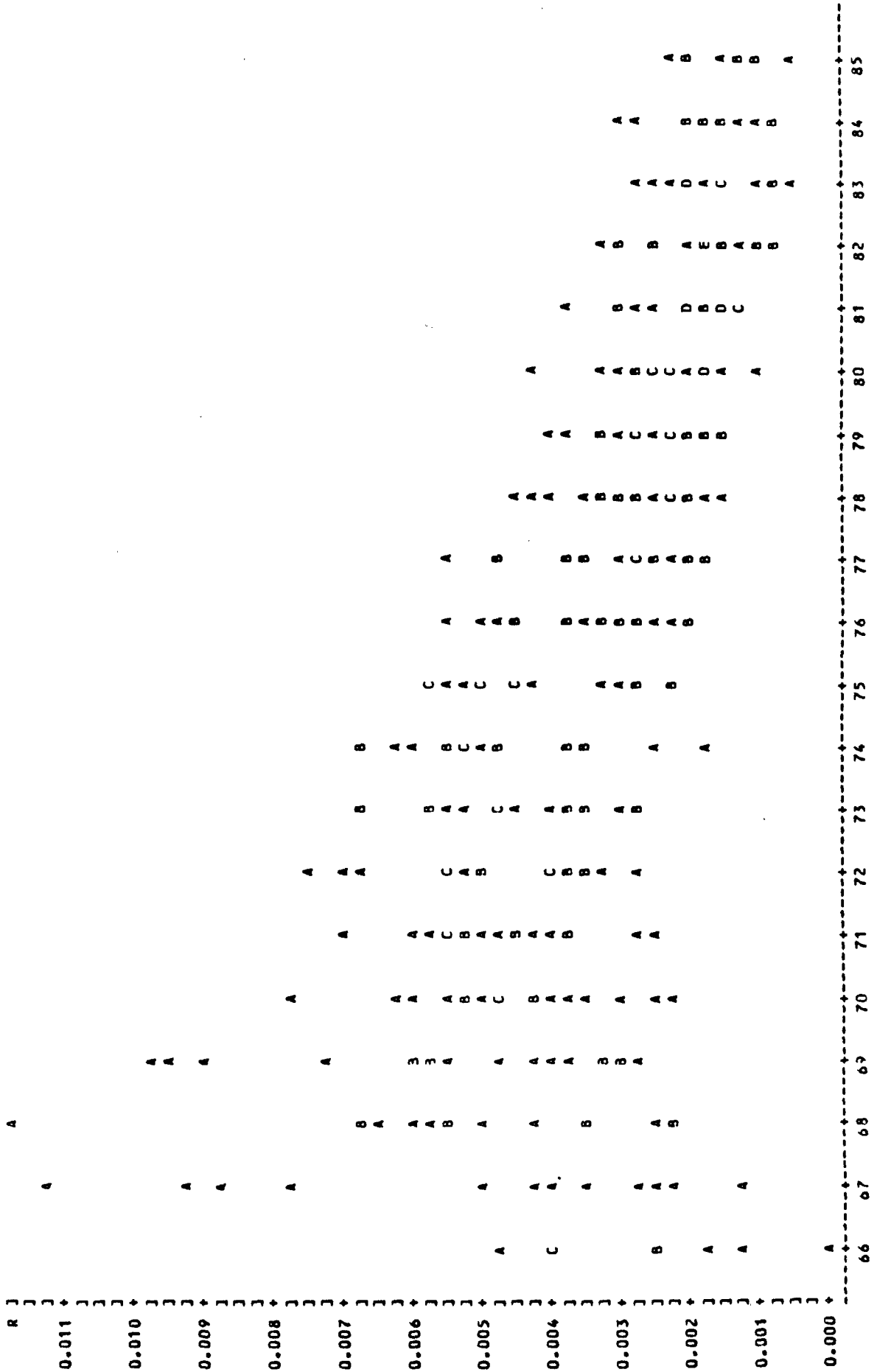

Figure 2-8 Michigan, Ohio, Maryland; Passenger Cars

are more susceptible to fire as the vehicles become older. The "mirror" trend of decreasing fire note with newer model years is interpreted as evidence of this same age trend, rather than a consistent structural improvement, model year by model year, that decreases the chances of fire.

Therefore, only the model with age and the Standard as independent variables is fitted in the overall analysis. The combined data produced 324 observations (after balancing for model years). The average age of the Pre-standard sample of passenger cars was 11.314 years.

The fitted model for the three States, combined, was:

$$R = 0.002005 + 0.0002237 X_1 (\text{age}) - 0.0006435 X_2 (\text{Std})$$

Both coefficients were significant, having t-values of 12.88 and -3.95, respectively, for age and the Standard.⁸ R^2 was somewhat less than for the individual State runs at .62.

The estimated effect for the Standard is:

$$\begin{aligned} \text{Effectiveness} &= \frac{-0.0006435}{.002005 + 11.314 (.0002237)} \\ &= - \frac{.0006435}{.004536} \\ &= .1418 = - 14.18 \text{ percent} \end{aligned}$$

⁸ Probability of greater t=.0001 for both X_1 and X_2 coefficients.

The fire rate for Post-standard cars, after adjusting for the effect of vehicle age, is 14.18 percent less than the rate for Pre-standard cars. Ninety-five percent confidence limits on the effectiveness estimate are:

$$14.18 \pm 7.04\% = 7.14\% \text{ to } 21.22\%$$

As would be expected, the 14.18% reduction is within the range of the three individual State estimates of 16.41%, 10.86%, and 15.12%, respectively, for Michigan, Ohio, and Maryland. It is also interesting to note that the regression estimate of effectiveness is very close to that obtained by merely taking a simple average of the three individual estimates, i.e.,

$$\frac{.1086 + .1512 + .1641}{3} = .1413 = 14.13\%$$

2.2.1.2 Analysis of Data from Illinois and Indiana

This section discusses the analyses of data from the States of Illinois and Indiana. Recall that the fire rates from these two States (Table 2-2) were considerably less than the fire rates from Michigan, Ohio, and Maryland, ranging from 0.4 fires per 1,000 vehicles to slightly above 2.0 fires per 1,000 vehicles.

Recalling also the accident reporting instructions for the two States, Indiana fires are to be defined by "vehicle caught fire as a result of the crash", while Illinois fires are to be positive answers to the question, "Did fire occur?" From these definitions alone, Indiana fires could be said to be post-crash fires, whereas Illinois fires would appear to cover pre-crash,

as well as post-crash fires. Given these conditions, it is interesting to note that the overall fire rates in the two States are surprisingly similar in magnitude (refer again to Table 2-2).

Figures 2-9 and 2-11 display the fire rate by age plots for Illinois and Indiana, respectively. Figures 2-10 and 2-12 contain the fire rate by model year plots.

Employing the same analysis procedures as used for the first three States, regression runs were made on the data from Illinois and Indiana, with the following results:

Data from Illinois

For the fire rate by age model, the age effect was significant with a t-value of 4.76,⁹ the fitted equation being:

$$R = 0.0007455 + 0.0000291 X_1 \text{ (age)}$$

The R^2 was .18, indicating significantly less of the variation in fire rate being explained by age than in the cases for Michigan, Ohio, and Maryland.

⁹ Probability of greater t = .0001.

PLOT OF R*AGE LEGEND: A = 1 OBS, B = 2 OBS, ETC.

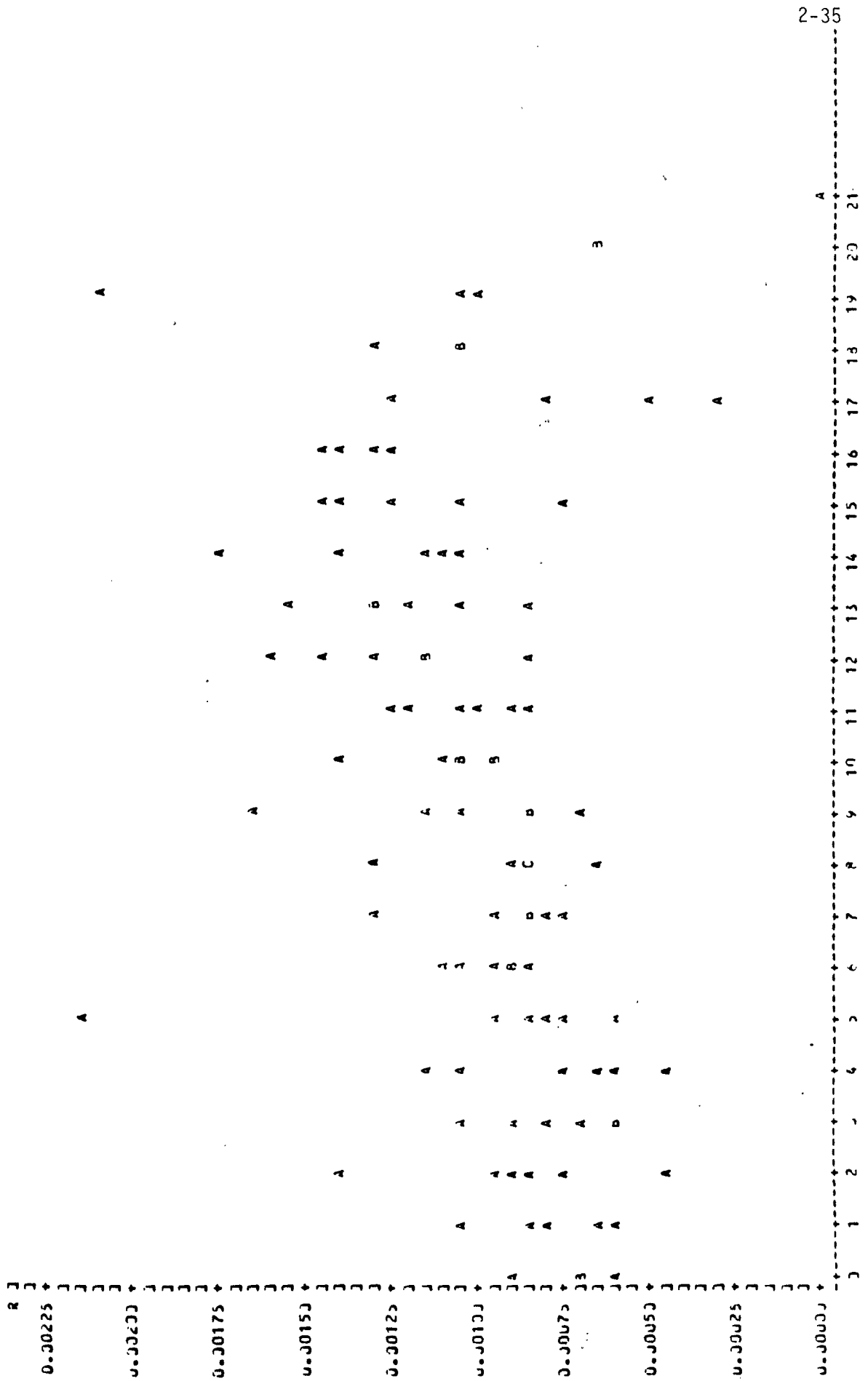

Figure 2-9
Illinois, Passenger Cars

PLUT OF R+MY LEGEND: A = 1 OBS, B = 2 OBS, ETC.

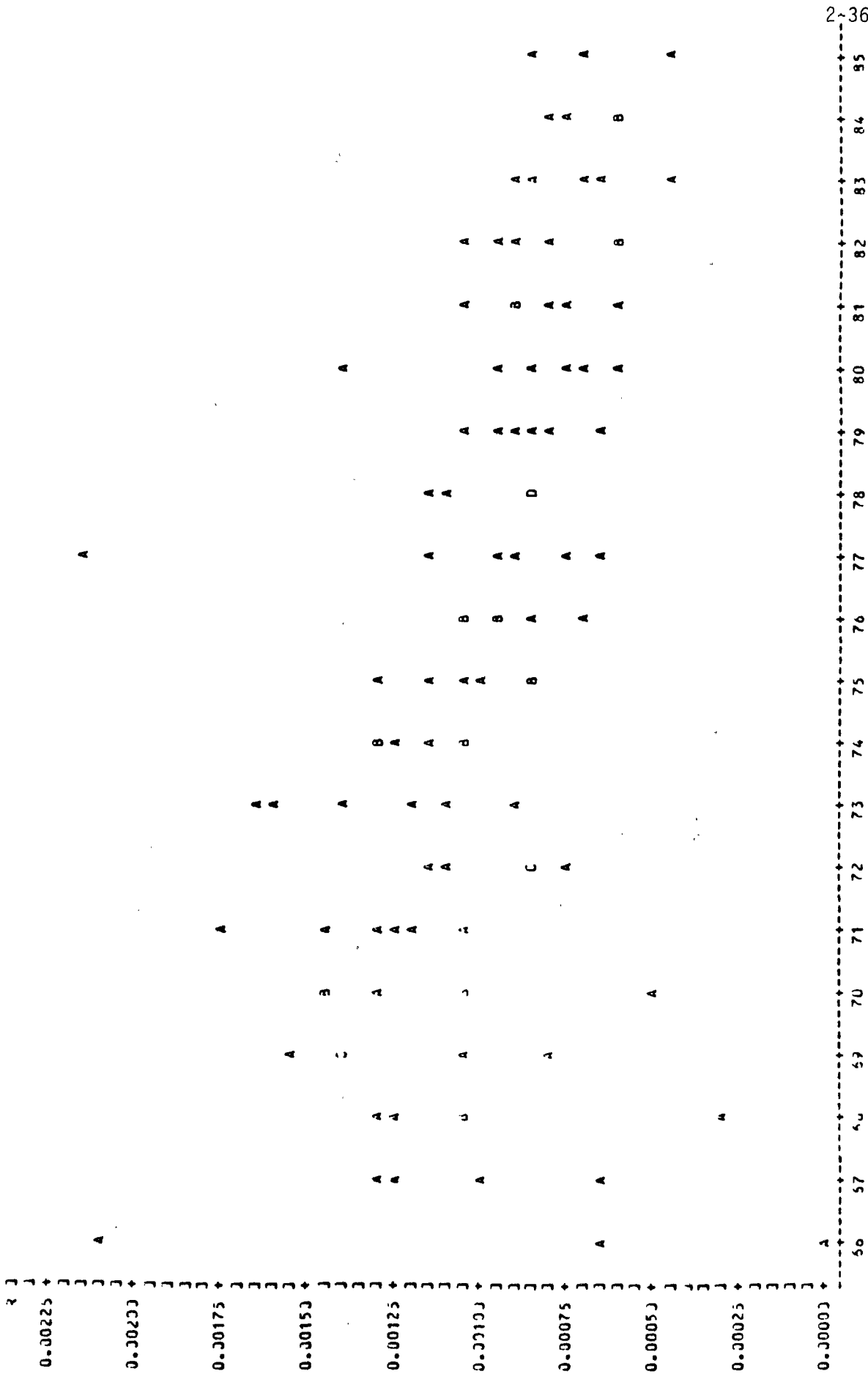

Figure 2-10
Illinois, Passenger Cars

PLOT OF PAGE LEGEND: A = 1 OBS, S = 2 OBS, ETC.

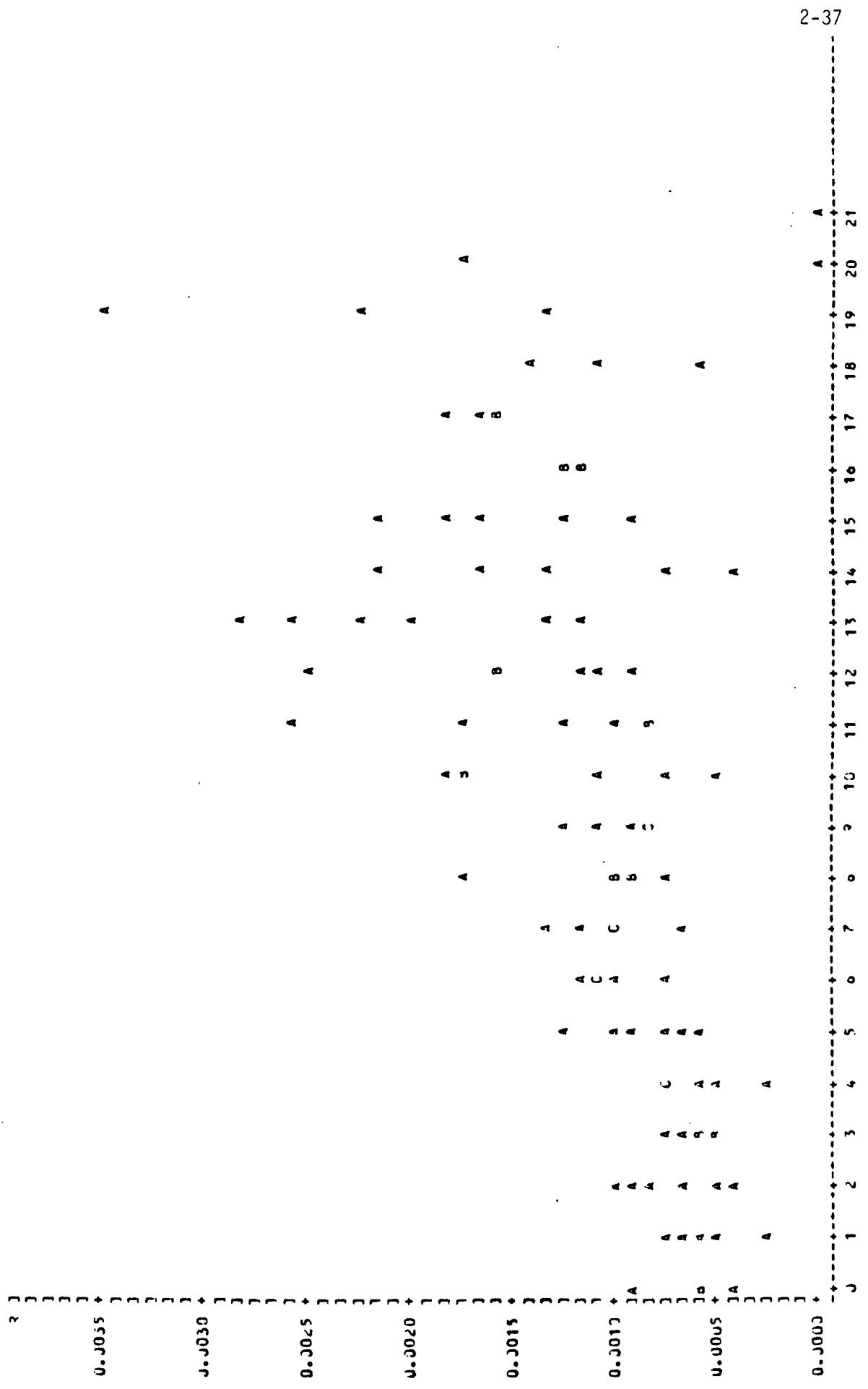

Figure 2-11
Indiana, Passenger Cars

PLOT OF R-MY LEGEND: A = 1 OBS, B = 2 OBS, ETC.

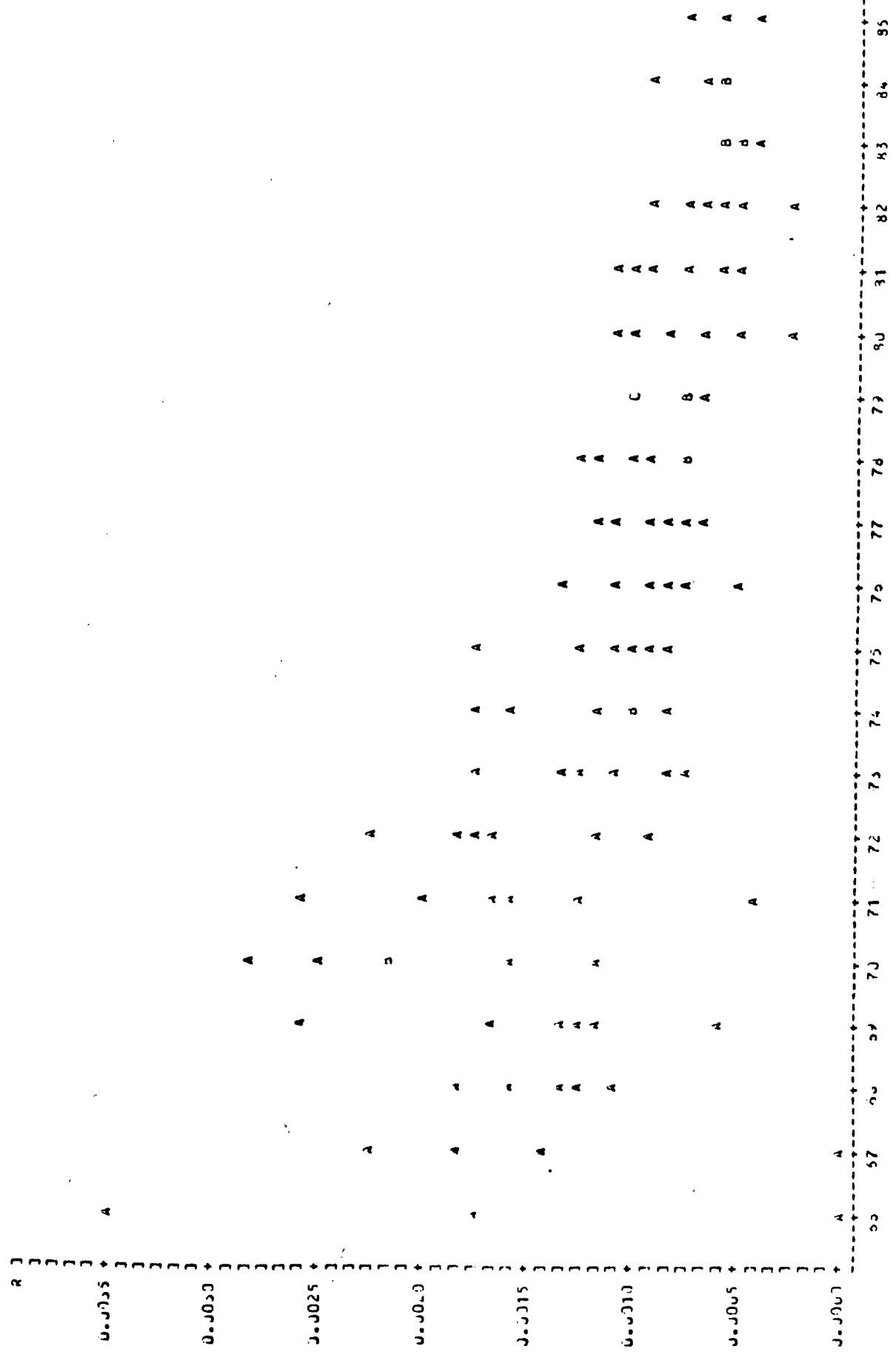

Figure 2-12
Indiana, Passenger Cars

Turning to the two-variable model to include the Standard effect, the fitted equation was:

$$R = 0.001022 + 0.0000120 X_1 (\text{age}) - 0.0002240 X_2 (\text{Std})$$

In this model, the Standard effect was significant, but the age factor was not significant. The t-value for the Standard effect was -2.84, while the t-value for the age effect was 1.41.¹⁰ The R² of 0.23 showed some improvement over the single variable (age) model, but still much below the model fits obtained for the States of Michigan, Ohio, and Maryland.

The next step is to estimate the effectiveness of the Standard from the fitted model. Given the age of the Pre-standard vehicles at 11.217 years, the effectiveness estimate is:

$$\begin{aligned} \text{Effectiveness} &= \frac{-.0002240}{.001022 + 11.217 (.0000120)} \\ &= \frac{-.0002240}{.001157} \\ &= -.1937 = -19.37\% \end{aligned}$$

The fire rate for the Post-standard of vehicles was significantly below the fire rate for Pre-standard vehicles, the magnitude of the difference being 19.37 percent.

¹⁰ For Standard effect, probability of greater t = .0054; for age effect, probability of greater t = .1601.

Attaching 95 percent confidence limits gives:

$$19.37 \pm 13.36\% = 6.01\% \text{ to } 32.73\%$$

Data from Indiana

The fire rates from Indiana are plotted in Figures 2-11 and 2-12. The regression equation for the single variable, age, was:

$$R = 0.0005085 + 0.0000669 X_1 \text{ (age)}$$

The fit was considerably better than those for the Illinois data, with an R^2 of .38. Age was significant with a t-value of 8.08.¹¹

Adding the second variable to estimate the effect of the Standard gave the following equation:

$$R = 0.0009783 + 0.0000374 X_1 \text{ (age)} - 0.0003724 X_2 \text{ (Std)}$$

In this model, both the age and the Standard effects are significant with $t \text{ (age)} = 3.24$ and $t \text{ (Std)} = -3.50$.¹² The fit was somewhat improved over the single variable (age) model with the R^2 rising to .45, from .38. The average age of the Pre-standard vehicles is 11.65 years.

¹¹ Probability of a greater $t = .0001$.

¹² Probability of greater $t = .0016$, and $.0007$, for age and Standard coefficients, respectively.

Estimating the Standard effectiveness from the Indiana data gives:

$$\begin{aligned}
 \text{Effectiveness} &= \frac{-0.0003724}{.0009783 + 11.65 (.0000374)} \\
 &= \frac{-0.0003724}{0.001414} \\
 &= -.2634 = -26.34 \text{ percent}
 \end{aligned}$$

The 95 percent confidence limits on the estimate are:

$$26.34 \pm 14.74\% = 11.60\% \text{ to } 41.08\%$$

Discussion of Results from Illinois and Indiana

Both the Illinois and the Indiana data produce effectiveness estimates that are higher, and at the same time, more variable, than the results from the three States, Michigan, Ohio, and Indiana. Illinois was the only State among the five where age was not a significant effect in the effectiveness model (i.e., 2-variable model). The five rates were generally of the same order of magnitude for Illinois and Indiana, even though one State apparently records only post-crash fires (i.e., Indiana) while the other State (Illinois) appears to record both pre-crash and post-crash fires. One other item of some concern for the Illinois data is the unusually high rate of "unknowns" for the fire variable. For the six years of Illinois data, the rate of unknowns ranged from 35 percent to 43 percent. The unknown rate for Indiana ranged from 3 percent to about 7 percent.

2.2.2 Analysis of State Injury Accident Data

In the preceding section (2.2.1), analyses of data for passenger car crashes from the States of Michigan, Ohio, and Maryland found a 14 percent reduction in fires for cars manufactured after Standard 301 took effect. That analysis and estimated reduction pertained to fires in all police reported accidents most of which are non-injury. A logical follow-on question is: "what effect has the Standard had in reducing injuries -- i.e., burn injuries resulting from vehicle crash fires?"

In order to explore this question, the analysis will focus on the rate of fire in injury crashes involving passenger cars and whether or not fires have been significantly reduced for vehicles produced after the Standard took effect.

Table 2-2a shows the fire rates for passenger cars in injury crashes for the three States, Michigan, Ohio, and Maryland, which have been shown to have the most complete data on fires. The table entries are the number of police reported fires per 100 crashes in which the driver sustains injury at severity level A (serious) or at severity level B (moderate). The data are overall, or aggregate values for the six calendar years, 1982 through 1987. It will be noted that the fire rates given here, for injury crashes, are 2 to 3 times higher than the fire rates for all reported crashes (i.e., both injury and noninjury) as shown in Table 2-2. This is true for Michigan and Ohio, but not for Maryland where the fire rates for injury crashes and all

Table 2-2a
 Fire Rates* in Passenger Car Injury Crashes
 by State and Vehicle Model Year

| Model Year | S T A T E | | |
|---------------|-----------|------|----------|
| | Michigan | Ohio | Maryland |
| 1987 | 0.44 | 0.54 | 0.40 |
| 1986 | 0.53 | 0.80 | 0.09 |
| 1985 | 0.43 | 0.52 | 0.22 |
| 1984 | 0.50 | 0.53 | 0.15 |
| 1983 | 0.39 | 0.55 | 0.10 |
| 1982 | 0.36 | 0.54 | 0.10 |
| 1981 | 0.43 | 0.48 | 0.16 |
| 1980 | 0.55 | 0.61 | 0.29 |
| 1979 | 0.64 | 0.76 | 0.27 |
| 1978 | 0.66 | 0.84 | 0.20 |
| 1977 | 0.68 | 0.80 | 0.35 |
| 1976 | 0.90 | 0.88 | 0.42 |
| ----- | | | |
| 1975 | 0.82 | 1.08 | 0.44 |
| 1974 | 0.82 | 1.21 | 0.38 |
| 1973 | 0.97 | 1.11 | 0.44 |
| 1972 | 1.08 | 1.33 | 0.56 |
| 1971 | 1.30 | 1.06 | 0.34 |
| 1970 | 0.91 | 1.08 | 0.34 |
| 1969 | 1.19 | 1.45 | 0.56 |
| 1968 | 0.68 | 1.51 | 0.55 |
| 1967 | 1.53 | 1.45 | 0.36 |
| 1966 | 0.90 | 0.98 | 0.16 |
| 1965 | 1.39 | 1.25 | 0.99 |

* Fire rates are police reported fires per 100 passenger car crashes where the driver is injured at severity level A (serious) or severity level B (moderate). Appendix C contains the actual counts of fires and injury crashes (vehicles) for each Model Year and State.

The data are overall aggregates for calendar years 1982 through 1987.

crashes lie approximately within the same range. Intuitively, fires would be expected to occur more frequently in injury crashes than in all crashes, because of their typically higher crash forces. Why the data from Maryland display a departure from this pattern is not apparent at this juncture.

The reasons for combining injury levels A and B is that the cell counts (i.e., number of fires for separate injury levels within some model year by calendar year combinations) are too small to support reliable analysis. Of course, all statistical inferences resulting from the analysis will apply to the rate of fires in the population of injury crashes where injury is defined as either A or B severity (to the driver). Separate inferences, with respect to A-injury crashes, or with respect to B-injury crashes will not be appropriate.

The individual counts of vehicle fires in A + B injury crashes and of all vehicles in A + B injury crashes are given in Appendix C, Table C-2a, where the counts are the 6-year totals for each of the three States. A quick review of Table C-2a reveals that the fire counts for Maryland are relatively small. Recalling that the data to be submitted to the model for analysis, following the convention in the preceding section for all accidents, are the individual model year x calendar year counts, this means that the Maryland data will be too sparse and must therefore be dropped from further analysis. The unusually low rate of fires in injury crashes for Maryland, as noted earlier, constitutes a second reason for excluding Maryland and restricting the effectiveness analyses to the data from the States of Michigan and Ohio.

The Michigan data will be analyzed first. The analysis approach is similar to that used in Section 2.2.1 for the analysis of fire rates in all police reported crashes.

Figures 2-12a and 2-12b are plots of the fire rates in A + B injury crashes by vehicle age and by vehicle model year, respectively. Each data point represents the fire rate for vehicle model year i , and calendar year j . As with the plots of fire rates in all crashes, the fire rates in injury crashes are also shown to have a distinct relationship with age (or model year), with the rate increasing with age.

Simple and multiple linear models were fitted to the data as follows:

$$\text{Age Model: } R_{ij} = a + b X_{ij}$$

$$\text{Model Year Model: } R_{ij} = a + b X_{ij}$$

$$\text{Age, Standard Model: } R_{ij} = a + b X_{1(ij)} + c X_{2(ij)}$$

In these equations, the dependent and independent variables have the same interpretation as those used in the analysis of fire rates in Section 2.2.1, with the exception that here the fire rates are those for injury crashes. The subscripts i, j , refer to vehicle model year and the calendar year in which the crashes occurred, respectively.

PLOT OF GRADE LEGEND: 1 = 1 OBS, 2 = 2 OBS, ETC.

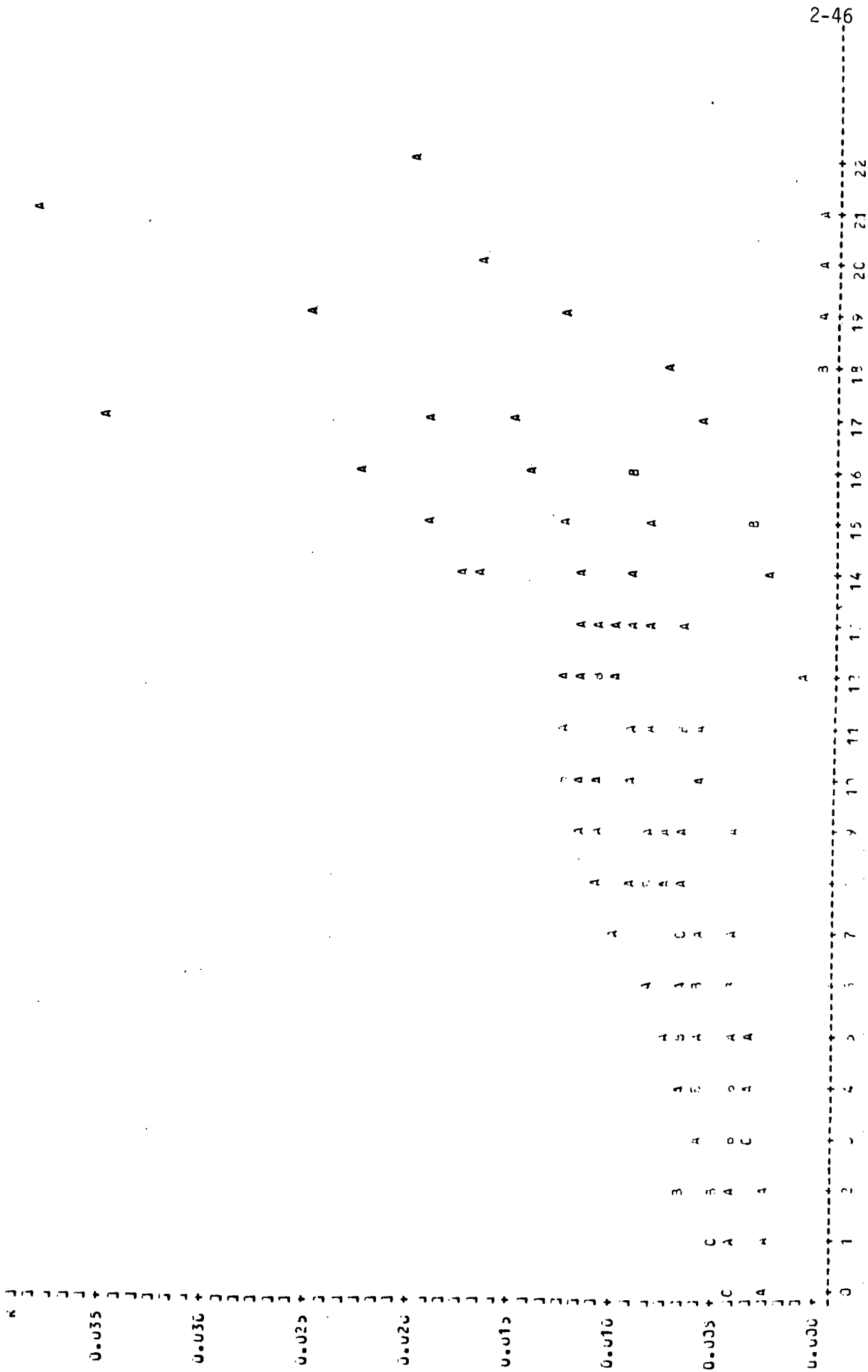

Figure 2-12a
Michigan, Passenger Cars

PLUT OF R+HY CPTAKD: 4 = 1 UPS, R = 2 DHS, ETC.

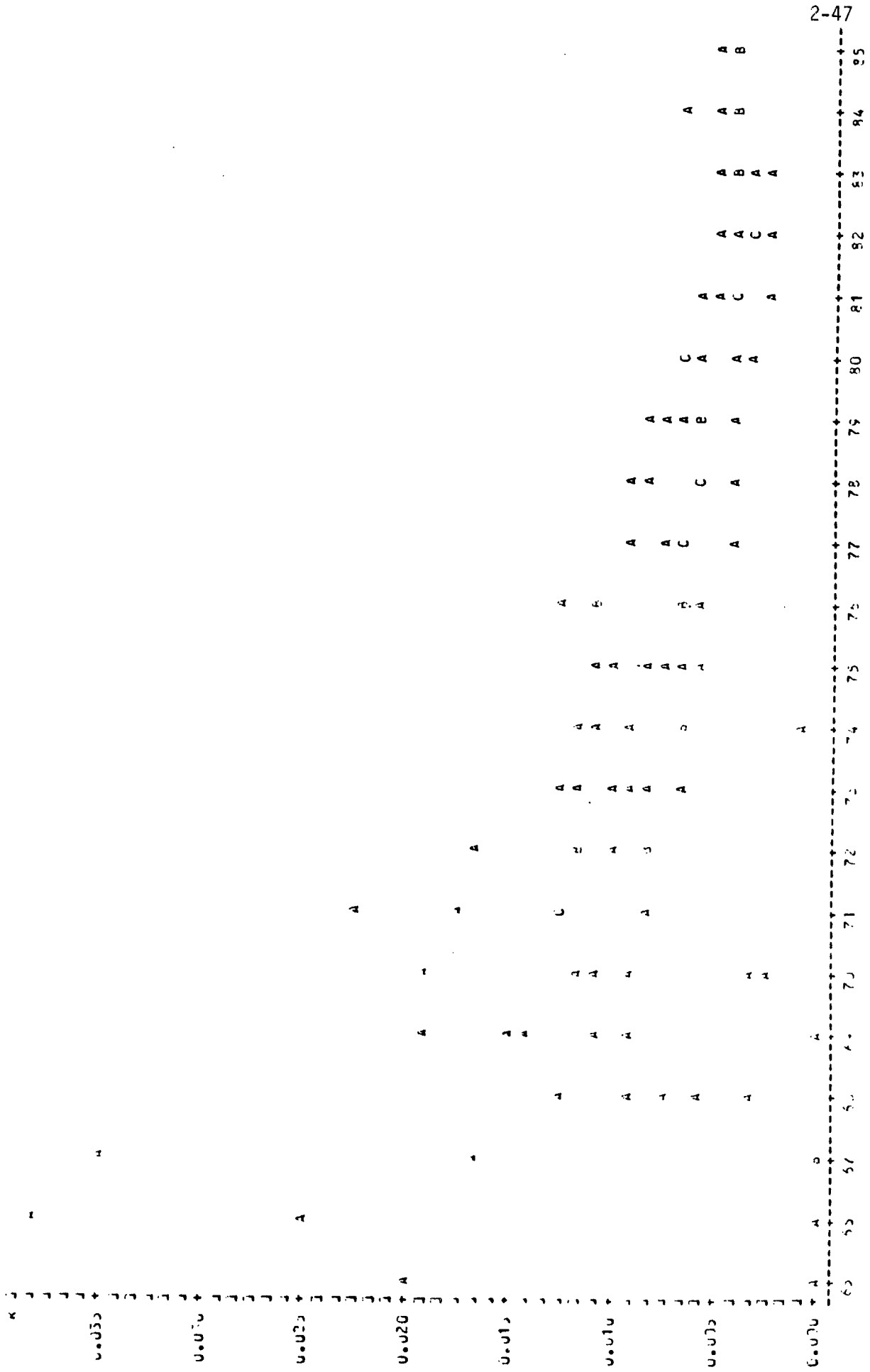

Figure 2-12b
Michigan, Passenger Cars

Fitting the data to the models produced the following results:

$$\text{Age Model: } R = 0.00344053 + 0.00051505 X_1(\text{age}) \quad R^2 = .44$$

$$\text{Model Year Model: } R = 0.04692532 - 0.00051447 X_1(\text{mod. yr.}) \quad R^2 = .46$$

$$\begin{aligned} \text{Age, Standard Model: } R = 0.00464540 + 0.00044165 X_1(\text{age}) \\ - 0.00098141 X_2(\text{Std}) \quad R^2 = .45 \end{aligned}$$

In all three cases, the age (or model year) coefficients are highly significant ($P > t = .0001$) while the coefficient for the effect of Standard 301 is non-significant ($P > t = .20$). Even though not significant, the effect of the Standard will be estimated. Given the average age of Pre-standard vehicles is 11.2 years, the estimate is:

$$\begin{aligned} \text{Effectiveness} &= \frac{-0.00098141}{.0046454 + 11.2 (.00044165)} \\ &= -.102 \\ &= -10.2\% \end{aligned}$$

Thus, the results of analyzing the Michigan fire rate in injury crashes for passenger cars finds the effect of the Standard to be not significant at a numerical reduction in fires of 10.2 percent.

Turning next to the data from Ohio, the fire rates in injury crashes as a function of age and model year are graphed in Figures 2-12c and 2-12d, respectively. Once again the relationship of fire rate and vehicle age is readily evident.

Fitting the Ohio data to the same 3 models produced the following equations:

$$\text{Age Model: } R = 0.00401897 + 0.00063687X_1(\text{age}) \quad R^2=.57$$

$$\text{Model Year Model: } R = 0.05526704 - 0.00060391 X_1(\text{mod.year}) \quad R^2=.54$$

$$\begin{aligned} \text{Age, Standard Model: } R = 0.00612149 + 0.00050309X_1(\text{age}) \\ -0.00167810X_2(\text{std.}) \quad R^2=.59 \end{aligned}$$

Similar to the results from Michigan, the coefficients for the age variable are highly significant ($P > t = .0001$) in all three equations, and the coefficients of determination indicate that age explains a substantial portion of the total variation in fire rates. Moving to the coefficient measuring the effect of Standard 301, however, a different result is noted from that obtained with the Michigan data. Here, the coefficient is statistically significant ($P > t = .0170$) indicating that fire rates in injury crashes are lower for Post-standard vehicles than they are for Pre-standard vehicles. Estimating the effect of the standard using the estimates from the last equation, above, and the average age of the Pre-standard vehicles at 11.41 years, yields;

FLY OF RANGE LEGEND: A = 1 OBS, B = 2 OBS, ETC.

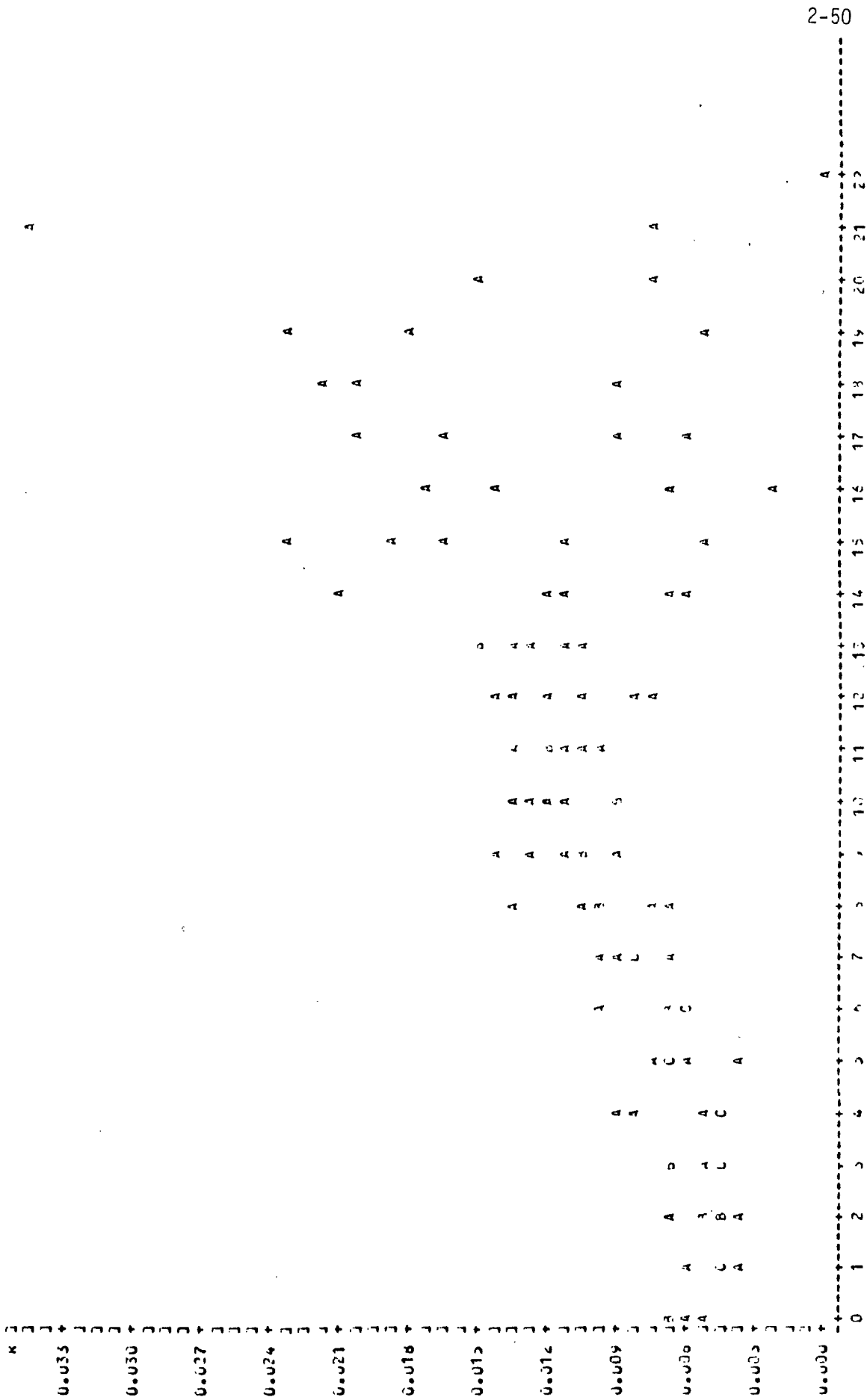

AGE
Figure 2-12c
Ohio, Passenger Cars

PLOT OF R*MY LEGEND: A = 1 OBS, B = 2 OBS, ETC.

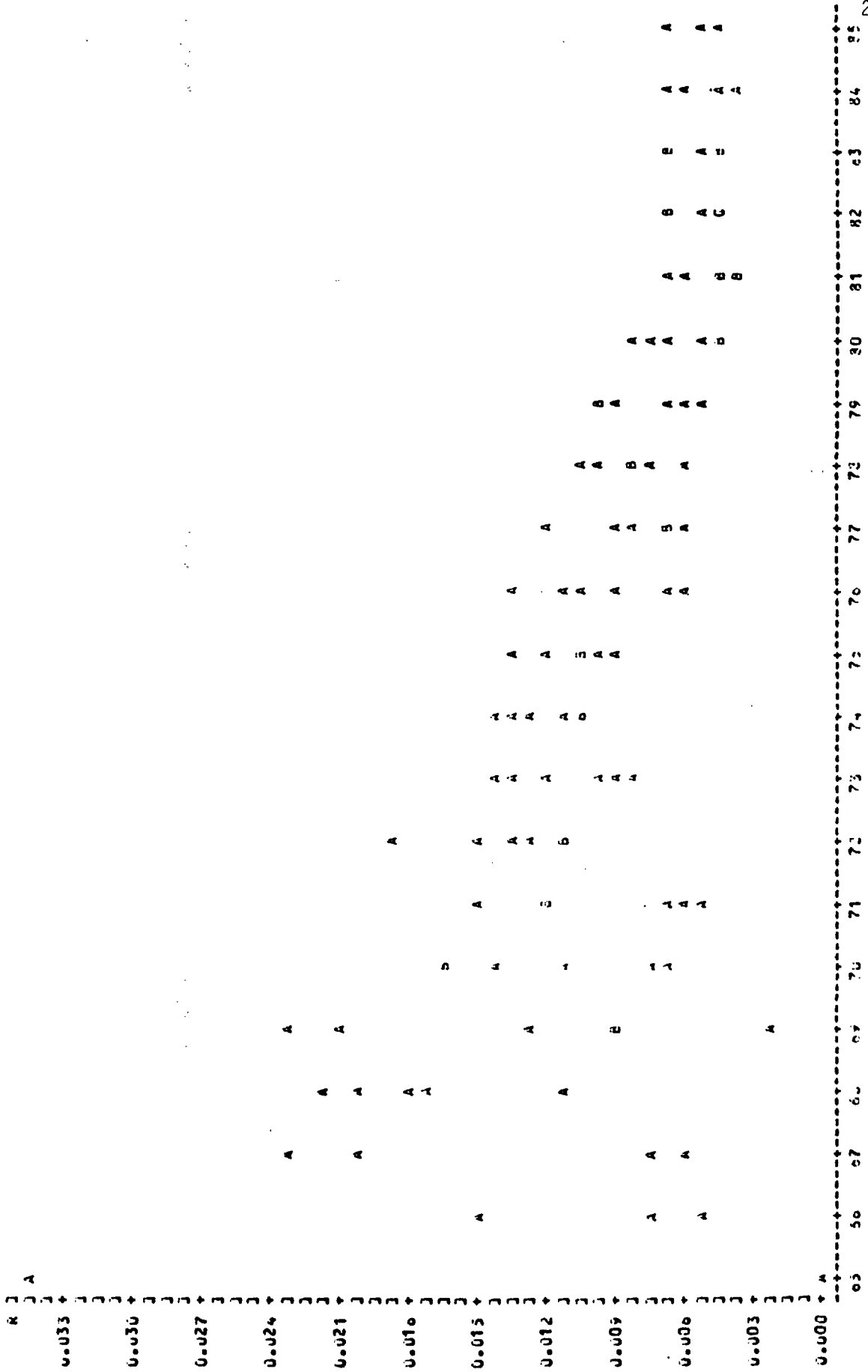

Figure 2-12d
Ohio, Passenger Cars

$$\begin{aligned} \text{Effectiveness} &= \frac{-0.00167810}{0.00612149 + 11.41 (0.00050309)} \\ &= -.141 \\ &= -14.1\% \end{aligned}$$

Therefore, using data from Ohio, a statistically significant reduction of 14 percent in fires in injury crashes is found for cars produced after FMVSS 301 took effect.

2.2.3 Analysis of Fatal Accident Data

In the previous sections, analysis of State data from five States was discussed. Analysis of State data can provide insight into the effect of FMVSS 301 on property damage and injury accidents. However, for the effect of the Standard on fatal accidents, the numbers in the State files are too small. Therefore, the data from the Fatal Accident Reporting System (FARS) are used.

To recall, FARS records, for each vehicle in the accident, the presence of fire according to the following convention:

NO - No fire

YES - Fire occurred in vehicle during accident

As with the State files, fires in the FARS files may contain fires which resulted from the crash as well as fires which occurred prior to the crash. The FARS data contain an additional variable, "FIRST HARMFUL EVENT," which can provide information on the origin of the fire. One of the codes for First Harmful Event (an accident-level variable) is "fire/explosion." Fires which are coded as "first harmful event" would presumably be pre-crash, rather than post-crash events. A sample check of the FARS data for six calendar years revealed that less than one percent of passenger car fires were coded in the "first harmful event" category.

Thus, it could be said that in excess of 99 percent of passenger car fires associated with fatal crashes are a result of the crash itself. However, while post-crash fires are expected to represent a much larger proportion of "fatal crash fires" than they are among "all accident fires" - owing to the much more severe forces involved in fatal accidents - it must still be recognized that to discern, reliably, the origin of the fire could still be a tenuous task for police investigating officers. It seems reasonable to assume that the very large majority of fires in fatal crashes would indeed be of the post-crash variety. However, to state that such proportion is over 99 percent of all fires associated with fatal car crashes may be a more precise statement than is warranted based on the overall data reporting mechanisms.

Given the above conditions, Table 2-3 lists the fatal crash fire rates for passenger cars as recorded in FARS from calendar years 1975 through 1988. Fire rates are given by vehicle model year, along with the actual frequencies of vehicle fires and frequencies of all passenger cars involved in fatal accidents. One item to note is that fire rates for passenger cars in fatal crashes is much higher (up to 10 times as high) as fire rates for cars in all (severity) accidents. This is no doubt a reflection of the much higher crash forces involved in fatal accidents.

Analyses similar to those performed on the State data were performed on the FARS data. Regression models, with weighting of individual observations, and balancing of Pre and Post model years within calendar years were run. For the FARS years 1975 through 1988, this produced a total number of 182 observations, each observation being the fire rate (i.e., number of passenger

Table 2-3
 Fire Rates* in Fatal Passenger Car Accidents
 by Vehicle Model Year

| <u>Model Year</u> | <u>No. Passenger Car Fires</u> | <u>No. Passenger Cars in Fatal Accidents</u> | <u>Fire Rate*</u> |
|-------------------|--------------------------------|--|-------------------|
| 1989 | 3 | 133 | 2.256 |
| 1988 | 56 | 2,798 | 2.001 |
| 1987 | 150 | 6,015 | 2.494 |
| 1986 | 218 | 8,969 | 2.431 |
| 1985 | 256 | 11,428 | 2.240 |
| 1984 | 339 | 14,289 | 2.373 |
| 1983 | 278 | 12,538 | 2.217 |
| 1982 | 319 | 14,645 | 2.178 |
| 1981 | 382 | 18,544 | 2.060 |
| 1980 | 538 | 23,578 | 2.282 |
| 1979 | 808 | 30,569 | 2.643 |
| 1978 | 800 | 33,308 | 2.402 |
| 1977 | 870 | 34,249 | 2.540 |
| 1976 | 857 | 33,121 | 2.587 |
| ----- | | | |
| 1975 | 771 | 27,191 | 2.835 |
| 1974 | 864 | 34,996 | 2.469 |
| 1973 | 879 | 37,211 | 2.362 |
| 1972 | 813 | 31,948 | 2.545 |
| 1971 | 637 | 25,371 | 2.511 |
| 1970 | 561 | 23,804 | 2.357 |
| 1969 | 505 | 21,558 | 2.343 |
| 1968 | 419 | 17,769 | 2.358 |
| 1967 | 320 | 13,701 | 2.336 |
| 1966 | 241 | 12,129 | 1.987 |
| 1965 | 189 | 9,587 | 1.975 |
| 1964 | 109 | 6,117 | 1.782 |
| 1963 | 76 | 3,803 | 1.998 |
| 1962 | 46 | 2,332 | 1.973 |
| <1961 | 88 | 3,792 | 2.321 |
| UNK | 67 | 3,420 | 1.959 |

SOURCE: Fatal Accident Reporting System files for calendar years 1975 through 1988.

* Fire rates are reported fires per 100 passenger cars in fatal accidents.

cars with fire divided by total involved passenger cars) for a given calendar year - model year combination.

The data are plotted in Figures 2-13 and 2-14 as a function of vehicle age and vehicle model year.

Fitting a simple function of fire rate versus age gave the following equation:

$$R = 0.02174 + 0.0006329 X_1 \text{ (age)}$$

The age coefficient was significant at a t-value of 9.21.¹³ This simple model of age explained approximately 32 percent of the variation in fire rate ($R^2 = .32$), somewhat less than was typically noted in the earlier age models of the State accident data.

Adding a second variable to account for the effect of FMVSS 302 resulted in the following model:

$$R = 0.02192 + 0.0006218 X_1 \text{ (age)} - 0.0001739 X_2 \text{ (Std)}$$

¹³ Probability of greater t = 0.0001).

PLOT OF R+AGE LEGEND: A = 1 OBS, 9 = 2 OBS, ETC.

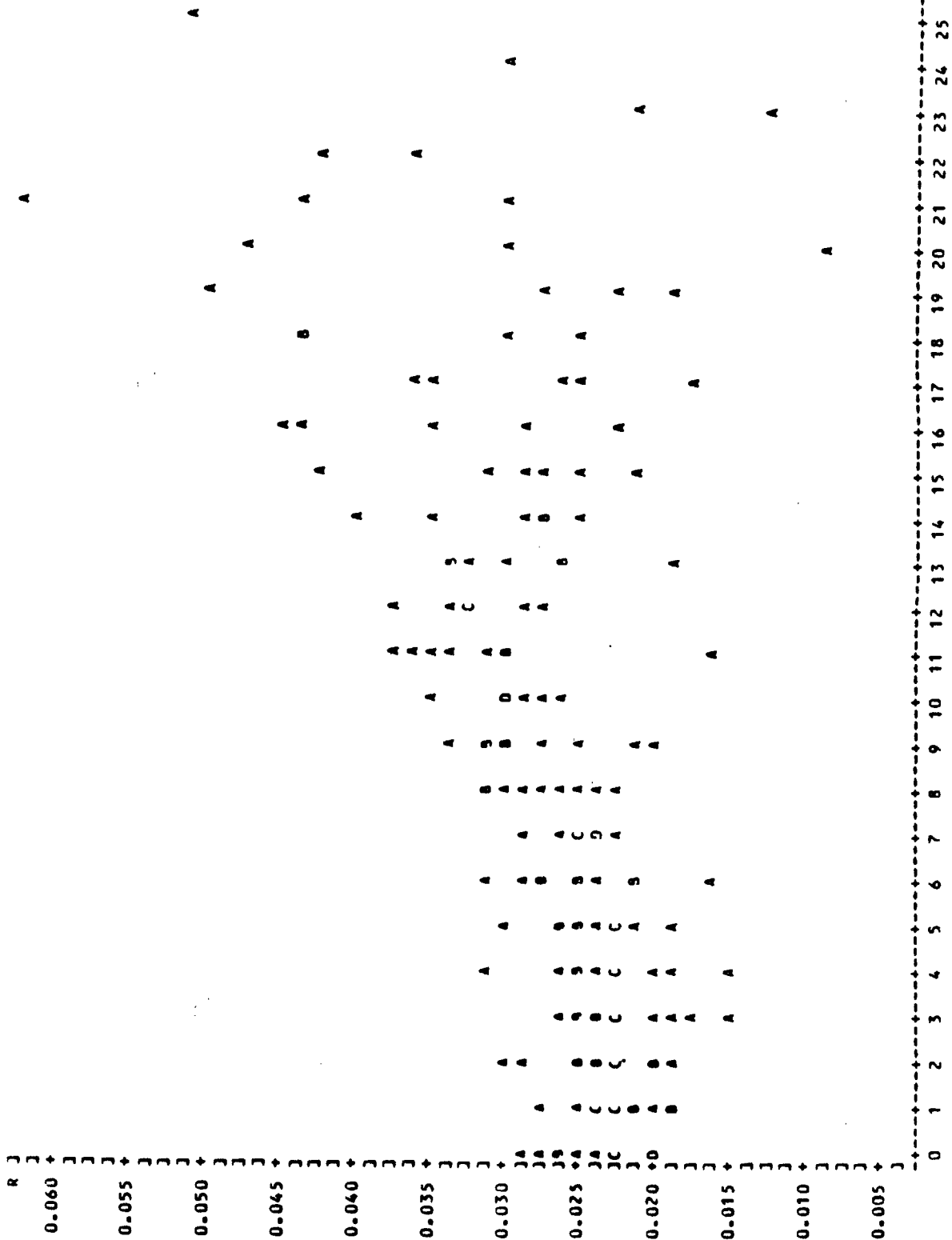

AGE
Figure 2-13
FARS, Passenger Cars

PLOT OF R+MY LEGEND: A = 1 OBS, B = 2 OBS, ETC.

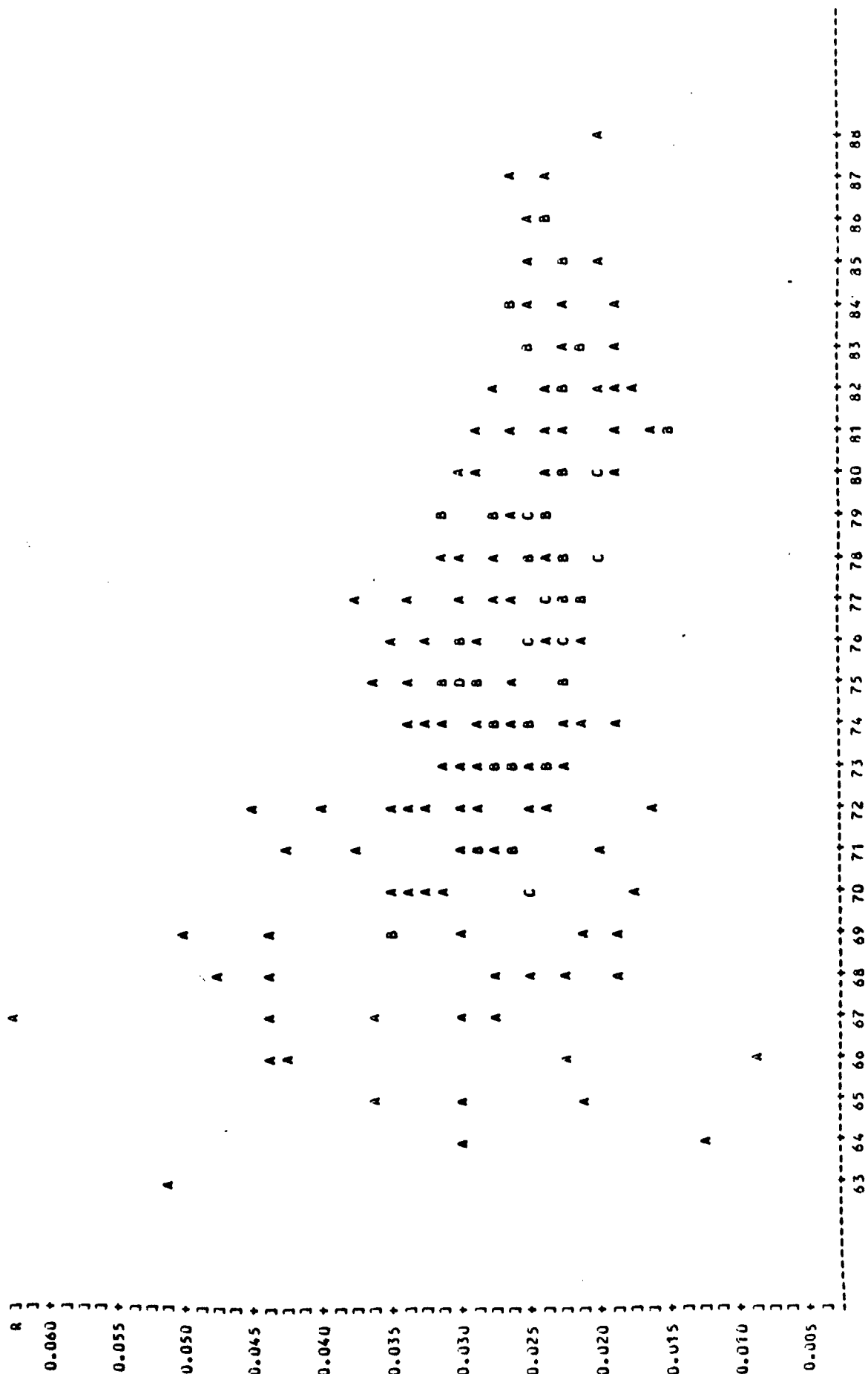

MY
Figure 2-14
FARS, Passenger Cars

While the sign of the X_2 coefficient is in the right direction, its magnitude is far from being sufficient for statistical significance, the t-value being only -0.22 .¹⁴ Therefore, the Standard effect is not significantly different from zero. The age factor, on the other hand, maintains significance with a t-value of 7.32 .¹⁵ The R^2 value remained unchanged (from the age only model) at $.32$, indicating further than the addition of the variable for the Standard had no effect in further explaining the variation in fire rate.

The average age of the Pre-standard cars was 9.066 years. Although not significantly different from zero, the estimate of the effect of the Standard is:

$$\begin{aligned} \text{Effectiveness} &= \frac{-0.0001739}{.02192 + 9.066 (.0006218)} \\ &= \frac{-0.0001739}{.02756} \\ &= -.006310 = -0.63\% \end{aligned}$$

Ninety-five percent confidence limits are:

$$.63 \pm 5.51\% = -4.88\% \text{ to } 6.14\%$$

14 Probability of greater t = $.8226$.

15 Probability of greater t = $.001$.

Based on this analysis, no effect is found for FMVSS 301 in reducing fires in fatal passenger car crashes, there being no difference in fire rates between Pre and Post-standard cars.

An alternate method of analyzing the fatal accident data for passenger cars is summarized in Table 2-4. Here, Pre-standard and Post-standard fire rates are compared for one, two, . . . , six model years before and after FMVSS took effect. For example, ± 1 MY in the first column of the table refers to Model Year 1975 for the Pre-standard sample and Model Year 1976 for the Post-standard sample. The comparisons are cumulative, i.e., ± 2 MY includes ± 1 MY and ± 2 MY and encompasses Model Years 1974, 1975 in the Pre-standard group, and Model Years 1976, 1977 in the Post-standard group. The fire rates include all eligible FARS data from calendar year 1975 through 1988. The comparisons are balanced in the same manner as was done for the regression analyses - in each calendar year of FARS, the number of model years in the Pre-standard group is kept equal to the number of model years in the Post-standard group.

It should be borne in mind that the comparisons in Table 2-4 do not account for the effect of the vehicle age upon fire rates. This will be considered later.

Columns 4 and 5 in the table give the actual and relative differences in fire rates between the Pre- and Post- groups within each comparison group. The difference is defined as the Pre-standard fire rate minus the Post-standard fire rate. The relative difference is the difference expressed as a percent of the Pre-standard fire rate.

Table 2-4
 Selected Comparisons of Pre-standard and Post-standard
 Fire Rates for Passenger Cars
 Fatal Accident Data

| Comparison (No. of Pre, Post Model Years) | Fire Rate ($\times 10^{-2}$) | | Difference ($\times 10^{-2}$) (Pre-Post) | Percent Difference |
|--|--------------------------------|-----------------------------|--|-----------------------|
| | Pre- Standard | Post- Standard | | |
| ± 1 MY | $\frac{722}{25175}=2.868$ | $\frac{855}{32995}=2.591$ | 0.277 | 9.65% |
| ± 2 MY | $\frac{1429}{52878}=2.702$ | $\frac{1724}{66158}=2.606$ | 0.096 | 3.55% |
| ± 3 MY | $\frac{2084}{78354}=2.660$ | $\frac{2520}{99321}=2.537$ | 0.123 | 4.62% |
| ± 4 MY | $\frac{2598}{96139}=2.702$ | $\frac{3324}{129712}=2.563$ | 0.139 | 5.14% |
| ± 5 MY | $\frac{2895}{106580}=2.716$ | $\frac{3858}{153122}=2.520$ | 0.196 | 7.22% |
| ± 6 MY | $\frac{3095}{113365}=2.730$ | $\frac{4240}{171572}=2.471$ | 0.259 | 9.49% |

For each of the six comparisons, it is seen that there is a small, but consistent difference between the Pre-standard and Post-standard groups, with the fire rate being lower for the Post-standard vehicles. On a relative basis, this difference ranges from about 3.5 percent to 9.5 percent. The direction of these differences is in line with a favorable effect of FMVSS 301 in reducing fatal crash fires.

However, recall that the comparison in Table 2-4 are confounded with the effect of vehicle age, which has been shown in prior analyses to have a significant impact on fire rates. In the two prior regression analyses, age was seen to increase the fire rate by 2.91 percent per year ($.0006329/.02174 = .0291 = 2.91\%$) in the age only model, and by 2.84 percent ($.0006218/.02192 = .0284 = 2.84\%$) in the age by Standard model. The average of these is approximately 2.9 percent per year - increase in fire rate due to age.

If the effect of age is introduced, the differences in Table 2-4 essentially disappear. Table 2-5 contains estimates of the adjustment effects for vehicle age. Columns 2 and 3 of the table list the average age of the Pre-standard and Post-standard samples within each of the six comparison groups. The average age is the weighted age, based on the total number of vehicles involved in fatal crashes within each group. Column 4 is the difference in age (in years) between Pre- and Post-standard samples. The last column contains the age adjustment factors for each of the six comparison groups. This is merely the product of the average age difference, in years, between Pre- and Post- samples times the average effect of age on fire rates (i.e., = + 2.9%/year, from the above calculation).

Table 2-5
 Adjustment for Vehicle Age on the Selected Comparisons
 of Pre-standard and Post-standard Passenger Cars
 (see Table 2-4)

| <u>Comparison Group</u> | <u>Vehicle Age (Years)</u> | | <u>Difference (Pre-Post)</u> | <u>Age Adjustment (%) (Difference x 2.9%/Yr)</u> |
|-------------------------|----------------------------|----------------------|------------------------------|--|
| | <u>Pre-standard</u> | <u>Post-standard</u> | | |
| ± 1 MY | 5.88 | 5.26 | 0.62 | 1.8% |
| ± 2 MY | 6.38 | 5.14 | 1.24 | 3.6% |
| ± 3 MY | 7.08 | 4.96 | 2.12 | 6.1% |
| ± 4 MY | 7.63 | 4.78 | 2.85 | 8.3% |
| ± 5 MY | 8.05 | 4.63 | 3.42 | 9.9% |
| ± 6 MY | 8.37 | 4.50 | 3.87 | 11.2% |

Comparing the last two columns in Tables 2-4 and 2-5, it is seen that the lower rates for Post-standard vehicles are negated by the effect of vehicle age. While an advantage still remains for Post-standard vehicles in the ± 1 MY comparison, this is considered the result of statistical fluctuation, with the successively higher sample sizes in the subsequent fire comparisons (± 2 MY through ± 6 MY) producing more stable results: In all 5 of these comparisons, the age effect exceeds the magnitude of the lower rates for Post-standard vehicles from Table 2-4.

The result of this alternate analysis of fire rates in fatal passenger car crashes is similar to the results of the prior regression analyses. No difference is found between Pre-standard and Post-standard vehicles.

2.3 EFFECTIVENESS ANALYSIS FOR LIGHT TRUCKS

This section discusses the analysis of State and FARS data to estimate the effect of FMVSS 301 in reducing fires in light truck crashes. The analysis proceeds along similar lines as employed in Section 2.2 on the analysis of passenger car data.

The procedures for recording light truck fires in the State accident data and in the fatal accident data are the same as described in Section 2.2 for passenger cars.

2.3.1 Analysis of State Accident Data

Table 2-6 lists the fire rates in light truck accidents for each of the five States. The individual counts of fires and accident involved vehicles are included in Appendix C. The data covers the same 1982 through 1987 time period as was the case for passenger cars. It is noted that the fire rates for trucks display essentially the same patterns found for passenger cars. In general, older vehicles have higher fire rates, and the data from Michigan, Ohio, and Maryland show considerably higher incidence of fire than do the data from Illinois and Indiana. In terms of overall magnitude, the fire rates for trucks are generally similar to those noted for passenger cars.

As was done for passenger cars, the analysis of the light truck data will be discussed in two separate groupings, owing to the overall difference in fire rates for the States of Michigan, Ohio, and Maryland, as compared to the fire rates from Illinois and Indiana. Data from the former three States will be analyzed first.

2.3.1.1 Data from Michigan, Ohio, and Maryland

Regression analysis of the data from these three States was performed in a manner similar to that for passenger cars. First a simple linear model was fit to evaluate the effect of vehicle age on fire rate. Secondly, a multiple linear model was fit, adding a second variable for FMVSS 301, along with the

Table 2-6

Fire Rate* in Light Truck Crashes
by State and Vehicle Model Year

| Model Year | S T A T E S | | | | |
|---------------|-------------|-------|----------|----------|---------|
| | Michigan | Ohio | Maryland | Illinois | Indiana |
| 1987 | 1.984 | 2.345 | 1.013 | 0.844 | 0.196 |
| 1986 | 1.200 | 2.150 | 1.895 | 0.917 | 0.497 |
| 1985 | 1.245 | 2.623 | 1.313 | 0.875 | 0.383 |
| 1984 | 1.739 | 2.686 | 1.838 | 0.942 | 0.694 |
| 1983 | 1.785 | 3.360 | 2.100 | 0.603 | 1.469 |
| 1982 | 1.630 | 2.519 | 2.267 | 1.079 | 0.944 |
| 1981 | 1.669 | 3.268 | 2.155 | 1.112 | 0.779 |
| 1980 | 1.500 | 3.086 | 3.350 | 1.060 | 0.433 |
| 1979 | 2.320 | 3.662 | 4.525 | 1.110 | 1.061 |
| 1978 | 2.057 | 4.485 | 4.235 | 1.409 | 0.855 |
| 1977 | 2.118 | 4.010 | 4.832 | 1.109 | 1.349 |
| ----- | | | | | |
| 1976 | 2.349 | 4.395 | 3.816 | 1.404 | 1.295 |
| 1975 | 3.068 | 5.737 | 5.031 | 1.805 | 1.329 |
| 1974 | 2.951 | 4.995 | 4.853 | 1.619 | 0.808 |
| 1973 | 2.655 | 4.789 | 5.670 | 1.247 | 0.727 |
| 1972 | 4.059 | 4.286 | 4.381 | 1.760 | 2.370 |
| 1971 | 3.941 | 4.853 | 8.368 | 1.683 | 1.978 |
| 1970 | 2.270 | 6.922 | 5.287 | 1.393 | 1.362 |
| 1969 | 2.870 | 5.778 | 5.123 | 0.931 | 1.882 |
| 1968 | 3.345 | 6.347 | 9.582 | 2.185 | 0.918 |
| 1967 | 1.607 | 5.958 | 4.237 | 0.679 | 1.421 |
| 1966 | 1.884 | 4.865 | 6.593 | 0.962 | 0.956 |

* Fire rates are police reported fires per 1,000 light trucks involved in accidents. In order to obtain the actual fire rate, table entries should be multiplied by 10^{-3}

Appendix C contains the actual counts of fires and light trucks for each model year and State. The data are for calendar years 1982-1987.

variable for age. As with the analysis for passenger cars. The data were balanced to give an equal number of vehicle model years, within each calendar year, for the Pre-standard sample and the Post-standard sample. This produced 102 individual observations for each model, with each observation being the fire rate for a given model year, i , and a given calendar year, j . In carrying out the model runs, the variable for the FMVSS 301 was coded one for Post-standard vehicles (i.e., \geq model year 1977) and zero for Pre-standard vehicles (i.e., \leq model year 1976). As with passenger cars, the regression runs were weighted. The following paragraphs summarize the analyses results for each of the three States.

Data from Michigan

The fire rates for light trucks from the Michigan accident files are shown in Figures 2-15 and 2-16, as a function of vehicle age and model year, respectively.

The simple model of fire rate as a function of age produced the following equation:

$$R = 0.001279 + 0.0001495 X_1 \text{ (age)}$$

PLOT OF RAISE LEGEND: A = 1 OBS, B = 2 OBS, ETC.

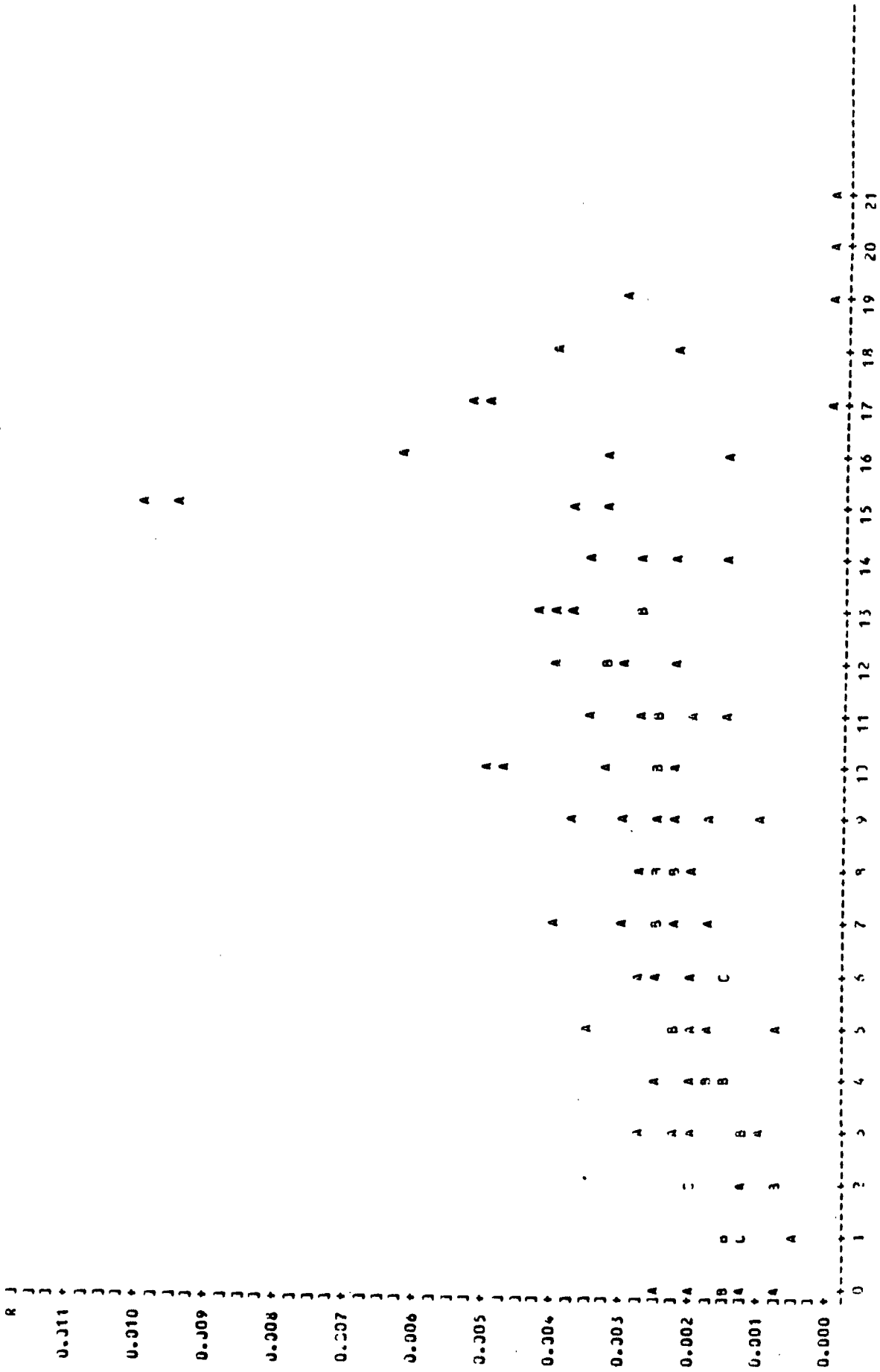

AGE
 Figure 2-15
 Michigan, Light Trucks

PL:Y OF R*MY LEGEND: A = 1 OBS, B = 2 OBS, ETC.

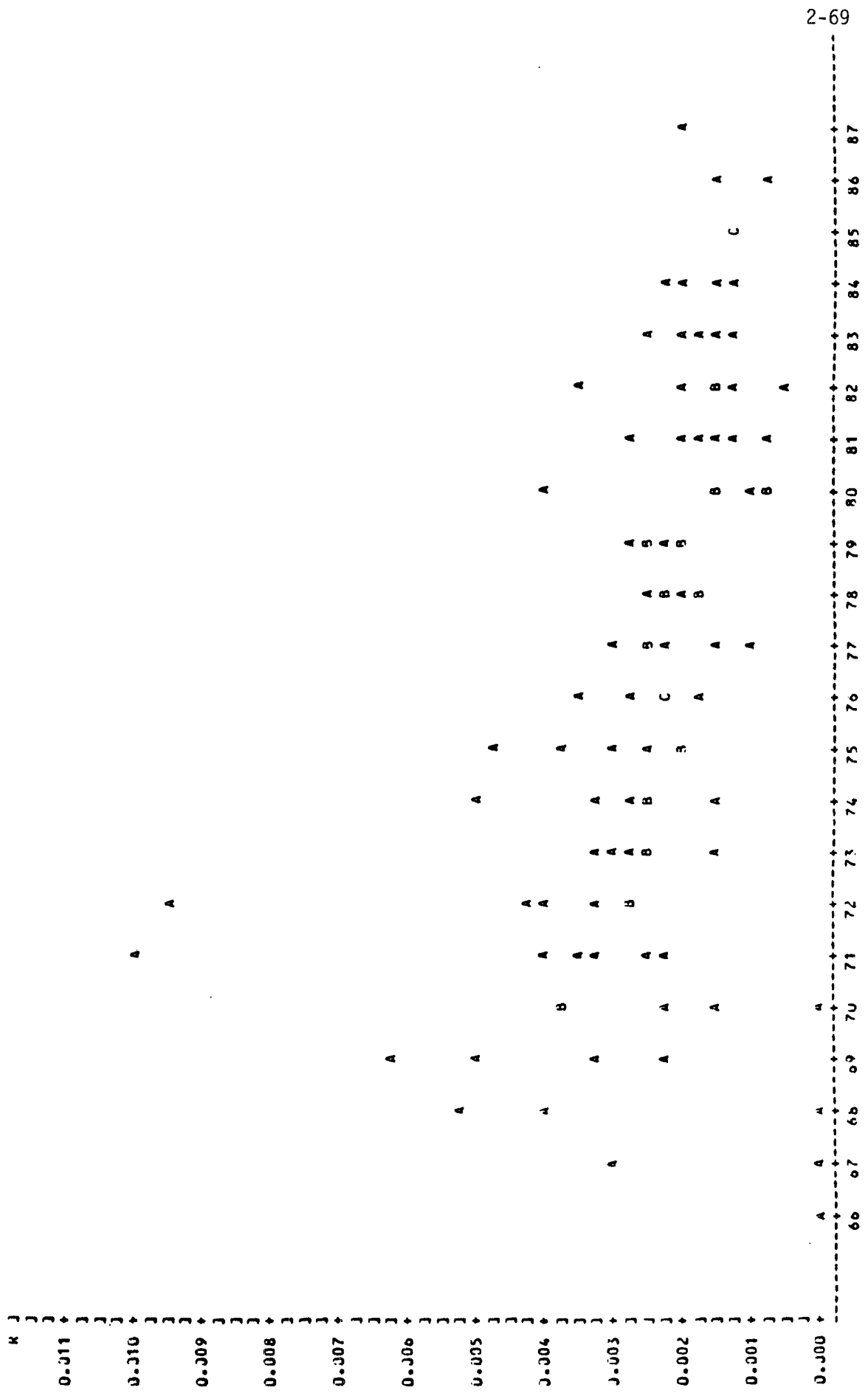

Figure 2-16
Michigan, Light Trucks

The age effect was significant with a t-value of 7.60.¹⁶ R^2 was .37, indicating a fit only about half as good as that obtained for passenger cars.

The 2-variable model assessing the effect of the Standard gave the following fit:

$$R = 0.001625 + 0.0001270 X_1 (\text{age}) - 0.0002965 X_2 (\text{Std})$$

Here, age was again significant, the t-value being 4.48,¹⁷ but the Standard effect was not, the t-value being -1.10.¹⁸ The fit of the model, as indicated by R^2 , remained unchanged at a value of .37.

While the Standard effect was not significantly different from zero, its magnitude will be estimated. Given the average age of Pre-standard trucks at 10.403 years, the estimate is:

$$\begin{aligned} \text{Effectiveness} &= \frac{-0.0002965}{.001625 + 10.403 (0.0001270)} \\ &= \frac{-0.0002965}{.002946} \\ &= -.1006 = -10.06 \text{ percent} \end{aligned}$$

16 Probability of greater t = 0.0001.

17 Probability of greater t = 0.0001.

18 Probability of greater t = 0.2757.

The fire rate for Post-standard trucks is 10 percent below that for Pre-standard trucks, after accounting for vehicle age, but this is not sufficient for statistical significance. The 95 percent confidence based is rather wide at:

$$-10.06 \pm 18.0\% = - 7.94 \% \text{ to } 28.06\%.$$

Data from Ohio

Plots of fire rate for trucks versus age and model year, for Ohio, are contained in Figures 2-17 and 2-18, respectively.

Fitting a simple linear function for vehicle age gave:

$$R = 0.002424 + 0.0002337 X_1 \text{ (age)}$$

Once again, age was significant ($t=10.27$).¹⁹ The fit was considerably better than for Michigan, with a R^2 of .51.

Adding the second variable, for the effect of the Standard, resulted in the following fit:

$$R = 0.002506 + 0.0002283 X_1 \text{ (age)} - 0.00006924 X_2 \text{ (Std)}$$

¹⁹ Probability of greater $t = 0.0001$.

PLOT OF RANGE LEGEND: A = 1 OBS, B = 2 OBS, ETC.

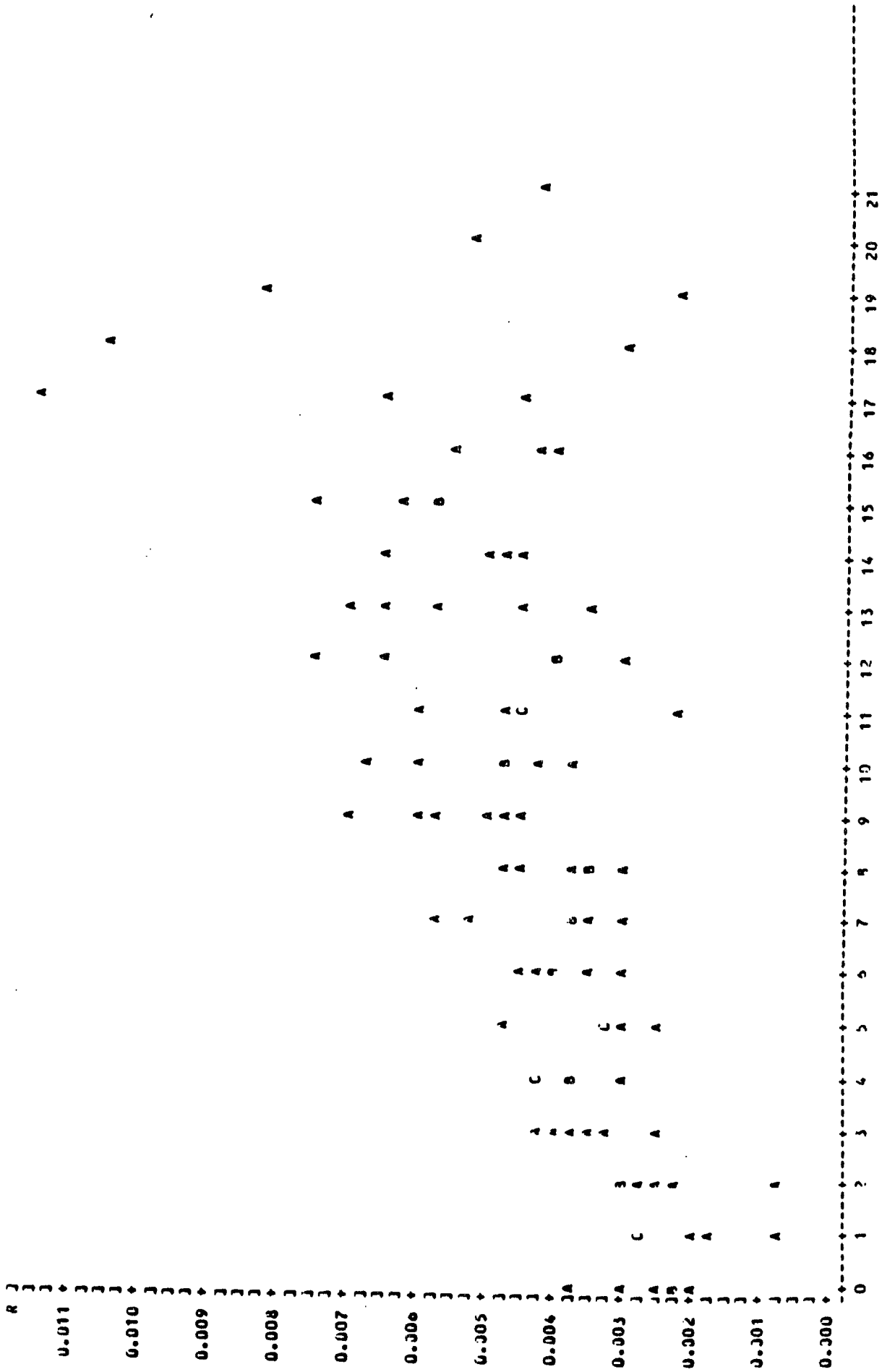

AGE
 Figure 2-17
 Ohio, Light Trucks

PLUT OF 1984 MY LEGEND: A = 1 OBS, B = 2 OBS, ETC.

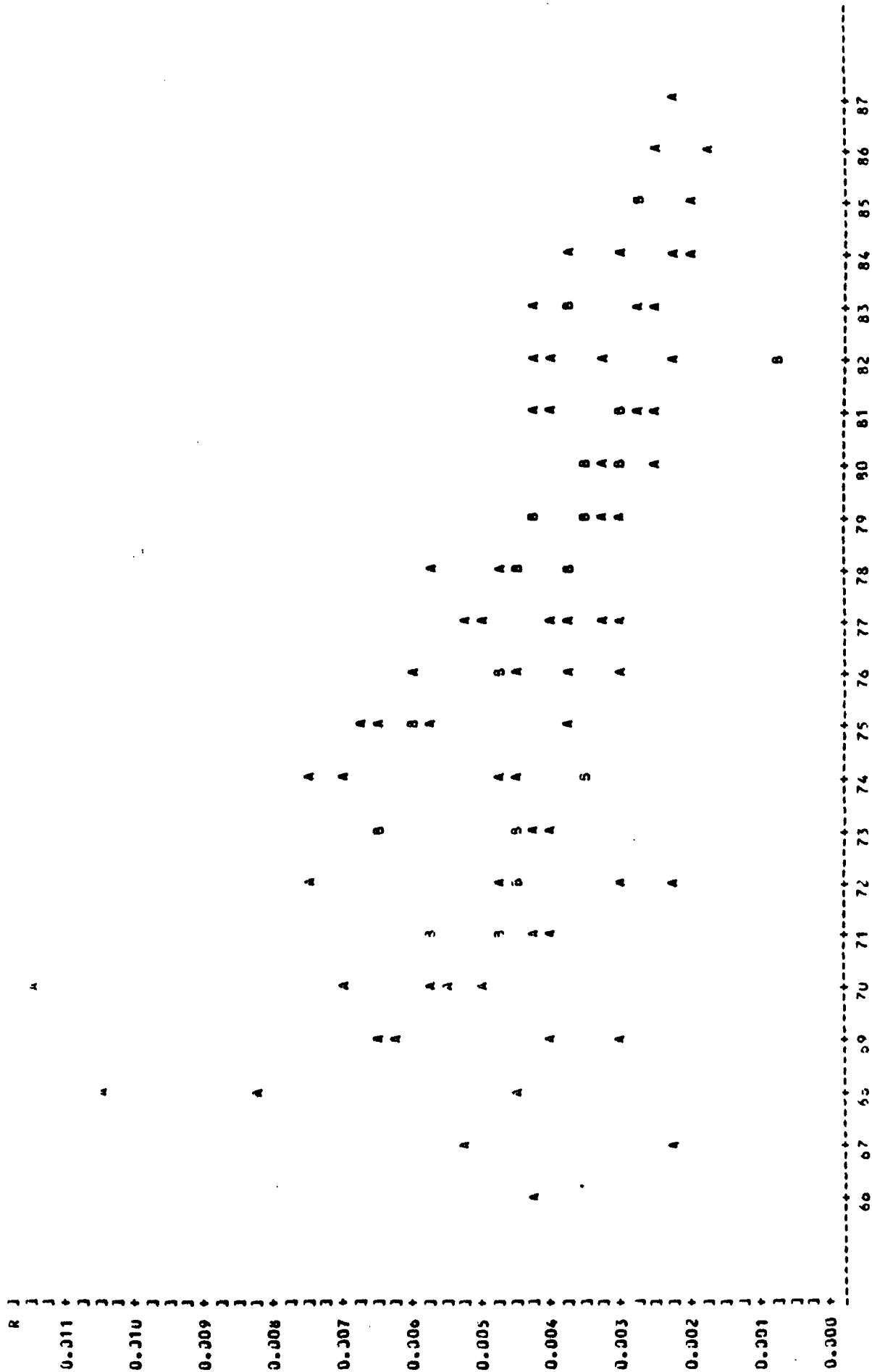

Figure 2-18
Ohio, Light Trucks

Age remained significant at a $t = 6.76$,²⁰ but, as with Michigan, the effect for the Standard was not significant, the t -value being only -0.22 .²¹

The effectiveness of the Standard, while not significantly different from zero, is estimated as:

$$\begin{aligned} \text{Effectiveness} &= \frac{-0.0000692}{.002506 + 10.495 (.0002283)} \\ &= \frac{-0.0000692}{.004902} \\ &= - .01412 = - 1.41\% \end{aligned}$$

Adding 95 percent confidence limits gives:

$$- 1.41 \pm 12.73\% = - 11.32\% \text{ to } 14.14\%$$

Data from Maryland

Fire rate versus age and model year plots for Maryland are shown in Figures 2-19 and 2-20. As with almost all data previously analyzed, the age relationship with fire rate is again apparent.

Fitting the simple linear model, fire rate as a function of age, gave the following result:

20 Probability of greater $t = 0.0001$.

21 Probability of greater $t=0.8285$.

PLOT OF N*MY LEGEND: A = 1 OBS, B = 2 OBS, ETC.

R J
 0.0225 +
 J J
 J J
 J J
 J J
 0.0200 +
 J J
 J J
 J J
 J J
 0.0175 +
 J J
 J J
 J J
 0.0150 +
 J J
 J J
 J J
 J J
 0.0125 +
 J J
 J J
 J J
 J J
 0.0100 +
 J J
 J J
 J J
 J J
 0.0075 +
 J J
 J J
 J J
 J J
 0.0050 +
 J J
 J J
 J J
 J J
 0.0025 +
 J J
 J J
 J J
 J J
 0.0000 +

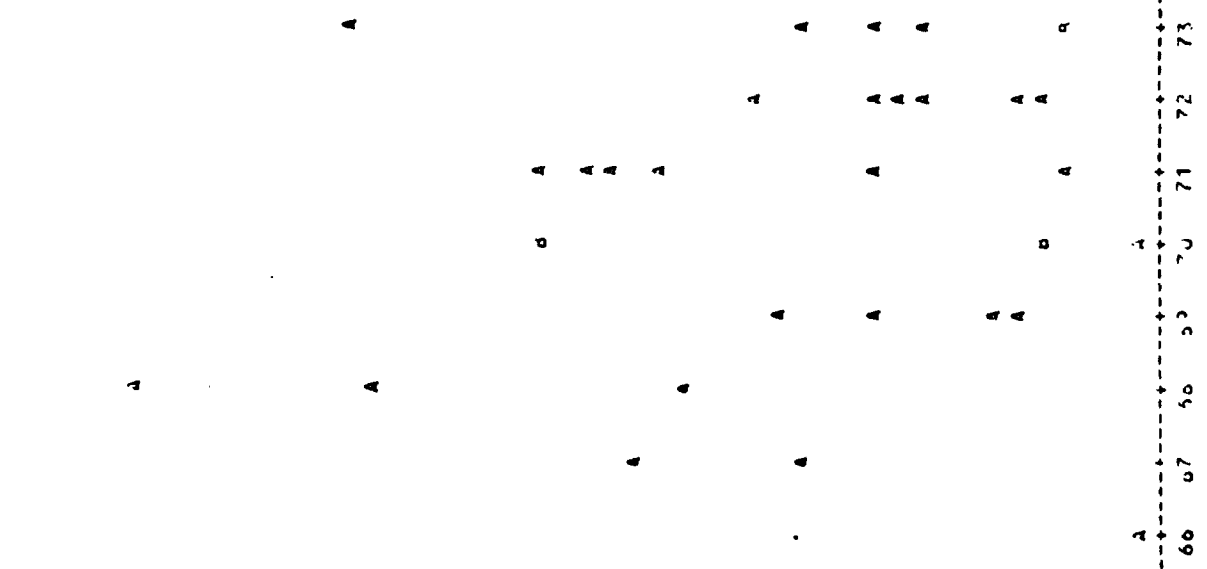

MY
 Figure 2-20
 Maryland, Light Trucks

$$R = 0.001247 + 0.0004227 X_1 \text{ (age)}$$

Age is again significant ($t=9.24$),²² and the amount of variation in fire rate that is explained by age is 46 percent ($R^2 = .46$), about the same as noted for Ohio, and slightly more than was found for Michigan.

Turning to the multiple linear model to evaluate the effect of FMVSS 301 in the Maryland data produced the following fit:

$$R = -0.001151 + 0.0005842 X_1 \text{ (age)} + 0.0020754 X_2 \text{ (Std)}$$

Age remains significant in the 2-variable model at a t -value of 8.52.²³ However, the effect of the Standard is not in the favorable direction in this model, but rather it has a positive sign, indicating that fire rates for Post-standard vehicles are higher, rather than below, the fire rates of Pre-standard vehicles. Furthermore, the estimated effect of the Standard here is significantly positive, having a t -value of 3.07.²⁴

22 Probability of greater $t = 0.0001$.

23 Probability of greater $t = 0.0001$

24 Probability of greater $t=0.0028$

These results seem unusual at first. However, a review of the Maryland fire rates in Table 2-6 and in Figure 2-20 shows that Model Year 1977, the first year following FMVSS 301 for trucks, had a considerably higher fire rate than 1976, the year immediately preceding the Standard. In interpreting these results, the most reasonable explanation is the variation inherent in the data for Maryland rather than an indication that the Standard acted to actually increase the fire rate. Both the fire frequencies and the number of accident involved trucks in Maryland are small, compared to the data from Ohio and Michigan (see Appendix C). A final observation is that the estimate of the intercept indicates a negative fire rate when the vehicle age is zero. The estimate is not significantly different from zero, however, with a t-value of -1.38,²⁵ and is again believed to be the result of the smaller numbers in the data from Maryland. The R^2 value for the model was .51.

The conclusion from analysis of the Maryland data is that there is no effect of FMVSS 301 in reducing vehicle fires in light truck accidents.

Overall Results from Michigan, Ohio, and Maryland

Since the overall magnitude of the fire rates from Michigan, Ohio, and Maryland, as well as the preceding individual analysis, were generally

25 Probability of greater t = .1699.

similar, the data were combined and analyzed. The number of observations for the combined data set was 306. Plots of the combined data showing fire rate by age and model year are contained in Figures 2-21 and 2-22, respectively.

The single variable model of fire rate as a function of age produced the following fit:

$$R = 0.001686 + 0.0002339 X_1 \text{ (age)}$$

The t-value for age was 12.12, again denoting age was a significant effect.²⁶ The R^2 value was .33.

The 2-variable model, incorporating the effect of the Standard gave the following result:

$$R = 0.0001597 + 0.0002397 X_1 \text{ (age)} + 0.0000760 X_2 \text{ (Std)}$$

The age effect remained significant at a t = value of 8.42.²⁷ The standard effect gave a positive value, indicating negative effectiveness. However, the standard coefficient of 0.0000760 was not significantly different from zero.²⁸ R^2 remained at .33, the same as for the simple model of age.

26 Probability of great t = 0.0001.

27 Probability of greater t = 0.0001.

28 Probability of great t = .7799

PLOT OF R*AGE LEGEND: A = 1 OBS, B = 2 OBS, ETC.

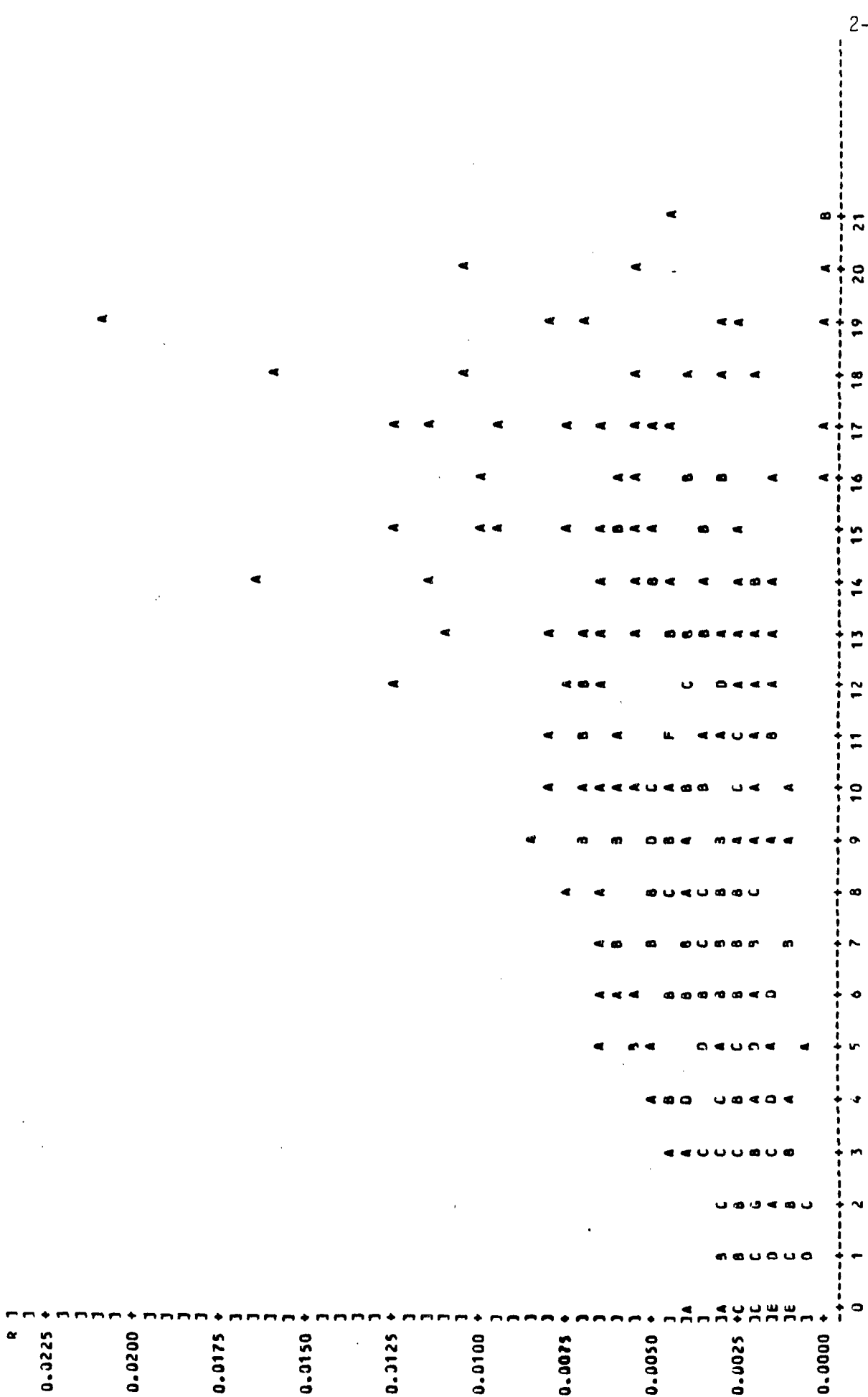

AGE

Figure 2-21
Michigan, Ohio, Maryland; Light Trucks

PLUT OF R+MY LEGEND: A = 1 OBS, B = 2 OBS, ETC.

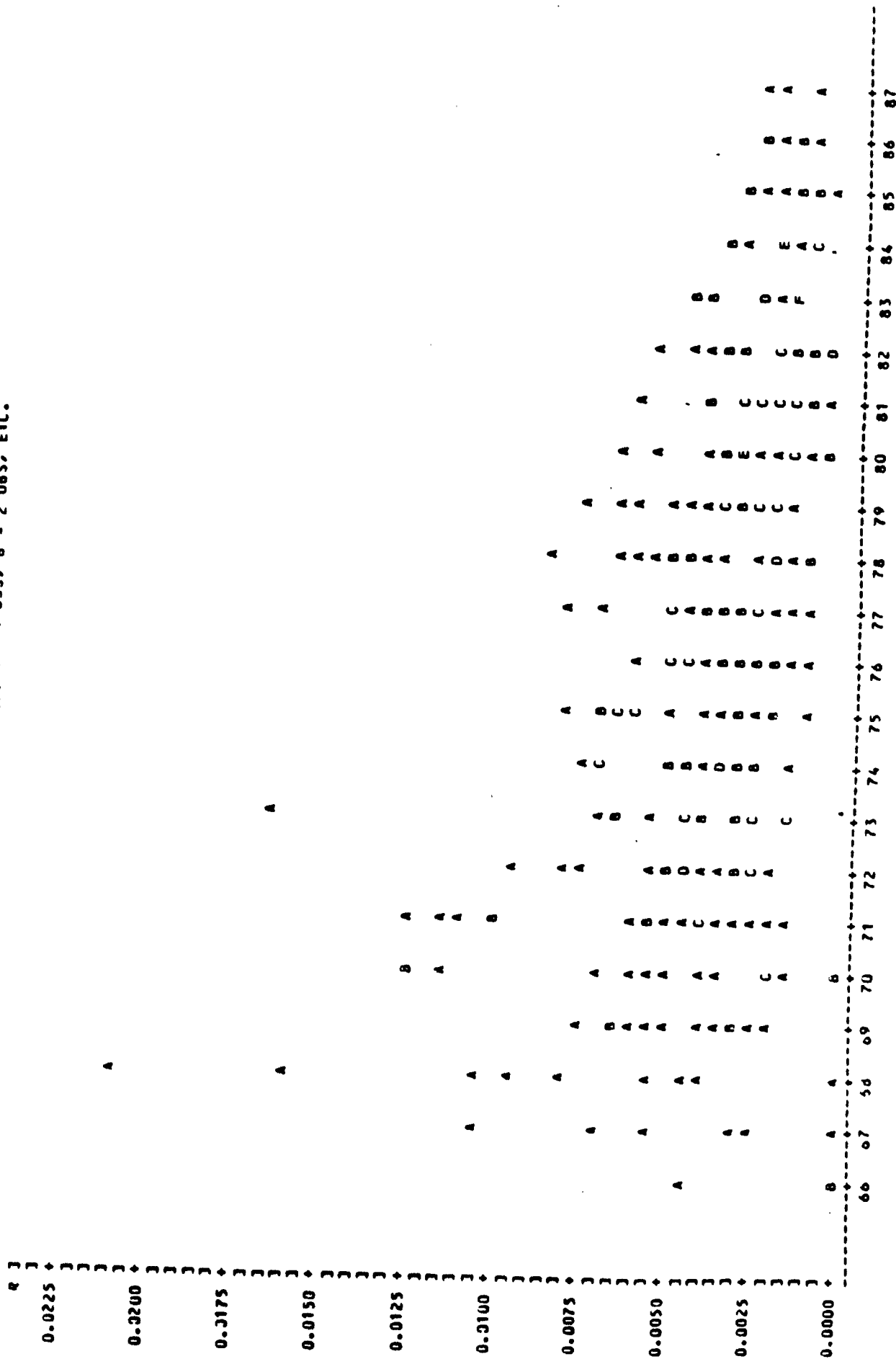

Figure 2-22
Michigan, Ohio, Maryland; Light Trucks

The average age of the trucks in the combined 3-State model is 10.431 years. Therefore, the effectiveness estimate from the overall data set is:

$$\begin{aligned}
 \text{Effectiveness} &= \frac{0.0000760}{.0001597 + 10.431 (.0002397)} \\
 &= \frac{0.0000760}{.00266} \\
 &= .02857 = 2.86 \text{ percent}
 \end{aligned}$$

While the estimate of 1.86 percent is positive, this is not to be interpreted as an indication that Post-standard fire rates are higher than Pre-standard fire rates. This "negative" difference is considered to lie within the range of normal statistical, or "chance variation", and the proper inference to be drawn is that the difference between Pre and Post-standard fire rates is zero.

This concludes the analysis of data from Michigan, Ohio, and Maryland for light trucks. Fires in light truck crashes involving occupant injury were too sparse for reliable analysis.

2.3.1.2 Data From Illinois and Indiana

As was the case for passenger cars, the fire rates for light trucks from the States of Illinois and Indiana were considerably below the rates found in the three States of Michigan, Ohio, and Indiana. Therefore, data from Illinois and Indiana are analyzed separately.

Data from Illinois

Figures 2-23 and 2-24 show the fire rates for light trucks from Illinois, respectively, as functions of age, and model year. For this State, the age effect is not so apparent as has been the case with most all data, including that for passenger cars, analyzed to this point.

The simple model fitted with age was:

$$R = 0.0008965 + 0.0000480 X_1 \text{ (age)}$$

The age coefficient was significant at a t-value of 3.83.²⁹ The fit was rather low, at an R^2 of .13, and this is considerably below the R^2 values obtained for all preceding analyses of State data.

Turning to the 2-variable model with age and the Standard effect, the result was:

$$R = 0.001296 + 0.0000219 X_1 \text{ (age)} - 0.0003403 X_2 \text{ (Std)}$$

In this case, the Standard effect is significant at a t-value of -2.03, while the age effect, with a t-value of 1.23, is non-significant.³⁰ R^2 was

29 Probability of greater t = 0.0002.

30 Probability of greater t for Standard coefficient = 0.0452; probability of greater t for age coefficient = 0.2227.

PLOT OF 3-AJE LEGEND: A = 1 OBS, B = 2 OBS, ETC.

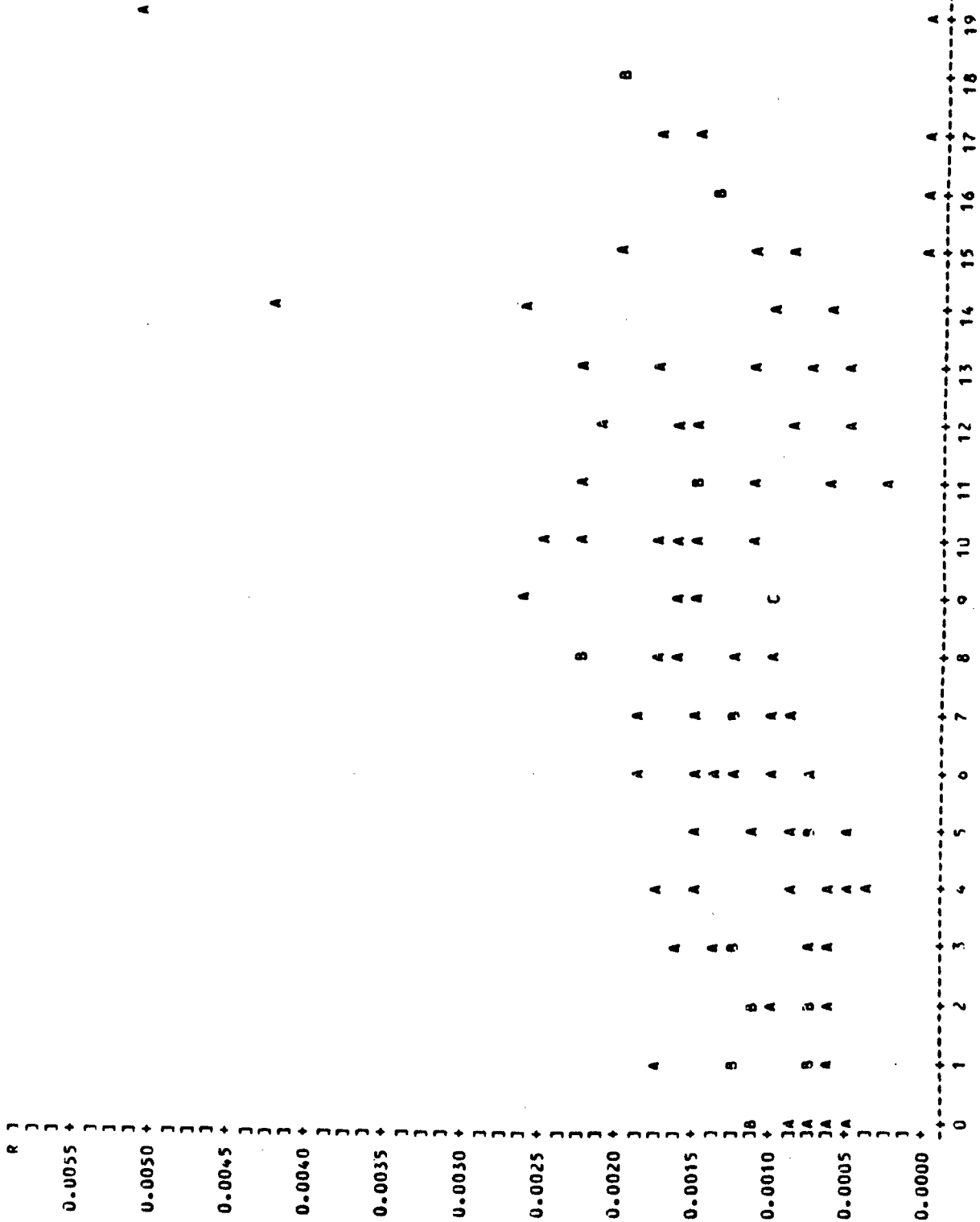

AGE
Figure 2-23
Illinois, Light Trucks

PLOT OF R*MY LEGEND: A = 1 OBS, B = 2 OBS, ETC.

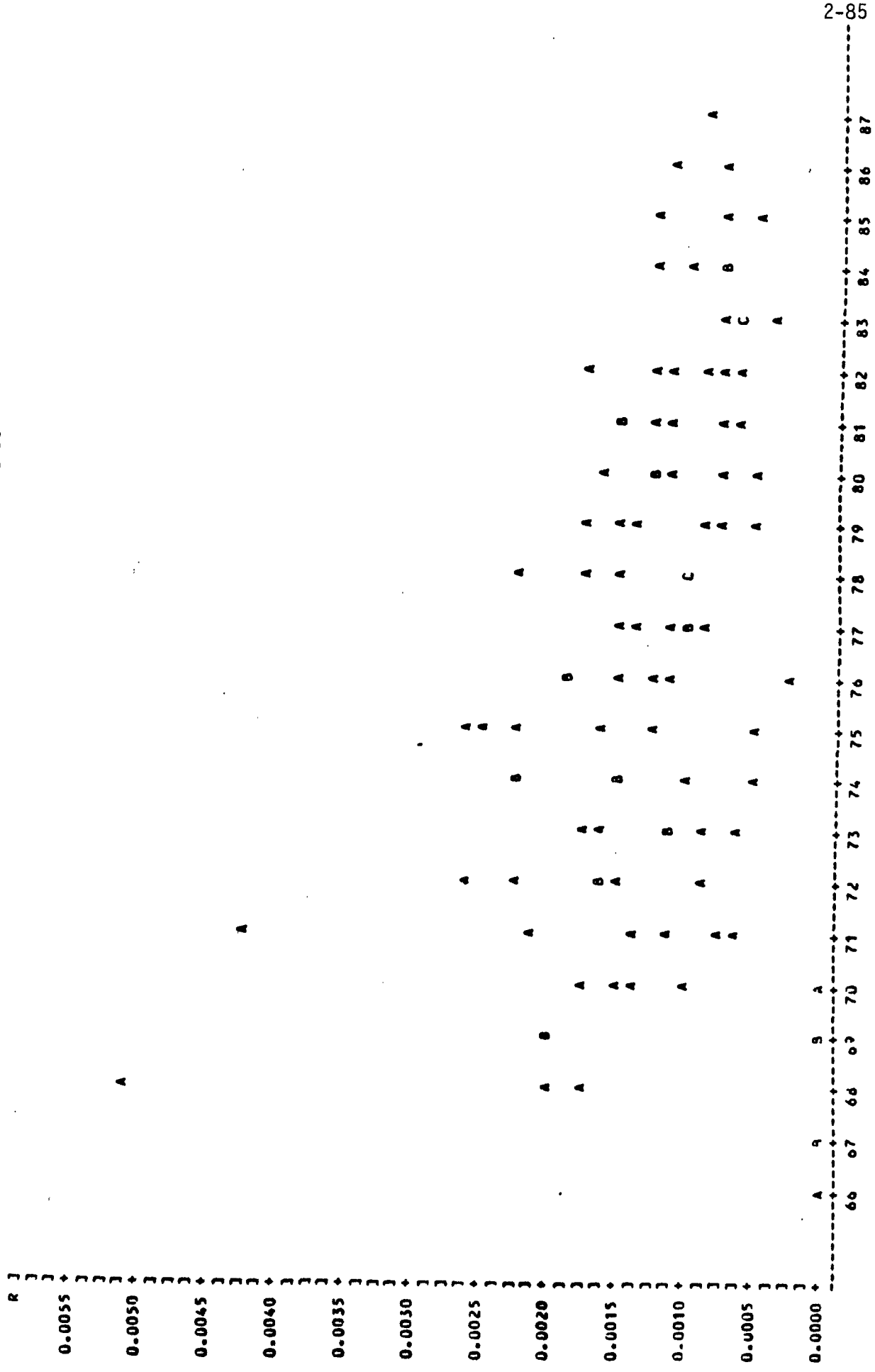

Figure 2-24
Illinois, Light Trucks

again quite low at .16, only a .03 increase from the simple age model.

Estimating effectiveness for the Standard from the Illinois data, given the average age of Pre-standard trucks to be 10.387 years, gives:

$$\begin{aligned} \text{Effectiveness} &= \frac{-0.0003403}{0.001296 + 10.387 (.0000219)} \\ &= - \frac{.0003403}{.001523} \\ &= - .2234 = - 22.34 \text{ percent} \end{aligned}$$

The Post-standard trucks are estimated to have fire rates 22 percent below the fire rates for Pre-standard trucks. Adding 95 percent confidence limits gives:

$$22.34\% \pm 21.60\% = 1.74\% \text{ to } 43.94\%$$

The wide band on the effectiveness estimate (which nearly encompasses the zero, or non-significant point), the relatively poor fit of the model, the lack of significance of the age effect, and the generally higher variability in the Illinois data make this State suspect in terms of providing a good basis for estimating the effect of FMVSS 301.

Data From Indiana

The fire rate by age and model year, from the Indiana data, are depicted in Figures 2-25 and 2-26 respectively. As with Illinois, the generally more sparse data from Indiana do not evidence as distinct an age relationship as found for the other States.

PLOT OF R-AGE LEGEND: A = 1 OBS, B = 2 OBS, ETC.

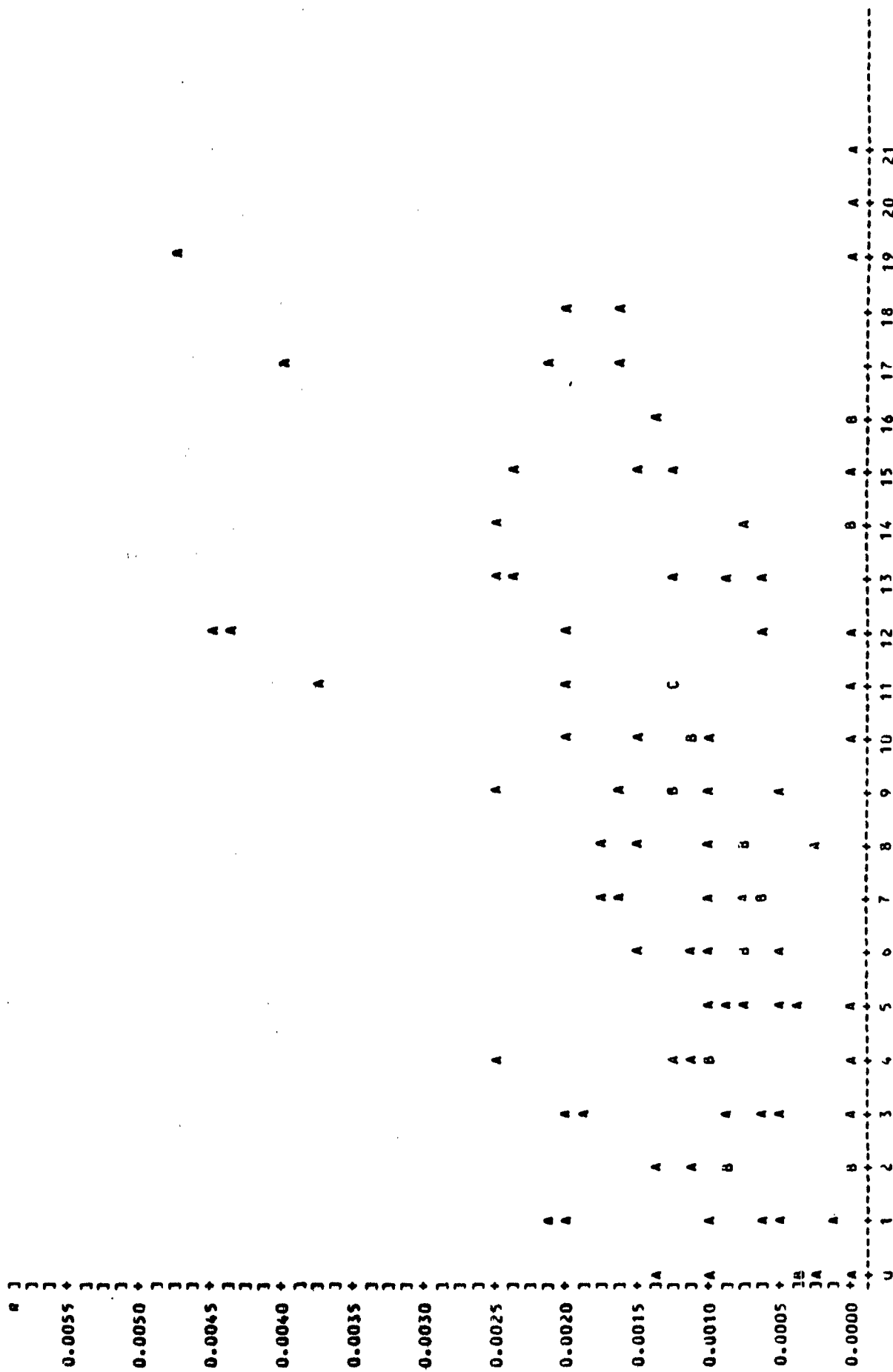

Figure 2-25
Indiana, Light Trucks

PLUT OF R*MY LEGEND: A = 1 OBS, B = 2 OBS, ETC.

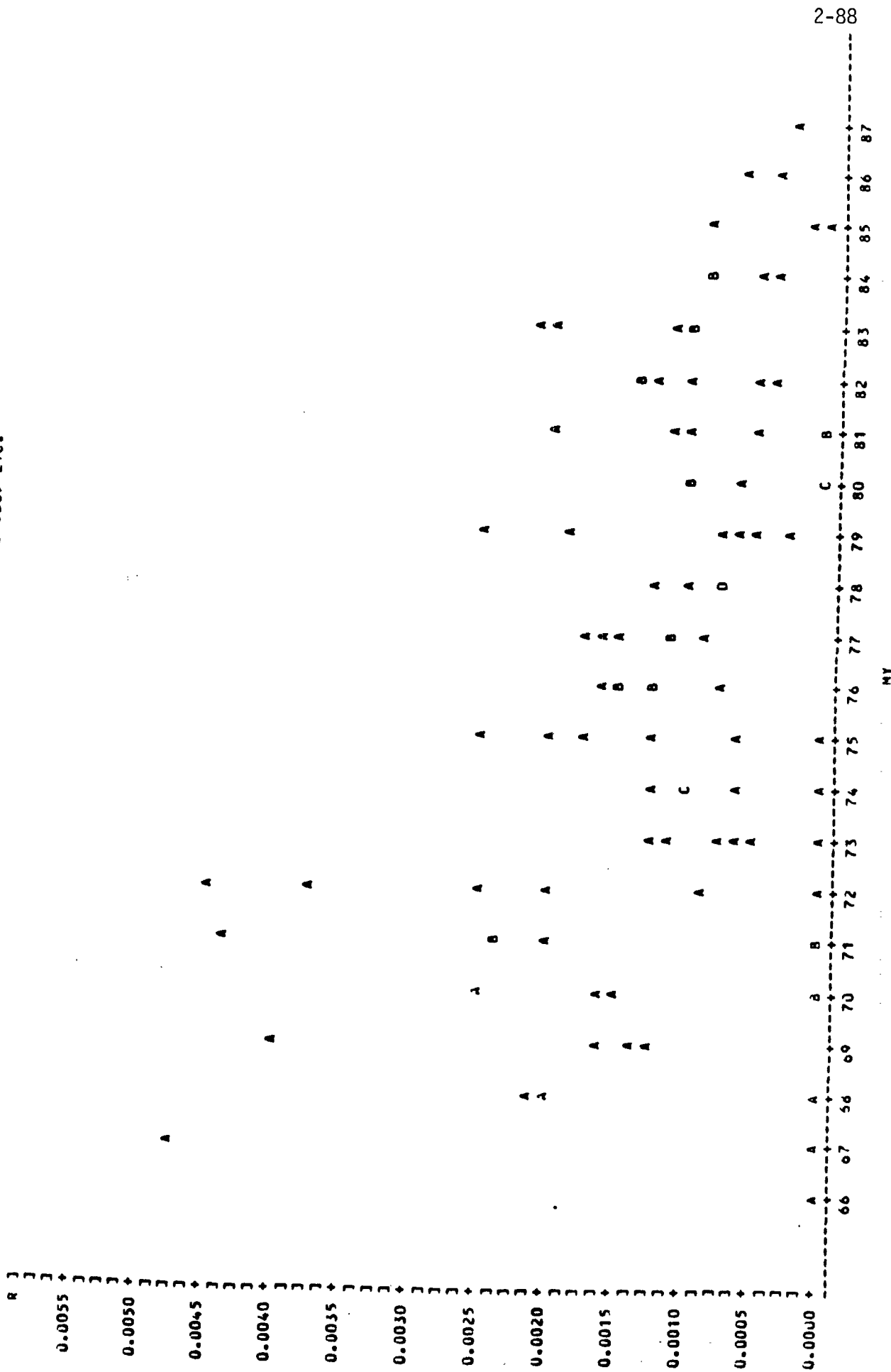

Figure 2-26
Indiana, Light Trucks

Fitting the simple linear model by age produced the following equation:

$$R = 0.0006756 + 0.0000543 X_1 \text{ (age)}$$

Here, age was significant at a $t=3.22$,³¹ but the fit was even poorer than for Illinois with an R^2 of only .09.

Adding the second variable for the Standard effect gave:

$$R = 0.009118 + 0.0000388 X_1 \text{ (age)} - 0.0002002 X_2 \text{ (Std)}$$

In the model, neither the age, nor the Standard effect was significant, although the age effect came closer.³² R^2 was .10, quite low and essentially the same as for the single model with age.

Discussion of Results from Illinois and Indiana

The analysis results from Illinois and Indiana were inconsistent. While age was significant in the simple models for both States, it was not significant for either State in the 2-variable model. The effect of the standard was

31 Probability of greater $t=0.0017$

32 T-value for age coefficient = 1.52 (probability of greater $t=0.1307$); t-value for Standard coefficient = -0.81 (probability of greater $t=0.4180$).

significant in the Illinois data, but was far from being significant in the Indiana data. The fit of the models was not good in either States, with R^2 values ranging from only .09 to .16 - much lower than found in the prior analyses of the Michigan, Ohio, and Maryland data. Small cell frequencies of fires were also more numerous in the Illinois and Indiana data.

2.3.2 Analysis of Fatal Accident Data

This section discusses the analyses of fire data for light trucks involved in fatal crashes. The data files used are those from NHTSA's Fatal Accident Reporting System for calendar years 1975 through 1988, the same as used in the analysis of fatal accident fire rates for passenger cars.

Table 2-7 summarizes the fire rates by truck model year. The data are aggregated over the 14 available years of FARS data, i.e., from 1975 through 1988. The fatal accident fire rates for trucks are seen to be reasonably close to those for passenger cars shown previously. Again, the fire rates for fatal crashes are seen to be an order of magnitude higher than the fire rates in all police reported accidents (i.e., State data).

Regression analyses were performed on the rates as in the prior analyses for passenger cars. The data were balanced so that the number of Pre-standard model years was equal to the number of Post-standard model years within each of the 14 FARS calendar years. Also the data were weighted as in prior runs. The number of observations for each of the two models fitted was 156, each observation being the fire rate for an individual model year - calendar year

Table 2-7
 Fire Rates* in Fatal Light Truck Accidents
 by Vehicle Model Year

| <u>Model Year</u> | <u>No. Light Truck Fires</u> | <u>No. Light Trucks in Fatal Accidents</u> | <u>Fire Rate*</u> |
|-------------------|------------------------------|--|-------------------|
| 1989 | 2 | 57 | 3.509 |
| 1988 | 32 | 1,361 | 2.351 |
| 1987 | 79 | 2,937 | 2.690 |
| 1986 | 127 | 4,786 | 2.654 |
| 1985 | 146 | 5,505 | 2.652 |
| 1984 | 139 | 6,179 | 2.250 |
| 1983 | 117 | 4,873 | 2.401 |
| 1982 | 124 | 5,163 | 2.402 |
| 1981 | 146 | 5,586 | 2.614 |
| 1980 | 141 | 6,380 | 2.210 |
| 1979 | 332 | 12,386 | 2.680 |
| 1978 | 330 | 12,840 | 2.570 |
| 1977 | 350 | 12,593 | 2.779 |
| ----- | | | |
| 1976 | 322 | 11,584 | 2.780 |
| 1975 | 256 | 8,920 | 2.870 |
| 1974 | 307 | 11,172 | 2.748 |
| 1973 | 273 | 10,171 | 2.684 |
| 1972 | 284 | 8,017 | 3.542 |
| 1971 | 176 | 5,604 | 3.141 |
| 1970 | 174 | 5,049 | 3.446 |
| 1969 | 194 | 5,227 | 3.711 |
| 1968 | 104 | 3,303 | 3.149 |
| 1967 | 72 | 3,196 | 2.253 |
| 1966 | 66 | 2,670 | 2.472 |
| 1965 | 76 | 2,251 | 3.376 |
| 1964 | 48 | 1,672 | 2.871 |
| 1963 | 26 | 1,255 | 2.072 |
| 1962 | 15 | 877 | 1.710 |
| <1961 | 151 | 4,153 | 3.636 |
| UNK | 26 | 960 | 2.708 |

* Fire rates are reported fires per 100 light trucks in fatal crashes.

Source: Fatal Accident Reporting System, NHTSA; calendar years 1975 through 1988.

combination. Figures 2-27 and 2-28 show the data plots of fire rate by age and model year.

The first model fit, that of fire rate as a function of vehicle age, produced the following results:

$$R = 0.02376 + 0.0007069 X_1 \text{ (age)}$$

The age effect was significant, the t-value being 5.26.³³ Age, however, did not explain much of the variation in fire rate with the R^2 being only .15. In this model the fire rate is seen to increase about 3 percent ($.0007069/.02376 = .0298$) per year of vehicle age.

The second model, with age plus the Standard effect resulted in the following equation:

$$R = 0.02559 + 0.0005885 X_1 \text{ (age)} - 0.001806 X_2 \text{ (Std)}$$

In this 2-variable model, age remained significant ($t=3.45$), while the Standard effect was not significant ($t=-1.12$).³⁴ Adding the Standard effect had negligible effect on explaining more of the variation in fire rate, as the R^2 increased by only .01, from .15 to .16.

33 Probability of greater $t=0.0001$.

34 Probability of greater t for age coefficient $=.0007$;
probability of greater t for Standard coefficient
 $=.2632$.

PLOT OF R*AGE LEGEND: A = 1 OBS, B = 2 OBS, ETC.

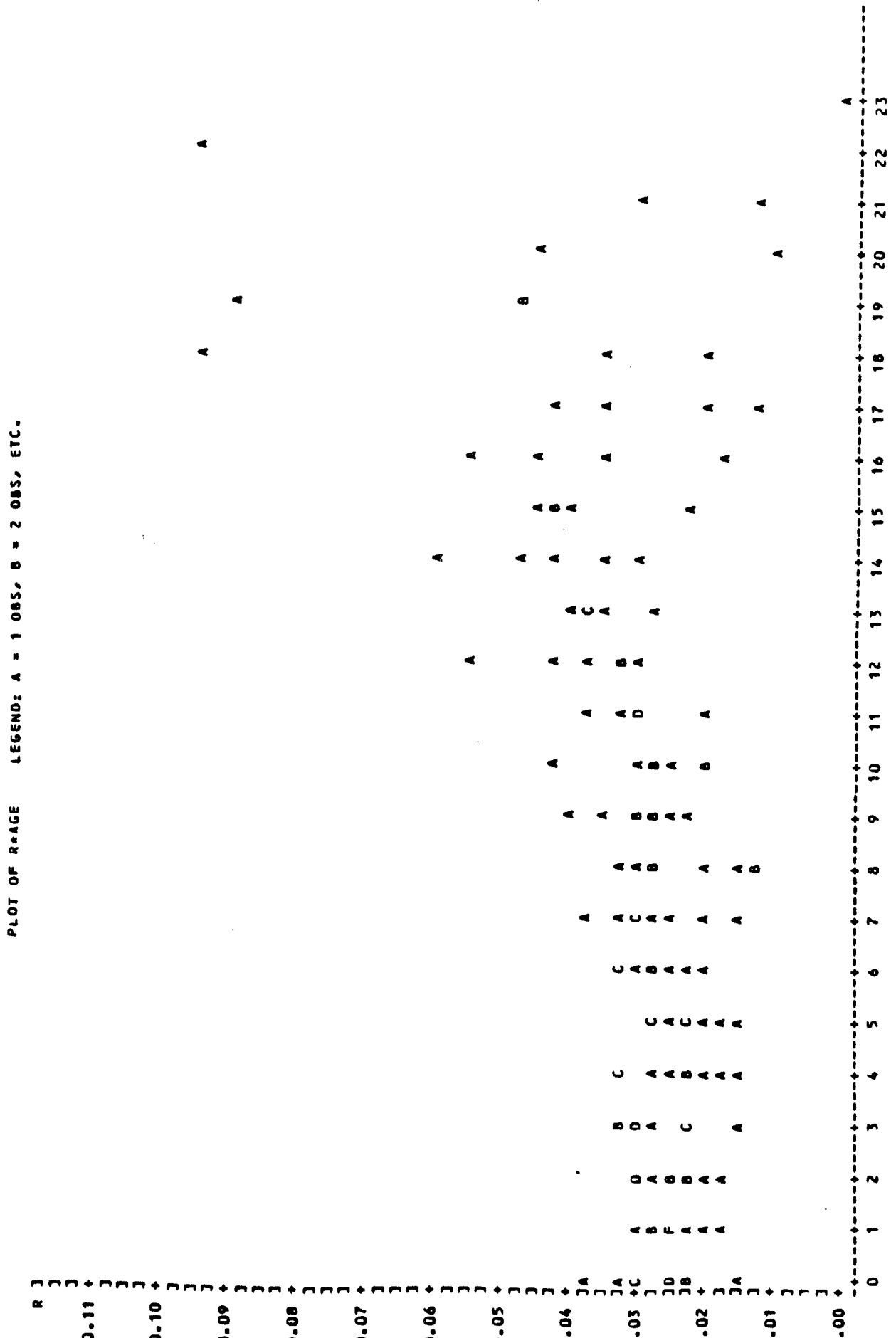

Figure 2-27
FARS. Light Trucks

PLOT OF R+MY LEGEND: A = 1 OBS, B = 2 OBS, ETC.

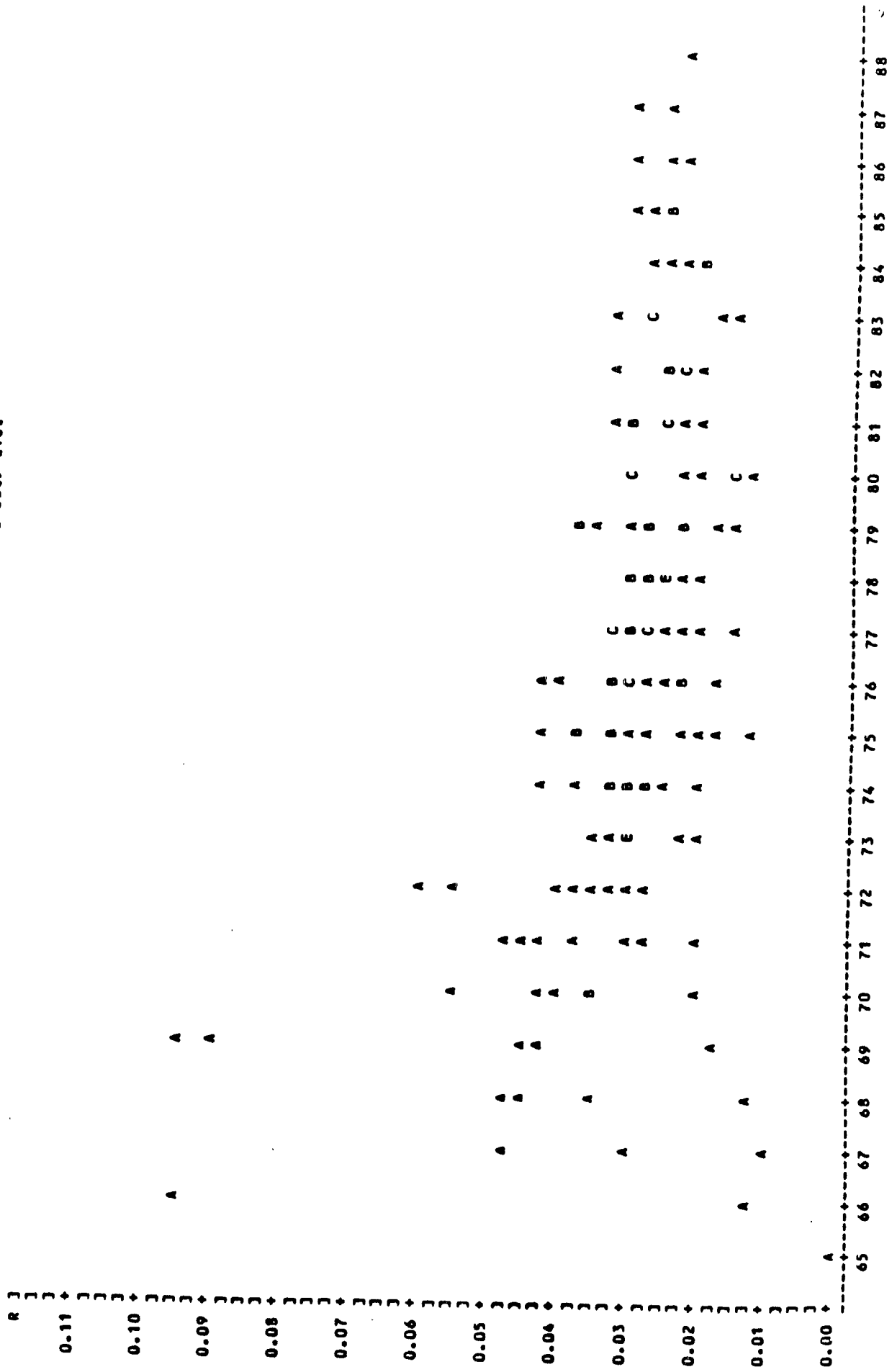

Figure 2-28
FARS, Light Trucks

The fire rate is estimated to increase about 2.3 percent ($.0005885/.02559 = .023$) per year of vehicle age. Although not significantly different from zero, the effect of the Standard, given the average of Pre-standard trucks to be 9.20 years, is estimated at:

$$\begin{aligned} & \frac{-0.001806}{0.02559 + 9.20 (0.0005885)} \\ & = \frac{-0.001806}{.03100} \\ & = -.05826 = - 5.83 \text{ percent} \end{aligned}$$

Alternate Analysis of Fatal Accident Data for Trucks

As was done for the analysis of fatal crash fire rates for cars, an alternate approach is taken to the analysis of fatal crash fire rates for light trucks. Six comparisons of Pre-standard and Post-standard fire rates are made, each comparison based on an increasing period (i.e., number of years) of time before, and after FMVSS 301 took effect. Pre-standard vehicles are model years 1976 and earlier, and Post-standard vehicles are 1977 and later. The six comparisons are ± 1 model year, ± 2 model years, ..., ± 6 model years. The comparisons are balanced with the Pre-standard and Post-standard samples containing an equal number of model years within each calendar year. Finally, the comparisons are cumulative -- i.e., ± 2 MY comparison includes ± 1 MY comparison, ± 3 MY comparison includes ± 1 MY, ± 2 MY, etc.

The data are shown in Table 2-8. In the first comparison, the Post-standard fire rate is slightly greater than the Pre-standard fire rate, the difference being -0.030 fires per 100 fatal truck crashes, or -1.1 percent. In the

remaining five comparisons, the Post-standard rate is less than the Pre-standard rate, the difference generally increasing from 2.8 percent for the ± 2 MY comparison to 11.1 percent for the ± 6 MY comparison. If age were a significant factor, the progression would be expected to follow such a trend.

Since age is included in the comparisons in Table 2-8, a second Table 2-9, has been constructed, which lists adjustment factors for age. The adjustment factors are based on the difference in vehicle age, between Pre-standard and Post-standard samples within each comparison group of Table 2-8, and the average age effect on fire rate. The age effect is taken as the average effect obtained in the two prior regression analyses described above, or 2.7 percent.

Comparing the last column of Table 2-9 with the last column of 2-8, it is seen that the age effect essentially cancels out the difference in Pre- and Post-standard fire rates. This is taken as further evidence that the Standard has had no effect on fires in fatal crashes involving light trucks, and is a finding similar to that for passenger cars discussed in Section 2.2.2.

2.4 EFFECTIVENESS ANALYSIS FOR SCHOOL BUSES

The analysis of fire data on school bus crashes is presented in this section. First, State data on all accident severities are analyzed. This is followed by an analysis of FARS data on fires in fatal school bus crashes. The reporting of fire for school bus crashes in the State and FARS data bases follows the same convention as discussed earlier in the analyses of fire rates for passenger cars and light trucks.

Table 2-8
Selected Comparisons of Pre-Standard Versus Post-Standard
Fire Rates in Fatal Light Truck Crashes

| Comparison (No. of Pre- Post Model Years) | Fire Rate ($\times 10^{-2}$) | | Difference (Pre-Post) | Percent Difference |
|--|--------------------------------|-------------------------------|--------------------------|-----------------------|
| | Pre-Standard | Post-Standard | | |
| ± 1 MY | $\frac{292}{10,579} = 2.760$ | $\frac{350}{12,545} = 2.790$ | -0.030 | -1.1% |
| ± 2 MY | $\frac{463}{16,771} = 2.761$ | $\frac{680}{25,341} = 2.683$ | 0.078 | 2.8% |
| ± 3 MY | $\frac{650}{23,103} = 2.813$ | $\frac{1010}{37,661} = 2.682$ | 0.131 | 4.7% |
| ± 4 MY | $\frac{793}{29,145} = 2.721$ | $\frac{1151}{44,006} = 2.616$ | 0.105 | 3.9% |
| ± 5 MY | $\frac{920}{32,438} = 2.836$ | $\frac{1297}{49,578} = 2.616$ | 0.220 | 7.8% |
| ± 6 MY | $\frac{1002}{34,320} = 2.920$ | $\frac{1421}{54,718} = 2.597$ | 0.323 | 11.1% |

Source: FARS files, NHTSA
Fire rates are based on aggregated frequencies for years
1975 through 1988.

Table 2-9

Age Adjustment Factors for Selected Comparisons
of Fire Rates in Pre and Post-Standard
Light Truck Fatal Crashes

| <u>Comparison</u> | <u>Average Age (Years)</u> | | <u>Difference (Pre-Post)</u> | <u>Age Adjustment (Difference x 2.7%)</u> |
|-------------------|----------------------------|----------------------|----------------------------------|---|
| | <u>Pre-Standard</u> | <u>Post-Standard</u> | | |
| ± 1 MY | 5.34 | 4.60 | 0.74 | 2.0% |
| ± 2 MY | 5.96 | 4.47 | 1.49 | 4.0% |
| ± 3 MY | 6.49 | 4.28 | 2.21 | 6.0% |
| ± 4 MY | 6.85 | 4.16 | 2.69 | 7.3% |
| ± 5 MY | 7.18 | 4.06 | 3.12 | 8.4% |
| ± 6 MY | 7.43 | 3.95 | 3.48 | 9.4% |

2.4.1 Analysis of State Accident Data

The fire rates for school buses are shown in Tables 2-10a and 2-10b. Table 2-10a lists the rates for the 3 States of Michigan, Ohio, and Maryland while Table 2-10b contains the rates for Illinois and Indiana.

Overall, it is seen that fire rates are higher in the States of Michigan, Ohio, and Maryland, than they are for Illinois and Indiana. This is consistent with the fire rates for passenger cars and light trucks analyzed in the previous sections.

Since the absolute frequencies of school bus fires and total crashes are very small, in comparison to the corresponding frequencies noted for cars and light trucks, the rates have been summarized in Table 2-11, by State and by Pre-standard (Model year 1976 and earlier) versus Post-standard vehicles (Model Year 1977 and later). Instances where the bus model year was unknown have been excluded from these data. A glance at the table reveals that 2 of the States (Michigan and Ohio) show lower fire rates for Post-standard buses, while for the other three States, fire rates are higher for Post-standard buses.

The data are much too sparse for performing regression analyses as was done for passenger cars and light trucks. Instead a simple test of hypothesis is made to determine whether the overall fire rate for all States is lower for Post-standard school buses than the rate for Pre-standard school buses.

Although differences among States are indicated, this approach is considered reasonable in view of the extremely small frequencies involved. Letting p_1

Table 2-10a
Fire Rates* in School Bus Crashes by State and Vehicle Model Year

| Model Year | S T A T E S | | |
|---------------|----------------|----------------|---------------|
| | Michigan | Ohio | Maryland |
| 1987 | 0/47 | 1/105 (9.524) | 1/88 (11.364) |
| 1986 | 0/270 | 1/278 (3.597) | 0/144 |
| 1985 | 0/509 | 2/524 (3.817) | 0/277 |
| 1984 | 1/593 (1.686) | 0/617 | 0/237 |
| 1983 | 0/386 | 0/522 | 0/308 |
| 1982 | 0/492 | 2/649 (3.082) | 0/271 |
| 1981 | 1/626 (1.597) | 1/651 (1.536) | 1/243 (4.115) |
| 1980 | 1/938 (1.066) | 8/1328 (6.024) | 0/487 |
| 1979 | 2/1124 (1.799) | 3/875 (3.429) | 0/530 |
| 1978 | 2/830 (2.410) | 1/716 (1.397) | 2/535 (3.738) |
| 1977 | 1/661 (1.513) | 7/662 (10.574) | 1/600 (3.333) |
| 1976 | 1/563 (1.776) | 5/637 (7.849) | 1/411 (2.433) |
| 1975 | 2/587 (3.407) | 2/616 (3.247) | 1/581 (1.721) |
| 1974 | 0/303 | 0/445 | 0/222 |
| 1973 | 1/151 (6.623) | 1/361 (2.770) | 0/269 |
| 1972 | 0/111 | 0/330 | 0/232 |
| 1971 | 1/63 (15.873) | 1/201 (4.975) | 0/99 |
| 1970 | 0/44 | 3/147 (20.408) | 0/60 |
| 1969 | 1/23 (43.478) | 0/101 | 0/38 |
| 1968 | 0/26 | 0/108 | 0/34 |
| 1967 | 0/21 | 0/78 | 0/12 |
| 1966 | 0/16 | 0/47 | 0/5 |
| 1965 | 0/10 | 0/11 | 0/4 |
| 1964 | 0/2 | 0/3 | 0/6 |
| 1963 | 0/6 | 0/6 | 0/3 |
| 1962 | -- | 0/1 | 0/1 |
| ≤ 1961 | 0/6 | 0/20 | 0/5 |
| UNK | 1/703 (1.422) | 1/1099 (0.910) | 0/48 |

* Fire rate is number of police reported fires per 1,000 school buses involved in crashes. Only non-zero rates are given (in parentheses).

Data are aggregated for calendar years 1982 through 1987.

Table 2-10b
Fire Rates* in School Bus Crashes by State and Vehicle Model Year

| Model Year | S T A T E | |
|---------------|----------------|---------------|
| | Illinois | Indiana |
| 1987 | 0/182 | 0/198 |
| 1986 | 1/533 (1.876) | 0/221 |
| 1985 | 2/868 (2.304) | 0/318 |
| 1984 | 0/1070 | 0/341 |
| 1983 | 2/1104 (1.812) | 1/460 (2.174) |
| 1982 | 1/899 (1.112) | 0/253 |
| 1981 | 2/1085 (1.843) | 0/535 |
| 1980 | 2/1411 (1.417) | 3/561 (5.348) |
| 1979 | 0/1501 | 0/493 |
| 1978 | 1/1280 (0.781) | 0/298 |
| 1977 | 1/904 (1.106) | 0/322 |
| ----- | | |
| 1976 | 0/663 | 0/248 |
| 1975 | 1/833 (1.200) | 0/370 |
| 1974 | 0/529 | 0/452 |
| 1973 | 0/307 | 0/170 |
| 1972 | 1/203 | 0/108 |
| 1971 | 0/134 | 0/182 |
| 1970 | 0/122 | 0/47 |
| 1969 | 0/50 | 0/40 |
| 1968 | 0/41 | 0/15 |
| 1967 | 0/12 | 0/31 |
| 1966 | 0/23 | 0/3 |
| 1965 | 0/13 | 0/2 |
| 1964 | 0/2 | 0/1 |
| 1963 | 0/1 | 0/4 |
| 1962 | 0/1 | 0/1 |
| ≤ 1961 | 0/21 | 0/6 |
| UNK | 2/2092 (0.956) | 0/104 |

* Fire rate is number of police reported fires per 1,000 school buses involved in crashes. To obtain actual fire rate table values should be multiplied by 10^{-3} . Only non-zero rates are given (in parentheses).

Data are aggregated for calendar years 1982 through 1987.

Table 2-11
 Fire Rates* in School Bus Crashes
 by State and Pre-Standard
 versus Post-Standard Vehicles

| <u>State</u> | <u>Fire Rates</u> | | <u>Overall</u> |
|--------------|------------------------------|------------------------------|------------------------------|
| | <u>Pre-Standard</u> | <u>Post-Standard</u> | |
| Michigan | $\frac{6}{1879}$ (3.1932) | $\frac{8}{6479}$ (1.2348) | $\frac{14}{8358}$ (1.6750) |
| Ohio | $\frac{12}{3113}$ (3.8548) | $\frac{26}{6931}$ (3.7513) | $\frac{38}{10044}$ (3.7834) |
| Maryland | $\frac{2}{2072}$ (0.9653) | $\frac{6}{3635}$ (1.6506) | $\frac{8}{5707}$ (1.4018) |
| Illinois | $\frac{2}{2907}$ (0.6880) | $\frac{12}{10883}$ (1.1026) | $\frac{14}{13790}$ (1.0152) |
| Indiana | $\frac{0}{1680}$ (0.000) | $\frac{4}{4040}$ (0.9901) | $\frac{4}{5720}$ (0.6993) |
| Overall | $\frac{22}{11,651}$ (1.8882) | $\frac{56}{31,968}$ (1.7518) | $\frac{78}{43,619}$ (1.7882) |

* Fire rates are $\times 10^3$, or fires per 1,000 bus crashes.

and p_2 represent the fire rates for Pre-standard and Post-standard buses, respectively, the test statistic, Z , is:

$$Z = \frac{p_1 - p_2}{\hat{\sigma}_{p_1 - p_2}}$$

where,

$$\hat{\sigma}_{p_1 - p_2} = \left[\hat{p} (1 - \hat{p}) \left(\frac{1}{n_1} + \frac{1}{n_2} \right) \right]^{\frac{1}{2}}$$

and,

$$\hat{p} = \frac{n_1 p_1 + n_2 p_2}{n_1 + n_2}$$

Substituting the respective values from Table 2-11 gives:

$$\begin{aligned} \hat{p} &= \frac{11651 (.001888) + 31968 (.001752)}{11651 + 31968} \\ &= .001788 \end{aligned}$$

$$\hat{\sigma}_{p_1 - p_2} = \left[.001788 (.9982) \left(\frac{1}{11651} + \frac{1}{31968} \right) \right]^{\frac{1}{2}}$$

$$= .0004572$$

$$Z = \frac{.001888 - .001752}{.0004572}$$

$$= \frac{.000136}{.0004572} = 0.2975$$

The Z-value is non-significant, being less than the critical value of $Z = 1.645$.³⁵ Thus, while the fire rate for Post-standard buses is lower than the Pre-standard rate by .000136 or 7.2 percent (.000136/.001888), this difference is not significantly different from zero.

If the comparison of Pre and Post-standard buses is performed using balanced (i.e., equal number of) samples of model years for each period, as was done earlier for cars and trucks, the overall rates become:

$$\text{Pre-standard: } \frac{20}{10855} = .0018425$$

$$\text{Post-standard: } \frac{56}{31914} = .0017547$$

The corresponding test statistic is:

$$Z = .1880$$

which, again is not significant. The difference in rates in this case is .0000878 or 4.7 percent, with the Post-standard group having the lower rate.

³⁵ Test performed at $\alpha = .05$, or 95 percent confidence level.

The above comparisons do not consider any effect that vehicle age might have on the fire rates. Data are simply too sparse to attempt to evaluate this factor. However, drawing upon the findings of the prior analyses for passenger cars and light trucks, it is reasonable to postulate that age would have an impact. The impact would be to decrease the magnitude of the difference in Pre and Post-standard fire rates obtained by a strict overall comparison such as done above.

Based on the above analyses, indications are that no difference exists in the fire rate, for all accidents, between Pre-standard and Post-standard school buses. However, due to the small frequencies of fires and total school bus crashes, no reliable inferences may be drawn.

2.4.2 Analysis of Fatal Accident Data

Table 2-12 summarizes the fire data for school buses in fatal crashes, as recorded in the FARS files for the years 1975 through 1988. For each FARS year, the table lists:

- o the total number of school buses in fatal crashes (col. 2)
- o a breakout of the total number of involved buses by Pre-standard, Post-standard, and unknown model year (cols. 3, 4, and 5, respectively)
- o the number and model year of the buses in which fire occurred (col.6).

It can be seen that the absolute frequencies of fires and fatal crashes are quite small for school buses. The overall fire rate for school buses in fatal crashes, including buses of unknown model years is:

$$\text{overall fire rate} = 17/1685 = .01009$$

This is about 1 fire per 100 fatal school bus crashes.

For Pre-standard and Post-standard buses, the rates are:

$$\text{Pre-standard: fire rate} = 7/948 = .007384$$

$$\text{Post-standard: fire rate} = 10/712 = .01404$$

The fire rate for Post-standard buses is higher (by a factor of nearly 2) than the fire rate for Pre-standard buses. However, as was the case for fire rates in the State data, these rates are not based on a balanced sample, in that the number of model years spanned by the Pre-standard group is equal to the number of model years spanned by the Post-standard group. Balancing the samples results in the following rates for Pre and Post buses:

$$\text{Pre-standard: fire rate} = 4/357 = 0.1120$$

$$\text{Post-standard: fire rate} = 10/681 = 0.1468$$

The fire rate for the Post-standard buses is still higher, although by much less than in the unbalanced comparison. There is no need to test for significance here, since for either comparison, the Z - statistic will be negative and hence non-significantly different from zero. As with the prior comparisons of fire rates from State data, these comparisons do not account for any effect due to vehicle age.

Because of the small frequencies of fires and fatal school bus crashes, these results are not considered conclusive. Nevertheless, evidence has not been produced that FMVSS 301 has had a positive effect in reducing fires in fatal school bus crashes.

2.5 DISCUSSION OF EFFECTIVENESS ANALYSIS PERFORMED

To close this chapter, a few comments are made to summarize the results of the several analyses performed to estimate the effect that FMVSS 301 has had on reducing fires in motor vehicle crashes.

Passenger Cars

For passenger cars, the analyses indicate that FMVSS 301 has reduced the overall rate of fire in accidents by about 14 percent. This estimate is based on analyses of the data from Michigan, Ohio, and Maryland. Both the methods

Table 2-12
 School Buses Involved in Fatal Crashes by Calendar
 Year, Pre-Standard versus Post-Standard and Fire Occurrence

| Calendar Year | No. of Vehicles (School Buses) Involved | | | | No. of Vehicles with Fire/(MY) |
|------------------|---|--------------------------|---------------------------|-----------|--------------------------------------|
| | Total Vehicles | Pre-Standard Vehicles | Post-Standard Vehicles | UNK MY | |
| 1988 | 105 | 11 | 91 | 3 | 1 (1977) |
| 1987 | 132 | 21 | 111 | 0 | 4 (1979,81 83,86) |
| 1986 | 101 | 27 | 73 | 1 | 2 (1985, 1986) |
| 1985 | 126 | 35 | 90 | 1 | 1 (1976) |
| 1984 | 119 | 43 | 75 | 1 | 1 (1977) |
| 1983 | 99 | 41 | 57 | 1 | 1 (1970) |
| 1982 | 104 | 41 | 62 | 1 | 1 (1979) |
| 1981 | 110 | 57 | 53 | 0 | 0 |
| 1980 | 117 | 77 | 39 | 1 | 2 (1973, 1978) |
| 1979 | 150 | 115 | 33 | 2 | 2 (1973, 1976) |
| 1978 | 143 | 115 | 20 | 8 | 0 |
| 1977 | 126 | 117 | 8 | 1 | 1 (1965) |
| 1976 | 123 | 120 | 0 | 3 | 0 |
| 1975 | 130 | 128 | 0 | 2 | 1 (1975) |
| TOTALS | 1685 | 948 | 712 | 25 | 17 (7 PRE, 10 POST) |

 Source: Fatal Accident Reporting System, NHTSA.
 Calendar Years 1975 through 1988.

of reporting vehicle fires and the magnitude of fire frequencies observed in these States make them the preferred choice on which to base the effectiveness estimates. The Illinois and Indiana data produced somewhat higher effectiveness estimates, but the small frequencies of reported fires in these States introduces more variation in the analyses and make the results less reliable. Also in Illinois, the very high rate of unknown codes for the fire variable together with the more indirect method of reporting fires are two additional reasons why the analyses results from this State are considered less reliable. While the Indiana data did not suffer from these same two problems, the overall fire rates were very similar to those for Illinois. The incidence of reported fires in Michigan, Ohio, and Maryland were considerably higher than for Illinois and Indiana, and this fact makes the data from these more suitable for analyses. It is difficult to conceive of police officers over-reporting vehicle fires - i.e., reporting fire when it did not occur. Therefore, the Michigan, Ohio, and Maryland data are believed to more nearly reflect the actual rate of fire occurrence, and that the consistently lower rates for the other two States are likely a result of under-reporting of fires (rather than an indication that fire rates are markedly lower in these two States).

For injury crashes, mixed results were obtained from the analyses. Analysis of Ohio data showed a statistically significant reduction of approximately 14 percent for post-standard vehicles whereas the Michigan data showed no significant difference between the fire rates for pre-standard and post-standard vehicles. Maryland data on fires in injury crashes were too sparse to support reliable statistical analyses. Although not statistically significant, post-standard cars from Michigan did show a 10 percent lower fire rate in injury crashes, compared to the 14 percent lower rate in Ohio. It

is therefore possible to postulate that an actual, modest, reduction in fires in injury crashes may have resulted from FMVSS 301. For example, if a larger sample size had been available from the State of Michigan, the 10 percent difference might have been statistically significant. However, the 10 percent difference in fire rate between pre-standard and post-standard vehicles was not close to being significant ($\alpha = .20$), and regardless of the magnitude or direction of the difference, the statistical conclusion to be drawn is that the difference is not significantly different from zero. Also, even if a larger sample size were available, statistical significance might, or might not be obtained. While the larger sample would be more likely to produce significance for a given percent difference, it must be remembered that the difference, itself, is subject to (sampling) variation and a new sample could produce an estimated difference lower than the 10 percent obtained in the current sample. Ninety-five percent confidence limits on this 10 percent show that the actual, or true, difference could lie anywhere between -5.2 percent and + 25.6 percent. Therefore, while the results of the analyses of the Ohio and Michigan data do provide some evidence that fire rates in injury crashes may be lower for post-standard vehicles, the information is inadequate to support definitive conclusions.

The analyses of fatal crashes did not show that fire rates for Post-standard cars differed significantly from the fire rates for Pre-standard cars.

Light Trucks

For light trucks, the analyses did not indicate that Post-standard vehicles experienced lower fire rates than Pre-standard vehicles - in either the all accident category or the fatal accident category. The finding of no effect on all accidents was supported by the analyses results of data from Michigan, Ohio, Maryland, and also by analyses of the Indiana data, although the latter is considered less reliable due to the shortcomings discussed above. The single State of Illinois did show a significantly lower fire rate for Post-standard vehicles, but this is considered a spurious finding likely due to the small frequencies of fires and greater variation in these data. Four out of five States and all three "preferred" States showed no significant difference between Pre- and Post-standard light trucks. Fires in light truck injury crashes in State data were too sparse for analysis. Additionally, since no effect was found in either the all accidents or the fatal accidents analyses, no effect would reasonably be expected for injury crashes, which have a severity level in between that for all accidents (least severe) and that for fatal accidents (most severe).

School Buses

For school buses, the data were simply too sparse - even at the State level - to permit reliable conclusions of the effect of FMVSS 301 in reducing vehicle fires. Only simple overall comparisons could be made. While not conclusive, these analyses did not support a significantly lower fire rate for school buses produced subsequent to the Standard's promulgation.

Consistency of Findings

Overall, the analyses and findings were generally consistent, with a few instances of disparateness. For passenger cars and light trucks in all reported crashes, the effectiveness findings were generally consistent for the five State data sources, and particularly so for the three States of Michigan, Ohio, and Maryland. For passenger cars in injury crashes, the two States with sufficient data for analysis both produced estimates of a reduction in fires for post-standard vehicles. However, one reduction was statistically significant (State of Ohio), while the other was non-significant (State of Michigan).

Findings for fatal accidents were similar for cars and for light trucks, with no reduction in fires noted for Post-standard vehicles. It may be that the crash force levels typically experienced in fatal crashes simply exceed those levels which are covered by the FMVSS 301 requirements (i.e., 20 mph to 30 mph force levels).³⁶

As to why effectiveness was found for all accidents for passenger cars, but not for light trucks; it may be that the design and placement of fuel system components (viz., the fuel tank) on light trucks is such that they are

³⁶ More insight into this possibility is provided in Chapter 3 which shows that fatal fire crashes typically involved more severe conditions than fatal crashes not accompanied by fire.

inherently less vulnerable to crash forces than the fuel systems on passenger cars, and therefore, the modifications made in response to FMVSS 301 had less effect for trucks than did the modifications for passenger cars.

Post-crash Versus Pre-crash Fires

With respect to the State data, it is recalled that both pre-crash and post-crash fires are included. A limited check of two States (Ohio and Maryland) which attempt to separate fires on this basis, via police reporting, indicated that pre-crash fires could approach 1/2 or more of the total fires reported in all crashes. In the more severe set of crashes that are most likely to produce injury, or fatality, it would be expected that the majority of the fires would have resulted from the crash.

Another estimate of the proportion of pre-crash fires in police reported data comes from a special study of "post-crash" factors in automobile crashes in the State of Utah in 1972 - 1973.³⁷ Fire was one of the post-crash topics of interest in this special study which utilized a bi-level (i.e., supplemental) reporting form as an addition to typical police reports to flag certain phenomena of interest, such as fires. These fire accidents were followed up by special accident investigation personnel, who categorized these

37 Study of Post-Crash Factors in Automobile Collisions," Volume 1, DOT HS-801 519, April 1975, Final Report.

fires as due to the crash, or other (non-collision) causes. Data were collected in a five county area in Utah for a one-year period. While the data cannot be considered nationally representative, 23 percent of 43 fire cases collected were classed as non-collision, with the remaining 67 percent being credited as collision fires.

While reliable estimates may not be available, the fact that pre-crash fires are included in the data implies that the true effectiveness for FMVSS 301 for passenger cars is greater than the estimate of 14 percent for all accidents. Assuming that pre-crash and post-crash fires are equally affected by vehicle age, and if the proportion of pre-crash fires is denoted by P , then the actual effectiveness estimate of the Standard would be $14/(1-P)$ percent. While the inclusion of pre-crash fires will result in underestimating percent effectiveness, it will not affect estimates of total fire crashes or injuries avoided (see Chapter 4).

The Effect of Age

The age factor was a consistent effect throughout the analyses. This is likely a reflection of the weakening of vehicle structures and components due to age-related degradation and corrosion (i.e., rust). Other studies have noticed this corrosion - induced weakening which can, in turn, reduce the

energy absorbing qualities of the vehicle structures.^{38, 39} Also flexible fuel hoses harden and become brittle with age, increasing the chances of failure and fuel leakage. Another aspect of the age effect could be artifactual in nature - the underreporting of older vehicles in accident files due to the lower economic value of older vehicles. This factor could be included in the State (i.e., all accident severities) data, but would not be expected to occur with fatal accident data. For fatal accidents, the injury severity would be sufficient to override any likelihood of not reporting due to old, low-value vehicles.

Age effects have been noted in other studies of motor vehicle fires, as well as in other studies of the effects of motor vehicle safety standards.

38 "Corrosion of Motor Vehicles: Safety and Environment: the User's View," by Marcus A. Jacobson, CEng, FIMechE, MIProdE, M Inst C Tech. - Article published in: "Corrosion of Motor Vehicles." Conference arranged by the Automotive Division of the Institution of Mechanical Engineers and the Institution of Corrosion Technology in collaboration with the Society of Chemical Industry; London, 13-14 November, 1974, published by Mechanical Engineers, London and New York.

39 "Weak Points of Cars" - 1987, 1988 Ed's; AB SVENSK BILPROVNING, the The Swedish Motor Vehicle Inspection Company.

The basic analytical assumption regarding age in the analyses of the effectiveness of FMVSS 301 conducted in this chapter has been that age affects Pre-standard and Post-standard vehicles in the same manner. This approach seems quite reasonable in that corrosion rates and degradation trends for vehicle components and structures should not vary as a consequence of whether the vehicles were manufactured before, or after, FMVSS 301 took effect. Even so, the question could still be raised as to whether this assumption could be investigated further. It will be noted in the earlier sections which describe the accident data bases analyzed that among the newer vehicles, there were relatively more Post-standard vehicles than Pre-standard vehicles. Conversely, among the older vehicles, there were relatively more Pre-standard vehicles than Post-standard. Could this imbalance of vehicle age distribution between Pre- and Post-standard samples have influenced the results of the effectiveness analyses performed?

In order to further explore these issues of the possible effect of vehicle age on fire rates, two additional sets of analyses were carried out. The first analysis consisted of testing whether the age effects, computed separately for Pre-standard and Post-standard vehicles, were significantly different. The second analysis involved additional computations of the effectiveness of FMVSS 301, but restricting the data to vehicles of the same ages in both the Pre- and Post-standard samples.

The additional analyses are discussed in detail in Appendix E. The results of the analyses support the assumption that the age effect operates in the same manner for Pre-standard vehicles as it does for Post-standard vehicles - i.e., no significant differences were found.

Possible Effects of Other Factors

There exist certain other factors, not studied in the effectiveness analyses described earlier, which could have some influence on crash fire rates. These factors all concern changes in the physical structure and design of vehicles manufactured primarily after FMVSS 301 took effect and were unrelated to the Standard.

For example, the size and weight of passenger cars were substantially reduced over the period encompassed by the accident data studied.⁴⁰ It is conceivable that smaller vehicles could be less crashworthy than larger vehicles, and therefore more likely to experience fuel leakage and fire, given a crash occurs. Also during the period, the type of fuel system used saw a nearly universal switch from carburetor systems to fuel injection systems. Fuel injection systems are typically more complex than carbureted systems, in that more components and connection points are required. Fuel injection

40 This reduction in size and weight was a primary response of the motor vehicle manufacturers to the world-wide oil crisis of the 1970's and to the Federal Corporate Average Fuel Economy (CAFE) requirements which grew out of that crisis. This "down sizing" was instituted to achieve more fuel-efficient vehicles.

systems also operate under higher fuel pressures. Collectively, these factors imply that the chances of failure could be higher for fuel injected systems, as compared with carbureted systems, all else being equal.⁴¹

A third item that could potentially increase the risk of fuel leakage and fire involves the area of exhaust system emission controls. In the mid-seventies, catalytic converters were added to the exhaust systems of passenger cars to reduce tailpipe emissions. These devices, required by Federal regulation to reduce air pollution, operate at very high temperatures and could therefore contribute to an increase in the risk of vehicle fire.

Since all three of the above factors (decreased vehicle size, fuel injection systems, and catalytic converters apply primarily to vehicles produced after FMVSS 301 took effect, it is possible that their combined influence could serve to increase the fire risk for Post-standard vehicles. To the extent this may be true, it could serve to produce lower effectiveness estimates for the Standard than might otherwise be obtained. The effect of vehicle size on

⁴¹ Generally, the chances of a failure, or malfunction, in a system are proportional to the complexity of the system - i.e., the number of components comprising the system. However, changes in system design and changes in materials used can offset the chances of failure such that given increases in system complexity may result in less than commensurate increases in the risk of failure. In the example discussed here, no attempt is made to assess the relative risks of system failure in other than a general sense.

fire rate is studied in Chapter 3, where vehicle curb weight is used as a measure of vehicle size. The results of these analyses were that fire rate was not found to be associated with vehicle size (i.e., fire rates did not increase for lighter vehicles).

Data were not available to evaluate the possible effects of the remaining two factors, fuel injection systems and catalytic converters, on vehicle fire rates. In summary, it may be stated that to the extent these two factors increase the risk of crash fires, they could serve to decrease the magnitude of the effectiveness estimates developed for FMVSS 301. No attempt is made here to speculate as to whether the magnitude of any effect due to these factors might be large enough to have significant impact of the probability of vehicle crash fire and hence the effectiveness estimates developed in this study for the Fuel System Integrity Standard.

Other Studies of Motor Vehicle Fires

The effectiveness results obtained in this study, for passenger cars, are lower than the results obtained in the earlier NHTSA evaluation of the Fuel System Integrity Standard, which only studied passenger cars.⁴² The earlier study found a substantial benefit for fatal accidents, whereas no reduction in fatal crashes was noted in this study. The earlier study was based on only 3

42 NHTSA Technical Report DOT HS 806 335, Op. Cit.

years of data from one State. Fatal accident data were not studied. Available data on vehicle fires at that time were quite scarce and a large part of the effort, including a special contractor study was involved in searching out, and making available accident data which record vehicle fires. That search turned up only one satisfactory State, Michigan, which began recording vehicle fires in 1978, and only three calendar years of data, 1978 through 1980. Elapsed time since the earlier study has generated several additional years of accident experience (including additional FARS years) that make possible more thorough analysis, including a more thorough study of factors such as age.

Flora, et. al., conducted one of the earlier (i.e., 1979) contract support studies for NHTSA on FMVSS 301.⁴³ This effort was primarily a search for data sources on vehicle fires and focused on two type of sources, fire department data, and police accident data. The report concluded that these data sources were inadequate to provide a definitive evaluation of FMVSS 301.

A followup study was done by Flora and O'Day in 1982, using, police accident data from Michigan and Illinois.⁴⁴ The study found: (1) no effect for the 1968 version of FMVSS 301 (passenger cars); (2) a significant reduction in fires for the 1976-1977 upgrade of the standard (passenger cars); (3) no reduction in fires for the 1977 version of FMVSS 301 for light trucks. The latter finding for light trucks was based on limited data.

43 "An Evaluation of FMVSS 301, Fuel System Integrity," UM-HSRI-79-12, March 1979.

44 "Evaluation of FMVSS 301 - Fuel System Integrity - Using Police Accident Data," DOT HS-806-362, Final Report, March 1982.

In 1983, the University of Michigan published an "interview summary" with Dr. Flora entitled "Automobile Fires in Traffic Crashes."⁴⁵ This was largely a summary of the 1982 research study cited above. In addition to the 1982 report findings, Dr. Flora was quoted as saying that: (1) "I think we have to conclude that (i.e., 301) has had no measurable effect on reducing fatalities," and (2)". . .we cannot reach any definite conclusion regarding the numbers of . . .injuries it (301) is preventing."

Two other contract studies were conducted for NHTSA by the Highway Safety Research Center, University of North Carolina.⁴⁶ The first study, using police (narrative) accident data from North Carolina, only studied the 1968 version of FMVSS 301 for passenger cars. The study found no reduction in fires due to the Standard.

The second North Carolina report studied the 1976 version of FMVSS 301 for passenger cars.⁴⁷ North Carolina police (narrative) accident data were again analyzed, together with police accident data from Maryland. The findings were that, "the 1976 modification of FMVSS 301 was at least

45 "Automobile Fires in Traffic Crashes," the UMTRI Research Review, May-June 1983, Vol. 13, No. 6.

46 "A Statistical Evaluation of the Effectiveness of FMVSS 301: Fuel System Integrity," DOT HS-805-969, Report No. 7 of 7, June 1981, Final Report.

47 "A Statistical Evaluation of the Effectiveness of the 1976 Version of FMVSS 301: Fuel System Integrity," DOT HS 806-365, November 1982, Final Report.

marginally effective in reducing the incidence of post-crash fires." Neither this report, nor the first North Carolina report attempted to evaluate the effect of any reduction in fires on occupant injury or fatality.

CHAPTER 3

THE NATURE AND MAGNITUDE OF FIRES IN MOTOR VEHICLE CRASHES

This chapter presents selected statistical data which describe the nature and magnitude of fire in motor vehicle crashes. The statistics are based on the same data sources as used in the effectiveness analyses of FMVSS 301 presented in Chapter 2, i.e., the Fatal Accident Reporting System and selected vehicle accident files compiled by the States. In the first section, fires in fatal crashes are presented, while the following section contains data on fires in all motor vehicle crashes.

3.1 FIRES IN FATAL CRASHES

Based on the data in FARS, from its inception in 1975 through calendar year 1988, an average of 2.6 fires per 100 fatal motor vehicle crashes have occurred. This is the rate for all vehicle types (passenger cars, light trucks, heavy trucks, motorcycles, etc.). For the three vehicle types of primary interest in this study, the average fire rates have been:

passenger cars: 2.4 per 100 crashes
light trucks: 2.8 per 100 crashes
school buses: 1.0 per 100 crashes

Table 3-1 lists the number and rate of vehicle fires for each of these classes for the 14 FARS years.

Table 3-1
Fires in Fatal Motor Vehicle Accidents

| Calendar Year | All Vehicles | | Passenger Cars | | Light Trucks | | School Buses | |
|------------------|--------------|-------|----------------|-------|--------------|-------|--------------|-------|
| | No. | Rate* | No. | Rate* | No. | Rate* | No. | Rate* |
| 1988 | 1,804 | 2.88 | 1,017 | 2.75 | 443 | 2.95 | 1 | 0.95 |
| 1987 | 1,713 | 2.77 | 961 | 2.63 | 399 | 2.80 | 4 | 3.03 |
| 1986 | 1,755 | 2.89 | 972 | 2.69 | 396 | 3.04 | 2 | 1.98 |
| 1985 | 1,483 | 2.55 | 809 | 2.36 | 318 | 2.55 | 1 | 0.79 |
| 1984 | 1,554 | 2.68 | 847 | 2.44 | 321 | 2.68 | 1 | 0.84 |
| 1983 | 1,420 | 2.58 | 836 | 2.51 | 265 | 2.38 | 1 | 1.01 |
| 1982 | 1,521 | 2.69 | 863 | 2.51 | 320 | 2.83 | 1 | 0.96 |
| 1981 | 1,809 | 2.89 | 1,031 | 2.65 | 373 | 3.02 | 0 | 0.00 |
| 1980 | 1,720 | 2.71 | 931 | 2.38 | 360 | 2.84 | 2 | 1.71 |
| 1979 | 1,774 | 2.74 | 978 | 2.45 | 379 | 3.02 | 2 | 1.33 |
| 1978 | 1,580 | 2.46 | 867 | 2.14 | 327 | 2.75 | 0 | 0.00 |
| 1977 | 1,505 | 2.49 | 832 | 2.13 | 290 | 2.79 | 1 | 0.79 |
| 1976 | 1,314 | 2.34 | 771 | 2.03 | 250 | 2.69 | 0 | 0.00 |
| 1975 | 1,252 | 2.25 | 744 | 1.96 | 206 | 2.39 | 1 | 0.77 |
| AVERAGE | 1,586 | 2.64 | 890 | 2.40 | 332 | 2.78 | 1.21 | 1.01 |

* Rate is number of fires per 100 fatal vehicle crashes.

SOURCE: Fatal Accident Reporting System, NHTSA

3.1.1 TRENDS IN FATAL FIRE CRASHES

In order to investigate the existence of overall trends in fire rates, simple linear functions were fitted to the data in Table 3-1 with fire rate as the dependent variable, and calendar year as the independent variable. Analyses were run for each of the three vehicle classes - passenger cars, light trucks, and "other" vehicles, where other vehicle was defined as all vehicles in FARS (i.e., column 1 of Table 3-1) less passenger cars and light trucks (i.e., minus columns 3 and 4 of the table). The data on school buses are too sparse for analyses of possible trends.

Figures 3-1, 3-2, and 3-3 are the data plots for the three analyses. The results showed that fire rates for passenger cars have increased significantly over the 14-year period, while no change in rates was noted for light trucks, or for (all) other vehicles. The resulting equations were:

passenger cars: $R = .02024 + .0005089 (\text{cal. year})$

light trucks: $R = .02665 + .0001356 (\text{cal. year})$

other vehicles: $R = .03380 - .0001144 (\text{cal. year})$

The passenger car increase in fire rate is about 2.5 percent per year and was significant at the 5 percent level ($t=5.92$) while the changes for the other two vehicle classes (0.5 percent increase per year for light trucks, and -0.3 percent decrease per year in other vehicles were not significant

SAS

PLOT OF RVEH=CY LEGEND: A = 1 OBS, B = 2 OBS, ETC.

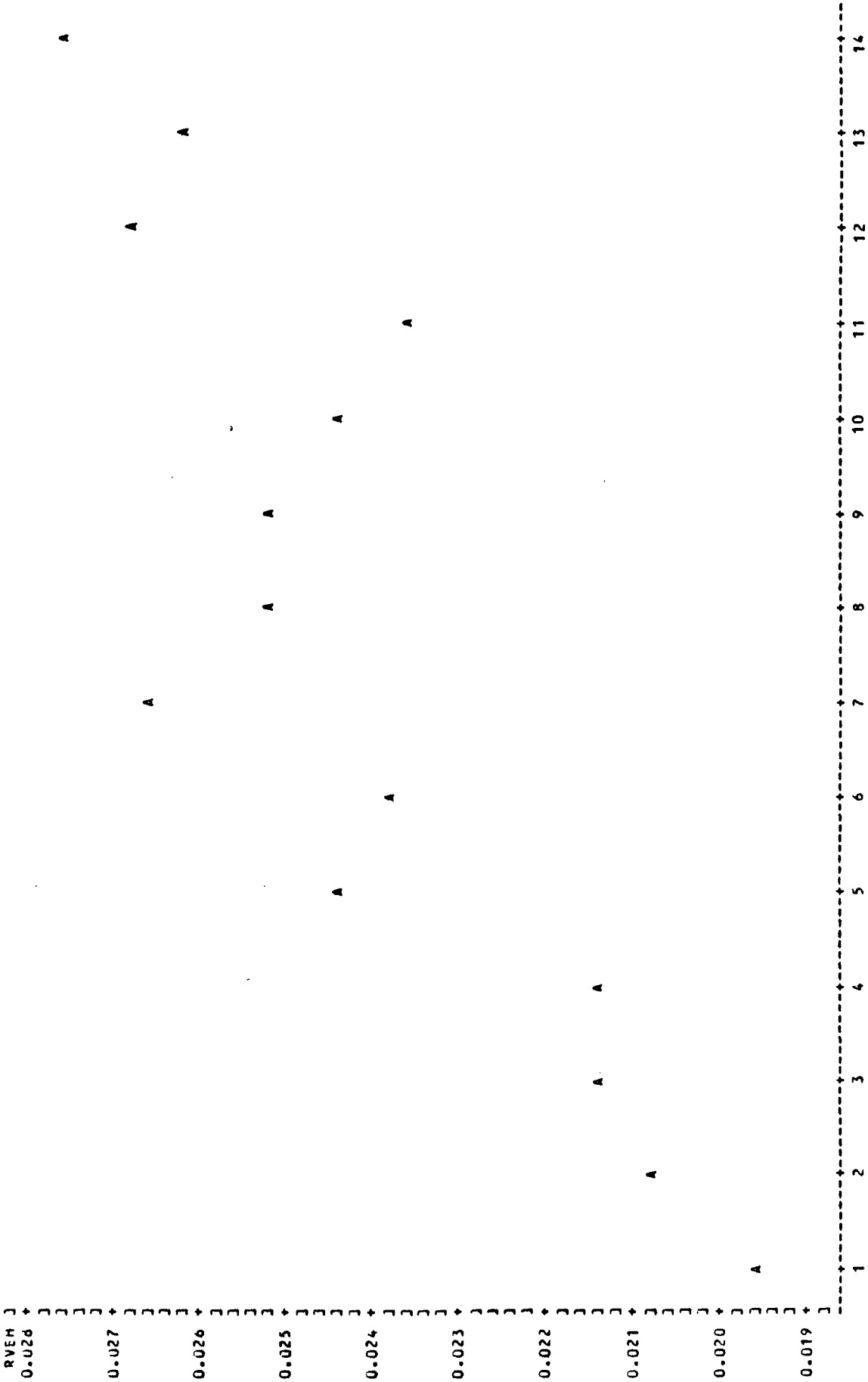

Figure 3-1
FARS, Passenger Cars
(1975=1, 1976=2, etc.)

SAS

PLOT OF RVEH*CY LEGEND: A = 1 OBS, B = 2 OBS, ETC.

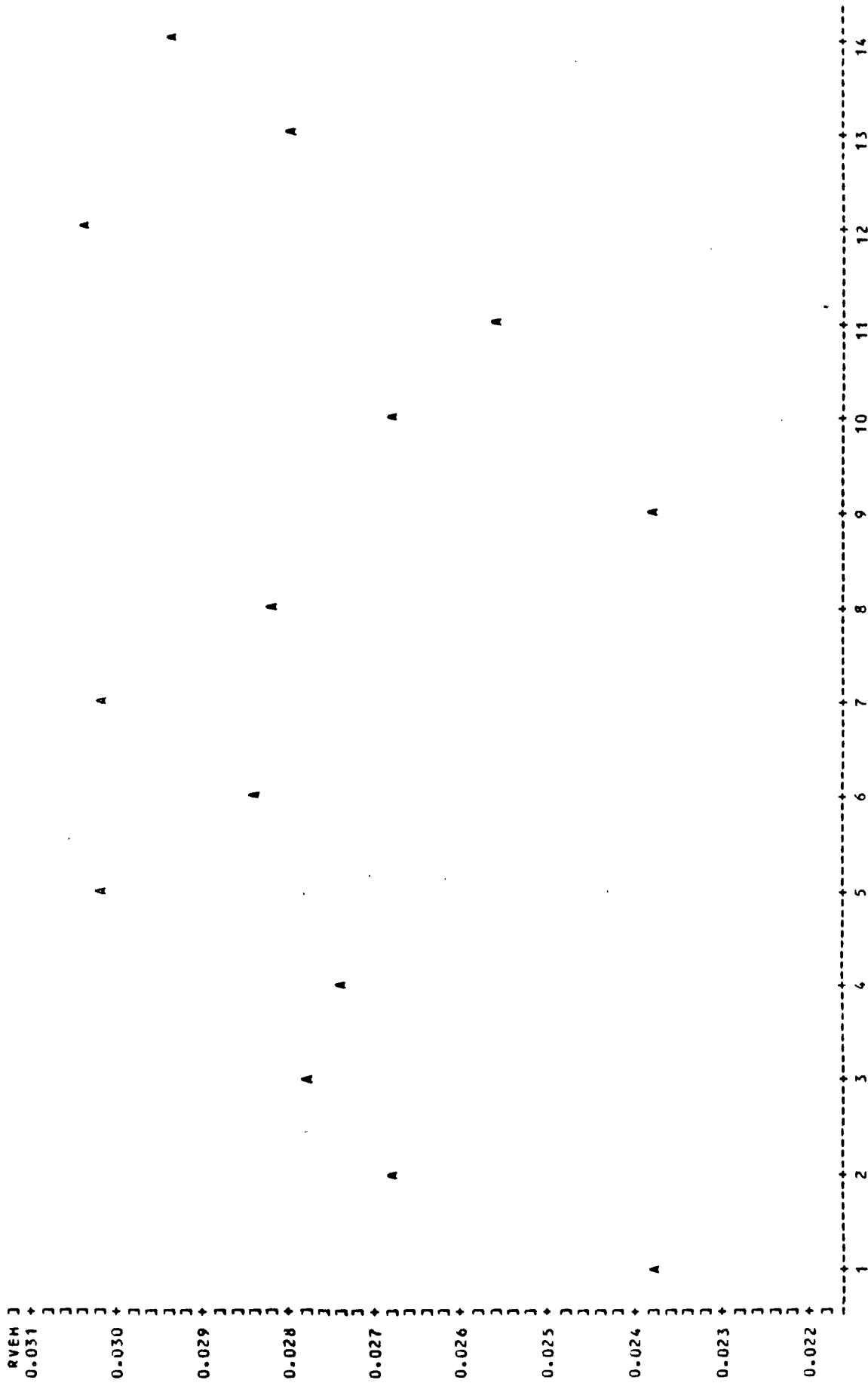

Figure 3-2
FARS, Light Trucks
(1975=1, 1976=2, etc.)

SAS

PLOT OF RVEH*CY LEGEND: A = 1 OBS, B = 2 OBS, ETC.

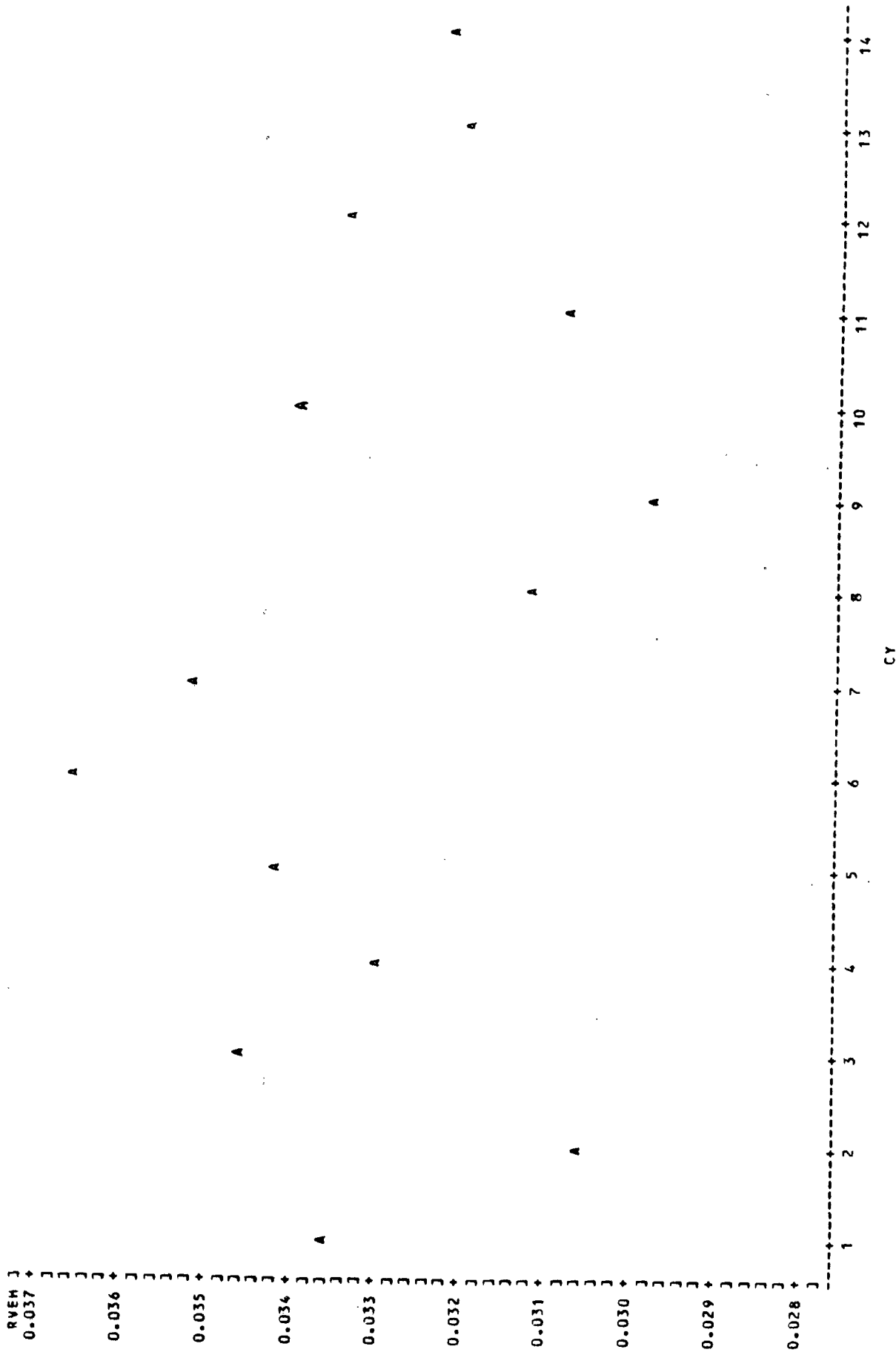

Figure 3-3
FARS, Other Vehicles
(1975=1, 1976=2, etc.)

($t = 0.95$; $t = -0.90$).¹ The calendar year trend for passenger cars was quite strong accounting for nearly 3/4 of the variation in fire rate ($R^2 = .74$). The fits were very poor for the light truck and other vehicle models, both having R^2 values of only .07.

Given the increasing trend in fire rates for passenger cars, an ensuing question is: "What could be contributing to the increase?"

Several factors could be involved. Age of the vehicle is a logical candidate -- it was almost universally found to be a significant factor in the effectiveness analyses, and over the last several years, the average age of the passenger car population has increased. Vehicle size is a second possibility. Over the period from the late seventies into the mid-to-late eighties, -- the period generally encompassed by the FARS data -- the U.S. new car population underwent significant downsizing, the vehicle becoming both smaller and significantly lighter.² Smaller vehicles could be less crashworthy and hence more likely to experience fuel system breaching in a crash, leading to greater fire risk.

¹ Probability of greater t for passenger cars (calendar year) coefficient = .0001. Probability of greater t for light trucks (calendar year) coefficient = .3623. Probability of greater t for other vehicles (calendar year) coefficient = .3878.

² Actually, most of the size reduction, as measured by vehicle curb weight, was confined to the domestically manufactured portion of the passenger car fleet. The average curb weight of the imported passenger car fleet actually increased over the period.

Other vehicle technology changes which took place over the study period, and which may have altered the risks of fuel leakage (and hence fire) include such factors as the switch from carburetor fuel systems to fuel injection systems and the addition of air pollution emission controls. Carburetors, which a decade or so ago were used almost exclusively to meter fuel to the vehicle's engine, have now been almost universally replaced with fuel injection systems. Fuel injection systems are substantially more complex than carburetted systems, requiring more fuel lines and connections and they also operate under higher fuel pressures. While changes in system design and in materials utilization can serve to reduce the risk of failure or malfunction, in general, the greater the number of components and connection points in a system the greater the chances of a failure occurring. Given a crash-induced breach in the fuel system, higher line pressures could also result in the discharge of more fuel and over a greater area or space. The fuel return line feature on fuel injected systems also results in increasing the temperature of the fuel in the lines and in the tank.

Emission controls could also affect the chances of fuel-fed fires. Underhood cannisters to capture gasoline vapors were installed on passenger cars in the early seventies. These cannisters are connected to the vehicle's fuel tank and to the fuel intake area of the engine via vapor lines and valving. The escape of vapors from a break in this system could increase the opportunity for fire. In the mid-seventies catalytic converters were also added to the vehicle's exhaust system to control exhaust emissions. These converters operate at very high temperatures and therefore may increase the risk of fire.

Higher travel speeds over the last several years could also be a contributing factor to more vehicle fires; higher speeds lead to more severe crash forces. Increases in fuel volatility could be involved. The average volatility of gasoline has steadily trended upward over the last 30 years. Evaporation of fuel (vapors) increases with higher volatility levels, thereby increasing the risk of escape of vapors.³ Still another possibility is the maturity of the FARS data. Increasing quality and completeness of the data, from the beginning years of the data system, could have increased the degree of reporting of certain data elements. The more rare, or unusual elements, such as vehicle fires, could have been more likely to be affected by better quality control and reporting procedures.

As one attempt at testing the reporting system maturity possibility, the calendar year model was rerun, dropping the initial two FARS years, 1975 and 1976. The calendar year effect still remained significant.⁴ Moreover, since fire rates for the other two classes of vehicles (light trucks, other vehicles) did not increase over the same 13-year period, the possibility that reporting system maturity has contributed to the increase in passenger car fires can be further discounted.

³ Federal Register, Vol. 52, No. 160, August 19, 1987. Environmental Protection Agency, 40 CFR Parts 80, 86, and 600. Regulation of Fuels and Fuel Additives: Volatility Regulations for Gasoline and Alcohol Blends Sold in 1989 and Later Calendar Years and Control of Air Pollution from New Motor Vehicles and New Motor Vehicle Engines: Evaporative Emissions Regulations for 1990 and Later Model Year Gasoline - Fueled Light-Duty Vehicles, Light-Duty Trucks, and Heavy-Duty Vehicles.

⁴ $t = 3.85$, probability of greater $t = .0032$.

Age is perhaps the strongest possibility, owing to its previously demonstrated significant and consistent effect in the effectiveness analyses. Also, car size is considered a reasonable possibility and since an automated file of passenger car weights by vehicle, make, model, and model year was readily available, a third analysis was conducted to investigate the effect of age and vehicle weight.⁵

A two variable model with fire rate as a function of vehicle age and weight was fitted to the FARS data. The individual observations were fire rates (R) by each calendar year by model year combination (age = calendar year - model year) and vehicle weight (wgt. = average curb weight for each calendar year by model year cell). The data were weighted to compensate for the variation in number of vehicles per cell.

The resulting model found age significant, but vehicle weight not significant. Figures 3-4 and 3-5 show the fire rate as a function of age and vehicle weight, respectively. The resulting equation was:

$$R = .02163 + .0005894 (\text{age}) - .0000002 (\text{wgt.})$$

Age was highly significant with a t-value of 7.25.⁶ Vehicle weight was far from being significant at a t-value of -0.16 and, in fact, the estimate for

⁵ Vehicle weights were the curb weights. In pounds, by individual make, model, and model year, as taken from the Automotive News Annual publications for the respective model years, 1968 through 1987.

⁶ Probability of greater t = .0001

PLOT OF R*AGE LEGEND: A = 1 OBS, B = 2 OBS, ETC.

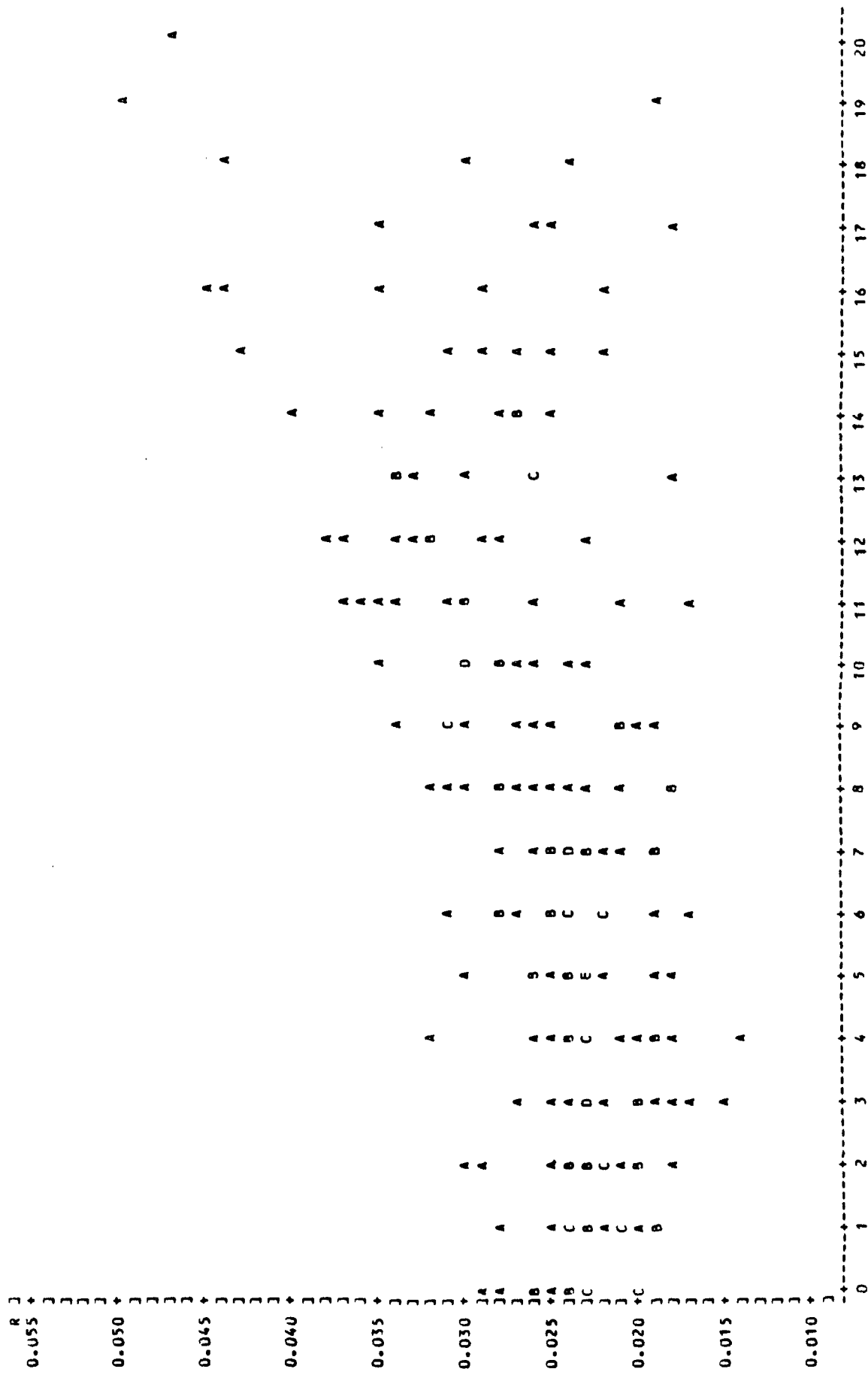

AGE
Figure 3-4
FARS, Passenger Cars

PLOT OF R*ALLWGT LEGEND: A = 1 OBS, B = 2 OBS, ETC.

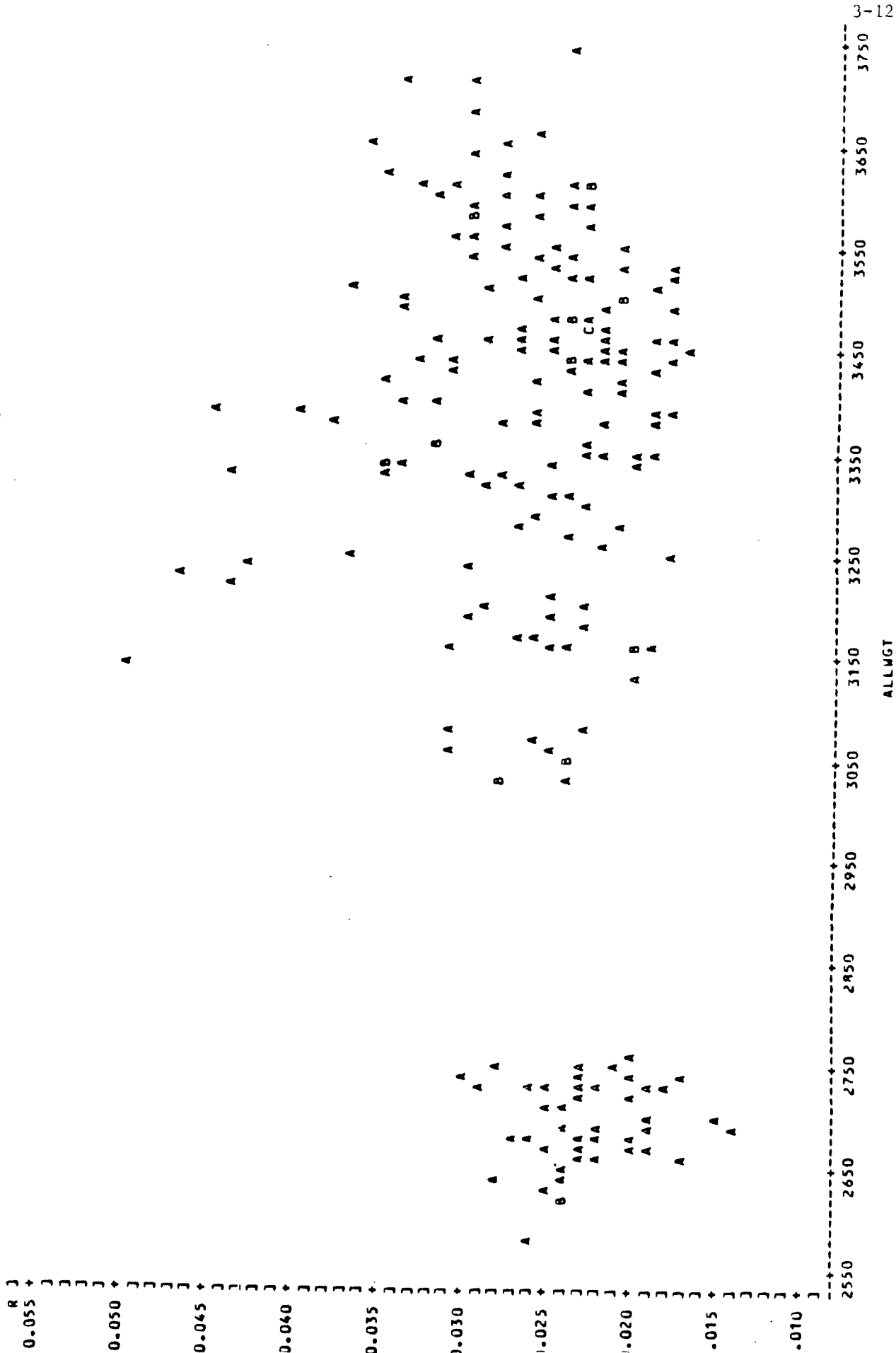

ALLWGT

Figure 3-5
FARS, Passenger Cars

the weight effect was extremely close to zero.⁷ Of course, the statistical conclusion from this analysis is that the effect of vehicle weight on fire rate is, indeed zero. R^2 for the model was .25.

Data to permit analyses of the effects of other potential factors (switch to fuel injection, emissions controls, higher travel speeds, increased fuel volatility) are not available. Therefore, the summary finding of these analyses is that a primary reason for the increase in fire rate for passenger cars, over the last several years, is age. An indication of the increasing age of the passenger car fleet can be seen in Table 3-2 which shows, by calendar year: (1) the percentage of all passenger cars in fatal accidents that were 10 years old, or older, at the time of the accident, and (2) the percentage of all fire-involved passenger cars in fatal accidents that were 10 years, or older for the same years. The trend of an increasingly older car population is clearly evident.

The percentage of older cars in fatal accidents (column 2) closely follows the percentage of older cars in the total population (i.e., total registered vehicles).⁸ Another item of note from Table 3-2 is the over-involvement of older cars in fire crashes. This trend is noted to have begun in about 1980

⁷ Probability of greater $t = .8694$.

⁸ Data on total vehicle population from "MVMA Motor Vehicle Facts and Figures" -- '89 and '85 editions.

Table 3-2

Percentage of Total Passenger Cars in Fatal Crashes, and Fire-Involved
Passenger Cars in Fatal Crashes That were Ten Years Old
or Older at the Time of the Crash

| <u>Calendar Year</u> | <u>Percent of Cars \geq 10 Years Old</u> | |
|--------------------------|---|------------------------------------|
| | <u>All Fatal Crashes</u> | <u>Fire-Involved Fatal Crashes</u> |
| 1975 | 15.5% | 13.4% |
| 1976 | 18.1% | 16.3% |
| 1977 | 18.4% | 16.8% |
| 1978 | 19.2% | 16.7% |
| 1979 | 20.2% | 19.1% |
| 1980 | 21.4% | 21.5% |
| 1981 | 22.1% | 24.7% |
| 1982 | 24.7% | 29.4% |
| 1983 | 27.5% | 30.5% |
| 1984 | 28.7% | 32.6% |
| 1985 | 26.5% | 35.2% |
| 1986 | 28.8% | 33.9% |
| 1987 | 29.0% | 33.5% |
| 1988 | 29.8% | 35.9% |

Source: Fatal Accident Reporting System, NHTSA

with the latter 3 to 4 years evidencing a leveling-off of the trend. The trend appears to coincide with the general increase in the mean age of the passenger car population which began in the late seventies (following the oil crisis), and has leveled off in the last 3-4 years.⁹

3.1.2 COMPARISONS OF FIRE FATAL CRASHES AND ALL FATAL CRASHES

In this section, selected statistics are presented which compare fatal crashes accompanied by fire with all fatal crashes.

Occupant Fatality Risk in Fire Crashes

The first comparison involves the risk of fatality in fire crashes versus the risk of fatality in all crashes. Comparisons are made for passenger cars and for light trucks. The key data are the occupant fatality rates for vehicles with fire and the occupant fatality rates for all vehicles. The data are summarized in Tables 3-3 and 3-4.

The primary observation from the tables is the considerably higher fatality rate for crashes accompanied by fire. Passenger car fatal crashes, with fire, average 66 percent more occupant fatalities than fatal car crashes without fire. For light trucks, the difference is even more pronounced, with fire crashes having 82 percent more occupant fatalities. The differences here are exaggerated somewhat since the all crash category includes pedestrian crashes

⁹ Data on mean age of passenger cars from "MVMA Motor Vehicle Facts," Op. Cit.

Table 3-3

Passenger Cars: Occupant Fatality Rates for Fatal Crashes
with Fire and All Fatal Crashes

| <u>Calendar Year</u> | <u>All Crashes</u> | | | <u>Fire Crashes</u> | | |
|--------------------------|-------------------------|------------------------------------|---------------------------|-------------------------|------------------------------------|---------------------------|
| | <u>No. Vehicles</u> | <u>No. Occupant Fatalities</u> | <u>Fatality Rates</u> | <u>No. Vehicles</u> | <u>No. Occupant Fatalities</u> | <u>Fatality Rates</u> |
| 1985 | 34,277 | 23,212 | 0.68 | 809 | 901 | 1.11 |
| 1984 | 34,648 | 23,620 | 0.68 | 847 | 971 | 1.15 |
| 1983 | 33,298 | 22,979 | 0.69 | 836 | 959 | 1.15 |
| 1982 | 34,334 | 23,330 | 0.68 | 863 | 994 | 1.15 |
| 1981 | 38,864 | 26,645 | 0.69 | 1,031 | 1,138 | 1.10 |
| 1980 | 39,059 | 27,449 | 0.70 | 931 | 1,073 | 1.15 |
| 1979 | 39,999 | 27,808 | 0.70 | 978 | 1,155 | 1.18 |
| 1978 | 40,544 | 28,153 | 0.69 | 867 | 1,033 | 1.19 |
| 1977 | 39,038 | 26,782 | 0.69 | 832 | 949 | 1.21 |
| 1976 | 37,206 | 26,166 | 0.70 | 771 | 937 | 1.22 |
| 1975 | 37,897 | 25,929 | 0.68 | 744 | 838 | 1.13 |
| AVG | 37,197 | 25,643 | 0.69 | 864 | 995 | 1.15 |

Source: Fatal Accident Reporting System (FARS), NHTSA

Table 3-4

Light Trucks: Occupant Fatality Rates for Fatal Crashes
with Fire and All Fatal Crashes

| <u>Calendar Year</u> | <u>All Crashes</u> | | | <u>Fire Crashes</u> | | |
|--------------------------|-------------------------|------------------------------------|---------------------------|-------------------------|------------------------------------|---------------------------|
| | <u>No. Vehicles</u> | <u>No. Occupant Fatalities</u> | <u>Fatality Rates</u> | <u>No. Vehicles</u> | <u>No. Occupant Fatalities</u> | <u>Fatality Rates</u> |
| 1985 | 12,464 | 6,689 | 0.54 | 318 | 315 | 0.99 |
| 1984 | 11,973 | 6,496 | 0.54 | 321 | 316 | 0.98 |
| 1983 | 11,118 | 6,202 | 0.56 | 265 | 266 | 1.00 |
| 1982 | 11,317 | 6,359 | 0.56 | 320 | 320 | 1.01 |
| 1981 | 12,331 | 7,081 | 0.57 | 373 | 374 | 1.00 |
| 1980 | 12,680 | 7,486 | 0.59 | 360 | 382 | 1.06 |
| 1979 | 12,544 | 7,178 | 0.57 | 379 | 418 | 1.10 |
| 1978 | 11,898 | 6,745 | 0.57 | 327 | 339 | 1.04 |
| 1977 | 10,400 | 5,976 | 0.57 | 290 | 320 | 1.10 |
| 1976 | 9,300 | 5,438 | 0.58 | 250 | 273 | 1.09 |
| 1975 | 8,636 | 4,856 | 0.56 | 206 | 224 | 1.07 |
| AVG | 11,333 | 6,410 | 0.57 | 310 | 322 | 1.04 |

Source: Fatal Accident Reporting System (FARS), NHTSA

which typically do not result in vehicle occupant fatalities. Adjustment for this factor reduces the above differences to 45 percent and 62 percent for cars and light trucks, respectively - still markedly higher fatality rates for fatal crashes with fire. These data are evidence that the presence of fire increases the lethality of even fatal crashes. However, other factors may also be at play, as will be seen in some of the other statistics presented in this chapter.

A secondary observation from Tables 3-3 and 3-4 is that the occupant fatality rates, for both fire and all crashes have remained quite consistent over the years, within the two vehicles classes.

Fatal Fire Crashes by First Harmful Event

The next comparison, in Table 3-5, shows fire crashes and all crashes by the "first harmful event" of the accident.

The distributions by first harmful event are reasonably similar for passenger cars and light trucks. With respect to fire crashes compared to all crashes, the biggest differences are that fire crashes rarely involve collisions with pedestrians, but are much more likely to be single vehicle collisions (i.e., with fixed objects, or with trees). Collectively, these data indicate that vehicles in fatal collisions with fire are more likely to experience greater collision forces than vehicles in non-fire fatal collisions. Greater impact forces would be expected to have greater potential for occupant injury, as well as greater potential for vehicle fire.

Table 3-5

Distribution of Fatal Fire Crashes and All Fatal Crashes
by First Harmful Event

| First Harmful Event | Passenger Cars | | Light Trucks | |
|------------------------|----------------|-------------|--------------|-------------|
| | Fire Crashes | All Crashes | Fire Crashes | All Crashes |
| Non-collision: | | | | |
| Overturn | 4.6% | 5.6% | 8.7% | 10.6% |
| Collision with: | | | | |
| Pedestrian | 0.8% | 12.9% | 0.6% | 11.9% |
| Rail Train | 0.6% | 1.0% | 2.1% | 1.2% |
| Parked Motor Vehicle | 1.1% | 1.4% | 2.0% | 1.3% |
| Vehicle in Transport | 49.7% | 52.8% | 50.1% | 52.2% |
| Fixed Object | 29.7% | 18.2% | 25.8% | 14.7% |
| Pedalcycle | 0.06% | 1.6% | 0.0% | 2.0% |
| Tree | 11.1% | 5.7% | 9.4% | 3.9% |
| Other | 1.1% | 0.8% | 1.3% | 2.4% |

Data are percent of involved vehicles in each event category.

Source: Fatal Accident Reporting System (FARS), NHTSA.
Distributions based on average of six calendar years
(1975, 1977, 1979, 1981, 1983, 1985).

Fatal Fire Crashes by Speed Limit

A third comparison of fire fatal crashes and all fatal crashes involves the speed limit of the roads on which the crashes occurred. While speed limit obviously does not indicate the actual traveling speed, or impact speed of the involved vehicles, it nonetheless should have a positive correlation with these and thus with the impact forces sustained by the vehicles.

Table 3-6 shows the speed limits, for both passenger cars and light trucks, for fatal crashes involving fire and for all fatal crashes.

For both vehicle types, the likelihood for fire crashes to involve higher speeds and, by inference, higher impact forces, is clearly seen. Passenger car fatal crashes with fire are 31 percent more likely to involve higher speeds (i.e., happen at speed limits of 50-55 m.p.h.) than all passenger car fatal crashes. For light trucks, fire fatal crashes are 28 percent more likely to occur at higher speeds than all fatal crashes.

Again, the presence of pedestrian accidents in the data (which primarily occur at lower speeds, and rarely involve a vehicle fire) will inflate the above comparisons, but the data are still sufficient to show that fire fatal crashes more often involve higher speeds than all fatal crashes.

Table 3-6

Distribution (percent) of Fatal Fire Crashes and
All Fatal Crashes by Roadway Speed Limit

| <u>Speed Limit (mph)</u> | <u>Passenger Cars</u> | | <u>Light Trucks</u> | |
|------------------------------|-----------------------|--------------------|---------------------|--------------------|
| | <u>Fire Crashes</u> | <u>All Crashes</u> | <u>Fire Crashes</u> | <u>All Crashes</u> |
| 5 - 25 | 2.80% | 5.28% | 1.90% | 4.92% |
| 30 - 45 | 23.00% | 33.57% | 16.58% | 32.19% |
| 50 - 55 | 65.93% | 50.33% | 74.16% | 58.10% |
| UNK | 8.27% | 10.82% | 7.36% | 4.79% |

Data are percent of involved vehicles in each speed limit.

Source: Fatal Accident Reporting System (FARS), NHTSA.
Distributions based on average of six calendar years
(1975, 1977, 1979, 1981, 1983, 1985).

Fatal Fire Crashes by Impact Direction

The last comparison to be made in this section on fatal crashes concerns the direction of impact to the vehicle.

From the data in Table 3-7, one of the principal observations is the over-involvement of passenger car fires in fatal rear end collisions. Among collisions with fire, the probability that the vehicle sustained an impact from the rear is over three times as likely as for all fatal passenger car involvements. This over-involvement rate for rear impacts does not appear for light trucks. This may be a reflection of the different location for fuel tanks in cars as compared with the location of tanks for many light trucks. In cars, the tank is typically located near the rear of the vehicle whereas for many light trucks, the tank is situated near the center of the vehicle.

Another item of note in Table 3-7 is that frontal impacts account for the large majority of fires, for either type of vehicle, with frontal plus rear impacts accounting for almost 3/4 of the fire crashes.

3.2 FIRES IN ALL REPORTED CRASHES

This section presents data on fire in all police reported motor vehicle crashes based on the accident files of the States used for the effectiveness analyses in Chapter 2.

Table 3-7

Distribution (percent) of Fatal Fire Crashes and
All Fatal Crashes by Impact Direction

| <u>Impact Direction</u> | <u>Passenger Cars</u> | | <u>Light Trucks</u> | |
|-----------------------------|-----------------------|--------------------|---------------------|--------------------|
| | <u>Fire Crashes</u> | <u>All Crashes</u> | <u>Fire Crashes</u> | <u>All Crashes</u> |
| Front | 59.3% | 65.0% | 65.8% | 66.3% |
| Right Side | 9.0% | 11.0% | 8.4% | 7.3% |
| Rear | 14.6% | 4.5% | 3.8% | 4.9% |
| Left Side | 7.6% | 10.7% | 7.3% | 7.2% |
| Non- Collision | 5.3% | 5.4% | 8.5% | 10.9% |
| UNK | 4.2% | 3.4% | 6.2% | 3.4% |

Data are percent of involved vehicles in each impact direction.

Impact direction is the initial impact point. Front-side-rear directions are defined by the "o'clock" direction data contained in the data files as follows:

front = 11-12-1
right side = 2-3-4
rear = 5-6-7
left side = 8-9-10
non-collision = non-collision

Source: Fatal Accident Reporting System (FARS), NHTSA.
Distributions based on average of six calendar years
(1975, 1977, 1979, 1981, 1983, 1985).

Table 3 - 8

Fire Rates in All Police Reported Crashes
by Vehicle Class and State
1982 through 1987

| | <u>S T A T E</u> | | | | |
|------------------------|------------------|-----------------|-----------------|-----------------|----------------|
| | <u>Ohio</u> | <u>Michigan</u> | <u>Maryland</u> | <u>Illinois</u> | <u>Indiana</u> |
| Passenger Cars: | | | | | |
| Total Vehicles | 2,932,274 | 2,657,781 | 1,017,579 | 4,210,341 | 1,711,575 |
| Total Fires | 10,540 | 5,554 | 2,796 | 3,713 | 1,620 |
| Fire Rate* | 3.594 | 2.090 | 2.748 | 0.882 | 0.947 |
| Light Trucks: | | | | | |
| Total Vehicles | 463,842 | 491,372 | 162,581 | 545,882 | 319,832 |
| Total Fires | 1,728 | 995 | 553 | 598 | 323 |
| Fire Rate* | 3.725 | 2.025 | 3.401 | 1.095 | 1.010 |
| School Buses: | | | | | |
| Total Vehicles | 11,143 | 9,084 | 5,755 | 15,882 | 5,824 |
| Total Fires | 39 | 15 | 8 | 16 | 4 |
| Fire Rate* | 3.500 | 1.651 | 1.390 | 1.007 | 0.687 |

* Fire rates given in terms of fires per 1,000 involved vehicles.

Source: Accident data files from above States for calendar years
1982 through 1987. Above data are totals for the 6 years.

3.2.1 Fire Rates and Total Fires in Motor Vehicle Crashes

Table 3-8 lists the overall fire rates for passenger cars, light trucks, and school buses, based on the 5 State data bases. The data represent totals, over the six years (1982 through 1987) for each State. The difference in rates among States was pointed out earlier in the effectiveness analyses. The States of Ohio, Michigan, and Maryland were considered the preferable sources, so these three States will be used here as the basis for developing national estimates of fires in all reported vehicle crashes. Combining the rates, from Table 3-8, for these three States produces the following estimates of fire rates for the three vehicle classes:

| | |
|-----------------|--------------------------------------|
| passenger cars: | 2.86 fires per 1,000 vehicle crashes |
| light trucks: | 2.93 fires per 1,000 vehicle crashes |
| school buses: | 2.39 fires per 1,000 vehicle crashes |

The fire rate for passenger cars and light trucks is about the same at 2.9 fires per 1,000 accident involved vehicles, while the rate for school buses is somewhat lower at 2.4 fires per 1,000 involved vehicles.¹⁰

¹⁰ Although not shown in Table 3-8, the estimated fire rate for all vehicle types (cars, light trucks, heavy trucks, motorcycles, motor homes, etc.) in police reported data is 2.97 fires per 1,000 vehicles involved in accidents. This estimate is based on the data from Michigan and Ohio for the years 1982, 1984, and 1987, and for Maryland for the years 1981, 1984, and 1987.

In order to project these rates to the National level, estimates of annual totals of vehicles in accidents are required, for each of the three vehicle classes. These estimates are: 8,239,000 passenger cars, 1,758,000 light trucks, and 25,500 school buses.¹¹

Applying the above fire rates to the total number of vehicles in accidents gives the following estimates of the total number of accident fires annually:

passenger cars:

$$\frac{2.86 \text{ fires}}{1,000 \text{ vehicles}} (8,239,000 \text{ vehicles}) = 23,564 \text{ fires}$$

light trucks:

$$\frac{2.93 \text{ fires}}{1,000 \text{ vehicles}} (1,758,000 \text{ vehicles}) = 5,151 \text{ fires}$$

school buses:

$$\frac{2.39 \text{ fires}}{1,000 \text{ vehicles}} (25,500 \text{ vehicles}) = 61 \text{ fires}$$

As was pointed out earlier in this report, these estimates of total fires include pre-crash as well as post-crash fires. While reliable separation of pre and post-crash fires is not possible, available information indicates that

¹¹ Annual totals of police reported passenger cars and light trucks in accidents from National Accident Sampling System (NASS), Annual Report, 1986 (A report on traffic crashes and injuries in the United States); NHTSA. Total school buses in accidents are NHTSA estimates based on prior unpublished analyses of school bus accident data.

pre-crash fires could account for as much as 1/2 of the total reported fires. Also, these data indicate that the proportion of total fires that are post-crash increases as the severity of the accident (as denoted by either vehicle damage or occupant injury) increases (see Table 3-10a).

Given that fires are estimated to occur at the rate of about 3 fires for every 1,000 crashes (for crashes involving either a passenger car or a light truck), it would be of interest to see how the rate changes if the crashes are restricted to those involving injury. Table 3-8a provides this information. The data are based on the overall average for the States of Michigan, Ohio, and Maryland, and for the three calendar years 1982, 1984, and 1987. The rates shown are the number of fires per 1,000 vehicle crashes, passenger car or light truck, where the vehicle driver sustains injury at either the A (serious) or the B (moderate) severity level. As would be expected, the fire rate, ranging from 7 to 8 fires per 1,000 crashes, is higher than the rate of 3 fires per 1,000 crashes for all reported crashes (i.e., those involving both injury and non-injury). Also the fire rate is seen to increase as injury severity increases. Again, this is what would be expected. A complete picture of how fires increase as injury severity increases can be gotten by recalling that earlier in this Chapter the fire rate for fatal crashes involving passenger cars or light trucks ranged from 26 to 28 fires per 1,000 crashes, several times the rate of fires in injury crashes.

Table 3-8a

Number of Fires per 1,000 Injury* Crashes

| <u>Injury Severity</u> | <u>Passenger Cars</u> | <u>Light Trucks</u> |
|------------------------|-----------------------|---------------------|
| A | 10.6 | 12.4 |
| B | 5.4 | 6.2 |
| A or B | 6.8 | 7.8 |

 *

Injury is to vehicle driver. Injury severity is typical police code A (serious) and B (moderate).

3.2.2 Severity of Fire Crashes in All Reported Crashes

Next, fire crashes will be compared with all crashes on the basis of two severity indices - the severity of occupant injury and the severity, or extent, of damage sustained by the vehicle. Data are presented only for passenger cars and light trucks, as the data on school bus fires are too sparse for developing reliable distributions.

Fire Crashes by Injury Severity

Table 3-9 compares the distribution of driver injury for fire crashes with the distribution of driver injury for all crashes. For both classes of vehicles, the much higher severity of injury for fire crashes is clearly evident, particularly for more serious injuries. The data are based on the

Table 3-9

Percent Distribution of Injury Severity*
for Fire Crashes and for All Reported Crashes

| <u>Injury Severity</u> | <u>Passenger Cars</u> | | <u>Light Trucks</u> | |
|------------------------|-----------------------|--------------------|---------------------|--------------------|
| | <u>Fire Crashes</u> | <u>All Crashes</u> | <u>Fire Crashes</u> | <u>All Crashes</u> |
| K | 2.64 | 0.15 | 2.94 | 0.14 |
| A | 8.18 | 2.24 | 7.60 | 1.86 |
| B | 12.20 | 6.59 | 10.79 | 5.32 |
| C | 7.79 | 11.62 | 6.83 | 8.10 |
| O | 69.19 | 79.40 | 71.84 | 84.63 |

* Injury is to vehicle driver. Injury severity codes are typical police reported codes.

| | |
|---|-----------------|
| K | fatality |
| A | serious |
| B | moderate injury |
| C | minor injury |
| O | no injury |

Table 3-10

Estimated Annual Injuries in Fire Crashes for
Passenger Cars and Light Trucks

| <u>Injury Severity</u> | <u>Passenger Cars</u> | <u>Light Trucks</u> |
|------------------------|-----------------------|---------------------|
| A | 2,892 | 587 |
| B | 4,313 | 834 |
| C | 2,754 | 528 |

overall average of the three States (Michigan, Ohio, and Maryland) for the years 1982, 1984, and 1987. Individual injury distributions by each calendar year were quite similar, so that the overall average of the three years should provide reliable estimates.

By combining the injury rates for fire crashes in Table 3-9 with total estimated fire crashes from Section 3.1.1, estimates of the total numbers of fire related occupant casualties can be obtained. These estimates appear in Table 3-10, for all injuries below fatalities. Actual counts of fatalities, based on FARS were given in Section 3.1, so these are not estimated from the State injury data. One other adjustment is included in the injury estimates in Table 3-10. Since the injury distribution (Table 3-9) is based on the vehicle driver, an adjustment is needed for injuries that occur to occupants of other seated positions in the vehicle. This estimate is 0.5 injuries to other vehicle occupants for each driver injury.¹²

The final table (Table 3-10a) in this section shows the proportion of total reported fires that are post-crash in nature (i.e., fires that result from the crash) as a function of the injury sustained by the vehicle driver. The data are from only one State, Ohio, and therefore the distributions are not necessarily considered as reliable estimates of the national situation. Also, it is likely a difficult task for investigating police officers to be able to

12

National Accident Sampling System, 1986. Op. Cit.

Table 3-10a
 Driver Injury Severity By Type of Fire
 Passenger Cars

| Type of <u>Fire</u> | <u>Injury Severity</u> | | | | | | <u>TOTAL</u> |
|-------------------------|------------------------|----------|----------|----------|----------|----------|--------------|
| | <u>UNK</u> | <u>K</u> | <u>A</u> | <u>B</u> | <u>C</u> | <u>O</u> | |
| Fire Due to Crash | 531 | 218 | 591 | 1,087 | 598 | 2,391 | 5,416 |
| Other Fires | 152 | 7 | 65 | 298 | 223 | 4,229 | 4,974 |
| TOTAL | 683 | 225 | 656 | 1,385 | 821 | 6,620 | 10,390 |
| Percent Due to Crash | 77.7% | 96.9% | 90.1% | 78.5% | 72.8% | 36.1% | 52.1% |

SOURCE: State of Ohio. Numbers are totals for 6 calendar years, 1982 through 1987.

distinguish between crash fires and fires due to other causes, based on available evidence and information from the crash. Even so, the increasing proportion of crash fires with increasing injury severity certainly accords with intuition. For example, it seems quite reasonable to expect that most all fires in vehicle crashes where an occupant is killed are fires that resulted from the crash, rather than from some other source (i.e., pre-crash fire).

Fires Crashes by Vehicle Damage Severity

Another indication of the severity of fire crashes, as compared to all crashes, can be gotten from comparing variables which denote the extent of damage to the involved vehicles. Vehicle damage indicators are available in each of the three State data bases -- Michigan, Ohio, and Maryland. These damage variables differ somewhat among the States, as to the number of damage levels coded, etc. For simplification, the levels have been condensed to two -- one for lower damage, and one for more severe damage. Table 3-11 summarizes these data for passenger cars and clearly shows the more severe levels associated with fire crashes. As with the data on injury severity, the table is based on the overall average of calendar years 1982, 1984, and 1987.

Table 3-11

Percent Distribution of Fire Crashes and All Crashes
by Vehicle Damage Severity - Passenger Cars

| State: | <u>Michigan</u> | | <u>Ohio</u> | | <u>Maryland</u> | |
|-----------------|----------------------------------|--------------|-------------------------------------|--------------|------------------------------------|--------------|
| Vehicle Damage: | <u>Low to</u> <u>Moderate</u> | <u>Major</u> | <u>Slight to</u> <u>Moderate</u> | <u>Major</u> | <u>Minor to</u> <u>Moderate</u> | <u>Major</u> |
| Fire Crashes: | 54.1% | 45.9% | 34.0% | 66.0% | 8.0% | 92.0% |
| All Crashes: | 90.6% | 9.4% | 79.8% | 20.2% | 65.4% | 34.6% |

Table 3-12 shows the same distributions light trucks. Again, the higher vehicle damage for fire crashes is evident. Generally, the vehicle damage codes are to indicate damage due to impact forces and not due to the presence of fire.

Table 3-12

Percent Distribution of Fire Crashes and All Crashes
by Vehicle Damage Severity - Light Trucks

| State: | <u>Michigan</u> | | <u>Ohio</u> | | <u>Maryland</u> | |
|-----------------|----------------------------------|--------------|-------------------------------------|--------------|------------------------------------|--------------|
| Vehicle Damage: | <u>Low to</u> <u>Moderate</u> | <u>Major</u> | <u>Slight to</u> <u>Moderate</u> | <u>Major</u> | <u>Minor to</u> <u>Moderate</u> | <u>Major</u> |
| Fire Crashes: | 58.2% | 41.8% | 38.7% | 62.3% | 6.3% | 93.7% |
| All Crashes: | 92.0% | 8.0% | 84.0% | 16.0% | 70.6% | 29.4% |

Fire in All Crashes by Direction of Impact

Tables 3-13 and 3-14 compare fire crashes and all crashes by the direction (or point of) impact to the vehicle. Separate tables are shown for the States of Michigan and Maryland, since the category definitions differ somewhat between the States, and since the distributions differ between the two States, especially for the category of "other/unknown," for fire crashes, which is unusually large for Maryland. The large proportion of other/unknown here may imply that vehicles with fire are more apt to experience complex crashes -- i.e., impacts from more than one direction -- or to have severe enough damage that a single impact direction can not be discerned. To facilitate comparisons of the data, the distributions for fire crashes have been recomputed, deleting the other/unknown category. The adjusted distributions are shown in parentheses.

Examination of the distributions leads to the following observations:

- o the distributions by impact are generally similar for cars and trucks.
- o the over-representation of fire in rear impact crashes for cars does not appear for all crashes as it did for fatal crashes. Rather for fire crashes, rear impacts are somewhat under-represented while frontal impacts are over-represented.
- o although small in number, rollovers or top impacts are over-represented in fire crashes.

- o frontal impacts account for the majority of fires, as was the case for fatal crashes.

3.3 FUEL LEAKAGE IN MOTOR VEHICLE CRASHES

Fuel leakage data were not analyzed in the effectiveness calculations for FMVSS 301 for the reasons stated earlier. However, since the prevention of fuel-fed fires is the purpose of the Standard, summary data on fuel leakage are included in this section from the one State which recorded these data in its accident files.

Table 3-15 summarizes the fuel leak rates for passenger cars and light trucks, as taken from the Michigan accident files for calendar years 1982 through 1987.

Overall, the incidence of fuel leakage is seen to average about 9.7 per 1,000 vehicles, for passenger cars, and about 11.7 per 1,000 vehicles for light trucks. Thus, based on these data, fuel leaks are estimated to occur 4 to 5 times as often as vehicle fires. A second observation is the very strong age (or model year) trend in the data. Although not statistically fitted, it is obvious the relationship is quite robust and likely even stronger than the age effects noted earlier for fire rates.

Table 3-13

Distribution (percent) of Fire Crashes and All Crashes
by Direction of Impact
State of Michigan

| <u>Impact Direction</u> | <u>Passenger Cars</u> | | <u>Light Trucks</u> | |
|-----------------------------|-------------------------|------------------------|-------------------------|------------------------|
| | <u>Fire Crashes</u> | <u>All Crashes</u> | <u>Fire Crashes</u> | <u>All Crashes</u> |
| None/ Rollover | 4.7% (6.6%) | 1.6% | 7.7% (9.5%) | 3.7% |
| Front | 50.1% (64.5%) | 58.9% | 49.8% (61.4%) | 56.2% |
| Right Side | 4.6% (6.3%) | 6.6% | 4.6% (5.7%) | 6.3% |
| Rear | 15.3% (17.9%) | 23.9% | 14.8% (18.2%) | 24.9% |
| Left Side | 3.8% (4.8%) | 7.0% | 4.2% (5.2%) | 6.5% |
| Other/ Unknown | 21.6% | 2.0% | 18.6% | 2.4% |

Data represent percent of vehicles involved by each impact direction.
Numbers in parentheses are based on deletion of other/unknown category.
Front = left front + center front + right front
Rear = left rear + center rear + right rear
Other/Unknown = other impact + "front & rear" + unknown

Source: Motor Vehicle Accident files from State of Michigan.
Distributions based on average for calendar years
1982, 1984, and 1987.

Table 3-14

Distribution (percent) of Fire Crashes and All Crashes
by Direction of Impact
State of Maryland

| <u>Point of Impact</u> | <u>Passenger Cars</u> | | <u>Light Trucks</u> | |
|------------------------|-----------------------|--------------------|---------------------|--------------------|
| | <u>Fire Crashes</u> | <u>All Crashes</u> | <u>Fire Crashes</u> | <u>All Crashes</u> |
| Top | 0.4% (1.2%) | 0.2% | 0.8% (2.2%) | 0.3% |
| Front | 24.9% (70.8%) | 58.0% | 27.2% (78.0%) | 56.9% |
| Right Side | 0.9% (2.7%) | 6.4% | 1.2% (3.3%) | 5.9% |
| Rear | 8.0% (22.6%) | 28.0% | 5.0% (14.3%) | 27.9% |
| Left Side | 0.9% (2.7%) | 4.9% | 0.8% (2.2%) | 5.3% |
| Other/ Unknown | 64.5% | 2.5% | 65.1% | 3.7% |

Data represent percent of vehicles involved by point of impact.
Numbers in paratheses are based on deletion of other/unknown category.
Front = left front + center front + right front
Rear = left rear + center rear + right rear
Other/Unknown = other + undercarriage + none/unknown

Source: Motor Vehicle Accident files from State of Maryland.
Distributions based on average for calendar years
1982, 1984, and 1987.

Table 3-15
 Fuel Leakage Rates for Cars and Light Trucks
 by Vehicle Model Year

| Model Year | Fuel Leak Rate | |
|---------------|----------------|--------------|
| | Passenger Car | Light Trucks |
| 1966 | 26.1 | 30.8 |
| 1967 | 23.9 | 28.5 |
| 1968 | 23.0 | 27.0 |
| 1969 | 24.4 | 35.3 |
| 1970 | 22.5 | 31.4 |
| 1971 | 20.3 | 25.8 |
| 1972 | 18.0 | 27.4 |
| 1973 | 16.5 | 20.4 |
| 1974 | 14.5 | 19.7 |
| 1975 | 12.4 | 19.8 |
| 1976 | 11.5 | 17.4 |
| 1977 | 9.3 | 14.3 |
| 1978 | 8.6 | 11.2 |
| 1979 | 7.4 | 10.4 |
| 1980 | 6.9 | 8.3 |
| 1981 | 6.0 | 8.1 |
| 1982 | 5.1 | 6.1 |
| 1983 | 5.0 | 6.4 |
| 1984 | 4.7 | 6.5 |
| 1985 | 5.0 | 5.2 |
| 1986 | 4.7 | 5.1 |
| 1987 | 5.1 | 6.2 |
| AVG | 9.7 | 11.7 |

* Rates are fuel leaks per 1,000 vehicles.
 Fuel leakage is sum of Michigan codes "01," "02," "03".

SOURCE: Michigan State files for 1982 through 1987.
 Total counts of fuel leakage: passenger cars-22,948; light trucks-5,565.

Chapter 4

THE BENEFITS AND COSTS OF FMVSS 301

Drawing upon the results of the effectiveness analyses discussed in Chapter 2 and selected statistical data from Chapter 3, this chapter develops estimates of the safety benefits of FMVSS 301. The costs of vehicle modifications resulting from FMVSS 301 are also developed, along with a detailed discussion of the various types of modifications made for each of the 3 vehicle classes studied in this report, passenger cars, light trucks, and school buses.

4.1 THE BENEFITS OF FMVSS 301

Of the three classes of vehicles studied in this report, statistically significant effectiveness, for FMVSS 301, was found only for passenger cars (Chapter 2). For light trucks, no significant difference - hence, no effectiveness - was found between the fire rates of vehicles manufactured before FMVSS 301, as compared to the fire rates for trucks produced subsequent to the Standard. Data were too sparse for school buses to permit reliable conclusions concerning the Standard's effectiveness. Preliminary indications, however, were that no difference existed between the fire rates Pre-standard and Post-standard buses. Therefore, estimates of safety benefits are applicable only for passenger cars.

4.1.1 BENEFITS FOR PASSENGER CARS

In Chapter 2, it was estimated that FMVSS 301 could be credited with a 14.2 percent reduction in passenger car fires in all police reported accidents. This estimate was based on analysis of the data from the three States of Michigan, Ohio, and Maryland, which were considered to have the most complete police reported accident data on vehicle fires. Also, the analyses of FARS data indicated that the Standard was not effective in reducing fires in fatal passenger car crashes.

Therefore, the task is to estimate the safety benefit of the 14.2 percent reduction in passenger car fires. Ideally, benefit estimates are in terms of numbers of crashes, and injuries avoided, if such detail can be developed from available data.

In Chapter 3, it was estimated that the total annual passenger car fires, as reported by investigating police officers in State accident files was approximately 23,600. Applying the reduction estimate, due to the Standard, of 14.2 percent yields:

$$\begin{aligned}
 \text{Reduction: } & \frac{23,600}{1 - .142} - 23,600 \\
 & = 23,600 \left(\frac{1}{1 - .142} - 1 \right) \\
 & = 23,600 (.1655) \\
 & = 3,906
 \end{aligned}$$

This is the estimated reduction in vehicle fires, annually, once the entire passenger car population conforms to FMVSS 301 modifications. Currently, it is estimated that about 85 percent of the fleet consists of Model Year 1976 and newer vehicles.

One benefit of this reduction could be said to be the dollar value of the property damage to passenger cars of the fires avoided, apart from the value of property damage caused by crash impact forces. Data do not exist with which to estimate this value.

The next step is to consider the reduction in occupant injury due to the 14.2 percent reduction in fires. Since no effectiveness was found for fatal passenger car crashes, no reduction in fire associated fatalities can be expected. The next most serious injuries are police-reported A and B. In Chapter 2, the analyses of fire rates in injury (A + B) crashes gave inconsistent results with respect to whether or not these rates decreased for cars produced after FMVSS 301 took effect. For the 2 States, Ohio and Michigan, which had sufficient data for analyses, one (Ohio) showed a statistically significant reduction, estimated at 14.1 percent, in the fire rate for post-standard vehicle crashes while the other State (Michigan) produced a non-significant result. Although not statistically significant, the estimated difference in fire rate between pre and post-standard vehicles in the Michigan data was in the positive (i.e., the right direction for a beneficial effect of the Standard) direction with post-standard vehicles showing an estimated 10 percent lower fire rate than pre-standard vehicles.

It could be argued that since both States showed lower fire rates in injury crashes for post-standard vehicles (14 percent lower for Ohio and 10 percent lower for Michigan) that there is reasonable evidence that the Standard has had a real effect, say in the 10 to 14 percent range. However, the 10 percent estimate from the State of Michigan was not really close to being significant ($\alpha = .20$) and regardless of the actual percent estimate, the proper statistical conclusion to be drawn, is that there was no effect -- i.e., the 10 percent difference in fire rate is not statistically significant from zero. Since: (1) only 2 States had sufficient injury data for analyses, and (2) these 2 States gave statistically inconsistent results, it is not possible to say whether or not FMVSS 301 has been effective in reducing fires in passenger car injury crashes. Although some evidence has been produced that fire rates in injury crashes may be lower for post-standard cars, the information is insufficient for definitive conclusions to be developed.

Therefore, no estimate of burn injuries prevented can be made. Even if the analyses had shown an overall, statistically significant reduction in fires in injury crashes, it would still not be possible to convert that reduction into an estimate of the number of burn injuries prevented. This is because available accident data do not provide sufficient information to separate the role of the fire vis-a-vis the role of crash forces in causing the injury. For example, of the estimated total injuries in fire crashes (i.e., 2,900 A injuries and 4,300 B injuries) developed in Chapter 3, it is not possible to say what proportions of these injuries are burn injuries as opposed to injuries resulting from crash forces. It is reasonable to assume that all of the injuries do not result from fire.

While not definitive, 3 sources do provide some insight into the role of fire as the injury-producing agent in motor vehicle crashes. The first source comes from a study done by Cooley in the State of Michigan.¹ Using data from various sources (police reports, policeman's confidential reports, certificates of death, pathologist's reports, etc.), Cooley made a study of 81 "fire fatalities" in Michigan which occurred over a 4-year period from 1968-1971. Acknowledging that subjectivity and uncertainties were involved, he estimated that 70 percent of the deaths were either a result of the fire, or were ensured by the fire. A second source of information deals with fire in injury crashes. In 1988, an NHTSA sponsored contract study using data from the agency's National Accident Sampling System estimated that less than 10 percent of the most serious injuries occurring in passenger car crashes accompanied by fire were burn injuries. This estimate was based on a very small sample and the study did not break out burns as a percent of each severity level (i.e., A,B).² The last source of information on burn injuries comes from accident data files from the State of Indiana. Under a variable called "Nature of Injury," Indiana files contain burn injuries along with several other types of injuries sustained by motor vehicle drivers in crashes. The injuries are the most severe injury sustained and include the following categories: severed, internal, minor burn, severe burn, abrasion,

1 "Fire in Motor Vehicle Accidents," MIT LAB Reports, Highway Safety Research Institute, University of Michigan, September 1974, Vol. 5, No. 1.

2 NHTSA Docket No. 73-20, "Study of Motor Vehicle Fires," February 1988.

minor bleeding, severe bleeding, fracture/dislocation, and contusion/bruise. Of all the injury types reported, burns (minor and severe) represented approximately eight tenths of one percent (.82 percent). These data are for all types of motor vehicle crashes, not just car crashes, and all reported crashes, not just those involving fires.³

Based on the above three sources of information, it appears that the bulk of the fire hazard for vehicle occupants involved in fire crashes is focused at the upper end of the severity spectrum -- i.e., the risk of serious injury or fatality. Since these crashes typically involve high levels of crash or impact severity, it is possible that these levels typically exceed the 20 to 30 mile per hour threshold set by FMVSS 301. Data developed in Chapter 3 indicate that most fatal crashes involving fire occur at speeds higher than these.

The estimates of benefits for passenger cars in this study are lower than those estimated in the 1983 NHTSA study of FMVSS 301. The primary difference is that in the earlier study, a substantial reduction in fatalities was estimated. As was discussed in Chapter 2, the reason for this difference in findings is due to the limited amount of accident data on fires available at the time the earlier study was conducted. Only three years of data from one

³ NHTSA, National Center for Statistics and Analysis, Univariate frequency tables of automated motor vehicle accident data from the State of Indiana, calendar years 1982, 1983, 1989.

State was available which was not sufficient to support a thorough analysis of the effect of vehicle age on fire rates. Also only a few years of FARS data existed at that time and these were not analyzed as the primary emphasis was placed on locating State data which recorded the presence of vehicle fire in their motor vehicle accident files.

This concludes the estimates of safety benefits for FMVSS 301 since no effectiveness in fire reduction was found for light trucks or school buses.

4.2 THE IMPLEMENTATION COSTS FOR FMVSS 301

In order to estimate costs for a particular motor vehicle safety standard, it is first necessary to know what vehicle modifications were introduced in response to the standard. In the past, NHTSA has often obtained information on costs and vehicle modifications attributable to its standards through contractor conducted vehicle "tear-down" studies. The methodology used in these studies has been to disassemble component parts of vehicles which were affected by a given safety standard, to describe the modifications made, and to derive the weight differentials of these parts for vehicles produced before and after the standard went into effect. Based on the types of changes made and the resultant increase in vehicle weight, cost estimates of the modifications were developed. From these individual cost estimates, overall fleet costs were projected, based on sales-weighted data for the various vehicle make model lines represented in the tear-down studies.

FMVSS 301, unlike many other standards whose effectiveness has been analyzed in prior agency studies, did not lend itself readily to cost estimation via tear-down studies. One reason for this is that vehicle modifications made in response to the Standard were not very weight sensitive. While some modifications did produce weight increases, many of the changes required no, or negligible weight increases. In certain, few instances, no modifications of any nature were made since the manufacturer had determined that the vehicle design which existed prior to the issuance of FMVSS 301 was sufficient to satisfy the requirements of the standard. Finally, in certain other instances, although rare, modifications for FMVSS 301 resulted in the deletion of a preexisting vehicle component. Such cases would typically produce weight and cost savings, rather than weight and cost increases.

A second reason why FMVSS 301 costs are not amenable to estimation by vehicle tear-down studies is that while the Standard specifically addresses the vehicle's fuel system, many of the resulting modifications involved vehicle components which were not a part of the fuel system. In such instances, a tear-down study approach, comparing fuel system components of Pre-301 vehicles with Post-301 vehicles, would fail to isolate component modifications (and any resultant weight and cost increases) since many changes did not involve the fuel system. Only by prior knowledge of "what to look for" would the tear-down approach produce valid results, and this prior knowledge did not exist, except within the vehicle manufacturing companies.

A final, additional factor which complicates the cost estimation of FMVSS 301 via the vehicle tear-down approach is that the specific types of modifications varied widely among the different vehicle manufacturers, the various

make-model lines within manufacturers, and among body styles (i.e., sedan, station wagon) within make-model lines. This wide variation of 301 modifications within the vehicle fleet not only means that the selection of a representative sample of vehicles for a tear-down study approach would be very difficult, but also cost-prohibitive due to the unusually large number of vehicles (sample size) that would be required to be disassembled.

For the above stated reasons, the primary basis for estimating the costs of FMVSS 301 has been to solicit information from the motor vehicle manufacturers. Specific questionnaires were sent to selected manufacturers requesting, by make-model line of vehicle:

- (1) The types of modifications made to vehicles in response to FMVSS 301,
- (2) estimates of weight increases due to the modifications,
- (3) estimates of costs incurred due to the modifications,
- (4) the date(s) such modifications were made.

Copies of specimen manufacturer questionnaires are contained in Appendix D. Separate questionnaires were sent for: (1) 301 modifications made for passenger cars; and for (2) 301 modifications made for light trucks, multipurpose passenger vehicles, and school buses.

Responses were received from all manufacturers. However, the degree of detail provided on 301 modifications varied considerably among manufacturers. Some companies provided a complete breakout by make-model of the specific type,

weight and cost of modifications made. Others provided only summary information. In one instance, the manufacturer was not able to furnish any useful information on the type, weight, or cost of modifications. Among the factors affecting the manufacturer responses were: the extent of company records kept on 301 modifications; the availability of personnel who were with the company at the time FMVSS 301 took effect and were familiar with the modifications made for the Standard; and the time that had elapsed between the issuance of the Standard and the time the manufacturers were surveyed.

Some of the manufacturers requested confidential treatment for the information they provided on the basis that the information was proprietary in nature. For this reason, the information in this section of the report has been summarized into general categories relating to the changes made for passenger cars, light trucks, and school buses. Specific data relating changes to individual manufacturers have been omitted, along with manufacturer names.

The information in the following sections concerning FMVSS 301 modifications, weight, and cost for passenger cars has been adapted from the Agency's 1983 report, the initial evaluation of the Standard as it applied to passenger cars.⁴ The information was developed from data supplied by the motor vehicle manufacturers in response to a "special order" request from the NHTSA. The information in the following Sections concerning 301 modifications, weight, and cost for trucks, MPV's and buses

⁴ "Evaluation of Federal Motor Vehicle Safety Standard 301 - 75, Fuel System Integrity: Passenger Cars". Op Cit.

is also based on manufacturer furnished data. These data were obtained in a special, more recent request, which was conducted in support of this second evaluation study of FMVSS 301. Manufacturers did not request confidential treatment for the data on light trucks, MPV's and buses.

4.2.1 THE NATURE OF VEHICLE MODIFICATIONS MADE FOR FMVSS 301.

The purpose of FMVSS 301 is to reduce the likelihood of fuel spillage, given crashes involving frontal, side, or rear impacts, or crashes in which the vehicle rolls over. Of course, the less likely fuel spillage is to occur, the less likely a fire is to occur. Consequently, the vehicle modifications instituted in response to the Standard were aimed at providing greater protection to the vehicle's fuel system during a crash situation. Table 4-1 lists the various components of the fuel system. The primary components are the fuel tank, fuel lines, fuel pump, carburetor or injection pump, and fuel filter.

Although not specifically a part of the basic fuel system, the fuel vapor (evaporation control) system is also included here since it is connected to primary fuel system components (fuel tank, carburetor) via fuel vapor lines. Therefore, it is conceivable that modifications made as a result of FMVSS 301 could involve the evaporation control system, as well as the basic fuel system. The purpose of the evaporation control system is to capture fuel vapors which can be emitted from the fuel system, in order to control environmental emissions. Figure 4-1 illustrates a typical layout of the fuel system for passenger cars.

TABLE 4-1
FUEL SYSTEM COMPONENTS

1. Fuel tank

fuel filler neck
fuel filler (gas) cap
fill vent tube, vapor tubes
tank mounting straps
tank mounting bolts, anchors
fuel gage sensor/sending unit
fuel tank skid plates/pads

2. Fuel lines

supply, return lines
connecting hoses, clamps
line clips/retainers

3. Fuel pump

mounting bolts
line fittings

4. Fuel evaporation (emissions) control system

vapor storage canister, air filter
vapor lines
connecting hoses, clamps
purge valve

5. Carburetor, Injection pump, injectors

6. Fuel filter

connecting hoses/housing, clamps

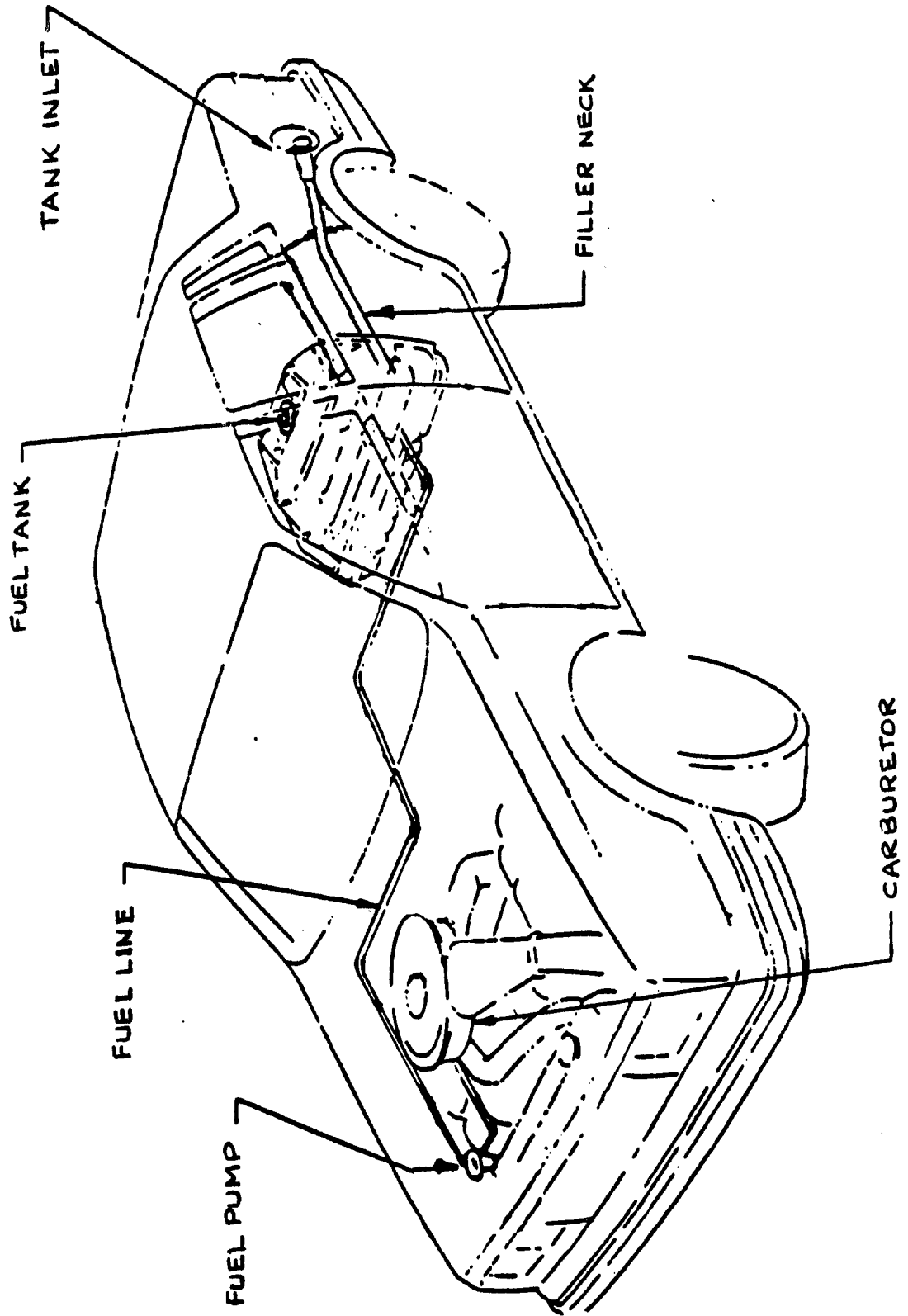

Figure 4-1
Typical Fuel System
Passenger Car

Table 4-2 summarizes the various modifications made to passenger cars in response to FMVSS 301,⁵ and is based on the information provided by the vehicle manufacturers.

It is important to note that Table 4-2 is an exhaustive listing of all the types of modifications made to passenger cars by all manufacturers. The specific modification(s) made to a given vehicle, varied widely among the different vehicle manufacturers and also among vehicle lines (make/models) within manufacturers. Some vehicles received only a single, minor modification, such as redesign of the sealing ring of the filler pipe cap (gas cap). In contrast, other vehicles required several changes, entailing not only the redesign of certain existing components, but the addition of new components, such as a fuel tank shield, as well.

As Table 4-2 shows, many of the modifications involved the fuel system itself, primarily the fuel tank. In general, the various modifications made were to strengthen the fuel system components against damage due to a vehicle crash. More specifically, the changes were intended to reduce the chances of fuel system components being contacted by other vehicle components, and to minimize the chances of fuel system component puncture or dislodgment, given a crash.

⁵ Adapted from "Evaluation of Federal Motor Vehicle Safety Standard 301-75, Fuel System Integrity: Passenger Cars, DOT HS-806-335, NHTSA Technical Report, January 1983.

Table 4-2 - SUMMARY OF TYPES* OF VEHICLE
 MODIFICATIONS MADE TO PASSENGER CARS IN
 RESPONSE TO FEDERAL MOTOR VEHICLE SAFETY STANDARD 301

Vehicle Components Affected

Fuel System Components

Modifications Made in Response to FMVSS 301

Fuel Tank

- Increase gauge of tank material
- Add protective shield
- Recontour to minimize contact/puncture by other adjacent vehicle components.
- Strengthen/shield filler neck
- Increase strength of solder/weld seams
- Strengthen mounting by adding brackets, revising mounting bolts, increasing torque of mounting straps.
- Strengthen filler cap seal, improve impact resistance.
- Strengthen mounting of fuel gage sensor

Fuel Lines

- Recontour

Fuel Evaporation Control System

- Recontour, revise vapor lines; revise clamps

Fuel Pump

- Provide shield

Other Vehicle Components

Rear Floor Pan/Support
 Rails/Wheel Housing

- Revise, add supports

Rear Suspension (Springs,
 Shock Absorbers)

- Change support brackets, revise mounting bolts, revise mounting procedure, add shield

Rear Axle Assembly

- Minor changes in contour of lines, screw heads, mounting clips; recontour vent cover

Table 4-2 (continued)

Vehicle Components Affected (cont.)

| <u>Other Vehicle Components (cont.)</u> | <u>Modifications Made in Response to FMVSS 301</u> |
|---|--|
| Tailgate (station wagon) | - Revise hinge assembly |
| Seat Belt Brackets | - Revise anchorage |
| Engine Mount | - Slight revision |
| Power Steering Pump Bracket | - Slight revision |

* This table is an exhaustive listing of all the types of vehicle modifications listed by the automotive manufacturers. The table should not be interpreted as changes that were made to all vehicles. Actual modifications varied widely among manufacturers and also among the makes, models, and body styles within manufacturers. Some vehicles received several changes, some received few changes, and others received minor changes or no changes at all. Also, some manufacturers were not able to provide information as to the types of modifications made to their vehicles in response to FMVSS 301.

While many changes involved the fuel systems, the table also shows that several modifications for 301 involved other vehicle components as well. Among these were the vehicles' rear floor pan and support rails, rear suspension system, rear axle, engine mounts, and power steering pump. Similar to the modifications made to the fuel system components, however, all changes made to these other vehicle components had the same objective - to minimize the chances of dislodgment or puncture of fuel system components, given a crash. For example, the changes to the rear axle assembly (contour of lines, screwheads, mounting clips) were primarily intended to reduce the chances of fuel tank or fuel line puncture, given a rear end impact.

4.2.1.2 Modifications Made to Light Trucks and Buses

Table 4-3 is similar to Table 4-2 and summarizes the types of modifications made to light trucks, multipurpose passenger vehicles, and buses in response to FMVSS 301.⁶ As can be seen, the vehicle components affected are essentially the same for trucks as they were for passenger cars. The fuel tank, as expected, was the subject of a rather large number of modifications. As noted previously for passenger cars, the modifications listed in Table 4-3 are not to be interpreted as having been made to all truck or bus fuel tanks. While changes varied rather widely between vehicle make models and manufacturers, most vehicles were subjected to only a few types of changes. In rare instances, vehicles received rather extensive modifications.

⁶ Light trucks, multipurpose passenger vehicles, and buses are defined as having Gross Vehicle Weight Ratings (GVWR) of 10,000 pounds, or less. FMVSS 301 also applies to school buses with GVWR greater than 10,000 pounds.

Table 4-3

SUMMARY OF TYPES* OF VEHICLE MODIFICATIONS MADE TO TRUCKS,
MULTIPURPOSE PASSENGER VEHICLES, AND BUSES
IN RESPONSE TO FEDERAL MOTOR VEHICLE SAFETY STANDARD 301

Vehicle Components AffectedModifications Made in Response to
FMVSS No. 301Fuel System Components

Fuel tank

- o redesign of fuel tank
- o reinforcement of fuel filler neck
- o redesign of fuel filler neck
- o increased length of fuel filler hose
- o redesign of fuel cap
- o revised fuel tank straps
- o added fuel tank straps
- o revised fuel tank mountings
- o revised skid plates
- o revised pads between fuel tank and skid plates
- o increased clearance between fuel tank and vehicle under-body
- o addition of rollover valve
- o revised liquid check valve
- o revised technique for forming flanges
- o upgraded solder joints
- o added inspection for cleanliness, integrity of solder connections (to ensure good hose seals).
- o revised fill vent tube and vapor tubes
- o upgraded pressure testing of tank assemblies
- o modified or eliminated tank baffles
- o revised fuel gage assembly and connectors (auxiliary fuel tanks)
- o elimination of auxiliary fuel tank
- o reinforcements of tank at mounting points
- o increased clearance between fill pipe and adjacent vehicle outer body sheet metal
- o increased gage of tank sheet metal
- o revised tank molding technique to assure more uniform wall thickness
- o relocation of fill pipe opening
- o added fill pipe housing/retainer
- o deleted fill pipe housing
- o added sleeve for vent hose support

Table 4-3 (continued)

| <u>Vehicle Components Affected</u> | <u>Modifications Made in Response to FMVSS No. 301</u> |
|--|---|
| <u>Fuel System Components</u> | |
| Fuel lines | <ul style="list-style-type: none"> o revised fuel lines o added check valve in fuel return line o rerouted fuel lines o upgraded armoring of fuel lines o increased number of line clips o upgraded torque requirements for fuel system connectors with controlled clamping load o replaced spring-type hose clamps with screw-type hose clamps |
| Fuel pump, Injection pump | <ul style="list-style-type: none"> o added gravity valve to fuel pump o added pump blocker to injection pump (diesel engines) |
| Fuel Evaporation (i.e., fuel emissions) Control System | <ul style="list-style-type: none"> o relocated vapor tubes on underbody crossmember o revised vapor lines |
| <u>Body/Underbody Frame Components</u> | <ul style="list-style-type: none"> o reinforcement of rear frame o reinforcement of rear body mountings o changes in rear body/frame o elimination of pintle hook o elimination of rear step bumper o redesigned draw bar o redesigned bumperette mountings o increased size of body mount bolts, washers o reshaped outer body sheet metal (to accommodate recessed fuel filler cap) o revised left rear quarter panel o revised mounting of spare tire o addition of metal cage around fuel tank* o slight modification in body skirt and skirt supports* o addition of plastic shield for rear of fuel tank o addition of protector for fuel tank o reinforcement of outer body sheet metal at fill pipe opening o reinforcements to B-pillars at points of fuel tank attachment o towing packages restricted to certain vehicle models o towing packages redesigned for availability on all vehicle models |

Table 4-3 (continued)

| <u>Vehicle Components Affected</u> | <u>Modifications Made in Response to FMVSS No. 301</u> |
|--|--|
| <u>Body/Underbody Frame Components</u> | |
| Rear Suspension | o upgraded rear spring center bolts |
| <u>Other Vehicle Components</u> | |
| Alternator Mounting Bracket | o modified alternator mounting bracket |

 * This table is an exhaustive listing of all the types of vehicle modifications listed by the automotive manufacturers. The table should not be interpreted as changes that were made to all vehicles. Actual modifications varied widely among manufacturers and also among the makes, models, and body styles within manufacturers. Some vehicles received several changes, some received few changes, and others received minor changes or no changes at all. Also, some manufacturers were not able to provide information as to the types of modifications made to their vehicles in response to FMVSS 301.

** Only applies to large school buses, i.e., buses with GVWR >10,000 pounds.

The table is an exhaustive listing of all types of modifications made, across all manufacturers and make/model lines, based on the information received from the special request to manufacturers.

For trucks, a rather large number of 301 modifications involved body, underbody, and frame components. As noted in Table 4-3, changes were made to rear sheet metal, rear bumpers, the mounting of spare tires, trailer towing packages, and the vehicle's B-pillars. The changes to B-pillars involved certain pickup truck lines with metal fuel tanks located in the truck cab, behind the seat. These changes were to strengthen the points at which the tanks were attached to the B-pillar supports.

One unusual type of vehicle modification for 301 is noted in the body/underbody/frame category -- the elimination of certain components which were part of the Pre-301 vehicle design. Two specific examples of this are the elimination of a rear step bumper and the elimination of a pintle hook. These examples of the deletion of certain components in response to FMVSS 301 requirements represent very rare cases. In fact, these are the only known instances of component elimination. The vast majority of modifications for 301 involved either changes to existing vehicle components or the addition of new components. While component modification and addition of new components are potential areas of weight and cost increases, component deletion produces just the opposite -- a decrease in vehicle weight and cost.

Another modification in Table 4-3 which falls, at least partially, in the category of component elimination is the "restriction of trailer-towing packages to certain vehicle models." While trailer-towing packages were

optional equipment, on certain truck models, as compared to step bumpers and pintle hooks, which were standard equipment, the deletion of the towing package option nonetheless resulted in a reduction in both vehicle weight and cost.⁷

4.2.1.3 Modifications Made to Large School Buses

One other modification to be noted in Table 4-3, under body/frame changes, is the addition of a metal cage around the fuel tank. This type of modification was peculiar to large school buses (i.e., buses with Gross Vehicle Weight Rating (GVWR) above 10,000 pounds). Large school buses (also referred to as conventional or transit coach school buses) are constructed using a frame-rail chassis. Fuel tanks for these vehicle are typically mounted on the right, outside frame rail, slightly rear of the passenger entrance door, and just

⁷ The normal interpretation of the cost of a vehicle safety standard, according to NHTSA's established methodology for conducting effectiveness evaluations, is the cost to the consumer. The vehicle manufacturer incurs a cost for vehicle modifications made in response to the standard, and this cost is typically passed on to the consumer (vehicle purchaser) via the car dealer. These modifications typically involve changes to existing vehicle components, or the addition of new components.

In the rare cases where components are deleted for the purpose of complying with a safety standard, it is possible to argue that there is a cost, to the manufacturer, in the form of foregone profit. Such an argument is perhaps more tenable if the deleted items were extra cost options (such as trailer-towing packages).

behind the bus body skirt. The only Pre-301 vehicle structure affording protection to the tank, from side impact, was the bus body skirt which consisted of sheet metal. In order to comply with FMVSS 301, large school buses were modified to incorporate a heavy gage steel cage around the fuel tank (Figure 4-2).

Most large school buses are constructed in a two-phase process. School bus companies purchase cab-chassis (including engine) which are built by one of the major truck companies (i.e., Navistar International, Chevrolet, or Ford). Stage one of the school bus construction is the production of the cab chassis. Stage two of the construction is the mounting of the school bus body onto the cab-chassis. In general, it is the responsibility of the cab chassis manufacturer to provide fuel system protection which complies with FMVSS 301.

Some school bus companies do build a limited number of large buses in which they not only construct the bus body, but the chassis as well. (The engine-drive train components are still furnished by a major motor vehicle manufacturer.) These buses are typically referred to as "transit coach" type buses, and are the largest school buses produced, having passenger capacities as high as 70 to 90. In these cases, the school bus manufacturer, since he builds the chassis as well as the bus body, has responsibility for certifying that the bus complies with FMVSS 301 and therefore installs the steel cage around the fuel tank. At least one manufacturer of the large transit coach bus goes a step further in protecting the fuel tank from crash damage. In addition to placing the steel cage around the tank, the manufacturer also locates the tank inboard, between the frame rails, rather than outboard on the right side frame rail. The large frame rails, on either side, provide an additional measure of crash protection for the fuel tank.

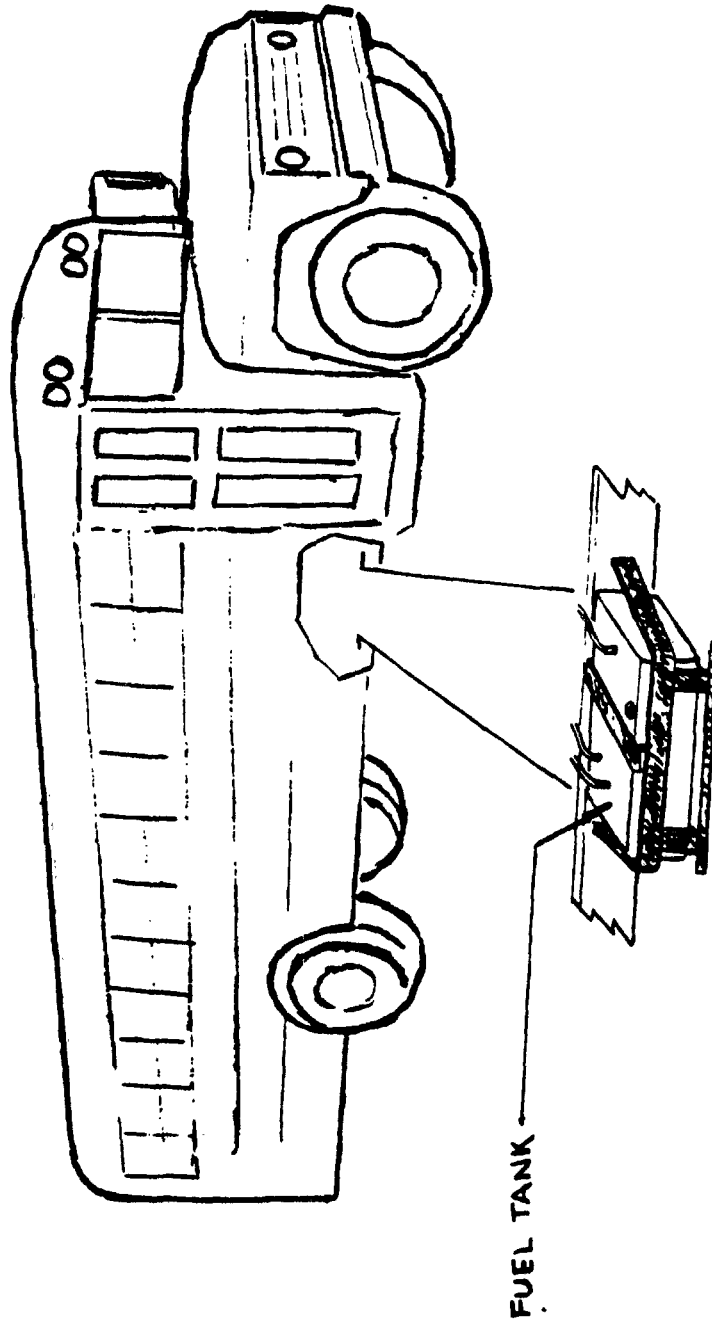

Figure 4-2

Fuel Tank Shield
Type I School Bus

In concluding this section on fuel system integrity modifications to large school buses, it should be noted that the NHTSA is currently engaged in rulemaking action that could result in more stringent requirements for school buses.⁸

4.2.2 THE WEIGHT AND COST OF VEHICLE MODIFICATIONS MADE FOR FMVSS 301

As stated previously in Section 4.2, the data for estimating the costs and weight of FMVSS 301 were obtained from a special request of the motor vehicle manufacturers concerning cost and weight of modifications by vehicle make/model. Separate requests were made for passenger cars, and for light trucks and buses.

Generally, the data received on passenger cars were more detailed than the data received on trucks and buses. Several manufacturers furnished both cost and weight estimates for passenger cars by individual car line or make/model series. For trucks and buses, less detailed data were supplied by the manufacturers. The cost and weight information for these vehicles was typically in the form of average figures for a manufacturer's entire light truck and bus line. No detail was provided as to cost and weight changes to individual make/models. However, manufacturers did provide specific estimates of the cost and weight of 301 modifications made to large school buses (i.e., buses with GVWR \geq 10,000 pounds).

⁸ Preliminary Regulatory Evaluation, **ANPRM** to Upgrade FMVSS No. 301 Fuel System Integrity, Office of Regulatory Analysis, Plans and Policy, National Highway Traffic Safety Administration, December 1988.

The cost and weight data received from the manufacturers has been combined with vehicle sales data to produce sales-weighted averages of the entire fleet of vehicles, both domestic and import, for the particular years in which the versions of FMVSS 301 became effective. Estimates are developed for three classes of vehicles: passenger cars, light trucks, and school buses. The light truck category includes pickup trucks, vans, multipurpose passenger vehicles, and buses, all with gross vehicle weight ratings (GVWR) equal to or less than 10,000 pounds. For school buses, estimates are made for both large buses (i.e., GVWR greater than 10,000 pounds), and small buses (GVWR equal to or less than 10,000 pounds).

It is noted that the sample of weight and cost data upon which the sales-weighted fleet estimates are based do not constitute a representative (i.e., random) sample in a statistical sense. While all major domestic manufacturers and a sample of foreign manufacturers were surveyed, not all were able to provide data on cost and weight of FMVSS 301 modifications. Also, in several instances, the individual cost and weight data received were manufacturer estimates, rather than actual figures, based on company records. In most of these instances, specific cost and weight data were not available within the company. In one instance (for light trucks), a major manufacturer was not able to provide any estimates of cost or weight, and in certain other instances (again for light trucks), manufacturers could only provide general aggregate estimates of 301 costs and weight, over all truck lines. Overall, the data were more detailed for passenger cars than for trucks; cost and weight estimates for cars were typically provided by individual make/model series.

4.2.2.1 Cost and Weight of FMVSS 301 for Passenger Cars

Cost and weight estimates of FMVSS 301 for passenger cars were developed as part of the initial evaluation study⁹ of the standard. These estimates are the average (i.e., sales or production weighted) incremental increases, per vehicle for 1977 Model Year cars, as compared to 1976 Model Year cars.

These estimates are:

Average cost increase: \$3.10 per vehicle.

Average weight increase: 3.07 lbs. per vehicles.

The cost is the cost to the consumer (vehicle buyer), in 1977 dollars, for FMVSS 301. It includes the variable cost to the manufacturer, the fixed cost to the manufacturer, and an allowance for dealer markup.¹⁰ Updating the 1977 figure to current (1988) economics yields:

Average cost increase: \$5.63 per vehicle (1988 dollars).

⁹ "Evaluation of Federal Motor Vehicle Safety Standard 301-15, Fuel System Integrity: Passenger Cars", Op. Cit.

¹⁰ The earlier evaluation study gave the consumer cost of FMVSS 301 as \$4.60 per vehicle. This was in terms of 1982 economics, which was consistent with the date of publication of the earlier study.

4.2.2.2 Cost and Weight of FMVSS 301 for Light Trucks

Cost and weight estimates of FMVSS 301 for light trucks were developed from manufacturer data solicited as part of this evaluation study.¹¹ The truck estimates are the sales-weighted averages, per vehicle, for 1978 Model Year trucks as compared to 1977 Model Year trucks.¹² Included in the light truck category are all trucks in the two weight categories (GVWR \leq 6,000 pounds; and 6,000 pounds $<$ GVWR $<$ 10,000 pounds) of the following types: pickups, multipurpose passenger vehicles, vans, and buses.

The estimates for light trucks are:

Average cost increase: \$11.76 per vehicle

Average weight increase: 7.76 lbs. per vehicle.

The consumer cost of \$11.76 is in 1978 dollars. Updating this to 1988 economics gives:

Average cost increase: \$19.94 per vehicle (1988 dollars)

¹¹ See manufacturer questionnaire, Appendix D.

¹² Statistical data on sales, number of production units taken from: (1) "Wards Automotive Reports," Vol. 53, No. 7, February 13, 1978; Vol. 53, No. 2, January 9, 1978; Vol. 53, No. 3, January 16, 1978; Vol. 54, No. 2, January 8, 1979; Vol. 54, No. 3, January 15, 1979; Vol. 53, No. 9, February 27, 1978; Vol. 54, No. 9, February 26, 1979. (2) "Automotive News, 1978 Market Data Book Issue," April 26, 1978.

4.2.2.3 Cost and Weight of FMVSS 301 for School Buses

Cost and weight estimates of FMVSS 301 for school buses were developed from the manufacturer data requested as part of this study (see Appendix D). The data covered both trucks and school buses. Estimates of cost and weight increases are produced for both small school buses and large school buses. Small buses are defined as having GVW ratings less than 10,000 pounds and large buses as having GVW ratings greater than 10,000 pounds. It will be recalled that FMVSS 301 only applies explicitly to large buses. However, school buses in the 10,000 pound or less category are covered, implicitly, by the Standard in the sections that apply to "vehicles with GVWR of 6,000 pounds or less, and vehicles with GVWR of more than 6,000 pounds but not more than 10,000 pounds. Many small school buses are built on a van chassis, sometimes referred to as a van, "front section," or a van, "cut-away chassis."

The type of 301 modification made to large buses -- a steel cage around the fuel tank -- was described in the preceding section. The modifications made to small school buses are among those types listed in Table 4-3 (excluding steel cages around the fuel tank).

For large school buses, the cost and weight estimates of 301 modifications are:

Cost increase, per vehicle = \$100.00 [1978 dollars]
= \$169.53 [1988 dollars]

Weight increase, per vehicle = 140.5¹³ pounds

For small school buses, the cost and weight estimates of 301 modifications are the same as for light trucks, i.e.,¹⁴

Cost increase, per vehicle = \$11.76 [1978 dollars]

= \$19.94 [1988 dollars]

Weight increase, per vehicle = 7.76 pounds

4.2.3 The Overall Cost of Standard 301

In the preceding section, the per vehicle weight and cost estimates for FMVSS 301 modifications have been developed. The cost estimate is the incremental increase in the (new) vehicle purchase cost borne by the vehicle

13 The estimates of 140.5 pounds, per vehicle, assumes the standard 60, 65 gallon fuel tank for the large (Type I) school bus. Some large school buses are equipped with smaller 22 and 35 gallon tanks, which require smaller protective steel cages weighing about 100 pounds, or some 42.5 pounds less than the average estimated cage weight for large buses. While no estimate is available for the proportion of large buses with 22, 35 gallon fuel tanks, it is assumed their number would be small as compared to the number with 60, 65 gallon tanks.

14 As noted above, small buses are often built on a van chassis. Manufacturer submitted data was typically aggregate in form, and therefore did not permit separation of weight and cost changes by specific type of truck within the light truck category.

buyer. In order to arrive at the total, or overall cost to the consumer, it is customary, in the Agency's evaluation studies, to also consider the additional fuel required to transport the increase in vehicle weight due to the modifications. This fuel cost would be an operational cost, over the lifetime of the vehicle, also to be borne by the original buyer and any subsequent owners. Adding this fuel cost to the vehicle purchase cost gives a total, vehicle lifetime estimate of the cost of FMVSS 301.

4.2.3.1 Fuel Costs of FMVSS 301

For purposes of estimating fuel costs for FMVSS 301, the following data and assumptions have been used:

Average total miles, per vehicle = 100,000

(vehicle lifetime mileage for passenger car, light truck or school bus)

Average on-road miles per gallon:¹⁵

Passenger car = 15.2 miles per gallon

Light truck (pickup, van, MPV) = 13.2 miles per gallon

Small (Type II) school bus = 9.5 miles per gallon

Large (Type I) school bus = 7.5 miles per gallon

¹⁵ Miles per gallon for passenger cars and light trucks taken from: "Fuel Economy and Annual Travel for Passenger Cars and Light Trucks: National On-Road Survey," NHTSA Technical Report, DOT HS 806 971, May 1986. Miles per gallon for school buses are estimates.

Average, on-road gross vehicle weight:¹⁶

Passenger car - 3,500 pounds

Light truck - 4,000 pounds

Type I school bus - 20,000 pounds

Type II school bus - 10,000 pounds

Average lifetime fuel consumption, per pound of additional weight due to FMVSS 301:¹⁷

16 Weight estimates are for vehicles of 1976-1977 model year vintage - the period when the Fuel System Integrity Standard became effective.

17 Fuel consumption estimates are based on the assumption that fuel usage bears an essentially linear relationship to vehicle weight. This follows from the linear relationship between a vehicle's weight and its resistance to motion ("Fuel Economy Trends and Catalytic Devices," SAE Paper by Robert C. Stempel and Stuart W. Marters, General Motors Corporation, published in "Automotive Fuel Economy," Selected SAE Papers 1965-1975). Fuel consumption is in terms of gallons/mile, or the reciprocal of miles per gallon. The form of the relationship is:

$$\frac{1}{\text{MPG}_{\text{Post301}}} = \frac{W_{\text{Post301}}}{W_{\text{Pre301}}} \left(\frac{1}{\text{MPG}_{\text{Pre301}}} \right)$$

where MPG is miles per gallon, W is vehicle weight, in pounds, and subscripts Pre 301 and Post 301 denote, respectively, vehicles produced before and after FMVSS 301 took effect.

Passenger car - 1.8795 gal/lb.

Light truck - 1.8875 gal/lb.

Type I school bus - 0.6648 gal/lb.

Type II school bus - 1.0567 gal/lb.

The additional lifetime fuel costs due to the 301 modifications can now be estimated for the four vehicle types. The following formula is used:

$$LC = WF \sum_{i=1}^n f_i C_i D_i$$

where, LC = lifetime fuel cost, in 1988 dollars,

W = weight of Standard 301 modifications, in pounds,

F = lifetime fuel consumption, in gallons/pound,

f_i = the fraction of total lifetime vehicle miles travelled in year
i of the n-year, total vehicle lifespan.

C_i = fuel cost for year i, in 1988 dollars/gallon,

D_i = discount rate.

For purposes of estimation, it is assumed that the average vehicle lifespan is 15 years, and that the lifetime mileage of 100,000 is distributed over the 15 years according to the data given in Table 4-4. This distribution of miles travelled by vehicle age incorporates a vehicle survivability factor which is defined as the probability that a vehicle will survive (i.e., still be "on the

road") at "i" years of age. Vehicle travel by vehicle age are only available for passenger cars and light trucks. Therefore, in estimating fuel penalty costs for school buses, the travel distribution for light trucks will be used.

Fuel price estimates are for gasoline for the years 1989-2003 and are listed in Table 4-5. A discount rate of 10 percent (Table 4-6) has been used to estimate the present value of fuel consumed in the 14 years beyond 1989.

Substituting into the above formula, the lifetime fuel cost for FMVSS 301, for passenger cars, can now be estimated:

$$\text{LFC} = 3.07 \text{ lb. (1.8795 gal./lb.)} \sum_{i=1}^{15} f_i C_i D_i$$

Using the appropriate data from Tables 4-4, 4-5, and 4-6, the summation factor is computed to be \$0.70/gallon, the present value per gallon of future fuel consumed. The fuel cost of the standard is therefore:

$$\text{LFC} = 3.07 \text{ lbs. (1.8795 gal./lb.)} (\$0.70/\text{gal.}) = \$4.04$$

Performing the same computations for light trucks, Type I (large) school buses, and Type II (small) school buses gives the following fuel cost estimates:

Light trucks

$$\text{LFC} = 7.76 \text{ lbs} (1.88747 \text{ gal./lb.}) (\$0.68469/\text{gal.}) = \$10.03$$

Type I school buses

$$\text{LFC} = 140.5 \text{ lbs} (0.6648 \text{ gal./lb.}) (\$0.68469/\text{gal.}) = \$63.95$$

Type II school buses

$$\text{LFC} = 7.76 \text{ lbs} (1.0567 \text{ gal./lb.}) (\$0.68469/\text{gal.}) = \$5.61$$

Table 4-4

Estimated Proportion of Vehicle Miles Travelled
Per Calendar Year, Passenger Cars and Light Trucks*

| <u>Calendar Year</u> | <u>Proportion Vehicle Miles Travelled</u> | |
|--------------------------|---|---------------------|
| | <u>Passenger Cars</u> | <u>Light Trucks</u> |
| 1989 | .183 | .181 |
| 1990 | .163 | .154 |
| 1991 | .155 | .144 |
| 1992 | .124 | .104 |
| 1993 | .103 | .079 |
| 1994 | .088 | .063 |
| 1995 | .043 | .052 |
| 1996 | .034 | .043 |
| 1997 | .026 | .032 |
| 1998 | .020 | .027 |
| 1999 | .015 | .023 |
| 2000 | .011 | .020 |
| 2001 | .009 | .016 |
| 2002 | .007 | .014 |
| 2003 | .017 | .047 |

- * Estimates of proportion of miles travelled include both estimates of miles travelled, by vehicle age, and vehicle survivability factors (i.e., probability that a given vehicle will survive to age 1,2,3,...15 years). Vehicle mile and survivability estimates are taken from "Fuel Economy and Annual Travel for Passenger Cars and Light Trucks: National On-Road Survey," DOT HS 806 971, NHTSA Technical Report, May 1988. Primary source for survival data: "Scrappage and Survival Rates of Passenger Cars and Trucks in 1970-1982," P. Hu, Transportation Energy Group, Oak Ridge National Laboratory, August 10, 1983. Report DOT HS 806 971 assumed a 20-year vehicle life; therefore, vehicle miles occurring within the 16-20 year span are assumed to occur in year 15, for purposes of this study.

TABLE 4-5
 Estimated Fuel Prices for Lifetime
 Fuel Penalty Costs

| <u>Year</u> | <u>Estimated Cost*</u> <u>of Gasoline</u> |
|-------------|--|
| 1989 | \$0.824 |
| 1990 | 0.864 |
| 1991 | 0.898 |
| 1992 | 0.929 |
| 1993 | 0.983 |
| 1994 | 1.039 |
| 1995 | 1.093 |
| 1996 | 1.147 |
| 1997 | 1.203 |
| 1998 | 1.256 |
| 1999 | 1.289 |
| 2000 | 1.319 |
| 2001 | 1.374 |
| 2002 | 1.427 |
| 2003 | 1.475 |

* Price projections are in 1988 dollars. Projections for individual years, 1989-2000 are from the U.S. Department of Energy, Energy Information Administration "1989 Annual Energy Outlook, Long Term Projections." DOE projections for "dollars per million BTU" were converted to dollars per gallon using 125,071 BTU's per gallon of gasoline (derived from DOE/EIA "Monthly Energy Review," November 1988. Fuel prices for years 2001-2003 were calculated using Implicit GNP Price Deflator and gasoline price deflator forecasts, DRI Forecast Trend 25YR0189, Long Term Review (Winter 1988-89).

NOTE: The above price projections do not include the effect of the rise in prices at the pump which occurred in late Spring, 1989. This increase was rather substantial and, if sustained, would mean that the fuel price projections used in this study would be underestimated.

Table 4-6
Discount Factors for Estimating Present Value of
Future Fuel Consumption

| <u>Year of Consumption</u> | <u>Discount Factor</u> |
|--------------------------------|----------------------------|
| 1989 | 1.0000 |
| 1990 | .9091 |
| 1991 | .8264 |
| 1992 | .7513 |
| 1993 | .6830 |
| 1994 | .6209 |
| 1995 | .5645 |
| 1996 | .5132 |
| 1997 | .4665 |
| 1998 | .4241 |
| 1999 | .3855 |
| 2000 | .3505 |
| 2001 | .3186 |
| 2002 | .2897 |
| 2003 | .2633 |

For discount rate = 10 percent per OMB Circular No. A-94, March 27, 1972.

4.2.3.2 Total Costs of FMVSS 301

The total consumer costs of the fuel system integrity standard can now be computed as the sum of: (1) the cost of the actual hardware modifications made to the vehicle, and (2) the cost of the additional fuel required to transport the weight of those modifications. On a per vehicle basis, these costs in 1988 dollars, for the 4 vehicle types are:

Passenger car: $\$5.63$ (modification cost) + $\$4.04$ (fuel cost) = $\$9.67$

Light truck: $\$19.94$ (modification cost) + $\$10.03$ (fuel cost) = $\$29.97$

Type I school bus: $\$169.53$ (modification cost) + $\$63.95$ (fuel cost) =
 $\$233.48$

Type II school bus: $\$19.94$ (modification cost) + $\$5.61$ (fuel cost) =
 $\$25.55$

It may be recalled that in the effectiveness analysis, large and small buses could not be broken out, and hence the effectiveness estimates applied to the entire national school bus fleet. Therefore, a cost estimate for the entire fleet is also given.

Type I school buses account for about 85 percent of the total school bus fleet, with Type II buses comprising the remaining 15 percent. An average

cost of the 301 Standard for the entire school bus fleet would therefore be:

$$.85 (\$233.48) + .15 (\$25.55) = \$202.29, \text{ or}$$

approximately \$200.

The average weight of the FMVSS 301 modifications corresponding to this overall average fleet cost is:

$$.85 (140.5 \text{ lbs.}) + .15 (7.76 \text{ lbs.}) = 120.6 \text{ lbs.}$$

A few observations can be made concerning the overall costs of the fuel system integrity standard:

- o Fuel costs represent a substantial portion of total cost, ranging from 22 percent, for small school buses, to a high of 42 percent for passenger cars. Furthermore, it is possible that the fuel cost may be underestimated. This is because the latest available gasoline cost data (i.e., Table 4-5) from the Department of Energy do not include the effect of the rather substantial rise in "price-at-the pump" which occurred in late Spring of 1989. This rise was approximately \$0.25/gallon or 30 percent higher than the 1989 per gallon price listed in Table 4-5.¹⁸ While it is admittedly a

¹⁸ Per Lundberg Survey of gasoline prices, U.S. average price was \$1.07 per gallon (per July 1989 article in "USA Today").

difficult exercise to try to project the effect of this 30 percent increase into the 15 year future, it is nonetheless considered likely that it will result in higher pump prices in the near future (i.e., initial 2-3 years) than those given in Table 4-5. Since fuel costs of FMVSS 301 are concentrated in the early years of vehicle life -- owing to the concentration of vehicle miles driven during these same years -- this would constitute yet a second reason to suspect that the fuel cost (and hence total cost) of 301 may be underestimated in this study.

- o Modification costs are greater for larger, heavier vehicles, ranging from \$5.63 for passenger cars to \$169.53 for large school buses.

- o With respect to the accuracy of the overall cost estimates (modification plus fuel), it is acknowledged that uncertainty exists. The manufacturer-supplied data on vehicle modifications for FMVSS 301 varied widely with some companies providing quite detailed data while others provided only general data, or no data at all. In this latter instance, the manufacturer stated that it was not possible to develop cost data specific to FMVSS 301.

On the fuel cost side, estimates are subject to uncertainties as well, as evidenced by a review of historical, multi-year gasoline price projections as contrasted with the actual prices which occurred for those periods. For example, in the early 1980's, gasoline prices were projected to climb steadily over the next decade and beyond. In actuality, prices fell in the mid-eighties. On the other hand,

projections for the late eighties had prices considerably lower than actually occurred (i.e., the gasoline price rise in early 1989).

REFERENCES

1. Automobile Fires in Traffic Crashes, The UMTRI Research Review, May-June 1983, Vol. 13, No. 6.
2. Automotive News, 1978 Market Data Book, April 26, 1978.
3. Cooley, P., Fire in Motor Vehicle Accidents, HIT LAB Reports, Highway Safety Research Institute University of Michigan, September 1974, Vol. J, No. 1.
4. Duncan, Acheson J., Quality Control and Industrial Statistics, Revised Edition 1959.
5. Executive Order 12291, Federal Register 46, February 17, 1981, 13193.
6. Executive Order 12498, Federal Register 50, January 8, 1985, 1036.
7. Fatal Accident Reporting System, Automated Files, 1975 through 1988 Calendar Years, National Center for Statistics and Analysis, National Highway Traffic Safety Administration.
8. Federal Motor Vehicle Safety Standard 301, Fuel System Integrity, 49 Code of Federal Regulations, Parts 400 to 999, Revised October 1, 1984.
9. Federal Register, Vol. 52, No. 160, August 19, 1987. Environmental Protection Agency, 40 CFR Parts 80, 86, and 600. Regulation of Fuels and Fuel Additives: Volatility Regulations for Gasoline and Alcohol Blends Sold in 1989 and Later Calendar Years and Control of Air Pollution from New Motor Vehicles and New Motor Vehicle Engines: Evaporative Emissions Regulations for 1990 and Later Model Year Gasoline-Fueled Light-Duty Vehicles, Light-Duty Trucks and Heavy-Duty Vehicles.
10. Flora, J., et. al., "An Evaluation of FMVSS 301, Fuel System Integrity," UM-HSRI-79-12, March 1979.
11. Flora, J., and O'Day, J., "Evaluation of FMVSS 301 - Fuel System Integrity - Using Police Accident Data," DOT HS 806-362, Final Report, March 1982.

References [Continued]

12. Hu, P., Scrappage and Survival Rates of Passenger Cars and Light Trucks in 1970-1982, Transportation Energy Group, Oak Ridge National Laboratory, August 10, 1983.
13. Jacobson, M.A., CEng, FIMechE, MIProdE, M Inst C Tech., "Safety and Environment: The User's View," Corrosion of Motor Vehicles; Conference arranged by the Automotive Division of the Institution of Mechanical Engineers and the Institution of Corrosion Technology in collaboration with the Society of Chemical Industry; London, 13-14 November 1974; (published by Mechanical Engineering Publications Limited for the Institution of Mechanical Engineers, London and New York).
14. "Monthly Energy Review," Energy Information Administration, U.S. Department of Energy, November 1988.
15. MVMA Motor Vehicle Facts and Figures, '85, Motor Vehicle Manufacturers Association of the United States, Inc.
16. MVMA Motor Vehicle Facts and Figures, '88, Motor Vehicle Manufacturers Association of the United States, Inc.
17. NHTSA Docket No. 73-20, "Study of Motor Vehicle Fires," February 1988.
18. National Accident Sampling System 1986 - A Report on Traffic Crashes and Injuries in the United States, National Highway Traffic Safety Administration, U.S. Department of Transportation.
19. 1989 Annual Energy Outlook, Long Term Projections, Energy Information Administration, U.S. Department of Energy.
20. Parsons, G., Evaluation of Federal Motor Vehicle Safety Standard 301-75, Fuel System Integrity: Passenger Cars, DOT HS-806-335, January 1983.
21. Parsons, G., Fuel Economy and Annual Travel for Passenger Cars and Light Trucks: National On-Road Survey, DOT HS 806 971, May 1986.
22. Preliminary Regulatory Evaluation, ANPRM to Upgrade FMVSS 301, Fuel System Integrity, Office of Regulatory Analysis, Plans and Policy, National Highway Traffic Safety Administration, December 1988.
23. Reinfurt, D.W., A Statistical Evaluation of the Effectiveness of FMVSS 301: Fuel System Integrity, DOT HS-805-969, Report No. 7 of 7, June 1981. Final Report.

References [continued]

24. Reinfurt, D.W., A Statistical Evaluation of the Effectiveness of the 1976 Version of FMVSS 301, Fuel System Integrity, DOT HS-806-365, November 1982. Final Report.
25. State Motor Vehicle Automated Accident Files, State of Illinois.
26. State Motor Vehicle Automated Accident Files, State of Indiana.
27. State Motor Vehicle Automated Accident Files, State of Maryland.
28. State Motor Vehicle Automated Accident Files, State of Michigan.
29. State Motor Vehicle Automated Accident Files, State of Ohio.
30. Stempel, Robert C. and Marters, Stuart W., "Fuel Economy Trends and Catalytic Devices," Automotive Fuel Economy, Selected SAE Papers 1965-1975.
31. Study of Post-Crash Factors in Automobile Collisions, Volume I, DOT HS-801-519, April 1975, Final Report.
32. Wards Automotive Reports, Vol. 53, No. 7, February 13, 1978; Vol. 53, No. 2, January 9, 1978; Vol. 53, No. 3, January 16, 1978; Vol. 54, No. 2, January 8, 1979; Vol. 54, No. 3, January 15, 1979; Vol. 53, No. 9, February 27, 1978; Vol. 54, No. 9, February 26, 1979.
33. Weak Points of Cars, 1987, AB SVENSK BILPROVNING, The Swedish Motor Vehicle Inspection Company.
34. Weak Points of Cars, 1988, AB SVENSK BILPROVNING, The Swedish Motor Vehicle Inspection Company.

Appendix A
Federal Motor Vehicle Standard 301;
Fuel System Integrity

**(49 Code of Federal Regulations,
Parts 400 to 999, October 1, 1984)**

MECHANICAL HEAD FORM BASH

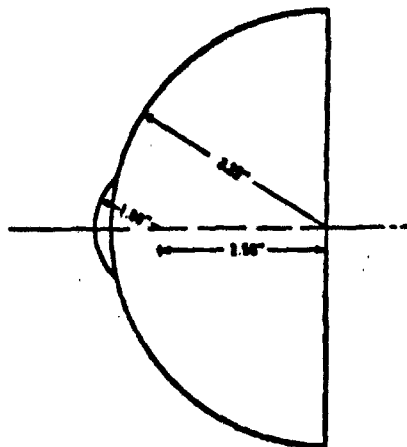

FIGURE 1

(Secs. 103, 119, Pub. L. 89-563, 90 Stat. 718 (15 U.S.C. 1392, 1407); Sec. 203, Pub. L. 93-492, 88 Stat. 1470 (15 U.S.C. 1392); delegation of authority at 49 CFR 1.50)

[41 FR 4018, Jan. 28, 1976, as amended at 41 FR 28528, July 13, 1976; 41 FR 26077, Aug. 26, 1976; 41 FR 54945, Dec. 16, 1976; 42 FR 64120, Dec. 22, 1977; 43 FR 9150, Mar. 6, 1978; 44 FR 18675, Mar. 29, 1979; 48 FR 12386, Mar. 24, 1983]

§ 571.301 Standard No. 301; Fuel system integrity.

S1. Scope. This standard specifies requirements for the integrity of motor vehicle fuel systems.

S2. Purpose. The purpose of this standard is to reduce deaths and injuries occurring from fires that result from fuel spillage during and after motor vehicle crashes.

S3. Application. This standard applies to passenger cars, and to multipurpose passenger vehicles, trucks, and buses that have a GVWR of 10,000 pounds or less and use fuel with a boiling point above 32° F, and to schoolbuses that have a GVWR greater than 10,000 pounds and use fuel with a boiling point about 32° F.

S4. Definition. "Fuel spillage" means the fall, flow, or run of fuel from the vehicle but does not include wetness resulting from capillary action.

S5. General requirements.

S5.1 Passenger cars. Each passenger car manufactured from September 1, 1975, to August 31, 1976, shall meet the requirements of S6.1 in a perpendicular impact only, and S6.4. Each passenger car manufactured on or after September 1, 1976, shall meet all the requirements of S6, except S6.5.

S5.2 Vehicles with GVWR of 6,000 pounds or less. Each multipurpose passenger vehicle, truck, and bus with a GVWR of 6,000 pounds or less manufactured from September 1, 1976, to August 31, 1977, shall meet all the requirements of S6.1 in a perpendicular impact only, S6.2, and S6.4. Each of these types of vehicles manufactured on or after September 1, 1977, shall meet all the requirements of S6, except S6.5.

S5.3 Vehicles with GVWR of more than 6,000 pounds but not more than 10,000 pounds. Each multipurpose passenger vehicle, truck, and bus with a GVWR of more than 6,000 pounds but not more than 10,000 pounds manufactured from September 1, 1976, to August 31, 1977, shall meet the requirements of S6.1 in a perpendicular impact only. Each vehicle manufactured on or after September 1, 1977, shall meet all the requirements of S6, except S6.5.

S5.4 Schoolbuses with a GVWR greater than 10,000 pounds. Each schoolbus with a GVWR greater than 10,000 pounds manufactured on or after April 1, 1977, shall meet the requirements of S6.5.

S5.5 Fuel spillage: Barrier crash. Fuel spillage in any fixed or moving barrier crash test shall not exceed 1 ounce by weight from impact until motion of the vehicle has ceased, and shall not exceed a total of 5 ounces by weight in the 5-minute period following cessation of motion. For the subsequent 25-minute period (for vehicles manufactured before September 1, 1976, other than school buses with a GVWR greater than 10,000 pounds; the subsequent 10-minute period), fuel

spillage during any 1-minute interval shall not exceed 1 ounce by weight.

S5.5 Fuel spillage: Rollover. Fuel spillage in any rollover test, from the onset of rotational motion, shall not exceed a total of 5 ounces by weight for the first 5 minutes of testing at each successive 90° increment. For the remaining testing period, at each increment of 90° fuel spillage during any 1-minute interval shall not exceed 1 ounce by weight.

S6. Test requirements. Each vehicle with a GVWR of 10,000 pounds or less shall be capable of meeting the requirements of any applicable barrier crash test followed by a static rollover, without alteration of the vehicle during the test sequence. A particular vehicle need not meet further requirements after having been subjected to a single barrier crash test and a static rollover test.

S6.1 Frontal barrier crash. When the vehicle traveling longitudinally forward at any speed up to and including 30 mph impacts a fixed collision barrier that is perpendicular to the line of travel of the vehicle, or at any angle up to 30° in either direction from the perpendicular to the line of travel of the vehicle, with 50th-percentile test dummies as specified in Part 572 of this chapter at each front outboard designated seating position and at any other position whose protection system is required to be tested by a dummy under the provisions of Standard No. 208, under the applicable conditions of S7., fuel spillage shall not exceed the limits of S5.5.

S6.2 Rear moving barrier crash. When the vehicle is impacted from the rear by a barrier moving at 30 mph, with test dummies as specified in Part 572 of this chapter at each front outboard designated seating position, under the applicable conditions of S7., fuel spillage shall not exceed the limits of S5.5.

S6.3 Lateral moving barrier crash. When the vehicle is impacted laterally on either side by a barrier moving at 20 mph with 50th-percentile test dummies as specified in Part 572 of this chapter at positions required for testing to Standard No. 208, under the applicable conditions of S7., fuel spillage shall not exceed the limits of S5.5.

S6.4 Static rollover. When the vehicle is rotated on its longitudinal axis to each successive increment of 90°, following an impact crash of S6.1, S6.2, or S6.3, fuel spillage shall not exceed the limits of S5.5.

S6.5 Moving contoured barrier crash. When the moving contoured barrier assembly traveling longitudinally forward at any speed up to and including 30 mph impacts the test vehicle (schoolbus with a GVWR exceeding 10,000 pounds) at any point and angle, under the applicable conditions of S7.1 and S7.5, fuel spillage shall not exceed the limits of S5.5.

S7. Test conditions. The requirements of S5. and S6. shall be met under the following conditions. Where a range of conditions is specified, the vehicle must be capable of meeting the requirements at all points within the range.

S7.1 General test conditions. The following conditions apply to all tests.

S7.1.1 The fuel tank is filled to any level from 90 to 95 percent of capacity with Stoddard solvent, having the physical and chemical properties of type 1 solvent, Table I ASTM Standard D484-71, "Standard Specifications for Hydrocarbon Dry Cleaning Solvents."

S7.1.2 The fuel system other than the fuel tank is filled with Stoddard solvent to its normal operating level.

S7.1.3 In meeting the requirements of S6.1 through S6.3, if the vehicle has an electrically driven fuel pump that normally runs when the vehicle's electrical system is activated, it is operating at the time of the barrier crash.

S7.1.4 The parking brake is disengaged and the transmission is in neutral, except that in meeting the requirements of S6.5 the parking brake is set.

S7.1.5 Tires are inflated to manufacturer's specifications.

S7.1.6 The vehicle, including test devices and instrumentation, is loaded as follows:

(a) Except as specified in S7.1.1, a passenger car is loaded to its unloaded vehicle weight plus its rated cargo and luggage capacity weight, secured in the luggage area, plus the necessary test dummies as specified in S6., restrained only by means that are in-

stalled in the vehicle for protection at its seating position.

(b) Except as specified in S7.1.1, a multipurpose passenger vehicle, truck, or bus with a GVWR of 10,000 pounds or less is loaded to its unloaded vehicle weight, plus the necessary test dummies, as specified in S8., plus 300 pounds or its rated cargo and luggage capacity weight, whichever is less, secured to the vehicle and distributed so that the weight on each axle as measured at the tire-ground interface is in proportion to its GAWR. If the weight on any axle, when the vehicle is loaded to unloaded vehicle weight plus dummy weight, exceeds the axle's proportional share of the test weight, the remaining weight shall be placed so that the weight on that axle remains the same. Each dummy shall be restrained only by means that are installed in the vehicle for protection at its seating position.

(c) Except as specified in S7.1.1, a schoolbus with a GVWR greater than 10,000 pounds is loaded to its unloaded vehicle weight, plus 120 pounds of unsecured weight at each designated seating position.

S7.2 Lateral moving barrier crash test conditions. The lateral moving barrier crash test conditions are those specified in S8.2 of Standard No. 208, 49 CFR 571.208.

S7.3 Rear moving barrier test conditions. The rear moving barrier test conditions are those specified in S8.2 of Standard No. 208, 49 CFR 571.208, except for the positioning of the barrier and the vehicle. The barrier and test vehicle are positioned so that at impact—

(a) The vehicle is at rest in its normal attitude;

(b) The barrier is traveling at 30 mph with its face perpendicular to the longitudinal centerline of the vehicle; and

(c) A vertical plane through the geometric center of the barrier impact surface and perpendicular to that surface coincides with the longitudinal centerline of the vehicle.

S7.4 Static rollover test conditions. The vehicle is rotated about its longitudinal axis, with the axis kept horizontal, to each successive increment of 90°, 180°, and 270° at a uniform rate,

with 90° of rotation taking place in any time interval from 1 to 3 minutes. After reaching each 90° increment the vehicle is held in that position for 5 minutes.

S7.5 Moving contoured barrier test conditions. The following conditions apply to the moving contoured barrier crash test.

S7.5.1 The moving barrier, which is mounted on a carriage as specified in figure 1, is of rigid construction, symmetrical about a vertical longitudinal plane. The contoured impact surface, which is 24.75 inches high and 78 inches wide, conforms to the dimensions shown in figure 2, and is attached to the carriage as shown in that figure. The ground clearance to the lower edge of the impact surface is 6.25 ± 0.5 inches. The wheelbase is 120 ± 2 inches.

S7.5.2 The moving contoured barrier, including the impact surface, supporting structure, and carriage, weighs $4,000 \pm 50$ pounds with the weight distributed so that 900 ± 25 pounds is at each rear wheel and 1100 ± 25 pounds is at each front wheel. The center of gravity is located 84.0 ± 1.5 inches rearward of the front wheel axis, in the vertical longitudinal plane of symmetry, 15.8 inches above the ground. The moment of inertia about the center of gravity is:

$$I_x = 371 \pm 13.6 \text{ slug ft.}^2$$

$$I_y = 3475 \pm 174 \text{ slug ft.}^2$$

S7.5.3 The moving contoured barrier has a solid nonsteerable front axle and fixed rear axle attached directly to the frame rails with no spring or other type of suspension system on any wheel. (The moving barrier assembly is equipped with a braking device capable of stopping its motion.)

S7.5.4 The moving barrier assembly is equipped with G78-15 pneumatic tires with a tread width of 6.0 ± 1 inch, inflated to 24 psi.

S7.5.5 The concrete surface upon which the vehicle is tested is level, rigid, and of uniform construction, with a skid number of 75 when measured in accordance with American Society of Testing and Materials Method E-274-65T at 40 mph, omitting water delivery as specified in paragraph 7.1 of that method.

§ 571.301

Title 49—Transportation

57.5.6 The barrier assembly is released from the guidance mechanism immediately prior to impact with the vehicle.

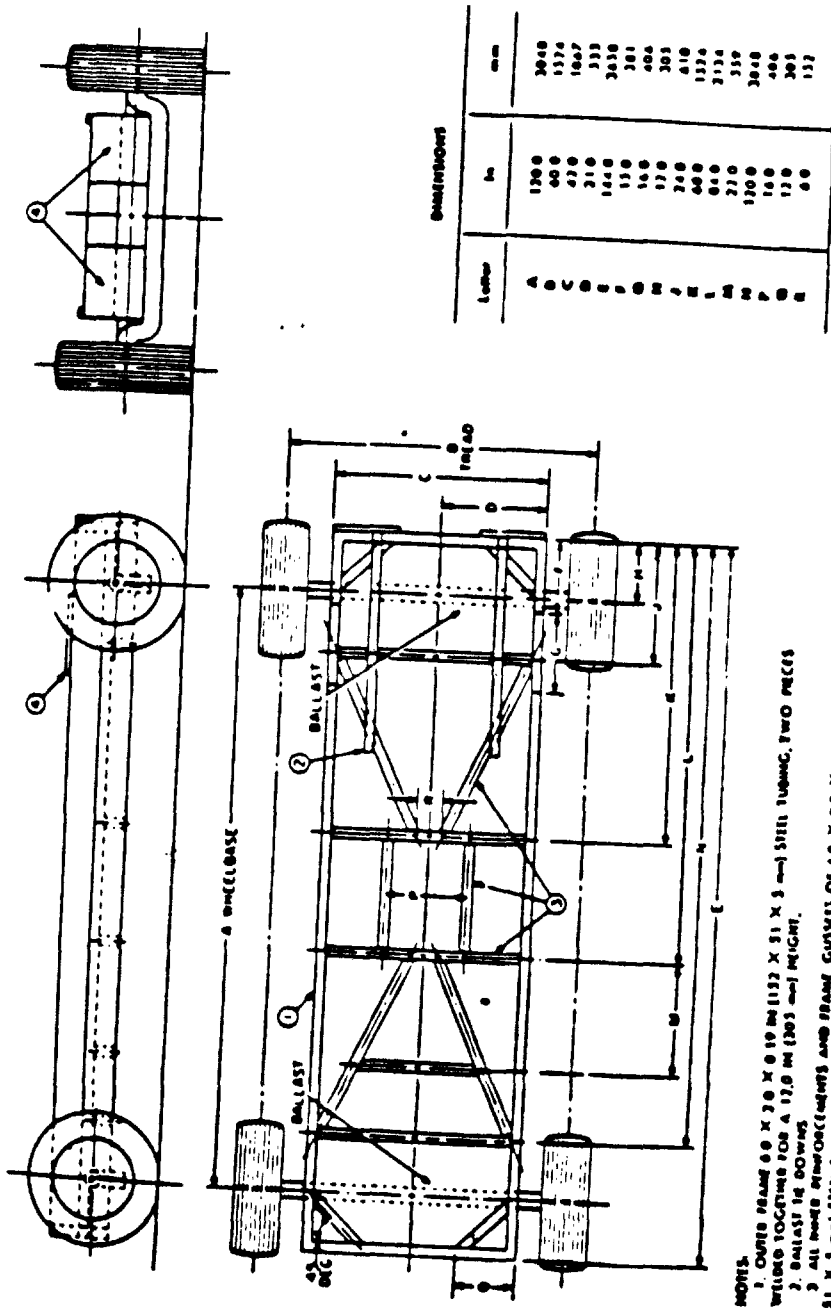
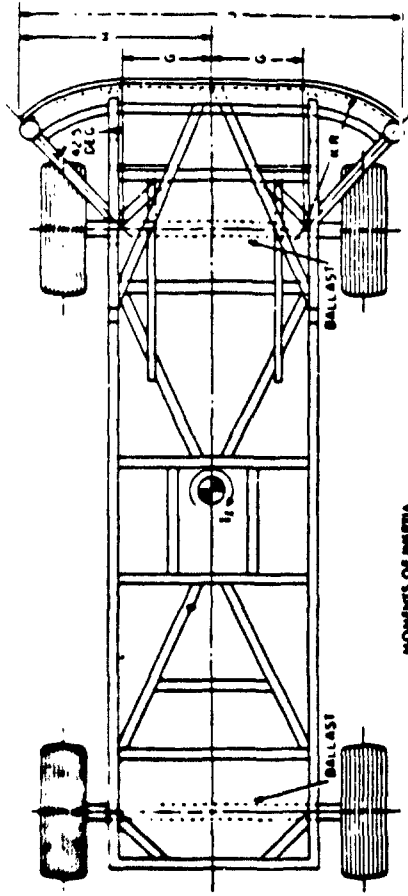
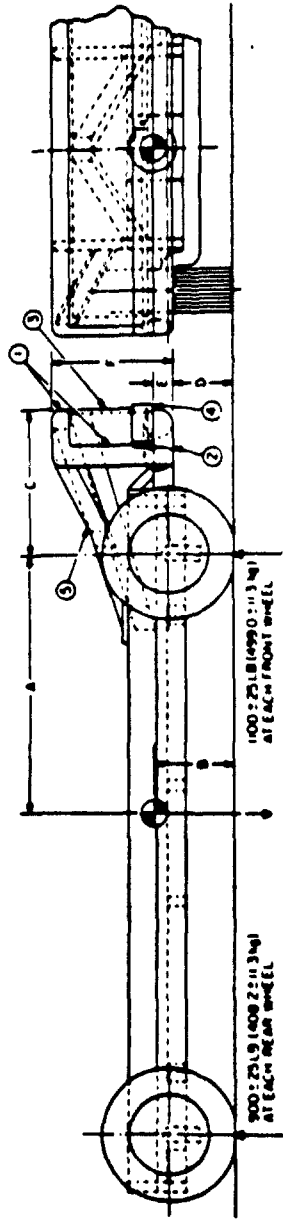

FIG. 1—COMMON CARRIAGE FOR MOVING BARRIERS



MOMENTS OF INERTIA
 $I_x = 271 \pm 13.0 \text{ slug} \cdot \text{ft}^2 (267 \pm 18.4 \text{ kg} \cdot \text{m}^2)$
 $I_y = 3675 \pm 174 \text{ slug} \cdot \text{ft}^2 (3675 \pm 236 \text{ kg} \cdot \text{m}^2)$

- NOTES
1. LOWER FRAME 4.0 IN DIA X 0.25 IN WALL (102 mm DIA X 6 mm WALL) STEEL TUBING (THREE SIZES)
 2. LOWER FRAME 6.0 IN DIA X 0.50 IN WALL (157 mm DIA X 13 mm WALL) STEEL TUBING.
 3. FACE PLATE 0.75 IN (19 mm) THICK COLD ROLLED STEEL.
 4. LEADING EDGE 1.0 X 4.0 IN (25 X 102 mm) STEEL BAND, SHARP EDGES BROKEN
 5. ALL INNER REINFORCEMENTS 4.0 X 2.0 X 0.19 IN (102 X 51 X 5 mm) STEEL TUBING.

| Letter | I_x | mm |
|--------|-------|------|
| A | 340 | 1372 |
| B | 156 | 401 |
| C | 300 | 742 |
| D | 1225 | 311 |
| E | 375 | 95 |
| F | 2475 | 439 |
| G | 186 | 457 |
| H | 390 | 991 |
| J | 760 | 1081 |
| K | 300 | 742 |

FIG. 2—COMMON CARRIAGE WITH CONTOURED IMPACT SURFACE ATTACHED

Appendix B
State and FARS Report Forms

DO NOT USE

ORIGINAL

AUTHORITY See 822, Act 300, P.A. of 1969
COMPLETION Required
PENALTY Misfeasance

CIRCLE THE APPROPRIATE SELECTION

X IF CORRECTED COPY

UD-10 (Rev. 5-68) State of Michigan Department Name LEIN Number Department Component No. Area

OFFICIAL TRAFFIC ACCIDENT REPORT County No. City No. Trap No. Section No. Day of Week S M T W T F S Accident Date: Mo/Do/Yr Time A.M. P.M. DO NOT USE

ACCIDENT LOCATION Name Route No. Pt. Intersection Route No. No. Lanes No. Inj. No. Killed

WEATHER 1 Clear or Cloudy 3 Rain 1 Day 3 Street Lights 1 Dry 3 Snow or Ice 1 Diverted 1 Construction Zone
2 Fog 4 Snow 2 Dawn or Dusk 2 Wet 4 Other 2 Limited Access Y N Investigated at Scene

VEHICLE DRIVER NO. 1 State Driver's License DOB Mo/Do/Yr Hazardous Action No. Citation Charge HSD Test Helmet Y N Y N

Driver's Name First M. Last Address City State Age Sex Inj. Year Make No. Type Trailer Reg. Vt/State VIN (Make Letters Larger Than Numbers) Removed to/by

Y N Haz. Citation Y N Driver Re-exam Y N Vehicle Defect Y N Fuel Leakage Impact Severity Truck Cargo Y N Cargo Damage Y N Other Citation Y N Vision Obstruct. Y N Veh. Drivable Y N Vehicle Fire Cargo Description

Restrained by occupants No. Name Address Sex Age Sex Inj. Helmet Y N

Total Occupants Local Use/Owner, Phone (If Veh. Type 7 or 8, List Carrier) Insurance Co. Agency Address Injured taken to/by

VEHICLE DRIVER NO. 2 State Driver's License DOB Mo/Do/Yr Hazardous Action No. Citation Charge HSD Test Helmet Y N Y N

Driver's Name First M. Last Address City State Age Sex Inj. Year Make No. Type Trailer Reg. Vt/State VIN (Make Letters Larger Than Numbers) Removed to/by

Y N Haz. Citation Y N Driver Re-exam Y N Vehicle Defect Y N Fuel Leakage Impact Severity Truck Cargo Y N Cargo Damage Y N Other Citation Y N Vision Obstruct. Y N Veh. Drivable Y N Vehicle Fire Cargo Description

Restrained by occupants No. Name Address Sex Age Sex Inj. Helmet Y N

Total Occupants Local Use/Owner, Phone (If Veh. Type 7 or 8, List Carrier) Insurance Co. Agency Address Injured taken to/by

ACCIDENT DESCRIPTION AND REMARKS (1" Square)

Reported: Mo/Do/Yr Time A.M. P.M. Investigators Range No. Damaged Property Other Than Vehicle

Process by Comp. Description (Open Closed) Person Admitted of Damaged Traffic Control Device Name: Date: Time: Street Address

* Use Accident Description and Remarks area for explanation. FORWARD COPY TO: Michigan Department of State Police, Traffic Services Bureau, 7180 Harris Drive, Lansing, MI 48913

Michigan



INCLUDE ALL TRAFFIC CONTROL DEVICES

Original size of document - 8 1/2 x 11

OHIO TRAFFIC ACCIDENT REPORT

OH-1 (REV. 1-82)

| | | | | | | | | | | | | |
|--|--|---|---|---|--|---|--|--|--------|----------------|-----------|------------|
| LOCAL REPORT NO. | <input type="checkbox"/> OH-1 <input type="checkbox"/> OH-2 | REPORTING AGENCY | R.C.I.C. | OOHS USE ONLY - DO NOT MARK ABOVE | | | | | | | | |
| REPORT AT STATION TA SR | NO OF VEH PEDESTRIANS INVOLVED | ACCIDENT SEVERITY (CHECK MOST SEVERE) <input type="checkbox"/> FATAL <input type="checkbox"/> INJURY <input type="checkbox"/> PROPERTY DAMAGE ONLY | | COMBINED VEH/PROP LOSS | <input type="checkbox"/> OVER \$100 <input type="checkbox"/> UNDER \$100 | WY HELP | <input type="checkbox"/> SOLVED <input type="checkbox"/> UNSOLVED | | | | | |
| IN COUNTY OF | | IN CITY VILLAGE TWP OF | | DATE OF CRASH | | TIME MILITARY | | | | | | |
| ACCIDENT OCCURRED ON | | | | WITHIN THE INTERSECTION OF | | | | | | | | |
| IF NOT IN INTERSECTION | | | | (LIST NEAREST INTERSECTING STREET, MILEPOST, HOUSE NO. CITY CODE) | | | | | | | | |
| LOG-1 | | LOG-2 | | LOC | JUR | PNE | PLT | | | | | |
| A | UNIT NO. | NO OF OCCUPANTS | OPERATING | PARKED | DRIVERLESS | WY & RUN | NON-CONTACT | INSURANCE CO. OR AGENT | | | | |
| DRIVER-PEDESTRIAN NAME (LAST, FIRST, MI) | | | | ADDRESS (NO., STREET, CITY, STATE, ZIP CODE) | | | | | | | | |
| PHONE NO. | | BIRTH DATE | AGE | SEX | SOCIAL SECURITY NO. | STATE | DRIVER'S LICENSE NO. OCCUPATION | | | | | |
| OWNER (IF SAME AS DRIVER, WRITE SAME) | | | | ADDRESS PHONE | | | | | | | | |
| VEH YR | MAKE | MODEL | COLOR | STYLE | STATE | LICENSE PLATE NO. | TOWING SERVICE VEH/REP DR | | | | | |
| CIRCLE DAMAGE AREAS | | 8 TOP 10 UNDERCAR 11 LOAD 12 TRAILER | DAMAGE SEVERITY <input type="checkbox"/> NON-FUNCTIONAL <input type="checkbox"/> FUNCTIONAL <input type="checkbox"/> DISABLING | DAMAGE SCALE <input type="checkbox"/> NONE <input type="checkbox"/> LIGHT <input type="checkbox"/> HEAVY | VEHICLE DISPOSITION <input type="checkbox"/> DRIVEN AWAY <input type="checkbox"/> REMAINED AT SCENE <input type="checkbox"/> TOWED | FIRE <input type="checkbox"/> NO FIRE <input type="checkbox"/> FIRE DUE TO CRASH <input type="checkbox"/> OTHER FIRE | FROM TO | | | | | |
| B | UNIT NO. | NO OF OCCUPANTS | OPERATING | PARKED | DRIVERLESS | WY & RUN | NON-CONTACT | INSURANCE CO. OR AGENT | | | | |
| DRIVER-PEDESTRIAN NAME (LAST, FIRST, MI) | | | | ADDRESS (NO., STREET, CITY, STATE, ZIP CODE) | | | | | | | | |
| PHONE NO. | | BIRTH DATE | AGE | SEX | SOCIAL SECURITY NO. | STATE | DRIVER'S LICENSE NO. OCCUPATION | | | | | |
| OWNER (IF SAME AS DRIVER, WRITE SAME) | | | | ADDRESS PHONE | | | | | | | | |
| VEH YR | MAKE | MODEL | COLOR | STYLE | STATE | LICENSE PLATE NO. | TOWING SERVICE VEH/REP DR | | | | | |
| CIRCLE DAMAGE AREAS | | 8 TOP 10 UNDERCAR 11 LOAD 12 TRAILER | DAMAGE SEVERITY <input type="checkbox"/> NON-FUNCTIONAL <input type="checkbox"/> FUNCTIONAL <input type="checkbox"/> DISABLING | DAMAGE SCALE <input type="checkbox"/> NONE <input type="checkbox"/> LIGHT <input type="checkbox"/> HEAVY | VEHICLE DISPOSITION <input type="checkbox"/> DRIVEN AWAY <input type="checkbox"/> REMAINED AT SCENE <input type="checkbox"/> TOWED | FIRE <input type="checkbox"/> NO FIRE <input type="checkbox"/> FIRE DUE TO CRASH <input type="checkbox"/> OTHER FIRE | FROM TO | | | | | |
| C | FROM UNIT NO. | NAME (LAST, FIRST, MI) | BIRTH DATE | AGE | PHONE | SEX | POSITION | INJURIES | | | | |
| D | FROM UNIT NO. | NAME (LAST, FIRST, MI) | BIRTH DATE | AGE | PHONE | SEX |  1 FATAL 2 SERIOUSLY VISIBLE 3 MINOR VISIBLE 4 NO VISIBLE INJURY 5 NOT INJURED CONDITION A B C D E F | | | | | |
| E | FROM UNIT NO. | NAME (LAST, FIRST, MI) | BIRTH DATE | AGE | PHONE | SEX | | | | | | |
| F | FROM UNIT NO. | NAME (LAST, FIRST, MI) | BIRTH DATE | AGE | PHONE | SEX | 1 APPARENTLY NORMAL 2 SICK 3 FATIGUED 4 APPARENTLY ABLISS 5 PHYSICAL DEFECT 6 OTHER CONDITION 7 UNKNOWN | | | | | |
| A B C | INJURED TAKEN TO | | BY | | RESTRAINTS | | ALCOHOL | | | | | |
| D E F | INJURED TAKEN TO | | BY | | 1 NOT USED 2 NONE AVAILABLE 3 LAP BELT USED 4 LAP/SHOULDER BELT USED 5 SHOULDER BELT USED 6 CHILD SAFETY SEAT 7 AIR BAG USED 8 USE NOT REPORTED | | A TESTED B TESTED <input type="checkbox"/> YES <input type="checkbox"/> NO <input type="checkbox"/> YES <input type="checkbox"/> NO | | | | | |
| OFFENSE CHARGES AND DESCRIPTION | | | | EJECTION | | | | DRUGS | | | | |
| A <input type="checkbox"/> O.R.C. CITY ORG. B <input type="checkbox"/> O.R.C. CITY ORG. | | | | A B C D E F 1 NOT EJECTED 2 PARTIAL 3 TOTAL 4 TRAPPED INSIDE VEHICLE | | | | A TESTED B TESTED <input type="checkbox"/> YES <input type="checkbox"/> NO <input type="checkbox"/> YES <input type="checkbox"/> NO 1 NO DRUGS DETECTED 2 USING PRESCRIBED DRUG 3 USING ILLEGAL DRUG | | | | |
| RECEIVED CALL | DISPATCHED | ARRIVED | CLEARED | OTHER TIME | TOTAL MINUTES | | DATE REPORT FILED | | PHOTOS | OFFICER'S NAME | SADGE NO. | CHECKED BY |
| DATE REPORT FILED | | PHOTOS | OFFICER'S NAME | SADGE NO. | CHECKED BY | | 1 NO DRUGS DETECTED 2 USING PRESCRIBED DRUG 3 USING ILLEGAL DRUG | | | | | |

HSY 881 2-1-82

Ohio

Original size of document - 8 1/2 x 11

2122361

STATE OF MARYLAND MOTOR VEHICLE ACCIDENT REPORT

FORM OF

1. LOCAL AREA CASE NO. 2. ACCIDENT DATE MO DAY YR 3. TIME (MILITARY) 4. DAY OF WEEK 5. REPORT TYPE
 1 - TRAFFIC ACCIDENT
 2 - NON TRAFFIC ACCIDENT

6. COUNTY 7. TIME NOTIFIED (MILITARY) 8. TIME ADVICE (MILITARY)

9. ACCIDENT SEVERITY
 1. Damage only
 2. Possible Injury
 3. Non-Injury/Damage
 4. Inhabiting
 5. Fatal

10. FIRST MAJOR EVENT
 01. Other Motor Veh in Intersection
 02. Pedestrian
 03. Motor Veh on other roadway
 04. Pedestrian
 05. Railroad
 06. Other Car/Veh
 07. Animal
 08. Fixed Object
 09. Road Object
 10. Other Object
 11. Obstructed
 12. Other Non-Car/Veh

11. SUBSEQUENT EVENTS

12. FIRED OBJECT STRUCK
 01. Bridge/Overpass
 02. Building
 03. Culture/Other
 04. Curb/Post
 05. Quarry/Warehouse
 06. Freeway/Overpass
 07. Fence
 08. Light Support Pole
 09. Sign Support Pole
 10. Other Gate
 11. Tree/Shrubbery
 12. Construction Barrier
 13. Crash Attenuator
 14. Other

13. COLLISION TYPE
 01. Front-End
 02. Rear-End
 03. Side-End
 04. Angle
 05. Single Vehicle
 06. Other
 07. Front-End
 08. Rear-End
 09. Side-End
 10. Angle
 11. Single Vehicle
 12. Other
 13. Front-End
 14. Rear-End
 15. Side-End
 16. Angle
 17. SINGLE VEH
 18. OTHER

14. RELATIONSHIP TO INTERSECTION
 1. Non-Intersection
 2. Intersection
 3. Intersection Related
 4. Driveway/Access

15. KIND OF LOCALITY
 1. Manufacturing or Industrial
 2. Shopping or Business
 3. Residential
 4. Street or Residential
 5. Open Country

16. DAMAGE TO PROPERTY OTHER THAN VEHICLE OBJECT 17. OWNER'S NAME 18. DAMAGE SEVERITY
 1. No Damage
 2. Moderate
 3. Substantial
 4. Extensive

19. ACCIDENT OCCURRED ON ROAD NAME 20. DISTANCE 21. REFERENCED ROAD NAME 22. CITY ACCIDENT OCCURRED IN - OR INDICATE RURAL 23. MUNICIPAL CODE

24. TYPE ROUTE NO. SUFFIX 25. GOING FROM ACCIDENT 26. TYPE ROUTE NO. SUFFIX 27. LOG MILE REFERENCE ON C-1 AT C-5 28. RAMP MOVEMENT
 1. N/A
 2. N to W
 3. E to W
 4. N to E
 5. W to E
 6. E to N
 7. W to S
 8. N to S
 9. S to N

29. MOVEMENT OF VEHICLES
 VEH 1: 01. Moving Constant Speed, 02. Accelerating, 03. Slowing or Stopping, 04. Starting from Traffic Lane, 05. Starting from Parked Position, 06. Stopped in Traffic Lane, 07. Changing Lanes, 08. Parking, 09. Parking
 VEH 2: 10. Parked, 11. Starting, 12. Making Left Turn, 13. Making Right Turn, 14. Making Right Turn on Red, 15. Making U Turn, 16. Stopping, 17. Driveway Moving Vehicle, 18. Other/Unknown

30. TRAFFIC CONTROLS
 1. FUNCTIONING
 2. NOT FUNCTIONING
 01. Police Officer, 02. E & Washington, Gate Vn, 03. Lane & Gate Signal, 04. Flashing Signal, 05. Lane Markings
 06. Channelization Revised, 07. Channelization Physical, 08. Construction/Maintenance Control, 09. Warning Sign, 10. Stop Sign
 11. Yield Sign, 12. Center Line, 13. Edge Line, 14. Other Traffic Control, 15. No Control Present

31. MV UNIT NO. 32. HIT & RUN 33. DRIVER NAME - FIRST, MIDDLE & LAST 34. ADDRESS - NO STREET, CITY, STATE & ZIP 35. PHONE NO.

36. DATE OF BIRTH MO DAY YR 37. SEX & DRIVER LICENSE NO 38. CLASS 'N' RESTRICTIONS 39. STATE 40. YEARS DRV EXP 41. DRIVER EDUCATION 42. MV SEV 43. SAFETY EQPT 44. LT
 1. Public 2. None
 3. Capt 4. Union

45. OCC 46. INJ 47. SEV 48. AGE 49. SEX 50. INJ SEVERITY 51. INJ EQPT 52. LT 53. OCC 54. INJ 55. SEV 56. OCCUPANT NAME & ADDRESS

57. OWNER - NAME & ADDRESS

58. MAKE 59. MODEL 60. YR 61. VEHICLE ID NO 62. PLATE NO 63. STATE 64. YR 65. VEH TYPE 66. DAMAGE SEVERITY
 1. Dents/Scratches
 2. Functional
 3. Other Veh Damage
 4. No Damage
 5. Unknown

67. VEHICLE REMOVED BY 68. VEHICLE REMOVED TO 69. REMOVAL AUTHORITY
 1. Owner
 2. Sheriff
 3. Other
 4. Occupant
 5. Other
 6. N/A

70. MV UNIT NO. 71. HIT & RUN 72. DRIVER NAME - FIRST, MIDDLE & LAST 73. ADDRESS - NO STREET, CITY, STATE & ZIP 74. PHONE NO.

75. DATE OF BIRTH MO DAY YR 76. SEX & DRIVER LICENSE NO 77. CLASS 'N' RESTRICTIONS 78. STATE 79. YEARS DRV EXP 80. DRIVER EDUCATION 81. MV SEV 82. SAFETY EQPT 83. LT
 1. Public 2. None
 3. Capt 4. Union

84. OCC 85. INJ 86. SEV 87. AGE 88. SEX 89. INJ SEVERITY 90. INJ EQPT 91. LT 92. OCC 93. INJ 94. SEV 95. OCCUPANT NAME & ADDRESS

96. OWNER - NAME & ADDRESS

97. MAKE 98. MODEL 99. YR 100. VEHICLE ID NO 101. PLATE NO 102. STATE 103. YR 104. VEH TYPE 105. DAMAGE SEVERITY
 1. Dents/Scratches
 2. Functional
 3. Other Veh Damage
 4. No Damage
 5. Unknown

106. VEHICLE REMOVED BY 107. VEHICLE REMOVED TO 108. REMOVAL AUTHORITY
 1. Owner
 2. Sheriff
 3. Other
 4. Occupant
 5. Other
 6. N/A

Maryland

8516202

TRAFFIC ACCIDENT REPORT

POLICE ACCIDENT NO.

DATE OF ACCIDENT

1. All Intersections With _____

2. At Non All Intersections _____

3. _____

4. _____

5. _____

6. _____

7. _____

8. _____

9. _____

10. _____

11. _____

12. _____

13. _____

14. _____

15. _____

16. _____

17. _____

18. _____

19. _____

20. _____

21. _____

22. _____

23. _____

24. _____

25. _____

26. _____

27. _____

28. _____

29. _____

30. _____

31. _____

32. _____

33. _____

34. _____

35. _____

36. _____

37. _____

38. _____

39. _____

40. _____

41. _____

42. _____

43. _____

44. _____

45. _____

46. _____

47. _____

48. _____

49. _____

50. _____

51. _____

52. _____

53. _____

54. _____

55. _____

56. _____

57. _____

58. _____

59. _____

60. _____

61. _____

62. _____

63. _____

64. _____

65. _____

66. _____

67. _____

68. _____

69. _____

70. _____

71. _____

72. _____

73. _____

74. _____

75. _____

76. _____

77. _____

78. _____

79. _____

80. _____

81. _____

82. _____

83. _____

84. _____

85. _____

86. _____

87. _____

88. _____

89. _____

90. _____

91. _____

92. _____

93. _____

94. _____

95. _____

96. _____

97. _____

98. _____

99. _____

100. _____

DATE OF ACCIDENT

TIME OF ACCIDENT

TOTAL DASHES INVOLVED

DAY OF THE WEEK

TYPE OF REPORT

CIRCLE ONE OR MORE

1. Fatal

2. Death

3. Injury

4. Property Damage

5. Arrest

6. Intoxicated/Impaired

7. Other

8. Other

9. Other

10. Other

11. Other

12. Other

13. Other

14. Other

15. Other

16. Other

17. Other

18. Other

19. Other

20. Other

21. Other

22. Other

23. Other

24. Other

25. Other

26. Other

27. Other

28. Other

29. Other

30. Other

31. Other

32. Other

33. Other

34. Other

35. Other

36. Other

37. Other

38. Other

39. Other

40. Other

41. Other

42. Other

43. Other

44. Other

45. Other

46. Other

47. Other

48. Other

49. Other

50. Other

51. Other

52. Other

53. Other

54. Other

55. Other

56. Other

57. Other

58. Other

59. Other

60. Other

61. Other

62. Other

63. Other

64. Other

65. Other

66. Other

67. Other

68. Other

69. Other

70. Other

71. Other

72. Other

73. Other

74. Other

75. Other

76. Other

77. Other

78. Other

79. Other

80. Other

81. Other

82. Other

83. Other

84. Other

85. Other

86. Other

87. Other

88. Other

89. Other

90. Other

91. Other

92. Other

93. Other

94. Other

95. Other

96. Other

97. Other

98. Other

99. Other

100. Other

VEHICLE TYPE

VEHICLE COLOR

VEHICLE IDENTIFICATION NO.

CITY/STATE/ZIP CODE

VEHICLE REGISTERED TO

DATE OF BIRTH

SEX

HAIR

EYES

HEIGHT

WEIGHT

VEHICLE REGISTERED TO

DATE OF BIRTH

SEX

HAIR

EYES

HEIGHT

WEIGHT

VEHICLE REGISTERED TO

DATE OF BIRTH

SEX

HAIR

EYES

HEIGHT

WEIGHT

VEHICLE LICENSE NO.

VEHICLE TYPE

VEHICLE COLOR

VEHICLE IDENTIFICATION NO.

CITY/STATE/ZIP CODE

VEHICLE REGISTERED TO

DATE OF BIRTH

SEX

HAIR

EYES

HEIGHT

WEIGHT

VEHICLE REGISTERED TO

DATE OF BIRTH

SEX

HAIR

EYES

HEIGHT

WEIGHT

VEHICLE LICENSE NO.

VEHICLE TYPE

VEHICLE COLOR

VEHICLE IDENTIFICATION NO.

CITY/STATE/ZIP CODE

VEHICLE REGISTERED TO

DATE OF BIRTH

SEX

HAIR

EYES

HEIGHT

WEIGHT

VEHICLE REGISTERED TO

DATE OF BIRTH

SEX

HAIR

EYES

HEIGHT

WEIGHT

VEHICLE LICENSE NO.

VEHICLE TYPE

VEHICLE COLOR

VEHICLE IDENTIFICATION NO.

CITY/STATE/ZIP CODE

VEHICLE REGISTERED TO

DATE OF BIRTH

SEX

HAIR

EYES

HEIGHT

WEIGHT

VEHICLE REGISTERED TO

DATE OF BIRTH

SEX

HAIR

EYES

HEIGHT

WEIGHT

VEHICLE LICENSE NO.

VEHICLE TYPE

VEHICLE COLOR

VEHICLE IDENTIFICATION NO.

CITY/STATE/ZIP CODE

VEHICLE REGISTERED TO

DATE OF BIRTH

SEX

HAIR

EYES

HEIGHT

WEIGHT

VEHICLE REGISTERED TO

DATE OF BIRTH

SEX

HAIR

EYES

HEIGHT

WEIGHT

VEHICLE LICENSE NO.

VEHICLE TYPE

VEHICLE COLOR

VEHICLE IDENTIFICATION NO.

CITY/STATE/ZIP CODE

VEHICLE REGISTERED TO

DATE OF BIRTH

SEX

HAIR

EYES

HEIGHT

WEIGHT

VEHICLE REGISTERED TO

DATE OF BIRTH

SEX

HAIR

EYES

HEIGHT

WEIGHT

VEHICLE LICENSE NO.

VEHICLE TYPE

VEHICLE COLOR

VEHICLE IDENTIFICATION NO.

CITY/STATE/ZIP CODE

VEHICLE REGISTERED TO

DATE OF BIRTH

SEX

HAIR

EYES

HEIGHT

WEIGHT

VEHICLE REGISTERED TO

DATE OF BIRTH

SEX

HAIR

EYES

HEIGHT

WEIGHT

VEHICLE LICENSE NO.

VEHICLE TYPE

VEHICLE COLOR

VEHICLE IDENTIFICATION NO.

CITY/STATE/ZIP CODE

VEHICLE REGISTERED TO

DATE OF BIRTH

SEX

HAIR

EYES

HEIGHT

WEIGHT

VEHICLE REGISTERED TO

DATE OF BIRTH

SEX

HAIR

EYES

HEIGHT

WEIGHT

Illinois



INDIANA OFFICER'S STANDARD ACCIDENT REPORT

State Form 2365BR/2/Stock 302

Mail to: Indiana State Police, Accident Records Section
100 North Senate Avenue Indianapolis IN 46204

OFFICE USE ONLY

Accident I.D. No.

1 Prim.
V1
V2
3
V1
V2
4
V1
V2
5
V1
V2
6
TRAILER 1
TRAILER 2

7
8
9
10
11
12
13
14
15
15A

Indiana

| | | | | | | |
|---|--|---|---|------------|---------|-------------|
| Date of Accident MONTH DAY YEAR | Day of Week | Actual Local Time AM PM | No Motor Vehicles | No Injured | No Dead | No Trainers |
| County | | Township | City/Town or Nearest City/Town | | | |
| Inside Corporate Limits? <input type="checkbox"/> Yes <input type="checkbox"/> No | Property? <input type="checkbox"/> Public <input type="checkbox"/> Private | Distance and Direction From Corporate Limits Miles North Miles South Miles East Miles West | | | | |
| Road Accident Occurred On | | | Intersecting Road/ Mile Marker/ Interchange | | | |
| If not at intersection, number of feet from | | Direction | Nearest Intersecting Road/ Mile Marker/ Interchange | | | |

Driver's Name (Last, First, MI)
Address (Street, City, State, Zip)

Apparent Phys Stat (enter no.) Sex Date of Birth MONTH DAY YEAR Arrested? Yes No

Driver's License No Lic Type Lic St Restr

Driver's Name (Last, First, MI)
Address (Street, City, State, Zip)

Apparent Phys Stat (enter no.) Sex Date of Birth MONTH DAY YEAR Arrested? Yes No

Driver's License No Lic Type Lic St Restr

Color Veh Yr Make Model Name

Veh Type (enter no.) Lic Yr License No Lic State

Veh Use (enter no.) Speed Limit Fuel Tax No

Direction of Travel No Occupants Fire? Yes No No Axles Transporting Hazardous Mat Yes No

Towed To Towed By

Color Veh Yr Make Model Name

Veh Type (enter no.) Lic Yr License No Lic State

Veh Use (enter no.) Speed Limit Fuel Tax No

Direction of Travel No Occupants Fire? Yes No No Axles Transporting Hazardous Mat Yes No

Towed To Towed By

Registered Owner's Name (Last, First, MI)
Address (Street, City, State, Zip)

Registered Owner's Name (Last, First, MI)
Address (Street, City, State, Zip)

Registered Owner's Name (Last, First, MI)
Address (Street, City, State, Zip)

Registered Owner's Name (Last, First, MI)
Address (Street, City, State, Zip)

License No Make Year Lic St Lic Yr

License No Make Year Lic St Lic Yr

| | | | |
|--------------------------------|--|---|----------------------------|
| INITIAL IMPACT V1 V2 | Area Damaged (Multiples) 3 4 8 10 2 8 8 1 8 7 | 10 Undercarriage 11 Trailer 12 None | 3 4 8 10 2 8 8 1 8 7 |
| OTHER PROPERTY (INCLUDE CARGO) | | | |
| Name of Object | OWNER'S NAME AND ADDRESS | | Damage Est (Last Chart) |

Direction Street/Highway Arrested? Yes No Apparent Phys Stat (enter no.)

What was pedestrian doing before accident? Enter No

- Not in roadway
- Standing in roadway
- Playing in roadway
- Pushing or working on vehicle
- Other activity in roadway
- Walking in roadway with traffic
- Walking in roadway against traffic
- Getting on or off vehicle
- Getting on or off school bus
- Crossing or entering path of intersection
- Crossing or entering at intersection
- Other

Pedestrian Traffic Control? Yes No

| | | | | | | | | | | | | | |
|---------------------------------------|----|----|----|----|----|----|----|----|----|----|----|----|----|
| 16 | 17 | 18 | 19 | 20 | 21 | 22 | 23 | 24 | 25 | 26 | 27 | 28 | 29 |
| DRIVER OF VEHICLE 1 (as listed above) | | | | | | | | | | | | | |
| DRIVER OF VEHICLE 2 (as listed above) | | | | | | | | | | | | | |

Indiana

Diagram



Large dotted grid area for drawing a diagram.

NARRATIVE (Refer to Vehicle by Number)

Series of horizontal lines for writing a narrative report.

| | | | | | | | |
|---|-----------------------------------|----------|--------------|---------------|---------------------------------|--|--|
| D1 Injured By | | | | D2 Injured By | | | |
| Other Participants (Name, Address (es)) | | | | | | | |
| Name of Witness No. 1 | | | Address | | | Location at Time of Accident | |
| Name of Witness No. 2 | | | Address | | | Location at Time of Accident | |
| Name of Person Arrested | | | I.C. Code(s) | | Name of Person Arrested | | I.C. Code(s) |
| INVESTIGATOR | Time Notified | AM PM | Time Arrived | AM PM | Other Location of Investigation | Investigation Complete | Photos Taken |
| | Assisting Officer | | I.D. No. | | Agency | <input type="checkbox"/> Yes <input type="checkbox"/> No | <input type="checkbox"/> Yes <input type="checkbox"/> No |
| | Assisting Officer | | I.D. No. | | Agency | | Date of Report |
| | Investigating Officer's Signature | | I.D. No. | | Agency | | Driver Report Form Furnished <input type="checkbox"/> D1 <input type="checkbox"/> D2 |

Original size of document - 8 1/2 x 11

100-A EXHIBIT FARS CODING FORMS (VEHICLE/DRIVER LEVEL)



A Department of Transportation
National Highway Traffic Safety Administration

1988 Fatal Accident Reporting System (FARS) VEHICLE/DRIVER LEVEL

Form Approved by
O & B No. 2127-0000

CODED BY _____
DATE CODED _____
STATE CASE NO. _____

| | | | | | | | | | | | | | | | | | | | | | | | | | | | | | |
|---|----|----|---|------------------------|---|---------------------------------------|---|--|-----------------------|-----------------------------|---|---|--|--|--|--|----|----|----|----|----|----|----|----|----|----|----|----|----|
| CASE NUMBER STATE | 1 | 2 | CONSECUTIVE NUMBER | 3 | 4 | 5 | TRANSACTION CODE 21 - Original Submission 22 - Update or Change | 6 | 7 | 8 | 9 | 10 | 11 | | | | | | | | | | | | | | | | |
| VEHICLE MAKE (See instruction Manual) | 14 | 15 | VEHICLE MODEL (See instruction Manual) | 16 | 17 | BODY TYPE (See instruction Manual) | 18 | 19 | MODEL YEAR | 20 | 21 | VEHICLE MAKE (Assigned by Analyst) | 22 | | | | | | | | | | | | | | | | |
| VEHICLE IDENTIFICATION NO. Actual Value Enter First 40 of no. with Remaining 4 of Unknown | | | | | | | | | | | | | 22 | 23 | 24 | 25 | 26 | 27 | 28 | 29 | 30 | 31 | 32 | 33 | 34 | 35 | 36 | 37 | 38 |
| REGISTRATION STATE | | | 39 | 40 | ROLLOVER | | | | | 41 | JACKKNIFE | | | | | 42 | | | | | | | | | | | | | |
| OSA CODES (Event) 01 - Not Reported 02 - Motor Vehicle 03 - Motorcycle 04 - U.S. Government Top 05 - Other 06 - Unknown | | | 0 - No Roll 1 - First Event 2 - Subsequent Event | | | | | 0 - Not an Articulated Vehicle 1 - No 2 - First Event 3 - Subsequent Event | | | | | | | | | | | | | | | | | | | | | |
| TRAVEL SPEED Actual Miles Per Hour Enter 0 - Unknown | | | 43 | 44 | HAZARDOUS CARGO | | 45 | VEHICLE TRAILERS | | | 46 | SPECIAL USE | | | | | 47 | | | | | | | | | | | | |
| 0 - No 1 - Yes 2 - Unknown | | | 0 - No 1 - Yes 2 - Unknown | | 0 - No 1 - Yes 2 - Yes 3 - Yes 4 - Yes 5 - Unknown | | | 0 - No Special Use 1 - Taxi 2 - Vehicle Used as School Bus 3 - Vehicle Used as other Bus 4 - Motor 5 - Police 6 - Ambulance 7 - Fire 8 - Unknown | | | | | | | | | | | | | | | | | | | | | |
| EMERGENCY USE | | | 48 | IMPACT POINT - INITIAL | | | | | 49 | 50 | IMPACT POINT - PRINCIPAL | | | | | 51 | 52 | | | | | | | | | | | | |
| 0 - No 1 - Yes | | | 0 - Non-Collision 01 - 12 - Close Proximity 13 - Top 14 - Underpassage | | | | | 15 - Annotated 16 - Overpass 0 - Unknown | | | 0 - Non-Collision 01 - 12 - Close Proximity 13 - Top 14 - Underpassage | | | | | 15 - Annotated 16 - Overpass 0 - Unknown | | | | | | | | | | | | | |
| EXTENT OF INFORMATION | | | 53 | VEHICLE ROLE | | | | | 54 | MANNER OF LEAVING SCENE | | | | | 55 | | | | | | | | | | | | | | |
| 0 - None 1 - Other 2 - Other 3 - Functionary | | | 0 - Non-Collision 1 - Steering 2 - Braking | | | | | 0 - Both 1 - Unknown | | | 1 - Steer 2 - Yawed Away 3 - Accelerated 4 - Unknown | | | | | | | | | | | | | | | | | | |
| FIRE OCCURRENCE | | | 56 | NUMBER OF OCCUPANTS | | | | | 57 | 58 | RELATED FACTORS | | | | | 59 | 60 | | | | | | | | | | | | |
| 0 - No Fire 1 - Fire Observed in Vehicle During Accident | | | Actual Value of Total Enter 0 - 0 or more 01 - Unknown - Only Reported Reported 0 - Unknown | | | | | See instruction Manual "Related Factors - VEHICLE LEVEL" | | | | | | | | | | | | | | | | | | | | | |
| VEHICLE MANEUVER | | | 61 | 62 | MOST HAZARDOUS EVENT | | | | | 63 | 64 | | | | | | | | | | | | | | | | | | |
| 0 - No 1 - Yes | | | 0 - No 1 - Yes | | | | | 0 - No 1 - Yes | | | | | 0 - No 1 - Yes | | | | | | | | | | | | | | | | |
| Card No. | 65 | 66 | DRIVER PRESENCE | 67 | 68 | LICENSE STATE | 69 | 70 | DRIVER LICENSE STATUS | | | 71 | DRIVER LICENSE TYPE COMPLIANCE | | | 72 | | | | | | | | | | | | | |
| 1 | 0 | 1 | 0 - Driver Present | 01 | 02 | 03 | 04 | NO VALID LICENSE 0 - No License 1 - Suspended 2 - Revoked 3 - Expired 4 - Concluded or Stated 0 - Unknown | | | VALID LICENSE 0 - Single Class License 1 - Multiple Class License 2 - License & Permit 3 - Temporary 0 - Unknown | | | 0 - Not Licensed 1 - No License Required for This Class Vehicle 2 - No Valid License for This Class Vehicle 3 - Valid License for This Class Vehicle 0 - Unknown | | | | | | | | | | | | | | | |
| 2 | 0 | 1 | 0 - Driver Present | 01 | 02 | 03 | 04 | 0 - No License 1 - No License Required for This Class Vehicle 2 - No Valid License for This Class Vehicle 3 - Valid License for This Class Vehicle 0 - Unknown | | | | | | | | | | | | | | | | | | | | | |
| COMPLIANCE WITH LICENSE RESTRICTIONS | | | 73 | VIOLATIONS CHARGED | | | | | 74 | PREVIOUS RECORDED ACCIDENTS | | | | | 75 | 76 | | | | | | | | | | | | | |
| 0 - No Restrictions 1 - Restricted Category Veh. 2 - Restricted Use Category Veh. 3 - Restricted Category Unknown 0 - Unknown | | | 0 - None 1 - Alcohol or Drug 2 - Speeding 3 - Alcohol or Drug and Speeding 4 - Running Wrong 5 - Driving with a Suspended or Revoked License 6 - Other Moving Violation 7 - Non-Moving Violation 8 - Violation Type Unknown or Other Violation 0 - Unknown | | | | | Actual Value Enter 0 - None 01 - Unknown | | | | | Actual Value Enter 0 - None 01 - Unknown | | Actual Value Enter 0 - None 01 - Unknown | | | | | | | | | | | | | | |
| PREVIOUS RECORDED SUSPENSIONS AND REVOCATIONS | | | 77 | 78 | PREVIOUS DWI CONVICTIONS | | | | | 79 | 80 | PREVIOUS SPEEDING CONVICTIONS | | | | | 81 | 82 | | | | | | | | | | | |
| Actual Value Enter 0 - None 01 - Unknown | | | Actual Value Enter 0 - None 01 - Unknown | | | | | Actual Value Enter 0 - None 01 - Unknown | | | Actual Value Enter 0 - None 01 - Unknown | | | | | | | | | | | | | | | | | | |
| PREVIOUS OTHER HAZARDOUS BY CONVICTIONS | | | 83 | 84 | DATE OF LAST ACCIDENT, SUSPENSION, OR CONVICTION | | | | | 85 | 86 | DATE OF FIRST ACCIDENT, SUSPENSION, OR CONVICTION | | | | | 87 | 88 | | | | | | | | | | | |
| Actual Value Enter 0 - None 01 - Unknown | | | Actual Value Enter 0 - None 01 - Unknown | | | | | Actual Value Enter 0 - None 01 - Unknown | | | Actual Value Enter 0 - None 01 - Unknown | | | | | | | | | | | | | | | | | | |
| DRIVER ID CODE | | | 89 | 90 | 91 | 92 | 93 | RELATED FACTORS | | | | | 94 | 95 | 96 | 97 | 98 | 99 | | | | | | | | | | | |
| Actual Value Enter 0 - None 01 - Unknown | | | Actual Value Enter 0 - None 01 - Unknown | | | | | See instruction Manual "Related Factors - DRIVER LEVEL" | | | | | | | | | | | | | | | | | | | | | |

NS Form 2146 (Rev. 1988)

U.S. GPO: 1988-261-672 5000

100-A EXHIBIT FARS CODING FORMS (PERSON LEVEL)



U.S. Department of Transportation
 National Highway Traffic Safety Administration

1988 Focal Accident Reporting System (FARS)
 PERSON LEVEL

O M S No 217/88B

CODED BY _____

DATE CODED _____

STATE CASE NO _____

| | | | | | | | | | | | |
|--|--|---|--|--|--|---|---|---|--|--|--|
| CASE NUMBER STATE DATA CODES | | ORIG CJ TYPE NUMBER | | TRANSACTION CODE 01 - Original Submission 02 - Update or Change | | CARD NO | VEHICLE NUMBER Assigned by Agency 00 - Non-Motorist | | PERSON NUMBER Assigned by Agency | | |
| NON-MOTORIST STRIKING VEHICLE NUMBER Assigned Vehicle Number Report 00 - Unknown | | | | AGE Actual Value 00 - Up to One Year 01 - One to Four Years or Older 02 - Unknown | | SEX 1 - Male 2 - Female 00 - Unknown | | | | | |
| PERSON TYPE 1 - Driver of a Motor Vehicle in Transport 2 - Passenger of a Motor Vehicle in Transport 3 - Operator of a Motor Vehicle Not in Transport 4 - Occupant of a Non-Motor Vehicle Transport Device 5 - Non-Occupant - Pedestrian 6 - Non-Occupant - Bicyclist 7 - Non-Occupant - Other Cyclist 8 - Non-Occupant - Other or Unknown 9 - Unknown Occupant Type in a Motor Vehicle in Transport | | | | SEATING POSITION 00 - Non-Motorist 01 - Front Seat - Left Side (Driver's Side) 02 - - Middle 03 - - Right Side 04 - - Other 05 - - Unknown 06 - Second Seat - Left Side 07 - - Middle 08 - - Right Side 09 - - Other 10 - - Unknown 11 - Third Seat - Left Side 12 - - Middle 13 - - Right Side 14 - - Other 15 - - Unknown 16 - Fourth Seat - Left Side 00 - - Middle 01 - - Right Side 02 - - Other 03 - - Unknown 04 - Other Person in Cab (Truck) 05 - Other Passenger in Seated Passenger or Cargo Area 06 - Other Passenger in Unseated Passenger or Cargo Area 07 - Other Passenger in Passenger or Cargo Area, Unknown Whether or Not Seated 08 - Riding on Vehicle Exterior 09 - Unknown | | | | | | | |
| MANUAL ACTIVE RESTRAINT SYSTEM - USE 0 - None Used - Vehicle Occupant Not Applicable - Non-Motorist 1 - Shoulder Belt 2 - Lap Belt 3 - Lap and Shoulder Belt 4 - Child Safety Seat 5 - Motorized Vehicle 6 - Reported Used - Type Unknown or Other including Other Motorist 9 - Unknown | | | | AUTOMATIC PASSENGER RESTRAINT SYSTEM - FUNCTION 0 - Not Equipped or Non-Motorist 1 - Automatic Belt in Use 2 - Automatic Belt-Not in Use 3 - Occupant Air Bag 4 - Non-Occupant Air Bag 9 - Unknown | | | | | | | |
| NON-MOTORIST LOCATION 00 - Not Applicable - Vehicle Occupant 01 - Intersection - in Crosswalk 02 - Intersection - On Roadway Not in Crosswalk 03 - Intersection - On Roadway Crosswalk Not Applicable 04 - Intersection - On Roadway Crosswalk Availability Unknown 05 - Intersection - Not on Roadway 06 - Intersection - Unknown 07 - Non-Intersection - in Crosswalk 08 - Non-Intersection - On Roadway Not in Crosswalk 09 - Non-Intersection - On Roadway Crosswalk Not Applicable 10 - Non-Intersection - On Roadway Crosswalk Availability Unknown 11 - Non-Intersection - in Parking Lot 12 - Non-Intersection - On Road Shoulder 13 - Non-Intersection - Side Path 14 - Non-Intersection - Outside Trafficway 15 - Non-Intersection - Other Not on Roadway 16 - Non-Intersection - Unknown 17 - Unknown | | | | LOCATION 0 - Not Reported 1 - Partially Reported 2 - Partially Reported 9 - Unknown | | DISTRICTION 0 - Not Reported 1 - Estimated 9 - Unknown | | METHOD OF ALCOHOL DETERMINATION (By Police) 1 - Instrument Test (Breath, Blood, Urine) 2 - Preliminary Breath Test (PBT) 3 - Instrument 4 - Positive Alcohol Screen (PAS) 5 - Observed 6 - Other (e.g. Saliva test) 9 - Not Reported | | | |
| POLICE REPORTED ALCOHOL INVOLVEMENT 0 - No Alcohol Test Reported 1 - Yes (Alcohol Involved) 2 - Not Reported 9 - Unknown (Police Reported) | | ALCOHOL TEST RESULT Actual Value (Reported Involvement Below Five Digit) (e.g.) 00 - Test Refused 01 - None Given 02 - AC Test Performed, Results Unknown 03 - Unknown | | DRUGS NOTED IN TOXICOLOGY REPORT (Other than alcohol) 0 - No drug test given 1 - No drugs reported 2 - Drugs reported 3 - Not tested for drugs 4 - Unknown if tested for drugs | | DRUGS NOTED IN TOXICOLOGY REPORT (Other than alcohol) 4 - Unknown if tested for drugs | | | | | |
| INJURY SEVERITY 0 - No injury (E) 1 - Possible injury (E) 2 - Nonpenetrating (Visible Injury) (E) 3 - Penetrating Injury (E) 4 - Head Injury (E) 5 - Injured, Severity Unknown 6 - Dead Prior to Accident 9 - Unknown | | TAKEN TO HOSPITAL OR TREATMENT FACILITY 0 - No 1 - Yes 9 - Unknown | | DEATH DATE MM - Not Applicable 99 - Unknown MONTH DAY YEAR | | | | | | | |
| DEATH TIME Military Time Design 0000 - Not Applicable 9999 - Unknown | | RELATED FACTORS See instructions Manual "Related Factors - PERSON LEVEL" | | | | | | | | | |

100-A EXHIBIT FARS CODING FORMS (ACCIDENT LEVEL)



US Department of Transportation
 National Highway Traffic Safety Administration

1988 Fetal Accident Reporting System (FARS) ACCIDENT LEVEL

Form Approved GSA
 O & B No. 1117-000
 CODED BY _____
 DATE CODED _____
 STATE CASE NO. _____

| | | | | |
|------------------------------------|------------------------------|---|-----------------|--|
| CASE CLASSIFIED BY STATE ORS CODES | | TRANSACTION CODE 11 - Original Submission 12 - Update or Change 13 - Closure 14 - LHM | | CASE NO. |
| CITY | COUNTY | MONTH DAY YEAR | TIME | |
| Number of Person Injured | | Number of Person Killed | | FEDERAL AID SYSTEM |
| ROADWAY FUNCTION CLASS | | ROUTE SIGNING | | |
| TRAFFICWAY IDENTIFIER | | MILEPOINT | | |
| SPECIAL JURISDICTION | | FIRST MAJOR EVENT | | MANNER OF COLLISION |
| RELATION TO JUNCTION | | RELATION TO ROADWAY | | TRAFFICWAY FLOW |
| NUMBER OF TRAVEL LANES | | SPEED LIMIT | | ROADWAY ALIGNMENT |
| ROADWAY SURFACE TYPE | | ROADWAY SURFACE CONDITION | | TRAFFIC CONTROL DEVICE |
| TRAFFIC CONTROL DEVICE FUNCTIONING | | WET AND SLIP | LIGHT CONDITION | |
| CONSTRUCTION / MAINTENANCE ZONE | | RESTRICTION TIME HAS | | ARRIVAL TIME ZONE |
| TIME AT HOSPITAL | | SCHOOL BUS RELATED | RELATED FACTORS | |
| CASE NO. | ADDITIONAL STATE INFORMATION | | | Number of Supplemental Forms Submitted |

HS Form 214 (Rev. 1988)

Appendix C

**Frequency Counts of Fires and Motor Vehicle
Crashes**

Table C-1

Counts of Vehicle Fires and Total Accident-Involved Passenger Cars
by Vehicle Model Year

States of Michigan, Ohio, Maryland
Calendar Years 1982 - 1987

| Vehicle Model Year | <u>Michigan</u> | | <u>Ohio</u> | | <u>Maryland</u> | |
|--------------------------|-----------------|-----------------|--------------|-----------------|-----------------|-----------------|
| | <u>Fires</u> | <u>Vehicles</u> | <u>Fires</u> | <u>Vehicles</u> | <u>Fires</u> | <u>Vehicles</u> |
| 1987 | 56 | 38,585 | 54 | 32,913 | 16 | 15,597 |
| 1986 | 142 | 103,274 | 218 | 85,398 | 29 | 33,978 |
| 1985 | 219 | 160,467 | 284 | 152,450 | 41 | 49,948 |
| 1984 | 269 | 195,298 | 415 | 171,949 | 81 | 68,620 |
| 1983 | 247 | 158,620 | 301 | 143,877 | 76 | 61,950 |
| 1982 | 267 | 168,774 | 391 | 161,844 | 100 | 66,998 |
| 1981 | 330 | 194,501 | 488 | 194,371 | 129 | 73,166 |
| 1980 | 400 | 208,851 | 638 | 215,992 | 158 | 75,797 |
| 1979 | 445 | 236,391 | 819 | 255,927 | 206 | 84,591 |
| 1978 | 529 | 235,440 | 915 | 265,801 | 203 | 79,861 |
| 1977 | 500 | 223,984 | 935 | 248,648 | 217 | 72,159 |
| 1976 | 410 | 168,825 | 835 | 204,047 | 214 | 60,130 |
| 1975 | 297 | 111,654 | 702 | 139,723 | 208 | 41,498 |
| 1974 | 329 | 104,112 | 785 | 147,308 | 247 | 44,695 |
| 1973 | 316 | 94,520 | 666 | 128,837 | 203 | 44,723 |
| 1972 | 254 | 70,664 | 552 | 98,541 | 167 | 36,023 |
| 1971 | 165 | 42,126 | 332 | 60,770 | 121 | 25,307 |
| 1970 | 99 | 29,292 | 252 | 48,718 | 104 | 20,272 |
| 1969 | 65 | 19,705 | 172 | 32,470 | 98 | 14,411 |
| 1968 | 43 | 14,857 | 154 | 24,815 | 53 | 10,702 |
| 1967 | 31 | 9,496 | 74 | 16,702 | 42 | 7,310 |
| 1966 | 19 | 6,481 | 52 | 12,673 | 18 | 5,393 |

Table C-2
 Counts of Vehicle Fires and Total Accident-Involved Passenger Cars
 by Vehicle Model Year

States of Illinois and Indiana
 Calendar Years 1982 - 1987

| <u>Vehicle Model Year</u> | <u>Illinois</u> | | <u>Indiana</u> | |
|-------------------------------|-----------------|-----------------|----------------|-----------------|
| | <u>Fire</u> | <u>Vehicles</u> | <u>Fires</u> | <u>Vehicles</u> |
| 1987 | 23 | 60,160 | 9 | 18,389 |
| 1986 | 92 | 133,489 | 30 | 45,202 |
| 1985 | 128 | 201,270 | 37 | 64,950 |
| 1984 | 185 | 265,289 | 58 | 82,582 |
| 1983 | 168 | 235,060 | 37 | 68,321 |
| 1982 | 208 | 255,572 | 45 | 76,144 |
| 1981 | 232 | 277,211 | 75 | 92,766 |
| 1980 | 261 | 292,888 | 72 | 98,497 |
| 1979 | 330 | 368,303 | 106 | 121,839 |
| 1978 | 316 | 338,447 | 122 | 126,172 |
| 1977 | 332 | 321,736 | 108 | 120,018 |
| 1976 | 261 | 283,088 | 88 | 97,139 |
| 1975 | 195 | 189,829 | 78 | 66,952 |
| 1974 | 217 | 185,323 | 84 | 69,939 |
| 1973 | 226 | 167,203 | 89 | 68,481 |
| 1972 | 119 | 123,204 | 87 | 52,739 |
| 1971 | 96 | 73,841 | 56 | 32,586 |
| 1970 | 67 | 53,645 | 57 | 26,039 |
| 1969 | 48 | 35,506 | 29 | 18,508 |
| 1968 | 37 | 25,746 | 18 | 14,029 |
| 1967 | 27 | 17,620 | 10 | 9,713 |
| 1966 | 17 | 12,929 | 16 | 8,001 |

Table C - 2a
 Counts of Vehicle Fires and Total Passenger Cars
 Involved in Injury Crashes by Vehicle Model Year

States of Michigan, Ohio, and Maryland
 Calendar Years 1982-1987

| Vehicle Model Year | Michigan | | Ohio | | Maryland | |
|-----------------------|----------|----------|-------|----------|----------|----------|
| | Fires | Vehicles | Fires | Vehicles | Fires | Vehicles |
| 1987 | 10 | 2,251 | 13 | 2,391 | 8 | 2,017 |
| 1986 | 32 | 6,011 | 54 | 6,657 | 4 | 4,242 |
| 1985 | 40 | 9,252 | 53 | 10,099 | 13 | 5,910 |
| 1984 | 61 | 12,270 | 72 | 13,635 | 12 | 7,965 |
| 1983 | 40 | 10,277 | 65 | 11,790 | 7 | 7,142 |
| 1982 | 44 | 12,151 | 76 | 14,188 | 8 | 7,864 |
| 1981 | 61 | 14,100 | 85 | 17,530 | 14 | 8,593 |
| 1980 | 85 | 15,559 | 120 | 19,704 | 25 | 8,718 |
| 1979 | 104 | 16,260 | 173 | 22,634 | 24 | 8,784 |
| 1978 | 106 | 15,976 | 189 | 22,553 | 16 | 8,088 |
| 1977 | 98 | 14,393 | 162 | 20,134 | 26 | 7,482 |
| 1976 | 103 | 11,407 | 154 | 17,586 | 24 | 5,718 |
| 1975 | 63 | 7,708 | 132 | 12,279 | 17 | 3,869 |
| 1974 | 64 | 7,814 | 163 | 13,479 | 17 | 4,505 |
| 1973 | 66 | 6,815 | 128 | 11,432 | 18 | 4,116 |
| 1972 | 56 | 5,189 | 118 | 8,855 | 19 | 3,406 |
| 1971 | 41 | 3,148 | 60 | 5,651 | 9 | 2,643 |
| 1970 | 20 | 2,211 | 50 | 4,621 | 7 | 2,057 |
| 1969 | 17 | 1,432 | 45 | 3,098 | 8 | 1,430 |
| 1968 | 8 | 1,168 | 35 | 2,320 | 6 | 1,092 |
| 1967 | 12 | 785 | 25 | 1,720 | 3 | 834 |
| 1966 | 5 | 555 | 13 | 1,322 | 1 | 642 |
| 1965 | 6 | 433 | 12 | 962 | 4 | 406 |

Table entries are: (1) the number of vehicles in crashes where the vehicle catches fire and the driver sustains injury at either the A or the B severity level; (2) the total number of vehicles in crashes where the driver sustains injury at either the A or B severity level

Table C - 3
 Counts of Vehicle Fires and Total Accident-Involved Light Trucks
 by Vehicle Model Year
 States of Michigan, Ohio, and Maryland

| Vehicle Model Year | Michigan | | Ohio | | Maryland | |
|-----------------------|----------|----------|-------|----------|----------|----------|
| | Fires | Vehicles | Fires | Vehicles | Fires | Vehicles |
| 1987 | 23 | 11,595 | 21 | 8,954 | 4 | 3,949 |
| 1986 | 34 | 28,335 | 47 | 21,857 | 18 | 9,498 |
| 1985 | 48 | 38,558 | 77 | 29,353 | 16 | 12,190 |
| 1984 | 69 | 39,681 | 82 | 30,534 | 26 | 14,147 |
| 1983 | 56 | 31,372 | 84 | 24,999 | 24 | 11,426 |
| 1982 | 43 | 26,383 | 60 | 23,821 | 23 | 10,144 |
| 1981 | 40 | 23,965 | 76 | 23,257 | 21 | 9,743 |
| 1980 | 35 | 23,326 | 70 | 22,682 | 31 | 9,254 |
| 1979 | 119 | 51,304 | 169 | 46,146 | 66 | 14,585 |
| 1978 | 95 | 46,173 | 206 | 45,932 | 50 | 11,805 |
| 1977 | 85 | 40,124 | 150 | 37,404 | 50 | 10,347 |
| 1976 | 69 | 29,374 | 120 | 27,303 | 30 | 7,862 |
| 1975 | 54 | 17,603 | 100 | 17,431 | 27 | 5,367 |
| 1974 | 49 | 16,604 | 99 | 19,819 | 30 | 6,182 |
| 1973 | 39 | 14,689 | 73 | 15,243 | 29 | 5,115 |
| 1972 | 45 | 11,089 | 49 | 11,432 | 18 | 4,109 |
| 1971 | 27 | 6,857 | 38 | 7,830 | 24 | 2,868 |
| 1970 | 12 | 5,286 | 45 | 6,501 | 13 | 2,459 |
| 1969 | 14 | 4,878 | 35 | 6,057 | 11 | 2,147 |
| 1968 | 12 | 3,589 | 27 | 4,254 | 14 | 1,461 |
| 1967 | 4 | 2,489 | 20 | 3,357 | 5 | 1,180 |
| 1966 | 3 | 1,592 | 11 | 2,261 | 6 | 910 |

Source: State accident files from Michigan, Ohio, and Maryland (converted to SAS format by NHTSA for analysis). Data include calendar years 1982 through 1987.

Table C - 4
 Counts of Vehicle Fires and Total Accident-Involved Light Trucks
 by Vehicle Model Year
 States of Illinois and Indiana

| <u>Vehicle Model Year</u> | <u>Illinois</u> | | <u>Indiana</u> | |
|-----------------------------------|-----------------|-----------------|----------------|-----------------|
| | <u>Fires</u> | <u>Vehicles</u> | <u>Fires</u> | <u>Vehicles</u> |
| 1987 | 9 | 10,665 | 1 | 5,108 |
| 1986 | 23 | 25,083 | 6 | 12,073 |
| 1985 | 31 | 35,429 | 6 | 15,664 |
| 1984 | 36 | 38,208 | 11 | 15,844 |
| 1983 | 20 | 33,176 | 20 | 13,611 |
| 1982 | 32 | 29,668 | 12 | 12,712 |
| 1981 | 29 | 26,075 | 9 | 11,557 |
| 1980 | 34 | 32,090 | 5 | 11,545 |
| 1979 | 66 | 59,947 | 27 | 25,450 |
| 1978 | 67 | 47,546 | 21 | 24,564 |
| 1977 | 46 | 41,493 | 28 | 20,758 |
| 1976 | 44 | 31,332 | 20 | 15,444 |
| 1975 | 35 | 19,390 | 13 | 9,784 |
| 1974 | 32 | 19,766 | 9 | 11,133 |
| 1973 | 18 | 14,436 | 7 | 9,631 |
| 1972 | 19 | 10,796 | 18 | 7,595 |
| 1971 | 12 | 7,131 | 10 | 5,055 |
| 1970 | 8 | 5,741 | 6 | 4,404 |
| 1969 | 5 | 5,369 | 9 | 4,781 |
| 1968 | 8 | 3,661 | 3 | 3,269 |
| 1967 | 2 | 2,947 | 4 | 2,815 |
| 1966 | 2 | 2,079 | 2 | 2,091 |

Source: State accident files from Illinois and Indiana (converted to SAS format by NHTSA for analysis). Data include calendar years 1982 through 1987.

Appendix D
Letters to Motor Vehicle Manufacturers

The National Highway Traffic Safety Administration is engaged in an evaluation of the safety benefits, and attendant costs, of its Federal Motor Vehicle Safety Standard No. 301-75, Fuel System Integrity. The study will consist of the first assessment of the standard as it applies to multipurpose passenger vehicles, trucks, buses and school buses, in addition to an update of an earlier (1983) evaluation of the Standard as it applies to passenger cars.

In order to complete this evaluation, the agency needs certain information from the motor vehicle manufacturers. The information needed pertains only to the latter three vehicle categories listed above; similar information for passenger cars, obtained in a prior request to manufacturers and used in the earlier evaluation, will be updated for use in the current study.

It would be most helpful if you could provide us with answers to the following questions:

1. Did your company make any changes in its vehicles with GVWR of 6,000 pounds or less (i.e., multipurpose passenger vehicles, trucks, or buses) as a result of the test requirements set forth in S6.1 (frontal crash, perpendicular), S6.2 (rear crash), and S6.4 (static rollover), which applied to Model Year 1977 vehicles; or as a result of the test requirements set forth in S6.1 (frontal crash, perpendicular and oblique), S6.2 (rear crash), S6.3 (side crash), and S6.4 (static rollover), which applied to Model Year 1978, and later vehicles?
2. If the answer to question No. 1 is affirmative, please provide the following additional information:
 - a. A description or listing of the vehicle modifications made, by make, model and model year in which the changes were effective. (Please provide descriptive information on the type, or nature of the modifications or structural changes made. It is not expected that you supply detailed engineering drawings, or blueprints.)
 - b. For each model in each model year listed in your response to a., above, an estimate of the total vehicle weight, if any, attributable to the modifications described.

- c. For each model and model year listed in your response to a., above, an estimate of the total amount, per vehicle, of any increase in manufacturer variable costs (including all costs for material, labor, supervision and variable burden that were directly related to the manufacturing, production volume, and assembly of the vehicle) attributable to the modifications described.
3. Did your company make any changes in its vehicles with a GVWR of more than 6,000 pounds, but not more than 10,000 pounds (i.e., multipurpose passenger vehicles, trucks, or buses) as a result of the test requirements set forth in S6.1 (frontal, perpendicular crash), which applied to Model Year 1977 vehicles; or as a result of the test requirements set forth in S6.1 (frontal crash, perpendicular and oblique), S6.2 (rear crash), S6.3 (side crash), and S6.4 (static rollover), which applied to Model Year 1978 and later vehicles?
 4. If the answer to question No. 3 is affirmative, please provide the information as listed in the subelements of question No. 2.
 5. Did your company make any changes in its truck engine-chassis with a GVWR of more than 10,000 pounds as a result of the test requirements set forth in S6.5 (moving contoured barrier crash), which applied to Model Year 1978 and later vehicles? (This would involve truck engine-chassis ordered by school bus manufacturers who would perform final vehicle assembly via the addition of school bus bodies to the chassis provided by your company.)
 6. If the answer to question No. 5 is affirmative, please provide the information as listed in the subelements of question No. 2. Additionally, if question No. 5 is answered affirmatively, were the changes confined to only those chassis ordered by school bus manufacturers or did such changes apply to the entire production volume of engine-chassis of that GVWR rating, regardless of the final type of truck body that was ultimately installed on the chassis?

The information submitted in response to this request is intended for use only in general summaries consisting of information received from all manufacturers. However, should you desire confidential treatment for any of the information submitted, the agency has procedures for handling this.

I would appreciate it if you could provide this information by October 24, 1986. Should you require further information concerning this request, please contact Mr. Glenn Parsons ((202) 366-2562)) of my office.

Thank you for your cooperation.

Sincerely,

Adele Spielberger
Associate Administrator for
Plans and Policy

The National Highway Traffic Safety Administration is engaged in an evaluation of the safety benefits, and attendant costs, of its Federal Motor Vehicle Safety Standard No. 301-75, Fuel System Integrity. The study will consist of the first assessment of the standard as it applies to multipurpose passenger vehicles, trucks, buses and school buses, in addition to an update of an earlier (1983) evaluation of the Standard as it applies to passenger cars.

In order to complete this evaluation, the agency needs certain information from the motor vehicle manufacturers. The information needed pertains only to the latter three vehicle categories listed above; similar information for passenger cars, obtained in a prior request to manufacturers and used in the earlier evaluation, will be updated for use in the current study.

It would be most helpful if you could provide us with answers to the following questions:

1. Did your company make any changes in its vehicles with GVWR of 6,000 pounds or less (i.e., multipurpose passenger vehicles, trucks, or buses) as a result of the test requirements set forth in S6.1 (frontal crash, perpendicular), S6.2 (rear crash), and S6.4 (static rollover), which applied to Model Year 1977 vehicles; or as a result of the test requirements set forth in S6.1 (frontal crash, perpendicular and oblique), S6.2 (rear crash), S6.3 (side crash), and S6.4 (static rollover), which applied to Model Year 1978, and later vehicles?
2. If the answer to question No. 1 is affirmative, please provide the following additional information:
 - a. A description or listing of the vehicle modifications made, by make, model and model year in which the changes were effective. (Please provide descriptive information on the type, or nature of the modifications or structural changes made. It is not expected that you supply detailed engineering drawings, or blueprints.)
 - b. For each model in each model year listed in your response to a., above, an estimate of the total vehicle weight, if any, attributable to the modifications described.

- c. For each model and model year listed in your response to a., above, an estimate of the total amount, per vehicle, of any increase in manufacturer variable costs (including all costs for material, labor, supervision and variable burden that were directly related to the manufacturing, production volume, and assembly of the vehicle) attributable to the modifications described.
3. Did your company make any changes in its vehicles with a GVWR of more than 6,000 pounds, but not more than 10,000 pounds (i.e., multipurpose passenger vehicles, trucks, or buses) as a result of the test requirements set forth in S6.1 (frontal, perpendicular crash), which applied to Model Year 1977 vehicles; or as a result of the test requirements set forth in S6.1 (frontal crash, perpendicular and oblique), S6.2 (rear crash), S6.3 (side crash), and S6.4 (static rollover), which applied to Model Year 1978 and later vehicles?
4. If the answer to question No. 3 is affirmative, please provide the information as listed in the subelements of question No. 2.

The information submitted in response to this request is intended for use only in general summaries consisting of information received from all manufacturers. However, should you desire confidential treatment for any of the information submitted, the agency has procedures for handling this.

I would appreciate it if you could provide this information by October 24, 1986. Should you require further information concerning this request, please contact Mr. Glenn Parsons ((202) 366-2562) of my office.

Thank you for your cooperation.

Sincerely,

Adele Spielberger
Associate Administrator for
Plans and Policy

The National Highway Traffic Safety Administration is engaged in an evaluation of the safety benefits, and attendant costs, of its Federal Motor Vehicle Safety Standard No. 301-75, Fuel System Integrity. The study will consist of the first assessment of the standard as it applies to multipurpose passenger vehicles, trucks, buses and school buses, in addition to an update of an earlier (1983) evaluation of the Standard as it applies to passenger cars.

In order to complete this evaluation, the agency needs certain information from the motor vehicle manufacturers. The information needed pertains only to the latter three vehicle categories listed above; similar information for passenger cars, obtained in a prior request to manufacturers and used in the earlier evaluation, will be updated for use in the current study.

It would be most helpful if you could provide us with answers to the following questions:

1. Did your company make any changes in its school buses as a result of the test requirements set forth in: (a) S6.1 (frontal, perpendicular crash), which applied to Model Year 1977 vehicles (under 10,000 pounds, GVWR); or (b) S6.1 (frontal crash, perpendicular and oblique), S6.2 (rear crash, S6.3 (side crash), and S6.4 (static rollover), which applied to Model Year 1978 and later vehicles (under 10,000 pounds, GVWR); or (c) S6.5 (moving contoured barrier crash), which applied to Model Year 1978 and later vehicles (over 10,000 pounds GVWR)?
2. If the answer to question No. 1 is affirmative, please provide the following additional information:
 - a. A description or listing of the vehicle modifications made, by bus model and model year in which the changes were effective. (Please provide descriptive information on the type, or nature of the modifications or structural changes made. It is not expected that you supply detailed engineering drawings, or blueprints.)
 - b. For each model in each model year listed in your response to a., above, an estimate of the total vehicle weight, if any, attributable to the modifications described.

- c. For each model and model year listed in your response to a., above, an estimate of the total amount, per vehicle, of any increase in manufacturer variable costs (including all costs for material, labor, supervision and variable burden that were directly related to the manufacturing, production volume, and assembly of the vehicle) attributable to the modifications described.

The information submitted in response to this request is intended for use only in general summaries consisting of information received from all manufacturers. However, should you desire confidential treatment for any of the information submitted, the agency has procedures for handling this.

I would appreciate it if you could provide this information by October 24, 1986. Should you require further information concerning this request, please contact Mr. Glenn Parsons ((202) 366-2562) of my office.

Thank you for your cooperation.

Sincerely,

Adele Spielberger
Associate Administrator for
Plans and Policy

Appendix E
Additional Analyses of the Effect of Vehicle Age
on Fire Rates

Additional Analyses of the Effect of Vehicle Age on Fire Rates

The analyses described in Chapter 2 to estimate the effectiveness of Federal Motor Vehicle Safety Standard 301 were carried out under the assumption that the effect of vehicle age on fire rates did not differ between vehicles manufactured before the Standard went into effect and vehicles manufactured after the Standard went into effect. This assumption appears reasonable on the basis that age - induced degradation and weakening of motor vehicle structures (and therefore increased likelihood of fuel system breaching and fire) would be expected to occur at the same rate, irrespective of whether the vehicle were produced before or after the Standard were issued.

Nevertheless, the question could be asked as to whether this assumption of a constant age effect between Pre and Post-standard vehicles can be further investigated. It is noted, for example, that among the newer vehicles in the data files analyzed in Chapter 2, there are relatively more Post-standard vehicles than there are Pre-standard vehicles. Conversely, among the older

vehicles, there are relatively fewer Post-standard vehicles and relatively more Pre-standard vehicles. This produces somewhat of an imbalance in the data samples for the Pre and Post-standard periods insofar as the age distribution of vehicles within each period. Is it possible that a predominance of Pre-standard vehicles in the older age ranges could contribute to a steeper slope (i.e., greater age effect) for the age factor, and thus affect the estimates of FMVSS 301 effectiveness found in the Chapter 2 analyses?

There are two ways to investigate this issue. First, age effects can be estimated separately, for Pre-standard and Post-standard vehicles, and then tested to ascertain whether they are significantly different, statistically. Secondly, equations of the Standard's effectiveness can be recomputed, according to the procedures used in Chapter 2, but restricting the accident data to vehicles of the same age in the Pre-standard and Post-standard samples.

Comparison of Age Effects Between Pre and Post-standard Vehicles

Simple linear least squares analyses were performed to estimate the age effect (independent variable) on vehicle fire rate (dependent variable), separately, for Pre-standard and Post-standard vehicles. Computations were made for the two vehicle types, passenger cars and light trucks; for the two data sets, State data ¹ and FARS data; for vehicles of equal age and for

¹ The State data used were the combined data sets from the States of Michigan, Ohio, and Maryland as described in Chapter 2.

all available data; and for both weighted and unweighted data observations. This gave a total of $2^5 = 32$ separate analyses, or $2^4/2 = 16$ separate comparisons of age effects between Pre and Post-standard samples. The preferred test here is between equal age samples; however, comparisons using all available (age) data are also included in order to provide a more comprehensive view of the age effect.

The analyses were run using the General Linear Models statistical subroutine of the SAS system for data analysis, the same as used in the analyses described in Chapter 2 of the report. The result of these analyses are shown in Tables E-1 and E-2, for passenger cars and light trucks, respectively.

It can be shown that the age effects for Pre and Post-standard samples can be tested for significant difference by the following formula:²

$$t = \frac{b_1 - b_2}{\left[\frac{(TSS_1 - RSS_1) + (TSS_2 - RSS_2)}{N_1 + N_2 - 4} \right]^{\frac{1}{2}} \left[\frac{b_1^2}{RSS_1} + \frac{b_2^2}{RSS_2} \right]^{\frac{1}{2}}}$$

where,

b = age coefficient estimated from model,
 TSS = total sum of squares for model,
 RSS = sum of squares component for age variable (i.e., due to regression),
 N = sample size (no. of observations),

and subscripts 1,2 refer to Pre-standard and Post-standard samples, respectively.

² Duncan, Acheson J., Quality Control and Industrial Statistics, Revised Edition, 1959.

Table E-1
 Statistical Comparison of the Effect of Age on Fire Rates
 in Accident Data — Passenger Cars

| Equal Age Data | | | | | | All Available Data | | | | | |
|---------------------|----------------------|----|------------------|------------------|---------------------|---------------------|----------------------|----|------------------|------------------|---------------------|
| Pre-Std Vehicles | Post-Std Vehicles | df | t-value Calc. | t-Dist. Value | Signi- ficance * | Pre-Std Vehicles | Post-Std Vehicles | df | t-value Calc. | t-Dist. Value | Signi- ficance * |

State Accident Data

| | | | | | | | | | | | | |
|----------------------------|-----------------------|-----------------------|----|-------|-------|------|----------------------|-----------------------|-----|-------|-------|---|
| No. of Observations | 45 | 45 | | | | 180 | 171 | | | | | |
| Age Range (Years) | 7-11 | 7-11 | | | | 7-21 | 0-11 | | | | | |
| Age Coeff. (Unwgt'd Model) | 1463×10^{-7} | 3906×10^{-7} | 86 | -1.43 | ±1.99 | NS | 210×10^{-7} | 2655×10^{-7} | 347 | -5.35 | ±1.96 | S |
| Age Coeff. (Wgt'd. Model) | 1676×10^{-7} | 3540×10^{-7} | 86 | -1.06 | ±1.99 | NS | 961×10^{-7} | 2437×10^{-7} | 347 | -3.75 | ±1.96 | S |

Fatal Accident Data

| | | | | | | | | | | | | |
|----------------------------|-----------------------|-----------------------|-----|-------|-------|------|-----------------------|-----------------------|-----|-------|-------|----|
| No. of Observations | 91 | 91 | | | | 210 | 91 | | | | | |
| Age Range (Years) | 0-12 | 0-12 | | | | 0-27 | 0-12 | | | | | |
| Age Coeff. (Unwgt'd Model) | 3791×10^{-7} | 7013×10^{-7} | 188 | -1.56 | ±1.96 | NS | 65×10^{-7} | 7013×10^{-7} | 297 | -2.28 | ±1.96 | S |
| Age Coeff. (Wgt'd. Model) | 3837×10^{-7} | 6533×10^{-7} | 188 | -1.39 | ±1.96 | NS | 4228×10^{-7} | 6533×10^{-7} | 297 | -1.45 | ±1.96 | NS |

* S: Statistically significant
 NS: Not statistically significant

Significance level $\alpha = 5\%$ (two-tailed)

Table E-2
 Statistical Comparison of the Effect of Age on Fire Rates
 in Accident Data -- Light Trucks

| Equal Age Data | | | | | | All Available Data | | | | | |
|---------------------|----------------------|----|------------------|------------------|---------------------|---------------------|----------------------|----|------------------|------------------|---------------------|
| Pre-Std Vehicles | Post-Std Vehicles | df | t-value Calc. | t-Dist. Value | Signi- * ficance | Pre-Std Vehicles | Post-Std Vehicles | df | t-value Calc. | t-Dist. Value | Signi- * ficance |

State Accident Data

| | | | | | | | | | | | | |
|-------------------------------|-----------------------|-----------------------|----|-------|------------|------|-----------------------|-----------------------|-----|-------|------------|----|
| No. of Observations | 45 | 45 | | | | 198 | 153 | | | | | |
| Age Range (Years) | 6-10 | 6-10 | | | | 6-21 | 0-10 | | | | | |
| Age Coeff. (Unwgt'd Model) | 3394×10^{-7} | 3467×10^{-7} | 86 | -0.27 | ± 1.99 | NS | 1641×10^{-7} | 3372×10^{-7} | 347 | -2.51 | ± 1.96 | S |
| Age Coeff. (Wgt'd. Model) | 3840×10^{-7} | 1288×10^{-7} | 86 | 1.00 | ± 1.99 | NS | 1992×10^{-7} | 2463×10^{-7} | 347 | -0.78 | ± 1.96 | NS |

Total Accident Data

| | | | | | | | | | | | | |
|-------------------------------|-----------------------|-----------------------|-----|------|------------|------|-----------------------|-----------------------|-----|------|------------|----|
| No. of Observations | 90 | 78 | | | | 223 | 78 | | | | | |
| Age Range (Years) | 0-11 | 0-11 | | | | 0-27 | 0-11 | | | | | |
| Age Coeff. (Unwgt'd Model) | 2398×10^{-7} | 1685×10^{-7} | 164 | 1.17 | ± 1.96 | NS | 5319×10^{-7} | 1685×10^{-7} | 297 | 1.08 | ± 1.96 | NS |
| Age Coeff. (Wgt'd. Model) | 3789×10^{-7} | 1773×10^{-7} | 164 | 1.81 | ± 1.96 | NS | 6656×10^{-7} | 1773×10^{-7} | 297 | 2.94 | ± 1.96 | S |

* S: Statistically significant
 NS: Not statistically significant

Significance level $\alpha = 5\%$ (two-tailed)

The above formula is equivalent to testing for the difference between the slopes of two fitted simple regression lines with slope coefficients b_1 and b_2 , respectively. The basis for significance testing is the comparison of the calculated t-value with the value of the tabled t-Distribution for degrees of freedom $(df) = N_1 + N_2 - 4$. All tests were run to determine whether the age coefficient (slope) differed between the Pre-standard and Post-standard vehicles, without interest in knowing whether the effect was higher, or lower, for Pre-standard versus Post-standard vehicles. Thus, the critical region for rejection of the (null) hypothesis of equivalent slopes was a calculated t-value which was greater than, or less than, the corresponding tabled values of the t-Distribution. All tests were made at the $\alpha = .05$ (i.e., 5%) level of significance.

Referring to tables E-1 and E-2 for the equal age categories, it is seen that none of the age comparisons is statistically significant. This includes the comparisons for both passenger cars and light trucks, and for both weighted and unweighted estimates. The preferred bases for comparison are those using equal age data, since this provides the "purest" test for age effect difference between Pre and Post-vehicles. Also, the weighted analyses are favored over the unweighted analyses, due to the considerable variation among in the individual observations (i.e., numbers of fires and accident-involved vehicles). The inference drawn from these analyses is that the effect of vehicle age behaves in the same manner for both Pre and Post-standard vehicles.

Turning to the comparisons for the all available data category, Tables E-1 and E-2 show that the age effects for Pre- and Post-standard vehicles are significantly different in 3 out of 4 instances (unweighted data). For the

weighted comparisons, 2 are significantly different while the remaining two are not. These latter comparisons are preferred due to the variation among the individual observations as stated above. Statistically, the results of the age effect comparisons in the all data category are mixed, with 2 of the (weighted) tests showing significance, while the remaining 2 are not significant. One possible reason for the two significant results is the larger sample sizes (and hence decreased error variances) for the all data category comparisons, as opposed to the equal age comparisons. A second possibility for the two significant results is the difference in the age range distributions between the Pre-standard and Post-standard samples. The difference may be due to the age effect varying somewhat, depending on the actual ages studied, rather than reflecting a difference between Pre and Post-standard vehicles. In fact, this is the most likely possibility in view of the finding of no significant differences in the age effect comparisons for the situation where vehicle ages are held constant for Pre-standard and Post-standard vehicles.

The summary conclusion based on the additional analyses conducted in this section is that the age effect on fire rates does not differ between Pre-standard and Post-standard vehicles.

Comparison of Effectiveness Analyses Based on Equal Age Vehicles

The second method of further investigating the possible difference in age effect for Pre and Post-standard vehicles, and its possible effect on estimated FMVSS 301 effectiveness, is to rerun the effectiveness analyses that

were carried out in Chapter 2. In these additional analyses, the age of the accident-involved vehicles will be restricted so that the ages of the Pre-standard vehicles are the same as the ages of the Post-standard vehicles.

The analyses take the same form as those used in Chapter 2 to estimate the effectiveness of the 301 Standard. Regression models incorporating fire rate as a function of vehicle age and Standard 301 are computed for each vehicle type, passenger cars and light trucks, and for each primary data set, State data and fatal accident data (i.e., FARS). The State data were the same as used in the analyses above and as used in the principal analyses of Chapter 2 -- i.e., the combined data from the States of Michigan, Ohio, and Maryland. Also as in Chapter 2, the data were weighted and balanced to include the same number of model years, Pre and Post, within each calendar year.

The results of the four analyses are shown in Table E-3. The principal item of interest in this Table is whether or not the coefficient for the Standard variable (i.e., FMVSS 301) is significant, thereby indicating positive effectiveness. The table shows that in one instance, passenger cars in the State data set, the Standard coefficient is significant. In the remaining three cases (passenger cars - fatal accident data, light trucks - State data, and light trucks - fatal accident data), the results are not significant. Overall, these results are in essential agreement with the effectiveness analyses performed in Chapter 2 where effectiveness was found only for passenger cars in the State data (i.e., all accidents) set.

Table E-3
 Summary of Effectiveness Analyses, Restricting Accident Data
 to Vehicles of Equal Age for Pre-standard and Post-standard Samples

| Vehicle Type | Data Set | Vehicle Age Range (Yrs) | N | df | Standard Variable | | | | Age Variable | | | |
|----------------|------------|-------------------------|-----|-----|-------------------------|---------|---------------|--------------------|-----------------------|---------|---------------|--------------------|
| | | | | | Coefficient | t-value | t-Dist. Value | Signi- * fificance | Coefficient | t-value | t-Dist. Value | Signi- * fificance |
| Passenger Cars | State Data | 7-11 | 90 | 87 | -6225×10^{-7} | -2.58 | -1.66 | S | 2739×10^{-7} | 3.14 | 1.66 | S |
| Passenger Cars | FARS Data | 0-12 | 133 | 130 | -1815×10^{-7} | -0.24 | -1.65 | NS | 6723×10^{-7} | 6.62 | 1.65 | S |
| Light Trucks | State Data | 6-10 | 90 | 87 | -834×10^{-7} | -0.23 | -1.66 | NS | 2346×10^{-7} | 1.86 | 1.66 | NS |
| Light Trucks | FARS Data | 0-11 | 114 | 111 | -14953×10^{-7} | -1.13 | -1.66 | NS | 727×10^{-7} | 0.41 | 1.66 | NS |

N = No observations

* S: statistically significant

NS: not statistically significant

Significance level $\alpha = 5\%$ (one-tail)

E-10

Summary

The additional analyses described in this appendix were performed to further investigate the effect of age on vehicle fire rates, and to further explore whether the different distribution of vehicle ages between Pre-standard and Post-standard vehicles could have affected the effectiveness estimates of FMVSS 301 developed in Chapter 2. The overall results of these additional analyses are in basic agreement with the effectiveness results obtained in Chapter 2.

Furthermore, as stated earlier, from a purely physical standpoint, there is no reason to suspect that age effects would be manifest differently, depending upon whether a vehicle were manufactured before, or after, FMVSS 301 took effect. In order for such a difference to be expected, the types of vehicle modifications made in response to the Standard would have had to alter the way in which the various vehicle structures and components are affected by corrosion and other degradation processes that occur over the lifetime of the vehicle. This would include not only components of the fuel system, but also other vehicle components and structures whose corrosion and weakening over time could also increase the chances of fuel leakage (and fire), by providing less energy absorption and other crashworthiness protection for the fuel system. Such degradation resistant changes in vehicle components and structures did not occur coincident with the issuance of Federal Motor Vehicle Safety Standard 301.