

Department of the Army
Headquarters, United States Army
Training and Doctrine Command
Fort Monroe, Virginia 23651-1047

*TRADOC Regulation 10-5-5

10 September 2010

Organization and Functions

UNITED STATES ARMY COMBINED ARMS SUPPORT COMMAND
AND SUSTAINMENT CENTER OF EXCELLENCE

FOR THE COMMANDER:

OFFICIAL:

JOHN E. STERLING, JR.
Lieutenant General, U.S. Army
Deputy Commanding General/
Chief of Staff

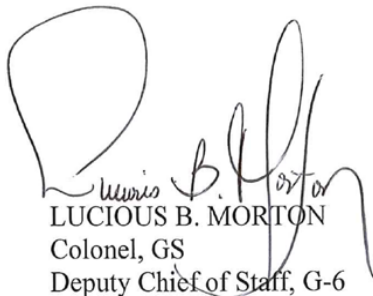

LUCIOUS B. MORTON
Colonel, GS
Deputy Chief of Staff, G-6

History. This publication is a major revision. The portions affected by this revision are listed in the summary of change.

Summary. This regulation documents the approved organization, mission, and functions of the U.S. Army Combined Arms Support Command and Sustainment Center of Excellence.

Applicability. This regulation applies to all organizational elements of the U.S. Army Combined Arms Support Command and Sustainment Center of Excellence.

Proponent and exception authority. The lead for this regulation is the Commander, U.S. Army Combined Arms Support Command and Sustainment Center of Excellence. The proponent has the authority to approve exceptions or waivers to this regulation that are consistent with controlling law and regulations.

Army management control process. This regulation does not contain management control provisions.

*This regulation supersedes TRADOC Regulation 10-5-5, dated 25 January 2006.

Supplementation. Supplementation of this regulation and establishment of command and local forms is prohibited without prior approval from the Commander, U.S. Army Combined Arms Support Command and Sustainment Center of Excellence, (ATTN: ATCL-RM), 2221 A Avenue, Fort Lee, VA 23801-2102.

Suggested improvements. Users are invited to send comments and suggested improvements on Department of the Army (DA) Form 2028 (Recommended Changes to Publications and Blank Forms) directly to the Commander, U.S. Army Combined Arms Support Command and Sustainment Center of Excellence, (ATTN: ATCL-RM), 2221 A Avenue, Fort Lee, VA 23801-2102. Suggested improvements may also be submitted using DA Form 1045 (Army Ideas for Excellence Program (AIEP) Proposal).

Distribution. This TRADOC regulation is available only on the TRADOC Homepage at <http://www.tradoc.army.mil>.

Summary of Changes

TRADOC Regulation 10-5-5

United States Army Combined Arms Support Command and Sustainment Center of Excellence

This revision, dated 10 September 2010-

- o Updates the roles, missions, organization, and functions based on the approved Base Realignment and Closure Commission's May 05 decision to direct realignment of the Transportation School and Ordnance Schools, to Fort Lee, VA, and collocate these schools with the Quartermaster School, Army Logistics Management College, and Combined Arms Support Command Headquarters to establish a Center of Excellence at Fort Lee, VA.
- o Defines all terminology to reflect the new Combined Arms Support Command and Sustainment Center of Excellence configuration and naming conventions.
- o Updates figures, tables, and acronyms to reflect the new Combined Arms Support Command and Sustainment Center of Excellence configuration.
- o Consolidates chapters to conform to United States Army Training and Doctrine Command Regulation 10-5, United States Army Training and Doctrine Command (Command Staff, Personal Staff, Special Staff, etc.).
- o Includes a new chapter entitled "Partnerships" to capture partnering relationships.
- o Changes all references to Army Logistics Management College to Army Logistics University.

Contents

	Page
Chapter 1 Introduction	9
1-1. Purpose.....	9
1-2. Executive summary.....	9
1-3. References.....	12
1-4. Explanation of abbreviations and terms.....	12
1-5. Responsibilities	12
1-6. Scope.....	13
1-7. Policy	13
Chapter 2 Combined Arms Support Command and Sustainment Center of Excellence Mission, Organization, Functions, and Designation of Responsibilities.....	13
2-1. Mission of CASCOM AND SCoE.....	13
2-2. Organization of CASCOM and SCoE	13
2-3. CASCOM and SCoE core competencies	14
2-4. CASCOM and SCoE core functions.....	14
2-5. Key enablers – Knowledge Management and lessons learned	14
2-6. CASCOM and SCoE lead responsibilities.....	15
2-7. Other CASCOM and SCoE functions.....	16
Chapter 3 Combined Arms Support Command and Sustainment Center of Excellence Headquarters Command Group	18
3-1. Commanding General	18
3-2. Deputy to the Commanding General	18
3-3. CASCOM and SCoE Deputy Commanding General, Initial Military Training.....	18
3-4. Deputy Commanding General, Capabilities Development.....	19
3-5 Deputy Commanding General, Human Capital Enterprise.....	19
3-6. Deputy Commanding General, Mobilization.....	19
3-7. Chief of Staff.....	20
3-8. Deputy Chief of Staff.....	20
3-9. Deputy Chief of Staff, U.S. Army Reserves	20
3-10. Deputy Chief of Staff, National Guard	21
3-11. Chief warrant officer	21
3-12. Command sergeant major	22
3-13. Command planning group.....	22
3-14. Secretary to the general staff.....	22
3-15. Executive operations	22
Chapter 4 Special Staff	23
4-1. Lessons learned/quality assurance	23
4-2. Civilian logistics career management office	23
4-3. Knowledge Management office	24
4-4. Logistics proponent office.....	25
4-5. Safety office	25
4-6. Equal opportunity office	26
4-7. Retention office.....	26
4-8. Historian.....	26

4-9. Acquisition, logistics, and technology-integration office	27
4-10. Headquarters and headquarters company	28
Chapter 5 Personal Staff	28
5-1. Public affairs office	28
5-2. Staff Judge Advocate	29
5-3. Inspector general	30
Chapter 6 HQ CASCOM and SCoE Coordinating Staff	31
6-1. G-1/4, Deputy Chief of Staff.....	31
6-2. G-3, Training and Doctrine.....	32
6-3. G-5, Strategic Initiatives Group.....	33
6-4. G-6, Command, Control, Communications, and Computers.....	33
6-5. G-8, Resource Management.....	34
Chapter 7 Training and Doctrine, Development and Integration	37
7-1. Mission, organization, and functions	37
7-2. Training and Doctrine Development Directorate.....	39
7-3. Training Support Directorate	41
Chapter 8 Director of Capabilities Development and Integration	42
8-1. Mission, organization, and functions	42
8-2. Program integration office	44
8-3. Force Development Directorate	44
8-4. Tactical wheeled vehicle management office	46
8-5. Sustainment Battle Lab and Capability Determination Directorate.....	47
8-6. TRADOC capabilities manager, transportation.....	48
8-7. TRADOC Capabilities Manager, Sustainment Command and Control/Enterprise Systems Directorate.....	50
8-8. Materiel Systems Directorate.....	52
Chapter 9 Army Logistics University.....	54
9-1. Mission, organization, and functions	54
9-2. Command group.....	54
9-3. Army Sustainment professional bulletin.....	55
9-4. Reserve component office.....	55
9-5. Dean of education and operations	56
9-6. Education division.....	57
9-7. Programs, plans, and operations division.....	58
9-8. College of professional and continuing education.....	58
9-9. Department of Systems Engineering.....	59
9-10. Department of Systems Acquisition	59
9-11. Department of Advanced Logistics Studies.....	59
9-12. Department Strategic Logistics	59
9-13. Logistics Leader College	60
9-14. Captain Career Training Department.....	60
9-15. Basic Officer Leader Department	61
9-16. Applied Logistics Studies Department	61
9-17. Technical Logistics College.....	61
9-18. Basic Warrant Officer Training Department	62
9-19. Advanced Warrant Officer Training Department	62

9-20. Logistics Noncommissioned Officer Academy	62
9-21. 71st Transportation Corps Battalion (Army Logistics University Student Battalion)...	63
Chapter 10 Quartermaster School	65
10-1. Mission, organization, and functions	65
10-2. Command Group.....	67
10-3. Reserve Component Affairs Office.....	68
10-4. Training Management office.....	69
10-5. 23rd Quartermaster Brigade.....	70
10-6. 262nd, 266th, and 244th Quartermaster Battalions.....	71
10-7. Marine Corps Detachment	72
10-8. Aerial Delivery Field Services Department	72
10-9. Instructional Division.....	73
10-10. Operations Division	74
10-11. Petroleum and Water Training Department	75
10-12. Advanced Petroleum and Water Division.....	76
10-13. Laboratory Training Division	77
10-14. Basic Petroleum Logistics Training Division	77
10-15. Water Training Division	78
10-16. Marine Corps Petroleum Training Division.....	79
10-17. Logistics Training Department	80
10-18. 92A10 Training Division	80
10-19. 92Y10 Training Division	80
10-20. Joint Culinary Center of Excellence	81
10-21. Army Center of Excellence Subsistence Directorate.....	81
10-22. Joint Culinary Training Division	82
10-23. Joint Culinary Center of Excellence, Special Programs Directorate	82
10-24. Joint Mortuary Affairs Center.....	83
10-25. Training Division	84
10-26. Operations Division	84
Chapter 11 Ordnance School	85
11-1. Mission, organization, and functions	85
11-2. Commandant/Deputy Commanding General.....	86
11-3. Chief of Staff.....	86
11-4. Museum.....	86
11-5. Historian.....	86
11-6. Proponency Office	87
11-7. Reserve Component Affairs Office.....	87
11-8. Current Operations	87
11-9. Regimental Command Sergeant Major.....	87
11-10. Regimental Chief Warrant Officer.....	87
11-11. Deputy to the Commandant	88
11-12. 59th Ordnance Brigade	88
11-13. Director of Training	89
11-14. Training Operations Division.....	89
11-15. Training Management Division	90
11-16. Armament and Electronics Maintenance Training Department	90

11-17. Track/Metal Working and Services/Recovery Training Department	90
11-18. Wheel Maintenance Department.....	91
11-19. Tactical Support Equipment Training Department.....	91
11-20. Munitions and EOD Training Department.....	92
11-21. Ordnance Electronics Maintenance Training Department (Fort Gordon, GA)	92
11-22. 832 nd , 73 rd , 16 th Ordnance Battalions	92
11-23. Explosive Ordnance Disposal Directorate	93
Chapter 12 Commanding General/Chief of Transportation/Commandant	94
12-1. Mission, organization and functions	94
12-2. Command Group.....	96
12-3. Special Staff	96
12-4. Reserve Component Affairs Office.....	97
12-5. Transportation Museum (Fort Eustis, VA)	97
12-6. Transportation Corps Regimental Safety Office.....	97
12-7. Transportation School	98
12-8. Training Management Office	99
12-9. The Army Driver Standardization Office	100
12-10. Quality Assurance and Lessons Learned	101
12-11. Deployment and Deployment Systems Department	101
12-12. Maritime and Intermodal Training Department, Fort Eustis, VA.....	102
12-13. Cargo Operations Training Division.....	102
12-14. Marine Operations Division.....	102
12-15. Marine Engineering Division.....	103
12-16. Maritime Simulation Division	103
12-17. Oversight and Liaison Responsibilities.....	103
12-18. Deployment Process Modernization Office	104
12-19. U.S. Air Force Transportation School (34Xth Training Squadron).....	105
12-20. Joint Deployment Training Center.....	105
Chapter 13 Soldier Support Institute.....	106
13-1. Command Group.....	106
13-2. Training Development Directorate	109
13-3. Capabilities Development and Integration Directorate.....	111
13-4. Noncommissioned Officer Academy.....	112
13-5. Training Support Battalion.....	113
13-6. 369 th Adjutant General Battalion	115
13-7. Adjutant General School.....	116
13-8. Financial Management School.....	118
13-9. Recruiting and Retention School	120
Chapter 14 Partnerships	121
14-1. Purpose.....	121
14-2. Schools and Responsibilities.....	121
14-3. Chaplain Center and School.....	122
14-4. AMEDDC&S	122
14-5. TJAGLC&S.	122
14-6. Liaison and Exchange Officers	122

Chapter 15 Coordinating Instructions	123
15-1. Coordination.....	123
15-2. Taskings	124
15-3. External coordination.....	124
Appendix A References	124
Section I Required Publications	124
Section II Related Publications	124
Section III Referenced Forms.....	127
Glossary	128
Section I Abbreviations	128
Section II Terms	132

Figure list

Figure 1-1. CASCOM and SCoE.....	9
Figure 3-1. DCG, Mobilization.....	19
Figure 3-2. DCoS, USAR	20
Figure 3-3. DCoS, ARNG.....	21
Figure 4-1. Acquisition, Logistics, and Technology-Integration Office	27
Figure 5-1. Staff Judge Advocate	29
Figure 6-1. CASCOM and SCoE G-8, Resource Management.....	34
Figure 7-1. Training and doctrine, development & integration	38
Figure 7-2. Training and Doctrine Development Directorate (TD3).....	39
Figure 7-3. Training Support Directorate	41
Figure 8-1. Capabilities Development & Integration	43
Figure 8-2. Force Development Directorate	45
Figure 8-3. Sustainment Battle Lab and Capabilities Determination Directorate	47
Figure 8-4. TCM-T	49
Figure 8-5. Enterprise Systems Directorate.....	50
Figure 8-6. Materiel Systems Directorate.....	52
Figure 9-1. Army Logistics University	55
Figure 9-2. Education and Operations	56
Figure 9-3. College of Professional and Continuing Education	58
Figure 9-4. Logistics Leader College.....	60
Figure 9-5. Technical Logistics College.....	61
Figure 9-6. Logistics Noncommissioned Officer Academy	62
Figure 9-7. 71st Transportation Battalion (Student Officer)	63
Figure 10-1. Quartermaster School (QMS)	65
Figure 10-2. 23 rd Quartermaster Brigade	71
Figure 11-1. Ordnance School (ODS)	85
Figure 11-2. 59 th Ordnance Brigade	88
Figure 11-3. Director of Training and Training Management Office (TMO)	89
Figure 11-4. Explosive Ordnance Disposal Directorate	93
Figure 12-1. Transportation School	95
Figure 13-1. Soldier Support Institute (SSI).....	106
Figure 13-2. Training Development Directorate (TDD).....	110

Figure 13-3. Capabilities Development and Integration Directorate.....	111
Figure 13-4. NCO Academy	112
Figure 13-5. Training Support Battalion.....	114
Figure 13-6. 369 th Adjutant General Battalion	115
Figure 13-7. Adjutant General School.....	116
Figure 13-8. Financial Management School.....	118
Figure 13-9. Recruiting and Retention School	120

**Chapter 1
Introduction**

1-1. Purpose

This regulation defines and delineates organization, functions, and responsibilities for the headquarters (HQ) staff and subordinate organizations. Army Regulation (AR) 5-22, The Army Force Modernization Proponent System, and Training and Doctrine Command Regulation (TR) 10-5, U.S. Army Training and Doctrine Command (TRADOC), provide authority.

1-2. Executive summary

a. This executive summary is provided to assist reader understanding of the Combined Arms Support Command (CASCOM) and Sustainment Center of Excellence (SCoE) elements and their mission, organization, and functions. See figure 1-1.

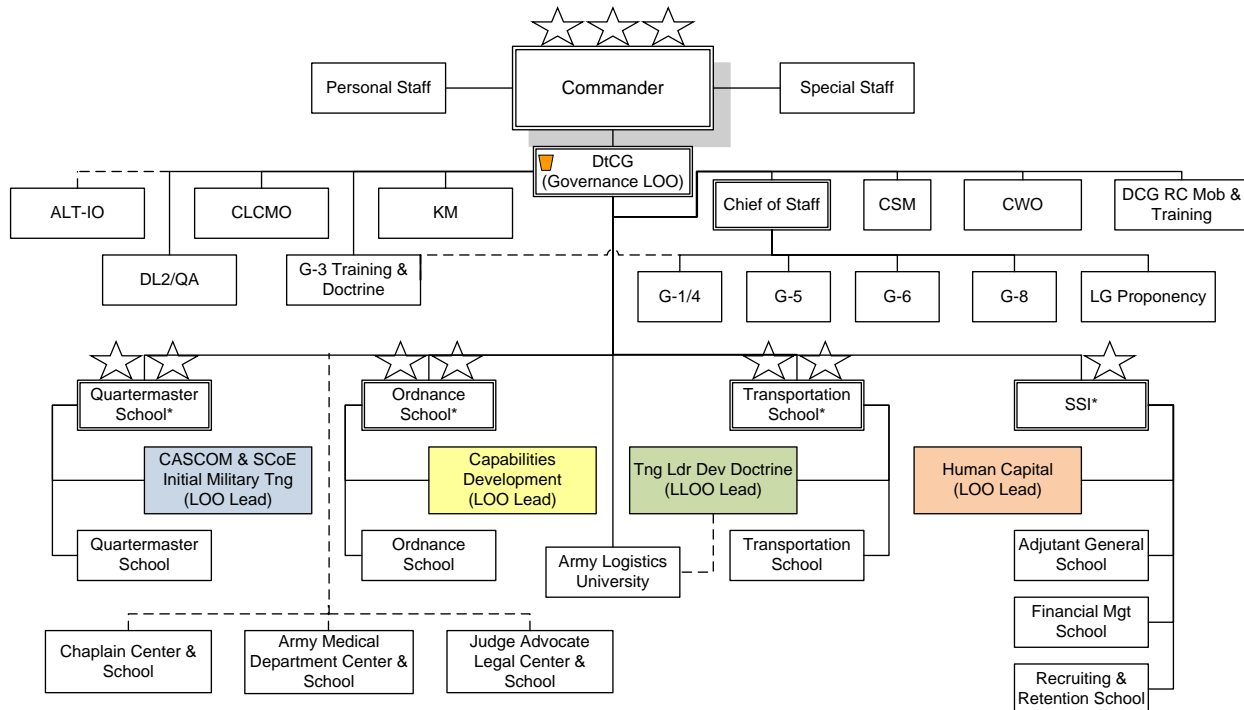

Figure 1-1. CASCOM and SCoE

b. On 1 May 2008, Department of the Army (DA) approved the CASCOM and SCoE Concept Plan with an effective date of 1 October 2009. TRADOC Campaign Plan Decision Point 29 designated CASCOM as a major subordinate organization (MSO) within TRADOC. In addition to being an MSO, CASCOM and SCoE is one of eight TRADOC Centers of Excellence (CoE) established as the centerpiece of the TRADOC Transformation of Institutional Training. The SCoE is a multiple-branch CoE (see paragraph c. below). This transformation is in accordance with the Defense Base Realignment and Closure (BRAC) Act of 1990, Public Law 101-510, as amended by the National Defense Authorization Act for Fiscal Year 2005, Public Law 108-375 and as approved by the TRADOC Commanding General (CG). This BRAC action colocates the Quartermaster School (QMS), Ordnance School (ODS), Transportation School

(TS), and establishes the Army Logistics University (ALU) at Fort Lee, VA. The Soldier Support Institute (SSI) located at Fort Jackson, SC, is also part of CASCOM and SCoE. CASCOM and SCoE also is responsible for integration across doctrine, organizations, training, materiel, leadership and education, personnel, and facilities (DOTMLPF) functions with The Judge Advocate General's Legal Center and School (TJAGLCS), the Chaplain Center and School (USACHCS), and the Army Medical Department Center & School (AMEDDC&S).

c. An Army CoE is a premier organization that creates the highest standards of achievement in an assigned sphere of expertise by generating synergy through an effective and efficient combination and integration of functions, while reinforcing the unique requirements and capabilities. A TRADOC CoE is a designated organization within an assigned area of expertise that delivers current warfighting requirements, identifies future capabilities, integrates assigned DOTMLPF dimensions, and presents resource-informed, integration-focused, outcomes-based recommendations to the TRADOC CG. There are three types of CoEs: the Single Branch CoE, the Multiple Branch CoE, and the Functional CoE. The SCoE is a multiple branch CoE.

d. This revision of TR 10-5-5, U.S. Army Combined Arms Support Command, documents the new CASCOM and SCoE organization and functions as designated by Permanent Order 191-9, dated 9 July 2008. Effective 1 October 2009, the CASCOM became the CASCOM and SCoE HQ.

e. A summary of key training and structure benefits resulting from the establishment of the SCoE are:

(1) Training benefits:

(a) Six schools to five. The two ODSs were merged into a single ODS.

(b) Consolidates professional military education (PME). There are two elements of higher learning within SCoE, ALU, and SSI.

- The ALU consolidates the Army's logistics PME previously conducted at four Logistics Branch Schools and Army Logistics Management College. The consolidation of PME at ALU focuses branch schools on advanced individual training (AIT).

- The SSI conducts PME for two branch schools, Adjutant General (AG) and Financial Management (FM), and conducts Recruiting and Retention education. The School of Music (SOM) conducts PME at Fort Story, VA.

(c) Five noncommissioned officer academies (NCOA) to three.

- Each logistics branch school consolidates its NCOA into one Fort Lee NCOA within ALU, eliminating NCOAs previously conducted at four logistics branch schools.

- SSI has two NCOAs: Fort Jackson, SC, NCOA conducts training for the adjutant general (AG), financial management (FM) and chaplains; Fort Story, VA, NCOA conducts training for all AG (42R) band-related military occupation specialties (MOS).

(2) Structure benefits:

(a) Consolidation and movement of OD training at Fort Bliss, TX to Fort Sill, OK, as well as all OD training at Aberdeen Proving Ground, MD, moving to Fort Lee, VA, reduces the number of training locations.

(b) Four brigades (BDEs) to two. An OD BDE and transportation BDE are inactivated with the colocation of AIT training at Fort Lee, VA.

(c) Twelve battalions (BNs) to nine. The reduction in BNs is based on consolidation of AIT training at Fort Lee, VA.

(d) Five warrior training areas (WTA) to two.

- Each logistics branch school consolidates its warrior training into one SCoE Warrior Training Exercise (WTX) conducted at Fort A.P. Hill.
- The AG, FM, paralegalists and chaplains' assistants use a consolidated WTA on Fort Jackson.

f. In 1994, CASCOM consolidated combat development and training development functions for the OD, quartermaster (QM) and transportation branches at Fort Lee saving 980 authorizations, creating efficiencies and synergy that were recognized by Headquarters, Department of the Army (HQDA) during the development and approval of the CASCOM and SCoE concept plan. With these consolidations, most sustainment training for the Army is now conducted at either Fort Lee, VA, or Fort Jackson, SC. The CASCOM and SCoE continues the consolidation process and establishes a consortium of organizations responsible for Army sustainment training, leader education, and associated combat and training development. Included in the CASCOM and SCoE is the creation of the ALU, which consolidates all of the Army's logistics PME previously conducted at four logistics branch schools and Army Logistics Management College. As a result, logistics branch schools remain focused on AIT. Other training locations remain outside of Fort Lee, VA: The Rail and Maritime Training Academy remains at Fort Eustis, VA; Elements of Explosive Ordnance Disposal (EOD) training at Eglin Air Force Base (AFB), FL and Fort Leonard Wood, MO; Hazardous Devices at Redstone Arsenal (RSA), AL; Patriot and radar maintenance training at Fort Sill, OK; and Electronic maintenance training at Fort Gordon, GA.

g. CASCOM is an MSO of TRADOC as defined in TR 10-5, December 2009. DOTMLPF integration responsibility for the USACHCS, and two non-TRADOC schools, AMEDDC&S and TJAGLCS, as defined in TR 10-5.

h. With expansion of the CASCOM to include designation as the SCoE, the following terms are used throughout this regulation to ensure consistent usage and understanding as well as document within internal and external relationships:

(1) CASCOM and SCoE HQ is used to define the CASCOM and SCoE HQ organization which includes personal, special, and coordinating staff who support not only the HQ, but also the three branch schools located at Fort Lee (QM, OD, and transportation), the ALU and SSI and their two branch schools. The term CASCOM and SCoE HQ also includes capabilities development integration (CDI) and training and doctrine, development, and integration at both Fort Lee and Fort Jackson.

(2) SCoE is used to define the CASCOM HQ, three branch schools (QM, OD, and transportation), ALU, and SSI and its assigned schools: Adjutant General School (AGS) including the SOM at Fort Story, VA, Financial Management School (FMS), and Recruiting and Retention School (RRS). The CASCOM HQ CG functions as the Commander of the CASCOM, the Commander of the SCoE, and serves as the senior commander for Fort Lee. Daily operations of subordinate organizations are directed by the respective commandants/ commanders.

(3) CASCOM and SCoE community is used to define the SCoE as identified above and the integration responsibility for DOTMLPF for the AMEDD&CS, USCHCS, and TJAGLCS.

1-3. References

Required and related publications and prescribed and referenced forms are listed in [appendix A](#).

1-4. Explanation of abbreviations and terms

Abbreviations and special terms used in this regulation are explained in the [glossary](#).

1-5. Responsibilities

a. The TRADOC Deputy Commanding General (DCG)/Chief of Staff (CoS) is the approval authority for this regulation.

b. The CASCOM and SCoE G-8. The G-8 will:

(1) Serve as lead for this regulation.

(2) Review and coordinate proposed changes and forward recommendations through the CASCOM and SCoE CG, for approval by the TRADOC DCG/CoS.

(3) Advise and assist CASCOM and SCoE elements on organizational and functional alignment.

c. CASCOM and SCoE commanders, commandants, and staff directors. The commandants, commanders, and staff directors will ensure their organizational structure, functions, and responsibilities shown in this regulation are current and accurate.

1-6. Scope

This regulation is focused on the mission, organization, and functions at all levels of CASCOM and SCoE. It describes major organizational structure, core competencies, essential tasks, major functions for CASCOM and SCoE, and the relationships between these organizations and their assigned responsibilities.

1-7. Policy

Responsibility for missions and tasks is decentralized to: Commandants, Deputy to the Commanding General (DtCG), DCG for Mobilization, CASCOM & SCoE DCG for Initial Military Training (IMT), DCG for CDI, DCG for Leader Development, DCG for Human Capital Enterprise (HCE), CoS, and Directors to the maximum extent possible. The CASCOM and SCoE HQ staff exists to assist the CG and DCGs, in accomplishing the mission by providing staff management, planning, and coordination capabilities. The coordinating, special, and personal staff elements provide professional and technical services and advice.

Chapter 2**Combined Arms Support Command and Sustainment Center of Excellence Mission, Organization, Functions, and Designation of Responsibilities****2-1. Mission of CASCOM AND SCoE**

CASCOM and SCoE provides training and leader development, and develops concepts, doctrine, organizations, lifelong learning, and materiel solutions, to provide sustainment to a campaign quality Army with joint and expeditionary capabilities.

2-2. Organization of CASCOM and SCoE

a. CASCOM and SCoE is one of TRADOC's five MSOs. Other TRADOC MSOs are: U.S. Army Accessions Command; U.S. Army Combined Arms Center (CAC); Army Capabilities Integration Center (ARCIC); and IMT-CoE. TRADOC executes its four core competencies with core competency lead organizations:

(1) Manage and execute the human resources (HR) lifecycle (lead: U.S. Army Accessions Command).

(2) Execute initial military training (lead: IMT-CoE).

(3) Prepare the Army to dominate in full-spectrum operations (FSO) in the joint, interagency, intergovernmental, and multinational (JIIM) environment (lead: CAC).

(4) Develop and integrate capabilities (lead: ARCIC).

b. TRADOC Campaign Plan 2009, Fragmentary Order (FRAGO) 17 to Operations Order (OPORD) 507894 (Decision Point 29), designated CASCOM and SCoE an MSO with significant mission scope and responsibilities across the broad sustainment community.

c. CASCOM and SCoE has assigned units, command responsibilities, and resources, as well as the broader responsibilities to support Army, Joint, interagency, and multinational requirements and programs. The SCoE reflects the colocation and consolidation of similar sustainment functions and activities at two locations to create a TRADOC multibranch CoE.

d. CASCOM and SCoE designates a general officer (GO)/Senior Executive Service to support each TRADOC line of operation (LOO). The GOs are designated as DCGs with functional oversight. DCGs are dual-hatted; they retain proponent responsibilities in addition to LOO oversight. For their assigned LOOs, DCGs/DtCG provide guidance to the CASCOM and SCoE staff and organizations (for example, common core (CC) training in IMT or in PME programs), as well as represent the command at external forums and venues requiring flag-level participation. LOO oversight responsibilities are not fixed permanently; current DCG designations are depicted in figure 1-1.

2-3. CASCOM and SCoE core competencies

- a. Execute IMT for sustainment of Soldiers and civilians.
- b. Prepare the Army to sustain FSO in a JIIM environment.
- c. Design, develop, and integrate sustainment capabilities into warfighting requirements, foster innovation, and lead change for the future force .

2-4. CASCOM and SCoE core functions

- a. Manage, recruit, access, and distribute DA civilian logistics interns for career programs (CPs) 13/17/24, and other sustainment CPs as appropriate.
- b. Develop and conduct sustainment related IMT that includes Inter-service Training Review Organizations (ITROs) and initial training for civilian interns in sustainment CPs.
- c. Develop sustainment doctrine and conduct sustainment leader development, military and civilian functional training, training development, and training support functions.
- d. Execute concept development, requirements determination, and capabilities integration.

2-5. Key enablers – Knowledge Management and lessons learned

- a. Knowledge Management (KM): Transfer sustainment operational knowledge throughout the force to maintain currency and convey the wisdom of the Army's collective expertise.
- b. Lessons learned/quality assurance: Deliberately and systematically collect, analyze, and archive sustainment field data for dissemination and integration in training and products for all TRADOC schools; and integration across the DOTMLPF domains to sustain, enhance, and increase the Army's preparedness to conduct current and future operations.

2-6. CASCOM and SCoE lead responsibilities

a. Core Functions. CASCOM and SCoE is the TRADOC lead for the sustainment dimension of many core functions. Examples include functional training, leader development and education, training support, doctrine, concepts, experimentation, requirements determination, and capability integration.

b. Other major responsibilities/tasks:

(1) The CASCOM and SCoE Commander is responsible for sustainment related force modernization proponentcy, and integrating and synchronizing sustainment DOTMLPF capabilities and requirements. This includes integrating DOTMLPF efforts with one TRADOC center and school (USACHCS) and two non-TRADOC centers and schools (AMEDDC&S and TJAGLCS).

(2) CASCOM and SCoE's broad responsibilities include execution of HQDA and Department of Defense (DOD) level programs such as excellence awards and civilian career management, Army and joint training such as FA 49 Operations Research Systems Analysis in coordination with (ICW) HQDA G-8 and FA51 (Acquisition) ICW Assistant Secretary of the Army Acquisition, Logistics and Technology (ALT), Postal Operations, Joint Culinary and Mortuary Affairs (MA), and to enable Army executive agency sustainment related execution such as MA and inland transportation support.

(3) ICW the broader Army/joint community, designs, develops, and integrates the sustainment warfighting function into warfighting requirements in the JIIM environment to ensure expeditionary, sustainable joint-nested capabilities are achieved for the combatant commands; fosters innovation in sustainment; and leads change for the future sustainment force.

(4) Provides vision, priorities, and guidance to assigned organizations. Develops comprehensive, integrated, and effective sustainment solutions for the Army through coordination with U.S. Army Materiel Command (AMC), U.S. Army Human Resources Command (HRC), U.S. Army Financial Management Command, AMEDDC&S, TJAGLCS, USACHCS, and CASCOM and SCoE subordinate activities.

(5) Serves as Army lead for sustainment transformation, to include Sustainment Enterprise Systems such as the Single Army Logistics Enterprise (SALE), General Fund Enterprise Business System and Integrated Personnel and Pay System-Army. Collaborates with HQDA G-1, G-4, and G-8; AMC, HRC, U.S. Army Financial Management Command, ARCIC, and CAC to produce agile, comprehensive, and effective sustainment policies, doctrine, organizations, equipment, information management systems, and sustainment-focused mission command (MC) systems. This includes the documentation of Army Enterprise Systems Integration Program capabilities that provide information to Army tactical units and organizations.

(6) Serves as Army lead for the deployment/redeployment process. Identifies and develops corresponding policies, concepts, doctrine, training, and conducts experiments, analyses, and studies to enhance the deployment and redeployment of Army forces. Collaborates

with HQDA, TRADOC, U.S. Army Forces Command (FORSCOM), Installation Management Command, U.S. Transportation Command, U.S. Joint Forces Command, Defense Logistics Agency (DLA), other services, and the Office of the Secretary of Defense to assist in developing joint, integrated end-to-end distribution processes.

(7) On behalf of HQDA G-4, designs, develops, and executes career management programs and policies for civilian logisticians Armywide. Collaborates with joint activities, DOD agencies, other services, HQDA, industry, and academia in support of these career management efforts.

2-7. Other CASCOM and SCoE functions

a. Core functions.

(1) IMT. Provides IMT at CASCOM and SCoE branch proponents and schools. Develops sustainment-related IMT instruction for TRADOC schools.

(2) Leader development. Conducts sustainment leader development courses. Sets standards and ensures execution to standard for sustainment-related individual training. Executes intern training for CPs 13, 17, 24, and 32.

(3) Lessons learned (L2). Evaluates and integrates sustainment L2 in training and products for all TRADOC centers and schools. Integrates other L2 into training at CASCOM and SCoE branch proponents and schools.

(4) Doctrine. Develops sustainment doctrine and provides sustainment-related input for other doctrine development.

(5) Training development. Provides individual and collective sustainment training programs and products for sustainment Soldiers, crews, teams, staffs, and units.

(6) Training support. Provides training support capabilities at CASCOM and SCoE branch proponents and schools. Enables sustainment training in units and at other centers and schools.

(7) Functional training. Provides position or specialty training at CASCOM and SCoE branch proponents and schools ICW CAC. Sets standards and ensures execution to standard for sustainment-related individual training, including individual training in all units, for those skills and tasks inherent in the functional training core function.

(8) Concept development. Develops Army sustainment concepts and supports joint concept development through TRADOC and non-TRADOC schools. Assists ARCIC with the integration of land force sustainment capabilities in the development of joint operating, functional, and integrating concepts ICW joint partners.

(9) Requirements determination. Manages implementation and execution of Joint Capabilities and Integration Development System (JCIDS) within CASCOM and SCoE.

Coordinates, synchronizes, and integrates Army sustainment capabilities development (to include automation and development of sustainment planning data on behalf of Army G-4) with other Army commands (ACOMs), the combatant commands, the Joint Staff, and other service development agencies across DOTMLPF.

(10) Capabilities integration. Manages capabilities integration ICW ARCIC to ensure sustainment solutions across all domains of DOTMLPF will interoperate in a manner consistent with the appropriate concepts. Performs logistics supportability and system training assessments to develop required capabilities, thus ensuring materiel systems are supportable at fielding and throughout the lifecycle. Supports systems development testing as the maintainer, maintenance trainer, battle damage assessment repair, and battlefield recovery lead.

b. Key enablers:

(1) KM. Provides KM for the sustainment warfighting function.

(2) L2. Deliberately and systematically collect, analyze, and archive sustainment field data for dissemination and integration in training and products for all TRADOC schools.

(3) Develops, integrates, validates, and maintains capabilities innovation in the sustainment areas. Develops, coordinates, prioritizes, and directs execution of sustainment experimentation through TRADOC and non-TRADOC centers and schools. Synchronizes and integrates Army sustainment experimentation with ARCIC; plans and coordinates Army participation in joint sustainment experiments.

c. Other major responsibilities/tasks:

(1) MC. Experiments with MC initiatives ICW ARCIC and CAC; provides standardized MC sustainment support system capabilities throughout the Army; identifies sustainment gaps and develops integrated capabilities that allow transition from the MC sustainment support system to joint logistics command and control (C2); develops and implements a migration strategy to facilitate interoperability and enhance sustainment capabilities; and integrates and standardizes sustainment tactical operation center capabilities.

(2) The Army modular force. Coordinates and integrates with CAC and joint partners on modular force-related DOTMLPF issues in support of Army sustainment transformation efforts. These include modular designs for corps and divisions, BDE combat teams, support BDEs, theater sustainment commands, and interface with the national sustainment base.

(3) Network integration. Ensures full integration of sustainment and sustainment federation of networks with MC, the SALE, and LandWarNet to leverage and enable interdependent network centric operations within the JIIM environment. Supports Army sustainment units by performing capabilities development processes for sustainment automated information systems interface and very small aperture terminal satellite communication systems.

(4) International engagement. ICW ARCIC and CAC, leads the development and exchange of deployment, sustainment, and EOD concepts, doctrine, and L2 with allies to sustain, enhance, or improve the Army's preparedness to conduct operations in a JIIM environment. Major activities include participation in Army and TRADOC Staff Talks, participation in North Atlantic Treaty Organization and American/British/Canadian/ Australian/New Zealand working groups, execution of agreed to actions, handling of requests for information, and relationship building.

(5) Conducts research, publishes, and maintains museum exhibits and other presentations to influence thought with regard to the role of sustainment in military operations both past and future.

Chapter 3

Combined Arms Support Command and Sustainment Center of Excellence Headquarters Command Group

3-1. Commanding General

The CG supports the CG, TRADOC priorities, develops leaders, generates combat and training educational products, and builds the sustainment force for the future Army. The CG is also the Fort Lee Senior Mission Commander.

3-2. Deputy to the Commanding General

The DtCG is a member of the Senior Executive Service, who acts in full authority and on behalf of the CG in all matters other than UCMJ and command authority. The DtCG supervises and directs execution of the CG's decisions and policies with a primary focus to direct the actions of CASCOM and SCoE HQ personnel engaged in the development of sustainment combat and training development products. Integrates the SSI, the USACHCS, the JAGLC&S, and the AMEDDC&S doctrine, training, and combat developments into all CASCOM and SCoE and TRADOC efforts.

3-3. CASCOM and SCoE Deputy Commanding General, Initial Military Training

a. Mission. CASCOM and SCoE DCG, IMT plans, develops, standardizes, evolves, and reviews sustainment-related training for IMT to include the WTX to support a more efficient and effective Army force generation (ARFORGEN) while providing Soldiers who can immediately contribute to their first unit of assignment.

b. Functions

- (1) Sets standards for and reviews sustainment-related training in IMT.
- (2) Establishes and provides oversight of the WTX.
- (3) Provides oversight for policy and priorities for sustainment-related matters in IMT.

- (4) Reviews warrior tasks and battle drills and recommends changes to the IMT-CoE.
- (5) Conducts research and experimentation analysis to improve sustainment training IMT.
- (6) Represents CASCOM and SCoE CG forums with TRADOC DCG IMT.

3-4. Deputy Commanding General, Capabilities Development

Integrates the design and development of Army, joint, and multinational logistics aspects of the future force from concept to capability development for the CASCOM and SCoE branch and force modernization proponents. Oversees development and integration of sustainment concepts, concept capability plans (CCPs), architectures, and DOTMLPF capabilities within the JIIM environment. Directs automated systems. Coordinates and integrates concepts, organizations, and materiel requirements with capabilities development and integration activities at SSI, CAC, HQ TRADOC, and HQDA.

3-5 Deputy Commanding General, Human Capital Enterprise

The CG SSI is also the CASCOM and SCoE DCG, HCE.

- a. Mission: Represents the CASCOM and SCoE CG at various HCE meetings. Recommends input and keeps the CG informed of the HCE initiatives.
- b. Functions. Attends HCE steering boards. Provides input concerning HCE policies and initiatives.

3-6. Deputy Commanding General, Mobilization

a. Mission. As principle advisor to the CG for all Reserve component (RC) affairs, the DCG Mobilization (DCG Mob) directs, coordinates, and reviews all RC support to the command as well as all actions of the command that impact the training, equipping, deployability, and readiness of RC sustainment units and personnel. At the direction of the CG, assumes duties as DCG for CASCOM and SCoE.

- b. Organization (see figure 3-1).

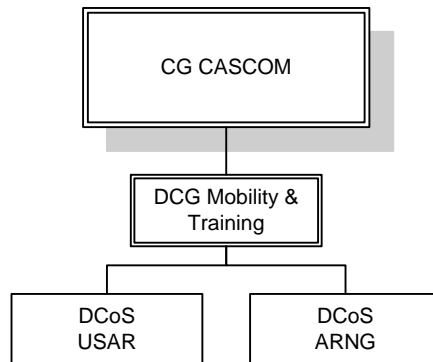

Figure 3-1. DCG, Mobilization

c. Functions. DCG Mob serves as the principal adviser to the CG on all Army Reserve (USAR) and National Guard (ARNG) matters. Serves as the principle liaison between the USAR, ARNG and CASCOM and SCoE. The position directs, coordinates, and reviews all actions of the command that impact training, equipping, deployability, and readiness of RC sustainment units and personnel. Through the Deputy Chief of Staff (DCoS) USAR and DCoS ARNG the position manages the mobilization of USAR and ARNG Soldiers in support of CASCOM and SCoE. The DCG Mob provides guidance on the management and utilization of active guard reserve (AGR) and mobilized soldiers assigned to CASCOM and SCoE.

3-7. Chief of Staff

The CoS is responsible for day-to-day execution of the CASCOM and SCoE HQ staff functions through direction, supervision, prioritization, and coordination of the special, personal, and coordinating staffs; and working directly with the DtCG, Chief Warrant Officer (CWO), and the Command Sergeant Major (CSM) to ensure coordinated actions. ICW the DtCG, CWO, and the CSM, the CoS also oversees execution and implementation of the CG’s decisions, intent, and policies. The CoS has oversight responsibility for administrative, budget, and logistical matters.

3-8. Deputy Chief of Staff

The DCoS reports directly to the CoS and serves as the staff synchronizer to the Command Group in the management of the CASCOM and SCoE HQ daily mission. The DCoS directly supervises the Secretary to the General Staff (SGS), Executive Operations, G-6, and sponsors the Foreign Liaison Officers (LNOs).

3-9. Deputy Chief of Staff, U.S. Army Reserves

a. Mission: Through DCG Mob, provides CG with specialized RC knowledge, management, and administrative support needed to effectively integrate both USAR support to CASCOM and SCoE and CASCOM and SCoE support to the USAR.

b. Organization (see figure 3-2):

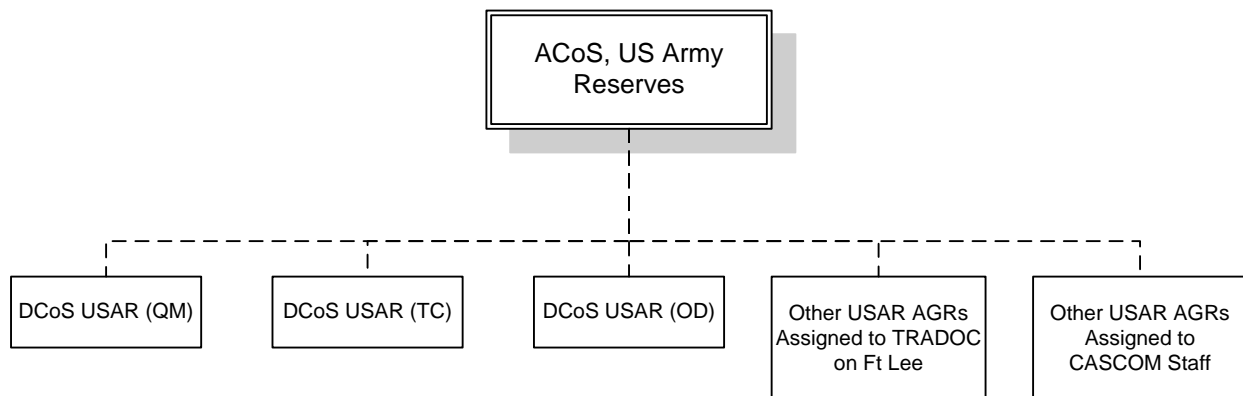

Figure 3-2. DCoS, USAR

c. Functions. DCoS USAR is the staff lead for all actions involving the USAR. Provides the daily management of all USAR issues affecting CASCOM and SCoE. The position coordinates and reviews all USAR support to the command as well as all actions of the command that impact the training, equipping, deployability, and readiness of USAR sustainment units and personnel. The DCoS USAR serves as the principle staff point of contact (POC) for liaison between CASCOM and SCoE and the USAR. ICW the schools and other directorates, manages the mobilization of USAR Soldiers in support of CASCOM and SCoE. The position oversees USAR AGR and mobilization authorizations on CASCOM and SCoE tables of distribution and allowances (TDA) and reviews USAR personnel assignments and utilization within CASCOM and SCoE.

3-10. Deputy Chief of Staff, National Guard

a. Mission. Through DCG Mob, provides CG with specialized ARNG knowledge, management, and administrative support needed to effectively integrate both ARNG support to CASCOM and SCoE and CASCOM and SCoE support to the ARNG.

b. Organization (see figure 3-3).

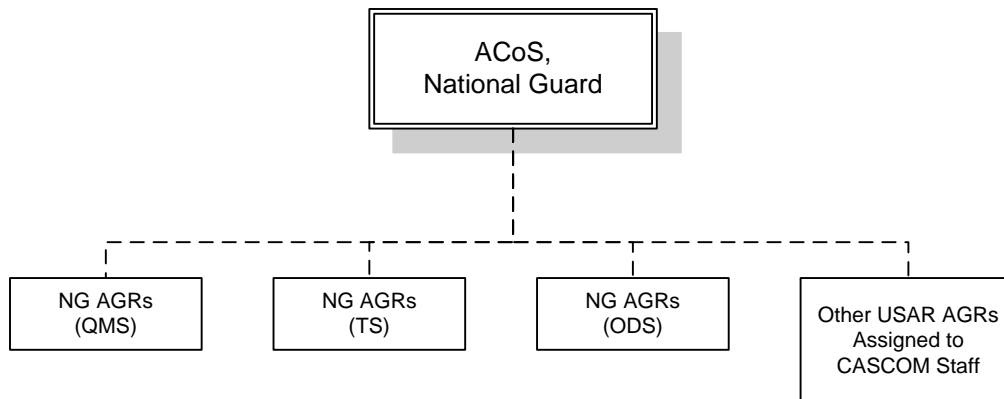

Figure 3-3. DCoS, ARNG

c. Functions. DCoS ARNG is the staff lead for all actions involving the ARNG. Provides the daily management of all ARNG issues affecting CASCOM and SCoE. The position coordinates and reviews all ARNG support to the command as well as all actions of the command that impact the training, equipping, deployability, and readiness of ARNG sustainment units and personnel. The DCoS ARNG serves as the principle staff POC for liaison between CASCOM and SCoE and the ARNG. ICW the schools and other directorates, manages the mobilization of ARNG Soldiers in support of CASCOM and SCoE. The position oversees ARNG AGR and mobilization authorizations on CASCOM and SCoE TDA and reviews ARNG personnel assignments and utilization within CASCOM and SCoE.

3-11. Chief warrant officer

Serves as the CWO for the command and is the principle warrant officer (WO) advisor to the CG on all matters pertaining to WOs. Representative for the command on all WO issues within DA. Assesses the status of WO programs with particular attention focused on training recruiting,

retention, professional development, morale, and any other areas affecting readiness across all logistics branches. Serves as the command representative WO within a number of councils for TRADOC, CAC, HRC and the Vice Chief of Staff, Army (CSA). Executes visits to various units, posts, and activities. Provides mentorship, guidance, counsel, and resource tools to WOs and their commanders as required.

3-12. Command sergeant major

The CSM provides advice and recommendations to the CG on issues regarding individual Soldier training, Soldier morale and welfare matters, and noncommissioned officer (NCO) development. The CSM monitors the execution of policies and interprets them for Soldiers as appropriate. The CSM also provides an open and "unique" channel of communications between the CG and the NCO support chain. The CSM advises the CG on quality of training provided by CASCOM and SCoE schools, and conducts visits to selected units and provides feedback to the appropriate CASCOM and SCoE activity.

3-13. Command planning group

Provides planning and operational support to the CG, DtCG, and CoS. Completes special actions such as speeches, briefings, presentations, video teleconferences, and articles for publications. Ensures the professional presentation and accuracy of all products presented to internal and external audiences. Plans, coordinates, and prepares for CASCOM and SCoE GO attendance at all events to include Army two-star and higher level conferences. Gathers information, reviews, and conducts executive analysis of designated key staff actions and exercises quality control over the CASCOM and SCoE GO read-aheads. Maintains effective communication with HQ TRADOC and other DOD agencies as required.

3-14. Secretary to the general staff

The key advisor to CASCOM and SCoE for administration. Coordinates CASCOM Command Group operations. Provides administrative support through the accomplishment of budget, manpower, and personnel administrative tasks; and integrates, coordinates, and supervises execution of staff actions. Coordinates with HQ TRADOC Command Group Actions Office and G-33 concerning all outside command channel taskings. Has primary responsibility for personnel security issues and administration within the CASCOM and SCoE. Responsible for facility management and building security for HQ CASCOM and SCoE.

3-15. Executive operations

Provides direct protocol support to the CASCOM and SCoE CG, DtCG, DCGs/Commandants, and CSM. Plans, coordinates, and executes ceremonies, conferences, meetings, and social events hosted by CASCOM and SCoE leadership. Provides protocol advice and guidance to all Fort Lee tenant activities including: ALU, Garrison, Defense Contract Management Agency, Defense Commissary Agency, and the USAR Gerow Center. Coordinates and executes visits by Colonel (P) and above personnel to Fort Lee, CASCOM and SCoE, (that is, escort, lodging, transportation, etc.) as required. Facilitates and coordinates visits by Foreign Delegations to Fort Lee, CASCOM and SCoE. Maintains and schedules the James Madison Conference Room and the Larkin Conference Center.

Chapter 4 Special Staff

4-1. Lessons learned/quality assurance

- a. Mission. Provide continuous feedback across DOTMLPF to ensure sustainment proficiency, quality assurance (QA), and relevancy to the U.S. Army.
- b. Organization. The Directorate of L2/QA is a special staff element and the "eyes and ears" of the DtCG, Governance and Transformation consisting of a two divisions: Analysis and Integration Division and Accreditation and Assistance Division.
- c. Major functions
 - (1) L2. Collects, analyzes, stores, and distributes sustainment L2, focusing on ongoing contingency operations. The focus is to bridge the information gap between the Generating Force and operating force through close coordination with the Center for Army Lessons Learned to determine the relevancy and effectiveness of sustainment functions across the DOTMLPF domains.
 - (2) External evaluation. Provides leadership with the feedback necessary to ensure sustainment training maintains the highest state of proficiency and relevancy to the U.S. Army.
 - (3) Combat training centers. Provides CASCOM and SCoE a direct link to the units in the field. Through very close association with National Training Center, Joint Readiness Training Center, Battle Command Training Program, and Joint Maneuver Readiness Center, the link offers the opportunity to observe and collect data from units as they rotate through one of the combat training sites. Provides the means for proficiency and doctrine review visits (right-seat-rides) and annual reverse right-seat-rides for our subject matter experts (SMEs).
 - (4) Active Army (AA) Training Evaluation. Conducts internal evaluation of the aligned sustainment training institutions using TRADOC accreditation standards, evaluates corrective actions, and provides governance procedures to respective commandants through the accreditation process to include self-assessments. Assesses and assists the improvement of IMT, PME, and functional training as a precursor to a formal accreditation visit from HQ TRADOC.
 - (5) RC training evaluation. Conducts assessment, accreditation, and assistance visits to verify functionally aligned (OD, QM, and transportation) RC training institutes meet TRADOC accreditation standards and certify administration, operations, and the sustaining base are adequate to support training to course standards.

4-2. Civilian logistics career management office

- a. Mission. Serves as the executing agent for HQDA G-4 roles and responsibilities as functional chief, outlined in AR 690-950, Career Management. Additionally, manages the personnel developer life-cycle functions as directed by AR 600-3, The Army Personnel Development System. The Civilian Logistics Career Management Office provides life-cycle

career management services to individuals in CPs 13, 17, and 24 to grow logisticians capable of operating and leading in a joint environment, as well as executing the DA Logistics Intern Program.

b. Functions. Manages and executes the following programs:

(1) DA Logistics Intern Program. Recruits, hires, trains, and develops high-caliber individuals to perform as logisticians throughout Army. This year program consists of functional, multifunctional, and interpersonal classroom and on-the-job training at activities throughout DOD.

(2) DA Logistics Competitive Professional Development Program. Provides university education, training, and professional development opportunities to develop an integrated, agile, and high-performing logistics workforce. This program serves to enhance the competencies of the enterprise logistician to succeed in a joint, interagency, and intergovernmental environment.

(3) Acquisition (life-cycle logistics). Influences certification requirements, policies, and guidance. Provides functional review of fulfillments packages, waivers, and certification equivalency requests.

(4) DA logistics career referral policies. Establishes unique requirements for merit promotion announcements that increase career opportunities for DOD logisticians and provides a diverse pool of premier logisticians to the hiring official.

4-3. Knowledge Management office

a. Mission. Develop, adapt, and implement DOD, joint, Army, and TRADOC enterprise KM policies, practices, and technologies within CASCOM and SCoE and the Army sustainment community.

b. Organization. The KM office is a special staff element directly reporting to the DtCG, Governance and Transformation, and consists of two divisions: Knowledge Management-Operations and Knowledge Management-Technologies.

c. Major Functions.

(1) Develops, monitors, and updates a KM strategy that links CASCOM and SCoE with sustainment Soldiers, Family members, Army civilians, and units through a network of enterprise knowledge sharing, collaboration, and social networking type capabilities.

(2) Assesses and improves processes used to create, share, and integrate knowledge within CASCOM and SCoE in terms of DOTMLPF, across the Army corps enterprises, and in support of ARFORGEN.

(3) Supports CASCOM and SCoE staff, faculty, and schools in applying KM to enhance learning and performance by leveraging talent, experience, best practices, and L2 through a structured KM network.

(4) Develops, tests, and implements knowledge sharing and collaboration technologies across DOD classified/unclassified and non-DOD public-facing network architectures, in both fixed and mobile environments.

4-4. Logistics proponency office

a. Mission. Serves as the executing agent to CG, CASCOM and SCoE for all proponency matters related to logistics branch (LG). Responsible for the eight personnel life-cycle management functions for LG officers and NCOs. Ensures that personnel management policies, programs, and procedures are established in conjunction with HRC, HQDA G-1, and ACOMs and incorporates LG considerations. Coordinates personnel proponency among Logistics Corps officer branches (transportation, QM, and OD). Manages associated training with industry and advanced degree programs. Serves as member of Officer Personnel Management System Council of Colonels.

b. Functions.

(1) Facilitates staffing of military occupational classification structure changes for officers and NCOs.

(2) Administers the Brehon A. Somervell Medal of Excellence.

(3) Evaluates current logistics force personnel system and identifies the need to revise current or establish new programs.

4-5. Safety office

a. Mission. Provides staff management of safety policies and procedures for integrating safety and occupational health and composite risk management for CASCOM and SCoE. The senior safety director directs and synchronizes garrison and mission safety programs and initiatives.

b. Functions.

(1) Serves as the CASCOM and SCoE risk management advisor, technical consultant, accident prevention policy and program developer, performance monitor, and lead for safety and occupational health matters as they apply to programs, personnel, property, and equipment.

(2) Manages the safety program to include safety education, training, and promotion activities; inspections and assessments; accident investigation, reporting and recordkeeping; hazard analysis; and countermeasure development as it applies to CASCOM and SCoE

organizations, personnel, property, and equipment. Provides analyses of current and future programs to ensure inclusion of composite risk management.

(3) Provides technical assistance in analysis and preparation of risk management plans for training, operations, and events.

4-6. Equal opportunity office

Mission. Advise the CG, CASCOM and SCoE on equal opportunity (EO). Monitor the execution of the EO program for CASCOM and SCoE and all commands, agencies, and activities under CG, CASCOM and SCoE jurisdiction to ensure equal and fair treatment of all military personnel and Family members without regard to race, color, gender, religion, or national origin. Provides training, awareness, and the prevention of sexual harassment (POSH). Promotes diversity, cultural awareness, and inclusion among military and civilian personnel.

4-7. Retention office

a. Mission. Serves as the primary program administrator and expert technical advisor to the CG, CASCOM and SCoE, and Fort Lee on all reenlistment aspects of the Army Retention Program.

b. Functions.

(1) Develop retention policy.

(2) Provides technical guidance for all CASCOM and SCoE career counselors.

(3) Assesses and evaluates the retention program across the CASCOM and SCoE and makes recommendations to the regimental CSMs, commandants, CASCOM and SCoE CSM, and CG CASCOM and SCoE for program adjustments.

(4) Exercise operational supervision over subordinate retention programs and personnel to ensure that retention policies are executed properly.

4-8. Historian

Mission. Serves as primary advisor to CG on all historical matters. Maintains a continuous history of the CASCOM and SCoE HQ, ALU, and Fort Lee (Garrison) through the collection, preservation, and archiving of historical information. Conducts historical research, to include oral interviews, and writing of monographs using information received from directorates, staff, and other offices. Produces annual reports and drafts other historical documents focusing on significant logistics initiatives. Provides guidance and assistance to SCoE associated branch schools in formulating and conducting their historical programs. Conducts professional development through effective use of military history. Serves as Professor of Military and Logistics History overseeing TR 350-13, Instruction in Military History, directed military history instruction and course development at ALU.

4-9. Acquisition, logistics, and technology-integration office

a. Mission. The acquisition, logistics, and technology-integration office (ALT-IO) is a direct reporting unit to the principal military deputy to the assistant secretary of the Army for acquisition, logistics & technology and is the capabilities developer for ALT. Supports the ALT and operational contract support (OCS) related aspects of the CASCOM and SCoE mission. The ALT-IO mission, in concert with the CASCOM and SCoE and AMC, is to exercise control and coordination over all ALT/OCS issues and processes related to capabilities development for DOTMLPF, standardizing ALT support, and OCS considerations in combat operations. ALT-IO develops, oversees, and coordinates the integration of ALT and OCS concepts, policy, doctrine, training and training support capabilities, tactics, techniques, and procedures into the Army's and joint warfighting logistical planning and doctrine. Collocation within CASCOM and SCoE, along with the collocation of AMC's liaison office and Logistics Civilian Augmentation Program planner, collectively facilitate the SCoE-ALT community integration effort.

b. Organization. The ALT-IO consists of three divisions: Doctrinal Developments, Acquisition Policy Compliance & Training Support, and Materiel Solutions & Force Developments (see figure 4-1).

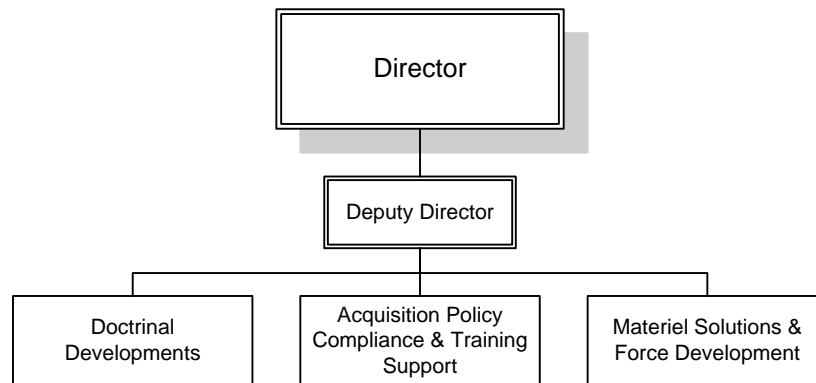

Figure 4-1. Acquisition, Logistics, and Technology-Integration Office

c. Functions.

(1) Within HQDA, ALT-IO functions as the Army acquisition executive's primary instrument for providing guidance and assistance in acquisition matters relative to the tactical insertion of ALT capabilities and OCS considerations into combat operations.

(2) Within AMC, ALT-IO functions as an advisory staff element, responsible for the integration and coordination of doctrine, training and training support, force development, combat development, and materiel solution requirements activities relating to employment of ALT capabilities and OCS considerations into combat operations.

(3) Within CASCOM and SCoE, ALT-IO is specifically charged with advising the CG on all matters concerning the integration of ALT and OCS capabilities across the force as well as to

support and coordinate with all ALT field operating commands and supporting agencies. The objective is to achieve a full integration of ALT/OCS capabilities into warfighting requirements.

4-10. Headquarters and headquarters company

Mission. Responsible for the health, morale, welfare, training, discipline, conduct and combat readiness of Soldiers assigned to HQ CASCOM and SCoE, and their Families. Provides C2, logistics, military justice, training and readiness, quality of life, worldwide deployment status tracking, and administrative support for the health, morale, and welfare of the command group, special staff, and 12 directorates. Provides a command climate that supports the CG's efforts in ensuring HQ CASCOM and SCoE mission is effectively and efficiently performed. Directs the unit training program and conducts the Army Physical Fitness Test, Physical Training, Weapons Qualification, Army Weight Control Program and NCO Education System tracking of enlisted Soldiers

Chapter 5

Personal Staff

5-1. Public affairs office

a. Mission. The public affairs (PA) mission is to help create a campaign quality force by increasing and promoting awareness and understanding of the Army, TRADOC, and CASCOM and SCoE missions, activities, and programs. This mission has greatly expanded with the re-organization of CASCOM and SCoE and the development/implementation of the SCoE. In addition to serving as personal staff to the CG, DtCG and other senior leaders, as a result of BRAC 2005 initiatives, the PA office directly supports the HQ CASCOM, ODS, QMS, TS, ALU, and SSI. The PA office serves as the principal adviser to the CG, CASCOM and SCoE on strategic, operational, and tactical PA strategies, plans, outreach, and operations. Coordinates PA outreach with CASCOM and SCoE staff; DOD, HQDA, TRADOC, U.S. Army Accessions Command, joint organizations, and other services, agencies, and organizations.

b. Functions.

(1) Serves as the senior advisor to the CG, CASCOM and SCoE on all PA matters. Lead for development of media relations and outreach plans and products in support of organizational priorities and desired outcomes.

(2) Provides professional and technical expertise to the CG, CASCOM and SCoE and HQ elements for PA plans and policy, internal/external outreach opportunities, marketing, media training, and PA program review and evaluation. Conducts training, develops and markets media opportunities in support of CASCOM and SCoE, TRADOC, and the Army.

(3) ICW DOD, HQDA, and TRADOC, facilitates PA guidance for CASCOM and SCoE operations and provides mission specific guidance to support public discussion and understanding of CASCOM and SCoE operations, priorities, and initiatives.

(4) Ensures PA integration into strategic communication efforts.

(5) Reviews all manuscripts and news articles prepared by CASCOM and SCoE elements for release on the missions and functions of CASCOM and SCoE for comprehensiveness, accuracy, and policy implications.

(6) Liaison with U.S. Army Garrison Fort Lee, VA. Coordinates support with garrison, Installation Management Command and regional offices for information, planning, and augmentation, as needed.

5-2. Staff Judge Advocate

a. Mission. The staff judge advocate (SJA) is the principal legal advisor to the CG and the CASCOM and SCoE Staff. The SJA also serves as the principal ethics counselor and directs all legal services provided on Fort Lee, VA; Fort Eustis, VA; and all tenant activities located on these installations.

b. Organization. The CASCOM and SCoE office of the SJA consists of four divisions and a branch legal office at Fort Eustis, VA: Criminal Law Division, Claims Division, Administrative and Civil Law Division, and the Legal Assistance Division (including the Tax Assistance Center) and the Fort Eustis, VA, legal office (see figure 5-1).

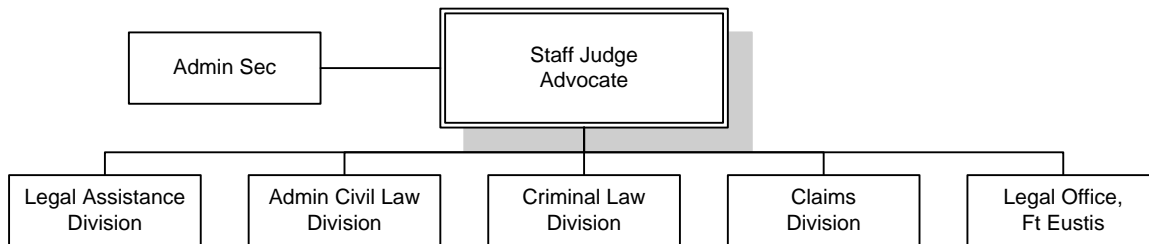

Figure 5-1. Staff Judge Advocate

c. Functions.

(1) Provides legal advice to the CG, CASCOM and SCoE, DtCG, commandants, and staff.

(2) Provides legal support to U.S. Army Garrison, Forts Lee and Eustis, VA.

(3) Controls command legal correspondence and furnishes guidance in interpreting administrative directives, policies, and procedures.

(4) Advises on the administration of military justice and other criminal law actions within the general court-martial jurisdiction of the CG, CASCOM and SCoE commandants.

(5) Oversees the U.S. District Court cases arising within the jurisdiction of Forts Lee, Eustis and Pickett, VA.

(6) Provides legal advice on the duties, functions, and authority of command as well as civil law matters and comparative, operational, and international law as it affects installation activities.

(7) Provides assistance and advice to active duty and retired military personnel, military dependents, and other authorized personnel.

(8) Provides claims services and legal assistance to Forts A. P. Hill and Pickett, VA, as well as claims services to West Virginia and most of Virginia except Northern Virginia and the Tidewater area.

(9) Supports the U.S. Army Trial Defense Field Office, Forts Lee and Eustis, VA.

(10) Plans and executes a preventative law program.

(11) Maintains liaison with RC and ARNG judge advocates and offices, local legal organizations, and local Commonwealth and Federal attorney's offices.

5-3. Inspector general

a. Mission. Confidential, fair, and impartial advisor to the CG. Determine and report to the CG the state of the economy, efficiency, discipline, morale, mission performance, training and readiness of the U.S. Army CASCOM and SCoE (to include Fort Lee and all other locations where we have subordinate units).

b. Major Functions.

(1) Assistance. Receives, inquires into, records, and responds to complaints or requests for assistance either brought directly to the inspector general (IG) or referred to the IG for action concerning matters related to the U.S. Army.

(2) Inspections. Conducts inspections as directed by the commander or as prescribed by law or regulation. Report inspection results to the directing authority complete with findings, applicable root causes, recommended solutions, and a recommended person/agency charged with implementing each solution.

(3) Investigations. Conducts fair, objective and impartial investigations and investigative inquiries as directed by the commander or as prescribed by law or regulation and provide a report of such investigations and inquiries to the directing authority.

(4) Teaching and training. Incorporates this function when conducting the other IG functions. Educate leaders and Soldiers on the IG system's purpose, functions, methods, benefits, and constraints. Train Soldiers and leaders on Army standards, policy, and procedures.

Chapter 6

HQ CASCOM and SCoE Coordinating Staff

6-1. G-1/4, Deputy Chief of Staff

a. **Mission.** Provides support and advice on military and civilian personnel, logistics, engineering, environmental, BRAC, and integration of base support.

b. **Organization.** The G-1/4 consists of three divisions: AG, Logistics, and Civilian Personnel. G-1/4 exercises operational/administrative control over the EO office, historian, retention office, and safety office.

c. **Major Functions.**

(1) **Personnel readiness management.** Manages the distribution of Soldiers and the recruitment/development of civilians to centers/schools and activities based on documented requirements and authorizations, commander's priorities, and anticipated needs.

(2) Provides overall management of the Army command retention program including promotion, implementation, and identification of signs which could potentially impede the retention effort.

(3) **Essential personnel support/services.** Provides timely, accurate military HR functions, and coordinates programs directly influencing Soldier well-being.

(4) Analyzes/evaluates civilian HR management programs. Analyzes/evaluates command civilian HR management program through data, reports, and on-site assessment.

(5) Provides timely and accurate civilian personnel management advice and coordinates civilian personnel programs directly influencing civilian well-being.

(6) **Logistics operations and plans.** Provides oversight and staff supervision over facilities management and equipment readiness.

(7) Develops command maintenance, transportation, and supply discipline policy.

(8) Synchronizes BRAC personnel issues. CASCOM and SCoE staff lead for BRAC personnel planning.

(9) Advocate and lead for base operations support and policy issues, TRADOC and CASCOM and SCoE transformation initiatives, Soldier Family readiness programs and well-being.

6-2. G-3, Training and Doctrine

a. **Mission.** Synchronizes SCoE responsibilities for individual training, collective training, training development, leader development, doctrine development, and training support. Provides staff management for the integration of programs, processes, and initiatives among CASCOM and SCoE agencies to include the aligned centers, schools, and activities under direct authority of the SCoE and those schools and agencies with a coordinating relationship with the SCoE including the USACHCS, TJAGLCS, and the AMEDDC&S. The CASCOM and SCoE G-3 executes these duties to ensure timely and effective prioritization, direction, monitoring, and implementation of the CASCOM and SCoE CG's intent. G-3 is the primary tasking authority for the CASCOM and SCoE.

b. **Organization.** Consists of a staff element and an operations branch.

c. **Functions.**

(1) Develops the training vision and annual training guidance.

(2) Recommends training resource strategies, priorities, and policies for the CG, SCoE.

(3) Determines the CASCOM and SCoE requirements for training resources and recommends allocation.

(4) Analyzes, integrates, and synchronizes command requirements and solutions; recommends command priorities to ensure subordinate organizations of the CASCOM and SCoE can execute their missions.

(5) Prepares, consolidates, and submits the CASCOM and SCoE input for the network unit status report (NETUSR).

(6) Prepares, coordinates, and publishes OPORDs, fragmentary orders (FRAGORDs), and warning orders (WARNORDs).

(7) Responsible for the process and monitoring of operational, organizational, and personnel taskings, both internal and external for CASCOM and SCoE. Receives, clarifies, distributes, monitors, and tracks all taskings originating from outside of the CASCOM and SCoE and prepares, issues, monitors, and tracks taskings originating internal to the CASCOM and SCoE.

(8) Coordinates the combined WTX for the CASCOM and SCoE.

(9) Coordinates and executes the command post exercise – sustainment (CPX-S) events for U.S. Army sustainment units preparing for deployment with follow-on combat operations.

(10) Establishes policies, procedures, roles, and responsibilities for the implementation, operation and maintenance of the SCoE enterprise resource planning (SERP) system throughout the CASCOM and SCoE organizations on Fort Lee, VA.

6-3. G-5, Strategic Initiatives Group

a. Mission. Coordinates Army and TRADOC Campaign Plan requirements, and other planning initiatives with greater than 1 year lead time to execution; facilitates the development of CASCOM and SCoE/Fort Lee strategic communication program; and provides Red Team expertise for the command.

b. Functions.

- (1) Lead organization to coordinate Army and TRADOC Campaign Plan requirements.
- (2) Develops planning initiatives with greater than 1 year lead-time to execution.
- (3) Facilitates the development of CASCOM and SCoE/Fort Lee's strategic communication plan.
- (4) Provides Red Team expertise for the command.
- (5) Army lead for logistics planning factors.

6-4. G-6, Command, Control, Communications, and Computers

a. Senior adviser to CG, CASCOM and SCoE for matters relating to information technology (IT) and information management (IM) necessary for the execution of the CASCOM and SCoE mission. Develops and executes IT and IM plans, policies, procedures, and its enterprise architecture. Provides staff management for the development, acquisition, integration, operation, and sustainment of IT and IM applications, systems, and services for CASCOM and SCoE.

b. Consists of three branches: Plans & Programs, Operations, and Analysis and Integration.

c. Functions.

(1) Exercises program responsibility for formulation, development, preparation, presentation, and administration of IT objectives, policies, programs, plans, and projects for CASCOM and SCoE to include capital planning, resource management, project management, and IT governance.

(2) Ensures the effective integration of plans, programs, and operations encompassing information systems. Ensures compliance with TRADOC and Army enterprise architecture standards and reporting requirements.

(3) Coordinates and monitors common-user command, control, communications, computers, and IM baseline service delivery and support from the Network Enterprise Center, identifying and validating requirements and funding for above baseline services.

(4) Provides information assurance awareness, mission system accreditation, compliance reporting, and management of information assurance programs.

(5) Provides information technology support for Standard Army Management Information System (STAMIS), battle command, and distribution management to include networking and system maintenance. Focal point for system program managers.

6-5. G-8, Resource Management

a. Mission. The CASCOM and SCoE G-8 formulates, allocates, administers, and reviews the utilization of CASCOM and SCoE funding and manpower programs to execute CASCOM and SCoE missions, and serves as principal advisor to the CG, commandants, CASCOM and SCoE's command and staff on finance, resource, and management matters.

b. Organization. CASCOM and SCoE G-8 consists of four divisions: Budget Division; Management and Manpower Division; Managerial Accounting Division; and Plans, Analysis, and Evaluation Division (see figure 6-1).

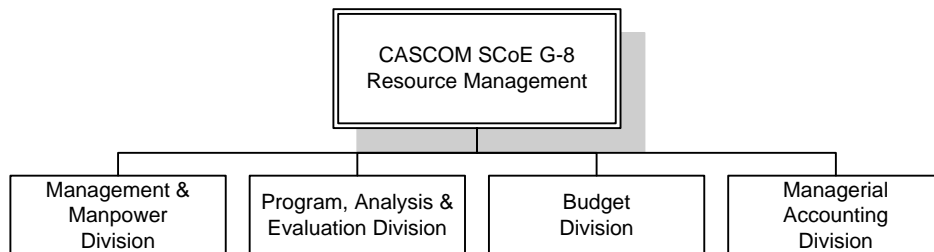

Figure 6-1. CASCOM and SCoE G-8, Resource Management

c. Functions.

(1) Develops, allocates, analyzes, and reviews the use of CASCOM and SCoE funding and manpower programs to execute those organizations' respective missions.

(2) Voting member of the HQ, TRADOC Mission and Resources Board for CASCOM and SCoE MSO.

(3) Provides all resource management support and services required to maintain oversight and facilitate the planning, programming, budgeting, and execution of the operating budgets for CASCOM and SCoE.

(4) Manages the process of the allocation of all resources.

(5) Provides management analysis, manpower, and equipment documentation and resource management support functions for CASCOM and SCoE.

(6) Conducts management studies, projects, and analyses to support senior CASCOM and SCoE leadership decisions.

(7) Reviews and processes acquisition management oversight packages for all CASCOM and SCoE activities.

(8) Provides expertise and technical support to the Management Controls Program, management studies, in-sourcing packages, and concept plans.

(9) Installation program coordinator for the Defense Travel System and the Lead Defense Travel Administrator (LDTA) for CASCOM and SCoE. Installation activity program coordinator for the government travel card program.

(10) Manages and coordinates CASCOM and SCoE TDAs and mobilization TDAs development, preparation, maintenance, and publication; develops and maintains the manpower modules; and provides resource management oversight of civilian personnel actions for all CASCOM and SCoE organizations.

(11) Coordinates all new equipment fielding for CASCOM and SCoE.

(12) Develops and administers the civilian Monetary Awards Program for CASCOM and SCoE.

(13) Provides all resource management support and services required to maintain oversight of interservice and/or intraservice support agreements, memorandums of understanding (MOU) and memorandums of agreement (MOA).

(14) Reviews manpower programs ensuring consistency with MSO priorities within the framework of command priorities and guidance.

(15) Serves as the CASCOM and SCoE G-8 representative at the structure & manning decision review (SMDR).

(16) Provides professional accounting advice on finance and accounting policy. Advises others on the legal restrictions on fund usage and other fiscal law issues.

(17) Performs/completes triannual joint reviews for all assigned funds/accounts. Analyzes and reconciles accounting reports with supporting financial records. Researches and resolves abnormal conditions and balances.

(18) Develops and executes local accounting guidance for year-end closeout. Validates year-end accounting reports in support of the certifying officer's certification.

(19) Continuously reviews reimbursable transactions to ensure data is timely, accurate, and complete.

(20) Liaison between appropriated fund civilian employees and the Defense Finance and Accounting Service (DFAS) payroll office.

(21) Assists in development and review of the TRADOC Commander's narrative memorandum to HQDA for the program objective memorandum (POM).

(22) Provides POM justifications to the TRADOC Mission and Resources Board, Senior Review Committee, and the Board of Directors.

(23) Provides expert research and analysis on the Institutional Training Resource Model.

(24) Validates requirements and provides recommendations, prioritization, and distribution of resources.

(25) Reviews, validates, and prioritizes CASCOM and SCoE branch proponent and schools' input for the POM/program budget review and requirement submissions.

(26) Provides input to HQDA, through HQ TRADOC, for CASCOM and SCoE; assists TRADOC in building and briefing CASCOM and SCoE branch proponent and schools to the program evaluation groups for POM builds.

(27) Provides resource management support and services required to maintain oversight and to facilitate the planning, programming, budgeting, and execution of the operating budgets for SCoE.

(28) Receives, processes, and analyzes funding, procurement, and personnel transactions; prevalidates requirements; and certifies funds by inputting data into the appropriate automated systems or preparing the appropriate manual documents for the various systems and programs utilized by DFAS. Supports the execution of current and prior operating budgets.

(29) Provides liaison resource management service and support to those activities whose functions, C2, source of funding, and budget execution are split between the Senior Mission Command and Garrison Commander, Fort Lee, VA.

(30) Manages, executes, and certifies funding received for international student training to include International Military Security Assistance Program.

(31) Manages the allocation of budget resources through the program budget advisory committee (PBAC) framework consisting of a working PBAC and a senior PBAC, with the final decision resting with the CG.

(32) Prepares, processes, reconciles, analyzes, and maintains various reports, schedules, and requests for information in support of DFAS inquiries; TRADOC budget estimates, and

budget guidance processes; TRADOC budget data calls; and local budget reporting requirements, budget data calls, and inquiries.

(33) Coordinates year-end closeout operations for CASCOM and SCoE, TRADOC Analysis Center – Fort Lee, Logistics Exercise and Simulation Directorate, and FORSCOM activities located at Fort Lee, VA.

(34) Develops CASCOM and SCoE resource and prioritization strategy for budget and execution years.

(35) Develops and analyzes CASCOM and SCoE resource allocation process.

(36) Reviews, validates, and prioritizes the CASCOM and SCoE branch proponent and Schools' input for the budget year requirement submissions. Provides operational impacts of not validating or resourcing requirements.

(37) Analyzes, validates, and prioritizes CASCOM and SCoE MSO branch proponent and schools' unfinanced requirements, TRADOC budget guidance, appropriated TBG, and mid-year and year-end closeout requirements. Consolidates operational impacts provided by using activities regarding funding shortfalls.

(38) Provides feedback to TRADOC G-8 on execution and budget year prioritization of funds and requirements.

(39) Assists TRADOC in reviewing CASCOM and SCoE program element split of allocation.

Chapter 7

Training and Doctrine, Development and Integration

7-1. Mission, organization, and functions

a. Mission. Analyzes, designs, and develops rigorous, relevant, and effective training products for the CASCOM and SCoE. These include IMT, PME, collective training, and life-long learning to support the current and future sustainment forces with well trained units, warriors, and adaptive/innovative leaders. Ensure total life-cycle training integration of Army systems as it applies to SCoE schools and active Army/RC materiel fieldings.

b. Organization. Under the direction of the Deputy Commander for Training and Doctrine, Development and Integration, the organization has two directorates: Training and Doctrine Development (TDD) and Training Support (see figure 7-1).

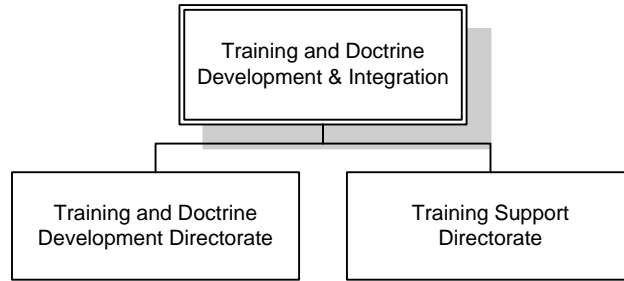

Figure 7-1. Training and doctrine, development & integration

c. Functions.

- (1) Designs and develops all sustainment training products for sustainment forces.
- (2) Develops and integrates the Army sustainment forces training efforts and programs.
- (3) Develops capabilities-based solutions to leverage technologies that support training, recommends sustainment science and technology (S&T) priorities, supports logistics experimentation, and synchronizes and integrates Army logistics capabilities within the JIIM environment.
- (4) Integrates sustainment CCPs, architectures, and DOTMLPF capabilities into training products.
- (5) Co-hosts the CASCOM and SCoE Training Support System Review/Mission Essential Review with the Army Training Support Center.
- (6) Assists CASCOM and SCoE DCG-IMT by developing and conducting sustainment-related IMT instruction for TRADOC schools.
- (7) Provides training products at sustainment schools for the sustainment mission area; sets standards for sustainment-related individual training, including individual training in units.
- (8) Assesses the application of new training or training delivery systems and provides collective training for crews, teams, staffs, and units for sustainment forces.
- (9) Provides training development support capabilities to training development divisions enabling sustainment forces training in units and at other schools.
- (10) Directs Army sustainment force training and leadership development efforts and initiatives to enhance PME throughout the SCoE.
- (11) Develops and fields all training development products, in accordance with the approved systems approach to training (SAT) and approved TRADOC policies and guidelines.

(12) Develops and supports the initiatives and strategies of The Army School System (TASS) and the TASS BNs, regional training institutes, TASS training centers, and regional training sites – maintenance.

(13) TRADOC lead for the full range of automated information systems training development and evaluation for sustainment forces.

(14) Lead in exploration and application of emerging technology for use in developing immersive, interactive, training products.

(15) Develops and integrates the lifelong learning center with existing and emerging sustainment training products to support efficient and cost-effective integration with TRADOC training support systems and lifelong learning.

(16) Lead in developing, managing, and integrating Army and joint doctrine, and allied logistics doctrine.

7-2. Training and Doctrine Development Directorate

a. Mission. CASCOM and SCoE lead for training and doctrine products. Develops individual, collective, and leadership development training for QM, OD, transportation and multifunctional logistics proponents and assists other proponent schools with sustainment-related training products. Develops, manages, and integrates Army, joint, and allied logistics doctrine.

b. Organization. Consists of six divisions: QM Division, OD Division, Transportation Division, Collective Training Development Division, Professional Military Education Division (ED), and Doctrine Division (see figure 7-2).

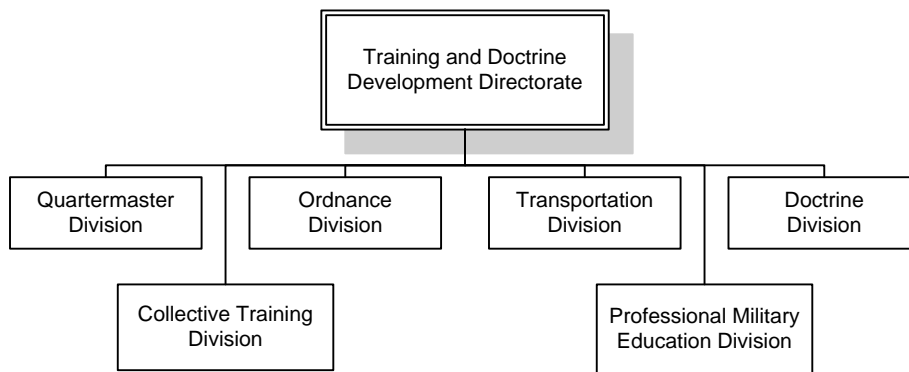

Figure 7-2. Training and Doctrine Development Directorate (TD3)

c. Functions.

(1) Develops and revises sustainment doctrine, individual and collective training products and strategies for all Army components (active and reserve).

(2) Coordinates doctrine and training development priorities with SCoE schools.

(3) Develops and fields all training development products in accordance with (IAW) the approved SAT and TR 350-70, Systems Approach to Training Management, Processes and Products.

(4) Conducts job and task analysis and task selection boards for each MOS. Develops task analysis for all critical tasks. Recommends location of training. Conducts needs, mission, and collective task analysis for CASCOM and SCoE branch proponent and schools' Operational Force units.

(5) Identifies technological change and its application to the training development process and acquires technologies to enhance training development and incorporate interactive multimedia instruction.

(6) Develops programs of instruction (POI), lesson plans, associated student handouts, and tests in support of proponent schools. Resources to develop lesson plans, associated student handouts and tests remain in the OD Training Detachment at Fort Sill, OK and the OD Electronic Maintenance Training Department at Fort Gordon, GA.

(7) Develops and sustains collective training products. These include, but are not limited to warfighter training support packages, drills, training circulars, collective tasks, and combined arms training strategies in support of CASCOM and SCoE branch proponent and schools' Operational Force units.

(8) Processes Training Requirements Analysis System (TRAS) documents for submission to TRADOC Training Operations Management Activity for approval and inclusion in the SMDR process. The lead approves all TRAS documents (AIT and PME) impacting their training. Maintains and manages resource tradeoff documentation based on SMDR.

(9) Manages the master copy of all formal test products; validates, coordinates, and distributes test materials to the proponent schools, IAW the directorate standard operating procedures on test control and validation except as outlined above.

(10) User representative for training requirements and related documentation associated with the development of new or emerging systems and provides this input to the appropriate activities on a timely basis throughout the life cycle of the system development process.

(11) Develops logistics functional doctrine and keystone, capstone, and multifunctional sustainment doctrine, integrated with other doctrine and supportability plans.

(12) Advises senior leaders on matters of Army, joint, multiservice and allied doctrine; and performs doctrinal studies as required.

(13) Advises senior leaders on matters pertaining to collective training. SCoE collective training development advocate for multifunctional logistics, QM (minus MA), OD (minus EOD), and transportation.

(14) SCoE lead for developing and maintaining training standards for sustainment unit gunnery and standards in training commission training ammunition requirements.

(15) Incorporates appropriately vetted observations, insights, and lessons and evaluation feedback into training and doctrine product development.

(16) Educates lead Operational Force units on doctrine and training products and solicits feedback on the effectiveness of products.

(17) Develops input and manages online sustainment training and doctrine forums. Manages the training and doctrine portion of the CASCOM and SCoE Web site.

7-3. Training Support Directorate

a. Mission. Provides training and developmental support to the Operational and Generating Force with a focus on sustainment requirements. Priority of efforts are to development of technological enhancements to education and training, battle staff training in distribution management, and other training support to integration of new systems into the Army's Operational Force. Provides a common operating picture to CASCOM and SCoE of all TRADOC directed taskings and emerging training requirements

b. Organizations. Consists of five divisions: Training Technologies Division, Systems Integration Division, Operations Division, Exercises Division, and IMT Division (see figure 7-3).

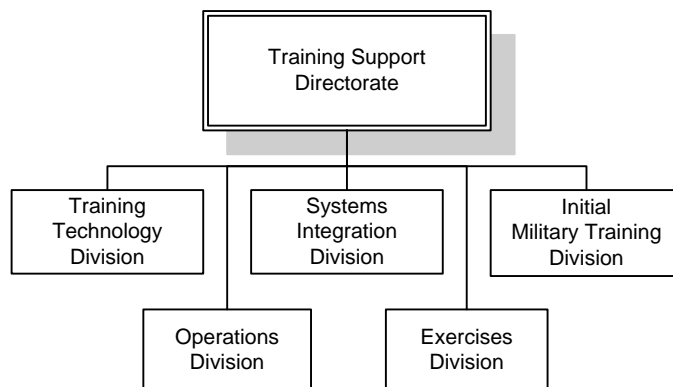

Figure 7-3. Training Support Directorate

c. Functions.

(1) Plans, organizes, directs, coordinates, and manages activities involved in analysis, design, and development of training products and programs and validation of training materials for sustainment forces.

(2) The Soldier operator and maintainer training representative for all systems operated or maintained by OD, Transportation Corps (TC) or QM Soldiers. Has approval authority for all

level maintenance technical manuals and has JCIDS training authority for all sustainment or non-sustainment new systems operated or maintained by OD, TC, or QM Soldiers.

(3) SCoE lead for identifying emerging training concepts and conducting training technology experimentations. Develops in-house computer- and web-based distributed learning (DL) courseware and training products, virtual and gaming training simulations, and mobile training device applications.

(4) Develops training development strategies for sustainment forces to optimize training productivity and effectiveness in an environment of constrained resources.

(5) Supports TD3 with both government and contract development of training and doctrine products for the SCoE schools and Army sustainment organizations.

(6) Plans, coordinates, and executes CPX-S for deploying expeditionary sustainment commands, sustainment BDES, and movement control BN HQ prior to their culminating training event.

(7) Provides Blackboard Learning Content Management System domain administration and maintains the SCoE Lifelong Learning Center.

(8) SCoE lead with support from TD3 divisions for AR 350-38, Training Device Policy Management; Training Aids, Devices, Simulations and Simulators.

(9) Standardizes practice of CC training among SCoE schools.

Chapter 8

Director of Capabilities Development and Integration

8-1. Mission, organization, and functions

a. Mission. Integrate the design and development of Army, joint, and multinational logistics aspects of the future force from concept to capability development for the CASCOM and SCoE branch and force modernization proponents. Develop and integrate sustainment concepts, CCPs, architectures and DOTMLPF capabilities; recommend sustainment-related S&T priorities; manage logistics experimentation; and synchronize and integrate Army sustainment capabilities within the JIIM environment. Directs and integrates all combat development activity for logistics C2 and logistics business automated systems. Provide oversight for combat development for SSI.

b. Organization. Consists of seven elements; Program Integration Office; Force Development Directorate (FDD) which includes the Tactical Wheeled Vehicle Management Office; Sustainment Battle Lab and Capability Determination Directorate; TRADOC Capabilities Manager - Transportation (TCM-T); TRADOC Capabilities Manager - Sustainment C2, Enterprise Systems Directorate (ESD); and Materiel Systems Directorate (see figure 8-1).

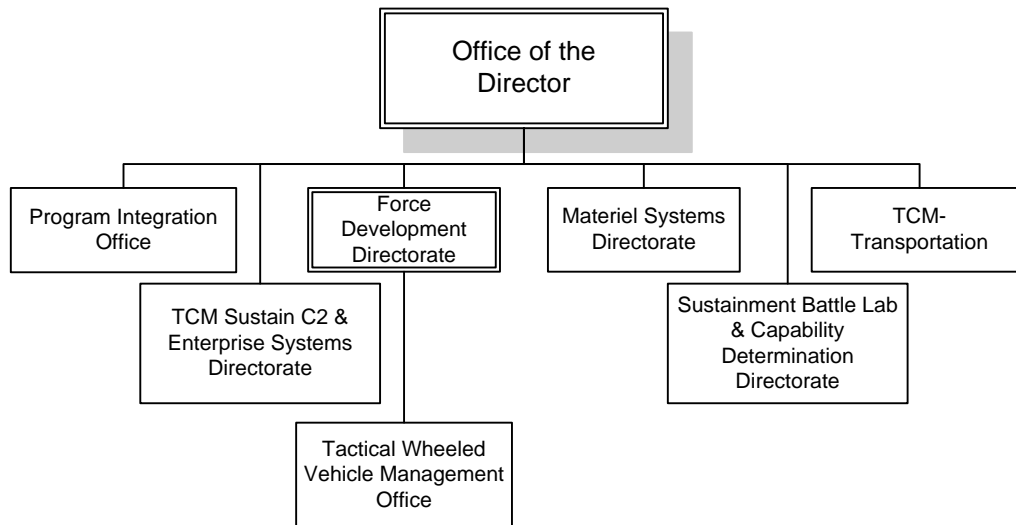

Figure 8-1. Capabilities Development & Integration

c. Functions.

(1) Designs, develops, and integrates all sustainment aspects of the future force into the joint force, from concept to capability development.

(2) Performs duties outlined in TR 71-12, TRADOC System Management, TCM-T, and TCM-Sustainment C2.

(3) Develops, coordinates, prioritizes, and executes experimentation through CASCOM and SCoE and non-CASCOM leads in consonance with joint, Army, and TRADOC guidance; assists ARCIC in developing the Army experimentation guidance; synchronizes and integrates Army logistical experimentation with joint experimentation ICW ARCIC; coordinates experimentation and experimentation support across CASCOM and SCoE ICW ARCIC.

(4) Develops and coordinates guidance, recommends policy, and provides direction to execute the JCIDS and manage its implementation and execution within CASCOM and SCoE, integrate DOTMLPF developments to support required capabilities; and coordinates, synchronizes, and integrate Army capabilities developments with TRADOC, ACOM, the combatant commands, the Joint Staff, and other service logistics developments.

(5) Identifies and refines required capabilities for the future Army and some joint capabilities.

(6) Manages the JCIDS capabilities-based assessment (CBA) to identify gaps in joint and Army capabilities and proposes materiel or nonmateriel approaches to resolve or mitigate those gaps.

(7) Manages the development of JCIDS capability documents that propose DOTMLPF solutions to sustainment capability gaps.

(8) Coordinates, staffs, and validates JCIDS capability documents and forwards to TRADOC.

(9) Develops sustainment concepts and supports joint concept development through CASCOM and SCoE and non-CASCOM leads; directs, manages, and synchronizes concept development by Integrated Capabilities Development Teams; and ensures the integration of land force logistics capabilities in the development of joint operating, functional, and integrating logistical concepts ICW ARCIC, HQDA G-4, and the Joint Staff J4.

(10) Develops sustainment organizational and force structure requirements. Army lead for logistics planning factors.

(11) Manages tactical wheeled vehicles (TWV) requirements for the Army. Develops Army TWV fleet goals, objectives, and management policies.

(12) Directs and integrates all combat development activity for sustainment C2 and sustainment business automation systems.

8-2. Program integration office

a. Mission. Provides centralized integration and operations support across DOTLMPF areas within CDI. Analyzes DOD, HQDA, TRADOC, and joint guidance, plans, policies, and initiatives to synchronize CDI actions.

b. Functions. Lead integrator throughout the capabilities developmental process. Ensures that required capabilities and associated gaps are analytically supported and that DOTLMPF solutions are properly coordinated, synchronized, and integrated across the sustainment warfighting function. Provides military and civilian administrative and logistical support: conducts and reports programmatic analysis; supports the development of manpower and fiscal requirements; and integrates information technology. Provides logistics analysis of capstone Army, joint, and DOD plans. Manages the implementation of the CDI initiatives. Provides Army logistics transformation coordination ensuring the synchronization of CASCOM and SCoE related actions with ARCIC and TRADOC MSOs. Manages CDI taskings, personnel actions, and position management tasks.

8-3. Force Development Directorate

a. Mission. Develops sustainment organizational and force structure requirements for the following functions: maintenance, ammunition supply, and EOD, supply distribution; retrograde; petroleum supply and services; water purification and distribution; MA; aerial delivery; field services; force provider logistics support to the Soldier, motor transport operations, Army watercraft, movement control, rail operations, and terminal operations. Serves

as the CASCOM and SCoE lead in the development of force designs and force structure requirements for multifunctional logistics organizations (Supply Requirements Code 63 Table of Organization and Equipment (TOE)) within the operational Army. Serves as the Army lead for sustainment planning data and provides staff management for the collection, validation, maintenance, and dissemination of Army sustainment planning factors, consumption rates, and data.

b. Organization. FDD consists of four divisions: QM Division; OD Division; Multifunctional Division; and Transportation Division (see figure 8-2).

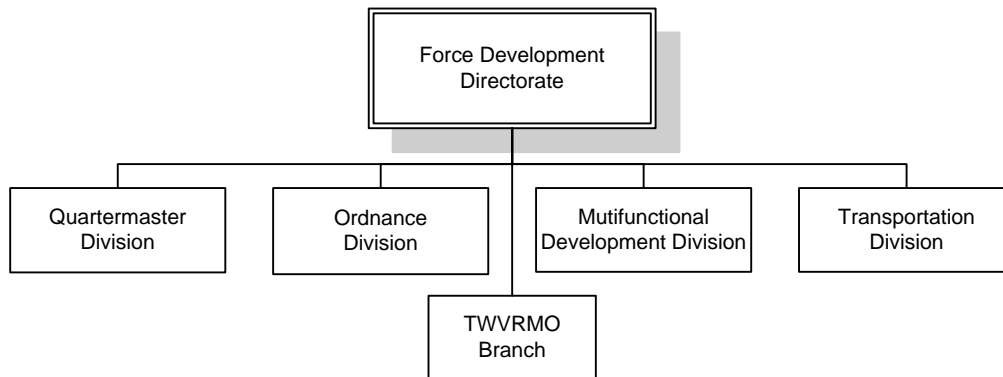

Figure 8-2. Force Development Directorate

c. Functions.

(1) Designs and integrates all lead and multifunctional unit designs, force structure, and TOE documentation actions to include the development of quantitative and qualitative allocation rules for TOEs.

(2) Identifies organizational and force structure solutions to resolve or mitigate gaps in sustainment capability.

(3) Provides analysis and data to ARCIC concerning force structure and integration through the total Army analysis and force design update (FDU) processes.

(4) Supports HQDA sponsored documentation assistance review team actions.

(5) Develops sustainment TOE and manpower requirements criteria (MARC) studies for U.S. Army Force Management Support Agency (USAFMSA) validation and approval. Reviews MARC schedules, questionnaires, and revision documents for functional adequacy.

(6) Collects, validates, maintains, and disseminates Army sustainment planning factors, consumption rates, and data.

(7) Provides input to the ARCIC Force Design Division recommending changes to AR 220-1, Army Unit Status Reporting and Force Registration – Consolidated Policies, for current and future force sustainment organizations.

(8) Develops Army TWV fleet requirement management goals, objectives, and policies, and manages Armywide TWV requirements.

(9) Provides sustainment force structure customer assistance and expertise to DOD, joint agencies, HQDA, and ACOMs to include all TRADOC proponents, and Army service component commands.

(10) ICW concept developer and USAFMSA documenters, identifies and coordinates operational facility architecture changes and provides to Army Signal CoE and HQ, TRADOC for processing and approval.

(11) Coordinates and supports sustainment force design issues with the HQDA G-3 organizational integrators.

(12) Conducts organization evaluation for product quality Deficiency Reports submitted to project director for Army watercraft systems (AWS). Determines if there is an organizational impact as part of the DOTMLPF assessment and recommends organizational solutions if required to resolve the deficiency.

(13) Maintains force requirements generator model configuration and coordinates model enhancements with Center for Army Analysis.

(14) Plans and coordinates collection, validation, and development of sustainment planning data and factors with other ACOMs and DRUs.

(15) Provides Army sustainment planning factors to all DOD, joint, and Army activities (to include acquisition programs and DOD-sponsored contractors) as required.

(16) HQDA G-4 lead for all Army sustainment planning factors and the development and implementation of the operations logistics planner, a multiechelon, user-driven sustainment planning tool.

8-4. Tactical wheeled vehicle management office

a. Mission. Chartered by the DCG, Futures/Director, ARCIC, TRADOC as the single manager of TWV requirements. Intensively manages Armywide TWV requirements for all proponents. HQDA G-3 action office for investigating Armywide TWV requirements issues, and develops Army positions on issues impacting TWV resourcing and acquisition.

b. Functions.

(1) Develops Army TWV fleet requirements, management goals, objectives, and policies (for example, AR 71-32).

(2) TRADOC lead for input to the TWV Annex to the HQDA Modernization Plan.

(3) Reviews FDU actions entering the FDU process for the impact of organizational changes on Armywide TWV requirements. Voting member of the FDU process and the HQDA G-3 review team.

(4) Validates TWV requirements in all Army lead TOEs, modified TOEs, TDAs, and basis-of-issue plans.

(5) Conducts TWV requirements analysis to support TWV modernization, force structure, procurement, and distribution decisions.

(6) Assesses combat development initiatives in all TWV mission areas for qualitative and quantitative fleet impacts.

(7) Develops TWV aggregate requirements for presentation to the HQDA, Office of the Secretary of Defense, and Congress.

(8) Develops and maintains a repository of tactical and wheeled vehicle requirements and rationale, as well as an information database for rapid response to Armywide inquiries on TWV requirements; to include, but not limited to fleet asset posture, density within specific units, vehicle age, and authorized substitutions.

8-5. Sustainment Battle Lab and Capability Determination Directorate

a. Mission. Develops concepts, determines and validates required capabilities for the Army to sustain the current and future force in a JIIM environment. Leads and assists in developing, managing, and integrating Army and joint CBA to validate sustainment required capabilities. Conducts and participates in maneuver sustainment experiments and war games using constructive simulation experiment environments to gain insights, impacts, and recommend DOTMLPF changes appropriate for current and future force concepts, systems, and organizations. Monitors and guides S&T experiment initiatives and recommends integration into current and future force.

b. Organization. Consists of three divisions: Concepts Division, Capabilities Determination Division, and Experimentation Analysis and Science and Technology Division (see figure 8-3).

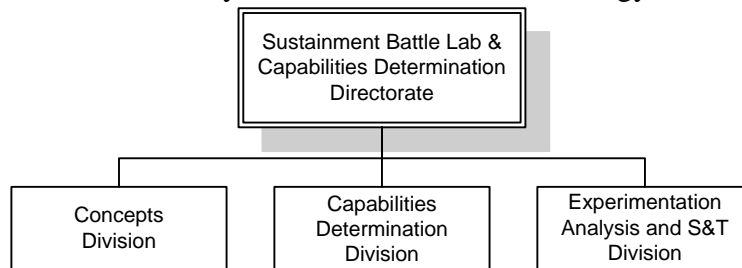

Figure 8-3. Sustainment Battle Lab and Capabilities Determination Directorate

c. Functions.

(1) Develops Army operational, functional and integrating concepts, white papers, implementation and capability plans.

(2) Supports the development of joint integrating, operating, and functional concepts and integrates emerging concepts across the TRADOC experimentation community of practice.

(3) Develops allied transformation and interoperability concepts and plans.

(4) Executes, synchronizes, and integrates sustainment CBAs.

(5) Contributes to the development and integration of joint logistics CBAs.

(6) Plans and conducts maneuver sustainment experimentation to refine and demonstrate the operational feasibility of concepts and the development of required DOTMLPF solutions in support of current and future force.

(7) Integrates maneuver sustainment experimentation objective, requirements, and other DOTMLPF products into other battle lab experimentation efforts.

(8) Supports and synchronizes CASCOM and SCoE participation in Army, other services, and joint concept experiments and war games.

(9) Provides modeling and simulation guidance and recommendations in support of experimentation and analysis functions across the CASCOM and SCoE community.

(10) Operates the Battle Lab Simulation Collaborative Environment.

(11) Identifies, validates, and documents sustainment shortfalls and identify S&T enablers for the force operating capabilities within the sustainment arena; coordinates and integrates sustainment requirements for major S&T programs and initiatives; integrates sustainment S&T initiatives into experimentation efforts; focuses S&T efforts by providing input to Army technology objectives, and other S&T prioritization efforts.

(12) Works in collaboration with Logistics Innovation Agency to investigate leading edge technology from DOD technology base, academia and industry research and development, and evaluates application to current and future force.

8-6. TRADOC capabilities manager, transportation

a. Mission. The TCM for all Army current TWVs and current Army watercraft modernization through the integration of DOTMLPF. Per TR 71-12, TRADOC System Management, TCM-T represents CG TRADOC and the Chief of Transportation (COT) on all issues concerning development, production, testing, deployment, and early operational life support for TWVs and AWS. Works in unison with materiel developers, testers, and Army staff

to provide intensive management of assigned systems and coordinates system development, production, testing, and fielding milestones with the materiel developer program manager to ensure user requirements are met.

b. Organization. TCM-T operates under a charter signed by the TRADOC CG as the "User Representative" and is functionally aligned to accomplish the duties outlined in the TCM-T charter. TCM-T consists of two branches: TWV branch and AWS branch that perform the functions of assistant TCM-T for their specific area (see figure 8-4).

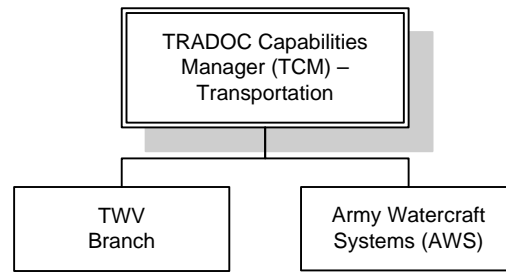

Figure 8-4. TCM-T

c. Functions.

(1) Responsible for duties as outlined in TR 71-12, TRADOC Capability Management, and CG TRADOC assigned charter.

(2) Participates and provides user guidance/feedback at system test and evaluation integrated product teams for all variants/systems. Participates and provides user guidance at system performance-based logistics integrated product teams.

(3) Provides user guidance on testing, fielding, and issue resolution for system modernization to support the various fleets.

(4) Ensures organizational, doctrinal, and training developments reflect capabilities of the various systems.

(5) Provides watercraft capabilities ensuring that watercraft systems are updated and provide the warfighter the ability to project forces worldwide.

(6) Ensures that TWV requirements across the force are correctly stated, justified, and documented in concept papers and material requirements documents.

(7) Army's user representative in the overweight waiver process for TWV.

(8) Ensures Army watercraft modernization efforts are synchronized with the Army Watercraft Master Plan.

(9) Supports new watercraft and system fieldings and is the link between the Soldier and the program office.

(10) Works with the AWS product director to ensure that the current fleet is maintained, sustained, and modernized IAW Army policies and doctrine to meet combatant command requirements.

8-7. TRADOC Capabilities Manager, Sustainment Command and Control/Enterprise Systems Directorate

a. Mission. Directs and integrates all combat development and user activities associated with the sustainment C2 and enterprise capability areas and contributes to sustaining FSO in a JIIM environment. Represents CASCOM and SCoE in all matters of sustainment automation support, development, fielding, and modernization and coordinates with the TRADOC Program Integration Office, Army Battlefield Command System (ABCS) and other joint or interagency organizations to ensure effective integration into the ABCS. Ensures automated sustainment solutions for multifunctional sustainment capability gaps are identified, documented, programmed by materiel developer (MATDEV) representatives and properly fielded. This includes the automated capabilities related to supply support activities, ammunition supply points, maintenance shops and facilities, movement control teams as well as other sustainment organizations.

b. Organization. TCM/ESD consists of three divisions: Sustainment C2 Division; Logistics Enterprise Systems Documentation Division; and Logistics Enterprise Systems Support Division (see figure 8-5).

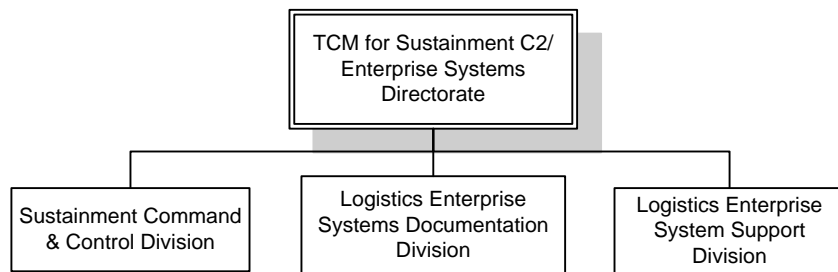

Figure 8-5. Enterprise Systems Directorate

c. Functions (TCM).

(1) Monitors and synchronizes all aspects of total system development, testing and evaluation, corrective actions, acquisition, materiel release, and fielding, to include direct interaction with the program/project/product managers and MATDEV of the primary and ancillary system(s), test community, and the fielding/gaining commands.

(2) Participates in MATDEV system concept analyses; cost performance tradeoff; and cost analyses by providing detailed warfighting capability impact of specific system characteristics.

(3) User representative for sustainment C2 systems. Prepares TRADOC position on and obtains approval, and participates in decision reviews (In Progress Review/Army Systems Acquisition Review Council/Army Requirements Oversight Council/Joint Requirements Oversight Council (JROC)/Defense Acquisition Board) and Business Process Engineering for assigned systems.

(4) Functional lead for definition, design, test development, deployment, and post deployment software support for the Battle Command Sustainment Support System.

d. Functions (ESD).

(1) Functional lead for definition, design, test development, deployment, and post deployment software support for the Global Combat Support System – Army and legacy STAMIS.

(2) User representative for assigned systems. Prepares TRADOC position on and obtains approval, and participates in decision reviews (In Progress Review/Army Systems Acquisition Review Council/Army Requirements Oversight Council/JROC/Defense Acquisition Board) for assigned systems.

(3) Monitors and synchronizes all aspects of total system development, testing and evaluation, corrective actions, acquisition, materiel release, and fielding, to include direct interaction with the program/project/product managers and MATDEV of the primary and ancillary system(s), test community, and the fielding/gaining commands.

(4) Supports information management aspects of sustainment battle lab and concept evaluation prototype initiatives designed to define sustainment enterprise systems requirements.

(5) Primary POC for the identification, analysis, review, and documentation of sustainment communications requirements.

(6) Maintains partnership for architecture responsibilities with Army integrated logistics architecture in coordination with ARCIC for sustainment enterprise systems.

(7) POC for the Logistics Domain, SALE Business Process Council, Executive Steering Committee, and the Army Logistics Enterprise Integration Office.

(8) Co-chairs with HQDA G-4 for the HQDA Automatic Identification Technology Technical Working Group.

(9) Army representative for determining integrated sustainment automation requirements for Army implementation of joint deployment systems, such as Transportation Automated Information Management System II and Movement Tracking System.

(10) Develops the structure, staffing, and deployment of the sustainment automation support management office. Provides tactics, techniques, and procedures; mission statements;

assistance and guidance to other activities and field users for the proper utilization of sustainment automation support management office organizations in the force.

(11) CASCOM and SCoE lead for Army Logistics Portfolio Management reporting and coordination with HQDA G4 and Army Logistics Enterprise Integration Office.

(12) Maintains contingency plans for STAMIS.

(13) Voting member of STAMIS Baseline Configuration Control Board and conducts biannual configuration control boards.

8-8. Materiel Systems Directorate

a. Mission. Identifies and documents requirements for materiel approaches that resolve or mitigate gaps in sustainment capabilities for the Army. Ensures that materiel solutions are logistically supportable, sustainable, and maintainable before fielding to Soldiers and units. Serves as the warfighter representative for logistical performance-based agreements. In support of force modernization and OD branch proponents, develop and document materiel solutions to resolve gaps in ammunition, calibration and repair, embedded diagnostics, ground maintenance, and test measurement and diagnostic equipment (TMDE) capabilities. In support of the force modernization and QM branch proponents, develops and documents materiel solutions to resolve gaps in sustainment-related capabilities and participates in the acquisition of materiel solutions from program start through fielding. Develops and documents materiel solutions to ground and surface mobility based on approved CBA sustainment capability gaps. Serve as CASCOM and SCoE Capabilities Integration Development Directorate lead in the planning, development, integration, assessment, and support of integrated logistics support (ILS) capability to all Army and joint interest materiel system development programs.

b. Organization. The Materiel Systems Directorate consists of six divisions: OD Materiel Division, Integrated Logistics Assessment Division, QM Materiel Division, Soldier Systems/Analysis Division, Transportation Materiel Division, and Future Systems Integration Division (see figure 8-6).

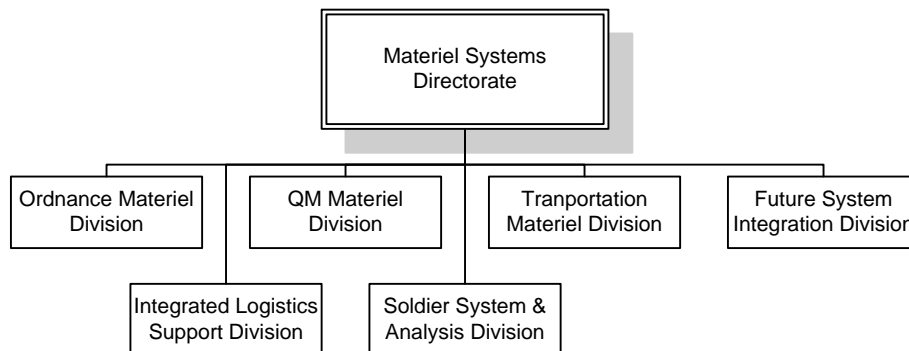

Figure 8-6. Materiel Systems Directorate

c. Functions.

(1) Capabilities developer and user representative for ground maintenance systems; automatic test equipment; calibration and repair; embedded diagnostics; prognostics; TMDE; tools, sets, kits, and outfits; munitions; petroleum and water storage; distribution; quality surveillance systems; water purification; container and material handling equipment; ground and watercraft transport systems; sustainment enablers for terminal operations; mobility enhancement systems; batteries; on-board power; tactical electric power generation (.5 KW to 200 KW); environmental control systems; individual equipment; shelters; field services systems; life support systems; cargo aerial delivery equipment; field feeding systems; and MA systems.

(2) Executes/supports all steps of the JCIDS process including initial capabilities document (ICD), capability development document (CDD), and capability production document development for sustainment systems. Supports program/product managers in the acquisition and fielding of materiel systems.

(3) TRADOC project office for battlefield recovery. Provides support to DOD live fire test and evaluation for new Army and joint interest equipment to determine battle damage assessment and repair (BDAR) requirements. Develop new BDAR and battlefield recovery capabilities based on documented capability gaps. Support the development of BDAR and recovery training and doctrine.

(4) Conducts logistics supportability assessments for emerging Army and joint materiel systems to develop and define ILS requirements. Support materiel and training proponents in the development of supportability strategies and the conduct of logistics test and evaluation. Defines the impact to Army sustainment and determines applicability to sustainment organizations. Supports Army and joint agencies in the planning of military and contracted logistics support through the ILS assessment and JCIDS development process. Reviews all associated logistics supportability documentation products for acquisition milestone decisions.

(5) Develops, analyzes, and recommends changes to materiel and acquisition policies, procedures, and regulatory requirements.

(6) Executing organization for the HQDA G-4 sponsored Supply and Maintenance Assessment and Review Team Suggestion Program. Receives suggestions, assigns appropriate evaluators, ensures timely evaluation, informs suggestion providers of evaluation, tracks awards, and promotes the benefits of the Supply and Maintenance Assessment and Review Team program throughout the Army.

(7) Conducts business case analysis for emerging sustainment materiel systems to determine life-cycle costs.

(8) Provides input to operational ration development to the Joint Culinary CoE Subsistence and the DOD Combat Feeding Program.

(9) TRADOC SME for international ammunition logistics program support.

(10) Provides analytic capability, including cost benefit analysis, to support the development and approval of JCIDS documentation.

(11) Researches, analyzes, documents, and integrates logistics support requirements, training products, and doctrine development for Army BDE modernization.

(12) Develops reliability, availability, and maintainability (RAM) and other supportability requirements for JCIDS documents supporting future materiel.

Chapter 9

Army Logistics University

9-1. Mission, organization, and functions

a. Mission. Enhances readiness and sustainability of U.S. forces through education and training in logistics, acquisition, and operations research and systems analysis.

b. Organization. ALU consists of a HQ, three colleges, Dean of Education & Operations, a NCO Academy and the 71st TC BN (student officer). The three colleges are College of Professional and Continuing Education, Logistics Leader College, and Technical Logistics College (see figure 9-1).

c. Functions. Manages, integrates, directs, and resources colleges to provide PME and functional training to Army and DOD logistics personnel, and to provide staff & faculty development in support of all logistics training activities.

9-2. Command group

a. Office of the University President. As a member of the Senior Executive Service, acts as the principal advisor to the CG, CASCOM on logistics leader education and education programs in operations research and Army acquisition. Directs all ALU education and operational activities in accordance with the policies and direction established by the CG. Directs and manages the ALU outreach efforts with universities, across DOD, and the international and interagency communities.

b. Vice President. Senior advisor and consultant to the President and staff on high level matters and is empowered to act for the President in his absence. Has full executive authority to direct mission activities including: resource management, contract management, civilian personnel, QA, reserve affairs, the *Army Sustainment* professional bulletin, and strategic planning.

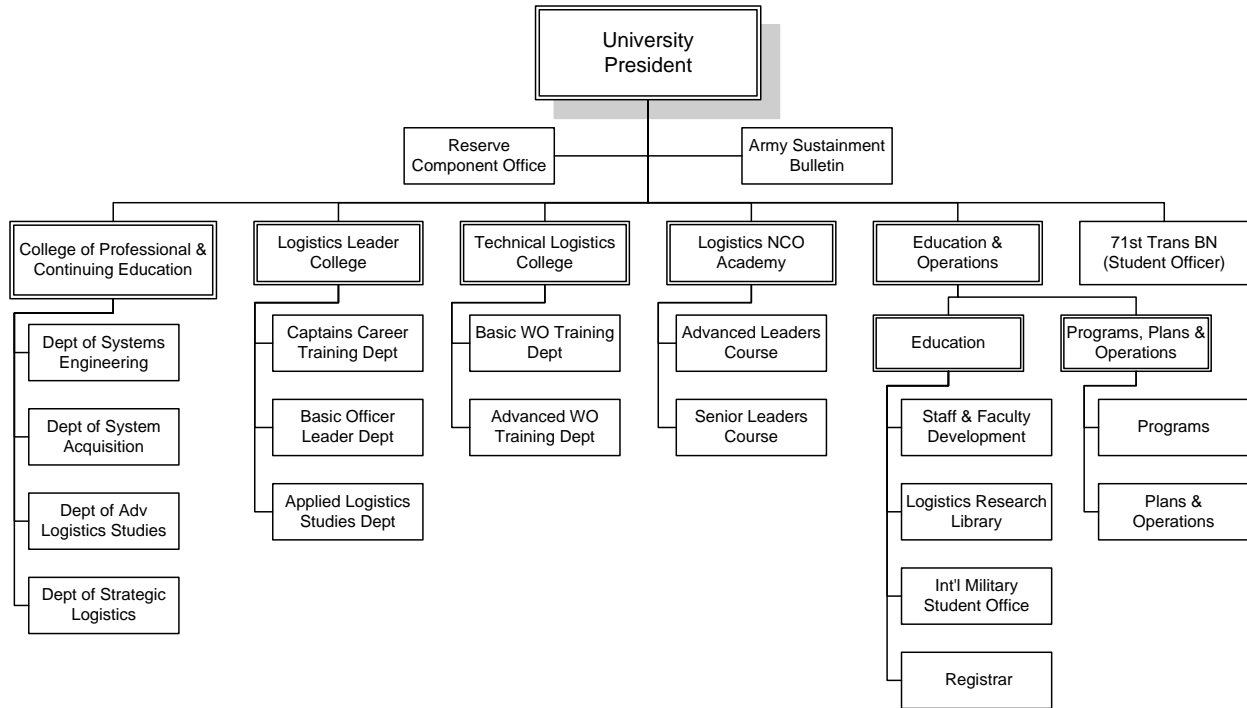

Figure 9-1. Army Logistics University

c. Commandant. Responsible for overseeing the day-to-day education operations of the ALU. The Commandant coordinates actions across the colleges and academy within the ALU and oversees the management of the 71st Student Battalion.

9-3. Army Sustainment professional bulletin

Publishes bimonthly issues of *Army Sustainment*, the official Army professional bulletin on logistics, and maintains the Army Sustainment Web site. *Army Sustainment* disseminates timely, authoritative information on Army and Defense sustainment plans, programs, policies, operations, procedures, and doctrine for the benefit of all Army personnel. *Army Sustainment* provides a forum for sustainers to express original, creative, and innovative thoughts about sustainment practices and experiences.

9-4. Reserve component office

Deputy vice presidents for the USAR and the ARNG. Advise the president on all matters concerning the RC and assists the ALU staff and faculty on administrative and instructional matters pertaining to the RC. Administers and coordinates the RC programs within ALU and promotes the ALU curriculum within the Reserve community. Represent the Chief, USAR, and the Chief, National Guard Bureau (NGB) on ALU matters that impact on the RC. Serves as a key element in the Army multicomponent unit force, ensuring that the AA, USAR, and ARNG work as a fully integrated team. Teach courses as required.

9-5. Dean of education and operations

a. Mission. Provide logistics, administrative, operational, training, and academic support to allow the effective functioning of the ALU.

b. Organization. The Dean of Education and Operations consists of two subordinate elements: ED and Programs, Plans & Operations Division. The ED includes Staff & Faculty Development, the Logistics Research Library, the International Military Student Office, and the Office of the ALU Registrar. The Plans, Programs, and Operations Division includes the Programs Branch, and the Plans & Operations Branch (see figure 9-2).

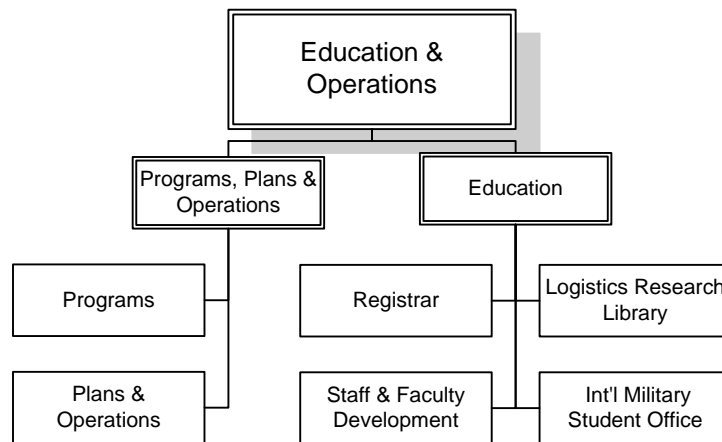

Figure 9-2. Education and Operations

c. Functions.

(1) Prepares guidance for training execution initiatives IAW HQDA/TRs and standards.

(2) Develops policies and procedures pertaining to the conduct and administration of resident, mobile, and distant learning training. Maintains liaison and coordinates with TRADOC G-3/5/7.

(3) Coordinates priorities of ALU input into the HQDA/TRADOC Army Training Requirements and Resources System (ATRRS) defining outyear resources and training workload.

(4) Prepares/coordinates the monthly NETUSR or successor system.

(5) POC for the HQDA SMDR to validate training requirements and capacities. Coordinates ALU resident training issues with HRC and HQDA G-3. POC for training requirements of the NGB; Office of the Chief, Army Reserves (OCAR); FORSCOM; U.S. Marine Corps (USMC); U.S. Navy (USN); the U.S. Air Force (USAF); and the U.S. Coast Guard (USCG).

(6) LDTA for the ALU.

(7) Synchronizes training requirements and resources across ALU.

(8) Manages ALU strategic functions, MOA/MOU and partnerships with other educational institutions and organizations.

(9) Coordinates with HQ TRADOC, TRADOC CoEs, and schools to develop programs that promote cultural understanding in instructional curriculum. Incorporates cultural understanding in instruction and exercises in PME education, officer, and WO IMT, and staff & faculty professional development.

9-6. Education division

a. Supports ALU by coordinating and facilitating academic accreditations with the American Council on Education (ACE) and the Council on Occupational Education.

b. Conducts quality assurance reviews on all ALU TRAS documents. Submits select TRAS documents (those developed by ALU) to Training Operations Management Activity. ALU POC on all automated sat/training development capability issues.

c. ED consists of the following:

(1) International Military Student Office. Plans and executes the International Military Education and Training and Foreign Military Sales components of the TRADOC Security Assistance Training Field Activity at Fort Lee according to AR 12-15, Joint Security Assistance Training. Provides C2, liaison, logistical, and administrative support to all assigned international military officers, NCOs, and families attending each logistics branch school and ALU.

(2) Army Logistics Research Library. Provides academic, technical, combat development, and doctrinal research support. Maintains a collection of reference material and online databases in support of PME, IMT, functional courses, and sustainment research.

(3) Staff and Faculty Development Office. Ensures instructors and training support personnel have the capability to perform their jobs to standard. Develops and certifies faculty and cadre members and provides educational services and professional development opportunities to support members in maintaining their military and educational competencies.

(4) Registrar. Manages all functions of ATRRS to maintain student load reports that include projected loads and actual inputs. Performs academic services to include: Establishing resident student records in the resident individual training management (RITM) system; preparing reports and statistical data from RITM and ATRRS; finalizing student records; preparing graduation documents/diplomas.

9-7. Programs, plans, and operations division

- a. Provides staff supervision of university level programs, develops short term and strategic plans, and manages current operations (COP).
- b. Conduit of official communication between SCoE G-3, the university, and its subordinate activities.
- c. Programs, plans, and operations consists of the following:

(1) Programs Branch. Manages instructor and support contracts; conducts QA reviews of contract instructors' work; develops and documents unfinanced requirements; prepares procurement actions; manages and oversees manpower actions; develops university outreach programs and activities; develops, coordinates, and maintains MOU/MOAs; oversees the university Web site; and documents university history.

(2) Plans and Operations Branch. Receives, processes, and acts on all external OPORDs, taskings and requirements directed to the university; prepares the NETUSR; develops and maintains the strategic plan; develops plans for events and future operations; coordinates and publishes OPORDs, WARNORDs and FRAGORDs; manages and oversees COP; and oversees integration and use of the SERP for the university.

9-8. College of professional and continuing education

- a. Mission. Enhances the readiness and sustainability of U.S. forces through training, education, consulting, and research in logistics, acquisition, and operations research systems analysis.
- b. Organization. Consists of The Office of the Dean plus four departments: Department of Systems Engineering, Department of Systems Acquisition, Department of Advanced Logistics Studies, and Department of Strategic Logistics (see figure 9-3).

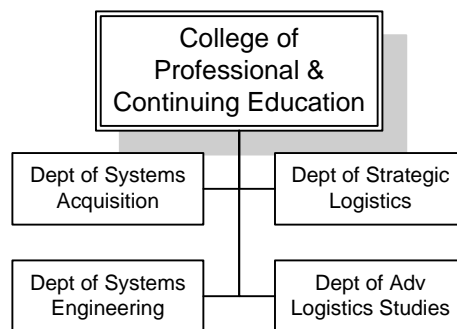

Figure 9-3. College of Professional and Continuing Education

c. Functions.

- (1) Educates on strategic and operational levels of logistics. Provides career development education for Army logisticians.
- (2) Educates on the acquisition process including requirements determination, contracting, program management, acquisition logistics, test and evaluation, and other acquisition specialties.
- (3) Educates on operations research and systems analysis tools and techniques as applied to the solution of military problems.
- (4) Provides SMEs for education, research, doctrine, and consulting in assigned areas of specialization.
- (5) Determines best educational mode (resident, onsite, satellite, accredited off-campus instruction, correspondence, computer-based training, or contract) and conducts/arranges and monitors required courses.
- (6) Counsels and advises students in all courses within the purview of each department and evaluates student progress during the conduct of instruction.
- (7) Reviews and comments on DOD, HQDA, and TRs, manuals, and other publications. Consults on matters concerning the specific functional areas within ALU.
- (8) Conducts annual reviews of courses as directed by DOD, HQDA, and TRADOC.

9-9. Department of Systems Engineering

Provides detailed instruction and application of mathematical, statistical, and computer skills necessary for military applications of operations research including: operations research and systems analysis, decision risk analysis, statistics, and computer science applications.

9-10. Department of Systems Acquisition

Colocated on Fort Lee, VA, and Huntsville, AL, develops and conducts courses that support the DOD, HQDA, and TRADOC acquisition and training process including: acquisition policy, program management, acquisition logistics, contracting, joint capabilities integration and development system, capability, doctrine, and training development, manpower and force management and manpower personnel integration.

9-11. Department of Advanced Logistics Studies

Develops and conducts training and educational courses designed to develop military and civilian career logisticians including: theater logistics; joint, interagency and multinational logistics; logistics pre-command; RC logistics; and logistics intern training.

9-12. Department Strategic Logistics

Develops and conducts training and educational programs focused at the strategic level of logistics in support of AMC, DLA, and other DOD elements including: maintenance,

distribution, and inventory management, demilitarization, logistics assistance program environmental policies, installation logistics, and supply chain management.

9-13. Logistics Leader College

a. Mission. Trains and educates QM, OD, TC and LG personnel and select Army Medical Services Corps officers on all functions associated with logistics leadership and sustainment operations Provides functional training to Soldiers and civilian personnel.

b. Organization. Consists of three departments: Captain Career Training Department, Basic Officer Leader Training Department, and Applied Logistics Studies Department (see figure 9-4).

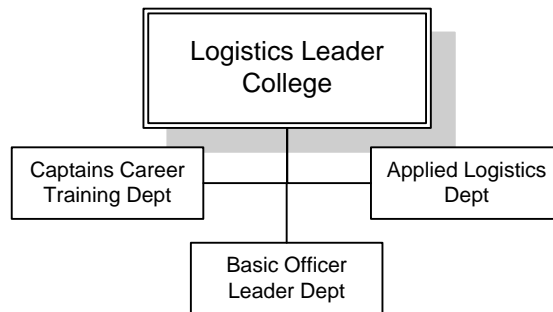

Figure 9-4. Logistics Leader College

c. Functions.

(1) Conducts IMT and PME training and educational courses designed to develop branch technical and multifunctional logistics competencies as well as leadership capabilities of career logisticians.

(2) Conducts the Combined Logistics Captains Career Course (CLC3) and branch functional RC Captains Career Courses (CCC).

(3) Conducts functional sustainment courses focused principally at the officer and NCO level.

(4) Conducts the pre-command course for command designees for Army operational logistics organizations.

(5) Conducts Basic Officer Leaders Course (BOLC) for QM, OD, and TC officers.

9-14. Captain Career Training Department

Instructs, supervises, and supports all resident phases of CLC3 and the logistics Reserve component CCC. Courses are attended by AA and RC 1st Lieutenants (Promotable) and Captains, and international officers and U.S. Marines. Upon course completion, U.S. Army officers are accessed into the LG.

9-15. Basic Officer Leader Department

Instructs, supervises and supports all QM, OD, and TC BOLCs. Courses are attended by AA and RC lieutenants; selected civilian interns; and international officers. Upon course completion, officers are prepared to serve in their accessed basic branches and HQDA interns have an understanding of future customer support requirements.

9-16. Applied Logistics Studies Department

Conducts functional sustainment courses focused principally at the officer and NCO level. Instruction is primarily classroom or automated system courses that do not depend on hands-on operation of field equipment. Supports the university for ABCS and simulations training.

9-17. Technical Logistics College

a. Mission. Provides IMT and PME to Army QM, OD, and TC WOs to enhance Army readiness and sustainability through mentoring, training, education, consulting, and research.

b. Organization. Consists of two departments: The Basic Warrant Officer Training Department and the Advanced Warrant Officer Training Department. Instructors assigned to the Technical Logistics College departments are attached to the branch schools to execute training under operational control of the branch commandants (see figure 9-5).

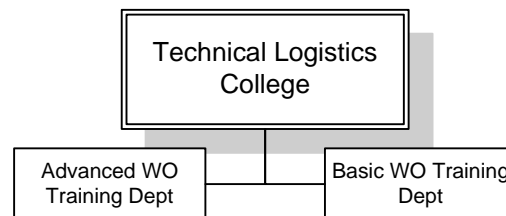

Figure 9-5. Technical Logistics College

c. Functions.

(1) Provides administrative oversight and support for implementing WO PME in advanced WO courses.

(2) Provides administrative oversight and support for implementing WO IMT in basic WO courses.

(3) Coordinates course schedules with ALU and branch proponent schools, student in-processing within the ALU chain of command, common-core instruction, and matrix instructional support provided to sister colleges/academies in the ALU. Provides matrix support to branch and proponent schools, to include their graduation ceremonies. Assists CASCOM and SCoE G-3 training, individual branch, and proponent schools in course POI and lesson plans reviews, and assists in the critical task review process to ensure training is relevant to the operational needs of the Army.

(4) Provides matrix support and access to all ALU facilities to support branch school commandants in training their WO force. This includes classrooms, general labs, STAMIS labs, and specific SME instructional talent within ALU.

(5) In partnership with ALU, provides the doorway to develop ongoing partnerships with accredited civilian institutes of learning specifically designed for WOs within the Logistics Corps.

9-18. Basic Warrant Officer Training Department

Coordinates course schedules with ALU and branch proponent schools, conducts student in-processing within the ALU chain of command, executes all common-core instruction, and provides matrix instructional support to the branch commandant schools. Responsible to sync each branch’s shared common core training within the ALU master schedule and manage that common core training execution in shared environments under ALU (when possible). (Exceptions are MOS 948B Electronic Systems Maintenance Technician certified at Signal School, Fort Gordon; MOS 919A Engineer Maintenance Technician certified at the Engineer School, Fort Leonard Wood; and MOS 880A Marine Deck WO and 881A Marine Engineer WO certified at the Maritime Training Department, TS, Fort Eustis.)

9-19. Advanced Warrant Officer Training Department

Coordinates course schedules with ALU and branch proponent schools, conducts student in-processing within the ALU chain of command, executes, and synchronizes all advanced common core and common leader development subject instruction, and provides matrix instructional support to the branch commandant schools. (Exceptions are MOS 948B Electronic Systems Maintenance Technician certified at Signal School, Fort Gordon; MOS 919A Engineer Maintenance Technician certified at the Engineer School, Fort Leonard Wood; and MOS 880A Marine Deck WO and 881A and Marine Engineer WO certified at by the Maritime Training Department, TS, Fort Eustis.)

9-20. Logistics Noncommissioned Officer Academy

a. Mission. Provides PME to QM, OD, and TC NCOs to enhance readiness and sustainability. Technical and hands-on training is provided ICW the support of branch schools.

b. Organization. Consists of an Administration, Operations and Supply Section and two training branches: Advanced Leaders Course (ALC) Branch and Senior Leaders Course (SLC) Branch (see figure 9-6).

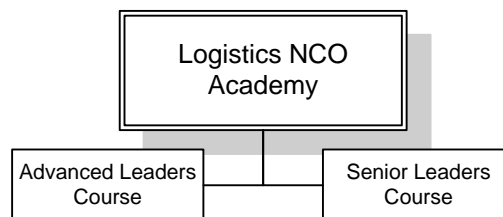

Figure 9-6. Logistics Noncommissioned Officer Academy

c. Functions.

(1) Develops skilled and adaptive logistics NCO leaders capable of supporting the force and leading Soldiers in the current operating environment.

(2) Provides administrative, operations management, and logistics support for assigned NCOA faculty, staff, and students.

(3) Logistics Noncommissioned Officer Academy. Conducts technical and common core training for SLC and ALC in quartermaster, ordnance, and transportation specialties. (Exceptions are ALC MOSs 88H Cargo Specialist, 88K Watercraft Operator, and 88L Watercraft Engineer at Fort Eustis; 91L Construction Equipment Repairer at Fort Leonard Wood, MO; and 91A Abrams Tank System Maintainer, at Fort Knox, KY).

d. Advanced Leaders Course Branch. Provides advanced MOS training and common leader development subjects designed to prepare NCOs for assignment at the platoon sergeant/battalion staff level.

e. Senior Leaders Course Branch. Provides senior MOS training and common leader development subjects designed to prepare NCOs for assignment at the first sergeant/brigade staff level.

9-21. 71st Transportation Corps Battalion (Army Logistics University Student Battalion)

a. Mission. Executes C2, administrative, and logistics support over subordinate companies, assigned students and administrative personnel that support and execute all logistics PME. Provides operational support for the NCOA and student services for civilian students. Coordinates the operational and support aspects of the educational mission.

b. Organization. Consists of a Command Group, Special Staff (S-Staff), Chaplain Office and five companies: Company A (CLC3), Company B (BOLC1), Company C (BOLC2), Company D (WO), and a Staff and Faculty Company (see figure 9-7).

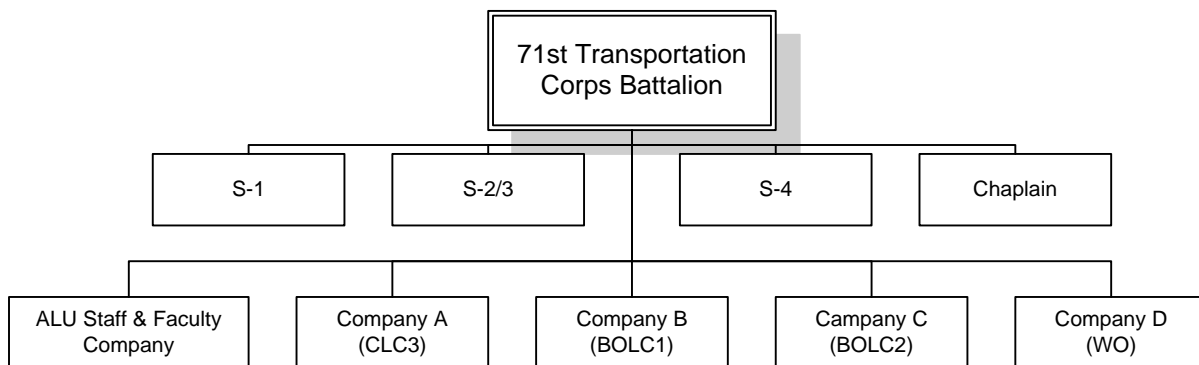

Figure 9-7. 71st Transportation Battalion (Student Officer)

c. Functions.

(1) Executes C2 over subordinate units, administrative personnel, and students assigned to the BN.

(2) Exercises and administers Uniform Code of Military Justice for assigned and attached personnel.

(3) Provides administrative, logistical, and operational support to the ALU.

d. Command Group.

(1) Commander. Directs all ALU activities IAW the policies and direction established by the ALU president. Principal C2 for staff, faculty, and students assigned. The commander also coordinates exercises and operations executed externally to the ALU.

(2) Executive Officer. Assists the commander in all areas related to the planning, resourcing, and execution of BN activities. Assumes C2 in the absence of the commander. Coordinates the efforts of the battalion staff and subordinate elements.

(3) Command Sergeant Major. Assists the Commander as the Senior NCO within the student BN. Principal advisor to the Commander regarding enlisted issues, disciplinary actions, and the execution of training for assigned staff and faculty.

e. Special Staff.

(1) S1 (adjutant office). Provides all personnel administrative support to assigned and attached students, staff, and faculty. Maintains the BN's sponsorship, welcoming and reception, and safety programs. Manages in-/out-processing and ensures the accountability of personnel.

(2) S2/3 (operations, training, and intelligence/security office). Coordinates and plans for all operations and training for personnel assigned and attached. Prepares short- and long-range training for the staff and faculty. Coordinates all support for courses requiring external exercises and training. Personal and physical security manager for ALU.

(3) S4 (logistics office). Oversees logistical support to the ALU. Manages and maintains ALU property IAW applicable regulations and guidance.

(4) Chaplain. Principal advisor ensuring that spiritual gifts, training, and leadership are integrated in the execution of command decisions.

Chapter 10 Quartermaster School

10-1. Mission, organization, and functions

a. Mission. Provides QM Warriors who are tactically and technically proficient leaders and Soldiers; develops and sustains adaptive QM battlefield functions that are globally executable by joint warfighters to ensure mission success.

b. Organization. Consists of a HQ, a Proponency Office, the QM Museum, the Army Women's Museum, a RC Affairs Office, a Training Management Office (TMO), the 23rd QM BDE, and five training departments: Aerial Delivery and Field Services Department; Petroleum and Water Department (PWD); Logistics Training Department; Joint Culinary CoE; and the Joint Mortuary Affairs Center (see figure 10-1).

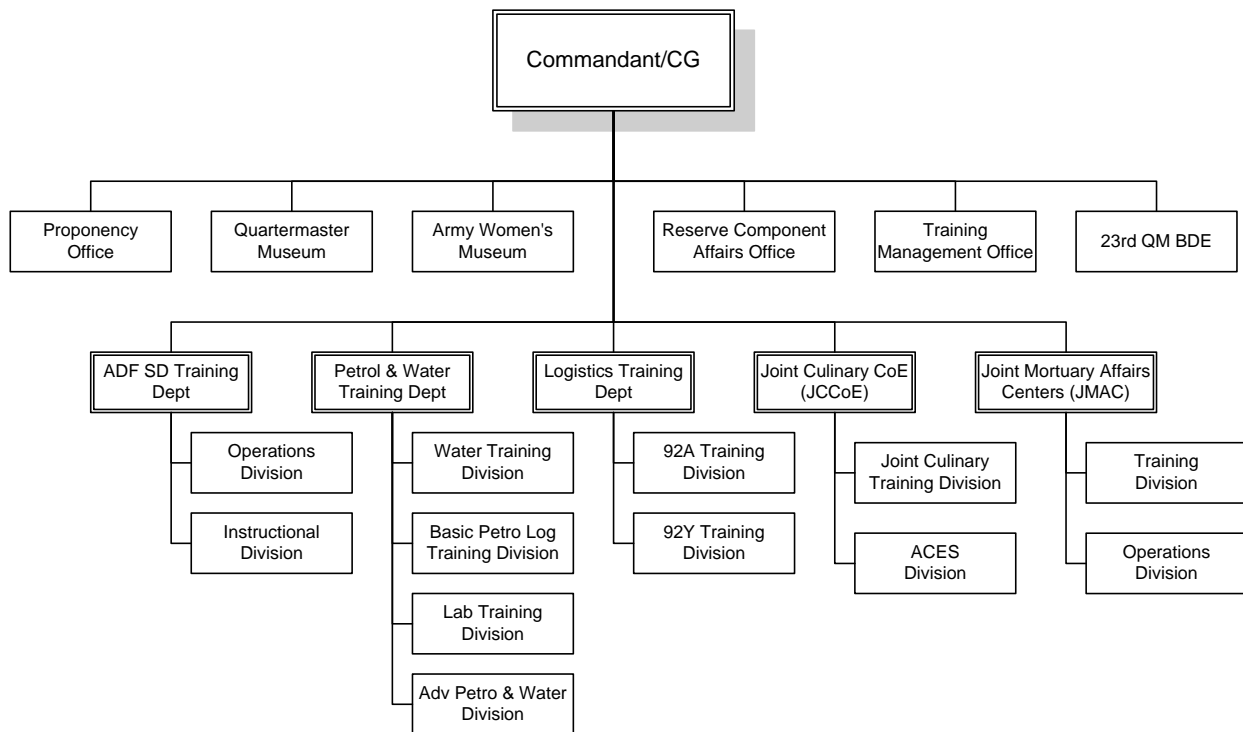

Figure 10-1. Quartermaster School (QMS)

c. Functions.

(1) Trains and educates Soldiers, civilians, and members of other services and nations in QM skills and functions. Develops aerial delivery, MA, and food service doctrine for the current and future Army and supports the Army's accessions mission.

(2) Conducts AIT, Soldierization, common skills, and warrior tasks and battle drills training for nine enlisted MOS. Lead on all QM matters to include QM commissioned officer specialty codes, WO MOS, enlisted career management fields (CMF), civilian occupational series, and associated lifecycle management functions, IAW AR 600-3, The Army Personnel

Development System. Executes the eight lifecycle personnel development functions (structure, acquisition, distribution, sustainment, separation, deployment, individual training, and professional development) for QM Soldiers and civilians.

(3) Supports the overseas contingency operation with mobile training teams (MTT) to assist deploying units and ARFORGEN training requirements. DOD training and doctrine integration center for MA and directed by HQDA G-4 to execute the logistics functions of the DOD executive agent (EA) mission for MA. Assists and provides technical advice to the Joint Staff, all services, and the Central Joint MA Board for the development of joint MA policy and procedures. Manages and chairs the configuration control boards for the Mortuary Affairs Reporting and Tracking System. Lead for joint and Army MA equipment development. Provides MA SME for mass fatality planning, management, and operations to support Federal and civil disaster relief and emergency response efforts.

(4) HQDA G-4 lead for the Army Food Service Programs. Monitors materiel development, acquisition, and fielding. Chairman and voting member of DOD Food Service Programs and Equipment Committees.

(5) HQDA G-4 lead for airdrop parachute recovery and aircraft personnel escape systems; joint airdrop inspection records; and malfunction investigations and activity reporting.

(6) Executes the HQDA Supply Excellence and Philip A. Connelly Award Programs.

(7) Oversees QA and the accreditation of the QMS.

(8) Accredits RC training.

(9) Provides proponency coordination and supervision of QM unique officer, WO, and NCO PME regardless of training location.

(10) Supports QM equipment-oriented technical training requirements for officers, WOs, and NCO courses within the ALU in accordance with locally negotiated procedures and commensurate with resources provided by HQ TRADOC.

(11) Responsible for rotational execution of the consolidated WTX for CASCOM and SCoE.

(12) Lead for QM materiel, force structure, and warfighting support concepts.

(13) Reviews and recommends revisions to training publications and media based on established doctrine and approved HQDA agencywide literature programs.

(14) Maintains liaison with and provides logistical and training support to the RC within the geographical support area.

(15) Exercises general court-martial jurisdiction over, and acts as general court-martial convening authority for the QMS and selected tenant and unit activities assigned and attached at Fort Lee.

(16) Oversees the QM and Army Women's Museums.

(17) Coordinates with the appropriate CASCOM and SCoE staff to manage and maintain QM training: includes SMDR; ATRRS; training requirements arbitration panel (TRAP); SERP system; POI implementation; lesson plans and training support development; and equipment fielding and training.

(18) Oversees the design, development, and integration of QM warfighting requirements; fosters innovation; and leads change.

10-2. Command Group

a. Commandant/DCG commands the QMS. Principal advisor to the CG, CASCOM and SCoE; and TRADOC on QM DOTMLPF matters. At the discretion of the CG, CASCOM and SCoE, serves in one of four rotational assignments: CASCOM and SCoE DCG for IMT; Leader Development; Capabilities Development; and Human Capital Enterprise. Ensures the QMS recruits, trains, and educates Soldiers, develops leaders, and supports training in units. Provides and supports equipment-oriented technical training requirements for officers, WOs, and NCO courses within the ALU and the QMS. As the QM General (QMG), leads all matters of proponency and development of the U.S. Army QM Corps to ensure it can perform its mission in support of the U.S. Army.

b. Deputy to the Commandant. Senior advisor and consultant to the commandant and staff. Directs mission activities including: training management, contract management, resource management, QA, reserve affairs and strategic planning. Activity career program manager (ACPM) for CP13.

c. Assistant Commandant. Responsible for the daily training operations of the QMS.

d. Regimental Command Sergeant Major. Regimental CSM to the QM Corps and the principal advisor to the commandant on all enlisted matters. Advises the commandant on status of QMS quality of training. Recommends assignment of QM Sergeants Major (SGM) ICW the BDE sergeant major and HRC. Examines career trends, develops, and implements proposals affecting career programs and opportunities for QM enlisted Soldiers. Identifies and recommends changes to structure and training to meet the technical needs of units supported by QM enlisted Soldiers. Provides professional development, mentorship, and counseling.

e. Regimental Chief Warrant Officer. Principal advisor to the Commandant on all WO matters. Advises the Commandant on status of QMS quality of training. Develops technical prerequisites and serves as the approval authority for all AA and RC QM WO applications. Examines career trends, develops and implements proposals affecting career programs and opportunities for QM WOs. Coordinates with U.S. Army Recruiting Command (USAREC) and

HQDA G1, to develop annual QM WO accession plans. Identifies and recommends changes to structure and training to meet the technical needs of units supported by QM WOs. Provides professional development, mentorship, and counseling.

f. Historian. Primary advisor to Commandant on all historical matters. Maintains a continuous history of the QMS through the collection, preservation, and archiving of historical information. Conducts historical research and writes monographs. Guides and assists subordinate organizations in formulating and conducting their historical programs. Guides, assists, and instructs military history professional development activities. Assists with the publication of featured articles in professional journals. Coordinates the submission of historical reports for the QMG and CG, CASCOM and SCoE.

g. Quartermaster Proponency Office, Office of the Quartermaster General. POC and coordinator for the QMG to affect QM matters of personnel development IAW AR 600-3, The Army Personnel Development System. Advisor to the QMG on all matters relating to branch personnel development, to include DA civilians (CP-13). Central manager for conduct and execution of the CSA Supply Excellence Award Program. Manages, reviews, and provides requests of waivers for MOS training prerequisite requirements. Responsible for the personnel portion of the NETUSR.

h. Quartermaster Museum. Provides training and education on the history and traditions of the Army and QM Corps. Acquaints the public with the history and accomplishments of the QM Corps and Army. Collects preserves, exhibits, and interprets historically significant properties related to the history of the QM Corps. Addresses the history of Fort Lee through artifacts, exhibits, and documents.

i. Army Women's Museum. Provides training and education on the history and traditions of women in the Army. Custodian and repository of artifacts and archival material pertaining to the service of women across the U.S. Army from inception to the present day. Collects, preserves, manages, interprets, and exhibits these unique artifacts as a means to provide educational outreach.

10-3. Reserve Component Affairs Office

a. Mission. Ensures the RC perspectives are fully integrated in the development of emerging doctrine, leader development, and force structure impacting the manning, equipping, training, readiness, and deployability and mobilization of RC QM units and personnel. Advises the QMG on personnel, equipment, training, and deployment issues that pertain to the RC QM community. The RC liaison NCO assists in the reception and processing of RC Soldiers into, through, and to completion of their training.

b. Functions.

(1) Sponsors conferences, workshops, training site visits, and staff assistance visits.

- (2) Integrates all facets of individual and collective training into the RC. Coordinates training, doctrine, and combat development activities.
- (3) Advises the Commandant to ensure AA and RC training equivalency.
- (4) Advises school on individual mobilization augmentee program, individual ready reserve (IRR) training, and other RC specific programs.
- (5) Assists with the mobilization of RC Soldiers to support QMS mission requirements.
- (6) Trains and advises unit commanders and cadre on RC-unique issues IAW AR 612-201, Initial Entry/Prior Service Trainee Support (RCS MILPC-17(R1)).
- (7) Assists Families of RC Soldiers.
- (8) Assists the military personnel office with RC actions.
- (9) Assists with investigations of fraudulent enlistments and recruiter impropriety.

10-4. Training Management office

a. Mission. Plans, coordinates, and supervises training actions for the QMS. Responsible for central tasking within the QMS; plans strategic training support missions, force protection/antiterrorism, ceremonies, and special events.

b. Functions.

- (1) Reviews acquisition packages concurrently with director of contracting, and provides contracting officer representatives for contract administration.
- (2) Prepares guidance for training execution initiatives IAW HQDA/TRs and standards.
- (3) Develops policies and procedures pertaining to the conduct and administration of resident/mobile training, and DL. Liaison with TRADOC G-3/5/7.
- (4) Coordinates priorities of QMS input into the HQDA/TRADOC ATRRS defining out-year resources and training workload.
- (5) Coordinates the SERP system across organizational elements within the QMS.
- (6) Prepares and submits the TRADOC NETUSR or successor system.
- (7) POC for the SMDR to validate training requirements and capacities. Coordinates resident training issues with HRC and HQDA G-3. QMS POC for training requirements of the NGB, OCAR, FORSCOM, USMC, USN, USAF, and the USCG.

- (8) Liaison for all matters pertaining to the TRADOC ITRO.
- (9) LDTA for the QMS.
- (10) Coordinates and facilitates academic accreditations with the ACE and the Council on Occupational Education.
- (11) Develops mobilization training input to the QMS mobilization plan.
- (12) Manages TRAP requests and resolves training constraints/issues.
- (13) Coordinates requests for schedule deviations and resolves resulting conflicts.
- (14) Responsible for academic records functions to include management of RITM or successor system.
- (15) Responsible for central tasking within the QMS, planning of strategic training support missions, physical security, force protection/antiterrorism, ceremonies, and other special events.
- (16) Coordinates with CASCOM and SCoE to fill taskings for QMS. Responsible for mission support requests, OPORDs, WARNORDs, FRAGORDs, TASKORDs, and operational procedures.
- (17) Recommends, tracks, and reports temporary change of station taskings and TDY assignments.
- (18) Collects, files, monitors, and forwards operating reports.
- (19) Responsible for the Antiterrorism and Force Protection Programs.
- (20) Performs emergency operations through the installation operations center.
- (21) Provides facilities support to all QMS departments and the BDE.
- (22) Develops and coordinates bomb threat, fire, and environmental conservation plans.
- (23) Manages all Freedom of Information Act requests in the QMS.

10-5. 23rd Quartermaster Brigade

a. Mission. Develops competent logistics Soldiers grounded in the Army values and Warrior Ethos, who will immediately contribute to the mission of their next unit of assignment; provide administrative control (ADCON) support to the USN, USMC, and USAF Training Detachments on Fort Lee.

b Organization. Consists of a HQ, S-staff, Chaplain Office, Headquarters and Headquarters Company, and three BNs: 244th QM BN, 262nd QM BN, and the 266th QM BN. Provides ADCON support to the Marine Corps Detachment and the 345th Training Squadron (USAF) on Fort Lee (see figure 10-2).

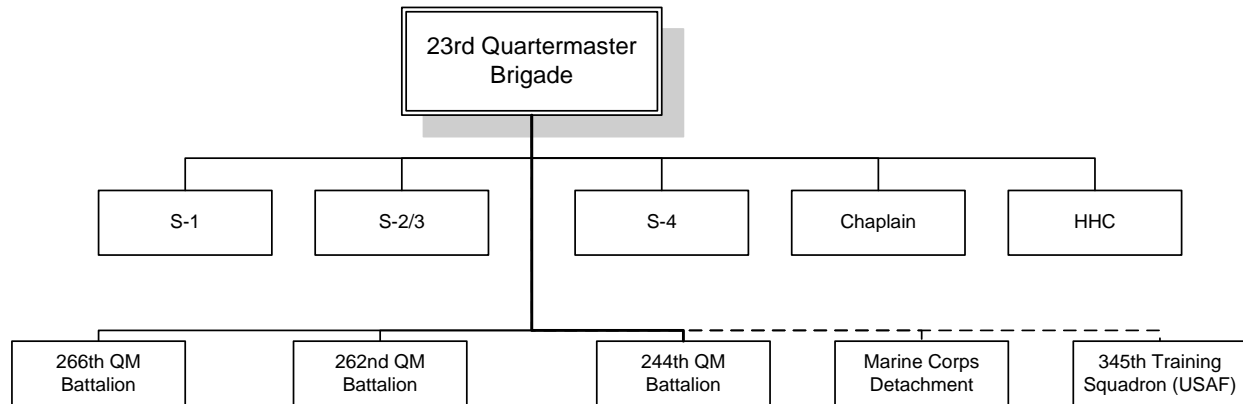

Figure 10-2. 23rd Quartermaster Brigade

c. Functions.

(1) Directs the completion of the Soldierization process. Transitions students from the total control environment of basic combat training (BCT) into the AIT environment.

(2) Graduates technically and tactically proficient, physically fit QM, TC, and other Service members capable of surviving on the modern battlefield and able to contribute to their first unit of assignment.

(3) Ensures permanent party Soldiers are prepared technically, tactically, physically, and administratively for worldwide deployment.

(4) Promotes comprehensive Soldier fitness.

(5) Cares for the BDE's Soldiers, Sailors, Airmen, Marines, civilians, and Families.

10-6. 262nd, 266th, and 244th Quartermaster Battalions

a. Mission. Continue the Soldierization process to train and develop motivated, disciplined, and fit Soldiers and leaders who are committed to Army values and the Warrior Ethos; demonstrate safety as part of their day-to-day activities; and can immediately contribute to the mission accomplishment of their next unit of assignment. Provide C2, force protection, administrative, and logistical support for assigned and attached personnel.

b. Organization. Each BN consists of up to seven companies adjusted annually through SMDR.

c. Functions.

(1) Transitions BCT Soldiers into the AIT environment and completes the Soldierization process.

(2) Serves on a rotational basis as the Task Force Commander for a multiechelon, scenario-driven, WTX reinforcing MOS training, common task, and battlefield survival skills.

(3) Maintains individual permanent party deployability and fitness.

(4) Provides Soldierization training for interservice transfers and prior service Soldiers (MOS-T).

(5) Company E, 266th QM BN provides command, control, administrative, and logistical support for Transportation AIT at Fort Eustis, VA.

(6) 508th Transportation Company (Provisional) provides direct logistical support for CASCOM and SCoE 's WTX and additional training support requirements for CASCOM and SCoE organizations.

10-7. Marine Corps Detachment

a. Mission. Mentor and train assigned and attached Marines to standard and develop "whole Marines" capable of meeting the Marine Corps wartime requirements.

b. Organization. Consists of a HQ and two companies under the ADCON of the 23d QM BDE.

c. Functions.

(1) Ensures the health and welfare of Marines and their Families.

(2) Mentors and trains Marines to standard.

(3) Provides resources and programs that promote a high quality of life.

10-8. Aerial Delivery Field Services Department

a. Mission. Train Soldiers from all branches of the armed services, allied nations, and civilians as parachute riggers; airdrop load inspectors; sling load inspectors; and shower, laundry, and clothing repair specialists (field services). Additionally, the aerial delivery and field services department develops doctrine, airdrop rigging and sling load operations manuals, resident and nonresident training support materials, and performs several proponentry functions related to aerial delivery, sling load, and field services.

b. Organization. The department consists of two divisions: Instructional Division and Operations Division.

c. Functions.

- (1) Trains MOSs 92R10, 92S10, and functional courses.
- (2) Trains Soldiers, Sailors, Airmen, Marines, civilians and students from other nations to standard.
- (3) Designs, develops, and validates interservice rigging and sling load general service technical manuals. Maintains liaison with U.S. Army Airborne Special Operations Test Board; Natick Research, Development, and Engineering Center; Soldiers System Command; USAF Air Mobility Command; and Yuma Proving Grounds to obtain technical data for doctrine manuals.
- (4) Conducts and hosts review and analysis of interservice Airdrop Summary and Malfunction Reports.
- (5) Publishes airdrop malfunction information in the Triannual Airdrop Review and Malfunction Safety Analysis.
- (6) Focal point for field services operations training.
- (7) HQDA G-4 field lead for AR 750-32, Airdrop Parachute Recovery and Aircraft Personnel Escape Systems, and AR 59-4, Joint Airdrop Inspection Records, Malfunction/Incident Investigations, Activity Reporting (*RAR 001, 06/23/2009).
- (8) Addresses interservice airdrop issues for rigging procedures, questions, and philosophies. Coordinates with all USAF major commands, and Army, Navy, and Marine Corps airdrop units for the airdrop of personnel and equipment. Develops and reviews interservice General Service Technical manuals/technical order revisions and changes. Provides USAF input to DOD airdrop testing agencies. Focal point for information and interpretation of policy and procedures for joint airdrop inspection. Provides oversight of USAF students while attending QMS courses. Provides input to reflect current doctrine on aircraft and loads for the development of POI and lesson plans for the Airdrop Load Inspector Certification Course. Coordinates requirements through operations office for MTTs supporting USAF units and ARFORGEN requirements. Performs additional duties for the HQ, Air Mobility Command. Represents Air Mobility Command Tactics Staff at USAF, major command, and joint conferences and meetings when requested. Assists Air Mobility Command Directorate of Evaluations in maintaining standardization of all USAF publications relating to aircrew airdrop rigging procedures.

10-9. Instructional Division

a. Mission. Coordinates student training and airborne operations to support the Parachute Rigger; Aerial Delivery Materiel Officer; RAM-Air; Automatic Rip Cord Release Assembly; Airdrop Load Inspectors; USN EOD Parachute Rigging Courses; Shower, Laundry, and Clothing Repair Specialist Course; and the Sling Load Certification Course. Writes lesson plans for courses and conducts airborne operations to support POIs.

b. Organization. The Instructional Division consists of six teams: Airdrop Materiel Officer Team; Shower, Laundry, and Clothing Repair Team; Sling Load Team; Parachute Pack Team; Airdrop Team and the Aerial Equipment Repair Team.

c. Functions.

(1) Trains fundamentals and procedures for packing personnel, small cargo, extraction parachutes, and RAM-air parachute systems.

(2) Trains procedures in the rigging of sling load equipment.

(3) Trains fundamentals and procedures on types and methods of airdrop, packing of cargo parachutes, including the G-11B and G-12E large cargo parachutes extraction systems, release systems, container deliver systems, rigging of supplies and equipment for airdrop, rigging, and inspection of combat rubber raiding crafts, and joint airdrop load inspection.

(4) Trains fundamentals and certifies personnel to properly prepare, rig supplies and equipment for sling load operations procedures of inspection of rig and pack equipment, classification, and repair of personnel, cargo, extraction parachutes, and airdrop equipment to include the service and maintenance of the High Altitude Low Opening Automatic Rip Cord Release Assembly.

(5) Trains procedures for the setup and operation of shower and laundry equipment.

(6) Trains fundamentals and procedures of fabric repair to include setting up, operating, and dismantling equipment used in fabric and canvas repair operations; how to inspect, mark, classify, measure and resize clothing; how to perform operator maintenance, adjustments, troubleshooting, and operating clothing and textile repair sewing machines; how to construct seams, patches, and repair of textile items.

10-10. Operations Division

a. Mission. Responsible for the central direction, management, and oversight of interservice General Service Technical Airdrop Manuals for Commandant and all services.

b. Organization. The Support Division consists of four teams: Operations Team, Technical Writer Team, USAF Liaison, and Supply Team.

c. Functions.

(1) Represents QMS, and sister services on issues, updates, and revisions involving interservice general service technical airdrop manual management and host and conduct review and analysis of interservice Airdrop Summary and Malfunction Reports.

(2) HQDA G-4 field lead for AR 750-32, Airdrop Parachute Recovery and Aircraft Personnel Escape Systems; and AR 59-4, Joint Airdrop Inspection Records, Malfunction Investigations, Activity Reporting.

(3) Manages and coordinates all interservice airdrop issues on rigging procedures, questions, and philosophies. Coordinates with all USAF major commands, and Army, Navy, and Marine Corps airdrop units for the airdrop of personnel and equipment.

(4) Develops interservice airdrop general service technical manuals/technical order revisions and changes. Provides input to DOD airdrop testing agencies. Focal point for information and interpretation of policy and procedures for joint airdrop inspection.

(5) Develops interservice sling load general service technical manuals/technical order revisions and changes. Provides input to DOD sling load testing agencies. Focal point for information and interpretation of policy and procedures for interservice sling load inspection.

10-11. Petroleum and Water Training Department

a. Mission. Provide quality training to select military personnel from various branches of the U.S. Armed Forces (Active, Reserve and National Guard), allied nations, and DOD civilians on petroleum and water logistics systems, equipment, and doctrine. Assist with doctrine development and force readiness items which help satisfy petroleum and water requirements for U.S. forces globally. The PWD is the lead for four MOSs and functional courses for one officer functional specialty code. The MOSs are 92F (Petroleum Supply Specialist), 1391 (Bulk Fuel Specialist), 92L (Petroleum Laboratory Specialist) and 92W (Water Treatment Specialist) and the officer specialty code is 92F (Petroleum and Water Logistics Officer). Additionally, the PWD, via formal arrangements and partnerships, provides specified administrative, logistical, and technical support to the DLA/DESC J-20 course, the Defense Contract Management Agency Quality Assurance Representative Employee Orientation Program, and the USN's bulk shore/ground training program.

b. Organizations. PWD consists of four divisions: Advanced Petroleum and Water Division, Laboratory Training Division, Basic Petroleum Logistics Training Division, and Water Training Division.

c. Functions.

(1) Trains MOSs 92L, 92F, and 92W functional courses.

(2) Trains Soldiers, Sailors, Airmen, Marines, civilians and students from other nations to standard.

(3) Directs/monitors the mission of training students and assists in the development of external materials.

(4) Assists with the development/validation of testing protocols for life-cycle/sustainment equipment support.

(5) Liaison for petroleum and water logistics actions.

(6) Participates in conferences, the Joint Water Management Action Group, logistics warrior exercises, developmental field testing of new equipment and displays.

(7) Provides technical and augmentee support to combatant commanders.

10-12. Advanced Petroleum and Water Division

a. Mission. Provides area of concentration (AOC) 92F (Petroleum Officer) and 923A (Petroleum and Water Technician) resident instruction. Responsible for the petroleum and water technical portions of the BOLC, Combined Logistics CLC3, RC CLC3, Warrant Officer Basic and Advanced Courses and other petroleum and water functional officer/WO courses. SME on all petroleum or water-related issues.

b. Functions.

(1) Plans, directs, coordinates, and provides instruction to active and RC personnel of the Army, USN, USAF, and USMC. Provides training to allied and other international officers and WOs as well as DOD civilians in the following areas:

(a) Petroleum and water logistics staff functions and procedures at the various levels (strategic, operational, and tactical), with primary emphasis on tactical and operational mission execution.

(b) Environmental considerations, operations, and maintenance of petroleum and water distribution systems and equipment.

(2) SME for petroleum and water operations, doctrine, equipment, and future developments.

(3) Provides new equipment training team (NETT) and MTT instructional support.

(4) Reviews and/or revises resident course materials and assists in the development of multimedia training literature.

(5) Supervises and coordinates maintenance of equipment, training aids, and facilities.

(6) Provides MOS/specialty-related doctrinal input to QMS organizations, and other government agencies.

10-13. Laboratory Training Division

a. Mission. The Laboratory Training Division provides MOS 92L resident instruction and serves as the SME of QMS. Responsible for addressing all petroleum quality (assurance and surveillance) lab-related issues/concerns surfaced to the QMS. Provides requisite technical assistance and support for validated instructional and operational requirements sanctioned by the Commander, QMS.

b. Functions.

(1) Plans, directs, coordinates, and provides instruction to active, RC and civilian personnel from the Army, USN, USAF, and USMC, and students from other nations on the following:

(a) Physical and chemical testing of petroleum products; evaluation of tests based on specification and deterioration limits; and disposition and reclamation techniques.

(b) Operation and maintenance of petroleum laboratory equipment.

(2) DOD standardized bulk fuel quality center for all services less USN.

(3) Quality control manager for all capitalized fuel stocks.

(4) Performs quality surveillance testing in support of DOD/HQDA authorized local petroleum product users.

(5) Maintains liaison with and performs operational testing of equipment for the U.S. Army Material and Equipment Readiness Command.

(6) Provides NETT and MTT instructional support.

(7) Reviews and/or revises resident course materials and assists in developing multimedia training literature.

(8) Provides MOS related doctrinal input to QMS organizations and other government agencies.

10-14. Basic Petroleum Logistics Training Division

a. Mission. Provides MOS 92F resident instruction, in addition to serving as SMEs in petroleum operations.

b. Functions.

(1) Plans, directs, coordinates, and provides instruction to Active, RC and civilian personnel from the Army, USN, USAF, and USMC, and students from other nations on the following:

- (a) General petroleum subjects.
- (b) Class III supply point operations (aviation, rail, pipeline and ground/maneuver).
- (c) Operation of military petroleum terminals and pipelines (Inland Petroleum Distribution System and Offshore Petroleum Discharge System).
- (2) Maintains, operates, and controls a combined 75-acre petroleum training facility and military-in-the-field training areas.
- (3) Provides NETT and MTT instructional support.
- (4) Reviews and/or revises resident course materials and assists in the development of multimedia training literature.
- (5) Coordinates and maintains loan agreements for interim non-approved TDA equipment.
- (6) Supervises and coordinates accomplishment of authorized division maintenance of equipment, training aids, and facilities.

10-15. Water Training Division

a. Mission. Provides MOS 92W resident and nonresident instruction for U.S. Army active, Reserve, and National Guard components. Also provides SMEs for water logistics operations.

b. Functions.

(1) Plans, directs, coordinates, and provides instruction to AA and RC personnel on the following:

(a) Performing set up, operation, maintenance, and movement of water purification and distribution equipment.

(b) Procedures to analyze and test both raw and treated water.

(c) Performance of water site reconnaissance and selection.

(d) Supervision of a water point operation.

(2) Maintains, operates, and controls five water training facilities/locations.

(3) Provides NETT and MTT instructional support.

(4) Reviews and/or revises resident course materials and assists in developing multimedia training literature.

(5) Coordinates and monitors accomplishment of authorized departmental maintenance of equipment, training aids, and facilities.

(6) Participates in conferences, the Joint Water Management Action Group, logistics warrior exercises, developmental field testing of new equipment, and displays.

10-16. Marine Corps Petroleum Training Division

a. Mission. Provides MOS 1391 resident instruction, in addition to serving as SMEs in USMC petroleum logistics matters. Coordinates and provides direct input and feedback to U.S. Marine Corps Systems Command at Quantico Marine Corps Base, VA.

b. Functions.

(1) Plans, directs, coordinates, and provides instruction to Active and RC Marine Corps personnel on the following:

- (a) General petroleum subjects.
- (b) Handling, storage, and distribution of bulk Class III and III.
- (c) Aircraft refueling operations.
- (d) Operation of Marine Corps tactical fuel systems.
- (e) Tactical fuel system installation and maintenance.

(2) Assists in the maintaining and care of the Military-in-the-Field/Petroleum Training Facility.

(3) Provides NETT and MTT instructional support.

(4) Reviews and/or revises resident course materials and assists in the development of multimedia training literature.

(5) Supervises and coordinates the maintenance of equipment, training aids, and facilities.

(6) Participates in conferences for development of Marine-unique equipment and petroleum related matters.

(7) Provides MOS/specialty-related doctrinal input to HQ USMC and other government agencies.

(8) Develops USMC bulk liquids doctrine and operational concepts.

10-17. Logistics Training Department

a. Mission. Provides QM automated supply training for all Soldiers in two AIT MOS: 1) 92A10 (Automated Logistical Specialist) and 2) 92Y10 (Unit Supply Specialist). Logistics Training Department also provides two functional courses: 1) Unit Armorer Certification Course and 2) Unit Level Logistics System-Aviation/Enhanced (ULLS-A/E) course. Direct the training for supported courses and coordinates with appropriate agencies on the fielding of new equipment as it relates to 92A10 and 92Y10 AIT. Provide the active Army force Soldiers in MOS 92A10 and 92Y10 who are trained to POI standards and ready for their first unit assignment. Graduates of the two functional courses will be able to assume the role of unit armorer and ULLS-A/E equipment operator.

b. Organization. Consists of two training divisions, 92A10 Training Division and 92Y10 Training Division.

c. Functions.

(1) Trains MOSs 92A10 and 92Y10 and functional courses.

(2) Trains Soldiers, Sailors, Airmen, Marines, civilians, and students from other nations to standard.

(3) SME on all automated supply training and supply issues directly related to MOS 92A10 and 92Y10.

(4) Provides the Army with certified unit armorers via the Unit Armorer Certification Course.

(5) Trains the additional skill identifier (ASI) of C-7 in the ULLS-A/E course.

10-18. 92A10 Training Division

a. Mission. Provides AIT to Soldiers to include MOS-Transition Soldiers and civilians in MOS 92A10 Automated Logistical Specialist. Provide 2-weeks of IRR training for Soldiers in MOS 92A10. Provide ULLS-A/E ASI course training via resident training, or if requested, using a MTT method of instruction to train Soldiers onsite. Ensure each and every Soldier trained meets or exceeds course standards via QMG-approved programs of instruction.

b. Functions. Plans, schedules, directs, and coordinates all training requirements and necessary resources to accomplish all training missions.

10-19. 92Y10 Training Division

a. Mission. Provides AIT training to Soldiers to include MOS-Transition Soldiers and civilians in MOS 92Y10 Unit Supply Specialist. Provide 2-weeks of IRR training for Soldiers in MOS 92Y10. Provide unit armorer certification course training via resident training, or if

requested, using a MTT method of instruction to train Soldiers onsite. Ensure each and every Soldier trained meets or exceeds course standards via QMG-approved POI.

b. Functions. Plans, schedules, directs, and coordinates all training requirements and necessary resources to accomplish all training missions.

10-20. Joint Culinary Center of Excellence

a. Mission. Provides joint proponent food operations training and direction for the Army's Food Program; central focal point for active and Reserve Army, Navy, Marines and Air Force food service program training execution. Conducts joint basic and advanced food service skill training for garrison and field operations.

b. Organization. Consists of three Directorates: Army CoE Subsistence Operations Directorate, Joint Culinary Training Directorate, and Special Programs Directorate.

c. Functions. Provides a single platform for consolidated and collocated training for all services except Coast Guard; develops and conducts resident and nonresident training in field and garrison food service and subsistence supply operations; lead for the execution of training of all military services basic and advanced food service skill training; the Army's lead for training all subsistence, equipment, automation, nutrition, and food service program oversight. Develops Army policy and doctrine for garrison and field food service programs.

10-21. Army Center of Excellence Subsistence Directorate

a. Mission. Responsible for the central direction, management, and oversight of the Army worldwide Food Service Program for the Commandant and HQDA G-4.

b. Organization. The Army Center of Excellence Subsistence Operations Directorate consists of five divisions – QA Division; Facilities and Engineer Division; RC Division; Management Assistance Division; and the Concepts, Systems, and Policy Division.

c. Functions.

(1) Trains MOS 92G10 and functional courses.

(2) Trains Soldiers, Sailors, Airmen, Marines, civilians, and students from other nations to standard.

(3) Develops HQDA regulations and doctrine governing the Army Food Service Program. Provides automated Class I system reports and Army feeding data to HQDA G-4. Develops Army prototype performance work statement for garrison dining facility contracting.

(4) Represents the QMG, TRADOC, and HQDA G-4 on issues involving subsistence management and feeding in both garrison and field environments.

(5) HQDA food adviser for the RCs.

(6) Army lead for operational rations and nutrition. Veterinary sciences technical advisor and the environmental health sciences technical advisor to HQDA G-4 and the QMG.

(7) Develops military construction, Army renovation and décor projects and budget for Army installation dining facilities. Army lead for equipment supporting garrison and field food service operations.

(8) Oversees the Army Food Service Program. Evaluates, trains, and reports food service operational findings.

(9) Administers the HQDA G-4 Philip A. Connelly Award Program recognizing excellence in field and garrison operations.

10-22. Joint Culinary Training Division

a. Mission. Develop, manage, and provide oversight of Army and joint services basic food service training provided for all branches of the U.S. Armed Forces. Train Soldiers, Sailors, Airmen, Marines, DOD civilians, and members of other allied countries in basic food operations skills, subsistence, and food service equipment operations for garrison and field training.

b. Organization. Consists of three divisions – Basic Food Service Training Division, Advanced Food Service Training Division, and Special Skills Division.

c. Functions.

(1) Supervises the conduct of basic and advanced food service training for all branches of the Armed Forces.

(2) Oversees and manages the development of training materials.

(3) Develops new training methodology supporting future joint service and Army field and garrison training equipment to include automation systems initiatives.

10-23. Joint Culinary Center of Excellence, Special Programs Directorate

a. Mission. Implement and conduct competitive programs to enhance levels of proficiency in Army Food Service; conducts service evaluations to promote excellence in food service to the customer; illuminates the Army's proficiency through competition with industry both in CONUS and abroad. Work in tandem with Accessions Command to support recruiting efforts.

b. Organization. Consists of two Divisions – the Philip A. Connelly Division and the Culinary Arts Division.

c. Functions.

(1) Executes the Philip A. Connelly Award Competition for Excellence in Army Food Service; conducts worldwide installation evaluations to identify and recognize the best operating dining establishments in five separate categories: large, small, field, Army Reserve, and National Guard.

(2) Conducts an annual culinary competition to promote refined dining and identify potential candidates for enlisted aide appointment, and/or view potential candidates for selection to the U.S. Army Culinary Team.

(3) Supports recruiting efforts with cooking demonstrations at annual events such as the All American Bowl; provides MTTs to recruiting BNs upon request; displays Army equipment at various events such as Public Service Recognition Week, Boy Scout Jamboree, and media events.

(4) Works in tandem with American Culinary Federation and Culinary Institute of America to obtain training, certifications, and stay abreast of competition rule changes.

10-24. Joint Mortuary Affairs Center

a. Mission. DOD training and doctrine integration center for MA. Execute the logistics functions of the DOD EA MA mission under the guidance of the HQDA G-4. Provides MA technical advice and assistance to DOD, Federal, and civil agencies as needed. Supports Federal and civil CONUS and OCONUS disaster relief and emergency response efforts by providing MA subject matter expertise, technical advice, planning assistance, coordination assistance, and functions as a DOD MA liaison. Provides joint MA training to officers, enlisted personnel, and civilians. Coordinates with appropriate agencies on the development and fielding of new MA equipment.

b. Organization. Consists of two divisions: Training Division and Operations Division.

c. Functions.

(1) Trains MOS 92M10 and functional courses.

(2) Trains Soldiers, Sailors, Airmen, Marines, civilians, and students from other nations to standard.

(3) Executes the full training development and doctrine development mission for all training and training literature products and doctrine within the MA functional area.

(4) Executes the logistics portion of the Army's role as the DOD EA for MA, on behalf of the HQDA G-4.

(5) Provides technical advice to the HQDA G-1, central joint MA board for the development of joint MA policy.

(6) Provides onsite MA assistance to field commanders.

(7) SME in support of MA materiel systems modernization.

10-25. Training Division

a. Mission. Develop, manage, and provide oversight of joint MA training. Provide joint MA training to officers, enlisted personnel, and civilians in multiple courses to include IMT for Army and USMC MA enlisted personnel and MA officers and civilians from all services.

b. Functions. Plans, schedules, directs, and coordinates all training requirements and necessary resources to accomplish the Joint Mortuary Affairs Center training mission.

10-26. Operations Division

a. Mission. Serves as the DOD functional expert for MA. Executes the logistics functions of the DOD MA mission under the guidance of HQDA G-4. Provides MA technical advice and support to DOD, Federal, and civil agencies. Drafts MA joint doctrine, procedures, and Army doctrine. Provides technical expertise and support to DOD. Ensures continuous, sustainable, and global joint MA support.

b. Functions.

(1) Appointed by HQDA G-4 to execute the logistics functions of the HQDA role as the DOD EA for MA.

(2) Provides comprehensive MA technical advice and assistance to DOD, Federal, and civil agencies as needed.

(3) Interfaces with DOD, Federal, and civil agencies to address issues of national significance.

(4) Supports Federal and civil disaster relief and emergency response efforts by providing MA SMEs, technical advice, planning assistance, coordination assistance, and functions as a DOD MA liaison.

(5) Monitors COP and the readiness of MA units.

(6) Provides SME input to appropriate agencies on the development of organizational structures, concepts, and MA equipment.

(7) Maintains EA-level records, conducts inquiries, performs analysis, and prepares reports for senior leaders.

**Chapter 11
Ordnance School**

11-1. Mission, organization, and functions

a. Mission. Trains OD Soldiers, leaders, and civilians in technical skills, values, common tasks, and the Warrior Ethos. Supports development of DOTMLPF capabilities that provide effective and efficient maintenance, munitions, and explosive ordnance support to the Army. Supports the Army’s enlisted and officer accession mission.

b. Organization. Consists of a HQ with Command Group, Proponency Office, Reserve Components Affairs Office, OD Museum, six training departments, TMO, EOD Department, and the 59th OD BDE. The training departments are: Armament & Electronic Maintenance Training Department (including OD Training Detachment at Fort Sill, OK); Track/Metal Working/Recovery Training Department; Wheel Maintenance Training Department; Tactical Support Equipment Training Department; Munitions and EOD Training Department (to include EOD Training Detachment, Eglin AFB, FL and Hazardous Training Devices Division, RSA, AL); and OD Electronic Maintenance Training Department, Fort Gordon, GA (see figure 11-1).

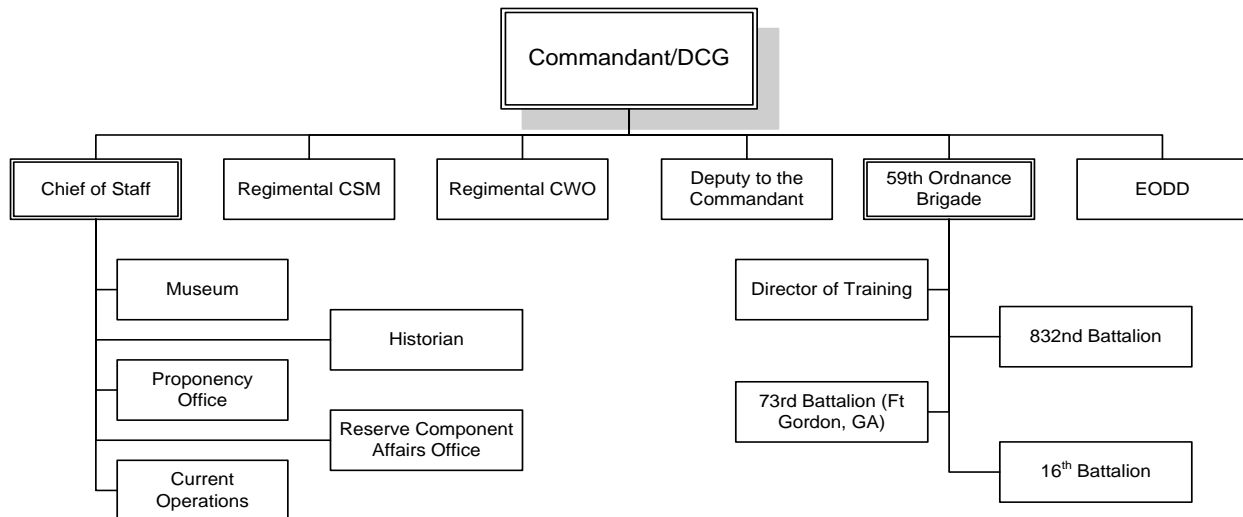

Figure 11-1. Ordnance School (ODS)

c. Functions.

(1) Trains Soldiers, Sailors, Airmen, Marines, civilians, and students from other nations in the fields of materiel maintenance equipment, ground mobility materiel, mobile electric power generation equipment, and mobile environmental conditioning equipment; munitions management; EOD; electronic and missile maintenance; TMDE. Coordinates related training conducted by other Army agencies, other services and agencies.

(2) Proponent for OD training conducted at: Fort Lee, VA; RSA, AL; Fort Benning, GA; Fort Jackson, SC; Fort Gordon, GA; Eglin AFB, FL; Fort Sill, OK; Fort Leonard Wood, MO; and regional training sites – maintenance and TASS OD BNs.

(3) Advises CASCOM and SCoE, ARCIC, and CAC on DOTMLPF implications relating to operational aspects and logistics support of combat firepower systems, ground mobility materiel, and missile and air defense systems; ammunition; EOD; mobile electric power generation; heating and air conditioning equipment; signal, radar, and air traffic control equipment repair.

(4) TRADOC lead for the CSA Award for Maintenance Excellence. ICW the HQDA G-4, develops and implements policies and directives necessary to execute the program. Provides a representative to the Army board to select nominees for the DOD Phoenix Award.

(5) Lead for all OD related issues to include oversight of the TRADOC Project Office for Battlefield Recovery.

(6) Army manager for the Environmental Protection Agency 608/609 Certification Program.

(7) Accredits RC training, including regional training sites – maintenance.

(8) Provides OD proponency coordination and supervision of OD unique officer, WO, and NCO PME conducted at ALU and other schools.

11-2. Commandant/Deputy Commanding General

Commands the ODS. Principal advisor to the CASCOM and SCoE CG and TRADOC on OD DOTMLPF matters. At the discretion of the CG, serves in one of three rotational assignments: DCG for training development integration (TDI), CDI, or ALU. Ensures ODS recruits, trains, and educates Soldiers; develops leaders; and supports training in units. Supports technical training requirements for officers, WOs, and NCOs. Lead on all matters of proponency and evolution of the U.S. Army OD Corps to ensure it can perform its mission in support of the U.S. Army.

11-3. Chief of Staff

Responsible for daily operations and coordination with ODS elements.

11-4. Museum

Provides training and education on the history, traditions, accomplishments of the OD Corps and U.S. Army. The mission is to collect, preserve, exhibit, and interpret historically significant properties related to the history of the OD Corps from 1812 to the present.

11-5. Historian

Primary advisor on all historical matters. Maintains a continuous history of the ODS through the collection, preservation, and archiving of historical information. Conducts historical research and writing of monographs.

11-6. Proponency Office

Central POC and coordinator for the Chief of OD as lead on all OD matters to include OD commissioned officer FCS, WO MOS, enlisted CMFs, civilian occupational series, and associated life-cycle management functions. Acts as liaison between AA and RC OD personnel and organizations, the field and the functional staff, and academic departments within the ODS. Principal advisor to the Chief of OD on all matters relating to branch personnel proponency including DA Civilians (CP-17). Serves as responsible activity for the CSA's Army Award for Maintenance Excellence. Manages, reviews, and awards requests for waivers for MOS training prerequisite requirements.

11-7. Reserve Component Affairs Office

a. Mission. Represents the Army's RC (USAR and ARNG) and serves as the principal advisor to the Commandant, U.S. Army ODS and staff on all RC matters.

b. Functions. Ensures that RC perspectives are fully integrated in the development of emerging doctrine, leader development, and force structure impacting the manning, equipping, training, readiness, deployability and mobilization of RC OD units and personnel while maintaining primary focus on Soldiers.

11-8. Current Operations

Provides consolidated planning and operational support. Prepares and monitors training guidance from CG to BDE for assigned personnel and subordinate units. Issues OPORDs, FRAGORDs, WARNORDs and TASKORDs from Command Group down to subordinate BDE. Conducts executive analysis of designated key staff actions and maintains effective communication with CASCOM and SCoE. Collects, monitors, forwards, and files operating reports.

11-9. Regimental Command Sergeant Major

Principal enlisted advisor on all enlisted matters. Advises the Commandant on status of ODS quality of training and recommends assignment of OD SGM in concert with SGM branch and HRC. Responsible for reviewing/examining trends and developing and implementing proposals affecting career programs for OD enlisted Soldiers. Provides professional development, mentorship, and counseling on career management.

11-10. Regimental Chief Warrant Officer

Examines career trends, develops and implements proposals affecting career programs and opportunities for OD WOs. Develops technical prerequisites and serves as the approval authority for all AA and RC WO applications. Coordinates with the USAREC and HQDA G-1, to develop annual OD WO accession plans. Identifies and recommends changes to structure and training to meet the technical needs of supported units. Provides professional development, mentorship, and counseling on the roles, responsibilities, and utilization of WOs.

11-11. Deputy to the Commandant

Senior advisor and consultant to the commandant and staff. Has full executive authority to direct and coordinate mission activities including: training management, contract management, resource management, QA, reserve affairs, and strategic planning. ACPM for CP17.

11-12. 59th Ordnance Brigade

a. Mission. Completes the Soldierization process for AIT Soldiers; enforces high standards of training and discipline; produces Soldiers of character who are physically fit, technically and tactically competent, highly disciplined, and have a Warrior spirit. Prepares Soldiers and leaders to sustain U.S. forces in peace and in contemporary operating wartime environment.

b. Organization. Consists of a HQ, S-staff, Chaplain, Headquarters and Headquarters Company and three battalions: 16th OD BN, 832nd OD BN, and 73rd OD BN located at Fort Gordon, GA (see figure 11-2).

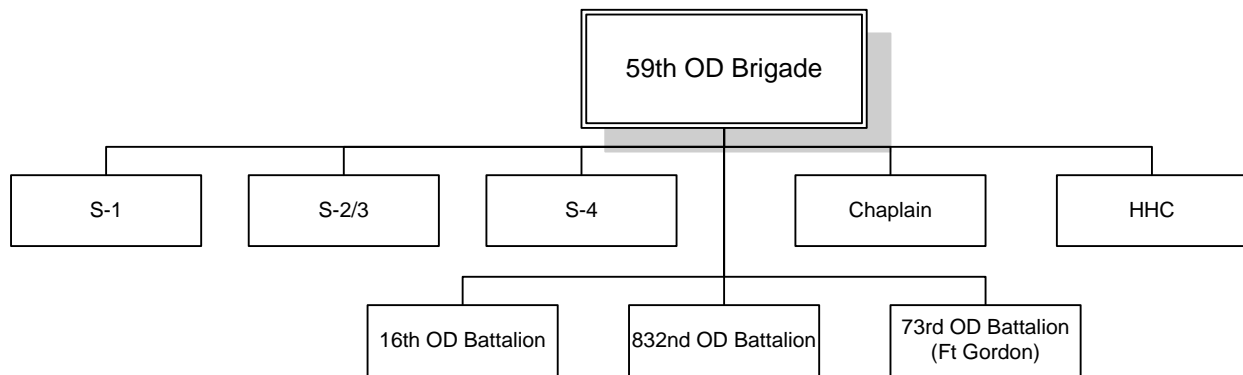

Figure 11-2. 59th Ordnance Brigade

c. Functions.

(1) Transitions students from the total control environment of BCT into the AIT environment.

(2) Graduates technically and tactically proficient, physically fit OD Soldiers capable of surviving on the modern battlefield and able to contribute to their first unit of assignment.

(3) Ensures Soldiers are prepared technically, tactically, physically, and administratively for worldwide deployment.

(4) Conducts operations and administrative/logistical functions to support training, Soldiers, and the installation.

(5) Cares for the Families.

11-13. Director of Training

a. Mission. Provides C2 of the Armament and Electronics Training Department; Track/Metal Working/Recovery Training Department; Wheel Maintenance Training Department; Tactical Support Equipment Training Department; Munitions and Explosive Ordnance Disposal Training Department; and the Ordnance Electronics Maintenance Training Department.

b. Organization. Consists of two divisions: Training Operations Division and Training Management Division; and six training departments: Armament and Electronics Maintenance Training Department (TD), Track/Metal Working/Recovery TD, Wheel Maintenance TD, Tactical Equipment TD, Munitions & EOD TD and Ordnance Electronics TD (see figure 11-3).

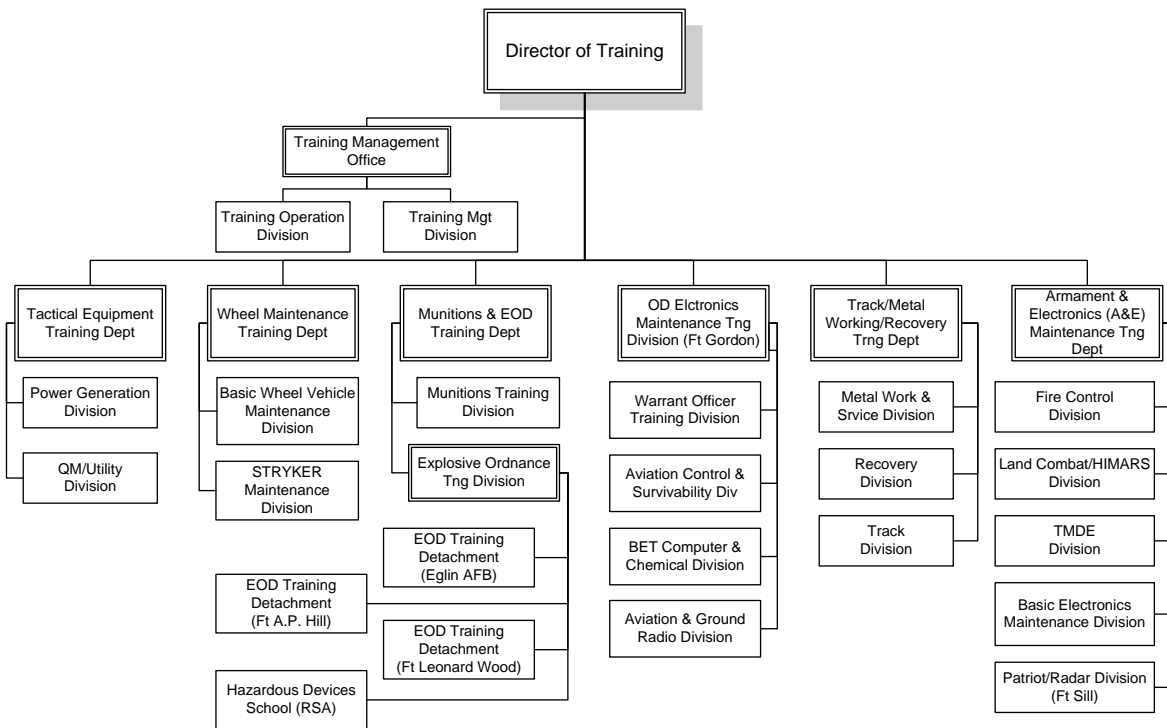

Figure 11-3. Director of Training and Training Management Office (TMO)

c. Functions. Lead for institutional training execution. Manages and resources the training departments. Manages daily operations of the TMO. Coordinates the ODS Institutional Training Management Board. Advisor for institutional training issues.

11-14. Training Operations Division

a. Mission. Oversees and coordinates operational, administrative, and logistical support of institutional training in the ODS.

b. Functions. Develops/reviews acquisition management oversight packages and acts as contracting officer representative. Prepares the NETUSR or successor system. Coordinates taskings with the training departments, plans operational training support missions, safety

guidance, force protection/antiterrorism, physical security, facility management, ceremonies, and special events. Coordinates and facilitates academic accreditations with the ACE and Council on Occupational Education. Responsible for HR management, facility and logistics management, manpower coordination, training budget, and personal/physical security. Support the WTX.

11-15. Training Management Division

a. Mission. Coordinates resource requirements for student loads. Serves as ITRO lead. Manages academic records and master training schedules.

b. Functions. Develops policies and procedures pertaining to the conduct and administration of training. Manages ATRRS defining outyear resources and training workload. POC for the SMDR to validate training requirements and capacities. Coordinates institutional training issues with HRC and HQDA G-3. Central coordinator/HHQ liaison for ODS matters pertaining to ITRO. Develops ODS mobilization training plan. Advisor to BN commanders on academic review board (ARB) recommendations. Manages TRAP requests. Manages the development and input to master class schedules. Coordinates requests for deviation from approved schedules and resolves resulting problems.

11-16. Armament and Electronics Maintenance Training Department

a. Mission. Manages resident instruction for assigned courses in Basic Electronics, Knowledge and Skills, Land Combat, High Mobility Artillery Rocket System /Multiple Launch Rocket System, TMDE, Conventional Weapons, Turret, and Fire Control.

b. Organization. Consists of seven divisions: Basic Electronics Maintenance Training Division; High Mobility Artillery Rocket System Division; TMDE Division; Conventional Weapons Division; Turret Division; Fire Control Division, and Patriot/Radar Division.

c. Functions. Manages, conducts, and evaluates resident instruction for assigned courses. Monitors the technical sequencing, scope, and changes to TSPs and other instructional materials; monitors maintenance of training facilities and operational status of training equipment. Conducts ARBs and recommends approval for student continuance in training or reclassification. plans, coordinates and executes graduation ceremonies. Assists in forming training strategies, goals, and objectives in related technical areas. Coordinates the development of training materials.

11-17. Track/Metal Working and Services/Recovery Training Department

a. Mission. Manage resident training for enlisted Soldiers to be technically and tactically proficient in the following areas: automotive basic knowledge and skills and repair of track vehicles at field and sustainment maintenance levels.

b. Organization. The Department consists of three divisions: Track Division, Metal Working and Services Division, and Recovery Division.

c. Functions. Manages, conducts, and evaluates resident instruction for assigned courses. Monitors the technical sequencing, scope, and changes to TSPs and other instructional materials; monitors maintenance of training facilities and operational status of training equipment. Conducts ARBs and recommends approval for student continuance in training or reclassification. Plans, coordinates and executes graduation ceremonies. Assists in forming training strategies, goals, and objectives in related technical areas. Coordinates the development of training materials.

11-18. Wheel Maintenance Department

a. Mission. Manage resident training to produce Soldiers who are technically and tactically proficient in automotive basic knowledge and skills and repair of wheel vehicles at field and sustainment maintenance levels.

b. Organization. The Department consists of two divisions: Basic Wheel Maintenance Division and Stryker Maintenance Division.

c. Functions. Manages, conducts, and evaluates resident instruction for assigned courses. Monitors the technical sequencing, scope, and changes to TSPs and other instructional materials; monitors maintenance of training facilities and operational status of training equipment. Conducts ARBs and recommends approval for student continuance in training or reclassification. Plans, coordinates, and executes graduation ceremonies. Assists in forming training strategies, goals, and objectives in related technical areas. Coordinates the development of training materials.

11-19. Tactical Support Equipment Training Department

a. Mission. Manage resident training to produce Soldiers who are technically and tactically proficient, in the repair of power generation, utilities/air conditioning and refrigeration, and QM/chemical at field and sustainment maintenance levels.

b. Organization. The Department consists of two divisions: QM/Utility Division and Power Generator Division.

c. Functions. Manages, conducts, and evaluates resident instruction for assigned courses. Monitors the technical sequencing, scope, and changes to TSPs and other instructional materials; monitors maintenance of training facilities and operational status of training equipment. Conducts ARBs and recommends approval for student continuance in training or reclassification. Plans, coordinates, and executes graduation ceremonies. Assists in forming training strategies, goals, and objectives in related technical areas. Coordinates the development of training materials. Provides SME and instructors for MTT. Administers Sections 608 and 609 of the Clean Air Act of 1990 ICW Environmental Protection Agency guidance as it pertains to the training, testing, and certification programs for air conditioning and refrigeration training.

11-20. Munitions and EOD Training Department

a. Mission. Manage resident training for Soldiers to be technically and tactically proficient in Ammunition (89A and 89B) and EOD.

b. Organization. The department consists of three divisions: Munitions Training Division; Explosive Ordnance Training Division with teams located at Eglin AFB, FL, Fort A.P. Hill, VA, and Fort Leonard Wood, MO; and Hazardous Devices School at RSA, AL.

c. Functions. Manages, conducts, and evaluates resident instruction for assigned courses. Monitors the technical sequencing, scope, and changes to TSPs and other instructional materials; monitors maintenance of training facilities and operational status of training equipment. Conducts ARBs and recommends approval for student continuance in training or reclassification. Plans, coordinates, and executes graduation ceremonies. Assists in forming training strategies, goals, and objectives in related technical areas. Coordinates the development of training materials.

d. Conducts courses at RSA as requested by the FBI and approved by the Commandant; provides instruction during FBI Bomb Data Center Regional Seminars as specified in the interdepartmental support agreement; and provides SMEs to write and review lesson plans, examinations, and other instructional material.

11-21. Ordnance Electronics Maintenance Training Department (Fort Gordon, GA)

a. Mission. Manage resident training to produce WO, Soldiers, and civilians who are technically and tactically proficient in electronic maintenance, avionics repair, and communications security.

b. Organization. The department, located at Fort Gordon, GA, consists of four divisions: Aviation Control and Survivability Division, Aviation and Ground Radio Division, Basic Electronics Training Computer and Chemical Division, and Warrant Officer Training Division.

c. Functions. Manages, conducts, and evaluates resident instruction for assigned courses. Monitors the technical sequencing, scope, and changes to TSPs and other instructional materials; monitors maintenance of training facilities, and operational status of training equipment. Conducts ARBs and recommends approval for student continuance in training or reclassification. Plans, coordinates, and executes graduation ceremonies. Assists in forming training strategies, goals, and objectives in related technical areas. Coordinates the development of training materials.

11-22. 832nd, 73rd, 16th Ordnance Battalions

a. Mission. Continue the Soldierization process to train and develop motivated, disciplined, and fit Soldiers and leaders who are committed to Army values and the Warrior Ethos; demonstrate safety as part of their day-to-day activities; and can immediately contribute to the

mission accomplishment of their next unit of assignment. Provide C2, force protection, administration, and logistical support for assigned and attached personnel.

b. Organization. Each BN consists of up to seven companies adjusted annually through SMDR.

c. Functions. Transitions BCT Soldiers into the AIT environment and completes the Soldierization process. Serves on a rotational basis as the task force commander for a multi-echelon, scenario-driven, WTX reinforcing MOS training, common tasks, and battlefield survival skills. Maintains individual permanent party deployability and fitness. Provides Soldierization training for interservice transfers and prior service Soldiers.

11-23. Explosive Ordnance Disposal Directorate

a. Mission. Develops, integrates, and synchronizes DOTMLPF-resource informed, integration-focused and outcome-based requirements for EOD throughout TRADOC and coordinates JIIM EOD requirements ICW CASCOM and SCoE, and HQDA G-3/5/7.

b. Organization. Consists of two divisions: Capability Development and Doctrine Division and Training Development Division (see figure 11-4).

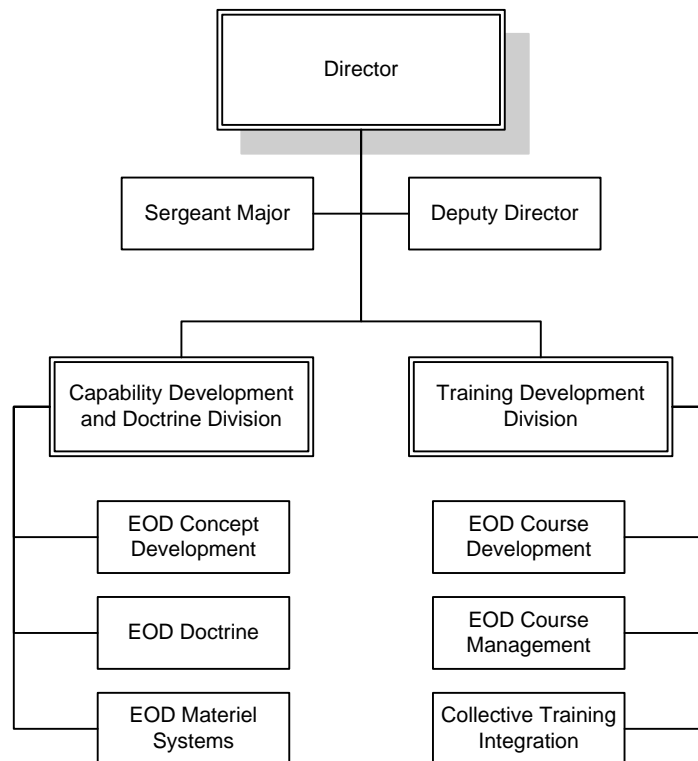

Figure 11-4. Explosive Ordnance Disposal Directorate

c. Functions.

(1) Assists ARCIC in the design, development, and integration of all aspects of the EOD future force into the joint force.

(2) Develops, coordinates, and recommends policy and guidance, and provides direction to execute the JCIDS and manage its implementation and execution for the EOD career field. Integrates DOTMLPF developments to support required capabilities. Coordinates, synchronizes, and integrates EOD capabilities developments with TRADOC, ACOMs, combatant commands, the Joint EOD Program Board and Joint Staff.

(3) Manages the JCIDS CBA to identify gaps in EOD capabilities, proposes resolutions and develops JCIDS capability documents.

(4) Designs, develops, resources, and integrates all Army specific training aspects of the EOD future force.

(5) Develops capabilities-based solutions to leverage technologies that support training, recommends EOD S&T priorities, supports experimentation, and synchronizes and integrates Army EOD capabilities within the JIIM environment.

(6) Develops and revises EOD training products in support of the CG ODS priorities and Army standards.

Chapter 12

Commanding General/Chief of Transportation/Commandant

12-1. Mission, organization and functions

a. Mission. Provides a full spectrum of transportation capabilities at the tactical, operational, and strategic levels of war, enabling a CONUS-based and forward-deployed Army to rapidly deploy, distribute, and maneuver forces, equipment, and materiel anytime, anywhere in support of the National Military Strategy.

b. Organization. The CG/Chief of Transportation/Commandant oversees the following: Command Group; TC Proponency and Regimental Offices; Special Staff; TS; and the Deployment Process Modernization Office. Commandant has POI oversight and liaison responsibilities to the 58th Transportation BN Motor Transport Operators Course located at Fort Leonard Wood, MO and assigned under the 3rd Chemical BDE, the Joint Deployment Training Center, and the USAF Transportation Management School (see figure 12-1).

c. Functions

(1) Plans, schedules, and supervises the use of each mode of transportation for the effective movement and distribution of units, personnel, equipment, and supplies.

(2) Synchronizes the use of all modes of transportation and serves as the Army’s single movement controller and traffic manager for the movement of materiel from the source to the combatant commanders.

(3) Provides theater port opening capabilities at fixed ports, unimproved beach sites, and during logistics-over-the-shore operations by conducting multimodal, common-user land and water-based transportation operations.

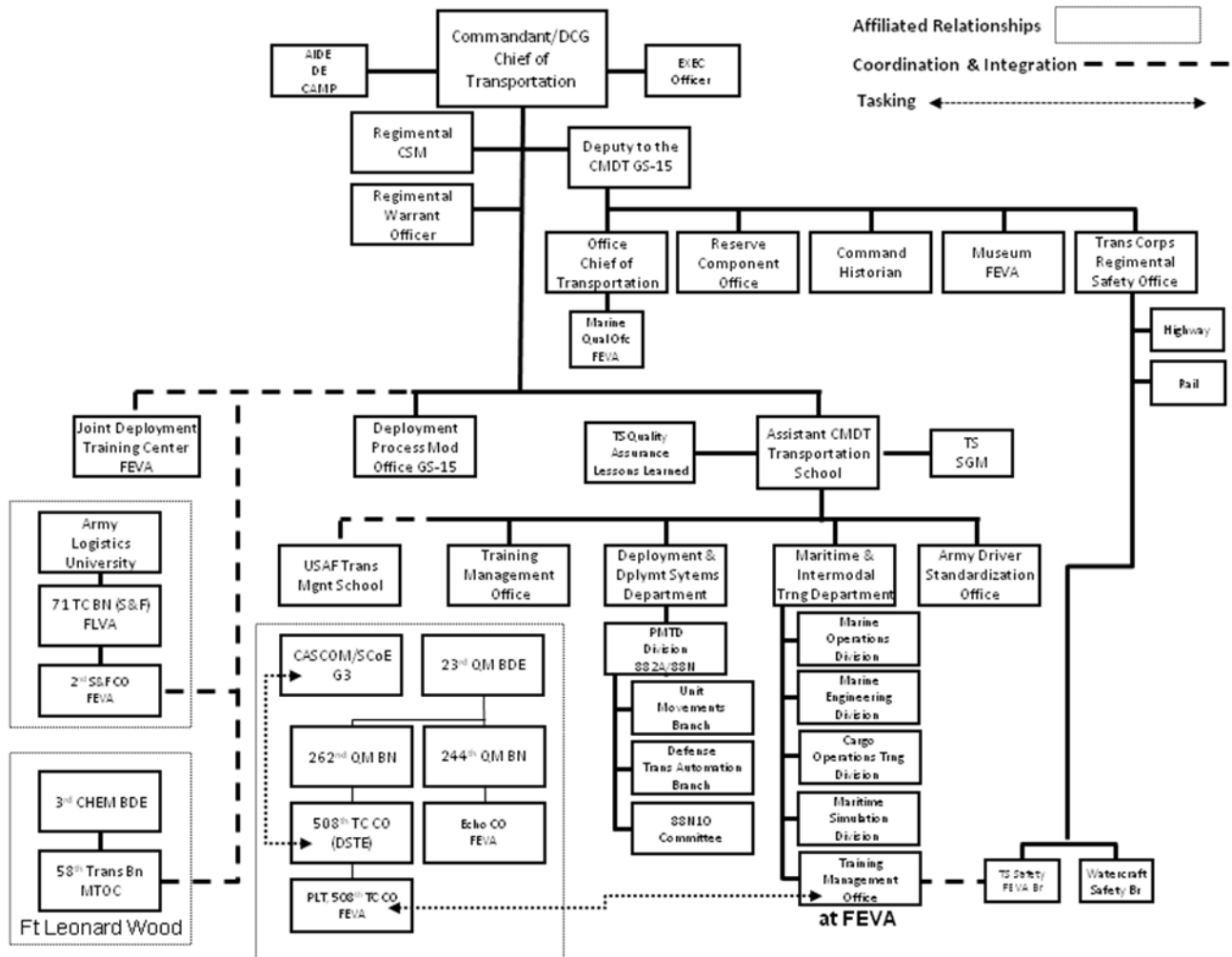

Figure 12-1. Transportation School

(4) Provides DOD worldwide, single agency management for military traffic, land transportation, and common-user ocean terminals.

(5) Develops transportation concepts and doctrine and develops unit organizations and the requirements to support acquisition of transportation systems for the Army.

(6) Provides joint service doctrine and training coordination to include training and professional development for active, RC, and civilian personnel in transportation and deployment methods.

(7) Provides field and sustainment maintenance and supply for marine and rail equipment.

12-2. Command Group

a. Commandant/Deputy Commanding General/Chief of Transportation. Commands the TS. Principal advisor to the CASCOM and SCoE CG, and TRADOC on TC DOTMLPF matters. At the discretion of the CG, serves in one of three rotational assignments: DCG for TDI, CDI, or ALU. Responsible for ensuring the TS recruits, trains, and educates Soldiers, develops leaders, and supports training in units. Provides and supports technical training requirements for officer, WO, and NCO courses within the ALU and the TS. Leads all matters of proponency and development of the U.S. Army TC to ensure it can perform its mission in support of the U.S. Army.

b. Deputy to the Commandant. Senior advisor and consultant to the Commandant and staff. Has full executive authority to direct and coordinate the actions of the special staff: Office of the Chief of Transportation, RC Affairs Office, Command Historian, Museum, and the Transportation Regimental Safety Office. Coordinates with outside agencies for mission support requirements beyond the scope of CASCOM and SCoE (that is, FORSCOM units who provide equipment to support our training requirements like watercraft). ACPM for CP24.

c. Regimental Command Sergeant Major. Principal enlisted advisor to the Commandant on all enlisted matters for students, staff, and faculty. Advises the Commandant on status of TS quality of training and recommends assignment of TC SGM in concert with SGM branch and HRC. Responsible for reviewing/examining trends, and developing and implementing proposals affecting career programs for TC enlisted Soldiers. Provides professional development, mentorship, and counseling to CMF 88 Soldiers.

d. Regimental Chief Warrant Officer. Examines career trends, develops and implements proposals affecting career programs and opportunities for TC WOs. Develops technical prerequisites and approves all TC WO applications. Coordinates with USAREC and HQDA G-1 to develop annual TC WO accession plans. Identifies and recommends changes to structure and training to meet the technical needs of units supported by TC WOs. Provides professional development seminars, mentorship, and counseling to officers, WOs, and enlisted Soldiers on the roles, responsibilities, and utilization of WOs.

12-3. Special Staff

a. Command Historian. Primary advisor on all historical matters. Maintains a continuous history of the TC through the collection, preservation, and archiving of historical information. Conducts historical research and writing of monographs. Produces annual reports and drafts other historical documents focusing on significant transportation initiatives. Provides history instruction to students IAW POI requirements.

b. Office of the Chief of Transportation. The Office of the COT is the TC proponency office, central point of contact and coordinator for the COT to effect TC matters of proponency. Liaison and referral between AA and RC TC personnel and organizations, functional staff, and academic departments within the TS. The director serves as the transportation corps regimental adjutant and is the principal advisor to the COT on all matters relating to TC personnel proponency, to include HQDA civilians (CP-24). Manages the Army's Marine Qualification and Licensing Program and Army Sea Pay Program and serves as the lead for AR 56-9, Watercraft. Manages, reviews, and awards requests of waivers for MOS training prerequisite requirements.

12-4. Reserve Component Affairs Office

a. Mission. Ensures the USAR and ARNG perspectives are fully integrated in the development of emerging doctrine, leader development, and force structure impacting the manning, equipping, training, readiness, and deployability and mobilization of RC transportation units and personnel while maintaining primary focus on Soldiers. Provides the COT perspectives on personnel, equipment, training, and deployment issues that pertain to the ARNG and USAR transportation community.

b. Functions.

(1) Sponsors conferences, workshops, training site visits and staff assistance that contribute to improving RC transportation training and readiness.

(2) Assists in the integration of all facets of individual and collective training into the RC to include TS support for RC officer and NCO leader development, MOS qualified, and unit training initiatives. Ensures training, doctrine, and combat development activities are well coordinated.

(3) Ensures training for AA and RC are to one standard.

(4) Advises school on individual mobilization augmentee program, IRR training, and other RC component specific programs.

(5) Spearheads the integration of individual training and coordinates all RC related force integration actions for FORSCOM, TRADOC, CASCOM, OCAR, U.S. Army Reserve Command, and ARNG.

12-5. Transportation Museum (Fort Eustis, VA)

Provides training and education on the history, traditions, and accomplishments of the TC and U.S. Army. Collects, preserves, exhibits, and interprets historically significant properties related to the history of the TC from 1942 to the present.

12-6. Transportation Corps Regimental Safety Office

A special staff serving as principle advisors to the COT, which consists of a TS safety specialist and highway, rail, and watercraft specialists with Armywide missions.

12-7. Transportation School

a. Assistant Commandant. Member of the command group responsible for the daily operations of the TS. Coordinates actions between the different divisions and TS elements located on Forts Lee and Eustis, VA. Oversees and supports training requirements, and proponency of the 88M POI executed by the 58th Transportation BN (Motor Transport Operators Course), Fort Leonard Wood, MO, assigned under the 3rd Chemical BDE.

b. Mission. Trains the Army's transportation Soldiers, civilians, and members of other services, develops transportation leaders, supports training in units, assists in developing deployment and movements doctrine, establishes applicable standards, and assists in developing future transportation capabilities. Coordinates joint transportation management, planning procedures, and technical skills for members of all uniformed services, including the military of allied nations.

c. Organization. Consists of a TMO; the Army Driver Standardization Office; a QA & L2 Office; a Safety office; and two training departments: Deployment and Deployment Systems Department and the Maritime and Intermodal Training Department (MITD).

d. Functions.

(1) Proponent for all transportation training conducted at Fort Lee, VA; Fort Eustis, VA; and Fort Leonard Wood, MO.

(2) Provides transportation proponency coordination and supervision of transportation unique officer, WO, and NCO PME conducted in the ALU and other schools.

(3) Trains automated transportation-related systems applications for situational awareness and deployment processes used to conduct joint operations.

(4) Proponent for all TS matters to include transportation officer FSCs, WO MOSs, enlisted CMFs, civilian occupational series, and associated life-cycle management functions.

(5) Trains AA and RC Soldiers, DA and DOD civilian transportation managers, and personnel from allied nations on career development and technical courses ranging from watercraft and marine terminal operations, air and highway transport/distribution operations, movement control, rail operations, unique transportation automated movement management systems, mobilization/deployment/redeployment operations, and strategic deployment planning.

(6) Trains and provides logistical and administrative support to USMC, USN, and USCG students in transportation management.

(7) Conducts ARBs to determine and recommend corrective actions.

12-8. Training Management Office

a. Mission. Oversees and coordinates training, administrative, and logistical support across the entire TS. Consists of two offices, the principal office at Fort Lee and a cell at Fort Eustis supporting the MITD.

b. Functions.

(1) Reviews acquisition packages concurrently with the director of contracting and is the alternate contracting officer representative for contract administration.

(2) Prepares guidance for training execution initiatives IAW HQDA/TRs and standards.

(3) Develops policies and procedures pertaining to the conduct and administration of resident, mobile, and DL training. Participates in the development and implementation of newly developed programs. Maintains liaison and coordination with TRADOC 3/5/7.

(4) Coordinates priorities of TS input into the HQDA/TRADOC ATRRS defining outyear resources and training workload.

(5) Prepares and coordinates the monthly TRADOC NETUSR or successor system.

(6) Validates training requirements and capacities for the SMDR. Coordinates TS resident training issues with HQDA HRC and HQDA G-3. POC for training requirements of the NGB; OCAR; FORSCOM; USN; and the USAF.

(7) Central coordinator/HHQ liaison for all matters pertaining to the TRADOC ITRO. Liaison with the USMC, USN, USAF, and the USCG for all ITRO matters.

(8) Serves as the organization Defense Travel Administrator for the TS.

(9) Coordinates and facilitates academic accreditations with the ACE and the Council on Occupational Education.

(10) Responsible for central taskings within the TS to include the 508th Detachment at Fort Eustis, planning of operational training support missions, safety guidance, force protection/anti-terrorism, physical security, facility management, ceremonies, and special events.

(11) Coordinates and programs projected workloads with TRADOC, CASCOM, and SCoE, and other service schools and agencies.

(12) Develops mobilization training input to the TS mobilization plan.

(13) Advises BN commanders on ARB recommendations. Processes approved ARB actions and appeals.

(14) Manages TRAP requests for resident training or student support involving external agencies and activities, off-site training facilities, and FORSCOM units, and resolves training constraints/issues.

(15) Manages the functions of ATRRS to maintain student load reports that include projected loads and actual inputs. Assists in identifying student reservations and quotas.

(16) Manages the development and input to master class schedules. Coordinates all requests for deviation from approved schedules and resolves conflicts that stem from sharing facilities/equipment. Coordinates the SERP system across organizational elements within the TS.

(17) Establishes resident student records in RITM and the class master folder. Prepares one-time and recurring reports and statistical data from RITM and ATRRS; finalizes student records, identifies honor students, prepares graduation documents and diplomas, and prepares history file. Prepares, updates and reviews RITM training data and receives notification of and processes student disposition and posts in RITM and ATRRS.

(18) Provides training management support to ALU for technical training.

(19) Responsible for human resource management, facility and logistics management, personnel and management control support and personnel/physical security.

12-9. The Army Driver Standardization Office

a. Executes lead responsibilities for a uniform driver training policy throughout the U.S. Army. Advises the commandant on all aspects of motor wheeled vehicle driver training. As the proponent, the commandant is the reviewing and approving authority for all motor wheeled vehicle driver training packages and products. Provides critical operator/driver tasks, conditions, and standards to TRADOC hardware leads. With oversight of AR 600–55, serves as the Army Driver and Operator Standardization Program (selection, training, testing, and licensing) and lead for the Army Driver Training Strategy and the Master Driver Trainer’s Program.

b. Functions.

(1) Army lead for motor wheeled vehicle driver selection, training, testing, and licensing. Maintains a standard/uniform driver training strategy for the Army.

(2) Responsible for MOS 88M, Motor Transport Operator, for AIT resident course.

(3) Provides MOS 88M technical advice for course quality and post-graduate surveys.

(4) Reviews and advises changes to the wheeled vehicle sections of AR 600-55, provides interpretation of the regulation to the field.

- (5) Reviews and recommends actions on the development of vehicle specific training circulars and TSPs for non-MOS 88M wheeled vehicle operators.
- (6) Provides military commercial driver's license technical guidance.
- (7) Provides technical advice and consultation concerning driver training areas to the Combat Readiness Safety Center, U.S. Department of Transportation, and other agencies.
- (8) Reviews training materials related to wheeled vehicle drivers including training aids, devices, simulations, and simulators.
- (9) Reviews procedures, policies, and regulations for potential impact on Army drivers.
- (10) Reviews/evaluates doctrine and training literature to determine impact on the motor wheeled vehicle driver training community.
- (11) Reviews MOS 88M reclassification packages and provides technical recommendations.

12-10. Quality Assurance and Lessons Learned

Ensures academic and training standards are known and followed by the training departments. Assists with implementing new standards and ensures standardization and compliance. Focal point for collecting and disseminating L2 from across the Army to the TS.

12-11. Deployment and Deployment Systems Department

a. Mission. Provides instruction on the Deployment and Defense Transportation System, deployment and sustainment planning and processes, movement control, distribution asset management, and supportive automation systems to Soldiers and civilian members of all services.

b. Organizations. The Deployment Training Department consists of one division (Professional Military Training Division, 882A and 88N), two branches (Unit Movements Branch and Defense Transportation Automation Branch) and the 88N10 Committee.

c. Functions.

(1) Trains Soldiers, civilians, and members of other services and nations in Transportation proponency skills and functions as related to Deployment and the Defense Transportation System.

(2) Transportation Specialist Team: provides AIT for MOS 88N (Transportation Management Coordinator).

(3) Deployment Systems Team: provides functional training in deployment processes, to include unit movements (surface and air) and in Defense Transportation System sustainment and automated transportation support systems.

(4) Manages, conducts, and evaluates assigned courses. Monitors the technical sequencing, scope, and changes to TSPs and other instructional materials; monitors maintenance of training facilities and operational status of training equipment. Plans, coordinates, and executes graduation ceremonies. Develops training strategies, goals, and objectives in related technical areas. Coordinates with TDI for the development of training materials.

12-12. Maritime and Intermodal Training Department, Fort Eustis, VA

a. Mission. Manages resident and onsite instruction in the areas of Army watercraft operations and maintenance; cargo handling and rail operations for Soldiers and civilian members of all services.

b. Organization. Consists of four training divisions: Marine Operations Division, Marine Engineering Division, Maritime Simulation Division, Cargo Operations Training Division and a TMO.

c. Functions. Manages, conducts, and evaluates assigned courses. Monitors the technical sequencing, scope, and changes to TSPs and other instructional materials; monitors maintenance of training facilities and operational status of training equipment. Plans, coordinates, and executes graduation ceremonies. Develops training strategies, goals, and objectives in related technical areas. Coordinates with TDI for the development of training materials.

d. Maritime and Intermodal Training Department Training Management Cell. Provides administrative, logistical, and resource management support to the Maritime Training Department and subordinate training division. Manages the Forward Operating Base at Fort Eustis in support of the WTX and other tasks/training as required. As required provides reports to the TS primary TMO at Fort Lee, VA.

12-13. Cargo Operations Training Division

a. Mission. Provides AIT for Army Cargo Handling Specialist MOS and technical training for 88H NCOs. Responsible for the conduct and execution of the Kalmar RT240 Rough Terrain Container Handler ASI R1 Course.

b. Functions. Provides AIT for enlisted who enlist in or are reclassified into the 88H10, 88P10, 88T10 and 88U10 MOS. Provides technical training for NCOs in the 88H30 MOS.

12-14. Marine Operations Division

a. Mission. Provides maritime (vessel) operations training for enlisted, WO, and civilian personnel.

b. Functions. Provides maritime (vessel) operations training to Army watercraft WOs in MOS 880A, functional watercraft operations training in MOS 88K20, technical training for basic and advanced NCOs in MOS 88K30 and 88K40, AIT for enlisted in MOS 88K10 and civilian watercraft personnel. Provide advanced technical training and common leader development subjects designed to prepare WOs for assignments at higher levels. Trains USN personnel on joint high speed vessel operations.

12-15. Marine Engineering Division

a. Mission. Provides maritime (vessel) engineering and rail training for enlisted, WO, and civilian personnel.

b. Functions.

(1) Provides maritime (vessel) engineering related training to Army watercraft WOs in MOS 881, technical training for NCOs in MOS 88L30 and 88L40, AIT for enlisted in MOS 88L10, and civilian watercraft personnel.

(2) Provides advanced technical training and common leader development subjects designed to prepare WOs for assignments at higher levels.

(3) Provides rail related training and certification in MOS 88P10, 88T10, and 88U10 and executes the DOD Locomotive Engineer Certification Program as the Designated Supervisor of Locomotive Engineers for AA, DA civilians, and contractors who have a rail operating mission in support of the military and selected Federal agency locations.

12-16. Maritime Simulation Division

a. Mission. Provides maritime related functional, high speed craft and simulation training to DOD officer, WO, NCO, enlisted, and civilian watercraft personnel. Provides integrated computerized deployment system and ship loading & stowage functional training to DOD civilian and military load planners.

b. Functions. Provides maritime specific standards of training and certification of watch-keepers functional training in support of Army marine licensing and certification.

12-17. Oversight and Liaison Responsibilities

a. 58th Transportation Battalion (Motor Transport Operators Course), Fort Leonard Wood, MO. The BN is subordinate to the 3rd Chemical BDE at Fort Leonard Wood. The TS Commandant is responsible for overseeing the 88M POI and assisting in coordinating required training support for the Motor Transport Operators Course.

b. 508th Transportation Company. A provisional company providing direct support to training events across the CASCOT and SCoE. The company conducts split-based operations between Fort Lee and Fort Eustis, VA. The Fort Lee contingent is tasked directly by the

CASCOM and SCoE G-3. The company maintains one autonomous platoon on Fort Eustis to provide direct support to training events to the MITD and to other training as available. Tasking authority for the Fort Eustis contingent is through MITD training management cell.

c. 2nd Staff & Faculty Company. Provides administrative support to all instructors assigned to the TS both on Fort Lee and Fort Eustis VA. The company is located on Fort Eustis and is subordinate to the 71st Transportation BN located on Fort Lee, VA.

d. Echo Company. Commands AIT student population located on Fort Eustis and is aligned under the 23rd QM BDE at Fort Lee. All AIT students attending courses on Fort Eustis are assigned to E Company.

12-18. Deployment Process Modernization Office

a. Mission. Lead for the Army deployment process. Guides the integration of deployment and distribution by identifying and developing corresponding policies, concepts, doctrine, training, related deployment and distribution automated information systems, and enablers; and conducting experiments, analyses, and studies to facilitate deployment and distribution capabilities.

b. Organization. Consists of five teams: Operations and Training Team, Information Fusion Team, Concepts and Doctrine Team, S&T Team, and Modeling and Analysis Team.

c. Functions.

(1) Provides guidance and recommendations to HQDA G-3 and G-4 on deployment and distribution issues.

(2) Develops, revises, and publishes deployment and distribution policies, concepts, and doctrine.

d. Supports developing, testing, and fielding of deployment and distribution transportation information systems and subsystems. Provides customer assistance and training during fielding. Assembles and prioritizes appropriate DOD data requirements for incorporation into the current deployment and distribution automation systems. Develops, collects, and screens issues and desired capabilities for the next generation transportation automation system or subsystem. Allies with CASCOM ESD to develop and facilitate a comprehensive end-to-end logistics enterprise solution.

e. Identifies capability gaps and technological shortfalls in the Army deployment process. Assesses the value of emerging deployment enablers to moderate the gaps and shortfalls through experimentation, analysis, and simulation.

f. Administers the CSA Deployment Excellence Award Program.

g. Supports CASCOM and SCoE CPX-S collective training exercises for Movement Control units to prepare them for their role in support of COP.

12-19. U.S. Air Force Transportation School (34Xth Training Squadron)

a. Mission. Trains USAF Air Transportation Apprentice (AFSC 2T2X1) 3-level and Traffic Management (AFSC 2T0X1) 3-level courses. The school also trains some 5-level Transportation functional skill courses.

b. Organization. The Squadron is commanded by a USAF Lieutenant Colonel and is assigned to the 37th Training Group.

c. Functions.

(1) Train USAF air transportation apprentices on passenger and cargo functions, weight & balance factors, airlift transportation directives & documentation, cargo securing techniques, border clearances, and operation of material handling and other types of loading equipment or devices, for all types of aircraft.

(2) Train USAF traffic management apprentices on Federal and military transportation regulations, instructions, directives; passenger and personal property entitlements; QA evaluation procedures; U.S. and foreign customs regulations; warehousing procedures; military, passenger, freight, and personal property rate computations; and packaging methods, specifications and orders.

(3) Train USAF personnel in the use of the Cargo Movements Operation System, including administration support menus, maintenance of the Cargo Movements Operating System database environment, and using the deployment modules to process passengers and cargo manifests.

12-20. Joint Deployment Training Center

a. Mission. Develop and deliver functional training, joint deployment planning and execution, education, and standardized curricula to the Combatant Commands, DOD Agencies, and PME institutions. Train automated systems applications, situational awareness, and deployment processes used to conduct joint operations.

b. Organization. Organized under a current Joint Manning Document and consists of Army, USAF, and USN personnel. Personnel are assigned to Joint Forces Command J7 with duty at Fort Eustis, VA.

c. Functions.

(1) Provides the joint community computer application and web-based training, conducted via resident instruction.

(2) Provides MTTs to Unified Commands, services, DOD agencies, and PME institutions.

(3) Provides training, curricula, and curricula development support to all services.

(4) Develops remediation methodologies, processes, and policies to resolve Joint Operation Planning and Execution System related L2 identified in JROC 042-05.

Chapter 13 Soldier Support Institute

13-1. Command Group

a. Trains and educates HR management, FM, recruiting and retention, postal operations, and music support Soldiers and civilians; develops complementary concepts, doctrine, organizations, and materiel in support of ARFORGEN and HCE to enable America’s Armed Forces to fight and win our Nation’s wars.

b. Organization (see figure 13-1).

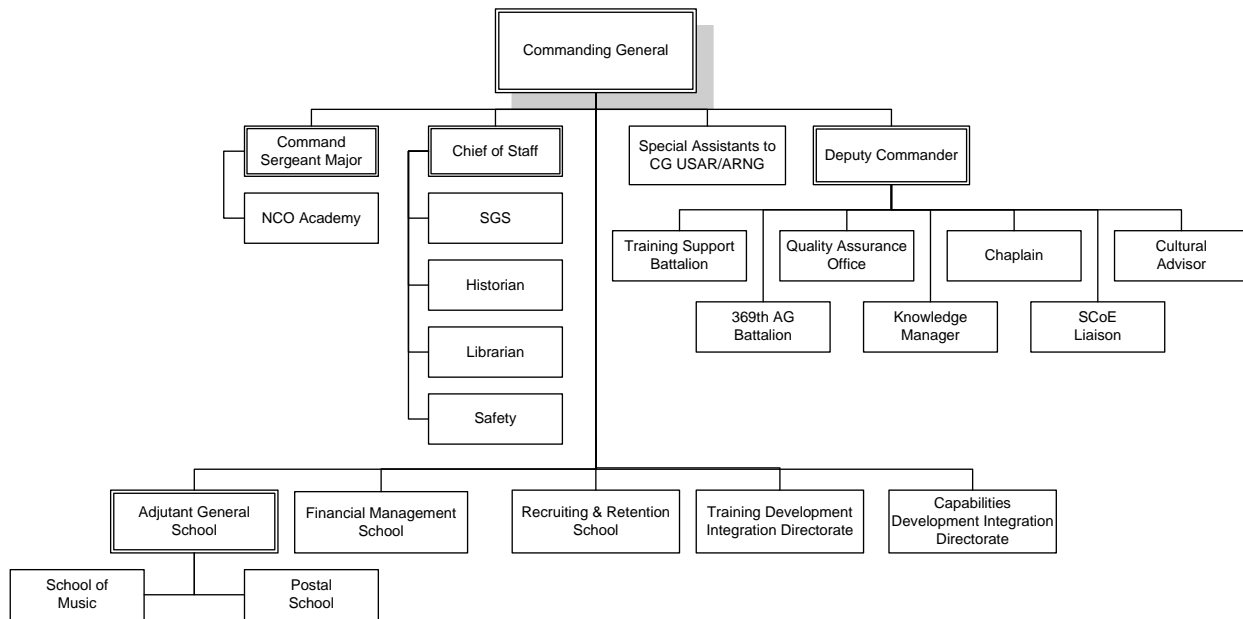

Figure 13-1. Soldier Support Institute (SSI)

c. Functions.

(1) Commanding General. Commands the U.S. Army SSI, a TRADOC school/center comprised of the AGS, FMS, RRS, the SOM, two NCO Academies, and two BNs. Responsible for IMT and leader development training for Soldiers, Sailors, Marines, Airmen and civilians of all the schools, to include the Army's legal specialists and the Interservice Postal Training Activity. Serves as a single voice for integrating doctrine, training, leader development, organization design, and combat development for the AG Corps, FM Corps, and Recruiters while supporting the Armywide personnel and FM systems.

(2) Deputy Commander. Acts for the CG in his/her absence. Supervises and directs the execution of the CG's decisions and policies with primary focus on combat and training developments.

(3) Chief of Staff. Principal coordinating agent for the command regarding operations and relationships with higher, adjacent, subordinate, and supported units, agencies, and activities. Provides strategic direction to the personal, special, and coordinating staff consistent with the CG's intent. Exercises daily staff supervision of SGS, executive services, SSI safety officer, director of resource management, operations, personnel, logistics, information technology, historian and the library.

(4) Command Sergeant Major. Provides advice and recommendations to the CG, regarding training, Soldier morale and welfare matters, and NCO development. Monitors the execution of policies and interprets them for Soldiers as appropriate. Provides an open and "unique" channel of communications between the CG and the NCO support chain. Conducts visits to selected units and provides feedback to the appropriate CASCOM and SCoE activity.

(5) Secretary to the General Staff. Principal POC for distinguished visitors and all protocol events for the SSI. Develops and coordinates itineraries for Colonel and above to SSI with subordinate schools and external agencies. Interfaces/coordinates with Fort Jackson.

(6) Chaplain. Advisor to the SSI Commander and school commandants on matters of religion, ethics, morals and morale as affected by religion. Provides religious support to the Soldiers and civilian personnel of the SSI and Fort Jackson community.

(7) Command Historian. Staff Historian for the CG SSI, and branch historian for the U.S. Army AG's Corps, and the U.S. Army Finance Corps. Provides historical reference services.

(8) Safety Officer. Implements and manages the Army Safety Program for SSI as outlined in: Field Manual 100-14; AR 385-10, The Army Safety Program; TRADOC Reg. 385-2, U.S. Army TRADOC Safety Program; and SSI Reg. 385-10. Advises and assists the CG SSI in overseeing command safety responsibilities. Collects, analyzes, and disseminates data concerning accidents. Provides periodic safety program progress reports and information concerning accidents.

(9) Resource Management. Principal financial advisor to the CG SSI; provides FM and civilian resource services; maintains internal controls, absolute financial integrity, and total visibility of public funds; ensures effective, efficient and relevant execution of resources in accordance with the SSI mission and CG priorities. Manages and maintains civilian personnel and resource policies. Manages and controls resource management policy and guidance, planning, programming, budgeting, and execution and equipment management.

(10) Library. Acquires, organizes, and maintains a collection of print and nonprint materials pertinent to SSI courses and to the professional development of students and staff. Assists students and staff in locating information.

(11) G-1 (Personnel). Manages military personnel readiness. Manages officer and enlisted evaluation programs, and Military and civilian awards programs.

(12) G-3 (Operations). Provides oversight of daily operations and long range planning, ensuring effective and efficient accomplishment of the SSI mission. Provides internal and external tasking coordination. Develops, coordinates, and publishes OPODs, WARNORDs, and FRAGORDs, as required to execute the CG's guidance. Manages TRAP planning, coordination, and execution.

(13) G-4 (Logistics Management). Coordinates logistics requirements. Executes expenditure of funds within logistics related accounts of the organization's budget. Oversees various logistical operations/functions pertaining to operations (exercises, activities, etc., under OPOD). Coordinates with installation master planner and engineer division pertaining to facility renovations and military Army construction projects. Facility management. Supply operations maintains accountability of unit's installation/TDA property (automation, support equipment, nontactical vehicles, furniture, and office equipment).

(14) Quality Assurance Office. Evaluates training and provides the CG and commandants with feedback and recommendations that promote development and implementation of current, effective, and relevant POIs to support Soldier, leader, and unit competencies. Develops and implements mission execution processes (MEPs) for SSI, the AGS, the FMS, the RRS, the NCOA, and the SOM. Conducts periodic internal evaluations of all SSI courses as scheduled in the MEPs using the applicable TRADOC accreditation standards.

(15) G-6 (Information Management). Principal staff officer to the CG for planning, employment, resourcing, and security of IM/IT. Coordinates directly with the local network enterprise center and the TRADOC Chief Information Officer to ensure that IM/IT is compliant.

(16) Knowledge Management. Develops, adapts, and implements DOD, Army, TRADOC, and joint KM practices, techniques, and technologies.

(17) Battle Simulations. Provides modeling and simulation support to the warfighter. Coordinates and conducts battle simulations and battle command training for applicable HR and FM officer, WO, and NCO courses. Represents SSI in the development and management of the Battle Command Arts and Science Program, and Battle Command Training Strategy implementation program.

(18) Retention. Staff adviser to the CG, commandants, and CSM for all retention matters.

(19) EO office. Provides advice and assistance to CG, commandants, commanders, directors, managers, and Soldiers. Staff adviser for all EO matters and recommends policy, vision, and priorities.

(20) Sustainment Center of Excellence Liaison. Liaison for the CG SSI to CASCOS and SCoE. Represents the CG SSI and subordinate Commandants within the CASCOS and SCoE

HQ. Primary advisor to the SCoE HQ for HR and FM integration into Army sustainment operations, doctrine, and training. Ensures SSI concepts and doctrine are integrated across the Army's DOTMLPF. Develops and maintains effective lines of communication. Develops and fosters strong partnerships between the two organizations.

(21) Cultural Advisor. Advises the CG SSI and coordinates with the TRADOC G-2 through the Director, TRADOC Army Culture and Foreign Language Management Office. Develops and implements the Army Culture and Foreign Language Strategy, ensuring these efforts are coordinated across the Army training enterprise. Possesses knowledge of the breadth and depth of the SSI scope of responsibility and integrates culture and foreign language efforts with TRADOC, other Army agencies, joint agencies, and the other services on behalf of the CG SSI. Supports TRADOC implementation of culture and language training across the TRADOC enterprise by providing unique expertise to other centers/schools as directed by TRADOC G-2 through the Director, Army Culture and Foreign Language Management Office. Routinely interacts at the directorate level across the SSI and with senior leaders across TRADOC and the Army to achieve the Army's endstate for culture and foreign language capability.

13-2. Training Development Directorate

a. Mission. Develops and sustains realistic, relevant, and responsive HR and FM individual and collective training in support of ARFORGEN that will enable military and civilian personnel to accomplish their mission in the contemporary operational environment and meet the demands of our Army at war.

b. Organization (see figure 13-2).

c. Functions.

(1) Director, TDD. Responsible to the CG and Commandants of the AGS, FMS, and RRS for the development, administration, internal evaluation, and regulatory compliance of all SSI courseware. Principal advisor to the CG and commandants on training development requirements, processes, and procedures. Integrates and coordinates Army training and education development actions. Directs training development resources and workload in accordance with priorities established by the commandants. Directs the integration of best practices, training concepts, and strategies across training development. Annually sponsors and implements the SSI Instructor Recognition Program.

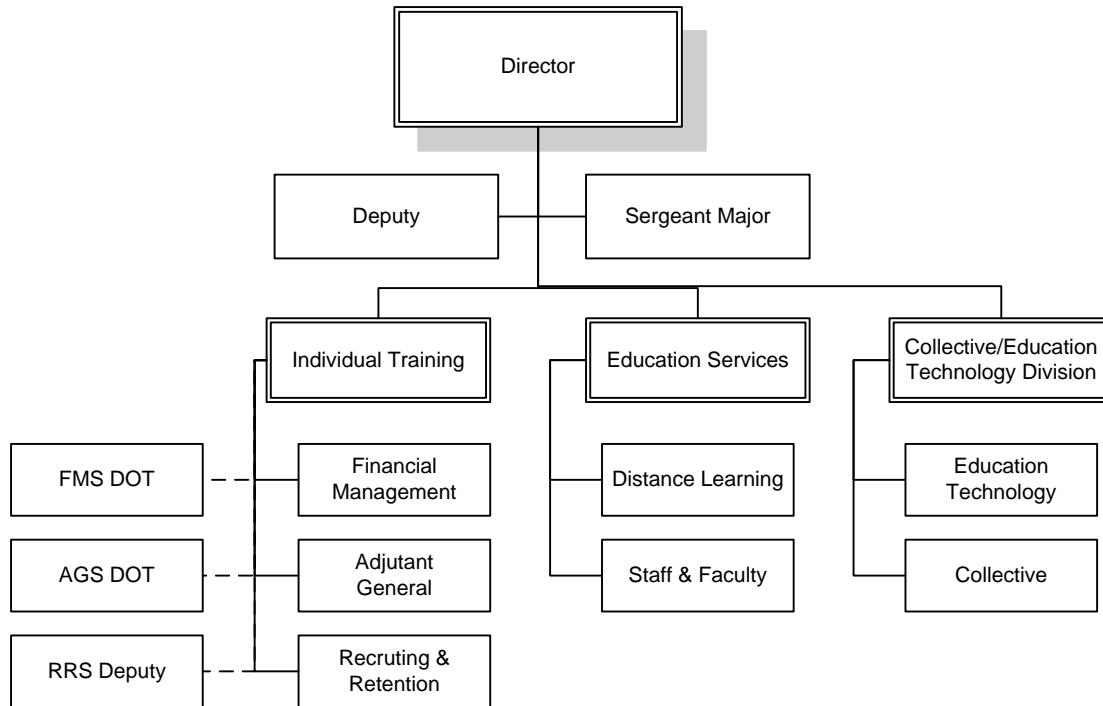

Figure 13-2. Training Development Directorate (TDD)

(2) Deputy Director, TDD. Manages training development workload and identifies/resolves development issues. Manages personnel, operational, and support activities. Administers contract management functions. Integrator and advisor on training development issues, assists in establishing priorities and recommending resource allocation.

(3) Sergeant Major. Principle enlisted advisor. Provides oversight for the design, development, and implementation of training products for the individual and collective training instruction and courseware delivery at the AGS, FMS, RRS, and the NCOA to include seven TASS BNs. Executes established policies and monitors standards of performance, training, and conduct of enlisted personnel.

(4) Individual Training Division. Responsible for the SAT management, processes, and products IAW the Army training and education development process and the analysis, design, development, implementation, and evaluation model. Develops and maintains individual training products and applicable TRAS documentation for the AGS, FMS, and RRS officer, enlisted, and functional courses.

(5) Collective Training and Education Technology. Analyzes, designs, and develops rigorous, relevant, and effective unit training products, including TSPs and combined arms training strategies, that support HR and FM teams and units in achieving operational readiness in FSO. Develops and maintains interactive multimedia instruction and DL courseware taught and delivered by the AGS, FMS, and RRS, using in-house capabilities and resources. Serves as SSI's training development capability database and blackboard content management system

administrator and provides technical support and training to instructors and training developers on the use of academic content development and systems applications.

(6) Education Services Division. Oversees the development of training concepts and strategies and determines training development direction for DL programs for AGS, FMS, and RRS, and staff and faculty program actions for SSI and other Fort Jackson schools, based on proponent school commandant's approved training strategy. Coordinates with the QA office and the proponent schools on actions related to self-assessment in preparation for TRADOC schools accreditation.

13-3. Capabilities Development and Integration Directorate

a. Mission. Develops and maintains relevant and timely HR and FM concepts and doctrine; designs, defines, and develops HR and FM organizations; and documents HR and FM materiel requirements for current and future Operational Forces to sustain our Army throughout the full spectrum of operations.

b. Organization (see figure 13-3).

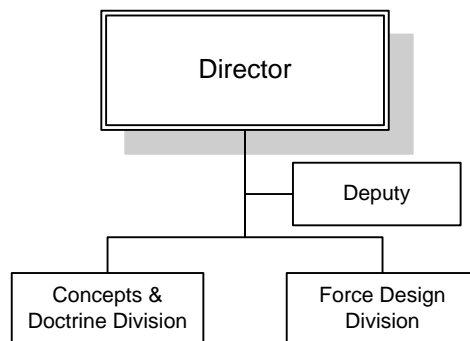

Figure 13-3. Capabilities Development and Integration Directorate

c. Functions.

(1) Director, Capabilities Development and Integration Directorate. Responsible for future battlefield concepts, doctrine, force structure, and materiel requirements for HR and FM support to the warfighter. Coordinates and integrates HR and FM concepts, doctrine, organizations, and materiel requirements with capabilities development and integration activities at CASCOM and SCoE, CAC, HQ TRADOC, and HQDA.

(2) Deputy Director, Capabilities Development, and Integration Directorate. Integrates and advises the directorate on capability issues, and assists in establishing priorities and recommending resource allocations. Controls and assigns tasks to division-level leaders, recommends priorities for accomplishment of tasks, and coordinates actions involving multiple divisions. Performs contract management functions for the directorate and manages budget activities.

(3) Concepts and Doctrine Division. Develops, coordinates, and publishes Army HR and FM doctrine and ensures that it properly aligns with joint doctrine. Reviews and prepares input for non-lead Army, joint and allied doctrinal publications. Validates and develops required conceptual and doctrinal linkages between strategic, operational, and tactical levels of HR and FM operations. Performs conceptual studies and analysis to support HR and FM systems development for the future force. Develops HR and FM concept plans and provides input to higher level CBA and reviews and provides input to non-lead concepts to ensure they address HR and FM implications. Manages the SSI's L2 program through the collection and dissemination of observations, insights, and lessons. Manages open issues and tracks DOTMLPF implications with domain managers and affected schools and organizations.

(4) Force Design Division. Plans, programs, develops, analyzes, and coordinates proposed force structure changes and coordinates the development of organizations, force designs, and requirement documents for force structure throughout the entire force design process. Develops, maintains, and coordinates TOE for Supply Requirements Code 12- and 14- Series. This division provides organizational product (TOE/MARC) assistance, guidance, and technical expertise to departments and divisions of the AG and FM schools. Force Design Division advises other Army leads and centers on potential impact within their specific TOEs regarding HR and FM requirements and documentation.

13-4. Noncommissioned Officer Academy

a. Mission. Trains and educates NCOs through relevant, objective evaluation to support ARFORGEN; grows adaptive leaders fostered in an environment that facilitates competence, confidence, creativity, and team-building to achieve success in any operating environment.

b. Organization (see figure 13-4).

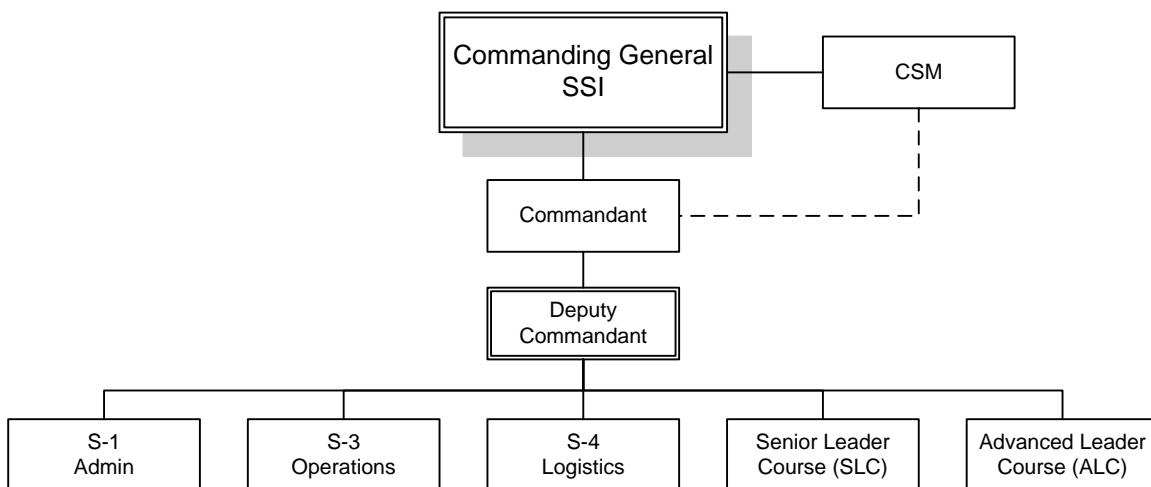

Figure 13-4. NCO Academy

c. Functions.

(1) Commandant, NCOA. Commands, manages, and controls the operation of the NCOA, SSI. Administers welfare and discipline (less Uniform Code of Military Justice) of cadre and students.

(2) Deputy Commandant, NCOA. Coordinates and supervises the daily operations of the NCOA. Directs, supervises, and coordinates academy staff activities, to include relationships with higher HQ.

(3) Administration (S1). Supervises, plans, and coordinates personnel and administrative operations. Lead for student and small group leader information guides. Prepares academic evaluation reports and provides administrative support for graduation ceremonies.

(4) Operations (S3). Coordinates and facilitates the management of training, plans, and operations for the NCOA. Requisitions, stores, and issues academic publications required to execute ALC, SLC, and CC POIs. Coordinates common leader training, POIs, course administrative data and individual training plans with the Directorate of Training Support and the U.S. Army Sergeants Major Academy.

(5) Logistics (S4). Advises the commandant on the logistical missions; determines and coordinates supply actions. Manages field support and organizational equipment under established procedures for storage, maintenance, issue, turn-in and replacement; determines equipment readiness status.

(6) Senior Leader Course. Conducts SLC for MOS' 42A, 44C, 56M, 79R, and 79S.

(7) Advanced Leader Course. Conducts ALC for MOS' 42A, 44C, 56M and CC (all MOS').

13-5. Training Support Battalion

a. Mission. Provides BN-level C2, battle-focused training, and administrative and logistical support to develop trained, ready, and agile military and civilian leaders capable of fighting and surviving in the contemporary operating environment.

b. Organization (see figure 13-5).

c. Functions.

(1) Commands, controls, disciplines, and oversees the welfare of military personnel assigned to attached for AG (BOLC, CCC, WOBC, WOAC), FM (GOLC, CCC) recruiting and retention courses or professional development courses within SSI.

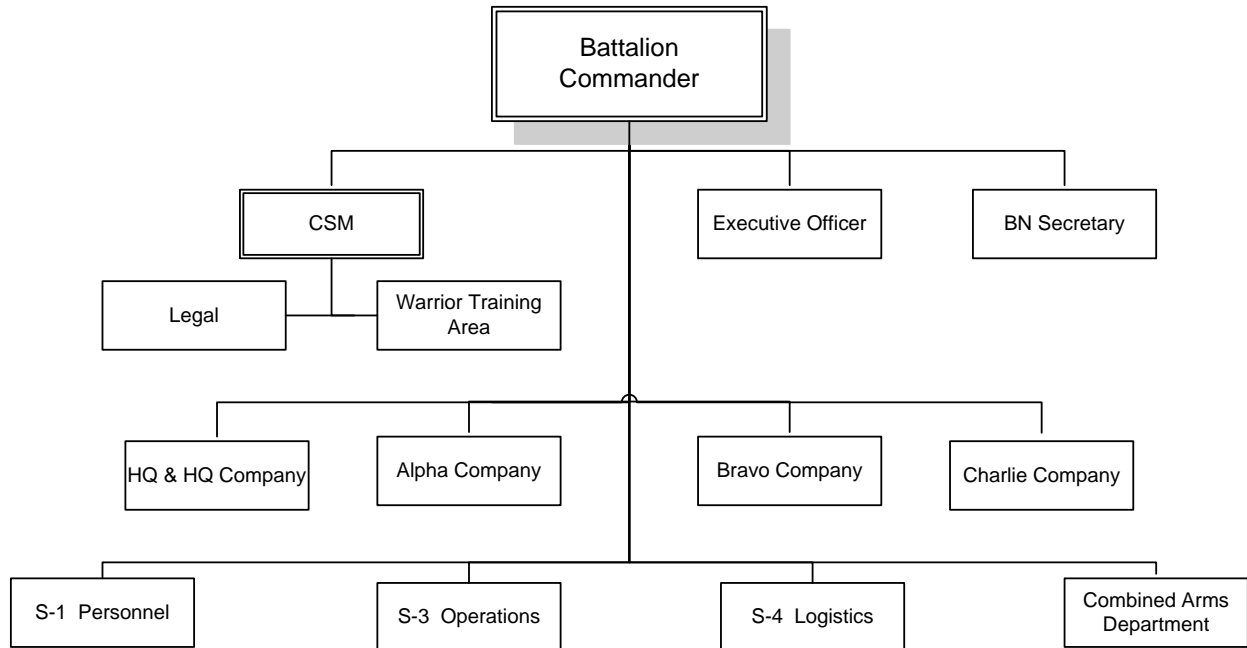

Figure 13-5. Training Support Battalion

(2) Graduates technically and tactically proficient, physically fit AG, FM, and other Service members capable of surviving on the modern battlefield and able to contribute to their first unit of assignment.

(3) Ensures permanent party Soldiers are prepared technically, tactically, physically and administratively for worldwide deployment.

(4) Promotes comprehensive Soldier fitness.

(5) Cares for the BN's Soldiers, Sailors, Airmen, Marines, civilians and their Family members.

(6) Oversees the Combined Arms Department. Responsible for CC training for CMF 44 (FM officers) BOLC-B, CCC and CCC-RC in addition to CMF 42/420 (HR officer/technician) BOLC-B, CCC, CCC-RC, WO basic course, WO advanced course and WO advanced course-RC. Conducts training IAW TRADOC and CAC guidance to include associated tactical training events.

(7) Controls the SSI WTA. Provides and maintains a facility for units to conduct a multi-echelon capstone event IAW TR 350-6, Enlisted Initial Entry Training Policies and Administration, to validate training core competencies and execute those tasks in a demanding environment that is realistic, relevant, and reflective of the common operating environment.

(8) Oversees the international student office for Fort Jackson. Plans and executes the international military education and training components of the TRADOC Security Assistance Training Field Activity at Fort Jackson, according to AR 12-15, Joint Security Assistance Training. Provides C2 liaison, logistical and administrative support to all assigned international military officers, NCOs, and Families attending training on Fort Jackson.

13-6. 369th Adjutant General Battalion

a. Mission. Conducts AIT for MOS 27D, 42A, 42F, and 44C and complete the Soldiers' initial entry training; to provide trained, ready, and agile Soldiers to the Operational Force.

b. Organization (see figure 13-6).

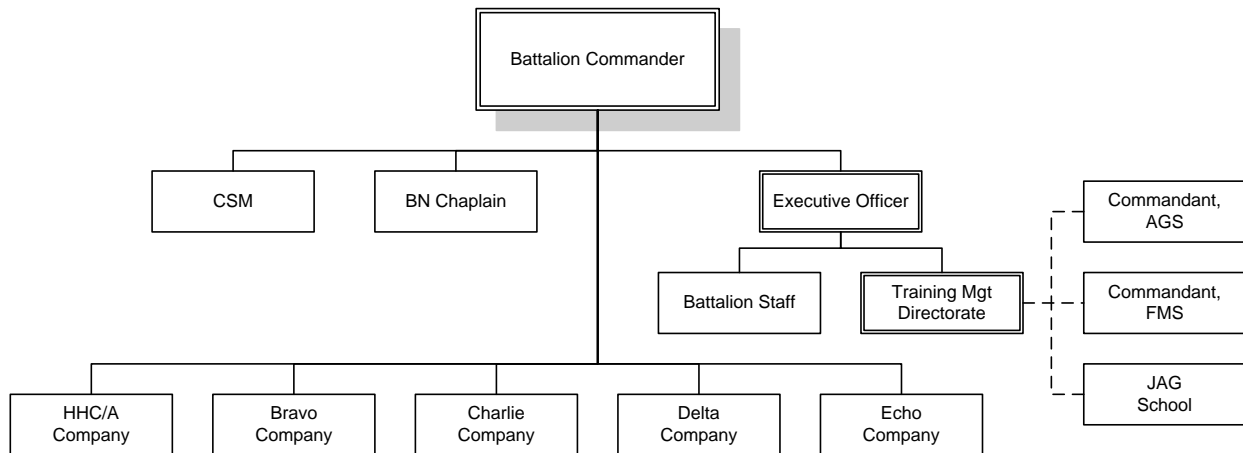

Figure 13-6. 369th Adjutant General Battalion

c. Functions.

(1) Directs the completion of the Soldierization process. Transitions students from the total control environment of BCT into the AIT environment.

(2) Graduates technically and tactically proficient, physically fit AG, FM, and paralegal Soldiers capable of surviving on the modern battlefield and bale to contribute to their first unit of assignment.

(3) Ensures permanent party Soldiers are prepared technically, tactically, physically, and administratively for worldwide deployment.

(4) Promotes comprehensive Soldier fitness.

(5) Cares for the BDE's Soldiers, civilians, and Families.

13-7. Adjutant General School

a. Mission. Educates, trains, and develops agile Soldiers and leaders, through the delivery of HR, postal operations, and music support to the Army. Provides relevant and effective doctrine, training, and organizational designs enabling our expeditionary Army to operate across the full spectrum of operations.

b. Organization (see figure 13-7).

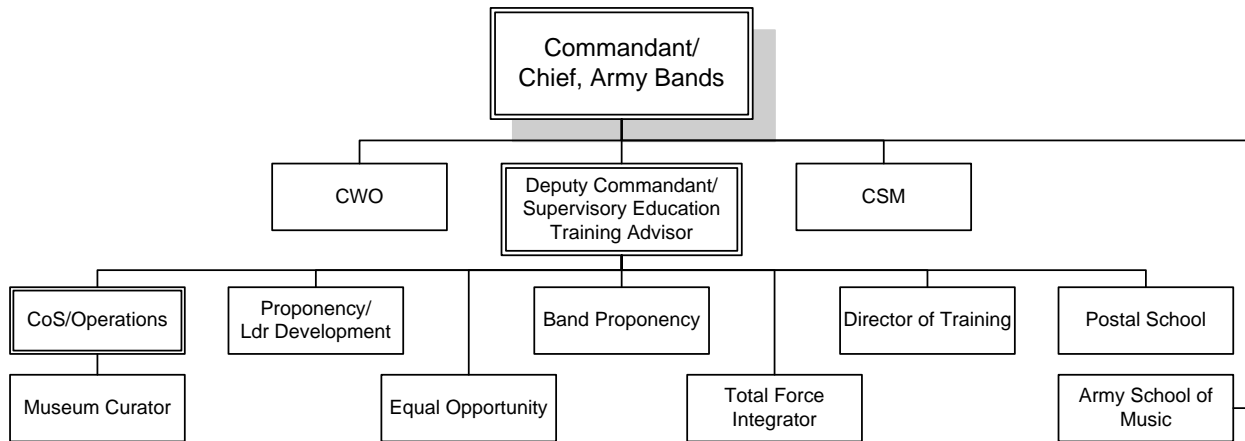

Figure 13-7. Adjutant General School

c. Functions.

(1) Commandant/Chief of the Corps. Commandant of the U.S. Army AGS and Chief of the AG’s Corps, serves as SSI senior SME on AG/HR personnel and administrative actions.

(2) Chief, Army Bands. Responsible for the U.S. Army SOM including the training design, development, and implementation of training for Army Bands. Chairs the Army Bands Steering Group and ensures it meets periodically to provide strategic direction to Army bands.

(3) Supervisory Education/Training Advisor and Deputy Commandant. Advises the commandant in the analysis, design, development, and integration of DOTMLPF requirements for the AG Corps. Principal advisor to the commandant. Assists in the review, evaluation, and execution of assigned programs and mission responsibilities. Oversees the development of training programs and studies in legal, postal, and HR MOSs: MOS 42A, HR specialist, branch Code 42, AG, AOC 42, postal operations. Coordinates among academic departments and principal staff to plan new courses, phase out or revise existing courses, implement common subjects, special studies, and problems. Recommends appropriate allocation of funds, personnel requirements, and assignment of personnel.

(4) Chief Warrant Officer of the Adjutant General’s Corps. Serves as SME for 420A conduct of training and method of instruction. Monitors quality control of course content and instructor performance. Senior WO advisor to the commandant, providing counsel as needed.

(5) Command Sergeant Major. CSM of the AGS and as the AG Corps Regimental CSM for all AG Soldiers (AGS, NCOA, SOM, and RRS), manages a comprehensive training and enforcement program aimed at establishing and maintaining the highest professional standards of performance and conduct for enlisted Soldiers. Serves as the SME for the AG enlisted 42 series conduct of training and method of instruction.

(6) Chief of Staff/Supervisory Human Resource Specialist. Senior administrative supervisor and HR systems integrator. Ensures the operational, administrative and HR systems integration needs of the AGS are met. Plans, coordinates, and executes AGS administrative operations, and manages personnel actions. Administers and evaluates internal management practices and controls to promote maximum organizational effectiveness. Develops AGS budget. Approves and manages monthly expenditures and ensures compliance with expenditure regulations and guidance.

(7) Equal Opportunity Proponency Office. Advises on matters relating to EO and the POSH. Serves as the training lead for EO and POSH; develops and coordinates EO and POSH training doctrine. Designs and coordinates the development of the POI for Army service-specific training at the Defense Equal Opportunity Management Institute.

(8) Proponency and Leader Development Division. Performs personnel functions (AR 600-3) for the military HR field in the following personnel areas: AOC 42, WO AOC 420A and 420C, enlisted CMF 42 (MOS 42A, 42F), executive assistant (ASI E3), postal (ASI 4J, F4 and F5), CMF 42 (Army bands), and DA civilian career fields 50 and 57. Proponency develops professional development publications for CMF and HR branch specialties. Develops, coordinates, and maintains the AA and RC programs.

(9) Training Department. Conducts officer education system courses within the AGS to include IMT for officers and WOs, PME courses, and the HR technical phase of the intermediate level education course.

(10) Total Force Integrator. Advises on activities pertaining to the USAR AG/HR community, including mobilization and force integration actions. Liaison to TDD to integrate USAR initiatives and actions into training. Develops, reviews, and refines USAR job positions and descriptions related to mobilization and total force integration.

(11) Army Bands Proponency Office. Advisor to the Chief, Army Bands on band matters. Reviews personnel changes to TOE, modified TOE, CTA, and TDA for Army bands and band activities. Recommends changes to other Army leads, USAFMSA, or ACOMs as appropriate. Assists and advises HRC in monitoring the DA Centralized Band Member Accession Management Program and the musical qualifications of all Army band personnel.

(12) Interservice Postal Training Activity. Single DOD postal training activity. Conducts training utilizing a joint service cadre of SMEs, operating under the ITRO consolidated and collocated training standard MOA. Performs advanced training instruction and testing for all

branches of service. Personnel for Interservice Postal Training Activity serve as the SME for military postal activities and operations.

(13) Operations. Perform personnel and administrative management, operations and logistical support, information systems management, publications, file management, distribution, and suspense control.

(14) Museum Curator. Principal adviser for all matters relating to Army culture and museum operations. Controls and ensures accountability of all Army historical artifacts and art placed within the custody and care of the museum, including their identification, designation, preservation and conservation, registration, cataloging, loan, or transfer. Serves as the Artifact Responsible Officer. Performs historical research to identify objects, develop the museum story line, and support special projects within the AGS.

(15) U.S. Army School of Music. Develops and conducts training for Army bands. Develops and documents doctrinal, equipment, and manpower requirements for Army bands. Coordinates with the Commanding Officer, SOM to ensure all policies prescribed by TRADOC and Chief, Naval Education and Training are effectively administered.

13-8. Financial Management School

a. Mission. Provides trained, ready, and agile military and civilian leaders and develops complementary concepts, doctrine, organization, and materiel across the spectrum of FM in support of America’s Armed Forces in war and peace. Acts as both the branch and personnel proponent for the Finance Corps, and serve as the home of the Finance Corps Regiment.

b. Organization (see figure 13-8).

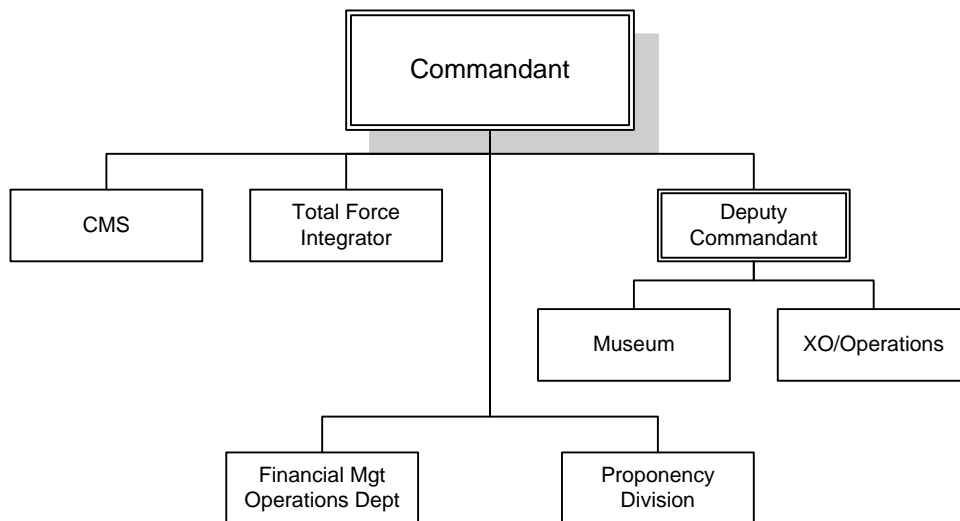

Figure 13-8. Financial Management School

c. Functions.

(1) Commandant. Proponent for the Finance Corps, and Chief of the Finance Corps and the Finance Corps Regiment. Directs professional and leader development and training to officers, enlisted, and civilian personnel assigned to the FMS as well as students in military pay operations, FM, accounting, and resource management courses. Supports force development, combat development, and tactical automation processes related to FM, accounting and resource management; coordinates actions with TRADOC and TRADOC schools, CASCOM and SCoE, HQDA functional area, and DFAS.

(2) Deputy Commandant. Oversees and directs the daily operations of the FMS. Oversees school resources.

(3) Command Sergeant Major. CSM of the Finance Corps, Finance Corps Regiment, and FMS, advises on matters affecting enlisted personnel in the FMS and Finance Corps. Executes the School's NCO professional and leader development program.

(4) Total Force Integrator. Primary RC advisor on activities that pertain to the RC FM community. Staff advisor concerning all mobilization and force integration actions, coordinates RC support to the FMS through requests for active duty for support work, annual tour, or other appropriate tours of duty. Monitors the mobilization TDA and coordinates recruitment of eligible individuals.

(5) Executive Officer/Operations. Supervises and coordinates administrative, logistical, and operational actions, plans, and policies. Maintains and coordinates the TDA and unit status report and submits to SSI monthly. Supervises and executes FMS personnel actions. Develops the annual operating budget and submits to SSI for approval/funding.

(6) Finance Corps Museum Curator. Operates the Finance Corps Museum under the guidance and policies of the U.S. Army Center for Military History. Develops and conducts heritage training on the history of U.S. Army FM operations by exhibiting historical memorabilia and providing interpretive displays and lectures. Liaison between FMS and the museum community at Fort Jackson, state and local museums, and historical sites.

(7) Chief, Proponency Division. Branch and personnel lead for the Finance Corps IAW AR 5-22, The Army Force Modernization Proponent System, and AR 600-3, The Army Personnel Development System. Coordinates FM personnel development issues with the Army staff, U.S. Army Finance Command, and ACOMs. Examines training for career field development to ensure sufficient professional development. Develops briefings, memorandums, information and decision papers on FM proponent issues. Reviews training development products to ensure compatibility with operational concepts, current and emerging doctrine, and professional development models.

(8) Financial Management Operations Department. Directs training for accounting, financial, and resource management operations. Conducts training at all echelons. Coordinates

the development of new and updated training with the TDD, Capabilities Integration Development Directorate, and FMS proponency.

13-9. Recruiting and Retention School

a. Mission. Trains officers and NCOs in the skills, knowledge, and techniques required to provide and maintain the personnel strength of America's Army. Trains NCOs for initial and advanced assignment as recruiters or career counselors. Prepare BN and company commanders for USAREC. Provides CMF 79 regulatory guidance for AR 611-21, Military Occupational Classification and Structure. Provides technical guidance and training support to USAREC.

b. Organization (see figure 13-9).

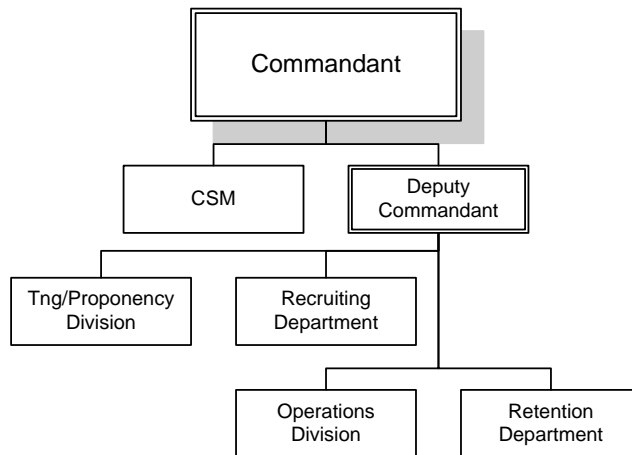

Figure 13-9. Recruiting and Retention School

c. Functions.

(1) Commandant. Provides leadership and guidance for recruiting and retention training missions. Coordinates support from SSI elements, HHQ. Coordinate POI and other issues with the 84th Reserve Training Academy and the ARNG Professional Educational Center, Strength Maintenance Training Center. Conducts a thorough curriculum review to ensure POI and lesson plans are in compliance with current governing USAREC doctrine and policy.

(2) Deputy Commandant. Directs the functional support areas of administration, operations, budget, and logistics as well as doctrine/proponency. Prepares the annual operating budget for resource management review. Ensures internal controls are in place and operational to manage government resources. Coordinates and manages overall problems dealing with training adjustments (ATTRS/TRAPS).

(3) Command Sergeant Major. SME on all doctrine and training related issues concerning recruiting and retention. Senior enlisted spokesperson for personnel proponency and enlisted constituency on personnel management, manpower management, and training management issues affecting CMF 79. Coordinates faculty training and development.

(4) Recruiting Department. Leads resident instruction on recruiting policy and procedures. Provides specialty training to recruiter candidates, station commanders, AMEDDC&S recruiters, recruiter trainers, guidance counselors, USAREC BDE and BN staff officers, and company commanders. Instructs the following resident courses: Army Recruiter Course, Station Commander Course, USAREC First Sergeant Course, Guidance Counselor/Operations Course, Operations Officer Course, Health Care Recruiting Course, Recruiting Company Commander Course, Recruiting Battle Staff Course, USAREC CSMs Course, pre-command course, Master Trainer Course and 79V ACC NCO Course. Prepares, maintains, and updates the Soldiers Training Publication and Officer/Civilian Foundations Standard for Army MOS 79R.

(5) Retention Department. Conducts instruction on basic retention as well as reserve transition policy and procedures. Coordinates with HQDA and HRC on retention policies for active Army and instructor replacement personnel.

(6) Operations & Supply. Maintains a correspondence control register. Prepares and processes requests or personnel actions; awards, NCO evaluation reports, etc. Maintain informal accountability and budget preparation to support budget management process. Coordinate billeting, mess, and transportation for students.

(7) USAREC Liaison Functions. Provides critical link between RRS and USAREC. Coordinates guest speaker program for RRS, maintains USAREC budget for student supplies. Determines eligibility for attendance to ARC. Disseminates information to USAREC and HRC on student de-enrollment/ineligible to train.

(8) Director, Training/Proponency Division. Performs proponency duties; accomplishes personnel responsibilities IAW applicable regulations, provides technical assistance to ARNG Professional Educational Center, Strength Maintenance Training Center and 84th Reserve Training Academy on TRADOC course materials and CMF 79 issues. Coordinates with USAREC to determine student training loads for the SMDR. Oversees the development of training concepts and strategies; determines training direction.

Chapter 14

Partnerships

14-1. Purpose

This chapter describes the partnerships that exist in the CASCOM and SCoE community. It includes the schools that are aligned under CASCOM and SCoE as their higher command, LNOs attached to CASCOM and SCoE, as well as LNOs assigned to CASCOM and SCoE but attached elsewhere. It also includes the DOTMLPF relationships with TRADOC schools.

14-2. Schools and Responsibilities

The CASCOM and SCoE Commander is responsible for integrating DOTMLPF efforts with one TRADOC center and school (USACHCS) and two non-TRADOC centers and schools (AMEDDC&S and TJAGLCS).

14-3. Chaplain Center and School

The USACHCS, Fort Jackson, SC, is responsible for educating and training chaplains (AOC 56A) and chaplain assistants (MOS 56M) to provide spiritual, religious, and moral leadership; and for formulating concepts/studies, designing force structure, researching and developing material for the chaplaincy.

14-4. AMEDDC&S

In support of the health service, AMEDDC&S, located at Fort Sam Houston, TX, produces concepts, doctrine, and organization structure that meet force requirements; conducts individual training, Soldierization, specialized/functional skills, and leadership development which provides the appropriate skill sets to DOD, non-DOD and allied Soldiers and leaders; creates training strategies, products, and programs and makes them available; and consults and collaborates with internal and external agencies and commands in matters of common interest. Provides base operations support to the Fort Sam Houston community.

14-5. TJAGLC&S.

TJAGLC&S, located in Charlottesville, VA, trains and educates military and civilian personnel in legal and leadership skills; conducts strategic planning; develops capabilities and doctrine; and captures lessons learned to provide trained and ready legal personnel, imbued with the Warrior Ethos, to perform the JAG Corps mission in support of the Army and the Joint Force.

14-6. Liaison and Exchange Officers

CASCOM and SCoE hosts LNOs and exchange officers from many different agencies and countries. CASCOM and SCoE agencies typically provide space, computers, and minor administrative supply support to the hosted LNOs.

a. Command Group.

(1) The Command Group is host to foreign LNOs from Korea, Germany, France, and Canada. The DCoS formally sponsors these LNOs.

(2) SSI will assign an officer to the Command Group as an LNO to provide local coordination and collaboration on SSI issues.

b. Transportation School.

(1) TS hosts Australian Transport Exchange officers as instructor in the Officer Basic Course assigned under ALU. They serve as a senior instructor and branch chief within the Basic Officer Leader Department. Coordination is accomplished through the COT during annual staff talks.

(2) Historically, the TS has sent exchange officers to both the Royal Logistics School in Britain and to Australia to serve as instructors. The Australian position is now filled by a Logistics Corps Officer.

c. CASCOM and SCoE G-8, Resource Management. G-8 hosts a contracting liaison from the Contract Support Element at TRADOC HQ. The Contract Support Element is a Mission and Installation Contracting Command asset, who provides acquisition solutions/advice to facilitate the award and administration of CASCOM and SCoE contract requirements.

d. Battle Lab. The Battle Lab hosts an LNO from the Natick Research & Development Center's TDA, who represents Natick's interests and coordinates various user tests that are conducted by Natick. Natick is the Research Development and Engineering Center responsible for most of the QM functions, food, shelter, uniforms and other Soldier support items.

e. Concepts and Doctrine Development & Integration.

(1) CDI hosts an LNO from the Logistics Innovation Agency. This LNO represents the agency at CASCOM and SCoE to coordinate, pass information, participate on relevant integrated concept development teams, coordinate mutual visits, manage and act upon significant actions, liaise with CASCOM and SCoE subordinate organizations (schools, and ALU), attend staff and other event to further information exchange between the Logistics Innovation Agency and CASCOM and SCoE.

(2) CDI also hosts an LNO from AMEDDC&S, who coordinates and collaborates on issues of mutual concern to AMEDDC&S and CASCOM and SCoE.

f. Force Development Directorate. Defense Ammunition Center (DAC) provides an LNO to coordinate issues of mutual concern to the DAC and the CASCOM and SCoE.

Chapter 15

Coordinating Instructions

15-1. Coordination

CASCOM and SCoE's distinctive culture and structure make communication and coordination both a priority and a challenge. Communication and coordination are tasks that affect everything CASCOM and SCoE achieves in support of TRADOC's multifaceted mission. The following considerations are included to ensure effective communication and coordination.

a. The lead organization has ultimate responsibility for ensuring complete internal and external communication and coordination prior to recommending approval of policy/guidance, generating a tasking, or implementing a command initiative.

b. The lead organization must ensure that organizations affected by an action or having information that could affect its outcome are included in the coordination process regardless of the time available for input; however, exercise caution when omitting organizations that may provide a different perspective and improve the capability or initiative, just to save time.

c. Carefully examine each action to determine whether it involves routine coordination or requires a tasking. Synchronization and integration between action officers across organizational

boundaries represents routine coordination and would not generate a tasking. Likewise, division-level coordination to develop and staff guidance, policy, or initiatives is also considered routine.

15-2. Taskings

- a. The tasking authorities in CASCOM and SCoE are the CG, DtCG, DCDRs, and CoS and will be disseminated by the G-3.
- b. The G-3 will develop the tasking for actions originating within CASCOM and SCoE with assistance from the lead organization. The lead organization conducts mission analysis, course of action development, and decisionmaking,
- c. The G-3 will process, disseminate, and track to completion all external taskings.

15-3. External coordination

CASCOM and SCoE HQ staff is the primary interface with external agencies.

Appendix A References

Section I Required Publications

AR 5-22
The Army Force Modernization Proponent System (*RAR 001, 08/19/2009)

AR 600-3
The Army Personnel Development System

TR 10-5
Organization and Functions

Section II Related Publications

AR 1-20
Legislative Liaison

AR 5-5
Army Studies and Analyses

AR 5-11
Management of Army Models and Simulations

AR 10-87
Army Commands, Army Service Component Commands, and Direct Reporting Units

AR 11-7
Internal Review Program

AR 12-15
Joint Security Assistance Training (JSAT)

AR 25-1
Army Knowledge Management and Information Technology

AR 25-30
The U.S. Army Publishing Program

AR 27-1
Legal Services, Judge Advocate Legal Services

AR 27-3
The Army Legal Assistance Program

AR 56-9
Watercraft

AR 59-4
Joint Airdrop Inspection Records, Malfunction/Incident Investigations, Activity Reporting (*RAR 001, 06/23/2009)

AR 70-1
Army Acquisition Policy

AR 71-9
Warfighting Capabilities Determination

AR 71-11
Total Army Analysis (TAA)

AR 71-32
Force Development and Documentation – Consolidated Policies

AR 220-1
Army Unit Status Reporting and Force Registration – Consolidated Policies

AR 350-1
Army Training and Leadership Development

AR 350-38
Training Device Policy Management; Training Aids, Devices, Simulations and Simulators

AR 350-50
Combat Training Center Program

TRADOC Reg 10-5-5

AR 360-1
The Army Public Affairs Program

AR 385-10
The Army Safety Program (*RAR 003, 06/14/2010)

AR 600-55
The Army Driver and Operator Standardization Program (Selection, Training, Testing and Licensing)

AR 612-201
Initial Entry/Prior Service Trainee Support (RCS MILPC-17(R1))

AR 690-12
Equal Employment Opportunity and Affirmative Action

AR 690-950
Career Management

AR 700-127
Integrated Logistics Support (*RAR 001, 04/29/2009)

AR 750-1
Army Materiel Maintenance Policy

AR 750-32
Airdrop Parachute Recovery and Aircraft Personnel Escape Systems

AR 870-5
Military History: Responsibilities, Policies, and Procedures

Chairman of the Joint Chiefs of Staff Instruction (CJCSI) 3170.01G
Joint Capabilities Integration and Development System

CJCSI 3180.01
JROC Programmatic Processes for Joint Experimentation and Joint Resource Change
Recommendations

DA Pamphlet 611-21
Military Occupational Classification and Structure

DOD 5000 Series

DODD 5100.1
Functions of the Department of Defense and its Major Components

Field Manual 7-0
Training for Full Spectrum Operations

Joint Publication 1-02
DOD Dictionary of Military Terms

TR 1-11
Staff Procedures

TR 25-36
The TRADOC Doctrinal Literature Program

TR 71-4
TRADOC Standard Scenarios for Combat Developments

TR 71-12
TRADOC System Management

TR 350-6
Enlisted Initial Entry Training Policies and Administration

TR 350-10
Institutional Leader Training and Education

TR 350-13
Instruction in Military History

TR 350-70
Systems Approach to Training Management, Processes and Products

TR 385-2
U.S. Army Training and Doctrine Command Safety Program

TR 870-1
TRADOC Military History Program

Section III
Referenced Forms

DA Form 1045
Army Ideas for Excellence Program (AIEP) Proposal

DA Form 2028
Recommended Changes to Publications and Blank Forms

Glossary

Section I

Abbreviations

AA	active Army
ABCS	Army Battlefield Command System
ACE	American Council on Education
ACOM	Army commands
ACPM	activity career program manager
ADCON	administrative control
AFB	air force base
AG	adjutant general
AGR	active guard reserve
AGS	Adjutant General School
AIT	advanced individual training
ALC	Advanced Leaders Course
ALT	acquisition, logistics and technology
ALT-IO	Acquisition, Logistics and Technology-Integration Office
ALU	Army Logistics University
AMC	Army Materiel Command
AMEDDC&S	Army Medical Department Center & School
AOC	area of concentration
ARB	Academic Review Board
AR	Army Regulation
ARCIC	Army Capabilities Integration Center
ARFORGEN	Army force generation
ARNG	Army National Guard
ASI	additional skill identifier
ATRRS	Army Training Requirements and Resources System
AWS	Army watercraft systems
BCT	basic combat training
BDAR	battle damage assessment and repair
BDE	brigade
BN	battalion
BOLC	Basic Officer Leaders Course
BRAC	base realignment and closure
C2	command and control
CAC	U.S. Army Combined Arms Center
CASCOM	Combined Arms Support Command
CBA	capability based assessments
CC	common core
CCC	captain career course
CCP	concept capability plans
CDD	capabilities development document
CDI	Capabilities Development Integration

CG	commanding general
CJCSI	Chairman of the Joint Chiefs of Staff Instruction
CLC3	Combined Logistics Captains Career Course
CMF	career management field
CoE	Center of Excellence
CoS	Chief of Staff
COP	current operations
COT	Chief of Transportation
CP	career program
CPX-S	command post exercise - sustainment
CSA	Chief of Staff, Army
CSM	command sergeant major
CWO	chief warrant officer
DA	Department of the Army
DAC	Defense Ammunition Center
DCG	deputy commanding general
DCG Mob	DCG mobilization
DCDR	deputy commander
DCR	DOTMLPF change recommendation
DCoS	Deputy Chief of Staff
DFAS	Defense Finance and Accounting Service
DL	distributed learning
DLA	Defense Logistics Agency
DOD	Department of Defense
DOTMLPF	doctrine, organizations, training, materiel, leadership and education, personnel, and facilities
DtCG	Deputy to the commanding general
EA	executive agent
ED	education division
EO	equal opportunity
EOD	explosive ordnance disposal
ESD	Enterprise System Directorate
FAA	functional area analysis
FDD	Force Development Directorate
FDU	force design update
FM	financial management
FMS	Financial Management School
FNA	functional needs analysis
FORSCOM	Forces Command
FRAGORD	Fragmentary Order
FSO	full-spectrum operations
GO	general officer
HCE	human capital enterprise
HHQ	higher headquarters
HR	human resources
HRC	Human Resources Command

HQ	headquarters
HQDA	Headquarters, Department of the Army
IAW	in accordance with
ICD	initial capability document
ICW	in coordination with
IG	inspector general
ILS	integrated logistics support
IM	information management
IMT	initial military training
IRR	individual ready reserve
IT	information technology
ITRO	Inter-service Training Review Organization
JCIDS	Joint Capabilities and Integration Development System
JCTD	Joint Culinary Training Division
JIM	joint, interagency, intergovernmental, and multinational
JROC	joint requirements oversight council
KM	Knowledge Management
L2	lessons learned
LDTA	lead defense travel administrator
LG	logistics group
LNO	liaison officer
LOO	line of operations
MA	mortuary affairs
MARC	manpower requirements criteria
MATDEV	materiel developer
MC	mission commander
MITD	Maritime and Intermodal Training Department
MOA	memorandum of agreement
MOU	memorandum of understanding
MOS	military occupational specialty
MSO	major subordinate organization
MTT	mobile training team
NCO	noncommissioned officer
NCOA	Noncommissioned Officer Academy
NETUSR	network unit status report
NETT	new equipment training team
NGB	National Guard Bureau
OCAR	Office of the Chief, Army Reserves
OCS	operational contract support
OD	ordnance
ODS	ordnance school
OPORD	operations orders
PA	public affairs
PBAC	program budget advisory committee
PME	professional military education
POC	point of contact

POI	program of instruction
POM	program objective memorandum
POSH	Prevention of Sexual Harassment
PWD	Petroleum and Water Department
QA	quality assurance
QM	quartermaster
QMG	quartermaster general
QMS	quartermaster school
RAM	reliability, availability, maintainability
RC	Reserve component
RITM	resident individual training management
RRS	Recruiting and Retention School
RSA	Redstone Arsenal
S&T	science & technology
SALE	single army logistics enterprise
SAT	systems approach to training
SCoE	Sustainment Center of Excellence
SERP	SCoE enterprise resource planning
SGS	secretary of the general staff
SGM	sergeant major
SJA	staff judge advocate
SLC	senior leaders course
SMDR	structure and manning decision review
SME	subject matter expert
SOM	School of Music
SSI	Soldier Support Institute
S-Staff	Special Staff
STAMIS	Standard Army Management Information System
TASS	The Army School System
TC	transportation corps
TCM	Training and Doctrine Command capability manager
TCM-T	Training and Doctrine Command capabilities manager, transportation
TD	training department
TD3	Training and Doctrine Development Directorate
TDA	table of distribution and allowances
TDD	training and doctrine development
TDI	training development integration
TJAGLCS	The Judge Advocate General's Legal Center and School
TMDE	test, measurement and diagnostic equipment
TMO	Training Management Office
TOE	table of organization and equipment
TR	TRADOC Regulation
TRADOC	U.S. Army Training and Doctrine Command
TRAP	training resources arbitration panel
TRAS	Training Requirements Analysis System
TS	Transportation School

TWV	tactical wheeled vehicle
ULLS-A/E	Unit Level Logistics System-Aviation/Enhanced
USACHCS	United States Army Chaplain Center and School
USAF	U.S. Air Force
USAFMSA	U.S. Army Force Management Support Agency
USAR	U.S. Army Reserve
USAREC	U.S. Army Recruiting Command
USCG	U.S. Coast Guard
USMC	U.S. Marine Corps
USN	U.S. Navy
WARNORD	warning orders
WO	warrant officer
WTA	Warrior Training Area
WTX	Warrior Training Exercise

Section II

Terms

Definitions of terms are found in Joint Pub 1-02. This glossary defines terms requiring expanded explanation.

analysis of materiel/nonmateriel approaches (AMA)

The AMA collates the information obtained during the FAA, the FNA, the ideas for nonmateriel approaches (DOTMLPF analysis), and the ideas for materiel approaches to determine the best materiel approach or combination of approaches to provide the desired capability or capabilities. (CJCSM 3170.01B)

administrative control

Direction or exercise of authority over subordinate or other organizations in respect to administration and support, including organization of service forces, control of resources, and equipment, personnel management, unit logistics, individual and unit training, readiness, mobilization, demobilization, discipline, and other matters not included in the operational missions of the subordinate or other organizations. (Joint Pub 1-02)

architecture

A framework or structure that portrays relationships among all the elements of the subject force, system, or activity. (JP 3-05)

assist

TRADOC organizations or staff elements that provide augmentation or other support to a lead for a function, task, or role. (TR 10-5)

capabilities-based assessment

The CBA is the JCIDS analysis process that includes four phases: the functional area analysis, the functional needs analysis, the functional solution analysis, and the post independent analysis. The results of the CBA are used to develop a joint capabilities document or initial capabilities document. (CJCSM 3170.01B)

capability

The ability to achieve a desired effect under specified standards and conditions through combinations of means and ways to perform a set of tasks. It is defined by an operational user and expressed in broad operational terms in the format of a joint capabilities document, initial capabilities document, or a joint DCR. In the case of materiel proposals, the definition will progressively evolve to DOTMLPF performance attributes identified in the CDD and the CPD. (CJCSI 3170.01E)

capability development document

A document that captures the information necessary to develop a proposed program(s), normally using an evolutionary acquisition strategy. The CDD outlines an affordable increment of militarily useful, logistically supportable and technically mature capability. (CJCSI 3170.01E)

capability documents

A generic term to refer collectively to ICDs, CDDs, CPDs, and DCRs.

capability gaps

The inability to achieve a desired effect under specified standards and conditions through combinations of means and ways to perform a set of tasks. The gap may be the result of no existing capability or lack of proficiency or sufficiency in existing capability. (CJCSI 3170.01E)

capability production document

A document that addresses the production elements specific to a single increment of an acquisition program. (CJCSI 3170.01E)

CASCOM and SCoE HQ

CASCOM and SCoE HQ (UIC W3XTAA)

CASCOM

The SCoE plus SSI (AGS, FMS, RRS)

CASCOM and SCoE community

The CASCOM and SCoE and the integrating role for AMEDDC&S, USCHCS, TJAGLCS as defined by TR 10-5, paragraph 7-2, 9 Mar 05

concept

A notion or statement of an idea – an expression of how something might be done – that can lead to an accepted procedure ([CJCSI 3010.02A](#)). A military concept is the description of methods (ways) for employing specific military attributes and capabilities (means) in the achievement of stated objectives (ends).

concept capability plan

The application of elements of operational joint and Army concepts to selected mission, enemy, terrain and weather, time, troops available, and civilian conditions. It is typically more illustrative and descriptive than a concept and more focused in purpose.

coordination

Consultation leading to an expressing of views. To cause to act or work together for a common purpose, as in timing, unifying, and integrating work. (TR 10-5)

core competencies

Core competencies represent command-wide capabilities created from the combined skills, knowledge, abilities, and behaviors of its Soldiers and civilians operating as individuals or members of teams. The command's mission determines these enduring qualities, built through many years of successfully meeting the Army's requirements, coupled with a process of continuous improvement and innovation. (TR 10-5)

direct authority

Broad authority to act on matters relating to the execution of an organization's assigned functions and responsibilities. The latitude direct authority provides is bounded by the overall commander's vision, priorities, and guidance, both written and verbal. Direct authority is a measure of control less than that included within the term command and more than that included within the term ADCON. Direct authority provides a leader the ability to influence the activities and initiatives of subordinate organizations but not to control day-to-day operations. (TR 10-5)

domain manager

HQDA designates a manager for each M&S domain. Domain managers coordinate M&S activities and develop and maintain supporting plans for their domains, to include domain management plans and domain investment plans. (AR 5-11)

DOTMLPF change recommendation (DCR)

A recommendation for changes to existing joint resources when such changes are not associated with a new defense acquisition program. (CJCSI 3170.01E)

essential task

An essential task is a collective task in which an organization has to be proficient to accomplish an appropriate portion of its wartime operational mission and is a fundamental part of capabilities development.

executive agent

The head of a DOD component to whom the Secretary of Defense or the Deputy Secretary of Defense has assigned specific responsibilities, functions, and authorities to provide defined levels of support for operational missions, or administrative or other designated activities that involve two or more of the DOD Components. (DODD 5101.1)

functional area analysis

The FAA is the first step of the JCIDS CBA. It identifies the operational tasks, conditions, and standards needed to achieve military objectives. It uses the national strategies, joint/Army concepts, the Unified Joint Task List and the Army Universal Task List, and the anticipated range of broad capabilities that adversaries might employ as input. Its output is a list of capabilities their associated tasks and attributes to be reviewed in the follow-on FNA. The FAA

includes cross-capability analysis and cross-system analysis in identifying the operational task, conditions, and standards. (CJCSM 3170.01B)

functional needs analysis

The FNA is the second step of the JCIDS CBA. It assesses the ability of the current and programmed joint and/or Army capabilities to accomplish the tasks, under the full range of operating conditions and to the designated standards that the FAA identified. Using the tasks identified in the FAA as primary input, the FNA produces as output a list of capability gaps that require solutions and indicates the timeframe in which those solutions are needed. (CJCSM 3170.01B)

functional solution analysis

The FSA is the third step of the JCIDS CBA. The FSA is an operationally based assessment of potential DOTMLPF and policy approaches to solving (or mitigating) one or more of the capability gaps identified in the FNA. The gaps identified in the FNA are inputs to the FSA; its outputs are potential solutions to resolve identified capability gaps. In considering these approaches, the following order of priority is used: changes to existing DOTMLPF and/or policy approach; product improvements to existing materiel or facilities alone; adoption of interagency or foreign materiel approaches that limited nonmateriel DOTMLPF and/or policy consequences; and finally, new materiel starts. The FSA is composed of three substeps: ideas for nonmateriel approaches (DOTMLPF analysis), ideas for materiel approaches, and the analysis of materiel/nonmateriel approaches (AMA). (CJCSM 3170.01B)

ideas for non-materiel approaches (DOTMLPF analysis)

As the first substep in the FSA, the DOTMLPF analysis determines whether a nonmateriel approach or an integrated DOTMLPF and/or policy approach can fill the capability gaps identified in the FNA. Nonmateriel approaches include changes in DOTMLPF. If the analysis determines that the capability gap can be partially addressed by an integrated DOTMLPF and/or policy approaches, the proponent will assess them in conjunction with the potential materiel approaches. If this approach is recommended, the proponent will develop a DCR in addition to required CDDs or CPDs. If the analysis determines that the capability gap can be completely addressed by a nonmateriel approach, the proponent will develop a DCR in lieu of completing the ICD. (CJCSM 3170.01B)

initial capabilities document

Documents the need for a materiel approach or an approach that is a combination of materiel and nonmateriel to satisfy a specific capability gap(s). It defines the capability gap(s) in terms of the functional area, the relevant range of military operations, desired effects, time, and DOTMLPF and policy implications and constraints. The ICD summarizes the results of the DOTMLPF and policy analysis and the DOTMLPF approaches (materiel and nonmateriel) that may deliver the required capability. The outcome of an ICD could be one or more DCRs or CDDs. (CJCSI 3170.01E)

institutional training

Institutional training and education courses qualify leaders for service in the Army, and provide them with the basic knowledge and skills needed to perform the duty position requirements of

future operational assignments. Institutional training and education usually precede a new level of operational assignment. In each case, the institutional training base is the foundation upon which individuals develop their maximum potential. (AR 350-1)

integration

The extent of coordination or interdependence that is needed within the organization to make effective, efficient decisions and successfully accomplish its roles, responsibilities, and functions. There are three levels of integration:

- **basic integration** which is accomplished through published rules and procedures. Integration is achieved through procedures and direct interaction is normally not required between organizational units.
- **complex integration** which is accomplished through an approved plan or order. Interdependence is achieved through an operational plan or order in which the responsibility for and sequence of task accomplishment are specified in detail.
- **highly complex integration** which is the process of mutual adjustment in which closely coordinated contact is required within the management hierarchy (or chain of command) and which also implies cross-functional teams or individual integrators. (TR10-5)

Each of these levels of integration is found in all Army organization to some extent. Effective organizations facing more diverse environments or complex tasks or functions will use all of these integrative processes.

key enabler

A significant function that underpins the ability to execute two or more core functions. An integral component of the set of functions or tasks required to execute a core function. One or more organizations can perform this function. (Annex B (Terms of Reference) to TRADOC Campaign Plan 2009)

lead

The organization or staff element having primary responsibility for a function, task, or role a higher headquarters (HHQ) assigns. Responsibility for the function, task, or role begins with initial assignment and ends with its completion. The responsibility also includes all aspects of planning, execution, and integration of all applicable DOTMLPF domains. The organization which receives assistance from another organization(s) or staff element(s), and is responsible for ensuring that the supporting organization(s) or staff element(s) understands the assistance required. Specifically, lead has three areas of responsibility:

- Develop, coordinate, and recommend command policy.
- Develop, coordinate, and recommend command guidance.
- Develop, coordinate, and recommend taskings to execute specific missions and tasks or provide specific support.

major Army command

A command directly subordinate to, established by authority of, and specifically designated by Headquarters, Department of the Army. Army component commands of unified and specified commands are major Army commands. (AR 10-87)

major subordinate command

An organization directly subordinate to HQ TRADOC and specifically designated by the TRADOC Commanding General. (TR 10-5)

memorandum

Command memorandums apply to HQ TRADOC only. They establish policies, responsibilities, and administrative procedures; patterns of organizations and workflow; and recurring and special forms and reports within HQ TRADOC. They are effective until superseded or rescinded. (TR 10-5)

modeling and simulation (M&S)

A "model" is a mathematical, logical, physical, or procedural representation of some real or ideal system, and "modeling" is the process of developing a model. A "simulation" is the implementation of a model in executable form or the execution of a model over time. Taken together, "modeling and simulation" or M&S refers to the broad discipline of creating, implementing, understanding, and using models and simulations.

M&S facilitates early identification and reduction of the risks associated with complex system acquisition programs; helps to better understand what kinds of system requirements and architectures are feasible and affordable given various programmatic and technological constraints; and provides insight into how to better manage system engineering efforts so as to improve the overall likelihood of a successful acquisition effort. (AR 5-11)

operational architecture

Portrays an operational warfighting concept. A description (often graphical) of the operational elements, assigned tasks, and information flows required to accomplish or support a warfighting function. It defines the type of information, the frequency of exchange, and what tasks these information exchanges supports. (TR 10-5)

operational control

Operational control is the authority to perform those functions of command over subordinate organizations involving organizing and employing commands and forces, assigning tasks, designating objectives, and giving authoritative direction necessary to accomplish the mission. Operational control should be exercised through the commanders of subordinate organizations. Operational control normally provides full authority to organize commands and forces and to employ those forces as the commander in operational control considers necessary to accomplish assigned missions; it does not, in and of itself, include authoritative direction for logistics or matters of administration, discipline, internal organization, or unit training. (Joint Pub 1-02)

operational environment

The operational environment is defined as the "composite of conditions, circumstances, and influences that affect employment of military forces and bear on the decisions of the unit commander." It is wide-ranging and geostrategic, encompassing geopolitics and globalization in economics, technology, and demographics, and incorporates both U.S. and threat military developments. (Joint Pub 1-02)

pamphlet

Command pamphlets are permanent instructional or informational publications that apply commandwide. Pamphlets are not directive. They provide guidance and information needed to carry out policies and procedures established by regulations. Forms established by pamphlets are for optional use only. (TR 10-5)

plan

A projected procedure for carrying out an undertaking. A plan sets forth the specific tasks the participants will perform and includes policy and procedural guidance. A plan differs from a program in that it may be less specific and normally does not schedule accomplishment or resource distribution within specified dates. Planning normally precedes programming. (TR 10-5)

policy

A high-level overall plan embracing the general goals and acceptable procedures of an organization in light of given conditions to guide and determine present and future decisions. (TR 10-5)

program

An organized procedure for carrying out a mission. Although its elements may vary considerably, it usually includes a statement of the mission, objectives to achieve within specific dates, priorities, provided resources, schedules to accomplish, progress indicators, and follow-on requirements. (TR 10-5)

regulation

Command regulations contain policies, responsibilities, and administrative procedures relating to subjects not contained in ARs or which support or better define command guidance derived from ARs and DOD directives. They are permanent directives, effective until superseded or rescinded. Each regulation is confined to a single subject and is the only authority to prescribe mandatory use of command forms. (TR 10-5)

requirement

An established need justifying the timely allocation of resources to achieve a capability to accomplish approved military objectives, missions, or tasks. (TR 10-5)

SCoE

CASCOM and SCoE HQ, three Branch Schools (QM, OD, TC) and ALU.

staff management

The responsibilities of the staff to assist and coordinate lead organization's efforts by analyzing, monitoring, assessing, and developing recommendations for the commander on all activities affecting policy, organization guidance, developmental processes, and implementation or execution processes in support of the organization meeting its mission. The staff will facilitate the coordination and dissemination of plans, doctrine, and training with higher HQ and external agencies as appropriate. (TR 10-5)

strategic communications

Identifying and communicating with the internal and external organizations or audiences to achieve desired outcomes. In doing so, the organization develops, synchronizes, and articulates key themes and messages in support of the strategic vision, goals, and objectives. Strategic communications will inform a broad variety of audiences and ensure command wide unity of effort. Effective strategic communication not only serves TRADOC, but must support the Army and the joint communities in their strategic communications efforts. (TR 10-5)

strategic engagement

Interaction with stakeholders who potentially affect the ability of the joint community, the Army, or TRADOC to accomplish their strategic goals or mission. Interaction includes deliberate communications activities with specific, concise, unifying, and consistent themes and messages, targeted at a specific stakeholder in a planned environment, using a designated messenger, that support a broader strategic communications plan. (TR 10-5)

strategic planning

The comprehensive process of an organization setting goals, developing strategies, and outlining tasks and schedules to accomplish its assigned mission within allocated resources. (TR 10-5)

system

The combination of the components and sub-elements which function together as an entity to accomplish a given objective. A system includes the hardware and all other required items, such as facilities, personnel, data, test measuring and diagnostic equipment, and training equipment. (TR 10-5)

user representative

The command or activity charged with the responsibility to ensure that combat and training developments are responsive to Army operational needs. (TR 10-5)